



**AXESS**

*Life in New Media*









# AXESS

---

## *Life in New Media*

**NAME** DYLAN MACHGEELS

**STUDENT NUMBER** 4603427

**GRADUATION STUDIO** ADVANCED HOUSING

**1<sup>ST</sup> MENTOR** THEO KUPERS

**2<sup>ND</sup> MENTOR** PIERIJN VAN DER PUTT

**3<sup>RD</sup> MENTOR** FERRY ADEMA

**DELEGATE** CHRISTIEN JANSSEN

**DATE** 29 JUNE, 2021





## PREFACE

This booklet is a collection of my graduation project within the Master Architecture at the Delft University of Technology. The project is done within the studio Advanced Housing and concerns the research-based design of dwelling within the soon to be transformed harbour area in Rotterdam called M4H. The aim for the designs is to offer or at least contribute to a solution for the housing shortage in the Netherlands. In order to come up with new solutions for this shortage we were tasked with the assignment to create a medium to large residential complex for a chosen target group, in need of a dwelling, in dense urban environments, such as Rotterdam.

This booklet represents almost an entire year of hard work. For me personally this project felt like my last chance to make something that I wanted to make and I tried to work as much on this aspect as possible. Focusing my efforts not only into making a good and solid building, but also into things that I like to do with both my research and the design. I tried to make a building in which I would like to live (and work), something that hasn't really been possible up until now. At least not to this extent.

The graduation project itself taught me a lot of things, especially because of the way that this studio is set up I learned the importance or rather usefulness of research in design. Not only are the best decisions often easy solutions, but they are found where you don't look, right under your nose. Besides learning about design this project has also taught me some valuable lessons, such as that I still have some aspects that I could work on as an architect as well as teaching me about certain interests I have in architecture that I didn't know before. As some of my tutors can attest to, I like doing things my own way. Often meaning that I go too much into detail about insignificant things, wanting to know the precise ins and outs of the sometimes unimportant aspects. In some cases this meant the complete precise design of a dwelling with custom furniture I designed or thought of myself. And I think this is primarily what I found out about myself as

well that giving something of yourself to the design is important, because without putting something of your own into a design can you call it your design?

A graduation project has always frightened me, it is the last thing you do before you graduate. Not only the length, of almost a year, its complexity, but also the importance are on another level from anything that I have done in my studies. Taking on this project took a tremendous amount of effort, dedication and hard work, which made this project stressful from time to time. Specifically this last year, might have been the most stressful of all, this is not only caused by the project, but also due to the pandemic. Because of the pandemic visits to the faculty were scarce (if there were any) and time between with my fellow students was limited, and their help and input in moments of need as well. Along with the tutoring via zoom, which admittedly didn't always go as smoothly as one would like, made it so most of my time was spent behind my computer at home. Despite all this however the project was fun to design. Of course there were moments where I felt like I had made no progress at all or I felt like I wanted to quit. However through the continued support and help of my mentors and my family I was able to work through these moments and finish this project. So for all their guidance and knowledge over this last year I wanted to thank them. Thank you Theo, Pierijn and Ferry for helping and keeping up with me, which I know isn't always easy. And a special thanks to my parents, who despite their busy schedules and them not being architects, always helped me out when I needed it and put up with me whenever I was stuck this past year.

## **CONTENTS**

<b>INTRODUCTION</b>	<b>9</b>
<b>RESEARCH</b>	<b>11</b>
New Media	16
New jobs, new working, new living	21
A place to live and work	28
Plan analysis	32
Conclusion	74
<b>DESIGN PRINCIPLES</b>	<b>77</b>
<b>SITE / LOCATION</b>	<b>83</b>
<b>MASS</b>	<b>99</b>
<b>PROGRAM</b>	<b>109</b>
<b>CIRCULATION</b>	<b>121</b>
<b>BUILDING</b>	<b>131</b>
<b>DWELLING</b>	<b>197</b>
<b>BUILDING TECHNOLOGY</b>	<b>233</b>
<b>REFLECTION</b>	<b>323</b>
Introduction	324
Relationship research and design	326
The topic in relation to the master track	347
Methods used	348
Position in social, professional and scientific framework	349
Ethical issues	350
Appendix A	352
Appendix B	361
<b>RESEARCH</b>	<b>365</b>



## INTRODUCTION

In this booklet my design project of the past year is presented. It can be seen as a summary of the most important aspects of my project and consists out of my research, the building and lastly a reflection.

First of all the research will be elaborated, which all started with choosing a specific target group to design for. In my case this was first of all streamers, yes that kind of streamers. However as streamers were too nuanced and a bit too little of a sample size to really design for the scope was broadened to New Media workers. New Media workers are largely reliant on New Media, in this case seen as technological advancements of a given time in this case internet, smartphones, laptop etc. Because of New Media these people are able to work more flexible, differently (to the point of the creation of new jobs) and most importantly from anywhere. Most of these people however work from home and it is here that the problem that these people deal with is found. None of the homes that they currently have are adapted to this new way of working, meaning that they are in need for dwellings that can provide the necessary space for them to work and live. Therefore I decided to search for a solution to this problem, as not only the new media workers, but because of Covid almost everyone has this same issue. It is expected that a lot of people will continue to work more from home even companies are thinking of implementing standard days on which their employees work from home, meaning that the issue will persist and even expand to more than just the New Media workers. Designing a housing complex that facilitates dwellings that are optimized for both work and live to try and find a solution to this problem for these people.

With the target group and aim down, the project got more specific already. The research done in relation to the influence of New Media in our lives, the New Media workers as well as their necessities and wishes for dwellings is collected in the first part of this booklet. Based on these necessities four different case studies were performed, which in combination with the rest of the research helped me determine the design principles for the building. The design of the building is in the middle of the booklet. Starting with the design principles and the concept of the building. The mass and most important aspects of the design including floorplans, construction, climate and detailing are all derived from these points.

The last part of my booklet contains the reflection of my whole process during this project. The reflection will elaborate on the relation between the research in the final graduation project and the final design. Here especially key turning points or changes are remarked along with the consequences these have had for the design. Also the relevance of the project, in terms of research and design, in relation to the broader social, professional and scientific framework will be explained. With this reflection I hope to give an insight in the rocky road towards the creation of my favorite design so far.



# RESEARCH



## RESEARCH OVERVIEW

### ABSTRACT

The world currently faces the problem of a lack of workhomes or in other words dwellings adapted to the New Media way of working. As our experience during Covid-19 times, as you personally may well know, research of Fersch, B., (2009) and my own questionnaire have shown there is currently a lack of workspace in our dwellings. This research aims to provide an answer to the question “How do you make a high-quality, affordable workspace in a workhome?” especially with the rise of New Media. New Media in this research is perceived as the advances in the way of networking, computing, and technologically. (Manovich, L., 2003)

To gain more insight in the problem, firstly New Media was researched in terms of what it entails and how it has influenced our work and life styles. It became apparent that New Media has changed our way of living and working a lot, due to the change in technological advancements we were able to work a lot more flexible both in terms of working hours and place. Along with this new way of working, new types of jobs were created, among these new jobs freelancing and streaming became popular. To get a better grip on the needs of these New Media workers, in this case freelancers and streamers, the work of Fersch, B., (2009) was used along with my own questionnaire. The needs between these two types of New Media workers didn't seem to differ much aside from special requirements regarding their workspace, which were closely related to their occupation.

By investigating Holliss' work it became clear that the term workhome wasn't really well known anymore and thus no good examples of these buildings exist nowadays, that fully cover all the needs that these target groups have. In addition the analyses of 4 case studies showed that there is no clear answer regarding how to make a high-quality, affordable workspace in a workhome. However recommendations, based on these case studies and findings, can be given of which the best result is to create rental single household dwellings, which can be either fully single person households with their own necessities, that means their own bed-, bath-, workroom and kitchen or coliving, where they only have their

own personal bed- and bathroom, and possibly a separate workroom.

### KEY-WORDS

Work-live – Workhome(s) – New Media – Streamer – Freelancer – Housing – (Flexibility)

### INTRODUCTION

Ever since the creation of the internet, a form of New Media, the way we work has been changed. Over the last decade especially work has become way easier and more convenient, as we aren't constrained by the place we work and how to work anymore. Nowadays the internet and its presence in our workflow can't be missed anymore since it is an integral part of how do our work. (Law, W.K., 2006)

As the importance of the internet, and thus New Media, over the last few years has grown, so have also the diversity in work. Freelancing for example have strived and amassed a bigger amount of workers than ever before. The ease of the internet has made it possible for us to work anywhere at any time, diminishing the need for us to work for companies and going to work, seeing as we can do everything ourselves at home. (Law, W.K., 2006)

One of these freelancing jobs that has become more and more popular since 2010 is live streaming. An online streamer, also known as a live streamer or streamer, is someone who broadcasts themselves online through either a live or pre-recorded video. With the first being the most well-known as streamer and latter more like a youtuber. Streams are found in various categories that range from video games, tutorials or even chatting streams. (Taylor, T. L., 2018)

With the growing interest in working from home, as a form of freelancing like streaming is, and the necessity of it due to Covid-19, it is clear that this type of trend will only keep growing. This necessity of working from home and online work, stresses the importance of the “New Media” even further and its influence on our work and life styles.

## PROBLEMSTATEMENT

As mentioned in the introduction the “New Media” allows for more flexible ways to work and the type of work we perform. While the amount of people doing this type of working is growing, so is also the lack of workspace for these people. The dwellings held by these people often are not meant for working at home, they don’t have a space where they can retreat to and work in peace. Like many of us, they are stuck with the current situation, often working from either their kitchen table or from the couch. People don’t have the space to comfortably work and have meetings for work or school. This is all due to a lack of space, my tutor Pierijn describes this perfectly in a meeting that we had a few weeks ago: “[...] having a space, where you can work and maybe have a meeting without a bra showing in screen or people bugging you, might be needed”.

As Covid-19 also stresses the fact of working from home, the need for dwellings that offer space for people to work from home only rises. To put it bluntly there is a shortage on dwellings / housing that offer good work-live environment, and this needs to be addressed not only for the current pandemic, but especially for the rise in flexible working due to the rise of the “New Media”.

## RESEARCH QUESTIONS

To address this problem regarding the lack of workspace, a solution has to be found for the question: **“How do you make a high-quality, affordable workspace in a workhome?”**.

To get this conclusion a few things have to be researched of which firstly the precise meaning and influence of the New Media on our work and life styles. **“What is New Media” “How has New Media influenced our work and life styles?”**

With a new way of working also new jobs come into play of which one is already pretty well-known among everyone, the freelancers. However for this research another job, which only exists because of New Media, is also going to be researched, namely the streamer. Seeing as both these jobs seem very different initially it must be researched what their relation is to each other **“What is the relation between freelancers**

**and streamers?”**. When that is established their needs or necessities for a dwelling can be researched as to know what could be the needs of New Media workers. **“What are their needs in terms of their work and dwelling?”**

Lastly the research will focus on the workhomes themselves to see if there are any already known examples of workhomes that fit the criteria of the New Media workers. **“Are there currently any workhomes, and if so what kind(s)?”**

## RELEVANCE AND POSITION

Although there are already studies on the concept of workhomes, for example Beyond Live/Work: The architecture of home-based work by Holliss (2015), these do not sufficiently explain how to create such a dwelling, nor does it provide examples of New Media home-based dwellings. For examples Law, F., (2006) has written that New Media has changed the way we work and live, and thus changing our needs regarding our work and life styles. In addition Holliss (2015) argues in her book that the examples that are given, maybe do not suffice for the New Media workers who might only need a bedroom to work from. These studies show that a link between the aspect of the workhome and New Media, and all its incidentals, is yet to be established.

## SOURCE ANALYSIS

For this research sources focusing on different subjects are used. To gain insight in the meaning of the term ‘New Media’ and its influence on our work and life styles, four sources are used. These sources are: Manovich, L., (2003) and Lister, M., (2009) give a good explanation on the meaning of ‘New Media’, while Law, K., (2006) and Howard, C. M., (2000) give better examples of the influence the developments in New Media have had on our way of working. Howard especially, being dedicated to the change of journalism, explains this in the most detail for this specific occupation.

Identifying the streamer and explaining the workings of their job Taylor, T. L., (2018) and Woodcock, J., (2019) are used. Additionally they give insight in the importance of livestreaming, their respective platforms nowadays and their pos-

sible importance in the future. These sources serve as confirmation on the importance of streaming and thus streamers as New Media jobs / workers. It lacks however information on the necessities of streamers in regards to their dwellings.

Fersch's research is used as a comparison material to link the chosen target group, in this case streamers, to already more known New Media workers. Fersch in her research writes about the work and life styles of freelancers and even has interviews, which give more insight in the personal thoughts of freelancers on their situation and their jobs. As this research is based on freelancers in Germany and Denmark, this research can't be taken 'one-to-one' to the Dutch situation, however it can be used as a comparison material to gain an idea of the relation of freelancers to other New Media jobs.

Giving the theoretical backbone to this research is Holliss' book *Beyond Live/Work: The architecture of home-based work* (2015). Holliss' book serves as a source of information on not only the history of workhomes, but also the workhomes that exist nowadays.

## METHODOLOGY

To answer the research questions several sources have been researched. Using three main differentiable methods: Literary Analysis, Questionnaire and Case study.

Firstly to identify what New Media is and its impact on our work and life style, four sources are used. Manovich, L., (2003) and Lister, M., (2009) explain the history and meaning of New Media the best, while Law, K., (2006) and Howard, C. M., (2000) focus more on the way that it has changed our work and daily lives. Using all four of these sources a basic understanding about the New Media and its influences is established. Meaning what exactly New Media is and what the influences of this New Media, as then determined by these sources, on our work and living conditions.

To understand the New Media workers themselves better a target group was chosen to act as an example, namely the streamers. To understand the term streamer and everything asso-

ciated with them two sources have been used. Taylor, T. L., (2018) and Johnson, M. R., & Woodcock, J. (2019) describe in their works what being a streamer entails, so to say what they do, how they start out and how they view the future of their streaming career and the platform.

As not all the required information, meaning the needs and wishes, regarding their workspace and dwellings, of streamer can be found in the works of Taylor and Woodcock, a questionnaire is made with questions regarding their work, life styles and dwellings. The information that I hope to gain is mainly about their living conditions. Questions along the line; is it an apartment? Are you in a house? What is the size? Is there anything lacking / missing in your home? With these type of questions I hope to establish a base of information to confirm what has been written by Taylor and Woodcock along with expanding on this research by asking specifically about their wishes and 'look-fors' in dwelling regarding their needs for living and working. The questionnaire is distributed to several considered 'big' streamers, who sadly didn't want to participate, and shared among several facebook communities for streamers. This allows to gain information of the 'generic' streamer instead of the 'big' streamers, giving thus more reliable information for the whole of the community instead of the top few percent. This way I hope to gain insight in maybe special requirements these New Media workers might need that you wouldn't get information about from other sources like Taylor and Woodcock.

To link the streamer better to the idea of New Media worker and make it seem less of a special case Fersch's research is used in a comparison between the needs of streamers and freelancers. Fersch's research includes several interviews with freelancers, which give insight in their work and life styles. Comparing these interviews with the information that is gained from Taylor, Woodcock and the questionnaire a conclusion is reached on how much streamers relate to freelancers and thus other New Media workers.

Holliss' work is used to introduce the concept and history of workhomes, along with some examples of these type of dwellings. By using Holliss' book *Beyond Live/Work: The architecture of home-based work* a clear understanding of

our current idea on workhomes along with what kinds exist nowadays is formed. Combining the information from Holliss' book with the information regarding the influence of New Media and the needs and wishes of New Media workers, as discovered with use of Fersch's interviews and the questionnaire, a conclusion is reached on the workhomes and their functionality towards New Media.

Similarly to the what happens on a literary scale this same concept of looking for compatible workhomes, that could cater to the needs and wishes of New Media workers, is done in the form of a case study. Four case studies are done to find out if something can be learned from these buildings that is applicable to the design of workspaces within workhomes, and thus workhomes themselves.

The chosen case studies consist of: Anna van Bueren Toren, Schiecentrale 4b, Treehouse and Tietgen Dormitory. These four case studies are all analysed on the same aspects, namely functions, accessibility, structure, size, dwelling and dwelling size. These analyses are then compared to the information found in the rest of the research in terms of how well they cater to the needs of the New Media workers.

Based on this last comparison a conclusion is reached in which all the findings that could serve as a reference or recommendation are listed that could either help improve the current dwellings or help in the design of new dwellings. These recommendations are not limited to just the dwellings, the overall structure and other interesting, and applicable, aspects of the buildings are used as well.

## NEW MEDIA

### THE ESSENCE OF NEW MEDIA

To properly understand how “New Media” influences our way of working and therefore our way of living, first it has to be explained. “New Media”, as I call it here, has a variety of meanings, even authors often differ on the meaning of the term. For example Manovich, L. (2003) distinguishes that there is a difference between the new media and cyberculture. Manovich explains this by stating that cyberculture is defined by the social aspects associated with Internet and other forms of network communication. Manovich specifically mentions that online communities, online multi-player gaming, email and cell phone usage fall under this aspect of cyberculture, while new media is a sort of all-encompassing aspect that focuses on the cultural and computing aspect of the media, meaning both the influence it has on the population as well as the new hardware and functioning of this.

While this view isn’t exactly shared by others it also isn’t frowned upon either. Lister, M. (2009) states that even after 30 years of new developments on the front of new media, there still isn’t a clear definition for the term New Media. However he does say that at the very least it is a combination of ‘rapid and ongoing set of technological experiments and entrepreneurial initiatives’ and the social aspect of the platforms that are created with the new media. He concludes by saying that according to him new media has a link with the following terms: digital, interactive, hypertextual, virtual, networked and simulated. (Lister, M., 2009, p. 30).

Even though they don’t exactly say the same thing they elude that “New Media” is defined by more than just the aspect of new developments. It is a combination of, on the one hand, new advances in the way of computing, networking and connections between companies and people, and other hand the social aspect, and thus the interactions that happen due to these new developments.

However in my opinion the best description of New Media is still given by Manovich, who states that

*“Rather than reserving the term new media to refer to the cultural uses of current computer and computer-based network technologies, some authors have suggested that every modern media and telecommunication technology passes through its “new media stage.” In other words, at some point photography, telephone, cinema, television each were “new media.” (Manovich, L., 2003, p.17)*

In short New Media is a complex term, involving both the aspects of the interaction between the people, with the use of new advances in the way of networking and computing, and the technological advances on which these interactions take place. If we look at New Media in this light, meaning that every type of media, telecommunication technology at some point have had a “new media stage” then this term will always be applicable even in the future and be more easily understood.

For my research in particular I will use this last way of defining New Media, as a stage in the development of media and telecommunication technology. This way both the term and my research might be viable in the future. Additionally my research will focus on the aspect of workhomes, so the way people use the these new technologies and how these have impacted their way of working and living, rather than the social interaction that these people have on the various platforms of New Media.

## CHANGING THE WAY WE WORK

Since New Media is defined as a stage of development or 'newness' of the technologies of that time and new technologies offer new ways to do work, thus changing the way we can and how we work, New media can be perceived as changing the way we work. This is really well illustrated by a number of authors, who all draw examples from different occupations.

A quote from Howard, C.M. (2000) illustrates how influential New Media is and also shows the extend of how fast and far the internet spread in the early 2000's.

*"As we enter the new millennium, more than 90 million individuals and businesses are connected to the Net. That figure, reached from a virtually motionless start less than five years ago, represents a rate of growth more than five times as fast as the acceptance of television two generations ago. Internet e-business is booming. As a result of the internet, every organization is now a 24-hour business, with customers – and journalists – expecting instant accessibility and immediate response."* (Howard, C.M., 2000, p. 9)

As Howard explains this new type of media spread fast and had a massive impact in transforming, in this case, the journalist world into a 24-hour business rather than a 9-5. This same idea can be translated to today, with this new wave of New Media, which can be described as the increase in network speeds and new technologies, giving us more freedom to do our work the way we want it to where we want to do it. Law's explanation on how the new media changed the workday of the workers is in line with what Howard says. According to Law in the earlier years we were limited to the way of working of back then because the technology didn't allow us to work anywhere but at our workplace. Law states however that nowadays due to the new technological advancements *"[...] the act of performing work is not limited to specific hours at a specific location."* (Law, W.K., 2006, p.306)

To give an example of how New Media has impacted the way we work I would like to refer back to Manovich. Manovich writes about how new

technologies have allowed us to do our jobs differently and even on different times, he explains this by introducing the example of the filmmaking industry. Manovich writes about how previously the type of camera's used by filmmakers didn't give them much to work with often being restricted by the amount of time they could film. Manovich explains this really well *"[...] The smallness of DV equipment allows a filmmaker to literally be inside the action as it unfolds. In addition to adopting a more intimate filmic approach, a filmmaker can keep shooting for a whole duration of a 60 or 120 minute DV tape as opposed to the standard ten-minute film roll. This gives the filmmaker and the actors more freedom to improvise around a theme, rather than being shackled to the tightly scripted short shots of traditional filmmaking."* (Manovich, L., 2003, p. 17)

Lister, M (2009) brings this idea back to the theme that we are discussing here, the New Media in current times. Lister underlines the fact that 'new developments online' especially in the early years of the century, like increased bandwidth and information processing speed of the Internet, have really changed the way we work and what is possible. Lister supports this statement by saying that it is especially easy to detect in the 'moving image services online', like Youtube or online TV services, with their massive growth of users over the years. Which are mostly thanks to the improvements of the bandwidth and processing speeds of the Internet making it possible for more people to visit and efficiently use these type of sites.

The growth of these sites is not just limited to these specific type of sites, as will explained in further detail in the next chapter, streamers and their platform have also gained a massive amount of following in recent times, showing that not only the amount of users (viewers) but also the streamers (employees) have increased.

To sum up a quote of Lister can be used, that really emphasizes the important aspects that the New Media and primarily the online network and new technologies have to offer.

*“The sheer flexibility of digital technologies, and the convergences between different media forms that digitization affords (for instance the promiscuities of USB) accentuate this complex nature of media technological development. Games consoles can also be DVD players or networked for online play and communication. A mobile phone can also be a games console, a text-based communication device, a camera, a web browser.”* (Lister, M., 2009, p. 273)

Not only do the improvements of the networks, as described by Lister, like the bandwidth and processing speeds have an effect on what we can offer it is also the technological advancements that can work with these new developments. This is, as shown, applicable to various occupations and not just limited to the online based work. Not only that, but because there are new ways of working and according to Law there is not real location restriction anymore, this gives rise to new type of jobs as well, an example being people primarily working from home.

## THE CURRENT STATE OF NEW MEDIA

But why is the New Media and the change it brings, so important now if it has been around for so long already?

To answer this simply, it is because work and live are more intertwined now than they ever were in the past. To illustrate that nowadays work and live are very closely intertwined and almost inseparable, stressing the need for it to be addressed, is something written by Law and Lister. Both state that nowadays due to the better networking and our devices being able to do so much more than they originally could, think of a mobile phone being able to also connect to internet and check your email instead of just being able to call someone, the line between work and live blurs. This in turn blurs the line of where work and live should stop, should work stop at your work place or are they part of the same thing, for example your home is your workplace.

Law even supports this point of blurring the line between work and live by saying:

*“Mobile technologies should also lead to an erosion of personal space. Eriksen (2000) supports his point by noting that people check voicemail at a busstop or even in a public bathroom. Brown (2002) observes that “cafés, bars, restaurants all become transformed into sites for work.” This marks a further eroding of the work/nonwork boundaries, with third spaces (i.e., cafés) between home and work becoming legitimate places of work (Brown, 2002, p. 13). Even the car now has become a mobile office (Corbett, 1994).”* (Law, W.K., 2006, p. 308-309)

Well specifically this last point is very relevant nowadays. I will explain this point more clearly with an example:

As an example of both the new jobs created, due to the possibilities that New Media offers, and work-live from home, streamers can be used. Streaming is a new type of job that is created with the rise of the New Media, where people record themselves or the things they do and broadcast this live over the ‘moving image services online’, like Youtube and Twitch. Twitch.tv especially is a well-known and dedicated streaming website. Twitch.tv has been gaining followers and users steadily over the last few years (see figure 1), even having over more than 6 million streamers per month, and an average concurrent viewers of 2 million.

As can be seen from figure 1, Twitch.tv on its own has a lot of average visitors, these being both broadcasters and viewers. This shows that streaming can be seen as a legitimate job that has been made possible due to the new developments surrounding New Media, that also improved the performance and growth of similar sites like Youtube and online TV streaming websites.

Okay, so work-live is hard to distinguish and are connected to each other. But why does it need to be addressed?

## TWITCH GROWTH



Figure 1: Twitch Games Statistics (z.d.). *Twitch growth* [Image]. Retrieved from <https://twitchtracker.com/statistics/games>

To answer this question I can bring about a topic well known to everybody during this time, Covid-19. Covid-19 has made the problems surrounding this blurred line between work and live more clear. As everybody has been instructed to work from home as much as possible, we all get to experience this work-live idea more.

Of course, as also is explained this is first of all only possible because we have the ability to work from home, because of the New Media (Law, W.K., 2006 & Manovich L., 2003). However as we all have experienced there are some issues with working from home, seeing as our society was mostly based upon working from a dedicated workplace, often for a company away from home, our current homes aren't well adapted to this new way of working.

Everybody has heard it before for example if you are student, being at and studying from home, you will once in a while hear your parent(s) complain about how they don't have the space that they require to do their work or that they "can't do this" or "can't do that". What I am trying to accomplish with this is to say that Covid-19 has shown us an issue that most people that are working from home will have a problem with and that is the lack of space in a dwelling, or to be more precise a private space for them to work in.

My tutor, Pierijn, had a good quote for this in a lecture we had a few weeks ago he said: "[...] having a space, where you can work and maybe have a meeting without a bra showing in screen or people bugging you, might be needed". My father also has similar responses to this he often goes to my sister's room, who is currently not living at home anymore, to work or hold meetings seeing as being at home and downstairs with my mother, who is also working, is very distracting for him. He often says: "I need a space where I can just have my meetings or work in peace, without you guys interrupting me."

To conclude New Media is an integral part of how people nowadays work and live, and in some cases work-live. It is found in almost all types of jobs and in some cases, as highlighted by Covid-19, is the only reason some jobs are possible. However it is not without its own set of problems, as especially Covid-19 has shown, there is often a lack of space in the dwellings for people who work from home for their jobs. Meaning that the current dwellings aren't adapted to the New Media way of working and I wish to offer a solution for this problem with this research and my design.



The following scheme, shows the problem and the road to it in simple terms (figure 2):

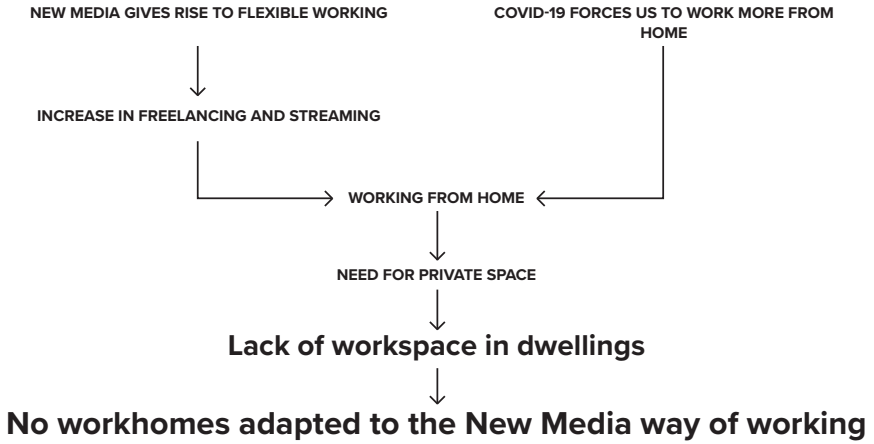


Figure 2: *The problem and the road to it.* (Machgeels, D., 2020)

## NEW JOBS, NEW WORKING, NEW LIVING

### STREAMING IN THE NEW WORK-LIVE

To precisely know what the current issues in the homes of the people working the New Media jobs are, it is important to investigate a group that works in this new environment. As streaming got more and more popular and I, myself, including a lot of my friends have ties to streaming, either with a friend who knows a streamer or stream themselves, these people seemed an especially good example of the New Media way of working.

The idea of a streamer is a fairly new concept, it was only with the development of the internet that streaming became possible. Much like Lister, M. (2009) said it is due to the improvements in bandwidth and the information processing speed that sites that offer these kinds of services exist and are accessible to such a huge part of the population. New Media is the only reason these kind of jobs are possible.

Of course since streaming is still kind of new and in its growing phases, it would be weird to dedicate a whole research regarding work-live in New Media to just streamers. Therefore streamers will be used as an example for the potential future users of this new type of working and their needs. Based on this an estimate can be made on what could be the issue for people working from home, seeing as the basic needs are similar.

### STREAMING IN THE NEW WORK-LIVE

Aside from the obvious, like needing a house, food and water there are other aspects about streamers that are very comparable to freelancers nowadays. Freelancers can be seen as home-based workers, seeing as these people often work from any space they want, because the Internet gives them the freedom to work flexibly wherever they want. In a sense this would be the same as streamers, streamers only really need a few things to be able to stream their content, obviously based on what they broadcast this may vary. But these things often can simple be listed as: a good internet connection and a device to stream from. Freelancers, again depending on their jobs, can do this with the exact same low requirements.

Other than having almost the same requirements for them to be able to work, this being a good internet connection and a device to work on, they also have a similar problem regarding work stability and income. In both the circles of streaming and freelancing their income is based on the amount of work they get. In the case of a freelancer this is the amount of jobs they get offered by clients (Fersch, B., 2009), while the streamer is based on the amount of concurrent viewers they have (Taylor, T. L., 2018). Both deal with the issue that their income is not fixed and may fluctuate from day to day.

This way of working as is mentioned by several interviewee's of Fersch bring some uncertainties with it. These uncertainties don't just lie with only the income, but also popularity or how well-known they are. In both of these lines of work it is important that you are well known in order to get clients or viewers.

Interview in Fersch's research show the following:

*"So, the advantage of being employed clearly is that you get the feeling of having a secure framework. Whether this is fake or not does not matter. It is a secure framework you are in. Your pension is taken care of. This and that,...]"* (2009, p. 139)

And

*"I am not afraid of sinking into poverty. I am afraid, because it is so difficult to come back [...] in such a creative branch. If you have been dropping out, so, if you get on the wrong track, then there is not so much that sticks to you. And then that's just how it is." (case excerpt 8, appendix 1, p.116 / interview transcript 8, appendix 2)* (2009, p.141)

These same kind of worries can be found in the book of Taylor, T. L. (2018) called *Watch Me Play: Twitch and the rise of game live streaming*. In his book he defines not only how streaming came to be and why it is possible a new and more important source of entertainment much, like TV is currently, but he also explains some of the problems that streamers have to deal with. Much like freelancers, it is important for them to have a good network or popularity and be able to keep up with it, as to not fall out of frame. It is like the last quote of Fersch's research, it is important that you keep up and don't drop out, because there is a chance that you can't get back up. Meaning that if you don't keep up with your work in this case for both streaming and freelancing there is a chance your publicity will drop and you will not get any work / income.

Aside from the their income and their requirements to do their work there are some other similarities between the two that only became apparent after a questionnaire . From this questionnaire a few things could be concluded.

Firstly not all of these respondents are full-time streamers, only about 30,8% of them were full-time streamers (see figure 3), meaning that their career/ occupation was solely streaming. However almost all of the respondents did mention the wish of wanting to take streaming further and seeing if they could make it their career, this in its own right shows that streaming indeed is a new way of working and living in the New Media.

Streamers, much like freelancers, have a certain age group in which they are often on their own or otherwise called single. The questionnaire showed that out of the 13 respondents 12 are between the ages of 20-35, meaning that they often are fairly young and start streaming either after finishing or during their studies (see figure 4). Of the respondents 46,2% answered that they were either living alone or went back to live with their parents, saying that a lack of money is the issue. This again can be related back to their age, seeing as at this age they probably wouldn't have a lot of money to spent. A precise measure of their income can't be determined as this fluctuates too much depending on their viewer amount and their popularity, however it could be assumed they have an income that is comparable to students or starters, judging by their age and answers to the questionnaire.

**Is streaming / content creation (Youtube) your career?**

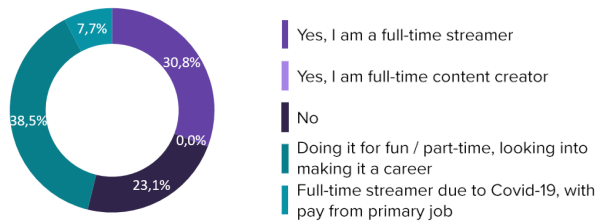


Figure 3: Is streaming / content creation (Youtube) your career? results of questionnaire. (Machgeels, D., 2020)

## Age

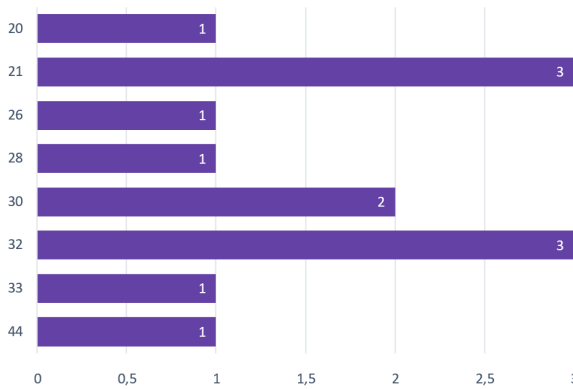


Figure 4: Age results of questionnaire. (Machgeels, D., 2020)

Because these people, in terms of age and financial status, are comparable to starters, they don't have a huge amount of money. Often forcing them into cheaper rental dwellings, like studio's, 2 room apartments or even go back to living in their parental homes (see figures 5 & 6). Comparing these dwellings to those of starters and even students, the type of dwellings seem to overlap, with the only difference being that some of the respondents answered by saying that they feel the dwellings is sometimes too small. Of all the respondents over 53% has said to have a rental dwelling currently and prefer to have this, one in particular even said that this was an aspect that they look for when they look into a new dwelling (see figure 7). This preference for a rental dwellings is mostly due to the fact that their financial status isn't as steady as other jobs and the fact that buying a property would be out of reach. Renting a place also offers them the possibility of moving and thus scale up their dwellings according to their future needs and income.

Answers from the other respondents support this claim. Of all the respondents 23,1% is a parent with a family and 23,1% said to be living with their significant other (see figure 5). Especially these respondents showed that they valued a bought dwelling over a rental, because they are looking into a place to permanently stay. What was apparent was that when people reached this point they mostly were to the farther end of the age

group, getting closer to the ages of 30-35. Along with their age these particular respondents reacted to these questions thinking not only of their own needs, but also the needs of their families. In contrast the people who were single they didn't just focus on their own needs

In contrast to these respondents, the respondents who are single didn't have to take this into account, thus only focusing on their own needs, focusing more on temporary stay until they can find something better. Along with this way of thinking their financial status also plays a big role in this decisions, as mentioned earlier their financial status isn't as steady as some one with a full-time job especially when they start out and try to amass a following, opting for a dwelling that is good enough for now with the flexibility of not being stuck to just one place when something better turns up.

What are your living conditions?

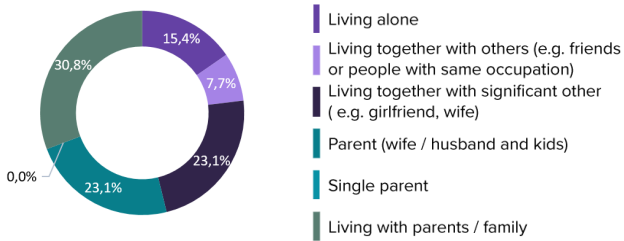


Figure 5: What are your living conditions? results of questionnaire. (Machgeels, D., 2020)

What type of dwelling do you have now?

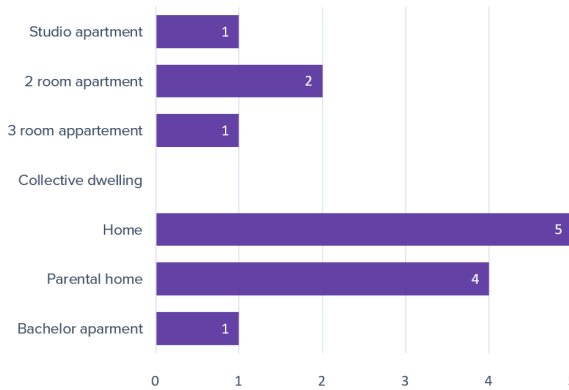


Figure 6: What type of dwelling do you have now? results of questionnaire. (Machgeels, D., 2020)

Is your dwelling a bought or rental property?

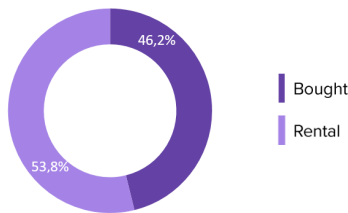


Figure 7: Is your dwelling a bought or rental property? results of questionnaire. (Machgeels, D., 2020)

This idea of putting their families' needs at the fore front is not only reserved to streamers, the interviews in Fersch's research pointed out the same thing. An interview with one of the freelancers named Jan shows that since he got a family his work habit and way of living have changed, having to organize work more around his daily life with his family rather than just being able to work whenever, wherever he wants.

*Jan: Now it is important to me, that I also have spare time, that I can integrate it well, NOW I realise that you reach the limits of THIS field of work, that is problematic, right? But apart from that...*

*Interviewer: In what way? [...]*

*Jan: Well, you are not as flexible anymore. [...] Generally, if you have a family [...] and you share the tasks, that is household and childcare work, then the flexibility is extremely limited (case excerpt 5, appendix 1 p. 76 / interview transcript 5, appendix 2) (Fersch, B., 2009, p. 180)*

Taking into account that both freelancers and streamers seem to think similarly when they have family, these people tend to not fit the group that currently is in the hardest need for a dwelling. Since these people often look for a bought property, that is more in line with a normal house often with a guestroom which can double as workroom, and have a more established fund to be able to afford such a dwelling. As one of my respondents Jay or K11ersix mentions he looks for a home where there is enough room for his whole

family and on top of that "Space where myself and my wife can have time to ourselves and time together. Big kitchen, comfortable family room, guest room".

When asked where these people were working / streaming and what they feel was missing / lacking from their dwelling almost all of them answered the same thing. Aside from the parents, who owned their own bought property and already had a separate workroom, all of the respondents answered that they did work from their dwelling (see figure 8), but felt that they were lacking a dedicated space for their work. When asked specifically what they were missing in their dwelling, almost all of them answered that they would love to have a workroom separate from their other living spaces, that is meant for streaming. Interestingly enough this same answer was later often in their answer to the question "what do you look for in a dwelling?".

Even the streamers who already had a workroom in their homes answered that they would love to have it improved in some way. Jay specifically answers it in the following way "Yeah currently the soundproofing for my studio isn't perfect so I'm unable to record content or stream at night. In a perfect world I could fix that".

### Where do you work / stream?

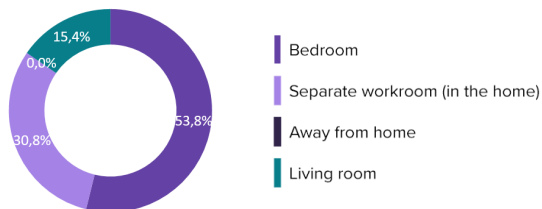


Figure 8: Where do you work / stream? results of questionnaire. (Machgeels, D., 2020)

The research of both Fersch and myself point out that streamers and freelancers are alike on a lot of aspects and that they can be seen as having the same requirements for dwellings to a certain extend. From my own research it became clear that streamers in particular, which is also very applicable to other target groups as Covid-19 has shown, is that they have a need for a separate private workspace. The requirements regarding this workspace are however related to the occupation of the resident, which as Jay has pointed out would ideally be soundproof for more flexibility in working hours, in the case of streamers. Aside from these points it also seems that New Media workers in the age group of 20-35 are the most in need for dwelling adapted to the New Media way of working, as these people tend to have a financial status similar to starters. The dwellings currently occupied by these people don't offer all the things that these people would need or want in their dwelling, this being that private workspace. As the somewhat older people in this branch, this being above the age of 35, often have a family and have a dwelling that is comparable to a normal family home, these people don't seem to be in the biggest need for a new dwelling. Even though there is still an issue here in terms of lack of space, there is often in these houses a space for them to retreat to do their work, for example like in the case of my father the room of my sister.

## STREAMERS AS AN EXAMPLE

What can be concluded?

Firstly streaming is a one of many new jobs that has been created with the rise of the New Media, which has allowed these kind of jobs to be possible. The rise of popularity, both in terms of viewers and broadcasters, on the sites shows that they are in the growing phase of their kind of job. This idea of streaming becoming more and more important is shared by both Taylor, T.L. (2018) and Johnson, M. R., & Woodcock, J. (2019).

Streamers according to interview conducted by Johnson, M. R., & Woodcock, J., state that they feel that Twitch and live streaming as a whole is just in the beginning phase of its development and that it will grow out to be more than just a gaming platform.

*"[...] All interviewees expressed strong agreement on two major points: firstly, the feeling that current streamers were in on the 'ground floor' of a massive new media platform and global social phenomenon, which made many streamers feel quite privileged; secondly, the common belief that Twitch and streaming would only continue to grow in future years, deploying a range of justifications for this belief, and that Twitch represented the earliest stages of a world-changing technological trajectory that would expand years or decades into the future."* (2019, p. 346)

One of Woodcock's interviewees even drew the connection to how live-streaming and twitch in particular could be seen as the next big thing, comparing it to the invention of the telephone. In his own words:

*"It's like the equivalent of Alexander Bell, I think his name was, laying down the first telephone lines back in the 1800s, 1700s, whenever it was. I think that's what we're doing right here, right now with Twitch, and that's something I want to be a part of."* (2019, p. 347)

Other than streaming showing us that New Media indeed offers, at least at the moment, all kind of new jobs that have the possibility to grow out into massive new enterprises, streamers themselves also have ties to various other groups of people which are already known in today's society. As my questionnaire has pointed out streamers are fairly young, with the majority being between the ages of 20-35. These ages are comparable to that of starters, students and even freelancers.

Not only their ages are comparable, but also their living conditions. In terms of financial status streamers, especially starting streamers, don't have a lot of money. This is due to their unfixed income and the fact that they often start streaming in a time where they are a student or have just finished their study, thus leaving them without a big sum to spend. Because they lack the funds to afford the dwelling they want they often look for cheaper rental dwellings or go back to living with their parents until they have saved enough to move out. My questionnaire

pointed out that there are two categories under which most of the dwellings fall in terms of size, these are 30-60 m<sup>2</sup> and 60-100 m<sup>2</sup> (see figure 9). Of the dwellings with a floorspace of 60 – 100 m<sup>2</sup> and above the houses and parental homes take up the large portion, thus leaving 30-60 m<sup>2</sup> as the major type of housing that streamers, if they are a single person household, have at the moment.

The preferred size of their dwelling changes however when their living situation changes, this being either living together with a significant other or starting a family. When their living situation changes the priority of the streamers, and the of course the other mentioned target groups, change. The priorities in the case of both the freelancers and streamers tend to shift to benefit the needs of their families rather than their own personal needs. Preferring to have a larger home with space for both them and their children, to receive guests, separate space for the parents and a workroom that is separated from the other living spaces but included in the home.

All of these different kind of people that have different occupation and vary in age have one thing in common. That is that almost all of the dwellings regardless of size have a need for a separate workspace in the dwelling, which in the case of streamers is soundproof. Especially the starting group of the New Media workers seem to have an issue of lack of space in the entire dwelling and would like to have an additional workroom in their home. If Covid-19 has shown us anything it is that in our current environment almost no dwelling is currently well enough adapted to handle this New Media way of working, where working from home or work-live has become a standard. Streamers and freelancers are a great example in showing this and thus should be taken as an example for future and potential users in terms of their needs and their wishes.

### What is the size of your current home?

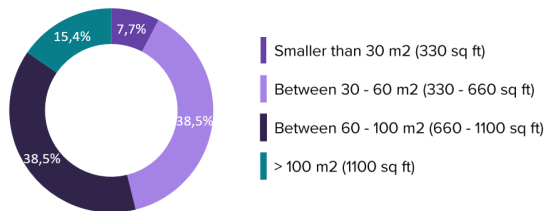


Figure 9: What is the size of your current home? results of questionnaire. (Machgeels, D., 2020)



## A PLACE TO LIVE AND WORK

### THE HISTORY OF THE WORKHOME

The idea of a workhome isn't at all new, in fact the idea behind a workhome has existed a long time. It was at one point even the most normal thing in the world. In the Middle ages almost all type of homes were workhomes, think of weaver's, herbalists, shoemakers and farmers. All of their homes doubled as their workplace and atelier during the day. They would often have space in the home reserved for working, or a room that doubled in function. During the day they would work in these spaces and would receive clients that went by to pick up orders or order something. As Holliss mentions it:

*"The workhome has existed for hundreds, even thousands, of years. Examples can be found worldwide, from the Japanese machiya to the Malaysian shop-house, the Iranian courtyard house to the Vietnamese tube house, the Lyons silk-weaver's atelier to the Dutch merchant's house. Taking different forms according to culture and climate, workhomes are often so familiar that they are no longer noticed."* (Holliss, F, 2015, p. 9)

In Industrial Revolution however the term of workhome became a bit less well known. As Holliss describes it "[...] the term house was to identify a building in which un paid domestic, rather than paid productive, work took place and which provided a base from which people could 'go out to work' to earn their livings." During this period the term workhome became lost, homes were in those days spaces where you would live and serve as a place from which you would depart to your work.

As working away from home was the norm the need for these workhomes became less. This trend continued for around two centuries. Even today the term workhome is hard to define, often the term of a 'dual-use' building is used. As Holliss explains that in English there isn't even a word that refer to all the buildings in which people both live and work. The terms that come close to the idea of a workhome are such as 'studio-house' or 'live/work unit'.

Even though the term workhome doesn't really exist, doesn't mean there aren't any examples of these type of workhomes. Often these type of homes do exist, but in small amounts and are catered to specific target group or even specifically made for a client. Holliss gives different examples of these workhomes in the second chapter of her book, however as mentioned these are mostly very unique examples that are all made for clients.

With the rise of the New Media and the current Covid pandemic, the need for workhomes has once again risen. Seeing as the New Media has allowed us to work differently and companies seeing the benefits of working from home, due to Covid-19, it is possible that we in the future will go into a more home based work society. With the change in our way of working and living, it is clear that we need to go back to something that was the former normal. Back to the time of the workhome.

### THE TYPE OF WORKHOMES

Of the, as Holliss describes them, current examples of workhomes there are a few types, that can be identified. None of the examples are exactly the same as they all seem to be some sort of commission for a client and thus don't all have a similar layout or look, but have certain similar characteristics.

#### Studio-house

One of these types is the 'studio-house'. Despite putting all of the examples mentioned by Holliss of 'studio-houses' under the same category they do have differences depending on for who it is designed. These differences mostly vary in terms of the size of the dwelling and the configuration of the whole building. For example the workhome apartments mentioned by Holliss are artists homes, where the building is designed in such a way that there is always enough room for the artists to move their creations from their ateliers, in their homes, through the building. For this all the hallways and staircases were given extra space as to make the handling of these creations a lot easier.

It is these kind of differences that identify each of these buildings. However the main theme of the 'studio-house' is seen in all of them. As the name suggests this type of dwelling focuses on the importance of the studio or workspace in the dwelling. In all of the given examples the workspace located in the dwelling takes up a two floor high space and is surrounded in a glass façade. The workspace here is used as a 'calling card' showing the work of the one using the dwelling. The living spaces therefore are conveniently placed around it or in Holliss' own words:

*"An artist inhabiting one of these buildings, like a weaver in a Coventry cottage factory, lived at their workplace rather than working in their home."* (Holliss, F., 2015, p.40)

As the groups that I try to represent don't necessarily need these kind of big spaces in their dwellings, these seem to be a bit too much for the target groups in question. However it does raise an interesting question regarding the importance of work opposed to living. If streamer answers are to be believed they hold a lot of value on entertainment and other things in the vicinity and having the dwelling for their living and working needs. However they deem their work to be important enough to dedicate a room to but not important enough to say that their whole dwelling revolves around this one aspect. For them this room just needs to be big enough for their as one respondent called it "A dedicated streaming room and soundproofing" and "extra space for a dedicated set up". Work does play an important role in the choice of dwelling and should be designed towards however as can be seen from the reactions and what is described in the book of Holliss it is definitely not to the same extent, with the past being more focused on this aspect of presenting yourself towards the public with your work as some sort of "calling card" rather than just a working space.

This idea of having just a workspace in the home that is isolated from the other living spaces, but not necessarily the front of your dwelling or 'calling card', but rather just a room in the home is supported by the answers given by several interviewee's in Fersch's research as well as mentioned by Law. Therefore this specific type of dwelling where the studio or workspace is the main focus of the dwelling is in this case not the best

fit, seeing as the dwellings for both freelancers and the New Media type of working isn't just a glorified workspace.

### Modernism

The second type Holliss defines is Modernism. Modernism focuses on the idea that *"its defining features are a rejection of historical precedent; the idea that form should be simplified (and generated from the inside out, by the functional spatial requirements of the building); an exploration of new materials (initially concrete, steel and glass) and a reduction of ornament. Despite the marginalization of home-based work many iconic Modernist buildings, both institutional and for individual/ family use, were designed as work-homes, but scant attention has been paid to their dual use."* (2015, p. 46-47)

The examples given all share the resemblance of a workspace embedded in the home. However all these examples differ from each other, each of the chosen projects are designed specifically for one person only, the owner, and aren't in a real sense able to be connected to each other in terms of layout or the way they work.

All these homes incorporated spaces for the workers or housekeepers for them to stay in. In our current day and age these aspects don't seem necessary and even a little weird. It is thus that I claim that these buildings up until now, described by Holliss are part of the elite class of people who have a lot of spending money or stature within their respective societies.

The only common aspects these different homes have is the way they divide public and private. In the examples given most of the public functions of the, or the ones that the public may see, are located towards the sides where the public is. Entrance halls all facing outwards, while all the private spaces like bedroom and workrooms are located on the more secure and inner parts of the dwellings.

In short Modernism brought about the change in the way workhomes were viewed no longer was it necessary to have your workspace front and center in the home as a calling card for your business. It could be integrated in the home depending on how the owner liked it to be. The change

in this time focused more on the adaptation of the owner / user rather than the presentation of the work of the person living there. The examples given are therefore also more unique and less broadly applicable like the studio-house is. Much like the studio house however there is only one aspect that could be taken into consideration for the creation of the dwellings for the current issues. That aspect is the way that they altered the dwellings in such a way that it was adapted to the way the user wanted it. This idea could be used in the creation of the dwellings for the New Media workers.

### Live/work unit

The last type introduced by Holliss is the live/work units. One of the live/work units that came to be were loft style units of 200 sq meters. These lofts would have a fully open floor plan and have no boundaries like kitchen, bedroom and living room often being in some sort of studio configuration. This allowed the user to have their own layout in these dwellings and often personalizing them in interesting ways. In some way this is comparable to how Modernism handled the idea of workhomes for the specific clients.

These loft type dwellings were in this time sold as the ideal place for artists. As they offered the ability for the buyers to change these dwellings into these type of live/work units, it often didn't turn out this way. High-earning middle class would buy up these apartment and turn them into luxury lofts. This sort of thing was later on encouraged by the government and thus written off as a scam.

The live/work units as described by Holliss had a different approach to the idea of the workroom than the 'studio-house' or 'Modernism' dwellings. These units can be more or less compared to what we currently call studio's, offering little in terms of separation in rooms and more in terms of the freedom to with as you want, being able to determine your own spaces.

Much like the idea behind the live/ work units also its applicability to the New Media way of working is better than the other types given by Holliss. From the interviews of Holliss' research, my questionnaire and comments made in *Watch Me Play* by Taylor, T.L. it is clear that the New Media

way of working doesn't always have a need for 2 floor high working space, or a dwelling completely dedicated to the idea of a workroom, like the 'studio-house' is. Besides this point also the size of these units is way bigger than needed. As seen from my questionnaire it became clear that the most common size lies anywhere between 30-100 m<sup>2</sup>.

Even the size of these workspaces and the size of these dwellings is questioned by Holliss herself when she goes into the idea of 'computer-based work', what could be defined as a New Media way of working. She stated the following:

*"Does computer-based work count as work in these circumstances, if it could just as easily be carried out in a bedroom?"* (Holliss, F., 2015, p. 64)

### CONCLUSION

If we go back a hundred or even thousands of years, we would find that our origin of dwellings is that of the workhome. In the Middle ages almost all type of homes were workhomes, think of weaver's, herbalists, shoemakers and farmers. All them had their homes that doubles as their workplace and atelier.

We only started to change this way of living when the Industrial Revolution came to be. In a short period of 2 centuries we started living according to the 'go out to work' mentality, where the house was nothing more than a place where only domestic and non-productive work was conducted.

With the changes over time in technology and thus offering new ways of working, in this case New Media and Covid-19, we once again have a need for workhomes. The idea for workhomes however isn't as well-known as it once was, and our attempts in to making workhomes all try to put the emphasize on the working aspect of the dwelling. As Holliss puts it:

*"An artist inhabiting one of these buildings, like a weaver in a Coventry cottage factory, lived at their workplace rather than working in their home."* (Holliss, F., 2015, p.40)

These kind of dwellings are not needed, often focusing too much on the workspace rather than the dwelling, because functions are more or less conveniently placed around the workspace rather than being a coherent and hybridity within the dwelling.

Regarding the use of these types in relation to the New Media way of working the only option that comes close to the needs and current use of the dwellings of the target groups, as is explained in Chapter II, is the live/work unit. The live/work unit is very similar to the housing type that some of the interviewees and streamers use, namely the studio dwelling. In this type of dwelling there is a lack of separation between function and most of it is an open floor plan concept, where bedroom, living room and sometimes workroom are integrated in one.

Despite the fact that Holliss offers a lot of options, most of them being the result of a commission of a client, all of them focus on the importance of the workspace rather than the dwelling or the hybridity of the two. In the examples given, with the exception of the live/work units, all of the workrooms have some sort of prominent function in the dwelling, either as 'calling card' or as the core of the home. This type of dual-use of a dwelling is out of balance and not suited for the needs that the New Media way of working is asking for.

There is a shortage problem of workhomes adapted to this new way of working, and especially in the case of the lack of private / separated workspace within the homes, however the examples given by Holliss do not suffice as examples that could be used to solve this problem, seeing as the idea of the importance of the workspace in the dwelling differs from the view that the future users have. As seen from the answers from the questionnaire most of the future users deem it necessary to have a separate room for their work, in the case of the streamers one that is soundproof, however they do not mention that this room should have extreme big proportions or is the focus of the dwelling, they deem this workroom to be a just a separate room, cut off from the other living space, but still embedded in the dwelling.

Even Holliss herself mentions that the type of workhomes, that she mentions, in her book may not be the solution for 'computer-based work'. This in combination with the various conflicting points of interest between the examples given by Holliss and the needs of the New Media way of working, shows us that we currently do not have what it takes to solve the problem of the workhomes in the New Media.

## PLAN ANALYSIS

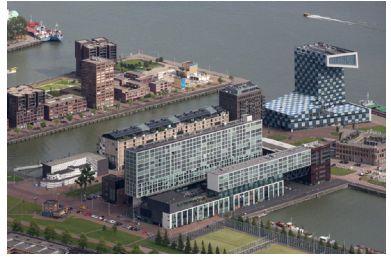
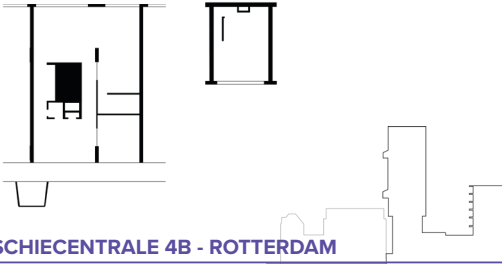
In this chapter a plan analysis is performed in which the analyzed building serve as an example of the current workhomes that exist. These buildings may not all be specifically labeled as workhomes however they either serve a similar function or have a similar way of dealing with the problems that accompany workhomes. In this chapter the reason of their choice and how they fall into place will be explained.

Each of the projects is analyzed on the same points: functions, accessibility, structure, size, dwelling and dwelling size.

To identify the buildings each has been given icons to represent; typology, functions, dwelling types, amount of rooms in a dwelling and the structure type. The icons and their meanings are listed below.

### Icon legend

	Tower typology		Two person household		Washing machine / Laundry room
	Slab typology		Family home		Bathtub
	Row-house typology		Co-living		Toilet
	Street typology		Communal workroom		Sink
	Gallery typology		Communal area		Shower
	Corridor typology		Amount of rooms in a dwelling	<b>Legend accessibility</b>  Collective  Public  Collective space  Public space  Collective workspace  Public workspace  Dwelling  Bathroom	
	Load bearing dividing wall + skeleton floor		Floor space of dwelling in m <sup>2</sup>		
	Load bearing dividing wall + monolith floor		Bathroom		
	Dom-ino skeleton		Bedroom		
	3D skeleton		Workroom		
	Average / most common distance structure		Living room		
	Single person household		Kitchen		



**SCHIECENTRALE 4B - ROTTERDAM**

**Architect:** Mei architects and planners  
**Address:** Schiehavenkade, Rotterdam  
**Client:** Municipal Development Company Rotterdam  
**Design-Completion:** 2003-2008  
**Purpose:** Residential and commercial building  
**Number of floors:** 17  
**Amount of dwellings:** 156 workhomes, 20 quayside houses and 7000 m2 offices

**Typology**



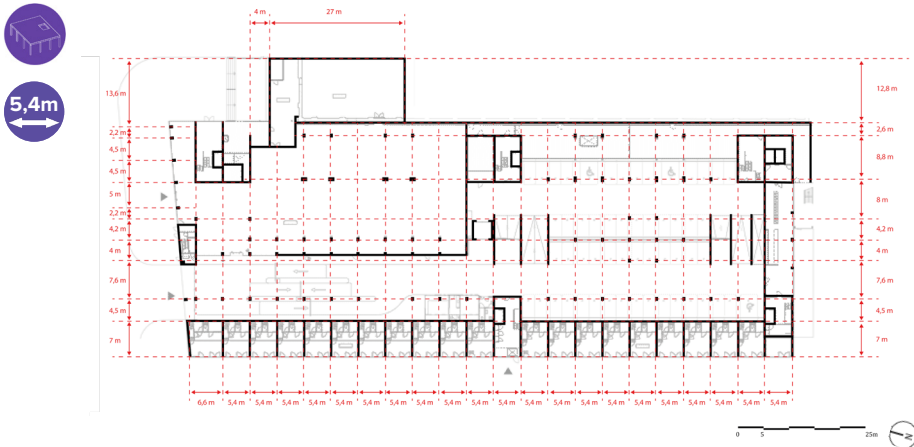
**Functions**



**Dwelling types**



**Structure Ground floor**



**Figure 10:** Structure Ground floor Schiecentrale. (Machgeels, D., 2020)  
 Analysed from Ground floor plan (Mei architects and planners, 2020)

### Structure Slab (5th-16th floor)

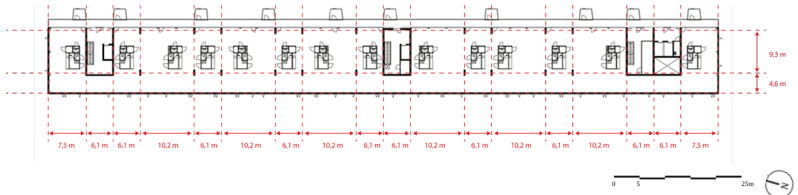


Figure 11: Structure Slab (5th-16th floor) Schiecentrale. (Machgeels, D., 2020)  
Analysed from Framework high plate (Mei architects and planners, 2020)

### Floorheights

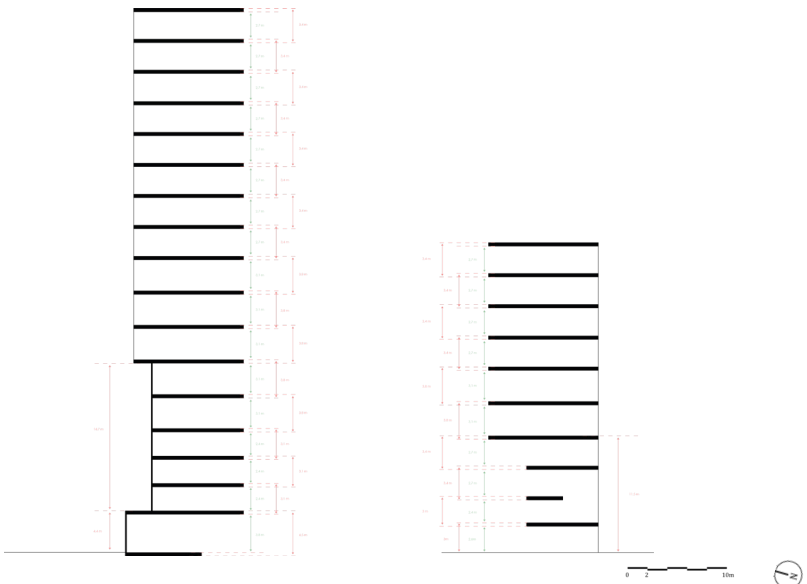


Figure 12: Floorheights Schiecentrale. (Machgeels, D., 2020)  
Analysed from Section (Mei architects and planners, 2020)

Accessibility and functions Ground floor plan



Figure 13: Accessibility and functions Ground floor plan Schiecentrale. (Machgeels, D., 2020) Analysed from Functions ground floor (Mei architects and planners, 2020)

Accessibility and functions First floor plan

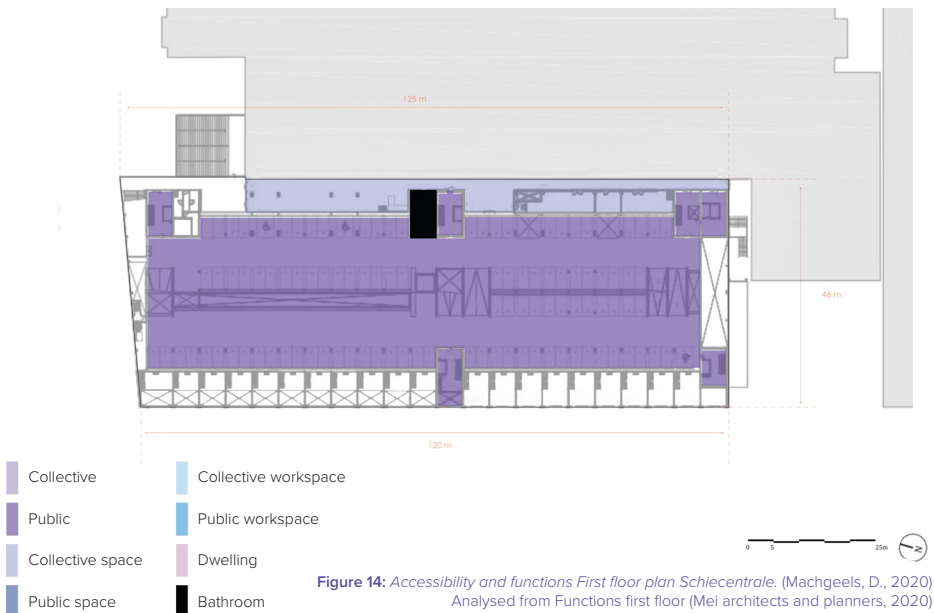


Figure 14: Accessibility and functions First floor plan Schiecentrale. (Machgeels, D., 2020) Analysed from Functions first floor (Mei architects and planners, 2020)



Accessibility and functions Fourth floor plan

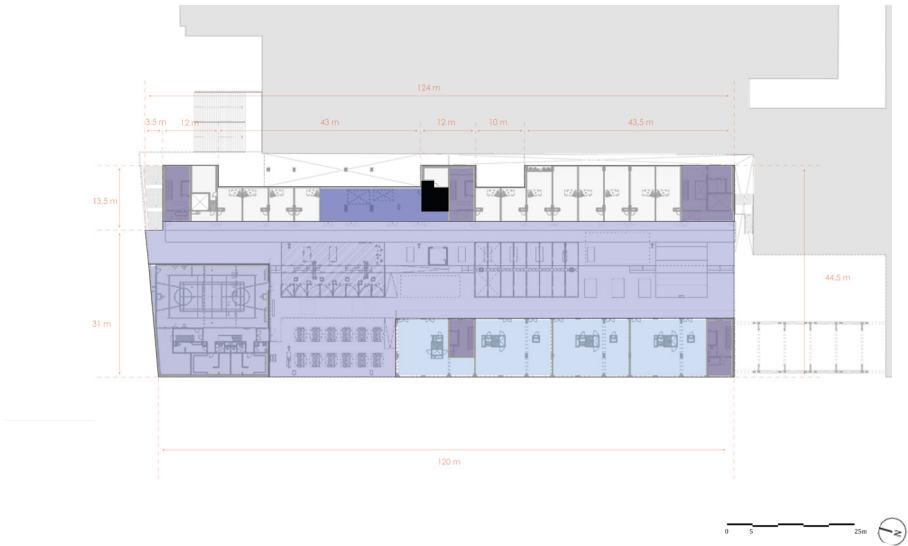


Figure 15: Accessibility and functions Fourth floor plan Schiecentrale. (Machgeels, D., 2020)  
 Analysed from Functions fourth floor (Mei architects and planners, 2020)

Accessibility and functions Fifth floor plan



- Collective
- Collective workspace
- Public
- Public workspace
- Collective space
- Dwelling
- Public space
- Bathroom

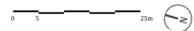


Figure 16: Accessibility and functions Fifth floor plan Schiecentrale. (Machgeels, D., 2020)  
 Analysed from fifth floor plan (Frearson, A., 2017)

Accessibility and functions Sixth floor plan



Figure 17: Accessibility and functions Sixth floor plan Schiecentrale. (Machgeels, D., 2020)  
Analysed from Functions sixth floor (Mei architects and planners, 2020)

Accessibility and functions Slab floor plan (9th-16th floor)



Figure 18: Accessibility and functions Slab floor plan (9th-16th floor) Schiecentrale. (Machgeels, D., 2020)  
Analysed from Completion (Mei architects and planners, 2020)

- Collective
- Public
- Collective space
- Public space
- Collective workspace
- Public workspace
- Dwelling
- Bathroom

Accessibility and functions Section



Figure 19: Accessibility and functions Section Schiecentrale. (Machgeels, D., 2020)  
Analysed from Section (Mei architects and planners, 2020)

145 m2 workhome in slab (9th-16th floor)

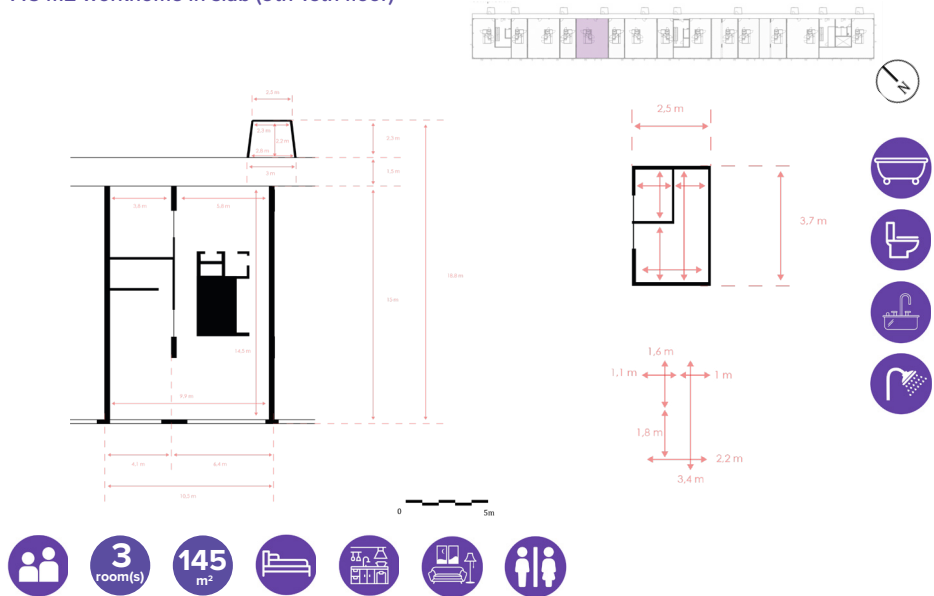


Figure 20: 145 m2 workhome in slab (9th-16th floor) + bathroom Schiecentrale. (Machgeels, D., 2020)  
Analysed from Workhome (ninth-sixteenth floor) in high-rise slab, representation (west)  
(van Gameren, D., Kuitenbrouwer, P., & Schreurs, E., 2019)

85 m2 workhome in slab (9th-16th floor)

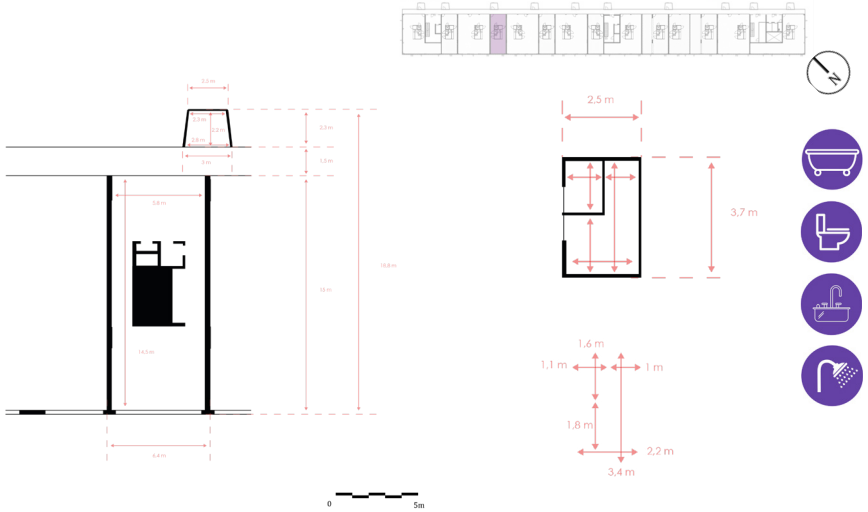
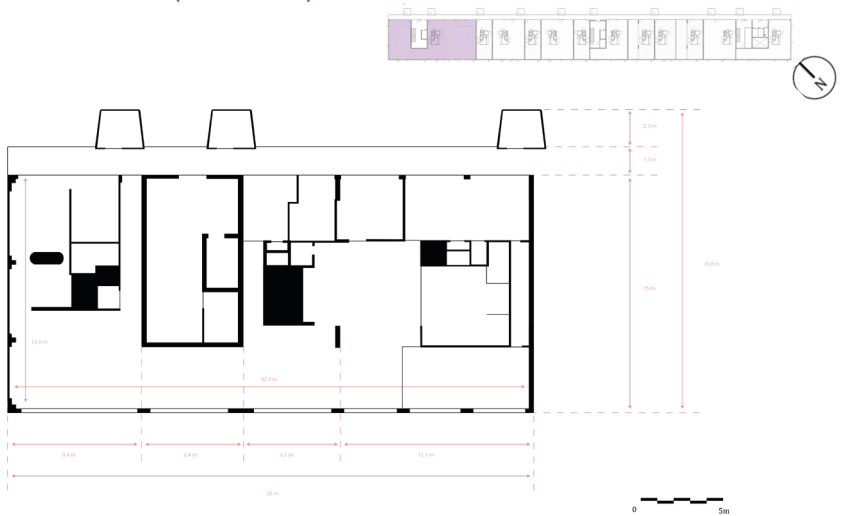


Figure 21: 85 m2 workhome in slab (9th-16th floor) + bathroom Schiecentrale. (Machgeels, D., 2020)  
 Analysed from Schematic view completion (Mei architects and planners, 2020)

470 m2 workhome in slab (9th-16th floor)



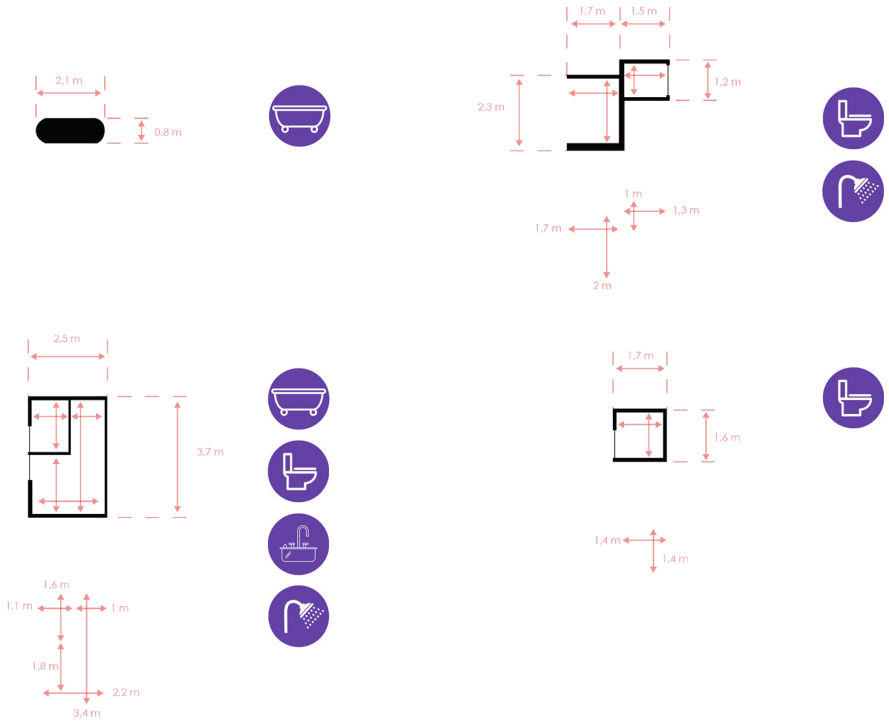
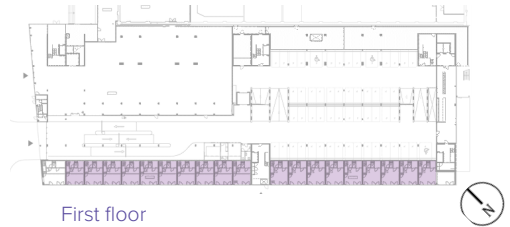
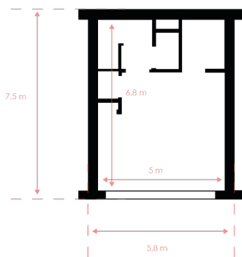


Figure 22: 470 m<sup>2</sup> workhome in slab (9th-16th floor) + bathroom Schiecentrale. (Machgeels, D., 2020)  
Analysed from (Unnamed) (Mei architects and planners, 2020)

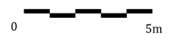
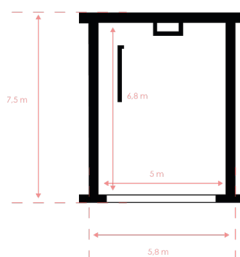
**Quayhouse**  
(Ground, first, second and third floor)



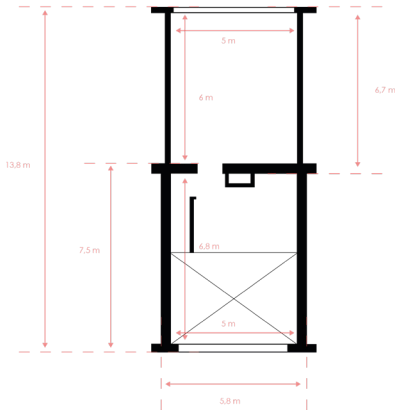
Ground floor



First floor



Second floor



Third floor



Figure 23: Quayhouse (Ground, first, second and third floor) Schiecentrale. (Machgeels, D., 2020)  
 Analysed from Quayside houses with private garage (ground floor, first, second and third floors)  
 (van Gameren, D., Kuitenbrouwer, P., & Schreurs, E., 2019)

**SCHIECENTRALE 4B**

The Schiecentrale located in Rotterdam has a few interesting aspects that could be taken as a good reference into making workhomes. First off all the buildings offers workhomes and rentable workspaces, that all make use of the same structure within the building. These workspaces and workhomes can be changed in size according to this structure and thus make it possible to create all kinds of dwellings and sizes.

The building itself is mostly collective, only for the residents and workers, however it does have a public plinth with public parking garage, grocery store and bike garage. The upper part of the building starting from the roof of the 4th floor is seen as collective. The roof itself doubles as space where activities can be held. From this rooftop access is granted to the slabs where the first two floors act as rentable office space and the remaining floors above it as work/live units, varying in size. These dwellings are accessed by the gallery placed along the East side of the slabs. Along the galleries several small storage boxes are placed, whose number is the same as the number of dwellings. Each of the dwellings

has the same size and amount of storage boxes regardless of the size of the dwelling. (figure 18)

The Schiecentrale has 2 main dwelling types and rentable offices spaces that make up the majority of the building.

The first being quayhouses (see figure 23), unlike many of the other examples that will be given here these dwellings are not located inside a building, as to say that the main entrance to these dwellings is located on the street, or rather quay, than alongside a gallery or corridor within the building. The quayhouses consist of a repeating floor plan over 4 floors. One of the floors is cut short creating a double floor high space. The size of these dwellings is around 119 m<sup>2</sup> and have a personal garage of 30 m<sup>2</sup> on the 3rd floor which can be accessed either through the dwelling or via the public parking garage. This dwelling has no integrated workspace and it seen as a family home.

The sheer size and the way that the dwelling is configured, is in the case of the New Media way of working a bit excessive. Of the questioned New Media workers most of them seemed to be

single, fairly young and have no need for a large dwelling, often opting for a smaller dwelling that covers their needs with a separate workroom. The quayhouse dwelling in this case would be better suited for a family and not for this particular group of people.

The second type is a work/live unit as they describe it. These dwellings (see figures 20, 21, 22) are found in the slabs that stand atop of the base, that is filled with a grocery store, gym and parking garage. Moving on from this mostly public area, one can get access to the collective rooftop, where various activities can be held. From this rooftop access is granted to one of the slabs containing both the office spaces and work/live dwellings.

The dwellings have various sizes and are placed along a gallery system, where all the galleries face East-wards. The various sizes of the dwelling are explained due to the repeating structure of the building dividing the slab horizontally in dwellings with a depth of 14,5 m. Depending on how the structure is used smaller dwellings of 85 m<sup>2</sup> can be created up to an undefined maximum (see figure 24), the largest dwelling currently in the building reaches a size of 470 m<sup>2</sup>, being the largest found floor plan in the drawing of Mei architects and planners.

All the sizes that could be found on the floor plans are 85 m<sup>2</sup>, 145 m<sup>2</sup> and 470 m. Though more sizes are given as possible configuration options, no drawings could be found of these types. However as the size of 470 m<sup>2</sup> is very large compared to the other examples it can be assumed that these dwellings can be configured however big you want them to be as long as the structure dividing the dwellings is used to configure this size.

Each of the dwellings have a set core in the middle containing all the essential functions, such as a bathroom, kitchen, breaker box, boiler and small broom closet (displayed as a fully colored in black box in figures 20 & 21). The placement of this core divides the dwelling in 2 sides, one more open side facing the gallery and a more private side, which is thus blocked off by the core, in the back of the dwelling.

The dwellings are called work/live units however from the given floorplans no real workspace could be found in the predetermined layout. As the dwelling is big enough to house at least two bedrooms and in some cases even three, adjusting one of these rooms into a workroom would suffice into making it a workhome. These type of dwellings and the way the configuration works is an interesting concept to apply to the idea of New Media workers, this way dwellings could grow to accommodate the future needs of the residents.

As mentioned before on the two lowest floors of both of the slabs rentable workspace can be found, which use the same typology as the work/live units in the slab. These workspaces much like the work/live units can be seen as configurable, each of the workspaces can be altered in size as long as they keep to the structure of the building. It is unclear whether these workspaces are meant for the residents or for anybody to rent. Much like the idea of changeable dwellings, floors dedicated to workspaces are a good idea to take to mind. If certain dwellings do not have the option of providing a workspace in the dwelling a collective work floor might be good for the New Media workers to have some sort of workspace close to home, where they can also try and expand their network. (see figures 16 & 17)

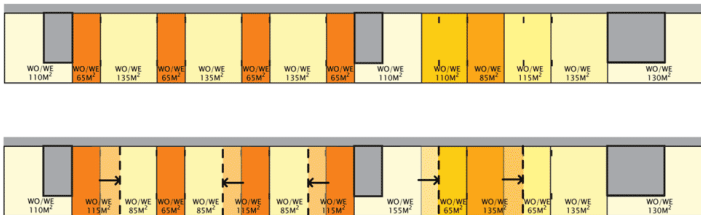
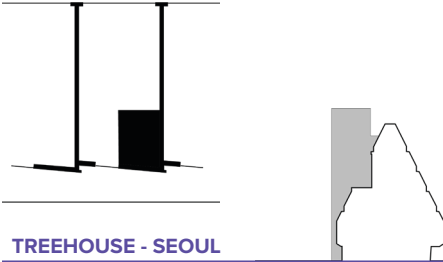


Figure 24: Schematic view completion & Flexibility. (Mei architects and planners, 2020)



**TREEHOUSE - SEOUL**

**Architect:** Bo-DAA  
**Address:** Seoul Yeoksamdong 791-15, South-Korea  
**Client:** Kolon Global Common Life  
**Design-Completion:** 2016-2018  
**Purpose:** Community Housing and Commercial  
**Number of floors:** (-)2 - 8 (from sub 2 to 8 floors)  
**Amount of dwellings:** 72 units

**Typology**



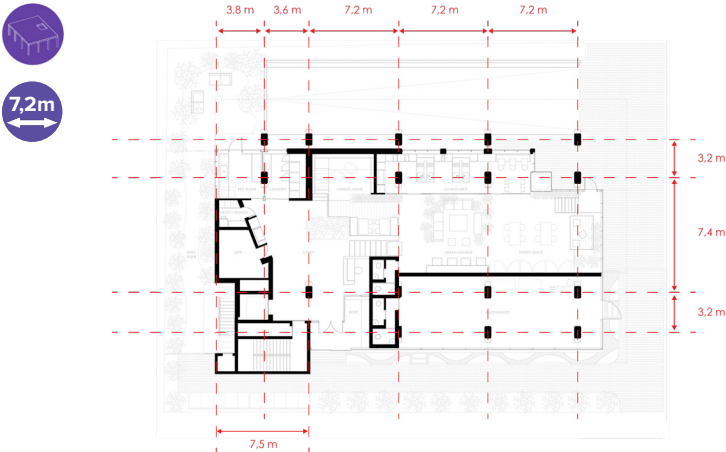
**Functions**



**Dwelling types**



**Structure Ground Floor**



**Figure 25:** Structure Ground Floor Treehouse. (Machgeels, D., 2020)  
 Analysed from Ground floor plan (Treehouse / Bo-da Architecture., z.d.)



Structure principal all floors



3,6m

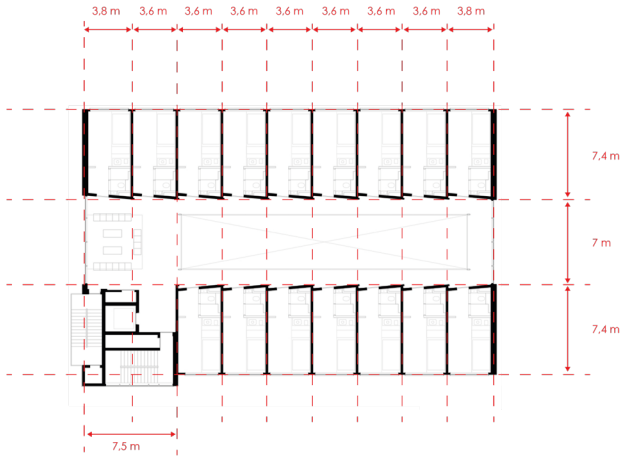


Figure 26: Structure principal all floors Treehouse. (Machgeels, D., 2020)  
Analysed from 3F Femme plan (Treehouse / Bo-da Architecture., z.d.)

Floorheights

3,8m

4,9m

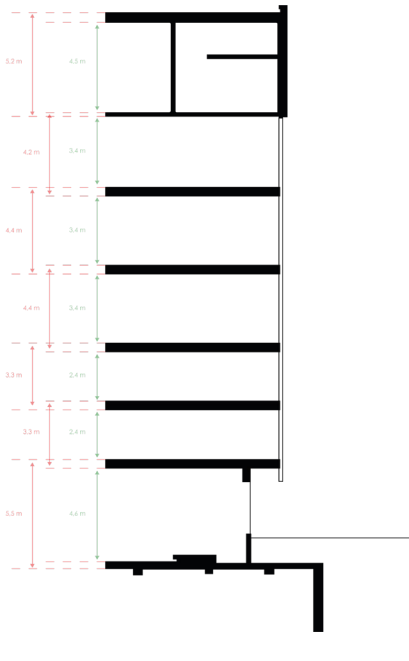


Figure 27: Floorheights Treehouse. (Machgeels, D., 2020)  
Analysed from Section 1 (Treehouse / Bo-da Architecture., z.d.)

Accessibility and functions Ground floor

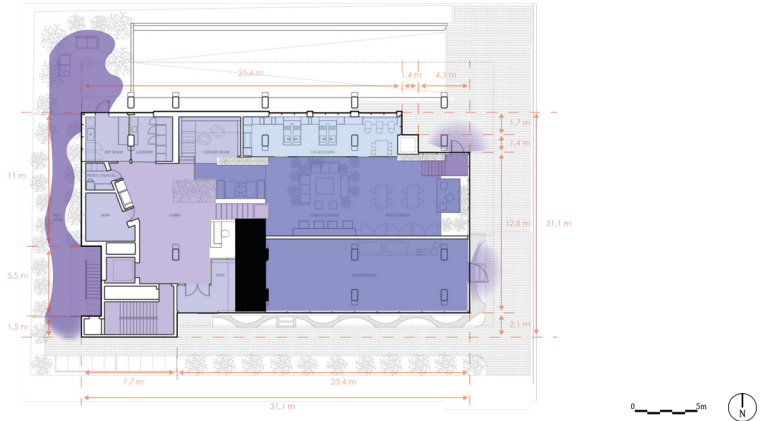


Figure 28: Accessibility and functions Ground floor Treehouse. (Machgeels, D., 2020)  
Analysed from Ground floor plan (Treehouse / Bo-da Architecture., z.d.)

Accessibility and functions 2F

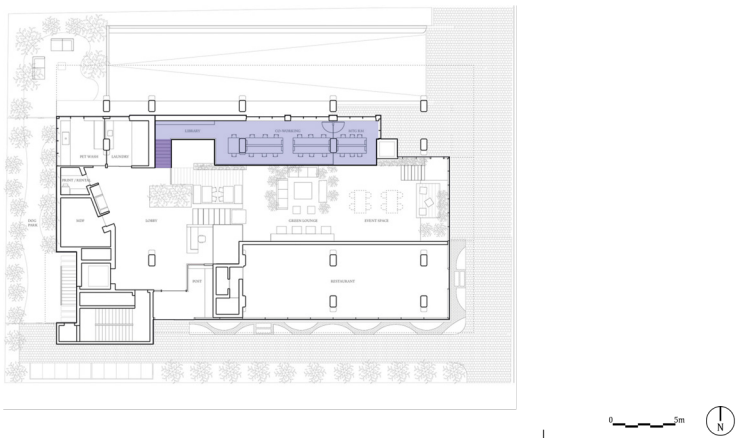


Figure 29: Accessibility and functions 2F Treehouse. (Machgeels, D., 2020)  
Analysed from 2F co-working plan (Treehouse / Bo-da Architecture., z.d.)

- Collective
- Collective workspace
- Public
- Public workspace
- Collective space
- Dwelling
- Public space
- Bathroom

Accessibility and functions 3F

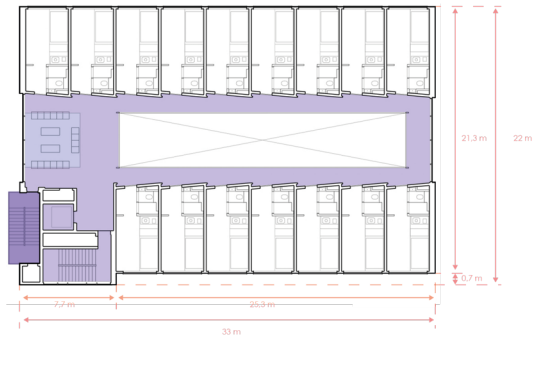


Figure 30: Accessibility and functions 3F Treehouse. (Machgeels, D., 2020)  
Analysed from 3F Femme plan (Treehouse / Bo-da Architecture., z.d.)

Accessibility and functions 4F

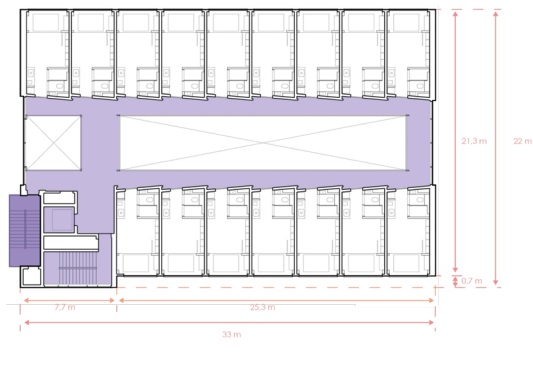


Figure 31: Accessibility and functions 4F Treehouse. (Machgeels, D., 2020)  
Analysed from 4F Nomad plan (Treehouse / Bo-da Architecture., z.d.)

- Collective
- Public
- Collective space
- Public space
- Collective workspace
- Public workspace
- Dwelling
- Bathroom

Accessibility and functions 5F

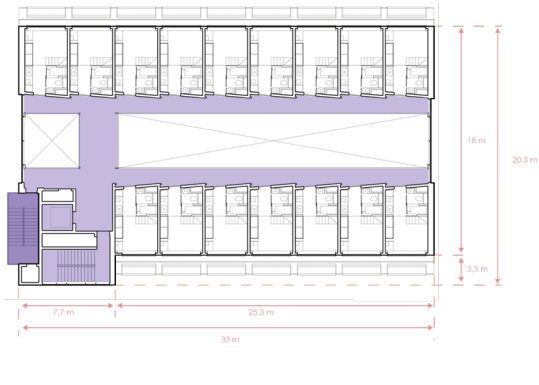


Figure 32: Accessibility and functions 5F Treehouse. (Machgeels, D., 2020)  
Analysed from 5F Cat Life plan (Treehouse / Bo-da Architecture., z.d.)

Accessibility and functions 6F

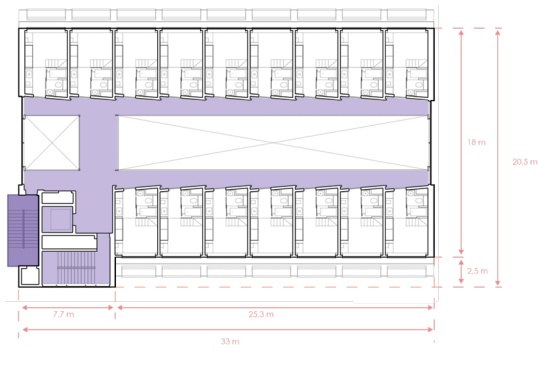


Figure 33: Accessibility and functions 6F Treehouse. (Machgeels, D., 2020)  
Analysed from 6F Terrace plan (Treehouse / Bo-da Architecture., z.d.)

- Collective
- Public
- Collective space
- Public space
- Collective workspace
- Public workspace
- Dwelling
- Bathroom

Accessibility and functions 7F

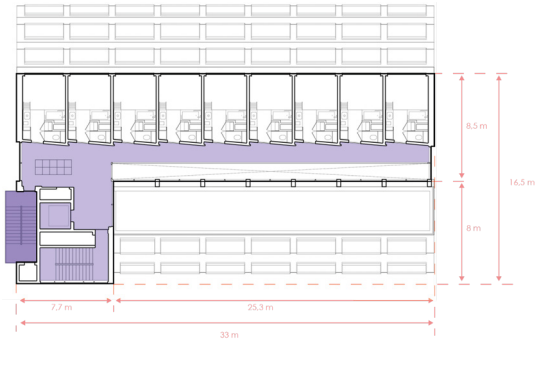


Figure 34: Accessibility and functions 7F Treehouse. (Machgeels, D., 2020)  
Analysed from 7F Minimal plan (Treehouse / Bo-da Architecture., z.d.)

Accessibility and functions 8F

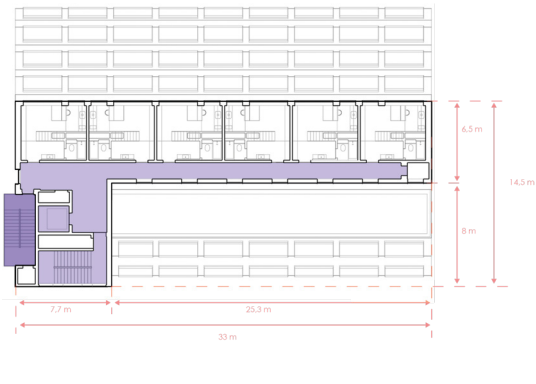


Figure 35: Accessibility and functions 8F Treehouse. (Machgeels, D., 2020)  
Analysed from 8F Pent plan (Treehouse / Bo-da Architecture., z.d.)

- Collective
- Collective workspace
- Public
- Public workspace
- Collective space
- Dwelling
- Public space
- Bathroom

Accessibility and functions Cross section

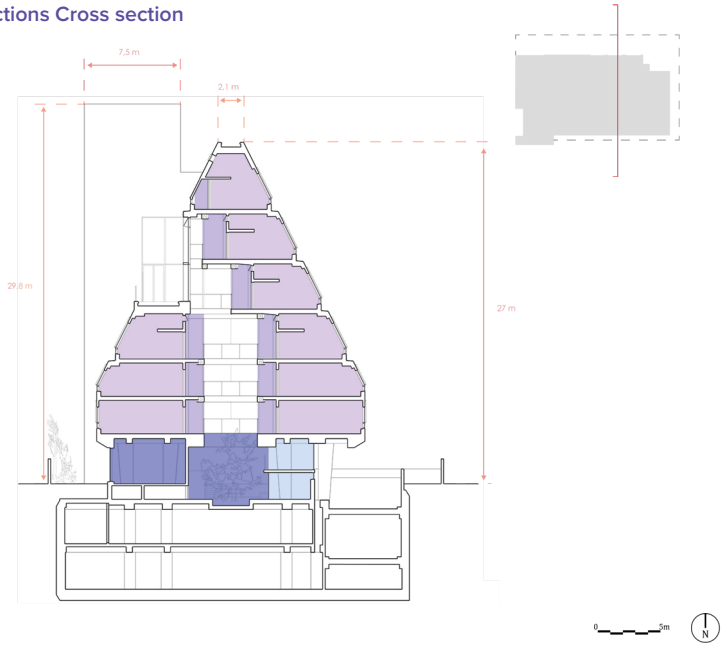


Figure 36: Accessibility and functions Cross section Treehouse. (Machgeels, D., 2020)  
Analysed from Section 2 (Treehouse / Bo-da Architecture., z.d.)

Accessibility and functions Longitudinal section

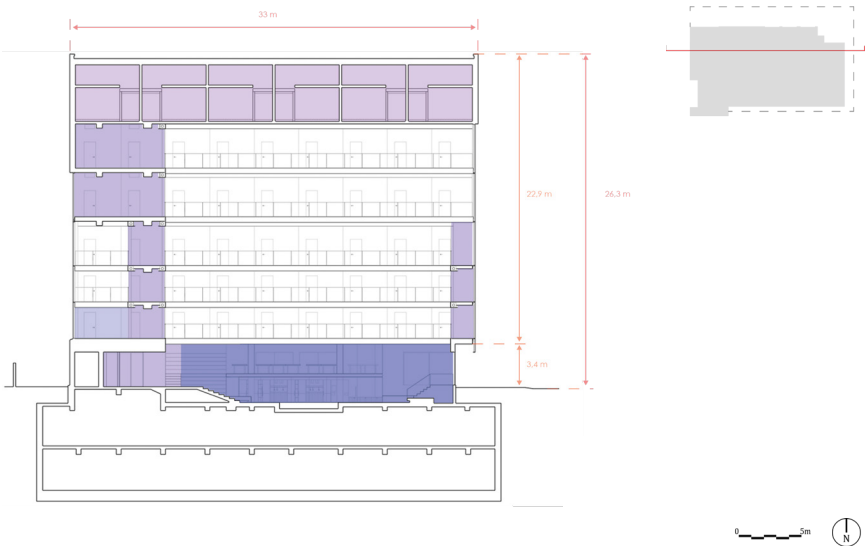


Figure 37: Accessibility and functions Longitudinal section Treehouse. (Machgeels, D., 2020)  
Analysed from 7F Section 1 (Treehouse / Bo-da Architecture., z.d.)

3F Femme dwelling

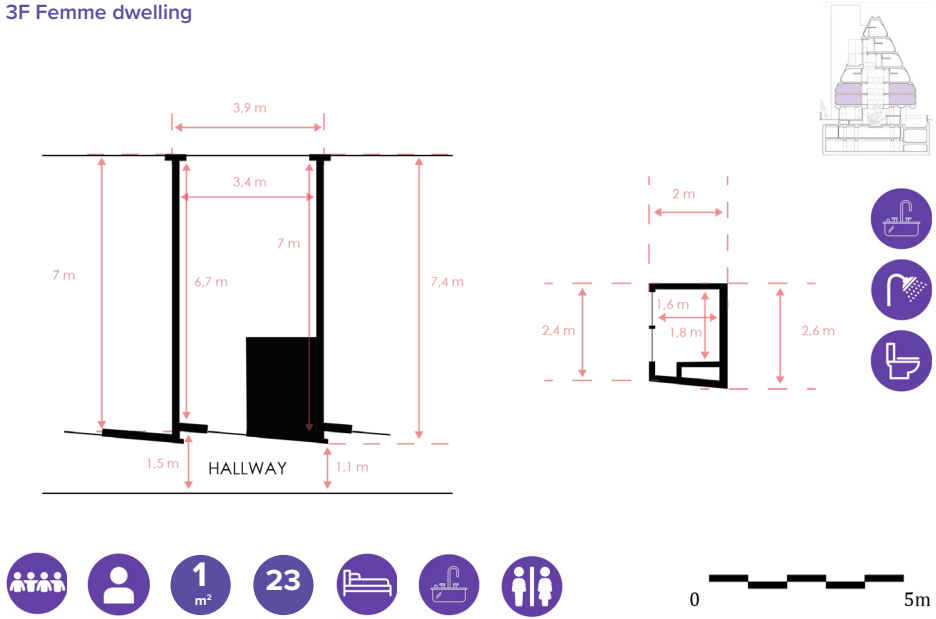
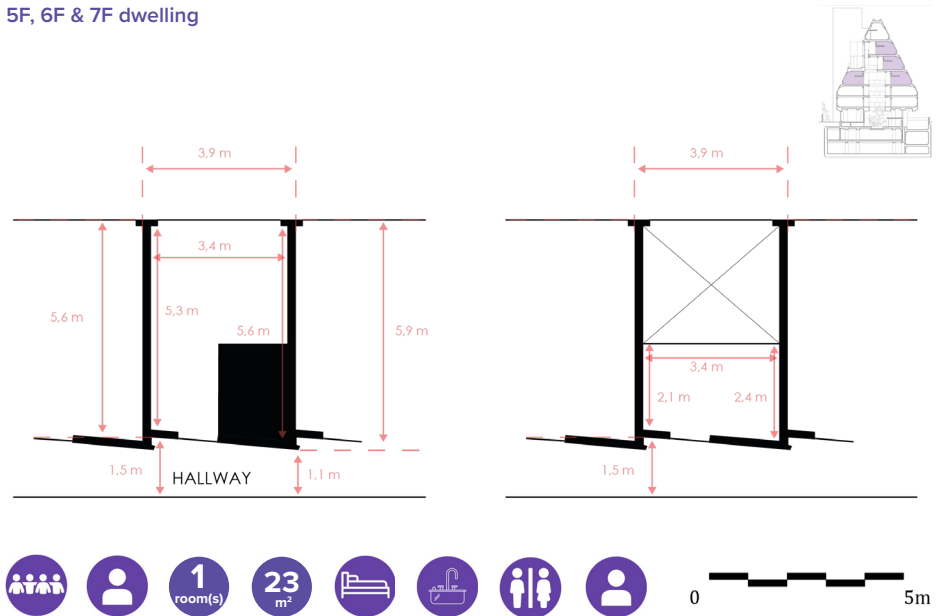


Figure 38: 3F Femme dwelling + bathroom Treehouse. (Machgeels, D., 2020)  
 Analysed from 3F Femme plan (Treehouse / Bo-da Architecture., z.d)

5F, 6F & 7F dwelling



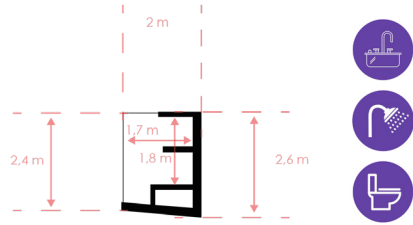


Figure 39: 5F, 6F & 7F dwelling + bathroom Treehouse. (Machgeels, D., 2020)  
 Analysed from 5F Cat Life plan, 6F Terrace plan & 7F Minimal plan (Treehouse / Bo-da Architecture., z.d.)

8F Pent dwelling

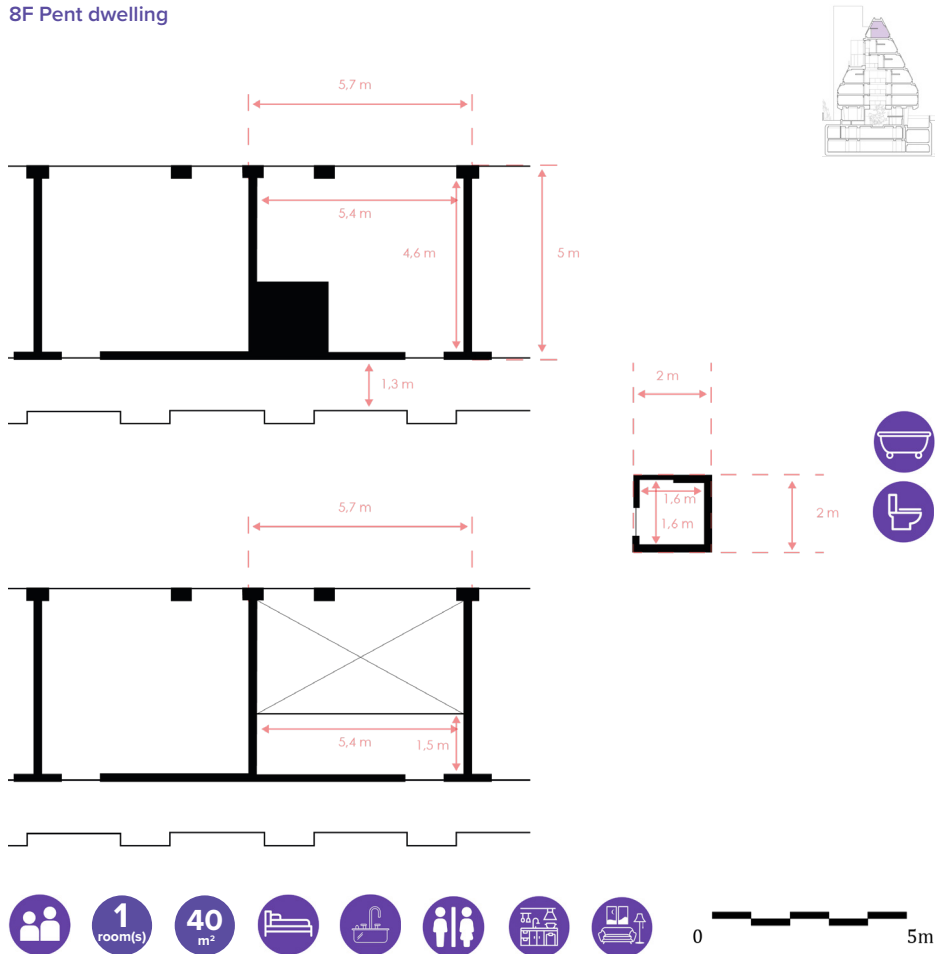


Figure 40: 8F Pent dwelling + bathroom Treehouse. (Machgeels, D., 2020)  
 Analysed from 8F Pent plan (Treehouse / Bo-da Architecture., z.d.)



## TREEHOUSE

One of the reasons that this building is included in the comparison regarding the plan analysis is for the configuration and size of the dwellings, which are meant for single persons. The way these dwellings are divided in the building along with their size and the included functions in them are all learning points or good references to the possible solution for the New Media way of working.

Because of the limited budget of the streamers and freelancers it can be said that coliving is an option into attaining a dwelling that has all the requirements that they look for in a dwelling, with the downside of having to share only the living spaces and kitchen. In the aspect of affordability this type of housing would be optimal for this target group.

The way that the workspaces in Treehouse are placed, located on the ground and first floor, is less optimal being completely communal and shared by the residents. The respondents of both my questionnaire and the research done by Fersch indicated that they do like to have a personal workspace, rather than a communal workspace. When asked if they would like to live in a coliving environment where they would have access to more equipment they wouldn't otherwise be able to afford, like a big streaming room with a green screen and other filming equipment, at the expense of having to share certain facilities like a kitchen, living room and laundry room, almost all of them reacted positively. People that didn't initially like this idea either had a family, in which case this is not applicable, or would only consider it as long as they had a personal bed-, bathroom, workroom and live with people that value hygiene and cleanliness. Other than that they would be willing to share a coliving environment. For this reason Treehouse was chosen as an example of coliving with personal space that has all the required functions, as mentioned in the questionnaire.

Much like Schiecentrale Treehouse houses more than one type of dwellings. Each of them also only varying in one dimension, however unlike the Schiecentrale, the dwellings in Treehouse vary in depth depending on the floor they are on. As the name of the building suggests Treehouse

appears from the outside as a tree, getting progressively smaller towards the top. Using an internal atrium and hallways/ galleries to get from and to the dwellings. The dwellings had to get progressively smaller as to still fit within the tree shape of the building. (see figure 36)

The idea of treehouse is that of coliving, everyone in the building has their own bed-, bathroom and small kitchen. However functions such as a laundry room and lounge area are all communal spaces shared with all the residents. Certain floors even have a bigger kitchen or sitting arrangement placed as to have a meeting space on the floor for the residents.

The building itself seems to serve only the resident as all the functions taking up the ground and first floor, seem to be for the residents. Functions such as a laundry room and pet wash, don't seem to belong to public functions. The only function on the ground floor which seems to have a public functions is the restaurant, which is indicated by its own separate entrance towards the outside, despite being directly next to the lounge area. (see figure 28)

Because the building gets progressively smaller towards the top in order to stick to the tree shape, multiple dwelling types had to be created. Keeping the same width for all the dwelling except the top floor dwellings. In total there are three different dwelling size to be found in Treehouse. (see figures 38, 39 & 40)

The first are located on the biggest floors in the building, or the lowest part of the tree, namely 3F and 4F. These dwelling have a size of 23m<sup>2</sup> and are created using a spacing of 3,7 meters between each of the dwelling. This grid of 3,6 m is used as the structure of the building and divides the dwellings in homes of all the same width. (see figure 26)

The dwellings on the 5F, 6F and 7F are located on the middle and thus smaller part of the tree. The dwellings here even though the floors are not all the same size are all kept to the same depth. Much like the dwelling on the 3F and 4F these dwelling have the same width of 3,6 meters, following the structure of the building. Considering that these dwellings are less deep the overall size of these dwellings is also a bit small.

ler with an floor space of 18 m<sup>2</sup>. The sleeping area of these dwellings, unlike the dwellings on the 3F and 4F are located on an off level within the dwelling. Taking this sleeping area into account with the floor space of the dwelling the total available floor space of the dwelling becomes 23 m<sup>2</sup>, like the dwellings on the lower floor. (see figure 41 for an interior impression of the dwellings)

Lastly are the bigger dwellings on the top floor. These dwellings aren't that much bigger but are a more square shaped. Because these dwellings are to be fitted within the tree shape of the building, the size of them is a bit restricted in terms of both depth and width. Being 5,4 m in width and 4,6 m in depth they are by far the widest and least deep of all the dwellings. Similar to how the rest of the dwellings are configured the dwellings has a dedicated core in the corner of the room containing their bathroom and small kitchen. Like the dwellings on the 5F, 6F and 7F this dwelling also has their bedroom on an off level within the space. (see figure 36 & 39)

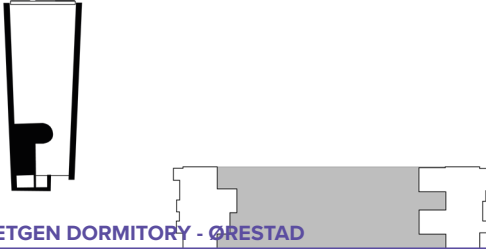
Even though the idea of affordability and the way the size of the dwellings in handled is very well executed here, these dwellings do not suffice as a single persons unit. Even though Treehouse seems to know that they are a coliving environment, offering a collective kitchen on the ground floor, they seem to try and make the dwellings as independent as possible by including a small personal kitchen. The sizes of these dwellings

are about 23 m<sup>2</sup> and this according to my research seems to be a bit too small for the average New Media worker. Most of the questioned answered saying that their current dwelling were between the sizes of 30-100 m<sup>2</sup>, with 30 m<sup>2</sup> being a little too small, seeing as these people all found that they lacked the space for a separate dedicated workroom. The dwelling size shown in Treehouse would be better suited for the idea of coliving as this would probably be a good example of a size for a bed-, bathroom and workroom type of dwelling, where all the other functions such as kitchen and living room are shared. Treehouse tries to more or less fit an entire single person household in a, for the New Media way of working, too tiny space.

In short Treehouse is better suited as an example for bedroom type rooms, that include a bath- and workroom in a coliving scheme rather than a full-fledged single person household. Treehouse adopts this idea of coliving to a certain degree, but to fulfill the wishes of the New Media workers the way that this is organized should be changed.



Figure 41: the interior spaces of the living units on the different floors [Image]. (Treehouse / Bo-da Architecture., z.d.)



**TIETGEN DORMITORY - ØRESTAD**

**Architect:** Lundgaard & Tranberg Architects  
**Address:** Rued Langgardsvej 10-18, Copenhagen, Denmark  
**Client:** Fonden Tietgenkollegiet, Nordea Danmark Fonden  
**Design-Completion:** 2003-2006  
**Purpose:** Dormitory (shared kitchen, utility and common room)  
**Number of floors:** 6  
**Amount of dwellings:** 360 rooms

**Typology**



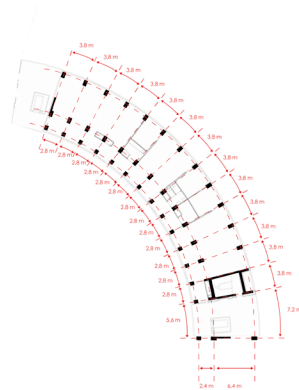
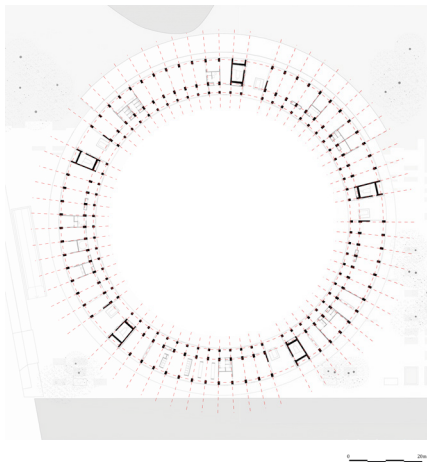
**Functions**



**Dwelling types**



**Structure Ground floor**



**Figure 42:** Structure Ground floor Tietgen Dormitory. (Machgeels, D., 2020)  
 Analysed from Ground floor plan (Sánchez, D., 2019)

Structure Dwelling floor



3,8m

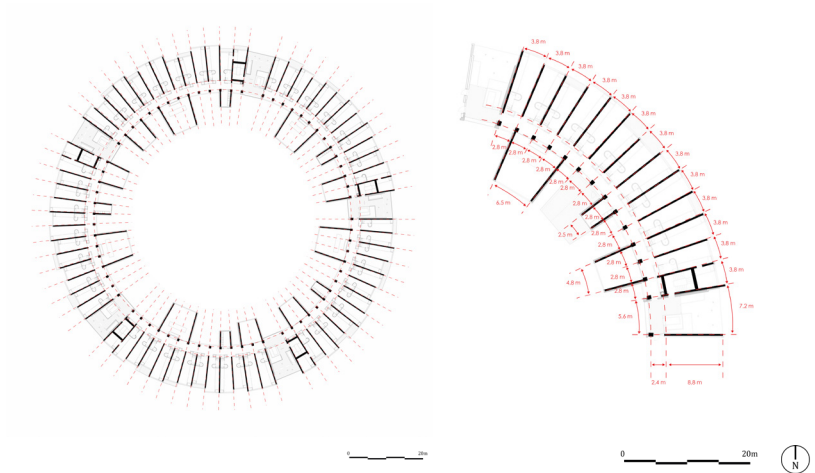


Figure 43: Structure Dwelling floor Tietgen Dormitory. (Machgeels, D., 2020)  
Analysed from Floor plan (Sánchez, D., 2019)

Floorheights

3,0m

4,8m

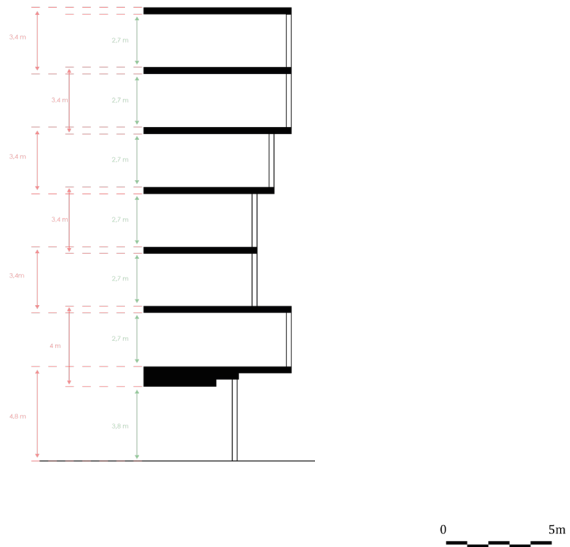


Figure 44: Floorheights Tietgen Dormitory. (Machgeels, D., 2020)  
Analysed from Section (Treehouse / Bo-da Architecture., z.d.)

Accessibility and functions Ground floor

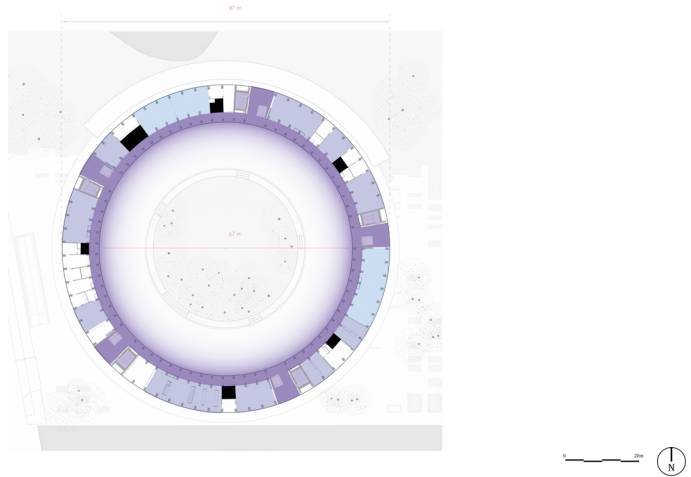
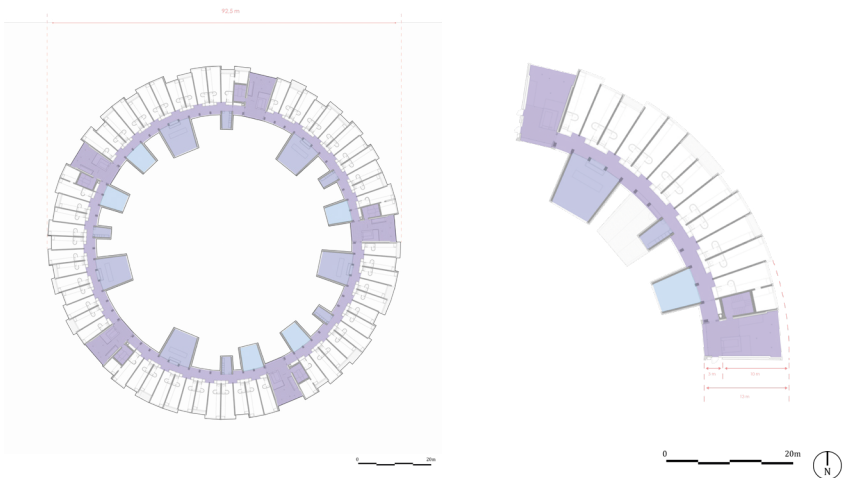


Figure 45: Accessibility and functions Ground floor Tietgen Dormitory. (Machgeels, D., 2020)  
Analysed from Ground floor plan (Sánchez, D., 2019)

Accessibility and functions Dwelling floor



- Collective
- Collective workspace
- Public
- Public workspace
- Collective space
- Dwelling
- Public space
- Bathroom

Figure 46: Accessibility and functions Dwelling floor Tietgen Dormitory.  
(Machgeels, D., 2020)  
Analysed from Floor plan (Sánchez, D., 2019)

Accessibility and functions Section

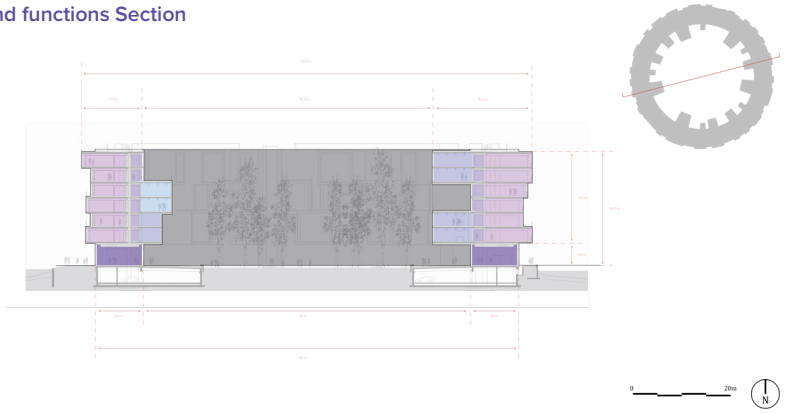


Figure 47: Accessibility and functions Section Tietgen Dormitory. (Machgeels, D., 2020)  
Analysed from Section (Sánchez, D., 2019)

24 m2 dwelling

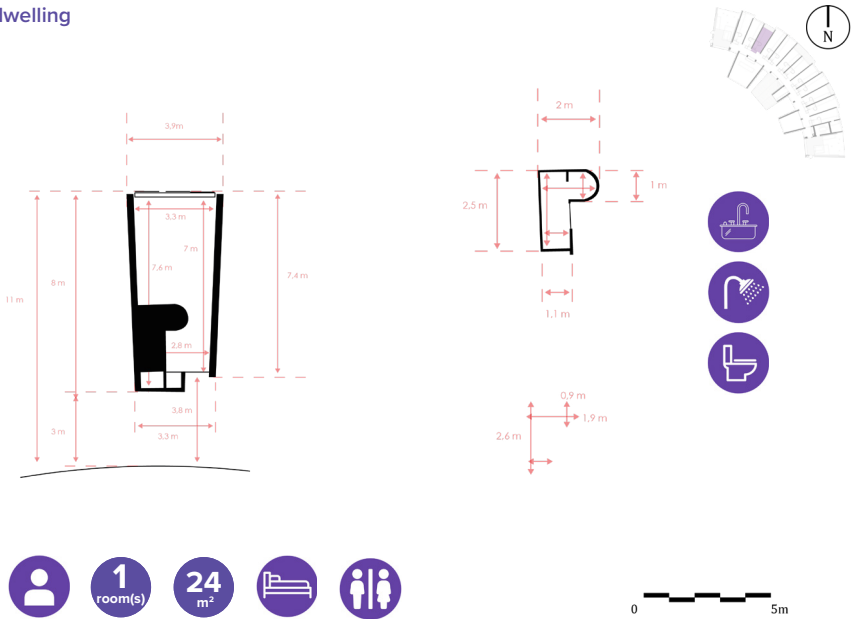


Figure 48: 24 m2 dwelling + bathroom Treehouse. (Machgeels, D., 2020)  
Analysed from Dwelling floor plan; Floor plan (Sánchez, D., 2019)

27 m<sup>2</sup> dwelling

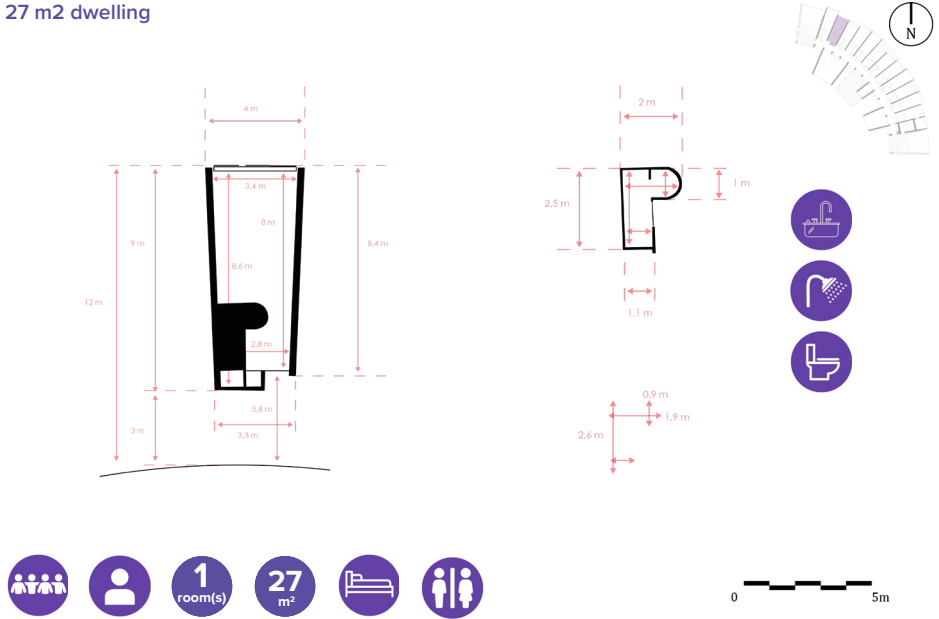


Figure 49: 27 m<sup>2</sup> dwelling + bathroom Treehouse. (Machgeels, D., 2020)  
Analysed from Dwelling floor plan; Floor plan (Sánchez, D., 2019)

30 m<sup>2</sup> dwelling

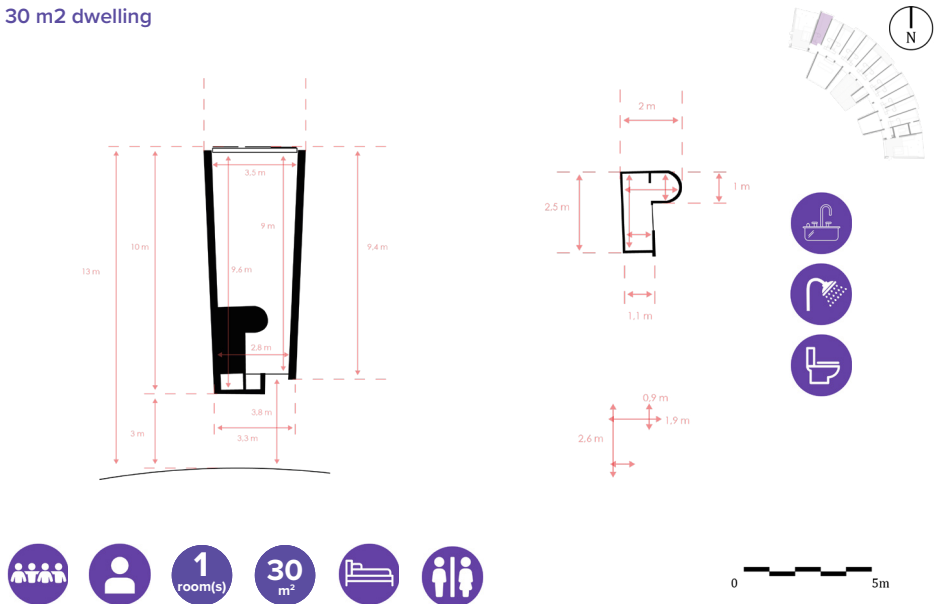


Figure 50: 30 m<sup>2</sup> dwelling + bathroom Treehouse. (Machgeels, D., 2020)  
Analysed from Dwelling floor plan (Sánchez, D., 2019)

48 m<sup>2</sup> two room dwelling

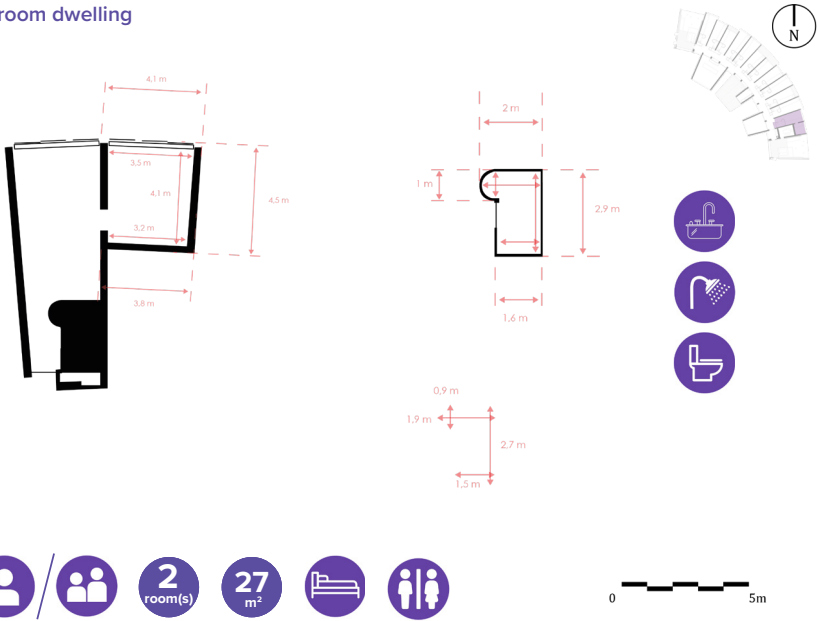


Figure 51: 48 m<sup>2</sup> two room dwelling + bathroom *Treehouse*. (Machgeels, D., 2020) Analysed from Floor plan (Sánchez, D., 2019) & The layout. retrieved from <http://tietgenkollegiet.dk/en/the-building/the-rooms/>

Communal kitchen

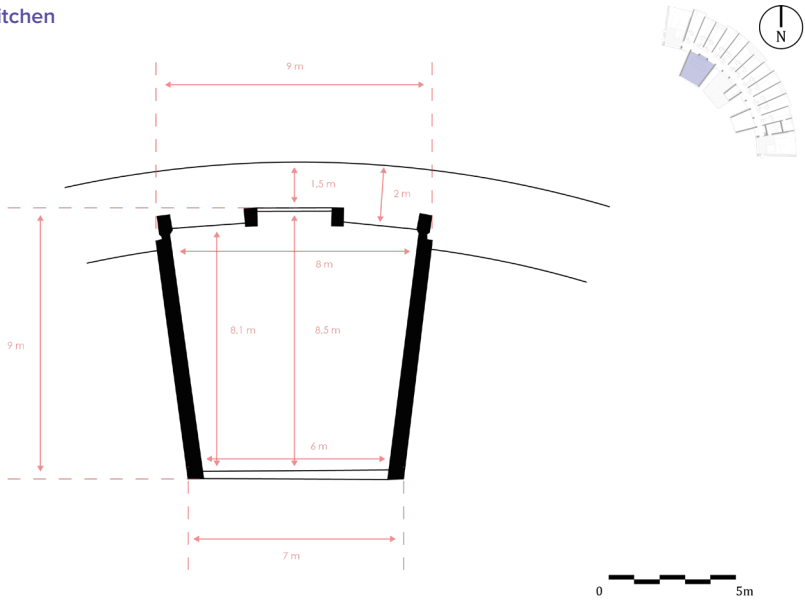


Figure 52: Communal kitchen *Treehouse*. (Machgeels, D., 2020) Analysed from Floor plan (Sánchez, D., 2019)



Communal room



36,5  
m<sup>2</sup>

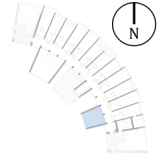
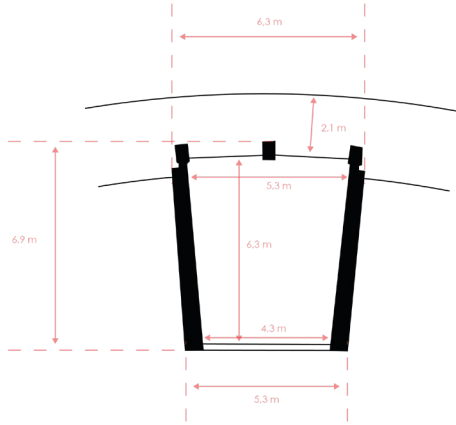


Figure 53: Communal room Treehouse. (Machgeels, D., 2020)  
Analysed from Floor plan (Sánchez, D., 2019)

Laundry room



15  
m<sup>2</sup>

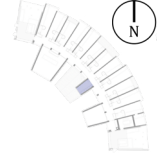
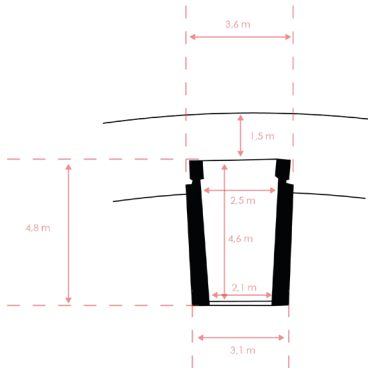


Figure 54: Laundry room Treehouse. (Machgeels, D., 2020)  
Analysed from Floor plan (Sánchez, D., 2019)

## TIETGEN DORMITORY

As my research has pointed out many of the streamers, and thus the people that will work in New Media, have similar dwellings, at least at the moment, as starters and students. This student dormitory is a perfect example of student coliving and is chosen to represent the student type of coliving as an option for creating workhomes for New Media workers. Unlike Treehouse however Tietgen Dormitory adopts this idea of personal bed-, bathroom a bit better, offering just these spaces as personal while all other living spaces are shared.

Tietgen dormitory is a circular building based in Denmark. It consists of a ground floor which is accessible from 5 sides, where also the rising points up to the upper floor of the ring are located. This ground floor houses several collective functions such as a music room, bike storage and laundry room. As the building is meant for students most of its functions are collective and thus not meant for the public, however its inner courtyard is publicly accessible. (see figure 45)

The rest of Tietgen is as mentioned accessible through one of the five rising points located along the circle. To reach the dwellings one has to take the gallery / hallway walking along the inside of the circle that gives access to both the dwelling and the communal rooms attached to them. (see figure 46)

In Tietgen most of the dwellings are the same, in order to create some sort of playful façade the depth of the dwellings has been altered. The depths of the dwellings vary between 10m, being the deepest, 9 meters, and 8 meters (see figures 48, 49 & 50). The square meters are as follows: 30 m<sup>2</sup>, 27 m<sup>2</sup>, 24 m<sup>2</sup>. Each of the dwellings has their own dedicated bathroom and adjustable bedroom compartment, that can be folded up and used as a workspace. In terms of flexibility within a smaller room this concept is very intriguing.

Besides the single person dwellings, there are also double bedroom versions. In these versions an extra bedroom is added using the same width of a normal dwelling, this being the standard of all the dwelling namely 3,5 meters at the widest point and, 2,8 at the smallest. The bedroom addition can function either as second bedroom or

as separate workroom and has a floor space of 18 m<sup>2</sup>. (see figure 51)

As mentioned before like Treehouse Tietgen Dormitory is a coliving environment where functions such as a kitchen and communal rooms are shared between the residents. In the case of Tietgen dormitory there is per 12 dwellings one kitchen, one communal room and one laundry room. These rooms are on the other side of the hallway facing inwards to courtyard. Unlike Treehouse however these dwellings are not equipped with their own tiny sink / kitchen and thus all cooking has to be done in the communal kitchen. Of the 3 communal spaces the kitchen is the largest, being about 9 m x 7m = 63 m<sup>2</sup>. The communal room is 5,3 m x 6,9 m = 36,5 m<sup>2</sup> and the laundry being the smallest of the three is 3,1 m x 4,8 m = 15 m<sup>2</sup>. (see figures 52, 53 & 54)

Even though I mentioned it earlier the student housing in Tietgen do not have their own dedicated workspaces, the dwellings can be altered in such a way that wardrobe can be moved (see figures 55 & 56) in order to make room for a small desk area. However this type of workspace might be applicable to freelancers, who only need a laptop and internet connection, to their work a streamer with their full computer setup, including camera, microphone and lights might not have enough space to do their work, additionally this room wouldn't be very soundproof.

In this case these type of dwellings would be applicable to a part of the potential new job types that will be created with New Media and therefore be interesting. However it will not be able to fit everyone's requirements for a workhome, as primarily its size is a downside in this regard.



Figure 55: moveable wardrobe [Image]. Retrieved from <http://tietgenkollegiet.dk/en/the-building/the-rooms/>

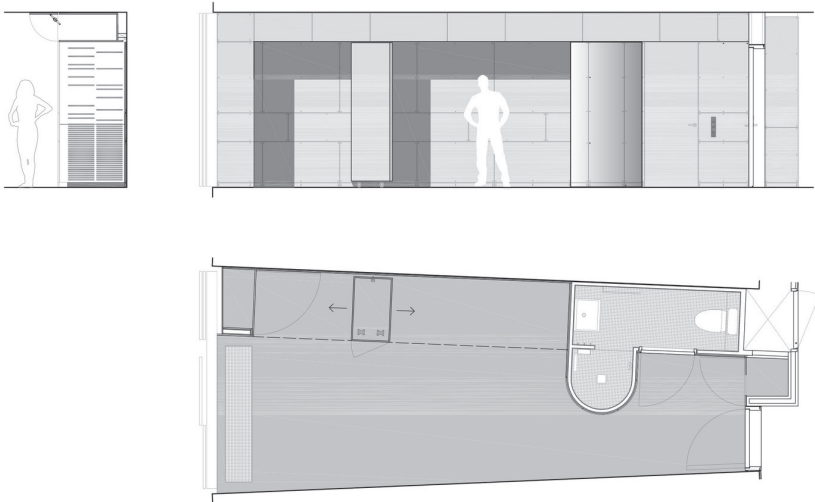
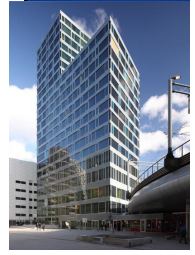
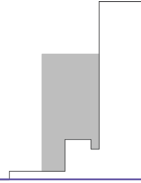
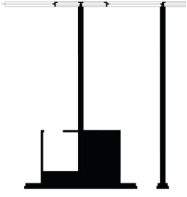


Figure 56: Dwelling floor plan [Image]. (Sánchez, D., 2019)



**ANNA VAN BUEREN TOREN - DEN HAAG**

**Architect:** Wiel Arets Architects (interiors: Studio RTM, Rotterdam)

**Address:** Anna van Buerenplein, Den Haag

**Client:** Anna van Buerenplein BV

**Design-Completion:** 2010-2013

**Purpose:** Vertical Campus (dwellings, café, university)

**Number of floors:** 22

**Amount of dwellings:** 396

**Typology**



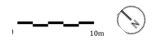
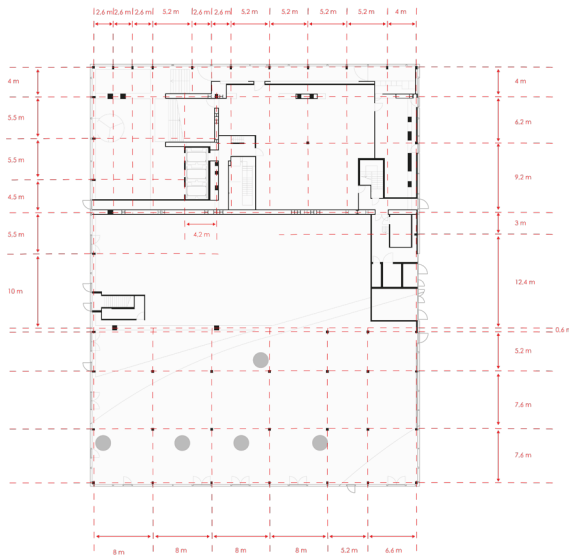
**Functions**



**Dwelling types**



**Structure Ground floor**



**Figure 57:** Structure Ground floor Anna van Bueren Toren. (Machgeels, D., 2020)  
 Analysed from Ground floor / Anna van Buerenplein (van Gameren, D., Kuitenbrouwer, P., & Mooij, H., 2014)

Structure Apartment floor (5th-14th floor)

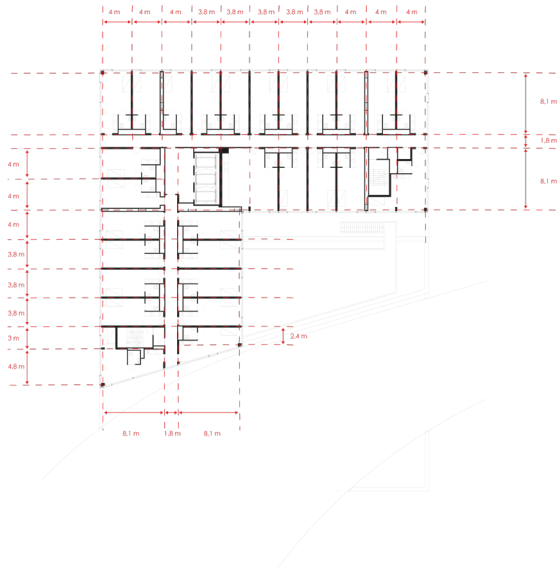


Figure 58: Structure Apartment floor (5th-14th floor) Anna van Bueren Toren. (Machgeels, D., 2020)  
Analysed from Typical apartmenet floor (5th-14th storeys) (van Gameren, D., Kuitenbrouwer, P., & Mooij, H., 2014)

Floorheights

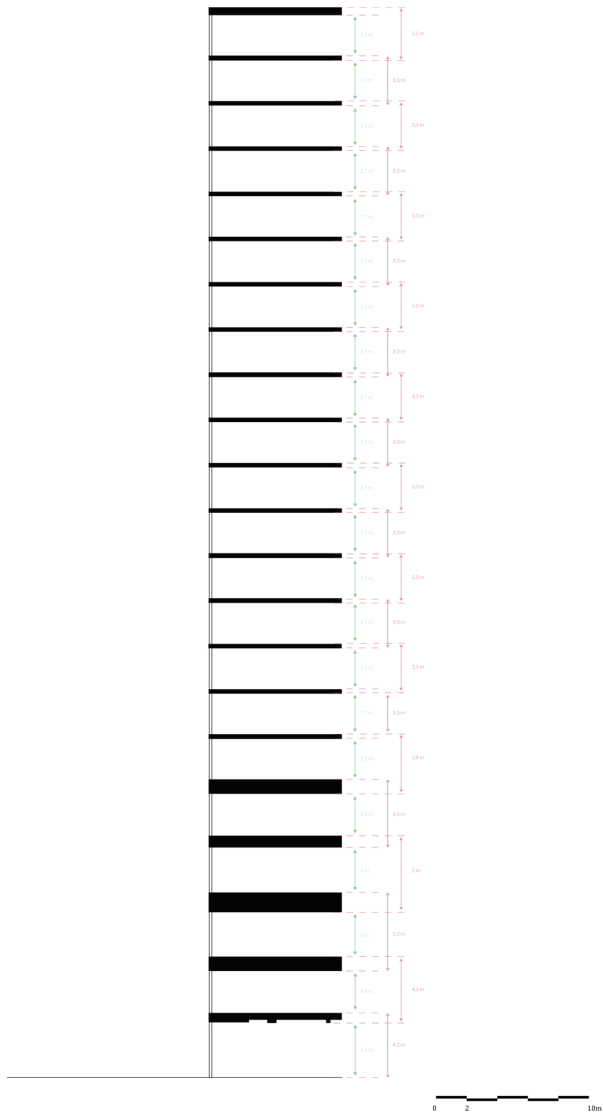


Figure 59: Floorheights Ams van Buuren Toren. (Machgeels, D., 2020)  
 Analysed from Cross section (van Gameren, D., Kuitenbrouwer, P., & Mooij, H., 2014)

Accessibility and functions Ground floor



Figure 60: Accessibility and functions Ground floor Anna van Bueren Toren. (Machgeels, D., 2020)  
 Analysed from Ground floor / Anna van Buerenplein (van Gameren, D., Kuitenbrouwer, P., & Mooij, H.,2014)

Accessibility and functions First floor

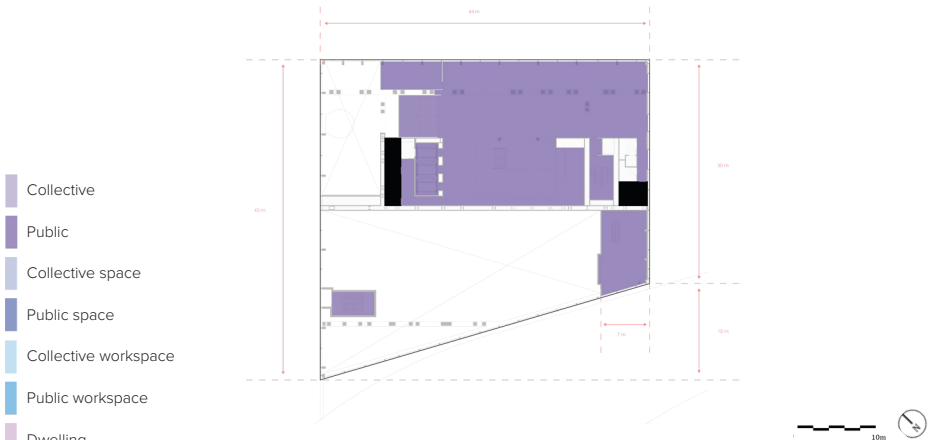
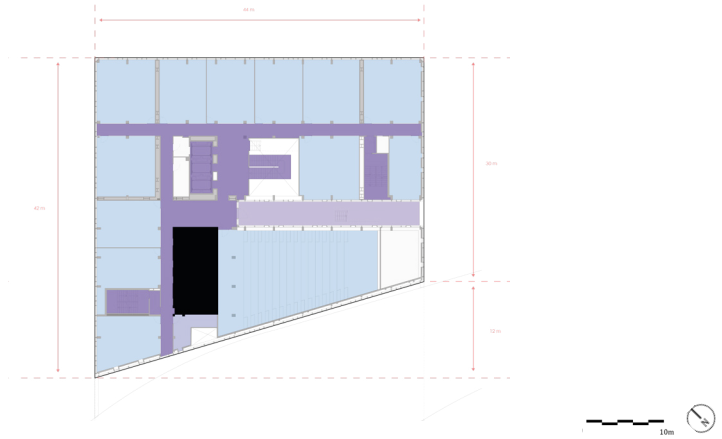


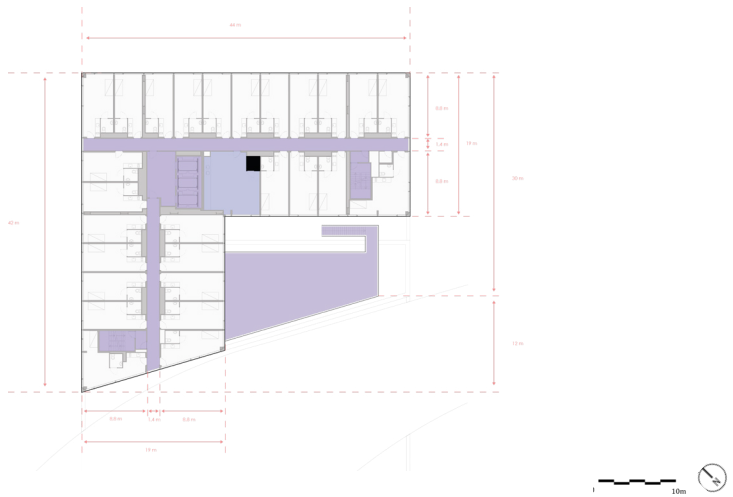
Figure 61: Accessibility and functions First floor Anna van Bueren Toren. (Machgeels, D., 2020)  
 Analysed from First floor, student lounge and bar (van Gameren, D., Kuitenbrouwer, P., & Mooij, H.,2014)

Accessibility and functions Third floor



**Figure 62:** Accessibility and functions Third floor Anna van Bueren Toren. (Machgeels, D., 2020)  
 Analysed from Third floor, auditorium and teaching areas (van Gameren, D., Kuitenbrouwer, P., & Mooij, H.,2014)

Accessibility and functions Apartment floor (5th-14th floor)



**Figure 63:** Accessibility and functions Apartment floor (5th-14th floor) Anna van Bueren Toren. (Machgeels, D., 2020)  
 Analysed from Typical apartment floor (5th-14th storeys) (van Gameren, D., Kuitenbrouwer, P., & Mooij, H.,2014)

- Collective
- Collective workspace
- Public
- Public workspace
- Collective space
- Dwelling
- Public space
- Bathroom



Accessibility and functions Cross section

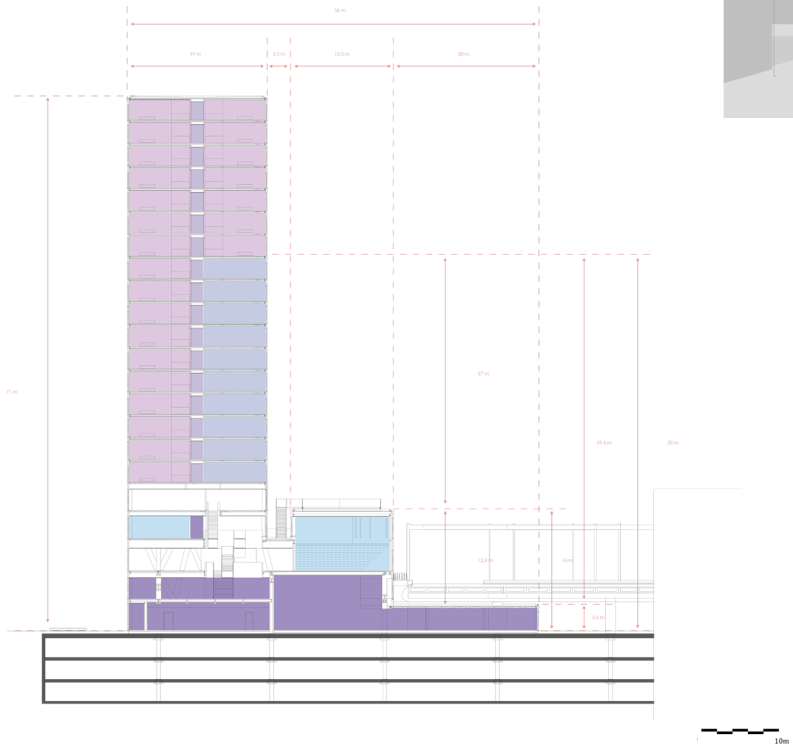


Figure 64: Accessibility and functions Cross section Anna van Bueren Toren. (Machgeels, D., 2020)  
 Analysed from Cross section (van Gameren, D., Kuitenbrouwer, P., & Mooij, H.,2014)

- Collective
- Public
- Collective space
- Public space
- Collective workspace
- Public workspace
- Dwelling
- Bathroom

Accessibility and functions Longitudinal section

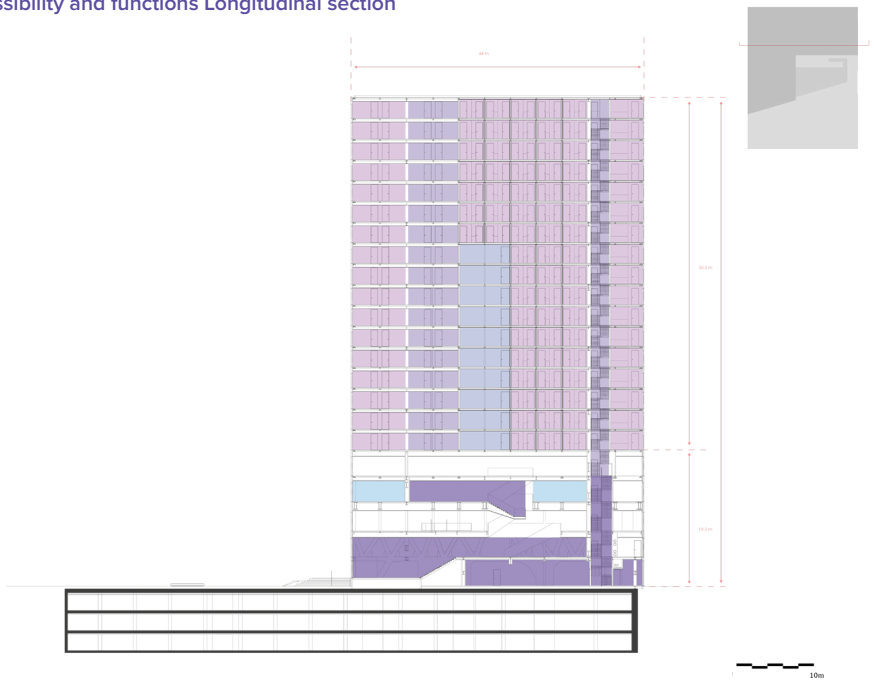


Figure 65: Accessibility and functions Longitudinal section Anna van Bueren Toren. (Machgeels, D., 2020)  
 Analysed from Longitudinal section (van Gameren, D., Kuitenbrouwer, P., & Mooij, H., 2014)

- Collective
- Collective workspace
- Public
- Public workspace
- Collective space
- Dwelling
- Public space
- Bathroom

Anna van Bueren dwelling (5th-22nd floor)

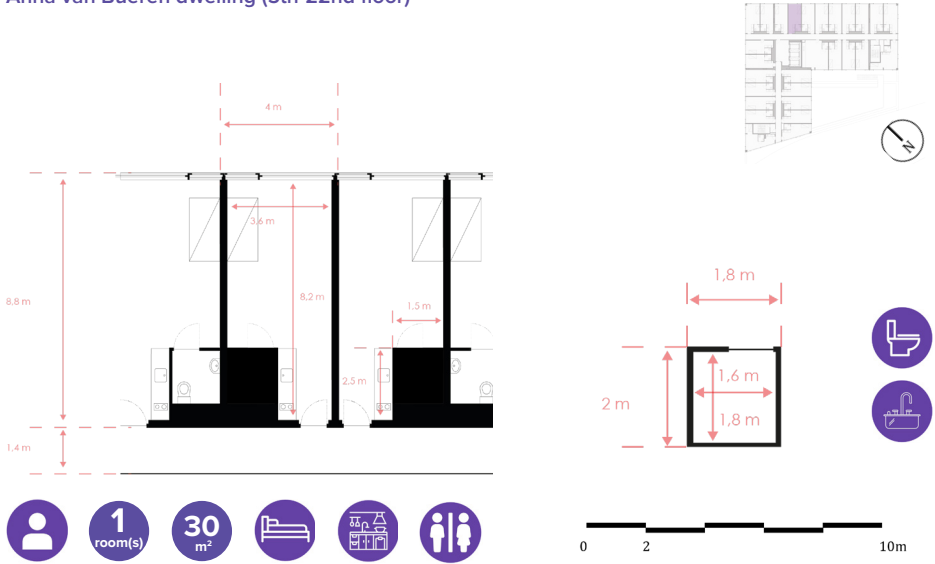


Figure 66: Anna van Bueren dwelling (5th-22nd floor)+ bathroom Schiecentrale. (Machgeels, D., 2020)  
 Analysed from Typical apartmenet floor (5th-14th storeys) (van Gameren, D., Kuitenbrouwer, P., & Schreurs, E., 2019)

Classrooms

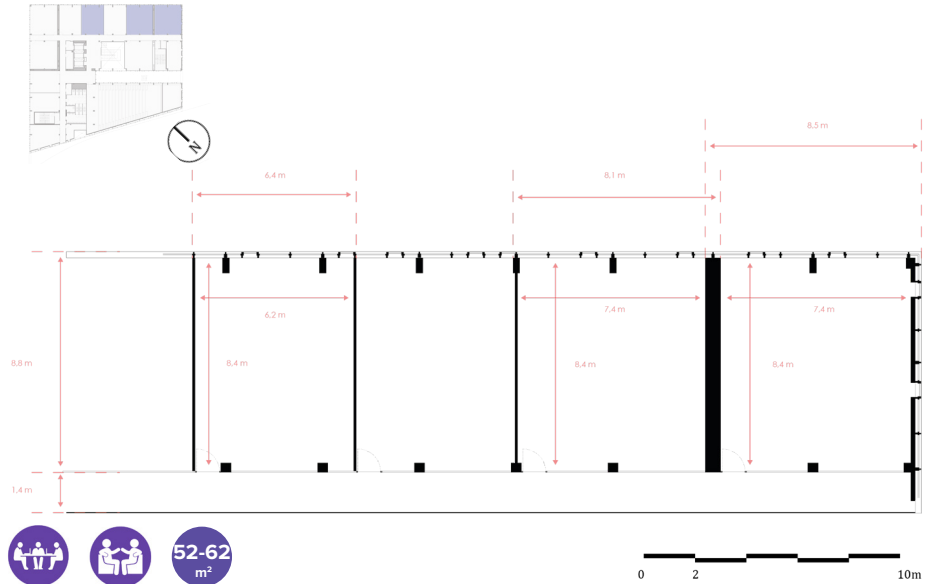


Figure 67: Classrooms Schiecentrale. (Machgeels, D., 2020)  
 Analysed from Third floor, auditorium and teaching areas (van Gameren, D., Kuitenbrouwer, P., & Schreurs, E., 2019)

## ANNA VAN BUEREN TOREN

Anna van Bueren is the last of the examples. It is duped a vertical campus and houses not only classrooms, but also student dwellings. The reason for the addition of this building is simple, it offered yet another perspective into student dwellings, which can be considered as affordable single person dwellings. Besides the possible single person household the building offers floors within the building that are dedicated to classrooms, which can be seen in a different daylight, where the classrooms could be interpreted as workrooms, thus transforming the building from a vertical campus into a vertical work/live building. (see figures 64 & 65)

Anna van Bueren is a special kind of building, mostly taking inspiration for its shape from the already existing trainlines going literally through the building. The first few floors of the building, namely the entrance hall and lobby, really take their shape from this trainline. The real building, as I would like to call it, starts at the tower part. The "L-shaped" tower is a stacking of student dwellings.

The dwellings located in the tower are all copies of each other with the exception of the ones on the corners, due to the odd shape of the building these dwellings have been altered to fit the shape (see figure 63). The main dwellings are all similar to a standard little studio type dwelling. Each of them consists of a living / bedroom combination with their own small bathroom and small kitchen. The dwellings are all 30 m<sup>2</sup> and are divided by the structure of the building which has a span of roughly 4 meters between construction elements (see figures 58 & 66). Additionally each of the floors has a communal kitchen and eating room where they can cook together. However as each of the dwellings includes their own small kitchen, this kitchen is more or less an addition rather than an example of coliving. (see figure 63)

The classrooms in the Anna van Bueren Toren are based on this same grid of 4 meters. Unlike the dwellings these classrooms take up the width of 2 dwellings, while keeping the same depth. The size of these classrooms vary slightly, depending on where the walls for the classrooms are placed. There are 2 variants in the tower that are reoccurring. The first being 8,4 m x 7,4 m = 62

m<sup>2</sup> and the other being 6,2 m x 8,4 m = 52 m<sup>2</sup>. (see figure 67)

From Anna van Bueren's Toren much like Tietgen dormitory the minimum size for a single person dwelling can be led back to around 30 m<sup>2</sup>, however as mentioned by many of the questioned streamers, this would be a little small if a separate workroom were to be included. However the idea of a floor dedicated to communal workrooms is very appealing as this could be an alternative to having your own workroom. This would in turn much like the Tietgen Dormitories example show to be a solution for maybe a part of the people who will work in the New Media.

## CONCLUSION

From this chapter a few things can be concluded regarding the already existing types of work-homes and the adaptability of these specific examples to the New Media workhomes.

Regarding the building that will house the dwellings, the shape of the building in most cases doesn't play a massive role in how the dwellings are made, often following some sort of grid in which dwelling sizes are determined. The only exception to this rule is Treehouse, and possibly Tietgen, where the dwellings vary in size in order to stay in the specific shape of the building. However despite Treehouse all of the other examples mostly use the structural grid within the building to determine the size of the dwellings, often making the different dwellings very similar, either always having the same depth in the case of Tietgen, Anna van Bueren and Schiecentrale or the same width like Treehouse. This concept of having a structural grid dictating the size of the dwelling and not letting them vary too much is a helpful reference in creating suitable dwelling for the New Media workers, without tailoring them too much to a specific line of work.

These dwellings especially the single person households have a minimum size as the examples and my research have indicated. This minimum size seems to be around 30 m<sup>2</sup>. However as my research has indicated this size is in most cases a bit too small for the wishes of at least one group of the New Media workers, saying that they often lack the space for a separate workroom. Dwellings therefore need to be a bit bigger than 30 m<sup>2</sup> for a single persons work-home, however the plans here show are a good reference in how these dwellings could be laid out, namely the placement of essential function cores, like in Schiecentrale for example.

Considering the idea of adaptability and to cater to a larger group of New Media workers than solely the single person workhomes, the concept used in Schiecentrale can be used. The idea behind this concept is that dwellings can be altered in size as long as they stay within the structure of the building (see figure 24). This concept is also used in Tietgen Dormitory with the additional bedroom and in Anna van Bueren Toren, where the classrooms take two times the width

of a dwelling. This concept helps to not restrict dwellings to one single size, but also make the building more flexible, allowing the possibility of the growth of dwellings, as the needs of the residents grow.

Aside from the stand alone single person households, coliving can also be seen as an option for workhomes. Seeing as described in Chapter II, not all the people who work in New Media have a lot of money to spend, coliving can be option in which they have less personal spaces, in exchange for more affordability. From what Tietgen Dormitory showed us and my questionnaire pointed out is that, at least the questioned streamers, the basic necessities such as a bedroom and bathroom need to be personal, but all other spaces within the home, such as a kitchen, living room or even communal workroom could be collective. Tietgen Dormitory is a great example of this coliving scheme where 12 people, each with their own personal bed- and bathroom of about 30 m<sup>2</sup>, share a kitchen, communal room and laundry room. As mentioned before this space is a bit limited in terms of the inclusion of a personal workroom, which according to my questionnaire is a preference. However as the dwellings in Tietgen are fairly narrow (see figures 48, 49 & 50), this could be solved with a different configuration or with the addition of an extra room, like the 2 bedroom dwellings in Tietgen (see figure 51).

Lastly the student housing and coliving examples, namely Anna van Bueren, Tietgen Dormitory and Treehouse, showed that communal workspaces could also serve as an extra function in the building in order to keep down the cost of the dwelling. Instead of including workspaces in the dwelling floors or spaces could be dedicated to communal working and even be added to buildings who do include personal workspaces as a space to meet people. In these spaces people with different occupations would be able to rent equipment and spaces, which they normally wouldn't be able to afford, to conduct their work. Seeing as these floors would be open to the whole building or even the public this would also serve as a good place to extend the network of the people working in New Media.

In short a few things can be used as a reference for the New Media workhomes. Firstly the idea of structuring the dwellings along a set grid, making all of them similar in their layout and thus refraining from designing it for one particular type of people. Secondly using this structural division allows for flexibility, allowing dwellings to grow as long as they stay within the structure of the building. Thirdly the minimum size of single person workhome should be bigger than 30m<sup>2</sup>. Fourth, coliving can be seen as a solution for people who have less to spend, as long as the dwellings have a personal bed- and bathroom, and preferably a separate workroom. And lastly dedicated work floors could be added to the building to lower the cost of dwelling by not including personal workroom. This communal workspace would be a place where they can rent out equipment and spaces, which they normally wouldn't be able to afford, while also having the possibility of expanding their network, which is an important aspect for people working in New Media.

## CONCLUSION

Starting this research I firstly had to define what I meant by New Media before I could conclude what influence this new way of working has had on the way we live and work. The first chapter of this research has shown that New Media is a really universal term, it is as I would like to call it timeless. As Manovich explains “[...] every modern media and telecommunication technology passes through its “new media stage.” (Manovich, L., 2013, p. 17).

It is with every type of New Media that our way of working changes and even our way of living. Especially now this is very urgent, as Covid-19 illustrates there is a lack of workspace within the current homes for home based work. This type of working that we are experiencing now is very similar to how New Media workers work, from home. Both the research of Fersch, B., (2015) and my own questionnaire show that almost all of the interviewed / questioned work from the confines of their own home.

Especially the questionnaire goes more into depth about this as the question “is there anything missing / lacking in your home?” was always answered with the same answer, namely “a separate space for my set up” or “separate workroom”. Additionally these people would answer on the question “where do you work / stream from?” that they worked from either their living or bedroom and always from within their dwelling. From this point it is clear that the lack of workspace in the current dwellings is indeed an issue, that not only Covid-19 has introduced us to, but among the New Media workers.

Streamers in this case are a good example of this New Media work, as their jobs wouldn’t exist without New Media, as we know it now. This research has pointed out that streamers themselves are not the main focus of this New Media way of working and nor are they a special kind either, they share an awful lot of similarities with other New Media workers. Freelancers for example are closely relatable to streamers in terms of their living conditions, needs, age and financial situation.

The current need and thus lack of workhomes and workspace in homes is quite surprising,

seeing as we originate from a workhome base society. Especially in the Middle Ages this type of workhome was the most normal thing in the world, think of a tailor or a herbalists whose house would double as their workspace. This idea of working from home only changed in the Industrial Revolution when the new norm changed to a ‘go to work’ mentality. During this period the term workhome became lost, homes were in those days spaces where you would live and serve as a place from which you would depart to your work. It was here that the idea of workhomes became lost.

With the rise of the New Media and the current Covid pandemic, the need for workhomes has once again risen. Seeing as the New Media has allowed us to work differently and companies seeing the benefits of working from home, due to Covid-19, it is possible that we in the future will go into a more home based work society. With the change in our way of working and living, it is clear that we need to go back to something that was the former normal. Back to the time of the workhome.

As explained by Holliss there is currently not something as a workhome, or atleast not purposefully mass produced mostly just client commissioned buildings. The best examples of workhomes that are applicable tot the New Media way of working can be found in the examples given in Chapter IV. However these aren’t 100% correct in their way of dealing with the issue of working from home. Certain aspects of these buildings can be used as a reference of how to deal with the issue of lack of space.

These being:

Firstly the idea of structuring the dwellings along a set grid, making all of them similar in their layout and thus refraining from designing it for one particular type of people. Secondly using this structural division allows for flexibility, allowing dwellings to grow as long as they stay within the structure of the building. Thirdly the minimum size of single person workhome should be bigger than 30m<sup>2</sup>. Fourth, coliving can be seen as a solution for people who have less to spend, as long as the dwellings have a personal bed- and

bathroom, and preferably a separate workroom. And lastly dedicated work floors could be added to the building to lower the cost of dwelling by not including personal workroom. This communal workspace would be a place where they can rent out equipment and spaces, which they normally wouldn't be able to afford, while also having the possibility of expanding their network, which is an important aspect for people working in New Media.

To summarize currently even though we come from a history of workhomes there are no good examples of workhomes that are well enough adapted to the current needs of the people working in New Media. The dwellings that are currently used by these groups are standard typologies, like studio's, 2 or 3 room apartments and family homes, however as my research has pointed out, especially the questionnaire, these do not cover all the needs of the New Media workers.

Buildings that come close to the idea of workhomes the ones analyzed in Chapter IV, do not fully encompass all the required aspects to fully function as a New Media workhome. All of the examples given in this chapter have interesting aspects that can be taken into account while creating the workhomes for the New Media way of working.

To answer the question stated in the beginning of my research: "How do you make a high-quality, affordable workspace in a workhome?"

Sadly from my research no clear cut answer can be given, the research up until now has given a lot of insight in to how workhomes can be created and what can be done to meet the requirements the New Media worker may have. However recommendations can be given on how to make sure that the idea of workhome that is fit for the New Media worker can be realized.

There are various possibilities to tackle this problem, as my research has shown the most common solution as indicated by the questionnaire is for people to have their own individual workroom, preferably soundproofed in the case of the streamers, that is separate from the other living spaces and situated in the home. Another option would be to adopt a similar approach to what Anna van Bueren Toren uses. By implementing floor dedicated to workspaces it is

possible to remove a dedicated workspace from the home, in order to reduce costs of living. This way a workspace is still offered very close to the home of the resident.

A few aspects that will prove useful in improving not only the quality of the dwellings, but of the overall building these dwellings will be a part of are also found within the examples of the plan analysis. This in first instance doesn't directly influence the quality of the workhomes, but improves their flexibility and future-proofness. These aspects include the use of a set structure of the building, in which all the dwellings are the same in width, using this structure the dwellings can be altered in size. This ability to change the dwellings allows for the dwellings to possibly grow with the growing needs of the resident or even change according to the needs of a future resident. Secondly the idea of coliving, in which each person in the building has at the very least their own bed- and bathroom, while all other living spaces, like the kitchen and living room are shared. Using the idea of coliving will allow people with lower income, seeing as they are primarily starters, to live in a dwelling that caters to all their needs, all be it at a lower cost and a bit less personal spaces, Tietgen Dormitory is a good example for this.

There is no clear way to distinguish how you make high-quality, affordable workspaces in a workhome, however there are several buildings that try to do this and can thus serve as a good reference into developing this new kind of dwelling. Just as workhomes were at one point our primary form of dwelling, now again comes an age in which this might be the case, and just like back then this issue can be resolved by trial and error. The examples mentioned in this research and by Holliss in her book *Beyond Live/Work: The architecture of home-based work* show our road to figuring out this New Media workhome, in which the workspace plays a big role. A road that is only just at its starting point as we figure out all the possibilities that New Media brings with it.





# DESIGN PRINCIPLES

## MAIN PRINCIPLES



### INDEPEDENT DWELLINGS

New Media workers prefer to have their own private dwelling with their own facilities. Sharing a bathroom or kitchen is out of the questions, at least for the older people and the ones with families. Creating independent dwellings for these people is therefore a must.



### AFFORDABILITY

As the people working in New Media have an unfixed income, affordable dwellings are an important factor for these people to obtain a house. Especially for singles and starters this is a real issue as they tend to move back into their parents' house due to financial issues. The creation compact dwellings and a cost-saving structure is key to affordable dwellings.



### CO-LIVING

Co-living could be seen as an option for affordability. As the majority of the singles said to they wouldn't mind sharing certain facilities, this can be seen as a cost-saving measure. The co-living scheme would consist out a shared kitchen, dining, living room and private bed- and bathrooms.



## ADAPTABILITY

The building should have a construction type that allows for the dwellings and or certain functions within the building to adapt to the changing needs of the New media workers.



## BALANCE

A good balance between work and live is important for people working from home. The dwellings therefore must offer a separation between work and live to some degree to separate these 2 aspects when necessary. Incidentally the building can offer leisure spaces for the residents to balance out the work atmosphere in the building.



## WORKSPACES

The building should offer additional workspaces. As people tend to need a change of scenery from time to time. These workspaces should be offered in different places. This way people who either can't or don't want to work form home can work within close proximity to their home, also contributing to this balance or separation between work and live.



## ACCESS

Access in both the sense of access to the building and to the internet. A good connection between all the functions in the building is necessary for them to be easily accessible and be used, meaning that a clear and understandable circulation is needed. Secondly a good internet connection is a must, since the majority of the residents make use of the internet and rely on it for their work. A good internet connection / network is therefore key throughout the building.



## COLLECTIVE FUNCTIONS

Creating connections is very important for people in the New Media branch. Spaces that allow for people with the same occupation, whether this is in the same field or not, to expand their network should be located in the building. A central hub with collective functions both work and leisure should be located in a central point in the building. The focus of these spaces is to help people build their network as well as create a nice atmosphere between residents.



## PUBLIC FUNCTIONS

The building and its residents should have a good connection to the neighbourhood. Inclusion of public functions that both residents and visitors of the building can use, will make sure that the people in the building will be part of the community in the area. Proposed functions are a gym, restaurant and commercial spaces.

## TARGET GROUP

The target group consists of different types of New Media workers, with the main focusing laying with the **singles / starters** within this category. Couples and small families are included.

For all of the mentioned people connections are everything. **Firstly a good connection to the internet** being the most important one as these people mostly work from home. Secondly a **good network** in terms of **people** is important, knowing people in the same industry or having connections to other branches is important for them to develop their careers.

Additionally having a **balance between work and live** is very important for them. Most of them currently deal with the fact that there is no separation between live and work. Seeing as they work from their bedrooms or living rooms. Dedicated workrooms or workspaces which are separated from the living area are for them a must.

The needs and wishes of the New Media workers changes over their life, especially when they transition from being single to more family oriented lives, this being couples and families. For all of them however the necessities of being close to amenities, public transport and the city remain relevant.

Circa 53,8% of the questioned New Media workers is single, of which 57% went back to live with their parents due to financial reasons. It is primarily for these people that the need for new dwellings arise.

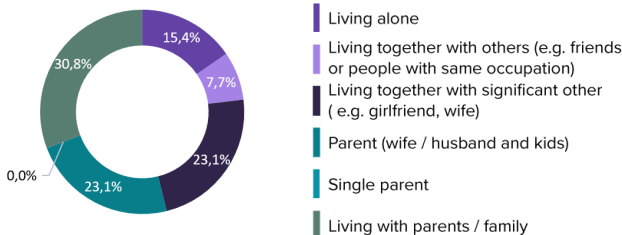


Figure 5: What are your living conditions? results of questionnaire. (Machgeels, D., 2020)



# LOCATION



## TRANSFORMING M4H

Within the Graduation Studio of Advanced Housing Design this year the focus laid on creating an urban master plan in the Rotterdam harbour for the area of M4H. Since the industrial hub of M4H is located between the harbor and the city it is a perfect place to create a place where both these aspects can come together. The way in which Rotterdam has envisioned this is in a combination with both work and living, focusing on attracting the new makers, a creative group of people that innovate and make.

Due to the scale of the M4H site the studio is focusing specifically on the area of Keilekwartier, an area envisioned to house both industry and residential dwellings. The goal being to develop a new urban master plan for this specific part of the M4H that is in accordance with the already established ideas for this site. To fit our studio approach better Keilekwartier was divided into four quarters and split between four groups of four students. The north east quarter was marked as "QA" or "quarter A", south east QB, south west QC and north west as QD.

In order to come up with a successful master plan each of the groups had to partake in a typology transfer where they looked into different urban plans to see how these could be amalgamated onto their respective quarters. These projects being;

"Strijp S" in Eindhoven for QA,  
 "Binckhorst" in Den Haag for QB,  
 "Kop van Zuid" in Rotterdam for QC,  
 "Katendrecht" in Rotterdam for QD.

For this typology transfer the four different reference projects had to be researched and their workings and key features had to be determined to see how they would be successfully integrated in M4H. Having analyzed the plans and chosen the typology, they were, with the use of various site analyses, altered to better fit the current location.

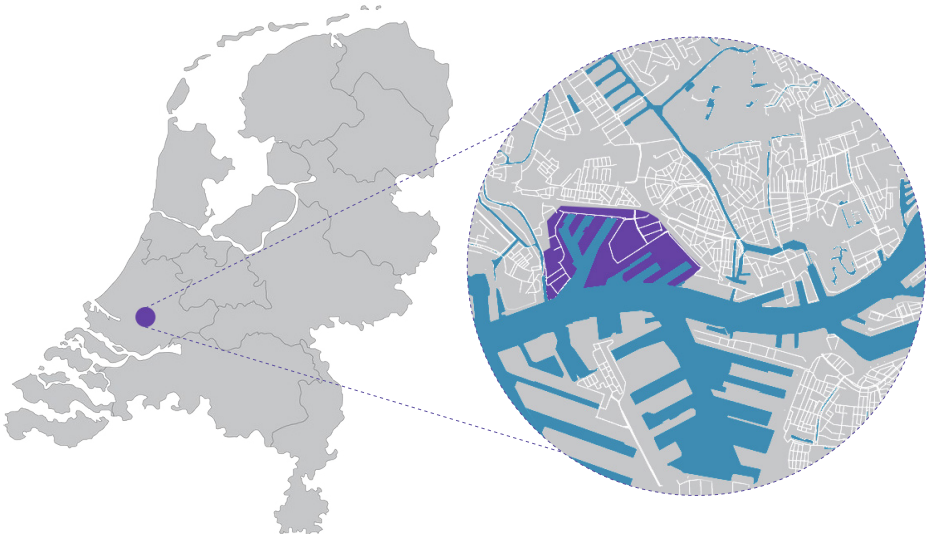


Figure 68: Location of M4H. (Machgeels, D., 2020)

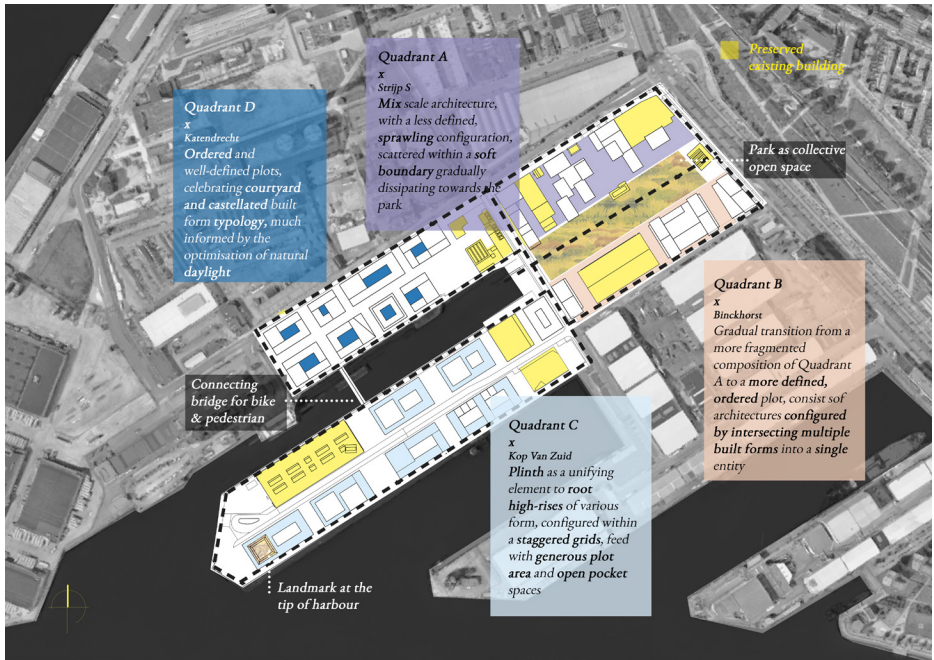


Figure 69: Quadrant overview. (Lim, S., 2020)

## MAIN PRINCIPLES

For this Master plan (see figure 73) a few principles (see figures 70-72) were determined that would be guide-lines for the whole area.

Firstly to keep inline with the wishes of the municipality the green spaces proposed in their original plan are kept. These green spaces are to be developed into lively meeting spaces such as a park, main example of this is located between the quadrants A and B.

Secondly to reduce the amount of unnecessary destruction of buildings and to keep the character / atmosphere of the area, iconic and monumental buildings were to be kept.

Thirdly the new proposed circulation system of the municipality is adapted to the site. The new circulation in the area is determined by the main roads around each of the plots. These main roads are accessible by car and bike, however the plots themselves are meant as a pedestrian only area. This is done to increase the use of the

space as well as increase the feeling of community.

Additionally all the newly proposed buildings as well as the monumental buildings, that are kept, all have to have a commercial plinth. This means that they either need to have a commercial function, like shops or restaurant, or offer workspaces that are publicly / collectively accessible for the New Makers in the community.

Lastly the function of all the new proposed buildings is to be determined as residential, while all monumental buildings are to be transformed into workspaces.

Other than this all the quadrants have their own specific requirements that are derived from the typology transfer.

LEGEND

- Monument Buildings
- Iconic Buildings
- Green Space



Figure 70: Iconic buildings and parks. (Connerney, J., 2020)

LEGEND

- Vehicular routes
- Bicycles routes
- Pedestrians routes



Figure 71: Circulation. (Asa, M., 2020)

LEGEND

— Commercial Zone



Figure 72: Commercial zone. (Connerney, J., 2020)

LEGEND

- — · plot border
- ▲ — ▲ obligatory facade
- △ — △ facade can't cross this line
- - - - - possible overhang
- commercial ground floor
- ⊙ plot number
- building's max. height
- tower placement
- residential
- workspace
- ▨ existing building
- green/open space



Figure 73: Urban Master plan. (Markowska, E., 2020)

### THE BUILDING PLOT

The plot for my graduation project is located in the north-east of the Keilekwartier. This part can be seen as one of the entrances to the area. The key features of the space are the inbetween zones that exist between the buildings, the park adjacent to the plot as well as the nearby monuments

The measurements of the plot are 38 x 52 meter. However the plot itself is a bit of an odd shape following the streetlines on one side causing the shape to become smaller towards the park side. The location of the plot is a special one, as mentioned before it stands right at the start of the Keilekwartier. Meaning that it is directly adjacent to both the main road next to the whole of M4H as well as one of the roads next to the plot. Considering its location the building is the perfect eyecatcher for the area. A great location with enough possibilities for public transport and / or easy transport by bike or even car also makes this place suited for New Media workers.



Figure 74: Location plot 5 Keilekwartier. (Machgeels, D., 2020)



Figure 75: Quadrant master plan. (Machgeels, D., 2020)



## CONSTRAINTS

Besides the already mentioned main principles the building plot and primarily the building itself is shaped by several principles (see figures 76 - 84) within the quadrant itself.

The most important aspect is that the all the buildings in the plot reference the existing monumental / iconic buildings within it. For example the building must have a public plinth of 12 meters, which coincides with the height of the warehouse to the west of my building. This way not only the height but also the functions of this part of my building is the same as the existing building.

Along with the height and functions, the boundary of the plot of each of the buildings in this quadrant are also determined by the warehouse. Both the north and south side of each of the buildings have to be in line with the warehouse in order to create a clean street profile.

My building specifically follows the lines of the adjacent streets to reference not only the already existing building but the area itself as well. This was done in an effort to integrate the building better into to area as well as make a more coherent street profile.

Along with specific constraints for the boundary of the plot, also the placement of towers as well as some insight in materiality was a principle within the quadrant plan.

The towers of each of the buildings in the plot, which are a result of the the typology transfer and the in some cases small footprints of the building, had to be placed on certain points. According to the wind and sun analysis of the area the most optimal spot for these towers were on the outer most corners of each of the buildings. In my case this meant that the tower itself would be placed diagonal on the building following the street, much like the plot itself. As this didn't seem to have any negative effects on daylight or wind, this position of the tower was kept.

Lastly the materiality of the plinth of the building had to be a different material from the tower to signify a difference in function and to better reference the warehouse. In my case specifically I chose to use the same color palette as the buildings in the surrounding to materialize the public plinth.

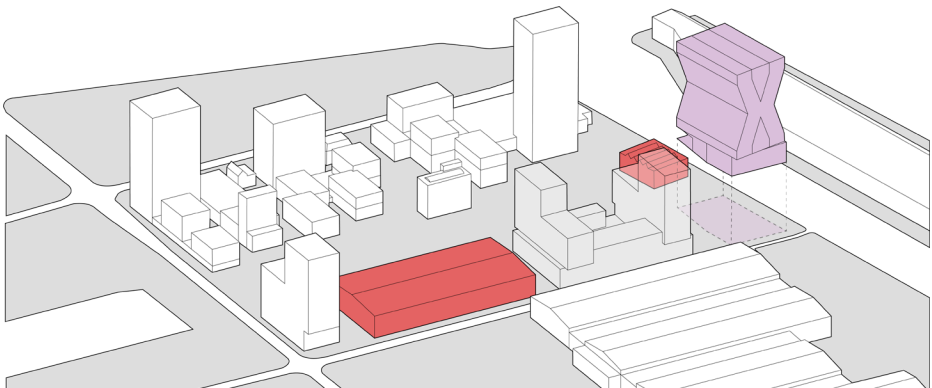


Figure 76: Keep monuments and iconic buildings. (Machgeels, D., 2021)

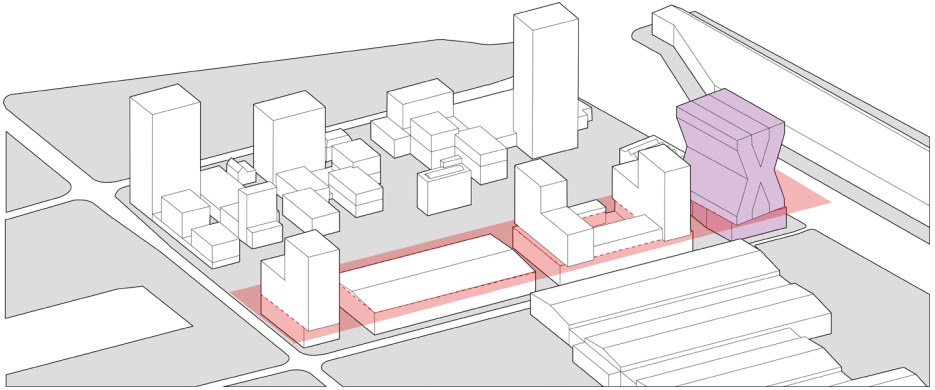


Figure 77: Reference warehouse height. (Machgeels, D., 2021)

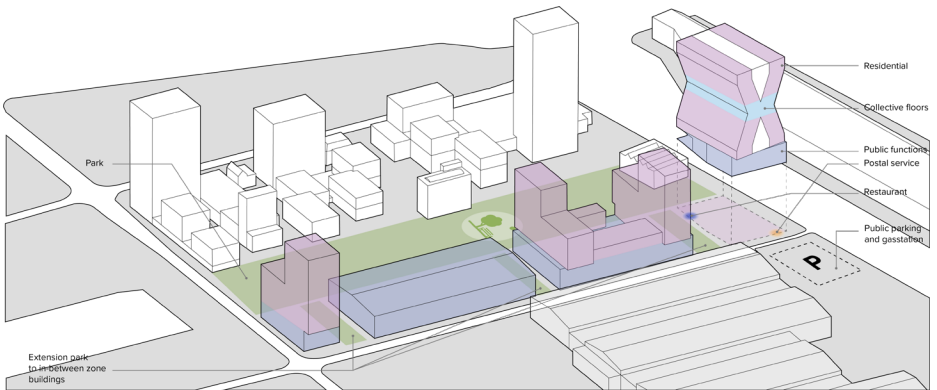


Figure 78: Functions in quadrant. (Machgeels, D., 2021)

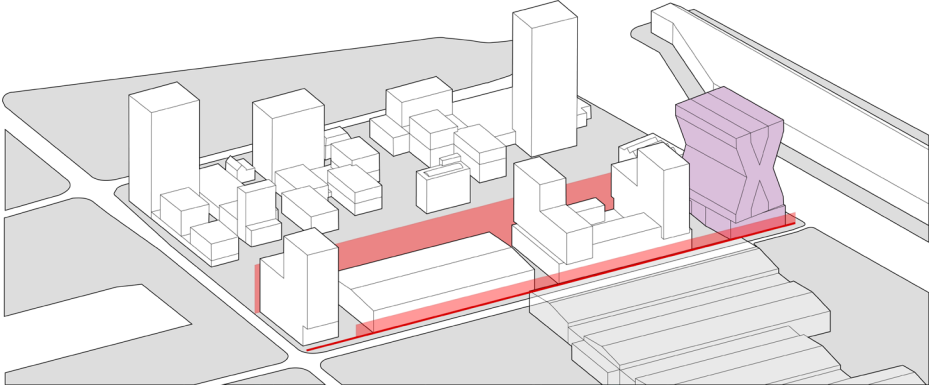


Figure 79: In line with warehouse. (Machgeels, D., 2021)

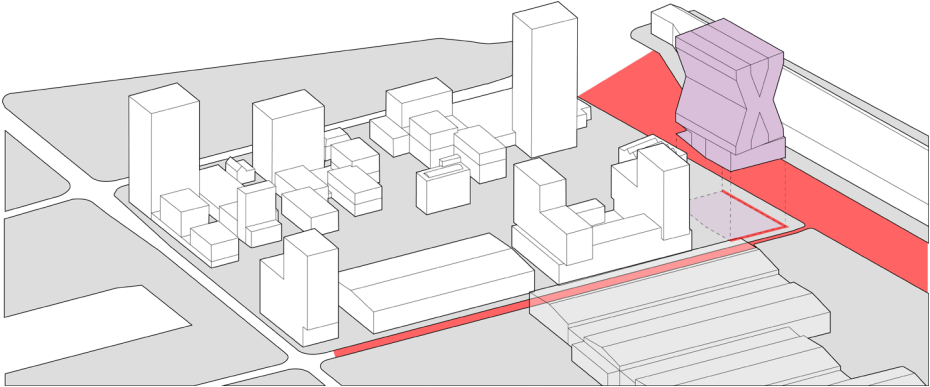


Figure 80: Follow the street. (Machgeels, D., 2021)



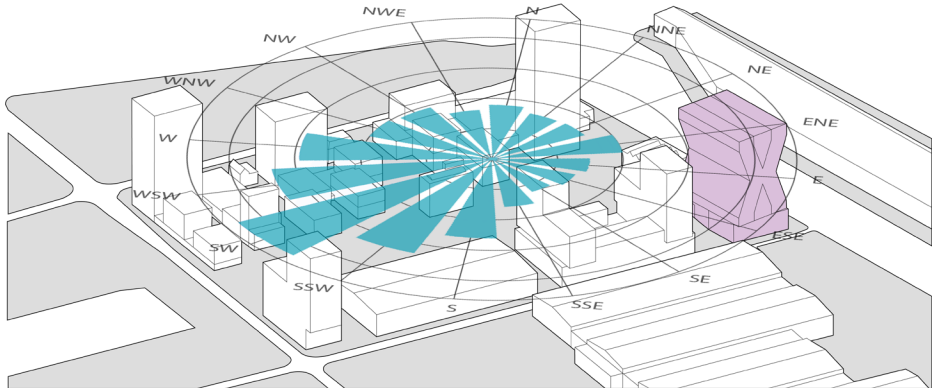


Figure 81: Wind in the area. (Machgeels, D., 2021)

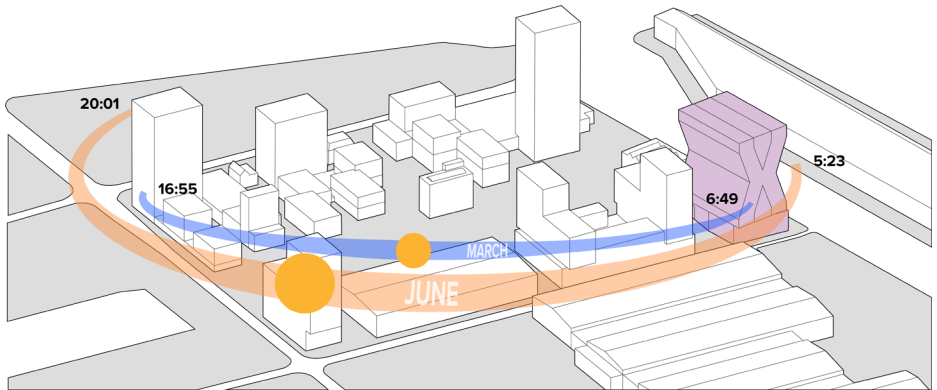


Figure 82: Sun path in the area. (Machgeels, D., 2021)

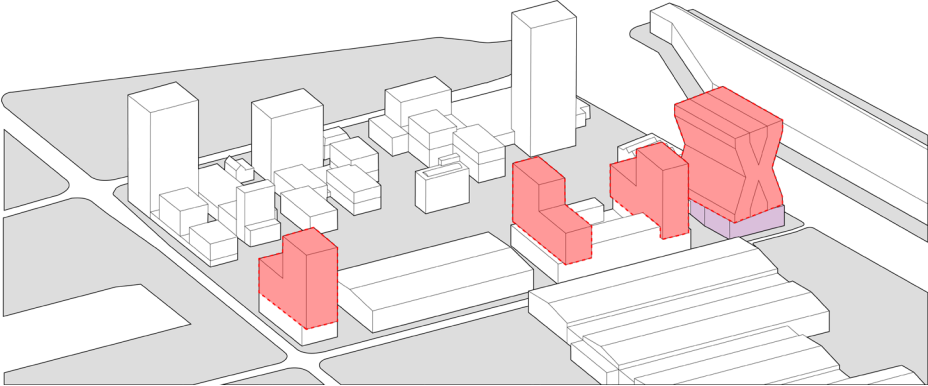


Figure 83: Tower placement inspired by sun and wind in the area. (Machgeels, D., 2021)

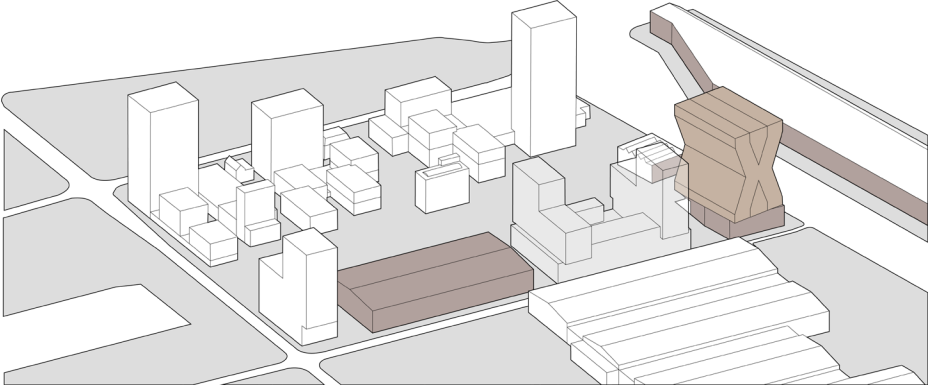
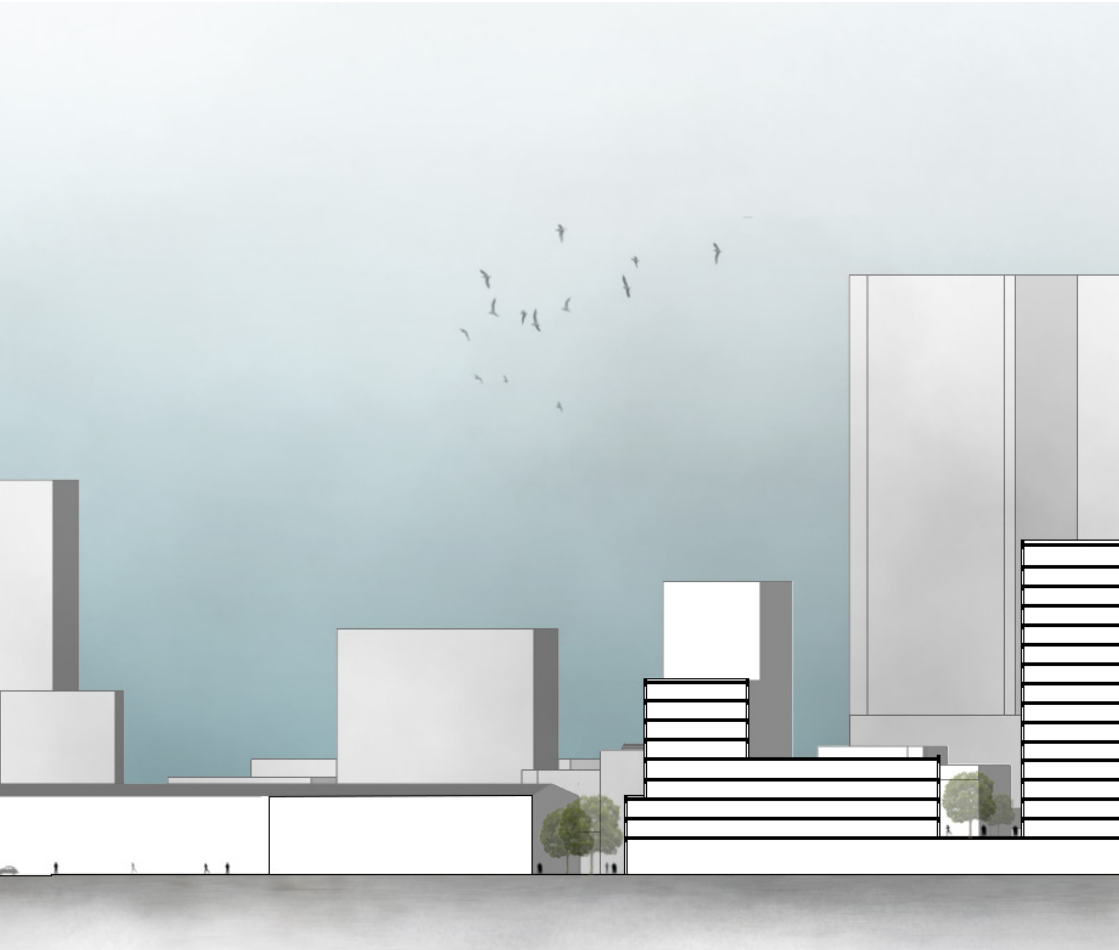


Figure 84: Use similar color / color palette as surrounding buildings. (Machgeels, D., 2021)



### PLACE IN THE LOCATION

The building as mentioned stands at the entrance to the Keilekwartier. It's unique shape acting as a landmark and welcoming beacon to the area.

From the south side the building is seen as an oddity in its surroundings. The X shape of the tower prominently different from the well established orthogonal rhythm. However this also can be seen as something new, refreshing. A new shape to introduce the New media workers to the site, the new residents.



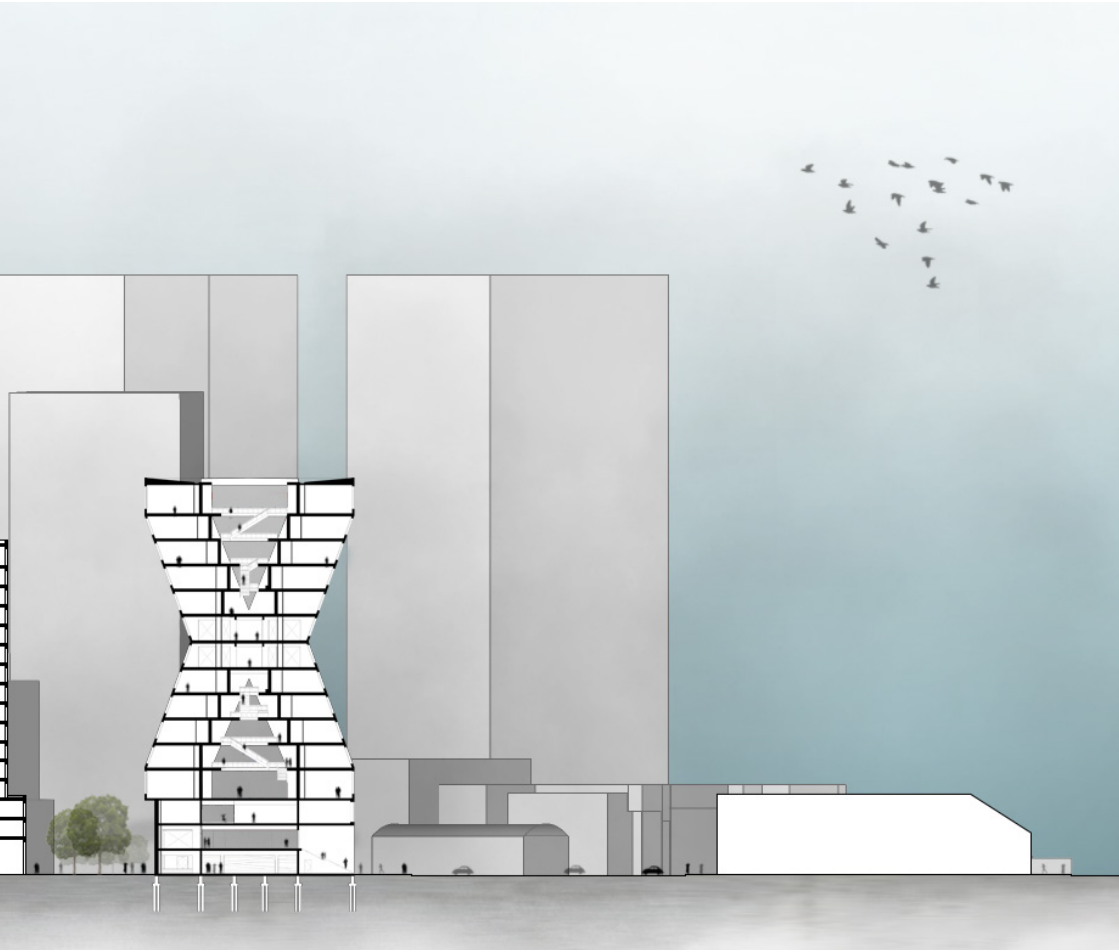
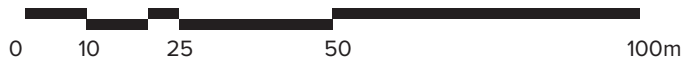
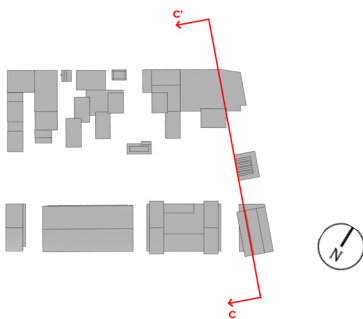


Figure 85: Cross urban section (Section BB'), (Machgeels, D., 2020)





Despite its unique shape from the south side, the building is also integrated in the site. From either the east or west side of the building, one can see that the building shape is different. From these sides the building is part of the orthogonal picture.

Not only the height of the plinth that matches perfectly with the height of its surrounding buildings and the warehouse, but also its max height. The building height is similar to the taller buildings in the area making the building, despite its exceptions, completely fit into its surroundings.

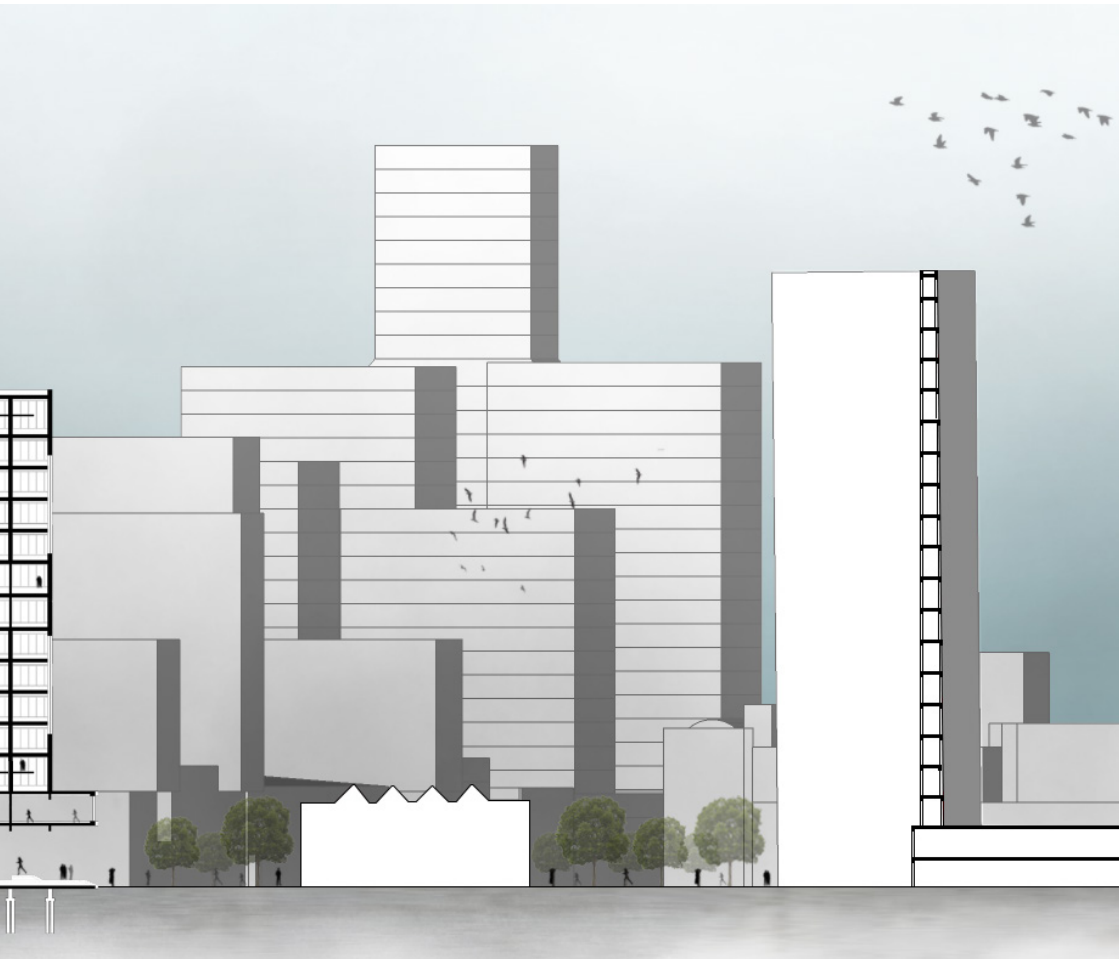


Figure 86: Longitudinal urban section (Section CC), (Machgeels, D., 2020)



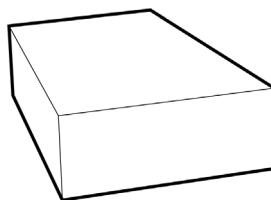
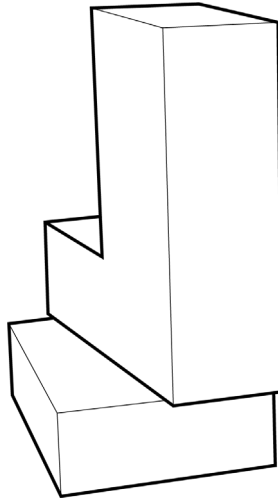


**MASS**



The chosen plot has a size of 38 metres wide and 52 metres long, with the starting point of the building already determined in the Urban Master plan.

Taking into account the tower placement, the tower was removed to create space for freedom of transformation. The base of the building was kept as a starting point, along with all the constraints bound to this shape.

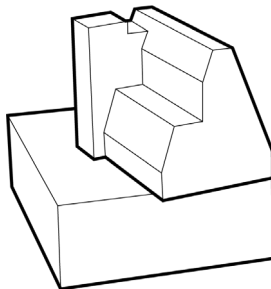
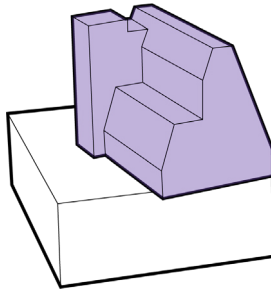


To expand on the already established base the volume of Treehouse was added on top to act as the residential tower. Treehouse was chosen for its interesting layout and its dwelling size.

Seeing as the building will house compact dwellings, Treehouse would be the best option in this regard. Along with this its interesting shape ad-

ding to the character of the building as an inviting landmark to the site.

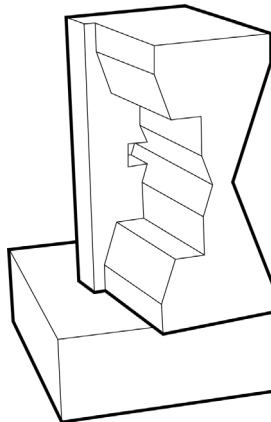
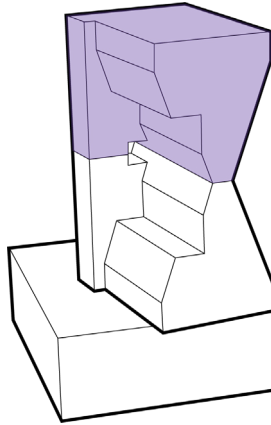
The addition of Treehouse is placed under the same angle as the previous tower as this was predetermined in the the constraints for the design.



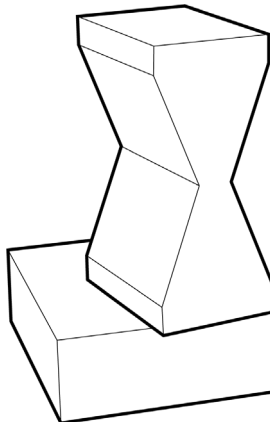
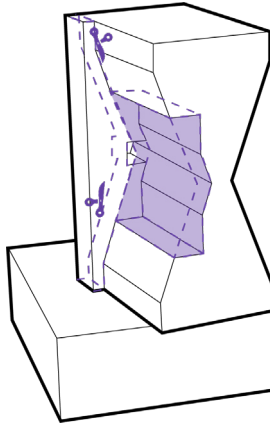
## 102 MASS | INCREASE VOLUME

Just adding treehouse didn't add enough dwelling space to act as a solution to the housing shortage in the Netherlands.

In order to make more space for dwellings the volume of Treehouse was mirrored on top of itself. Increasing its volume, height and create an even more interesting shape.

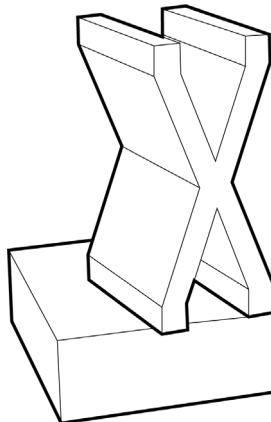
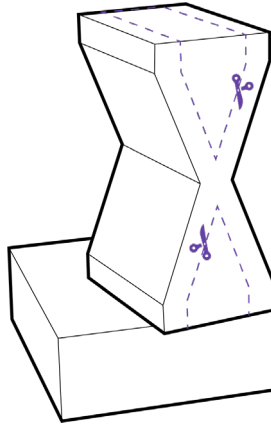


To allow for dwellings to be placed on both sides of the tower instead of one side, like in Treehouse, the shape was made uniform.

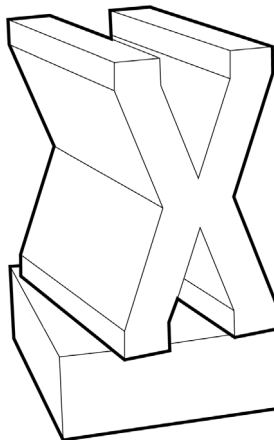
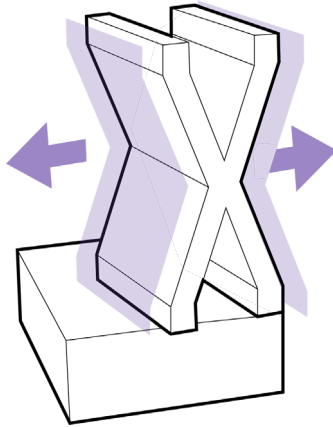


To create a good circulation in the building as well as collective meeting and usable space, the actual floor space is reduced. This reduction in floor space allows for the creation of 2 atria.

These 2 atria act both as a gallery system, which give access to the dwellings as well as a meeting space for the residents.

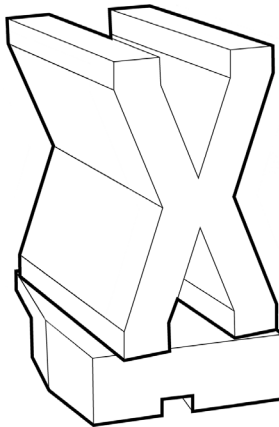
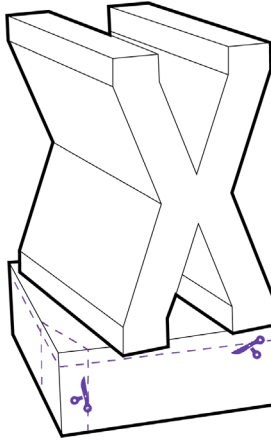


In order to accommodate dwellings with a size of circa 30 m<sup>2</sup> the sides of the tower had to be widened.



After a good look it seemed that the height of the base did not correctly align with the warehouse height.

In order to better reference the warehouse as well as the tower some adjustments to the base / plinth were done.

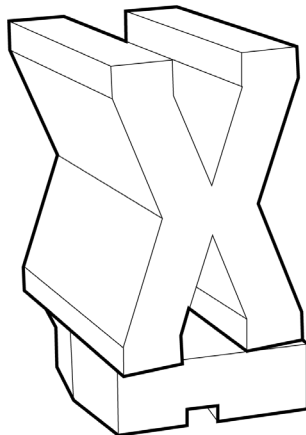
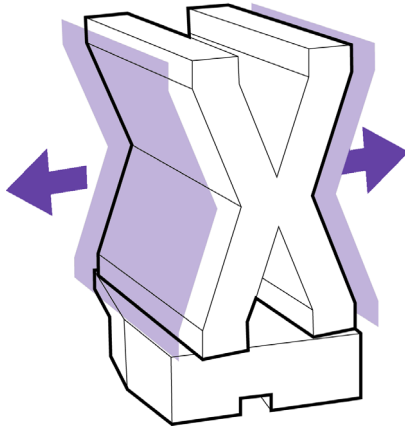


Because of the slant of the façade the dwellings in the bottom part of the tower weren't the desired minimum size. In order to get these dwellings to the desired size the sides had to be widened once more.

Besides adjusting the dwellings the tower now also aligns perfectly with the base cut-off corner

of the base / plinth.

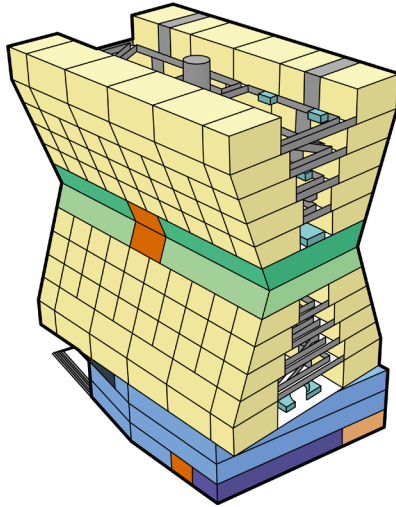
The tower part on the building can be seen as a mirror image of itself both vertically and horizontally.



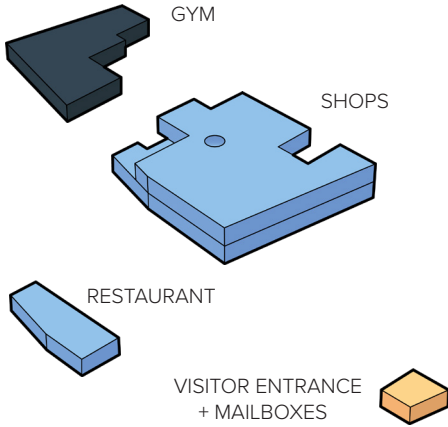




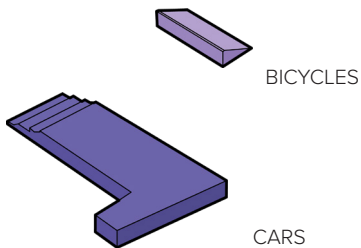
# PROGRAM



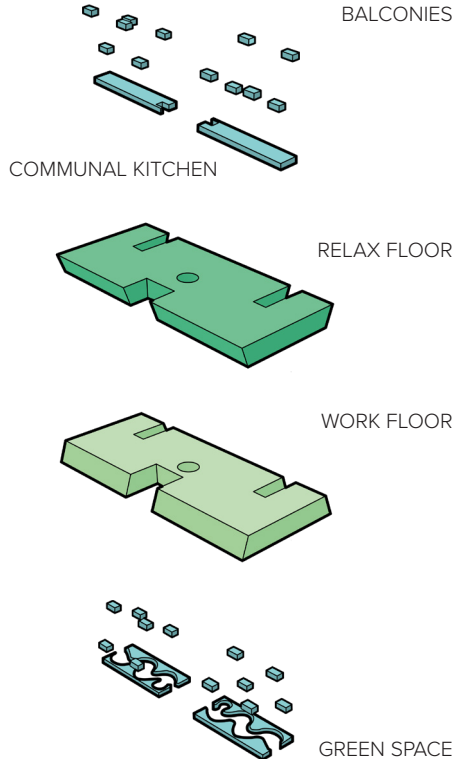
**PUBLIC / COMMERCIAL SPACES**



**PARKING**



**COLLECTIVE SPACES**



**OVERVIEW**

The building houses a variety of functions, to create a balance between work and live. Offering not only collective workspaces, but also leisure spaces. Commercial spaces are situated on the first and second floor of the plinth. The ground floor itself houses a restaurant facing the inbetween zone in the building and the park as well as a visitor entrance, mailboxes for the resident and parking for bicycles and cars.

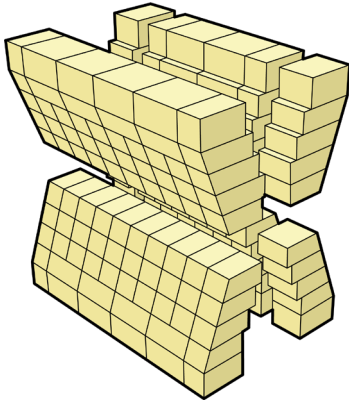
In the middle of the tower two collective floors are located. These floors act as the heart of the building, a lively place where a lot of interaction happens. These two floors are meant for the residents only, however residents can invite people up. The main purpose for these floors is for the residents to expand their network. By getting to know more people within their and other fields

of work, their employability as well as versatility grows exponentially. The two floors have two completely different atmospheres, but ultimately serve the same purpose: expanding the network of residents and balancing work and live.

Additionally the two top and bottom floors of the tower have the ability for dwellings to be adjusted along the grid of the structure. In this design however the choice was made to showcase a larger dwelling typology meant for smaller families.

The dwellings in the bottom part of the tower are slightly smaller than the ones on top. Due to the way that the façade slants the actual usable space in the dwelling is less, even though the floorspace is the same.

**ALL DWELLINGS**



**TECHNICAL SPACES**



BATTERIES + FIBER DISTRIBUTOR

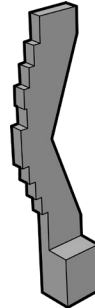


HEATPUMP

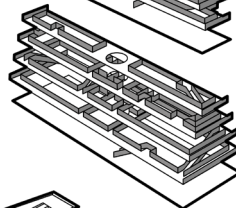
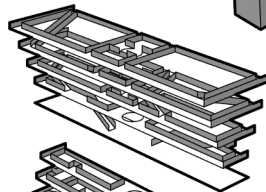
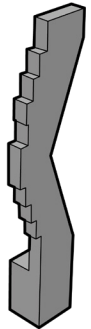
**CIRCULATION**



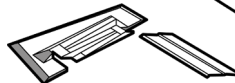
ELEVATOR



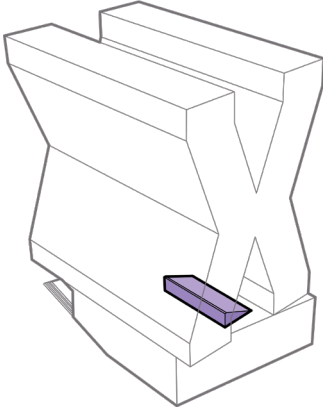
STAIRCASES



ATRIUM + GALLERIES



GRAND STAIRCASES

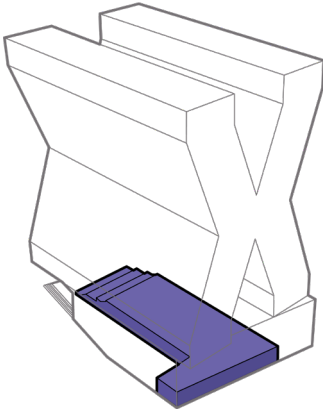


### **BICYCLE STORAGE**

180 - 230 bicycles

1 layer (Ground floor, under stairs east side)

Accessible through the entrances on the east side or parking garage.

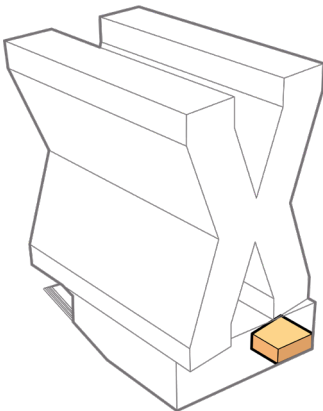


### **PARKING GARAGE**

20 (shared) cars

1 layer (Ground floor)

Direct connection to Keilestraat

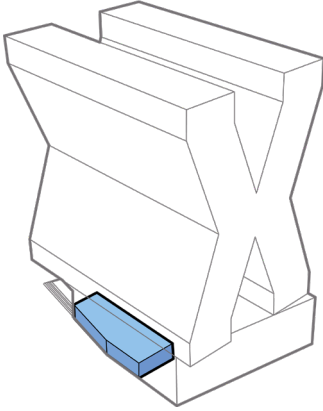


### **VISITOR ENTRANCE + MAILBOXES**

Ground floor

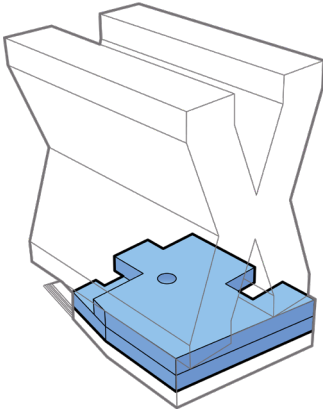
Mailboxes + Doorbell / Intercom + Waiting area

Direct connection to Keilestraat



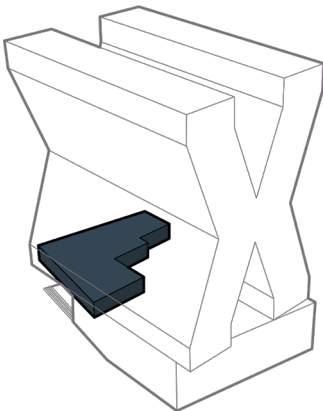
## RESTAURANT

Ground floor  
Direct connection to park, inbetween zone buildings and plateau of the grand stairs



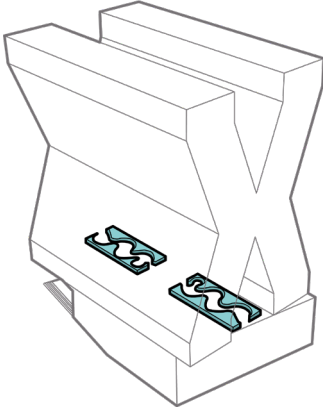
## COMMERCIAL SPACES

2 layers (First + Second floor)  
Retail  
Size shops adaptable due to open structure



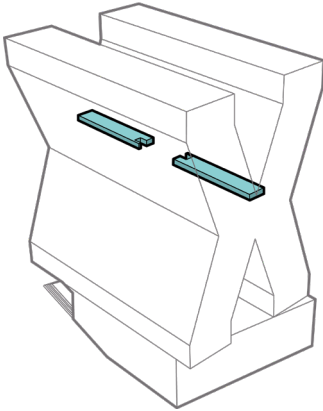
## GYM

Second floor  
Visual connection to outside + View park  
Changing room + Sanitair (showers + toilets)  
Accessible for visitors and residents



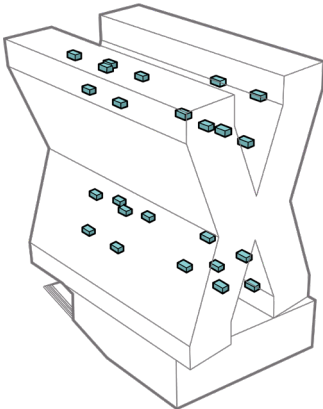
### GREEN SPACE

Third floor  
Collective space for work and leisure  
Greenery + Seating area  
Directly connected to atrium circulation system



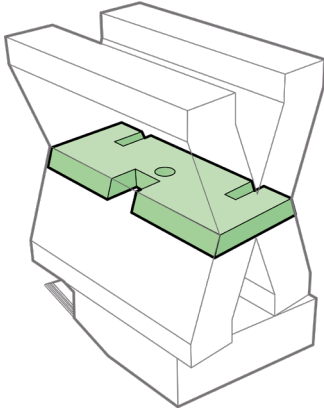
### COMMUNAL KITCHEN

Tenth floor (co-living)  
2 shared spaces, one per atrium side  
Shared Kitchen + Dining room + Lounge  
Accessible by all residents, meant for co-living  
Directly connected to atrium circulation system



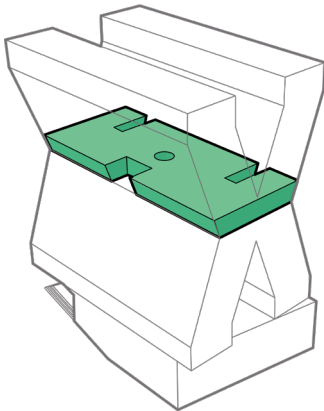
### BALCONIES

24 Balconies (12 per atrium)  
2 sizes  
Collective work and leisure spaces  
Flexible function  
Expanding network and connections between residents



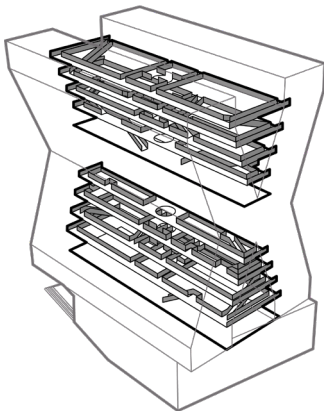
### WORKFLOOR

Eight floor  
 Collective work space  
 Free work spaces + Meeting rooms + Personal cells (permanent and removable) + Outdoor terrace  
 Expanding network and connections between residents



### RELAX FLOOR

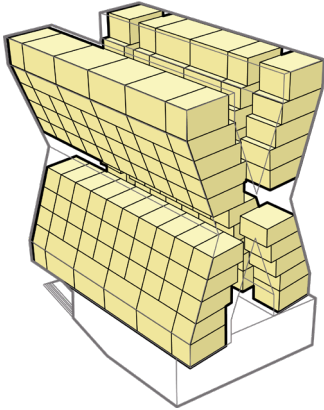
Ninth floor  
 Collective leisure space  
 Lounge + Bar + Games + Laundry room + Group tables + Outdoor terrace  
 Expanding network and connections between residents



### ATRIA

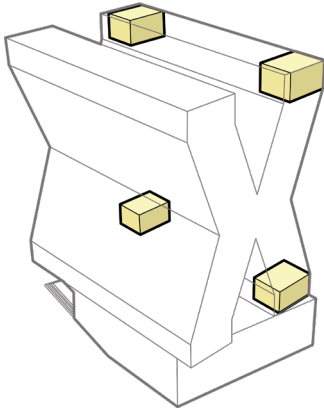
Spans from 3<sup>th</sup>-7<sup>th</sup> and 10<sup>th</sup>-14<sup>th</sup> floor  
 Meeting space + Circulation  
 Balconies directly attached to atrium





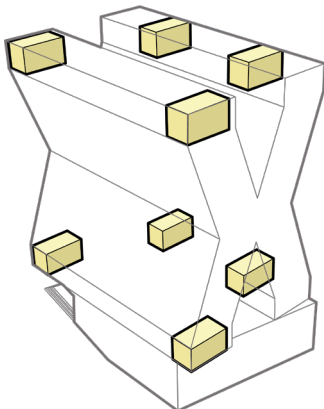
### ALL DWELLINGS

156 Dwellings (current configuration)  
180 Dwellings (max. if only 1 grid wide dwellings are used)



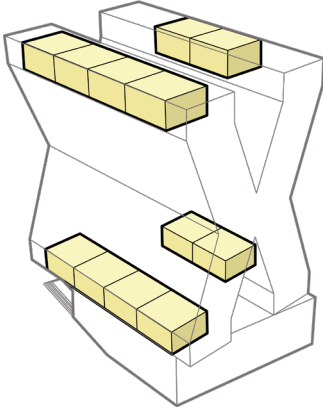
### MULTILAYER CORNER APARTMENT

75 m<sup>2</sup>  
4 Dwellings  
Private facilities  
Separate workspace / workroom



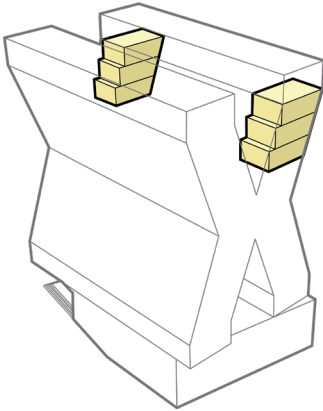
### LOFT

60 m<sup>2</sup>  
8 Dwellings  
Private facilities  
Separate workspace / workroom



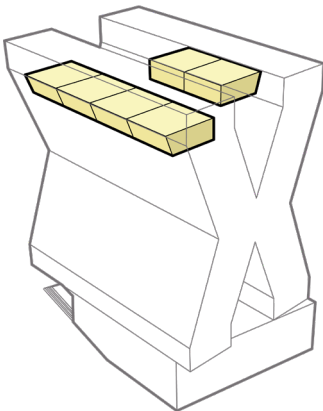
**MULTILAYER LARGE APARTMENT**

115 m<sup>2</sup>  
 12 Dwellings  
 Can be split into two Lofts  
 Private facilities  
 Separate workroom



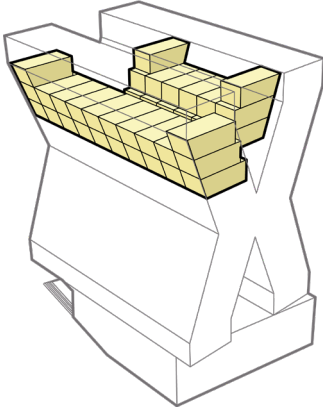
**CORNER APARTMENT**

55 m<sup>2</sup>  
 6 Dwellings  
 Private facilities  
 Dedicated workspace



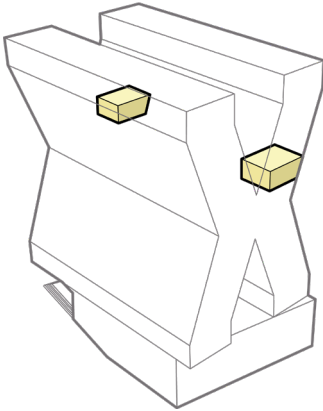
**LARGE APARTMENT I**

82 m<sup>2</sup>  
 6 Dwellings  
 Can be split into two Studio+ apartments  
 Private facilities  
 Separate workroom



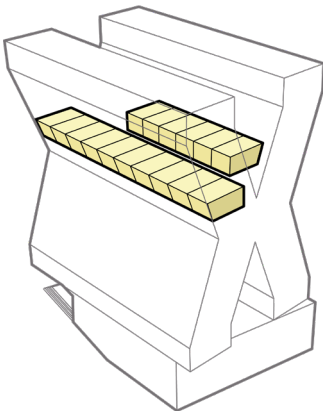
**STUDIO+**

38 m<sup>2</sup>  
36 Dwellings  
Private facilities  
Dedicated workspace



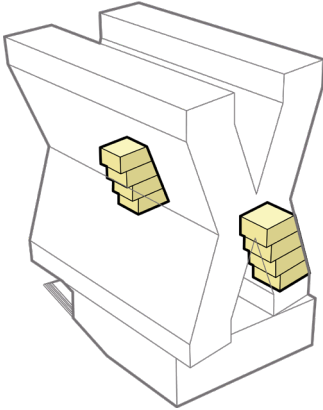
**CO-LIVING CORNER APARTMENT**

40 m<sup>2</sup>  
2 Dwellings  
Shared Kitchen + Dining  
Dedicated workspace



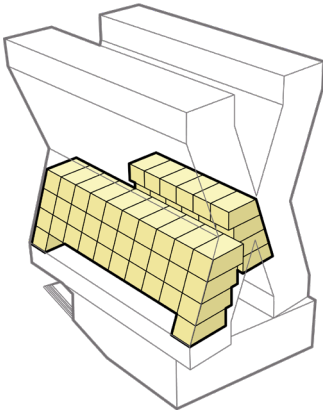
**CO-LIVING APARTMENT**

27 m<sup>2</sup>  
16 Dwellings  
Shared Kitchen + Dining  
Dedicated workspace



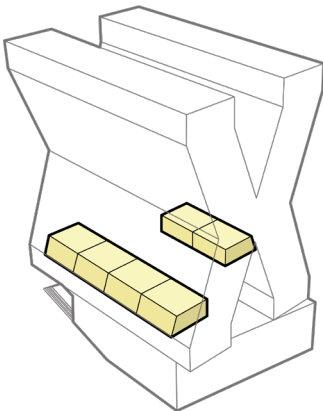
### **CORNER APARTMENT**

52 m<sup>2</sup>  
6 Dwellings  
Private facilities  
Dedicated workspace



### **STUDIO+**

36 m<sup>2</sup>  
52 Dwellings  
Private facilities  
Dedicated workspace



### **LARGE APARTMENT II**

77 m<sup>2</sup>  
6 Dwellings  
Can be split into two Lofts  
Private facilities  
Separate workroom



# CIRCULATION

### CONNECTION TO THE AREA

Movement and accessibility play a big role in the building. I wanted the building to be inviting not only to the residents, but also visitors and passersby and make them want to take a peak inside or admire the building.

In order to create such a building a strong connection to the outside was necessary either with a function, such as a shop or an entrance to the building. This need for a strong connection to the outside was based on one of the main principles of the urban master plan.

Within the master plan the main idea of circulation entailed a pedestrian only / friendly within the plot, while cars and bikes had their circulation around it. Additionally the in between zones in the specific quadrant where my building stands would act as an entry to the park and extension of the greenery.

This principle in mind (see figure 87) several entrances were planned in the building. One on the front side of the building acting as the main entrance for visitors of the park and people from within the community. A secondary entrance on the east side of the building facing the shopping mall on the other side of the road. A third entrance on the south side of the building towards the street, that surrounds the plot, meant for visitors of the residents, and lastly a garage entrance for the residents directly adjacent to the streets for easy access.

### CIRCULATION SCHEME

The two main entrances (the front and east entrance) are characterised by their monumental staircases, that not only draw attention but pull people into the building.

The east entrance, facing the main road through M4H and the shopping mall, has two additional cores. These cores each have two elevators, which cover the whole commercial plinth, and a fire escape staircase, that goes through the whole building.

The circulation on the first floor changes and introduces the central glass elevator core that allows movement from the first to the top floor of the building. Within the core two elevators are placed, one facing the front entrance, while the other faces the opposite way. Access in the elevator is limited for visitors to the communal floors. The residential floors and the communal heart of the building are reachable by providing a keycard / tag.

In the residential tower the circulation system changes drastically. Besides the main elevators and the staircases, the main circulation method is the use of the gallery system within the respective atria. The atria consists out of a series of galleries, on each floor, that connect in the middle and on the ends of the building. A connection between the floors is made by staircases that allow movement between from floor to floor.

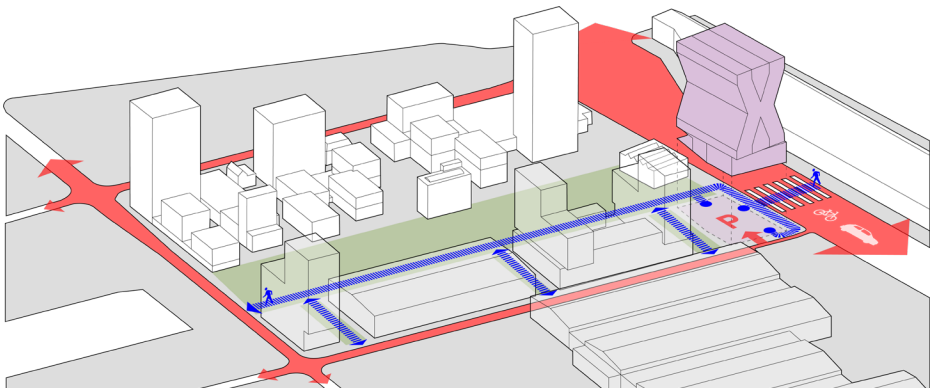
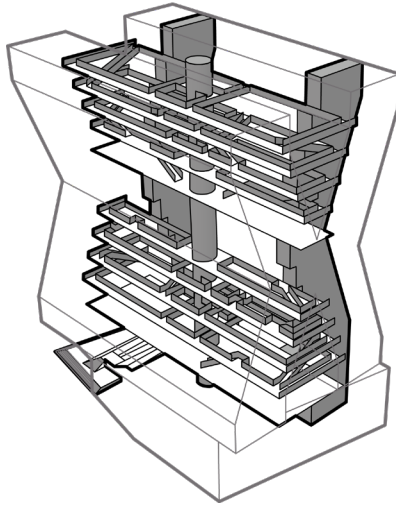
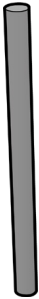


Figure 87: Circulation in the area. (Machgeels, D., 2021)

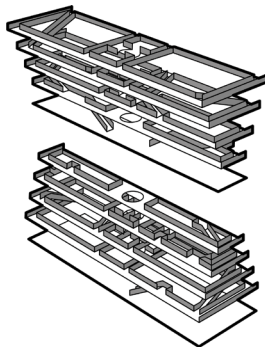
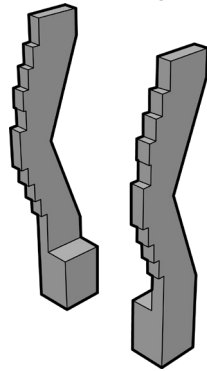


**CIRCULATION**

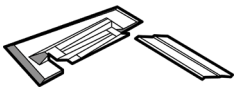
ELEVATOR



STAIRCASES

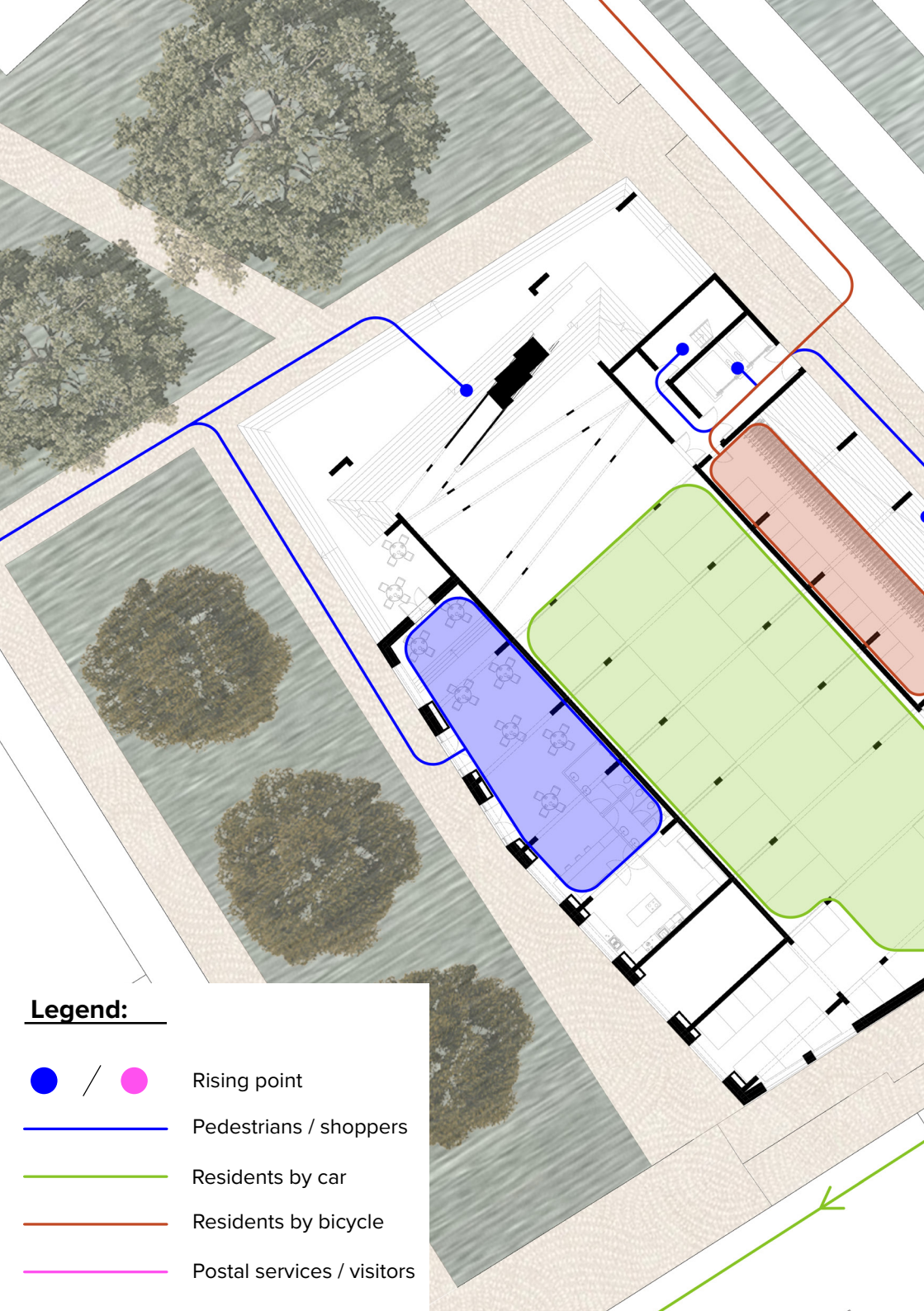


ATRIUM +  
GALLERIES



GRAND STAIRCASES





**Legend:**

- / ● Rising point
- Pedestrians / shoppers
- Residents by car
- Residents by bicycle
- Postal services / visitors

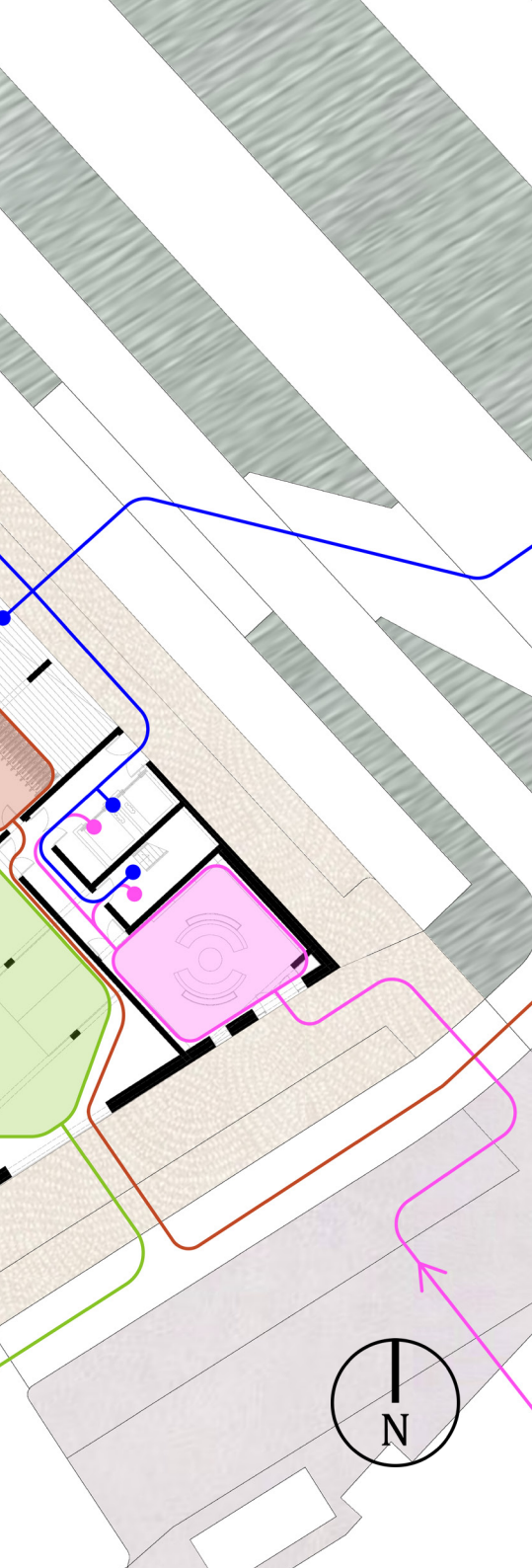
**GROUND FLOOR**

The ground floor is combination of collective and public functions. It not only houses the parking garage, bike storage and mailboxes, but also a restaurant, visitor entrance as well as the grand staircases up to the rest of the commercial plinth. The commercial plinth can either be reached via the main staircases on the North and East side of the building or via one of the cores located next to the East stairs.

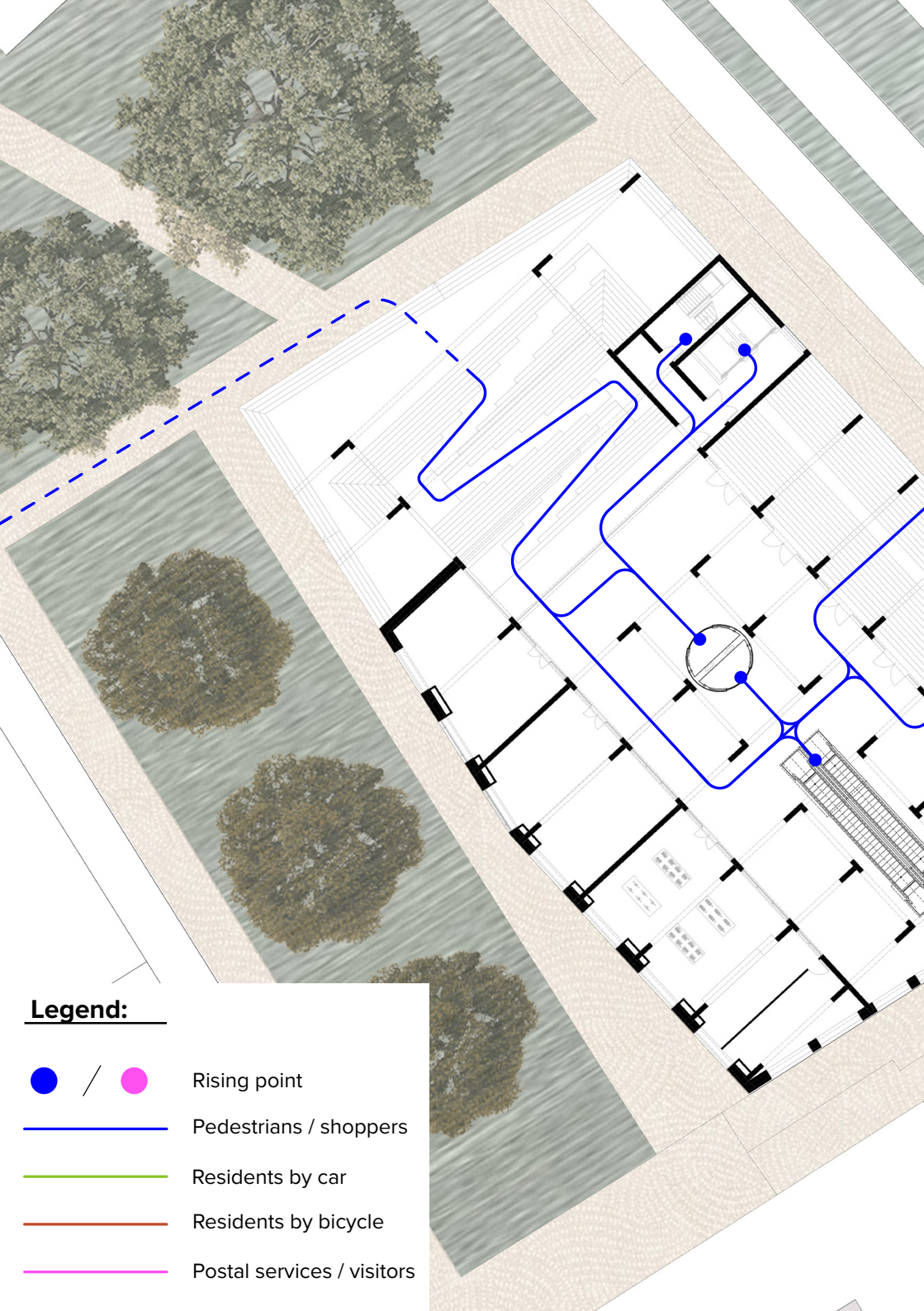
The Northern entrance in particular is fairly special. The stairs facing the park and acting as grand entrance to the building are a combination of stairs and slopes, meaning that the front entrance from the park side is accessible for everyone, even the less able.

Hiding underneath the East entrance is the bike storage for the residents. The storage is accessible either by entry through one of the two cores on either side of the main stairs or via the parking garage. Entry to the bike storage is restricted with the use of a key or tag.







Facing the inbetween zone of the buildings a restaurant is placed. With its placement along the inbetween zone of the buildings, this restaurant is in the perfect place for people either walking to or from the park. Inviting not only passersby, but also the community with its great location at the edge of the plot and park.





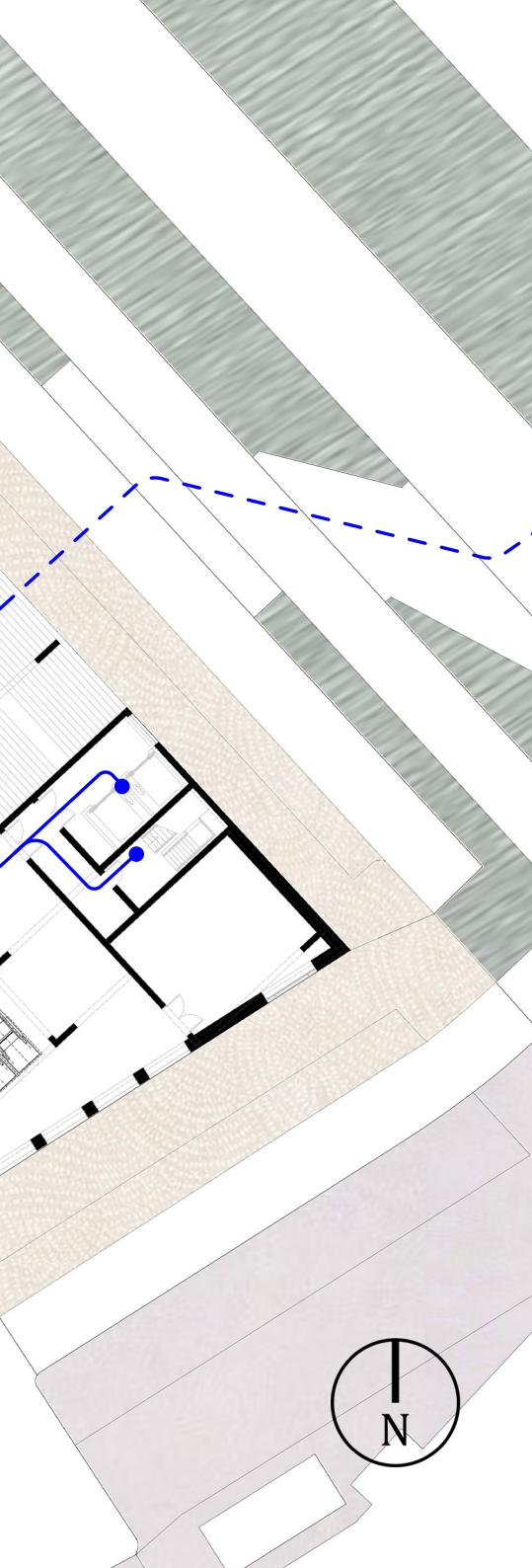


**Legend:**

-  /  Rising point
-  Pedestrians / shoppers
-  Residents by car
-  Residents by bicycle
-  Postal services / visitors

**FIRST FLOOR**

Upon reaching the first floor the circulation changes. With the addition of the central elevator core and the escalators the main circulation method changes. Instead of using only the escalators in the cores, the central elevators as well as the escalators will also become a part of the main circulation between the two commercial floors. Residents specifically will make a lot of use of this central elevator core, meaning that interaction between the residents and visitors will be in abundance.



**ATRIA + FIRE SAFETY**

Reaching the tower of the building, the circulation changes once again. From here on galleries on either side of the atrium are used as main method of circulation. The tower has two atria, one for the residential floors above the communal heart connecting all the different floors and the communal kitchen. And a second one connecting the bottom residential floors with the communal green / relax area. Access to the dwellings is provided via the galleries that are located on either side of the atrium, these galleries connect to each other in the middle, where the central elevator is located and on the ends of the building, to create more escape routes.

For movement between the floors one can either take the central elevator, stairs (on the east side of the building) or the stairs connecting the various floors of the atrium. The central elevator separates the atrium in two halves with each their own circulation system, meaning that each atria has two separate circulation systems. The atria

are not only a mirror image of each other, but the two halves are a mirror image of each other as well in terms of placements of stairs and even balconies.

In terms of fire safety the buildings is perfectly adapted to handle this. The atria specifically offer a wide variety of escape options. Either a resident can take the most nearby fire escape stairs or in the case of a blockage, they can take either one of the 2 circulations systems in the atrium to get to another entrance to these stairs. Of all the possible routes to safety only 1 scenario is longer than 50 meters, however due to all the possible escape routes it seems unlikely that this would be the only option. Additionally the fire escape stairs have a buffer zone of 1,5 meters to keep out smoke and create a new fire compartment.

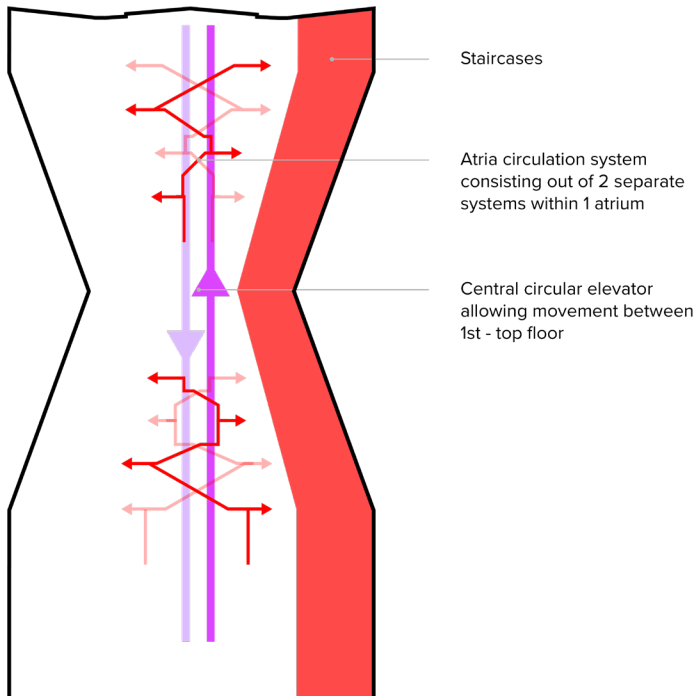
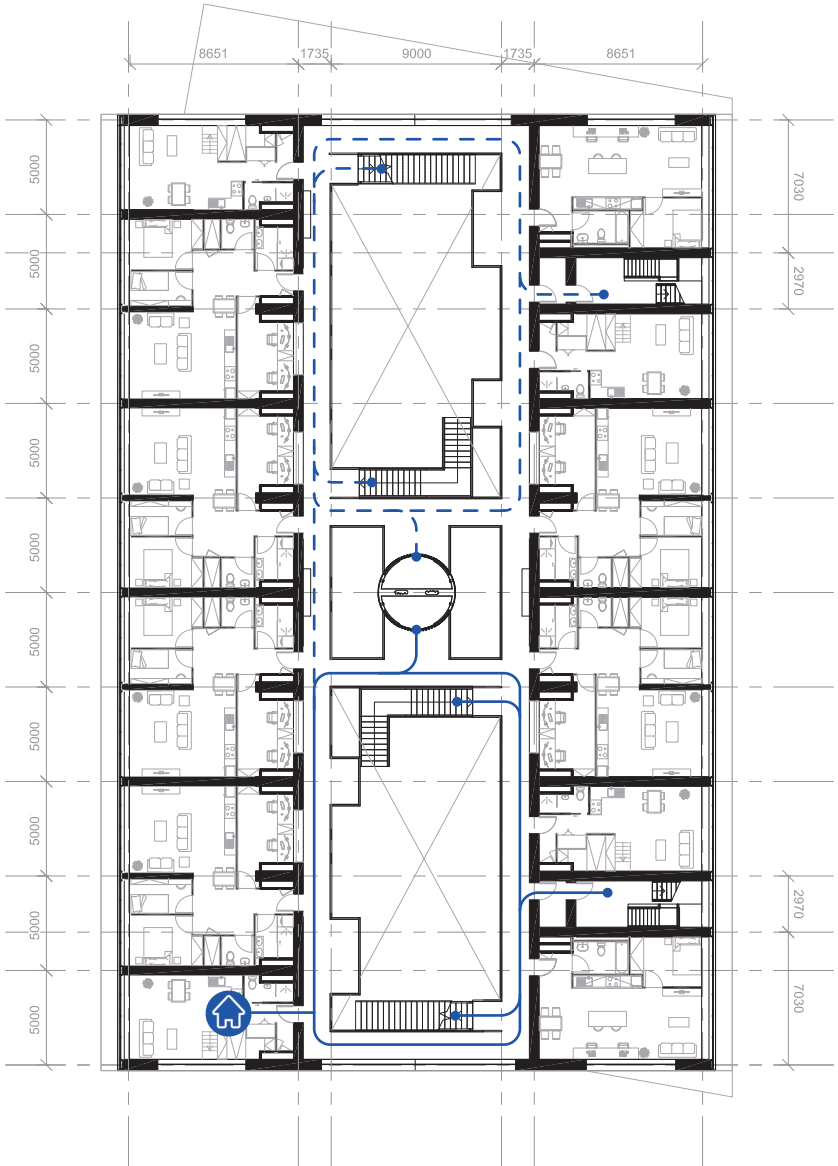


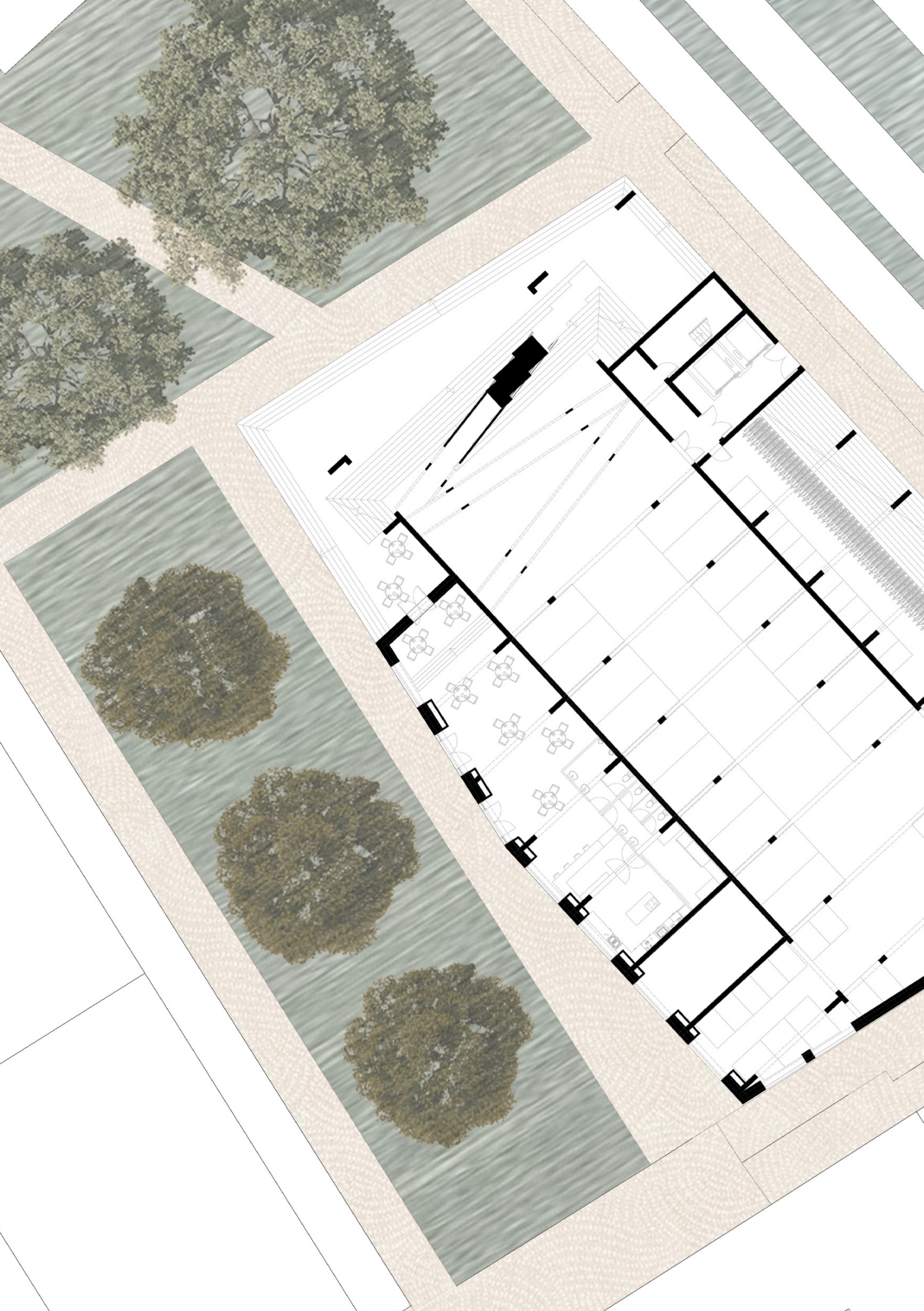
Figure 88: Circulation concept resident. (Machgeels, D., 2021)





**BUILDING**





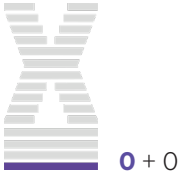
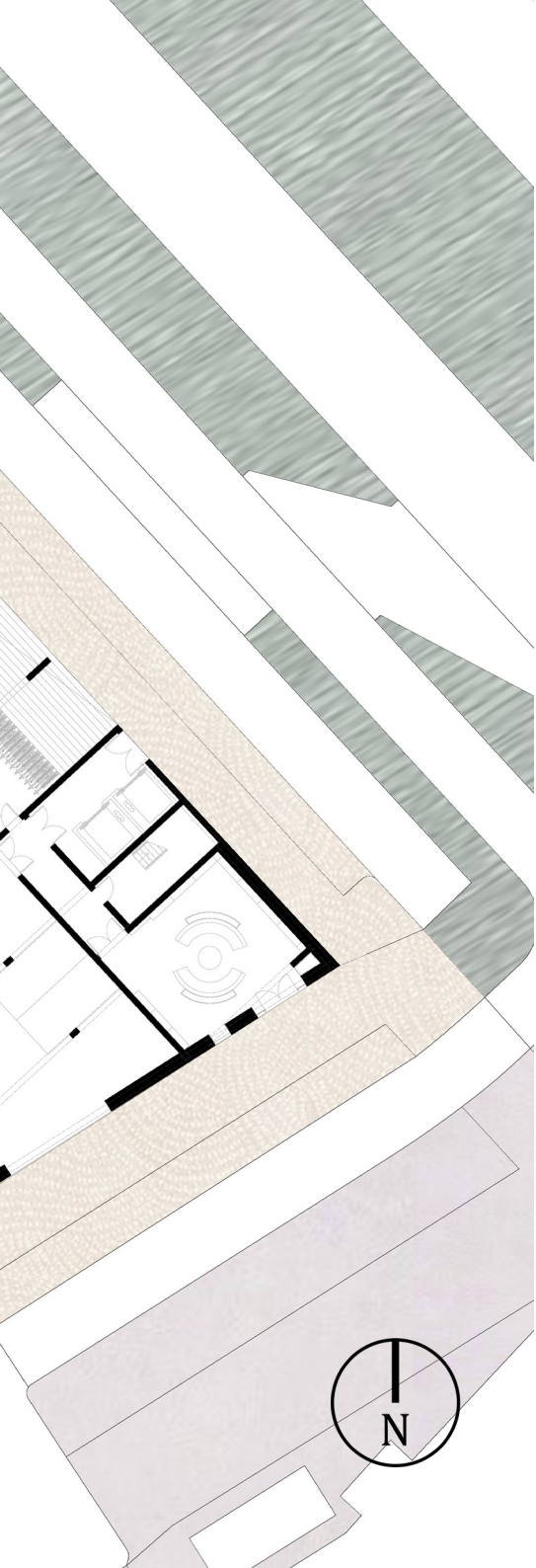


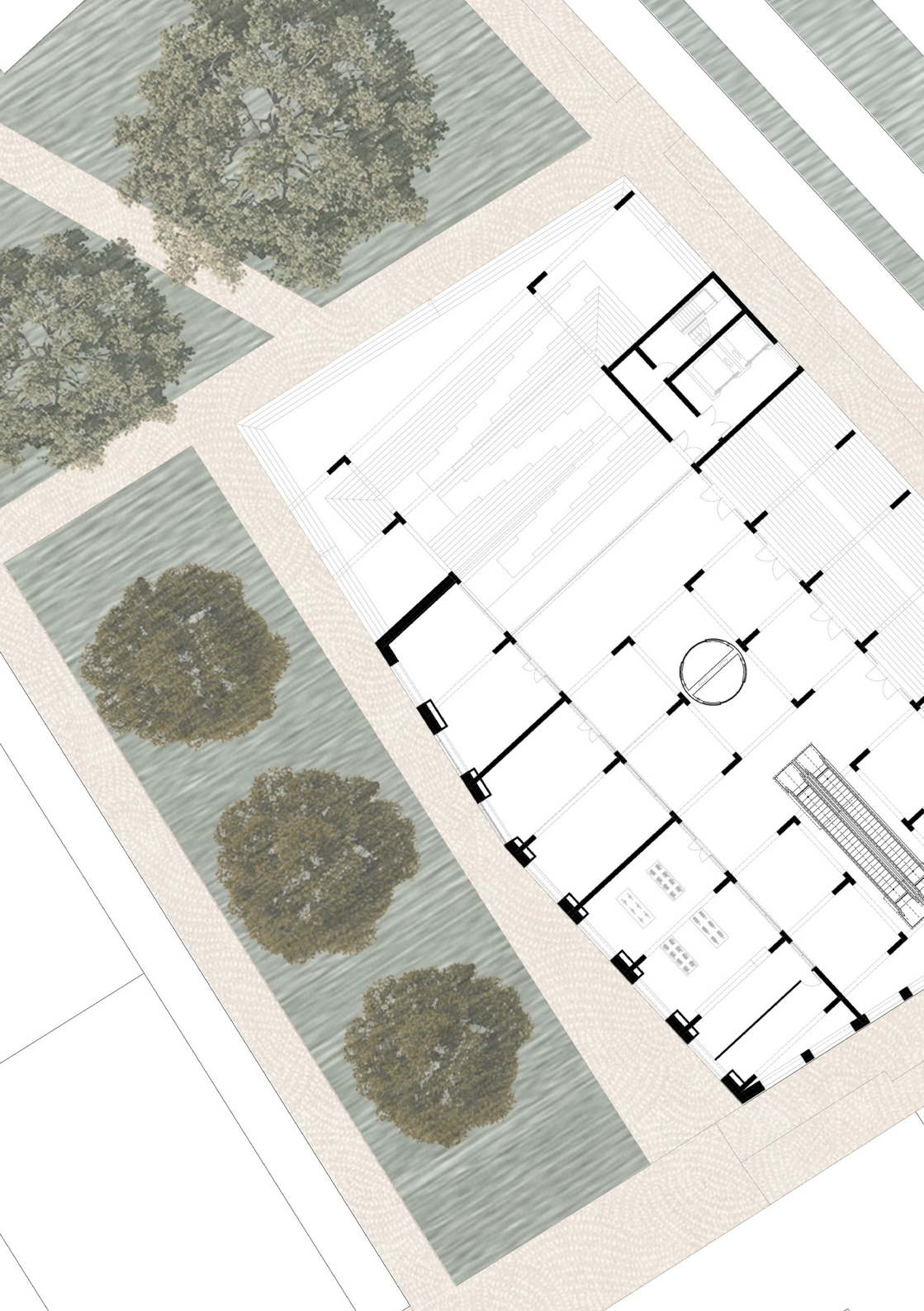


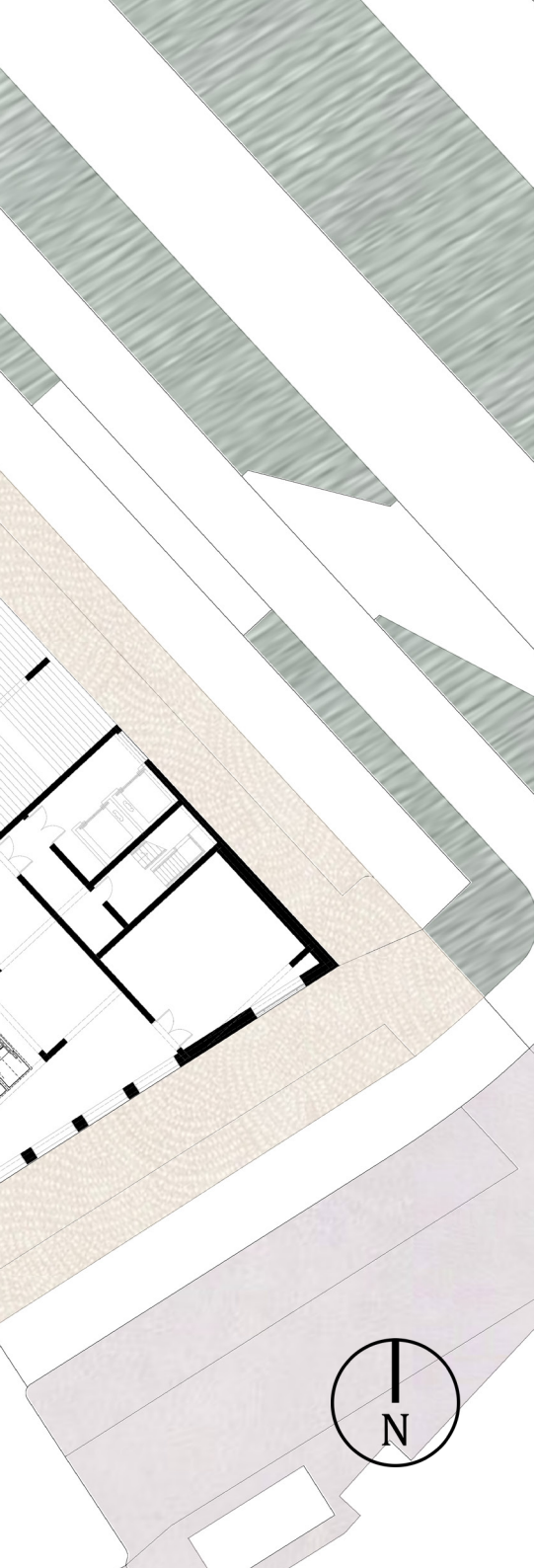




Figure 89: Postal service + visitor waiting area. (Machgeels, D., 2021)







1 + 4000



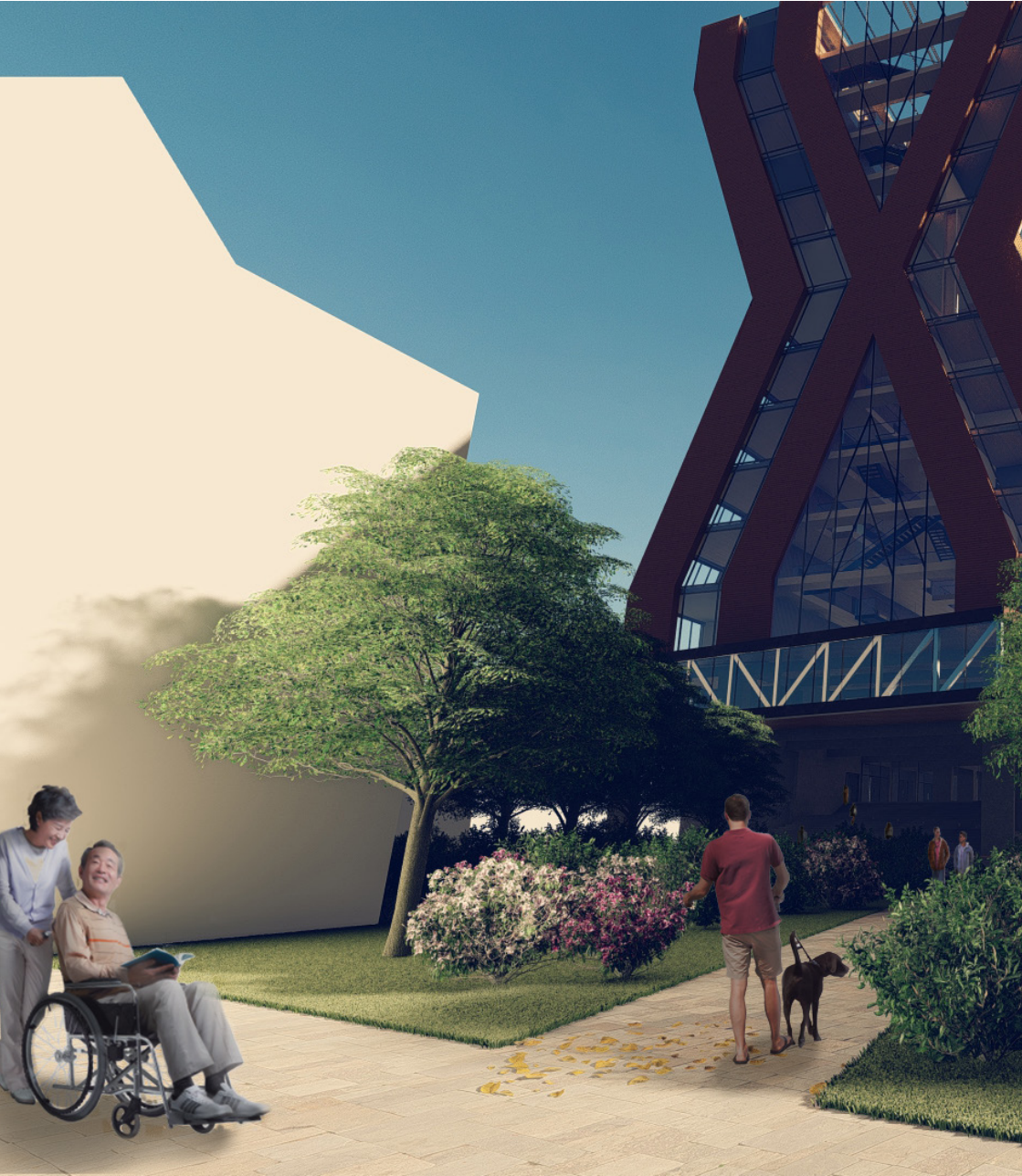




Figure 90: *Axess from the park.* (Machgeels, D., 2021)





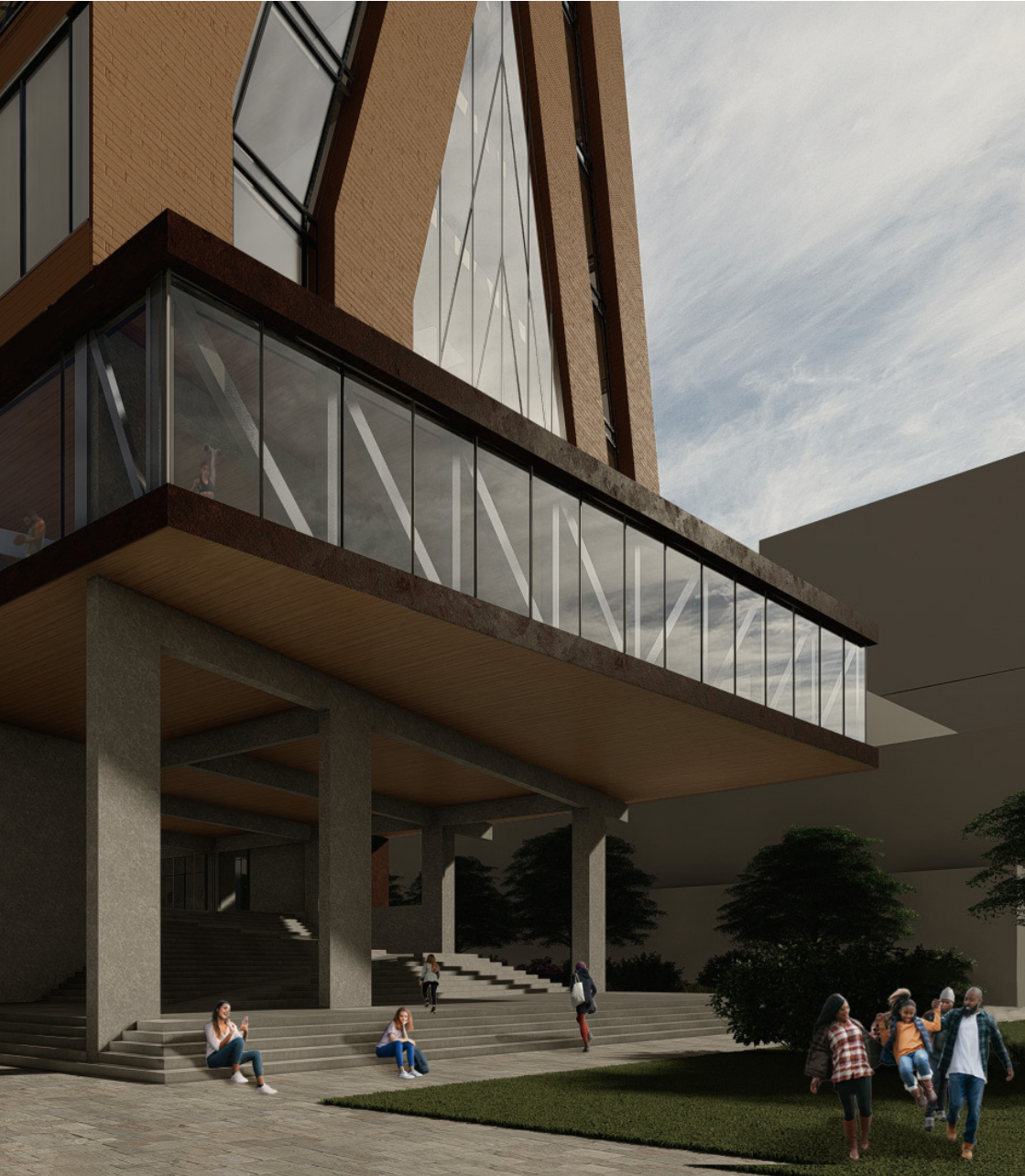


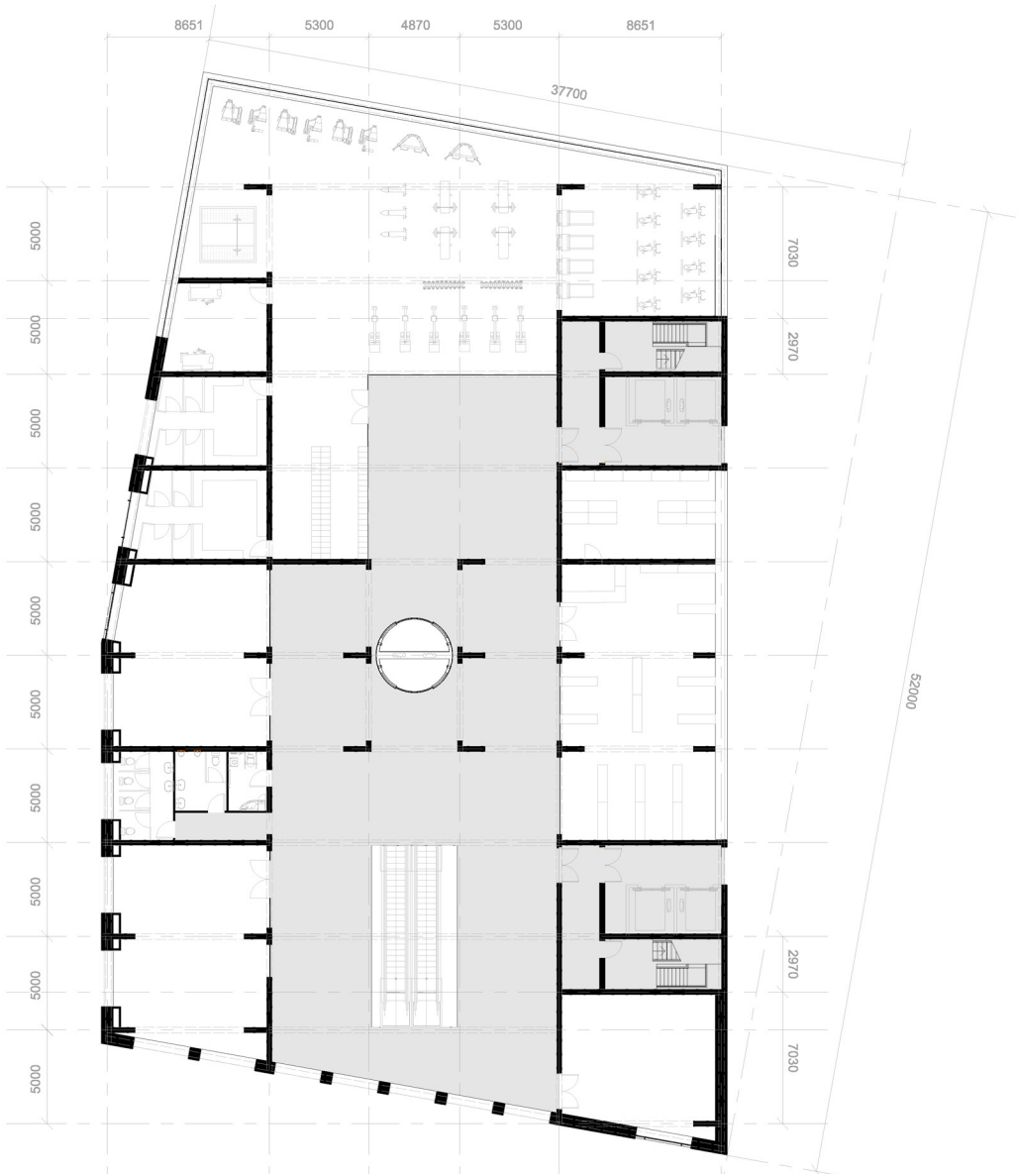
Figure 91: Grand stairs and side entrance. (Machgeels, D., 2021)





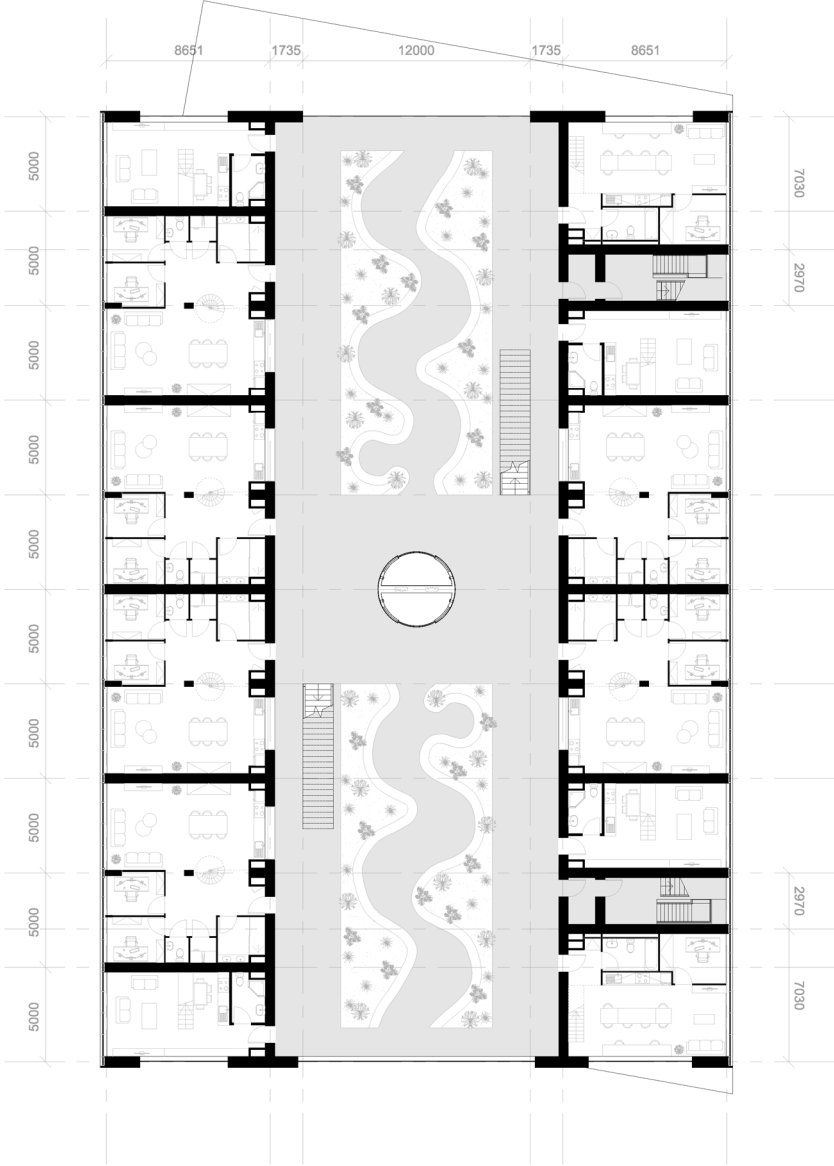


Figure 92: Entrance garage + visitor entrance + park entrance. (Machgeels, D., 2021)



2 + 8000

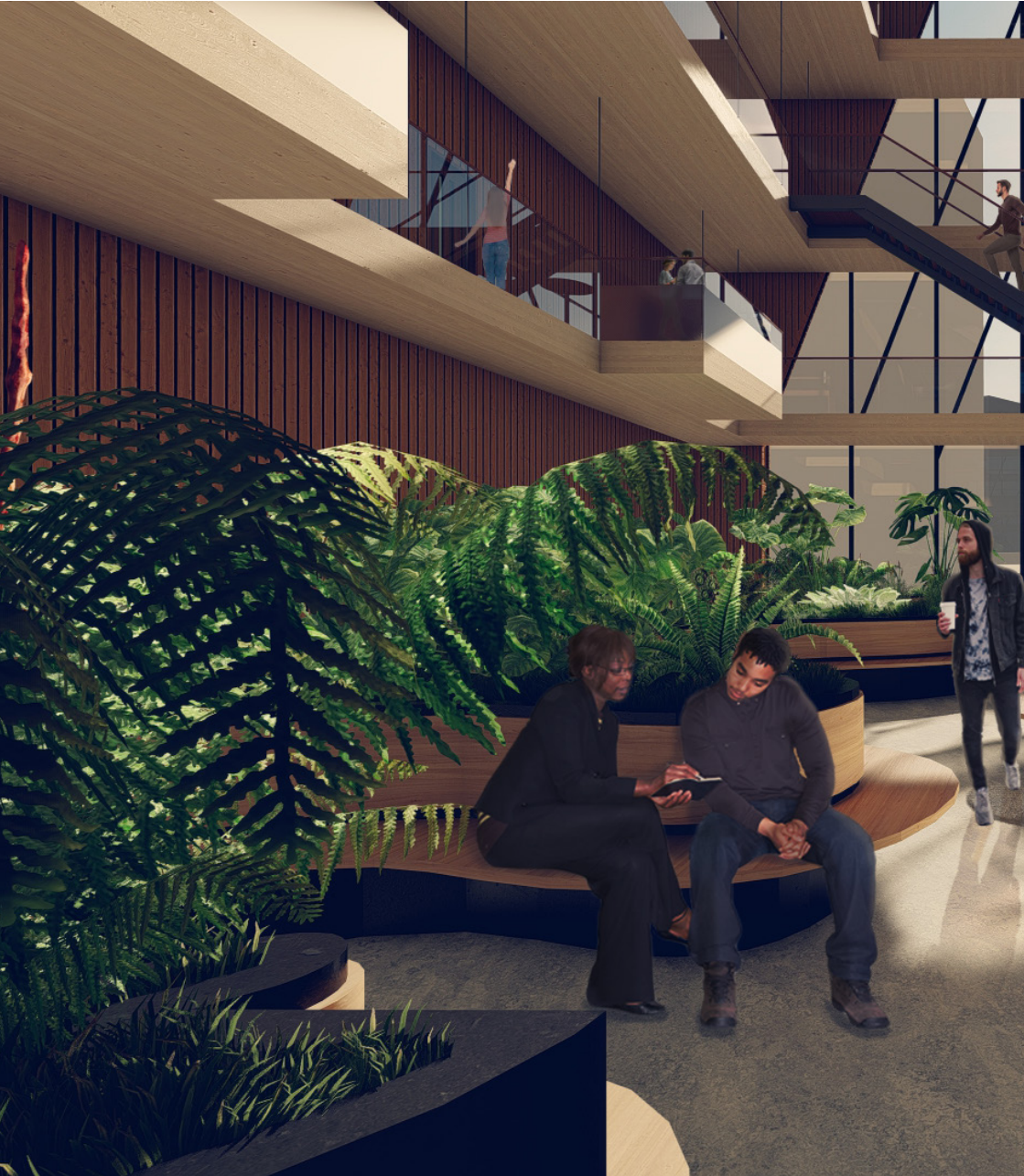




3 + 12000







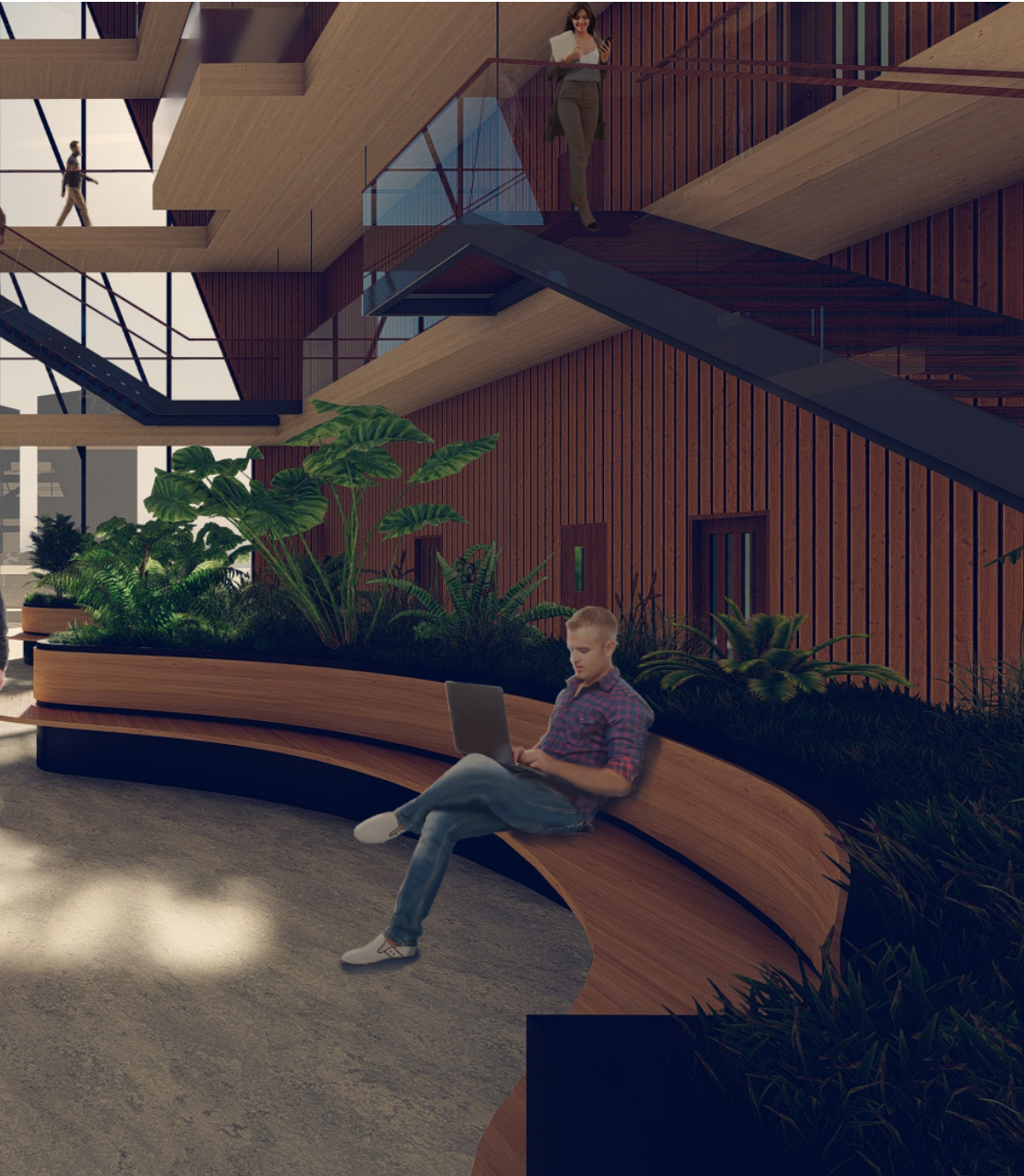
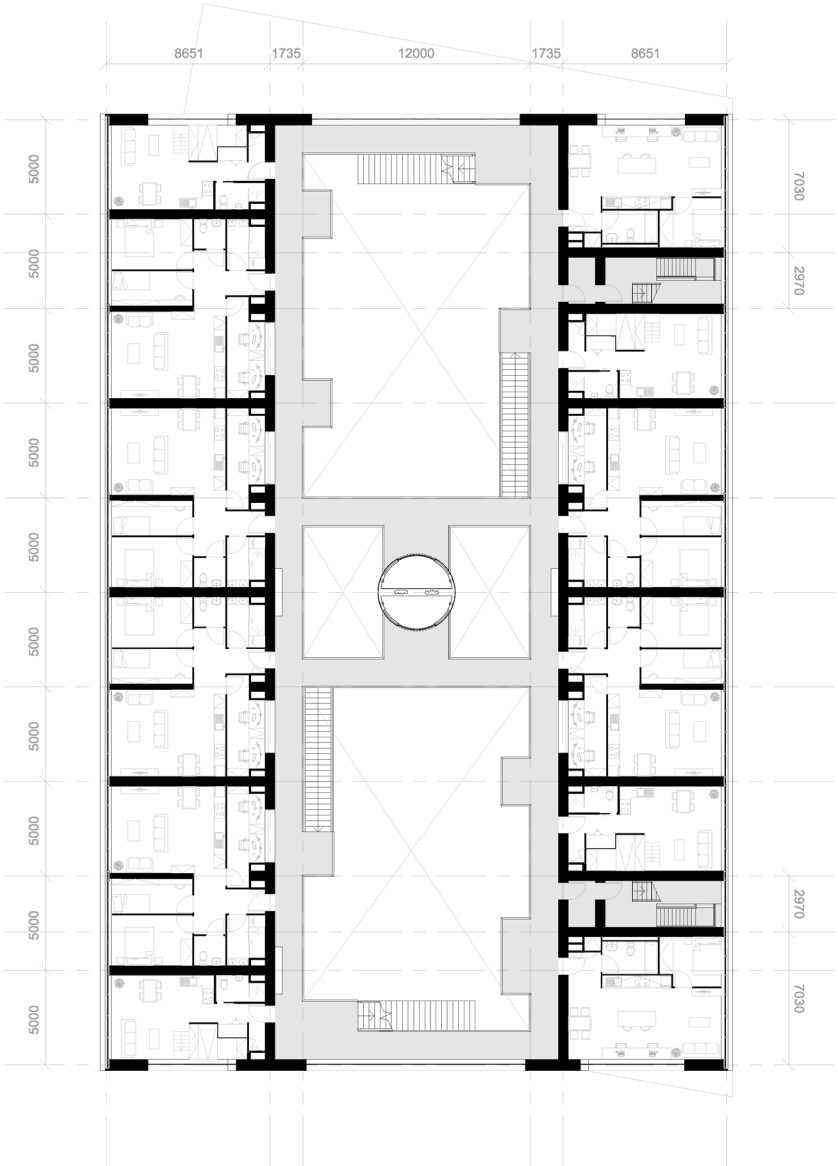
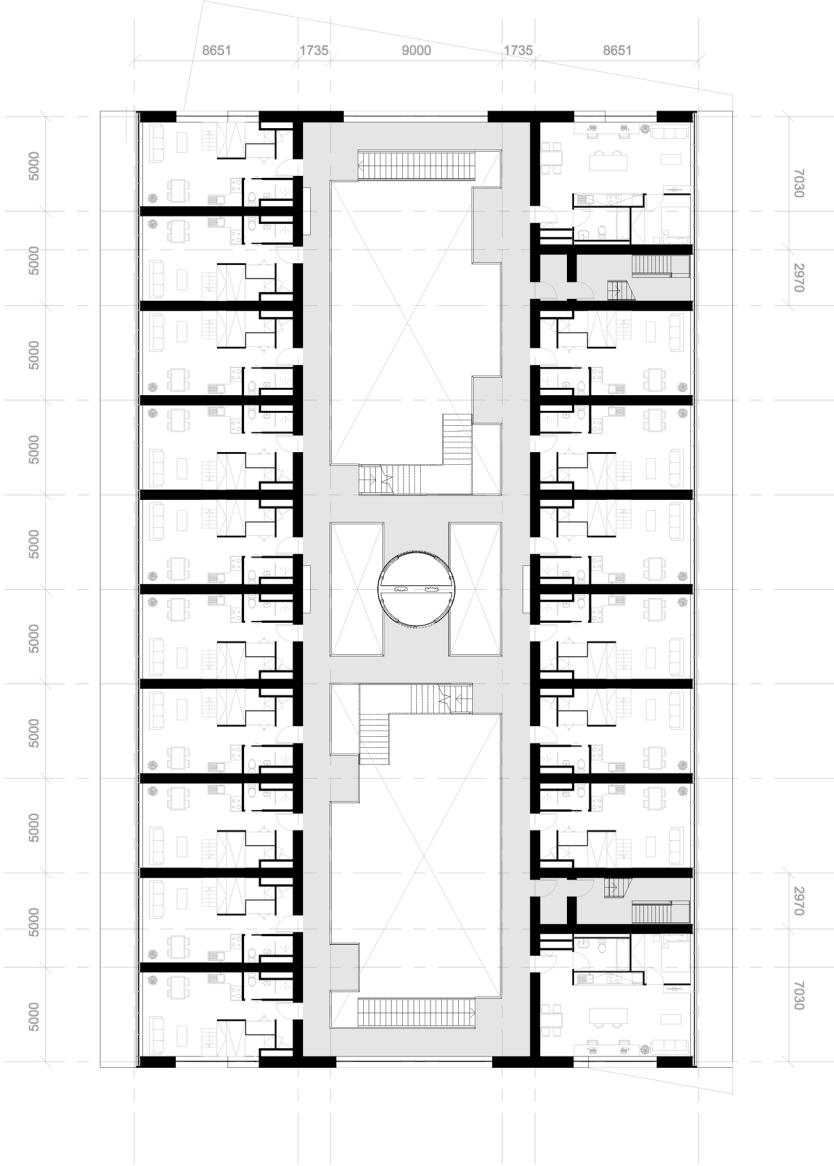


Figure 93: Oasis on first residential floor. (Machgeels, D., 2021)

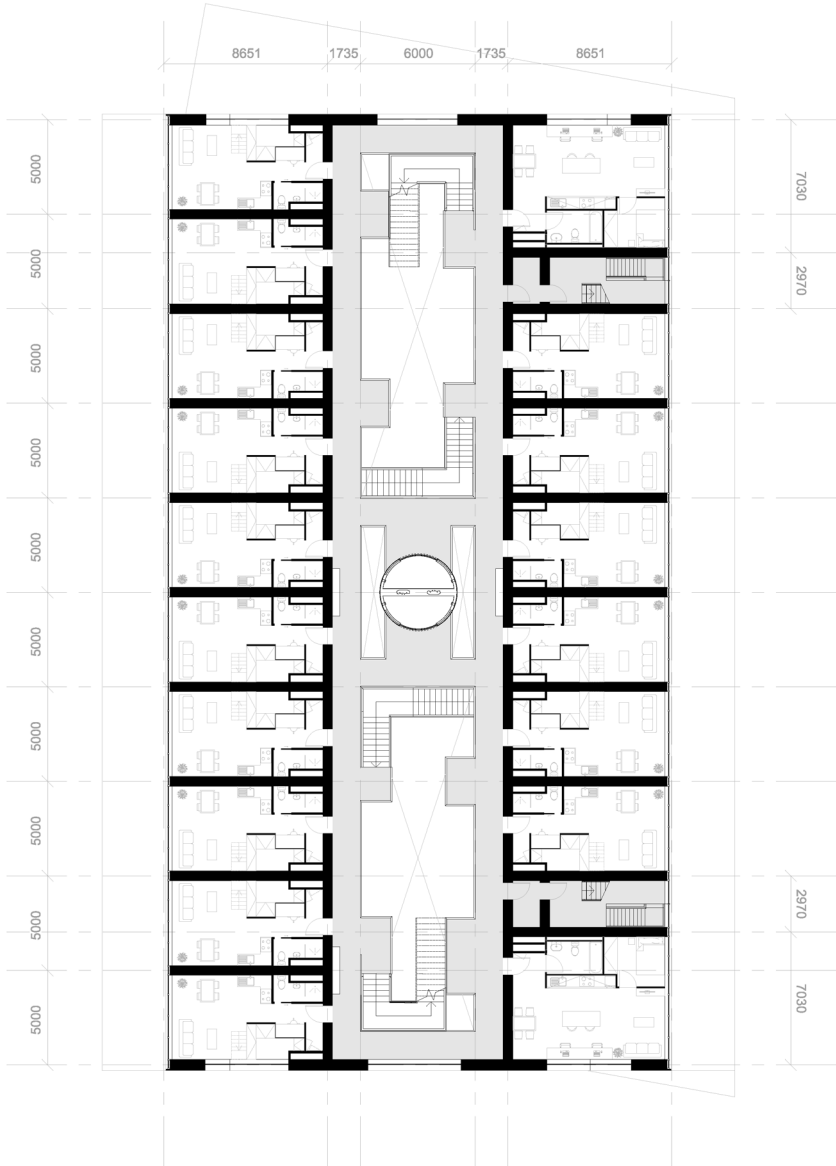


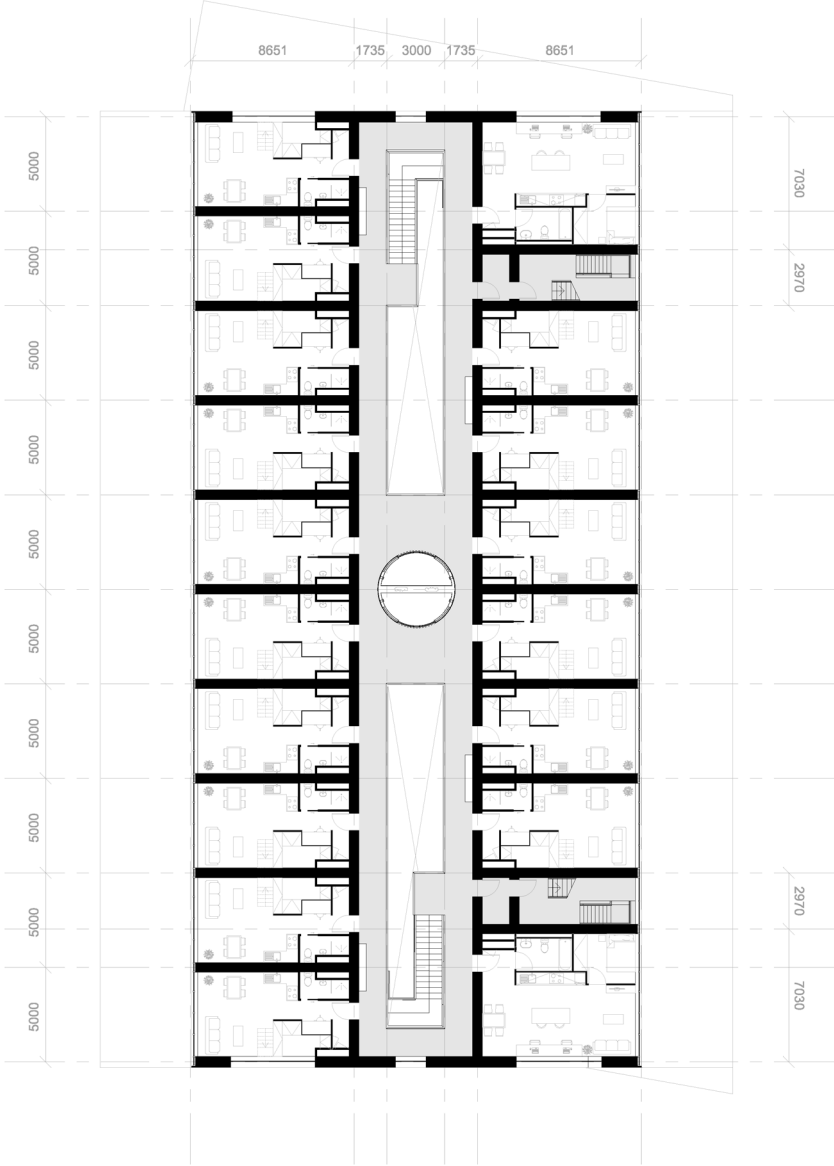




5 + 20975







7 + 28975

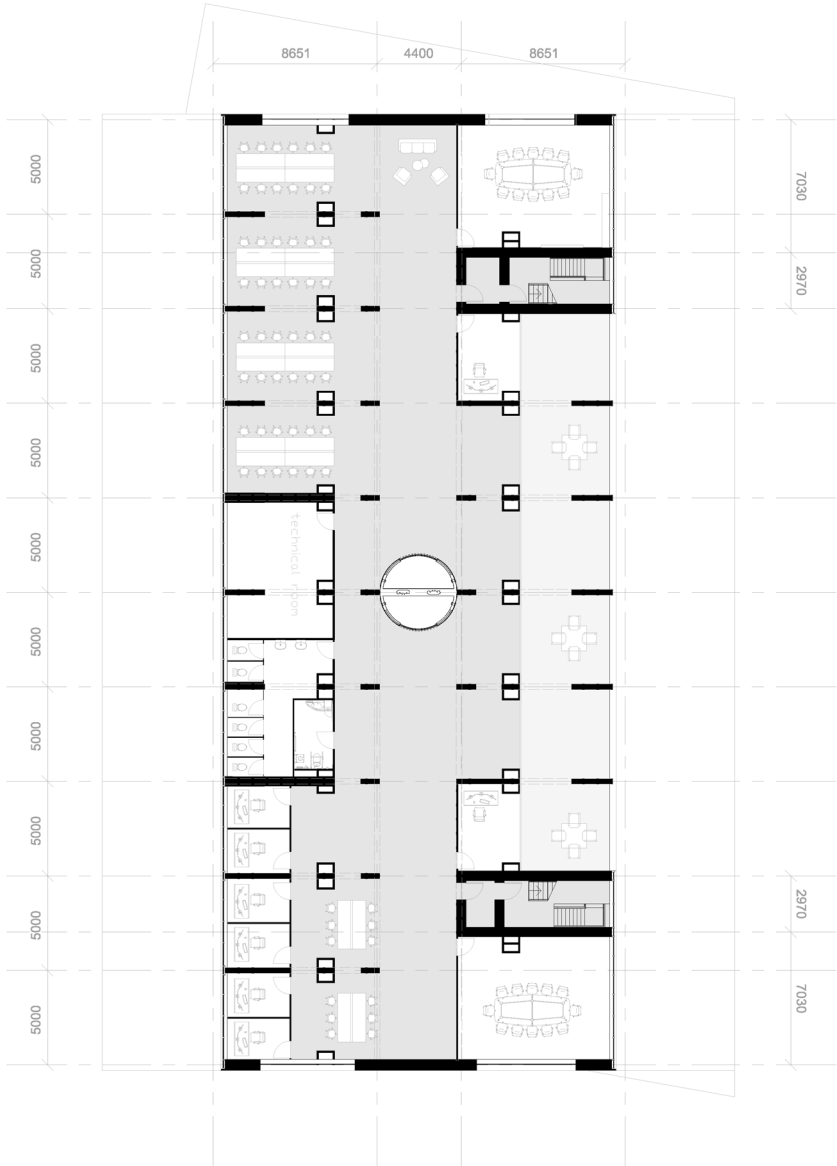








Figure 94: Bottom atrium. (Machgeels, D., 2021)



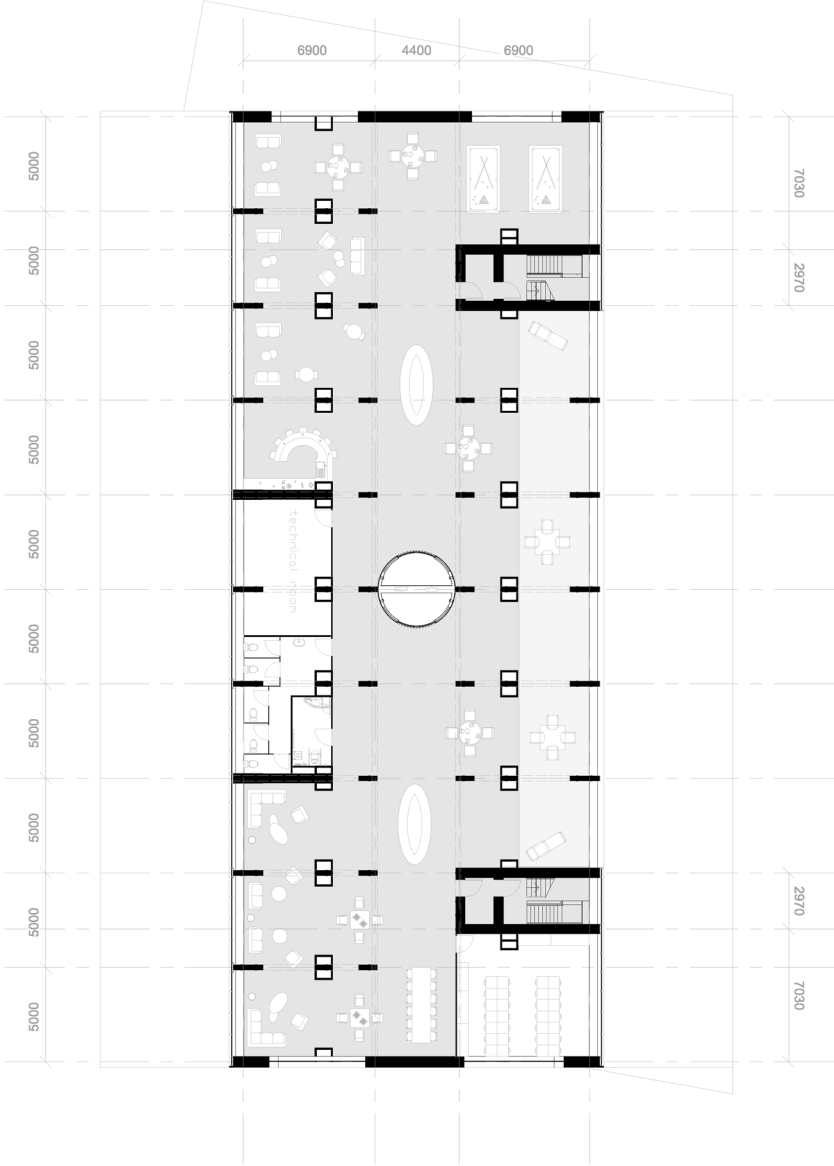








Figure 95: Free workspaces workfloor. (Machgeels, D., 2021)







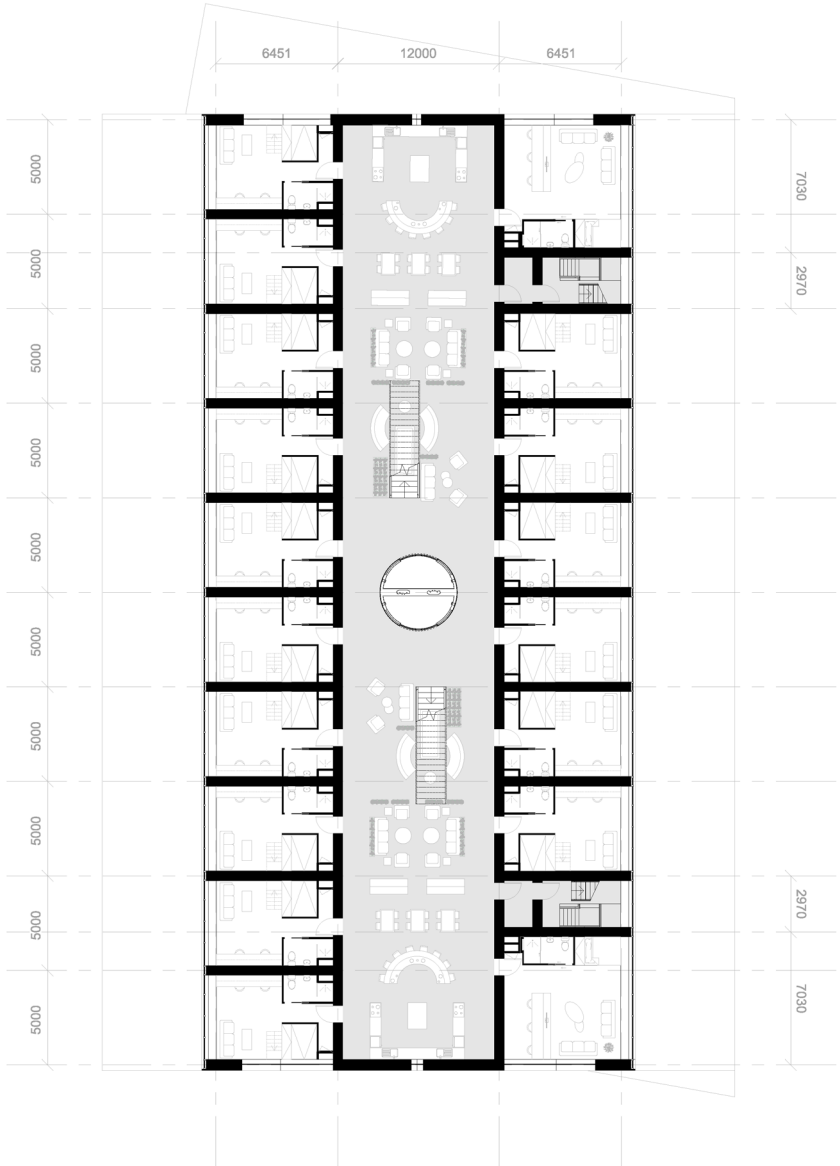
Figure 96: Relax floor lounge. (Machgeels, D., 2021)

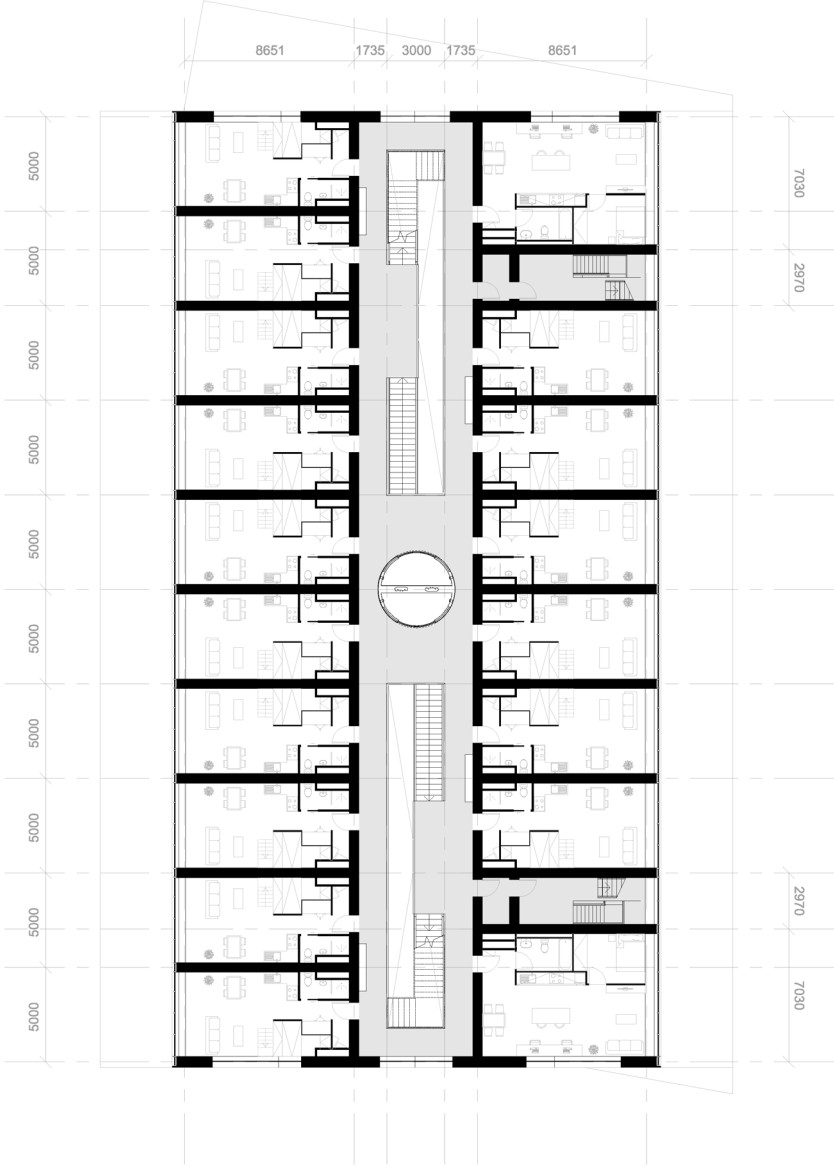






Figure 97: Outdoor terrace communal floors. (Machgeels, D., 2021)





11 + 45475



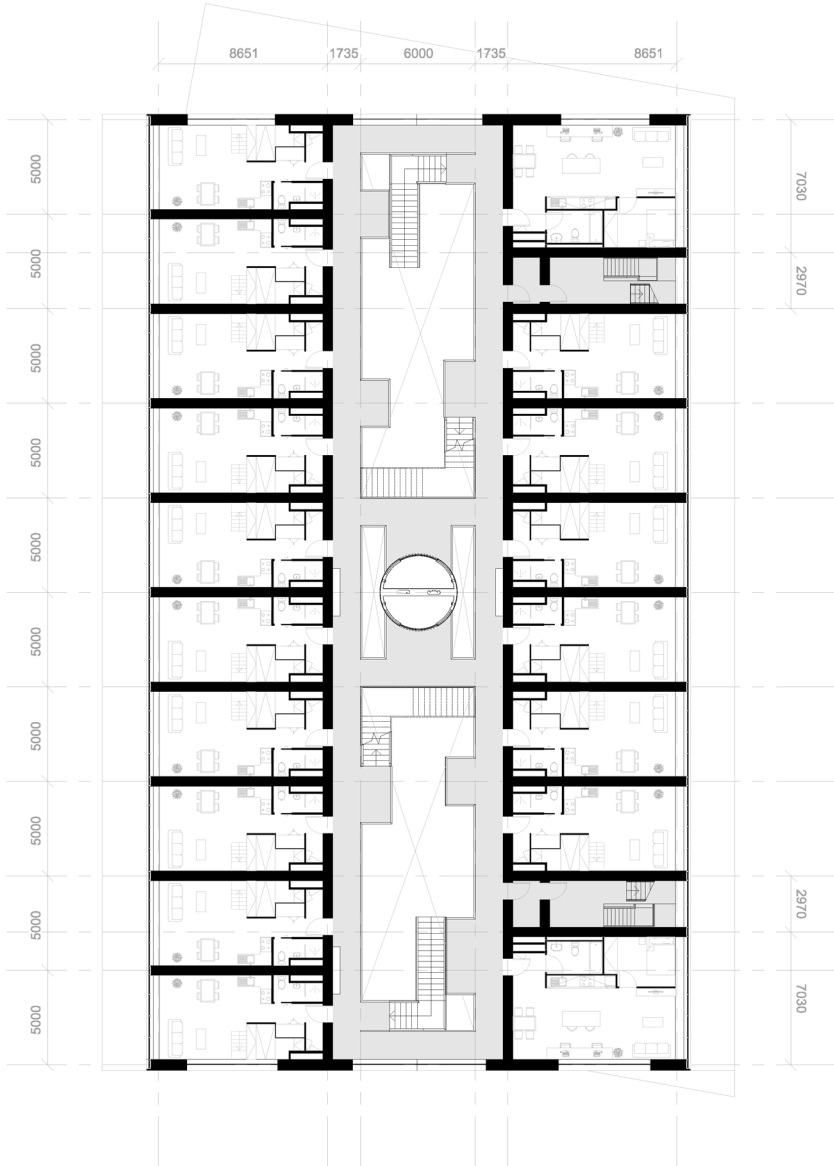






Figure 98: Communal kitchen (bottom floor top atrium), (Machgeels, D., 2021)





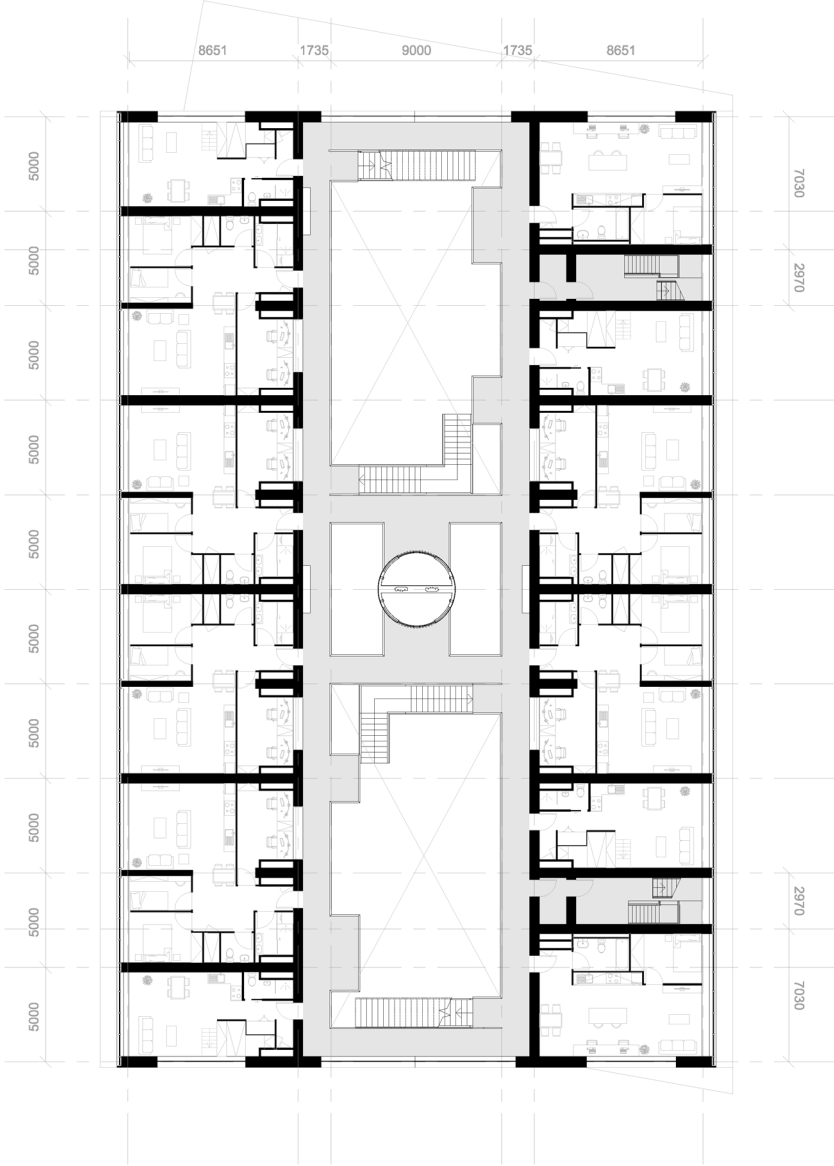
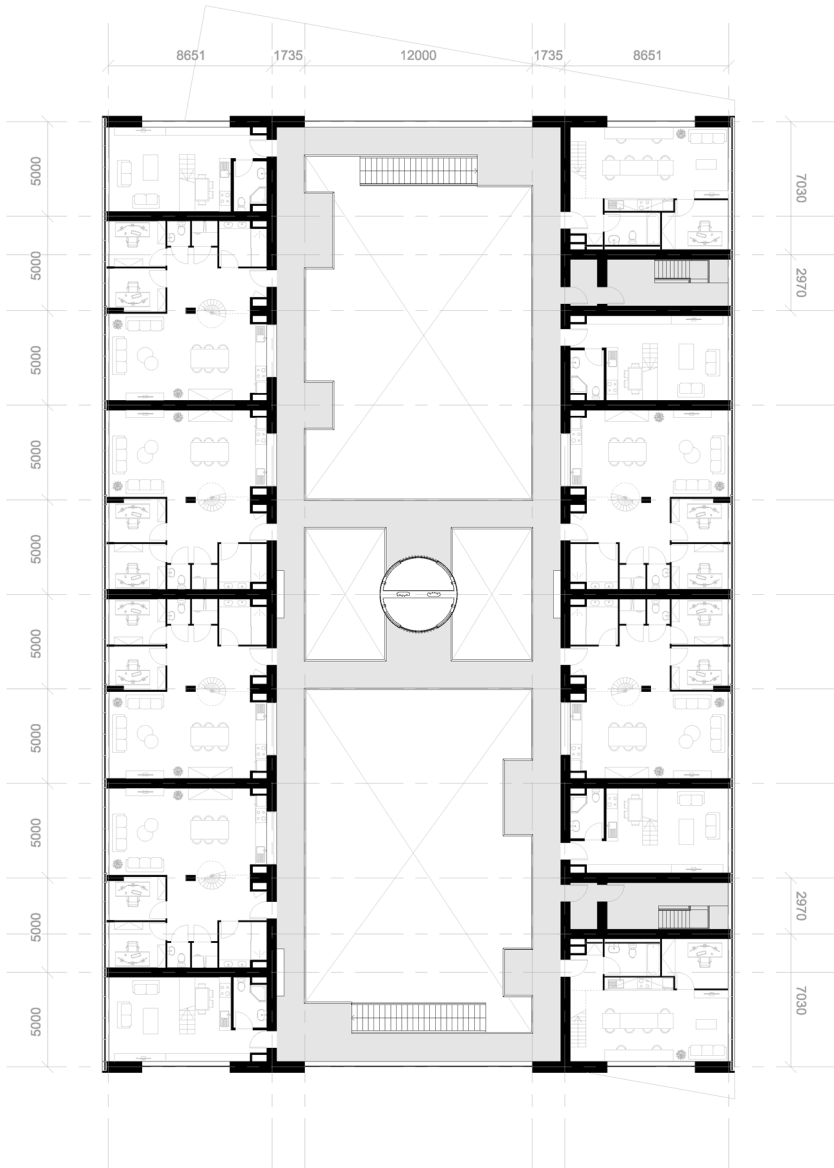






Figure 99: Top atrium. (Machgeels, D., 2021)





## MORE THAN AN ELEVATED CURB

Within the atrium a total of 24 balconies and other additions can be found. These additions transform the atrium into an extension of the work and live environment of the residents. By creating a variety of spaces for the residents to meet or work together literally outside of their front door, the community feeling within the building will be improved.

The spaces within the atrium do not act as a replacement for the communal floors at the heart of the building, but can rather be seen as an extension of this space. The atrium itself is mostly going to function as a space where people will sit when they either want to have a change of scenery, but don't want to bother walking down to the communal floors, or when they want to meet / work / have a chat with their neighbours.

Meetings between neighbours will be very frequent in this space as it offers not only workspaces, but also coffee corners, lounge spaces, benches receded in the atrium walls and a nice light and open atmosphere. Additionally greenery is added within the atrium, receded into the wall in the same way as the benches to liven up the atrium.

The balconies have two sizes, one of 2,5 x 1,5 meters and another of 4 x 1,5 meters. The amount of people that can meet or will be able to work together in these spaces is determined by the size of these balconies.

However unlike the communal workfloor, these balconies are not meant as a complete replacement of your workspace, but rather an in-between. As mentioned before it is an extension of the work live, a place for neighbours to chat and work together for a time and then after a while go their separate ways again.

Each of the balconies (see figure 100) is provided with their own power outlets, which are prefabricated into the floor panels. These power outlets are recessed into the floor and can be almost completely hidden away by closing the lids on the sockets. These sockets not only provide power but also have ethernet ports, however as the whole atrium has Wi-Fi these are optional. Depending on the size of the balcony the amount of sockets can be increased, the same installation is used for multiple sockets. The only requirement is to place the sockets along the railing to reduce their visibility.

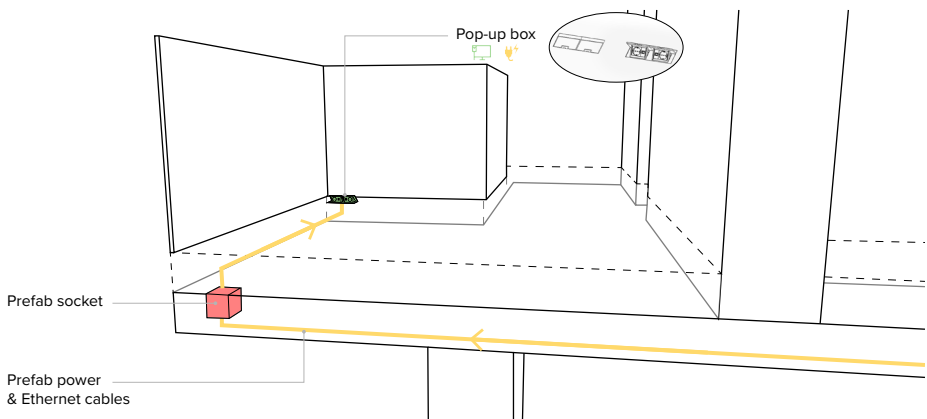


Figure 100: Power and internet to balconies. (Machgeels, D., 2021)



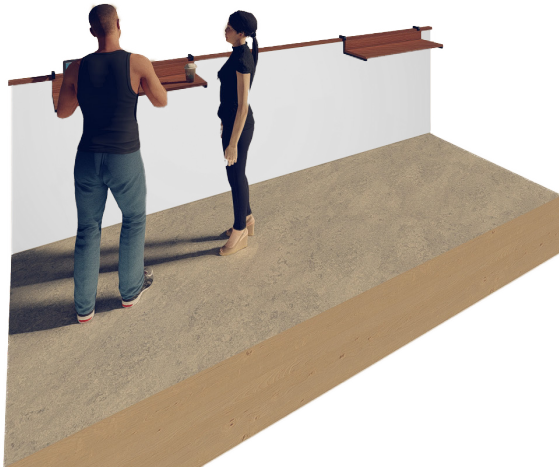


Figure 101: Hanging tables / shelves on railing. (Machgeels, D., 2021)

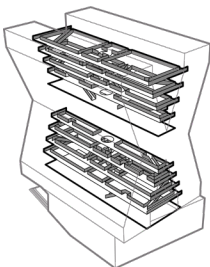




Figure 102: Greenery element in atrium wall. (Machgeels, D., 2021)

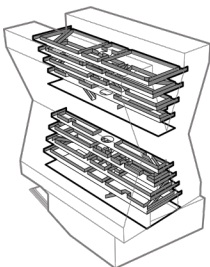




Figure 103: *Integrated bench.* (Machgeels, D., 2021)

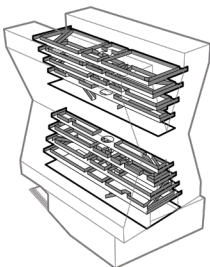
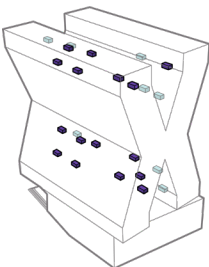




Figure 104: Small balcony workspace. (Machgeels, D., 2021)



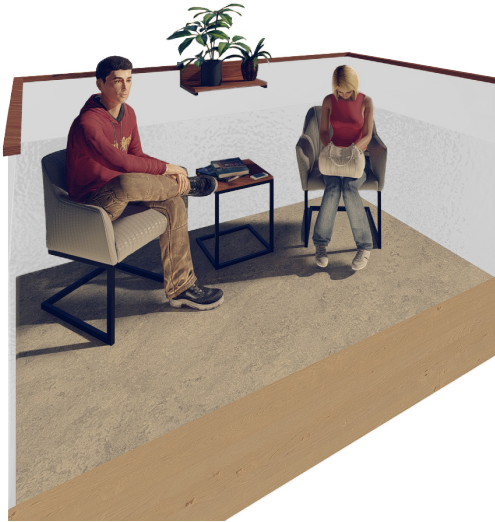


Figure 105: Small balcony casual seat. (Machgeels, D., 2021)

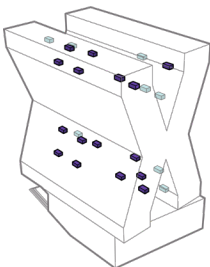
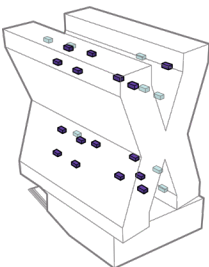




Figure 106: Small balcony booth (work + leisure). (Machgeels, D., 2021)



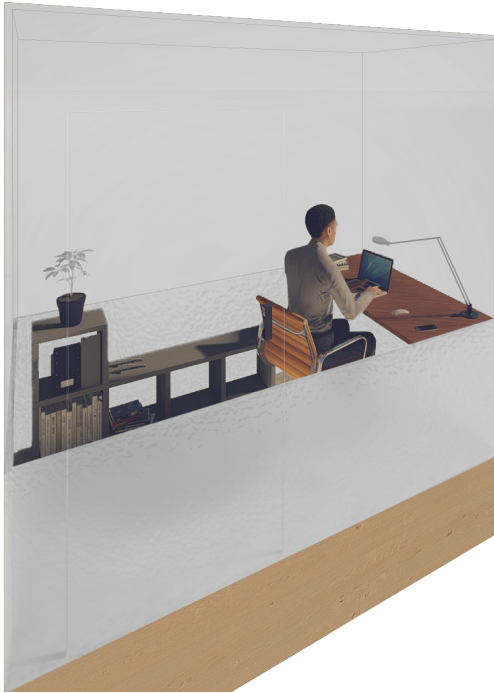


Figure 107: Small balcony private work cell. (Machgeels, D., 2021)

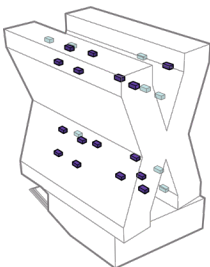






Figure 108: Large balcony coffee corner + bar. (Machgeels, D., 2021)

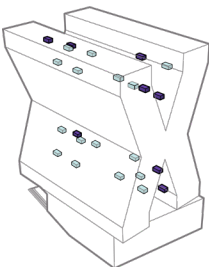




Figure 109: Large balcony coffee corner + standing tables. (Machgeels, D., 2021)

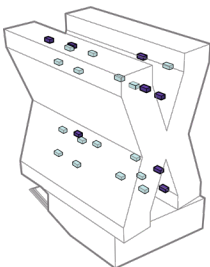




Figure 110: Large balcony workspace. (Machgeels, D., 2021)

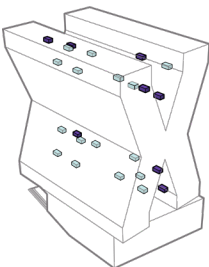




Figure 111: Large balcony play / reading corner. (Machgeels, D., 2021)

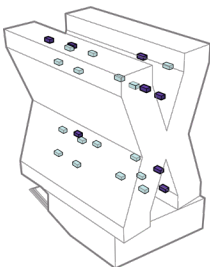




Figure 112: Large balcony double booth (work + leisure). (Machgeels, D., 2021)

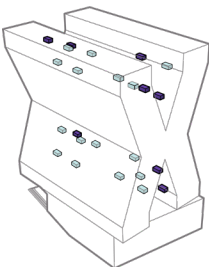




Figure 113: Large balcony lounge. (Machgeels, D., 2021)

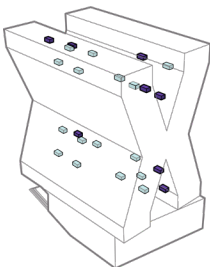




Figure 94: *Bottom atrium.* (Machgeels, D., 2021)



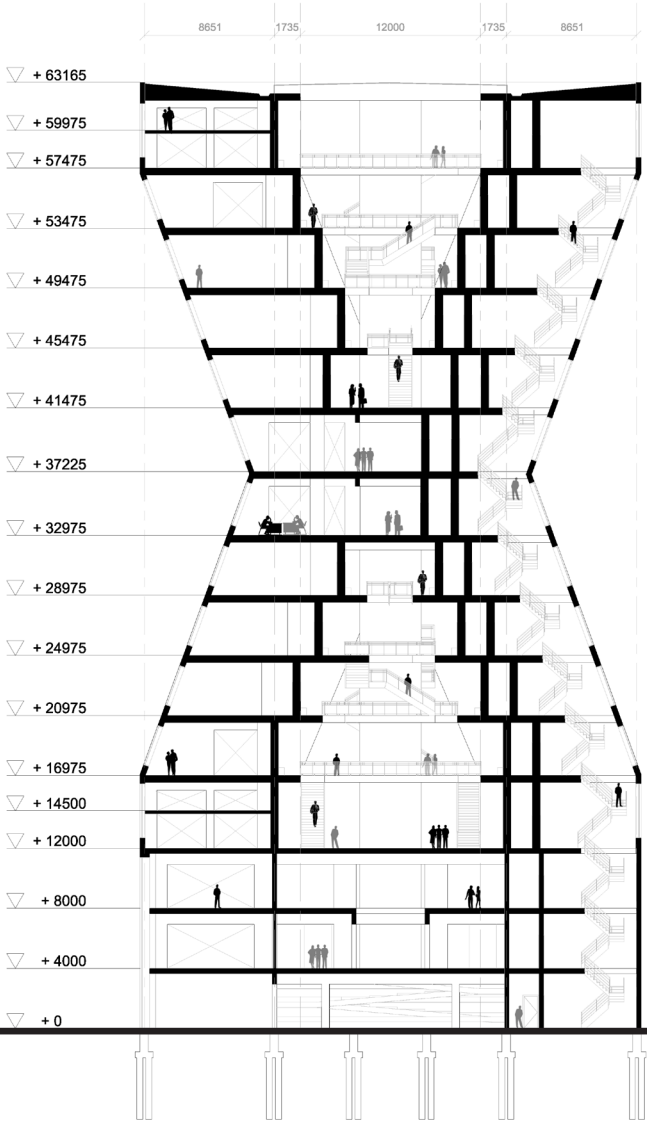
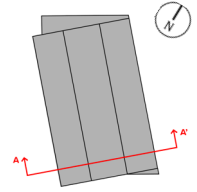


Figure 114: Section AA' (Machgeels, D., 2021)

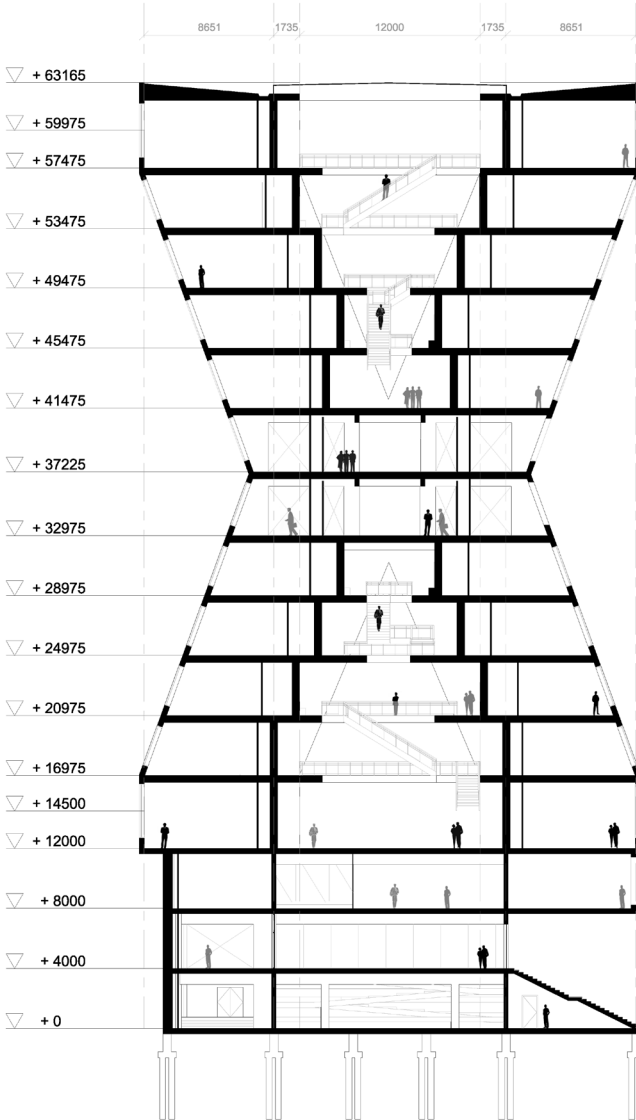
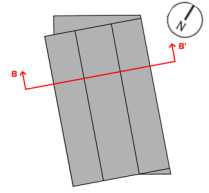


Figure 115: Section BB'. (Machgeels, D., 2021)

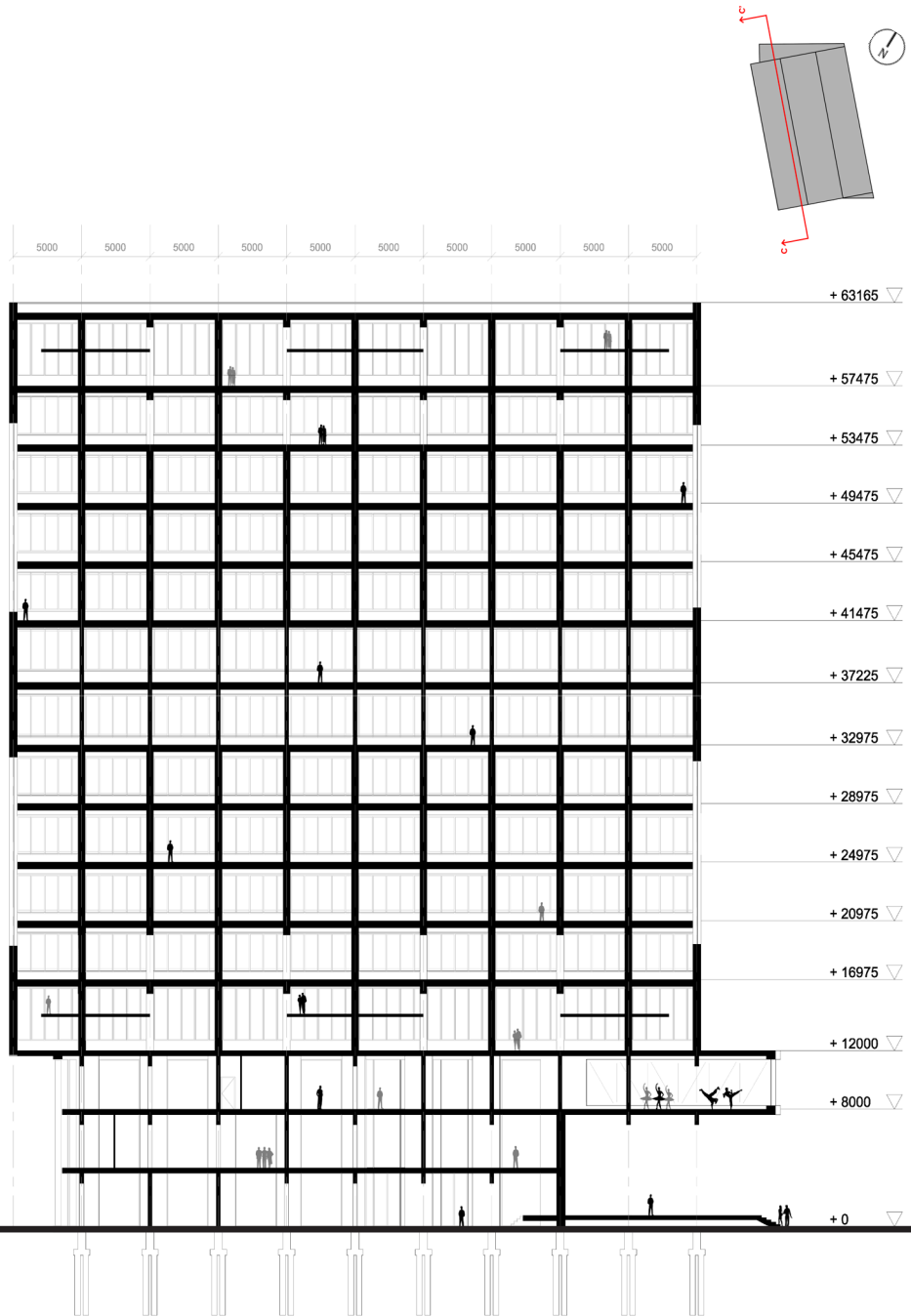


Figure 116: Section CC: (Machgeels, D., 2021)

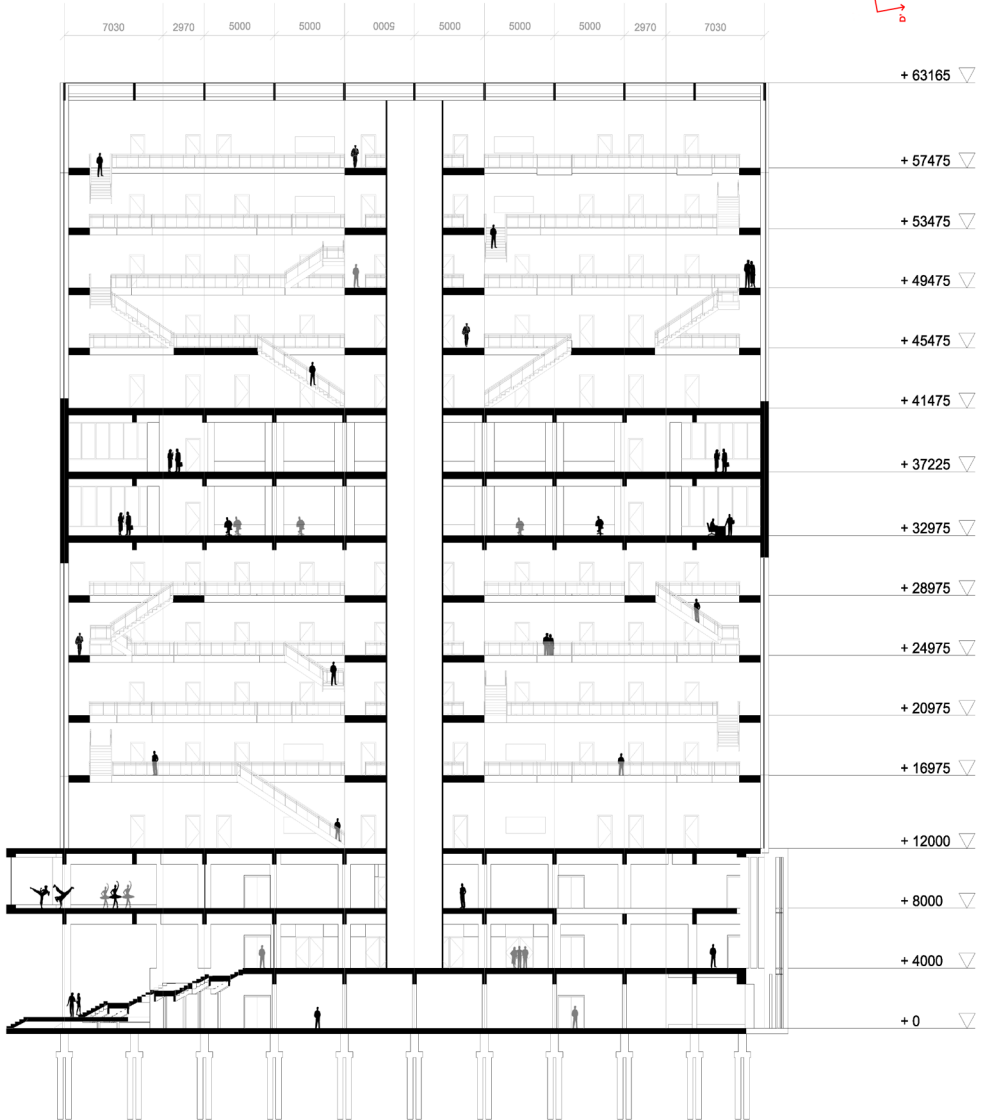
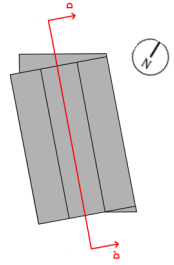


Figure 117: Section DD'. (Machgeels, D., 2021)

## BUILDING APPEARANCE

Taking inspiration from the surrounding area and its buildings the materials for AXess were chosen. As AXess adds a new type of function into the area, something that has nothing to do with the current functions, it only seemed fitting to also give the building or at least the part of the building a new look. The tower part of AXess is clad with Pine wood planks, these planks are treated with oil as to preserve the light brown color, which matches the overall brown color scheme in the area. Even though a new material is introduced the overall color scheme used by the already existing building and the aesthetic of M4H won't be disturbed as this color will fit nicely within the already present brown color scheme.

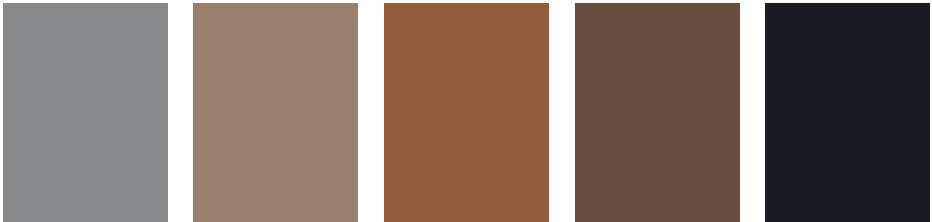
Building on the idea of referencing the already present buildings and history of the harbor several similar materials are chosen to be used within the new building. First of all concrete is used for the construction of the bottom part of the building as well as part of the cladding, serving both a structural and aesthetic purpose as in some of the other buildings on the site. Secondly dark / black steel is used for the window frames. Keilepand for example uses black steel as an accent to highlight its railings and staircases on the outside of the building. As my building doesn't

have these ornaments on the outside of the building, the choice was made to bring this material back in a different way, in this case in the window frames.

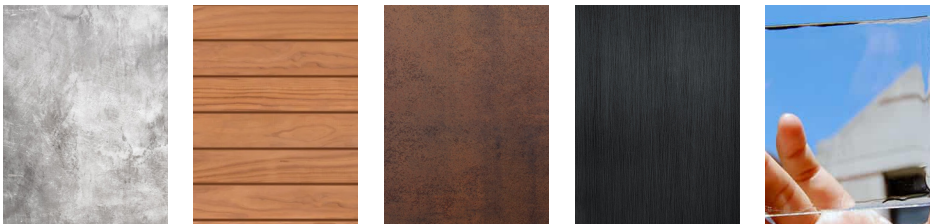
Lastly and possibly the biggest reference to the harbor idea and its history is the corten steel, used on the commercial plinth. The first three floors are the same height as the warehouses and the Keilepand in the area, referencing the harbor first of all that way and secondly in its material. As mentioned in the material context (see appendix A in the reflection), there are several parts in the harbor that have these weathered metal constructions, using corten steel this same kind of color and feel will be created by the building. Increasing the harbor like atmosphere and paying homage to its heritage.

Additionally since the function is that of a residential complex, more and bigger windows are used compared to the other buildings in the area. My building, which makes use of 2 big atria, can be seen as a direct link to the Studio Roosegaarde next door because of its large glass surfaces. The glass surfaces do not only reference the surroundings, but also create a more open and welcoming sphere in the area and building.

### COLOR-AIM



### MATERIALS



Concrete

Pine thermowood

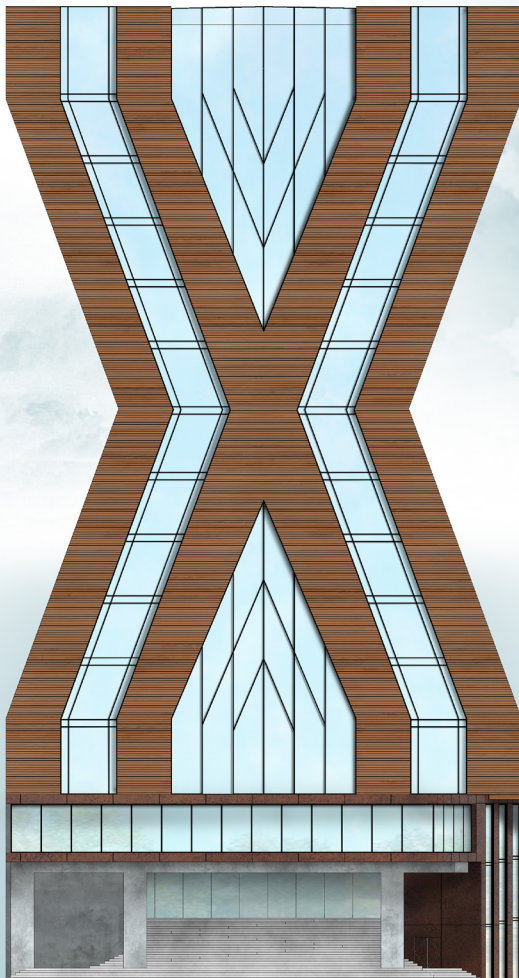
Corten steel

Black aluminium

PV-cell glass

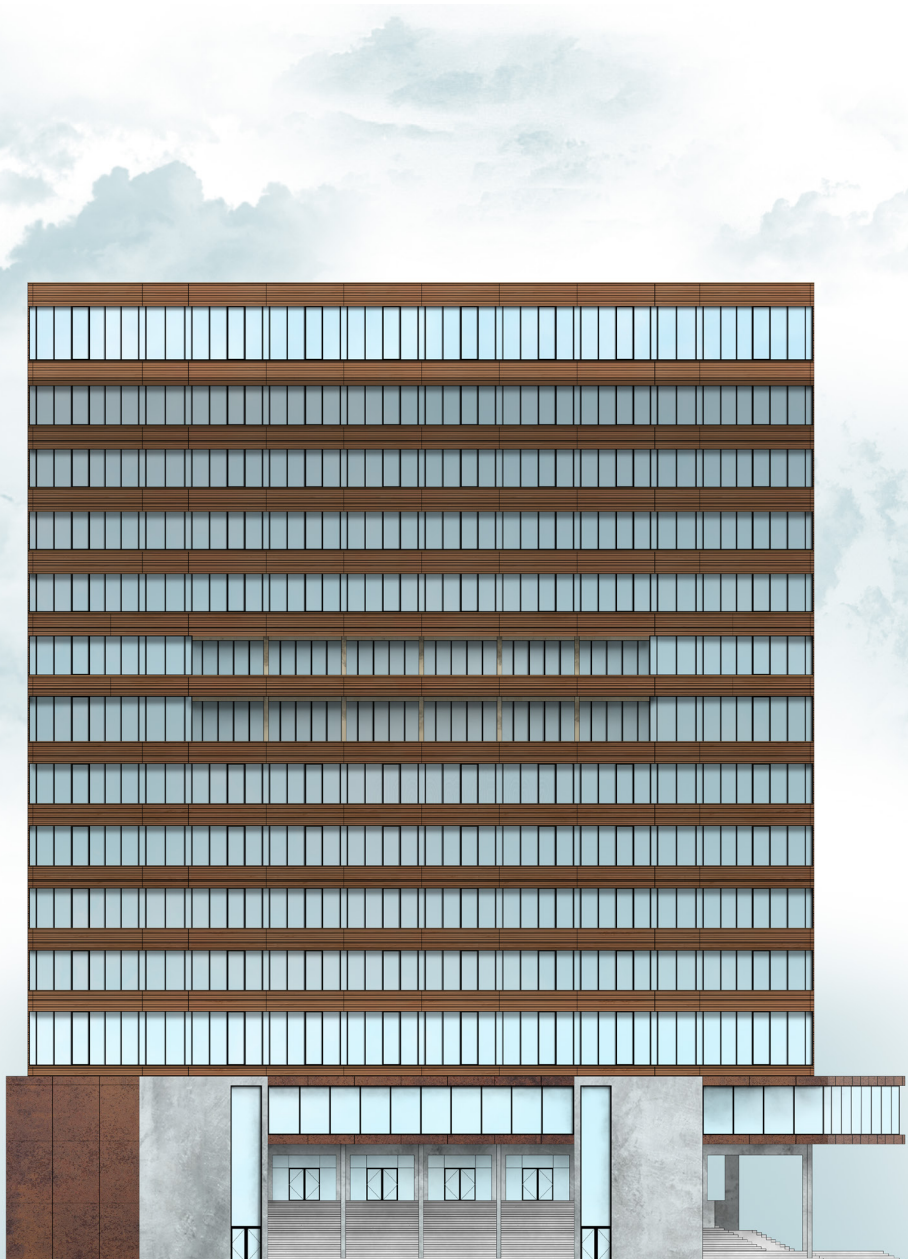
**NORTH (WEST) FAÇADE**

Figure 118: North (West) façade. (Machgeels, D., 2021)



**(NORTH) EAST FAÇADE**

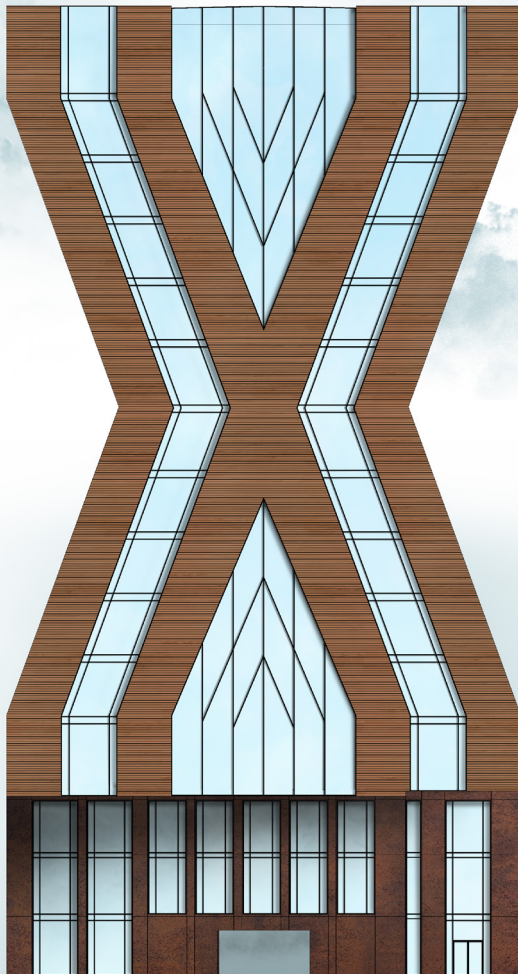
Figure 119: (North) East façade. (Machgeels, D., 2021)





**SOUTH (EAST) FAÇADE**

Figure 120: *South (East) façade.* (Machgeels, D., 2021)



**(SOUTH) WEST FAÇADE**

Figure 121: (South) West façade. (Machgeels, D., 2021)

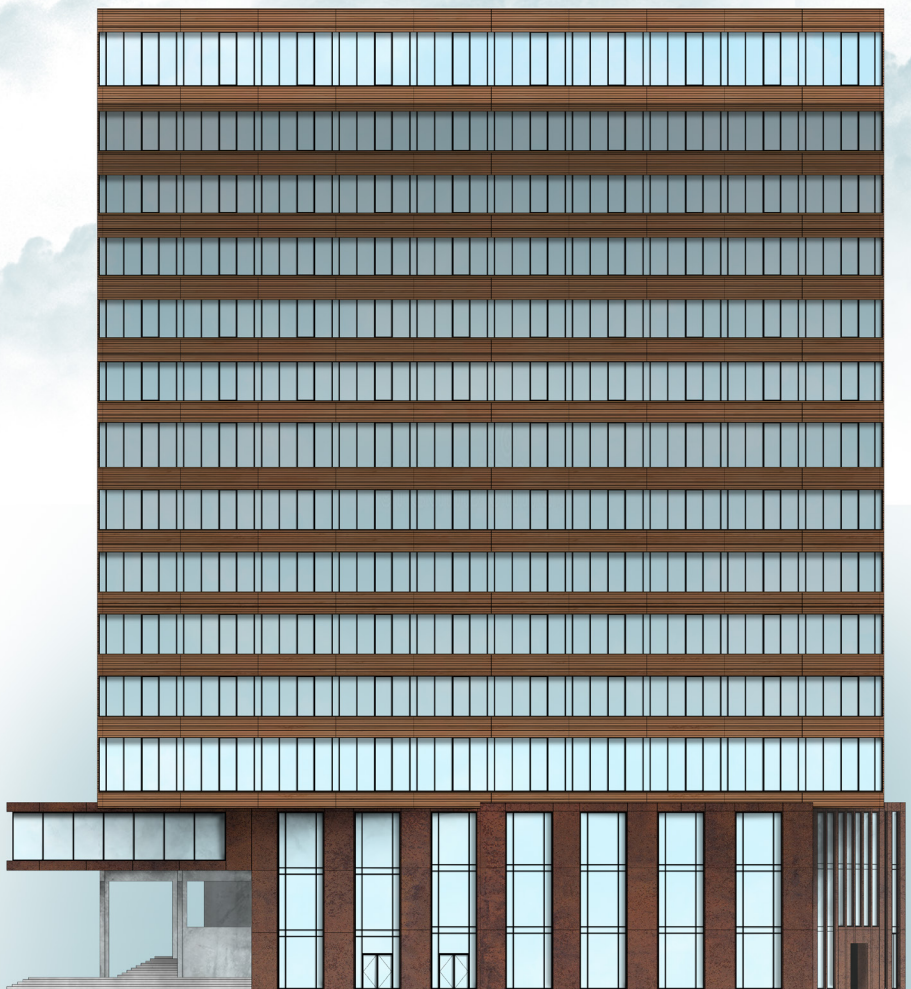
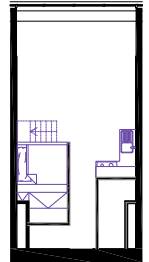
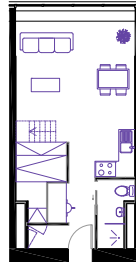
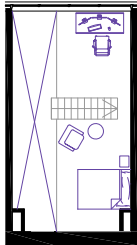
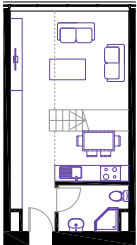
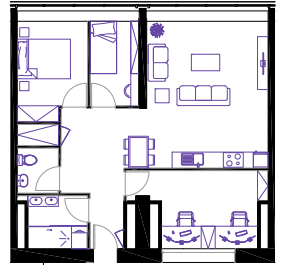
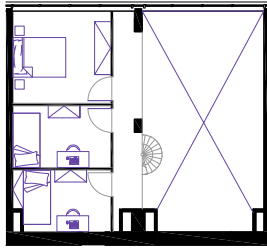
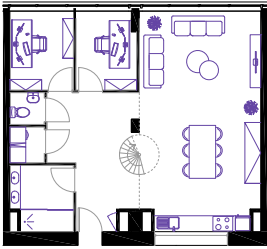
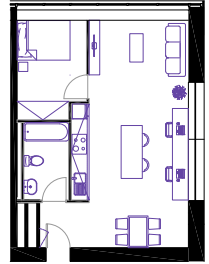
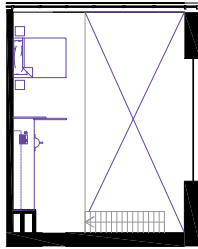
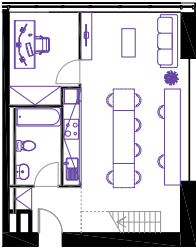


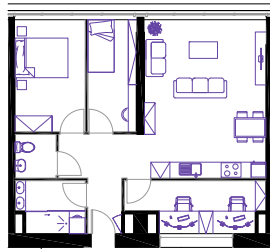
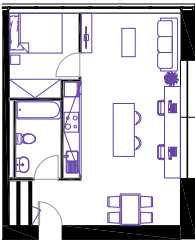
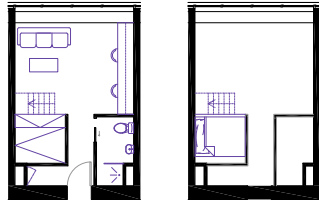
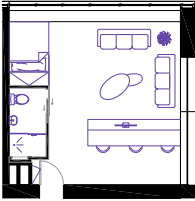


Figure 122: Building in location birdseye. (Machgeels, D., 2021)

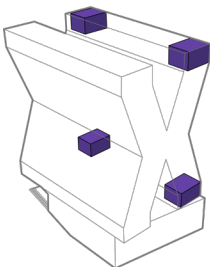
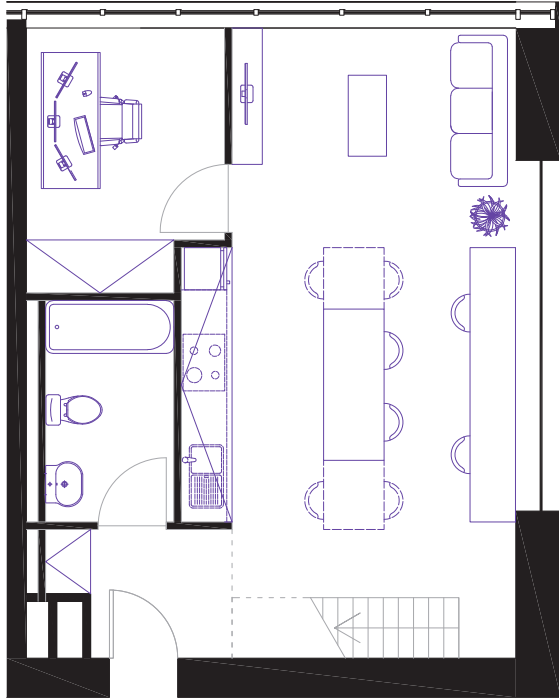


# DWELLING



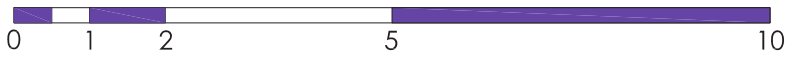
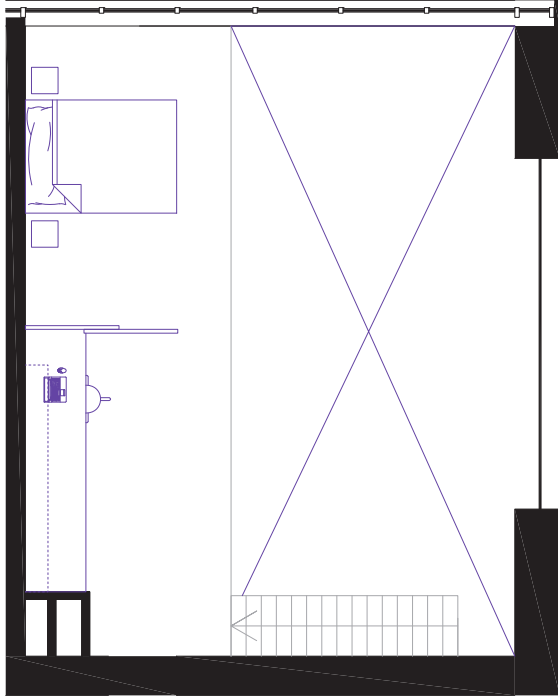


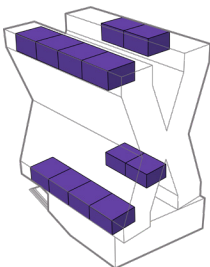
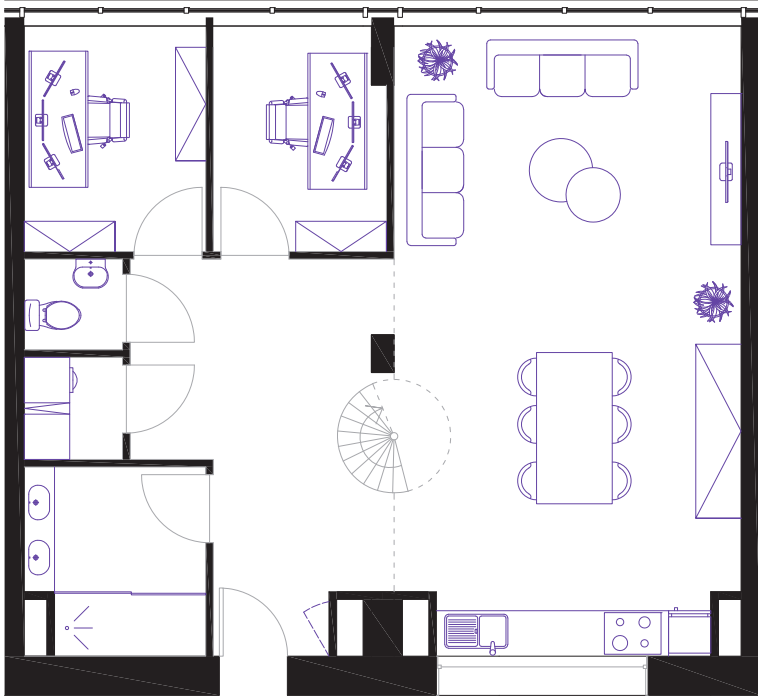




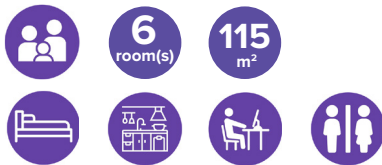
### MULTILAYER CORNER APARTMENT

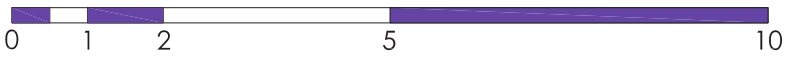
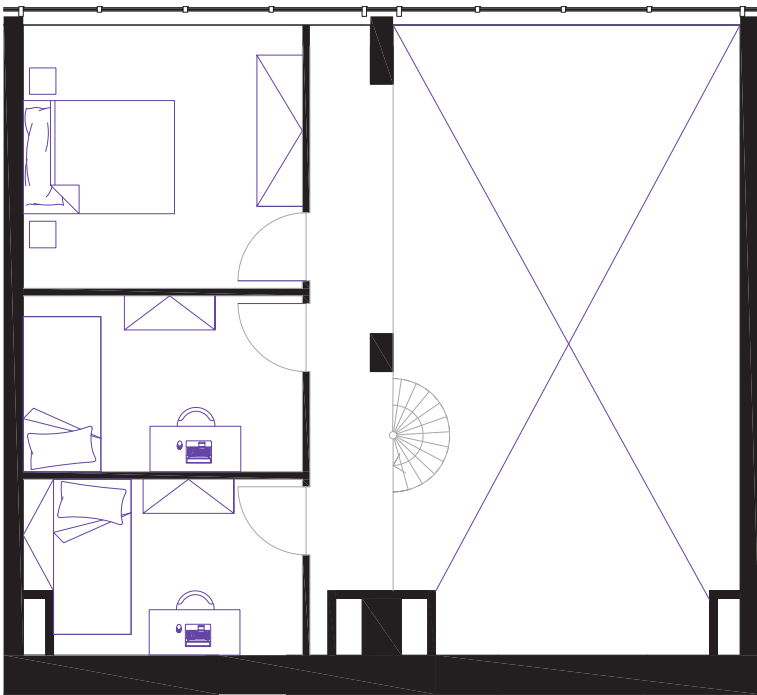


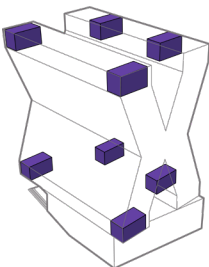
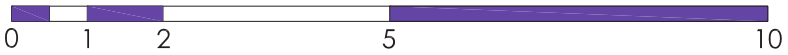
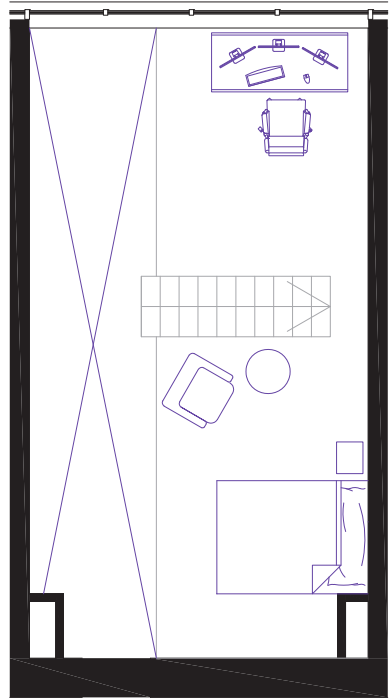
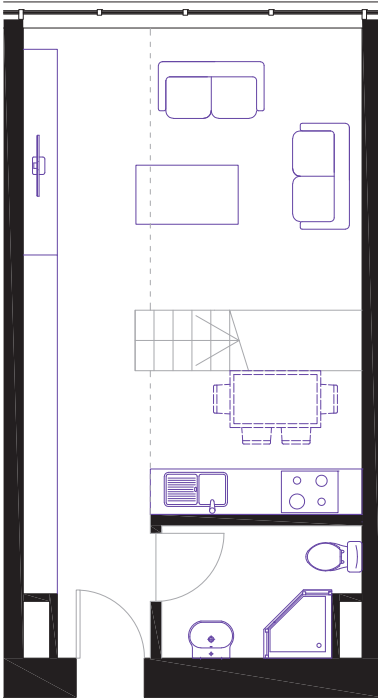




### MULTILAYER LARGE APARTMENT







**LOFT**



## LOFT

The Loft type apartment is located on the 4th and 14th floor of the tower. Besides the Studio+ dwellings this is the main dwelling typology in the building, catering to singles and couples. Because of the flexible structure the 4th and 14th floor can house the multilayer large apartment, as is seen in the current configuration. However it is possible to split these up to create 2 Loft apartments, by adding a separation wall in the open structure to create two closed apartments with each a 5 meter grid. As the floor height on these floors is higher than the regular floors in the building, the loft apartment like the other apartments on the same floor has a second floor with a ceiling height of 2 meters.

A special element is placed in the middle of the dwelling. This element is the staircase to the up-

per floor. This staircase acts as not only a staircase, but also doubles its function as a closet for the living room as well as a refrigerator, closet and foldable table for the kitchen side.

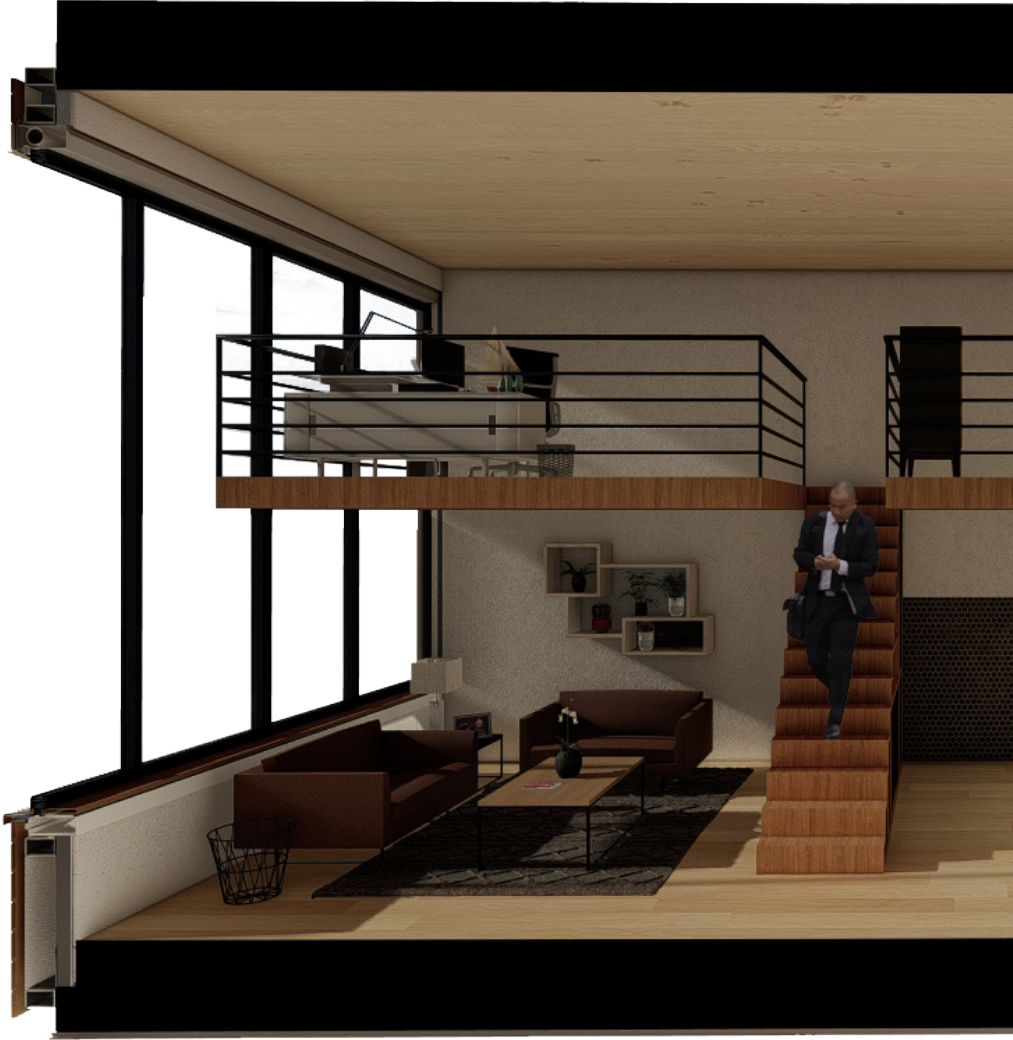
This staircase divides the dwelling in 2 parts, one part facing the window where the living room is located and on the other side the kitchen, entrance and bathroom. This same division can be found in a more subtle gesture in the second floor of the dwelling. Here the staircase acts as a separation element between the bedroom and workroom. Due to the open concept of the second floor these two functions could be switched around by the residents if they do so desire.







Figure 123: *Front section Loft.* (Machgeels, D., 2021)



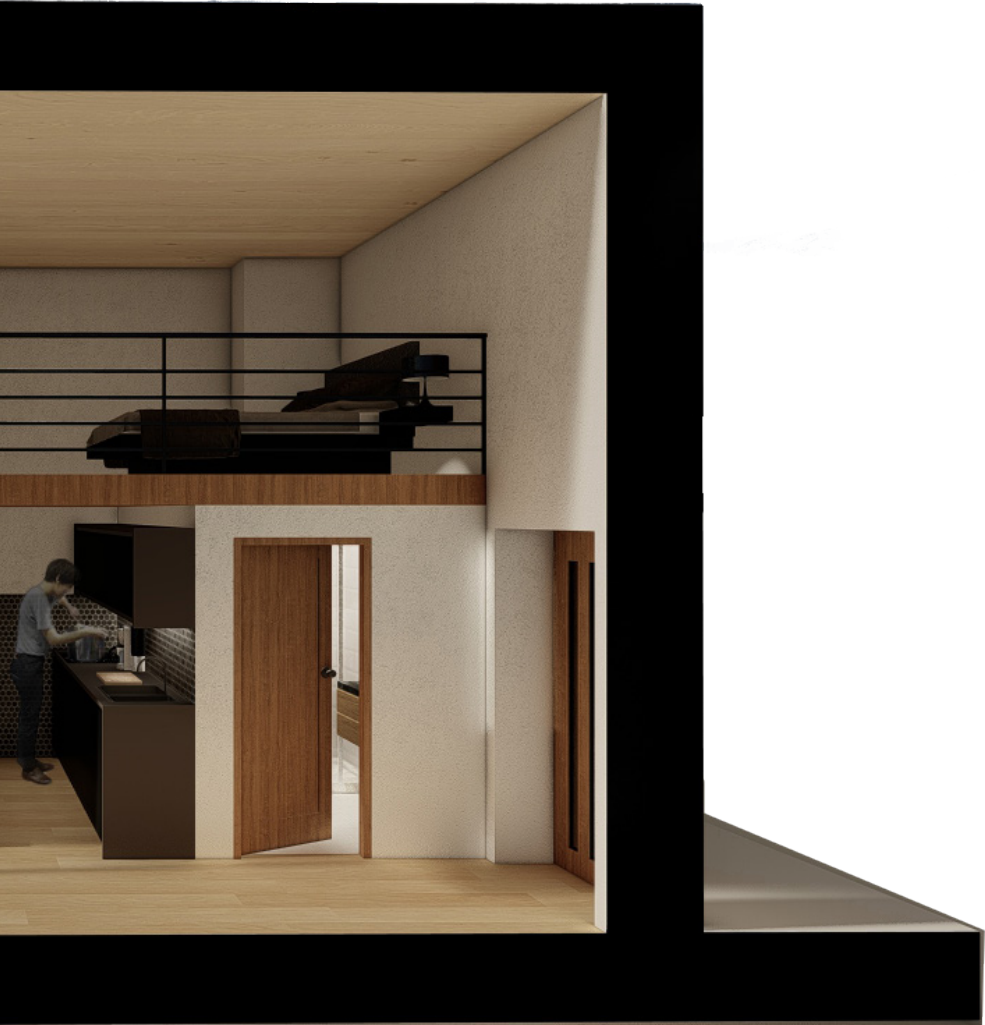


Figure 124: Side section Loft. (Machgeels, D., 2021)

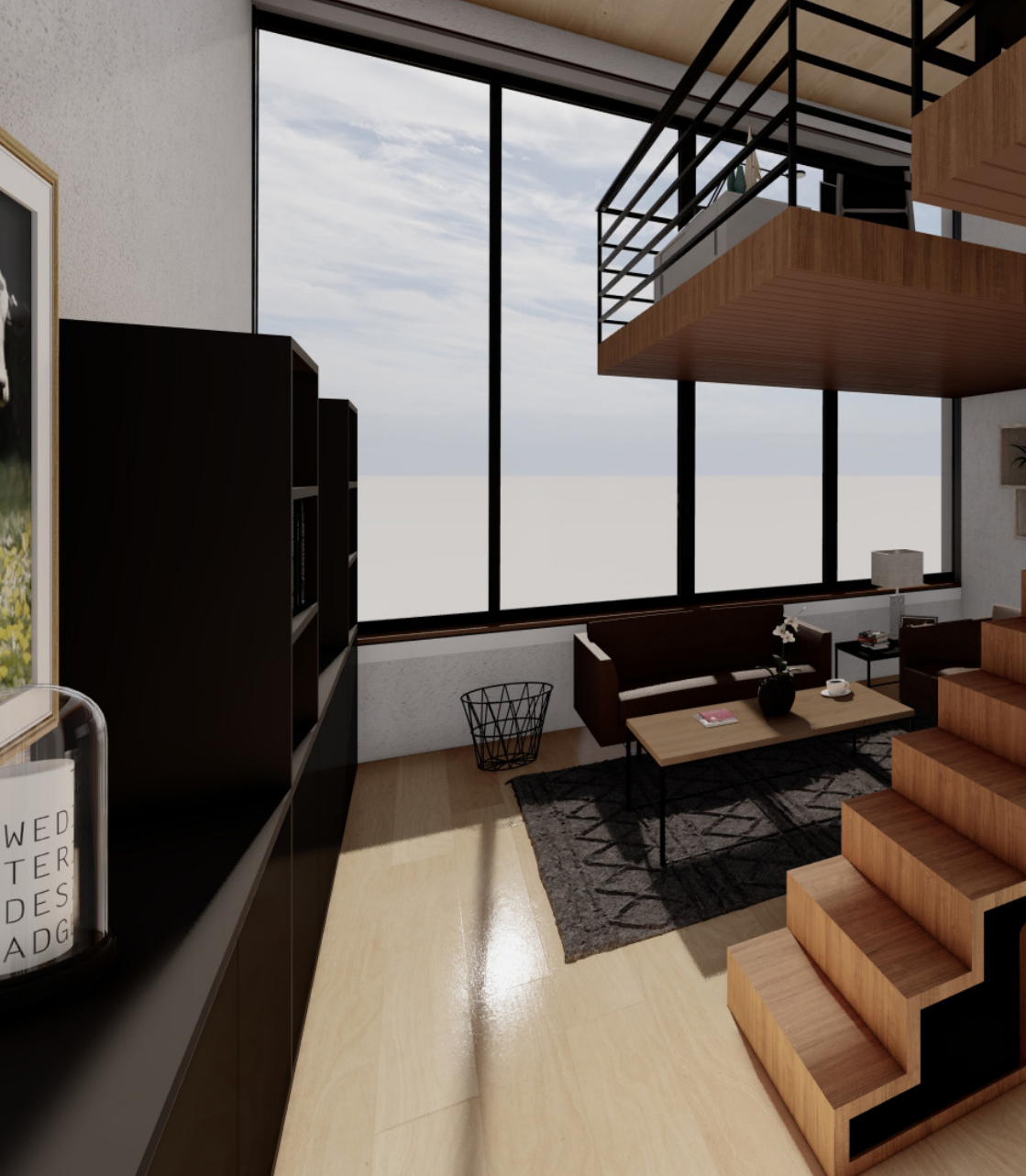






Figure 125: Kitchen + living room Loft. (Machgeels, D., 2021)



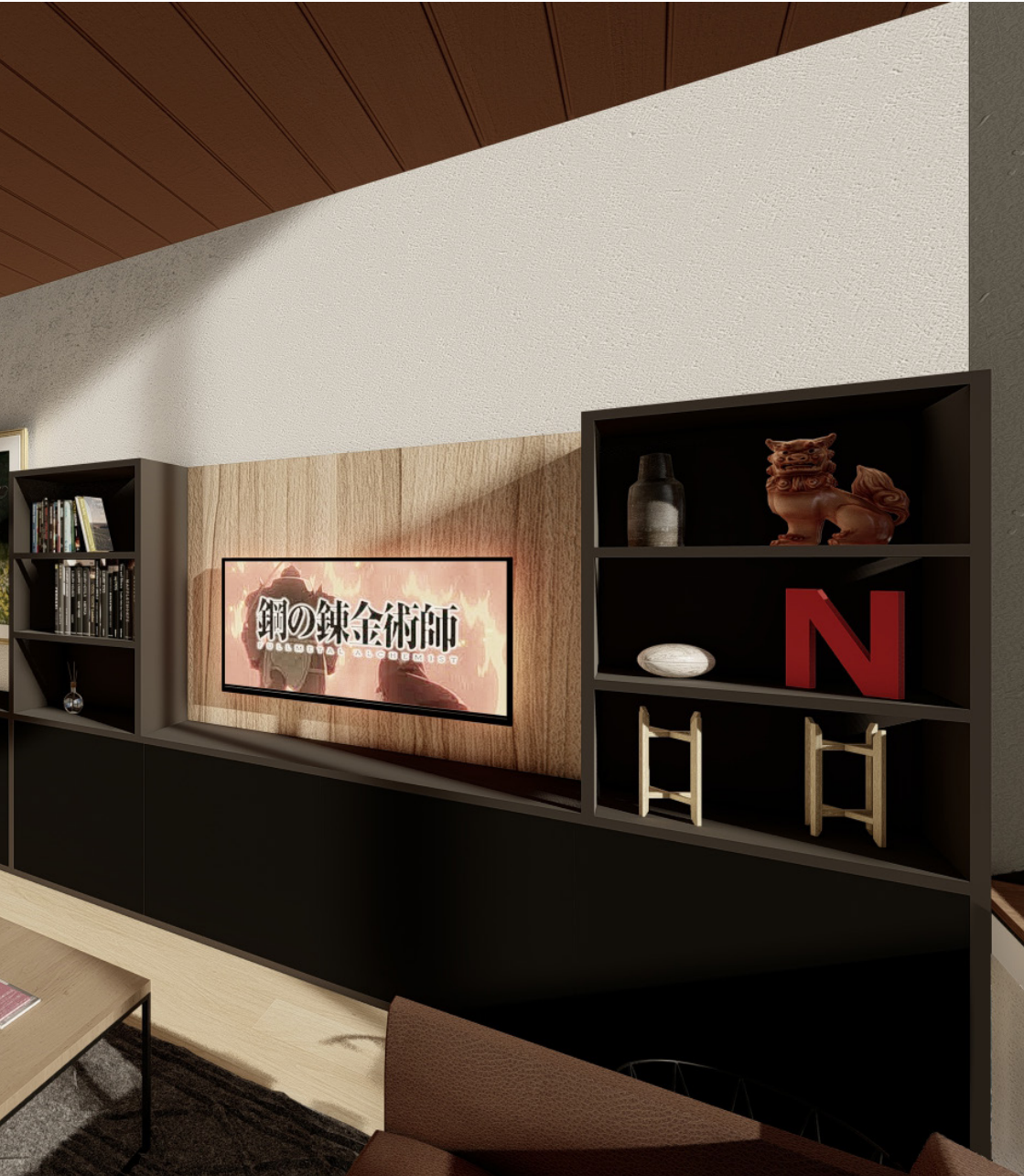
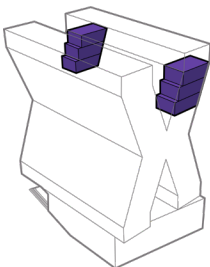
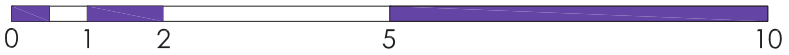
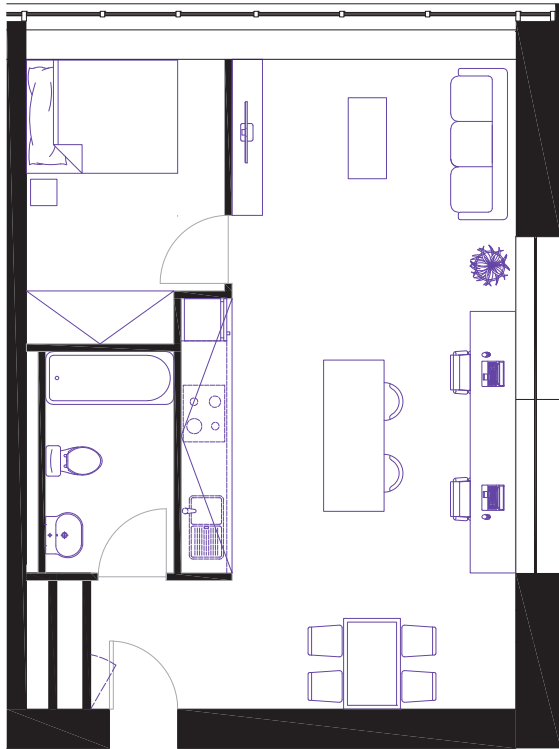


Figure 126: Living room + entrance Loft. (Machgeels, D., 2021)

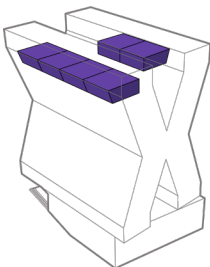
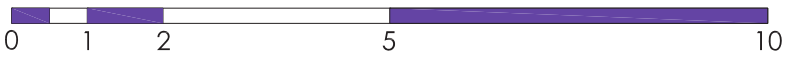
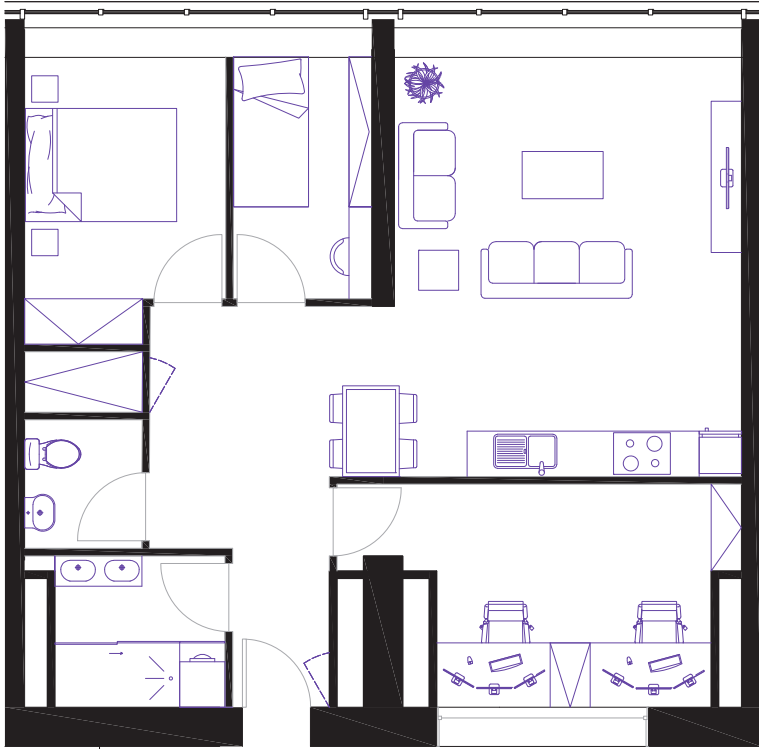




**CORNER APARTMENT (TOP PART TOWER)**

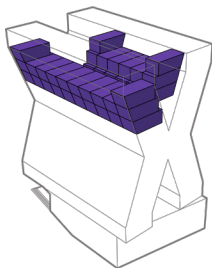
2 room(s)  
54 m<sup>2</sup>









### LARGE APARTMENT (TOP PART TOWER)



**STUDIO+ (TOP PART TOWER)**

-  **1** room(s)
-  **38** m<sup>2</sup>
- 
- 
- 
- 

## STUDIO+

The Studio+ is the standard dwelling in the building, it is by far the most common covering 56% of all dwellings in the tower. Similar to the Loft apartment there are two floors in the buildings on which these dwellings can be transformed into bigger dwellings. By following the open structure on the 5th and 13th floor larger dwellings can be created, with the max size being dictated by the grid and available space. That means that the Large apartments on these floors are just examples and can also be divided into two of these Studio+ dwellings.

An important aspect of these Studio+ dwellings is their affordability. These compact dwellings are made affordable by not only their size but also the prefabricated wooden elements in them (see figure 127). The first element houses the bedroom, storage, workroom and coat rack, while the second contains the bathroom and kitchen (with some additional cabinets above the kitchen). Similar prefabricated elements can be found in the co-living apartments (both the standard and corner apartment). These elements are not exactly the same however, they are slightly smaller to increase the living space within the dwelling.

The layout of the dwelling is primarily based on the concept of work and live, or rather the balance between it. The workspace, located in the prefab element is completely zoned off from the sleeping area and not in direct line of sight of the living room, something that people in my questionnaire especially requested: “a workspace away or separate from the other living functions.”

By creating 2 prefabricated elements near the entrance of the dwelling a large living space is created. This space is up to the resident to utilize in of course. The retractable stairs leading up to the bedroom, can be hidden away in the element to increase the living space even further during the day.

On the bottom part of the tower this same dwelling is found, however like all the other dwellings on the part of the tower the actual usable space in the dwelling is slightly less. Due to the slant of the façade on the bottom part of the tower these all the dwellings on the 4th - 7th floor have a slightly smaller usable space, even though the overall floorspace is the same.

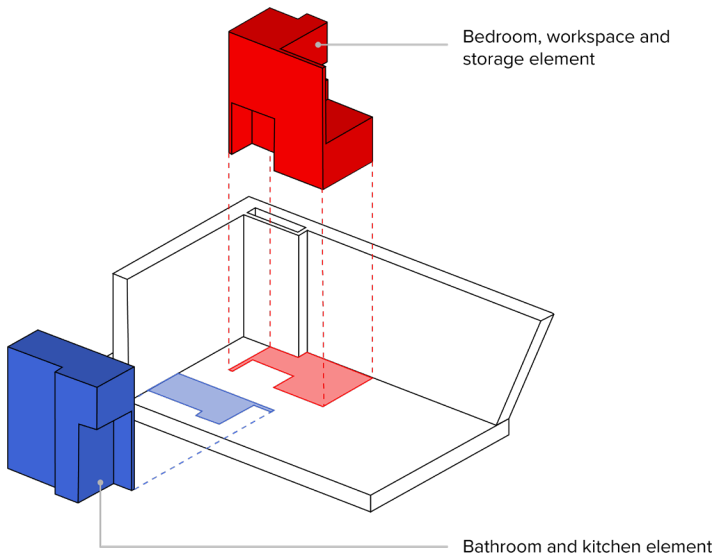


Figure 127: Prefabricated elements Studio+. (Machgeels, D., 2021)





Figure 128: Front section Studio+. (Machgeels, D., 2021)

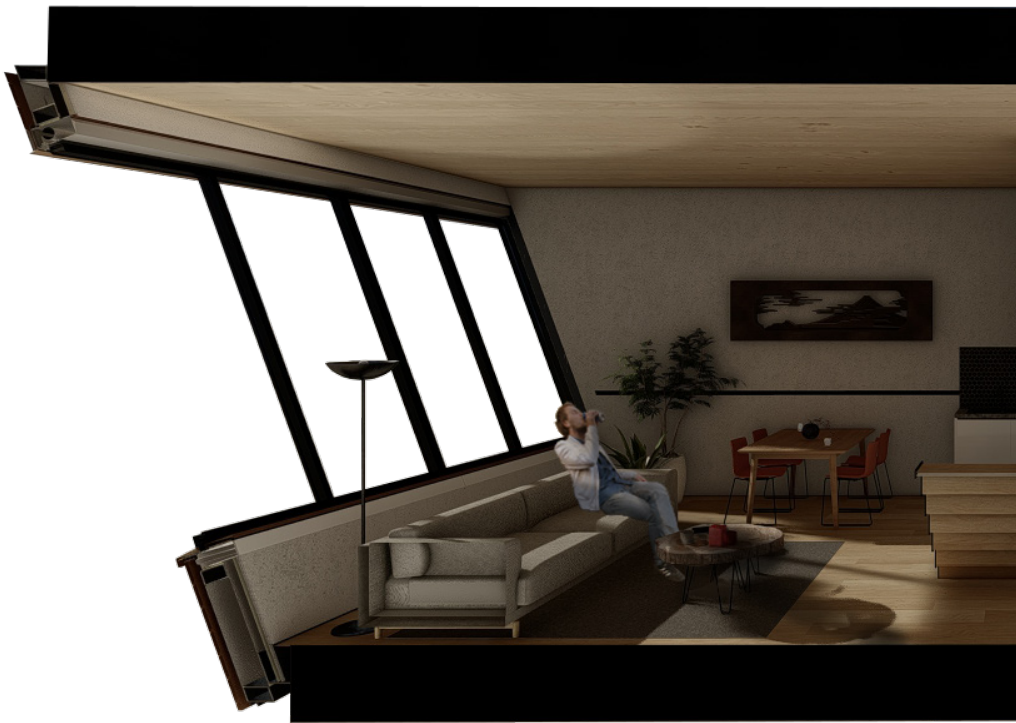




Figure 129: Side section Studio+. (Machgeels, D., 2021)







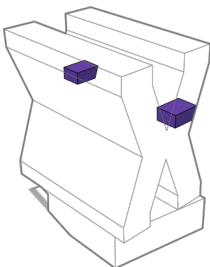
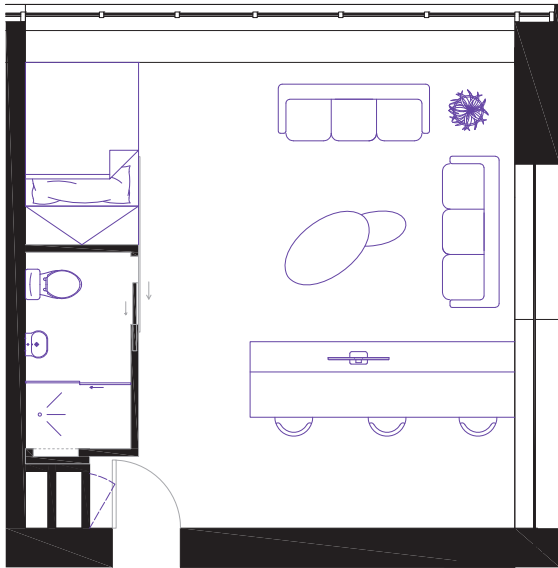
Figure 130: Workroom + closet + view into living room Studio+. (Machgeels, D., 2021)





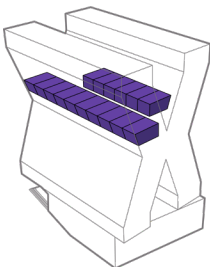
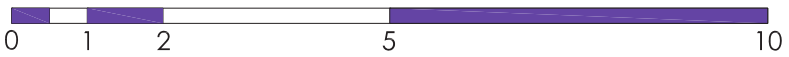
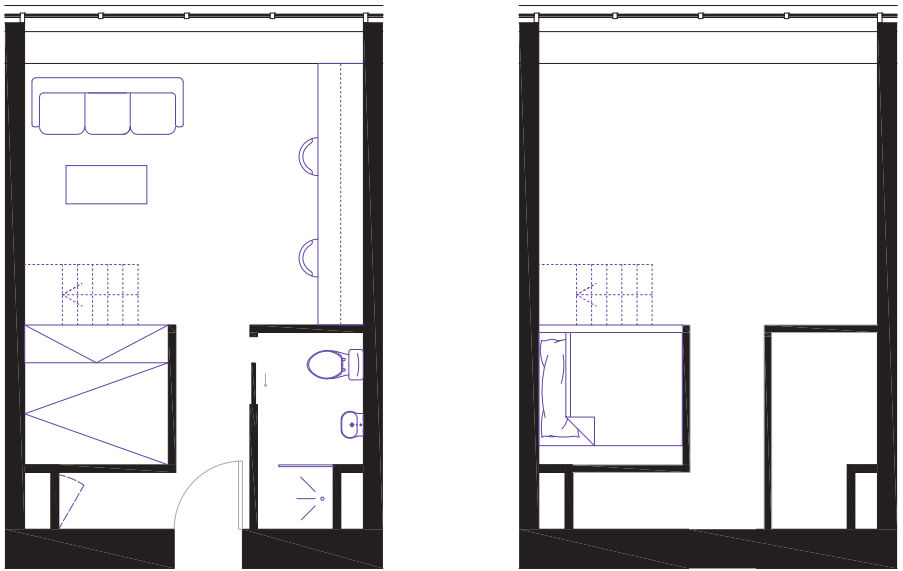


Figure 131: Bedroom + kitchen Studio+, (Machgeels, D., 2021)



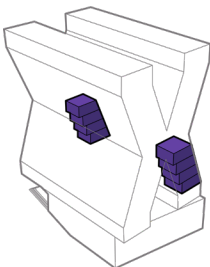
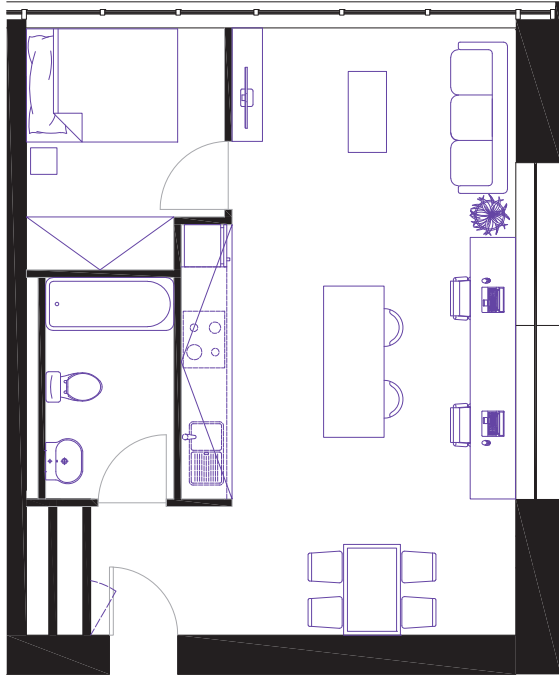
### CO-LIVING CORNER APARTMENT

A set of icons representing apartment specifications. The icons are arranged in two rows. The top row includes a single person icon, a group of two people icon, a group of three people icon, a circle with the number '1' and 'room(s)' below it, and a circle with '40' and 'm²' below it. The bottom row includes a bed icon and a group of two people icon.



### CO-LIVING APARTMENT



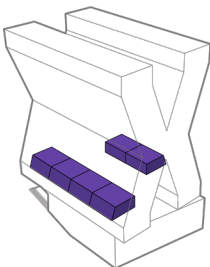
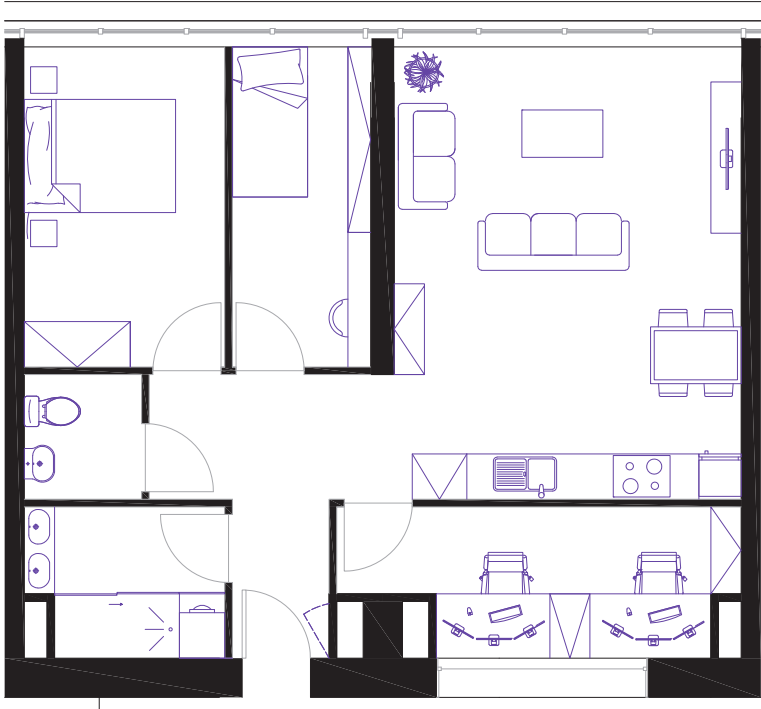


**CORNER APARTMENT (BOTTOM PART TOWER)**

Icon representing 2 people / 2 room(s)     **2** room(s)     **52** m<sup>2</sup>

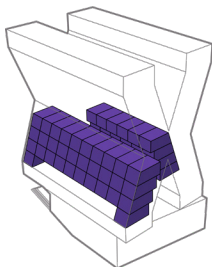
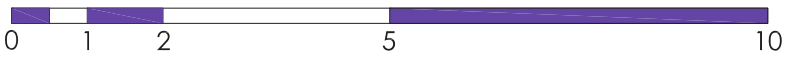
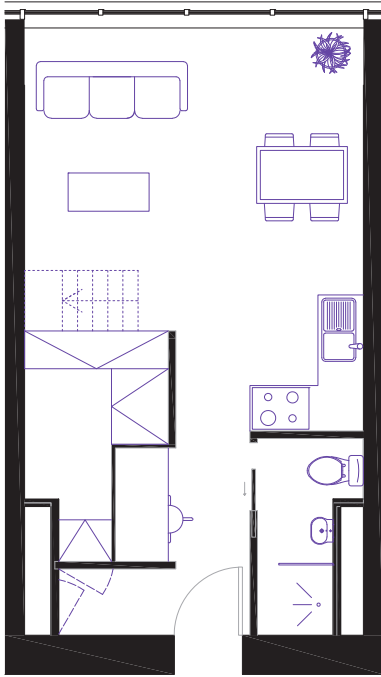
Icon representing a bed     Icon representing a kitchen     Icon representing a bathroom





**LARGE APARTMENT (BOTTOM PART TOWER)**

	/			



**STUDIO+ (BOTTOM PART TOWER)**



**1**  
room(s)

**36**  
m<sup>2</sup>





Figure 131: Bedroom + kitchen Studio+. (Machgeels, D., 2021)



# TECHNOLOGY

## MAIN STRUCTURE

The main construction of the building (the residential tower) consists of CLT load bearing walls and floors. These walls have a thickness of 300 mm and are spaced along a grid of 5 meters. An exception to this grid is made on the east side of the building to make space for the fire escape stairs. This causes the structure to have a secondary grid only on this side of 2970 mm and 7030 mm, this grid also introduces a new typology in the building, namely the corner apartment.

The choice for CLT is based on first of all for its climate friendly nature (see figure 135) and secondly because it is one of the few materials which has the least interference with internet and WiFi (see figures 133 & 134). Considering this building is meant for people working from home (New Media workers) connectivity and internet are very important, thus making the choice for CLT a necessity.

The bottom few floors, namely the Ground, first and second floor make use of a concrete structure which is set on the same grid as the dwell-

ling tower. Since there is a possibility of flooding in the area a concrete structure was chosen over a CLT one. Using CLT for these floors would be catastrophic for the structure of the building in the event of a flood.

Because flexibility of the dwellings and a larger variation of dwellings was important several walls have been changed to have holes in them (indicated with the colorless zones within the yellow in figure 132 and in red in figure 137). These holes in the walls allow for dwellings within these floors to expand past the standard one unit grid (Studio+). In the 3rd, 4th, 13th and 14th floor it is possible for people to buy a larger dwelling, like the large apartments. The position of the holes is dictated by the bearing construction. The holes either had to be fully supported by a completely closed wall or have a similar gap underneath it. The placement of these holes on top of columns or half openings would make the whole construction unstable, meaning that the current position is the only option in terms of achieving the most flexibility in the building.

### Ground floors:

Combination of a concrete structure using columns and beams and concrete floors.

### Floors:

CLT floors (8,5 x 5 meters)

### Windows and facade:

Prefabricated façade elements with Schuco windowframes and ducotwin sun shading.

### Load-bearing construction:

CLT walls of 300 mm thick

### Facade cladding:

Thermo pine wood, gathered from European forests, (recyclable)

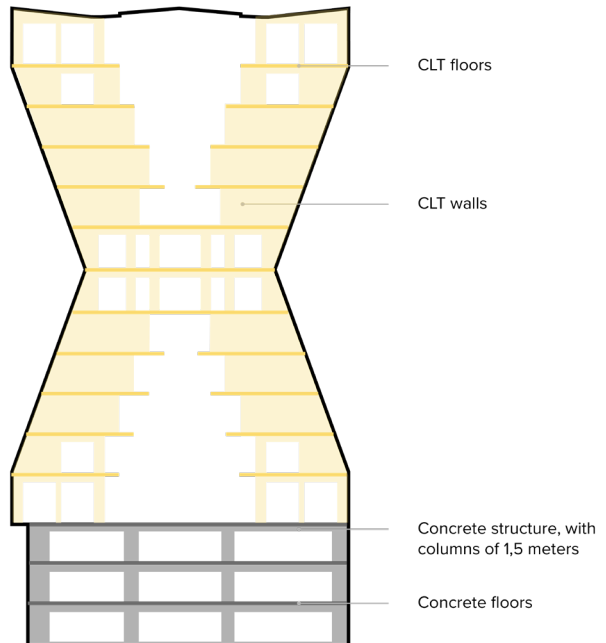


Figure 132: Concept structure. (Machgeels, D., 2021)

**Table 1. Permittivity and conductivity of some material**

<i>Material</i>	<i>Relative Permittivity</i>	<i>Conductivity (S/m)</i>	<i>Frequency (GHz)</i>
Concrete	5.31	0.0326	1-100
Brick	3.75	0.038	1-10
Plasterboard	2.94	0.0116	1-100
Wood	1.99	0.0047	0.001-100
Glass	6.27	0.0043	0.1-100
Ceiling board	1.50	0.0005	1-100
Metal	1	10	1-100

Figure 133: Permittivity and conductivity of some material [Image]. (Suherman et al, 2018)

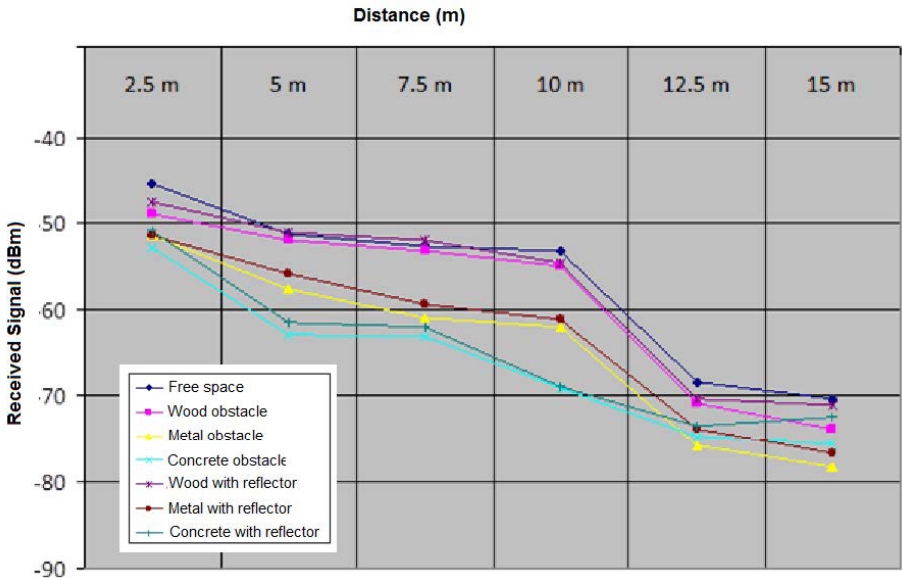


Figure 134: Reductions due to Propagation and Obstacle [Image]. (Suherman et al, 2018)



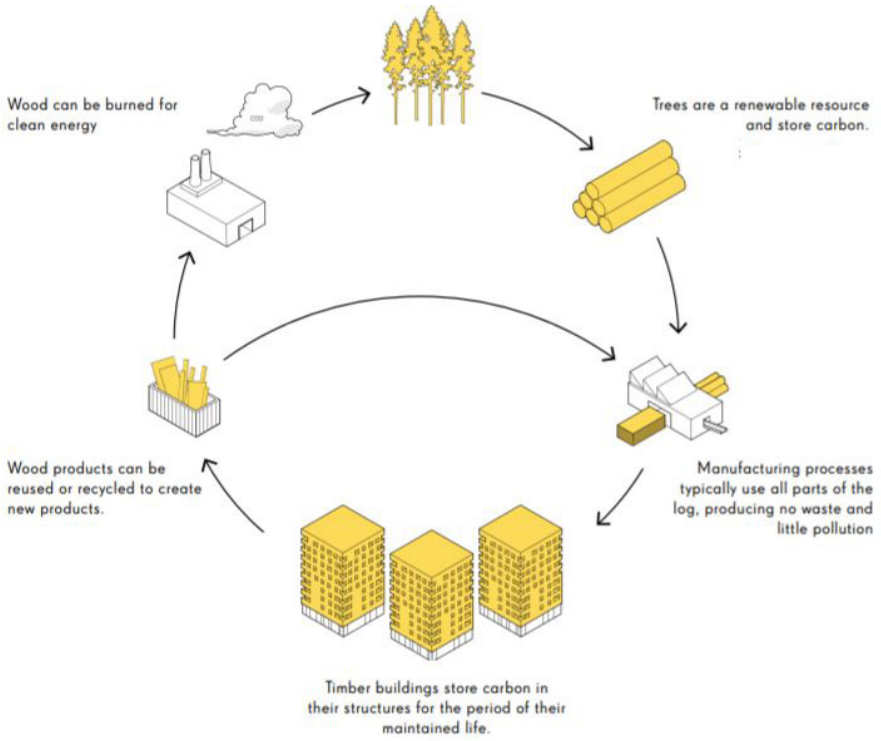


Figure 135: *The lifecycle of timber constructions* [Image]. (Thistleton, W., 2018)

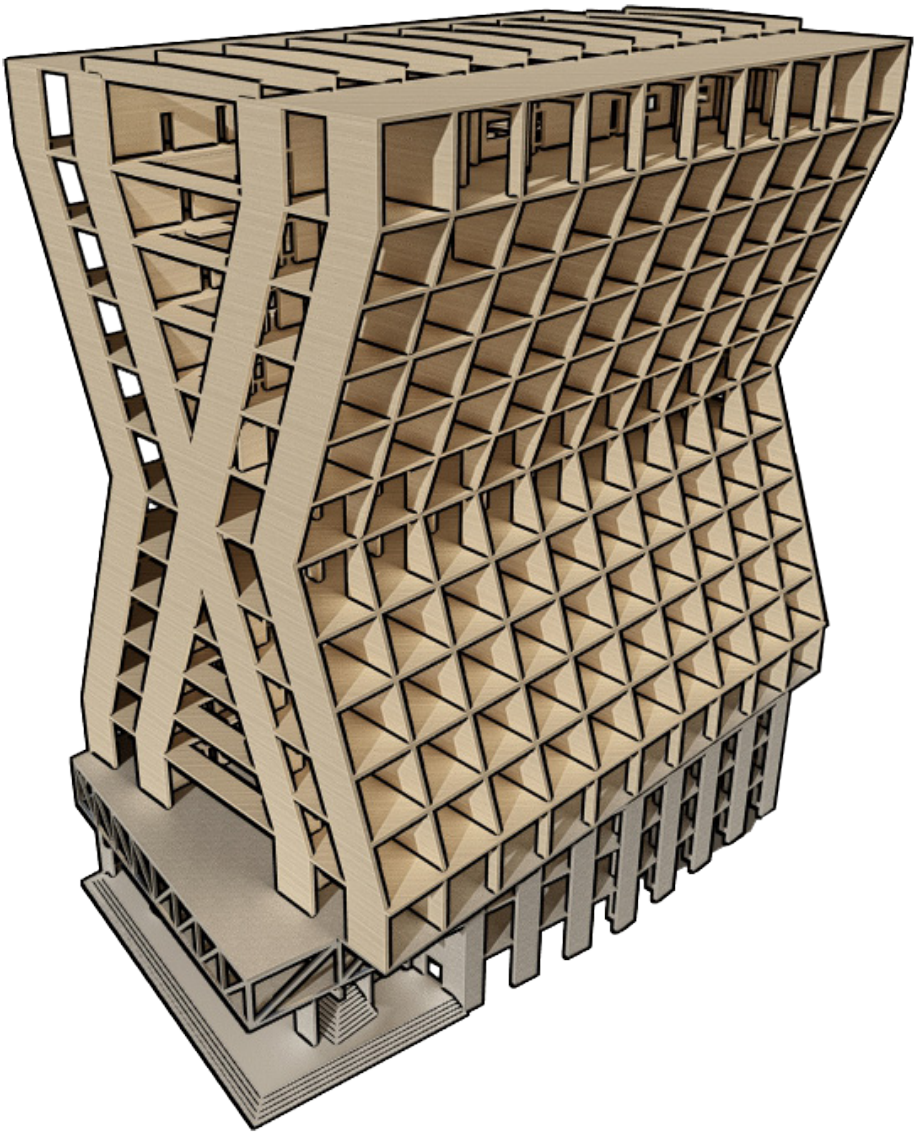


Figure 136: Construction 3D overview. (Machgeels, D., 2021)

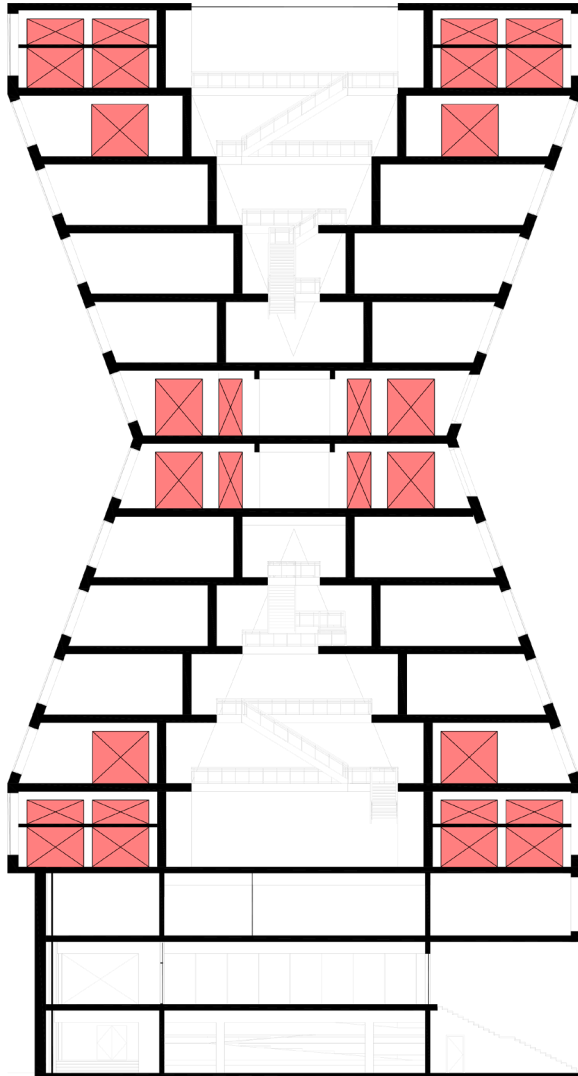
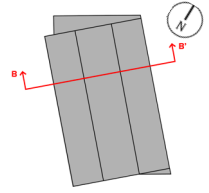


Figure 137: Openings in the walls. (Machgeels, D., 2021)

## GRAND STAIRS

The grand stairs and the stairs on the side of the building need a separate structure to support them. Specifically the grand stairs need a special construction to accommodate the slopes in the staircase.

The construction of the stairs is made from a lightweight steel construction, using 100 x 160 mm steel tube beams. The construction, highlighted in red, consists out of a main structure of slanted beams running underneath the slopes, 2 beams per slope with each 2 columns, which are in line with the structure on the ground floor. Attached to these beams are other steel beams going in the other direction directly supporting the stair elements which can be placed on these beams.

The base of the stairs, meaning the first area in front of the stairs with the integrated slope, is a complete concrete element on its own.

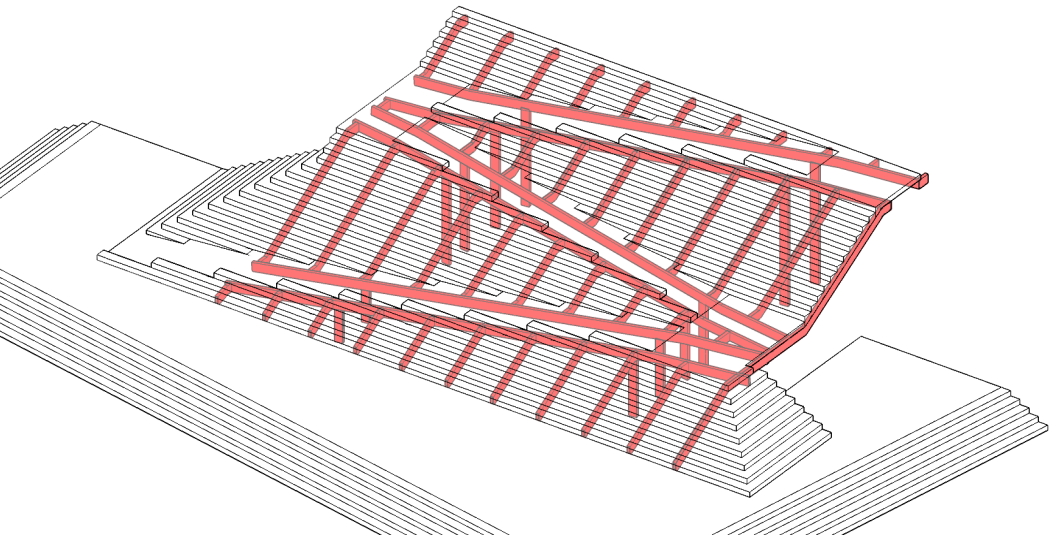


Figure 138: Structure grand stairs. (Machgeels, D., 2021)

## CANTILEVER ROOF

On the second floor, specifically at the location of the gym, the building falls out of the grid preset 5 meter grid. Following the exact lines of the actual building plot a cantilevering roof is created. In order to support the roof which stretches beyond the predetermined concrete structure a truss is used. From a simple calculation the approximate size of the truss would need to be 1 meter high. For both aesthetic and structural reasons I chose to make the truss the height of the full floor. Creating a full floor truss benefits not only from being more integrated into the design, it has better structural advantages.

A floor high truss can be supported from below by the concrete structure and directly carries the roof at the same time. Choosing the full floor high truss made it possible to distribute the weight of the roof more evenly over the whole construction.

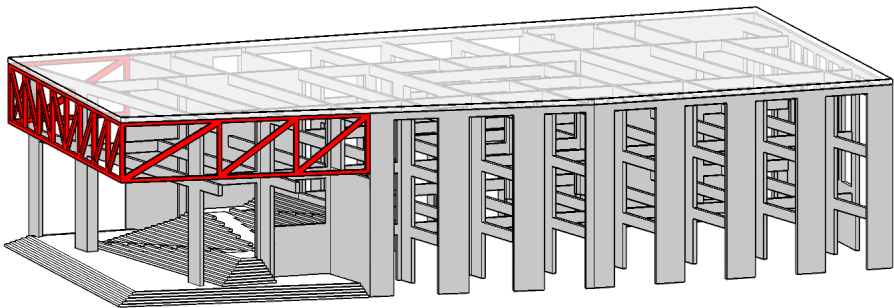


Figure 139: Diagram of the truss on the second floor holding cantilever roof. (Machgeels, D., 2021)

## BOTTOM ATRIUM SUPPORT

The galleries in the bottom atrium are different from the ones in the top atrium. Instead of resting directly on a bearing wall the galleries in the bottom floor are suspended in the air. The galleries of 1,5 meters wide is placed next to the dwelling, with the shift of the dwellings inwards with another 1,5 meters the galleries become a cantilever of 3 meter, this cantilever is too large to be carried by the nearest wall. In order for the galleries to be positioned similar to the top atrium cables had to be used to suspend the galleries from.

The steel cables supporting the galleries are 2 cm in diameter and are attached to the bottom of the floor that has to be carried. They then go through predrilled holes in the CLT flooring of the floor above and are attached on the joint of the wall and the floor above. This way the load of the floor is placed on a joint where the forces are already being diverted down into the rest of the structure. The cables are placed circa every 3 meters throughout the whole of the bottom atrium.

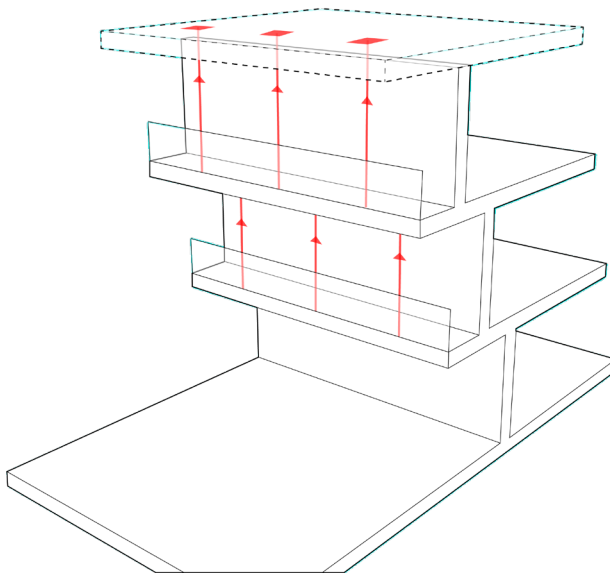


Figure 140: Cables holding galleries bottom atrium. (Machgeels, D., 2021)

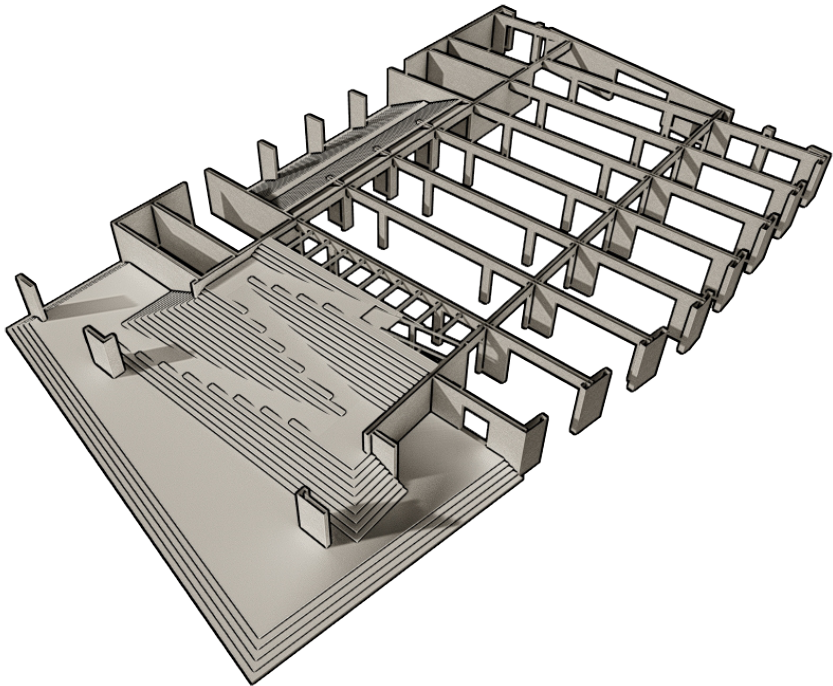
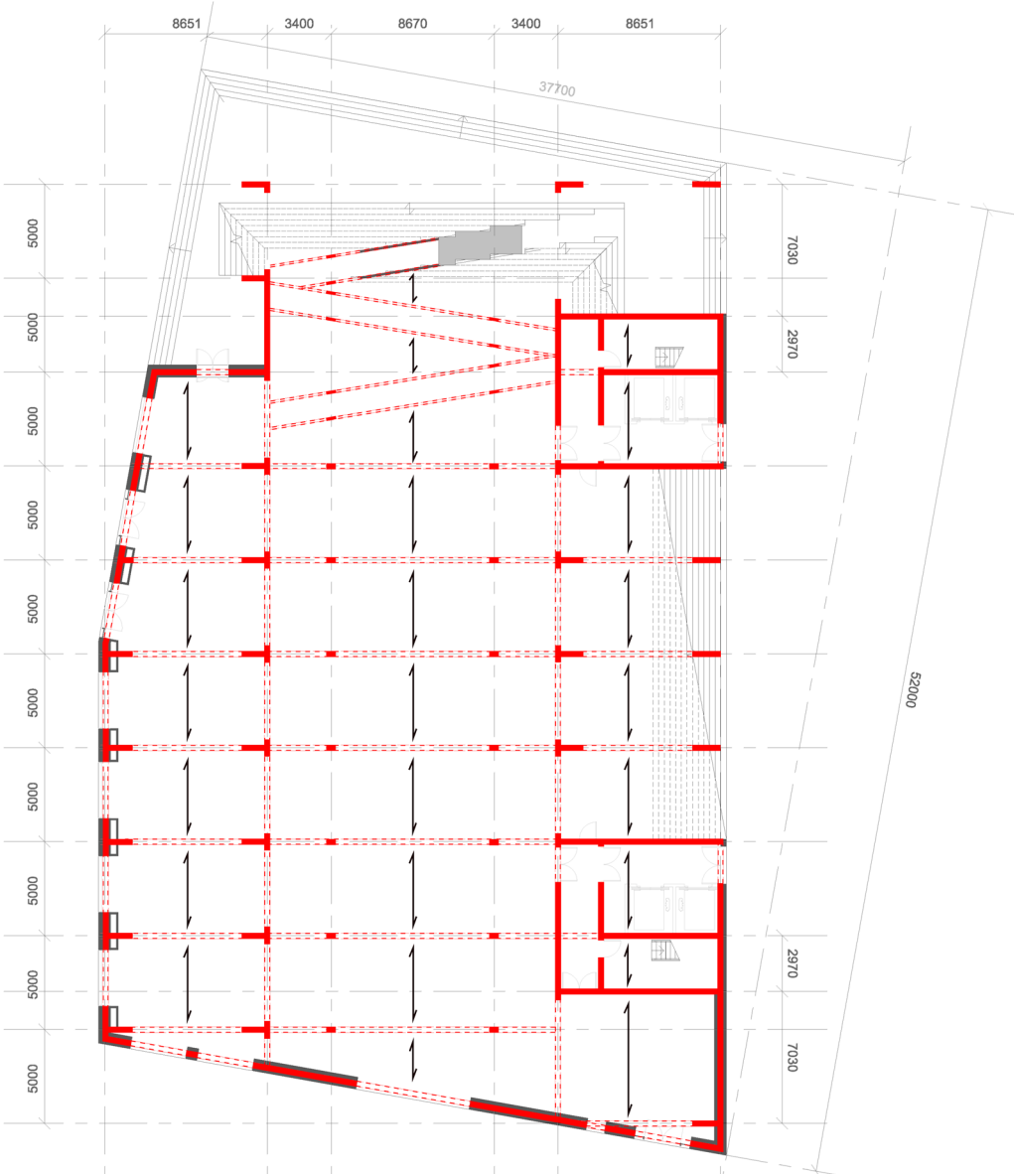


Figure 141: Construction ground floor 3D. (Machgeels, D., 2021)





0 + 0



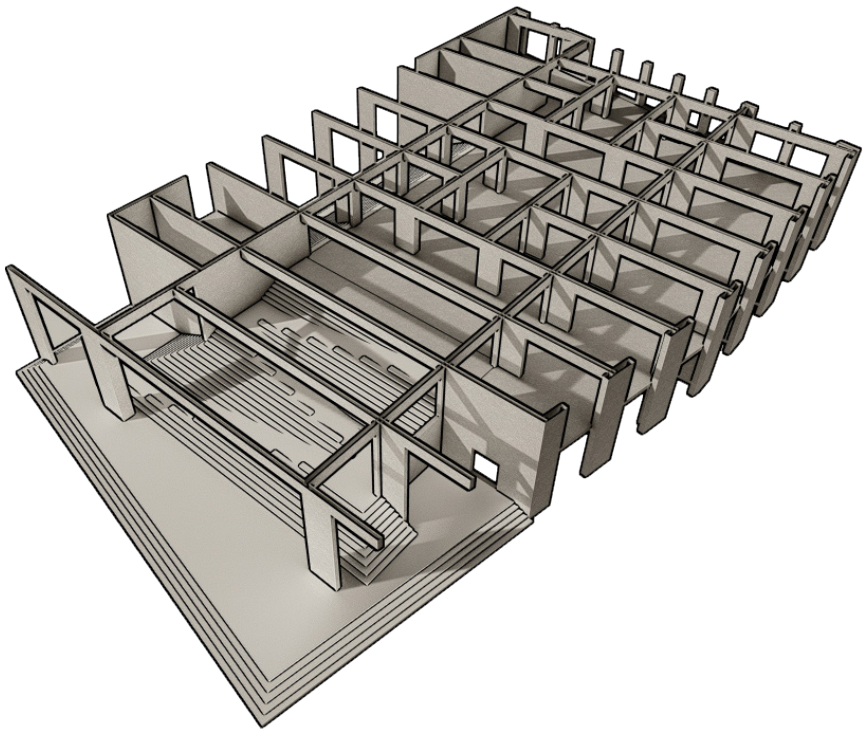
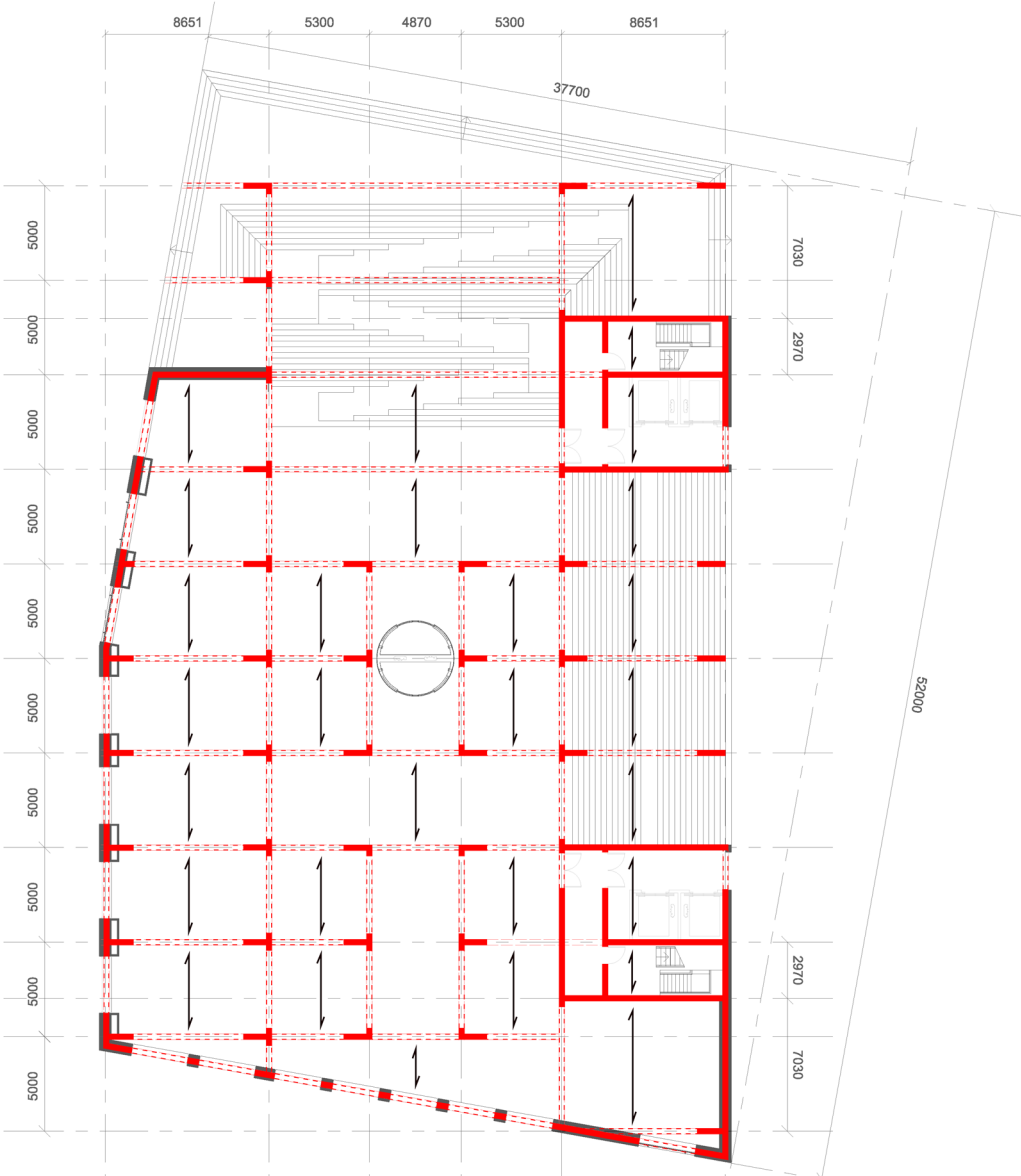


Figure 142: Construction first floor 3D. (Machgeels, D., 2021)



1 + 4000



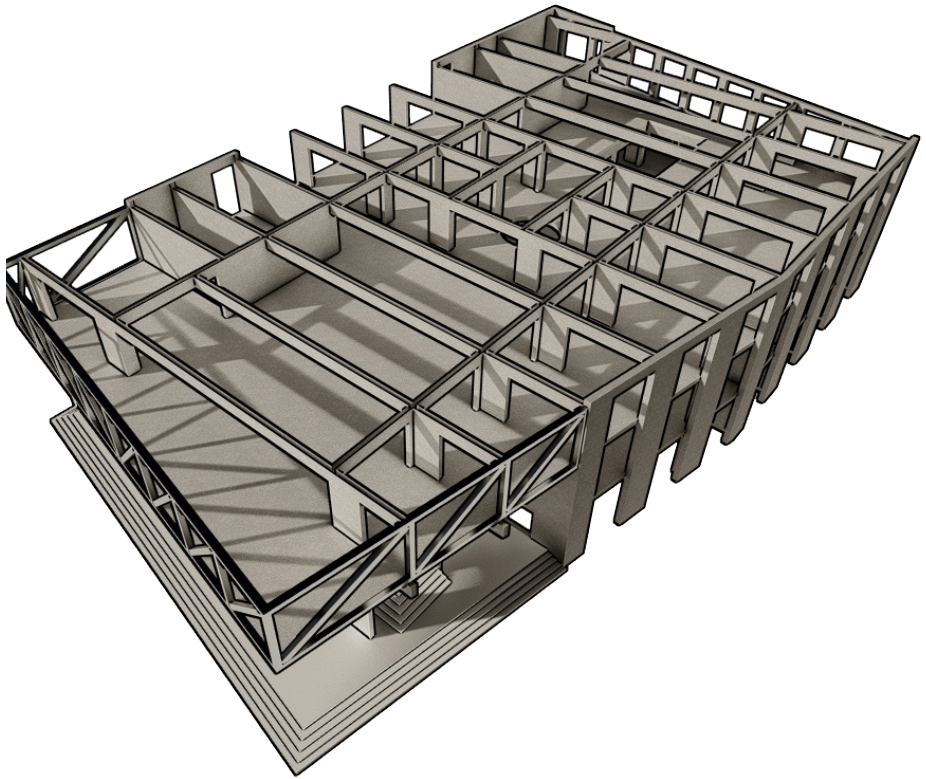
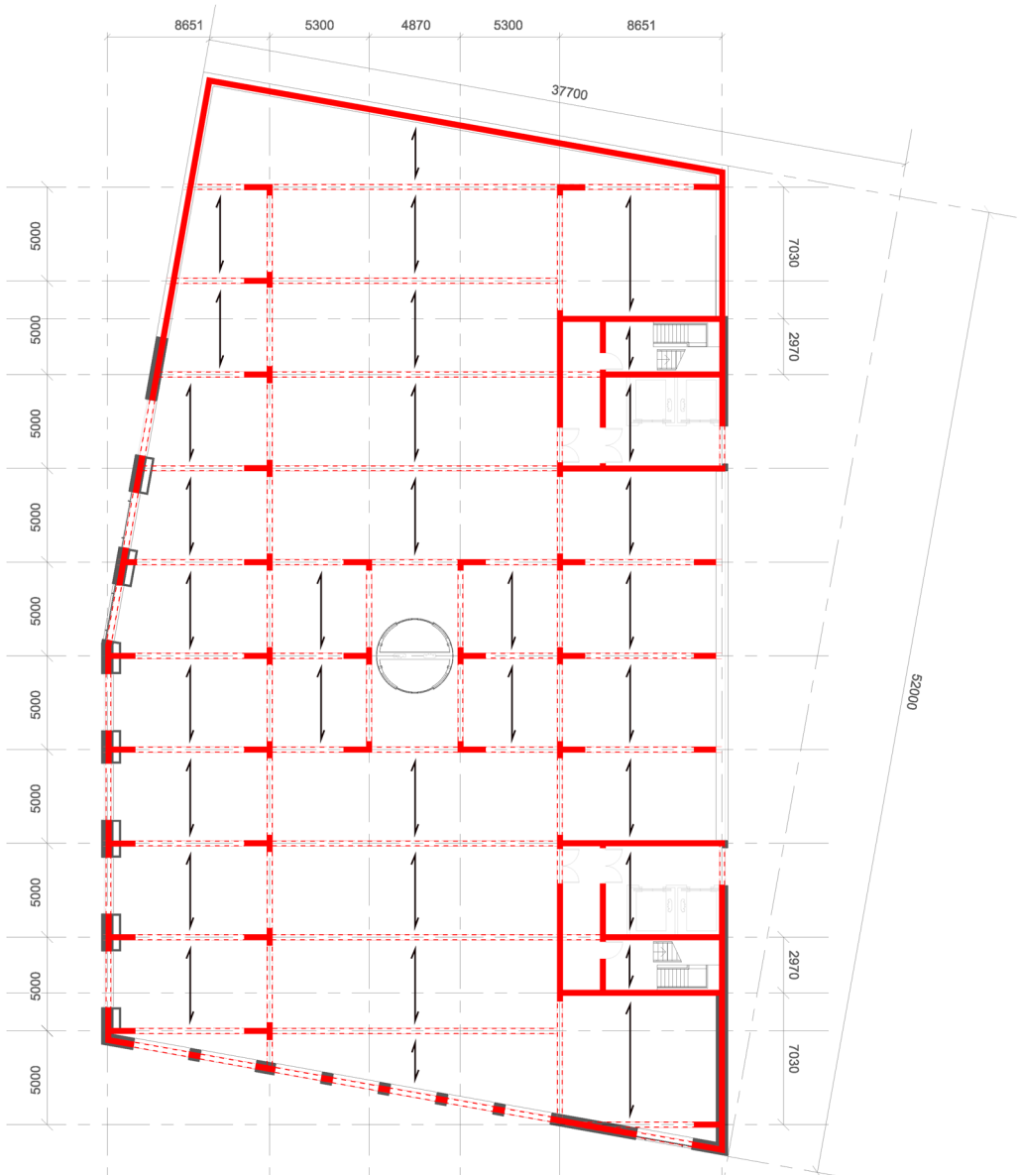


Figure 143: Construction second floor / plinth 3D. (Machgeels, D., 2021)



2 + 8000



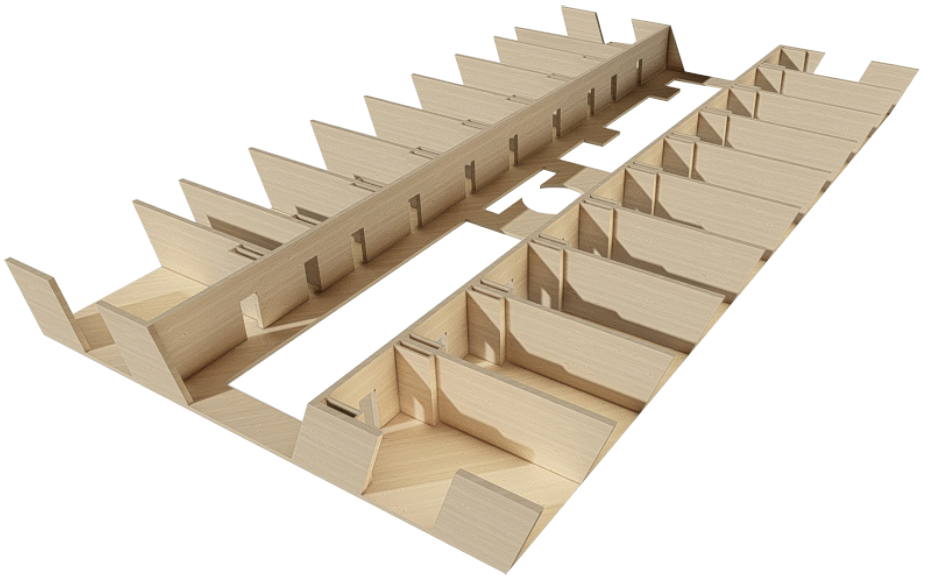
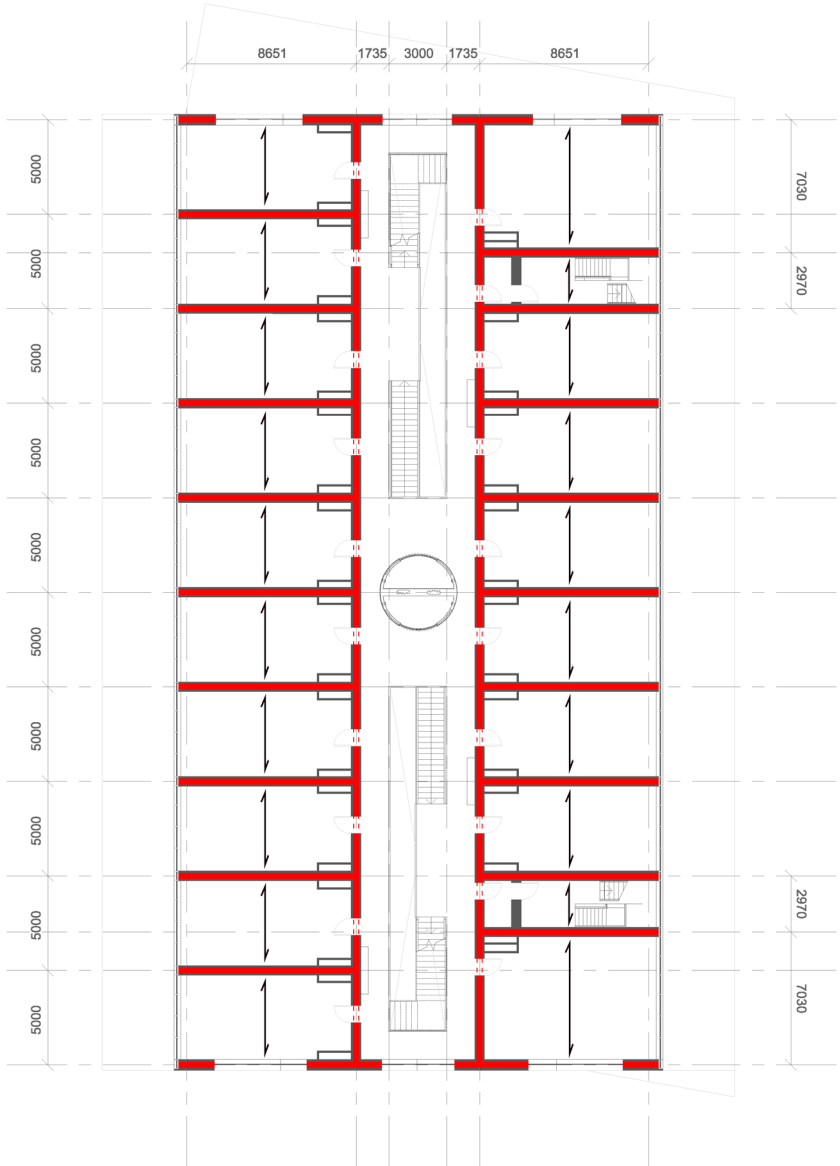


Figure 144: CLT construction average floor 3D. (Machgeels, D., 2021)





## WATER

Water is handled by a heatpump located on the ground floor. Instead of using a ground heatpump, a water heatpump, using the river Maas as a medium to heat up the water, is chosen. Being so near a natural source of water, which has a better consistent temperature than the ground ensures that during the whole of the year water can be preheated using the river. As the temperature of the water will remain more consistent this also means that it will reduce costs for heating as the base temperature will always remain the same.

The water coming in at the ground floor is distributed through the building via the shafts (see figures 146 & 147). In the public plinth all the shafts

are located at the west façade of the building. Moving up in the building the pipes get rerouted to the shafts of the tower with the use of a lowered ceiling on the second floor.

Water is not only used for warm and cold water in the dwellings. Each of the dwellings, has its own floor heating and cooling. These systems are dwelling concentrated meaning that each 5 meter a new floor heating and cooling system is placed. Each dwelling therefore has its own system.

Additionally rain water caught by the roof can be collected in the various shafts along the gutter and used for flushing the toilets in the building.

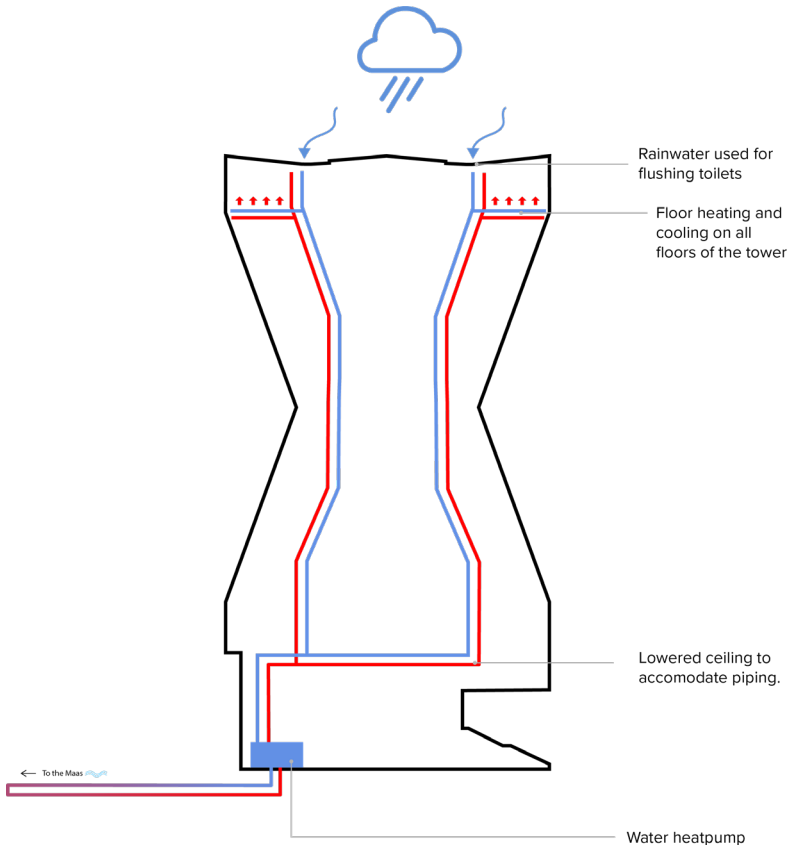


Figure 145: *Concept water.* (Machgeels, D., 2021)

## SHAFTS

Because of the unique shape of the building the shafts don't go up all the way in a straight line (see figure 146) like you would normally see in other buildings. The overall size of the shafts is 1800 x 350 mm, with the exception of the spaces where they do perfectly align, here the shafts are a minimum of 750 x 350 mm as per the minimum requirements for meter closets.

The quite large size is necessary for all the shafts to perfectly align with each other. Because the dwellings shift 1,5 meters outwards / inwards, depending on where in the building you are, the shafts had to already be a minimum of 1,5 meters to even connect. In order for these shafts to properly connect and leave space for piping, these were made even larger. Now the shafts have an overlap of circa 300 mm, where all the plumbing and piping is passed through (see figure 147).

The distribution of water to balconies for the coffee corners and to parts in the dwelling further towards the façade is handled similarly to how the electricity is provided. Like with the electricity and internet, certain parts are prefabricated into the CLT panels (see figure 100), a good example of this is the SAWA floor (see figure 148). In order to fit plumbing and other piping into a smaller floor profile, certain parts within the CLT panels will be cut away beforehand so that pipes can run along the created crevices. From the balcony these pipes then connect back to the shafts through these crevices. Besides the similar approach in terms of floor, also the same principle applies. The idea behind the SAWA floor is mainly that most of the parts used to create the floor are detachable and reusable, seeing as my floor is similar in structure the same principle would apply.

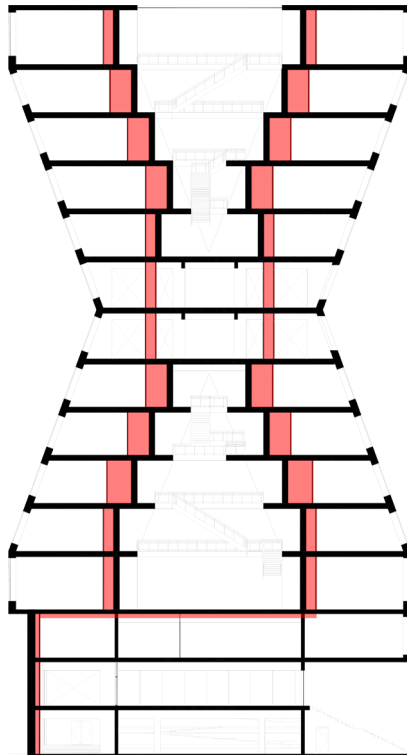


Figure 146: Shafts in the building. (Machgeels, D., 2021)

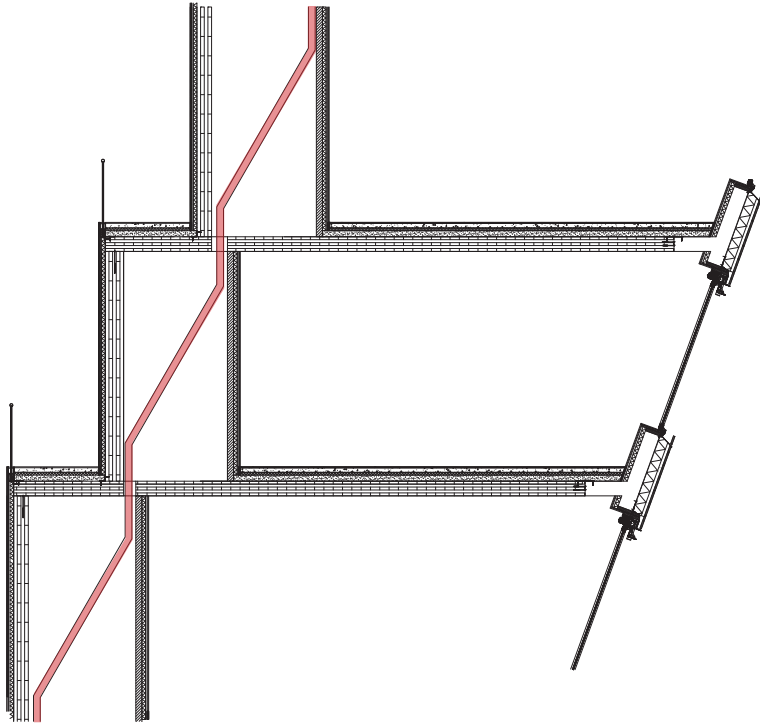


Figure 147: Shaft connection. (Machgeels, D., 2021)

Floor | circular & detachable | installations separated from the floor

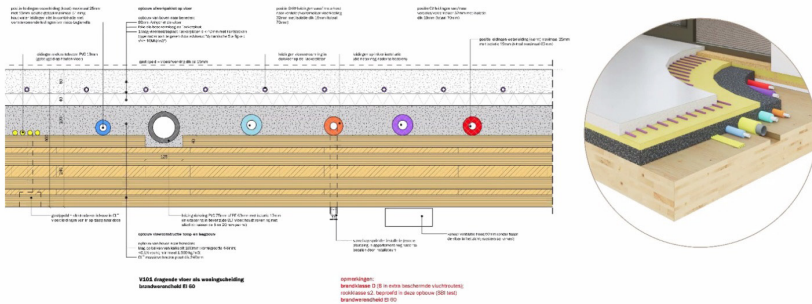
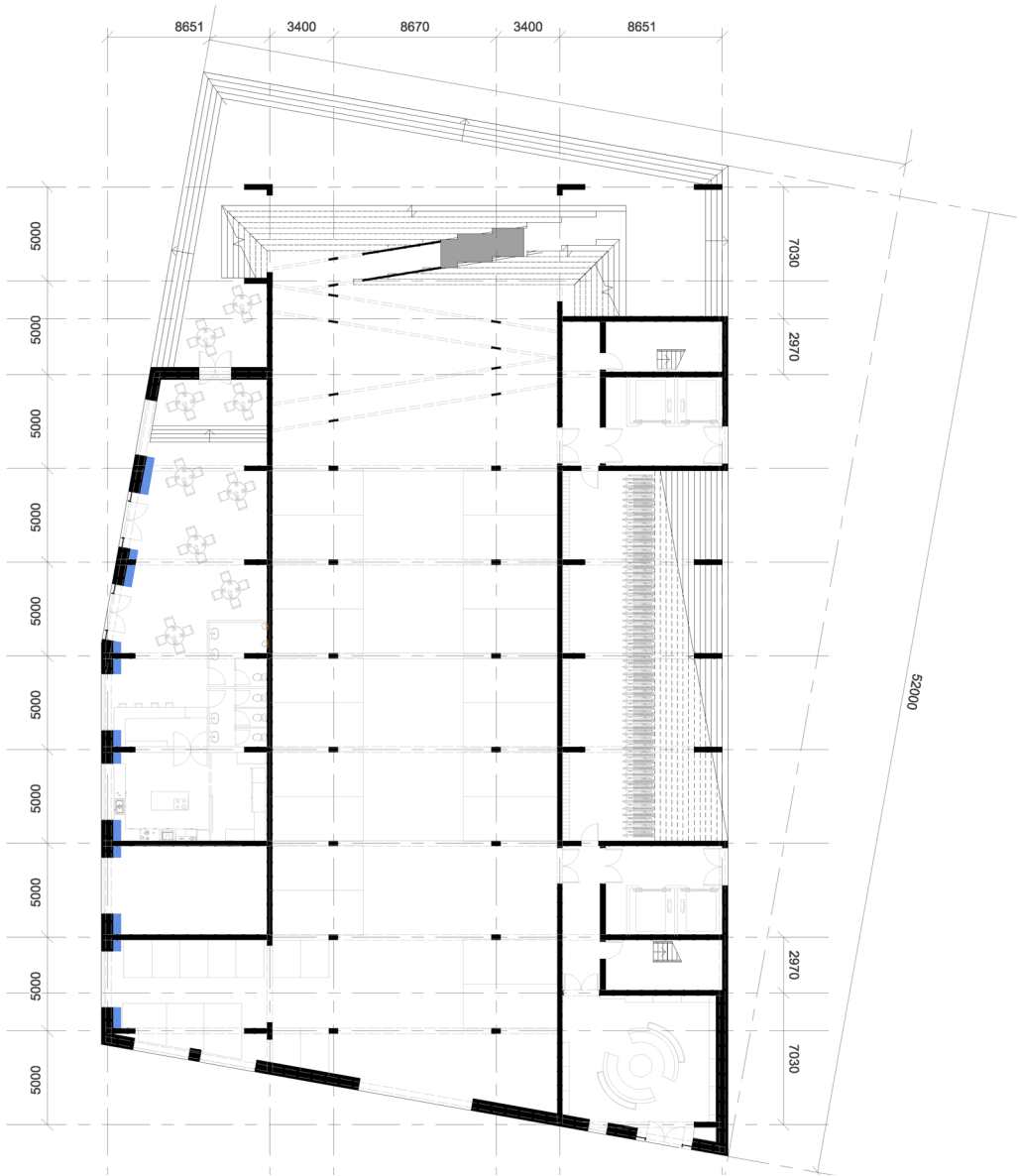
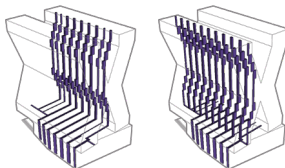
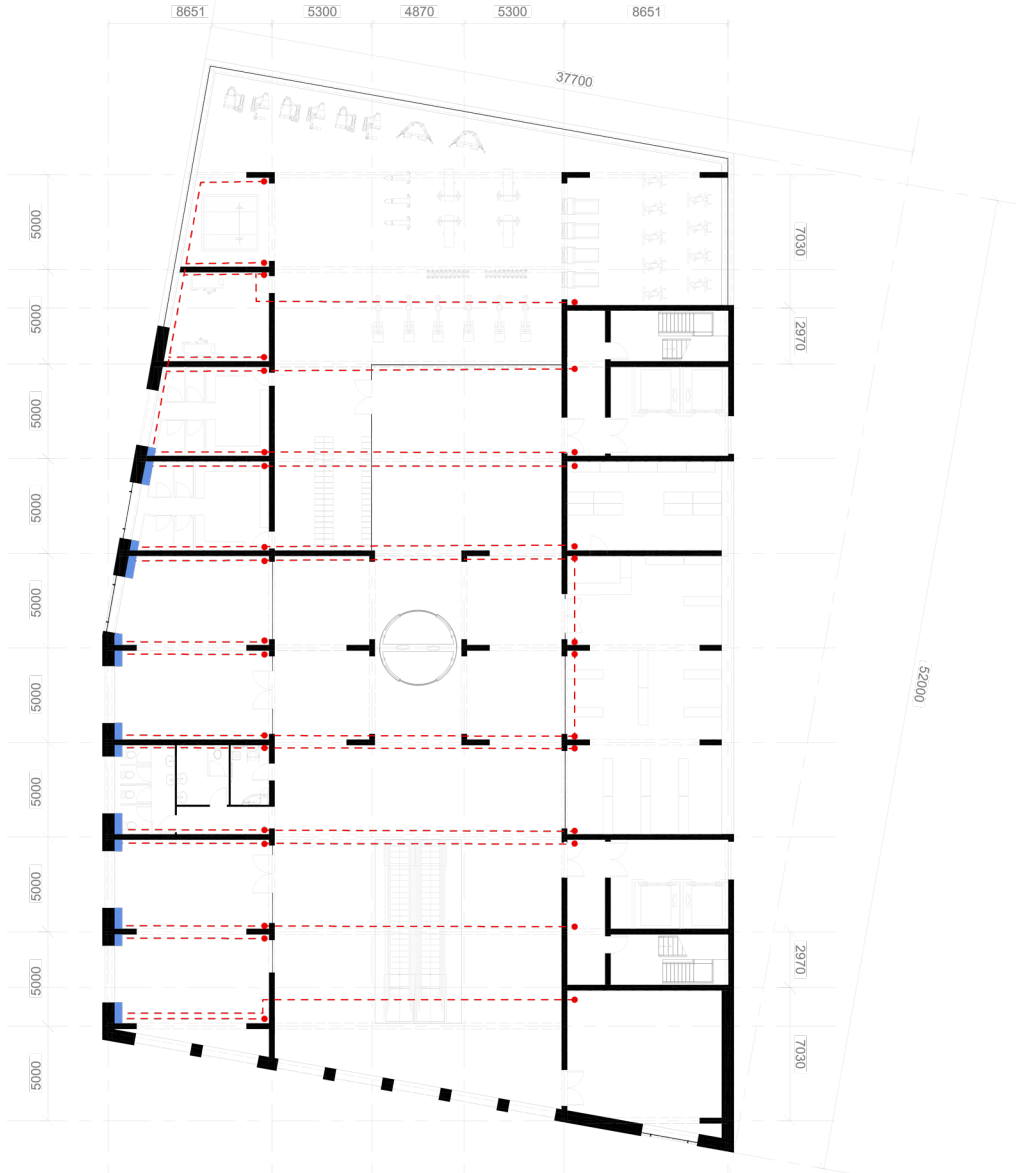


Figure 148: Floor | circular & detachable | Installation separated from the floor [Image] (Mei architects and planners, 2020)

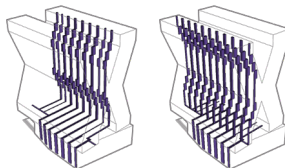


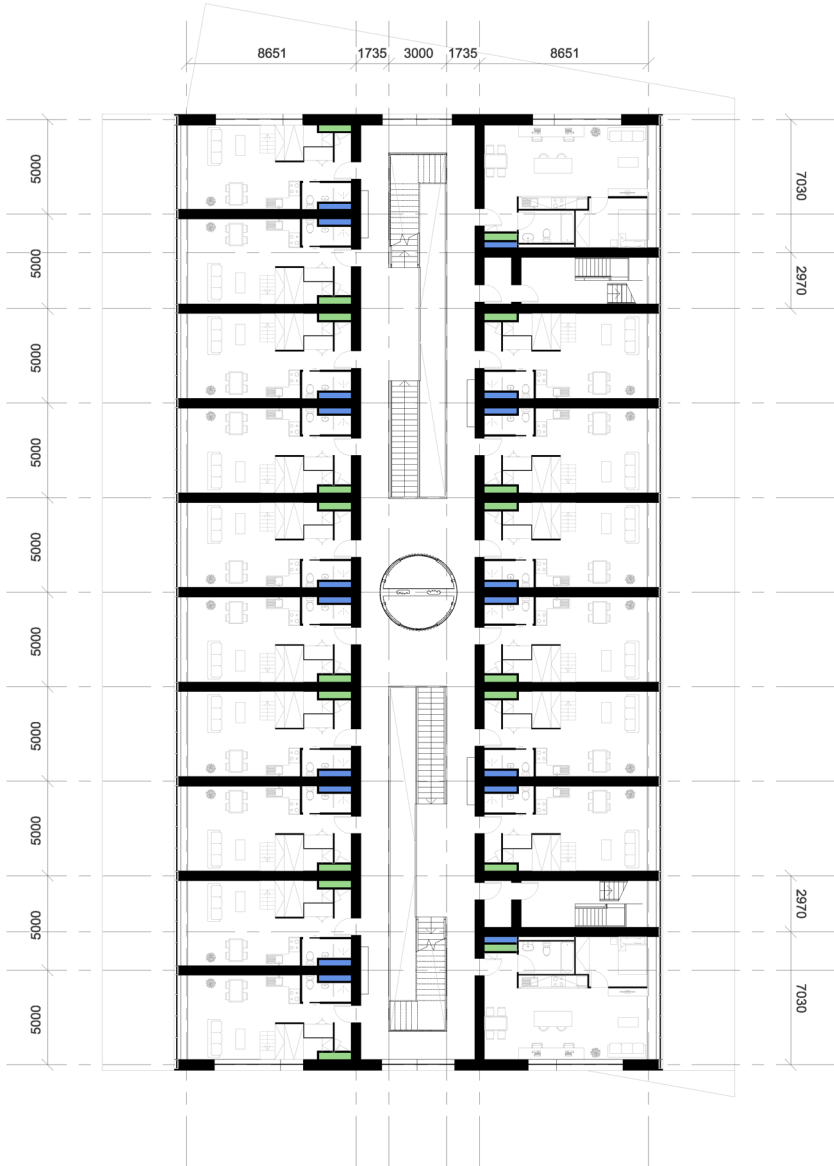
0 + 0



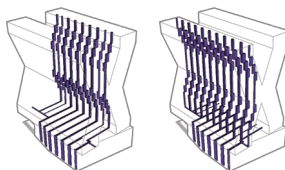


2 + 8000





11 + 45475



## SUN ORIENTATION

As the sun orientation shows eventhough the tower is placed under an angle there is no loss of sunlight for either of the building sides, making it possible to have dwellings on both sides that receive sufficient daylight. The East side of the building receives most of its sun during the morning and early afternoon, while the West side receives this during the afternoon and late afternoon.

As all sides receive sunlight throughout not only the day but also in different seasons the application of solar panels was a must. To make the building as energy efficient and self-sufficient as possible the building needed to provide its own energy. Because the building is catered towards people working from home a lot of electricity will be used at all times of the day. To deliver the needed power, solar panels are integrated in the roof. Seeing as the roof is only 1000 m<sup>2</sup> this didn't suffice in providing enough energy for the whole building. To compensate for the remaining

needed power, the façades are used to generate energy as well. As the majority of the façades in my building are made out of glass, circa 1500 m<sup>2</sup> on both the east and west façade, these could be used to generate power as well. To produce the necessary energy the normal window panes are replaced by windows with PV cells in them.

These PV-cell glass windows are transparent glass PV panels, which deliver 10% of the capacity of a regular solar panel. Seeing as the majority of my façades are glass, the integration of these PV-cell glass windows will greatly increase the energy output without sacrificing building aesthetics or visibility from within the dwellings. A benefit of using this type of glass is not only cost saving, but also climate friendly.

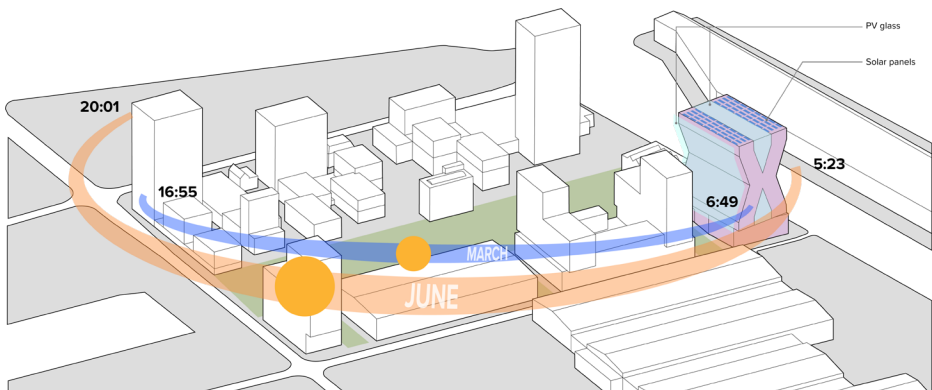


Figure 149: PV-cell glass and solar panels according to sun path. (Machgeels, D., 2021)

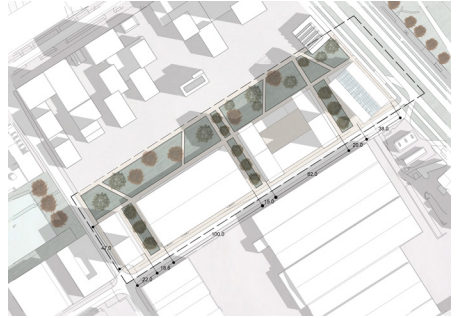


MARCH



9:00

JUNE



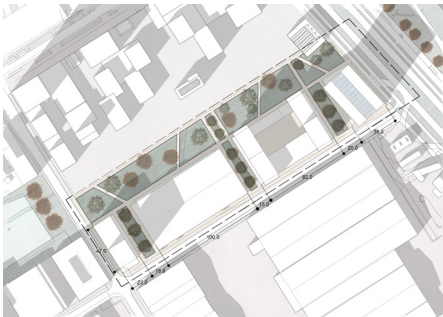
9:00



12:00



12:00



15:00



15:00

Figure 150: Sun orientation quadrant B. (Machgeels, D., 2021)

### ENERGY + INTERNET + VENTILATION

In terms of energy the building would suffice in providing the necessary power it needs to functions, with the use of the solar roof and the PV-cell glass around the whole building. Any excess energy can be stored within the batteries located in the technical spaces of the communal floors. This is especially nice since both the Tesla solar roof and the PV-cell glass can generate storable energy.

To provide internet access in the building a Fiber connection is chosen. Seeing as Rotterdam is currently upgrading their network to Fiber, like the rest of the Netherlands, it is a great way to hop on and make the building future proof from the start instead of having to upgrade this system later. Fiber not only is future proof but also

has lower latency, better connectivity and higher bandwidth meaning that the residents can work more efficiently.

For the Fiber connection 4-5 cables enter the building at the ground floor from a local source. From the ground floor the cables move up to a distributor located in the technical space on one of the communal floors in the tower. Here the cables get split into all the needed connections and distributed over the four legs of the tower via the shafts. From here they make connections to not only the dwellings, but the whole of the building, making sure that the entirety of the building has WiFi and there are standard ethernet connections to both the balconies and communal floors in the building.

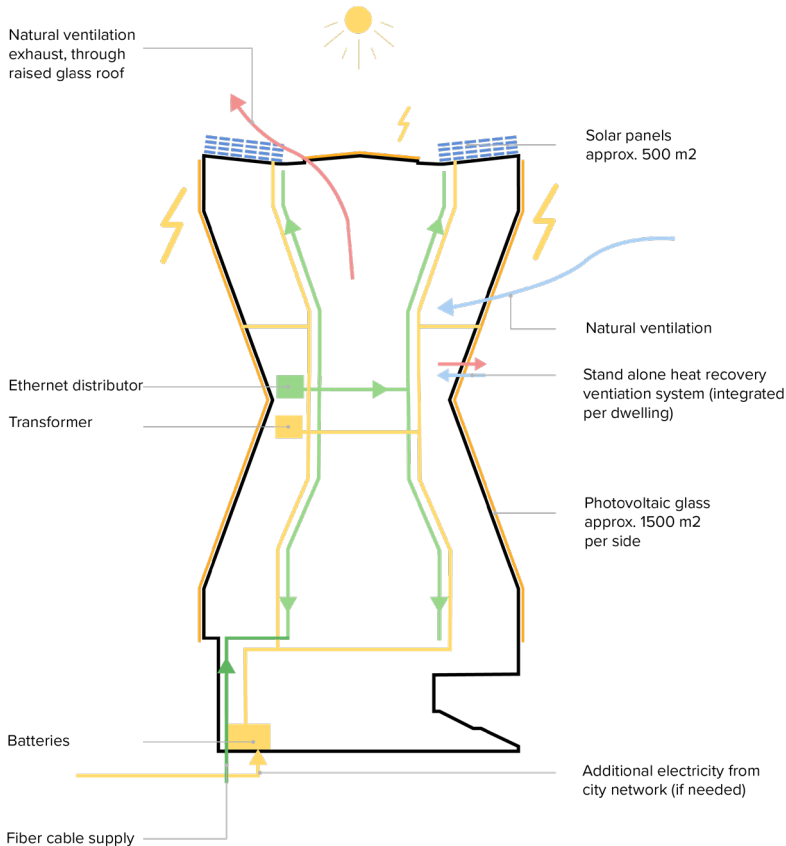


Figure 151: Energy + Internet + Ventilation concept. (Machgeels, D., 2021)

Ventilation is also done in a more environmental friendly way. Because nearly all the spaces of the building have large window surfaces separating them from the outside, natural ventilation can be used as the main ventilation principal. Especially in the dwellings the natural ventilation of just one window would be enough for the whole of the dwelling (see figure 153). Every 5 meters there is 2,6 x 1,1 meter openable window, that provides this natural ventilation, along with passive ventilation of a Ducotwin unit above the window frame.

Since natural ventilation in the dwellings would not suffice all year round another system is integrated in the dwellings to make sure that it has another way to ventilate the space. Other than the standard climate machines that are in the

building, the remaining systems are more catered to the user. Each of the dwellings has their own systems integrated in the façade which the resident can control themselves either via a controller on the wall or their smart devices. These systems include a stand-alone heat recovery system for ventilation located under the window frame (named the Aeromat VT) and a shading system, hidden behind the façade cladding, which is situated above the window frame. (see figure 155 & 156).

Any excess unventilated air can also be exhausted via grills in the walls towards the water shaft in the bathroom module, from here the air will travel through the shaft and be exhausted at the roof.

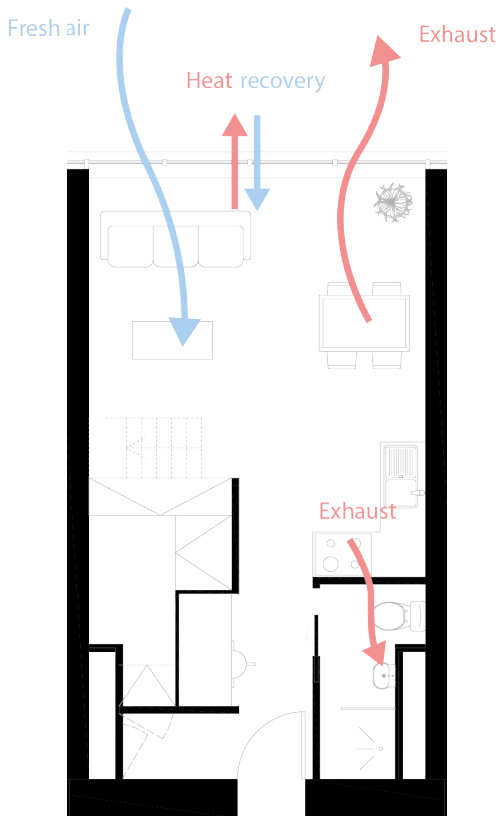


Figure 152: Dwelling ventilation. (Machgeels, D., 2021)

## NATURAL VENTILATION STUDIO+

### THE DWELLING

#### NEEDED VENTILATION

#### L X B X H X VENTILATION FACTOR

##### ventilation factor

living room: 5

kitchen: 15

bathroom: 10

Living room (includes all other living spaces)

$$\begin{aligned} & ((2,98 \times 8,1) + (3,6 \times 1,5)) \times 3,525 \times 5 = \\ & (24,138 + 5,4) \times 3,525 \times 5 = \\ & 520,60725 \text{ m}^3/\text{h} \end{aligned}$$

##### Kitchen

$$\begin{aligned} & (1,5 \times 1,8) \times 3,525 \times 15 = \\ & 2,7 \times 3,525 \times 15 = \\ & 142,7625 \text{ m}^3/\text{h} \end{aligned}$$

##### Bathroom

$$\begin{aligned} & (1,5 \times 2,7) \times 3,525 \times 10 = \\ & 4,05 \times 3,525 \times 10 = \\ & 142,7625 \text{ m}^3/\text{h} \end{aligned}$$

#### Total ventilation need Studio+ (36 m<sup>2</sup>)

$$520,60725 + 142,7625 + 142,7625 = 806,13225 \text{ m}^3/\text{h}$$

$$806,13225 / 3600 = 0,223925625 \text{ m}^3/\text{s}$$

#### VENTILATION THROUGH WINDOW

$$Q = 0,5 \times A_{\text{eff}} \times \sqrt{0,0035 \times \Delta T \times h \times (0,001 \times U^2) \times 0 \times 01}$$

$$\begin{aligned} A_{\text{eff}} &= l \times h \times 0,98 \\ &= 2,6 \times 1,085 \times 0,98 \\ &= 2,76458 \end{aligned}$$

$$h = 2,6 \text{ m}$$

$$\Delta T = 3$$

$$U = 5 \text{ m/s}$$

$$\begin{aligned} Q &= 0,5 \times 2,76458 \times \sqrt{0,0035 \times 3 \times 2,6 \times (0,001 \times 5^2) + 0,01} \\ &= 1,38229 \times \sqrt{0,0273 \times 0,025 + 0,01} \\ &= 1,38229 \times 0,25377155 \\ &= 0,3507858758495 \end{aligned}$$

That equates to:

$$\begin{aligned} & 0,3507858758495 / 0,223925625 \times 100\% = \\ & 156,65285\dots\% = \\ & 156,7\% \text{ of the necessary ventilation} \end{aligned}$$

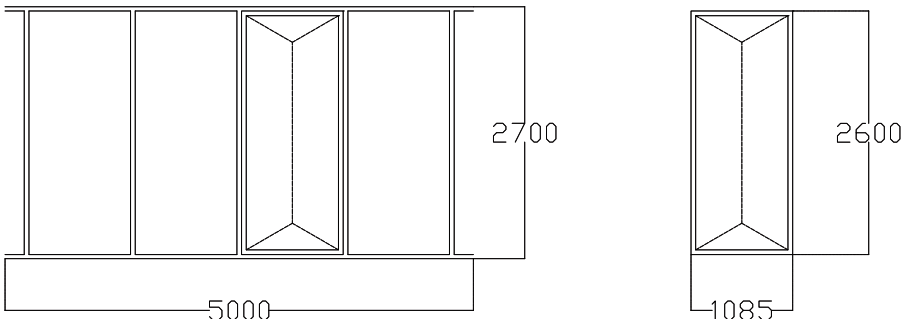


Figure 153: Size openable window Studio+. (Machgeels, D., 2021)

## ATRIUM ROOF + ROOF

The atrium roof consists out of a few elements that all work towards creating an atrium that can be naturally ventilated. The roof of the atrium itself is raised to make room for a vent along the raised edge to allow for natural exhaust. This vent is environmentally controlled and opens and closes depending on the weather.

Similar to the dwellings the atrium roof, which sees almost constant sun, has retractable sunscreens to prevent overheating of the atrium. These sunscreens are placed within the cavity of the cantilevering ceiling of the gallery and along the wooden beams supporting the roof, in order to hide most of their mechanical parts.

As to not impede on the natural ventilation of the atrium when these sunscreens are closed, grates have been installed along the wall of the

atrium up to the vent. This way even when the sunscreens are closed the atrium can be naturally ventilated. Additionally the closed sunscreens will create a buffer zone for heat above the atrium instead of in the space itself.

Other technical aspects of the roof include the PV-cell glass for the glass top of the atrium and the Tesla solar roof for the sloped roof on either side of the atrium. The Tesla solar roof is used because of the similar performance to normal solar panels and their overall better look and integration into the design. Using the solar roof the roofscape of the building is a lot cleaner looking as well as result in better power delivery. Because these panels act more like normal roof tiles they can be more tightly placed on the roof resulting in a larger surface area of PV-cells.

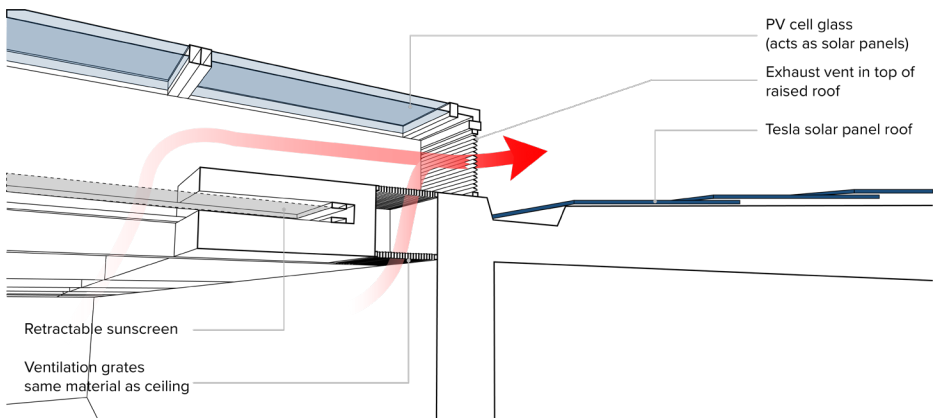


Figure 154: Concept atrium roof + roof. (Machgeels, D., 2021)

### AEROMAT VT

The Aeormat VT is an independent heat recovery system which can be placed underneath, above or next to a window frame. It can be controlled via smartphone, laptop or via sensors within the dwelling, which measure room temperature, CO<sub>2</sub> levels etc.

These systems can be integrated within the façade of any building with the only requirement being a space of minimally 250 mm (depending on the unit type) wide in the wall and a grill towards the outside and inside of the dwelling to function for inlet and outlet.

### TECHNICAL INFORMATION

#### AREMOAT VT WRG 1000:

Dimensions, H x L x D: 100 mm x 1000-3000 mm x 250 - 500 mm  
 Air throughput: up to 52 m<sup>3</sup>/h  
 Sound absorption Dn,e,w: 54 dB  
 Inherent noise: 43 dB(a) at 52 m<sup>3</sup>/h  
 Power consumption: 5-24 W

#### AREMOAT VT WRG 1100:

Dimensions, H x L x D: 100 mm x 1150-3000 mm x 320-550 mm  
 Air throughput: up to 56 m<sup>3</sup>/h  
 Sound absorption Dn,e,w: 55 dB  
 Inherent noise: 43 dB(a) at 56 m<sup>3</sup>/h  
 Power consumption: 7-21 W

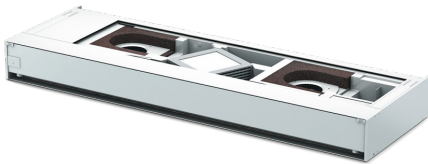


Figure 155: Aeromat VT and installation methods [Image], (SIEGENIA, 2020)

**DUCOTWIN 120 “ZR” AK(+)**

The Ducotwin is a standalone unit, placed above the window frame, with included sunshading and ventilation. These units have rails fitted to the window frame along which the sunscreen can move. Using these units will make it possible to hide the shading solution in my building and even contribute to ventilating the dwelling. The guiding rails that attach to the window frame ensure that the sunscreen can be used along slanted façades as well.



Figure 156: *Ducotwin 120 'ZR' AK* [Image]. (Machgeels, D., 2021)

## PV-CELL GLASS

Photovoltaic glass is fairly new and introduces the concept of PV cells into normal translucent glass. This new PV cell type glazing is only 10% as effective as a normal solarpanel however they can be applied to much larger area's. These new window types are installed all over the building and used to produce electricity for the whole building making it more self-sufficient.

This type of glass is also available in different slightly shaded colors as well as patterns. Tinted windows produce slightly more electricity since more PV-cells can be hidden in the coloration of the window.

The installation is the same as a normal glass window panel, making them really easy to use.

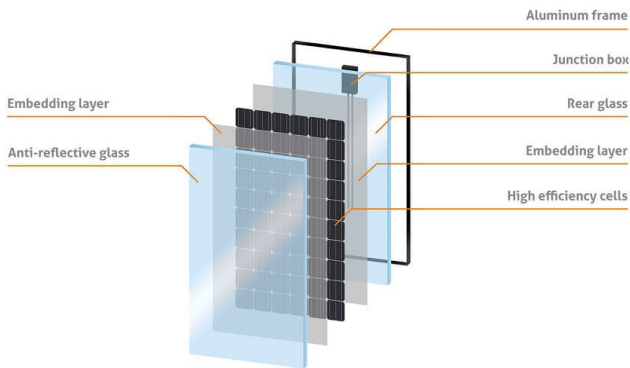


Figure 157: Principle of PV-cell glass. (z.d.)

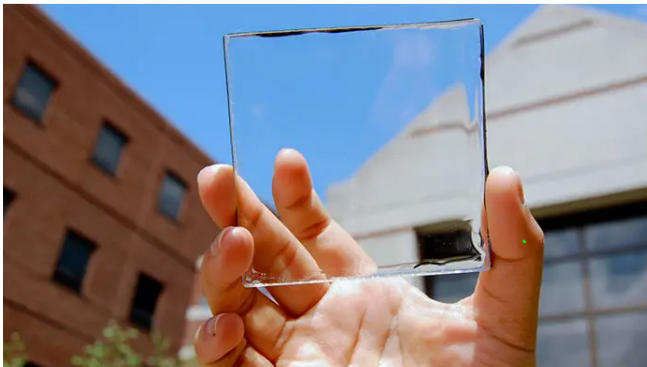


Figure 158: PV-cell glass. (Lunt, R., 2020)



## TESLA SOLAR ROOF

The Tesla solar roof is a product of Tesla combining two of the most sought after aspects for roofs, namely aesthetics and functionality.

The tesla roof comes in a few different designs from regular roof tiles to smooth glass panels. In my design I used the glass tiles. The design choice however has as far as they mention no impact on the efficiency of the PV cells in the tiles themselves.

The roof is assembled similarly to a normal roof consisting out of roof tiles and has because of this reason a bigger surface area for PV-cells. This bigger surface area also results in a better power delivery, making them a good replacement for regular solarpanels.

## TECHNICAL SPECIFICATIONS

- Warranty rooftiles:** 25 years
- Power delivery warranty:** 25 years
- Warranty weather resistance:** 25 years
- Roof pitch:** 2:12 to 20:12
- Hail resistance:** Class 3 ANSI FM 4473
- Wind resistance:** Class F ASTM D3161
- Fire resistance:** Class A (highest rating)
- Tile size:** 45" x 15" ( 365 x 184 mm)

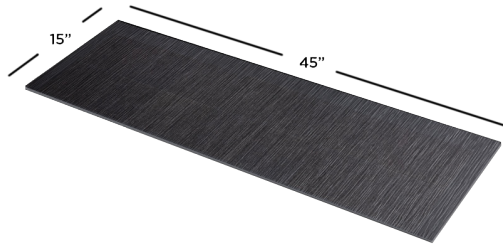


Figure 159: Tesla solar roof tile size. (Tesla, z.d.)

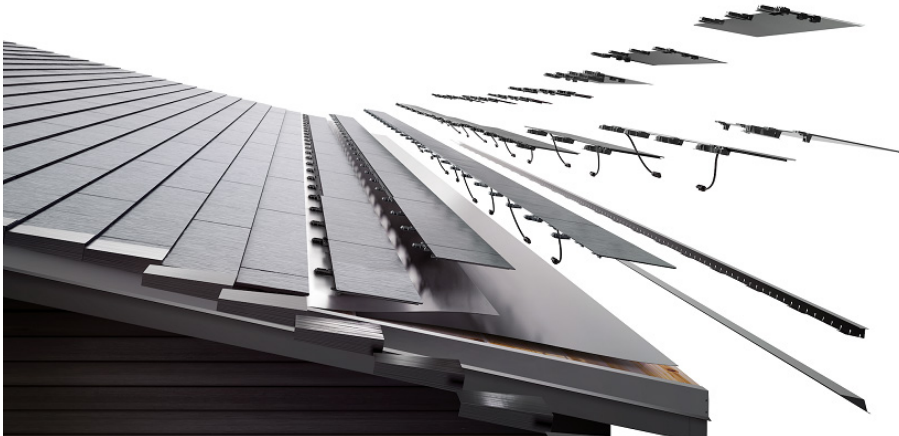


Figure 160 Tesla Solar Roof. (2019) Retrieved from <https://solarmagazine.nl/nieuws-zonne-energie/i19768/tesla-introduceert-solarglass-productie-van-der-de-verse-zonedakpan-per-direct-van-start>

## LAST MINUTE ADJUSTMENT

At the end of the project I found a new window-frame that functions even better than the solution that is currently in my details. Both in terms of safety, preventing people from falling out of the window, and in ease of use.

Unfortunately I didn't have time enough to adjust the details accordingly. The windowframe however doesn't change the building aesthetically and can be constructed in a similar way as the current windowframe, as they are produced by the same manufacturer.

In figure 161 the new windowframe "Schüco AWS 114" is shown. This will replace the AWS 75 SI+ windowframe that is in my current details.

In terms of changes to the current windowframe. Instead of opening inwards or sliding to the side the new window opens outwards parallel to the façade (see figure 163). Because of several limiters the gap between the window and the façade can never be bigger than 15 cm meaning that it is completely prevents falling out of the window. Additionally it is easy to operate as it can be opened either manually, manually assisted by mechanical parts or fully mechanical.

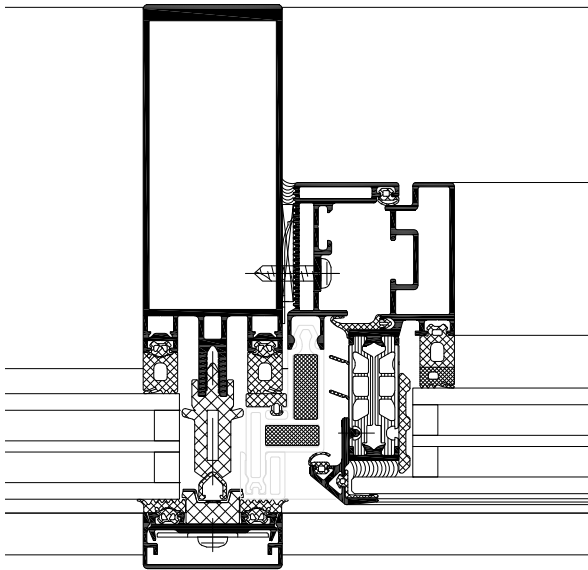


Figure 161: Schüco AWS 114 in FW 50 SI+. (Schüco, 2020)

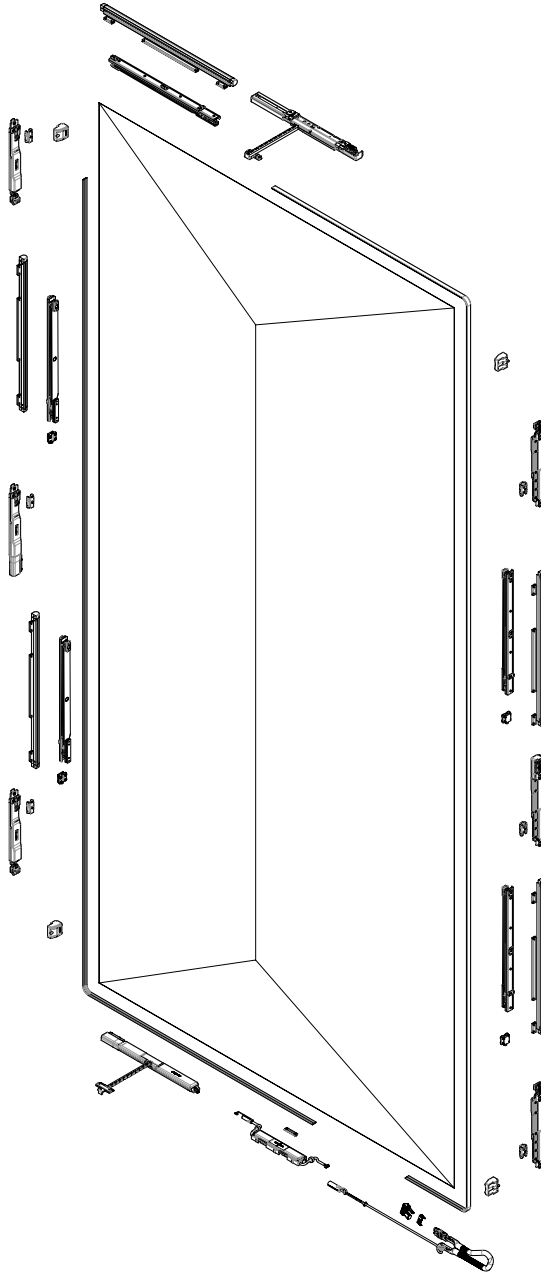


Figure 162: Fittings system for Schüco AWS 114 parallel-opening window [Image], (Schüco, 2020)



Figure 163: Schüco AWS 114 parallel-opening window in action [Image], (Schüco, 2020)

## THE FAÇADE

To lower the cost of the building the façade is constructed out of prefabricated elements, which connect to the two floors confining a dwelling. Each of the elements has the same width as the structural grid of the building, meaning that each element covers a dwelling completely.

Using prefabricated elements has several advantages for the building, the residents and even the builders. First of all due to the fact that these panels will be mass produced (circa 200 panels) the cost of a façade that doesn't have to be built on site will be lower. This reduction in cost greatly benefits not only the building cost, but also the eventual dwellings cost, which is a benefit for the residents and specifically the target group.

Secondly the use of prefabricated elements greatly speeds up the process of the construction of the building, because of its seamless fit within the assembly process (see figure 166). A faster construction process of the building means that the building will be fully operational earlier as well, this not only has advantages for the owner, but also offers a quicker solution to the current housing shortages for not only the target group, but also the Netherlands.

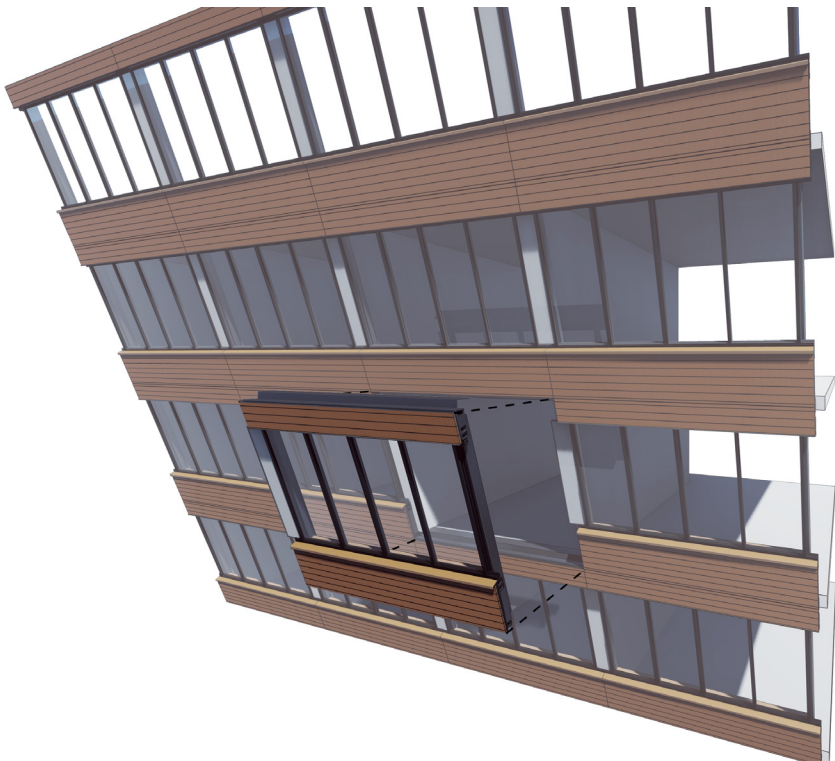


Figure 164: Exploded view façade. (Machgeels, D., 2021)

**THE ELEMENT**

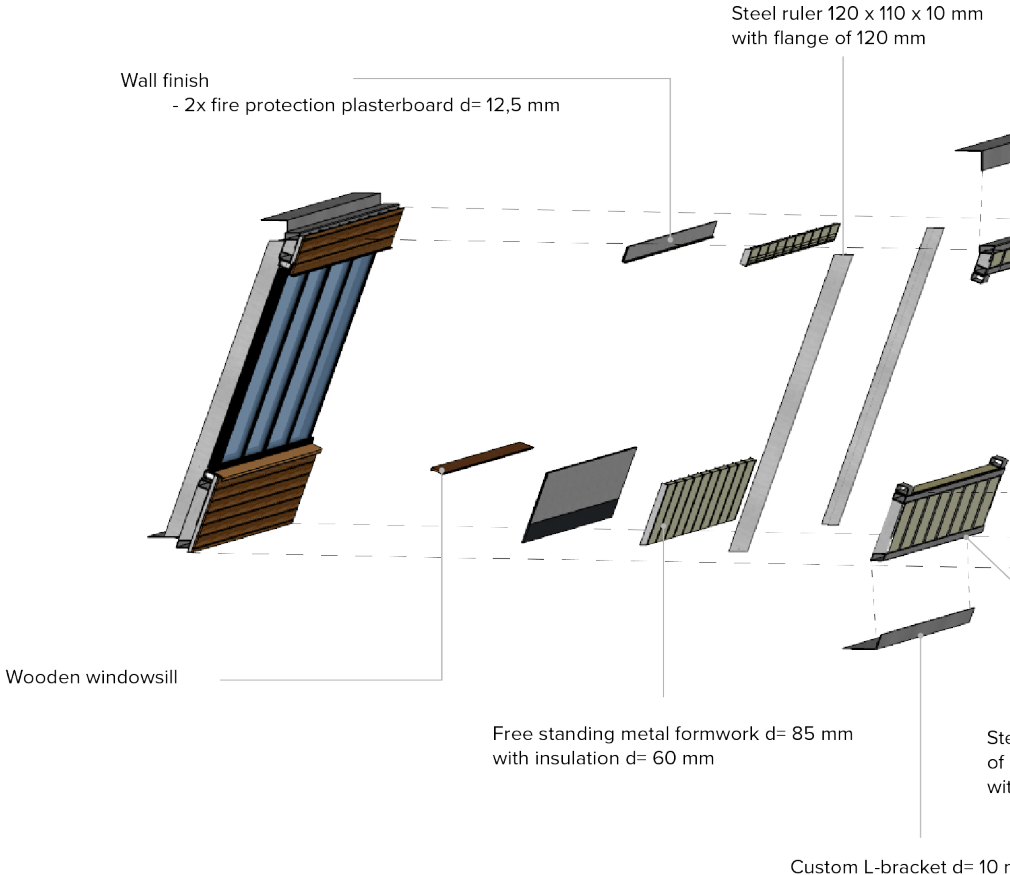
The element consists out of a main steel construction that is insulated with 160 mm of mineral wool insulation. Attached to this main construction are all the various elements that make up the prefabricated element. These include the before mentioned: Ducotwin, Aeromat VT, Schüco windowframe.

To attach the main steel construction to the CLT construction of the tower 2 principles are used. The first uses custom steel L-brackets on both the top and bottom of the element. With these brackets the bearing construction of the ele-

ment is attached to the respective bottom and top floor of the dwelling.

To make sure the element won't fall out of the construction and to also directly attach the windowframe to the CLT construction 2 steel rulers are attached to the bearing construction of the element, one on each side. These rules attach to the CLT walls that separate the dwellings.

On top of the bearing construction 2 free standing steel formworks are placed, one on the outside and one of the inside. On the inside an



additional 60 mm of insulation is placed to prevent any cold-bridges from occurring. On top of these formworks the finishes of the inside and outside of the building are fitted.

On the outside this consists of Gadero Wooden planks or otherwise known as Pine Thermowood. To compensate for the possible discoloration these planks are coated in a special oil beforehand. With this oil the wood will keep its color for at least 15 years, before showing any signs of wear. Another option for cladding is the use of Trex composite cladding. This is a recy-

clad plastic based cladding that can be made to look exactly like wood, also specifically this wood, which has a life span of over 50 years. This cladding has the exact same finish and construction as these wooden planks, but are a bit more environmentally friendly.

Finally as to hide the water hammers as much as possible they have been anodized to match the color of the wood cladding.

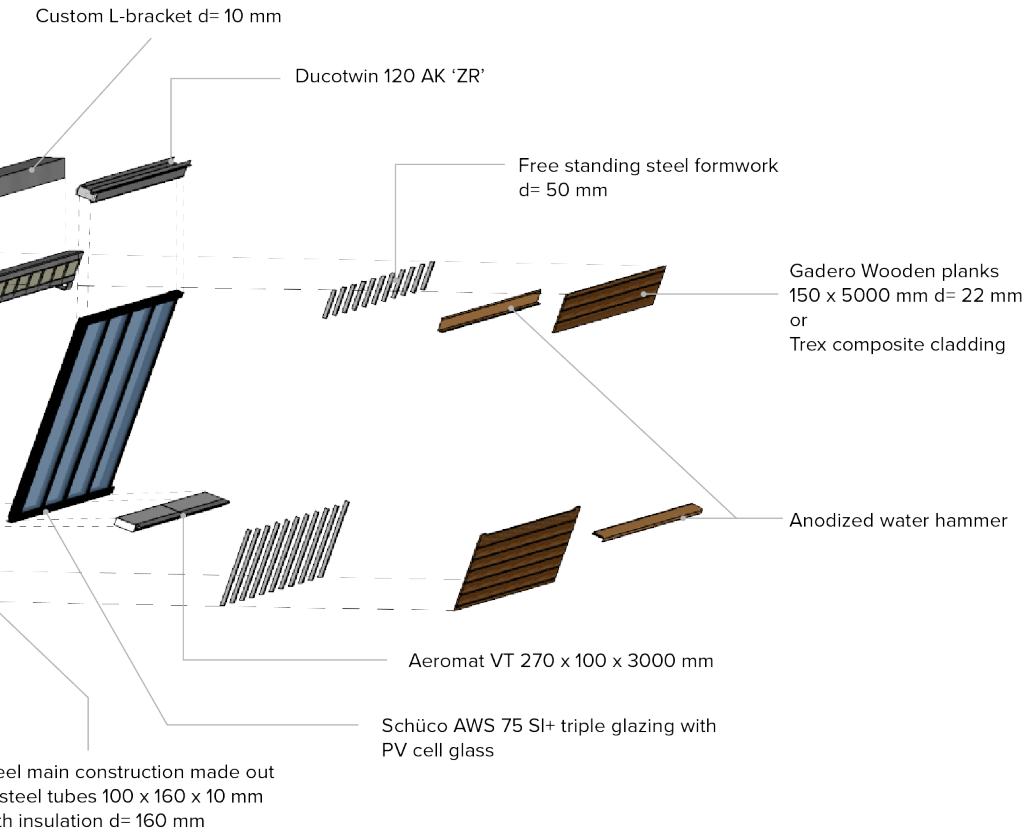
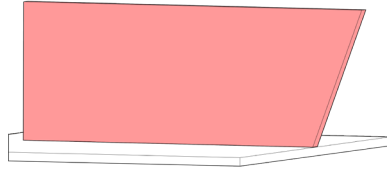


Figure 165: Exploded view element. (Machgeels, D., 2021)

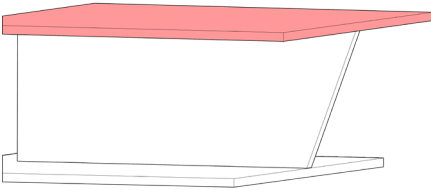
**1. PLACE FLOOR**



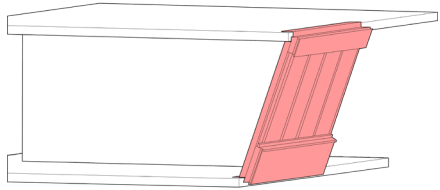
**2. ADD WALLS**



**3. PLACE SECOND FLOOR**



**4. PLACE ELEMENT**



**5. ADD INTERIOR FINISHES**

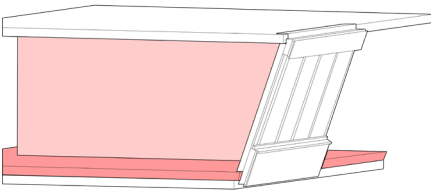
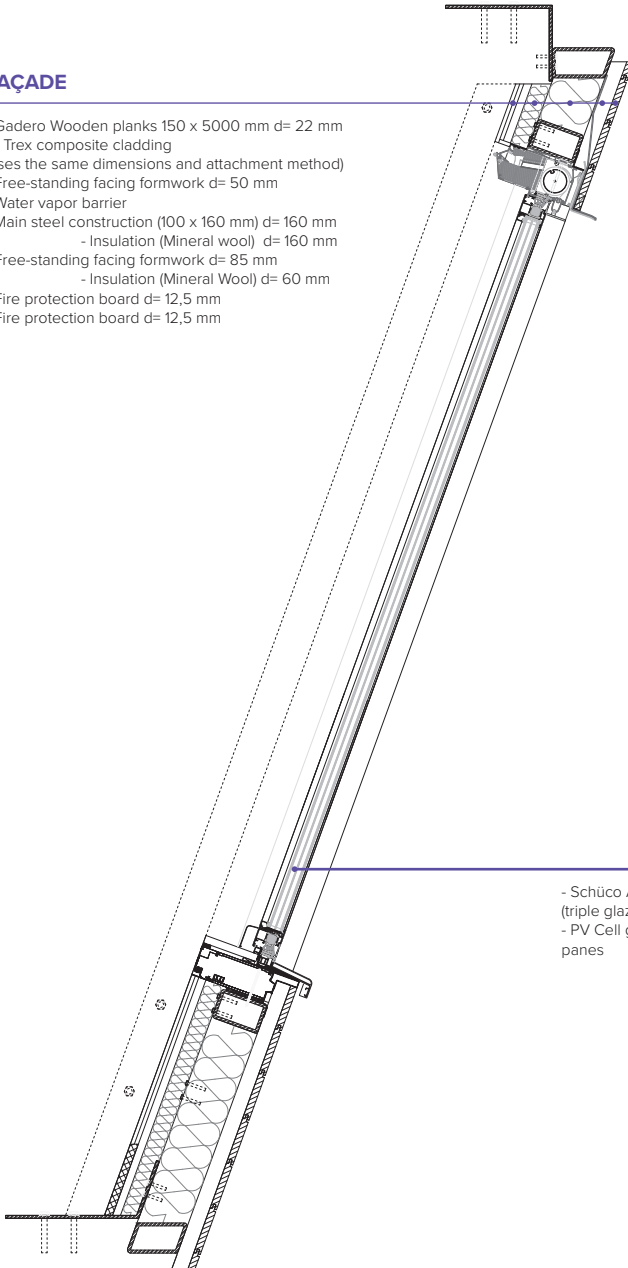


Figure 166: Assembly process façade. (Machgeels, D., 2021)



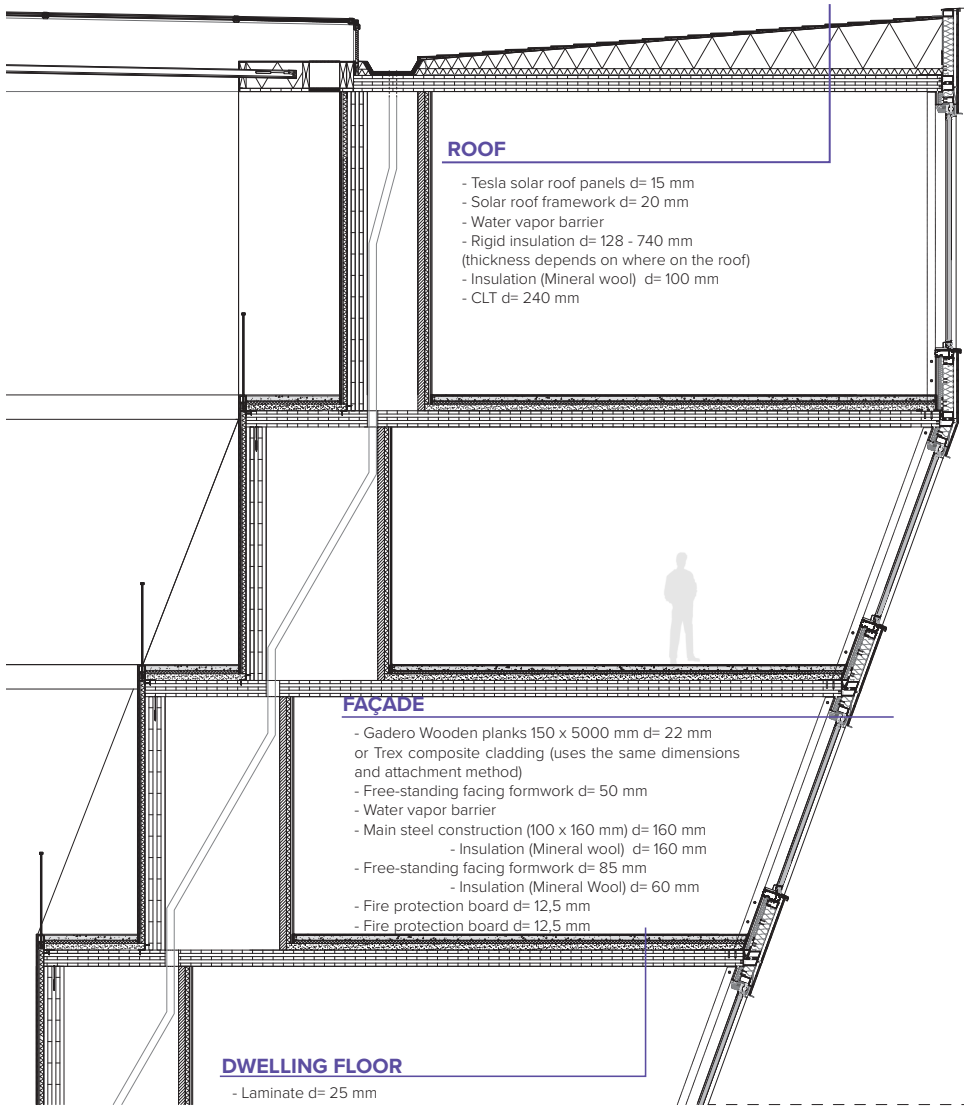
**FAÇADE**

- Gadero Wooden planks 150 x 5000 mm d= 22 mm or Trex composite cladding (uses the same dimensions and attachment method)
- Free-standing facing formwork d= 50 mm
- Water vapor barrier
- Main steel construction (100 x 160 mm) d= 160 mm
  - Insulation (Mineral wool) d= 160 mm
- Free-standing facing formwork d= 85 mm
  - Insulation (Mineral Wool) d= 60 mm
- Fire protection board d= 12,5 mm
- Fire protection board d= 12,5 mm



**GLASS FAÇADE**

- Schüco AWS 75 SI+ (with Ducotwin 120 'ZR' AK) (triple glazing)
- PV Cell glass instead of normal glass window panes



**ROOF**

- Tesla solar roof panels d= 15 mm
- Solar roof framework d= 20 mm
- Water vapor barrier
- Rigid insulation d= 128 - 740 mm  
(thickness depends on where on the roof)
- Insulation (Mineral wool) d= 100 mm
- CLT d= 240 mm

**FAÇADE**

- Gadero Wooden planks 150 x 5000 mm d= 22 mm or Trex composite cladding (uses the same dimensions and attachment method)
- Free-standing facing formwork d= 50 mm
- Water vapor barrier
- Main steel construction (100 x 160 mm) d= 160 mm
  - Insulation (Mineral wool) d= 160 mm
- Free-standing facing formwork d= 85 mm
  - Insulation (Mineral Wool) d= 60 mm
- Fire protection board d= 12,5 mm
- Fire protection board d= 12,5 mm

**DWELLING FLOOR**

- Laminate d= 25 mm
- Screed d= 80 mm
  - Floor heating
- Water vapor barrier
- Insulation d= 40 mm
- Gravel d= 110 mm
  - Drainage d= 110 mm
  - Water pipes
- CLT d= 240 mm

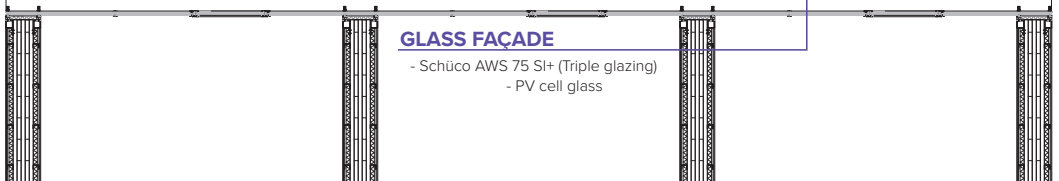
**PARTITION WALL**

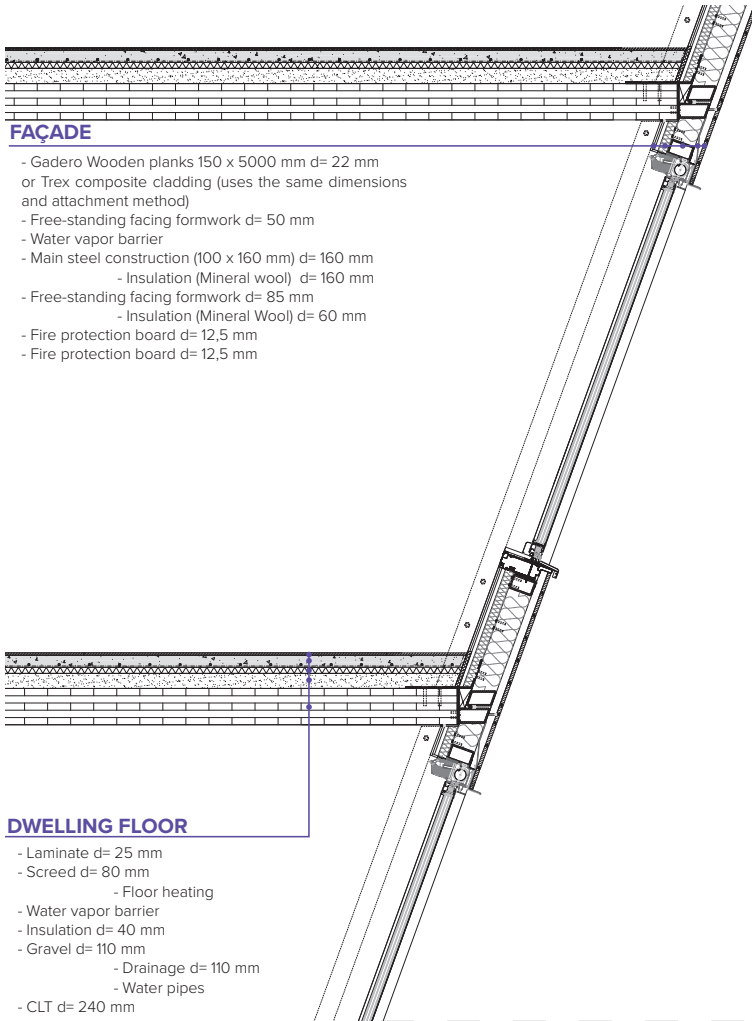
- Fire protection board d= 12,5 mm
- Fire protection board d= 12,5 mm
- Free-standing facing formwork d= 85 mm
  - Insulation (Mineral wool) d= 60 mm
- CLT d= 300 mm
- Free-standing facing formwork d= 85 mm
  - Insulation (Mineral wool) d= 60 mm
- Fire protection board d= 12,5 mm
- Fire protection board d= 12,5 mm



**GLASS FAÇADE**

- Schüco AWS 75 SI+ (Triple glazing)
- PV cell glass



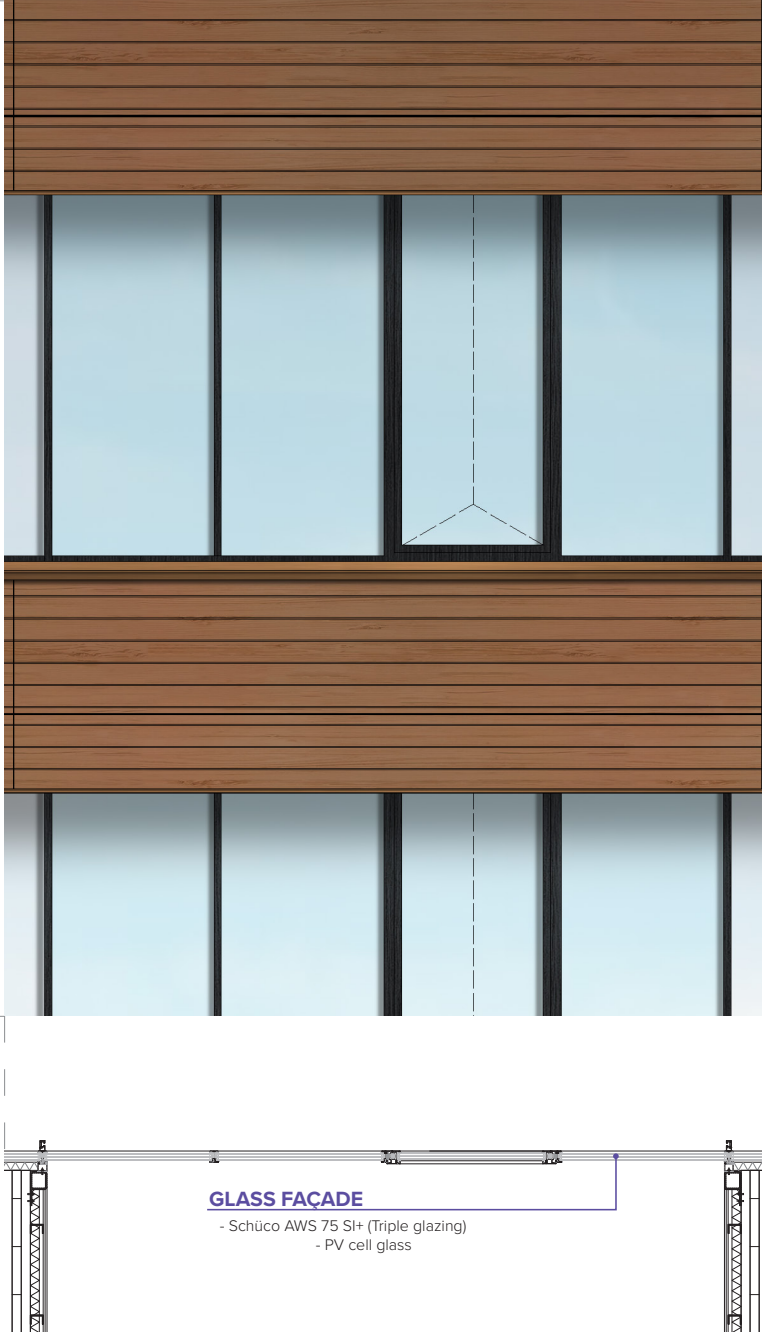


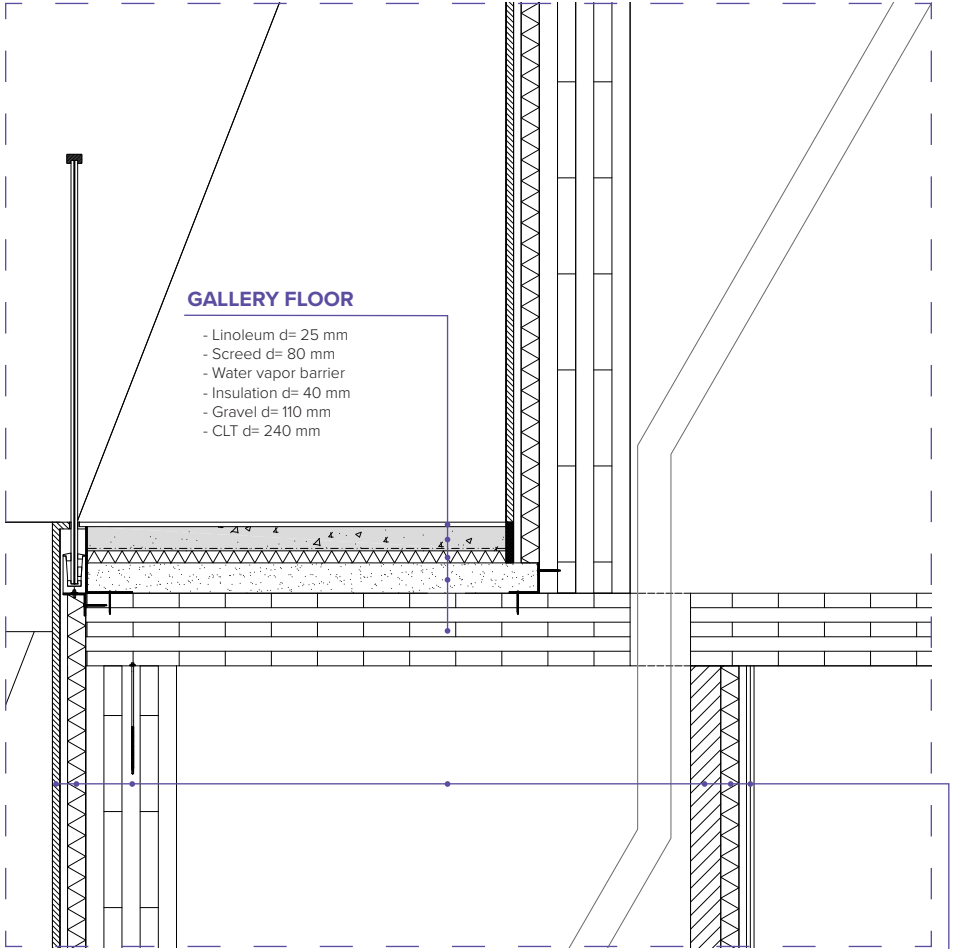
**FAÇADE**

- Gadero Wooden planks 150 x 5000 mm d= 22 mm or Trex composite cladding (uses the same dimensions and attachment method)
- Free-standing facing formwork d= 50 mm
- Water vapor barrier
- Main steel construction (100 x 160 mm) d= 160 mm
  - Insulation (Mineral wool) d= 160 mm
- Free-standing facing formwork d= 85 mm
  - Insulation (Mineral Wool) d= 60 mm
- Fire protection board d= 12,5 mm
- Fire protection board d= 12,5 mm

**DWELLING FLOOR**

- Laminate d= 25 mm
- Screed d= 80 mm
  - Floor heating
- Water vapor barrier
- Insulation d= 40 mm
- Gravel d= 110 mm
  - Drainage d= 110 mm
  - Water pipes
- CLT d= 240 mm





**GALLERY FLOOR**

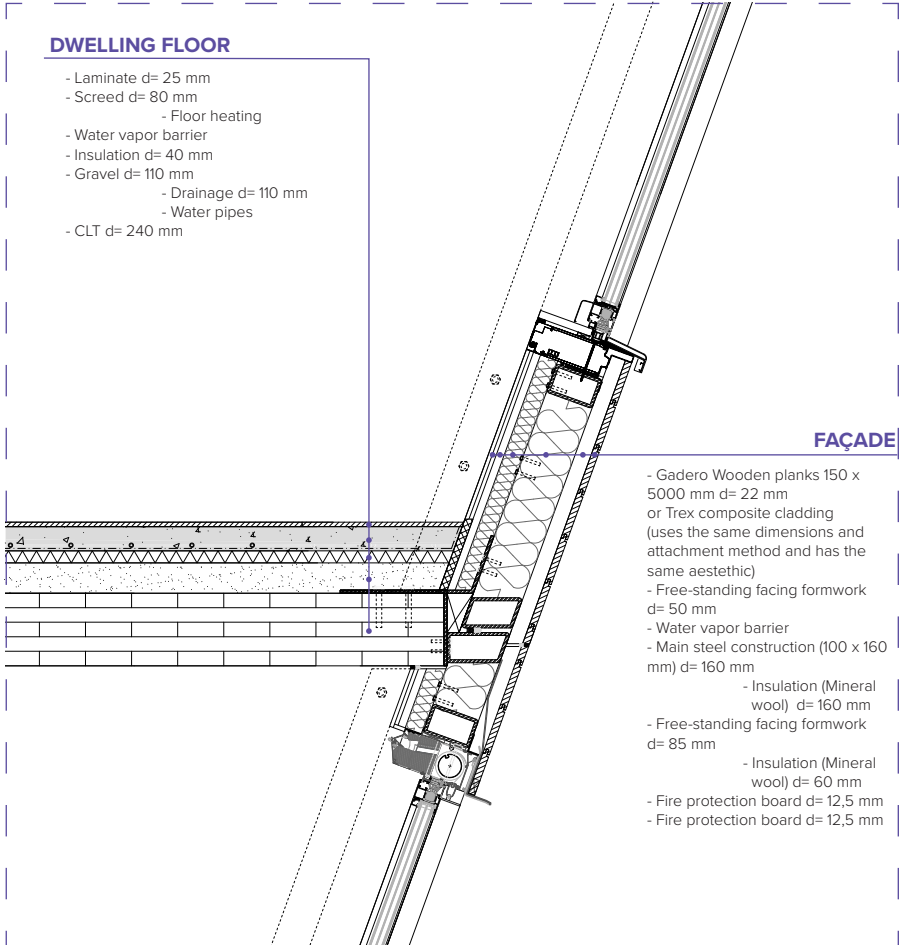
- Linoleum d= 25 mm
- Screed d= 80 mm
- Water vapor barrier
- Insulation d= 40 mm
- Gravel d= 110 mm
- CLT d= 240 mm

**GALLERY DWELLING WALL**

- Wooden planks 150 x 4000 mm d= 25 mm
- Free-standing facing formwork d= 85 mm
  - Insulation (Mineral wool) d= 60 mm
- CLT d= 300 mm
- Shaft d= 1700 mm
- Wooden partition frame d= 50 mm
- Free-standing facing formwork d= 85 mm
  - Insulation (Mineral wool) d= 60 mm
- Fire protection board d= 12,5 mm
- Fire protection board d= 12,5 mm

**DWELLING FLOOR**

- Laminate d= 25 mm
- Screed d= 80 mm
  - Floor heating
- Water vapor barrier
- Insulation d= 40 mm
- Gravel d= 110 mm
  - Drainage d= 110 mm
  - Water pipes
- CLT d= 240 mm



**FAÇADE**

- Gadero Wooden planks 150 x 5000 mm d= 22 mm or Trex composite cladding (uses the same dimensions and attachment method and has the same aesthetic)
- Free-standing facing formwork d= 50 mm
- Water vapor barrier
- Main steel construction (100 x 160 mm) d= 160 mm
  - Insulation (Mineral wool) d= 160 mm
- Free-standing facing formwork d= 85 mm
  - Insulation (Mineral wool) d= 60 mm
- Fire protection board d= 12,5 mm
- Fire protection board d= 12,5 mm

## FAÇADE

---

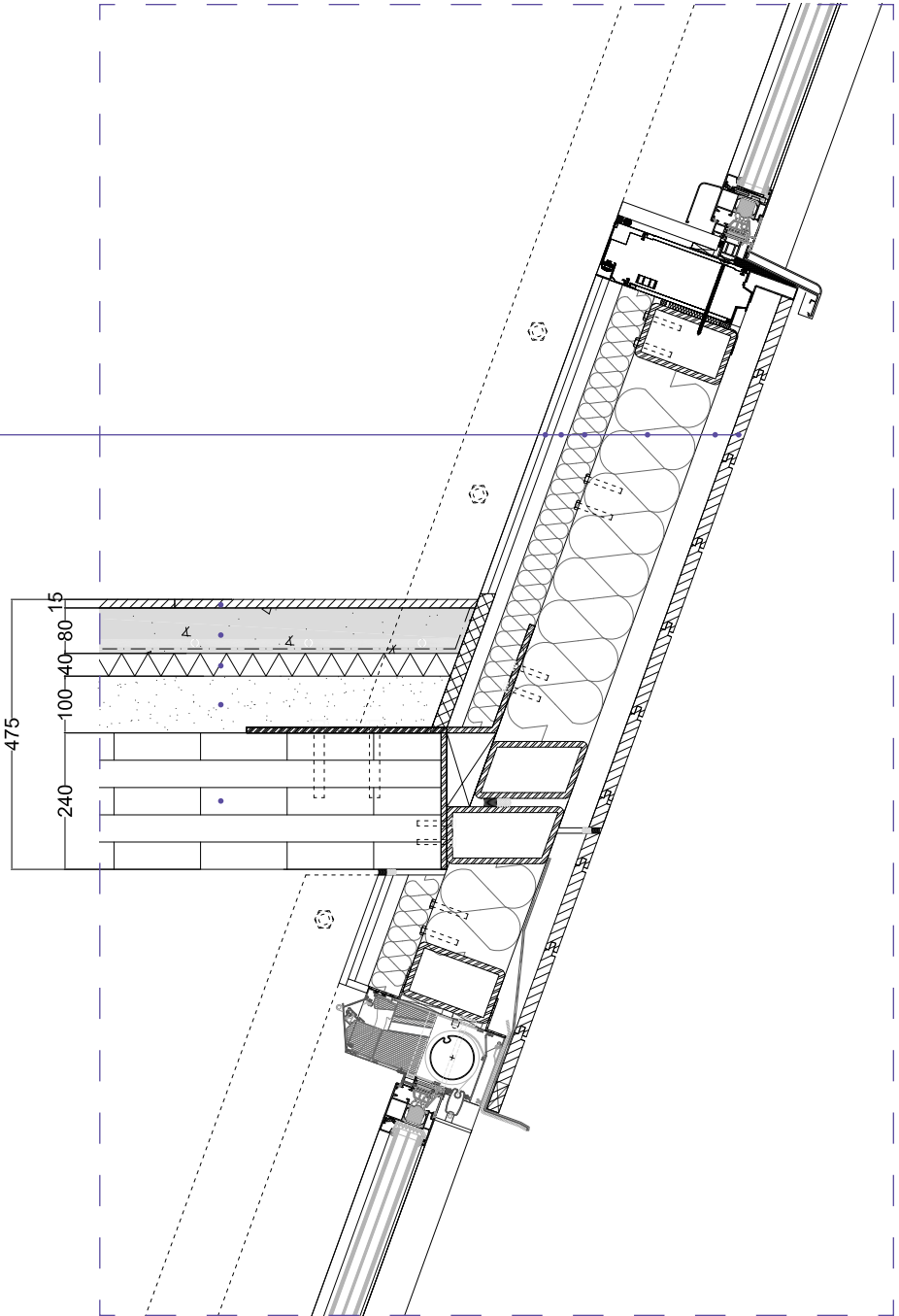
- Gadero Wooden planks 150 x 5000 mm d= 22 mm or Trex composite cladding (uses the same dimensions and attachment method)
- Free-standing facing formwork d= 50 mm
- Water vapor barrier
- Main steel construction (100 x 160 mm) d= 160 mm
  - Insulation (Mineral wool) d= 160 mm
- Free-standing facing formwork d= 85 mm
  - Insulation (Mineral Wool) d= 60 mm
- Fire protection board d= 12,5 mm
- Fire protection board d= 12,5 mm

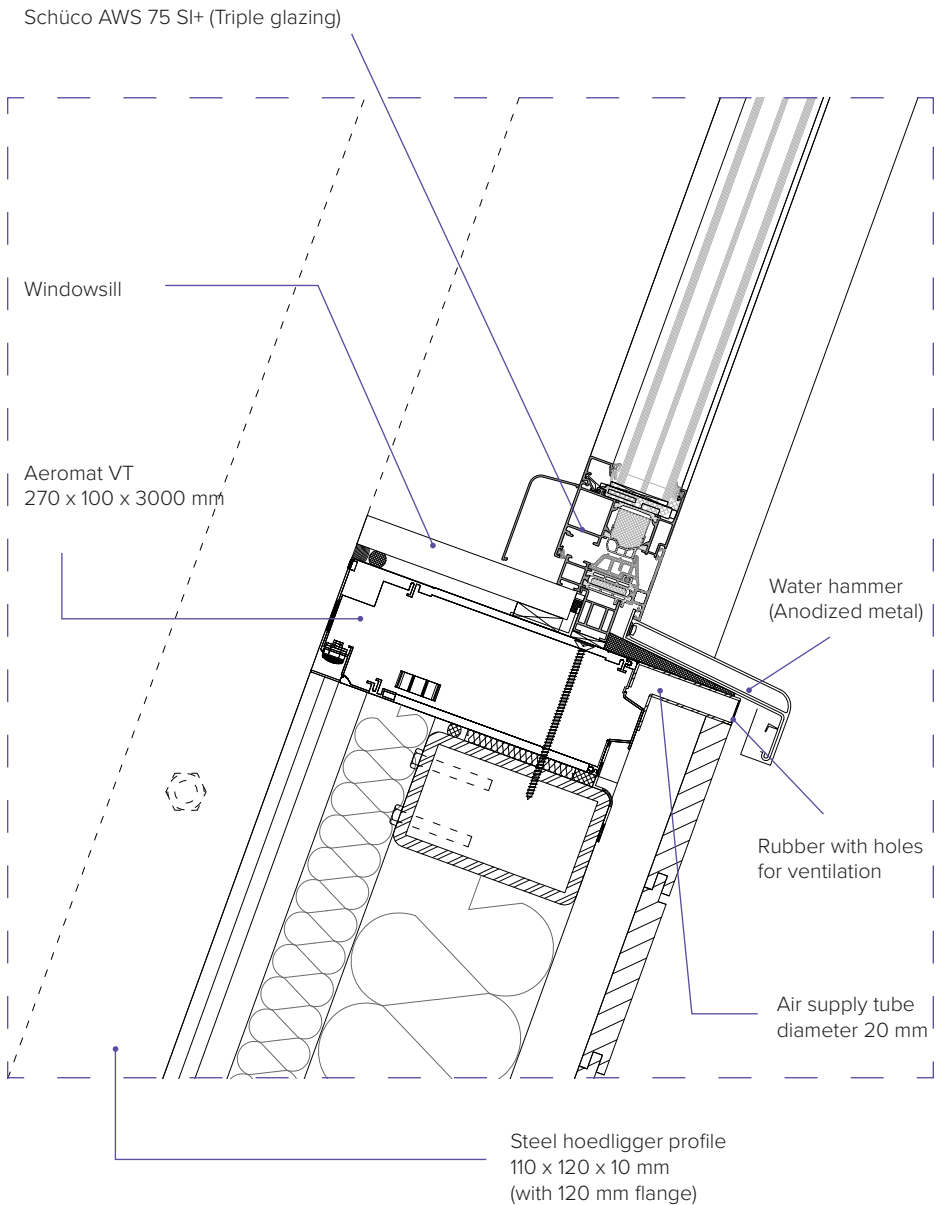
## DWELLING FLOOR

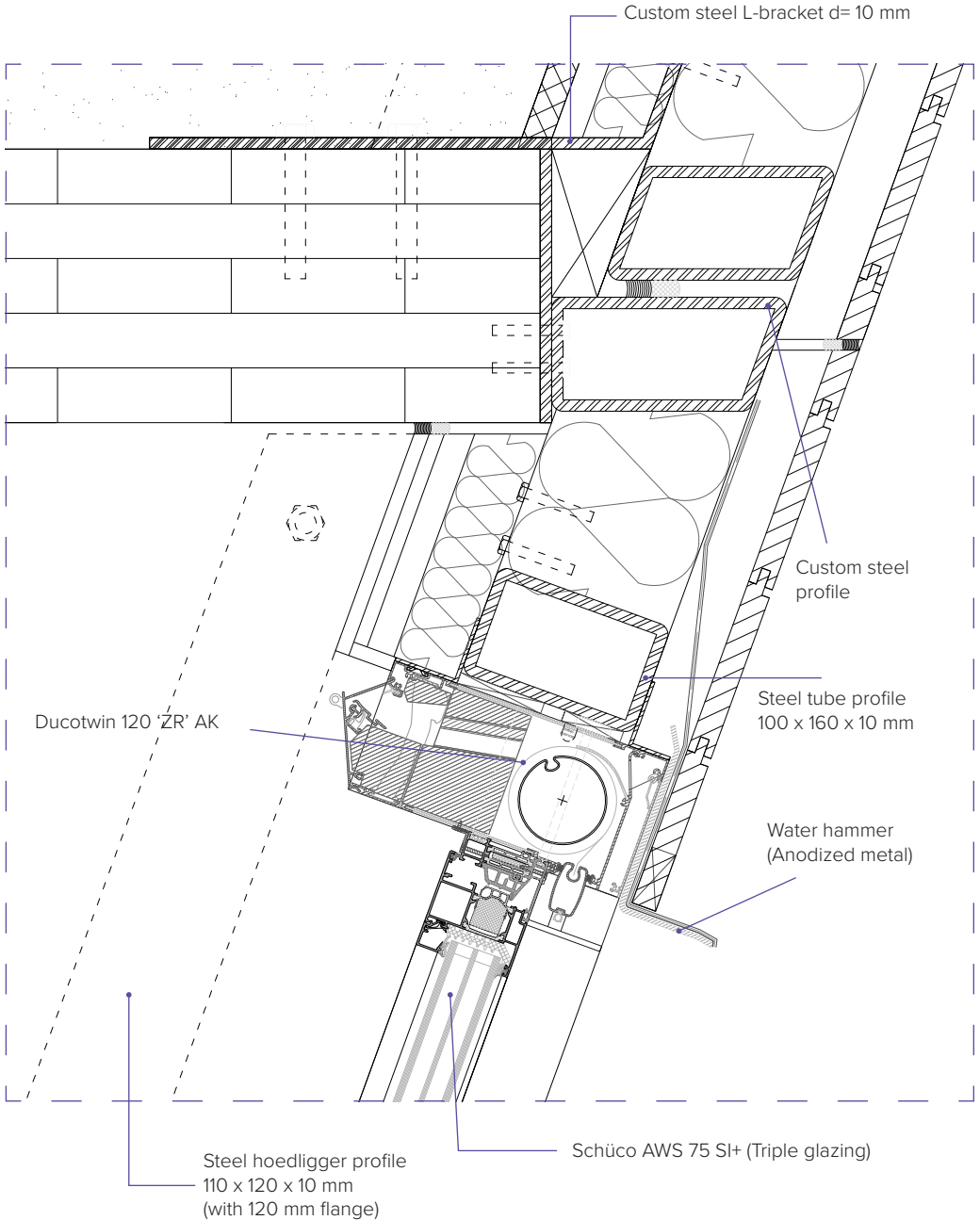
---

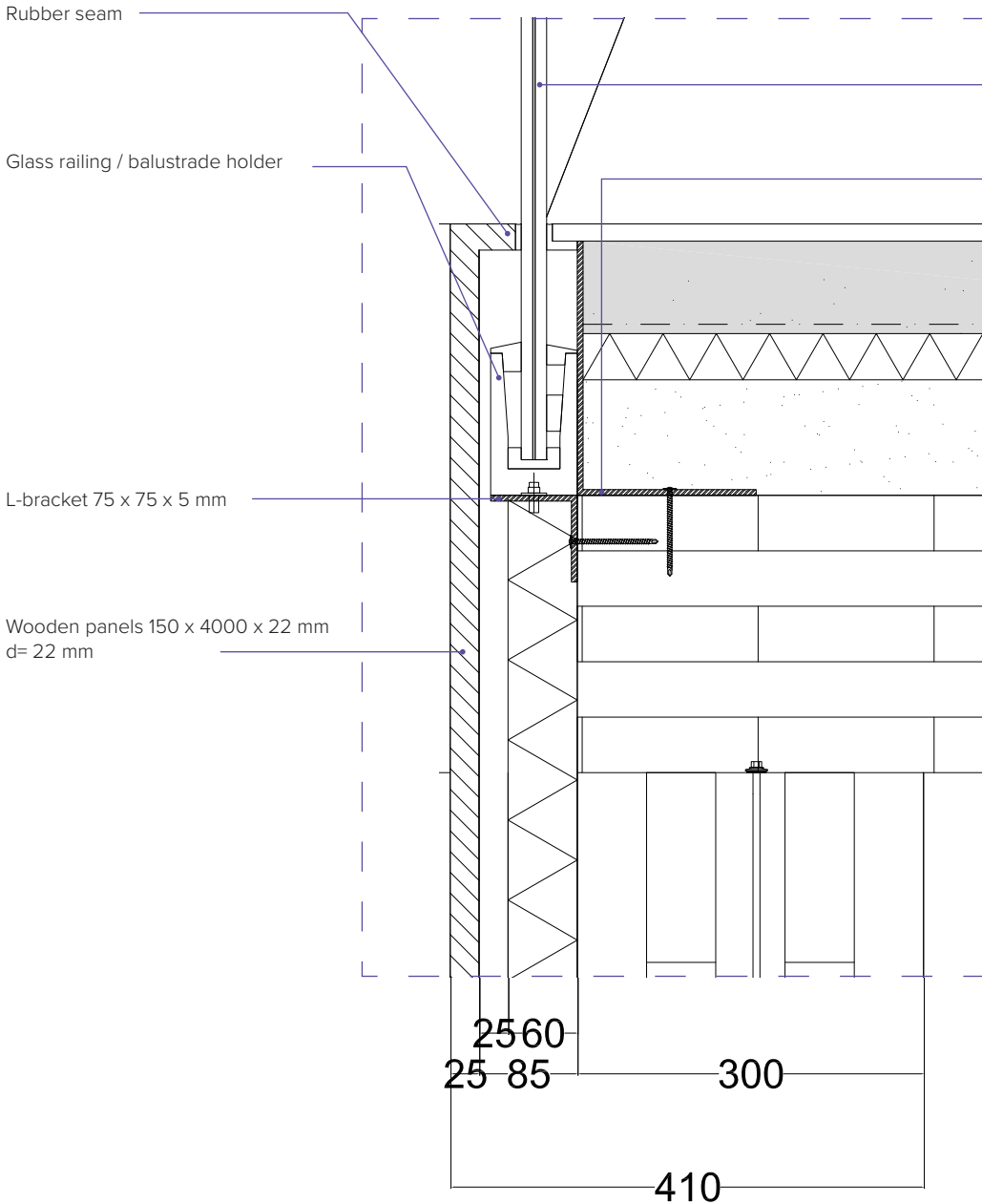
- Laminate d= 25 mm
- Screed d= 80 mm
  - Floor heating
- Water vapor barrier
- Insulation d= 40 mm
- Gravel d= 110 mm
  - Drainage d= 110 mm
  - Water pipes
- CLT d= 240 mm

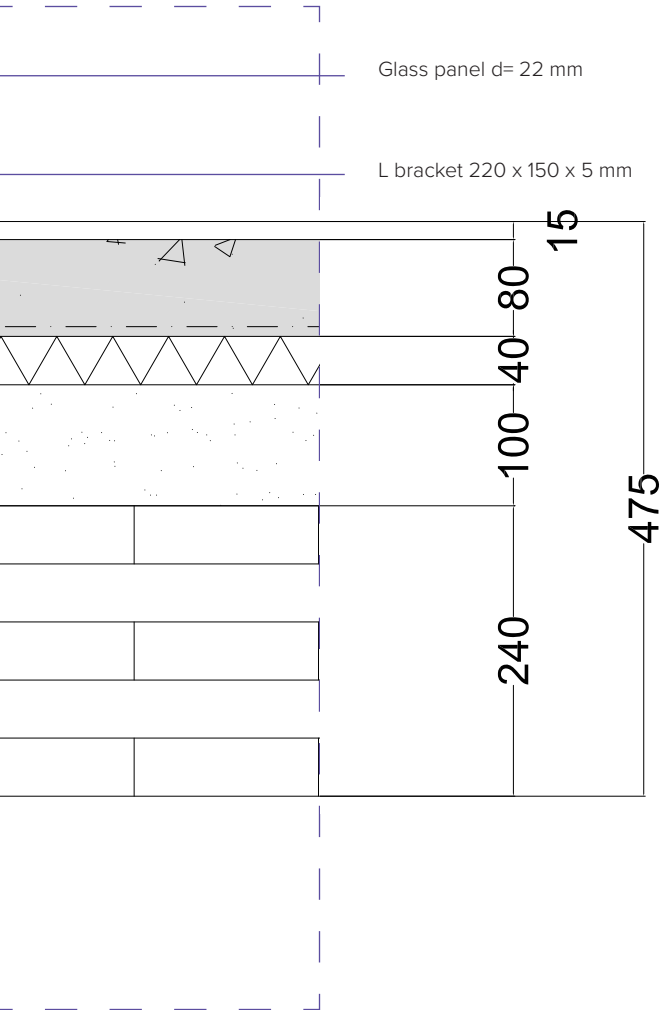


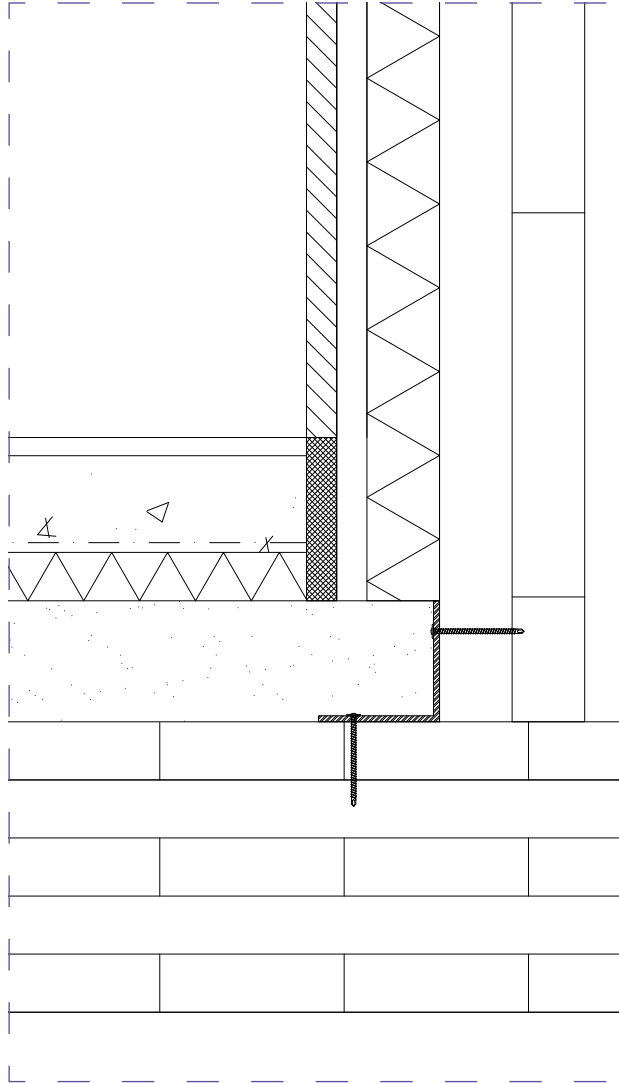


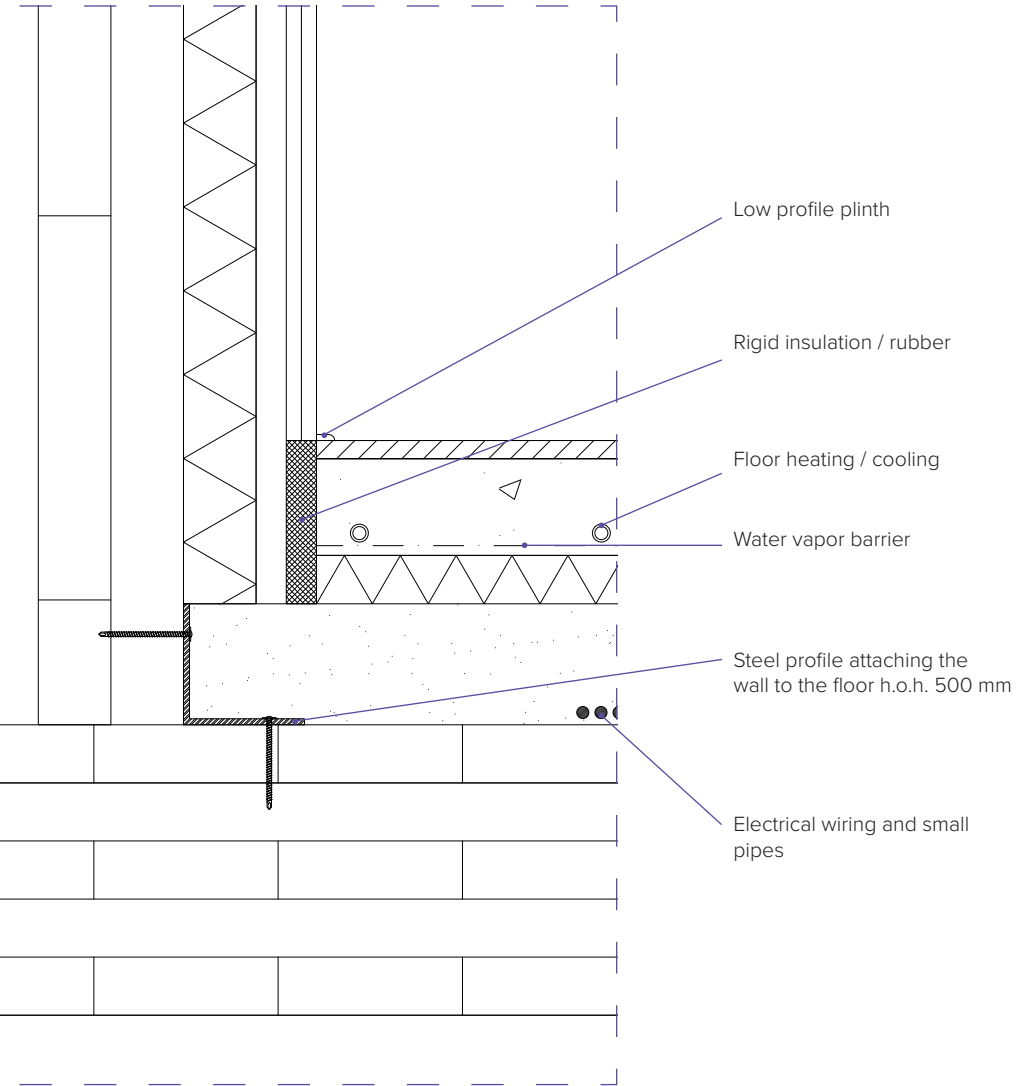


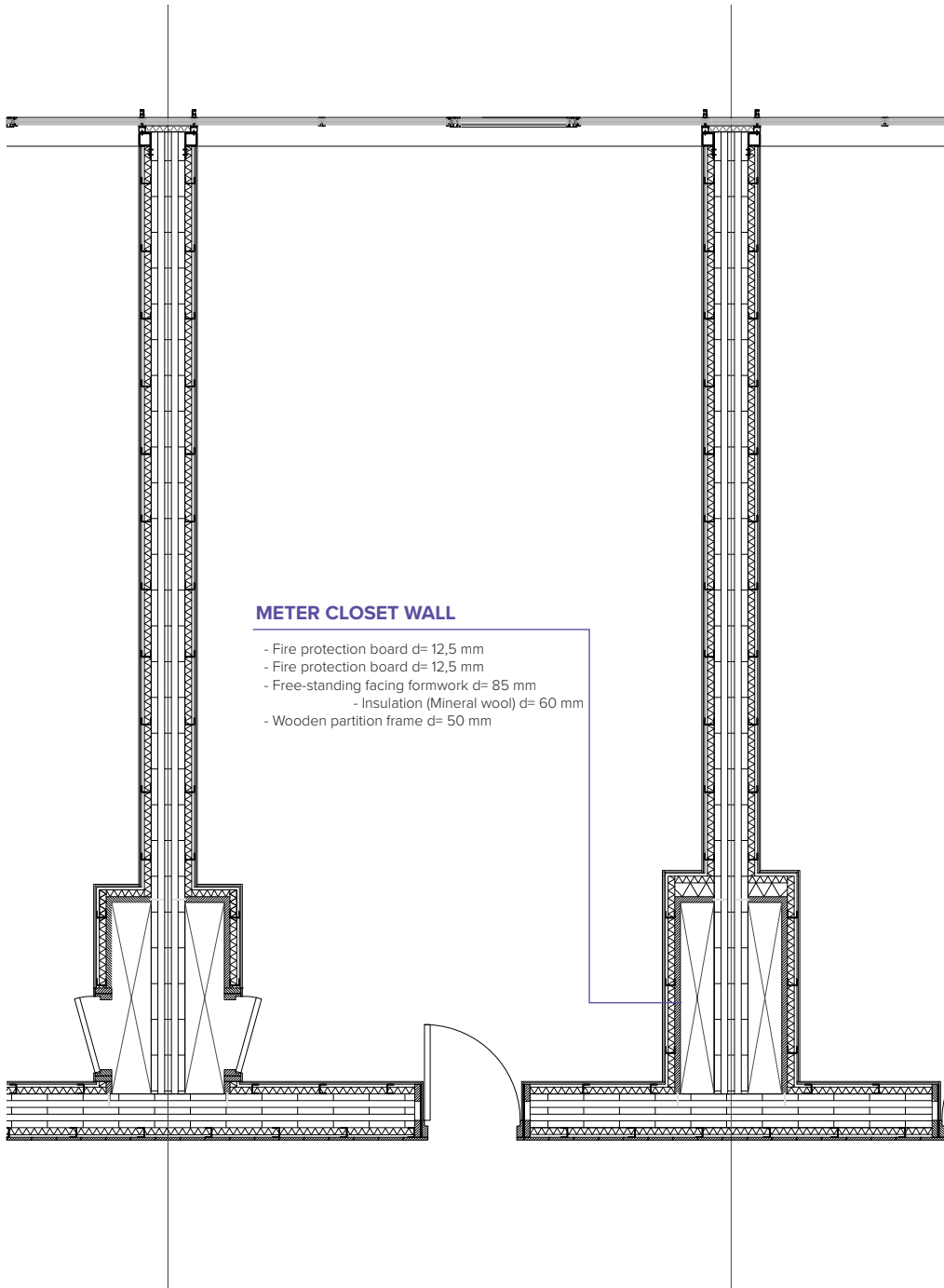












### METER CLOSET WALL

- Fire protection board d= 12,5 mm
- Fire protection board d= 12,5 mm
- Free-standing facing formwork d= 85 mm
  - Insulation (Mineral wool) d= 60 mm
- Wooden partition frame d= 50 mm



### GLASS FAÇADE

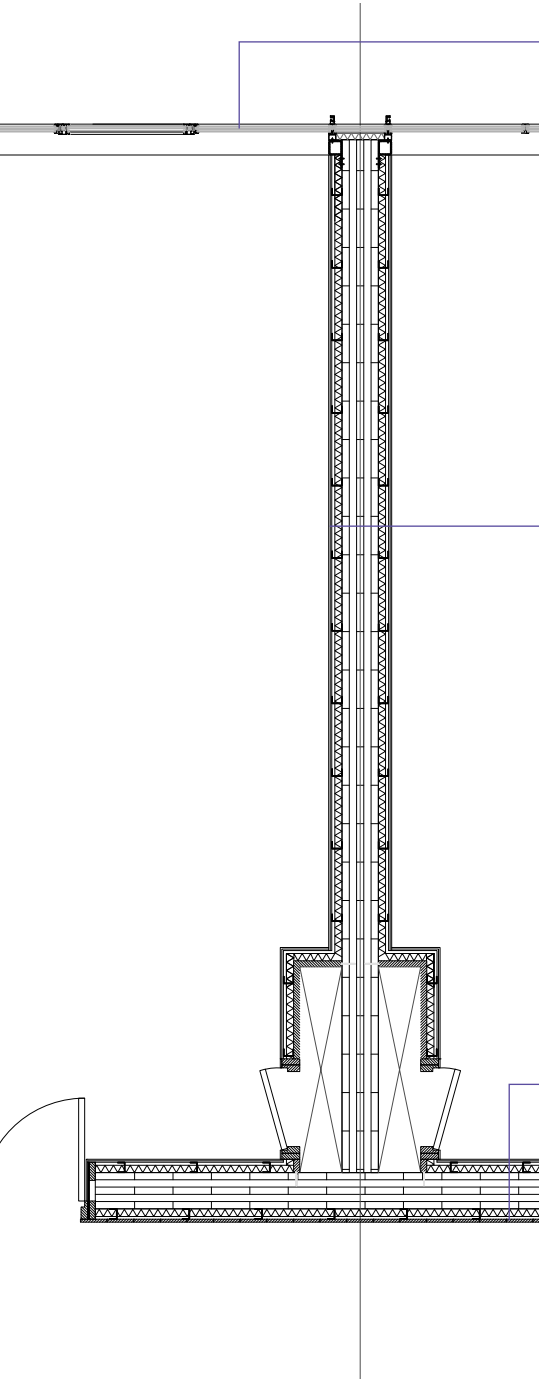
- Schüco AWS 75 SH+ (with Ducotwin 120 'ZR' AK) (triple glazing)
- PV Cell glass instead of normal glass window panes

### PARTITION WALL

- Fire protection board d= 12,5 mm
- Fire protection board d= 12,5 mm
- Free-standing facing formwork d= 85 mm
  - Insulation (Mineral wool) d= 60 mm
- CLT d= 300 mm
- Free-standing facing formwork d= 85 mm
  - Insulation (Mineral wool) d= 60 mm
- Fire protection board d= 12,5 mm
- Fire protection board d= 12,5 mm

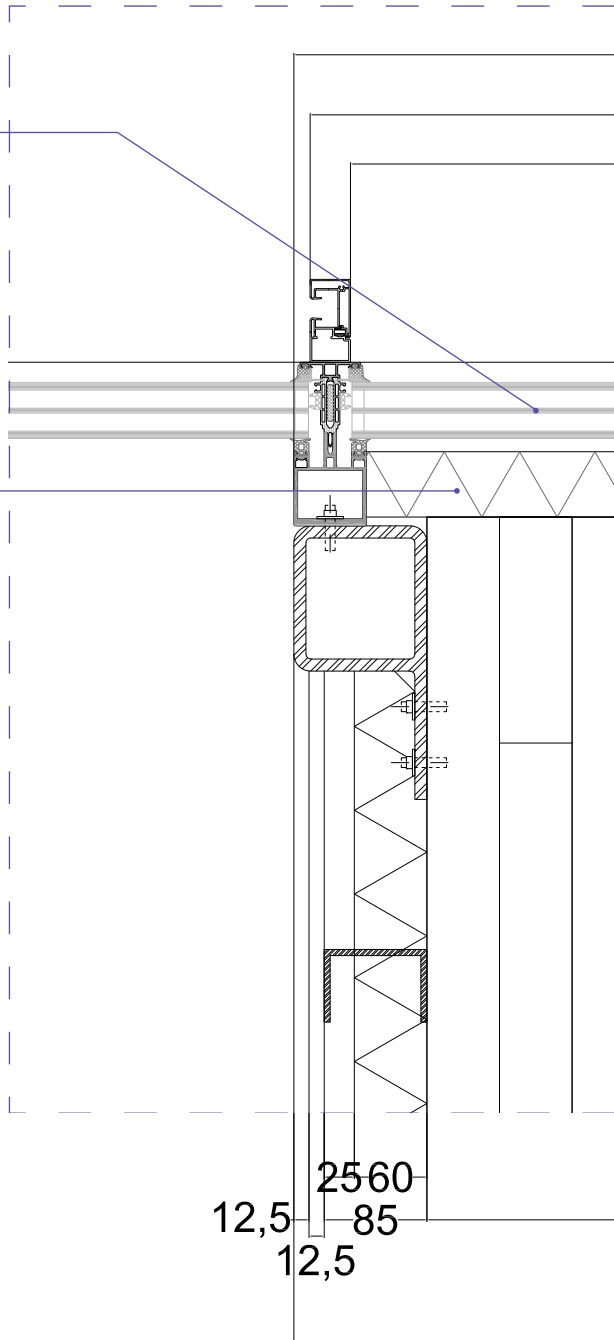
### GALLERY DWELLING WALL

- Wooden planks 150 x 4000 mm d= 25 mm
- Free-standing facing formwork d= 85 mm
  - Insulation (Mineral wool) d= 60 mm
- CLT d= 300 mm
- Free-standing facing formwork d= 85 mm
  - Insulation (Mineral wool) d= 60 mm
- Fire protection board d= 12,5 mm
- Fire protection board d= 12,5 mm

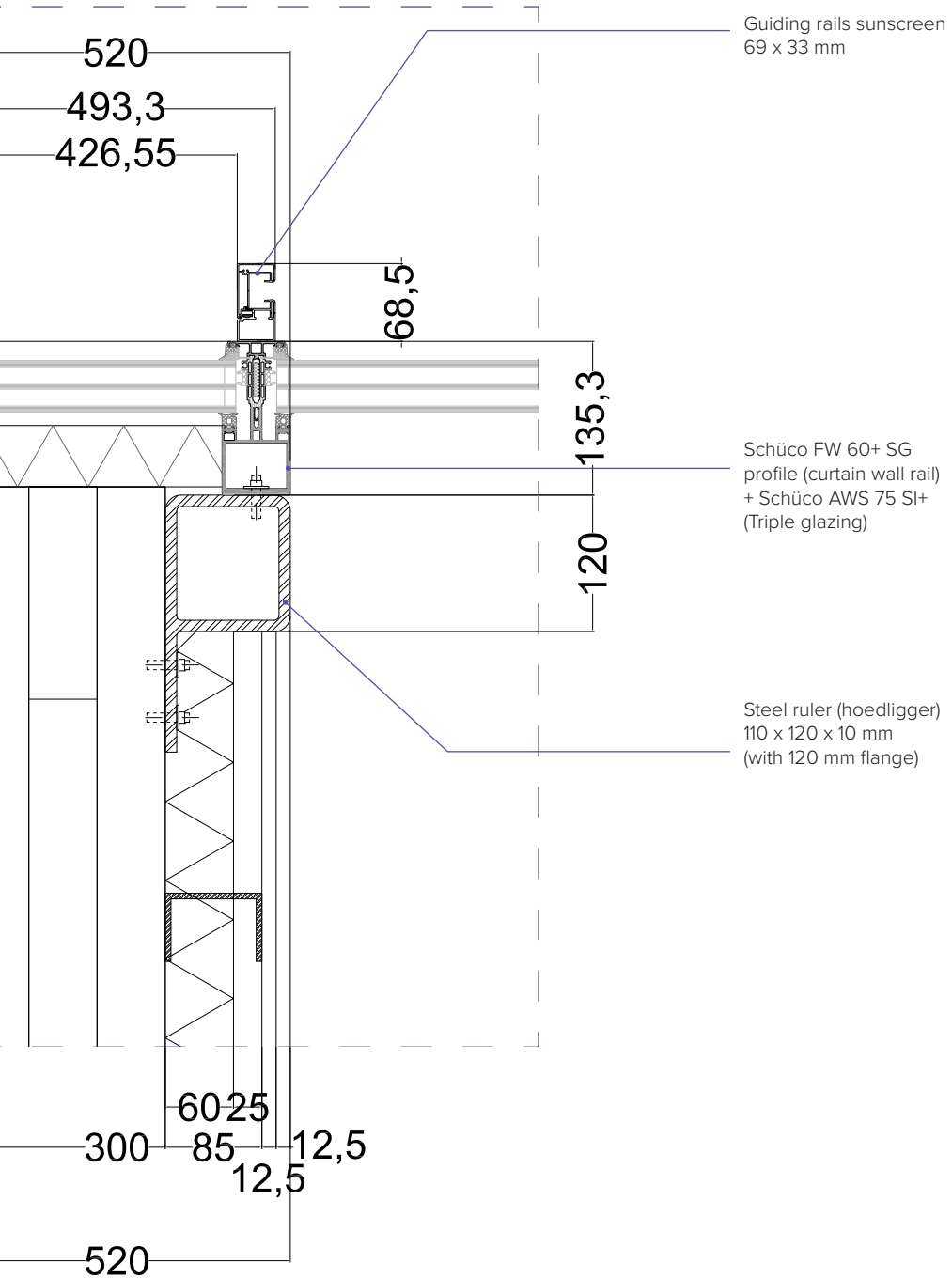


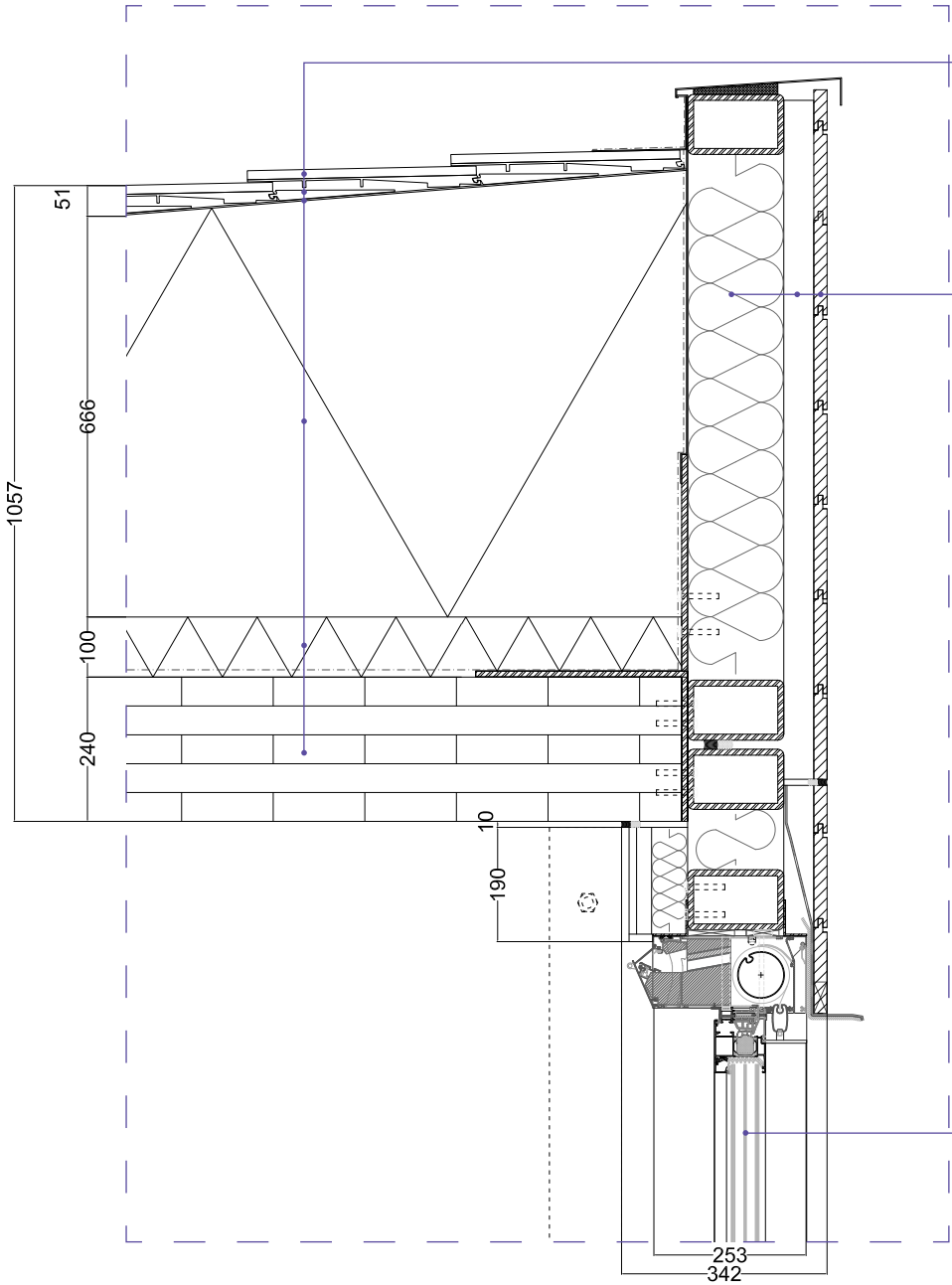
Frosted glass panel

Rigid insulation panel d= 54 mm



12,5 2560  
12,5 85





---

## ROOF

- Tesla solar roof panels d= 15 mm
- Solar roof framework d= 20 mm
- Water vapor barrier
- Rigid insulation d= 128 - 740 mm  
(thickness depends on where on the roof)
- Insulation (Mineral wool) d= 100 mm
- CLT d= 240 mm

---

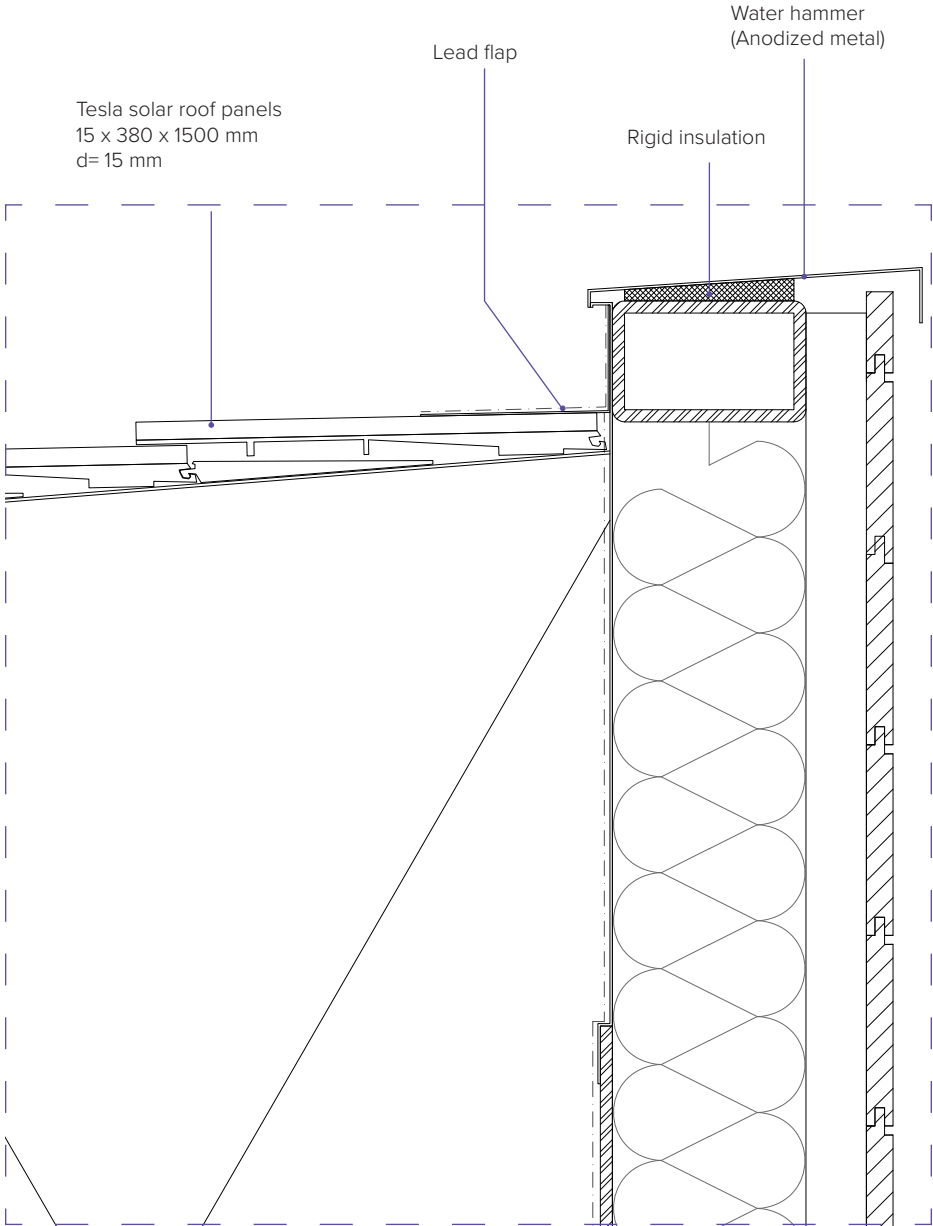
## ROOF FAÇADE ELEMENT

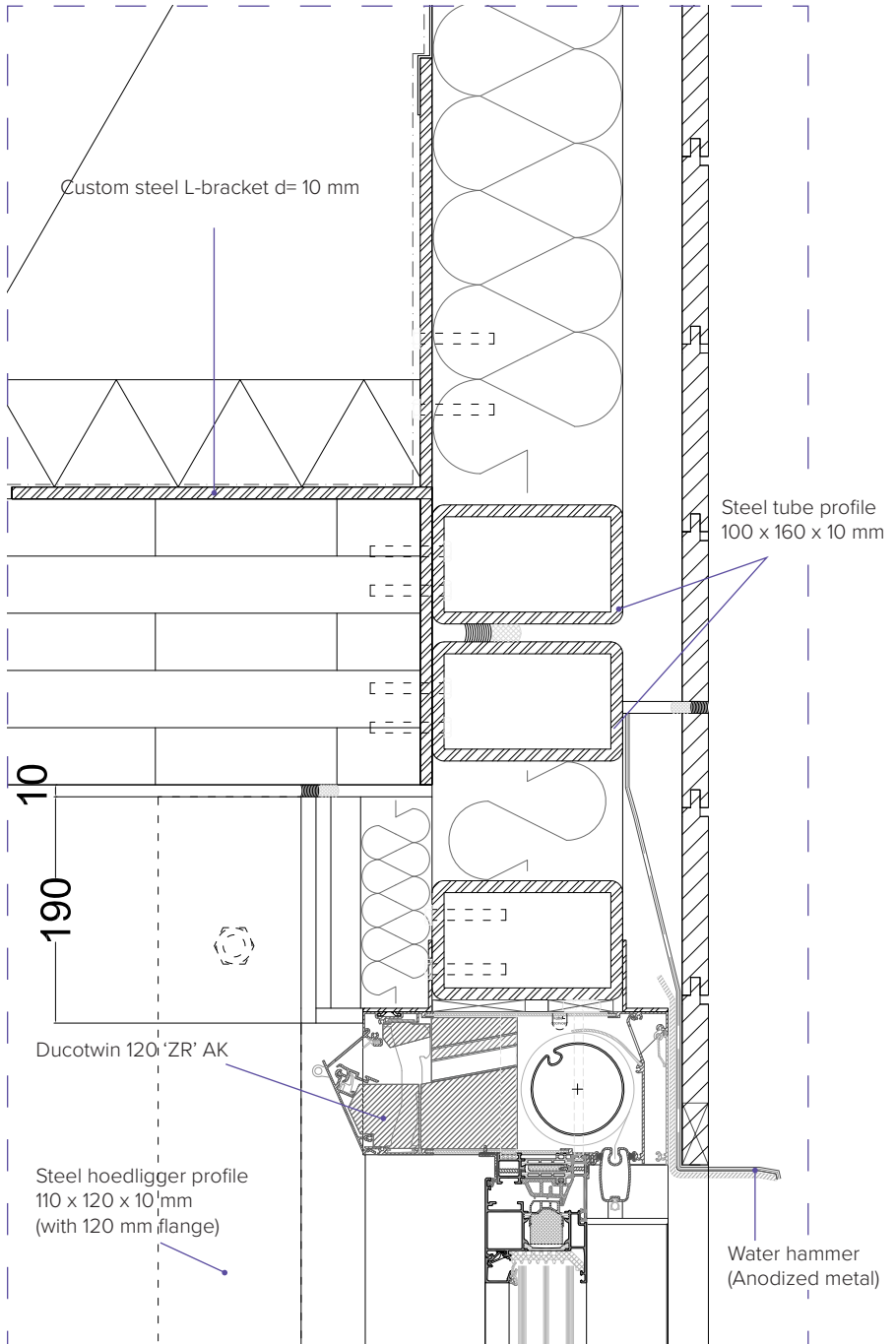
- Gadero Wooden planks 150 x 5000 mm d= 22 mm or Trex composite cladding (uses the same dimensions and attachment method)
- Free-standing facing formwork d= 50 mm
- Water vapor barrier
- Main steel construction (100 x 160 mm) d= 160 mm
  - Insulation (Mineral wool) d= 160 mm

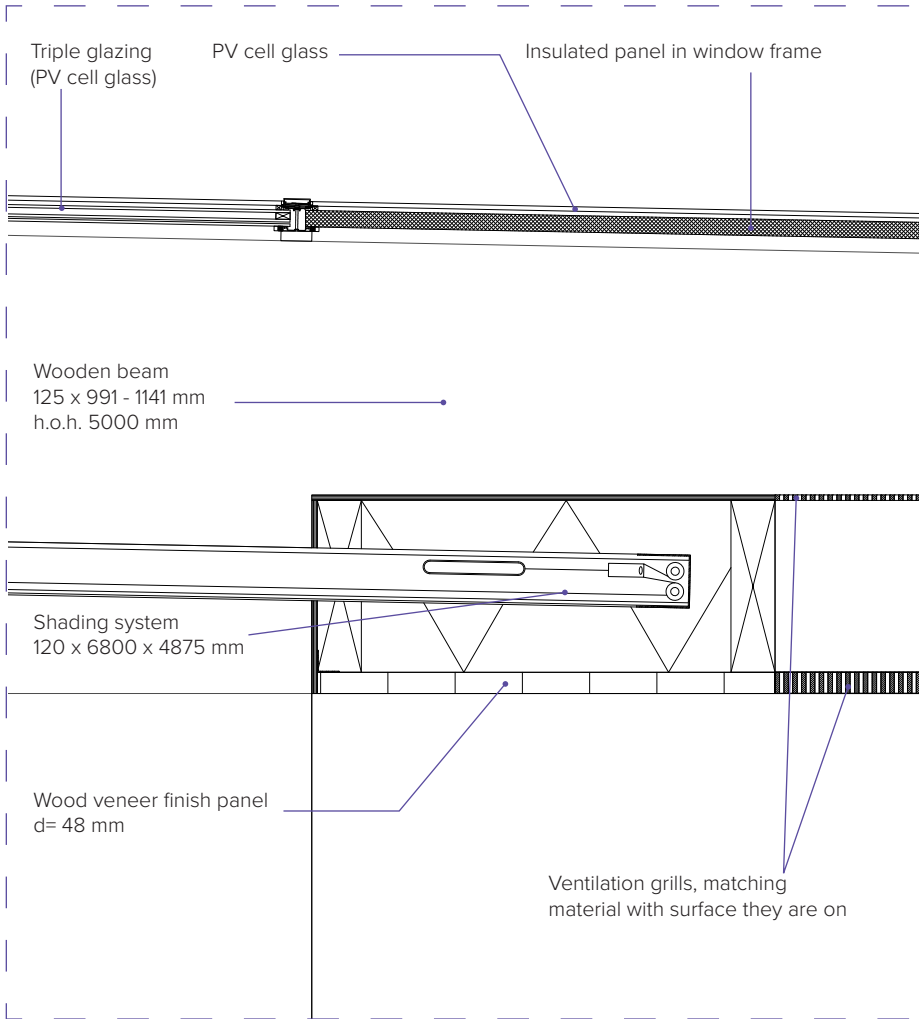
---

## GLASS FAÇADE

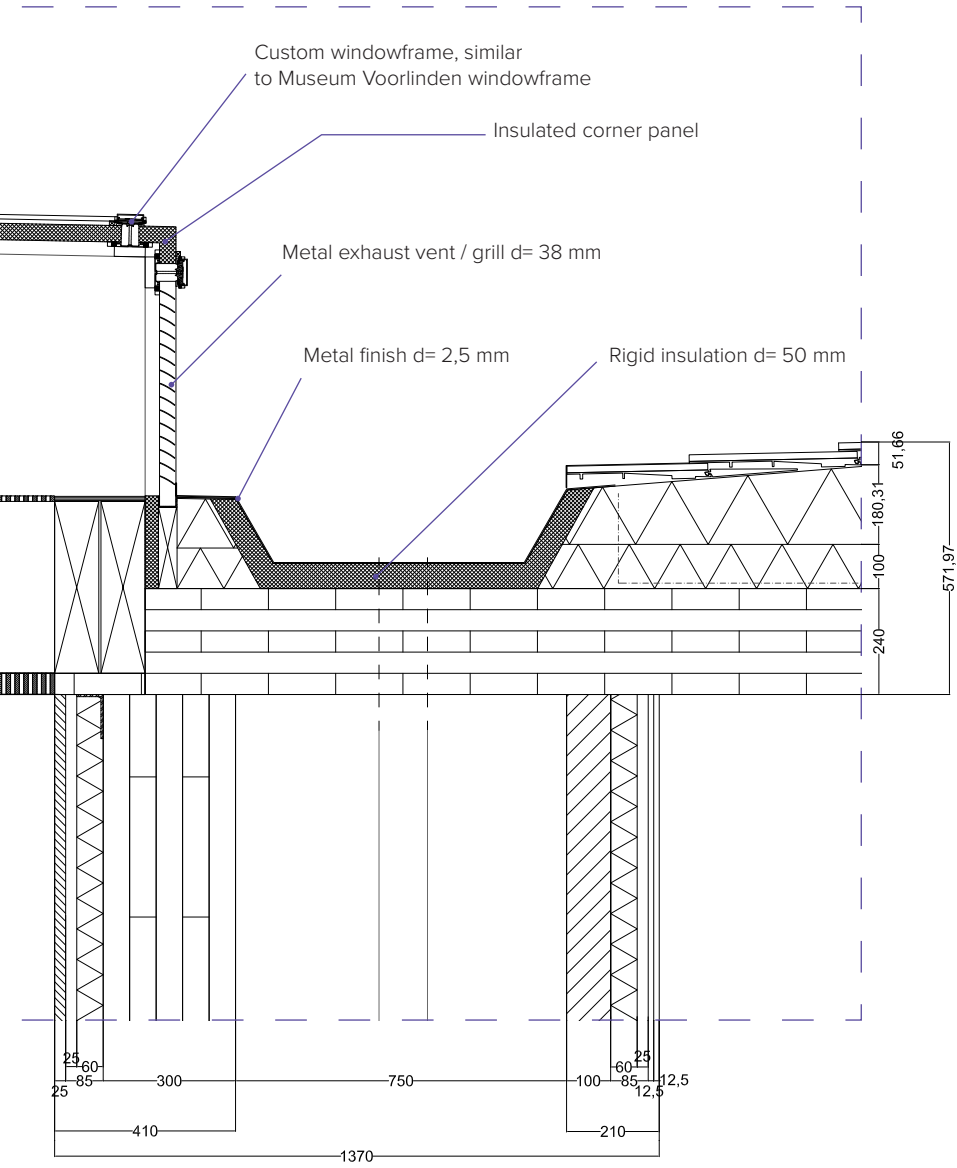
- Schüco AWS 75 Sl+ (with Ducotwin 120 'ZR' AK)  
(triple glazing)
- PV Cell glass instead of normal glass window panes

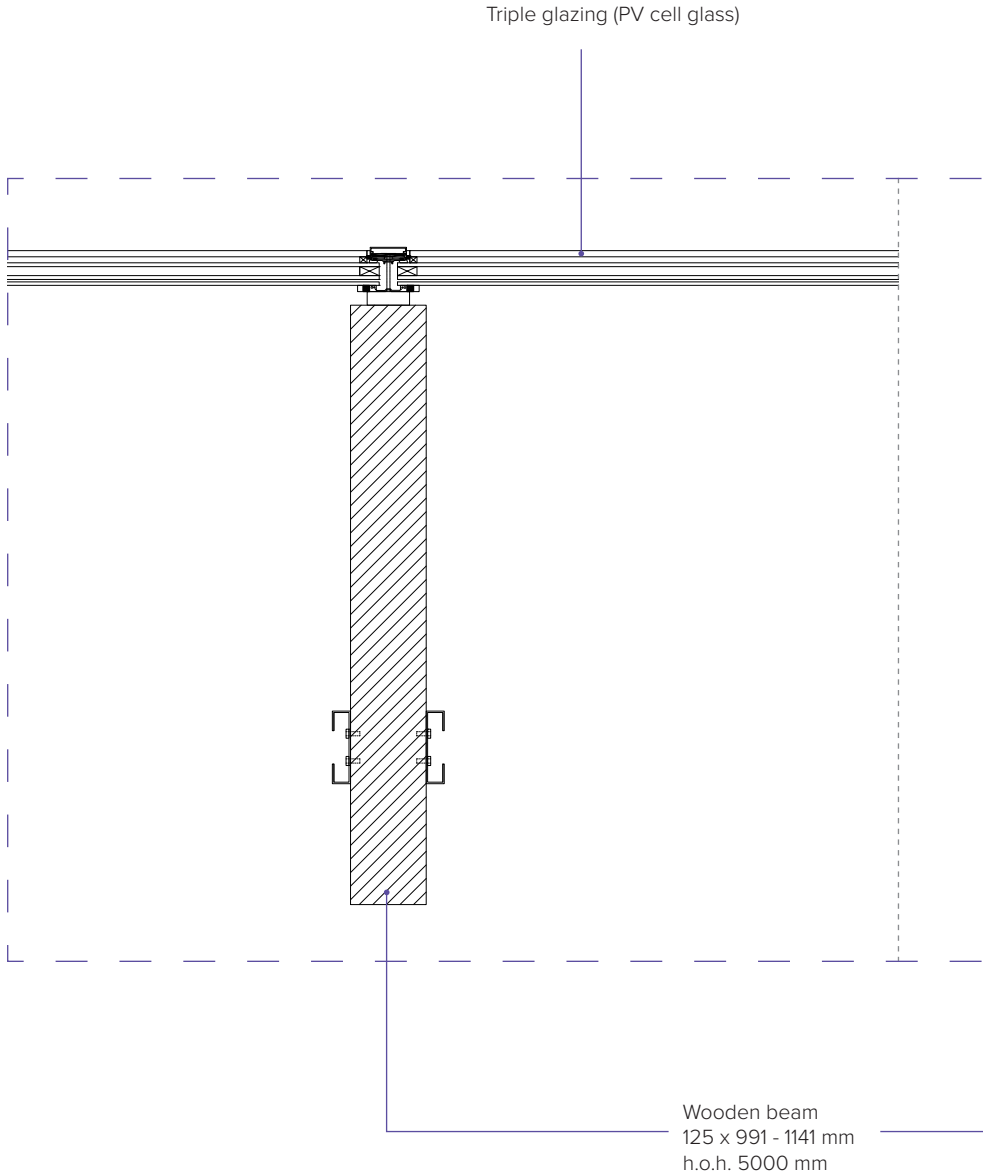




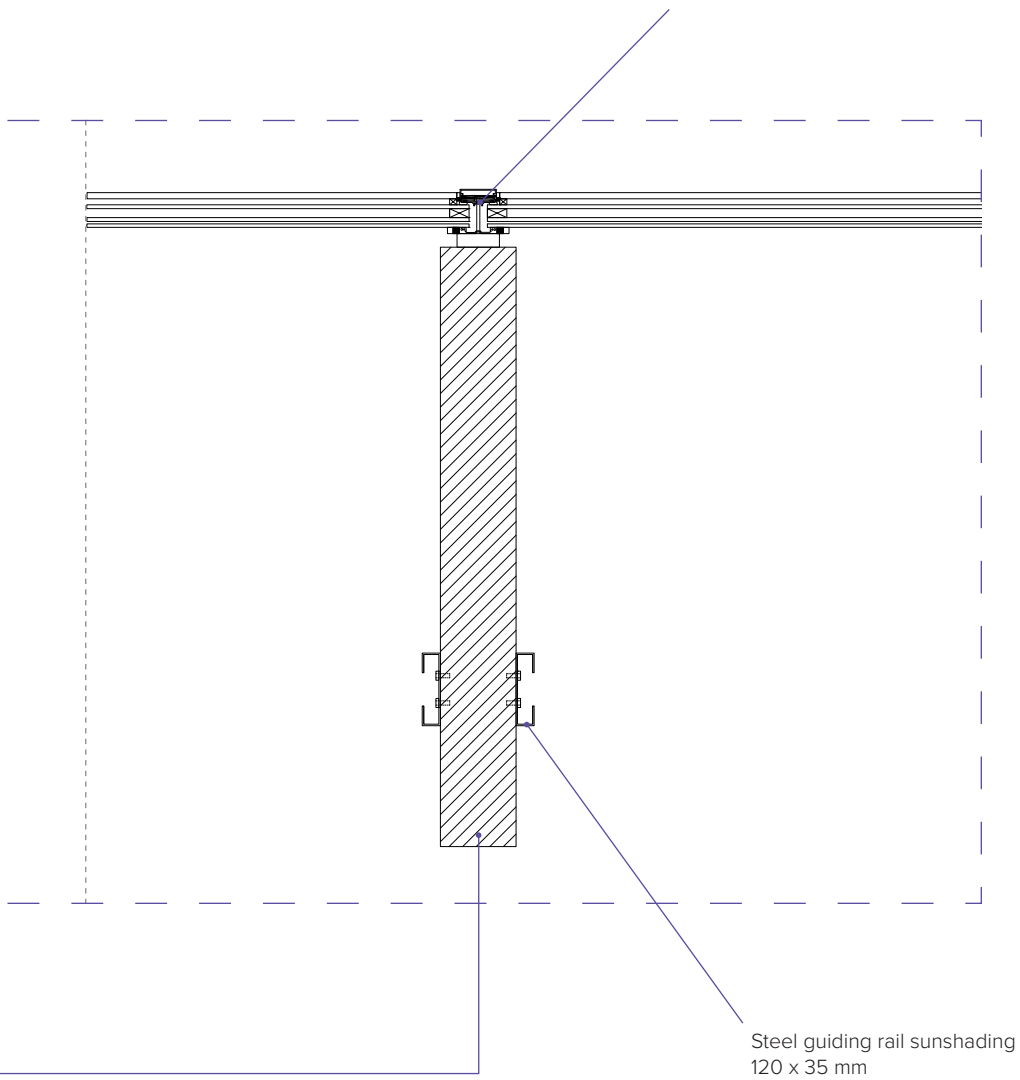




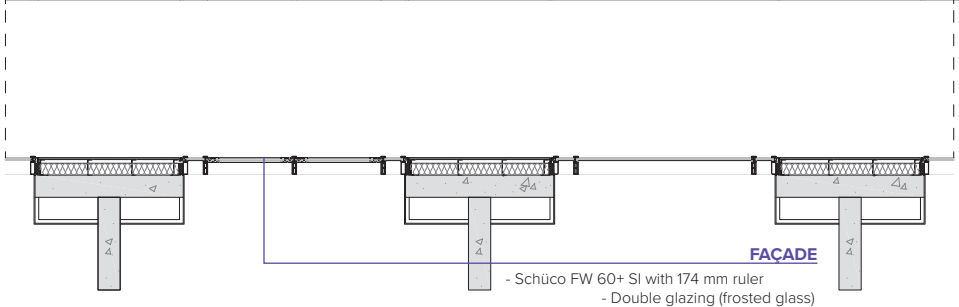


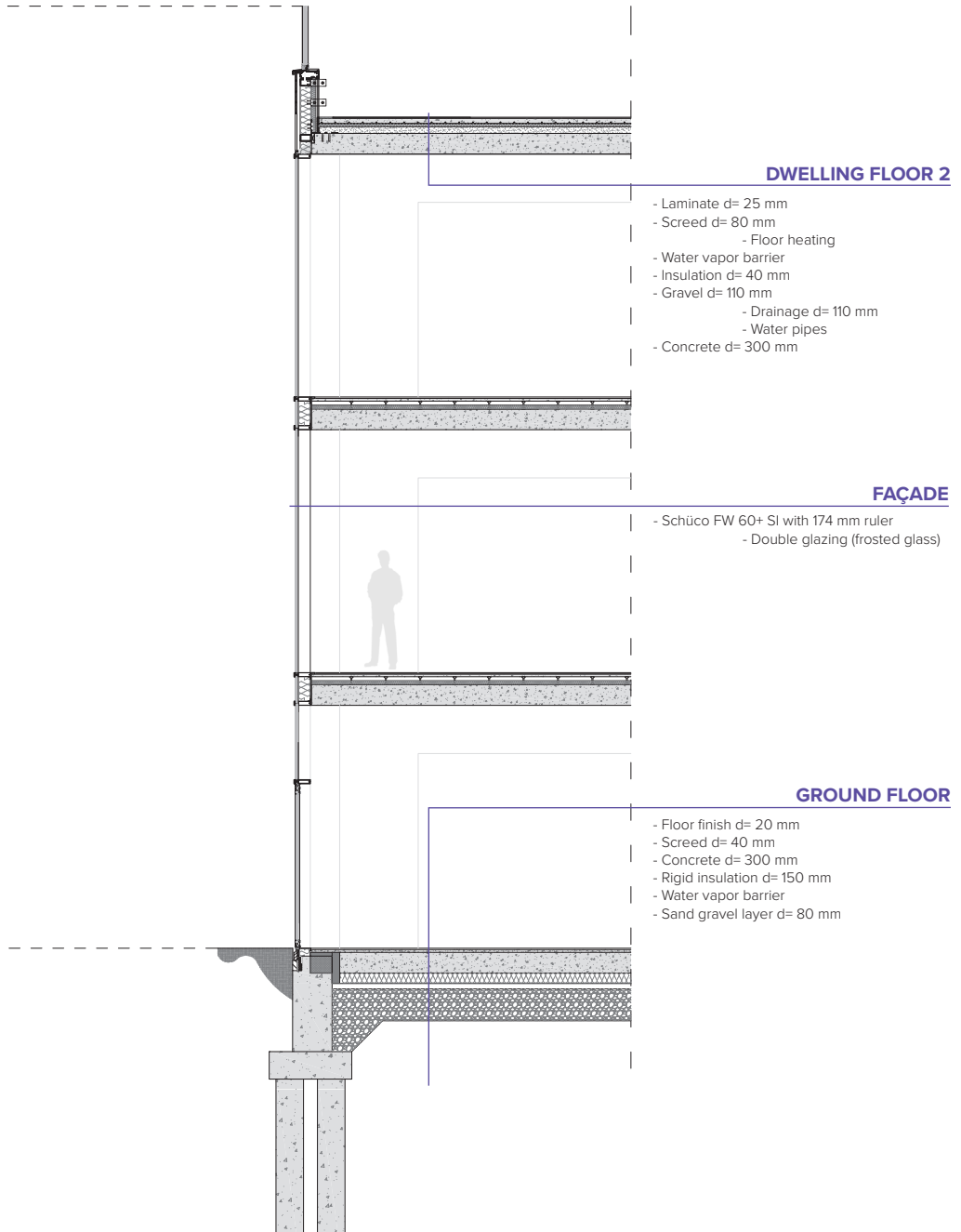


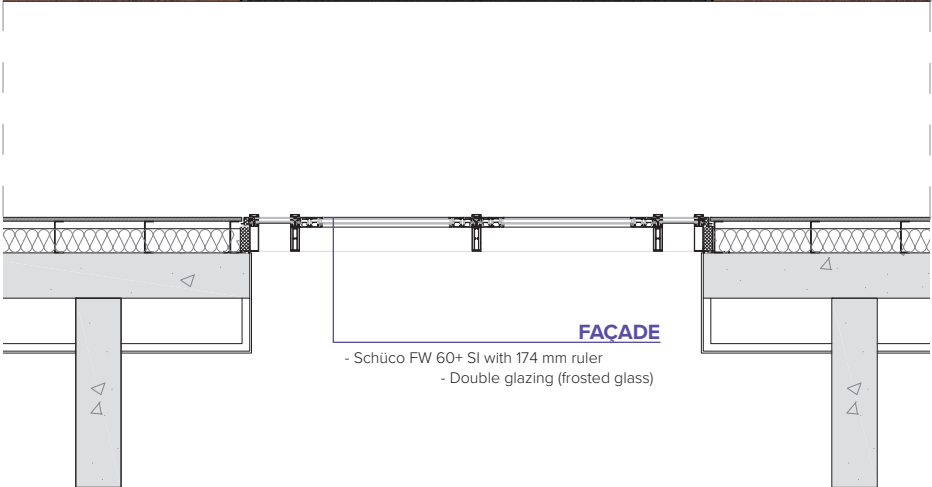
Custom windowframe, similar  
to Museum Voorlinden windowframe



Steel guiding rail sunshading  
120 x 35 mm







**FAÇADE**

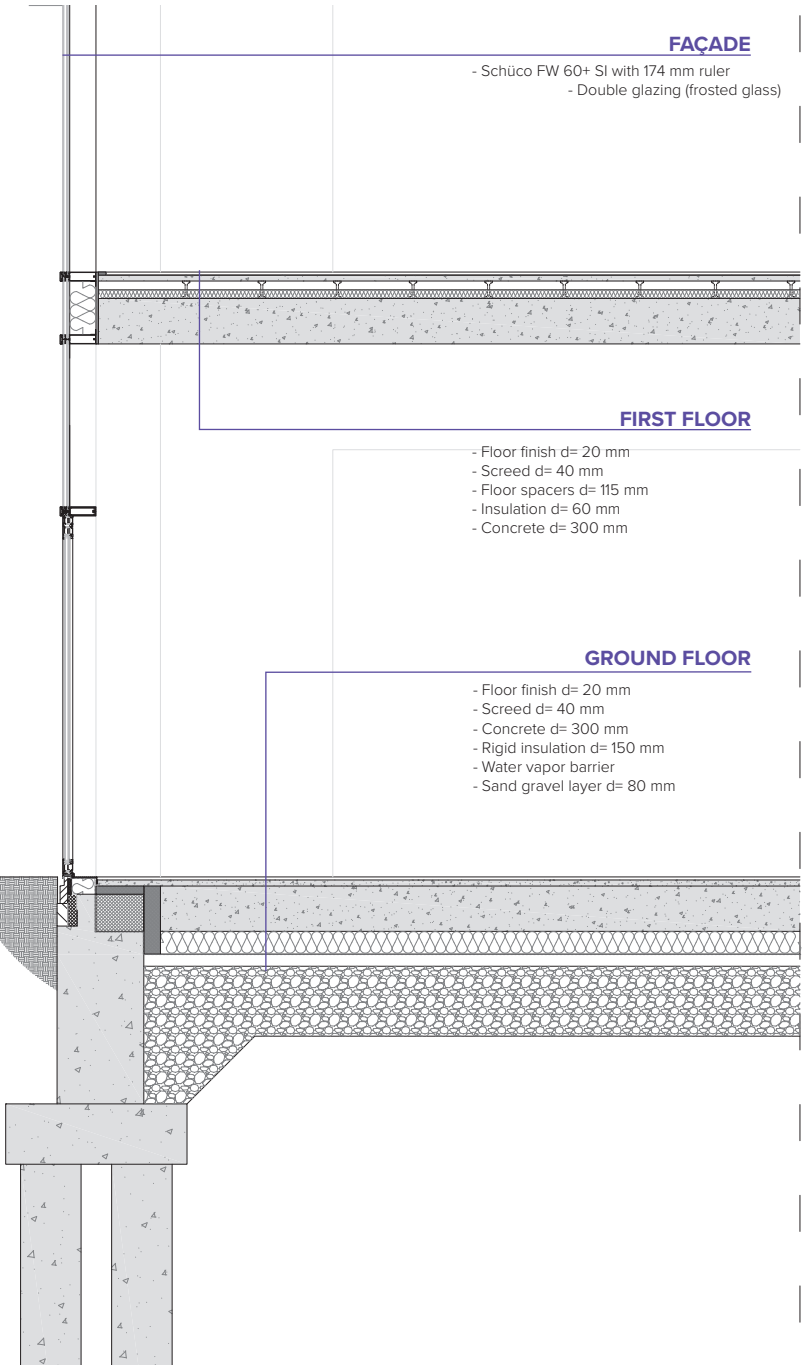
- Schüco FW 60+ SI with 174 mm ruler
- Double glazing (frosted glass)

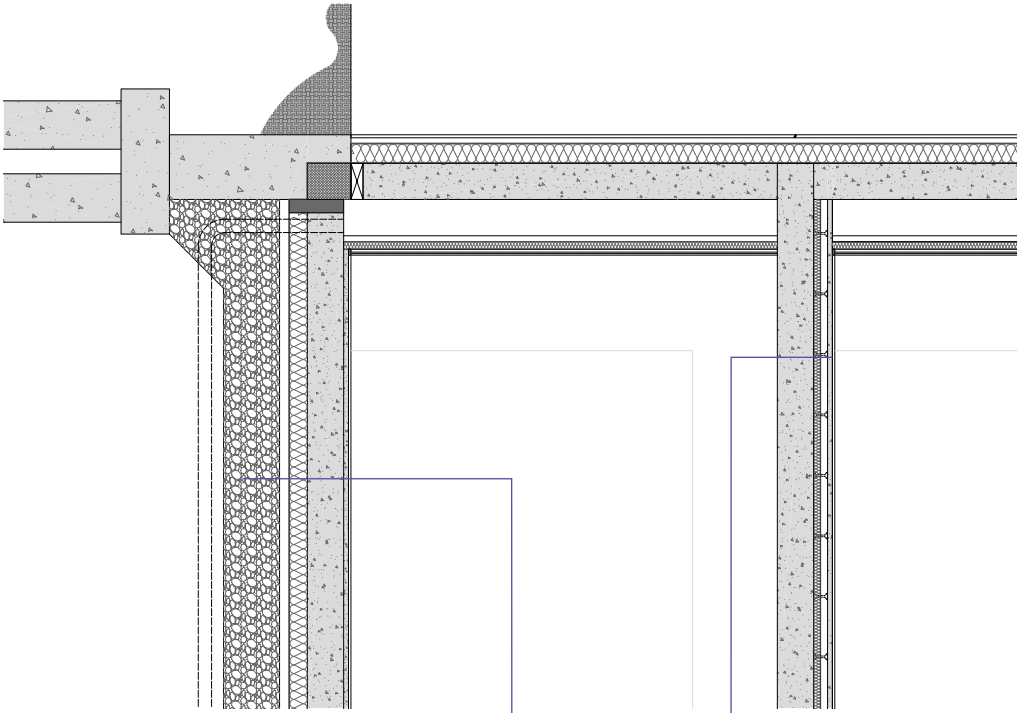
**FIRST FLOOR**

- Floor finish d= 20 mm
- Screed d= 40 mm
- Floor spacers d= 115 mm
- Insulation d= 60 mm
- Concrete d= 300 mm

**GROUND FLOOR**

- Floor finish d= 20 mm
- Screed d= 40 mm
- Concrete d= 300 mm
- Rigid insulation d= 150 mm
- Water vapor barrier
- Sand gravel layer d= 80 mm





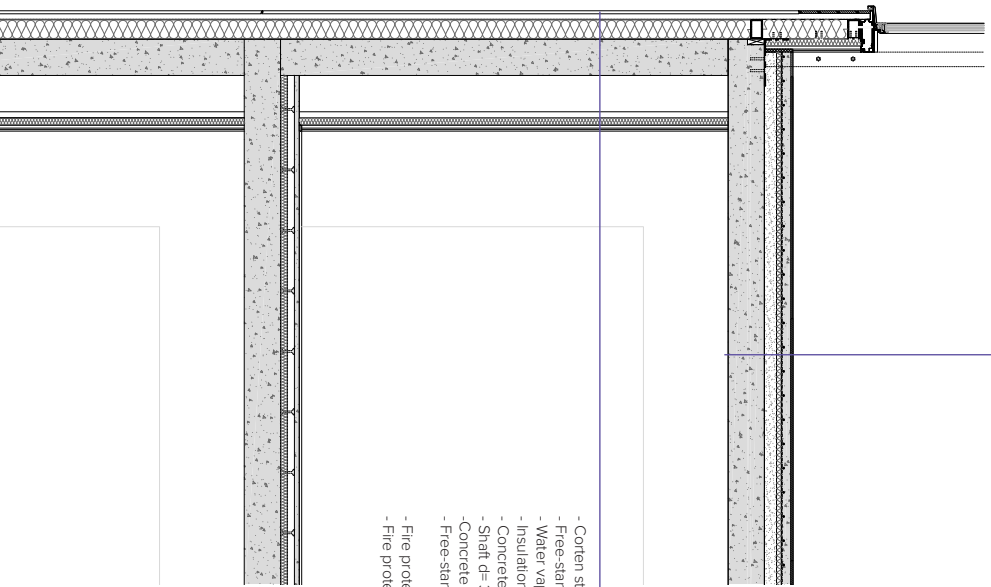
**FIRST FLOOR**

- Floor finish d= 20 mm
- Screed d= 40 mm
- Floor spacers d= 115 mm
- Insulation d= 60 mm
- Concrete d= 300 mm

**GROUND FLOOR**

- Floor finish d= 20 mm
- Screed d= 40 mm
- Concrete d= 300 mm
- Rigid insulation d= 150 mm
- Water vapor barrier
- Sand gravel layer d= 80 mm



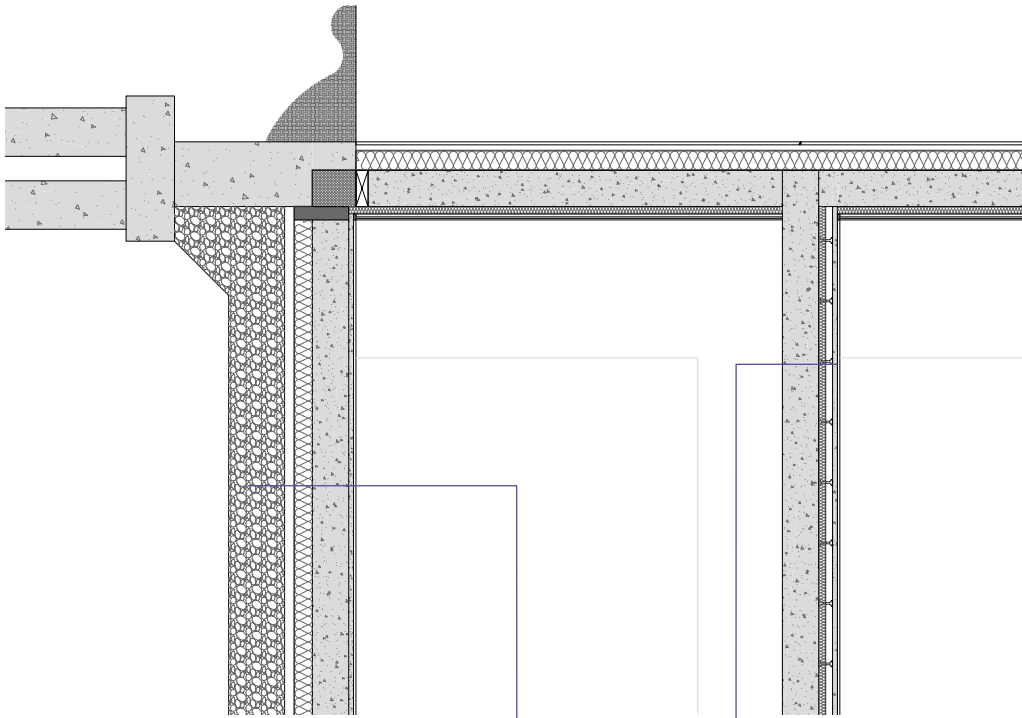


**DWELLING FLOOR 2**

- Laminate d= 25 mm
- Screed d= 80 mm
- Floor heating
- Water vapor barrier
- Insulation d= 40 mm
- Gravel d= 110 mm
- Drainage d= 110 mm
- Water pipes
- Concrete d= 300 mm

**FAÇADE**

- Corten steel 25 x 1500 x 4000 mm d= 25 mm
- Free-standing facing formwork d= 50 mm
- Water vapor barrier
- Insulation (Mineral wool) d= 160 mm
- Concrete d= 300 mm
- Shaft d= 350 mm
- Concrete d= 50 mm
- Free-standing facing formwork d= 85 mm
- Fire protection board d= 12,5 mm
- Insulation (Mineral Wool) d= 60 mm
- Fire protection board d= 12,5 mm

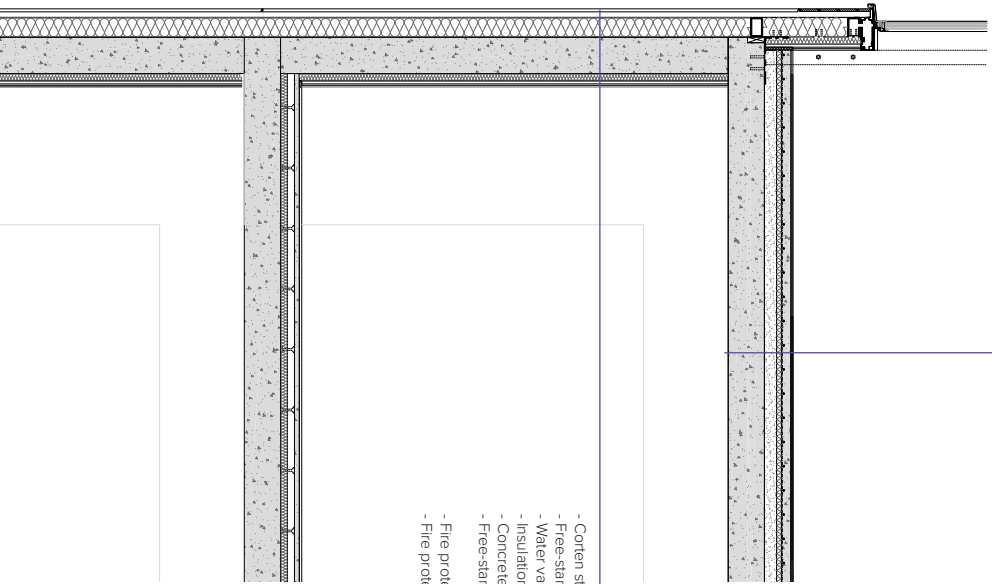


**FIRST FLOOR**

- Floor finish d= 20 mm
- Screed d= 40 mm
- Floor spacers d= 115 mm
- Insulation d= 60 mm
- Concrete d= 300 mm

**GROUND FLOOR**

- Floor finish d= 20 mm
- Screed d= 40 mm
- Concrete d= 300 mm
- Rigid insulation d= 150 mm
- Water vapor barrier
- Sand gravel layer d= 80 mm

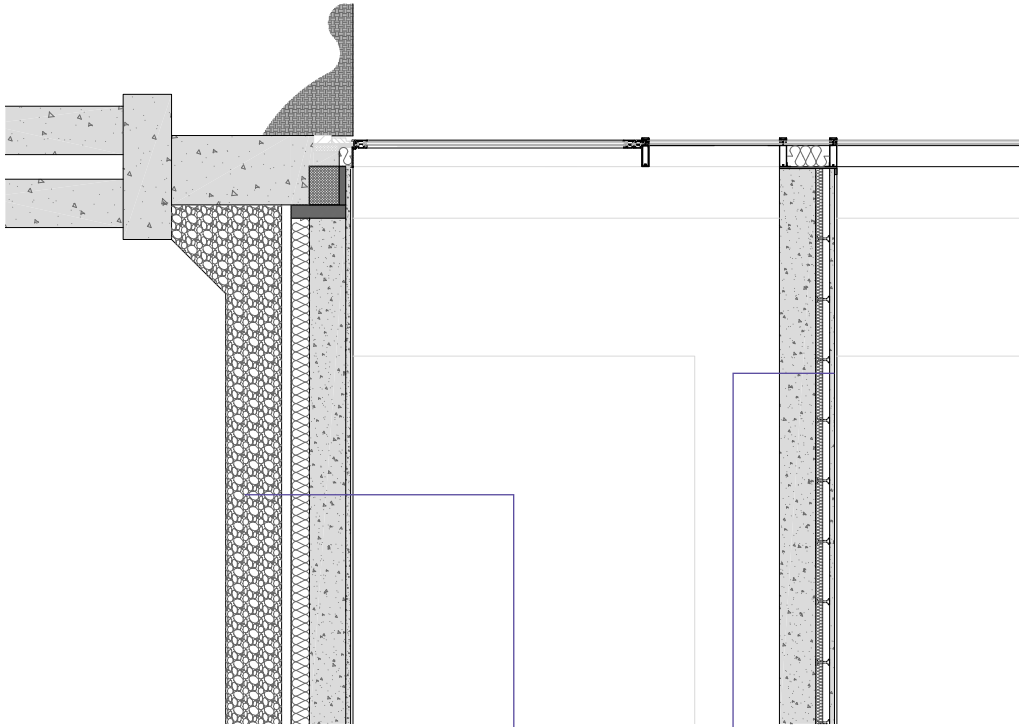


## DWELLING FLOOR 2

- Laminate d= 25 mm
- Screed d= 80 mm
- Floor heating
- Water vapor barrier
- Insulation d= 40 mm
- Gravel d= 110 mm
- Drainage d= 110 mm
- Water pipes
- Concrete d= 300 mm

## FAÇADE

- Corten steel 25 x 1500 x 4000 mm d= 25 mm
- Free-standing facing formwork d= 50 mm
- Water vapor barrier
- Insulation (Mineral wool) d= 160 mm
- Concrete d= 300 mm
- Free-standing facing formwork d= 85 mm
- Insulation (Mineral Wool) d= 60 mm
- Fire protection board d= 12,5 mm
- Fire protection board d= 12,5 mm



**FIRST FLOOR**

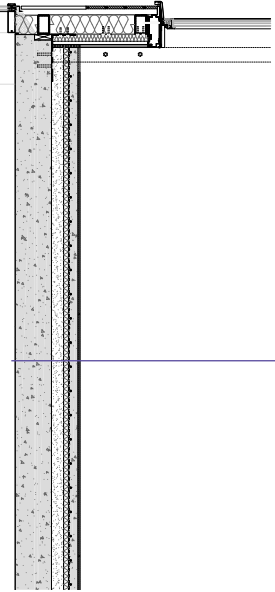
- Floor finish d= 20 mm
- Screed d= 40 mm
- Floor spacers d= 115 mm
- Insulation d= 60 mm
- Concrete d= 300 mm

**GROUND FLOOR**

- Floor finish d= 20 mm
- Screed d= 40 mm
- Concrete d= 300 mm
- Rigid insulation d= 150 mm
- Water vapor barrier
- Sand gravel layer d= 80 mm

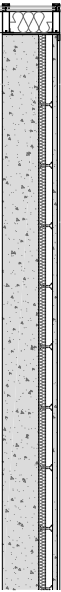
**DWELLING FLOOR 2**

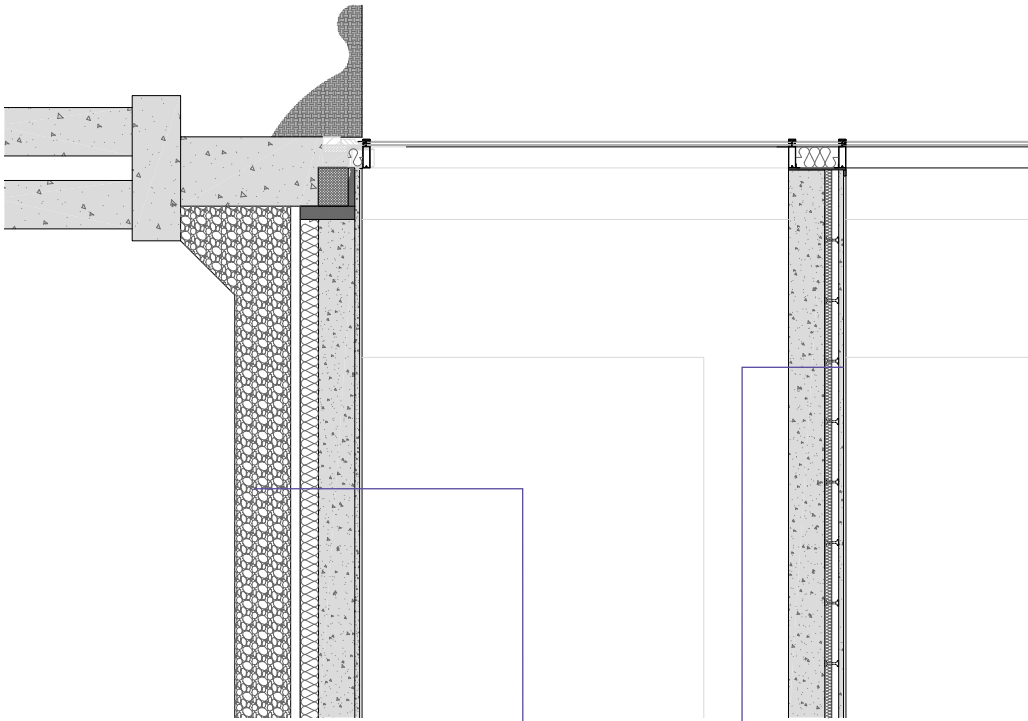
- Laminate d= 25 mm
- Screed d= 80 mm
- Floor heating
- Water vapor barrier
- Insulation d= 40 mm
- Gravel d= 110 mm
- Drainage d= 110 mm
- Water pipes
- Concrete d= 300 mm



**FAÇADE**

- Schüco FW 60+ SI with 174 mm ruler
- Double glazing (frosted glass)





**FIRST FLOOR**

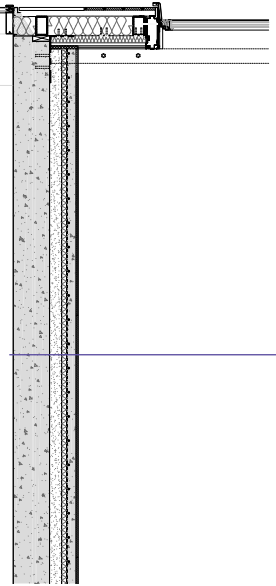
- Floor finish d= 20 mm
- Screed d= 40 mm
- Floor spacers d= 115 mm
- Insulation d= 60 mm
- Concrete d= 300 mm

**GROUND FLOOR**

- Floor finish d= 20 mm
- Screed d= 40 mm
- Concrete d= 300 mm
- Rigid insulation d= 150 mm
- Water vapor barrier
- Sand gravel layer d= 80 mm

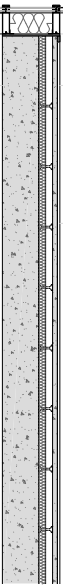
**DWELLING FLOOR 2**

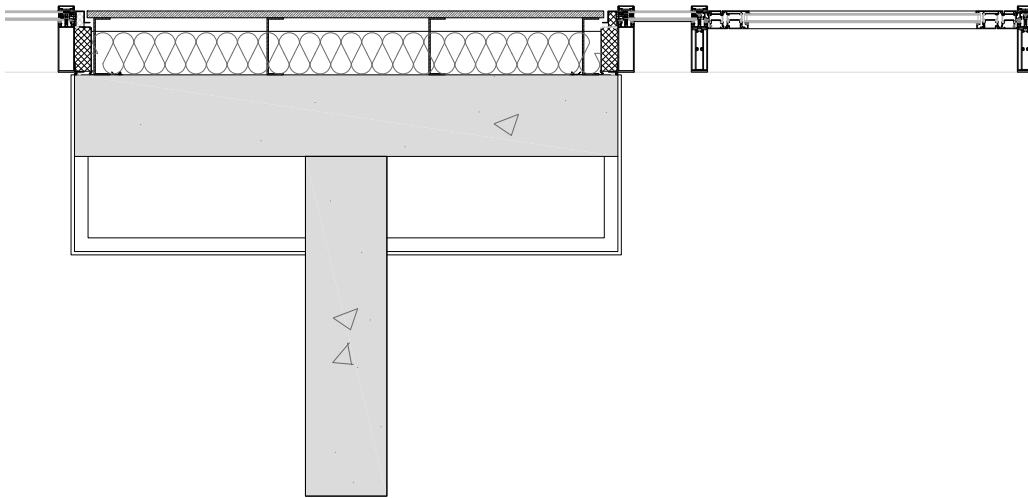
- Laminare d= 25 mm
- Screed d= 80 mm
- Floor heating
- Water vapor barrier
- Insulation d= 40 mm
- Gravel d= 110 mm
- Drainage d= 110 mm
- Water pipes
- Concrete d= 300 mm



**FAÇADE**

- Schüco FW 60+ SI with 174 mm ruler
- Double glazing (frosted glass)



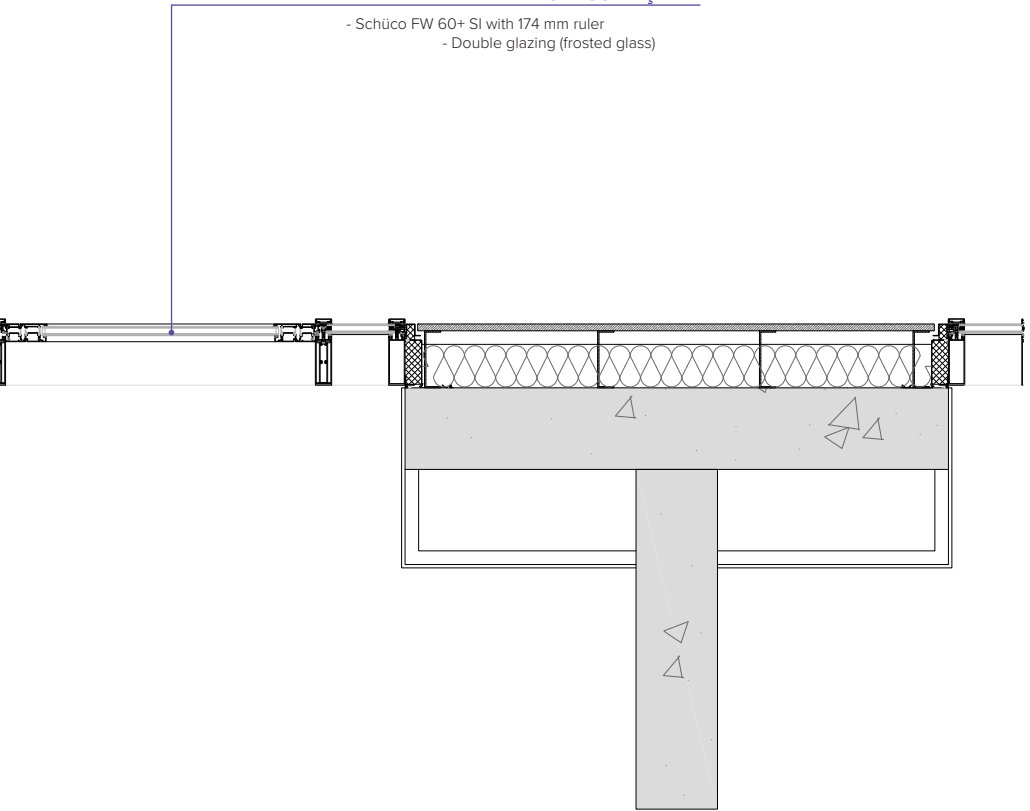


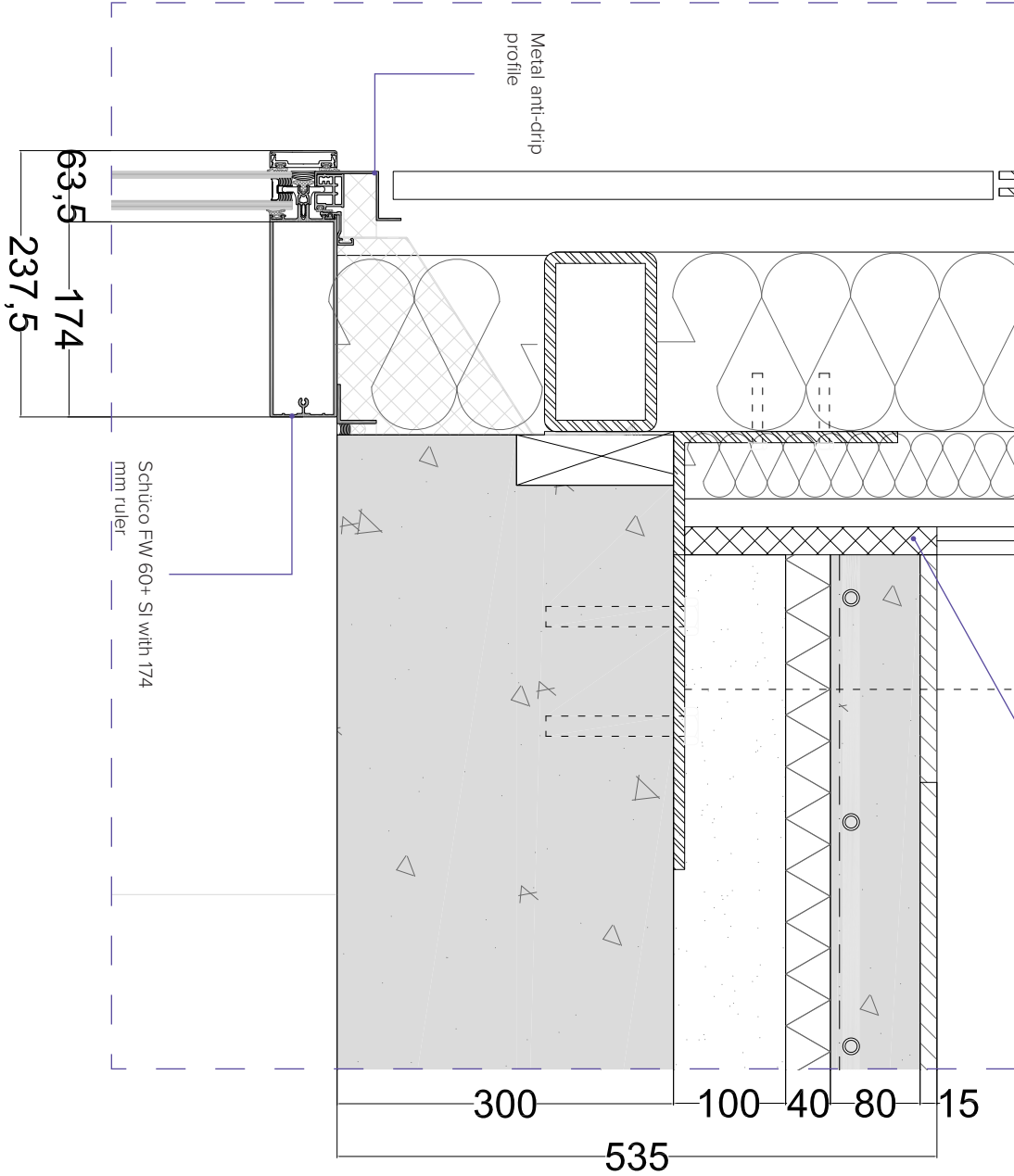
- 1 standing seam facing formwork d= 63 mm
- Insulation (Mineral Wool) d= 60 mm
- Fire protection board d= 12,5 mm
- Fire protection board d= 12,5 mm

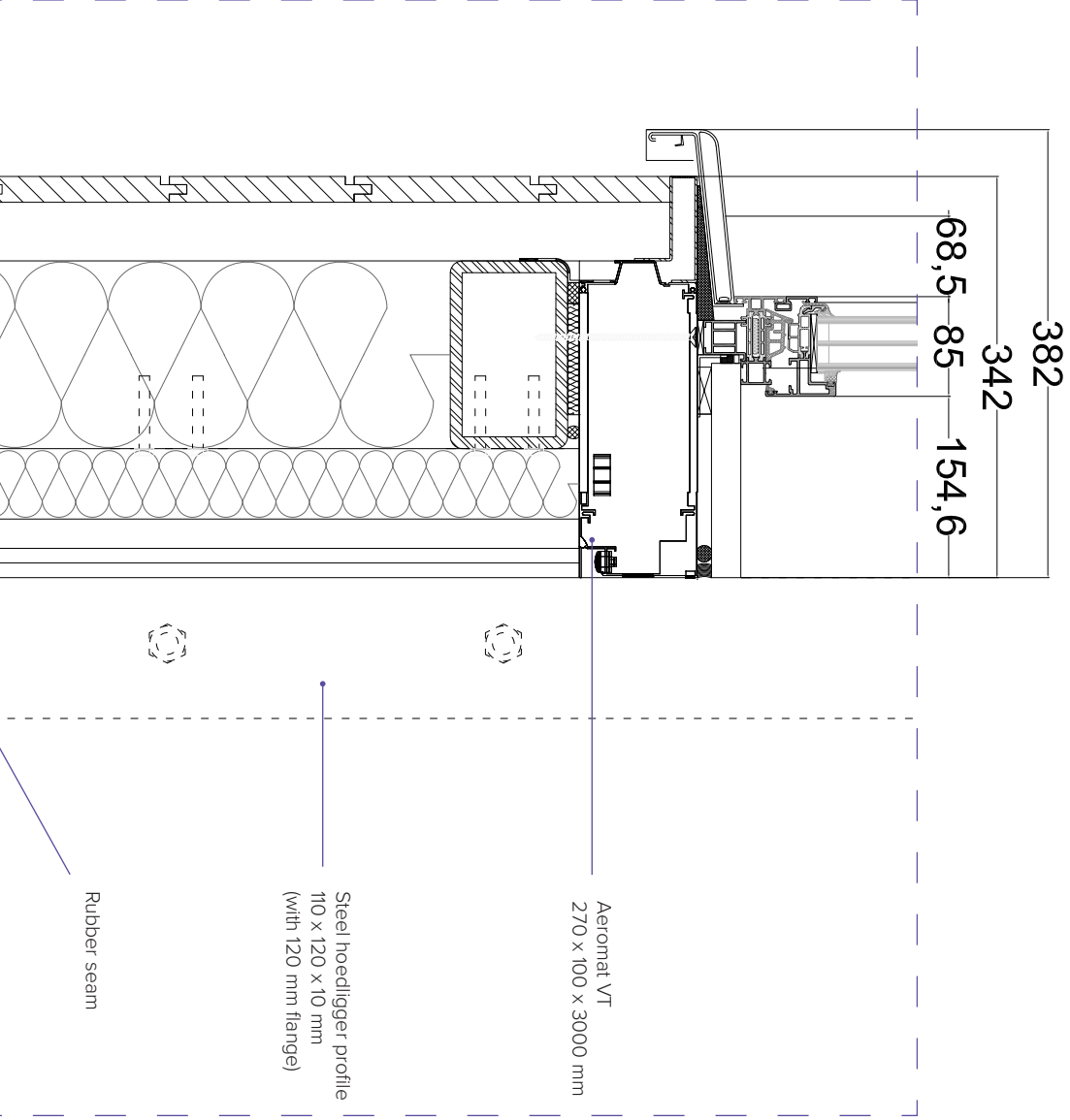


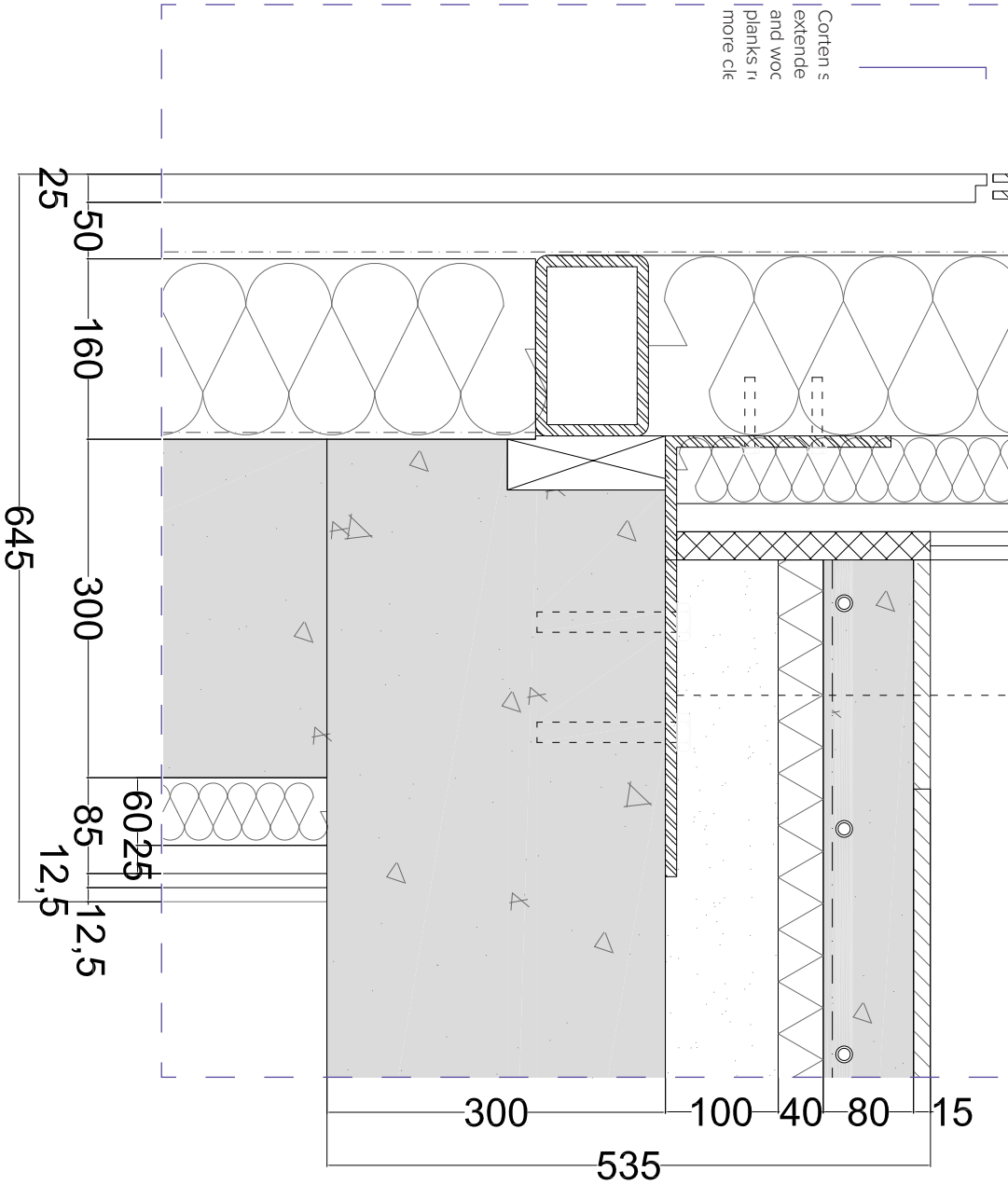
**GLASS FAÇADE**

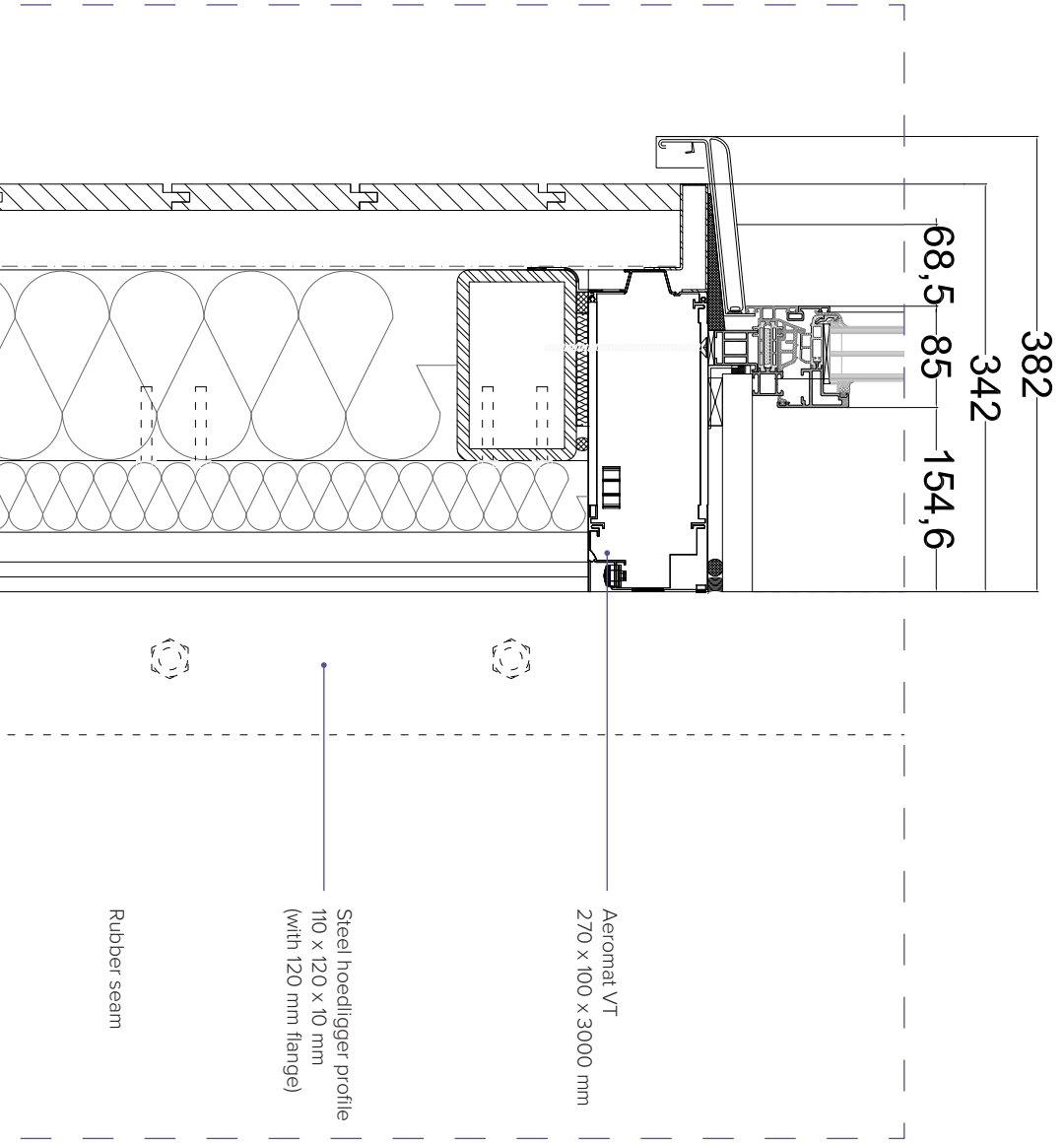
- Schüco FW 60+ SI with 174 mm ruler
- Double glazing (frosted glass)





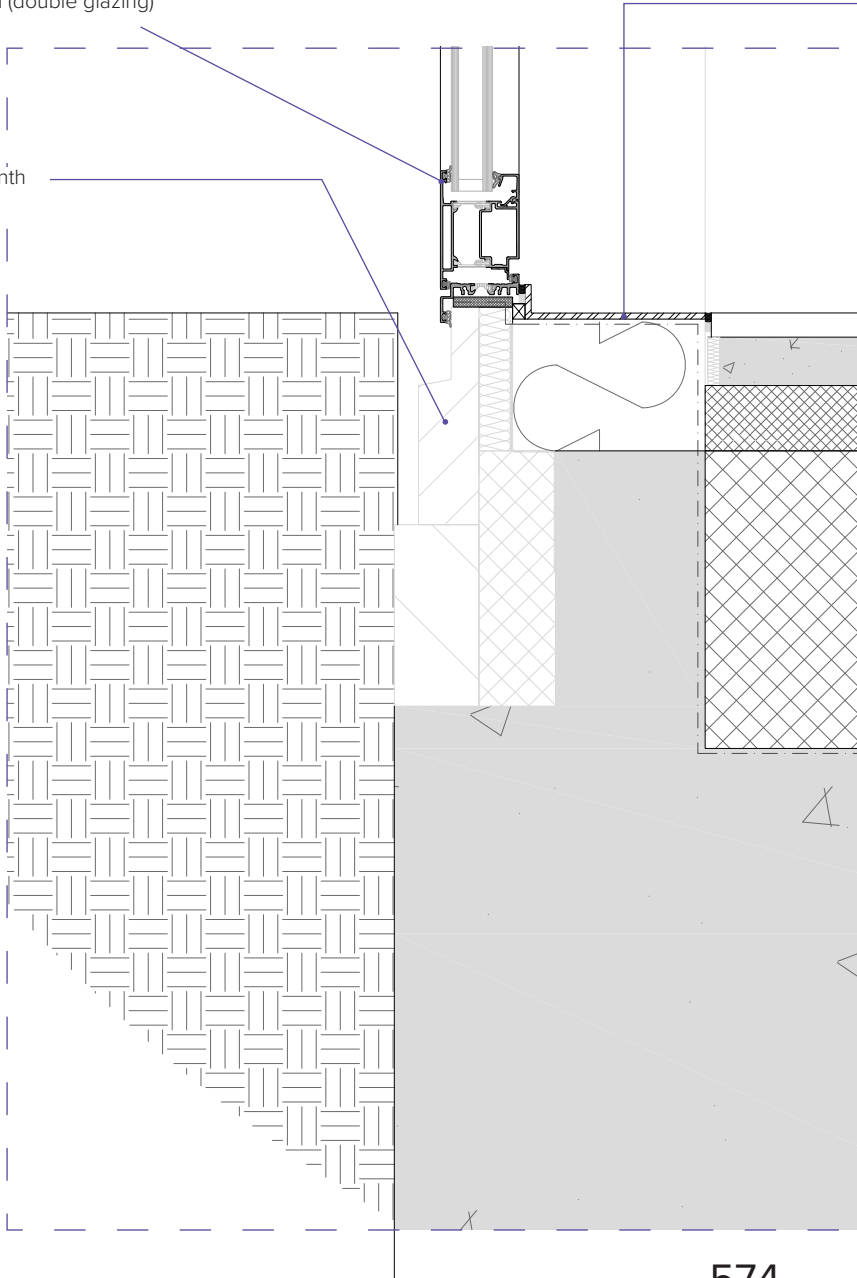


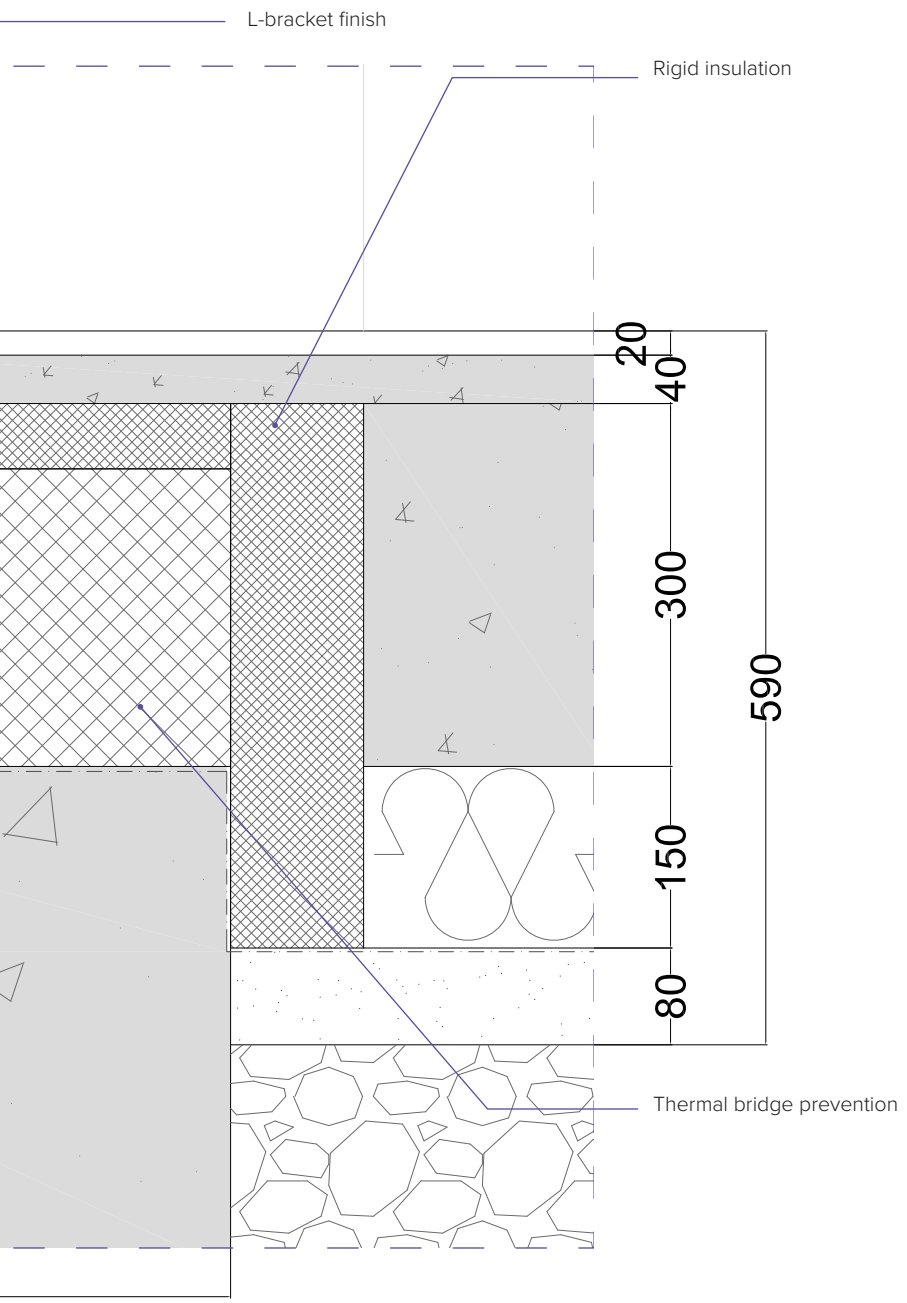


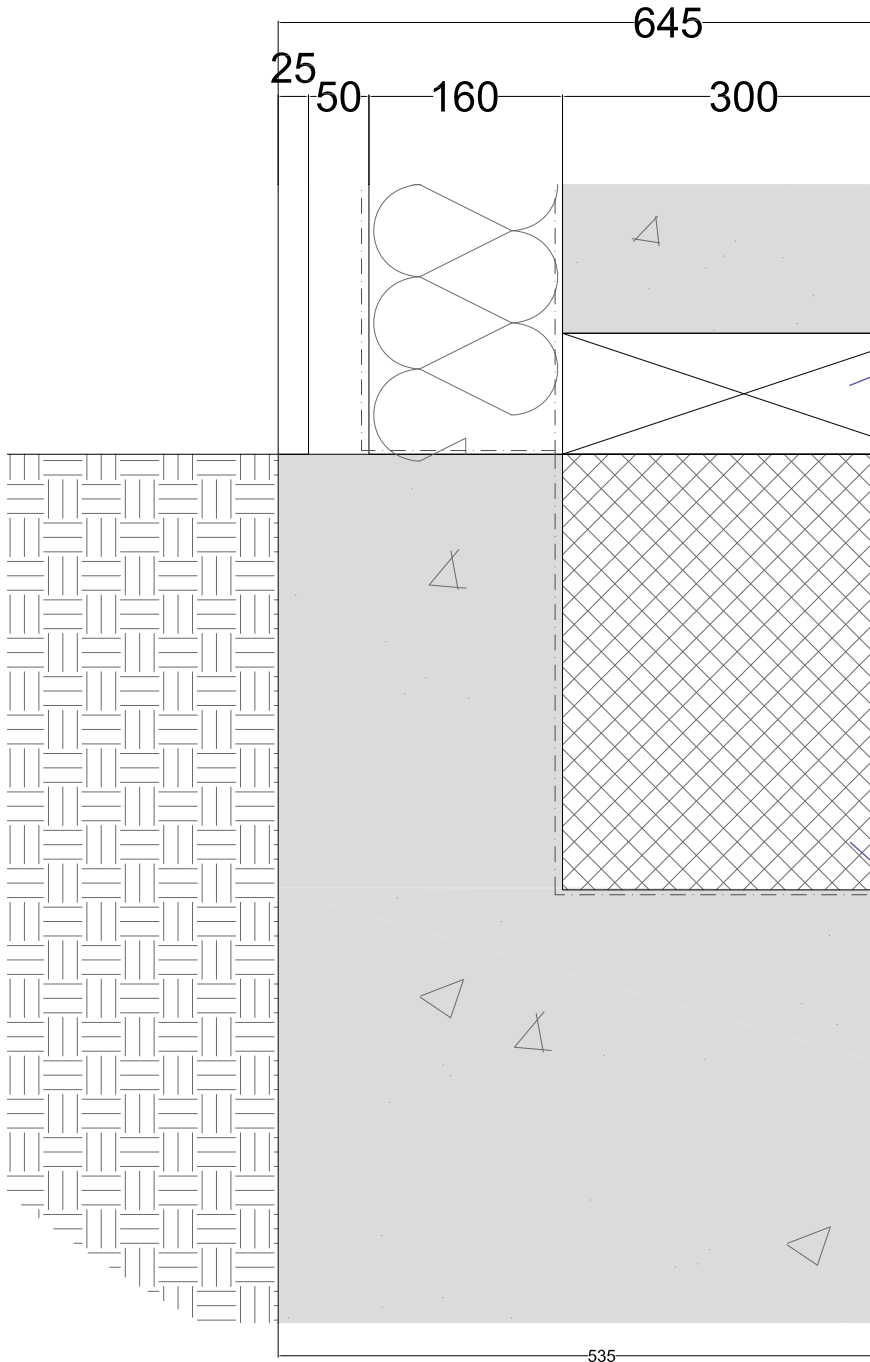


Schüco FW 60+ SI (double glazing)

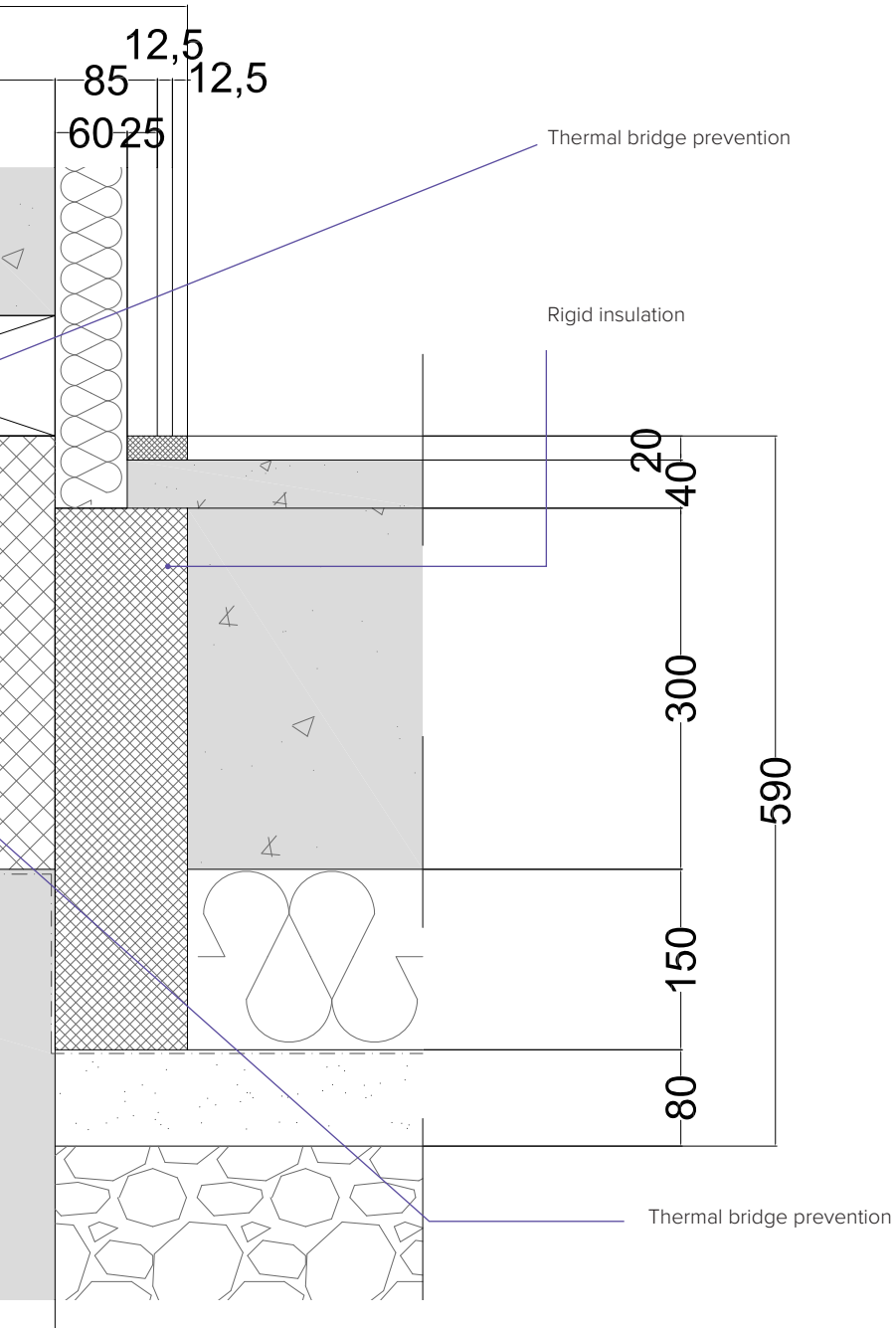
Water resistant plinth













# REFLECTION

## INTRODUCTION

The aim of the reflection is mostly for the student to look back at his work and see if several aspects of the project are well intertwined and make sense. Doing a reflection on my own research not only will I be able to tell if the concept of research and design are well enough linked, or if a better connection on several fronts would be necessary. Additionally this will also give the readers of this reflection a good idea of how I came to certain ideas and show that my design is based on scientific and academic research, rather than a sudden idea that has no background research to back up the choices made.

The reflection itself can be seen as the process of the student and by reflecting on several aspects it is able to follow both the change in design and the importance that research might have had on these changes. The aspects that are addressed in this reflection are as follows:

### Aspect 1

*The relationship between research and design.*

### Aspect 2

*The relationship between your graduation (project) topic, the studio topic (if applicable), your master track (A,U,BT,LA,MBE), and your master programme (MSc AUBS).*

### Aspect 3

*Elaboration on research method and approach chosen by the student in relation to the graduation studio methodical line of inquiry, reflecting thereby upon the scientific relevance of the work.*

### Aspect 4

*Elaboration on the relationship between the graduation project and the wider social, professional and scientific framework, touching upon the transferability of the project results.*

### Aspect 5

*Discuss the ethical issues and dilemmas you may have encountered in (i) doing the research, (ii, if applicable) elaborating the design and (iii) potential applications of the results in practice.*

*In this reflection specifically the first aspect plays a big role, seeing as the basis of any design, must be found and supported by research into not only the desired target group, but also several other additional researches performed during the Msc3 & 4 track.*

*To properly convey if design and research are indeed linked and the design and its possible changes is based on the research done by the student. I look back at the following factors:*

- **Whether my approach worked**, meaning the methods I used and how I used them.
- **My understanding of “how and why”**, explaining mostly how certain things were done and why they were important in their own right. Also explaining the need for them and possible use in my own design.
- **My reflection on the feedback given by my tutors**
- **How I translated or used this feedback into my work**
- **How I have learned from my own work**

*By going through my process and reflecting on the choices I made I hope to have given a bit of insight into my own design and validated the scientific and academic value of my design, as well as made it enjoyable to read.*

## MY REFLECTION

*My reflection focuses on the aspect of New Media workers and their need for dwellings. Ever since the creation of the internet, the way we work has been changed. Over the last decade especially work has become way easier and more convenient, as we aren't constrained by the place we work and how to work anymore. Nowadays the internet and its presence in our workflow can't be missed anymore since it is an integral part of how do our work.*

*As the importance of the internet over the last few years has grown, so have also the diversity in work. Freelancing for example have strived and amassed a bigger amount of worker than ever before. The ease of the internet has made it possible for us to work anywhere at any time, diminishing the need for us to work for companies and going to work, seeing as we can do everything ourselves at home.*

*With the growing interest in working from home, as a form of freelancing like streaming is, and the necessity of it due to Covid-19, it is clear that this type of trend will only keep growing. This necessity of working from home and online work, stresses the importance of the "New Media" even further.*

*With the growth of jobs in this sector of the "New Media" there is also a rise with issues, which are really well emphasized by Covid and the problems that arise from working from home. From experience and talks with people around me it is clear that working from home isn't always as easy as most people make it out to be. People often don't have the space to comfortably work and have meetings for work or school. This is all due to a lack of space, my tutor Pierijn describes this perfectly in a meeting, that we had a few weeks ago: "having a space, where you can work and maybe have a meeting without a bra showing in screen or people bugging you, might be needed".*

*From my initial research and during the whole of my project it became clear that this issue is still as prevalent as ever and that specifically the people in the New Media sector, that I am targeting suffer not only greatly from this issue, but also the lack of suitable, affordable housing. In this research the impact of my research towards making a high-quality, affordable workspace in a workhome or otherwise a high-quality, affordable workhome can be seen.*

*This research is made as a step in the right direction towards solving the ever present issue of the housing shortage, not only for New Media workers, but as a whole. Viewing this reflection I hope that some insight can be given into what the steps were that were undertaken and how they influenced the buildings morphological as well as structural changes to best adjust to the housing needs of the target group. This reflection is to be seen as a part of a larger overall research on housing shortage and offers a new insight in how the housing shortage can be solved.*

## ASPECT 1 | THE RELATIONSHIP BETWEEN RESEARCH AND DESIGN

### METHODS

The methods used in my design process vary a lot. In the group collectivity research almost everybody, me included, used visual ethnography. With visual ethnography we displayed the results of our research. Acquiring the information for our research had various methods ranging from observation and interviews to recordings and even photographs. I personally used annotated images, photographs and observations to create my visual ethnography. This collectivity research was eventually combined in one research booklet, meaning that we had an overview of all the project and a conclusion regarding the collectivity in these communities. Most of these conclusions gave me personally an idea or a hint towards what I should and shouldn't do in my design concerning the creation of collective spaces and circulation.

The type of research that was the bread and butter of my design can be described as mostly case studies. Although Literary Analysis and a Questionnaire were a huge part of the research regard-

ing the New Media workers and almost all the information regarding them came from these two research methods, the case studies helped me further my project on so many levels. Just being able to look at references of different buildings and using their layout or details as an example for how to make mine really helped me design certain aspects of aXess. I am calling them case studies, but rather they are just references, taking a lot of inspiration from various projects and looking at the general overview of the plan and some specific parts, which were handy to me at that time. None of these examples were fully analyzed as the case studies in my graduation research, meaning I didn't make any drawings or diagrams.

Other than this I think a lot of the research that I did was either talking to professionals about internet connection and how to distribute this in the building, reading up on information about materials for the building, internet connectivity and research into the material context to base my own materialization off of.

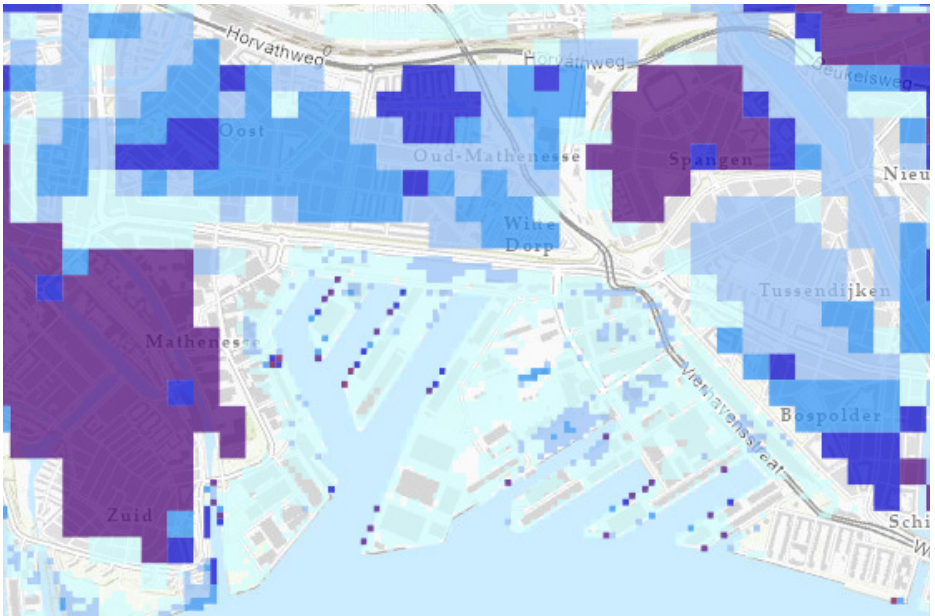


Figure 167: Flood map of M4H [Image]. (Machgeels, D., 2021)

## TARGET GROUP

With the target group / future residents in mind the building has been altered both in terms of its structural construction and its assembly to make it more affordable to build and thus lower the cost of the dwellings. The building started off as a concrete building, with both its walls and floors made from concrete, as I had seen in my case studies. However as I got into a discussion with my tutors about this decision it became clear that using CLT for the construction would be the more optimal choice as this would be more eco-friendly as well as more affordable to make. Similarly this would speed up the process of making the building. To attune for the possibility of flooding (see figure 167) that is apparent in the area, the bottom part of the building is still made out of concrete, this not only serves as a solid base for the rest of the building, but also won't be affected by water as much as metal or wood would.

Using the New Media workers, people working from home and mostly use their computers and the internet for their work, as a guiding theme I realized that a good network in the building was essential. Considering this fact it was important that internet and Wi-Fi were good in the building. After contacting a professional over at Delta Fiber Nederland, I was told that the best option for a building like this was to use Fiber as connection. Seeing as my building was meant to have good connections and high speed internet without a lot of maintenance Fiber, as a new type of network and connection, would serve as a great step towards future proofing the building as well as satisfying the future residents. Seeing as Rotterdam is now being addressed as a point for connection for Fiber it would be possible to tag along in this renovation of the network system, this way there wouldn't be an increase in the cost of the dwelling nor cost a lot of money to integrate in the building. He told me that picking up something like normal connections, like we have to our houses nowadays, would be very expensive as well as an excess of cables coming into the building that needed to be distributed somewhere from the ground floor through the building with a max run length of 100 meters.

Seeing as some of the runs that needed to be made would definitely be over 100 meters this was also a reason for not choosing this option. Opting for Fiber however would allow me to place the distribution point somewhere in the middle of the building making dividing the cables very easy. Additionally Fiber only required a max of 8 cable to enter the building which could be split into over 200 internet cables. As my idea was for each of the dwelling to have their own network point this option would be the best, seeing as this way nobody could ride along on another's bandwidth possibly slowing down their internet speed or causing unstable connections. (see figure 168)

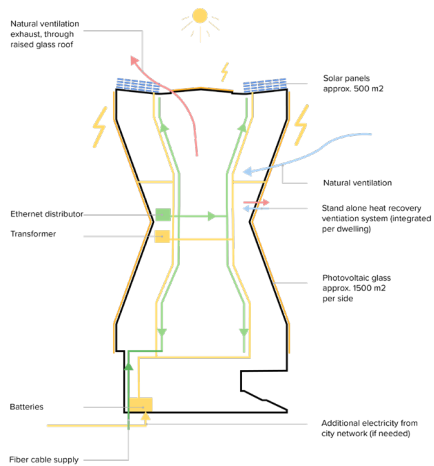


Figure 168: Energy + Internet + Ventilation concept. (Machgeels, D., 2021)

The construction choice as mentioned earlier was also a topic here, after doing a little bit of research into signal strengths of Wi-Fi and connections of Fiber, I came to the realization that not all materials act well with Wi-Fi connectivity. The way that connectivity seemed to work had to do with the permittivity and reflectivity of the material. The lower the permittivity and reflection the better the signal strength through the material was, the higher the reflection and permittivity the better the signal would be reflected to another spot. (see figure 169).

**Table 1. Permittivity and conductivity of some material**

Material	Relative Permittivity	Conductivity (S/m)	Frequency (GHz)
Concrete	5.31	0.0326	1-100
Brick	3.75	0.038	1-10
Plasterboard	2.94	0.0116	1-100
Wood	1.99	0.0047	0.001-100
Glass	6.27	0.0043	0.1-100
Ceiling board	1.50	0.0005	1-100
Metal	1	10	1-100

Figure 169: Permittivity and conductivity of some material [Image]. (Suherman et al, 2018)

As my building was originally completely from concrete and the study showed (look at the graph) that this was the absolute worst for internet and Wi-Fi I decided to pick another building material. As steel seemed to be pretty good at reflecting the signal I thought that this would be a good option, however as my building slanted steel would not be the best solution for the construction type that was needed, as well as that the benefits of steel over just a free space of wood was negligible I chose for the latter. (see figure 170) Using CLT therefore gave the best results regarding the connectivity. For both the use of Wi-Fi in the dwellings as well as in the atrium it was chosen to make a complete CLT structure, taking the best for both the residents as well as the environment.

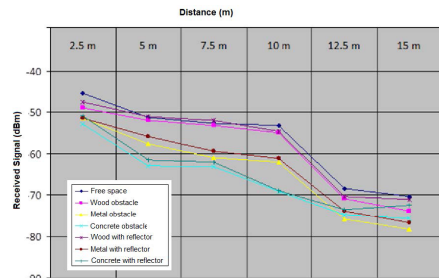


Figure 170: Reductions due to Propagation and Obstacle [Image]. (Suherman et al, 2018)

**BUILDING EXTERIOR**

The building exterior was a pretty hard topic for this building. As I took a lot of inspiration from Treehouse in Seoul, the is a very noticeable building, especially in its environment. The shape itself is formed by taking the original plan, made for P1 and expanding on this by applying the idea of Treehouse’s shape and layout to it. Because I found that the scale of Treehouse was a bit on the small wide I decided to place it on top on itself and mirror the building to create a different interesting shape. A new target group or rather new way of working deserves a new building with a new shape in a new area. (see figure 171)

The “X”- shaped building is very prominent in its surroundings by its shape alone, given this fact I decided that the material used on the building should not be too different from the rest of the surroundings. Using either the same materials or the same color palette the building was made to what I had envisioned. The bottom part of the building or rather the public realm references the warehouse that is located along the same street (see figure 172) in both height and color, the material choice for this part of the building was chosen because of the other surrounding buildings and the old Rotterdam harbor. In the harbor and its surrounding metal is found in abundance from the containers in the harbor to the cladding of the warehouses found on the other side of the street. Using this material as reference and keeping the color palette of the rest of M4H, corten steel was chosen as the material for the bottom floors, this way the height, material and color all reference it surroundings keeping a strong connection to the already existing atmosphere there.

Turning to the “X”-shaped building itself, the ma-

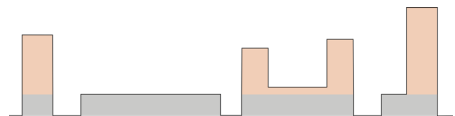


Figure 172a: Reference the surroundings in color (warehouse). (Machgeels, D., 2020)

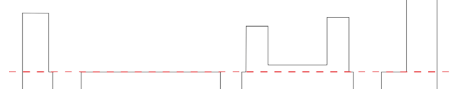


Figure 172b: Reference the surroundings in height (warehouse). (Machgeels, D., 2020)



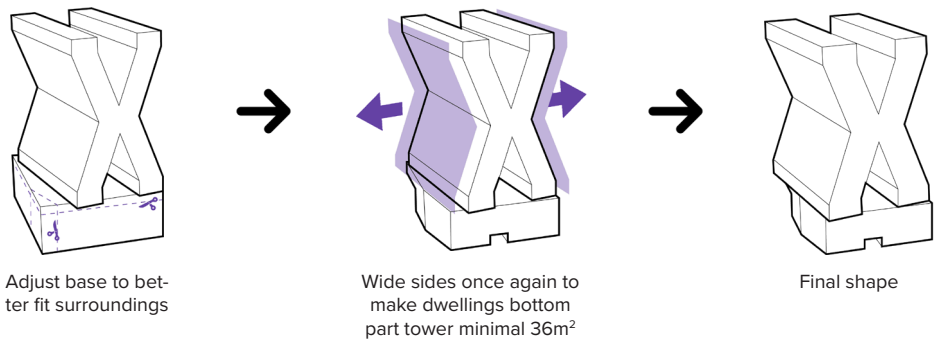
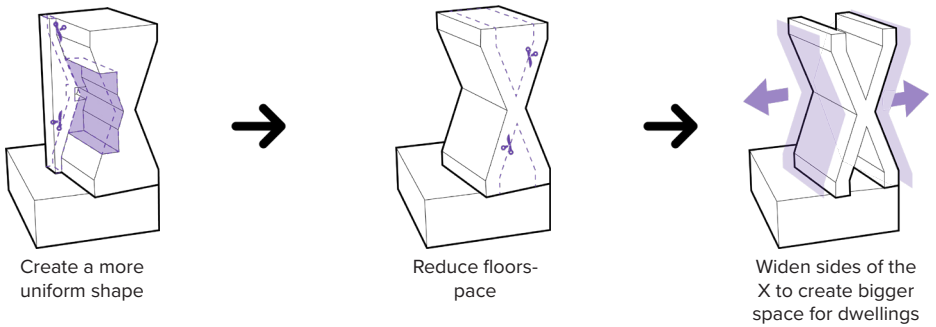
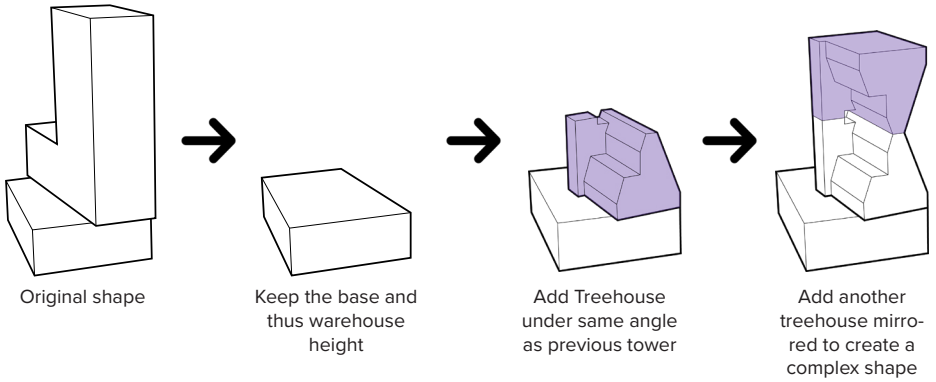


Figure 171: Transformation of the shape of the building [Image]. (Machgeels, D., 2021)

terial is a bit different from what is already present. As this would signify the home for a new group of people with a new way of working and new type of jobs, my idea was that to keep it to have that identity a new material could be introduced to the site as well. Keeping in mind the already established color palette of the area I chose to go with a wooden cladding for the building. Settling on a somewhat lighter color of brown rather than a very dark one as to keep the building feeling warm and inviting rather than it being dark and repelling. (see appendix A) All these choices were inspired after doing a research regarding the colors and materials used in the surrounding, which are all put in my material context.

Regarding the actual look of the building, I went with a very open glass façade which opens the dwellings towards the outside. I got several comments from tutors saying that it looks like an office building saying that it should be something that I either need a good reason for or that needs to be changed. However as I see it, it is a compliment, my target group “the New Media workers” are people that have their office in their home, meaning that calling this building an office building, is something that fits the aesthetic that these people are looking for. Similarly this creates a duality in the building where the outside acts as stern an clean office like building, while the inside offers a very warm and inviting sphere for the people living there to meet and work, taking the best of both worlds.

Continuing on the aspect of affordability the



Figure 173: Building in location birdseye. (Machgeels, D., 2021)



Figure 174: Top atrium. (Machgeels, D., 2021)

choice was made to make a prefab façade. A prefab façade would be easy to install and change later, as well as be cheaper to manufacture as these prefab elements would all be the same. (see figure 175) To design this prefab element a lot of research was done by collecting reference detail of mostly slanted façades and prefab elements. Combining the information from these details as well as input from the tutor I came to the current façade. The element itself is placed after the floors and walls have been put in after which these elements can just be attached to the floors. After attaching the façade element the interior of the dwelling can be finished. (see figure 176)

Using a slanted façade made creating this prefab

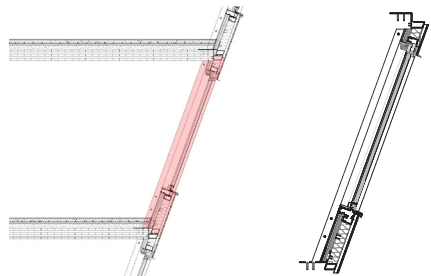


Figure 175a: Prefab façade element in façade. (Machgeels, D., 2021)

Figure 175b: Prefab façade element. (Machgeels, D., 2021)

element a lot harder as there aren't that many examples for slanted façades that are made from prefab element, often the examples show a façade which is fixed to the whole of the construction and part of the floor and wall construction. The principles used for this façade element should

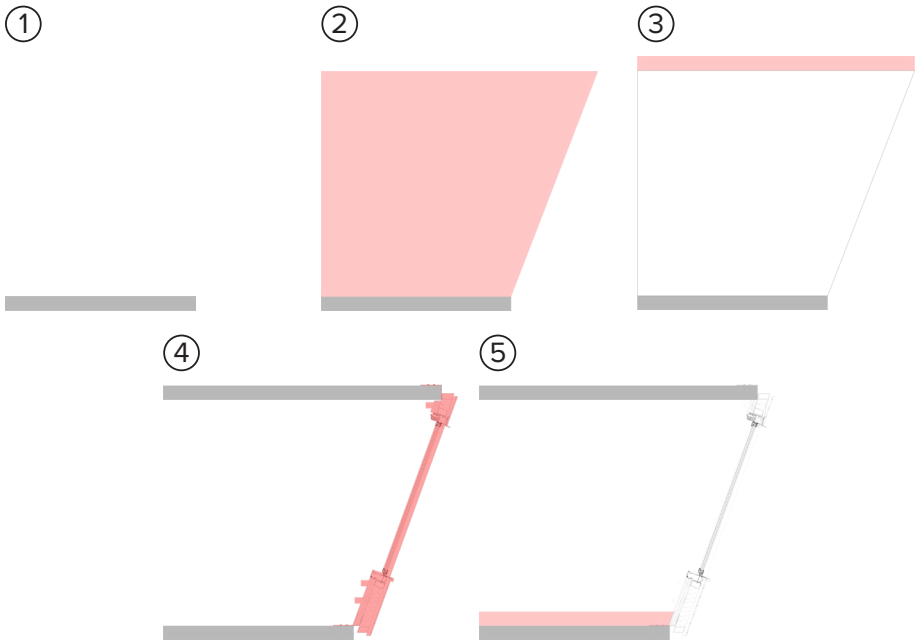


Figure 176: Assembly process diagram. (Machgeels, D., 2021)

be applicable to other buildings as well, the principle can easily be adapted to straight façades as well since the way that it is attached to the construction is not dependent on whether the façade is slanted or not.

## BUILDING LAYOUT

The functional layout of the building is characterized by its clear division between its public realm and collective came from my case study. After determining that my target group had an inkling towards smaller and more affordable dwelling around the 30 m<sup>2</sup> category, due to financial reasons mostly. (see figure 177) I took to find case studies that had either similar dwellings or layout that could be used in order to form a building that could house my target group or rather these “New Media workers”.

### What is the size of your current home?

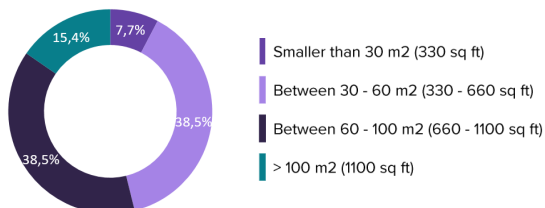


Figure 177: What is the size of your current home? results of questionnaire. (Machgeels, D., 2020)

The biggest similarity can be seen from the sections of each of these buildings. The way that “the ” is made up is inspired by the sections of each of these case studies, however as can be seen there is a slight difference between the examples. (see figures 178-182) The main division that is used is as follows: on the bottom there is the public realm, often filled with functions such as either an atrium, restaurant or just lounge area where people can meet. On top of this some sort of communal function, like a floor filled with workspaces accessible to both residents and visitors, and lastly the dwellings themselves. The last part can either be seen as only dedicated residential space or a mix of private dwellings and communal areas, like Treehouse or Tietgen Dormitory.

In my design I altered the main principal used here, similar to the main principal the public realm is on the bottom with the residential function located above this public realm. However instead of placing a collective or communal space for both visitors and residents in between to separate these two functions, I placed these floors in the middle of the building dedicated only to the residents. Since my building is meant for people mostly working from home with the use of New Media, it can be assumed that these people need a good network of people to do their work or expand their brand. Having spaces within the building, such as the 2 floors in the heart of the building, as a central meeting spot, people are able to meet others in their business or other businesses to expand their network and skills so that they may be more broadly deployable. Similarly the bottom floors of the building are essentially meant as public realm, however it does hold functions such as a gym, restaurant, electronic repair-shop and parking for the residents to ensure that these floors are also used by the residents and invoke interaction between the visitors of the building and its residents.

Schiecentrale 4B, Rotterdam



Figure 178: Accessibility and functions Section Schiecentrale. (Machgeels, D., 2020) Analysed from Section (Mei architects and planners, 2020)

Treehouse, Seoul

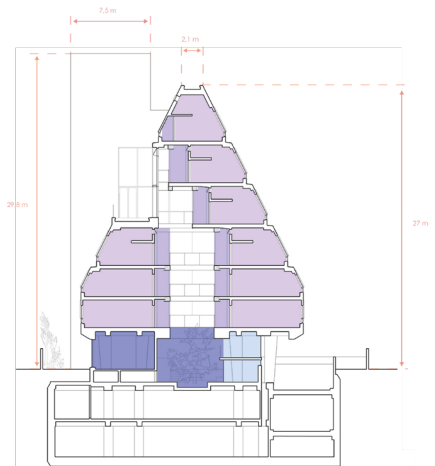


Figure 179: Accessibility and functions Cross section Treehouse. (Machgeels, D., 2020) Analysed from Section 2 (Treehouse / Bo-da Architecture, z.d.)

- Dwellings
- Public space
- Collective space
- Collective access

Tietgen Dormitory, Copenhagen

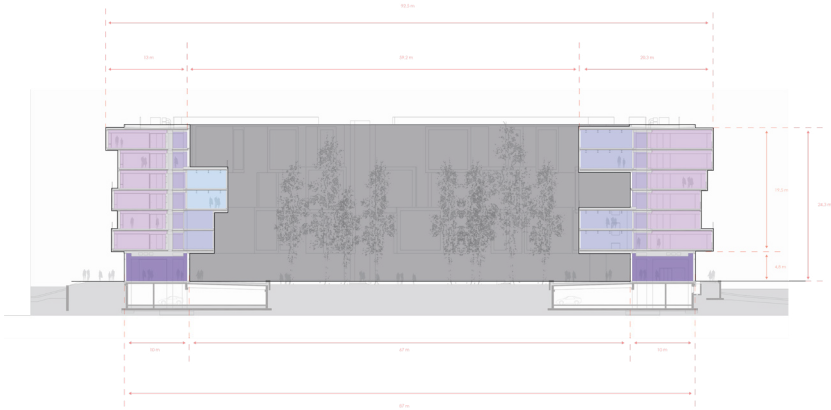


Figure 180: Accessibility and functions Section Tietgen Dormitory, (Machgeels, D., 2020)  
Analysed from Section (Sánchez, D., 2019)

Anna van Bueren Toren, Den Haag

AXESS, Rotterdam

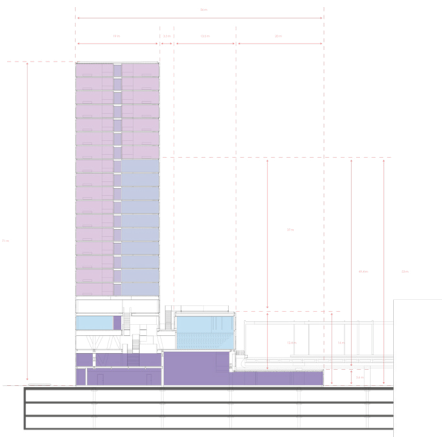


Figure 181: Accessibility and functions Cross section Anna van Bueren Toren, (Machgeels, D., 2020)  
Analysed from Cross section (van Gameren, D., Kuitenbrouwer, P., & Mooij, H., 2014)

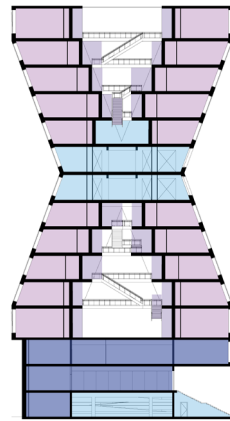


Figure 182: Accessibility and functions (Machgeels, D., 2020)

The way that the dwelling dimensions were determined and their overall fit within the building is also taken from the case studies, as mentioned in my graduation research I stated that in order to make a “high-quality, affordable workspace in a workhome?” or rather “a high-quality and affordable workhome”, the building firstly had to be set along a set grid. As the building construction of my building is a lot thicker than seen in the examples my grid is also a little with larger, however retaining a similar interior size for the dwellings.[show some examples of grids case studies] [show grid structure my building] Secondly that this structure should be used to increase flexibility in dwelling typology allowing dwellings to grow as long as they stayed within the grid. Continuing in my design this part of my research became a nice addition rather than a goal to strive for, as most of the questioned in my questionnaire answered that they did not have the money to afford larger dwellings and as a cause most of them therefor going back to either living with their parents or staying in dwellings of around 30m<sup>2</sup>. Saying that they didn’t need or could afford anything more, meaning that these expandable dwellings didn’t seem like something that my target group would need. (see figure 178)

Additionally the way that my building is shaped / constructed, the idea of these expandable dwellings also wasn’t possible throughout the whole building. Only a few select floors, namely 3rd, 4th, 13th and the top floor were able to house these expandable dwellings (see figure 183). Even on these floors the amount of flexibility was limited to where holes in the walls could be made to allow for the growth of these dwellings. [show diagram holes in wall] Because I did have some space where this was possible I looked into at least the possibility of creating double wide dwellings, dwellings that use 2 units within the grid located next to each other. (see figure 184) The main reason for this was that the size of these double wide dwellings still fell under the most common house size of my target group.

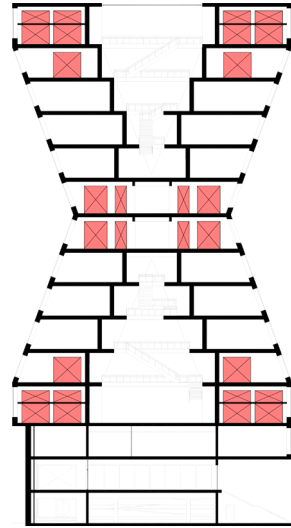


Figure 183: Openings in the walls. (Machgeels, D., 2021)

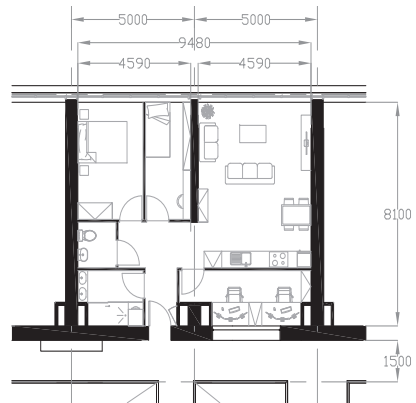


Figure 184: Large apartment bottom part tower floor plan. (Machgeels, D., 2021)

As most of the questioned, as mentioned earlier, had dwellings in and around the 30-60 m<sup>2</sup> range, I focused on the more affordable and compact dwellings as main topic for this building. As my third point pointed out the size of these dwellings, where everything is included like kitchen, bathroom, workspace, bedroom etc, should be at least 30 m<sup>2</sup>. (see figure 185) Additionally to also accommodate for the people that don't have a need for a personal kitchen and as a possible way to save dwelling cost some co-living units were also introduced in the building where the dwelling size in reduced to 27 m<sup>2</sup> and it does not include a personal kitchen.

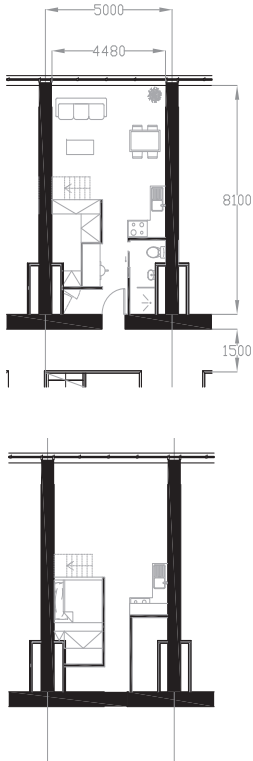


Figure 185: Studio+ 36m<sup>2</sup> floor plan. (Machgeels, D., 2021)

## TUTORING FEEDBACK

During the whole studio I got a lot of feedback regarding my work, often related to the questions I ask during my tutoring session. I think other than the feedback I received to my own questions, the feedback I received on my P2 and P3 have been the most useful into making the project a more complete design. According my tutors, my idea for the atria in my buildings did not meet the vision that I had for them. The initial idea for these atria was to act as both a circulation space, where the stairs and galleries were used as main way of getting around, with the fire escape stairs and elevator as a secondary means, and a space of meeting and interaction. As my atria were very bland and didn't have any space for people to wait and talk to each other the space only acted as a circulation space offering no places for interaction. (see figures 174, 186 & 187)

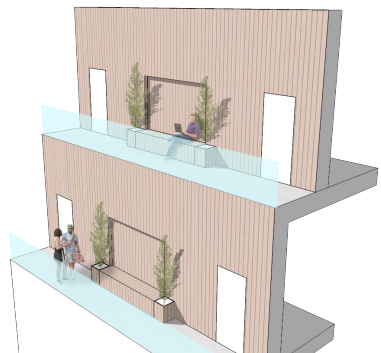


Figure 186: Benches as meeting and interaction space. (Machgeels, D., 2021)

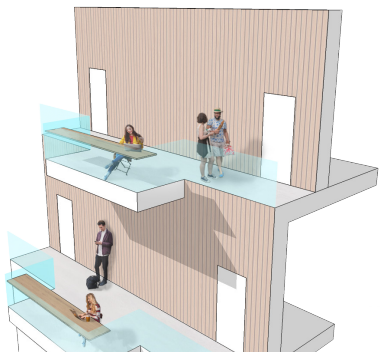


Figure 187: Balcony workspaces. (Machgeels, D., 2021)

As mentioned in the collectivity research a lot of the examples that we looked at, especially Heliport and Justus van Effenblok, use this same idea of having galleries and streets that allow for interaction. However as the research pointed out both these examples have their positive and negative points. From Heliport for example I learned that the dimensions of these galleries are very important to the way that the space is perceived. A problem at Heliport was namely that these galleries were only 1 meter wide and didn't offer the space for the people to meet and interact. Taking a page out of the book of Justus van Effenblok where the galleries or rather streets are a bit wider and offered benches and such for relaxation and interaction, I got the idea to change the galleries in my atria.

The knowledge of my collectivity research together with the reminder of the tutors to go back to my initial idea for this atrium, caused me to change the appearance of the atrium as well as give me the initial thought of making these galleries a bit wider than usual. Adding benches and planters receded into the otherwise very bland, closed and uninviting atrium walls changes the perception of the whole of the atrium. Additionally balconies are added to the certain levels where these people can work within the naturally lit atriums, rather than their own workspace as a change of pace. This change will also allow for more interaction between the people lounging in the atrium and the ones passing through it, making it more easy to strike a conversation.

As concluded in the Collective research creating spaces solely for interaction, mostly has a negative or opposite effect on the users, however providing spaces where people can do what they want or sit at, like benches or nooks somewhere in space, allows for freedom of use and often see more use as well. Using this strategy I made the choice for my atrium, hoping that it would have the same effect.

Besides the atria also the ground floors have had a change, but not only on the level of interaction, but also circulation. Originally the plan was to have the ground floor act as a passage, much like the Passage in The Hague. After some discussion with the tutors I came to the conclusion that this was not the best solution for the building

itself, seeing as the passage didn't add anything other than providing a solution, but not THE solution, to making a connection between the road on one side of the building, the south side and the park. (see figure 188) After pondering about this I came to the realization that the south side of the building was only attached to a secondary road in the Keilekwartier and not a major entrance to the building. Deciding that I still wanted some sort of connection from the east road, where most of the shops are located plus a pedestrian crossing, and the park I decided to change the look of the building and its circulation.

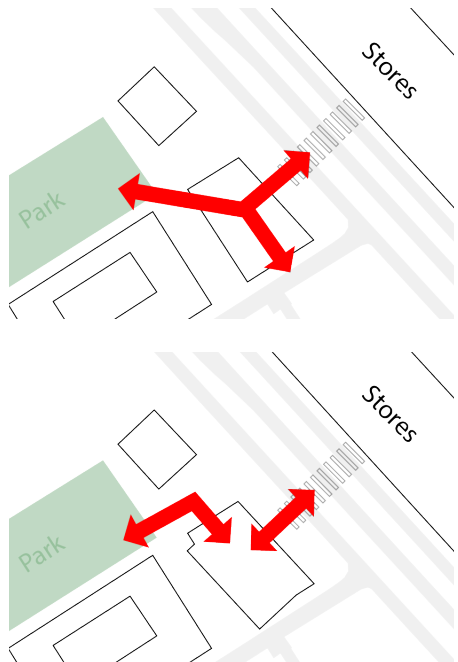


Figure 188a: Old circulation concept. (Machgeels, D., 2021)

Figure 188b: Current circulation concept. (Machgeels, D., 2021)



My initial idea for this circulation didn't work for 2 reasons. The first being that I had no other function for this passage other than a passageway between the 3 sides of the building, which didn't all need as much direct connections. And secondly the fact that I needed a parking garage which couldn't be placed on the first floor due to space limitations. (see figure 189) Seeing as if I wanted to place the parking on the first floor I would need a ramp of at least 40 meters which would span across the whole side of the building, making that space unusable. After a discussion with one of my tutors deciding whether this garage should or shouldn't be placed on the ground floor, I made the decision to place it on the ground floor. Placing the parking however on the ground floor would save space and make the entry in the garage, local share hub, a lot easier. The choice for a share hub was made for a few reason, firstly because these people often work from home they don't have a direct need for a car, thus making having a large garage unnecessary, and secondly using a share hub, the restrictions for the measurements of these garages could be smaller as well as have fewer parking spots, making it possible to use the rest of the floor space more efficiently.



Figure 189: Hellingpercentages in parkeergarages [Image]. (Machgeels, D., 2021)

After that the connection between the first floor in the building, where the public realm continues, and the outside, the park and the pedestrian crossing, was made with the introduction of grand stairs on both the northern and east side of the building. These giant stairs invite people in while also being dimensioned in a way that they can be used a nice place to relax and have an overview over the park. Additionally if one didn't

want to take the stairs and/or stairs with included ramps, one could take the elevators located on the East side of the building. Arriving on the first floor one can make a selection of ways to go up into the rest of the building using either the elevators in the separate cores of the building (marked red), which only go up to the public floors, the main circular elevator in the middle (marked blue), which access is restricted beyond the public floors, the stairs cases also located in the cores or the escalator in the middle of the floor (marked green). (see figure 190)

The only thing I worry about with this circulation is the fact that people might use the middle elevator too often in the public floors, but removing it from those floors would ruin my whole idea for the building. Restricting the floors people can go up to without a keycard and providing other means of moving between floors, which in this case are only 2, however the elevators and escalators seem like they would provide enough alternatives to the movement between only 2 floors.

Additionally my tutor told me about changing my floorplan a little to accommodate for postal services, my previous floor plan had both the mailboxes and bicycle storage in the same space, making this a very awkward place to deliver mail. He however suggested to add an additional postal / mailbox area in the building that is separate from the bike storage, as their security needs are different as well. Currently I am still working on incorporating this into the design however this will be added as I think this was indeed still an issue in the current configuration of the ground floor.

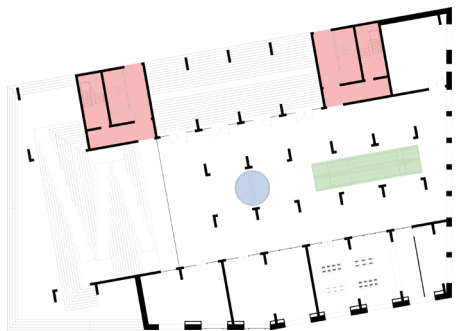


Figure 190: Circulation possibilities ground floor. (Machgeels, D., 2021)

## CLIMATE

In an effort to make the building more environmentally friendly and adhere to the BENG rules, several climate systems were integrated. Several of the used systems are building wide, such as the water heatpump, which uses the Maas as source, providing warm and cold water. Not only does this address warm and cold water throughout the building, it also feeds the floor heating that is located in each of the dwellings. Additionally the building is covered in solar panels or rather Photovoltaic glass. Because my façades mostly consist out of glass and the demand for electricity in the building will be very high with all the people working from home, the building needed to produce a lot of electricity. The normal amount of solar panels which could be placed on the roof of approximately 1000 m<sup>2</sup> wouldn't be enough for the whole building. Using a new innovation in solar technology, the Photovoltaic glass, it was possible to replace all the windows in the building with this new PV glass. Because of the large surface area these panels should provide enough electricity for the building or at least cut down the cost for the necessary electricity significantly without trading in the look of the building. This new type of PV glass, is just as transparent as normal glass, can be installed in the same way, but has about 10% efficiency compared to a normal solar panel of similar size. (see figure 191)

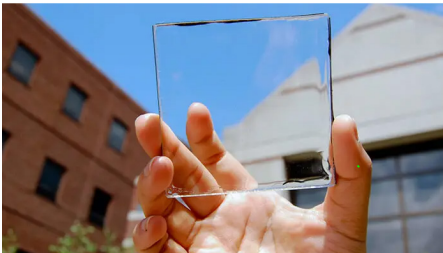


Figure 191: PV-cell glass [Image]. (Lunt, R., 2020)

Ventilation is also done in a more environmental friendly way. Because nearly all the spaces of the building have large window surfaces separating them from the outside, natural ventilation can be used as the main ventilation principal. Especially in the dwellings the natural ventilation of just one window would be enough for the whole of the dwelling (see figure 192). Because natural ventilation in the dwellings would not suffice all year round another system is integrated in the

dwellings to make sure that it has another way to ventilate the space.

Other than the standard climate machines that are in the building, the remaining systems are more catered to the user. Each of the dwellings has their own systems integrated in the façade which the resident can control themselves either via a controller on the wall or their smart devices. These systems include a stand-alone heat recovery system for ventilation located under the window frame (named the Aeromat VT) and a shading system, hidden behind the façade cladding, which is integrated in the window frame. (see figure 193 & 194)



Figure 193: Ducotwin 120 'ZR' AK [Image]. (DUCO, z.d.)

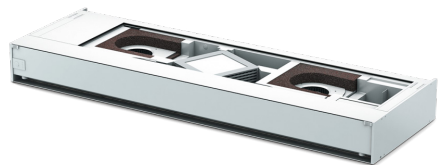


Figure 194: Aeromat VT [Image]. (Siegenia, z.d.)

**NATURAL VENTILATION STUDIO+****NEEDED VENTILATION****L X B X H X VENTILATION FACTOR****ventilation factor****living room: 5****kitchen: 15****bathroom: 10****Living room (includes all other living spaces)**

$$((2,98 \times 8,1) + (3,6 \times 1,5)) \times 3,525 \times 5 =$$

$$(24,138 + 5,4) \times 3,525 \times 5 =$$

$$520,60725 \text{ m}^3/\text{h}$$

**Kitchen**

$$(1,5 \times 1,8) \times 3,525 \times 15 =$$

$$2,7 \times 3,525 \times 15 =$$

$$142,7625 \text{ m}^3/\text{h}$$

**Bathroom**

$$(1,5 \times 2,7) \times 3,525 \times 10 =$$

$$4,05 \times 3,525 \times 10 =$$

$$142,7625 \text{ m}^3/\text{h}$$

**Total ventilation need Studio+ (36 m<sup>2</sup>)**

$$520,60725 + 142,7625 + 142,7625 =$$

$$806,13225 \text{ m}^3/\text{h}$$

$$806,13225 / 3600 = 0,223925625 \text{ m}^3/\text{s}$$

**VENTILATION THROUGH WINDOW**

$$Q = 0,5 \times A_{\text{eff}} \times \sqrt{0,0035 \times \Delta T \times h \times (0,001 \times U^2)}$$

$$\times 0 \times 01$$

$$A_{\text{eff}} = l \times h \times 0,98$$

$$= 2,6 \times 1,085 \times 0,98$$

$$= 2,76458$$

$$h = 2,6 \text{ m}$$

$$\Delta T = 3$$

$$U = 5 \text{ m/s}$$

$$Q = 0,5 \times 2,76458 \times \sqrt{0,0035 \times 3 \times 2,6 \times (0,001$$

$$\times 5^2) + 0,01}$$

$$= 1,38229 \times \sqrt{0,0273 \times 0,025 + 0,01}$$

$$= 1,38229 \times 0,25377155$$

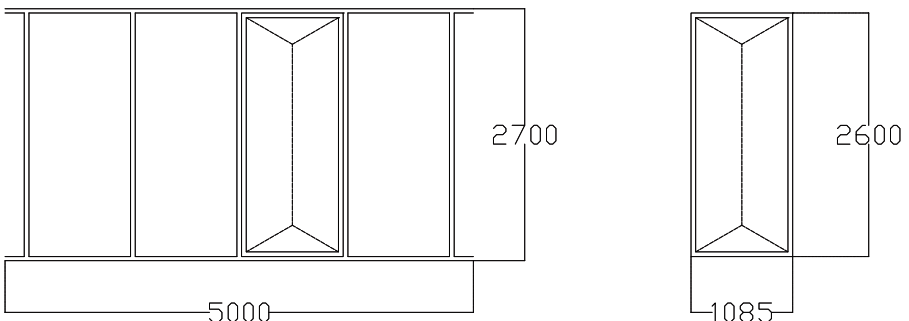
$$= 0.3507858758495$$

**That equates to:**

$$0.3507858758495 / 0,223925625 \times 100\% =$$

$$156,65285\dots\% =$$

$$156,7\% \text{ of the necessary ventilation}$$

**Figure 192:** Size openable window Studio+. (Machgeels, D., 2021)

Currently I haven't done an exact research regarding the ventilation demand for the atria. Treating them as a space in between indoors and outside makes it possible for the space to only work on natural ventilation however, if the building were to be build some more attention has to be paid to this aspect in particular. As well as the ventilation the specifics about the shading of the atria is not researched and should be worked on as well if this were to be build, as currently only the roof of the atrium, where most of the sunlight comes from, (see Appendix B) has shading and not the sides, even though it does not seem necessary to apply sun shading here from my initial findings.

### ANSWERING THE RESEARCH QUESTION

Answering the question of my research: "How do you make a high-quality, affordable workspace in a workhome?" or otherwise "How do you make a high-quality, affordable workhome?" is still very hard. In my design there are certainly aspects that work towards creating a high-quality and affordable workhome, however nothing in this design really jumps out saying that it is perfect. Much like all the other examples of work I found it is a step in the right direction, using not only the answers of the questioned and the feedback of the tutors but also taking a look at more compact dwelling to see how these fit into the equation. Taking notes from compact dwelling such as Treehouse, New York micro-apartments, RV layouts and just normal corridor typology dwellings, it can be said that the main dwelling type in my building makes a good starting point for a dwelling that is catered to affordability with, prefab elements for both bath, bedroom and kitchen, while also offering space to live and work and integration of these concepts and catering them a bit to the specified target group. (see figure 195)

Additionally as mentioned in my research where there is a lack of something in the dwelling I tried to compensate this with a function or place within the same building, close to their dwelling. This can be seen as the collective floors in the heart of the building forming a hub for both the bottom and top atrium to come together, relax and expand their network or the several work and meeting spaces within the atria.

I think that to answer the question fully a look at the overall building must be taken, meaning that not everything that the New Media workers wanted could be realized within just their dwelling just yet, however it is a step in the right direction. As workhomes can be found in many different forms, such as is described in my research in "Chapter III: A place to live and work", it is very hard to find a solution that would fit the workhomes as a whole. But as this project shows it is possible to create something that can solve the problem that is currently present (see figure 196) while providing the target group with a dwelling that answers to most of their needs and offering that what lacks in the rest of the building.

Making a workhome as I have experienced it in this project is a lot of trial and error, taking into account the wishes of the specific target group and trying to overlay that on top of the other requirements you have such as affordability. Certainly some aspects of what I have researched and found can be used as part of answer to that questions, such as using prefab elements, which can save space, to make room for things like workspaces within the dwelling, and reduce the cost of dwellings. Or that using CLT and things like PV cell glass make the building more future proof as well as improve internet and Wi-Fi connectivity within the building. Other than that creating a high-quality, affordable workhome is a balancing act of the wishes of the user / target group, keeping it universally usable in for other target groups and not compromising on space. In my opinion these dwelling could be improved upon if the target group / questioned would be approached once more with a finished 3D model and floor plan of the dwelling in which they could look around and make remarks. However this would also serve as creating dwellings catered to personal taste rather than the target group itself. It would on the other hand give insight in how these dwellings could be improved if multiple people answer similarly.

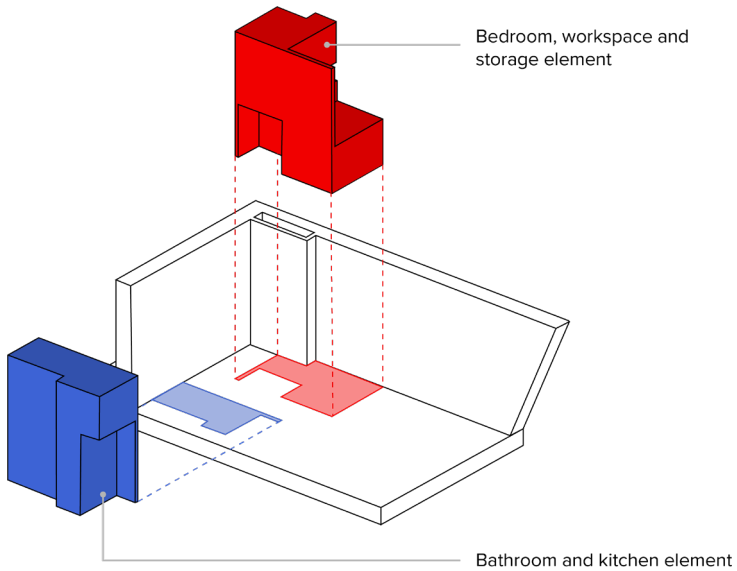


Figure 195: Basic dwelling assembly.. (Machgeels, D., 2021)

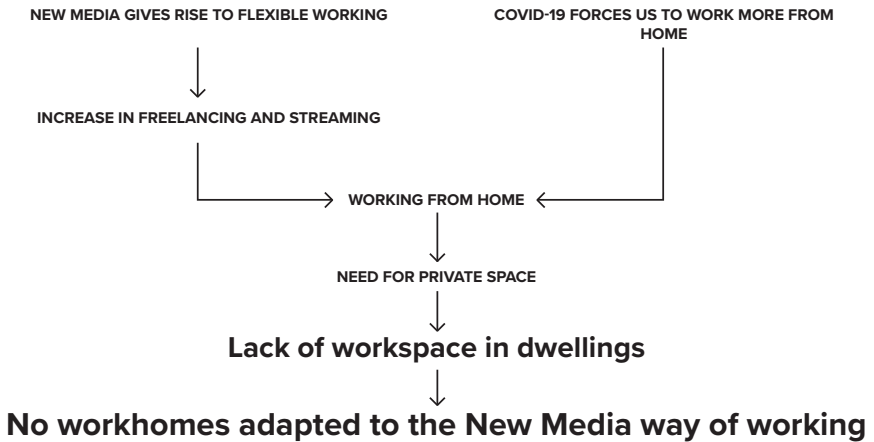


Figure 196: The problem and the road to it. (Machgeels, D., 2021)

**AFTER P4**

After my P4 presentation I got a few more things to work on, the feedback mentioned that certain things about my design could be improved. Mostly in the aspect of making a coherent story. For example the function of my atrium was portrayed differently from the preceived intention of the space.

Besides my atrium, what they defined to be a big part of my design, they urged me to focus on improving some of my drawings and try and find a solution to the safety issue of the windows. As the windows, as of the P4, could be opened either by tilting or fully opening them, opening them this way would pose a risk of people falling out of them. Along with the issue of safety, ease of use was also questioned, seeing as the windows are fairly large, 2,6 x 1,1 meter, and should be opened in their entirety the windowframes that were chosen wouldn't suffice.

During my time till P5 I challenged myself to change the aspects mentioned in my P4 feedback. Changing not only my atrium, offering more than just a workplace functions, but rather letting the balconies, which are a main part of the atrium, be flexible in their layout and function. Besides a flexible function some of the balconies have been enlarged to allow for more people to gather and meet / work in the same balcony. As P4 made clear the space in the atrium is meant for people to meet and work or relax together however the balconies I created were only reserved for one singular function, work. Along with the restriction of one function they also didn't allow for more than 3-4 people to meet comfortably. With the introduction of the larger balconies the atrium can now house more people and functions, making the whole atrium more lively and a better balance between work and live.

Besides the atrium I also changed several drawings and concepts to either be more detailed and representative or to be more clear in their intention, much like the atrium. One of the major adjustments is the change to my façade (see figure 197 & 198). To better follow the concepts already applied to the other parts of the façade, the two main windows on the North and South façade accentuating the X shape in the building, has been changed. Instead of it being a single

piece of glass some realism has been added to the window, having added windowframes to properly dimensions this otherwise dimensionless piece of glass. The way the window is now divided is similar to the windows on the public plinth. Using the windowframe to accentuate the location of the floors as well as the main shape of the building, by placing 2 windowframes parallel to the outline of the building. The main principle used for these windows is to highlight floors and to follow the outline of the building, to make the shape more apparent.



Figure 197: South façade P4. (Machgeels, D., 2021)

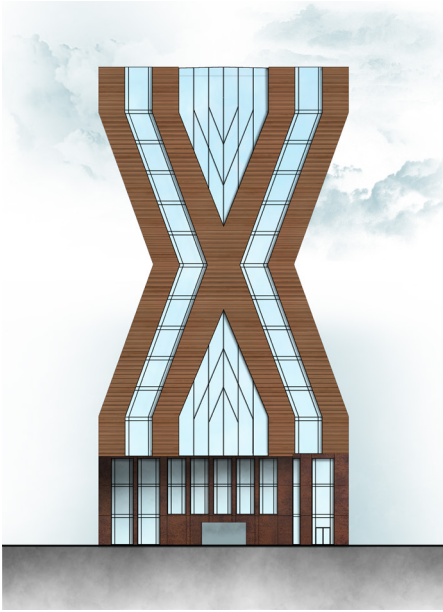


Figure 198: South façade P5. (Machgeels, D., 2021)

The windows themselves have also been slimmed down and extended to the roof. With the new dimensions of the windows the building became more realistic and better accentuates the X shape of the building, rather than the façade being mostly glass.

In concern with the changes to my windows in the eye of safety and ease of use I changed the window frames to a sliding and tilting window. However even though the ease of use would significantly increase the danger of falling out of the window still persisted. To counter this either the windows had to be permanently closed up to a certain height or some sort of railing had to be placed either in- or outside the dwelling. Because my concept was to have a clean looking façade, where every window had to be opened in its entirety, a part of the window that couldn't be opened would not suffice. As this would need an extra windowframe, which would disturb my otherwise uniform façade. My choice therefore went to a railing, and to save space on the inside of the dwelling and as to not interfere with the opening of window when it tilts, the railing was placed on the outside (see figure 199). To make

the railing as invisible as possible the choice was made to make it out of glass as well. (see figure 200)

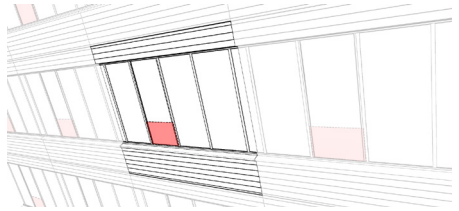


Figure 199: Location of glass railing. (Machgeels, D., 2021)



Figure 200: Glass railing in real life situation [Image]. (Machgeels, D., 2021)

After another meeting with one of my tutors I was advised to seek some advice from the manufacturer of the windows to see if they had any solutions for my specific case. A bit later near the end of my time between P4 and P5 I got an answer with the perfect solution. The solution was a new type of window (see figure 201) that they had developed recently and wasn't yet fully advertised on their site. I got several PDF documents containing the specifications of this product as well as how it worked.

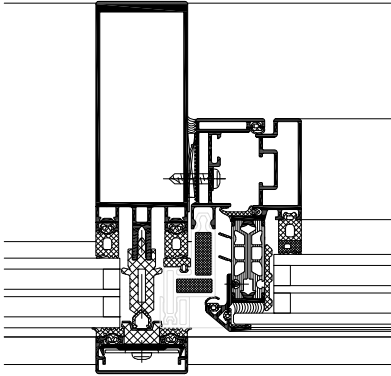


Figure 201: Schüco AWS 114 in FW 50 Sl+. (Schüco, 2020)

The aesthetics of my building wouldn't change at all seeing as all the windowframe thicknesses were the same as the previous and my current windowframes. Even the construction method would be similar. The only change that this window brought was the way that the window was opened and the fact that I didn't need glass railings in front of the windows, while keeping the clean aesthetic that I wanted.

Instead of opening inwards or sliding to the side the new window opens outwards parallel to the façade (see figure 202). Because of several limiters the gap between the window and the façade can never be bigger than 15 cm meaning that it completely prevents falling out of the window. Additionally it is easy to operate as it can be opened either manually, manually assisted by mechanical parts or fully mechanical.

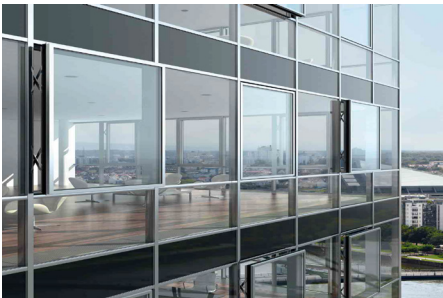


Figure 202: Schüco AWS 114 parallel-opening window in action [Image]. (Schüco, 2020)

Due to time constraints I wasn't able to adjust my details to fit this new windowframe. Talking to my Building Technology tutor about this he said to leave the details as they are and mention this in the report.

To say it in short I tried to improve all the aspects of my building as mentioned in the P4 feedback. I sincerely think my building has changed for the better during the period between P4 and P5, with several aspects even strengthening my story and intentions for the building. The only regret I have is that I didn't contact the manufacturers earlier to get the necessary information in order to change my details. Even as of writing this I am still looking for a way to be able to change the details, however time won't allow it.



## RESEARCH AND DESIGN

From what I can say and what I experienced during this project is that research and design are strongly connected to one another. Even without realizing it I would find myself researching certain things to make sure that the choices I made in my design were founded by some sort of logic. In my case this research mostly consisted out of comparative research, where I looked for other examples of a problem or to gain inspiration on how to make certain parts of the building. However I have also done a lot more of other type of research than I had anticipated, for example the Wi-Fi and connectivity research really helped me determine the construction material of the building, because of this the choice for this material is not only founded in a reason for environmental friendliness but also in scientific reason.

Doing research especially regarding the target group, location and collectiveness in general have made me realize that I often designed things a certain way without really thinking about it. Because I had researched these aspects I had a basis of knowledge on which I could build, without having to actually really think about how and why it was that way. Especially the earlier researches in this project, helped me set some base principals, which I can still see in my design today. Keeping these principals in mind, as the tutors said that I should, also really helped designing certain aspects of the building in a way that it made sense or that it fit principles better, rather than just another loose statement.

Designing as I experienced it is not just drawing something from your imagination it is through a lot of research and cross referencing ideas of others that you can build up your knowledge to create a good and working building. The design itself stems from the information that you have gathered through all of the research you have done, whether these are literary based, questionnaires or case studies, they all help you build up that knowledge library that you need to make a good design.

## RELATION TO SCIENTIFIC METHOD

In this reflection I have mostly talked about the influence research had on my design and how it impacted the outcome and eventual building, however I have yet to mention its relation to actual science and scientific method.

Science itself is very simple to explain it is verifiable human knowledge, that is acquired with the use of several methods. The general idea of scientific method is best explained in figure 203.

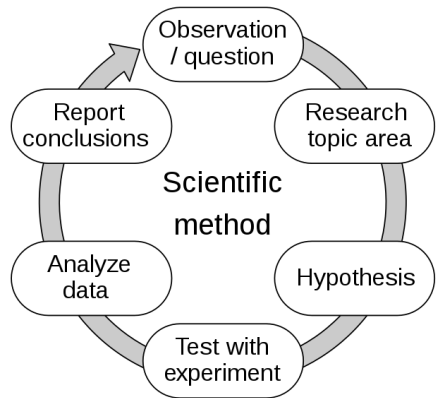


Figure 203: *The Scientific Method* [Image]. (Efbrazil, 2021)

In my target group research I have undertaken these steps as to set up a proper scientific research. As the prescribed method is about empirical research, which revolves around experimenting and using the results of these experiments to form a conclusion to the question or observation made in the beginning of the research. It could be said this both is and isn't present in my project.

At first glance one would say that my project is primarily based on literary research, social science, comparative research. Looking at these examples it would seem that my research on its own would not suffice in being a fully fledged scientific project. However since the most important aspect is that as mentioned earlier the knowledge is verifiable or in case of an empirical science that it can be replicated, it can be said that my research on its own is scientific. Much like the figure above the research uses the steps seen above.

In my initial research of my target group I made the observation that there was a problem and stated a question that allowed me to seek answers to solve this issue. In my case the “lack of suitable dwellings” along with the housing shortage, was the start for this. My question specifically focused on a target group that dealt with this problem narrowing down and specifying my topic. This part can be seen as research the topic area a bit further. Based on the information I had received so far I made a hypothesis that seemed like a likely answer to the question, that I stated in the beginning of my research, and a possible solution to the problem at hand.

Normally at this point an experiment would be conducted from which the results would serve as the clue to forming conclusions / answers to this problem. Seeing as the research I conducted was a mixture of literary and comparative studies from which I got my data to later on write my conclusions, it could be said that the experimental part in scientific research is found within these methods. Viewing it this way the research I did on the target group and the problem of housing for these people is seen as a scientific research, following the exact same steps as shown in figure 203, only replacing the experimental part with literary and comparative studies. As everything is verifiable and can be checked or even replicated this would only strengthen the similarity between the two.

On the other hand taken the whole project into account, one can say that the design itself can be seen as the experiment in this scientific research. If this would be true the floorplans, circulation and obviously the dwellings can be seen as conclusions or answers in this research. In this case the question and hypothesis of the target group research stay as main topics in this research, however the literary and comparative methods have exchanged for a experiment in which is aimed to create a solution using my hypothesis and the information received from my other researches.

Regarding the verifiability of this whole project this reflection can be used for that. Since this reflection shows the steps I have taken and how they have influenced my project and in what way, if one where to do the same research and try to replicate this project he or she can come to the

same end result. Some parts within the design are of course a personal choice, however these are still derived from verifiable knowledge / sources and can be recreated using these.

In the end it is clear that no matter how this project is viewed it can't be denied that it is not only founded in scientific and academic information, but is also in line with how normally scientific research is conducted.

## ASPECT 2 | THE RELATIONSHIP BETWEEN THE GRADUATION TOPIC, STUDIO TOPIC, MASTER TRACK AND PROGRAMME

For my graduation I started out with a special topic. In my case I had the topic of streamers, which when I look at it now was a fine starting point, but a bit too nuanced to center a whole graduation project around. Talking it over with my tutors and developing my research I soon came to the realization that streamers were just an example of the group of people I wanted to address, using this information I went about making my graduation research. Eventually I came to the conclusion that my research topic would be workhomes and specifically high-quality, affordable workhomes for the New Media workers.

As far as the studio topic an master track is concerned it was focused on creating housing for groups that are in desperate need for housing. The 1 million homes initiative was a really important aspect in this as well, as this seamlessly connected to the goal of the studio, creating modern households for the people in need. In my case I took the idea of modern a bit literally, focusing on the New Media workers, which are (as I explain in my research) a group of people that work differently from how we used to, mostly working from home. As my research states we went from a go-to-work mentality to this new way of working that allows us to also work from home. With the growth of New Media, which allows us to work from home, and Covid-19 forcing us to do this more often, the amount of people doing so grew and keeps growing. In the research I go into depth about how these people often have a lack of space in their dwellings, because they are not adapted to this new way of working as we normally went to our work instead of doing it where we lived. This whole idea really fit the studio idea of having a target group that has a sincere problem regarding their housing needs and can't find a house currently.

As I chose the track architecture I thought that the focus of my track would be on the integration of these homes within the building, its circulation and of course how the building looks, not only on its own but in its environment. As I chose my topic I didn't really think about it at first, however as I developed my design and sharpened my topic I saw that it allowed me to give a twist to an otherwise very normal master track. Due

to my topic I felt like it was possible for me to experiment with different shapes of the building and different ways of handling circulation that I wouldn't have otherwise thought about. Considering this I think that my topic fit very well in the Architecture master track. Not only did this odd shape allow me to express myself better within the field of architecture it also made sure that I clearly focused on the other aspects considered a part of the Built environment. Especially dealing with the building and its surrounding was an important point, I had to have a reason to use a certain material otherwise, why would I use it. Additionally this odd shape required me to carefully detail my façade and construction parts in order to see how it would all tie together, working on these aspects only made my design more fleshed out.

In short I would say that my topic, which I admit, at first wasn't really connected to any of the topics except maybe the studio topic itself, turned into a topic that has allowed me to experience all the aspects related to architecture making it in my opinion a perfect fit for both the Master track and programme.

### ASPECT 3 | RESEARCH METHOD AND APPROACH

In my explanation in aspect 1 I already touched up on this topic, but to clarify I will explain it a bit more here. For the first part of the studio we had the task of making a collectivity booklet with the whole Msc3 group. In this booklet the main research method was visual ethnography, using mostly visualization to explain / convey the message of the research. Personally I am not that good at this way of working and had a hard time coming up with a working strategy for this part, this also led to my visual ethnography being very different from those of the other students. While working on this aspect I got a lot of help from my tutor as well, guiding me through this process and coming up with something that would fit my way of working. This research on it's own didn't seem to that relevant to me at first, however as I got further in my own design I came to the realization that this really helped determine what things I should do and what I should avoid. Specifically from my research I learned that I should avoid making a large network of stairs and galleries, because doing so would only be confusing, as this was the case in the complex that I visited. Other than this my personal research can be seen as an example of how Heliports streets and galleries are used during the pandemic by its users.

After the collectivity research we had to work on our graduation research, which mainly was explaining the problem the chosen target group had and coming up with the reasoning to what could be the solution to this problem so that this may be used in your design. This part was mostly Literary Analysis and partly based on a questionnaire / interviews. In my case this research consisted for a large part out of literary analysis, coming up with a lot of information on my topic and trying to condense and summarize this to the best of my ability. To link this vast amount of information to my target group I did a questionnaire with a few people within my target group to determine if my found information was correct as well as to fill any missing information. I think that mainly this part of the graduation research is the most scientific of all the research I have performed, seeing as most of the information that I used in this is either derived from scientific articles or books on the subject. As I also described in my research itself, because of the way

that I viewed New Media in my report, the assumptions and conclusions that I came to in this research would still be applicable to a problem relating this same topic somewhere in the future.

Lastly and I think most of all case studies and references were used. Comparative research was one of the most helpful ways of furthering my design. Simply searching for certain buildings or specific details would help immensely in giving examples of building from which I could learn a lot and apply to my own design. Seeing as my design is inspired by many different buildings that already have been built, I think that aspects of my building can certainly be viewed as something scientifically relevant. Not only to this extend, but as far as what I could find the idea of having a prefab slanted façade is yet to be done and thus my attempt at this, that is inspired by already existing idea of prefab façade and slanted façades, can serve as a new innovation in this field.

Regarding following the set course by the studio, I think that I mostly did this. I did all the researches the way that they had advised us to do and benefitted from this in the later design of my building. After these 2 researches they didn't really have a set course for us to follow along anymore, however I think that with my mix of visual ethnography, literary analysis and case studies I did a lot of extra research not mentioned in the studio handbook that were certainly useful to my own design.

## ASPECT 4 | RELATIONSHIP GRADUATION PROJECT AND WIDER SOCIAL, PROFESSIONAL AND SCIENTIFIC FRAMEWORK

New Media is fairly new and introduces us to many new ways of working and new jobs, of which the New Media workers (and streamers) are great examples. Not only does New Media allow for more new work, it also allows for more flexibility in how we currently conduct our work. The pandemic that currently is affecting us really emphasizes the possibilities of New Media, by making it possible for us to do our work from home. If this has shown us anything it is that not only will, due the ease and flexibility that New Media offers, this way of working continue to be a thing, but also grow exponentially and become an even more integral part of our work pattern, and thus our society. Meaning that the credibility of this research might even be viable in many years from now seeing as the concept of New Media won't change, but only the circumstances in which this New Media can be found.

Since this research is based on scientific papers, articles and books, its basis is founded within already scientific established works and is only expanded upon by surveying people in this branch of work.

The transferability of the finding of my research can be applied to other problems regarding housing for people working in this industry, however if we look into the specifics of the solutions used in the design itself, this is a bit more complicated. My design itself was catered towards the people I questioned in my questionnaire rather than the whole of the New Media workers, as described in aspect 1: "Making a workhome as I have experienced it in this project is a lot of trial and error, taking into account the wishes of the specific target group and trying to overlay that on top of the other requirements you have such as affordability. Other than that creating a high-quality, affordable workhome is a balancing act of the wishes of the user / target group, keeping it universally usable in for other target groups and not compromising on space."

Therefore not all the aspects of my building can be seen as universally applicable. Certain parts like the method of construction, the way it is integrated in its surroundings, its link to the material context, circulation system and of course prefabricated façade elements can be seen aspects that could be applied to other building dealing with the same issues. The integration in its surrounding and material context are very specific examples so these cannot be copied 1 to 1 however the way this is carried could be used to derive a strategy for other buildings.

## ASPECT 5 | ETHICAL ISSUES

During my research there were certain points at which I found, that I was crossing the line of what was acceptable or rather what was ethically responsible. Especially in doing the research this was an issue, not so much for designing itself. Conducting the collectivity research prescribed that we should observe and capture moments of interaction or collectivity in the spaces we visited so that we could write about them and learn from these experiences. However as I made clear to my teacher as well as could be seen in the work of my fellow colleague Karwan, it was a fine line between research and privacy which we were constantly walking and often crossing. I personally found it ethically irresponsible to photograph people in or near their homes, going through their day to day life just so I could gain some information for my project. I felt like I was constantly intruding on their privacy and this combined with the feeling of unbelonging in the area made it even more awkward to take these pictures and even conduct the research to its full extend.

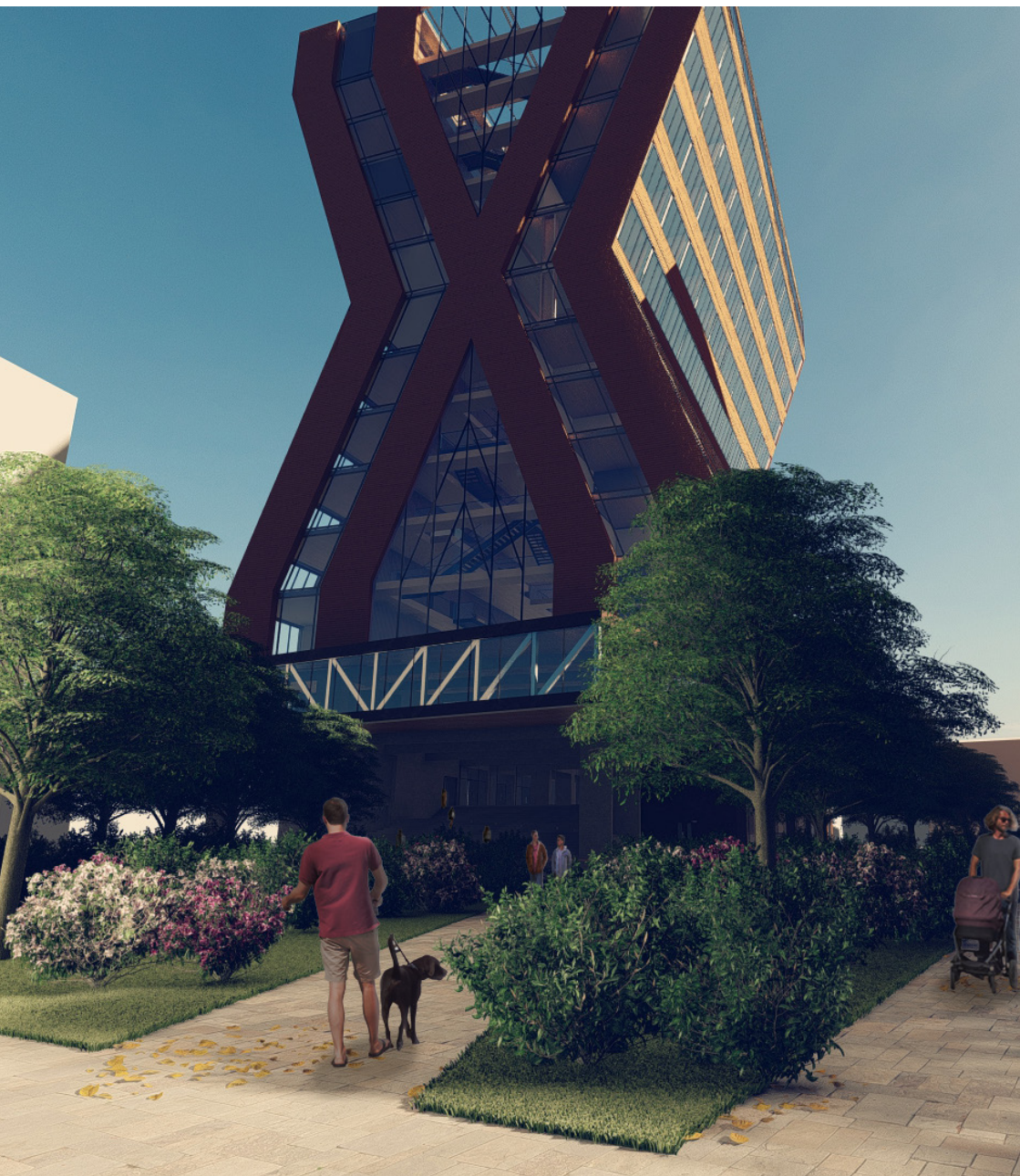
Similarly this was also an issue in the target group research, while compounding the questionnaire for the target group. I was often questioning whether the questions I was asking them were responsible and not rude to ask of them, seeing as this was all their personal information and not something that you would want just anyone to read. Choosing questions for this questionnaire was therefor also a task on its own, constantly questioning whether or not certain questions could be misunderstood and be considered rude. I eventually overcame this problem by only making the most important questions within my questionnaire obligatory to answer while all the others were skippable if the participant felt like the question was too personal.

Besides the before mentioned instances I had no real ethical issues within my design. There is one aspect that could be seen as an ethical issue focused on the security of their personal property. Within my design I had the idea to combine the mailboxes and bike storage in one room, adjacent to the entrance of the building. However as mentioned by one of my tutors this could be considered unethical, seeing as the security levels of both of these functions differ a lot and placing

them within the same space would both the illogical and irresponsible.

The last instance I could think of that could be seen as an ethical issue would be the façade that I chose for my building. My building has a very open glass façade towards the outside where the only way to close the dwellings off from the outside is to either use the integrated sun shading or by closing the curtains in the dwelling. This constant uninterrupted view towards the outside and vice versa could be seen as an issue of ethical value, but because there are various things that the resident can do to minimize or eliminate this problem completely I don't see this as a real issue.

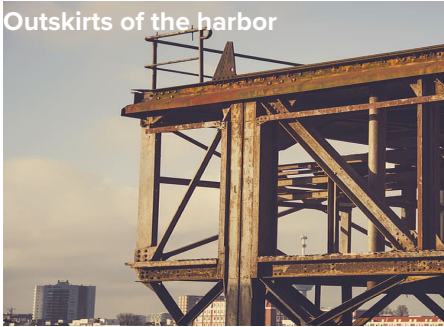




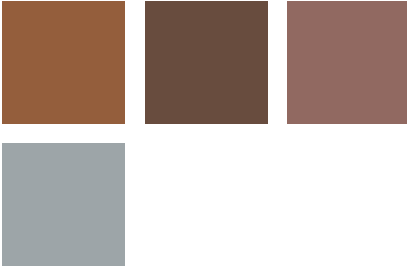
MATERIAL - CONTEXT



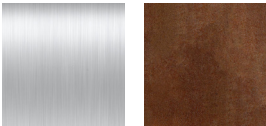




### Colors



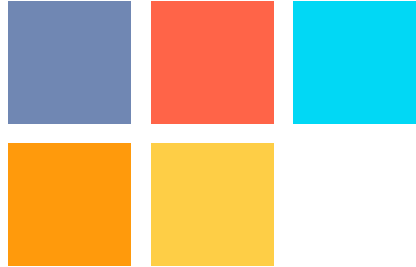
### Materials



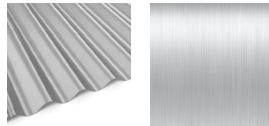
Besides the harbors around the world who are marked by the thousands of moving metal containers, the harbor also has its older historic or rather used parts. It is in these parts that we find the biggest reference to the harbor and its identity. The outskirts of the harbor (and some abandoned harbor posts) are marked by these weathered metal constructions. The metal we usually now use for the harbor are coated in a colored paint which helps against the rusting, however the weathered metal in these parts of the harbor encapsulate the essence of the harbor and its origin.



### Colors



### Materials

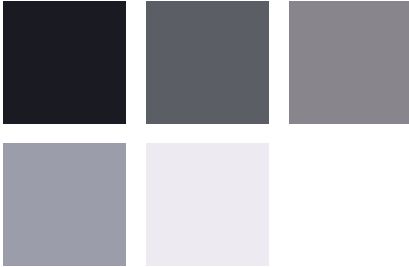


The heart of the harbor of Rotterdam is dominated by colorful steel containers, being moved from point A to point B almost constantly during the day. The colorful containers are a true landmark not only of the harbor of Rotterdam, but also harbors across the globe. Contrary to the Keilekwartier the harbor is, thanks to primarily these containers, a lot more color.

Besides the containers the cranes, moving the containers, have over the years also been colored, this is due to the anti rusting / weathering paint that is applied to them.



**Colors**



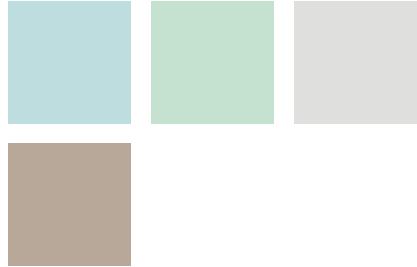
**Materials**



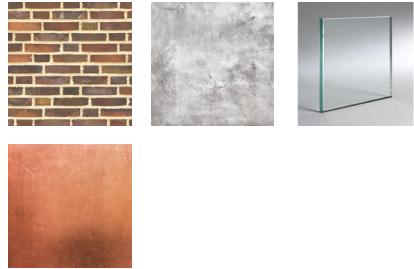
Unlike the M4H area and primarily the Keilekwartier, what is very low rise buildings all around, the Lee towers dominate the skyline. The style of the towers is very simple and consists of horizontal and vertical lines accentuating the square windows covering the building. The two-tone color palette also helps with bringing out the major difference between the squares and the lines over the façades.



**Colors**

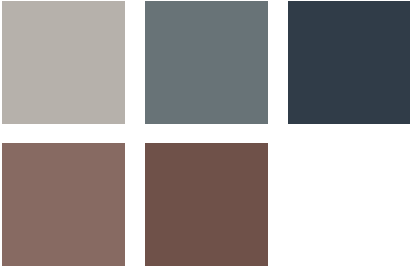


**Materials**



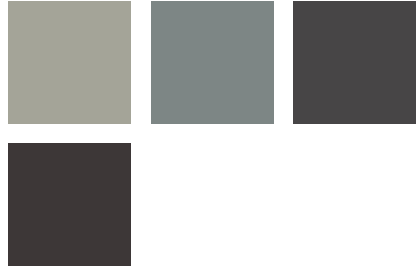
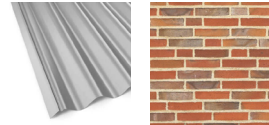
The citrusveiling is an important monument in the Keilekwartier. Just as the outskirts of the harbor show a significant part of the history of the harbor so does the Citrusveiling. From this location, all the fruit that arrived in the harbor were sold and distributed across Europe. The building itself fits in with the character of the Keilekwartier. The recurring bricks and brown accents are present even in this building. Besides the bricks also the green / blueish steel additions are found in several other building. Special however is the copper detailing on the building providing some extra brown accents.

Keilepand

**Colors****Materials**

Keilepand's history is a simple one, it was used as a normal warehouse. Over time the demand for the use of the many warehouses in the harbor grew smaller, leaving this one empty. Nowadays the Keilepand has been transformed in a multifunctional building in which there is room for working, making and meeting, fitting in its new environment of the New Makers district. The building itself still holds its old look, which uses a combination of the often seen brown / reddish bricks, concrete (both painted and unpainted) and black steel staircases and railings.

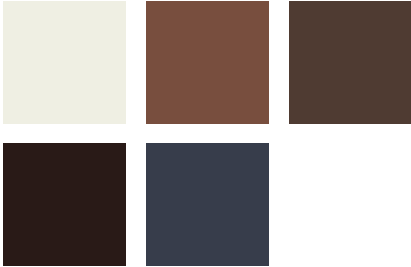
Warehouses

**Colors****Materials**

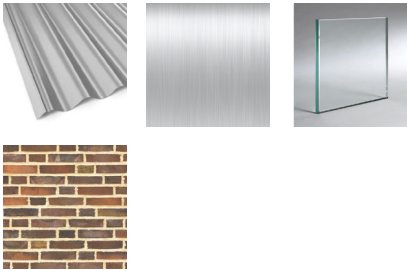
Unlike Keilepand there are also several other warehouses and storage spaces, such as this one located all over the M4H area. All of these buildings are very simple in their look and materials. These warehouses consist of white corrugate plates and dark red bricks.



**Colors**



**Materials**



Located next to my building as well as prominently placed within the green space of the area is studio Roosegaard. Formerly known as a glass factory the building now houses a social design lab that focuses on connecting people and technology in artworks that improve daily life in urban environments. The building itself has some reoccurring features as can found in other building in the area, mainly the red / brown bricks, white corrugate plates and the green / blueish steel accents. Different however from the other buildings is it large glass surfaces. This building unlike the others in the enviroment seems very open and inviting.

## MATERIAL - AXESS

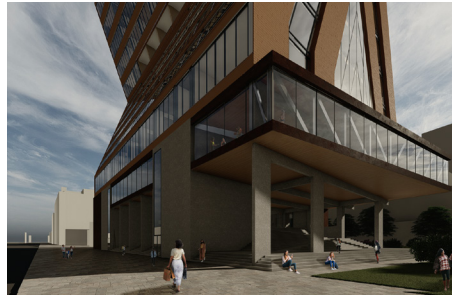
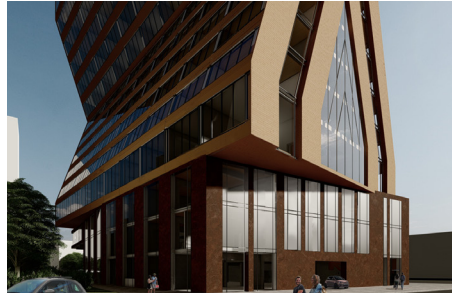
Taking inspiration from the surrounding area and its buildings the materials for AXess were chosen. As AXess adds a new type of function into the area, something that has nothing to do with its old function, it only seemed fitting to also give the building or at least the part of the building with a completely different function a new look. The tower part of AXess is clad with Pine wood planks, these planks are treated with oil as to preserve the light brown color. Even though a new material is introduced the overall color scheme used by the already existing building and the aesthetic of M4H won't be disturbed as this color will fit nicely within the already present brown color scheme.

Building on the idea of reference the already present buildings and history of the harbor several similar materials are chosen to be used within the new building. First of all concrete is used for the construction of the bottom part of the building as well as part of the cladding, serving both a structural and aesthetic purpose as in some of the other buildings on the site. Secondly dark / black steel is used for the window frames, as can be seen primarily on the Keilepand there are accents of black steel in the form of either railings or staircases. As my building doesn't have these ornaments on the outside of the building, the choice was made to bring this material back in a different way, in this case in the window frames.

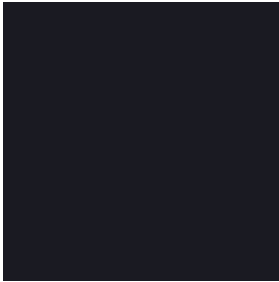
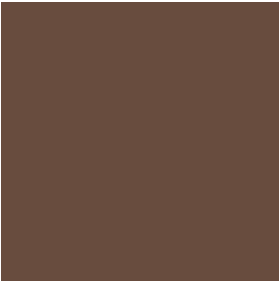
Lastly and possibly the biggest reference to the harbor idea and its history is the corten steel, used on the first 3 floors of the building. The first three floors are the same height as the warehouses and the Keilepand in the area, referencing the harbor first of all that way and secondly in its material. As mentioned in the material context, there are several parts in the harbor that have these weathered metal constructions of the old harbor, using corten steel this same kind of color and feel will be created within the building.

Additionally since the function is that of a residential complex more and bigger windows are introduced to this building compared to the others in the area. My building, which makes use of 2 big atria, can be seen as a direct link to the Studio Roosegaarde next door because of its large glass surfaces, making the building feel

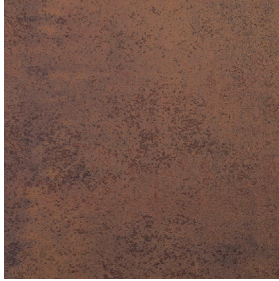
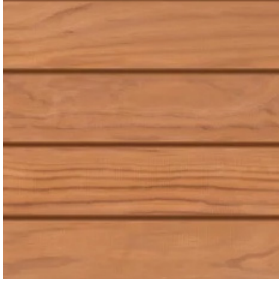
welcoming and open.



COLOR-AIM



MATERIALS







**Profile**



**Profile**



**Weathering**



**Weathering**



Pine wood in itself gives a warm feeling. Due to its lighter color it will fit in perfectly with the lighter tinted buildings in the area like Citrusveiling and Keilepand. Because wood has a severe weathering effect, if left untreated these planks (any of these three choises) will be treated with oils, meaning that they won't be subjected to weathering for at least 10 years. These planks themselves orginate from both American and European forests and can last up to 30 years on the building façade.

Pine wood in itself gives a warm feeling. Due to its lighter color it will fit in perfectly with the lighter tinted buildings in the area like Citrusveiling and Keilepand. Because wood has a severe weathering effect, if left untreated these planks (any of these three choises) will be treated with oils, meaning that they won't be subjected to weathering for at least 10 years. These planks themselves orginate from both American and European forests and can last up to 30 years on the building façade.



**Profile**



**Weathering**



Seeing as the bottom three floors are already a pretty dark color color of brown due to the dark corten steel, very dark wood wouldn't fit the building. That said this Thermo Ash wood has a slight hint of lighter brown in the coloring giving it a lively vibe.

The choice for either an open or closed façade has to be researched further as it seems that both have their benefits and downsides. At the moment however my preference goes to the closed façade because of it's cleaner look and less distracting black lines.

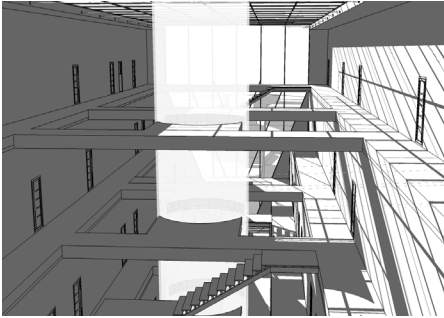
Other than that the weathering of the wood could also work in favor of the building that after the coating has worn off, the weathering will kick in and start working the building, aging it and making it more at home at the M4H harbor area as this is also an older area with a lot of building with weathered materials. For now however the oils and coats will be chosen as main choice for the wood as the brown color that the wood fits better in the color palette of Keilekwartier, as well as making the building look more inviting.

Another option is to use Trex composite panneling, which is a recycled and recyclable material, which can be made to look exactly like any type of wood. This material, specifically, doesn't need any treatment and can permanently stay on the façade. Additionally this material has the same way of construction as the chosen Pine wood cladding of Gadero.

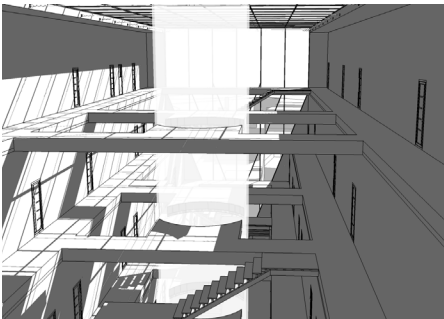


# SUNLIGHT IN ATRIUM | GLASS ROOF

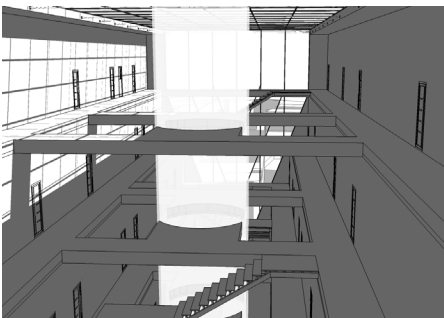
## MARCH



9:00

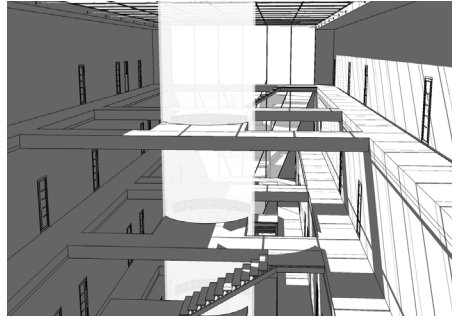


12:00

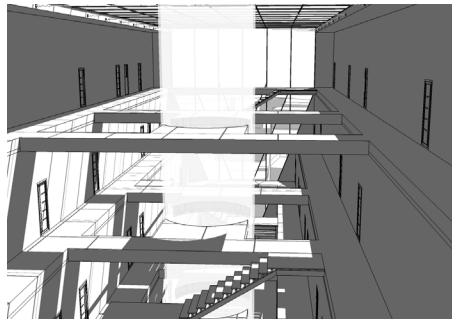


15:00

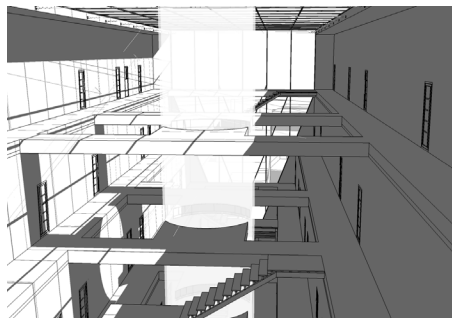
## JUNE



9:00



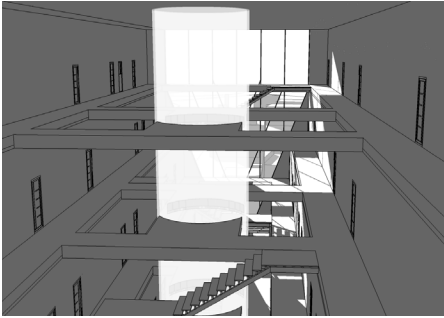
12:00



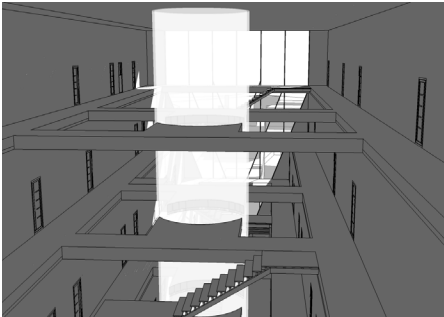
15:00

# SUNLIGHT IN ATRIUM | GLASS ROOF

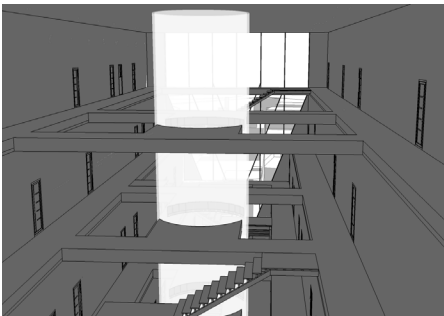
## MARCH



9:00

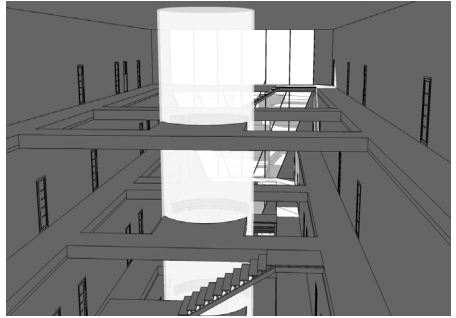


12:00

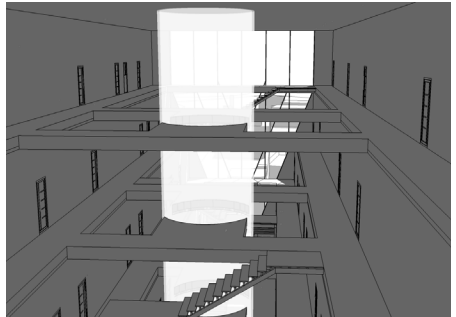


15:00

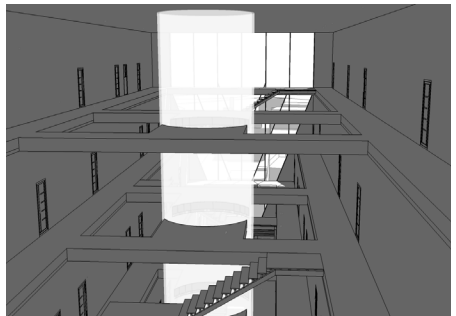
## JUNE



9:00



12:00



15:00





# REFERENCES

## BIBLIOGRAPHY

- AEROMAT VT with heat recovery. (2020, 12 November). SIEGENIA. <https://www.siegenia.com/en/products/comfort-systems/window-ventilators/aeromat-vt-wrg>
- D. (z.d.). *DucoTwin 120 "ZR" AK(+)*. DUCO. Retrieved on 19 January 2021, from <https://www.duco.eu/nl/producten/raamventilatie/ventilatie-en-zonwering/ducotwin-120-zr-ak>
- DUCO. (z.d.-a). *DucoTwin 120 "ZR" AK(+)* [Image]. DUCO. <https://www.duco.eu/nl/producten/raamventilatie/ventilatie-en-zonwering/ducotwin-120-zr-ak>
- DUCO. (z.d.-b). *Uitvoeringen en ventilatiewaarden* [Image]. DUCO. <https://www.duco.eu/nl/producten/raamventilatie/ventilatie-en-zonwering/ducotwin-120-zr-ak>
- Duxbury, L., Towers, I., Higgins, C., & Thomas, J. A. (2007). *From 9 to 5 to 24/7: How technology has redefined the workday*. In Information resources management: Global challenges (pp. 305-332). IGI Global.
- Efbrazil. (2021). *The Scientific Method* [Image]. Retrieved from [https://en.wikipedia.org/wiki/Scientific\\_method#/media/File:The\\_Scientific\\_Method.svg](https://en.wikipedia.org/wiki/Scientific_method#/media/File:The_Scientific_Method.svg)
- Fairs, M. (2020, 12 March). *Coronavirus offers a blank page for a new beginning says Li Edelkoort*. Retrieved from <https://www.dezeen.com/2020/03/09/li-edelkoort-coronavirus-reset/>
- Feitelberg, R. (2020, 7 July). *Welcoming 'The Age of the Amateur' and Parting With Consumer Consumption*. Retrieved from <https://wwd.com/fashion-news/fashion-features/welcoming-the-age-of-the-amateur-and-parting-with-consumer-consumption-1203668472/>
- Fersch, B. (2009). *Work and life patterns of freelancers in the (new) media: A comparative analysis in the context of welfare state and labour market regulations in Denmark and Germany* (Doctoral dissertation, Institut for Sociologi, Socialt Arbejde og Organisation, Aalborg Universitet).
- Frearson, A. (2017, 16 January). *Schiecentrale 4B tower with protruding storage by Mei Architecten en Stedenbouwers*. Retrieved from <https://www.dezeen.com/2013/11/06/schiecentrale-4b-by-mei-architecten-en-stedenbouwers/>
- Frearson, A. (2017, 16 January). *Fifth floor plan* [Image]. Retrieved from <https://www.dezeen.com/2013/11/06/schiecentrale-4b-by-mei-architecten-en-stedenbouwers/>
- Holliss, F. (2015). *Beyond Live/Work: The architecture of home-based work*. Routledge.
- Howard, C. M. (2000). *Technology and tabloids: How the new media world is changing our jobs*. Public Relations Quarterly, 45(1), 8.
- Johnson, M. R., & Woodcock, J. (2019). *'It's like the gold rush': the lives and careers of professional video game streamers on Twitch*. tv. Information, Communication & Society, 22(3), 336-351.
- Law, W. K. (Ed.). (2006). *Information Resources Management: Global Challenges: Global Challenges*. IGI Global.
- Linde, J. M. (z.d.). *Tietgen Dormitory / Lundgaard & Tranberg Architects* [Image]. Retrieved from <https://www.archdaily.com/474237/tietgen-dormitory-lundgaard-and-tranberg-architects/52f3041de8e44eb12300006a-tietgen-dormitory-lundgaard-and-tranberg-architects-photo>
- Lister, M., Dovey, J., Giddings, S., Kelly, K., & Grant, I. (2009). *New media: A critical introduction*. Taylor & Francis.
- Lundgaard & Tranberg Arkitekter A/S. (z.d.). *Tietgen Dormitory*. Retrieved from <https://www.ltarkitekter.dk/tietgen-en-0>
- Lundgaard & Tranberg Arkitekter A/S. (z.d.). *Plan, Ground floor* [Image]. Retrieved from <https://www.ltarkitekter.dk/tietgen-en-0>
- Lundgaard & Tranberg Arkitekter A/S. (z.d.). *Plan, 4th floor* [Image]. Retrieved from <https://www.ltarkitekter.dk/tietgen-en-0>

Lundgaard & Tranberg Arkitekter A/S. (z.d.). *Section* [Image]. Retrieved from <https://www.ltarkitekter.dk/tietgen-en-0>

Lunt, R. (2020, 29 February). *PV-cell glass* [Image]. Solar Magazine. <https://solarmagazine.com/solar-panels/transparent-solar-panels/>

Manovich, L. (2003). *New media from Borges to HTML*. The new media reader, 1, 1-32.

Mei architects and planners. (2020). *Schiecentrale 4B, Rotterdam*. In *Mei projects – English version* (pp. 444–463). Retrieved from [https://issuu.com/meiarch/docs/projectboeken\\_issuu](https://issuu.com/meiarch/docs/projectboeken_issuu)

Mei architects and planners. (2020). *Framework high plate* [Image] In *Mei projects – English version* (p. 444–463). Retrieved from [https://issuu.com/meiarch/docs/projectboeken\\_issuu](https://issuu.com/meiarch/docs/projectboeken_issuu)

Mei architects and planners. (2020). *Framework high plate with divisions* [Image] In *Mei projects – English version* (p. 444–463). Retrieved from [https://issuu.com/meiarch/docs/projectboeken\\_issuu](https://issuu.com/meiarch/docs/projectboeken_issuu)

Mei architects and planners. (2020). *Completion* [Image] In *Mei projects – English version* (p. 444–463). Retrieved from [https://issuu.com/meiarch/docs/projectboeken\\_issuu](https://issuu.com/meiarch/docs/projectboeken_issuu)

Mei architects and planners. (2020). *Schematic view completion* [Image] In *Mei projects – English version* (p. 444–463). Retrieved from [https://issuu.com/meiarch/docs/projectboeken\\_issuu](https://issuu.com/meiarch/docs/projectboeken_issuu)

Mei architects and planners. (2020). *Flexibility* [Image] In *Mei projects – English version* (p. 444–463). Retrieved from [https://issuu.com/meiarch/docs/projectboeken\\_issuu](https://issuu.com/meiarch/docs/projectboeken_issuu)

Mei architects and planners. (2020). *Functions ground floor* [Image] In *Mei projects – English version* (p. 444–463). Retrieved from [https://issuu.com/meiarch/docs/projectboeken\\_issuu](https://issuu.com/meiarch/docs/projectboeken_issuu)

Mei architects and planners. (2020). *Functions first floor* [Image] In *Mei projects – English version* (p. 444–463). Retrieved from [https://issuu.com/meiarch/docs/projectboeken\\_issuu](https://issuu.com/meiarch/docs/projectboeken_issuu)

Mei architects and planners. (2020). *Functions fourth floor* [Image] In *Mei projects – English version* (p. 444–463). Retrieved from [https://issuu.com/meiarch/docs/projectboeken\\_issuu](https://issuu.com/meiarch/docs/projectboeken_issuu)

Mei architects and planners. (2020). *Functions sixth floor* [Image] In *Mei projects – English version* (p. 444–463). Retrieved from [https://issuu.com/meiarch/docs/projectboeken\\_issuu](https://issuu.com/meiarch/docs/projectboeken_issuu)

Mei architects and planners. (2020). *Section* [Image] In *Mei projects – English version* (p. 444–463). Retrieved from [https://issuu.com/meiarch/docs/projectboeken\\_issuu](https://issuu.com/meiarch/docs/projectboeken_issuu)

Mei architects and planners. (2020). - [Image] In *Mei projects – English version* (p. 444–463). Retrieved from [https://issuu.com/meiarch/docs/projectboeken\\_issuu](https://issuu.com/meiarch/docs/projectboeken_issuu)

Mei architects and planners. (z.d.). *Schiecentrale 4B* [Image]. Retrieved from <https://mei-arch.eu/projecten-archieff/schiecentrale-4b/>

*Moveable wardrobe* [Image]. Retrieved from <http://tietgenkollegiet.dk/en/the-building/the-rooms/>

Onyxsolar. (z.d.). *Onyx Solar - Photovoltaic Glass for Buildings*. Onyxsolar.Com. Retrieved on 19 January 2021, from <https://www.onyxsolar.com/>

*Principle of PV-cell glass*. (z.d.). [Image]. pv-manufacturing. <https://pv-manufacturing.org/glass-glass-modules/>

Rohspace. (z.d.). *Night view of the Treehouse* [Image]. Retrieved from <https://www.gooood.cn/treehouse-coliving-by-bo-da-architecture.htm>

Sánchez, D. (2019, 24 October). *Tietgen Dormitory / Lundgaard & Tranberg Architects*. Retrieved from <https://www.archdaily.com/474237/tietgen-dormitory-lundgaard-and-tranberg-architects>

Sánchez, D. (2019, 24 October). *Ground floor plan* [Image]. Retrieved from <https://www.archdaily.com/474237/tietgen-dormitory-lundgaard-and-tranberg-architects>



Sánchez, D. (2019, 24 October). *Dwelling floor plan* [Image]. Retrieved from <https://www.archdaily.com/474237/tietgen-dormitory-lundgaard-and-tranberg-architects>

Sánchez, D. (2019, 24 October). *Floor plan* [Image]. Retrieved from <https://www.archdaily.com/474237/tietgen-dormitory-lundgaard-and-tranberg-architects>

Sánchez, D. (2019, 24 October). *Section* [Image]. Retrieved from <https://www.archdaily.com/474237/tietgen-dormitory-lundgaard-and-tranberg-architects>

Sánchez, D. (2019, 24 October). *Detail (part of a floor plan)* [Image]. Retrieved from <https://www.archdaily.com/474237/tietgen-dormitory-lundgaard-and-tranberg-architects>

Schüco (2020). Fittings system for Schüco AWS 114 parallel-opening window [Image]. In System overview AWS 114.

Schüco (2020). *Schüco AWS 114 in FW 50 Sl+* [Image]. Retrieved from <https://schuecoworks-pace.nl/cad-page/>

Schüco (2020). *Schüco AWS 114 Opening Unit*.

Schüco (2020). *Schüco AWS 114 parallel-opening window in action* [Image]. In Schüco AWS 114 Opening Unit.

Schüco (2020). *System overview AWS 114*.

SIEGENIA. (z.d.). *Aeromat VT* [Image]. <https://www.siegenia.com/en/products/comfort-systems/window-ventilators/aeromat-vt-wrg>

Solar Magazine. (2021, 15 January). *Transparent Solar Panels: Reforming Future Energy Supply*. <https://solarmagazine.com/solar-panels/transparent-solar-panels/>

*Solar Roof* | Tesla. (z.d.). Tesla.com. Retrieved on 19 January 2021, van [https://www.tesla.com/nl\\_nl/solarroof](https://www.tesla.com/nl_nl/solarroof)

Taylor, T. L. (2018). *Watch me play: Twitch and the rise of game live streaming*. Princeton University Press.

Tesla. (z.d.). *Specificaties Solar Roof* [Image]. [https://www.tesla.com/nl\\_nl/solarroof](https://www.tesla.com/nl_nl/solarroof)

*Tesla Solar Roof*. (2019). [Image]. <https://solarmagazine.nl/nieuws-zonne-energie/i19768/tesla-introduceert-solarglass-productie-van-derde-versie-zonnedakpan-per-direct-van-start>

*The layout* [Image]. Retrieved from <http://tietgenkollegiet.dk/en/the-building/the-rooms/>

The rooms | Tietgenkollegiet. (z.d.). Retrieved from <http://tietgenkollegiet.dk/en/the-building/the-rooms/>

Thistleton, W. (2018, 18 September). *the lifecycle of timber construction* [Image]. Cleantech.com. <https://www.cleantech.com/are-we-overdue-a-building-construction-revolution/>

Treehouse / Bo-da Architecture. (z.d.). Retrieved from <https://www.gooood.cn/treehouse-coliving-by-bo-da-architecture.htm>

Treehouse / Bo-da Architecture. (z.d.). *Ground floor plan* [Image]. Retrieved from <https://www.gooood.cn/treehouse-coliving-by-bo-da-architecture.htm>

Treehouse / Bo-da Architecture. (z.d.). *the interior spaces of the living units on the different floors* [Image]. Retrieved from <https://www.gooood.cn/treehouse-coliving-by-bo-da-architecture.htm>

Treehouse / Bo-da Architecture. (z.d.). *2F co-working plan* [Image]. Retrieved from <https://www.gooood.cn/treehouse-coliving-by-bo-da-architecture.htm>

Treehouse / Bo-da Architecture. (z.d.). *3F Femme plan* [Image]. Retrieved from <https://www.gooood.cn/treehouse-coliving-by-bo-da-architecture.htm>

Treehouse / Bo-da Architecture. (z.d.). *4F Nomad plan* [Image]. Retrieved from <https://www.gooood.cn/treehouse-coliving-by-bo-da-architecture.htm>

Treehouse / Bo-da Architecture. (z.d.). *5F Cat Life plan* [Image]. Retrieved from <https://www.gooood.cn/treehouse-coliving-by-bo-da-architecture.htm>



Treehouse / Bo-da Architecture. (z.d.). *6F Terrace plan* [Image]. Retrieved from <https://www.goood.cn/treehouse-coliving-by-bo-da-architecture.htm>

Treehouse / Bo-da Architecture. (z.d.). *7F Minimal plan* [Image]. Retrieved from <https://www.goood.cn/treehouse-coliving-by-bo-da-architecture.htm>

Treehouse / Bo-da Architecture. (z.d.). *8F Pent plan* [Image]. Retrieved from <https://www.goood.cn/treehouse-coliving-by-bo-da-architecture.htm>

Treehouse / Bo-da Architecture. (z.d.). *Section 1* [Image]. Retrieved from <https://www.goood.cn/treehouse-coliving-by-bo-da-architecture.htm>

Treehouse / Bo-da Architecture. (z.d.). *Section 2* [Image]. Retrieved from <https://www.goood.cn/treehouse-coliving-by-bo-da-architecture.htm>

Triflex BV. (z.d.). *Bouwstenen voor de perfecte parkeergarage*.

Triflex BV. (z.d.). *Hellingspercentages in parkeergarages* [Image] In *Bouwstenen voor de perfecte parkeergarage*.

Twitch Games Statistics (z.d.). Retrieved from <https://twitchtracker.com/statistics/games>

Twitch Games Statistics (z.d.). *Twitch growth* [Image]. Retrieved from <https://twitchtracker.com/statistics/games>

van Gameren, D., Kuitenbrouwer, P., & Mooij, H. (2014). *Housing the Student. DASHI Delft Architectural Studies on Housing*, (10).

van Gameren, D., Kuitenbrouwer, P., & Mooij, H. (2014). *Ground floor / Anna van Buerenplein* [Image] In *Housing the Student. DASHI Delft Architectural Studies on Housing*, (10).

van Gameren, D., Kuitenbrouwer, P., & Mooij, H. (2014). *First floor, student lounge and bar* [Image] In *Housing the Student. DASHI Delft Architectural Studies on Housing*, (10).

van Gameren, D., Kuitenbrouwer, P., & Mooij, H. (2014). *Third floor, auditorium and teaching areas* [Image] In *Housing the Student. DASHI Delft Architectural Studies on Housing*, (10).

van Gameren, D., Kuitenbrouwer, P., & Mooij, H. (2014). *Typical apartment floor (5th-14th storeys)* [Image] In *Housing the Student. DASHI Delft Architectural Studies on Housing*, (10).

van Gameren, D., Kuitenbrouwer, P., & Mooij, H. (2014). *Cross section* [Image] In *Housing the Student. DASHI Delft Architectural Studies on Housing*, (10).

van Gameren, D., Kuitenbrouwer, P., & Mooij, H. (2014). *Longitudinal section* [Image] In *Housing the Student. DASHI Delft Architectural Studies on Housing*, (10).

van Gameren, D., Kuitenbrouwer, P., & Schreurs, E. (2019). *Project Documentation House Work City. DASHI Delft Architectural Studies on Housing*, (15).

van Gameren, D., Kuitenbrouwer, P., & Schreurs, E. (2019). *Quayside houses with private garage (ground floor, first, second and third floors)* [Image] In *Project Documentation House Work City. DASHI Delft Architectural Studies on Housing*, (15).

van Gameren, D., Kuitenbrouwer, P., & Schreurs, E. (2019). *Workhome (ninth-sixteenth floor) in high-rise slab, representation (west)* [Image] In *Project Documentation House Work City. DASHI Delft Architectural Studies on Housing*, (15).

van Hoek, B. (z.d.). *Anna van Bueren toren* [Image]. Retrieved from [https://www.architectuur.org/bouwwerk/649/Anna\\_van\\_Buerentoren.html](https://www.architectuur.org/bouwwerk/649/Anna_van_Buerentoren.html)

*Woningnood in Rotterdam nog lang niet voorbij*. (2019, 4 oktober). Retrieved from <https://www.erasmusmagazine.nl/2019/10/04/woningnood-in-rotterdam-nog-lang-niet-voorbij/>





# AXESS

A BUILDING THAT DOES WHAT THE NAME IMPLIES. IT PROVIDES ACCESS TO THE BUILDING FOR VISITORS AND RESIDENTS, BUT ALSO TO THE INTERNET AS WELL AS A GREAT VARIETY OF SPACES FOR PEOPLE TO INTERACT.

# AXESS

GIVES ACCESS TO A NEW WAY OF LIVING, A LIFE IN NEW MEDIA.