

Uncertainties and Margins in the Ship Propulsion System Design Process

Vrijdag, A; de Vos, P

Publication date

2012

Document Version

Accepted author manuscript

Published in

Proceedings of the International Naval Engineering Conference and Exhibition (INEC)

Citation (APA)

Vrijdag, A., & de Vos, P. (2012). Uncertainties and Margins in the Ship Propulsion System Design Process. In C.J. Newell (Ed.), *Proceedings of the International Naval Engineering Conference and Exhibition (INEC)* (pp. 618-630). Institute of Marine Engineering, Science and Technology.

Important note

To cite this publication, please use the final published version (if applicable). Please check the document version above.

Copyright

Other than for strictly personal use, it is not permitted to download, forward or distribute the text or part of it, without the consent of the author(s) and/or copyright holder(s), unless the work is under an open content license such as Creative Commons.

Takedown policy

Please contact us and provide details if you believe this document breaches copyrights. We will remove access to the work immediately and investigate your claim.

Uncertainties and Margins in the Ship Propulsion System Design Process

Arthur Vrijdag, MSc, PhD, Damen Shipyards, the Netherlands
Peter de Vos, MSc, Delft University of Technology, the Netherlands

SYNOPSIS

An important aspect for a new-built vessel is the contract speed. Not reaching the contract speed can lead to penalties for the shipbuilder and dissatisfaction for the customer, while an under-predicted contract speed can lead to non-competitive design and a lower income for the shipbuilder. The performance of a new-built vessel is uncertain due to the uncertainties that are involved in the design of the ship and its propulsion installation. Another type of uncertainty is introduced during the full scale trial measurements at which the contract speed is to be demonstrated. This paper aims at quantification of the uncertainties that are involved in the predicted performance of a ship in terms of predicted trial ship speed. This is done by systematic analysis of the propagation of uncertainty from input (design) variables up to the predicted trial speed. An 80m, 22 kts Offshore Patrol Vessel is used as a case study. The effect of uncertainty reduction by means of model testing is analysed and discussed.

INTRODUCTION

In the various design iterations of a ship, the maximum ship speed needs to be predicted. The initial design iterations are relatively crude, and the further the design is matured, the more certain the predicted ship speed is. A very important aspect for both the shipbuilder and the (potential) customer is the contract speed, which is based on a prediction by the shipbuilder, combined with their appetite for risk balanced by potential reward. In general terms it can be said that the more effort is put into the prediction, the lower the uncertainty in the predicted ship speed will be. However, the amount of time and money that can be spent on making an accurate prediction is limited, and should be traded off against risk and reward.

In this paper an uncertainty analysis is carried out with regards to the predicted ship powering performance in general and the predicted ship speed in particular. This analysis reveals how uncertainties in input variables such as resistance curve and wake fraction end up as uncertainties in output variables such as predicted maximum ship speed. A part of the analysis focuses on the sensitivities of output to input variations. This gives valuable information about which input parameters should be considered with extra care, while other parameter might have little effect on the output and therefore do not need special attention.

The input uncertainty can be reduced by for instance carrying out model tests. The effect of such additional work is analysed. Whether model scale tests are required depends on the balance between risk and reward for both the shipbuilder and the customer.

Author's biography

Arthur Vrijdag graduated from the Royal Netherlands Naval College in 2004 and in the same year he obtained his MSc degree in ship hydromechanics at Delft University of Technology. In 2009 he finished his PhD research titled 'Control of Propeller Cavitation in operational Conditions' at the same university. He currently works as research engineer at Damen Shipyards, the Netherlands.

Peter de Vos holds the position of assistant professor in Marine Engineering at the Delft University of Technology (DUT) since 2010, after having fulfilled the position of researcher for two years at DUT. He graduated cum laude in 2008 on a dynamic simulation of a fuel reformer necessary for PEM fuel cell application. His main research topics are design and dynamic behaviour of complex marine systems.

OVERVIEW OF THE SHIP SPEED PREDICTION PROCESS

This section gives a description of a typical ship speed prediction process. It is based on Klein Woud and Stapersma [1] and [2], who give a detailed description of the design process of a ship propulsion system. Some subtle differences however exist between the *design* of an installation and the *analysis* of a given installation. The latter case is considered here, implying that the gearbox ratio and propeller diameter are fixed and the engine has already been selected. This assumption is not a rule, but in general such choices have been made before the exact contract speed is to be defined.

In terms of Figure 1, the analysis task is to find the predicted ship speed for a given installation. First of all the ship resistance curve is transformed to a propeller load by making use of the open water propeller diagram for the given nominal P/D ratio. Then, by making use of the given gearbox ratio, the propeller load is transformed to required brake engine power. Given the fact that at this stage the engine choice has often already been made, the available brake power and maximum engine speed are also known. The intersection of the propeller line with the engine envelope now gives the predicted ship speed. This predicted ship speed is however not guaranteed by the shipyard. Based on experience a “contract speed reduction factor” is applied by the shipyard to prevent a penalty in case the measured ship speed is slightly lower than the calculated value. The exact size of this ship speed reduction factor is determined based on experience and trust in the available input data. Due to a conservative approach, in most cases the ship will sail faster than the contract speed and no penalty is to be paid.

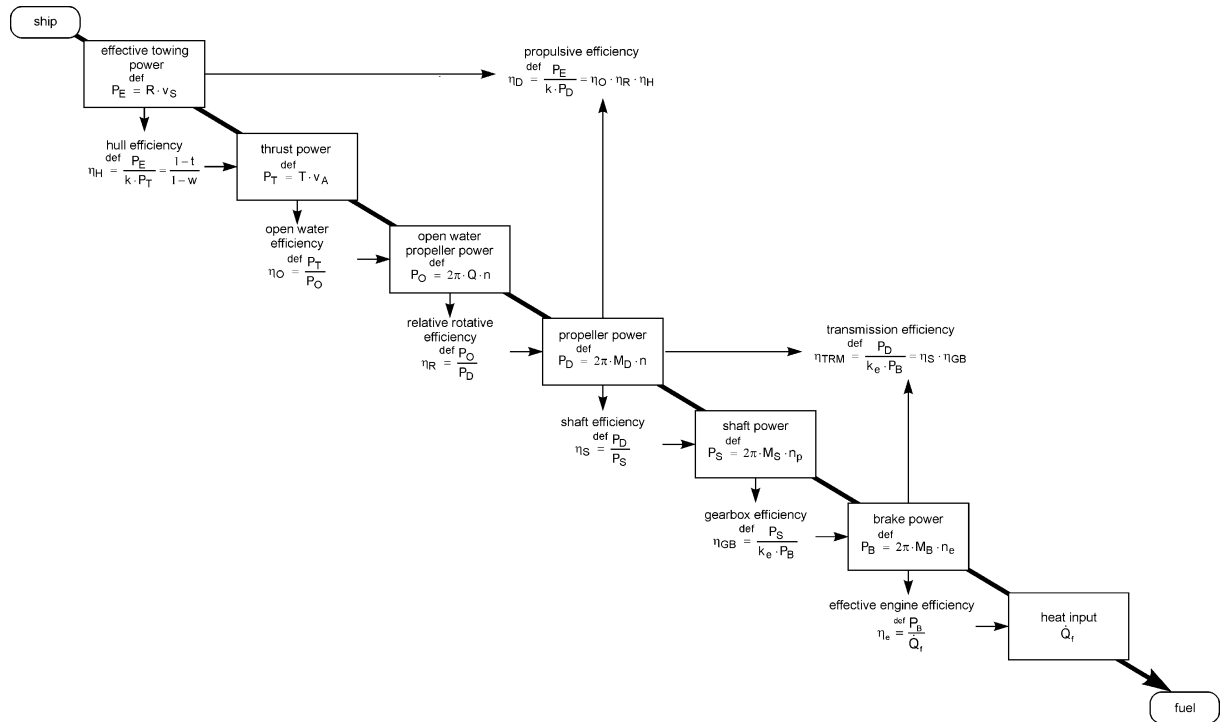

Figure 1: Schematic ship propulsion train, reproduced from [1]

From ship resistance to propeller load

The ship resistance curve is the first input to the ship speed prediction process. Although in a general case the ship resistance curve does not need to be quadratic, by introducing a (not necessarily constant) coefficient c_1 the resistance curve can always be described as:

$$R = c_1 \cdot v_s^2$$

Note that for reference the various variables used throughout this paper are described in the nomenclature section at the end. Introducing the wakefactor w via $v_a = v_s (1 - w)$, thrust deduction factor t , and number of shafts k_p via $R = k_p \cdot (1 - t) \cdot T$, this can be written as :

$$T = c_8 \cdot v_a^2$$

with

$$c_8 = \frac{c_1}{k_p \cdot (1-t) \cdot (1-w)^2}$$

The thrust coefficient required by the ship at the required ship speed can now be written as¹:

$$K_{T,ship} = \frac{T}{\rho n_p^2 D^4} = \frac{c_8}{\rho \cdot D^2} \cdot \frac{v_a^2}{n_p^2 \cdot D^2} =$$

$$\frac{c_8}{\rho \cdot D^2} \cdot J^2 = c_7 \cdot J^2$$

where

$$c_7 = \frac{1}{\rho \cdot D^2} \cdot \frac{c_1}{k_p \cdot (1-t) \cdot (1-w)^2}$$

The "constant" c_7 incorporates all influences that may disturb the propeller operation in real service. By plotting the relation $K_{T,ship} = c_7 \cdot J^2$ in the open water propeller diagram of the given P/D ratio, the intersection between $K_{T,ship}$ and the propeller K_T -curves can be found. Besides the propeller thrust coefficient, the intersection point determines the propeller operating point in terms of advance ratio $J = \frac{v_s(1-w)}{n_p D}$, propeller

efficiency η_0 and propeller torque coefficient $K_Q = \frac{Q}{\rho n_p^2 D^5}$.

In a *design* case, the specific propeller P/D ratio that gives the best propeller efficiency in the nominal operating condition can be selected. In the *analysis* case that is considered in this paper, the P/D ratio has been decided before and is a given. The intersection between the K_T -curves of ship and propeller therefore directly defines the advance ratio J , from which the propeller rotation rate can be found by:

$$n_p = c_3 \cdot v_s$$

where the constant c_3 is defined as:

$$c_3 = \frac{(1-w)}{J \cdot D}$$

As the title of this section indicates, the propeller load needs to be determined. Based on the propeller torque coefficient K_Q as found from the intersection in the open water diagram, the open water torque Q is determined by

$$Q = K_Q \cdot \rho n_p^2 D^5$$

The real propeller torque in behind conditions M_p is found by correcting for relative rotative efficiency η_R :

$$M_p = \frac{Q}{\eta_R}$$

This gives the propeller torque in behind condition as:

$$M_p = \frac{K_Q \cdot \rho n_p^2 D^5}{\eta_R}$$

The propeller power can now be written as:

$$P_p = c_4 \cdot n_p^3$$

with

¹ Note that the coefficients that are used here are not necessarily required to arrive at the solution. Many textbooks directly state that $\frac{K_{T,ship}}{J^2} = \frac{R}{\rho D^2 \cdot v_a^2 \cdot k_p (1-t)}$, which is equivalent to what is presented here.

$$c_4 = \frac{2\pi\varphi \cdot D^5}{\eta_R} \cdot K_Q$$

The curve described by the latter two equations can be plotted in a $P_p - n_p$ diagram, which in case of a CPP will show various propeller curves. Such a $P_p - n_p$ diagram is often provided by propeller manufacturers, and may include transmission losses. Such shaft and gearbox related losses are however treated in the following section.

From propeller load to brake engine power

The propeller power P_p (note that total propeller power is given by $P_D = k_p \cdot P_p$) as defined in the previous section needs to be delivered by the driving machine, allowing for transmission efficiency η_{tm} (due to gear and shaft efficiencies) and possible Power Take Off (PTO). Taking into account the possibility of driving one single shaft with multiple identical diesel engines, the required brake power is:

$$P_B = \left(\frac{P_p}{\eta_{tm}} + P_{PTO} \right) \cdot \frac{1}{k_e}$$

where k_e is the number of engines per shaft. In many cases this simplifies to

$$P_B = \frac{P_p}{\eta_{tm}}$$

The obtained brake power should match the operating envelope of the driving engine. Typically the MCR point of an engine lies at higher rotation speed than required by the propeller, and therefore a reduction gearbox is introduced. In the *analysis* case the reduction ratio has already been decided. For reference it is defined as:

$$i = \frac{n_{e,max}}{n_p}$$

In the case that no PTO is present, the brake power can now be expressed in terms of propeller load and transmission efficiency ($P_B = \frac{P_p}{\eta_{tm}}$). By combining this with the earlier defined relation between propeller load

and shaft speed $P_p = c_4 \cdot n_p^3$, where $c_4 = \frac{2\pi\varphi \cdot D^5}{\eta_R} \cdot K_Q$, brake power is expressed in terms of engine speed as²:

$$P_B = c_9 \cdot n_e^3$$

where

$$c_9 = \frac{c_4}{\eta_{tm} \cdot k_e \cdot i^3}$$

This relation can be used to plot the propeller operating line in the envelope of the driving machine. By plotting this propeller line in the envelope of the driving machine their intersection can be determined. The ship speed at this intersection is the predicted ship speed in trial conditions. The subject of this paper is the uncertainty in this predicted ship speed due to uncertainty in design parameters. This uncertainty is traditionally taken into account in the contract speed by application of a factor based on experience. In the next sections a more scientific approach is applied to estimate the uncertainty in the predicted ship speed.

EFFECT OF UNCERTAINTY ON THE SHIP SPEED PREDICTION PROCESS

The calculation process from resistance curve to required brake power was described in the previous sections. As was shown, this process depends on various known inputs that are certain (such as number of propellers k_p and

² Note that the coefficients c_2 , c_5 and c_6 are not used in this paper. This is a deliberate choice in order to match the notation used in [1].

number of engines per shaft k_e). At the same time various inputs have a degree of uncertainty, which in turn leads to uncertainty in the main output variable of interest: the predicted trial ship speed. Many input parameters carry some degree of uncertainty such as for instance the resistance data, the open water propeller curves and the propeller-hull interaction coefficients. Parameters like these can be based on shipyard experience, model basin resistance and self-propulsion measurements or potentially on CFD. Other examples of variables with some degree of uncertainty are the transmission efficiency and even the density of seawater. Note that for the case study considered in this paper, the gearbox reduction factor is considered as a given since this is chosen from a standard range.

Both the certain and the uncertain variables are shown in Figure 2, which gives a high level overview of the ship speed prediction process. It could be argued that a perfect prediction can only be obtained if the input uncertainties are reduced to a minimum. If not, a good prediction is a matter of chance. On the other hand one could argue that the effect of uncertainty is not that important because the effect of slight input variations on the final ship speed is not necessarily that large.

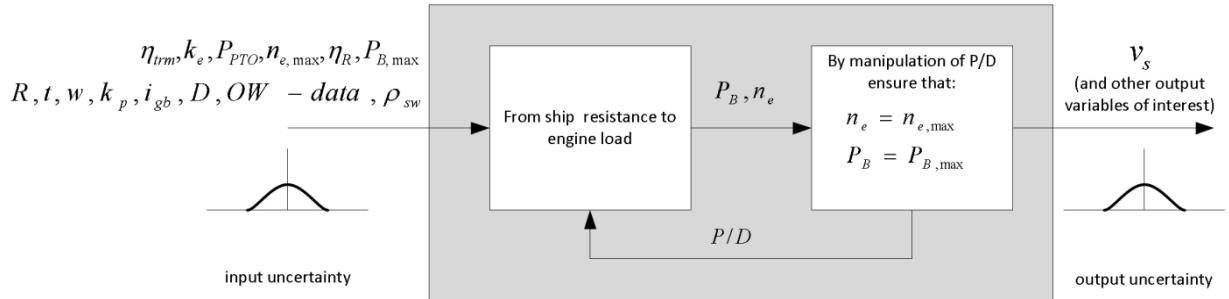

Figure 2: High level ship speed prediction process

Note that the P/D manipulation that is shown accounts for the fact that during the acceptance trial, the propeller pitch is manually adjusted to ensure that the propeller line intersects the engine envelope in the upper right hand corner. In case of fixed pitch propellers (FPPs) this possibility is not present.

Further note that for this study the boundary of the speed prediction process is drawn such that the resistance curve is a given uncertain input. Another method would be to determine the uncertainty in R, based on all parameters that are input into the resistance prediction method (such as for instance the Holtrop and Mennen method [3], [4]), combined with the uncertainty of that method itself. Such an approach can be seen as an extension to the process as described here.

The following sections aim at quantifying the uncertainty in predicted ship speed based on estimated input uncertainties in combination with derived output sensitivities.

QUANTIFICATION OF UNCERTAINTIES

The uncertainty in output variables can be quantified based on the following:

Output sensitivity: In terms of the block diagram shown in Figure 3, the output sensitivities are expressed as

$$\frac{\partial z}{\partial x}, \text{ which are often presented as the normalised sensitivities } \frac{\partial z^*}{\partial x} = \frac{\partial z}{\partial x} \cdot \frac{x_0}{z_0}, \text{ where } x_0 \text{ and } z_0 \text{ are the}$$

nominal values of input and output. This normalised presentation allows for a more intuitive interpretation, since it expresses the percentage of change in output based on a percentage change in input.

Input uncertainty: The uncertainty in input variables can be quantified in various ways. Mostly a Gaussian (normal) distribution is assumed, which can be defined via its mean value μ_x and its standard deviation σ_x . Other often-used ways of expressing the size of uncertainty are the variance σ_x^2 and the 95% interval, which

roughly is the interval described by $[\mu_x - 2\sigma_x, \mu_x + 2\sigma_x]$. It can be convenient to use the normalised uncertainty $\sigma_x^* = \frac{\sigma_x}{\mu_x}$.

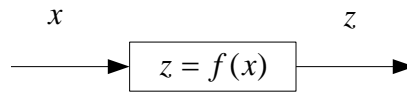

Figure 3: General blockdiagram with input x and output z

By combining output sensitivities and input uncertainties via

$$\sigma_z^2 = \sum_i \left(\frac{\partial z}{\partial x_i} \right)^2 \cdot \sigma_{x_i}^2$$

the output uncertainties are obtained³. If the previously introduced normalised sensitivities and uncertainties are used, this equation changes to:

$$(\sigma_z^*)^2 = \sum_i \left(\frac{\partial z}{\partial x_i} \right)^2 \cdot (\sigma_{x_i}^*)^2$$

Another possible method to obtain the output uncertainties is via Monte Carlo Simulation (MCS). The principle of MCS is to calculate the output variables over and over again, while randomly picking the input values from their (not necessarily Gaussian) distributions. If this calculation is carried out enough times, the output distribution will be found. This method is however not used here since, although perhaps giving a more accurate numerical answer, it does not provide direct insight into the variables that play the biggest role during uncertainty propagation. In particular MCS does capture non-linear effects in the underlying mathematical model, while usage of $\frac{\partial z}{\partial x}$ implicitly assumes a linear system so that theoretically the method is only exact for infinitesimal small input uncertainties. By systematic investigation it has been concluded that the ship propulsion system under consideration behaves closely to linear for reasonably sized variations of input parameters. The assumption of a Gaussian distribution of the various uncertain input parameters might not always hold if very detailed information on the actual distribution would be available. However, such detailed data is practically not available and estimation of non-Gaussian distributions seems difficult, even for subject matter experts.

CASE STUDY

To get a feeling for the uncertainty in predicted ship speed based on the uncertainty in the inputs, an offshore patrol vessel is analysed in a case study. The main particulars of this ship are listed in Table I.

Table I: ship particulars

Lwl	76 [m]
B moulded	13 [m]
Design draught moulded	3.6 [m]
Displacement	1700 [t]
Block coefficient	0.476 [-]
Approximate ship speed	22 kts
Propeller diameter	3 [m]
Propulsion configuration	Mechanical system, twin shaft.
	4080 bkW per shaft
Gearbox reduction ratio	3.960:1

³ This holds under the assumption that the input parameters x_i are mutually independent.

Based on these and other particulars (such as the predicted resistance curve, t , w , and the transmission efficiency η_{trm}) the propulsion system is analysed and by selection of the propeller pitch P/D, a situation is defined where the propeller operating line intersects the engine envelope exactly in the upper right corner. This intersection point corresponds to the speed that is predicted based on the nominal values of all uncertain inputs. This is visualised in Fig 4A. Note that this speed is traditionally corrected by a factor based on experience before it is guaranteed by the shipyard.

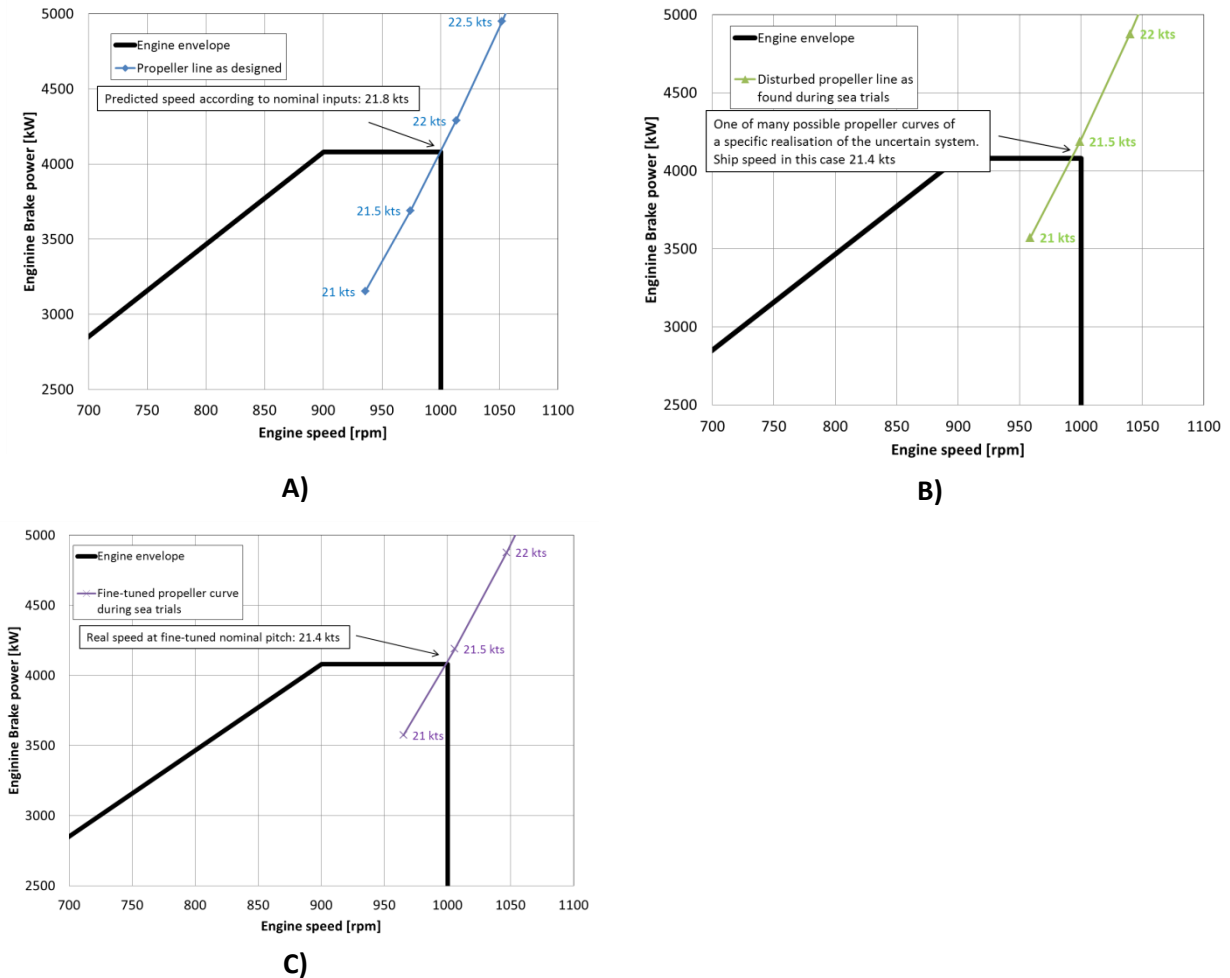

Figure 4: Nominal system as intended by the designer. B) A possible realisation of the uncertain system, still with design P/D value. C) Propeller line after adjustment of the nominal P/D during the sea trials

Subsequently the ship is built, and the acceptance trial is held. During this trial the CPP specialist and the diesel engine specialist are on board to fine-tune their respective components of the propulsion train. Let us for now assume that the trial is taking place in ideal trial conditions, which in reality is almost never the case. Despite these ideal trial conditions, due to uncertainty in various input parameters, it is highly unlikely that the propeller line intersects the engine envelope exactly in the upper right corner. One out of many possible propeller lines is visualised in Fig 4B.

The CPP specialist (in cooperation with the diesel engine specialist) now starts to manipulate the nominal P/D setting to ensure that the propeller line does intersect the engine envelope exactly in the upper right corner. This is shown in Fig 4C. The ship speed at which this intersection takes place is not equal to the intersection speed that was predicted based on nominal values of the uncertain inputs to the calculation process (as was shown in Fig 4A). The difference in the predicted and realised speed is the result of the difference between the system behaviour with nominal input values and the system behaviour with the actual realisation of the input values. The larger the uncertainties in input parameters are, the larger the uncertainty in ship speed during the trial is. The relation between input uncertainty and output uncertainty is considered in the following sections.

Determination of sensitivities

To determine the uncertainty in the output variables of interest, the normalised sensitivities $\frac{\partial z^*}{\partial x} = \frac{\partial z}{\partial x} \cdot \frac{x_0}{z_0}$ are

determined first. This is done by subsequent perturbation of the uncertain input parameters x_i in the mathematical model and then logging the resulting values of the uncertain outputs z , after which the sensitivities can be calculated. To reflect the actual method of fine-tuning during the trials, the sensitivities are determined under the condition that the propeller pitch is set such that the propeller operating line intersects the engine

envelope in the upper right corner: $\frac{\partial z^*}{\partial x}$ at the P/D value required to force propeller line through the upper right corner of engine envelope. This thus means that after perturbation of

each input parameter, the P/D value is changed to achieve this.

The normalised sensitivities of ship speed to perturbations in uncertain input parameters is visualised in Figure 5. The figure should be interpreted as follows:

“A variation of +1% in (1-t) leads to a variation of +0.17% in ship speed (in the operating conditions under consideration, with the P/D value set such that the propeller operating line intersects the engine envelope in the upper right corner).”

The figure further shows that ship speed is almost equally sensitive to variations in resistance, (1-t), (1-w), η_R , η_{trm} , open water K_T data and open water K_Q data. Other sensitivities are very low, and thus are of less importance in this case (unless the uncertainty is very high, which is not the case for ρ_{sw} and the propeller diameter D_p).

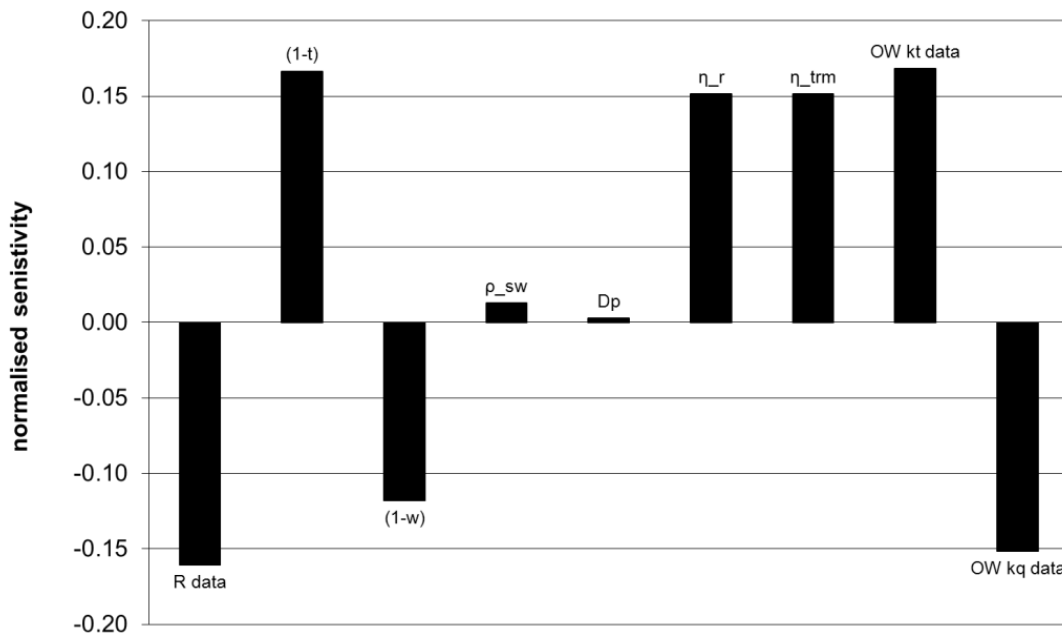

Figure 5: Sensitivities of ship speed to input parameters

Sensitivities such as shown in Figure 5 are determined for all outputs of interest. It might for instance be of interest to consider the operating point of the propeller in terms of the values of J , K_T and K_Q . The resulting uncertainties can for instance be used to express uncertainty in a cavitation prediction as is for instance shown in [6].

Input uncertainty estimation

Estimation of input uncertainty is difficult. Detailed studies regarding the uncertainty of experimentally and computationally determined variables such as wake and ship resistance are available [7]. Such studies look into the uncertainty introduced by measurement equipment and measurement method. Another indication of uncertainty is given by CFD benchmark studies, where specific CFD codes are set to solve the same problem. The difference between the results of such CFD benchmark tests gives some idea of the uncertainty in the results. In this study it is chosen to base the input uncertainty on expert opinion.

It is acknowledged that this approach could be improved if better data on input uncertainty would be available more easily. The input uncertainty is estimated in two cases:

- Case 1 is the *pre-model scale test* situation, where input data is chosen based on experience with similar ships. This means that the input uncertainty is relatively high.
- Case 2 is the *post-model scale test* situation. The uncertainty of certain input parameters is decreased by the experiment so that more certainty in the expected top speed is obtained. Note that some parameters uncertainties remain unchanged after the model tests. This for instance holds for the transmission efficiency η_{trm} . The estimated uncertainties in both cases are visualised in Figure 6. As an example the uncertainty in transmission efficiency is expressed as a standard deviation of 1.5% of the nominal value. For a nominal transmission efficiency of 0.95 this means that with 95% certainty the transmission efficiency (in the operating point under consideration) will lie between 0.92 and 0.98.

Note that the uncertainty in propeller open water data is equal before and after the model tests. This is due to the assumption that no additional open water test were carried out, and that a stock propeller was used in the resistance and propulsion test.

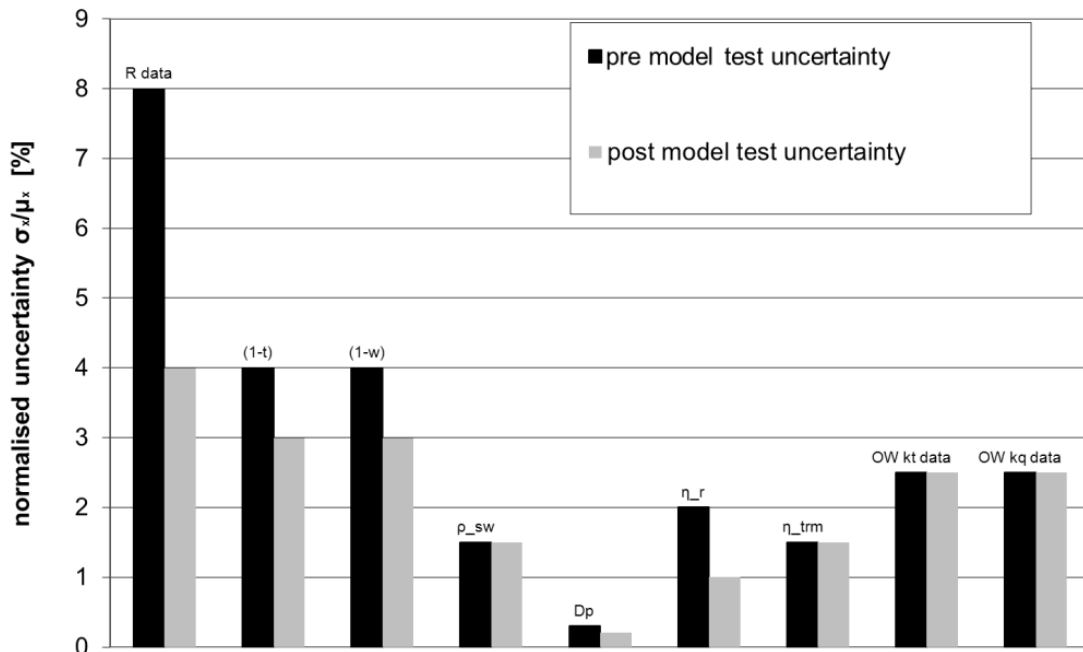

Figure 6: Input uncertainty estimations based on expert opinion

Output uncertainty quantification

The uncertainty in output variables is the result of the sensitivities of those variables in combination with the input uncertainties. For this case study the output uncertainties are shown in Figure 7. Note that the output variable “ship speed” that is of most interest for this study is shown as the left most variable. The figure shows that the pre-model test uncertainty in predicted ship speed (σ_{v_s}) equals 1.7%, which means that with 68%

certainty the real ship speed will lie between $\pm 1.7\%$ of the predicted ship speed. This is equivalent to stating with 95% certainty that the ship speed will lie between $\pm 3.4\%$ of the predicted ship speed. For a predicted ship speed of around 21.8 kts, this means that the actual ship speed will lie in the interval $[21.1kts - 22.5kts]$ (with 95% certainty), as is illustrated in Figure 8. After model tests this 95% uncertainty interval is reduced to $[21.3kts - 22.3kts]$

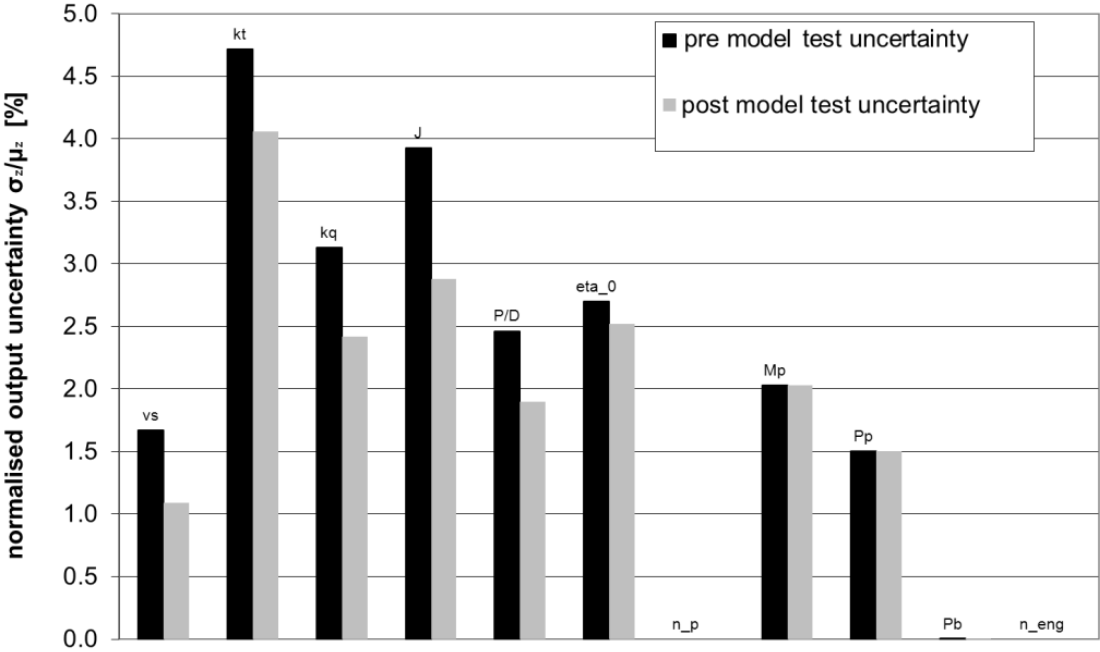

Figure 7: Uncertainties in various output variables

The uncertainty in propeller rpm, engine rpm and brake power is practically zero, which illustrates that the propeller operating line was forced through the upper right hand corner of the engine envelope. The uncertainty in P/D value is 2.5%, which indicates the variation that can be expected between predicted and actual pitch setting after fine-tuning in trial conditions. The open water propeller efficiency has a similar uncertainty.

Model tests are carried out for more reasons than just decreasing uncertainty in maximum ship speed. However, since the focus in this paper is on prediction of ship speed, one can question whether in this particular case the model tests were worth the effort and cost. This question cannot be answered here, since the answer depends on the importance of “getting it right”. If the market is such that one could easily sell this vessel at a speed of 21 kts, resistance and propulsion tests don’t seem to add significant value for this particular case. However, if the market is such that one needs to “sell” a higher top speed, the reduction of uncertainty by means of model tests soon becomes attractive.

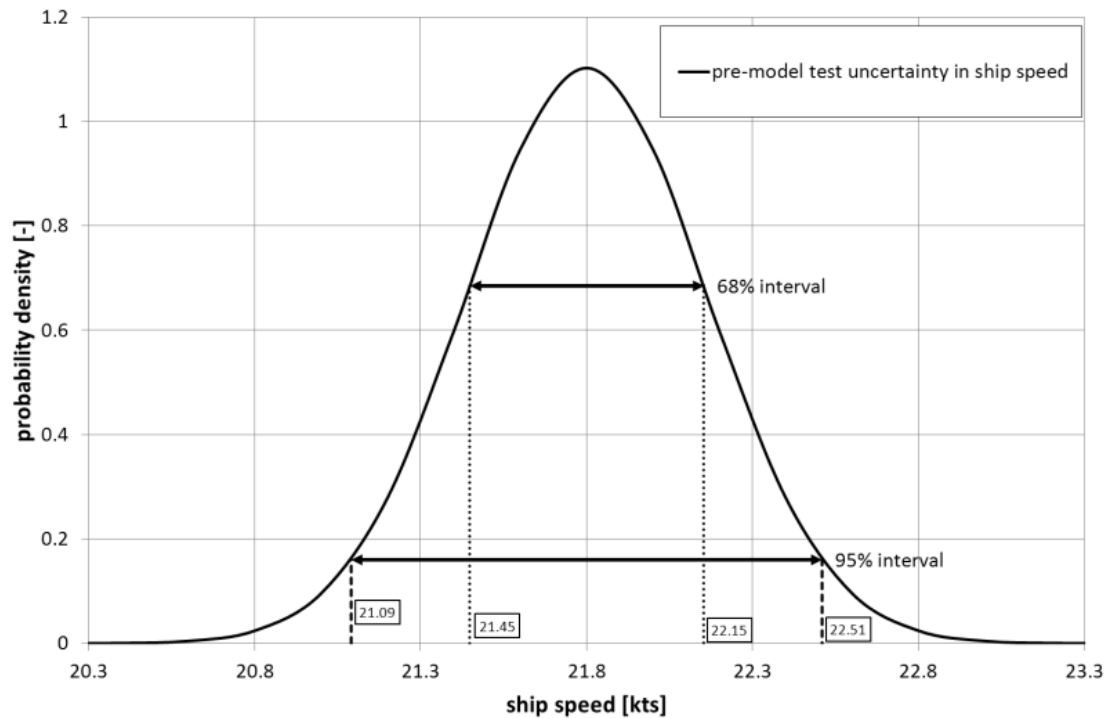

Figure 8: Detailed view of uncertainty in output "Ship speed" before model tests. Note that both the 68% and 95% uncertainty interval are shown.

CONCLUSIONS AND RECOMMENDATIONS

The speed that is to be stated in the contract depends on the appetite for risk by the shipbuilder. In this paper the relation between input uncertainty and risk is quantified in terms of an uncertainty interval for ship speed.

The quantification of the uncertainties in input parameters remains a difficult issue, and therefore expert opinion is used in this paper. Better insight and understanding of the importance of uncertainty analysis will likely lead to more attention for the determination/ estimation of these input uncertainties.

Despite the crude method of input parameter uncertainty estimation, the uncertainty analysis as carried out here gives some indication of the size of deviations that are to be expected between the real ship speed and the predicted ship speed. The effect of uncertainty reduction by means of carrying out model tests is estimated as well.

Another important in-between result of the uncertainty analysis as carried out here is the graph showing the sensitivities. This graph helps to identify those parameters that require most attention during the design process. It is therefore recommended to carry out this uncertainty analysis for various types of vessels, and thereby get a feel for the sensitivities of the system. The analysis will be slightly different for ships with waterjets or FPPs.

In the long run uncertainty analysis studies such as carried out here can help to determine sensible contract speeds of newly built vessels.

ACRONYMS

CFD	Computational Fluid Dynamics
CPP	Controllable Pitch Propeller
DE	Diesel Engine
FPP	Fixed Pitch Propeller
MCS	Monte Carlo Simulation
OPV	Offshore Patrol Vessel
OW data	Open water propeller data
PTO	Power Take Off

REFERENCES

1. Klein Woud, H. and Stapersma, D. 2008. Design of Propulsion and Electric Power Generation Systems. ISBN 1-902536-47-9
2. Stapersma, D. and Klein Woud, H. 2005. Matching Propulsion Engine with Propulsor, Journal of Mar. Eng. and Technology nr A7, pp 25 – 32, IMarEST 2005, ISSN 1476 – 1548
3. Holtrop, J. and Mennen, G. An Approximate Power Prediction Method. International Shipbuilding Progress, Vol 29, July, 1982
4. Holtrop, J. A Statistical Re-Analysis of Resistance and Propulsion Data, International Shipbuilding Progress, Vol 31, Nov, 1984
5. Vrijdag, A., Schulten, P., Stapersma, D., and van Terwisga, T. 2007. Efficient uncertainty analysis of a complex multidisciplinary simulation model. Journal of Marine Engineering and Technology, A10:79–88.
6. Vrijdag, A., Stapersma, D., and Grunditz, G., Adjustable bolted propellers: Mitigating Uncertainty. Submitted to IMarEST Journal of Mar. Eng. and Technology. August 2011.
7. Joe Longo and Fred Stern. Uncertainty Assessment for Towing Tank Tests With Example for Surface Combatant DTMB Model 5415. Journal of Ship Research, Vol 49, No. 1, March 2005, pp. 55-68.

NOMENCLATURE

D	Propeller diameter
g	Gravitational acceleration
i	Gearbox ratio
J	Advance ratio
k_e	Number of engines per shaft
k_p	Number of propellers
K_Q	Torque coefficient
K_T	Thrust coefficient
M_p	Propeller torque
n_e	Engine speed
n_p	Propeller speed
p_{atm}	Atmospheric pressure
P_B	Brake power
P_D	Total Propeller power
P_e	Effective power
P_p	Propeller power
P_{PTO}	PTO power
p_v	Vapour pressure of seawater
P/D	Pitch ratio
Q	Open water propeller torque
R	Resistance
t	Thrust deduction factor
T	Thrust
v_a	Advance speed
v_s	Ship speed
w	Wake factor
x	Input parameter
z	Immersion of propeller/ output variable
η_0	Open water propeller efficiency

η_{trm}	Transmission efficiency
η_R	Relative rotative efficiency
ρ	Seawater density
σ_n	Cavitation number
σ_x	Standard deviation of variable x
μ_x	Mean value of variable x

