

Long-distance electron transport in individual, living cable bacteria

Bjerg, Jesper T.; Boschker, Henricus T.S.; Larsen, Steffen; Berry, David; Schmid, Markus; Millo, Diego; Tataru, Paula; Meysman, Filip J.R.; Wagner, Michael; Nielsen, Lars Peter

DOI

[10.1073/pnas.1800367115](https://doi.org/10.1073/pnas.1800367115)

Publication date

2018

Document Version

Accepted author manuscript

Published in

Proceedings of the National Academy of Sciences of the United States of America

Citation (APA)

Bjerg, J. T., Boschker, H. T. S., Larsen, S., Berry, D., Schmid, M., Millo, D., Tataru, P., Meysman, F. J. R., Wagner, M., Nielsen, L. P., & Schramm, A. (2018). Long-distance electron transport in individual, living cable bacteria. *Proceedings of the National Academy of Sciences of the United States of America*, 115(22), 5786-5791. <https://doi.org/10.1073/pnas.1800367115>

Important note

To cite this publication, please use the final published version (if applicable).
Please check the document version above.

Copyright

Other than for strictly personal use, it is not permitted to download, forward or distribute the text or part of it, without the consent of the author(s) and/or copyright holder(s), unless the work is under an open content license such as Creative Commons.

Takedown policy

Please contact us and provide details if you believe this document breaches copyrights.
We will remove access to the work immediately and investigate your claim.

1 **Title Page.**

2 *Classification: Biological Sciences, Microbiology*

3 *Title: Long-distance electron transport in individual, living cable bacteria*

4 *Short title: Long-distance electron transport in cable bacteria*

5 **Authors:**

6 Jesper T. Bjerg^{1,2*}, Henricus T.S. Boschker^{3,4}, Steffen Larsen², David Berry^{5,6}, Markus
7 Schmid^{5,6}, Diego Millo⁷, Paula Tataru⁸, Filip J. R. Meysman^{4,3}, Michael Wagner^{5,6}, Lars Peter
8 Nielsen^{1,2}, and Andreas Schramm^{1,2*}

10 **Affiliations:**

11 ¹ Center for Electromicrobiology, Aarhus University, Ny Munkegade 114, DK-8000, Aarhus
12 C, Denmark.

13 ² Center for Geomicrobiology, Section for Microbiology, Department of Bioscience, Aarhus
14 University, Ny Munkegade 114, DK-8000, Aarhus C, Denmark.

15 ³ Department of Biotechnology, Delft University of Technology, 2629 HZ Delft, The
16 Netherlands

17 ⁴ Ecosystem Management Research Group, Department of Biology, University of Antwerp,
18 BE- 2610 Wilrijk (Antwerp), Belgium

19 ⁵ Division of Microbial Ecology, Department of Microbiology and Ecosystem Science,
20 University of Vienna, A-1090 Vienna, Austria.

21 ⁶ Research Network Chemistry meets Microbiology, University of Vienna, A-1090 Vienna,
22 Austria

23 ⁷ Department of Physics and Astronomy, VU University Amsterdam, 1081 HV Amsterdam,
24 The Netherlands

25 ⁸ Bioinformatics Research Centre, Aarhus University, DK-8000, Aarhus C, Denmark.

26

27 ***Correspondence:** jjbjerg@bios.au.dk - +45 40433087 or andreas.schramm@bios.au.dk -
28 +45 60202659

29

30 **Keywords:** *Electromicrobiology, Raman spectroscopy, Cytochrome C, Cable bacteria*

31

32 **Abstract.**

33 **Electron transport within living cells is essential for energy conservation in all respiring**
34 **and photosynthetic organisms. While a few bacteria transport electrons over μm -**
35 **distances to their surroundings, filaments of cable bacteria are hypothesized to conduct**
36 **electric currents over cm-distances. We used resonance Raman microscopy to analyze**
37 **cytochrome redox states in living cable bacteria. Cable bacteria filaments were placed in**
38 **microscope chambers with sulfide as electron source and oxygen as electron sink at**
39 **opposite ends. Along individual filaments a gradient in cytochrome redox potential was**
40 **detected, which immediately broke down upon removal of oxygen or laser-cutting of the**
41 **filaments. Without access to oxygen, a rapid shift towards more reduced cytochromes**
42 **was observed, as electrons were no longer drained from the filament but accumulated in**
43 **the cellular cytochromes. These results provide the first direct evidence for long-**
44 **distance electron transport in living multicellular bacteria.**

45 **Significance Statement.**

46 Cable bacteria are cm-long, multicellular filamentous bacteria, which are globally occurring
47 in marine and freshwater sediments. Their presence coincides with the occurrence of
48 electrical fields, and gradients of oxygen and sulfide that are best explained by electron
49 transport from sulfide to oxygen along the cable bacteria filaments, implying electric
50 conductance by living bacteria over cm-distances. Until now, all indications for such long-
51 distance electron transport were derived from bulk sediment incubations. Here we for the first
52 time present measurements on individual cable bacteria filaments that allow us to quantify a
53 voltage drop along cable bacteria filaments and show a transport of electrons over several
54 mm. This is orders of magnitude longer than previously known for biological electron
55 transport. \body

56

57 **Main text:**

58 Cable bacteria are multicellular, centimeter-long filamentous bacteria that occur globally in
59 marine and freshwater sediments (1–5). In their presence the sediment exhibits an electrical
60 coupling between the oxidation of sulfide (H_2S) in deeper sediment layers and the reduction
61 of oxygen (O_2) near the sediment-water interface, thereby generating a 1-4 cm deep suboxic
62 zone devoid of O_2 and H_2S (6, 7). Cable bacteria spanning this suboxic zone thus appear to
63 transfer electrons over centimeter distances, which is several orders of magnitude longer than
64 previously found in any organism (1, 7–10). Long-distance electron transport by cable
65 bacteria is supported by several observations: (i) changes in oxygen availability in the water

66 column have an immediate effect on sulfide oxidation several centimeters into the sediment,
67 which is faster than what can be explained by diffusion (6); (ii) electron transport occurs even
68 where cable bacteria span a non-conductive barrier in the sediment like an inserted glass bead
69 layer or a filter with pore size $\geq 2 \mu\text{m}$ (1); and (iii) a wire cutting through the suboxic zone
70 rapidly disrupts conduction (1). However, direct demonstration of electric conductance by
71 individual cable bacteria filaments is still lacking (1, 11).

72 The mechanism of conductance has remained unclear but continuous periplasmic fibers,
73 running along the entire filament length, have been proposed as conducting elements (1).
74 Electrostatic force microscopy measurements indicated a significant charge storage capacity
75 in these fibers (1). Capacitance has also been observed in another electrogenic bacterium,
76 *Geobacter sulfurreducens*, where it is due to abundant c-type cytochromes (12). The type and
77 redox state of cytochromes can be analyzed using resonance Raman microscopy (13), and
78 this method has revealed gradients in cytochrome redox states in electrically conductive
79 *Geobacter* biofilms (14–16). We hypothesized that any electron conduction by the cable
80 bacteria from sulfide to oxygen must be associated with a potential gradient along the
81 conductive structure (7). Since cytochromes are common electron carriers in bacterial cells,
82 we further hypothesized that, as seen in *Geobacter* biofilms, this potential gradient should be
83 reflected by the redox state of cytochromes. Here we used resonance Raman microscopy as a
84 noninvasive technique to detect a gradient in cytochrome redox state along living cable
85 bacteria filaments and to demonstrate its dependence on an intact electrical connection
86 between the electron donor H_2S and the electron acceptor O_2 .

87

88 **Results**

89 **Positioning of living cable bacteria in gradients of sulfide and oxygen**

90 We constructed a microscope chamber setup (Fig. S1) that allowed to position individual
91 cable bacterium filaments between a sulfide source and an oxygen source located 5 mm apart
92 from each other (17) (see Supplementary Materials for details). Sediments from one
93 freshwater site and two marine sites were enriched for cable bacteria (see Supplementary
94 Materials) and used as source of sulfide and cable bacteria. Within a day, cable bacteria
95 emerged from the sediment and reached the oxic zone near the air inlet (see Movie S1 and
96 (17)). Cable bacteria filaments, which had emerged from the sulfidic sediment but had not yet
97 reached the oxic zone were used as controls. Swarming, microaerophilic single-celled

98 bacteria positioned themselves approx. 1 mm from the air inlet (Fig. 1A), and microsensor
99 measurements showed that this bacterial veil provided a good marker for the oxic-anoxic
100 transition zone. Microsensor measurements further confirmed the absence of sulfide and
101 oxygen in a 4 mm wide suboxic zone between the veil and the sediment edge (Fig. 1B).

102

103 **Resonance Raman microscopy reveals c-type cytochromes in cable bacteria**

104 We recorded nearly 2,000 Raman spectra for 15 cable bacteria filaments, which spanned the
105 suboxic zone from sulfide to oxygen. Cable bacteria diameters ranged from 1.6 to 6.6 μm ,
106 and only motile filaments were used, as these are certain to be metabolically active. All
107 filaments displayed the four most prominent bands reported for c-type cytochromes at 750
108 (ν_{15} pyrrole breathing mode), 1130 (ν_{22}), 1315 (ν_{21}), and 1588 cm^{-1} (ν_2) (Fig. 2A, S2, S3)(17),
109 which all decreased in intensity across the suboxic zone from near the sediment to the oxygen
110 front. Thick filaments ($> 4 \mu\text{m}$ diameter) provided more detailed spectra, with additional
111 small bands of several vibrational modes of the cytochrome heme groups (Fig. 2A, S2). Near
112 the sediment, the ν_4 and ν_3 bands were centered at 1361 and 1496 cm^{-1} , respectively (Fig. 2A
113 and S2, red trace). Near the oxic zone, the overall spectra intensity decreased, the ν_4 band
114 shifted to 1369 cm^{-1} , the ν_3 band was no longer detectable, and a broad ν_{10} mode at 1637 cm^{-1}
115 appeared (Fig. 2A, B, and S2, blue trace). All these changes are consistent with a c-type heme
116 having a six-coordinated low-spin central iron atom varying its oxidation state from reduced
117 (near the sediment) to oxidized (near oxygen)(18, 19). Broadening of the ν_2 (featuring a
118 shoulder at 1593 cm^{-1}) and ν_{10} bands suggests the presence of at least two different
119 conformers having His-Fe-His and His-Fe-Met axial ligation (18). Both of these conformers
120 were also detected for *Geobacter* species grown on electrodes, where these cytochromes
121 connect the cell metabolism to the electrode (13, 20).

122

123 **Cytochrome redox state changes gradually along the cable bacterium filaments**

124 Throughout the rest of the study, the most prominent band in all cable bacteria filaments, at
125 750 cm^{-1} (Fig. 2A, S3), was used as proxy of cytochrome redox state (21, 22). Along all cable
126 bacterium filaments connected to both O_2 and H_2S (N=15), we observed a gradual decrease
127 of the absolute intensity of this 750 cm^{-1} band from the sulfidic sediment towards the oxic
128 zone (Fig. 2B, C, S4). In the subset of thick filaments (N=6), we also observed a gradual

129 increase of the band at 1637 cm^{-1} . In contrast, filaments without connection to oxygen (N =
130 3) showed highly reduced spectra (N = 300) with high intensities of the 750 cm^{-1} band, even
131 close to the oxic-anoxic transition. Filaments briefly incubated in oxic water (N = 4) all
132 showed spectra typical for oxidized cytochromes (N = 98), with low intensities at 750 cm^{-1}
133 (Fig. S5). These controls demonstrate that the observed differences in cytochrome band
134 intensities along cable bacteria filaments were not due to varying cytochrome abundance
135 along the filaments, but are caused by the cytochrome redox state.

136

137 **Fast shift in cytochrome redox state upon disconnection of O₂**

138 In order to directly link the change in cytochrome redox state to electron transport along
139 individual bacterial cables, we used two experimental manipulations that have previously
140 been demonstrated to impede the electron flow in sediment cores with cable bacteria activity
141 (1, 6).

142 First, we removed oxygen from the air inlet by either filling the inlet with oxygen-free water
143 or by flushing it with dinitrogen gas (Fig. 3A). Within approx. 10 min, the cytochrome redox
144 state near the sediment, i.e. 4 mm away from the site of manipulation, showed a small but
145 significant shift towards a more reduced pattern (Fig. 3B). This shift was more pronounced at
146 the center of the suboxic zone (midpoint; Fig. 3A-B), where the initial cytochrome redox
147 state was more oxidized, in concordance with the redox potential gradient from sediment to
148 oxic zone (Fig. 2C). The shift could be reversed by reintroducing oxygen, which re-
149 established the original redox state within 3 min, i.e., as fast as we could measure (Fig. 3C).
150 Cable bacteria filaments connected to the sediment but not to the oxic zone (Fig. 3A) had
151 already highly reduced cytochromes and showed no change upon removal of oxygen.

152 In a second experiment, we stopped the electron transport by cutting individual filaments
153 using a laser microdissection microscope and measured the response in cytochrome redox
154 state near the sediment edge (Fig 4A). An advantage of this approach is that cutting a single
155 filament will have only limited effects on sulfide and oxygen gradients. Within 5 minutes, a
156 clear shift towards more reduced cytochromes was detected in the part of the cable filament
157 that was still connected to the sediment (Fig. 4B). Cable bacteria not reaching the oxic zone
158 showed no change in cytochrome redox state upon cutting.

159

160 **Discussion**

161 In both manipulation experiments, we observed a significant shift towards more reduced
162 cytochromes when filaments were no longer connected to oxygen. With the terminal electron
163 acceptor suddenly unavailable, cytochromes in the cable bacteria apparently accumulate
164 electrons released by sulfide oxidation in the sediment and thereby become more reduced.
165 The response time of minutes is too fast to be explained by diffusion of chemical compounds
166 over a distance of millimeters either outside or inside the cable bacteria filaments. Therefore,
167 we infer from our manipulation experiments that the rapid changes observed in the
168 cytochrome redox state must depend on the capability of transporting electrons across
169 millimeter distances from the sulfidic zone to the oxic zone.

170 At present, the exact role of the cytochromes in cable bacteria-mediated electron transport
171 from electron donor to electron acceptor remains elusive. The gradual change in cytochrome
172 redox state cannot result from a change in the external redox conditions, as both oxygen and
173 sulfide were absent from the intermediate, suboxic zone. The redox state of the cytochromes
174 thus reflects an internal redox potential gradient within individual cable bacteria filaments,
175 which is consistent with three scenarios. First, the cytochromes could theoretically be part of
176 the conductive structure, which would then suggest a mechanism of electron-hopping via
177 heme groups along the redox gradient (14, 23). However, the electron hopping frequency and
178 the amount of heme groups required to explain the observed rates of electron transport would
179 be unprecedented (7). Secondly, cytochromes could operate in combination with pilus
180 nanowires, as proposed for electroactive biofilms thicker than 10 μm (24). Finally, the
181 cytochromes could be involved in the up- and downloading of electrons to and from a yet
182 unknown internal conductive structure (Fig 1D). Analogous to how a voltmeter measures the
183 electrical potential gradient along the length of a resistor, the cytochromes would then
184 measure the potential gradient along the conductor. The observed gradient in cytochrome
185 redox states thus reflects the voltage drop along the internal conductor of the cable bacteria.

186 This voltage drop can be quantified applying the Nernst equation and the ratio of reduced to
187 oxidized cytochromes at either side of the suboxic zone (for details see SI Material and
188 Methods). Using the cable bacteria filaments with the largest diameters and thus the best-
189 quality Raman spectra (Fig. S4I-O), we calculated a voltage drop of $12.3\text{-}14.6 \pm 3.8\text{-}4.1$ mV
190 mm^{-1} (mean \pm SD; N = 6; Table S1). This voltage drop represents energy loss in the
191 conductor. If extrapolated to the natural setting, where cable bacteria typically span suboxic

192 zones of 20 mm, the voltage drop would be up to 293 mV to maintain the same current.
193 Considering the theoretical maximum of about 1000 mV available for aerobic sulfide
194 oxidation, this is a significant dissipation of energy and it is suggested that extension of the
195 operational length of a cable bacterium eventually forces a lower current or a lower energy
196 yield per electron transferred.

197 These findings hence provide the first direct evidence of long-distance electron conduction in
198 individual cable bacteria, which in our experiments takes place over several mm, i.e. about
199 1000x the length of individual cells. In natural sediments, long-distance electron transport by
200 cable bacteria is extended to centimeter distances (6).

201

202 **Methods**

203 Please see SI Appendix for a detailed description of the materials and methods.

204 **Sampling and incubation**

205 Surface sediment was collected from a freshwater lake and two marine sites containing cable
206 bacteria of the genera *Candidatus* *Electronema* and *Ca. Electrothrix* (4). The sediments were
207 enriched in the laboratory for cable bacteria as previously described (1) and used for transfer
208 to microscope chamber setups.

209

210 **Microscope chamber setups**

211 Two microscope chamber setups (A and B, Fig. S1) were used to examine cable bacteria
212 filaments. Both setups mimicked the redox gradient conditions that cable bacteria experience
213 in their natural habitat, with a sulfide source (sediment) on one side, and an oxygen source
214 (air) on the other side. In setup A, two wells (diameter 1-4 mm, separation 5 mm) were drilled
215 into 4 mm-thick glass microscopy slides using a diamond drill. One well was filled with the
216 cable bacteria-enriched sediment, while the other was left open and hence filled with ambient
217 air. Cable bacteria reached out of the sediment and moved across the water zone towards the
218 air-filled well within 24 hours (Movie S1).

219 In setup B, glass slabs were glued onto a microscope slide, creating a trench in the middle,
220 which was filled with the cable bacteria-enriched sediment and covered with a cover slip. As
221 in setup A, cable bacteria reached out of the sediment towards the oxic zone near the edge of
222 the microscope slide.

223

224 **Oxygen and hydrogen sulfide microsensors measurements**

225 Microelectrodes for O₂ and H₂S were inserted between the microscope slide and the cover
226 slip of slide setup B. O₂ and H₂S concentration were recorded from the edge of the cover slip
227 until 2 mm into the suboxic zone, or all the way into the sediment, respectively.

228

229 **Resonance Raman microscopy**

230 Raman spectra were recorded on confocal Raman microscopes (Horiba and Renishaw) along
231 individual filaments of cable bacteria starting from the sediment and moving towards the air-
232 inlet. At each longitudinal position, 2-3 line scans with 10-20 measuring points each were
233 performed across the filament. The ν_{15} (at 750 cm⁻¹) and the ν_{10} vibrational modes (at 1637
234 cm⁻¹) were used as measure of cytochrome redox state, and data reported for each filament
235 position are means of the quality-filtered and normalized band intensities (see ‘Data Analysis’
236 in SI Material and Methods). Statistical analyses are described in SI Material and Methods.

237

238 **Manipulation experiments**

239 Two manipulation experiments were performed where electron transport was inhibited and
240 the change in cytochrome redox state was recorded by Raman microscopy. First, oxygen was
241 removed from the oxic end of slide setup A by either filling the air inlet with nitrogen-
242 flushed, oxygen-free water or by flushing it directly with a gentle flow of nitrogen gas.
243 Raman spectra were recorded at approx. 500 μ m from the sediment and at the midpoint
244 between the sediment and the start of the oxic zone every 1-3 min over a period of 15-30 min
245 before and after the manipulation. The first 5 min after removing oxygen were excluded to
246 account for the time it took to fully deplete oxygen at the end of the cable bacteria. Oxygen
247 was re-introduced by stopping the flow of nitrogen gas, and the response in cytochrome
248 redox state was immediately recorded at midpoint only. Second, a laser microdissection
249 microscope (Leica, Germany) was used to make two cuts 10 μ m apart in the cable bacteria
250 filament, approx. 1000 μ m from the sediment. Raman spectra were recorded at approx. 500
251 μ m from the sediment, directly before and about 5 min after the cut. In both experiments, the
252 band intensity at 750 cm⁻¹ before the manipulation was normalized to 1, and any response to
253 the manipulation is given as fold-change relative to that value. Cable bacteria filaments,
254 which were only connected to the sediment but did not reach the oxic zone, were used as
255 controls.

256

257 **Acknowledgements:**

258 We thank Lars B. Pedersen and Preben G. Sørensen for help with making the customized
259 micro-sensors, Simon Agner Holm for providing the movie of cable bacteria, Anton Tramper,
260 Silvia Hidalgo-Martinez, and Diana Vasquez-Cardenas for sediment collection, incubation
261 and transport, and Arno Schintlmeister and Bo Barker Jørgensen for valuable discussions.
262 This study was supported by the European Research Council (Advanced Grant: Coulombus
263 291650), the Danish National Research Foundation (DNRF104 and DNRF136), and The
264 Danish Council for Independent Research | Natural Sciences (FNU) and Technology and
265 Production Sciences (FTP). DB was supported in part by Austrian Science Fund (P26127-
266 B20 and P27831-B28) and European Research Council (Starting Grant: FunKeyGut 741623).
267 DM acknowledges the Netherlands Organisation for Scientific Research (NWO) grant
268 722.011.003. PT was supported by the European Research Council under the European
269 Union's Seventh Framework Program (FP7/20072013, European Research Council grant
270 311341). FJRM was supported by the European Research Council (Grant: SedBioGeoChem
271 306933), the Research Foundation Flanders (FWO grant G031416N) and VICI grant
272 016.VICI.170.072 from NWO. MW was supported by the European Research Council
273 (Advanced Grant: NITRICARE 294343).

274

- 275 1. Pfeffer C, et al. (2012) Filamentous bacteria transport electrons over centimetre
276 distances. *Nature* 491(V):10–13.
- 277 2. Malkin SY, et al. (2014) Natural occurrence of microbial sulphur oxidation by long-
278 range electron transport in the seafloor. *ISME J* 8(9):1843–1854.
- 279 3. Risgaard-Petersen N, et al. (2015) Cable bacteria in freshwater sediments. *Appl*
280 *Environ Microbiol* 81(17):6003–6011.
- 281 4. Trojan D, et al. (2016) A taxonomic framework for cable bacteria and proposal of the
282 candidate genera *Electrothrix* and *Electronema*. *Syst Appl Microbiol* 39(5):297–306.
- 283 5. Burdorf LDW, et al. (2017) Long-distance electron transport occurs globally in marine
284 sediments. *Biogeosciences* 14(3):683–701.
- 285 6. Nielsen LP, Risgaard-Petersen N, Fossing H, Christensen PB, Sayama M (2010)
286 Electric currents couple spatially separated biogeochemical processes in marine
287 sediment. *Nature* 463(7284):1071–4.

- 288 7. Meysman FJR, Risgaard-Petersen N, Malkin SY, Nielsen LP (2015) The geochemical
289 fingerprint of microbial long-distance electron transport in the seafloor. *Geochim*
290 *Cosmochim Acta* 152:122–142.
- 291 8. Lovley DR (2017) Syntrophy goes electric: direct interspecies electron transfer. *Annu*
292 *Rev Microbiol* 71(1):644–657.
- 293 9. Schauer R, et al. (2014) Succession of cable bacteria and electric currents in marine
294 sediment. *ISME J* 8(6):1314–22.
- 295 10. Risgaard-Petersen N, Revil A, Meister P, Nielsen LP (2012) Sulfur, iron-, and calcium
296 cycling associated with natural electric currents running through marine sediment.
297 *Geochim Cosmochim Acta* 92:1–13.
- 298 11. Meysman FJR (2017) Cable bacteria take a new breath using long-distance electricity.
299 *Trends Microbiol*:1–12.
- 300 12. Esteve-Núñez A, Sosnik J, Visconti P, Lovley DR (2008) Fluorescent properties of c-
301 type cytochromes reveal their potential role as an extracytoplasmic electron sink in
302 *Geobacter sulfurreducens*. *Environ Microbiol* 10(2):497–505.
- 303 13. Viridis B, Harnisch F, Batstone DJ, Rabaey K, Donose BC (2012) Non-invasive
304 characterization of electrochemically active microbial biofilms using confocal Raman
305 microscopy. *Energy Environ Sci* 5(5):7017.
- 306 14. Lebedev N, Strycharz-Glaven SM, Tender LM (2014) Spatially resolved confocal
307 resonant Raman microscopic analysis of anode-grown *Geobacter sulfurreducens*
308 biofilms. *ChemPhysChem* 15(2):320–327.
- 309 15. Robuschi L, Tomba JP, Busalmen JP (2017) Proving *Geobacter* biofilm connectivity
310 with confocal Raman microscopy. *J Electroanal Chem* 793:99–103.
- 311 16. Snider RM, Strycharz-Glaven SM, Tsoi SD, Erickson JS, Tender LM (2012) Long-
312 range electron transport in *Geobacter sulfurreducens* biofilms is redox gradient-driven.
313 *Proc Natl Acad Sci* 109(38):15467–15472.
- 314 17. Bjerg JT, Damgaard LR, Holm SA, Schramm A, Nielsen LP (2016) Motility of
315 electric cable bacteria. *Appl Environ Microbiol* 82(13):3816–3821.
- 316 18. Oellerich S, Wackerbarth H, Hildebrandt P (2002) Spectroscopic characterisation of

- 317 nonnative conformational states of cytochrome c. *JPhysChemB* 106:6566–6580.
- 318 19. Kranich A, Ly HK, Hildebrandt P, Murgida DH (2008) Direct observation of the
319 gating step in protein electron transfer: electric-field-controlled protein dynamics. *J*
320 *Am Chem Soc* 130:9844–9848.
- 321 20. Robuschi L, et al. (2013) Spectroscopic slicing to reveal internal redox gradients in
322 electricity-producing biofilms. *Angew Chemie - Int Ed* 52(3):925–928.
- 323 21. Brazhe NA, et al. (2012) Mapping of redox state of mitochondrial cytochromes in live
324 cardiomyocytes using raman microspectroscopy. *PLoS One* 7(9):1–8.
- 325 22. Adar F (1978) Resonance Raman spectra of ferric cytochrome c. A probe of low-lying
326 electronic levels of the iron ion. *J Phys Chem* 82(2):230–234.
- 327 23. Strycharz-Glaven SM, Snider RM, Guiseppi-Elie A, Tender LM (2011) On the
328 electrical conductivity of microbial nanowires and biofilms. *Energy Environ Sci*
329 4(11):4366.
- 330 24. Steidl RJ, Lampa-Pastirk S, Reguera G (2016) Mechanistic stratification in
331 electroactive biofilms of *Geobacter sulfurreducens* mediated by pilus nanowires. *Nat*
332 *Commun* 7(12217). doi:10.1038/ncomms12217.

333

334

335

336

337

338 **Figure Legends**

339 **Figure 1.**

340 (A) Dark field micrograph of cable bacteria in the microscopic chamber setup reaching from
341 sulfidic sediment (left) to oxygen (right). Arrows show the position of the veil composed of
342 swarming microaerophilic microbes (white) and the positions, where the reduced (red) and
343 oxidized (blue) Raman spectra shown in Fig. 2A were recorded. (B) Sulfide (red) and oxygen
344 (blue) concentration gradients across the chamber setup as determined by microsensor
345 measurements (N = 6). Grey shading indicates the microaerophilic veil.

346

347 **Figure 2**

348 (A) Raman spectra from an individual cable bacterium filament (site Rattekai, NL) near
349 sediment (red) and near oxygen (blue). (B) Difference in normalized band intensity between
350 either ends of the suboxic zone. Red = data points closest to sediment (Figures 1F and S4);
351 blue = data points closest to microaerophilic veil and oxygen. Stippled and open bars display
352 band intensities at 750 and 1637 cm^{-1} , respectively, given as percentage of the maximum
353 band intensities (mean \pm standard deviation). Asterisks depict significant differences between
354 cable bacteria ends. N (for 750 cm^{-1} /1637 cm^{-1} band) = 15/6 filaments (379/200 spectra,
355 Shapiro-Wilk test p-value: 0.493/0.28, t-test p-value = $5.31 \cdot 10^{-6}$ / $8.8 \cdot 10^{-4}$). (C) Normalized
356 band intensities (mean \pm standard deviation) showing the cytochrome redox gradient along a
357 single cable bacterium filament (Fig. S4M), reaching from sediment (to the left) towards
358 oxygen. Grey shading indicates the microaerophilic veil.
359 (D) Conceptual model of electron transport in cable bacteria. Cells in the sulfidic zone, with
360 reduced cytochromes, upload electrons from H_2S to periplasmic fibers, while cells in the oxic
361 zone, with oxidized cytochromes, download electrons from these fibers to O_2 .

362 **Figure 3.**

363 Effect of oxygen availability on cable bacteria redox state. (A) Schematic of the setup for
364 oxygen manipulation experiments. A filament (light grey wave) reaches out from sulfidic
365 sediment (left) towards the air inlet (right), from which oxygen can be removed; dark grey
366 shading indicates the position of the microaerophilic veil. Filaments that did not reach the
367 veil were used as controls. Positions of Raman spectra recordings are marked with red (near
368 sediment) and purple (midpoint) arrows. (B) Change in cytochrome redox state resulting
369 from a change in oxygen availability. Bars represent fold change in normalized band

370 intensities at 750 cm^{-1} relative to the intensity in the presence of oxygen (mean \pm standard
371 deviation). Significant changes in redox state are marked by an asterisk. N = 16 filaments
372 near sediment (1666 spectra, Shapiro-Wilk test p-value: 0.0003, Wilcoxon sign test p-value:
373 0.000122), N = 4 filaments at midpoint (50 spectra, Shapiro-Wilk test p-value: 0.551, t-test p-
374 value: 0.000488), and N = 6 control filaments near sediment (744 spectra, Shapiro-Wilk test
375 p-value: 0.903, t-test p-value: 0.659). (C) Change in cytochrome redox state (band intensity at
376 750 cm^{-1}) of a single cable bacterium filament over time (42 min) during changes in oxygen
377 availability. Measurements were done at midpoint. White area represents time when the air
378 inlet was flushed with N_2 ; shaded blue area represents time with oxygen available.

379

380 **Figure 4.**

381 Effect of filament cutting on cable bacteria redox state. (A) Schematic of the setup for laser
382 cut experiments. A filament (light grey wave) reaches out from sulfidic sediment (left)
383 towards the air inlet (right); dark gray shading indicates the position of the microaerophilic
384 veil. Filaments that did not reach the veil were used as controls. Positions of Raman spectra
385 recordings are marked with red arrows (near sediment), positions of laser cuts are marked
386 with green bars. (B) Change in cytochrome redox state in response to laser cutting of the
387 filaments. Bars represent fold change in normalized band intensities at 750 cm^{-1} relative to
388 the intensity before the cut (mean \pm standard deviation). A significant change in redox state is
389 marked by an asterisk. N = 10 filaments (1143 spectra, Shapiro-Wilk test p-value: 0.117, t-
390 test p-value: 0.000517) and N = 5 control filaments (852 spectra, Shapiro-Wilk test p-value:
391 0.84, t-test p-value: 0.879).

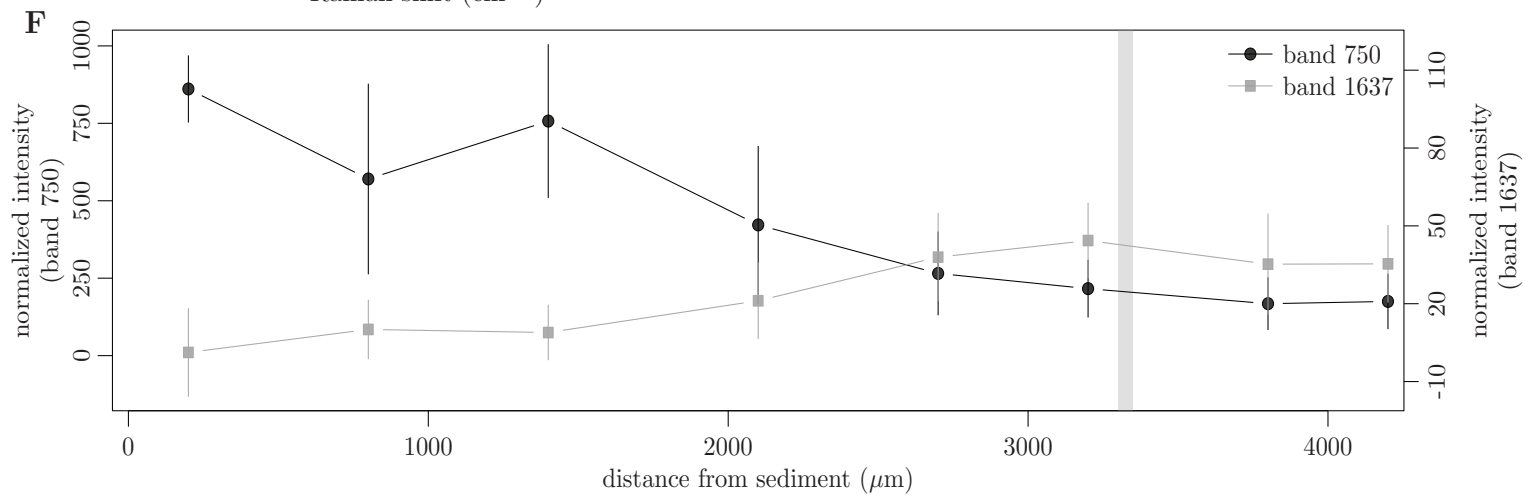
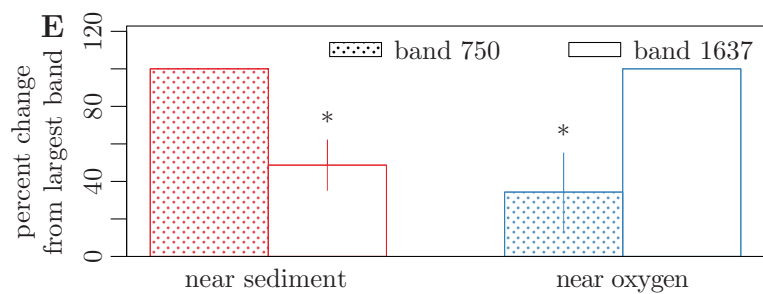
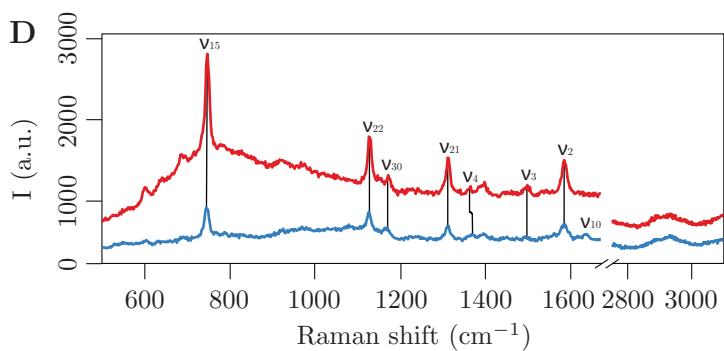
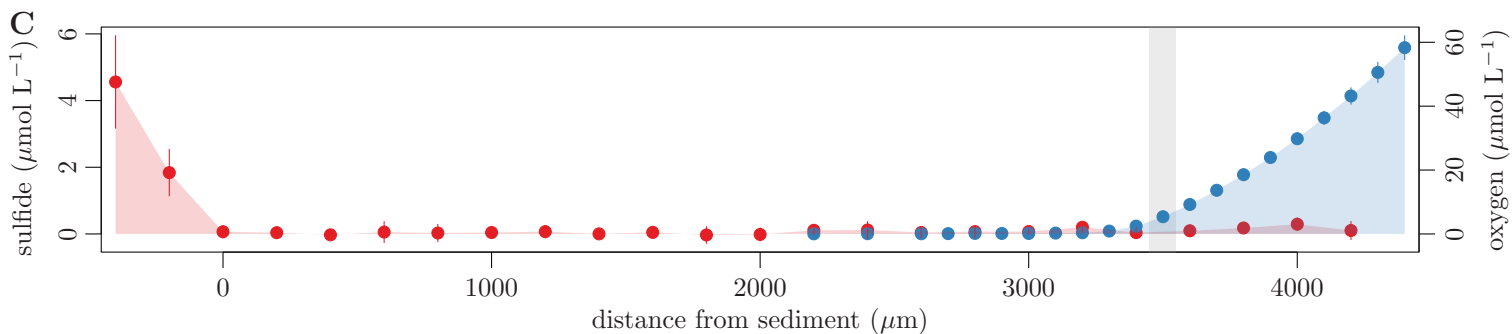
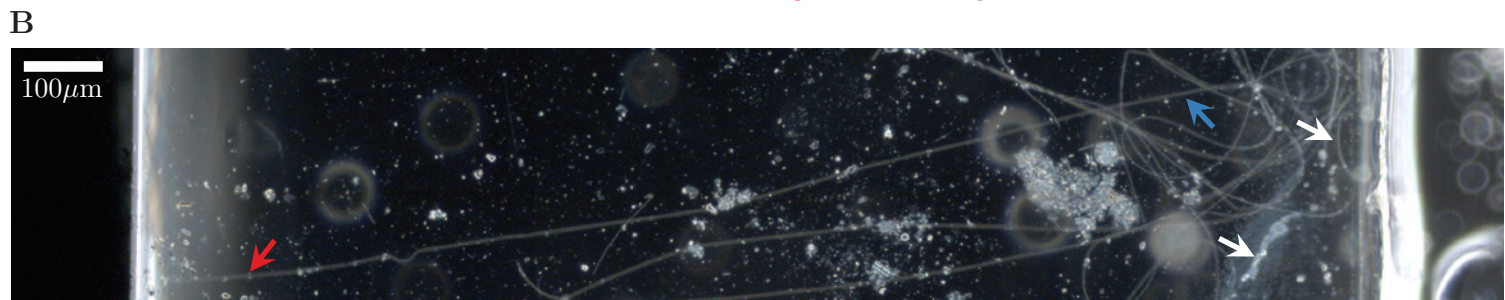
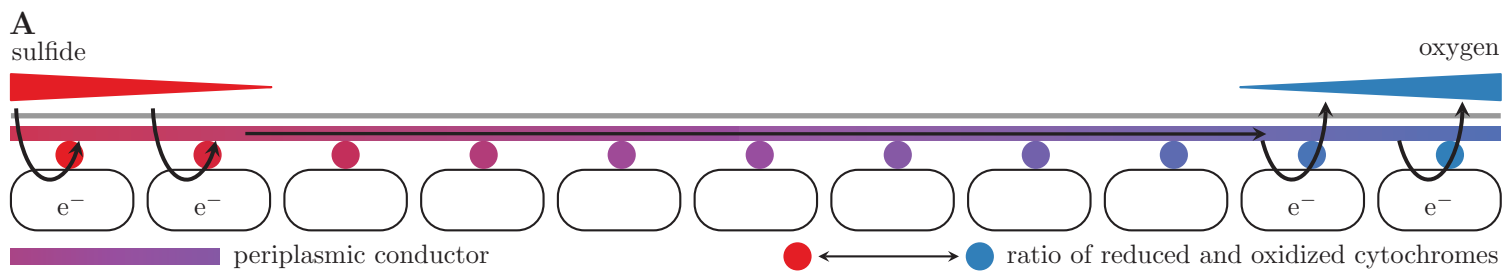

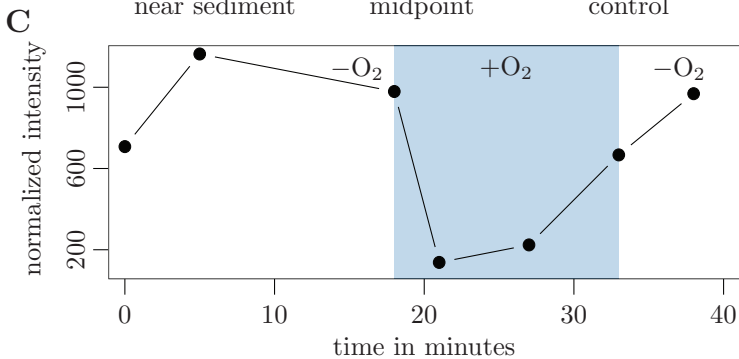
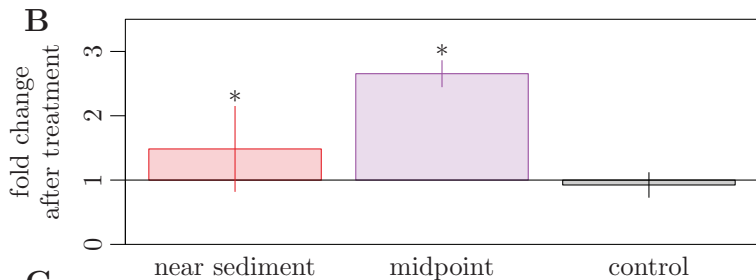
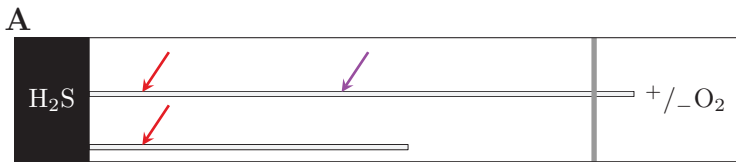

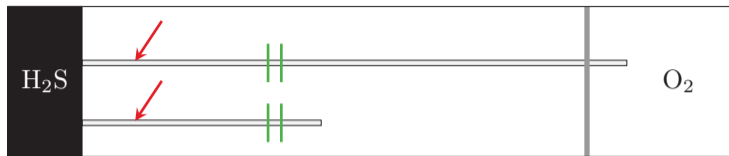
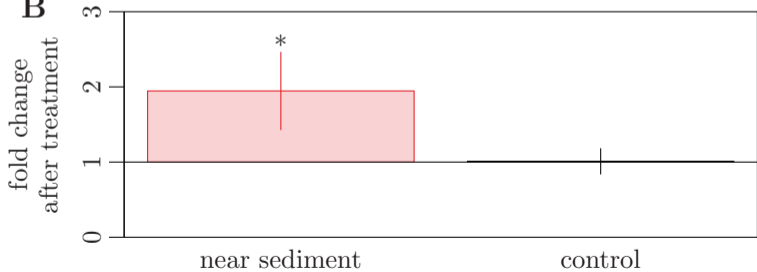
A**B**

Supporting Information Appendix

Jesper T. Bjerg, Henricus T.S. Boschker, Steffen Larsen, David Berry, Markus Schmid, Diego Millo, Paula Tataru, Filip J. R. Meysman, Michael Wagner, Lars Peter Nielsen, and Andreas Schramm. Long distance electron transport in individual cable bacteria.

Detailed Materials and Methods

Sampling and incubation

Surface sediment was collected from three locations containing cable bacteria of the genera *Candidatus* *Electronema* and *Ca. Electrothrix* (1): a freshwater lake at Aarhus University Campus, Denmark (56°16'47"N, 10°20'79"E), a marine salt marsh at Rattekaai, The Netherlands (51°26'21"N, 04°10'11"E), and an intertidal mud flat at Mokbaai, Texel, The Netherlands (53°00'27.1"N, 4°45'05.1"E). Sediments were sieved, homogenized, and incubated at 15°C with either oxygenated overlying water or an air-exposed sediment surface. The development of cable bacteria was monitored by microscopy and their metabolic activity evaluated by O₂, H₂S and pH microsensor measurements (2, 3) as previously described (4). When the sediment showed a clear geochemical fingerprint of electrogenic sulfur oxidation (as determined by O₂, H₂S and pH microsensor profiling) and revealed abundant cable bacteria (as detected by microscopy), sediments were used for transfer to the microscope chamber setups.

Microscope chamber setups

Two microscope chamber setups (A and B, Fig. S1) were used to examine cable bacteria filaments. Both setups mimicked the redox gradient conditions that cable bacteria experience in their natural habitat, with a sulfide source (sediment) on one side, and an oxygen source (air) on the other side. In setup A, two wells (diameter 1-4 mm, separation 5 mm) were drilled into 4 mm-thick glass microscopy slides using a diamond drill. One well was filled with the cable bacteria-enriched sediment, while the other was left open and hence filled with ambient air. Tap water or seawater (depending on the sediment source) was flushed with nitrogen gas and pipetted onto the microscope slide in between the two wells, the wells and interspace were covered by a coverslip (25 x 40 mm), and sealed with Vaseline or silicon grease to prevent evaporation, thus forming a 5 mm wide, 50-100 µm high water layer between sediment and air. Cable bacteria reached out of the sediment and moved across the water zone towards the air-filled well within 24 hours (Movie S1).

In setup B, glass slabs (obtained by cutting of microscope slides) were glued onto a microscope slide, thus creating a trench (10 x 50 mm) in the middle. This trench was filled with the cable bacteria-enriched sediment, a large cover slip was mounted on top, and the slide was flooded with nitrogen gas-flushed water, creating a 5 x 50 mm water-filled interspace between the sediment trench and the edge of the cover slip. The edges of the cover slip were subsequently sealed with nail polish to prevent evaporation but allow oxygen diffusion. As in setup A, cable bacteria reached out of the sediment towards the oxic zone near the edge of the cover slip.

Oxygen and hydrogen sulfide microsensors measurements

Extra-long and thin microelectrodes for O₂ and H₂S were custom-made at Aarhus University, with a tip diameter of less than 50 µm. Microelectrodes were mounted sideways on a motorized micromanipulator, and inserted between the microscope slide and the cover slip of slide setup B. The oxygen concentration was recorded at 100 µm-step resolution, from the edge of the cover slip until the sensor was 2 mm beyond the veil of microaerophilic bacteria. For H₂S, a concentration profile was recorded from the edge of the cover slip all the way into the sediment at 200 µm-step resolution.

Resonance Raman microscopy

Most Raman spectra were recorded on a LabRAM HR Evolution confocal Raman microscope (Horiba, Germany) equipped with a 500 mW 532 nm laser, an Andor EM CCD detector adapted to 500-650 nm emissions, 300 grating with a spectral resolution of 2.8 cm⁻¹, and the pinhole set to 250 µm. Additional spectra were recorded on a Renishaw InVia confocal Raman microscope (Wotton-under-Edge, United Kingdom) equipped with a Leica light microscope with 50X air objective and 532 nm laser. The output of the laser was set between 4 and 10% of maximum power. Raman spectra were recorded along individual filaments of cable bacteria starting from the sediment and moving towards the air-inlet. At each longitudinal position, 2-3 line scans with 10-20 measuring points each were performed across the filament (i.e. perpendicular to its longitudinal axis), with 2.5-20 s exposure time for each measuring point. The ν_{15} (at 750 cm⁻¹) and the ν_{10} vibrational modes (at 1637 cm⁻¹) were used as measure of cytochrome redox state, and data reported for each filament position are means of the quality-filtered and normalized band intensities (see 'Data Analysis' below) at 750 cm⁻¹ and at 1637 cm⁻¹ from multiple line scans (see 'Data Analysis' below).

Manipulation experiments

Two manipulation experiments were performed where electron transport was inhibited and the change in cytochrome redox state was recorded by Raman microscopy. First, oxygen was removed from the oxic end of slide setup A by either filling the air inlet with nitrogen-flushed, oxygen-free water or by flushing it directly with a gentle flow of nitrogen gas. Raman spectra were recorded at approx. 500 μm from the sediment and at the midpoint between the sediment and the start of the oxic zone (as marked by a veil of putative microaerophilic bacteria) every 1-3 min over a period of 15-30 min before and after the manipulation. The first 5 min after removing oxygen were excluded to account for the time it took to fully deplete oxygen at the end of the cable bacteria. Oxygen was re-introduced by stopping the flow of nitrogen gas, and the response in cytochrome redox state was immediately recorded at midpoint only.

Second, a laser microdissection microscope, LMD7000 (Leica, Germany) was used to make two cuts 10 μm apart in the cable bacteria filament, approx. 1000 μm from the sediment. The cut was microscopically inspected to confirm that the filament sections had separated. Raman spectra were recorded at approx. 500 μm from the sediment, directly before and about 5 min after the cut (the time it took to move the chamber between laser microdissection and Raman microscope).

In both experiments, cable bacteria filaments, which were only connected to the sediment but did not reach the oxic zone, were used as controls.

Data analysis

Pre-processing. Raman spectra were preprocessed (5) by background correction with a sensitive non-linear iterative peak-clipping algorithm with optimized parameters (smoothing = true, iteration = 70, window = "15").

Quality filtering. Because cable bacteria filaments are constantly moving, and measuring a cross-section takes > 1 min, it was necessary to use the C-H region of the spectra (2800 to 3000 cm^{-1}) as indicator for a cable bacterium hit. The maximum peak height between 2800 and 3000 cm^{-1} was divided by the median baseline from 2800 to 2850 cm^{-1} . All ratios from an entire filament data set were then plotted as histogram for each filament, and data sets with a bimodal distribution of ratios were discarded, as this indicated that multiple cable bacteria filaments or additional bacteria had been recorded in that data set. Of the remaining data sets, only spectra with a ratio > 3.5 were kept as "high quality spectra", while those with a ratio < 3.5 were discarded as hits outside the cable bacteria. After the filtering, 3430 high quality

spectra remained of a total of 8729 recorded spectra.

Normalization. For the line scan measurements along cable bacteria and the two manipulation experiments, the band intensity at 750 cm^{-1} was normalized by subtracting the median of the baseline from 735 to 740 cm^{-1} and from 760 to 765 cm^{-1} , to enable comparison within an individual cable bacterium. A similar approach was used for normalization of all other bands (1130 , 1315 , 1497 , 1588 , and 1637 cm^{-1}). Means were calculated for each individual, normalized line scan, and subsequently the mean for each position or treatment was calculated from these means. Standard deviations were calculated from all individual data points for a given position.

In the two manipulation experiments, where comparison between different filaments was necessary, the band intensity at 750 cm^{-1} before the manipulation were normalized to 1, and any response to the manipulation is given as fold-change relative to that value.

Statistical Analysis

All data for which statistical analysis was performed were first tested for deviation from a normal distribution using a Shapiro-Wilk test of normality.

The normalized intensity change between the reduced and the oxidized filament ends was tested for being greater than 0 using a one-sided t-test. The observed change after oxygen and laser cutting manipulations in the normalized intensity was tested for being different than zero using a two-sided t-test (for normal data) or Wilcoxon sign test (for non-normal data).

All calculations for data and statistical analysis were performed using the statistical software program R (6).

Quantifying the voltage drop along individual cable bacteria

The recorded gradients in cytochrome redox status of single filaments through the suboxic zone allow for calculation of the voltage gradient, assuming that the cytochromes are in equilibrium with the electron conductor in this zone. The local cytochrome redox potential is determined by the Nernst equation for single electron transfer:

$$E = E^0 - \frac{RT}{F} \ln \left[\frac{[Red]}{[Ox]} \right] \quad (\text{Equation 1})$$

Where E^0 is the midpotential, Red and Ox the numbers of reduced and oxidized cytochromes, and R, T, and F denote the gas constant, the absolute temperature, and the Faraday constant,

respectively. The voltage difference between two sites in the suboxic zone, near sediment (a) and near the oxic zone (b), is then

$$E = E^b - E^a = \left(E^0 - \frac{RT}{F} \ln \frac{[Red]^b}{[Ox]^b} \right) - \left(E^0 - \frac{RT}{F} \ln \frac{[Red]^a}{[Ox]^a} \right) \quad (\text{Equation 2})$$

This condenses into

$$E = \frac{RT}{F} \ln \left(\frac{\frac{[Red]^a}{[Red]^b}}{\frac{[Ox]^a}{[Ox]^b}} \right) \quad (\text{Equation 3})$$

Assuming that

$$\frac{[Red]^a}{[Red]^b} = \frac{[band\ 750]^a}{[band\ 750]^b} \quad (\text{Equation 4})$$

and

$$\frac{[Ox]^a}{[Ox]^b} = \frac{[band\ 1637]^a}{[band\ 1637]^b} \quad (\text{Equation 5})$$

the voltage difference can be calculated as

$$E = \frac{RT}{F} \ln \left(\frac{\frac{[band\ 750]^a}{[band\ 750]^b}}{\frac{[band\ 1637]^a}{[band\ 1637]^b}} \right) \quad (\text{Equation 6})$$

The same equation holds when band 750 is replaced with any of the other reduction bands (1130, 1315, 1497, and 1588, cm^{-1}). Therefore, for the final calculation, we apply the ratio of all reduction bands for every filament (Table S1). For the analyzed 2.1-4.3 mm long suboxic segments of 6 large cable bacteria filaments (Rattekaai, NL), the average voltage difference, normalized to the length of the suboxic zone, was $14.6 \text{ mV mm}^{-1} \pm 4.1 \text{ (SD)}$.

This result was confirmed by another measure of $[Ox]^a/[Ox]^b$ than the relatively uncertain $1637^a/1637^b$ ratio (Equation 5): The increase in band intensities near the sulfidic zone after laser-cutting (Figure 3) was assumed to represent maximum electron saturation of the

cytochromes, and thus represents the situation were all cytochromes are reduced. Therefore [Ox], being the unsaturated cytochromes, can be expressed as

$$[Ox] = [Red]^{max} - [Red] \quad (\text{Equation 7})$$

where $[Red]^{max}$ represents the total concentration of cytochromes.

Introducing this in Equation 4 and 5 leads to the solution

$$\frac{[Ox]^a}{[Ox]^b} = \frac{[band\ 750]^{max} - [band\ 750]^a}{[band\ 750]^{max} - [band\ 750]^b} \quad (\text{Equation 8})$$

As before the band 750 can be replaced with 1130, 1315, 1497, and 1588 cm^{-1} bands. For the 10 laser-cut Rattekaai cable bacteria filaments (Figure 3), the ratio Ox^a/Ox^b became 0.62 ± 0.04 SD (± 0.08 SD with Red^{max} estimate), i.e. not different from the $1637^a/1637^b$ ratio (0.49 ± 0.16 SD); see Table S1 for data and calculations. Using this value for the above calculation, and normalizing for length, the voltage gradients were $12.3\ \text{mV}\ \text{mm}^{-1} \pm 3.8$ (SD).

SI Figures

Figure S1.

(A) Microscope setup used for gradients and oxygen manipulations. Top, thick microscope slide with two wells (light gray); red bar shows the 5 mm interspace between wells. Bottom, filled slide setup with sediment in one well (dark gray), from which cable bacteria reach towards the other well (light gray, air inlet). Availability of oxygen can be manipulated at the open air inlet (marked by an arrow). (B) Microscope slide setup used for gradients and laser cuts. Top, microscope slide with long trench in the center; red bar shows the 5 mm space from trench to edge of slide. Bottom, filled slide setup with sediment (dark gray) in the trench, from which cable bacteria reach out towards the edge of the slide, where oxygen is available.

Figure S2. Raman spectra from a $>4 \mu\text{m}$ thick individual cable bacterium filament from a marine salt marsh (Rattekai, NL) near sediment (red) and near oxygen (blue). An enlargement of the area between 1330 cm^{-1} and 1660 cm^{-1} of the same spectrum displayed in Figure 1D is shown.

Figure S3. (A) Raman spectra from a thin individual cable bacterium filament from freshwater sediment (Aarhus, DK) near sediment (red) and near oxygen (blue). (B) Raman spectra from an individual cable bacterium filament from intertidal mud flat (Mokbaai, Texel, NL) near sediment (red) and near oxygen (blue).

Figure S4. Cytochrome redox gradient along individual cable bacteria filaments reaching from sediment towards oxygen. The displayed values (mean \pm standard deviation; $N = 1\text{-}35$ spectra per position) are normalized band intensities at 750 cm^{-1} (black dots) and 1637 cm^{-1} (grey squares). (A-D) Cable bacteria from freshwater sediment (Aarhus, DK). (E-H) Cable bacteria from intertidal mud flat (Mokbaai, Texel, NL). (I-O) Cable bacteria from marine salt marsh (Rattekaai, Texel, NL).

Figure S5. Cytochrome redox state (mean \pm standard deviation of the normalized band 750 cm^{-1} intensities) along control cable bacteria. Red, 4 filaments in fully oxic water (98 spectra); blue, 3 filaments, which did not reach the oxic zone (301 spectra).

SI Material as additional files

Movie S1. Time-lapse movie of cable bacteria emerging from sediment (left side) in the microscope chamber setup and gliding towards oxygen (to the far right). 16 min were compressed to 17 sec. Scale bar, 100 μm .

Table S1. Data and calculations to quantify the voltage drop over the length of individual cable bacteria filaments.

SI References

1. Trojan D, et al. (2016) A taxonomic framework for cable bacteria and proposal of the candidate genera *Electrothrix* and *Electronema*. *Syst Appl Microbiol* 39(5):297–306.
2. Revsbech NPN, Jørgensen BBB (1986) Microelectrodes: their use in microbial ecology. *Adv Microb Ecol* 9:293–352.
3. Jeroschewski P, Steuckart C, Kuhl M (1996) An Amperometric Microsensor for the Determination of H_2S in Aquatic Environments. *Anal Chem* 68(24):4351–4357.
4. Pfeffer C, et al. (2012) Filamentous bacteria transport electrons over centimetre distances. *Nature* 491(V):10–13.
5. Bocklitz T, Walter A, Hartmann K, Rösch P, Popp J (2011) How to pre-process Raman spectra for reliable and stable models? *Anal Chim Acta* 704(1–2):47–56.
6. R Core team (2016) R: A Language and Environment for Statistical Computing. Available at: <https://www.r-project.org/>.

A

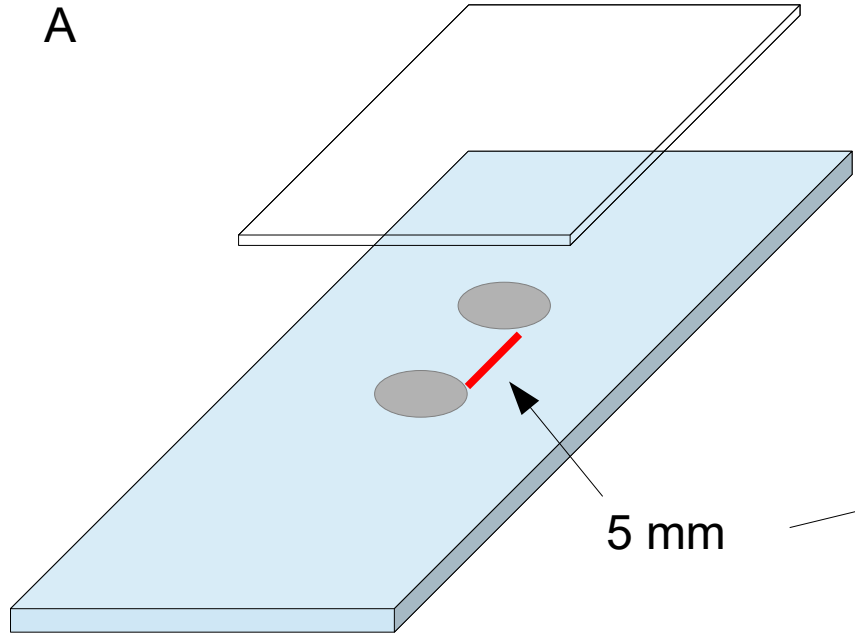

B

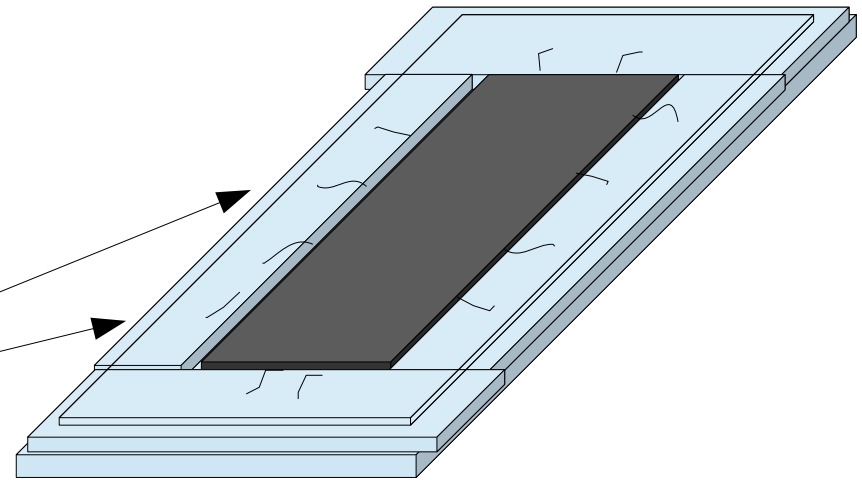
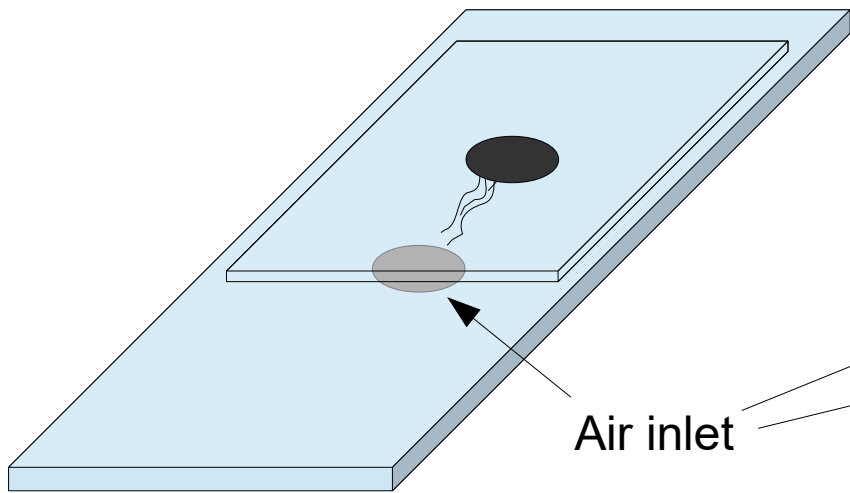
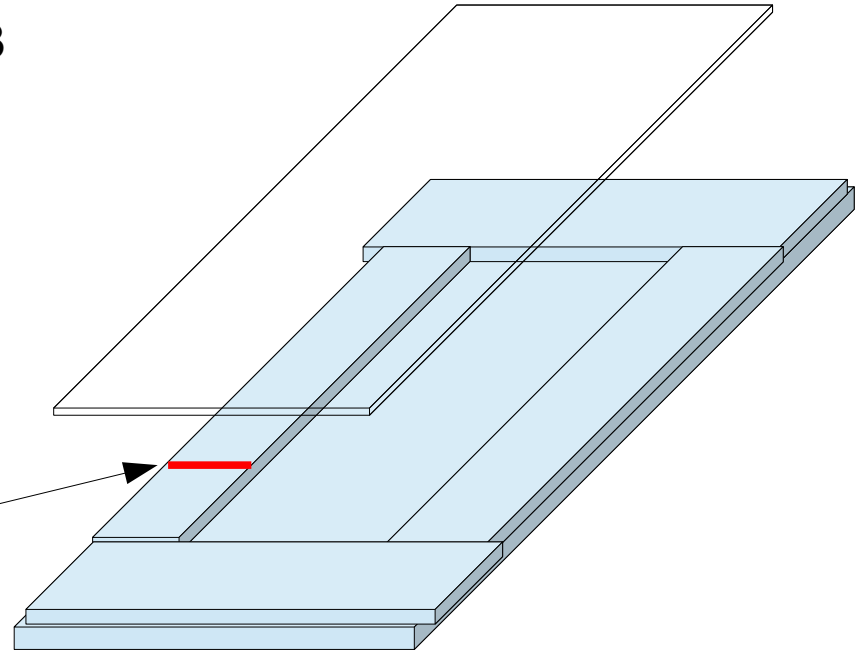

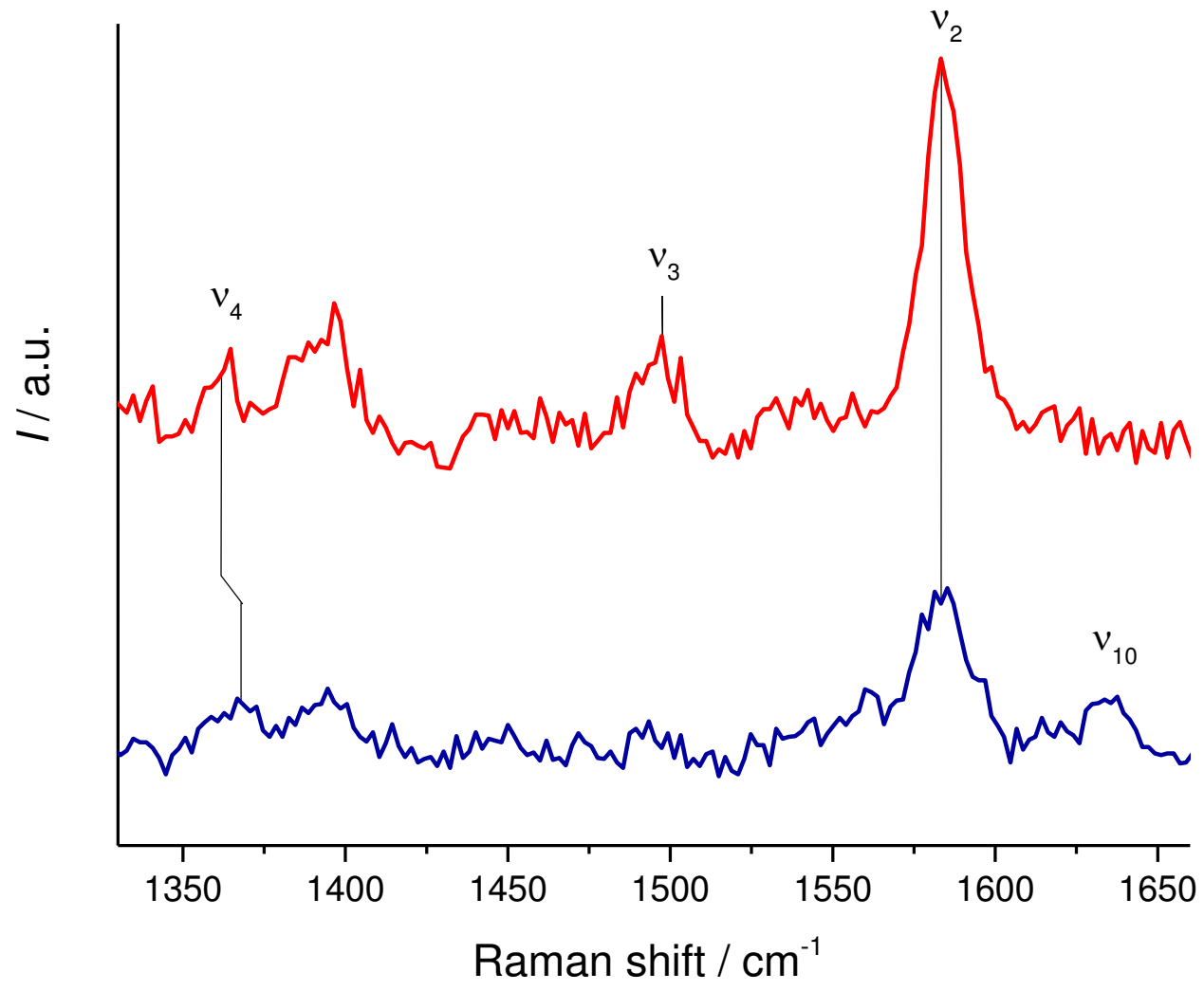

A

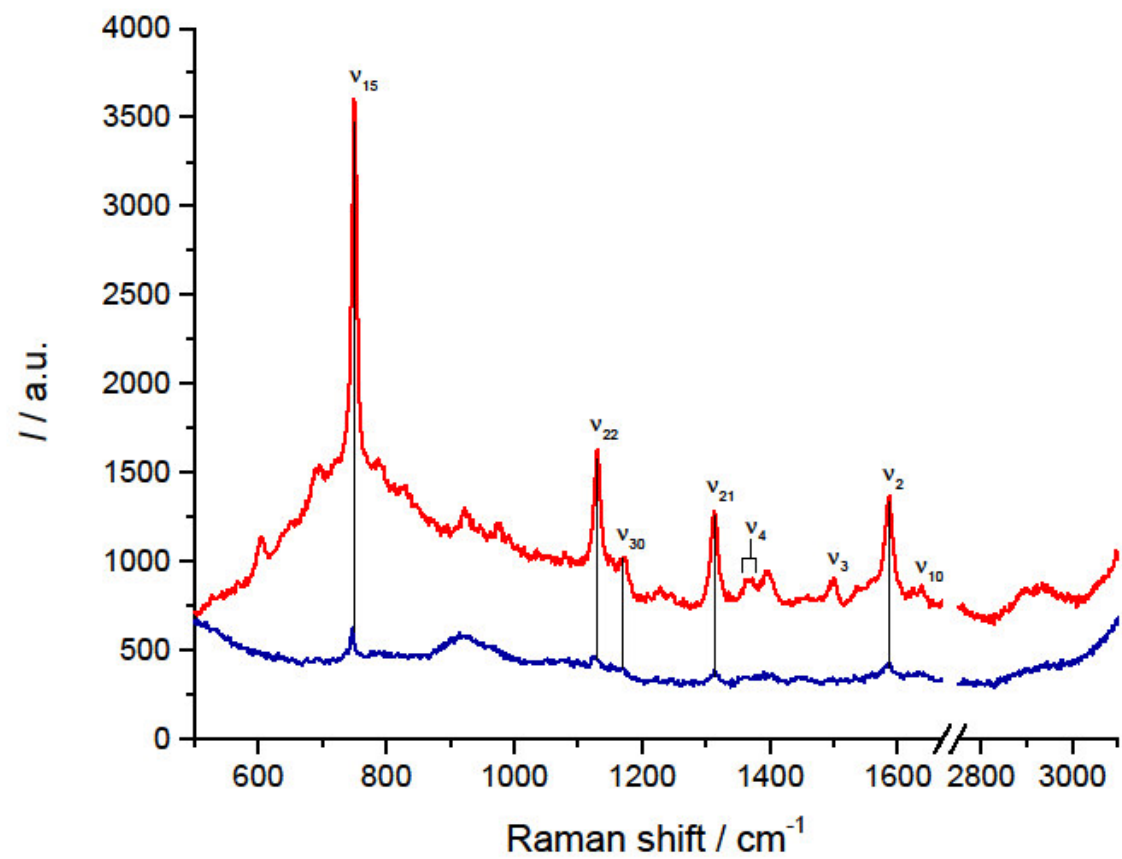

B

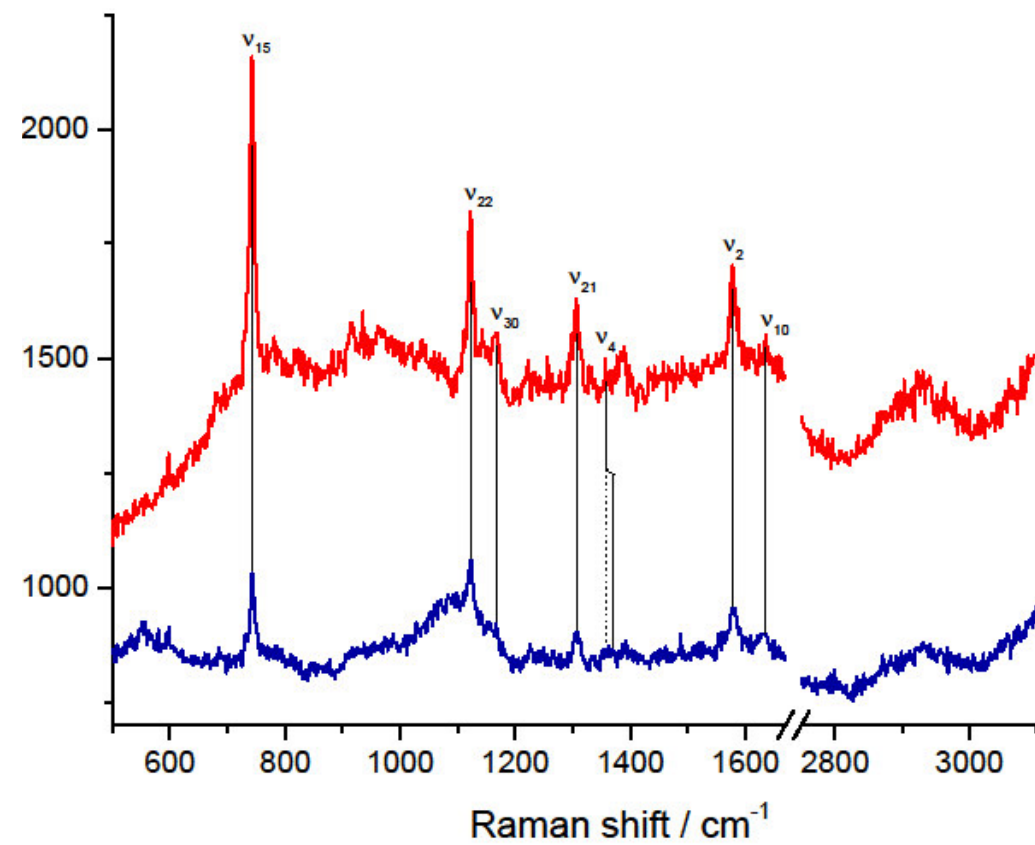

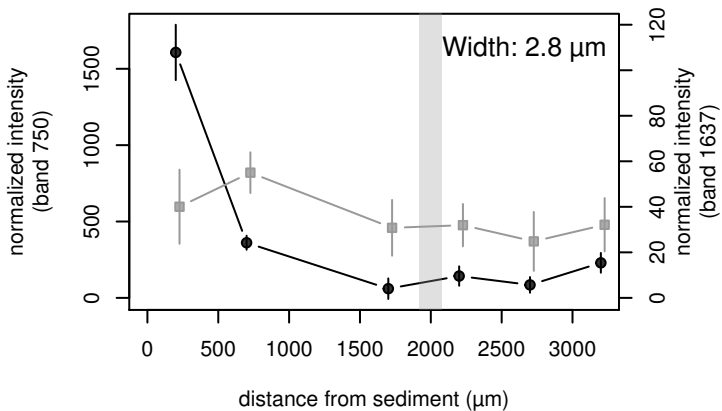
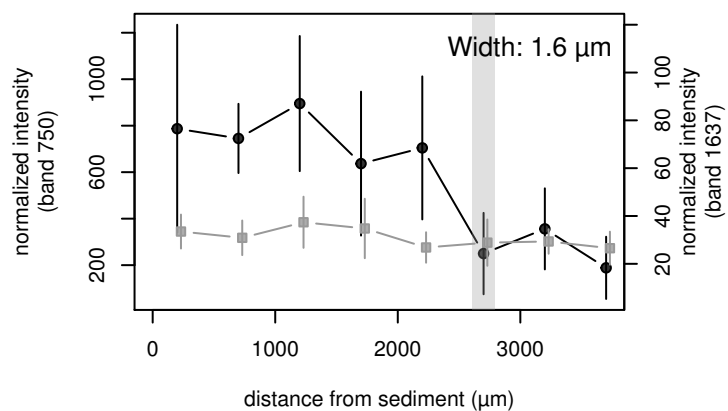
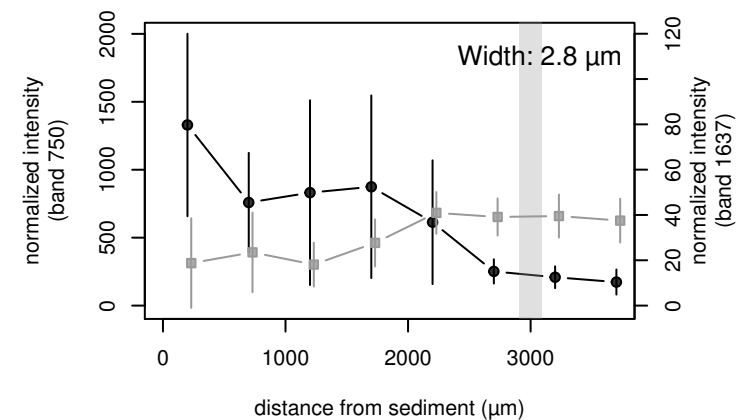
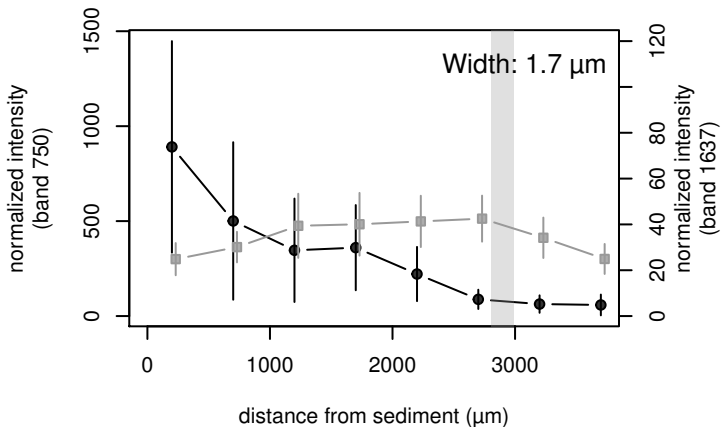
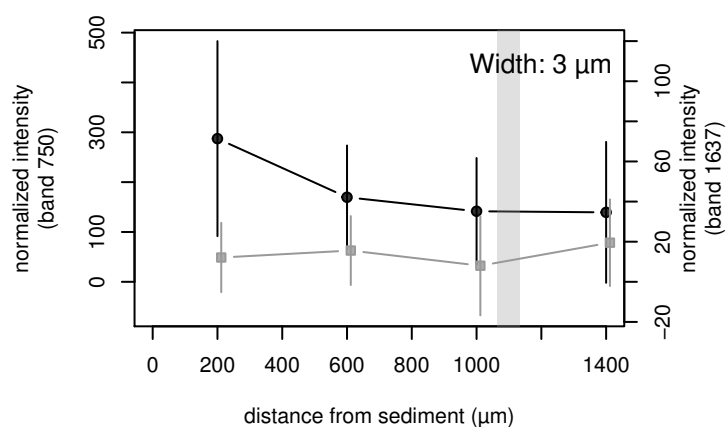
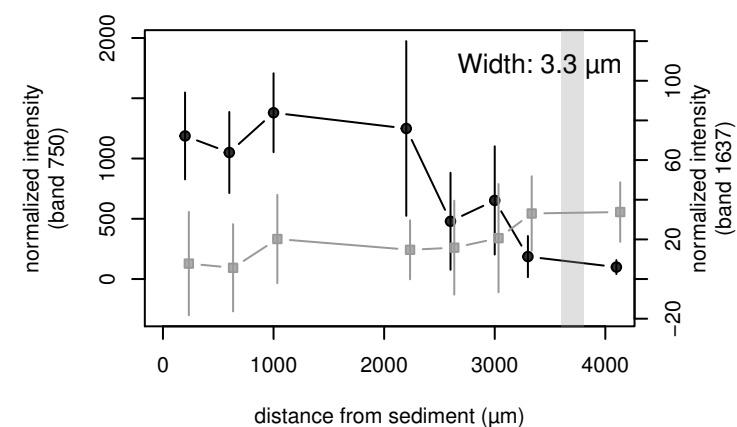
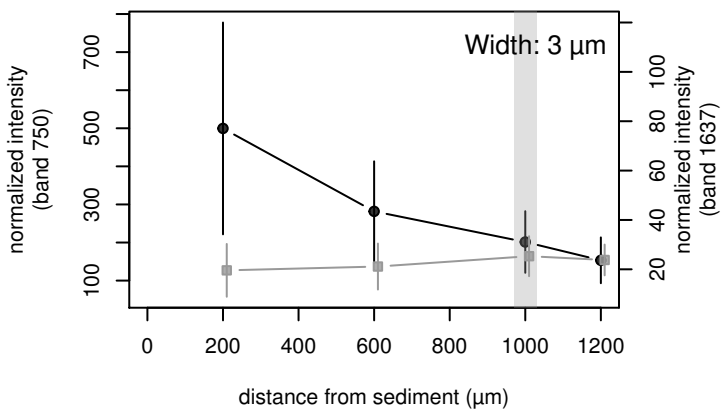
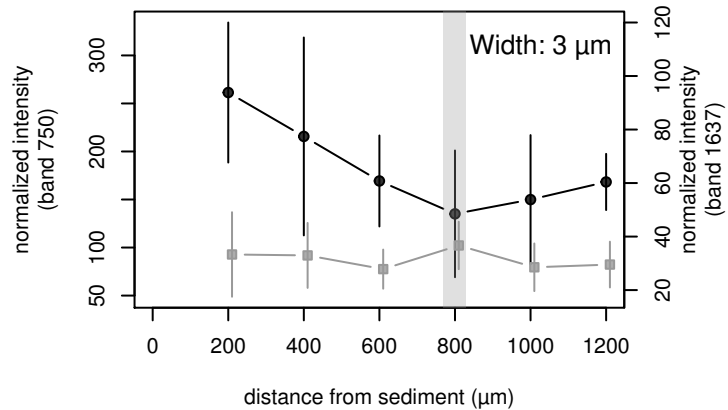
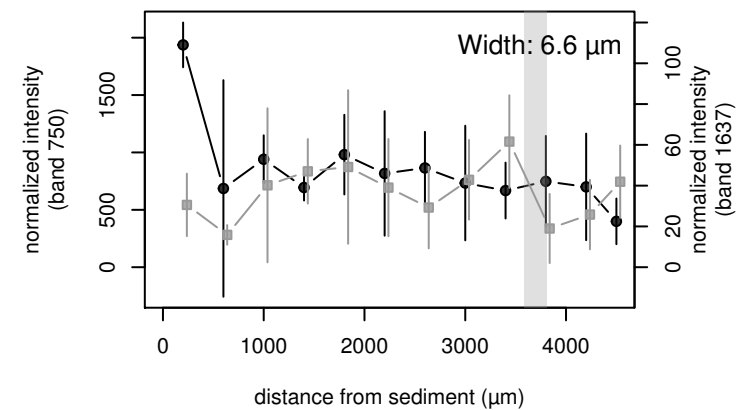
A**B****C****D****E****F****G****H****I**

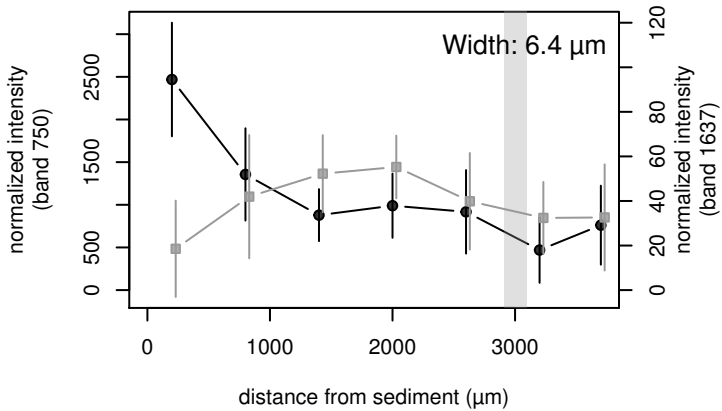
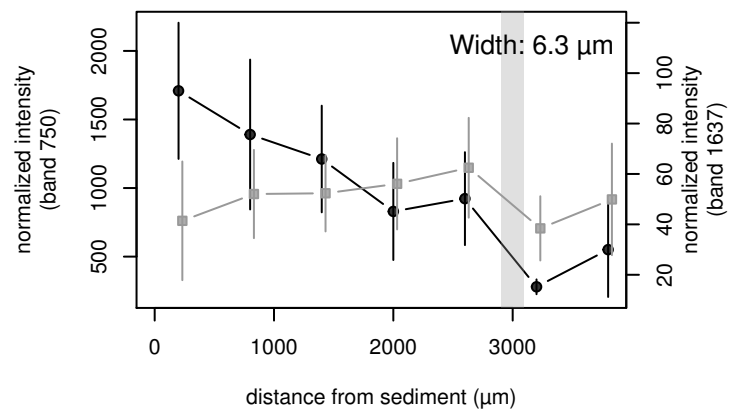
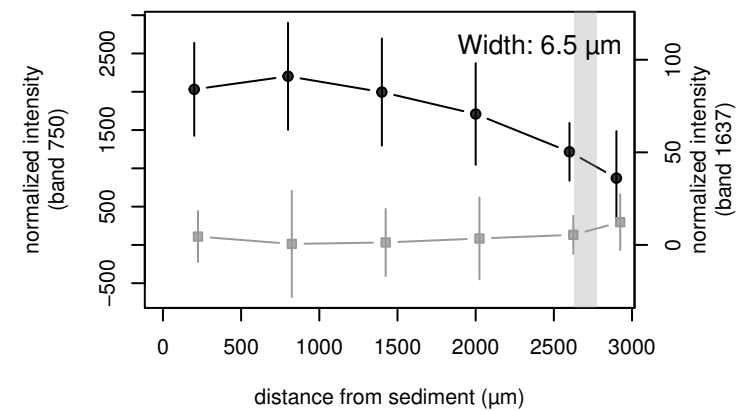
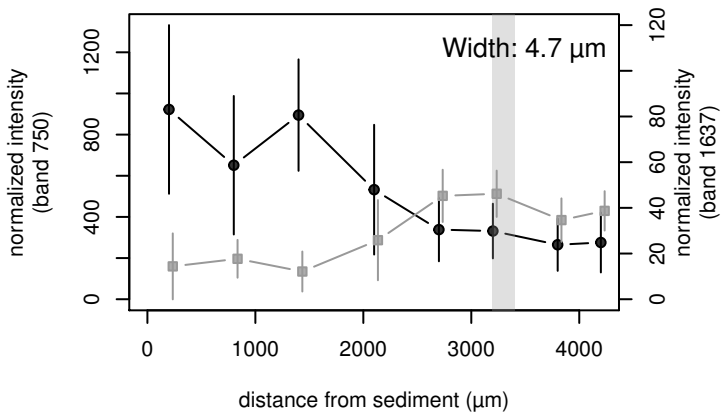
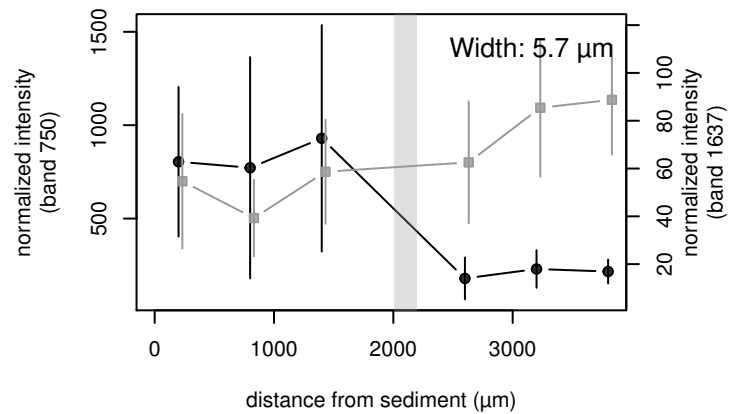
J**K****L****M****N****O**