

Climate Proof Cities Eindrapport

Schrijvers, Patrick; van der Hoeven, Franklin; Wandl, Alexander; Hensen, J; van den Dobbelseen, Andy; Kleerekoper, Laura; Echevarria Icaza, L; Roders, Martin; van Hove, Bert; Blocken, Bert

Publication date

2014

Document Version

Final published version

Citation (APA)

Schrijvers, P., van der Hoeven, F., Wandl, A., Hensen, J., van den Dobbelseen, A., Kleerekoper, L., Echevarria Icaza, L., Roders, M., van Hove, B., Blocken, B., Spit, T., Dikmans, M., Bosch, P. (Ed.), Rovers, V. (Ed.), & Albers, R. (Ed.) (2014). *Climate Proof Cities Eindrapport*.

Important note

To cite this publication, please use the final published version (if applicable).
Please check the document version above.

Copyright

Other than for strictly personal use, it is not permitted to download, forward or distribute the text or part of it, without the consent of the author(s) and/or copyright holder(s), unless the work is under an open content license such as Creative Commons.

Takedown policy

Please contact us and provide details if you believe this document breaches copyrights.
We will remove access to the work immediately and investigate your claim.

Climate Proof Cities

Final report





Final report Climate Proof Cities 2010-2014

Date: October 2014

Climate Proof Cities consortium¹

Final editing: Vera Rovers, Peter Bosch, Ronald Albers (TNO)

Translation: Hannah Kousbroek Text & Translation, Amsterdam



KfC report nr: 129/2014

Climate Proof Cities was conducted as part of the Dutch research programme 'Knowledge for Climate', co-financed by the Dutch ministry of Infrastructure and Environment.

¹ <http://www.knowledgeforclimate.nl/climateproofcities>



Colophon

Many researchers (see Appendix A) contributed to this report (and the research programme). The editing of the content-based chapters was done by the work package leaders:

- Chapter 1 Bert van Hove (Wageningen University)
- Chapter 2 Bert Blocken (Eindhoven University of Technology)
- Chapter 3 Andy van den Dobbelsteen (Delft University of Technology)
- Chapter 4 Tejo Spit, Marjolein Dikmans (Utrecht University)
- Chapter 5 Peter Bosch (TNO)

The following people are responsible for the content of the chapters (texts and research results):

Hoofdstuk	Naam	Instituut
1	Bert van Hove	Wageningen University
	Cor Jacobs	WUR-Alterra
	Bert Heusinkveld	Wageningen University
	Oscar Hartogensis	Wageningen University
	Reinder Ronda	Wageningen University
	Reinder Brolsma	Deltares
	Lisette Klok	TNO
	Patrick Schrijvers	TU Delft
	Ronald Hutjes	WUR-Alterra
2	Bert Blocken	TU Eindhoven
	Hein Daanen	TNO
	Twan van Hooff	TU Eindhoven
	Karin Stone	Deltares
	Frank van der Hoeven	TU Delft
	Alexander Wandl	TU Delft
	Jan Hensen	TU Delft
	Frans van de Ven	Deltares
	William Veerbeek	Unesco-IHE
3	Andy van den Dobbelsteen	TU Delft
	Hamid Montazeri	TU Eindhoven
	Twan van Hooff	TU Eindhoven
	Harry Timmermans	TU Eindhoven
	Wiebke Klemm	Wageningen University
	Toine Vergroesen	Deltares
	Reinder Brolsma	Deltares
	Laura Kleerekoper	TU Delft
	Leyre Echevarria Icaza	TU Delft
	Jan Hofman	KWR
	Chris Zevenbergen	Unesco-IHE
Herbert ter Maat	WUR-Alterra	
4	Tejo Spit	Universiteit Utrecht
	Caroline Uittenbroek	Universiteit van Amsterdam/Universiteit Utrecht
	Anita Kokx †	Universiteit Utrecht
	Liz Root	Radboud Universiteit
	Beitske Boonstra	Universiteit Utrecht/TNO
	Martin Roders	TU Delft
	Marjolein Dikmans	Universiteit Utrecht
5	Peter Bosch	TNO
	Annemarie Groot	Wageningen University
	Cor Jacobs	Wageningen University



Policy summary

All cities in the Netherlands, large and small, are vulnerable to the effects of climate change. The degree of vulnerability varies considerably within urban areas. This means that making cities more climate proof can be done most efficiently by taking many relatively small and local measures. Many of these can be carried out simultaneously with major repairs or renovations. This does require collaboration with many and various parties.

These are the most important findings of the Climate Proof Cities (CPC) research programme. This programme has yielded much insight in making Dutch cities climate proof, with a focus on heat stress and flooding due to heavy rainfall. The programme was carried out by a consortium of ten universities and knowledge institutes that worked together for four years with municipalities, water boards and the national government to provide answers to knowledge questions from practice.

The urban climate is changing

Climate change leads to more heat waves, more frequent heavy rainfall events, and more periods of drought. If cities do not prepare for this, it will influence people's health, quality of life in city districts, comfort in houses and buildings, and productivity, leading to economic problems.

The high percentage of paved area in the city, combined with the increasing chances of heavy rainfall, can lead to greater material and financial damage through traffic disruptions, problems with infrastructure and the expense of calling in emergency services. The thresholds for flooding in the urban environment have stayed the same or even decreased in recent years, and flooding is a recurring problem in some districts. More summery and tropical days are also expected in the future. Without an explosive increase in air conditioning in buildings, this will lead to much higher temperatures in a vast proportion of Dutch housing. Heat stress can lead to illness and increased mortality among sensitive sections of the population, such as the elderly and the chronically ill, but also to decreased productivity and sleeping disorders.

Both large and small cities are vulnerable

During heatwaves, it is warmer in every city in the Netherlands, large or small, than it is in the surrounding area. This heat island effect is clearly noticeable and can reach a difference of more than 7 °C, especially in the evening. Because of climate change, the number of days with heat stress in the city can increase substantially. Heavy rainfall can also hit any city.

Vulnerability varies greatly within the city

A striking conclusion of the CPC research is that within the urban area, there is great spatial variation in vulnerability, depending on the properties of the district and the building and the distribution of sensitive persons and objects. Exposure to heat and flooding, for instance, is mainly determined by the amount of paved area and the density of buildings in an area. Overheating in buildings strongly depends on the presence of sun blinds and degree of insulation. Information about exposure, combined with the locations of sensitive groups (for instance, the elderly) and of objects (such as switch boxes and houses with cellars), forms the basis for identifying areas that need attention.

Adapting to climate change is a matter of the combined effects of relatively small, local measures

Because vulnerability to the effects of the climate is determined locally, the choice of measures is also dependent on the local context. The input of generic measures for a whole city is less effective. A wide variety of adjustment measures exists, ranging from influencing the urban climate or the urban water system (for instance, collecting and storing rain water, creating a cooler layout of streets and squares), adapting buildings and infrastructure (e.g. installing doorsteps), changing human behavior and increasing



acceptance of discomfort and preventing damage when an extreme event does take place (such as care for the elderly). Various adjustment measures contribute to easing problems with flooding, heat and drought at the same time, and an integral approach to these three problems is preferred. Rain water from wetter periods could for instance be stored underground and used to combat dryness, and, through evaporation, heat. Many measures have a positive effect on other policy themes, such as migration and biodiversity, and/or contribute to the improvement of the general living conditions in buildings and in public spaces. The CPC research has provided a number of new and sometimes startling insights about the effectivity of measures:

- Traditional green roofs, without restricted discharge measures, are hardly effective for both the indoor climate, the outdoor climate and the temporary storage of extreme rainfall.
- The cooling effect of the surface water in the city is not unequivocal: bodies of water can even contribute to the warming of the city; large bodies of water, depending on their orientation in terms of the direction of the wind, can have a cooling effect.
- Insulating buildings without paying attention to protection against sunshine can lead to more heat problems in hot summers.

Planting deciduous trees with large crowns, and more generally adding green elements in private and public spaces leads to better thermal comfort and lessens problems caused by extreme rainfall.

Many measures can easily be integrated into other policy, but require interdisciplinary collaboration

Many measures require collaboration between different parties: the departments within a municipality, water boards, home owners, sometimes businesses. However, integration of climate adaptation in other sectors is not self-evident. Institutional entrepreneurs can help to connect different goals and ensure widely supported solutions for urban development and realising cost savings simultaneously. Making cities climate proof should be an integral part of decision-making for all sorts of parties interested in the urban environment. Only when authorities, citizens and private parties realise a climate proof city requires combined effort, will there be a basis for success.

Now is the time to define the areas for special attention and to develop a strategy, and in the execution, join in with larger renovation and restructuring projects

The climate is changing slowly but steadily. Because investments that are currently being made in the urban environment, for instance in renovations or new construction projects, will result in buildings and infrastructures that will still exist in roughly fifty years, it is important to determine already whether adjustments to a future climate can be made. More and more studies, both international and national, show that the costs of adjustments made now are limited compared to the damage that can be caused in one day due to extreme weather conditions.

Because becoming climate proof requires a long-term plan, it is important to clarify already which measures should be applied in which areas. In policy terms this is known as a climate stress test and a climate adaptation strategy. The execution can subsequently take place in phases in the next decennia by joining in with regular maintenance and renovations, so that costs are limited. Identifying these windows of opportunity for planning and executing adaptation measures gives a time plan for implementation. Missing opportunities for including adaptation measures during large transformations can lead to greater costs later.



Inhoudsopgave

Policy summary.....	3
Introduction	8
1 How does the local climate work in Dutch cities, and how does urban design influence the local climate?.....	11
Summary	11
1.1 Introduction	12
1.2 The interaction between the city and the countryside	17
1.3 The influence of anthropogenic heat production.....	19
1.4 Evaporation in the city	20
1.5 Climate variations within the city	23
1.5.1 The variation in temperature.....	23
1.5.2 The influence of neighbourhood characteristics on temperature.....	24
1.5.3 The variation in thermal comfort.....	30
1.5.4 The influence of neighbourhood characteristics on thermal comfort.....	31
Conclusions	32
2 How vulnerable are Dutch cities to climate change?.....	34
Summary	34
2.1 Introduction	35
2.2 Heat stress	37
2.2.1 Sensitivity.....	37
2.2.2 the role of buildings	39
2.2.3 Vulnerability maps for heat	41
2.3 Pluvial flooding.....	44
2.3.1 Vulnerability to damage and tresholds.....	44
2.3.2 Vulnerability maps for flooding	46
2.4 Tools for policy makers	49
2.4.1 3Di area model for flooding.....	49
2.4.2 Heat/Drought Stress Model	50
2.5 Conclusion.....	51



3	Which measures can be taken to better adapt cities to climate change?	52
	Summary	52
3.1	Introduction	53
3.1.1	Categorising climate adaptation	53
3.1.2	Description of the measures	54
3.2	Buildings	56
3.2.1	Goal	56
3.2.2	Measures	56
3.2.3	Design principles	62
3.3	From street to neighbourhood	64
3.3.1	Goal	64
3.3.2	Measures	64
3.3.3	Design principles	72
3.4	City and region	78
3.4.1	Goal	78
3.4.2	Measures	78
3.4.3	Design principles	83
3.5	The Linking Method	84
3.6	Tools for adaption planning	86
3.6.1	Use of calculation models for flooding	87
3.6.2	3Di area model for flooding	88
3.6.3	Climate Adaptation App	89
3.6.4	Adaptation Support Tool	89
3.6.5	Heat and Drought Stress Model	89
3.6.6	Health scan	90
4	Urban governance: the implementation of climate adaptation in urban development	91
	Summary	91
4.1	Introduction	92
4.2	Municipalities	92
4.2.1	Organisation	92
4.2.2	Financial instruments: the use of TIFs	95
4.3	Housing associations	97
4.4	Citizens	98
4.5	Conclusions	100



5 Integration in Bergpolder Zuid	101
Summary	101
5.1 Introduction	101
5.2 Integration within CPC	101
5.3 Bergpolder Zuid.....	102
5.4 The stakeholders' desires for the study.....	102
5.5 The research results.....	103
5.6 Lessons on integration.....	108
5.7 Conclusions and related research questions	110
ANNEXES	111
Annex A Researchers CPC	112
Annex B bibliography.....	115
Bijlage C Thermal comfort and indicators.....	126
Bijlage D Heat exchange between the urban environment and the atmosphere	128



Introduction

The climate is changing

Worldwide climate change leads to more summery and tropical days and more days with extreme rainfall in summer, among other things. The KNMI'14 climate scenarios² indicate what climate change in the Netherlands most likely entails (KNMI, 2014). According to these scenarios, in 2050, the average temperature in summer will be 1.0 to 2.3 °C higher than in the reference period of 1981-2010. The number of summery days (with a max temperature of ≥ 25 °C) will increase with 5 to 15 days in view of an average of 21 now. Heat waves will occur more often. Depending on the scenario it will become dryer or wetter in summer. The most extreme rainfall events in summer, however, are influenced by local processes and cannot be predicted with climate models. In all scenarios, warming leads to more water vapour in the air, which increases the chances of heavy rainfall.

Cities are vulnerable

The concentration of population and economic capital makes cities important centres for a well-functioning economy and society. At the same time, it makes cities vulnerable to the effects of climate change. In the Netherlands, 40% of the population lives in the 36 biggest cities and this number is growing. These cities generate three quarters of the gross national product (G32, 2011). Extreme weather conditions, therefore, such as heat waves and extreme rainfall, threaten a large number of people, vital infrastructures and value chains. The combination of urbanization and climate change demands that cities take a proactive approach towards increasing their resilience in order to guarantee good quality of life for citizens and to maintain their competitive position.

Cities are dynamic systems that are continuously in development. Adapting to climate change is only one aspect of this development. Making cities climate proof must therefore be an integral part of decision-making on the part of all stakeholders in the urban environment.

Action for climate proofing is urgent

The climate is changing slowly but steadily. Because investments that are currently being made in the urban environment, for instance in renovations or new construction projects, will result in buildings and infrastructures that will still exist in roughly fifty years, it is important to determine already whether adjustments to a future climate can be made (EEA 2010). In addition, more and more studies, both international (Isoard, 2011; Stern, 2006; Watkiss, 2011) and national (Court of Audit, 2012; PBL, 2011), show that, when compared to the possible damage caused by climate change in the future, the costs of adjustments made now are low and the advantages are significant. In a number of cases, adjustments within the built environment are already necessary now in order to decrease inconvenience and damage caused by current extreme weather conditions.

Climate Proof Cities

In order to adapt existing structures to a changing climate, it is necessary to make decisions based on well-founded knowledge and to take an integral approach. From 2010 to 2014, the Climate Proof Cities (CPC) research programme devoted itself to generating this knowledge for climate proof urban policy.

² Voor onderzoek binnen CPC is nog vooral gebruik gemaakt van de KNMI'06 scenario's.



At the beginning of the programme, municipalities and water boards outlined the 5 most important knowledge questions that formed the point of departure for 5 work packages in CPC (**Figure 0.1**):

1. How does the local climate work in Dutch cities?
2. How vulnerable are Dutch cities to the effects of climate change?
3. Which measures can be taken to better adapt cities to a future climate?
4. How can these measures be implemented in urban areas?
5. What is the final cost-benefit balance of the adaptation measures?

These five questions also form the skeleton of this report. Each chapter answers one of the questions. The fifth and final chapter dwells especially on the integration of knowledge about adaptation, both within science and between science and policy.

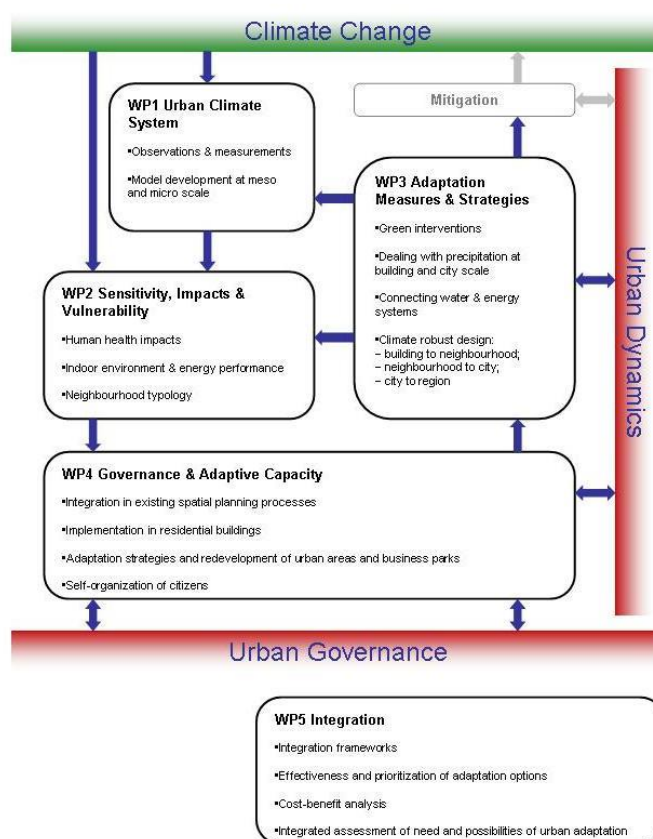

Figure 0.1 Main structure of the Climate Proof Cities research programme

The research programme has especially paid attention to heat in the city and the increasing risks of prolonged periods of warm weather, and to inconvenience caused by more frequent and more intensive rainfall. Water and heat are connected with each other, for instance because prolonged periods of warm weather can lead to drought and because water can bring down temperatures through evaporative cooling. In practice, the research was organized into twenty studies, carried out by 9 PhD students, 3 postdocs and many researchers from 10 different research institutes. In order to increase the usefulness of the results in practice, the researchers worked together in 5 case studies in different Dutch urban areas, namely Rotterdam, The Hague Region, Amsterdam, Arnhem/Nijmegen, Utrecht and cities in North Brabant (**Figure 0.2**).

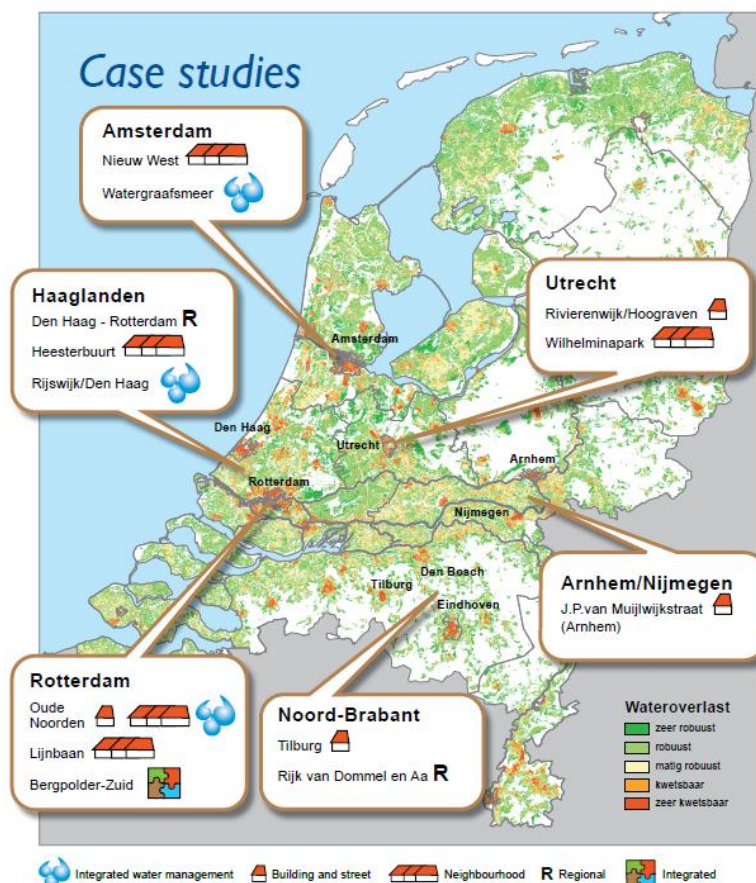

Figure 0.2 Case studies within the CPC research programme

The Spatial Adaptation Delta Decision

Around the same time as the Knowledge for Climate programme was set up, awareness of climate change began to grow among Dutch cities. At the beginning of the CPC research programme there were only a handful of cities (and individuals) who concerned themselves with climate change. There were barely any connections between municipalities and water boards when it came to this subject. Partially stimulated by the New Construction and Restructuring Delta Programme, a broad movement has formed in the past few years, leading to, for instance, the 'Manifesto for the Climate Proof City' and the 'Guide to Spatial Adaptation'³. Both give advice about making cities climate proof, formulated around the three steps;

1. **Knowledge:** analysis of the area (links to CPC research questions 1 and 2);
2. **Desire:** formulating ambitions (research question 3), and;
3. **Practice:** implementation in policy and regulations (research questions 4 and 5).

On Prinsjesdag 2014 (Prince's Day, the opening of the Dutch parliament), the Spatial Adaptation Delta Decision was presented to the House of Representatives; its aim is to make spatial policy more water-robust and climate proof. This report and all underlying CPC studies⁴ offer support in this.

³ <http://www.ruimtelijkeadaptatie.nl/en/>

⁴ All CPC publications can be found at <http://www.kennisvoorklimaat.nl/publicaties>



1 How does the local climate work in Dutch cities, and how does urban design influence the local climate?

Summary

Climate change leads to more summery and tropical days and more days with extreme rainfall in summer. The average amount of precipitation in an urban area does not differ from that in the surrounding countryside. However, this does not apply to temperatures. It is almost always warmer in the city than in the surrounding areas, which is known as the urban heat island effect (or UHI). The results of the Climate Proof Cities (CPC) programme offer more insight into this heat island effect.

The urban heat island effect is caused by the absorption of sunlight by (stony) materials, the lack of evaporation and the emission of heat caused by human activities ('anthropogenic heat'). The emission of heat through industry, houses, buildings, traffic, people and animals contributes substantially to the development of the UHI: in Rotterdam, it reaches around 10%. In the daytime, the difference in temperature between the city and the countryside are minimal ($< 2\text{ }^{\circ}\text{C}$). The differences are especially great after sunset because the city cools off more slowly than the surrounding areas do. The maximum UHI intensities in Dutch cities range from 3 to 7 $^{\circ}\text{C}$. With global warming continuing throughout the next decades heat stress can become an important issue.

Within an urban area, there are substantial spatial variations in UHI. The properties of the direct surroundings turn out to be of great influence here. The most influential factors are the proportion of built surfaces, paved surfaces and the proportion of vegetated surfaces. In addition, the average building height has a clear effect. The ratio of building height to street width also influences the absorption of sunlight, thermal emissions from buildings and other surfaces into the atmosphere, and the transportation of heat within the street. The optimal ratio of height to width seems to be around 1. Higher or lower ratios both have advantages and disadvantages when it comes to ventilation and shade effects.

The final effect of open water on temperature is not unequivocal and strongly depends on the dimensions (surface area, depth), the situation in terms of the direction of the wind and the situation in terms of buildings and other structures in the surroundings.

Thermal comfort for human beings varies even more than the temperature of the surroundings and is also dependent on atmospheric radiation, humidity and wind velocity. During the day, the thermal comfort in the city is largely determined by the differences in wind velocity; the differences in humidity and radiation are too minimal to have a noticeable effect. After sunset, temperature plays a more important role, and factors that influence the air temperature are important in determining the thermal comfort.

Furthermore, because of the changes in the climate we will have deal with long, warm and dry periods in the future. Understanding the city's water balance is essential in order to plan the urban area in such a way that cooling through evaporation is secured with as little water consumption as possible. Evaporation, however, is an unknown quantity. In CPC first estimates have been made of the evaporation in Rotterdam and Arnhem.



1.1 Introduction

Following on from the 'Analysis' step of the 'Guide to Spatial Adaptation'⁵, it is important to understand the workings of the urban climate and the interaction between the city and the regional climate. The average amount of precipitation in an urban area does not differ from that of the surrounding area⁶. However, this does not apply to the temperature. In the city it is almost always warmer than in the surrounding area, which is known as the 'Urban Heat Island' (UHI) (see text box on 'The Urban Heat Island effect'). This means that cities stand a greater chance of experiencing extremely high temperatures than the rest of the Netherlands. This chapter therefore focuses on the results of climate change on heat and drought in the city. Understanding the way in which cities themselves influence the urban climate offers insight into the choice of measures against extreme heat.

The urban climate and climate change

The UHI effect has already been discussed in the international literature for a century. Maximum temperature differences between cities and surrounding areas measured and calculated in international studies (Memon et al., 2009) show values of up to 12 °C, where the greatest differences usually occur at night. In the Netherlands, Conrads (1975) was the first, in the 70s, to research the urban effects for a Dutch city. Using temperatures measured in Utrecht in summer it turned out that at night, the temperature in Utrecht is an average of 2.7 °C higher than outside the city, with peaks of up to 8 °C. The urban effects in Rotterdam were studied a decade later by Roodenburg (1983). Here, too, maximum temperature differences of 8 °C were found between the city and its surroundings, especially during windless nights with few clouds.

After this, the research into the urban climate in Dutch cities was at a standstill for almost 30 years. The thread was eventually resumed in 2009. In the summer of that year, orientation measurements were taken in Rotterdam⁷ and Arnhem⁸ with mobile measuring platforms (meteorological measuring instruments attached to a cargo bicycle). The results of these measurements also show a substantial heat island effect. After sunset the differences in temperature between densely constructed areas and the surrounding areas can reach over 7 °C, especially on clear and windless summer days. In the daytime, the measured differences in temperature are less noticeable, with a maximum of up to 2 °C (Van Hove et al., 2010; Van Hove et al., 2011c; Heusinkveld et al., 2010, 2014). Since then, this data has been confirmed by the results of the CPC's permanent monitoring network in the Rotterdam area (Van Hove et al., 2011a,b). A detailed interpretation of the measurements can be found in section 1.5.

In order to form a national impression, surface temperatures from satellite images from the 2006 heat wave were analyzed (Klok et al., 2012). These images show that each city in the Netherlands, large or small, experiences a heat island effect. (**Figure 1.3**). It is important to note that this concerns the *surface* UHI that is especially present during the daytime. Discussions about the urban climate almost always refer to the *atmospheric* UHI of the 'Urban Canopy Layer' because of the effect on living conditions (see also the text box on the 'Urban Heat Island effect'). The atmospheric UHI is the difference in air temperature between the city and the nearby countryside. Unlike the surface UHI, the atmospheric UHI is minimal during the day; a maximum intensity (UHI_{max}) is reached after sunset because the city cools down more slowly than the nearby countryside.

⁵ <http://www.ruimtelijkeadaptatie.nl/en/>

⁶ It is noticeable that there is more than the average amount of rainfall near large urban agglomerations, such as the greater Rotterdam area (see *De Bosatlast van het Klimaat*; www.klimaatatlas.nl). Possible causes are blocking of the wind by buildings, extra warming and the presence of more cloud condensation nuclei (fine particles that water drops condense on). These factors are conducive to cloud formation and the development of precipitation on the lee side of cities.

⁷ This project was carried out as part of the first section of KvC (Heat stress in Rotterdam project)

⁸ Part of the EU Future Cities project



The Urban Heat Island effect (UHI)

Cities are generally warmer than their surrounding areas. Because of the high volume of buildings and the properties of the urban material, warmth is retained better in cities and the so-called heat island effect occurs (**Figure 1.1**). There are three types of urban heat island effect (UHI):

- The surface UHI, the difference in surface temperature between the city and the surrounding countryside.
- The atmospheric UHI, the difference in air temperature between the city and the surrounding countryside. The atmospheric UHI can be subdivided into:
 - The UHI at the atmospheric boundary layer above the city (Urban Boundary Layer UHI), of which the intensity depends on the geographical situation of the city, general configuration and morphology.
 - The UHI at living level (Urban Canopy Layer UHI), where the presence of buildings, street surfacing, trees and water have a direct and noticeable effect on the climate at living level (microclimate). Discussions about the urban climate generally concern this heat island effect.

The surface UHI exists both during the day and after sunset. A maximum is reached in the daytime when the surfaces absorb sunlight. After sunset, the differences are smaller, but can still be substantial. In contrast, the atmospheric UHI is minimal or absent during the day. A maximum is reached after sunset because the countryside cools down faster than the city. Discussions about the urban climate generally concern the atmospheric UHI of the Urban Canopy Layer, because of the effect on the living environment.

The local climate and microclimate are influenced by processes that take place at city level (the mesoscale) and vice versa (**Figure 1.2**). The spatial planning of an urban area, for instance, has an effect on local wind patterns, and the materials used in buildings in a neighbourhood (such as the use of materials with high sun reflectivity) directly influence not only the indoor climate, but also the climate in the area surrounding these buildings. In order to develop effective adaptation strategies and measures it is important to take all levels of scale into account. Therefore, as part of the CPC programme, research was done on meteorological processes at all levels of scale.

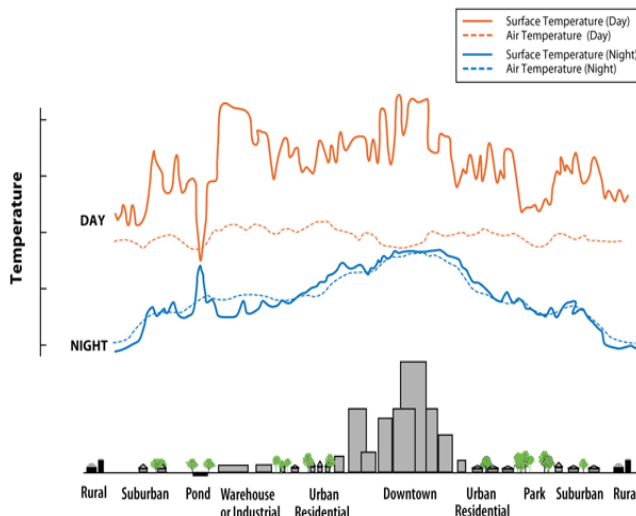
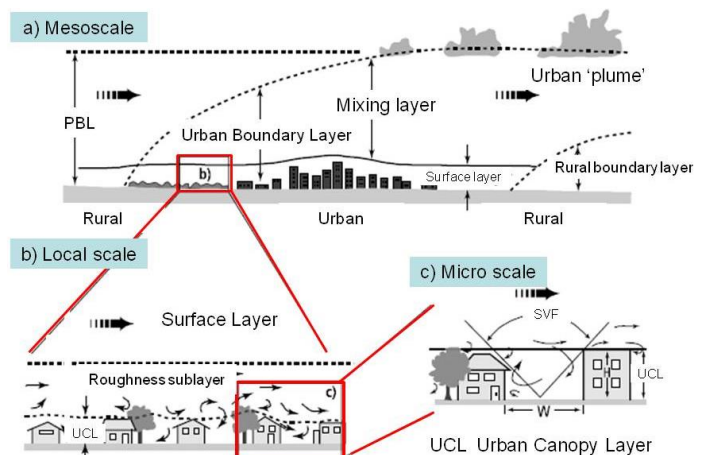

Figure 1.1 The urban heat island effect: difference in air and surface temperature between the city and surrounding countryside in/during the daytime and at night. Source: <http://www.epa.gov/heatisland/about/index.htm> (last accessed: July 2014).

Figure 1.2 The horizontal city scales and the related vertical atmospheric layers. The large arrows indicate the usual direction of the wind; the small arrows show the turbulent air movements. We distinguish three horizontal scales and the related vertical atmospheric layers: 1. Mesoscale (city and surroundings) and the 'Urban Boundary Layer', 2. Local scale (city district) and 'Urban Boundary Layer'/'Urban Canopy Layer', and 3. Micro scale (street, block of housing) and 'Urban Canopy Layer'. PBL-planetary boundary layer, (Source: Oke, 1976).



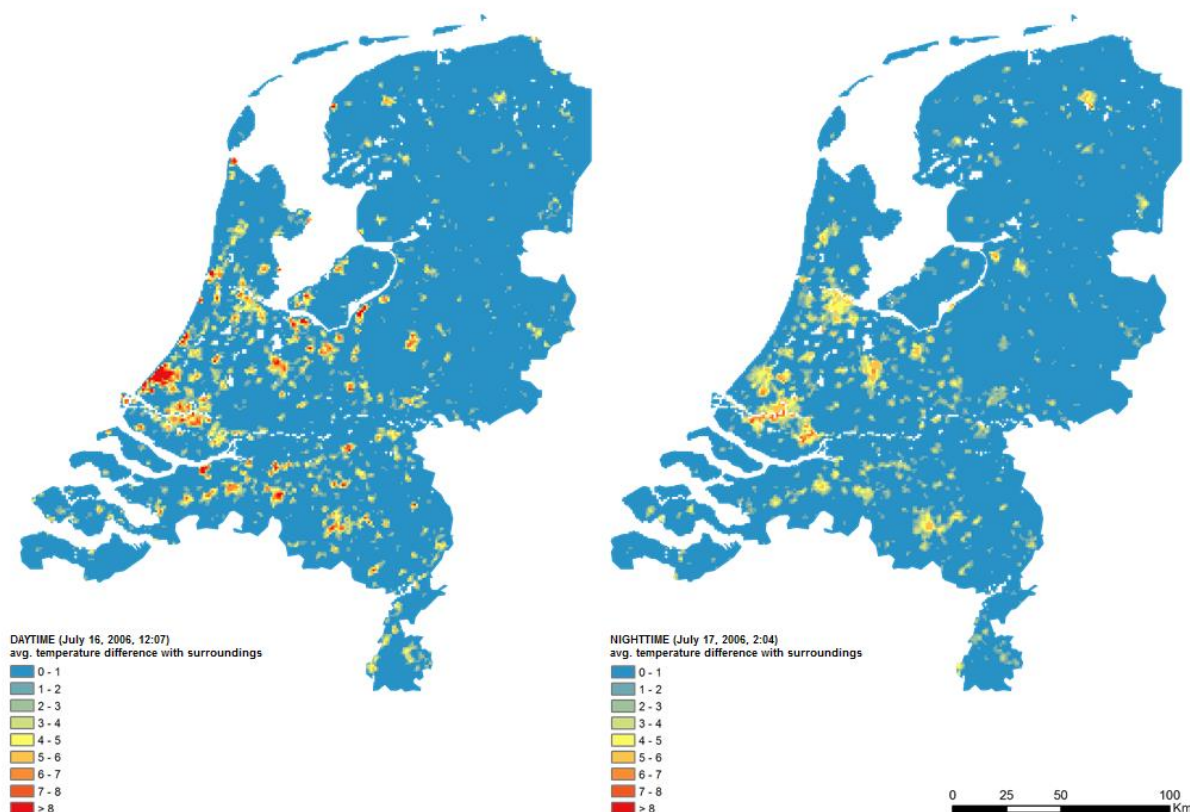

Figure 1.3 The surface heat island effect of Dutch cities during the day (left) and at night (right). The maps are based on two NOAA-AVHRR satellite images of surface temperature taken during the heat wave period of 2006 (Source: Klok et al., 2012).

Amateur meteorologist databases show that the UHI_{\max} values of Dutch cities range from 3 to more than 7 °C (Steenefeld et al., 2011; Wolters en Brandsma, 2012) (Figure 1.4). These values can be compared to UHI values determined for other European cities. Oke (1973) found a linear relationship between the UHI_{\max} and a city's population⁹. This relationship does not exist for Dutch cities (Figure 1.5); the UHI can also be substantial in smaller cities and villages. This shows that local features are highly important for the UHI intensity.

Figure 1.4 also shows the effect on thermal comfort. The 95th percentile values calculated for thermal comfort (based on the 'Approximated Wet Bulb Globe Temperature' (AWBGT) , see Appendix C) in densely built urban areas in the Netherlands are now just below the threshold value for heat stress. This means that thermal discomfort and heat stress can become an important issue if global warming continues throughout the next decades.

⁹ He used the logarithmic value of the number of inhabitants

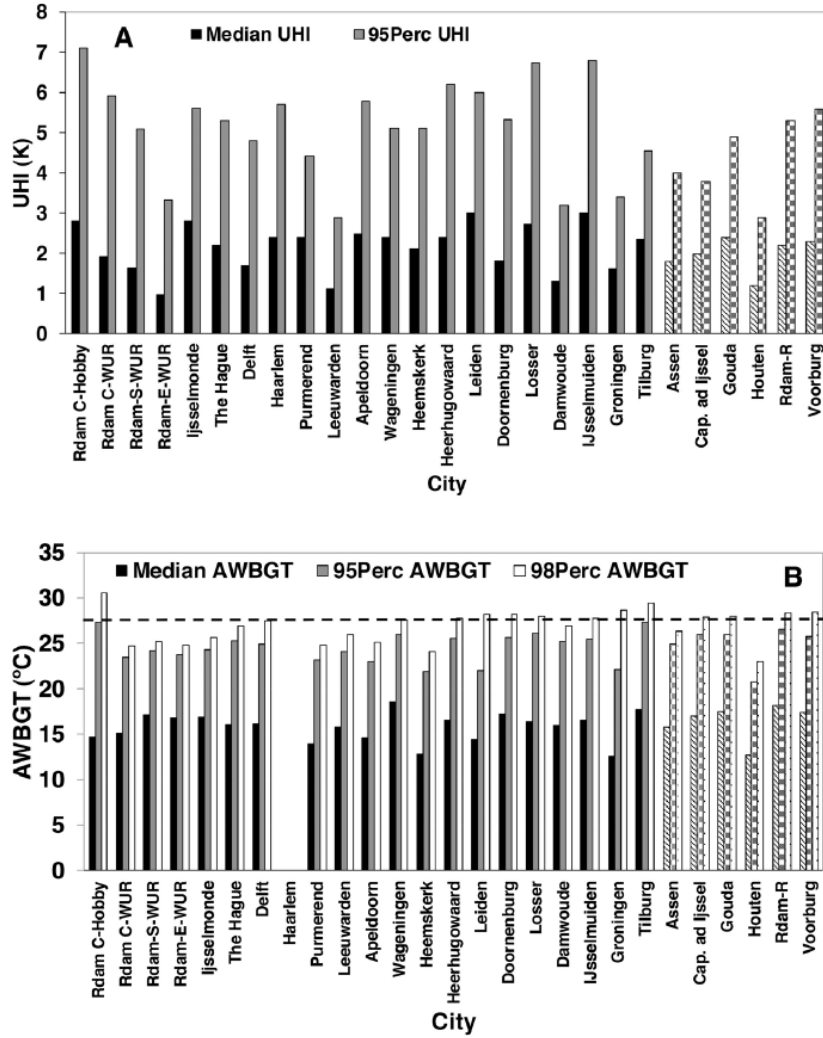

Figure 1.4 Median and percentile values for UHI_{max} and thermal comfort in Dutch cities, based on AWBGT. The dotted line is the threshold value for thermal discomfort. Rooftop stations are shaded (source: Steeneveld et al., 2011).

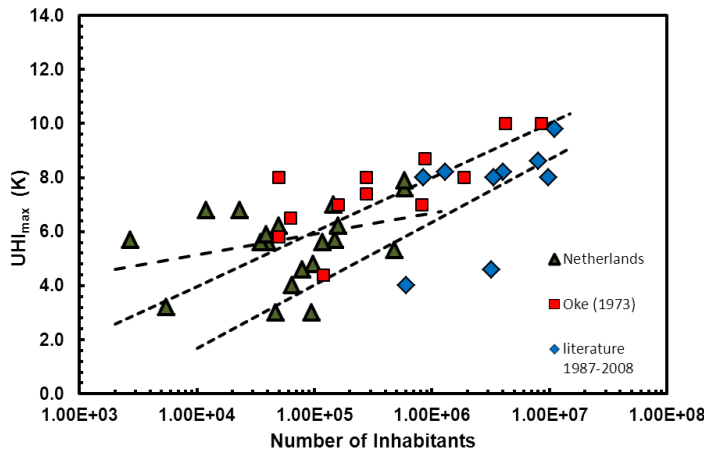

Figure 1.5 UHI_{max} (95th percentile values, in Kelvin) for cities versus the number of inhabitants of cities (logarithmic scale) for European cities and Dutch cities. Dotted lines are linear regression lines calculated for Oke's results (1973), results published between 1987 and 2006 and for Dutch cities (source: Van Hove et al. 2011c).



Thermal comfort and other meteorological variables

Thermal comfort is not only dependent on the air temperature, but also on other meteorological variables such as atmospheric humidity, radiation and wind speed. These parameters were also analyzed using the measuring network.

The atmospheric humidity in the city is lower than that of the countryside, which is essentially beneficial for the thermal comfort during warm summer's days. However, the differences are minimal: less than 5% for the *absolute* atmospheric humidity¹⁰ and 9-15% for the *relative* atmospheric humidity.

The differences in absolute humidity are present especially during the day; due to evaporation from vegetation the air above the countryside contains more water vapour, while the amount of water vapour in the urban air stays more or less the same. However, the differences in relative atmospheric humidity are present both in the day time and at night. During the day, the lower relative atmospheric humidity in the city is mostly due to minimal evaporation, and at night, it is due to the higher temperature.

The average global solar radiation (i.e. the amount of solar radiation per surface area unit) in the city is also lower (12-14%) compared to the reference location. This is mainly due to shadows cast by buildings and other objects (such as trees) near the weather stations. During summery days, a lower amount of direct solar radiation is beneficial for thermal comfort. This also applies to diffuse radiation, but this was not measured separately.

The average wind speed measured in cities is considerably lower (40-65%) than in rural areas. Especially during summery days, the lack of a breeze is detrimental for thermal comfort. This also applies to the air quality. Both have detrimental health effects on humans and animals.

Climate change and the future urban climate

In order to have an idea of the urgency of the heat problem, current temperature values from the 'Zuid'¹¹ weather station in Rotterdam and the reference location were transformed into temperature values for 2050 and 2100¹². This took place before the KNMI'06 'W+' climate scenario, which can be seen as a realistic worst case scenario in terms of heat issues. In this scenario, we can expect a substantial increase in the number of days with lower thermal comfort in both cities and the countryside (**Figure 1.6**). We would like to emphasize that this is a first rough result, where only the difference in temperature has been examined. For a complete analysis, variables such as discussed above also need to be taken into account.

¹⁰ The absolute atmospheric humidity is the amount of water vapour per volume of air. The relative atmospheric humidity is the amount of water vapour in the air compared to the maximum amount of water vapour the air can contain. As opposed to the absolute atmospheric humidity, the relative atmospheric humidity depends on the air temperature; air with a higher temperature can contain more water vapour. It is not yet known exactly if the absolute atmospheric humidity or the relative atmospheric humidity is the determining factor for thermal comfort. Both variables occur in the thermal indices.

¹¹ Near Zuidplein

¹² http://www.knmi.nl/index_en.html

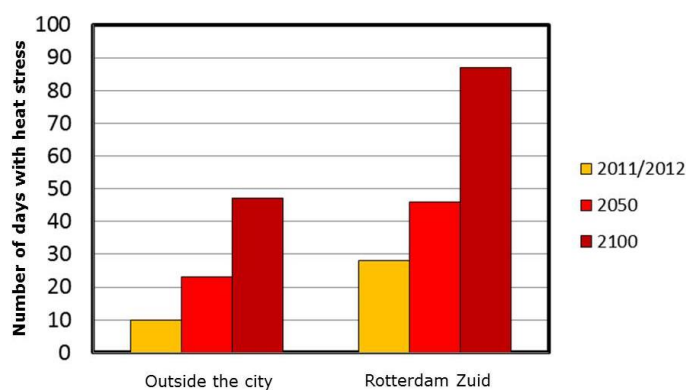

Figure 1.6. The number of days with moderate to strong heat stress (Effective Temperature, see **Appendix C**) for the countryside and 'Rotterdam Zuid' locations, calculated for the current situation, 2050 and 2100 according to the KNMI'06 W+ scenario.

1.2 The interaction between the city and the countryside

It is known that the city influences the climate of the surrounding countryside. In reverse, the use of the land in the countryside could have an effect on the climate in the city. However, it is unclear how large the footprints of both effects are. In order to gain more insight into this, CPC carried out airplane measurements and used model simulations.

Six flights were carried out above Rotterdam and its surroundings, where air temperature, surface temperature, atmospheric humidity and CO₂ concentration were measured. The measurements offer insight into not only the horizontal footprint of the UHI effect, but also the vertical footprint. The measurements took place during the daytime¹³, usually at a height of around 300 metres. In addition, vertical profiles (300 – 1700 metres) were measured in order to characterize the build-up of the atmospheric boundary layer (**Figure 1.7**).

The UHI effect at 300 metres is minimal and difficult to distinguish from the daily range of variables measured. On warm days the air at 300 metres above the city is around 1 °C warmer. Equal differences were found during the daytime for the air temperature between the weather stations in Rotterdam and the reference station (to the north of Rotterdam).

The leeward air temperatures (legs 2-4) are higher (0.2 – 1.0 degrees) than the windward air temperatures (leg 1). The higher air temperatures above the greenhouse area and above the coastline are also striking (leg 4). In contrast, the surface temperatures show great disparities, for instance between surface temperature for water and for built surfaces (asphalt on roads or roofs). The difference can reach up to 40 °C. The diffusion of the urban heat measured downwind from the urban areas is also found in model simulations, the so-called 'urban plume' effect (**Figure 1.8**) (see also Theeuwes et al., 2013).

It thus seems as though the city's vertical footprint is limited (around 300 metres), but that the horizontal footprint reaches dozens of kilometres into the rural areas downwind from built areas. It is also interesting to note that the measurements show that the air above the city contains, on average, 4 ppm more CO₂ than the air above the countryside, peaking above the Botlek area (a difference of around 8 ppm).

¹³ Permission was only granted for flying during the daytime

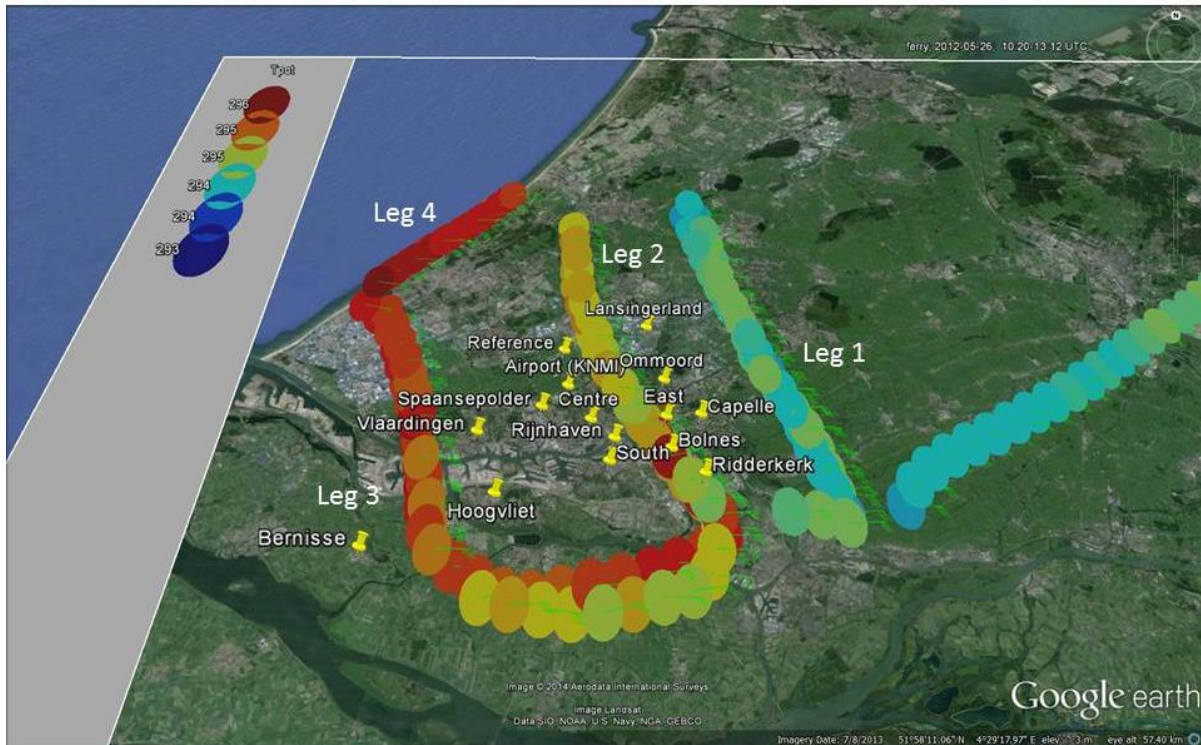

Figure 1.7 Flight paths and measurement results of Lagrangian flights above the southern Randstad at 300 metres on 26 May 2012 between 10:20 and 13:12 UTC (easterly 25-35 kn, clear $Q_n \sim 600 \text{ W m}^{-2}$, $T_{\text{max}} 26 \text{ }^\circ\text{C}$). The boundary layer height (for explanation, see **Figure 1.2**) was around 1200 metres at that time. Leg 1 is upwind of the urban area, leg 2 follows a trajectory right across the city (or between the urban areas), leg 3 is downwind. In addition, measurements were taken along the coast (leg 4). The colour of the trajectory corresponds to the surface temperature measured.

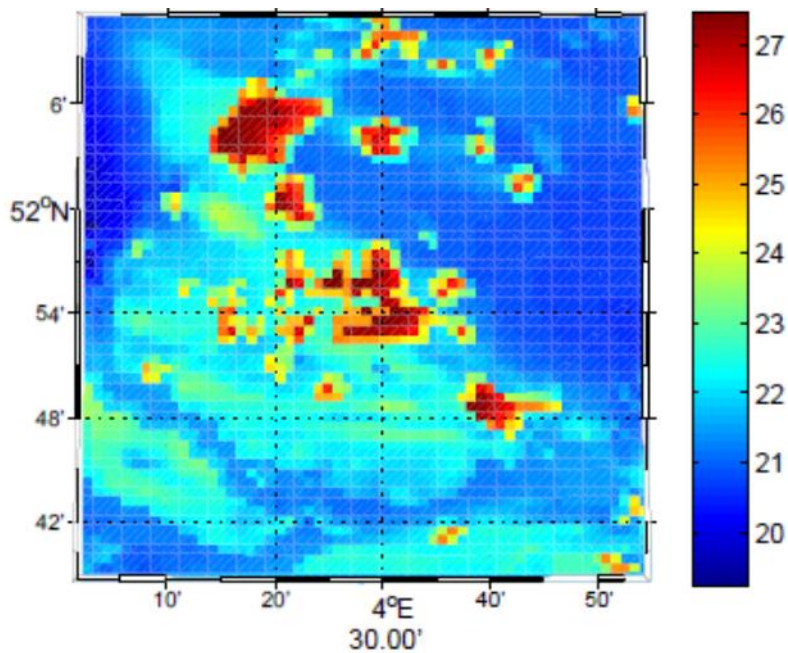

Figure 1.8 Model simulation of the temperature distribution in the southwestern Randstad at UT 20:00 (22:00 LT). Temperatures are in $^\circ\text{C}$ (source: Ronda et al., 2010).



1.3 The influence of anthropogenic heat production

Within CPC, much time has been spent on improving the representation of the urban area in the WRF (Weather and Research Forecasting) mesoscale model, for instance with regard to anthropogenic heat sources (Ronda et al., 2012). Important anthropogenic heat sources include industry, individual households, buildings, traffic, people and animals. Until recently, little data was available about the size of the anthropogenic heat sources on city and neighbourhood level in Dutch cities on the one hand, and the locations of these sources on the other (Klok et al., 2010). This is why these emissions are not generally included in calculations of the UHI effect (or only in a relatively simple way) by mesoscale models.

Using the LUCY model (Large scale Urban Consumption of energy; Lindberg en Grimmond, 2013) spatial variation in anthropogenic emissions in the Randstad was first examined. This took place for an area of 5 x 5 km. On a warm day in the Netherlands, the local differences in anthropogenic heat emitted turned out to be quite large (**Figure 1.9**): in the urban areas around The Hague and Rotterdam the emission of anthropogenic heat reaches values of around 20 W m^{-2} at night and around 70 W m^{-2} during the day, while the emission of heat is much lower in the countryside. These spatial differences in anthropogenic emissions found with the LUCY model were then implemented into the WRF model (Ronda et al., 2012).

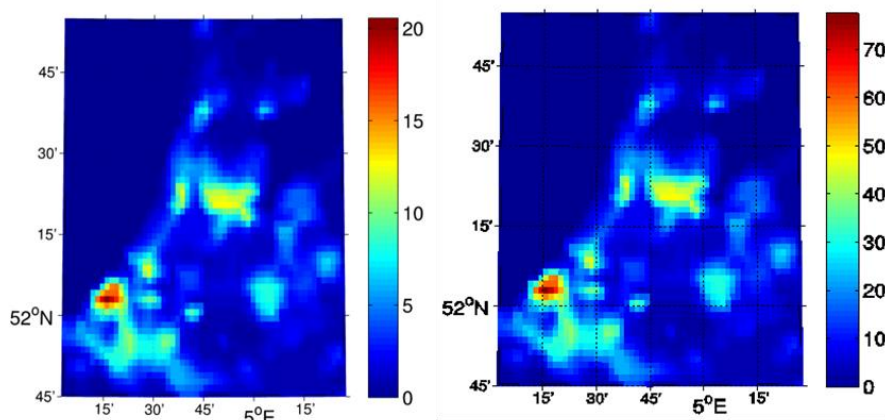

Figure 1.9 Anthropogenic emissions of heat (in W m^{-2}) for the Randstad at 2 AM local time (left) and 12 noon local time (right) as estimated using version 3.1 of the LUCY model (Lindberg en Grimmond, 2013).

The most important conclusions are:

1. in the Netherlands, anthropogenic emissions of heat are an important parameter that determine the UHI effect in Dutch cities. Incorporating anthropogenic emissions of heat from LUCY leads to simulated temperatures that are (locally) up to $0.6 \text{ }^\circ\text{C}$ higher or $0.3 \text{ }^\circ\text{C}$ lower than the temperatures that were calculated without taking into account anthropogenic emissions of heat. These simulations suggest that anthropogenic emissions in the Randstad are locally responsible for 10% extra UHI effect;
2. the spatial variations in anthropogenic emissions have an effect on the local climate at city and neighbourhood level in the Netherlands that cannot be ignored. If temporal and spatial variations in anthropogenic emissions are not taken into account in the model, the local temperature is underestimated by up to $0.2 \text{ }^\circ\text{C}$ or overestimated by up to $0.6 \text{ }^\circ\text{C}$. Traditionally, this spatial variation is not taken into account in mesoscale models for the atmosphere. This means that weather predictions based on these models calculate an overestimation of the temperature, while for other areas, the temperature is underestimated.



1.4 Evaporation in the city

Under the influence of climate change, long warm and possibly dry periods will have to be dealt with more often in the future. There will be more demand for cooling of the urban area. At the same time it is important to be careful with water usage, especially in such periods, in order to prevent nature reserves from drying up and groundwater levels from decreasing. Evaporation is central to this problem: evaporation can help moderate heat in the city, but by definition, this requires water.

Relatively little is known about the evaporation of water in the city. Data about evaporation can help in urban water management policy. A good estimate about the evaporation during warm, dry periods can help in the distribution of the available water across different needs (such as vegetation management, drinking water) in relation to different policy goals (such as cooling urban areas and preventing the degradation of wooden pile foundations¹⁴ and salt intrusion (Brolsma et al., 2012). Insight into the workings of evaporation in the city can aid in designing the urban area in such a way that cooling is ensured through evaporation, using as little water as possible. This makes it easier, for instance, to assess how much water the vegetation needs for survival and maintenance of its cooling properties.

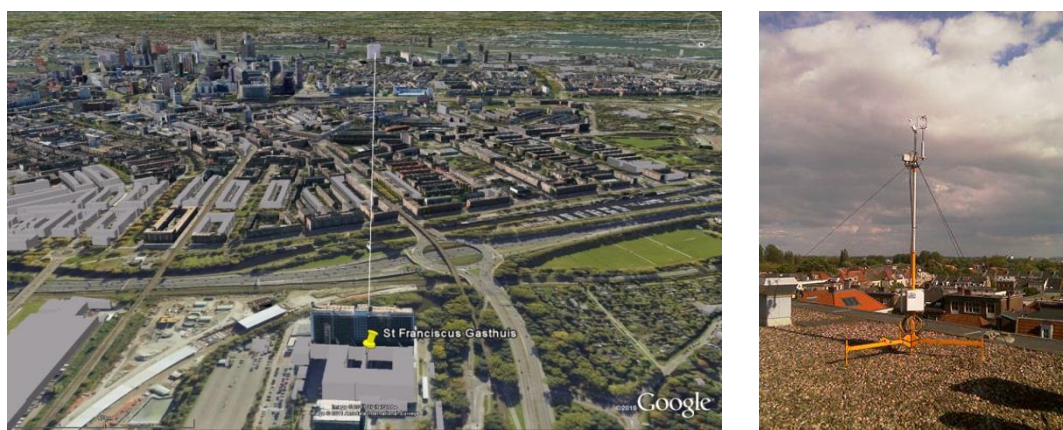

Figure 1.10 Left: Scintillometer path between the Sint Franciscus Gasthuis (Lat/Lon 51.56478/4.27747, elevation 51 metres) and the Erasmus MC (Lat/Lon 51.54632/4.28128, hoogte 77 m) in Rotterdam. The distance between transmitter and receiver is 3451 metres, orientation $\sim 180^\circ$. Right: set-up for evaporation measurements on top of an apartment complex on the Ingenieur J. P. Van Muijlwijkstraat in Arnhem (51°59'4.97"N, 5°55'5.73"E) <http://www.climatexchange.nl/sites/arnhem/index.htm>. The measuring system consists of a 3D ultrasonic anemometer (Gill R3-50) in combination with a fast open-path infrared gas analyzer (Li-Cor LI-7500) attached to the top of a 4-metre-high mast.

In CPC, first estimates of the evaporation in Arnhem and Rotterdam were made (Jacobs et al., 2014). The results for Arnhem come from Eddy covariance measurements carried out since spring 2012 (**Figure 1.10 right**). For Rotterdam, the Large Aperture Scintillometer data was used, through which the evaporation can be calculated indirectly¹⁵ (**Figure 1.10 left**; **Appendix D**). In addition, the results of the sap flow measurements were analyzed (Slingerland, 2012), which also give an indication of the effects of evaporation caused by trees on the city's water balance.

¹⁴ Fluctuations in ground water level can provoke a rotting process in wooden piles that support older buildings.

¹⁵ Recently a so-called 'microwave' scintillometer was developed by WUR-MAQ for an STW project (Hartogensis et al., 2012). Together with an optical scintillometer, this can determine both the average perceptible heat flux for an area and the evaporation. This development offers new possibilities (i.e. routine assessments of average evaporation in cities) for the water management in the city.



The results of the scintillometer measurements in Rotterdam show a pattern where high peaks in evaporation go hand in hand with relatively sunny days. (**Figure 1.11 top**). Approximately 21% of the average precipitation in Rotterdam in the summer months (3.2 mm per day¹⁶) evaporates again (0.67 mm). This evaporation amounts to a cooling rate of 20 W m^{-2} (approx. 11% of the incoming solar radiation) (**Table 1.1**).

In Arnhem, the evaporation correlates strongly with precipitation (**Figure 1.11 bottom**). Around 60% of the average precipitation per day (= 24 hours) from April to September (1.44 mm) is used for evaporation (0.86 mm). This amounts to a cooling rate (E) of 25 W m^{-2} per day; this is approx. 14% of the average daily solar radiation incoming during that period in Arnhem (ca. 180 W m^{-2}).

According to these measurements, the connection with precipitation during the summer months is clearly stronger in Arnhem than in Rotterdam (**Figure 1.11**). The evaporation in Arnhem decreases much less slowly after precipitation. Jacobs et al. (2014) offer a possible explanation for this difference: the flat roofs around the weather station in Arnhem retain the water better and for longer than in Rotterdam. This would mean that building styles or other measures that help retain rainwater better and for longer benefit cooling at the beginning of warm, dry periods.

Sap flow measurements are a very different kind of measurements to the previously mentioned measurements. However, we find comparable evaporation rates: 0.72 and 0.98 mm per day, amounting to a cooling rate of 21 and 28 W m^{-2} . Calculations show that the average cooling rate varies from 1.1 kW to 2.2 kW from tree to tree. On some clear days the hourly average of maximum water consumption reaches 12 to 16 litres, which amounts to an hourly average of 8.2-10.9 kW per tree.

The average water consumption of the 5 trees studied was 50 litres per day (April – September). Taking the crown diameter into account, we used this to calculate an average water consumption of 0.64 mm per day. Extrapolating this result to all trees (600 000) in the Rotterdam area (319 km^2) amounts to a total evaporation of < 4% of the precipitation in this period (386 mm). Although this concerns rough estimates, it shows that the water consumption of the current number of trees only has a minimal effect on the city's water balance. However, this can vary locally, especially on days that the trees' water consumption reaches its maximum (approx. 170 litres per day).

Because it is difficult to carry out routine measurements of evaporation in the city, scientists sometimes try to deduce them from the so-called reference evaporation. That is the evaporation of '*a healthy and actively growing field with a good water supply*' which is subsequently corrected for the properties of the urban surface. However, it turns out that this is not possible: the evaporation in a city reacts differently to the weather than that in a field. In the city, evaporation decreased on dry days, while it increased in fields and woods (Jacobs et al., 2014).

There is much less evaporation in a city than in the countryside. As a result, a large part of the incoming solar energy is transformed into perceptible heat. In order to limit the UHI effect, there should be more evaporation. More vegetation and more water in the city contribute to this. The water supply of urban vegetation can also be improved during dry periods, which would keep the evaporation at more or less the same level.

¹⁶ This did concern an extremely wet summer in Rotterdam.



Table 1.1 Comparison of the average daily evaporation in Arnhem (Eddy covariance measurements) and in Rotterdam (LAS), and evaporation calculated on the basis of sap flow measurements of trees in Rotterdam. S_{in} incoming shortwave radiation; L_{in} incoming longwave radiation; All_in total incoming shortwave and longwave radiation; E evaporation (source: Jacobs et al., 2014).

	S_{in} ($W\ m^{-2}$)	L_{in} ($W\ m^{-2}$)	All_in ($W\ m^{-2}$)	Evaporation ($mm\ day^{-1}$)	E ($W\ m^{-2}$)	E/S_{in} (%)	E/All_in (%)
Arnhem EC	183	352	535	0.86	25	14	5
Rotterdam LAS	188	354	542	0.68	20	11	4
Sap flow park surroundings	190	364	554	0.72	21	11	4
Sap flow street surroundings	190	364	554	0.98	28	15	5

- All radiation fluxes are own measurements, on the roof in Arnhem or from the reference station from the Rotterdam monitoring network.
- Arnhem EC period: June-September 2012 and April-September 2013
- Rotterdam LAS period: April-September 2012
- Sap flow measurements: June-September 2012

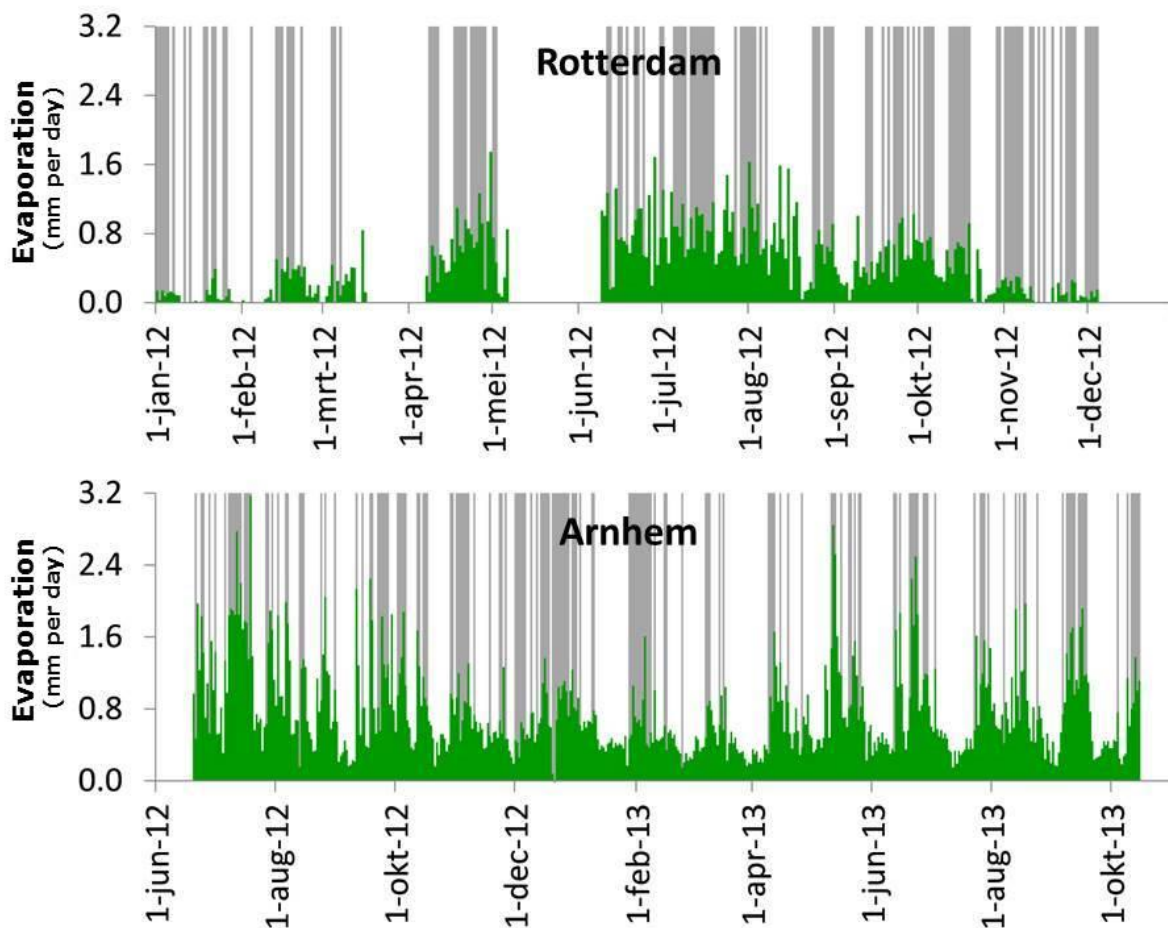

Figure 1.11 Daily evaporation measured (green foreground, mm per day) in Rotterdam in the year 2012 (top) and in Arnhem from June 2012 – October 2013 (bottom). The grey bars in the background indicate days with more than 1 mm of precipitation (source: Jacobs et al., 2014). (mrt=March, mei=May, Okt=October).



1.5 Climate variations within the city

The results below of local differences in urban climate are largely based on the data from the CPC monitoring network in Rotterdam (Van Hove et al., 2011b, 2014). The measuring network makes it possible to analyze the temporal and spatial variation in the local urban climate in the metropolitan area in more detail and to relate it to neighbourhood properties. Each weather station measures not only the usual variables (air temperature, humidity and wind speed and direction), but also the global radiation and black globe temperature. This can also offer insight into the temporal and spatial variation in thermal comfort outdoors and the influence of neighbourhood properties on this. Note that this concerns average values for an area; very locally (on a micro scale), large differences in thermal comfort occur. In addition we have used results derived from satellite images (Klok et al., 2012), mobile measurements (Heusinkveld et al., 2014) and model simulations (Schrijvers et al., 2014).

1.5.1 The variation in temperature

The UHI in the urban area of Rotterdam can be substantial: maximum differences in temperature (UHI_{max}) between the city and the surrounding countryside of 7 degrees and more are not an exception (**Figure 1.12**). It turns out that this does not only go for the summer months, but also for a large part of the year. In the winter months (DJF) the UHI intensities are generally minimal. However, on some winter's days the UHI effect can be considerable. The effect is usually of short duration (less than 1 day) and it occurs when the wind turns to the east and brings in cold air. There is a sharp decrease in temperature in the rural area, while the temperature in the city remains unchanged for some time.

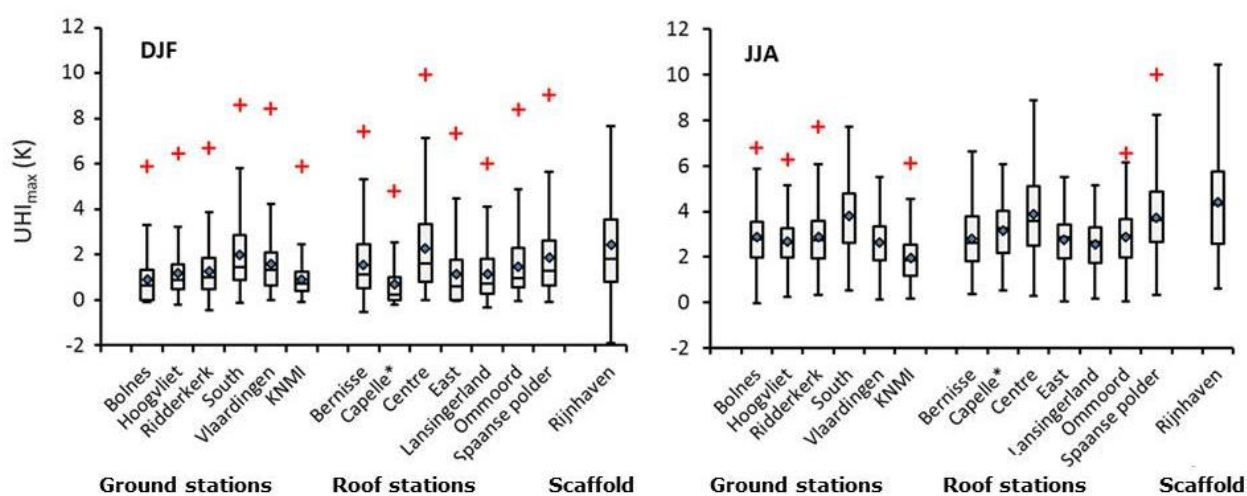

Figure 1.12 Box-whisker plot of UHI_{max} at the measuring locations in the Rotterdam metropolitan area. NB: UHI_{max} is defined as the maximum difference in air temperature between city and surrounding area during a twenty-four hour period. The values have been calculated for the months of June, July and August (JJA) in 2010, 2011 and 2012 and for the months of December, January and February (DJF) in 2009/2010, 2010/2011 and 2011/2012. A distinction was made between rooftop and ground stations (source: Van Hove et al., 2014).



The variation in UHI within Rotterdam is considerable, as **Figure 1.13** also shows. The densely built locations ‘Centrum’, ‘Rijnhaven’, ‘Zuid’, and ‘Spaanse polder’ show the highest UHI intensities. This applies to all years (2010-2012) and seasons studied. Furthermore, it is striking to note that the temperatures measured by the KNMI station at the Rotterdam-The Hague airport are higher on average than at the reference location in the countryside north of Rotterdam. A possible cause is the city’s urban plume effect mentioned earlier.

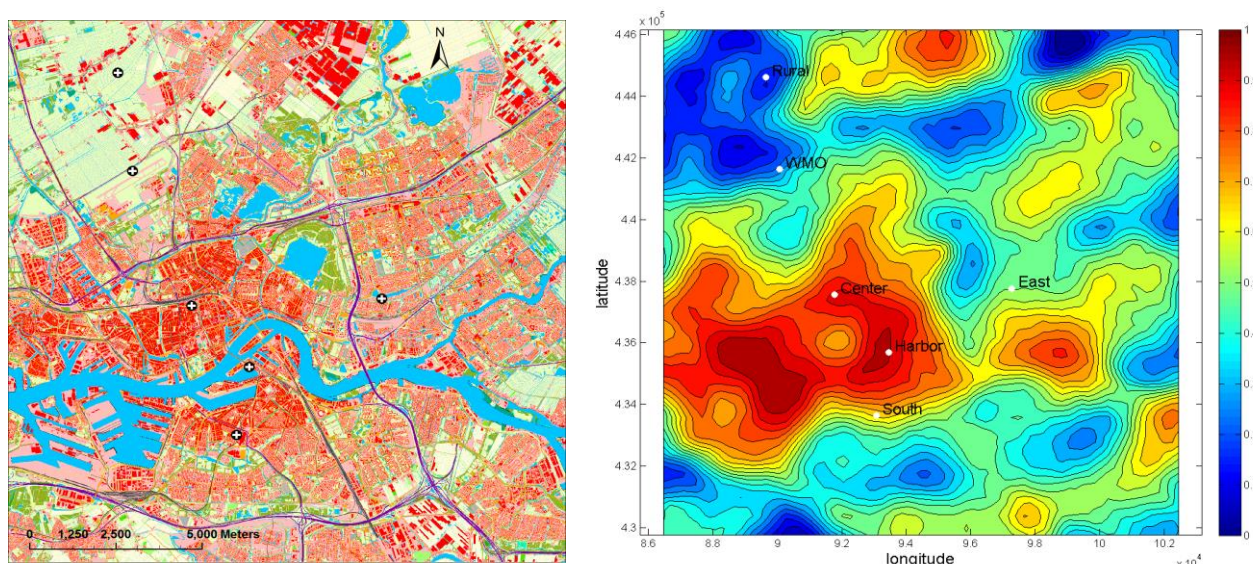

Figure 1.13 Topographic map (left) and spatial variation in UHI (right) in Rotterdam and surroundings (14.9 x 14.3 km). Normalized UHI values are presented (UHI Centre = 1). In the summer (JJA) the average median and 95th percentile values for UHI_{max} in the centre are 4.2 and 7.5 K (Bron: Heusinkveld et al., 2014).

1.5.2 The influence of neighbourhood characteristics on temperature

In order to have an impression of the influence of neighbourhood properties on temperature, the land use, geometry and ‘urban canyon’ effect were examined.

Urban land use

For both the surface temperature and the air temperature significant¹⁷ correlations ($p < 0.05$) were found for the fraction of built surface, the fraction of paved surface and the fraction of urban vegetation. This was not the case for the fraction of surface water (**Tables 1.2** and **1.3**).

Buildings and surfacing

Urban areas with many buildings and a lot of surfacing have a higher surface temperature and UHI intensity. The fraction of built surface appears to be of decisive influence. The surface temperature rises by 1.4 °C for each 10% increase in the built fraction. In this case, the median value for air temperature rises by 0.34 °C and the 95th percentile value by 0.63 °C. A 10% increase in the fraction of paved surface gives a 0.7 °C higher surface temperature and an increase of the median and 95th percentile UHI_{max} of respectively 0.25 °C and 0.44 °C.

¹⁷ The p-value is used to assess if the correlation is ‘significant’. A p-value lower than 0.05 (i.e. a 5% chance that the correlation is a coincidence) shows that a correlation is statistically significant.



Table 1.2 The influence of urban land use and geometry on the variation in **surface temperature** in the daytime in neighbourhoods in the Rotterdam metropolitan area. The surface temperatures were calculated using satellite images. The correlations are significant based on a 95% confidence interval (source: Klok et al. 2012).

Heat factor	Range of values	Increase/decrease in surface temperature (°C) with 0.1 increase (10%)		Pearson correlation - r	Comments
Urban land use¹					
Built fraction	0.00 – 0.39	1.4		0.54	
Fully paved fraction	0.00 – 0.96	0.7		0.62	
Green fraction	0.02 – 0.66	-1.3		-0.83	
Water fraction	0.00 – 0.63	0.2		0.13	Insignificant correlation
Urban geometry¹					
Sky View Factor (SVF)	0.52-1.00	-1.4		-0.61	Upon increase in SVF
Building height	3 - 38 m	0.3		0.52	Upon increase of 1 m
Albedo	0.06 – 0.16	-0.8		-0.64	Upon increase of 0.01
Emissivity	0.92 – 1.00	-1.7		-0.90	Upon increase of 0.01

¹:determined for neighbourhoods

Table 1.3 The influence of the urban land use and geometry on the variation in UHI_{max} (°) within the Rotterdam metropolitan area. The UHI_{max} values are based on **air temperature data** after sunset. The correlations are significant based on a 95% confidence interval ($p > 0.05$). (Source: Van Hove et al. 2014).

Heat factor	Range of values ²	Increase/decrease in UHI_{max} (in °C) with increase of 0.1 (10%)				Comments
		median	r^2	P95	r^2	
Urban land use¹						
Built fraction	0.03-0.38	0.34	0.64	0.63	0.60	
Fully paved fraction	0.14-0.74	0.22	0.58	0.44	0.60	
Green fraction	0.01-0.64	-0.33	0.65	-0.62	0.48	
Water fraction	0.00-0.39	Geen significante relatie				zowel toename als afname
Urban geometry¹						
Sky View Factor (SVF)	0.44-0.78	Geen significante relatie				
Building height	2.3 - 26.6 m	0.08	0.69	0.19	0.80	bij toename van 1 m
Albedo	0.08-0.17	Geen significante relatie				

¹: determined within a radius of 250m around each weather station; ²excl. Zestienhoven (WMO) and Reference



Vegetation

The fraction of vegetation is often inversely proportional to the fraction of fully paved surface. Indeed, an increase in the amount of vegetation is often at the cost of the paved surface¹⁸. If 10% of the paved and built surface makes way for vegetation, the surface temperature decreased by 1.3 °C. In this case the median value for the UHI_{max} decreases by 0.33 °C and the 95th percentile value by 0.62 °C. The results of mobile measurements show a comparable reduction (Heusinkveld et al. 2014). The same applies to the correlation between UHI_{max} values in different cities and the amount of vegetation in those cities (Steenefeld et al., 2011). The correlation between UHI_{max} and the amount of vegetation is thus a robust one (Figure 1.14).

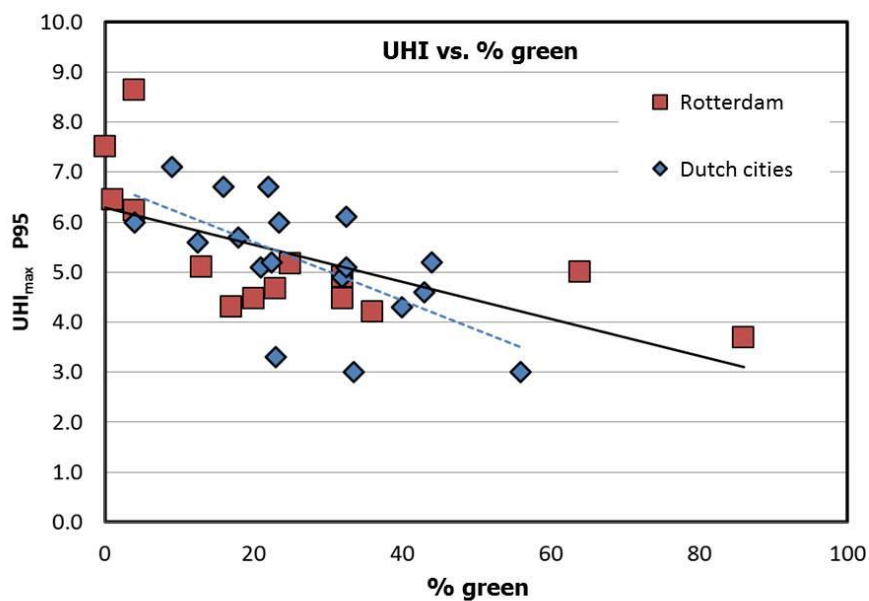

Figure 1.14 Maximum UHI intensity (UHI_{max} , 95th percentile values) as a function of the percentage of vegetation in an urban area, determined for the Rotterdam metropolitan area and Dutch cities (source: Steeneveld et al., 2011).

Surface water

In general, it is assumed that surface water in the city has a cooling effect on the surrounding area in summer. However, this is not always the case. The cooling effect occurs thanks to the fact that part of the solar energy is absorbed and transformed into evaporation of the water. In addition, solar energy is stored. Water has a great capacity for heat and can emit the stored energy as heat. The cooling effect of open water is therefore highly dependent on the water temperature in comparison with the temperature of the area surrounding it. During the summer, the water heats up gradually, as a result of which the cooling effect on the surroundings decreases. After sunset the water temperature can even be higher than the temperature of the surrounding built area, with the result that the last cools down less quickly (Figure 1.15).

¹⁸ Green roofs, façades and trees on streets form an exception to this.

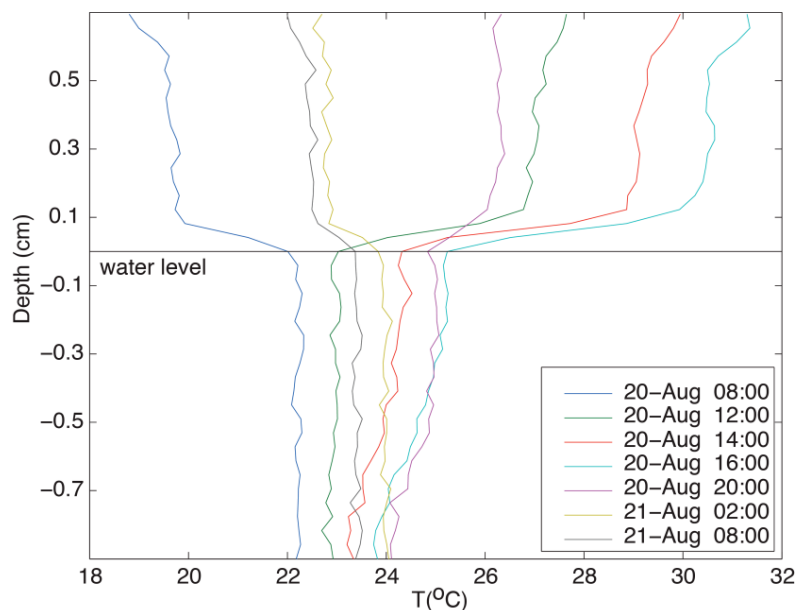

Figure 1.15 Variation of the temperature of the air and the water, measured in 2010 in the Westersingel in Rotterdam (Brolsma et al., 2011; Slingerland, 2012).

Steenefeld et al. (2014) even give a weak positive correlation between UHI intensities in Dutch cities and the fraction of surface water in these cities. However, large bodies of water also offer a surface across which the wind may blow without obstacles. During the day this natural ventilation can have a beneficial effect on the thermal comfort during warm days. The 'Rijnhaven' neighbourhood can be used as an example to show the contradictory effects of urban surface water. For this location the highest UHI_{max} values were found as a result of the warming effect of the surface water after sunset. During the day, the situation is different, however: the relatively high wind speed ensures that it is more pleasant than other locations in Rotterdam on summery days.

The eventual effect of open water is thus highly dependent on the dimensions (surface, depth), the situation in terms of the direction of the wind and in terms of buildings and other structures in the area. This 'complex character' of water also explains the absence of a clear, strong correlation between air temperature and the fraction of surface water.

As noted earlier, the above analyses provide information about the influence of the properties of an area on a neighbourhood level. Within that (i.e. on the micro scale) the differences can be considerable. The results of measurements carried out in a small park in Rotterdam illustrate this. They show that on summery days (days with a maximum temperature of 25 to 30 °C) the average air temperature in a park can be up to 3 °C lower than outside the park (Figure 1.16; from Slingerland, 2012). This makes the air temperature equal to the temperature outside the city. However, the measurements also indicate that this 'Park Cool Island' effect only has a limited influence on the air temperature in the surrounding built area. Comparable results were found with mobile measurements (Heusinkveld et al., 2010).

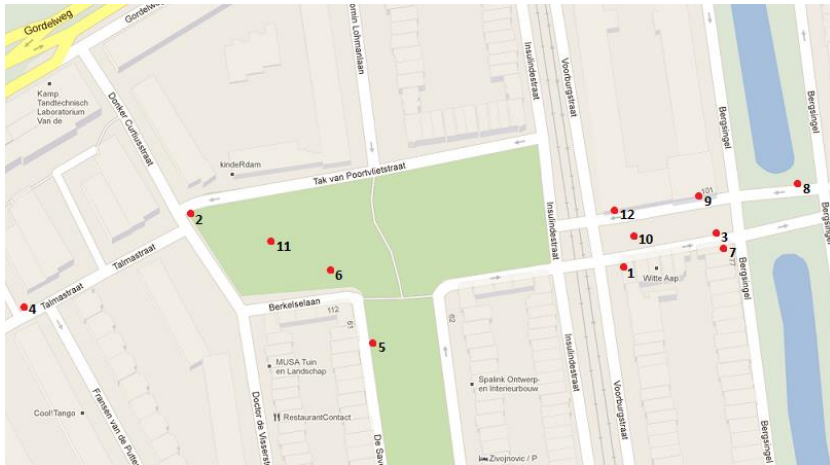
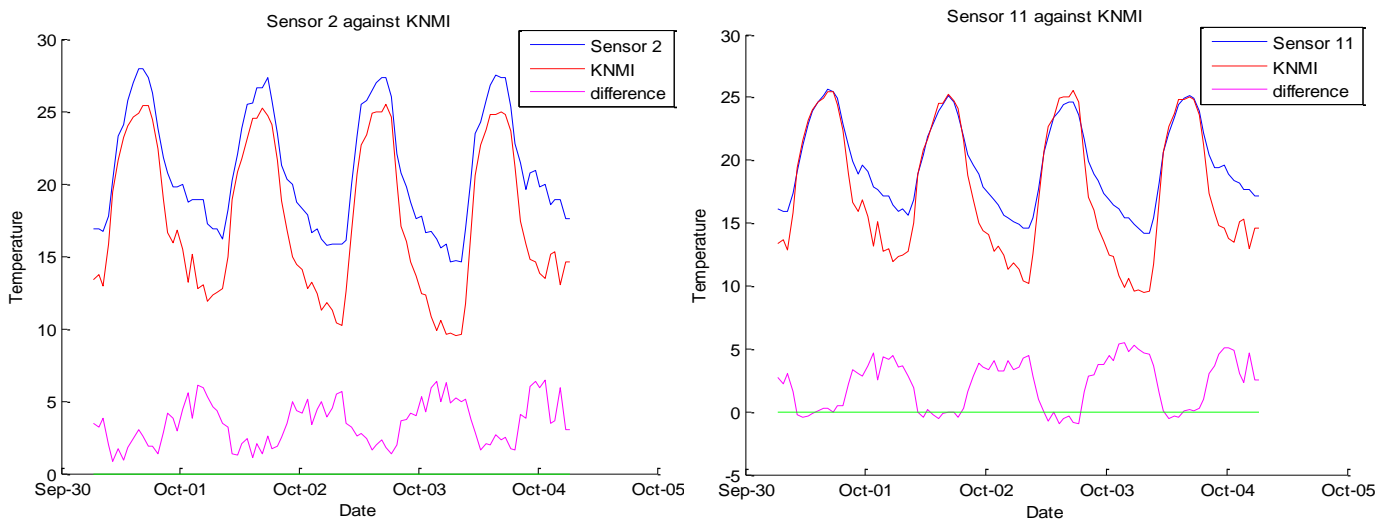

Figure 1.16 Temperature variation at the edge of a park (sensor 2) and in a park (sensor 11) in Rotterdam. The differences in temperature measured by the sensors and the KNMI are also shown. KNMI is the weather station at Zestienhoven airport on the outskirts of Rotterdam (source: Slingerland, 2012).



Urban geometry

The spatial variation in both surface temperature and air temperature within Rotterdam turns out to be related to local differences in average heights of buildings and other obstacles. This is a highly influential factor especially for the UHI_{max} ($r^2 = 0.69-0.80$): if the average height in an area increases by 1m, the median value increases by approx. 0.1 °C and the 95th percentile value increases by approx. 0.2 °C.

The spatial variation in surface temperature also turns out to be related to the average 'Sky View Factor' (SVF) and surface albedo in an area. Neighbourhoods in Rotterdam with a larger average SVF and a greater surface albedo have a lower surface temperature. A possible explanation is that a higher SVF and greater surface albedo mean that less solar radiation is absorbed, so that surfaces heat up less during the day. However, we did not find a clear correlation between these parameters and the spatial variation in air temperature within Rotterdam. Apparently, thermal properties of buildings in an area, such as 'thermal admittance' (the ability to store heat and emit it) play a greater role after sunset. In addition, the differences in air temperature between the locations are less substantial than those in surface temperature, which could be a consequence of advection (the sideways influx of air).



Urban Canyon Effect

An important phenomenon on the micro scale is the so-called ‘Urban Canyon’ effect. An Urban Canyon represents a narrow street with tall buildings on both sides. Within CPC a microclimate model was developed that makes it possible to analyze processes in the Urban Canyon more accurately. The simulation model combines radiative transfer, conductive heat transfer and convective heat transport by Computational Fluid Dynamics (CFD) modelling at 1 meter spatial resolution. (**Figure 1.17**). This makes the model unique in comparison to other models for the microclimate (Schrijvers et al., 2014).

During the day it is possible to distinguish two opposite effects: tall buildings provide shade, with the result that street and wall surfaces heat up less in the Urban Canyon. However, the model simulation also shows that incoming sunlight is very efficiently absorbed between tall building through ‘multi-reflection’. Then, warming of the street and wall surfaces takes place in the Urban Canyon. After sunset, the high buildings decrease the thermal emissions from buildings into the atmosphere (‘long-wave trapping’) so that it stays warm for longer in the Urban Canyon.

In addition, the model simulation shows that ventilation, or rather the transportation of heat through convection, is of high importance. The ratio of building height to street width (H/W) is significant here. In model simulations with (‘Weather and Research Forecasting’) WRF, Theeuwes et al. (2014) find an optimum H/W ratio of around 1 (the buildings are as tall as the street is wide). Higher or lower ratios both have advantages and disadvantages in terms of ventilation and shade.

The best ventilation in the street is achieved through a H/W ratio of 0.5 or lower (the street is (more than) twice as wide as the buildings are tall). Up to a height-width ratio of 1.0, the air at street level still mixes with the *canopy layer* (the air above the city)¹⁹. At higher ratios (the buildings are taller than the street is wide), especially the top part of the Urban Canopy is mixed. In this case a highly stable air situation occurs in the lower part of the canyon where wind speeds are very low and there is hardly any mixing of the air. There is, however, more shade, and there is therefore less warming of surfaces in the Urban Canyon (although it is not the case that a H/W ratio of 1 or higher means that there is no warming through solar radiation at all) (Kleerekoper 2012).

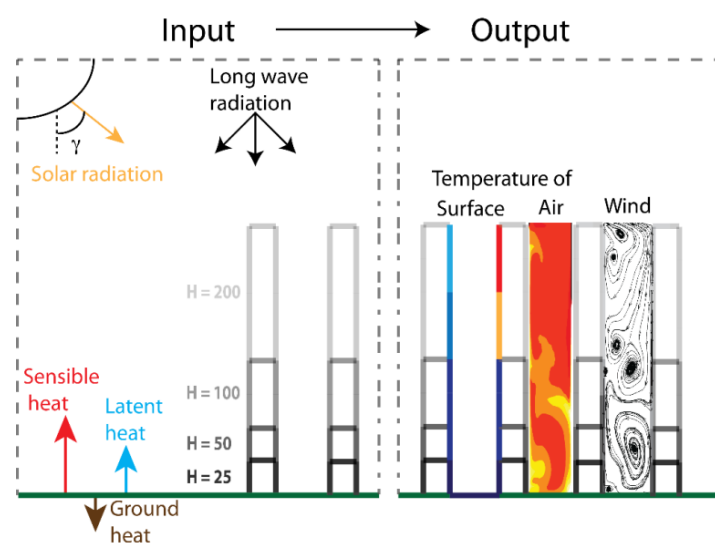

Figure 1.17 Schematic reproduction of the micro scale model developed. The input is on the left, with buildings and accompanying parameters such as height-width ratio, and material properties such as albedo and heat capacity. The various physical properties can be switched on and off independently (ventilation, radiative transfer (short/longwave), etc.). The output is on the right, with surface temperature, air temperature and air currents (Schrijvers et al., 2014).

¹⁹ In the Netherlands most streets are wider than the buildings are high (ratio below 1).



1.5.3 The variation in thermal comfort

The variation in thermal comfort in the Rotterdam metropolitan area was determined using the Physiologically Equivalent Temperature (PET). The PET values calculated were subsequently related to physiological stress and stress perception (**Appendix C**).

The number of hours that can be classified as hours with moderate to high heat stress ($PET > 23^\circ$) is greater at the city locations than at the reference location in the countryside (**Figure 1.18**). Exceeding the threshold value for thermal discomfort almost always took place during the day (157 hours at the city locations and 93 hours at the reference location, or 21 and 12.5% of the total number of hours that month). The months of July in 2011 and 2012 were cooler than usual. Although the number of hours with $PET > 23^\circ\text{C}$ was lower (32 hours in 2011 and 77 hours in 2012), the relative differences found between the locations is comparable to those of 2011.

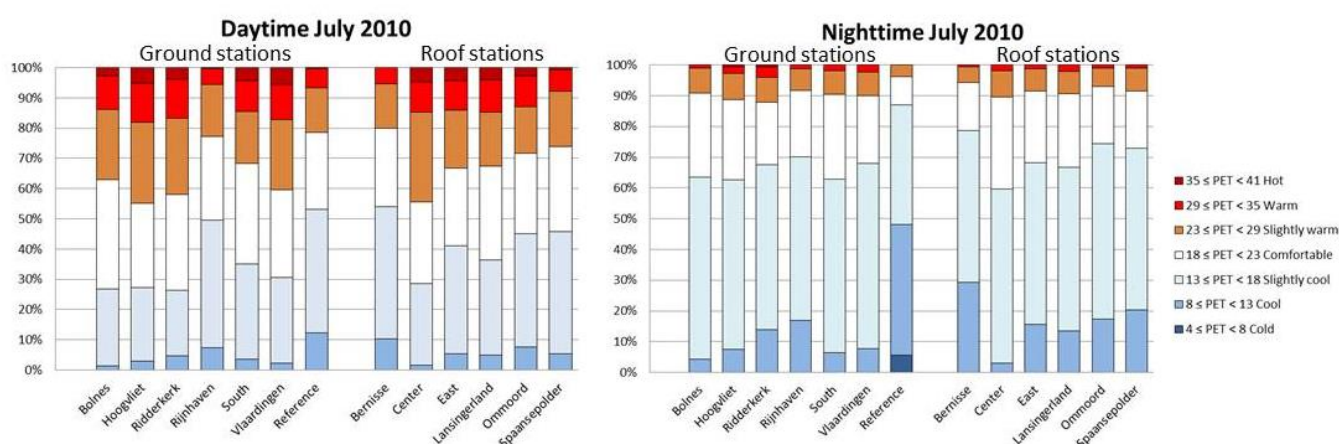

Figure 1.18 Frequency distribution for the different thermal comfort classes during the day and at night for July 2010 for the different locations in the city and for the reference location (source: Van Hove et al., 2014).

We can ascribe the greater number of hours with lower thermal comfort in the urban areas to the lower wind speeds. The differences in air temperature between the city locations and the countryside are minimal during the day ($< 2^\circ\text{C}$) or even negative (for instance “Rijnhaven”). In addition, we have seen that the direct radiation from the sun on the urban locations is less on average than in the countryside. The same applies to the atmospheric humidity. The differences in radiation and humidity, however, do not have a noticeable effect on PET.

The variation in thermal comfort within the metropolitan area also turns out to be largely related to differences in wind speed. The wind speed at the ‘Rijnhaven’ location, for instance, is relatively high (approx. 80% of reference) due to the presence of a large body of water. This also explains why the number of hours with reduced thermal comfort is relatively low for this location. In reverse, the large number of hours that exceed the threshold in Ridderkerk can be explained by much lower wind speeds at this location.

The situation changes after sunset when the UHI effect plays a greater role. The variation in PET in the urban area is then determined in large part by local differences in temperature. As we have seen earlier, Rijnhaven has the highest maximum UHI values, while relatively low values are found for the green location of Ridderkerk. An important conclusion is therefore that a greater UHI_{max} at a certain location does not automatically mean less thermal comfort during the day.



1.5.4 The influence of neighbourhood characteristics on thermal comfort

The spatial variation in PET during the day is largely determined by differences in average wind speed at the locations. It is not possible to deduce clear, direct correlations with land use or geometric factors, such as building height, from the measurements from the measuring network in Rotterdam. When the situation changes after sunset and the UHI effect begins to play a more prominent role, outdoor thermal comfort is tied to urban properties that are important for the UHI effect.

However, this result requires further explanation:

- The PET values calculated for the locations in Rotterdam are average values for the areas. Very locally (on the micro scale) large differences in PET can occur. **Figure 1.19** shows this for a street in the Geitenkamp neighbourhood in Arnhem (Heusinkveld et al. 2012). In the same street there are 15 degree differences in PET because the south of the street is in the shade (trees and houses) and the north is in full sun. Wind can have a cooling effect but on this particular day wind was not significant in lowering the PET.
- PET is one of the many thermal comfort indices that have been developed. The sensitivity of the different indices for meteorological variables turns out to vary greatly.
- PET is calculated based on physical and physiological factors. The latter factors were only studied for a standard person. Subsequently the results from German research were used to relate the values calculated to stress perception. However, this relationship could be different for Dutch citizens, for Dutch weather conditions. In addition, psychological factors were not taken into account. According to research done by Klemm et al. (2014) these are highly influential for how people truly perceive thermal comfort in an environment.

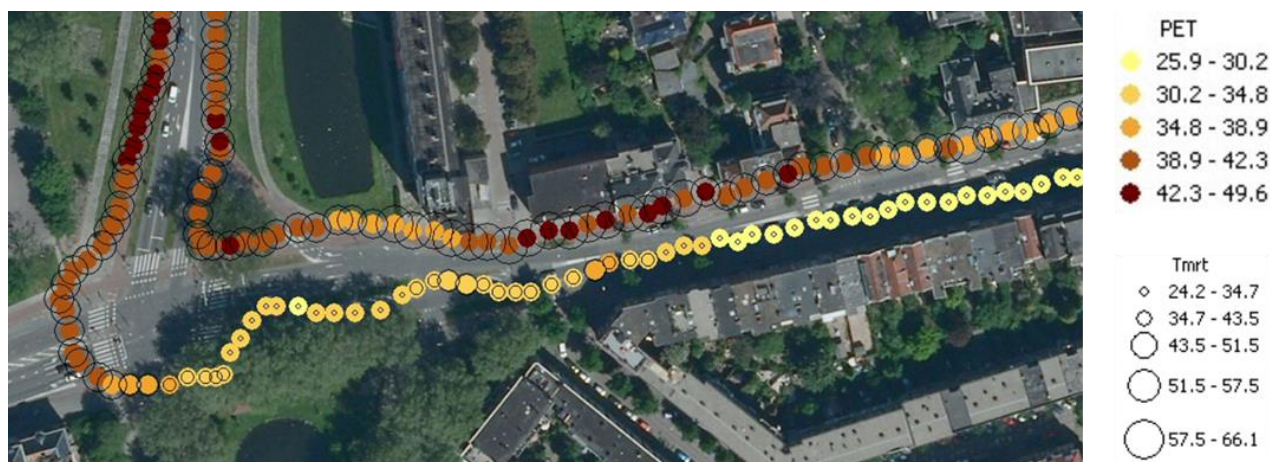

Figure 1.19 Physiologically Equivalent Temperature (PET) and radiation exposure (mean radiant temperature, T_{mrt}) in the Doctor Schaepmanlaan and Rozendaalseweg in Arnhem. (source: Heusinkveld et al., 2012).



Conclusions

In relation to the vulnerability of the built environment, the CPC programme has yielded the following conclusions:

How does the local climate work in Dutch cities?

Temperature

- Each city or city district in the Netherlands experiences an Urban Heat Island effect (UHI) and substantial differences can occur in UHI at living level within the city;
- The UHI intensity of Dutch cities is considerable and comparable to that of other European cities;
- The UHI intensity is especially great after sunset because the countryside cools down much faster than the city, where cooling only takes place at the end of the night;
- The UHI intensity is the greatest in the summer months and in spring and much lower in winter. However, even on some winter's days the night-time differences in temperature between the city and the countryside can be large. The latter is often a short-lived phenomenon (< 1 day);
- The difference in temperature between the city and the countryside is especially large at living level; the UHI at a greater altitude in the boundary layer above the city is minimal;
- The developments of the micro scale model show that the increased absorption of shortwave solar radiation through reflection between tall buildings is the driving force behind the UHI effect; evaporation was not considered in this model for densely constructed high-rise areas.
- Heat production through human activities contributes to the UHI. In and around the large cities of The Hague and Rotterdam, the anthropogenic emissions of heat are a maximum of 20 W m^{-2} at night and around 70 W m^{-2} during the day.

Thermal comfort

- In general, the number of days with heat stress in urban areas is greater than in the countryside. In the coming decades, thermal discomfort and heat stress can become important issues for many cities;
- A greater UHI_{max} for a certain location does not always mean less thermal discomfort during the day. The UHI's value as a proxy or indicator for thermal comfort is therefore limited;
- The spatial variation in thermal comfort during the day seems to be predominantly determined by differences in average wind speed at the locations, while the spatial variation during the night is determined in large part by differences in maximum temperature.

Evaporation

- In the period from April until September, 20-60% of the average precipitation is lost through evaporation; this creates an average cooling speed of $20\text{-}25 \text{ W m}^{-2}$ per day (i.e. 11-15% of the incoming solar radiation)
- First rough estimates for Rotterdam show that the water consumption of trees only has a minor effect on the water balance; locally, however, this may vary.

The minimal evaporation – partly caused by paved surfaces in the city, partly by lack of moisture for evapotranspiration – ensures that a city's temperature increases. It is not yet known how great this effect is. It is also not yet clear what the effect of evaporation is on the thermal comfort.



What is the influence of spatial planning?

- The correlation between UHI and a city's population (as proxy for the size of the city) as reported by Oke (1973) is not confirmed in our research; other factors such as population density and city/neighbourhood properties are most likely more important for the UHI;
- The properties of a city or neighbourhood also seem to be more important for the UHI than the geographical situation;
- Both the daytime surface temperature and the maximum UHI intensity during the night show significant (linear) relationships to factors of urban land use, such as the fraction of build surface, the fraction of paved surface and the fraction of vegetation (see **Table 1.4**).
- The *surface* temperature during the day and maximum UHI intensity during the night also show a significant correlation to the average building height.
- The longer the warm spell takes, the less quickly a densely built neighbourhood cools off at night. In a green neighbourhood this accumulating effect is less present.
- Urban vegetation cools the environment through transpiration and shade. This does mean enough water must be present.
- On summery days it can be 3 °C cooler in a small park than in the surrounding built area. However, the influence of the Park Cool Island effect on the surrounding built environment is minimal.
- The ratio of building height to street width (H/W) is at its best at H/W = 1. At H/W < 1 there is good ventilation, but little shade, while at H/W > 1 there is more shade, but there is no mixing of the air near the ground.
- Due to water's vast capacity for heat, surface water in the city can have both a cooling and warming effect on the surroundings. The cooling abilities of surface water, for instance, decrease in the summer months because of an increase in the water temperature. The final effect of open water is therefore highly dependent on the dimensions (surface, depth), the situation in terms of the direction of the wind and in terms of buildings and other structures in the surroundings.

Table 1.4 Summarizing overview of the influence of neighbourhood properties on the UHI_{max} (air temperature) (source: Steeneveld et al., 2011)

Factor	Effect or average UHI _{max} summer months
Antropogenic heat	+0.5 °C average across Rotterdam (38 W/m ²) +2.0 °C industrial area (200 W/m ²)
Population density*	+0,1 °C tot +0.3 °C per increase of 1000 inhabitants/km ²
Built surface	+0,4 °C tot +0.6 °C per 10% increase
Paved surface	+0,2 °C tot +0.4 °C per 10% increase
Urban vegetation	-0,3 °C tot -0.6 °C per 10% increase
Open water	no significant correlation
Sky View Factor	no significant correlation
Albedo	no significant correlation
Building height	+0.08-+0.19 °C per increase of 1 m



2 How vulnerable are Dutch cities to climate change?

Summary

The persons or objects affected by a climate effect are the starting point for a vulnerability analysis. In the case of heat, it is people who suffer from heat stress, while for flooding because of extreme rainfall it is capital goods that risk damage. As part of the Climate Proof Cities programme, research was done on the vulnerability of these objects, which is determined by three factors: the sensitivity to a climate threat, the level of exposure and the adaptive capacity, and which therefore varies greatly by location.

Heat stress

Elderly over the age of 75 are especially sensitive to periods of heat and can become ill or even die. Research carried out during a heat wave in 2010 shows that many old people suffered and the heat stress was considerable. At rest, body temperatures were measured that suggest fever. It seems that the elderly do not acclimatize to heat within a warning period of three days. This means that this vulnerable group needs extra attention during heat waves. The productivity of workers outdoors or in buildings without air conditioning also decreases during heat waves, with macro-economic costs as a consequence.

Buildings can reduce the exposure to heat by providing a cool indoor climate, but research based on the KNMI'06 climate scenarios shows that in the future a large proportion of Dutch houses will regularly experience indoor temperatures higher than the accepted levels (the temperature at which the inhabitants find it 'warm'). Important factors for the heating of buildings is the amount of insulation and the degree to which the sun can shine directly into the building. The latter depends mainly on the surface area of windows facing east and west and the presence of solar shading.

By projecting information about the properties of neighbourhoods, buildings and communities on a map, a vulnerability map can be composed that shows which parts of the city require extra attention. In Rotterdam, vulnerable neighbourhoods in terms of the elderly are Spangen, Bospolder, parts of the old north, Feijenoord, Charlois and other parts of Zuid. In Amsterdam, an analysis was carried out into the vulnerability of workers, where the historical centre stands out with its combination of a high density of workplaces in badly insulated buildings.

Pluvial flooding

Buildings, especially their interiors, and switch boxes are in particular sensitive to material damage through flooding. Furthermore, economic damage can take place through interruption of activities, traffic disturbances and power cuts. In addition, there are the costs of calling in emergency services and there are social implications if hospitals and so on are less accessible or functional. Risks and damage due to extreme rainfall are often dependent on a threshold that differs per object, for instance the height at which switch boxes are installed. Reducing the exposure during extreme rainfall can be achieved locally by ensuring that the water stays below the threshold (by increasing local storage and infiltration) or by increasing the threshold (e.g. higher doorsteps or installation of switch boxes). Analyses carried out within the Climate Proof Cities (CPC) programme show that a large number of vulnerable and simultaneously vital objects and networks are present in urban areas. Making an inventory and overview of this is highly important in order to understand the vulnerability of an urban area as a whole.

Building on chapter 1, the vulnerability maps also show that the vulnerability to heat or flooding in a city shows great spatial variation. Vulnerability analyses or climate stress tests, as they are called by the coalitions of the New Construction and Restructuring Delta sub-programme, should pay attention to the factors named and can then offer insight into the vulnerability of an area at a very local level.



2.1 Introduction

In order to gain insight into which buildings require more or less attention in terms of climate change, a vulnerability analysis can be carried out (the 'Analysis' step from the 'Guide to Spatial Adaptation'²⁰). Vulnerability of cities to climate change is defined as the degree to which the urban system is receptive to changes in climate parameters and not able to deal with the negative consequences. Within the Climate Proof Cities (CPC) research programme there was a focus on changes in the climate as expressed in temperature and rainfall (see chapter 1). Extremely high temperatures and heavy rainfall can form a threat to the city and its inhabitants, but a climate threat alone does not immediately imply damage. The true vulnerability is determined by three factors: the sensitivity to the climate threat, the level of exposure and the adaptive capacity (IPCC, 2007). Together with the (increasing) chance of an extreme event of a certain intensity, this vulnerability determines the risk for an urban system. The 'Vulnerability' text box explains these concepts. Because the exposure has already been discussed in chapter 1 and no research was done on the adaptive capacity within CPC, this chapter is especially concerned with the sensitivity and resulting vulnerability of the urban area.

Two types of methods can be distinguished for analyzing vulnerability, each with its advantages and disadvantages (Veerbeek and Husson, 2013); the *contextual vulnerability analysis*, an approach that examines the causes and determining factors of vulnerability and uses this to identify areas with relatively higher and lower vulnerability. The *outcome vulnerability analysis* focuses, as the name suggests, on the potential effects of climate change at a given moment in the future. Veerbeek and Husson (2013) argue that insight into the urgency and severity of the climate threat is what is most needed at the moment and that an outcome analysis is most effective here. This was confirmed by the input of stakeholders during CPC meetings, who indicated that they would like information about thresholds or tipping points, especially in terms of time.

However, an outcome analysis requires a lot of data for scenario development, and spatial details, as well as agreements about norms and goals. For water management this method seems workable and we will explore it further in section 2.3. This is more difficult for heat stress. How do you determine, for instance, how much heat stress one can handle or how many heat-related deaths are acceptable? Therefore, the contextual vulnerability analysis was used for heat (2.2). The chapter closes with an overview of tools for carrying out vulnerability analyses that are available or in development (2.4) and main conclusions (2.5).

²⁰ <http://www.ruimtelijkeadaptatie.nl/en/>



Vulnerability

The **exposure** to climate phenomena simply has to do with the degree to which the system comes in contact with that threat. The surroundings of a system is key here: cities in the higher parts of the Netherlands, for instance, are not exposed to flooding from the sea. Precipitation patterns will not differ much within a city, but some parts are lower than others, which means that the exposure can vary from neighbourhood to neighbourhood. Neighbourhood characteristics do influence the (comfort) temperature, so that the exposure to high temperatures varies greatly according to location (see chapter 1).

The **sensitivity** to a climate threat concerns the degree to which a system is influenced by the changing climate parameters. Unlike exposure, sensitivity relates to the intrinsic characteristics of a system. The sensitivity of the urban area is determined by the number and type of sensitive elements in the system, such as people and objects, and the sensitivity of these elements to impact or damage. Buildings in a lower part of the city with many basements containing small workplaces, for instance, are more sensitive to flooding than buildings without basements.

The **capacity for adaptation** is a system's (i.e. a city's) capacity to deal with the effects of climate change, realize possible adaptations and limit the damage (Smit et al., 2001). A good capacity for adaptation can decrease the overall vulnerability to a climate threat and increase resilience. The capacity for adaptation depends on many (social) factors that are difficult to quantify. The question is to what extent the dimension of capacity for adaptation is relevant at neighbourhood level. 'Access to technology', for example, is often not organized at neighbourhood level.

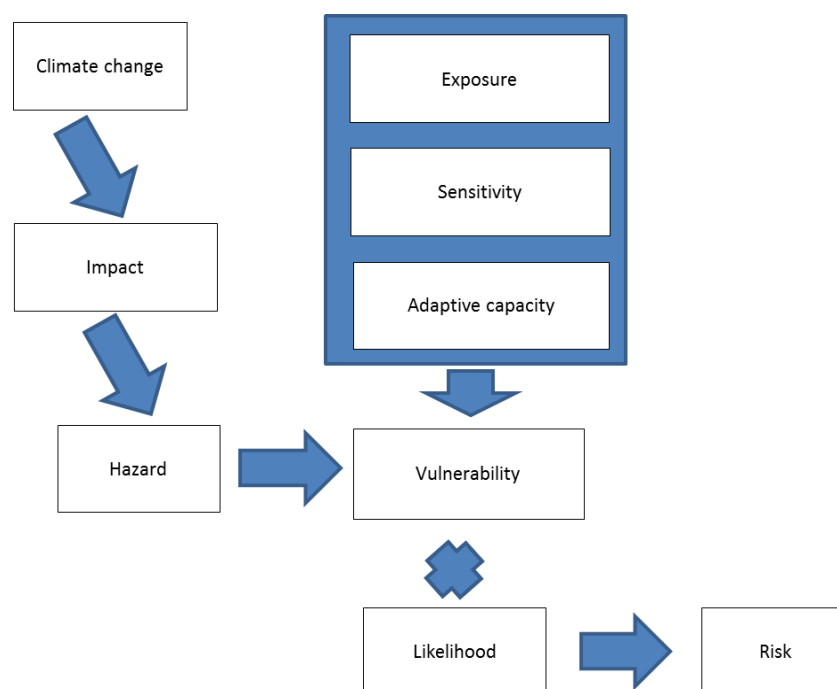

Figure 2.1 Impact of climate change on the (urban) system (Pásztor and Bosch, 2011).



2.2 Heat stress

In order to carry out a contextual vulnerability analysis, the sensitive elements affected by climate change must first be identified. For heat waves this is first and foremost the people themselves who experience heat stress. A next question is whether there are sections of the population that are more sensitive to heat stress than others (2.2.1) and where these are located. Are they located in an area where they are exposed to high temperatures?

In terms of exposure, it is possible to draw a distinction between indoors and outdoors, with the terminology of “first shell” and “second shell” respectively (**Figure 2.2**). A building can be seen as a first shell that can reduce people’s exposure to heat stress, depending on the characteristics of the building (2.2.2). In terms of the outdoor climate, several neighbourhood properties were named in chapter 1 that can increase or decrease the exposure. The presence of trees in a neighbourhood, for instance, decreases the exposure to extreme heat (of buildings and their inhabitants). The elements for exposure and sensitivity are combined in 2.2.3 to form vulnerability maps that offer insight into both the location of vulnerable groups and the exposure to climate influences.

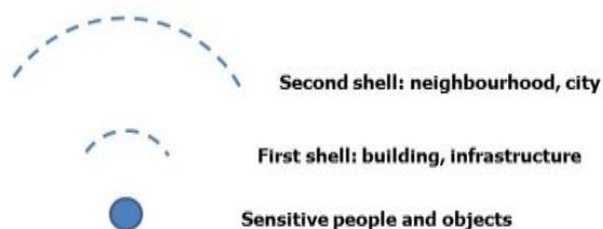

Figure 2.2 First and second shell around sensitive people and objects.

2.2.1 Sensitivity

Above a certain limit, high temperatures lead to heat stress. This heat stress can lead to a decreased thermal comfort, sleep disruption, behavior changes (greater aggression) and decreased productivity. However, heat stress can also lead to serious heat-related illnesses such as skin rashes, cramps, exhaustion, strokes, kidney failure and breathing problems. Heat stress can sometimes even lead to death (Howe and Boden, 2007).

During heat waves both hospital admissions (for emergencies) and death rates increase significantly (Kovats and Hajat, 2008). In the Netherlands, death rates increase by 12% during heat waves (approximately 40 deaths more per day) (Huynen et al., 2001). Within CPC, a database of climate data (KNMI) and death rates (CBS) was made. This charted the extent of the excess mortality in hot and cold periods. **Figure 2.3** shows that during heat waves, there is an excess mortality of 8 extra people for every degree above 20°C. That is more than was initially thought. In addition, it turns out that the combination of temperature and humidity, for which combined indices exist, such as the heat index and the humidex, is a slightly better predictor for mortality than temperature alone.

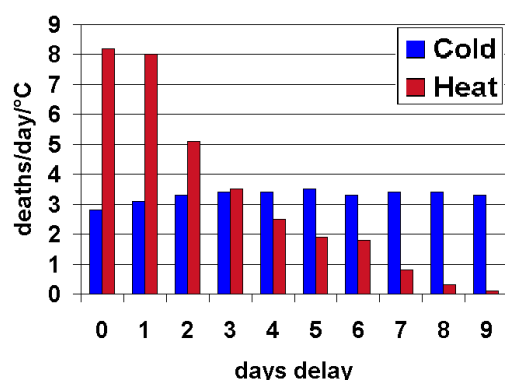

Figure 2.3 Excess mortality per day per °C for heat and cold related to the number of days after the hot or cold day.

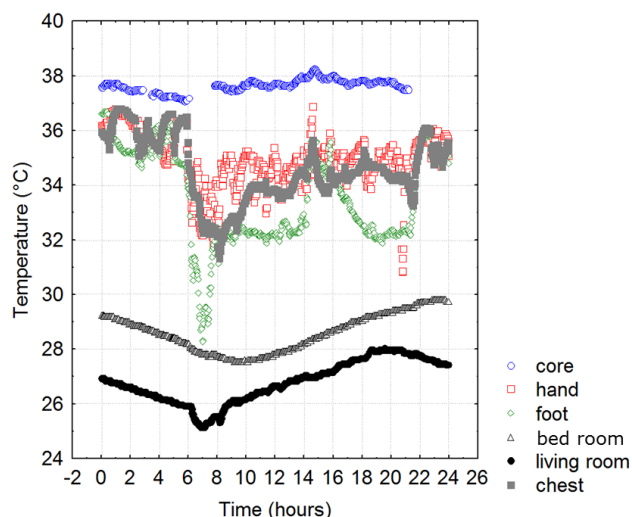

Figure 2.4 Typical temperature course in living room, bedroom, on the skin and inside the body of an elderly woman during the heat wave of 2010 (Daanen et al., 2011).

The people who are the most sensitive to heat-related illnesses and death are the elderly over the age of 75 and the chronically ill, especially if they have heart, breathing and kidney diseases (Kovats and Hajat 2008; Hajat et al., 2010). An investigatory CPC study in Tilburg during a heat wave in 2010 showed that the elderly suffered many symptoms and the heat stress was considerable. At rest, body temperatures of over 38 degrees Celsius were measured (Daanen et al., 2011) (**Figure 2.4**).

Aside from the factors mentioned above, the elderly often exhibit sub-optimal behavior during heat waves. The elderly are often afraid of draughts, and this means that they keep the windows closed in the morning, even though that would be a good time to create ventilation. They also do not tend to turn on the air conditioning, so that the temperature in the house increases needlessly. Because of their impaired perception of temperature they tend to wear too much clothing.

Based on the research done on the elderly in Tilburg, the most important behavioural factors that increase heat sensitivity are:

- Not drinking enough
- Preventing ventilation by keeping windows shut
- Wearing inappropriate clothing
- Moving too much
- Not looking for cool spots enough

Within CPC research was also done on the possibility of acclimatization of the elderly, which comes down to increasing the people's own capacity for adaptation. Since meteorological services like the KNMI can predict a heat wave a number of days in advance, this period could be used to prepare the elderly physically for the coming heat wave. Healthy young people are able to adapt well to heat (Strydom et al., 1966). There have been studies in which sweat production doubled itself in seven days, increasing these people's cooling abilities. The capacity to acclimatize was never studied among the elderly.



Eight women aged over 75 and eight women aged 20-30 took part in the CPC experiment. Under controlled circumstances they did moderate exercises at high temperatures for a number of days, to see if they adapted to the heat. The older women had a significantly lower sweat production than the younger women, but neither of the groups showed signs of acclimatization. Possibly a period of three days is too short for acclimatization (Daanen and Herweijer, 2015).

The insights above have already been incorporated into the national heat plan (Ministry of Health, Welfare and Sport, 2007), which offers guidelines for heat waves to the elderly, their families, carers and health care institutions. Aside from guidelines derived from the abovementioned vulnerability factors (such as drinking enough, providing ventilation, or having a bath or shower to cool off) and ensuring that information about this is available, an important guideline is that help is offered. Many elderly people are not able to carry out these actions independently.

Heat also leads to decreased productivity. With temperatures above 25 °C productivity decreases by 2% per degree of temperature increase (Seppanen et al., 2004). The increase of the outdoor temperature will not have equal consequences for every sector. People who work outdoors, such as in the agrarian sector, will experience the temperature effects the most directly. People who work in buildings sometimes have access to active cooling (air conditioning) and can use this to regulate temperature and humidity. The increased morbidity (illness) and mortality (death) and decreased productivity during a period of extreme heat have economic consequences.

For the Netherlands a model was developed as part of CPC which made estimates of this (Daanen et al., 2013). Based on the W+ KNMI'06 scenario (van den Hurk et al., 2006), the economic costs of climate change were estimated at approximately 100 million Euro per year around 2050. The most important factor in the costs is decreased productivity as a result of heat. This is partially compensated by the lower costs of decreased mortality rates and hospital stays due to less cold in winter. Since more people die of cold than heat in the Netherlands, each of the KNMI'06 scenarios leads to a decrease of the number of deaths per year. For the "warmer" scenarios, however, the number of heat-related deaths increases with higher average temperatures (without adaptation). The same correlation exists for temperature-related hospital stays: it decreases throughout the year, but increases in summer (Stone et al., 2013).

Because cities house both old and young, ill and healthy people, heat sensitivity varies greatly locally.

2.2.2 the role of buildings

Buildings can both increase and decrease the exposure to heat. Research within CPC, based on the KNMI'06 climate scenarios (van den Hurk et al., 2006), shows that overheating indoors will occur more often due to climate change and will last for longer in a large proportion of Dutch residential buildings (Van Hooff et al., 2014). Overheating occurs when indoor temperatures are higher than the thresholds for thermal comfort. This threshold is variable and depends on the outdoor temperature.

The research focused on detached houses, terraced houses and apartments. The numerical simulations were carried out with a category of models known as Building Energy Simulation software (Hensen et al., 2002; Crawley et al., 2001, 2008; Costola et al., 2009). These simulations provide detailed insight into the temperatures that occur in each room of these houses, during each hour of the year. The simulations show that detached houses and terraced houses suffer from overheating less often than apartments (**Figure 2.5**). This applies both to apartments directly situated under the roof and apartments located more centrally in the building. The orientation of the building is an important factor here: windows facing east and west cause an increase in overheating hours because of the lower position of the sun in summer, which enables more solar radiation to enter the house (**Figure 2.6**).

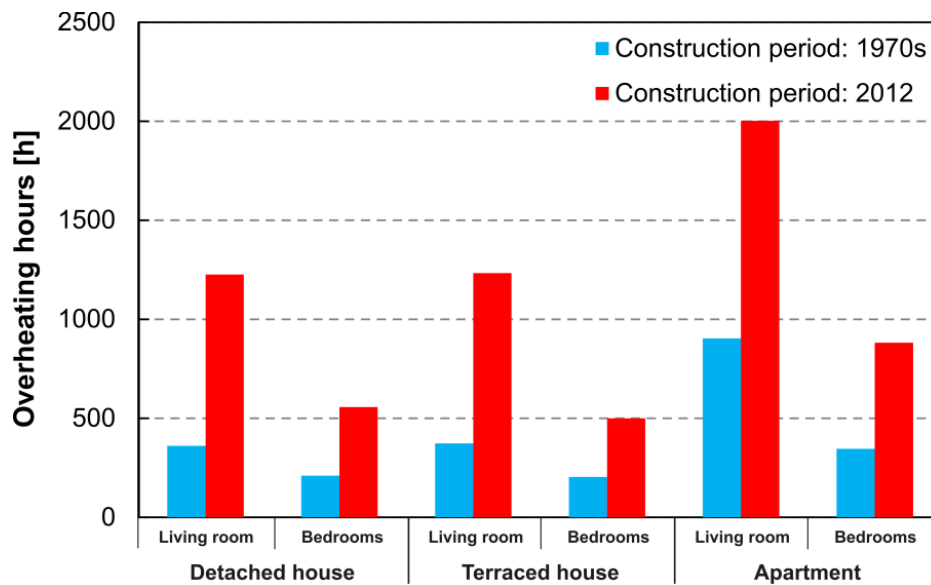

Figure 2.5 Annual number of overheating hours for three types of houses and on average for four orientations N, E, S, W per building type (Building Energy Simulations). Per building type there are also two different construction years and accompanying insulation values (1970 and 2012). The simulations were carried out for the climate year 2006 in De Bilt. This heat wave year is a year that can be seen as a typical “future” year, with a hot summer and various heat consequences (van Hooff et al., 2014).

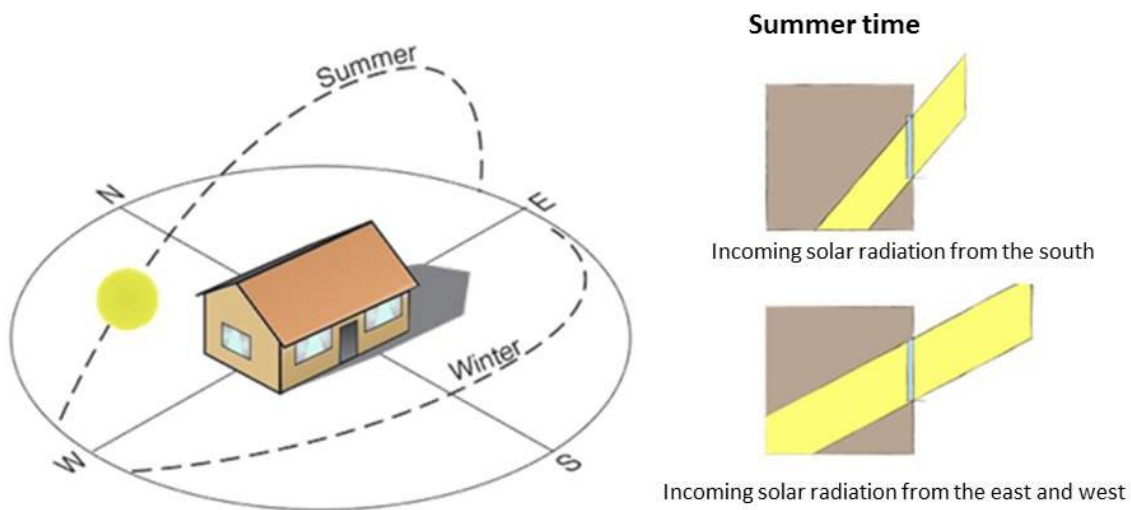

Figure 2.6 Schematic overview of the sun’s path in summer and winter. The figure on the right shows that the sun penetrates comes into the rooms furthermore through the windows facing east and west than through windows facing south in summer.



In addition, modern and therefore more well-insulated houses (often constructed without outdoor sunblinds) heat up faster than older houses: they have around 3x as many excess hours (**Figure 2.5** and **Figure 3.2**). Having more insulation and still suffering from heat seems like a contradiction, but this is caused by the greenhouse effect in combination with the degree of insulation. The greenhouse effect means that shortwave solar radiation enters the house easily through the glass, is subsequently absorbed by the materials in the house, and is then emitted as longwave radiation. This longwave radiation cannot pass through glass, and this form of heat must therefore leave in another way (convection and conduction). In more well-insulated houses this heat has more trouble leaving than in less well-insulated houses. Good insulation is key for limiting heat loss in winter, but the same insulation ensures that in the summer, an overheated space cools down less quickly. Sunblinds (especially outdoor sunblinds) and ventilation are therefore very important, especially for modern and well-insulated houses (Van Hooff et al., 2014) (see also chapter 3.2).

The role of buildings can differ greatly according to construction year and typology. Because cities consist of a broad range of different building types, heat sensitivity is very locally determined here too, and adaptation is an accumulation of relatively small, local measures.

2.2.3 Vulnerability maps for heat

The vulnerability maps that were drawn up as part of CPC for the cities of Amsterdam and Rotterdam²¹ bring together the information about the exposure and sensitivity of man, buildings and environment, as described in the previous chapters (van der Hoeven and Wandl, 2014). Combining aspects of the built environment with the people in it offers insight into areas requiring attention (“hotspots”), and thus into priorities for policy.

This results in different maps: **Figure 2.7** focuses on the elderly in Amsterdam and is based on the surface temperature, the liveability in the neighbourhood, the average energy label of the houses and the number of people aged 75 or older per hectare. Large social areas requiring attention can especially be found in the western part of the city, but also in Noord, Oost and Zuidoost. The most vulnerable type is characterized by an extraordinarily high number of elderly people per hectare while the average energy label is mediocre. In addition there are parts of the city where, although there are fewer people over the age of 75, both the liveability and the energy label of the buildings leaves much to be desired.

Based on the surface temperature, the average energy label and the number of workers per hectare, a vulnerability map for workers was made for Amsterdam (**Figure 2.8**). The assumption here is that workplaces with a bad energy label in warm parts of the city rate low on comfort or use a relatively large amount of energy for cooling. The historical centre of Amsterdam (Burgwallen) deserves special attention. Here the combination of a high density of workplaces (more than 1000 workplaces per hectare) and bad energy performance (energy label G) occurs frequently.

Both maps show that the vulnerability to heat in a city shows great spatial variation. Within a neighbourhood, areas with high vulnerability (local “hotspots”) can be interspersed with less vulnerable parts.

²¹ The vulnerability map for Rotterdam can be found in Chapter 5.



Typology Vulnerability of Inhabitants: elderly

	UHI surface temperature	Quality of Life index	Average energy label of buildings	75+/ha
most vulnerable	8 C°	modest positive	D	18.3
more vulnerable	8 C°	modest	G	5.0
vulnerable	8 C°	modest positive	G	6.5
little vulnerable	8 C°	modest positive	E	4.6
little vulnerable	7 C°	positive	G	4.5
other	-	-	-	< 1.5
water	-6 C°	-	-	0

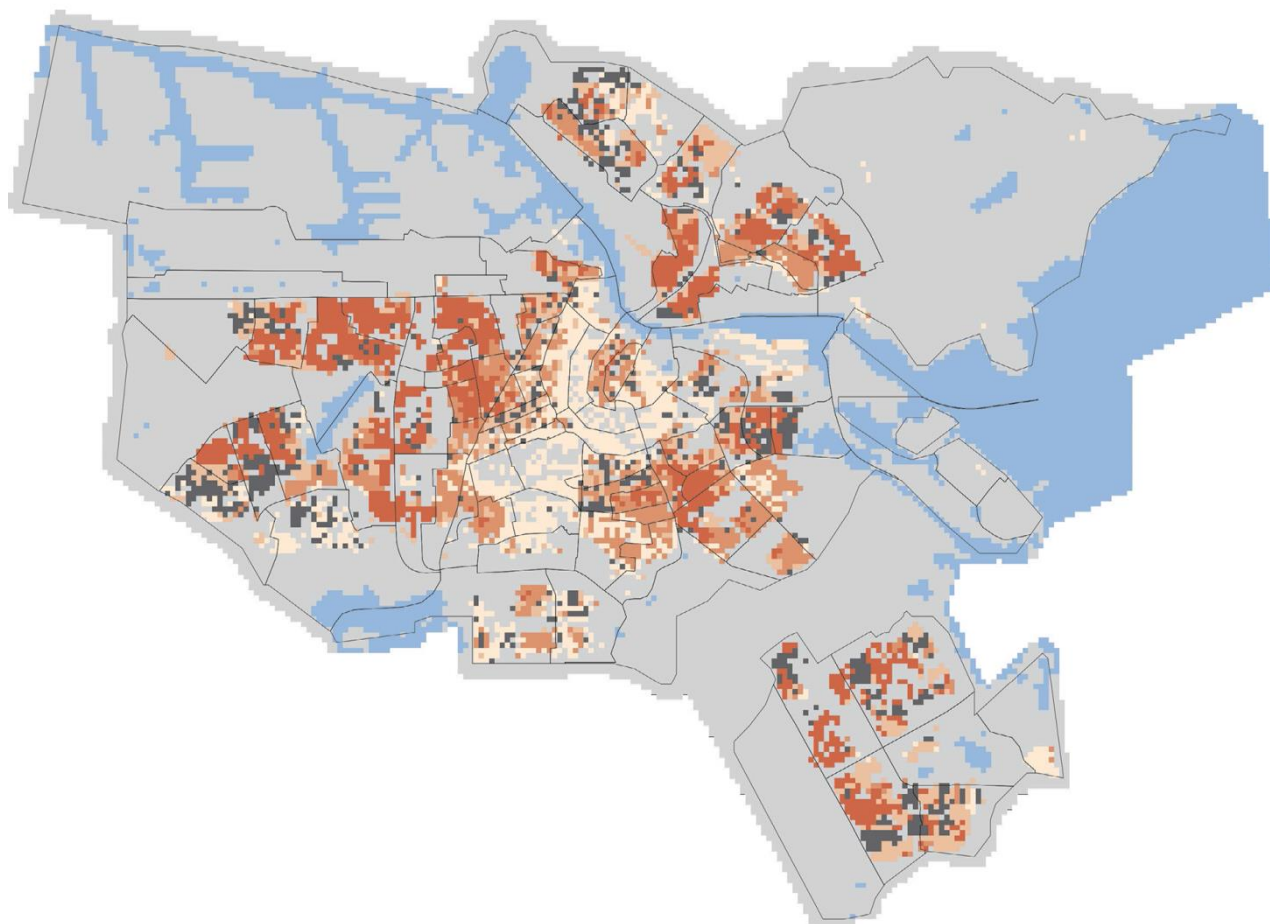

Figure 2.7 Vulnerability map of Amsterdam's inhabitants related to heat stress. (Van der Hoeven and Wandl, 2014).



Typology energie-efficiency workplaces

	UHI surface temperature	average energy label of buildings	workplaces/ha
very inefficient	9 C°	G	1058
inefficient	8 C°	G	43
inefficient	8 C°	F	53
somewhat efficient	8 C°	E	48
somewhat efficient	8 C°	D	48
efficient	8 C°	C	45
most efficient	8 C°	A	90

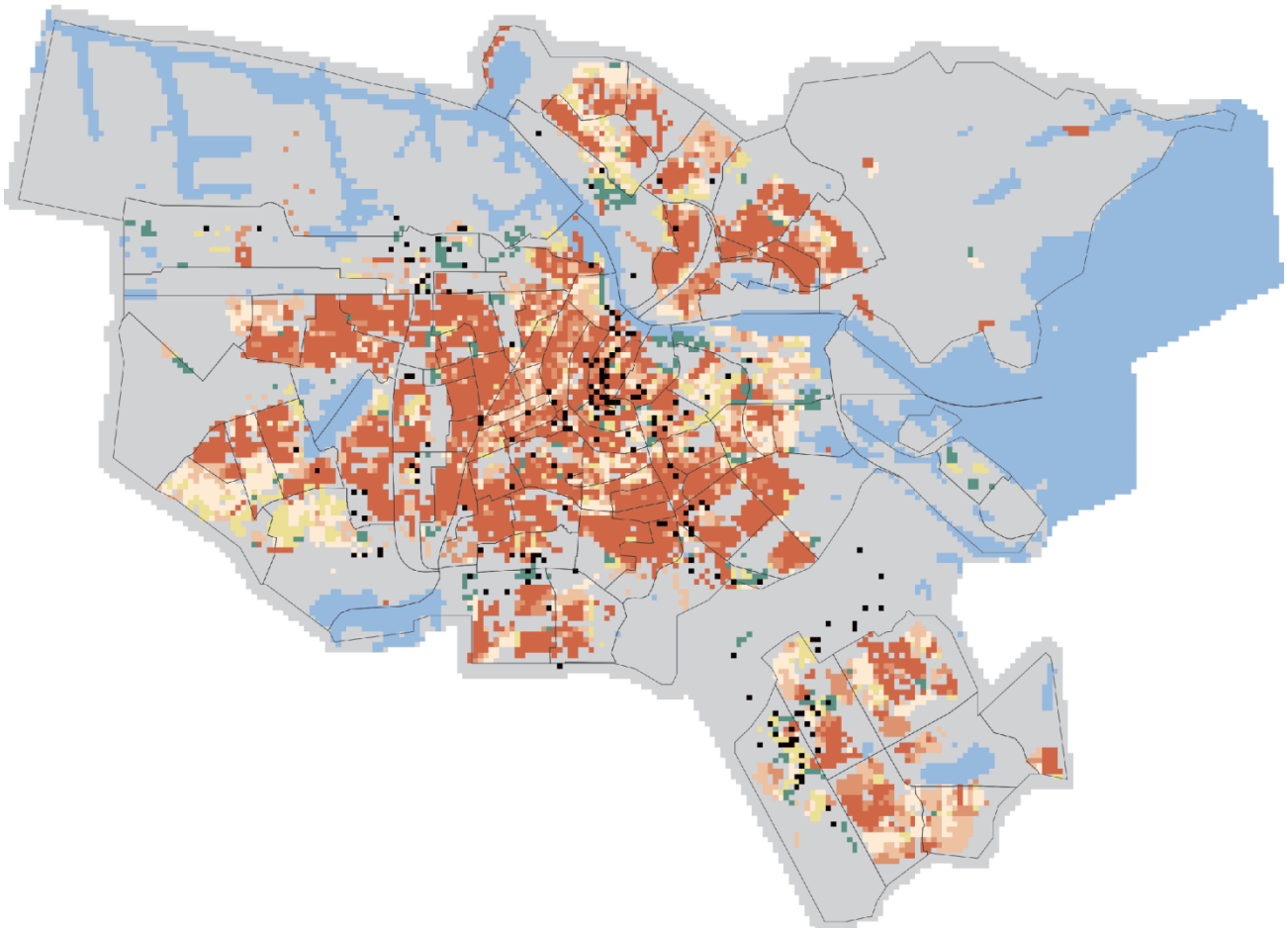

Figure 2.8 Vulnerability map of the working population of Amsterdam for heat stress (Van der Hoeven and Wandl, 2014).



2.3 Pluvial flooding

The sensitivity to flooding in streets can be mapped with measuring instruments such as 3Di (see 2.4.1). Map layers which show potential damage can be added to the results of these model calculations, according to the contextual vulnerability analysis model. For flooding in streets an outcome vulnerability analysis is also possible based on the Adaptation Tipping Point method (Kwadijk et al., 2010; Veerbeek and Husson, 2013). A tipping point is the moment at which the degree of climate change is such that current strategy or policy no longer reaches its goals. At this point, different policy is needed. The tipping point method takes into account climate uncertainties, but without being dependent on (more and more) climate scenarios. This method was used experimentally within CPC for Rotterdam Noord and Nijmegen (2.3.2). Information about the urban system's vulnerability to damage and thresholds is important input for the tipping point method. Within CPC, separate research was carried out on this subject (2.3.1).

2.3.1 Vulnerability to damage and thresholds

Cities have many paved surfaces, with the result that water tends to stay in the street during heavy rainfall. Indeed, in the summer of 2014 various urban areas in the Netherlands had to deal with flooding, causing damage to buildings and requiring the fire brigade to clear flooded basements, tunnels and roads blocked for traffic. Due to the increasing amount of surfacing in urban areas, the increased frequency of extreme rainfall and overdue maintenance work the design standards²² are not adhered to more and more often. Flooding occurs in more than 90% of municipalities, mainly in one location (Luijtelaar, 2008). The chances of extreme rainfall increase due to climate change and can cause urban drainage systems to fail more frequently. Perhaps equally important is the increased sensitivity to damage of the urban system. Because of the more intensive and expensive design of the urban area, flooding can cause more damage than it could several decades ago. Urban areas have therefore become more vulnerable to flooding.

Damage functions that describe the consequences of flooding quantitatively are an aid to municipalities in determining which elements in the city are most sensitive to pluvial flooding. Subsequently one can look at which measures contribute most to reducing the flooding and the sensitivity to damage. Within CPC a first version of damage functions was developed that describes the consequences of flooding (Stone et al., 2013).

Research by Spekkers et al. (2012) about the relation between precipitation intensity and damage to buildings and interiors shows that the variation in damage cannot only be explained through precipitation characteristics. There are also other variables, such as building characteristics and properties of the drainage system, that can play a role in explaining this. The functions developed by CPC describe the damages in relation to different variables such as the depth of the water, the duration of the flooding or the presence of basements.

The first version of damage functions have in common a threshold for water depth at which damage begins to occur. Up to this depth no damage occurs. This damage already offers insights into the sensitivity of the various urban elements. An urban element with a low threshold will become damaged sooner than an element with a high threshold. Water in the streets is the first hindrance that occurs, and a water depth of 30 cm causes serious traffic disruptions. Especially in areas with more relief or depressions (such as tunnels), this water depth is quickly reached. However, traffic disruptions only occur when alternative routes are barely available, or not at all.

²² Of old, drains were designed to manage a type of heavy rainfall that is expected to occur once every two years. That is to say that once every two years, such heavy rainfall can take place that it (almost) causes there to be water on the streets. For surface water in urban areas, a maximum flooding frequency of once per 100 years is assumed.



Electricity supplies have a threshold of 30 cm or higher, but these supplies are often higher up on the pavement, against the façades of buildings, and at these locations a water depth of 30 cm is not quickly reached. However, it is assumed that a building with a basement is already flooded as soon as the water reaches the façade. Water in buildings causes considerable damage to houses, and in the case of a commercial building, also brings risks of a temporary disruption of business.

These results show that especially the flooding of buildings (basements, in particular) and traffic disruptions can cause more serious damage. The costs for the fire brigade are also considerable, considering they are always called in case of flooding. Damage to electricity supplies does not occur often but does have far-reaching consequences. A summary of the thresholds and range of damage caused by precipitation is included in **Table 2.1**.

Table 2.1 Summary of the thresholds and range of damage caused by precipitation (Stone et al., 2013).

Impact	Urban aspect	Threshold (m)	Average costs per unit (euros 2012) ((min - max)	Unit
Material damage	Houses and interior	0 (basement) 0.1 (w/o basement)	Content : 750 - 1750 House: 400 - 1200	House per event
	Electricity supply	0.3 (low tension) 0,35 (street lights) 0,5 (middle tension)	5000 55.000,	Substation Street light per event
Economic damages	Business interruption	0 (basement) 0.1 (w/o basement)	5,- - 2000,- (2010)	Business per hour
	Traffic disruption	0.3	Transport: 10 – 40 Personal: 1,50 – 6 Commuter traffic: 2 – 8,5 Business traffic: 7,5 – 30 (2006)	Vehicle per 15 – 60 min
	Electricity failure	0.3 (low tension) 0,5 (middle tension)	Households: 0 – 80 Businesses: 80 – 2500 (based on legal compensation)	Per event 1 – 8 hour
Emergency assistance	Fire brigade	0 (house with basement) 0.3 (roads)	250 - 1000	Per turn-out
Social disruption	Accessibility health facilities	0 (basement) 0.1 (w/o basement) 0.3 (roads)	-	Per health facility



The damaging effects of water in the streets on public health were not included in the analysis. Recent research (De Man and Leenen, 2014; Sales Ortells and Medema, 2014) indicates that the number of pathogens in 'water on the streets' is so high that it forms a threat to public health. In other sectors there are calculation models to transform the health risks into a damage function (Kemmeren et al., 2006), but these have not (yet) been applied to water.

The urban area's sensitivity to damage can be lowered by raising the water depth at which an urban element experiences damage. Veerbeek and Husson (2013) have shown that a small increase in doorstep height has a great effect on buildings' sensitivity to damage. However, lowering water depths by, for instance, adjusting the street profiles – making them deeper – can also contribute to this. Reducing the duration of the inconvenience and the time it takes to clean up, especially when it concerns roads and commercial buildings, also contributes to lowering the costs of the damage. Decreasing the amount of flooding also always lowers the costs of calling in the fire brigade.

2.3.2 Vulnerability maps for flooding

In order to test whether the tipping point approach is suitable as a vulnerability analysis, it was used experimentally within CPC at two locations and analyzed with a SWOT⁴ analysis (Veerbeek and Husson, 2013). These tests must be seen as proof-of-concepts, and not as substantiated vulnerability analyses. The Rotterdam Noord case is explained below as an example.

The tipping point method attempts to offer insight into the moment when a system or policy no longer complies with the predetermined aims or standard for a range of future scenarios. The methodology can, for instance, be used to estimate until when the current flood protection policy is sufficient under a range of climate change scenarios, but also, on a smaller scale, to research until when a local drainage system complies with the prescribed standard in scenarios involving a changing number of users or an intensification of rainfall.

In essence, the methodology is a sensitivity analysis in which uncertainties are classified under scenarios. First of all, a series of indicators is defined, as well as the accompanying measuring methodology and the resulting thresholds that operationalize the aim or standard. The indicators and thresholds are based on the current standard or are formulated in consultation with stakeholders and depend on the local situation and ambitions. The indicators chosen for Rotterdam Noord are the percentage of flooded buildings and traffic disruption in the area (see **Figure 2.9**) which thus gives shape to a broader interpretation of flooding in terms of simply not accepting water nuisance. Thresholds were defined for a number of standard showers with different repetition times, where the percentage of flooded houses must be smaller than 0.1% for a shower that occurs twice a year, for instance (this takes into account the height of doorsteps at entrances). As such, many indicators can be used based on different criteria, measuring methodologies and thresholds within the same analysis.



Rainfall event	Return period	Threshold
Bui 8 (T=1/2 year)	2 years	Percentage of flooded houses in neighbourhood < 0,1% Percentage of flooded commercial buildings < 0,1 % Traffic nuisance index = 10%
Bui 50 (T=1/50 year)	50 years	Percentage of flooded houses in neighbourhood < 0,5% Percentage of flooded commercial buildings < 0,5% Traffic nuisance index = 30%
Bui 100(T=1/100 year)	100 years	Percentage of flooded houses in neighbourhood < 1% Percentage of flooded commercial buildings < 1% Traffic nuisance index = 35%

Figure 2.9 Thresholds chosen for Rotterdam Noord (“bui” = rain shower).

The system’s performance is then calculated using a quantitative model, based on both the design value (i.e. a heavy shower with a return period of two years) and a series of increments of the most influential variables (i.e. +5%, 10%). These increments are related to a series of scenarios where the values are plotted against time: a 5% and 10% increase of river drainage are reached in 2040 and 2070 according to climate scenario A, for example, and in 2060 and 2100 according to climate scenario B. The next step examines at which increment the threshold is reached. Considering the increments are related to the scenario, it is possible to determine for each scenario when the threshold is reached: the so-called tipping points. For Rotterdam Noord these have been illustrated in **Figure 2.10** based on KNMI’06 climate scenarios G and W. **Figure 2.11** shows which buildings will flood in each scenario. This often turns out to be individual cases and not groups of buildings.

Figure 2.10 shows that for both KNMI’06 scenario G and W, the tipping point is not reached before 2028 (traffic disruption Bergpolder, for a shower of T=50). For many other indicators, however, it looks as though the tipping points are reached in 2040 for the W scenario. However, for the G scenario, most tipping points shift to past 2090.

In this example, this information would tell the municipality that urgent measures are not necessary and that the vulnerability is distributed relatively equally across neighbourhoods. In their report, Veerbeek and Husson (2013) show that the results for the Provenierswijk, Liskwartier and Bergpolder areas are characteristic of Rotterdam Noord. Because of the relatively uniform character of the neighbourhood, there are no hotspots where measures need to be taken with extra urgency. However, this is not the case everywhere. For the case study area in Nijmegen, which is characterized by a greater difference in height, the tipping points have already been reached under the current conditions in the Benedenstad area.

In addition to the current policy and accompanying system (i.e. drainage system), the tipping points for alternatives are also often calculated. Depending on the implementation period and the possibilities of building on the current system, adaptation paths can be defined. The so-called adaptation tipping point method thus facilitates flexible adaptation strategies that can be maintained under various scenarios.

An important aspect in the evaluation of flooding in the urban environment is a better understanding of the vulnerabilities. Aside from the possible flooding of buildings and roads, it is important to gain insight into the vulnerability of vital objects, networks and locations where large groups of people are present (i.e. day care centres or care institutions). Insight into the relationship with indirect damage (for instance disruptions of services in businesses) is essential here, which means that further inventory of critical infrastructure, especially electricity supplies, is more and more important.

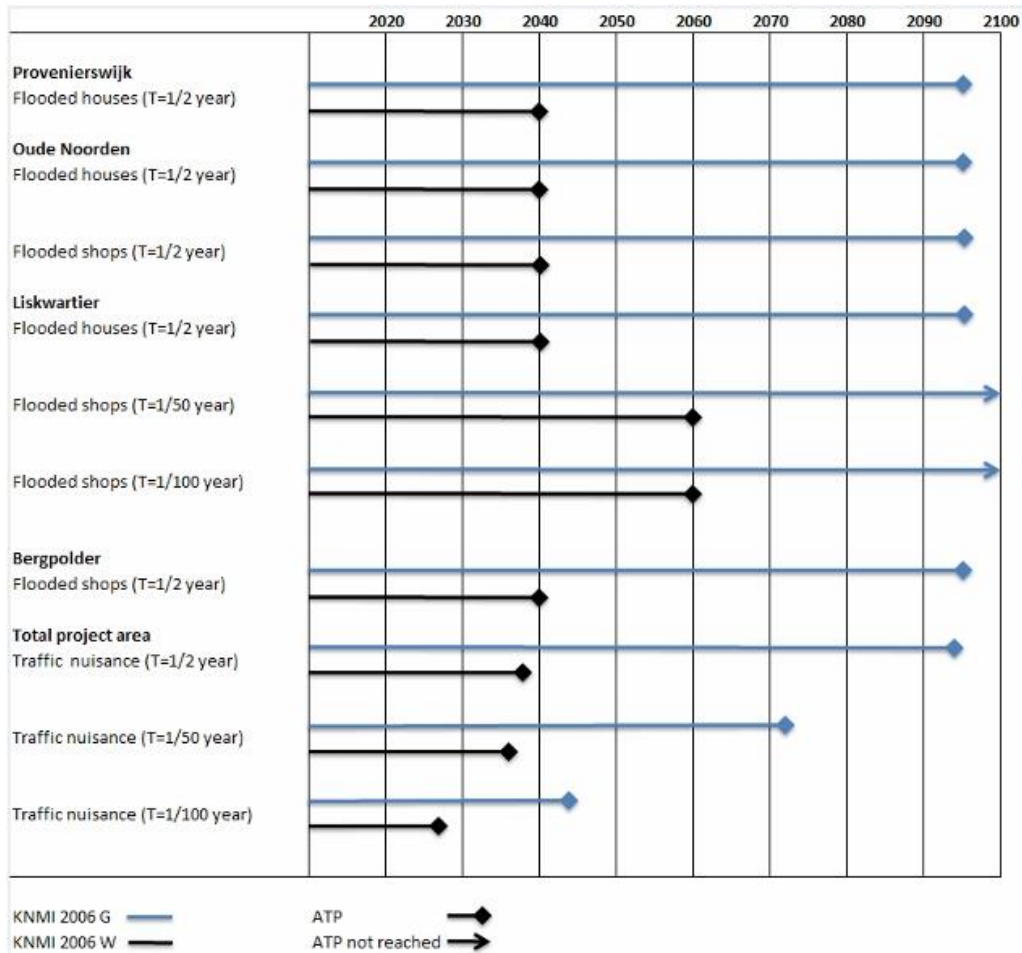

Figure 2.10 The Adaptation Tipping Points (ATPs) calculated for Rotterdam Noord. The top lines for the Provenierswijk, for instance, show that the tipping point for flooded houses will be reached in 2095 according to KNMI'06 climate scenario G (blue line) and in 2040 according to scenario W (black line) (Veerbeek and Husson 2013). NB: this is a Proof-of-Concept, not a substantiated vulnerability analysis.

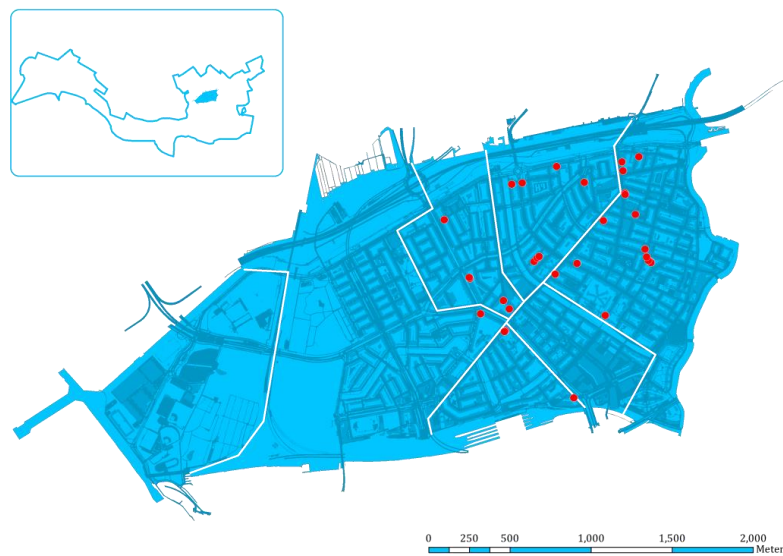

Figure 2.11 Map of Rotterdam Noord, marking the buildings that will flood at least once every two years (Veerbeek and Husson, 2013). NB: this is a Proof-of-Concept, not a substantiated vulnerability analysis.



2.4 Tools for policy makers

In order to organize the urban environment in a more climate-robust way and compile effective packages of measures, a number of tools were developed within and in connection with Climate Proof Cities. The New Constructions and Restructuring Delta sub-Programme was an important motive for this development. As part of this, guides, procedures and aids were developed and made publicly available.²³ Municipalities, water boards and other parties concerned are facilitated by these products and tools in making their areas, objects and networks more climate proof. A number of tools are explained below.

2.4.1 3Di area model for flooding

CPC has contributed to the development of the 3Di area model. 3Di makes it possible to chart quickly and accurately where, to what extent, and how quickly extreme precipitation leads to water hindrance and pluvial flooding (**Figure 2.12**). Using the extremely detailed AHN2 height database it becomes easy to see how much water there will be in roads, properties and gardens, and where this water will go. If required, this can be visualized in 3Di; it is possible to fly virtually over the area to see where the problems are concentrated. This makes it possible to determine if vital or vulnerable objects, networks and groups are affected by the problems.

A 3Di area model can be used for a desk study to identify the vulnerable places, but also as an interactive instrument in workshops, to study the how effective certain adaptation measures are; see 3.6.2).

CPC partner involved: Deltares.

More info: <http://www.3di.nu/international/>

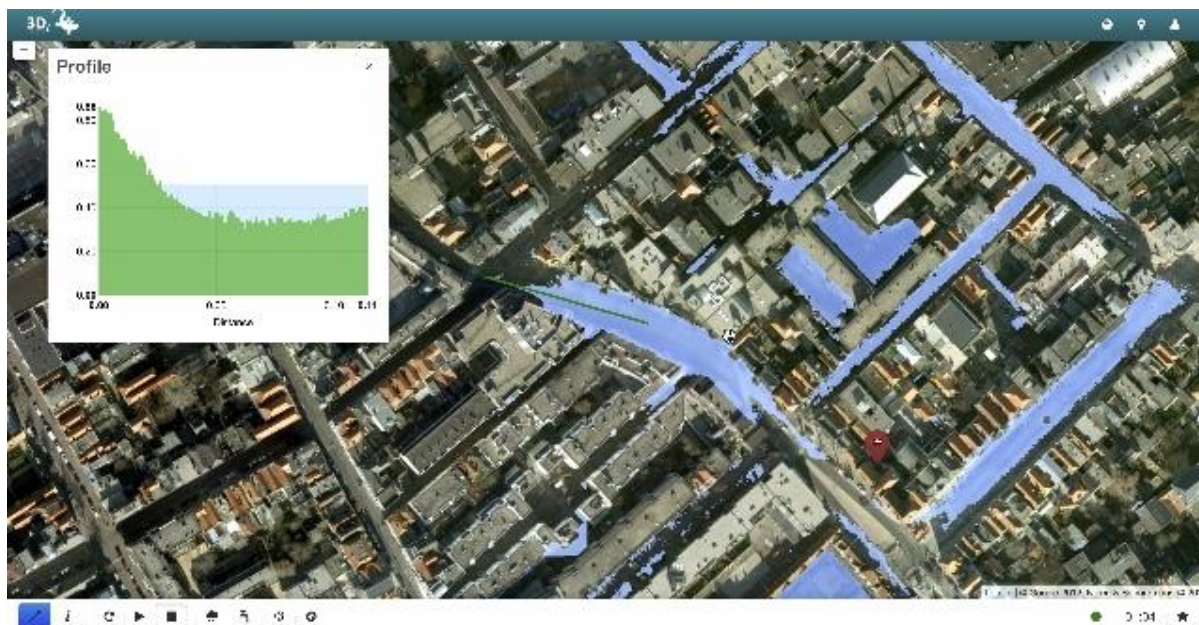

Figure 2.12 Screenshot of a vulnerability analysis with the 3Di area model.

²³ <http://www.ruimtelijkeadaptatie.nl/en/>



2.4.2 Heat/Drought Stress Model

In order to support the first phase of policy development for municipalities and water boards, partners in CPC are developing a quick-scan tool that quickly offers insight into areas sensitive to heat and drought stress, both in terms of the exposure and the sensitivity to damage. The model can also determine indicatively how effective the adaptation measures are. The resulting heat/drought maps give highly detailed input for prioritising actions for climate proof cities.

CPC partners involved: TNO, Deltares, Wageningen University.



2.5 Conclusion

The CPC programme has yielded the following conclusions in relation to the vulnerability of the built environment:

- The vulnerability of our built environment depends on the exposure, its sensitivity (to damage) and its capacity for adaptation. The CPC research has focused on the exposure (chapter 1) and sensitivity (chapter 2) for heat and flooding.
- The elderly over the age of 75 and the chronically ill are the most sensitive to heat-related illness and death. The elderly often exhibit sub-optimal behaviour during heat waves: behaviour factors (drinking, clothing, ventilation, moving) can strongly influence heat sensitivity. Acclimatization to heat was not observed for periods of up to three days.
- For exposure to heat, a distinction can be made between two shells around the vulnerable people or objects: the first shell (building, infrastructure) and the second shell (neighbourhood, city).
- Heat stress and flooding have various serious consequences, for instance for public health. Flooding is the most obvious one and leads to damage quickest and most directly. Drought and heat have fewer immediate results, but can also lead to a decreased quality of life and enormous damage.
- Buildings can reduce the exposure, and therefore also the sensitivity to heat stress. Newly constructed houses are more sensitive to heat stress than old houses. Because of the improved insulation, once heat has entered the house, it is retained for longer. The presence of outdoor sunblinds and ventilation can play a crucial role in limiting the overheating of houses in general and of newly constructed houses in particular.
- Apartments heat up faster than terraced and detached houses.
- The orientation of buildings/windows is an important factor that can strongly influence the degree to which heat is a problem. Windows facing east and west will lead to more overheating than if they face north and south.
- The indirect and subsequent damage through loss of productivity due to heat stress, extra costs of calling out the fire brigade for flooding and so on are often considerable and definitely not negligible;
- Up to a certain level – literally and figuratively – water damage can be prevented by increasing the threshold and reducing the sensitivity of objects; it is essential that measures are also taken to limit the damage when this threshold is passed.
- Vulnerability maps for heat for Amsterdam and Rotterdam show that there is great spatial variation in vulnerability to heat in the city.
- The vulnerability is very locally determined because of the great spatial variation in exposure to heat stress and flooding and because of the location of sensitive objects and groups of the population. Especially vital and vulnerable objects, networks and groups (hospitals, shopping centres, transformer buildings, tunnels, cellars, electricity, roads, telephone, the elderly) lead to areas that are locally very sensitive to damage in the urban area.



3 Which measures can be taken to better adapt cities to climate change?

Summary

There are many and various measures available to achieve a climate proof city. The Climate Proof Cities (CPC) research has focused on measures that prevent or decrease flooding due to extreme rainfall or heat stress. Because both themes are connected to each other, an integral approach would be preferred: water from wet periods, for instance, should not be drained away, but should be stored and used to combat drought and heat, the latter through evapotranspiration. More vegetation has a positive effect on both climate aspects. For the implementation of measures, the effect on other policy themes such as climate mitigation, biodiversity or air quality is often an important argument. Because the vulnerability for climate effects is determined locally, the choice of measures also depends on the local context. More generic design guidelines for 3 levels of scale are:

Buildings

As mentioned in chapter 2, a building's orientation is highly important; south-facing windows offer the best indoor climate in all seasons. Applying exterior solar shading and extra ventilation of the house when the outdoor temperature is lower than the indoor temperature are also effective measures and can almost completely prevent overheating in modern, well-insulated housing.

In addition, homeowners can help to prevent flooding by collecting as much rainwater as possible, for instance in a tank or water bag, or by reducing the amount of impervious surface around the building so that the water can infiltrate in the soil. The harvested water can be used for toilet flushing or cooling. Water storage on a small scale, however, is relatively expensive. Traditional green roofs, without delayed drainage, only offer a limited capacity for water storage and have little insulating effect on the building underneath (because of the good insulation value of modern buildings) and little cooling effect on the surroundings. A rooftop water storage with delayed drainage (green or blue) is more effective from the point of view of water storage.

From street to neighbourhood

Applying more vegetation in streets is a good measure against the heat island effect. Street trees are the most effective in reducing the local outdoor temperature through their combination of shade and cooling through evaporation. The type and placement of the trees regarding orientation towards the sun and the direction of the wind is important here. If the street is supplied with enough elements providing shade, it is ideally also twice as wide as the buildings are high to ensure good ventilation. Also at street or neighbourhood level, flooding can be prevented by collecting and storing rainwater. Because this involves larger volumes than at building level, the storage capacity must also be greater. Solutions include water squares or underground storage. The latter makes it possible to reuse water again.

City and region

During heat waves, inhabitants gratefully make use of city parks to cool off. During hot summer days it can be an average of 2 °C cooler in parks than in the city and 5 °C cooler than the surrounding area (expressed in thermal comfort), which makes them real cool islands. By laying out more parks with different microclimates, citizens can go to places where they feel comfortable.



Parks can simultaneously act as a water buffer during extreme rainfall. In order to enlarge the water storage function, elements such as wadis, infiltration ditches, crates and drains, and surface level adjustments can be applied. For open water storage, the quality of the water and possible health effects must, however, be taken into account. In addition, coolspots can be created just outside the city that can ensure cool air in the city.

Given these design guidelines, adaptation seems to be an accumulation of relatively small, local measures. By taking these guidelines and available adaptation measures into account already during the planning stage, steps can be taken at the same time as maintenance and renovation works, and costs can be kept down.

3.1 Introduction

3.1.1 Categorising climate adaptation

Because vulnerability is very much locally determined, adaptation will also depend on the local context. A broad range of adaptation measures is available, but which measures against flooding and urban warming are more effective than others, and which measures are best suited to a certain urban context? This is the central question in this chapter of the Climate Proof Cities (CPC) programme and forms part of the 'Ambition' step of the 'Guide to Spatial Adaptation'²⁴.

Until now, rising temperatures in and around urban agglomerations have been part of relatively unexplored and unexplained territory, which is why the studies presented here have focused in large part on the effects of measures on heat in the city. Water management in urban areas has a much longer history and much more is known about it. Designing an urban water system that can drain away extreme rainfall immediately through drains may be technically possible, but is not desirable from a financial point of view. An assessment framework that also considers alternative options is important here.

In addition, many suitable measures for combating flooding in urban areas can lead to an increase in drought and heat stress in that same area. Measures to better adapt cities to the climate must therefore be aimed at draining away the excess water so slowly that there is enough water present to bridge dry and warm periods without any problems. It is also important to see to what extent adaptation measures can contribute to the mitigation question or other policy themes. Adapting cities to the (changing) climate therefore requires an integral approach in most cases.

In this chapter we offer an overview of adaptation measures that have been studied at three scale levels in the CPC programme: buildings (3.2), from street to neighbourhood (3.3) and city & region (3.4). There is a short description of the working and effectiveness of a number of measures in terms of flooding and/or heat stress. The complete analyses can be found in the various reports and publications referred to in the text. Finally, design guidelines are set out for each scale level. Climate change occurs gradually during a period of dozens of years. This offers the possibility of introducing measures in stages and carrying them out at the same time as other activities such as maintenance, renovations, new constructions, reconstructions and urban development, at lower costs. The last chapter (3.5) then offers an overview of helpful tools for outlining the adaptation strategy that are available in or in development.

²⁴ <http://www.ruimtelijkeadaptatie.nl/en/>



3.1.2 Description of the measures

A great many different adaptations to a changing climate are possible in urban areas. These range from influencing the urban climate (water and temperature) and adjusting buildings and infrastructure to adapting human behaviour and increasing the acceptance of the inconvenience that occurs. The costs of the measures named here can also differ greatly, both the costs of implementing these changes and managing and maintaining them. The parties who carry these costs and enjoy their benefits also vary greatly per measure. Therefore, a the cost-benefit analysis must be built up from within the local situation. For an area-specific approach, however, where the emphasis is placed on co-benefits, a breakdown of the expenses that are incurred specifically for climate adaptation is less essential.

Important aspects that determine the suitability of a measure are the primary goal of the measure, its effectiveness and its versatility. The overview table at the beginning of each scale level paragraph uses letters and symbols to show how the measure scores for these properties.

Goal

CPC research has focused on measures that can prevent or reduce heat stress (H) or damage caused by flooding due to extreme rainfall (W). Some measures, such as vegetation, influence both climate aspects (H/W).

All heat measures described here aim at decreasing the exposure of people to high (comfort) temperatures. People's sensitivity to heat stress is an intrinsic property and adaptation measures regarding this aspect are not explored. All measures for the prevention of flooding mentioned in this chapter are also geared at decreasing exposure. There are measures that can decrease an urban element's sensitivity, like raising the threshold of a building or placing switch boxes higher up or making them waterproof, but these measures were not studied within CPC (see also chapter 2 and Van de Ven et al. (2009)). Within CPC, there was a focus on measures for preventing the accumulation of water in the streets, such as water storage, infiltration and drainage (delayed or speeded up), and as such decreasing the exposure of damage-sensitive objects to flooding.

Effectiveness

Pluvial flooding

In order to make a first order estimate of the effectiveness of the measures against flooding, calculations were made for each measure to determine how much area (per ha) is needed to process an extra 10 mm of rainfall (Vergroesen, 2013). Per ha, this assumes 0.20 ha of roof surface, 0.10 ha of road surface, 0.2 ha of other paved surface, 0.45 ha of unpaved surface and 0.05 ha of surface water. This means that an extra 50 m³ must be stored per hectare.

The figures that follow from this give an impression of the required scope of a measure. However, before another 10 mm of rainfall can be processed, the storage space in this facility must be fully available again. This is why the approximate emptying time of the measure is also listed. The longer the emptying time of a measure is, the lower the effectiveness of the measure is assessed. In the overview table the effectiveness of a measure is therefore rated ++ when it is available again within a day, and + when the emptying time is longer than 24 hours.



Heat stress

The effectiveness of measures in lowering the indoor temperature was calculated with computer simulations and expressed in terms of the number of hours that the temperature in a house exceeds a certain limit. Determining the effectiveness of measures on the outdoor climate is more complex. On the one hand, one can track the actual physical cooling, for instance by looking at the effect of measures on the comfort temperature, calculated in PET or UTCI²⁵ (see **Appendix C**), air temperature or radiative temperature. On the other hand, one can look at the psychological effects of measures on human perception (of temperature): for instance, how do people perceive warmth in a green street or in a paved street? Both aspects are important in order to describe the effectiveness of measures for the perception of heat and thermal comfort comprehensively (Nikolopoulou 2003; Klemm et al., 2014a; Klemm et al., 2014b in review). However, there is no standard scale with which to read the effectiveness of a measure. The arrangement in the overview table is therefore an estimate on the part of the researchers and can vary from negative (-), little to no effect (+/-), to very positive (++)

Type

In addition to the direct effectiveness, a distinction can be made in the type of measure in terms of the versatility:

The measure is generically (G) applicable, which means that the effects found are generally valid, irrespective of urban or building typology and also independent of a specific context.

It is typology-linked (T), which means that the effects found are valid for a certain urban or architectonic typology, independent of a specific context.

It is context-dependent (C), which is to say that the effects of these measures are so dependent on the local circumstances that they must only be determined for each individual situation.

²⁵ PET: Physical Equivalent Temperature; UTCI: Urban Thermal Comfort Index (see also **Appendix C**).



3.2 Buildings

3.2.1 Goal

Measures at building level apply to the indoor climate of buildings or on water processing on top of and directly surrounding buildings:

1. Preventing rising temperatures indoors, or active cooling (H)

A cool indoor climate can decrease the exposure of humans to high temperatures. This can be achieved by preventing rising temperatures indoors, so-called passive measures. Chapter 2.2.2 gives insight into the characteristics of a building that cause overheating quickly, such as the type of building, its orientation and the degree of insulation. A building can also be cooled actively, preferably in a manner that does not use fossil energy and does not contribute to climate change. Cooling through evaporation, for instance by keeping roofs and façades wet, is one example of this.

2. Infiltration and rainwater storage in and around buildings (W)

Buildings and the impervious surface around them prevent the infiltration of water. They collect the water that is often drained away through sewers in cities. Buildings can also be deployed to store water and/or drain it slowly during heavy showers. A contra-productive trend is the surfacing of gardens, so that the percentage of paved surface increases and more water flows away faster. Through 'rainwater harvesting', the collecting and utilizing of rainwater on top of, in or near the building, flooding can be prevented, and water can be stored in order to be employed for something useful.

3.2.2 Measures

Table 3.1 gives an overview of the building measures that were studied within CPC. A number of measures are briefly explained below. More information can be found in CPC publications such as Vergroesen (2013), Van Hooff et al. (2014) and Brolsma (2013).

Table 3.1 Overview of 'Buildings' measures

Measure	Goal	Effectiveness	Type
Solar shading	H	++	G
Thermal mass	H	+/-	G
Ventilation	H	++	G
Albedo	H	+	G
Building orientation	H	++	G
Green roof (extensive; traditional)	H/W	+/-, +/-	T
Green dak (intensive; delayed drainage)	H/W	+/-, +	T
Blue roof	W	+	T
Rain barrel/storage tank	W	+	G
Water storage in crawl space	W	++	T
Green façades	H/W	+/-	G
Water storage in buildings, gardens and courtyards	W	++	
Desurfacing private gardens	W/H	+ / ++	G
Active cooling	H	++	

H: prevention of heat stress; W: prevention of damage through flooding

G: Generic; T: Typology-linked; C: Context-dependent



In CPC, six climate adaptation measures for heat stress were studied for a typical Dutch detached house, terraced house and apartment (according to Agentschap NL (2013)) (**Figure 3.1**). Calculations were carried out for houses built in two different construction periods: houses built according to guidelines and practices from the 70s of the last century, and houses built according to the Building Policy of 2012. The research studied the number of hours the temperature in a house exceeds a certain limit (= overheating hours) (Van Hooff et al., 2014). This limit is variable and depends on the temperature outdoors.

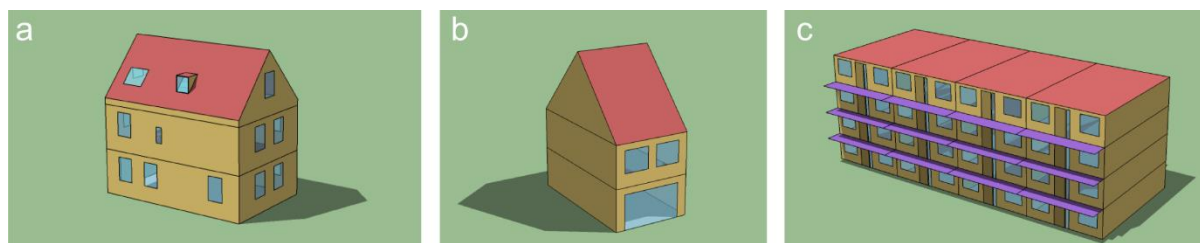

Figure 3.1 The three types of houses studied: (a) detached house; (b) terraced house; (c) apartment.

The building performance simulations were carried out for the climate year 2006 (KNMI, 2014). The summer of 2006 saw an above-average number of warm and tropical days and it can therefore be assumed that there will be more years like this in the future, due to climate change. The results of the simulations can be found in **Figure 3.2**.

In general, it can be concluded that applying an extensive green roof has little effect on the indoor temperatures in the houses. Using exterior solar shading and additional natural ventilation in the house when the outdoor temperature is lower than the indoor temperature has the most effect and can also almost completely prevent overheating in modern, well-insulated houses (see section 2.2.2). The overall findings can be called generic, although the absolute effects will depend on building type, the surroundings, the inhabitants' behavior, etc. The measures of albedo, use of solar shading, green roof and opening of windows are briefly explained below.

Albedo values (H)

Increasing the albedo values (reflection factor of shortwave solar radiation) of the building's shell limits the overheating of the walls and roof through solar radiation and therefore results in fewer overheating hours. For a terraced house, the decrease in average number of overheating hours is around 50% (house dating from the 70s) to 14% (house dating from 2012). The absolute extent of the effect depends on the thermal resistance of the building's shell and the type of house. The effect becomes much greater as the insulation rating of the building's shell is lower. In winter, however, a higher albedo value will lead to an increased consumption of energy for heating. This increase is at around 2% for a terraced house dating from 2012 and around 7% for a terraced house built in the 70s.



a

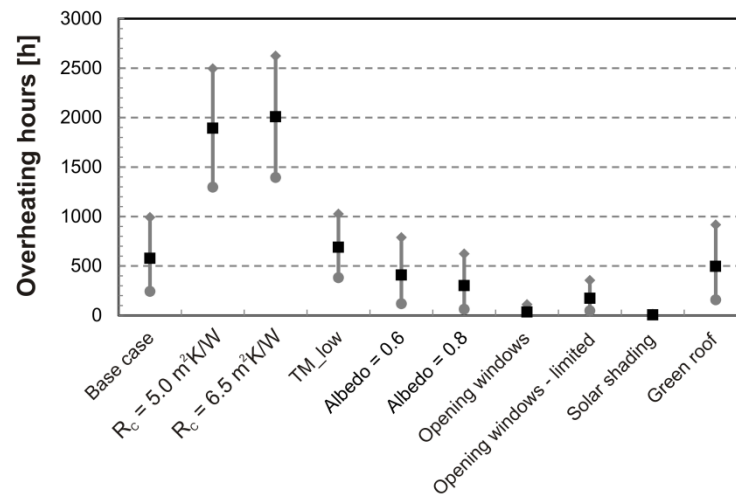

b

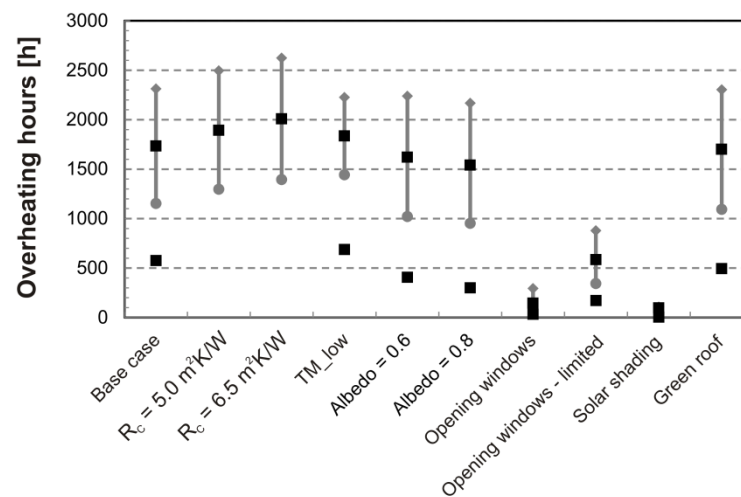

Figure 3.2 Total number of annual overheating hours in the terraced house for the base case and for the various adaptation measures. (a) Terraced house from the 70s (low thermal resistance). (b) Terraced house with thermal insulation according to the 2012 Building Policy (high thermal resistance), where ■ stands for the average number, ● for the minimum number, and ♦ for the maximum number of overheating hours for the four calculated orientations (north, east, south, west) (based on van Hooff et al., 2014).

Solar shading (H)

The sun is one of the most important causes of high indoor temperatures in houses. The solar radiation that enters the house through transparent parts of the façade warms up the space considerably (see also chapter 2.2.2). This strong overheating can be prevented by applying sunblinds to the windows. This study has shown that fitting windows with moveable exterior solar shading and lowering these as soon as the total solar radiation on the window is greater than 150 W/m^2 has a substantial effect on the number of overheating hours per year in the three types of housing. For detached houses and terraced houses, the number of overheating hours can be reduced to around 0-100, while for apartments the number can usually be reduced to around 200.



Green roofs (H/W)



A green roof is called extensive when the growing material is a maximum of 15 cm thick. An intensive green roof is between 15 and 30 cm thick. Anything beyond that is known as a roof garden.

Extensive green roofs with growing material of a maximum of 15 cm (sedum roof, grass roof, etc.) should reduce the heat transfer from outdoors to indoors due to (1) a different reflection factor for shortwave radiation (albedo value); (2) an increase in the thickness of the insulation layer; (3) an increase in the convective heat transfer; (4) evapotranspiration. However, in the simulation study, applying an extensive green roof only had a very limited effect on the number of overheating hours indoors; the number of overheating hours stays more or less the same. The positive effects are countered by the adverse effect that extra insulation brings. The effect of applying a green roof is greater the lower the insulation rating of the building's shell is.

Vergroesen (2013) examined the impact of green roofs for storage of the water that falls on the roof. The storage capacity of green roofs is significantly lower than the porosity, and decreases (relatively) as thickness increases. Experience shows that for extensive green roofs an effective storage of 5 – 20 mm can be expected. The effectiveness of green roofs depends primarily on the evaporation, which determines how quickly the storage in the growing material becomes available again. The effectiveness of a green roof is therefore much higher in summer than in winter.

A green roof only stores the water that falls on the roof itself. Assuming a roof surface of 2000 m² per hectare and a storage capacity of 15 mm for an extensive roof, a maximum of 30 m³ can be stored, where 50 m³ is needed (see 3.1.2 for an explanation of the principles behind this). The time needed to be able to use the storage again depends strongly on the evaporation taking place, and can vary from three days in summer to almost three weeks in winter. An intensive green roof with a minimal thickness of 15 cm (e.g. a roof garden) has a greater margin in terms of storage capacity. In addition, the temporary storage of water that has seeped into the drainage layer under the growing material and the delayed drainage of water can increase the effectiveness of green roofs as a measure for prevention of flooding.

Opening windows (H)

Opening windows in the night/morning enables additional ventilation on top of the usual ventilation which takes place throughout the whole day. By ventilating when it is cooler outside than inside, excess heat can be diverted. The windows only need to be opened when it is cooler outside than in, otherwise opening windows has a counterproductive effect. The research has shown that applying additional natural ventilation by opening windows above a certain indoor temperature, and only when the outdoor temperature is lower than the indoor temperature, significantly lessens the number of overheating hours (to almost 0) for all types of housing.

Active cooling (H)

Buildings can also be actively cooled during periods of heat to create a pleasant indoor climate, for instance by using aquifer thermal energy storage. In CPC, research was done to determine whether open water in a neighbourhood could supply buildings in the Netherlands with heating and cooling. In this country heating forms the greatest challenge because of the relatively large demand for heating in winter and limited demand for cooling in summer. The balance will become more advantageous in the future because of climate change.



A case study from Watergraafsmeer illustrates that it is in fact possible to obtain the amount of heat that is currently used for heating buildings in this neighbourhood from the water system and the water chain (Brolsma et al., 2013). Because the heat is mostly collected in summer and used in winter, it must be stored. The capacity for storage of heat and cold in the subsoil of Watergraafsmeer is also sufficient to satisfy peak demand.

Water storage in the crawl space (W)

Run-off water can be collected in a tank or bag in the basement or crawl space of houses and other buildings. This harvested water can be used for toilet flushing and the irrigation of gardens and roofs (green, blue or grey) in dry, warm periods²⁶. Depending on what the water is used for it can be necessary to add a purification step. From the point of view of quality, it is also advisable not to store the first rainwater after a dry period (the so-called first flush) in the tank.

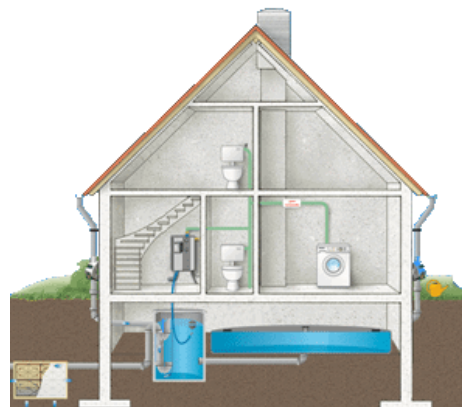

Assuming a depth of 50 cm, 100 m² of crawl space is needed per hectare to store 50 m³ of water (see 3.1.2 for an explanation of the principles behind this) (Vergroesen, 2013). This corresponds to around 4 houses. For emptying the water bag it was assumed that if necessary, the water bag can be emptied more quickly than is needed for using this water in the house or garden. With a pumping capacity of 4 m³/hour the emptying time is 12 hours.

A study within CPC further shows that storage and use of rainwater at house level is relatively expensive (Hofman and Paalman, 2014). If the costs for such a system are compared to the use of drinking water, it is not possible to earn back the investment. If this option is chosen anyway, the economic comparison will have to be made in a broader context, related to the damage through flooding that is thus avoided. In addition, deciding to purchase these systems will have to be made attractive to homeowners, for instance through subsidies or reductions on sewage charges. Applying more large-scale systems does seem to be economically viable.

Desurfacing private gardens (W/H)

The paving of private gardens is often mentioned as a (joint) cause of climate problems because more water needs to be drained through the sewage and the water balance in the subsoil is disturbed. Initiatives like 'Operatie Steenbreek'²⁷ are focused on depaving private gardens. Still, further differentiation of the problem and the solution is relevant here. Many of these paved gardens drain the rainwater into unsurfaced areas, where it will infiltrate. The surfacing then has few negative consequences for water management. In addition, much of the surfacing used is gravel or small stones. These retain a certain level of porosity, so that the natural replenishment of the groundwater is largely preserved. Surfacing made of asphalt, concrete and old tiles and bricks, however, are not at all or minimally porous. Assuming that an example neighbourhood consists of 25% private gardens, a total surfacing of all gardens would yield a loss of subsoil storage of around 25-37 m³. These gardens provide extra drainage to sewers.

²⁶ The Drinking Water Provision (Drinkwaterbesluit) (2011) currently permits collected rainwater to be used within the household, but only for flushing the toilet: see <http://wetten.overheid.nl/BWBR0030111>

²⁷ 'Operatie Steenbreek' ('Operation Depave') is a national initiative where nature organizations and ecologists from universities such as Groningen and Wageningen declare war on paving in Dutch gardens.



Less storage of rainwater in the ground in private gardens can have negative effects on street trees or other public vegetation in the direct surroundings of private gardens. When there are more unsurfaced areas and water storage nearby, street trees are better able to withstand dry periods. In addition, green (depaved) front gardens contribute to a better perception of thermal comfort for passers-by in the street (3.3.2) (Klemm et al., 2013a; Klemm et al., 2014b in review). Following on from the depaving of private gardens, it is important to safeguard unsurfaced areas in cities. The more surfacing, the higher temperatures become (**Table 1.4**, Van Hove et al. 2014; **Table 3.3**, Kleerekoper in review a).

At the same time, improvements can be made in industrial zones and large shopping centres, where large areas are surfaced for parking and the storage of materials. Desurfacing these areas, or at least providing them with a porous surface, leads to substantial improvements to local water management. If these areas become greener, this also leads to a reduction in the possibility of heat stress.



3.2.3 Design principles

Considering that 90% of the real estate of 2030 has already been built, it is important to analyze the weak spots of existing buildings in detail in terms of heat and flooding and to design specific measures in response. For heat, consecutive steps can be taken for the prevention of indoor overheating, passive cooling and finally active cooling. A number of general guidelines for this are given below and are summarized in **Figure 3.3**.

General guidelines

- Exterior solar shading is important for the prevention of overheating indoors, particularly in well-insulated modern buildings, but also in older buildings.
- South-facing windows contribute to passive heating in winter and the prevention of indoor overheating in summer. This is because having fewer windows facing west or east ensures less solar radiation (overheating) in summer. A roof surface that faces south is also advantageous for solar energy production.
- Ensuring good ventilation in houses so that heat (and moisture) can be disposed of through ventilation when it is colder outside than in.
- Storing as much run-off rainwater as possible ('harvesting'), in, under or near buildings and reusing it.
- Desurfacing gardens and large parking and storage areas contributes to more balanced water management, an improved perception of temperature for passers-by, and to the cooling of the urban environment.
- Consider the pros and cons when deciding whether to use green roofs: traditional green roofs – without delayed drainage – only offer a limited amount of extra water storage and insulation.
- Determine whether the heating and cooling needs of a neighbourhood can be covered locally by heat and cold from the local urban surface water, groundwater and water chain.
- Avoid the use of air conditioners when cooling is needed. They work negatively because of the heat production in the urban environment and use energy so that they contribute, in turn, to climate change.
- Provide information to inhabitants on how they can prevent overheating in their houses: using ventilation and sunblinds efficiently and at the right moment.

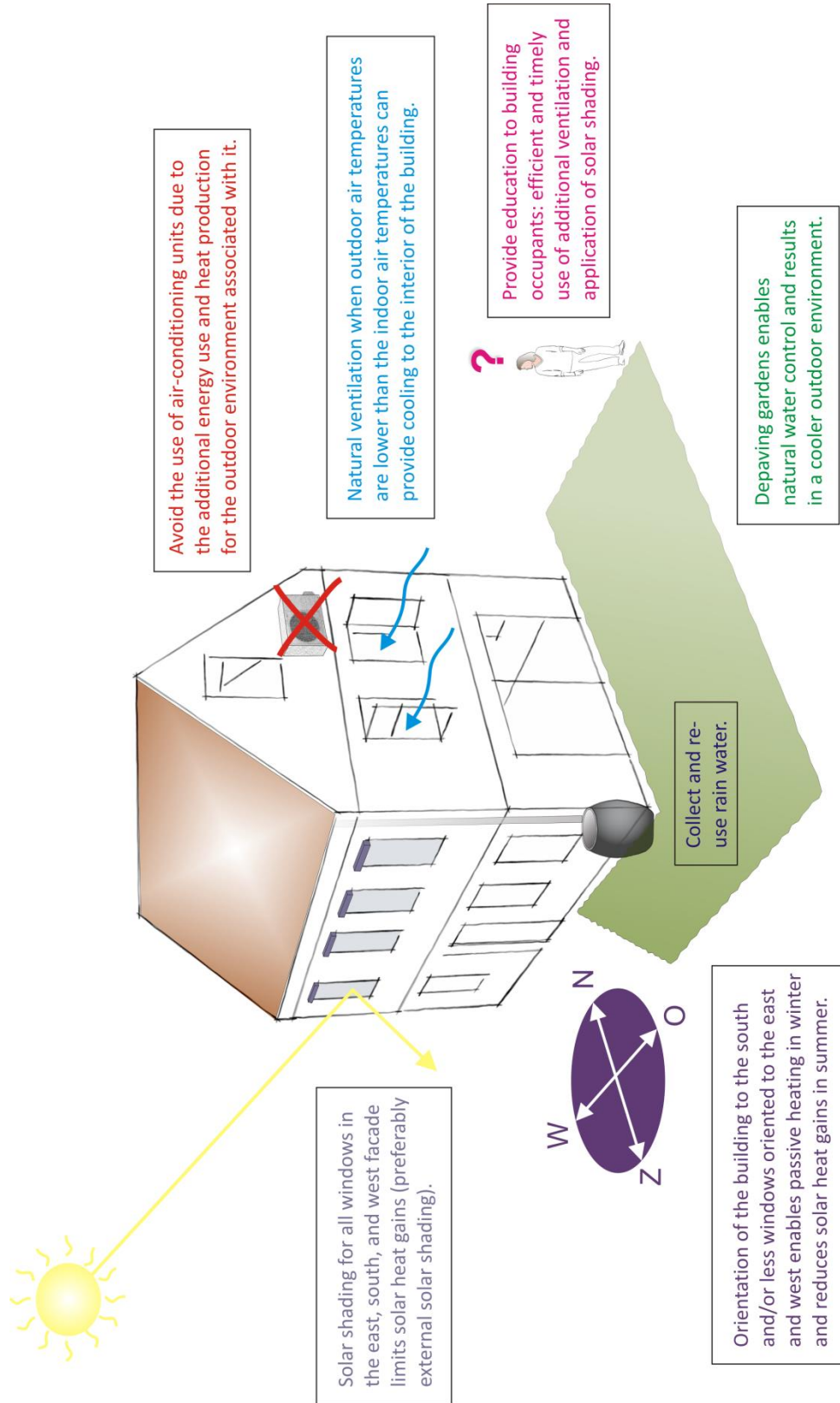

Figure 3.3 Design guidelines for a climate proof house.



3.3 From street to neighbourhood

3.3.1 Goal

Measures at street and neighbourhood level are geared at limiting rising outdoor temperatures, improving thermal comfort and storing, infiltrating or draining away water on a local scale:

1. Limiting rising outdoor temperatures and improving the thermal comfort with regard to the surrounding country side (H)

Chapter 1 dealt with the neighbourhood properties that contribute to the heat island effect. It turned out that the percentage of built/surfaced/green surface and the height of the buildings are the most important factors. Measures in this chapter take this as a starting point.

2. Water storage, infiltration and transport (W)

The high percentage of surfacing in the urban environment ensures that rainfall during extreme showers cannot infiltrate or drain away quickly enough, which can cause local flooding and can lead to damage and traffic disruption (see also chapter 2). There is a range of measures available for water storage, infiltration or transport.

3.3.2 Measures

Table 3.2 gives an overview of measures at street and neighbourhood level that have been studied in CPC. There is a brief explanation of a number of measures below. More information can be found in CPC publications such as Vergroesen (2013), Kleerekoper (2012), Klemm (2013a, 2014b in review) and Montazeri et al. (2015).

Table 3.2 Overview of 'Street and neighbourhood' measures

Measure	Goal	Effectiveness	Type
Street trees	H/W	++/+	T/C
Green façades	H	+/-	C
Green roofs	H/W	+/-	C
Green gardens	H/W	+/-	G
Light-coloured roofs	H	+/-	G
Evaporative cooling	H	++	G
Height/width ratio	H	+	
Enlarging sewage system	W	++	G/C
Depaving	W	+/>++	G
Underground storage tanks	W	+/>++*	G
Storage on existing surface water	W	++	G
Sunken roads/raised sidewalks	W	++	G
Storage in/under roads	W	+/>++*	G
Water square	W	++	G
Infiltration units/crates	W	+/>++*	T
Infiltration wells (deep/shallow)	W	+	T
Infiltration ditches	W	+	T
Infiltration transport sewers	W	+	T
Infiltration drainage sewers	W	+	T
Wadis	W	+/>++*	T
Adapting ground level	W	+	C
Disconnecting sewers	W	+/>++*	C

H: prevention of heat stress; W: prevention of damage due to flooding

G: Generic; T: Typology-linked; C: Context-dependent

* The effectiveness depends on the size of the storage and/or the local situation.



General heat measures (H)

Many parameters are important for the microclimate, such as the degree of surfacing, the type and colour of the material, the amount and type of vegetation, the amount and type of water, the height and width of the streets, and within areas, openness, orientation, type of buildings, the land utilization (residential, mixed urban functions, industry, city centre, business district, agriculture, sports and recreation) and density (population per ha, houses/ha, FSI (Floor Space Index), GSI (Gross Space Index), height/width ratio). In choosing a certain measure all the aspects mentioned above play a role.

Comparing the effectiveness of various heat measures using existing studies with measurements and/or simulations is barely possible. This is because they all concern different conditions: different climate zones, weather conditions and other urban contexts. In addition, the measuring methods and simulations differ in terms of measuring locations (especially the height), and different indicators are used to express comfort, such as air temperature, radiative temperature, surface temperature, thermal comfort (PET, UTCI), etc. (see also **Appendix C**).

By carrying out model calculations in the ENVI-met microclimate model, the difference in effects of the different measures on thermal comfort was studied under comparable conditions and with comparable measuring methods in CPC (Kleerekoper et al., in review a and b). The effects were studied in a specific urban context and in an open field where the complexity was slowly built up. By changing one aspect each time it is possible to see what effect this measure has (**Figure 3.4**). In **Table 3.3** below it can be seen which measures were studied and what the calculated effect was. Measurements were taken at four positions at a height of one metre (Kleerekoper et al., in review b).

This study of the generic effects of measures has led to the conclusion that design measures and measures that influence solar radiation and wind have a great effect on the local thermal comfort. By contrast, measures that influence air temperature and atmospheric humidity have a more limited effect in terms of degrees Celsius, but a larger action radius.

The evaporation from the ground and through vegetation was also considered in the simulations. Evaporative cooling by, for instance, mist spraying was not examined. Local effects can be expected from this, but this will be because of direct evaporation and not because of a higher atmospheric humidity.

A. Pavement versus grass

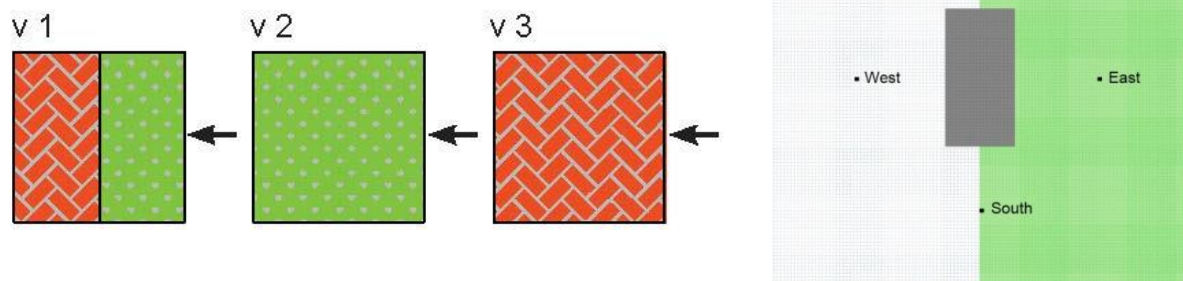

Figure 3.4 Example of an open field where the effects of grass vs. paving are analyzed (left); and the four measuring positions in this field (right) (Kleerekoper et al., in review b).



Table 3.3 The maximum effects in PET measured at one of the four measuring positions and the average effects in PET across the four measuring positions (Kleerekoper et al., in review b).

	Maximum effects in PET measured at one of the four measuring positions (°C)	Average effects in PET across the four measuring positions (°C)
A. Grass vs pavement	-8	-5.5
B. Detached building of 20*40*8 m (l*w*h) with brick paving vs. empty field with brick paving	-8	-0.6 – 0.7
C. Direction of wind (North, South, East, West, North-East and South-West)	3	0.0 – 0.9
D. Wind speed from 1 to 6 m/s	-12.4	-11.6
E. Grid size		
F. Area rotation		
G. Two buildings vs 1 building	10	3.5 – 4.2
H. Two buildings with different heights vs two buildings of the same height	-3.5 and 4.5	-1.1 – 0.9
I. Half-closed building with courtyard vs two rectangular buildings	0.2	0.1
J. Detached building with trees vs building without trees	-20	-5.8 – 0.3
K. Half-closed building with courtyard and trees vs courtyard without trees	-16	-0.5 – -0.1
L. Detached building with hedges vs building without hedges	-13	-2.9 – 3.5
M. 20 m high detached building vs 8 m high detached building	-1.5 and 3.5	0.5

Green elements in the street (H/W)

International research has shown that urban vegetation can improve the urban climate because of the shade provided by tree crowns and the cooling effect of evapotranspiration (Bowler et al., 2010). The goal of the research on green infrastructures within CPC is therefore to chart the influence of urban vegetation on the urban climate in warm summer periods – especially in terms of the thermal comfort of the city's inhabitants. Data about this was collected via micrometeorological measurements, Computational Fluid Dynamics (CFD) simulations and street interviews with inhabitants.

In addition, green infrastructures can play a role in the buffering and infiltration of excess rainwater. The effects of street vegetation on flooding reduction was charted using the 3Di calculation model. 3Di allows one to trace the effects of one or more adaptation measures on the scope and degree of the flooding (see chapter 3.5.2).

Street trees and green gardens

(Cargo bicycle) measurements taken at street level in Utrecht show a limited cooling effect for street trees in terms of air temperature (T_{air})²⁸, but a clear reduction of the radiative temperature (*mean radiant temperature*, T_{mrt}), especially because of large tree crowns. The average T_{mrt} in a street with a 54% surface of tree crowns was 4.5 °C lower than in a street without trees. 10% more tree crowns in a street

²⁸ Presumably partly because of the fact that the measurements took place in the middle of the street and not directly in the shade beneath the trees.



leads to a cooling of 1 K T_{mrt} (radiative temperature) (Klemm et al., 2013a; Klemm et al., planned for 2014). The measurements show a limited influence of green gardens on the physical climate conditions in outdoor areas, such as air temperature or radiative temperature, excepting, of course, large trees that offer shade.

Using CFD simulations for the J.P. van Muijlwijkstraat in the city centre of Arnhem (based on the warm summer's day of 16 July 2003) a reduction in the average and maximum temperatures of respectively 0.6 °C and 1.6 °C was measured for street trees in comparison with the situation without trees in the street (**Figure 3.6 and 3.7**) (Gromke et al., 2015).

Green gardens show a significant positive influence on how passers-by perceive temperature (**Figure 3.5**). Seeing green elements at different heights (low shrubs, hedges, tree crowns) makes heat more bearable for people, and they also appreciate such streets more from an esthetic point of view (Klemm et al., 2013a, Klemm et al., planned for 2014).

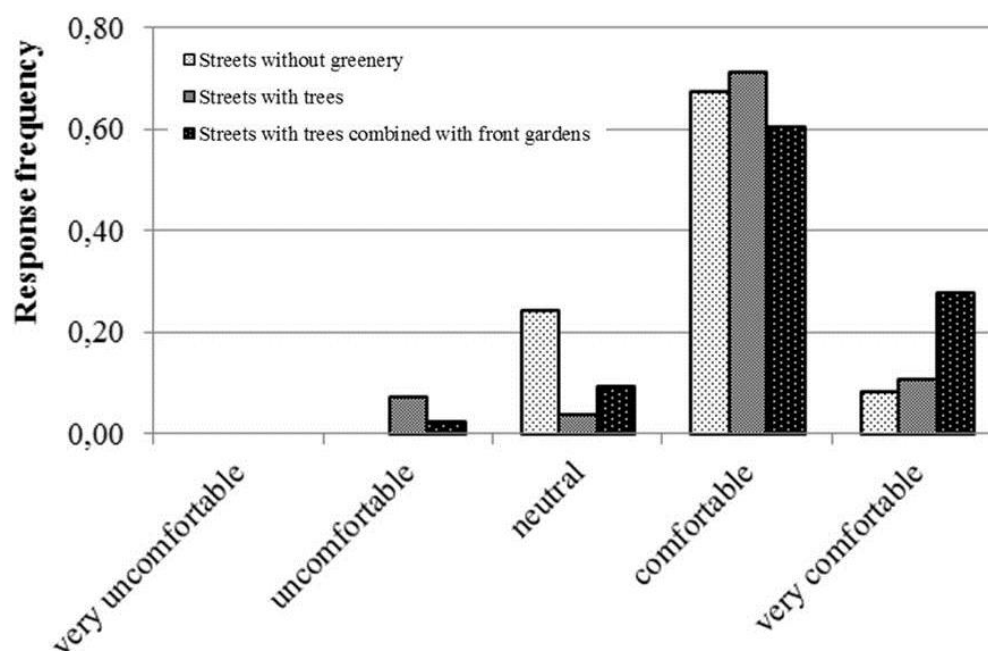

Figure 3.5 Temperature perception of pedestrians in three types of streets (Klemm, 2013a).

In addition to making gardens greener (depaving), tree pits can also be applied with vegetation. All unsurfaced (or semi-surfaced) parts of the streets thus contribute to the improvement of the perceived temperature for passers-by, the infiltration of rainwater and the storage of rainwater for irrigation of vegetation in the street.

Green façades

The CFD simulations show that applying green façades results in relatively low reductions of the air temperature in the street: an average of 0.1 °C and a maximum of 0.3 °C (**Figure 3.5 and Figure 3.6**) (Gromke et al., 2015). The effect of green façades on the outdoor temperature strongly depends on the type of green façade, but for each façade type the effect is only noticeable very close to the façade. In a study in Singapore, where different green façades were examined, it turned out that the vegetation gives a reduced temperature of around 2 °C at around 30 cm away from the façade (Wong et al 2010). The façades with a good substrate seem to be the most effective for this.



In order to prevent overheating of buildings indoors, a green façade is certainly not the most effective measure. There is a limited effect for poorly insulated buildings, and the effect is negligible for well-insulated buildings (van Hooff et al., 2014). Green façades also do not play a role as a measure against flooding due to rainwater (Vergroesen, 2013). Due to their visual impact, green façades or climbing constructions for plants do contribute to a better temperature perception outdoors (Klemm et al., 2013a; Klemm et al., planned 2014).

Green roofs

Applying green roofs in CFD simulations did not result in a noticeable reduction of the air temperature at pedestrian level in the street (**Figure 3.6** and **Figure 3.6**) (Gromke et al., 2015). In general, the cooling effects were limited to a distance of a few meters from the vegetation. These results reflect the differences in temperature measured in earlier studies (e.g. Alexandri & Jones 2008, Errel et al. 2009). Green roofs can play a role in the storage of water during extreme rainfall (see also chapter 3.2.1 and Vergroesen (2013)). Furthermore, green roofs have little effect on the indoor temperature (see also section 3.2.2).

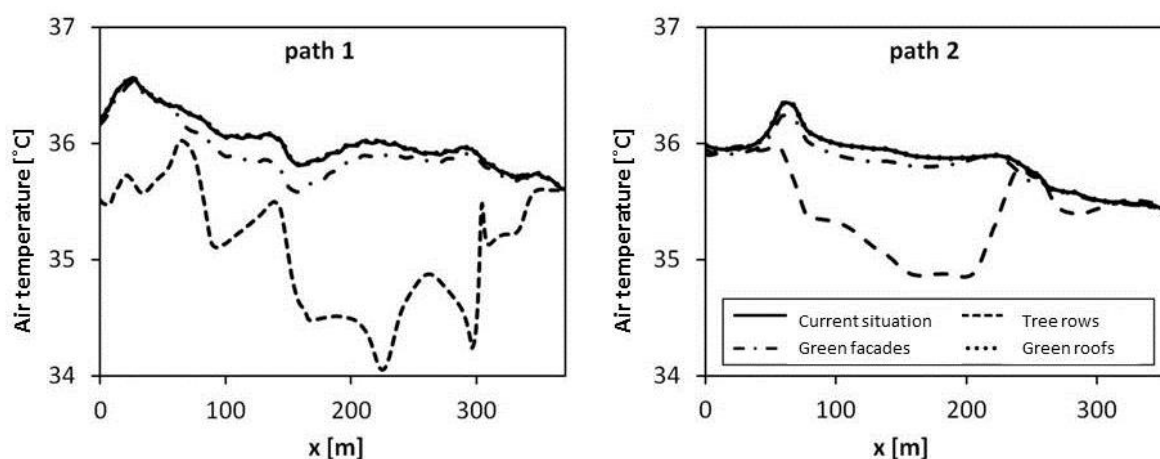
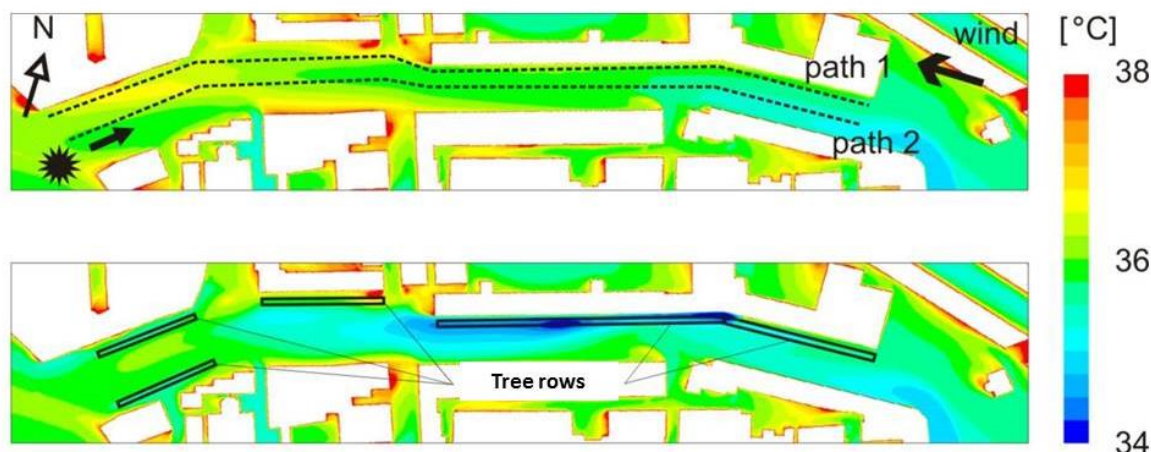

Figure 3.6 Air temperature at 2 metres above the ground in the J.P. van Muijlwijkstraat in Arnhem on paths 1 and 2, as shown in Figure 3.7, both for the current situation and for the three alternative vegetation scenarios (Gromke et al., 2015).

To sum up, placing trees along the side of the street (due to the added shade) has an especially positive effect on the physical conditions of thermal comfort, namely air and radiative temperature. In addition, the evaporation from trees can prevent the translation of a significant part of the incoming shortwave solar radiation into a rise in the air temperature in the city. Street trees are an effective way of improving thermal comfort in existing streets that catch a lot of sun. But street trees are not needed everywhere; depending on the orientation of the street or the street profile (height-width ratio) buildings themselves can create shade for pedestrians. In streets with busy traffic too many trees can even have a negative effect, due to the dense canopy: the tree crowns then create a ‘tunnel effect’ so that the air cannot circulate and the exhaust fumes linger in the street.

In addition, all green elements in streets, such as front gardens, façades, tree pits, have a psychological effect, namely that pedestrians see vegetation and therefore experience better thermal comfort and find the heat more bearable.



Figuur 3.7 Air temperature at pedestrian height (2 m above the ground) in the J.P. van Muijlwijkstraat in Arnhem for the current situation (top) and for the scenario with rows of trees in the whole street (bottom). The rows of trees are represented by black rectangles (Gromke et al., 2015).

Increasing albedo/light-coloured roofs

Satellite images show that a higher albedo (and therefore a higher reflection value) leads to a lower surface temperature (section 1.3.2), but the effect on the air temperature at street level is not unambiguous. The measuring data in Van Hove et al. (2014) (section 1.3.2) does not show a clear relation between albedo and air temperature in Rotterdam. It is important to note here that the albedo value was registered as an average value for the area around the measuring equipment.

As part of a simulation study, Kleerekoper (in review a) calculated that the transformation from a black to a white roof at a height of 9 m does offer a temperature reduction of 0.5-1 °C at a height of 2 metres. This reduction is obtained in 50% of a radius of around 15 metres in and around the building block. Various foreign studies also describe the cooling effects of albedo on the air temperature (Taha et al., 1988; Sailor, 1995).

CPC research showed that high albedo values are in any case undesirable for façades, because the reflected radiation can in turn be reflected towards people in the street and can influence the thermal comfort or temperature perception of pedestrians at living level.

Height/width ratio

The ratio between building height and street width (H/W) is important. In model simulations with the 'Weather and Research Forecasting' model, Theeuwes et al. (2014) find an optimal H/W ratio of around 1 (the building is just as tall as the street is wide) (see also 1.3.2 – Urban Canyon Effect). A wider street profile (low H/W) is preferable, however, because of better ventilation; sufficient shade can then be attained through well-located deciduous trees. In addition, in winter, the street actually benefits from the solar radiation.

Evaporative cooling (H)

Mist spraying systems are used more and more often as a system for local cooling and the improvement of thermal comfort in the built environment (Figure 3.8a and b). Because the fine water droplets take in the heat and evaporate, the air around them cools down. To prevent Legionella, the application of spraying systems must take place with great care, and only with purified water that has been kept refrigerated during storage.

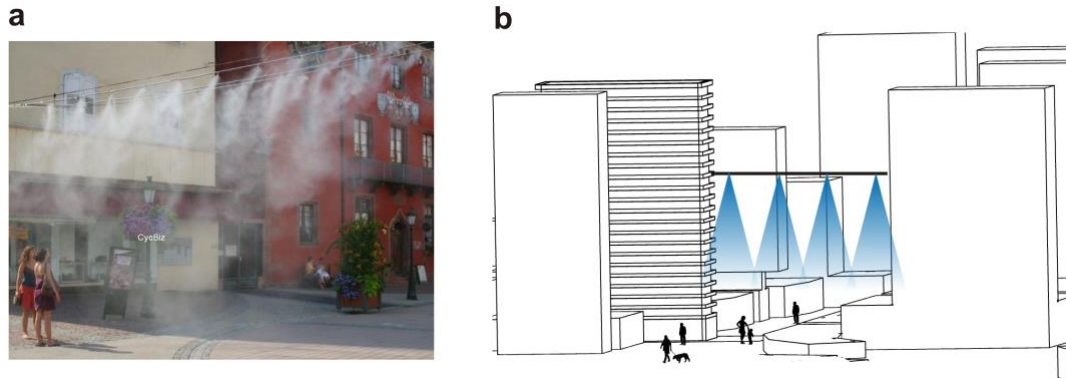

Figure 3.8 (a) Direct evaporative cooling (through humidifiers) in an urban area. (b) Schematic overview of a case study including the nozzles of the humidifying system.

Within CPC, high-resolution numerical models were developed to analyze the performance of evaporative cooling through humidifying systems in urban areas (**Figure 3.8b**) (Montazeri et al., 2015). The evaluation, done using Computational Fluid Dynamics (CFD), is based on grid sensitivity analysis and on a validation study using wind tunnel measurements by Sureshkumar et al. (2008).

The simulation consists of a water spray system with a hollow-cone nozzle configuration used at pedestrian level and on balconies of a building of medium height (**Figure 3.9**). The study was carried out for various wind speeds and properties of the water vapour, in order to evaluate the performance of the spraying system in terms of reducing heat stress (based on UTCI, see also **Appendix C**). One of the evaluations shows that for lower wind speeds, the system reduces temperatures especially at pedestrian level, while at higher wind speeds, the façades are cooled more (**Figure 3.10**). The results show that the upstream wind speed has an important effect on the cooling performance of the spraying system at pedestrian level and on balconies. In addition, the first results show that the UTCI can decrease locally by around 2 °C due to the use of the spraying system, and the effects are noticeable at up to 10-20 metres away from the system (Montazeri et al., 2015).

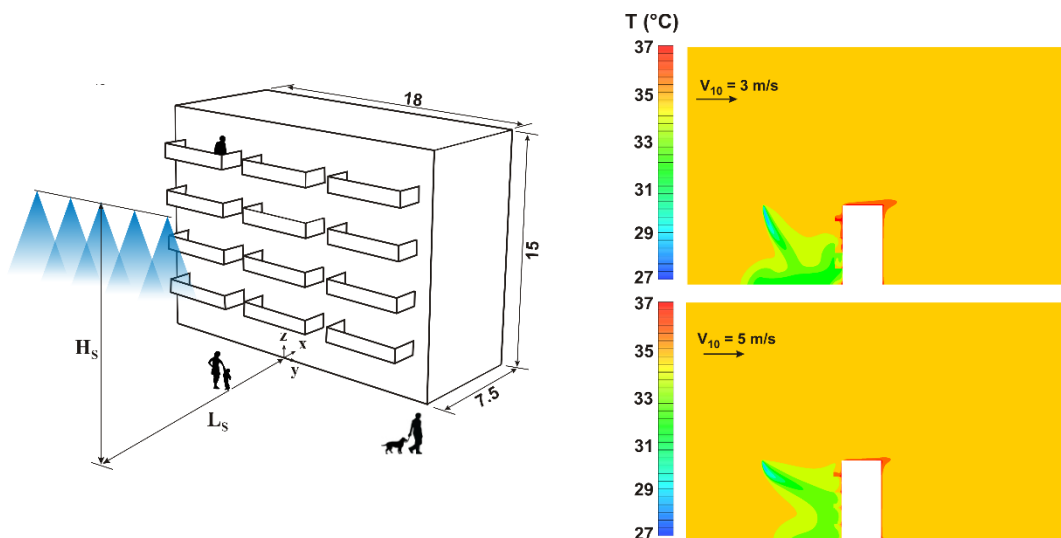

Figure 3.9 Image of the hollow cone nozzles for the generic building with balconies (source: Montazeri et al., 2015).

Figure 3.10 Contours of the air temperatures around the building when a humidifying spraying system is applied for two different wind speeds at a height of 10 metres (V_{10}) (source: Montazeri et al., 2015).



Water square (W)

A water square, like Benthem square in Rotterdam, is a square that is primarily meant for water storage in shallow constructions during extreme rainfall. In dry periods a water square is no different to a normal square. When it is not raining, the square is dry and accessible and it can be used for all sorts of recreational purposes.

A surface of 167 m² per hectare is needed to store 50 m³ at an average water depth of 30 cm (see 3.1.2 for an explanation of the principles behind this) (Vergroesen et al., 2013).



Figure 3.11 Benthemplein Rotterdam

The collected water can be drained into the sewer with a pump, or the water can infiltrate. The latter will depend on the surface and the design of the square. The emptying time for a pump capacity of 4 m³/hour is half a day. For infiltration, the emptying time can vary from 0.5-5 days. Infiltration can combat drought and can locally reduce a lack of moisture by a maximum of 20 mm.

When infiltration is applied in the deep substratum, the water can be stored for a longer time and be pumped up for reuse. A good example of this is a practical experiment in Westland, where rainwater from the roofs of greenhouses is collected and infiltrated into the ground. As a result, the above-ground basins near the greenhouses can be kept at a low level, so that when there is intensive rainfall, there is enough water storage available to prevent flooding, and in addition, there is always water of sufficient quality available for agriculture in the underground storage. A similar system could also be realized in the urban environment, where the underground water store could be used for low-grade water applications in the city (toilet flushing, water for extinguishing fire, cooling, etc.) (Hofman and Paalman, 2014).

Depaving (W)

Porous surfacing allows rainwater to locally infiltrate into the substratum below. Water infiltrates through the joints of the bricks or paving or in the granulation of porous asphalt. Brick and paved surfacing are especially effective for low intensity showers, while the high permeability of porous asphalt ensures that relatively large amounts of water can be stored even for high intensity. Because more water is retained in the area, the water balance improves and the chance of drought-related problems decreases.



Assuming a road surface of 1000 m² and a sand substratum with an effective porosity of 25%, a depth of 20 cm is required to store 50 m³ of rainfall (see the principles behind this in section 3.1.2) (Vergroesen, 2013). The time needed to use the storage again varies from a few hours to about a day, depending on the porosity of the surface below.



Sunken roads/raised sidewalks (W)



Water can be temporarily stored in a controlled way on streets and in verges, especially away from main roads. This is the most effective in a combination of a small drainage capacity and deeper roads so that more run-off water is stored temporarily and can drain away slowly. Compartmentalizing roads, for instance with ramps, prevents water from flowing (too quickly) to lower areas that are sensitive to flooding due to rainfall. This measure is especially suited to relatively flat areas.

To store 50 m³ of water with a depth of 5 cm, 1000 m² of street surface is needed per hectare. The emptying time through sewers is half a day (Vergroesen, 2013). If infiltration is possible, for instance through porous surfacing, the measure can also have an effect on drought.

Roads and pavements are constructed on top of a bed of sand. Infiltration crates and other forms of water storage under roads – often in combination with drainage to prevent high groundwater levels in the sand bed – can offer extra water storage underground.

Verges are often very suitable for storing water, better than allowing rainwater to stay in streets. By lowering verges and making as much space as possible for an infiltration ditch or groove, or putting infiltration crates under them, a lot of room can be created for water storage. If necessary, some extra drainage can be put in in order to control the groundwater levels on the spot and to guarantee the emptying time.

3.3.3 Design principles

When examining a street or a square the local context plays a decisive role: where is it convenient to have sun/shade, and where should there be shelter/ventilation? Also, the physical circumstances determine the effect of, for instance vegetation. On this scale, too, various relatively small, local measures can make the street/neighbourhood less vulnerable to climate change. A number of general guidelines are summarized below and in **Figure 3.13**.

General guidelines

- Add green elements (in private and public spaces), preferably at as many different heights as possible and with different microclimates. (Street) vegetation ensures shade and evaporative cooling and is appreciated esthetically. More vegetation also ensures better infiltration in the subsoil. To prevent overheating of the urban environment, spreading out green elements is more effective; however, for offering cool spaces, recreation and biodiversity, parks are very important. To allow inhabitants to choose themselves what they find pleasant, creating differences between microclimates (sun and shade) is important in the layout of the city.
- Add trees with large crowns in streets, parks or squares that catch a lot of sun. Considering that the shade effect of (large) tree crowns plays an important role (in streets and squares, **Figure 3.12**), the location of trees, types of tree and maintenance policy should be taken into account specifically during the design phase, in order to place trees as effectively as possible. Therefore, pay attention to optimum shade and sufficient maintenance (irrigation). Use deciduous trees in particular: shade in summer, sun and light in winter.

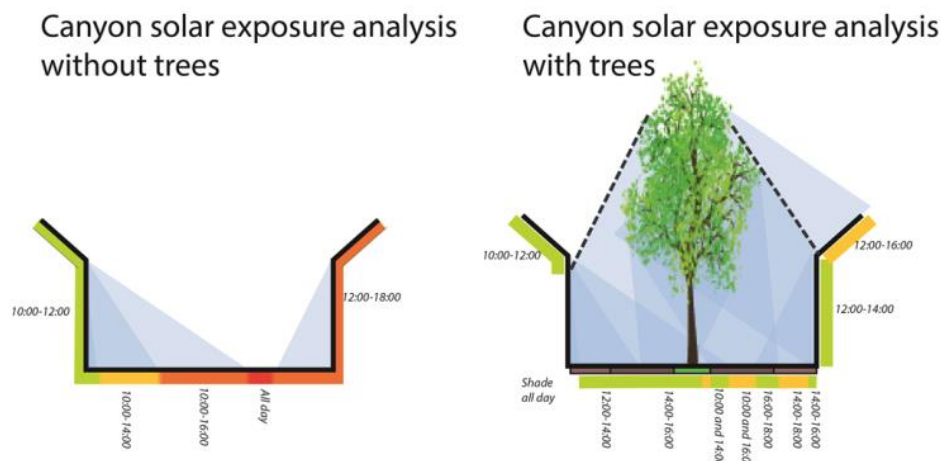

Figure 3.12 Solar exposure analysis with and without trees (Hotkevicica, 2013).

- Apply infiltration to ensure sufficient moisture in the ground for vegetation. In many cities with an arid sandy substrate, little water is retained naturally, so that there is a lack of moisture in dry periods and the effect of evaporative cooling through vegetation is limited. By not draining away rainwater straight away but allowing it to infiltrate and stay in the ground, the evaporation from the vegetation can be kept at an appropriate level in dry periods. The infiltration can be improved by applying less surfacing, for instance, or by working with permeable surfacing. Measures against heat stress and flooding can be linked.
- Create room for underground and above-ground water storage. Infiltration crates can for instance be used underground, while above ground water can be stored by lowering the ground level locally, such as that of roads and verges, but also lawns and strips of green, so that the excess rainwater can collect there without causing damage or inconvenience. Water squares and water parks (hollows in a park; artificial wetlands) are multifunctional spaces for water storage, recreational activities and nature development that are generally highly rated by inhabitants. For above-ground water storage it is important to take into account the risk of exposure to infectious diseases.
- Ideally, a street should be at least twice as wide as the buildings are tall (allowing good ventilation) provided that it offers (enough) shade elements.
- Prevent heat emissions and intercept heat for storage and use in winter. Anthropogenic heat sources cause a significant increase in the heat island effect and must be limited as much as possible (section 1.3). By dealing cleverly with the excess heat in summer and intercepting it and storing it in the substrate, it can be reused in winter.
- Smart management. The effectiveness of the adaptation measures mentioned depends completely on good construction *and* good management. Therefore, during the design and construction process the manageability of the adaptation option must already be taken into detailed account. Many of the options will be situated in open spaces and must fit into maintenance schedules for vegetation, roads, drainage, sewers and waterways belonging to municipalities and water boards.

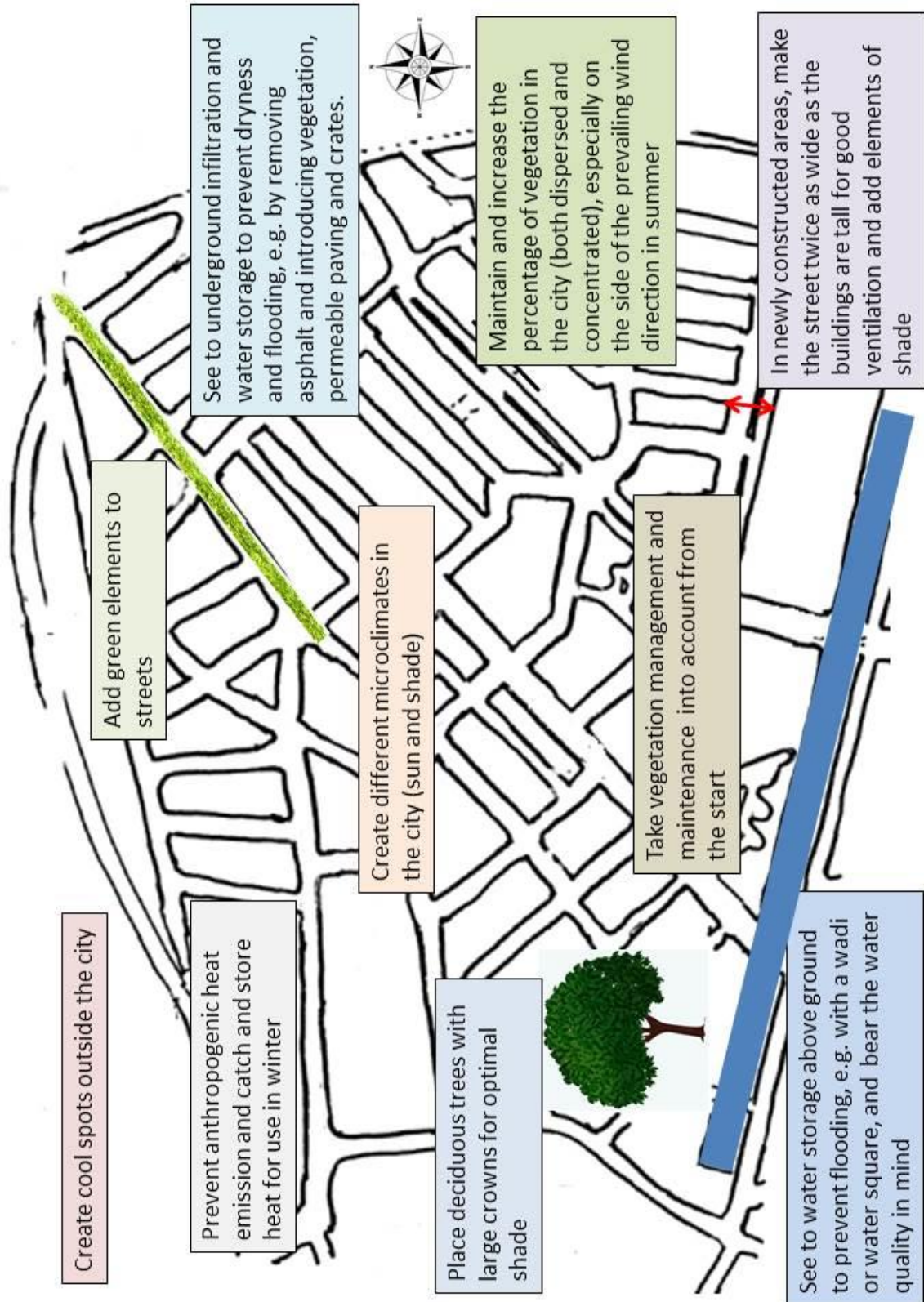

Figure 3.13 Design guidelines for climate proof neighbourhoods. The design guidelines for cities and regions (3.4) are also included in this diagram.



Guidelines for a heat proof neighbourhood

Classifying neighbourhoods into categories can depend on many characteristics. The most important parameters distinguishing Dutch neighbourhood types in relation to the degree of overheating are shown in **Table 3.4**.

Table 3.4 Categorising building typologies in relation to the microclimate (based on Berghauser Pont & Haupt, 2009).

Construction height	Type of construction	Percentage of green/blue
Low (up to 3 floors)	Strips	Hardly any green (0-20%)
Medium-high (4-6 floors)	Open block of buildings	Moderately green (20-40%)
High (7-10 floors)	Closed block of buildings	Very green (40-70%)
High rise (9 and more floors)	Spread out	Extremely green (70-100%)

It is possible to make sound decisions in adaptation measures for an improvement of thermal comfort without detailed knowledge of microclimate processes or simulation models. A neighbourhood can be classified into a microclimate category based on the neighbourhood typology and the type of layout. This categorization can easily be identified by urban developers and policymakers themselves. Subsequently, there is a set of measures available that are appropriate for that category (Kleerekoper, in preparation).

The neighbourhood typology that was set up within CPC is described in **Table 3.5**. Historic city centres, for instance, belong to the category of *medium-high closed building blocks, hardly any green* and the garden cities in Amsterdam West belong to the category of *low open building blocks, moderately to very green*.

Table 3.5 From neighbourhood typology to microclimate category.

Typology	Period	Footprint	Height	Vegetation
Historic city centre	before 1910	closed block of buildings	medium-high	hardly any green
Garden city/village	'10-'30	closed block of buildings	low	moderately to very green
Residential neighbourhood	'30-'40	closed block of buildings	low	hardly any green
Low garden city	'45-'55	open block of buildings	low	moderately to very green
High garden city	'50-'60	open block of buildings	medium-high/ high	moderately to very green
Cul-de-sac neighbourhood	'75-'80	strips; open block of buildings	low	hardly to moderately green
Vinex ²⁹	'90-'05	strips; closed block of buildings	low	moderately green
High rise city centre area	'60-present	spread out	high rise	hardly any green

²⁹ A Vinex neighbourhood is a Dutch residential area with new construction developed between 1995-2005.



Historic city centre (medium-high closed blocks of buildings, hardly any green)

- Temporary and flexible measures such as cotton cloths over streets and squares, spraying water at pedestrian height, watering the street in order to lessen the radiative heat of the stone, seats that offer shade in summer and protection from the wind in winter and introducing elements that improve ventilation in the street;
- Permanent and robust measures such as pergolas that are covered with deciduous climbers, arcades along south façades, a covered part (or footpath) of the street, water streams in the street (see for instance Freiburg), fountains, white roofs, green roofs, façades with climbing plants, or green façades (also plants rooted in façade).

Garden city/village (low closed blocks of buildings, moderately to very green)

- Promoting vegetation in private gardens, for instance by inspiring inhabitants and providing information about the importance and benefits of vegetation.
- Promoting the installation of facilities for storage reuse of rainwater in houses. Levies can be adjusted according to the degree of surfacing in gardens through water board or municipal taxes, or if precipitation is collected on a private property this can be rewarded with a lower levy;
- Add street trees at strategic locations.

Residential neighbourhood (low closed block of buildings, hardly any green)

- Front gardens and façade plants;
- Type of surfacing: half-surfacing, porous surfacing, light colours;
- Parking solutions combined with a construction for climbing plants;
- Flat roofs for thermal comfort at street level: a white, reflective coating, green roofs with a sufficiently thick substrate layer
- Improving ventilation: when more vegetation is not possible, improving ventilation can be extra important. This can be achieved by applying more differences in height between the buildings or by working with 'hot' and 'cool' spots, between which the air will begin to;
- Try to find parking solutions: the streets can be laid out with a single row of trees that protect the south, east or west side. In carless streets a double row of trees can even be planted. In some cases trained trees can be a good option if the position of the tree cannot be placed far enough away from the façade.

Low garden city (low open block of buildings, moderately to very green)

- Promoting vegetation in private gardens;
- Increasing the value of semi-public vegetation: improving the quality of the vegetation and linking several functions to the green areas. The semi-public inner spaces have a green field in the middle of around 30*50 m. The uses linked to this should not only be for the inhabitants, as the public character will then be lost. However, public uses are less appropriate here as the inhabitants can see this as a breach of their privacy; it does after all concern their back garden. When such a social function is of a quiet nature and attracts a limited number of people at a time this will cause less friction. This could be a (dog) walking route, water storage, butterfly or bee garden, fruit and nut orchard, etc.



High garden city (medium-high/high open block of buildings, moderately to very green)

- Promoting green in private gardens;
- Improving the value of semi-public and public vegetation. The large size (70*100) of the semi-public inner spaces lends itself to special uses, such as a water purification area with reeds and water courses, mixed cultivation (urban farming or vegetable gardens), a petting zoo, water playground, dog training field, sunbathing area/event space with fixed BBQs and a licence for a refreshments stand. Throughout the neighbourhood: footpaths, asphalted road for bikes and roller blades, track for mountain bikes.

Cul-de-sac neighbourhood (low strips of buildings and open blocks, hardly to moderately green)

- In cul-de-sac neighbourhoods the large number of cars is often a problem. Solutions for fitting in cars would go hand in hand with vegetation and shade. Decreasing the number of cars is not an option as the neighbourhoods are often far away from the centre. It is possible to consider shared (electric) cars or parking spaces on the outskirts of the neighbourhood. If this frees up more space in the neighbourhood it can be used for more playgrounds, more trees, rainwater collection and infiltration through wadis, rainwater storage in deep substrate;
- Façade plants;
- White roofs.

VINEX neighbourhoods (low strips of buildings and closed blocks, moderately green)

- Promoting vegetation in private gardens, also try to reverse the fashion for anthracite flagstones;
- Car parking solutions combined with vegetation and shade.

High rise city centre area (high rise buildings, hardly any green)

- Offer a diversity of spaces: sheltered from the wind, shady, sunny, and possibly sheltered from the rain;
- Decrease the high degree of surfacing by realizing roof parks, for instance;
- Try to turn solar energy into heat or electricity using large roof and façade surfaces.



3.4 City and region

3.4.1 Goal

In this chapter we look at measures that rise above the level of individual buildings, streets and neighbourhoods. Research was carried out on the level of the city and urban region into how spatial planning can influence heat stress and flooding in the city. How can the city and surrounding countryside be arranged so that:

1. the outdoor temperature in the city does not increase too much compared to the countryside and heat stress is limited (H)

If carried out well, cool islands in the city and cool spaces just outside the city can have a positive effect on the temperature inside the city.

2. rainwater is processed well and flooding and drought in the city can be reduced (W).

Possibilities for water storage and infiltration around the city can contribute to urban water management. A precondition for these measures is that they are safe and healthy for inhabitants.

3.4.2 Measures

Table 3.6 gives an overview of measures at urban and regional level that were studied within CPC. A number of measures is briefly explained below. More information can be found in CPC publications like Vergroesen (2013), Klemm (2013b, 2014a), Kleerekoper et al. (in review a), Echevarria et al. (planned for 2014 b).

Table 3.6 Overview of 'City and Region' measures.

Measure	Impact	Effectiveness	Type
Parks	H/W	++/++	G
Cool wind corridor	H	unknown	C
Surface water	H/W	+/-, +	C
Storage and subsidence basin	W	+	T
Extra reclaiming/raising surface level	W	+	T
Pre-draining/accelerated draining	W	+	T

Parks in the city (H/W)

The effect of vegetation at street level was discussed in 3.3.2. Here we will examine larger green surfaces in the shape of parks (on city level up to 8 hectares). Results of (cargo bicycle) measurements taken at city level in Utrecht as part of CPC show an average difference in air temperature in a park compared to its direct built surroundings of 1 °C (measured in the afternoon of a hot summer's day) (**Table 3.7**). In terms of thermal comfort (PET), parks are on average 2 °C cooler than the city and 5 °C cooler than the countryside. 10% more tree crowns in a park leads to a cooling of 3.2 °C T_{mrt} (radiative temperature). This turns parks into cool islands during daytime in the city (Klemm et al. 2013b, Klemm et al. 2014a).



Table 3.7 Average and daily maximum values for T_a , T_{mrt} and PET in 13 parks studied in Utrecht, the city centre and above an open field outside the city on 24 July 2012 (12:00 - 17:00 UTC) (source: (Klemm et al., 2013b, Klemm et al., 2014a).

	Average (12-17:00 UTC)			Daily maximum values		
	T_a [C°]	T_{mrt} [C°]	PET [C°]	T_a [C°]	T_{mrt} [C°]	PET [C°]
13 parks	27.4	42.7	32.3	27.7	46.4	34.0
City center	28.2	44.4	34.2	28.5	47.6	35.1
Open field	27.1	56.3	37.3	27.5	60.0	39.2

The vegetation on the windward side (the side where the wind comes from) improves the air temperature in parks during the day and at night (Klemm et al. 2014a; Heusinkveld et al. 2014). This means that not only large green spaces in the city contribute to a lower air temperature, but that the accumulated effect of all green spaces (consisting of private and public green spaces and elements) also has a positive effect. It is important that this vegetation receives a good supply of water because the cooling effect is obtained in part through its evaporation (evapotranspiration).

In addition, people experience urban green spaces as more thermally comfortable than spaces consisting mainly of water or surfacing. Around 800 interviews with passers-by in Utrecht, Rotterdam and Arnhem show that urban vegetation plays an important role when it comes to thermal comfort and recreation on warm summer's days. 91% of all those questioned indicated that they found parks and other large green spaces pleasant; 70% thought parks were important. The favourite places for people to go on warm summer's days were Wilhelmina park (Utrecht), the Kralingse bos (Rotterdam) and Sonsbeek park (Arnhem) (Drost, 2013; Klemm, 2014a). Green spaces in the city are also more popular for outdoor visits on warm summer's days than areas with water or surfaces spaces in the city. Green spaces are therefore highly important for outdoor recreation on warm summer's days (Klemm, 2014a), see **Table 3.8**.

Table 3.8 Preferred urban spaces in terms of thermal comfort.

Type of area	Number of times chosen
Green	399 (59.4%)
Water	171 (25.4%)
Buildings	102 (15.2%)
<i>Total</i>	<i>672 (100%)</i>

Larger green infrastructures in cities, such as parks and strips of vegetation, also cause infiltration of rainwater, so that it does not have to be drained away, and can be used to store water. The simplest implementation is directly draining run-off water from paths and roads into the neighbouring vegetation. In order to increase the water storage capacity, measures such as wadis, infiltration ditches, crates and wells, and surface level adjustments can be implemented (Vergroesen, 2013) (Echevarria et al., planned for 2014 b).



Coolspots outside the city (H)

In CPC, satellite images were used to identify and analyze coolspots for Zuid-Holland. Coolspots are the areas with lower surface temperatures during heat waves. Land surface images from the night of 18 July 2006 were used for this (the hottest night of the 2006 heat wave). **Figure 3.14** shows coolspots in Zuid-Holland that are an average of 4-5 °C cooler than the city centres (Echevarria et al., planned for 2014 b).

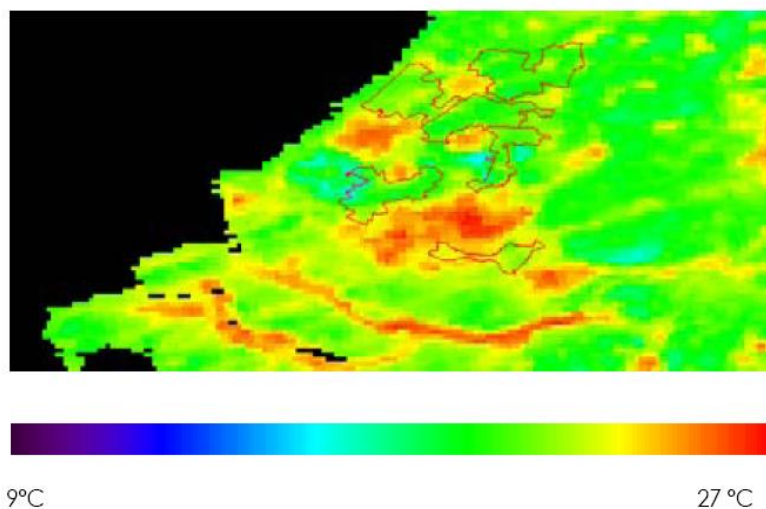

Figure 3.14 Satellite image of the surface temperature at night on 18 July 2006 in Zuid-Holland. Satellite: Modis 11A1 (Echevarria et al., planned for 2014 b).

In order to determine the characteristics of a coolspot, each coolspot was analyzed in terms of the ground type, land usage, soil type, vegetation index, topography, building height, groundwater level and of course the surface temperature at night (**Figure 3.15**).

The analysis shows that coolspots in Zuid-Holland generally have a high vegetation index and are often used as grassland or farmland. The Vegetation Index (SAVI) varies from 0.36 to 0.47. The maximum amount of surfaces covered by roads and buildings is not more than 10% of the total buffer surface (Echevarria et al., planned for 2014 b). The size of the coolspots analyzes varies from 3700 ha to 10 600 ha. In addition, light and heavy loam and light and heavy clay seem to increase heat, while sandy and peaty soil are often connected to areas with lower surface temperatures at night during heat waves. Free circulation of the wind also has a potentially positive effect on the cooling capacity of the landscape.



MIDDEN DELFLAN **7.866 ha**

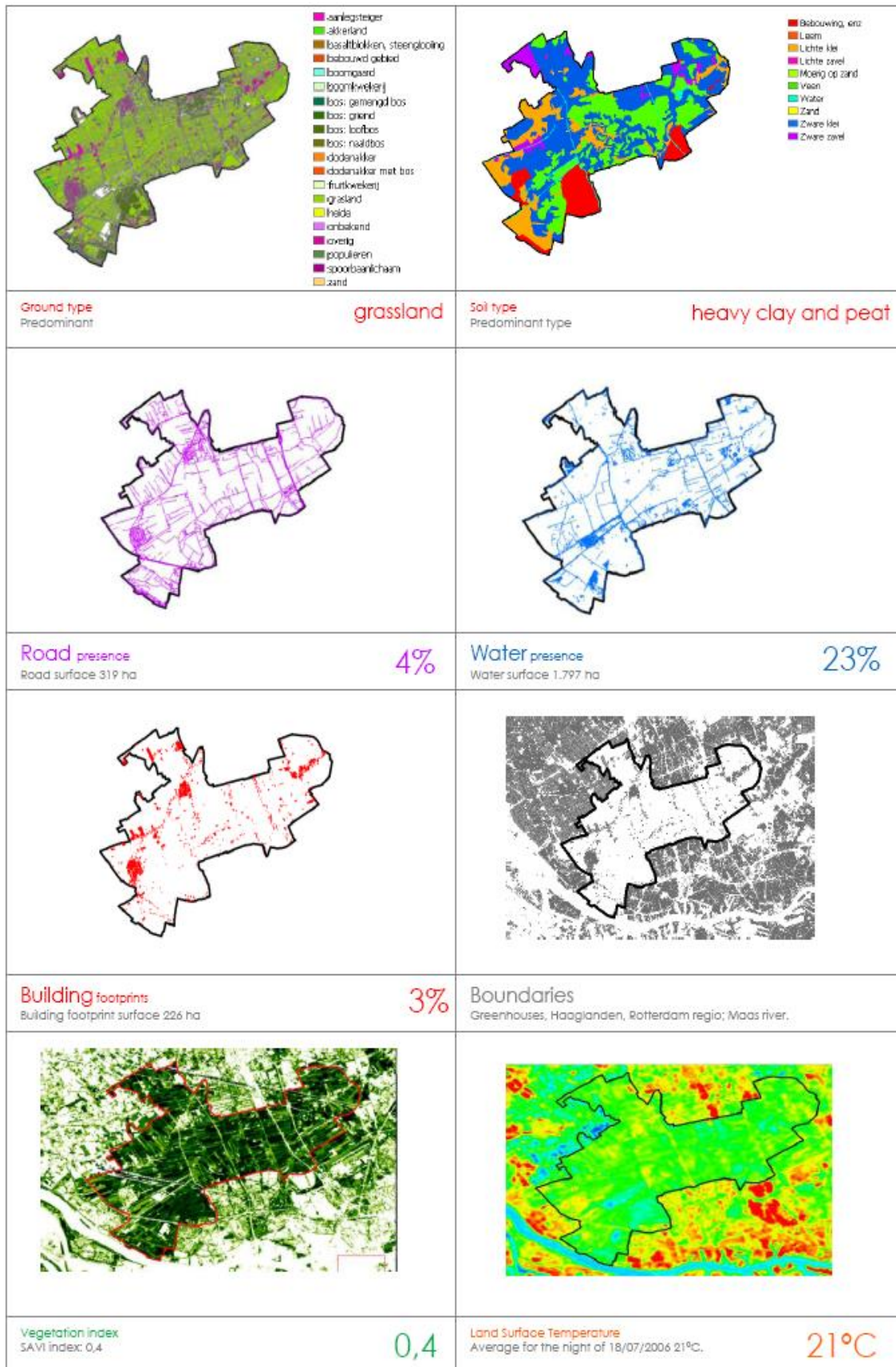

Figure 3.15 Coolspot analysis of Midden Delfland (Echevarria et al., planned for 2014 b).



Model simulations were also carried out for Rotterdam to see what the difference in temperature in the city would be with the current land usage, mainly grassland, and if Rotterdam were surrounded by forests. These model simulations were carried out with a detailed fine-meshed atmospheric model (RAMS) linked to a comprehensive model for the urban area (TEB/LEAF-3) (Ter Maat et al., 2014). In daytime it barely matters whether the city is surrounded by grassland or forest, but at night it would be 0.3-0.8 °C cooler in the city if it were surrounded by forest.

The effect is most noticeable on the edge of the city, close to the forest, but the influence also reaches to the centre (**Figure 3.16**). The temperature difference in the east is greater than in the west and has to do with the dominant direction of the wind, which usually comes from the east during a heat wave. In addition, not many changes have occurred in the land usage west of the city.

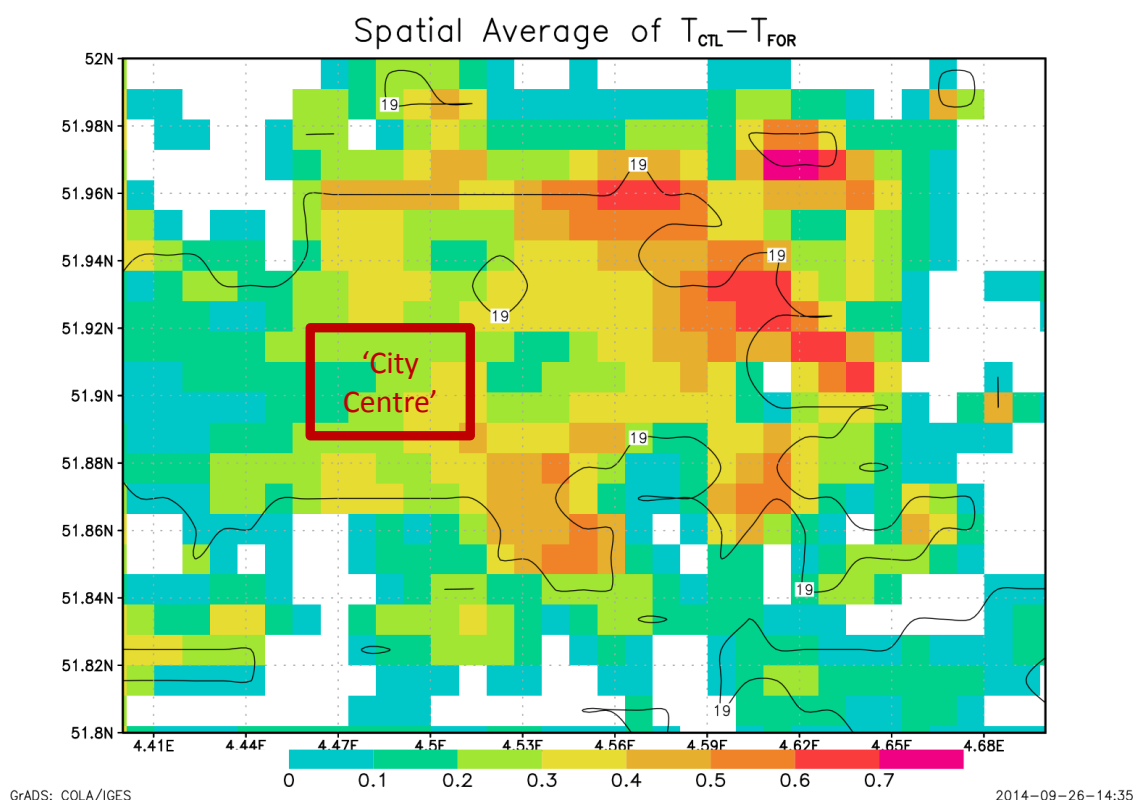

Figure 3.16 The difference in temperature at night (°C) in the city of Rotterdam (black outline) for the current land usage (mostly grassland) in its surroundings (T_{CTL}) and if Rotterdam were surrounded by forest (T_{FOR}) (source: Ter Maat et al., 2014).

Cool wind corridors (H)

Cool wind corridors can ensure that the cool air from coolspots just outside the city is transported to hotspots inside the city. The so-called 'urban plume' effect can help in moving cool air from cool areas to warm areas (**Figure 3.17**; see also **Figure 1.8**). Earlier studies for larger suburban parks show that green areas can have a cooling effect at great distances: up to 4 kilometers away from the park in Seoul (Choi et al., 2012) and up to 2 kilometers in the case of the 500 hectare Chapultepec Park in Mexico City (Jauregui, 1990). However, more information about the distance between coolspots and hotspots and identification of existing wind routes, as well as more thorough wind simulations and other studies are needed in order to design the cool wind corridors in detail.

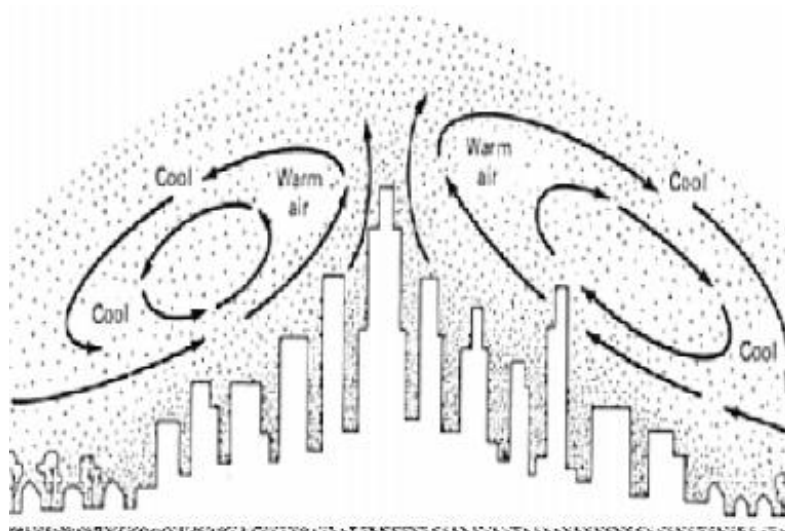

Figure 3.17 The 'urban plume' effect: warm air rises above the hotspots so that the cool air from the hotspots is drawn in via the 'urban canopy' layer at street level. The warm air subsequently circulates from the hotspots to the coolspots via the 'urban boundary' layer. When there's wind, the warm air from the city is spread out across the surrounding area (adapted from: Oke, 1976) (see also the 'Urban Heat Island effect' text block).

3.4.3 Design principles

General guidelines for City and Region

- Retain, and if possible increase the percentage of vegetation in the city, taking into account the dominating wind direction in summer. Vegetation on the side where the wind comes from improves the air temperature in parks. This means not only that large green spaces in the city contribute to a lower air temperature, but also that the accumulated effect of all green spaces (consisting of private and public green spaces and elements) has a positive effect (Klemm, 2014a; Heusinkveld, 2014). A good water supply for this vegetation is important because the cooling effect is thanks in part to its evaporation (evapotranspiration). In addition, more vegetation ensures better infiltration of rainwater into the ground and therefore prevents drought.
- Develop coolspots around the city. Despite the fact that more research is needed about the working and application of cool wind corridors, it is worth looking at the possibilities of developing coolspots around the city. Coolspots are composed for 90% or more of vegetation (i.e. grass, farmland or forest). Coolspots on the windward side of the city have the most effect, so that the wind blows the cool wind into the city. The prevailing direction of the wind in the Bilt during heat waves is mainly north-easterly (Kleerekoper et al., in review a). However, during heat waves there is often (almost) no wind. Due to the 'urban plume' effect, cold air from the surroundings can still be attracted, but the position in terms of the direction wind is less important.



3.5 The Linking Method

Adaptation measures will almost always be part of 'linking' with other projects. CPC has contributed to the development of the 'linking method'; a new, integral approach to identifying the optimum linking moments for adaptation measures within the urban dynamic (Van Herk et al., 2012; Gersonius et al., 2013). This method is a dialogue-supporting tool. It aims to stimulate the cooperation between parties on a local level, so that (local) concerns and knowledge are included. By definition, urban renewal aims at realizing various social, economic and physical goals that must be weighed up and connected by various parties. In addition, the linking method supports communication with and among administrators. The chances of linking with urban renewal, the integration of goals and the long-term validity of strategies are understood as a concept and stimulate a discussion about the ambitions in terms of climate durability. The new approach helps in a transition from sectoral to integral water management and spatial development.

Example: municipalities can make more cost-effective choices if there is more insight into the functioning of the urban water system. The tipping point for drains can for instance be pushed forward in time with measures elsewhere in the water system, for instance in public spaces. This interchange of measures in different parts of the water system does call for good insight into the whole urban water system. Thus well-considered choices relating to (not) separating rainwater from sewage water drainage, the type of pipes, the measures in public spaces and the amount of surface water can lead to substantial savings in costs and a greater climate durability of the whole water system. Using the tipping point approach, municipalities can see whether the measures make the system more climate proof (i.e. if the tipping point is postponed).

The linking method consists of three parts: (1) Analysis of the opportunities for adaptation, (2) Analysis of Adaptation Tipping Points (ATP) and (3) Determining optimum Adaptation Linking Moments (ALM) (see **Figure 3.18**).

1. Identify the opportunities for adaptation in the city (Steps 1+2, AMM)

In urban areas, the continuous flow of urban renewal, such as restructuring projects, maintenance and management projects of public spaces, and maintenance and management of buildings, offers opportunities for implementing adaptation measures (**Figure 3.19**). From this perspective, the urban dynamic can be seen as an impetus for including climate resilience. If there is no renovation, restoration or maintenance planned, an analysis can be made of the autonomous renovation, revitalization and development cycles for infrastructure, buildings and public spaces (i.e. sewage works, neighbourhood repairs, urban vegetation). A simple but practical way of doing this is by using predictions of the expected physical life span of various objects in urban areas.

2. Carry out tipping point analysis (Steps 1 t/m 5, ATP)

The tipping point analysis as described in section 2.3.2 is carried out to chart the consequences of climate change and to test how robust measures are. The analysis consists of several steps and can be used to show how much climate change (increase in intensity of precipitation) the urban system can handle. The steps to be followed will not be further explained here. More information can be found in section 2.3.2.



3. Identify optimum adaptation linking moments (Steps 3+4, AMM)

The most suitable linking moments are determined using an analysis of both the critical tipping points and the opportunities for adaptation based on the planning of the (extensive) maintenance, management and renovation projects in the city. If a tipping point for the system takes place later than an opportunity for adaptation, a linking moment occurs in which adaptation measures can be included. Using this information, supplemented by information about other tasks in the neighbourhood, measure packages can be formulated that both move the tipping point for the water system and contribute to other tasks in the city. An analysis of the potential adaptation measures and the most important tipping points (repeating steps 3 and 4 a number of times) leads to a number of adaptive strategies. The critical tipping points will move up (in time) because of the implementation of the chosen strategy.

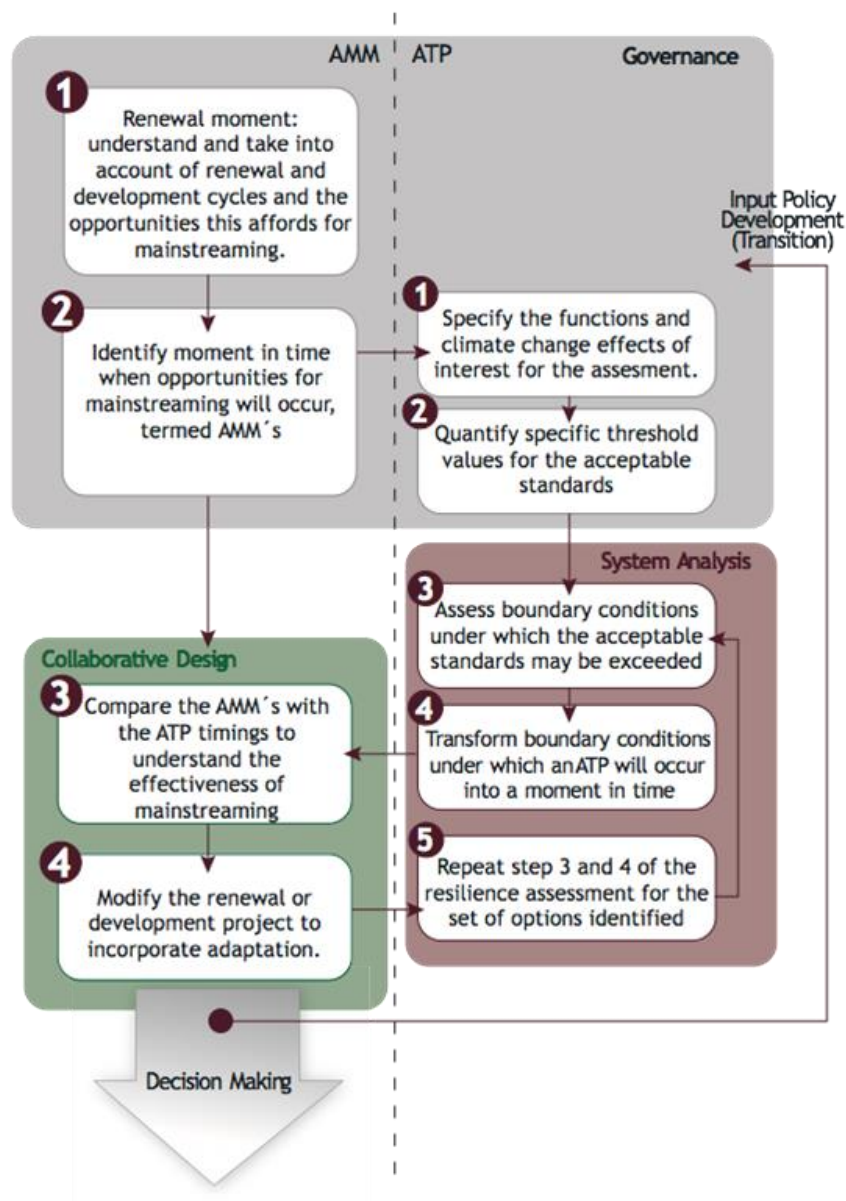

Figure 3.18 Combined approach of opportunities for adaptation and tipping points: the linking method (Van Herk et al., 2012).



Permeable surfacing in parking places ensures water retention underground and makes it possible to give a green character to the large number of new parking places that are needed in Wielwijk (source: Hesper Landscape Architecture and Urban Design)



The filtering of the separated rain water that falls on a road to be constructed is linked to the creation of nature-friendly river banks (source: Rijnbout Architecture, Urban Development and Landscape)



A 'water veranda' that functions as a super rain barrel and as unique architectural feature can be applied both in new constructions and in renovation projects (source: Faro Architects)



A 'green gully' consists of differences in height that make it possible to store water temporarily. This measure can be integrated into the construction of the new parking zone in the heart of the neighbourhood (source: Hesper Landscape Architecture and Urban Design)



Figure 3.19 Selection from the photomontages of promising measures.

3.6 Tools for adaption planning

In order to organize the urban environment more robustly in terms of climate and compose effective packages of measures, a number of tools were developed as part of and following on from the Climate Proof Cities (CPC) programme. An important motive for this development was the New Construction and Restructuring part of the Delta programme. Within this scope, guidelines, procedures and resources were developed and made publicly available³⁰. A stress test was developed for identifying and prioritizing problem areas; this test closes with a goal-oriented adaptation plan.

³⁰ <http://www.ruimtelijkeadaptatie.nl/en/>



These tools and procedures facilitate municipalities, water boards and other parties concerned in making their areas, objects and networks more climate proof. A number of tools are explained below, after a general introduction about the use of calculation models. The paragraph below about the use of calculation models for flooding applies, *mutatis mutandis*, equally to the use of calculation tools for other climate risks.

3.6.1 Use of calculation models for flooding

In order to steer the processing of extreme rainfall in the right direction, calculation tools are being used. These tools determine and monitor the dimension of the urban drainage system. Combining this with water usage models in buildings also gives insight into the uses and applications of the rainwater collected. Calculation tools are also used to predict the effect of measures that increase the robustness of the drainage system.

The calculation tools in this document span a broad scale, ranging from common sense to complex numerical models. It goes without saying that common sense in combination with knowledge of the area and experience must always be used. However, when using numerical models, increasing complexity means that there is an increased risk that common sense is switched off and the results are unthinkingly taken as correct and precise (Vergroesen 2013).

In general it can be stated that as the calculation tools become more complex, the necessity of their use decreases, while the amount and quality of the data needed to use these tools well increases. We can distinguish three research levels, where the order of the calculation tools needed is also different. The table below gives an overview of the calculation tools available (**Table 3.9**).

Table 3.9 Relation between research level and the use of calculation tools (Vergroesen 2013).

Research level	Calculation tools needed
Exploratory research into how the urban drainage system works or into the effect of measures on that drainage system.	<ul style="list-style-type: none"> – common sense – knowledge of the area and experience – proxies – first order models <ul style="list-style-type: none"> • water balances • ground level analyses (GIS) – already present models
Research into the workings of specific parts of the urban drainage system or into the effect of “no regrets” measures on that part of the drainage system, where the interaction with other parts of the drainage system is negligible.	<ul style="list-style-type: none"> – common sense – knowledge of the area and experience – already present models – second order models: <ul style="list-style-type: none"> • 1D sewage models • 1D surface water models • 2D flooding models • 3D groundwater models
Research into the workings of the total urban drainage system or into the effect of expensive measures on that drainage system, where interaction occurs among the different parts of the drainage system.	<ul style="list-style-type: none"> – common sense – knowledge of the area and experience – already present models – third order models: <ul style="list-style-type: none"> • linked flow models • integral flow models



3.6.2 3Di area model for flooding

The 3Di area model that was developed in conjunction with CPC was already discussed in 2.4.1 as a tool that offers insight into how vulnerable an area is to flooding. 3Di can also be used as an assessment tool, where the effects of changes to the system can be shown interactively on a touch screen during a work session (Leeuwen and Schuurmans, 2014). Because the spatial resolution is very high and the calculation speed is a factor 1000 faster than comparable instruments, calculations can be made 'at the table' during the decision-making process. The fact that calculations can be paused, adjusted, and started again means that all those involved, including non-specialists, can 'try out' climate adaptive measures. Thus consensus can be reached quickly about the use and necessity of measures, and worthwhile measures can be separated from those that are not worthwhile.



Figuur 3.20 Interactive work session with 3Di on a touch screen

Conclusions of the workshops organized as part of CPC:

- Climate adaptation is less a communication problem than an information problem. Problems during design sessions with water that were until recently seen as communication problems in fact turned out to be largely information problems. If the correct information can be provided on the spot through effectiveness calculations with a touch screen, it turns out that difficult discussions are soon settled.
- In practice, working with 3Di models means looking at the effects together in order to be able to take broadly supported decisions. Designing together during a work session, which was once the idea behind 3Di, turns out not to be possible, also because most parties involved are not designers.
- 3Di stimulates working from specific to general (instead of the other way around). Devising an adaptation strategy often moves from general to specific, from general solutions to measures. Working with 3Di, however, makes it clear that the effect of measures is to such an extent dependent on the details that this does not really work. The detail effects allow one to devise a strategy.

More info: <http://www.3di.nu/en/international/>



3.6.3 Climate Adaptation App

The Climate Adaptation App is a tool that can be used at the start of the planning process by all those involved. Based on a limited number of properties of the project area and depending on the climate problems expected, a list of more than 100 possible measures is created. Measures that are most likely easy to apply appear at the top of the list.

The effect of this tool in practice is that the parties involved research a much broader scale of possible adaptation measures than before they used the tool; they see more possibilities for realizing a more robust situation. The group's creativity is stimulated and the dialogue about possible solutions is widened.

A short description is available of all the measures that are included in the tool, in which, in addition to a technical description, the effects and effectiveness are elucidated. The CAPP is available for free.

References: www.climateapp.org or in the app stores

CPC partner involved: Deltares

3.6.4 Adaptation Support Tool

The Adaptation Support Tool is being developed for urban developers who, together with the water managers and other parties involved, want to quantify the effects of blue-green and greyer measures in their project area interactively. To do this, a design table is used (Matable) with which the effects of measures against flooding, drought and heat stress are estimated. This takes place using indicators; results such as extra storage obtained, peak drainage reduction, water quality effects, costs and benefits are shown on a 'dashboard'. Then it is up to the people at the design table to decide which versions they prefer and based on which criteria. Freedom of design is maintained here; alternatives can be discussed and weighed up.

CPC partners involved: Deltares, WUR/Alterra

More info: <http://bgd.org.uk/>

3.6.5 Heat and Drought Stress Model

The Heat and Drought Stress Model (HDSM) consists of two modules for making an analysis of the places that are sensitive to heat stress and drought. Using the presence of trees, vegetation, water, shade, the albedo and a number of other factors, the heat stress module determines to what extent each place in the city will be relatively warm or cool. The drought module covers a water balance calculation for (extremely) dry years, so that the change of the ground water levels and the evaporation of an urban area are determined. This evaporation of trees and vegetation influences heat stress; the low groundwater levels determine the subsidence and – if they are present – the possible damage to wooden pile foundations of buildings. HDSM is used to identify the vulnerable places in the city and, in the adaptation planning stage, to determine the effects of possible adaptation measures.

CPC partners involved: TNO, Deltares



3.6.6 Health scan

A tool was also developed in CPC to scan climate adaptation measures for their effect on the health of nearby inhabitants via gastrointestinal diseases (**Table 3.10**) (Sales Ortells en Medema, 2014). This Health Scan is aimed at measures for local precipitation storage, such as wadis, and storage of rainwater in local surface water, and on the link between climate adaptation measures and local recreational provisions such as water squares or water playgrounds. The Health Scan was developed as an iterative and flexible assessment tool consisting of three steps (expert evaluation, scan and analysis). For the assessment, reference values for healthy water systems were also suggested.

Table 3.10 Steps in the health scan of adaptation measures (source: Sales Ortells en Medema, 2014).

Level	Required information	Result
1. Expert evaluation	“Sanitary survey”: description of measure / site, contamination sources and estimate of degree of exposure of the population	<ul style="list-style-type: none"> - General scan of possible health effects, differentiates sites from possible to no risk - Prioritizes for next levels
2. Scan	Selection of data from literature about water quality and intensity of exposure of the population.	<ul style="list-style-type: none"> - Estimate of health risks of the adaptation measures / sites. - Prioritizing of sites with higher vs. lower risk. - Assessment of risks in terms of reference values.
3. Analysis	Location-specific research into water quality and exposure	<ul style="list-style-type: none"> - Location-specific, well-founded health scan. - Location-specific understanding of contamination sources, health risks and intervention measures. - Location-specific assessment of risks in terms of reference values.

Different kinds of water, different kinds of exposure of people to water, and different effects on health can be measured with the Health Scan. The Health Scan was tested on water systems and climate adaptation measures in an urban area (Watergraafsmeer). During this testing, a lot of information was gathered from the literature about water quality and exposure that can also be used in other cities in the Health Scan. The Health Scan showed that for a number of water systems, the annual chance of gastrointestinal diseases for the exposed population is close to or higher than the reference values (swimming or rowing in surface water that is contaminated by household waste water; wading in water on the street that comes from a combined sewer overflow; and probably also for wading in the wadis). Therefore, better risk management of these water systems is needed. The insight into the health risks also offers a starting point for recommendations for limiting these risks.

CPC partner involved: KWR, Waternet



4 Urban governance: the implementation of climate adaptation in urban development

Summary

Climate proof developments call for a different approach to urban development than is traditional. Currently, climate change is a minimal concern compared to the many other concerns in local urban spatial design. In order to interweave climate adaptation within urban spatial development, the Climate Proof Cities (CPC) programme studied other ways of working for the most important parties involved: municipalities, housing corporations and citizens (Spit and Kokx, 2015). To safeguard the importance of climate issues effectively within local government, it is essential to use a combination of a 'dedicated approach' and 'mainstreaming'. There are advantages and disadvantages to both approaches. By combining both approaches, it is possible to link goals to one another and to create enough support (and compensate for disadvantages). In order to connect different goals it is important to have so-called 'institutional entrepreneurs' within the organization, who can use their networking skills to link climate to spatial developments or policy goals .

It also seems that within the working method of housing corporations, applying one approach does not contribute sufficiently to a switch to a climate proof way of acting. The introduction of a construction supply chain, where housing corporations, together with, for instance, the building sector, are responsible for the realization of houses, does not automatically lead to climate proof innovations. However, in combination with financial incentives, formulating policy and 'framing' of climate proof solutions, a construction supply chain can lead to implementation of adaptation measures. Cooperation can also be sought with other parties that can influence the physical characteristics of the housing supply and surroundings, such as water boards and municipalities. In addition, citizens can contribute to the realization of climate proof cities. This requires municipalities to approach citizens in a different way. In order to be able to link citizens' initiatives to the climate concerns of public parties, it is essential to keep the public planning process flexible and to communicate actively with inhabitants.

To implement climate measures successfully, it is especially important that links are not only made between different parties within the process, but that they are also (dynamically) maintained. Only if municipalities (including water boards), citizens and private parties see the realization of climate proof cities as a shared problem will there be a platform for success. Linking the public domain with the private domain could potentially yield better results; this is known as capacity-building (Hartmann and Spit, 2014). By using the knowledge, skills, networks and means of all parties involved in urban design, the realisation of a climate proof city can be achieved.



4.1 Introduction

The extreme weather conditions and climate change, as described in the previous chapters, make it necessary to adapt the spatial layout of the urban environment to these circumstances. The application of climate proof measures can considerably improve the social and physical qualities of urban areas. Despite the research into the issues surrounding climate change and the effectiveness of the solutions, the implementation of local policy is still minimal (Kabat et al., 2005).

Although many cities in the Netherlands foster the ambition of including climate adaptation in their policy, and although this has translated into the development of an adaptation strategy or formulation of a vision, implementation of measures is often limited to appealing pilots and demonstration projects in the so-called frontrunner cities. This can be partially explained by a lack of urgency as well as the lack of a cost-benefit analysis that justifies the climate proof measures. In addition, there is not enough knowledge and skill available at a local level to transform or interweave these measures into actual projects. The financial and economic crisis, finally, also played a significant role here. The demand for houses and commercial properties, for instance, has decreased strongly in the last 5 years, so that expensive land has lost its value. Many municipalities are therefore in the red, and as a result, the building sector has displayed a contraction of around 10%. This trend is still continuing. The consequences are not only that there has been (and still is) less construction, but also that the more complex, integrated area development projects are considerably smaller in size and take much more time to be realized. It is precisely the projects from this last category, with their integrated character, that lend themselves best for the application of climate proof measures.

The realization of the climate proof city is more and more dependent on the decentralized parties such as municipalities, citizens and housing corporations. As the above shows, various interferences can be identified in the current situation that especially hinder the implementation of climate proof solutions for these parties. In addition, the goals and the methods of these parties do not always contribute to the implementation of the climate proof solutions. This is why more research was carried out in this area within the Climate Proof Cities (CPC) programme. The next sections (4.2-4.4) further explain the ways in which the most important parties in urban development (municipalities, housing corporations and citizens) can enforce adaptation measures in their policy and/or process. Finally, the last section (4.5) presents the conclusions in a practical framework. This chapter links up with the 'Action' step from the 'Guide to Spatial Adaptation'³¹.

4.2 Municipalities

4.2.1 Organisation

Implementing climate proof solutions in the urban environment is not obvious for municipalities. In order to introduce climate resilience as a policy objective, CPC examined the use of different strategies, including the (politically supported) approach that is specifically focused on climate adaptation (dedicated approach) and the integrated approach (mainstreaming) (Uittenbroek et al., 2013).

³¹ <http://www.ruimtelijkeadaptatie.nl/en/>



Mainstreaming versus a dedicated approach

In a *dedicated approach* there is an explicit (political) focus on climate adaptation. This means that there are policymakers who address climate adaptation specifically, where they have their own money/budget at their disposal. An example of a local government that employs this dedicated approach is the city of Rotterdam. In the past four years, the Rotterdam climate office, together with others, such as water managers from the Rotterdam 'Waterloket', has realized various climate adaptation measures, like the water squares at Benthemplein and Bellamyplein (Uittenbroek et al., 2014a).

However, a specific focus on climate adaptation is not always possible or is not supported politically or administratively. In these cases *mainstreaming* is often discussed as an alternative. Here the policy domains are conscious of the fact that climate change relates to their policy domain and they look for ways to safeguard climate adaptation measures in existing policy or to link them to goals in policy processes. Climate change is not seen as the ultimate goal, but as added value (Root et al., 2014). Searching for different links within policy domains is carried out by a institutional entrepreneur. In the city of Amsterdam various climate adaptation projects were set up via the mainstreaming approach between 2010-2014, such as the 'Polderdak' (rooftop water storage) (Uittenbroek et al. 2014a).

However, there are still advantages and disadvantages to both strategies. A 'dedicated approach', for example, will lead to actual realization of adaptation measures sooner, because money and manpower are available. However, if this specific (political) concern disappears, the question remains whether other policy domains will then feel called upon (or possess the financial means) to realize climate adaptation. A 'dedicated approach' though, will lead to consciousness about climate adaptation and possibly even a sense of urgency about it within the government or within society. Mainstreaming, on the other hand, is more focused on the long term. This is because a policy domain itself looks for possibilities for safeguarding climate adaptation in its policy, so that the realization is dependent on existing structures and means. As a result, a learning process takes shape that can lead to structural changes. However, it is also possible that no links can be made between climate adaptation and the existing structures/means. In that case, extra (political) concern and/or a 'dedicated approach' may be desirable (Uittenbroek et al. 2014a), which shows that the two approaches in practice will alternate instead of existing alongside each other (Uittenbroek et al., *submitted*).

Barrières en stimuli

Mainstreaming climate adaptation in existing urban policy is not always apparent. There are various barriers and incentives to be found in the literature and in practice that can influence this process, where a distinction is made between three policy stages: understanding, planning and implementing (Uittenbroek et al., 2013).

In the first policy stage, 'understanding', social, cognitive, organizational and/or institutional barriers can occur. Mainstreaming climate adaptation in existing policy or new projects takes place based on goodwill. All these types of barriers can then come up. After all, in the case of mainstreaming, there are no regulations or political guidelines that require climate adaptation to be included. Ideas about the problem, risks, urgencies, responsibilities and possible solutions will be crucial in answering the question of why a policy domain does or does not choose to integrate climate adaptation into their policy. Research in three Dutch cities (Amsterdam, Rotterdam and The Hague) confirms that climate adaptation is seen as an important subject. There is also consensus when it comes to risks and possible solutions.



The differences mostly lie in the ideas that are related to perspectives on urgency and responsibility. There are policy domains that do not see climate adaptation as being part of their range of duties. In addition, there are policy domains that do want to act on behalf of climate adaptation, but that receive very little official time to do this. Without political support there is in fact little room in the organizational structure for addressing climate adaptation. In order to raise awareness of climate adaptation, other or supplementary terms are often used to make climate adaptation relevant and to link it to existing policy, such as water safety, spatial quality and quality of life. By stressing the importance of climate adaptation and the possible effects for urban policy from various angles, a narrative is shaped that fits in with the political agenda (Uittenbroek et al. 2014b).

In the second policy stage, planning, it is important to translate the urgency of climate adaptation into policy. In this stage, financial, organizational and institutional barriers can occur. In mainstreaming, the concept of climate adaptation can use the political support that exists for the other policy goals of the policy domain. The lack of political support is often listed as a barrier by researchers, because there are no new means (money and/or manpower) available to devise and carry out climate adaptation policy. However, research has shown that mainstreaming is still possible without explicit support, in a process where “institutional entrepreneurs” play an important role. The institutional entrepreneurs have the pioneer’s role of convincing policymakers of the relevance and importance of climate adaptation. Here they must also employ their networking skills to build bridges and attract parties that bring new means and skills with them (Uittenbroek et al. 2014a; Uittenbroek et al. submitted).

Despite the fact that climate adaptation has been included in policy plans, this does not mean that it actually leads to the implementation of climate adaptation measures. In the third policy stage, ‘implementing’, policymakers often have to deal with financial, technical and organizational barriers. The existing organizational structures, in which the interaction and coordination between policymakers and implementers are fixed, do not always support mainstreaming of climate adaptation. It is important that the policy implementers think the adjustments to the structures are legitimate; that is to say that the new routines must be at least as (or more) effective and efficient. Only then will there be a structural change in the relation between policy and implementation that could possibly benefit the mainstreaming of climate adaptation. Changing current routines demands perseverance from the institutional entrepreneurs and implementers, as well as flexibility and time. Mainstreaming climate adaptation in policy processes will definitely be a time-consuming and uncertain process, especially during the first attempts (Uittenbroek et al., in review; Uittenbroek et al., submitted).

The findings above lead to two insights that are important for (policy) practice. Firstly, a combination of a dedicated approach and a mainstreaming approach seems the most promising for realizing climate adaptation measures in the city. While both approaches have positive and negative characteristics, the approaches can reinforce each other. Secondly, mainstreaming climate adaptation is more targeted on the long(er) term and can hardly or barely be forced. All parties within a governmental organization have duties and routines that accompany them. Changing these routines takes time and different ‘narratives’ for persuasion. Here it is important that someone (an institutional entrepreneur) has an overview of which parties and skills are important for mainstreaming climate adaptation and when these are missing, searches for these parties and skills. This is a learning process that can possibly lead to structural changes.



4.2.2 Financial instruments: the use of TIFs

As indicated above, the lack of financial means is often listed as an important barrier for the implementation of climate proof measures. However, research shows that prevention (now) costs considerably less than the (estimated) total damage in the future, which concerns not only material damage but also economic and social disruption (Watkiss, 2011; Stern, 2006). In addition, in the literature, the lack of financial means is seen as too general an explanation for the limited investments in climate proof measures. This calls to question whether current planning tools are useful for bridging the financial gap or whether other means should be introduced. Here it is essential to evaluate how parties involved in spatial planning see this change.

TIF ('Tax Increment Finance') offers – theoretically, at least – possibilities for facilitating this innovation. The literature shows this to be a promising local financing construction (Heurkens, 2012; van der Krabben and Jacobs, 2013; Offerman and Van de Velde, 2004). The construction employs the operational tax system and is based on future property tax income. These are calculated in terms of cash value and can then be (partially) used to facilitate investments in the present, such as climate measures. For this method the municipality will invest in strict, public measures in a demarcated area. Usually this involves investments to do with infrastructure, green spaces and social facilities. The assumption is that these investments make property values for nearby buildings rise and therefore the property tax rises too (Squires, 2012). The resulting increased value in terms of property tax can be used to pay for the investments. TIF is mainly geared at local and long-term projects, where the costs and benefits are divided among the current and future users. That is why this approach seems like a particularly suitable method for adaptation geared at future climate change and why it was researched within CPC.

Technically it is possible to introduce this instrument within the current planning system, where (future) incomes are designated for local investments now. Property tax is a local source of income and can be used flexibly by local authorities (local council). However, the application of TIF is also dependent on the long-term socio-political developments within the organization (*internal drawbacks*) (Root, *planned*).

- Firstly, because of the introduction of new collaborations, other concerns or political movements, the chosen path can change, which can influence the expected property tax revenue.
- Secondly, levying taxes is not always linked directly to the 'concrete' infrastructural investments made by government parties. 'Leaking away' as process costs also takes place. Because of this, the tax payer does not see what has been done with the amounts collected, which can damage the support for the measure.
- Thirdly, when TIF is used, the financial risk is still carried by the government, which seems to conflict with the current view within spatial planning that market risks must also be carried by the market as much as possible.

However, is this instrument also suitable for the implementation of climate proof measures? Ideally, if TIF is used, there is already a clear administration, where the income from an area is transformed into investments. As has already been noted, this type of means depends on many social and political developments. Therefore it is essential to try to use the social and political debates to (continue to) convince and interest all parties in investments in climate proof measures. However, using TIFS implies some (*external*) long-term drawbacks in terms of society:



- Firstly, the Dutch system of public management is based on equal distribution, where in principal, everyone should have access to certain services. The use of TIF can be perceived as incompatible with this. Within the TIF methodology, it is the person who pays that profits.
- Secondly, determining the relationship between making investments in climate proof measures and increasing property tax revenues is difficult. This means objections can be encountered from social parties.

The overview in **Table 4.1** shows that there are different ideas about the use of TIF within the current governance process to solve the current financial deficit. According to practice representatives, TIF has limited applications for financing climate adaptation. This hesitation is related to reasons such as uncertainty about future value, the planning period and indirect benefits.

Table 4.1 Tax Increment Financing and climate adaptation: an overview (Root, planned).

TIF: Characteristics	General	Climate Adaptation		
Market-focused	+	Individual focus for slowly/organically growing developments	-	It is expected that climate proof measures will not lead to higher market values.
	-	Speculating based on future income is politically sensitive	-	The market is focused on the short term and climate adaptation is focused on the long term
Use of wealth tax	+	The flow of income can be combined with other budgets and programmes to stimulate the market	-	Insufficient income as instrument for investments in 'strict' measures.
	-	Risk that the national government will change the tax system		
Appointed areas	+	TIF can break open closed areas	-	TIF can create 'winners and losers' in neighbouring municipalities.
	-	Is attractive for projects/goals without a sufficient financial basis	-	TIF will focus on 'one area at a time', which means that the scale is very limited.
Earmarking means	+	Integrating with existing planning instruments to reach specific investments	-	The advantages of climate proof measures are not recognized by the tax payer or the investors.
	-	This system can decrease the flexibility of the budget during the project		
Different financial means	+	Design a model in order to spread the financial risk among those who profit from it	+/-	Municipalities themselves take the risk for specific climate proof investments
	-	An analysis is needed to decide if the investments of municipalities lead to savings elsewhere in their budget		



4.3 Housing associations

Housing associations manage relatively many houses (30% of Dutch houses) with relatively few organizations (around 400 corporations). As part of CPC, research was done into how these parties can be stimulated to apply adaptation measures, so that a large part of Dutch houses becomes more climate proof.

Awareness

A content analysis of the annual reports and policy plans of housing corporations suggests that they show little awareness of climate change. However, this does not mean that Dutch houses are not being adapted to this. Some corporations have in fact implemented adaptation measures, but not under the heading of 'climate adaptation' (Rodgers et al., 2012a). The generally low awareness of adaptation exhibited by employees and policy documents means that the implementation of measures is currently not (or barely) taking place structurally, while, based on their social goals, a more proactive stance could be expected of corporations. After all, various measures have a positive influence on the indoor climate of the house and therefore the inhabitants' comfort (Rodgers et al., 2013).

Construction supply chain

In order to support the corporations in implementing adaptation measures, various instruments can be used that are based on supplying information, financial or political stimuli and regulations. For a variety of reasons, not all instruments can be applied, so an examination was carried out to see if possibilities for implementing climate adaptations can be created in other ways. Because this concerns physical changes to houses and/or the surroundings, opportunities exist for involving the construction industry in the search for solutions. In order to improve the current construction process, projects are carried out in construction supply chains. A construction supply chain is: "(...) the cooperation between partners, involved in the construction process, with the goal of optimizing the performance of the whole chain" (Chao-Duvis and Wamelink, 2013). Because efficiency is increasing within such processes, financial room is being created to finance adaptation measures and because the executive parties are involved in the project early on, they can bring in their expertise to make it technically possible to implement measures.

The foundation for construction supply chains lies in the *trust* that parties place in one another. A number of important success factors that can strengthen this trust are *leadership*: the projects must be supported by the management of the chain partners; *communication*: a clear consultation structure must be set up; and *partner capacities*: sub-contractors should not be selected only in terms of costs, but based on their qualities. *Coordination* is a success factor that relates to attuning the concerns of the various parties and the pursuit of a common goal. Furthermore, parties should show *commitment* and wish to link themselves to a project and/or partners for a long time. It is also important that parties devise a *conflict management system* beforehand, so that differences of opinion can be identified and solved in good time, before they escalate (Rodgers et al., 2012b).



However, construction supply chains do not automatically lead to innovations in terms of better houses and probably also not to the realisation of adaptation measures (Roders et al., *in preparation*). Broadly speaking, the implementation of climate adaptations by the corporations is not seen as obvious because of their current financial situation and the low priority of climate adaptation on their policy agenda. However, a number of corporations do acknowledge the combination of including climate adaptation in policy, involving external parties (such as municipalities, insurance companies and water boards) in order to share costs and applying a construction supply chain as successful ways to realize adaptation. What also turns out to be important is the correct positioning ('framing') of adaptation measures, because the implementation of measures has proven attainable, but not from the point of view of climate adaptation but from the point of view of energy savings or improving the quality of the air (Roders en Straub, 2014).

4.4 Citizens

Due to trends surrounding the retreating government and the economic crisis, municipalities that want to carry out climate adaptation measures are more and more dependent on investments by other parties, including citizens' initiatives. Not only do citizens play a role in the process of thinking about climate policy and climate adaptation projects, they can also take initiative themselves, for instance by laying out façade gardens and green roofs. This is possible on an individual level, where each citizen takes his own initiative, but also in a collective setting. Such initiatives are part of the trend of 'active citizenship', also known as a 'participation society'. Given the amount of citizens' initiatives that have evolved over the past years in the spatial domain, and the media attention given to this kind of initiative, it seems there is indeed evidence of a social change. This means a significant break from routines that have evolved from decades of top-down urban planning, where professional parties such as municipalities, the government, housing corporations, design firms and developers were leaders. Therefore, there is still little understanding of the planning tools (legal, process-based, financial, etc.) and the work forms that offer an adequate answer to this change. That is why more research was done on this subject within CPC.

Current planning strategies aimed at active citizens often limit themselves to an invitation to help decide on or carry out government policy (participation). Also, planning strategies have been developed that focus on creating frameworks in which initiatives can take place. Both strategies, however, place the government's perspective at the centre, and therefore do not seek enough affiliation with the potential and dynamic that can develop from within society itself (Boonstra and Boelens, 2011, Boonstra and Specht, 2012). This mostly has to do with both parties' work forms. Governments tend to work from plans, which come from visions and policy, which are focused on creating clarity and (legal) security, safeguarding public values and equality between citizens. Active citizens, however, work from their own system, where they look for support for their concerns and for ways to realize their initiative, driven by local, specific moments and coincidences (Boonstra and Boelens, 2011, Boonstra et al., 2014, Boonstra, 2013). If the governmental perspective stays central, it is difficult to develop planning strategies that link up with the trend of real 'active citizenship'.

The worlds of citizens' initiatives and government do overlap: in the research, four different methods, or planning strategies were found which can simultaneously be used by both these initiatives and the government. The first of these is **identifying general principals**, which explain what should be aimed for in the development of a city or location. These principles should not be detailed, but in fact flexible towards changing demand. A citizens' initiative would also do well to make it clear from the beginning which principles will be used during the process, without making a detailed plan immediately.



Establishing connections continually is a second planning strategy. Professional parties can intervene actively and participate in an initiative (without taking control) by bringing in knowledge, making connections between parties, suggesting technology or locations, making negotiations, etc. From the point of view of an initiative, it is important that there is a focus on finding supporters, rather than convincing opponents. From both worlds (public and private), the input of people who can look across boundaries ('boundary spanners') and the mutual willingness to adapt and reconsider roles and responsibilities are very stimulating for success.

A third strategy is **organizing points of entrance and contact**. Citizens' initiatives are often driven by just one person, or a few people, who lean heavily on a personal network. Professional parties can offer support here by providing fixed and visible contact persons. In addition, they can use their experience with citizens' initiatives and translate this to new procedures to help resolve problems and uncertainties. Possible options include area-oriented work, a municipal point of entrance and contact, invitation strategies, supplemented with legal instruments that offer both legal certainty and flexibility.

A fourth strategy is using and building on (including learning from) initiatives that have already been realized. In this strategy, policy and initiatives continually adapt to each other's reality, also known as **co-evolution**: mutual adaptation to each other across time, without losing their individuality. Initiatives often leap into a 'gap' that professional parties have left, and this can easily be successful. Professional parties then try to implement their policy to build on and supplement initiatives that are already taking place, and find their own complementary role in the changing network (Boonstra and Specht, 2012, Van Meerkerk et al., 2013, Boonstra et al., 2014).

For a government that wants to carry out climate adaptation measures in a process-based way, a successful planning strategy could be as follows. First of all, climate change must be translated into a general principle, such as 'more green in the city is good'. It is also highly important to make a broad and preferably interactive inventory of everything that is (already) happening in the city. Where are citizens taking initiatives, what are these initiatives about, and how can the government possibly contribute to stimulate their development? Only then should these ideas be worked out in terms of vision and policy. Can the government stimulate citizens' initiatives by making connections and organizing points of entrance and contact, and can the government use their own investments in co-evolution to build on a broad movement of initiatives focused on making things more green? Only when these steps have been carried out can the government roll out a climate adaptation strategy that optimally complements society's capacity to organize such matters itself.



4.5 Conclusions

Why are meticulous 'governance arrangements' so valuable for climate adaptation in urban areas? The answer to this question is hidden in the reluctance of the existing spatial policy to incorporate new concerns. After all, it is relatively usual that the (policy) system resists any concerns that try to gain a position in it ('external integration'). The weaker a concern manifests itself there, the more successful the system will be in turning it away. In other words, if a new concern emerges that is relatively weak, such as climate change, the way in which that concern organizes itself is important in gaining importance in urban planning and reconstruction. In order to be successful, climate concerns must not only seek as many structural links with the most important parties within urban planning and reconstruction processes, such as housing corporations and citizens, but also with the urban policy of the municipalities involved. The CPC research shows that this is no simple matter, especially because the anchoring of climate concerns represents a long(er) term concern. The background of the dynamic in the urban area for (re)development and the continually shifting concerns of the parties involved in it make this considerably more difficult.

Still, it does not seem impossible. Mainstreaming, for instance, can ensure a somewhat consistent input of climate concerns in the policy of an important party, such as a municipality. Combined with some political prioritization (a 'dedicated approach'), it can also accentuate its urgency. If other important parties, such as citizens and housing corporations subsequently also manage to integrate climate concerns in the implementation of urban development policy, the recipe for success seems to be there. The central question remains to what degree climate adaptation is able to organize its own weak sides (the fact that it is a long-term concern and has a weak financial position) in urban (re)development processes. Although municipalities will continue to play an important role structurally in the implementation of adaptation, it is becoming clearer and clearer that the key to success is hidden in the (degree of) involvement of other parties.

Practice has shown that urban planning is largely a pragmatic process in which many concerns must be united, where each concern strives for optimization. From that point of view, support from each party in this process is welcome to make the development of climate proof cities a success. Although the road towards this seems long, it is an exciting challenge that must be shaped by the parties involved in real practice. However, scientists can also play an important role here by putting forwards new insights in time and in the right way.



5 Integration in Bergpolder Zuid

Summary

CPC researchers have worked together with local parties from Rotterdam to integrate insights from their research and make them useful for local policy and management. This took place in the “case study” Bergpolder Zuid (“Bergpolder South”), part of the largely 19th century neighbourhood of the ‘Oude Noorden’ in the north of Rotterdam. Researchers have contributed to mapping the vulnerability of the neighbourhood and to the different possibilities for making the Master Plan for the renovation of the neighbourhood more climate proof. Important factors that have determined the degree of success of this case study are:

- researchers’ willingness to look beyond the boundaries of their discipline;
- the impossibility of comparing the effectiveness of adaptation measures;
- the timing of the availability of research results;
- the match between supply and demand of information;
- the role of “boundary workers”, who facilitated the interaction between researchers and stakeholders;
- the Master Plan for Bergpolder Zuid as a catalyst.

For a more complete integration of research results to support policy, more research is needed on the effectiveness of measures and their costs, together with the damage that was prevented by the measures in different climate scenarios.

5.1 Introduction

In research on climate adaptation, ‘integration’ is an often-used concept; this is also the case in Climate Proof Cities. The concept seems to be predominantly used normatively: integration is something positive. However, it is often unclear what exactly is meant by integration, which elements are integrated and what does and does not work well to stimulate integration. In this chapter we describe how ‘integration’ took place within CPC, how it was stimulated and which lessons were learned. We base this mostly on experiences in Bergpolder Zuid in Rotterdam.

5.2 Integration within CPC

Because CPC is a research programme, the concept of integration is primarily expressed in an integrated research approach. ‘Integration’ is used to link the insights from the research themes for which a process is followed from measurements -> identification of vulnerability -> (modelling of) possible measures -> underlying principles of urban design -> (policy) instruments for implementation. In CPC, integration is also used to link insights at different levels of scale, such as buildings, streets, neighbourhoods or regions. In both cases this involves linking disciplinary knowledge (i.e. climate science, hydrology, public administration), methods, models and data. Within the theme of governance, the concept of integration is also used for fitting climate adaptation into other sectors or policy. Last but not least, integration also meant attuning and linking the CPC research to the needs and interests of the stakeholders involved.



In CPC a number of activities were carried out to create conditions to reach integration in research results. A vision on integration in the research project was presented during a consortium meeting (Döppen Bosch, 2011). An attempt was made to come to a communal usage of the same “language” around climate change and vulnerability (Pasztor en Bosch, 2011). Additionally, in a new research area such as climate adaptation in cities, conventions for measuring the effectiveness of measures are lacking: where do you measure, when, under which conditions and in which units? CPC has made a first attempt at a guideline for this (Bosch, 2014). These guidelines were applied in the Bergpolder Zuid neighbourhood.

5.3 Bergpolder Zuid

Bergpolder Zuid is a typical 19th century neighbourhood in the north of Rotterdam. The neighbourhood consists of a mixture of older houses and more modern office and businesses. There is little vegetation in the neighbourhood and no open water. The area is densely populated and popular among students and starters on the housing market who leave again after a few years. The public spaces are generally perceived as not attractive and not very comfortable. The houses are placed close together and the quality of the air is poor due to the proximity of the A20 motorway. In 2007, Bergpolder-Zuid was designated a “Krachtwijk”, an area that urgently needs improvement, both in terms of buildings and in a socio-economic sense. The housing corporation Vestia, which owns the largest part of the houses, was the driving force behind the development of a Master Plan for the improvement of the neighbourhood. Because of the crisis that took place at Vestia in 2012, the implementation of this plan was put on a back burner.

5.4 The stakeholders’ desires for the study

When CPC began the research in Bergpolder Zuid in 2011, Vestia was still active, and the goal of the project was to improve the Master Plan by adding measures that would make the neighbourhood more climate proof. After a number of discussions at municipality level, in April 2012, the researchers organized a meeting with the different stakeholders of the Bergpolder Zuid neighbourhood, such as the housing corporation, the Public Health Authority, the water board, the local authority, and various departments of the municipality of Rotterdam. At this meeting, various research questions and desires were identified for CPC, such as:

- What is the vulnerability of Bergpolder Zuid (in the current situation, during and after implementation of the Master Plan (with and without extra adaptation measures)?
- Try to make the vulnerability tangible by choosing for appealing variables, such as the number of people experiencing problems sleeping due to heat in the city. Are there threshold values for this?
- Present the results as appealing visualisations, for instance in the form of recognizable maps.
- What are possible “quick win” adaptation measures?
- Is there a definition for and target value of climate resilience?
- Transfer results that could be useful for policy as soon as possible, even if they are uncertain. Do indicate the type and degree of uncertainty in this case.

The ‘desires’ above were further specified in subsequent meetings in which interim results were discussed. When Vestia dropped out, and the implementation of the Master Plan was no longer possible, the focus in the project gradually faded. More emphasis was placed on the usefulness of the research for the city of Rotterdam as a whole.



5.5 The research results

The CPC research results for vulnerability and climate resilience have been linked and presented using the logical framework below (**Figure 5.1**). The EVAI model connects vulnerability and adaptation to the effects of climate change. The implementation of adaptation measures in Bergpolder Zuid has not been discussed.

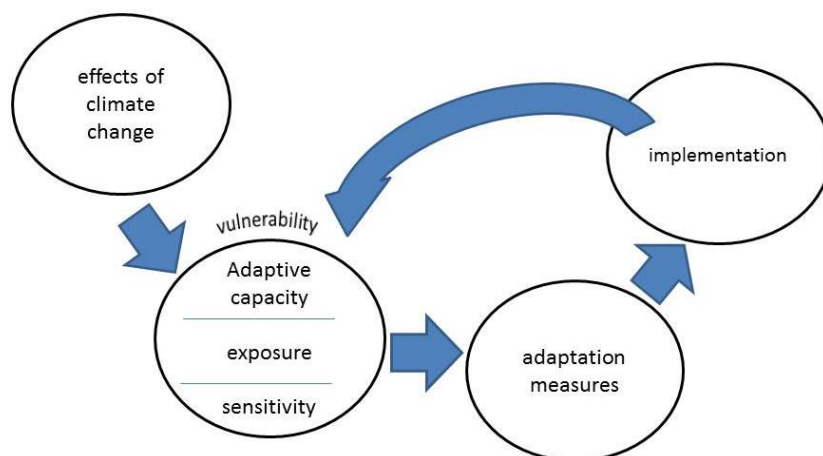

Figure 5.1 The EVAI model (Effect –Vulnerability–Adaptation – Implementation).

For each of the elements in this model, fitting information products were developed to share the results of the research with the stakeholders.

Firstly, the **effects of climate change** are not specific for Bergpolder Zuid. Therefore existing results were used, such as the **tables** with the changes in climate parameters, like average temperature, number of summery days (maximum temperature higher than 25 °C), or changes in the average amount of precipitation (as in KNMI, 2014). The **maps** from the interactive climate (effect) atlas for Rotterdam (Gemeente Rotterdam, 2013) were used in discussions with stakeholders to show the effects of climate change (flooding, heat, drought) in comparison to other neighbourhoods.

In order to map the **vulnerability** of the Bergpolder Zuid area, various methods were used that primarily focus on exposure and sensitivity to heat (see section 2.2 for an explanation of these concepts): modelling of the temperature (Toparlar et al., 2014), sensitivity profiles for streets (Hotkevica, 2013) and vulnerability typology of neighbourhoods (Van der Hoeven and Wandl, 2014). Using these methods, the vulnerability of Bergpolder Zuid to the effects of climate change has been shown on various **maps** (**Figures 5.2 to 5.5**).

The meteorological measurements taken in CPC were not directly focused on Bergpolder Zuid. Therefore the temperature was mapped using models (**Figure 5.2**). In a number of cases, results of measurements in other neighbourhoods were translated to Bergpolder Zuid. The models clearly show that the buildings in the neighbourhood retain heat during the day and release it at night. Enclosed gardens and streets perpendicular to the direction of the wind are more sensitive to warming because of the lack of cooling through ventilation.

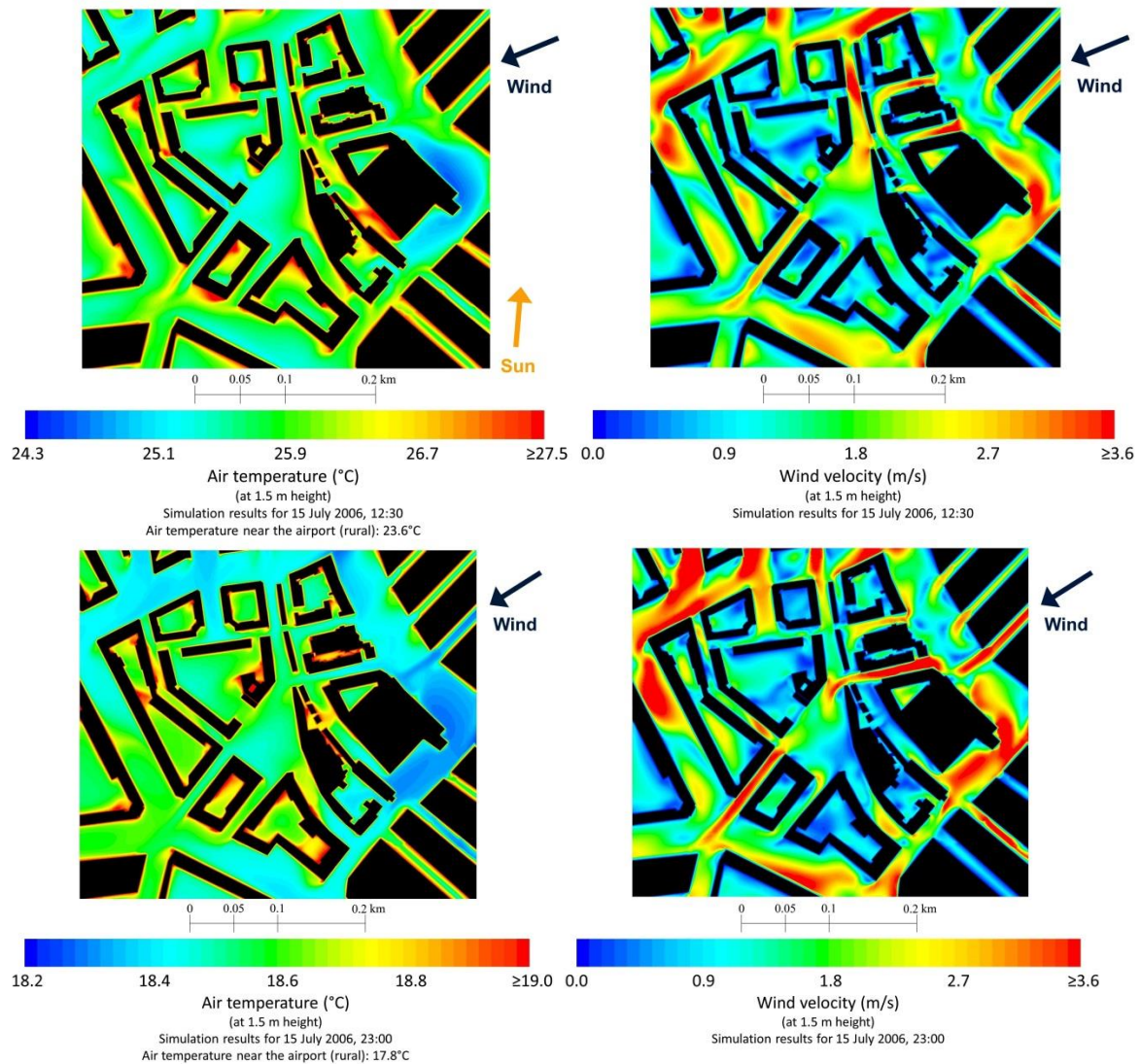

Figure 5.2 Results of the model study: air temperature (left) and wind speed (right) in the daytime (top) and at night (bottom) in Bergpolder Zuid (Toparlar et al., 2014).

During the day, the solar radiation largely determines the level of comfort in the street. A detailed analysis (Figure 5.3) shows which streets (for instance, Schieweg) and which parts of a street are sensitive to overheating. The topmost apartments on the sunny side are especially vulnerable to warming indoors due to greater radiation from the sun.

There are no historical records of flooding in the neighbourhood. Extreme rainfall, however, is rare and very local. If it rained more than 20 mm in an hour in Bergpolder Zuid, the drains would overflow (Vergroesen, 2013) and problems would occur due to water in the street. Modelling shows that the low-lying enclosed gardens are especially exposed to flooding (Figure 5.4, Veerbeek and Husson, 2013). Incidentally, experiences in Amsterdam and Copenhagen show that actual sensitivity to damage depends on very local factors, such as the presence of doorsteps, cellars and other building characteristics.

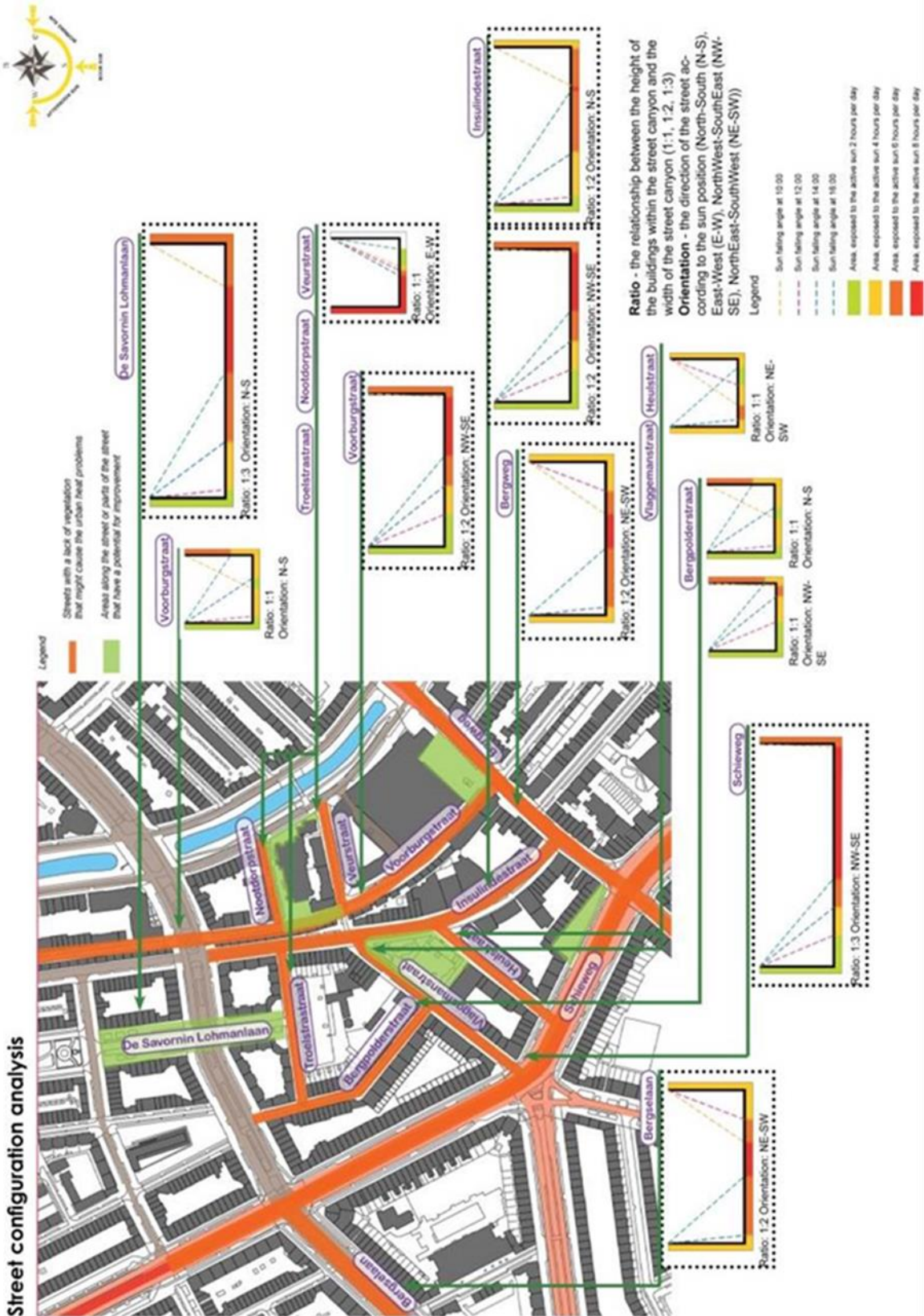

Figure 5.3 Sensitivity profiles for streets in Bergpolder Zuid, Rotterdam. The number of hours of direct solar radiation in the street and on the façades is shown in the coloured street profiles (source: Hotkevica, 2013).

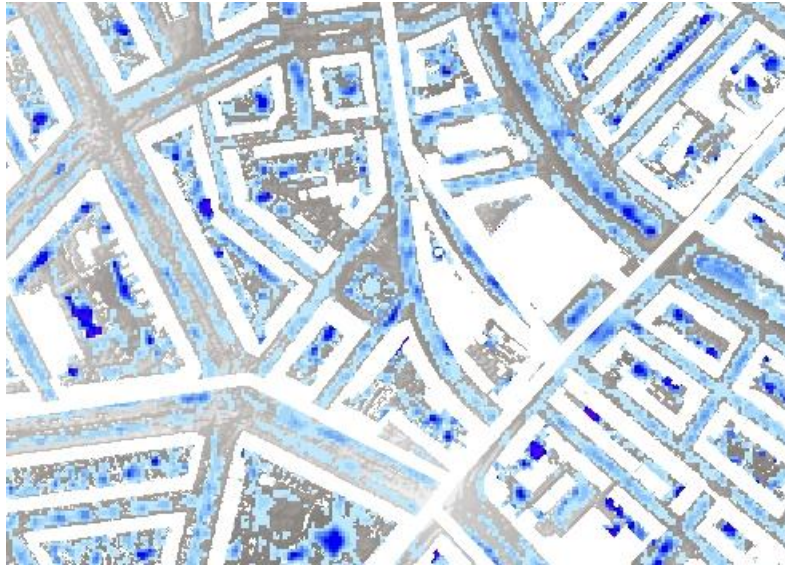

Figure 5.4 Flooding map of Bergpolder Zuid for rainfall that occurs once every 10 years and with 35 mm of precipitation in an hour. The darker the blue colour, the deeper the water (Veerbeek and Husson, 2013).

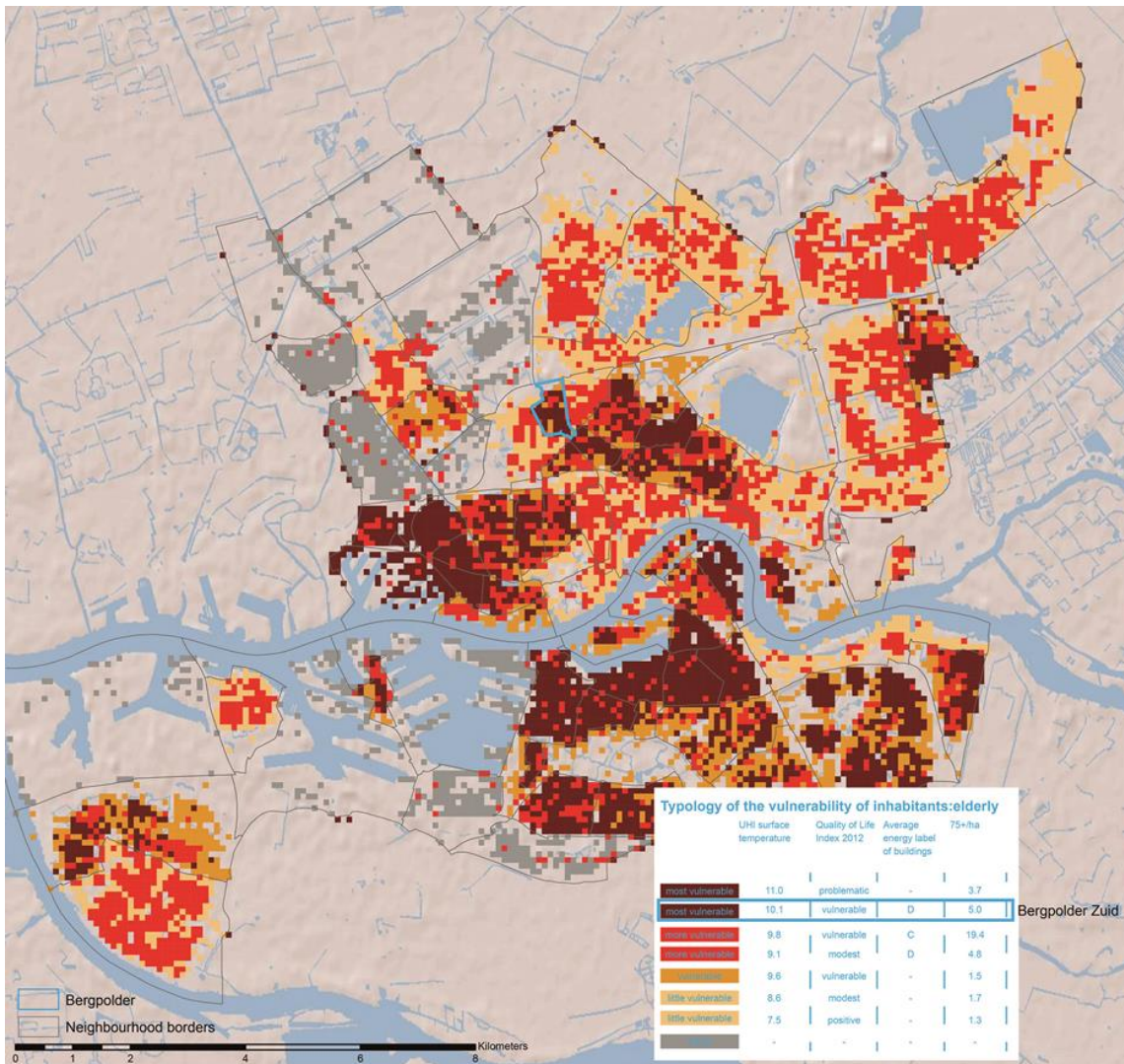

Figure 5.5 Vulnerability map for heat for the elderly, Rotterdam (Van der Hoeven and Wandl, 2014).



Figure 5.5 brings the different elements together in a vulnerability map (in this case for heat, for all of Rotterdam) (Van der Hoeven and Wandl, 2014). The vulnerability is determined by neighbourhood characteristics, quality of the buildings, presence of elderly people (as a very sensitive group) and the quality of life per neighbourhood. On this map, Bergpolder Zuid emerges as one of the most vulnerable neighbourhoods in Rotterdam for heat stress because of the properties of the neighbourhood (a lot of surfacing, high density of buildings, little vegetation) and the quality of the buildings. Within Bergpolder Zuid, it is the open areas with the most surfacing, the railway triangle and narrow east-west oriented streets that are most exposed to heat. The neighbourhood shows an average level when it comes to flooding in the street.

Because the different results became available at very different times, it was not possible to combine the results into one integral and detailed vulnerability map for Bergpolder Zuid. It was also not possible to show the effects of the implementation of the Master Plan on vulnerability in an integrated manner.

For the discussion with stakeholders about **adaptation measures** and quick wins, a booklet of ideas was made as working material. The effects of measures at buildings level and of green measures were detailed in particular. For the type of gallery flat of which there are many in Bergpolder Zuid it turns out that opening windows when the outdoor temperature is lower than the indoor temperature and the use of moveable sunblinds result in the greatest decrease in the number of hours with uncomfortably high indoor temperatures (**Figure 5.6**) (Van Hooff et al., 2014). House insulation will have to be combined with, for instance, one of the measures mentioned above, because otherwise it will lead to worsening of the indoor climate in hot summers. Green roofs barely seem to change the number of uncomfortable hours.

A combination of problems related to attuning the various partial studies, making the results comparable, and the data collection on costs and benefits of the individual adaptation measures made a systematic and quantitative comparison of the measures impossible. A design workshop was organized as an alternative method. In this workshop, stakeholders and researchers worked on a plan for a climate proof Bergpolder Zuid (**Figure 5.7**).

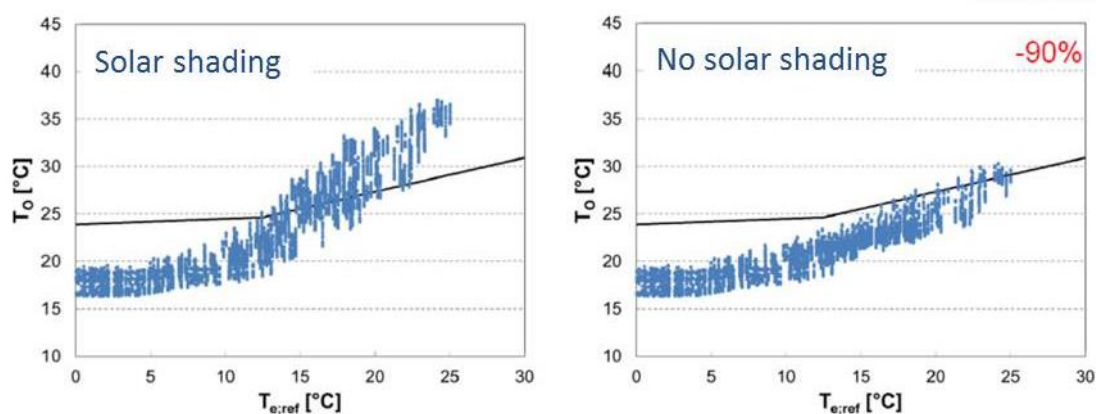

Figure 5.6 The application of moveable sunblinds results in a 90% decrease in the number of overheating hours in a gallery flat. The horizontal axis shows the outdoor temperature; the vertical axis shows the corresponding indoor temperature; each dot represents an hour. Dots (hours) above the black line are uncomfortably warm (for further explanation see section 2.2.2) (Van Hooff et al., 2014).



Figure 5.7 Sketch of the possibilities for climate adaptation in Bergpolder Zuid made during the design workshop with stakeholders.

The interim results of the CPC research and the stakeholders' knowledge of the area and policy formed the basis for this. This activity turned out to work well for drawing out the knowledge of stakeholders about, for instance, the condition of the subsoil, the opinions of inhabitants, the location of cables and drains. At the same time it offered an excellent opportunity for CPC to bring in knowledge about, for instance, the effectiveness of green measures. Different measures were compared to one another, where 'desirability' and 'potential for implementation' were used as important criteria, in addition to 'effectiveness'.

The design workshop also brought to light differences between the various stakeholders: where the representatives from the municipality generally wanted more trees in the neighbourhood, the neighbourhood coordinator was very explicit about the desires and complaints of inhabitants about such plans and pointed out the difficulties of realizing this in practice.

5.6 Lessons on integration

Although some progress was made in the study of Bergpolder Zuid, many of the anticipated ambitions turned out not to be feasible. Important factors that have determined the success of this case study are:

-The researchers' willingness to look beyond the boundaries of their discipline. Researchers taking part in the case study and the discussions about Bergpolder Zuid illustrated their willingness to do so is present to a high degree. However, the disciplinary orientation of the university groups and the need and pressure to eventually present a dissertation within a subject area form impediments to intensive collaboration.



-The timing of the availability of the research results. In the Climate Proof Cities research programme, all sorts of subjects were studied simultaneously. This meant that there was only information available about, for instance, vulnerability after some time, while the people who were studying measures and designs needed this information much sooner. The time that is needed to collect measuring data and process it is often also underestimated. Because of this, it was difficult to deliver the information for strategic documents such as the Rotterdam Adaptation Strategy in a format that was useful for the municipality.

-The possibility of adjusting management in terms of time and focus. At the beginning of the four-year research programme, sub-studies were defined that would be carried out by different university groups and institutes. This is fitting for a scientific research programme. However, it turns out that the possibilities for central management or changes afterwards are limited. Such management or changes are necessary in order to link up with new research questions or in order to anticipate new desires of interested parties.

-The impossibility of comparing the effectiveness of adaptation measures. In a relatively young research area such as climate adaptation in the city, conventions are lacking. For instance, it has not been established where, when and in which units and compared to which reference the effect is determined. In addition, the range of adaptation measures makes comparison difficult. An attempt at harmonization was made in CPC (Bosch, 2014), but it turned out that it was not easy to follow this.

-The match between supply and demand of information. In practice, the Bergpolder Zuid case revolved around this match. There were lively discussions about the question of what level of accuracy is enough, the timeliness of information for policy, which information is needed exactly, and in what form. In this process of attuning, a proper balance in the role of the policymaker asking questions (are they workable questions?) and that of the researcher giving answers (does the answer match the question?) is important.

-The role of "boundary workers", who facilitate the interaction between researchers and stakeholders. For the organization and facilitation of the process, boundary workers are needed who are capable of stimulating the integration of science and practice. This is a separate skill that goes much further than translating research results into understandable language. It requires insight into recent developments in the field and into the practices of the user of climate (adaptation) knowledge. In addition, expertise is needed in applying methods that promote integration, and insight into which results may be useful in policy.

-The Master Plan for Bergpolder Zuid as a catalyst. The communal reference point (referred to as "boundary object" in Table 5.1) in the form of the Master Plan provided a sense of relevance and urgency for both researchers and stakeholders. When Vestia dropped out and the implementation of the Master Plan became uncertain, there was a lack of focus in the process.



Table 5.1 Lessons on integration (Groot et al., 2015).

	Means of integration	Usable	Limiting
Within the research	A shared goal	The CPC research agenda spanned the whole spectrum from climate change to governance of adaptation	At the beginning of the research, the researchers had too little insight into their results and the possibilities of integrating them
	Mutual understanding	CPC Guideline “Vulnerability terminology”, “effectiveness” and meetings of researchers	
	Theoretical model	EVAI model	No development of new collaborative concepts
	Method	Internal discussions about collaborative analysis and reporting	Applying common units in the different disciplines
	“Boundary object”	Master Plan was an important incentive	
	Product	Overview of adaptation measures, vulnerability charts	We missed opportunities for integration with various other products made by separate researchers
Between research and practice	A shared goal	Was formulated in the various meetings	
	Mutual understanding	Workshops, presentations, discussions	Rapporten
	Theoretical model	“linking method”	
	Method	Meetings with stakeholders & researchers, design workshop	Detailed scientific results are difficult to translate into information that can be used for policy
	“Boundary object”	Master Plan was an important incentive	
	Product	Research agenda, sketch map (no obligations)	

NB: a “boundary object” is something that can bring groups together to work on a mutual task. The “linking method” involves linking onto existing developments in an area, often using initiatives from the area itself (see section 3.5).

5.7 Conclusions and related research questions

Although CPC research has contributed to an increase in knowledge about urban adaptation to climate change, the Bergpolder Zuid case shows that more is needed in order to integrate and implement this knowledge in (policy) practice:

- A link with the results of climate scenarios (such as KNMI’14) requires a systematic buildup of a research programme with models that are linked to one another;
- In order to compare different adaptation measures, determining their effectiveness must be (much more) harmonious; in addition, an overview of the costs and benefits of the measures is lacking;
- More insight is needed into the methods and processes that are effective for integrating: 1) the work of researchers from different disciplines, and 2) social needs and scientific research.



ANNEXES



Annex A Researchers CPC

Project	Name		Surname	Institute	Role
WP 1 Urban Climate System	Bert	van	Hove	Wageningen University	Work package leader
1.1 observations	Bert	van	Hove	Wageningen University	project leader
	Bert		Holtslag	Wageningen University	project leader
	Cor		Jacobs	WUR-Alterra	researcher
	Lisette		Klok	TNO	researcher
	Bert		Heusinkveld	Wageningen University	researcher
	Jan		Elbers	WUR-Alterra	researcher
	Rogier		Westerhof	Deltares	researcher
	Reinder		Brolsma	Deltares	researcher
	Reinder		Ronda	Wageningen University	researcher
	Oscar		Hartogensis	Wageningen University	researcher
	Henk		Verhagen	Wageningen University	researcher
1.2 meso model	Bert		Holtslag	Wageningen University	project leader
	Bert	van	Hove	Wageningen University	project leader
	Reinder		Ronda	Wageningen University	postdoc
	Sytse		Koopmans	Wageningen University	postdoc
1.3 micro model	Harm		Jonker	TU Delft	project leader
	Patrick		Schrijvers	TU Delft	PhD
	Sasa		Kenjeres	TU Delft	researcher
	Stephan	de	Roode	TU Delft	researcher
WP 2 Vulnerability	Bert		Blocken	TU Eindhoven	Work package leader
2.1 indoor performance buildings	Jan		Hensen	TU Eindhoven	project leader
	Mike	van der	Heijden	TU Eindhoven	PhD
	Mohamed Hamdy		Hassan Mohamed	TU Eindhoven	postdoc
	Bert		Blocken	TU Eindhoven	researcher
	Twan	van	Hooff	TU Eindhoven	postdoc
2.2 human health impacts	Hein		Daanen	TNO	project leader
	Ries		Simons	TNO	researcher
	Lydia		Kistemaker	TNO	researcher
2.3 sensitivity & vulnerability	Frans	van de	Ven	Deltares	project leader
	Matthieu		Spekkers	TU Delft	researcher
	Karin		Stone	Deltares	researcher
	Rianne	van	Duinen	Deltares	researcher
	Hein		Daanen	TNO	researcher
	Chris		Zevenbergen	Unesco-IHE	researcher
	William		Veerbeek	Unesco-IHE	researcher
	Sonja		Döpp	TNO	researcher
	Wouter		Jonkhoff	TNO	researcher
	Wouter	van	Riel	Deltares	researcher
2.4 neighbourhood typology	Frank	van der	Hoeven	TU Delft	project leader
	Andy	van den	Dobbelsteen	TU Delft	project leader
	Nico		Tillie	TU Delft	researcher
	Alexander		Wandl	TU Delft	researcher
	Stefan	van der	Spek	TU Delft	researcher
	Maarten		Tjon Sie Fat	TU Delft	PhD



Project	Name		Surname	Institute	Role
WP 3 Measures and strategies	Andy	van den	Dobbelsteen	TU Delft	Work package leader
3.1 green interventions	Sanda		Lenzholzer	Wageningen University	project leader
	Wiebke		Klemm	Wageningen University	PhD
	Adri	van den	Brink	Wageningen University	researcher
	Ingrid		Duchhart	Wageningen University	researcher
3.2 rainfall interception, building and street	Bert		Blocken	TU Eindhoven	project leader
	Jan		Hensen	TU Eindhoven	researcher
	Hamid		Montazeri	TU Eindhoven	PhD
3.3 rainfall interception, cities	Frans	van de	Ven	Deltares	project leader
	Jan		Hofman	KWR	project leader
	Toine		Vergroesen	Deltares	project leader
	Eelco		Verschelling	Deltares	researcher
	Daniel		Tollenaar	Deltares	researcher
	Gertjan		Medema	KWR	researcher
	Marthe	de	Graaff	KWR	researcher
	Elgard	van	Leeuwen	Deltares	reviewer
	Hanneke	van der	Klis	Deltares	researcher
3.4 water & energy systems	Reinder		Brolsma	Deltares	project leader
	Daniel		Tollenaar	Deltares	researcher
	Roel		Brand	TNO	researcher
	Jan	de	Wit	TNO	researcher
	Marthe	de	Graaff	KWR	researcher
	Matthijs		Bonte	KWR	researcher
3.5 adaptive building envelopes	Harry		Timmermans	TU Eindhoven	project leader
	Twan	van	Hooff	TU Eindhoven	postdoc
	Bert		Blocken	TU Eindhoven	researcher
	Anika		Haak	TU Eindhoven	researcher
	Wendy		Janssen	TU Eindhoven	researcher
	Christof		Gromke	TU Eindhoven	researcher
	Yasin		Toparlar	TU Eindhoven	researcher
	Jan		Hensen	TU Eindhoven	researcher
3.6 urban climate design	Andy	van den	Dobbelsteen	TU Delft	project leader
	Laura		Kleerekoper	TU Delft	PhD
	Truus		Hordijk	TU Delft	researcher
	Machiel	van	Dorst	TU Delft	researcher
3.7 metropolitan areas	Frank	van der	Hoeven	TU Delft	project leader
	Leyre		Echevarria Icaza	TU Delft	PhD
	Andy	van den	Dobbelsteen	TU Delft	researcher
	Maarten		Tjon Sie Fat	TU Delft	PhD
WP 4 Governance	Tejo		Spit	Utrecht University	Work package leader
4.1 external integration	Tejo		Spit	Utrecht University	project leader
	Willem		Salet	University of Amsterdam	project leader
	Hens		Runhaar	Utrecht University	co-supervisor
	Caroline		Uittenbroek	University of Amsterdam Utrecht University	PhD
	Leonie		Janssen-Jansen	University of Amsterdam	researcher
4.2 self organization	Luuk		Boelens	Utrecht University	project leader
	Beitske		Boonstra	TNO	PhD



Project	Name		Surname	Institute	Role
4.3 residential buildings	Henk		Visscher	TU Delft	project leader
	Ad		Straub	TU Delft	project leader
	Martin		Roders	TU Delft	PhD
4.4 redevelopment urban areas	Tejo		Spit	Utrecht University	project leader
	Anita		Kokx	Utrecht University	postdoc
	Marjolein		Dikmans	Utrecht University	researcher
	Thomas		Hartmann	Utrecht University	researcher
4.5 financial instrument	Tejo		Spit	Utrecht University	project leader
	Erwin	van der	Krabben	Radboud University Nijmegen	project leader
	Liz		Root	Radboud University Nijmegen	PhD
WP 5 Integration	Peter		Bosch	TNO	Work package leader
5.1 effectiveness assessment	Eddy		Moors	Wageningen University	project leader
	Annemarie		Groot	WUR-Alterra	researcher
	Herbert	ter	Maat	WUR-Alterra	researcher
	Peter		Bosch	TNO	researcher
	Cor		Jacobs	WUR-Alterra	researcher
	Anikó		Pásztor	TNO	researcher
	Sonja		Döpp	TNO	researcher
	Vera		Rovers	TNO	researcher
5.2 integration frameworks	Peter		Bosch	TNO	project leader
	Chris		Zevenbergen	Unesco-IHE	researcher
	William		Veerbeek	Unesco-IHE	researcher
	Jeroen		Rijke	Unesco-IHE	researcher
	Sonja		Döpp	TNO	researcher
	Anikó		Pásztor	TNO	researcher
5.3 integrated assessment report	Vera		Rovers	TNO	researcher
	Peter		Bosch	TNO	project leader
	Vera		Rovers	TNO	researcher



Annex B bibliography

Introduction

Algemene Rekenkamer (2012). Aanpassing aan klimaatverandering: strategie en beleid. kst-33470-1. ISSN 0921 – 7371. 's-Gravenhage.

EEA (2010). The European Environment – State and Outlook 2010. Adapting to climate change. Copenhagen: European Environment Agency.

G32 (2011). Werkprogramma 2011. Pijler Fysiek G32-Stedennetwerk

Isaord, S. (2011). Perspectives on Adaptation to Climate Change in Europe. In: Ford, J.D., and L. Berrang-Ford (eds), Climate change adaptation in Developed Nations. Springer.

PBL (2011). Een delta in beweging. Bouwstenen voor een klimaatbestendige ontwikkeling van Nederland. Den Haag. Planbureau voor de Leefomgeving.

Stern, N. (2006). The Economics of Climate Change. The Stern Review. Cambridge: Cambridge University Press.

Watkiss, P. (ed) (2011). The ClimateCost Project. Final Report. Volume 1: Europe. Published by the Stockholm Environment Institute, Sweden. ISBN 978-91-86125-35-6.

Chapter 1

Brolsma R, Buma J, Van Meerten H, Dionisio M, Elbers J. (2012). Effect van droogte op stedelijk gebied. Kennisinventarisatie. Utrecht: Knowledge for Climate.

Brolsma, R.J, G. Verhoeven, E. Foka (2011). Invloed stedelijk oppervlaktewater op omgevingstemperatuur. Deltares, 1200473.

Conrads, L.A. (1975). Observations of meteorological urban effects. The heat island of Utrecht. PhD thesis University Utrecht. 84 pp.

Heusinkveld, B.G., Van Hove, L.W.A., Jacobs, C.M.J., Steeneveld, G.J., Elbers, J.A., Moors, E.J., Holtslag, A.A.M. (2010). Use of a mobile platform for assessing urban heat stress in Rotterdam. Proceedings of the 7th Conference on Biometeorology. Albert-Ludwigs-University of Freiburg, Germany, 12-14 April 2010. 433-438. <http://www.meteo.uni-freiburg.de/forschung/publikatione/berichte/index.html>

Heusinkveld, B., van Hove, B. Jacobs, C. (2012). Ruimtelijke analyse van het stadsklimaat in Arnhem. 24pp. WUR publicatie.

Heusinkveld B.G., Steeneveld G.J., van Hove L.W.A., Jacobs C.M.J., Holtslag A.A.M. (2014). Spatial variability of the Rotterdam urban heat island as influenced by urban land use J. Geophys. Res. DOI: 10.1002/2012JD019399.

Jacobs, C., Elbers, J., Brolsma, R., Hartogensis, O., Moors, E., Rodríguez-Carretero Márquez, M-T, and van Hove, B. (2014). Assessment of 1 evaporative water loss from Dutch cities. Building and Environment. Available online 10 July 2014. DOI: 10.1016/j.buildenv.2014.07.005



- Klemm, W.,** Heusinkveld, B.G., Lenzholzer, S., Jacobs, M.H., Van Hove, B. (2014). Psychological and physical impact of urban green spaces on outdoor thermal comfort during summertime in The Netherlands. *Building and Environment* <http://dx.doi.org/10.1016/j.buildenv.2014.05.013>.
- Klok, E.J.,** Broeke, H. ten, Harmelen, T. v., Verhagen, H., Kok, H., en Zwart, S. (2010). Ruimtelijke verdeling en mogelijke oorzaken van het hitte-eiland effect. TNO publicatie, TNO-034-UT-2010-01229_RPT-ML, 78 pp..
- Klok, L.,** Zwart, S., Verhagen, H., Mauri, E. (2012). The surface heat island of Rotterdam and its relationship with urban surface characteristics. *Resources, Conservation and Recycling* 64, 23-29.
- KNMI** (2014). KNMI'14-klimaatscenario's voor Nederland; Leidraad voor professionals in klimaatadaptatie, KNMI, De Bilt, 34pp.
- Lindberg, F.,** Grimmond, C.S.B. (2013). Global to City Scale Anthropogenic Heat Flux model: The LUCY Model. User manual –Version 2013a, [Online].
<http://geography.kcl.ac.uk/micromet/Manuals/LUCY_Manual.pdf> (accessed 25.02.13).
- Matzarakis, A. & Amelung, B.** 2008. Physiological Equivalent temperature as indicator for impacts of climate change on thermal comfort of humans. *Seasonal Forecasts, Climatic Change and Human Health*. Springer
- Memon, R.A.,** Leung, D.Y.C., Liu, C.-H. (2009). An investigation of urban heat island intensity (UHII) as an indicator of urban heating. *Atmospheric Research* 94, 491-500.
- Oke TR.** (1973). City size and the urban heat island. *Atmospheric Environment* 7: 769–779.
- Oke TR.** (1976). The distinction between canopy and boundary-layer urban heat islands. *Atmosphere*, Volume 14, Issue 4, pp 268-277.
- Ronda R.,** Steeneveld, G.J., van Hove, B. (2010). Modelsimulaties van het stadsklimaat van Rotterdam. WUR publicatie 27 pp.
- Ronda, R.J,** Steeneveld, G.J., van Hove, L.W.A., Holtslag, A.A.M. (2012): Anthropogenic heat release and urban heat island effects in Rotterdam, the Netherlands. *Urban Environmental Pollution 2012*, Amsterdam, the Netherlands
- Roodenburg J.** (1983). Adaptation of rural minimum temperature forecasts to an urban environment. *Archives for Meteorology Geophysics and Bioclimatology*; 32: 395-401;
- Schrijvers, P.J.C.,** H.J.J. Jonker, S. Kenjereš, S.R. de Roode (2014). Breakdown of the nighttime urban heat island energy budget. DOI: 10.1016/j.buildenv.2014.08.012
- Slingerland, J.** (2012). Mitigation of the urban heat island effect by using water and vegetation. MSc thesis TUDelft. 87 pp.
- Steeneveld, G.J.,** Koopmans, S., Heusinkveld, B.G., van Hove, L.W.A., Holtslag, A.A.M. (2011). Quantifying urban heat island effects and human comfort for cities of variable size and urban morphology in the Netherlands. *J. Geophys. Res.* 116, D20129, 14pp., doi: 10.1029/2011 JDO15988.



- Steenefeld, G.J., Koopmans, S., Heusinkveld, B.G., Theeuwes, N.E.** (2014). Refreshing the role of open water surfaces on mitigating the maximum urban heat island effect. *Landscape and Urban Planning* 121; 92–96
- Ter Maat, H.W., C.M.J. Jacobs, R.W.A. Hutjes, E.J. Moors** (2014 - to be submitted). Quantifying local impacts of regional adaptation measures in the urban environment.
- Theeuwes N.E., Solcerová A. and Steeneveld G.J.** (2013). Modeling the influence of open water surfaces on the summertime temperature and thermal comfort in the city. *J. Geophys. Res. Atmos.*; 118: 15pp. DOI: 10.1002/jgrd.50704
- Theeuwes, N.E., Steeneveld, G.J., Ronda, R.J., Heusinkveld, B.G., van Hove, L.W.A. and Holtslag, A.A.M.** (2014). Seasonal dependence of the urban heat island on the street canyon aspect ratio. *Q. J. R. Meteorol. Soc.* (2014) DOI:10.1002/qj.2289
- Van Hove, B., Steeneveld, G-J, Jacobs, C., H. ter Maat, H., Heusinkveld, B., Elbers, J., Moors, E., Holtslag, B.** (2010). Modelling and observing urban climate in the Netherlands. KVR 020/10.
- Van Hove, L.W.A., Elbers, J.A., Jacobs, C.M.J., Heusinkveld, B.G., Jans, W.W.P.** (2011a). Stadsklimaat in Rotterdam; Eerste analyse van de meetgegevens van het meteorologische meetnet. Alterra, Wageningen. Alterra-rapport 2192. 32 pp.
- Van Hove, L.W.A., Jacobs, C.M.J., Heusinkveld, B.G., Elbers, J.A., Steeneveld, G-J, Koopmans, S., Moors, E.J. and Holtslag, A.A.M.** (2011b). *Exploring The Urban Heat Island Intensity Of Dutch Cities. In: City Weathers, meteorology and urban design 1950-2010.* Edited by Michael Hebbert, Vladimir Jankovic & Brian Webb. Published 2011 by Manchester Architecture Research Centre, University of Manchester. ISBN: 978-1-907120-98-5 <http://www.sed.manchester.ac.uk/research/marc>
- Van Hove, L.W.A., Steeneveld, G-J, Jacobs, C., Heusinkveld, B.G., Elbers, J. and Holtslag, A.A.M.** (2011c). Exploring the Urban Heat Island Intensity of Dutch cities. Assessment based on a literature review, recent meteorological observations and datasets provided by hobby meteorologists. Alterra, Wageningen. Alterra report 2170. 62 pp. ISSN 1566-7197.
- Van Hove, L.W.A., Jacobs, C.M.J., Heusinkveld B.G., Elbers, J.A., van Driel, B.L., and Holtslag, A.A.M.** (2014). Temporal and spatial variability of urban heat island and thermal comfort within the Rotterdam agglomeration. *Building and Environment* . DOI: 10.1016/j.buildenv.2014.08.029
- Wolters, D. and Brandsma, T.** (2012). Estimating the Urban Heat Island in Residential Areas in the Netherlands Using Observations by Weather Amateurs. *J.App.Meteorol.Climatol.* 51; 711-721.



Chapter 2

Costola D, Blocken B, Hensen JLM. 2009. Overview of pressure coefficient data in building energy simulation and airflow network programs. *Building and Environment* 44(10): 2027-2036.

Crawley DB, Lawrie LK, Winkelmann FC, Buhl WF, Juang YJ, Pedersen CO, Strand RK, Liesen RJ, Fisher DE, Witte MJ, Glazer J. (2001). EnergyPlus: creating a new-generation building energy simulation program. *Energy and Buildings* 33(4): 319-331.

Crawley DB, Hand JW, Kummert M, Griffith BT (2008). Contrasting the capabilities of building energy performance simulation programs. *Building and Environment* 43(4): 674-685.

Daanen, H. A. M., Heusinkveld, B., Van Hove, B., & Van Riet, N. (2011). Heat strain in elderly during heat waves in the netherlands. In S. Kounalakis, & M. Koskoulou (Eds.), *Abstract book XIV international conference on environmental ergonomics*, Nafplio, Greece, 2011 (pp. 168-170)

Daanen, H. A. M., Jonkhoff, W., Bosch, P., & Ten Broeke, H. (2013). The effect of global warming and urban heat islands on mortality, morbidity and productivity in the Netherlands. *Environmental Ergonomics XV Conference Proceedings*. Queenstown New Zealand, ISBN 978-0-473-2281-7, , 6-9.

Daanen, H. A. M., & Herweijer, J. A. (2015). Effectiveness of an indoor preparation program to increase thermal resilience in elderly for heat waves. *Building and Environment*, DOI:10.1016/j.buildenv.2014.04.010

De Man H, Leenen I. (2014). Water in de openbare ruimte heeft risico's voor de gezondheid. Rapport 2014/28, STOWA/RIONED, ISBN 97 890 73645 44 8

Hajat, S., O'Connor, M., & Kosatsky, T. (2010). Health effects of hot weather: From awareness of risk factors to effective health protection. *The Lancet*, 375(9717), 856-863.

Hensen JLM, Lamberts R, Negrao COR. (2002). A view of energy and building performance simulation at the start of the third millenium. *Energy and Buildings* 34(9): 853-855.

Howe, A. S., & Boden, B. P. (2007). Heat-related illness in athletes. *American Journal of Sports Medicine*, 35(8), 1384-1395.

Hurk, B. van den, Klein Tank, A.K., Lenderink, G., Ulden, A. van, Oldenborgh, G.J. van, Katsman, C., Brink, H. van den, Keller, F., Bessembinder, J., Burgers, G., Komen, G., Hazeleger, W., Drijfhout, S. (2006). *KNMI Climate Change Scenarios 2006 for the Netherlands*. KNMI, De Bilt, The Netherlands

Huynen, M.M.T.E., Martens, P. Schram, D., Weijenberg, M.P., Kunst, A.E. (2001). The impact of heat waves and cold spells on mortality rates in the Dutch population: *Environmental Health Perspectives*, v. 109, p. 463-470.

IPCC (2007). *Impacts, Adaptation and Vulnerability, Contribution of Working Group II*. In: Perry, M., Canziani, O., Palutikof, J., Van der Linden, P., Hanson, C. (eds), *Fourth Assessment Report of the Intergovernmental Panel on Climate Change*. Cambridge University Press, Cambridge, UK. Polsky et al. (2007).

Kemmeren, J.M., M.-J.J. Mangan, Y.T.H.P. van Duynhoven, A.H. Havelaar (2006). Priority setting of foodborne pathogens. Disease burden and costs of selected enteric Pathogens. Report 330080001, RIVM



Kovats, RS, S Hajat, 2008, Heat stress and public health: a critical review: Annual Review of Public Health, v. 29, p. 41-55

Kwadijk, J. C. J., Haasnoot, M., Mulder, J. P. M., Hoogvliet, M. M. C., Jeuken, A. B. M., Van Der Krogt, R. A. A., Van Oostrom, N. G. C., Schelfhout, H. A., Van Velzen, E. H., Van Waveren, H. & De Wit, M. J. M. 2010. Using adaptation tipping points to prepare for climate change and sea level rise: a case study in the Netherlands. Wiley Interdisciplinary Reviews: Climate Change, 1, 729-740.

Luijtelaar, H. van (2008). Regenwateroverlast in de bebouwde omgeving Inventariserend onderzoek onder gemeenten. In opdracht van Stichting RIONED.

Ministerie van Volksgezondheid, Welzijn & Sport (VWS) (2007). Nationaal Hitteplan.

Pásztor, A., Bosch, P. (2011). Guideline Vulnerability terminology. KfC report nr 108/2013.

Sales Ortells H, Medema G. (2014) Health impact assessment of urban climate change adaptations. Kennis voor Klimaat / KWR / TU Delft

Seppänen, O., Fisk W.J., Faulkner, D. (2004). Control of temperature for health and productivity in offices. Report NBNL-55448, www.osti.gov.

Smit, B., Pilifosova, O., Burton, I., Challenger, B., Huq, S., & Klein, R. (2001). Adaptation to climate change in the context of sustainable development and equity. In McCarthy, J. et al. (eds), Climate Change 2001: Impacts, Adaptation and Vulnerability. Contribution of Working Group II to the Third Assessment Report of the Intergovernmental Panel on Climate Change. Cambridge, UK and New York, USA: Cambridge University Press.

Spekkers, M. H., Ten Veldhuis, J. A. E., Kok, M., & Clemens, F. H. L.R. (2011). Analysis of pluvial flood damage based on data from insurance companies in the Netherlands. In Zenz, G., Hornich, R. (eds), Urban Flood Risk Management Conference (pp. 461–466). Graz (Austria).

Stone, K., Daanen, H., Jonkhoff, W., Bosch, P. (2013). Quantifying the sensitivity of our urban systems Impact functions for urban systems Revised version; Knowledge for Climate; Deltares project number: 1202270.008

Strydom, N. B., Wyndham, C. H., Williams, C. G., Morrison, J. F., Bredell, G. A. G., Benade, A. J. S., & Von Rahden, M. (1966). Acclimatization to humid heat and the role of physical conditioning. Journal of Applied Physiology, 21(2), 636-642.

Van der Hoeven, F., Wandl, A. (2014). Amsterwarm: Mapping the landues, health and energy-efficiency implications of the Amsterdam urban heat island. Building Serv Eng Res Technol.

Van Hooff, T., Blocken, B., Hensen, J.L.M., Timmermans, H.J.P. (2014). On the predicted effectiveness of climate adaptation measures for buildings. Building and Environment 82: 300-316

Veerbeek, W., Husson, H. (2013). Vulnerability to Climate Change: Appraisal of a vulnerability assessment method in a policy context. KfC report number: 98/2013 (Unesco-IHE OR/MST/177).



Chapter 3

Agentschap NL (2013). Referentiewoningen nieuwbouw 2013. Agentschap NL, Sittard, the Netherlands.

Alexandri E., Jones P., (2008) Temperature decreases in an urban canyon due to green walls and green roofs in diverse climates, *Building and Environment* 43, 480-493.

Berghauser Pont & Haupt (2009). *Spacematrix. Space, Density and Urban Form*. NAI, Rotterdam.

Bowler, D.E., et al. (2010). Urban greening to cool towns and cities: A systematic review of the empirical evidence. *Landscape and Urban Planning*, 2010. 97(3): p. 147-155.

Brolsma, R.J., Boderie, P., de Graaff, M., Bonte, M., Brand, R., de Wit, J., Hofman, J. (2013). Combining water and energy supply. Deltares.

Choi H., Lee W., Byun W. (2012). Determining the Effect of Green Spaces on Urban Heat Distribution Using Satellite Imagery. *Asian Journal of Atmospheric Environment* Vol. 6-2, 127-135.

Drost, A. (2013). Mental maps describing thermal comfort in the urban environment - A GIS methodology to analyse spatial variables defining places of thermal comfort. Master-thesis Centre for Geo-Information. WUR. Supervisors: R. van Lammeren, W. Klemm, et al..

Echevarría Icaza L., van der Hoeven F., van den Dobbelsteen A.A.F. (gepland in 2014 a). The Urban Heat Island Effect in Dutch city centres – identifying relevant indicators and first explorations-.

Echevarría Icaza L., Carter J., Gill S., Butlin T., Van der Hoeven, F. (gepland in 2014 b). Climate change adaptation in urban areas: enhancing the role of hinterland spaces as 'climate buffers'.

Errel E., Shashua-Bar L., Pearlmutter D. (2009). The cooling efficiency of urban landscape strategies in a hot dry climate. *Landscape and Urban Planning* 92, 179-186.

Gromke CB, Blocken B, Janssen WD, Merema B, van Hooff T, Timmermans HJP. (2015). CFD analysis of transpirational cooling by vegetation: Case study for specific meteorological conditions during a heat wave in Arnhem, Netherlands. *Building and Environment*. doi:10.1016/j.buildenv.2014.04.022.

Heusinkveld, B. G., G. J. Steeneveld, et al. (2014). "Spatial variability of the Rotterdam urban heat island as influenced by urban land use." *Journal of Geophysical Research: Atmospheres*: 2012JD019399.

Hofman J & Paalman M, (2014). Rainwater harvesting, a sustainable solution for urban climate adaptation? *Kennis voor Klimaat / KWR*

Hotkevica, I. (2013). Green elements in street canyons - Research by design for heat mitigation and thermal comfort in urban areas. Master thesis Landscape Architecture, Wageningen University and Research Centre. Supervisors: Wiebke Klemm, Sanda Lenzholzer, et al..

Jauregui, E. (1990). Influence of a large urban park on temperature and convective precipitation in a tropical city. *Energy Build.* 15(16) 457–463.

Kleerekoper L., van Esch, M., Salcedo, T. B., (2012) How to make a city climate-proof, addressing the urban heat island effect, *Resources, Conservation and Recycling*. 64, 30-38.



Kleerekoper, L., Dobbelsteen, A.A.J.F. v. d., Bruin-Hordijk, T.D., Dorst, M.J. v. (in review a), "Climate adaptation strategies: Achieving insight in microclimate effects of redevelopment options". Submitted to the Journal of Smart and Sustainable Built Environments.

Kleerekoper, L., Taleghani, M., Dobbelsteen, A. A. J. F. v. d., Hordijk, T. D. (in review b), "Urban measures for hot weather conditions in the Netherlands: an extensive theoretical comparative study". Submitted to Solar Energy.

Kleerekoper, L., (in voorbereiding). Climate adaptation measures in specific Dutch neighbourhood typologies. Thesis Chapter 6, TU Delft.

Klemm, W., Lenzholzer, S., Heusinkveld, B., Hove, B. van (2013a). Towards green design guidelines for thermally comfortable streets. In PLEA 2013.

Klemm, W., Heusinkveld, B., Lenzholzer, S., Hove, B.v. (2013b). Thermal and perceived impact of urban green on thermal comfort on warm summer days in Utrecht, The Netherlands.
[http://www.regklam.de/ccrr-2013/programme-contents/parallel-session-2/?tx_sbtabs_pi1\[tab\]=315](http://www.regklam.de/ccrr-2013/programme-contents/parallel-session-2/?tx_sbtabs_pi1[tab]=315).
Geraadpleegd op 21-09-2013.

Klemm, W.; Heusinkveld, B. G.; Lenzholzer, S.; Jacobs, M. H.; Van Hove, B. (2014a). "Psychological and physical impact of urban green spaces on outdoor thermal comfort during summertime in the Netherlands." Building and Environment 82.

Klemm, W., Lenzholzer, S., Heusinkveld, B., Hove, B. van (2014b, in review). Street greenery and its physical and psychological impact on thermal comfort. Landscape and Urban Planning.

KNMI (2014). KNMI weather data. Available from:
http://www.knmi.nl/climatology/daily_data/download.html (accessed 28-01-2014).

Montazeri H., Blocken B., Hensen J.L.M. (2015). Evaporative cooling by water spray systems: CFD simulation, experimental validation and sensitivity analysis. Building and Environment.
<http://dx.doi.org/10.1016/j.buildenv.2014.03.022>.

Nikolopoulou, M. and K. Steemers (2003). "Thermal comfort and psychological adaptation as a guide for designing urban spaces." Energy and Buildings 35(1): 95-101.

Sailor, D.J. (1995). Simulated Urban Climate response to modification in surface albedo and vegetative cover. Journal of applied meteorology 34 (7) 1694-1704.

Sales Ortells, H., Medema, G. (2014). Health impact assessment of urban climate change adaptations. Kennis voor Klimaat / KWR / TU Delft

Sureshkumar, R., Kale, S.R., Dhar, P.L. (2008). Heat and mass transfer processes between a water spray and ambient air- I. Experimental data. Applied Thermal Engineering 28: 349-360.

Taha H., Akbari H., Rosenfeld A.H. and Huand Y.J. (1988). Residential cooling loads and the urban heat island. The effects of albedo. Building and Environment 23. 271-283.

Van de Ven, F., E. Luyendijk, M. de Gunst, E. Tromp, M. Schilt, L. Krol, B. Gersonius, C. Vlaming, L. Valkenburg, R. Peeters (2009). Waterrobuust Bouwen; de kracht van kwetsbaarheid in een duurzaam ontwerp. SBR Artikelnr 604.08 Beter Bouw- en Woonrijp Maken / SBR, Rotterdam, ISBN 9789053674963



Van Hooff, T., Blocken, B., Hensen, J.L.M., Timmermans, H.J.P. (2014). On the predicted effectiveness of climate adaptation measures for buildings. *Building and Environment* 82: 300-316.

Van Leeuwen, E., W. Schuurmans (2014). 3Di- techniek en mogelijkheden van een geïntegreerd omgevingsmodel voor water in de stad. In: RIONED, 2014. Ervaringen met de aanpak van regenwateroverlast in gebouwd gebied, voorbeelden en ontwikkelingen anno 2014. RIONED reeks 18.

Vergroesen, T., Brotsma, R., Tollenaar, D. (2013). Verwerking van extreme neerslag in stedelijk gebied. Deltares report 1202270-009.

Wong N.H., Kwang Tan, AY (2010). Thermal evaluation of vertical greenery systems for building walls. *Building and Environment* 45, 663-672.

Chapter 4

Boonstra, B., Vogel, R. en Slob, A. (2014). Van organisch ontwikkelen naar organisch organiseren – lessen over zelforganisatie uit Almere. In: G. Bouma, E. Vanempen, C. Uitenbroek (eds.), *Regie en loslaten. Bijdragen aan de Plandag 2014*. BNSP en VRP.

Boonstra, B. (2013). Co-housing as self-organization in spatial development: mapping the trajectories of becoming of four Danish co-housing initiatives. Paper presented at the 11th meeting AESOP's thematic group on Complexity & Planning – Self-organization and spatial planning: in-depth analysis. Aveiro, 2-3 May 2013

Boonstra, B. & L. Boelens (2011). Self-organization in urban development: towards a new perspective on spatial planning. *Urban Research & Practice*, Vol.4(2): 99-122.

Boonstra, B. & M. Specht (2012). The Appropriated City: self-organization as rehearsal spaces for future urban governance, the case of Rotterdam. Paper presented at the 'Spatial Planning in Transition' Conference, Ministry of Infrastructure and Environment, 6th November 2012, The Hague.

Chao-Duivis, M.A.B., & Wamelink, J.W.F. (2013). 'Juridische aspecten van ketensamenwerking, naar een multidisciplinaire benadering', Den Haag: Instituut voor Bouwrecht.

Gersonius, B., Nasruddin, F., Ashley, R., Jeuken, A., Pathirana, A. & Zevenbergen, C. (2012) Developing the evidence base for mainstreaming adaptation of stormwater systems to climate change. *Water Research*. <http://dx.doi.org/10.1016/j.watres.2012.03.060>

Hartmann, T. & T. Spit, (2014), Capacity Building for Integrating Climate Adaptation into Urban Planning Processes: the Dutch Experience. *American Journal of Climate Change*. (forthcoming).

Heurkens, E. (2012). Private Sector-Led Urban Development Projects: Management, Partnerships and Effects in the Netherlands and the UK Delft: TU Delft.

Janssen-Jansen, L., Lloyd, G., Peel, D., & van der Krabben, E. (2012). Planning in an Environment Without Growth. Invited essay for the Raad voor de leefomgeving en infrastructuur [Dutch Council for Living Environment and Infrastructure]. The Netherlands: Raad voor de leefomgeving en infrastructuur (Rli)

Kabat, P., W. van Vierssen, J. Veraart, P. Vellinga & J. Aerts (2005). Climate proofing the Netherlands. *Nature*, Vol. 438(7066): 283-284.



- Offerman, R., & van de Velde, D. (2004).** Value Capturing: potentieel financieringsinstrument voor Nederland? [Value Capturing: a potential financial instrument for the Netherlands?]. In E. U. Rotterdam (Ed.). Rotterdam: Erasmus University.
- Roders, M., Straub, A. & Visscher, H. (2012a)** 'Awareness of climate change adaptations among Dutch housing associations', *Open House International*, 37(4), pp. 61–71.
- Roders, M., Straub, A. & Gruis, V. (2012b)** 'Interpersonal aspects of partnering in housing renovation', in Michell, K., Bowen, P., and Cathell, K. (eds.) *Delivering value to the community*. Cape Town: University of Cape Town, pp. 180–186.
- Roders, M., Straub, A. and Visscher, H. (2013)** 'Evaluation of climate change adaptations by Dutch housing associations', *Structural Survey*, 31(4), pp. 267–282. doi: 10.1108/SS-01-2013-0009.
- Roders, M., Straub, A. and Visscher, H. (2014).** Assessment of the likelihood of implementation strategies for climate change adaptation measures in Dutch social housing. *Building and Environment*.
- Roders, M., Straub, A. and Gruis, V. (In voorbereiding)** 'Lessons from partnering in housing refurbishment and implications for policymaking'.
- Root, L., E. van der Krabben & T. Spit (2014),** Bridging the Financial Gap in Climate Adaptation: Dutch Planning and Land Development Through a New Institutional Lens. *Journal of Environment Planning and Management*.
- Root, L. E. van der Krabben & T. Spit (gepland).** Between Structures and Norms: Assessing Tax Increment Financing for the Dutch Spatial Planning Toolkit. *Town Planning Review*.
- Savini, F., Salet, W., & Majoor, S. (2014).** Dilemmas of planning: intervention, regulation, and investment. *Planning Theory*, 1473095214531430.
- Spit, T. & A. Kokx † (2015),** Tracing Climate Adaptation in a Hard Planning Process. The Dutch experience. In: Edward Ng & Chao Ren (2014) *The Urban Climatic Map for Sustainable Urban Planning*. London: Routledge: Taylor & Francis Group. (forthcoming)
- Squires, G. (2012).** 'Dear Prudence': an overview of tax increment financing. *Journal of Urban Regeneration and Renewal*, 5(4), 1-12.
- Stern, N. (2006).** The Economics of Climate Change. The Stern Review. Cambridge: Cambridge University Press.
- Uittenbroek, C.J., Janssen-Jansen, L.B., Runhaar H.A.C. (2013)** Mainstreaming climate adaptation into urban planning: overcoming barriers, seizing opportunities and evaluating the results in two Dutch case studies. *Regional Environmental Change*. Vol. 13, No. 2, pp. 399-411.
- Uittenbroek, C.J., Janssen-Jansen, L.B., Spit, T.J.M., Salet, W.G.M., Runhaar H.A.C. (2014a)** Political commitment in organizing municipal responses to climate adaptation: the dedicated approach versus the mainstreaming approach. *Environmental Politics*. DOI:10.1080/09644016.2014.920563
- Uittenbroek, C.J., Janssen-Jansen, L.B., Spit, T.J.M., Runhaar H.A.C. (2014b)** Organizational values and the implications for mainstreaming climate adaptation in Dutch municipalities: Using Q methodology. *Journal of Water and Climate Change*. DOI:10.2166/wcc.2014.048



Uittenbroek, C.J., Janssen-Jansen, L.B., Runhaar, H.A.C. (submitted) Stimuli for municipal responses to climate adaptation: insights from Philadelphia – an early adapter. *Submitted in June 2014.*

Uittenbroek, C.J. (in review) Organizational barriers and the implications for mainstreaming climate adaptation in urban planning processes. *Resubmitted in May 2014.*

Van der Krabben, E., and H. Jacobs. 2013. “Public Land Development as a Strategic Tool for Redevelopment: Reflections on the Dutch Experience.” *Land Use Policy* 30 (1): 774–783.

Van Herk, S., Kelder, E.T.G., Bax, J.H., Gersonius, B en Hulsebosch, M. (2012), Meekoppelmethode voor het klimaatbestendig maken van bestaand stedelijk gebied, Pilot: Wielwijk Klimaatbestendig, MARE.

Van Meerkerk, I. van, Boonstra, B. and Edelenbos, J. (2013), Self-organization in urban regeneration – a two case comparative research, *European Planning Studies*, 21:10, 1630-1652

Watkiss, P. (ed) (2011). The ClimateCost Project. Final Report. Volume 1: Europe. Published by the Stockholm Environment Institute, Sweden. ISBN 978-91-86125-35-6.

Chapter 5

Bosch, P. (2014). Guideline Effectiveness of Adaptation Measures. KfC report

Döpp, S., Bosch, P. (2011). Climate Proof Cities: an integrated research framework, KfC report 109/2013.

Gemeente Rotterdam (2013). Rotterdamse adaptatiestrategie.

Groot A.M.E., et al. (2015). Integration in urban climate adaptation: Lessons from Rotterdam on integration between scientific disciplines and integration between scientific and stakeholder knowledge, *Building and Environment* 83, <http://dx.doi.org/10.1016/j.buildenv.2014.07.023>.

Hotkevica, I. (2013). Green elements in street canyons - Research by design for heat mitigation and thermal comfort in urban areas. Master thesis Landscape Architecture, Wageningen University and Research Centre. Supervisors: Wiebke Klemm, Sanda Lenzholzer, et al..

KNMI (2014). KNMI'14-klimaatscenario's voor Nederland; Leidraad voor professionals in klimaatdaptatie, KNMI, De Bilt, 34pp.

Pasztor, A., Bosch, P. (2011). Guideline Vulnerability terminology, KfC report 108/2013.

Toparlar, Y., Blocken, B., Vos, P., van Heijst, G.J.F., Janssen, W.D., van Hooff, T., Montazeri, H., Timmermans, H.J.P. (2014). CFD simulation and validation of urban microclimate: A case study for Bergpolder Zuid, Rotterdam. *Building and Environment* 82.

Van der Hoeven, F., Wandl, A. (2014). Amsterwarm: Mapping the landues, health and energy-efficiency implications of the Amsterdam urban heat island. *Building Serv Eng Res Technol*.

Van Hooff, T., Blocken, B., Hensen, J.L.M., Timmermans, H.J.P. (2014). On the predicted effectiveness of climate adaptation measures for buildings. *Building and Environment* 82: 300-316

Veerbeek, W. Husson, H. (2013). Vulnerability to Climate Change: Appraisal of a vulnerability assessment method in a policy context. KfC report number: 98/2013 (Unesco-IHE OR/MST/177).

Vergroessen, T. (2013). Afvoer in stedelijk gebied. Deltares, presentatie.



Annexes

Baranowska M., Gabryl B. (1981). Biometeorological norms as tolerance interval of man to weather stimuli. *Int J Biometeorol* 25:123–126.

Bröde, P. & D. Fiala, K. Błażejczyk, I. Holmér, G. Jendritzky, B. Kampmann, B. Tinz, G. Havenith (2012). Deriving the operational procedure for the Universal Thermal Climate Index (UTCI). *Int J Biometeorol* (2012) 56:481–494. DOI 10.1007/s00484-011-0454-1.

Höppe, P. (1999). The physiological equivalent temperature—a universal index for the biometeorological assessment of the thermal environment. *Int J Biometeorol* 43:71–75.

Matzarakis, A. & Amelung, B. 2008. Physiological Equivalent temperature as indicator for impacts of climate change on thermal comfort of humans. *Seasonal Forecasts, Climatic Change and Human Health*. Springer.



Bijlage C Thermal comfort and indicators

The temperature humans perceive differs from the real air temperature. This difference has to do with energy regulation in our bodies. Just like all other mammals, humans are warm-blooded. As part of the metabolism in our bodies, energy is released in the form of warmth. At rest, humans produce around 80-100 W because of this, while during physical exertion such as exercise, this can reach up to 900 W. In addition, our bodies – when we are in the sun – also take in shortwave radiation. The body can process this energy in three ways:

- through transport of heat to the air around the body (as long as the air is colder than the body);
- through the evaporation of sweat (the latent warmth needed for this is taken from the body);
- by emitting extra longwave radiation (through an increase in body temperature);

The perceived temperature is then determined by the energy exchange with the environment, and that depends on a number of meteorological factors:

- the air temperature (temperature difference between the body and its surroundings)
- the atmospheric humidity
- the wind speed (determines the exchange of both heat and water vapour between the body and its surroundings);
- the amount of direct solar radiation.

If the temperature of the air is much lower than the temperature of the body, it can happen that more energy is taken from the body than the body itself produces: the body cools off and becomes cold. If the temperature of the air is high and the evaporation of sweat does not remove enough energy from the body, the body has trouble losing the energy and overheating can be a consequence.

However, the perceived temperature does not only depend on the physical factors above, but also on physiological factors (level of exertion, health, age), behavior (clothing, work times, etc.) and psychological factors (for instance: habituation to heat/cold, temperature experience previously, influence of the surroundings).

Throughout the world, there are many different indicators for people's experience of 'thermal comfort', where the emphasis until now has been on the physical factors. A rough distinction can be made between direct and indirect indicators. The direct indicators for thermal comfort are calculated by means of experimental relations using data for the air temperature, atmospheric humidity and wind speed. The indirect indicators are based on the energy balance of the human body. Models ("tools") have been developed to calculate these indicators.

In the CPC research, 4 indicators were used:

'Effective Temperature'

The Effective Temperature (ET) is a direct measure for thermal comfort that is calculated using an experimental relation based on air temperature, atmospheric humidity and wind speed. Humans experience more heat stress at an ET value of higher than 21 °C (source: Baranowska and Gabryl, 1981).

'Approximated Wet Bulb Globe Temperature'

The 'Approximated Wet Bulb Globe Temperature' (AWBGT) is a simplified 'Wet Bulb Globe Temperature' (WBGT) (Bureau of Meteorology, Australian government). It is a direct indicator based on air temperature, atmospheric humidity and wind speed. Heat stress is experienced if AWBGT > 27,5 °C.



'Physiologically Equivalent Temperature'

'Physiologically Equivalent Temperature' (PET) is an indirect indicator based on the heat balance of the human body (Höppe 1999). PET is calculated based on physical and physiological factors. In the CPC research the calculations were carried out with the Raymann model for a standard person: a healthy man of 35, with a weight of 75 kg and height of 1.75m, with a clothing factor of 0.9, who is undertaking light work (80 W).

In temperate climate areas people experience moderate to high heat stress at a PET of > 23 °.

Table C.1. PET as indicator for human comfort (Matzarakis and Amelung, 2008)

PET	Thermal perception	Grade of physiological stress
4°C	Very cold	Extreme cold stress
8°C	Cold	Strong cold stress
13°C	Cool	Moderate cold stress
18°C	Slightly cool	Slight cold stress
23°C	Comfortable	No thermal stress
29°C	Slightly warm	Slight heat stress
35°C	Warm	Moderate heat stress
41°C	Hot	Strong heat stress
	Very hot	Extreme heat stress

'Universal Thermal Climate Index'

Recently, a new (indirect) indicator was developed in the framework of a COST initiative of the EU (COST 730), the 'Universal Thermal Climate Index' (UTCI) (www.utci.org). The UTCI is comparable to PET, with a 10-point scale ranging from extreme heat stress to extreme cold stress (Table C.2).

Table C.2 UTCI equivalent temperature ranges and perceived thermal stress (source: Bröde et al. 2012).

UTCI range (°C)	Stress category
Above +46	Extreme heat stress
+38 to +46	Very severe heat stress
+32 to +38	Severe heat stress
+26 to +32	Moderate heat stress
+9 to +26	No thermal stress
+9 to 0	Slight cold stress
0 to -13	Moderate cold stress
-13 to -27	Severe cold stress
-27 to -40	Very severe cold stress
Below -40	Extreme cold stress



Bijlage D Heat exchange between the urban environment and the atmosphere

Research was also carried out within CPC to better chart the energy balance of the city by means of insight into fluxes (Jacobs et al., 2014). This data was also used to validate the models. The research has proven its use by offering extra input/an extra calculation method for evaporation (see chapter 1.2.3).

Measuring turbulent fluxes over a complex landscape such as a city, with its extreme topography, is an enormous challenge. The 'Large Aperture Scintillometer' (LAS)³² offers great advantages for these purposes. The measurements are integrated across a large area that corresponds to the scale of the city itself. Since the end of May 2011, an LAS has continually been measuring the heat exchange of the urban area of Rotterdam with the Urban Boundary Layer between the Sint Franciscus Gasthuis and Erasmus MC (Figure D.1).

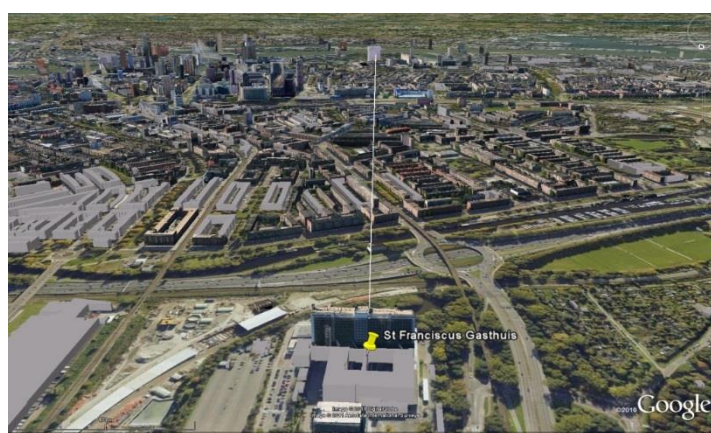

Figure D.1 Scintillometer path between the Sint Franciscus Gasthuis and Erasmus MC in Rotterdam. NB: Sint Franciscus Gasthuis Lat/Lon 51.56478/4.27747, height 51 m), Erasmus MC (Lat/Lon 51.54632/4.28128, height 77 m). The distance between transmitter and receiver is 3451 m, orientation ~180°.

The scintillometer allows one to deduce a thermal comfort parameter that applies to the scale of the whole city. To illustrate this, **Figure D.2** shows a seasonal overview of the perceptible heat flux for the year 2012.

The x axis shows hours; the y axis shows the days. The colour codes indicate the heat flux. A positive heat flux is defined as a heat flux from the surface to the atmosphere. It can be seen that in winter, the fluxes are low during the day (50-100 W m⁻²). In summer, the sunniest periods jump out as those with the highest locally generated heat flux. In addition, it is striking that the fluxes also often stay positive at night. This is a consequence of fact that the heat stored during the day in stone objects is set free again at night, in combination with the relatively short nights we experience at our degree of latitude.

More research is needed to see how this heat measure (it is not an index) is related to the air temperature and thermal comfort.

³² The quivering of the air above a hot asphalt road is an example of a phenomenon known as scintillation. This phenomenon is caused by density differences in the air as a consequence of the turbulent transport (transport through swirls) of warmth and moisture. A scintillometer is a measuring instrument consisting of a transmitter and a receiver that registers the intensity of these air vibrations in order to be able to determine, indirectly, surface fluxes across distances of 100 m to 10 km.

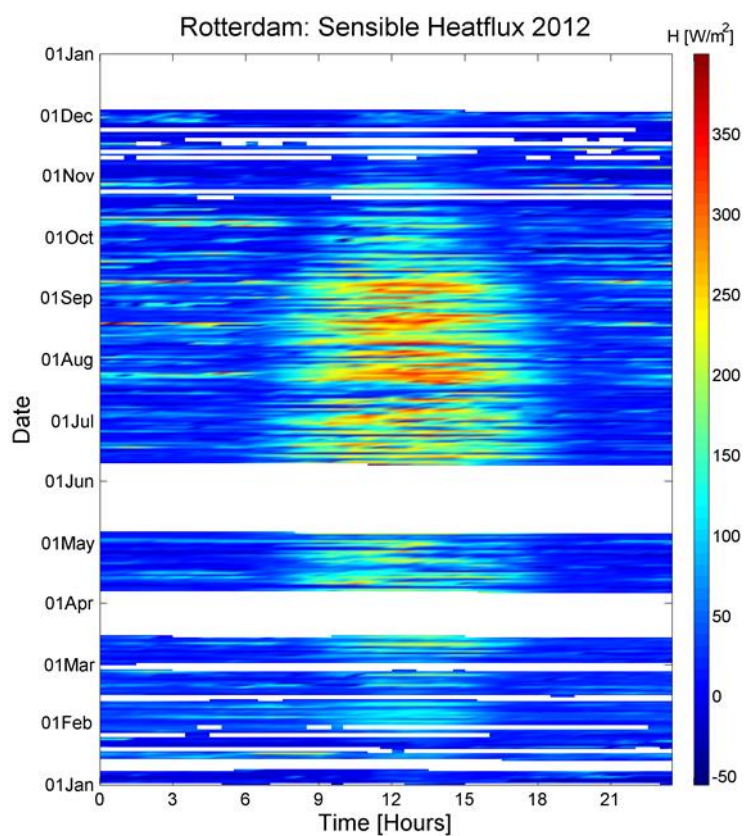

Figure D.2 Season overview of the scintillometer heat flux for Rotterdam for the year 2012. NB: In 2012 there were problems with the modem during two periods of time, as a result of which data from some weeks in the months of April and May was lost.



