



Reconstructing vaults 2.0

The potential of cast glass for reconstructing
historical buildings

TU Delft
MSc Architecture, Urbanism & Building science
Track: Building Technology

Publication date 02 July 2020

Graduation committee

1st supervisor Dr. Ir. F. Oikonomopoulou

2nd supervisor Dr. Ing. M. Bilow

Delegate of the Board of Examiners Ir. H. Plomp

Student

Name Angela Smit

Student number 4463021

Preface

You just opened the thesis “Reconstructing vaults 2.0: The potential of cast glass for reconstructing historical buildings”. The research regarding this research is by doing literature research and simulations. A case study was chosen to test the designed principles: The Notre Dame de Paris. The thesis is written for graduation purpose for the Msc Architecture, Urbanism & Building science - Track: Building Technology at the TU Delft, the Netherlands. The graduation period was between November 2019 – June 2020. Special thanks to my mentors Faidra Oikonomopoulou and Marcel Bilow. With their help, I was able to scope my thesis subject and the research question. Also, Lida Barou supported me as a non-official mentor as she made time to give me feedback on my project from her engineer and heritage perspective. Therefore, I want to thank all three of them to support me from their chair perspective. I experienced their support positive as they gave suggestions where needed but gave all the freedom to perform the research. They were positive, but critical where needed. Also, they were very flexible by giving online support during the Covid-19 lockdown period.

Also, I would like to thank Mickie Stoter, my colleague, for pre-reading the thesis on grammar and storytelling. As she is not specialized on building technology, she was the perfect person to tell me what was clear and what was not. Finally, all thanks to my family and friends who have supported me morally during this process.

I hope you will enjoy reading this thesis.

Angela Smit

Den Haag, July 2nd, 2020

Abstract

This thesis is about reconstructing historical vaults with cast glass. The vision is to design a complete dry-assembly cast glass arch vault where the Notre Dame de Paris is the chosen case study. The main question is: To what extent can a historical masonry arch vault be reconstructed by using cast glass components? The method is based on literature research and FEA simulations.

The thesis contains three main phases of the research. First, the background, problem statement and research objectives/ questions are discussed in the introduction. Then, the complete literature research where heritage, arch vault structures, structural glass and cast glass in structures will be discussed. The third part describes the complete design phase including the criteria and final design. The thesis finishes with a conclusion and discussion chapter.

The main results of this thesis are that a historical arch vault can be reconstructed from cast glass, but this will bring high risks and costs. Therefore, the suggestion is to use cast glass for the structural arches as this meets the complex geometry but use traditional materials for complex nodes and float glass where single, abstract curves can be made. The connections between different components are dry thanks to interlayers, but the cast glass elements are adhesively bonded. From safety, assembly, and labor perspective, these connections are chosen. This way, the blurry effect of glass in a heritage is reached, but the method is simplified. This principle can also be applied as roof structures for future buildings, but also for small pedestrian bridges as the geometry possibilities are unlimited.

Table of content

Preface	3
Abstract	3
Part 1: Introduction	6
1 Research framework	7
1.1 Background & Problem statement	7
1.2 Research objectives	7
1.3 Research question	8
1.4 Research framework	9
Part 2: Literature research	10
2 Heritage	11
2.1 Restoration versus reconstruction versus conservation	11
2.2 Guidelines for reconstruction of monuments	12
2.3 Brief history of the restoration debate	13
2.4 Traditional materials versus glass	13
2.5 Case study: Notre Dame de Paris	16
2.6 Discussion	21
3 Arch vault structure	22
3.1 General	22
3.2 Arches & their support system	22
3.3 Masonry arch vault	24
3.4 Traditional construction process	25
3.5 Discussion	28
4 Structural glass	29
4.1 Types of glass	30
4.2 Manufacturing processes	32
4.2.1 Float glass	32
4.2.2 Extruded glass	34
4.2.3 3D printed glass	35
4.2.4 Cast glass	36
4.3 Casting and annealing process	37
4.4 Strength of cast glass	38
4.4.1 Safety strategies	39
4.5 Moulds	41
4.6 Discussion	42
5 Cast glass in structures	44
5.1 Current building systems with cast glass components	44
5.1.1 Metal substructures	44
5.1.2 Adhesive bonded	45
5.1.3 Interlocking/ dry assembly	46
5.2 Interlocking modules used in contemporary vault structure	48
5.3 Discussion	51

Part 3: Design	52
6 Design criteria	53
7 Design development	56
7.1 Arch	56
7.2 Components of the arch	58
7.2.1 Moulds	62
7.3 Keystone	64
7.4 Web	69
7.4.1 Connect the web with the arch	72
7.5 Interlayer	75
7.6 Assembly	78
7.7 Discussion	80
8 Prototype arch components	81
8.1 Mould	81
8.2 Components	83
8.3 Discussion	84
9 Final Design	85
9.1 Vault	85
9.2 Moulds	93
9.3 Transport	95
Conclusion	96
Discussion	98
References	99
Appendices	104

Part 1: Introduction

In this part, the research framework of this research is described. This includes the background & problem statement, research objectives, research questions and methodology.



Figure 1.1: Wooden roof structure (Chiddingstone Orangery Castle). Retrieved from Carpenteroak (2007).



Figure 1.2: Steel roof structure (Apple store). Retrieved from Worldarchitecturenews (2011).



Figure 1.3: Glass roof structure (Castle Ruurlo). Retrieved from Verlaan&Bouwstra (2013).



Figure 1.4: Cast glass façade for the Chanel Crystal house in Amsterdam. Retrieved from ABT (2016).

1 Research framework

1.1 Background & Problem statement

Buildings are structures which have a longer life span than their function. Therefore, the function of a building changes through time. Buildings which already exist for a long time and which contain cultural, historical or other values, are known as heritage structures. To cover or to connect parts of the heritages, glass roofs are introduced to keep the transparency while giving potential to the area which is protected from external factors such as wind and rain. These roof structures are mainly wooden or steel structures and filled with float glass, which is mostly known as window glass, see figure 1.1 and 1.2. The last few years, window glass is also used as structural elements to create full transparency, see figure 1.3.

Personally, I believe structural float glass is too modern for heritage buildings (e.g. Castle Ruurlo) as it is not integrated with other materials and their geometry. It takes away the attention from the building and its original architecture. Now, float glass is limited in dimension and shape due to the manufacturing and strengthening process, which means application of float glass structures are limited. I believe cast glass has potential to create fully transparency roof structures without taking all attention from the heritage. Currently, cast glass is mainly used for art purpose. However, Oikonomopoulou (2019) built a 1:1 cast glass façade prototype for the Chanel Crystal House in 2016. This was done in cooperation with MDRV, ABT and other companies, see figure 1.4. This project is only the beginning of cast glass in the built environment.

1.2 Research objectives

The objective of this research is to understand the potential of cast glass for masonry arch vaults for heritage purpose. For heritage buildings, many restrictions and parties are involved in the reconstructing process. There are many opinions about what reconstructing a monument is and how this should be applied. When the potential of cast glass is known, this can be taken into consideration in strategy and material choice. Also, when cast glass is applicable for heritage, it is also possible to use for new structures with less heritage restrictions such as new buildings or bridges.

The scope of this project is the structural design, product design and heritage strategy. For structural design, the behavior of masonry arch vaults, properties and manufacturing of cast glass and proven structural cast glass projects will be described. For product design, the detailing of how the cast blocks are connected to each other and how to connect to the existing walls will be studied. For heritage, the strategies of different opinion groups will be discussed, and one approach will be chosen. The Notre Dame de Paris is chosen as a case study to test and visualize the outcome of the research. After the fire in April 2019, the wooden roof and a part of the masonry arch vault is damaged. Only one part of the masonry arch vault is used for this research. Images of the roof and masonry arch vault can be found in figure 1.5. In this research, the original roof structure is not in scope due to time limitations and heritage limitations. In figure 1.6, options of other architects are shown to modernize the Notre Dame de Paris. Climate design is out of scope as it does not provide added value for this case study, and due to time limitations.

1.3 Research question

The **main** question for this research is as follows:

To what extent can a historical masonry arch vault be reconstructed by using cast glass components?

The **sub-questions** are divided in four categories:

Heritage

- What are the strategies and restrictions of reconstructing heritage structures?
- What are the key elements of the inner roof structure of the Notre Dame de Paris?

Structural arch vault

- What is the structural behavior of a rib arch?
- How are the traditional masonry arch vaults of cathedrals constructed?

Structural (cast) glass

- What are the properties of glass and what is glass used for?
- What is the manufacturing process and limitations of cast glass?

Connections

- What kind of connection systems are applied for cast glass in realized projects?
- What interlocking systems are studied for cast glass?
- What interlocking modules is used in contemporary vault structures?
- How to attach the cast glass to the existing taking material property and surface differences into account?



Figure 1.5: Interior before the fire (left), Interior after the fire (middle) and exterior before the fire (right). Retrieved from Shaw (2019).



Figure 1.6: Glass roof proposal from Nerovnya (left) and from Callebaut (right). Retrieved from ABC news (2019) and CBS news (2019).

1.4 Research framework

The approach of this research is divided in four phases. These phases are summarized in figure 1.7. The planning of the research is shown in appendix A.

Phase 1: Literature research

The literature research is connected to the previous summed main topics: Heritage, structural arch vault, structural glass and connections. These topics will be discussed per chapter to answer the sub-questions based on literature research.

Phase 2: Analysis and design criteria

In the analysis phase, the case study will be described, and the critical elements will be used as input together with the literature research to set up the design criteria. Also, the approach to cast glass connections will be included.

Phase 3: Design and validation

The arch vault will be designed in this phase. The geometry will be generated in Rhinoceros and Grasshopper. The validation will be performed in DIANA FEA to understand the structural behavior theoretically. The structure and interlocking system will be tested. The best option will be physically tested, but the glass will be replaced with concrete as the properties for density, tension and compression are almost the same.

Phase 4: Results and evaluation

In this phase, the results and process will be concluded and evaluated.

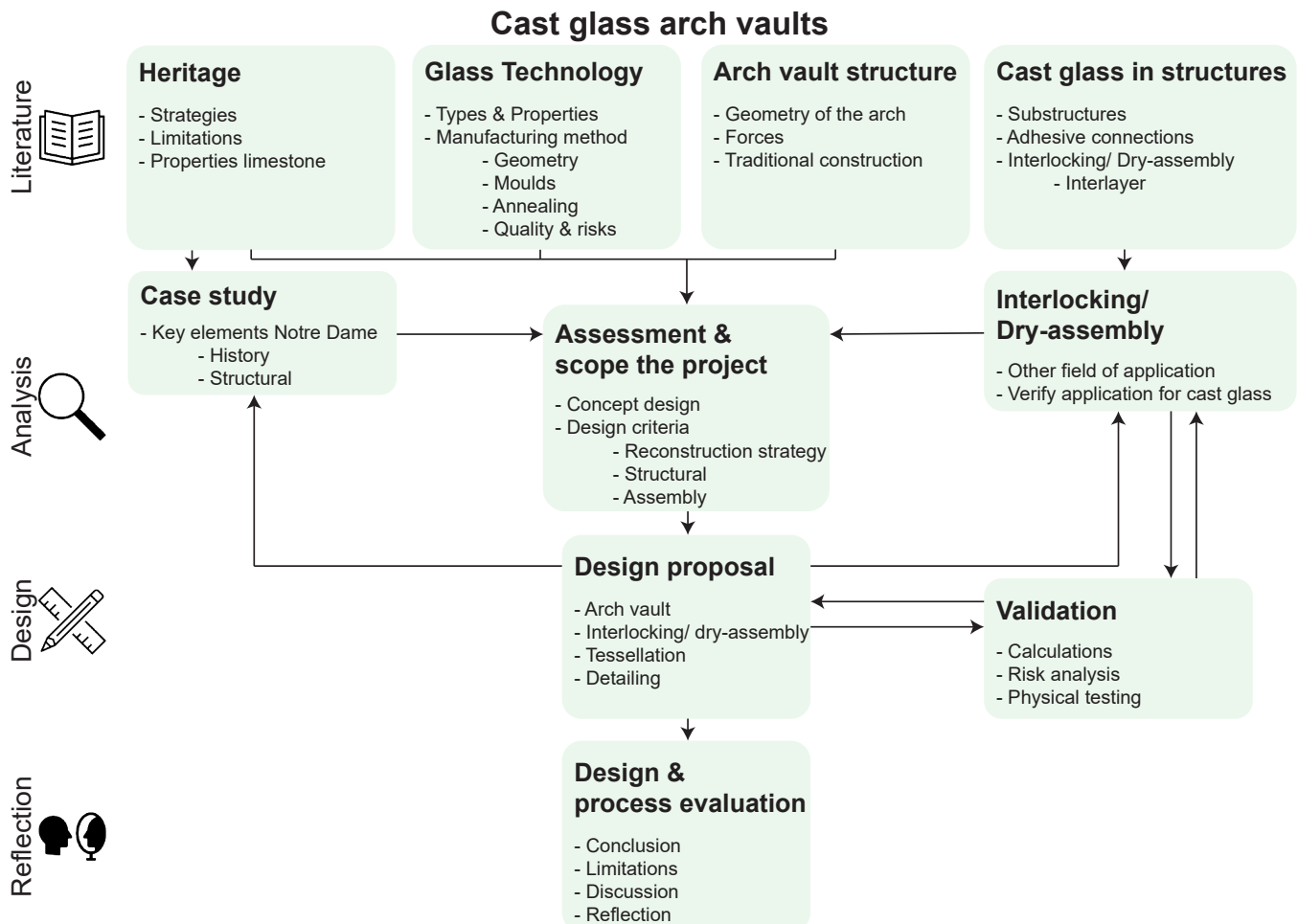

Figure 1.7: Research framework.

Part 2: Literature study

In this part, the theoretical background of the topic heritage, arch vault structure, structural glass and cast glass in structures will be discussed. All chapter will be concluded in a discussion with the main elements for this thesis.



Figure 2.1: St. Jacobs church in The Hague (left) and a commercial event inside (right). Retrieved from Grote Kerk Den Haag (n.d.).

2 Heritage

Historic monuments are a message from the past which includes knowledge, tradition and culture of generations of people (ICOMOS, 1964). Therefore, it is important to maintain and conserve heritage. These days, well preserved monuments perform a different function than originally due to changing requirements of people, see figure 2.1. Even less preserved monuments can be transformed, but then the questions raises: How can this be done respectfully to the history of the building and its social aspects?

2.1 Restoration versus reconstruction versus conservation

Maintenance is required to keep historical buildings as part of a place and people's lives. Therefore, Burra Charter (ICOMOS, 2013) defines it as follows: '*the continuous protective care of a place, and its settings. It is to be distinguished from repair which involves restoration or reconstruction*'. The definition is depending on the location, the status and the approach of maintenance. Restoration, reconstruction and conservation are defined based on four charters which are guidelines for monuments and sites in different locations in the world: 1. Burra charter (Australia), 2. Nara charter (Japan), 3. Riga (East Europe) and 4. Venice charter (Italy). The use of glass is not mentioned in these charters but will be discussed in paragraph 2.4 'Traditional materials versus glass '.

Restoration is defined as '*returning a place to a known earlier state by removing accretions or by reassembling existing elements without the introduction of new material*' according to the Burra charter (ICOMOS, 2013). This means the main materials which are used for restoration should be equal to the original material. The Riga Charter (ICCROM, 2000) states clearly that replication of cultural heritage is a misrepresentation of the past. Buildings should use technology of the time period when it was built. The Venice Charter (ICOMOS, 1964) described restoration as a highly specialized operation as it should preserve and reveal the cultural and historical value of the heritage. Then again, it also mentions the moment when it stops at restoration and begins with reconstruction when the conjecture is visible. Only traditional techniques are permitted for restoration, otherwise it will be reconstruction or conservation. Independently of what technique or approach is chosen, there should always be respect for the heritage, its style and history. The new parts should be integrated with the complete heritage, its style and history. The new components should not be a distracting factor of the heritage and its surrounding.

Reconstruction is similar to the definition of restoration; however, introduction of new material is allowed according to the Burra charter (ICOMOS, 2013). The Riga charter (ICCROM, 2000) says reconstruction is required when the heritage is incomplete due to damage or tragic loss by disasters where recovering cultural significance is required. When reconstruction is performed, it must be legible, reversible and least impacting for the heritage and presentation of the location. Also, reconstruction can be an interpretation restoration or a replication of a previous form, but this must be clear in appearance. The Venice charter (ICOMOS, 1964) states that when reconstruction is applied, the reassembling of components can be integrated, but should always be recognizable as reinstatement of its form. In paragraph 2.4 'Traditional materials versus glass' the discussion and options are reflected regarding the reconstruction of heritage.

Conservation is according to the Burra charter (ICOMOS, 2013) 'all the processes of looking after a place to retain its cultural significance'. This is part of a regular inspection and cleaning of the place. The Nara charter (ICMOS, 1994) mentions the importance of understanding the cultural heritage based on history, material and presentation. The Riga Charter (ICCROM, 2000) states that maintenance and repair based on the historical period style of the heritage is the primary focus of conservation. Finally, Venice Charter (ICOMOS, 1964) mentions heritage as ruins must be maintained for permanent protection as undiscovered objects should be protected. New constructions, demolition or modifications which can impact the mass and color in relationship with the heritage are forbidden.

2.2 Guidelines for reconstruction of monuments

Understanding history

Every monument has a history. Through time, it has been maintained or changed with the ideas and technology of that period. Therefore, the original style and statement and every choice through time is a layer which is an important and crucial part of history. So, this must be respected and considered when reconstructing the heritage. Even when the group of conservators do not accept this approach. Orbasli (2008) believes integrity is part of understanding history before reconstruction can start. Therefore, the physical, structural, design, aesthetic and context integrity should be considered. A historical study is an important part of this process as the architect must work with the available evidence. Only then, choices in material, technique and approach can be made.

Minimalizing intervention

As new materials are added to the heritage in the reconstruction process, this should interfere with the traditional materials as little as possible. The application must blend in as the new object has to be integrated in the whole heritage and surrounding. As the Venice charter in article 12 states: the missing parts of the heritage can be replaced but this must be done distinguishable from the original. This way, the new element can be integrated but not be used as part of the original historical evidence. Also, it is an honest way to repair the heritage by adding an extra layer of history. Orbasli (2008) believes authenticity is related to form, material, techniques and traditional processes, context and function. This can be different per culture and region as the Nara charter stated. Therefore, it is important to understand the context and for who the heritage is most important with regard to cultural value.

Maximizing reversibility

The new object and materials should be reversible and not leave marks when it is removed. This means dry-assembly or bolted connections are required. Also, the difference in material properties should be considered as this can damage the heritage even when it is applied with a reversible connection. Furthermore, the reversibility is applicable for the function of the building as this can change through time. Therefore, the reversibility is not only important for remaining the heritage in the original state, but also for economic, cultural and identity value. Finally, the sustainability of the new object should be considered. The perspective of sustainability is not only the material usage and the recycling possibilities, but also to protect the function of the building (Orbasli, 2008).

Analyzing finance

Depending on the material and technology approach, the financial part should be considered. The parties will not only base their decision on the architectural and historical perspective, but also if it fits the budget. Therefore, an analysis should be considered for traditional approach of restoration and new approach of reconstruction. New techniques might be required due to new challenges to avoid structural failures. For example, due to earthquakes the building became instable and needs permanent reinforcements to make sure it is conserved for the future. For that reason, a structural analysis is required (Orbasli, 2008 and Stanley-Price, 2009).

2.3 Brief history of the restoration debate

For centuries people are maintaining heritages for re-using buildings but also for technology knowledge as a case study. Since the 17th century, conserving heritages became more popular. This was only performed by wealthy people who were interested in historical artifacts. Since the 20st century, historic preservation became part of law system in the Western world.

In the field of historic preservation, there are two opposing movements according to Barou, Oikonomopoulou, Bristogianni, Veer and Nijse (2018). There is one movement that wants all heritages restored to their original state, including the use of original materials and techniques. A sub-division of this movement feels that buildings can be conserved by only performing the minimum required maintenance. A second movement states that heritages should be used for the needs of today and therefore, reconstruction is required even if new materials and techniques must be introduced. This includes adjusting the heritage according to sustainable codes in order to connect the past and future. According to Bridney (2019) and Frey (2019) there is a third movement. This group is not a fan of heritages as they do not believe in the cultural and historical value of buildings and therefore criticize the cost of maintenance, which, in their opinion, is higher than to realize a new building.

A historical example of the second movement (reconstruction): Viollet-le-Duc's approach of restoration regarding Gothic cathedrals was also under discussion in his days. He designed imaginary aesthetic unity and disregarded the heritage's history. This was in his time a modern approach of renovation. He integrated all latest techniques and materials in his design. When this was realized, it was visible what was new and what was the original part of the heritage according to Orbasli (2008). Now, most people would not realize the approach of Viollet-le-Duc and believe it is the original design due to aging of the materials.

2.4 Traditional materials versus glass

Most of the traditional structural materials are solid and non-transparent or non-translucent. When reconstruction is performed with a solid material, the scene behind this structure is hidden from the users of the building. For example: in general, most of the users of historical buildings do not realize heritage dome or vault roofs contain two parts. The idea of blur interpretation of the original material is represented by transparency and translucency (Barou et al, 2018). What if the interior roof of this structure is transparent, the user will realize there is also an exterior roof. This way, the structure of the building will be more transparent. There are different ways to create transparency with structures (Barou et al, 2018): 1) By only outlining the general shape of the missing object (see figure 10) and 2) by using transparent materials (see figure 2.2).

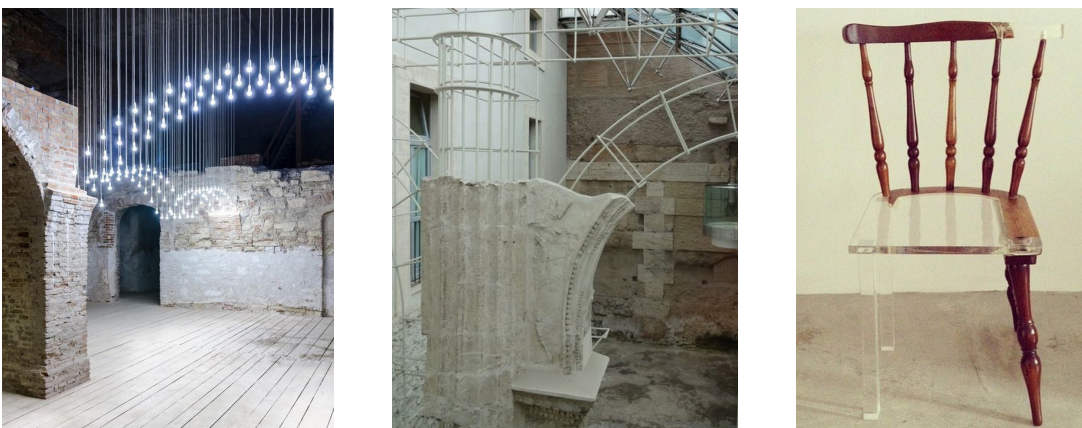
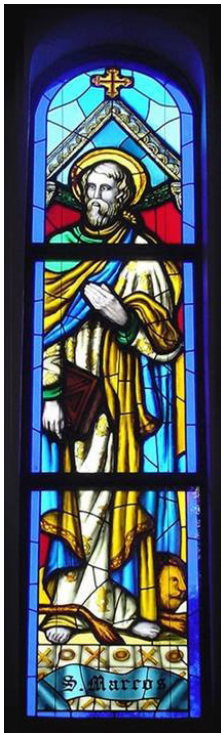

Figure 2.2: Outlining with light (left), outlining with wire (middle) and use of transparent materials (right). Retrieved from Fleseriu and Eszter (2016), Marigliani (2014) and Freitas (2010).

Glass

Glass is a material which is used in architecting for a long time e.g. windows for churches (Eskilson, 2018). In the 19th century, glass was used to create complete buildings as steel was used as sub-structure. In this period, they were able to make bigger glass plates thanks to the floating glass production process. This will be discussed later in the chapter 4 'Structural glass'. From then, glass was used for more transpiration. For commercial purpose, shops became more transparent as they wanted to attract people in their shop. Later, bigger windows were used for residentials. This was not only done with glass sheets, but also with hollow glass blocks. Nowadays, complete glass buildings are realized without other material substructures. See figure 2.3 for the transformation of glass in buildings.



a



b



c



d



e

Figure 2.3: Transformation flow of glass in architecting. Church windows (a), full glass with steel substructure, Crystal house (b), commercial use of glass (c), hollow glass blocks (d) and full glass structures (e). Retrieved from Eskilson (2018).

Glass is a material which can be made (non) transparent and (non) translucent depending on the recipe. The properties of glass will be discussed later in this literature research. In general, glass is as strong as concrete without reinforcement in compression. The density of both materials is also almost equal. Also, glass is stiffer than traditional materials. Therefore, it can be designed more optimal and less weight is required to load on the existing structure than original structure. In later process, the effect of reducing weight on the existing structure will be shown as this can result in positive but also negative results. The optimization of glass design should take this into account. Heritage structures are mostly made from bricks or stones which are brittle materials. These materials only function when structures are designed as primarily compression load walls, arches, and vaults (Barou et al (2018)). Thanks to this, glass can be used as a structural material which creates an almost dematerialized intervention as it is transparent.

According to Barou et al (2018), by using glass, the theoretical guidelines of restoration and glass technology are feasible for consolidation and reuse of historic buildings. Glass shows all layers of history and is free for own interpretation. Glass is a scar of a tragic event and is therefore an honest material to use for reconstruction purposes. Also, glass can be applied to a structure based on reversible design. Therefore, the heritage will not be damaged as it is not permanent connect to the new material. Next to this, the visual effect of glass can be done by the shaping potential of cast glass. Complex shapes can be made with cast glass. Even if the structure is not transparent, glass can still be used as alternative material to realize complex geometries.

In comparison with traditional materials, glass is durable in resisting the weather factors (e.g. water, UV), but it also protects the building itself from these factors. Also, the property, color and transparency of glass do not change when it is aging. Therefore, the lifespan of the material is longer than with traditional materials (Barou et al, 2018)

Barou et al (2018) developed a methodology for designing with glass for heritage structures. Degree of intervention as:

- Protection of the historic fabric;
- Reinforcement by filling of the form;
- Adaptive re-use;
- Reproduction of craftsmanship.

Degree of representativeness as:

- Treat older monuments with greater respect;
- Determine the social, religious, education, symbolic and aesthetic value as place of memory.

Assessment of glass types & Comparative restoration strategy with structural glass:

- Float glass as abstract representations;
- Cast glass as realistic representation;
- Extruded glass for exceptional purpose;
- 3D printed glass for exceptional purpose.

2.5 Case study: Notre Dame de Paris

The Notre Dame de Paris, also known as 'Our Lady of Paris', is a cathedral and is located on an island, Ile de la Cité, in the middle of the center of Paris, France. Bishop Maurice de Sully started the construction in 1160 which spans more than 200 years and was financed by the king of France Louis VII (Borrus, 2019). The Gothic's cathedral was replacing four churches which used to be Roman temples. When the construction was completed, it became a place of pilgrimage as it is the house of three items of Christ. Later, many other religious activities were connected to the Notre Dame de Paris to make sure it will exist in the future. Many kings were crowned in the Notre Dame de Paris as it was marked as center of France and their religion.

During the French revolution, the Notre Dame de Paris became the Temple of reasons as it should promote the universal religion of 'liberty, equality and fraternity'. In this period, a part of the Notre dame was on fire and destroyed as materials were re-used for weapons and other buildings. In this fire, the spire on the roof disappeared. Also, parts were destroyed as the people assumed it was related to the French kings. See figure 2.4 and 2.5 for an impression of the Notre Dame from the Middle Ages till the French Revolution.



Figure 2.4: Notre dame in the Middle Ages on the background (left) and the map of Paris in 1600 (right). Retrieved from Arrivée de Louis II d'Anjou à Paris (n.d.) and Musée Carnavalet/ Rogier-Voillet.



Figure 2.5: Inside the Notre Dame before the French Revolution (left) and the attack on the Notre dame during the French revolution (right). Retrieved from unknown and Granger Historical Picture Archive.

After the French Revolution Napoleon Bonaparte was crowned as emperor of the French. After him, other coronations followed in the Notre Dame de Paris. In 1838, Daguerre, who was a chemist, made his first experimental photograph of the Notre dame. In figure 2.6, the spire is not visible anymore, which was destroyed during the French Revolution.

In 1844, architect Viollet-le-Duc made his layer in the history of the Notre Dame de Paris. The cathedral was neglected for years and was visibly damaged due to the French Revolution. So, he replaced the spire, damaged facades and sculptures and updated the flying buttresses due to wind forces (Courtenay, 1997). As mentioned before in paragraph 2.2 'History of the restoration discussion', Viollet-le-Duc had to withstand many criticisms from cultural superiors as they believed this renovation would be worse than leaving the building in its neglected state. Viollet-le-Duc argued with the Ecole des Beaux-arts in Paris by stating the architects from that school are nothing more than imitators of historical buildings. His vision was not to create a replica of the building but use the best available materials and most innovative engineering to construct the cathedral to one of the greatest Gothic structures in that period. This way, Viollet-le-Duc was able to continue his vision regarding the Notre Dame de Paris and many other Gothic buildings from then on. The reconstruction of the Notre Dame de Paris was finished in 1911. During World War I and II, the cathedral was protected with sandbags. The damage during these wars was limited e.g. broken windows and bullet holes, see figure 2.7.

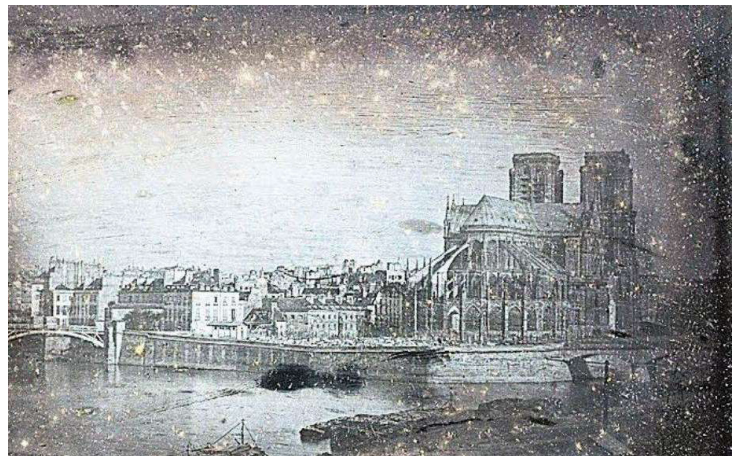
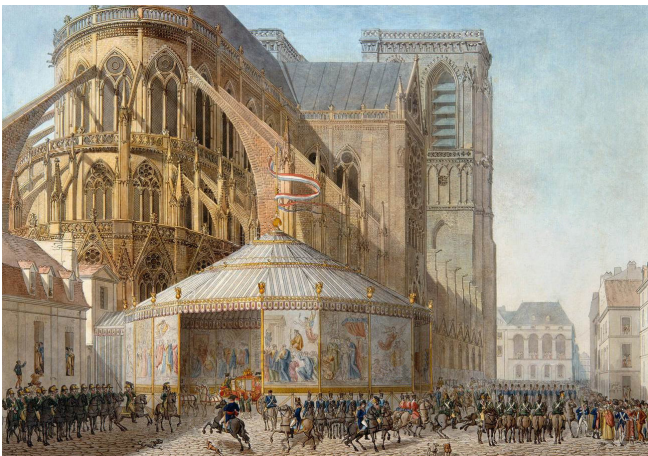

Figure 2.6: Arrival of Napoleon at the Notre Dame (Left) and first photograph of the Notre Dame. Retrieved from Fontaine (1804) and Daguerre (1838).

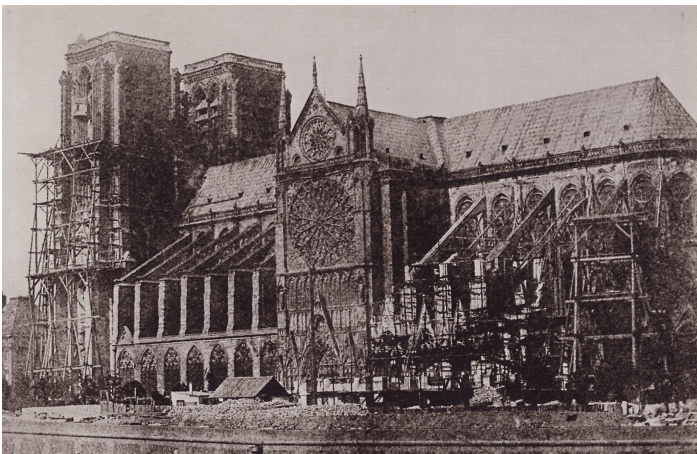

Figure 2.7: Notre Dame during the renovation of Viollet-le-Duc (left) and sandbags for protection during WW I and WW II (Left). Retrieved from Brination (2019) and Judd (2019).

On April 15, 2019 the cathedral caught fire when it was under renovation. The spire, oak roof beam supported roof and a part of the masonry arch vault was destroyed. In two days, € 1 billion is collected to fund the renovation of the Notre Dame de Paris. See figure 2.8 for the impressions before and after the fire.

The question is now what the future will be for the Notre Dame de Paris. Before the fire, the cathedral had four layers of history: 1) original, 2) French Revolution, 3) Renovation of Viollet-le-Duc and 4) World war I and II. Now a fifth layer will be added due to this big fire that destroyed the roof and spire. How this layer will be shaped will be known in the future, but some modern architects already visualized their vision regarding the reconstruction of the roof, see figure 2.9.



Figure 2.8: Exterior before the fire (top), the fire (middle), Interior before & after the fire (bottom). Retrieved from Brination (2019) and Shaw (2019).



Figure 2.9: Glass roof proposal from Nerovnya (top), from Fantozzi (middle) and from Callebaut (bottom). Retrieved from ABC news (2019), Abramovitch (2019) and CBS news (2019).

Structural elements

The general dimensions of the Notre Dame de Paris are 130m long, 48m width, 32,5m vault high and 45m wooden roof high, see figure 2.10 (Vannucci, Masi and Stefanou, 2019). The Western towers are 69m high but is excluded in this research.

According to Vannucci et al (2019), structures like the Notre Dame de Paris are based on compression only, as the materials are brittle and cannot resist tension. It is one of the cathedrals which included extreme wind forces in the renovation process. As mentioned before, Viollet-le-Duc included it by adjusting the flying buttresses. Every structural unit is a modular element. One structural unit is 12m long and the width of the cathedral. The vault is a sexpartite, which means each vault contains six arches. In the center of the vault, a keystone is placed to connect all six arches. The material which is used for these vaults is limestone from the north of France. The thickness of the vault is 60cm and this is exceptional as other vaults are around 20cm thick. Properly, the builders increased the thickness of the vault as the Notre Dame de Paris was aiming to be the largest cathedral in Europe (Courtenay, 1997). Due to many renovations through the years and the different composition of the mortar, the general properties of limestone will be used in this research, see table 2.1. When the reconstruction of glass is a potential option, samples have to be taken and tested to understand the type and properties of the direct limestone. See figure 2.11 for the exploded view of the complete Notre Dame de Paris.

Table 2.1: General properties of Limestone. Retrieved from Barou et al (2018).

Property	Unit	Limestone*
Density	10^3 kg/m^3	2.55-2.6
Young's Modulus	GPa	35-55
Compressive Strength	MPa	30-200
Tensile Strength	MPa	8-22
Thermal Expansion Coef.	10^{-6} K^{-1}	3.7-6.3
Thermal Conductivity	$\text{W/m}^\circ\text{C}$	0.92-2.15
Porosity	%	0.006-0.12

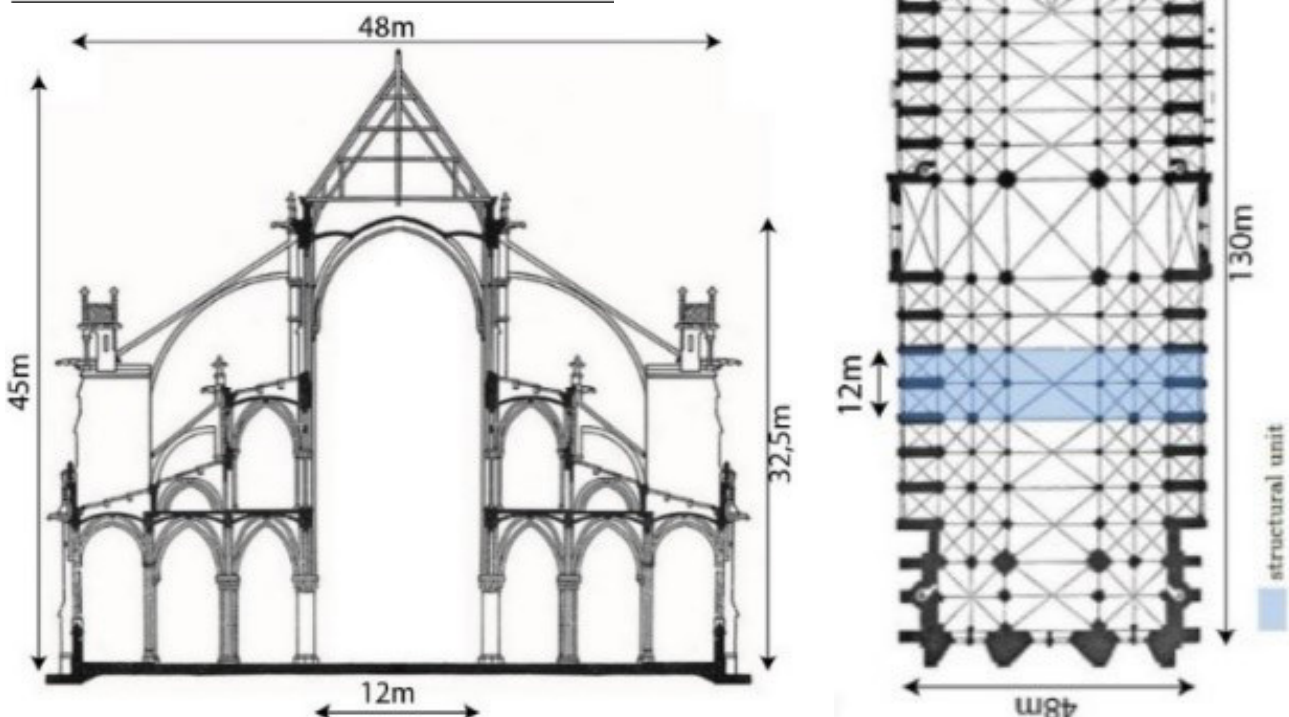

Figure 2.10: Section (left) and plan view (right) of the Notre Dame de Paris. Retrieved from Vannucci et al (2019).

NOTRE-DAME OF PARIS

Notre-Dame was the same shape as the older Romanesque cathedrals, but was far taller and lighter, with pointed arches and vaults, and stained glass windows to let in plenty of light.

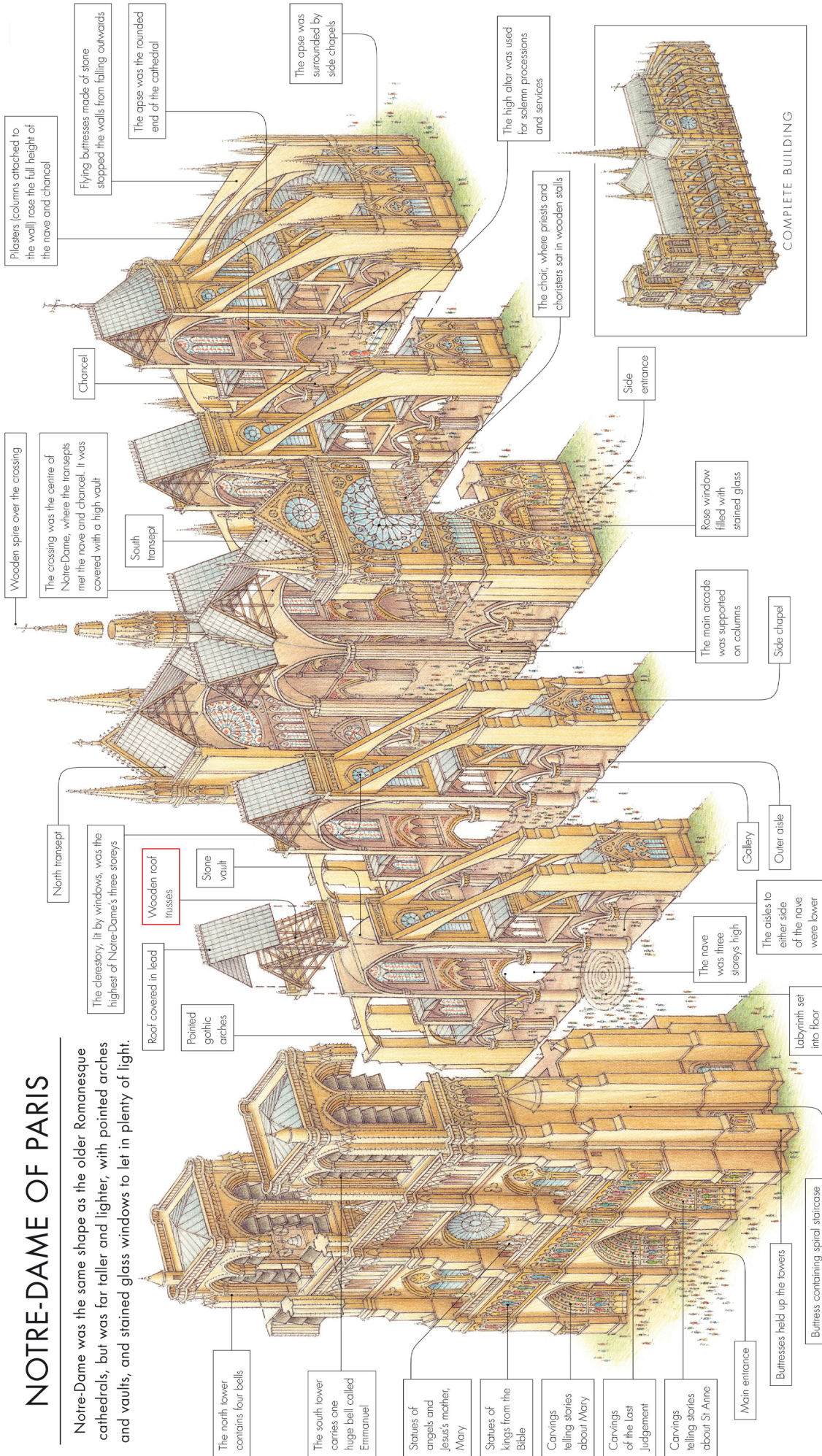

Figure 2.11: Exploded view of the Notre Dame de Paris. Retrieved from Dillon (2014).

2.6 Discussion

As monumental buildings are part of our past which includes knowledge, tradition and culture of generations of people, maintenance is a high priority to keep these buildings in our life. It is an object that represents a cultural identity as this is important for most people in a world where everybody is connected. For the case study, a part of the rib vault of the Notre Dame de Paris is chosen for this research. It was damaged due to a disaster, the fire in April 2019. Therefore, the approach will be a reconstruction instead of restoration or conservation as a new material, structural glass, and technique will be introduced. There are two opposite movements in the historic preservation: 1) Keep it in the original state and 2) Adjust the building for the needs of today with the newest technology which is available.

In this thesis, the approach of the second movement will be followed as the case study will be a heritage which will be reconstructed after damage with new materials. Many people will be against this approach; however, the historical layer of the Notre Dame de Paris should be maintained for future generations. As Barou et al (2018) mentioned: *'If architectural conservation is assumed to be the process of managing the change, what better way to leave our trace as a society of continuous change, technological advancements and innovation.'*

By using glass, a blur interpretation of geometry is made. This way, glass is a scar of a tragic event and is an honest material to use to reconstruct the Notre Dame de Paris, as long as the new structure can be reversed without damaging the heritage.

Guidelines

Before realizing reconstruction of the Notre Dame de Paris, several guidelines should be applied. First, a historical study must be performed to understand the building's history. This includes all maintenances but also the physical and structural design, aesthetics and context integrity. By doing this, the degree of intervention can be determined with the new structure. Minimalize intervention as much as possible with the traditional materials. Missing parts should be repaired but must still be visible as this is the honest way to repair the monument. This includes the maximizing reversibility of the new object as it should not leave marks when it is removed. Finance is out of scope in this project. Assessment of what type of glass can be used is part of the strategy. For this thesis, the cast glass is considered as it has a realistic representation of the lost structure.

Case Study: Notre Dame de Paris

The cathedral has five important layers of history:

1. Original (Centre of France and coronations of kings);
2. French Revolution (End of kingdom and coronation of Napoleon Bonaparte);
3. Renovation of Viollet-le-Duc;
4. World war I and II;
5. The reconstruction after the fire in 2019 (ongoing reconstruction).

The question is now what the future will be for the Notre Dame de Paris. For a historical building as the Notre Dame in Paris, it is an important building in cultural, religious and identity value for the French and many people in the world. Therefore, the statement for the Notre Dame de Paris in this thesis is:

Renovate the exterior roof as it used to be in appearance, but the interior rib vault can be reconstructed with glass technology as a signature of this time period. It will be a scar and a visible layer in history for this building.

3 Arch vault structure

There are many variants of vaults e.g. rib vaults, Nubian vaults, and groin vault. The Notre Dame de Paris has damaged rib vaults and therefore this will be the focus point in this chapter. In this chapter the principle of vault structures and how they were built will be discussed.

3.1 General

Every structure must be safe and must meet many safety regulations. Structural criteria are applicable for every structure, so also the masonry arch vault. The main criteria for structural safety are:

- Strength (no failure);
- Stiffness (acceptable deflection);
- Stability requirements.

Strength is not only applicable for dead weight, but also for (un)equal variable distributed forces e.g. wind forces. The structure must be stiff enough as it may not contain large unstable displacements. This can be caused by dead weight, but also due to (un)equal variable forces (Heyman, 1995).

3.2 Arches & their support system

Arches are curved lines which mainly transfer downward loads as compression forces. Gaudi is one of the famous architects who used chains and weights to create a full compression structure by mirroring the shape of the chain, see figure 3.1. The idea is that the chains will be under full tensile stress due to gravity and will find its own optimal shape. Different than with chain cables, arches are the opposite of chain cables, but it must resist gravity. Therefore, the structure is under full compression, but also stiff in bending and shear. The outcome of bending and shear of an arch will always be less than a regular beam structure (Welleman, 2019).

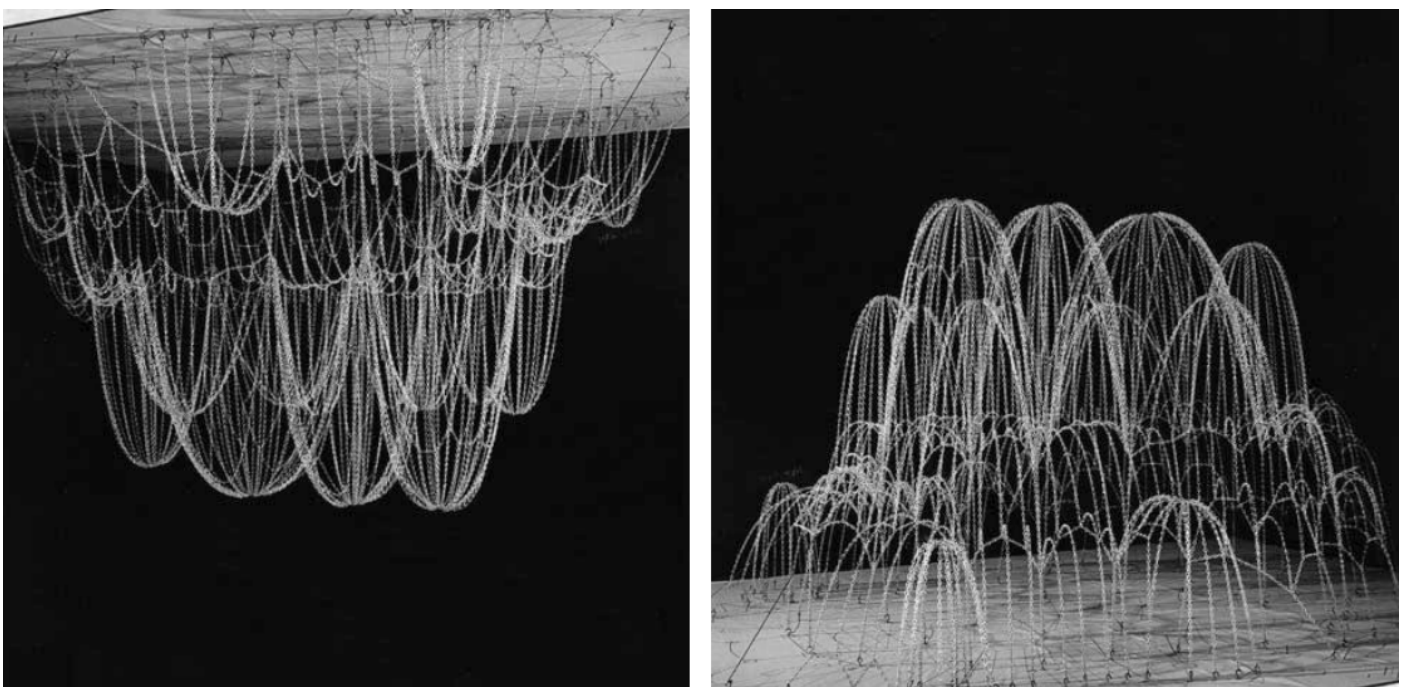

Figure 3.1: Gaudi's research to chain models and compression only structures. Tensile model (left) and compression model (right). Retrieved from Welleman, 2019.

Thrust line

What Gaudi was trying to achieve is finding the thrust line. The thrust line is an internal force flow which passes through a structure, Hooke's study of the catenary curve (Rippmann & Block, 2018). This is also known as the ideal shape for an arch as only compression force occurs. However, the thrust line for dead weight is fixed, but variable forces e.g. wind and point forces cause a shift of the thrust line. See figure 3.2 for examples of the thrust line and variable forces. The parabola is created by a horizontally distributed load. A catenary ideal shape is created by a distribution along the cable.

The shape of the arch has a limited effect on the thrust line, but the thrust line should stay within the arch. Eccentricity will occur as the thrust line is not on the centroidal axis of the arch. This will create a momentum in the structure with consequence that tensile stress will occur. For brittle materials this means failure of the structure. The thrust line will never be perfect on the centroidal axis of the arch due to construction mistake or variable forces on the structure. According to Hoogenboom (2018) and Eigenraam (2019), no tension occurs when the eccentricity is smaller than $\frac{1}{6}$ of the thickness. This means when the thrust line is in the middle $\frac{1}{3}$ of the rectangular cross section, there is no tensile stress in the structure. This is also known as the 'middle third rule' for shell structures, see figure 3.3 for the scheme.

There are many ways to build a vault as this is performed for more than thousands of years, Mallikarjun (2017). The most used arches in cathedrals are groin vaults (intersection of semi-circular vaults) and rib vaults (where the pointy arches perform as ribs of the structure) according to Encyclopedia Britannica (n.d). After experimenting, the builders understood that rib vaults can distribute the forces better, which means the cathedrals could be built bigger, see figure 3.4.

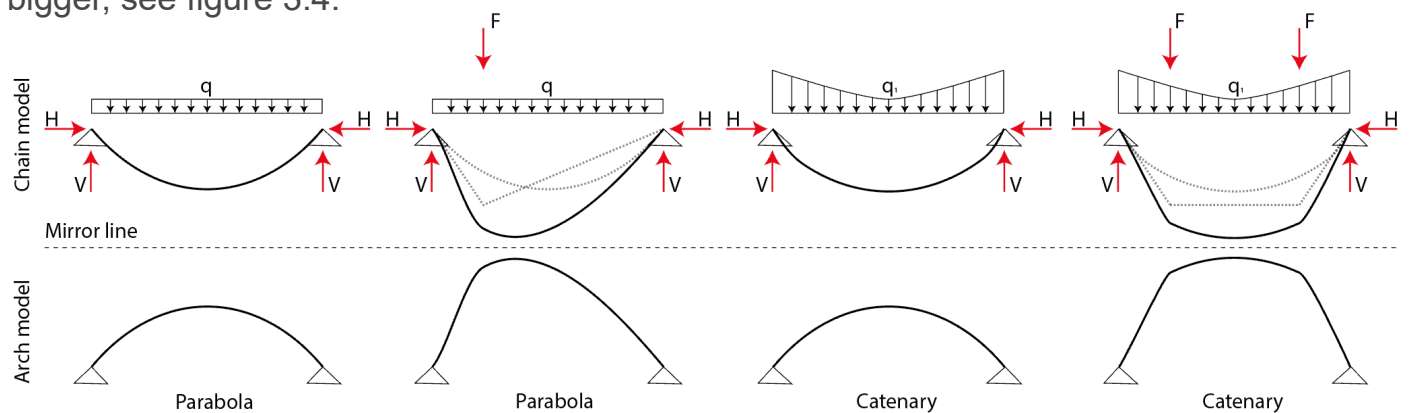

Figure 3.2: Ideal shape of an arch based on the thrust line. Based on Welleman (2019).

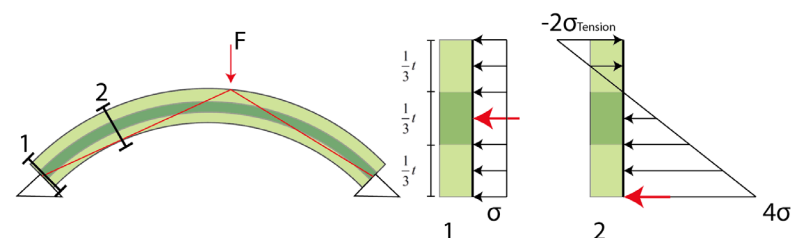

Figure 3.3: Thrust line and stress distribution due to eccentricity. Based on Hoogenboom (2018) and Eigenraam (2019).

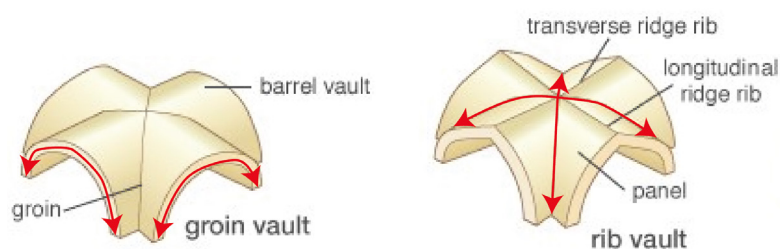

Figure 3.4: Distribution of forces Groin vault (a), rib vault (b) and Reaction force based on the force flow in the structure(c). Based on Encyclopedia Britannica (n.d.) and Heyman (1995).

3.3 Masonry arch vault

The general structural criteria are strength, stiffness and stability as mentioned before. For a masonry arch vault, the following structural criteria are assumed (Heyman, 1995):

- Masonry arch vault must be designed for compression only structure;
- Tensile stress is only applicable due to forces additional to the dead weight;
- There is no sliding failure due to compression and interlocking.

Tensile stress must be as low as possible in the structure due to the brittleness of the materials. When stress concentrations arise, this can lead to cracking of the materials followed by failure of the structure. Therefore, the focus should be on compression only. In general, masonry arch vaults are stiff and designed such that tensile stress is low. For stability, it is important that the arches and supports do not buckle due to horizontal forces, see figure 3.5. The flatter the arch is, the bigger the horizontal force will be. This force needs to be absorbed by mass of the structure to avoid failure. For cathedrals, the horizontal force issue was solved by adding (flying) buttresses. At the end of the buttresses, there was an ornament as added weight to push the forces downward into the column (Courtenay, 1997), see figure 3.5. Sliding failure only occurs when there is a general loss of cohesion.

As mentioned before, the eccentricity causes a momentum. This can result in deflection, which can impact the stability and can cause the failure of the structure (Heyman, 1995). Figure 3.3 shows what happens with the stress in the structure when the thrust line is not in the middle $\frac{1}{3}$ of the structure's cross section. When this occurs, hinges can appear in the structures where the mortar layer is located. Thermal expansion or other factors can give the structure the last push to fail. Heyman (1995) has provided a simplified illustration, see figure 3.6. The solution of this problem can be solved by adding more mass to the structure to make sure the thrust line is not deviating from the center axis. Traditionally, this is done by filling up the space between the wall and the vault with rubble to push the forces more downwards (Courtenay, 1997).

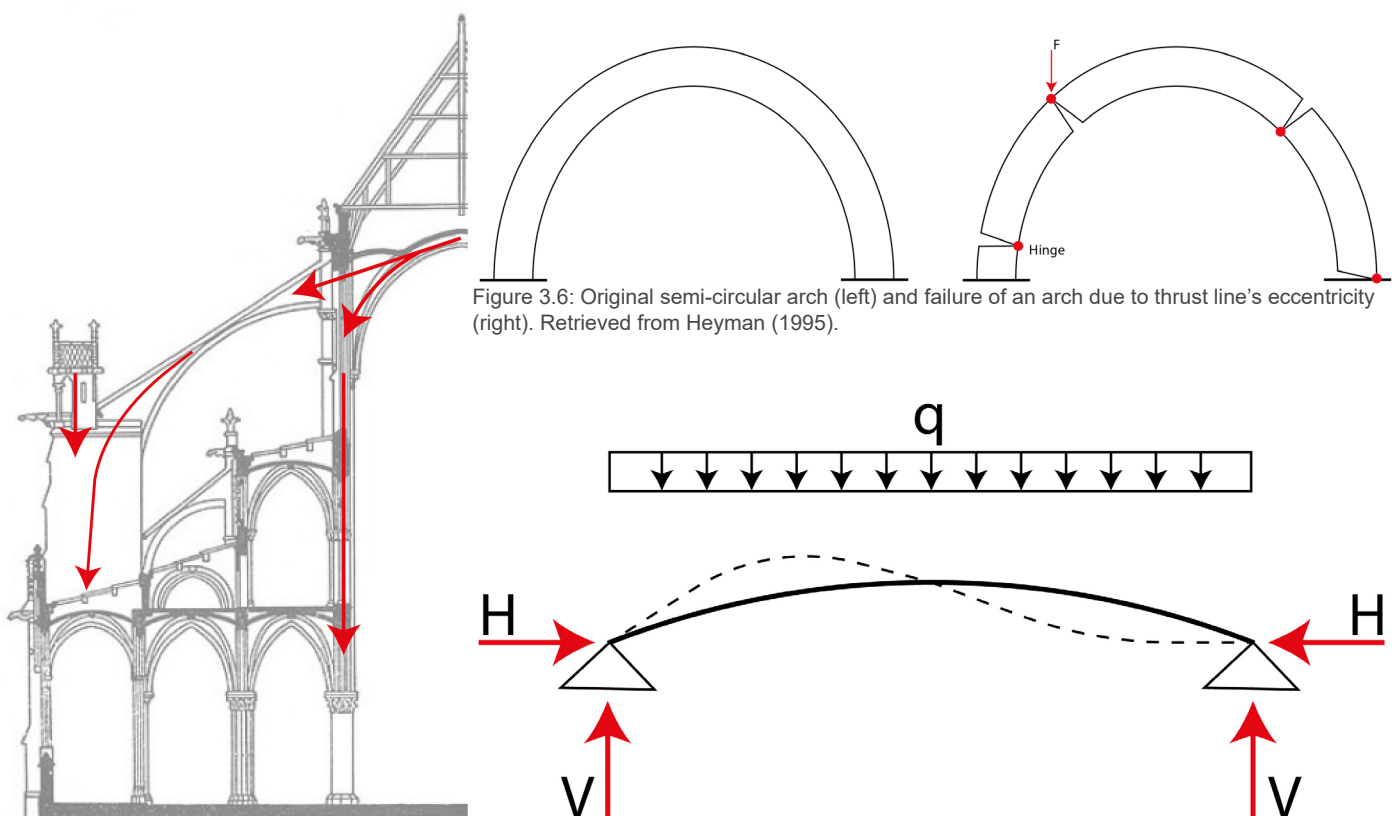

Figure 3.6: Original semi-circular arch (left) and failure of an arch due to thrust line's eccentricity (right). Retrieved from Heyman (1995).

Figure 3.5: Buckling of an arch (left) and flows in arch vault via flying buttresses of the Notre Dame de Paris (right). Based on Courtenay (1997).

The geometry factor of safety

In theory, building a structure based on the thrust line will be the most optimal material saving option. However, to determine the actual thrust line and realize this practice is difficult and full of risks. The risk would be an error in installation or a greater variable (distributed) force which will cause a momentum in the structure. The left figure of figure 3.7 shows the boundaries of a vault structure. The chance of failure is greater than adding an extra factor to create more mass to make sure the thrust line is in the middle $\frac{1}{3}$ structure's section. A factor of 3 can be applied to the structure to ensure the thrust line is in the middle $\frac{1}{3}$ structure's section. Then again, in practice a factor of 2 is used to include the imperfection during construction and other factors. These factors are only applicable for forces which are loaded on the structure as the shape of the arch is already based on the dead weight's thrust line. Also, unequal distributed and point forces should be considered as a scenario (Heyman, 1995). This is especially applicable for the Notre Dame de Paris as it is the highest building in the surroundings. Therefore, extreme wind forces must be included.

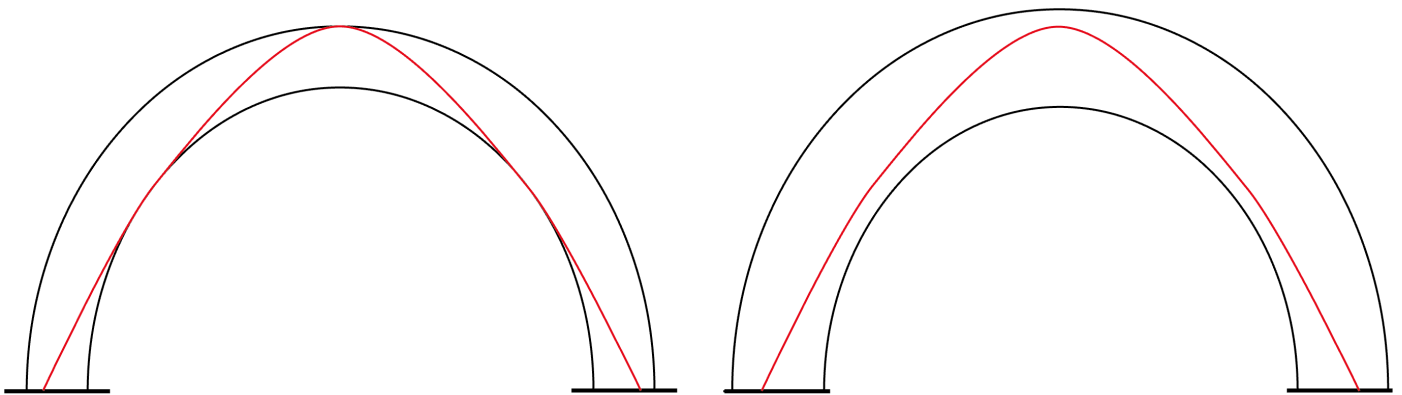

Figure 3.7: Arch where the thrust line is eccentric (left) and safe geometry without eccentricity (right). Retrieved from Heyman (1995).

3.4 Traditional construction process

Constructing arches are performed all over the world. For West-Europe, the cathedral's rib vaults used to be constructed with wooden supports. These vaults contain baked-clay or limestone bricks as this is the most available material in the region. The definitions of the vault's components are shown in figure 3.8.

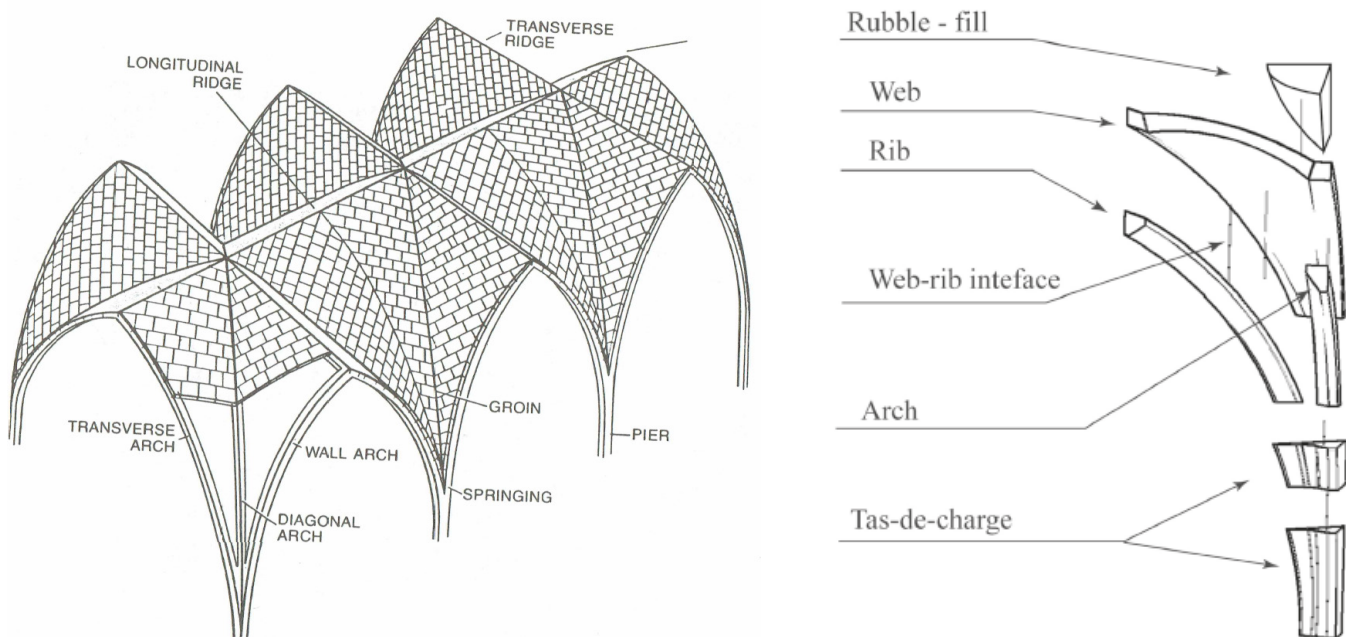
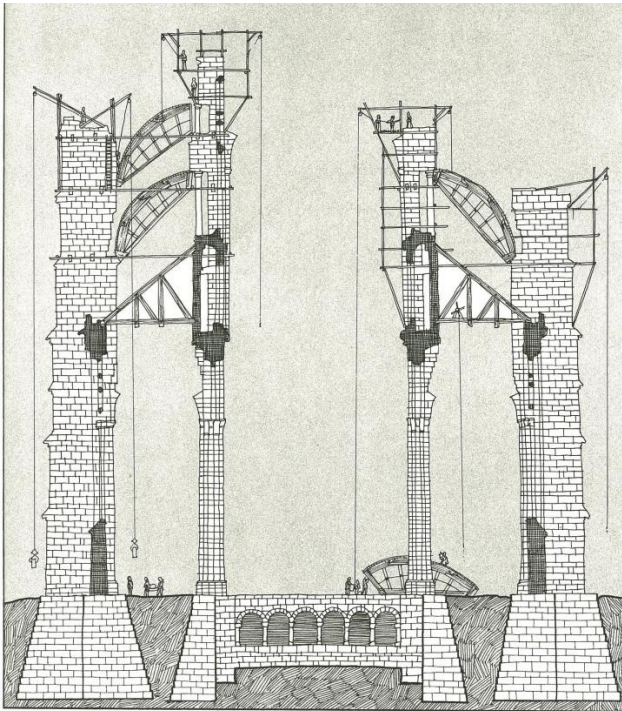
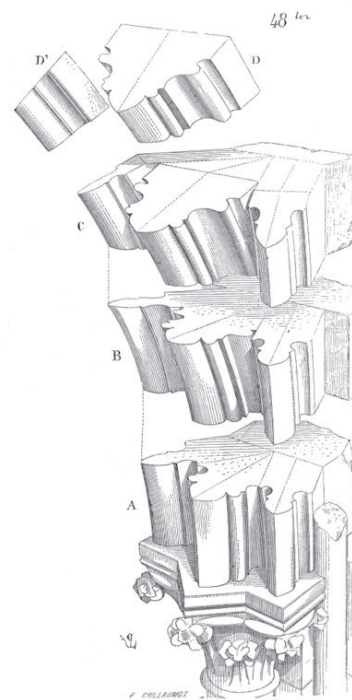

Figure 3.8: Definitions of the vault's components. Retrieved from Courtenay (1997).

A masonry arch can only function as curved line support system when the construction is completed and the arch's ends are constrained (Heyman, 1995). Therefore, the building phase is critical for realizing the arches. As shown in figure 3.9, first the columns and (flying) buttresses were constructed. Then a scaffolding and wooden framework were built. The framework was used for temporary support during construction, but also as guideline. Therefore, it is important that the carpenters work is precise. Bricklayers will brick the arches from bottom to top equally on both sides. Where the arches meet, a keystone is placed. When the ribs are bricked, the web between the arches can be completed. By adding weight with rubble in the corners where the arches come together, the thrust line is pushed downwards to make sure it stays within the structure. When the structure is completely dry, the temporary framework is removed, and the ceiling can be finished.



1: Buttresses & columns



2a: Bricklaying arches

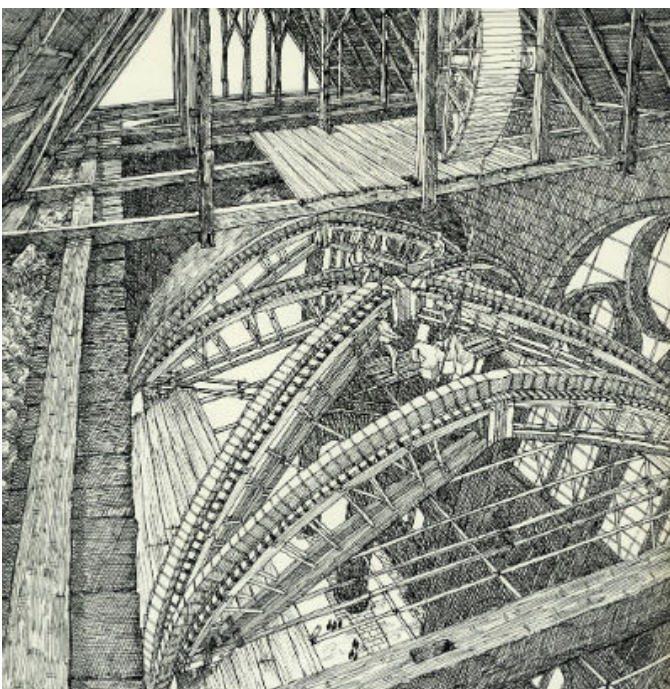

2: Wooden supports & bricklaying arches

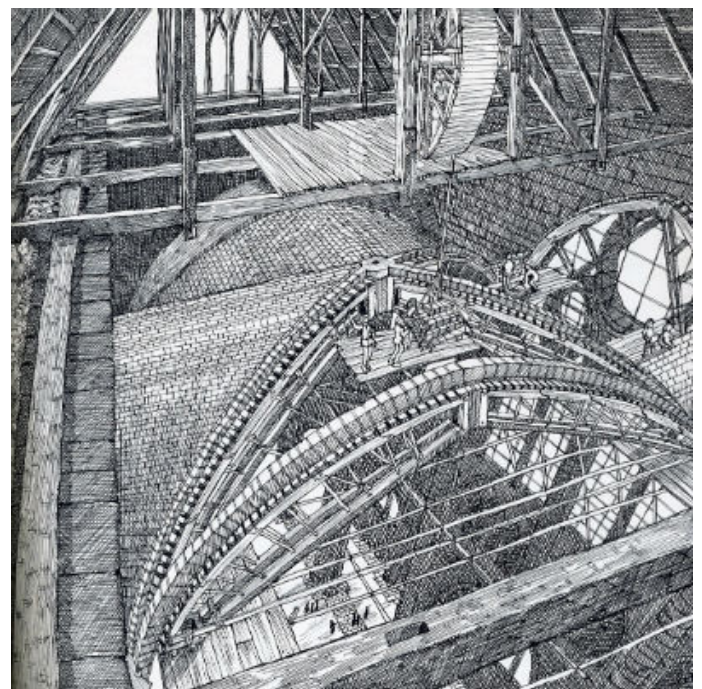

3: Webbing between arches & add rubble.

During the construction phase, imperfections always occur (Heyman, 1995). When the temporary framework is removed, stresses in the structure will occur. This is caused by the self-weight of the structure as it is looking for a stable position. This can cause displacements at the supports or in the middle of the arch (keystone). Therefore, tolerances are required to make sure the structure can move due to this settlement or external forces. The tolerances can function as a designed hinge without failure of the structure (Heyman, 1995 and Courtenay, 1997). Imperfections of the arch are shown in figure 3.10. When designing with glass, the imperfections can be part of the design strategy.

A method to avoid cracks due to the imperfections is by adding tolerances in the key stone when an arch is overreaching. This way, the arch will deflect in the shape as designed when the framework is removed, see figure 3.11. Another method is to implement a horizontal adjustable support on one side. This way, an imperfection at the bottom of the keystone can be solved, see figure 3.12 (Heyman, 1995). The last method is also used these days for big constructions which need tolerances e.g. bridges.

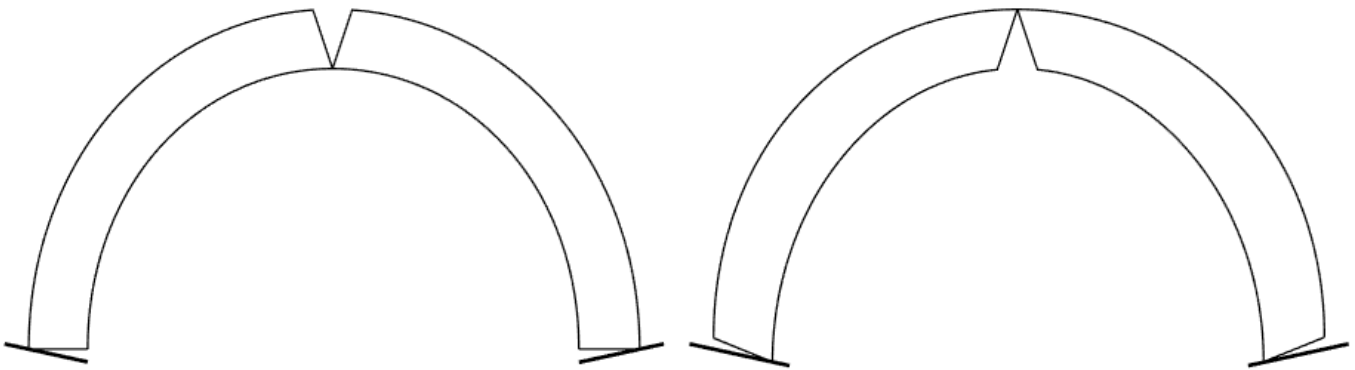

Figure 3.10: Imperfections after removing the framework. Based on Heyman (1995).

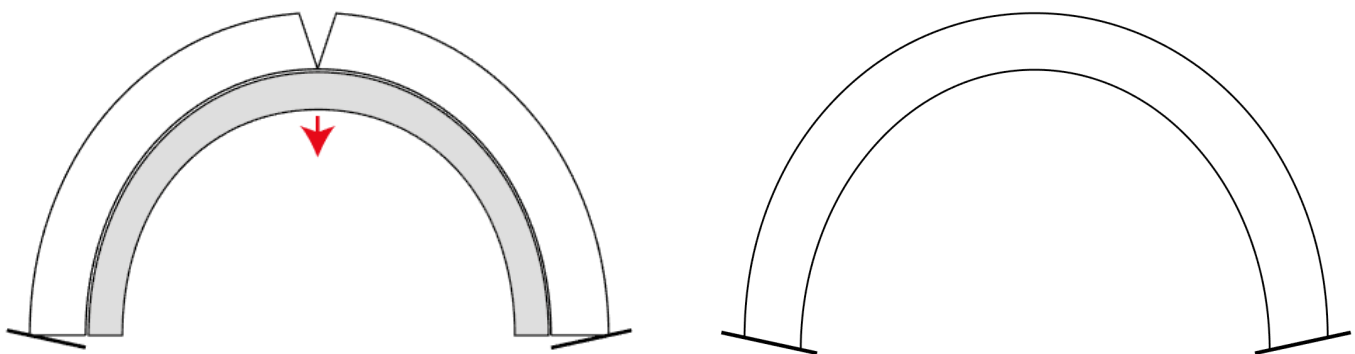

Figure 3.11: Method 1 to avoid and to reduce cracks due to imperfections. Based on Heyman (1995).

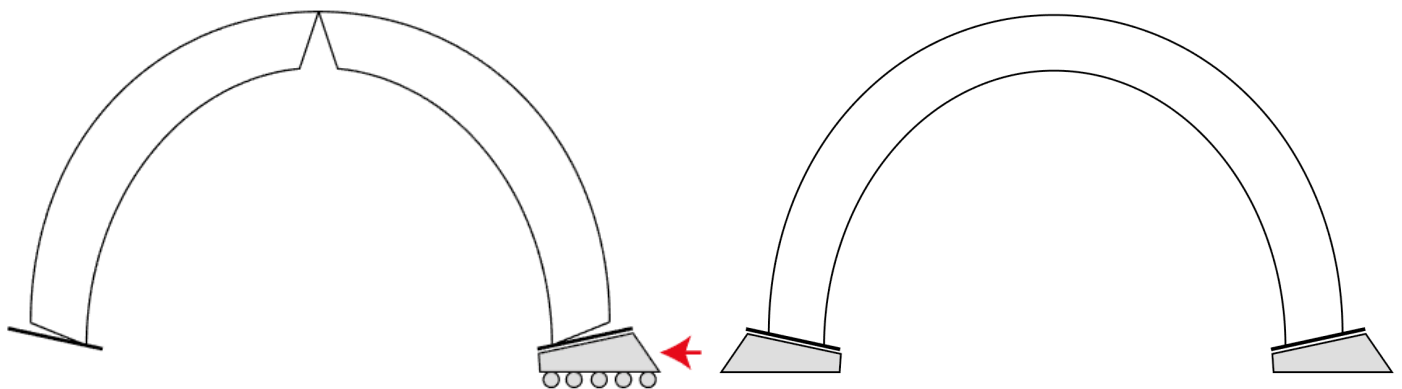

Figure 3.12: Method 2 to avoid and to reduce cracks due to imperfections. Based on Heyman (1995).

3.5 Discussion

The rib arch vault should meet the three general structural safety requirements:

- Strength (no failure due to tensile stress of the brittle material);
- Stiffness (acceptable deflection);
- Stability (no buckling).

Next to these requirements, the masonry arch vault should also meet the additional structural criteria:

- Masonry arch vault must be designed for compression only structure;
- Tensile stress is only applicable due to forces additional to the dead weight;
- There is no sliding failure due to compression and interlocking.

Also, strategy for facing the intolerances during production and assembly phase should be part of the cast glass design. This way, the chance on failure due to intolerances is reduced.

As glass, like other traditional materials like limestone in the Notre Dame de Paris, is a brittle material, the arch must limit tensile stress. Therefore, the eccentricity should be in the middle $\frac{1}{3}$ of the rectangular cross-section of the arch. Also, eccentricity should be limited as it can create deformation followed by cracks which will function as hinges and will result in instability of the structure. Therefore, tolerances between the interlocking blocks should be designed to reduce the deformations. To make sure the thrust line stays within the arch structure, the thickness of the arch should be increased with a safety factor of 2 on the variable forces.

4 Structural glass

Window glazing is one of the first functional usages of glass in the built environment in the Roman period. Before this, glass was used in a more decorative way e.g. jewels in the ancient Egypt period (Schittich, Staib, Balkow, Schuler & Sobek, 1999). Glass is from origin a brittle material, and therefore only used as filler in the built industry to create transparency. Nowadays, glass is also used for structures to create fully transparent buildings. There are different types of glass and manufacturing methods. Which one to choose all depends on the application of the glass. Also, not only the function of the glass is important, but also where it is placed in the building and which factors it should resist. Currently, structural glass is used as beam and column structures. This is mostly float glass. However, experiments are ongoing to create columns from extruded and cast glass. See figure 4.1 for examples of structural glass elements. In this chapter, the families of glass, manufacturing processes and safety of glass will be discussed.

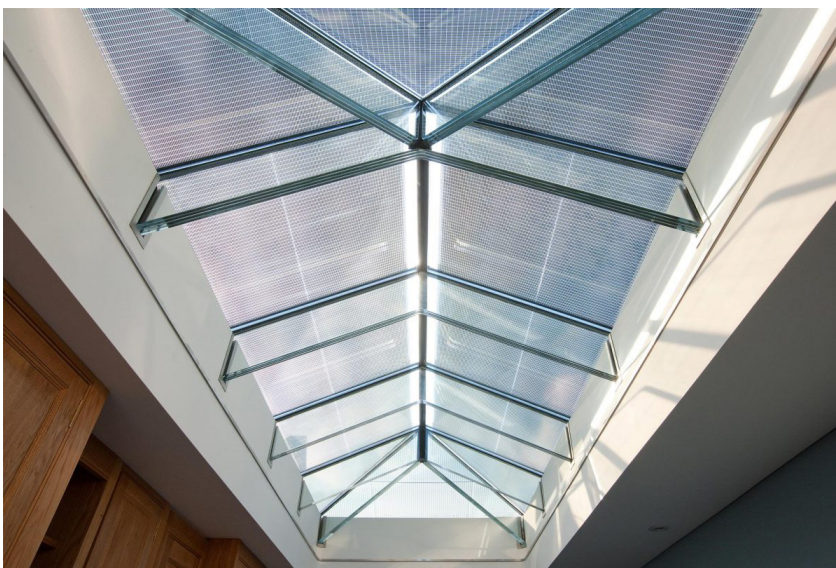

a



b



c



d

Figure 4.1: Realized structural glass components: float glass beam (a), float glass column (b), cast glass wall (c) and extruded column (d). Retrieved from Visionagi (n.d.), Bagger (n.d), ABT (2016) and ABT (2019).

4.1 Types of glass

Glass is a composition of different raw materials. Liquid glass is created when all these materials are mixed and heated. The moment when the liquid cools down, the structure of the glass composition on molecular level will 'freeze' in a rigid state (Wigginton, 1996). The cooling down process is called annealing and discussed later in this chapter. According to Oikonomopoulou (2019) there are six main families of glass compositions. Depending on the application and costs of the glass, the family can be chosen, and the composition of raw materials can be set depending if the glass should be (non) transparent, translucent or based on the thermal expansion (Balou, 2018). In table 4.1, the families of the glass are summed with composition, observation of the glass and typical applications. See figure 4.2 for the examples of the applications.

Table 4.1: Approximate chemical composition and application of different types of glass. Retrieved from Oikonomopoulou (2019).

Glass Type	Approximate composition	Observations	Typical applications
Soda-lime (window glass)	73% SiO ₂ 17% Na ₂ O 5% CaO 4% MgO 1% Al ₂ O ₃	Durable. Least expensive type of glass. Poor thermal resistance. Unacceptable resistance	Window panes Bottles Façade glass
Borosilicate	80% SiO ₂ 13% B ₂ O ₃ 4% Na ₂ O 2.3% Al ₂ O ₃ 0.1% K ₂ O	Good thermal shock and chemical resistance. More expensive than soda-lime and lead glass.	Laboratory glassware Household ovenware Lightbulbs Large telescope mirrors
Lead silicate	63% SiO ₂ 21% PbO 7.6% Na ₂ O 6% K ₂ O 0.2% CaO 0.2% MgO 0.2% B ₂ O ₃ 0.6% Al ₂ O ₃	Second least expensive type of glass. Softer glass compared to other types. Easy to coldwork. Poor thermal properties. Good electrical insulating properties.	Artistic ware Neon-sign tubes Television screens Absorption of Xrays (when PbO % is high)
Aluminosilicate	57% SiO ₂ 20.5% Al ₂ O ₃ 12% MgO 1% Na ₂ O 5.5% CaO	Very good thermal shock and chemical resistance. High manufacturing cost.	Mobile phone screens fiber glass High temperature thermometers Combustion tubes
Fused-silica	99,5% SiO ₂	Highest thermal shock and chemical resistance. Comparatively high melting point. Difficult to work with. High production cost.	Outer windows on space vehicles Astronomical telescopes
96% Silica	96% SiO ₂ 3% B ₂ O ₃	Very good thermal shock and chemical resistance. Meticulous manufacturing process and high production cost.	Furnace sight glasses outer windows on space vehicles

Soda-lime, lead silicate and borosilicate are the cheapest glass types to produce. This is not only caused by the cost of raw material, but also due to the melting point as this requires a lot of energy. This is shown in table 4.2. Therefore, the potential of structural glass for the built environment is the type soda-lime, lead silicate and borosilicate.

As this research is performed to understand the potential of glass for reconstructing arch vaults, the material properties of the chosen glass types and the traditional materials should be known. The structure of the heritage may not fail due to the application of glass. Therefore, it is important to understand the difference is between these materials. Furthermore, glass is a brittle material, just like other traditional materials as bricks and limestones. See table 4.3 for the overview of properties per material.



Figure 4.2: Application of glass types. Retrieved from Jackofglass (n.d.), Smithsonian (2019), Yang (2015), Corning (n.d.), Heraldssystem (2019) and Spacemood (n.d.).

Table 4.2: Properties of different types of glass. Retrieved from Oikonomopoulou (2019).

Glass type	Mean melting Point at 10 Pa.s** [°C]	Soft. Point [°C]	Anneal. Point [°C]	Strain Point [°C]	Density Kg/m ³	Coeff of Expan. 0–300 °C 10 ⁻⁶ /°C	Young's Modulus GPa
Soda-lime (window glass)	1350–1400	730	548	505	2460	8.5	69
Borosilicate	1450–1550	780	525	480	2230	3.4	63
Lead silicate	1200–1300	626	435	395	2850	9.1	62
Aluminosilicate	1500–1600	915	715	670	2530	4.2	87
Fused-silica	> > 2000	1667	1140	1070	2200	0.55	69
96% silica	> > 2000	1500	910	820	2180	0.8	67

^a These values are only given as a guideline of the differences between the various glass types. In practice, for each glass type there are numerous of different recipes resulting into different properties.

Table 4.3: Properties of different types of glass and traditional materials. Retrieved from Balou (2018) and Salem, Smith & Ersahin (2015).

These values are based on the literature and the historical materials (*) may deviate with the actual.

Properties	Unit	Soda-Lime glass	Borosilicate Glass	Lead Silicate glass	Unreinf. Concrete	Marble *	Limestone *	Brick *
Density	10 ³ kg/m ³	2.5	2.2-2.5	2.8-2.9	2.2-2.6	2.72-2.85	2.55-2.6	2.1-2.5
Young's Modulus	Gpa	68-72	61-64	53-64	15-25	50-70	35-55	30-35
Compressive Strength	Mpa	300-420	260-350	230-1370	13.3-30	55-105	30-200	45-150
Tensile Strength	MPa	30-35	22-32	23-137	1.1-1.3	6-10	8-22	5-15
Thermal Expansion Coef.	10 ⁻⁶ K ⁻¹	8.5-9.5	3.2-4	9.1	5-10	3-5	3.7-6.3	5-8
Thermal Conductivity	W/m°C	0.9-1.1	1.1-1.3	0.9-1.3	0.7-2.6	5-6	0.92-2.15	0.8-1
Porosity	%	0	0	0	0.1-0.15	0.002-0.004	0.006-0.12	0.06-0.2

4.2 Manufacturing processes

As mentioned before in the chapter 2 'Heritage', there are four ways how glass can be shaped and used for the heritage. These four are: float glass, extruded glass, 3D printed glass and cast glass.

4.2.1 Float glass

Almost 90% of the flat glass for the building industry is produced by the float glass method (Oikonomopoulou, 2019). Soda-lime is one of the most used types of glass for this process. Float glass method is a continuous process which makes it a cheap manufacturing process. Also, it can produce large sizes of glass sheets which have a superior optical quality. See figure 4.3a for the process flow. First, the raw materials are mixed and melted till around 1150°C. Then, the melted glass will float in the tin bath and continues cooling down in the annealing lehr. The cooling down is the moment when the glass shrinks and flaws on the surface reduces. Also, this process cannot be done too quickly, otherwise the glass will break due to the thermal shock. After this process, the glass sheet is inspected and cut in pieces including drilling holes. From there, the glass can be bended (hot or cold) and strengthened by a reheating process (annealed, heat strengthened or tempered). The tessellation of the glass depends on the strengthening, see figure 4.3b. With annealing and heat strengthened glass, the glass cracks, but will remain its shape. For tempered glass, it loses its shape completely including the strength when it fails. After this process, the glass can be strengthened with a laminated sheet between two surfaces. This way, there are multiply layers in one structure which reduces the risk of failure. Due to this lamination process, the float glass is difficult to recycle and therefore downcycled by using it for other purposes e.g. foundation of roads. However, there are new developments and technology to recycle laminated glass structures (Donico Inter, n.d.). They developed a method to separate the interlayer from the glass in two steps (figure 4.3c).

1. By crushing the laminated glass;
2. Wet processing by washing off the interlayer from the glass and separate them.

As float glass can be produced till max 25mm thickness, the microscopical cracks and damages on the surface of the glass can be critical as this mostly causes the failure of the plate. Therefore, tensile stress must be avoided. Float glass can be made crystal clear or translucent, depending on the chemical composition of the glass. An example of structural float glass is shown in figure 4.4.

Connections of float glass can be done with steel elements or structural glue. Steel elements are like clamps and spiders. Structural glue is an irreversible method (Bos, Louter & Veer, 2008).

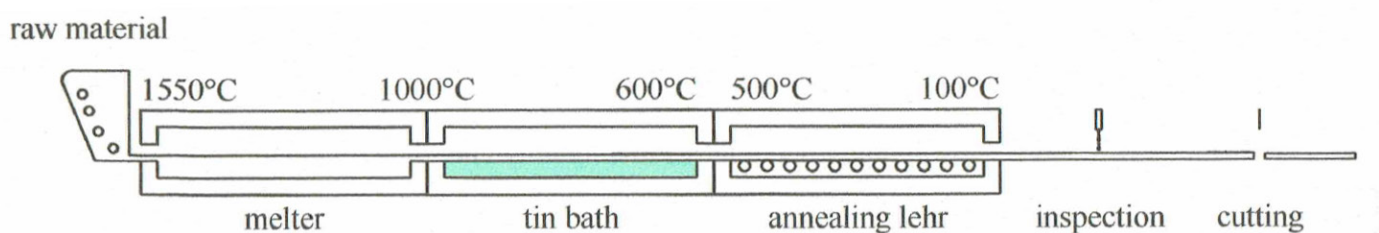
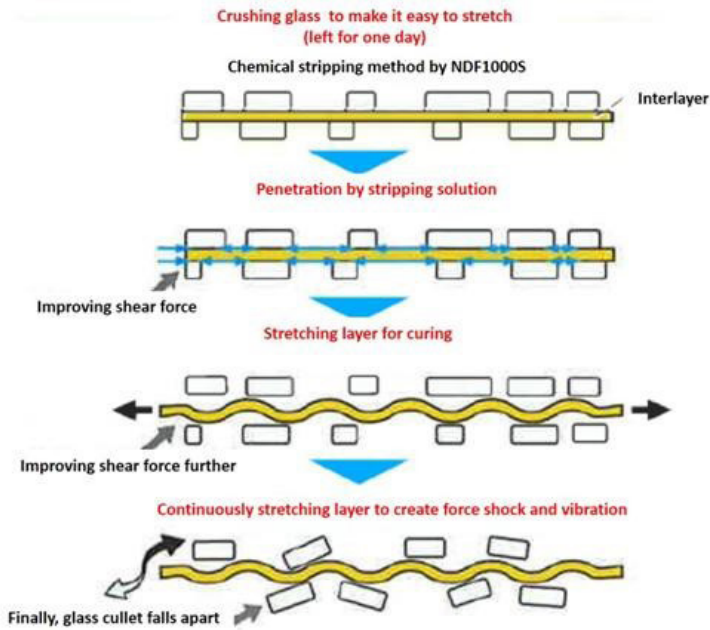

Figure 4.3a: Manufacturing process of float glass. Retrieved from Oikonomopoulou (2019) based on Louter (2011).



Figure 4.3b: Failure pattern of strengthened float glass: annealed (left), heat strengthened (middle) and tempered (right). Retrieved from Louter (2011).



The characteristics of NDF1000S is the unique stripping method to completely separate laminated glass into glass and interlayer without damaging and changing the material condition of both glass and interlayer.

Figure 4.3c: Recycling of laminated glass panels. Retrieved from Donico Inter (n.d.).



Figure 4.4: Structural float glass panels as metro entrance. Retrieved from EOC Engineers (n.d.).

4.2.2 Extruded glass

Extruded glass are tubes, rods or other linear products with a constant cross-section (Oikonomopoulou, 2019). Most of the time, these elements are used for interior architecture areas, lighting or art. The Danner process is an example of an extrusion process to create hollow glass tubes, see figure 4.5. This is a cheap manufacturing process as it is a continuous process where molten glass flows onto a rotating element. This way, the glass is being pushed downwards into the shape. Speed of the machine and air flow controls the diameter and thickness of the product. The maximum thickness is 10mm for the Danner process. When the extruded glass exits the machine horizontal, it will be cut. Schott AG is leading in producing extruded glass and supported the research team of TU Delft to build a glass truss bridge at the Green Village in Delft, see figure 4.6. Extruded glass works best when the force is directly orientated on the middle of the cross section as it is with a truss. The glass can fully be recycled for other purposes and will not be downcycled. The research regarding extruded glass is still ongoing as it is still new for the built environment.

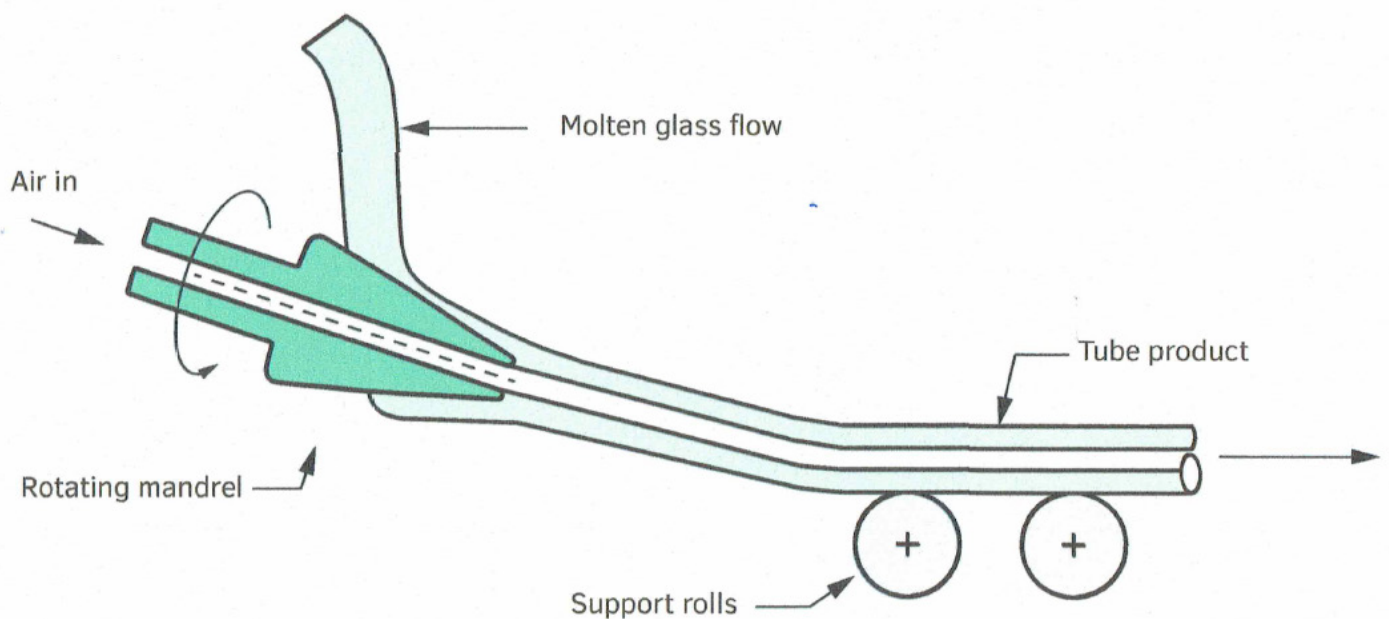

Figure 4.5: Manufacturing process of extruded glass (Danner process). Retrieved from Oikonomopoulou (2019).

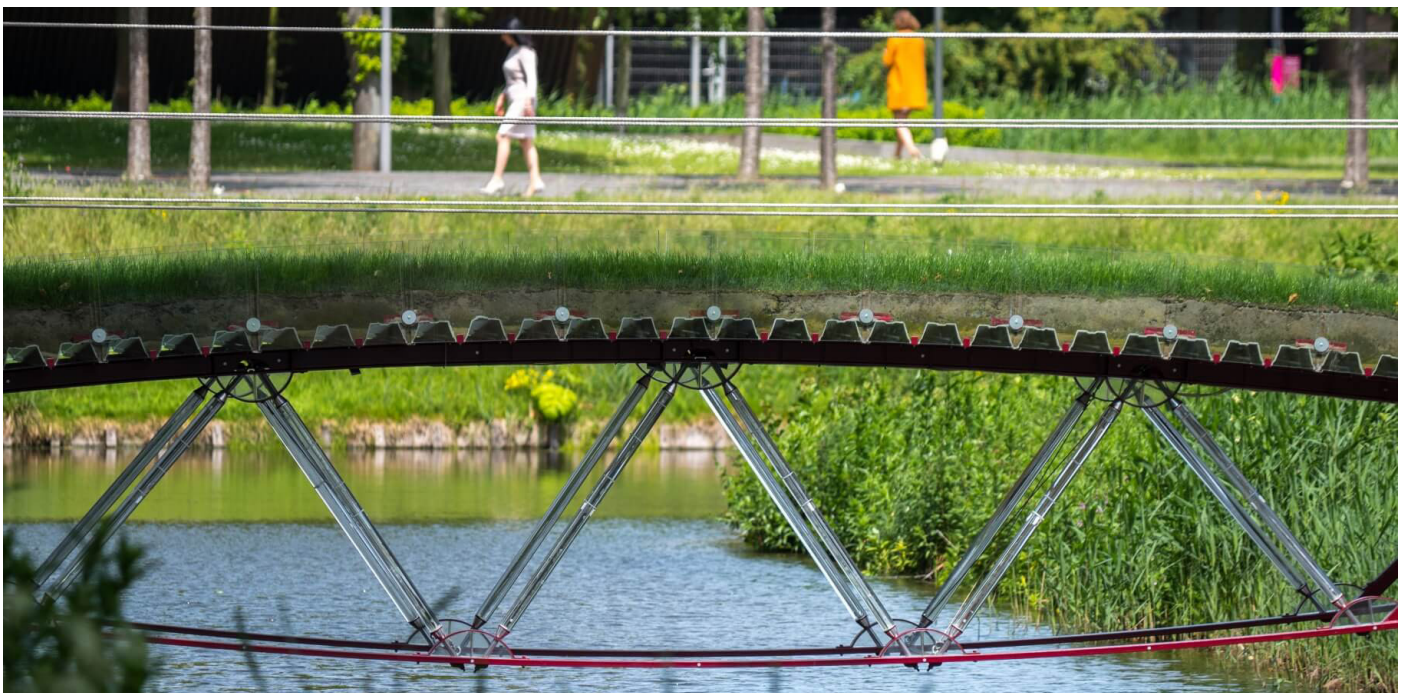

Figure 4.6: Glass truss bridge with extruded glass. Retrieved from Schott (2017).

4.2.3 3D printed glass

3D printed glass is still in an early stage and still in development by the Department of Mechanical Engineering and Glass Lab of MIT (Oikonomopoulou, 2019). For now, soda-lime glass is used for experimentations. The base plate where the glass is injected on is heated. Also, the room where the printing takes place is dual heated. Top part acts as mould where the product is shaped. The lower part is the annealing process where the glass is cooled down but keeps it on temperature as the next layer still needs to be applied. Big temperature difference between layers cannot occur due to thermal shock. The lower the glass, the lower the temperature will be as part of the annealing process. The annealing process is the most crucial part of 3D printed glass as this determines the quality of the product. The downside of this process is that the printing and annealing room must be bigger than the final product. Another method is multi-axis machining. This method cuts, drills, mills and polishes in all axis without limitations. This is a very expensive and time-consuming process and currently only used by glass artists (Cutler, 2012). Recycle potential of this product is still under investigation. See figure 4.7 for an example.



Figure 4.7: Glass 3D printing process (top) and result glass 3D print (left). Retrieved from Drupa (2015).

4.2.4 Cast glass

Cast glass is a 3D glass object which is a substantial, monolithic cross-section and/ or of complex geometry (Oikonomopoulou, 2019). 3D printed glass is the only process that might have potential as an alternative to create a 3D glass object. However, 3D printed glass will contain layers that could be a way point in the object. Cast glass is smooth and shaped by the mould without layers. Flat glass can be limited bended in a shape to create a 3D geometry but is always limited due to the maximum thickness of 25mm. The biggest cast glass element is the Hale Telescope blank and is produced in 1929, see figure 4.8. The object weights 20 ton and it took 10 months to complete this cast glass object (CMOG, 2011). Shaping glass by casting it is one of the oldest methods. It was used in ancient Egypt and Roman period. An example of cast glass in the built environment is the Crystal House in Amsterdam, The Netherlands (figure 4.9). In this project, the size of the original Dutch bricks is used to construct the front façade.

The cast glass can be transparent, translucent and non-transparent depending on the composition of the raw materials. Also, the object is full glass without any added material in contrast to float glass. Therefore, cast glass can be recycled without being downcycled.

The geometry is created by pouring molted glass in a mould. Two methods are possible to produce cast glass: hot-forming casting and Kiln casting. As with 3D-printing, the annealing process is critical for the quality of the cast glass object. This will be discussed in detail in paragraph 4.3 'Casting and annealing process'. A disposable and permanent mould can be used for the casting process. Details about this will be discussed in paragraph 4.3 'Casting and annealing process'.

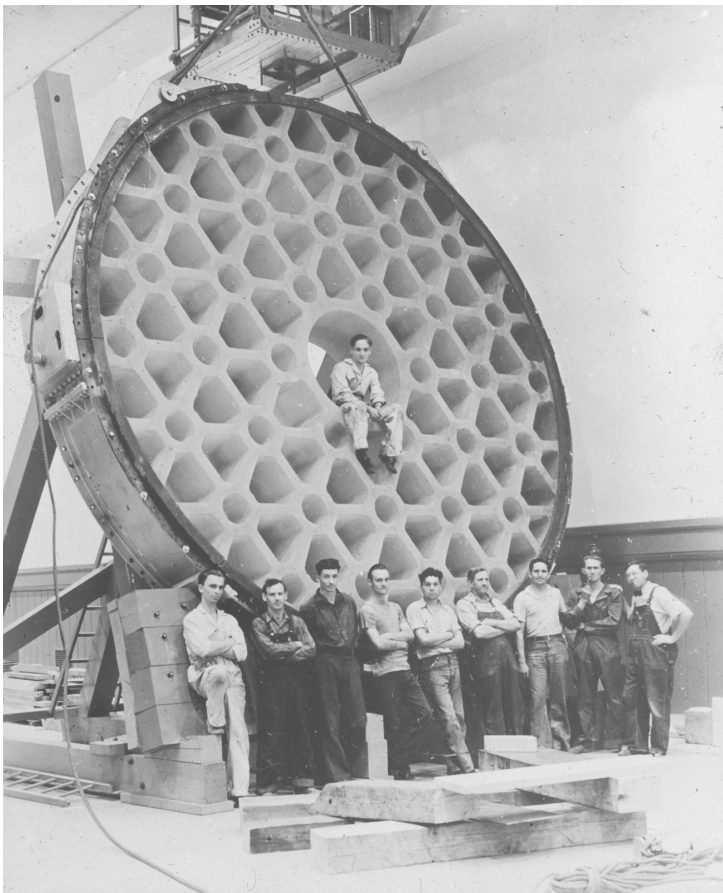

Figure 4.8: Largest cast glass object: Hale telescope blank. Retrieved from CMOG (2011).



Figure 4.9: Cast glass façade for the Chanel Crystal house in Amsterdam. Retrieved from ABT (2016).

4.3 Casting and annealing process

First the production and annealing process will be discussed to understand what kind of moulds are possible for casting glass.

Manufacturing and annealing process

For casting glass there are two different methods available (Oikonomopoulou, 2019):

- Primary process (Hot-forming casting);
- Secondary process (Kiln casting).

In figure 4.10 two different methods of cast glass are shown. In the primary process (hot-forming casting) is a mix of raw materials which are mixed and melted. The hot liquid is poured in a mould. For the secondary process, Kiln casting, small pieces of glass are reheated and the liquid flows into the mould which is positioned below the container of molted small pieces of glass. In this variant of methods, it requires less energy as the pieces of glass only need to be re-heated till it flows in contrast to hot-forming which must heat the raw materials till it flows for the mixing process. See figure 4.10 for the process of hot-forming and Kiln casting.

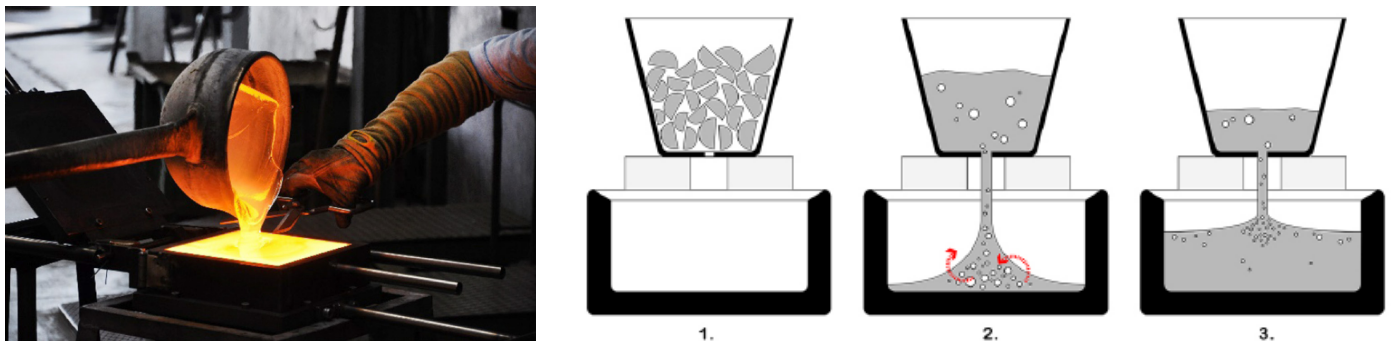

Figure 4.10: Hot-forming casting (left) and Kiln casting (right). Retrieved from Oikonomopoulou (2019) and Bristogianni (2017).

The moment the liquid is poured into a mould, the annealing process starts. This is one of the most crucial parts of the cast process as the cooling down determines the strength as the glass will shrink slowly. For the tolerances and connections, the shrink factor should be taken into account (Oikonomopoulou, 2018). For both casting methods, the annealing phase is similar. When the glass liquid reaches the softening point, it will shape itself in the mould due to its own weight. Then, it is cooled down till the annealing point. From this point, the actual annealing process starts. The initial cooling phase will slowly reduce the temperature from the annealing point till strain point. This is also the point when the material reaches the stress equilibrium. The temperature difference between surface and core must be below 4°C (Cummings, 2001). In other words, this influences the anneal time when the thickness of the geometry increases. The more complex the geometry, the longer it will take to cool down. In the 2nd cooling phase, the temperature will drop quicker from strain point till 50°C than in the initial cooling phase. However, the quicker it cools down, the bigger the risk for thermal shock in the component. The last phase of the annealing process is the final cooling which is from 50°C till room temperature (Oikonomopoulou, 2019). Depending on the mould, volume and geometry of the component, the annealing phase deviates between hours and months. See figure 4.11 for the complete process from raw materials till component. The graph regarding the ratio between temperature and time of the anneal process is also shown. In table 4.5 the temperatures per point for each glass type is shown. The annealing time can be reduced by limiting the volume of the geometry e.g. introducing honeycomb. This depends on the forces which are applied on the components (Jacobs, Shough & Connors, 1984). After the quality control, the components can be cut and polished if required for optimal results.

Table 4.5: Crucial temperature points per type of glass. Retrieved from Oikonomopoulou (2019).

Glass type	Mean melting Point at 10 Pa.s** [°C]	Soft. Point [°C]	Anneal. Point [°C]	Strain Point [°C]	Density Kg/m ³	Coeff of Expan. 0–300 °C 10–6/°C	Young's Modulus GPa
Soda-lime (window glass)	1350–1400	730	548	505	2460	8.5	69
Borosilicate	1450–1550	780	525	480	2230	3.4	63
Lead silicate	1200–1300	626	435	395	2850	9.1	62
Aluminosilicate	1500–1600	915	715	670	2530	4.2	87
Fused-silica	> > 2000	1667	1140	1070	2200	0.55	69
96% silica	> > 2000	1500	910	820	2180	0.8	67

^a These values are only given as a guideline of the differences between the various glass types. In practice, for each glass type there are numerous of different recipes resulting into different properties.

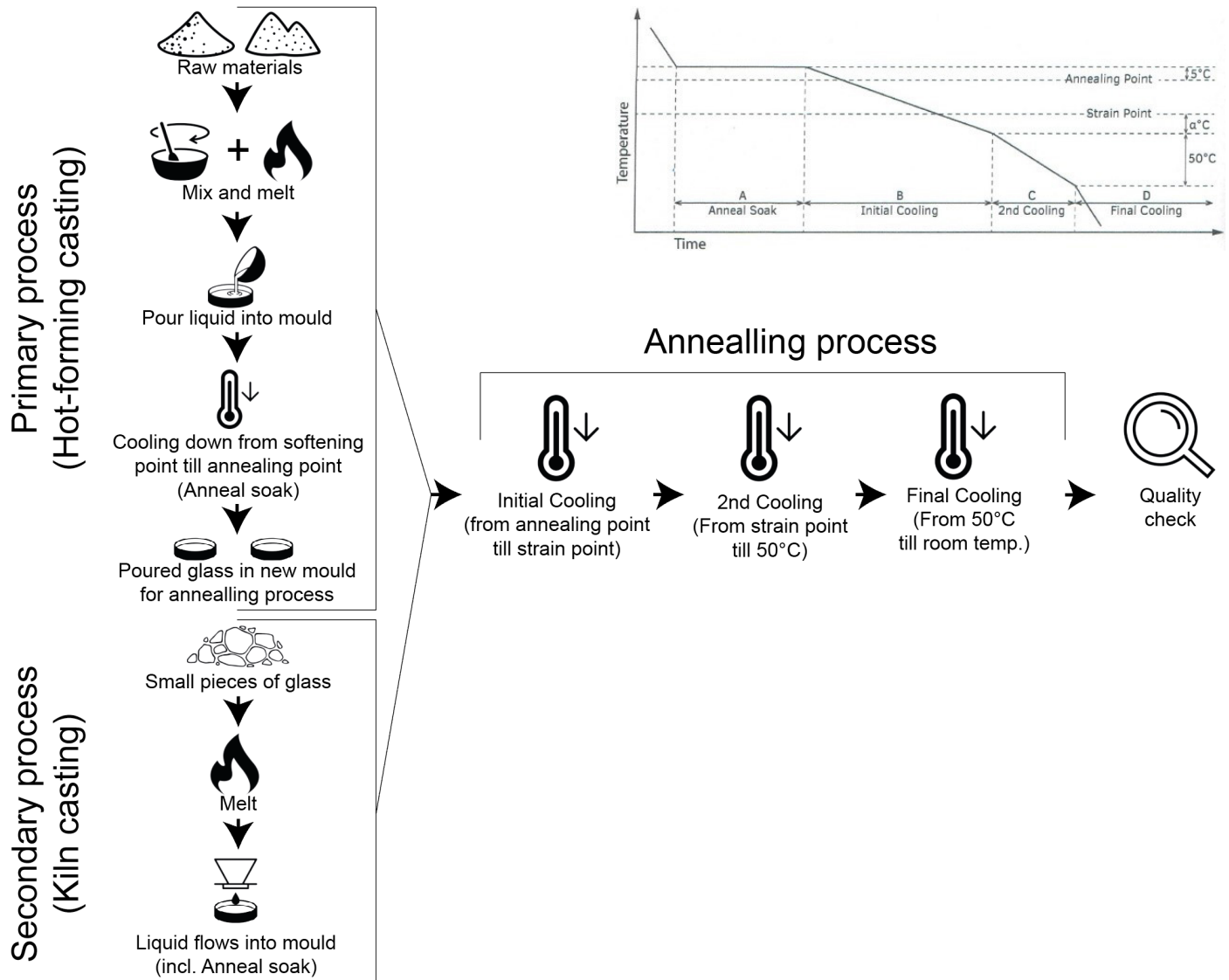

Figure 4.11: Casting and annealing process. Based on the description of Oikonomopoulou (2019).

4.4 Strength of cast glass

As the properties of different types of glass is discussed in paragraph 4.1 'type of glass', the last phase of manufacturing cast glass is the inspection. Currently, there are limited possibilities to perform a quality check of cast glass. For now, polariscope is used to understand the stress in the material as methods which are now used for float glass are not applicable to cast glass because of the volume in cross-section.

There are three different flaws for cast glass (Oikonomopoulou, 2019), see figure 4.12:

- Gaseous inhomogeneities (bubbles or seeds);
- Crystalline inclusions (stones);
- Glassy inhomogeneities (cords or striae).

Bubbles or seeds can cause peak stresses already when the bubble or a cluster of bubbles are bigger than 1mm (Bristogianni, Oikonomopoulou, Veer, Snijder and Nijse, 2017). The bigger the section of the cast glass object is, the lesser the chance of failure. That is why this flaw is one of the crucial problems with float glass. It can be caused by different reasons:

- Decomposition of raw materials;
- Nucleation growth;
- Chemical, electrochemical and mechanical reaction.

Crystallized stones are imperfectly melted (raw) materials which are not well mixed. These stones have a different mechanical property than glass which can cause internal peak stress. Cords or striae are glassy inclusions with optical properties differing from the glass matrix as described by the ASTM (American Society for Testing and Materials). Insufficient stirring of molted material or chemical reactions can cause this flaw.

For the Kiln process, it is important to place the mould as close as possible to the container with liquid glass. When the distance between these objects increases, the chance on air bubbles also increases. When air bubbles are clustered, these can cause weak spots in the cast glass. These weak spots will become stress concentration spots where tensile stress will cause failure of the element (Bristogianni et al, 2017).



Figure 4.12: Flaws in cast glass. Retrieved from Oikonomopoulou (2019).

4.4.1 Safety strategies

Risk assessment

Glass is considered as a brittle material which is not suitable as structural material. However, this is shown different in realized projects which is discussed earlier in this chapter. NEN2608:2014 is written as Dutch regulations for structural glass based on the new Eurocode on the design of structural glass (ABT, 2019). It is also based on the standard European Codes as structural design, actions on structures etcetera. However, it only focuses on flat glass elements, and not cast glass. Therefore, physical tests and simulations must prove if the structure is safe to use. Furthermore, a risk analysis is required including a formula. According to the NEN 2608, the risk factor should be calculated based on the probability, exposure and consequence. Therefore, the following formula is used for the risk analysis:

$$\text{Risk} = \text{Probability} * \text{Exposure} * \text{Consequence}$$

The outcome of the risk factor determines how a part of a structure can fail (table 4.6). Again, this is still based on flat glass. When the factor is below 70, one layer of the glass structure can fail. When it is between 70 and 400, two layers can fail. Above 400 is complete failure of the structure. This means for float glass, that this possibility should be added as layer in the structure next to the required layers based on structural calculations. The factors of probability, exposure and consequence are shown in table 4.7.

Avoiding a risk is nearly impossible, but reducing the risk is possible. Therefore, many scenarios should be sketched, and the most likely situations should be included in the design phase. For example, for hollow glass block wall, Engelsman, van Tol and Scheutjens (2000) recommend a dilatation of 6-8mm every 6m. This way, the wall has tolerance for thermal expansion and can function without failure. Also, when an element of the glass structure fails, it should be considered in the design phase how to replace this element without failure of the complete structure.

General safety application of cast glass block structures

According to Oikonomopoulou (2019), three general applications should be considered during the design process for increasing safety of cast glass block structures. These three are also applied in realized projects which are discussed in chapter 5 'Cast glass in structures':

Enhanced resistance of the assembled structure can be achieved by fragmenting the interlocking, dry-assembled system. By fragmenting the structure, the failure of a component does not have catastrophic effect on the complete structure as the other components will transfer the force. When the blocks are not bonded, the crack cannot spread through the system. This means a barrier is created in case a failure appears. For stability reasons, fragmentation of the structure can include the displacements which makes it more flexible. When this will not be the case, the structure will tear apart (e.g. masonry walls in earthquake regions).

Improving mechanical properties by reducing the size of the elements. Even when one block in the complete structure has many flaws, the impact when it fails is limited. The failed element will interlock in the structure and will still function as an overall structure.

Redundancy is added in the cast glass block systems as a missing component should be included in the scenario. Failure is localized but again, the overall structure will remain. This way, tolerance is added as a safety factor.

Table 4.6: Risk outcome categories. Retrieved from ABT (2019).

Damage to constructive element	Risk
Lateral fracture on one side	RD < 70
Lateral fracture on two sides	70 < RD < 400
Complete breakage of the constructive element	RD > 400

Table 4.7: Factors of probability, exposure and consequence. Retrieved from ABT (2019).

Pobability intentionally or unintentionally	Factor	Exposure structural element	Factor	Consequence at complete failure	Factor
Virtual impossible	0,1	Very rarely	0,5	First Aid	1
Practically impossible	0,2	Sevral times a year	1	Minor injury	3
Possible, but very unlikely	0,5	Monthly	2	Serious injury	7
Only possible in the longer term	1	Weekly	3	One dead	15
Uncommon, but possible	3	Daily	6	More than one dead	40
The best possible	6	Constantly	10	Catastrophie, many deaths	100
Can be expected	10				

4.5 Moulds

According to Oikonomopoulou (2019), disposable and permanent mould are possible for casting glass. The choice what type of mould a process requires, depends on the wished result. If the cast glass elements are used as prototype, then disposable moulds are a good option as this is relatively cheap for small batches. Furthermore, the glass will be translucent, and a post-process is required to bring back the transparency. This introduces new risks for the element due to the brittle property. This type of mould is less accurate than permanent moulds as it is custom made per element and the material of the mould. As shown in table 4.8, two different mould materials are compared with each other for the disposable mould. Disposable moulds can only be used once as the mould is removed from the cast glass with water.

Permanent moulds suit best for the series production. These moulds are made from stainless steel. Thanks to this, melt-quenching technique is possible to save time in comparison with disposable moulds. Also, high press methods are applicable to create high precision elements. Also, an adjustable mould is possible when the element must deviate in longitudinal direction. The permanent moulds should be pre-heated to create transparency of the cast glass. The mould should not be removed till the end of the annealing process. When the mould is coated with graphite to release the cast glass from the mould easier, the cast glass should be removed from the mould before the annealing process. See table 4.8 for a complete overview of disposable and permanent moulds.

The complexity of the geometry does influence the price of the permanent moulds in comparison with disposable moulds. Therefore, it is important to understand how many elements need to be produced, the level of accuracy and transparency. There is no limitation for the maximum weight of casting glass, but this will influence the annealing time of the product which will bring extra risks in the accuracy of the cast glass's properties. However, the technology of 3D-printed sand moulds can be used for casting glass in the future as complex and customized geometry can be made with high precision, low labor and satisfactory costs. In figure 4.13, the manufacturing process of creating a 3D-printed sand mould is shown. The model is built per layer according to the CAD file. The maximum size for Voxeljet (n.d.) is currently 4m x 2m x 1m. The size limitation is not a limitation for casting glass as the 3D-printed moulds can later be connected as one mould. As the CAD file is an input for this process, the mould can be designed at maximum functionality and optimized weight (Voxeljet, n.d.). Also, this process is economically feasible as it is flexible and time saving for complex geometries. Now, this process is feasible for prototypes and small series.

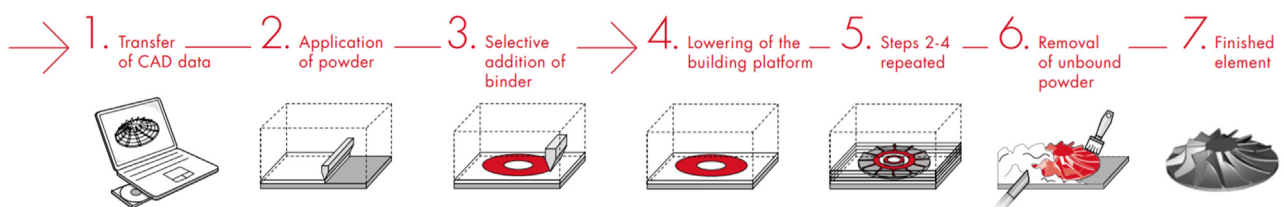

Figure 4.13: Manufacturing process of 3D-printed sand mould. Retrieved from Voxeljet (n.d.).

Characteristics	Mould type							
	Disposable			Permanent				
Material	Silica Plaster	Alumina-silica fiber	Sand	Steel/ stainless steel			Graphite	
Adjustability	-	-	-	Adjustable	Fixed	Pressed	Adjustable	Fixed
Production method	Investment casting/ lost wax technique	Milling	3D-printing	Milling/ cutting and welding			Milling/ grinding	
Manufacturing costs	Low	High	Low	Moderate to high			High	High
Top temperature	900-1000 °C	≈ 1650 °C	≈ 1650 °C	≈ 1200 °C/ 1260 °C			Unknown	Unknown
Release method	Immerse in water	Water pressure	Brush	Release coating necessary (ex. Boron Nitride)			Release coating necessary	
Level of precision	Low/ moderate	High	High	Moderate/ high	High	Very high	Moderate/ high	High
Finishing surface	Translucent/ rough	Translucent/ rough	Translucent/ rough	Glossy, surface chills may appear if the mould is not properly pre-heated			Glossy with surface chills	
Glass annealing method	Mould not removed for annealing			Mould usually removed for annealing but can also remain if high accuracy is required			Mould removed for annealing	
Post-processing requirements	Grinding and polishing required to restore transparency and increase accuracy.			Minimum or none post-processing required			Minimum or none post-processing required	
Applicability	Single component/ low volume production.			High volume production			High volume production	

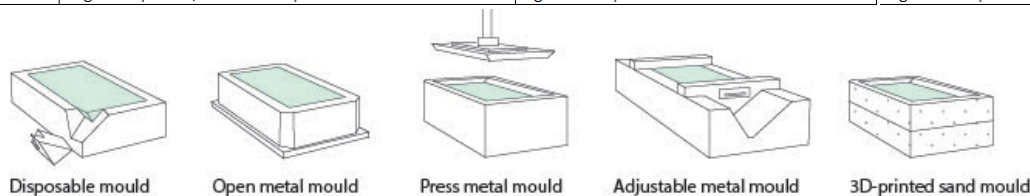

Table 4.8: Characteristics of prevailing mould types for glass casting. Retrieved from Oikonomopoulou (2018) and Voxeljet (n.d.).

4.6 Discussion

For the built environment, soda-lime, lead silicate and borosilicate have potential as structural glass. Therefore, these three types of glass will be optional in this thesis depending on the mechanical properties of the limestone in the Notre Dame de Paris. In table 4.9, the numbers of the potential types of glass and limestone are summed. For the optimal situation, the following guidelines should meet the mechanical properties:

- The density should be lower than the limestone;
- The Young's Modulus should be higher than the limestone;
- The compressive strength should be higher than the limestone;
- The tensile strength should be higher than the limestone;
- The thermal expansion coefficient should be within the range of the limestone;
- The thermal conductivity should be within the range of the limestone.

These guidelines are based on literature research for vault structures and heritage as traditional and new materials should not interfere with each other, otherwise it will cause more damage than before the renovation/ reconstruction. Based on this, borosilicate glass has the most potential for reconstructing the rib arch vault of the Notre Dame. Soda-lime glass still has potential by changing the composition of the glass to meet the thermal expansion coefficient.

Properties	Unit	Soda-Lime glass	Borosilicate Glass	Lead Silicate glass	Limestone (average)
Density	10 ³ kg/m ³	2.5	2.2-2.5	2.8-2.9	2.55-2.6
Young's Modulus	Gpa	68-72	61-64	53-64	35-55
Compressive Strength	Mpa	300-420	260-350	230-1370	30-200
Tensile Strength	MPa	30-35	22-32	23-137	8-22
Thermal Expansion Coef.	10 ⁻⁶ K ⁻¹	8.5-9.5	3.2-4	9.1	3.7-6.3
Thermal Conductivity	W/m°C	0.9-1.1	1.1-1.3	0.9-1.3	0.92-2.15
Porosity	%	0	0	0	0.006-0.12
Mean melting point at 10	°C	1350-1400	1450-1550	1200-1300	n/a
Softening point	°C	730	780	626	n/a
Annealing point	°C	548	525	435	n/a
Strain point	°C	505	480	395	n/a

Table 4.9: Crucial points per type of glass. Retrieved from Oikonomopoulou (2019), Balou et al (2018) and Salem, Smith & Ersahin (2015).

All manufacturing processes of glass are summarized in table 4.10. As mentioned in chapter 2 'heritage', cast glass represents the most realistic situation of the original arch. Cast glass is currently used for the art industry, but by showing the potential of cast glass in reconstructing an important heritage with cast glass, it might open a new world in the built environment. Furthermore, there is no limitation in using all types of glass. Cast glass can be cast in every shape which is required to bring back the original shape of the arch but can still be adjusted due to the forces within the arches. Also, the risk of failures due to flaws is reduced as cast glass components have more mass than float, extruded and 3D-printed glass.

By the position of the moulds and reduce the height of the moulds, flaws like air bubbles can be reduced. Flaws due to stones is less as the glass is reheated and re-mixed. Cords on the surface of cast glass is less of a problem than with float glass due to the cross-section thickness.

For the mould, there are permanent and disposable moulds. Later in this thesis, the type of mould will be selected based on the geometry of the components and the number of different geometries.

Glass process	Optical Characteristics	Main type of glass applied	Standard size (mm)	Thickness (mm)	Main limitations
Float	Smooth Transparent	Soda-lime	3210 x 6000 (longer is possible)	2-25	Flaws on the surface; Strengthening by secondary process and additional material.
Extruded	Smooth Transparent	Borosilicate Silica	1500-10000 (in length)	Hollow: Ø 460 Solid: Ø 300	Limited by the die formation; Symmetrical cross-section; Limited glass are suitable.
3D-printed	Layered Transparent	Soda-lime	Currently up to 30kg	Currently up to 30mm	Speed of printing and limited size; Risk of uneven distribution of mass which causes annealing challenges.
Cast	Smooth Transparent	Soda-lime Borosilicate Lead	Currently up to 20.000kg	n/a	Labor intensive process; High manufacturing costs; It can be a heavy element which is difficult to handle without equipment.

Table 4.10: Summary of all glass processes which are discussed. Retrieved from Oikonomopoulou, 2019).

For increasing safety of the cast glass structure, four different elements have to be included when designing the structure and the interlocking system:

- Risk assessment (Risk = Probability * Exposure * Consequence);
- Enhanced resistance of the assembled structure by fragmenting the interlocking, dry-assembled system;
- Improving mechanical properties by reducing the size of the elements;
- Redundancy is added in the cast glass block systems as a missing component should be included in the scenario.

5 Cast glass in structures

Today, there are different projects realized with cast glass. These are performed as dry-assembly but also adhesive bonding structures. As the dry assembly and interlocking is the focus point in this thesis, other possible connections from other fields and materials will also be discussed as this knowledge could be used for cast glass.

5.1 Current building systems with cast glass components

There are different ways to construct cast glass elements. Now, there are three options available according to Oikonomopoulou (2019). First, the additional substructure is discussed. Then the adhesive bonding and dry assembly & interlocking possibilities.

5.1.1 Metal substructures

Vertical metal substructures in combination with cast glass is performed in the façade of the Optical House, see figure 5.1. The substructure carries the tensile forces (caused by wind force), increases the stiffness and reduces the buckling factor (Hiroshi, n.d.). The glass blocks carry their own weight. This system is mortar free and can be disassembled when needed. The Crown Fountain (figure 5.2) also uses a metal substructure as an internal frame. The frame has a T-profile in zigzag pattern. This frame carries both vertical and lateral forces (Oikonomopoulou, 2019).



Figure 5.1: Optical house. Retrieved from Hiroshi (n.d.)

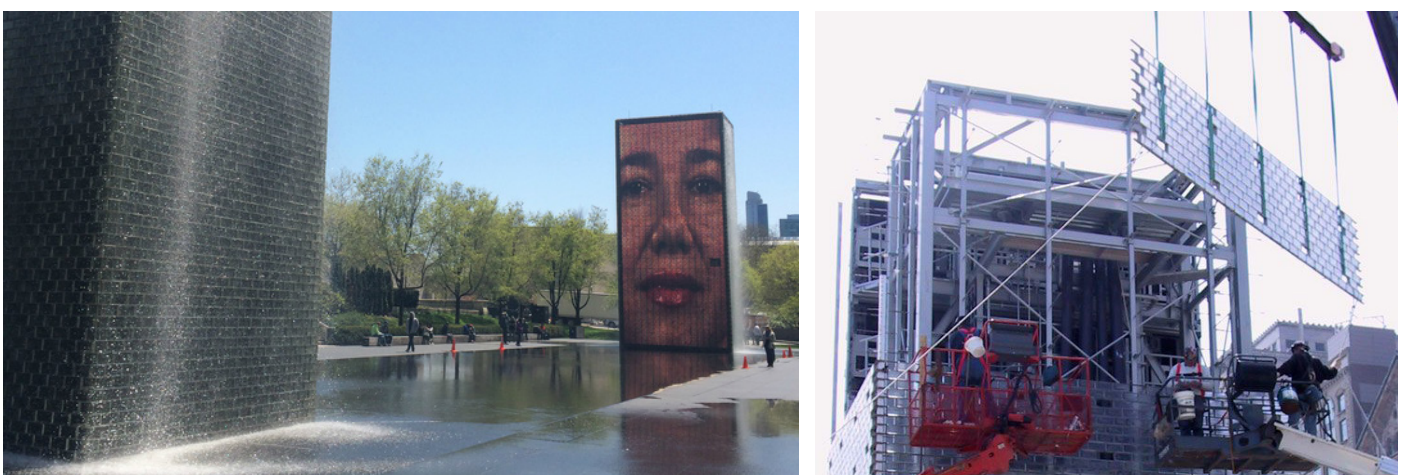

Figure 5.2: Crown Fountain. Retrieved from Matthews (2017) and Krueck & Sexton (n.d.).

5.1.2 Adhesive bonded

A transparent mortar can be used as adhesive bonding (Oikonomopoulou, 2019). The adhesive must act like the glass bricks to remain the low stress, but still connects the components permanently. As this connection is affected by the weather conditions, UV radiation, humidity and temperature, it should resist this for many years. Otherwise, it will be a very expensive structure if it must be maintained more frequent than a regular structure. In this system, tolerance is minimum as it is only the glue layer thickness. The glue should be equally applied all over the clean connection surface. When the surface is not cleaned, the glue cannot attach to the glass with a non-connected structure as result. Also, air bubbles should be prevented. For the Atocha memorial building (figure 5.3), the structure was built on site per component. This means, the quality control per brick and the application of the glue was important. For the Crystal house (figure 5.4), prefab elements were manufactured indoor. This way, the indoor climate conditions were controlled for the best connection. These prefab elements were shipped to the site and connected. During the research on how to build the façade of the Crystal house, strength tests were performed to understand the effect of the glue's thickness. The optimum bond strength is between 0,2mm and 0,3mm.

When adhesive bonding is used for cast glass, it is especially important to polish the surface as the glue must be applied on the total surface. Also, the surface should be flat to avoid concentrated stress which causes failure of the brick.



Figure 5.3: Atocha memorial building (left) and distribution of glue on the brick (right). Retrieved from Bellapart & Sau (n.d.).



Figure 5.4: Cast glass façade for the Chanel Crystal house in Amsterdam. Retrieved from ABT (2016).

5.1.3 Interlocking/ dry assembly

Interlocking and dry-assembly structures are not yet used in realized projects. It is still a concept in an ongoing research. When a structure can be constructed with a dry-assembly principle, the cast glass blocks can be simply removed without damage to the building. Also, as there are no additional materials added to the glass, the blocks can be fully recycled without downcycling the material. As no mortar or glue is used, the components should stay in place thanks to an interlocking. As direct glass-glass connection can create concentrated stress, a soft interlayer is introduced to this system (Oikonomopoulou, 2019). In her research regarding polyurethane rubber as interlayer, she determined the following requirements for a façade interlayer:

- Shore hardness between 60A – 80A (figure 5.5);
- Compressive strength ≥ 20 MPa;
- Good creep and deformation resistance under long term compressive load;
- Ability to pre-form due to organic shape of the interlocking;
- Transparency and durability to UV-lighting;
- Water resistance;
- Service temperature between -20 °C and $+ 50$ °C;
- Fire resistance.

Together with her graduation students, they have developed many different interlocking systems to create a structural wall, see figure 5.6 for the most potential systems. The geometry of the blocks should be organic and should not contain sharp angles due to manufacturing limitations and avoiding stress concentrations in the glass. Aurik, Snijder, Noteboom, Nijssse, & Louter (2018) have designed and tested a dry-assembly glass brick. This is one of the first tested interlocking systems for an arch structure, see figure 5.7. The focus of this research was on the interlocking and the interlayer of the blocks to create a bridge. In this study, they concluded the interlayer is creeping out of structure which creates direct glass-glass contact. This results in concentrated stress and failure of the component. This also occurs with the wall interlocking systems of Oikonomopoulou. Furthermore, Aurik et al (2018) also mention the challenge in replacing the failed component as it is all interlocking. Therefore, the bridge did not meet the safety requirements. Janssens (2018), another master graduation student, designed an interlocking system for domes. She introduced organic ball structure which can stack in an angle, see figure 5.8. Another student, Weijst (2019) introduced an interlocking system based on the tessellation of a shell, see figure 5.9. The connection between the tessellation elements is a circular element placed.

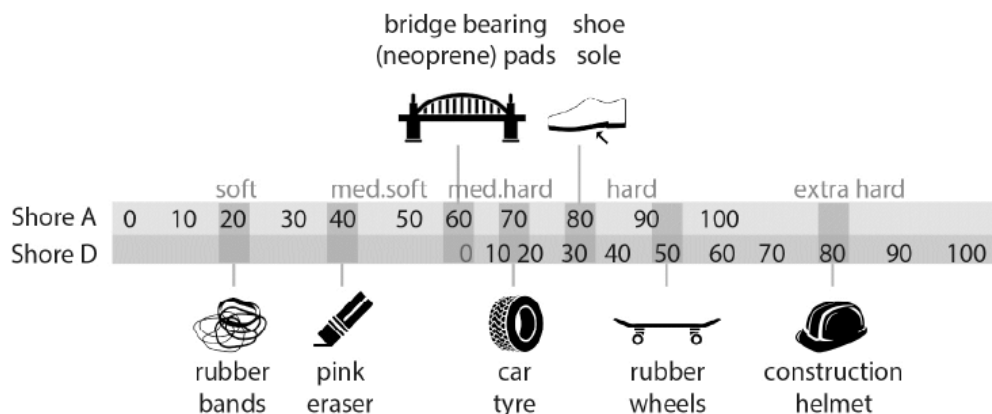

Figure 5.5: Rubber interlayer softness and compressive strength. Retrieved from Oikonomopoulou, Veer, Bristogianni, & Barou (2019).





Block type	A	B	C	D	E
					
Interlocking mechanism	smooth curves	smooth curves	male and female blocks	sliding blocks – intense curves	semi-sphere (intense) keys for vertical stacking – ability to rotate
Shear capacity	high	high	moderate	moderate	moderate to high
Self-alignment/damping	high	high	high	low	high
Multifunctionality	high	high	moderate (cannot accommodate corners)	moderate (cannot accommodate corners)	very high (due to rotation, many geometries can be achieved)
Homogeneous cooling in casting	effective	effective	risk of internal residual stresses	risk of internal residual stresses	effective
Ease of assembly	high	high	moderate	moderate	high
Peripheral structure	needed	needed	needed	needed on top	needed on top

Figure 5.6: Researched interlocking systems by Oikonomopoulou. Retrieved from Oikonomopoulou (2019).

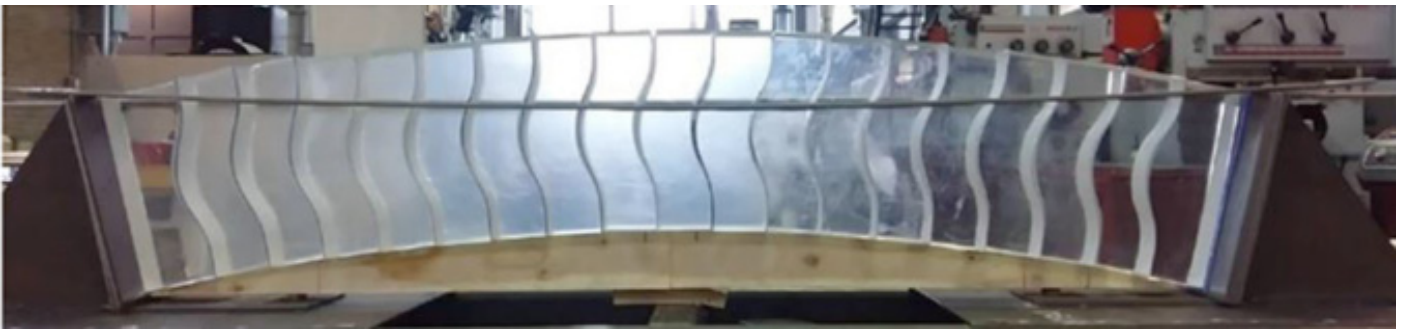

Figure 5.7: Dry-assembly interlocking glass bridge structure. Retrieved from Aurik, Snijder, Noteboom, Nijse, & Louter (2018).



Figure 5.8: Interlocking system for a dome structure. Retrieved from Janssens (2018).



Figure 5.9: Interlocking system for a shell structure. Retrieved from Weijst (2019).

5.2 Interlocking modules used in contemporary vault structures

Lockblock (n.d.) has introduced a method to build a dry-assembly vault with concrete blocks for tunnels and bridges. An interlocking system is designed where temporary support from below is not required. The blocks are kept in position by pulling it backwards. See figure 5.10 for examples of this system.

According to Rippmann & Block (2018) the dry-assembly and interlocking of a vault is only feasible when the tessellation pattern is part of the design criteria. The tessellation is based on geometric rules:

- To prevent sliding failure, the voussoirs need to be aligned to the load-transferring contact faces. This needs to be perpendicular to the local force flow;
- The pattern must be staggered to overlap the connections;
- Reduce the number of sizes as much as possible.

Rippmann & Block (2018) mention the importance of reducing the angle between load-transferring face and local force vector as this causes the sliding failure in an “unsupported” edge of an arch. In figure 5.11, a possible tessellation based on hexagonal is shown. This minimalizes the angle to reduce the sliding failure and is perpendicular to the force flow.



Figure 5.10: Interlocking system for a concrete vault. Retrieved from Lockblock (n.d.).

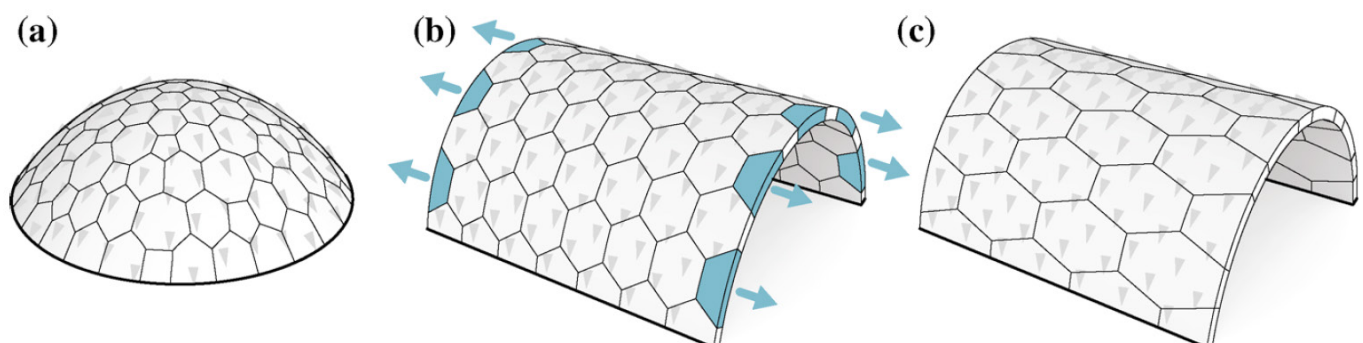

Figure 5.11: Isotropic, hexagonal-dominant tessellation geometries for dome (a) and barrel vault (b). Anisotropic, hexagonal-dominant tessellation geometry for a barrel vault (c). Retrieved from Rippmann & Block (2018).

As manual approach of tessellation is too complex, a computational method is developed to create these tessellations which meets the requirements (figure 5.12):

- A NURBS surface which represents the funicular shape of the structure;
- Define the supports;
- Divide the supported boundaries based on the defined length. The unsupported boundaries are based on the defined height;
- Generate mesh based on the defined points on the boundaries by using Delaunay Triangulation;
- Set valencies targets before refining the mesh;
- Refine the mesh based on the previous input;
- Generate hexagon based on the refined mesh;
- Improve when needed.

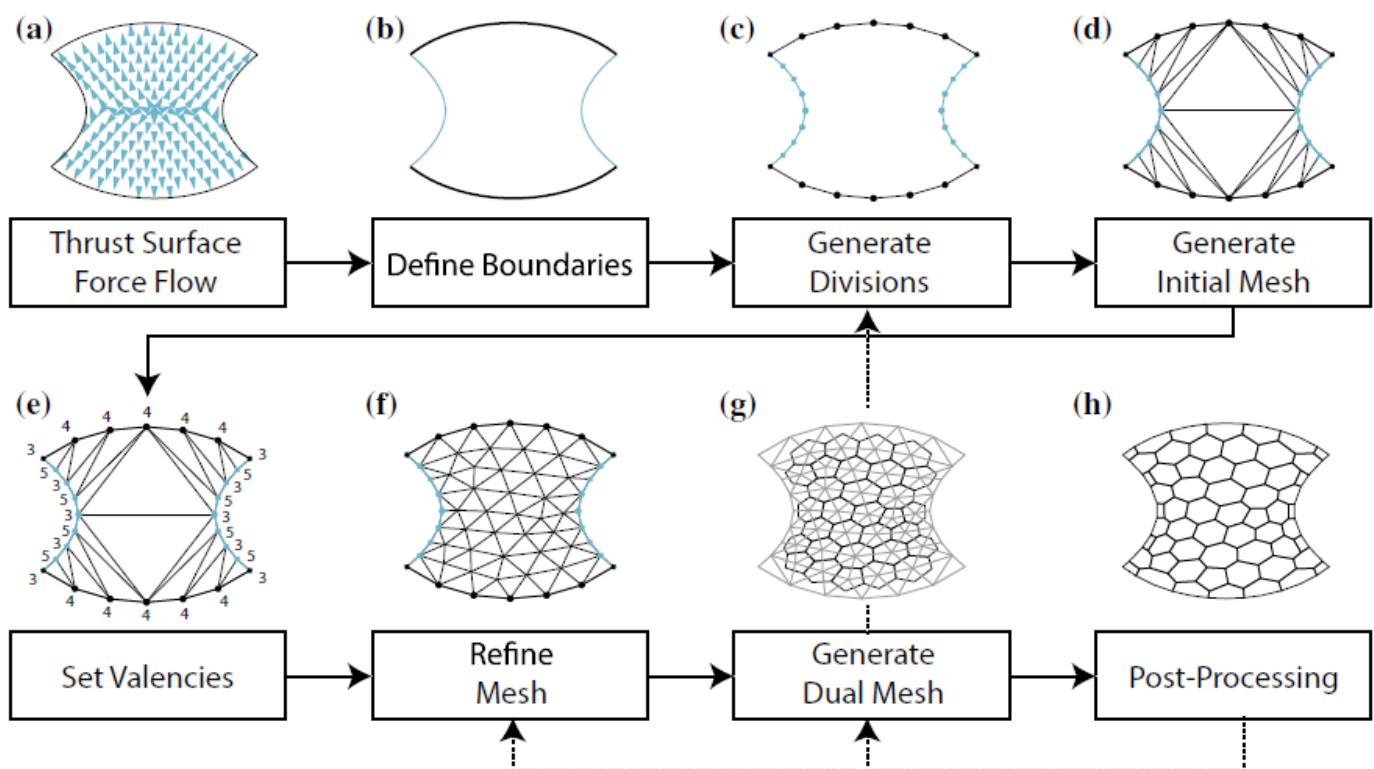

Figure 5.12: Flow diagram of how to create a tessellation to reduce the sliding failure and is perpendicular to the force flow. Retrieved from Rippman & Block (2018).

When the tessellation is known, the interlocking system can now be designed. Out-of-plane behavior is important to understand as a brittle material can fail quicker due to this. However, interlocking assemblies can deflect more than monolithic variants of the same thickness due to the tolerances in the interlocking system (Oikonomopoulou, 2019). Casapulla, Mousavian & Zarghani (2019) developed a method to design an interlocking system for arches:

- Understanding the interlocking block resistance to sliding (figure 5.13);
- Stability of the arch based on the interlocking system;
- Optimize thickness of the arch and interlocking system:
 - Increasing sliding resistance regarding to geometry of interlocking;
 - Keep the sliding resistance constant by changing number of components.

Casapulla et al (2019) states that bending failure before shear failure can be prevented when the height of the interlocking geometry (h) is smaller than the width of the interlocking geometry (s). In other words, the thickness of the interlocking should be $h \leq s$. In this study, the conclusion is to add a flexible part in the interlocking system to avoid failure due to sliding, see figure 6.14.

The Armadillo vault (figure 5.15) is an example of a double curved dry-assembly interlocking shell structure made from limestone. The mechanical property of limestone is weaker than glass regarding brittle and compression. This structure was realized with a temporary wooden support system.

Another example which is used since the Middle ages is a wooden roof interlocking system often used in churches due to the big span (figure 5.16). This system cannot directly be used for compression only constructions, but it shows how an interlocking system can be designed without additional materials like glue.

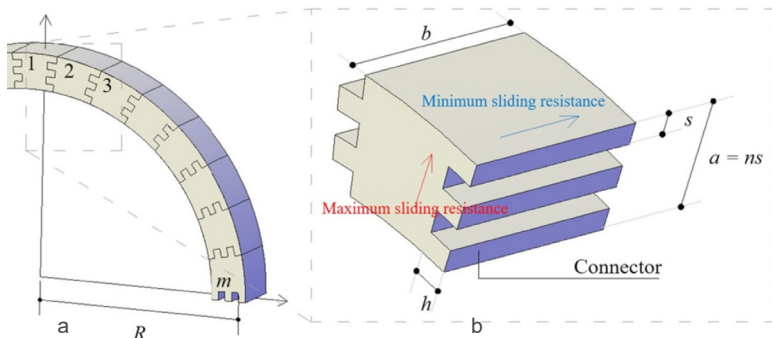

Figure 5.13: Sliding resistance of an interlocking block in an arch. Retrieved from Casapulla et al (2019).

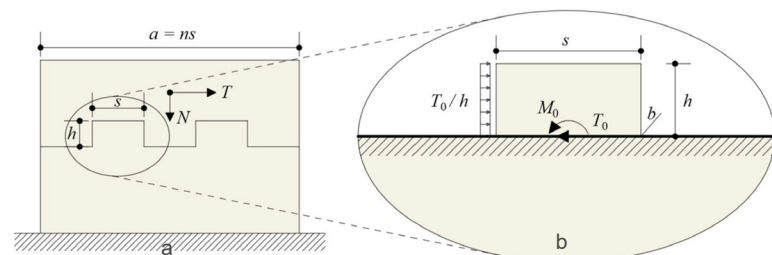

Figure 5.14a: Forces in an interlocking block: Own weight (N) and Lateral force (T). Retrieved from Casapulla et al (2019).

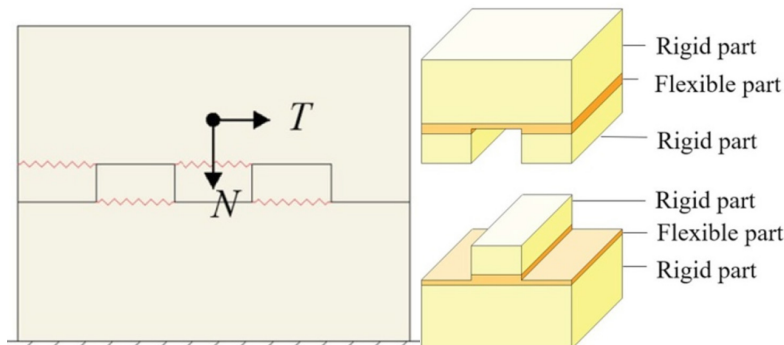

Figure 5.14b: Sliding failure (left) and introducing flexible part to increase the sliding resistance (right). Retrieved from Casapulla et al (2019).

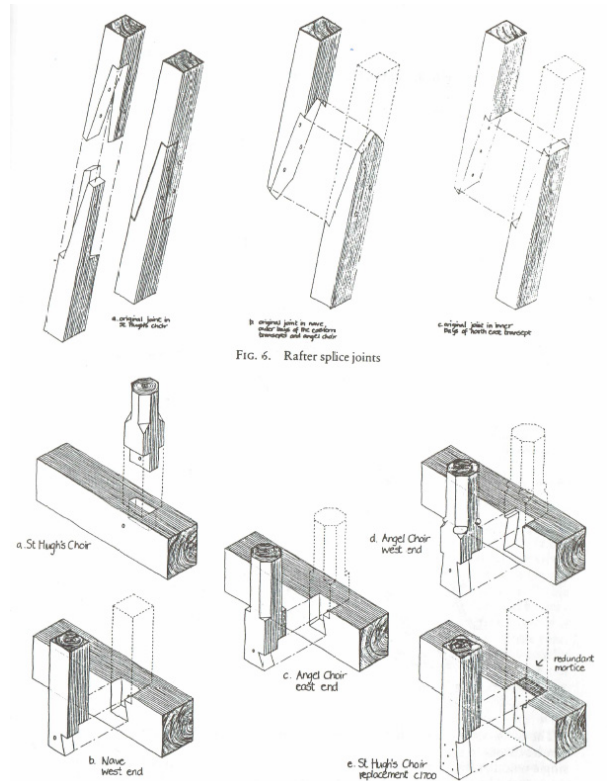

Figure 5.16: Wooden connections from the Middle Ages in West-Europe. Retrieved from Courtenay (1997).



Figure 5.15: Armadillo vault (left) and interlocking system (right). Retrieved from Escobedo (n.d.).

5.5 Discussion

To summarize, there are three different ways to construct cast glass (figure 5.17). As one of the criteria of reconstructing a heritage is the reversibility and reducing the impact on the current structure, a dry assembly method is chosen. As an arch structure is based on compression only forces, an additional metal structure is not required to reduce the tensile stresses. Also, an arch structure is an assembled structure which can include an interlocking system. Therefore, no adhesive bonding is required. An interlayer is required as stress concentrations occur when there is direct glass-glass contact which results in failure of the component.

As most of the interlocking systems are based on a structural wall, there is limited knowledge about glass interlocking systems for arches or domes. For now, four interlocking geometries are designed to create a span with cast glass:

- Interlocking blocks for a bridge arch;
- Dumbbell structure for domes;
- Interlocking plates based on tessellation of a shell;
- Flexible elements added around the interlocking volume of the component.

These three methods are interesting to test for reconstructing the arch of the Notre Dame de Paris, but it needs to meet the tessellation and interlocking requirements:

- To prevent sliding failure, the voussoirs needs to be aligned to the load-transferring contact faces. This needs to be perpendicular to the local force flow;
- The pattern must be staggered to overlap the connections;
- Reduce the number of sizes as much as possible.
- Understanding the interlocking block resistance to sliding;
- Stability of the arch based on the interlocking system;
- Optimize thickness of the arch and interlocking system:
 - Increasing sliding resistance regarding to geometry of interlocking;
 - Keep the sliding resistance constant by changing number of components.

Additional substructure Tensile forces are carried by an additional metal substructure	Adhesively bonded glass structure <i>A rigid adhesive of high stiffness ensures homogeneous load transfer in the glass assembly</i>	Interlocking cast glass units <i>The structure's stiffness is obtained by the interlocking geometry of the units</i>
		
<p>Dry-assembly (or adhesively bonded) Interlayer accommodates deviations Easily assembled Compromised transparency Reversible</p>	<p>Adhesively bonded Adhesive's thickness cannot account for size deviations Meticulous and intensive labour of high precision High transparency Non-reversible</p>	<p>Dry-assembly Interlayer accommodates deviations Easily assembled High transparency Reversible</p>

Figure 5.17: Available connections for cast glass in the built environment. Retrieved from Oikonomopoulou (2019).

Part 3: Design

In this part, the criteria and guidelines for the designs as set and the choices and developments during the design phase are discussed. Also, a prototype is made to test the principle of the design. This includes the production of the mould and the components in concrete. In the last part, the final design will be shown.

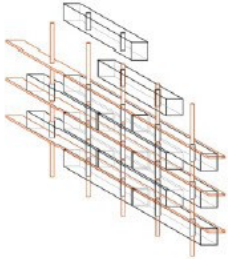
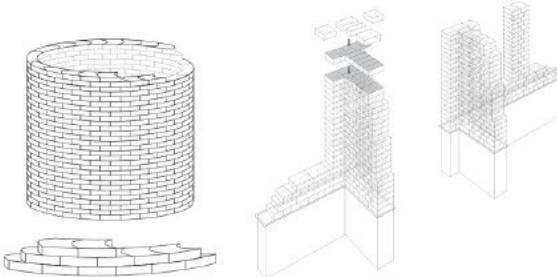
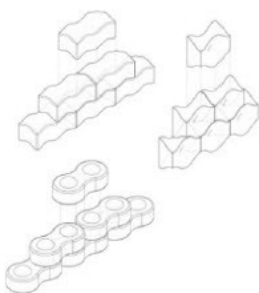
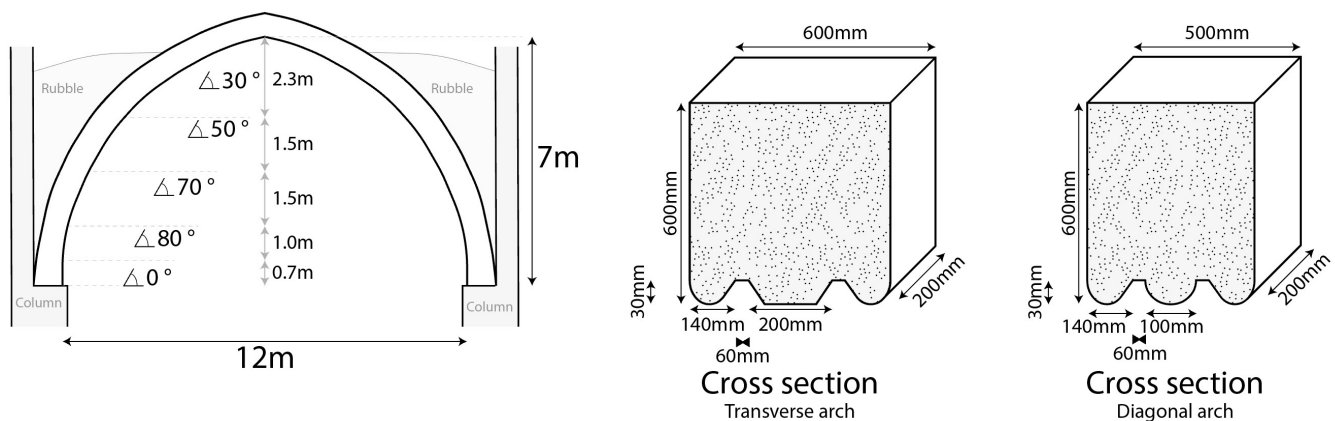

Figure 6.1: Current dimensions of the rib arch of the vault. Own assumption based on section of Vannucci et al (2019).

6 Design criteria

Based on the literature research, the below design criteria are set for this thesis.

Heritage, construction & glass

The main guidelines for reconstruction are according to literature:

1. Understanding the history layers;
2. Minimalize intervention;
3. Maximizing reversibility and;
4. Compatibility.

As only the rib vault of the Notre Dame de Paris is reconstructed, new material can be introduced with the newest technology. This way, the concept of minimum intervention, as glass is transparent or translucent, and maximum reversibility, due to interlocking system, a new construction can be introduced. The external roof structure is out of scope. The below criteria for the case study are set up based on the guidelines.

Criteria Notre Dame de Paris

Compatibility:

- Only one module of the rib vault will be reconstructed in glass (As historical layer);
- Cast glass is chosen as this can represent the most realistic geometry of the original rib vault;
- Type of glass (borosilicate) cannot interfere with the material properties of the connected traditional material: limestone;
- Temporary support system during construction is allowed.

Geometry:

- The outline of the components of the arch must have the same geometry as the original, see figure 6.1 (Minimum intervention in relationship with the geometry of the other rib vaults);
 - » The angle of the arches is restricted based on the original vault.
 - » The dimensions (height and width) of the component cannot be changed. Also, the geometry of the bottom of the section should be the same.
- The geometry of the rib structure on the top is not restricted as this gives flexibility for structural purpose;
 - » Newest technology application and not visible for public.
 - » To influence the thrust line into the traditional structure.
- In principle, respect the modulus size to the extent that results in a safe redundant structure;
- Tessellation of the vault cannot be too intensive as this will draw the attention away from the rest of the monument;
- Complete structure must meet the safety restriction including risk analysis and reduction.

Production & Mould method

- Hot-forming cast production;
 - » As approx. 400 sections (depth: 200mm) are required, hot-forming cast production is cheaper and faster.
- Limited complexity of geometry;
 - » Due to casting and mould challenges.
 - » Due to equal distribution of the mass.
- Geometry is organic shaped;
 - » To reduce risks during casting and annealing phase.
 - » To reduce stress concentrations in the interlocking.
- Limited volume (max. 25kg);
 - » Due to the annealing time.
- Limited number of different geometries;
 - » As different permanent moulds must be produced for the hot-forming cast production.

Interlocking

- Geometry of the interlocking is organically shaped;
 - » To reduce risks during casting and annealing phase.
 - » To reduce stress concentrations in the interlocking.
 - » To optimize shear capacity;
- Tolerance in longitudinal and transverse direction;
 - » For corrections during constructions.
 - » For finding stability when substructure is removed.
- Thickness of the interlocking should be $h \leq s$;
- Interlocking for easy assembly and disassembly.
 - » Reducing construction mistakes.
 - » Possibility for replacing new component when it failed.

Interlayer

- To resist compressive strength ≥ 20 MPa;
- To be soft to reduce stress concentrations in the glass component;
- To resist creep and deformation for long-term;
- To be flexible to follow the geometry of the interlocking;
- To be water and fire resistant;
- Act at service level temperatures of -20 °C – 50 °C (considering extreme temperature between the vault and external roof as there are no cooling or heating).

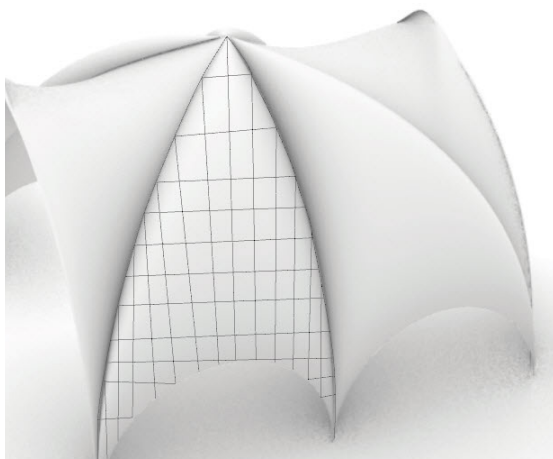

Figure 6.2: Concept of glass components in the vault.

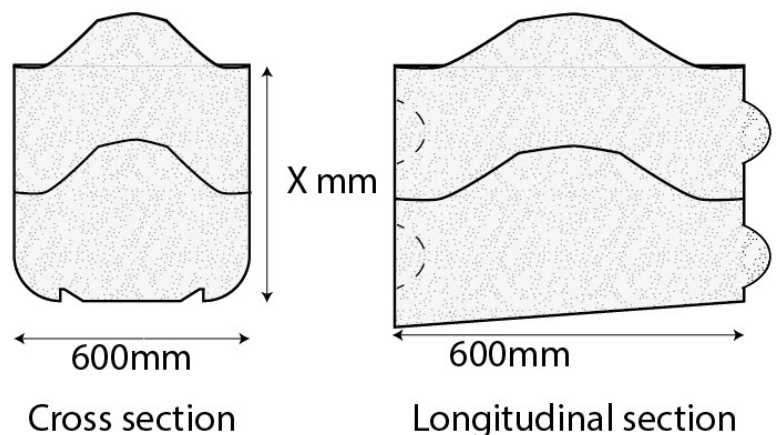

Figure 6.3: Concept of interlocking system

As a vision (figure 6.2), the rib arch of the vault will contain two or more components per section to increase the safety of the structure. Each component will overlap the seam to create a complete structure even when a component fails. Also, to replace the rubble of the original vault, the glass vault will increase in mass due to the thrust line. Finally, the web between the webs will be tessellated.

The goal is not only to reproduce the geometry of the arch and the vault (figure 6.5) in appearance, but also by reducing the required number of geometries (figure 6.3). Therefore, the aim is to create a 'Lego' system where:

- The bottom components in the arch are based on the geometry of the original arch;
- The main components in the arch are equal;
- The weight-increasing components can be attached easily to the main arch and the web where needed (figure 6.4);
- The keystone is custom-made (properly will consist of a couple of components due to safety);
- Web of the vault based on the tessellation with a minimum number of geometries including the edges.

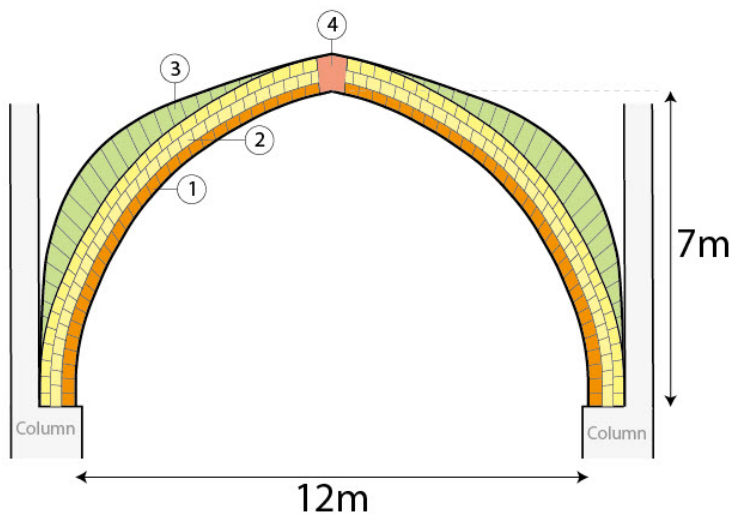

Figure 6.4: Concept of minimum number of geometries.
 1 component based on the bottom geometry of the original arch.
 2 component of the arch
 3 added weight components
 4 keystone

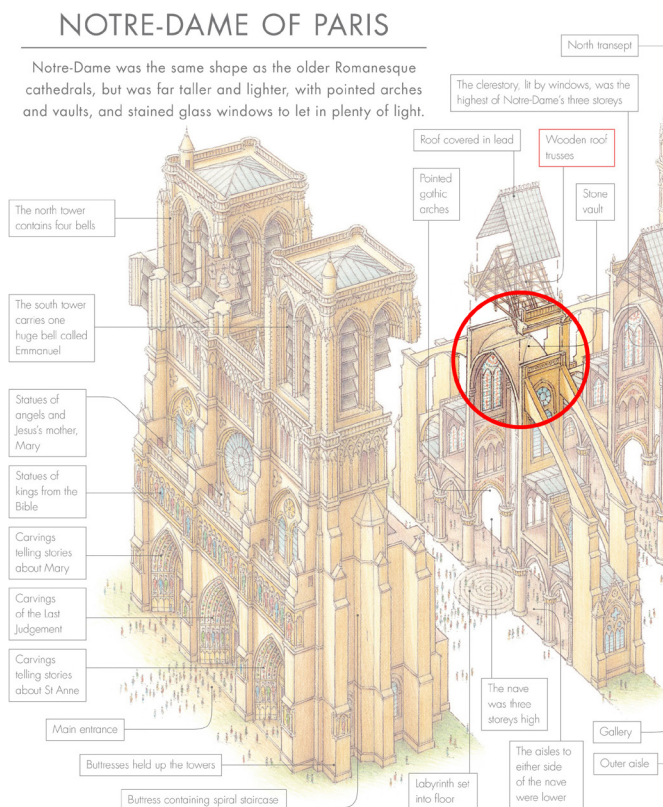

Figure 6.5: Exploded view of the Notre Dame de Paris + location of the vault which will be used in this thesis. Retrieved from Dillon (2014).

7 Design development

In this chapter, the structural arch in general, the detail of the components in the structural arch and the keystone which connects all structural arches together will be discussed. The web, which closes the opening between the glass and limestone structural arches will be discussed including the connection. Finally, the use of the interlayer in the chosen structure is explained including the assembly possibilities. See figure 7.1 for the design phases.

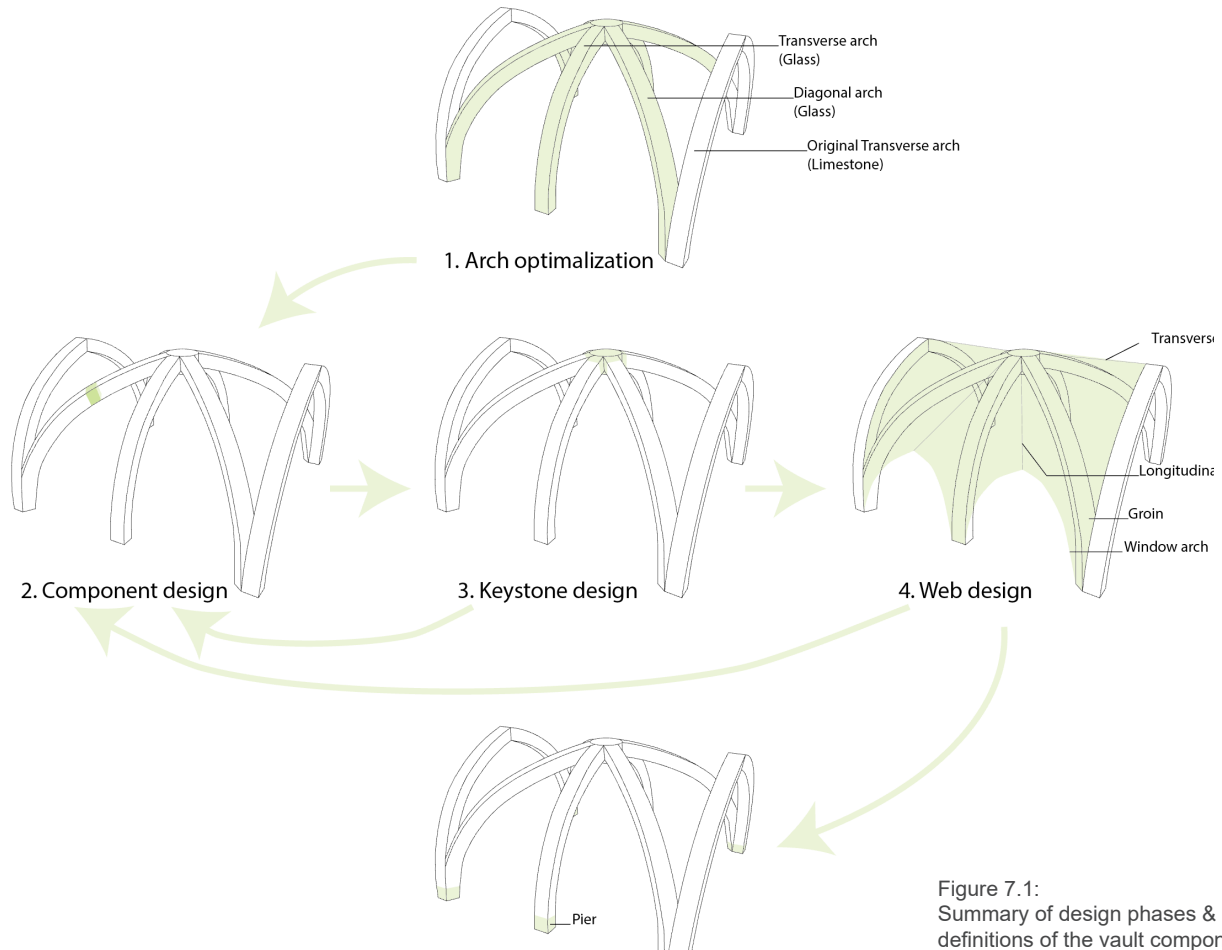

Figure 7.1:
Summary of design phases &
definitions of the vault components.

7.1 Arch

The original limestone arch of the Notre Dame de Paris is solid, and the dimension of one stone is 600mm x 600mm x 200mm. When this was constructed in the Middle-Ages, the builders did not calculate the structure and over dimensioned the structure to make sure it would stand. When these dimensions per component would be used for glass, a lot of raw material and long annealing time is required. These days, we can calculate and simulate the arch based on the properties of the material. Therefore, the first step in the design is to understand how much material can be reduced in the structural arch.

Different structural models are modelled in Rhino which are used in FEA Diana. First, the original arch dimensions are simulated with the properties of borosilicate glass. The simulation showed the structure was over dimensioned and that there was space for reduction. In this search, different aspects (figure 7.2) are considered:

- The width of the arch remained, but the height was adaptable.
- In FEA Diana, only the arches are simulated. Forces which are applied are:
 - » Dead weight of the arch;
 - » Dead weight of the web;
 - » Dead weight of a part of the façade;
 - » Wind force from the façade transferred in the bottom of the arch.

Only the height of the section is variable as the impact of the mass in the section was quickly visible. The height of the section is the most impacting part for the stiffness and strength of the structure. The width cannot be changed as this would impact the architecture of the original vault.

For the web, a thickness of 10cm borosilicate glass is calculated. The thickness is an extreme number to make sure there is space for improvement later in this design process as it is unknown in this phase of the design if the web will contain small components or complete plate structure. Determining the surface of the web is based on the curvature of the web. It spans from arch to arch or from arch to window arch. The web between two structural arches is split in the middle. The details will be discussed in paragraph 7.4 'Web'.

The wind force is based on the wind force against the walls of the cathedral. The wind load will be transferred via the vault and floors to the columns and ground. The vault is not only important for transferring the load, but also for the stability of the cathedral. Therefore, the wind load is added to the bottom of the arch as this is where the wind force collects and transfers to the other side of the cathedral. For the wind force, 1 N/m² and a safety factor of 1,5 is calculated. The top part of the façade is also included in this calculation as a big part of the façade is supported by the floors. As the vault moves with the façade, a negative wind force is added on the other side of the arch to simulate this situation.

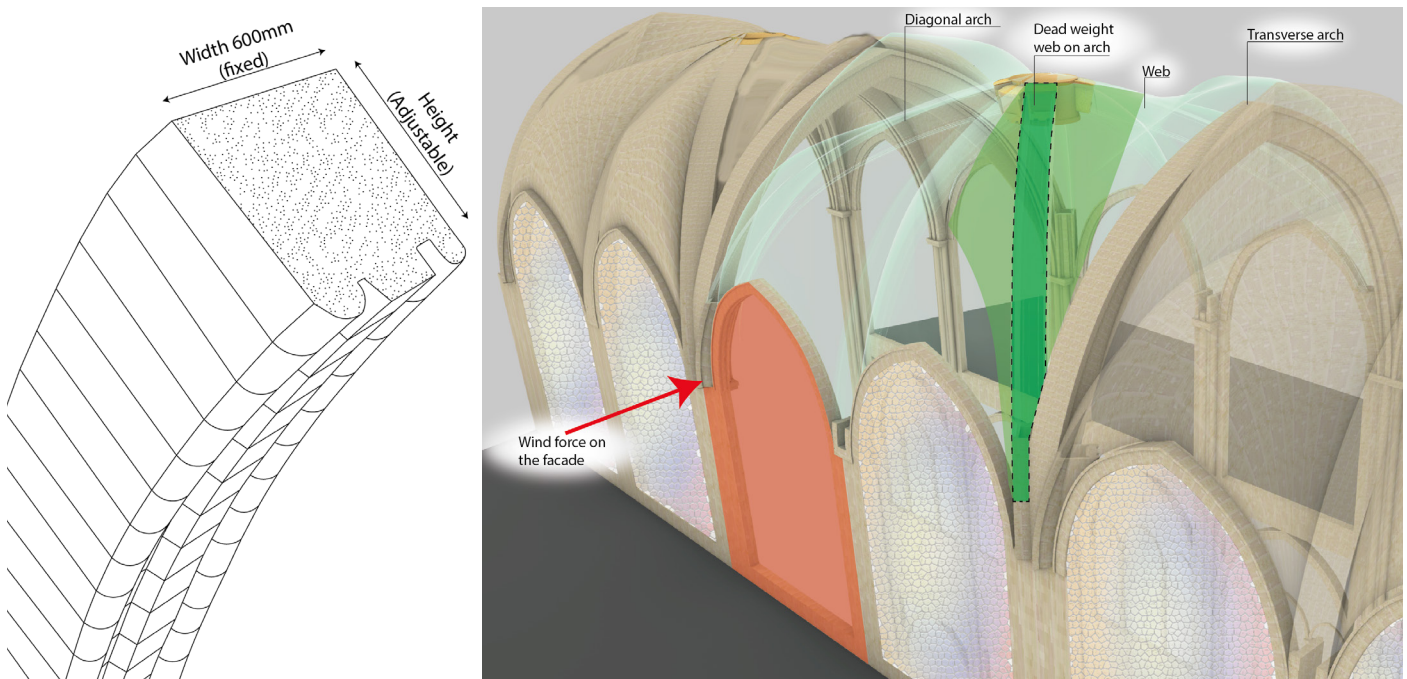

Figure 7.2: Arch dimensions for saving material (left) and Definition of the forces in the arch (right).

Many options were tested, but the five main options are shown in table 7.1. When simulating the different models (appendix B), it was clear the critical point would be the bottom of the arch as this is the point where the thrust line will transfer from the arch to the column and buttress. The thrust line should be in $\frac{1}{3}$ structure's section of the arch to reduce eccentricity which causes a momentum, so stress. Therefore, to be on the safe side of deflection, $\frac{1}{6}$ of the thickness is the allowable deflection. The most promising dimension is 250mm x 600mm at the bottom of the arch and 150mm x 600mm at the top where it connects with the keystone. From this point, the design from the component perspective will start.

For now, the thickness of the arch is divided in three different thicknesses, see figure 7.3. This way, the thrust line can be pushed into the column and flying buttresses without changing the original force flow. This way, material usage can be spared without impacting the heritage structure. As the original outline of the geometry is remained, no visual changes are visible from the ground floor where the users of the building are. The top of the arch does change, but this is not open for public. In the original vault's situation, the top was not finished nicely as nobody except for the building keepers will see this.

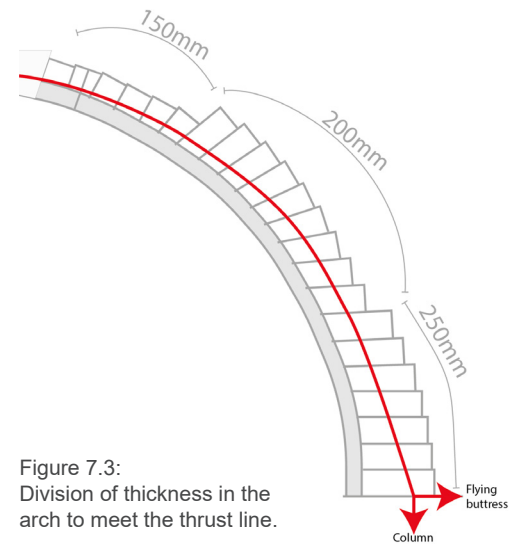

Figure 7.3:
Division of thickness in the arch to meet the thrust line.

Table 7.1: Variants of structural arch's dimension based on the section.

Variant	Dimension section (mm)		Deflection (mm)		Stress (N/mm ²)									
	Bottom	Top	Allowed	Simulated _{max}	Glass		S1		S2		S3			
					Compres. max	Tensile max	Compres. Max	Tensile max	Compres. Max	Tensile max	Compres. Max	Tensile max		
Current	600 x 600	600 x 600	100	0,42	260	22	1	10	3	1	15	1		
1	600 x 600	300 x 600	50	0,31	260	22	0	2	0	0	2	0		
2	300 x 600	300 x 600	50	0,84	260	22	1	5	2	2	6	1		
3	150 x 600	150 x 600	25	11	260	22	10	33	27	17	44	8		
4	50 x 600	50 x 600	8	9	260	22	44	236	62	76	182	61		
5	250 x 600	150 x 600	25	3,7	260	22	3	16	-7	7	19	3		

7.2 Components of the arch

As the arch dimensions and restrictions are now known, the tessellation of the arch section can now start. Four main steps are taken to design the components in the arch. In figure 7.4, these four steps of designing the structural arch components from section view are shown.

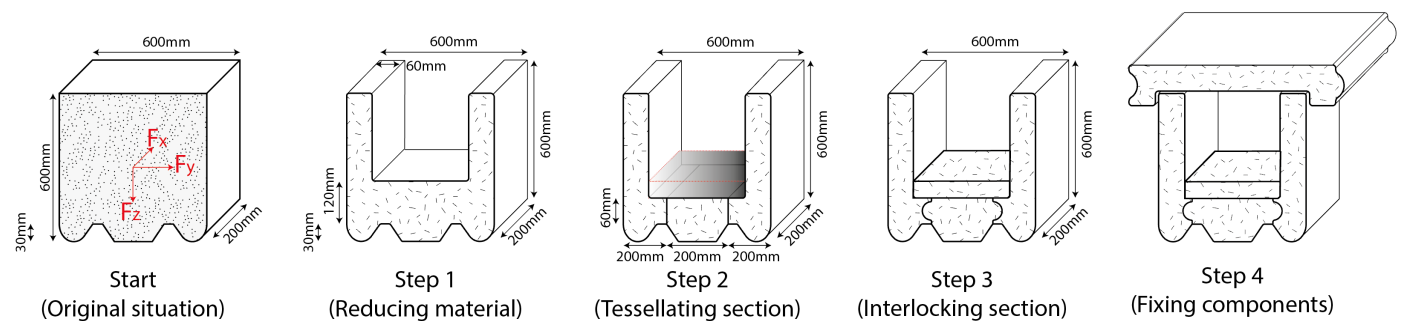

Figure 7.4: Steps from original till cast glass components of reconstructing the original arch.

Step 1: The non-restricted elements are taken out of the section. This way, a hole is created in the arch which saves materials and additional weight on the existing walls. The less weight is added on the walls, the lower the risk of failure. The starting point of the thickness of the vertical wall is based on the Crystal house brick dimensions (Oikonomopoulou, 2019) due to the annealing time. As 50 till 75 sections of 200mm are required in each arch of the vault, the speed of the annealing process is essential. Otherwise, it will take years till the complete cast glass arch is produced when a minimum number of moulds are used. The indication of annealing time is shown in table 7.2. Next to this, the thickness is also important to avoid buckling of the vertical wall. However, as the complete component should have an equal thickness as much as possible due to annealing, the greatest force (x-direction) is leading in determining the thickness.

Table 7.2:
Approx. annealing time based on the thickness of the section. Retrieved from Bullseyeglass (2019).

Thickness (mm)	Min. Time (hours)
12	5
19	9
25	14
38	28
50	47
62	70
75	99
100	170
150	375
200	654

Step 2: Tessellation of the one arch component is required as the preferred weight per component is 25kg (Oikonomopoulou, 2019). This is not only because of the annealing time, but also due to flaws in the component, which are caused during the pouring and annealing process. Next to this, tessellation is required for increasing the safety factor. When one element of the component fails, the other elements will take over the forces. The structure will not fail when one element fails. Also, the flexibility in the assembly phase is important and this has a risk factor in damaging the components when assembling the arch. When the arch is divided equally, all components are below 25kg. However, when forces from the web are applied on the web, a momentum can appear due to the lifting effect in the interlocking. This can cause failure in the corner of the vertical and horizontal part of the outside tessellated elements. Therefore, the interlocking should be as close as possible to the vertical part of the element. Figure 7.5 shows the forces in both situations when the component is tessellated. In appendix C, the details of these two variants can be found including the weight and pro/con analysis.

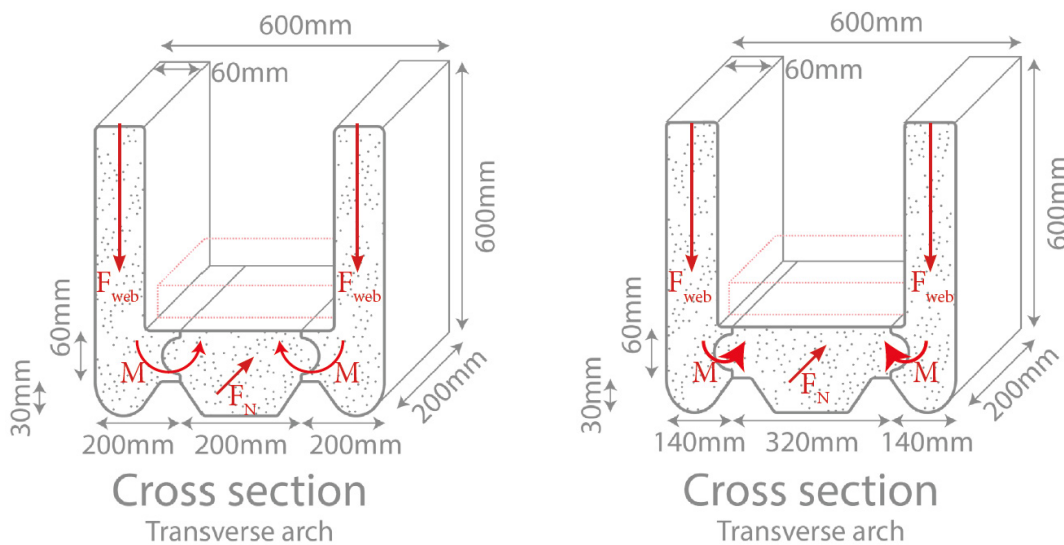
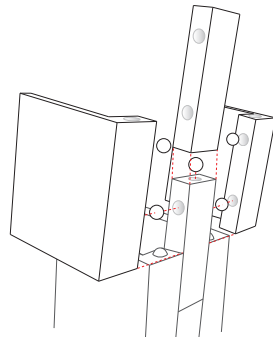

Figure 7.5: Forces which causes a momentum in the tessellated elements – Equal divided (left) and unequal divided (right).

Step 3: When the component is tessellated, the elements should stay together by own force as the vision of this thesis is creating a dry-assembly cast glass structure. Many variants are made in a physical model out of clay, but the six most potential variants are summed in figure 7.6. In this overview, the pros and cons are summed to understand which interlocking system will work best for the arch situation. In appendix D, the details of the elements and pictures of the clay models can be found.

Variant 4 and 6 have the most potential in stabilization and force resistance. Both variants can overlap joints in different levels and interlocks all four elements together in x, y and z direction without rotation or shear force. Also, the level of complexity for assembly is low in both variants, while the others will face tolerance and small components issues. E.g. variant 1 contains small glass balls which will not only create rotation in the component, but also precise work in the assembly phase. Many glass balls will be required as some will be dropped by the construction workers.

Now, two variants are selected for further development. However, this project is about reconstructing heritage arches. So, the appearance of the elements in the arch is also important. Variant 6 deviates more than variant 4 from the original lay-out of the limestone arch. The limestone arch was simply divided in straight blocks. Therefore, variant 4 is chosen to continue with.



Variant 1

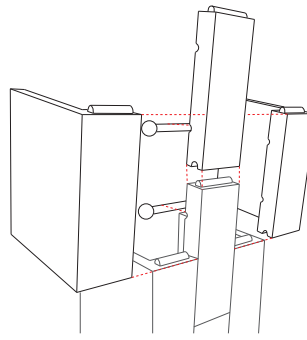

Variant 2

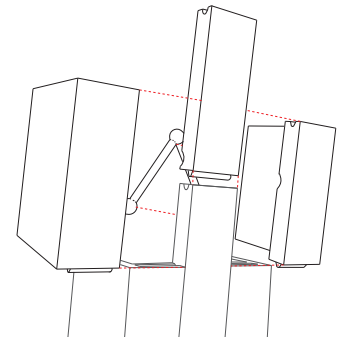

Variant 3

Number of moulds	3	4	4
Weight smallest component	0,3 kg	1,2 kg	2,4 kg
Weight biggest component	66,9 kg	61,5 kg	61,5 kg
Similar to original lay-out?	Yes, longitudinal component	Yes, longitudinal component	Yes, longitudinal component
Findings	<ul style="list-style-type: none"> + Lowest number of different moulds required; - Balls create rotation within the structure; - Small elements make assembly difficult; - Minimum contact surface: Peak stress; - Different thickness of the component is required depending on location in arch; - One component layer in z axis, lowers the safety aspect; 	<ul style="list-style-type: none"> + Universal connection for components; + Easy to assembly; - Connection element fails due to shear stress; - Location of connection hole has no tolerance; - Different thickness of the component is required depending on location in arch; - One component layer in z axis, lowers the safety aspect; 	<ul style="list-style-type: none"> + Universal connection for components; + Easy to assembly; - Connection element fails due to shear stress, even when the connection is in the normal force line; - Location of connection hole has no tolerance; - Different thickness of the component is required depending on location in arch; - One component layer in z axis, lowers the safety aspect;

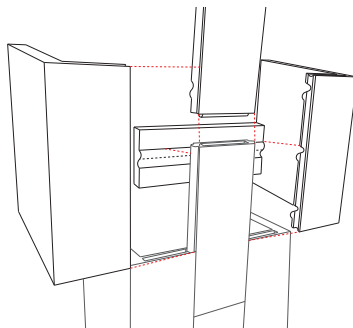

Variant 4

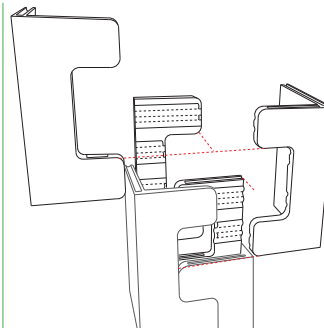

Variant 5

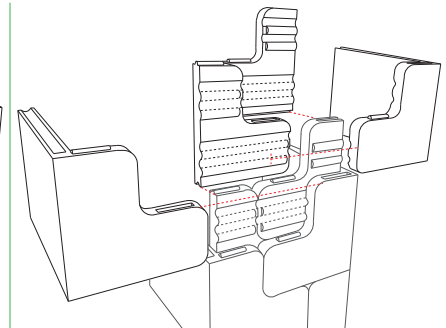

Variant 6

Number of moulds	4	4	4
Weight smallest component	11,3 kg	24,8 kg	12,5 kg
Weight biggest component	56,1 kg	84,4 kg	42,5 kg
Similar to original lay-out?	Yes, longitudinal component	No, square components	No, square components
Findings	<ul style="list-style-type: none"> + Connection element overlaps joints and creates a complete structure; + Near the original lay-out of the arch structure; + Easy to assembly; 	<ul style="list-style-type: none"> + Connection element overlaps joints and creates a complete structure; + Easy to assembly; 	<ul style="list-style-type: none"> + Connection element overlaps joints and creates a complete structure; + Small components increases safety; + Easy to assembly;
Disadvantages	<ul style="list-style-type: none"> - Forces only in the bottom components. Top layer is only for connection and weight; 	<ul style="list-style-type: none"> - Only two components per layer. When one fails, the other has to take over the forces of the full structure; - Requires extra precision in the connection to avoid tensile stress in the component; 	<ul style="list-style-type: none"> - Only two components per layer. When one fails, the other has to take over the forces of the full structure;

Figure 7.6: Variant table of Interlocking system arch components.

Step 4: Now, time to zoom in on the geometry of the interlocking. In figure 7.7, different options of the interlocking are shown. The position of the interlocking is where two different tessellated components meet. Not only in y-direction for keeping the components together as this will contain the least forces, but in x-direction as this is where the thrust line is located. This means the x-direction must resist the greatest compressive and tensile forces. The z-direction only must resist the sliding force due to gravity. Next to this, according to Casapulla, Mousavian & Zarghani (2019) the interlocking geometry must meet the following rule: $h \leq s$. This means that the height (h) is smaller than the width of the interlocking (s).

Variant 1 is most suitable when no dry assembly is required, and adhesive bonding is applied. **Variant 2 and 3** both have sharp edges which complicates the annealing process. Also, these variants have no tolerance when the angle changes of the arch. The interlocking must follow the curvature of the arch. Otherwise, the interlocking system will fail due to local peak stresses. **Variant 4** has tolerances when the angle of the curvature changes and has space for correction. In corrections can not only be caused during the production phase, but also during the construction phase. Therefore, this must be part of the construction to avoid peak stresses. Variant 4 is chosen for further development.

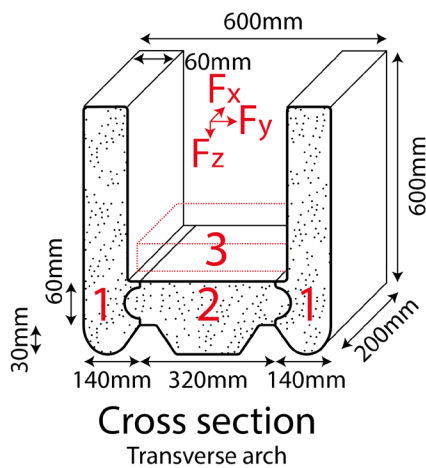

Variant 1 (Straight)	Variant 2 (Tetris)	Variant 3 (Teeth)	Variant 4 (Curves)
<p>Findings</p> <ul style="list-style-type: none"> + Thickness of connection is equal in the section + Full contact surface for transferring compression force (x axis) - Shape edges which complicates the annealing - No resistance against sliding (y axis) 	<p>Findings</p> <ul style="list-style-type: none"> + Full contact surface for transferring compression force (x axis) + Resistance against sliding (y axis) - Shape edges which complicates annealing - No equal or tapped interlocking which complicates annealing - No correction possibility in the connection as there is no tolerance. 	<p>Findings</p> <ul style="list-style-type: none"> + Full contact surface for transferring compression force (x axis) + Resistance against sliding (y axis) - Shape edges which complicates the annealing - No equal or tapped interlocking which complicates annealing - No correction possibility in the connection as there is no tolerance. 	<p>Findings</p> <ul style="list-style-type: none"> + Full contact surface for transferring compression force (x axis) + Resistance against sliding (y axis) + tapped interlocking which reduces risks during annealing + Correction possible in the connection as there is tolerance. - Shape edges which complicates the annealing

Figure 7.7: Location of the components (top) and Variant table of interlocking system (bottom).

The interlocking is now known, but a risk of failure of the biggest element (1) is still there. The elements have the risk of falling over due to the high center of gravity. There is a support in the interlocking, but when this fails, the complete structure can fail. Therefore, an extra safety element is introduced. This component will have a second purpose as this will also be part of the connection with the web (the fill between the arches). For now, three variants are designed which are shown in figure 7.8. The third variant does not lock the arch and can still fail. Variant 1 and 2 do lock the arch together, but they deviate from the original lay-out of the vault. However, it remains to be seen if viewers of the building will notice this, as they view the arch from 32m below. For now, the decision is made that this is acceptable. Variant 1 is heavier than variant 2 and this does not add any value to the complete structure. So, variant 2 is the design which is used to continue the research. In this phase, it is still the goal to create a full dry-assembly vault. This includes the web which will interlock in the arch. This will be further researched in paragraph 7.4 Web.

<p>Variant 1 (Fixed)</p>  <p>Cross section Transverse arch</p>	<p>Variant 2 (Push back)</p>  <p>Cross section Transverse arch</p>	<p>Variant 3 (Compression)</p>  <p>Cross section Transverse arch</p>
<p>Findings</p> <ul style="list-style-type: none"> + Rib structure is completely fixed which makes it one structure. - Approximately 30kg - The web/ arch connection component covers a part of the arch which deviates from the original situation. 	<p>Findings</p> <ul style="list-style-type: none"> + Rib structure is fixed from the outside. The side components cannot fall out of the structure. + Approximately 23kg. - The web/ arch connection component covers a part of the arch which deviates from the original situation. 	<p>Findings</p> <ul style="list-style-type: none"> + Approximately 21kg. - No connection component; Arch structure is supporting the web - Weight of the web increases the momentum in the bottom interlocking. Higher risk that component 1 rotates from the structure.

Figure 7.8: Variant table of the fixation element of the arch in the top.

7.2.1 Moulds

As part of the design phase, the feasibility of production must be considered. Otherwise, the design will end up in an expensive and complex production process. Therefore, the moulds must be designed to verify if it is possible to produce the designed elements of the arch component. As there are 50 to 75 components per arch, a permanent mould is chosen. The criteria of the moulds are shown in figure 7.9.

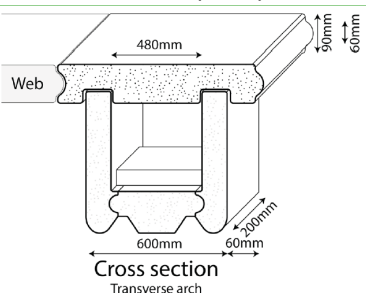
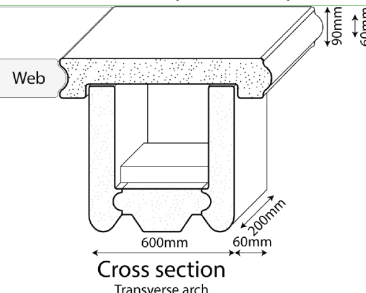
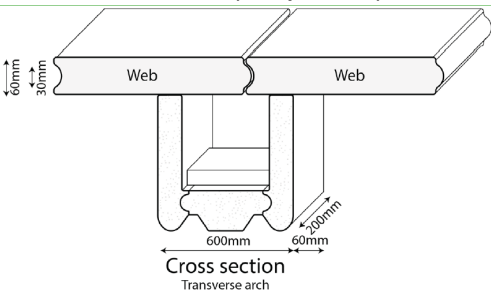
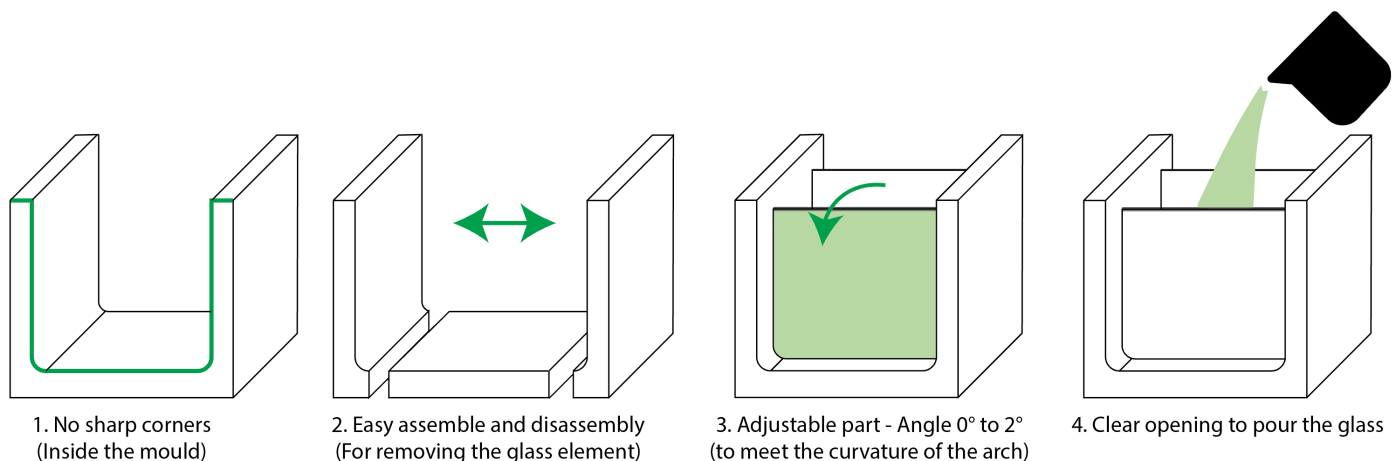

Figure 7.9: Criteria of designing the moulds for the glass elements.

For all elements of the arch component, the concepts are designed. In appendix E, all concepts including the pro/cons of the design are shown in detail. For example, the concept mould design for element 2/3 is shown in figure 7.10. All inside corners are made blunt to make sure the glass element has no sharp edges which can cause issues during the annealing phase. The complete mould can be assembled and disassembled as followed (figure 7.10):

0. The base of the mould are the fixed walls.
1. The adjustable parts can be pushed in the fixed part. This is also the moment when the angles of the mould will be determined. It depends on which component of the arch is going to be produced.
2. Add the fixed part of the mould as this closes the geometry of the mould. If this part was already fixed from the beginning, the adjustable wall was not able to change its angle. Now, the complete mould is fixed. Powder can be added to the mould before pouring the glass, so removing the glass from the mould will be easier.
3. After the molted glass is poured in the mould, the last part of the geometry can be stamped in the semi-solid glass. When the glass is around 700 °C, the geometry can still be adjusted (Oikonomopoulou, 2019). This way, the stamp only needs a few minutes to shape the semi-solid glass. When the stamp is removed, the annealing phase continues.
4. When the glass is around 50 °C, it can be removed from its mould and continue the last phase of the annealing.

In chapter 8 ‘Prototype arch component’, the moulds are built from wood. The lessons learned and changes will be described here.

Mould 2&3

Permanent & adjustable

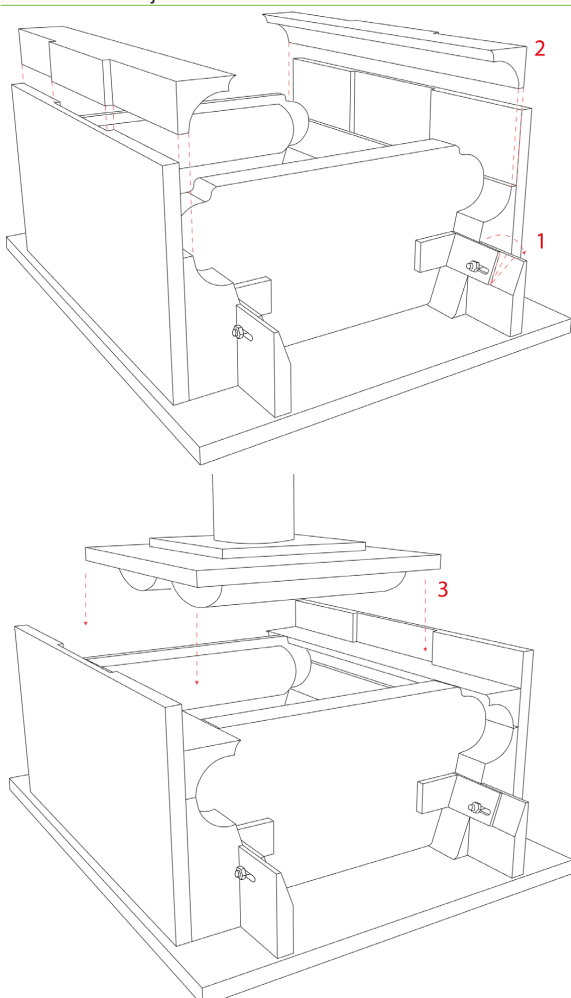

Order of assembly

- 1 Determine the angle in the x_{local} axis of the component. This depends on the location in the arch. The position of mould is fixed with a bolt.
- 2 The final y_{local} interlocking geometry can be slid from the top to finish the mould where the glass is poured in.
- 3 The molten glass is in the mould. The interlocking geometry of component 4 or 5 will be pressed in the poured glass when it is still liquid.

Figure 7.10: Concept mould design for element 2/3 of the arch component (bottom) and position of the elements (top).

7.3 Keystone

Before designing the keystone, the dimensions and original lay-out should be known as the priority is still to follow the original geometry. In figure 7.11, the original keystone and its dimensions are shown. The complete research of the keystone including the pro/cons and other findings can be found in appendix F.

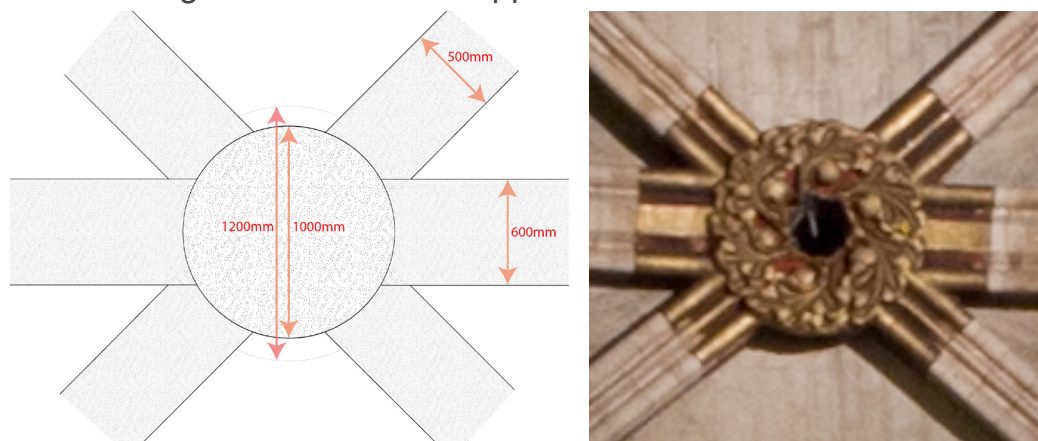

Figure 7.11: Original dimensions of the keystone (left) and a picture of the original keystone from below (right).

The original keystone is made from limestone and was stone carved on site. Back then, the stone was carved until it would fit between the six arches. Later, when a part of the supporting scaffolding was removed and the arches were structural self-standing, a decoration plate was carved and pasted on the keystone with mortar. After the arch was polished and cleaned, the paint was applied on and around the keystone. When the keystone is made from glass, it is not feasible to follow the original way of working. When the **original** keystone lay-out is copied and pasted in the glass structure, conflicts will appear between the keystone and the arches. Also, the arches will meet each other in the corner which will create overlap. On site, the glass component cannot be carved. Therefore, two other variants are designed. These can be seen in figure 7.12. A **second** variant was designed to create a smaller keystone, but with interlocking for the components. Next to this, the center of the keystone is hollow for saving material and weight. In this variant, the interlocking will be too thin to act as an interlocking. In the **third** variant, the keystone is extended to the arches. This way, there is no conflict between the arches and no thin sections where the interlocking or contact point faces issues. From architectural view, this is still following the original lay-out when visualizing the keystone. The original key stone and a part of the arches are painted gold. Therefore, variant 3 is chosen to continue.

Variant 1 (Follow original)	Variant 2 (Original + material saving)	Variant 3 (Extend to arches)
<p>Findings</p> <ul style="list-style-type: none"> + Original lay-out stays the same. - Mass overdimensioned. - No smaller components, no safety elements when it fails. - Conflicts between arches does not fit the standard size of the arch components. 	<p>Findings</p> <ul style="list-style-type: none"> + Original lay-out stays the same. + Keystone is divided which makes it safer if one part fails. - Connection between arch and keystone is fragile for annealing. - Conflicts between arches does not fit the standard size of the arch components. 	<p>Findings</p> <ul style="list-style-type: none"> + Original lay-out stays the same. + Keystone is divided which makes it safer if one part fails. + Separation keystone/ arch not visible. - Connection is a risk for the annealing process.

Figure 7.12: Variant table of determining the lay-out of the keystone.

This thesis has the goal to reconstruct a heritage vault completely from glass (**first** variant). However, there should not only be one option which material to use for the keystone. The original keystone also deviates from the vault's appearance as it is painted gold. Therefore, other options are also explored which are summarized in figure 7.13. The **second** option is to keep the original idea of cast glass keystone but reinforce it with steel due to the compressive stresses. This way, the glass will not deform due to the forces from the arches. Failure risk will be reduced this way. The **third** option is to go back to the original material, limestone. The arch is made with borosilicate glass which meets the mechanical and thermal properties of limestone. Also, limestone is easy to cut in the required geometry without expensive processes. From architectural point of view, it is the point where the structure is coming together. By reconstructing the original keystone, the newest technology is blended in with the traditional technology. The **fourth** option is to use modern material with the newest production technology e.g. 3D printing. This can be done in concrete, steel, glass, plastic etcetera. However, most of these materials do not meet the mechanical and thermal properties of borosilicate glass. This means, extra tolerance must be introduced. This could have negative visual impact due to the gap.

Variant 1 (Complete glass)	Variant 2 (Glass + Steel reinforcement)	Variant 3 (Traditional limestone)	Variant 4 (Modern materials)
			
Technique: Casting glass	Technique: Casting glass + steel shaping/ welding	Technique: Cutting/ milling	Technique: 3D printing
Findings + The complete structure is one continuous material. + With cast glass, historical geometry can be imitated. - Number of moulds required: 10 - 35 - Intensive and complex process	Findings + Steel is stiff and can function as a compression ring. + Minimum extra material required to increase the stiffness in the keystone. - Number of moulds required: 10 - 20 - Most steel types have a higher thermal expansion coefficient than borosilicate glass. - Intensive and complex process - Reinforcement plate might be visible from the ground floor.	Findings + Meets the traditional connection. + The thermal expansion coefficient of limestone and borosilicate glass is comparable. + Material has a architectural and structural value in the structure. + Cheap process without restrictions due to annealing. + Element can be made from one piece - It interrupts the principle of full cast glass structure.	Findings + Element can be made from one piece + High precision + Newest technology for creating a historical layer. + Different materials can be applied e.g. steel/concrete - It interrupts the principle of full cast glass structure.

Figure 7.13: Variant table of material options for the keystone.

As mentioned before, the challenge is to what extent it is possible to reconstruct the vault completely from glass. Therefore, the 'only cast glass' option is chosen to continue the research. The keystone cannot be made from one piece due to different reasons:

- Extreme long annealing time;
- Precision is crucial as it is prefab and must fit the arches. Due to impressions, tolerances are needed for correction;
- Assembly of the stone will be difficult due to the weight and size. Precision is difficult to achieve;
- When the keystone fails, there are no other safety measurements to take over the forces.

By tessellating the keystone, all the summed challenges are reduced. In figure 7.14, three different variants are shown. **First**, an equal tessellation is made. This way, minimum different components are needed to increase the safety and reduce the annealing time. However, all joints are not overlapping. This means, it can slide from each other due to the applied forces from the arches. Even the interlocking will slide from each other. **Second** option is tessellated in more pieces and the joints are slightly overlapping. The tessellation is made based on reducing the number of moulds. However, this is not completely required as the moulds will be temporary and only needed once. Also, the components are still very heavy which does not make it easy to assemble. The **third** option is to not only tessellate from vertical view, but also from horizontal view. This way the keystone is tessellated in eight pieces vertically, but also in three pieces horizontally. This way, all joints will overlap each other. The con side of this variant is that the tessellation will be visible from the ground floor and will not match with the original keystone. It will be a brick-laying method instead of installing the keystone. This will also make it more labor intensive. However, it creates tolerance during installation of the keystone, and it increases the safety rate. Therefore, the third option is chosen to continue.

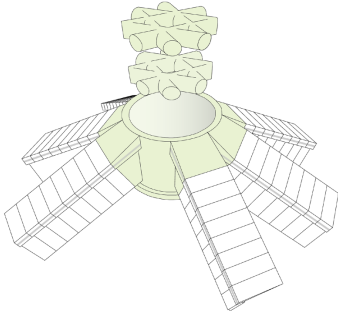
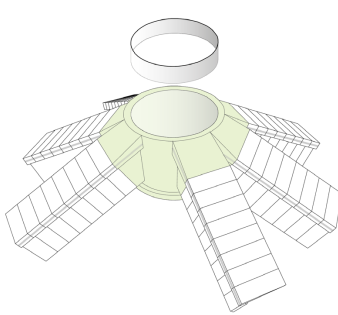
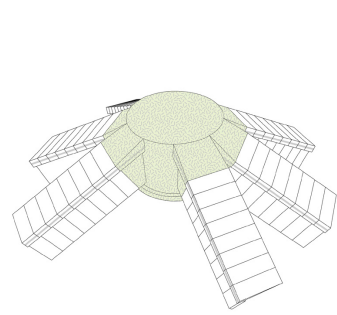
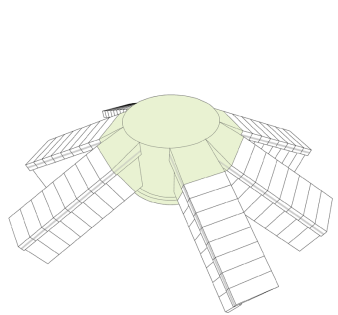
Variant 1 (Equal)	Variant 2 (Arch lay-out)	Variant 3 (Overlapping joints)
<p>topview</p>  <p>3D view</p> 	<p>topview</p>  <p>3D view</p> 	<p>topview</p>  <p>3D view</p> 
Weight comp. 1: 200 kg - 285 kg	Weight comp. 90 kg - 350kg	Weight comp. : 40-80 kg
<p>Findings</p> <ul style="list-style-type: none"> + Simple assembly order. - Extreme heavy components which increases assembly precision incorrection. - High annealling time per component. - Complex mould per component. High risk of flaws during casting and annealling. - Big heavy lifting support equipment required. 	<p>Findings</p> <ul style="list-style-type: none"> + Simple assembly order. - Extreme heavy components which increases assembly precision incorrection. - High annealling time per component. - Complex mould per component. High risk of flaws during casting and annealling. - Big heavy lifting support equipment required. 	<p>Findings</p> <ul style="list-style-type: none"> + Multiple components increases safety rate. + Overlapping joints increases safety rate. + Low weight and less complex geometry. + Less risk in flaws due to small components and pour height. - High labour intensity to assemble on site. - Temp. moulds required due to different geometry per component.

Figure 7.14: Variant table of tessellating the glass keystone.

Finally, reinforcement is required as the material saving choice creates deflection in the keystone. Therefore, four options are shown in figure 7.15. the **first** option is the starting point without reinforcement. The **second** option shows a honeycomb reinforcement and connects with the keystone there where the arches transfer the compressive force. The element is too heavy and too big to install with precision. Even when the honeycomb will be tessellated horizontal. Still, this issue is also the case with the **third** option, but the geometry is simplified which makes it easier to cast. The **fourth** option has the most potential as the mass is around 38kg per element. The node of the arches is the location where the compressive forces are transferred which means the reinforcement is required here. Minimum weight is added to the keystone this way. However, the casting process will be a challenge and 3D printed moulds will be required.

Variant 1 (hollow)	Variant 2 (Honeycomb)	Variant 3 (Solid contour)	Variant 4 (Corner pipes)
			
Weight reinforcement: - kg	Weight reinforcement: 1.300 kg	Weight reinforcement: 950 kg	Weight reinforcement: 38 kg
Thickness reinforcement: - mm	Thickness reinforcement: 10 mm	Thickness reinforcement: 60 mm	Thickness reinforcement: 60 mm
Findings <ul style="list-style-type: none"> + No extra mass added which impacts the arches and reaction forces. - When forces are applied to the keystone, it will deform. This causes tensile stress. - Low safety rate as there is no reinforcement to tessellate. 	Findings <ul style="list-style-type: none"> + Honeycomb structure fills up the complete hole. - Mass extreme high which impacts the arches dimensions and annealing time Findings with tessellation <ul style="list-style-type: none"> + Tessellation per hexagon increases the safety rate. - Tessellation per hexagon possible which reduces weight to 75kg per component. - High annealing time per component. 	Findings <ul style="list-style-type: none"> + The forces in the arch continues in the same contour in the reinforcement. - Mass extreme high which impacts the arches dimensions and annealing time Findings with tessellation <ul style="list-style-type: none"> + Tessellation per hexagon increases the safety rate. - Tessellation per hexagon possible which reduces weight to 160kg per component. - High annealing time per component. 	Findings <ul style="list-style-type: none"> + Only the corner points of the arches are used for compression force in the keystone. + Temp. mould (3D printed sand moulds) required to make the geometry possible - Mass bigger than 25kg (based on design criteria). - Complex moulding process

Figure 7.15: Variant table of reinforcement of the glass keystone.

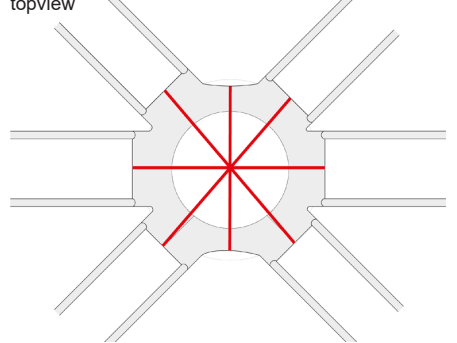
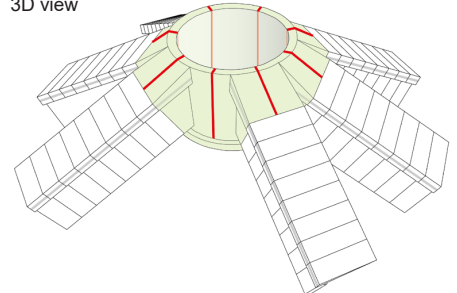
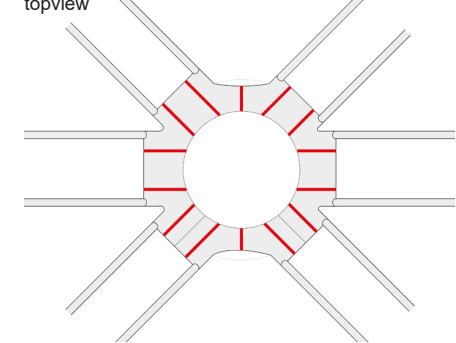
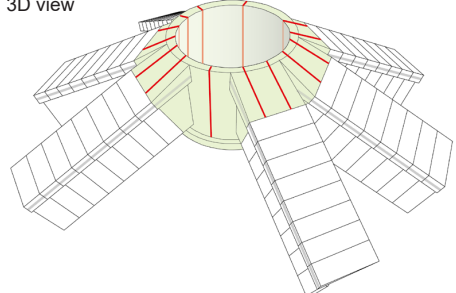
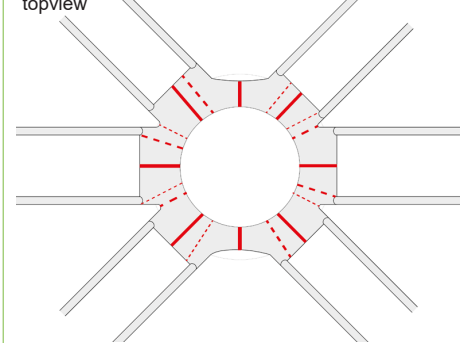
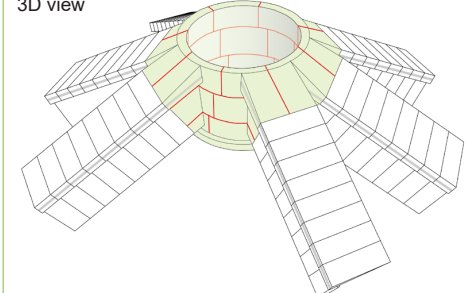
To summarize (figure 7.16), all choices made for the keystone are based on a full cast glass component, which is tessellated like a brick structure to overlap joints for safety reasons and corner pipes as reinforcements to transfer the compressive forces and to reduce deformation in the keystone.

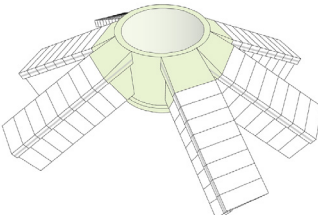
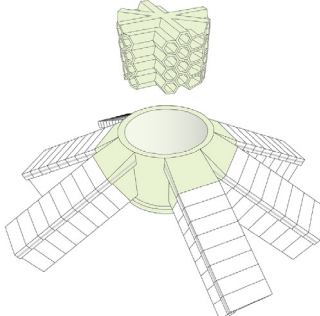
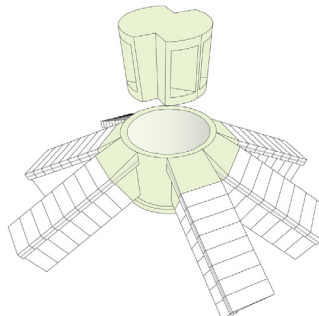
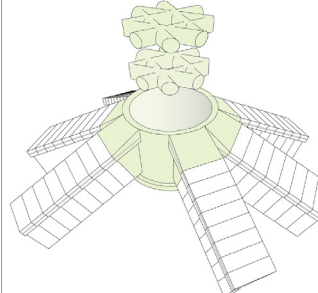
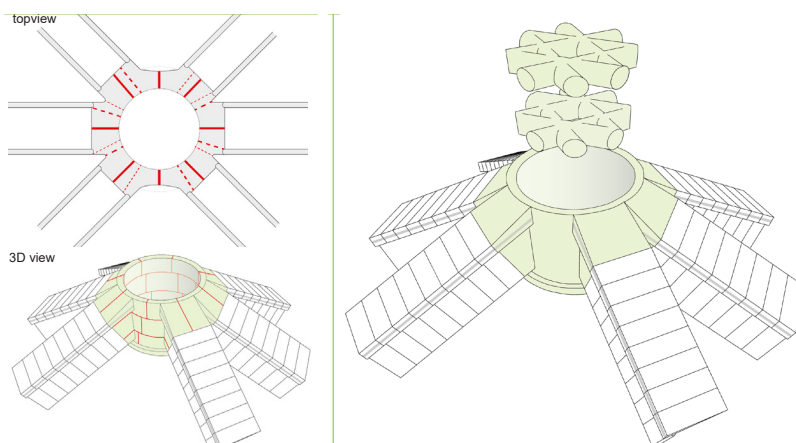

Figure 7.16: Overview of choices for a cast glass keystone.

However, when taking a step back to reflect on these options, they may require too much energy, risk and challenge to be considered as best option. The choices made for a full cast glass keystone make the structure even more complex. It is important not to get lost in the complexity of the project and take simplicity into account to ensure builders are able to build the structure without too much risk of making mistakes. Making different choices could prevent this project becoming too expensive, complex, and high-risk. Probably, a full glass keystone is possible when more time is put in it and more simulations are done. Therefore, the decision is made to go back to the material choice matrix which is shown in figure 7.13. From structural and architectural point of view, the other option is number three 'limestone keystone'. This way, this structure will go back to basics and combines new and traditional technology together. The limestone already proved that it could transfer the compressive forces of the arches without any problem. The vault of the Notre Dame de Paris only failed as the wooden roof collapsed on the vault. This is an additional force that was not considered in the design of the vault. Next to this, users of the building will realize how important a keystone is, as it will be 'floating' in the air while it is keeping everything together.

variant 1 (Complete glass)	variant 2 (Glass + Steel reinforcement)	variant 3 (Traditional limestone)	variant 4 (Modern materials)
			
Technique: Casting glass	Technique: Casting glass + steel shaping/ welding	Technique: Cutting/ milling	Technique: 3D printing
Findings <ul style="list-style-type: none"> + The complete structure is one continuous material. + With cast glass, historical geometry can be imitated. - Number of moulds required: 10 - 35 - Intensive and complex process 	Findings <ul style="list-style-type: none"> + Steel is stiff and can function as a compression ring. + Minimum extra material required to increase the stiffness in the keystone. - Number of moulds required: 10 - 20 - Most steel types have a higher thermal expansion coefficient than borosilicate glass. - Intensive and complex process - Reinforcement plate might be visible from the ground floor. 	Findings <ul style="list-style-type: none"> + Meets the traditional connection. + The thermal expansion coefficient of limestone and borosilicate glass is comparable. + Material has a architectural and structural value in the structure. + Cheap process without restrictions due to annealing. + Element can be made from one piece - It interrupts the principle of full cast glass structure. 	Findings <ul style="list-style-type: none"> + Element can be made from one piece + High precision + Newest technology for creating a historical layer. + Different materials can be applied e.g. steel/concrete - It interrupts the principle of full cast glass structure.

Figure 7.13: Variant table of material options for the keystone.

7.4 Web

The complete structural part of the vault is designed, and now it is time to design the web, the fill between the structural arches (figure 7.17). The top view dimension of the webs is between 6 x 12m and 6 x 6m. The surface of the web is bigger as it moves around a curve. The web has no additional forces than its own weight. The original method is bricklaying the web with mortar. Where needed, the brick was cut on site. Afterwards, the web was filled from the top with rubble to make sure the thrust line will continue in the flying buttress. For the glass structure, the rubble is not required as the arches are calculated to take the thrust line into account. The bricklaying is not possible for cast glass, so the components should be tessellated small, so it is able to secure to each other in an interlocking in the curvature that is needed. The smaller the elements, the easier it is to make this curvature. Next to this, tessellating the component in small elements increases the safety factor. When one fails, the other will take over. Therefore, this was the **first** option for realizing the web. The details per variant can be found in appendix G

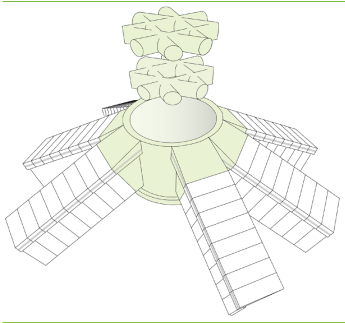
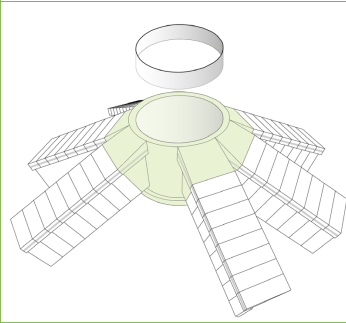
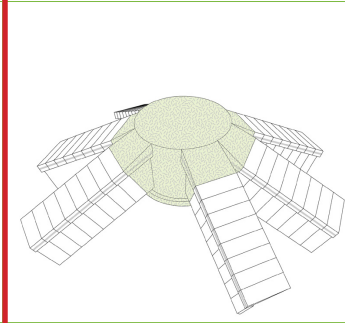
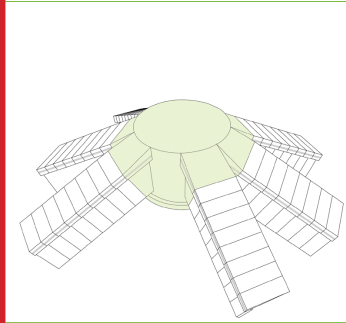
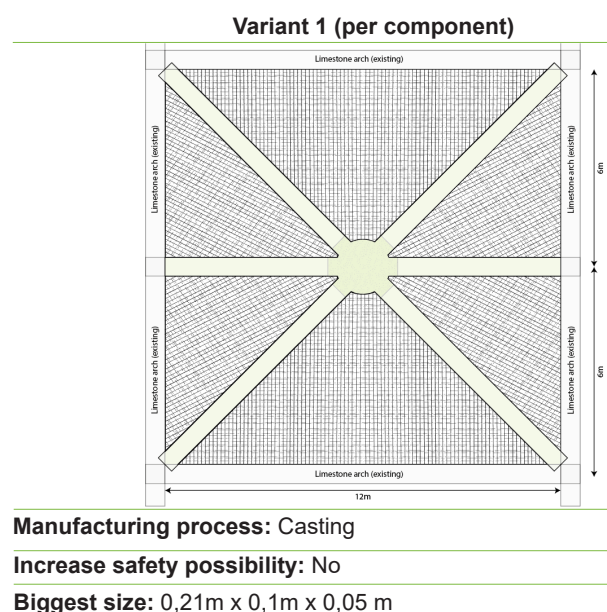

Figure 7.17: Tesselation of the web. Green part is the structural arch and keystone. White part is the web.

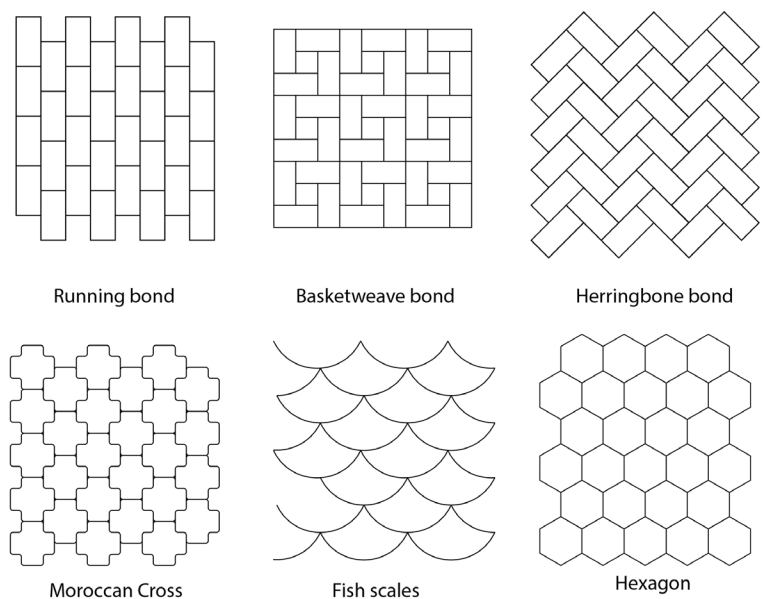

Figure 7.18: Examples of patterns of the web of a vault.

However, the Notre Dame de Paris has used a simple pattern for the web. It is also possible that other vaults have a more complex pattern which makes it more difficult to use small component. See figure 7.18 with an example of patterns which are used in vaults.

To create a more generic solution, the option for glass strips or plates between the arches is studied. These are the other options which are shown in figure 7.17. For options two till four, there are two manufacturing possibilities in glass

1. The plates can be casted in the surface geometry of the web;
 - a. This will be a single plate per span. When the plate fails, there are no safety options;
 - b. A big mould is required.
2. The standardized float glass which can be engraved for the surface pattern.
 - a. Laminate two or more plates for increase of the safety factor.

As safety is an important part for the method 'building with glass' the option of float glass is chosen. Also, the assembly process can be performed quicker than option one with many elements. Next to this, there are unlimited possibilities of patterns which can be engraved on the surface, see figure 7.19 for examples of the possibilities.

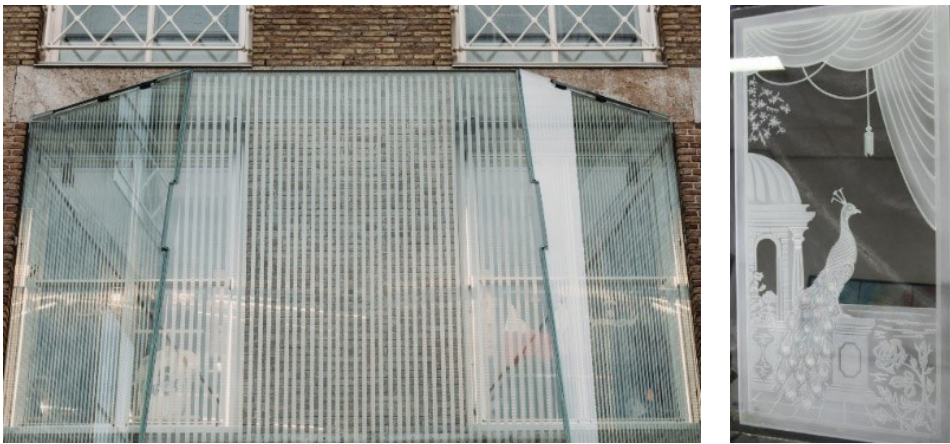

Figure 7.19: Simple and complex engraved patterns on float glass. Retrieved from UN Studio (2020) and Glasatelier J. Boersma (n.d.).

As the decision is made to design the web with float glass, it is important to understand the production, transport, and assembly restrictions. These restrictions are shown in figure 7.20. All three options are designed based on these restrictions. For transport, a standard truck size is used as restriction because the Notre Dame de Paris is one of the few heritages that is located on a main road. Most heritages are in old city centers or other difficult to reach locations, which would require exceptional transport. Also, exceptional transport makes the product even more expensive and the risk of damage increases. For the Notre Dame de Paris, a fixed crane is already on location and can be used for lifting the glass elements. However, when that is not possible for other heritages, installation with a flexible mini crane is feasible.

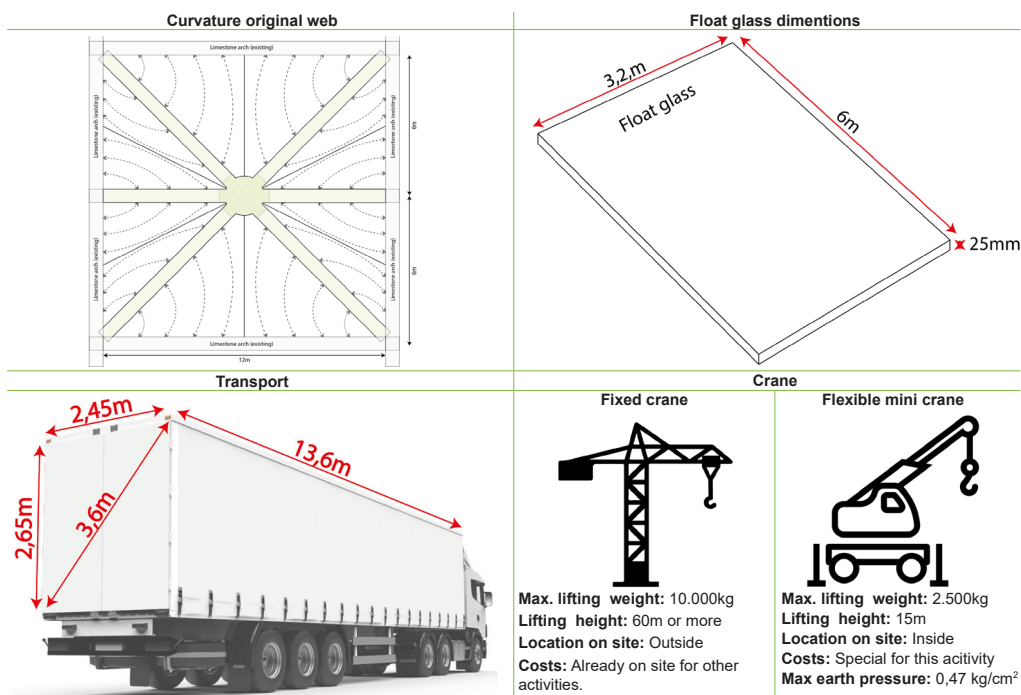

Figure 7.20: Restrictions of float glass, transport and assembly.

Now, all possibilities and restrictions are known, and the design of the strips and plates variants can continue. In figure 7.21, the overview of the variants is shown. The **first** option is not applicable as this contains cast glass components only as discussed before. The **second** option contains small strips of laminated glass which meets the curvature of the original web. See figure 7.20 for the curvature direction of the web. However, this will increase the labor intensity and increases the risk of assembly mistakes. Next to that, the joints will be visible and will distract too much from the original lay-out. The **third** option contains big plates which meets the biggest size of float glass. It spans in the shortest direction. This impacts the thickness of the glass as less material is required. However, it deviates from the original span. Also, the plates close to the keystone have to be double curved. This complicates the post-processing of float glass.

The **fourth** option is following the original span and only single curved plates are required. Due to the restrictions of the production process, more than two plates per web are required. The maximum length of a float glass plate is 6m. In the floorplan it looks like the web spans 6m, however the surface length is different due to the curvature. In figure 7.22 a 3D model is shown of the web. The actual length of the web from keystone till the corner of the diagonal arch is 11m. In China there is a glass manufacturer who produces plates longer than 6m but shipping it to Europe and multiple loading from transport equipment will increase the risk of damage. So, the plates must be split to meet the European sizes. However, the joints of the plates will not be in direct vision of the visitors of the Notre Dame de Paris. The focus will be on the keystone as it is 'floating'. Therefore, option four is chosen as tessellation of the web.

Variant 2 (Strips)	Variant 3 (Plate)	Variant 4 (Plate)
Manufacturing process: Casting/ float glass	Manufacturing process: Casting/ float glass	Manufacturing process: Casting/ float glass
Increase safety possibility: Lamination	Increase safety possibility: Lamination	Increase safety possibility: Lamination
Biggest size: 4,8m x 0,4m	Biggest size: 5,2m x 3m	Biggest size: 4,8m x 3m
Findings <ul style="list-style-type: none"> + Imitates the original brick geometry. <ul style="list-style-type: none"> • Casting geometry determines the pattern. • Float glass needs to be engraving to create identical pattern. + Efficient transport due to straight plate geometry. - Strips spans longest direction which increases thickness of the element. - Extra process: Float glass needs to be bended to meet the vault's curvature. - Float glass contains double curved surface to meet curvature. 	Findings <ul style="list-style-type: none"> + Imitates the original brick geometry. <ul style="list-style-type: none"> • Casting geometry determines the pattern. • Float glass needs to be engraving to create identical pattern. + Plates spans in the shortest direction, so less thickness required. + The surface curve will be reconstructed and benefits the strength of the plate. - Deviates from the original span lay-out. - Extra process: Float glass needs to be bended to meet the vault's curvature. 	Findings <ul style="list-style-type: none"> + Imitates the original brick geometry. <ul style="list-style-type: none"> • Casting geometry determines the pattern. • Float glass needs to be engraving to create identical pattern. + Efficient use of standard production size (float glass). + The surface curve will be reconstructed and benefits the strength of the plate (single curved). - Strips spans longest direction which increases thickness of the element, but follows original span. - Extra process: Float glass needs to be bended to meet the vault's curvature.

Figure 7.21: Tessellation of the web. Green is the structural arch and keystone. White is the web.

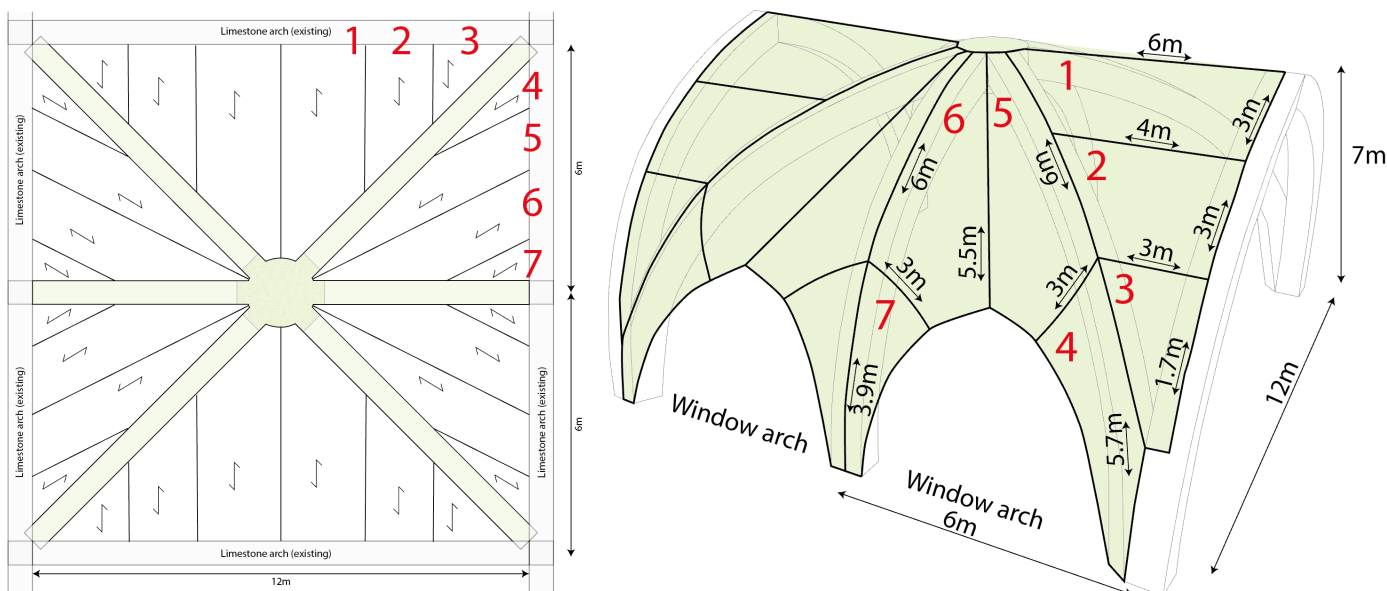

Figure 7.22: 3D model of the arch and web (variant 4).

The thickness and number of layers of the laminated plate for the web is simulated in FEA Diana. Different thicknesses are tested, and the results of the variants can be found in table 7.3. The thickness is based on the available thicknesses for float glass. This is 3mm, 4mm, 5mm, 6mm, 8mm, 10mm, 12mm, 15mm, 19mm and 25mm according to Glassshape (n.d.).

A part of the web is simulated in Diana as it is a repeating geometry in the vault. When the complete vault model was simulated in Diana, unsolvable errors appeared. Therefore, the model is simplified. Only dead weight is simulated as the web is resting on the arches and does not have to face other forces. The results of the web from FEA Diana per simulation can be found in appendix H.

As discussed in paragraph 4.4.1 'Safety strategies', laminated plates increase the safety factor by splitting up the number of plates in the panel instead of having one plate. When one plate fails, the other plates will keep the complete structure together. Otherwise, it will fall 32m. Therefore, at least three plates are introduced in the web's laminated panels. The strength of the panels is also determined by the interlayer, but this will be discussed briefly in paragraph 7.5 'Interlayer'.

After simulating different options for the web, a panel thickness of 24mm with triple 8mm plates is a safe option to go as the deflection is less than $\frac{1}{6}$ of the thickness. The biggest deflection appeared in plate 1 (figure 7.22) as the top has the biggest span but is also the flattest part of the web. As this is the minimum required thickness for this plate, it will be applied to all plates in the vault to keep a standard size.

Table 7.3: Overview of results of the web's thickness in FEA Diana.

Variant	Dimension section (mm)		Deflection (mm)		Stress (N/mm ²)							
	Thickness	Plates	Allowed	Simulated _{max}	Glass	Glass	S1		S2		S3	
					Compres. max	Tensile max	Compres. Max	Tensile max	Compres. Max	Tensile max	Compres. Max	Tensile max
1	30	10-10-10	5,00	2,39	300	30	0,00	4,38	0,15	0,89	1,43	0,00
2	24	8-8-8	4,00	3,25	300	30	0,00	5,06	0,23	1,04	1,68	0,00
3	20	6-8-6	3,33	4,17	300	30	0,00	5,64	0,30	1,16	1,95	0,00
4	22	8-6-8	3,67	3,66	300	30	0,00	5,34	0,26	1,09	1,81	0,00

7.4.1 Connect the web with the arch

The designs of the arch and web are now known. Now, the connection between these two components must be designed. In appendix I all variants are shown including the details. In the very beginning of the design process, a top component was designed to keep the complete arch structure together. This top component is shown in figure 7.23 as a **first** option for connecting the web with the structural arch. However, this principle was designed based on small elements, representing the bricks. Now, the web will be made from float glass. The **second** option shows the web is kept in place because of compression. This might work for the top part, but as shown in figure 7.22 and figure 7.23, the bottom plate will fall over due to the angle of the arch. Also, the vault moves due to wind force on the façade. So, the plate can move from its installed location. This becomes dangerous for the users of the building and therefore this option is striped out.

So, the search continues in glass connections and different connections in the laminated float glass are possible. Bedon and Santarsiero (2018) summarized the all glass connection options as clamped (a), bolted (b), bolted with countersunk bolt (c), hybrid with countersunk bolt (d), adhesive (e), embedded with thick insert (f) and embedded with thin insert (g). This is shown in figure 7.24.

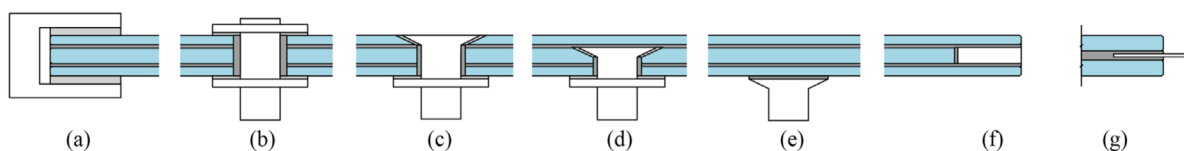

Figure 7.24: Scheme of connection used in structural glass applications - clamped (a), bolted (b), bolted with countersunk bolt (c), hybrid with countersunk bolt (d), adhesive (e), embedded with thick insert (f) and embedded with thin insert (g). Retrieved from Bedon and Santarsiero (2018).

Based on connection typology 'clamped', the **third** option is introduced. It has an embedded steel plate in the top element where the web is attached to. The forces of the web will be equally distributed on the arch, but steel is solid. So, the transparent/ translucent effect of the cast glass structure will be reduced till none when this system is applied. A reference picture of the connection is shown in figure 7.25. Therefore, this is no option. The **fourth** option has several embedded bolts in the top element. When the plate is installed, it is fixed to the steel bolt. This connection is only meant for positioning the plates and to prevent it from moving. It only should only take minimum shear force. The compressive (main) force is directly transferred into the arch. The location of the bolt is in the node of the complete arch structure. This way, it will be less visible from the ground floor as it will be blurry in this area. Also, it is so small, it might not be visible from 32m down. A reference picture of the connection is shown in figure 7.25. The interlayer between the arch and web is applied as a buffer for the thermal expansion difference between Soda-lime (float glass) and Borosilicate (cast glass). Next to this, the interlayer is also a buffer for equalizing all bumps and flaws in the float glass and cast glass. This way, the force is equally distributed over the surface of the glass. This decreases the chance of failure of the component.

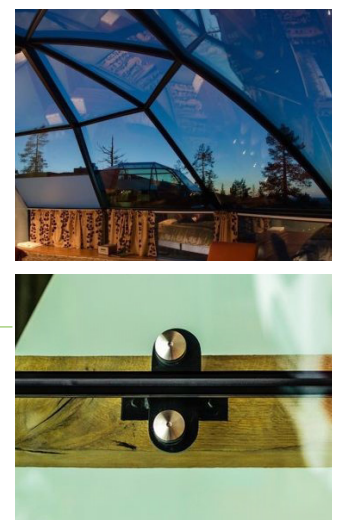
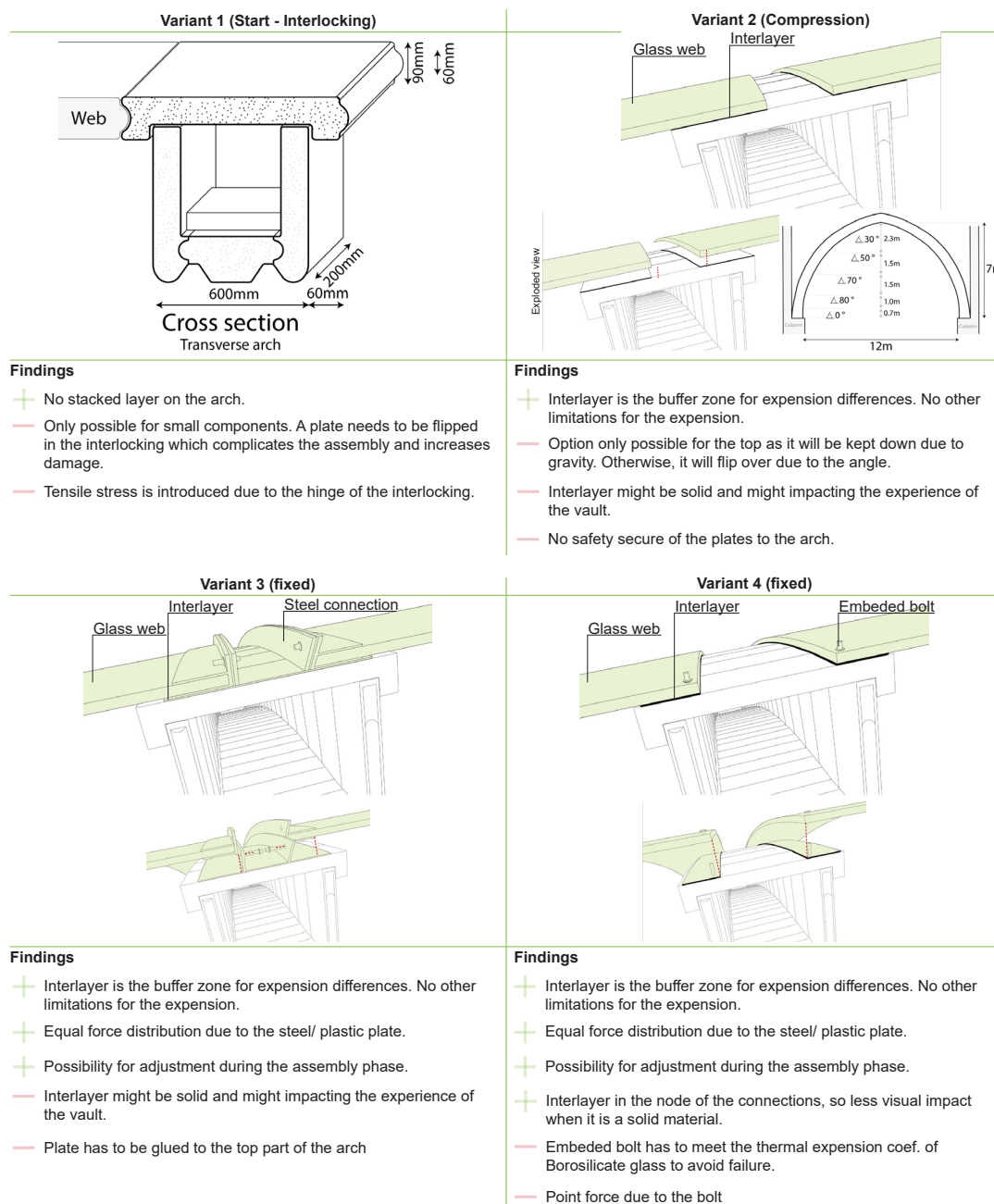

Figure 7.25: Reference connection of a steel structure (top) and a bolt (bottom). Retrieved from Architectureartdesign (n.d.) and Trombe (n.d.).

Figure 7.23: Variants of web – structural arch connection.

As option four with the steel embedded bolt sounds promising, it is still another material in borosilicate glass and soda-lime. These materials have different thermal and mechanical properties which can conflict when it is embedded (Bedon and Santarsiero, 2018). Therefore, fabrication compensations and installation tolerances are required. Also, the hole in the glass creates more local stress. The pros of adhesive bonding connections can be different per application but for this situation the adhesive bonding can transfer the forces over a distributed surface without creating peak stresses and no additional drilling or polish process is required. Adhesive bonding can be activated by three methods: moisture or additive, UV-light (UV cured adhesive) and lamination process. Of course, there are also failure modes for adhesive bonding which should be known before designing:

- Adherends (for example failure of the bonded materials);
- Cohesive (for example failure due to the thickness of the adhesive);
- Adhesive (for example failure caused by the interface between adherend and adhesive).

The possibility of an adhesive connection is studied, and two variants are designed, see figure 7.26. The **fifth** option contains a main adhesive to the arch and a clamp connection (figure 7.27). Here, only one adhesive connection per section is required. The web's laminated glass panel will be placed on an interlayer which will function as a buffer and equalizer for bumps. Then a steel plate including an interlayer is placed over the adhesive metal conductor. These two elements are bolted together. This way, there is a tolerance for installation and expansion. As the web is mostly transferring its compressive forces via the arch, the adhesive connection is only there for keeping it in place. To compare with the embedded bolt variant (figure 7.23), this variant does not require any drilling, cutting or other processing which does not weaken the laminated plate. The **sixth** option has a laminated steel element in the web's laminated plate (figure 7.27). This will be connected to the adhesive connected metal conductor on the arch. These are bolted together and is fixed. As with the previous, the adhesive connection should only keep the components on location as the main forces are directly transferred into the arch. This connection type has the benefit that it is a metal – metal connection. Also, no drilling or other process which would weaken the plate is required in this variant.

As the assembly process should be kept as simple as possible due to time and risks, option 5 is chosen to continue with. No special lamination processes will be required, but the positive size of no-drilling and metal-metal connection is still there.

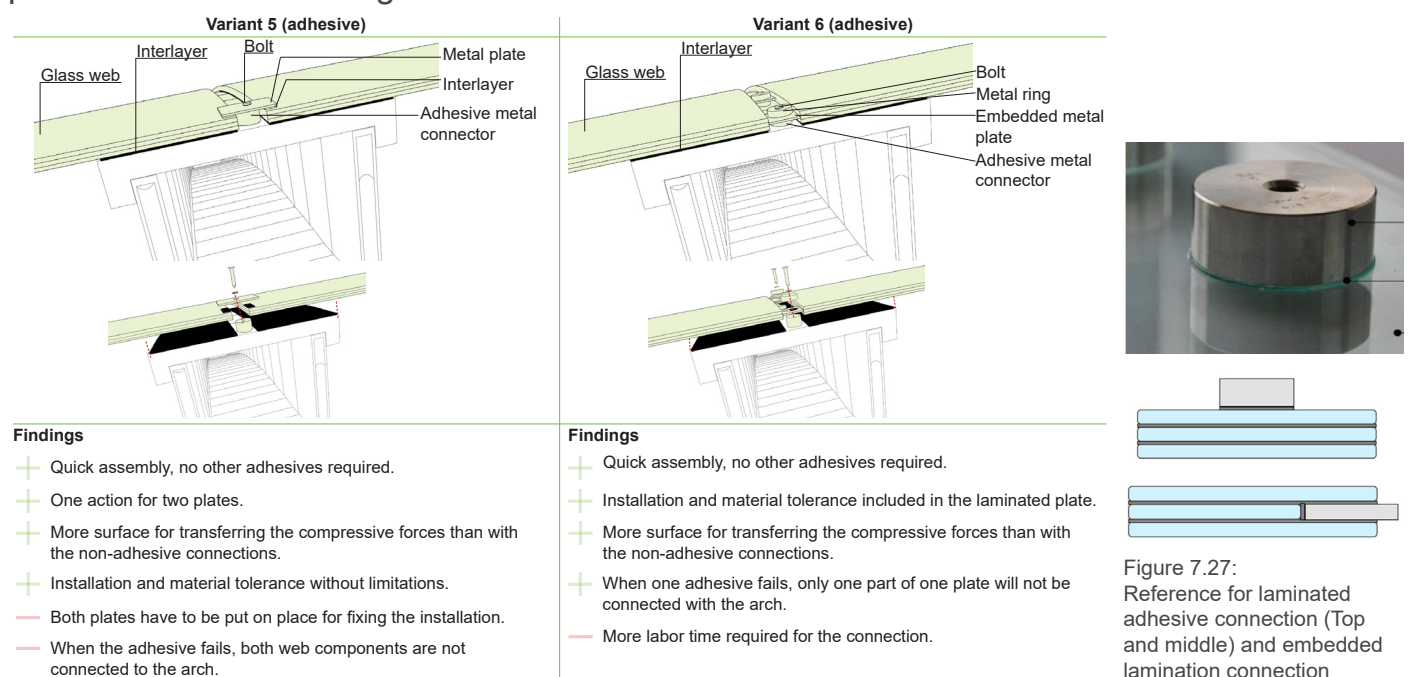

Figure 7.26: Variants for adhesive connections for the arch-web components.

Figure 7.27: Reference for laminated adhesive connection (Top and middle) and embedded lamination connection (bottom). Retrieved from Bedon and Santarsiero (2018).

7.5 Interlayer

The study regarding the interlayer will be done briefly in this thesis as **Maria Dimas** (BT graduation student 2019/2020) is focusing only on interlayer for glass structures in her thesis. She shared her literature research. A summary based on her literature research is mentioned, but also own findings are added in this thesis. The interlayer which is required for the vault must meet the following criteria:

- Compressive strength ≥ 20 MPa;
- Stiffness $<$ glass;
- Water/ Fire resistance;
- Creep resistance;
- Recycle possibility;
- Flexibility in geometry for interlocking;
- Act at service level temperatures of -20 °C – 50 °C;
- Optical: Transparent/ translucent.

Material in general

Materials are defined in six families (Ashby, Shercliff, & Cebon, 2007): polymers, elastomers, glasses, ceramics, metals, and hybrids (a combination of any of these families). These families are split up again in classes and members. This determines the material and what the properties are. For example, metals are stiff and strong but need extra processing for protection against fire and water. Ceramics and glass are hard and stiff but are brittle. Polymers can be strong; however, the behavior of this material depends on the temperature. Elastomers are like polymers, but it has a memory. It can deform due to forces but restore its original shape when the forces are not applied. An example of all families is shown in figure 7.28.

Depending on what type of material is chosen, different methods can be applied to create a material in a way that is useful for a design. This is called the production processing. This is split up in three families: Shaping, joining, and finishing. From here, every family has its own class and members. E.g. glass can be shaped by casting (glass) in sand (member) and finished by polishing (class) it.

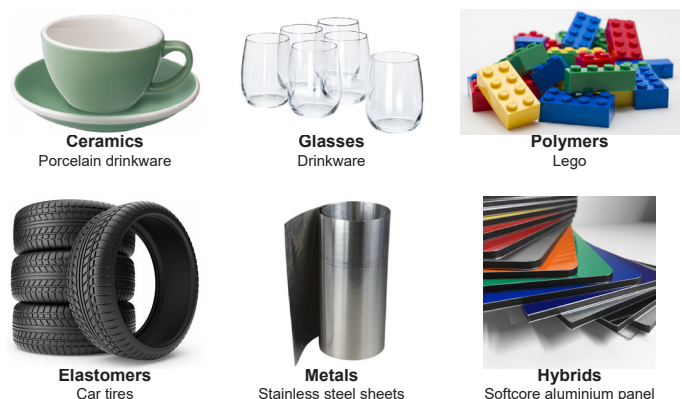

Figure 7.28:
Examples of material families. Retrieved from RS (n.d.), Lego group (n.d.), Dreven (n.d.), Ikea (n.d.) and PlasticWarehouse (2020).

Dry interlayer

According to Dimas literature research, several materials have potential to function as interlayer in a glass structure. In figure 7.29 a summary can be found based on her research and the selected materials which she will be testing in her thesis. She selected these materials on price, creep resistance, free geometry shaping, fire and water resistance and toxic properties. Also, the shaping, joining, and finishing processing are reflected in her selection.

Based on Dimas's summary, the criteria which were set for this thesis, reconstruction vaults with cast glass, were used to select the materials which can be used. In table 7.4, the properties of the glass and potential interlayers are summarized. For the arch structure, the following are primary criteria:

- Compressive strength ≥ 20 MPa;
- Water/ Fire resistance;
- Creep resistance;
- Transparent/ translucent.

	POLYMERS			ELASTOMERS			METALS			HYBRIDS			
	PU	PVC	VIVAK®	NEOPRENE	SILICONE	TEFLON	COPPER	ALUMINIUM	LEAD	METAL FOAM SANDWICH	LAMINATED PU	SOFT CORE ALUMINIUM	
PRIMARY	COMPRESSIVE STRENGTH $\geq 20\text{MPa}$	YES	YES	YES	YES	YES	YES	YES	YES	YES	YES	YES	
	CREEP RESISTANT	UNKNOWN	NO	UNKNOWN	UNKNOWN	NO	MAYBE	YES	YES	YES	MAYBE	YES	
	SLIGHTLY LESS STIFF THAN GLASS	NO (MUCH LESS)	NO (MUCH LESS)	YES	NO (MUCH LESS)	NO (MUCH LESS)	MAYBE	NO (MORE)	YES	YES	YES	MAYBE	YES
	ABILITY TO BE SHAPED IN FINAL GEOMETRY & THICKNESS	YES INJECTION MOLDING	YES INJECTION MOLDING	YES VACUUM FORMING	NO N/A	YES INJECTION MOLDING	MAYBE/ NO MILLING	YES PRESS FORMING	YES PRESS FORMING	YES PRESS FORMING	MAYBE/ NO *COMBINATION*	MAYBE *COMBINATION*	MAYBE *COMBINATION*
	CIRCULARITY	YES	YES	YES	YES	NO	MAYBE	YES	YES	NO	MAYBE/ NO	MAYBE/ NO	MAYBE/ NO
SECONDARY	OPTICAL QUALITY	TRANSPARENT/ TRANSLUCENT	TRANSPARENT/ TRANSLUCENT	TRANSPARENT/ TRANSLUCENT	OPAQUE WHITE	TRANSLUCENT	TRANSLUCENT	REFLECTIVE RED-BROWN	REFLECTIVE SILVER	OPAQUE ASH GRAY	REFLECTIVE	TRANSLUCENT/ OPAQUE	REFLECTIVE
	THERMAL EXPANSION COEFFICIENT* GLASS: 4-10 MSTRAIN/ °C	90-92	45-180	120-130	110-240	250-300	120-180	15-23	18-26	18-30	UNKNOWN	UNKNOWN	UNKNOWN
	DURABILITY: WATER, FIRE & UV	YES	YES	YES	YES	WATERTIGHT FOR APPROX. 20 YEARS YES	YES	YES *DISCOLORATION FROM WATER*	YES	YES	MAYBE *CONSIDER THE EDGES*	YES	YES

*The values for the thermal expansion coefficient have been retrieved from CES EduPack 2019

POSITIVE DEBATABLE NEGATIVE CHOSEN

Figure 7.29: Literature summary of Dimas's thesis (2020) regarding interlayer for glass structures.

The other criteria can be met thanks to the processing phase. Therefore, PU and VIVAK (Polymers) are selected. Next to that, transparent aluminum and transparent graphene are added to the overview. These materials are as strong or stronger than steel. However, both materials are ceramics which still makes them brittle when they are used incorrectly. Next to that, transparent graphene is still in development in labs. This might have potential for the future, but not for this research

Table 7.4: Overview of used glass properties and potential interlayers.

Properties	Unit	Glass web		Original material	Interlayer			
		Soda-Lime glass	Borosilicate Glass	Limestone (average)	Trans. Aluminum	PU	VIVAK	Graphene
Density	10^3 kg/m^3	2.5	2.2-2.5	2.55-2.6	3.68-3.69	1.2	1,27	2.267
Young's Modulus	Gpa	68-72	61-64	35-55	320	2.8-5.5	2.2	500
Compressive Strength	Mpa	300-420	260-350	30-200	2700	1-67	55	130000
Tensile Strength	MPa	30-35	22-32	8-22	unknown	1-63	53	76800
Thermal Expansion Coef.	10^{-6} K^{-1}	8.5-9.5	3.1-6	3.7-6.3	7.5	50-140	3.8	unknown
Thermal Conductivity	$\text{W/m}^{\circ}\text{C}$	0.9-1.1	1.1-1.3	0.92-2.15	13	0.14-0.39	0,13	unknown
Porosity	%	0	0	0.006-0.12	0	0	0	0
Mean melting point at 10 Pa.s	$^{\circ}\text{C}$	1350-1400	1450-1550	n/a	n/a	n/a	n/a	n/a
Softening point	$^{\circ}\text{C}$	730	780	n/a	n/a	n/a	n/a	n/a
Annealing point	$^{\circ}\text{C}$	548	525	n/a	n/a	n/a	n/a	n/a
Strain point	$^{\circ}\text{C}$	505	480	n/a	n/a	n/a	n/a	n/a

To conclude, VIVAK sounds promising as interlayer for this project as it meets all primary criteria and can be vacuum shaped in the required interlocking. This way, it is installed correctly on the site without having issues that the interlayer is moved when the prefab elements are installed. Also, this product is transparent/ translucent with minimum impacts on the appearance of the glass structure. As mentioned before, the angle of the arch changes which can impact the view of the interlayer more than when only one position is installed. However, this type of polymer is not yet tested. Later in this chapter, the visual effect of the interlayer during the assembly phase will be discussed. When it is needed, another material which will not creep, but is also not transparent can be chosen. An example is aluminum as it is slightly less stiff than glass.

Mortar

The structural glass arches must be connected to the current structure of the Notre Dame de Paris. This means it must be connected to a steel connection or with mortar. A steel connection is simple by shaping it and use an interlayer to act as a buffer between the original and new structure. Mortar can also be used as this was traditionally used too in the heritage. As the mortar is in contact with glass, it should be acid and alkali free. Otherwise, it will damage the glass and failure will follow. Next to this, the mortar should be shrink-free as the arch is a full compressive structure. When the mortar shrinks, force distribution in the connection can change. This can create damage or failure on both structures. For example, the mortar of the Acropolis is custom made for the restoring heritage (Aggelakopoulou ,2013). Samples are taken so the mortar could be re-produced including the newest criteria. This way, the heritage was restored with custom made mortar as modern mortar might have damaged the heritage more than it already was.

Lamination interlayer

The vault does not have to resist UV and rain as it is part of the inner structure. The interlayer of the vault should meet the following criteria:

- Transparent;
- Good short and long-term behavior;
- High bond strength with the glass component;
- Resistance against compressive and shear force.

Three different foils are mostly applied for laminated glass structures: EVA, PVB and SGP (NORN, 2011). According to Su (2011), the cost and transparency ratio between these foils are: SGP > PVB > EVA.

Ethylene Vinyl Acetate (**EVA**) has a better fluidity and lower melting temperature than PVB and SGP, but the transparency changes to yellow, then black as it is not UV resistant.

Polyvinyl butyral (**PVB**) is standard used as interlayer foil for laminated glass panels for architectural and automotive glass. For processing the foil between the glass panels, it requires a higher temperature and humidity than EVA. The cooling down process needs to be more controlled than with EVA as this is crucial. Therefore, it takes more time for the autoclave to finish the lamination process. However, PVB has a better safety, sound insulation, transparency, and UV resistance than EVA, but still has a poor water resistance.

SentryGlass Plus (**SGP**) is an ionic interlayer film. SGP has a higher strength and better mechanical properties than PVB as SGP can carry twice as much load than PVB in the same thickness. Also, the tear strength is five times higher than PVB. When the glass fails, it will keep its strength as shown in figure 7.30. Next to this, it has a strong stability as it is moisture and UV resistant so the colorless and transparent remain.

To conclude, PVB can be used for the glass laminated structure as it meets the requirements. It is a part of a standard process which makes it cheaper to produce. Also, SGP is stronger and stiffer than PVB, this will not be needed for the vault structure as it is not under influence of impacts or vandalism. When the plates fail, it will be kept together thanks to the connection with the arch.

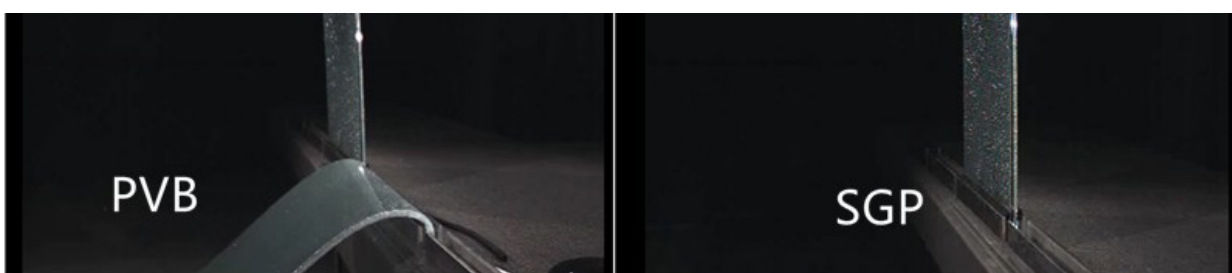

Figure 7.30: Effect of interlayer after failure of heat strengthened glass. Retrieved from ESG-glass (n.d.).

Adhesive

The adhesive for the vault needs to meet the following requirements:

- Transparent;
- Good short and long-term behavior;
- High bond strength with the glass component;
- High bond strength with the glass and metal component;
- Fast, easy and safe construction which is performed at the manufacture;
- No poison or other toxic reactions when applying the adhesive;
- Resistance against compressive and shear force.

According to Bedon and Santarsiero (2018), there are two adhesive types for metal-glass connections. Transparent Structural Adhesive Silicon (**TSSA**) is a material which differs with traditional silicon from mechanical properties perspective. TSSA has a higher stiffness and strength capacity. It is stable against temperature differences between -55°C and 130°C . The material is transparent, but when it faces stresses, it changes color. When the stresses are gone, the adhesive returns to transparency. Also, lower temperature is required than SG.

Sentry Glas (**SG**) is a transparent ionomer polymer and is mostly used for interlayers in laminated glass structures. This product has proven it has a high stiffness, an enhanced durability, and a higher mechanical resistance on long term. DELO Photobond (**DP**) is selected by Oikonomopoulou (2019) when the mock items were produced for the Crystal House in Amsterdam, The Netherlands. This type of adhesive is also UV and weather resistant. The adhesive is optimized for high force transduction in glass-glass and glass-metal bonds. The thickness of the bond should be 0.25mm equally distributed.

7.6 Assembly

All components of the vault are designed and now it is the question: What are the challenges with assembling the vault? The assembly of the web to the arch is already discussed in paragraph 7.4.1 'Connect the web with the arch'. The goal of this thesis is to understand how far a vault can be build based on a dry-assembly principle. Now, the assembly of the arch including the possibility of the interlayer is tested. The selection of the variants are based on the following criteria:

- Interlayer possibility & Visual effect;
- Labor intensity & Quality control (installation errors);

Four different variants are possible to assemble the arch. This is shown in figure 7.31.

The **first** option is a full dry assembly on site, which was also the vision of this thesis. As discussed in paragraph 7.5 'interlayer', there are limited materials which can be used for a compressive structure which can resist creep. However, the materials which can be used are not fully transparent. This means it has a visual impact on what the full glass structure will look like. This is also visualized in figure 7.31. The non-transparent/ translucent interlayer will create a solid structure appearance which takes away the complete effect of a full glass structure. Next to this, the labor intensity and installation error will be high as all has to be done manually. When an interlayer is available in the future which is fully transparent, this option will be possible.

The **second** option is a complete adhesive bonding principle. The complete structure will be assembled per element. The interlocking geometry will not be required anymore, as a polished surface is required. The visual effect will be completely transparent. However, the adhesive bonding process is challenging to perform on site due to temperature and dust. All these elements impact the quality of the bonding. This means the quality of the bonding cannot be controlled and there is a risk the structure could fail.

The **third** option is also based on adhesive bonding, but a part of the arch is prefab. The elements are bonded in a controlled environment at the manufacturer. These prefab elements of the arch will be transported to the site and will be adhesively bonded on location. Still, the issue of non-controlled environment is not solved. Therefore, the visual effect of the arch will be equal to variant two, but still has the risk of failure due to quality of the bonding. The pro of this system is that the construction can be built quick and is less labor intensive. So, the risk of installation error is lower than assembly per element. A complete arch prefabricated is not possible due to the dimension restriction of transport. When the complete arch is bonded at the manufacturer, the dimensions will be 7m high, 6m width and 0,6m depth for the transverse arch and 7m high, 6,8m width and 0,6m depth for the diagonal arch. The transport restriction is shown in figure 7.20.

The **fourth** option is a combination between adhesive bonding at the manufacturer and dry assembly on location. This way the prefab elements were produced and bonded in a controlled environment and the interlayer is not impacted by the temperature and air quality on the site. The interlayer will be visible as shown in figure 7.31, but the split of the prefab component can be done based on the visual effect of the interlayer and the transport restrictions. This will be considered for the final design which will be discussed in chapter 9 'final design'. Another benefit of tessellating the arch is when a part fails due to an event (worst case scenario) the prefab component can be removed and replaced with a new one. Of course, this cannot be done quickly as a scaffolding has to be installed again for supporting the structure, a part of the web and keystone must be removed. But this will only be the case if a worst-case scenario becomes effective. All variants are discussed in detail in appendix J.

To summarize, option 4 is chosen for assembling the arch structure together with the connection option six of the web, where the adhesive connection is linked with a steel clamp on the web's laminated panel. Interlayer VIVAK is needed to act as a buffer for the mechanical and thermal property difference between the web (float glass – Soda Lime) and arch (Borosilicate). Also, the interlayer is required as a buffer for the bumps between the two glass pieces to avoid peak stresses and equal distribution of the compressive forces.

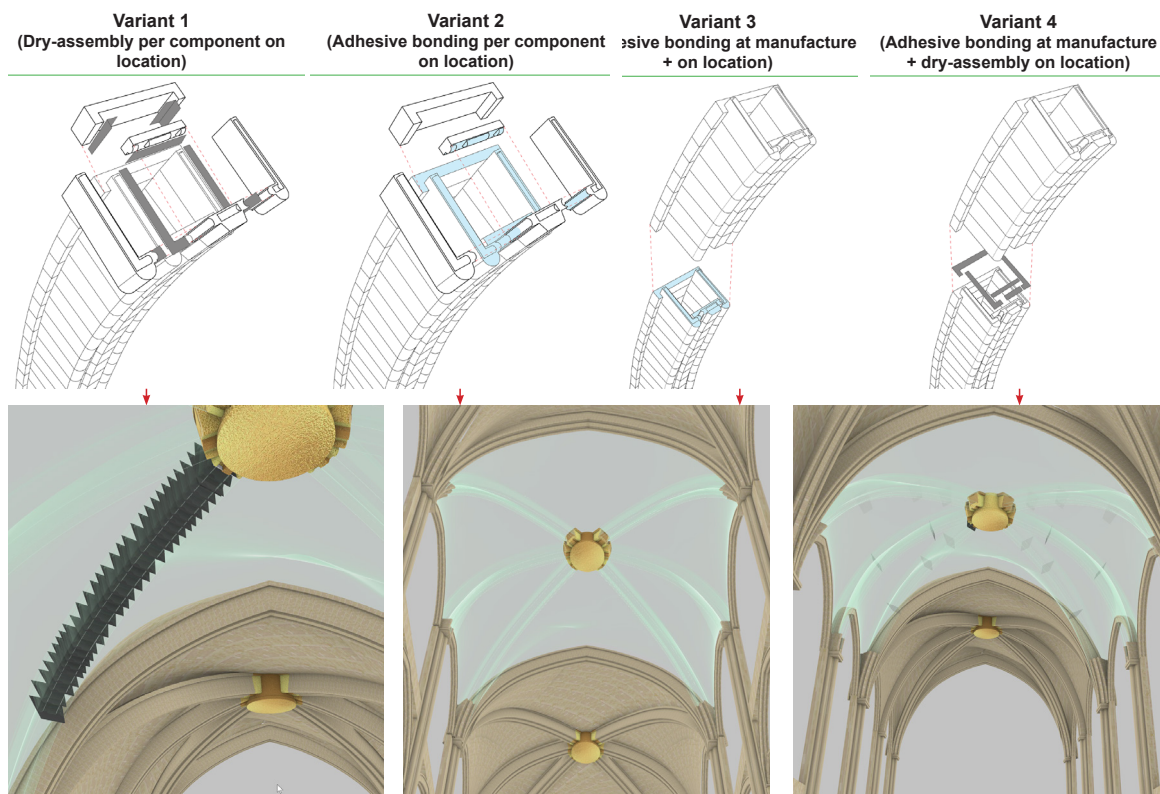

Figure 7.31:
Variants of assembly of the structural arch and their visual effect.

7.7 Discussion

After understanding different heights of the arch structure and the effect on the thrust line, the design phase of the arch component starts with a mass section which is 600mm (width), 150/250mm (height) and 200mm (long). The thickest part of the section is in the bottom of the arch, the thinnest part is in the top near the keystone.

For the arch component, the section is reduced in material and has a thickness of 60mm on the thinnest section where the interlocking has a width and height of 50mm. The arch component is divided in 5 pieces due to the annealing time. The outline is tessellated in three unequal pieces due to reducing the momentum in the interlocking. An element is added in the inside of the arch to add weight where that is required due to the thrust line and is keeping the bottom components together for any y-direction forces. The top element is 60/90mm thick. This element is not only for keeping the complete arch structure together, but also part of the connection with the web. The related moulds of the designed elements are designed based on four criteria and will be tested as a prototype in chapter 8 'prototype arch component':

- No sharp inside corners & Easy assembly and disassembly of the mould;
- Adjustable part & Clear opening for pouring the glass.

The keystone was first designed in full glass to understand the potential and challenges. As the complete glass keystone faced many challenges e.g. number of moulds, assembly speed and sensitivity to intolerances in the structure, a choice must be made based on feasibility if this ever was possible to build this way. Also, the appearance of the keystone will be different and complex in comparison with the original keystone. Therefore, the decision is made to continue with a keystone made from limestone. The keystone will not only be the middle part of the arch, but a part of the arch is included to solve the issues with the glass arch connection. Next to this, it was also an architectural decision as the keystone will bring traditional and new material and construction methods together.

The web component was more challenging to design than expected. It is a curved surface which is spanning from arch to arch. During this research, the decision is made to produce the web component from float glass as plates are easy to produce and to install. Next to this, the safety factor of laminated float glass panels is high. When one plate fails, it will not fall. The tessellation of the web is made based on the curvature direction of the vault as single plates are possible with float glass. Also, the production and transportation size restrictions are included. This way, small casted glass components will not be required. The consequence of this decision is that two type of glass will be used in the vault. To avoid damage or failure due to property difference, tolerance in the connection is introduced. This way, the different components can move free from each other without stresses. Adhesive connections are used to create a clamp to connect the web and arch together. The connection only secures the web in place. The forces will be directly transferred to the arch without the connector in between.

Assembling the arch per element on size with a dry-interlayer or adhesive bonding will be extremely time consuming. Also, by using a dry interlayer, this will be visible from the ground floor, as the arch changes in angle multiple times. This way, the glass appearance will disappear. For an adhesive bonding on site, the quality cannot be confirmed due to the humidity, temperature, time, and dust. Therefore, the choice has been made to assemble the arch structure with prefab arch components and interlock on site with a non-transparent/translucent interlayer (aluminum) as creep is not allowed in a heritage. It should not be the case that the complete structure has to be disassembled to replace the interlayer frequently.

8 Prototype arch components

This chapter will be about the prototype of the arch's section and the lessons learned. The outcome of the prototype will be included in finalizing the design of the vault's components. In figure 8.1, the designed elements of the arch are shown. First, the moulds will be discussed, later the components which are made from concrete. Please note: The prototypes were made when the study on the section components was completed. This was done from time perspective of building the moulds and drying process of the concrete during the 'lockdown' restrictions from the Dutch government and TU Delft due to COVID-19. The outcome of the keystone and web were not considered yet. Therefore, inconsistencies from choices in chapter 7 and the prototypes can appear.

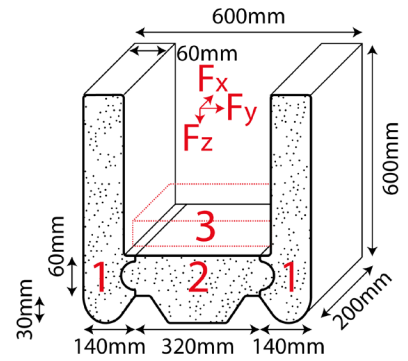

Figure 8.1: Overview of the position of the elements.

8.1 Mould

For producing one arch section, four moulds will be required. The moulds are made from wood as this was a cheap and easy to work with material. Also, concrete will be used to produce the prototypes, so a wooden mould will do. As discussed in paragraph 7.2.1 'Moulds', the criteria are shown in figure 8.2. All pictures of the moulds are shown in appendix K.

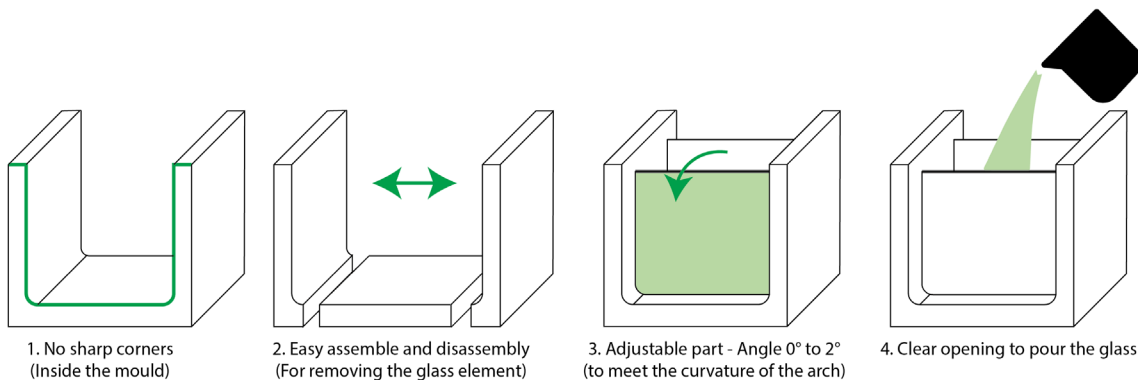

Figure 8.2: Criteria of designing the moulds for the glass elements.

The moulds are made on scale 1:1. This way, every error or challenge is shown on the correct scale. In figure 8.3 the wooden moulds are shown. For meeting the criteria, the following actions are taken:

First, all inside corners were sandpapered to make the corners a bit blunt. For the corners which could not be sandpapered, silicone kit was applied to make the corner blunter.

Second, all outline walls can be disassembled from the base plate as it is assembled with screws. This way, the prototype can be removed easily and the mould can be reused. This was tested for mould a (element 1). Element 1 can be produced twice from the same mould to complete the section. The mould was easy to remove after the concrete element was dry. In advance, an 'easy to remove' (silicone) kit was used to close the small gaps in the woodwork to avoid that concrete will stick. Also, formwork oil was used to make it easier to remove the wood from the concrete. This all worked out according to plan. However, when assembling mould again for a second concrete element, it was a bit challenging to get it all back on the same place as the wood was expanded due to the water of the concrete. It was not much, but this was eventually shown in the final concrete component, as it was smaller than the first one. This will not be a problem for the steel moulds and glass elements.

Third, the wall which should be adjustable due to the angles of the arch. This was included in the mould making. In figure 8.4a, the adjustable system is shown. An aluminum frame was fixed to the fixed part of the mould. This part can be disassembled but will always keep its original location and angle. Therefore, this is the starting point. From the aluminum frame, two screws were inserted. These are connected to the adjustable plate via a steel connector. This steel connector has an inside wire end where the screw moves. This way, the adjustable plate can be put in the correct angle. The adjustable plate can move at the bottom as it is inserted in the base plate, see figure 8.4b. Only mould d does not have the adjustable part. This should be included, but the material was limited, and the principle was tested by the other three moulds.

Fourth, the concrete was easy to pour due to the big opening of the mould. For mould b, which is made for element 2, the concrete was first poured and later the stamp was added. When the concrete was poured, the table was vibrating to release a part of the air bubbles. When this was done, the stamp was added including extra weight to make sure the concrete would not push out the stamp.

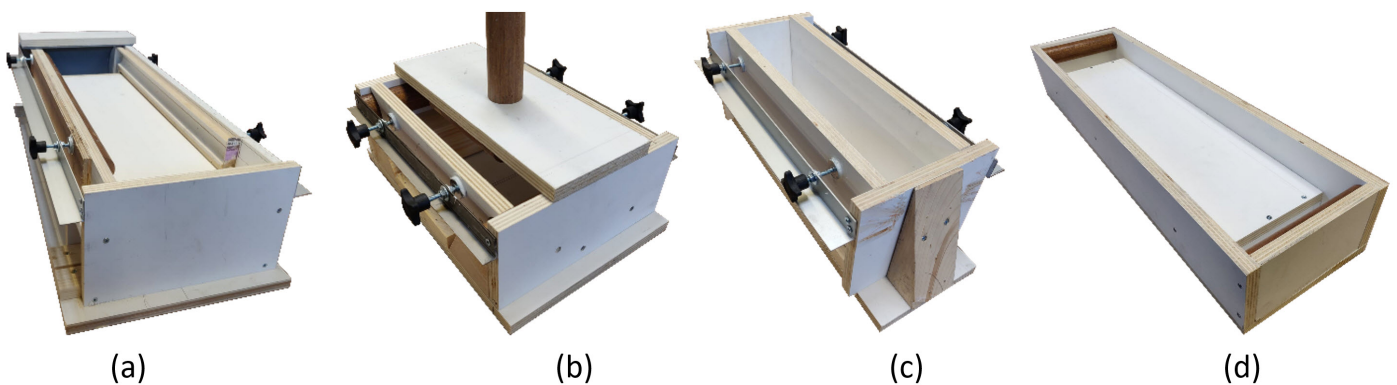
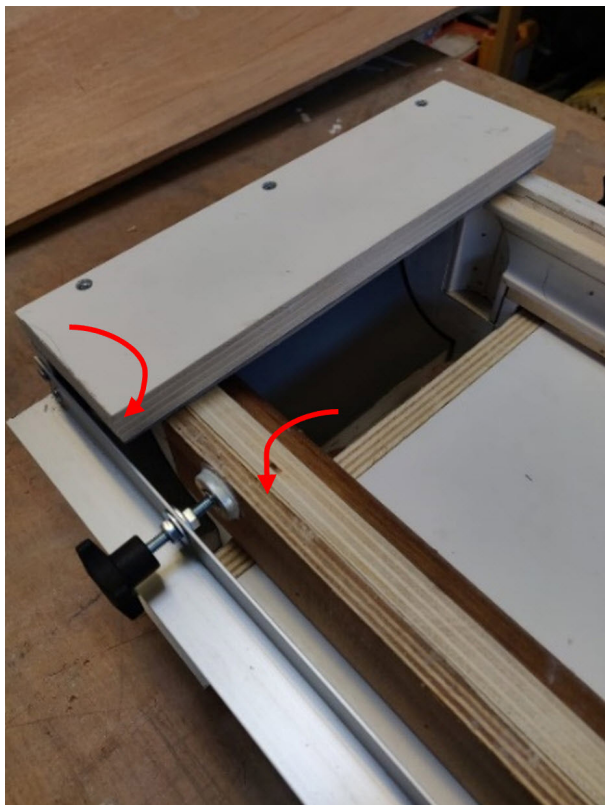
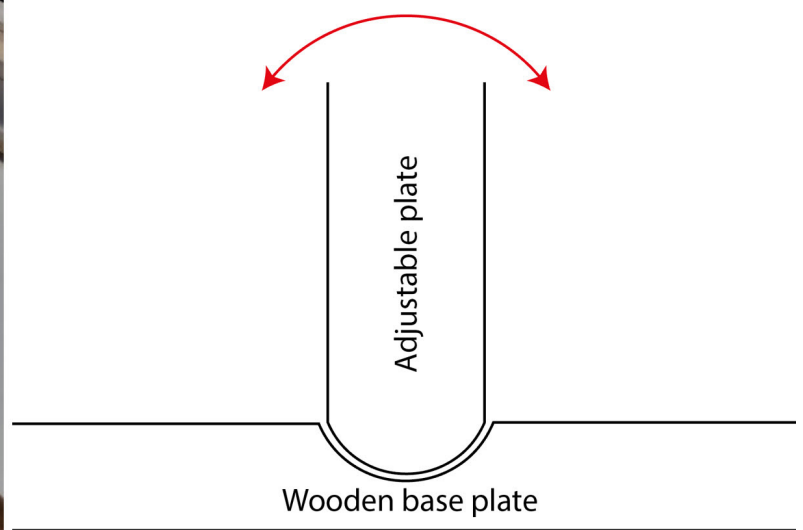

Figure 8.3: Prototype moulds out of wood. Mould 1 - element 1 (a), mould 2 - element 2 (b), mould 3 - element 4 (c), mould 4 - top element (d).



(a)



(b)

Figure 8.4: Adjustable part of mould a, top part with screw (a) and insert bottom (b)

8.2 Components

When the moulds were removed, the components are ready (figure 8.5). Now, these can be inspected and assembled to see if the designed principle works. In appendix L all pictures are shown.

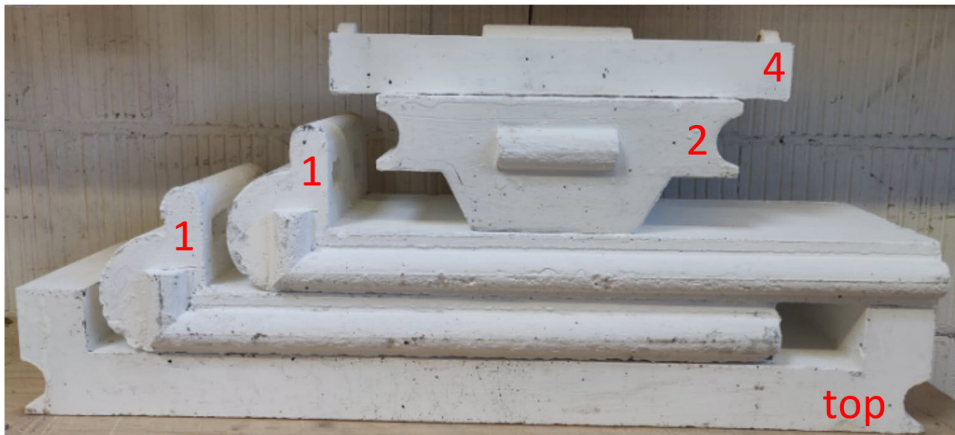
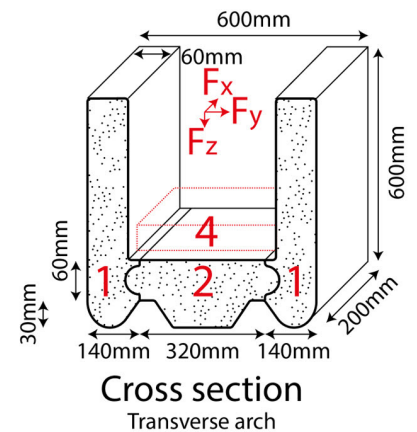

Figure 8.5: Concrete prototypes.



The elements were assembled as how it will be done per section. This is shown in figure 8.6. Temporary support was required for element 1 as these will fall over. This is something to keep in mind for the final design as this makes the assembly process more complex on the site. Also, this increases the risk of assembly mistakes which could increase the chance on failure. When the top element is installed, the temporary support can be removed. A calculation mistake was made when making the moulds as it shows a gap on both sizes. When testing the section on forces, this was filled up.

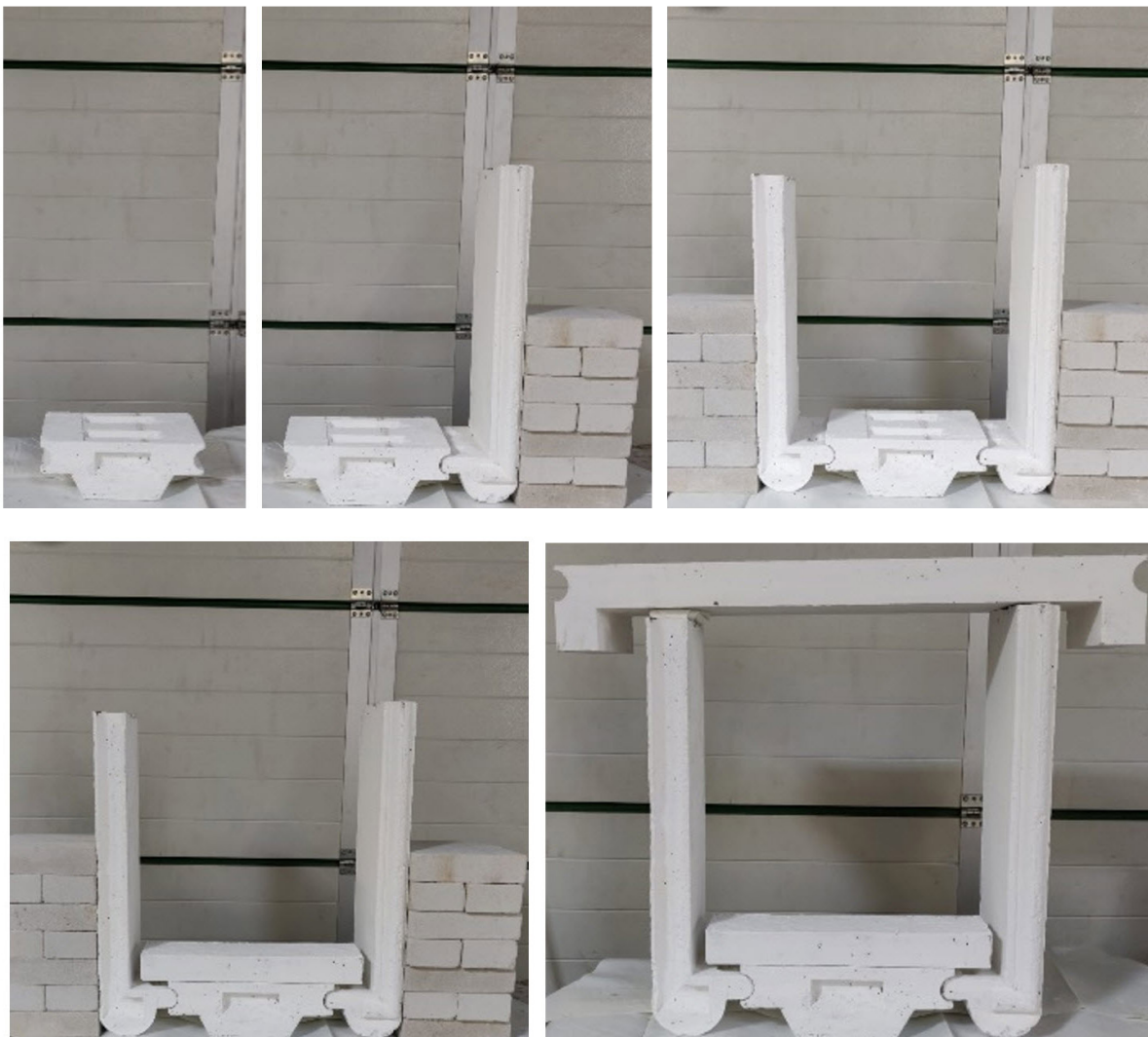

Figure 8.6: Assembly sequence.

After assembling the section, it was checked on flaws and design errors. This is shown in figure 8.7. **First**, the interlocking walls are too thin. In this part, it must resist the least forces from the y-direction, but it already fails when removing from the mould. **Secondly**, a calculation mistake is made in the fourth element, which should add weight to the section for the thrust line and keep the bottom components together. The interlocking edge should be thicker. Also, element 1's thickness is too thin which makes the gap only bigger. **Thirdly**, the top component. Like with the first flaw, this interlocking wall is too thin. This part did not fail when it was removed from the mould but feels fragile. This way, the web's element would not be able to interlock. This means the choice for a float glass web solution makes more sense and is confirmed with this prototype.



Figure 8.7:
Errors in the prototypes.
1) Damage in the edges of the interlocking when removing the mould,
2) Miscalculation when building the mould,
3) Too thin edge for web interlocking.

To understand if the interlocking works, different forces were applied by hand on the section. This is shown in figure 8.8. The first test was put on the ground as the section will be resting on each other with a small angle. Different locations were pushed in y-direction, but it does not move. Only when the top part was heavily pushed, there was a small movement. When the other sections are resting on each other this is not expected. So, bucket filled with bricks was added to simulate this scenario. The top part did not move. But then again, forces in y-direction are minimum. The forces in x- and z- direction are leading.

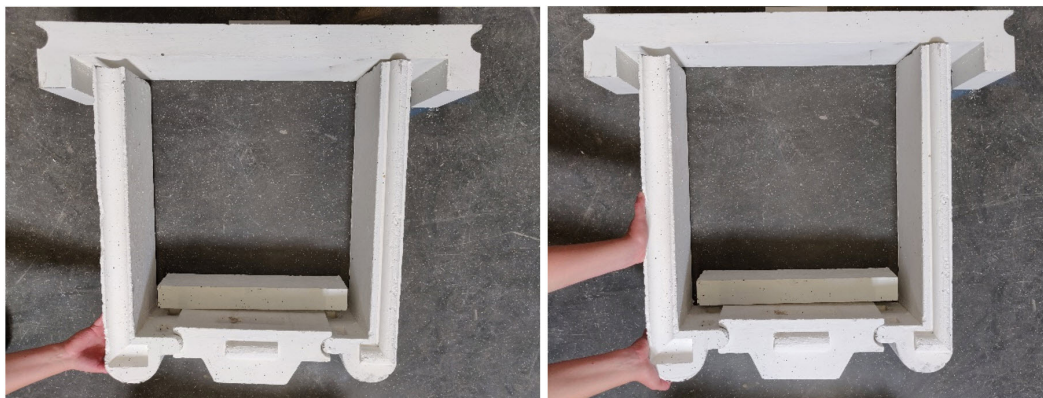

Figure 8.8:
Quick test of the section.

8.3 Discussion

The designed moulds with the four criteria are built and work as expected. A few changes were performed differently from the original drawings as that was easier to realize. A few dimension calculations were done incorrectly when building the moulds. This became visible in the concrete elements but will be easy to solve in the drawings. It was easy to assemble and disassemble the moulds. This proved it was easy to remove the casted elements without damaging it. This way, the cast glass can also be removed without a problem.

For the components, the interlocking thickness must be changed. The walls of the interlocking should be at least 1cm thick to make it stronger. Air bubbles of the concrete made some parts a bit more fragile, but this will not be the case when glass is casted. In the end, the concrete elements which made the section were better than expected for a prototype with the experience I have in building moulds.

9 Final Design

In this chapter, the final design will be explained. The components are shown in the exploded view in figure 9.1. Here, the vault's components are divided in five topics. This is also how the vault will be assembled in the end. Next to this, the moulds of the arch components will be discussed and illustrated. Finally, the transport of the components will be explained.

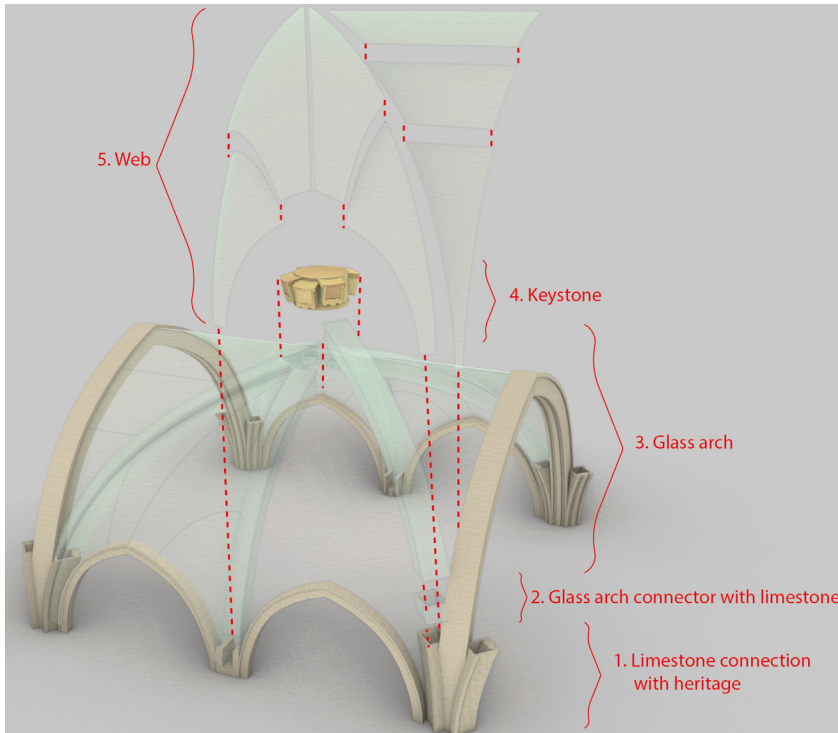

Figure 9.1: Exploded view of the glass vault.

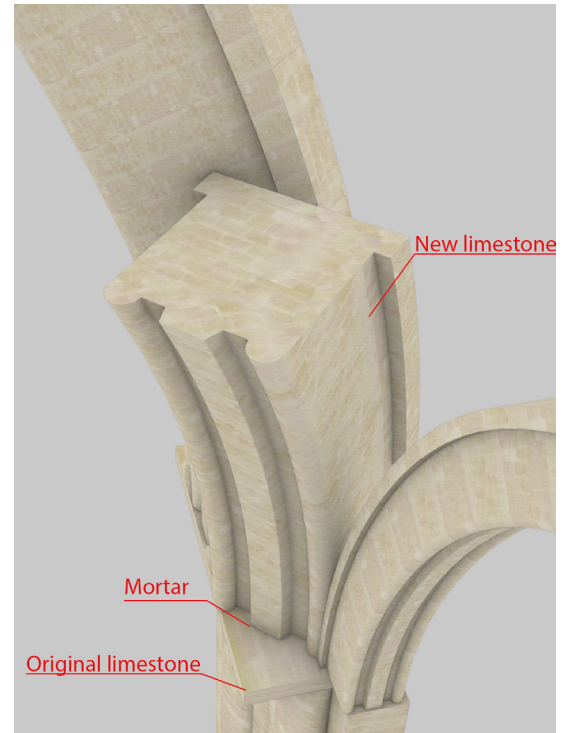

Figure 9.2: Connection limestone component with the heritage.

9.1 Vault

1. Limestone connection with heritage

The impost of the arch will be made from limestone. Not only to blend the connection between the glass vault and the original structure, but also due to the complex shape of the impost as it is fixed between two other arches. As it is made from limestone, it is easier and cheaper to shape the material than glass. Also, this component will be the buffer between the new (glass) and traditional (original limestone) material. This way, there is no direct contact between glass and the original limestone. From architectural perspective, the view of the connection will appear as a direct connection of the vault with the heritage. See figure 9.2 for the 3D detail of the component.

Before the glass vault can be installed, the connecting parts of the heritage should be cleaned and inspected. Once this is completed; mortar can be applied on the original plateau of the column. The mortar is custom made, based on samples of the original used mortar of The Notre Dame de Paris. The samples are taken where the original arch was located. Due to different renovations and reconstructions of the heritage through time, the location of the sample is essential. When the mortar is applied, the custom-made limestone component is placed on location. Again, samples are taken from the original arch as the composition of the new limestone should be close due to mechanical properties of the original arch. The arch is set in position and required adjustments in the arch can be made directly.

2. Glass arch connector with limestone

Based on different simulations in the designing phase (chapter 7), the dimensions of a glass section are 600mm x 600mm x 200mm with a thickness of 60mm. This way, material and weight was reduced based on the acceptable stresses for borosilicate glass. Borosilicate glass is selected as it is easier to melt and shape for casting, but mainly for the thermal and mechanical properties. The properties of borosilicate glass are like limestone, which is used in The Notre Dame de Paris. Due to the weight of the glass component per section, the section needs to be tessellated. Several steps are taken which are shown in figure 9.3.

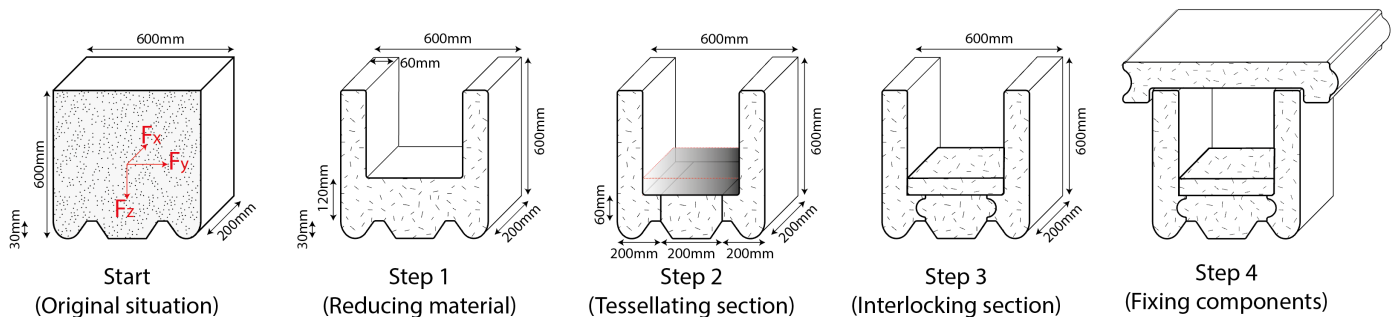

Figure 9.3: Steps from original till cast glass components of reconstructing the original arch.

The final design is tessellated in five pieces to meet the limitation of 25kg. This is shown in figure 9.4 and 9.5. The five components overlap all joints in x-, y- and z-direction. This way, the risk of failure due to joints is reduced. In figure 9.5b, the functions per element are shown. Element 1 and 2 are the outer line geometry of the arch. These are also the components that will transfer the biggest part of the compressive force. Element 3 has the function to keep elements 1 and 2 together and resist rotation. This is also the element which varies in thickness (50mm, 100mm or 150mm) depending on the position in the arch, see figure 9.5a. This way, the thrust line stays in the arch and transfers smoothly into the column and buttresses. Element 4 keeps the complete component together. This way, element 1 cannot rotate to the outside. Also, it contributes in transferring the compressive forces and is part of the mass of the arch which influences the thrust line.

The elements are adhesive bonded to create a prefab section. The transparent adhesive bonding which is chosen is TSSA as it has a high stiffness and strength capacity. Also, it is stable in temperature difference between -55°C and 130°C . The arch component is prefabricated in a manufacturing environment as the temperature, humidity, dust, and other factors can be controlled when the adhesive bonding is performed. Next to this, the precision of the position of the elements in the component is higher than when it is performed on site. The adhesive bonding has effect on the original vision of this thesis: to design a complete dry-assembly structure. However, during the design phase it became clear this criterion is not required as the vault is part of the structure of the heritage. The structure will not be removed and will be a permanent part of the building. Next to this, the adhesive bonding has minimum impact on the recycling process when the glass is molten.

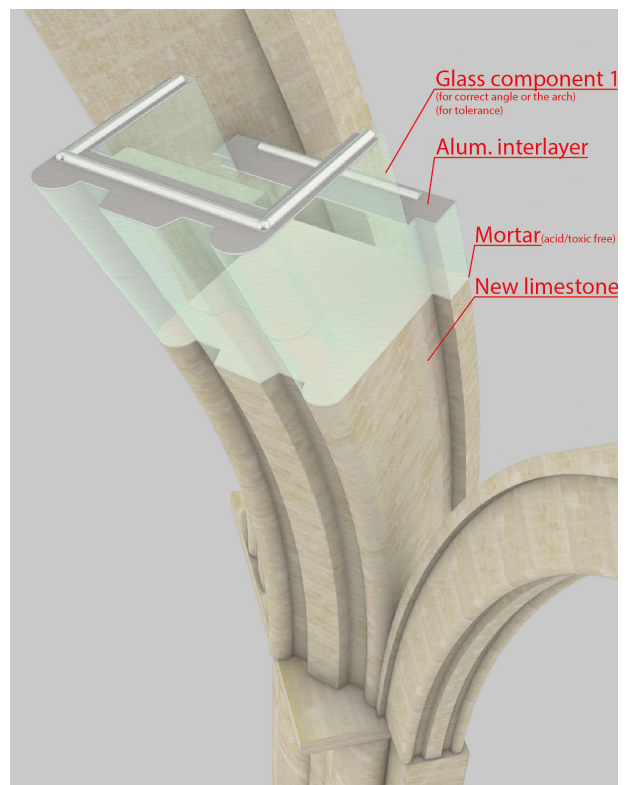

Figure 9.6: 3D connection with limestone component and glass arch component 1.

When the limestone component is installed, and the mortar is dry, the small glass component of the arch can be installed. The last adjustments of the angle can be performed thanks to the mortar which connects the limestone arch and the glass component. The mortar must be toxic- and acid free, otherwise it will damage the glass. This glass component is not only for the last adjustments to meet the angle of the arch, but also to create a dry connection with the rest of the arch. Also, this creates a tolerance in the arch structure. This way, the arch can move without increasing stresses in the structure. The chance of failure is reduced this way. The interlayer which is used for the connection between the two glass arch components is a soft aluminum plate. The plate will have a thickness of 2mm and is shaped in advance. The shape is based on the interlocking geometry. A soft aluminum is chosen as the stiffness is less than borosilicate glass. This way, glass will not fail. The interlayer has space to move, so thermal expansion is possible. Next to this, the interlayer will only be applied twice in the arch. Once above the impost and between the keystone and the arch. Also, the interlayer is positioned above the impost on a height of 32m. This means, even when the aluminum is not transparent/ translucent, the visual impact is minimal. See figure 9.6 for the 3D detail of the component. The moulds for these components will be discussed in paragraph 9.2 'Moulds'.

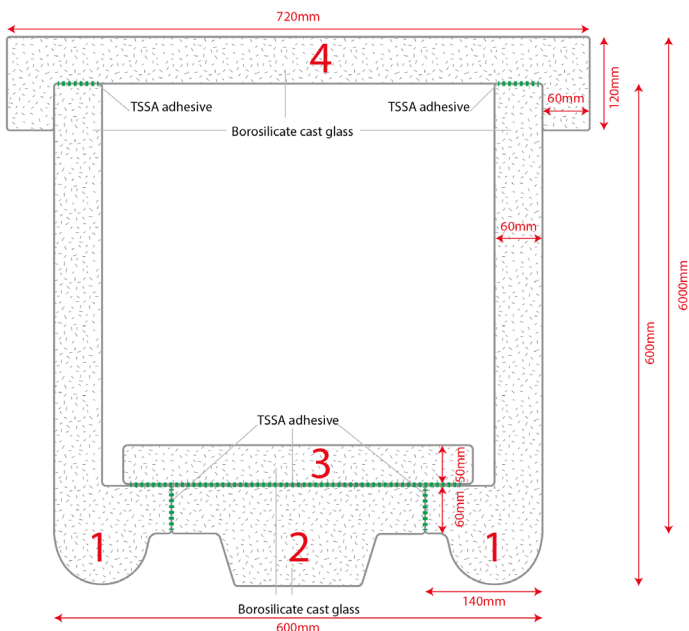

Figure 9.4a: 2D of the tessellation per section (adhesive connection).

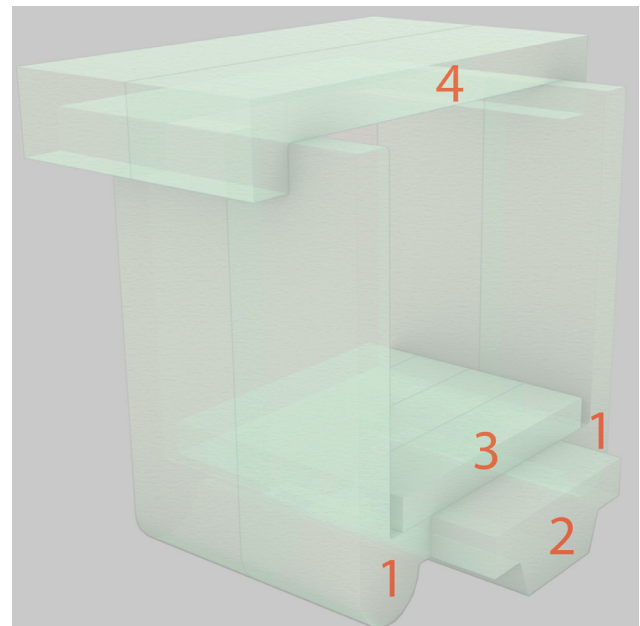

Figure 9.4b: 3D of an assembled section (adhesive).

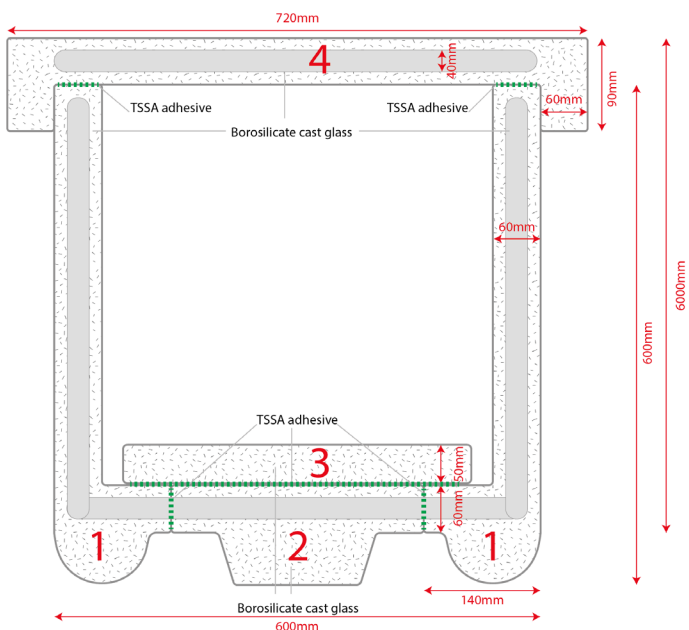

Figure 9.4c: 2D of the tessellation per section (interlocking connection).

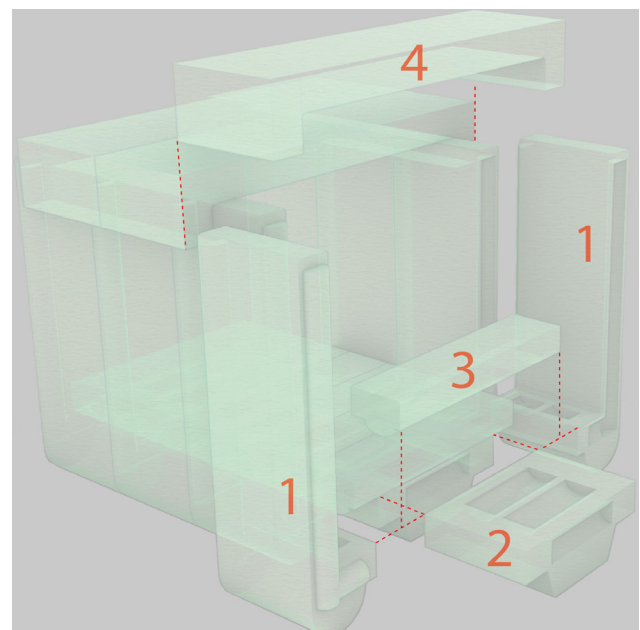

Figure 9.4d: 3D exploded view (prefab Interlocking connection)

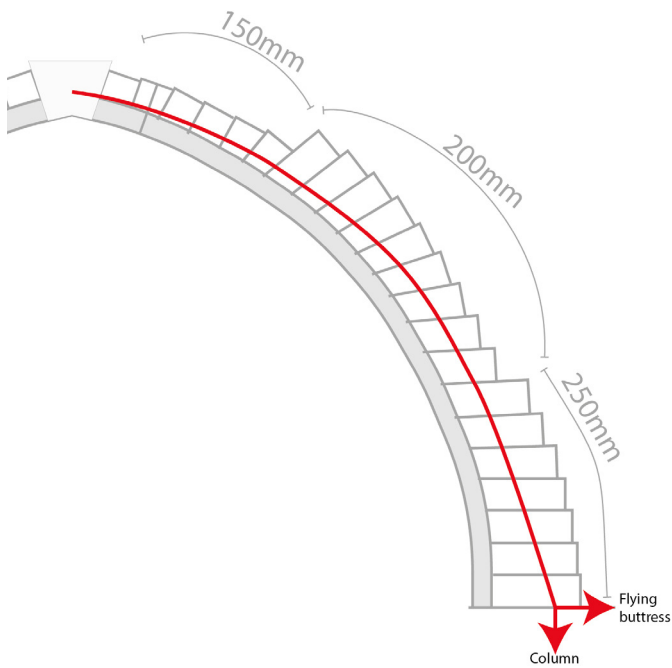

Figure 9.5a: Division of thickness and thrust line in the arch.

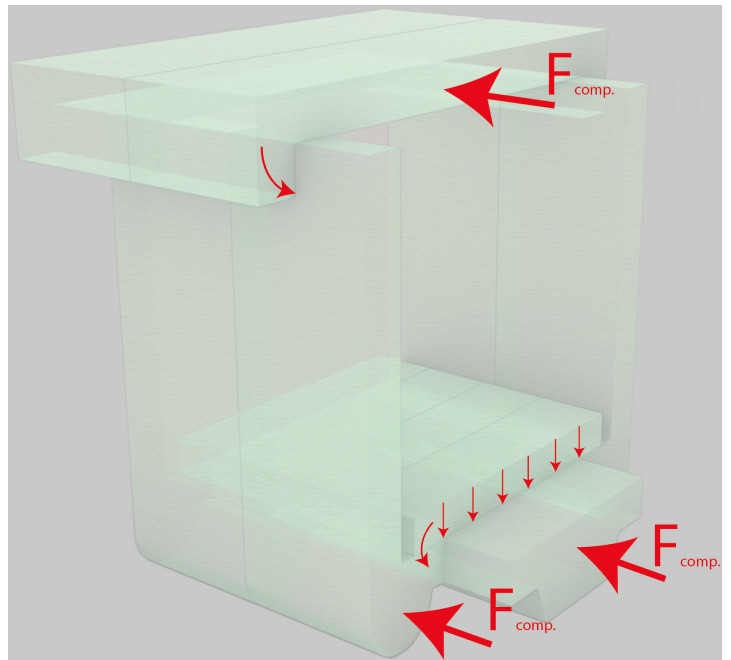

Figure 9.5b: Function per component.

3. Glass arch

In figure 9.7, a 3D detail is shown of the connection between the two glass components in the arch. As described before, the second part of the glass arch is also prefabricated. When the component is installed, it will be temporarily supported with a scaffolding. The scaffolding is shaped in the angle of the arch, so it can be used as guideline for installation. The arch component will be lifted from the truck which is located outside the building. From there, the arch will be lowered down to position via the roof as the wooden roof is not yet restored. The component will be locked thanks to the interlocking geometry. Also, the L-shape of both components creates an overlapping joint. This is shown in the 2D detail in figure 9.8.

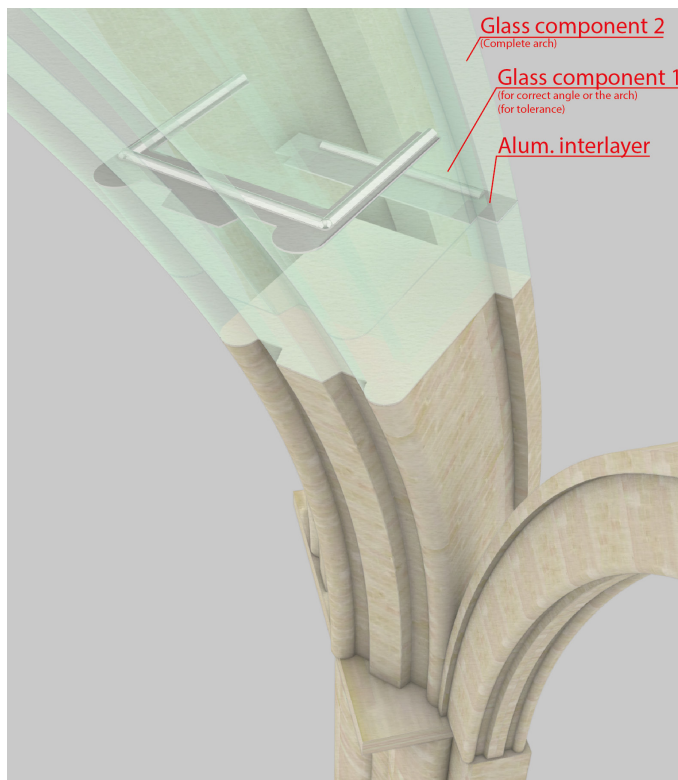

Figure 9.7: 3D connection between glass arch component 1 and glass arch component 2.

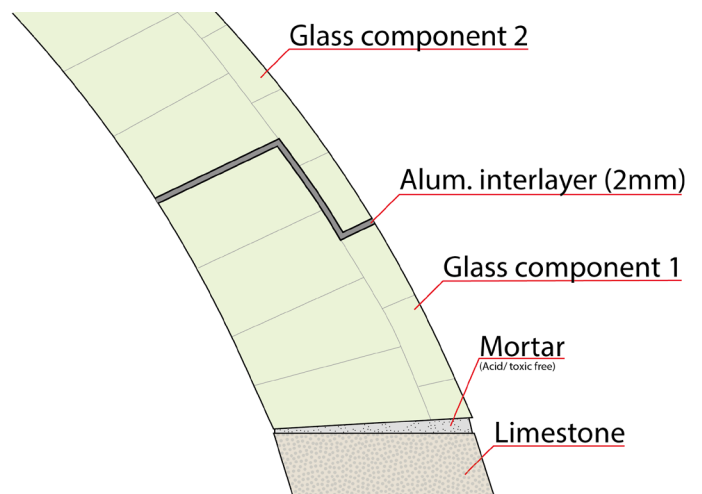

Figure 9.8: 2D detail connection between glass arch component 1 and glass arch component 2.

4. Keystone

As with the impost of the arch, the decision is made to manufacture the keystone from limestone. The limestone has not only proven that it can resist the forces in the vault, but also the appearance of the original keystone is different from the rest of the vault. The keystone and a part of the arch was painted gold and therefore deviates from the vault. To simplify the connection between the arches and the keystone, the keystone is slightly extended to the arches, just as the original paint. This way, the glass arches will not conflict with each other, and risks during the installation phase of the keystone is reduced. The keystone is installed from the top and slighted in. Thanks to the gravity, the structure is kept together as the keystone is pushed into the arches and only compressive stress appears. This way, gravity will be an ally instead of an enemy. As the keystone will be 'floating' in the air, the users of the building will realize how important a keystone is, as it is keeping everything together. See figure 9.9 for the 3D connection.

When the keystone is installed on the scaffolding, the keystone is slowly lowered with a hydraulic system. This way, the connection between the arches and the keystone can be supervised carefully and where needed corrected. Each arch also has a hydraulic system so all components can be installed with precision. The 2D principle is shown in figure 9.10.

When the keystone is installed, the scaffolding only functions as a safety back-up construction for the builders.

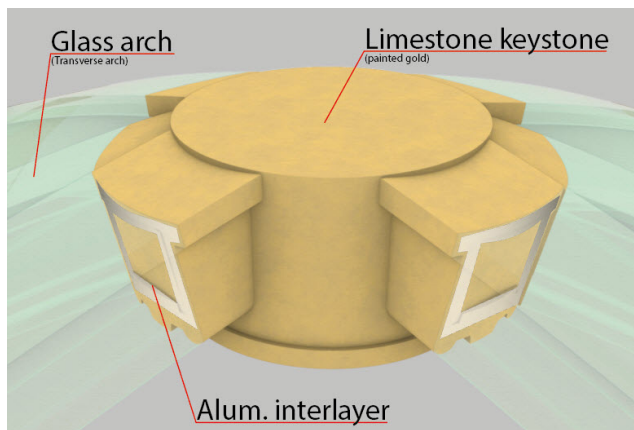

Figure 9.9: 3D connection between glass arch component 2 and keystone.

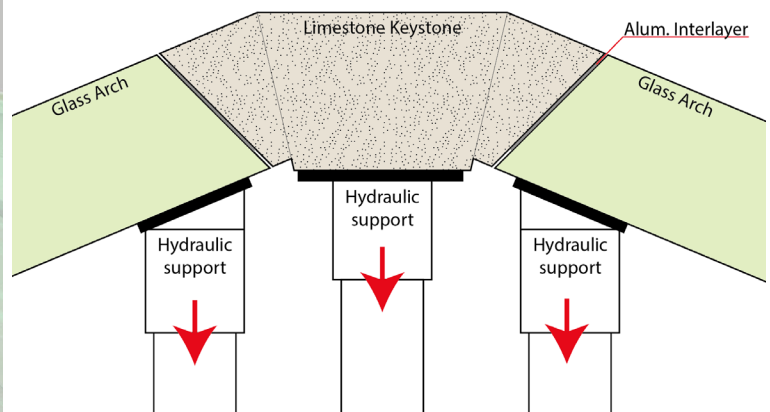

Figure 9.10: 2D abstract principle of the hydraulic system to install the keystone with the arches.

5. Web

The web is made from laminated PVB float glass (3 x 8mm plates). Float glass is chosen as this is a standardized process. To increase the safety of the web, a laminated structure is designed. In case one plate fails, the structure will not deform completely and will stay in place. This way, the plates will not fall where the pedestrians are. Next to this, unlimited patterns can be engraved in float glass, so the original brick pattern is visually brought back in the vault. Finally, the web curves will follow the original curvature of the web. The web is tessellated to meet the single curvature, original span, and production limitations. The tessellation is shown in figure 9.11.

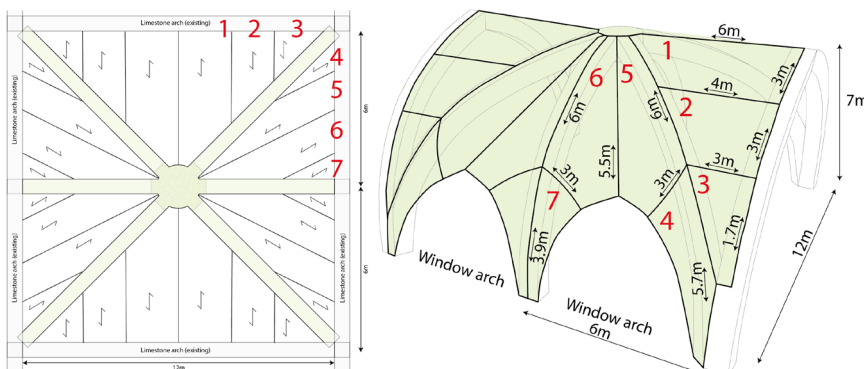

Figure 9.11: 3D model of the arch and web.

The web will rest on the new glass arches and original limestone arches. The web components only transfer dead weight to the arch structure. The web does have minimal impact on the structural behavior of the vault.

In figure 9.12, the connection for glass arches is shown, but the principle is also applied on the original limestone connection. As mentioned before, the web only has dead weight to transfer to the web and therefore, the connector only must keep the web in place. It has minimum shear or tensile stress.

250mm of the web will rest on the arch with a transparent VIVAK interlayer. This interlayer creates space for both glass types to move on its own. VIVAK is a polymer material, so it can move in different directions. Next to this, the interlayer is a buffer for any flaws in both glass objects. Thanks to the interlayer, forces are equally distributed. The adhesive metal connector is already installed on the arch at the manufacturer. When the web is placed, the interlayer is installed between the float glass and metal clamp. Again, this is for the protection of the glass and will function as a buffer due to the different material properties. Also, the interlayer fills up the height difference between the metal connector and the web. The clamp is fixed with a metal bolt in the adhesive metal connector with an O-ring in between.

The metal connector is repeated every 1m to ensure the web is kept in place even if one connector's adhesive bonding fails or due to failure of a cast glass element. This means 10 connectors per transverse arch and 12 connectors per diagonal arch are required. In total, 68 connectors will be placed on the glass arches and 60 connectors will be placed on the original limestone arches. The connectors will hardly be visible from the ground floor as there will be 32m till 39m height difference. The connector will be \varnothing 200mm. Also, the different layer of the cast glass in the arch will create a blurry effect, which makes it even less visible.

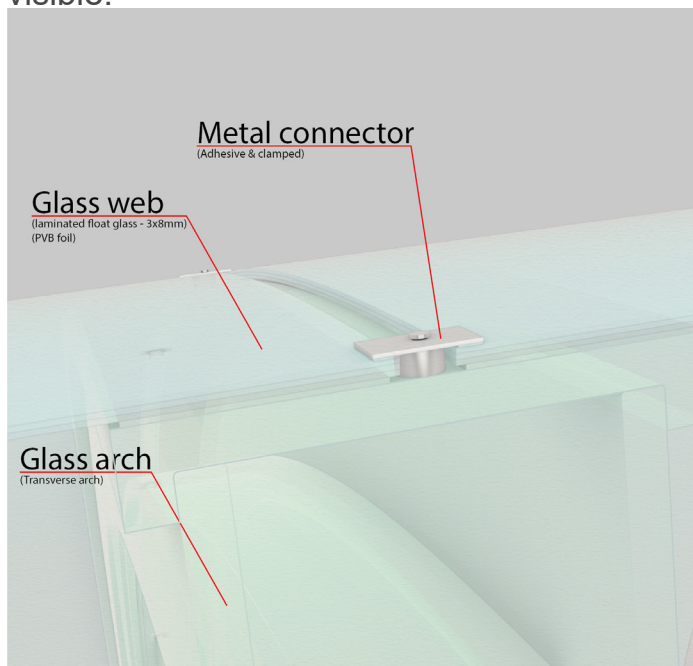

Figure 9.12a: 3D connection between glass arch component 2 and web (assembled).

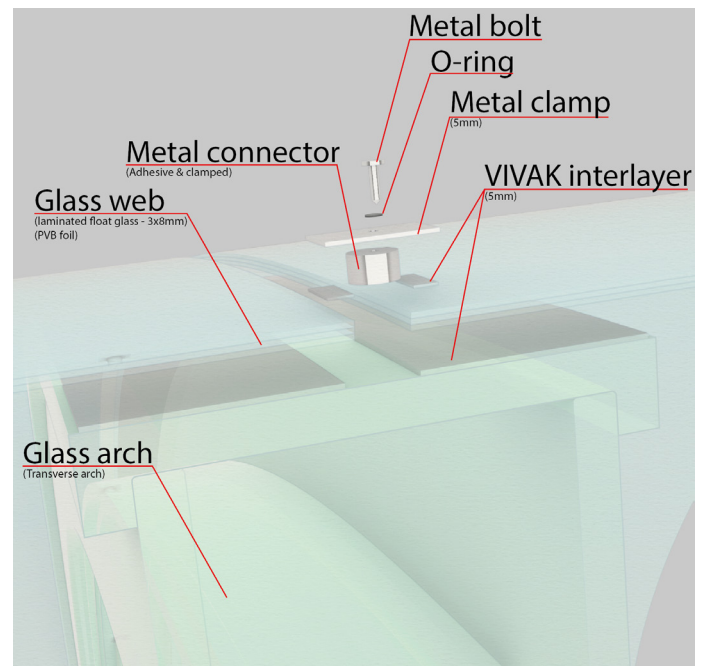

Figure 9.12b: 3D connection between glass arch component 2 and web (exploded view).

To summarize the complete assembly sequence, an overview of the phases is made and can be found in figure 9.13. The bigger variant is shown in appendix M.

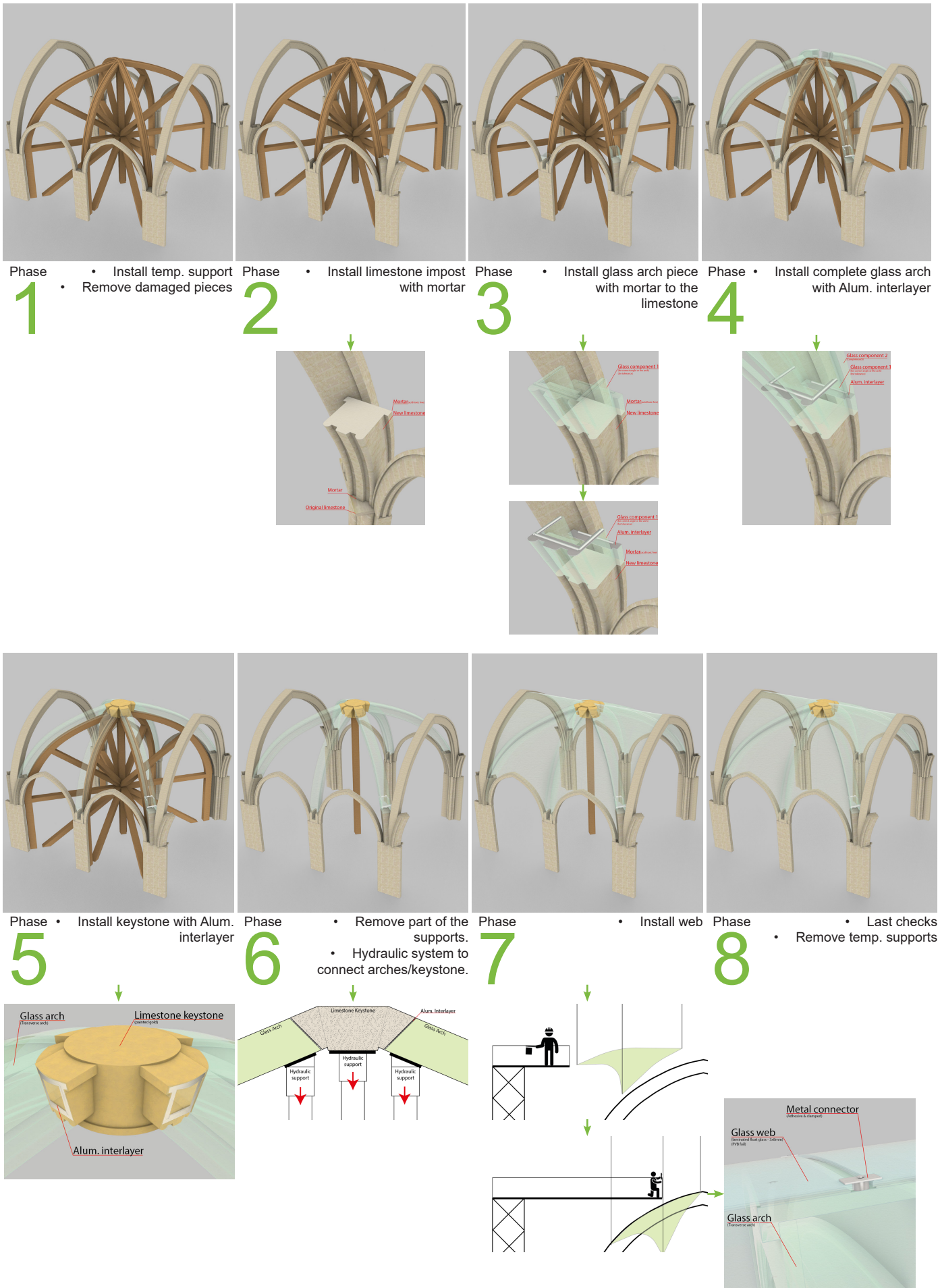

Figure 9.13: Phases of assembling the glass vault.



Figure 9.14: Impression when traditional restored.



Figure 9.15a: Impression when reconstructed with glass.

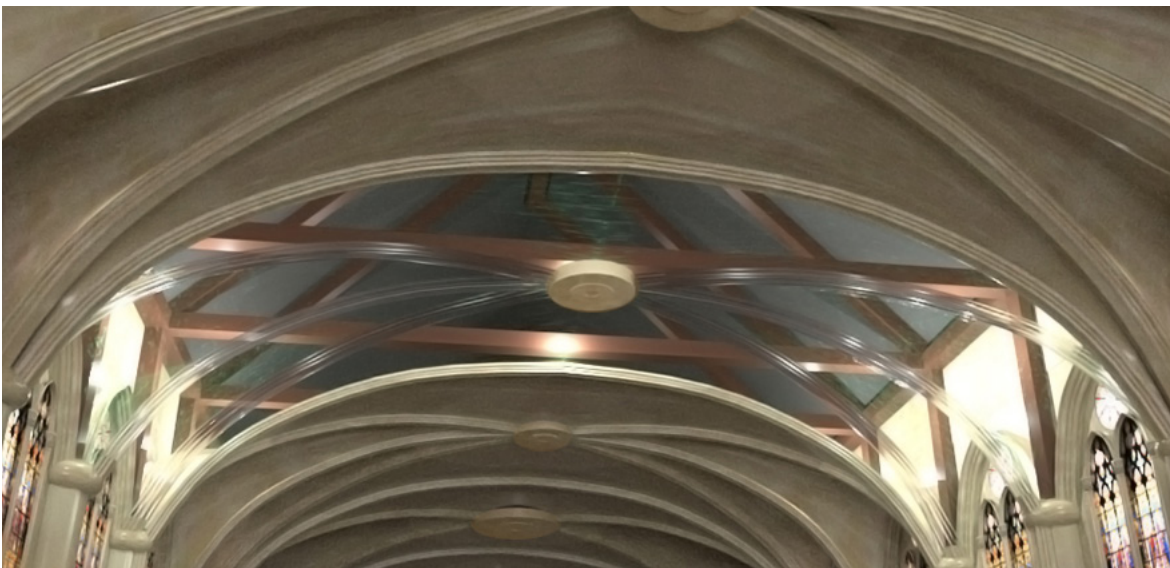

Figure 9.15b: Impression when reconstructed with glass - close up.

9.2 Moulds

As the geometry of the components are now known, the moulds need to be designed. The moulds need to meet several requirements for glass casting, which are shown in figure 9.16.

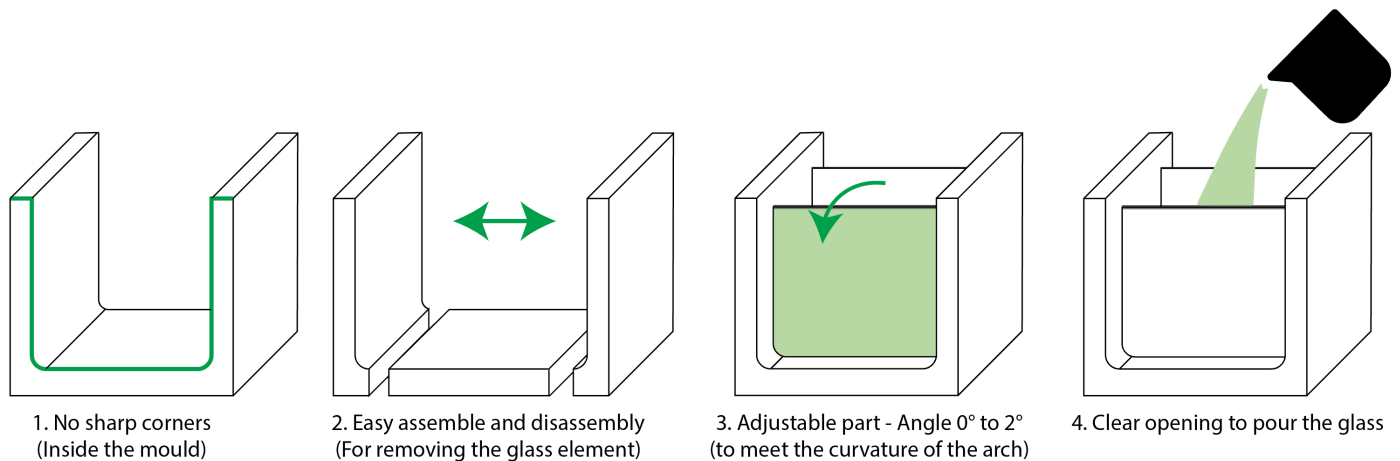

Figure 9.16: Criteria of designing the moulds for the glass elements.

All designed moulds are shown in appendix N, but in figure 9.17 the mould of element 2 is shown to explain the principle.

The mould only has blunt corners inside the mould where the glass is poured. This way, there will be less risk in failure during the annealing phase of the cast glass. Also, the mould can be disassembled. This is shown in figure 9.18. The base plate has several gaps where the elements of the moulds can be placed. This way, the mould will always be assembled in the same position without any deviations. The deviations should be avoided as this can result in angle and size differences in the end. In **phase 2**, the fixed walls of the mould are pushed in the base plate and fixated from below with a screw. Now, this is part of the base plate. In **phase 3**, the adjustable walls are placed in the base plate. These elements are not yet fixed as it should be adjustable till the end of the assembly. For **phase 4**, the fixed rails for the adjustable elements will slide in the base plate. This will always be on the same location as there is an opening in the fixed wall element. Finally, the adjustable screws are installed in the mould and the adjustable wall can be put in place in **phase 5**. As the angle of the element only deviates between 0° to 2° , this is precision work. Therefore, two fixation points per wall are made to ensure the adjustable wall is kept in place on both sides. The principle of the adjustable system is shown in figure 9.19.

The moulds which are required for the impost and keystone interlocking will be disposable 3D-printed sand mould due to the angle and geometry difference per arch.

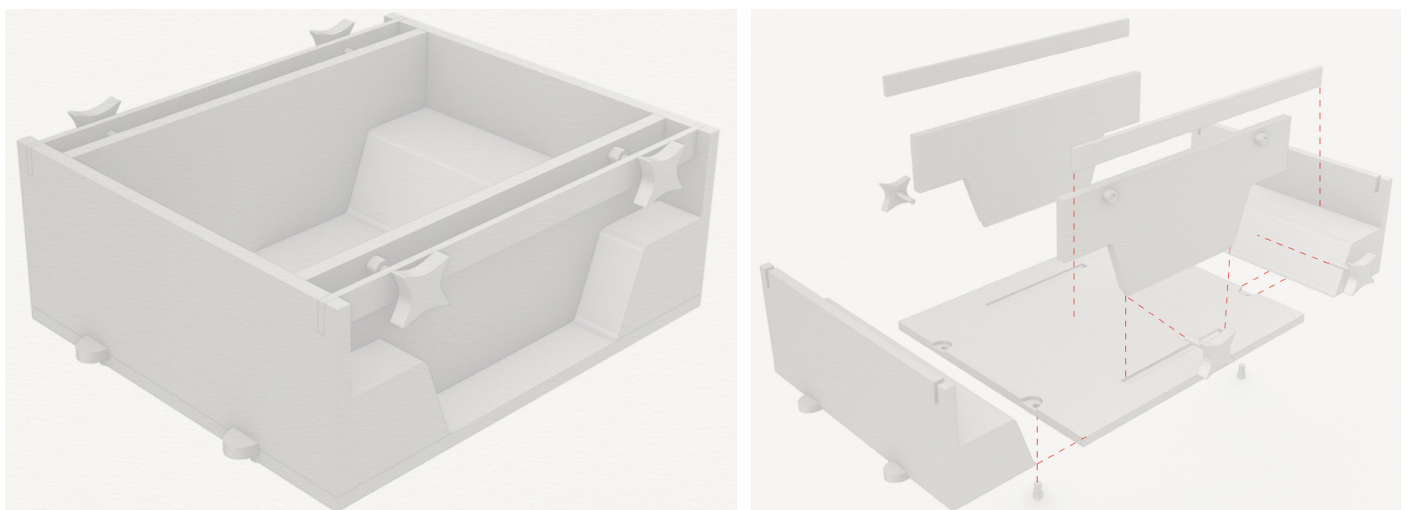

Figure 9.17: Mould for element 2 - Assembled (left) and exploded view (right).

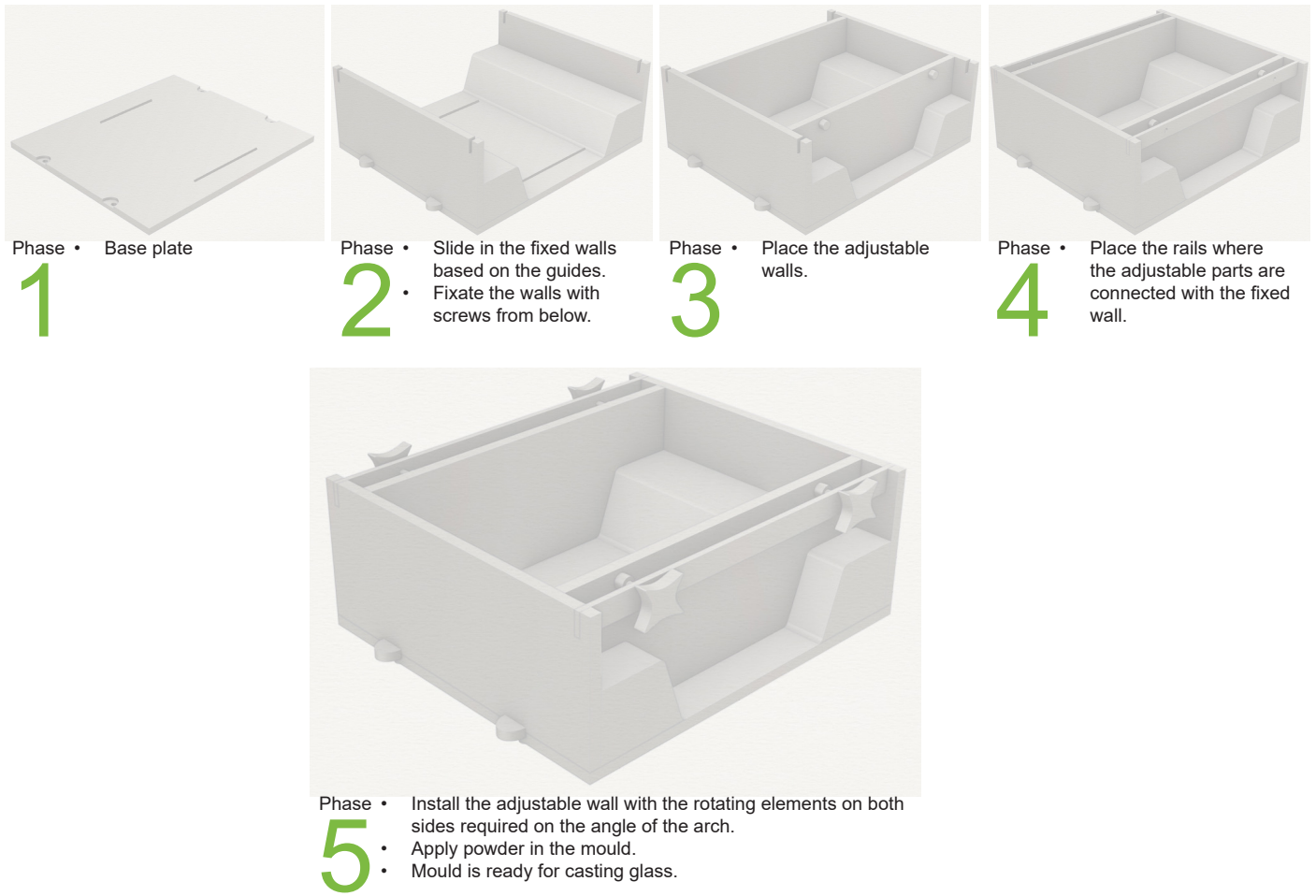

Figure 9.18: Assembly order of the mould for element 2.

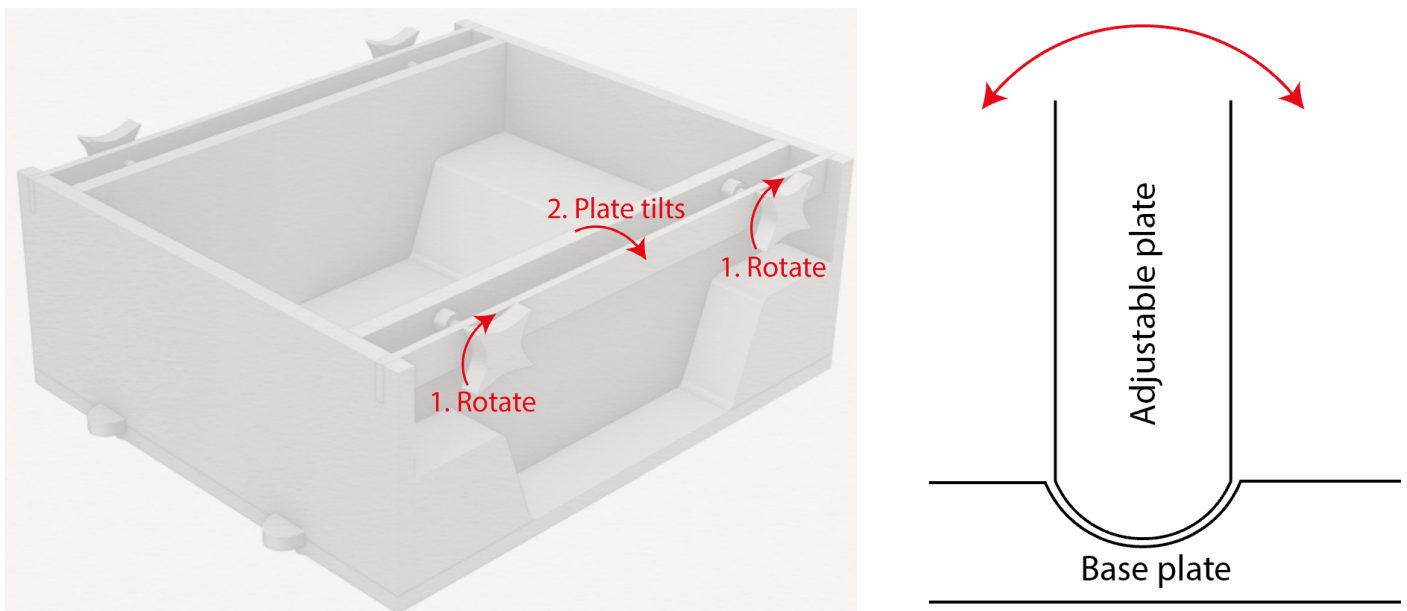

Figure 9.19: Adjustable part of the mould for element 2.

9.3 Transport

As the complete production and assembly phases are now known, the transport can be studied. From the beginning of this thesis, the statement is made that all products should be produced in the EU. Based on this, only the road transport is considered. Water transport is out of scope for now but could be an option in the future. The lay-out of the trailers are restricted based on weight and dimensions. Maximum 40.000kg is allowed on the truck, and the standard dimensions of a truck are 2.45m x 2.65m x 13.6m. This is also based on the general free height of bridges and tunnels.

In figure 9.20, the lay-out of the trucks are shown. The allocation of each element per truck is summed below:

- A: 1x keystone and all limestone connectors
- B: 1x Transverse glass arch
- C: 2x Diagonal glass arch
- D: 1x Web parts 2,4 & 7
- E: 1x Web parts 5
- F: 1x Web parts 6
- G: 1x web parts 1 & 3

The glass and limestone elements will be transported in custom made wooden boxes which are filled with solid foam. This is how fragile electronics are transported as well, see figure 9.21 for an example.

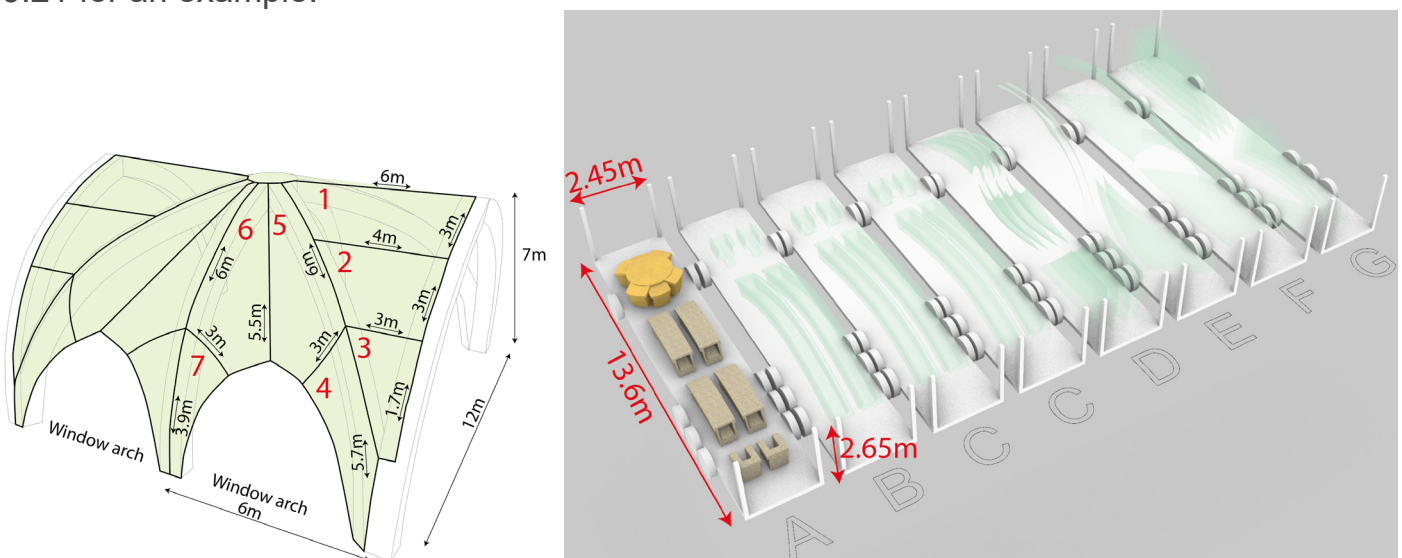

Figure 9.20: Lay-out of the trucks for the complete glass vault.



Figure 9.21; Example of fragile electronic transport: Television. Retrieved from Moving buddies (n.d.).

Conclusion

In the beginning of this thesis, the following main question was set: *To what extent can a historical masonry arch vault be reconstructed by using cast glass components?*. To understand what is possible with cast glass components, The Notre Dame de Paris is chosen as a case study.

To answer this question several sub-questions based on literature research are asked and divided in four categories: Heritage, structural arch vaults, structural (cast) glass and connections.

For heritage, there are several strategies and restrictions for reconstruction. First strategy is to keep the original and the second is reconstructing with the newest technology to adjust the building for the needs of today. The last strategy is chosen for this thesis as glass structures will represent a blur of the original part of the heritage while a modern material is introduced. This way, a new layer of technology is added to the heritage for future generations. It is important to understand the restrictions of reconstructing a heritage as the new structure should be in harmony with the rest. Therefore, the new structure should have minimum intervention with the traditional materials, the new structure should be clearly visible as this will be an honest way in repairing a monument. Next to this, the new structure should have the option to be removed from the heritage without damaging the original materials. The key elements in the vault of the case study, The Notre Dame de Paris, are the curvature of the arches and web, the geometry of the arches and keystone and the connection with the columns.

For structural arch vaults, it was important to understand the structural behavior of the vault. First, it must meet the standard requirements of structures. It must be strong (no failure due to stresses or material choice), stiff (acceptable deflection) and stable (no buckling). A masonry arch vault should meet the additional criteria: designed on compression force only, tensile stresses may only appear when additional forces are added to the deadweight and no sliding failure of the components in the arches. The thrust line should always be in $\frac{1}{3}$ of the arch section. Otherwise, the structure might face tensile forces which causes failure when brittle materials are used. When an arch vault is designed, it should include tolerances during the construction phase as there can be production of construction flaws. Additional forces can create stresses which can cause failure of the structure when there are no tolerances considered. The traditional construction method of a vault is by building a temporary support which is also the guideline of the arches. The components will be cut on site before it is installed with mortar. Later, the keystone was added to complete the arch structure. Afterwards, the openings between the arches, the web, were closed by the bricklaying bricks in a curvature from arch to arch.

For structural (cast) glass, the properties of the traditional material which is used in the heritage and the type of glass should not interfere with each other. Otherwise, damage or failure of the traditional material will be irreversible. Therefore, several guidelines are set up to decide what type of glass can be used. For the Notre Dame de Paris, limestone is used as structural material. It is not clear what type of limestone, but the type of glass which meets the guidelines is borosilicate glass. Both glass and limestone are brittle materials but are strong under compressive stresses. There are four ways how glass can be manufactured: float glass, extruded glass, 3D printed glass and cast glass. According to the findings during the heritage research, cast glass is one of the methods which can represent the most realistic geometry of the original. Therefore, cast glass is chosen. When cast glass is designed, the annealing phase is especially important. This determines how quick and how blunt the corners of cast glass components should be. When this is not considered, the component will fail before the production process is completed.

For the connection of glass, several projects are realized with cast glass. Three different connections can be used for cast glass, depending on its geometry: additional substructure, adhesively bonded glass, and interlocking cast glass. When the interlocking system is used, the following criteria is set for the geometry of an interlocking: height < width.

Now that the foundation of information of designing a cast glass structure is known, the design phase of the vault can start. First, design criteria are summed for the heritage based on the compatibility and geometry. Also, the production/mould methods are mentioned together with the interlocking geometry as the vision of this thesis is to design a dry-assembly cast glass arch vault structure. The design phase started with understanding how much material is required for the structural arch of the vault. The original arch's section was 600mm high, 600mm width and 200mm depth. After simulating the behavior of the structure with different thicknesses, the new section will be 600mm high, 600mm width and 200mm depth with a hole inside. The thickness of the section will be between 150mm and 250mm in z-direction. This way, the thrust line will be in the middle of the structure and will not cause tensile stresses. For safety and production reasons, the section of an arch is divided in five pieces. The keystone was first designed as a full-cast glass component, but due to complexity and architectural reasons, it was decided to design the keystone out of limestone. The keystone will be extended as part of the arches due to connections and stresses. The web component was first designed out of small cast glass elements, but this would be difficult to assemble and many moulds would be required to realize this. Therefore, float glass was chosen as this can be laminated for safety reasons.

Now that all research is performed, the main question can be answered based on the final design:

To what extent can a historical masonry arch vault be reconstructed by using cast glass components?

A historical arch vault can be made from cast glass completely, but then the question will be: at what cost? When everything will be made from cast glass, the assembly and production will be high, while other alternatives in glass will reduce the risks in manufacturing and assembly. Therefore, the final design has an impost of limestone to function as a buffer between the heritage and cast glass arch. The arch will be made from complete adhesive bonded cast glass and can be assembled with a dry interlocking with the impost. The connection with the limestone keystone will also be dry. This way, the components can move independently from each other and no additional stresses will appear. The web is made from float glass as it is quick in assembly and the production of float glass is standardized. Next to this, it can be single bended in the current curvature and engraved to mimic the original pattern of the web. The goal of this thesis was to design a full dry-assembly cast glass vault, but in the end the connections between different components are dry. During the design phase, the criteria changed as the vault will always be part of the heritage. It is a permanent structure, so why should it have a temporary connection including all risks. Therefore, dry connections are used to create tolerances in the structure, but adhesive bonding for the fixed components. This way, a full blurry effect of glass is made in the heritage without interfering with the original design.

The principle of this thesis can also be applied in other fields. For example, roof structures for future buildings can be designed with cast/ float glass. These have less restrictions than historical buildings, but still want to use the newest transparent/ translucent technology. Also, another application like constructing small pedestrians might be possible. This will require additional risk and demands of the structures.

Discussion

For this thesis, different criteria and guidelines are set to validate the final design. The criteria and guidelines are based on the literature research. The different perspectives in literature research are considered and summed up in the research. The perspectives which is most suitable for the Notre Dame de Paris are considered when setting the architectural guidelines. The engineering guidelines and criteria are also based on literature research i.e. properties and simulations. The results of the simulations must meet the mechanical properties, otherwise the simulated option is not accepted. Also, the architectural impact per variant is summed in a pro/con table to understand what the most promising option is. All options were verified with the mentors of this thesis and adjusted where needed.

The limitations of this research are based on time and software knowledge. The software skills for parametrical design are limited to perform all simulations in Grasshopper. Also, the limitations of the software did not show the complete picture of the behavior of some elements. For example, simulations of the interlocking system which is 3D was challenging to simulate in Diana FEA. Only 2D interlocking options are possible, but that is not applicable for the designed elements. It is important to understand the complete behavior of the interlocking as the position of the interlocking changes every time based on the location in the arch. In the top of the arch, the sliding factor would be more critical than in the bottom of the arch. Next to this, the Covid-19 lockdown did interfere in software support communication. Normally, support can be requested from other students on the faculty, but now, all must be done remotely. This is time consuming and the decision had to be made that the interlocking simulation must be performed in later studies. Also, the simulation of the keystone with glass component was a challenge in several software due to limitations. Therefore, the decision for a limestone keystone is also based on the lack of simulations of the glass keystone. Finally, most structural cast glass scientific research is performed by a few scientists. Therefore, this research was also trial and error by casting components from concrete to understand what challenges to expect with casting glass. However, the most critical part of cast glass, the annealing phase, was not studied.

With this thesis, hopefully a new perspective is shown how to design with structural glass for heritage purpose. It shows there are more options than only one method of glass. The mix of glass and traditional materials is the suggested option of this thesis. Now, there are more methods how to reconstruct heritages than only the traditional or abstract ways. There is also the middle option of using new technology in combination with the traditional geometry.

For future research, more simulations can be performed for understanding the interlocking system of the arch components. As the position of the interlocking keeps changing in the arch, it is important to understand when and where different interlocking is required to resist all forces. Another option is to research the option of combining cast glass and 3D printing to reduce the number of moulds. Also, the option of a cast glass keystone can be studied and simulated. Maybe, with other production methods and optimization of the keystone, a safe and architectural accepted option is possible.

References

- ABC news. (2019, May 18). Notre Dame proposals envision 'green' roof, glass spire, beam of light. Retrieved from <https://abcnews.go.com/International/notre-dame-proposals-envision-green-roof-glass-spire/story?id=63079341>
- Abramovitch, I. (2019, May 14). Should Notre-Dame Be Rebuilt With a Glass Roof? Retrieved from https://www.yahoo.com/lifestyle/architect-responds-controversy-over-proposal-205900939.html?guce_referrer=aHR0cHM6Ly93d3cuZ29vZ2xlLmNvbS8&guce_referrer_sig=AQAAALSu2x1DqFoRVGramrrIOTgawn9bp-EGuwWGGingF4HwKyoFcZNo1keVkOBxvIFTDYnTsOCBohZnMB1CcPiK5MNUMWH5btBGJxWGbuvE00KGurCmKiL1gnuRx6QJc8ixJY1Ndcgnhlg35VHKNBYTR_L2kaM3MA9DkeQXQX9Y7IErF&guccounter=2
- ABT. (2016). Crystal Houses P.C. Hoofstraat - Amsterdam. Retrieved from <https://www.abt.eu/projecten/crystal-houses-pc-hoofstraat.aspx>
- ABT. (2019). 190221_AB_TUD_Glass-calculations_DEF [Presentation slides]. Retrieved from <https://brightspace.tudelft.nl/d2l/le/content/124737/viewContent/1228448/View>
- Aggelakopoulou, E. (2013, December 13). The Acropolis Restoration News - Design and evaluation of restoration mortars for the Acropolis monuments. Retrieved from http://www.ysma.gr/static/files/Newsletter13_en.pdf
- Angjeliu, G., Cardani, G., & Coronelli, D. (2019). A parametric model for ribbed masonry vaults. *Automation in Construction*, 105, 102785. <https://doi.org/10.1016/j.autcon.2019.03.006>
- Architectureartdesign. (2020, February 28). Glass Roof - Advantages and Ideas for Inspiration. Retrieved from <https://www.architectureartdesigns.com/glass-roof-advantages-and-ideas-for-inspiration/>
- Arrivée de Louis II d'Anjou à Paris,. (n.d.). [Photograph]. Retrieved from http://www.histoire-fr.com/valois_charles6_1.htm
- Ashby, M. F., Shercliff, H., & Cebon, D. (2007). *Engineering, Science, Processing and Design*. Oxford, UK: Butterworth-Heinemann.
- Aurik, M., Snijder, A., Noteboom, C., Nijse, R., & Louter, C. (2018). Experimental analysis on the glass-interlayer system in glass masonry arches. *Glass Structures & Engineering*, 3(2), 335–353. <https://doi.org/10.1007/s40940-018-0068-7>
- Bagger. (n.d.). Glass columns at Danfoss. Retrieved from <http://www.annebagger.dk/en/projects/glass-columns-at-danfoss.aspx>
- Barou, L., Oikonomopoulou, F., Bristogianni, T., Veer, F. A., & Nijse, R. (2018). Structural glass: a new remedial tool for the consolidation of historic structures. *Heron*, 63(1/2), 159–198.
- Bedon, C., & Santarsiero, M. (2018). Transparency in Structural Glass Systems Via Mechanical, Adhesive, and Laminated Connections - Existing Research and Developments. *Advanced Engineering Materials*, 20(5), 1700815–1700833. <https://doi.org/10.1002/adem.201700815>
- Bellapart, & Sau. (n.d.). Glass Monument in Remembrance of the Terrorist Attacks in Madrid. Retrieved from <http://www.bellapart.com/uploads/files/entradas/glass-monument-in-remembrance-of-the-terrorist-atta.pdf>
- Bhatia, I. (2019). Shaping transparent sand in sand. Retrieved from <https://repository.tudelft.nl/islandora/object/uuid%3Acaabb4cd-1bf4-48bc-b04d-e5ff8a1d1580>
- Borrus, K. (2019). *Notre Dame de Paris: A Celebration of the Cathedral*. New York (US): Running Press.
- Bos, F., Louter, C., Veer, F. A., & Technische Universiteit Delft. Faculteit Bouwkunde. (2008). *Challenging Glass: Conference on Architectural and Structural Applications of Glass*, Faculty of Architecture, Delft University of Technology, May 2008. Delft: Delft University Press.
- Brination, I. (2019, April 16). Restorations Rather than Acquisitions: Fashion Groups for Notre-Dame. Retrieved from https://www.irenebrination.com/irenebrination_notes_on_a/2019/04/rebuild-notre-dame.html
- Briney, A. (2019, April 10). The Importance of Historic Preservation. Retrieved from <https://www.thoughtco.com/historic-preservation-and-urban-planning-1435784>

- Bristogianni, T., Oikonomopoulou, F., Veer, F. A., Snijder, A., & Nijse, R. (2017). Production and Testing of Kiln-cast Glass Components for an Interlocking, Dry-assembled Transparent Bridge. *Glass Performance Days 2017 Conference Proceedings*. Retrieved from <https://www.semanticscholar.org/paper/Production-and-Testing-of-Kiln-cast-Glass-for-an-Bristogianni-Oikonomopoulou/f6243cbde5134eb65eae16a1d51feb3d3df6fb9>
- BullseyeGlass. (2019, May 2). Annealing Thick Slabs | Kilncasting. Retrieved from <https://www.bullseyeglass.com/methods-ideas/annealing-thick-slabs.html>
- Carpenteroak. (2007). Chiddingstone Orangery Castle. Retrieved from <https://carpenteroak.com/projects/chiddingstone-orangery/>
- Casapulla, C., Mousavian, E., & Zarghani, M. (2019). A digital tool to design structurally feasible semi-circular masonry arches composed of interlocking blocks. *Computers & Structures*, 221, 111–126. <https://doi.org/10.1016/j.compstruc.2019.05.001>
- Cbsnews. (2019, May 17). This Notre Dame redesign would turn the cathedral roof into a solar-powered urban farm. Retrieved from <https://www.cbsnews.com/news/this-notre-dame-redesign-would-turn-the-cathedral-roof-into-a-solar-powered-urban-farm/>
- CMOG. (2011, October 30). MIRROR TO DISCOVERY: THE 200-INCH DISK AND THE HALE REFLECTING TELESCOPE AT PALOMAR. Retrieved from <https://www.cmog.org/collection/exhibitions/mirror-to-discovery>
- Corning. (n.d.). Gorilla Glass 5 | Superior Glass Protection Against Drops | Corning Gorilla Glass. Retrieved 20 December 2019, from <https://www.corning.com/gorillaglass/worldwide/en/glass-types/gorilla-glass-5.html>
- Courtenay, L. T. (1997). *The Engineering of Medieval Cathedrals*. Hampshire: Ashgate.
- Cummings, K. (2001). *Techniques of Kiln-Formed Glass* (2nd ed.). Philadelphia, PA, USA: University of Pennsylvania Press.
- Cutler, V. (2012). *New Technologies in Glass*. Londen, UK: A&C Black.
- Daguerre, L. (n.d.). First picture of the Notre Dame de Paris [Photograph]. Retrieved from <https://www.lemonde.fr/blog/lunettesrouges/files/2012/09/Daguerre-Notre-Dame-et-l%C3%8Ee-de-la-Cit%C3%A9-vers-1838-15.5x20.6cm-b.jpg>
- Delgado, C. (n.d.). notre dame cathedral to be rebuilt following fire. here is how you can help [Photograph]. Retrieved from <https://www.designboom.com/architecture/notre-dame-cathedral-fire-rebuilt-restoration-04-16-2019/>
- Dillon, P. (2014, July 24). THE STORY OF BUILDINGS BY PATRICK DILLON, ILLUSTRATED BY STEPHEN BIESTY, 96 PP, RL 4. Retrieved from <https://www.books4yourkids.com/2014/06/the-story-of-buildings-by-patrick.html>
- Dreamstime. (n.d.). Notre Dame Interior [Photograph]. Retrieved from <https://www.dreamstime.com/royalty-free-stock-photo-notre-dame-interior-image2638865>
- Dreven, van W. (n.d.). Autobanden vervangen, wanneer en wat zijn de kosten. Retrieved 1 May 2020, from <http://www.autogeschiedenis.nl/auto-tips/autobanden-vervangen.htm>
- Drupa. (2015, August 24). 3D-Printed Glass Technique Is Beautiful And Mesmerising. Retrieved from <https://blog.drupa.com/de/printing-glass/>
- Eigenraam, P. (2019). Unit D04 Free form shell (doubly curved plates loaded in and out of plane). Retrieved from <https://brightspace.tudelft.nl/d2l/le/dropbox/61259/25422/DownloadAttachment?fid=698534>
- EncyclopediaBritannica. (n.d.). Vaults. Retrieved from <https://www.britannica.com/technology/vault-architecture#ref51993>
- Engelsman, C. G., Van Tol, A., & Scheutjens, L. J. H. (2000). *Vakwerk Metselen*. Leiden: Spruyt.
- EOC Engineers. (n.d.). Dilworth Park. Retrieved from <https://www.eocengineers.com/en/projects/dilworth-park-185>
- Escobedo, D. (n.d.). Armadillo Vault. Retrieved from <http://www.armadillovault.com/armadillo>
- ESG-glass. (n.d.). Technical Section. Retrieved 2 May 2020, from <http://www.esg.glass/technical>

- Eskilson, S. (2018). *The Age of Glass: A Cultural History of Glass in Modern and Contemporary Architecture*. London: Bloomsbury Academic.
- Fleseriu, A., & Eszter, P. (2016, September 28). *Reframe / Alexandru Fleşeriu + Péter Eszter*. Retrieved 8 December 2019, from <https://www.archdaily.com/795982/reframe-alexandru-fleseriu-plus-peter-eszter/>
- Fontaine, P. F. L. (1804). *he Rotunda, Decorated with Tapestries, which Greeted Guests on their Arrival at Notre-Dame for the Coronation of Napoleon as Emperor [Painting]*. Retrieved from <https://www.napoleon.org/en/history-of-the-two-empires/paintings/the-rotunda-decorated-with-tapestries-which-greeted-guests-on-their-arrival-at-notre-dame-for-the-coronation-of-napoleon-as-emperor/>
- Freitas, T. (2010). *New old chair*. Retrieved 8 December 2019, from <https://www.tatianefreitas.com/projects/6070852>
- Frey, P. (2019, February 8). *Why Historic Preservation Needs a New Approach*. Retrieved from <https://www.citylab.com/perspective/2019/02/tax-credit-historic-preservation-old-town-main-street/581989/>
- Glasatelier Johannes Boersma. (n.d.). *Zandstralen*. Retrieved 30 April 2020, from <https://www.glasatelierjohannesboersma.com/zandstralen.html>
- Glassshape (n.d.) *Information regarding Glass types and properties*. Retrieved 05 May 2020, from <https://glassshape.com/wp-content/uploads/2015/08/Information-on-various-glass-types-used-by-Glassshape.pdf>
- Grote Kerk Den Haag. (n.d.). *Home*. Retrieved from <https://www.grotekerk-den Haag.nl/>
- HeraldSystem. (2019, November 5). *Telescope Lens Market 2019, Trend, CAGR Status, Growth, Analysis and Forecast to 2024*. Retrieved from <https://heraldsystem.com/2019/11/05/telescope-lens-market-2019-trend-cagr-status-growth-analysis-and-forecast-to-2024/>
- Heyman, J. (1995). *The Stone Skeleton: Structural Engineering of Masonry Architecture*. Cambridge: Cambridge University Press.
- Hiroshi. (n.d.). *Optical Glass House*. Retrieved from <https://www.nakam.info/jp/works/optical-glass-house/>
- Hoogenboom, P. C. J. (2018). *CIE4143 Shell Analysis, Theory and Application*. Retrieved from http://homepage.tudelft.nl/p3r3s/b17_schedule.html
- ICCROM. (2000). *Riga Charter on authenticity and historical reconstruction in relationship to cultural heritage*. Retrieved from <http://patrimoniomundial.cultura.pe/sites/default/files/pb/pdf/Documento66.pdf>
- ICMOS. (1994). *The Nara Document on Authenticity*. Retrieved from <https://www.icomos.org/charters/nara-e.pdf>
- ICOMOS. (1964). *The Venice Charter*. Retrieved from https://www.icomos.org/charters/venice_e.pdf
- ICOMOS. (2013). *The Burra Charter*. Retrieved from http://portal.iphan.gov.br/uploads/ckfinder/arquivos/The-Burra-Charter-2013-Adopted-31_10_2013.pdf
- Ikea. (n.d.). *IKEA Nederland | Interieur – Online bestellen*. Retrieved 1 May 2020, from <https://www.ikea.com/nl/en/>
- Jackofglass. (n.d.). *Glass Balustrades*. Retrieved from <https://www.jackofglass.co.uk/>
- Jacobs, S. F., Shough, D., & Connors, C. (1984). *Thermal expansion uniformity of materials for large telescope mirrors*. *Applied Optics*, 23(23), 4237–4244. <https://doi.org/10.1364/ao.23.004237>
- Janssens, E. J. (2018). *The Glass dome*. Retrieved from <https://repository.tudelft.nl/islandora/object/uuid%3A061c2a5e-58fd-4530-b479-03a9c4bd9de9>
- Judd, B. (2019, April 16). *Notre Dame survived centuries of turmoil, but was almost destroyed in a fire during renovation works*. Retrieved from <https://www.abc.net.au/news/2019-04-16/notre-dame-fire-history-and-cultural-impact-of-paris-cathedral/11018226>
- Krueck & Sexton. (n.d.). *Krueck + Sexton | Crown Fountain*. Retrieved from <https://www.ksarch.com/crown-fountain>
- Lego Group. (n.d.). *The LEGO® Group*. Retrieved 1 May 2020, from <https://www.lego.com/nl-nl>

- Lockblock. (n.d.). Arch-Lock™ - Classic concept. Modern solutions. Retrieved from <http://www.lockblock.com/arches.php>
- Mallikarjun, K. (2017). Vaults. Retrieved from <https://www.slideshare.net/krishnakanthmallikar/vaults>
- Marigliani, A. (2014, October 13). Museo Nazionale Romano – Crypta Balbi. Retrieved 8 December 2019, from http://www.archidiap.com/opera/museo-nazionale-romano-crypta-balbi/?_sf_s=crypta%20balbi
- Matthews, D. (2017, May 5). Who Are The Faces On Crown Fountain? - Downtown - Chicago - DNAinfo. Retrieved from <https://www.dnainfo.com/chicago/20170505/downtown/how-to-get-face-on-the-millennium-park-fountain/>
- Moving Buddies (n.d.). FLAT SCREEN TV CRATING. Retrieved from <https://www.movingbuddiesaz.com/flat-screen-tv-crating/>
- NEN2608. (2014). Vlakglas voor gebouwen - Eisen en bepalingmethode. Retrieved from <https://www.nen.nl/NEN-Shop/Norm/NEN-26082014-nl.htm>
- NORM. (2019, November 3). Difference between PVB,EVA ,SGP interlayer. Retrieved from <https://www.cnmorn.com/difference-between-pvbeva-sgp-interlayer.html>
- Oikonomopoulou, F. (2019). Unveiling the third dimension of glass (1st ed.). Delft: Tu Delft Open.
- Oikonomopoulou, F., Bristogianni, T., Barou, L., Veer, F. A., & Nijse, R. (2018). The potential of cast glass in structural applications. Lessons learned from large-scale castings and state-of-the art load-bearing cast glass in architecture. *Journal of Building Engineering*, 20, 213–234. <https://doi.org/10.1016/j.job.2018.07.014>
- Oikonomopoulou, F., Veer, F. A., Bristogianni, T., & Barou, L. (2019). Advances in Engineering Materials, Structures and Systems: Innovations, Mechanics and Applications. Dry Interlayers out of Cast Polyurethane Rubber for Interlocking Cast Glass Structures Experimental Exploration and Validation, 1709–1714. <https://doi.org/10.1201/9780429426506>
- Orbasli, A. (2007). *Architectural Conservation: Principles and Practice*. Oxford: Wiley.
- Plasticwarehouse. (2020, February 14). Aluplas ACM Board | Aluminium Composite Panel. Retrieved from <https://plasticwarehouse.com.au/product/acm-board-aluminium-composite-panel/>
- Rippmann, M., & Block, P. (2018). Computational Tessellation of Freeform, Cut-Stone Vaults. *Nexus Network Journal*, 20(3), 545–566. <https://doi.org/10.1007/s00004-018-0383-y>
- RS. (n.d.). Green Steel Shim, 100in x 6in x 0.203mm | RS Components. Retrieved 1 May 2020, from https://nl.rs-online.com/web/p/steel-shims/0518756?cm_mmc=NL-PLA-DS3A-_-google-_-PLA_NL_NL_Abrasives_And_Engineering_Materials_New-_-Shim_Stock%7CSteel_Shims-_-PRODUCT_GROUP&matchtype=&pla-391568785867&gclid=EAlaQobChMI697r3suS6QIVkLh3Ch3_cAr4EAQYASABEgKLCvD_BwE&gclid=aw.ds
- Salem, A., Smith, N. A., & Ersahin, A. (2015). Mechanical Properties of a High Lead Glass Used in the Mars Organic Molecule Analyzer. *Nasa*. Retrieved from <https://ntrs.nasa.gov/archive/nasa/casi.ntrs.nasa.gov/20150017735.pdf>
- Schittich, C., Staib, G., Balkow, D., Schuler, M., & Sobek, W. (1999). *Glass construction manual*. Basel, Switzerland: Birkhäuser.
- Schott. (2017, February 6). Technology meets aesthetics. Retrieved from <https://www.us.schott.com/innovation/technology-meets-aesthetics/>
- Shaw, J. (2019, April 24). Don't modernize Notre Dame. Retrieved from <https://www.lifesitenews.com/blogs/dont-modernize-notre-dame>
- Smithsonian. (2019, October 20). Mirror, Primary Backup, Hubble Space Telescope. Retrieved 20 December 2019, from <https://airandspace.si.edu/collection-objects/mirror-primary-backup-hubble-space-telescope>
- Spacemood. (n.d.). Nasa Space Shuttle Enterprise Interior. Retrieved from <https://ccswim.info/space/nasa-space-shuttle-enterprise-interior.html>
- Stanley-Price, N. (2009). The Reconstruction of Ruins: Principles and Practice By Nicholas Stanley-Price. In A. Richmond & A. Bracker (Eds.), *The Reconstruction of Ruins* (pp. 32–46). Retrieved from https://www.archaeological.org/pdfs/sitepreservation/N_S-P_Article_Dec_2009.pdf

- Stöver, J. (n.d.). Kopie en navolging in het middeleeuwse bouwen. Retrieved from <https://www.henrickus.nl/mvk06-kopie-en-navolging-in-het-middeleeuwse-bouwen/>
- Su, S. (2011, July 24). The Difference Between PVB and SGP Laminated Glass (PVB vs SGP). Retrieved from <https://www.linkedin.com/pulse/difference-between-pvb-sgp-laminated-glass-vs-susan-su/>
- Tallon, A. (2010). 3D scans and pictures of the Notre Dame. Retrieved from <https://notredame.truview-cloud.com/scan/c01a7219-a820-45b3-ad33-66505aa57f27>
- Trombe. (n.d.). The Architecture of Glass. Retrieved 1 May 2020, from <https://www.trombe.co.uk/>
- Un Studio. (2020, February 13). 18 Septemberplein. Retrieved from <https://www.unstudio.com/en/page/12329/18-septemberplein>
- Weijst, van der F. (2019). Glass vaults. Retrieved from <https://repository.tudelft.nl/islandora/object/uuid%3A37a693fc-4835-4d46-a4e1-086e96c2ef1a>
- Vannucci, P., Masi, F., & Stefanou, I. (2019). A nonlinear approach to the wind strength of Gothic Cathedrals: The case of Notre Dame of Paris. *Engineering Structures*, 183, 860–873. <https://doi.org/10.1016/j.engstruct.2019.01.030>
- Verlaan&Bouwstra. (2013). Kasteel Ruurlo. Retrieved from <http://verlaanenbouwstra.nl/herbestemming/oplevering-kasteel-ruurlo/>
- Visionagi. (n.d.). Glass Beam Supported Archives. Retrieved from https://www.visionagi.co.uk/media_category/glass-beam-support-glass-rooflights/
- Voxeljet. (n.d.). Voxeljet offers industrial 3D printing solutions on demand. Retrieved from https://www.voxeljet.com/fileadmin/user_upload/PDFs/Servicebrochure_2018_web_01.pdf
- Welleman, J. W. (2019). NOTITIES OVER KABELS EN BOGEN Parametrisch modelleren met MAPLE. Retrieved from http://icozct.tudelft.nl/TUD_CT/BendAndBreak/files/2019%20Notities%20over%20kabels%20en%20bogen.pdf
- Wigginton, M. (1996). *Glass in Architecture*. London, England: Phaidon Press.
- Worldarchitecturenews. (2011, September 30). APPLE STORE, LONDON. Retrieved from <https://www.worldarchitecturenews.com/article/1508847/apple-store-london?ctid=4>
- Yang, S. (2015). Crashing Glass Waves Sculptures by Paul DeSomma and Marsha Blaker. Retrieved from <http://4rtgallery.blogspot.com/2015/04/crashing-glass-waves-sculptures-by-paul.html>

Appendices

- Appendix A: Planning
- Appendix B: Results solid arch simulation
- Appendix C: Arch component tessellation
- Appendix D: Interlocking bottom arch section
- Appendix E: Concepts of the moulds for the arch components
- Appendix F: Keystone
- Appendix G: Web
- Appendix H: Results web simulations
- Appendix I: Web – structural arch connection
- Appendix J: Assembly of the structural arch (Options)
- Appendix K: Prototype moulds
- Appendix L: Prototype arch section
- Appendix M: Assembling sequence of the glass vault
- Appendix N: Impressions of the moulds
- Appendix O: Risk analysis of the glass vault



This page intentionally left blank.

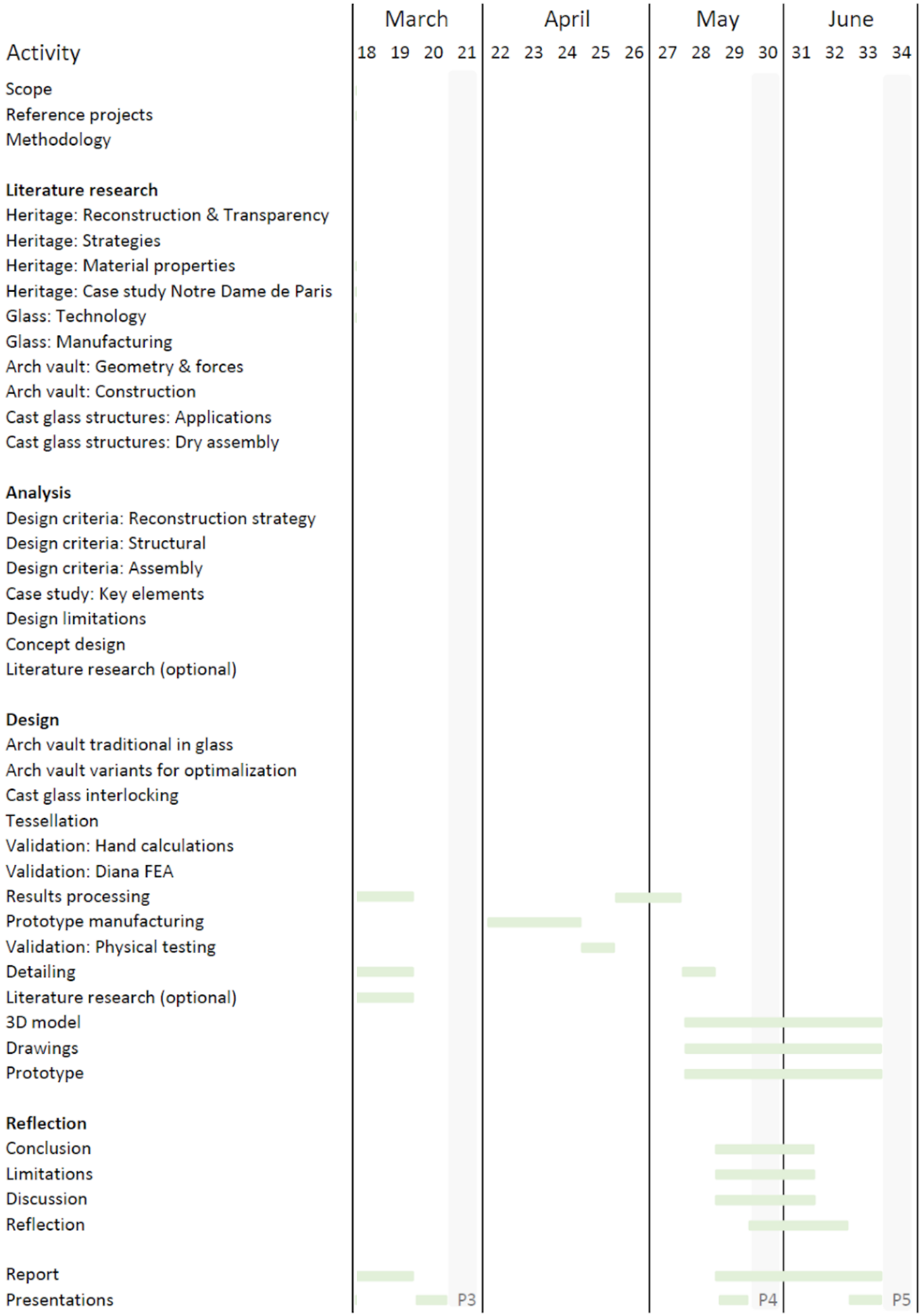

P3

P4

P5

Appendix B: Results solid arch simulation

Current arch:

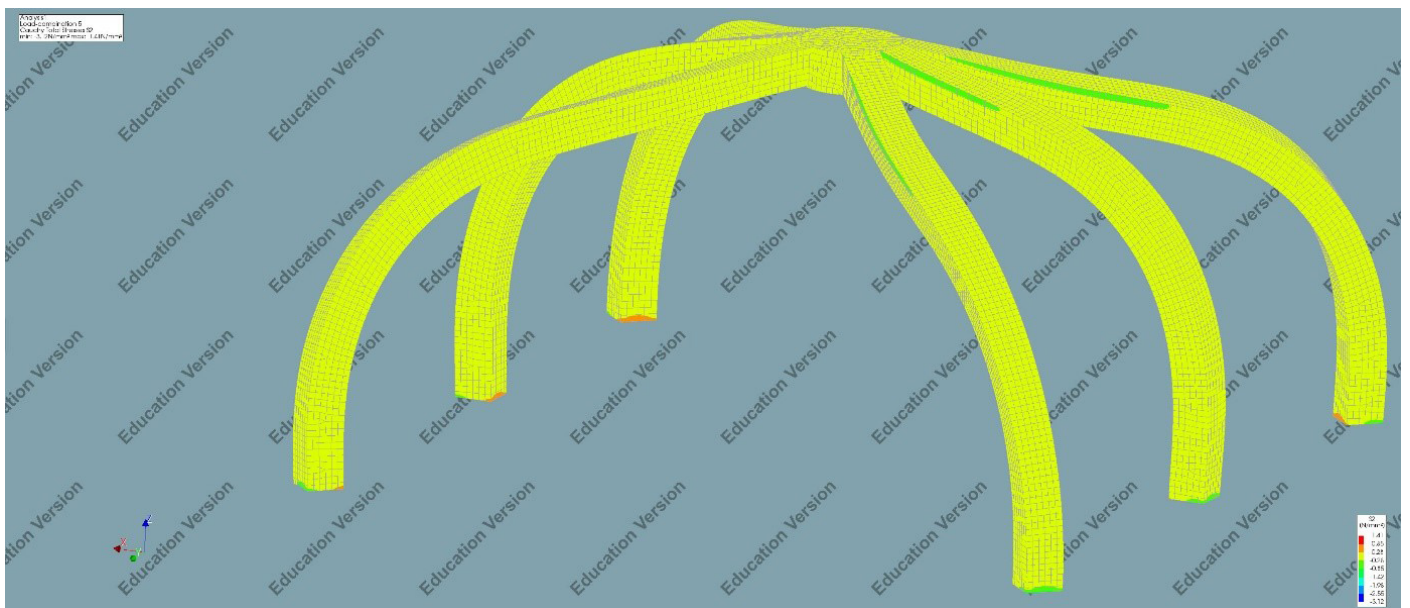
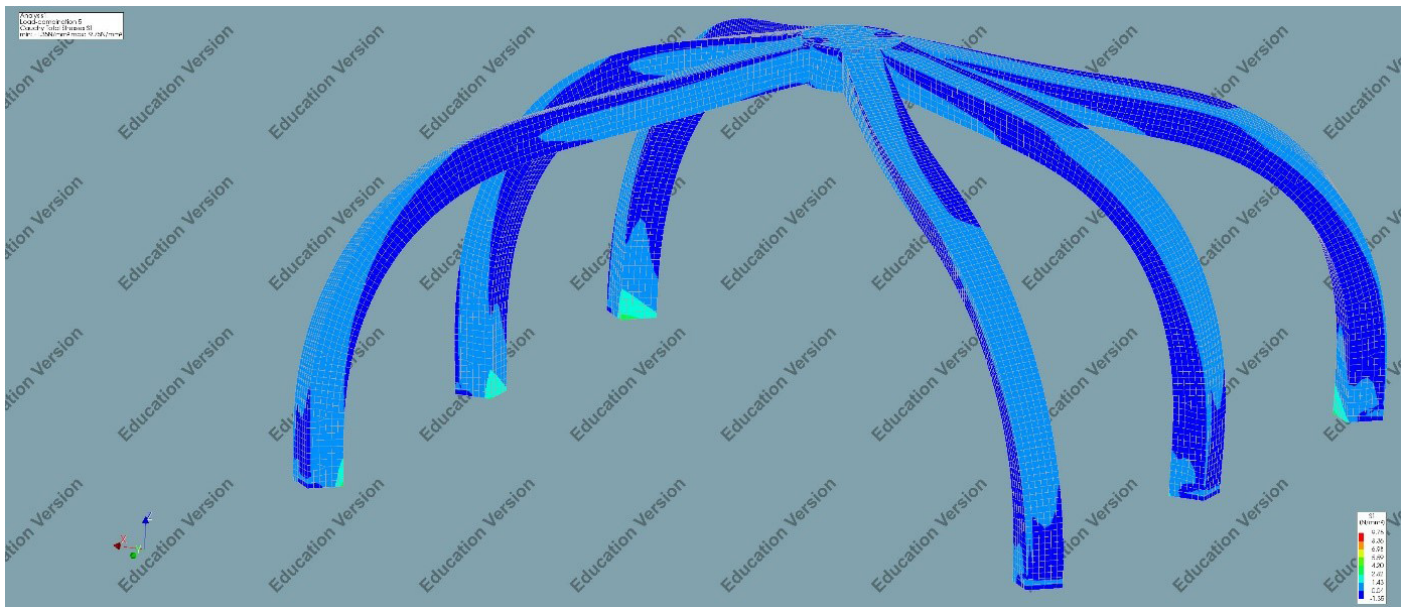
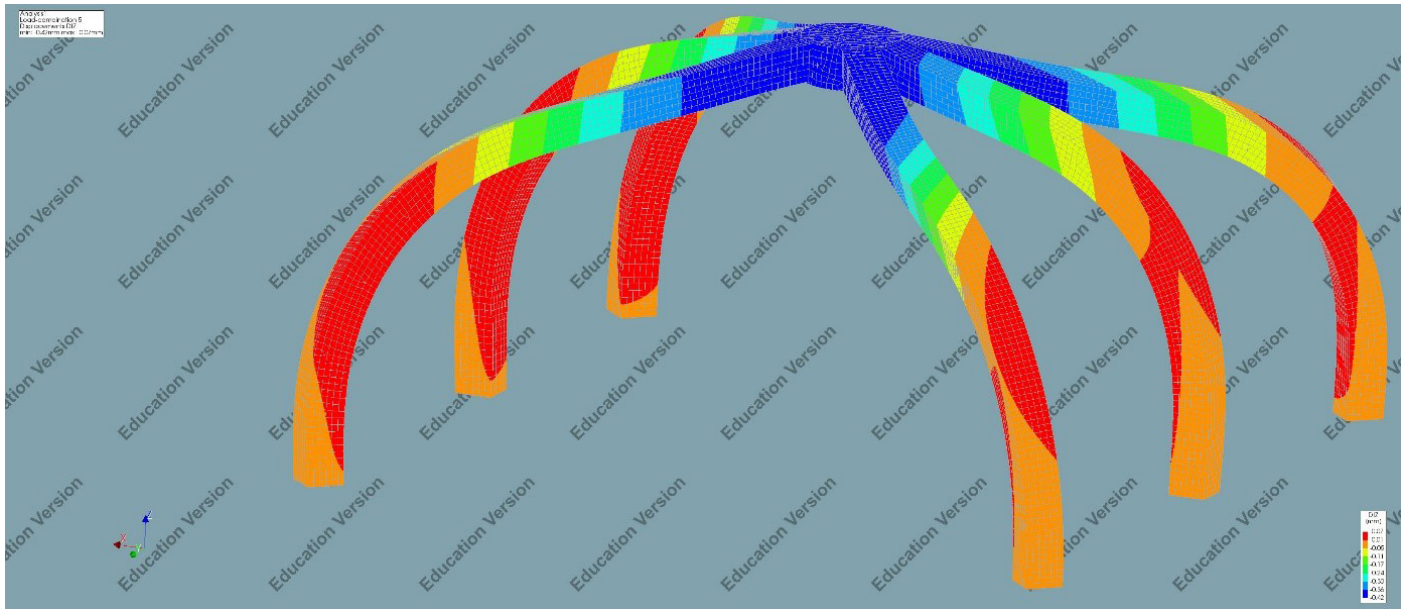

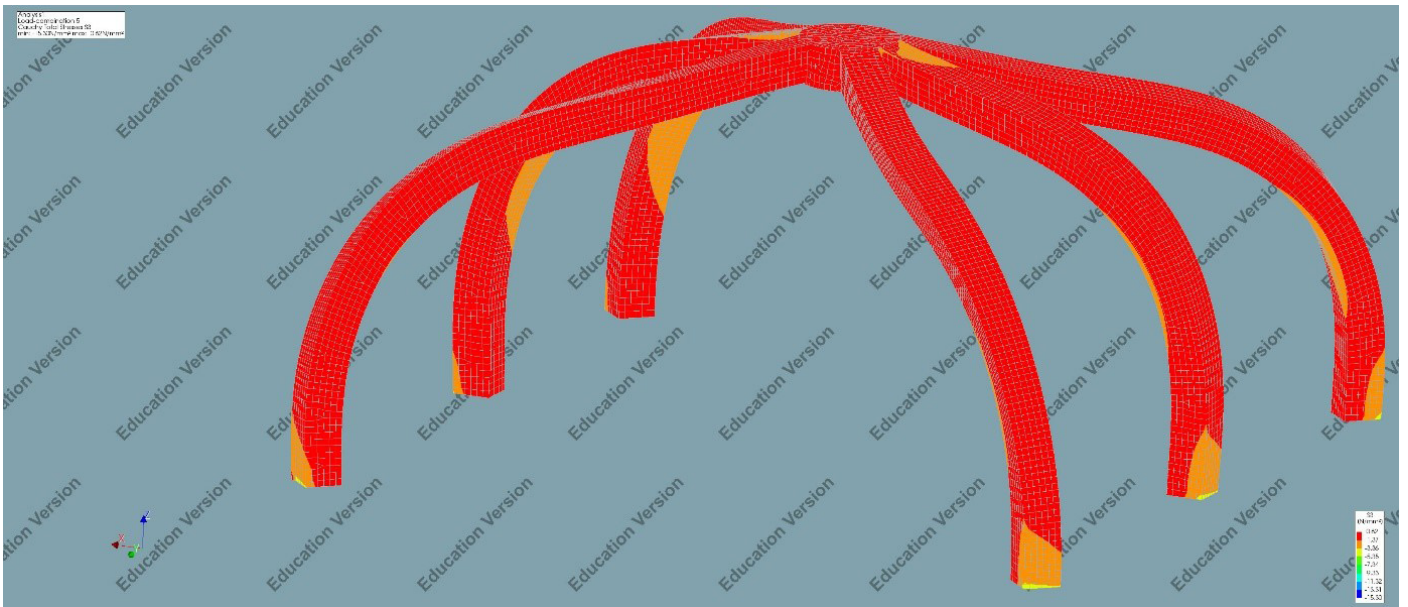

Variant 1 (bottom 600 x 600mm, top 300 x 600mm)

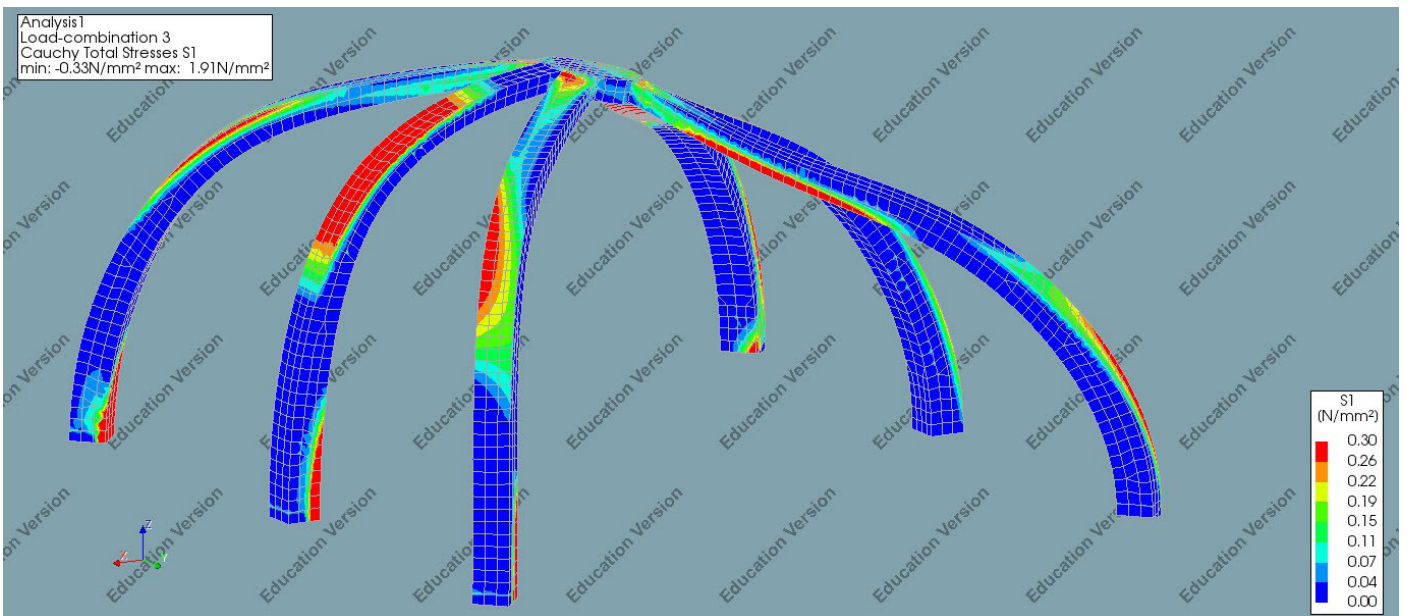
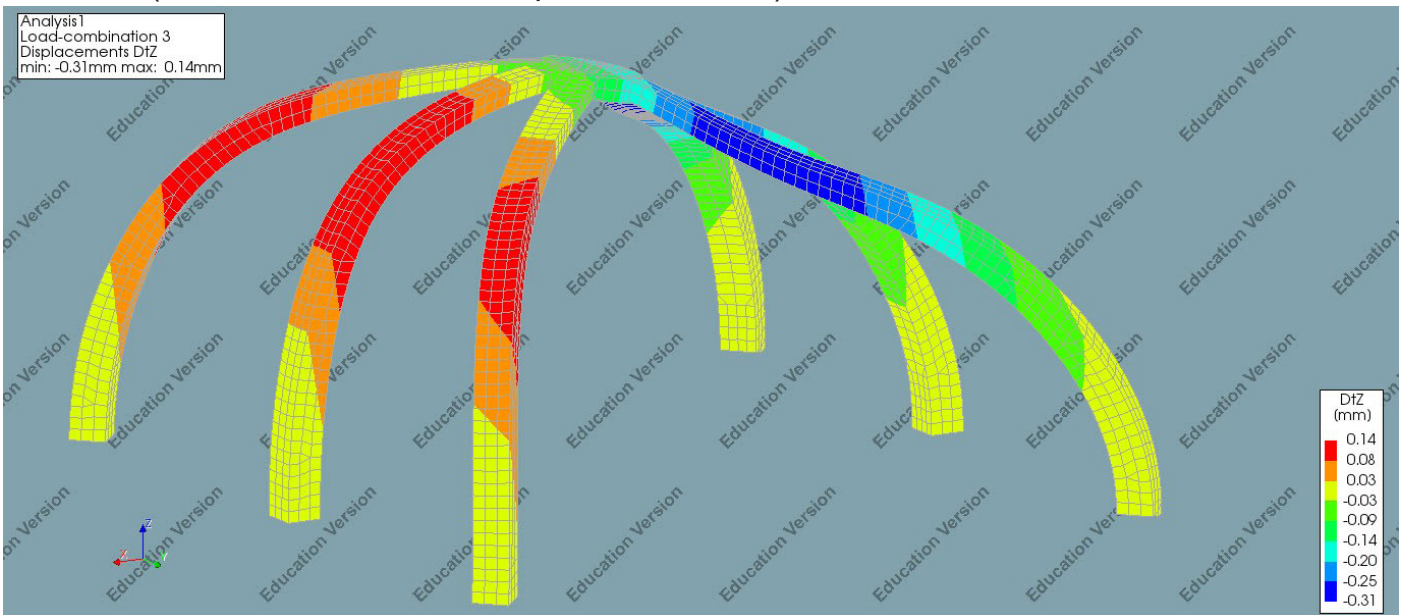

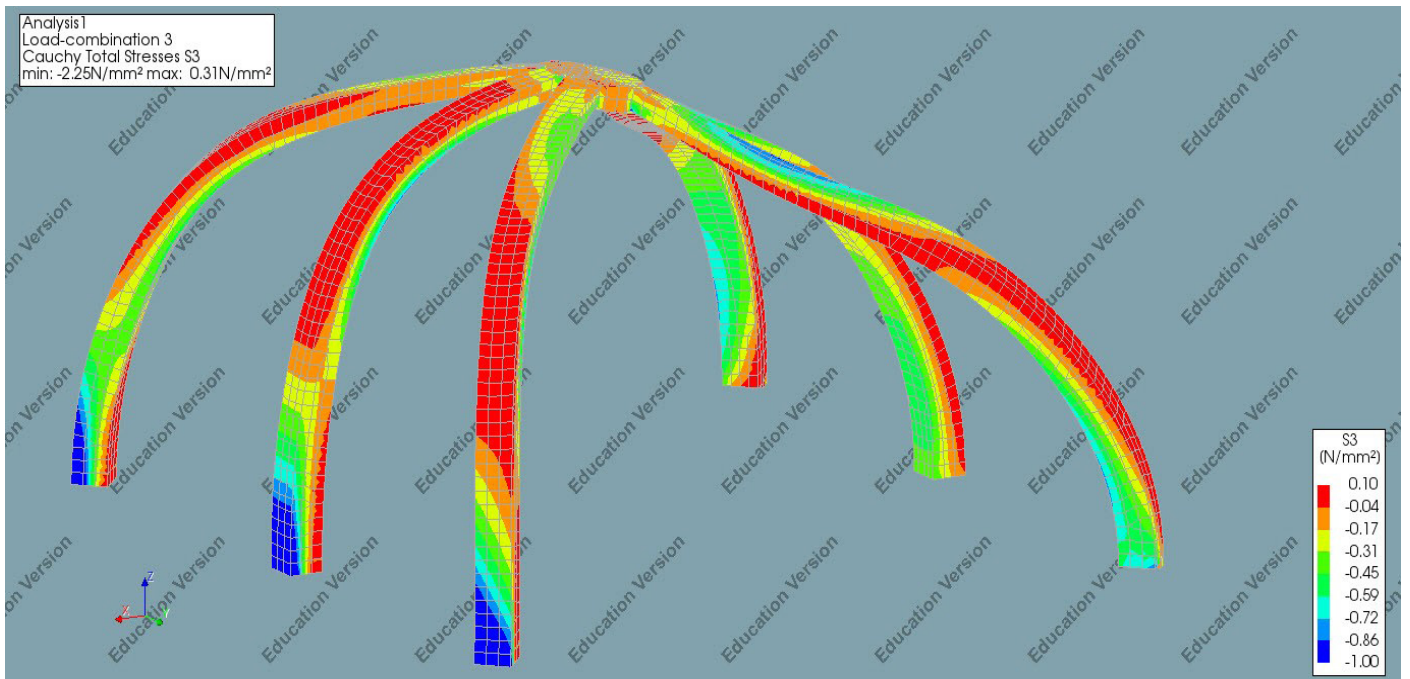
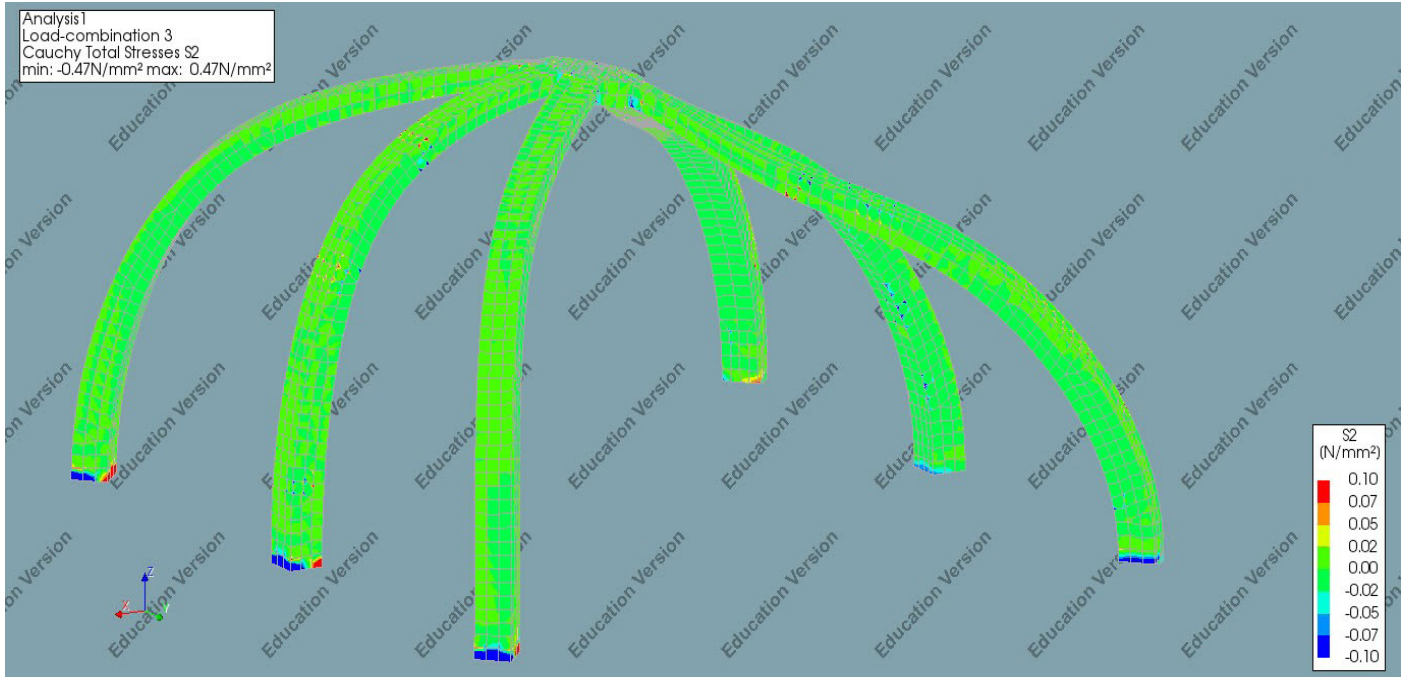

Variant 2 (bottom 300 x 600mm, top 300 x 600mm)

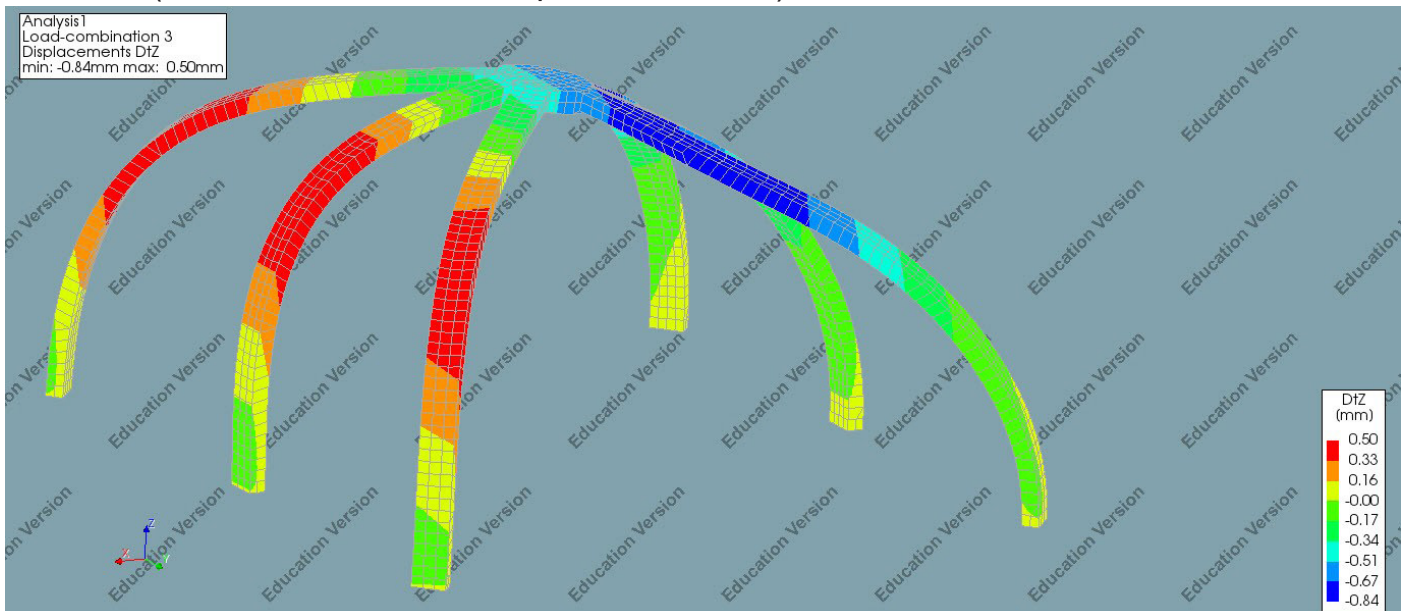

Analysis 1
Load-combination 3
Cauchy Total Stresses S1
min: -0.97N/mm² max: 4.94N/mm²

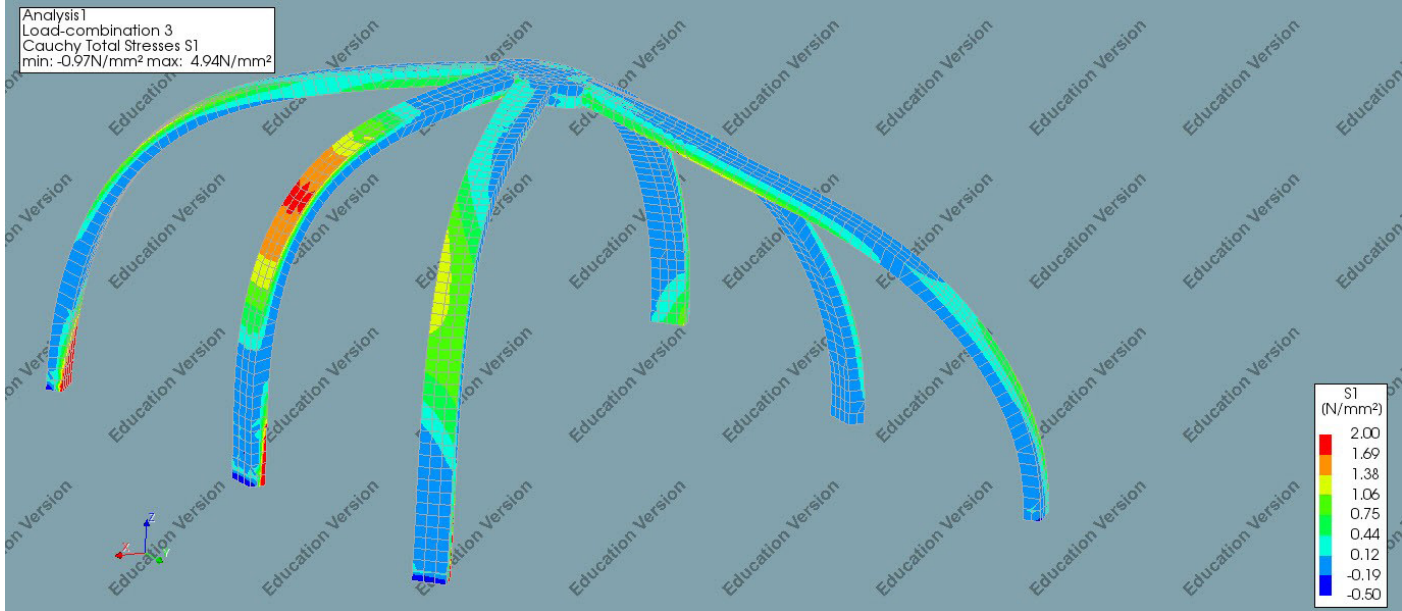

Analysis 1
Load-combination 3
Cauchy Total Stresses S2
min: -2.46N/mm² max: 2.29N/mm²

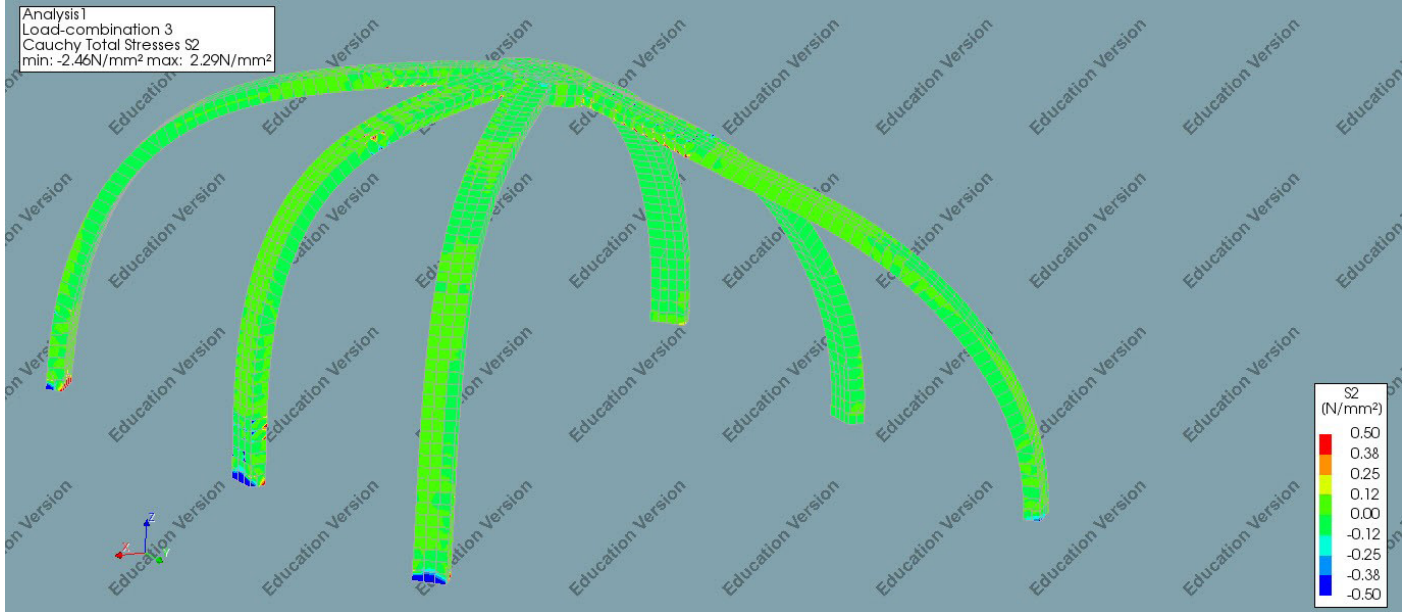

Analysis 1
Load-combination 3
Cauchy Total Stresses S3
min: -5.70N/mm² max: 0.84N/mm²

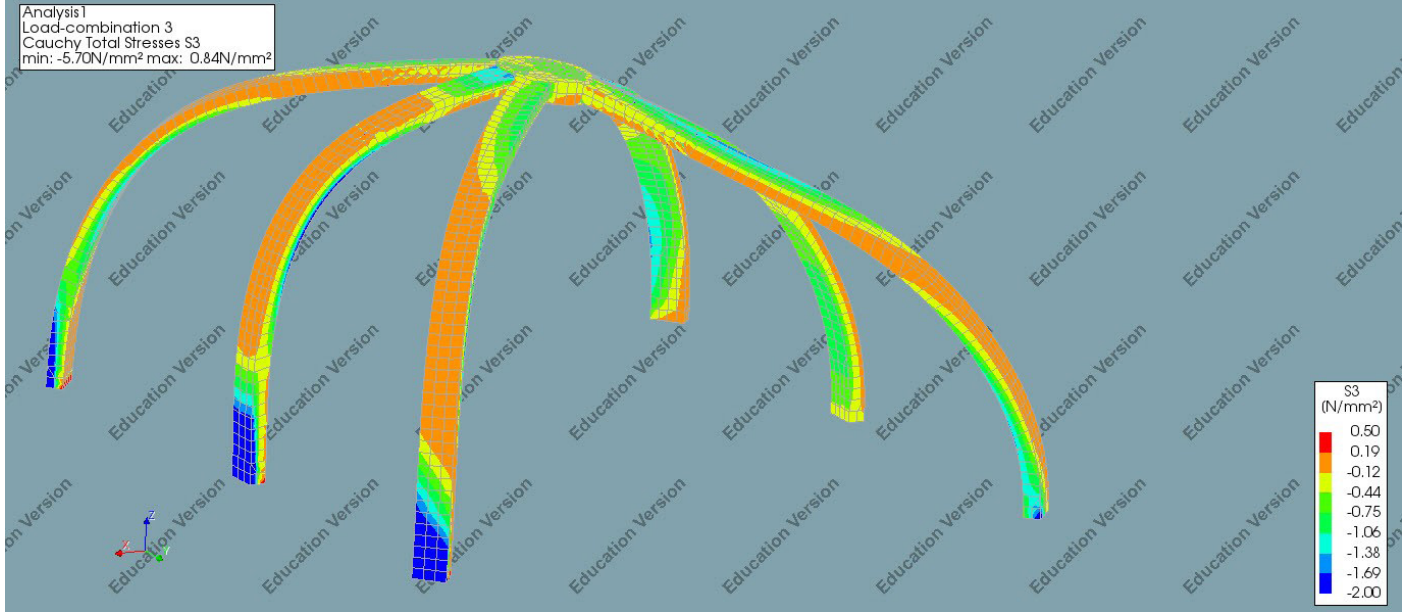

Variant 3 (bottom 150 x 600mm, top 150 x 600mm)

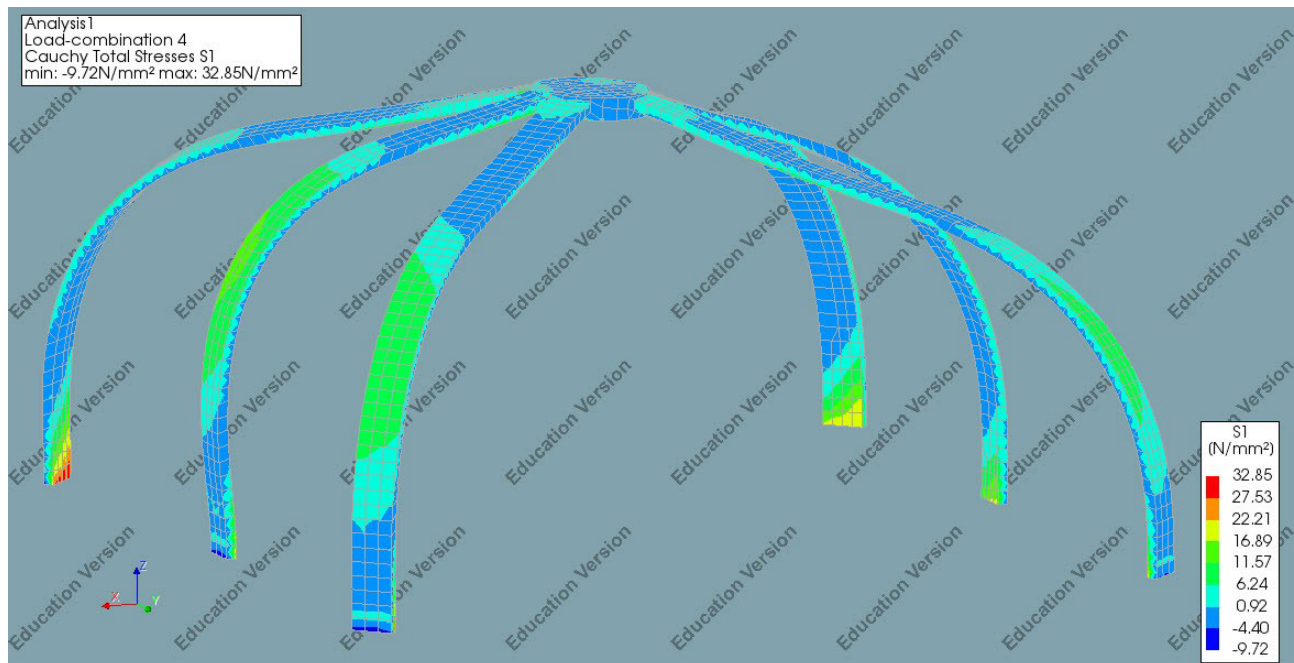
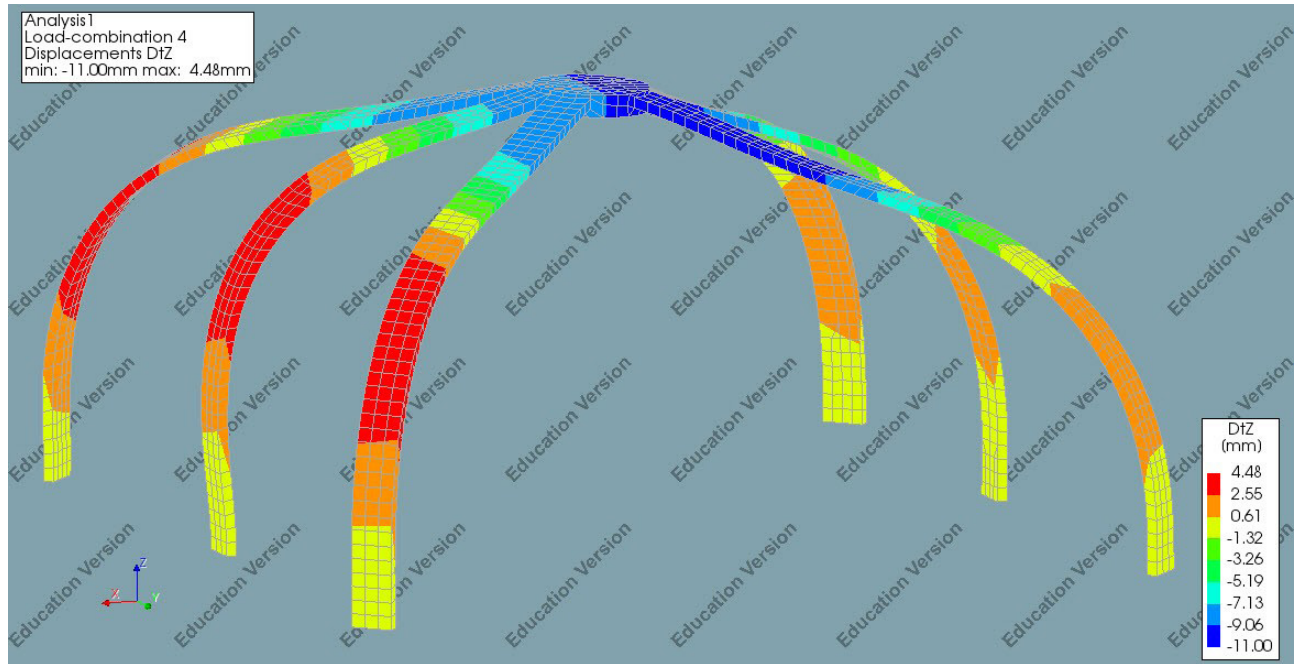

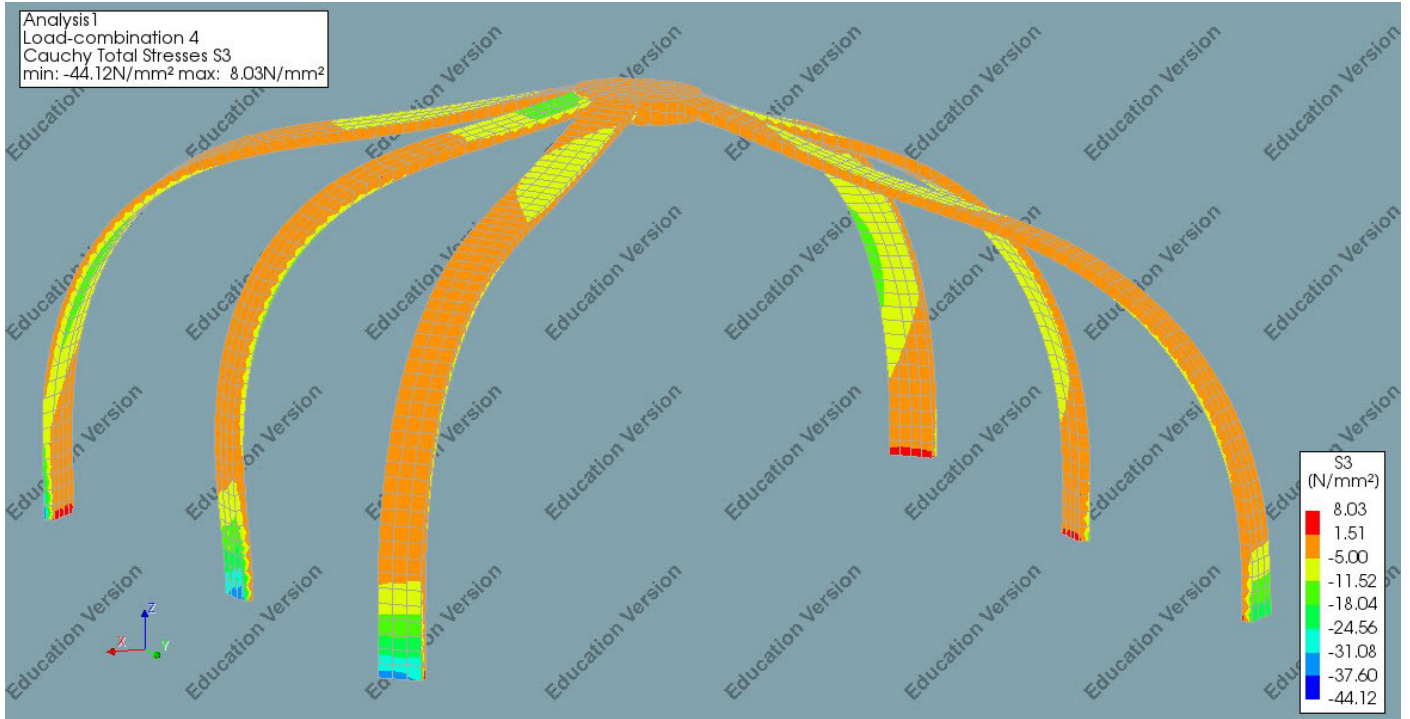

Variant 4 (bottom 50 x 600mm, top 50 x 600mm)

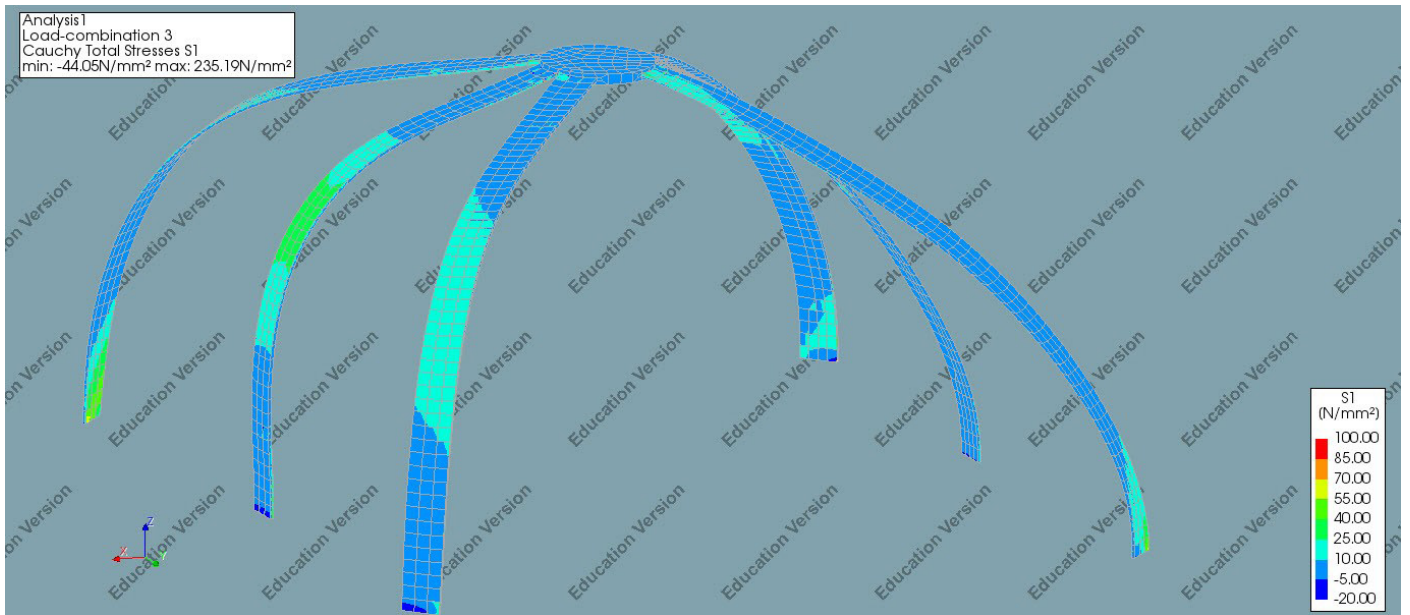
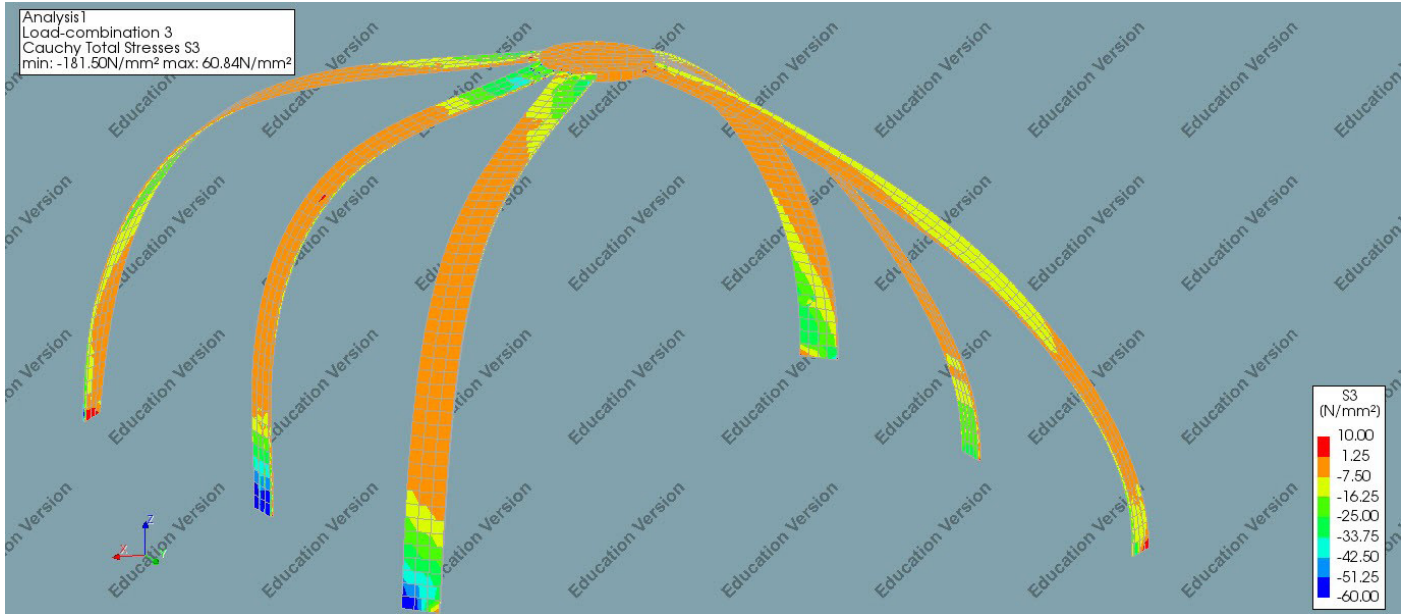



Variant 5 (bottom 250 x 600mm, top 150 x 600mm)

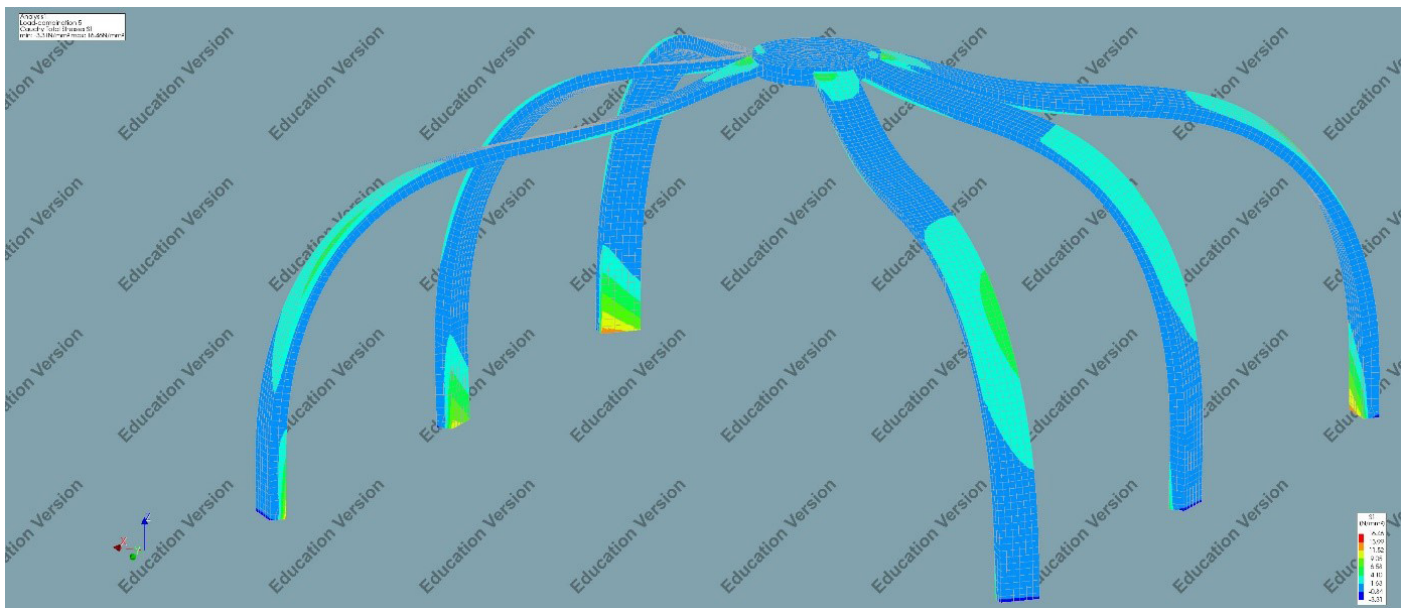
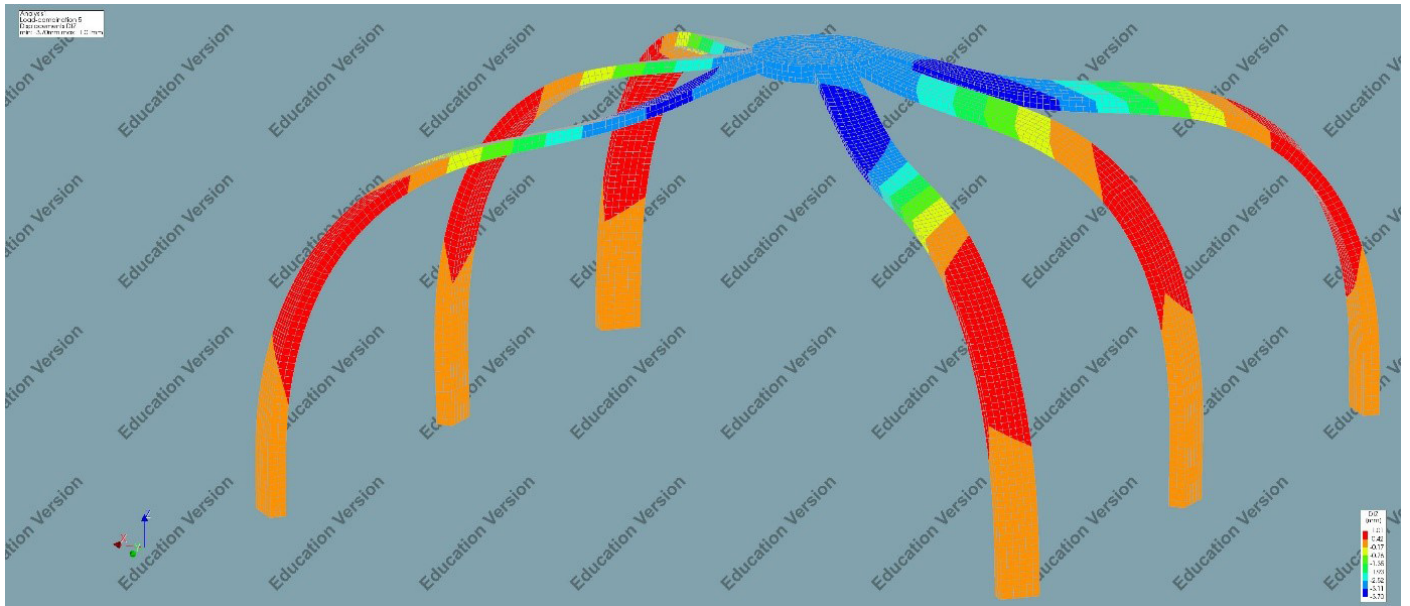

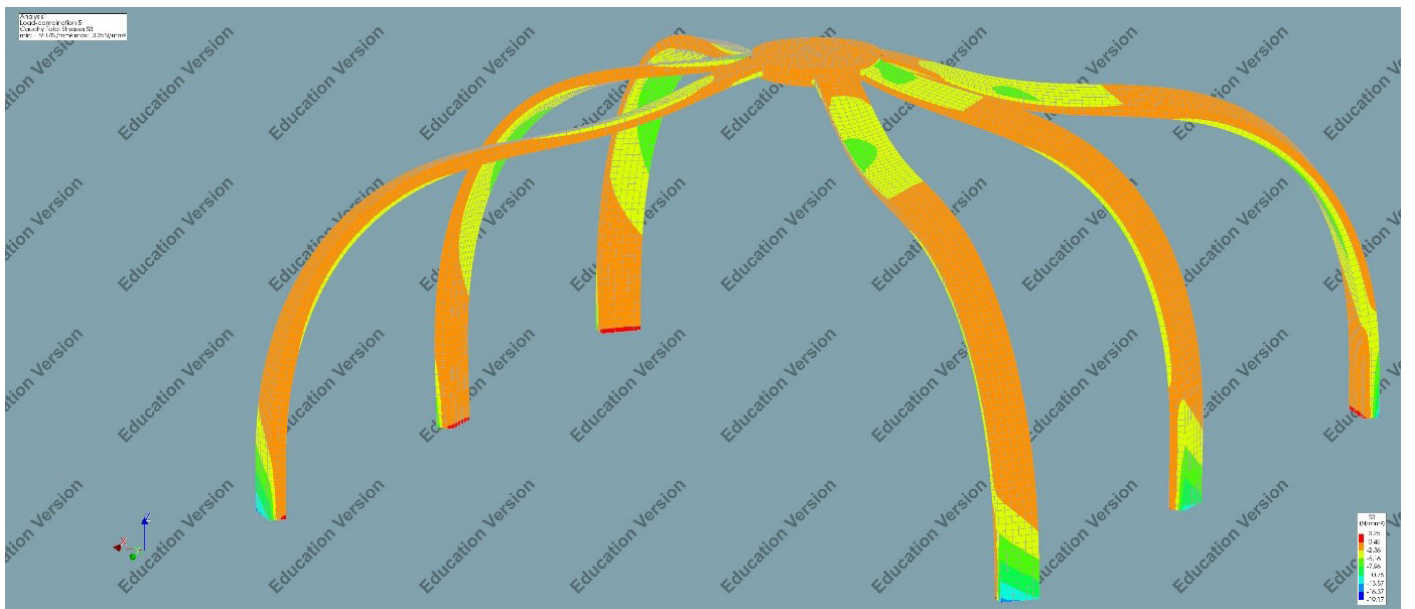

Appendix C: Arch component tessellation

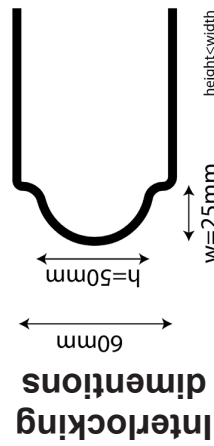

Interlocking dimensions	Component	Weight per element	Forces in the components	Findings
<p>Original Cross section Transverse arch Cross section Diagonal arch</p>	1	735 kg	<p>Cross section Transverse arch</p>	Components equal divided. There is a momentum in the interlocking which can cause failure. Local failure (inner corner of component 1) can appear due to sharp corner.
	2	610 kg		
<p>Variant 1 Cross section Transverse arch Cross section Diagonal arch</p>	1	23,0 kg	<p>Cross section Transverse arch</p>	Middle component is the biggest for the F_n . Momentum in interlocking is smaller than in variant 1. Local failure (inner corner of component 1) can appear due to sharp corner.
	2	11,1 kg		
	3	5,2 kg		
	4	6,4 kg - 17,4 kg - (50mm - 150mm)		
	5	4,9 kg - 13,4 kg		
<p>Variant 2 Cross section Transverse arch Cross section Diagonal arch</p>	1	22,3 kg	<p>Cross section Transverse arch</p>	Middle component is the biggest for the F_n . Momentum in interlocking is smaller than in variant 1. Local failure (inner corner of component 1) can appear due to sharp corner.
	2	12,5 kg		
	3	6,6 kg		
	4	6,4 kg - 17,4 kg - (50mm - 150mm)		
	5	4,9 kg - 13,4 kg		

Appendix D: Interlocking bottom arch section

Variant 1

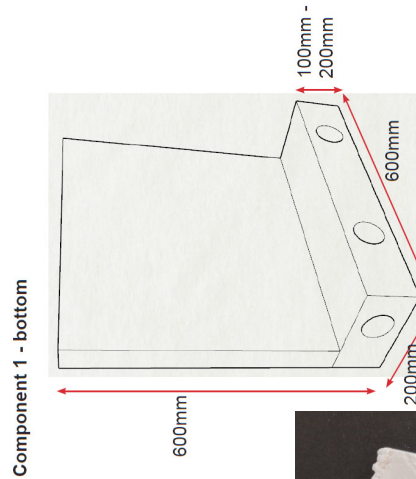
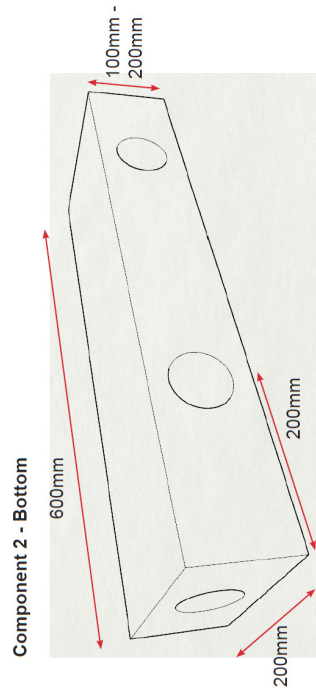
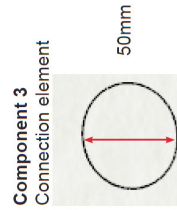
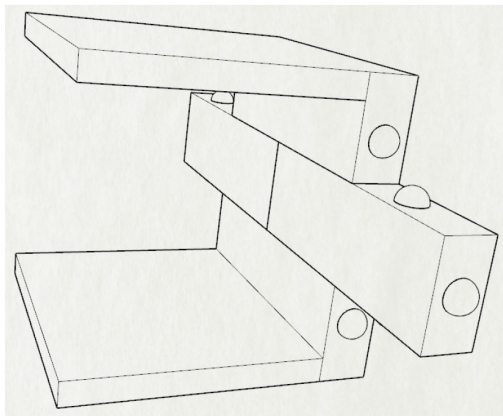
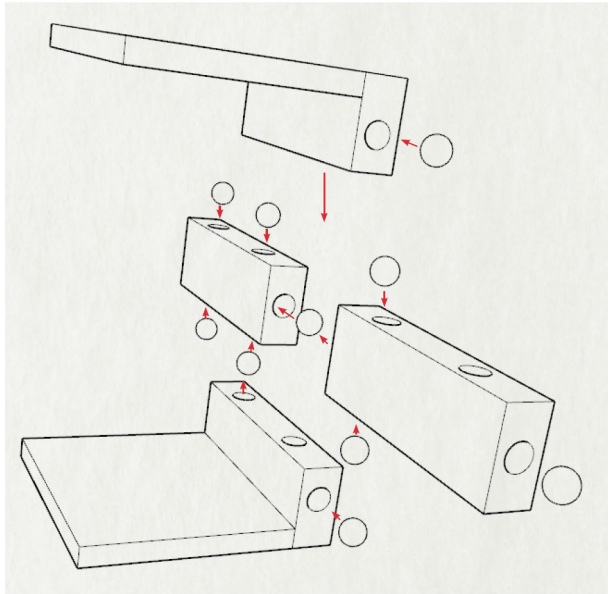

Variant 2 & 3

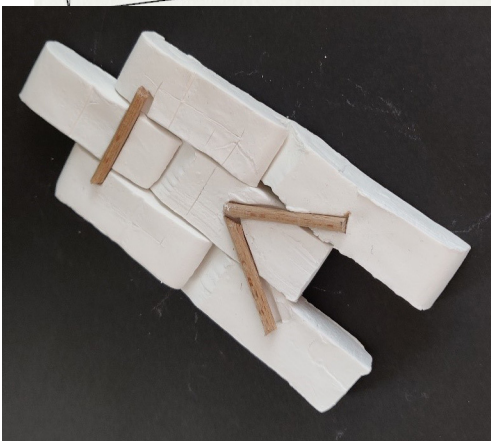
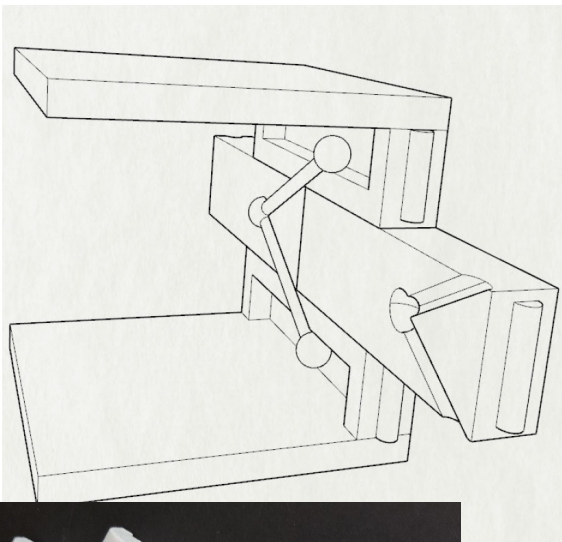
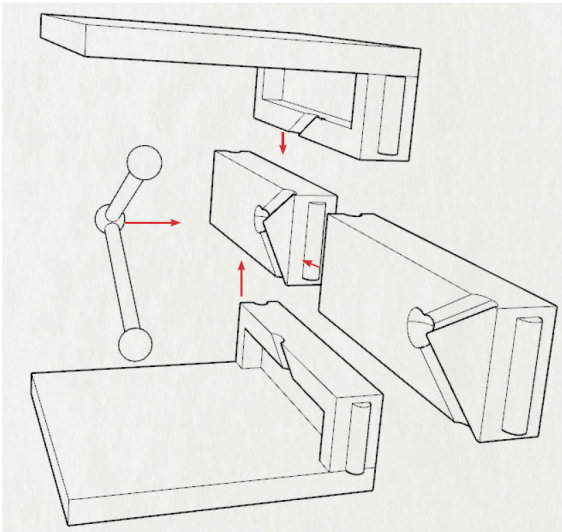

Component 3 - Bottom

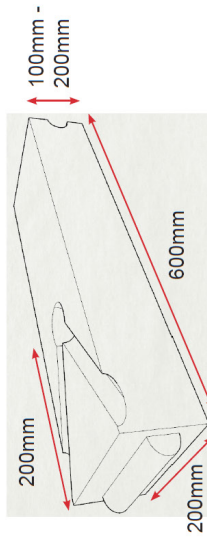

Component 4 - Top
Connection element

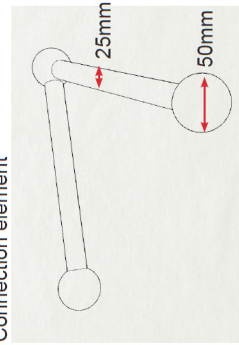

Component 2 - Bottom

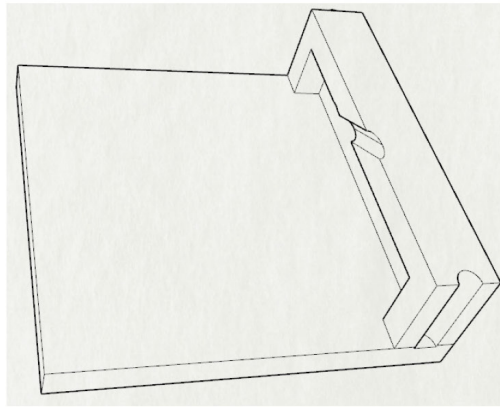

Component 1 - bottom

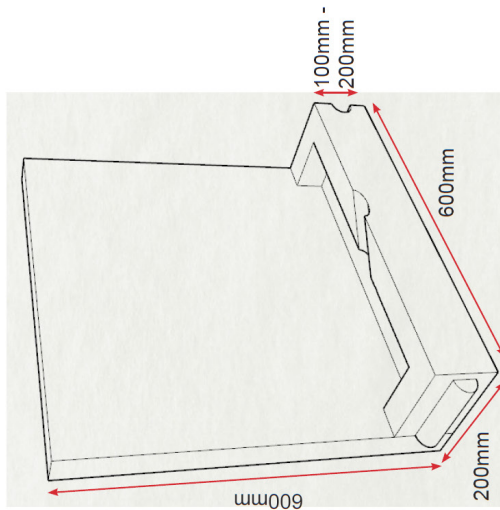

Variant 4

Component 4 - Top
Variants in thickness depending on position

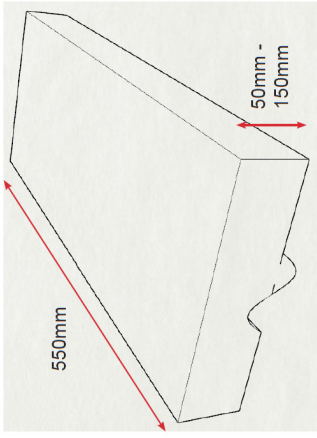

Component 3 - Bottom

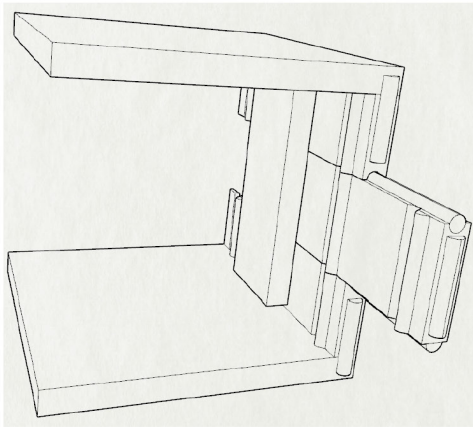
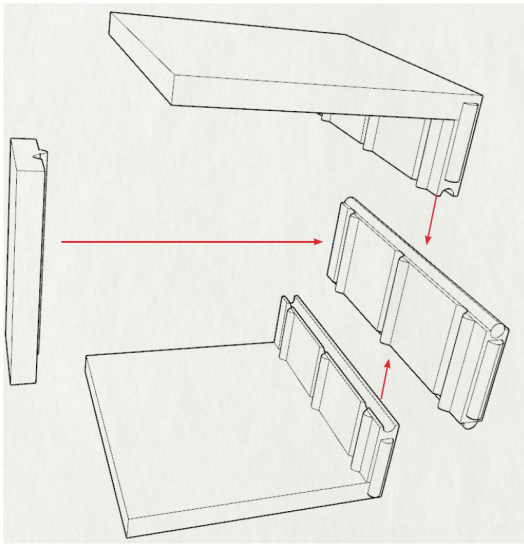
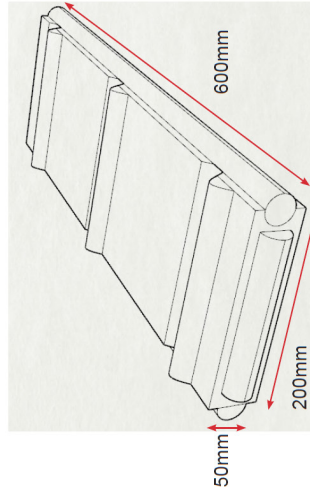

Component 2 - Bottom

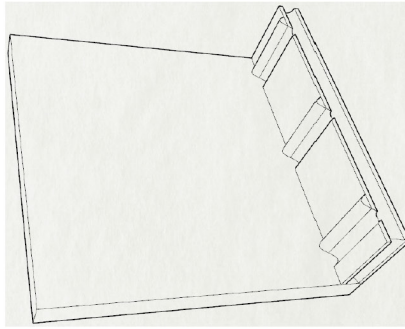

Component 1 - bottom

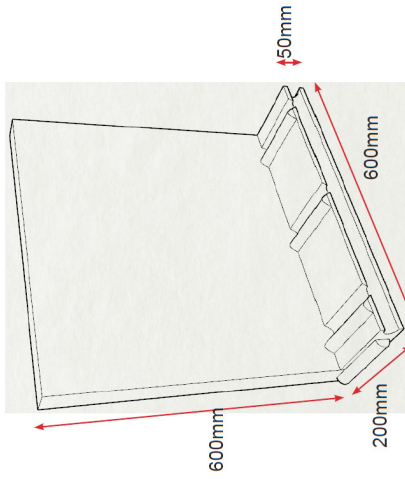

Variant 5

Component 2 - Bottom

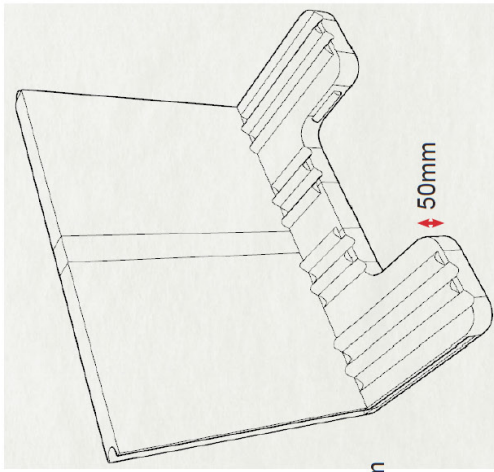

Component 4 - Top
Variants in thickness depending on position

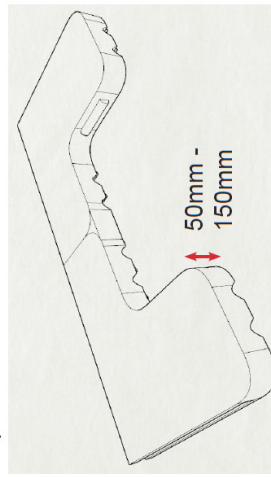

Component 1 - bottom

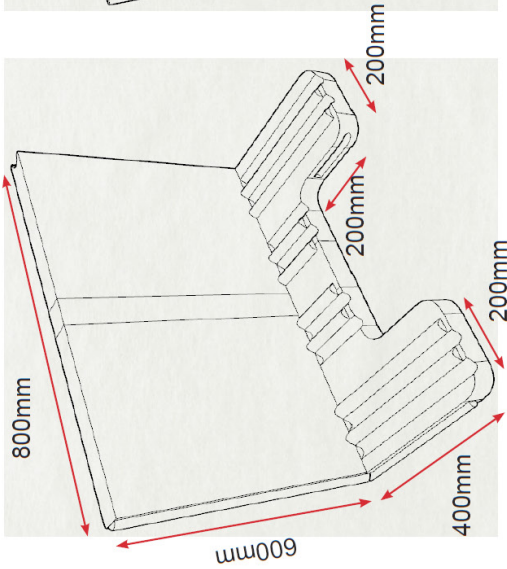

Component 3 - Top
Variants in thickness depending on position

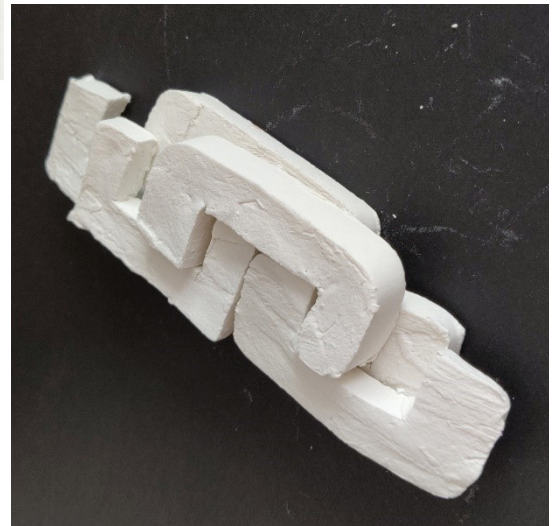
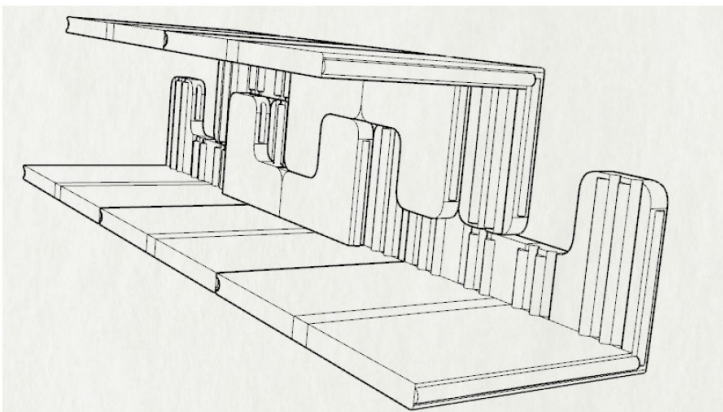
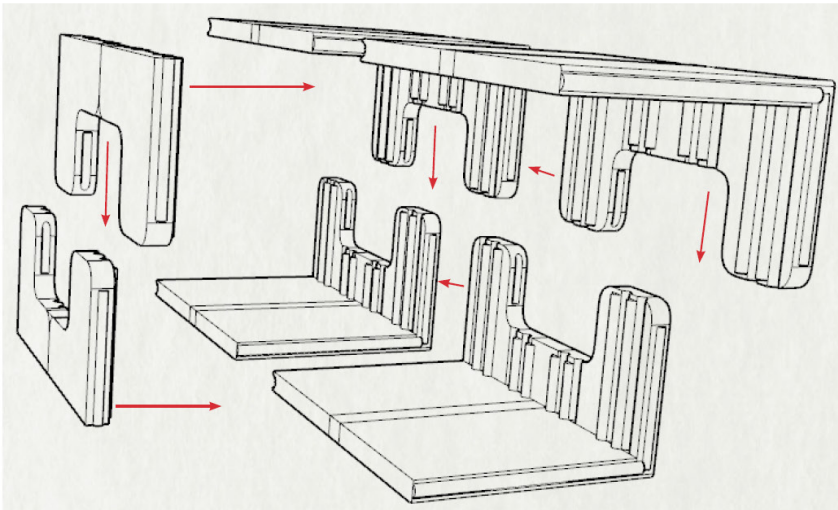
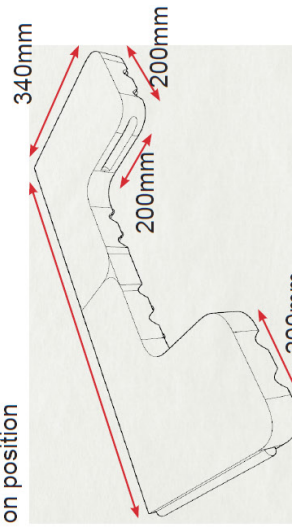

Variant 6

Component 2 - Bottom

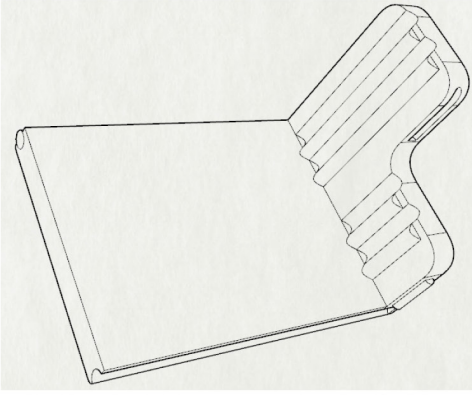

Component 4 - Top

Variants in thickness depending on position

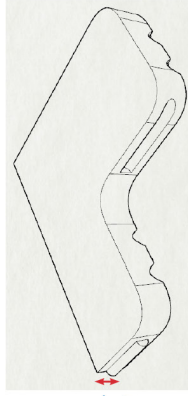

50mm -
150mm

Component 1 - bottom

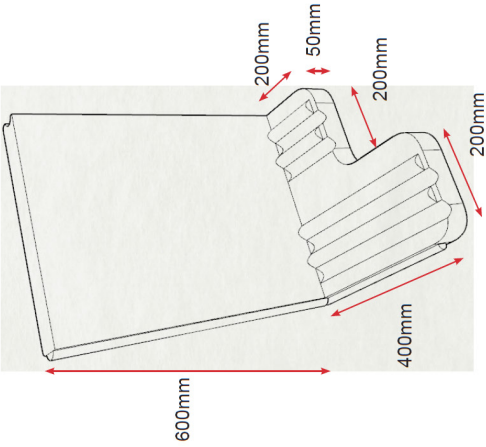

Component 3 - Top

Variants in thickness depending on position

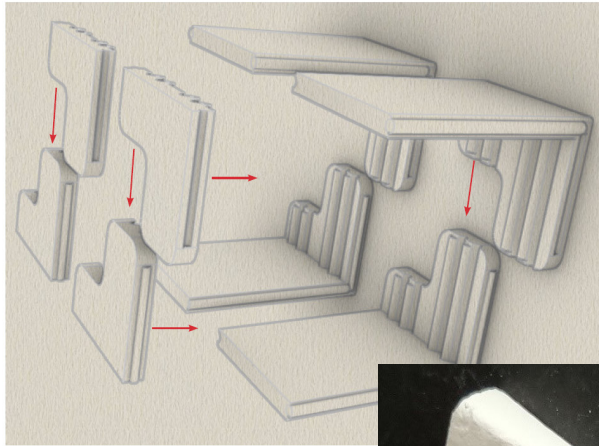
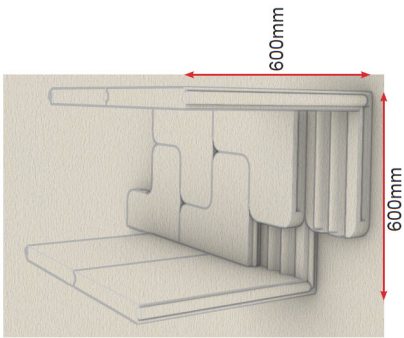
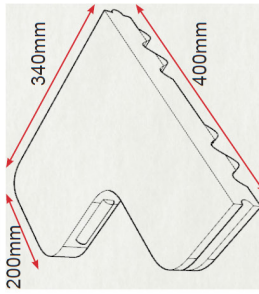

Component and interlocking variants

	Variant 1	Variant 2	Variant 3
Number of moulds	3	4	4
Weight smallest component	0,3 kg	1,2 kg	2,4 kg
Weight biggest component	66,9 kg	61,5 kg	61,5 kg
Similar to original lay-out?	Yes, longitudinal component	Yes, longitudinal component	Yes, longitudinal component
Findings	<ul style="list-style-type: none"> + Yes + Lowest number of different moulds required; - Balls create rotation within the structure; - Small elements make assembly difficult; - Minimum contact surface: Peak stress; - Different thickness of the component is required depending on location in arch; - One component layer in z axis, lowers the safety aspect; 	<ul style="list-style-type: none"> + Yes + Universal connection for components; + Easy to assembly; - Connection element fails due to shear stress; - Location of connection hole has no tolerance; - Different thickness of the component is required depending on location in arch; - One component layer in z axis, lowers the safety aspect; 	<ul style="list-style-type: none"> + Yes + Universal connection for components; + Easy to assembly; - Connection element fails due to shear stress, even when the connection is in the normal force line; - Location of connection hole has no tolerance; - Different thickness of the component is required depending on location in arch; - One component layer in z axis, lowers the safety aspect;

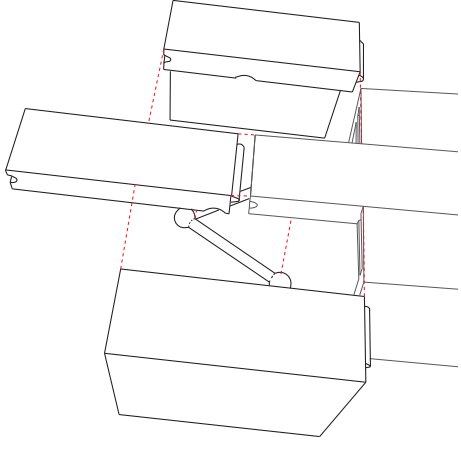
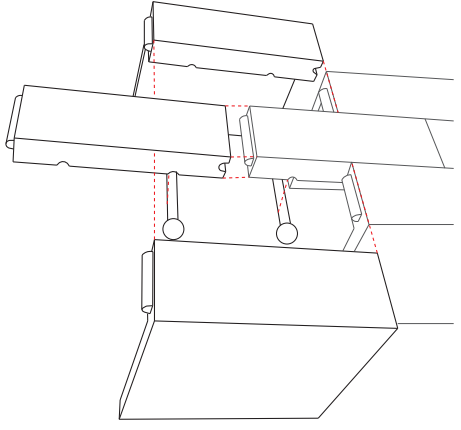
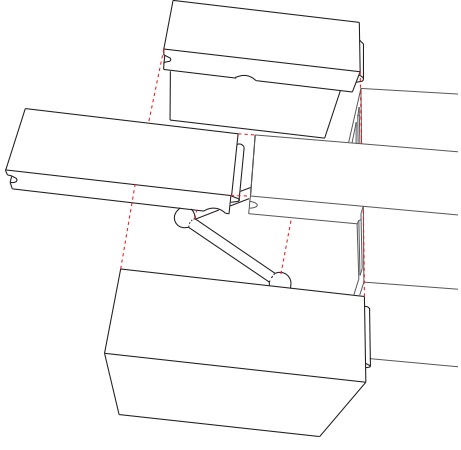

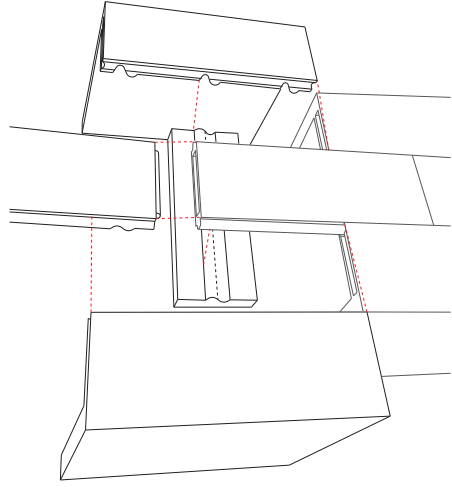

Variant 4

4

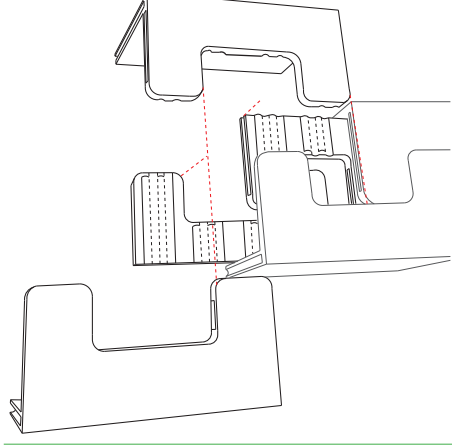

Variant 5

4

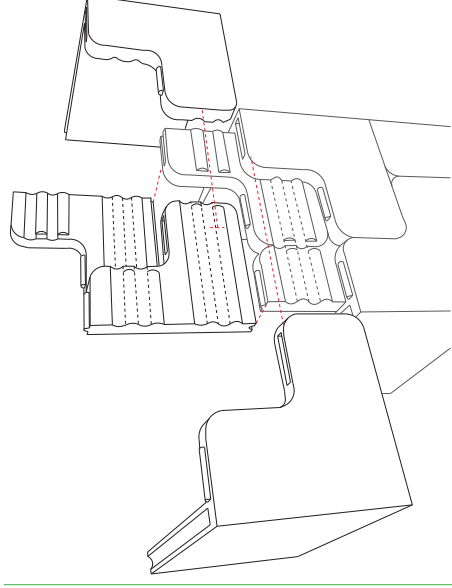

Variant 6

4

Number of moulds

11,3 kg

24,8 kg

12,5 kg

Weight smallest component

56,1 kg

84,4 kg

42,5 kg

Similar to original lay-out?

Yes, longitudinal component

No, square components

No, square components

Findings

+ Connection element overlaps joints and creates a complete structure;

+ Connection element overlaps joints and creates a complete structure;

+ Connection element overlaps joints and creates a complete structure;

+ Near the original lay-out of the arch structure;

+ Easy to assembly;

+ Small components increases safety;

+ Easy to assembly;

+ Easy to assembly;

Disadvantages

- Forces only in the bottom components. Top layer is only for connection and weight;

- Only two components per layer. When one fails, the other has to take over the forces of the full structure;

- Only two components per layer. When one fails, the other has to take over the forces of the full structure;

- Requires extra precision in the connection to avoid tensile stress in the component;

The different interlocking systems which are tested in clay:

Connections of components

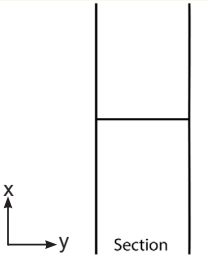
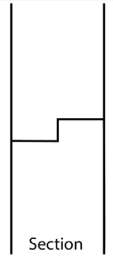
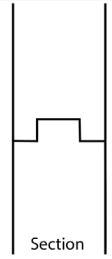
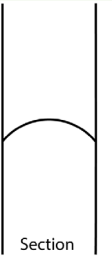
Variant 1 (Straight)	Variant 2 (Tetris)	Variant 3 (Teeth)	Variant 4 (Curves)
 <p>Section</p>	 <p>Section</p>	 <p>Section</p>	 <p>Section</p>
<p>Findings</p> <ul style="list-style-type: none"> + Thickness of connection is equal in the section + Full contact surface for transferring compression force (x axis) - Shape edges which complicates the annealling - No resistance against sliding (y axis) 	<p>Findings</p> <ul style="list-style-type: none"> + Full contact surface for transferring compression force (x axis) + Resistance against sliding (y axis) - Shape edges which complicates annealling - No equal or tapped interlocking which complicates annealling - No correction possibility in the connection as there is no tolerance. 	<p>Findings</p> <ul style="list-style-type: none"> + Full contact surface for transferring compression force (x axis) + Resistance against sliding (y axis) - Shape edges which complicates the annealling - No equal or tapped interlocking which complicates annealling - No correction possibility in the connection as there is no tolerance. 	<p>Findings</p> <ul style="list-style-type: none"> + Full contact surface for transferring compression force (x axis) + Resistance against sliding (y axis) + tapped interlocking which reduces risks during annealling + Correction possible in the connection as there is tolerance. - Shape edges which complicates the annealling

To fixate the component structure with 5 elements:

Avoid rotation in components

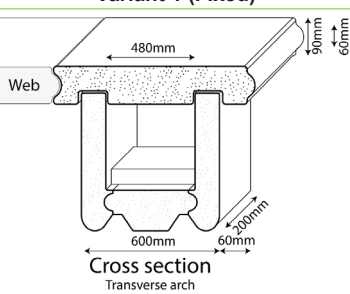
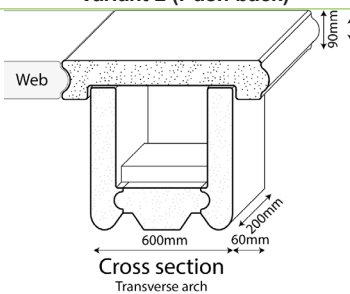
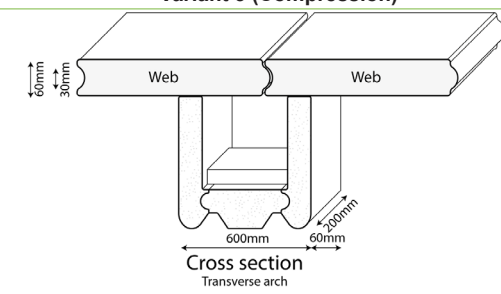
Variant 1 (Fixed)	Variant 2 (Push back)	Variant 3 (Compression)
 <p>Cross section Transverse arch</p>	 <p>Cross section Transverse arch</p>	 <p>Cross section Transverse arch</p>
<p>Findings</p> <ul style="list-style-type: none"> + Rib structure is completely fixed which makes it one structure. - Approximately 30kg - The web/ arch connection component covers a part of the arch which deviates from the original situation. 	<p>Findings</p> <ul style="list-style-type: none"> + Rib structure is fixed from the outside. The side components cannot fall out of the structure. + Approximately 23kg. - The web/ arch connection component covers a part of the arch which deviates from the original situation. 	<p>Findings</p> <ul style="list-style-type: none"> + Approximately 21kg. - No connection component; Arch structure is supporting the web - Weight of the web increases the momentum in the bottom interlocking. Higher risk that component 1 rotates from the structure.

Appendix E: Concepts of the moulds for the arch components

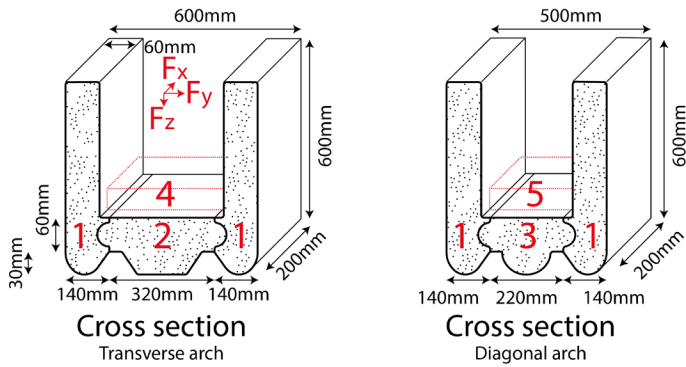

Mould for top element:

Mould sketch

Mould 6

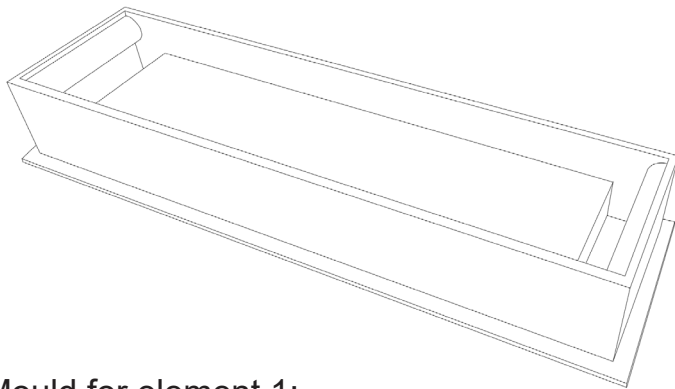

Findings

- + Fixed system, so no deviation caused by adjustments
- + Easy to pour the molten glass in by taken off unnecessary height.
- + Equal thickness in the section creates less failure risk during the annealing phase.
- Mould has to be based on the measurements of mould 1 & 2/3 as this determines the bottom dimentions.

Mould for element 1:

Mould sketch

Mould 1

Permanent & adjustable

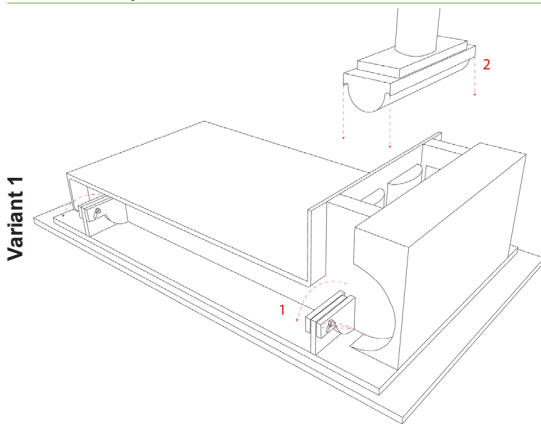

Order of assembly

- 1 Determine the angle in the x_{local} axis of the component. This depends on the location in the arch. The position of mould is fixed with a bolt.
- 2 When the glass is poured in the mould, the interlocking geometry is pressed in the liquid glass.

Findings

- + Easy to assemble and disassemble
- + The angle of the component is adjustable from 0° to 2° . Fixed by a bolt on both sides.
- Risk in expansion of the mould after intensive usage. Components might not fit.
- Risk in not fully filled in the end of the mould.
- Small surface to pour the glass in the mould.

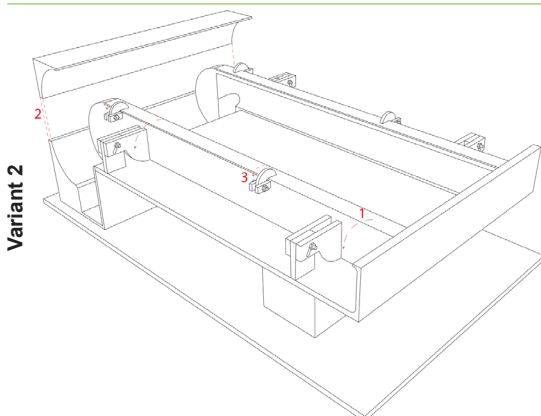

- 1 Determine the angle in the x_{local} axis of the component. This depends on the location in the arch. The position of mould is fixed with a bolt.
- 2 Slide the round geometry element in the mould.
- 3 Close the small edges by moving the top plate.

- + Easy to assemble and disassemble
- + The angle of the component is adjustable from 0° to 2° . Fixed by a bolt on both sides.
- + Easy to pour the glass in the mould due to big surface.
- Risk in expansion of the mould after intensive usage. Components might not fit.

Mould sketch
Mould 2&3
 Permanent & adjustable

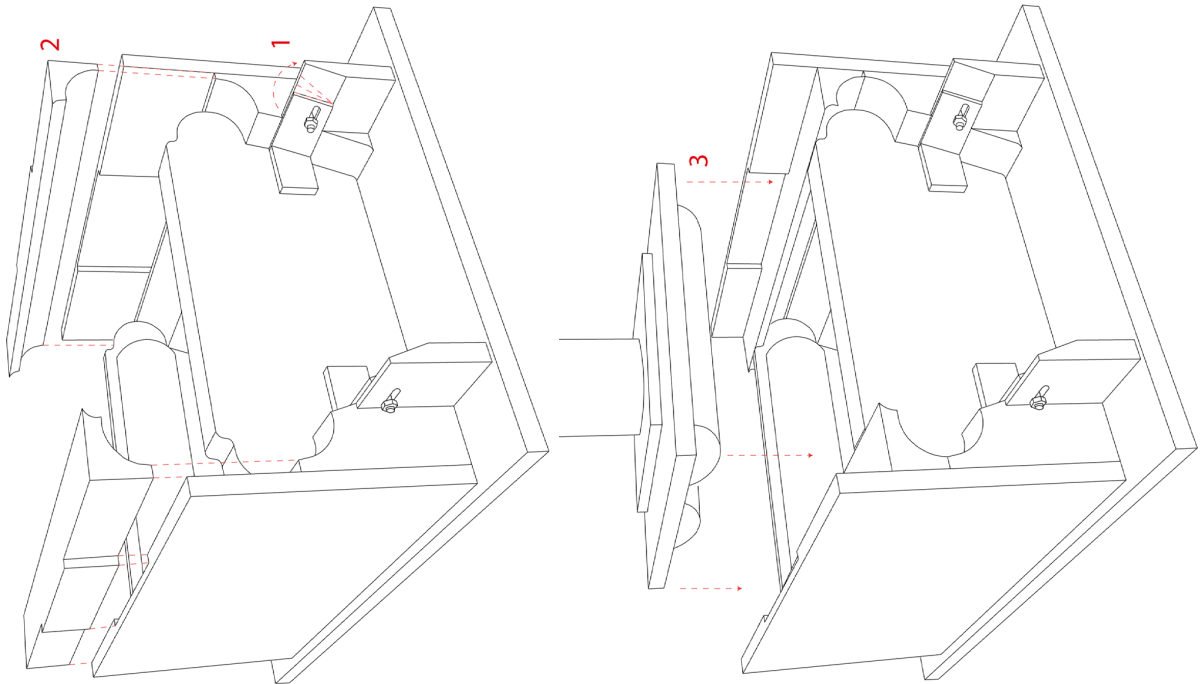

Order of assembly

- 1** Determine the angle in the x_{local} axis of the component. This depends on the location in the arch. The position of mould is fixed with a bolt.
- 2** The final y_{local} interlocking geometry can be slid from the top to finish the mould where the glass is poured in.
- 3** The molten glass is in the mould. The interlocking geometry of component 4 or 5 will be pressed in the poured glass when it is still liquid.

Findings

- + Easy to pour the molten glass in the mould.
- + Easy to assemble and disassemble
- + The angle of the component is adjustable from 0° to 2° . Fixed by a bolt on both sides.
- Risk in expansion of the mould after intensive usage. Components might not fit.

Mould sketch Mould 4&5

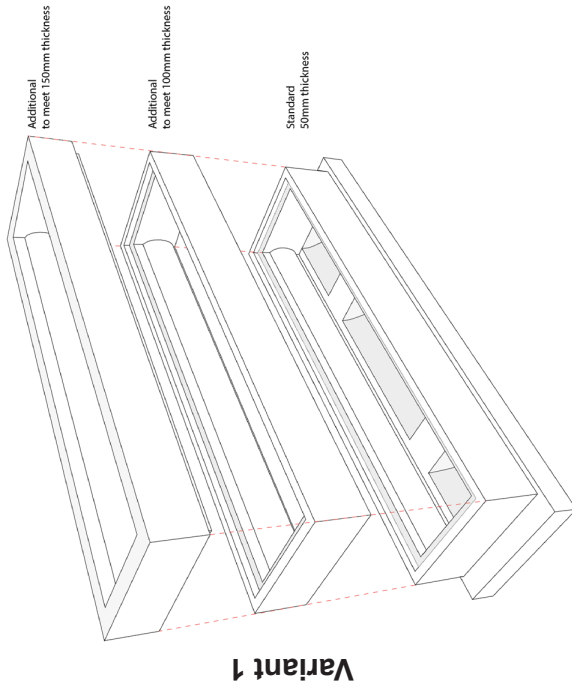

Variant 1

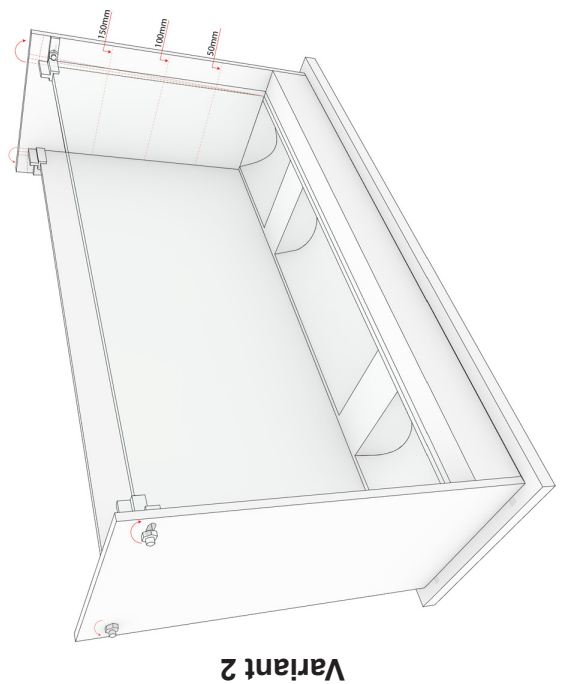

Variant 2

Section of the component	Type of mould	Findings
<p>Longitudinal section 350mm or 450mm</p> <p>Cross section</p>	<p>Permanent & fixed</p>	<p>● Thickness depends on the position in the arch.</p> <p>+ Easy to pour the molten glass in by taken off unnecessary height.</p> <p>+ Equal thickness in the section creates less failure risk during the annealing phase.</p> <p>- Geometry of the component can create problems during the assembly phase.</p> <p>- Geometry of the mould makes it expensive to manufacture.</p>
<p>Longitudinal section 350mm or 450mm</p> <p>Cross section</p>	<p>Permanent & Adjustable</p>	<p>● Thickness depends on the position in the arch.</p> <p>+ Equal thickness in the section creates less failure risk during the annealing phase.</p> <p>+ Simple geometry</p> <p>+ The angle of the component is adjustable from 0° to 2°. Fixed by a bolt on both sides.</p>

Appendix F: Keystone

Top view lay-out = Determine where the keystone starts and where the arches meet the keystone:

Keystone - Topview lay-out

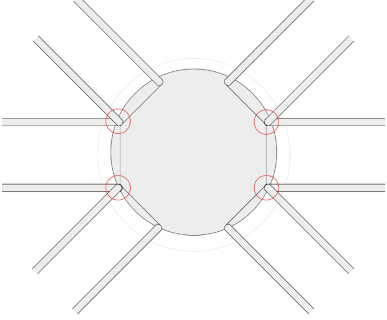
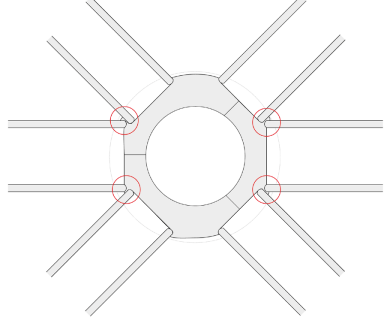
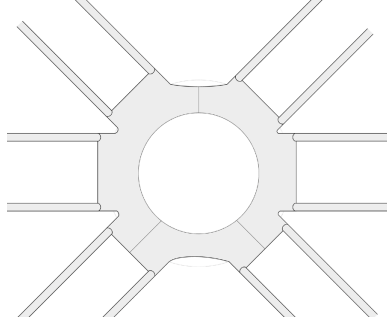
Variant 1 (Follow original)	Variant 2 (Original + material saving)	Variant 3 (Extend to arches)
		
<p>Findings</p> <ul style="list-style-type: none"> + Original lay-out stays the same. - Mass overdimensioned. - No smaller components, no safety elements when it fails. - Conflicts between arches does not fit the standard size of the arch components. 	<p>Findings</p> <ul style="list-style-type: none"> + Original lay-out stays the same. + Keystone is divided which makes it safer if one part fails. - Connection between arch and keystone is fragile for annealing. - Conflicts between arches does not fit the standard size of the arch components. 	<p>Findings</p> <ul style="list-style-type: none"> + Original lay-out stays the same. + Keystone is divided which makes it safer if one part fails. + Separation keystone/ arch not visible. - Connection is a risk for the annealing process.

Determine the material of the keystone:

Keystone - Material

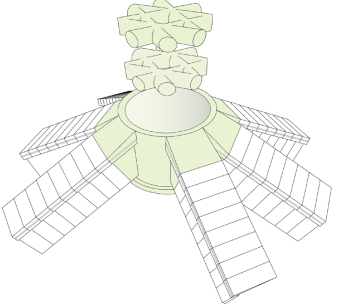
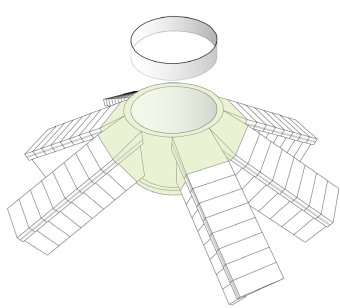
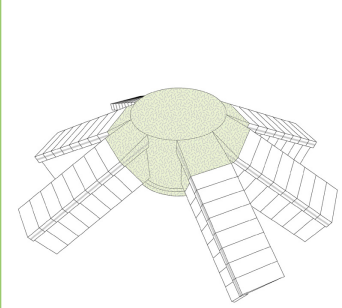
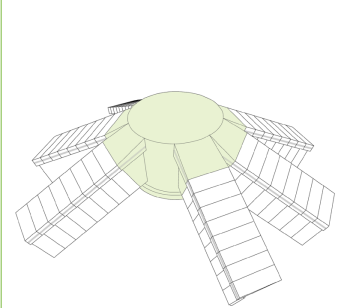
Variant 1 (Complete glass)	Variant 2 (Glass + Steel reinforcement)	Variant 3 (Traditional limestone)	Variant 4 (Modern materials)
			
<p>Technique: Casting glass</p>	<p>Technique: Casting glass + steel shaping/ welding</p>	<p>Technique: Cutting/ milling</p>	<p>Technique: 3D printing</p>
<p>Findings</p> <ul style="list-style-type: none"> + The complete structure is one continuous material. + With cast glass, historical geometry can be imitated. - Number of moulds required: 10 - 35 - Intensive and complex process 	<p>Findings</p> <ul style="list-style-type: none"> + Steel is stiff and can function as a compression ring. + Minimum extra material required to increase the stiffness in the keystone. - Number of moulds required: 10 - 20 - Most steel types have a higher thermal expansion coefficient than borosilicate glass. - Intensive and complex process - Reinforcement plate might be visible from the ground floor. 	<p>Findings</p> <ul style="list-style-type: none"> + Meets the traditional connection. + The thermal expansion coefficient of limestone and borosilicate glass is comparable. + Material has a architectural and structural value in the structure. + Cheap process without restrictions due to annealing. + Element can be made from one piece - It interrupts the principle of full cast glass structure. 	<p>Findings</p> <ul style="list-style-type: none"> + Element can be made from one piece + High precision + Newest technology for creating a historical layer. + Different materials can be applied e.g. steel/concrete - It interrupts the principle of full cast glass structure.

Tessellation of the keystone when it is made from glass:

Keystone - Tessellation main component

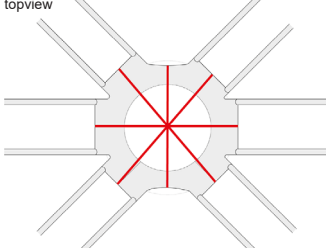
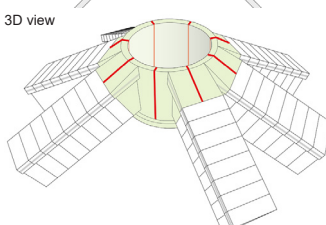
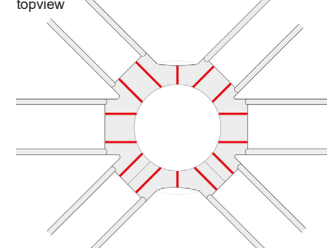
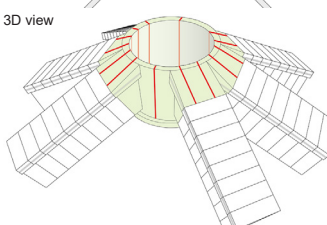
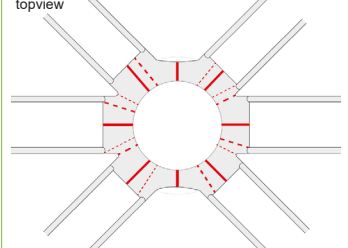
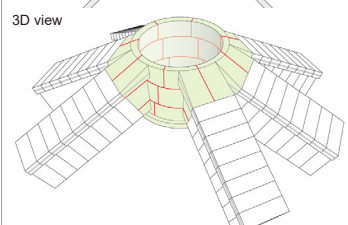
Variant 1 (Equal)	Variant 2 (Arch lay-out)	Variant 3 (Overlapping joints)
<p>topview</p>  <p>3D view</p> 	<p>topview</p>  <p>3D view</p> 	<p>topview</p>  <p>3D view</p> 
Weight comp. 1: 200 kg - 285 kg	Weight comp. 90 kg - 350kg	Weight comp. : 40-80 kg
<p>Findings</p> <ul style="list-style-type: none"> + Simple assembly order. - Extreme heavy components which increases assembly precision incorrection. - High annealling time per component. - Complex mould per component. High risk of flaws during casting and annealling. - Big heavy lifting support equipment required. 	<p>Findings</p> <ul style="list-style-type: none"> + Simple assembly order. - Extreme heavy components which increases assembly precision incorrection. - High annealling time per component. - Complex mould per component. High risk of flaws during casting and annealling. - Big heavy lifting support equipment required. 	<p>Findings</p> <ul style="list-style-type: none"> + Multiple components increases safety rate. + Overlapping joints increases safety rate. + Low weight and less complex geometry. + Less risk in flaws due to small components and pour height. - High labour intensity to assemble on site. - Temp. moulds required due to different geometry per component.

Reinforcement of the glass keystone:

Keystone - Reinforcement

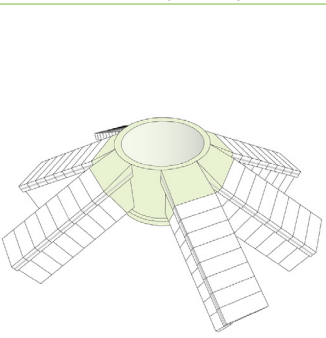
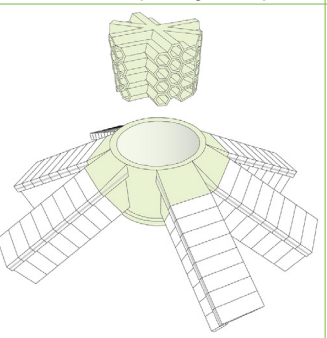
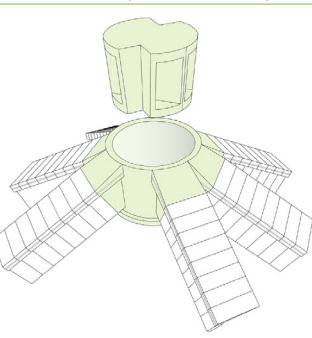
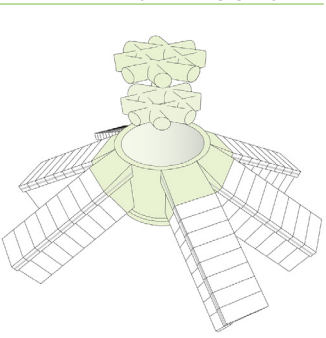
Variant 1 (hollow)	Variant 2 (Honeycomb)	Variant 3 (Solid contour)	Variant 4 (Corner pipes)
			
Weight reinforcement: - kg	Weight reinforcement: 1.300 kg	Weight reinforcement: 950 kg	Weight reinforcement: 38 kg
Thickness reinforcement: - mm	Thickness reinforcement: 10 mm	Thickness reinforcement: 60 mm	Thickness reinforcement: 60 mm
<p>Findings</p> <ul style="list-style-type: none"> + No extra mass added which impacts the arches and reaction forces. - When forces are applied to the keystone, it will deform. This causes tensile stress. - Low safety rate as there is no reinforcement to tessellate. 	<p>Findings</p> <ul style="list-style-type: none"> + Honeycomb structure fills up the complete hole. - Mass extreme high which impacts the arches dimensions and annealling time <p>Findings with tessellation</p> <ul style="list-style-type: none"> + Tessellation per hexagon increases the safety rate. - Tessellation per hexagon possible which reduces weight to 75kg per component. - High annealling time per component. 	<p>Findings</p> <ul style="list-style-type: none"> + The forces in the arch continues in the same contour in the reinforcement. - Mass extreme high which impacts the arches dimensions and annealling time <p>Findings with tessellation</p> <ul style="list-style-type: none"> + Tessellation per hexagon increases the safety rate. - Tessellation per hexagon possible which reduces weight to 160kg per component. - High annealling time per component. 	<p>Findings</p> <ul style="list-style-type: none"> + Only the corner points of the arches are used for compression force in the keystone. + Temp. mould (3D printed sand moulds) required to make the geometry possible - Mass bigger than 25kg (based on design criteria). - Complex moulding process

Appendix G: Web

Tessellation of the web

Web - Tessellation

Variant 1 (per component)

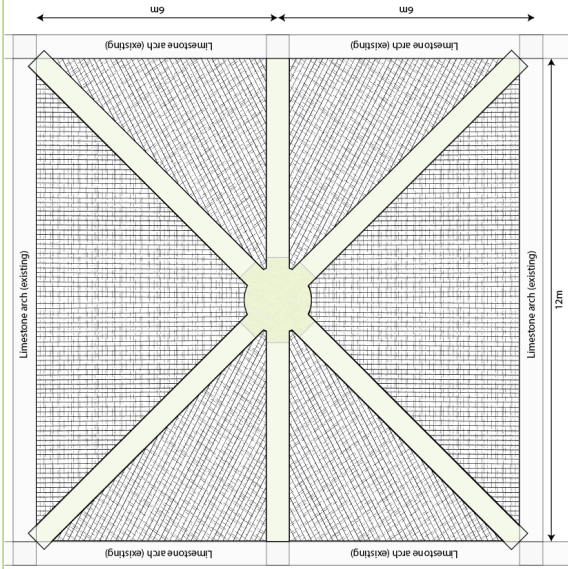

Manufacturing process: Casting

Increase safety possibility: No (Fragmenting = increase safety factor)

Biggest size: 0,21m x 0,1m x 0,05 m

Findings

- + Original lay-out stays the same.
- + Number of moulds can be reduced with a adjustable mould.
- Extreme labour intensive due to individual connections and components.
- Joints of the original vault cannot be imitates, so the bricks will be bigger than original;
- Extra process: Float glass needs to be bended to meet the vault's curvature.

Variant 2 (Strips)

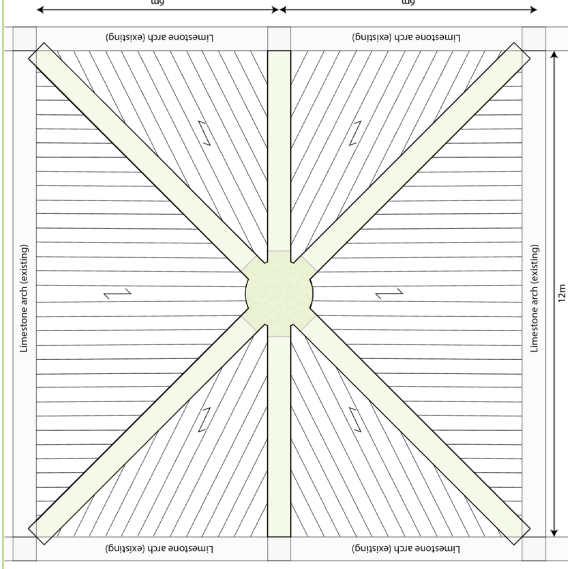

Manufacturing process: Casting or float glass

Increase safety possibility: Lamination

Biggest size: 4,8m x 0,4m

Findings

- + Imitates the original brick geometry.
 - Casting geometry determines the pattern.
 - Float glass needs to be engraving to create identical pattern.
- + Efficient transport due to straight plate geometry.
- Strips spans longest direction which increases thickness of the element.
- Extra process: Float glass needs to be bended to meet the vault's curvature.
- Float glass contains double curved surface to meet curvature.

Variante 3 (Plate)

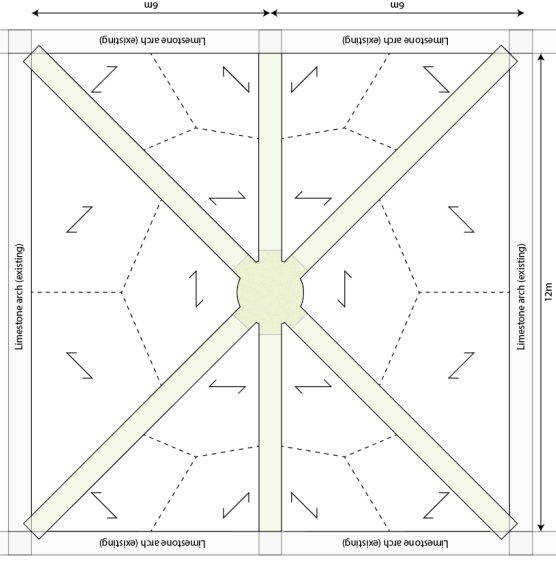

Manufacturing process: Casting or float glass

Increase safety possibility: Lamination

Biggest size: 5,2m x 3m

Findings

- + Imitates the original brick geometry.
 - Casting geometry determines the pattern.
 - Float glass needs to be engraving to create identical pattern.
- + Plates spans in the shortest direction, so less thickness required.
- + The surface curve will be reconstructed and benefits the strength of the plate.
- Deviates from the original structural lay-out.
- Extra process: Float glass needs to be bended to meet the vault's curvature.

Variante 4 (Plate)

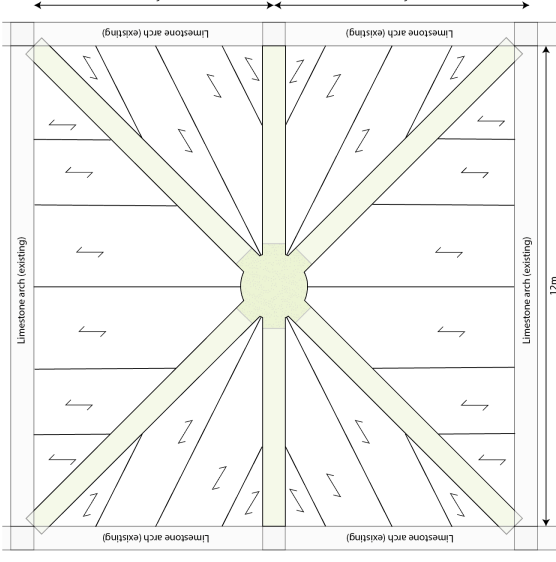

Manufacturing process: Casting or float glass

Increase safety possibility: Lamination

Biggest size: 4,8m x 3m

Findings

- + Imitates the original brick geometry.
 - Casting geometry determines the pattern.
 - Float glass needs to be engraving to create identical pattern.
- + Efficient use of standard production size (float glass).
- + The surface curve will be reconstructed and benefits the strength of the plate (single curved).
- Strips spans longest direction which increases thickness of the element, but follows original span.
- Extra process: Float glass needs to be bended to meet the vault's curvature.

Appendix H: Results web simulations

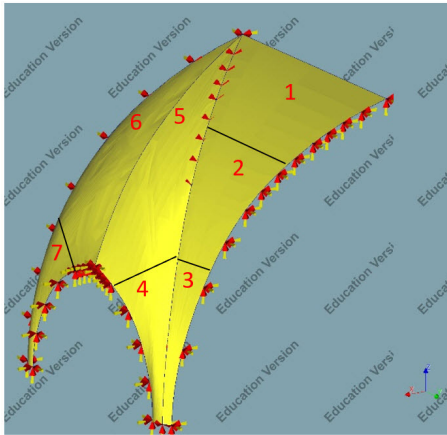

Thickness 30mm (10-10-10)

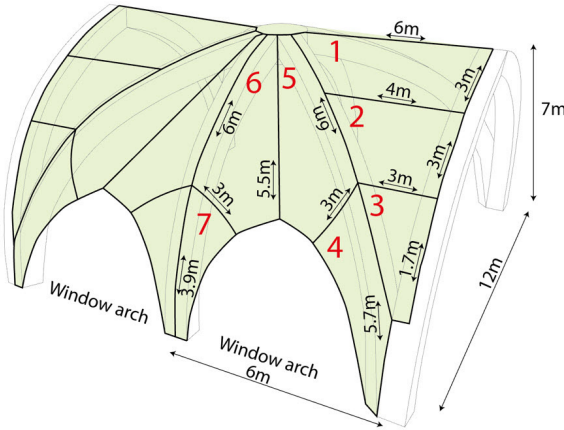

Deflection z

S1

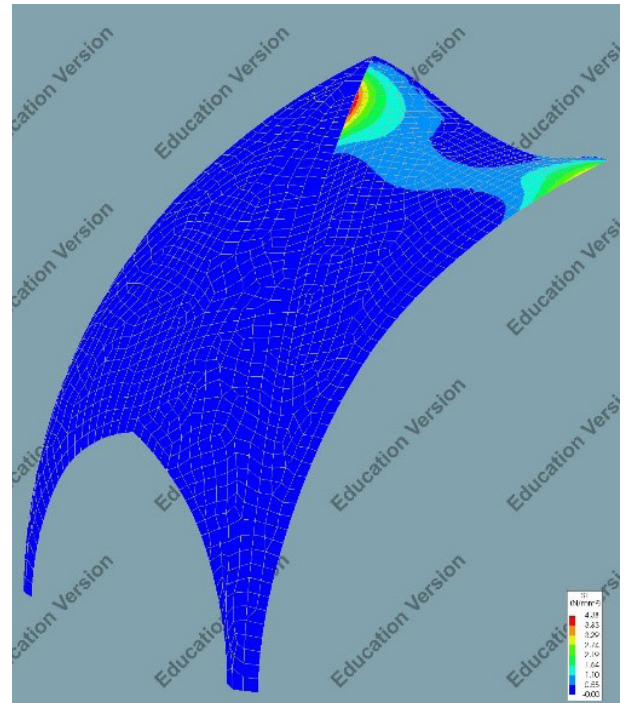
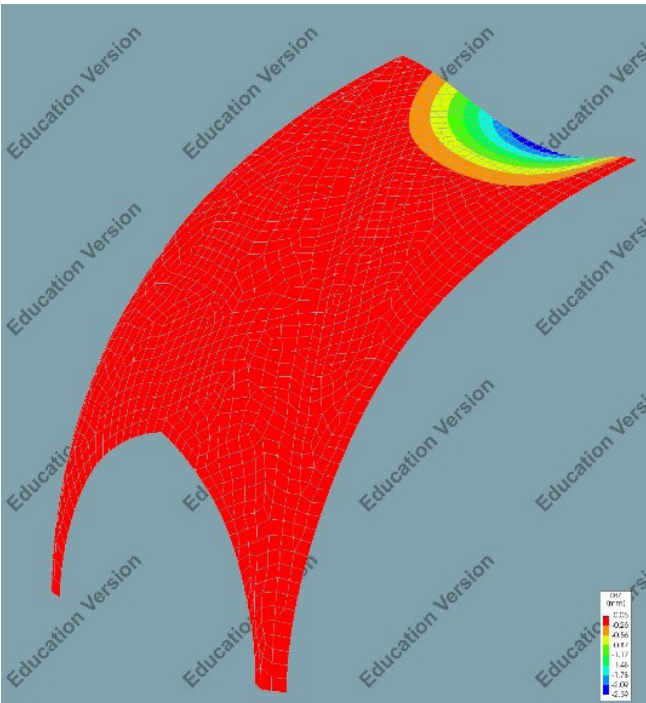

S2

S3

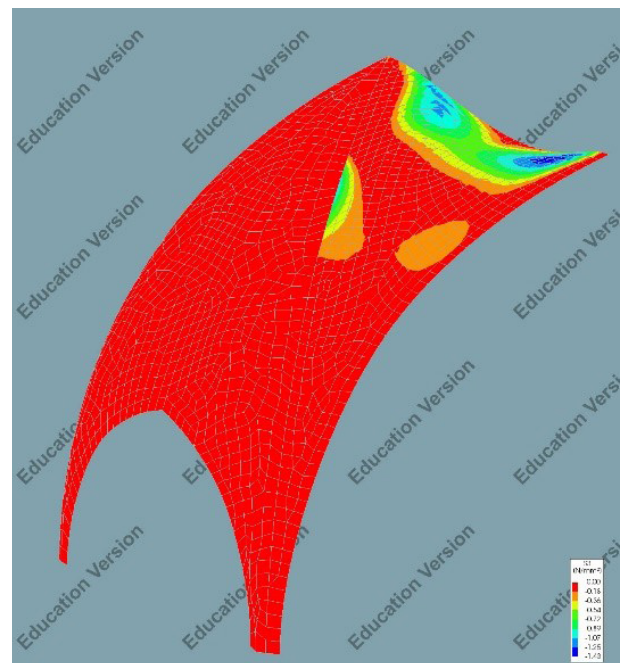
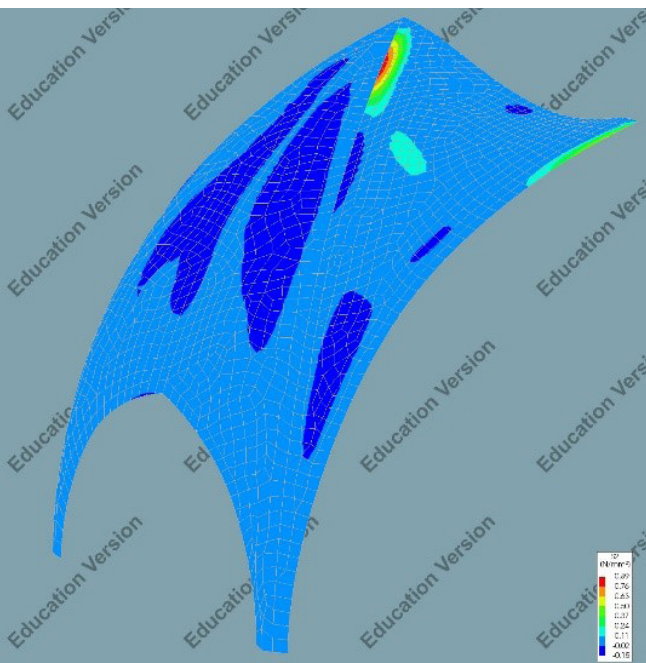

Thickness 24mm (8-8-8)



Deflection z

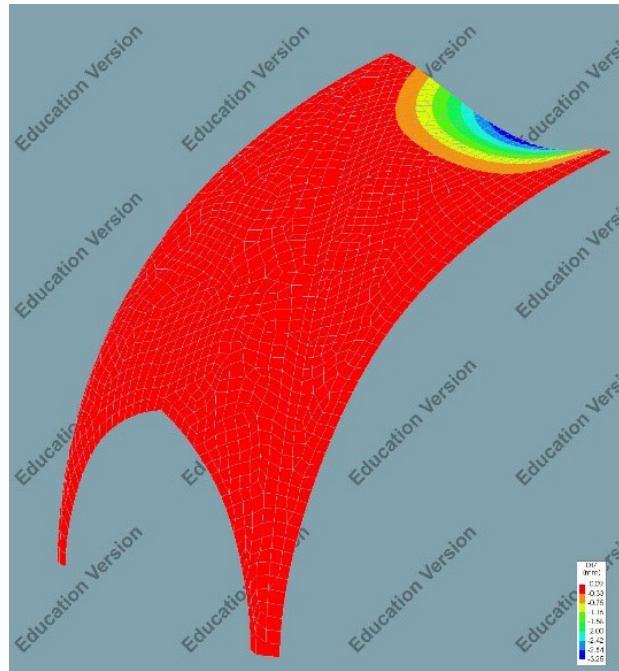

S1

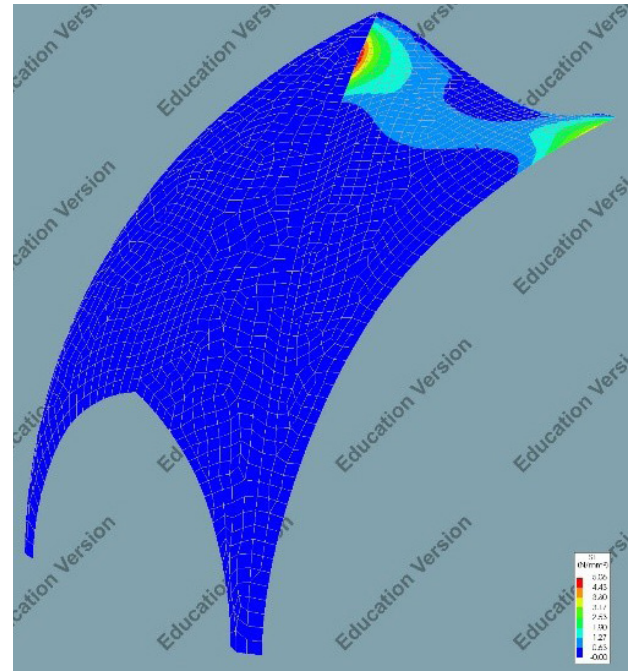

S2

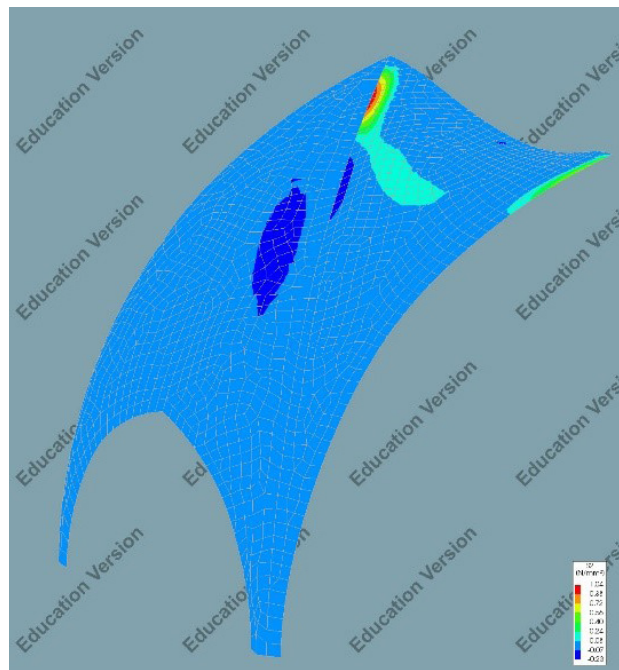

S3

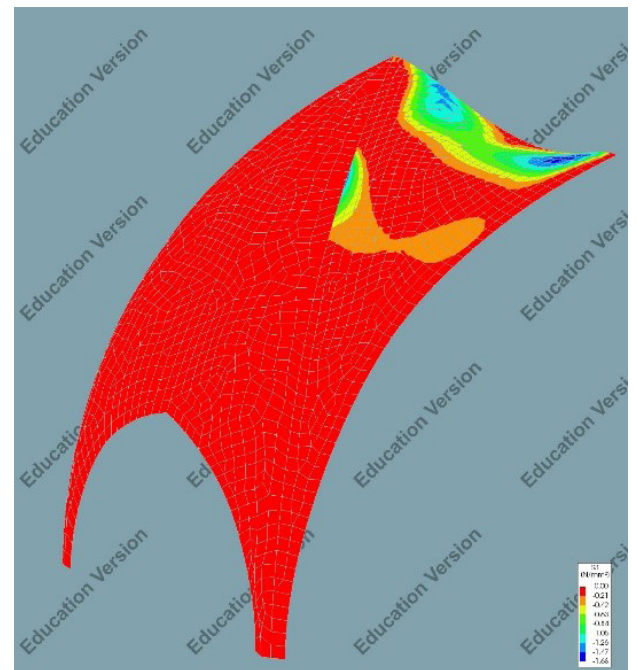

Thickness 22mm (8-6-8)



Deflection z

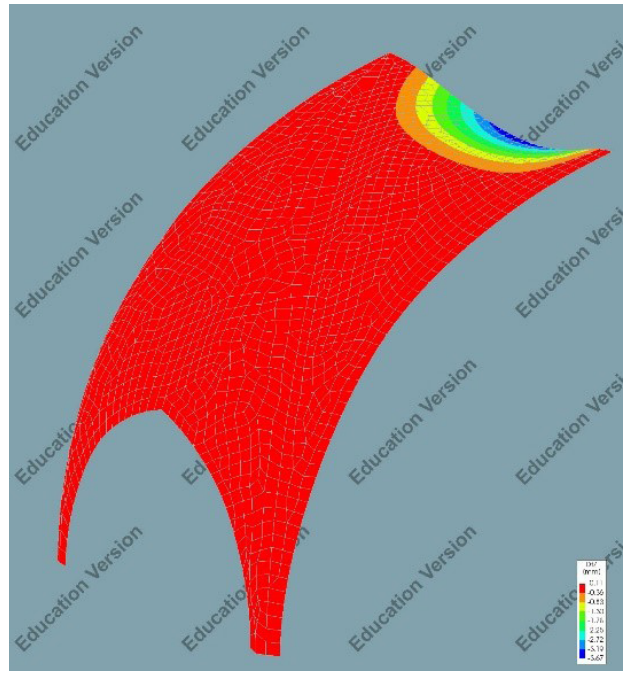

S1

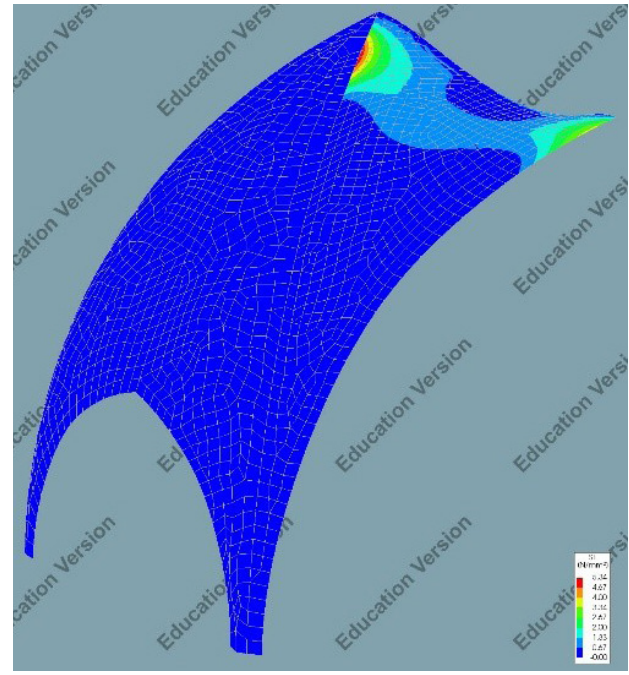

S2

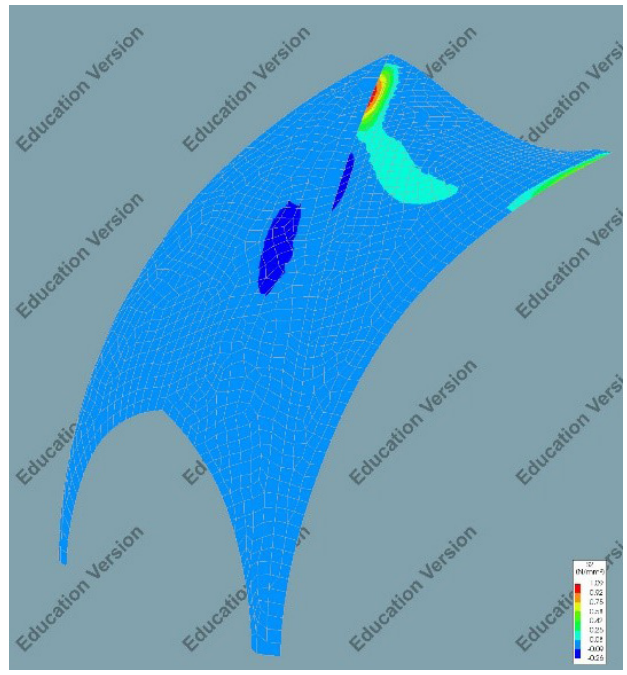

S3

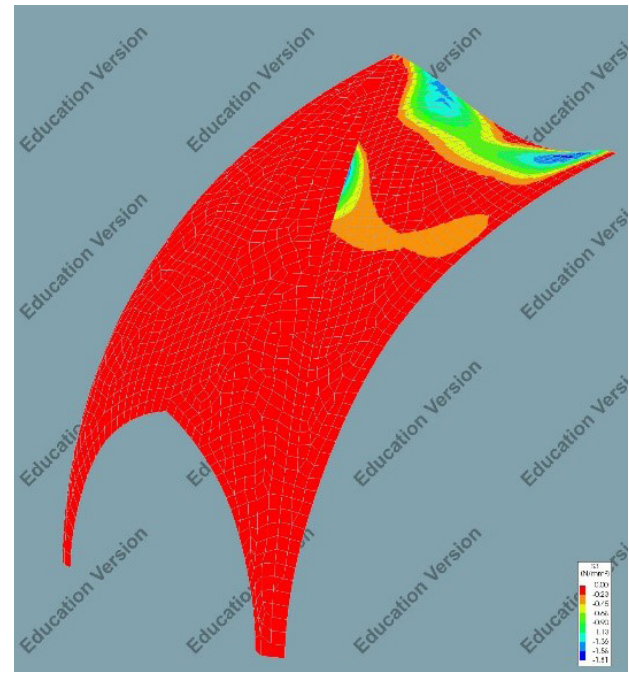

Thickness 20mm (6-8-6)

Deflection z

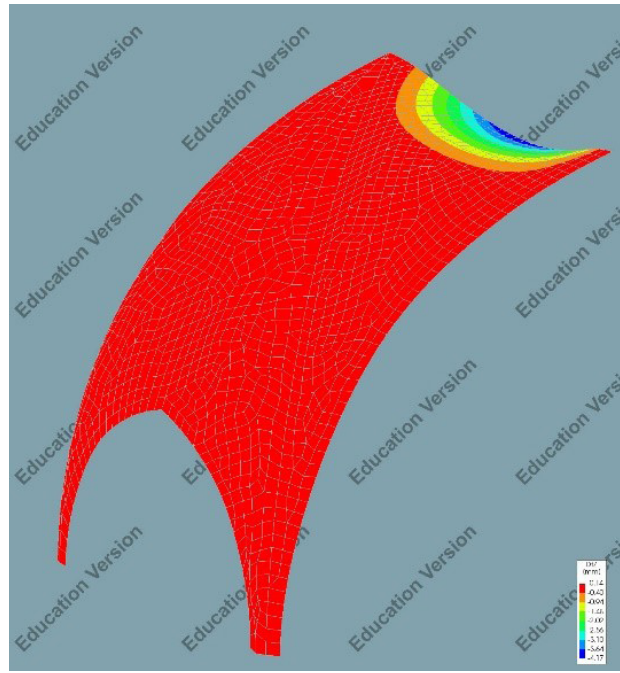

S1

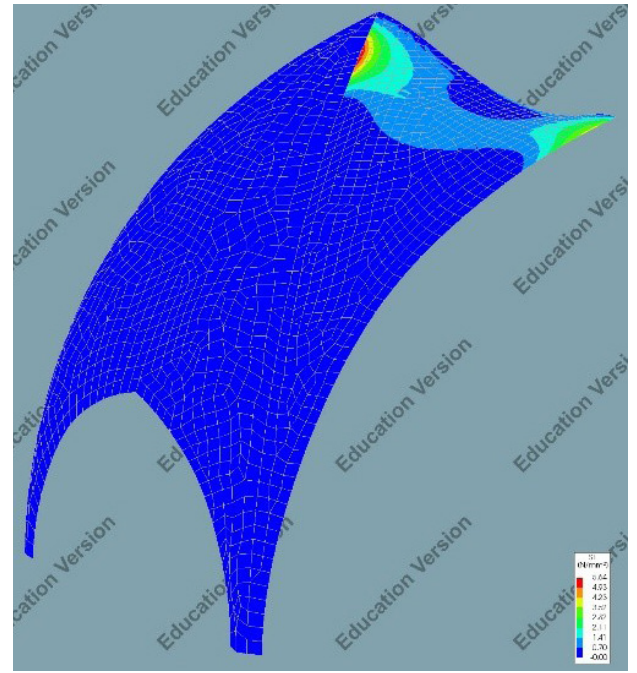

S2

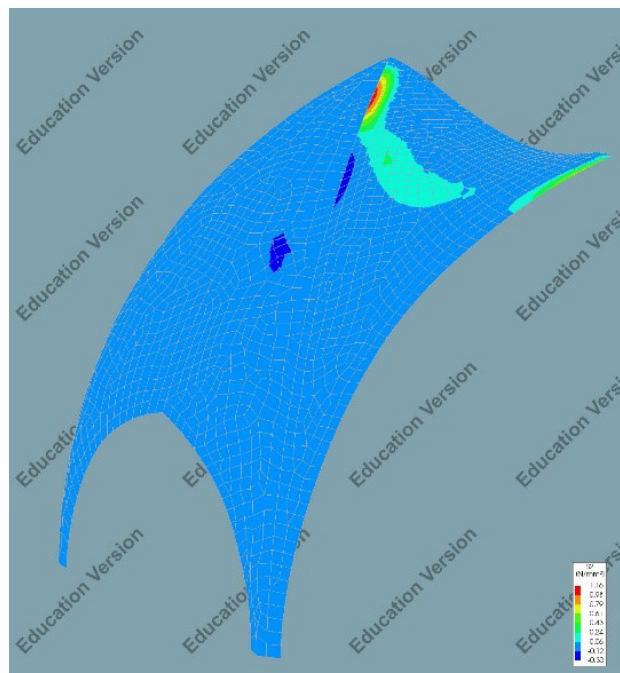

S3

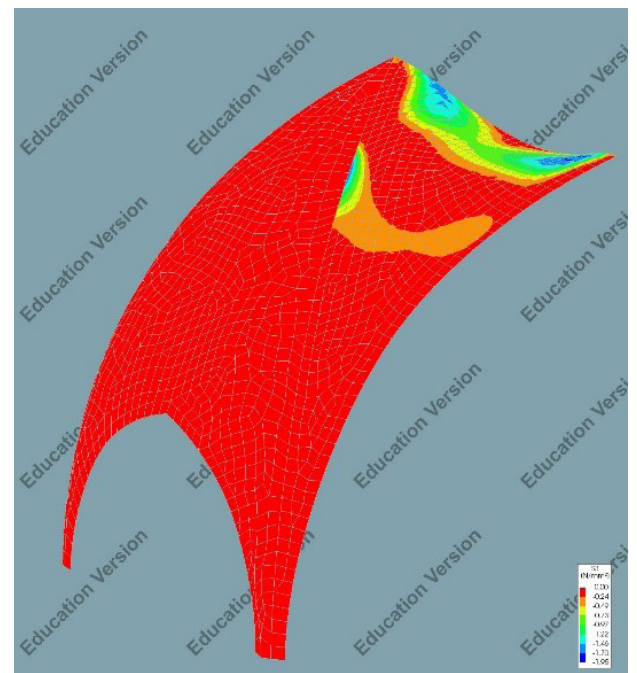

Appendix I: Web - structural arch connections

Variant 1 (Start - Interlocking)

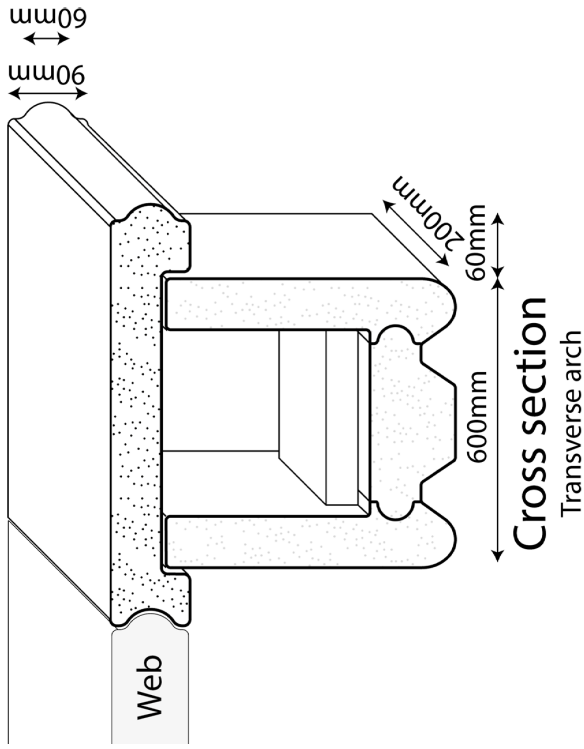

Findings

- + No stacked layer on the arch.
- Only possible for small components. A plate needs to be flipped in the interlocking which complicates the assembly and increases damage.
- Tensile stress is introduced due to the hinge of the interlocking.

Variant 2 (Compression)

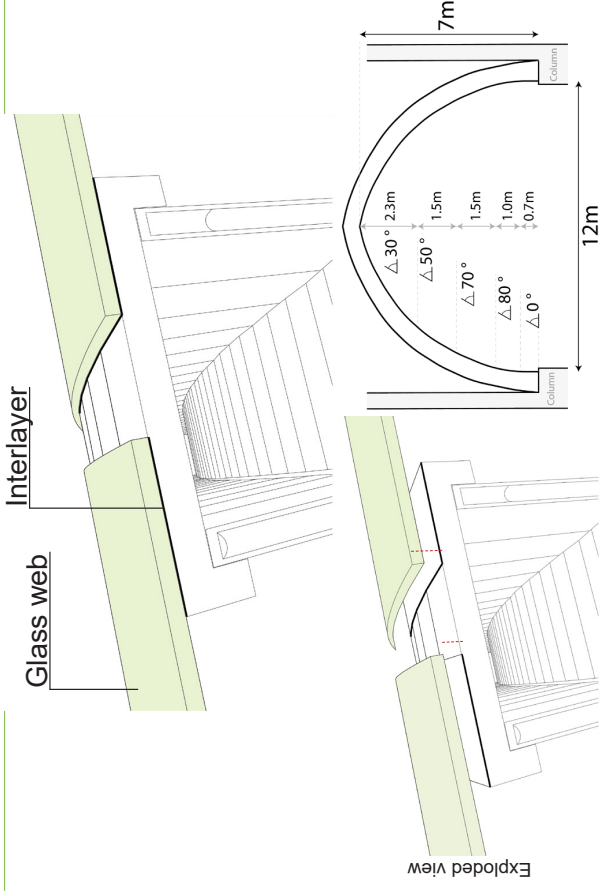

Findings

- + Interlayer is the buffer zone for expansion differences. No other limitations for the expansion.
- Option only possible for the top as it will be kept down due to gravity. Otherwise, it will flip over due to the angle.
- Interlayer might be solid and might impacting the experience of the vault.
- No safety secure of the plates to the arch.

Variant 3 (fixed)

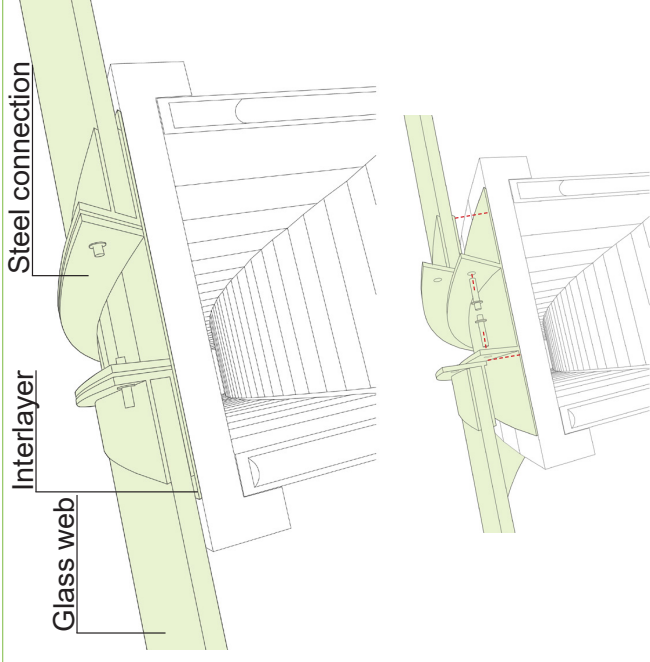

Variant 4 (fixed)

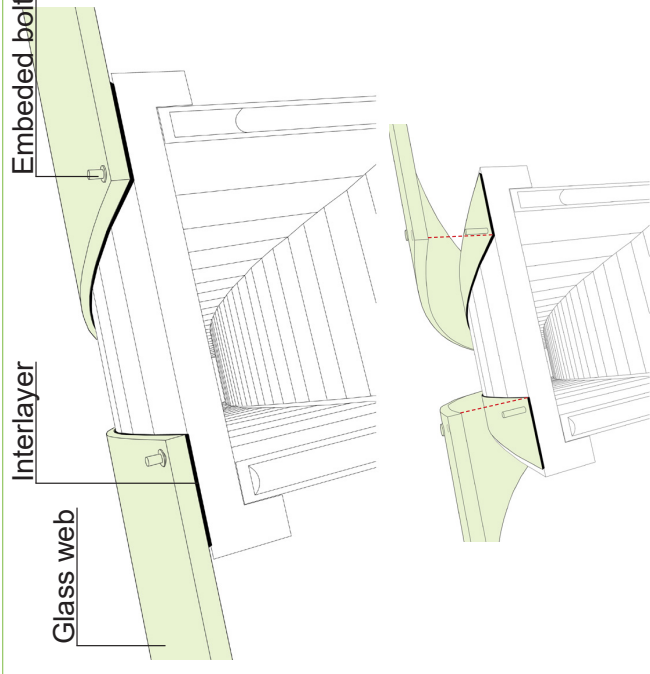

Findings

- + Interlayer is the buffer zone for expansion differences. No other limitations for the expansion.
- + Equal force distribution due to the steel/ plastic plate.
- + Possibility for adjustment during the assembly phase.
- Interlayer might be solid and might impacting the experience of the vault.
- Plate has to be glued to the top part of the arch

Findings

- + Interlayer is the buffer zone for expansion differences. No other limitations for the expansion.
- + Equal force distribution due to the steel/ plastic plate.
- + Possibility for adjustment during the assembly phase.
- + Interlayer in the node of the connections, so less visual impact when it is a solid material.
- Embedded bolt has to meet the thermal expansion coef. of Borosilicate glass to avoid failure.
- Point force due to the bolt

Variant 5 (adhesive)

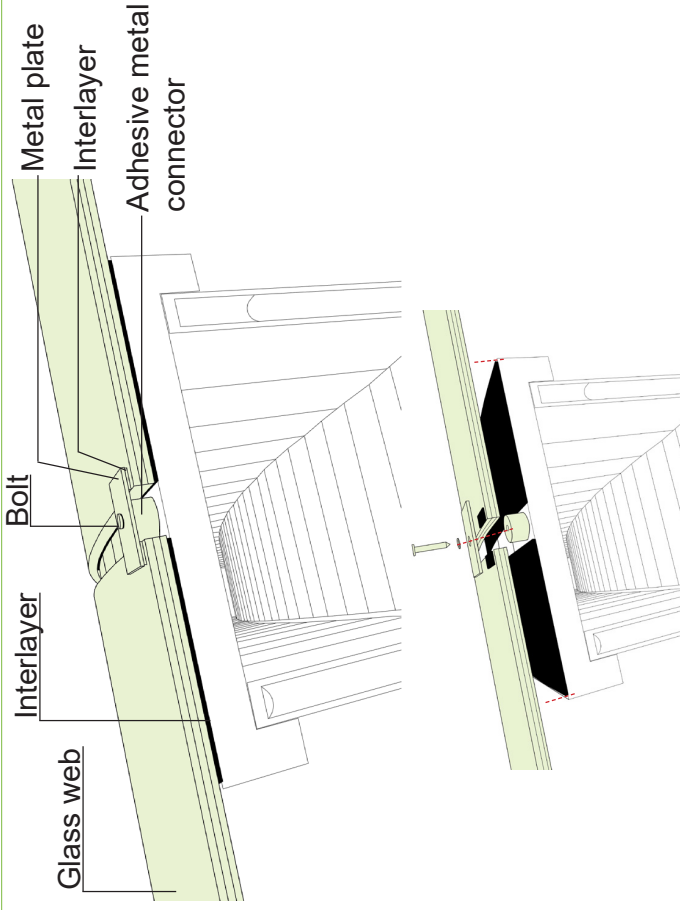

Findings

- + Quick assembly, no other adhesives required.
- + One action for two plates.
- + More surface for transferring the compressive forces than with the non-adhesive connections.
- + Installation and material tolerance without limitations.
- Both plates have to be put on place for fixing the installation.
- When the adhesive fails, both web components are not connected to the arch.

Variant 6 (adhesive)

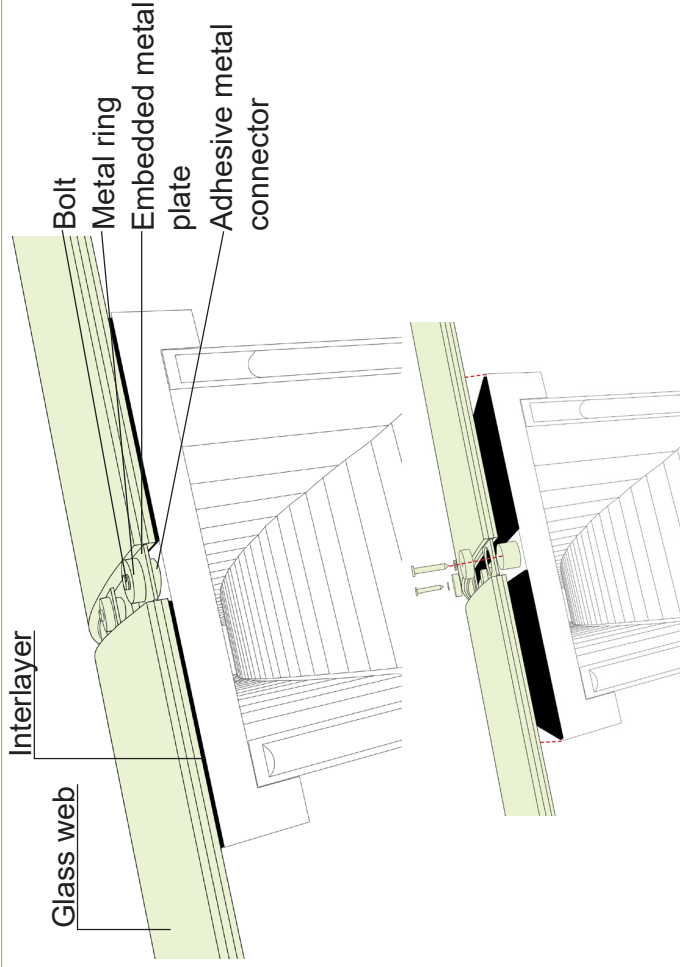

Findings

- + Quick assembly, no other adhesives required.
- + Installation and material tolerance included in the laminated plate.
- + More surface for transferring the compressive forces than with the non-adhesive connections.
- + When one adhesive fails, only one part of one plate will not be connected with the arch.
- More labor time required for the connection.

Appendix J: Assembly of the structural arch (options)

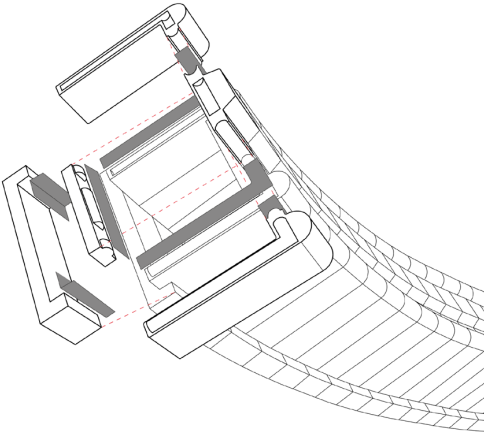
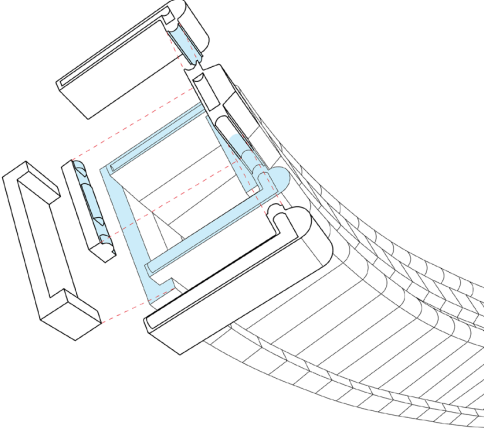
<p>Structural connection</p> <p>Variant 1 (Dry-assembly per component on location)</p>	<p>Variant 2 (Adhesive bonding per component on location)</p>
	
<p>Labour intensity: High</p>	<p>Labour intensity: High</p>
<p>Installation error risk: High</p>	<p>Installation error risk: High</p>
<p>Max weight per element: 22,3kg</p>	<p>Max weight per element: 22,3kg</p>
<p>Findings</p> <ul style="list-style-type: none"> + Recycle glass without contamination. + Interlayer can be recycled separately. + Interlocking creates tolerance and reduces tensile stress. - Visible repeating interlayer. - Most interlayers creep - Long construction duration - Manual process which cannot be corrected afterwards. 	<p>Findings</p> <ul style="list-style-type: none"> + Simplify interlocking geometry and only use it for positioning. + Recycling of glass possible. - Surface of glass components needs to be polished before applying the glue. - Extra action required to harden the glue. - Adhesive bonding process is time restricted and challenging on site.

Variant 3
(Adhesive bonding at manufacture
+ on location)

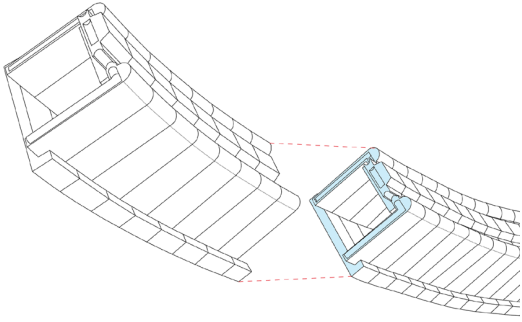

Labour intensity: Medium

Installation error risk: Medium

Max weight per element: 870kg

Findings

- + Simplify interlocking geometry and only use it for positioning.
- + Recycling of glass possible.
- + Adhesive bonding mostly performed indoor and controlled environment.
- + Quick assembly process thanks to the prefab elements.
- Surface of glass components needs to be polished before applying the glue.
- Extra action required to harden the glue.
- Adhesive bonding process is time restricted and challenging on site.
- When a component fails, it cannot be replaced without replacing the complete arch.
- A crane is required for lifting the prefab elements.

Variant 4
(Adhesive bonding at manufacture
+ dry-assembly on location)

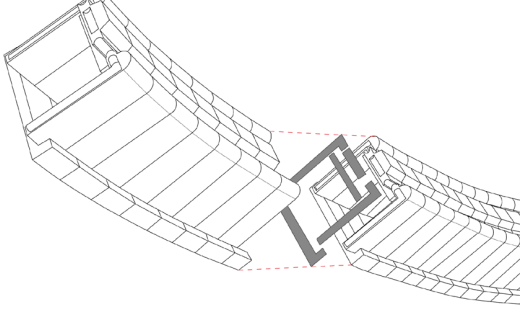

Labour intensity: Low

Installation error risk: Low

Max weight per element: 870kg

Findings

- + Simplify interlocking geometry and only use it for positioning.
- + Recycling of glass possible.
- + Adhesive bonding mostly performed indoor and controlled environment.
- + Quick assembly process thanks to the prefab elements.
- + When a component fails, only a part of the arch has to be replaced.
- Surface of glass components needs to be polished before applying the glue.
- Visible repeating interlayer.
- Most interlayers creep
- A crane is required for lifting the prefab elements.

Appendix K: Prototype moulds

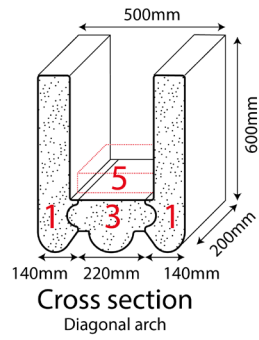
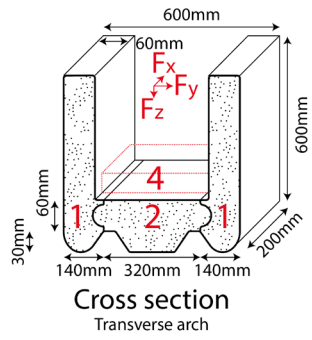

Mould for element 1

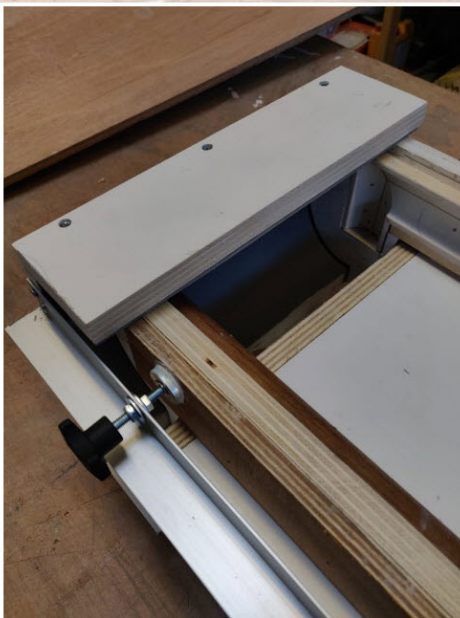
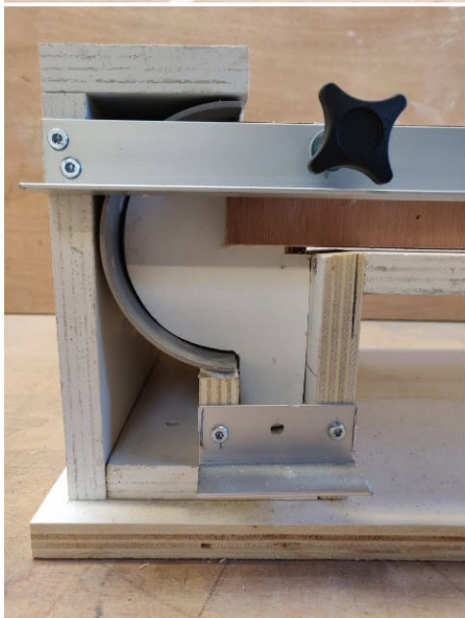
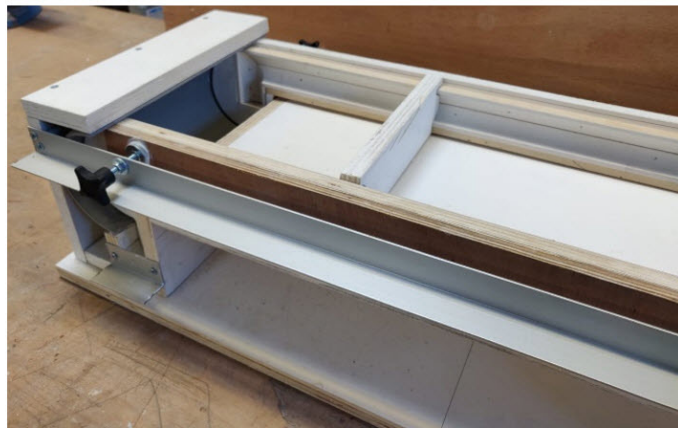

Mould for element 2

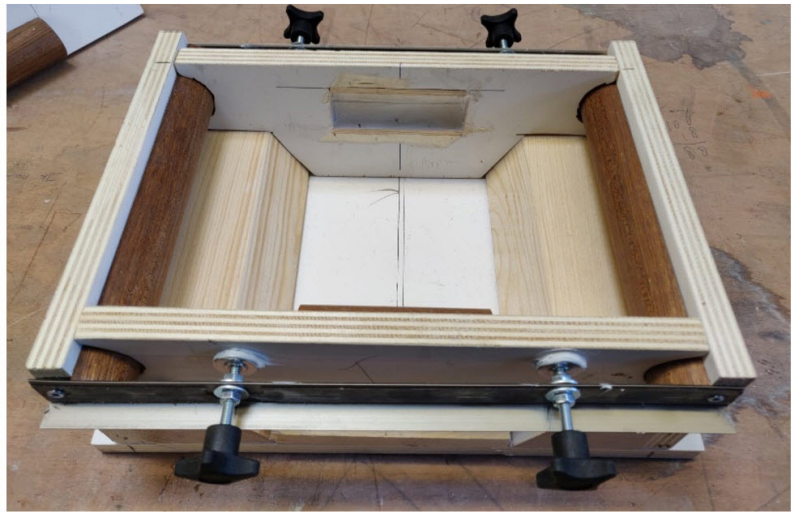
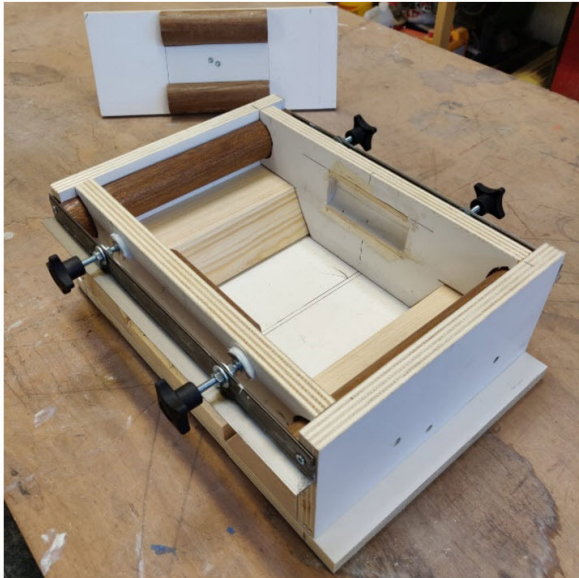
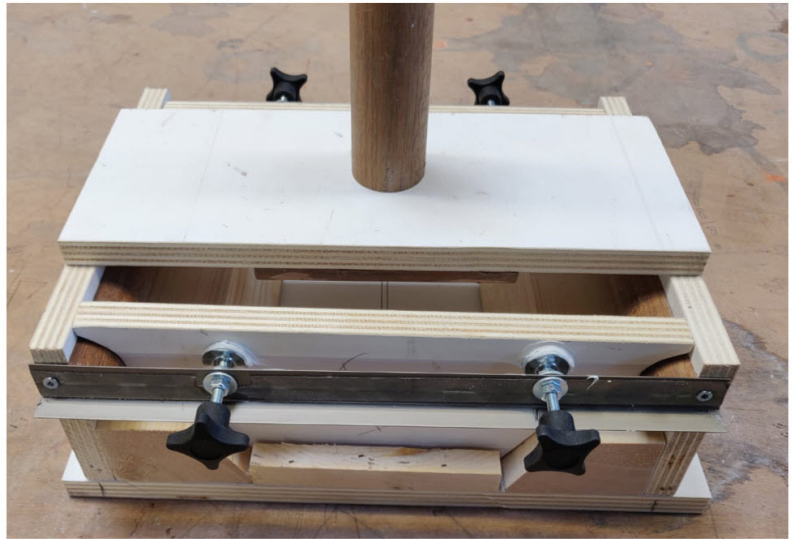
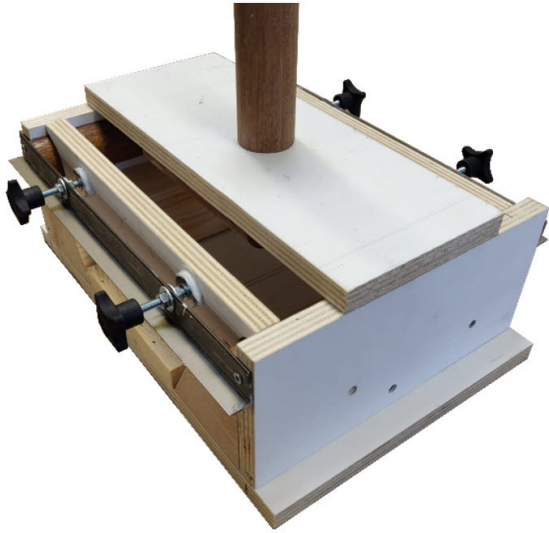

Mould for element 4

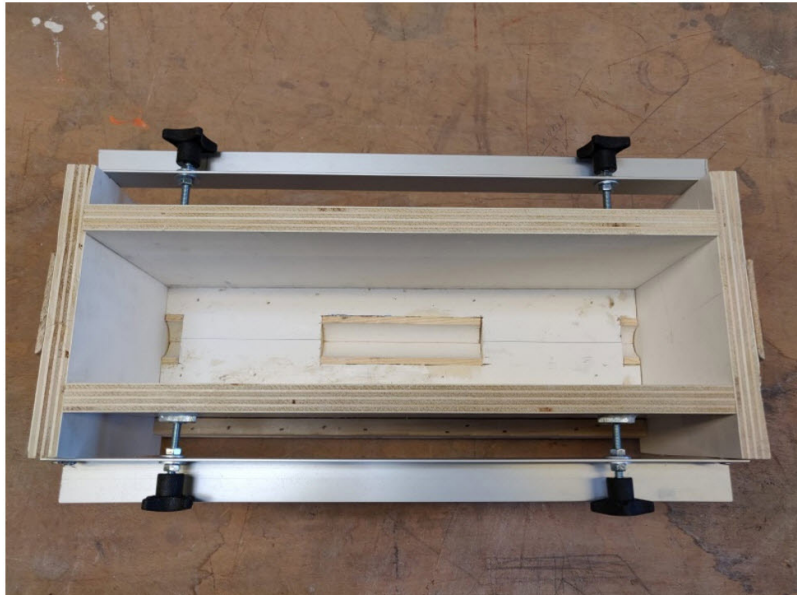

Mould for top element



Moulds poured with concrete

Mould 1



Mould 2

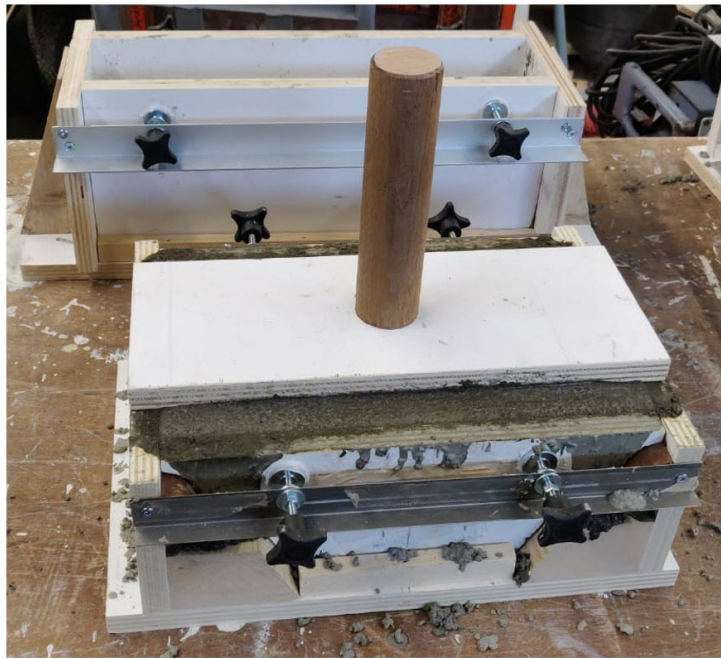

Mould 3:



Mould 4:



Appendix L: Prototype arch section

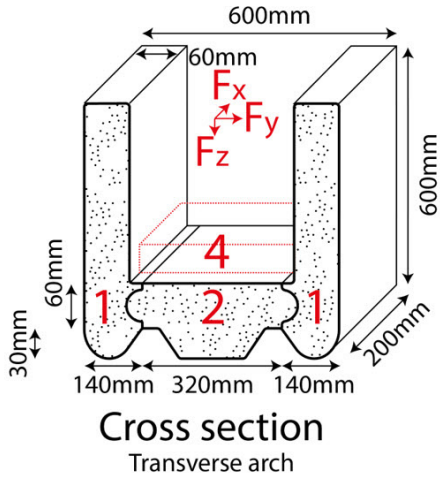

Element 1:



Element 2:





Element 4:



Element top:





Assembly order:

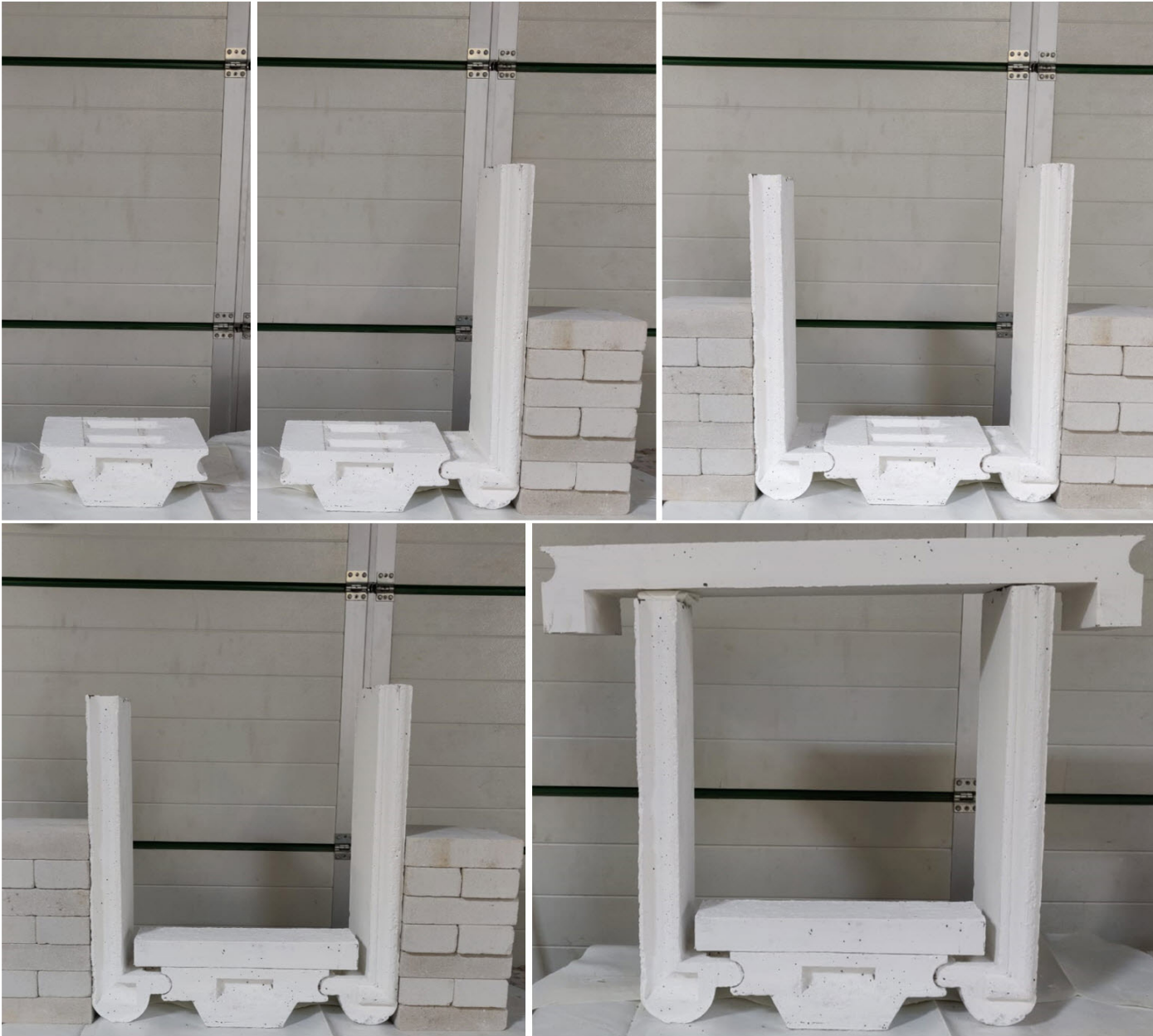

Assembled and details:

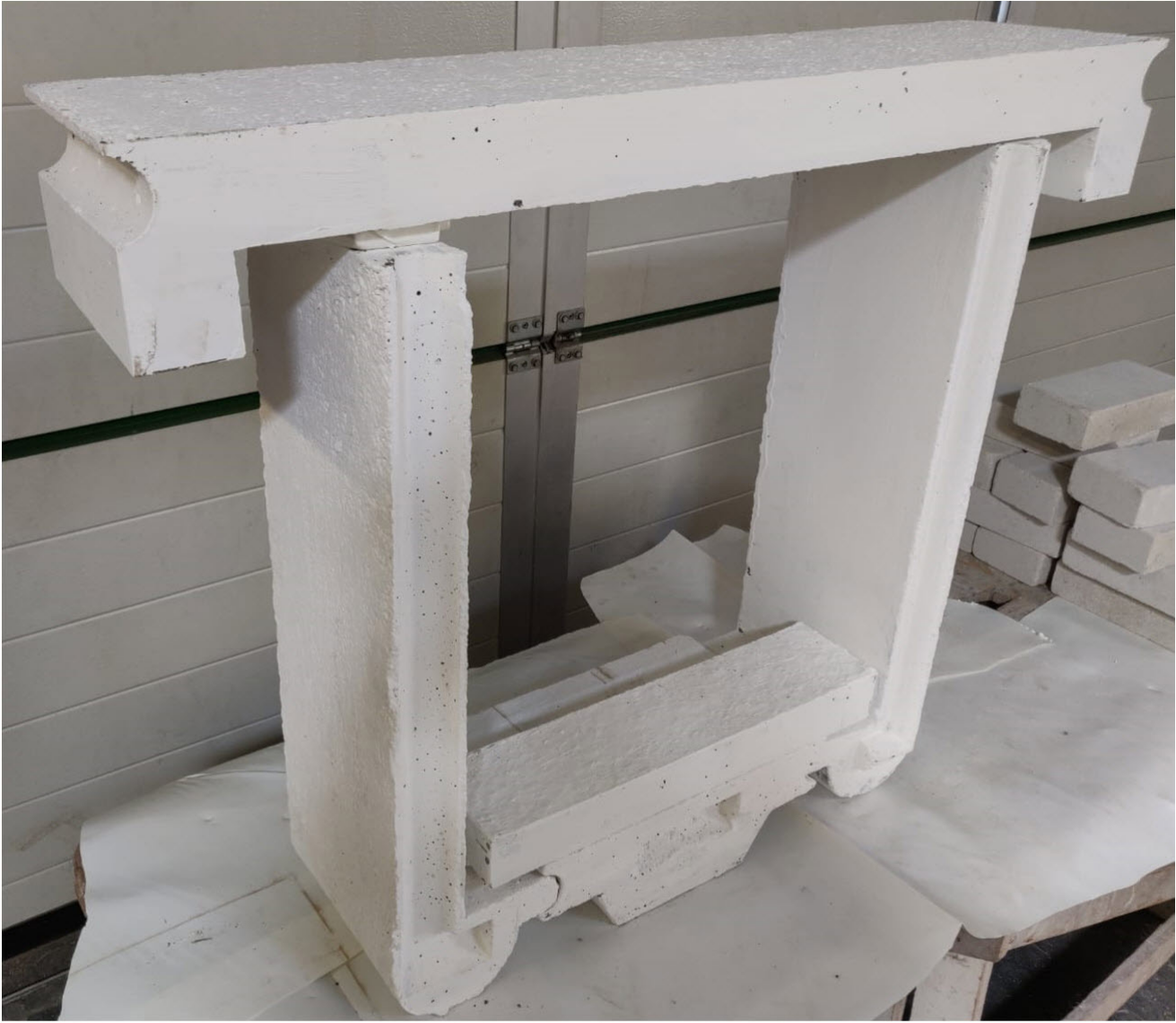





Appendix M: Assembling sequence of the glass vault

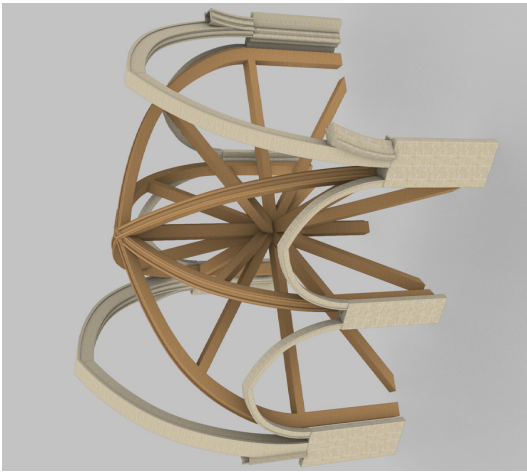

Phase **1**

- Install temp. support
- Remove damaged pieces



Phase **2**

- Install limestone impost with mortar

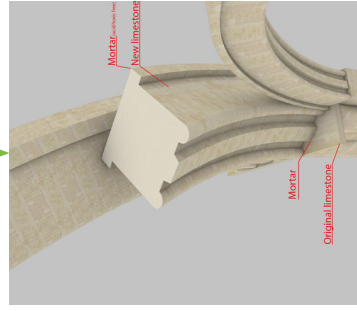

Phase **3**

- Install glass arch piece with mortar to the limestone

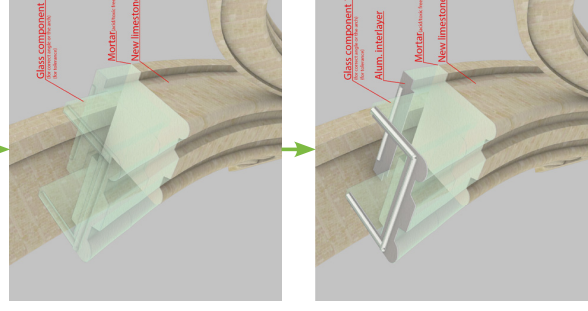

Phase **4**

- Install complete glass arch with Alum. interlayer

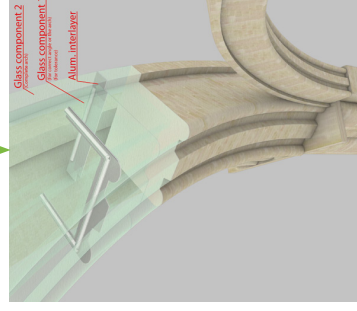

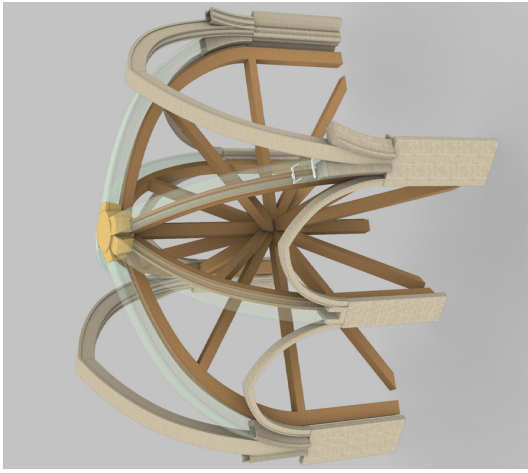

Phase 5 • Install keystone with Alum. interlayer

5

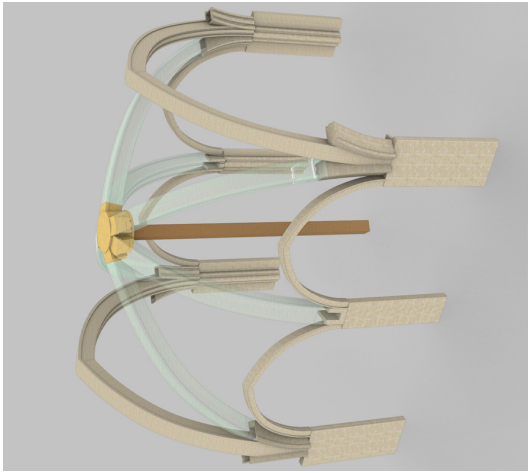
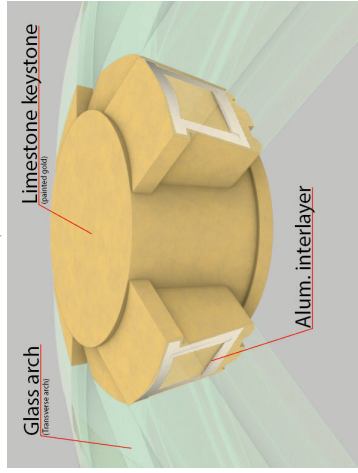

Phase 6 • Remove part of the hydraulic supports.

6

• Hydraulic system to connect arches/keystone.

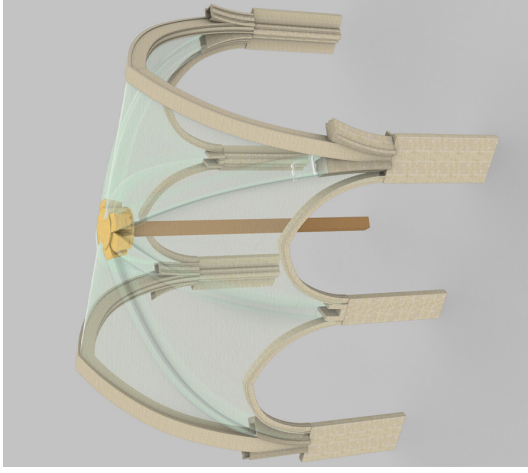
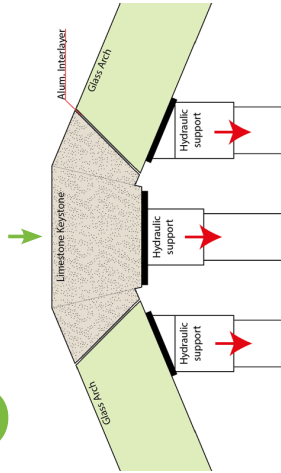

Phase 7 • Install web

7

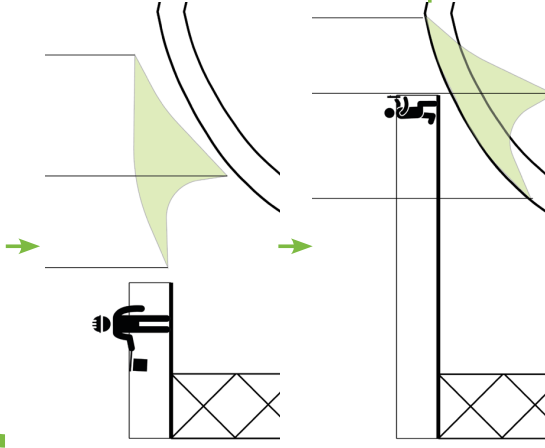

Phase 8 • Last checks

8

• Remove temp. supports

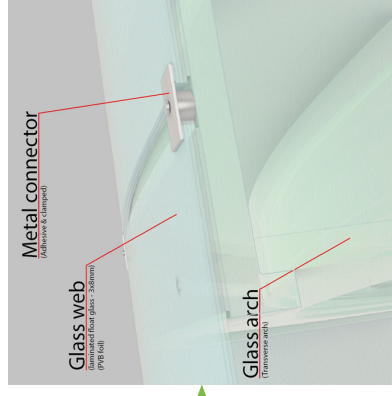

Appendix N: Impressions of the moulds

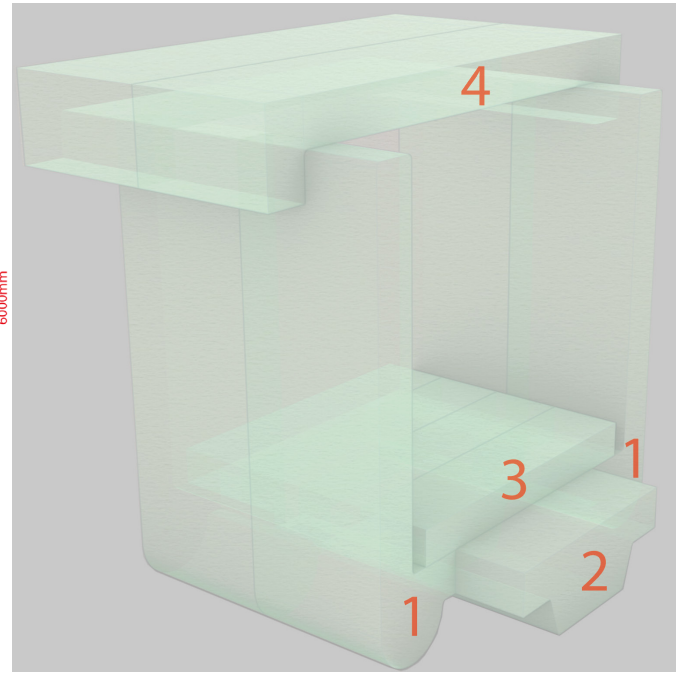
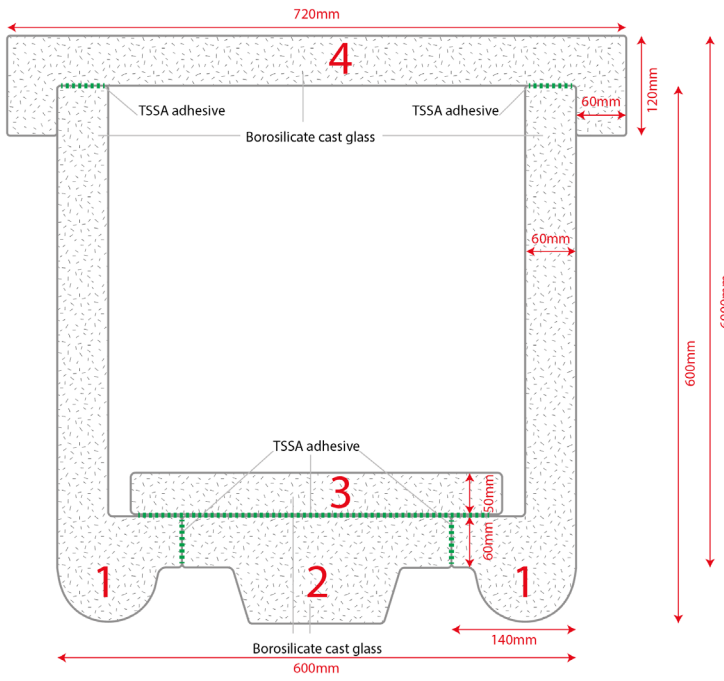

Mould for element 1:

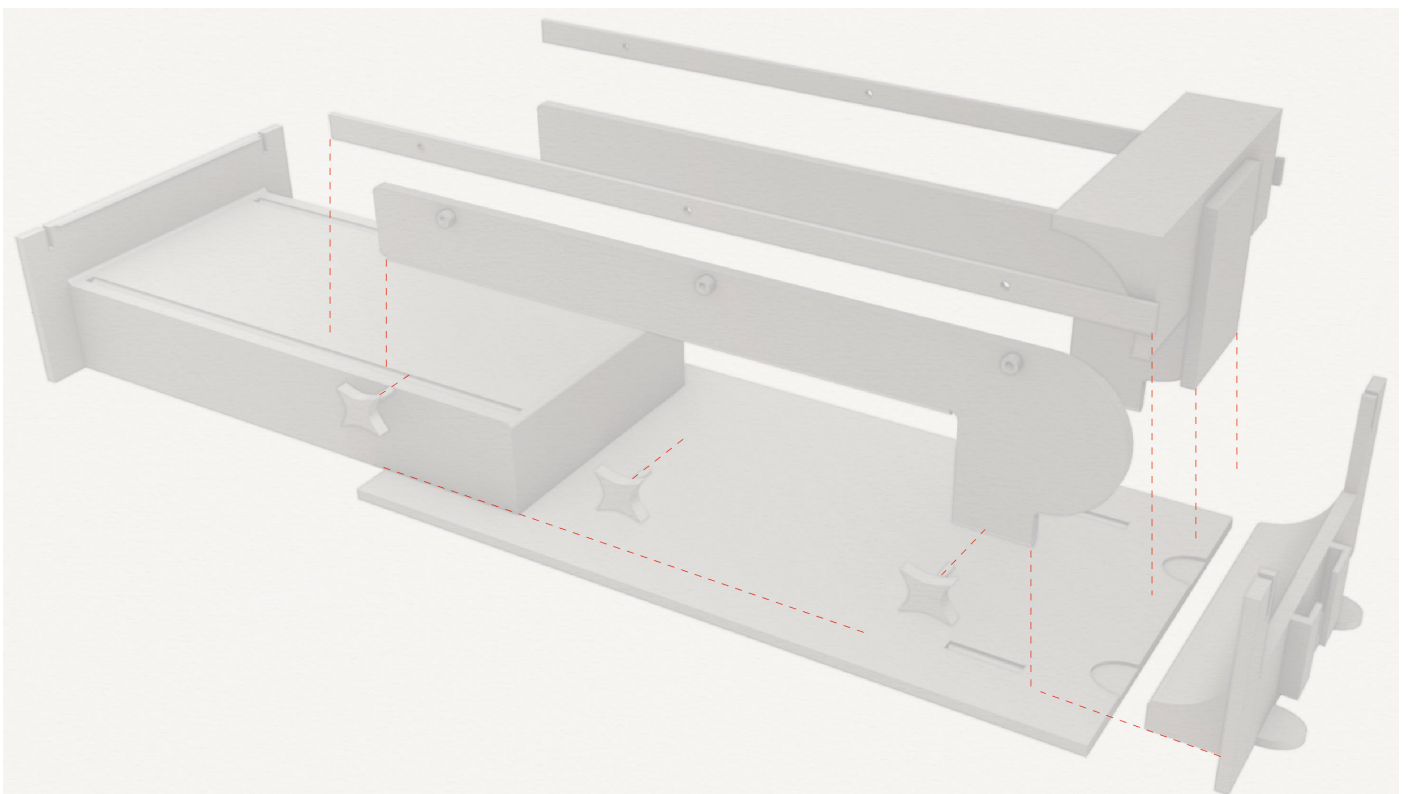
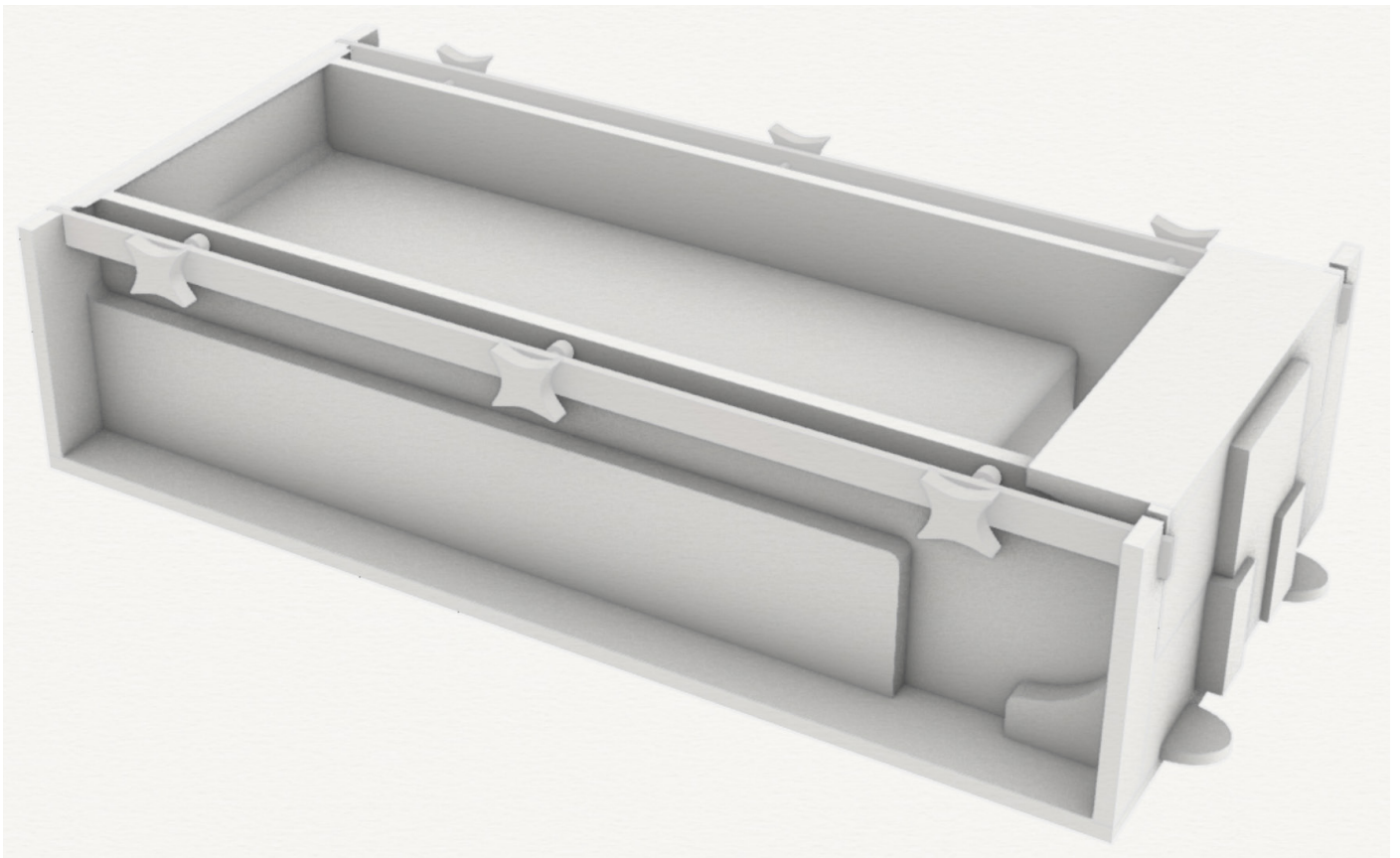



Phase • Base plate

1

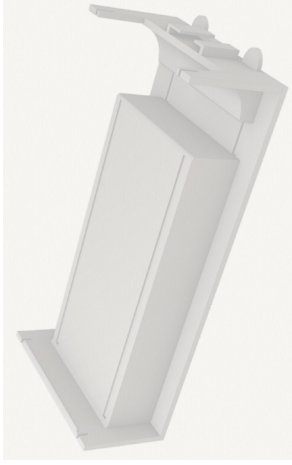

Phase • Slide in the fixed walls based on the guides.

• Fixate the walls with screws from below.

2



Phase • Place the adjustable walls.

3



Phase • Place the rails + rotating com. where the adjustable parts are connected with the fixed wall.

4

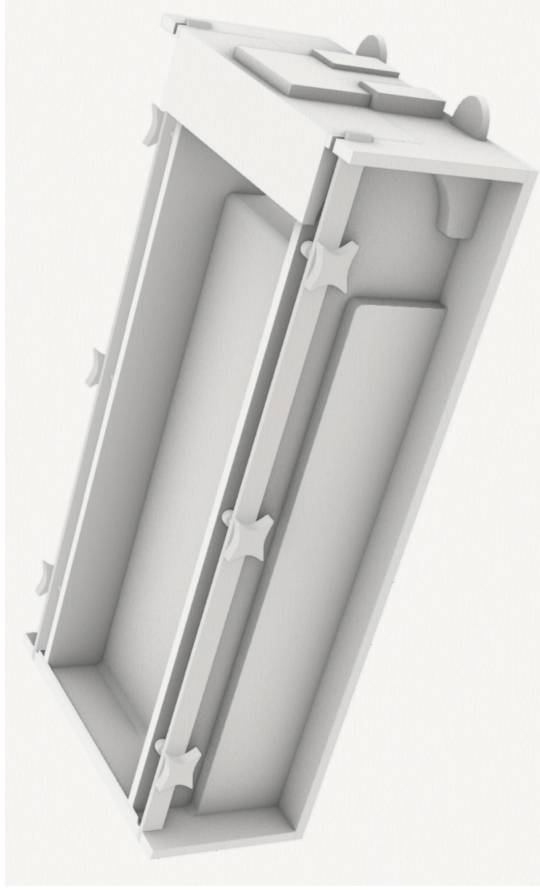

Phase • Install the adjustable wall with the rotating elements on both sides required on the angle of the arch.

• Push in the last top part
• Apply powder in the mould.
• Mould is ready for casting glass.

5



Mould for element 2:

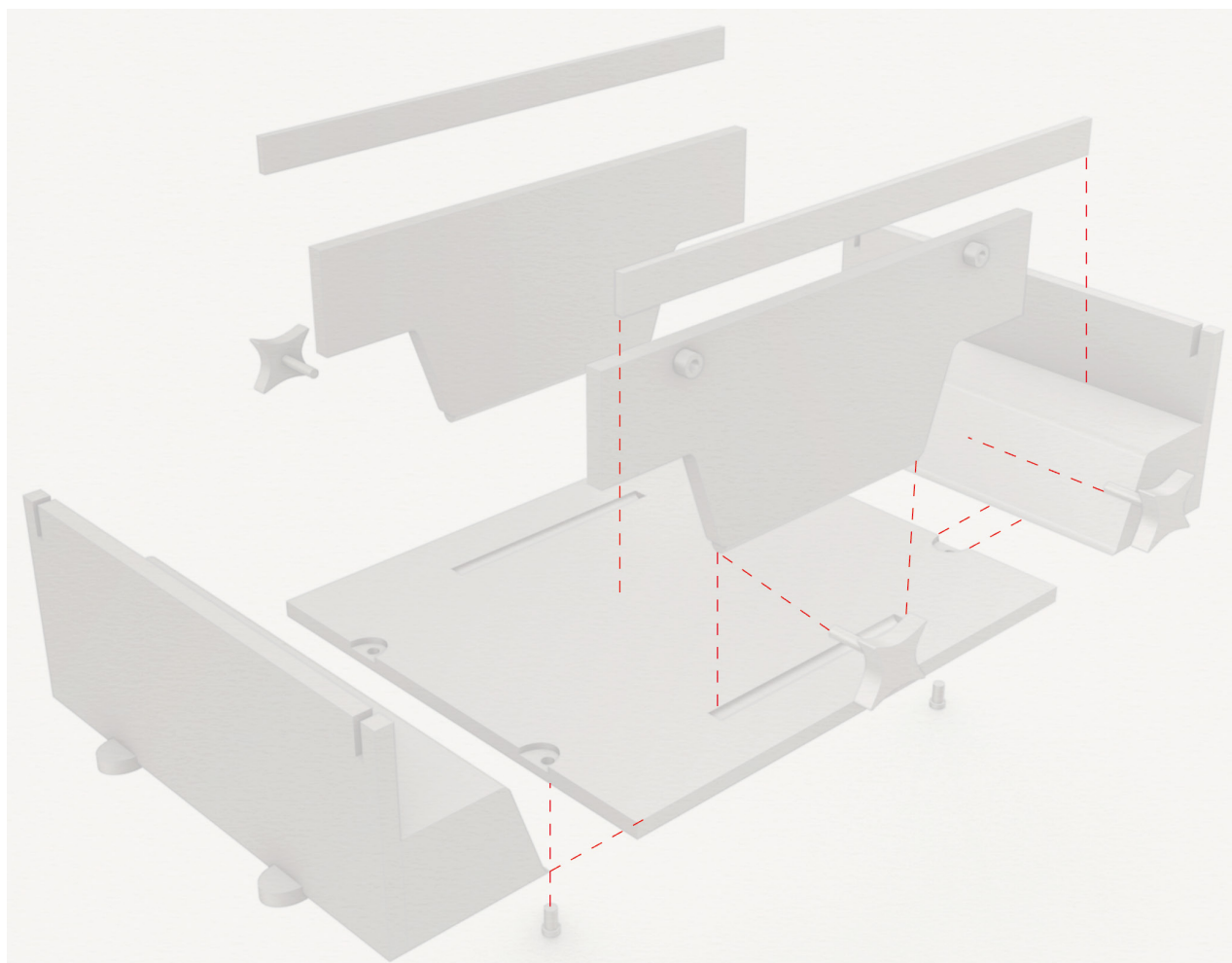
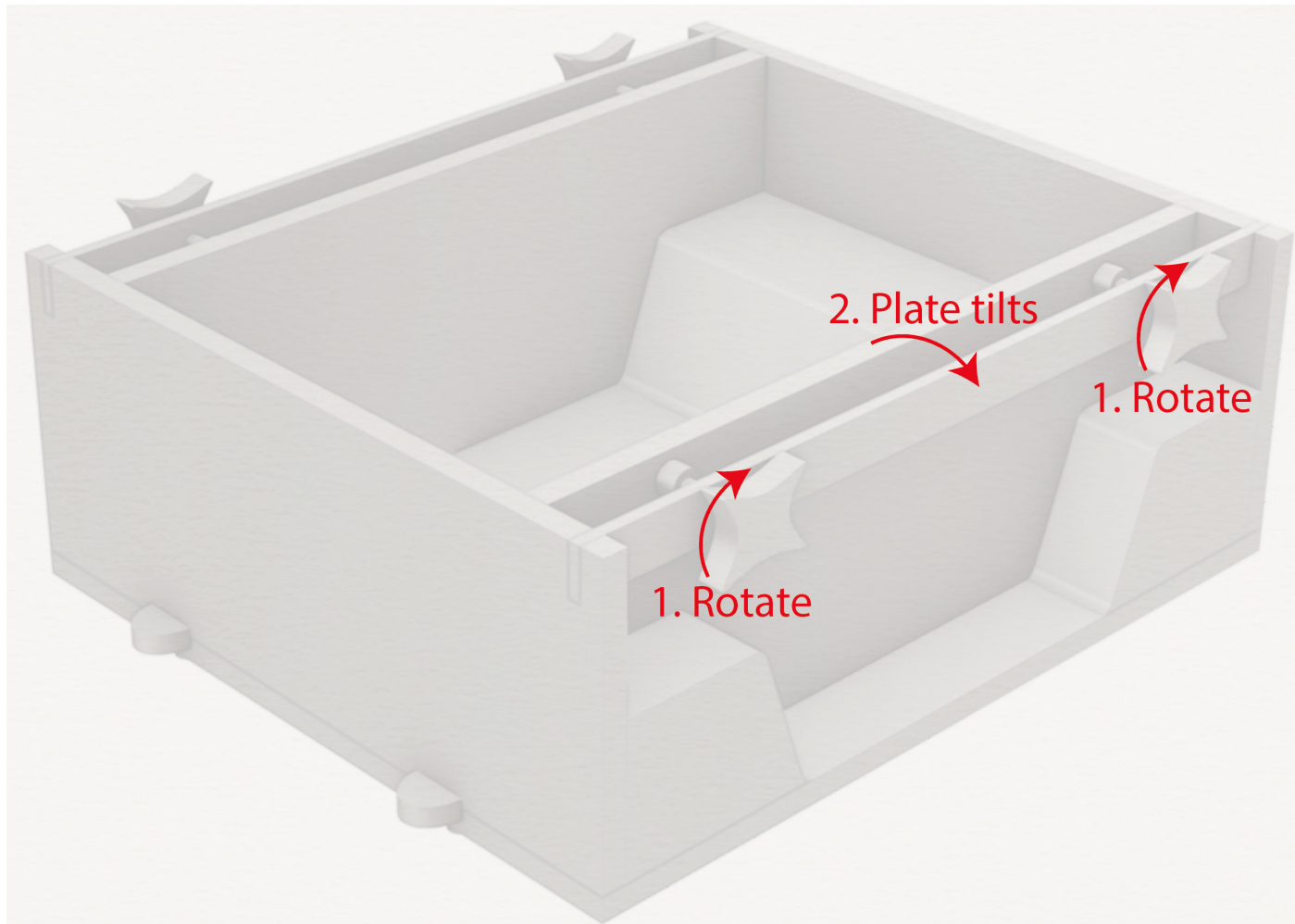



Phase • Base plate

1



Phase • Slide in the fixed walls based on the guides.
• Fixate the walls with screws from below.

2

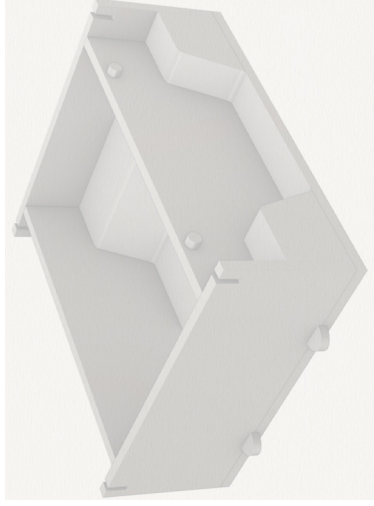

Phase • Place the adjustable walls.

3



Phase • Place the rails where the adjustable parts are connected with the fixed wall.

4

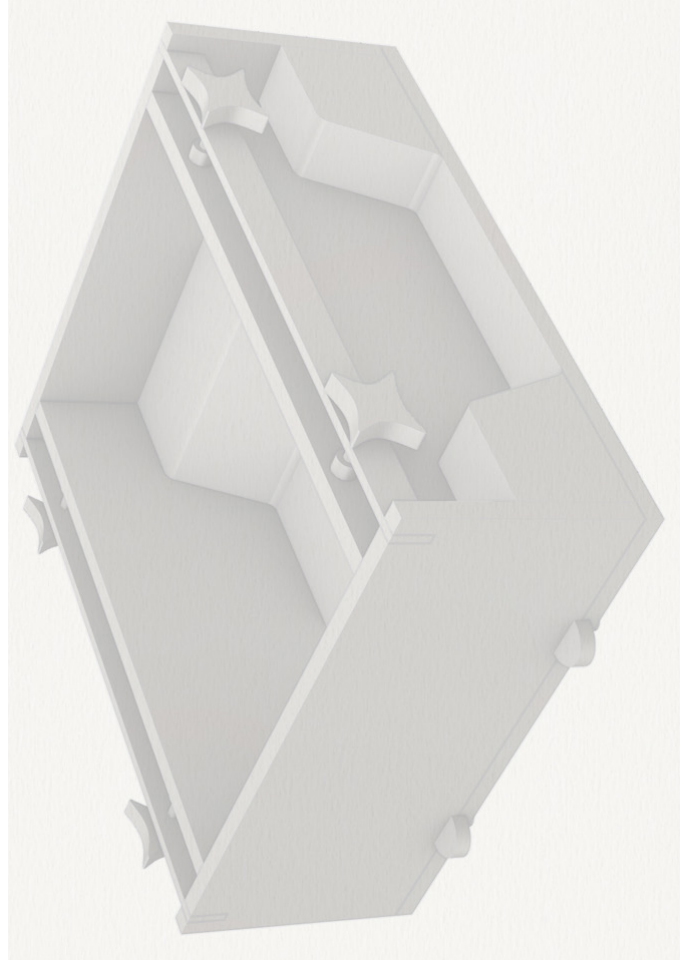

Phase • Install the adjustable wall with the rotating elements on both sides required on the angle of the arch.
• Apply powder in the mould.

5

• Mould is ready for casting glass.



Mould for element 3:

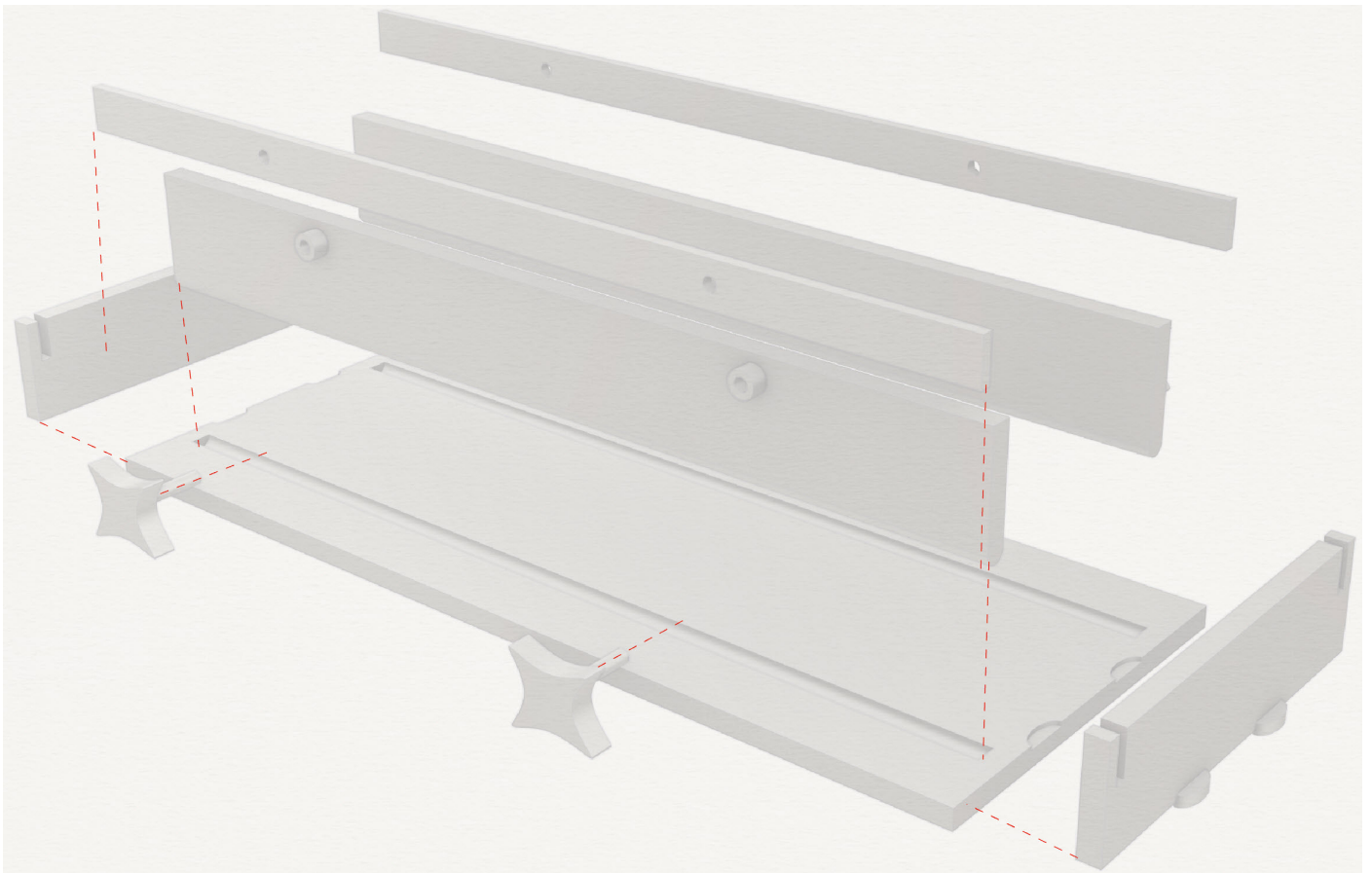
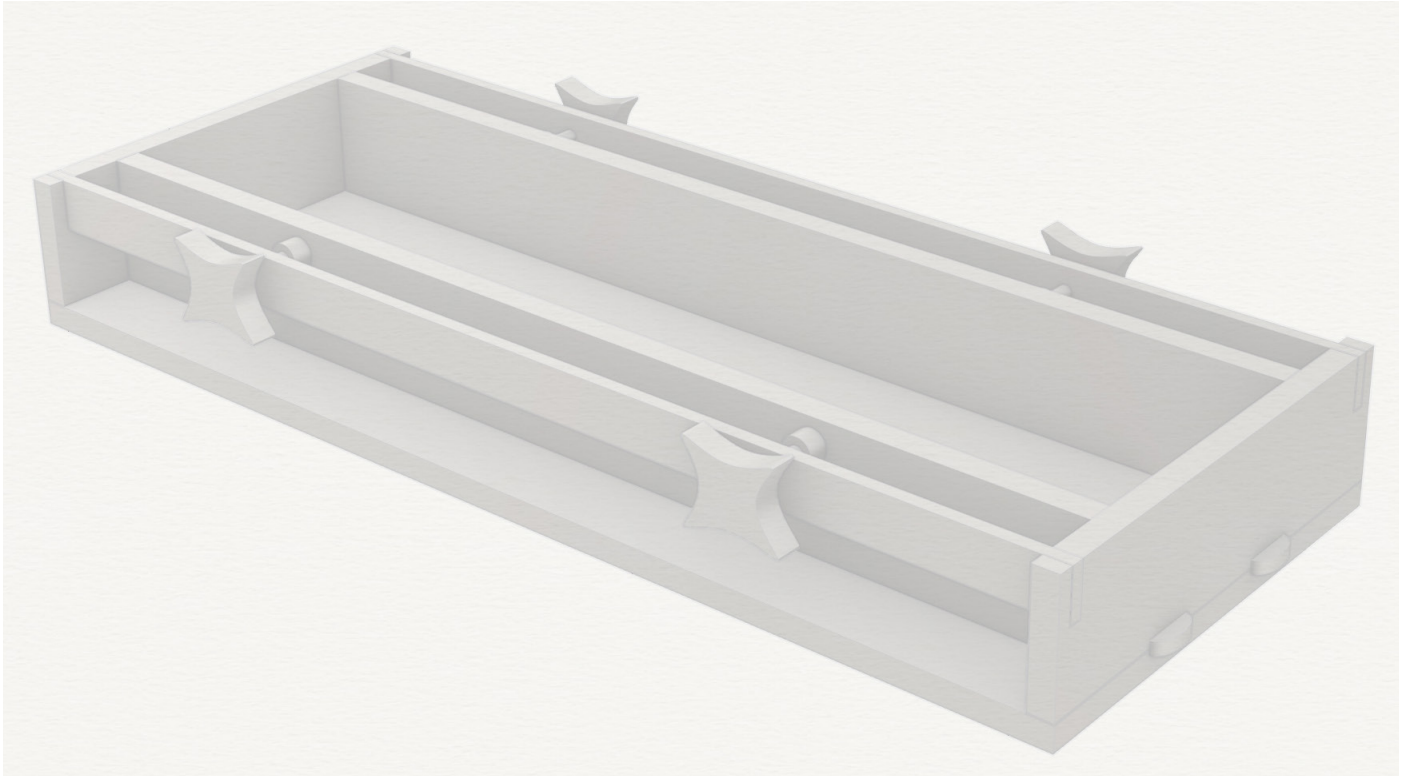



Phase

1

- Base plate



Phase

2

- Slide in the fixed walls based on the guides.
- Fixate the walls with screws from below.



Phase

3

- Place the adjustable walls.



Phase

4

- Place the rails where the adjustable parts are connected with the fixed wall.



- Phase
- Install the adjustable wall with the rotating elements on both sides required on the angle of the arch.

5

- Apply powder in the mould.
- Mould is ready for casting glass.



Appendix O: Risk analysis of the glass vault

Risk	Pobability	Factor	Exposure	Factor	Consequence	Factor	Total
From the top - Person stands on it (point force)	Uncommon, but possible	3	Several times a year	1	More than one dead	40	120
From the top - Variable equal distributed force	Uncommon, but possible	3	Very rarely	0,5	More than one dead	40	60
From the top - Variable unequal distributed force	Uncommon, but possible	3	Very rarely	0,5	More than one dead	40	60
From the top - Point impact	Uncommon, but possible	3	Very rarely	0,5	More than one dead	40	60
From the top - Temperature difference due to fire	Uncommon, but possible	3	Very rarely	0,5	More than one dead	40	60
From below - Temperature difference due to fire	Possible, but very unlikely	0,5	Very rarely	0,5	More than one dead	40	10
External - Extreme windforce	Only possible in the longer term	1	Several times a year	1	More than one dead	40	40