

Design and Development of a Novel Robotic Gripper for Automated Scaffolding Assembly

Follini, Camilla; Cheng, Alexander Liu; Latorre, Galoget; Amores, Luis Freire

DOI

[10.1109/ETCM.2018.8580276](https://doi.org/10.1109/ETCM.2018.8580276)

Publication date

2018

Document Version

Final published version

Published in

Proceedings IEEE 3rd Ecuador Technical Chapters Meeting (ETCM 2018)

Citation (APA)

Follini, C., Cheng, A. L., Latorre, G., & Amores, L. F. (2018). Design and Development of a Novel Robotic Gripper for Automated Scaffolding Assembly. In D. Benítez, & M. Huerta (Eds.), *Proceedings IEEE 3rd Ecuador Technical Chapters Meeting (ETCM 2018)* Article 8580276 IEEE. <https://doi.org/10.1109/ETCM.2018.8580276>

Important note

To cite this publication, please use the final published version (if applicable). Please check the document version above.

Copyright

Other than for strictly personal use, it is not permitted to download, forward or distribute the text or part of it, without the consent of the author(s) and/or copyright holder(s), unless the work is under an open content license such as Creative Commons.

Takedown policy

Please contact us and provide details if you believe this document breaches copyrights. We will remove access to the work immediately and investigate your claim.

Green Open Access added to TU Delft Institutional Repository

'You share, we take care!' - Taverne project

<https://www.openaccess.nl/en/you-share-we-take-care>

Otherwise as indicated in the copyright section: the publisher is the copyright holder of this work and the author uses the Dutch legislation to make this work public.

Design and Development of a Novel Robotic Gripper for Automated Scaffolding Assembly

Camilla Follini¹, Alexander Liu Cheng^{2,3}, Galoget Latorre⁴, Luis Freire Amores⁵

¹Fraunhofer Italia Research s.c.a.r.l, Bolzano, Italy

²Faculty of Architecture and the Built Environment, Delft University of Technology, Delft, The Netherlands

³Facultad de Arquitectura e Ingenierías, Universidad Internacional SEK, Quito, Ecuador

⁴Facultad de Ingeniería de Sistemas, Escuela Politécnica Nacional, Quito, Ecuador

⁵Facultad de Arquitectura y Urbanismo, Universidad Tecnológica Equinoccial, Quito, Ecuador

E-mail: camilla.follini@fraunhofer.it, a.liucheng@tudelft.nl, galoget.latorre@epn.edu.ec, luis.freire@ute.edu.ec

Abstract—Scaffolding assembly constitutes a potentially dangerous and time-consuming task within the construction process. In most industrialized nations, said assembly is the process in which most of the causalities of the Construction Industry happen, especially in projects characterized by high complexity and restricted operation space. The repetitiveness of the profile elements and of the assembly operations may open the possibility for automating the scaffolding construction process, which is however a difficult task due to the unstructured environment of construction sites and the implied strong collaboration of human and machine agents. As a possible automation solution, the startup KEWAZO proposes a novel robotic scaffolding assembly system. The solution focuses on the development of small-sized robotic climbing modules controlled as an integrated system. This paper focuses on the development of the robotic gripper of said modular system. The gripper system is validated through static analysis and the construction of a fully functional prototype. Furthermore, the system is integrated with a voice identification / authentication and control mechanism that enables it to recognize a variety of human identities and to engage with verbal commands according to the authority and privileges assigned to each individual.

Keywords—Automation in Construction, Robotic Gripper, Wireless Sensor and Actuator Networks, Robotic Assembly, Voice Identification and Authentication.

I. INTRODUCTION

Despite the technological advancements adopted in several manufacturing industries during the last decades, the Construction Industry is still mostly based on manual work and requires the presence of several professional figures, from the design to the production stage. This implies a considerable amount of time and money, difficult to define in the early stages of work [1, 2]. Climbing robots have been used in construction, cleaning, and maintenance, especially in hazardous environments due to their capability to access areas otherwise impossible or difficult to access by human labor. The climbing locomotion has been achieved in different ways, from the setting of vertical rails to climbing motions performed by the robot—in case of irregular or complex unknown structures [3]. Among the different implementation

scenarios where climbing robots can be applied to, scaffolding assembly is a salient option, as it is one of the most dangerous, costly, and time-consuming process of the construction process. KEWAZO[®] GmbH [4] has offered their own solution after considering the opportunity for automation in the scaffolding industry. Their goal is to improve safety and reduce time as well as costs of scaffolding construction by means of an automated system aimed to enhance logistics and assembly of the scaffolding parts. A previous iteration of their robotic system, and one which is used in the present work, takes biological inspiration from centipede locomotion. The body of centipedes can be considered modular, as composed of numerous and functionally identical segments. The great number of legs ensures higher speed and stability, as the system always has a backup in case of limb malfunction. Every segment is connected to the two adjacent ones with one joint, granting the insect high flexibility in movement. Given the robotic architecture and locomotion considered, the robotic gripper at the end of each module's manipulator is of utmost importance. Moreover, in the context of the KEWAZO research aimed to increase the safety of scaffolding construction, the robotic gripper of the climbing system constitutes undoubtedly a critical point of development. Among the different prehension methods analyzed by Wolf and Steinmann [5], a mechanical gripper has been developed, as more suitable for dirty or curved surfaces with a small area of contact and material independent.

Additionally, the present work imbues KEWAZO's system and implemented gripper with voice identification / authentication and control capabilities in order to render *Human Computer Interaction* (HCI) more intuitive for the user. That is to say, spoken control and/or override commands given by authorized users may be used to engage with the systems—to differing degrees—to cause them to stop, retreat, approach, grip, release, etc. The present paper does this by implementing the voice identification / authentication and control mechanism to KEWAZO's system via a *black box* approach, where said mechanism is developed and tested in parallel, and whose functionality is verified via scaled down and/or limited implementations of KEWAZO's system and gripper.

A. With respect to the Robotic Gripper

First, an extensive literature review of grippers developed for climbing operations is conducted to find a solution relevant to KEWAZO's scope. A first screening of grippers tailored to climb tubular and truss-like structures is carried out, focusing on those able to climb both horizontally and vertically [6–8], climb structures composed of tubular elements [9–11], and being developed in view of creating a modular robot [12–14]. None of the solutions analyzed prove to be efficient for scaffolding climbing, especially concerning the need of detaching the gripper from the structure on regular intervals due to the presence of structural joints (i.e., rosettes). Thus, a novel gripper focused on KEWAZO's requirements is developed, adapting the method for gripper selection proposed by Schmalz and Reinhart [15]. Requirements derived from four critical categories (i.e., part, handling device, process, and environment) are used to evaluate and prioritize solutions and features of a first pre-selection. Thereafter, operational elements are dimensioned and optimized based on the estimated gripping force required and, in a subsequent stage, on a reiteration of a static stress and displacement analysis (see Section III.A for details).

B. With respect to the Voice Identification / Authentication and Control mechanism

The voice identification / authentication mechanism is motivated by HCI considerations. The intention is to implement an intuitive interface in order for human agents to accurately control / override multiple automated non-human agents (i.e., KEWAZO system modules) within a field of operations if and when necessary. Privileges over degrees of control / override are individually assigned to present human agents, who may play supervisory or supporting roles within the operations. As detailed before, KEWAZO's modules and the presently developed gripper are automated systems, yet there may be occasions when they must be commanded to stop, retreat, approach, grip, release, etc., by humans in order to avoid potential accidents and/or to pause operations for inspections, etc. This voice identification / authentication mechanism decentralizes override control and deploys it throughout the entire field of operations—that is to say, the systems may be engaged whenever and wherever users with appropriate privileges are heard.

This mechanism is composed of two cloud-based services working locally in tandem (see Section III.B for details). The first authenticates user-identity via voice biometrics. Once a user has been authenticated, the returned confirmation is used to engage the second service, which translates subsequent speech to text commands used to trigger reactions within the system. The second service requires a triggering word to inform the system when it should start listening to speech and to translate it into text (i.e., *String*) commands. These *String* commands serve as inputs to trigger actuations (e.g., stop, retreat, approach, grip, release, etc.) across the network of robotic agents, which operate within a *Wireless Sensor and Actuator Network* with a meshed topology.

A. With respect to the Robotic Gripper

The first dimensioning is achieved based on geometrical considerations. It is then used as a basis for the force analysis, with the aim of gradually optimizing the system with the refinement of the most critical variants. The fingers are dimensioned following the method prescribed by Pedrazzoli, Rinaldi, and Boer [16]. The V-shape is preferred as an appropriate geometry to grab cylindrical objects and one that is more flexible than the C-shape. The calculation of the gripping force is computed with the formula prescribed by Hesse [17], based on the friction mating principle. However, since the formula is conceived to evaluate the gripping force on a work-piece transported by the gripper in a manufacturing setting, it is readapted to the current scenario. The original formula implies, in fact, that the center of mass of the piece is located on the axis passing through the center of the fingers. The situation in the present case is reversed, being the robot the weight to be sustained and the profile in the middle of the fingers the load bearing part. Therefore, some additional geometrical considerations are made to calculate the gripping force—on both the vertical and horizontal scenarios—considering the torque generated by the shift of the center of masses at a distance. This results in the definition of the formula (1), where F_g is the gripping force, τ the torque generated by the weight of the robot and the payload at a distance d , and S is the safety factor. The other variables are determined by the fingers: μ is the coefficient of friction depending on the material of their surface, n is their number, and β the angle between the two wings of the V.

$$F_g = \frac{\tau}{\mu \cdot n \cdot d} \cdot \sin \frac{\beta}{2} \cdot S \quad (1)$$

In the vertical scenario, the height of the fingers influences the final gripping force, as it changes the value of d . The horizontal climbing motion sees the robot with the same disposition as the vertical, with a different direction of the weight force. The torque generated in this case is a rotary force about the axis of the scaffolding profile, which generates frictional forces acting on the opposite direction. Gripping forces represent the amount of force necessary to counteract this torque. Thus, while the vertical case has the advantage of the weight of the robot creating a counteracting force, the gripper sustains itself horizontally by friction. This means that the horizontal case is the most critical and is therefore used as basis for the further design development. After determining the gripping force needed, a suitable kinematic configuration, is chosen. The gripper needs relative flexibility, since the diameter of scaffolding profiles is regulated by building codes. Thus, an angular configuration is selected, since although less flexible than the parallel one, it gains in terms of speed and force. The finger shape is optimized (see Fig. 1) by means of an iterative topology analysis, which aims to reduce the volume of the bodies while maintaining their mechanical properties at the same time. This method enables a consistent mass reduction of approximately 80% of the initial weight. The new design, evaluated through Finite Element Method (FEM) on commercial software, is proven stiff enough to sustain the system under horizontal and vertical climbing.

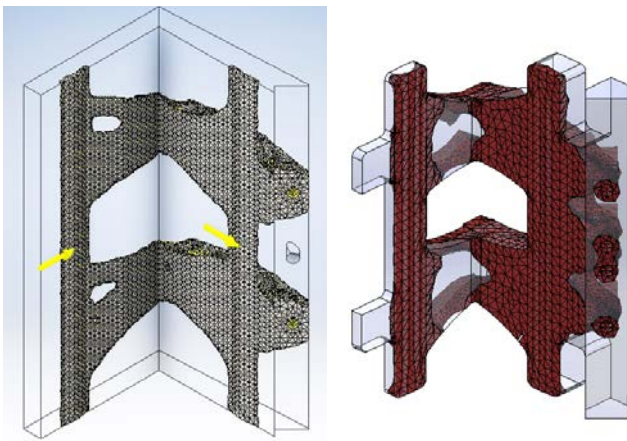

Fig. 1. Iterative topology optimization of the fingers.

B. With respect to the Voice Identification / Authentication and Control mechanism

The voice identification / authentication mechanism is implemented via *Voicelt*[®]'s [18] API in Python. The script first creates a new user and then uploads a minimum of three voice samples—in WAV format (see Fig. 2)—of the person to *enroll* (*Voicelt*'s platform allows for the creation of user groups). These samples must be between 1.2 to 5 seconds in length. While the system has predetermined phrases for the user to repeat as part of its training process, it is also possible to add custom phrases. However, these custom phrases must be in English, unless *Voicelt*'s paid version is used. The present *proof-of-concept* implementation used “[m]y face and voice identify me” as the training phrase. The Python script processes the API's returned JSON in a way that details each action and its result in log-format.

Following the successful enrollment of a given number of users, the system is ready to ascertain user-identity via voice. In the present set-up, each specific user is given differing authority levels in order to engage the robotic system into a variety of actions. This scenario attempts to mirror real-life situations where supervisors may have more decision-making privileges over workers, etc. In this implementation, if a particular voice corresponds to a user who has authority to issue commands, then once he/she is identified, the mechanism readies to accept them and to execute actions / actions accordingly. To do this, the present work is integrated with a previously developed Speech and Voice-Command Recognition mechanism [19] based on Google Cloud Platform[®]'s *Cloud Speech-to-Text* service [20]. More specifically: once a user is recognized via his/her voice, the system is ready to receive commands and to execute corresponding actions. This is verified to work with both KEWAZO's module and the presently developed gripper via a *black box* approach and multiple simulations where the module is commanded to go up, down, left, and right; and the gripper to grip and to release.

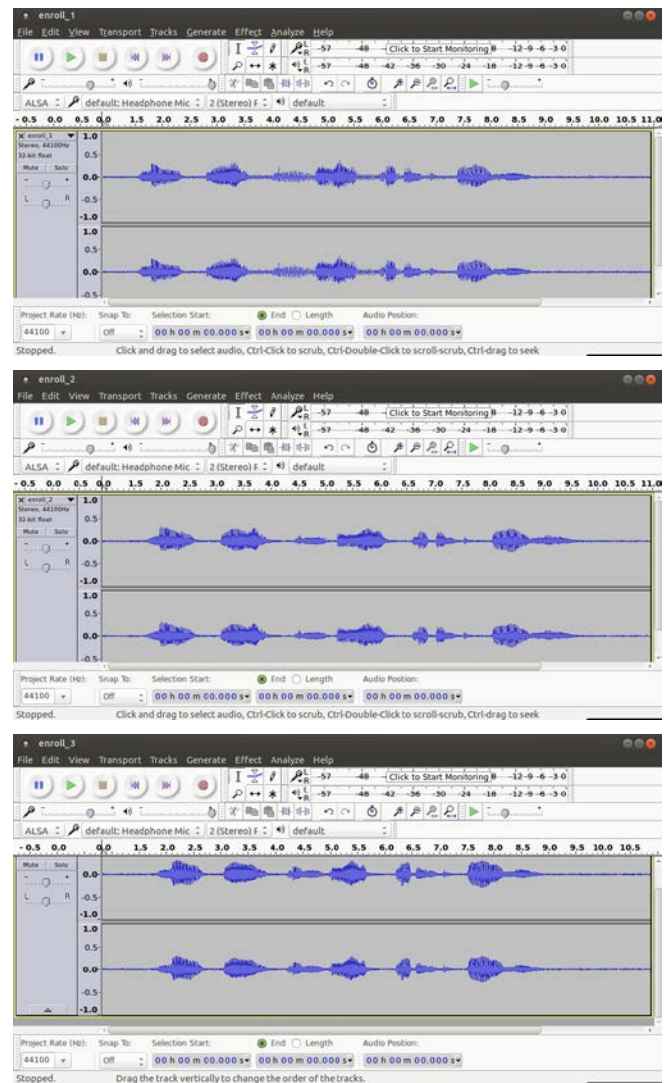

Fig. 2. Three obligatory instances of the predetermined phrase “my face and voice identify me” used to *enroll* the user via *Voicelt*.

IV. RESULTS AND DISCUSSION

After evaluating the constraints given by the operational environment and the handling device, which results in the determination of the first dimensioning and the evaluation of the forces acting on the system, the design development proceeds with finding the best solutions for the kinematics and the mechanism for the gripper. These two parts are then finally translated into a preliminary design, which maintain the geometrical constraints determined in the first part of development. The final design of the system is achieved after an iterative optimization through FEM analysis. The outcome of the system is shown in Fig. 3, *Top*, which presents the final conceptual design of the gripper.

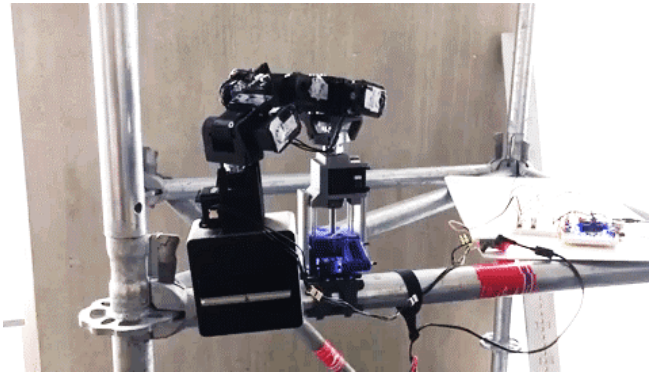
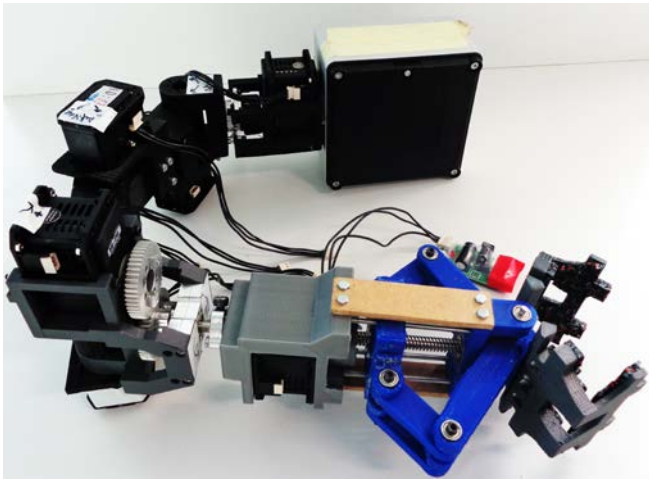
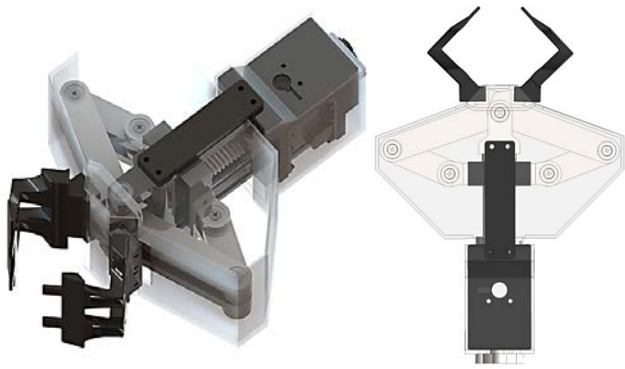

Fig. 3. Top: Final conceptual design of the gripper in the closed position. Middle: Partial prototype of the robotic module. Bottom: The prototype performing the horizontal climbing motion on a regular scaffolding structure

The final design is modeled after several iterations of optimization cycles. The simulation of the final design shows that the gripper is capable of sustaining the stress of both the vertical and horizontal scenarios with acceptable displacement. An analysis is then performed on the scaffolding profile, to assess whether it can hold the amount of gripping force generated by the system. After the validation computed in the by means of software simulation, a prototype (see Fig. 3, *Middle*) of the system is built, to further assess its feasibility. The values obtained through numerical and prototype testing are compared to the initial requirements, in order to assess whether the system is successful.

The gripper is tested in the performance of the actual task of supporting the manipulator during the climbing motion. The design is proven to be strong enough to support the weight of the prototype, even with a different material of the gripper. Since in the vertical scenario the motion is essentially identical for the two hands of the robot, only one motion test is carried out. On the contrary, the horizontal motion test is split in two different tests. As with the vertical motion, the first test (see Fig. 3, *Bottom*) is performed with the gripper grabbing the profile from above, while the second test from the bottom. Overall, the gripper's performance demonstrates its capacity to meet stipulated functional requirements.

Similarly, the voice identification / authentication & control mechanism performs successfully and as expected. Following the user *enrollment* process, the identity of the user is authenticated via the same predetermined phrase (i.e., "my face and voice identify me") from three different distances to gauge the precision of VoiceIt's voice biometrics service in relation to volume and proximity.

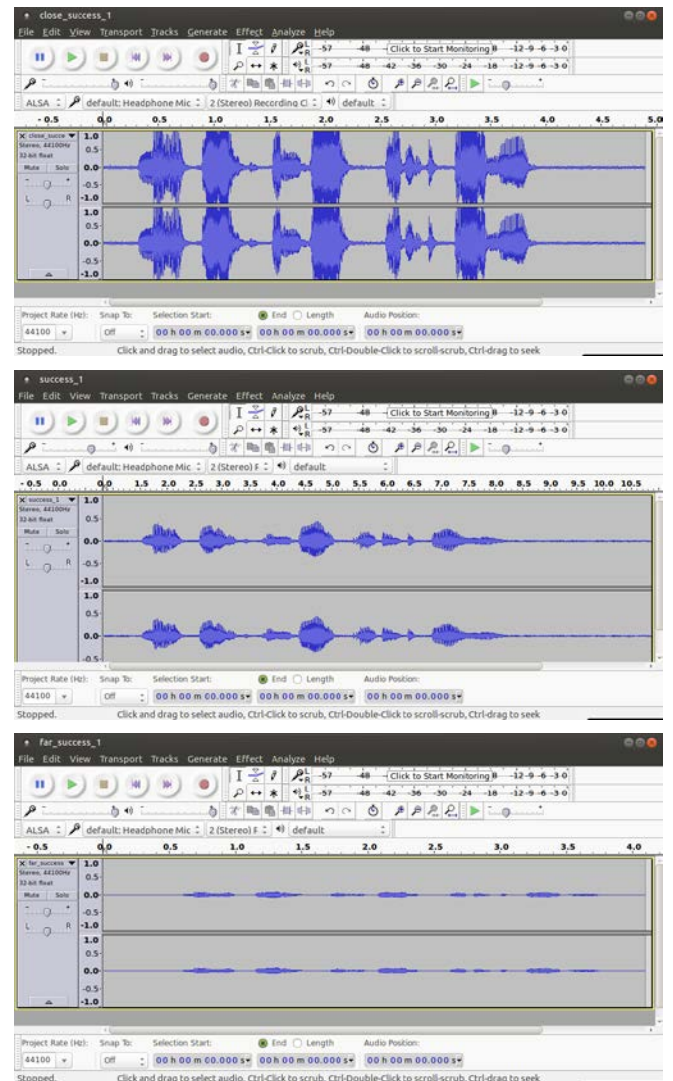

Fig. 4. VoiceIt Authentication Success in close-range (Top), medium-range (Middle), and long-range (Bottom).

During this process it is verified that with a normal speaking volume, VoiceIt is capable of identifying users (1) at an exceedingly close proximity, in spite of the noise / distortion involved in speaking directly into a microphone (see Fig. 4, *Top*); (2) at a medium-range distance of 1.5 to 2 meters (see Fig. 4, *Middle*); and (3) at a long-range distance of 3 to 5 meters (see Fig. 4, *Bottom*). Moreover, the same process is tested using a *non-enrolled* user to identify the service's susceptibility to false-positives. This is also tested at an exceedingly close range (see Fig. 5, *Top*), medium-range (see Fig. 5, *Middle*), and long-range (see Fig. 5, *Bottom*) with no instances of false-positives—that is, in all these cases authentication fails and authorization to engage with the KEWAZO module and the gripper via speech-to-text command actuations is denied (see Fig. 6). Successful performance under these ranges is, of course, dependent on the quality and sensibility of the microphone as well as the volume of each user's natural speaking voice (among other environmental factors).

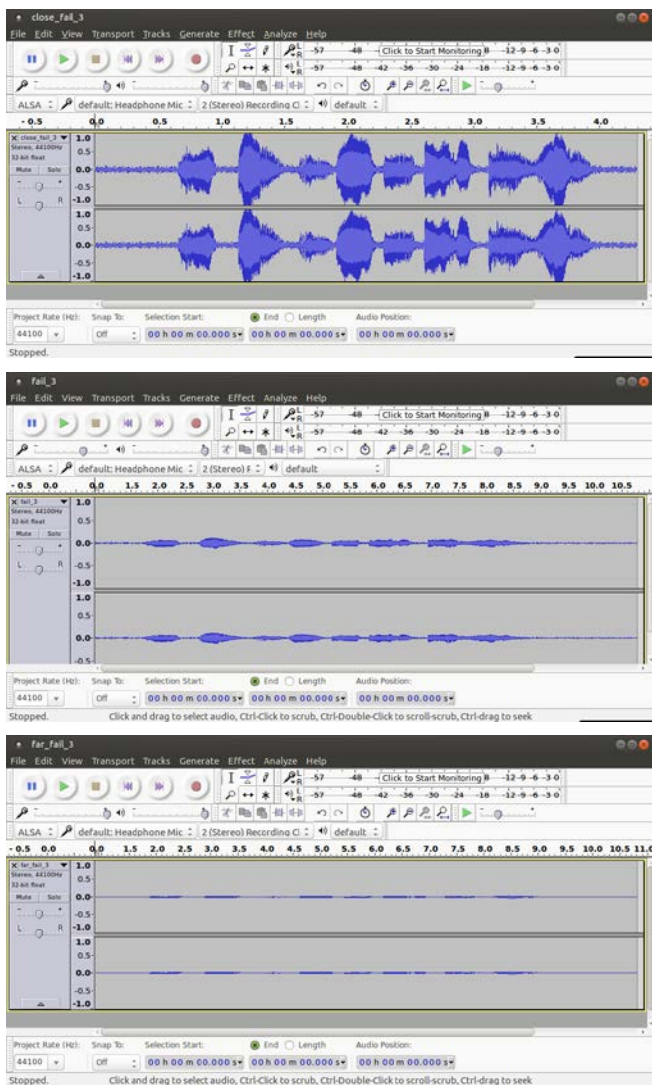

Fig. 5. VoiceIt Authentication Failure in close-range (Top), medium-range (Middle), and long-range (Bottom).

```

gl@hackem:~$ python3 voice_auth.py
hackem.log{ Creating User... }
[==> User Created Successfully, userId: usr_7354ce793c34417f9599d93c857c172f
[==> Please enter a name for the New User: Galoget
hackem.log{ Adding Voice Enrollment for Galoget... [1/3] }
[==> Successfully added voice enrollment for user with userId: usr_7354ce793c34417f9599d93c857c172f
[==> Language: en-US
hackem.log{ Adding Voice Enrollment for Galoget... [2/3] }
[==> Successfully added voice enrollment for user with userId: usr_7354ce793c34417f9599d93c857c172f
[==> Language: en-US
hackem.log{ Adding Voice Enrollment for Galoget... [3/3] }
[==> Successfully added voice enrollment for user with userId: usr_7354ce793c34417f9599d93c857c172f
[==> Language: en-US
hackem.log{ Verifying sample 'success_1' against user with userId: usr_7354ce793c34417f9599d93c857c172f
[==> Successfully verified user with userId : usr_7354ce793c34417f9599d93c857c172f
[==> Ready to receive orders from authenticated user Galoget with us
hackem.log{ Verifying sample 'success_2' against user with userId: usr_7354ce793c34417f9599d93c857c172f
[==> Successfully verified user with userId : usr_7354ce793c34417f9599d93c857c172f
[==> Ready to receive orders from authenticated user Galoget with us
hackem.log{ Verifying sample 'success_3' against user with userId: usr_7354ce793c34417f9599d93c857c172f
[==> Successfully verified user with userId : usr_7354ce793c34417f9599d93c857c172f
[==> Ready to receive orders from authenticated user Galoget with us
hackem.log{ Verifying sample 'fail_1' against user with userId: usr_7354ce793c34417f9599d93c857c172f
[==> You were not authenticated, you are not an authorized user.
hackem.log{ Verifying sample 'fail_2' against user with userId: usr_7354ce793c34417f9599d93c857c172f
[==> You were not authenticated, you are not an authorized user.
hackem.log{ Verifying sample 'fail_3' against user with userId: usr_7354ce793c34417f9599d93c857c172f
[==> You were not authenticated, you are not an authorized user.
hackem.log{ Deleting Test User and Voice Enrollment registries... }
[==> Deleted user with userId : usr_7354ce793c34417f9599d93c857c172f

```

Fig. 6. VoiceIt JSON API log (before interfacing with Voice-Command), indicating successful and failed user authentication attempts.

However, these results are indicative of the service's capability to recognize users at a variety of volume and distance ranges. In cases of authentication imprecision, VoiceIt's confidence level may be regulated (by direct request to the service providers) in order to decrease the number of false positives as well as false negatives.

V. CONCLUSION

The presented gripper system is tailored to respond specifically to KEWAZO's requirements and is successful in satisfying the most crucial ones. Two requirements need further attention: the opening and closing speed needs to be reduced, as the current value would be probably considered unacceptable in the industry. The weight of the system lies in the acceptable range but could be decreased in the future development. Moreover, given that the work presented in this paper concerns principally the conceptual design of the gripper, some aspects are not evaluated. The interface, cost, and power consumption requirements stated in the same section shall be evaluated in a later stage of the project. The interface to the arm is still at the early prototype stage, being both the gripper and the arm conceptual. Cost must be evaluated with an analysis of the materials and manufacturing method, after the detailing of the gripper components. Self-locking would greatly enhance energy efficiency, but this factor must be assessed after selecting the right servo for the system and the embedment of other electronic components such as sensors.

The voice identification / authentication & command mechanism successfully performs under laboratory conditions in a controlled environment, which may not be presupposed in a real-world scenario. For example, although VoiceIt claims its service is capable of noise-cancelling as well as voiceprint adaptation over time (to account for minor variations in the voice of *enrolled* users due to sickness and/or the natural aging process), further field tests must be conducted to verify consistently reliable performance.

Notwithstanding this caveat, the voice identification / authentication and control mechanism demonstrates the potential of a more intuitive way of communicating between human and non-human agents in collaborative tasks in the context of construction robotics or, for example, in the discourse of Intelligent Built-Environments. Furthermore, said mechanism is one of several cloud-based mechanisms subsumable by the system that enhance HCI. For example, the authors have previously developed *Machine Learning* (ML)-based *Human Activity Recognition* [21] and *Object and Facial-Identity and -Expression Recognition* mechanisms [22], two mechanisms that may be implemented into the present system in order to increase context-awareness and interaction pertinence.

ACKNOWLEDGEMENT

This paper has profited from the contribution of Ekaterina Grib, Artem Kuchukov, Leonidas Pozikidis, Eirini Psallida, Alimzhan Rakhmatulin, and Sebastian Weitzel, members of KEWAZO® GmbH; and from the guidance of Lukas Richter, of the Institute of Machine Tools and Industrial Management at Technische Universität München. Furthermore, as the present work has bearing over the *Design-to-Robotic-Production, -Assembly, and -Operation* discourse [23], the authors wish to acknowledge Henriette Bier, Director of Robotic Building, Technische Universiteit Delft, for her advice.

REFERENCES

- [1] T. Bock, "Construction Robotics enabling Innovative Disruption and Social Supportability," in *Proceedings of the 32nd International Symposium on Automation and Robotics in Construction (ISARC 2015)*, 2015, p. 1.
- [2] T. Bock and T. Linner, *Robot-Oriented Design: Design and Management Tools for the Deployment of Automation and Robotics in Construction*. Cambridge: Cambridge University Press, 2015.
- [3] B. Chu, K. Jung, C.-S. Han, and D. Hong, "A survey of climbing robots: Locomotion and adhesion," *International Journal of Precision Engineering and Manufacturing*, vol. 11, no. 4, pp. 633–647, 2010.
- [4] KEWAZO®, *KEWAZO: Smart Robotic Scaffolding Transportation System*. [Online] Available: <https://www.kewazo.com/>. Accessed on: May 04 2018.
- [5] A. Wolf and R. Steinmann, *Greifer in Bewegung: Faszination der Automatisierung von Handhabungsaufgaben*. München: Hanser, 2004.
- [6] Y. Yoon and D. Rus, "Shady3D: A Robot that Climbs 3D Trusses," in *IEEE International Conference on Robotics and Automation, 2007: 10 - 14 April 2007, [Roma, Italy]*, Piscataway, NJ, Piscataway, NJ: IEEE Service Center, 2007, pp. 4071–4076.
- [7] C. Balaguer, A. Giménez, J. M. Pastor, V. M. Padrón, and M. Abderrahim, "A climbing autonomous robot for inspection applications in 3D complex environments," *Robotica*, vol. 18, no. 3, pp. 287–297, 2000.
- [8] M. Vona, C. Detweiler, and D. Rus, "Shady: Robust Truss Climbing with Mechanical Compliances," in *Springer Tracts in Advanced Robotics*, vol. 39, *Experimental robotics: The 10th International Symposium on Experimental Robotics*, O. Khatib, V. Kumar, and D. Rus, Eds., Berlin: Springer, 2008, pp. 431–440.
- [9] J. S. Dai, M. Zoppi, and X. Kong, *Reconfigurable Mechanisms and Robots* (English): KC Edizioni.
- [10] M. Tavakoli, L. Marques, and A. T. de Almeida, "A low-cost approach for self-calibration of climbing robots," *Robotica*, vol. 29, no. 01, pp. 23–34, 2011.
- [11] J. - C. Fauroux and J. Morillon, "Design of a climbing robot for cylindrical - conic poles based on rolling self - locking," *Industrial Robot*, vol. 37, no. 3, pp. 287–292, 2010.
- [12] J. Mämpel, S. Köhring, C. Schilling, and H. Witte, "Using Different Adhesion Technologies in Modular Robot for Climbing," in *Robotics (ISR), 2010 41st International Symposium on and 2010 6th German Conference on Robotics (ROBOTIK)*, 2010.
- [13] Y. Guan *et al.*, "Climbot: A modular bio-inspired biped climbing robot," in *2011 IEEE/RSJ International Conference on Intelligent Robots and Systems*, [Place of publication not identified]: IEEE, 2011, pp. 1473–1478.
- [14] L. Jiang, Y. Guan, X. Zhou, X. Zhang, and H. Zhang, "Grasping analysis for a biped climbing robot," in *IEEE-ROBIO 2010: 2010 IEEE International Conference on Robotics and Biomimetics : December 14-18, 2010, Tianjin, China*, Piscataway, N.J.: IEEE, 2010, pp. 579–584.
- [15] J. Schmalz and G. Reinhart, "Automated Selection and Dimensioning of Gripper Systems," *Procedia CIRP*, vol. 23, pp. 212–216, 2014.
- [16] P. Pedrazzoli, R. Rinaldi, and C. R. Boer, "A rule based approach to the gripper selection issue for the assembly process," in *Assembly and Task Planning, Proceedings of the IEEE International Symposium on Assembly and Task Planning (ISATP) 2001*: IEEE, 2001, pp. 202–207.
- [17] S. Hesse, *Greifertechnik: Effektoren für Roboter und Automaten*. München: Hanser, Carl, 2011.
- [18] VoiceIt®, *Your Voice Is Key®: Cloud Based Biometrics Service*. [Online] Available: <https://voiceit.io/>. Accessed on: May 30 2018.
- [19] A. Liu Cheng, "Machine Learning as enabler of Design-to-Robotic-Operation," *Archidoc*, vol. 6(1), no. 11, pp. 37–49, 2018.
- [20] Google Cloud Platform®, *Cloud Speech-to-Text: Speech to text conversion powered by machine learning and available for short or long-form audio*. [Online] Available: <https://cloud.google.com/speech-to-text/>. Accessed on: Apr. 25 2018.
- [21] A. Liu Cheng, H. Bier, G. Latorre, B. Kemper, and D. Fischer, "A High-Resolution Intelligence Implementation based on Design-to-Robotic-Production and -Operation strategies," in *Proceedings of the 34th International Symposium on Automation and Robotics in Construction (ISARC 2017)*, 2017.
- [22] A. Liu Cheng, H. Bier, and G. Latorre, "Actuation Confirmation and Negation via Facial-Identity and -Expression Recognition," in *Proceedings of the 3rd IEEE Ecuador Technical Chapters Meeting (ETCM) 2018*, 2018, in press.
- [23] H. Bier, Ed., *Robotic Building*, 1st ed.: Springer International Publishing AG, 2018.