

DESIGN BOOKLET

'TOGETHER, SELF-RELIANT'

Name: Coen Jager
Studio: Designing for Care
Student nr: 4993837
Date of edit: 30-06-2021

FINAL DESIGN

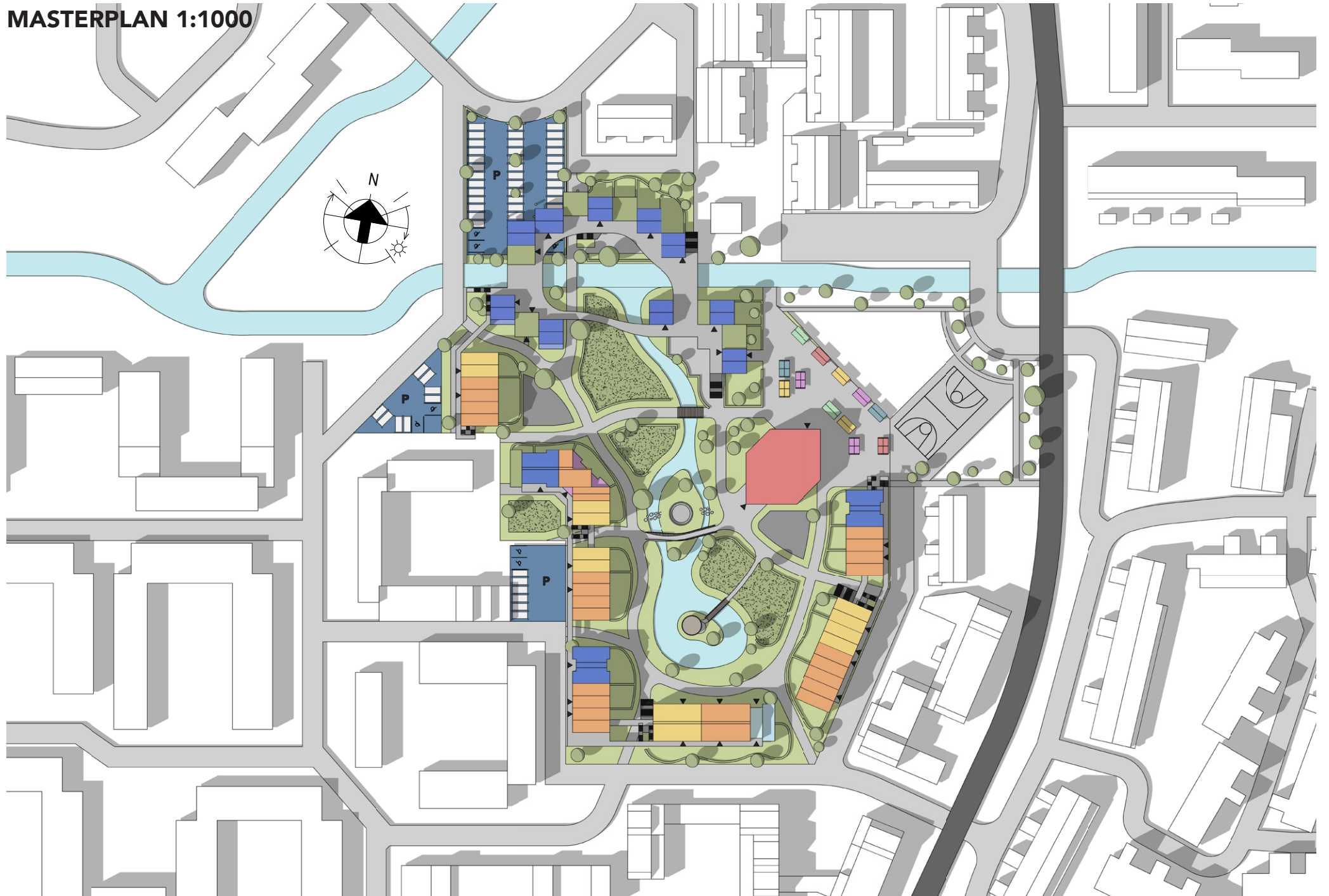

MASTERPLAN 3D

- Public amenity
- Shared amenity
- Shared greenhouse
- Family home (or co-housing)
- Co-housing homes
- Singles / Couples homes
- Consistent care homes

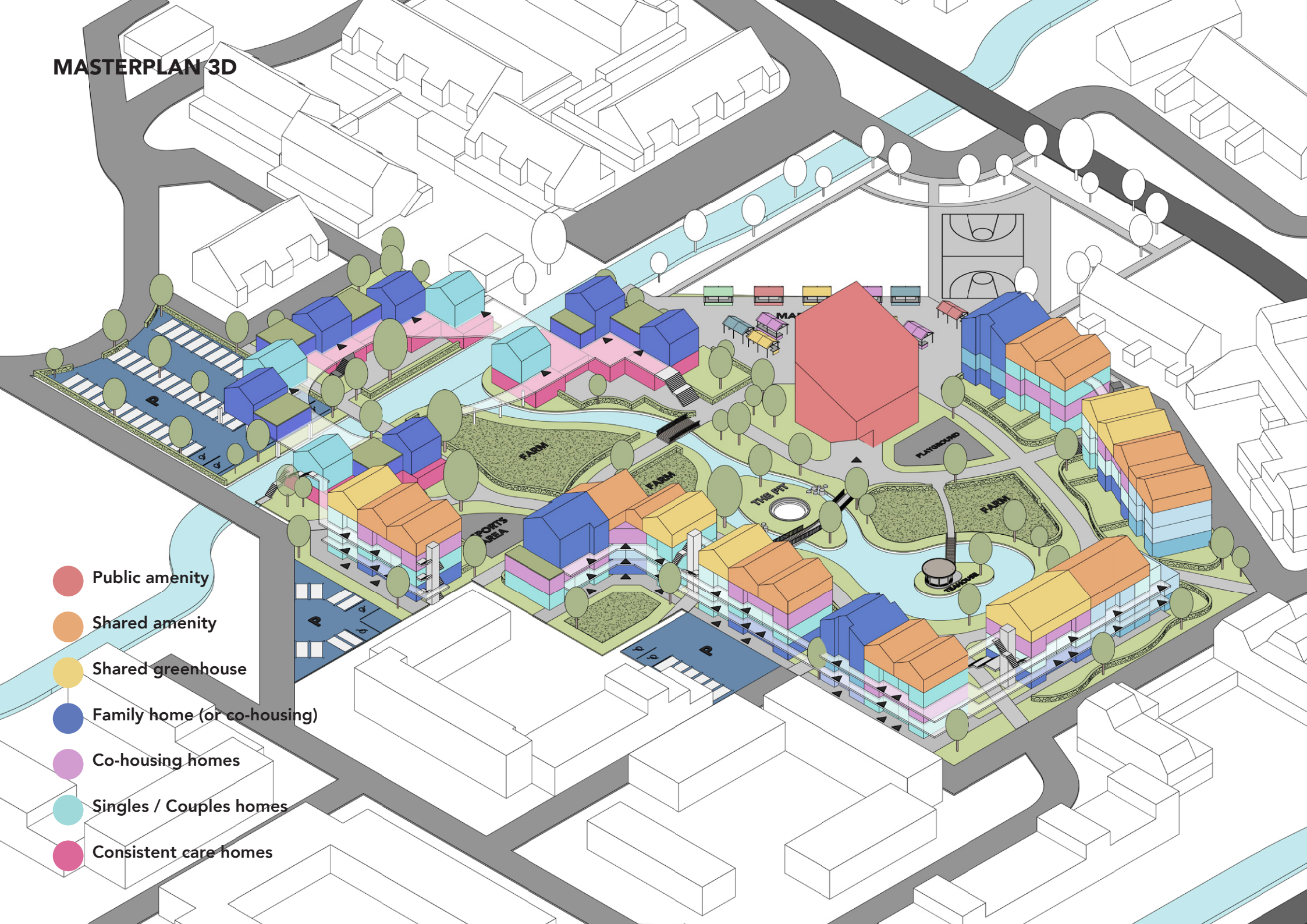

-1

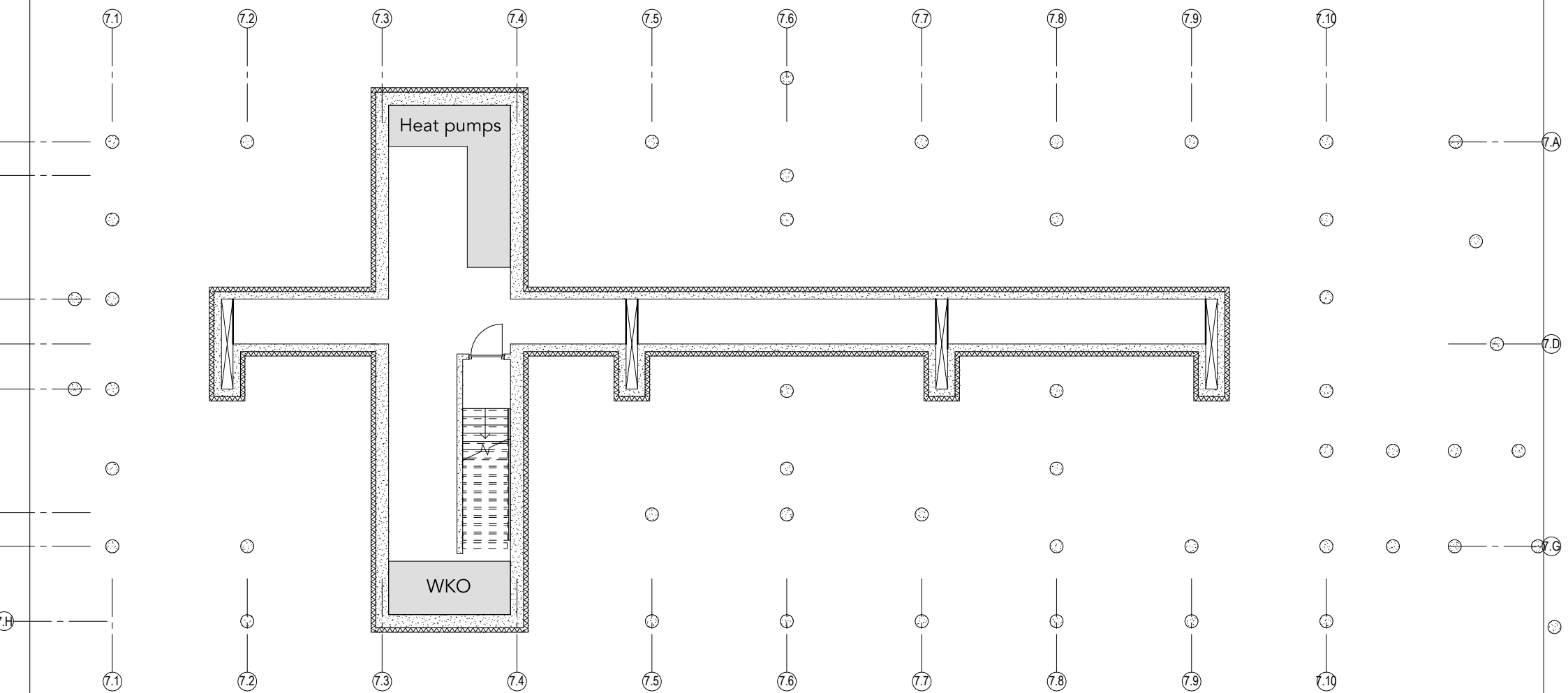

0

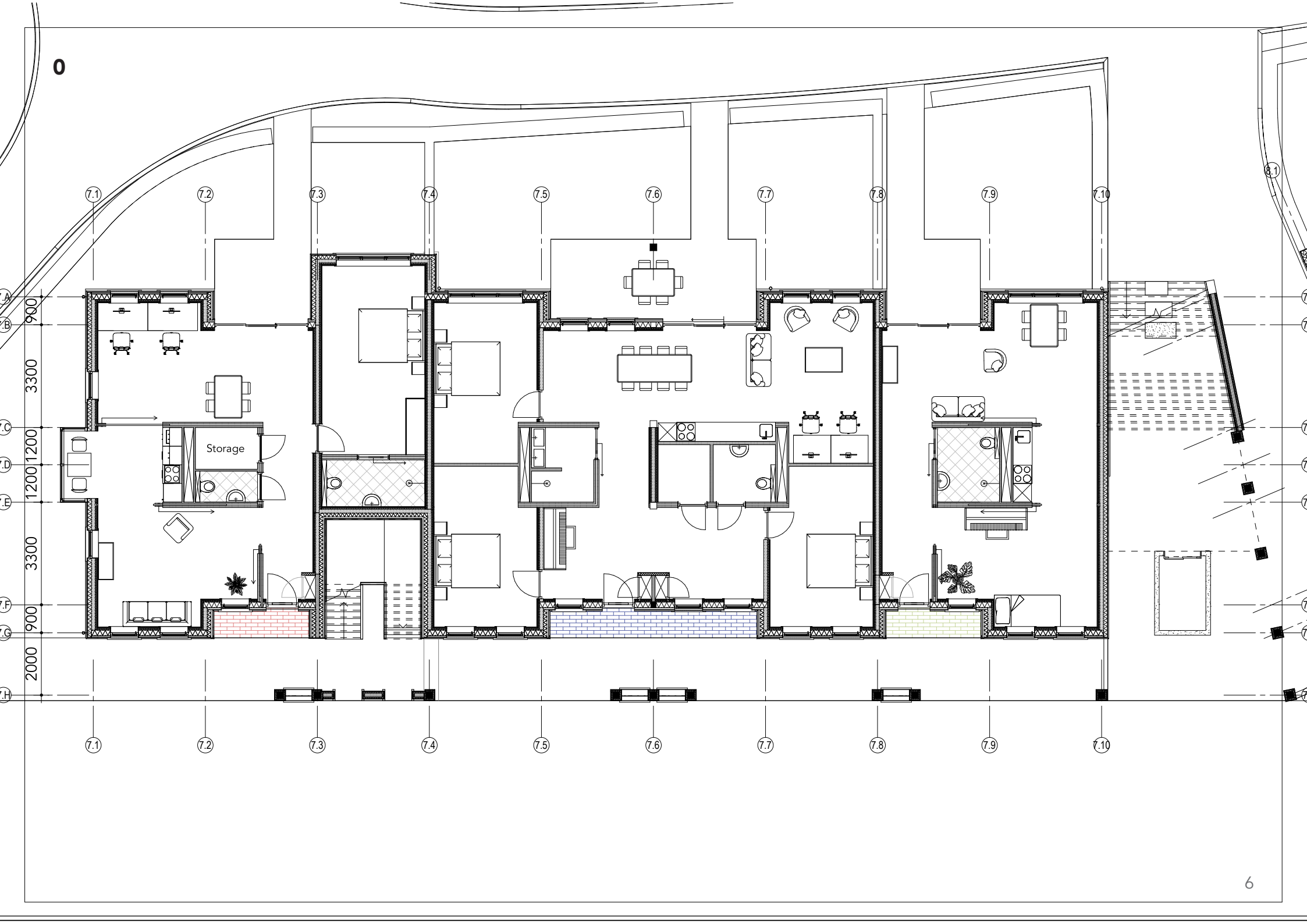

1

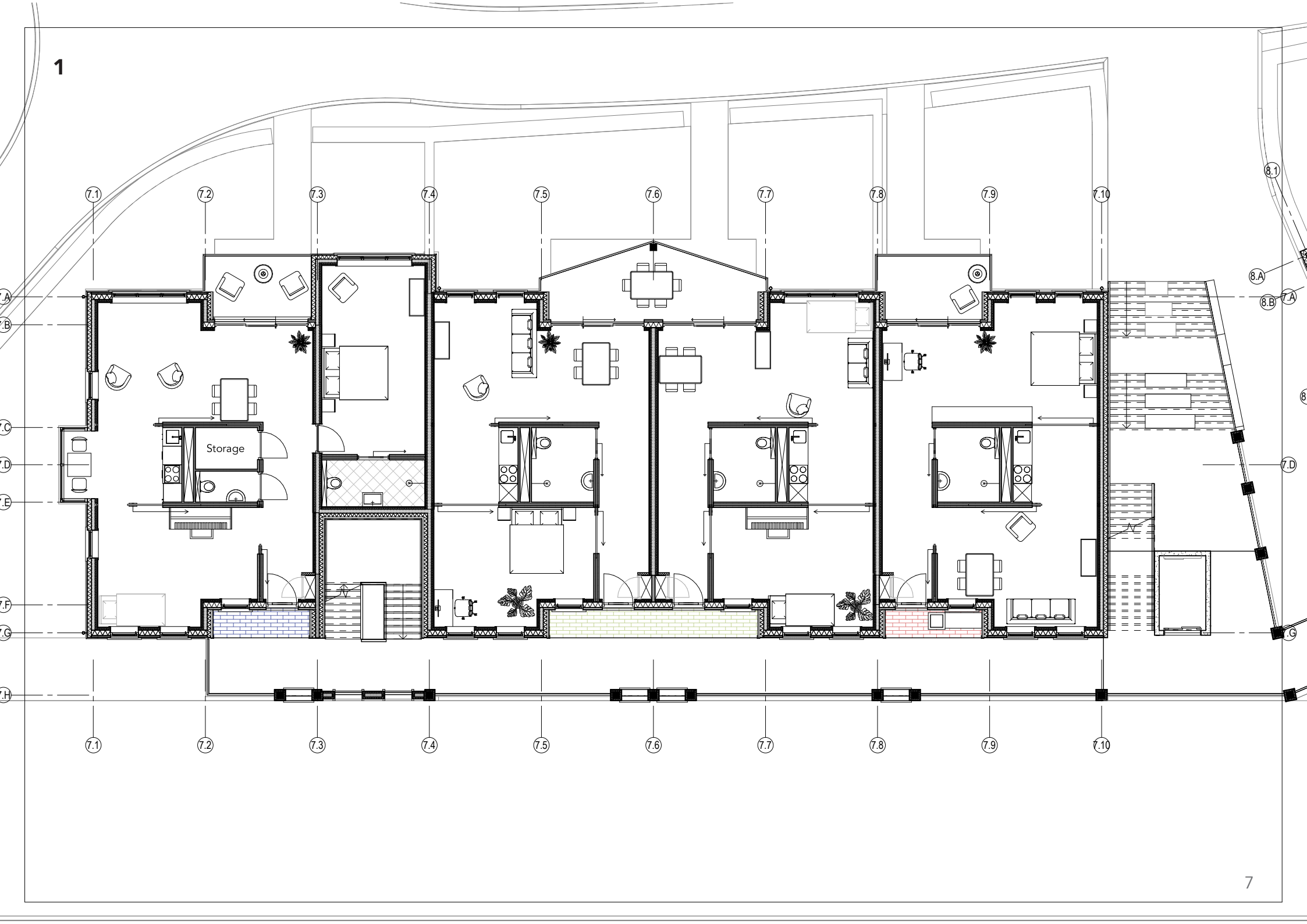

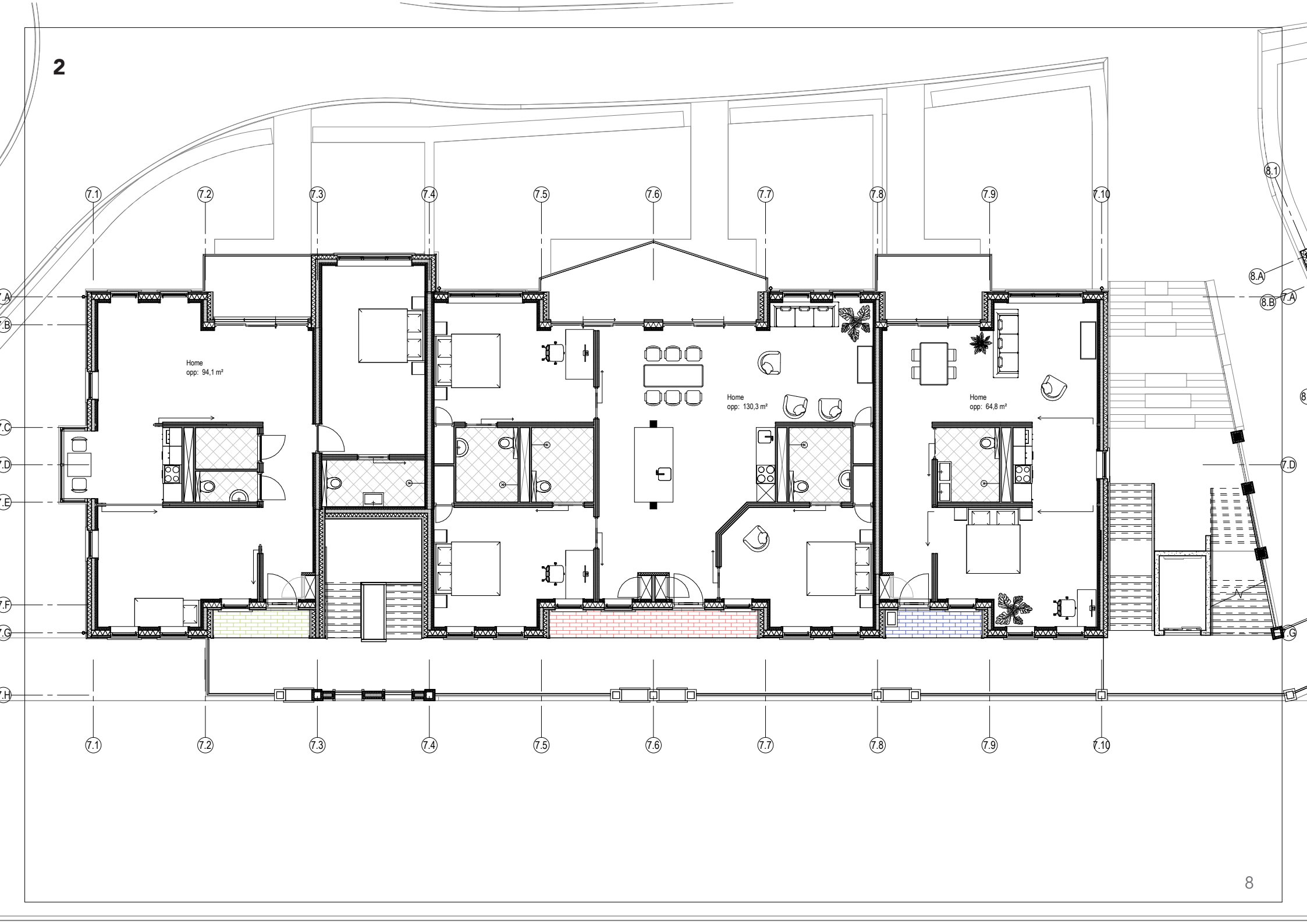

3

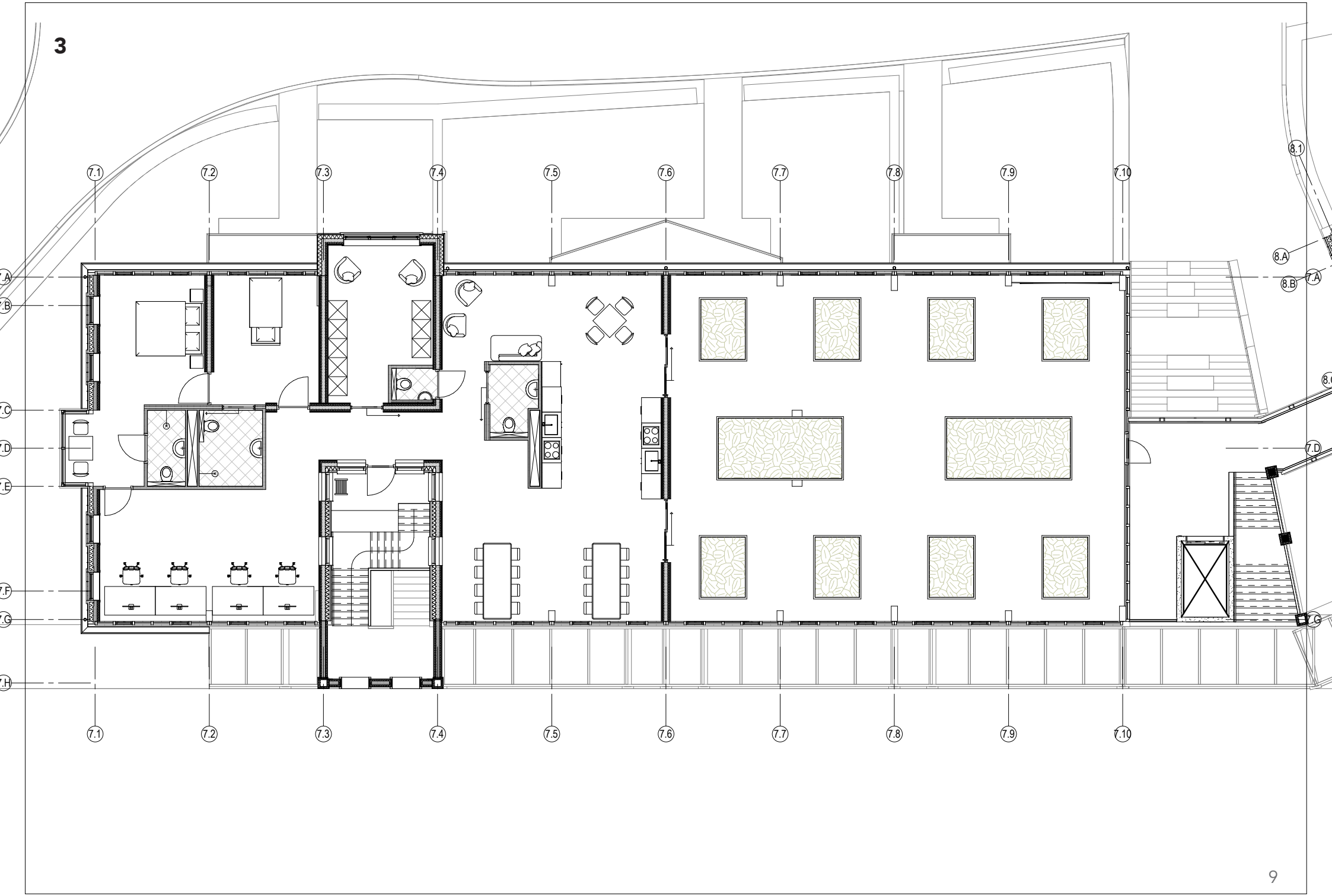

4

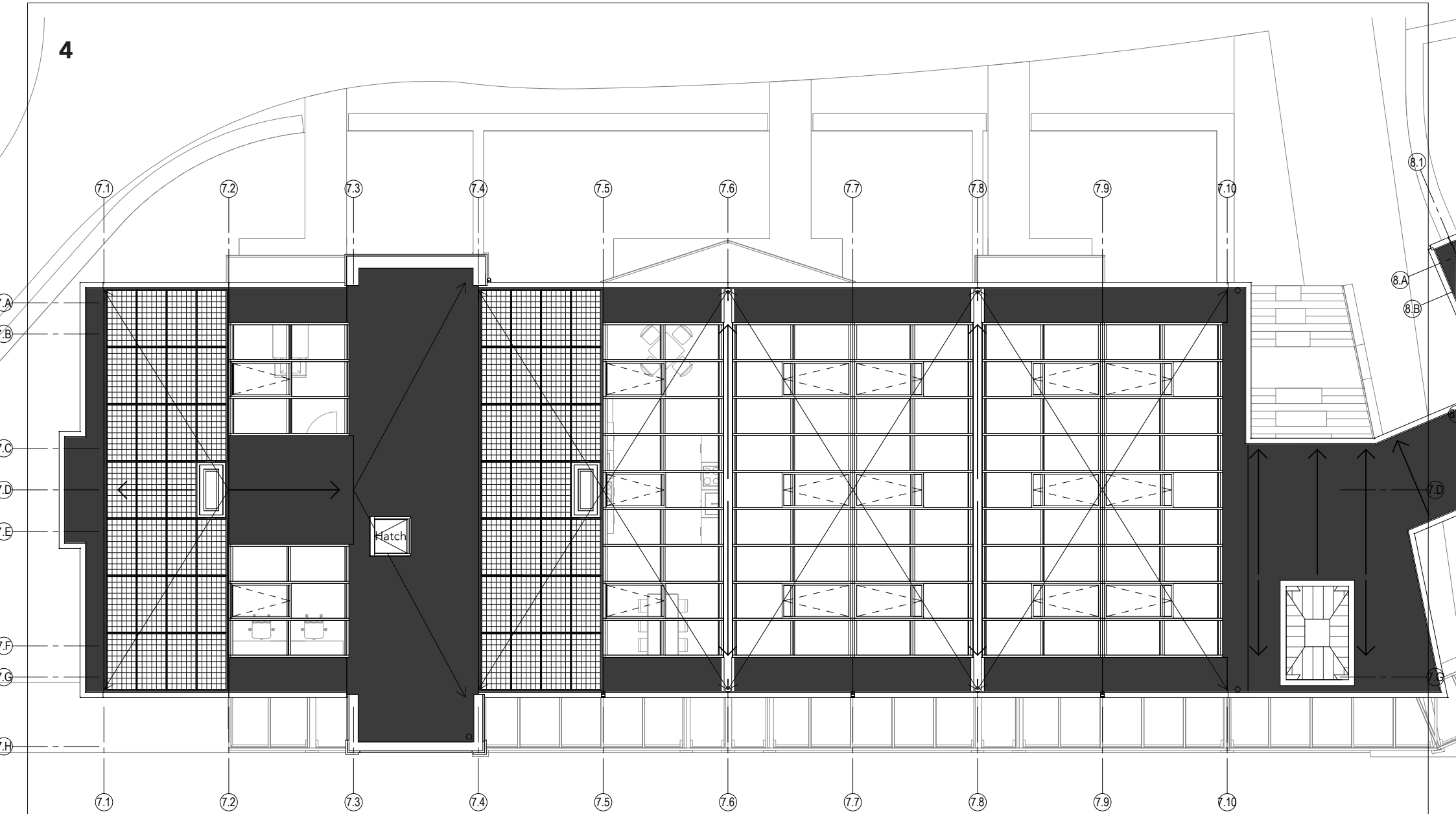

FACADES



CONSTRUCTION

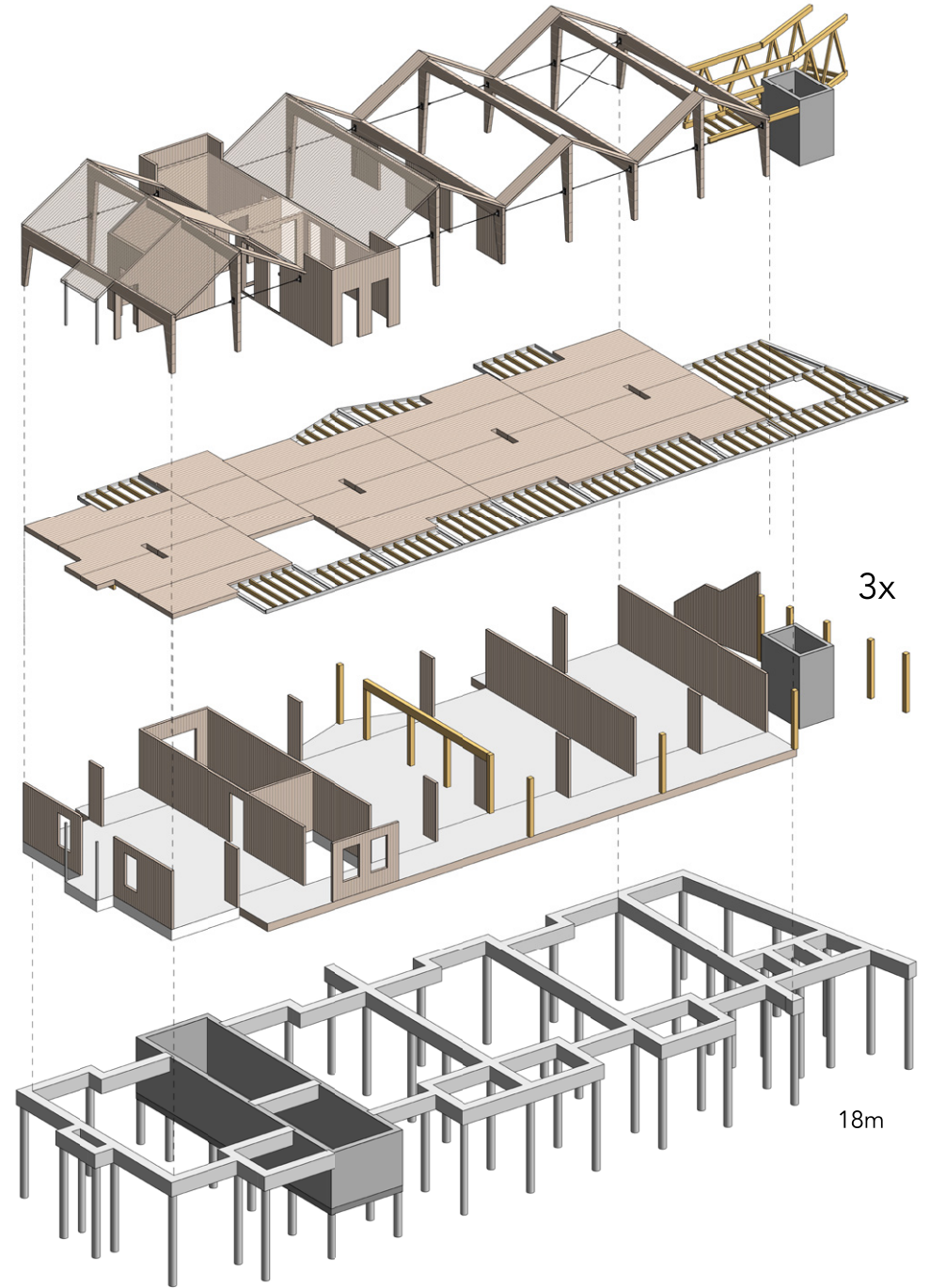
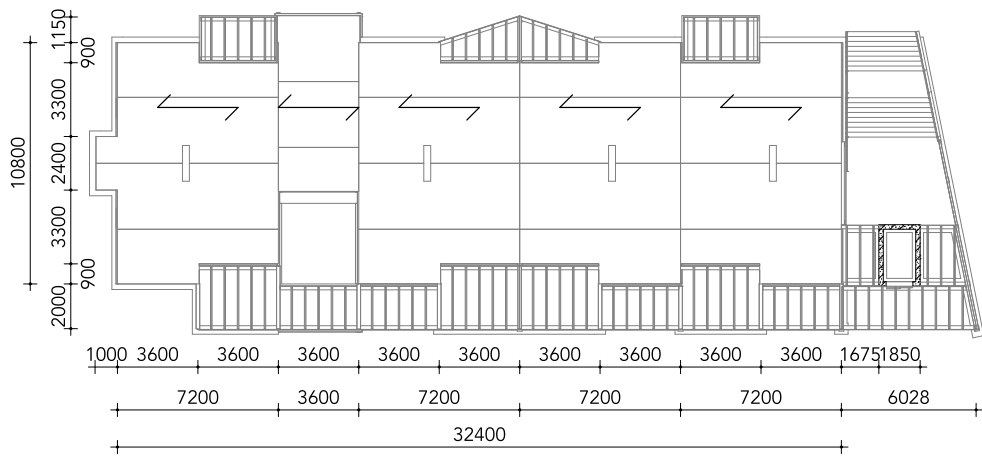

SECTION SHORT SIDE



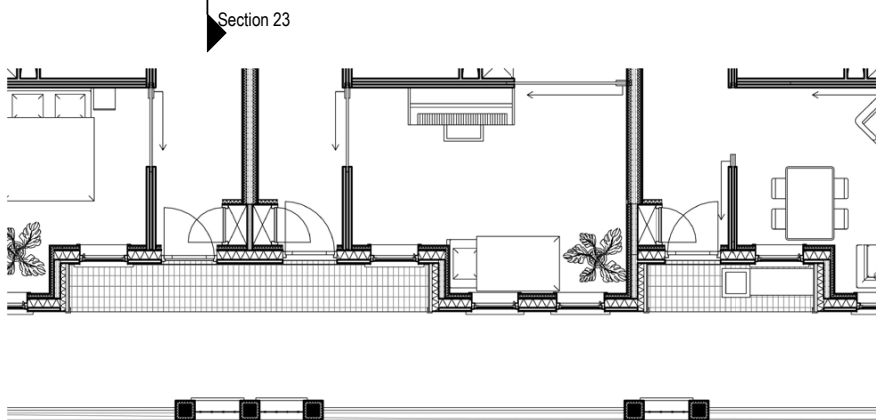
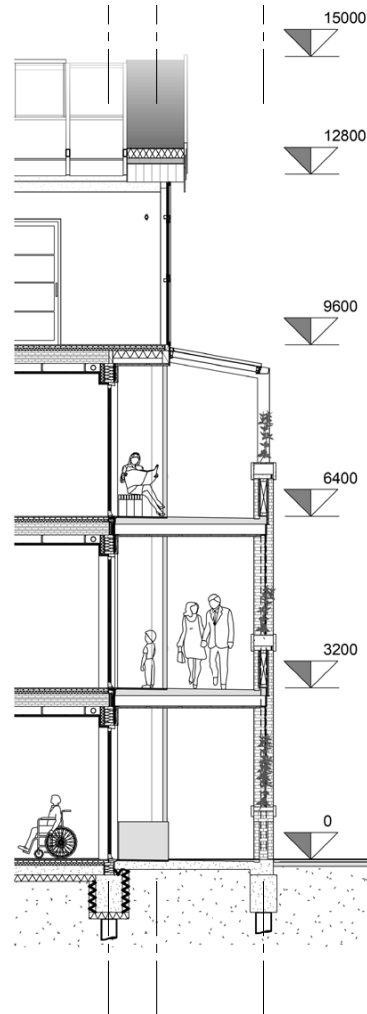

Solar panels on 30° south facing roofs

Greenhouse heats and cools naturally

Cross ventilated greenhouse

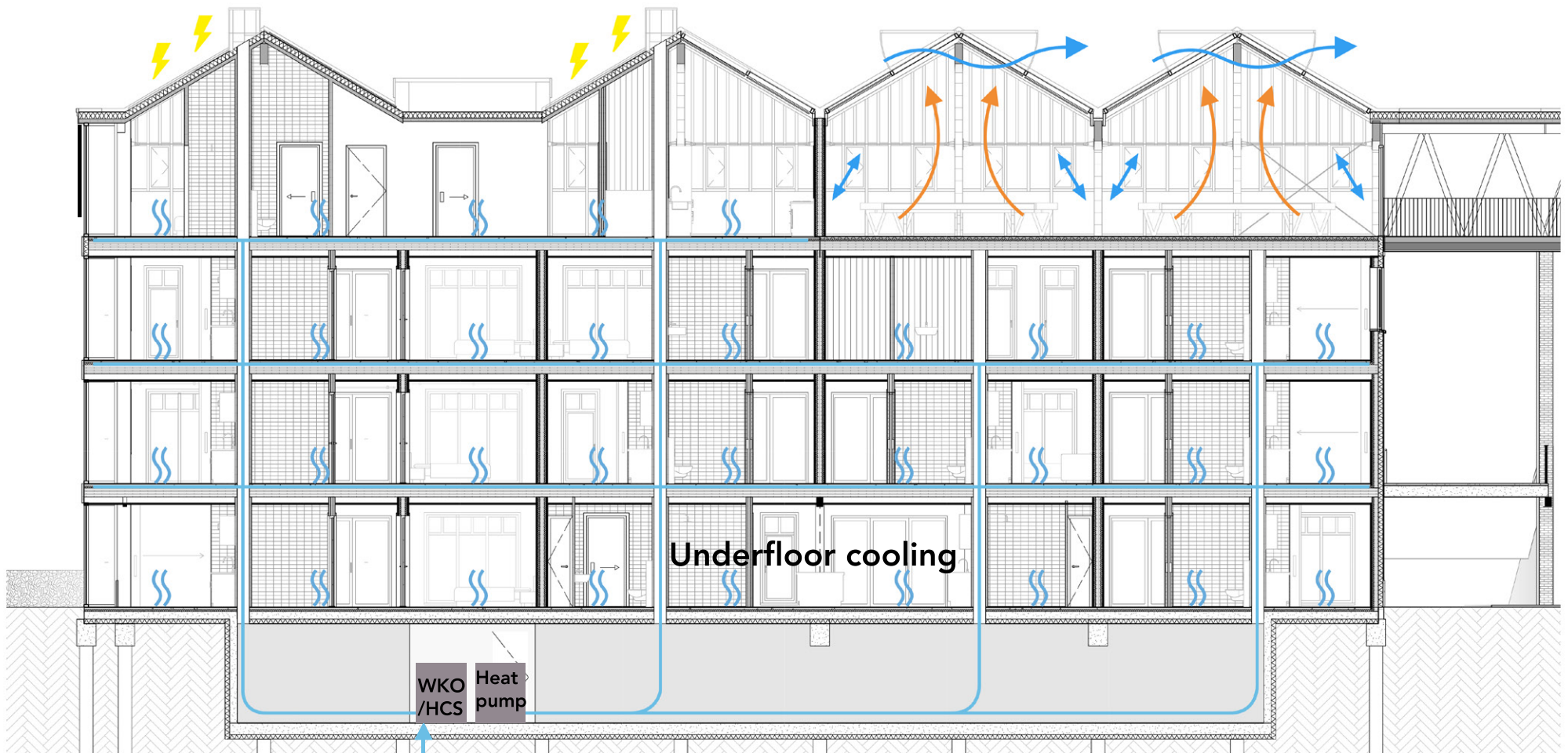

Underfloor cooling

WKO / HCS Heat pump

Underground cold water is used

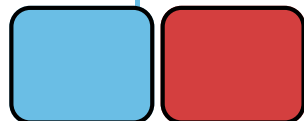

SUMMER SITUATION



Solar panels on 30° south facing roofs

Solar heat is used in the greenhouse

Windows closed

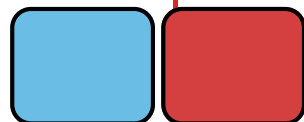
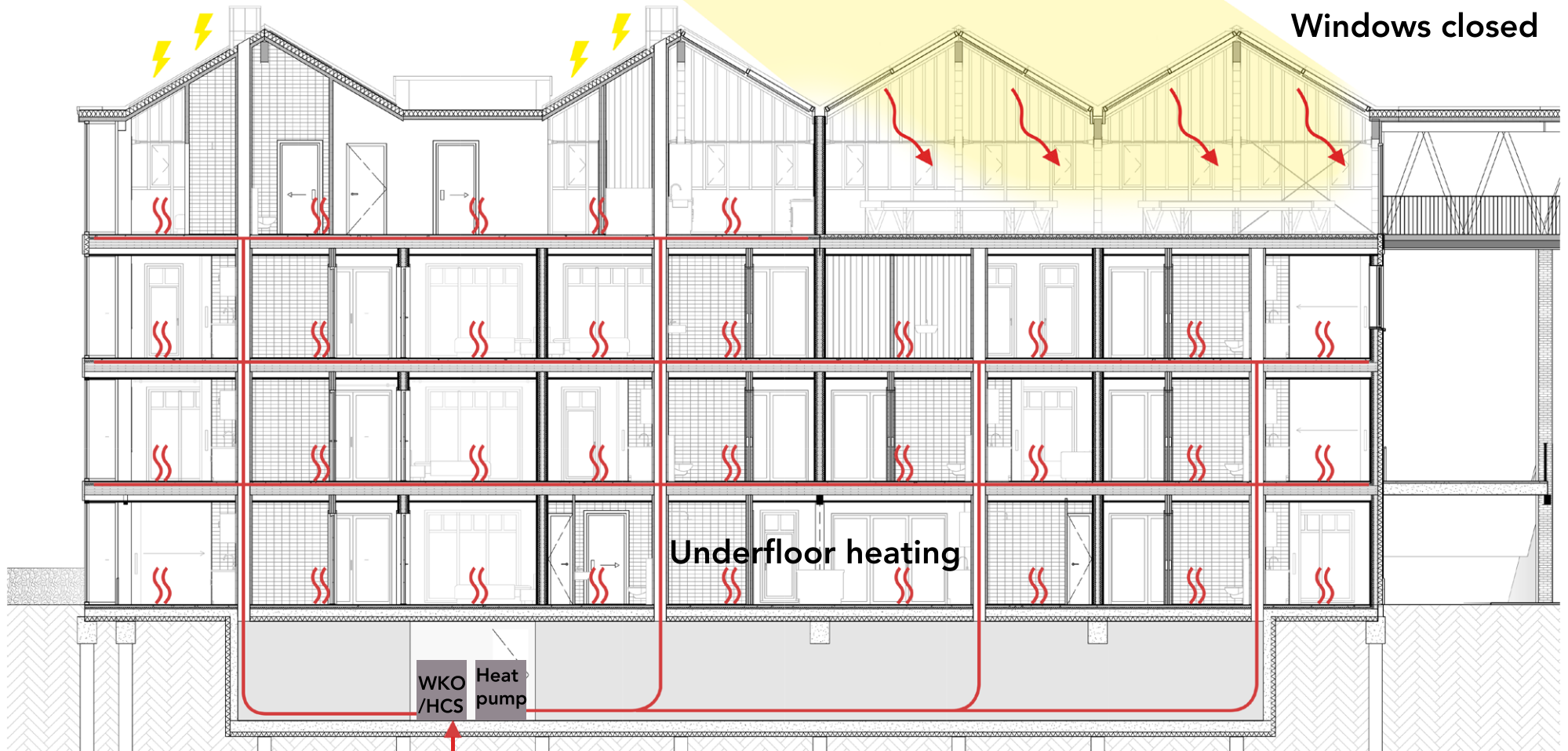

Underground warm water is used

WINTER SITUATION



VENTILATION

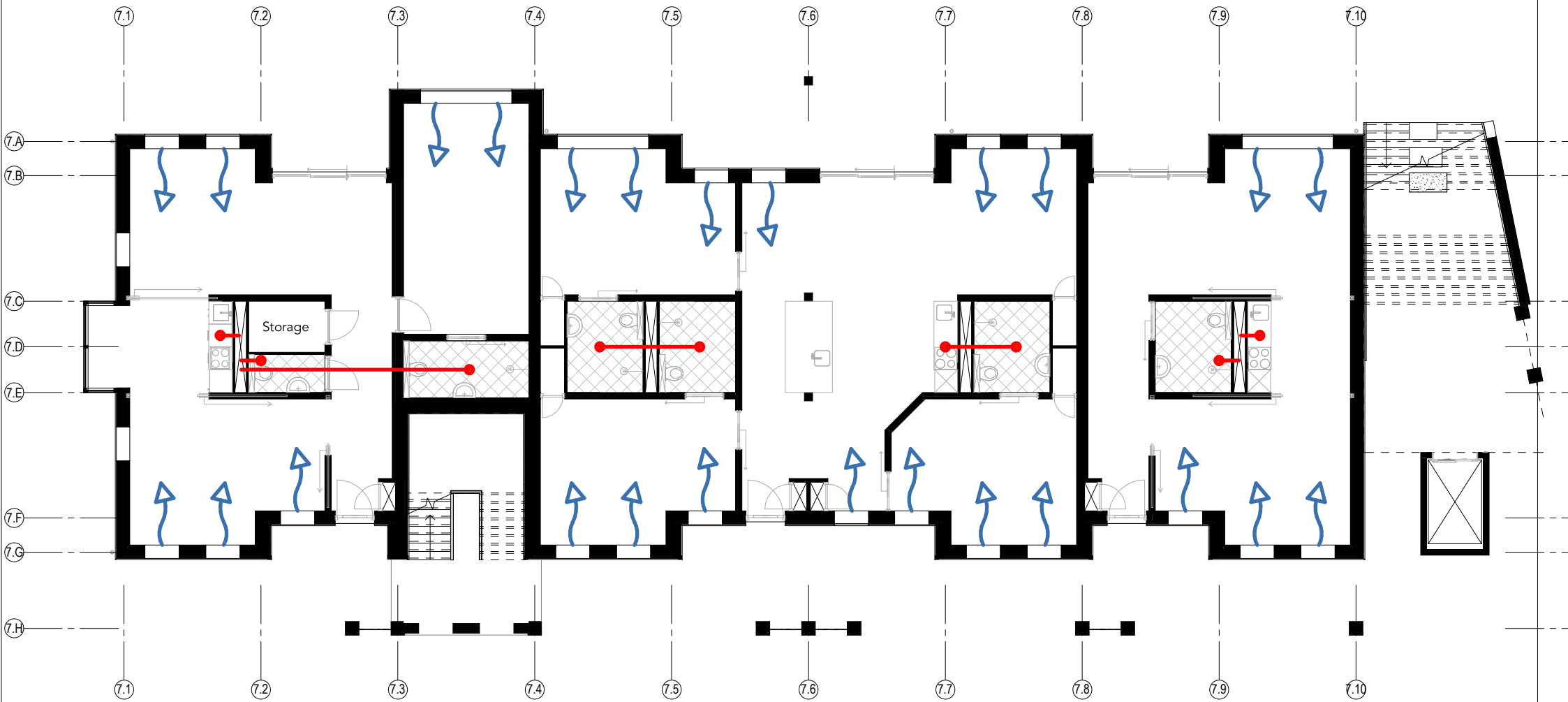

VENTILATION



DETAIL - GALLERY (V)

Floor structure:

- Wooden floor
- JK fermafloor (Fermacell with underfloor heating)
- Floor insulation
- CLT Floor 240mm
- Cavity 150mm
- Plywood
- Plasterboard 2 x 12,5mm

Wall structure:

- Vertical wooden plank finish
- Cavity with battens
- Waterproof layer
- Timberframe construction
- Installation cavity 50mm
- Plywood
- Plasterboard 2 x 12,5mm

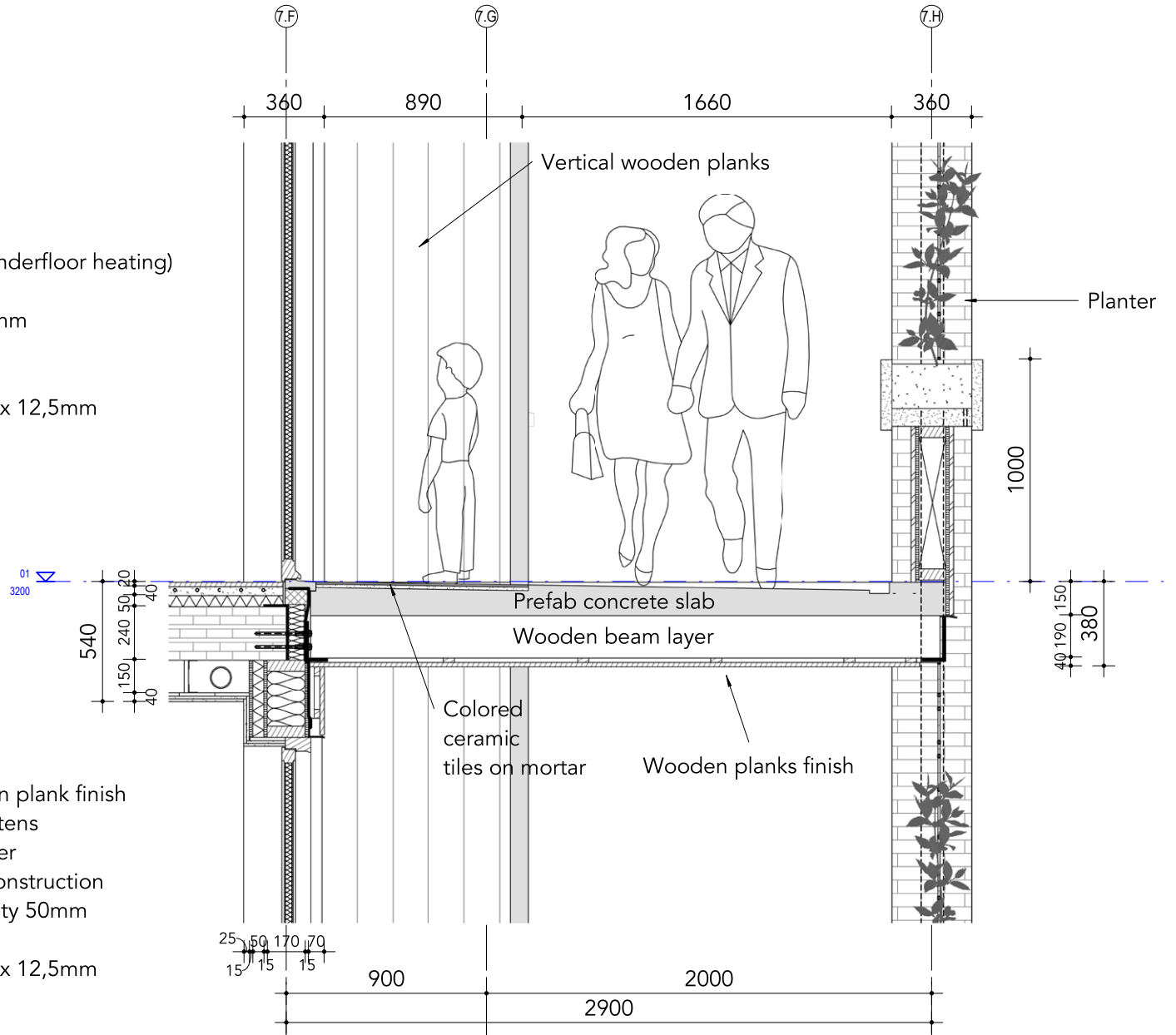

DETAIL - GALLERY (H)

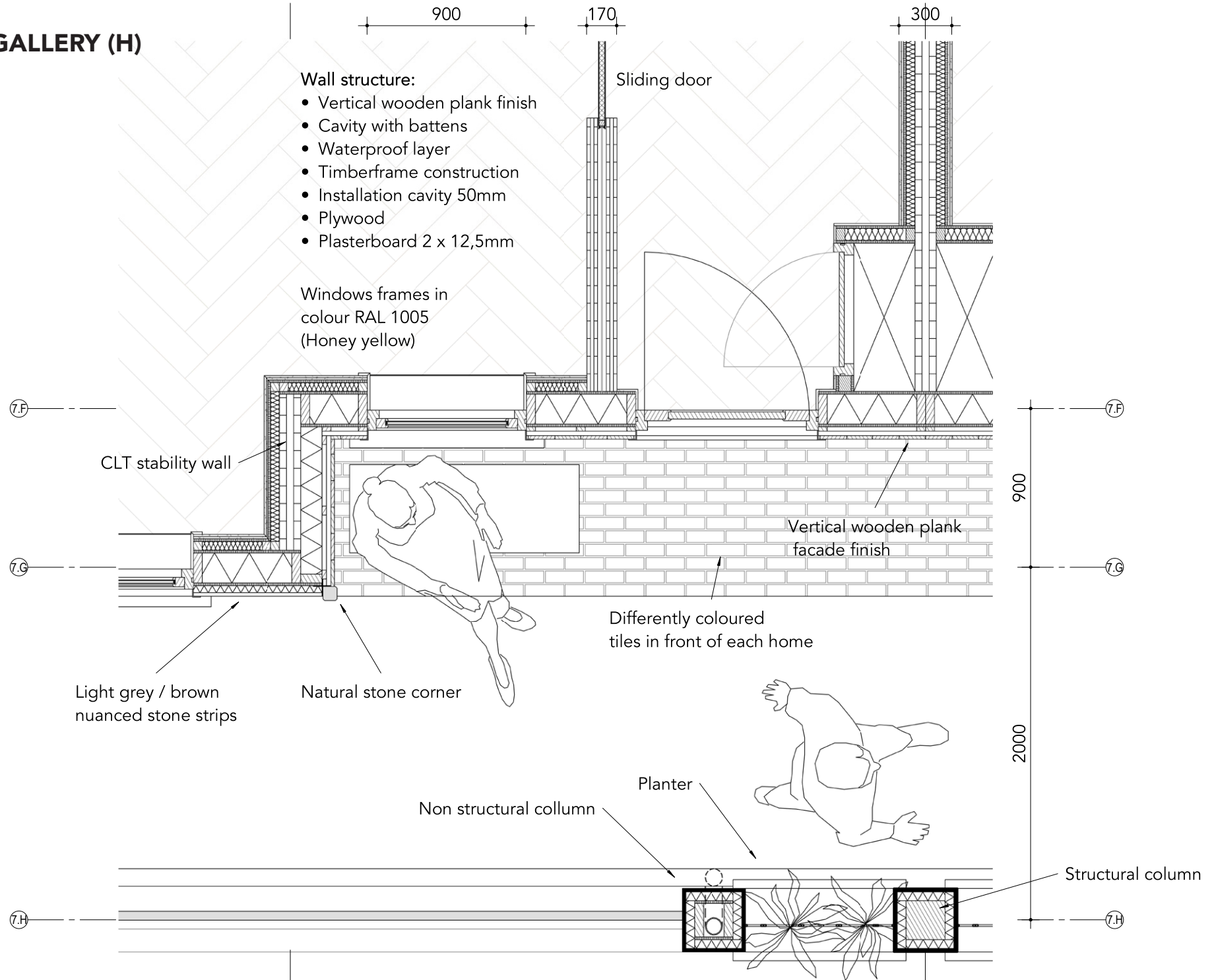

DETAIL - GREENHOUSE ROOF (V)

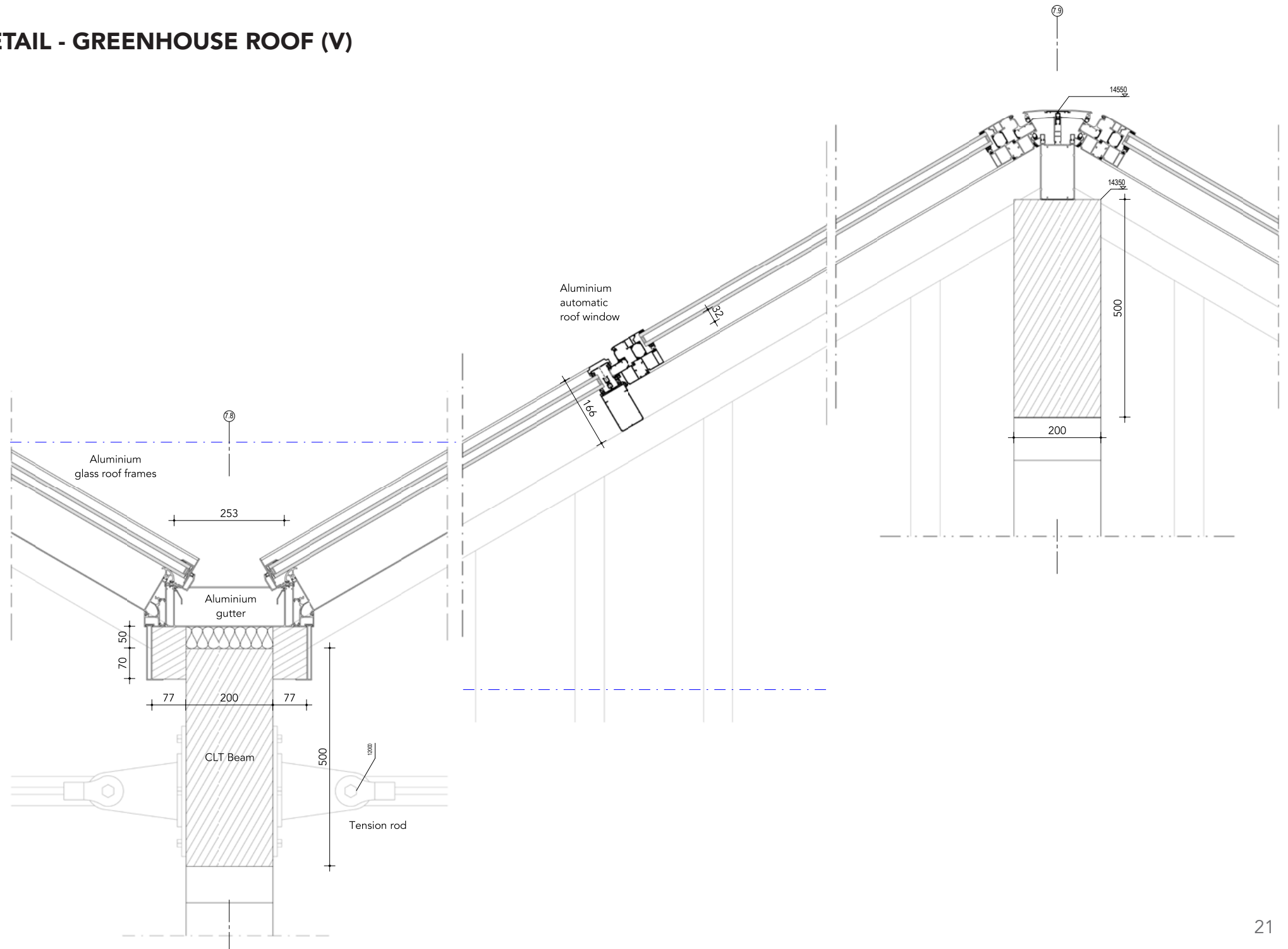

DETAIL - EAVES (V)

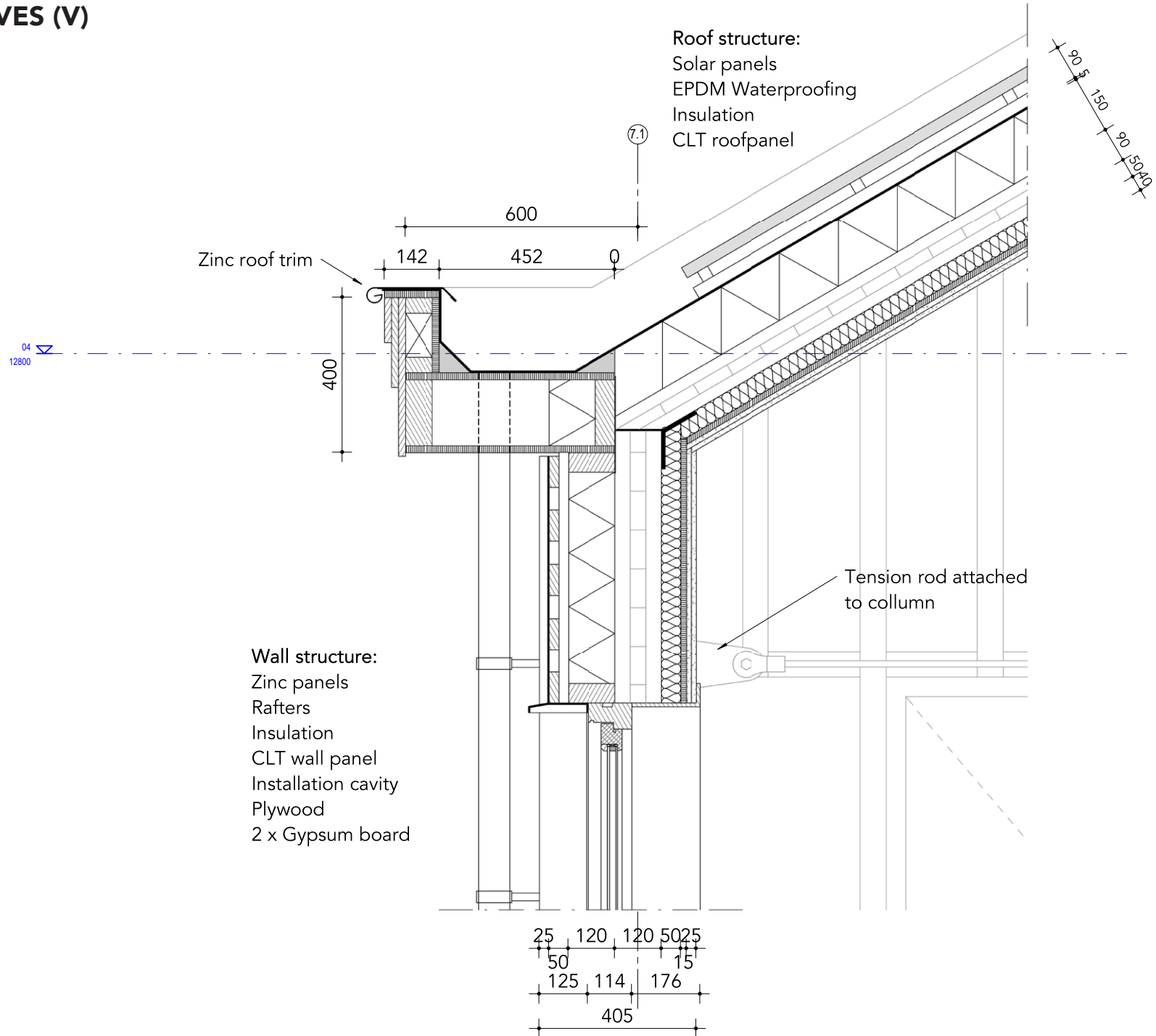

DETAIL - FOUNDATION (V)

Floor structure:

- Wooden floor
- JK fermafloor (Fermacell with underfloor heating)
- Floor insulation
- Concrete floor 200mm
- Floor insulation

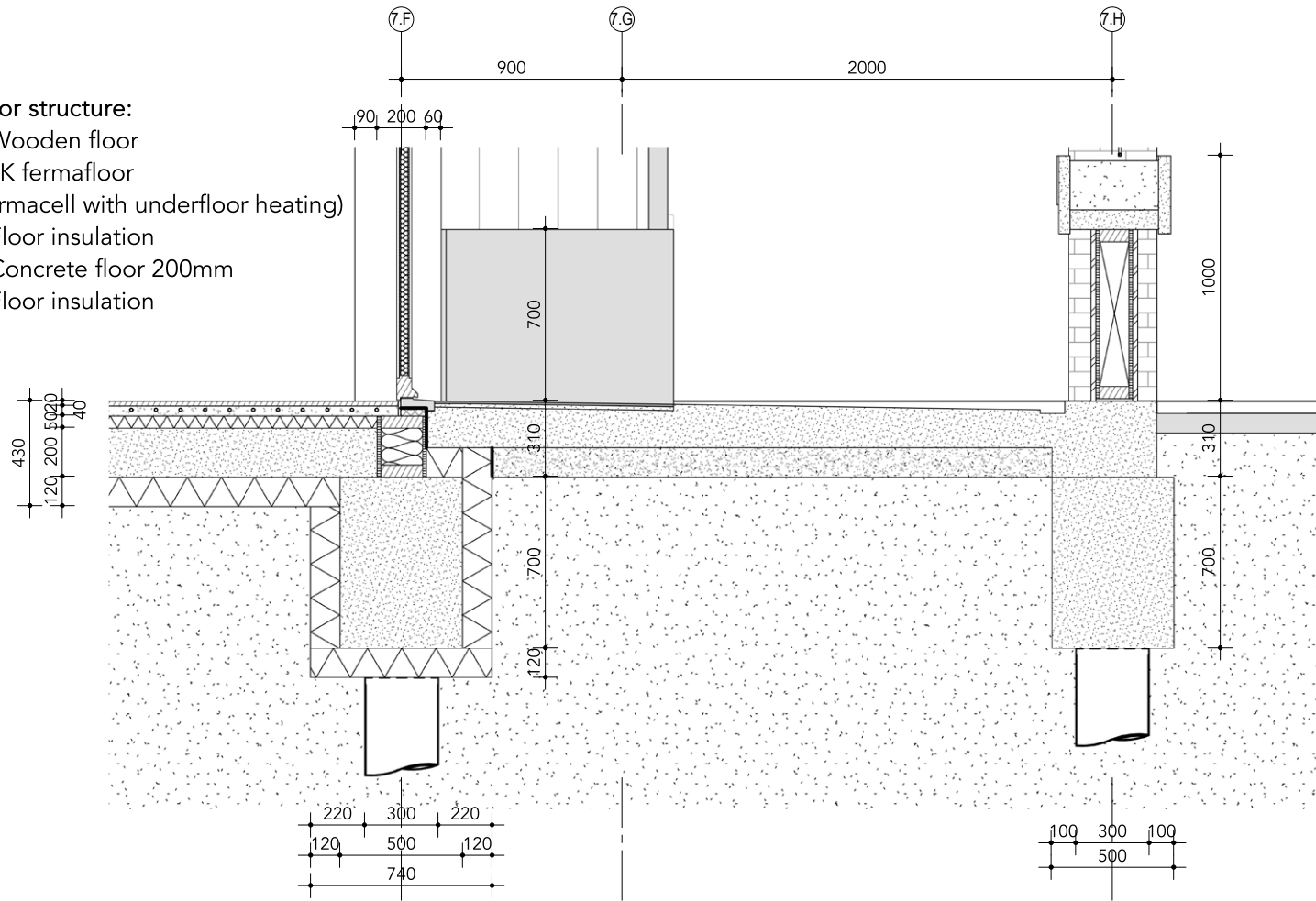

DETAIL - SLIDING DOOR (H)

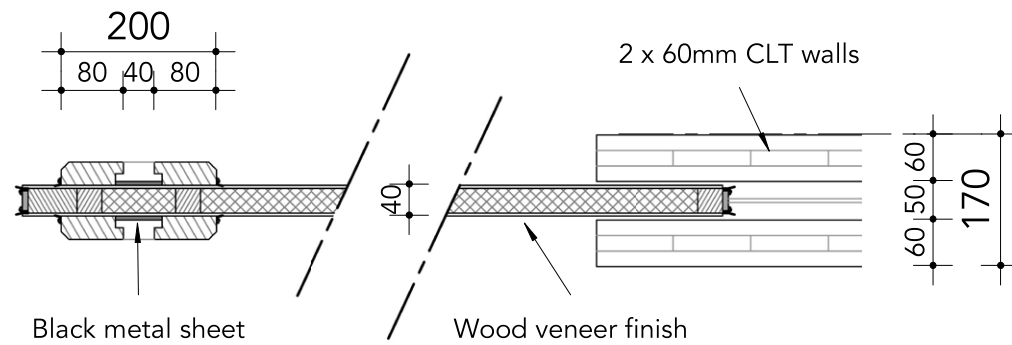
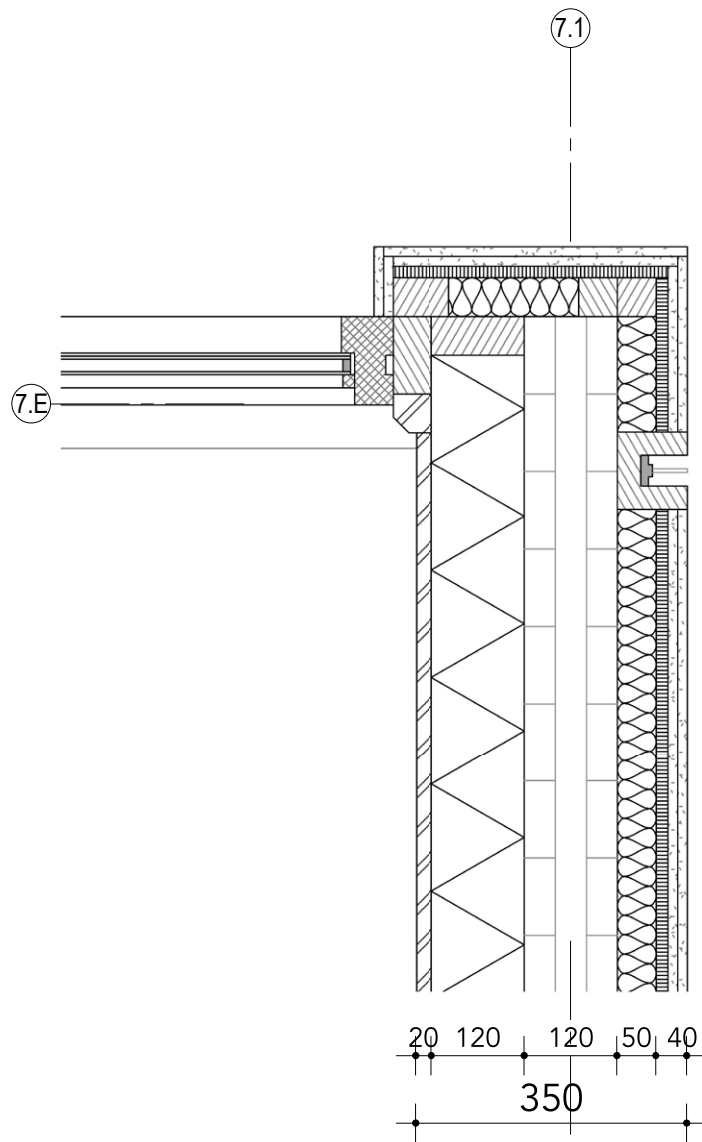

DETAIL - SLIDING DOOR (V)

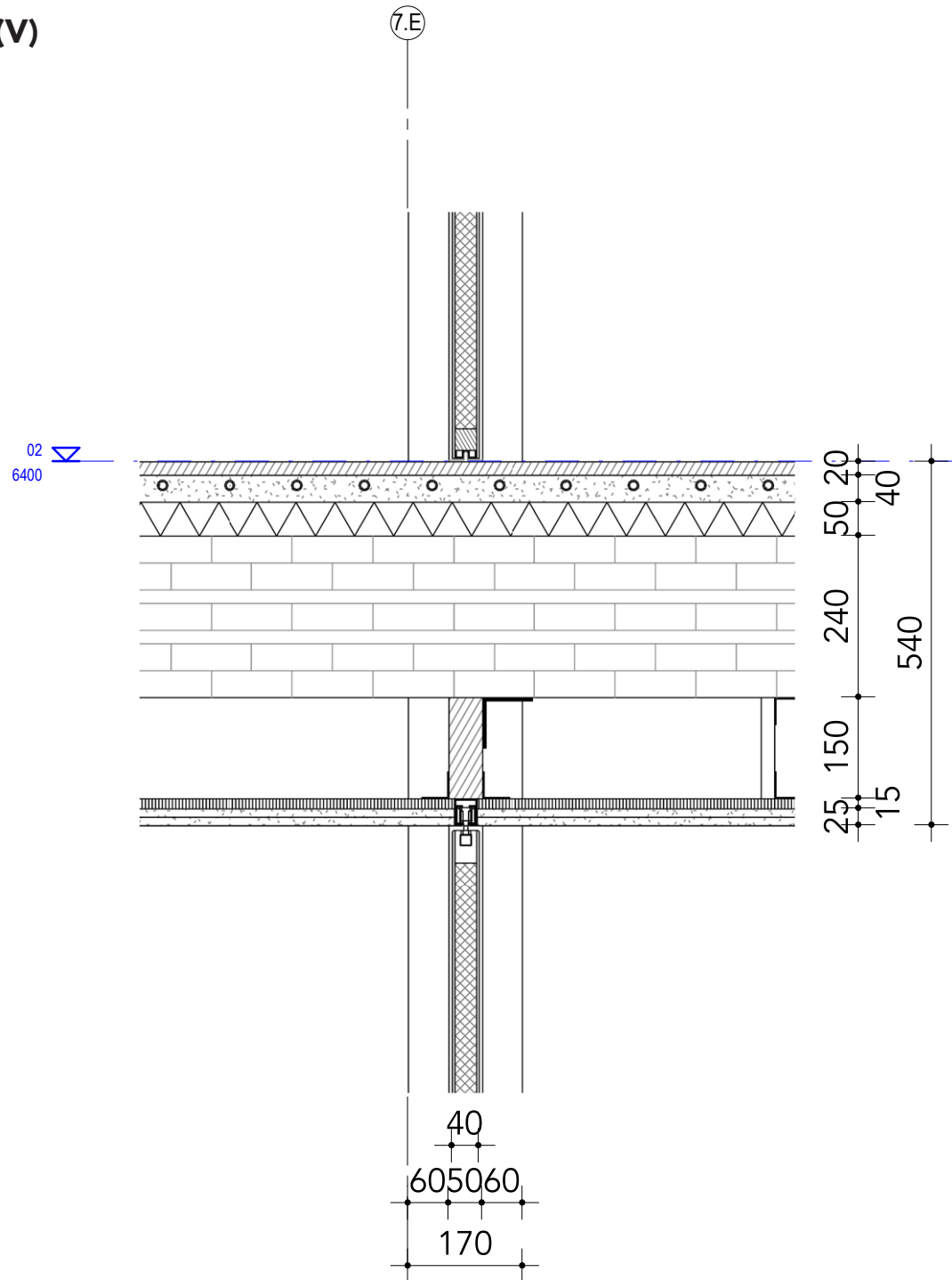

































MAIN PROGRESS DRAWINGS

CASE STUDY PLACEMENT

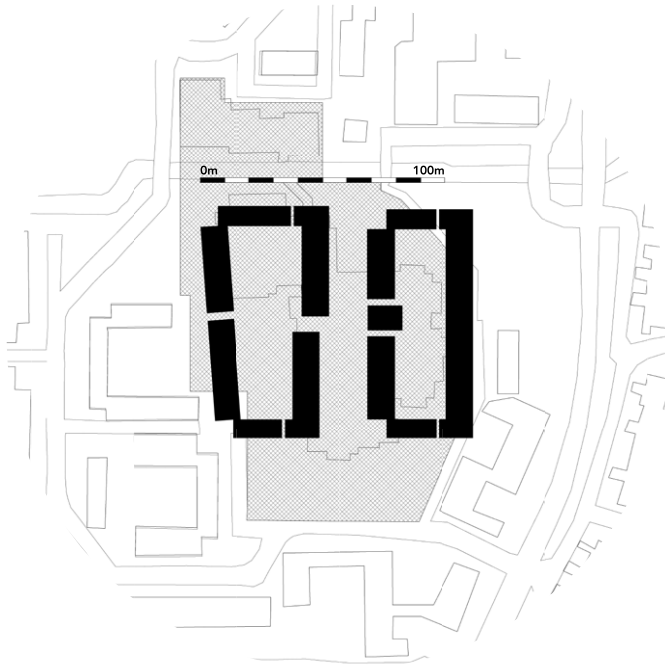

Knarrenhof nollisite placed in site location

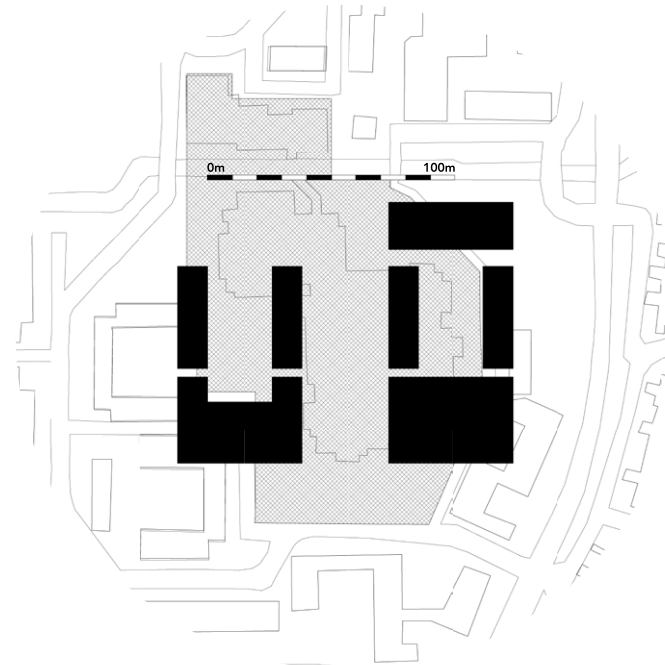

ParkEntree nollisite placed in site location

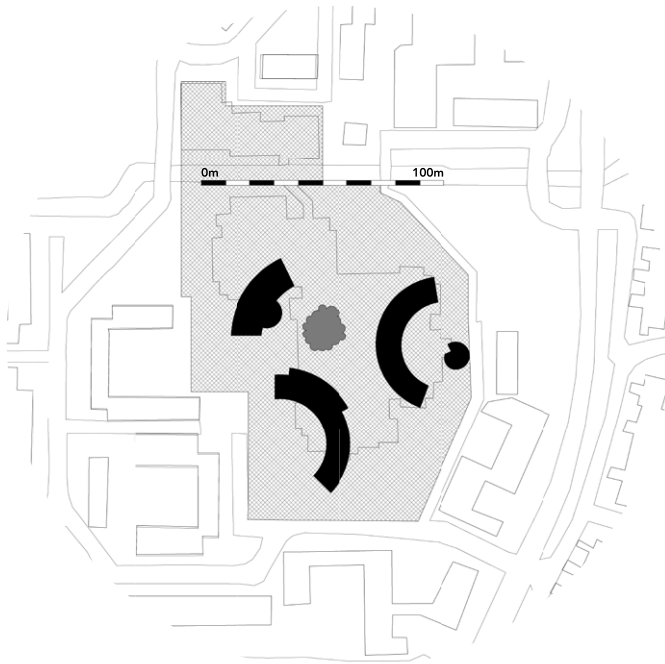

Eikpunt nollisite placed in site location

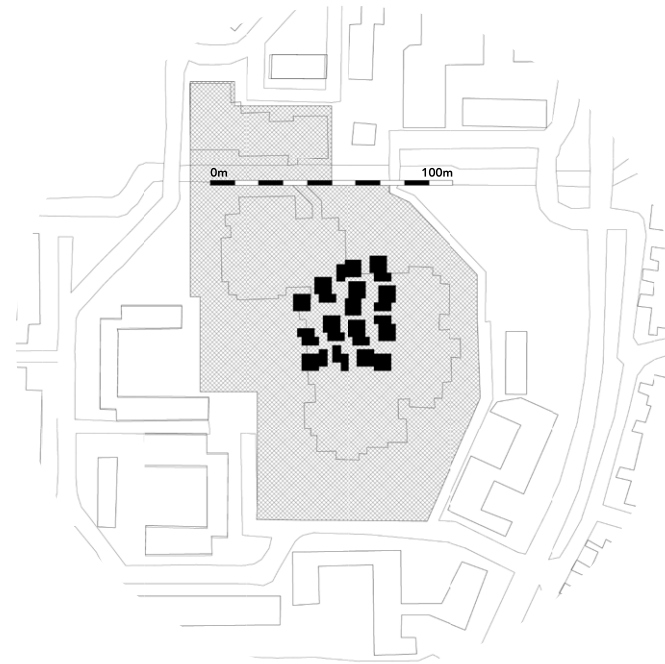

BloemkoolBurenBond nollisite placed in site location

SKETCHES

Variant 1

 Circulation

 Shops / amenities

 Public building

 Green areas

 Parking

 Houses

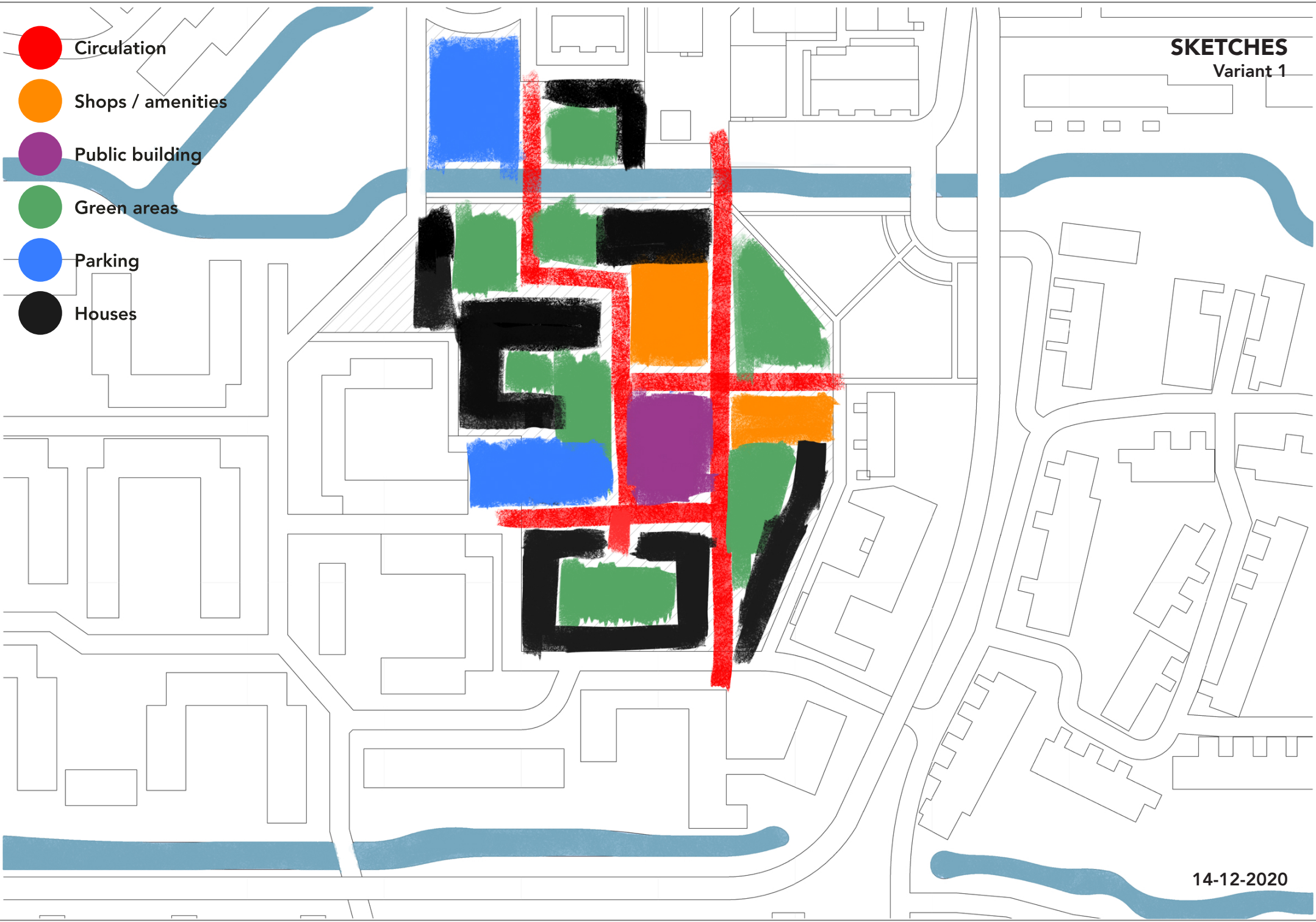

SKETCHES

Variant 2

 Circulation

 Shops / amenities

 Public building

 Green areas

 Parking

 Houses

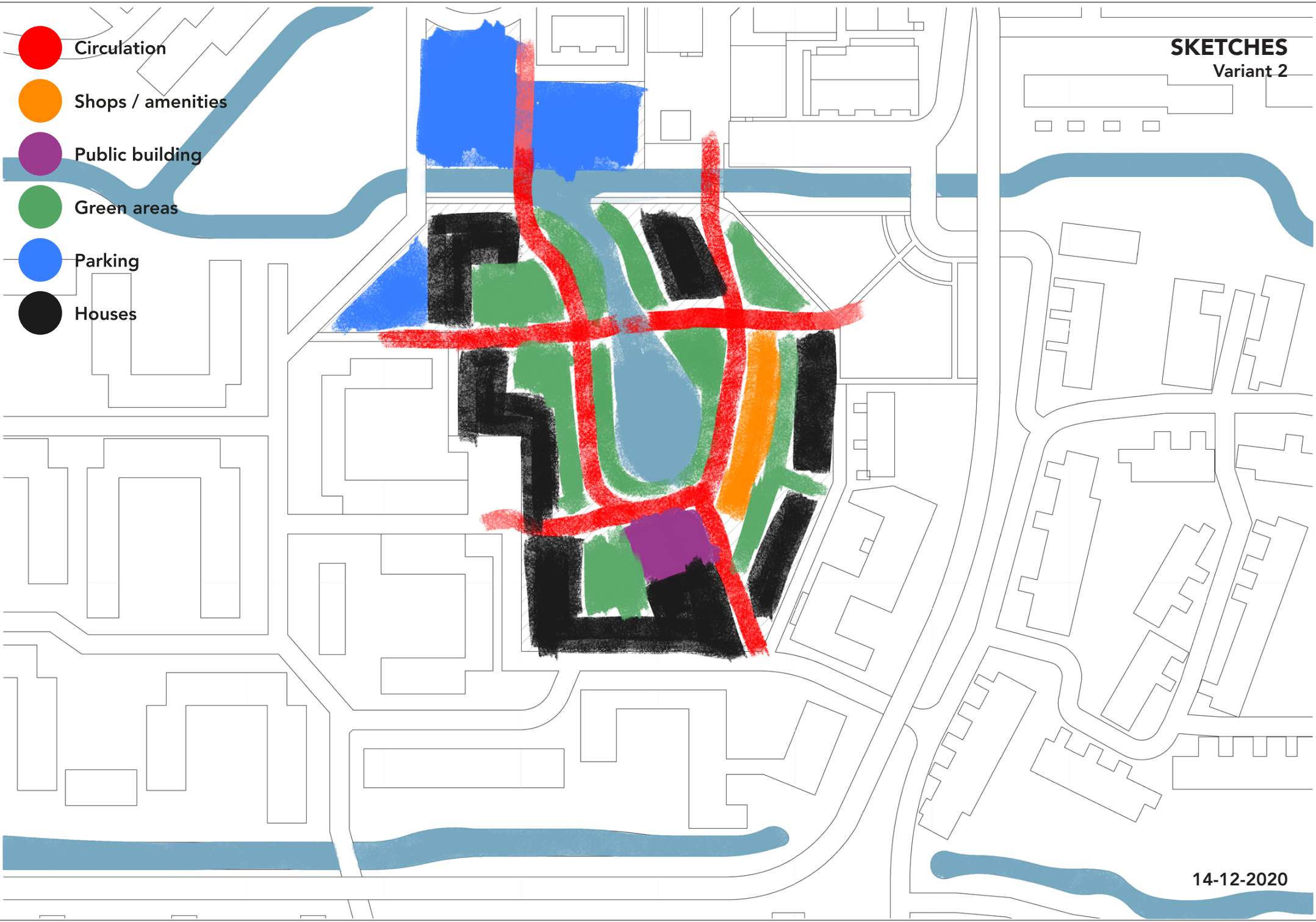

SKETCHES

Variant 3

 Circulation

 Shops / amenities

 Public building

 Green areas

 Parking

 Houses

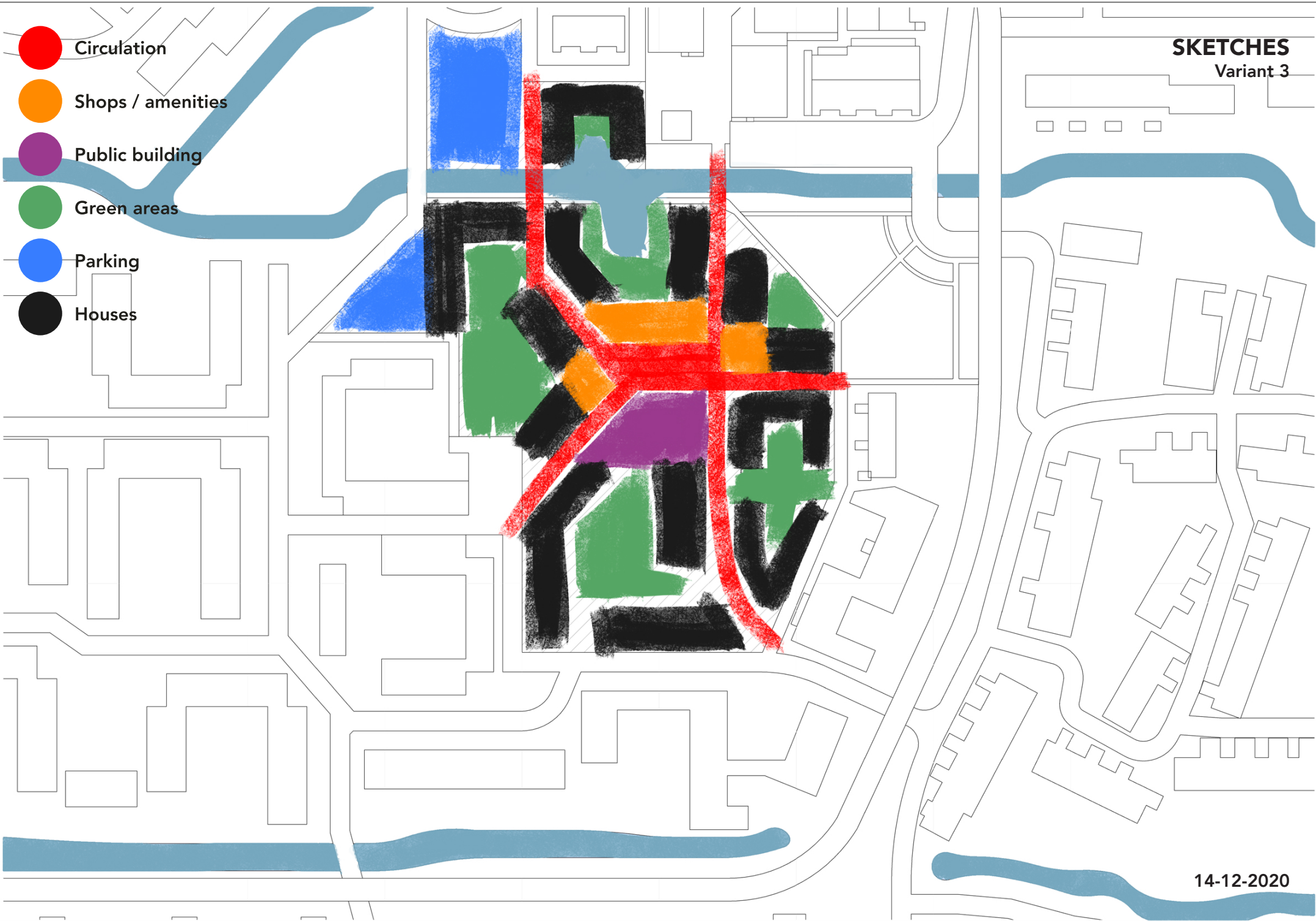

SKETCHES

Variant 4

 Circulation

 Shops / amenities

 Public building

 Green areas

 Parking

 Houses

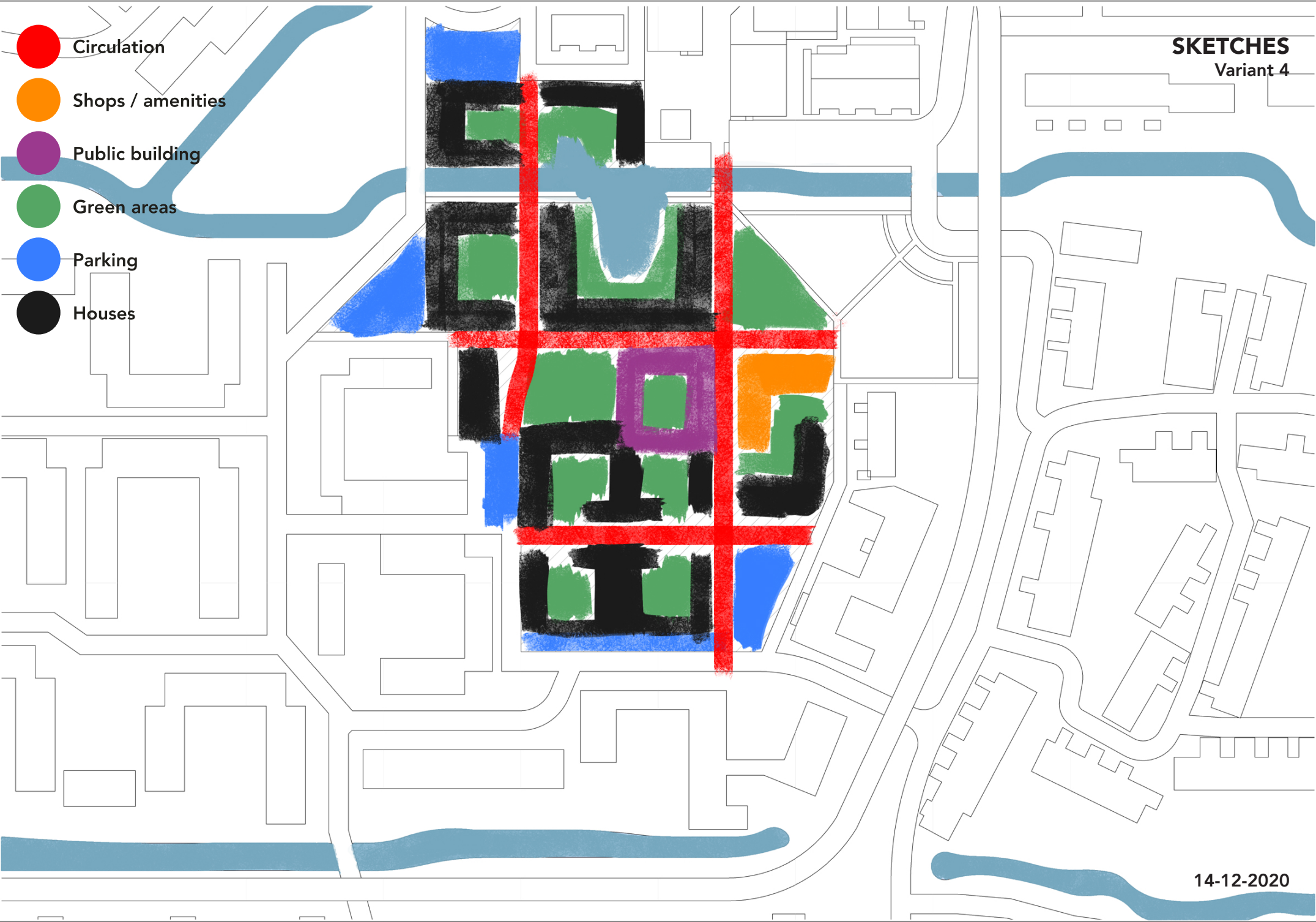

SKETCHES

Variant 5

 Circulation

 Shops / amenities

 Public building

 Green areas

 Parking

 Houses

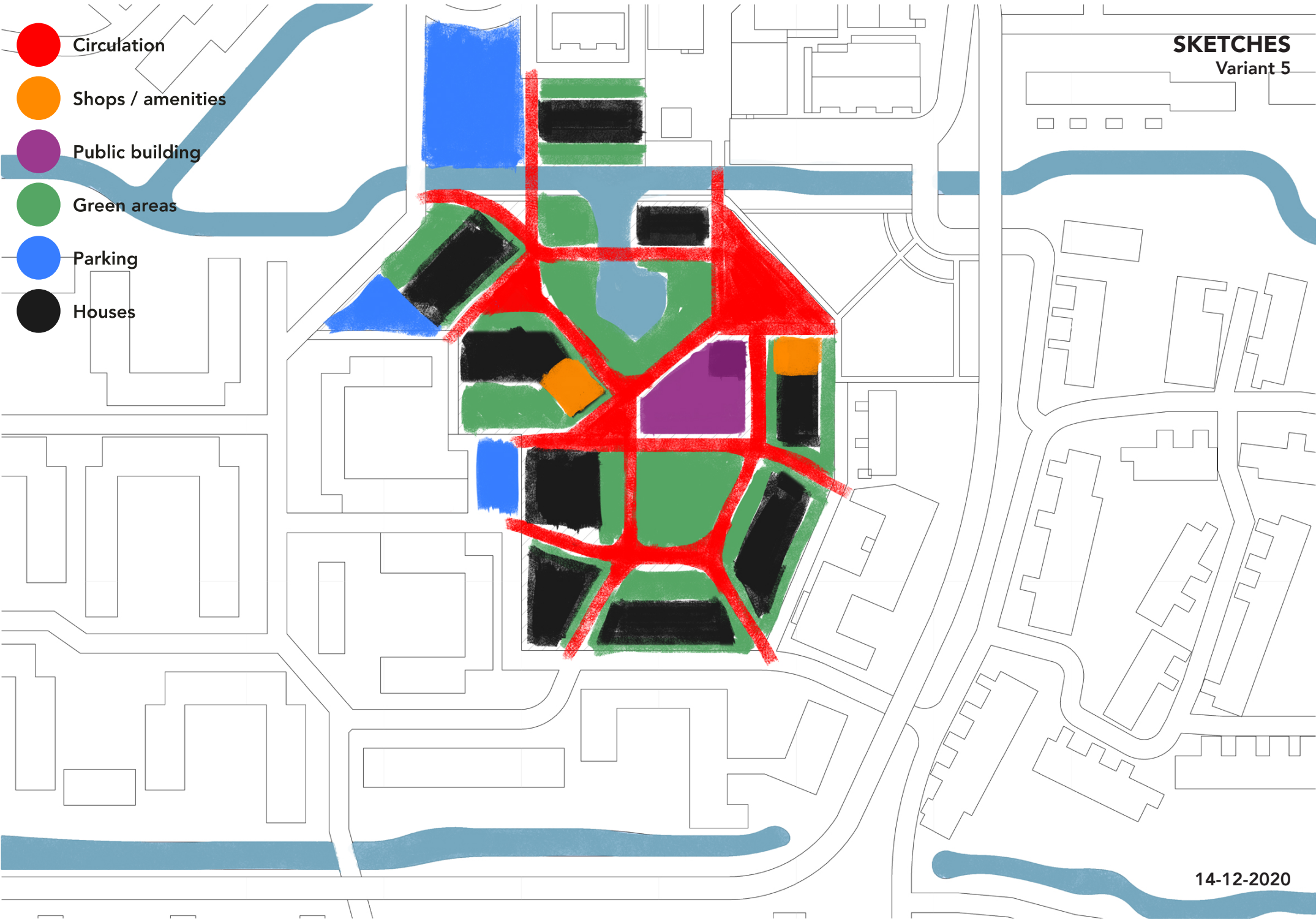

14-12-2020

MASS STUDIES
Variant 1

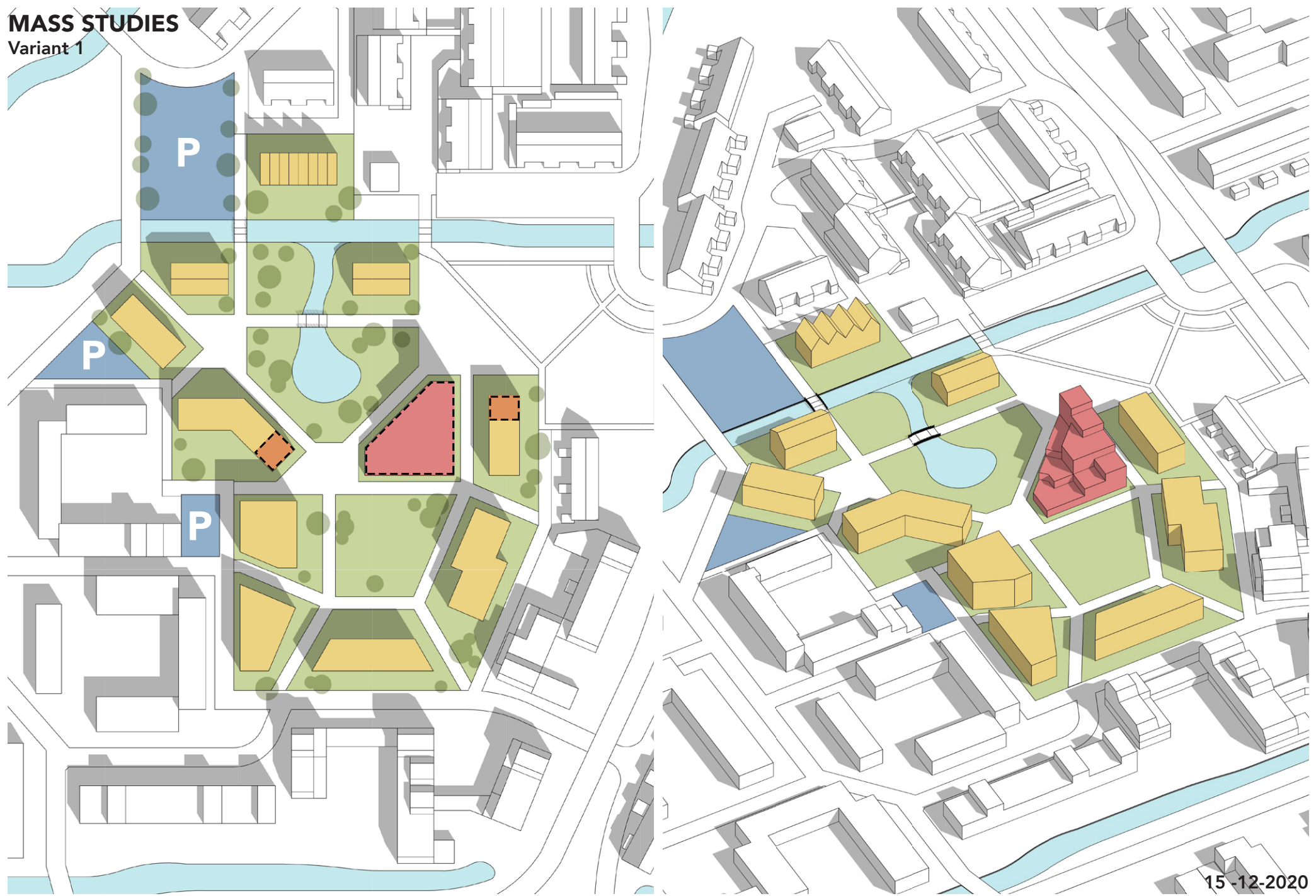

Views

1



2

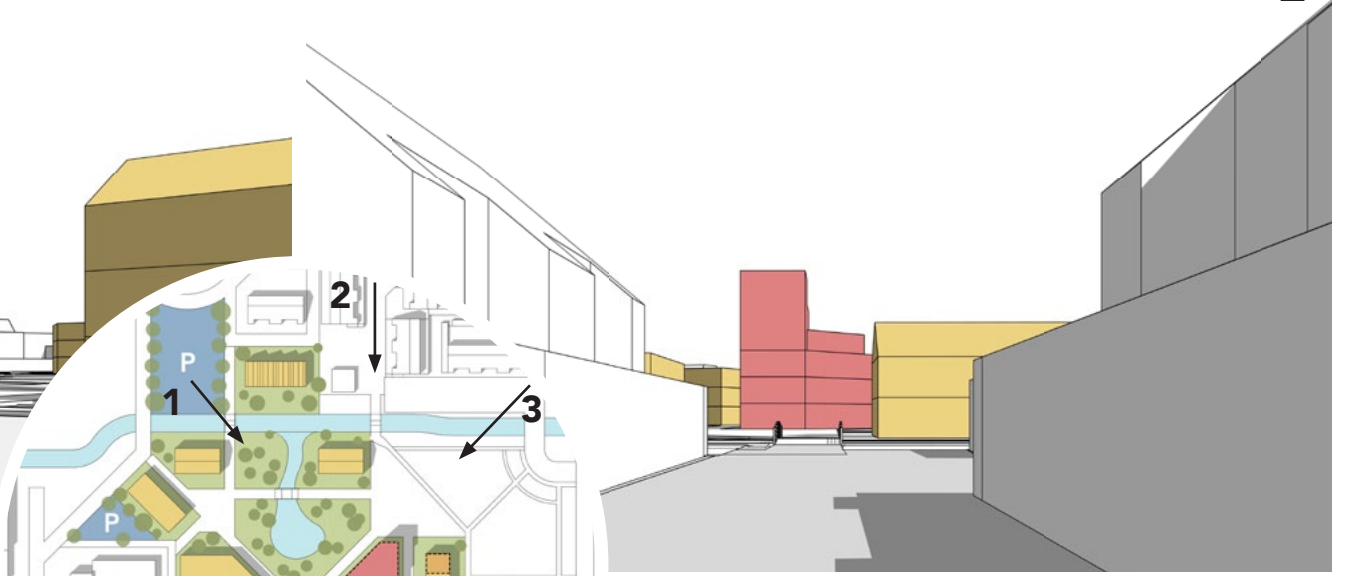

3

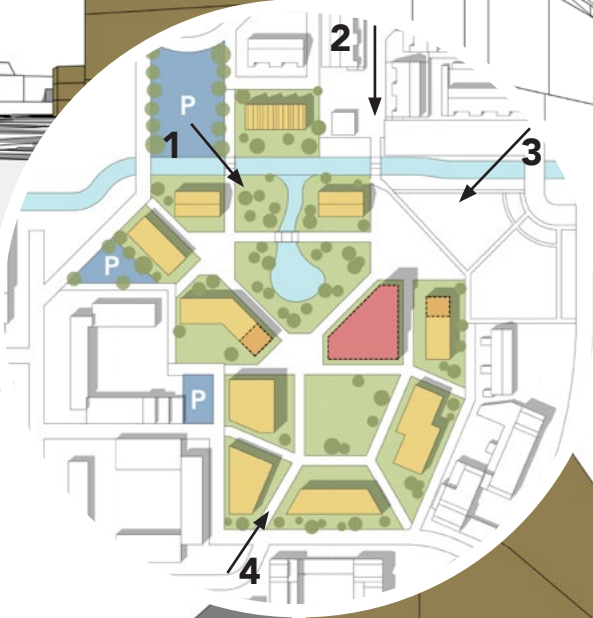

4

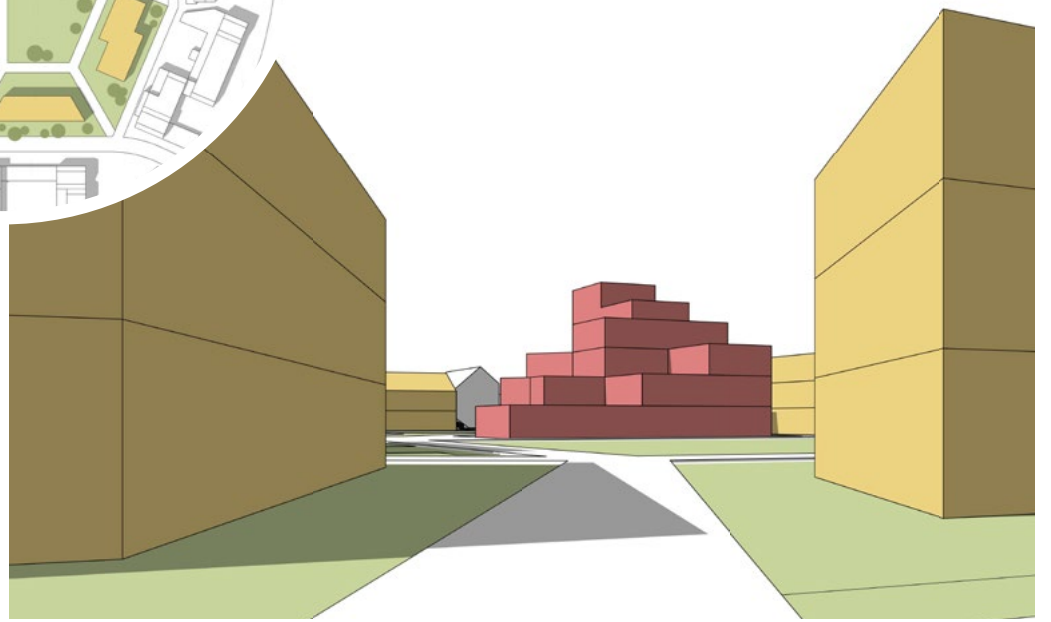
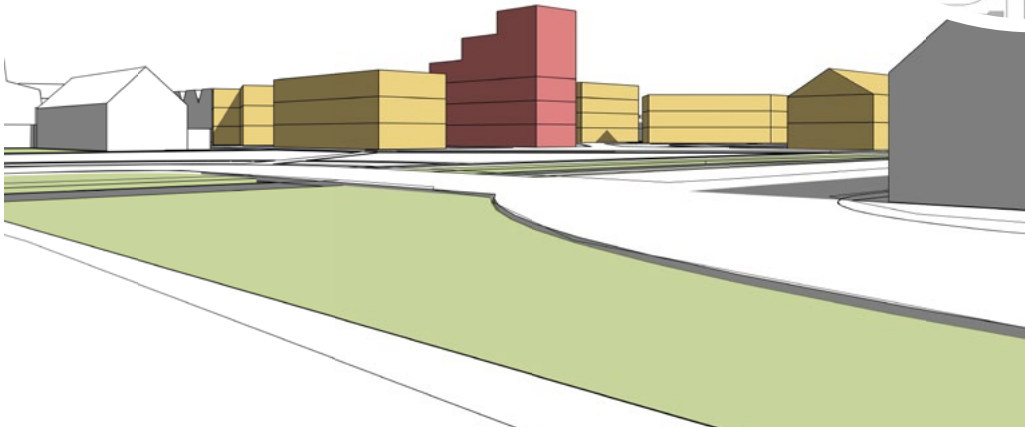

MASS STUDIES
Variant 2

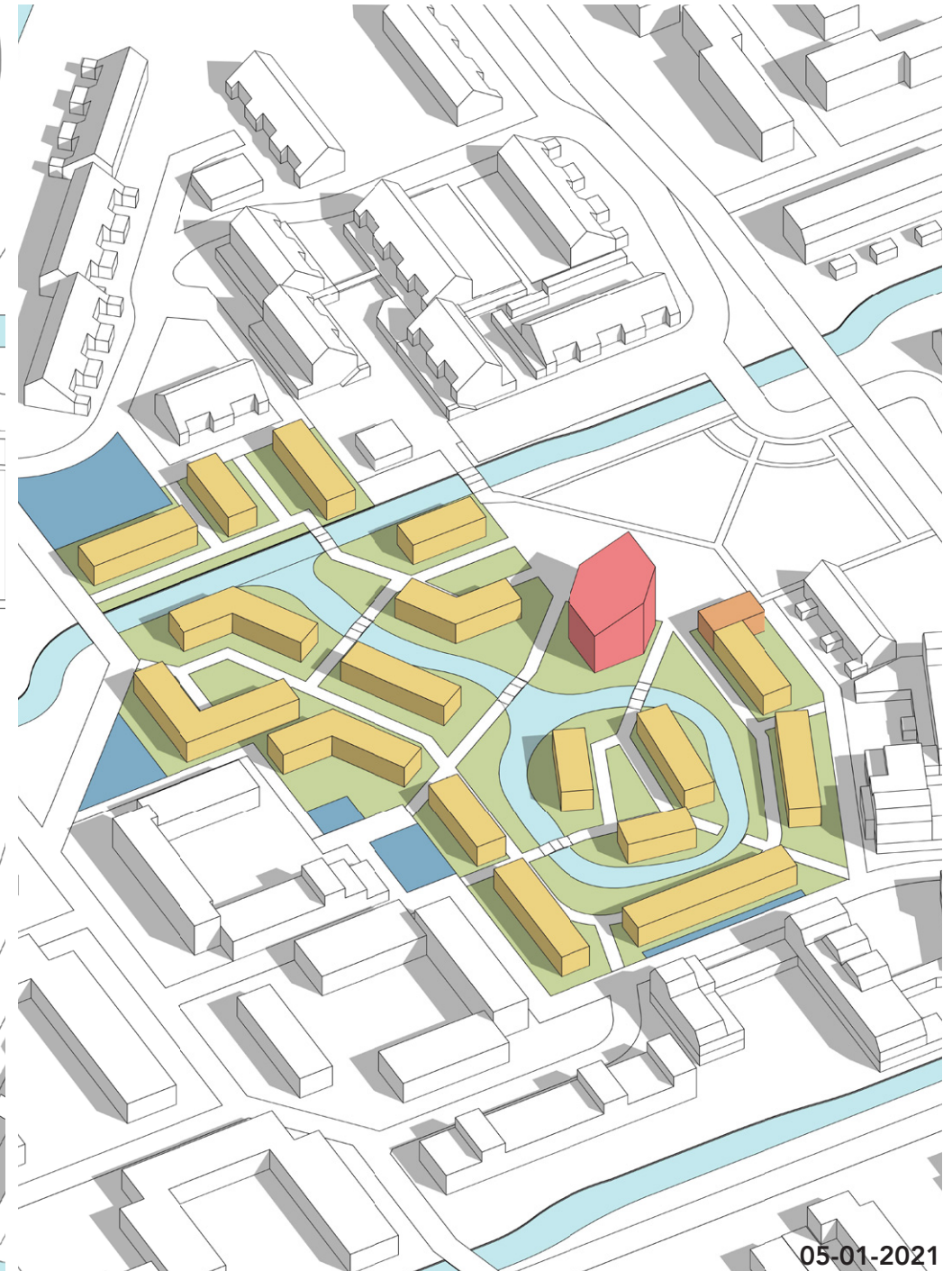
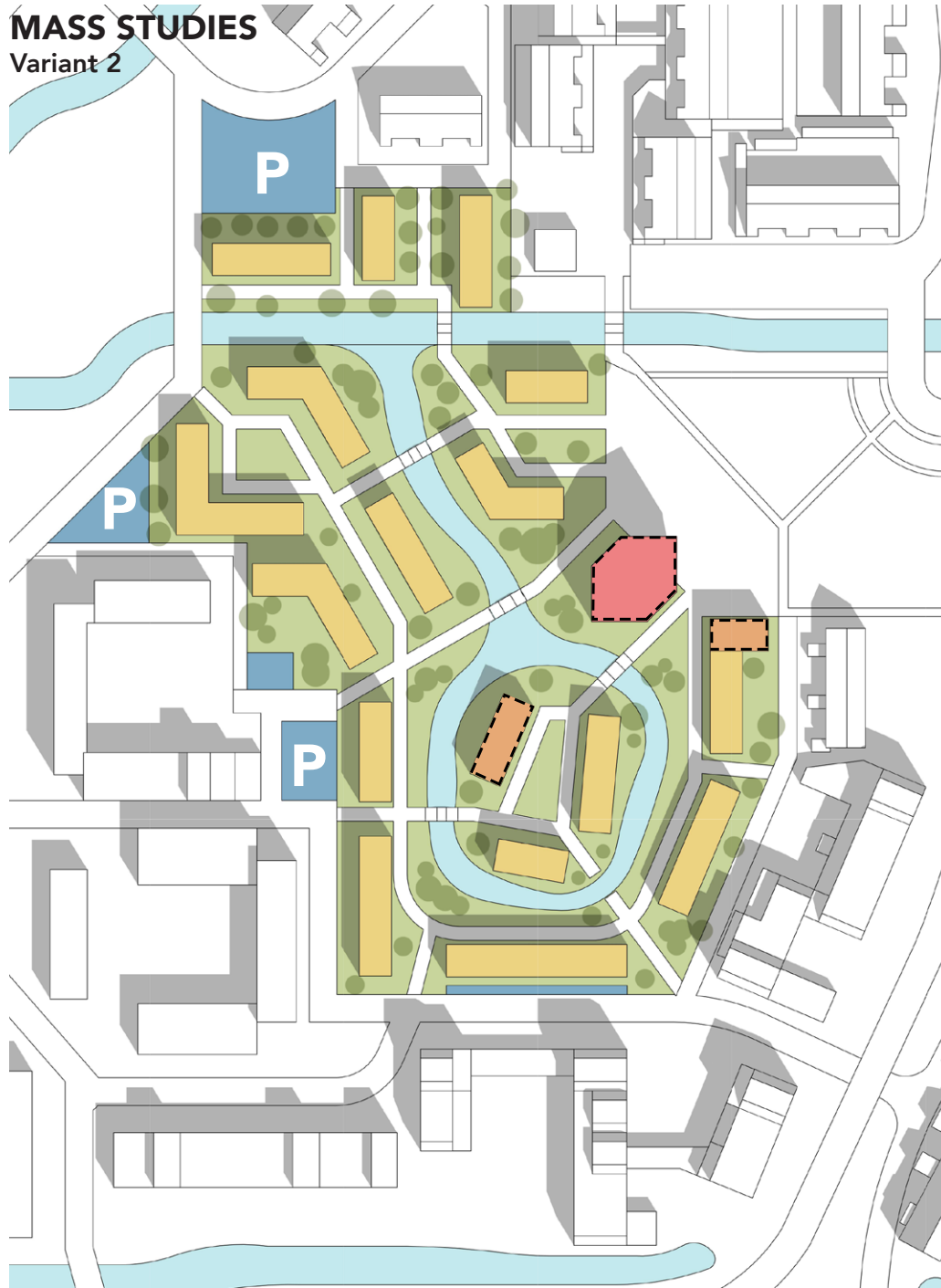

VIEWS
1

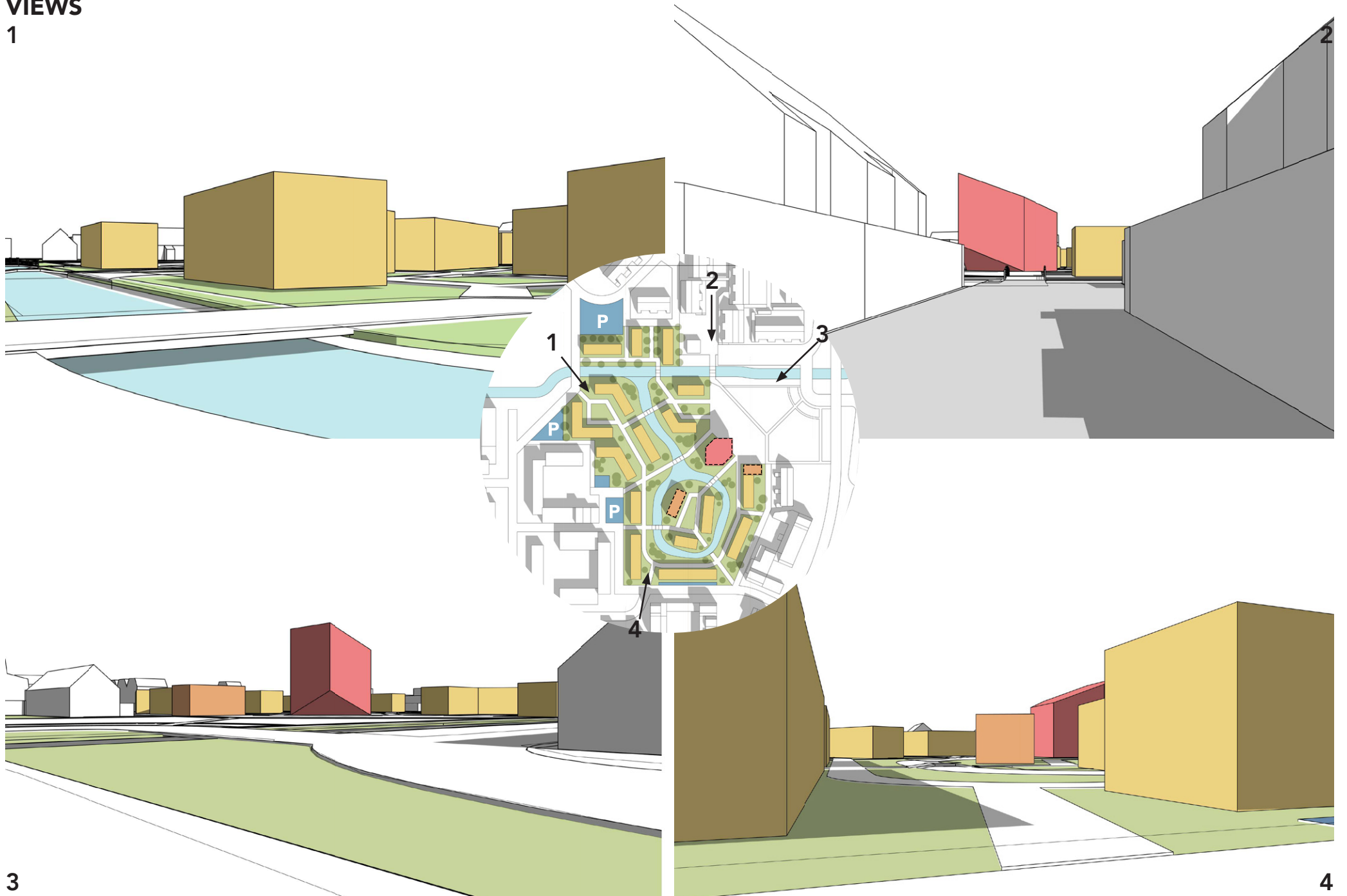

3

4

MASS STUDIES
Variant 3

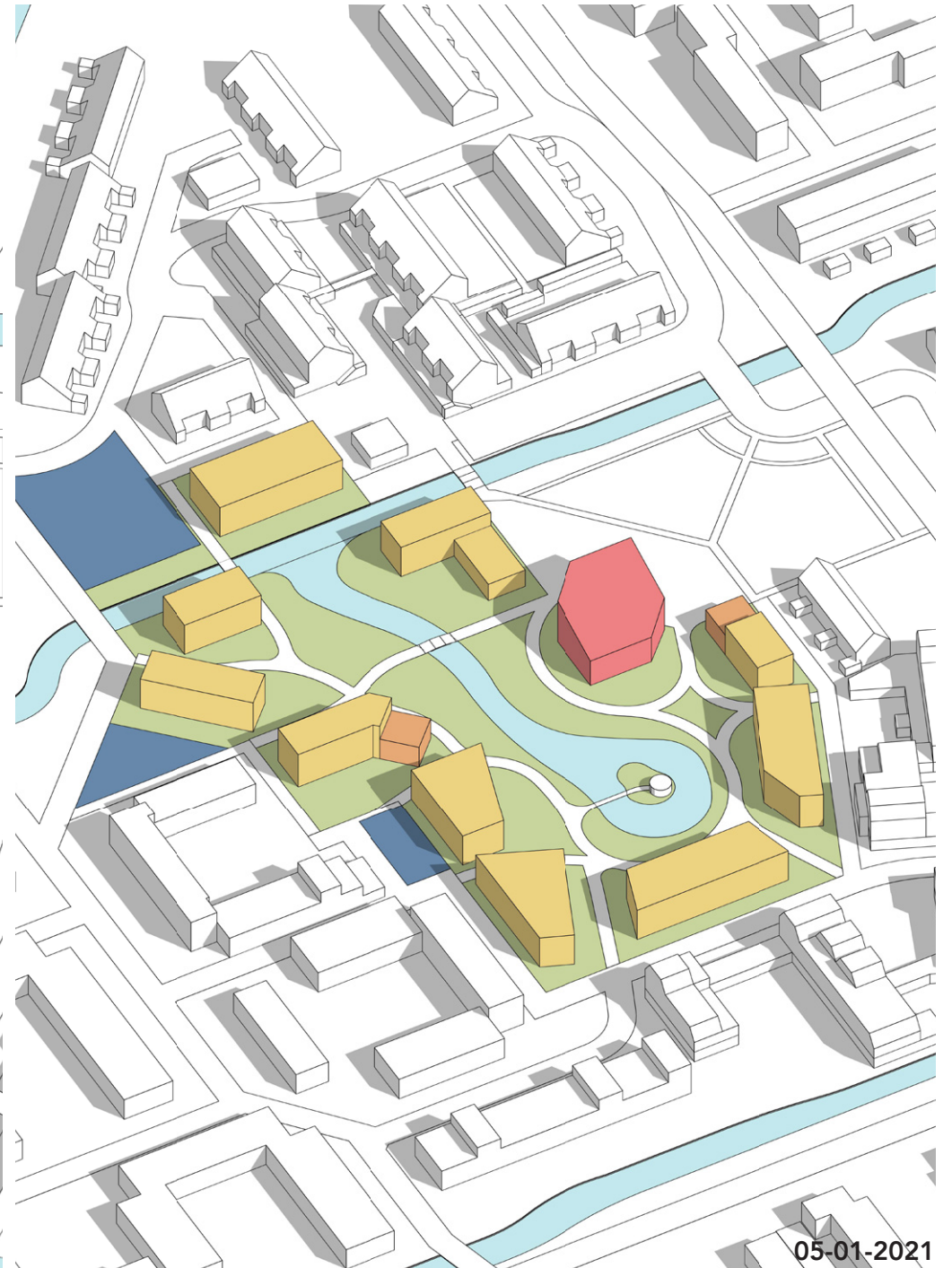

VIEWS

1

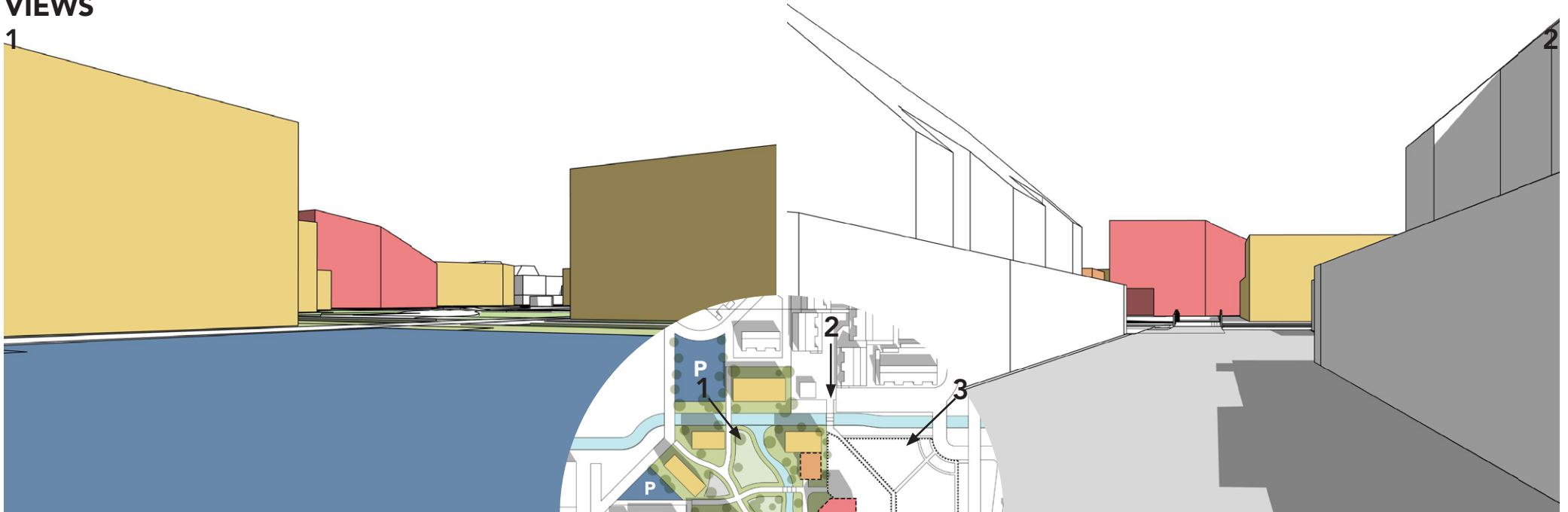

2

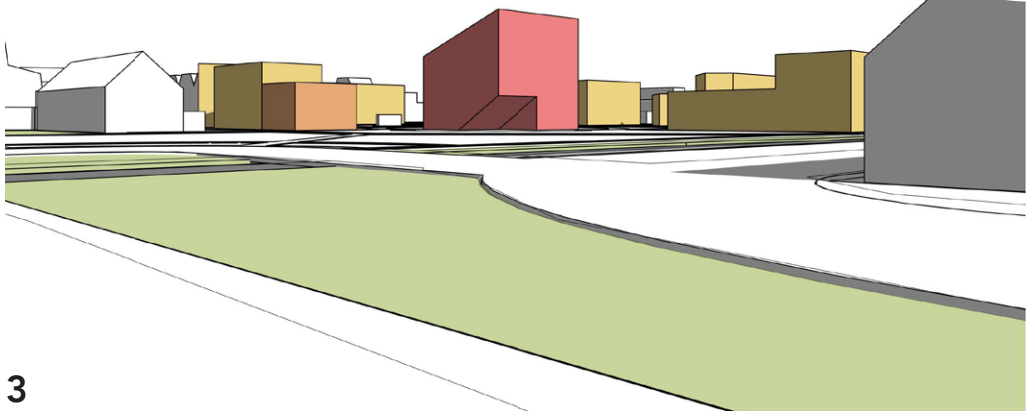
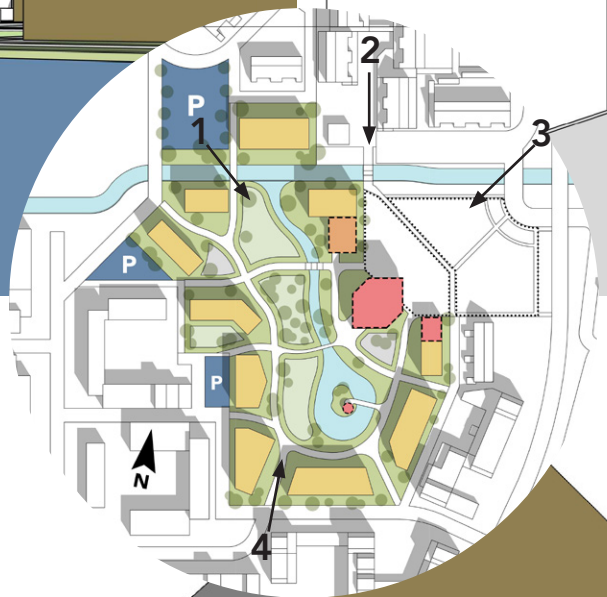

3

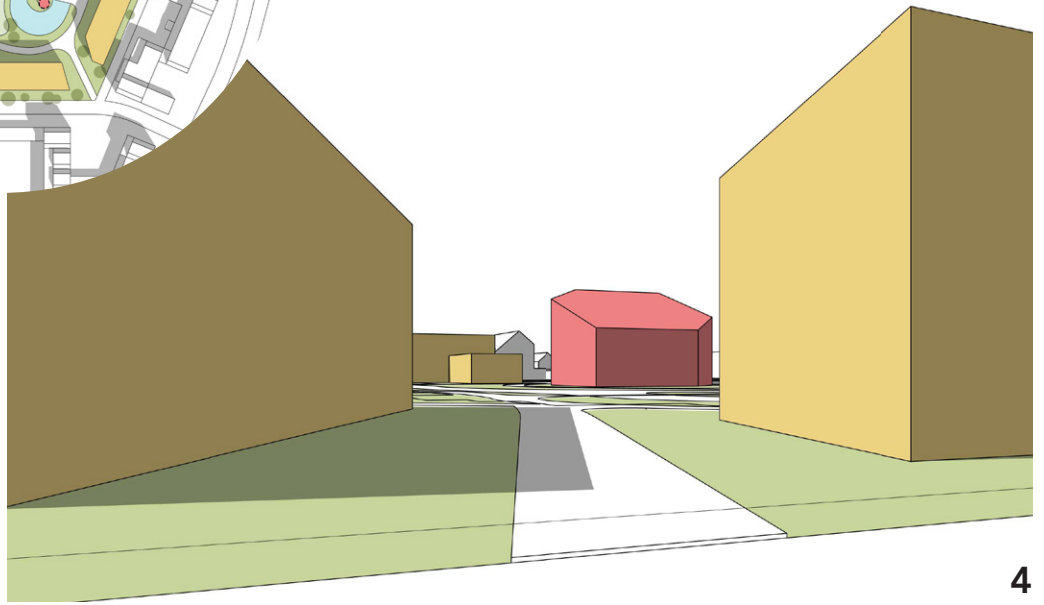

4

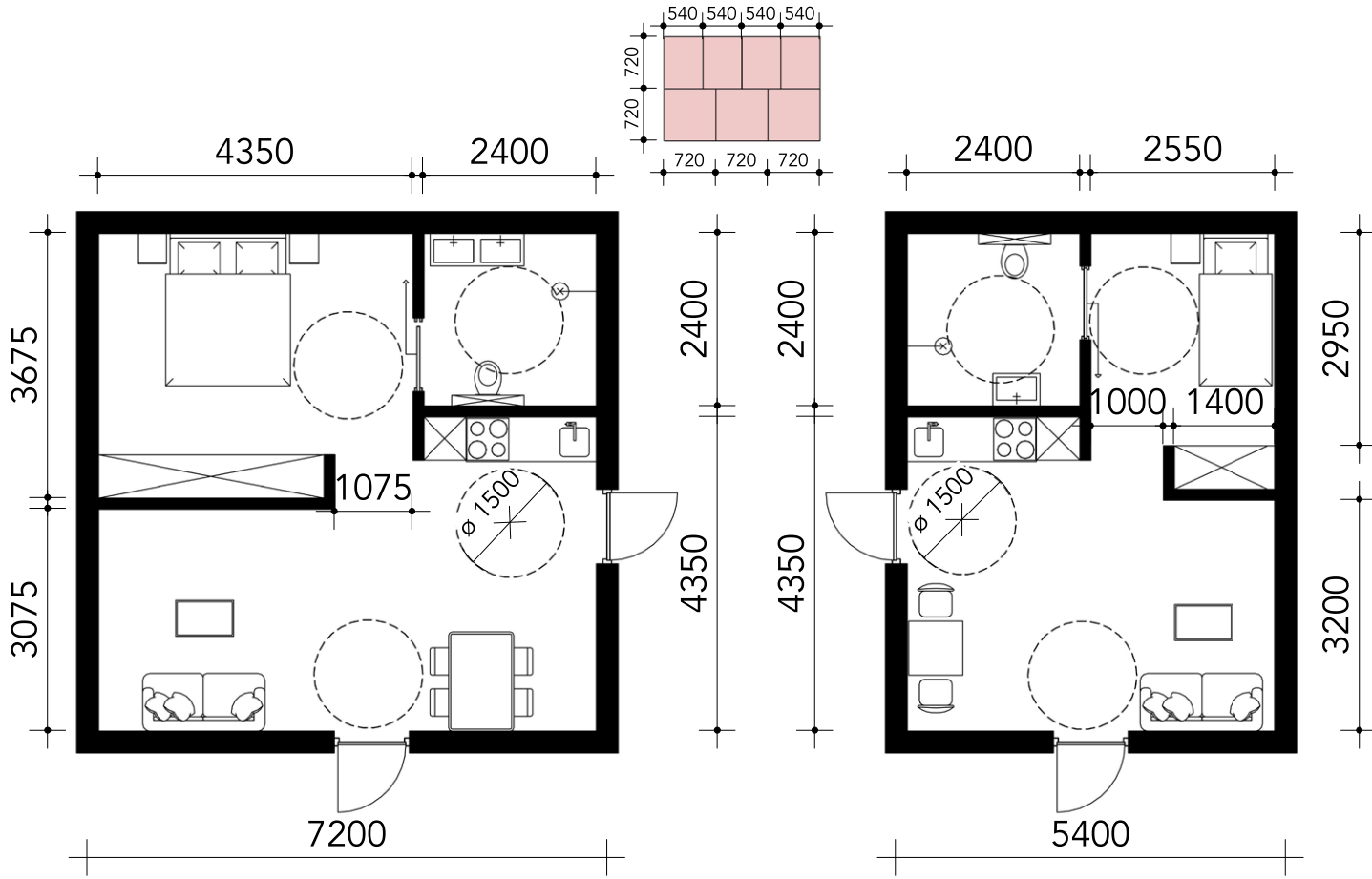

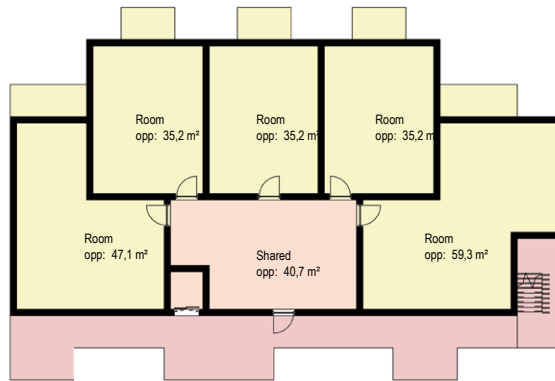
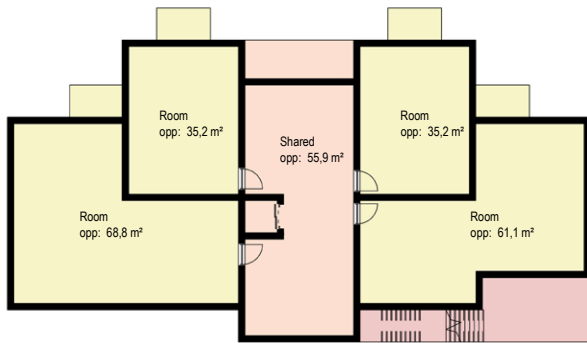
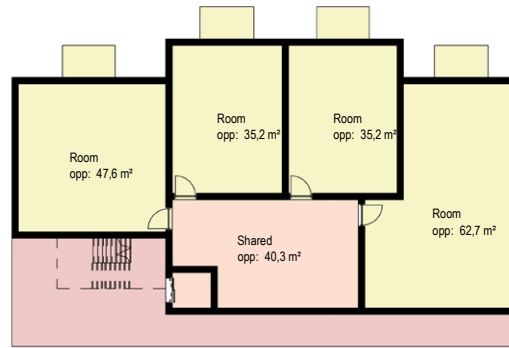

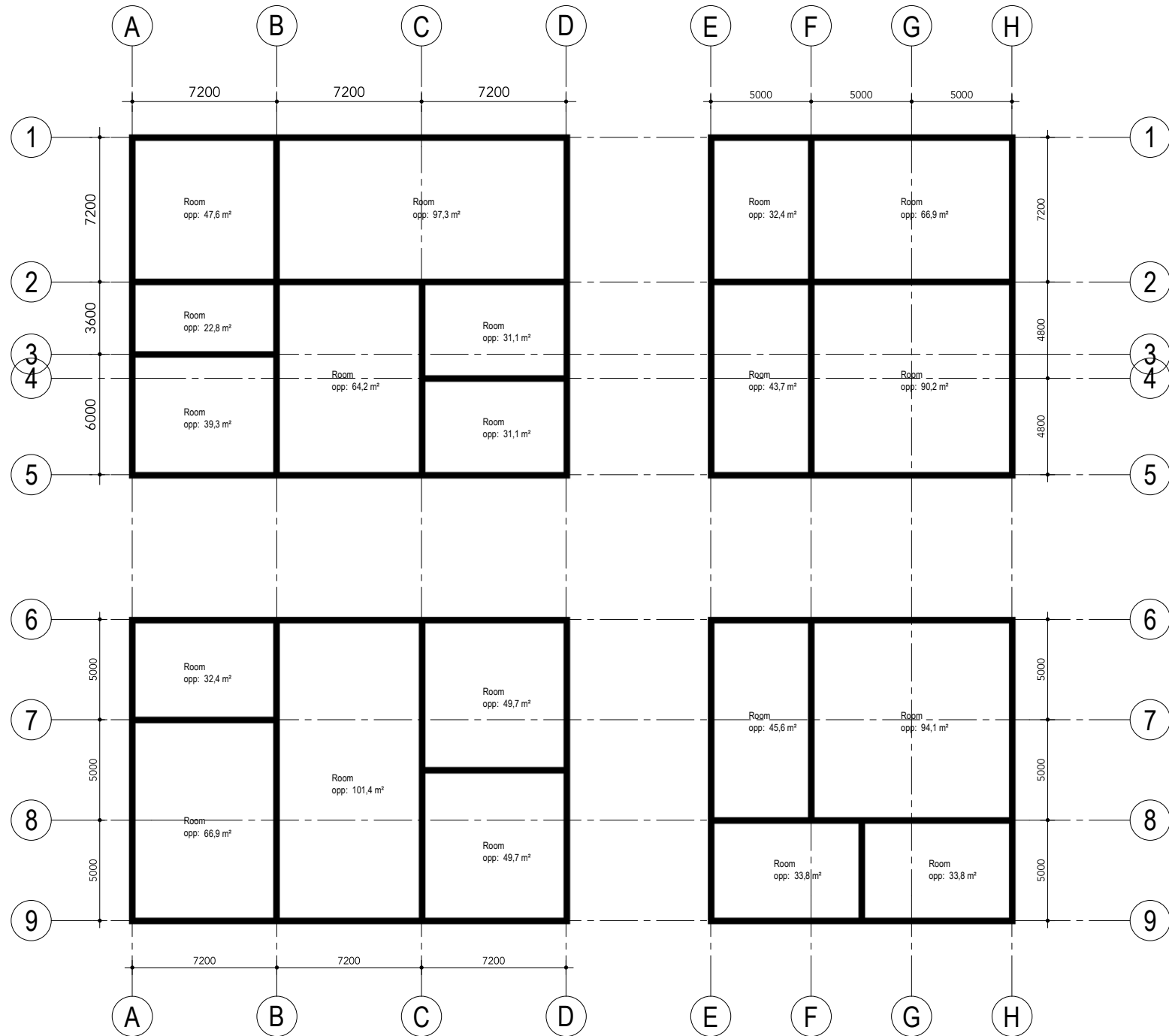

FLOORPLAN STUDIES



FLOORPLAN STUDIES

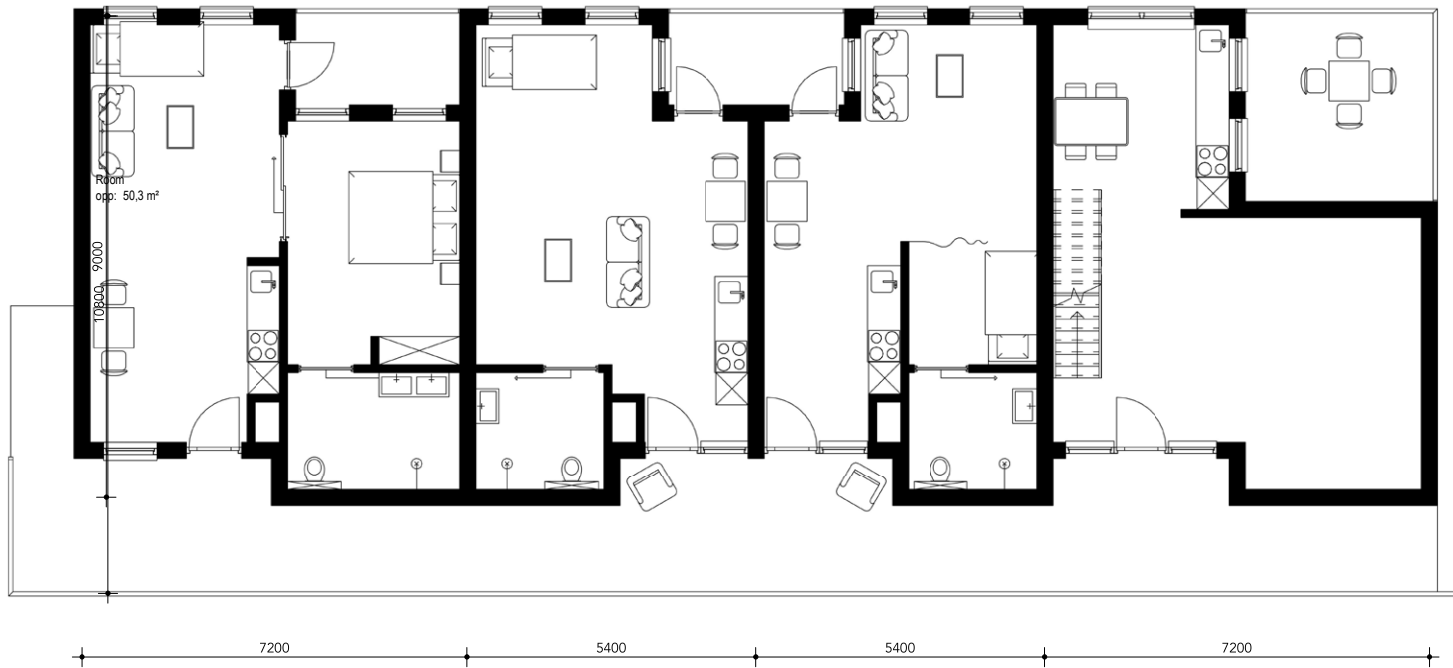

FLOORPLAN STUDIES

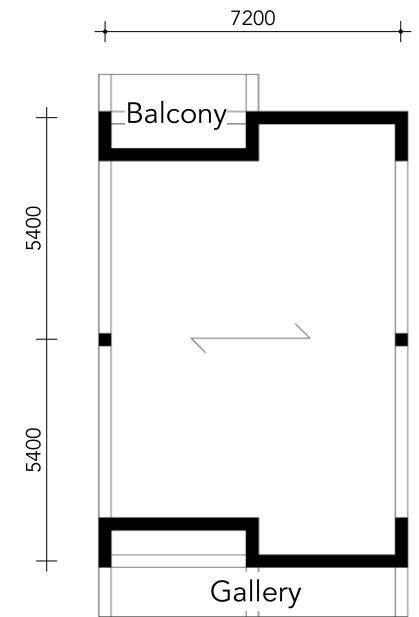
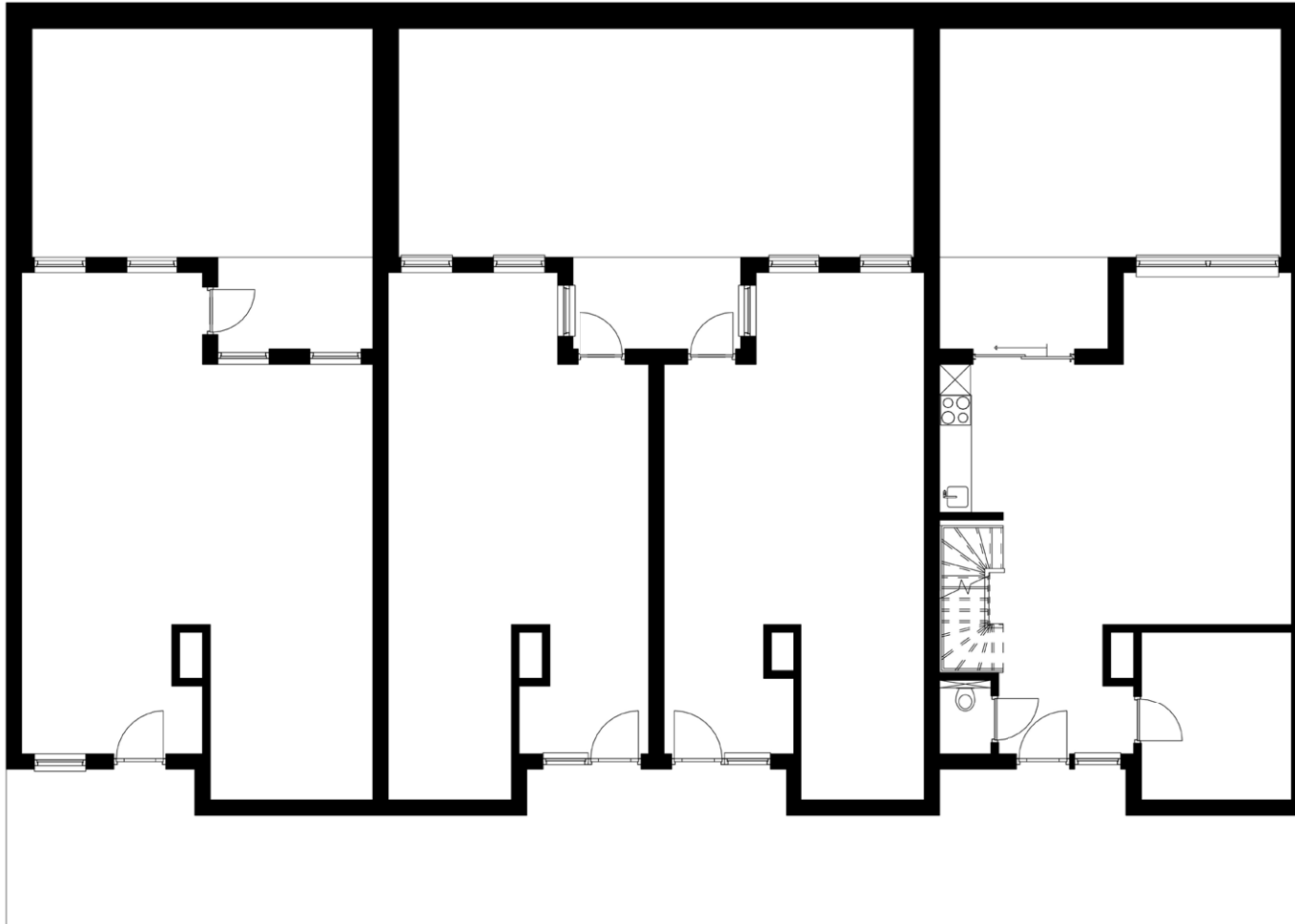

FLOORPLAN STUDIES

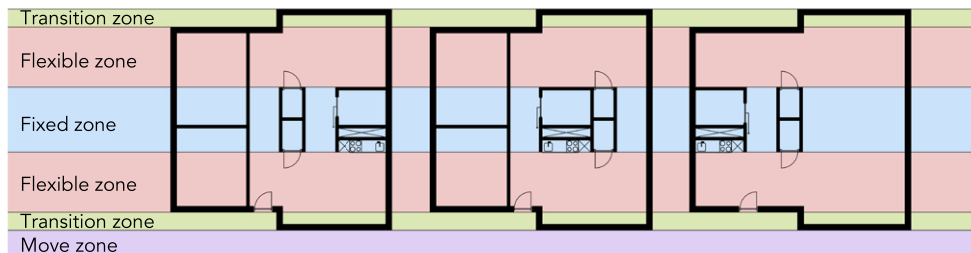
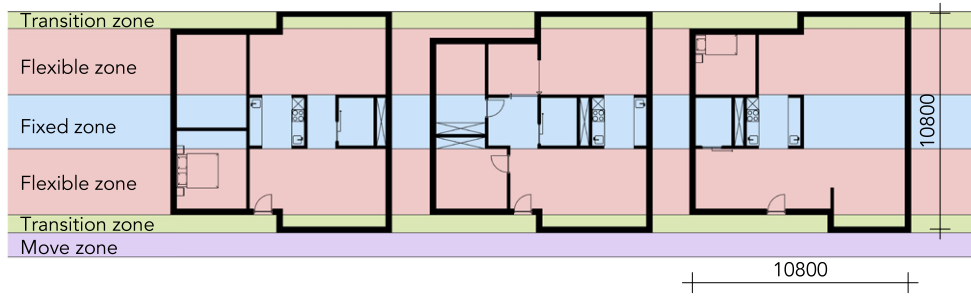
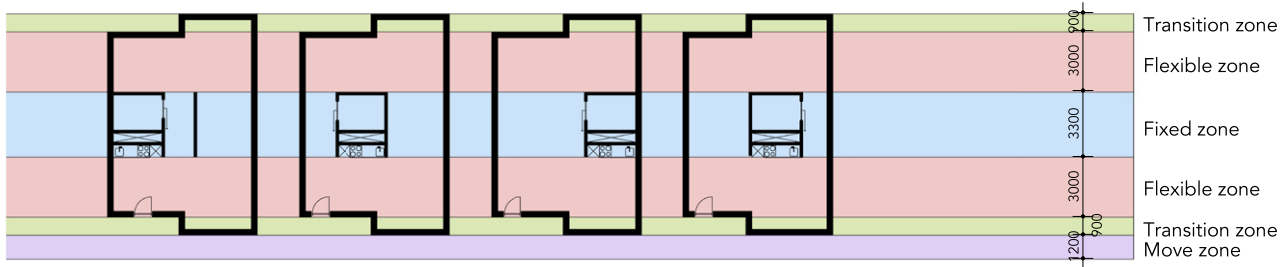
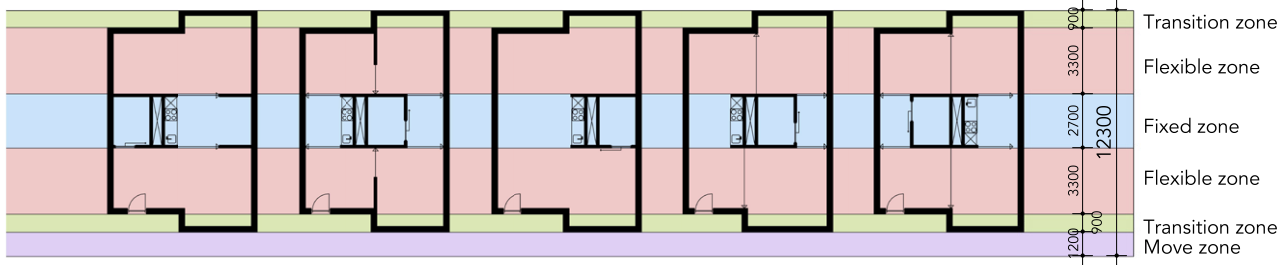

14400

10800

10800 7200

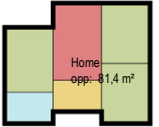
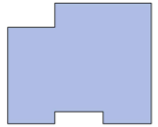
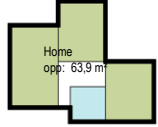
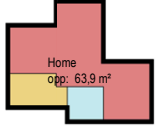
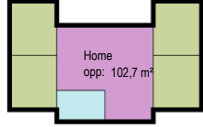
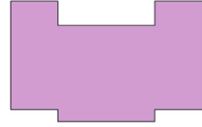
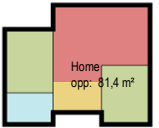
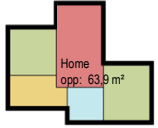
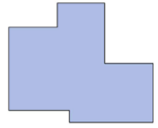
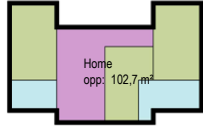
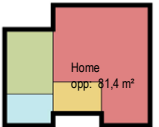
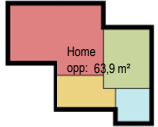
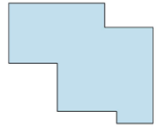
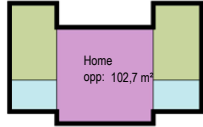
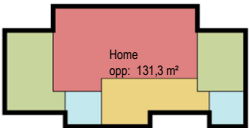
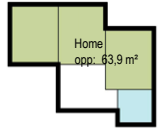
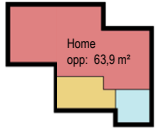
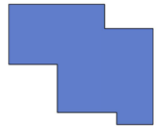
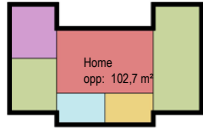
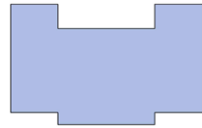
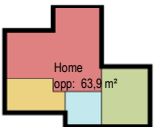
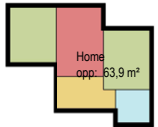
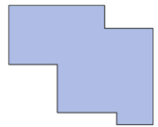
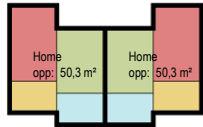
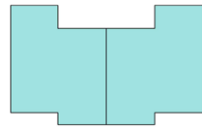



FLOORPLAN STUDIES

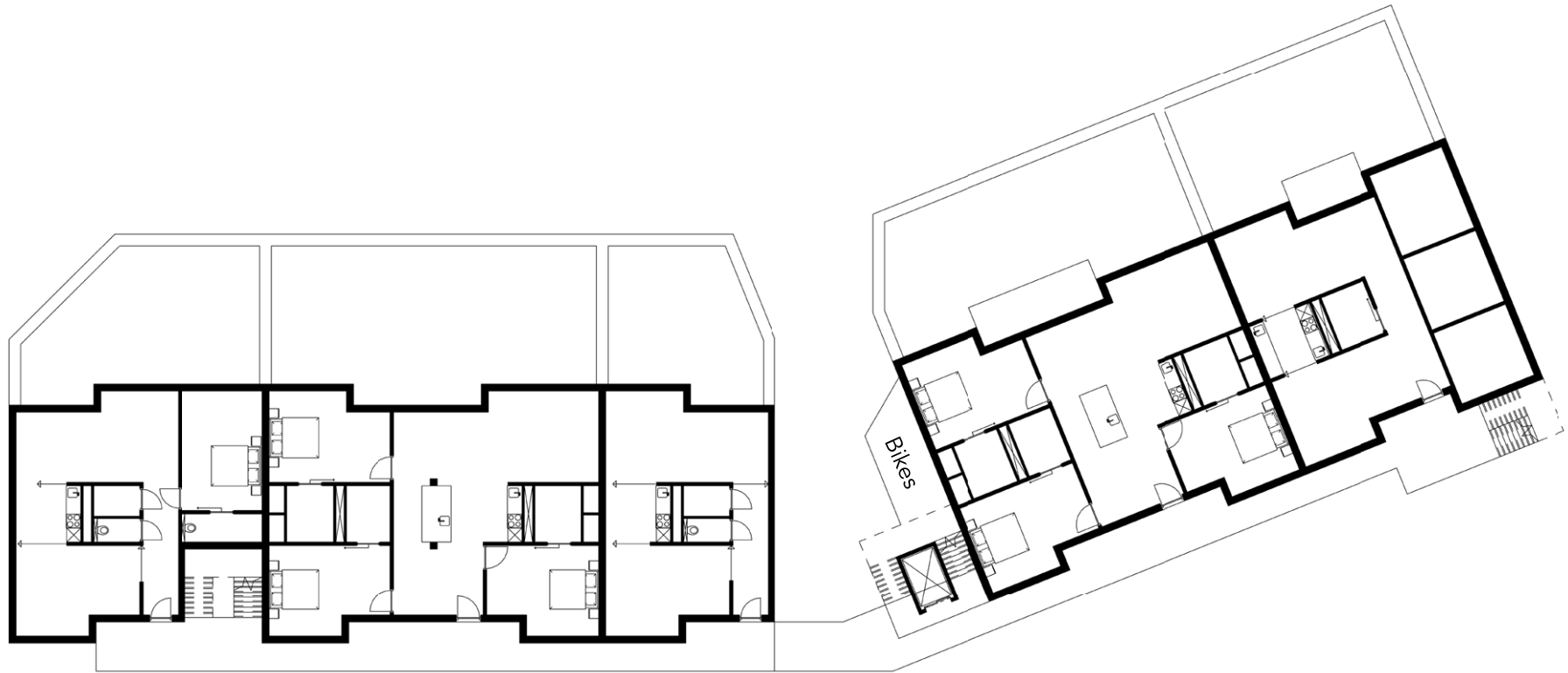

FLOORPLAN STUDIES

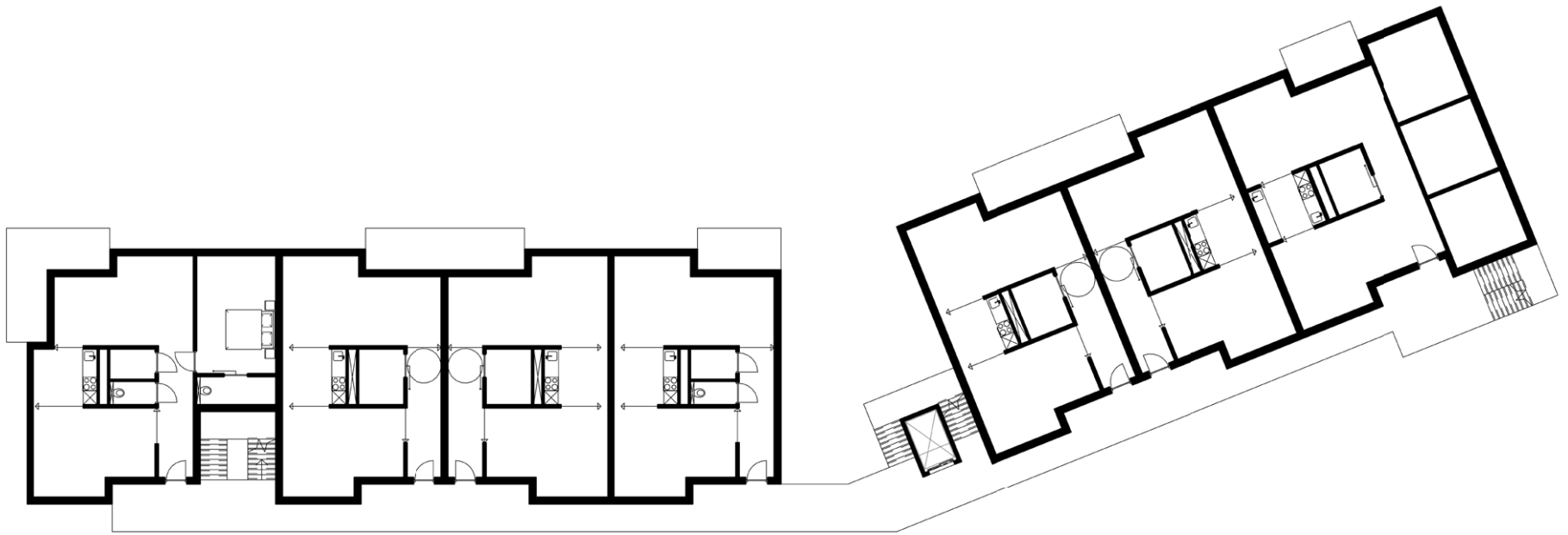

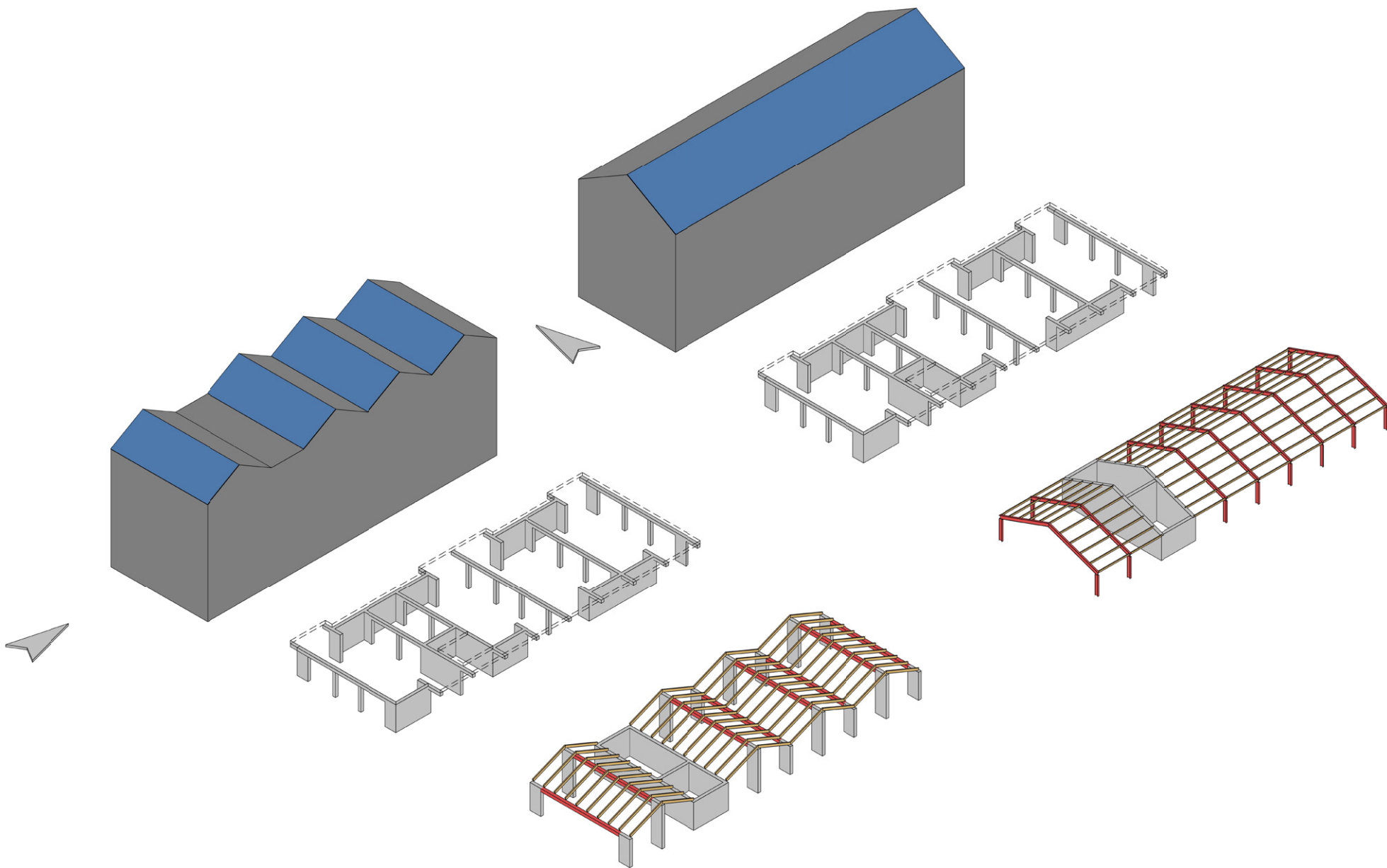

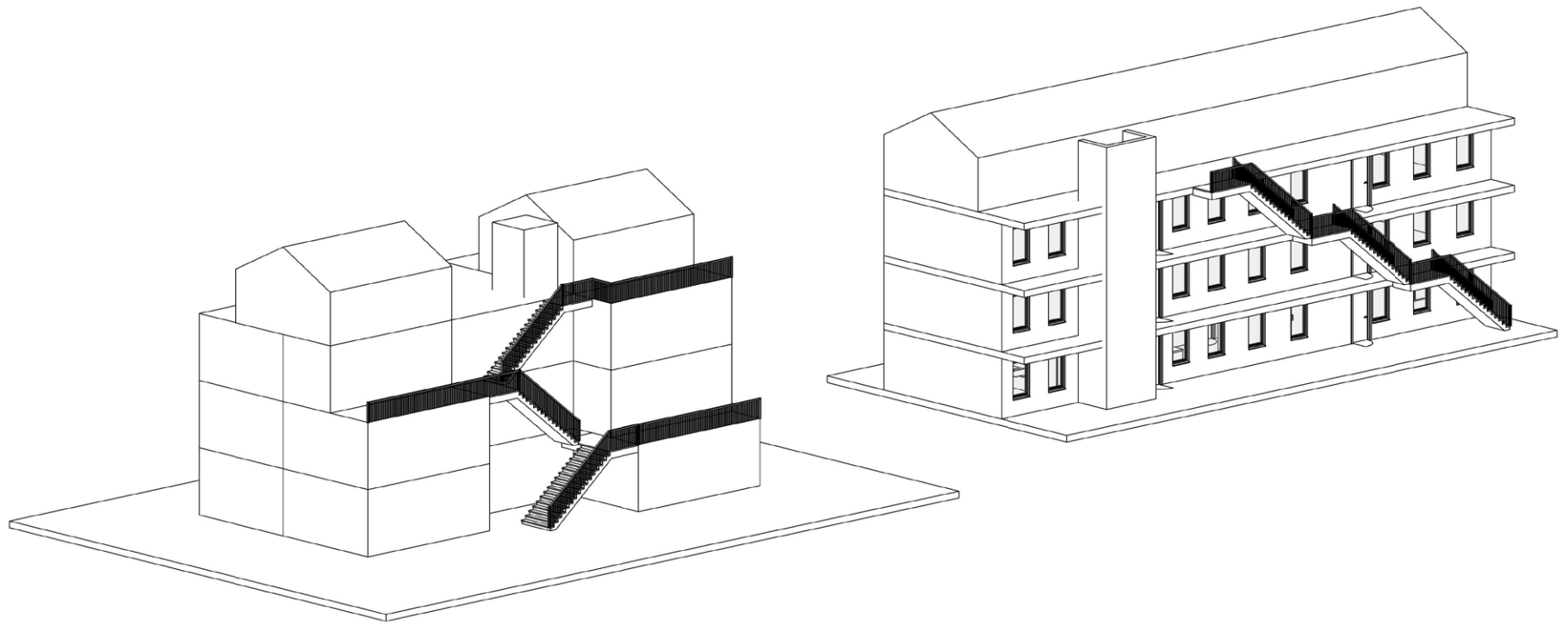

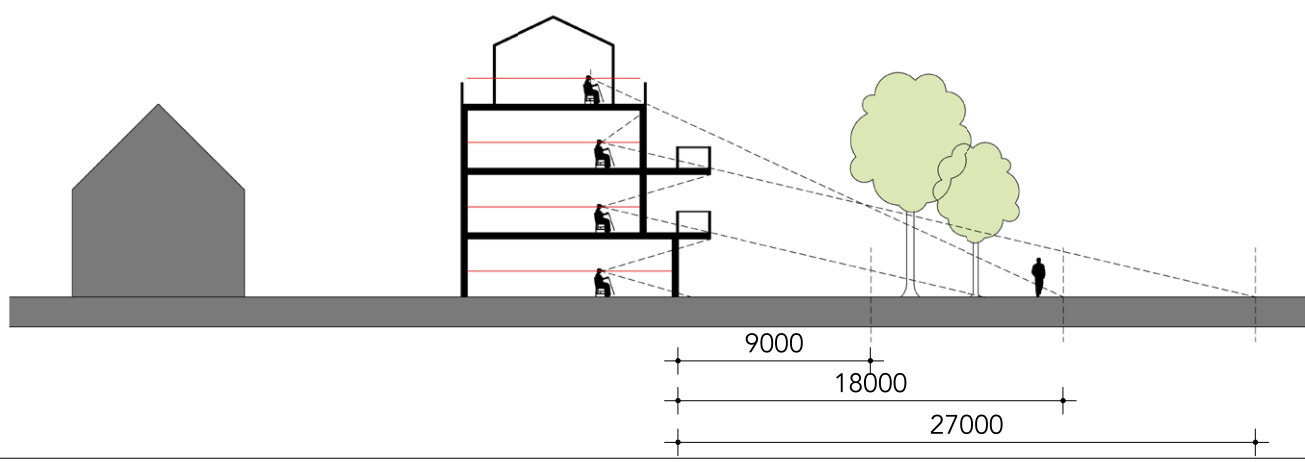
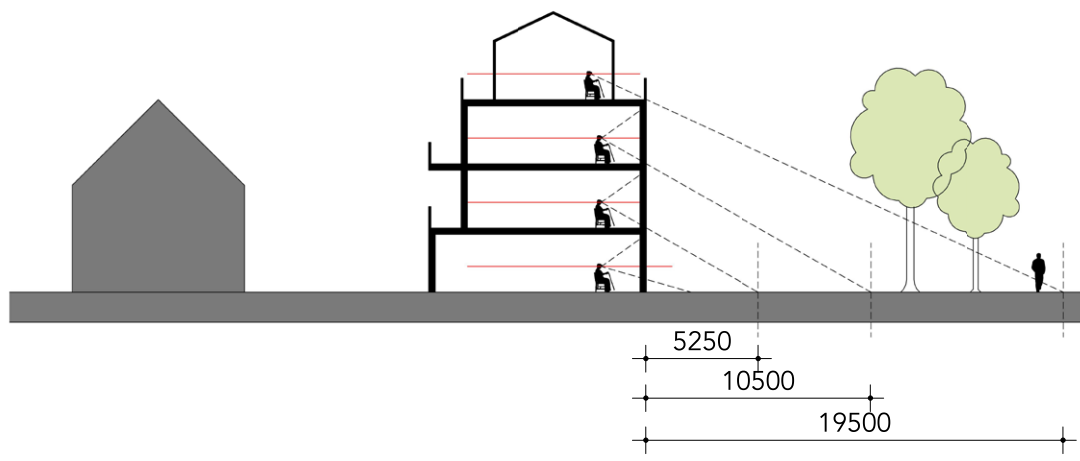
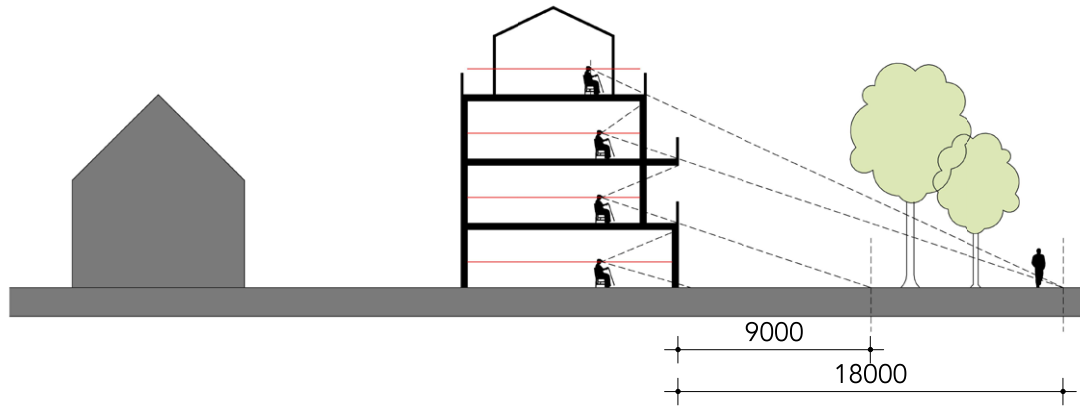

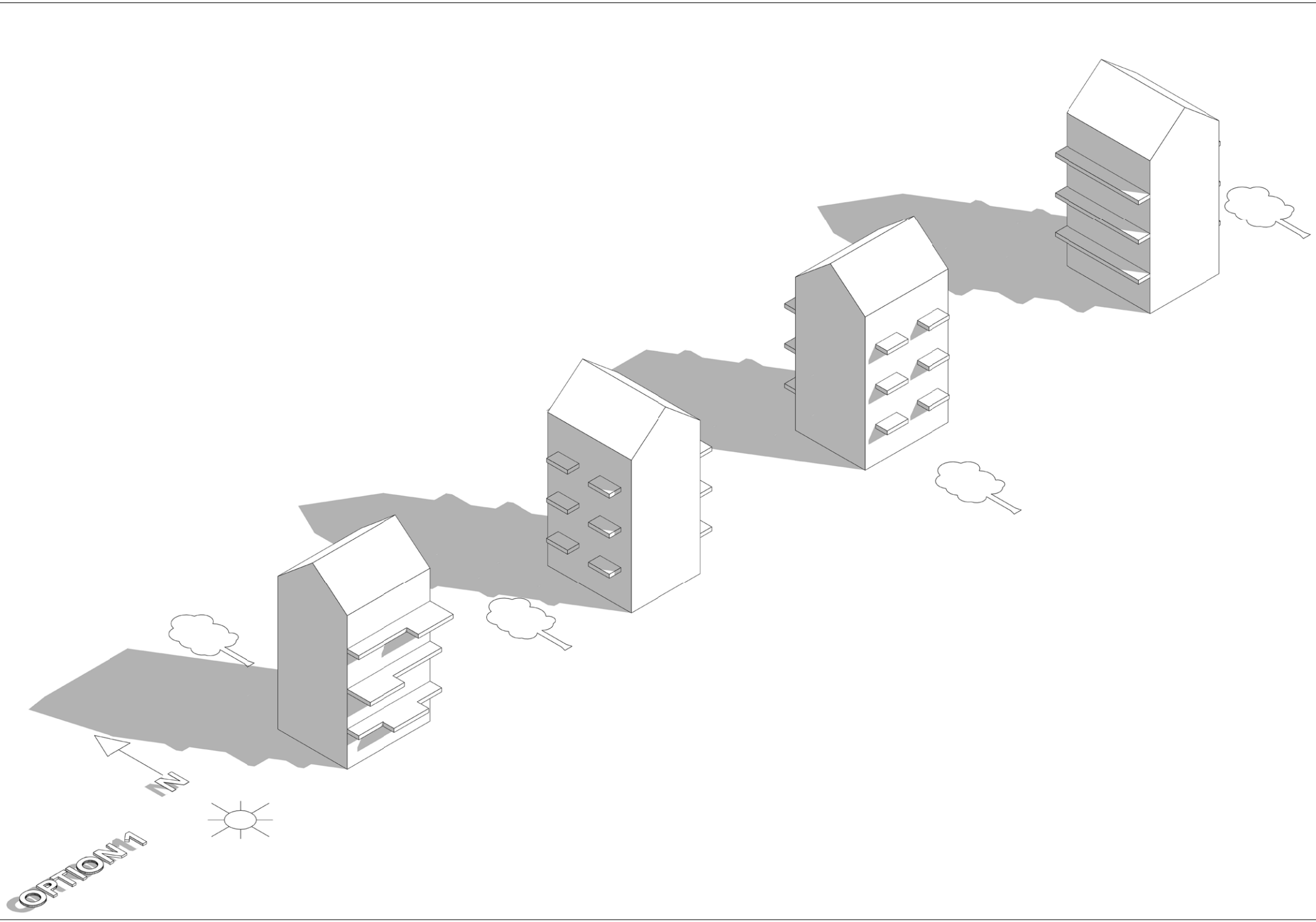

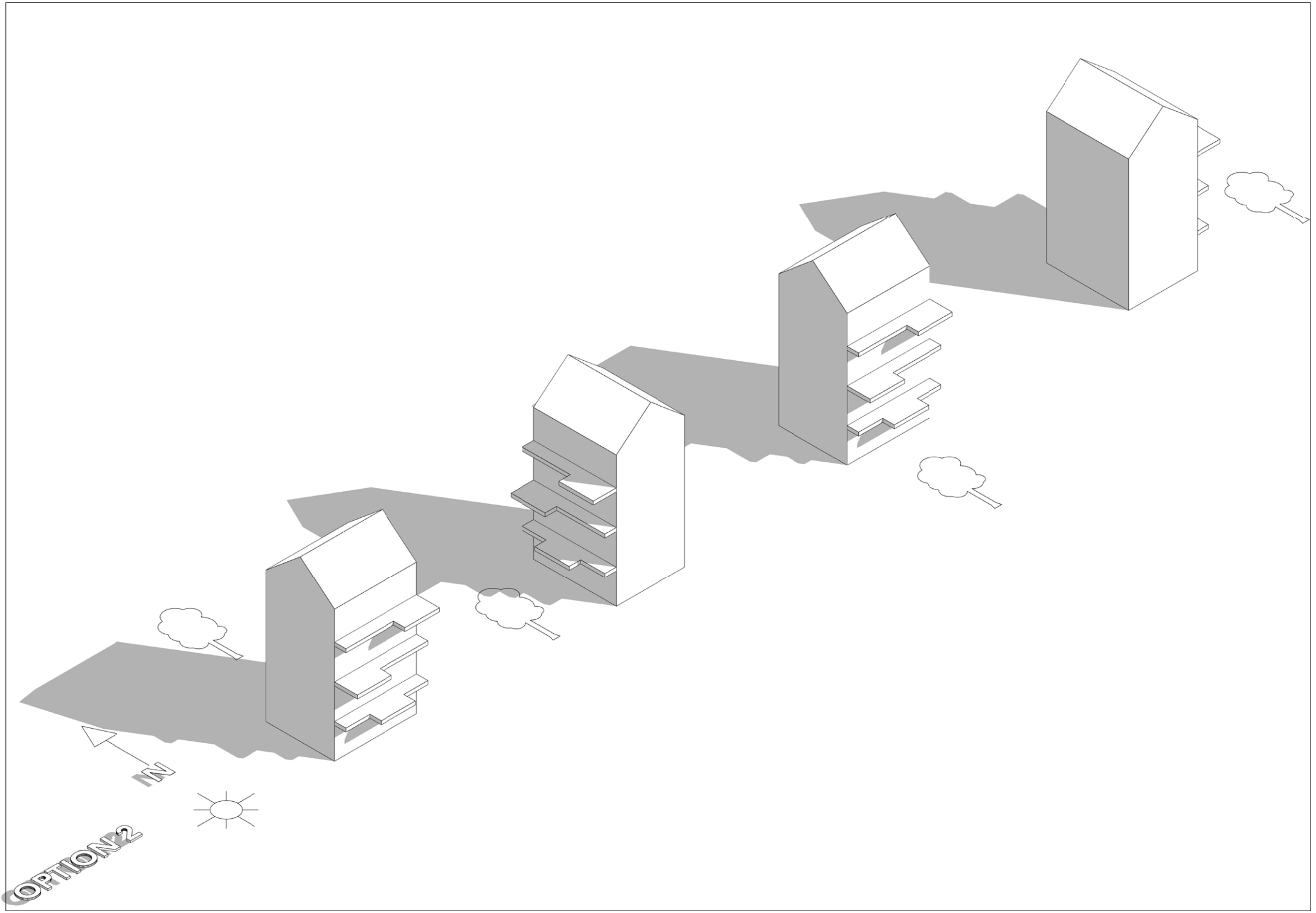

OPTION 2

N

OPTION 3

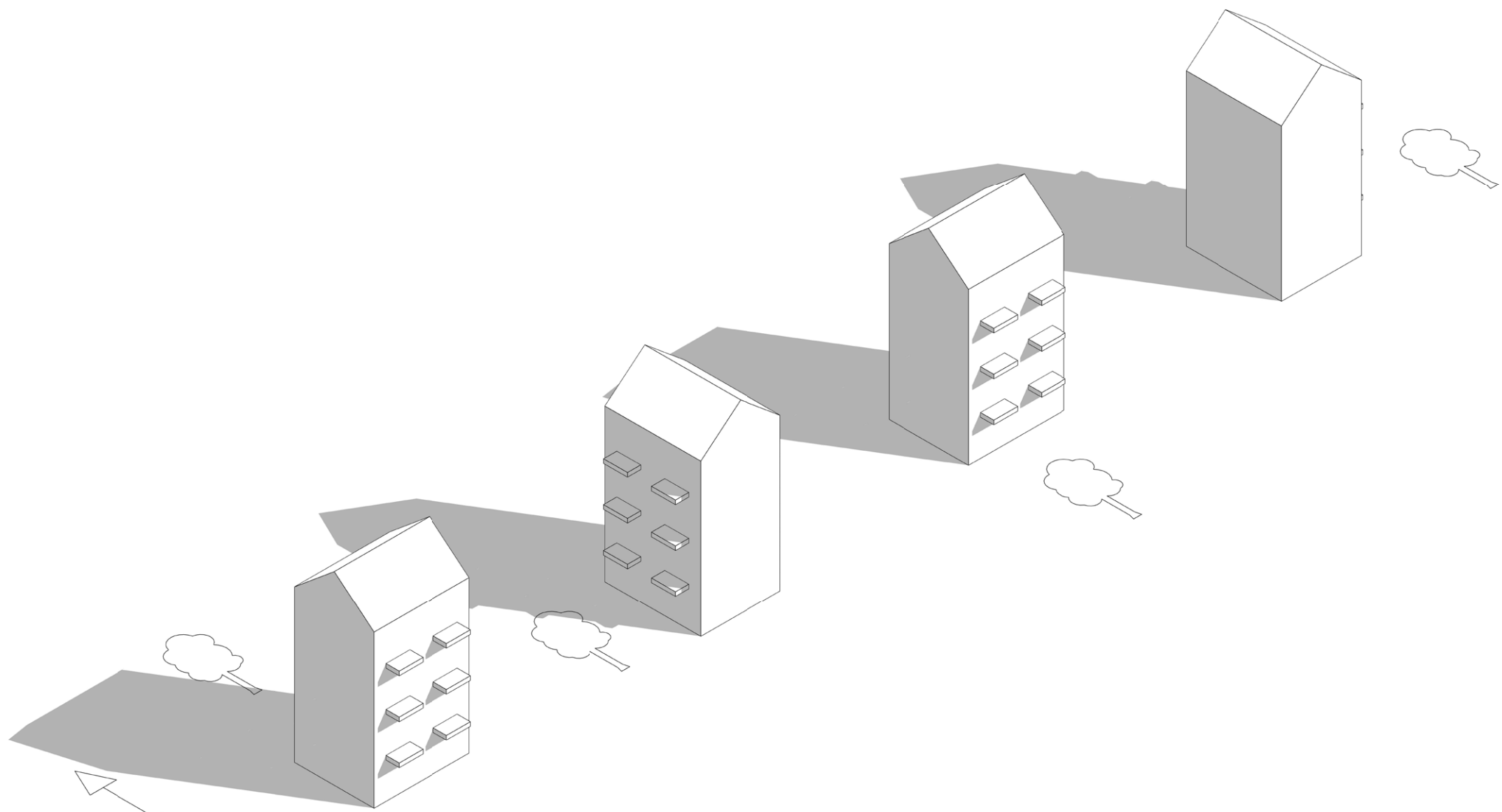
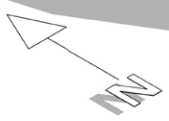
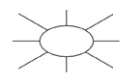

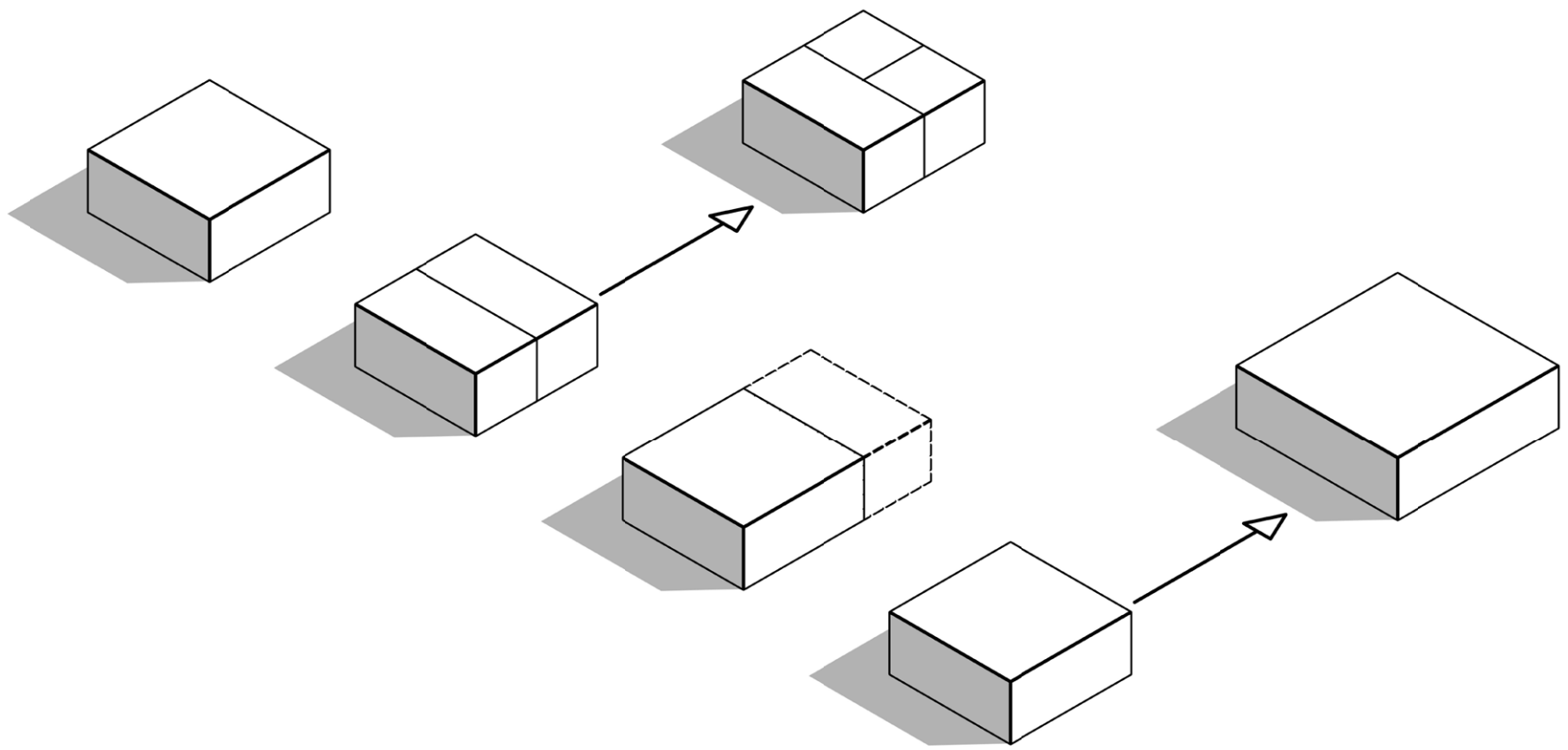

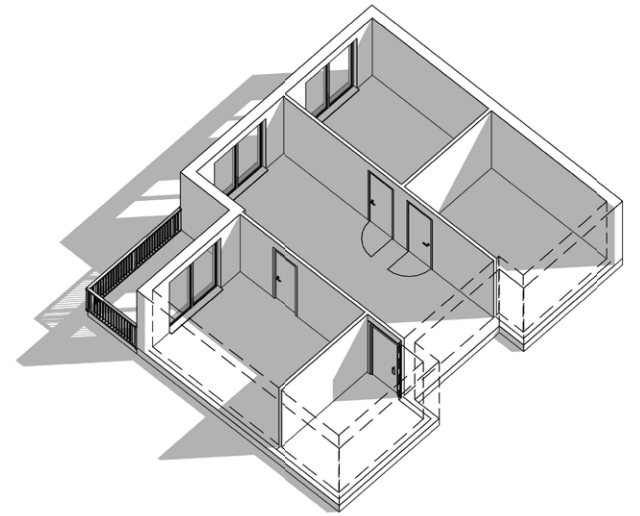
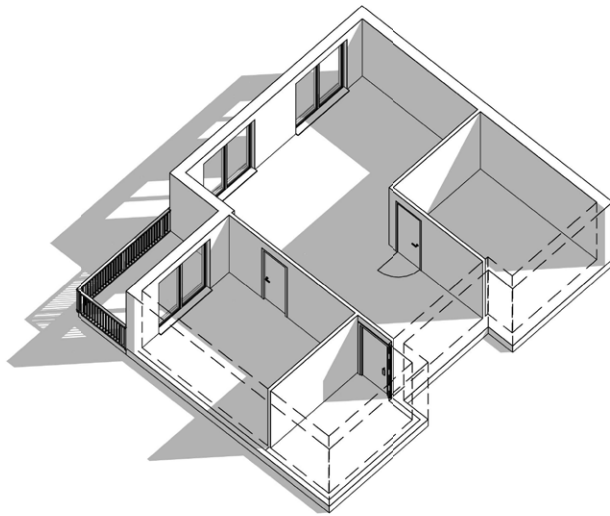
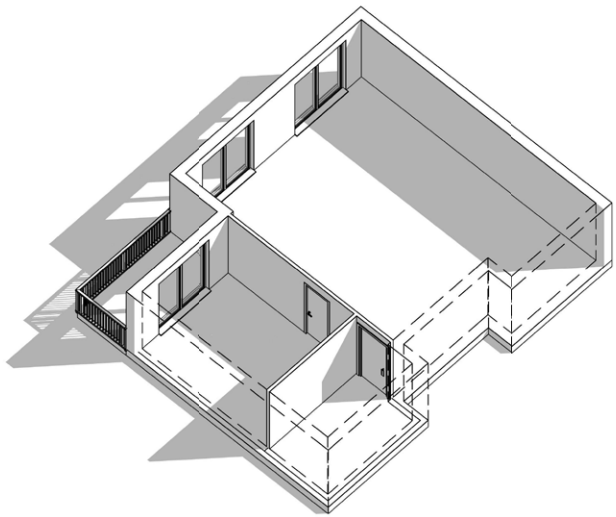

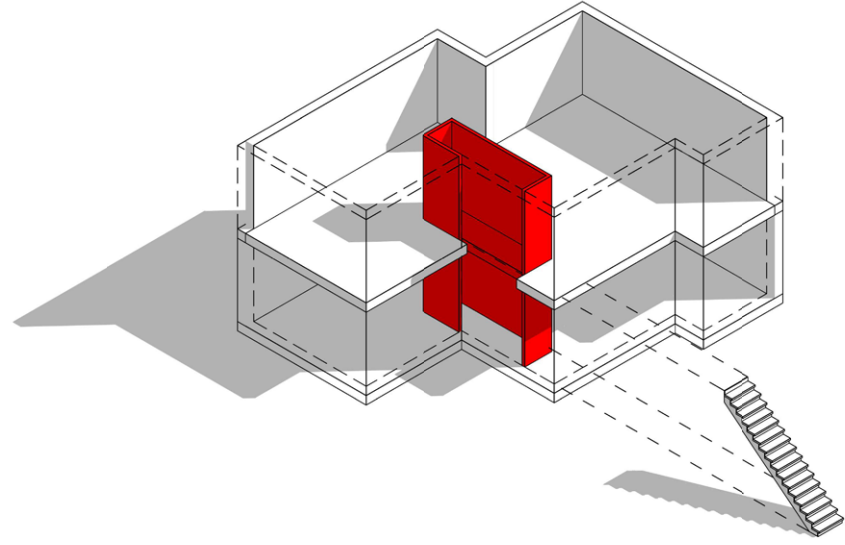
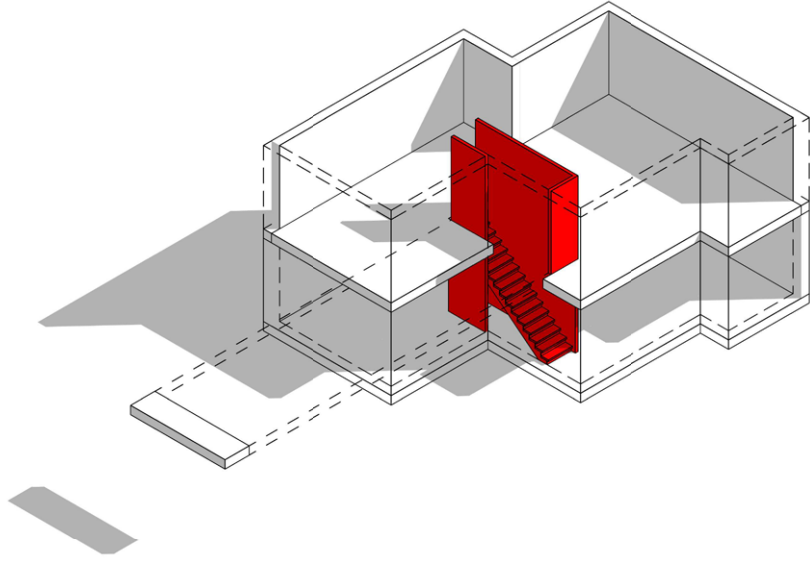

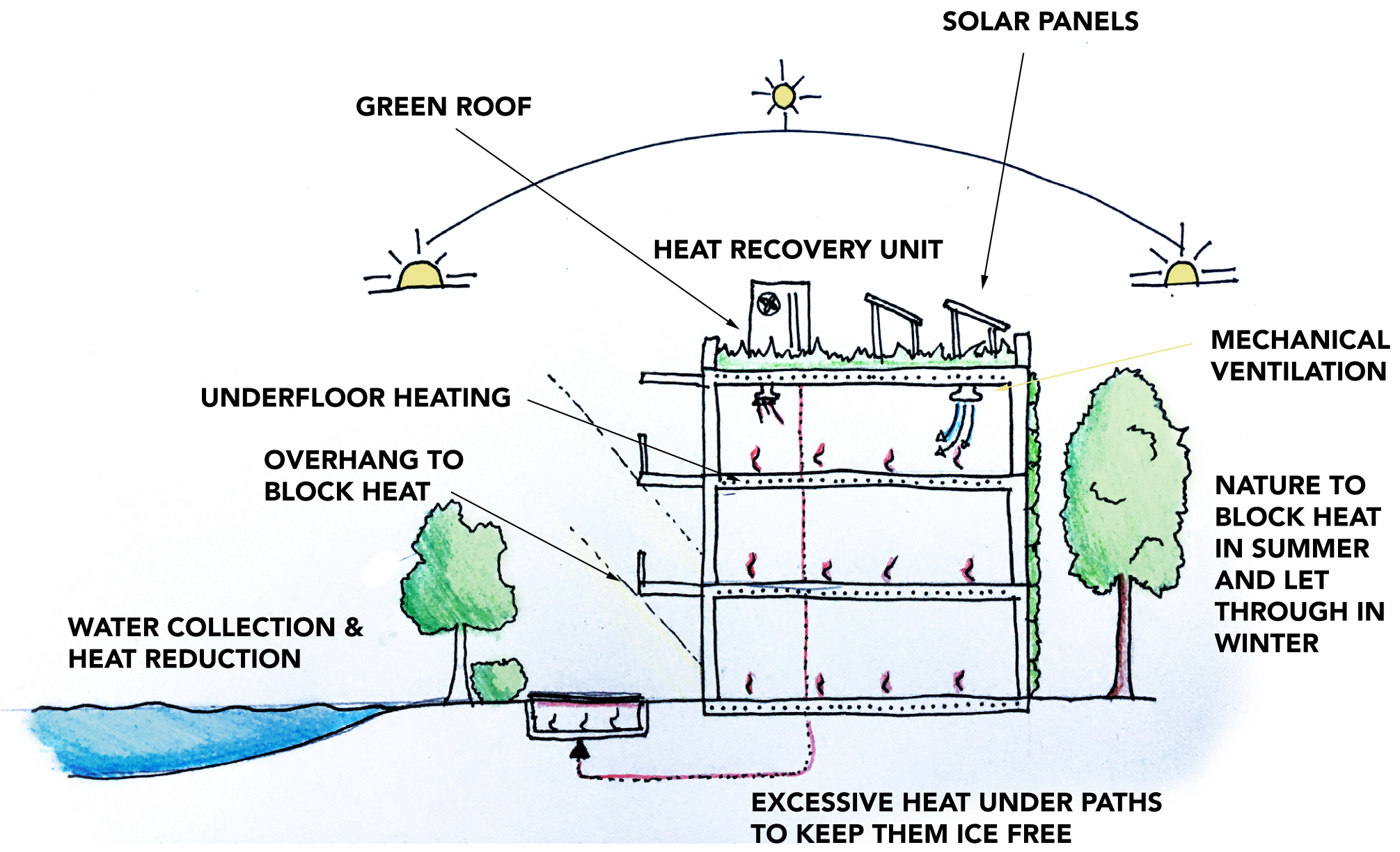

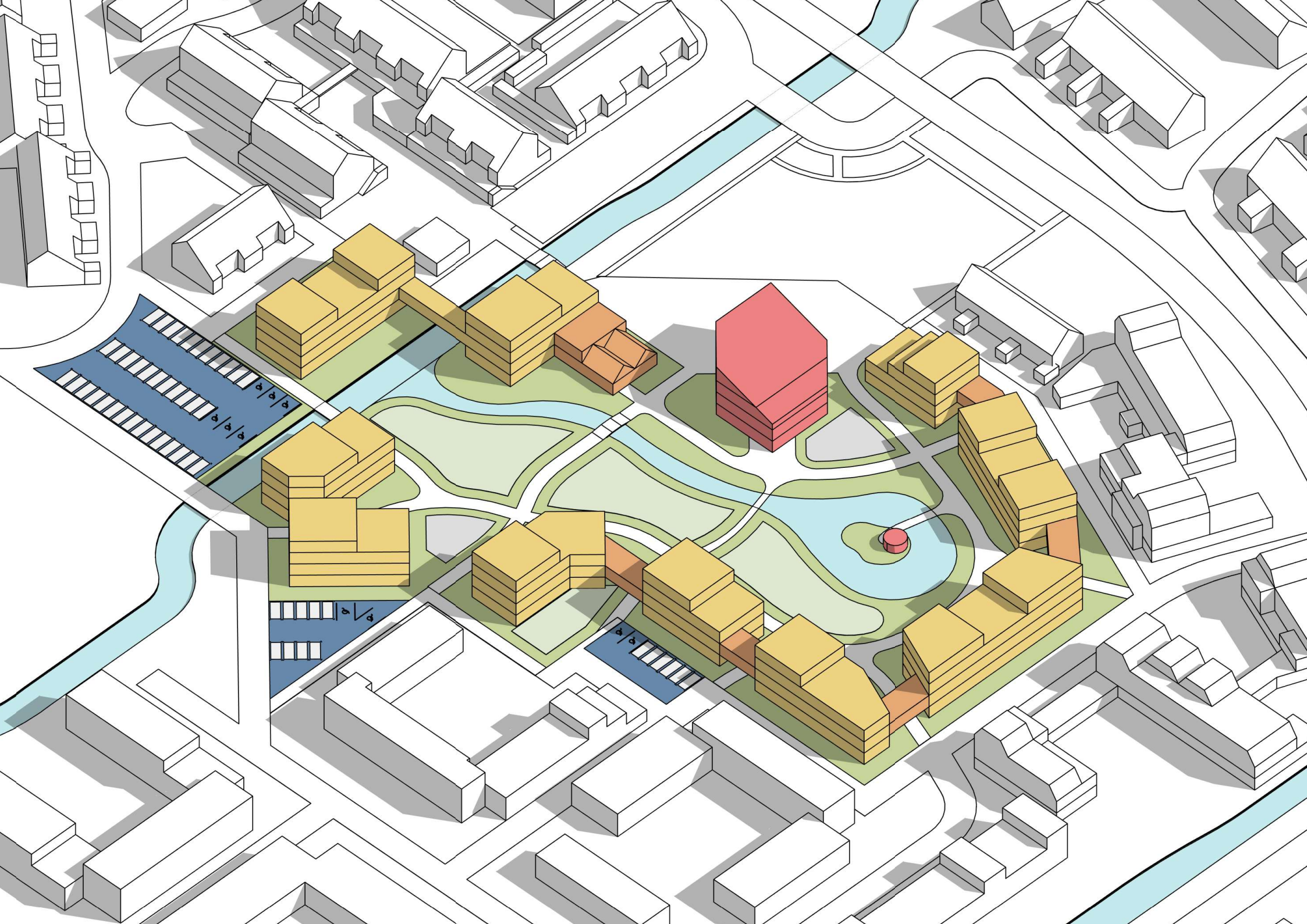

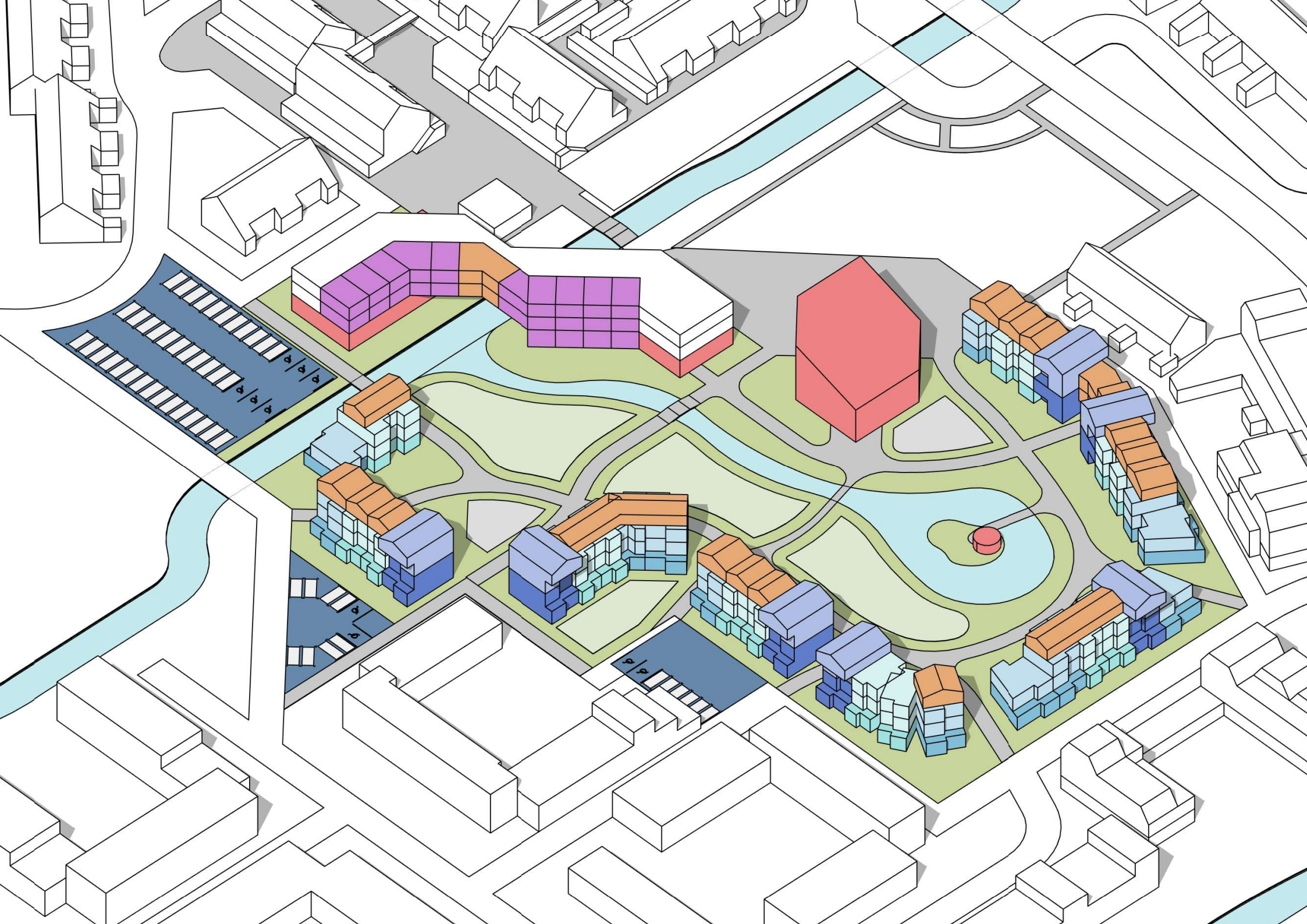

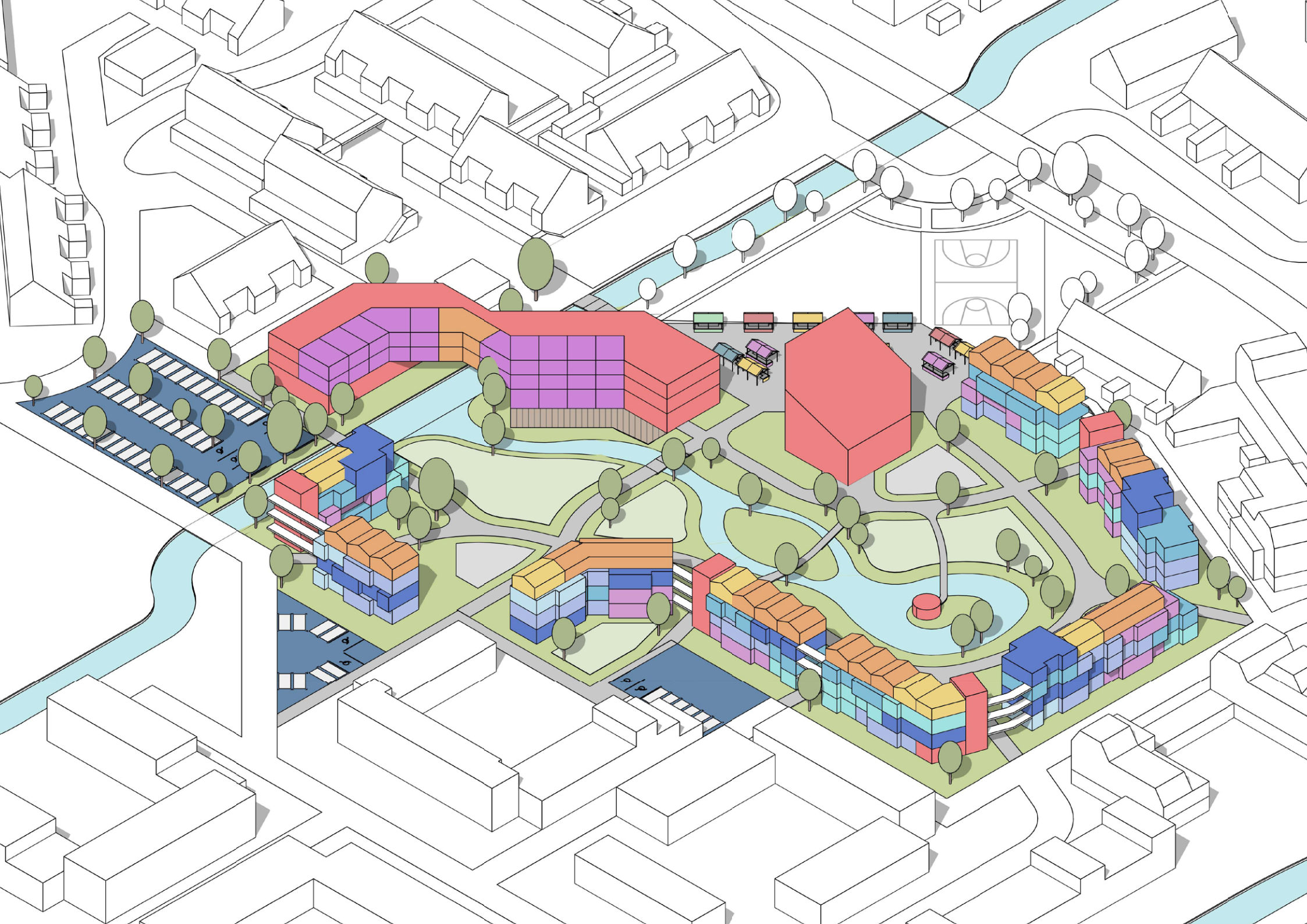

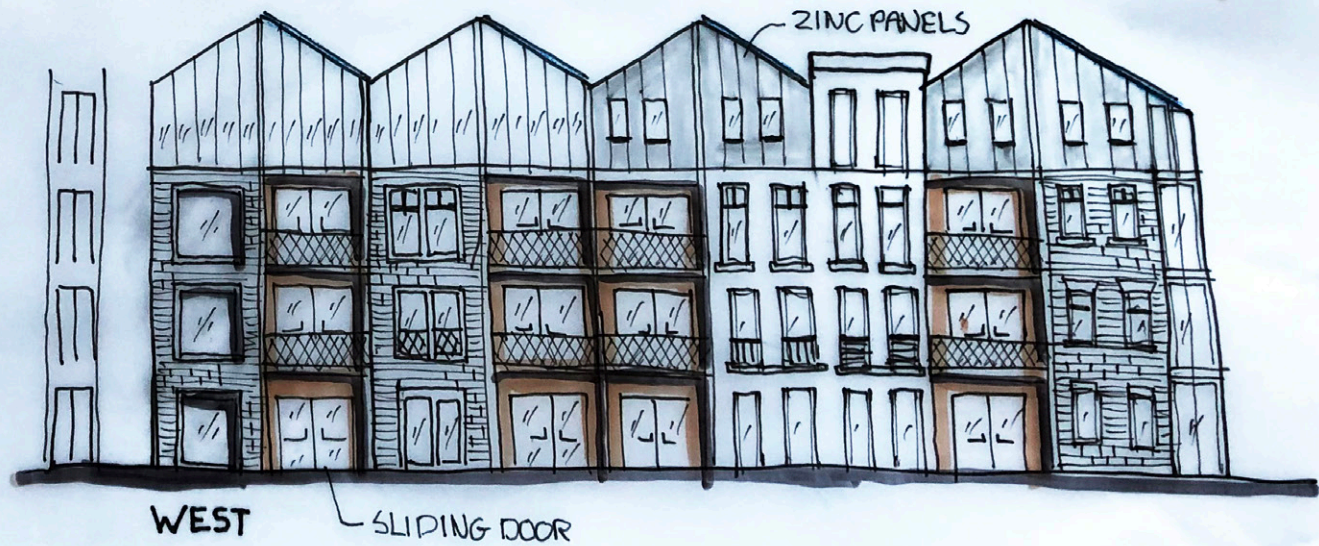
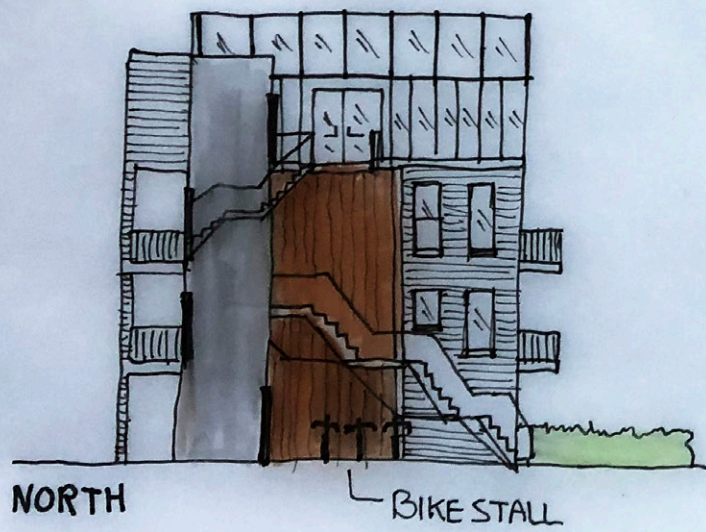
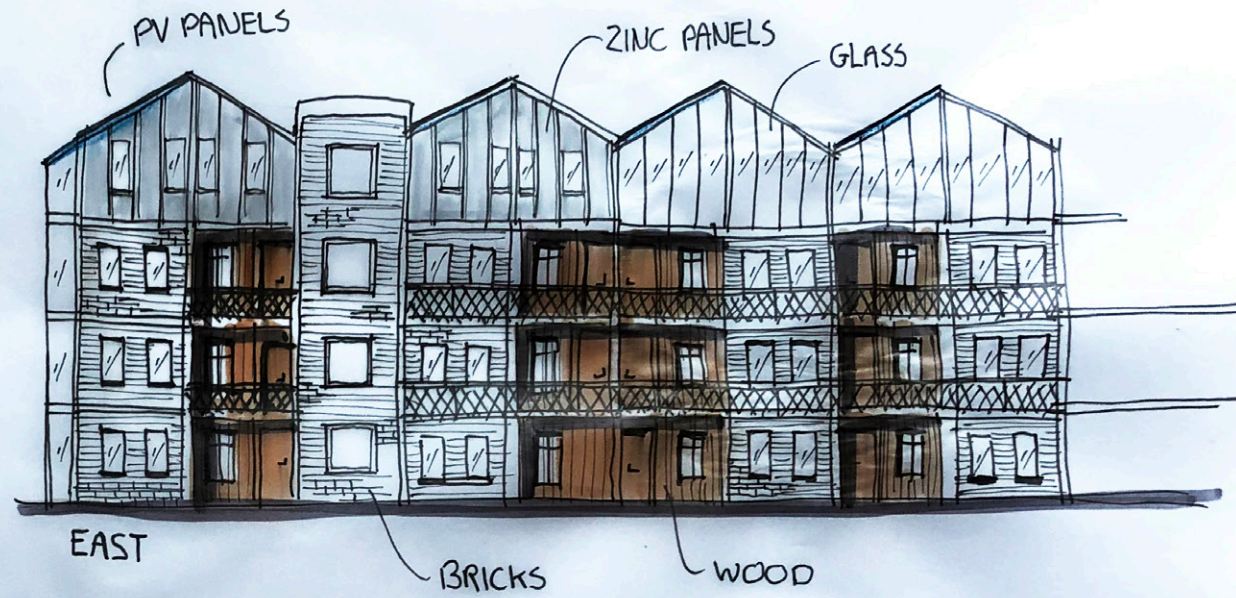
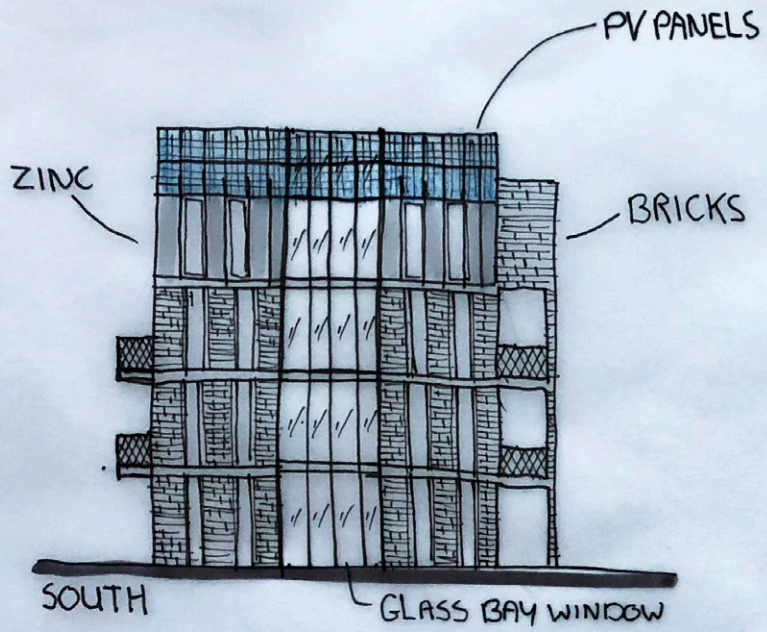

VISION

