

Evaluation of Software Tools for Standalone Microgrid Design and Optimization

Rituraj, G.; Oritz, Jorge; Ficarelli, Niccolo; Chandra Mouli, G.R.; Rodden, Paul; Martell, Christopher; Vallve, Xavier; Bauer, P.

Publication date

2024

Document Version

Final published version

Citation (APA)

Rituraj, G., Oritz, J., Ficarelli, N., Chandra Mouli, G. R., Rodden, P., Martell, C., Vallve, X., & Bauer, P. (2024). *Evaluation of Software Tools for Standalone Microgrid Design and Optimization*. IEA International Energy Agency. <https://iea-pvps.org/wp-content/uploads/2024/03/IEA-PVPS-TASK-18-Report-Software-Tools-.pdf>

Important note

To cite this publication, please use the final published version (if applicable). Please check the document version above.

Copyright

Other than for strictly personal use, it is not permitted to download, forward or distribute the text or part of it, without the consent of the author(s) and/or copyright holder(s), unless the work is under an open content license such as Creative Commons.

Takedown policy

Please contact us and provide details if you believe this document breaches copyrights. We will remove access to the work immediately and investigate your claim.



Task 18 Off-Grid and Edge-of-Grid Photovoltaic Systems

PVPS

Evaluation of Software Tools for Standalone Microgrid Design and Optimization

2024



What is IEA PVPS TCP?

The International Energy Agency (IEA), founded in 1974, is an autonomous body within the framework of the Organization for Economic Cooperation and Development (OECD). The Technology Collaboration Programme (TCP) was created with a belief that the future of energy security and sustainability starts with global collaboration. The programme is made up of 6.000 experts across government, academia, and industry dedicated to advancing common research and the application of specific energy technologies.

The IEA Photovoltaic Power Systems Programme (IEA PVPS) is one of the TCP's within the IEA and was established in 1993. The mission of the programme is to “enhance the international collaborative efforts which facilitate the role of photovoltaic solar energy as a cornerstone in the transition to sustainable energy systems.” In order to achieve this, the Programme's participants have undertaken a variety of joint research projects in PV power systems applications. The overall programme is headed by an Executive Committee, comprised of one delegate from each country or organisation member, which designates distinct 'Tasks,' that may be research projects or activity areas.

The 25 IEA PVPS participating countries are Australia, Austria, Belgium, Canada, China, Denmark, Finland, France, Germany, Israel, Italy, Japan, Korea, Malaysia, Morocco, the Netherlands, Norway, Portugal, South Africa, Spain, Sweden, Switzerland, Thailand, Turkey, and the United States of America. The European Commission, Solar Power Europe, the Smart Electric Power Alliance, the Solar Energy Industries Association, the Solar Energy Research Institute of Singapore and Enercity SA are also members.

Visit us at: www.iea-pvps.org

What is IEA PVPS Task 18?

The objective of Task 18 is to find technical issues and barriers which affect the planning, financing, design, construction and operations and maintenance of off-grid and edge-of-grid systems, especially those which are common across nations, markets and system scale, and offer solutions, tools, guidelines and technical reports for free dissemination for those who might find benefit from them.

Authors

- **Main Content:** Gautam Rituraj (the Netherlands), Jorge Ortiz (Spain), Niccolo Ficarelli (Spain), Gautham Ram Chandra Mouli (the Netherlands), Paul Rodden (Australia), Christopher Martell (Australia), Xavier Vallve (Spain), Pavol Bauer (the Netherlands)
- **Editor:** Gautam Rituraj (G.Rituraj@tudelft.nl)

DISCLAIMER

The IEA PVPS TCP is organised under the auspices of the International Energy Agency (IEA) but is functionally and legally autonomous. Views, findings and publications of the IEA PVPS TCP do not necessarily represent the views or policies of the IEA Secretariat or its individual member countries

COVER PICTURE

Creative commons license

ISBN 978-3-907281-45-1

INTERNATIONAL ENERGY AGENCY
PHOTOVOLTAIC POWER SYSTEMS PROGRAMME

Evaluation of Software Tools for Standalone Microgrid Design and Optimization

IEA PVPS Task 18 Off-Grid and Edge-of-Grid Photovoltaic Systems

Report IEA-PVPS T18-03:2024
March 2024

ISBN 978-3-907281-45-1



TABLE OF CONTENTS

Acknowledgements.....	6
List of abbreviations.....	7
Executive summary.....	9
1 Introduction.....	10
1.1 Background.....	10
1.2 What’s this report about?.....	10
1.3 Literature review.....	11
2 Software tools Selection and definition of the criteria for comparison.....	14
2.1 Selection of software tools.....	14
2.2 Selected criteria for comparison of software tools and its definition.....	17
3 Case studies of standalone microgrids.....	25
3.1 Case study 1 (Australia).....	25
3.2 Case study 2 (the Netherlands).....	26
3.3 Case study 3 (USA).....	28
4 Simulations and analysis of results for each case study.....	30
4.1 Simulation of case study 1.....	30
4.2 Simulation of case study 2.....	35
4.3 Simulation of case study 3.....	40
5 Evaluation of the software tools and recommendations.....	45
5.1 Evaluation of the software tools.....	45
5.2 Recommendations on software tools.....	49
References.....	50
Appendix A.....	51
Appendix B.....	58
Appendix C.....	63
Appendix D.....	68



ACKNOWLEDGEMENTS

This work was led by the DCE&S research group at the Department of Sustainable Energy, TU Delft, and supported in collaboration with various international partners, namely, Trama Tecnoambiental (TTA) Barcelona, Spain; Ekistica, Australia; and GSES Global Sustainable Energy Solutions, Australia.

The authors thank the Netherlands Enterprise Agency (RVO) for funding this work under the grant TSE1210055.

The authors thank several IEA PVPS Task 18 members and other international experts for their valuable feedback and suggestions for this report. Many thanks to Otto Bernsen (RVO, the Netherlands), Michael Müller (OFRES, Germany), Kunaifi (Indonesia), and Stefan Trittler (Asantys Systems, Germany).

The authors also thank the iHOGA PRO+ creator, Prof. Rodolfo Dufo López, for providing a free license for this work and helping us understand this software.

The authors thank Ekistica, Australia, for providing measurement data of the Daly River site standalone microgrid.



LIST OF ABBREVIATIONS

AC	Alternating Current
BESS	Battery Energy Storage System
DC	Direct Current
DG	Diesel Generator
EDU	Educational
ESS	Energy Storage System
GUI	Graphical User Interface
GHI	Global Horizontal Irradiance
HDI	Human Development Index
HOMER	Hybrid Optimization of Multiple Energy Resources
HRES	Hybrid Renewable Energy Systems
IEA	International Energy Agency
iHOGA	improved Hybrid Optimization by Genetic Algorithms
JC	Job Creation
LCOE	Levelized Cost of Energy
MA	Monthly Average
MHOGA	MegaWatt Hybrid Optimization by Genetic Algorithms
NASA	National Aeronautics and Space Administration
NEDU	Nederlandse Energie Data Uitwisseling
NPC	Net Present Cost
NPV	Net Present Value
NREL	National Renewable Energy Laboratory
NT	Northern Territory
O&M	Operation and Maintenance
OS	Operating System
POWER	Prediction of Worldwide Energy Resource
PV	Photovoltaic
RAM	Random Access Memory
RES	Renewable Energy Sources
RET	Renewable-energy and Energy-efficient Technology
SAM	System Advisor Model
SETuP	Solar Energy Transformation Program



SM Standalone Microgrid
WT Wind Turbine



EXECUTIVE SUMMARY

The standalone microgrid (SM) is getting attention and being adopted by energy communities due to several factors, such as increasing access to electrification, electrification of vehicles, and reducing greenhouse gas emissions in a generation. It involves different phases to get the comprehensive design of SM. The objective of the first phase is to pre-design the SM and to optimize the capacities of each component. In this phase, software tools, if used properly, play a valuable role and help to ensure an efficient, reliable, and cost-effective SM.

Various publicly available software tools (whether freely accessible or paid) supporting microgrid initial sizing and analysis are reported in the literature. However, the questions are: Are they really for sizing and optimization? If yes, then which one should be used? If more than one similar tool is available, will they produce similar results for the same inputs? If the results are similar, which tool provides results more aligned with the measurement data? These are the common questions for users when selecting software tools for pre-designing and optimizing SMs (with single or multiple energy sources used). In this context, this report attempts to answer these questions to help engineers, designers, and planners select the right software tools during the initial phase of designing and optimizing SM per their requirements.

A literature survey has been done to find publicly available software tools for pre-designing, analyzing, and optimizing SM. From the survey, it has been found that HOMER Pro is widely utilized for it. Besides that, another tool, iHOGA PRO+, is reported to have a similar objective to the HOMER Pro. Since both software tools use distinct optimization algorithms, they may produce different results for a given set of inputs. Therefore, these tools (HOMER Pro version 3.16.2 and iHOGA PRO+ version 3.4 build 20231114) have been evaluated in detail to know their results' differences, main advantages and weaknesses, and the existing gaps.

For a fair comparison, the number of criteria (i.e., 22) has been defined and categorized under quantitative (i.e., 1-7) and qualitative (i.e., 8-22). For quantitative comparison, three case studies are defined based on the geographical location, with different system components. These locations are the Daly River, Australia (case study 1); Delft, the Netherlands (case study 2); and Sheldon (Vermont), U.S.A. (case study 3). Each case is simulated in both software tools for the same inputs. The obtained results are compared using quantitative criteria. Moreover, for case study 1, the simulation results are compared with the measurement data. Thus, a total of three different quantitative comparisons are presented. However, the qualitative comparison of these tools was independent of the specific case studies presented.

Simulations in both software tools have proven to match (within a reasonable tolerance) measurement data from a real microgrid (i.e., case study 1). However, both software tools arrive at slightly different optimum sizing when optimizing a microgrid from scratch (i.e., case studies 2 and 3).

In summary, this report provides and analyses 22 criteria for comparison of HOMER Pro and iHOGA PRO+. However, per the user's requirement, the software must be selected based on the criteria that apply to their needs.



1 INTRODUCTION

1.1 Background

The need for the standalone microgrid (SM) is increasing due to multiple factors, such as increasing access to electrification, electrification of vehicles, reducing greenhouse gas emissions in a generation, enhancing resilience, and promoting cleaner and more efficient energy consumption. Usually, SM contains various energy sources, such as solar energy, wind energy, generators, and energy storage systems (ESSs), which are integrated with the controlled power electronics interface to provide power to localized areas, such as a remote community, industrial site, or critical facility.

The design of an SM can be divided into two main phases. First, a pre-design is conducted using software optimization tools that provide a first iteration of the main sizing parameters, such as the capacities of the power generation sources and the ESS. The sizing parameters are optimized to maximize or minimize certain indicators specified in the project's first phases. For example, a project may aim only to minimize the levelized cost of energy (LCOE), or it could also require a multi-variable optimization, such as minimizing LCOE while minimizing CO₂ emissions. Secondly, the sizing parameters of the pre-design phase are fed into the detailed design phase. During this phase, the sizing parameters are adapted to ensure the overall technical feasibility of the SM, considering all the technological and manufacturing possibilities (and limitations) of the different components used. The detailed design phase shall never be done, trusting unquestioningly the results of the software optimization tools. Instead, it requires a professional design engineer with extensive knowledge of the specificities of all the microgrid components and processes. However, this report focuses on the first phase of microgrid design (i.e., software tools).

1.2 What's this report about?

This report aims to evaluate publicly available software tools (whether freely accessible or paid) that facilitate the optimization to be done during the pre-design phase of SMs, and the creation of SM case studies for comparison of these tools.

For this subtask (of IEA PVPS Task 18), four stages have been identified as follows:

- A) Selection of software tools and definition of the criteria for comparison of these tools,
- B) Case studies of SMs with measurements (and/or synthetic) data,
- C) Simulations and analysis of results,
- D) Evaluation of the software tools and recommendations.

This chapter presents the literature review of publicly available SM design, analysis, and optimization software tools. Based on the literature review in Section 1.3, the software selection will be done in Chapter 2. Moreover, Chapter 2 defines the selected criteria. Chapter 3 presents the considered case studies, the objective for the simulation study, and the source(s) of data taken into account. Chapter 4 performs the simulations using the selected software tools and analyzes the results. Finally, Chapter 5 evaluates the selected software tools based on the criteria discussed in Chapter 2 and provides recommendations based on the analysis of the discussed (in Chapter 3) case study results.



1.3 Literature review

Reference [1] has discussed twenty software tools for simulating and optimizing hybrid renewable energy systems (HRES) based on their limitations and capabilities. Out of them, four software tools, such as HOMER (Hybrid Optimization of Multiple Energy Resources), RETScreen, HYBRID2, and iHOGA, are the best for the simulation and optimization of HRES. In [2], various software tools for sizing and optimizing PV-wind-based hybrid systems are reviewed in detail and summarized characteristics of the most suitable tools, such as HOMER, HYBRID2, iHOGA, and HYBRIDS. Moreover, in [3], a comprehensive review of the configurations, operation, and integration of multiple energy sources for microgrid power plants is performed. Further, the different software tools used for similar purposes have been studied. Moreover, in [4], HOMER Pro, iHOGA, RETScreen, and PVsyst are discussed for the design, analysis, and optimization of HRES. Hence, with this information, a comparison of some popular software tools is made in Table 1, based on various features and characteristics [1], [2], [3].

One popular software tool for SM is HOMER Pro, as shown in Table 1, which is widely used for commercial and educational purposes [1], [2], [3]. It is an optimization software tool for designing and analyzing microgrids and other distributed energy systems. It offers two algorithms (i.e., the Search Space or HOMER Optimizer) to optimize the system's configuration, size, and financial performance [5]. In the literature, many works have used the HOMER Pro software tool for designing and analyzing microgrid systems [6], [7], [8]. In [6], five microgrid scenarios with PV, wind, battery storage, and diesel combinations are modelled and simulated using HOMER Pro. Further, based on their total net present cost (NPC), energy cost, excess electricity, and emissions, microgrid systems' economic and comparative analysis are presented to find the optimum design. In [7], a case study of microgrids for Medellín city is analyzed under standalone and grid-connected conditions using the HOMER Pro software tool to find the return on investment and its viability. Moreover, in [8], HOMER Pro is used to optimize the system size and perform the sensitivity analysis of PV and wind-based microgrids for Bangladesh. Thus, it can be seen that HOMER Pro is widely adopted within the microgrid sector worldwide.

Table 1: Summary of characteristics/features of the generally used software tools for simulation and/or optimization of microgrids.

Software tools	HOMER Pro	iHOGA PRO+	RETScreen	HYBRID2	HYBRIDS	SAM
Features						
PV	✓	✓	✓	✓	✓	✓
Battery storage	✓	✓	✓	✓	✓	✓
Pumped hydro storage (actual)		✓				
Wind	✓	✓	✓	✓	✓	✓
Diesel generator	✓	✓	✓	✓	✓	
Hydro	✓	✓	✓	✓	✓	
Fuel cell	✓	✓		✓	✓	
Electrolyzer	✓	✓		✓	✓	



Hydrogen tank	✓	✓		✓	✓	
Hydrogen load	✓	✓		✓	✓	
Thermal load	✓		✓	✓	✓	
Water load		✓				
Control strategies	✓	✓		✓		
Standalone	✓	✓	✓			
Grid-connected	✓	✓	✓			
Simulation	✓	✓	✓	✓	✓	✓
Meteorological data from NASA	✓	✓	✓			
Meteorological data from PVGIS		✓				
Meteorological data from RENEWABLES NINJA		✓				
Technical analysis	✓	✓				
Economic analysis	✓	✓	✓	✓	✓	✓
Emission analysis	✓	✓	✓			
Sensitivity analysis	✓	✓	✓			
Probability analysis		✓				
Multi or mono-Objective Optimization	✓	✓				

Another software tool is iHOGA PRO+, or iHOGA (improved Hybrid Optimization by Genetic Algorithms) [1], [2], [3], which can function similarly to HOMER Pro, as shown in Table 1. It uses different algorithms (i.e., Genetic algorithms) for optimization compared to HOMER Pro. Moreover, it can also be used to perform probability analysis (Monte Carlo simulation) [9]. This tool is mainly studied with the HOMER Pro for comparison in very few works [10], [11]. Reference [10] has compared the optimized design of HRES for the site located at Aralvaimozhi, India, under specific criteria using HOMER Pro and iHOGA and listed their advantage and disadvantages. In [11], a hybrid power system is designed using HOMER Pro and iHOGA, and their results are analyzed based on economics.

Other software tool options include RETScreen (Renewable-energy and Energy-efficient Technologies), HYBRID2, HYBRIDS, and System Advisor Model (SAM), as shown in Table 1. RETScreen clean energy management software (RETScreen Expert) is used to assess the feasibility of cogeneration projects and conduct ongoing energy performance analyses. It allows users to perform financial, technical, and life cycle cost analyses and to create detailed reports on the energy performance of a project [12], [13]. HYBRID2 was developed by the National Renewable Energy Laboratory (NREL) and the University of Massachusetts [1]. This software tool can give good precision in simulation by providing time series data in the interval



from 10 min to 1 h [2], [3]. It does not support multi-objective optimization. HYBRIDS is produced by Solaris Homes. This tool is an Excel spreadsheet-based renewable energy assessment application [1], [2]. It is based on NPC to determine the potential of the hybrid systems. This tool requires a daily average of environmental data and load demand for every month of the year [3]. SAM evaluates the feasibility and potential of renewable energy projects and identifies potential opportunities for improvement [14]. It allows users to enter detailed information about the site, the technology, and the financial parameters and then generates performance and economic predictions based on that data.



2 SOFTWARE TOOLS SELECTION AND DEFINITION OF THE CRITERIA FOR COMPARISON

This chapter identifies the publicly available software tools for the simulation of SMs based on the literature review in Chapter 1.2. Then, the criteria are discussed for their comparison, and their definitions are presented.

2.1 Selection of software tools

When designing and optimizing a standalone/edge-of-microgrid, choosing the right software tools is essential to ensure an efficient and cost-effective system. Numerous software tools, each with its strengths and weaknesses, are reported in the literature for microgrid analysis, such as technical, economic, and environmental [1], [2], [3]. Some critical factors to consider when selecting software tools for SM design include the system's complexity, the type and number of energy sources and loads, and the level of control and monitoring required.

Table 1 shows that HOMER Pro has most of the features for designing and optimizing the SM. Moreover, from the authors' best knowledge and Table 1, iHOGA PRO+ has similar functionality to HOMER Pro. These software tools may produce different results for a given set of inputs because of the distinct optimization algorithm used. Hence, it is interesting to evaluate these software tools in detail to understand the differences in their results, the main advantages and weaknesses, and the existing gaps in these software tools. In this context, the criteria are defined and discussed in Section 2.2. However, before going into detail about the criteria discussion and its definition, an overview of the selected software tools, i.e., HOMER Pro and iHOGA PRO+, is presented to help in understanding these tools better.

2.1.1 Overview of HOMER Pro

HOMER Pro is a software by HOMER Energy that specializes in optimizing microgrid systems [5]. The NREL initially developed this software, but now it is a part of UL Solutions. It allows users to evaluate and compare various configurations of microgrids, including renewable energy sources, energy storage and management systems, converters, grids, and traditional generators, to determine the most cost-effective and efficient option. Moreover, it also gives the option to perform sensitivity analysis. Furthermore, it can be used to conduct a comprehensive financial (that includes calculating internal rate of return, net present value (NPV), and other financial metrics) and environmental analysis [15].

HOMER Pro employs two different optimization techniques. The first one, the grid search algorithm, evaluates all the possible system setups defined by the search space. The second algorithm, the HOMER Optimizer, utilizes a unique algorithm that uses a proprietary derivative-free algorithm to find the system with the least cost. HOMER Pro then presents a list of system configurations that are ordered by net present cost (NPC, life-cycle cost). This list can be utilized to compare different design alternatives.



Figure 1: HOMER Pro software graphical user interface (GUI) showing the home tab where the architecture of the simulated system and suggestions can be seen.

The software can be utilized for various applications, including remote communities, islands, military bases, campuses, and commercial and industrial facilities. As per the applications, different license options are available for this software. The HOMER knowledgebase can be accessed online at <http://support.homerenergy.com/index.php?/Knowledgebase/List> by logging into an account. Moreover, the input data requirements of the HOMER Pro software tool to design a SM (having PV, diesel generator, battery, and load) can be seen in **Appendix A**.

2.1.2 Overview of iHOGA PRO+

iHOGA is one of the versions of Hybrid Optimization by Genetic Algorithms (HOGA) software, developed by researchers of the University of Zaragoza (Spain), led by the principal researcher Dr. Rodolfo Dufo López. C++ is used to create this software. It is used to simulate and optimize hybrid renewable systems that utilize a combination of renewable sources such as solar, wind, and hydropower, as well as storage options like batteries, backup generators, and fuel cells (combined or not with electrolyzer and hydrogen tank) [9]. With this tool, there is a possibility of connecting to the grid and generating hydrogen for sale. The system size to be optimized in iHOGA must be up to 5 MW. For higher power, MHOGA (another version of HOGA) software can be used.



Figure 2: iHOGA PRO+ software GUI showing different tabs and architecture of the simulated system.

Genetic algorithms are used to determine the optimal combination of components and control strategies efficiently. In iHOGA, two forms of optimization can be seen: minimizing the NPC for scenarios with high load or off-grid (standalone) systems or maximizing the NPV for grid-connected power generation systems. It allows us to define different cases of Net Metering and Net Billing. It also includes the optimization of energy arbitrage (using batteries, hydrogen, or pumped hydro storage) in grid-connected systems. The software includes advanced features like multi-period simulation and optimization, considering the changes in load and electricity production from renewable sources over the system's lifetime, multi-objective optimization, simulating in time steps ranging from 1 minute to 1 hour, sensitivity analysis, probability analysis using Monte Carlo simulation, and more.

In the economic calculations, iHOGA uses different inflation rates (one for general inflation, another one for the fuel price of the DG, and another one for the electricity price). It even considers different inflation rates for the replacement cost of the different components to estimate their cost when they must be replaced.

iHOGA can also be used for various applications (as mentioned in the case of HOMER Pro) with only a single paid license (i.e., PRO+ version). However, the EDU version is free for training or educational fields with conditions. Detailed information about this software can be found in their user manual [9]. Moreover, the input data requirements of the iHOGA PRO+ software tool to design a SM (having PV, diesel generator, battery, and load) can be seen in **Appendix A**.



2.2 Selected criteria for comparison of software tools and its definition

The following criteria can be used to evaluate the selected software tools (i.e., HOMER Pro and iHOGA PRO+) for SM design, as shown in Table 2. Its definition is provided after that. These criteria cover many aspects of software tools evaluation, such as functionalities, portability, usability, supportability, interoperability, licensing and pricing, efficiency, optimization technique, and technical, economic, and environmental parameters [3], [16], which are categorized into two types, i.e., quantitative and qualitative. Quantitative criteria are shown from 1-7, which cover technical, economic, and environmental parameters obtained from the software simulation, and the data for these criteria depends on the case study. For a fair comparison, the same inputs and constraints will be given to each software tool for each case simulation to get the data for criteria 1-7, as shown in Table 3. On the other hand, qualitative criteria are presented from 8-22, used to compare the general differences of software tools, independent of the discussed case studies (except point 8), and will be shown once in this report. Since HOMER Pro cannot calculate the social criteria (point 8), it is not used in comparison for each case and, hence, is included in the qualitative criteria.

Table 2: Selected criteria for software tool comparison [10], [17], [18].

Sr. no.	Criteria	Parameters	Unit	Software tools		
				Homer Pro	iHOG A PRO+	
1	Optimum system size of SM (for the same inputs) suggested by each software tool	Battery inverter	kW			Quantitative criteria. The data here will be dependent on case studies.
		PV	kW			
		WT	kW			
		DG	kW			
		BESS	kWh			
2	Electrical	Electricity generated by PV	kWh/yr			
		Electricity generated by WT	kWh/yr			
		Electricity generated by DG	kWh/yr			
		Energy in (BESS)	kWh/yr			
		Energy out (BESS)	kWh/yr			
		Excess Electricity	kWh/yr			
			in %			
Unmet electric load	kWh/yr					
	in %					
3	Autonomy		hr			
4	Economics	NPC		\$		
		LCOE		\$/kWh		



		Total O&M cost	\$			
		Replacement cost	\$			
		Initial capital cost	\$			
		Fuel cost	\$			
5	RES use factors	Renewable penetration	%			
		Renewable fraction	%			
6	Emissions	CO ₂	kg/yr			
		SO ₂	kg/yr			
		NO ₂	kg/yr			
7	Simulation time		sec			
8	Social	Job creation calculated by tool	-			
		Human development index calculated by tool	-			
9	Load type		-			
10	Optimization type		-			
11	Optimization technique used		-			
12	Hardware requirements to install software	OS required	-			
		Processor	-			
		RAM	-			
		Hard drive	-			
13	Complexity of a project file	does one project contains single/multiples files?	-			
14	User interface	Look and feel of software home tab	-			
		Presentation of information in each tab	-			
		How easy/hard to access information in minimum number of tabs?	-			
15	Installability	Is it straightforward to install?	-			
16	Learnability	Getting started guide is provided outlining a basic example of using the software	-			



		Instructions are provided for many basic use cases.	-			Qualitative criteria. The data here will be independent of case studies.
		Tutorial videos are available whether free or paid	-			
		Reference guides are provided for all configuration options.	-			
		How straightforward is to learn basic functional task?	-			
		How straightforward is to learn advanced functional task?	-			
17	Licensing and pricing	Free or commercial	-			
		License types (Std./Acad./Pro.)	-			
		Price range of different license types	-			
		License duration	-			
		Is a free trial available?	-			
18	Interoperability	Interoperable with other required/related software?	-			
19	Input data availability	Wind data	-			
		Solar irradiance data	-			
		Temperature data	-			
		Laod profile	-			
20	Output file accesssibility	Format of the results	-			
		Able to generate a report of optimized design?	-			
		Able to show various graphs in software tool itself?	-			
		Able to generate a proposal for a project?	-			
21	Update frequency of software and manual		-			
22	Software' customer support facility	Do developers respond to emails/call?	-			
		Do they listen to feedback?	-			



		Easy/quick to get technical support from developer on any issue related to functionality/working of tool	-				
--	--	--	---	--	--	--	--

Table 3: Input requirements of software tools.

Sr. no.	Input Parameters	Unit	Software tools		Comments
			HOMER Pro	iHOGA PRO+	
1	Single PV module specification				
2	Single battery specification				
3	Single WT specification				
4	DG specification				
5	Fuel properties				
6	Single inverter specification				
7	Economics input				
8	System controller parameters				
9	Solar GHI profile				monthly average
10	Temperature profile				monthly average
11	Load profile				monthly average
12	Wind speed profile				monthly average
13	Site location				
14	Constraints: Minimum renewable fraction				
15	Constraints: Unmet load (max)				

2.2.1 Criteria definition

The definition of the criteria mentioned in Table 2 is discussed in this section.

2.2.2 Optimum System size of microgrid suggested by each software tool

Here, we will compare the system size (in terms of power ratings and number of modules) of each component obtained from the optimization results by each software tool for the same inputs, as shown in Table 3. Below is the list of essential components of the microgrid whose optimum values, provided by each software tools, can be compared:

- Renewable Energy Sources (RES), such as PV (kW or kWp and total quantity) and wind (kW and total quantity).



- ESS, such as battery (kWh and total quantity).
- Converters (kW)
- Backup power generation (kW and total number)

2.2.3 Electrical

Here, some electrical parameters, such as electricity generated by various sources, excess electricity, and unmet load will be given.

2.2.4 Autonomy (in hr)

The battery bank autonomy (it is the ratio of the battery bank size to the electric load) and/or hydrogen tank autonomy will be compared from each software tool.

2.2.5 Economics

Various costs associated with the architecture, in the long run, are one of the deciding factors in the selection of that architecture. Therefore, we will compare the obtained architecture from the optimization based on the following costs:

- NPC (or life cycle cost) of system (\$): The present value of all the costs of installing and operating it over the project lifetime – profit over the project lifetime.
- LCOE: Total annualized cost of electricity production (\$/yr) / Total electrical load served (kWh/yr). The expression is as follows:

$$LCOE = \frac{C_{ann,tot} - c_{boiler} H_{served}}{E_{served}}$$

where $C_{ann,tot}$ is the total annualized cost of the system in \$/yr, c_{boiler} is the boiler marginal cost in \$/kWh, H_{served} is the total thermal load served in kWh/yr, and E_{served} is the total electrical load served in kWh/yr.

- Total O&M cost (\$): The total O&M cost of the system is associated with the sum of the O&M cost of each component.
- Replacement cost (\$): It is the cost associated with the replacement of the component at the end of its lifetime.
- Initial capital cost (\$): As per HOMER Pro, “The initial capital cost of a component is the total installed cost of that component at the beginning of the project”.
- Fuel cost (\$): It the cost of fuel to run the AC generator over the project lifetime.

The software tool for each optimized configuration will compute these costs.

2.2.6 RES use factors

Here, we will compare RES use factors (given below) from the obtained architecture from the software tools.

- Renewable Penetration (in %): Total renewable electrical power output in this time step (kW) / total electrical load served in this time step (kW)
- Renewable fraction (in %): It is the fraction of the energy delivered to the load, which is generated from RES.



2.2.7 Emissions

Emissions are another crucial factor that we must look for while selecting the architecture. Therefore, we will compare the following emissions computed by the software tools for the optimized architecture.

- CO_x (kg/yr)
- SO_x (kg/yr)
- NO_x (kg/yr)

2.2.8 Simulation Time

Simulation time is a crucial factor in evaluating software tools. Depending on the algorithm(s) used by the software, the simulation time may vary. Typically, the lowest simulation time for the same input is considered good as long as the output of the software tool retains its accuracy.

2.2.9 Social

One of the comparative criteria could be the social aspect, where we can focus primarily on job creation and the Human Development Index.

- *Job creation (JC)*: JC refers to the creation of employment opportunities during the plant installation and commissioning phase, where local manpower is hired [16]. It also includes the generation of adequate income opportunities once the plant is operational, through the operation of various businesses, shops, offices, etc.
- *Human Development Index (HDI)*: HDI measures the overall well-being of a human being, including access to a decent standard of living and improved economic conditions. [16]. It can be determined by taking into account the use of excess energy [9], and is closely related to energy access and consumption pattern [16]. A high score on this index indicates a higher lifespan, education level, and gross national income per capita.

2.2.10 Optimization technique used

Different software tools may employ distinct optimization technique(s), which can impact the output. Understanding the optimization techniques utilized by each software can help identify the variations in the output.

2.2.11 Optimization type

The software tools can provide various optimization types used to formulate the optimization problem. For this, mono and multi-optimization types are used to solve the problem. Knowing which optimization type the software tools offer helps the user to select the tool per their requirement.

2.2.12 Load type

While modelling the microgrid, various load types, such as AC, DC, thermal, etc., are used. Therefore, the knowledge of these load types must be known to the user while selecting the software tool for microgrid design.



2.2.13 Complexity of a project file in each software tool

Each software tool creates a project file as defined by its creators. A project file may consist of multiple files or only require a single file. While a single file offers simplicity in moving or reopening the project, multiple files can complicate this process.

2.2.14 System requirements to install software tool

The minimum configuration of computer hardware, such as processor, memory, and operating system, to smoothly run the software tool, which is defined by its creators. Therefore, it is critical to compare this parameter while evaluating the software tools.

2.2.15 User interface (UI) of the software tool

The UI contains software's visual and interactive elements that allow for user interaction and control in performing tasks. The quality of the UI design and functionality greatly impact the software's ease of use and overall user experience.

2.2.16 Installability

Installability indicates the simplicity and ease of installing and setting up a software tool on a computer [18]. It assesses the user-friendliness of the installation process. A software tool with high installability can be installed and configured effortlessly and without needing specialized technical knowledge or training.

2.2.17 Learnability

Learnability of a software tool specifies the ease with which a user can understand and utilize the tool effectively. It is a measure of how quickly and effortlessly a user can learn how to perform tasks and operations within the software. A tool with high learnability is easy to understand, intuitive, requires minimal training, and straightforward to use [18], with clear and concise instructions and guidance for users.

2.2.18 Licencing and pricing

Licensing and pricing refers to the conditions and cost associated with obtaining and utilizing a software tool, including the duration of usage, number of users allowed, and any usage limitations.

2.2.19 Interoperability

Interoperability is the ability of the software tool to work seamlessly with other software tools, regardless of their different technologies or platforms.

2.2.20 Input Data availability with the software tool

Designing microgrids requires complete data to obtain a useful solution. If a software tool can provide missing data, such as solar irradiance, wind profile, temperature profile of the selected geographical location, and load data, it can be valuable in microgrid design.

2.2.21 Output file accessibility

Each software tool may produce different output data formats, such as *.html, *.pdf, *.word, etc., which include the optimum system specifications. Furthermore, for economic analysis, various cost-related graphs and data are required for use in other software. In this context,



various questions are asked to evaluate each software tool in terms of output data format compatibility and data transferability, as shown in Table 2.

2.2.22 Update frequency of software and manual

The update frequency of software and manual can be defined by the frequency with which a software tool and its accompanying documentation are updated. It involves the release of new versions of the software, bug fixes, and improvements to the software's performance, as well as any updates to the accompanying manual or other documentation. This frequency of update is important to consider as it can impact the overall performance and reliability of the software, and affect the user's experience with the tool.

2.2.23 Software' customer support facility

It is crucial factor to consider the good customer support provided by the software vendor or manufacturer while evaluating the software tools. This support may include technicality, documentation, training materials, forums, and other resources to help users troubleshoot issues and get the most out of the software. The level of customer support provided can impact the overall satisfaction and success of a software tool.



3 CASE STUDIES OF STANDALONE MICROGRIDS

Three different case studies are formulated and presented in this report for the comparison of different software tools. These case studies consider three different geographical locations (i.e., Australia, the Netherlands, and USA) to simulate different environmental conditions such as solar irradiance, wind speed, and ambient temperature and loads.

The source of data and the objective of the simulation for each case study (i.e., case studies 1-3) are presented in Sections 3.1 – 3.3.

3.1 Case study 1 (Australia)

Case study 1 simulates an existing microgrid (in operation), located on the Daly River community in Australia, which is the part of the Northern Territory (NT) Solar Energy Transformation Program (SETuP). It uses real measurement data as inputs (irradiance and load) and it simulates the actual capacities of the different components.

3.1.1 Description of the microgrid

This SM consists of the following components.

- Source of generation (PV and DG)
- BESS
- DC-AC converter (battery inverter)
- Load

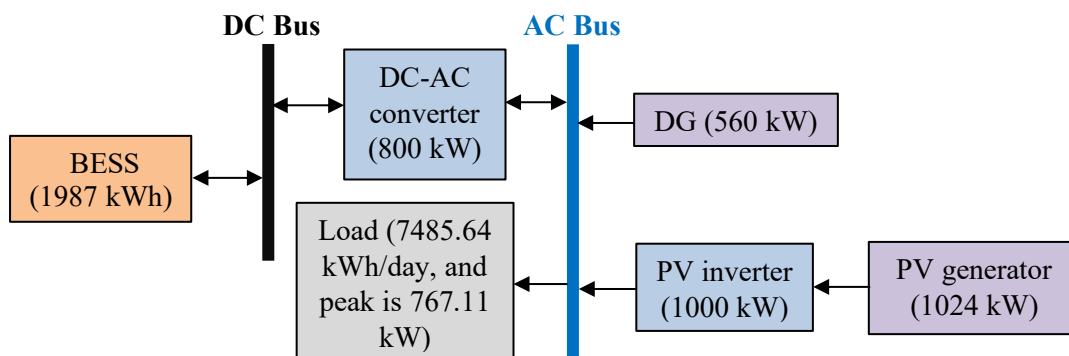

Figure 3: Illustration of different components used in SM of case study 1.

The arrangement of abovementioned components with their actual rating is shown in Figure 3. Here, AC- and DC-based architecture is used to arrange these components [19]. The objective and data source of this case study are given in Sections 3.1.2 and 3.1.3, respectively.

3.1.2 Objective

The principal objective is the comparison between the electrical simulation outputs (i.e., the electricity generated by DG and PV along with the energy in and out of the battery) obtained from both software tools and the actual electric measured data, considering the actual component sizes and using irradiance and load profile measurement data as inputs.

A secondary objective is the comparison of the output economic data from both software tools.



3.1.3 Data Source

In this case study, we have used the measured data (provided by Ekistica) of load profile, solar global horizontal irradiance (GHI) profile, system size, and components specification used in Figure 3. Figure 4 shows the HOMER Pro snapshot of the actual load profile (average daily, monthly, and yearly) of the Daly River site for 2018. The discussed profiles have hourly time series data. Figure 4(b) shows the average day minimum, average day maximum, average, maximum, and minimum values of load for each month. From Figure 4(c), the annual average load is 7485.64 kWh/day, and the peak load is 767.11 kW. It can also be noticed that there is almost no load on certain days in the first quarter. This is due to some of the measurement equipment was not in operation. A similar pattern can also be found in the solar irradiance profile and electrical outputs (Chapter 4.1). However, it will not affect the objective of this case study.

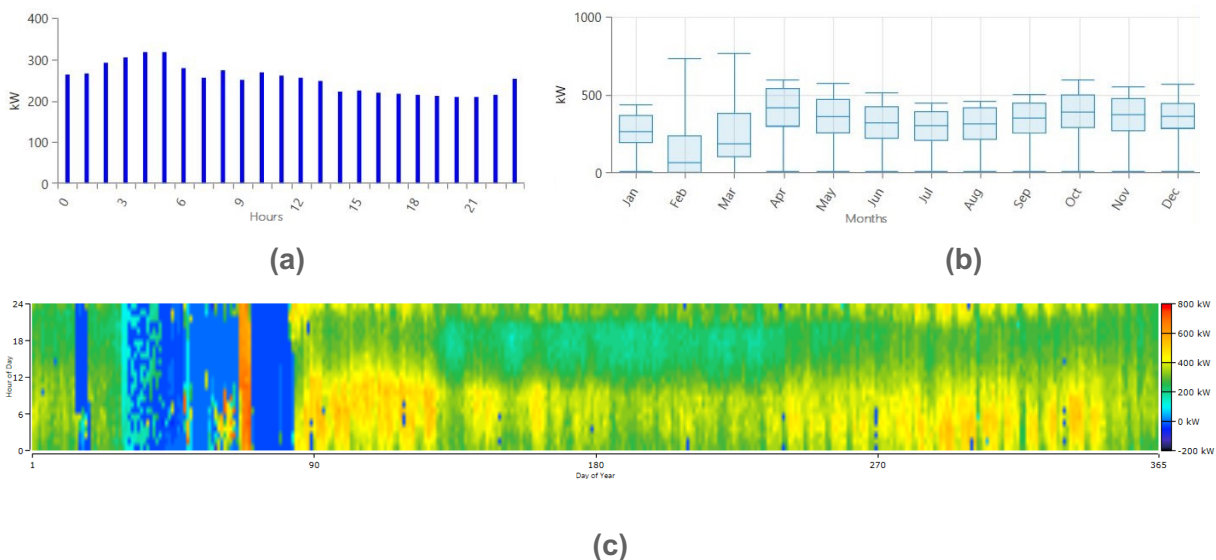

Figure 4: Actual load profile of Daly River (provided by Ekistica) for 2018. (a) Average daily load profile. (b) Monthly load profile. (c) Yearly load profile.

The specification, solar GHI profile, temperature profile, and simulation (HOMER and iHOGA) of Figure 3 have been given in Chapter 4.1. For the temperature profile, synthetic data is used (extracted from the HOMER Pro). Besides that, the measured data of electricity generated by DG and PV, along with battery energy in and out, are used to compare the output of HOMER Pro and iHOGA PRO+ in Chapter 4.1.

3.2 Case study 2 (the Netherlands)

This case study simulates fictitious SM that do not exist in reality, using synthetic input data (except load). The geographical location of this case study is the Netherlands and the site is the Delft.

3.2.1 Description of the microgrid

Netherlands has a very good potential for wind power. Therefore, we have used this energy source as well in this microgrid, and the related components of the same are listed as follow:

- Source of generation (PV, WT, and DG)



- BESS
- DC-AC converter
- Load

The abovementioned components used in this microgrid are arranged in AC- and DC-based architecture [19], as shown in Figure 5. The objective and data source for this case study is given in Sections 3.2.2 and 3.2.3, respectively.

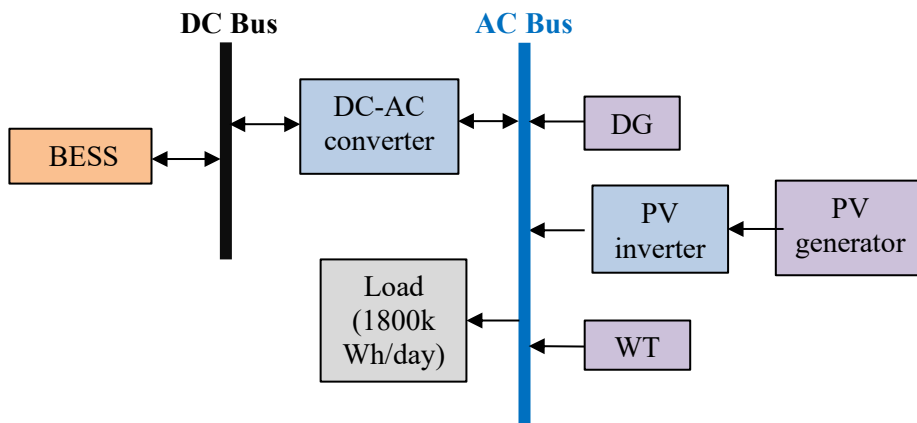

Figure 5: Illustration of various components used in SM of case study 2.

3.2.2 Objective

To find the optimum capacities of the BESS and all power generation sources that minimize the LCOE for the constraints of the minimum renewable fraction of 50% and the maximum unmet load of 5%.

3.2.3 Data Source

In this case study, the actual data is used to make the load profile. The load profile data of Delft for 2021 is obtained from Nederlandse Energie Data Uitwisseling (NEDU) website. Further, this load profile is scaled to form a reasonable size of microgrid for Delft, as shown in Figure 6. The daily average, monthly, and yearly load profiles are given in Figure 6(a)-(c), respectively. Figure 6 (c) shows that the (scaled) annual average load is 1800 kWh/day, and the peak load is 283.66 kW.

Besides that, the synthetic data for the solar GHI profile, wind speed profile, and the temperature profile are used. These profiles use hourly time series data. The data for these profiles is obtained either from HOMER Pro or iHOGA PRO+ and is used in other software. So that both software tools have the same inputs. These profiles, the specification of components used, and the simulation (HOMER and iHOGA) of Figure 5 are presented in Chapter 4.2.

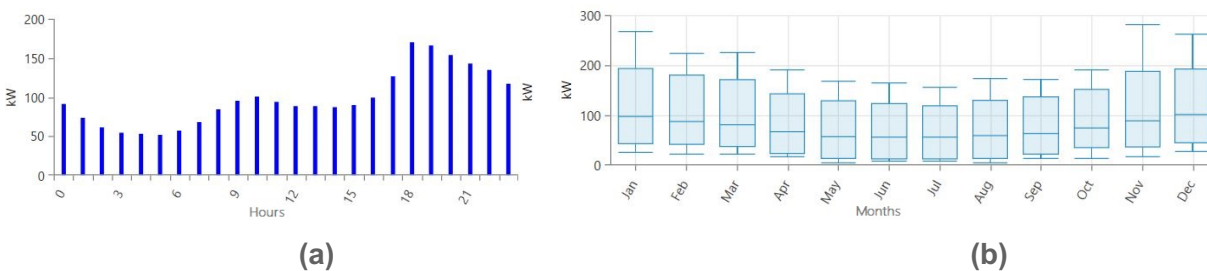

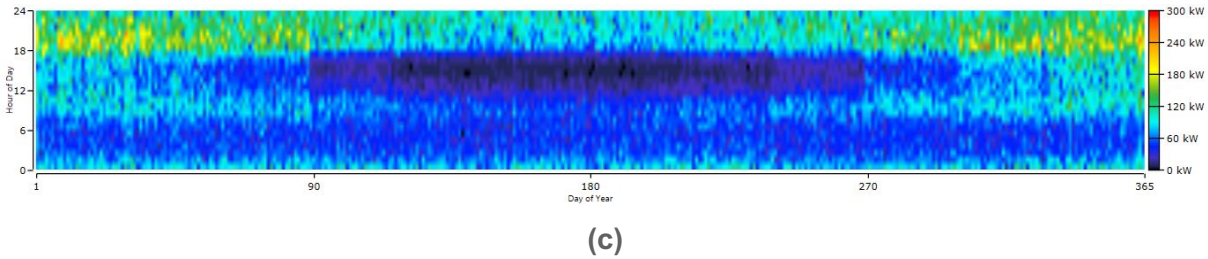

Figure 6: Scaled load profile of Delft for an year 2021 obtained from NEDU website. (a) Daily average load profile. (b) Monthly load profile. (c) Yearly load profile.

3.3 Case study 3 (USA)

This case study is based on the geographical location is the USA, and the site is Sheldon, Vermont. This case study also simulates fictitious SM that do not exist in reality, using synthetic input data only. The geographical location for this case study is the USA, and the site is Sheldon, Vermont.

3.3.1 Description of the microgrid

This SM consists of the following components.

- Source of generation (PV and DG)
- BESS
- DC-AC converter
- Load

Figure 7 shows the arrangement of abovementioned components of this microgrid in AC- and DC-based architecture [19]. The objective and data source details of this case study is presented in Sections 3.3.2 and 3.3.3, respectively.

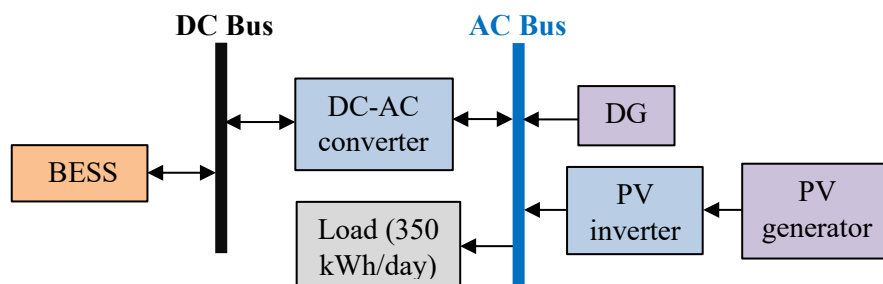

Figure 7: Illustration of different components used in SM of case study 3.

3.3.2 Objective

To find the optimum capacities of the BESS and all power generation sources that minimize the LCOE for the constraints of the minimum renewable fraction of 50% and the maximum unmet load of 5%.

3.3.3 Data Source

This case study is purely based-on synthetic data. The load, solar GHI, and temperature profiles are taken either from HOMER Pro or iHOGA PRO+ and are used in other software.



So that both software tools receive the same inputs. The data for load profile is generated from HOMER Pro and scaled it to form a microgrid for Vermont site. The daily average, seasonal, and yearly load profiles are shown in Figure 8 (a)-(c), respectively. Figure 8 (c) shows that the average annual load is 350 kWh/day, and the peak load is 49.36 kW.

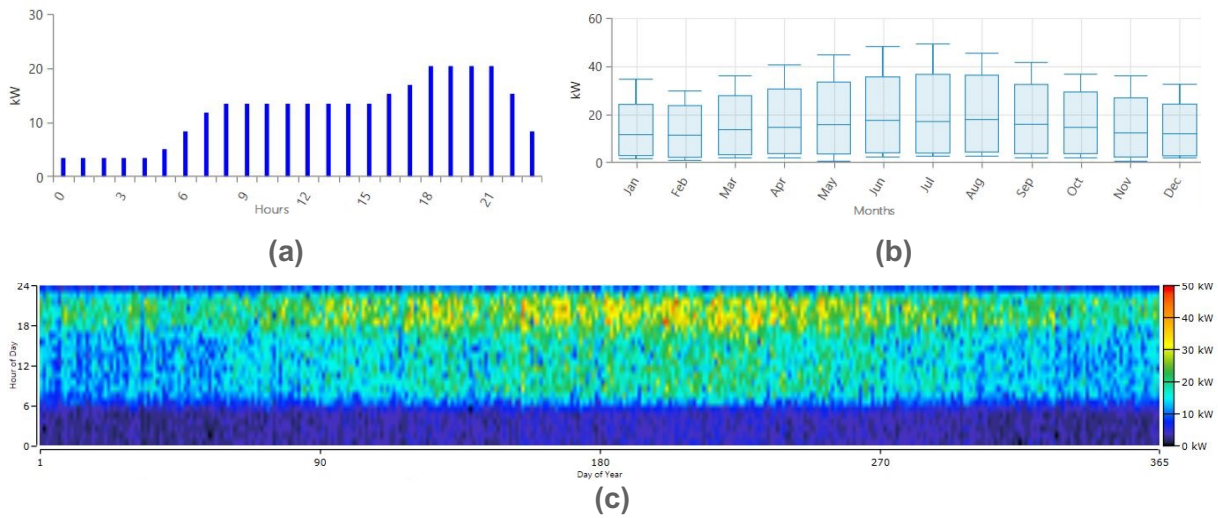

Figure 8: Synthetic load profile of Vermont. (a) Daily average load profile. (b) Monthly load profile. (c) Yearly load profile.

Besides that, the specification of components used, plots of solar and temperature profiles, and the simulation (HOMER Pro and iHOGA PRO+) of Figure 7 are presented in Chapter 4.3.



4 SIMULATIONS AND ANALYSIS OF RESULTS FOR EACH CASE STUDY

This chapter presents the inputs for case studies 1-3, its simulation study, and the analysis of the results obtained.

4.1 Simulation of case study 1

Table 4 provides the specifications of the installed microgrid in the Daly River site. For this site location (see latitude and longitude in Table 4), the measured solar GHI hourly data is used to make the solar GHI profile, as shown in Figure 9. From Figure 9, the annual average radiation is seen to be 5.07 kWh/m²/day. Moreover, it is also observed that in February, the solar irradiance is zero, whereas March has a smaller value. This is due to the error in the measurement device, which did not record data during this period.

Table 4: Specifications of various components used in Figure 3 and inputs for software tools.

Sr. no.	Input Parameters	Unit	Software tools		Comments
			HOMER Pro	iHOGA PRO+	
1	PV module specification	kW	1024	1024	JA Solar 320 Wp
2	PV inverter	kW	1000	1000	
3	BESS specification	kWh	1987	1987	QINOUS
4	DG specification	kW	560	560	Caterpillar 3512
5	Fuel properties		Diesel; 1.5\$/L	Diesel; 1.5\$/L	
6	Battery inverter specification	kW	800	800	
7	Economics input	%	2.34	2.34	real discount rate
8	System controller parameters		Load following	Load following	see Appendix B for more detail
9	Solar GHI profile		Figure 9	Figure 9	Actual data (MA)
10	Temperature profile		Figure 10	Figure 10	Data is extracted from HOMER Pro (MA)
11	Load profile		Figure 4	Figure 4	Actual data (MA)
12	Site location		Daly River, Australia (13°42.7'S, 130°41.3'E)	Daly River, Australia (Latitude: 13.751 and Longitude: 130.689)	'-' sign refers the south direction



13	Constraints: Minimum renewable fraction	%	10	10	
14	Constraints: Unmet load (max)	%	5	5	

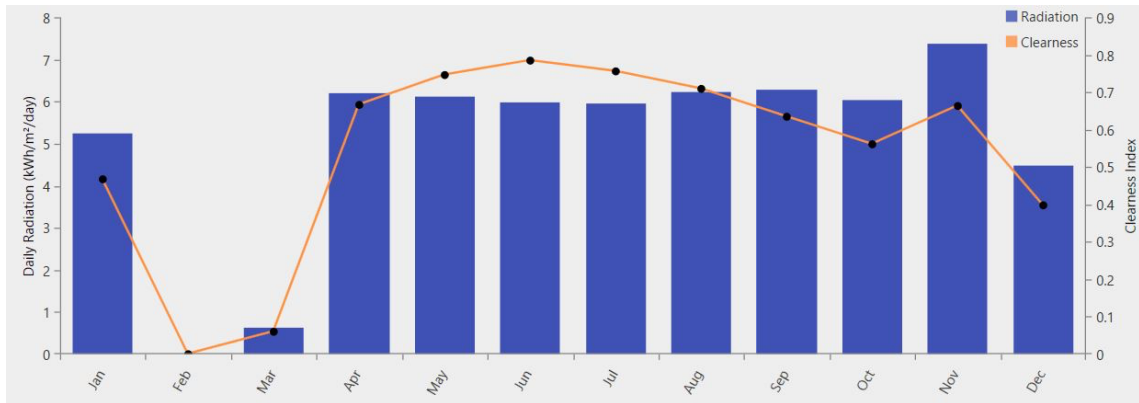

Figure 9: Actual solar GHI profile (MA) of Daly River site for 2018.

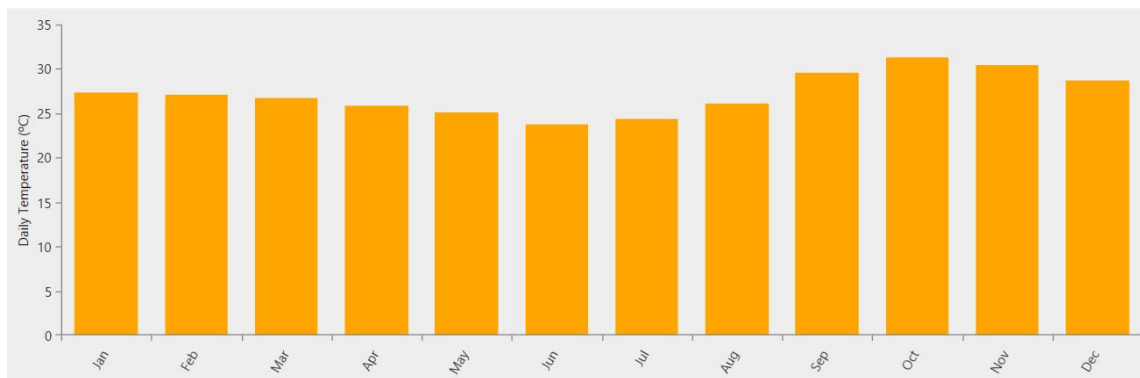

Figure 10: Temperature profile (MA) of Daly River site extracted from HOMER Pro.

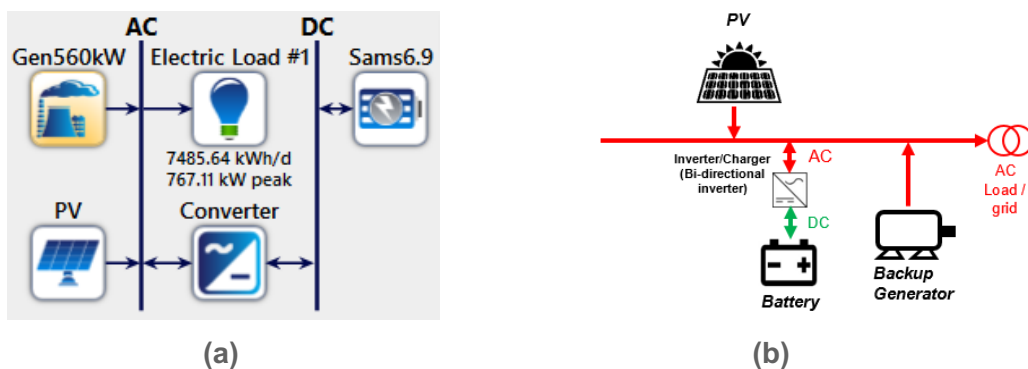

Figure 11: Illustration of the architecture of Figure 3 (i.e., case study 1) generated by (a) HOMER Pro and (b) iHOGA PRO+.



The monthly average (MA) temperature data is extracted from the HOMER Pro software tool, as mentioned in Chapter 3.1.3. This data is downloaded from the NASA Prediction of Worldwide Energy Resource (POWER) database. The temperature profile for the Daly River is depicted in Figure 10. Here, the annual average temperature of 27.19 °C is seen.

With the load mentioned above, solar, and temperature profiles of Daly River and the other inputs mentioned in Table 4, case study 1 microgrid is simulated in HOMER Pro and iHOGA PRO+ for the objective in Chapter 3.1.2. The illustrations of case study 1 architecture generated by both software tools are shown in Figure 11. From Figure 11(a) and (b), it can be seen that the generated architecture by HOMER Pro is comparatively more informative than iHOGA PRO+.

Table 5(a) compares the solution obtained from the HOMER Pro and iHOGA PRO+ for the case study 1 microgrid. Here, the compared solutions have various parameters, such as electrical, economic, RES use factors, emissions, and simulation time. From Table 5(a), it is observed that to serve an electrical load demand of 2732259 kWh/yr, HOMER Pro and iHOGA PRO+ show almost the same average annual electricity generation by PV and DG along with the energy stored in and energy discharged from BESS. However, HOMER Pro simulates 15.85% higher excess electricity generation than iHOGA PRO+. Both software tools have almost the same unmet load. Since both software tools use the same battery capacity, it indicates the same autonomy duration (i.e., 6.05 hrs) for this microgrid.

Regarding the economic solution, both software tools give almost similar (within 1% variation) NPC, LCOE, replacement cost, initial capital cost, and fuel cost. However, HOMER Pro's solution has a 2.62% lower total O&M cost than the iHOGA PRO+'s solution.

Both tools suggest similar renewable penetration and fraction values, indicating a high proportion of renewable energy in this microgrid. Moreover, the CO₂ emissions are 24.95% higher in iHOGA PRO+ compared to HOMER Pro for the same amount of fuel burning. This is because iHOGA PRO+ also considers equivalent CO₂ lifecycle emissions, i.e., emissions due to CO₂ when burning the fuel plus the equivalent CO₂ emissions due to NO₂ and other exhaust gasses plus the emissions due to the production and transport of the diesel fuel. Therefore, the total CO₂ emissions from burning per litre of diesel fuel in iHOGA PRO+ are considered to be 3.5 kg (mentioned in **Appendix B**). However, HOMER Pro only considers the CO₂ emissions of burning diesel fuel, which is approx. 2.6 kg of CO₂/L. Further, the iHOGA PRO+ does not provide the SO₂ and NO₂ emissions. Although this case study's simulation time is negligible, the HOMER Pro simulation time was higher than the iHOGA PRO+.

Table 5(a): Comparison of solution provided by HOMER Pro and iHOGA PRO+ for case study 1 (negative sign in percentage represents smaller).

Sr. no.	Criteria	Parameters	Unit	Software tools		Actual % difference in output of	
				Homer Pro	iHOGA PRO+	Homer Pro w.r.t iHOGA PRO+	iHOGA PRO+ w.r.t Homer Pro
1	System size of	Battery Inverter	kW	800	800	0	0
		PV	kW	1024	1024	0	0



	standalone microgrid	PV inverter	kW	1000	1000	0	0
		DG	kW	560	560	0	0
		BESS	kWh	1987	1987	0	0
2	Electrical	Electricity generated by PV	kWh /yr	1333808	1330048	0.28	-0.28
		Electricity generated by DG	kWh /yr	1529062	1526551	0.16	-0.16
		Energy in (BESS)	kWh /yr	422352	423761	-0.33	0.33
		Energy out (BESS)	kWh /yr	381908	383129	-0.32	0.32
		Excess Electricity	kWh /yr	60292	50734	15.85	-18.84
			in %	2.11	1.78	15.64	-18.54
		Unmet electric load	kWh /yr	11449	11452	-0.03	0.03
in %	0.419		0.419	0	0		
3	Autonomy		hr	6.05	6.05	0	0
4	Economics	NPC	\$	17635306	17557113	0.44	-0.45
		LCOE	\$/kWh	0.3454	0.3438	0.46	-0.47
		Total O&M cost	\$	1227236	1259369	-2.62	2.55
		Replacement cost	\$	1495074	1503450	-0.56	0.56
		Initial capital cost	\$	2183520	2183520	0	0
		Fuel cost	\$	12895096	12839747	0.43	-0.43
5	RES use factors	Renewable penetration	%	49	48.9	0.20	-0.20
		Renewable fraction	%	43.8	43.7	0.23	-0.23
6	Emissions	CO ₂	kg/yr	1198082	1596310	-33.24	24.95
		SO ₂	kg/yr	2936	-	-	-
		NO ₂	kg/yr	652	-	-	-
7	Simulation time		sec	2	<1	>50	>100



4.1.1 Comparison of simulated electrical output with the measurement data

To assess the accuracy of HOMER Pro and iHOGA PRO+ in forecasting electricity generation, the monthly average generation by DG and PV is compared with the measured data, as shown in Figures 12(a) and 12(b), respectively. Moreover, the annual average generation by DG and PV and the yearly energy stored in and discharged from the BESS are also compared with the measured data in Table 5(b). This comparison aims to determine the level of agreement between the software simulations and the actual data.

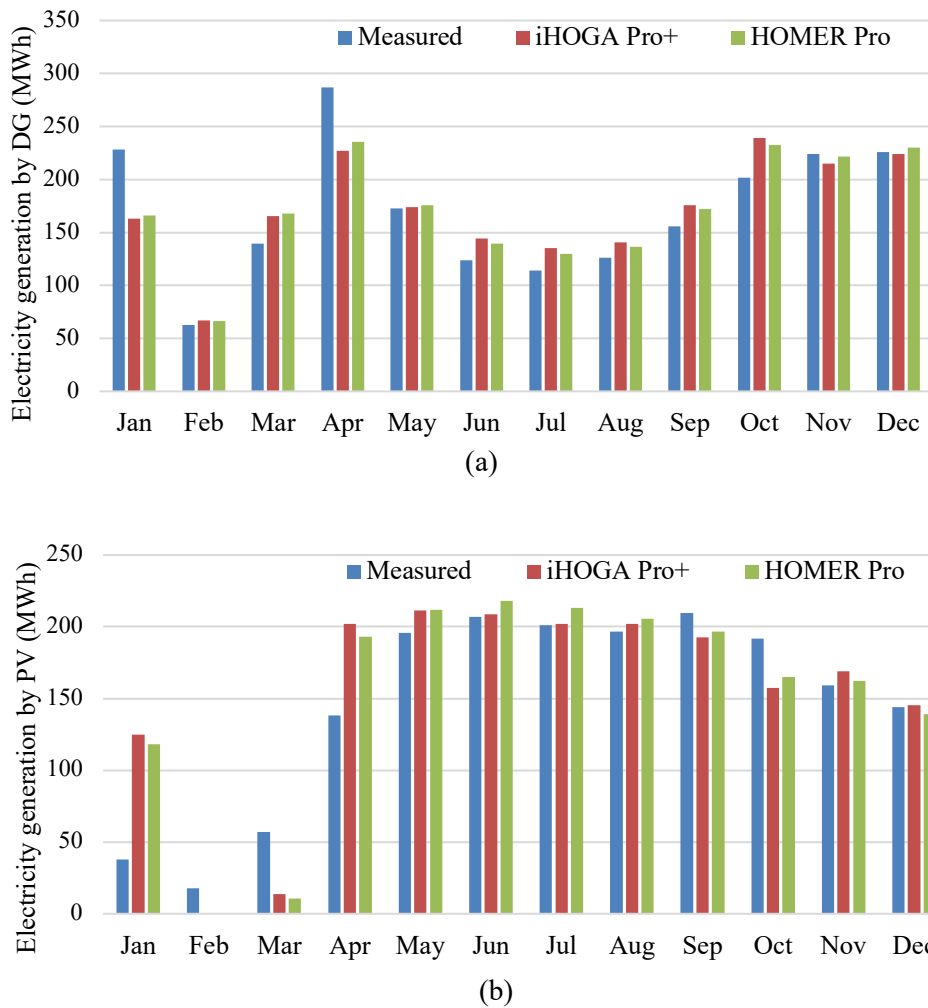

Figure 12: Comparison of iHOGA PRO+ and HOMER Pro output of the monthly average electricity generation by (a) DG and (b) PV, with the measurement data.

From the analysis of Figures 12(a) and 12(b), it is clear that both software tools, HOMER Pro and iHOGA PRO+, demonstrate a similar pattern in forecasting DG and PV generation. However, considerable variations between the measured data and the simulated output can be observed. In Figure 12(a), the measured DG generation for January and April surpasses the simulated output while it falls below the simulated data for October. On the other hand, Figure 12(b) reveals that the measured PV generation is lower than the simulated data for January and April while it exceeds the simulated data for February, March, and October. These differences are significantly pronounced compared to the generation patterns (from measured



and simulation) observed in the remaining months. The possible cause for these differences could be that the microgrid operator was tweaking and optimizing the control algorithms of the DG. In contrast, the simulations use a fixed control algorithm (i.e., load following) throughout the year. Nevertheless, when the yearly average of these outputs (PV and DG generations) is seen, the difference in the simulated output of both software tools w.r.t. the measurement is less than 5%, as indicated in Table 5(b). These differences fall within an acceptable range. Table 5(b) also shows that iHOGA PRO+ demonstrates a lower error in DG and PV generation w.r.t. the measured data compared to HOMER Pro. However, when analyzing the BESS energy in and energy out, both software tools yield values that closely align with the measured data (with an error of less than 2%). In conclusion, both software tools reasonably agree with measurement data.

Table 5(b): Comparison of yearly average electrical outputs of HOMER Pro and iHOGA PRO+ for case study 1 w.r.t. the measurement.

Electrical Parameters	Unit	Software tools' output		Measurement	Error w.r.t. measurement (%)	
		HOMER Pro	iHOGA PRO+		HOMER Pro	iHOGA PRO+
Electricity generated by PV	kWh/yr	1333808	1330048	1282698	3.98	3.69
Electricity generated by DG	kWh/yr	1529062	1526551	1506889	1.47	1.30
Energy in (BESS)	kWh/yr	422352	423761	422440.4	0.02	0.31
Energy out (BESS)	kWh/yr	381908	383129	377676.3	1.12	1.44

4.2 Simulation of case study 2

Table 6 concisely overviews the essential input parameters and component specifications used to simulate the case study 2 microgrid in HOMER Pro and iHOGA PRO+. These inputs are the same for both software tools. Moreover, the cost of all components is also kept the same in both software tools, which can be seen in **Appendix C** (also, the detailed inputs). The latitude and longitude for the site location in Delft are specified in Table 6. Based on this, the hourly solar GHI data for 2021 is extracted from iHOGA PRO+. This data is used to generate the monthly average solar profile, as illustrated in Figure 13, and it was input into HOMER Pro (so that both software tools should have the same inputs). From Figure 13, the annual average radiation is observed to be 3.18 kWh/m²/day.

Table 6: Specifications of various components used in Figure 5 and inputs for software tools.

Sr. no.	Input Parameters	Unit	Software tools		Comments
			HOMER Pro	iHOGA PRO+	
1	Single PV module specification	kW	1	1	Generic



2	Single battery specification	kWh	6.9	6.9	Samsung
3	Single WT specification	kW	10	10	Generic
4	DG specification	kW	10-60	10-60	size-your-own
5	Fuel properties		Diesel; 1.5\$/L	Diesel; 1.5\$/L	
6	Single inverter specification	kW	1	1	Generic
7	Economics input	%	2.0	2.0	real discount rate
8	System controller parameters		Load following	Load following	see Appendix C for more detail
9	Solar GHI profile		Figure 13	Figure 13	Data is extracted from iHOGA PRO+ (MA)
10	Wind speed profile		Figure 14	Figure 14	Data is extracted from iHOGA PRO+ (MA)
11	Temperature profile		Figure 15	Figure 15	Data is extracted from HOMER Pro (MA)
12	Load profile		Figure 6	Figure 6	Scaled actual data from NEDU website (MA)
13	Site location		(44 52.9'N, 72 56.6'W)	(Latitude: 44.869° and Longitude: -72.935°)	'-' sign refers the west direction
14	Constraints: Minimum renewable fraction	%	50	50	
15	Constraints: Unmet load (max)	%	5	5	

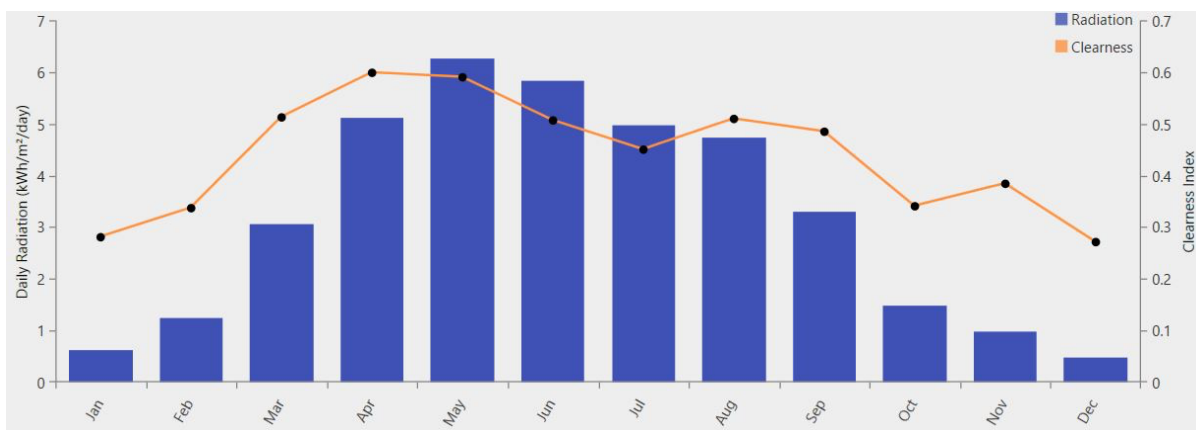

Figure 13: Solar GHI profile (MA) of Delft for 2021.

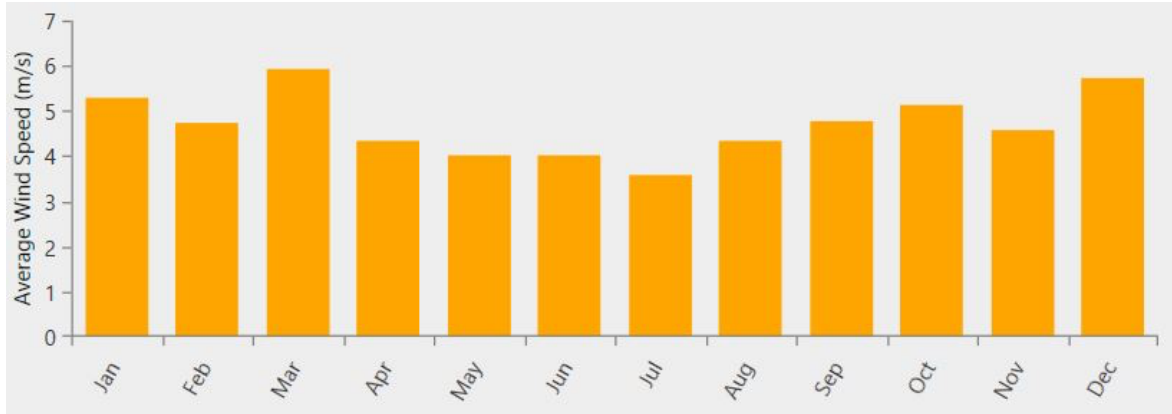

Figure 14: Wind speed profile (MA) of Delft for 2021.

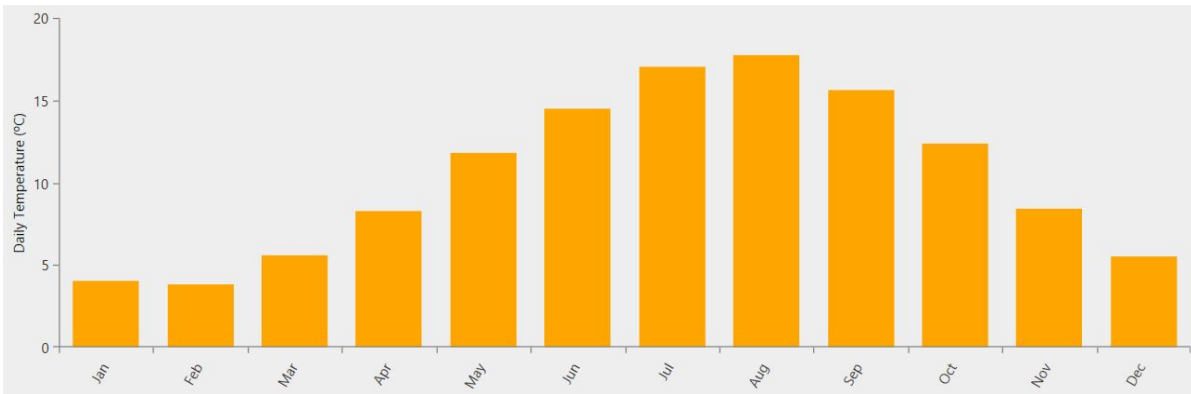

Figure 15: Temperature profile (MA) of Delft for 2021.

Similarly, the wind speed data for Delft is sourced from iHOGA PRO+ to create the monthly average wind speed profile, as depicted in Figure 14, and it was input into HOMER Pro. Here, the site exhibits an annual average wind speed of 4.5 m/s. Besides that, the temperature data for 2021 is obtained from HOMER Pro. By using this data, a monthly average temperature profile was created, as shown in Figure 15, and it was input into iHOGA PRO+. From Figure 15, the annual average temperature for this location is observed to be 10.39 °C.

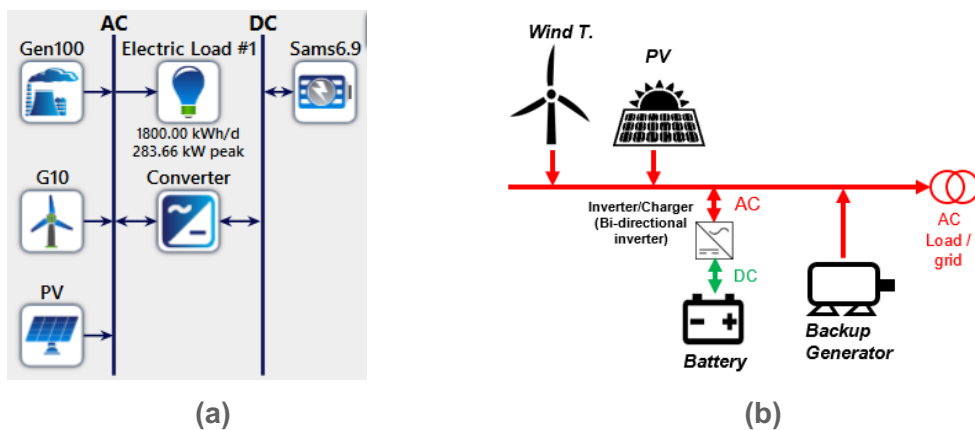

Figure 16: Illustration of the architecture of Figure 5 (i.e., case study 2) generated by (a) HOMER Pro and (b) iHOGA PRO+.



By utilizing the above-discussed load, solar GHI, wind speed, and temperature profiles for Delft, along with the additional input parameters tabulated in Table 6, the case study 2 microgrid is simulated using both HOMER Pro and iHOGA PRO+ to achieve the objective outlined in Chapter 3.2.2. The resulting architecture illustrations generated by both software tools are displayed in Figure 16. Here, it can be observed that the architecture illustration generated by HOMER Pro conveys a more comprehensive set of information compared to the illustration produced by iHOGA PRO+ for the same microgrid configuration. Nevertheless, using distinct colors to represent AC and DC elements in the iHOGA PRO+ diagram adds an appealing visual element.

Table 7 compares the optimal solution recommended by HOMER Pro and iHOGA PRO+. For the objective mentioned in Chapter 3.2.2, HOMER Pro proposes a slightly bigger system size than iHOGA PRO+ to serve the same electrical load demand (i.e., 657000 kWh/yr). Except for the DG and battery inverter size, between 5 to 10% difference in the sizes of PV, WT, and battery capacity can be seen in the proposed optimum solutions from these tools. It is also observed that both software tools use a higher portion of wind power in their recommended system sizes, aligning with the assumed wind potential in Chapter 3.2.

Table 7: Comparison of optimized solution provided by HOMER Pro and iHOGA PRO+ for case study 2 (negative sign in percentage represents smaller).

Sr. no.	Criteria	Parameters	Unit	Software tools		Actual % difference in output of	
				Homer Pro	iHOGA PRO+	Homer Pro w.r.t iHOGA PRO+	iHOGA PRO+ w.r.t Homer Pro
1	Optimum system size of SM (for the same inputs) suggested by each software tool	Battery inverter	kW	146	150	-2.74	2.67
		PV	kW	381	350	8.14	-8.86
		WT	kW	760	710	6.58	-7.04
		DG	kW	50	50	0	0
		BESS	kWh	1290.3	1214	5.91	-6.29
2	Electrical	Electricity generated by PV	kWh /yr	373997	354985	5.08	-5.36
		Electricity generated by WT	kWh /yr	840538	766454	8.81	-9.67
		Electricity generated by DG	kWh /yr	55712	51075	8.32	-9.08
		Energy in (BESS)	kWh /yr	229893	219768	4.40	-4.61



		Energy out (BESS)	kWh /yr	207883	209706	-0.88	0.87
		Excess Electricity	kWh /yr	602188	490280	18.58	-22.83
			in %	47.4	23.78	49.83	-99.33
		Unmet electric load	kWh /yr	33445	32685	2.77	-2.33
			in %	5.09	4.97	2.36	-2.41
3	Autonomy		hr	13.8	12.9	6.52	-6.98
4	Economics	NPC	\$	2798027	2593260	7.32	-7.90
		LCOE	\$/kWh	0.2299	0.2128	7.44	-8.04
		Total O&M cost	\$	282923	263277	6.94	-7.46
		Replacement cost	\$	813699	745890	7.23	-7.79
		Initial capital cost	\$	1507391	1412760	6.28	-6.70
		Fuel cost	\$	562575	502897	10.61	-11.87
5	RES use factors	Renewable penetration	%	195	179.6	7.89	-8.58
		Renewable fraction	%	91.1	87.25	4.23	-4.41
6	Emissions	CO ₂	kg/yr	50793	60120	-18.36	15.51
		SO ₂	kg/yr	123	-	-	-
		NO ₂	kg/yr	27.4	-	-	-
7	Simulation time		sec	400	170	57.50	-135.3

Furthermore, Table 7 shows that the slightly bigger system (by HOMER Pro) has around 19% more excess electricity than the system proposed by iHOGA PRO+. This excess electricity (in HOMER Pro) is due to the higher DG production and electricity generation because of oversized PV and WT. Nevertheless, the electricity generations from PV and WT are aligned well with the recommended sizes by both software tools.

Almost similar unmet load is seen in the recommended system by both software tools. HOMER Pro suggests a higher autonomy of 13.8 hours, whereas iHOGA PRO+ recommends a slightly lower autonomy of 12.9 hours. This is due to HOMER Pro's larger battery capacity than iHOGA PRO+.

Regarding the economic solution, HOMER Pro calculates an NPC around 7% higher than iHOGA PRO+ due to its slightly bigger system size. As a result, the HOMER Pro solution suggests around 7% higher LCOE than the iHOGA PRO+ solution. Besides that, total O&M costs, replacement costs, and initial capital costs are around 7% higher for the system suggested by the HOMER Pro than for iHOGA PRO+. However, for the same size of DG, the



fuel cost in the HOMER Pro solution is around 10% higher than the iHOGA PRO+ solution. This is due to the higher DG production in HOMER Pro.

HOMER Pro shows a slightly higher renewable penetration and renewable fraction than iHOGA PRO+. Moreover, the predicted emissions differ between the two software tools. HOMER Pro estimates around 18% lower CO₂ emissions compared to iHOGA PRO+. This is when HOMER Pro uses more DG (i.e., more diesel). The reason for higher CO₂ emissions in the case of iHOGA PRO+ is the same as explained in case study 1 in Section 4.1.

However, only HOMER Pro provides data on SO₂ and NO₂ emissions. Furthermore, the simulation time required by each software tool also showcases a difference. HOMER Pro takes longer, with a simulation time of 400 seconds, while iHOGA PRO+ completes the simulation in a shorter time of 170 seconds.

It should be noted that only the optimum design of each software tool is presented in Table 7. However, each software tool performs hundreds of simulations, and there may be another system configuration with a slightly higher LCOE but quite different component capacities. For example, it may be that HOMER Pro has also simulated a system similar to iHOGA PRO+'s, with fewer renewable energy components and less DG use. However, it does not recommend it because it has a slightly higher LCOE. The characteristics of these LCOE minima shall be carefully analyzed while SM is being predesigned via these software tools.

4.3 Simulation of case study 3

Table 8 summarises the crucial input parameters and component specifications for simulating the case study 3 microgrid using HOMER Pro and iHOGA PRO+. These inputs are kept the same in both software tools, including the cost of all components, which can be seen in **Appendix D**.

Table 8: Specifications of various components used in Figure 7 and inputs for software tools.

Sr. no.	Input Parameters	Unit	Software tools		Comments
			HOMER Pro	iHOGA PRO+	
1	Single PV module specification	W	327	327	Sun Power E20-327
2	Single battery specification	kWh	9.6	9.6	Fortress Power LPF-10
3	DG specification	kW	0-30	0-30	size-your-own
4	Fuel properties		Diesel; 1.5\$/L	Diesel; 1.5\$/L	
5	Single inverter specification	kW	10	10	Victron Quattro
6	Economics input	%	2.0	2.0	real discount rate
7	System controller parameters		Load following	Load following	see appendix D for more detail



8	Solar GHI profile		Figure 17	Figure 17	Data is extracted from iHOGA PRO+ (MA)
9	Temperature profile		Figure 18	Figure 18	Data is extracted from HOMER Pro (MA)
10	Load profile		Figure 8	Figure 8	Data is extracted from HOMER Pro (MA)
11	Site location		Sheldon, VT 05483, USA (44 52.9'N, 72 56.6'W)	Sheldon, VT 05483, USA (Latitude: 44.869° and Longitude: - 72.935°)	'-' sign refers the west direction
12	Constraints: Minimum renewable fraction	%	50	50	
13	Constraints: Unmet load (max)	%	5	5	

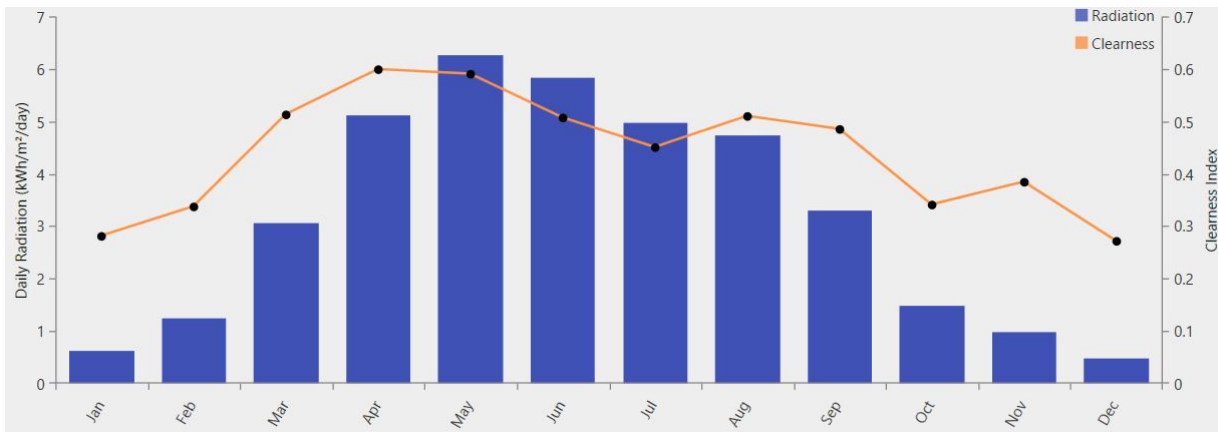

Figure 17: Solar GHI profile (MA) of Sheldon for 2021.



Figure 18: Temperature profile (MA) of Sheldon for 2021.



The latitude and longitude for the Sheldon site can be seen in Table 8. With this information, hourly solar GHI data for 2021 is obtained from iHOGA PRO+. This data is then used to plot the monthly average solar profile, as depicted in Figure 17, and it was input into HOMER Pro. The plot shows that the annual average radiation at this location is 3.57 kWh/m²/day.

Additionally, the temperature data for 2021 is sourced from HOMER Pro. Then, this data is used to create a monthly average temperature profile, as shown in Figure 18, and it is input into iHOGA PRO+. From Figure 18, the annual average temperature for the Sheldon location is found to be 5.44 °C.

By using the above-displayed load, solar GHI, and temperature profiles for Sheldon, along with the additional inputs summarized in Table 8, the case study 3 microgrid is simulated using both HOMER Pro and iHOGA PRO+ to achieve the objective mentioned in Chapter 3.3.2. Illustrations of the resulting architecture, generated by both software tools, are shown in Figure 19. Here, as well, similar observations (as in case studies 1 and 2) on the generated architecture can be seen.

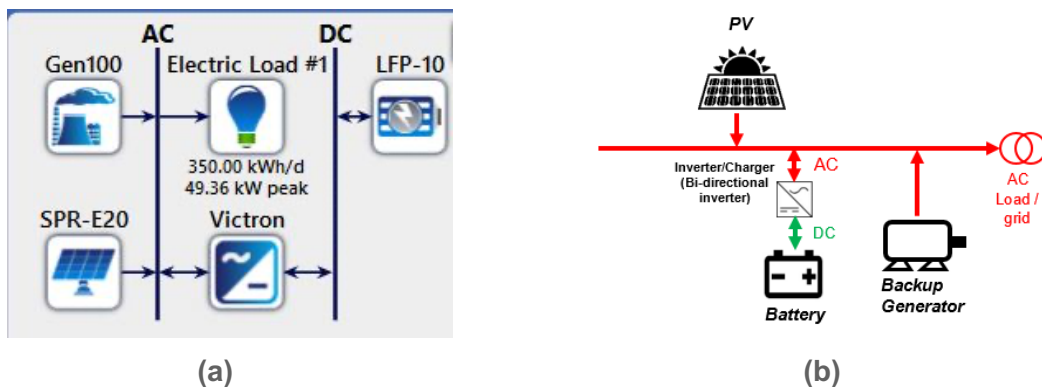

Figure 19: Illustration of the architecture of Figure 7 (i.e., case study 3) generated by (a) HOMER Pro and (b) iHOGA PRO+.

Table 9: Comparison of optimized solution provided by HOMER Pro and iHOGA PRO+ for case study 3 (negative sign in percentage represents smaller).

Sr. no.	Criteria	Parameters	Unit	Software tools		Actual % difference in output of	
				Homer Pro	iHOGA PRO+	Homer Pro w.r.t iHOGA PRO+	iHOGA PRO+ w.r.t Homer Pro
1	Optimum system size of SM (for the same inputs) suggested	Battery Inverter	kW	41.2	40	2.91	-3.00
		PV	kW	155	125.57	18.99	-23.44
		DG	kW	10	10	0	0



	by each software tool	BESS	kWh	268.8	230	14.43	-16.87
2	Electrical	Electricity generated by PV	kWh/yr	177797	151818	14.61	-17.11
		Electricity generated by DG	kWh/yr	14317	12657	11.59	-13.12
		Energy (BESS) in	kWh/yr	57208	54418	4.88	-5.13
		Energy (BESS) out	kWh/yr	56290	53456	5.03	-5.30
		Excess Electricity	kWh/yr	63993	28238	55.87	-126.6
			in %	33.3	17.17	48.44	-93.94
		Unmet electric load	kWh/yr	5166	2101	59.33	-145.9
in %	4.04		1.64	59.41	-146.3		
3	Autonomy		hr	15.7	13.4	14.65	-17.16
4	Economics	NPC	\$	566541.2	477438	15.73	-18.66
		LCOE	\$/kWh	0.2368	0.1945	17.86	-21.75
		Total O&M cost	\$	95171.2	70715	25.70	-34.58
		Replacement cost	\$	103593.6	92886	10.34	-11.53
		Initial capital cost	\$	269513.4	226208	16.07	-19.14
		Fuel cost	\$	123492.8	110387	10.61	-11.87
5	RES use factors	Renewable penetration	%	145	120.8	16.69	-20.03
		Renewable fraction	%	88.3	88.46	-0.18	0.18
6	Emissions	CO ₂	kg/yr	11032	14040	-27.27	21.42
		SO ₂	kg/yr	27	-	-	-
		NO ₂	kg/yr	6	-	-	-
7	Simulation time		sec	28	150	-435.7	81.33

Table 9 summarizes and compares the optimal solution recommended by HOMER Pro and iHOGA PRO+ for the inputs in Table 8. For the objective mentioned in Chapter 3.3.2, HOMER



Pro proposes a bigger system size than iHOGA PRO+ to meet the same electrical load demand of 127750 kWh per year. Moreover, the bigger system has around 56% more excess electricity.

When analyzing the optimal system size, both software tools agree on the size of DG (i.e., 10 kW). However, the DG production in the HOMER Pro system is around 12% higher than the iHOGA PRO+ system, which is one of the contributors to higher excess electricity.

As far as other components are concerned, battery inverter size is almost similar. However, a bigger size of about 19% and 15% PV and BESS, respectively, are recommended by HOMER Pro's system. The electricity generation by PV is aligned well with the recommended sizes by both software tools. However, the HOMER Pro's system underutilizes BESS usage by around 10%. Besides that, about 15% higher autonomy is seen in HOMER Pro's system because of the bigger size of BESS (around 15%).

Economic calculations revealed that HOMER Pro's system has around 16% higher NPC. The LCOE is also higher by about 18% in HOMER Pro. Moreover, HOMER Pro provides a 26% higher total O&M cost for their proposed system. HOMER Pro's replacement cost is also higher by 10.34%. Similarly, the initial capital cost in HOMER Pro is higher, around 16%, because of the bigger system size. Additionally, HOMER Pro projected higher fuel costs (\$123492.8) than iHOGA PRO+ (\$110387), exhibiting a difference of about 11% (w.r.t. iHOGA PRO+'s cost). This difference is due to around 11% higher DG production in HOMER Pro.

HOMER Pro provides around 16% higher renewable penetration than iHOGA PRO+. However, both software tools achieve a similar renewable fraction. Although the DG production in the case of iHOGA PRO+'s system is lower, around 21% higher CO₂ emissions are seen than HOMER Pro's. The reason for this higher CO₂ emission is mentioned in Sections 4.1 and 4.2. Besides that, iHOGA PRO+ does not provide the SO₂ and NO₂ emissions. The simulation time in iHOGA PRO+ was significantly higher than in HOMER Pro for this case study.



5 EVALUATION OF THE SOFTWARE TOOLS AND RECOMMENDATIONS

In this chapter, HOMER Pro and iHOGA PRO+ software tools are evaluated by using the criteria defined in Chapter 2.2 and the critical insights observed from the results analysed in Chapter 4 for each case study. Based on the same, the recommendations have been provided.

5.1 Evaluation of the software tools

This section evaluates the HOMER Pro and iHOGA PRO+ based on the results analysed in Chapter 4 for case studies 1-3 and the criteria 8-22, as mentioned in Table 2.

5.1.1 Critical insights from case studies 1-3

Case studies 1-3 have provided valuable insights into the performance of HOMER Pro and iHOGA PRO+. Here are the critical insights gained from these studies:

- **System size optimization:** From case studies 2 and 3, it is observed that the HOMER Pro do oversize the system. This can also be seen from the higher excess electricity in case studies 1-3 than iHOGA PRO+.
- **Deviations from measured data:** Both software tools align with the measured data, except for certain DG and PV generation months in case study 1. When comparing the yearly averages of PV and DG generation, along with the battery energy in and out, the simulated outputs of both tools exhibit differences of less than 5% compared to the measured data. This level of accuracy is considered acceptable.
- **NPC:** The results of case studies 2 and 3 indicated that iHOGA PRO+ consistently yields lower NPC values than HOMER Pro. For case study 1, it is almost the same.
- **LCOE:** In case studies 2 and 3, iHOGA PRO+'s system has a lower LCOE than HOMER Pro's. For case study 1, it is almost the same.
- **O&M and replacement costs:** The calculation of O&M and replacement costs in iHOGA is a bit complex because one has to download the Excel sheet to calculate the same. However, HOMER Pro presents this information in their UI and allows downloading it in an Excel file. These costs in case studies 2 and 3 were lower in iHOGA PRO+ than in HOMER Pro. However, for case study 1, these costs in iHOGA PRO+ were slightly higher.
- **Initial Capital Costs:** The results in case study 1 indicated similar values of the initial capital costs calculated by both software tools because of the same system size. However, this cost in case studies 2 and 3 differ due to the different system sizes.
- **Total Fuel Costs:** Total fuel costs were in agreement in both tools per the fuel consumed by DG in all case studies.
- **Autonomy:** Since HOMER Pro estimated the oversize of the system, higher autonomy is obtained in case studies 2 and 3 than in iHOGA PRO+.
- **Emissions:** iHOGA PRO+ does not have the option to calculate SO₂ and NO₂ emissions. Moreover, HOMER Pro only considers CO₂ emissions from burning diesel fuel, whereas the iHOGA PRO+ also considers equivalent CO₂ lifecycle emissions in calculating CO₂ emissions by DG.



- **Simulation time:** Higher simulation time is observed in HOMER Pro for case studies 1 and 2 than in iHOGA PRO+. However, for case study 3, it was the opposite.

These insights shed light on the strengths and weaknesses of HOMER Pro and iHOGA PRO+ in techno-economic analysis based on case studies 1-3. From the observation of the results of these case studies (especially 2 and 3), iHOGA PRO+ demonstrates advantages in terms of lower costs (discussed in Tables 7 and 9). Meanwhile, HOMER Pro demonstrates advantages in terms of higher autonomy, provides insights into other emissions such as SO₂ and NO₂, and provides a more informative illustration of the simulated microgrid.

Note: The obtained system sizes from the software tools must be analyzed to ensure the overall technical feasibility of the SM (including technological and manufacturing possibilities of the different components), as discussed in Section 1.1. For example, in case study 2, HOMER Pro suggests 76 (of 10 kW) wind turbines, whereas iHOGA PRO+ provides 71 (of 10 kW). Now, it should be investigated further for the possible cost (LCOE/NPC/initial) and the installation space reduction of the wind turbines if one can use a bigger size (e.g., 3 number of 250kW ~ 76*10kW) turbine based on the installation space availability and wind speed profile at a given height and the practical limitation. Then, it can be reoptimized in the software tools to get the new system size closer to the practicality.

5.1.2 General comparison of HOMER Pro and iHOGA PRO+ independent of case studies

Table 10 compares the HOMER Pro and iHOGA PRO+ based on the mentioned criteria in Table 2. These criteria provide a qualitative comparison between these software tools.

Table 10: Comparison of HOMER Pro and iHOGA PRO+ based on the criteria in Table 2.

Sr. no.	Criteria	Parameters	Software tools	
			Homer Pro	iHOGA PRO+
8	Social	Job creation calculated by tool	no	yes
		Human development index calculated by tool	no	yes
9	Load type		AC, DC, thermal, hydrogen	AC, DC, hydrogen, water
10	Optimization type		Mono-objective (Economic)	Multi-objective up to three objectives (Economic, electric, CO ₂ emission, HDI)
11	Optimization technique used		grid search algorithm (Space search) and derivative-free algorithm (HOMER Optimizer)	Genetic Algorithms



12	Hardware requirements to install software	OS required	windows (7 or higher), 10 is recommended	Windows (XP or higher)
		Processor	intel core i3 or equivalent	-
		RAM	2 GB	-
		Hard drive	450 MB	-
13	Complexity of a project file	does one project contains single/multiples files?	single	multiple
14	User interface	Look and feel of software home tab	excellent	good
		Presentation of information in each tab	simple	complex
		How easy/hard to access information in minimum number of tabs?	hard	easy
15	Installability	Is it straightforward to install?	yes	yes
16	Learnability	Getting started guide is provided outlining a basic example of using the software	yes	yes
		Instructions are provided for many basic use cases.	yes	yes
		Tutorial videos are available whether free or paid	yes	no
		Reference guides are provided for all configuration options.	yes	yes
		How straightforward is to learn basic functional task?	very easy	comparatively tough
		How straightforward is to learn advanced functional task?	easy	comparatively tough
17	Licensing and pricing	Free or commercial	commercial	free and commercial
		License types (Std./Acad./Pro.)	Std., Acad., and Pro	EDU (free) and PRO+
		Price range of different license types	\$125, \$249, and \$379 per month	€500 (6 months), €2800 (permanent)
		License duration	monthly and annually, no permanent	six months, one year, and permanent



		is free trial available?	yes	yes
18	Interoperability	Interoperable with other required/related software	yes (with Matlab link module, Helioscope, PVSyst, Python, C++)	no
19	Input data availability	Wind data	yes	yes
		Solar irradiance data	yes	yes
		Temperature data	yes	yes
		Laod profile	yes	yes
20	Output file accessibility	Format of the results	Excel (.csv), word, pdf, html	Excel (.xls), pdf, rtf
		Able to generate a report of optimized design?	yes	yes
		Able to show various graphs in software tool itself?	yes	yes
		Able to generate a proposal for a project?	yes	no
21	Update frequency of software and manual		irregular	frequent
22	Software' customer support facility	Are developers respond on emails/call?	yes	yes
		Are they listen to feedbacks?	-	yes
		easy/quick to get technical support from developer on any issue related to functionality/working of tool	easy but takes time	very easy and quick

Table 10 shows that both software tools do the same in most criteria. However, there are some differences observed in the capability of these tools, which are listed as follows:

- iHOGA PRO+ can calculate the social criteria for the designed microgrid, whereas HOMER Pro cannot.
- HOMER Pro does not support water load, whereas iHOGA PRO+ does not support thermal load. Besides that, iHOGA PRO+ uses accurate models, e.g., inverter and inverter-charger variable efficiency, and advanced battery ageing models (specific for lead-acid and Li-ion).
- HOMER Pro can only do mono-objective optimization, whereas iHOGA PRO+ can do multi-objective (up to three) optimization and optimize up to 12 control variables.



- iHOGA PRO+ supports OS from Windows XP, whereas HOMER Pro is from Windows 7.
- iHOGA PRO+ has higher complexity in handling a project file than HOMER Pro because of the multiple files created for a project.
- Based on the look and feel, the UI of HOMER Pro is good. However, based on the information access with minimum effort, the UI of iHOGA PRO+ is good.
- HOMER Pro is the best based on the points compared for learnability.
- Based on the licensing and pricing, iHOGA PRO+ makes a good impression.
- HOMER Pro offers excellent interoperability, whereas iHOGA PRO+ does not.
- Output file accessibility in the HOMER Pro is slightly better than in iHOGA PRO+.
- iHOGA PRO+ has better software and manual update frequency than HOMER Pro.
- Moreover, iHOGA PRO+ offers the best software customer support facility compared to HOMER Pro.

The above discussion shows that among the fifteen criteria (i.e., 8-22) in the qualitative comparison, iHOGA PRO+ is doing well in six criteria, while HOMER Pro is in four. However, both software tools do the same or nullify each other's advantages in the five criteria.

5.2 Recommendations on software tools

This report has presented and analyzed a total of 22 criteria (quantitative and qualitative) to compare both software tools (i.e., HOMER Pro and iHOGA PRO+). However, per the user's requirement, the software must be selected based on the criteria that apply to their needs. For example, HOMER Pro will be the best choice if the user is concerned about interoperability.



REFERENCES

- [1] D. Kaur and P. S. Cheema, "Software tools for analyzing the hybrid renewable energy sources:-A review," in *International Conference on Inventive Systems and Control (ICISC)*, Coimbatore, 2017.
- [2] K. Anoune, M. Bouya, A. Astito and A. B. Abdellah, "Sizing methods and optimization techniques for PV-wind based hybrid renewable energy system: A review," *Renewable and Sustainable Energy Reviews*, vol. 93, pp. 652-673, 2018.
- [3] P. Shaikh, A. Shaikh, Z. Memon, A. Lashari and Z. Leghari, "Microgrids: A review on optimal hybrid technologies, configurations, and applications," *Int J Energy Res.*, vol. 45, no. 9, pp. 12564-12597, 2021.
- [4] A. P. Kumar, "Analysis of Hybrid Systems: Software Tools," in *International Conference on Advances in Electrical, Electronics, Information, Communication and Bio-Informatics (AEEICB16)*, 2016.
- [5] *HOMER Energy*. (2022). [Online]. Available: <https://www.homerenergy.com/>.
- [6] R. Ahshan, N. Hosseinzadeh and A. Al-Badi, "Economic evaluation of a remote microgrid system for an Omani island," *International Journal of Smart Grid and Clean Energy*, vol. 9, no. 3, pp. 495-510, 2020.
- [7] D. Restrepo, B. Restrepo and L. A. Trejos-Grisales, "Microgrid analysis using HOMER: a case study," *DYNA*, vol. 85, no. 207, pp. 129-134, 2018.
- [8] M. Nurunnabi, N. K. Roy, E. Hossain and H. R. Pota, "Size Optimization and Sensitivity Analysis of Hybrid Wind/PV Micro-Grids- A Case Study for Bangladesh," *IEEE Access*, vol. 7, pp. 150120-150140, 2019.
- [9] *Dufo R* (2022). *iHOGA User's manual*. [Online]. Available: https://ihoga.unizar.es/Desc/iHOGA_User_manual.pdf.
- [10] N. Sai prasad, A. Kalam and A. Zayegh, "Comparative Study of Optimization of HRES using HOMER and iHOGA Software," *Journal of Scientific and Industrial Research*, vol. 77, pp. 677-683, 2018.
- [11] T. Iqbal and S. Ogbikaya, "Design of a hybrid power system using Homer Pro and iHOGA," in *30th IEEE NECEC Conference*, 2021.
- [12] *RETScreen*. (2022). [Online]. Available: <https://www.nrcan.gc.ca/maps-tools-and-publications/tools/modelling-tools/retscreen/7465>.
- [13] A. Mehmood, S. F. A. and A. Waqas, "Modeling of the solar photovoltaic systems to fulfill the energy demand of the domestic sector of Pakistan using RETSCREEN software," in *International Conference and Utility Exhibition on Green Energy for Sustainable Development (ICUE)*, Pattaya, 2014.
- [14] *SAM*. (2022). [Online]. Available:<https://sam.nrel.gov/>.
- [15] *HOMER Pro Manual*. (2022). [Online]. Available: <https://www.homerenergy.com/products/pro/docs/3.14/index.html>.
- [16] A. Kumar, A. R. Singh, Y. Deng, X. He, P. Kumar and R. C. Bansal, "Integrated assessment of a sustainable microgrid for a remote village in hilly region," *Energy Conversion and Management*, vol. 180, pp. 442-472, 2019.
- [17] T. Illes, A. Herrmann, B. Paech and J. Rückert, "Criteria for Software Testing Tool Evaluation – A Task Oriented View," 2005.
- [18] M. Jackson, S. Crouch and R. Baxter, "Software Evaluation: Criteria-based Assessment," Software Sustainability Institute, 2011.
- [19] G. Rituraj, G. R. C. Mouli and P. Bauer, "A Comprehensive Review on Off-Grid and Hybrid Charging Systems for Electric Vehicles," *IEEE Open Journal of the Industrial Electronics Society*, vol. 3, pp. 203-222, 2022.



APPENDIX A

The input requirements to design a SM (having PV, DG, battery storage, and load) using Homer Pro and iHOGA Pro are given below:

HOMER Pro input					iHOGA PRO+ input				
Single PV Module Specification					PV Generator				
Sr. no.	Descriptions	Value	Unit	Comments	Sr. no.	Descriptions	Value	Unit	Comments
1	Manufacturer			Generic/some brand	1	Manufacturer			Generic/some brand
2	Panel type			Flat/concentrated. It will decide the type of irradiance (GHI/DNI)	2	Panel type			Flat/concentrated. It will decide the type of irradiance (GHI/DNI)
3	Rated capacity		kW	PV property	3	Rated capacity		kW	
4	Efficiency		%	PV property	4	Capital cost		\$	Per kW
5	Capital cost		\$	Per kW	5	O&M cost		(\$/year)	
6	Replacement cost		\$		6	Lifetime		Years	
7	O&M cost		(\$/year)		7	Ground reflectance		%	Daily resolution
8	Lifetime		Years	PV property	8	NOCT		° C	
9	Derating factor		%		9	Power T coefficient		%/° C	
10	consider temperature effect			Yes/No	10	Efficiency due to degradation, wires, dirt		%	
11	Ground reflectance		%		11	Variation in cost per year		%/y	
12	Tracking system			No tracking/Horizontal axis/vertical/both axis	12	Emissions		kgCO ₂ /kWp	
13	Slope		deg	(as per location)	13	PV inverter efficiency curve		% vs kW	
14	Daily radiation data for an year			enter time series data or monthly averages	14	Slope of PV generator 1		deg	
15	Temperature coefficient		%/° C	PV property	15	Slope of PV generator 2		deg	Only one PV Generator is simulated
16	Operating temperature		° C	PV property	16	Azimuth of PV generator 1		deg	
17	Azimuth		deg		17	Azimuth of PV generator 2		deg	
18	PV inverter efficiency		(%)	It is also possible to input the efficiency curve.	18	Tracking system type			No tracking/Horizontal axis/Vertical axis/Both axes
					19	Factor for back albedo			For bifacial modules, as per Durusoy 2020 study
					20	Calculation method for hourly irradiation		Collares - Pereira	Four different methods available



10	Heat recovery ratio		%	
11	Minimum runtime		minutes	
Fuel Properties				
Sr. no.	Descriptions	Value	Unit	Comments
1	Select fuel			Diesel/ others
2	Price		\$/L	
3	Lower heating value		MJ/kg	
4	Density		kg/m3	
5	Carbon content		%	
6	Sulphur content		%	
7	Limit Consumption		L/yr	check/uncheck (then enter value)
Emissions				
Sr. no.	Descriptions	Value	Unit	Comments
1	CO		g/L fuel	
2	Unburned HC		g/L fuel	
3	Particulates		g/L fuel	
4	Fuel Sulfur to PM		%	
5	No_x		g/L fuel	

8	Fuel cost		\$/L	
9	Annual Inflation Rate for Fuel Prices		%/y	
10	Fuel emissions		kgC O ₂ /L	
11	Consumption A coefficient (fuel curve slope)		L/k Wh	Two input parameters needed, A and B, as per Skarstein & Ulhen, 1989
12	Consumption B coefficient (fuel curve intercept coefficient)		L/k Wh	Two input parameters needed, A and B, as per Skarstein & Ulhen, 1989
13	CO ₂ emissions for generator manufacturing		kgC O ₂ /k VA	
14	Extra ageing when running out of optimal conditions (50%-80%). Factor for running at 30% Pn		%	
15	Extra ageing when running out of optimal conditions (50%-80%). Factor for running at 100% Pn		%	
16	Generator runs all the time	Yes/No		
17	Spinning reserve +1gen	Yes/No		
18	Spinning reserve only if load is higher than Pn	Yes/No		
19	Availability	Yes/No		To be defined hourly, both for weekdays and weekends
20	Permissible overloads for temporary steps of less than 60 minutes - 30 min		%higher than nominal	
21	Permissible overloads for temporary steps of less than 60 minutes - 15 min		%higher than nominal	
22	Permissible overloads for temporary steps of less than 60 minutes - 10 min		%higher than nominal	
23	Permissible overloads for temporary steps of less than 60 minutes - 5 min		%higher than nominal	



									Minutes of lifespan at full load	
									24	
									Penalty on the consumption during each start	
BESS					BESS					
Sr. no.	Descriptions	Value	Unit	Comments	Sr. No.	Descriptions	Value	Unit	Comments	
1	Manufacturer			Generic/ brand	1	Manufacturer			Generic/ brand	
2	battery type			(Li-ion/lead acid)	2	battery type			Lead Acid/Li	
3	Capital cost		\$		3	Capital cost		\$		
4	Replacement cost		\$		4	O&M cost		(\$/year)		
5	O&M cost		(\$/year)		5	Minimum state of charge		%		
6	Lifetime		Years		6	Nominal capacity (kWh)		kWh		
7	Initial state of charge		%	Site specific input	7	Nominal voltage		V		
8	Minimum state of charge		%		8	Nominal capacity (Ah)		Ah	To specify C rate (not stated in datasheet)	
9	Nominal capacity		kWh		9	Self-discharge		%/month		
10	Nominal voltage		V	Battery properties	10	Maximum Acceptable Intensity		kA		
11	Ampere hour capacity		Ah		11	Roundtrip efficiency		%		
12	Roundtrip efficiency		%		12	Floating life		years		
13	Throughput		kWh		13	K factor			Default value can be used.	
14	Maximum Charge current		A		14	C factor			Default value can be used.	
15	Maximum discharge current		A		15	Temperature			Same as PV temperature	
16	Maximum charge rate		A/Ah		16	Battery simulation model	Li ion Model Ah			Different models available based on literature
17	String size				17	CO ₂ eq emissions for manufacturing			kgCO ₂ eq/kWh	
				18	SoC at beginning of simulation			%		
				19	Nominal capacity dependence on temperature				3 parameters to define the curve. a= 0.8, b=0.012 and c= -0.00011	
				20	Battery ageing simulation model	Rainflow			Different models available based on literature. Parameters are customizable	
				21	Remaining capacity at EoL			% of nominal		



		22	Annual inflation rate expected for battery costs		%/year	
		23	Program full charge if AC generator available, every x days or y equivalent full cycles		years	
		24	#Cycle dependence on temperature			3 parameters to define the curve. Default values are a= 1.62, b= 0.0354 and c= 0.0002
		31	#Cycles at DoD 80%		#Cycles	
Battery Inverter						
Sr. no.	Descriptions	Value	Unit	Comments		
1	Manufacturer			Generic/ brand		
2	Capital cost		\$	per kW		
3	Replacement cost		\$			
4	O&M cost		(\$/year)			
5	Lifetime (inverter input)		Years			
6	Efficiency (inverter input)		%			
7	Capacity		kW			
8	parallel with AC generator?			Yes/no		
9	Rectifier input (relative capacity)		%			
10	Rectifier input (efficiency)		%			
Battery Inverter						
Sr. no.	Description	Value	Unit	Comments		
1	Manufacturer			Generic/ brand		
2	Capital cost		\$	per kW		
3	Power		kVA			
4	Lifespan		years			
5	maximum charge current		kA			
6	Charger efficiency		%			
7	Minimum Vdc (battery)		Vdc			
8	Maximum Vdc		Vdc			
9	Maximum input power from the photovoltaic generator		kW			
10	Efficiency curve		%	15 points, at the following %Pn: 0, 2, 3, 4, 5, 10, 20, 30, 40, 50, 60, 70, 80, 90, 100		
Load, solar, and temperature profiles						
The data for these profiles can be either imported or download from the server(s) available in the software as per the site location.						
Load, solar, and temperature profiles						
The data for these profiles can be either imported or download from the server(s) available in the software as per the site location.						
Emissions Penalties						
Sr. no.	Descriptions	Value	Unit	Comments		
1	Carbon dioxide penalty		\$/t			
2	Carbon monoxide penalty		\$/t			
3	Unburned hydrocarbons penalty		\$/t			
4	Particulate matter penalty		\$/t			
5	Sulphur dioxide penalty		\$/t			
Emissions Penalties						
There is no emissions penalty. However, there is the possibility to do a multi-objective simulation (max 3 objectives) and set "Minimize CO ₂ emissions" as one of the objectives.						



Economics Input					Economics Input				
Sr. no.	Descriptions	Value	Unit	Comments	Sr. no.	Descriptions	Value	Unit	Comments
1	Nominal discount rate		%	Used to calculate real discount rate	1	Nominal discount rate		%	
2	Expected inflation rate		%		2	Project lifetime		Years	
3	Project lifetime		Years		3	Annual inflation rate		%	
4	Capacity shortage penalty		\$/kWh		4	Consider residual cost of components at end of project lifetime	Yes/No		
5	System fixed capital cost		\$		5	Currency			USD
6	System fixed O&M cost		\$	Can be selected any one from the list	6	Installation cost		\$	Can put to 0 as unit cost include installation cost because HOMER does not allow separation
7	Currency		\$		7	Variable initial cost		% of initial cost	
					8	Amount of loan		% of initial investment	Since Homer does not allow
					9	Loan interest		%	
					10	Duration of loan		years	
					11	Extra cash flow			Net extra cash flow to be defined at each year
System Control					System Control				
Sr. no.	Descriptions	Value	Unit	Comments	Sr. no.	Descriptions	Value	Unit	Comments
1	Minutes per time step			8760 (time steps per year)	1	Global strategy			Load following / Cycle charging
2	Multi-Year enabled			Yes/No	2	SoC for cycle charging		%	0-100
3	Allow systems with multiple generators			Yes/No	3	Variables to optimize relative to global strategy			Default fixed variables used
4	Allow systems with multiple wind turbine types			Yes/No	4	Variables accuracy		%	0-100
5	Battery autonomy threshold		hrs		5	Max grid price for battery charging from grid		\$/kWh	No grid connection
6	Allow Diesel-off Operation			Yes/No	6	Min grid price for battery discharging to grid		\$/kWh	No grid connection
7	Maximum renewable penetration threshold		0-100						
8	Warn about renewable penetration			Yes/No					
9	Control selected			Load/cycle following					
10	Capital cost		\$						
11	Replacement cost		\$						
12	O&M cost		(\$/year)						



13	Lifetime		years		7	Optimization strategy for grid-connected batteries			Extended algorithm
Constraints					General data				
Sr. no.	Descriptions	Value	Unit	Comments	Sr. no.	Descriptions	Value	Unit	Comments
1	Maximum annual capacity shortage	(0-100)	%	if put zero then the optimized component size will be larger	1	Components	PV GEN, Battery bank, Back up Genset, Inverter, Wind Turbine		
2	Minimum renewable fraction	(0-100)	%						
Operating Reserve (OR)					2	Min and Max Batteries in parallel	Min = , Max =		Min and Max are in number string from 0
3	as a percentage of load in current time step	(0-100)	%	load	3	Min and Max PV Generators in parallel	Min = , Max =		Min and Max are in number string from 0
4	as a percentage of annual peak load	(0-100)	%		4	Min and Max AC Generators in parallel	Min = , Max =		Min and Max are in number string from 0
5	as percentage of solar power output	(0-100)	%		5	Maximum Unmet demand		%	0-100
					6	Min days of battery autonomy			
					Options				
Sr. no.	Descriptions	Value	Unit	Comments	1	Simulation and optimization			Simulation of the 1st year and extrapolate results
					2	Economic optimization	NPC		
					3	Minimum renewable fraction		%	0-100



APPENDIX B

The input requirements to design a SM for case study 1 using HOMER Pro and iHOGA PRO+ are given below:

HOMER Pro input for case study 1				iHOGA PRO+ input for case study 1			
Single PV Module Specification				PV Generator			
Sr. no.	Descriptions	Value	Unit	Sr. no.	Descriptions	Value	Unit
1	Manufacturer	JA SOLAR		1	Manufacturer	JA SOLAR	
2	Panel type	Flat		2	Panel type	Flat	
3	Rated capacity	0.32	kW	3	Power	1024	kW
4	Efficiency	19.2	%	4	Capital cost	1024000	\$
5	Capital cost	320	\$	5	O&M cost	10240 (1%)	(\$/year)
6	Replacement cost	320	\$	6	Lifetime	25	Years
7	O&M cost	3.2	(\$/year)	7	Ground reflectance	20	%
8	Lifetime	25	Years	8	NOCT	45	° C
9	Derating factor	90	%	9	Power T coefficient	-0.36	%/° C
10	consider temperature effect	Yes		10	Efficiency due to degradation, wires, dirt	90	%
11	Ground reflectance	20	%	11	Variation in cost per year	2.6	%/y
12	Tracking system	No		12	Emissions	0	kgCO ₂ /kWp
13	Slope	15	deg	13	PV inverter efficiency curve	see PV inverter table	% vs kW
14	Daily radiation data for an year	Figure 9		14	Slope of PV generator 1	15	deg
15	Temperature coefficient	-0.36	%/° C	15	Slope of PV generator 2	NA	deg
16	Operating temperature	45	° C	16	Azimuth of PV generator 1	180	deg
17	Azimuth	180	deg	17	Azimuth of PV generator 2	NA	deg
18	PV inverter efficiency	efficiency table is used	(%)	18	Tracking system type	No	
PV inverter efficiency table				19	Factor for back albedo	0.33	
input %	Efficiency (%)			20	Calculation method for hourly irradiation	Collares-Pereira	
0	0			21	Shadows	NA	
2	30			22	Irradiation data source	measured data	
3	50			23	Variability, correlation factor	0.9	
4	70			24	Variability, std deviation	0.2	
5	85			PV Module Stringing			
10	93			Sr. no.	Descriptions	Value	Unit
20	92			1	P _{nom}	320	W
30	90			2	V _{mpp}		V
40	89						
50	88						
60	87						
70	86						
80	85						
90	84						
100	83						



				3	I_{mpp}		A
				4	V_{oc}		V
				5	I_{sc}		A
				6	P Temp Coef	-0.36	%/° C
				7	Voltage Temp Coef		mV/° C
				8	Current Temp Coef		mA/° C
				9	Modules per AC Generator		
				10	String Voltage at V_{mp} (STC)		V
				11	String Voltage at V_{oc}		V
				12	String Power	1024	kW
DG				DG and Fuel Details			
Sr. no.	Descriptions	Value	Unit	Sr. no.	Descriptions	Value	Unit
1	Manufacturer	Generic		1	Manufacturer	Generic	
2	Size to consider	560	kW	2	Capital cost	224000	\$
3	Capital cost	224000	\$	3	O&M cost	11.2	\$/op.hour
4	Replacement cost	224000	\$	4	Lifetime	20000	Hours
5	O&M cost	11.2	\$/op.hour	5	Min. load ratio	25	%
6	Lifetime	20000	Hours	6	Power (rating)	560	kVA
7	Min. load ratio	25	%	7	Fuel type	Diesel	
8	Fuel curve intercept	0.028	L/hr/kW	8	Fuel cost	1.5	\$/L
9	Fuel curve slope	0.253	L/hr/kW	9	Annual Inflation Rate for Fuel Prices	2.6	%/y
10	Heat recovery ratio	0	%	10	Fuel emissions	3.5	kgCO ₂ /L
11	Minimum runtime	0	minutes	11	Consumption A coefficient (fuel curve slope)	0.253	L/kWh
Fuel Properties				12	Consumption B coefficient (fuel curve intercept coefficient)	0.028	L/kWh
Sr. no.	Descriptions	Value	Unit	13	CO ₂ emissions for generator manufacturing	0	kgCO ₂ /kVA
1	Select fuel	Diesel		14	Extra ageing when running out of optimal conditions (50%-80%). Factor for running at 30% P _n	1	
2	Price	1.5	\$/L	15	Extra ageing when running out of optimal conditions (50%-80%). Factor for running at 100% P _n	1	
3	Lower heating value	43.2	MJ/kg	16	Generator runs all the time	No	
4	Density	820	kg/m ³	17	Spinning reserve +1gen	No	
5	Carbon content	88	%	18	Spinning reserve only if load is higher than P _n	No	
6	Sulphur content	0.4	%				
7	Limit consumption	unchecked	L/yr				
Emissions							
Sr. no.	Descriptions	Value	Unit				
1	CO	17.794	g/L fuel				
2	Unburned HC	0.72	g/L fuel				
3	Particulates	0.0712	g/L fuel				
4	Fuel Sulphur to PM	2.2	%				
5	No _x	1.4235	g/L fuel				



				19	Availability	24 hrs 7 days a week	
				20	Permissible overloads for temporary steps of less than 60 minutes - 30 min	20	%higher than nominal
				21	Permissible overloads for temporary steps of less than 60 minutes - 15 min	30	%higher than nominal
				22	Permissible overloads for temporary steps of less than 60 minutes - 10 min	30	%higher than nominal
				23	Permissible overloads for temporary steps of less than 60 minutes - 5 min	30	%higher than nominal
				24	Penalty on the consumption during each start	5	Minutes of lifespan at full load
BESS				BESS			
Sr. no.	Descriptions	Value	Unit	Sr. no.	Descriptions	Value	Unit
1	Manufacturer	Samsung		1	Manufacturer	Samsung	
2	battery type	Li-ion		2	battery type	Li-ion	
3	Capital cost	2415	\$	3	Capital cost	2415	\$
4	Replacement cost	2415	\$	4	O&M cost	24.15	(\$/year)
5	O&M cost	24.15	(\$/year)	5	Minimum state of charge	5	%
6	Lifetime	15	Years	6	Nominal capacity (kWh)	6.9	kWh
7	Initial state of charge	100	%	7	Nominal voltage	74	V
8	Minimum state of charge	5	%	8	Nominal capacity (Ah)	93.2	Ah
9	Nominal capacity	6.9	kWh	9	Self-discharge	1	%/month
10	Nominal voltage	74	V	10	Maximum Acceptable Intensity	-	kA
11	Ampere hour capacity	93.2	Ah	11	Roundtrip efficiency	90	%
12	Roundtrip efficiency	90	%	12	Floating life	15	years
13	Throughput	45600	kWH	13	K factor	-	
14	Maximum Charge current	0.7	A	14	C factor	-	
17	String size	12		15	Temperature	-	
				16	Battery simulation model	Li ion Model Ah	
				17	CO ₂ eq emissions for manufacturing	0	kgCO ₂ eq/kWh
				18	SoC at beginning of simulation	100	%
				19	Nominal capacity dependence on temperature		
				20	Battery ageing simulation model	Rainflow	



		21	Remaining capacity at EoL	80	% of nominal
		22	Annual inflation rate expected for battery costs	2.6	%/year
		23	Program full charge if AC generator available, every x days or y equivalent full cycles	x=14,y=8	
		24	#Cycle dependence on temperature	NA	
		31	#Cycles at DoD 80%	NA	#Cycles
Battery Inverter					
Sr. no.	Descriptions	Value	Unit		
1	Manufacturer	Generic			
2	Capital cost	240000	\$		
3	Replacement cost	240000	\$		
4	O&M cost	0	(\$/year)		
5	Lifetime (inverter input)	15	Years		
6	Efficiency (inverter input)	95	%		
7	Capacity	800	kW		
8	Parallel with AC generator?	Yes	-		
9	Rectifier input (relative capacity)	100	%		
10	Rectifier input (efficiency)	95	%		
Emissions Penalties					
Sr. no.	Descriptions	Value	Unit		
1	Carbon dioxide penalty	0	\$/t		
2	Carbon monoxide penalty	0	\$/t		
3	Unburned hydrocarbons penalty	0	\$/t		
4	Particulate matter penalty	0	\$/t		
5	Sulphur dioxide penalty	0	\$/t		
Economics Input					
Sr. no.	Descriptions	Value	Unit		
1	Nominal discount rate	5	%		
2	Expected inflation rate	2.6	%		
3	Project lifetime	25	Years		
4	Capacity shortage penalty	0	\$/kWh		
5	System fixed capital cost	0	\$		
6	System fixed O&M cost	0	\$		
7	Currency	US Dollar	\$		
Battery Inverter					
Sr. no.	Descriptions	Value	Unit		
1	Manufacturer	Generic			
2	Capital cost	240000	\$		
3	Power	800	kVA		
4	Lifespan	15	years		
5	Maximum charge current	20	kA		
6	Charger efficiency	95	%		
7	Minimum Vdc (battery)	850	Vdc		
8	Maximum Vdc	950	Vdc		
9	Maximum input power from the photovoltaic generator	1E15	kW		
10	Efficiency	95	%		
Economics Input					
Sr. no.	Descriptions	Value	Unit		
1	Nominal discount rate	5	%		
2	Project lifetime	25	Years		
3	Annual inflation rate	2.6	%		
4	Consider residual cost of components at end of project lifetime	no			
5	Currency	dollar	\$		
6	Installation cost	0	\$		
7	Variable initial cost	0	% of initial cost		
8	Amount of loan	0	% of initial investment		



				9	Loan interest	0	%
				10	Duration of loan	0	years
				11	Extra cash flow	0	
System Control				System Control			
Sr. no.	Descriptions	Value	Unit	Sr. no.	Descriptions	Value	Unit
1	Minutes per time step	60		1	Global strategy	Load Following	
2	Multi-Year enabled	No		2	SoC for cycle charging	-	%
3	Allow systems with multiple generators	Yes		3	Variables to optimize relative to global strategy	-	
4	Allow systems with multiple wind turbine types	Yes		4	Variables accuracy	5	%
5	Battery autonomy threshold	0	hrs	5	Max grid price for battery charging from grid	0	\$/kWh
6	Allow Diesel-off Operation	Yes		6	Min grid price for battery discharging to grid	0	\$/kWh
7	Maximum renewable penetration threshold	>55	%	7	Optimization strategy for grid-connected batteries	-	
8	Warn about renewable penetration	Yes					
9	Control selected	HOMER Load following					
10	Capital cost	0	\$				
11	Replacement cost	0	\$				
12	O&M cost	0	(\$/year)				
13	Lifetime	25	years				
Constraints				General data			
Sr. no.	Descriptions	Value	Unit	Sr. no.	Descriptions	Value	Unit
1	Maximum annual capacity shortage	5	%	1	Components	PV GEN, Battery bank, Back up Genset, Inverter, Wind Turbine	
2	Minimum renewable fraction	10	%	2	Min and Max Batteries in parallel	Min = , Max =	
Operating Reserve (OR)				3	Min and Max PV Generators in parallel	Min = , Max =	
3	as a percentage of load in current time step	0	%	4	Min and Max AC Generators in parallel	Min = , Max =	
4	as a percentage of annual peak load	0	%	5	Maximum Unmet demand	5	%
5	as percentage of solar power output	0	%	6	Min days of battery autonomy	0	
				Options			
Sr. no.	Descriptions	Value	Unit	Sr. no.	Descriptions	Value	Unit
				1	Simulation and optimization	-	
				2	Economic optimization	NPC	
				3	Minimum renewable fraction	10	%



APPENDIX C

The input requirements to design a SM for case study 2 using HOMER Pro and iHOGA PRO+ are given below:

HOMER Pro input for case study 2				iHOGA PRO+ input for case study 2			
Single PV Module Specification				PV Generator			
Sr. no.	Descriptions	Value	Unit	Sr. no.	Descriptions	Value	Unit
1	Manufacturer	Generic		1	Manufacturer	Generic	
2	Panel type	Flat plate		2	Panel type	Flat plate	
3	Rated capacity	1	kW	3	Rated capacity	1	kW
4	Capital cost	1000	\$	4	Capital cost	1000	\$
5	Replacement cost	1000	\$	5	O&M cost	1000	(\$/year)
6	O&M cost	10	(\$/year)	6	Lifetime	25	Years
7	Lifetime	25	Years	7	Ground reflectance	20	%
8	Derating factor	88	%	8	NOCT	43	° C
9	consider temperature effect	No		9	Power T coefficient	-0.40	%/° C
10	Ground reflectance	20	%	10	Efficiency due to degradation, wires, dirt	88	%
11	Tracking system	No		11	Variation in cost per year	4.9	%/y
12	Slope	29	deg	12	Emissions	0	kgCO ₂ /kWp
13	Daily radiation data for an year	Figure 13		13	PV inverter efficiency curve	see PV inverter table	% vs kW
14	Azimuth	0	deg	14	Slope of PV generator 1	29	deg
15	PV inverter efficiency	efficiency table is used (see appendix B)	(%)	15	Slope of PV generator 2	NA	deg
				16	Azimuth of PV generator 1	0	deg
				17	Azimuth of PV generator 2	NA	deg
				18	Tracking system type	No	
				19	Factor for back albedo	0.33	
				20	Calculation method for hourly irradiation	Collares-Pereira	
				21	Shadows	0	
				22	Irradiation data source	NASA 2020 hourly downloaded	
				23	Variability, correlation factor	0.9	
				24	Variability, std deviation	0.2	
				PV Module Stringing			
				Sr. no.	Descriptions	Value	Unit
				1	P _{nom}	1000	W
				2	V _{mpp}	-	V
				3	I _{mpp}	-	A
				4	V _{oc}	-	V



				5	I _{sc}	-	A
				6	P Temp Coef	-	%/°C
				7	Voltage Temp Coef	-	mV/°C
				8	Current Temp Coef	-	mA/°C
				9	Modules per AC Generator	-	
				10	String Voltage at V _{mp} (STC)	-	V
				11	String Voltage at V _{oc}	-	V
				12	String Power	50	kW
WT				WT			
Sr. no.	Descriptions	Value	Unit	Sr. no.	Descriptions	Value	Unit
1	Manufacturer	Generic		1	Manufacturer	Generic	
2	Capital cost	7000	\$	2	Capital cost	700	\$/kW
3	Replacement cost	7000	\$	3	Replacement cost	700	\$/kW
4	O&M cost	70	(\$/year)	4	O&M cost	70	(\$/year)
5	Lifetime	20	Years	5	Lifetime	20	Years
6	electrical bus	AC		6	electrical bus	AC	
7	Capacity	10	kW	7	Capacity	10	kW
8	Hub height	14	m	8	Hub height	14	m
9	Consider ambient temp effects?	Yes		9	Wind speed profile (m/s)	Figure 14	
10	Wind speed profile (m/s)	Figure 14					
DG				DG and Fuel Details			
Sr. no.	Descriptions	Value	Unit	Sr. no.	Descriptions	Value	Unit
1	Manufacturer	Generic		1	Manufacturer	Generic	
2	Size to consider	1	kW	2	Capital cost	4000	\$
3	Capital cost	400	\$	3	O&M cost	0.03	\$/op.hour
4	Replacement cost	400	\$	4	Lifetime	15000	Hours
5	O&M cost	0.003	\$/op.hour	5	Min. load ratio	25	%
6	Lifetime	150000	Hours	6	Power (rating)	10	kVA
7	Min. load ratio	25	%	7	Fuel type	Diesel	
8	Fuel curve intercept	0.048	L/hr/kW	8	Fuel cost	1.5	\$/L
9	Fuel curve slope	0.286	L/hr/kW	9	Annual Inflation Rate for Fuel Prices	4.9	%/y
10	Heat recovery ratio	0	%	10	Fuel emissions	3.5	kgCO ₂ /L
11	Minimum runtime	0	minutes	11	Consumption A coefficient (fuel curve slope)	0.286	L/kWh
Fuel Properties				12	Consumption B coefficient (fuel curve intercept coefficient)	0.048	L/kWh
Sr. no.	Descriptions	Value	Unit	13	CO ₂ emissions for generator manufacturing	0	kgCO ₂ /kVA
1	Select fuel	Diesel		14	Extra ageing when running out of optimal conditions (50%-80%). Factor for running at 30% P _n	1	
2	Price	1.5	\$/L				
3	Lower heating value	43.2	MJ/kg				
4	Density	820	kg/m ³				
5	Carbon content	88	%				
6	Sulphur content	0.4	%				
7	Limit Consumption	unchecked	L/yr				
Emissions							
Sr. no.	Descriptions	Value	Unit				



1	CO	0.035	g/L fuel	15	Extra ageing when running out of optimal conditions (50%-80%). Factor for running at 100% Pn	1	
2	Unburned HC	0.72	g/L fuel	16	Generator runs all the time	No	
3	Particulates	0.0712	g/L fuel	17	Spinning reserve +1gen	No	
4	Fuel Sulphur to PM	2.2	%	18	Spinning reserve only if load is higher than Pn	No	
5	No_x	1.4235	g/L fuel	19	Availability	24 hrs 7 days a week	
				20	Permissible overloads for temporary steps of less than 60 minutes - 30 min	20	%higher than nominal
				21	Permissible overloads for temporary steps of less than 60 minutes - 15 min	30	%higher than nominal
				22	Permissible overloads for temporary steps of less than 60 minutes - 10 min	30	%higher than nominal
				23	Permissible overloads for temporary steps of less than 60 minutes - 5 min	30	%higher than nominal
				24	Penalty on the consumption during each start	5	Minutes of lifespan at full load
BESS				BESS			
Sr. no.	Descriptions	Value	Unit	Sr. no.	Descriptions	Value	Unit
1	Manufacturer	Samsung		1	Manufacturer	Samsung	
2	battery type	Li-ion		2	battery type	Li-ion	
3	Capital cost	2760	\$	3	Capital cost	2760	\$
4	Replacement cost	2760	\$	4	O&M cost	2760	(\$/year)
5	O&M cost	27.6	(\$/year)	5	Minimum state of charge	20	%
6	Lifetime	15	Years	6	Nominal capacity (kWh)	6.9	kWh
7	Initial state of charge	100	%	7	Nominal voltage	74	V
8	Minimum state of charge	20	%	8	Nominal capacity (Ah)	93.2	Ah
9	Nominal capacity	6.9	kWh	9	Self-discharge	1	%/month
10	Nominal voltage	74	V	10	Maximum Acceptable Intensity	NA	kA
11	Ampere hour capacity	93.2	Ah	11	Roundtrip efficiency	95	%
12	Roundtrip efficiency	90	%	12	Floating life	15	years
13	Throughput	45600	kWh	13	K factor	-	
14	Maximum Charge current	0.7	A	14	C factor	-	
17	String size	11		15	Temperature	-	
				16	Battery simulation model	Li ion Model	Ah



				17	CO ₂ eq emissions for manufacturing	0	kgCO ₂ eq/kWh
				18	SoC at beginning of simulation	100	%
				19	Nominal capacity dependence on temperature	NA	
				20	Battery ageing simulation model	Rainflow	
				21	Remaining capacity at EoL	70	% of nominal
				22	Annual inflation rate expected for battery costs	4.9	%/year
				23	Program full charge if AC generator available, every x days or y equivalent full cycles	x=14,y=8	
				24	#Cycle dependence on temperature	NA	
				31	#Cycles at DoD 80%	NA	#Cycles
Battery Inverter				Battery Inverter			
Sr. no.	Descriptions	Value	Unit	Sr. no.	Descriptions	Value	Unit
1	Manufacturer	Generic		1	Manufacturer	Generic	
2	Capital cost	400	\$	2	Capital cost	400	\$
3	Replacement cost	400	\$	3	Power	1	kVA
4	O&M cost	0	(\$/year)	4	Lifespan	15	years
5	Lifetime (inverter input)	15	Years	5	maximum charge current	3.75	kA
6	Efficiency (inverter input)	95	%	6	Charger efficiency	95	%
7	Capacity	1	kW	7	Minimum Vdc (battery)	700	Vdc
8	Parallel with AC generator?	Yes		8	Maximum Vdc	900	Vdc
9	Rectifier input (relative capacity)	100	%	9	Maximum input power from the photovoltaic generator	1E15	kW
10	Rectifier input (efficiency)	95	%	10	Efficiency curve	95	%
Emissions Penalties							
Sr. no.	Descriptions	Value	Unit				
1	Carbon dioxide penalty	0	\$/t				
2	Carbon monoxide penalty	0	\$/t				
3	Unburned hydrocarbons penalty	0	\$/t				
4	Particulate matter penalty	0	\$/t				
5	Sulphur dioxide penalty	0	\$/t				
Economics Input				Economics Input			
Sr. no.	Descriptions	Value	Unit	Sr. no.	Descriptions	Value	Unit
1	Nominal discount rate	7	%	1	Nominal discount rate	7	%
2	Expected inflation rate	4.9	%	2	Project lifetime	25	Years
3	Project lifetime	25	Years	3	Annual inflation rate	4.9	%
4	Capacity shortage penalty	0	\$/kWh	4	Consider residual cost of components at end of project lifetime	yes	
5	System fixed capital cost	0	\$	5	Currency	dollar	\$
6	System fixed O&M cost	0	\$				



7	Currency	US Dollar	\$
6	Installation cost	0	\$
7	Variable initial cost	0	% of initial cost
8	Amount of loan	0	% of initial investment
9	Loan interest	0	%
10	Duration of loan	0	years
11	Extra cash flow	0	
System Control			
Sr. no.	Descriptions	Value	Unit
1	Minutes per time step	60	
2	Multi-Year enabled	No	
3	Allow systems with multiple generators	Yes	
4	Allow systems with multiple wind turbine types	Yes	
5	Battery autonomy threshold	2	hrs
6	Allow Diesel-off Operation	Yes	
7	Maximum renewable penetration threshold	>100	%
8	Warn about renewable penetration	Yes	
9	Control selected	HOMER Load following	
10	Capital cost	0	\$
11	Replacement cost	0	\$
12	O&M cost	0	(\$/year)
13	Lifetime	25	years
System Control			
Sr. no.	Descriptions	Value	Unit
1	Global strategy	Load Following	
2	SoC for cycle charging	NA	%
3	Variables to optimize relative to global strategy	NA	
4	Variables accuracy	5	%
5	Max grid price for battery charging from grid	0	\$/kWh
6	Min grid price for battery discharging to grid	0	\$/kWh
7	Optimization strategy for grid-connected batteries	NA	
Constraints			
Sr. no.	Descriptions	Value	Unit
1	Maximum annual capacity shortage	5	%
2	Minimum renewable fraction	50	%
Operating Reserve (OR)			
3	as a percentage of load in current time step	0	%
4	as a percentage of annual peak load	0	%
5	as percentage of solar power output	0	%
General data			
Sr. no.	Descriptions	Value	Unit
1	Components	PV GEN, Battery bank, Back up Genset, Inverter, Wind Turbine	
2	Min and Max Batteries in parallel	Min = , Max =	
3	Min and Max PV Generators in parallel	Min = , Max =	
4	Min and Max AC Generators in parallel	Min = , Max =	
5	Maximum Unmet demand	5	%
6	Min days of battery autonomy	0.1	days
Options			
Sr. no.	Descriptions	Value	Unit
1	Simulation and optimization	NA	
2	Economic optimization	NPC	
3	Min. renewable fraction	50	%



APPENDIX D

The detailed input to design a SM for case study 3 using HOMER Pro and iHOGA PRO+ are given below:

HOMER Pro input for case study 3				iHOGA PRO+ input for case study 3			
Single PV Module Specification				PV Generator			
Sr. no.	Descriptions	Value	Unit	Sr. no.	Descriptions	Value	Unit
1	Manufacturer	Sun Power	E20-327	1	Manufacturer	Sun Power	E20-327
2	Panel type	Flat plate		2	Panel type	Flat plate	
3	Rated capacity	0.327	kW	3	Power	3.924	kWp
4	Efficiency	20.4	%	4	Capital cost	3924	\$
5	Capital cost	327	\$	5	O&M cost	39.24	(\$/year)
6	Replacement cost	327	\$	6	Lifetime	25	Years
7	O&M cost	3.27	(\$/year)	7	Ground reflectance	20	%
8	Lifetime	25	Years	8	NOCT	45	°C
9	Derating factor	88	%	9	Power T coefficient	-0.38	%/°C
10	consider temperature effect	Yes		10	Efficiency due to degradation, wires, dirt	88	%
11	Ground reflectance	20	%	11	Variation in cost per year	4.9	%/y
12	Tracking system	No		12	Emissions	0	kgCO ₂ /kWp
13	Slope	45	deg	13	PV inverter efficiency curve	100 (assumed ideal)	% vs kW
14	Daily radiation data for an year	Figure 17		14	Slope of PV generator 1	45	deg
15	Temperature coefficient	-0.38	%/°C	15	Slope of PV generator 2	NA	deg
16	Operating temperature	45	°C	16	Azimuth of PV generator 1	0	deg
17	Azimuth	0	deg	17	Azimuth of PV generator 2	NA	deg
18	PV inverter efficiency	100 (assumed ideal)	(%)	18	Tracking system type	No	
				19	Factor for back albedo	NA	
				20	Calculation method for hourly irradiation	Collares-Pereira	
				21	Shadows	0	
				22	Irradiation data source	NASA 2020 hourly downloaded	
				23	Variability, correlation factor	0.9	
				24	Variability, std deviation	0.2	
				PV Module Stringing			
				Sr. no.	Descriptions	Value	Unit
				1	P _{nom}	327	W
				2	V _{mpp}	54.7	V
				3	I _{mpp}	5.98	A
				4	V _{oc}	64.9	V



		5	I _{sc}	6.46	A		
		6	P Temp Coef	-0.35	%/° C		
		7	Voltage Temp Coef	-176.6	mV/° C		
		8	Current Temp Coef	2.6	mA/° C		
		9	Modules per AC Generator	12			
		10	String Voltage at V _{mp} (STC)	656.4	V		
		11	String Voltage at V _{oc}	778.8	V		
		12	String Power	3.924	W		
DG				DG and Fuel Details			
Sr. no.	Descriptions	Value	Unit	Sr. no.	Descriptions	Value	Unit
1	Manufacturer	Generic		1	Manufacturer	Generic	
2	Size to consider	10/20/30	kW	2	Capital cost	4000	\$
3	Capital cost	400	\$/kW	3	O&M cost	0.03	\$/op.hour
4	Replacement cost	400	\$/kW	4	Lifetime	15000	Hours
5	O&M cost	0.03	\$/op.hour	5	Min. load ratio	25	%
6	Lifetime	15000	Hours	6	Power (rating)	10	kVA
7	Min. load ratio	25	%	7	Fuel type	Diesel	
8	Fuel curve intercept	0.028	L/hr/kW	8	Fuel cost	1.5	\$/L
9	Fuel curve slope	0.253	L/hr/kW	9	Annual Inflation Rate for Fuel Prices	4.9	%/y
10	Heat recovery ratio	0	%	10	Fuel emissions	3.5	kgCO ₂ /L
11	Minimum runtime	0	minutes	11	Consumption A coefficient (fuel curve slope)	0.253	L/kWh
Fuel Properties				12	Consumption B coefficient (fuel curve intercept coefficient)	0.028	L/kWh
Sr. no.	Descriptions	Value	Unit	13	CO ₂ emissions for generator manufacturing	0	kgCO ₂ /kVA
1	Select fuel	Diesel		14	Extra ageing when running out of optimal conditions (50%-80%). Factor for running at 30% P _n	1	%
2	Price	1.5	\$/L	15	Extra ageing when running out of optimal conditions (50%-80%). Factor for running at 100% P _n	1	%
3	Lower heating value	43.2	MJ/kg	16	Generator runs all the time	No	
4	Density	820	kg/m ³	17	Spinning reserve +1gen	No	
5	Carbon content	88	%	18	Spinning reserve only if load is higher than P _n	No	
6	Sulphur content	0.4	%	19	Availability	24 hrs 7 days a week	
7	Limit consumption	unchecked	L/yr	20	Permissible overloads for temporary steps of less than 60 minutes - 30 min	20	%higher than nominal
Emissions				21	Permissible overloads for temporary steps of less than 60 minutes - 15 min	30	%higher than nominal
Sr. no.	Descriptions	Value	Unit				
1	CO	17.794	g/L fuel				
2	Unburned HC	0.72	g/L fuel				
3	Particulates	0.0712	g/L fuel				
4	Fuel Sulphur to PM	2.2	%				
5	No _x	1.4235	g/L fuel				



				22	Permissible overloads for temporary steps of less than 60 minutes - 10 min	30	%higher than nominal
				23	Permissible overloads for temporary steps of less than 60 minutes - 5 min	30	%higher than nominal
				24	Penalty on the consumption during each start	5	Minutes of lifespan at full load
BESS				BESS			
Sr. no.	Descriptions	Value	Unit	Sr. no.	Descriptions	Value	Unit
1	Manufacturer	Fortress Power	LPF-10	1	Manufacturer	Fortress Power	LPF-10
2	battery type	Li-Fe phosphate		2	battery type	Li-Fe phosphate	
3	Capital cost	3360	\$	3	Capital cost	3360	\$
4	Replacement cost	3360	\$	4	O&M cost	33.6	(\$/year)
5	O&M cost	96	(\$/year)	5	Minimum state of charge	15	%
6	Lifetime	15	Years	6	Nominal capacity (kWh)	9.6	kWh
7	Initial state of charge	100	%	7	Nominal voltage	48	V
8	Minimum state of charge	15	%	8	Nominal capacity (Ah)	200	Ah
9	Nominal capacity	9.6	kWh	9	Self-discharge	1	%/month
10	Nominal voltage	48	V	10	Maximum Acceptable Intensity	0.1	kA
11	Ampere hour capacity	200	Ah	11	Roundtrip efficiency	98	%
12	Roundtrip efficiency	98	%	12	Floating life	15	years
13	Throughput	48000	kWH	13	K factor	0.06	
14	Maximum Charge current	100	A	14	C factor	0.6	
17	String size	1		15	Temperature	Ambient Temperature in case study	
				16	Battery simulation model	Li ion Model Ah	
				17	CO ₂ eq emissions for manufacturing	0	kgCO ₂ eq/kWh
				18	SoC at beginning of simulation	100	%
				19	Nominal capacity dependence on temperature	a= 0.8, b=0.012 and c= -0.00011	
				20	Battery ageing simulation model	Rainflow	
				21	Remaining capacity at EoL	80	% of nominal
				22	Annual inflation rate expected for battery costs	4.9	%/year



		23	Program full charge if AC generator available, every x days or y equivalent full cycles	no	yes/no		
		24	#Cycle dependence on temperature	a= 1.62, b= 0.0354 and c= 0.0002			
		31	#Cycles at DoD 80%	6000	#Cycles		
Battery Inverter				Battery Inverter			
Sr. no.	Descriptions	Value	Unit	Sr. no.	Descriptions	Value	Unit
1	Manufacturer	Victron		1	Manufacturer	Victron	
2	Capital cost	4000	\$	2	Capital cost	4000	\$
3	Replacement cost	4000	\$	3	Power	10-70	kVA
4	O&M cost	0	(\$/year)	4	Lifespan	10	years
5	Lifetime (inverter input)	10	Years	5	Maximum charge current	0.14	kA
6	Efficiency (inverter input)	96	%	6	Charger efficiency	96	%
7	Capacity	10	kW	7	Minimum Vdc (battery)	38	Vdc
8	Parallel with AC generator?	Yes		8	Maximum Vdc	66	Vdc
9	Rectifier input (relative capacity)	100	%	9	Maximum input power from the photovoltaic generator	8/16/24/32/40/48/56	kW
10	Rectifier input (efficiency)	96	%	10	Efficiency	96	%
Emissions Penalties							
Sr. no.	Descriptions	Value	Unit				
1	Carbon dioxide penalty	0	\$/t				
2	Carbon monoxide penalty	0	\$/t				
3	Unburned hydrocarbons penalty	0	\$/t				
4	Particulate matter penalty	0	\$/t				
5	Sulphur dioxide penalty	0	\$/t				
Economics Input				Economics Input			
Sr. no.	Descriptions	Value	Unit	Sr. no.	Descriptions	Value	Unit
1	Nominal discount rate	7	%	1	Nominal discount rate	7	%
2	Expected inflation rate	4.9	%	2	Project lifetime	25	Years
3	Project lifetime	25	Years	3	Annual inflation rate	4.9	%
4	Capacity shortage penalty	0	\$/kWh	4	Consider residual cost of components at end of project lifetime	No	
5	System fixed capital cost	0	\$	5	Currency	dollar	\$
6	System fixed O&M cost	0	\$	6	Installation cost	0	\$
7	Currency	US Dollar	\$	7	Variable initial cost	0	% of initial cost
				8	Amount of loan	0	% of initial investment
				9	Loan interest	0	%
				10	Duration of loan	0	years
				11	Extra cash flow	0	



System Control			
Sr. no.	Descriptions	Value	Unit
1	Minutes per time step	60	
2	Multi-Year enabled	No	
3	Allow systems with multiple generators	Yes	
4	Allow systems with multiple wind turbine types	Yes	
5	Battery autonomy threshold	2	hrs
6	Allow Diesel-off Operation	Yes	
7	Maximum renewable penetration threshold	>100	%
8	Warn about renewable penetration	Yes	
9	Control selected	HOMER Load following	
10	Capital cost	0	\$
11	Replacement cost	0	\$
12	O&M cost	0	(\$/year)
13	Lifetime	25	years

System Control			
Sr. no.	Descriptions	Value	Unit
1	Global strategy	Load Following	
2	SoC for cycle charging		%
3	Variables to optimize relative to global strategy		
4	Variables accuracy	5	%
5	Max grid price for battery charging from grid	0	\$/kWh
6	Min grid price for battery discharging to grid	0	\$/kWh
7	Optimization strategy for grid-connected batteries		

Constraints			
Sr. no.	Descriptions	Value	Unit
1	Maximum annual capacity shortage	5	%
2	Minimum renewable fraction	50	%
Operating Reserve (OR)			
3	as a percentage of load in current time step	0	%
4	as a percentage of annual peak load	0	%
5	as percentage of solar power output	0	%

General data			
Sr. no.	Descriptions	Value	Unit
1	Components	PV GEN, Battery bank, Back up Genset, Inverter, Wind Turbine	
2	Min and Max Batteries in parallel	Min =0 , Max = 4	
3	Min and Max PV Generators in parallel	Min =0 , Max = 30	
4	Min and Max AC Generators in parallel	Min =0 , Max =3	
5	Maximum Unmet demand	5	%
6	Min days of battery autonomy	0.5	
Options			
Sr. no.	Descriptions	Value	Unit
1	Minimum renewable fraction	50	%
2	Economic optimization	NPC	

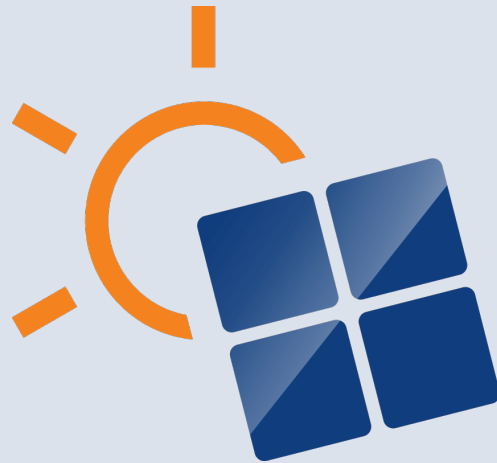

ISBN 978-3-907281-45-1

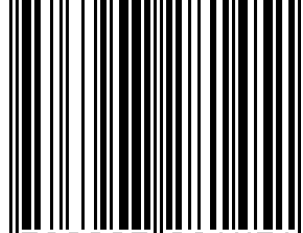

9 783907 281451