

UNIT

Centraal Beheer, Herman Hertzberger, Apeldoorn

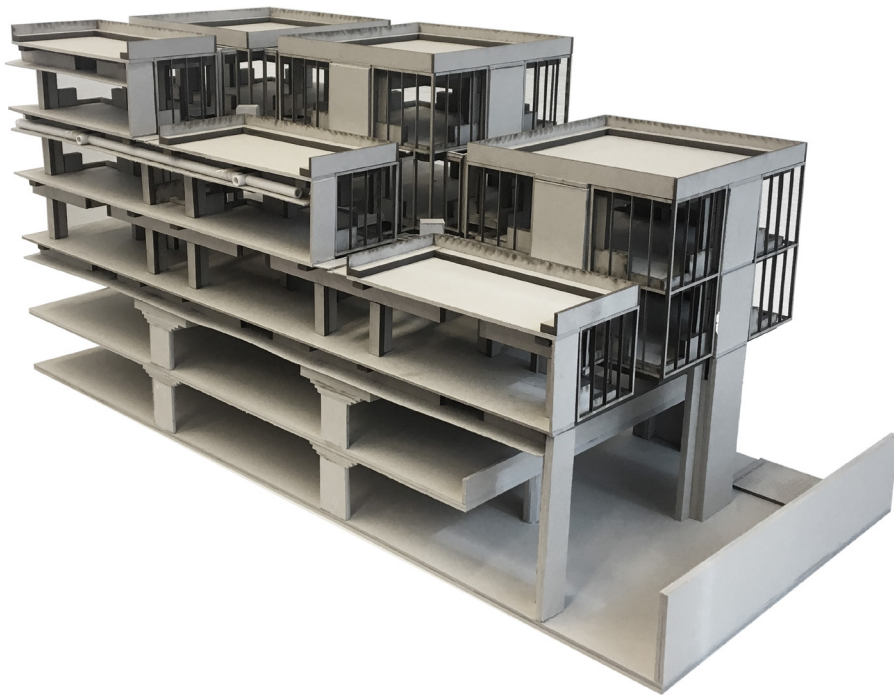

Anne Ebbenhorst
Jelmer Dankers
Jeroen Boogaard
Josefine Uittenbogert
Lydia de Vries

Msc3 The future of structuralism
17-4-2018

Content

Introduction	4
The architect	6
Start of modular spatial units	7
Context	10
Building	11
Shape	12
Disorder of the perfect shape	13
Overview	14
The street	15
Orientation	16
9x9 unit	17
Definition	18
Construction	19
Installations	22
Workspaces	24
Material	27
The perfect quadrant	29
Facade	30
Orientation in offices	31
Roof terraces	32
Gutters	33
Installations	35
The actual quadrant	36
Overview	37
Construction ending	39
Voids	40
Continuous floors	41
Cultural value	42
Conclusion	51
Appendix	53
Bibliography	84

Introduction

This analysis is the result of the research phase of the graduation studio of Heritage and Architecture: The Future of Structuralism (MSc3 AR3AR111, 2017/2018 Q3). The subject of the analysis is the iconic Centraal Beheer building in Apeldoorn by Herman Hertzberger. The goal of this analysis is not only to get to know and understand the building, but also to value its architectural, technical and cultural value. This document reveals opportunities and challenges that will serve as starting points for the (re) design phase.

The building of Centraal Beheer has been analyzed previously by students who started this graduation project in September. They used four different themes to approach the analyses of the building in order to create a more diverse and in depth analyses,. These themes were:

- time (by Giulio Di Giuseppe, Krist van Herck, Amanda Schuurbiers, Dirk Gevers)
- space (by Lim Jin Hyuck, Mengran Wang, Anthony van Pelt)
- material (by Yiyi Chen, Vangvasu and Feng Wang)
- social (by Anna, Ruiqi Lv, Xiaokang Liu, Xiaoyu Xu, Zhihao Wei)

These analyses left a lot of questions unanswered and new questions arose. A lot of the questions revolved around themes like regularity and variation, rule and exception, circulation and orientation, themes that are very relevant to the ideas of structuralism and Hertzberger's work. In his book 'Architectuur en Spelregels' Hertzberger talks about how rules create a certain freedom (for exceptions and variations, but mainly for interpretation) (Hertzberger, 2014).

We decided to try and find answers to these questions using the overarching subject 'unit'. Our research question that forms the guiding thread in this analysis is:

What is the perfect unit?

Because the building is made out a repetition of units it is important to firstly understand one unit, to also understand the building.

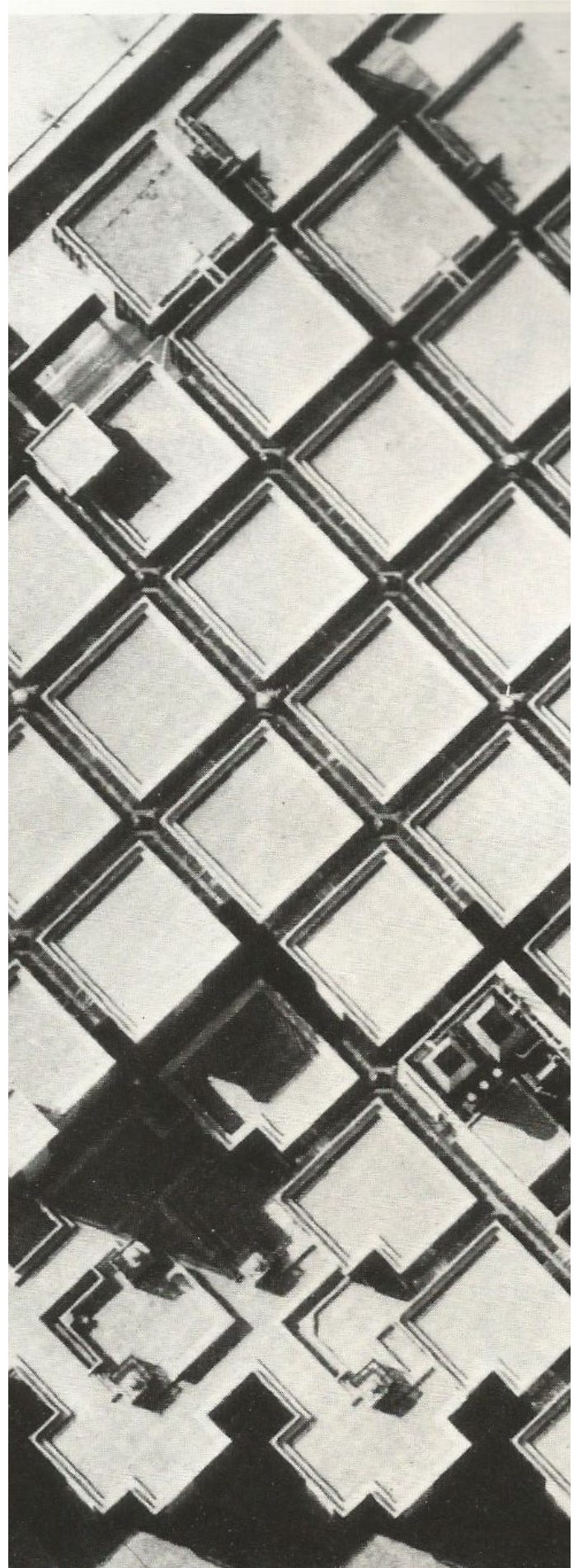

Fig. 1: Topview on the building Centraal Beheer.



In the first chapter the architect Herman Hertzberger will be introduced and his vision on architecture (specifically structuralism) will be discussed. A timeline shows projects of architects that influenced Hertzberger and the development of the modular spatial unit in his work. A description of the location of Centraal Beheer and its history.

The second chapter explains the spatial configuration of the building and some of the design concepts of Centraal Beheer.

The third chapter describes our interpretation of the notion 'unit', both theoretically and applied to the Centraal Beheer building.

The next chapter shows the unit of which Centraal Beheer was composed. This unit acts as 'the rule' of the building. The chapter explains several aspects: the construction, the climate control, the materials, and the use of the space.

In chapter 5 we zoom out to one of the four quadrants that make up the building. The northern quadrant is chosen for this, because it is the most regular. It shows how the different units work together spatially and functionally.

Chapter 6 shows some of the deviations from the ideal in the quadrants that were necessary to make the building functional. The biggest and most noticeable exceptions to the rules set in previous chapters are the parking garage, the restaurant, the technical tower and the double high floor between layer 1 and 2.

The final chapter assesses the cultural value of Centraal Beheer, using a matrix. This matrix combines the shearing layers of Steward Brand (site, skin, structure, space plan, services, stuff, with the addition of surrounding/setting, surfaces, and spirit of place) and the dialectic value set of Alois Riegl (age, historical, intentional and nonintentional commemorative, use, newness, and art value, with the addition of rarity and other relevant values). The matrix was slightly modified to suit this specific building better with the addition of a structuralism value.

The conclusion summarizes the most important findings. It describes opportunities and challenges of the building that can help us with the (re)design. Also remaining and new questions are posed.

Finally, the appendix contains detailed descriptions of a lot of (smaller) exceptions to the rule we found in the building of Centraal Beheer. At first glance, the building appears very repetitive, but in the appendix a lot of variations and exceptions are exposed.

Fig. 2: Interior of Centraal Beheer in use.

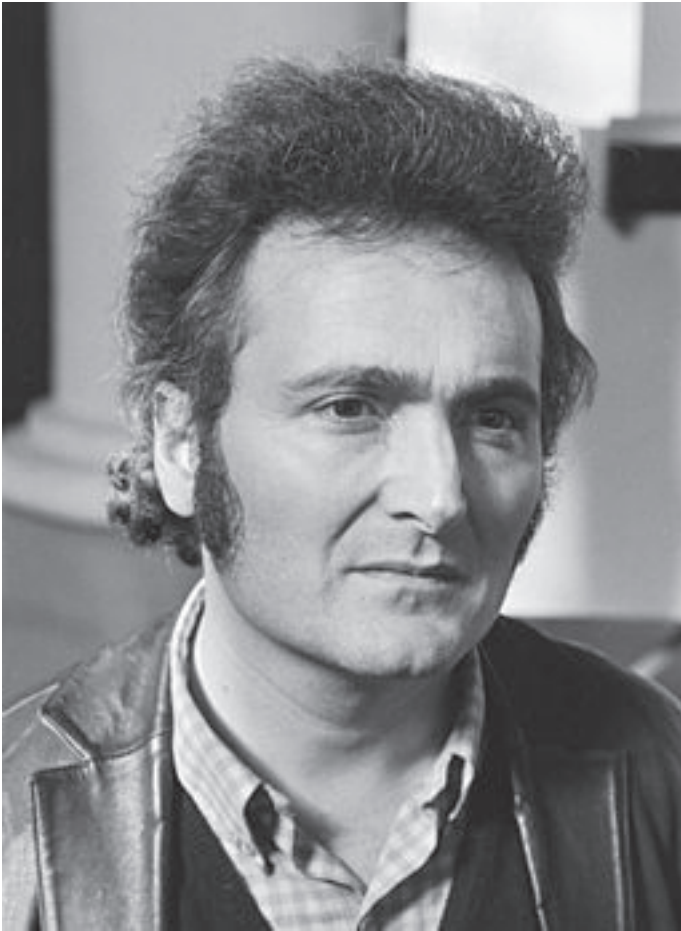

Fig. 3: Portret of Herman Hertzberger in his younger years.



Fig. 4: Herman Hertzberger on his 85th birthday.

The architect of Centraal Beheer is Herman Hertzberger, and with this building he established his name as up and coming architect definitively (Weustink, Hoekjen, 2004). Together with the Apollo School and Vredenburg, Centraal Beheer is considered one of his three great public masterpieces.

Hertzberger was born in 1932 and graduated in 1958 at the TH Delft where he met Aldo van Eyck who was a professor at the TH Delft. This had as a result that he was asked to join the magazine Forum directly after his study where he became acquainted with the ideals and principles which later would be described as the foundation for structuralism. Hertzberger sees himself as an instigator for this movement, being a driving force behind the social aspect of architecture so strongly implemented in its architecture. For Hertzberger this meant a focus on architecture designed from the interior instead of prioritising the exterior expression of the building. But also adapting to the contemporary thoughts and critiques on architecture. Until the later 80's Hertzberger was influenced by the work of Le Corbusier and his tutor Aldo van Eyck, but he became independent and start to form his own architecture vision to a more modern timeframe.

The definition of architecture in 2004 by Hertzberger shown in the book 'Het architecten boek' is that architecture is the organisation of the space in such a way that the users can use it as much as possible. So in the first place the space must be designed on the basis of the functionality that it required. Hertzberger blames architects who lose sight of the spatial experience with a lack of responsibility. According to Hertzberger these architects are only out to earn money and acquire status, which all too often are based on the outside of the design. After five years these buildings will no longer be part of the collective memory of architecture (Weustink, Hoekjen, 2004). If a building owns an added value to spatiality the building can be used for various purposes and is therefore a more sustainable building.

After his years as a dean of the berlage instituut Hertzberger started to write the books: 'Lessons in architecture about space.' During this time he also get less involved in big projects of his own company. He still works on smaller parts of the projects to test ideas, and to sharpen his vision about architecture. He is very motivated to share his vision of architecture as legacy through books, presentations and debates, because he thinks that a lot of architects nowadays are not occupied with human things. Hertzberger said during the debate that he did not invent anything he only saw it. According to him designing is a process of what you see around you and not an inspiration of god. This corresponds with his quote "Architecture is a 'thinking process'."

In the following timeline his thinking process towards the design of Centraal Beheer is visualized.

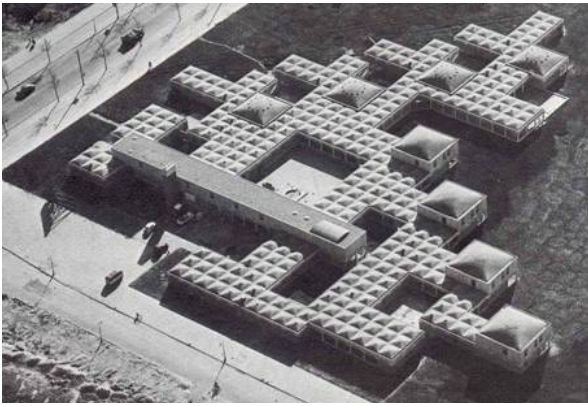

Burgerweeshuis.

The Burgerweeshuis in Amsterdam, built in 1955-1960 by Aldo van Eyck was designed during the same time that Louis Kahn was designing the Richards medical research laboratory. In this project he showed how to create a spatial structure by only using minimum elements in a strict system. Van Eyck followed his own rules in a disciplined way and did not step outside his borders.

Extension LinMij.



The extension of the LinMij factory in Amsterdam was the first project where Hertzberger implemented his own version of the principle of repeated, and linked construction units.

In the workshop for the extension of the LinMij factory, Hertzberger came to several conclusions with regard to the modular spatial units and their structuralist ordering system, which was the beginning of his vision on workplaces. "Such units must be suitable for various purposes, not only for one specific programme. Each unit must therefore have such a strong identity of its own that it remains the same in all conditions. And moreover, must be capable of giving identity to the greater whole of which it forms a part." (McCarter, 2015). This quote shows that he already thought about a structure built up out of units long before Centraal Beheer was in the picture.

1955

Jewish community centre.

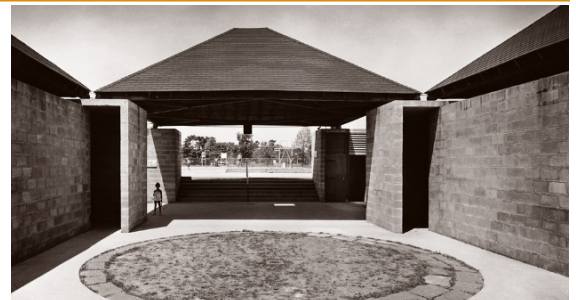

In the design of the Jewish community centre in Trenton, Louis Kahn dealt with autonomous, quirky space-units for the first time. He made a distinction between 'servant spaces' and 'served spaces' by which he brought to the attention that the elements who are always there can be shaped in an autonomous way, regardless of the destination of the building (Hertzberger, 2014).

1960

Richards Medical Research Laboratory.

1965



1968

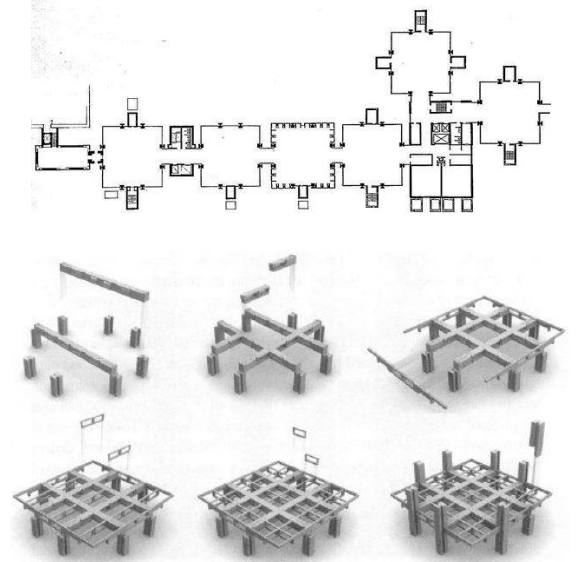

The university of Pennsylvania medical laboratories, built in 1957-1965 by Louis Kahn was a inspiration for Hertzberger. The concrete structure that is used in Centraal Beheer is inspired by the similar structural system of the research laboratory. However, here the system is not interconnected like the structure of Centraal Beheer, but self-contained.

Competition design, city hall Valkenswaard



In this design the real obsession of Hertzberger for patterns and linked identical space units came forward. Here he attempted to create inbetween space that is equivalent to the useful unit. The construction is related to that of the Linmij factory, where the columns are in the corners of the units.

The size and proportions of the unit were intended to allow the large building to integrate with its immediate smaller scaled surrounding.

1966

1967

Competition design, city hall Amsterdam.

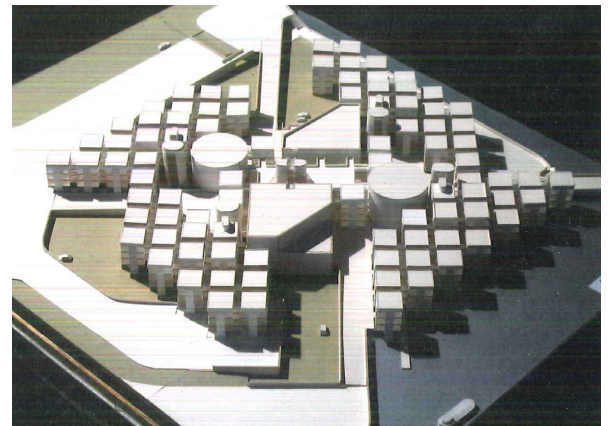

For this design, Hertzberger proposed a public and anti-monumental building. Where a series of square office modules are stacked into small towers and set in a square grid. In contradistinction to the design for Valkenswaard the modules are rotated 45 degrees and the construction idea of the research laboratory of Louis Kahn is used to create free corners for the office space. These ideas are also used in the design for Centraal Beheer. There is a reason why Hertzberger used a lot of his ideas for this design in Centraal Beheer, it was a setback that this design had not been chosen. He sad during the debate we had with him that the plan for the city hall in Amsterdam was a better design than Centraal Beheer, and he would have rather built this plan.

1972

Centraal beheer, Apeldoorn

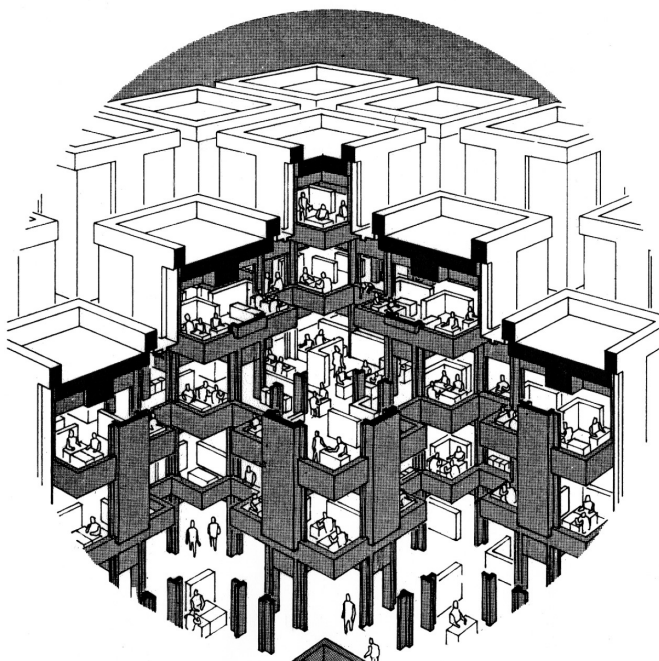

The timeline shows a clear development towards the design of Centraal Beheer. In the sketch in figure 5 you can see that Hertzberger played with the composition and size of the street in the building and the function of it. In contrast to the design of the city hall Amsterdam there were three identical quadrants which were divided by the street (later in the process there were four quadrants). During the debate with Herman Hertzberger on april 4 2018 he mentioned that he wanted to create a bigger street but he could not sell more space than he already did to the client. The function of the building did simply not need more public space.

In an article from 'the architect' of 1976 Hertzberger mentioned that the building is not finished. The user will finish it and the architect offers the framework. This corresponds with his vision on the social aspect of architecture and his ideas about how the new workplaces should be. According to the changed business culture which arose from the democratization and individualization wave of the 60's.

Nowadays the buiding is empty and does not function as an office anymore. One of the explanation Hertzberger gives is that there was a shift which already started in the

80's in the business culture. Since 1990 there is not much left from the imaginative and colorful decoration of the workplaces, the personal expression of the 70's has made place for order and elegance (Habracken, 2010). Besides this aspect, the workplaces do not meet the working requirements (Arboret) anymore and parts of the climate of the building are almost uncontrollable. This is also why

an estate agent qualified the complex as economically no longer usable and very dated. The paradox of this building is that a new function fits perfectly into the philosophy of the original design but because the building from a technical point of view is so outdated it is very hard to find a new purpose.

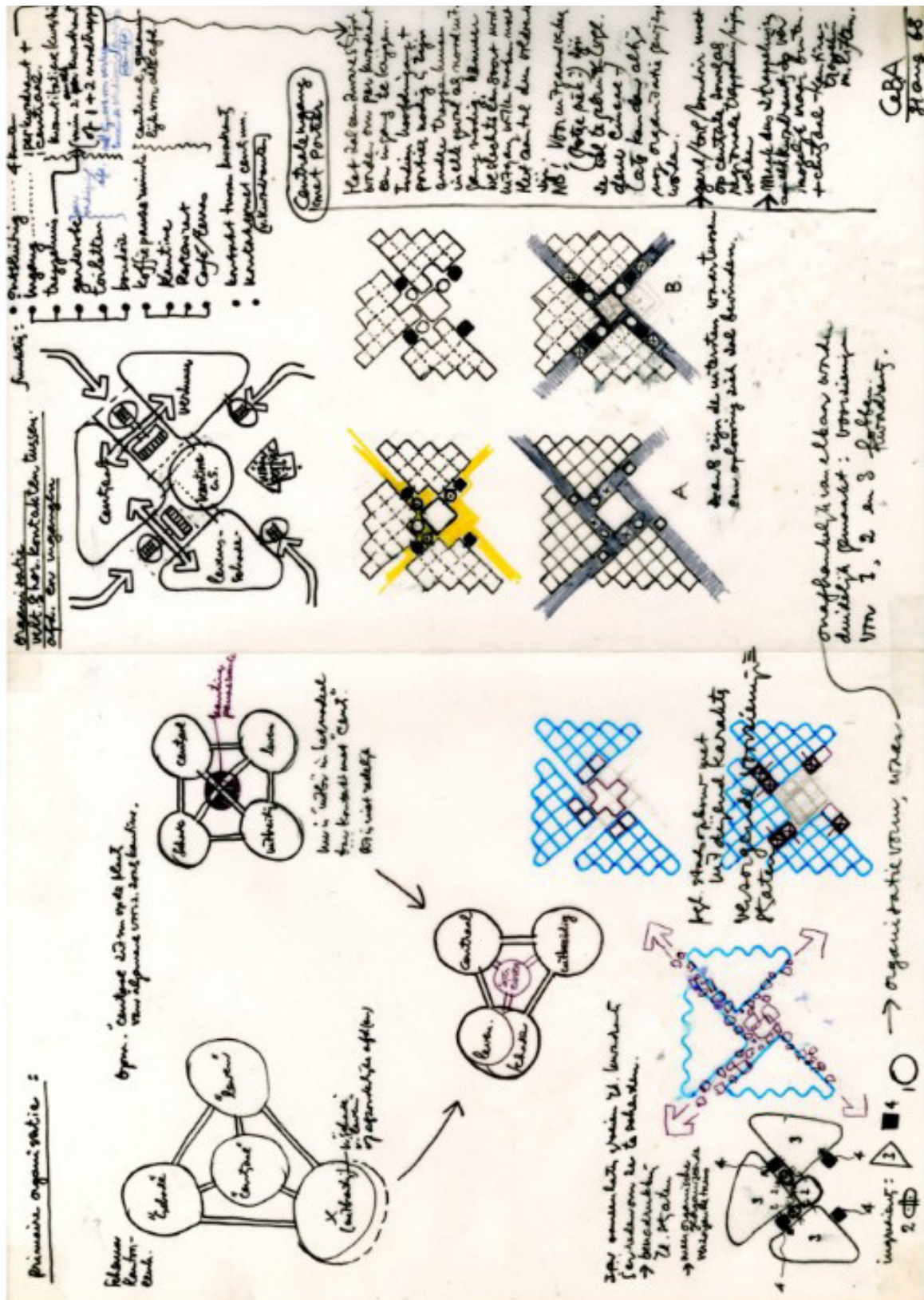

Fig. 5: Sketch of Hertzberger in the beginning of the designproces of Centraal Beheer. .

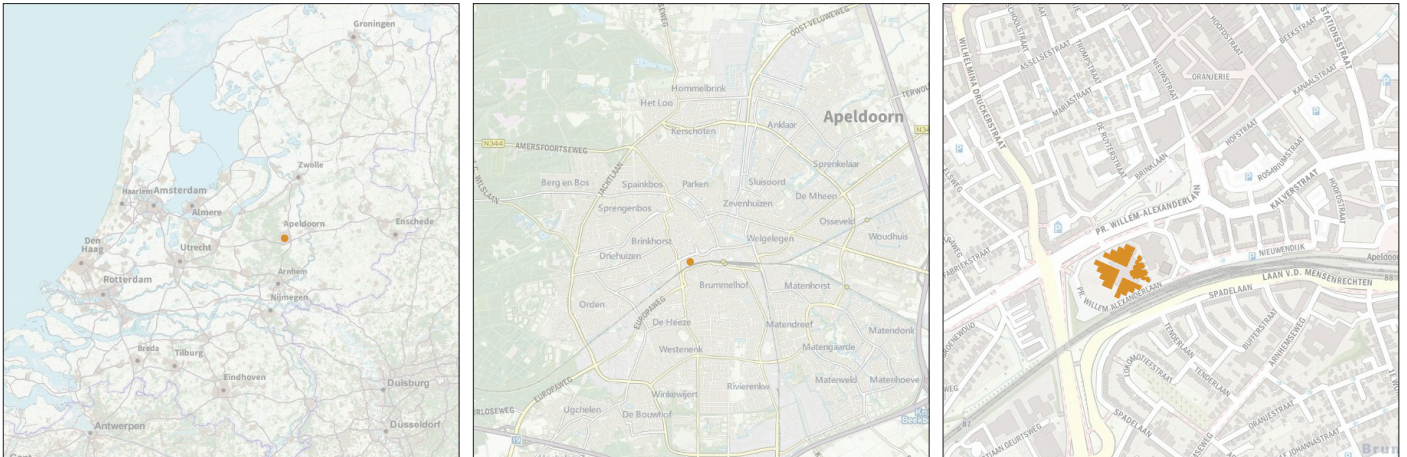

Fig. 6: The location of Centraal Beheer in different scales

The assignment for Centraal Beheer was to design a workplace for 1000 people. One spends a large part of the conscious life in the office, therefore one must be able to feel at home.

The site of Centraal Beheer is at the inner edge of the inner city of Apeldoorn. The site is enclosed by the Prins Willem Alexanderlaan in the North, the Koning Stadhouderslaan in the west and in the South by the railway tracks.

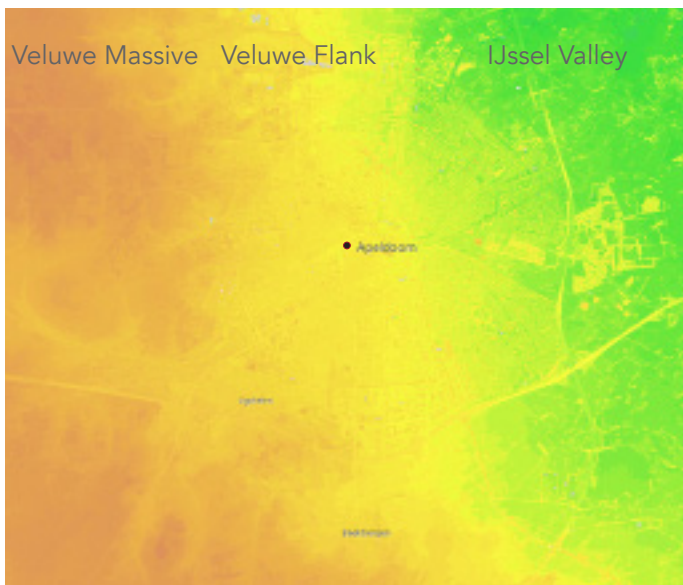

Fig. 7: The location of Centraal Beheer in the landscape (ahn.nl)

Centraal Beheer is located in Apeldoorn. But if we zoom out on a bigger scale Apeldoorn is divided in three different landscape types; Veluwe Massive, Veluwe Flank and the IJssel Valley. The site of Centraal Beheer is located in the Veluwe Flank area.

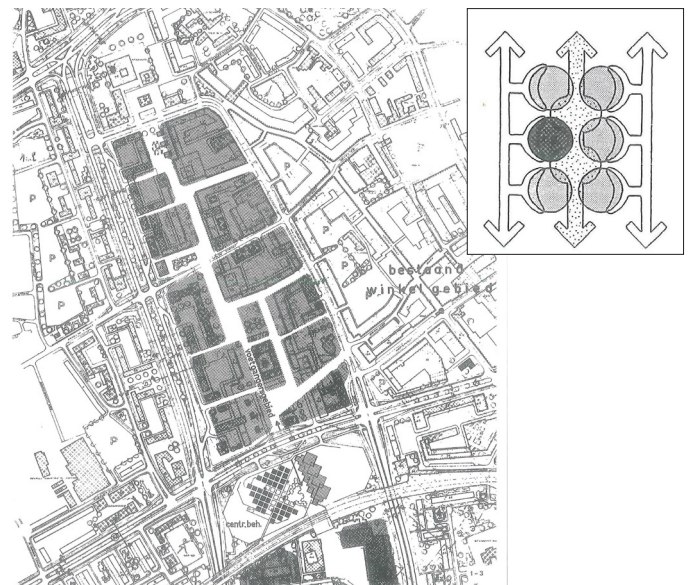
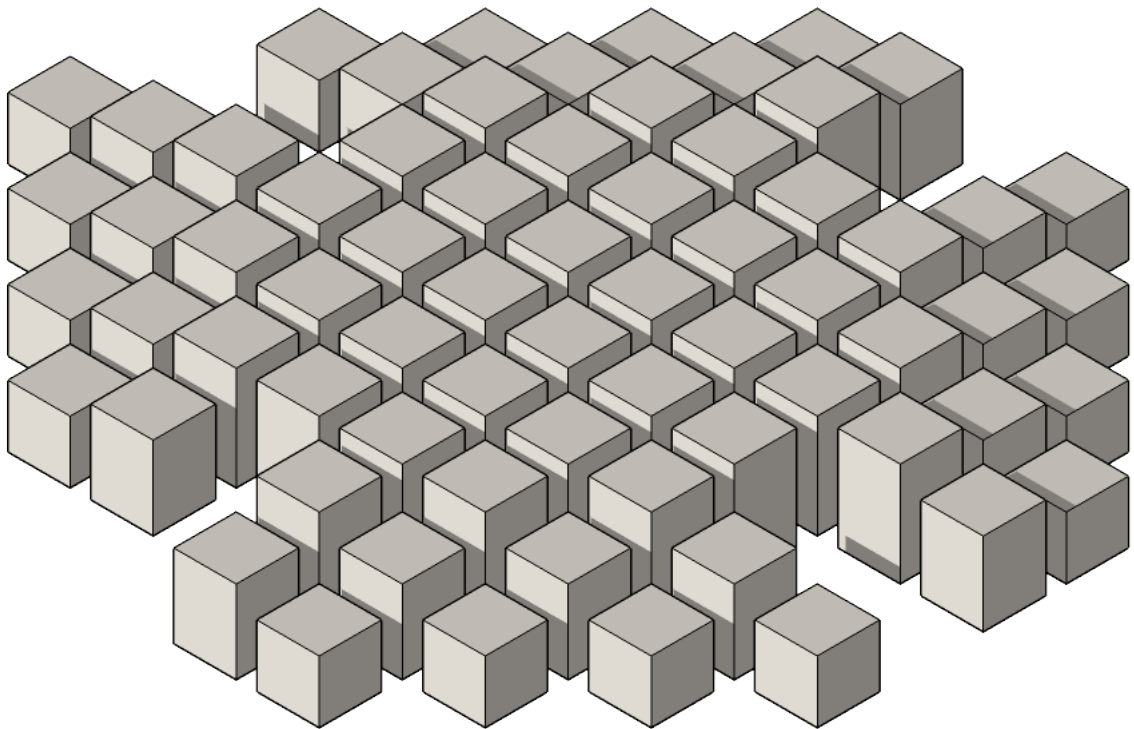

Fig. 8: Pedestrian zone as backbone of the city centre

Although it was never realised, the original plan for the urban design was to create a pedestrian zone as a connection between the station and the city centre. Centraal Beheer would be located along side this pedestrian zone. To create this the train station would be moved to the south side of Centraal Beheer.

In appendix I, a timeline of the transformation of the building Centraal Beheer is shown. In appendix II, the timeplanning and organisation of the construction is explained.

Building



The building of Centraal Beheer by Herman Hertzberger is located along the Prins Willem Alexanderlaan in Apeldoorn. The building is an icon for structuralism and is well known for its iconic cube structure. That, combined with the height difference between the cubes, gave it the nickname "de apenrots".

The building has four places where cubes seem to have been taken out. these form the approaches to the building, from which you enter the so called "street". Not all of the approaches were completed due to changes in city planning. The "street" cuts through the building in the shape of a pinwheel and forms the main communal space, connecting the different parts of the building. This street connects but also divides the building into four quadrants. Each quadrant is different and defined by the changes made to the underlying structure. Some of these changes, or exceptions are visible on the exterior, others are only visible from the interior.

Building | Shape

The building was designed on a square grid of 9 by 9 meter, with in between the 9 by 9 meter squares a 3 meter wide intermediary space. The grid was then turned 45 degrees in relation to the plot. Several of the outer squares were taken out, which created the four quadrants that each seemed to mirror each other. This possibly became the starting point for shaping the building. Each layer of the building however seems to have several reductions from this theoretical base form. Even the second layer, which most closely resembles the base form, isn't exactly the same. On this layer the outer squares of the south and east quadrant were removed.

Each layer above the second layer is consecutively reduced by a single row of squares, which created the iconic stepped volume. There is an exception to this pattern at the east quadrant, where more squares were taken out to create a large roof terrace above the restaurant.

layer 0 and 1 have the largest deviation to the base form. This is mostly due to the parking garage. (Appendix III)

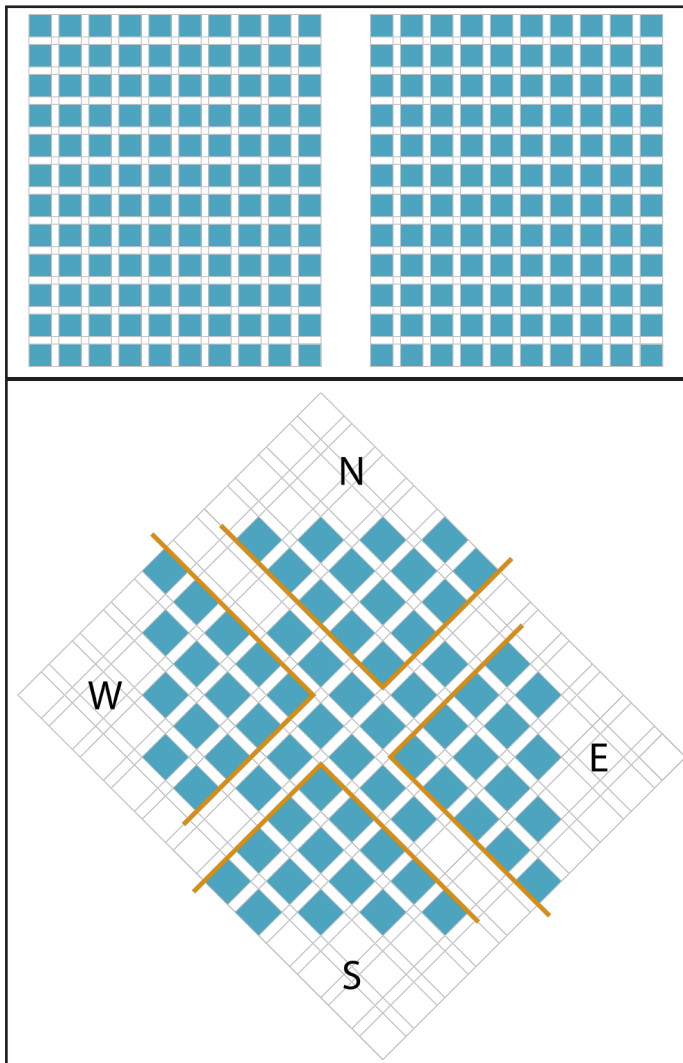

Fig. 9: Diagram of the theorised perfect form.

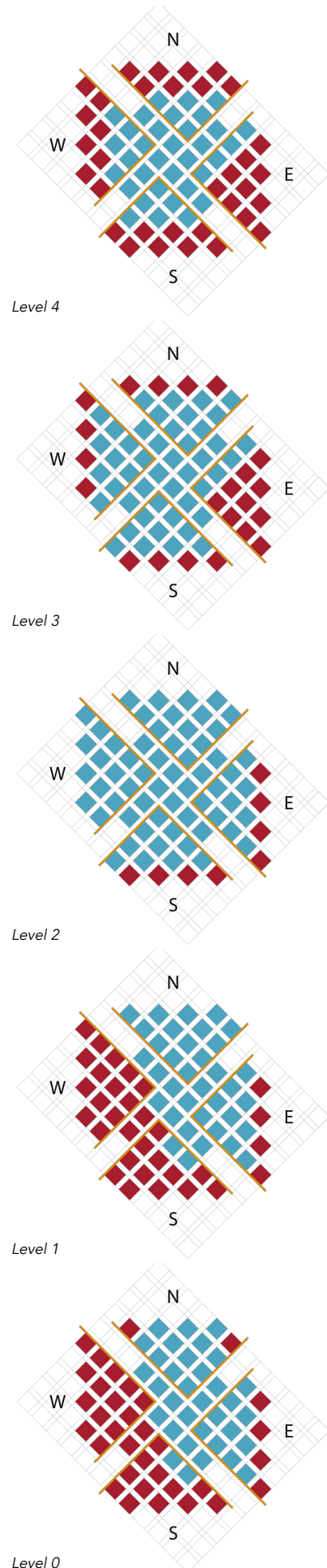
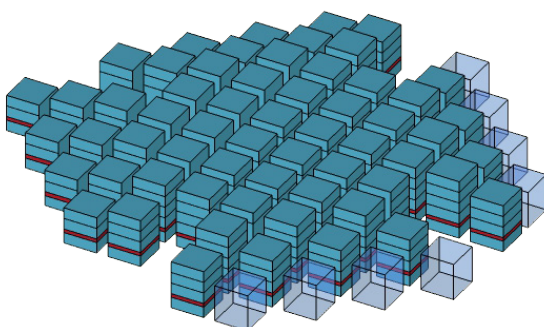
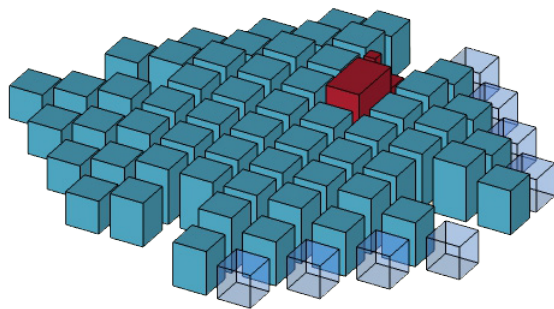
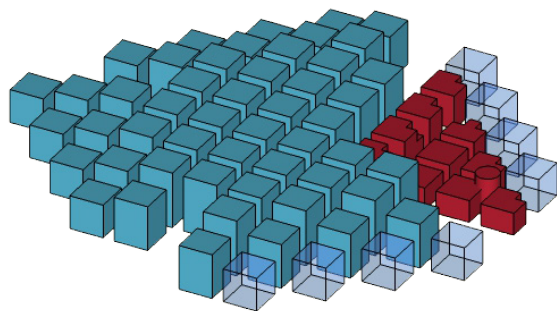
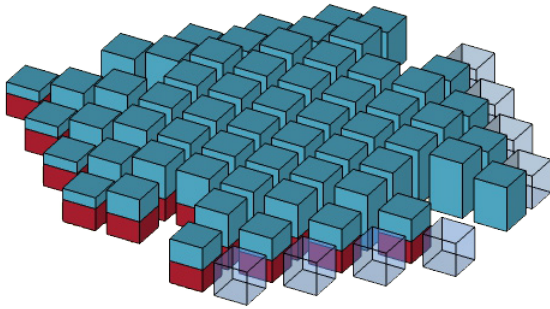

Fig. 10: Diagrams of building form.



Garage

In the south and west quadrant the first two layers are an open garage. Because the column structure of the building does not fit in the parking pattern, there is a different construction created for the garage. For more information see appendix IV.

Restaurant

The east quadrant has a restaurant function what creates a large exception of the structure of the building, see appendix V for all the exceptions.

Besides the different function of this part, there was also a pedestrian area intended along this side to connect the railway with the inner centre of Apeldoorn and thereby make the building part of the city. Because of this there were designed a few exceptions to integrate the building with the pedestrian area.

Technical Tower

All the services for the building are housed in the technical tower. The tower is a separate element located in the grid of the building but is in appearance and composition a large exception in the structure of the building. For more information see appendix VI.

Extra construction layer

Between layer 0 and layer 1 there is an extra layer of construction added. This made it possible to create different levels in the floor of the restaurant and to make a wooden floor in the computerroom in need of extra installation to achieve the strict requirement for this area. For more information see appendix VII.

Fig. 11: Mass models with the big exceptions on the outside.

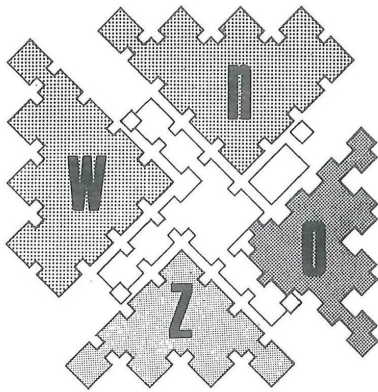

The building is divided in four quadrants (North, East, South, West). These quadrants are connected by the 'inner streets'. The floorplans clearly show that the building gradually reduces when reaching the higher layers.

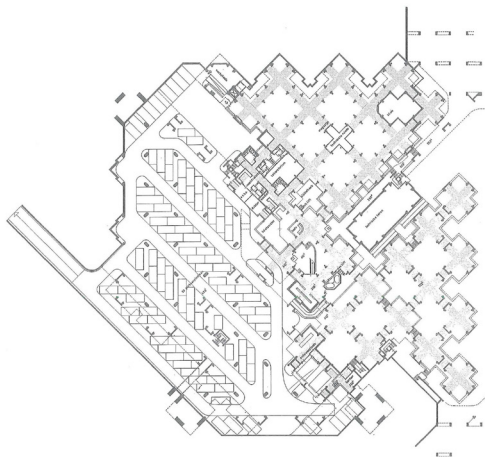

Layer 0

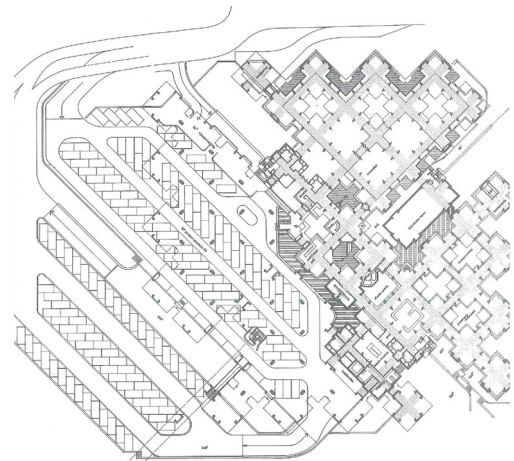

Layer 1

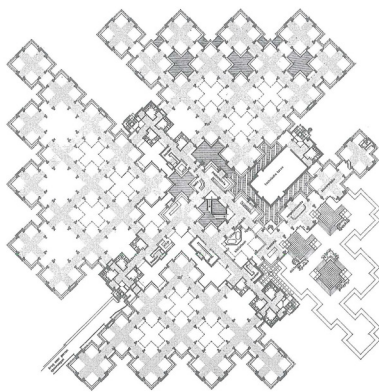

Layer 2

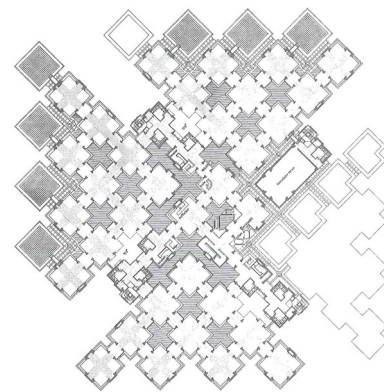

Layer 3

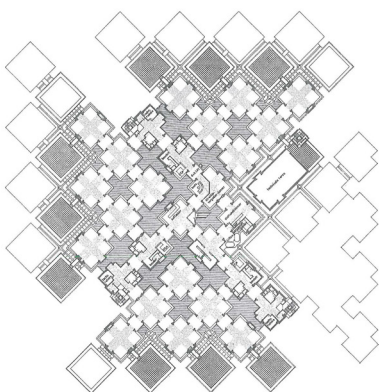

Layer 4

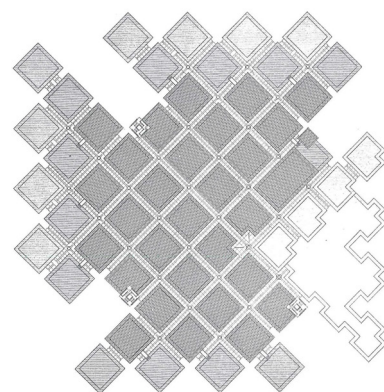

Layer 5

Fig. 12: Floorplans of Centraal Beheer.

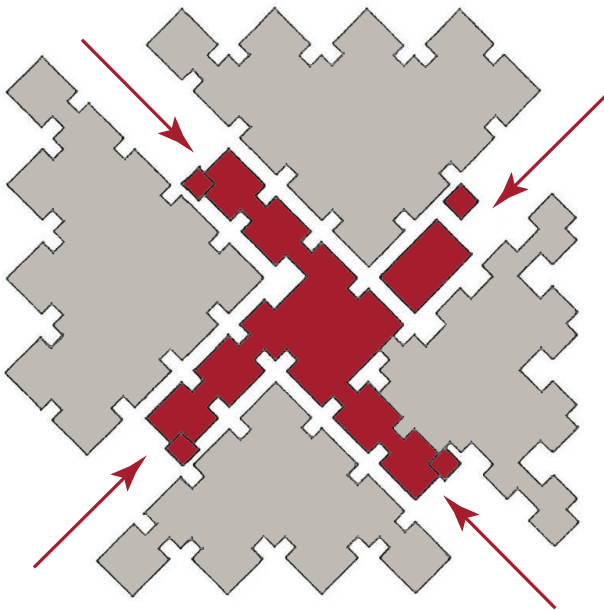

The street is the communal space in the center of the building that connects the four quadrants. The pinwheel shaped street has an entrance on each end, that lie slightly recessed into the building mass. The possibility to enter the building from different sides was meant to give the building a good and non-hierarchical connection with its surroundings. However, some of the accesses to the entrances were never completed. The entrances are small and partially hidden behind the stairwells, making them hard to find. It comes as no surprise that this was one of the complaints by those needing to visit the building. It resulted in the addition of a main entrance, that was placed in the new building next to Centraal Beheer.

Their recessed position made them a quick access to the central area, were visitors could use the escalators to reach their designated floor. More about the orientation and exceptions of the street can be found in (Appendix VIII)

Fig. 13: Diagram of the street and the quadrants.



Fig. 15: South-west street enclosure.



Fig. 16: North-west street enclosure.

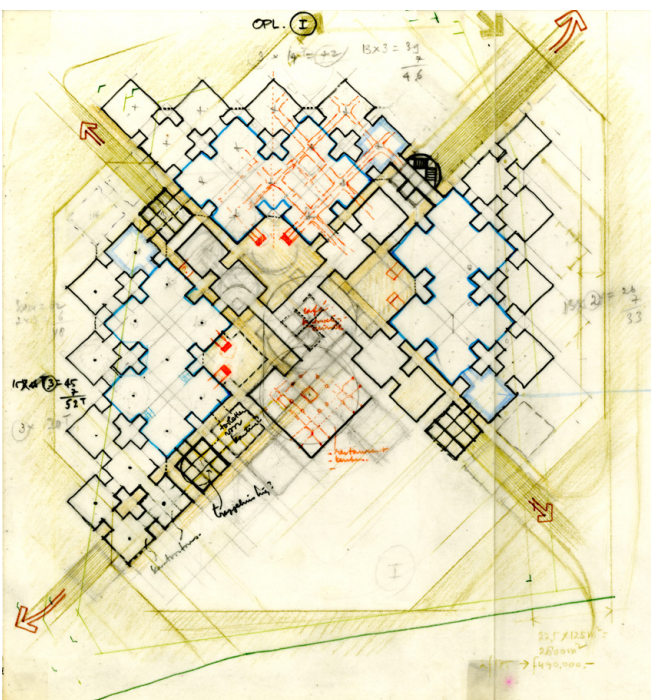

Fig. 14: Sketch with the streets by Herman Hertzberger.

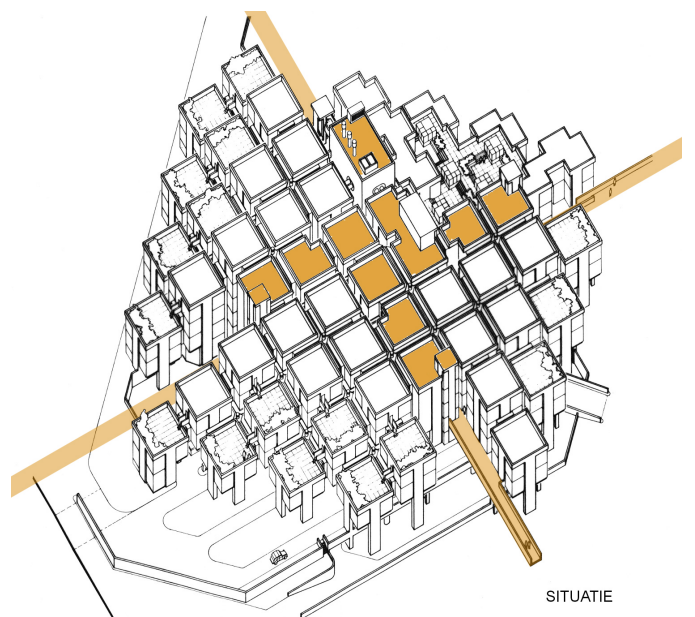

Fig. 17: Axonometric view showing the street approach.

Centraal Beheer has a non-hierarchical facade and no clear back or front of the building (Fig. 22). In an effort to define what could be the front and the back, we take a look at the different entrances of the building. In the urban plan for Apeldoorn in the 1960's a new train station would be build next to the Centraal Beheer building. From the station people could walk via an underground pedestrian tunnel to the building. With this idea in mind, the east side (or even the underside) of the building could be considered the front (Fig. 18). The lowest layer of the building was also where people coming from the direction of the city center, and people who came by car would enter. However, this plan was never executed.

The most used entrances were the ones on the two layers of the parking garage. This means the west side of the building could be considered the front as well (Fig. 19). Finally, in 1990, to solve some of the problems people had with finding the entrance, Herman Hertzberger himself designed a new entrance building. This changed the 'front' of the building to the north side, situated at the Prins Willem-Alexanderlaan (Fig. 20). This representative main entrance goes against the original idea of having multiple equal entrances (Fig. 21). But it does help workers and visitors to be able to find the entrance and orientate.

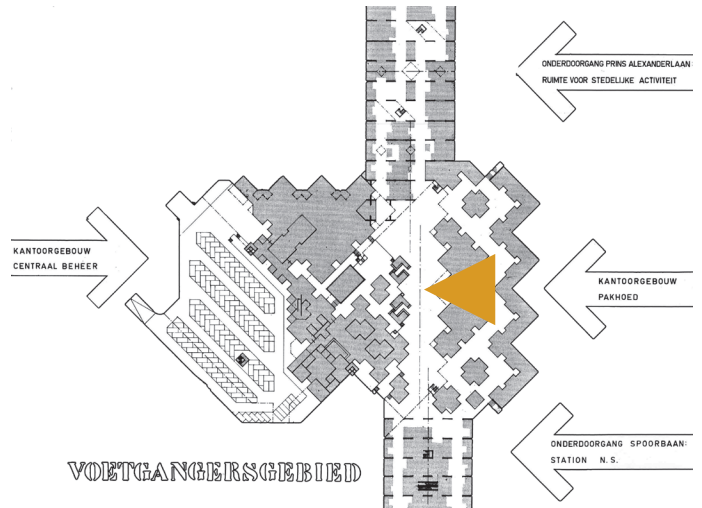

Fig. 18: Original urban plan.

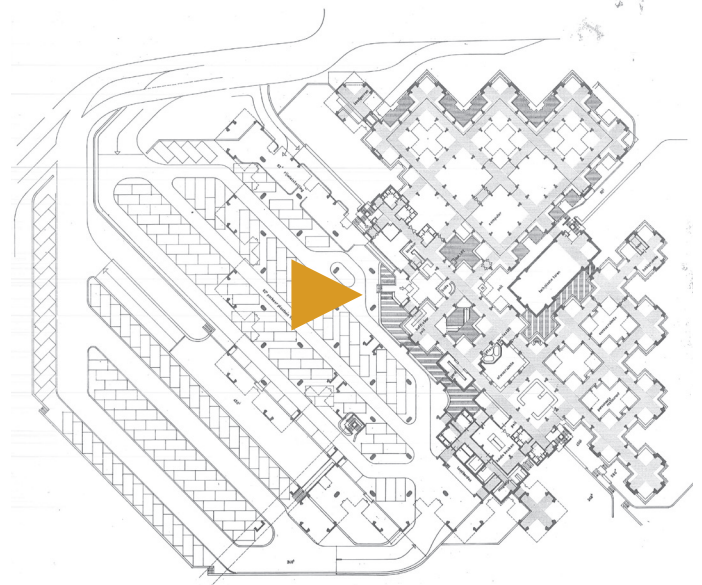

Fig. 19: Main entrance at layer 1.

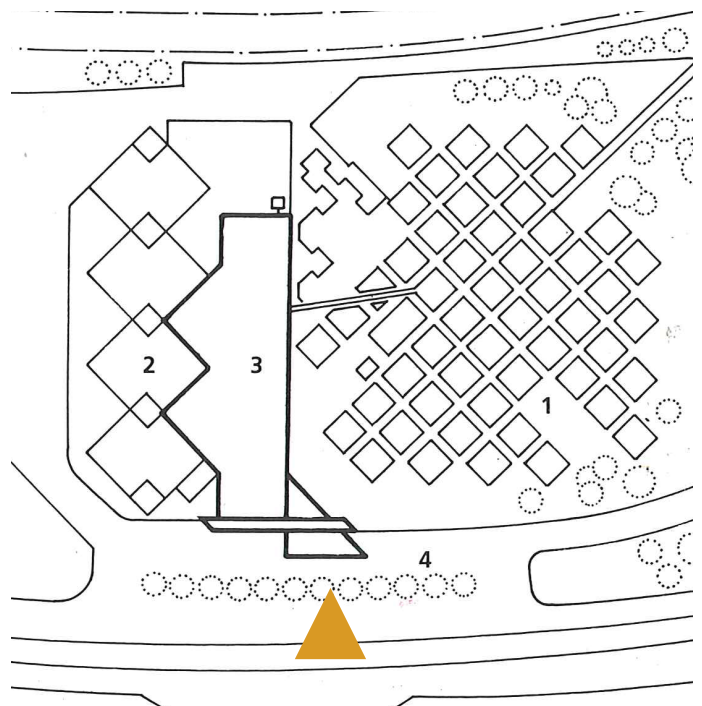

Fig. 20: Latest main entrance.

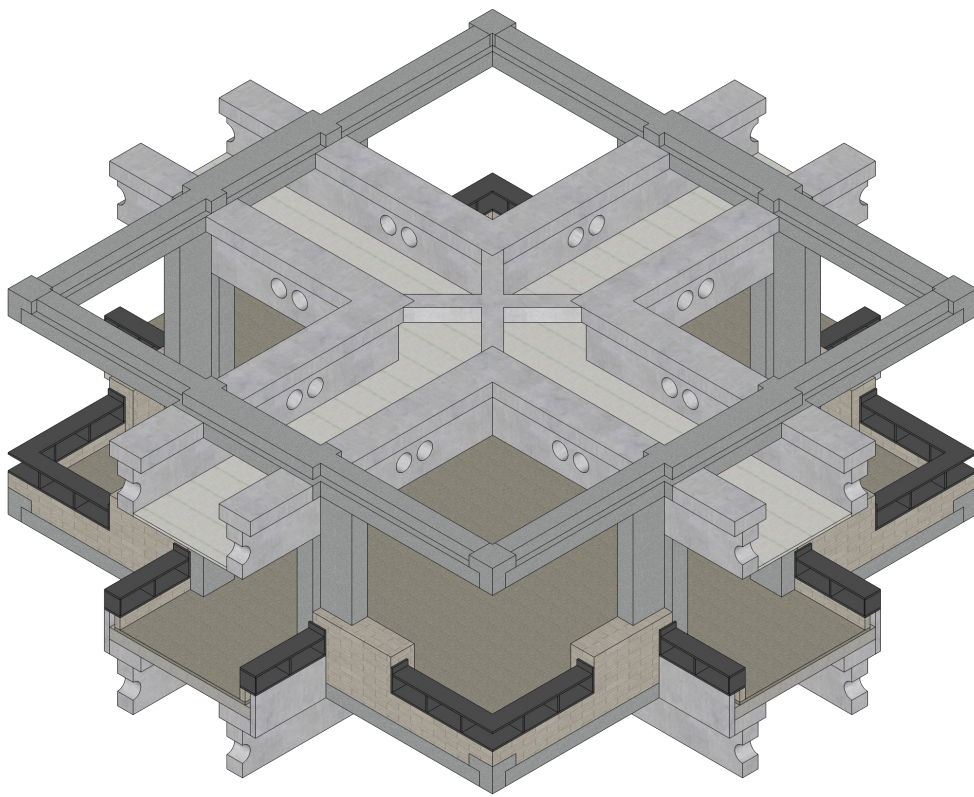

Fig. 22: Non hierarchical facade does not have a clear entrance.



Fig. 21: Some of the secondary entrances.

9x9 Unit



Unit | Definition

Structuralism started as an alternative to the impersonality and functionality of modernism. It is an architecture movement which focusses on creating spaces that are on a human scale, that are adaptable, expandable, non hierarchical, and interpretable. Often this is expressed in a repetition of spatial building elements that form the structure of the building. This structure can be used and decorated in different ways, depending on the user and on what is needed. Herman Hertzberger compares the permanent structure and the personal interpretation with language (structure) and speech (interpretation). The permanent structure should have a big competence (a containing capacity) in order to create a good performance (be interpretable).

The Merriam Webster dictionary defines 'unit' as "a single quantity regarded as a whole in calculation", or "a single thing, person, or group that is a constituent of a whole". So according to these definitions a unit is a whole in itself, but is also part of a (bigger) whole. This is a relevant definition for structuralist architecture and the Centraal Beheer building in particular. The building consists of smaller units that again form the whole of the building.

The unit that forms the base of the design of Centraal Beheer is the so-called 'island' of 9 by 9 meters. It is recognizable from the outside, in the expression of the facade and roof, but also from the inside. The construction of the building and the voids clearly define the unit. In the next chapter, this unit will be explained.

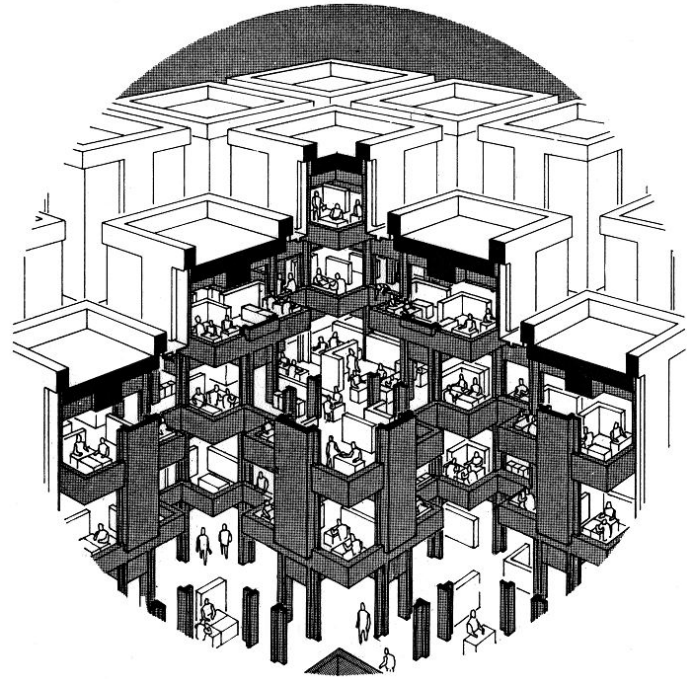

Fig. 23: Example of the building built out of units.

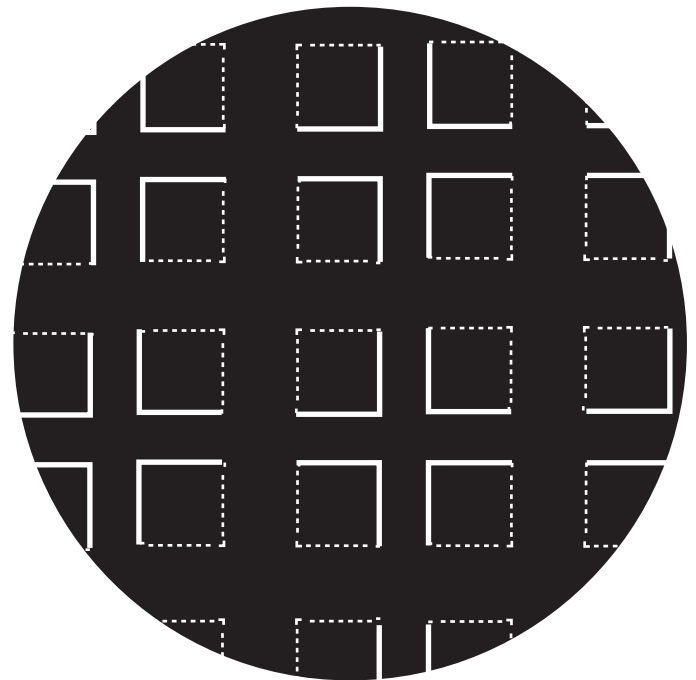

Fig. 24: Schematic drawing of the two different units in the building.

Unit | Construction

The standard construction system of the Centraal Beheer building consist of columns, primary and secondary beams and flooring. The construction follows a grid system and an endless repetition of the construction in horizontal and vertical direction is possible.

In Figure 26 you can see the different building phases of the construction. The columns are not located at the edges of the beams but at 1/3 and 2/3 of the length, so the beam has a cantilevers on both ends.

Phase 1: Columns.

The columns are provided with 2 pins at the bottomside to transfer horizontal forces and with 3 adjusting bolts to adjust the height.

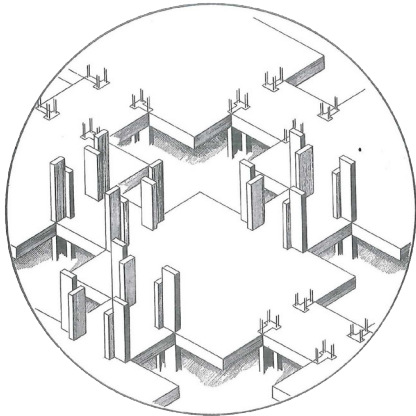

Phase 3: Secondary beams.

After placing the beams they are connected by pouring 8 bars into the saved holes. The remaining space will be filled with an injection mortar. As a result fixed connections are formed.

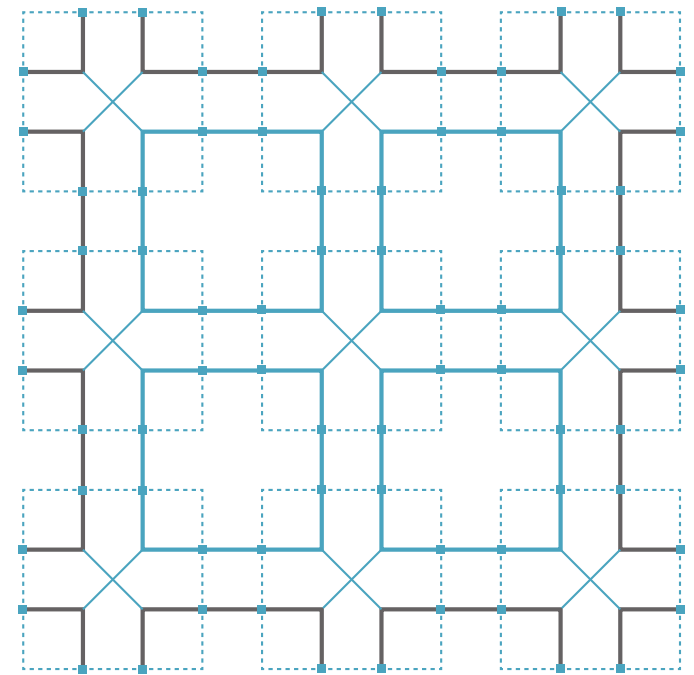
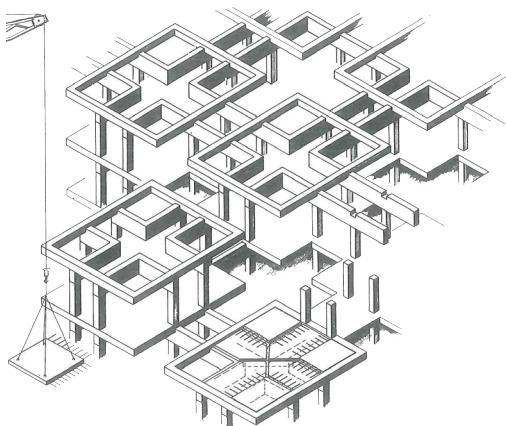
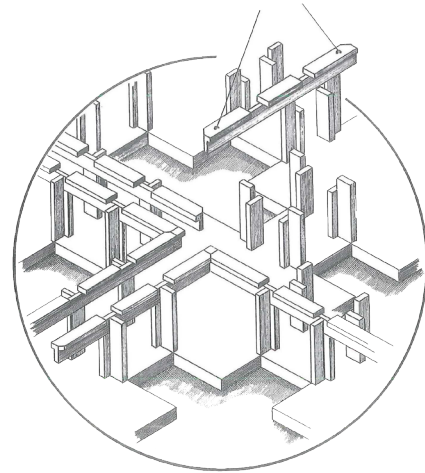

Fig. 25: Standard grid system 2D, with columns and beams.

Phase 2: Primary beams in plan



Phase 4: Floors.

Stability against horizontal twisting is obtained by filing all joints inbetween plates and beams with a mortar and adding a pressure layer in two directions.

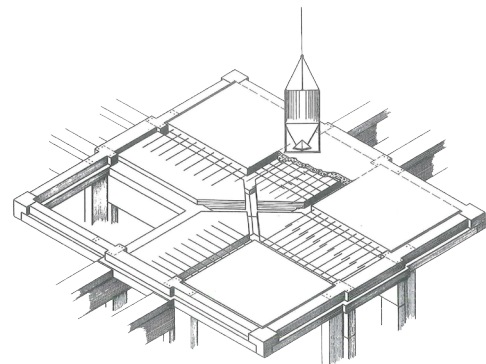

Fig. 26: Construction sequence in different phases.

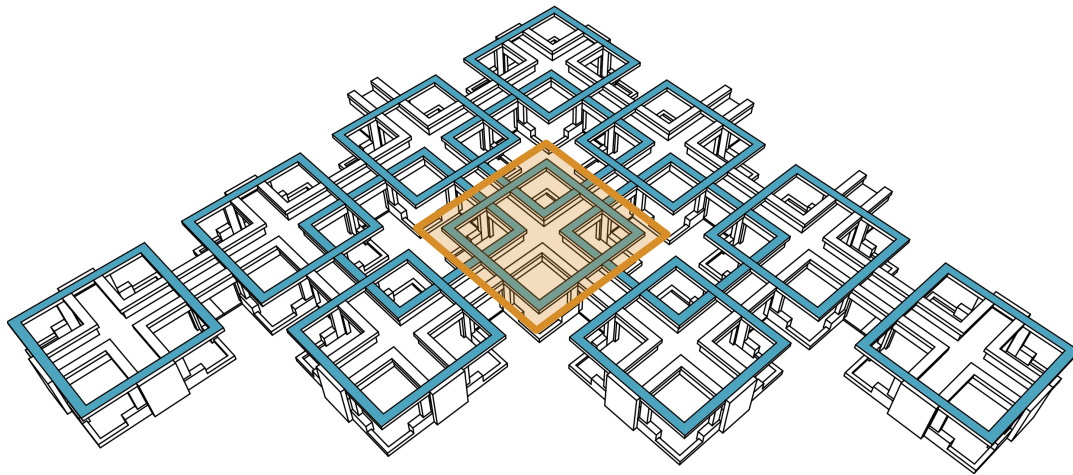
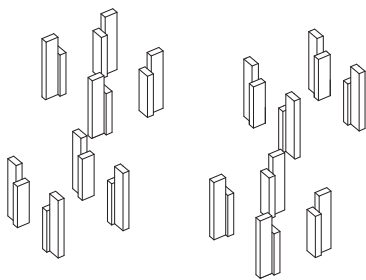

Fig. 27: 3D model of the construction from one layer.

The construction of 1 unit consists of 8 columns, 4 quarters of the primary beam structure, a full square of the secondary beam structure and the flooring.

The drawings below are a detailed representation of the prefabricated system and its joint process.



1. Prefabricated columns

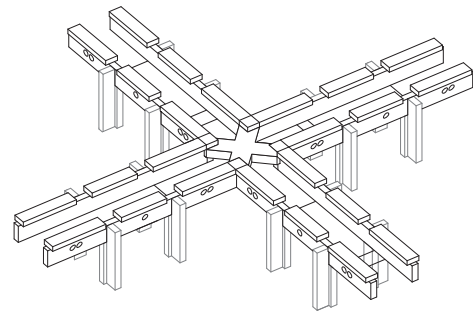

2. Primary beam structure on columns

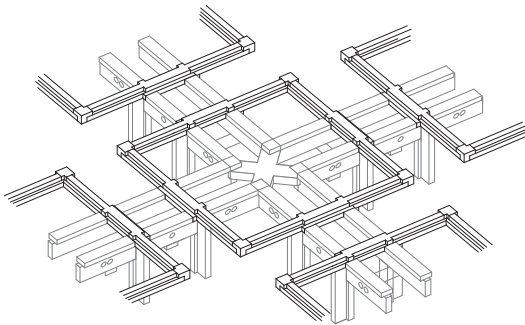

3. Secondary beam structure on primary structure

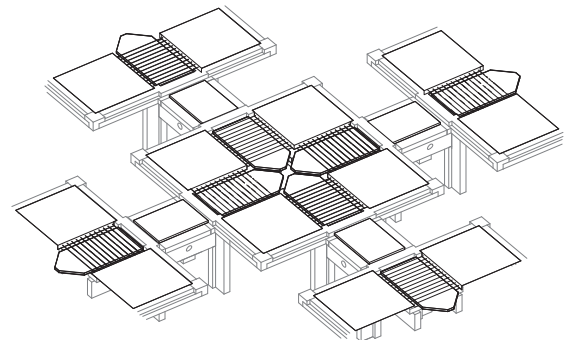

4.1. Floor components on the corridor

4.2. Floor components on the individual space

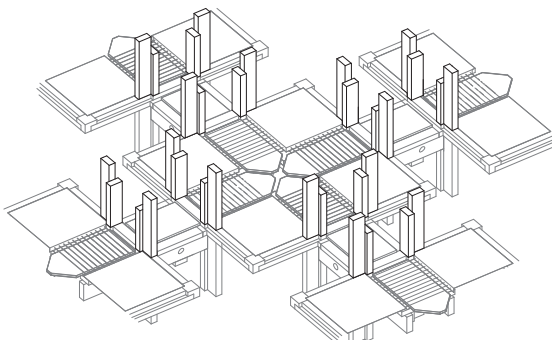

5. Columns for a new level on secondary beams

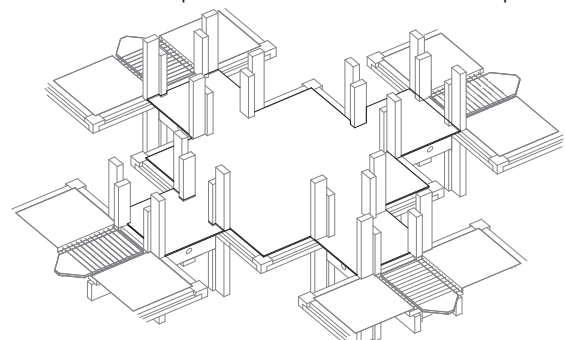

6. Place the floor

Fig. 28: Adjustment of the drawing from previous analysis Space, by J. Lim. (Space, p. 35.)

To be able to transmit horizontal forces the columns are provided with two protruding pins on the bottom and three adjusting bolts for the correct height adjustment. After the primary and secondary beam were placed on the column, the three were connected to each other by inserting eight rods into the saved holes and fill up the remaining space with an injection mortar. As a result, momentary fixed connections are formed. Stability against horizontal twisting is obtained by filling all joints between plates and beams with mortar and pouring a pressure layer onto the plates in two directions.

In Figures 30 and 31 the connection between columns and beams is represented in more detail.

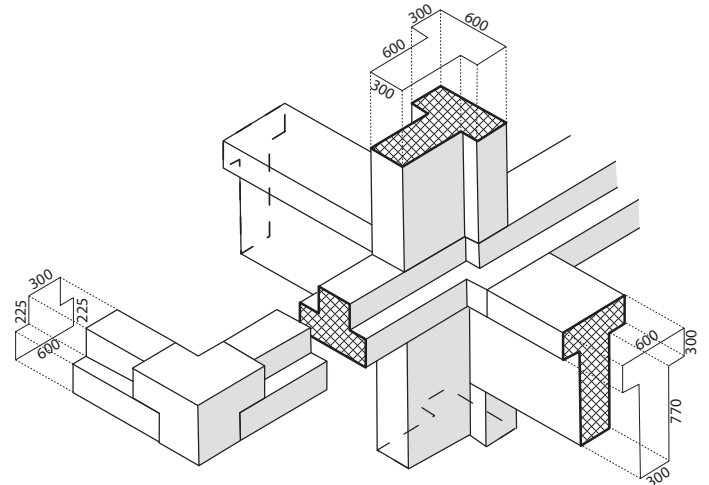

Fig. 30: Detail of the constructive elements of one unit with dimensions.

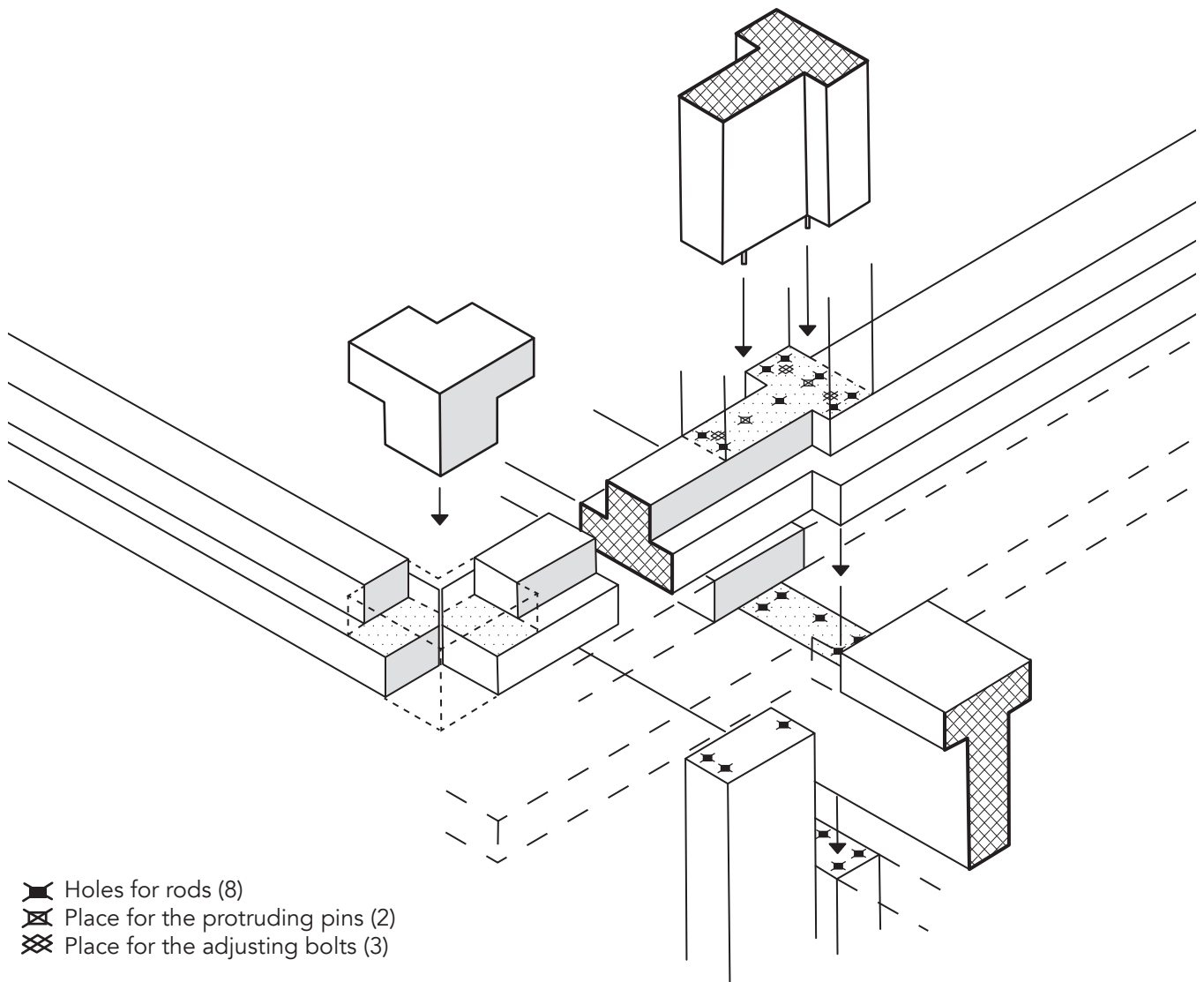

Fig. 29: Detail of ensemblage of the constructive elements of one unit.



Fig. 31: *Frengerceiling in a workplace.*

Basic system

Hertzberger wanted to create a flexible building, therefore the climate delivery system was intergrated in the ceiling of the workplaces. The system they chose for the basic climate was the frengersystem; a heating, cooling, and ventilation system. This ceiling consists of perforated aluminium panels that are clammed around water pipes. In the winter warm water runs through these ducts and in the summer cold water. The air supply was blown in by the frengerceiling so the ventilation air was heated up or cooled down by the ducts in the ceiling. Basic lighting of 400 lx was also intergrated in the ceiling.

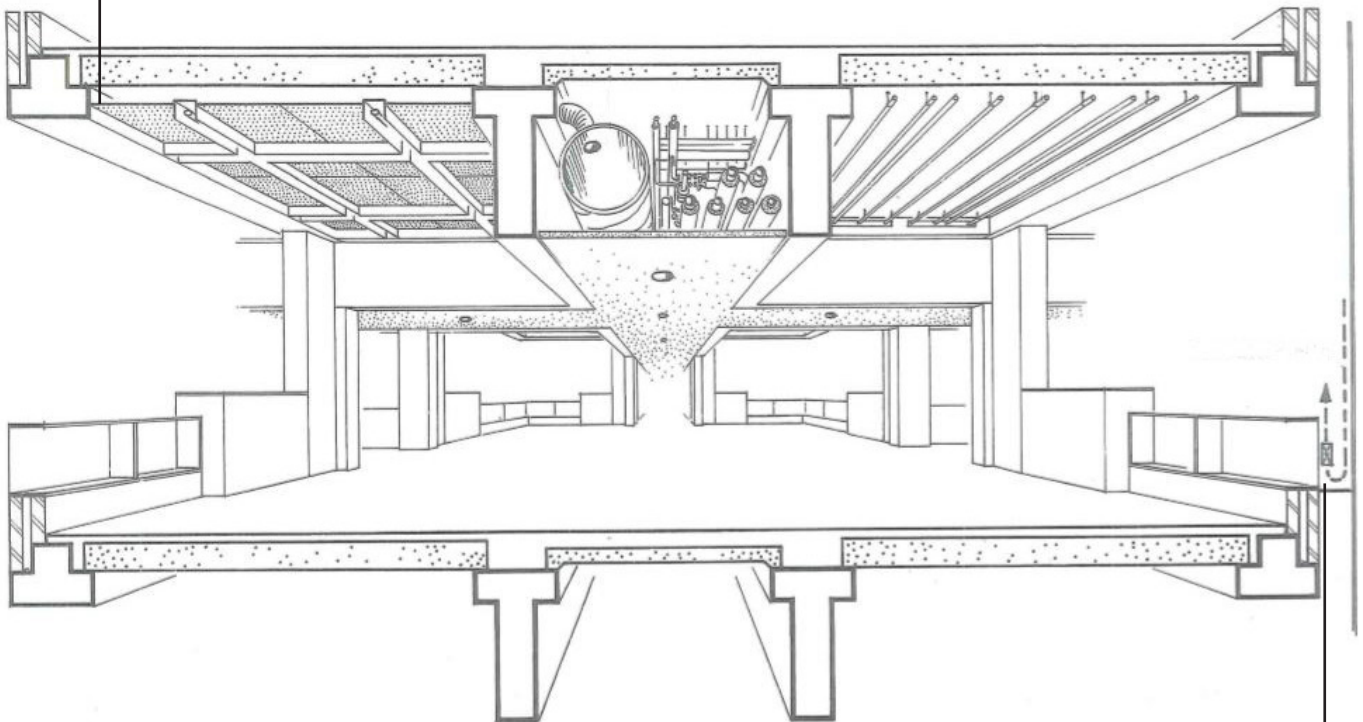

Fig. 34: *Section through the unit with the installation*

Secondary system

Because the basic system did not have sufficient capacity a secondary system was needed for ventilation, heating and lighting. The heating convectors were placed between the windows and the balustrades to heat up the cold air coming from the windows (see figure 32).

The required norm of lighting in offices is between 500 and 1000 lux. In Centraal Beheer however the basic lighting does not suffice according to these norms. The basic lighting could be complemented with special designed desk lamps (see figure 33) or even with lamps that the employees brought in themselves.

To meet the ventilation standards induction units have been added in the lowered ceiling, which led or drained secondary air through the prefabricated holes in the primaire construction.

Beside the secondary system there are more exceptions in the installation and delivery system. For example, the computerroom and restaurant have their own unique installation system.



Fig. 32: *Convectors behind the window.*



Fig. 33: *Designed desk lamp in the meeting area in the street.*

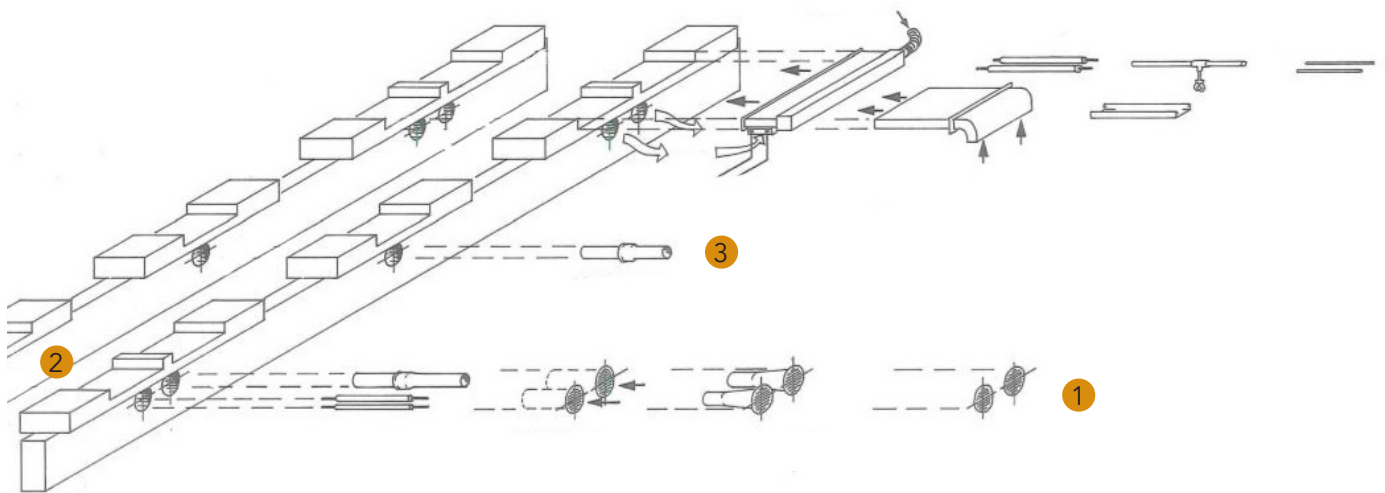

Fig. 39: Prefabricated beams with the openings, and the standard function of it.

1



Fig. 35: A ventilation grille and a fire alarm on the spot of the openings.

2



Fig. 36: Ventilation tubes between the primary beams.

3



Fig. 38: Rainwater drainage on the facade going back in the building.

The order within the beams is that every beam is prefabricated with the openings because they knew they needed it for the secondary ventilation and the rainwater drainage. The two circular openings are mainly used for the secondary ventilation and the single opening for rainwater drainage. But it was not necessary everywhere, only 2.000 of the 4.000 holes are used. This gives the opportunity to create a lot of different purposes for the openings which are not in use. In many places, mirrors are placed at the location of the openings but also fire alarms or installations who were added later used these openings (see figure 35). At the location of the singular opening in the building they often placed a round lamp to light up the voids.

However there were a lot of possibilities to go through the beams, on some places they made an extra hole to go through, for example in the restaurant (see figure 37)



Fig. 40: Airco system added through the openings.



Fig. 37: Rainwater pipe going through an extra hole in the beam.

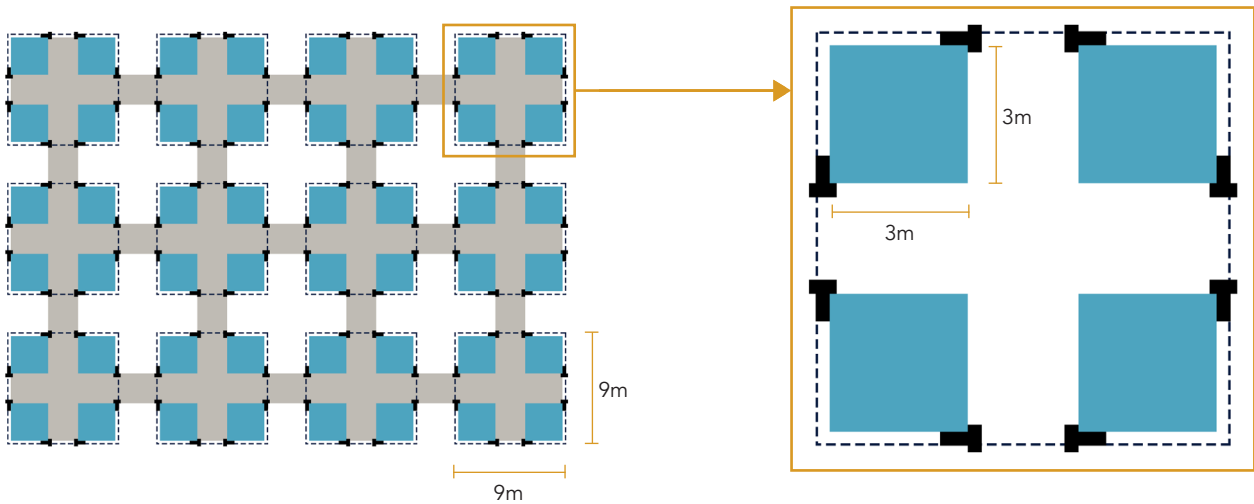

Fig. 43: The grid of islands with highlighted one island and the interpretable zones within.

Every 'island' of 9x9 meters consists of four interpretable zones, or workspaces, in the corners. They measure 3x3 meters, with inbetween them the walking route which is strongly defined by the primary construction beams. The high dimension of these beams creates a walking route where the ceiling is lower than in the corners of the island.

The corners of the island, the 3x3 m interpretable zones, therefore have higher ceilings than the walking route. This creates the feeling that these zones are separate 'rooms'.

These interpretable zones can in essence contain all functions of the building, yet the most common one is office workspace.

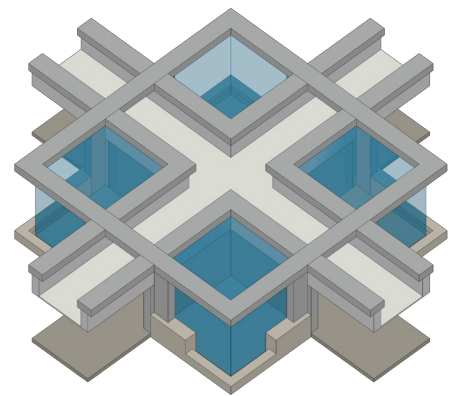

Fig. 41: 3D diagram that shows how the workspaces are defined in height by the construction.

Lay-out grid

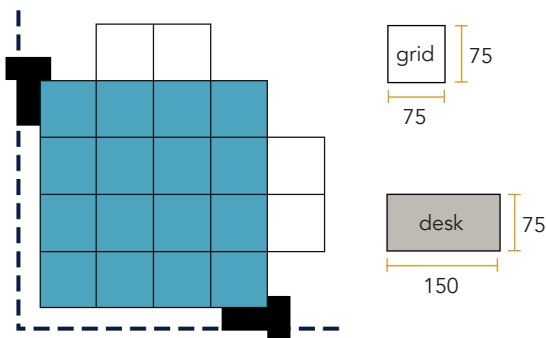

Fig. 42: The 75x75 grid that defines the workspace.

The size of the workspaces is defined by the size of the desks for the office workers.

The standard size of the desk that was used in the design of the building was 75x150 cm. Creating a grid of 75x75 cm allowed for the desks to be set up in many different variations as can be seen in the diagram below.

This eventually resulted in the 3x3 meters (4 x 0,75) size for the workspace, a size that eventually defined the grid size of the whole building.

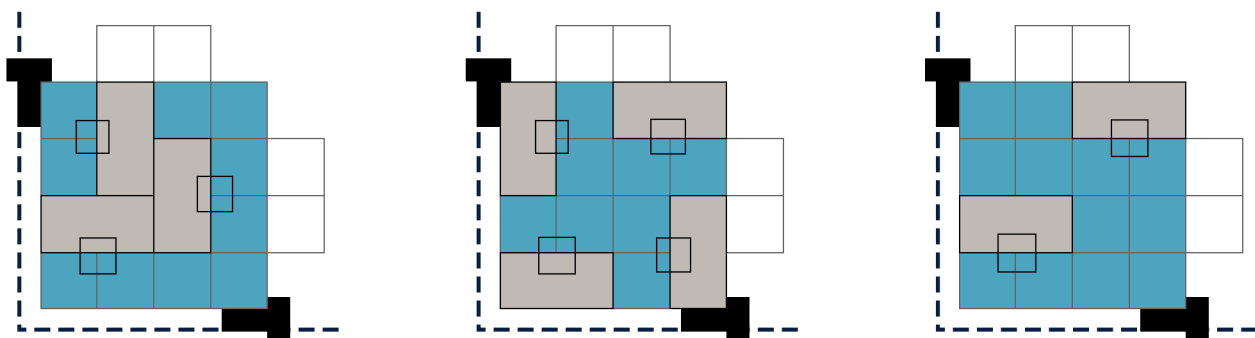

Fig. 44: Different set-up variations of desks placed in the 75x75 cm grid.

There was not a fixed lay-out for the furniture in the workspaces. Multiple options were given (see figure 46), but if office workers figured out different ways for their lay-out that would work well for them, that was allowed. In essence the building is just a framework and the users are free to do with it as suits them and their workplace.

This allows for a big variety of lay-outs of all the workspaces that together with the stuff people brought in themselves, such as posters, decorations and even pets, creates a very diverse office space, in contrast to what the building itself is: a repetition of the same unit.



Fig. 45: An office worker in a personalised workspace, working in a set-up with 4 desks.

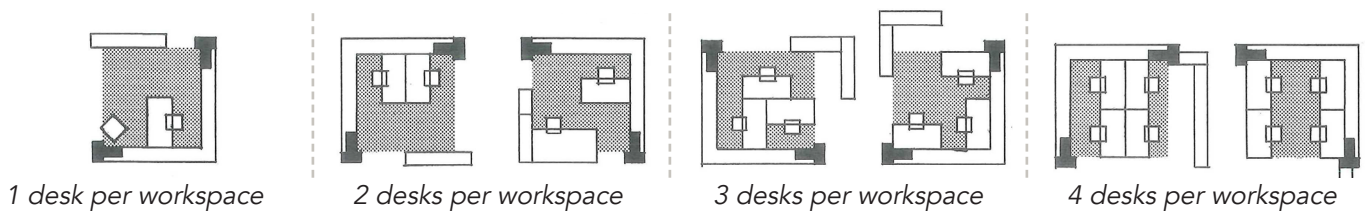

Fig. 46: Given options by the architect of how the workspaces could be filled in with desks.

Other uses of interpretable zone

As discussed before, the interpretable zones do not only house the workspaces, but are in essence able to house every function this building has.

The scheme on the right depicts other set-ups for the interpretable zones designed by the architect, to prove they are possible. These functions consist of public functions such as boudoirs, toilets, break spaces, sitting/waiting spaces and conference spaces. These can mostly be found in the central area of the building, along the 'inner street' to keep the office quadrants fully available for workspaces.

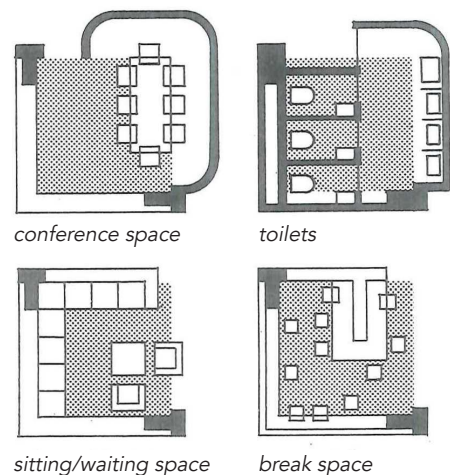

Fig. 47: Different solutions to fit other function in the units.

The workspaces were designed to fit one to four people per workspace of 3x3 meters. This means that, with four workspaces per unit, it would be possible to have four to sixteen desks per unit. On average this resulted in twelve personal workspaces per unit.

In total, across all the quadrants and floor layers, approximately 110 units are within the building are suitable for office workspace. With an average of twelve people per unit this means in total the building offers workspace to approximately 1320 people.

This amount is more than the 1000 workspaces the company of Centraal Beheer asked for. The architect however kept in mind that this amount might change over the years and created this buffer of approximately 300 extra workspaces.

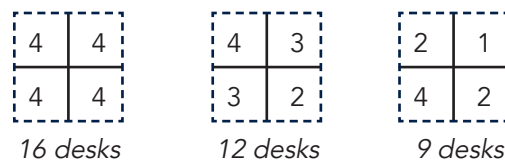

Fig. 49: Examples of possible configurations of desks per island.

Efficiency in floor usage

Notable is the fact that the primary beams of the construction divides the unit into nine equal parts (see figure 48) of which only four parts are effectively used as workspace. The other five, that form a cross in the middle, are used as traffic space. This means that within a unit approximately 44% of the floorspace is effectively used as workspace.

Nowadays, these kind of numbers would not meet modern standards, which allows for only a small difference between gross and net floorspace for maximum efficiency.

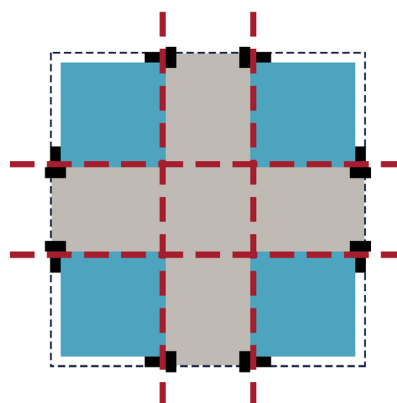

Fig. 48: Only 4/9th of the floorspace in an island is effectively used as workspace.

Unit | Materials | Concrete blocks

Concrete blocks is a material used in the interior and exterior of Centraal Beheer. It is quite literally the building block and smallest unit of the building. Contrary to what one might expect, the size of the concrete blocks does not determine the size of larger units. The determining unit is the workspace of 3 by 3 meters and everything else is adjusted to that size. Four workspaces form, together with traffic area, a unit of 9 by 9 meters. The concrete blocks are adjusted to the 3 by 3 meter measurement. Different sizes of blocks are used to be able to fit in with the 3 x 3 meter grid (See figure 51 and 52).

The concrete blocks were left bare to emphasize the unfinished state of the building. This would encourage people to make their workplace their own by for example hanging art or posters on the walls.



Fig. 50: Plain (left) and painted (right) concrete blocks.

Also notice the difference between the bare material inside and the grey painted concrete on the exterior (See figure 50). A reason for painting the facade (in a similar color to the concrete itself) is to make the facade appear to be clean and new.

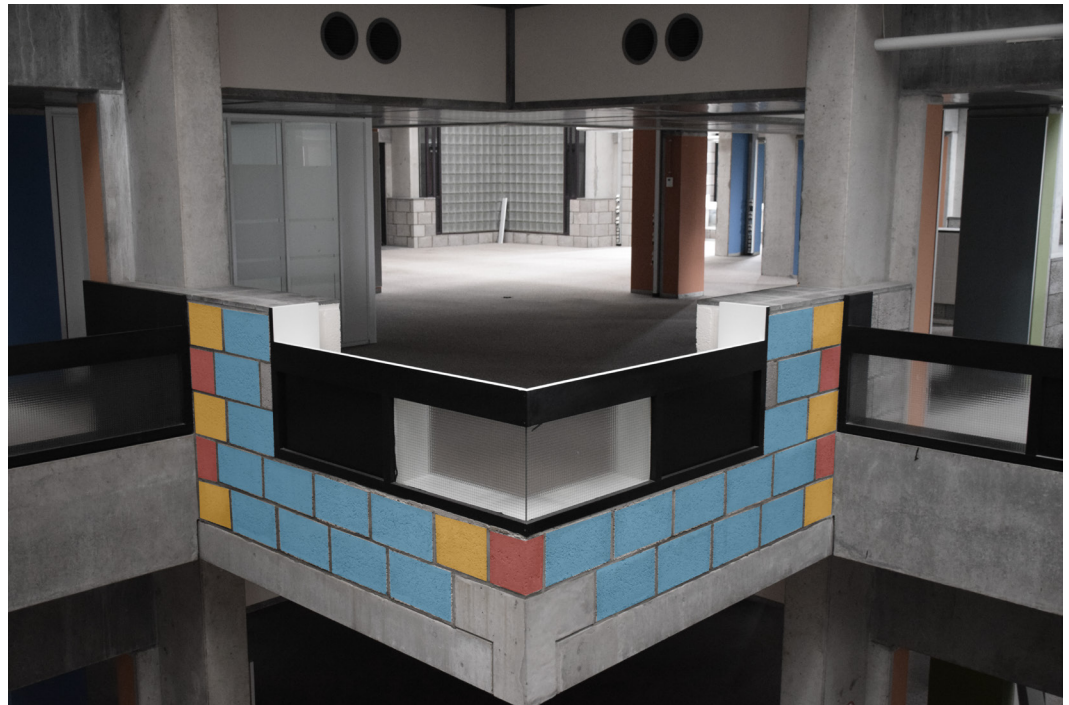
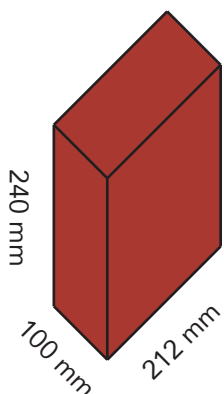
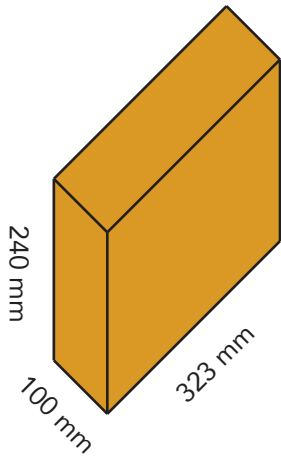
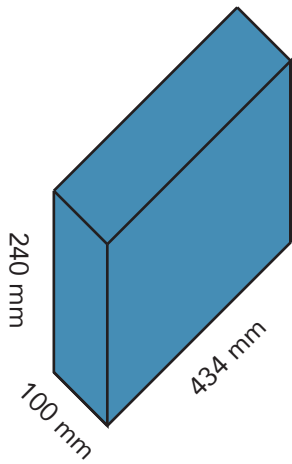

Fig. 51: Left, different sizes of concrete blocks.

Fig. 52: Top and bottom, configuration of concrete blocks in the balustrades.

For the infill of the balustrades, walls and other separations 'softer' materials like wood and glass were used. Black painted wooden cabinets complete the balustrades around the workspaces and coffee corners (Fig # and #). Herman Hertzberger does not believe that architecture should be neutral, but that it should be polyvalent: it should instigate different kinds of uses and it should encourage people to claim their space. The cabinets do exactly that. They can be used to store things, to display personal belongings or to put a plant on it.

Another infill material used is glass building blocks. They are mainly used around the indoor street, to separate the offices from the noisy public area (Fig #). The blocks let light through, but you can not see through them, which ensures a level of privacy and separation.

Instead of the walls, the material of the floors is used to indicate different areas. The office spaces are carpeted and the public areas have outdoor flooring. For more details, see appendix X.

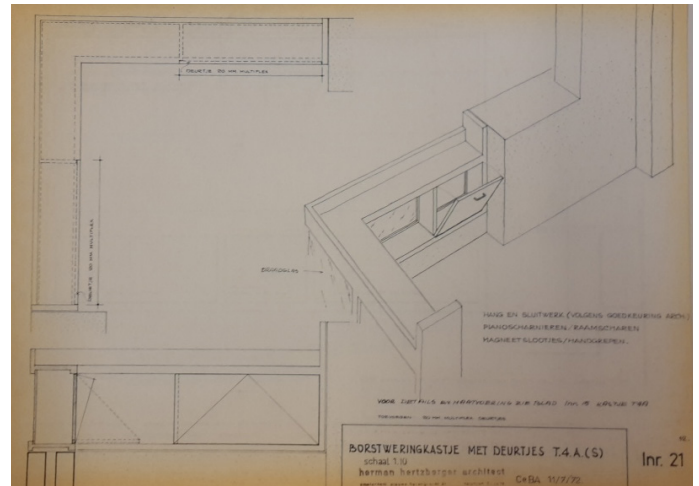

Fig. 53: One variation for the wooden cabinets in the balustrades.

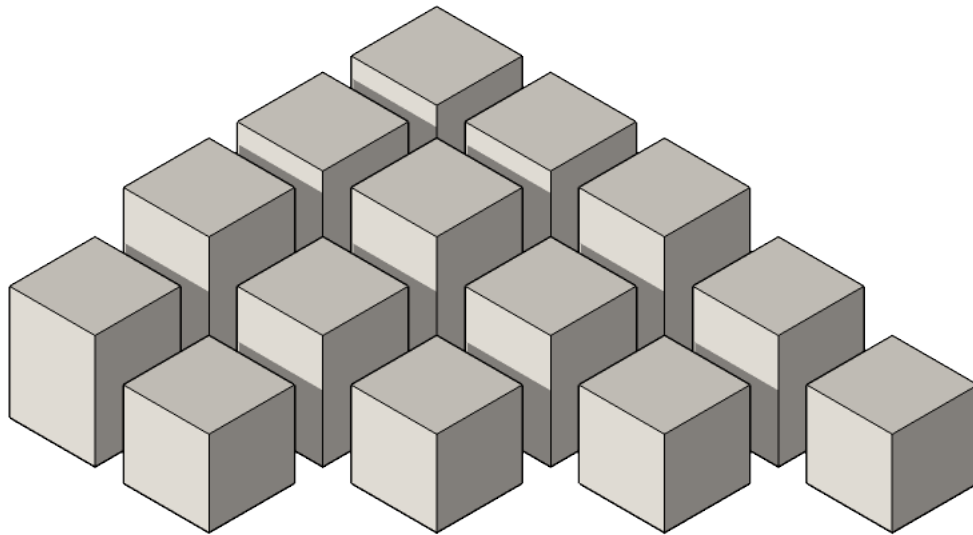

Fig. 55: The public street is screened of with glass building blocks.



Fig. 54: Different materials as flooring are used to indicate zones, from left to right: paving stones, carpet in public street, carpet in offices, parquet.

The perfect quadrant



The perfect quadrant is the theoretical perfect representation of a quarter of the Centraal Beheer building if no exceptions and adjustments were made for specific functions. In essence this means that the perfect quadrant consists of the connection between a number of units that are joined together to create a quadrant of the building.

From the outside perspective this means this creates the general shape that the building is partially famous for, the units that work together to create an exterior expression of different cubes creating a rock-like formation.

Internally this means that together these units form an open office space created by the workspaces within the unit and connected by the bridges inbetween. Inbetween the units a void in the floor creates openness within the building and creates vertical relationships within the office spaces.

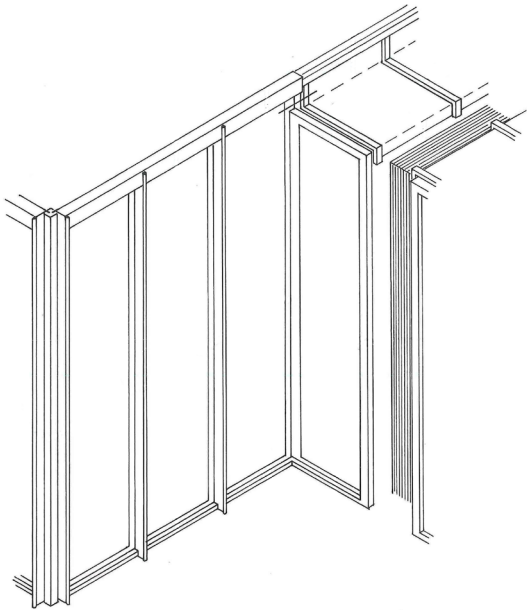

Fig. 60: Facade Fragment.

The composition of the facade reflects the spatial structure of the 9x9 units. The window frames mark the locations of the 3x3 workspaces, and the closed facades show the ends of the traffic zones. This composition strongly contributes to the identification of the separate units that make up the building. However, in the vertical direction there is a much less direct line between the stacked units. It appears as if the window frames are like dresses, that are placed over the facade and hang from the roof edge. Only a thin aluminum frame connects the two layers. Important to note is that the windows of two layers are connected through a single frame, and not the stacking of two frames. This is interesting, because part of the unit's design are the voids. The voids allow for visual connections between people across different layers, just like how the facade connects different layers. It is almost as if the facades are another reflection of the interior spatial design. So what seems like an exception on the scale of a unit, might actually be a deliberate rule on the scale of a quadrant. For more information see appendix XII.



Fig. 59: Picture of the facade.

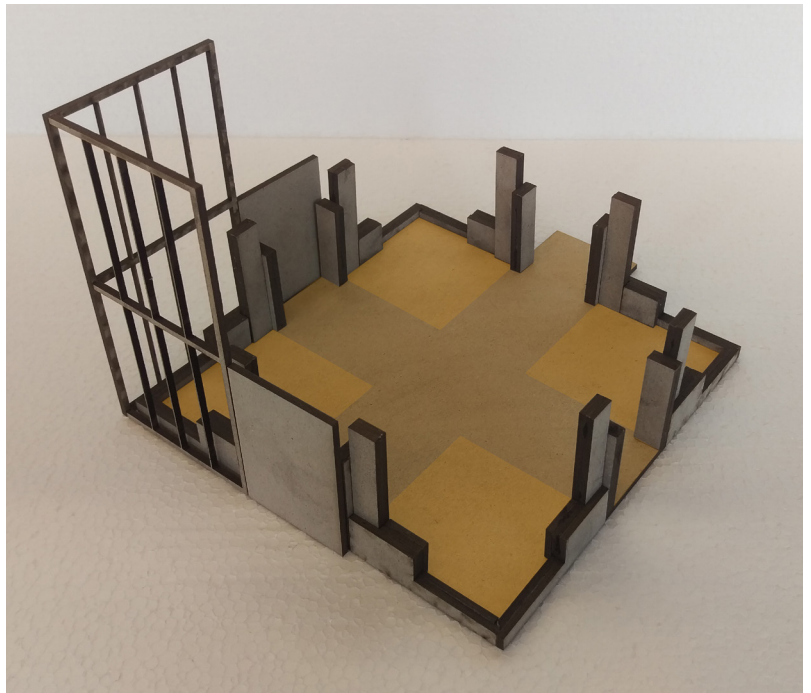

Fig. 58: Facade reflecting the interior space plan, shown in model.

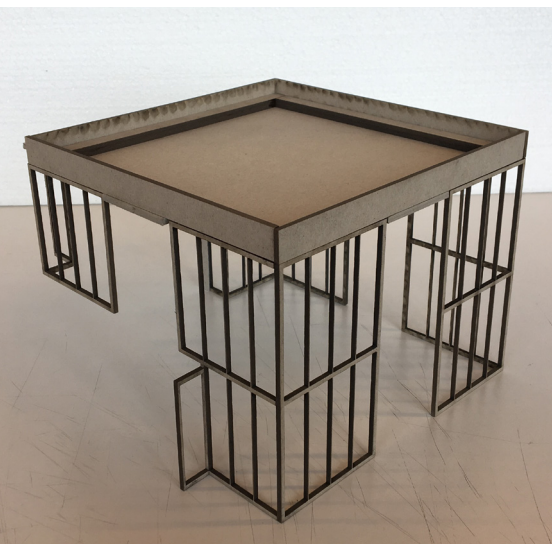

Fig. 56: The window frames as dresses, shown in model.



Fig. 57: Window frame reflecting the 3x3 workspaces, shown in model.

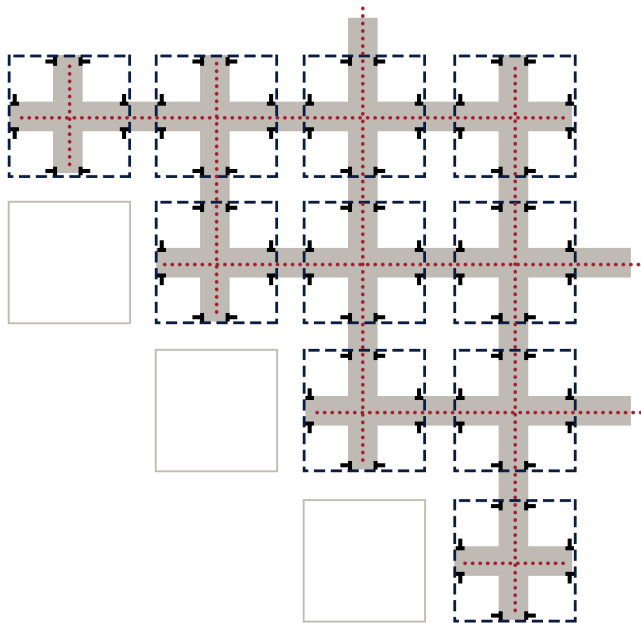

Fig. 61: Quadrant of the building on itself without furniture: a maze.

The building on itself can be seen as a whole where the same unit has been copy-pasted. This creates a building which is very uniform. In combination with the many interrelations between the different units in the form of bridges, the building itself lacks a feeling of orientation and almost feels like a maze.

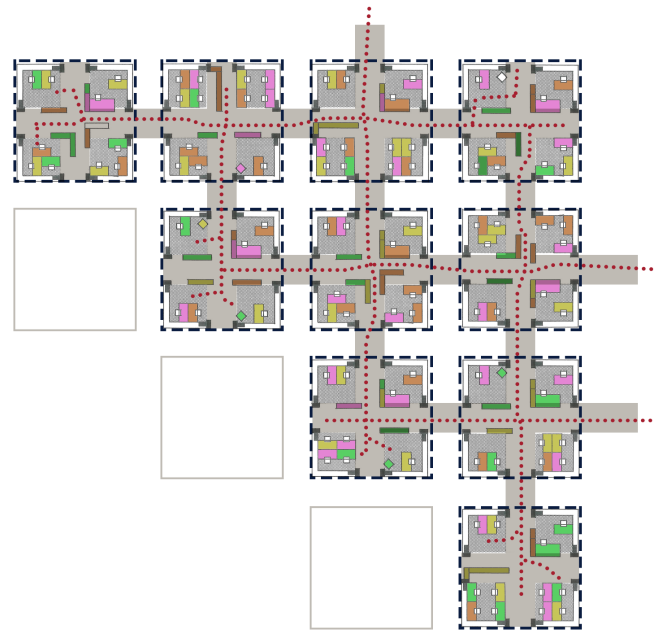

Fig. 65: The diversity in furniture and personalisation of workspaces creates recognizable points for orientation.

The orientation for the users is created by the 'stuff' that is brought in by the users. The fact that the users were allowed to create a personal set-up for their office space, bring in their own furniture (and even animals like birds and fish) and decorate their workspaces themselves allowed for a very wide variation of elements and 'stuff'. (See page 24 for more information on the lay-out of workspaces)

This creates recognisable points or 'landmarks' within the open office plan, where people will use the stuff of other users as a point of orientation, to find their way around and describe the way across the building. For more information about the orientation see appendix XIII.

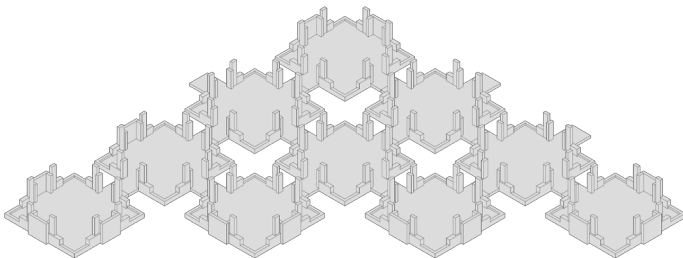

Fig. 62: 3D image of an open office quadrant of the building without furniture.



Fig. 63: Photograph of an empty office space in the abandoned building in 2018.



Fig. 64: Photograph from the 80s of an office worker in her personalized workspace with many visual recognition points.

The perfect quadrant | Roof terraces

The iconic stepped volume has allowed for several roof terraces to be placed along the office spaces. The roof terraces are accessible from the third and fourth layer. To enter a terrace, you must climb a small stair, then exit through a door that leads out onto a small bridge that crosses the skylight with the integrated gutter. All the roof terraces on a single floor of a quadrant are accessed in the same direction. Because of this there are a few terraces that are not accessible. Why there wasn't just simply another exit added in a different direction is unclear. Maybe it was to uphold a certain aesthetic value, or maybe this would have clashed with the spacial structure and the non hierarchical nature of the building that Herman Hertzberger envisioned. The reason might be unclear, but in this aspect he stuck to the rule he made.

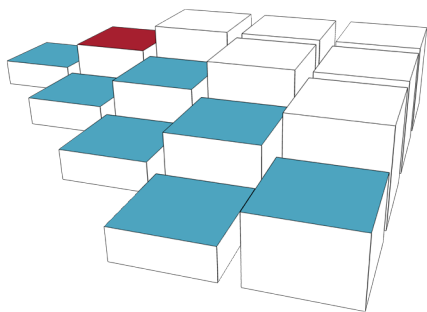

Fig. 67: Quadrant diagram showing the accessible and inaccessible roof terraces.

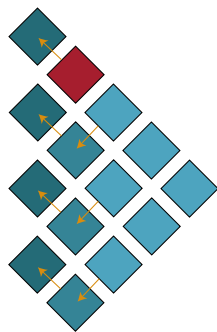

Fig. 68: Diagram showing terrace entry direction.



Fig. 69: Roof terrace entrance.

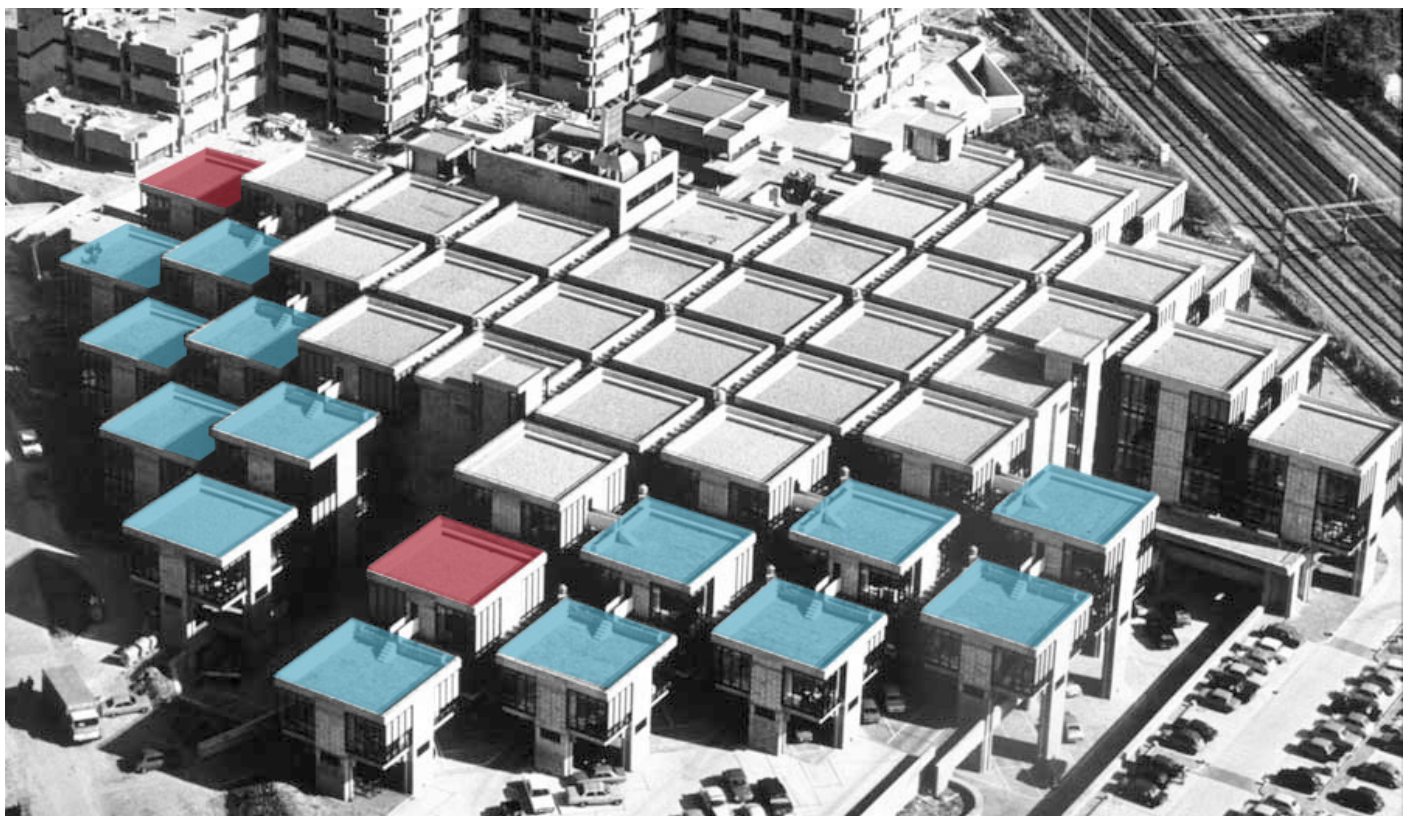

Fig. 66: Bird's-eye view showing the accessible and inaccessible roof terraces.

The perfect quadrant | Gutters

The gutters are integrated into the skylight system that runs in the space inbetween the units. This system allows for both the entry of daylight in the inner parts of the building, but also takes care of the required drainage of rainwater. Where two of the gutters meet, there is a square cross. Sometimes this square has a skylight, but often this is where the outlet for the ventilation system is placed. The gutters run down to the edge of the building, to eventually stop just below the ceiling of layer 1. Here the gutters are connected to pipes that run the rainwater into the building or parking garage.

The skylight and gutter system is important for the architectural expression of the building, but als has some challenges. The rainwater does not flow down naturally, because the gutters are not sloped, the open gutters along the facade attract algae, and everything is difficult to clean.

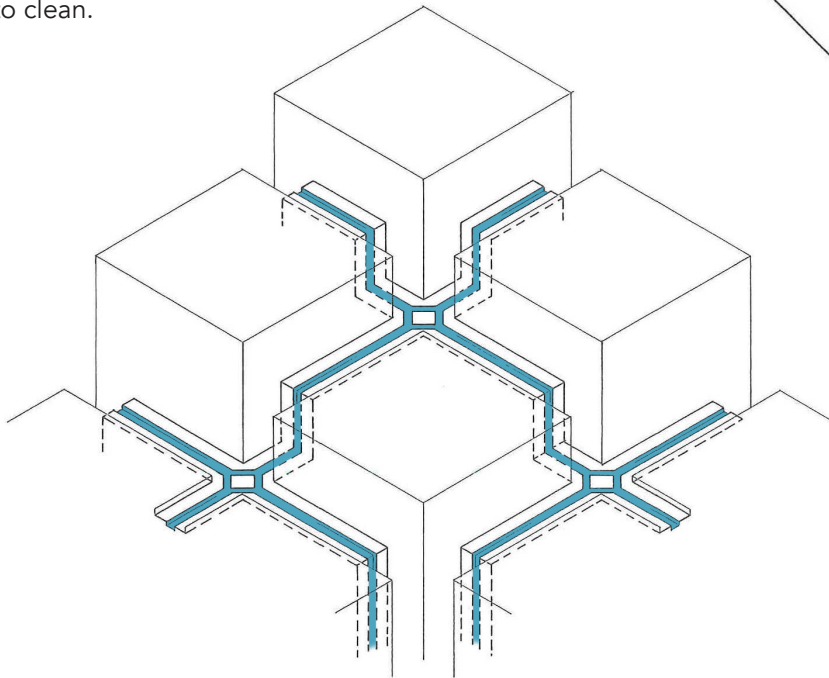

Fig. 70: Axonometric scheme of the gutter principle.

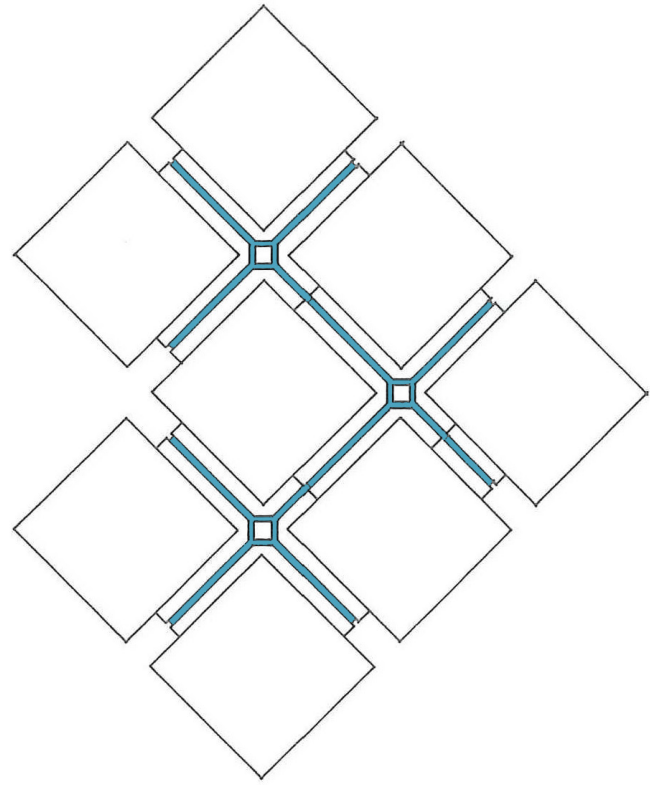

Fig. 72: Top view of the drainage principle

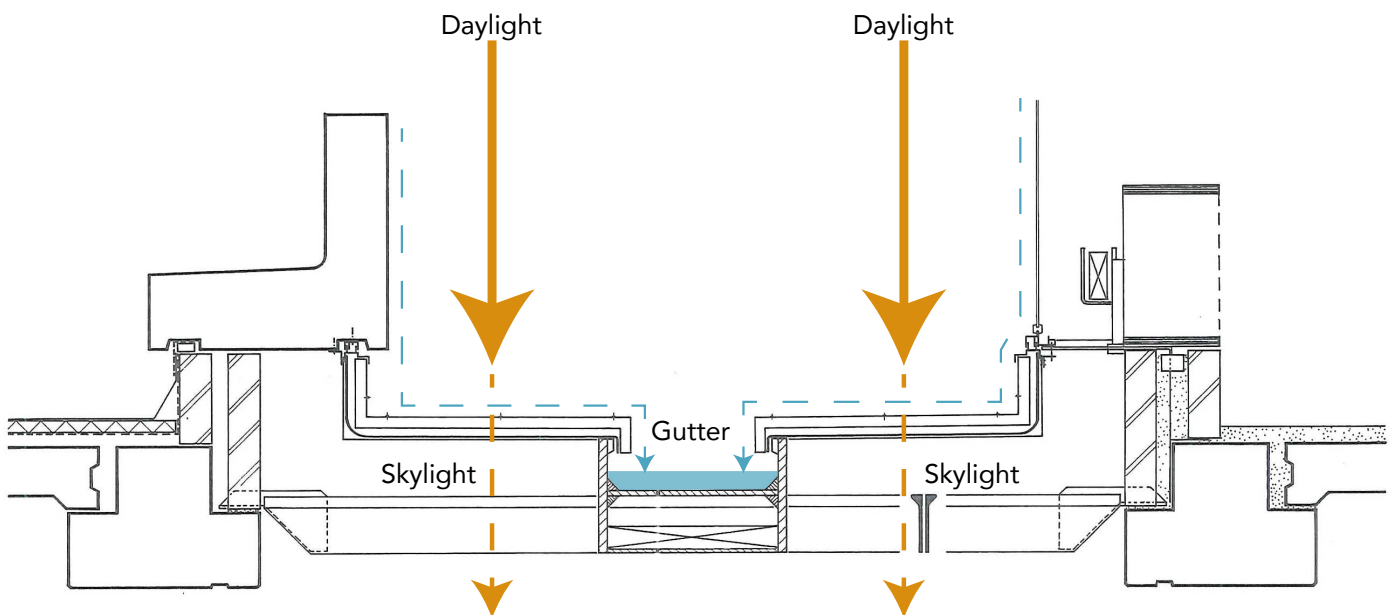

Fig. 71: Section detail of the gutter and skylight.

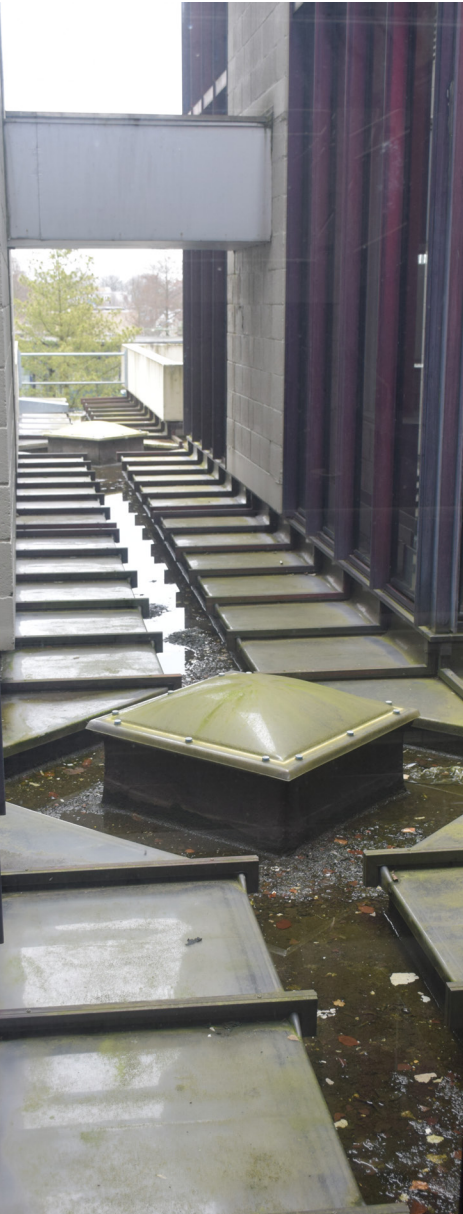

Fig. 77: Picture of the gutter and skylight.



Fig. 75: The end of the gutter and the continuation of the rainwater drainage.



Fig. 74: Ventilation unit at a cross section of two gutters.



Fig. 73: Picture of the gutter and skylight as seen from inside the building.

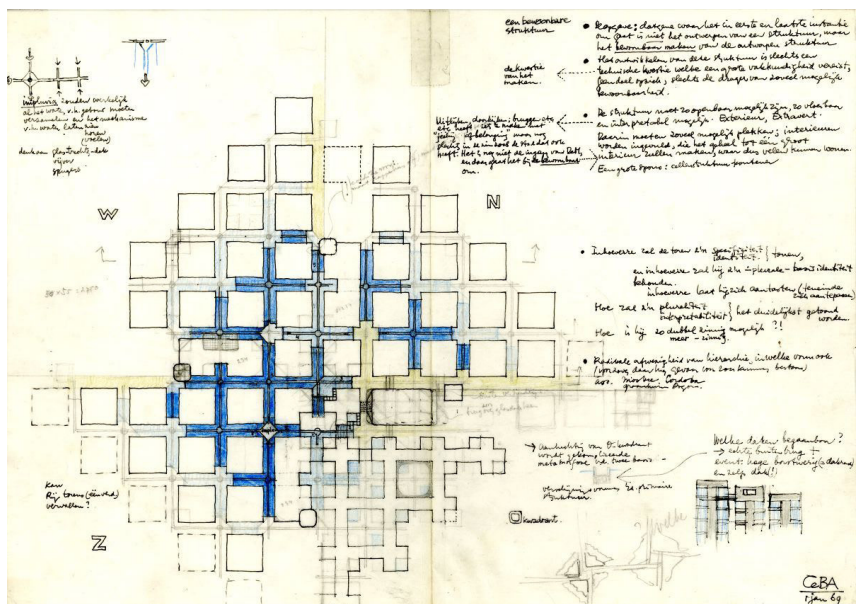
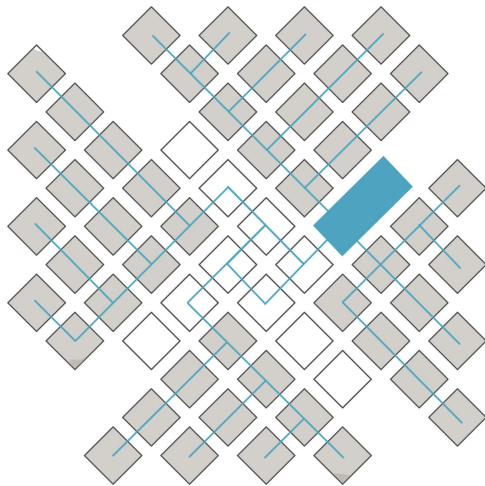

Fig. 76: Sketch of the gutters by Herman Hertzberger.



In this project the technical advisor was engaged in a very early stage, because the building shell is executed in prefabricated materials. All the technical services are housed in a technical tower. From this tower all hot and cool air, hot and cool water and electrical energy is transported through ducts, pipes and cables which are situated in the space between the primary beams to all the workspaces (see figure 78). For financial and organisational reasons it was logical to place the technical tower in the centre of the building. The computer room and restaurant have separate installation systems to regulate the specific demands. These systems are also placed in the technical tower. Therefore the tower is placed between these two areas.

Fig. 78: Powering of the islands by the central tower.

1. Primary air supply.
2. Primary air extraction through the voids.
3. Secondary air (can be extra air supply or air extraction)
4. Cold air of the facade is heated by the convector.

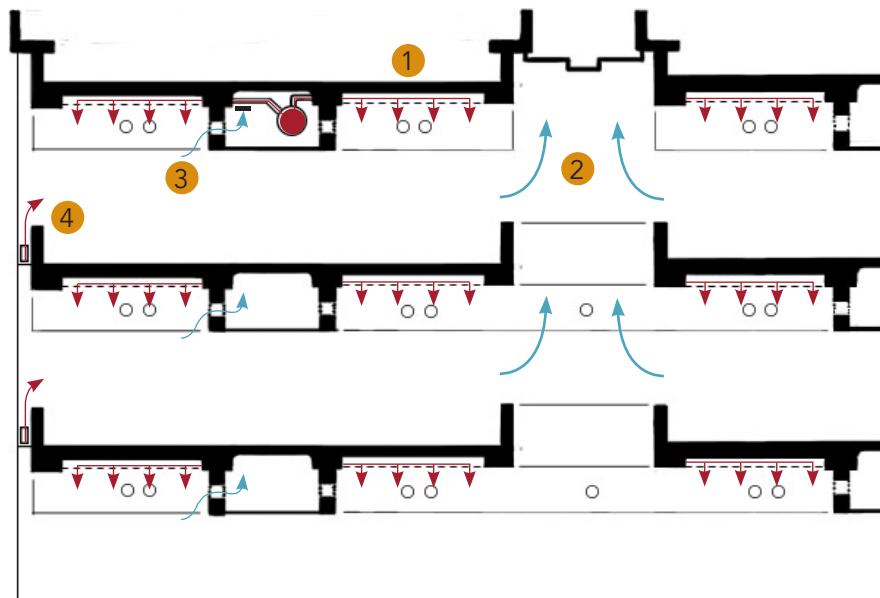

Fig. 79: Section with the ventilation scheme in the winter.

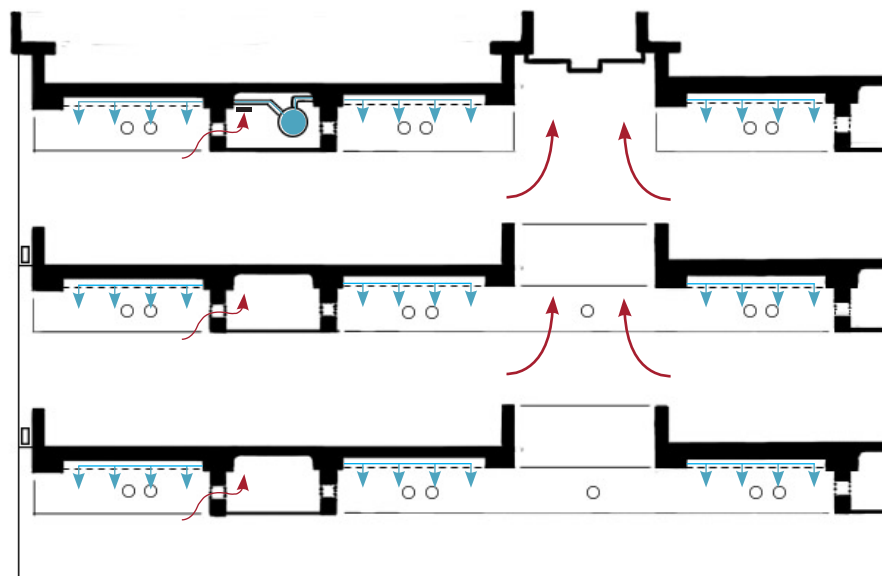
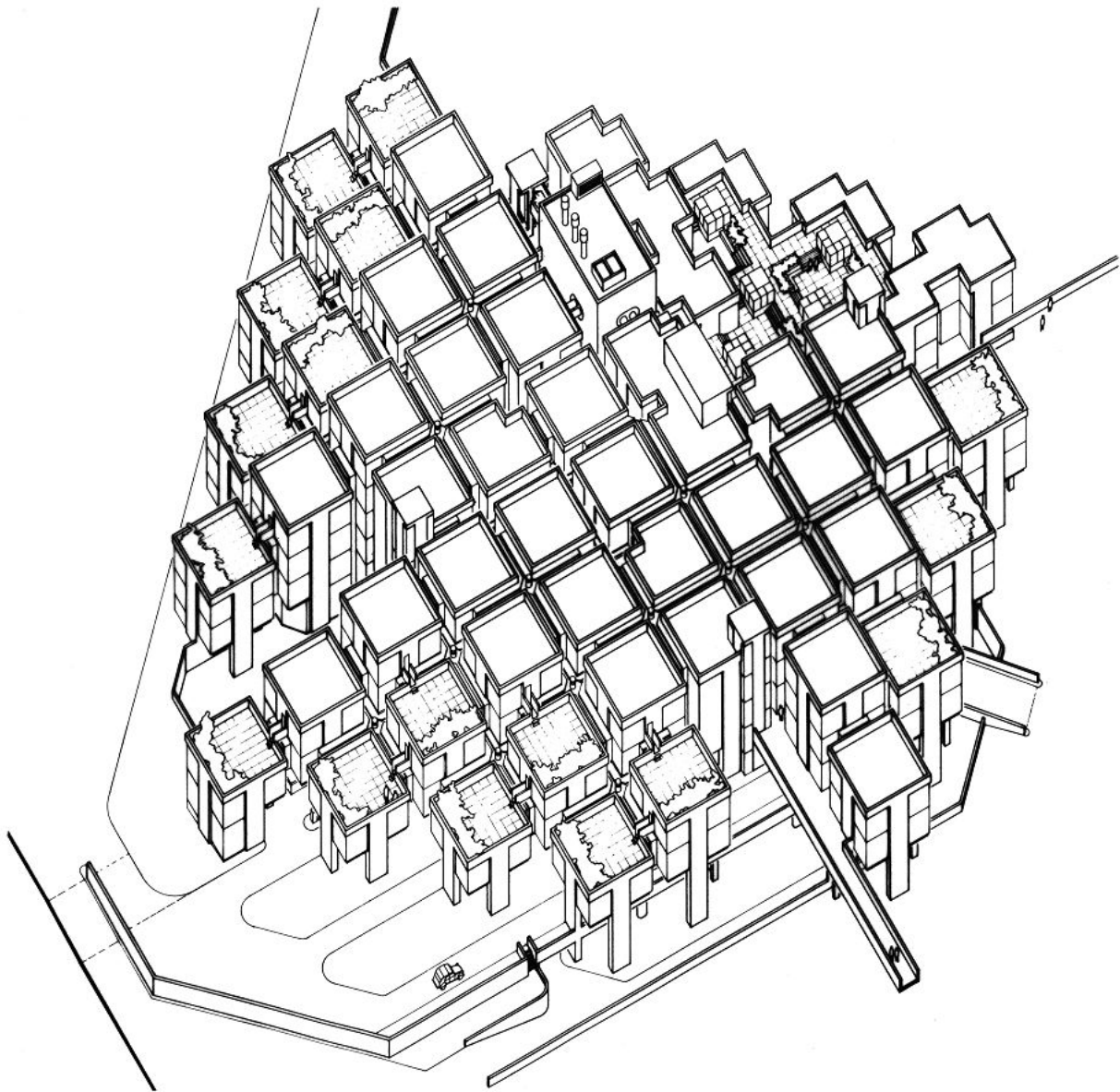

Fig. 80: Section with the ventilation scheme in the summer.

Actual quadrant



The perfect quadrant is the theoretical perfect representation of a quarter of the Centraal Beheer building if no exceptions and adjustments were made for specific functions. In essence this means that the perfect quadrant consists of the connection between a number of units that are joined together to create a quadrant of the building.

From the outside perspective this means this creates the general shape that the building is partially famous for, the units that work together to create an exterior expression of different cubes creating a rock-like formation.

Internally this means that together these units form an open office space created by the workspaces within the unit and connected by the bridges inbetween. Inbetween the units a void in the floor creates openness within the building and creates vertical relationships within the office spaces.

Actual quadrant

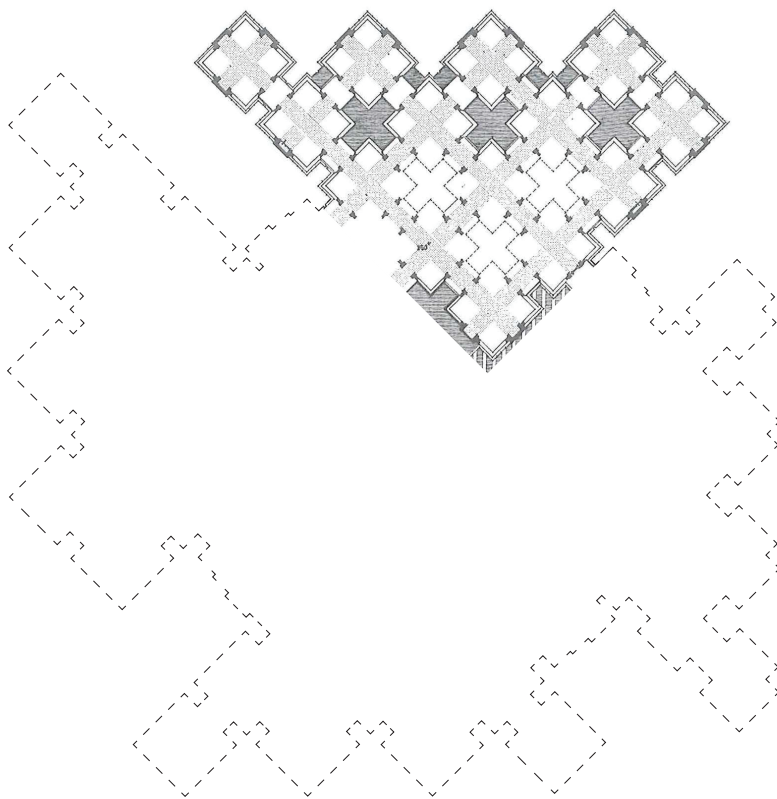

Fig. 81: *Quadrant North floorplan layer 2.*

The North quadrant

can be seen as the most 'perfect' quadrant of the building. The program contains offices and the computer room.

Main exceptions:

- Computer room
- Extra voids

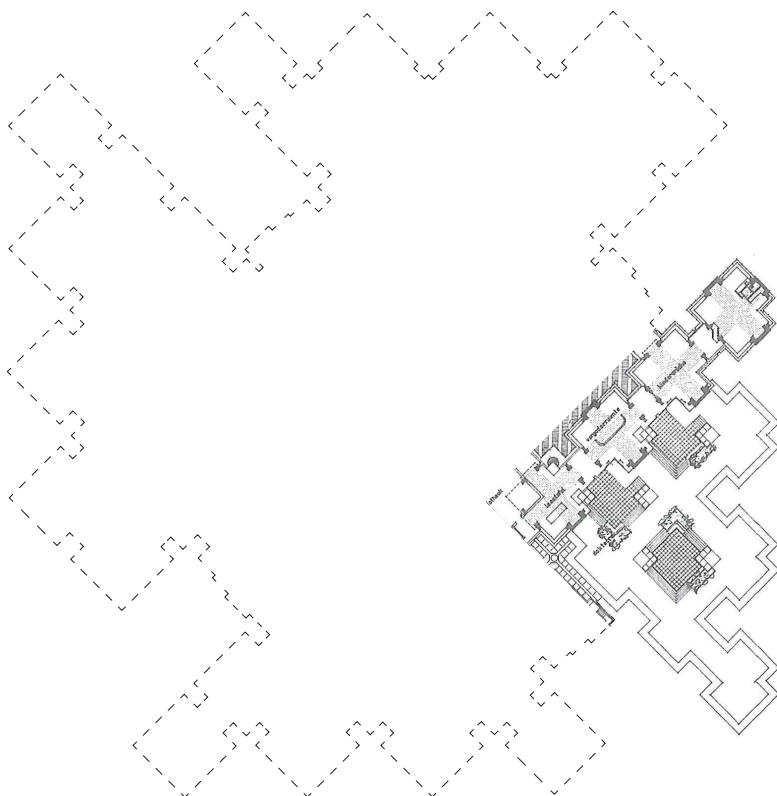

Fig. 82: *Quadrant East floorplan layer 2.*

The East quadrant

is the lowest quadrant in height. The program contains the restaurant and roofterraces.

Main exceptions:

- Restaurant function
- Pits floor and roof
- Extra construction

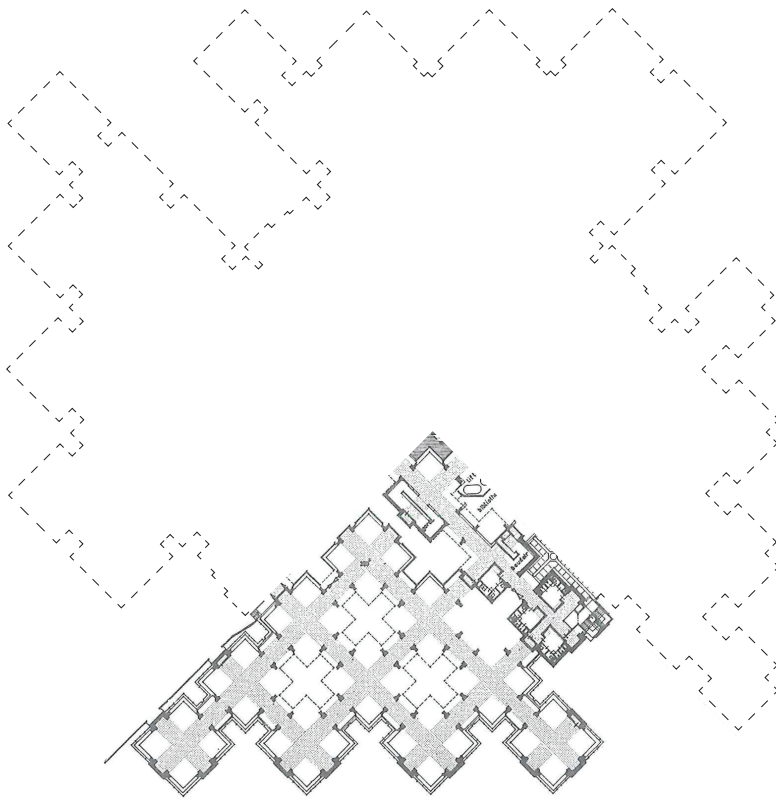

The South quadrant

The program contains parking on layer 0 and 1 and offices.

Main exceptions:

- Parking

Fig. 83: *Quadrant South floorplan layer 2.*

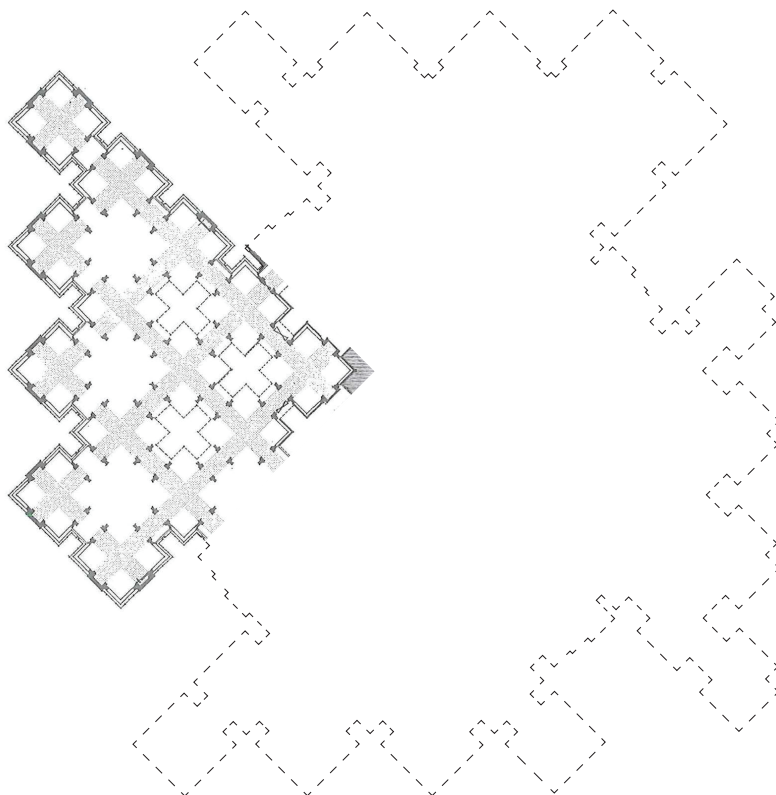

The West quadrant

The program contains parking on layer 0 and 1 and offices.

Main exceptions:

- Parking

Fig. 84: *Quadrant West floorplan layer 2.*

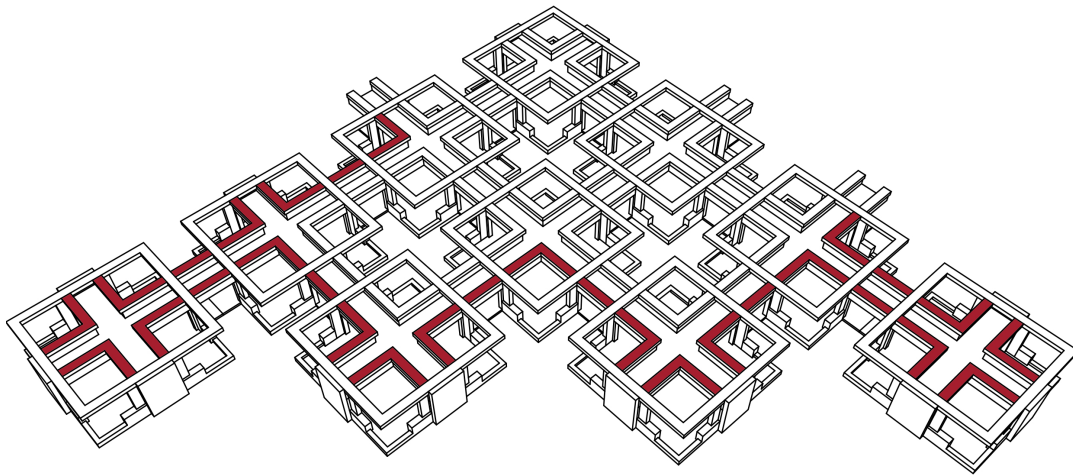

Fig. 87: 3D model of the construction with the exceptions at the construction ends.

In the perfect unit the construction does not end: it could be expanded forever. However, the construction does end and this can be considered as an exception to the unit. In Figure 87 the 'exceptions' of the construction at the endings are highlighted in red. The primary beams, that usually form a square, are cut partially by a quarter, a half or three quarters.

In the continuous construction momentary fixed connections are formed by pins, bars, bolts and mortar. The primary beams stop at the end of the construction. this is most likely possible due to the momentary fixed connection between the different elements.

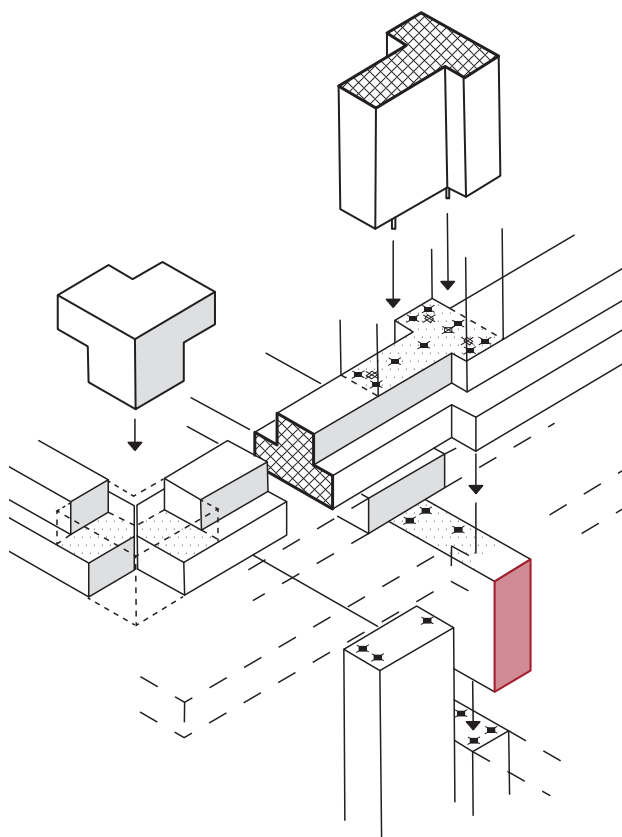

Fig. 88: Detail of ensablage of the constructive elements with an ending of the primary beam.

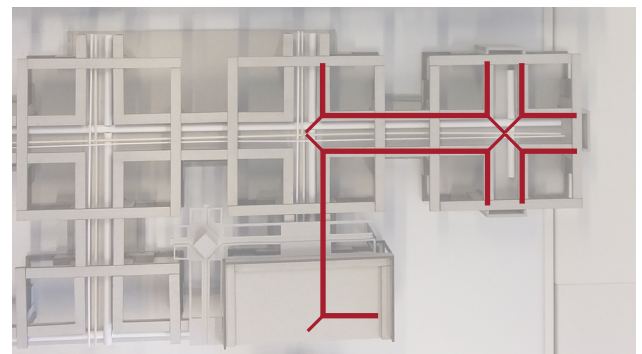
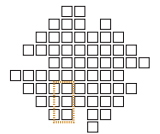

Fig. 85: Exception of the endings of the construction in top view of the model

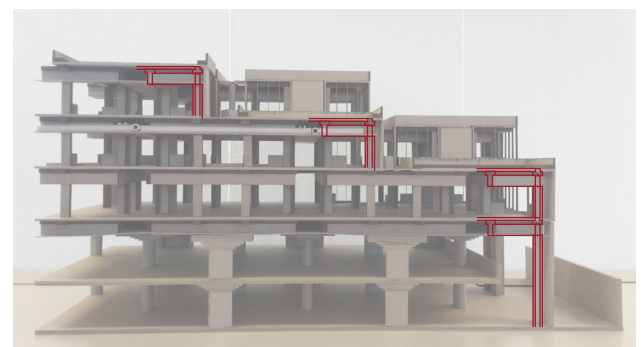

Fig. 86: Exception of the endings of the construction in section of the model.

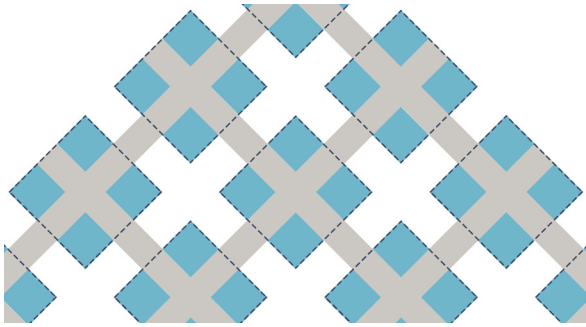

Fig. 90: The unit (dashed blue) are connected by walking paths/bridges (grey), which creates voids inbetween (white).

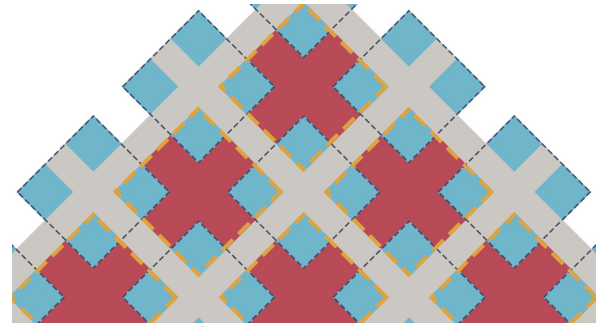

Fig. 91: When the floor inbetween the islands is continuous bigger workspaces are created (dashed yellow).

Within the office floors, not only horizontal connections are emphasized, but also vertical connections are established. This happens through voids in the floor, that exist in the space between the units. The units are connected by bridges, which creates cross shaped voids.

These voids create a vertical relationship between floors. This creates a "strong feeling of connect with those working on a lower or higher floor."

At the same time it also prevents densification within the office space, as a void in the floor means there is no space to put desks and office furniture.

It is possible to fill in the voids with floors, but it is important to take in account the problem of over-densification that this might create.

On the lowest office levels there are also no voids, mainly because of functions in the layer underneath that need to be closed off such as the parking spaces. This means that for example on layer 2 there are no voids in the floor except in the street. There are voids above though that still allows contact with the floors above.

This lack of voids creates a continuous floor between the units, which means that the units are not physically separated anymore on that floor. This also creates bigger workspaces, that allow for a different set-up of office furniture (see page 41)



Fig. 92: Photograph showing the office vertical relationships through the voids.

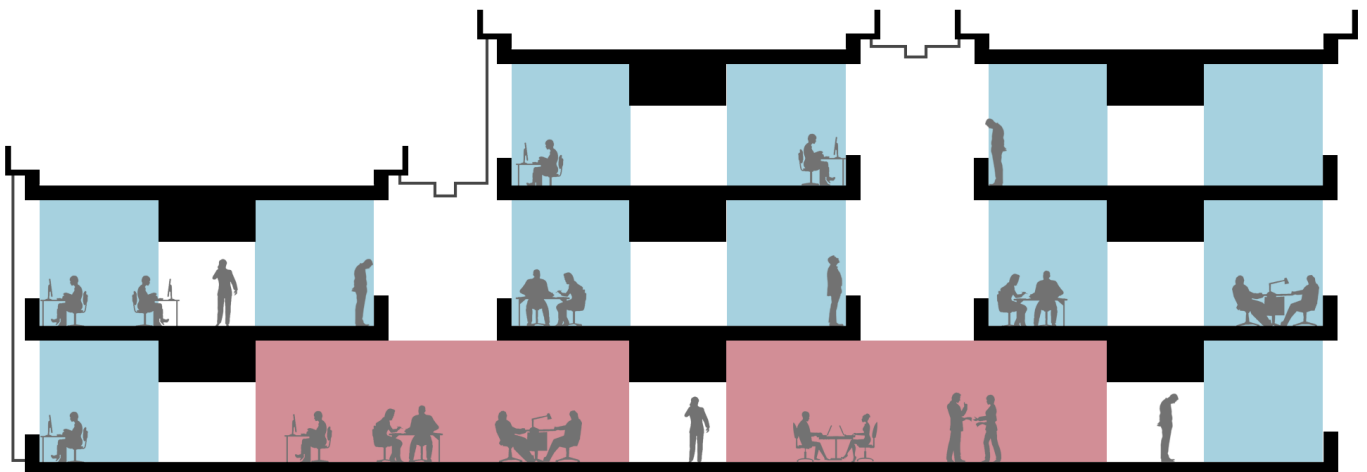

Fig. 89: The differences between an office space that is situated on a continuous floor and floors with voids.

Actual quadrant | Continuous floors

On the bottom layer of the office spaces the 'units' are not separated by voids, but connected through continuous floors. This creates a 9x9 meter working space that is not interrupted by columns of defined by construction beams, instead of the usual 3x3 meter working space. This space allows for an even bigger freedom of layout when filled in with office furniture. Because of the larger space, bigger combinations of desks as well as rotations of desks are made possible.

The danger though, which the architect describes, is the danger of over-densification, which could lead to a feeling similar to the 'grossraum' open office plan idea, where no order or structure, or open 'breathing' space is created inbetween the workspaces. (see fig. 93)

Another possible disadvantage of having desks and working space in this area, considering the fact that a void is usually located above, is that other people will be able to look directly onto your desk from above, which could create a feeling of being watched.

For more information see appendix XIV

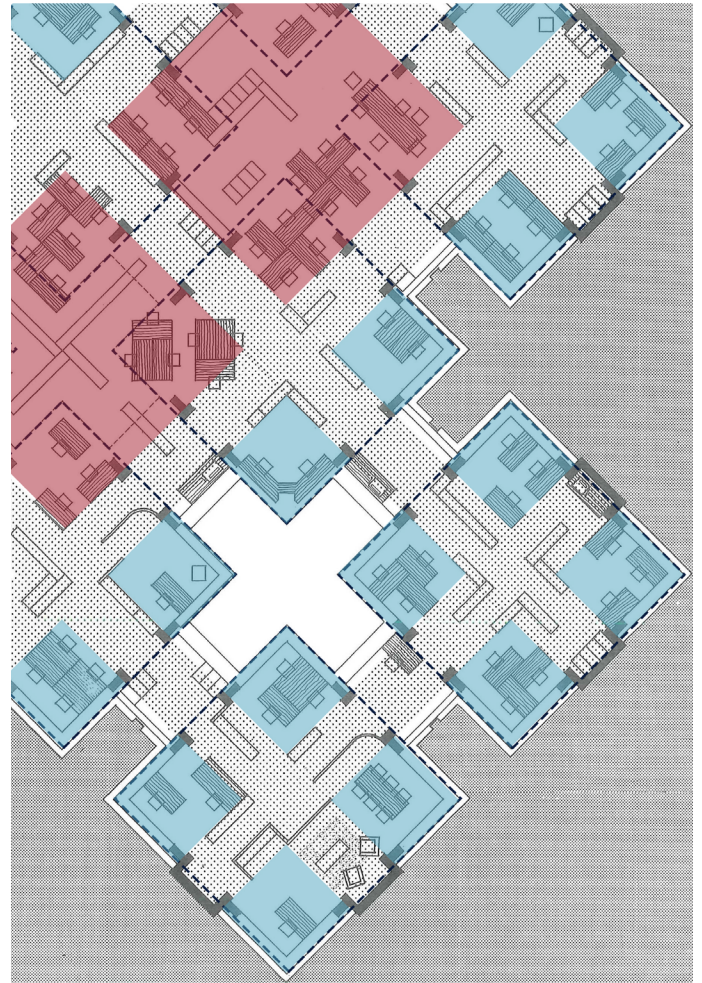

Fig. 94: The differences between a floorplan that includes voids and a floorplan that has a continuous floor.

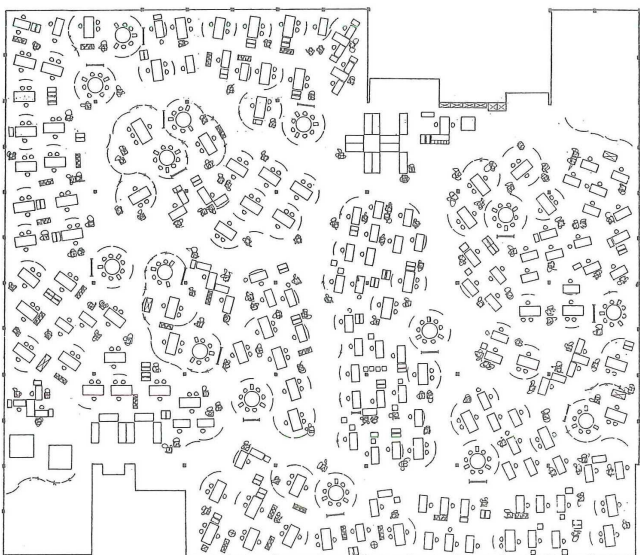

Fig. 93: A schematic drawing depicting how a 'grossraum' open office plan works. When an office space has continuous floors instead of voids inbetween the working spaces it shows some resemblance to the idea of 'grossraum'



Fig. 95: An office workspace on the lowest office floor (bottom) allows for rotation of furniture because a larger space is available.

Cultural Value Matrix

Cultural value matrix introduction

Besides the cultural value being an integral part of every analysis of an existing building within the track of Heritage & Architecture, it is very helpful to define cultural values by filling in a 'cultural value matrix'.

This is a matrix in which a range of values that are of cultural influence are plotted against the building, spread over multiple layers and scales within the building.

There are many examples to be found of cultural value matrixes, but not every building asks for the same values to be assessed. As a base for our cultural value matrix we used the one defined in 'Designing from Heritage' by Marieke Kuipers and Wessel de Jonge.

However, for the Centraal Beheer specifically we felt this was not sufficient to represent all aspects of the building. Therefore we have left some out, but more importantly we added some extra values such as 'Structuralism value', 'Conflict' and 'Opportunities'.

The building is an important icon of structuralism and famous within national and international architecture. For this reason, we felt that a value called 'Structuralism value' would add another dimension to the cultural value matrix in which the characteristics could be defined which make the building structuralist.

The value of 'Conflict' is not necessarily meant as a value, but rather as a way to emphasise and realise that not every aspect of the building is perfect or function the way it was intended. These conflicts are important to keep in mind when creating a transformation design.

In contrast to conflict, we have also added a column called 'Opportunities', in which possible positive opportunities will be emphasised, which can create a basis for specific problems to be solved when transforming the building.

We have also added a new layer to the building itself called 'Spirit of time'. In this layer we want to depict the way the building functions within its time frame, since the ideas and visions of nowadays differ from those when the building was designed and built.

Symbols

The values in the cultural value matrix are represented by using abstract symbols. These symbols are explained in the pages that follow since sometimes they represent more than can be expressed in using one symbol.

High/medium/low cultural value

The values represented in the cultural value matrix are not all positive values or values that are essential to keep in mind when transforming the building. Some are specific for the office function that the building originally had, while others are a more essential part of the building itself. This means that a gradation in cultural value has been created, which will be represented in the matrix by the use of the colors red, yellow and green, going from high cultural value to low cultural value.



High cultural value
Do not touch



Medium cultural value
Think thoroughly before making a change



Low cultural value
Feel free to change

Surrounding/setting



Historical value: A new economical center

During the 60's and 70's it was attempted to turn Apeldoorn into an eastern counterpart for the governmental and economical center that was located in the west of the Netherlands.

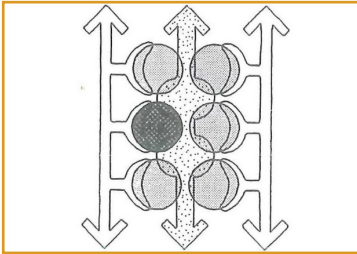

Use value: Part of bigger connection

Originally the building was planned to be an element in a bigger connection created from the to be built new train station and the center. Even though this was part of the assumptions in the design, the new train station was never built and the connection is lost.

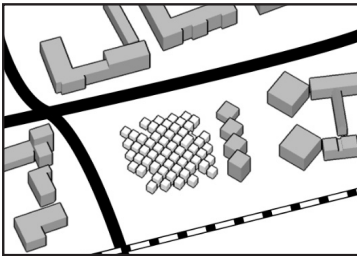

Conflict: Isolated location

Instead of its intended good connection with the surroundings, the building has become very isolated. The building is located inbetween two big roads to the north and east and the train tracks to the south.



Opportunity: Close to center

Even though it is partly isolated by the roads, the Centraal Beheer building is located very close to the city center of Apeldoorn, providing opportunities for a public connection.

Site

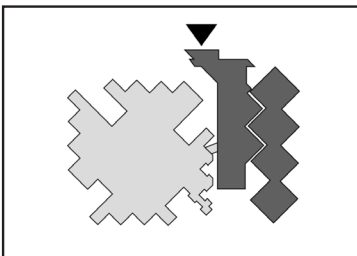

Conflict: Pakhoed and entrance building

Because of lack of space within the Centraal Beheer building a new building was built right next to it, the Pakhoed Building, creating more office space.

Where the building was originally supposed to have several entrances that would naturally exist, this turned out to be a problem in orientation and an entrance building was created inbetween the Centraal Beheer and Pakhoed buildings.

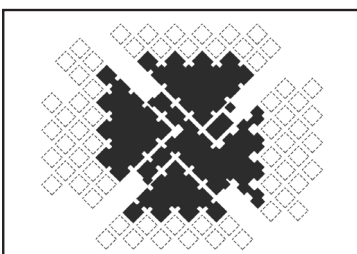

Opportunity: Space on site

The close surroundings of the building provide enough space for the building to expand its footprint or to create better connections to public space.

Skin (exterior)

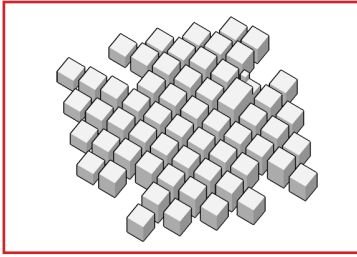

Historical value: Icon of structuralism

The building's exterior is an expression in shape and arrangement of cubes that (even though this is not the main structuralist aspect of the building) gives the building an outer appearance that has become iconic in structuralism.

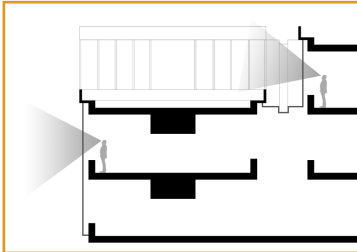

Use value: Relations outside/inside

Because of the big windows as the main facade element, the visual connection from the inside towards outside is very good.

Skylights also provide extra natural light inside the building. The roofs of adjacent units can be used as roof terraces, creating a physical relation from the inside to outside.

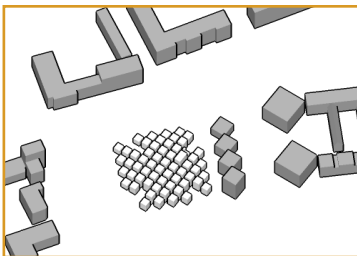

Art value: Unique building shape

The building can be seen as a very unique building in its exterior appearance. The building consists of many small cubes (or units) to form a big building that has a rock like shape.

It contrasts highly with the surrounding buildings.

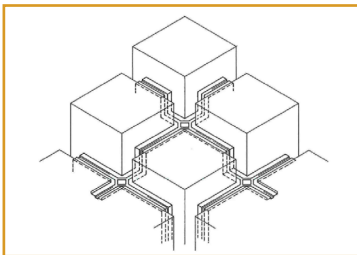

Rarity value: Unique rainwater system

The Centraal Beheer building has a very unique rainwater collection system. The rainwater collected on the roofs flows towards gutters that are created inbetween the roofs of the units. These gutters are all connected and the water flows off the building similar to a waterfall. The gutters play a big part in the architectural expression of the building.

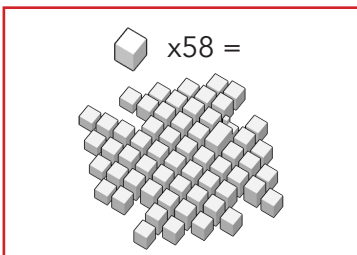

Structuralism value: Structuralist appearance

The building can in essence be seen as a repetition of smaller units that form the building as a whole, which is also very apparent in the exterior of the building where you can see the different units of the building.

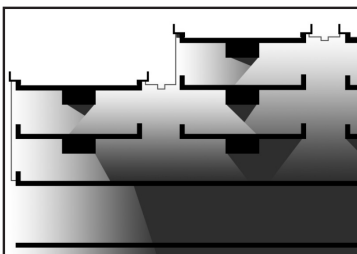

Conflict: Lack of natural light

Even though the building has a lot of skylights and big glass facades, natural light is a problem in the building. Especially on the lower floors near the center of the building there is a lack of natural light.

Because of the large glass facades the building is also difficult to control on a climate level (thermal isolation).

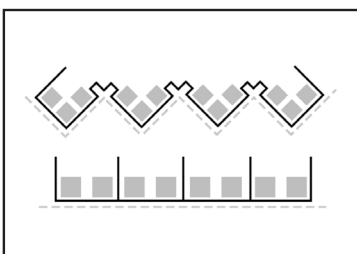

Opportunity: Bigger facade area

Because the building has an outer facade that is turned 45 degrees if compared to a more regular facade, this creates more facade area, which allows for more working space that is located next to a facade and has a view to the outside.

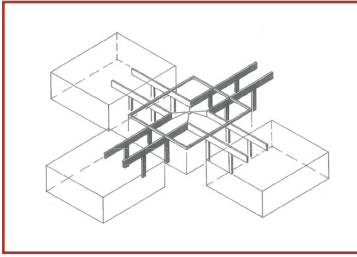

Historical value: Structuralist construction

The Centraal Beheer building is constructed in a way that allows for the units to function separately, but the units are also strongly connected to each other through the primary construction beams.

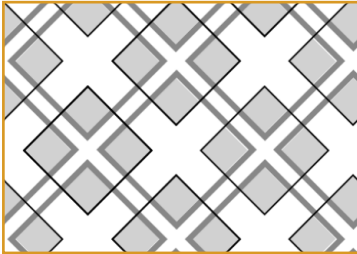

Use value: Construction defines space

Because of the height difference of the primary and secondary beams, the primary beams are a space defining element. Together with the space for installation this creates the traffic space which is considerably lower than the working spaces. This defines the working spaces in height and guides the traffic inbetween them.

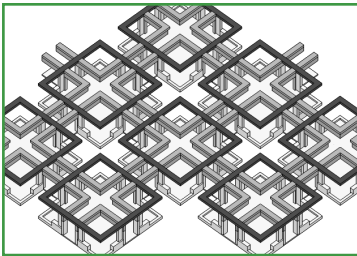

Rarity value: Multiple layer beam construction

The building is constructed using a concept of multiple layers of interlocking beams, both constructing different parts of the building. This concept is not very common and especially at the time was very unique.

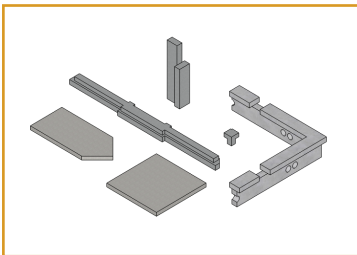

Structuralism value: Prefabricated elements

The main construction of the building exists from many smaller elements that mostly have been prefabricated. This also allowed for a fast building process.

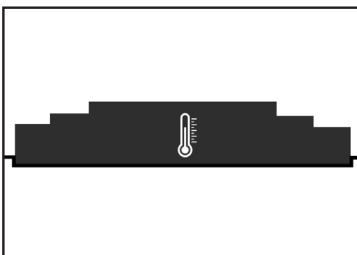

Conflict: Big thermal mass

Because of the concrete construction as the main elements in the building, the building works as a thermal mass. When the weather outside has changed from cold to warm, the building's interior climate will remain cold for a while and vice versa. This could be used to stabilise the interior climate, but this only works in a well insulated building and Centraal Beheer is not.

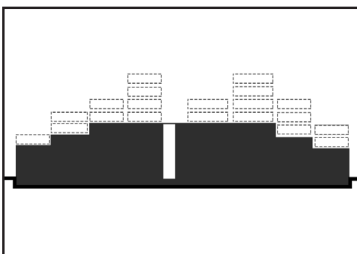

Opportunity: Expandable building

The construction of the building allows it to be expanded like a crystal in floorplan. The overdimension of the main building construction also allows for the expansion in a vertical way, allowing for additions on top of the building.

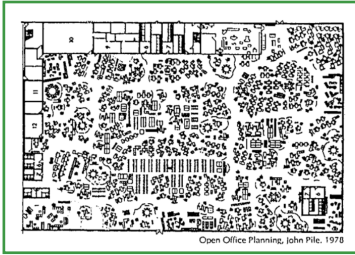

Historical / Newness value: Open office plan

The office floors of the Centraal Beheer function as an open office plan, allowing for free movement and connections between the workspaces. No inner walls were used in these office floors, creating a non-hierarchical open space.

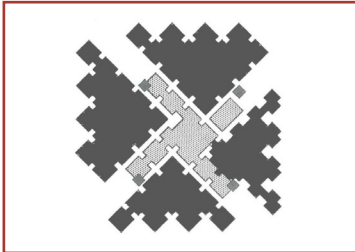

Use value: Public street vs private offices

The building has clearly been divided into four quadrants that house 'private' office spaces, which have no visual connection towards the more public center of the building: the inner street that connects everything together. This creates less distraction and functional work spaces.

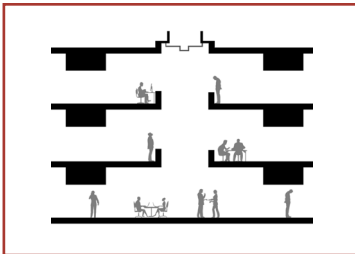

Use value: Vertical connections

The voids inbetween the units give the building an internally open structure, and also creates good vertical connections allowing people to communicate over different layers of the building.

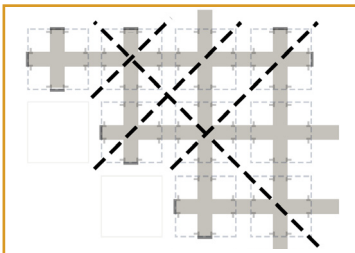

Art/ Use Value: Diagonal connections

Within the open office floorplans, an important design aspect are the diagonal connections that are created. Because there are no columns placed on the corners of the units, there is no obstruction, which allows for diagonal connection within the open floor plan, creating a non-hierarchical office space.

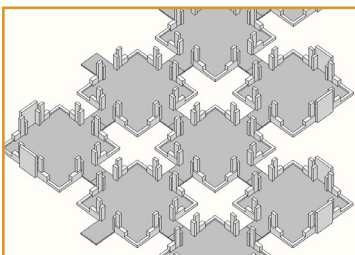

Rarity value / Opportunity: Open structure

The office floors in the quadrants consist of an open structure that allows for a flexible interpretation of the space. This possibly also allows easier transformation. The open structure also comes forth from the voids in the floors, which also allows for easier transformation because creating vertical connections is easier.



Structuralism value: Polyvalent space

The building provides the user with a polyvalent space, allowing them to change the use of the space, and giving them a framework to do this in.

The open floorplans also creates a high level of social interaction and feeling of 'community'.

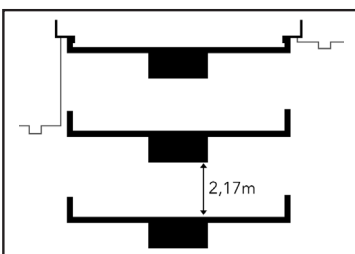

Conflict: Less flexibility in height

The height of the spaces within the building is not very flexible, especially the height beneath the installation spaces shaped by the primary construction beams. This space is only 2,17 meters high, which is (also admitted by Herman Hertzberger) a very low space to work with.

Surfaces (interior)



Historical / Structuralism value: Material interpretation

The buildings interior surfaces are mainly left as they were constructed giving them a raw appearance. This has been done intentionally by the architect, allowing for freedom for the users of the building to interpret the space as it is, and decorate the space themselves.

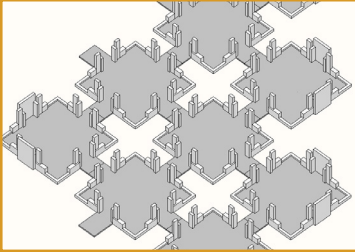

Rarity value: No inner walls

The building itself contains as few inner walls as possible within the office areas, creating a very open space, also creating less interior surfaces.

Services

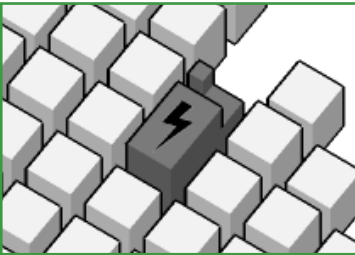

Historical / Newness value: Installation tower

The Centraal Beheer building has all of its installations managed from one central installation tower. This tower houses all of the main installation services, including the ability to generate its own electricity, making the building self-sufficient. The building was one of the first to have these type of installation services.

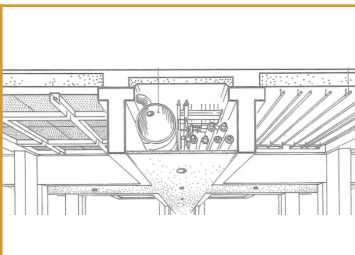

Use value / Opportunity: Integration

The construction of the buildings allows for the service installations to be integrated and kept out of sight. This allows for an open office space without any ducts or cables to run through open space.

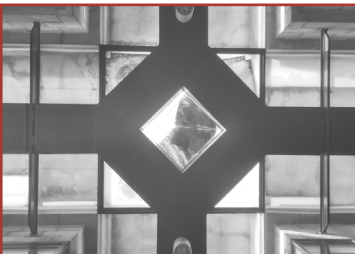

Art value: Integration of aesthetics and services

The rainwater collection system is made up out of gutters that allow for the water to flow away in a unique way. They are also visible from the inside because they are combined with the skylights. On the connecting parts between units they form crosses that create artistic value for the interior.

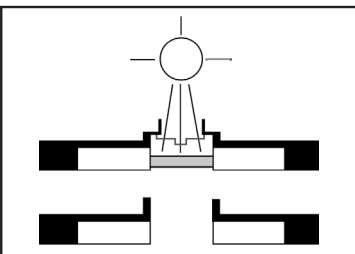

Conflict: Installations in the inner street

To connect the installation services through the inner street, where the construction does not continue, the installations run through specially made ducts, which contradicts the openness of the street and blocks natural light from the skylight above.



Age / Historical value: Furniture by Hertzberger

Within the building there are some particular pieces of furniture such as chairs, and specially designed lamps for the restaurant, that because of their age have become rare. They are specially designed by Herman Hertzberger, a big name in Dutch architecture.

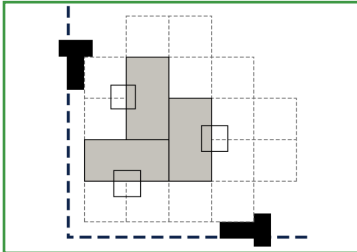

Use / Rarity value: Free interpretation of workspace

The workspaces of 3x3 meters have been designed with the desk size of 75 x 150 cm as a starting point. This creates a grid that allows for many different set-ups of desks within this space, ranging from 1 to 4 desks per workspace.



Newness value: Coffee corners

One of the new principles of working in the building meant that special coffee/break corners were created in the building where people would go to get and drink their coffee. At this time it was still common for someone to walk around with coffee which meant people would never get away from their desk.



Art value: Rainwater collection pool

In the middle of the public inner street there is an odd shaped rainwater collection pool. This pool used to collect rainwater from above that would drip into it. A problem was that when it would rain too much, the water would flood into the inner street. This was described by the architect however as an artistic value.



Structuralism value: Freedom of interpretation

The building has been built as a structure that houses space, rather than functions. The building allows for a free interpretation of space, and the use of raw materials meant that people had the freedom to decorate their own working space and create a comfortable working environment.

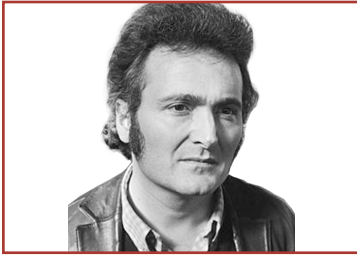

Historical value: First big Hertzberger project

The Centraal Beheer building was the first really big project for architect Herman Hertzberger and is still seen as one of his most important and defining buildings.

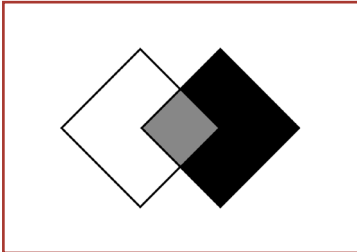

Use / structuralism value: conflict spaces

The building creates conflict spaces: spaces that force people to interact and meet each other. This was an aspect that was important in use, defining how people interact with each other, and also an important idea in structuralism.

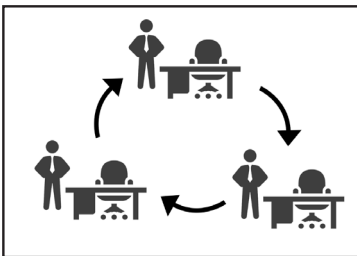

Opportunity: Flexible working spaces

In the modern times flexible working spaces are once more of big importance and widely used in office spaces, and the building lends itself well for this.

ICON OF STRUCTURALISM

Within the cultural value matrix column of structural value, we have chosen to give every layer of the building the value of 'Icon of structuralism'. The building can be seen as one of the most famous examples of structuralism in many levels that we think every aspect of the building is a part of this. From the exterior appearance to the freedom of personalization to the open and flexible space plan, they are all factors in making this building the icon of structuralism that it has become.

Conclusion

Our research question for this analysis was “What is the perfect unit?”

According to the dictionary a unit is a whole in itself, but is also part of a (bigger) whole. The unit that forms the base of the design of Centraal Beheer, and that we analysed, is the so-called ‘island’ of 9 by 9 meters. It is recognisable from the outside, in the expression of the facade and roof, but also from the inside. The construction of the building and the voids clearly defined the unit.

The perfect unit exists for the Centraal Beheer building, but only in theory. Theoretically, these units are linked together to form a ‘perfect quadrant’, which could be expanded endlessly. However, in reality the building has to be functional, so many exceptions were created. Besides, the building has to end and therefore have facades. Because of this the building will never work as the theoretical ‘perfect building’ made out of perfect units.

The exterior of the building at first sight does look quite perfect. It seems to be a very structural and logical expression of the perfect units, that are combined and linked together to form a whole. However, the many exceptions that the building contains means that the building has become very complex and difficult to comprehend.

Herman Hertzberger designed the building from the inside out, meaning that the functionality of the building and the social interaction that could take place are the most important elements and the exterior is just a result of the interior of the building. The exterior of the building however has such an expressive composition which clearly expresses the units, that the appearance of the building has become iconic and a symbol of structuralism. Because of this iconic value the building has been granted the status of municipal monument, meaning that the exterior has unintentionally become a very important aspect of the building.

This analysis searches for the perfect unit in the building of Centraal Beheer. However, the goal of Herman Hertzberger was not to create the perfect unit in the perfect building, but to make social spaces in which the unit is just the means to an end. It forms the foundation to create an office space that is flexible and interpretable, but does not have to be perfect everywhere. The exceptions are created to make the building functional, but the ‘perfect unit’ will still be a base on which these exceptions are created. These exceptions also create variety in the building and make it an interesting whole.

This analysis does not contain the answer to all questions and not every aspect of the building has completely been analysed. This leaves space for future research to possibly answer questions that we still have and more.

The cultural, architectural, and technical value of the Pakhoed building and the entrance building have not been analysed yet. The main focus of this analysis (and the ones from the previous semester) was the original building built in 1972. Even though these later additions do not share the monument status with the original building, they still could be valuable or usable. More practical questions regarding the construction of the building were not all answered. How exactly the double layer of construction in between layer 0 and 1, allowing for difference in floor height (pits) and extra installation, was constructed is not clear. Also, in the computer room special adjustments were made to create an autonomous climate for this specific use, yet this room is connected with normal office space above, by the use of voids. The question remains whether these voids were part of the original design or whether they were added in later, since no traces of demolition or adaptation are visible.

Some more questions remained about the (lack of) use of color. Hertzberger remained very neutral in his material choices within the building. Creating raw material surfaces and leaving space for interpretation by the user. However the window frames in the facade and the construction of the gutters and the skylights have been painted purple, but it is not clear if there is a reason for choosing this specific color. Furthermore, a variety of shades of purple currently exists on different parts of the facade. Has this been intended or is this part of a natural process in which the sunlight affected the color?

The biggest question remains how this building could be transformed for future use. In the next phase of the design process we will try to find multiple answers to this question.

Appendix

- I. Transformation of the building
- II. Timeplanning and organisation
- III. Building shape
- IV. Garage
- V. Restaurant
- VI. Technical tower
- VII. Extra construction layer
- VIII. The street
- IX. Change office use
- X. Flooring
- XI. Bridge extension
- XII. Facade
- XIII. Orientation
- XIV. Computer room

I. | Transformation of the building

Centraal Beheer, by Herman Hertzberger, was built

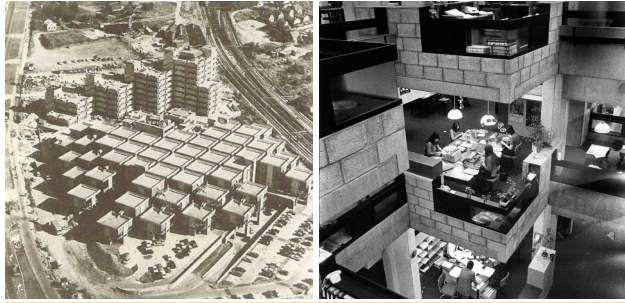

Pakhoed building was built

Extension between Centraal Beheer and the Pakhoed building was realised.



Centraal Beheer is listed as a monument

The insurance company left and the building became vacant.



Plan for the transformation of the office building Westpoint into a housing complex by BUN.

1970's

Office Building Kadaster is built

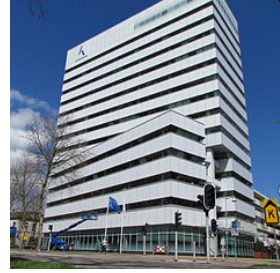

1972

1973

Glazed bridges were added and the floors were covered with carpet. The building was made more 'formal'.

1990's

1995



1997

Renovation of the Kadaster building by Mart van Schijndel

2007

Renovation, by EGM architects, of the interior of the Kadaster building

2009

2012

Certitudo Capital planned Hertzberger parc, a plan to transform the building into a housing-working program.

2017



II. | Timeplanning and organisation of Centraal Beheer



Fig. 99: Photos during the construction of Centraal Beheer.

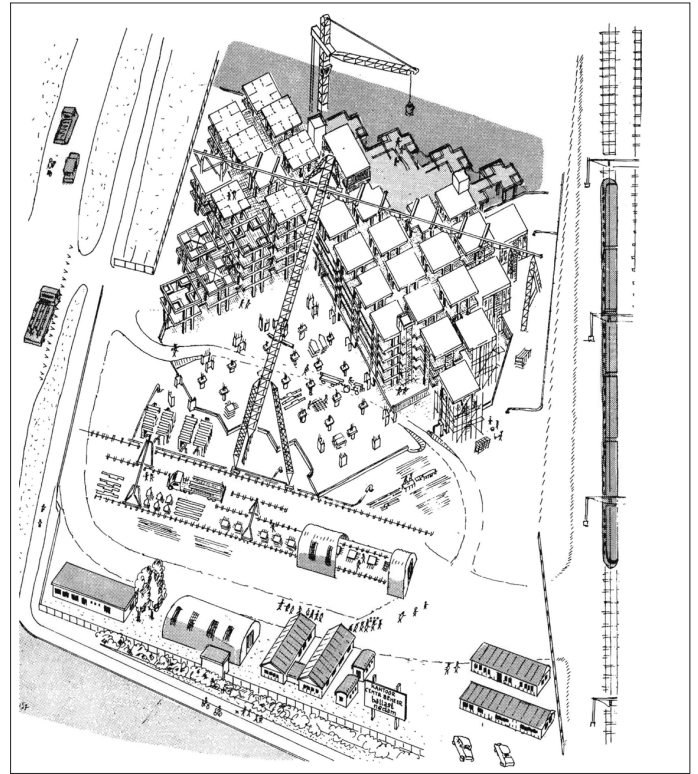

Fig. 98: Drawing of the construction of Centraal Beheer.

In 1968 a basic program was made and a global overall plan with the most important data. The project should be finished around August 1972. The program was finalised August 1968. 35 departments should be housed in the building, and an open office landscape should be considered.

In Fig 96 we can see the overall plan, and that the time scheme was retained so far.

An important element missing in the overall timeplanning for Centraal Beheer is the consultation with the municipality of Apeldoorn about the placement of the office in the context.

The overall plan was not detailed enough so a network plan was set up (Fig 97).

In the planning and network scheme strong detailing in the design- phase does not seem desirable.

But closer to the construction phase, detailing is desirable to control the whole process.

The total costs for the Centraal Beheer building was around the 32 -36 million (gulden).

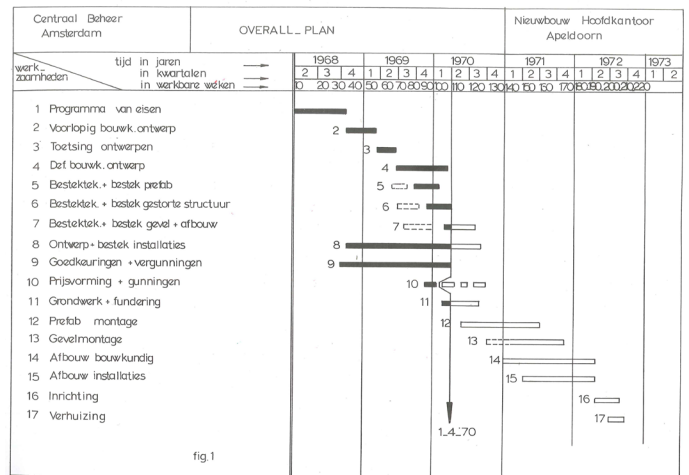

Fig. 96: Overall Timeplanning for Centraal Beheer.

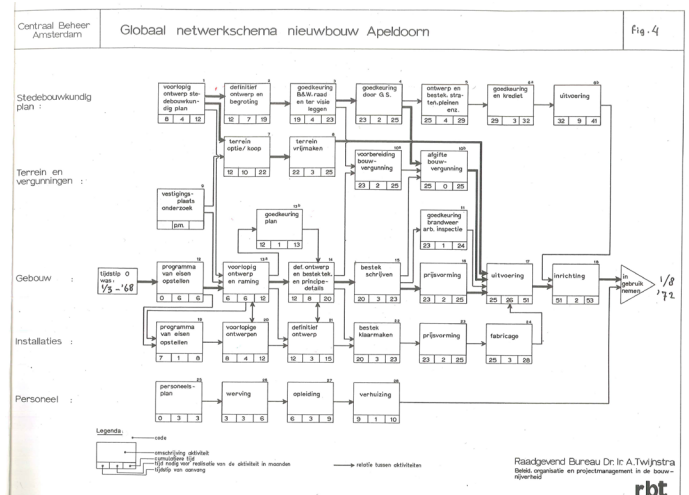

Fig. 97: Network scheme for Centraal Beheer.

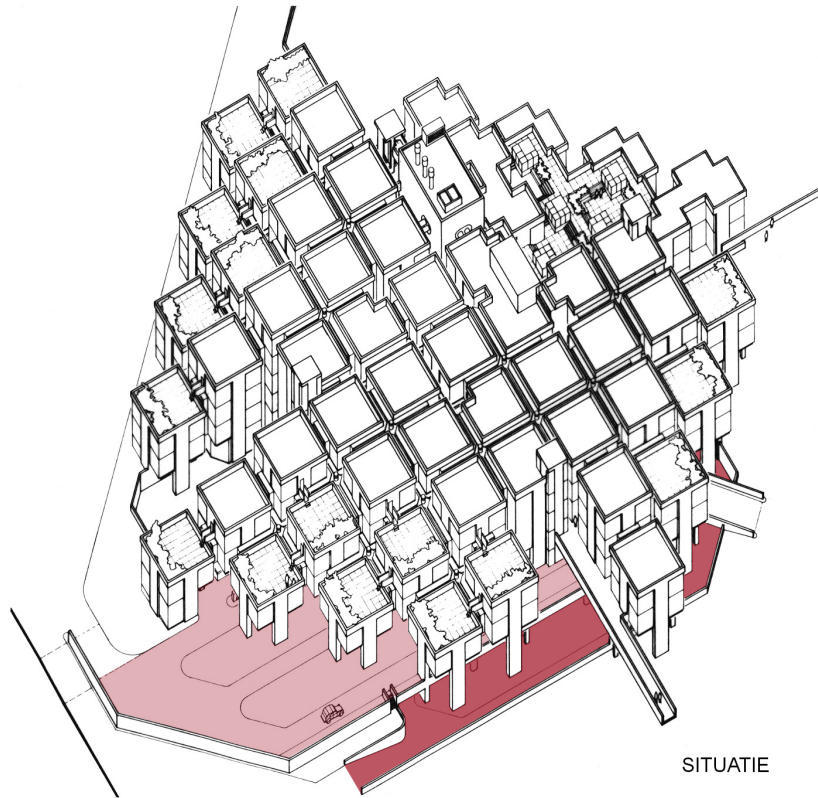

Fig. 106: Axonometric view showing the edge of the parking garage.

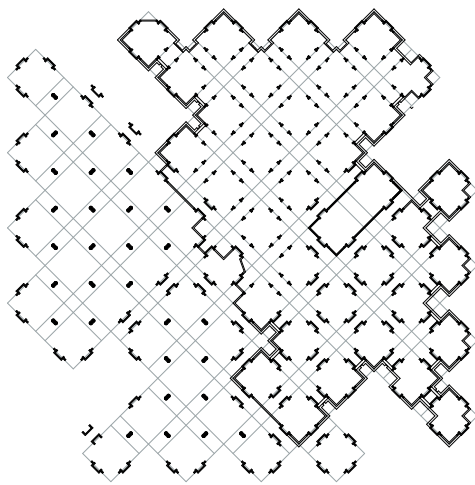

Fig. 104: Edge of the cellar parking garage.

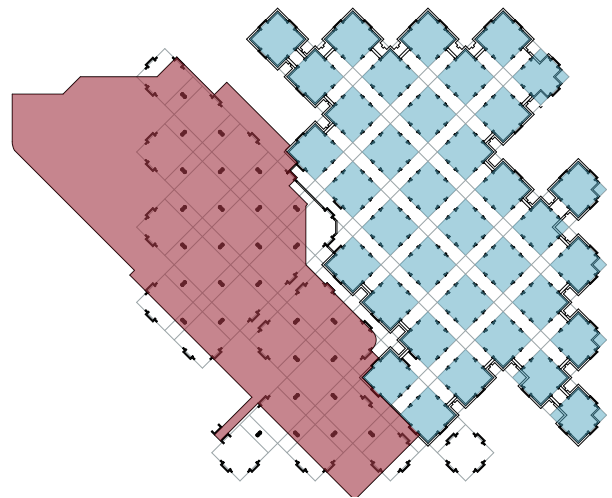

Fig. 103: Edge of the parking garage, layer 1



Fig. 105: Picture of an inward corner.

Layer 0 and 1 show the largest deviation from the established base form. This is mostly due to the parking garage being placed on these floors. A lesser, but still notable exception to the rule found on these floors, are the corners of several squares that are turned inward, diverging from the base shape of the 9 by 9 meter square.

IV. | Garage



Fig. 110: Schematic models of the exception on the general order (left), with the parking spaces underneath the building (right).

On the bottom two layers of the building the general order of cubes is interrupted by the parking spaces underneath the building. This creates a new type of space within the building, where besides outside and inside space, there is now a part of the building which is sheltered. The south and west quadrant of the building on the bottom two layers are in open connection with outside, but covered by the building above.

Hertzberger's opinion on outside parking is that having to cross "endless fields of shiny tin-plate" before finally reaching the entrance of a building covered by a small shelter is highly depressing and inhumane. His solution to this problem is integrating the parking with the building as he did for the Centraal Beheer building, where you are already 'inside' the building when parking your car. This way the walking distance from car to entrance was minimised.

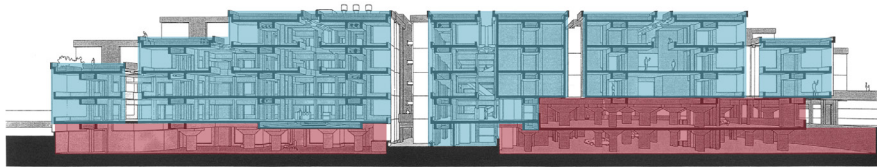

Fig. 109: Section that shows where the parking spaces are placed underneath the building.



Fig. 111: Photograph of cars outside of the Centraal Beheer, not long after completion of the building.



Fig. 108: Photograph of the 'sheltered' parking spaces under the building.

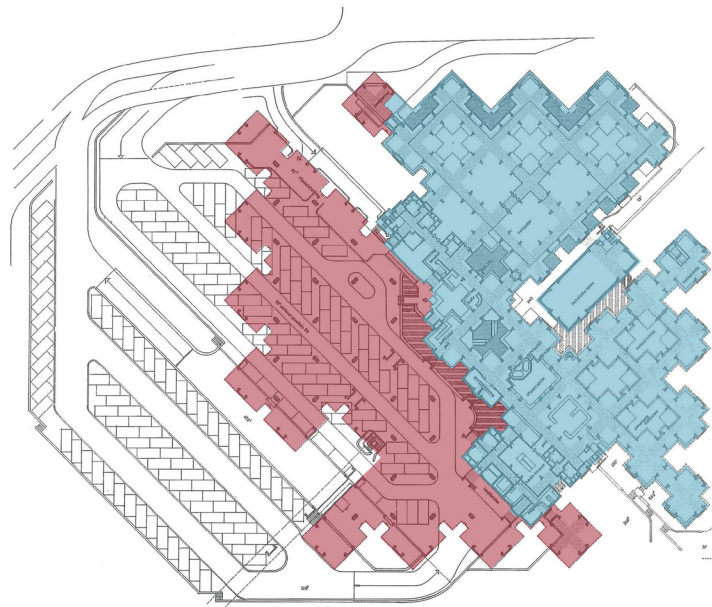

Fig. 107: Floorplan of layer 1. Blue depicts the closed/built area, red depicts the sheltered area where cars are parked and white is outside space.

IV. | Garage | Construction

An exception of the standard construction system is visible in layer 0 and 1, in the south and west quadrant. Instead of offices, the space here is in use as parking spaces. The standard grid system does not allow for a efficient parking garage, so another grid with less but bigger columns is constructed here.

Instead of the T columns, oval shaped columns tapered at the top are constructed on a grid. Concrete square blocks are places on these round columns to transport the forces of four T columns on top.

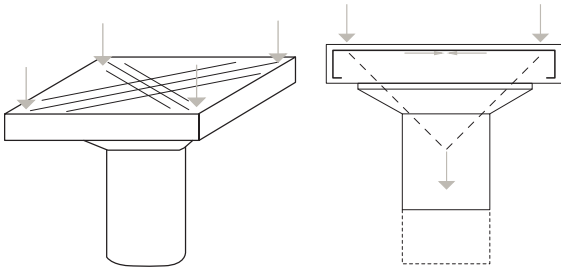

Fig. 116: Forces and shape of the columns in the parking.

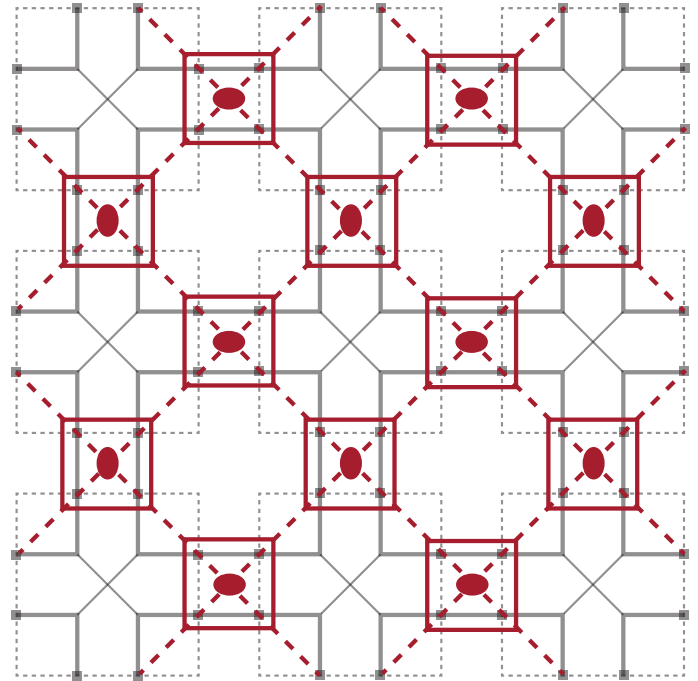

Fig. 112: Standard grid system with the exceptional grid of the parking layers.

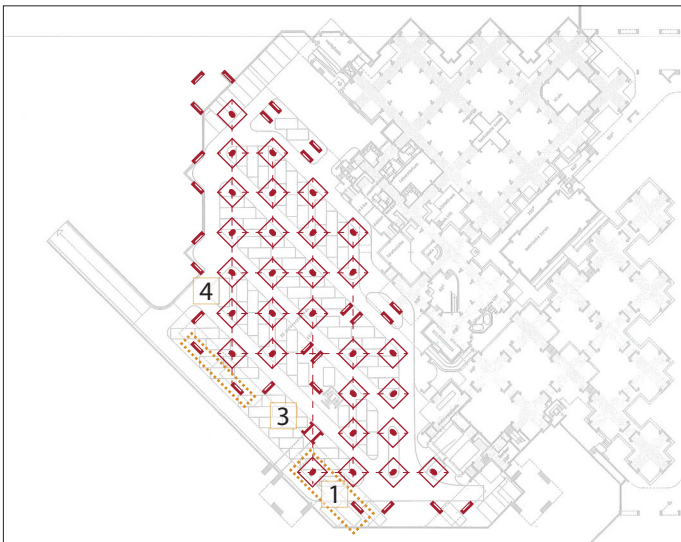

Fig. 113: Grid of the parking in layer 0.

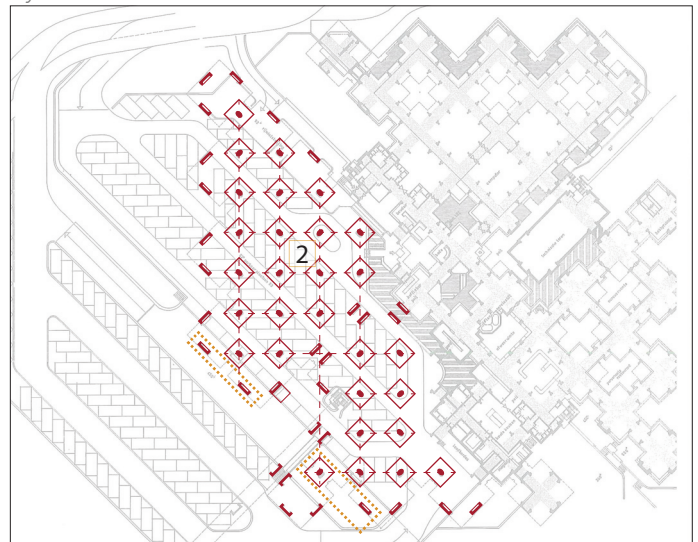

Fig. 114: Grid of the parking in layer 1.

Even in the parking grid there are some exceptions. One of the rounded columns has a length over two layers instead of one. At the edges of the grid/building, the standard T columns and facades of the levels above are extended down into the parking. The T columns and the facade element form an U-shape element with one open side. But at some places these elements are closed, and some have the length of two levels. The reason for closing these elements is probably to create vertical shaft space for installations in the building. All these exceptions are visible in Fig 115, 1/4.



Fig. 115: Photos taken in Centraal Beheer with the exceptions of the construction at the parking layers.

V. | Restaurant | Facade

The restaurant of the building can be found on the first floor. This part of the building not only differs in function from the rest of the building, but also differs in shape. Looking from above the general shape of the squares that define the outside facade is not continued in the restaurant. On most corners of the units, a part of the facade comes inside the grid of the squares. This creates a different spatial experience inside the building and allows for sunlight to reach deeper into the restaurant.

The interior of the restaurant also has a change in the general rules of the units on the level of the lay-out in the interpretable zones, where pits are created where people can have their meals. (see page 63)

Later an extension was made in the restaurant, where a circular shape was inserted within the tissue of the squares. The space created is used as a rentable conference space and connects the restaurant to the roof terrace. The circular shape is contradictory to the general order of the building where only square shapes are used, and therefore stands out in a very noticeable way.

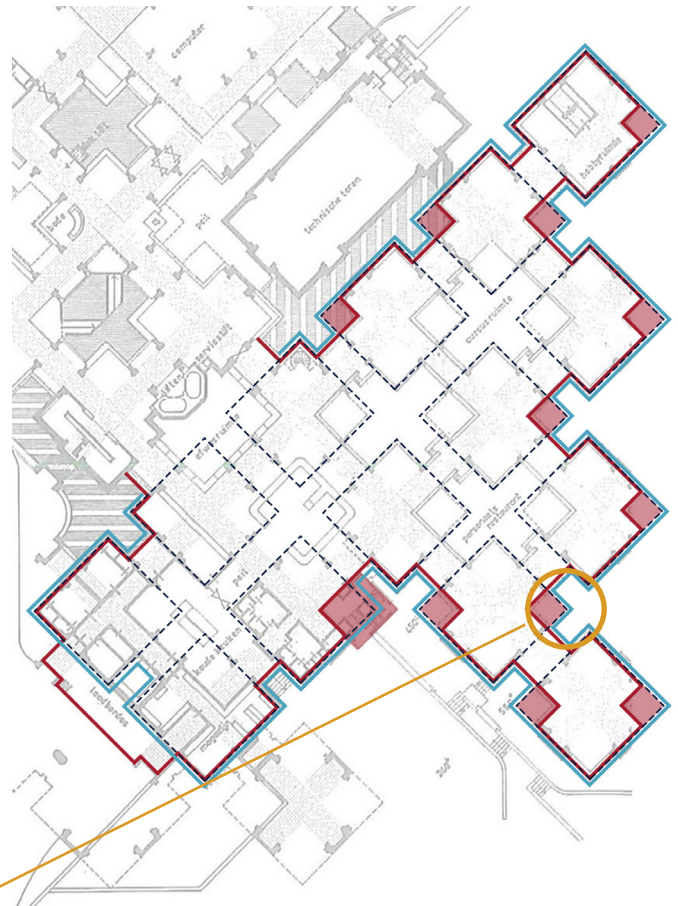

Fig. 117: Floorplan of the restaurant area shows the exceptions on the grid of squares, mainly in the facade (red), in comparison with the general order facade (blue). A later extension is marked in yellow.



Fig. 118: Photograph of the restaurant facade exceptions from the outside.

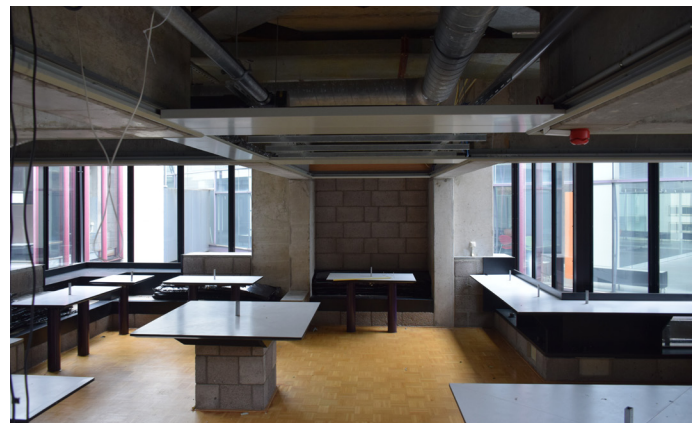

Fig. 119: Photograph of the interior of the restaurant, where on the left you see the glass facade that follows the general rule of the facade, and on the right you see the corner coming inwards.

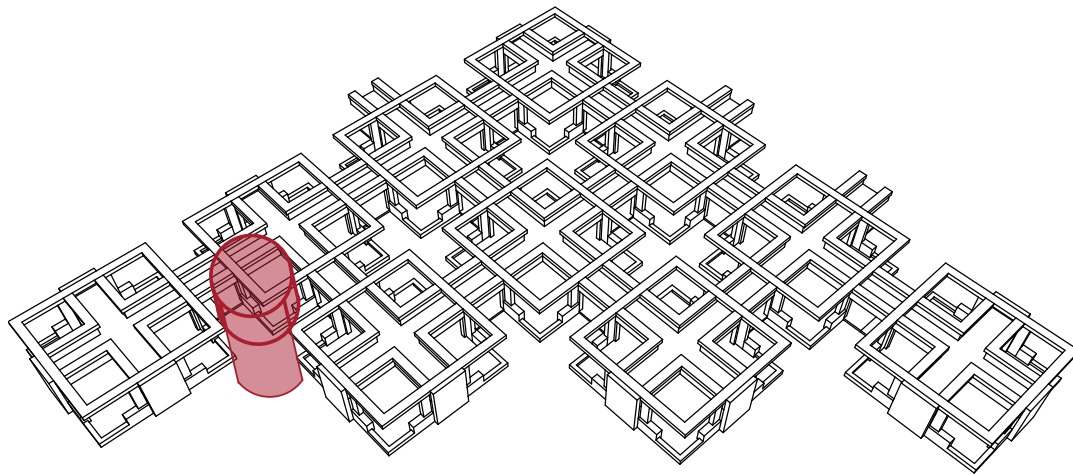

Fig. 123: 3D model of the construction with the exceptions at the construction ends.

The complete structure of Centraal Beheer seems to be constructed out of squares and straight lines in a grid system. But there is one outstanding element; an extension at the roof terrace above the restaurant. It seems topped up at the terrace, it has a circular form and the construction and window frames seem to be from steel. Not only the topped up part is an exception, there are also 3 lowered terraces at the roof.

The extension closes off the whole corner of the building from layer 1 up till the roof. This extension is a later addition, since the station stayed at its old place there was no pedestrian walkway next to Centraal Beheer. In the original design there was a stair and elevator in the extension from the ground floor to connect the pedestrian street with the restaurant and the roof terrace. In the current extension there only is a stairs from the restaurant up to the roof terrace.

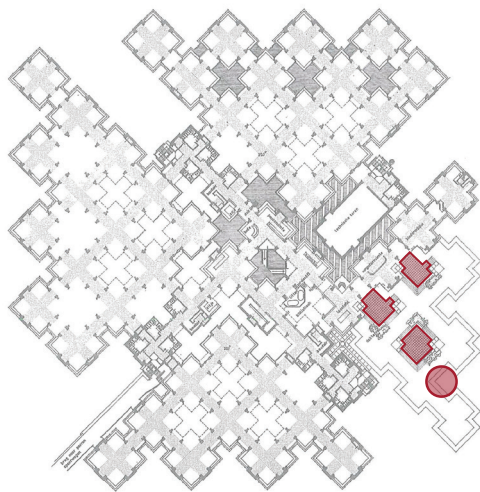

Fig. 120: Plan of layer 2 with the exceptions of the roof above the restaurant.

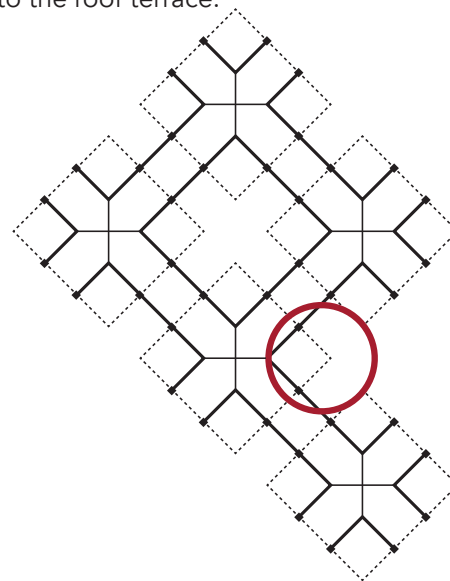

Fig. 122: Zoomed in construction with the circle exception.



Fig. 121: Photo's of Centraal Beheer of the extension above the restaurant.



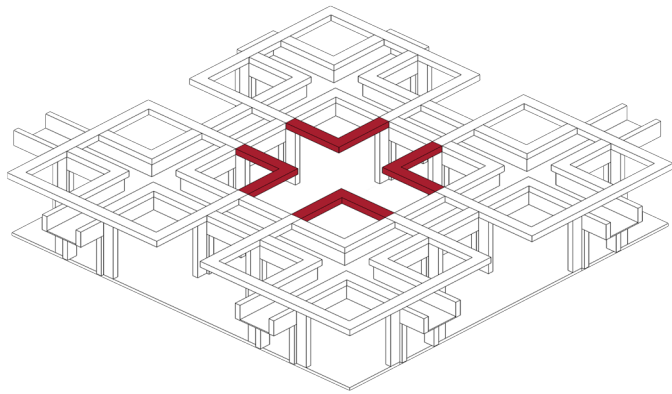

Fig. 129: Regular structure.

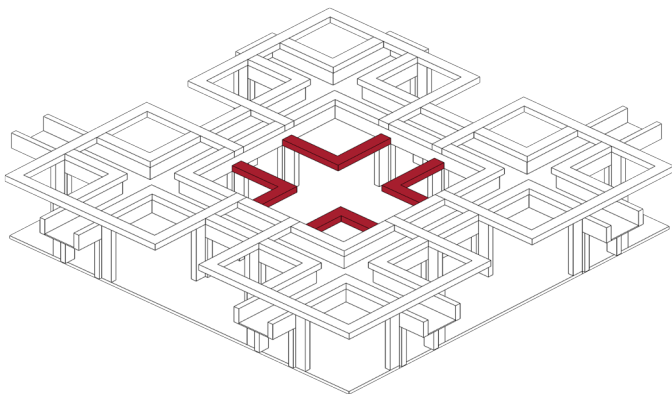

Fig. 128: Theorised lowered beams.

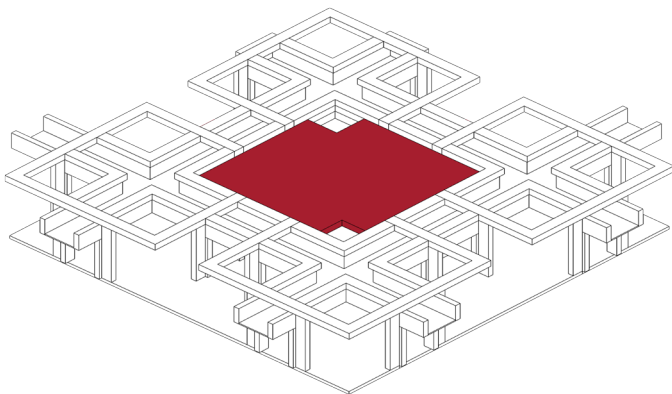

Fig. 127: Lowered floor.

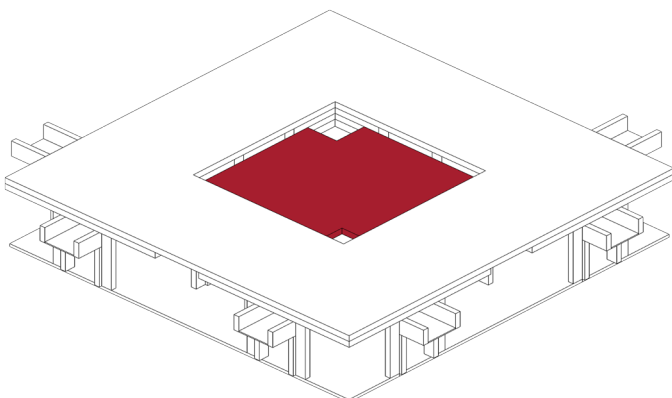

Fig. 124: Lowered floor compared to the regular floor height.

The roof terrace above the restaurant is an exception to the stepped pattern of the whole building. This terrace, located on the 2nd floor, runs from the outer edge almost completely to the inner street. Aside from that, there are also several changes in its spatial composition compared to the other roof terraces.

There are several lowered area's. There had to be some changes to the construction to allow for this difference in height. Four of the secondary beam corners were probably lowered. Because these beams lose some of their structural security by doing this, it might very well be, that between these beams is a concrete cross. This would be similar to the cross found at the intersection of the service ducts (fig. 130)

Small cubic skylights that pertrude from the terrace allow for light to enter the restaurant without any artificial light sources. This creates a few well lit up corners within the restaurant. These cubic skylights are unique to the east quadrant, and therefore an exception. The rule is the use of the inbetween space to allow light to enter te building, through skylights that run along the gutters.

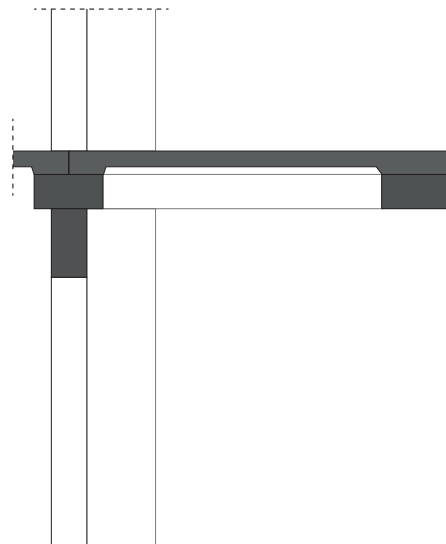

Fig. 126: Detail of regular beam and flooring situation.

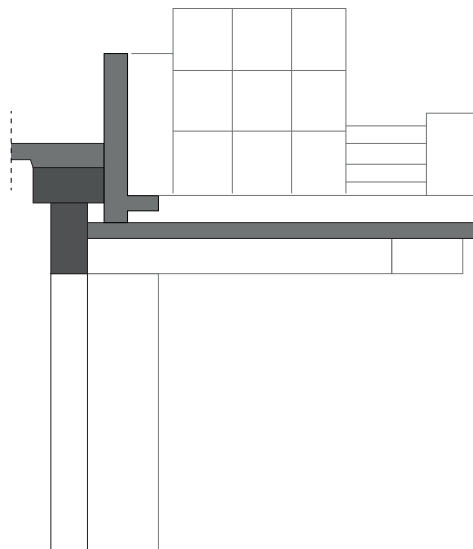

Fig. 125: Theorised detail of the lowered restaurant terrace.

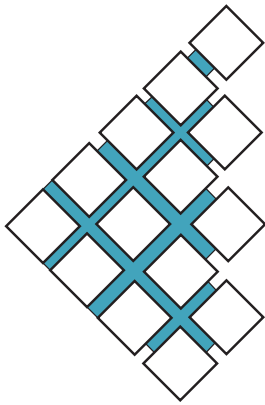

Fig. 131: Skylights normal quadrant.

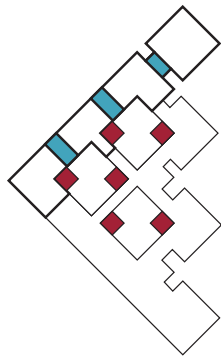

Fig. 132: Skylights Restaurant.



Fig. 135: Skylights and lowered terrace above the restaurant.



Fig. 130: Concrete cross supporting the primary beams.



Fig. 134: Light falling through the restaurant skylight.

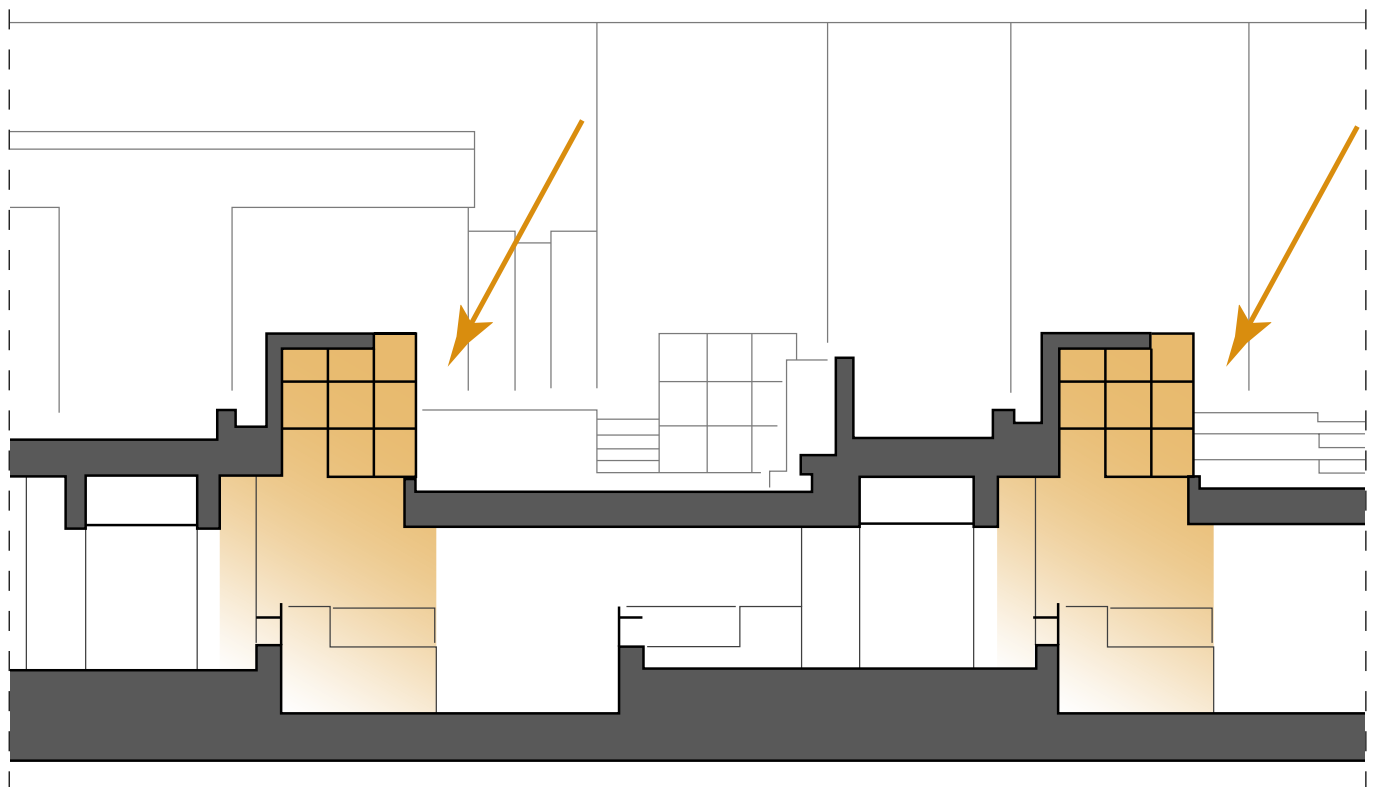

Fig. 133: Schematic section showing daylight entry in the restaurant.

V. | Restaurant | Lay-out

As explained previously, the restaurant is an exception to the rules of the unit, where the facade of the restaurant does not follow the general order of the unit.

However, also the lay-out of the restaurant differs greatly from the general order lay-out, used in the offices. In the interior of the restaurant 'pits' are created in the floor that also don't follow the general grid of squares that exists in the rest of the building. In these 'pits' tables and chairs are placed where people can sit and eat their meals. This is however not only a place where people have their meals but also social interaction takes place in many forms.

Set-ups of tables, chairs and stools in the restaurant create different types of possible social interaction. Hertzberger feels that in the general office restaurant generic tables of 6 or 8 people create a unity based social setting.

To create more interaction 3 different set-ups are created:
 R1: For those who are alone and want to be alone.
 R2: For those who are alone but don't want to be alone, these tables allow for people to join others.
 R3: For groups of 2 or 4 people that want to be together as a group.

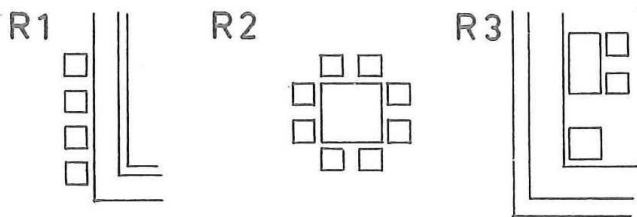

Fig. 137: Restaurant set-ups that offer different forms of interaction.



Fig. 136: Photograph of a restaurant 'pit' in use.



Fig. 141: Photograph of seating on the outside edge of the pit.



Fig. 139: Photograph of a restaurant pit in 2018.

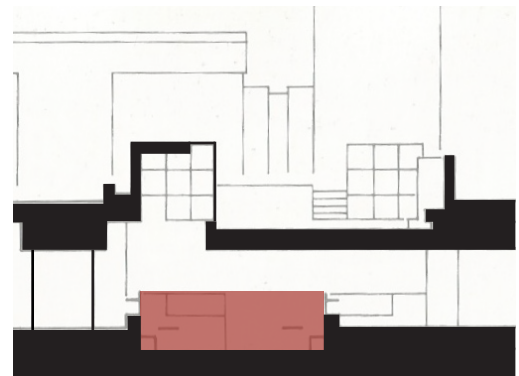

Fig. 140: Section of part of the restaurant pit.

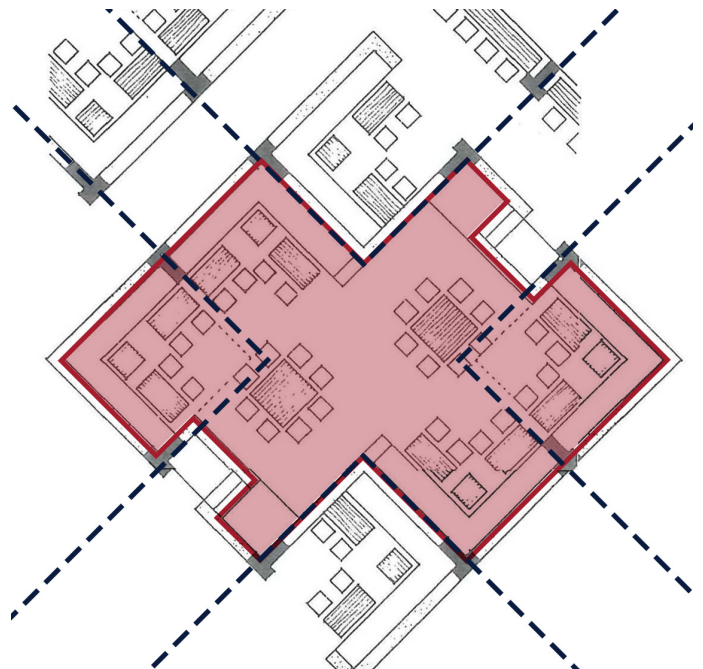

Fig. 138: The exception of the restaurant 'pit' and its furniture.

VI. | Technical tower

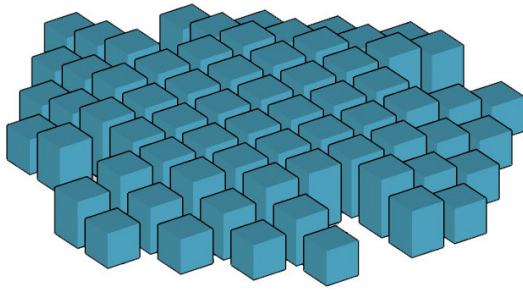

Fig. 142: The mass of the building if they continued the order.

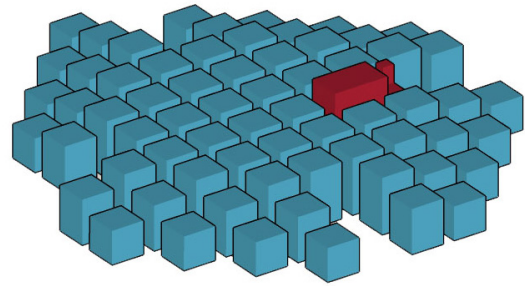
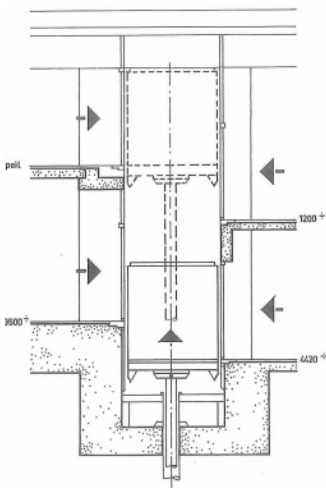

Fig. 144: The technical tower is a disorder in height and size.

The technical tower housed all the technical facilities for the installations of Centraal Beheer, see figure 143. Centraal Beheer is the first office building in the Netherlands that generated a part of the needed electric energy itself through its own electric power plant which is located on layer 0 of the tower. The power plant contain:

- Three transformers with a total power of 2200 kVA.
- Three gas engines 450 kW to power three generators.
- Three residual heat boilers, using the heat of the hot exhaust gases from the engines.



In figure 144 & 145 it clear that the tower is a large exception in the exterior of the building. It is together with the stairs the only part of the building that is higher than the rest of the building. Interestingly they choose a hydraulic elevator to prevent it from sticking out of the roof, but the technical tower and stairs are allowed to stick out.

Fig. 146: Hydraulic elevator.

Layer 5:

Cooling towers and gas reduction station.

Layer 4:

Boiler house and cooler.

Layer 3:

Central air treatment chamber and water heaters.

Layer 2:

Air distribution system.

Layer 1:

P.T.T central.

Layer 0:

Power plant.



Fig. 145: The existing situation of the site were the tower really stand out.

Beside the fact that the tower falls outside order in the height, you can see that also the appearance of the skin of the tower is different. The same material is used but the composition of the tower is very closed in comparison to the rest of the building that has a very open composition.

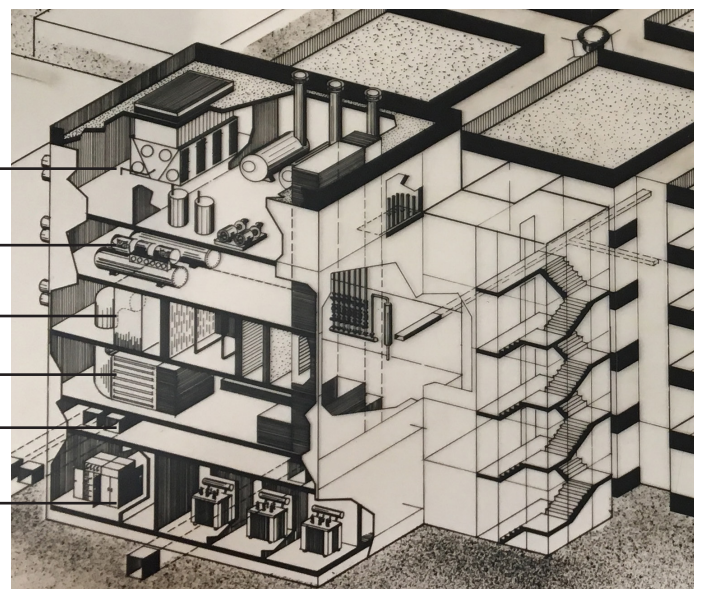

Fig. 143: Section through the technical tower.

VI. | Technical tower

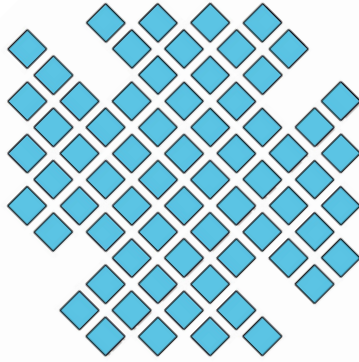

Fig. 151: The order of the grid from above without any disorder.

At first glance it looks as if the tower stands exactly on two units of the grid but if you look closer there are much more exceptions. The tower ends in the middle of a unit and for the maximum flexibility in the tower they left out four columns.

If you walk through the building the tower feels like a completely detached element of the building. After layer 2 it really stands loose from the rest, while the islands around the tower are four layers high. On the place of the traffic space (the gray line in figure 153) the tower is still connected on one place with closed pipes and on the other place by a bridge. Even by the brigdes the walking line is blocked by a stair and a wall.

1



Fig. 147: Space between technical tower en facade, covered pipes.

2

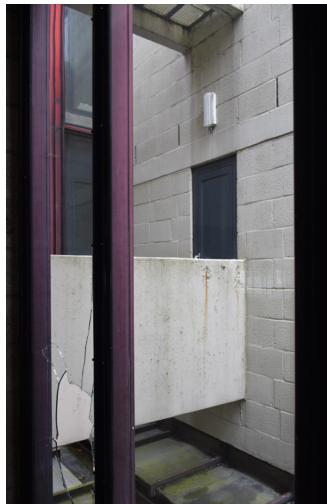

Fig. 150: Bridge between technical tower and facade.



Fig. 148: View on the tower from the roof terrace of the restaurant.

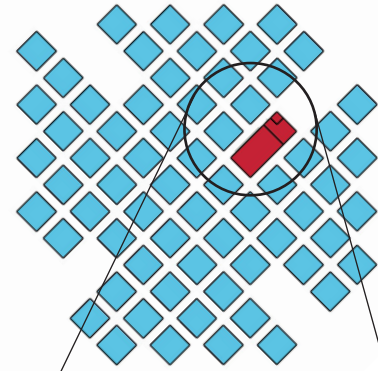

Fig. 152: Grid of the floorplan with the tower as a expection.

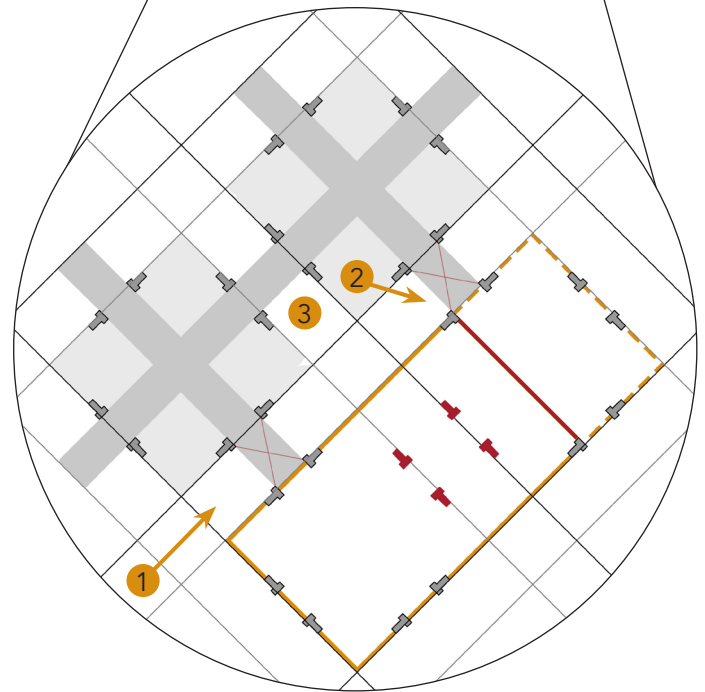

Fig. 153: Space between technical tower en facade and place of the tower in the construction system.

3



Fig. 149: Closed void between technical tower and computerroom.

The void in the street between the tower and the computerroom is closed off. This is probably because of the separate climate system of the computerroom.

VI. | Technical tower | Technical areas



Fig. 154: Technical rooms, now and in the first drawing.



Fig. 155: Escape floorplan of layer 0, with the interior how it is now.

1



Fig. 156: Added technical room under bridge.

In the original drawings there are two technical areas, the technical tower and a technical room under the computerroom. The second one is shown in figure 154 in yellow exactly in the traffic space of the floorplan. In later floorplans this room was expanded but now is moved to the former safe.

The technical rooms shown in number 1 and 2 are added later but we have no information when this happened because even in the most up-to-date floorplan these rooms are not shown. However, it can be concluded that the original technical areas were not enough for the changing desires and requirements.

2



Fig. 157: On the right the added technical room under the island and on the left the other added technical room.

3



Fig. 158: Oiltanks likely used as backup generators.

VII. | Extra construction layer



Fig. 159: Photos of Centraal Beheer of the extra construction in between level 0 and 1.

In the eastern quadrant a lot of different exceptions are visible. One striking element is the lowered floor in the interior of the restaurant and the lowered floor of the roof terraces. Also in the North quadrant on layer 1 there is a computer room, partly with a wooden floor.

All these elements made us think that there possibly is an 'extra' construction to make these exceptions possible. But we are not certain if there is a difference in the construction and how it is constructed.

VIII. | The street | Communal space

The street functions as the communal space for the entire building. It is an intricate space with many corners, small spaces, places to sit, and places to meet. Hertzberger used street materials to get the feeling of being outdoors. He used concrete tiles, skylights, and stone benches. Although the street was made within the structure of the 9 by 9 meter units, it does largely diverge from the perfect unit. The 3 by 3 meter workspaces are often not recognisable anymore, or branch out by the placement of structures, walls, etc. On the higher floors the voids sometimes connect, breaking the connection between units, and with that alter the direction of movement. The street is also the place where the more unique objects can be found. For example the basin in figure 186.

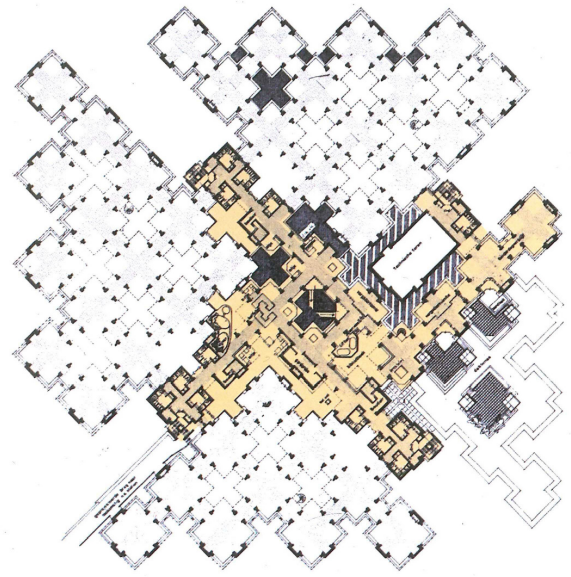

Fig. 164: Street on the 2nd layer.

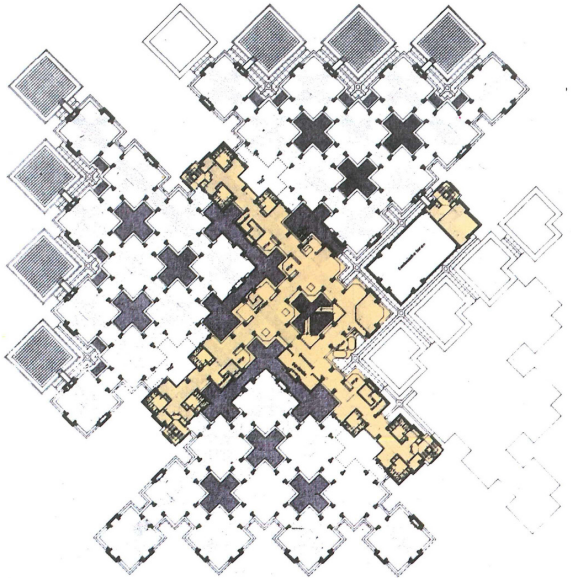

Fig. 162: Street on the 3rd layer.

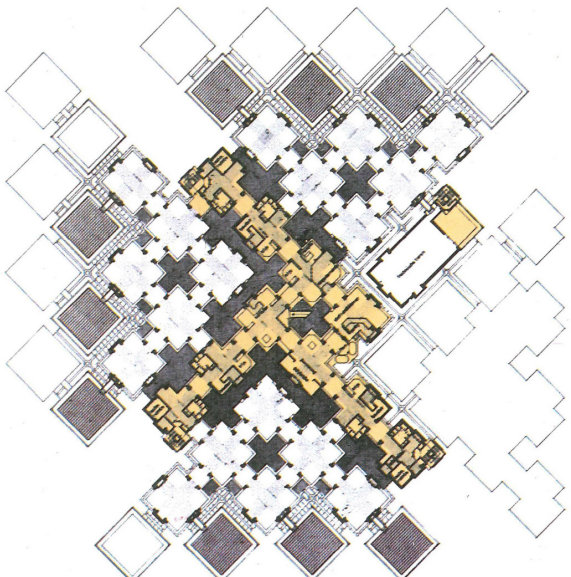

Fig. 163: Street on the 4th layer.

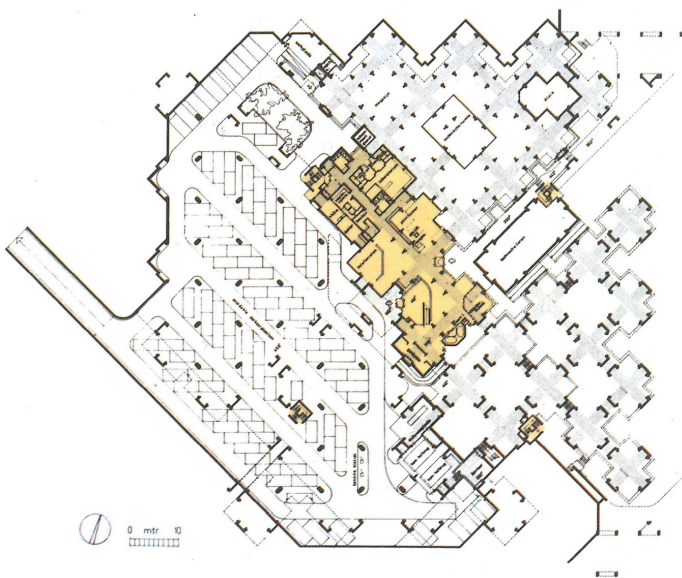

Fig. 161: Street on layer 0.

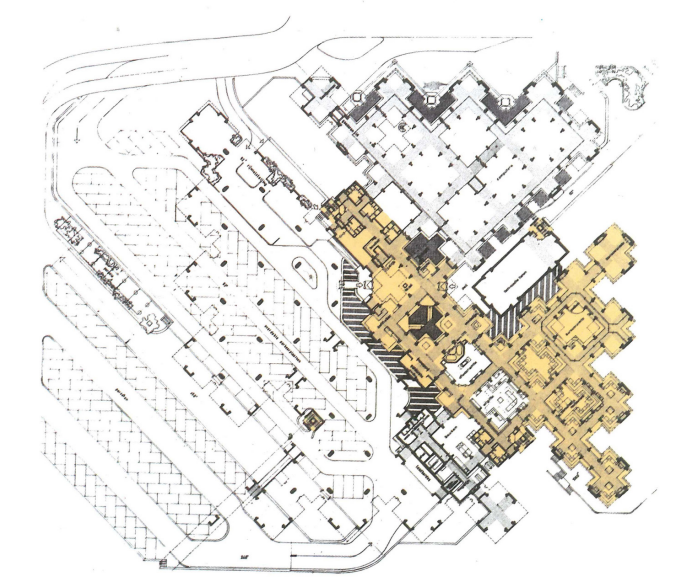

Fig. 160: Street on the 1st layer.

VIII. | The Street | Vertical movement

The Centraal Beheer building is very flexible in its vertical routing connection. The primary vertical connection to the different floors lays within the heart of the building. From here the different floors can be reached using the escalators or the adjacent elevators. Although the escalators are large objects, they can be dismantled and removed with relative ease.

Because of the size of the building there was need for secondary staircases. These were placed at some of the voids to allow for quicker access between floors. These stairs are lightweight, made of steel, and can easily be removed, making it possible to alter the placement of vertical connections to the need of the building.

The only exception to the flexible vertical connections are the 4 stairwells placed at the far ends of the central communal space, 'the street'. The stairwells are made of concrete, making them dark and closed off. It's very likely these stairs were placed as a fire safety requirement, serving as the main escape routes. People may have used them as a quick connection between floors, but if they were intended in such a way is unclear.

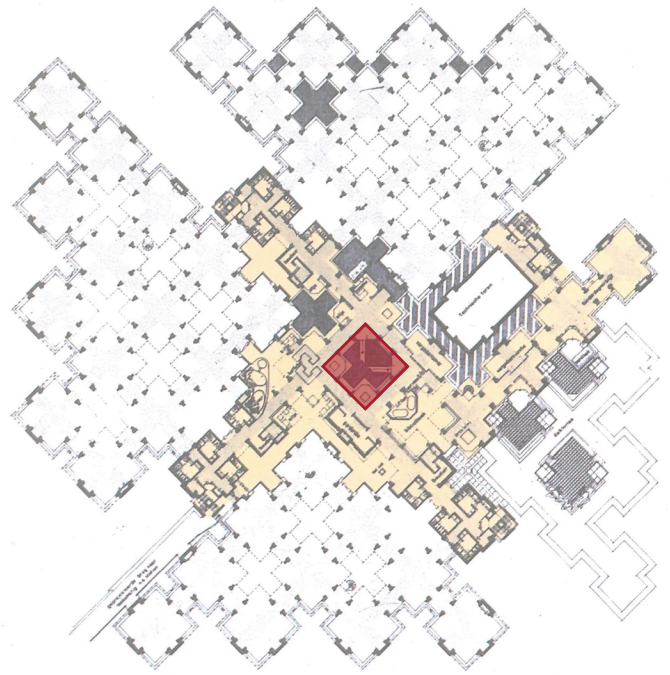

Fig. 165: Escalators central location in the building.



Fig. 166: Escalator landing.

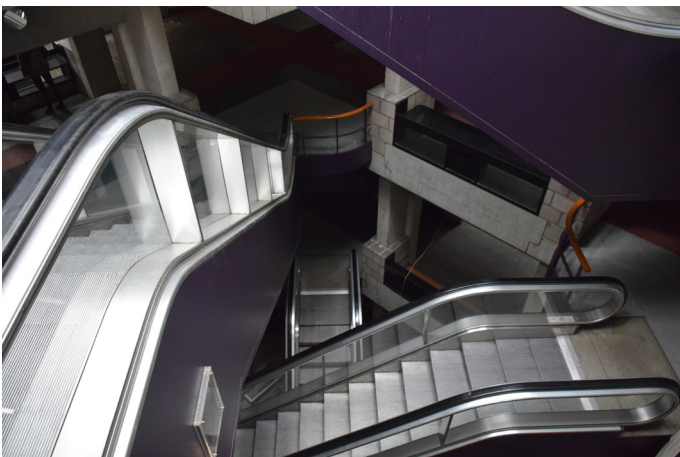

Fig. 167: Crossing of the escalators.



Fig. 168: Winding staircase in the street.



Fig. 170: Winding staircase as seen from above.

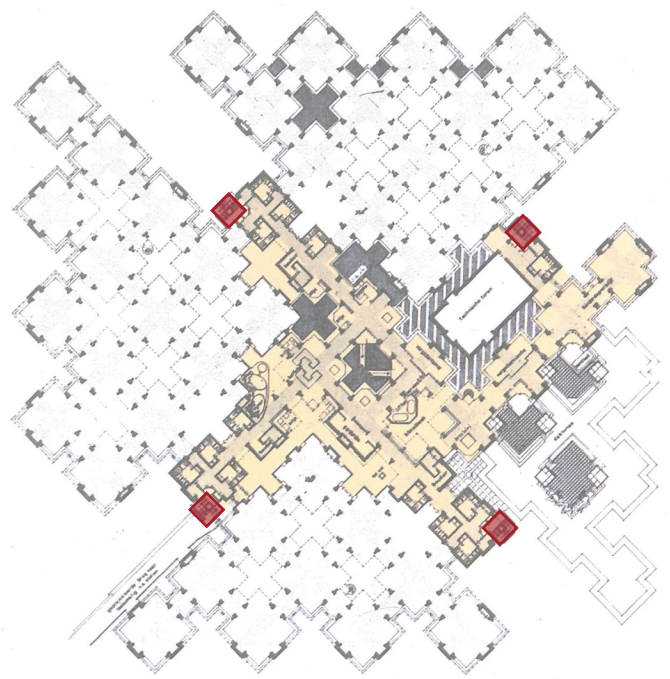

Fig. 169: Location of the stairwells.



Fig. 171: Winding staircase as placed at several of the voids.



Fig. 172: Stairwell located at the four ends of the street.

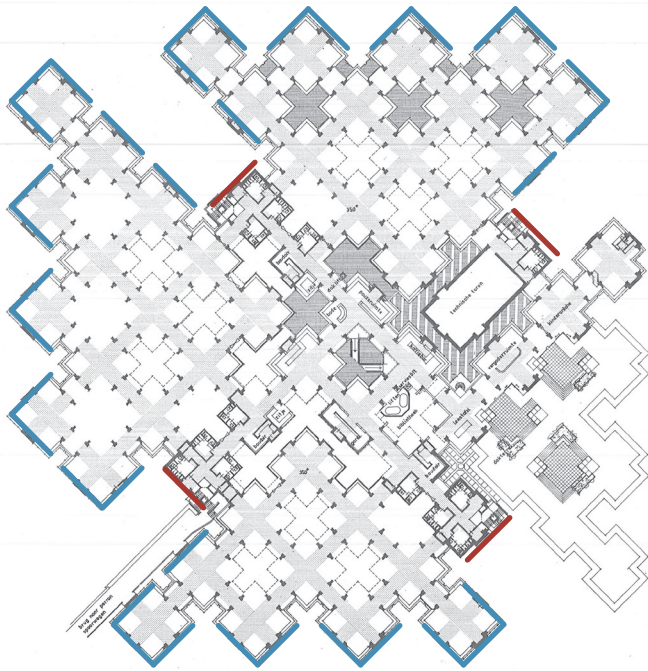

Fig. 178: Regular facade (blue) and closed exceptions (red).

The exterior of the Centrale Beheer building is very repetitive and non-hierarchical. The facade is organised per unit and symmetrically composed. The facade is divided into three equal parts. Full height four part windows enclose the workspaces and concrete bricks are used to fill in the middle (Fig. 177).

One of the exceptions to this regular facade are the stairwells and toilet groups that form the ends to the public streets (Fig. 173 to 176). The stairwells have access to daylight through one part width windows (instead of four). The horizontal sills are adjusted to the height of the stairs. The facade of the toilet groups is completely closed and has some vents.

The reason for this exception is very practical. The stairs and toilets would simply not have fit behind the standard open facade. It offers opportunities for future uses, because the stairs can still be used and the toilets could remain or this area could be used for other vertical transportation like shafts.

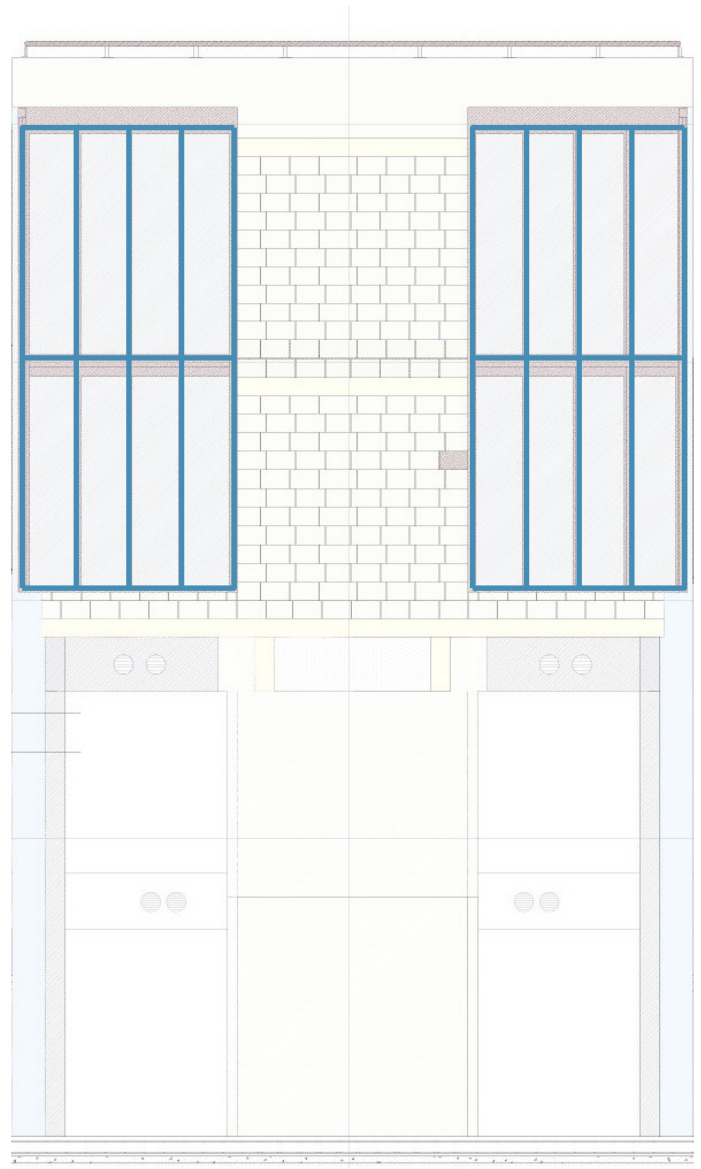

Fig. 177: Standard facade.

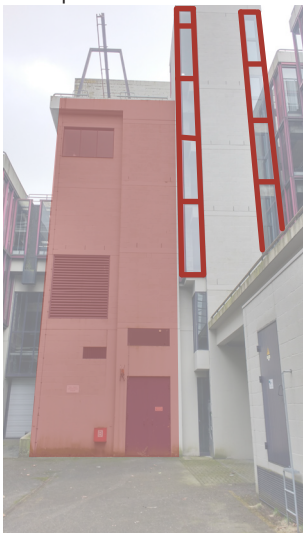
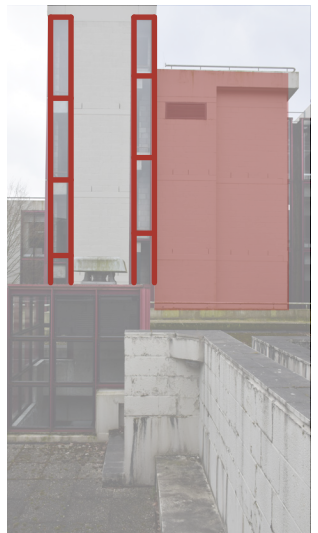

Fig. 175: Left, closed facade north.
Fig. 176: Top, closed facade west.



Fig. 173: Top, Closed facade south.
Fig. 174: Right, closed facade east.



VIII. | The street | Interruption of the construction

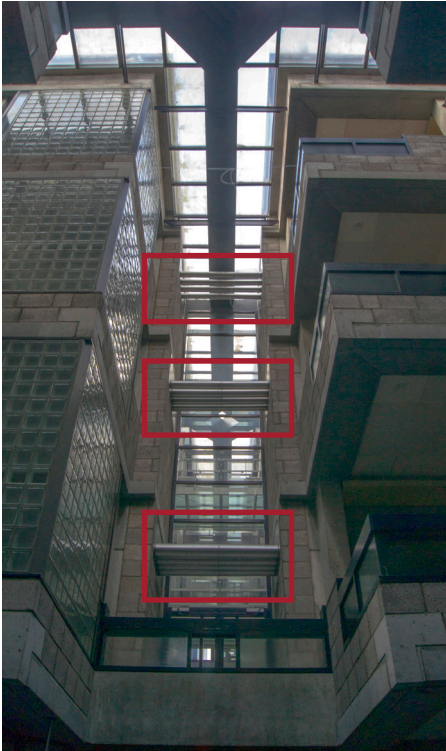

Fig. 179: Open pipes in the street.

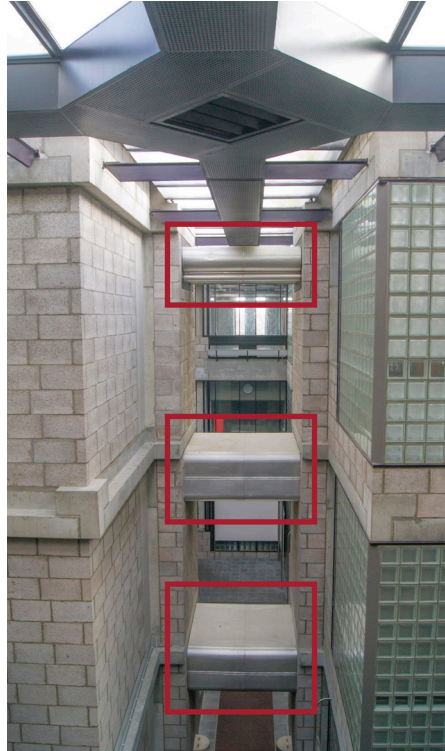

Fig. 180: Closed off pipes in the street.

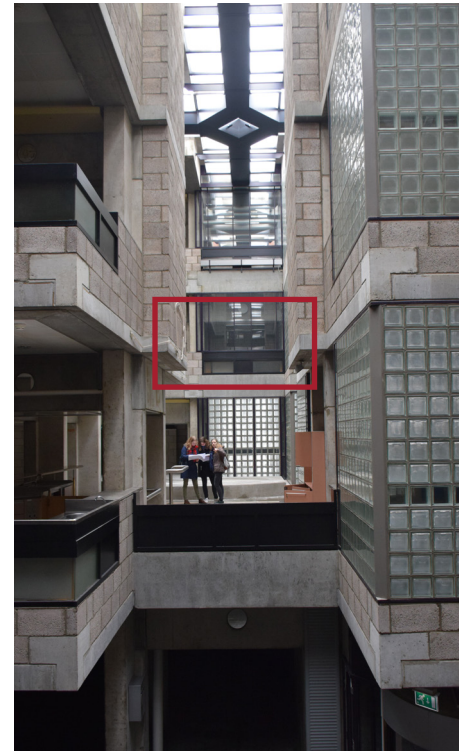

Fig. 181: Street without pipes.

In the street the connection between the units has been removed to create the street in the centre of the building like you can see in figure 181. However, this is only created in the direction where the ducts are not there to supply the quadrants. In the other places in the street the skylights are still blocked by the ducts and pipes. It is also strange that in the whole building the installations are hidden yet in the big open space where everybody is gathered the installations are in sight and going straight through the walls.

VIII. | The Street | Interior

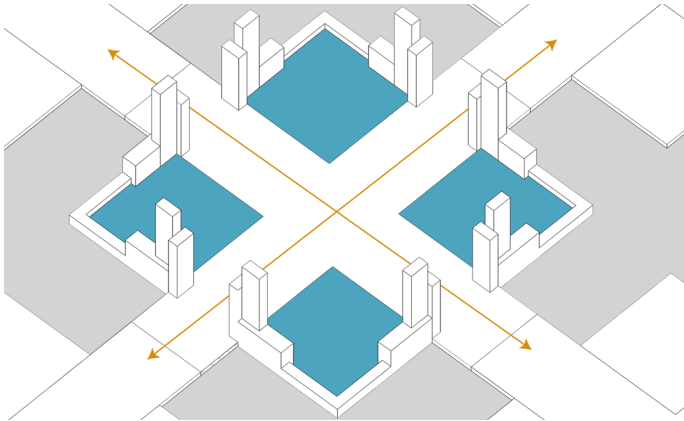

Fig. 182: Perfect unit layout.

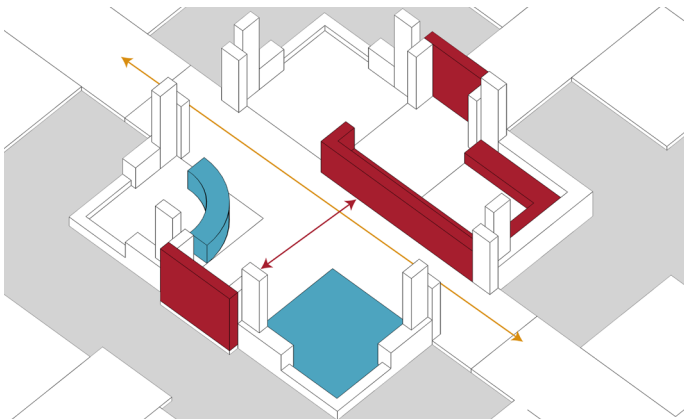

Fig. 183: Diagram of alterations found within the street.



Fig. 184: Escalators in the center of the street.

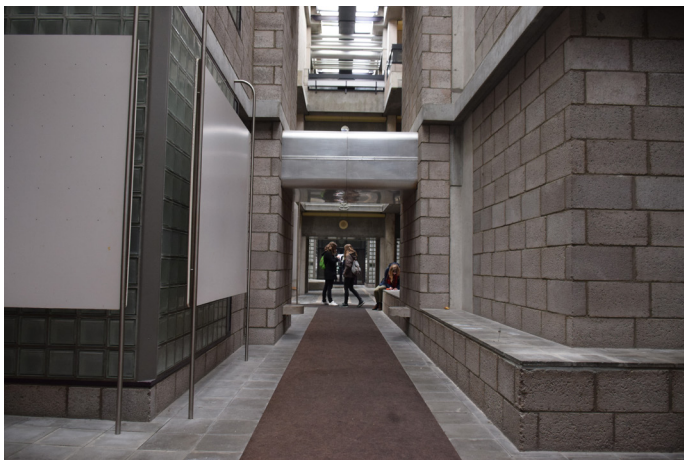

Fig. 185: Picture of the street with a place to sit.



Fig. 186: Picture of the basin in the street.



Fig. 187: Picture of reception in the street, looking from the entrance at the parking garage.

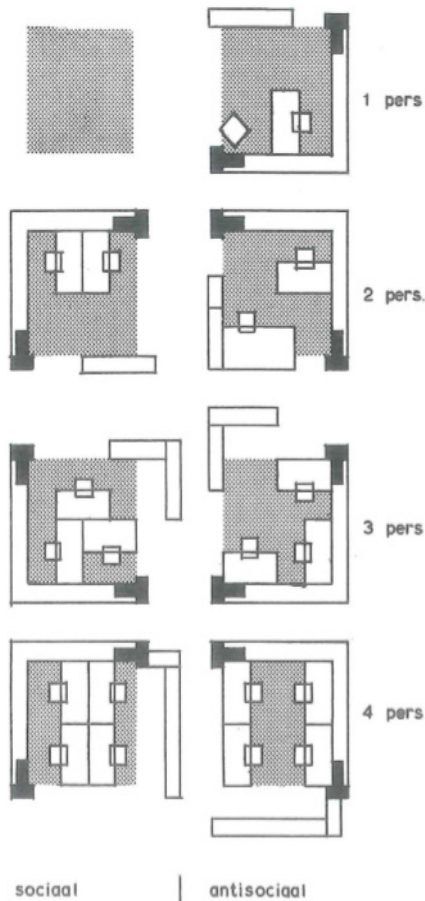

Fig. 190: Social and antisocial setup of desks in a workplace.



Fig. 191: How desks opposite of each other look like nowadays.

For the design of Centraal Beheer Hertzberger already thought about how to setup the desks in the workplaces. For him a social placement, which is showed in figure 190, is two desks facing each other. And in figure 189 you can see how that worked in 1970 in the building and how it created interaction between colleagues. However, with the development of the computers the concept of social changed. If you work in an office nowadays you have more interaction with the people working behind you than the one in front of you because of the big computer screen (see figure 191). In figure 188 you can see that this was already happening in Centraal Beheer when it was used by Centraal Beheer Achmea.



Fig. 189: Use of office space in a social setup in 1970.



Fig. 188: Use of office space in a social setup in 2000.

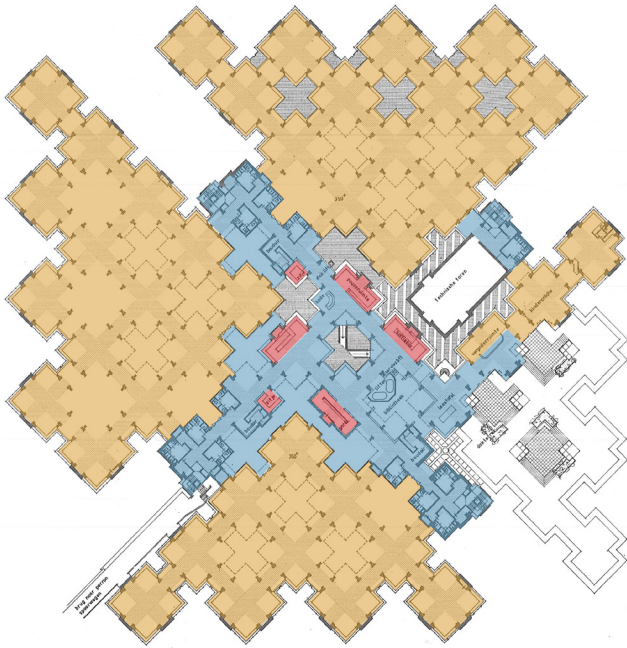

Fig. 192: Floor finishes: carpet (yellow), paving stones (blue), and timber (red).

In the interior of Centraal Beheer flooring is used to indicate different areas in the building (Fig 192 and 193). Exterior materials are used, for example the concrete paving stones, to indicate the public inner street. A light timber parquet with weaving pattern is used in communal areas like the restaurant and breakrooms. However, in old photos you can see that there used to be paving stones in these areas as well (Fig 195). So it appears that the parquet flooring has later been added. The workspaces are carpeted.

In the streets a red carpet has been added to partially cover the paving stones (Fig 194). Reasons could have been noise reduction or adding warmth.



Fig. 193: Top right, floor finishes: timber parquet, concrete paving stones, and carpet.
 Fig. 194: Bottom right, different zones are indicated with flooring.
 Fig. 195: Bottom left, the restaurant (and break corners probably too) did not have timber parquet flooring originally.

XI. | Bridge extensions

The bridges that create the connections inbetween the units are the same width and height as the walking route between the workspaces. Therefore it makes them less suitable for creating office space. However, an extension is often made in this place, where the bridge becomes wider and extends into the void. This way an extra workspace is created and one or two desks can be fitted in this space. Though this was not meant to be part of the general system, in reality the largest part of the bridges have this extension to create extra office spaces.

The extension is created by a pre-fabricated concrete floor element, which is placed in the void and supported by the secondary beams of the main construction. On the side of the void a concrete plate creates a ballustrade in combination with concrete bricks. On top of this ballustrade mostly some form of shelf or cabinets are created.

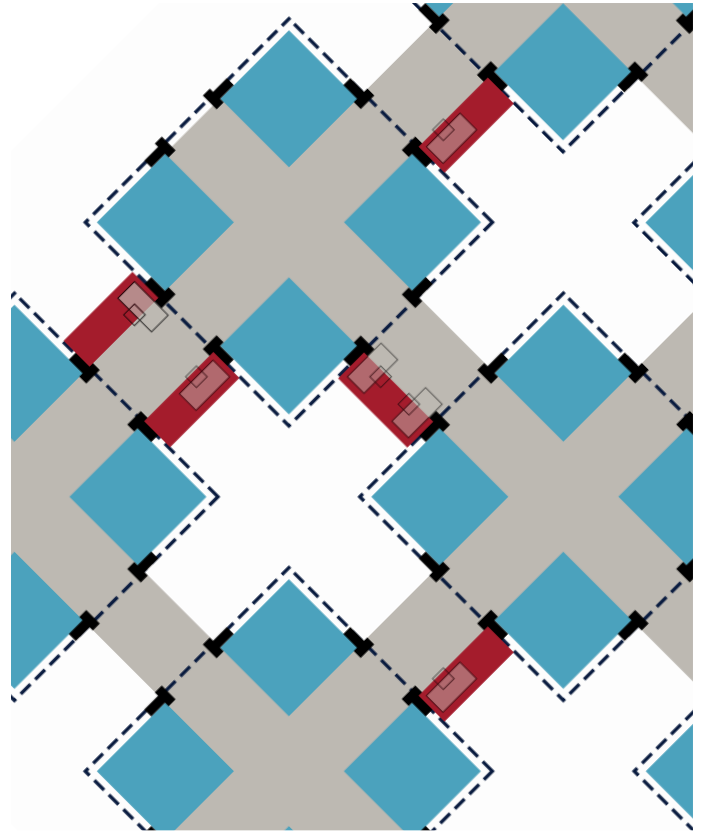

Fig. 196: Bridge extension plates (red) provide extra office space between the units.

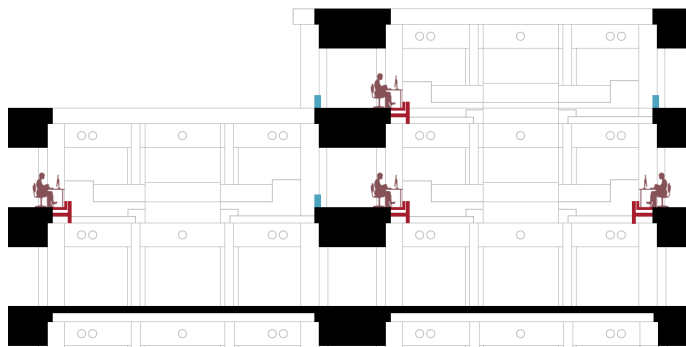

Fig. 199: Section showing bridge extension plates (red) that provide extra office space between the units.

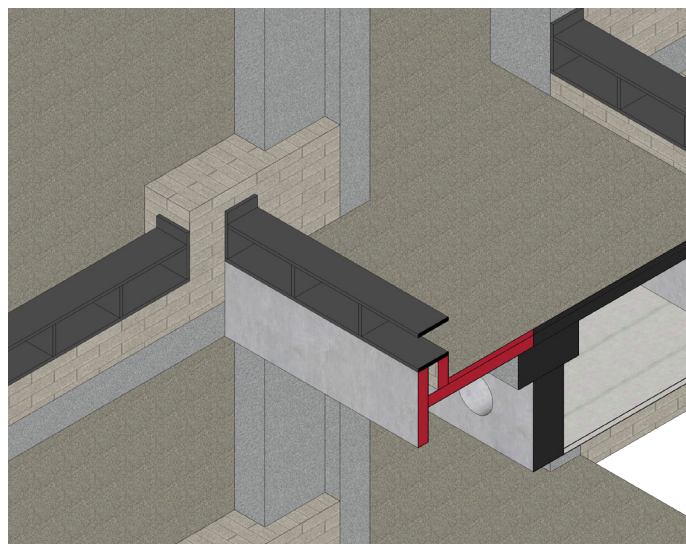

Fig. 198: 3D section model of the bridge extension and how it is constructed.



Fig. 197: Photograph of two examples of the bridge extensions above each other (dashed red).

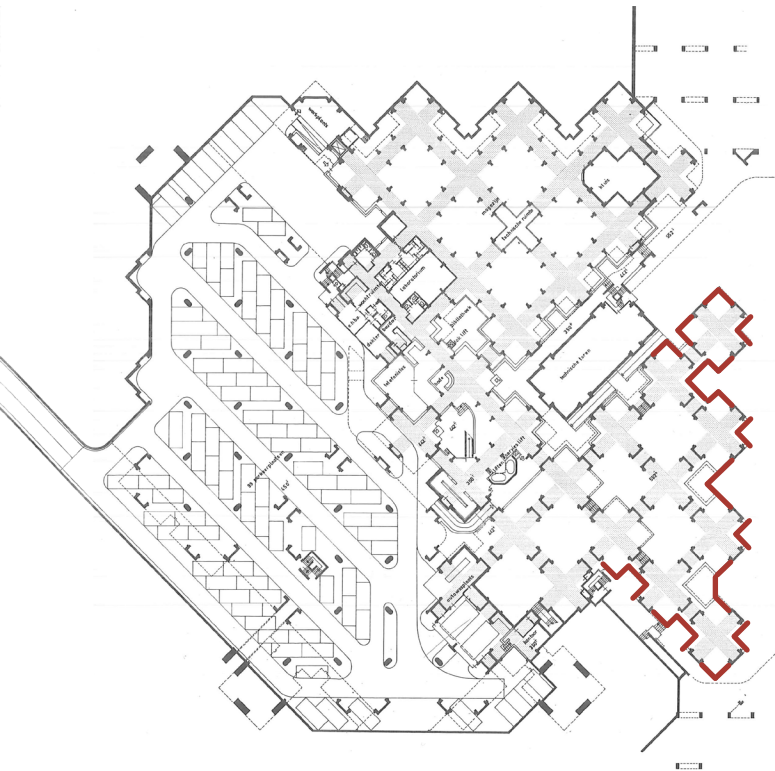

Fig. 200: Windows inbetween the construction (red).

The curtain wall windows are an important part of the expression of the Centraal Beheer building. At first, each window seems to be the same, but after looking at it more carefully there are some variations. The windows on the higher floors hang in front of the facade and have a more pink toned purple color. The windows on the lower floors are placed inbetween the construction and the color is a more blue toned purple (Fig201 to 203). The latter color is also used in the interior on for example the escalators and finishes on partitions and the gutters. The reason for the color difference is not quite clear. One explanation could be that the upper window frames are discolored due to the weather and sunlight.



Fig. 201: Windows in front of and inbetween the construction.



Fig. 202: Color difference at side entrance.



Fig. 203: Pink toned purple and blue toned purple.

XIII. | Orientation | Entrance

The entrance from the garage (the one that most employees would have used) is quite small for a 'main entrance'. Going through the small revolving door you enter the area where the streets cross (see photos on bottom left). The view on this level is limited by the over dimensioned construction and walls. Above is a void which allows light to come in and view into the building (see photos on bottom right). However, there are not many clues that help with orientation.

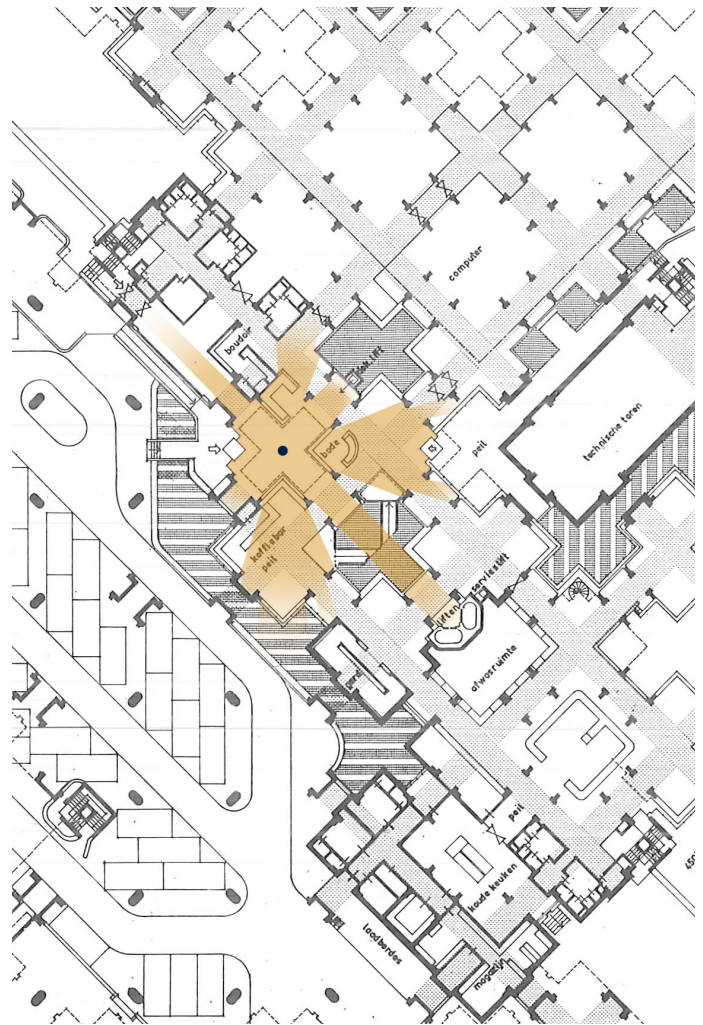

Fig. 204: Sightlines when entering the building.



Fig. 205: Entrance from garage.



Fig. 206: Entrance from garage from the interior.



Fig. 207: Limited view from the entrance.

XIII. | Orientation | Quadrant

It is difficult to orientate yourself and find your way within the building, especially when you are unfamiliar with the building. A pragmatic way that this has been tried to solve is by using wayfinding signs. These signs can be found in the central area of the building, near the elevators, the escalators and the entrances to the office spaces.

They contain numbers, arrows and terms like “North-quadrant” and “South” to help people find their way.



Fig. 208: Wayfinding signs within the building.

Upon visiting the building, we were explained by someone who worked on the building during the project development and later worked inside the building in the offices, that one of the ways to orientate yourself within the building is to look outside and try and locate the installation tower. The reason for this is that the installation tower is such a big exception on the order of the building that it stands out in both height and shape. If you understand how the installation tower is placed within the whole of the building, it is possible to determine your location based on where you locate the installation tower.



Fig. 209: The installation tower that can be used for orientation because of the way it stands out.

When walking through the office spaces, along the walking path that is defined by the construction, it is very remarkable that you are never walking towards natural light. This is because the walking paths end in closed facades (often with a cabinet in front of it).

These closed facade parts are in contrast with the workspaces, where an emphasis is placed on openness towards it surrounding by the big glass facades. This means that you can always look outside or experience natural light from the workspaces, but not from the walkingways.

The fact that you can not look outside or walk towards natural light when looking ahead of you when walking along the walking paths can be of negative influence on the orientation, since no landmarks or other recognition points from outside can be observed.

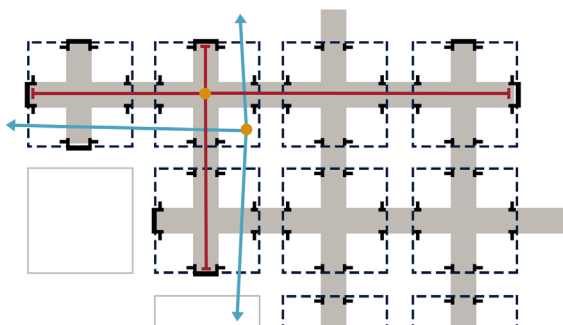

Fig. 211: Diagram depicting how a visual connection outside is denied from the walking paths (red) but not from the workspaces (blue).

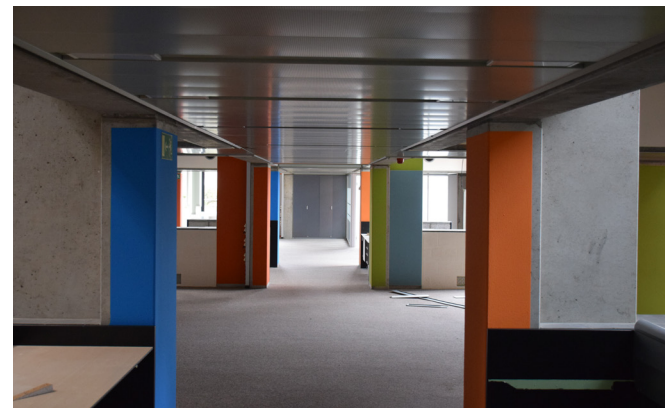

Fig. 212: The walking path ends with a closed facade.



Fig. 210: The workspaces have views to the outside.

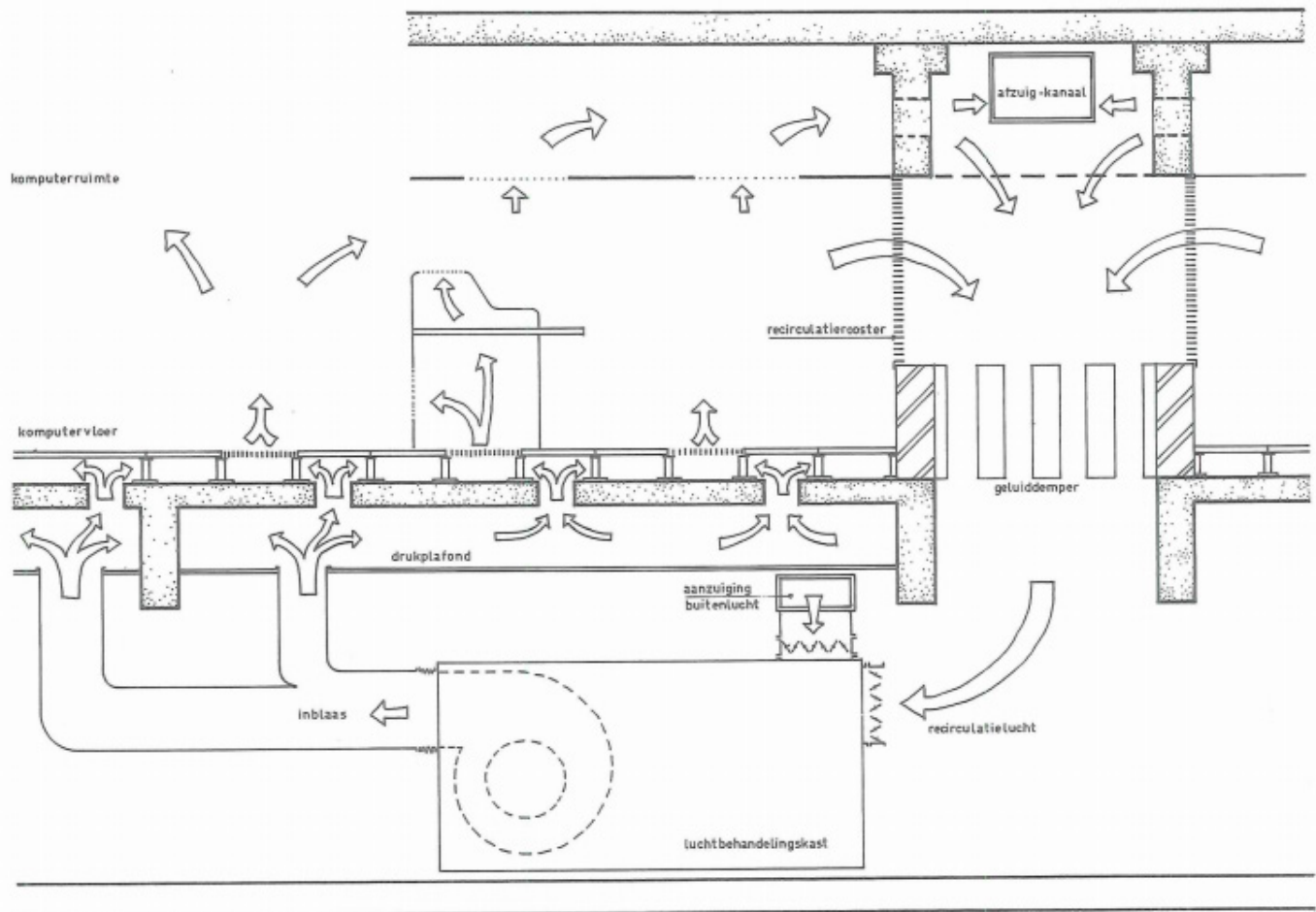

Fig. 213: Installation scheme of the computerroom.

A lot of companies used to build the computer areas outside of the main building because of the different facilities it needs and the flexibility a free standing building offers. In Centraal Beheer they decided to place the computer area in the building which results in some structural consequences. One of them is a raised wooden floor 25 a 30 cm above the concrete construction, consisting of dismantlable panels so it is easy to move cables. Secondly the computerroom has his own installation system which can be seen in figure 213.

The requirements are a temperature of 18 - 24 degrees and a relative humidity of 55 a 60%. To fulfill these criteria the computerroom has its own air handling system which supplies the air through the raised wooden floor into the room and the facade is provided with double-glazing so it can also meet the relative humidity in the winter.

During our visit we saw that there were also radiators added in the room see figure 215.



Fig. 215: Radiator in computerroom.



Fig. 214: Extra construction under computerroom for wooden floor.



Fig. 216: Floorplan of the north quadrant with the order of the unit and the disorder of the double glazing facade.

The computer room has other (climate) requirements than the rest of the building. This is the reason adaptations were necessary. One of those things is the temperature norm of 18 - 24 degrees and a relative humidity of 55 - 60%. To meet the standards of this relative humidity in winter double glazing was also required in the computerroom, as well as closing the room off from the rest of the building. In the drawing above the yellow line indicates the outside glazing and the red line indicates the inside glazing and the inside walls.

In figure 218 you can see how interior walls were put up in the open space. Contradictory to the aforementioned interventions one of the voids in the computerroom is open to the office space above. If you look closely at the material in figure 217 you can not see any clue that the void is opened up after the function of the room changed. The other two voids are still closed and have the same ceiling as the rest of the room so also there we can not see if the way of covering the voids is dismantlable or fixed.



Fig. 217: The only void of the computerroom that is open.



Fig. 218: Inner walls in computerroom.

XIV. | Computerroom | shift in facade



Fig. 220: Floorplan of the north quadrant with the order of the outside of the facade and the disorder of the facade of the computerroom.



Fig. 221: Disorder in the facade on the first layer.



Fig. 222: Disorder in the facade of the first layer for a garage door.

Besides all the exceptions for installation purposes there are also exceptions in the facade of the computerroom. The drawing above shows the regular facade in blue line and the deviations in red. Here you can see there are five corners that are different from the rule. The material and composition are the same but the corners with the size of a workplace are pushed inward like you see in figure 220. There is no logical explanation why Hertzberger did this.

One corner is an exception of the exception. Here not one workplace is pushed in but the corner is chamfered. In this case it is done to create a garage door towards the street see figure 221.



Fig. 224: Computerroom in North quadrant with the extra voids.

1



Fig. 223: Extra voids in computerroom.

2



Fig. 225: Stair in extra void from layer 1 to layer 0.

In the computer room extra voids are added between the double glazed facade with glass flooring. It is likely that this is done to provide daylight in layer 0. The computer room is totally closed off from layer 0 because of the special wooden floor for the computerroom that is used for climate reasons. However, looking at the original plans the function under the computerroom was meant to be a stockroom, so it did not need daylight. It is possible that these 'skylights' were added with the idea that the

building has to be flexible and that the space should be able to house different functions. The windows on layer 0 start 1,80 m above the floor and are quite small, this in combination with a continuous would make it a very dark space.

The only physical connection between layer 1 and 0 in the north quadrant is a stair that is located in one of the extra voids see figure 224.

Bibliography

Literature

- AHH. (2018). Retrieved on 12 march 2018, from <https://www.ahh.nl/index.php/nl/>
- Bruijn, A., Lv, R., Liu, X., Xu, X., Wei, Z. (2017). Centraal Beheer, social.
- Buro Herman Hertzberger. (1992). Gebouwen en projecten. Amsterdam: architectenbureau HH.
- Chen, Y., Vangvasu, S., Wang, F. (2017). Ordering substance: A study on the materiality of Centraal Beheer.
- Gerritsen, J.G., Mulder, J., Ruiters, J.W. (1970). Een werkplaats voor duizend mensen. Amsterdam: vereniging "Centraal Beheer" G.A.
- Gevers, D., Schuurbijs, A., Herck, K. van, Giuseppe, G. Di. (2017). Analysis Centraal Beheer, scope: Time.
- Gregorio, L., Saiz, M., Solis, A., et al. (2010) Arquitectura en construccion. Retrieved on 12 march 2018, from <http://www3.uah.es/~arquitecturaenconstruccion/E1-INICIO.html>
- Habraken, T. (mei 2010). Jaren 70: Centraal Beheer Apeldoorn, Herman Hertzberger. De Architect, p.14-17.
- Hertzberger, H. (2014). Architectuur en structuralisme, speelruimte en spelregels. Rotterdam: nai010 uitgevers.
- Hertzberger, H., Dicke, H.A., Vonno, W. van, Kruijt, J.W.L. (1971). Dokumentatie bouwtechniek. Delft: Technische hogeschool bouwkunde Delft.
- Hertzberger, H., Wiegers, D., Gilad, U., Berg, F. van den. (2018). Herman Hertzberger. Retrieved on 12 march 2018, from <https://www.hertzberger.nl/index.php/nl/>
- Hoekjen, H., Weustink, E. (2004). Het architectenboek. Nederland: Gelderland vakblad.
- Lim, J., Wang, M., Pelt, A. van. (2017). Analysis of Centraal Beheer Apeldoorn, spatial.
- McCarter, R. (2015). Herman Hertzberger. Rotterdam: nai010 publishers.
- Nakamura, T. (1991). Herman Hertzberger 1959 - 1990. Japan: a + u publishing Co.
- Reinink, W.A. (1990). Herman Hertzberger: architect. Rotterdam: uitgeverij 010.

List of figures

- Front page report: Own photograph
- Front page building, p.11: Own illustration
- Front page Unit, p.17: Own illustration
- Front page perfect quadrant, p.29: Own illustration
- Front page actual quadrant, p. 36: Illustration retrieved from: <https://www.ahh.nl/index.php/nl/projecten/12-utiliteitsbouw/85-centraal-beheer-hoofdkantoor-apeldoorn>

- Timeline Start of modular spatial units:
 - Jewish community centre: <https://en.wikiarquitectura.com/building/jewish-community-center/#lg=1&slide=2>
 - Burgerweeshuis: <http://www.vastgoedmarkt.nl/beleggingen/nieuws/2018/01/bpd-betrekt-gerenoveerd-burgerweeshuis-amsterdam-101129377>
 - Richards Medical Research Laboratory: <https://www.cadblocksdownload.com/products/richards-medical-research-laboratories-louis-i-kahn>
 - Extension LinMij: <https://www.architectenwerk.nl/box/archief.2012.06.htm>
 - City hall Valkenswaard: <https://hiveminer.com/Tags/cityhall,maquette/Recent>
- City hall Amsterdam: McCarter, R. (2015). Herman Hertzberger. Rotterdam: nai010 publishers. p. 313.
- Centraal Beheer: <https://www.ahh.nl/index.php/en/projects/2/12-utiliteitsbouw/85-centraal-beheer-offices-apeldoorn>

- Timeline transformation of the building:
 - Centraal Beheer, retrieved from: <http://architectuul.com/architecture/central-beheer>
 - <http://www.dearchitect.nl/projecten/centraal-beheer-in-apeldoorn-door-herman-hertzberger>
 - Kadaster, retrieved from: [https://nl.wikipedia.org/wiki/Kadaster_\(Nederland\)](https://nl.wikipedia.org/wiki/Kadaster_(Nederland))
 - Extension Centraal Beheer, retrieved from: <https://architectenweb.nl/nieuws/artikel.aspx?ID=27243>
 - Own photograph
 - Additions glazed bridges, carpet:
 - Own photographs

- Building became vacant:
 - Own photographs
 - Hertzberger parc, retrieved from: <https://www.certitudo.com/real-estate/residential/cba-apeldoorn/>
 - <https://www.i-residence.com/huurraanbod/apeldoorn/apeldoorn-hertzberger-parc/hertzberger-parc/>
 - <https://www.ahh.nl/index.php/nl/projecten/2/14-woningbouw/83-hertzberger-parc>

- Fig 1: Photo retrieved from: <https://i.pinimg.com/originals/c8/de/37/c8de37458633d18ccffcf5e03b64e4.jpg>
- Fig 2: Photo retrieved from: <https://www.ahh.nl/index.php/en/projects/2/12-utiliteitsbouw/85-centraal-beheer-offices-apeldoorn>
- Fig 3: Photo retrieved from: https://nl.wikipedia.org/wiki/Herman_Hertzberger
- Fig 4: Photo retrieved from: <https://www.hertzberger.nl/index.php/nl/nieuws/2/68-herman-hertzberger-viert-85e-verjaardag>
- Fig 5: Illustration retrieved from: <http://www.dearchitect.nl/projecten/centraal-beheer-in-apeldoorn-door-herman-hertzberger>
- Fig 6: Maps retrieved from google maps
- Fig 7: Retrieved from: <https://ahn.arcgisonline.nl/ahnviewer/>
- Fig 8: Retrieved from: Hertzberger, H., Dicke, H.A., Vonno, W. van, Kruijt, J.W.L. (1971). Dokumentatie bouwtechniek. Delft: Technische hogeschool bouwkunde Delft. (p. 2 - 3)
- Fig 9: Own illustration
- Fig 10: Own illustration
- Fig 11: Own illustration
- Fig 12: Retrieved from: Hertzberger, H., Dicke, H.A., Vonno, W. van, Kruijt, J.W.L. (1971). Dokumentatie bouwtechniek. Delft: Technische hogeschool bouwkunde Delft. (p. 4 - 9, 12)
- Fig 13: Illustration modified from: Hertzberger, H., Dicke, H.A., Vonno, W. van, Kruijt, J.W.L. (1971). Dokumentatie bouwtechniek. Delft: Technische hogeschool bouwkunde Delft. page 12
- Fig 14: Illustration retrieved from: McCarter, R. (2015). Herman Hertzberger. Rotterdam: nai010 publishers. (p. 323)
- Fig 15: Own Photograph
- Fig 16: Own Photograph
- Fig 17: Illustration modified from: <https://www.ahh.nl/index.php/nl/projecten/2/12-utiliteitsbouw/85-centraal-beheer-hoofdkantoor-apeldoorn>
- Fig 18: Illustration retrieved from: Gerritsen, J.G., Mulder, J., Ruiters, J.W. (1970). Een werkplaats voor duizend mensen. Amsterdam: vereniging "Centraal Beheer" G.A., (p. het ontwerp 3)
- Fig 19: Illustration retrieved from: Gerritsen, J.G., Mulder, J., Ruiters, J.W. (1970). Een werkplaats voor duizend mensen. Amsterdam: vereniging "Centraal Beheer" G.A., (p. het ontwerp 6)
- Fig 20: Illustration retrieved from: Reinink, W. (1990). Herman Hertzberger. Uitgeverij 010 Rotterdam (p. 52)
- Fig 21: Own photograph
- Fig 22: Own photograph
- Fig 23: Retrieved from: <https://www.ahh.nl/index.php/en/projects/2/12-utiliteitsbouw/85-centraal-beheer-offices-apeldoorn>
- Fig 24: Own illustration
- Fig 25: Modification of illustration retrieved from: Bruijn, A., Lv, R., Liu, X., Xu, X., Wei, Z. (2017). Centraal Beheer, social (p. 43)
- Fig 26: Retrieved from: Hertzberger, H., Dicke, H.A., Vonno, W. van, Kruijt, J.W.L. (1971). Dokumentatie bouwtechniek. Delft: Technische hogeschool bouwkunde Delft. (p. 27, 28)
- Fig 27: Own illustration
- Fig 28: Modification of illustration retrieved from: Lim, J., Wang, M., Pelt, A. van. (2017). Analysis of Centraal Beheer Apeldoorn, spatial (p. 35)
- Fig 29: Modification of illustration retrieved from: Hertzberger, H., Dicke, H.A., Vonno, W. van, Kruijt, J.W.L. (1971). Dokumentatie bouwtechniek. Delft: Technische hogeschool bouwkunde Delft (p. 19)
- Fig 30: Modification of illustration retrieved from: Hertzberger, H., Dicke, H.A., Vonno, W. van, Kruijt, J.W.L. (1971). Dokumentatie bouwtechniek. Delft: Technische hogeschool bouwkunde Delft (p. 19)
- Fig 31: Own photograph
- Fig 32: Own photograph
- Fig 33: Photo retrieved from: <https://www.ahh.nl/index.php/nl/projecten/2/12-utiliteitsbouw/85-centraal-beheer-hoofdkantoor-apeldoorn>
- Fig 34: Illustration retrieved from: Hertzberger, H., Dicke, H.A., Vonno, W. van, Kruijt, J.W.L. (1971). Dokumentatie bouwtechniek. Delft: Technische hogeschool bouwkunde Delft. p. 3-5.
- Fig 35: Own photograph

Fig 36: Own photograph
 Fig 37: Own photograph
 Fig 38: Own photograph
 Fig 39: Illustration retrieved from: Hertzberger, H., Dicke, H.A., Vonno, W. van, Kruyt, J.W.L. (1971). Dokumentatie bouwtechniek. Delft: Technische hogeschool bouwkunde Delft. p. 3-7.
 Fig 40: Own photograph
 Fig 41: Own illustration
 Fig 42: Own illustration based on Hertzberger, H., Dicke, H.A., Vonno, W. van, Kruyt, J.W.L. (1971). Dokumentatie bouwtechniek. Delft: Technische hogeschool bouwkunde Delft. p.1-35
 Fig 43: Own illustrations
 Fig 44: Own illustrations
 Fig 45: Photograph retrieved from: Bruijn, A., Lv, R., Liu, X., Xu, X., Wei, Z. (2017). Centraal Beheer, social.
 Fig 46: Illustrations retrieved from: Hertzberger, H., Dicke, H.A., Vonno, W. van, Kruyt, J.W.L. (1971). Dokumentatie bouwtechniek. Delft: Technische hogeschool bouwkunde Delft. p.1-17
 Fig 47: Illustrations retrieved from: Hertzberger, H., Dicke, H.A., Vonno, W. van, Kruyt, J.W.L. (1971). Dokumentatie bouwtechniek. Delft: Technische hogeschool bouwkunde Delft. p.1-14
 Fig 48: Own illustration
 Fig 49: Own illustrations
 Fig 50: Own photograph
 Fig 51: Own illustration
 Fig 52: Own illustration, based on own photograph
 Fig 53: Illustration, retrieved from archive Het Nieuwe Instituut
 Fig 54: Own photograph
 Fig 55: Retrieved from: <https://www.flickr.com/photos/krokor/5473844665>
 Fig 56: Own photograph
 Fig 57: Illustration based on own photograph
 Fig 58: Illustration based on own photograph
 Fig 59: Own photograph
 Fig 60: Illustration modified from: Hertzberger, H., Dicke, H.A., Vonno, W. van, Kruyt, J.W.L. (1971). Dokumentatie bouwtechniek. Delft: Technische hogeschool bouwkunde Delft. page 29
 Fig 61: Own illustration
 Fig 62: Own illustration
 Fig 63: Own photograph
 Fig 64: Photograph retrieved from: Bruijn, A., Lv, R., Liu, X., Xu, X., Wei, Z. (2017). Centraal Beheer, social.
 Fig 65: Own illustration
 Fig 66: Illustration modified from: <https://www.ahh.nl/index.php/nl/projecten2/12-utiliteitsbouw/85-centraal-beheer-hoofdkantoor-apeldoorn>
 Fig 67: Own illustration
 Fig 68: Own illustration
 Fig 69: Own photograph
 Fig 70: Illustration modified from: Hertzberger, H., Dicke, H.A., Vonno, W. van, Kruyt, J.W.L. (1971). Dokumentatie bouwtechniek. Delft: Technische hogeschool bouwkunde Delft. page 26
 Fig 71: Illustration modified from: Hertzberger, H., Dicke, H.A., Vonno, W. van, Kruyt, J.W.L. (1971). Dokumentatie bouwtechniek. Delft: Technische hogeschool bouwkunde Delft. page 12
 Fig 72: Illustration modified from: Hertzberger, H., Dicke, H.A., Vonno, W. van, Kruyt, J.W.L. (1971). Dokumentatie bouwtechniek. Delft: Technische hogeschool bouwkunde Delft. (p. 27)
 Fig 73: Own photograph
 Fig 74: Own photograph
 Fig 75: Own photograph
 Fig 76: Illustration retrieved from: McCarter, R. (2015). Herman Hertzberger. Rotterdam: nai010 publishers. (p. 322)
 Fig 77: Own photograph
 Fig 78: Own illustration based on Hertzberger, H., Dicke, H.A., Vonno, W. van, Kruyt, J.W.L. (1971). Dokumentatie bouwtechniek. Delft: Technische hogeschool bouwkunde Delft. p. 3-10.
 Fig 79 & 80: Own illustration based on Hertzberger, H., Dicke, H.A., Vonno, W. van, Kruyt, J.W.L. (1971). Dokumentatie bouwtechniek. Delft: Technische hogeschool bouwkunde Delft. p. 3-4.
 Fig 81: Modification of illustration retrieved from: Modification of illustration retrieved from: Hertzberger, H., Dicke, H.A., Vonno, W. van, Kruyt, J.W.L. (1971). Dokumentatie bouwtechniek. Delft: Technische hogeschool bouwkunde Delft (p. 6)
 Fig 82: Modification of illustration retrieved from: Modification of illustration retrieved from: Hertzberger, H., Dicke, H.A., Vonno, W. van, Kruyt, J.W.L. (1971). Dokumentatie bouwtechniek. Delft: Technische hogeschool bouwkunde Delft (p. 6)
 Fig 83: Modification of illustration retrieved from: Modification of illustration retrieved from: Hertzberger, H., Dicke, H.A., Vonno, W. van, Kruyt, J.W.L. (1971). Dokumentatie bouwtechniek. Delft: Technische hogeschool bouwkunde Delft (p. 6)
 Fig 84: Modification of illustration retrieved from: Modification of illustration retrieved from: Hertzberger, H., Dicke, H.A., Vonno, W. van, Kruyt, J.W.L. (1971). Dokumentatie bouwtechniek. Delft: Technische hogeschool bouwkunde Delft (p. 6)
 Fig 85: Modification of own photograph
 Fig 86: Modification of own photograph
 Fig 87: Own illustration
 Fig 88: Modification of illustration retrieved from: Hertzberger, H., Dicke, H.A., Vonno, W. van, Kruyt, J.W.L. (1971). Dokumentatie bouwtechniek. Delft: Technische hogeschool bouwkunde Delft (p. 19)
 Fig 89: Own illustration
 Fig 90: Own illustration
 Fig 91: Own illustration
 Fig 92: Photograph retrieved from: https://www.e-architect.co.uk/images/jpgs/holland/centraal_beheer_apeldoorn_r061211_w2.jpg
 Fig 93: Illustration retrieved from: Hertzberger, H., Dicke, H.A., Vonno, W. van, Kruyt, J.W.L. (1971). Dokumentatie bouwtechniek. Delft: Technische hogeschool bouwkunde Delft. p.1-15
 Fig 94: Modification of illustration retrieved from: Hertzberger, H., Dicke, H.A., Vonno, W. van, Kruyt, J.W.L. (1971). Dokumentatie bouwtechniek. Delft: Technische hogeschool bouwkunde Delft. p.1-18
 Fig 95: Photograph retrieved from: <http://www.dearchitect.nl/projecten/centraal-beheer-in-apeldoorn-door-herman-hertzberger>
 Fig 96: Diagram retrieved from: Hertzberger, H., Dicke, H.A., Vonno, W. van, Kruyt, J.W.L. (1971). Dokumentatie bouwtechniek. Delft: Technische hogeschool bouwkunde Delft (p. 68)
 Fig 97: Diagram retrieved from: Hertzberger, H., Dicke, H.A., Vonno, W. van, Kruyt, J.W.L. (1971). Dokumentatie bouwtechniek. Delft: Technische hogeschool bouwkunde Delft (p. 75)
 Fig 98: Illustration retrieved from: Gerritsen, J.G., Mulder, J., Ruiter, J.W. (1970). Een werkplaats voor duizend mensen. Amsterdam: vereniging "Centraal Beheer" G.A.
 Fig 99: Photographs retrieved from: Hertzberger, H., Dicke, H.A., Vonno, W. van, Kruyt, J.W.L. (1971). Dokumentatie bouwtechniek. Delft: Technische hogeschool bouwkunde Delft (p. 38)
 Fig 103: Own illustration
 Fig 104: Own illustration
 Fig 105: Own photograph
 Fig 106: Illustration modified from: <https://www.ahh.nl/index.php/nl/projecten2/12-utiliteitsbouw/85-centraal-beheer-hoofdkantoor-apeldoorn>
 Fig 107: Modification of illustration retrieved from: Hertzberger, H., Dicke, H.A., Vonno, W. van, Kruyt, J.W.L. (1971). Dokumentatie bouwtechniek. Delft: Technische hogeschool bouwkunde Delft. p.1-5
 Fig 108: Own photograph
 Fig 109: Modification of illustration retrieved from: <https://www.ahh.nl/images/projecten/utiliteitsbouw/CeBa/14.jpg>
 Fig 110: Own illustration
 Fig 111: Photograph retrieved from: <https://www.ajbuildingslibrary.co.uk/projects/display/id/5044>
 Fig 112: Modification of illustration retrieved from: Hertzberger, H., Dicke, H.A., Vonno, W. van, Kruyt, J.W.L. (1971). Dokumentatie bouwtechniek. Delft: Technische hogeschool bouwkunde Delft (p. 13)
 Fig 113: Modification of illustration retrieved from: Hertzberger, H., Dicke, H.A., Vonno, W. van, Kruyt, J.W.L. (1971). Dokumentatie bouwtechniek. Delft: Technische hogeschool bouwkunde Delft (p. 4)
 Fig 114: Modification of illustration retrieved from: Hertzberger, H., Dicke, H.A., Vonno, W. van, Kruyt, J.W.L. (1971). Dokumentatie bouwtechniek. Delft: Technische hogeschool bouwkunde Delft (p. 5)
 Fig 115: Modification of own photograph
 Fig 116: Modified of illustration retrieved from: Hertzberger, H., Dicke, H.A., Vonno, W. van, Kruyt, J.W.L. (1971). Dokumentatie bouwtechniek. Delft: Technische hogeschool bouwkunde Delft (p. 47)
 Fig 117: Modification of illustration retrieved from: Hertzberger, H., Dicke, H.A., Vonno, W. van, Kruyt, J.W.L. (1971). Dokumentatie bouwtechniek. Delft: Technische hogeschool bouwkunde Delft. p.1-5
 Fig 118: Own photograph
 Fig 119: Own photograph
 Fig 120: Modification of illustration retrieved from: Hertzberger, H., Dicke, H.A., Vonno, W. van, Kruyt, J.W.L. (1971). Dokumentatie bouwtechniek.

Delft: Technische hogeschool bouwkunde Delft (p. 6)

Fig 121: Own photographs

Fig 122: Modification of illustration retrieved from: Bruijn, A., Lv, R., Liu, X., Xu, X., Wei, Z. (2017). *Centraal Beheer, social* (p. 43)

Fig 123: Own illustration

Fig 124: Own illustration

Fig 125: Own illustration

Fig 126: Own illustration

Fig 127: Own illustration

Fig 128: Own illustration

Fig 129: Own illustration

Fig 130: Own photograph

Fig 131: Own illustration

Fig 132: Own illustration

Fig 133: Own illustration

Fig 134: Own photograph

Fig 135: Own photograph

Fig 136: Photograph retrieved from: <https://www.ahh.nl/index.php/nl/projecten/12-utiliteitsbouw/85-centraal-beheer-hoofdkantoor-apeldoorn>

Fig 137: Illustrations retrieved from: Hertzberger, H., Dicke, H.A., Vonno, W. van, Kruyt, J.W.L. (1971). *Dokumentatie bouwtechniek*. Delft: Technische hogeschool bouwkunde Delft. p.1-18

Fig 138: Modification of illustration retrieved from: Hertzberger, H., Dicke, H.A., Vonno, W. van, Kruyt, J.W.L. (1971). *Dokumentatie bouwtechniek*. Delft: Technische hogeschool bouwkunde Delft. p.1-19

Fig 139: Own photograph

Fig 140: Own illustration

Fig 141: Photograph retrieved from: Nakamura, T. (1991). *Herman Hertzberger 1959 - 1990*. Japan: a + u publishing Co. p. 78

Fig 142 & 144: Own illustration

Fig 143: Illustration retrieved from archive NHI Rotterdam, HERT.

Fig 145: Photo retrieved from: <https://indebuurt.nl/apeldoorn/wonen/grootse-plannen-oude-centraal-beheer~5775/>

Fig 146: Illustration retrieved from: Hertzberger, H., Dicke, H.A., Vonno, W. van, Kruyt, J.W.L. (1971). *Dokumentatie bouwtechniek*. Delft: Technische hogeschool bouwkunde Delft. p. 3-11.

Fig 147: Own photograph

Fig 148: Own photograph

Fig 149: Own photograph

Fig 150: Own photograph

Fig 151 & 152: Own illustration

Fig 153: Own illustration

Fig 154: Modification of illustration retrieved from: Gerritsen, J.G., Mulder, J., Ruiter, J.W. (1970). *Een werkplaats voor duizend mensen*. Amsterdam: vereniging "Centraal Beheer" G.A. p.het ontwerp (7).

Fig 155: Illustration found in the building

Fig 156: Own photograph

Fig 157: Own photograph

Fig 158: Own photograph

Fig 159: Own photographs

Fig 160: Illustration retrieved from: Nakamura, T. (1991). *Herman Hertzberger 1959 - 1990*. Japan: a + u publishing Co. page 73

Fig 161: Illustration retrieved from: Nakamura, T. (1991). *Herman Hertzberger 1959 - 1990*. Japan: a + u publishing Co. page 73

Fig 162: Illustration retrieved from: Nakamura, T. (1991). *Herman Hertzberger 1959 - 1990*. Japan: a + u publishing Co. page 73

Fig 163: Illustration retrieved from: Nakamura, T. (1991). *Herman Hertzberger 1959 - 1990*. Japan: a + u publishing Co. page 72

Fig 164: Illustration retrieved from: Nakamura, T. (1991). *Herman Hertzberger 1959 - 1990*. Japan: a + u publishing Co. page 73

Fig 165: Illustration modified from: Nakamura, T. (1991). *Herman Hertzberger 1959 - 1990*. Japan: a + u publishing Co. page 73

Fig 166: Own photograph

Fig 167: Own photograph

Fig 168: Own photograph

Fig 169: Illustration retrieved from: Nakamura, T. (1991). *Herman Hertzberger 1959 - 1990*. Japan: a + u publishing Co. page 73

Fig 170: Own photograph

Fig 171: Own photograph

Fig 172: Own photograph

Fig 173: Own illustration, based on own photograph

Fig 174: Own illustration, based on own photograph

Fig 175: Own illustration, based on own photograph

Fig 176: Own illustration, based on own photograph

Fig 177: Modification of illustration, retrieved from: <http://www3.uah.es/arquitecturaenconstruccion/E2-PROYECTOS-HERTZ-SECCIONES.html>

Fig 178: Modification of illustration, retrieved from: Gerritsen, J.G., Mulder, J., Ruiter, J.W. (1970). *Een werkplaats voor duizend mensen*. Amsterdam: vereniging "Centraal Beheer" G.A., (p. het ontwerp 7)

Fig 179: Modification of own photograph

Fig 180: Modification of own photograph

Fig 181: Modification of own photograph

Fig 182: Own illustration

Fig 183: Own illustration

Fig 184: Own photograph

Fig 185: Own photograph

Fig 186: Own photograph

Fig 187: Own photograph

Fig 188: Photo retrieved from: McCarter, R. (2015). *Herman Hertzberger*. Rotterdam: nai010 publishers. (p. 316).

Fig 189: Photo retrieved from: McCarter, R. (2015). *Herman Hertzberger*. Rotterdam: nai010 publishers. (p. 317).

Fig 190: Illustration retrieved from: Hertzberger, H., Dicke, H.A., Vonno, W. van, Kruyt, J.W.L. (1971). *Dokumentatie bouwtechniek*. Delft: Technische hogeschool bouwkunde Delft. p. 1.17.

Fig 191: Photo retrieved from: <http://www.broadwayofficefurniture.com/>

Fig 192: Modification of illustration, retrieved from: Gerritsen, J.G., Mulder, J., Ruiter, J.W. (1970). *Een werkplaats voor duizend mensen*. Amsterdam: vereniging "Centraal Beheer" G.A., (p. het ontwerp 7)

Fig 193: Own photograph

Fig 194: Own photograph

Fig 195: Still from video, retrieved from: https://www.youtube.com/watch?v=ysK_9u0DJ3w&list=PLLCUVatcq-xMsFKfNaVovxJnosSmVNYD&index=11

Fig 196: Own illustration

Fig 197: Modification of own photograph

Fig 198: Own illustration

Fig 199: Own illustration

Fig 200: Modification of illustration, retrieved from: Gerritsen, J.G., Mulder, J., Ruiter, J.W. (1970). *Een werkplaats voor duizend mensen*. Amsterdam: vereniging "Centraal Beheer" G.A. (p. 7)

Fig 201: Own photograph

Fig 202: Own photograph

Fig 203: Own photograph

Fig 204: Modification of illustration, retrieved from: Gerritsen, J.G., Mulder, J., Ruiter, J.W. (1970). *Een werkplaats voor duizend mensen*. Amsterdam: vereniging "Centraal Beheer" G.A. (p. 6)

Fig 205: Own photograph

Fig 206: Own photograph

Fig 207: Own photograph

Fig 208: Own photographs

Fig 209: Modification of own photographs

Fig 210: Own photograph

Fig 211: Own illustration

Fig 212: Own photograph

Fig 213: Illustration retrieved from: Hertzberger, H., Dicke, H.A., Vonno, W. van, Kruyt, J.W.L. (1971). *Dokumentatie bouwtechniek*. Delft: Technische hogeschool bouwkunde Delft. p. 3-9.

Fig 214: Own photograph

Fig 215: Own photograph

Fig 216: Modification of illustration retrieved from: Gerritsen, J.G., Mulder, J., Ruiter, J.W. (1970). *Een werkplaats voor duizend mensen*. Amsterdam: vereniging "Centraal Beheer" G.A. p.het ontwerp (7).

Fig 217: Own photograph

Fig 218: Own photograph

Fig 219: Modification of illustration retrieved from: Gerritsen, J.G., Mulder, J., Ruiter, J.W. (1970). *Een werkplaats voor duizend mensen*. Amsterdam: vereniging "Centraal Beheer" G.A. p.het ontwerp (7).

Fig 220: Own photograph

Fig 221: Own photograph

Fig 222: Own photograph

Fig 223: Modification of illustration retrieved from: Gerritsen, J.G., Mulder, J., Ruiter, J.W. (1970). *Een werkplaats voor duizend mensen*. Amsterdam: vereniging "Centraal Beheer" G.A. p.het ontwerp (7).

Fig 224: Own photograph