



# Improving radiation safety for hospital staff during interventional surgery

Tom Gudde

Graduation Thesis - Master Integrated Product Design  
Faculty of Industrial Design Engineering (TU Delft)

 **TU Delft** 

Ruud van Heur (Chair TU Delft)  
Margreet Beets (Mentor TU Delft)  
Bert Bloemen (Coach Philips)

## Project introduction

During interventional (catheter based) surgery, physicians use X-ray imaging to guide them. This imaging technique comes with a downside. While a scan of a broken bone only uses one or two images, during an intervention, live x-ray is used. This greatly increases the received radiation dose for all people in the operation room.

Because of this radiation exposure, the continued execution of this type of operations could lead to a array of complications ranging from hair-loss to cancer. At least, if not properly protected.

Physicians already use personal protection such as lead aprons and movable shielding solutions but these come with their own set of problems due to weight or obstruction of the procedure.

Next to this, operating rooms designed for this type of surgery are in most cases crowded with essential medical staff like the physicians and the anaesthesiologists. This makes the introduction of more physical products difficult and might interfere with the procedure.

As more and more operations are switching to this less invasive x-ray guided interventions, the risk for physicians will only increase due to more exposure. Therefore, a solution that drastically lowers the received dose for the physicians will become more and more significant.

The goal of this graduation project is stated as follows:

**Improving the radiation safety and increasing sustainable deployment of hospital staff during interventional surgery by introducing a product/product service that does not interfere with or obstruct the operation in a Hybrid OR.**

# Report Structure

4 Abstract

Research

6 Radiation & Market  
26 User & Awareness  
42 Combined insights

Design

46 Ideation & conceptualization  
58 Exposure Prevention Package  
80 Recommendations

88 Contact List  
89 References  
93 Appendices

# Abstract

Radiation is increasingly used to treat otherwise dangerous operations such as valve replacements with minimal consequences for the patient using live X-ray and catheters. These minimal invasive interventions are beneficial for the patient but physicians are exposed to high doses of radiation as a result.

Products in the market of radiation protection are focusing on physical barriers for the radiation such as lead aprons and acrylic lead shields. Although effective, these are often not properly used, which increases the risk for exposure. Next to this, new products will enter a highly saturated market with vast generic alternatives.

A design opportunity was found in the range of product aiming for training of physicians to properly work with radiation. From interviews and observations, it was concluded that there is no common consensus among cardiologists regarding where the dangerous scatter radiation is present surrounding the patient. It is therefore vital to train or even reprogram their instinctive mind to have a clear idea about the presence of scatter in the OR; radiation safety through behavior change.

Philips is involved in a strategy that is called the Quadruple aim. Where the current focus is more directed to the patient experience, the quadruple aim also includes the staff experience as a large influence in better healthcare.

A product concept is created where staff experience is key. With this direction Philips will fill a gap in the market for training products and create a common consensus for safe radiation behavior.

Introduced to new generations of hybrid OR's as the Exposure Prevention Package (EPP), the concept solution will provide a set of clear indicators for safe radiation conduct. Physicians and other staff can now identify when they are exposed to the harmful, but invisible, radiation and act upon it.

Through further involvement in the hospital itself Philips will be engaged in an introduction phase of their systems. This includes a introductory course in which operators learn to work with the system and at the same time experience a "learning by doing" style radiation safety course.

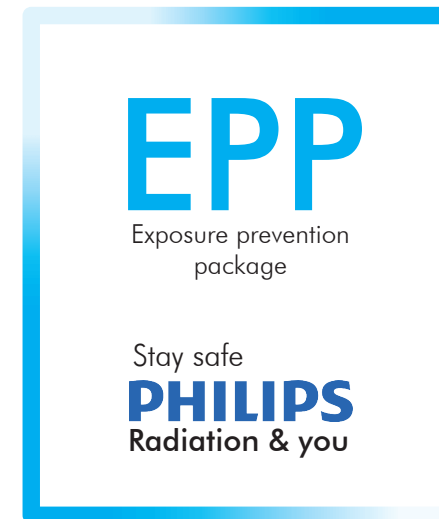

# Terminology and abbreviations

<b>OR</b>	Operating Room	<b>Sievert</b>	(Sv or mSv) Unit of measurement for radiation based on the Gray multiplied by a weighting factor.
<b>Fluoroscopy</b>	Usage of continuous X-ray radiation to create live images of the internal body. Prominently used in catheter based surgery.	<b>Shielding</b>	Radiation protection in the form of leaded panels. Can be transparent in rigid or flexible form. Either mounted on the ceiling or table or rollable on the floor.
<b>Intervention</b>	Minimal invasive catheter based surgery using fluoroscopy imaging.	<b>Allura &amp; Azurion</b>	Product names of Philips C-arm systems. Azurion is the most recent generation.
<b>X-ray tube</b>	Source of the X-ray in use during the intervention. Image receiver/intensifier: Mounted above the to form an image of the radiation passing through the patient body.	<b>TAVI/TAVR</b>	Trans Aortic Valve Replacement
<b>C-arm</b>	Fluoroscopy machine in the shape of a large C. An x-ray source is integrated in the bottom of the C and an image receiver on top.	<b>PCI</b>	Percutaneous Coronary Intervention
<b>Hybrid OR</b>	Rooms designed to support a range of image guided operations as they feature fixed imaging systems such as the C-arm fluoroscopy machine.	<b>Draping</b>	Covering of medical instruments in a plastic cover to maintain sterility in the OR.
<b>Operator</b>	Hospital staff engaged with the C arm system.	<b>Dose Aware</b>	Product for live insight in radiation dose levels in an operation room based on wearable badges.
<b>Scatter</b>	The effect of the incoming beam of radiation hitting an object and deflecting in a random direction.	<b>IGT</b>	Image Guided Therapy. Department of Philips Healthcare.
<b>Attenuation</b>	The absorption of energy in matter		
<b>Dose</b>	The received amount of radiation.		
<b>Gray</b>	(Gy or mGy) Unit of measurement for radiation.		

# Radiation & Market

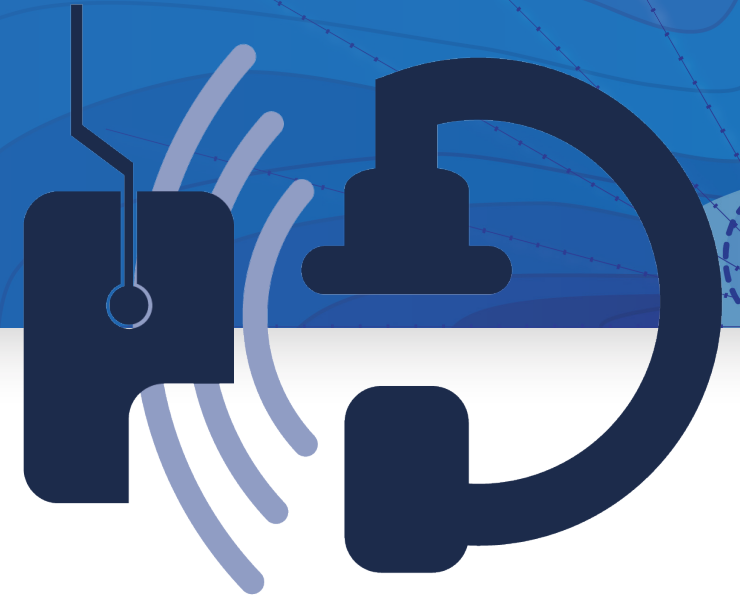

- 7** 1. Radiation in the OR
- 18** 2. Procedures
- 20** 3. Competitor stand
- 23** 4. Products in the market

# 1. Radiation in the OR

## The dose limit

The OR environment has been subject to radiation imaging, and along side it with protection from it, for a considerable time. Protection from radiation sources in the medical field can be traced back to the early 20th century (1918) where primitive lead aprons were used.

The increasing awareness of the negative effects of radiation over time has kick-started an increasingly sharp policy towards occupational radiation. The graph below shows the allowed occupational dose limit set by the National Council on Radiation Protection and Measurements (NCRP). As can be seen the dose limit has been lowered significantly, from around 700 mSv to ~50 mSv per year.

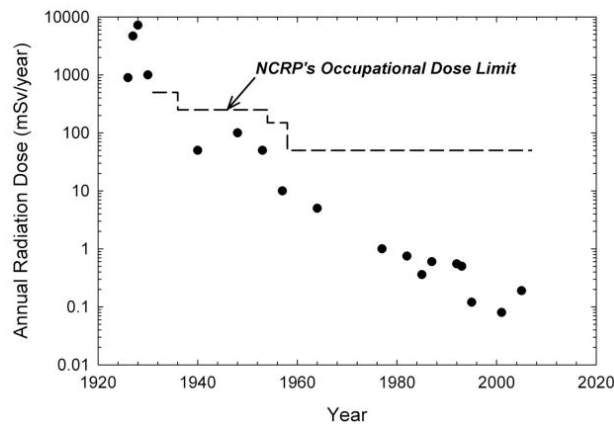

Figure 1.1 History of dose limits (Linnet et. al., 2010)

From 2018 onward, the European union has passed the Basic Safety Standards (BSS). This document captures the limits of occupational radiation as follows:

“The limit on the effective dose for occupational exposure shall be 20 mSv in any single year. However, in special circumstances or for certain exposure situations specified in national legislation, a higher effective dose of up to 50 mSv may be authorized by the competent authority in a single year, provided that the average annual dose over any five consecutive years, including the years for which the limit has been exceeded, does not exceed 20 mSv.” (EURATOM Basic Safety Standards, 2018).

A medical professional such as an interventional radiologist can therefore not exceed this average of 20 mSv. Crossing this boundary means a stop in procedures for the individual.

To increase the sustainable deployment of medical staff that come in contact with radiation, it is therefore vital to lower the dose as much as possible; the lower the dose, the more procedures.

This is why the trend of annual radiation dose, the black dots in figure 1, is still steadily declining although the dose limit has been fixed for quite some time.

To identify the most prominent area's for a design solution, the area's most dangerous to the operators must be identified. Scatter plots, or isodose plots, are commonly found on the Internet, but are specific to a certain case (e.g incoming radiation or patient thickness). To make predictions on the most dangerous area's a universal understanding of the behavior of scatter radiation is necessary.

## 1.1 Radiation intensity

Originating from a source, e.g. the x-ray tube of patient, radiation interacts with matter on its path. Based on the material, the radiation is weakened to a certain degree. Just like lead shielding the air itself also blocks a part of the radiation. The weakening of the radiation is called attenuation and can be defined as a function of the incoming radiation ( $I_0$ ), the material attenuation coefficient ( $\mu$ ) and the distance ( $x$ ) (Schatzlein et. al., 2005).

$$I = I_0 \exp(-\mu * x)$$

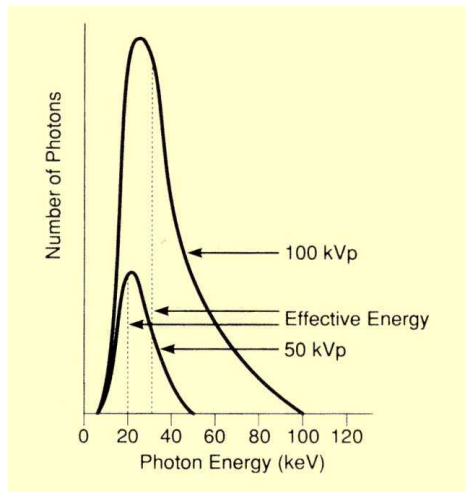

Based on the type of radiation used, the attenuation coefficient differs as a result of the photon energy. In the case of the Philips Allura Xper FD20, which operates at 100kV, photons with an effective energy of 35keV are created.

Figure 1.1.1 Effective Energy of X-Ray Spectra (Sprawls, n.d.).

Scatter however, which originates from collisions within the patient body and the operating table, has a lower photon energy level. This is the effect of Compton scattering.

These photons collide with a series of electrons as they pass through the solid matter (either the table or patient) and transfer a portion of their energy onto the electron.

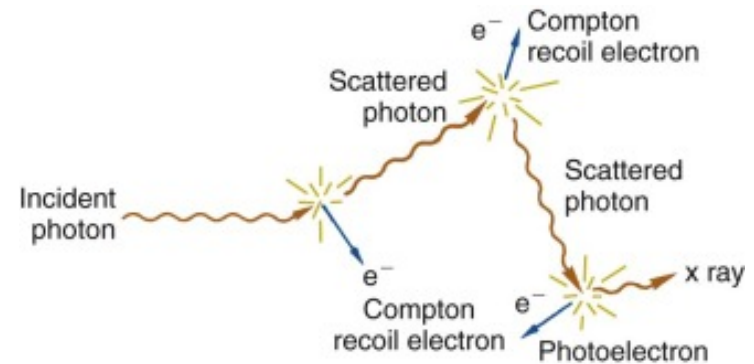

Figure 1.1.2 "Multiple interactions of a photon passing through matter. Energy is transferred to electrons in a sequence of photon-energy degrading interactions." (Cherry et. al., 2012)



## 1.2 Radiation at patient body

The Philips Allura Xper creates an incoming beam of photons at  $\sim 55$  mGy/min for a patient torso thickness of 22cm (Philips, 2014)(Ubeda et al., 2015)

We take that the incoming radiation is divided over the body equally and at random, as is the case with Compton scattering. When dividing the torso in 12 parts (6 per half) originating from the radiation beam, the percentual division as shown in the figure below is created.

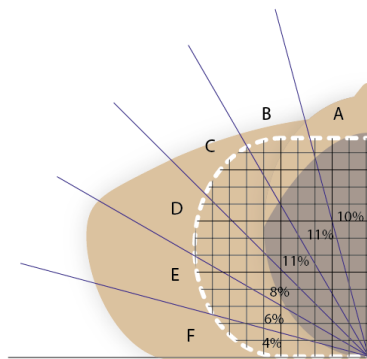

When the percentual data is combined with the attenuation effects within the patient body using the equation on the previous page, the values of Gy/h can be calculated at the patient skin level. The full section and calculation can be seen in appendix A.

Figure 1.2.1 Procentual division of torso in 12 pieces. Origin at x-ray beam

Section (Figure 4.2.1)	Percentage of section	Percentage after attenuation	Percentage of initial beam	Resulting dose (At patient skin level)
A	10%	0.5%	0.050%	1.5 mGy/h
B	11%	0.3%	0.033%	1.1 mGy/h
C	11%	0.4%	0.044%	1.4 mGy/h
D	8%	0.8%	0.064%	2.1 mGy/h
E	6%	2%	0.12%	4.0 mGy/h
F	4%	14%	0.56%	18.9 mGy/h

Table 1.2 Resulting dose at patient skin level

The following plots are only valid close to the operation table as it does not take the spread of the scatter into account in the longitudinal direction of the operation table. Therefore it only serves as an indication of the spread of radiation where the physicians are standing.

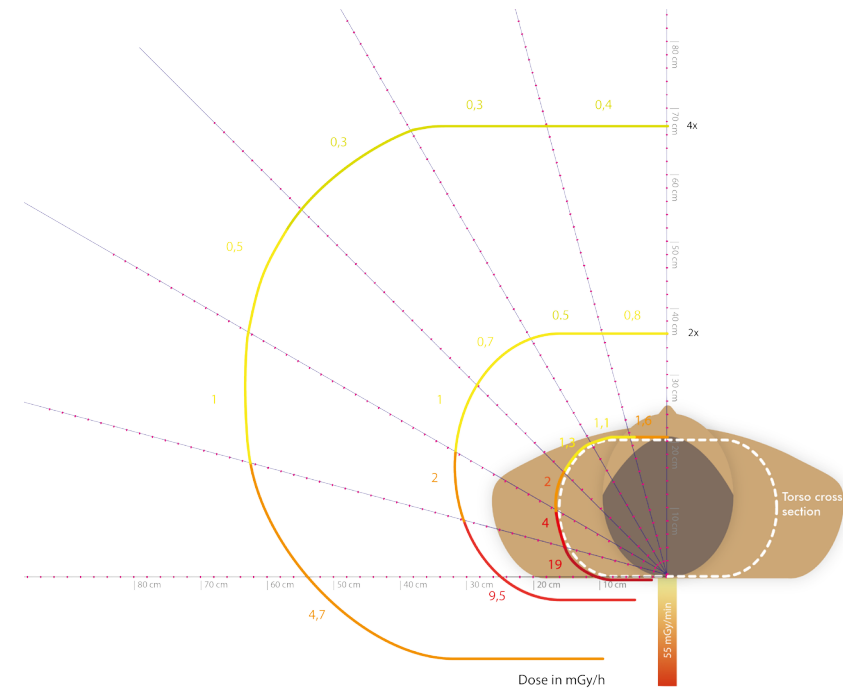

Figure 1.2.2 Scatter plot around patient body at 2\*X and 4\*X (mGy/h)

### 1.3 Back scatter & machine orientation

Underneath the patient, the influence of scatter is more difficult to calculate. This is due to the fact that the previous calculations are all based on protrusion through tissue which causes the decrease in intensity. The problem is the absence of the source; where does it emerge from to calculate this decrease as a function of tissue protrusion. For instance, a source at the center of the patient body ~10cm would result in only 5% compared to 22% if the source is at 5cm inside the patient body.

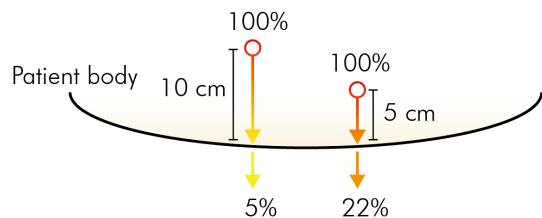

Figure 1.3.1 Back scatter source depth influence.

Instead the earlier discussed “random” distribution of Compton scattering has to be used. For a single collision however there is a probability of scattering at certain angles. For lower energy photons such as 35 keV, there is a high probability of 180 degrees back scatter.

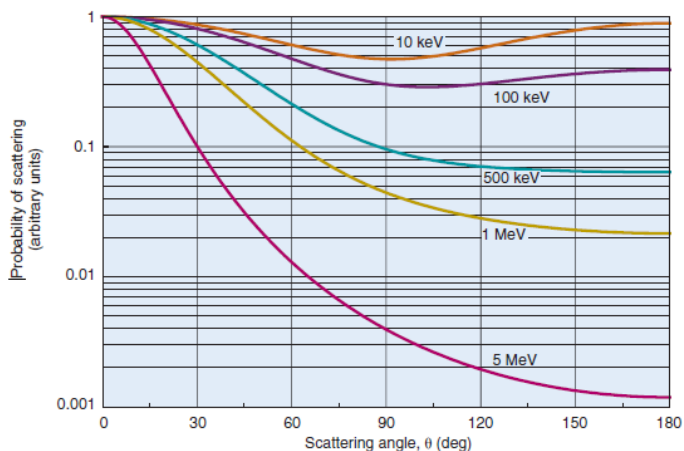

Figure 1.3.2 Scatter probability at different angles (Cherry et. al., 2012)

When the graph is adapted for a single collision the following probability in % regarding the exiting direction of the photon is created when we split it in 8 possible directions.

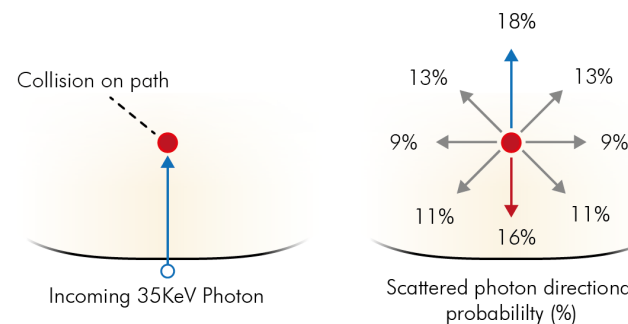

Figure 1.3.3 Individual photon collision and scattering angle probability

This does however not mean that 16% of all radiation that comes into contact with the patient body gets scattered back directly. This 16% only effects photons which actually interact with matter, hence the photons that are attenuated via Compton scattering. Both not 100% of the incoming beam; attenuation is a function of depth as indicated in figure 4.3.1 and the share of Compton scattering is around 70% of the attenuation in total for 35 keV.

Next to this a photon bundle which gets scattered back at depth x needs to continue back through this height x during which a % is attenuated again.

The total amount of backscatter is therefore sum of attenuated photons in a section of the torso ( $\Delta x$ ) at torso height x minus the attenuation that occurs on the way back through over said height x. Taken over the total height of the patient torso ( $0\text{cm} > x > 22\text{cm}$ ).

$$\int (\text{Attenuation at } \Delta x * 16\% * \text{Attenuation at depth } x) dx$$

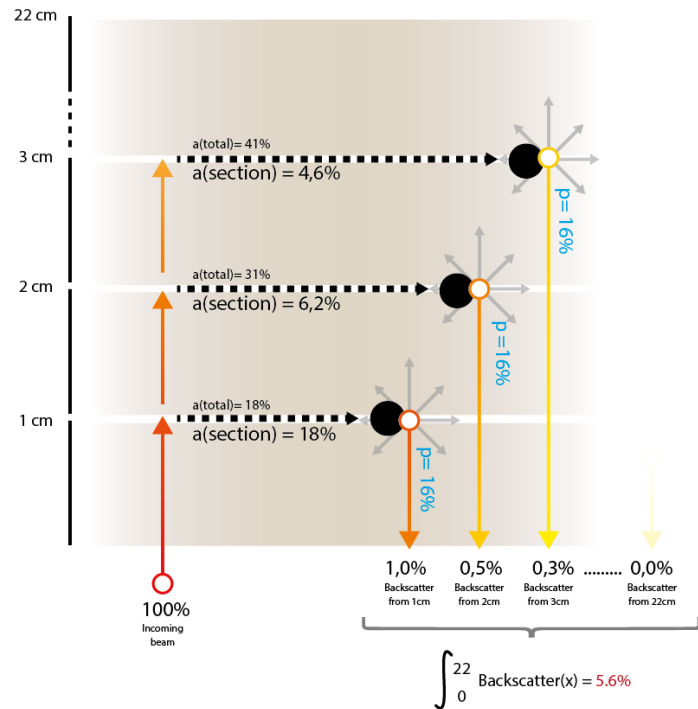

Figure 1.3.4. Black dot = collision with matter,  $a(\text{total})$  = attenuation in matter at height  $x$ ,  $a(\text{section})$  = attenuation over the section  $\Delta x$ .  $P$  = probability for backscatter in 180 degrees.

For example: At depth 2 cm ( $x$ ) the total attenuation is 31%, the section from 1 to 2 cm ( $\Delta x$ ) accounts for 6,2%. The probability of a photon scattering in a 180 degree direction is 16%, thus 16% of 6,2% (1%). These photons have to travel back over 2cm ( $x$ ) after which 0.5% remains. When  $\Delta x$  is reduced to 0, the integral from 0 cm to 22 cm accounts for a total of 5,6% back scatter.

It is worth mentioning that after penetrating more than 10cm, the radiation does not contribute to the backscatter anymore (Appendix 4. Backscatter calculations). Hence, for tissue thicker than 10 cm, which includes practically all patients, the backscatter is always the same amount of percentage of the incoming beam.

This also means that an orientation change, where the radiation sometimes passes through more tissue to reach the image sensor, does not influence the percentual amount of backscatter.

Using the same division as in figure 4.2.1, where the torso is divided in 12 parts, the bottom side of the patient body would be divided in 4 parts. Every segment would then account for 46 mGy/h at the patient skin level. When this is included into the previously shown plots (figures 4.2.3 & 4.2.4) the plot in figure 4.3.5 is created.

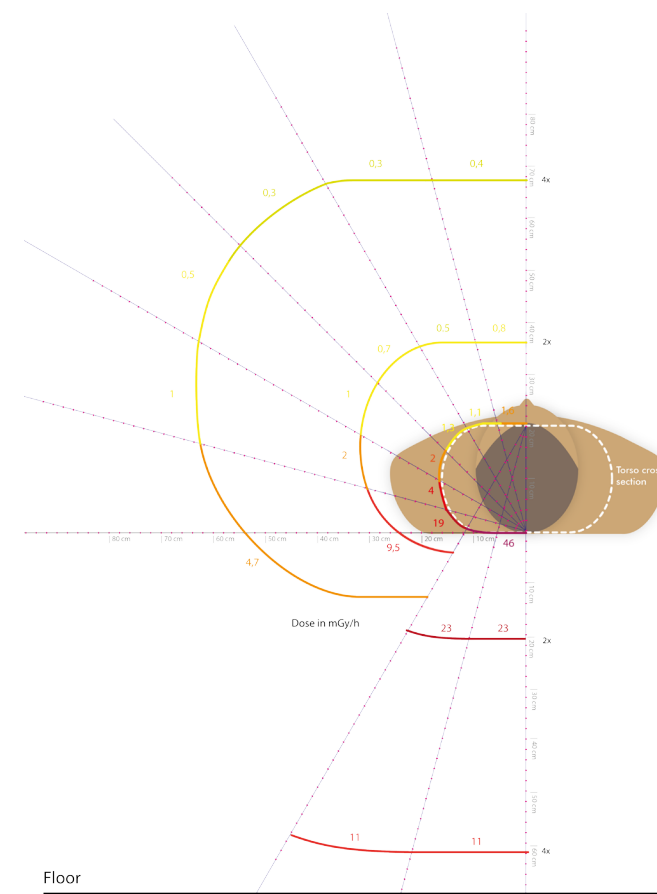

Figure 1.3.5 Scatter plot at doubled and quadrupled distance from source in mGy/h for an incoming beam of 55mGy/min at 35 keV

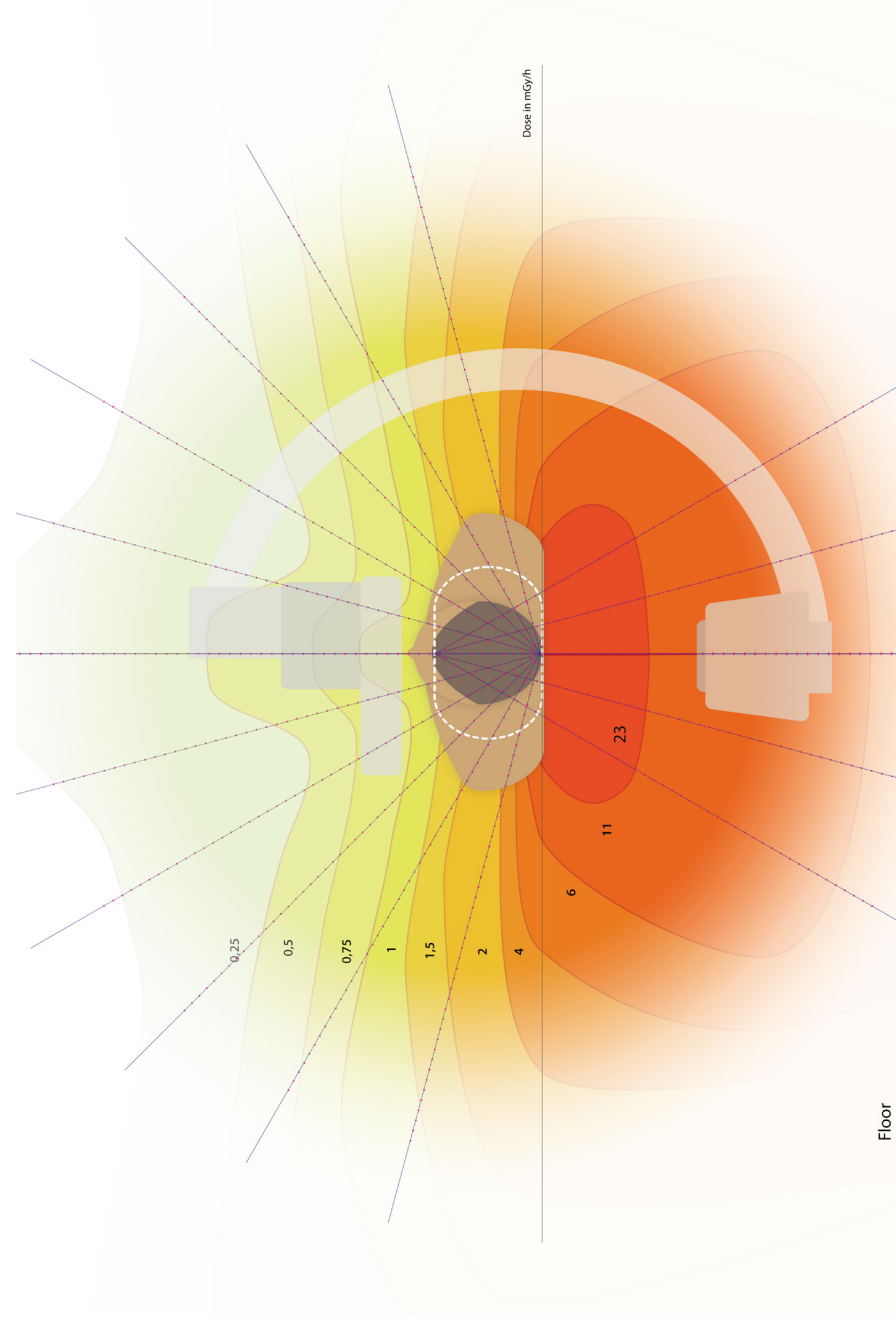
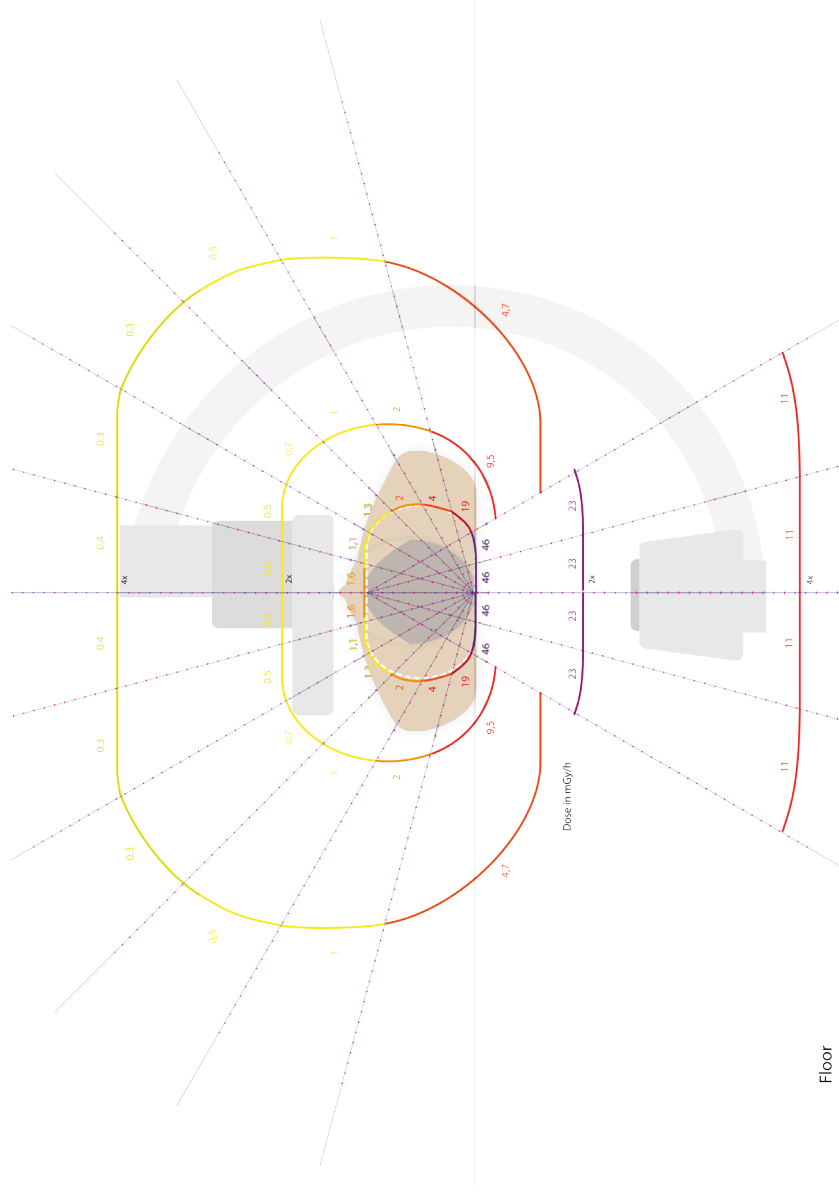

Figure 1.3.6 Radiation levels in mGy/h for an incoming beam of 55mGy/min at 35 keV at 0 degrees rotation

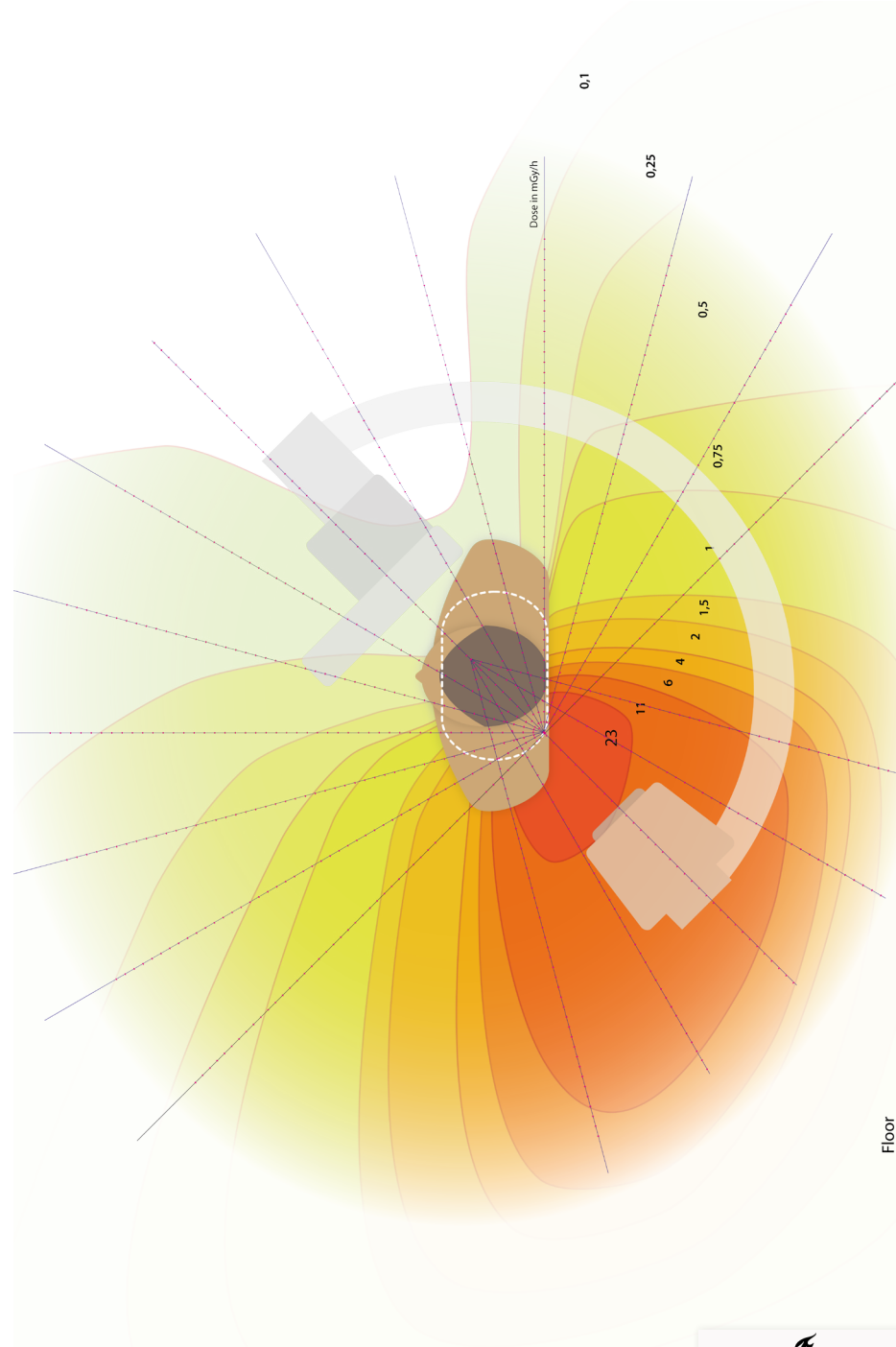
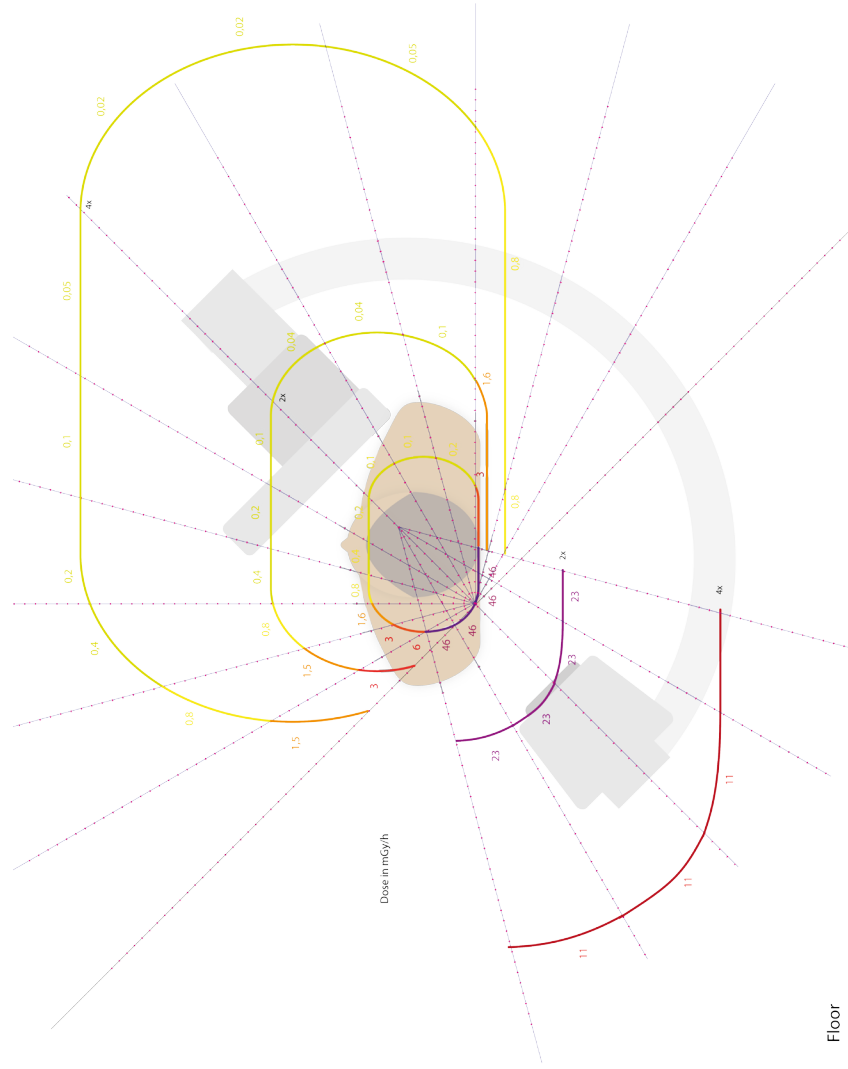

Figure 1.3.7 Radiation levels in mGy/h for an incoming beam of 55mGy/min at 35 keV at 45 degrees rotation

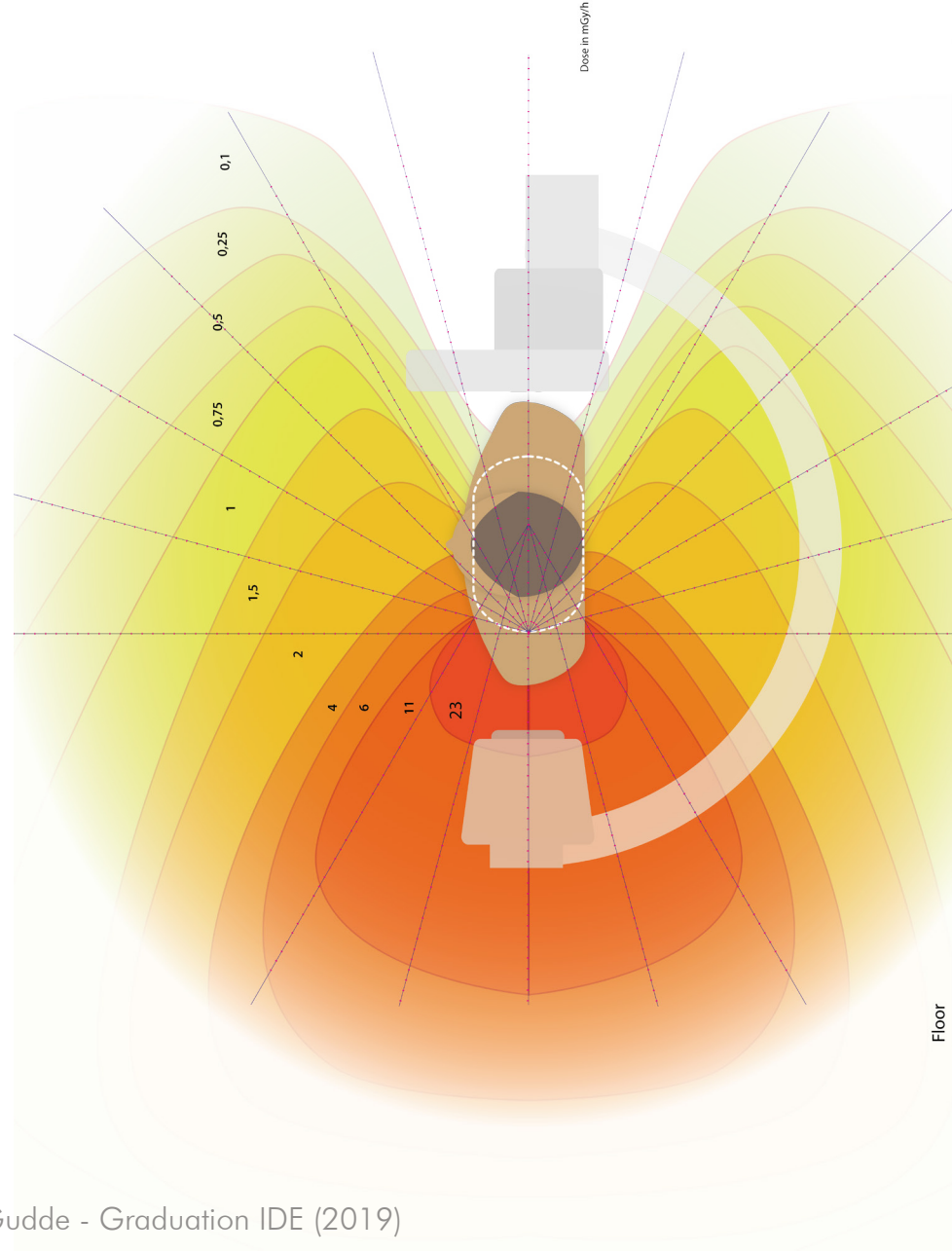
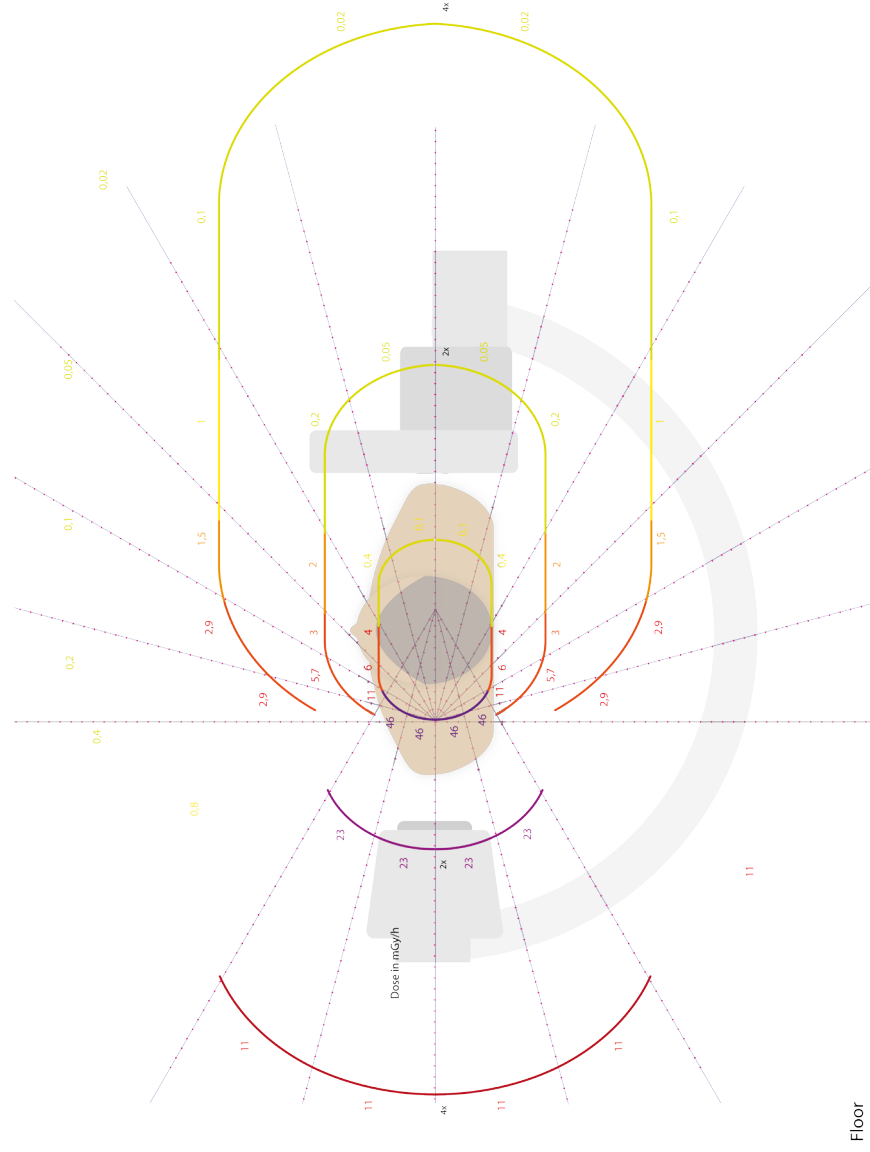

Figure 1.3.8 Radiation levels in mGy/h for an incoming beam of 55mGy/min at 35 keV at 90 degrees rotation

## 1.4 Radiation & standing position

As mentioned, the figures for the three orientations in section 1.3 are taken over the length of the patient torso to include all radiation entering the body. The torso is approximately 3 times the width of an operator (mean 388 mm DINEN, 2004). The radiation dose should therefore be taken for the where the operator body is present. This divides the values in these figures by 3.

The images with scatter radiation from section 1.3 are divided in segments of 15 degrees (figure 1.2.1). When an operator is introduced, the segmentation divides its body too. The operator segments receive different dose levels, which can be added together to get the accumulated dose over the body at a certain position from the table in mGy/h (figure 14.1).

As the division also separates organs it is possible to add the weighting factors as mentioned in appendix C2.8 and express the spread in mSv/h.

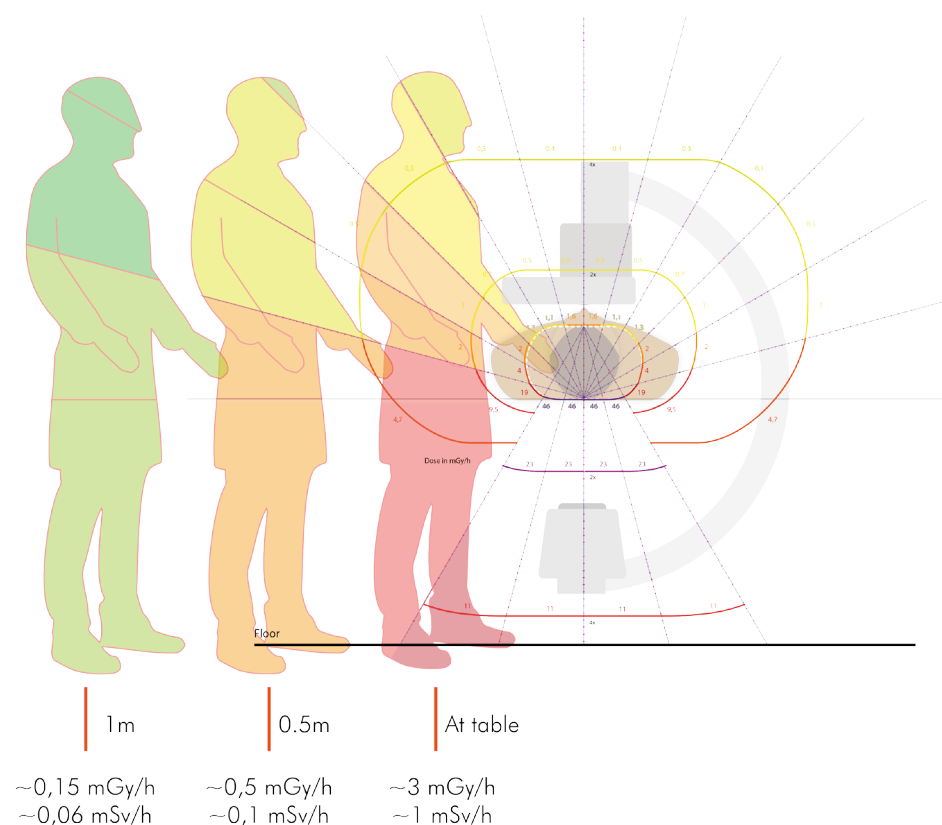
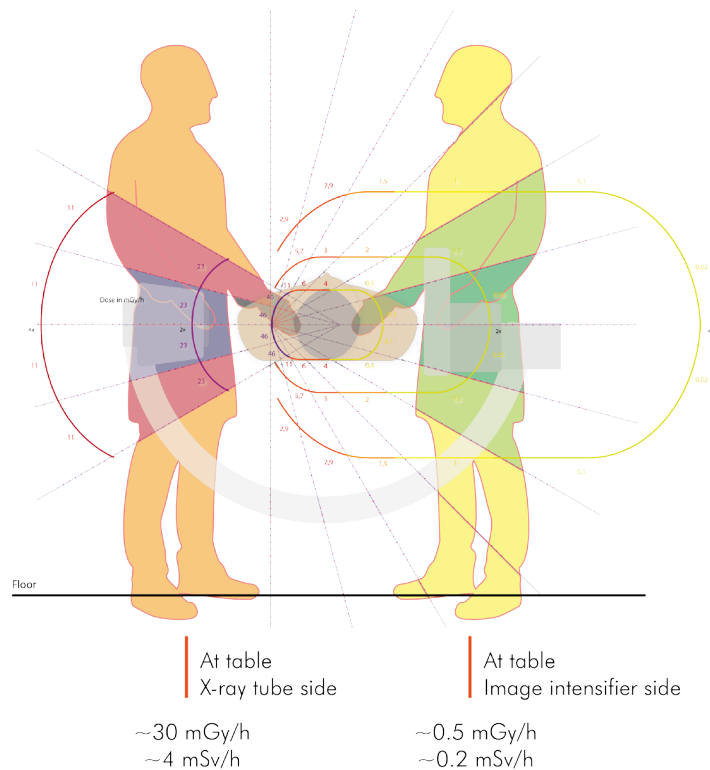

Figure 1.4.1 Accumulated dose over segments at three distances from table.



Of course the mentioned values do not occur when proper shielding is in place. In most cases a table mounted shield is present which blocks the radiation in the 0 degree orientation.

Personal protection like lead aprons and thyroid collars, play a role too in protecting the operators from organ exposure. Their maximum levels for occupational exposure of radiation are however set as measurements made by the dosimeters on top of this personal protection.

This therefore does not influence the spread shown in figures 1.4.1, 1.4.2 and 1.4.3

---

*Note: The mentioned dose levels are approximations as operators differ in height and as segmentation is not 100% accurate for the organs as they might cross over different segments.*

Figure 1.4.2 Difference in dose when C-arm is under an angle. Approximately 12mSv/h for the x-ray tube side vs approximately 0.5mSv/h at the image intensifier side.

Figure 1.4.1 can be produced for orientations other than 0 degrees where there is a difference in intensity on the x-ray tube side compared to the image intensifier side.

These clearly show a significant difference in accumulated and effective dose for standing on the safe side of the table (Image receiver side).



Radiation accumulation at standing positions around operation table (mSv/h)

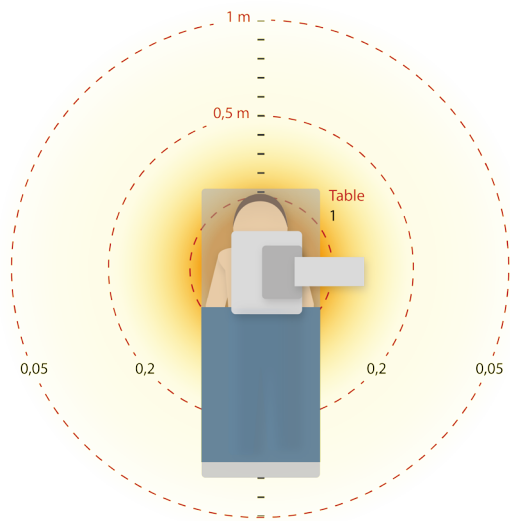
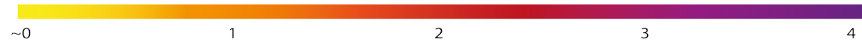

0 degrees

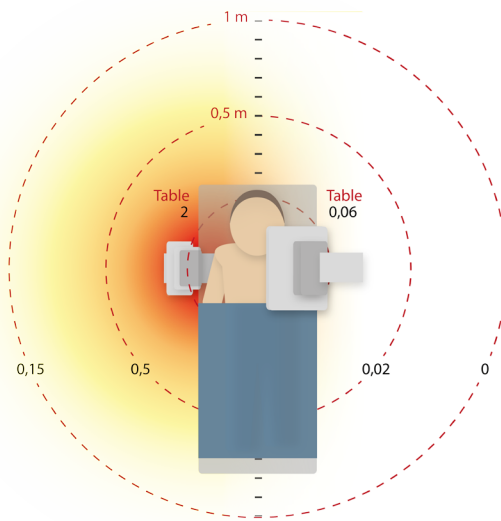

45 degrees

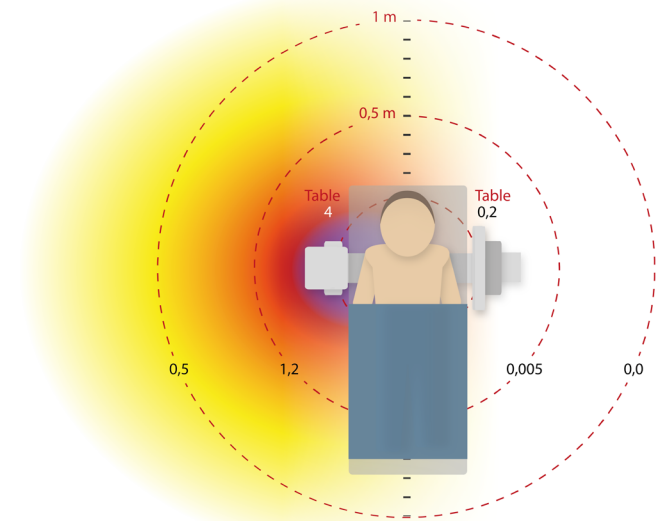

90 degrees

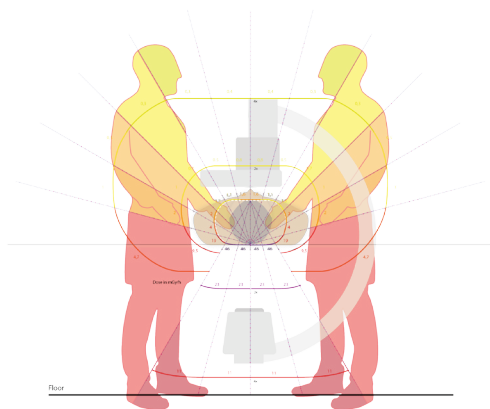

At table  
-3 mGy/h  
-1 mSv/h

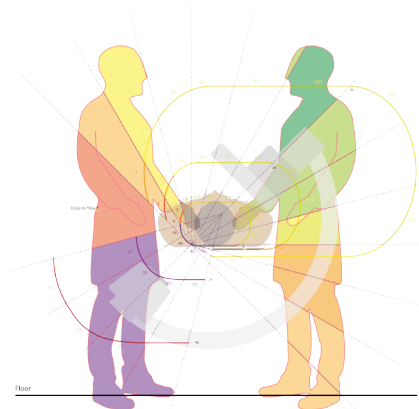

At table  
X-ray tube side  
-10 mGy/h  
-2 mSv/h

At table  
Image intensifier side  
-0.4 mGy/h  
-0.06 mSv/h

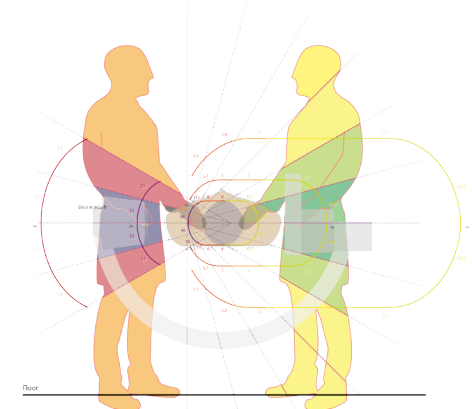

At table  
X-ray tube side  
-30 mGy/h  
-4 mSv/h

At table  
Image intensifier side  
-0.5 mGy/h  
-0.2 mSv/h

Figure 1.4.3 Effective dose surrounding patient. Importance of conscious compared to mindless repositioning

## 2. Procedures

### 2.1 Radiation per procedure

The envisioned product aims to lower radiation exposure. Hence a procedure with more radiation usage is more suitable for improvements as even small decreases can add up to large “savings” in operator exposure over time.

To identify the relative exposure of specific image guided procedures 5 datasets were collected which examined the dose area product (DAP) in Gy/cm<sup>2</sup>. The full list of datasets can be found in appendix 3.

3rd quartile dose area product values per procedure (Gy/cm<sup>2</sup>)

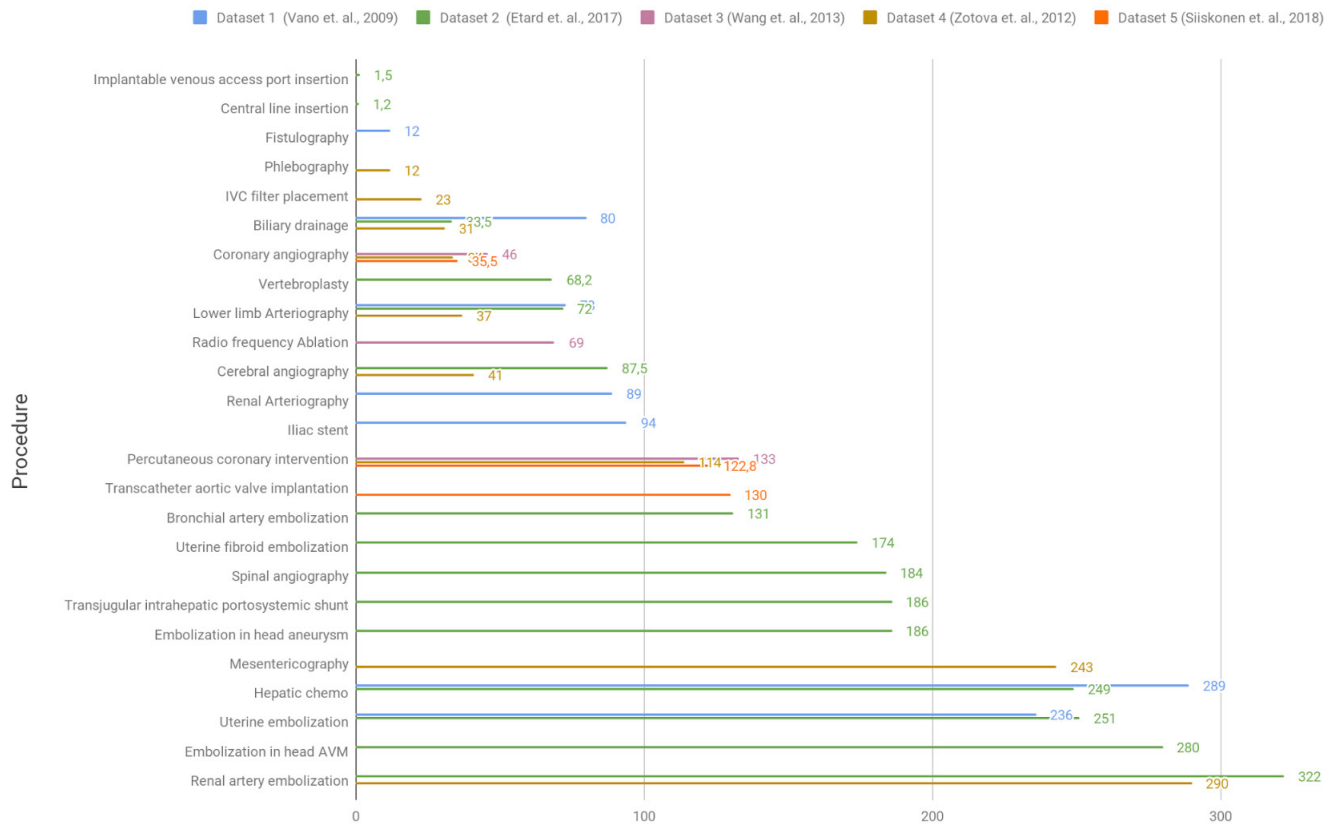

Figure 2.1.1 Dose area product per procedure acquired from 5 datasets

As can be seen in appendix 3, the individual data points in table 5.1 do not represent a single measurement of a procedure but the 3rd quartile value for in some cases more than 600 procedures. The datasets represent a review study on how procedures score compared to the reference values set by government legislation. In this type of review study it is common to use the 3rd quartile instead of the mean.

Next to relative radiation exposure, the frequency of execution for these procedures is of course an important factor. To achieve the highest reduction of radiation exposure and to ensure a proper fit into the market, ideally the product would be designed for the most commonly performed procedure(s).

In a meeting with Clinical Marketing Specialist Monique Weijers, it was advised to primarily focus on cardiac interventions. This because of the current market share of these types of procedures but also because of their future importance as interventional procedures are increasingly preferred over highly invasive surgery (e.g. open heart surgery).

Besides cardiac interventions it was advised to also include arteriography (imaging of veins and arteries involving full rotations of the C-arms) in the scope. This is commonly done before each intervention to map the operational area.

Using the data in table 2.1 the highest exposure for cardiac procedures was found for TAVI and PCI procedures.

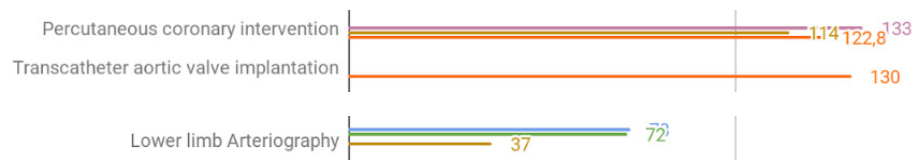

## 2.2 Procedure characteristics

### TAVI/TAVR (transcatheter aortic valve implantation /replacement)

#### Description

*"This minimally invasive surgical procedure repairs the valve without removing the old, damaged valve. Instead, it wedges a replacement valve into the aortic valve's place. The surgery may be called a transcatheter aortic valve replacement (TAVR) or trans-catheter aortic valve implantation (TAVI)."*

*(American heart association, 2016)*

Procedure duration: ~75 minutes

Patient consciousness: 70% of the time the patient is conscious

Machine rotation: Primarily 30 degrees caudal left

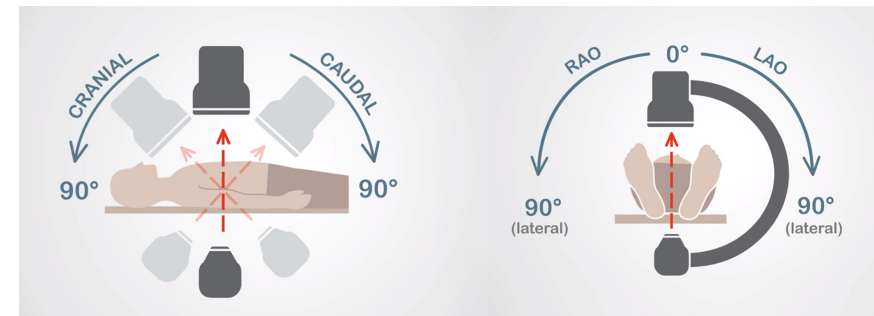

Figure 2.2.1 Machine orientation directions. Cranial: rotation to the head, Caudal: rotation towards the feet. RAO: right anterior oblique LAO: left anterior oblique. Video stills 1m20 & 2m40 (Medmastery, 2015).

## PCI (Percutaneous Coronary Intervention)

### Description

Special tubing with an attached deflated balloon is threaded up to the coronary arteries. The balloon is inflated to widen blocked areas where blood flow to the heart muscle has been reduced or cutoff. Often combined with implantation of a stent (see below) to help prop the artery open and decrease the chance of another blockage..."

*(American heart association, 2017).*

Procedure duration: ~50 minutes

Patient consciousness: Patient is almost always conscious

Machine rotation: Lots of alterations on orientation

### Arteriography

"During an angiogram, your doctor inserts a thin tube (catheter) into an artery and up to the heart. Once in place, a dye that is visible by X-rays (contrast dye) is injected into the bloodstream. The X-ray machine takes a series of images (angiograms) which will show any areas of narrowing. This procedure is done as part of the cardiac catheterization procedure."

*American heart association, n.d).*

Procedure duration: ~ 5 minutes

Patient consciousness: -

Machine rotation: Full rotations around patient body

## 4. Competitor stand on radiation

A quick overview of the stand of companies in the medical imaging market on radiation and its occupational hazards. All information is taken from the product description pages on the website of the manufacturer.

### Philips

Philips follows the theory of the Quadruple aim to improve healthcare outcomes. In comparison with the Triple aim this new framework now includes the "improved staff experience" as one of the pillars.

As a result of this in the product portfolio aimed at a full operation rooms, Philips mentions the patient and staff safety in almost every setup.

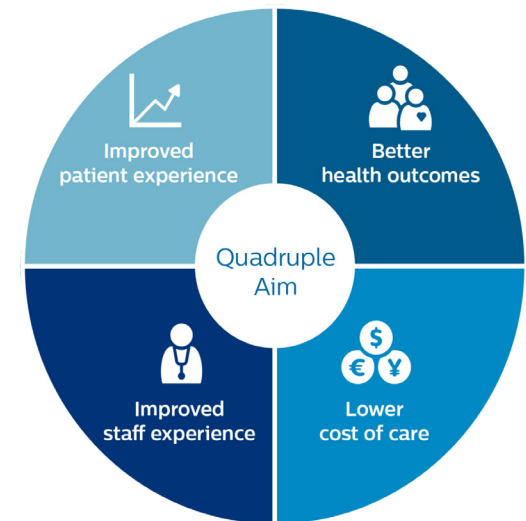

*Figure 4.1 Quadruple aim*

...Take control over patient care, staff safety, and regulatory compliance with our DoseWise Solutions, a comprehensive suite of radiation dose management tools, training and integrated product technologies...

*- Azurion 3 F15 (Philips,2019)*

Additional products for detecting radiation for the operators is mentioned in some product descriptions too.

The DoseAware family offers immediate feedback on dose to increase radiation awareness and help manage occupational medical radiation exposure to physicians and staff.

- *Dose Aware (Philips, 2019)*

## Siemens

General stand on safety as mentioned by Siemens founder Carl Friedrich von Siemens:

“Enterprises [...] also have the obligation to provide [...] for their employees, not to mention all such measures [...] ultimately also serve to improve job satisfaction and their ability to perform.”

- *Carl Friedrich von Siemens (Siemens, 2019)*

Siemens features no explicit text regarding occupational dose in the product features. They do however specify this in add-ons which can be included in the products. The following text is taken from the Care+Clear package pages.

...They are designed to help you deliver better care at the lowest reasonable dose. These cutting-edge functions are designed to reduce radiation dosage for both patient and clinical staff to make dose monitoring and reporting easy and structured for the hospital.

*Care + Clear (Siemens, 2019)*

Siemens also created material on radiation safety in the form of guidelines. These can be found in flyers and posters.

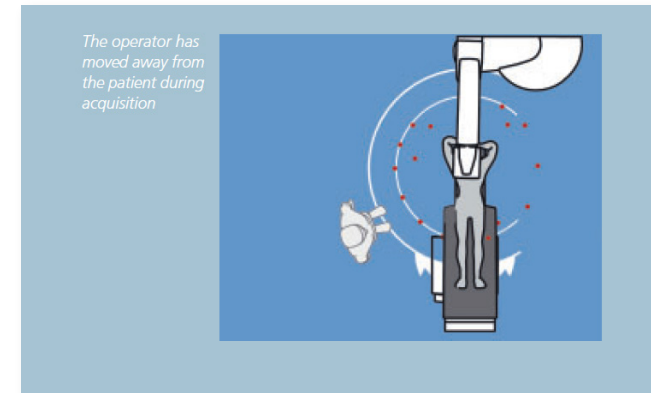

Figure 4.1 Guidelines in Siemens flyer (Siemens, 2019)

## GE Healthcare

General Electronics Healthcare shows a broader perspective on occupational dose in the form of their product “Dose Management”.

It takes more than just low-dose devices. A comprehensive dose management program also demands the collaborative efforts of the entire imaging team, from the referring physician and technologists operating the equipment to the radiologists reading the scan and medical physicists evaluating protocols.

- *Dose management (GE Healthcare 2018)*

They have also published the Brilliant program, a learning program in which practical guidelines are thought.

Brilliant is a comprehensive program designed to help reduce operator dose long term through education, tools and improved dose management...

- Brilliant program (GE Healthcare, 2011)

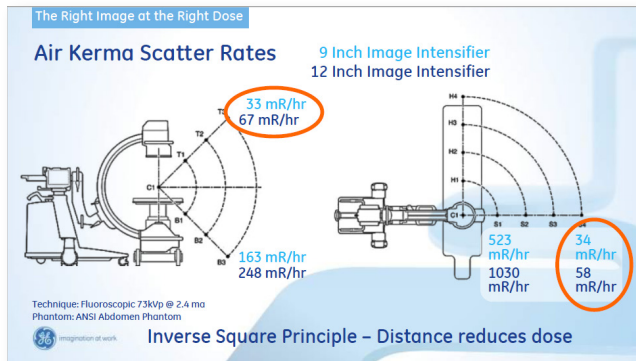

Figure 4.2 Slide from a Brilliant program powerpoint (GE Healthcare, 2011)

## Conclusion

Although some competitors do mention the effect of radiation, or means to limit it, it is never really used as a unique selling point or advantage opposed to other brands. Philips is the only company that is selling safety as an integral part of their whole OR system solutions.

Canon, DMS Imaging, Hologic, Sternmed, Assing & Ibis X-Ray Systems, which are all manufacturers of C-arm xray machines, do not even feature a single mention of either 'radiation' or 'dose' on their product pages. These companies have a strictly technical approach to showcasing their product and only data such as the energy levels or dimensions are mentioned.

Competitors are clearly not invested in the full display of safety with the showcasing of their products. It could therefore be possible that there is a competitive advantage for companies to focus more on the 'package deal' where radiation safety is more prominently included.

Next to this, the Quadruple aim opens a relatively new direction for Philips to focus on staff safety during the use of their systems too.

## Ziehm imaging

Ziehm imaging is taking a mainly informational approach in communication regarding radiation. A white paper was released in which the basics of radiation and scatter are explained.

The goal of this paper is to help readers understand the basic principles of radiation dose, its benefits and challenges.

- White Paper (Ziehm, 2016)

## 4. Occupational Radiation Hygiene

### 4.1 Layers of protection

As the need for protection from occupational radiation exposure is clear, it makes sense for a hospital or clinic to invest in this line of protective measures. Within radiation protection a division can be made into the “layers” of protection. For this assessment of existing measures a division is made following the “occupational health strategy” (OHS) guideline as set by the Dutch government (Arbo, n.d.).

This guideline is to be followed when employees are exposed to occupational hazards such as radiation. In this case the employer is obligated to minimize the hazards by taking measures in the following layers in ascending order:

OHS layer	Description
Source measures	Remove origin of hazard
Collective measures	Place protection
Individual measures	Set organizational rules
Personal measures	Provide personal protection

Table 4.1.1 Occupational health strategy

The OHC layers can be translated into categories for protection in the Hybrid OR. This creates the protection layers in figure 4.1.1.

Here the collective measures include all protective products that are present in the OR; either fixed to ceiling or tables or movable by rolling over the floor.

The individual layer includes protocols and products meant for training as well as products aiming for awareness surrounding radiation.

The personal layer includes all wearable protection and also detection, e.g. the dose badges, worn by a specific individual.

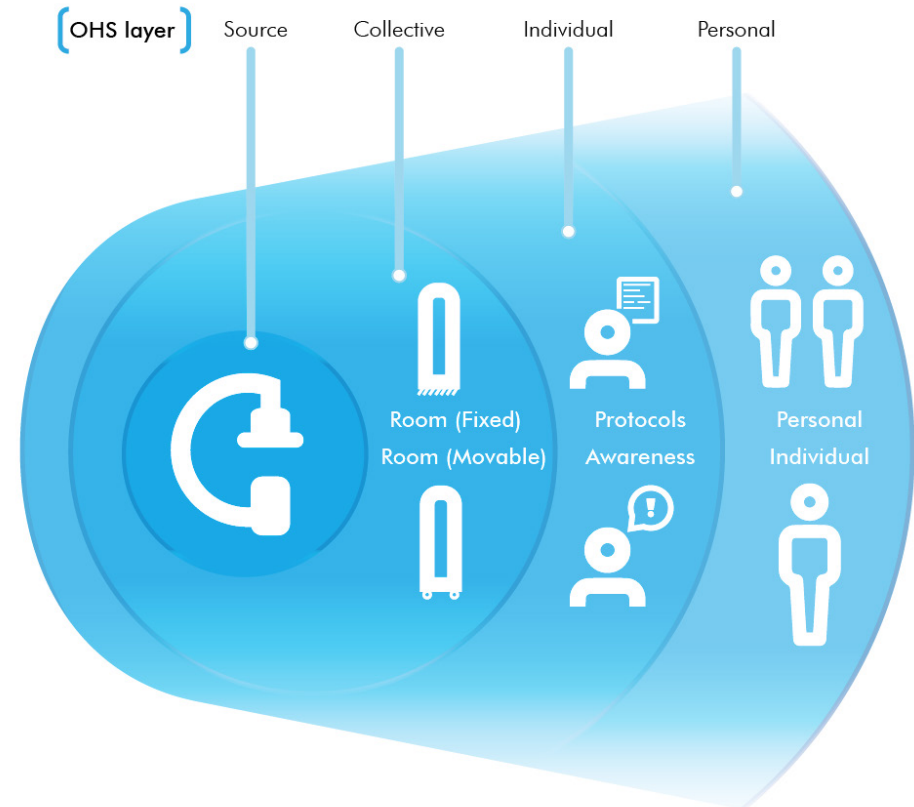

Figure 4.1.1 OHS layers in the Hybrid OR

### 3.2 Protective measures in the market

Each layer in the mentioned OHS was examined to find a potential opportunity for product design. The detailed overview of all products can be found in appendix C.

Besides the expected physical barriers, the market for protective products also includes a selection of software solutions which lower radiation exposure by digitally enhancing the images. These can be accounted to the 'source protection' layer.

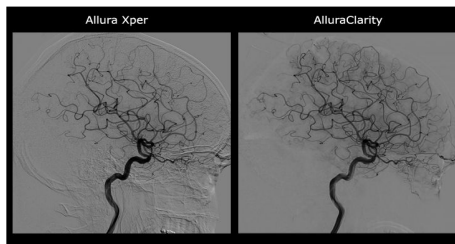

Figure 3.2.1 Example of software enhancement of the image: Philips Clarity software

The most prominent protective measures however are the physical products which are present in two layers of the OHS: the collective protection and the personal protection.

These layers include a variety of different solutions as can be seen in figure 3.2.2 (and the detailed examination in appendix C). The 'collective protection' layer is shown on the right. Here hospitals can select 14 different styles of either ceiling or table mounted and rollable shields. Most of these styles are covered with similar products by all competing companies. What is primarily made clear by exploring these physical shields is that almost all shapes and solutions are already present in the market.

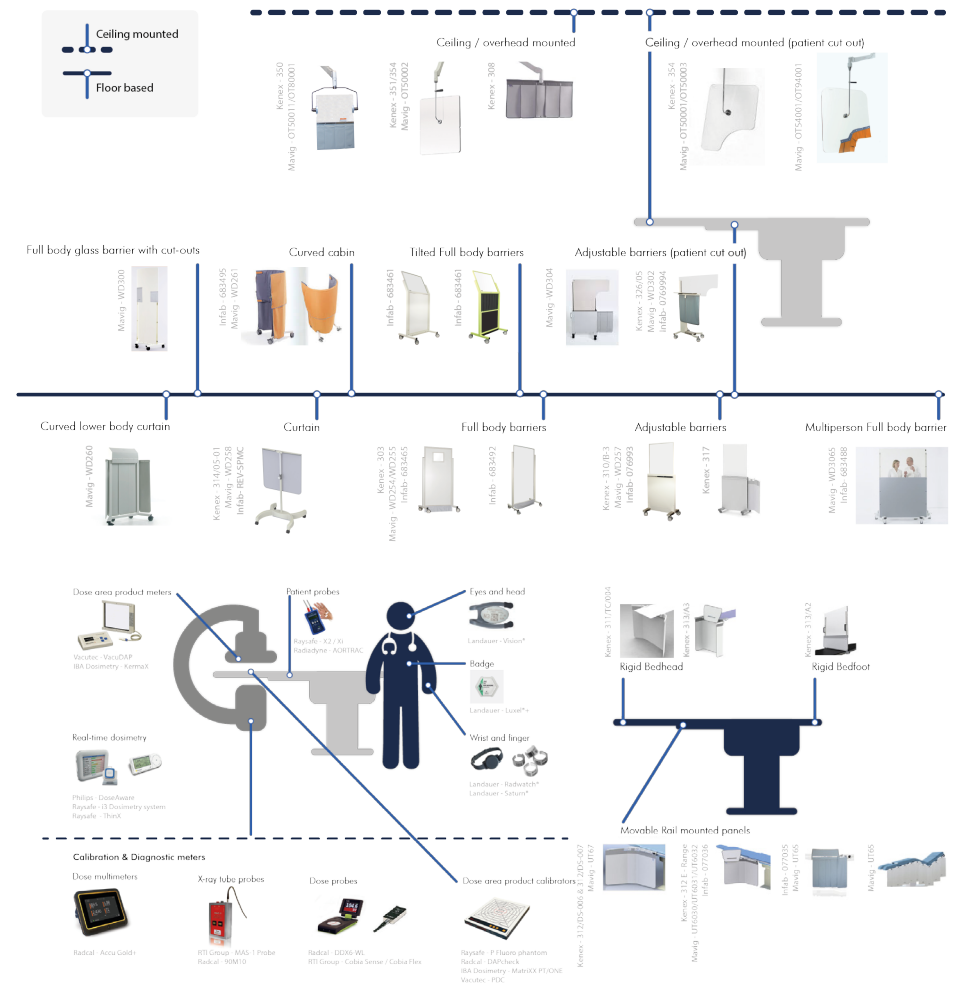

Figure 3.2.2 Collective measures. Clear abundance of options in all protective forms of shielding. Appendix C2.6



The 'individual protection' layer contains guidelines and training to avoid exposure by gaining knowledge of radiation.

The ALARA (as low as reasonably achievable) principle is the main "protocol" in radiation usage. It is taught through practical guidelines such as double your distance to cut exposure in four (the inverse square law figure 3.2.4)

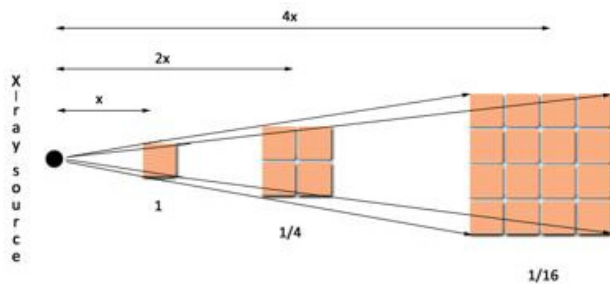

Figure 3.2.3 Inverse square law

Here the mandatory courses for radiation safety are located. These train the operators to work safely around the C-arm system and teach the usage of shielding. This layer does however not include any physical products meant for such courses or the following of protocols.

Similar to the 'collective protection' layer, the market in the 'personal protection' layer is considerably saturated. Almost every bodypart already has a specific personal shielding product (figure 3.2.4). Besides that, all companies producing these products have highly overlapping product portfolio's practically ruling out an opportunity for a specialization on a single type of protection.

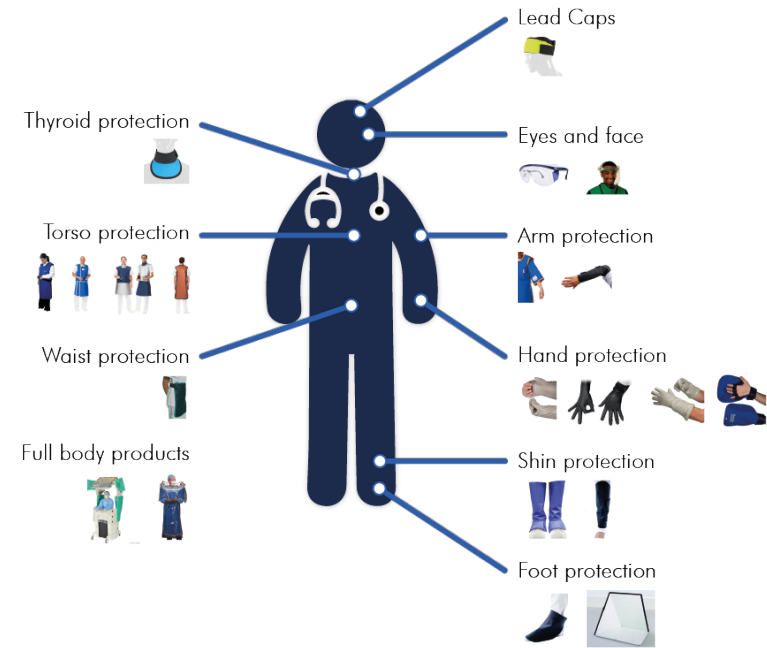

Figure 3.2.4 Personal protection products. Highly saturated as every body part has a variety of products fitted for it and different companies producing it.

## Conclusion

A new product in the 'collective' or 'personal' layers will have to compete in a considerably saturated market. A new product would have to compete with several renowned brands and its products that already in use by hospitals.

Ideally the product would therefore be present in either the source layer or the individual layer as physical products in these categories are scarce. The quadruple aim as mentioned in section 4 also fits with this direction as it accomplishes staff safety through training. This therefore could provide an opportunity for product design.

# User & Awareness



**27** 5. Procedure observations

**35** 6. User awareness interviews

## 5. Procedure observations

The goal of these observations is to gain insight in the various procedures that require radiation and in the usage of shielding by the medical staff.

- How is the present shielding used?
- How is it repositioned and by whom?
- Does it interfere with the procedure?

To observe the usage of shielding equipment and the interaction with radiation, video footage is used that is created for either educational purposes or to showcase a new technique during a medical congress.

These procedures are used as an example for conduct in a procedure and interaction with (new) equipment. They should therefore set a standard on how the average procedure, where cameras are not present, is conducted.

By answering the questions stated above, problems during the interaction and potential opportunities for design can be identified. To make identification of the shielding easier they have been marked with a red outline.

The following chapter contains images of actual medical procedures. The images (video stills) taken from these can therefore contain blood.

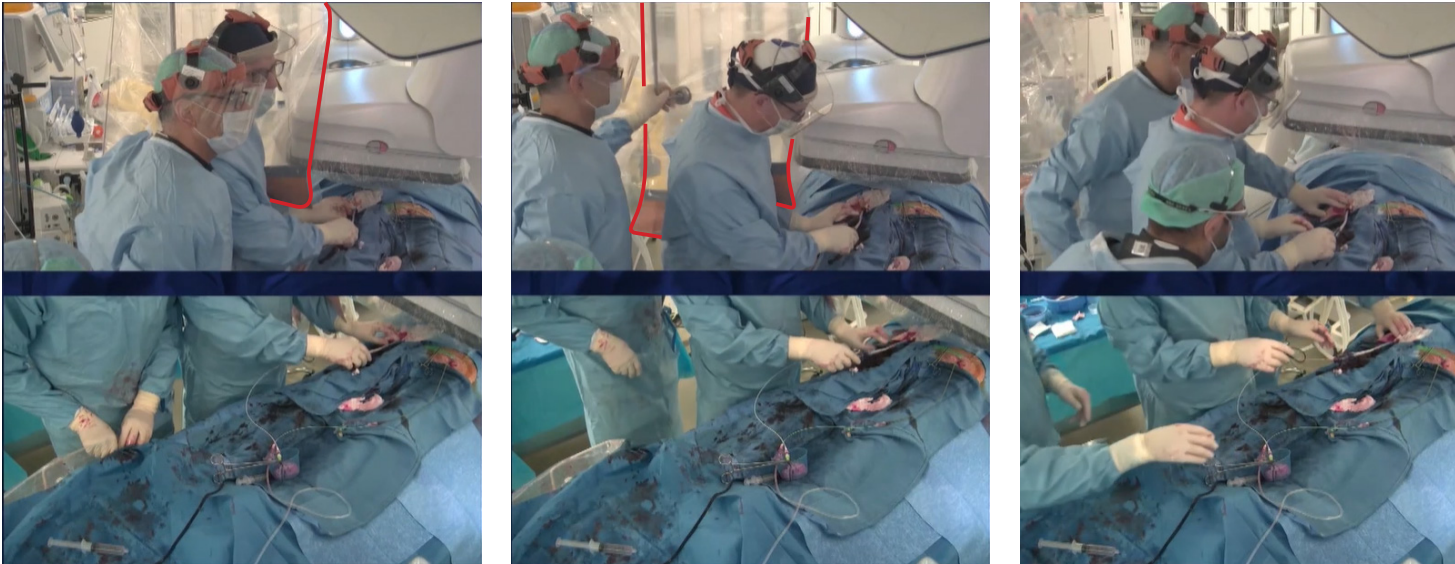

Figure 5.1 Shield interaction TAVI - Video stills 42m21 (Cardio Live, 2019)

### Video 1. Valve replacement

When the imaging is no longer required, the shield is removed to better access the patient in order to remove the catheter.

After this however, the imaging is resumed to guide the catheter out of the body. This is done without the shield in place.

Procedure: TAVI  
 Hospital: Paris Saint Joseph  
 Date: 30/03/2019

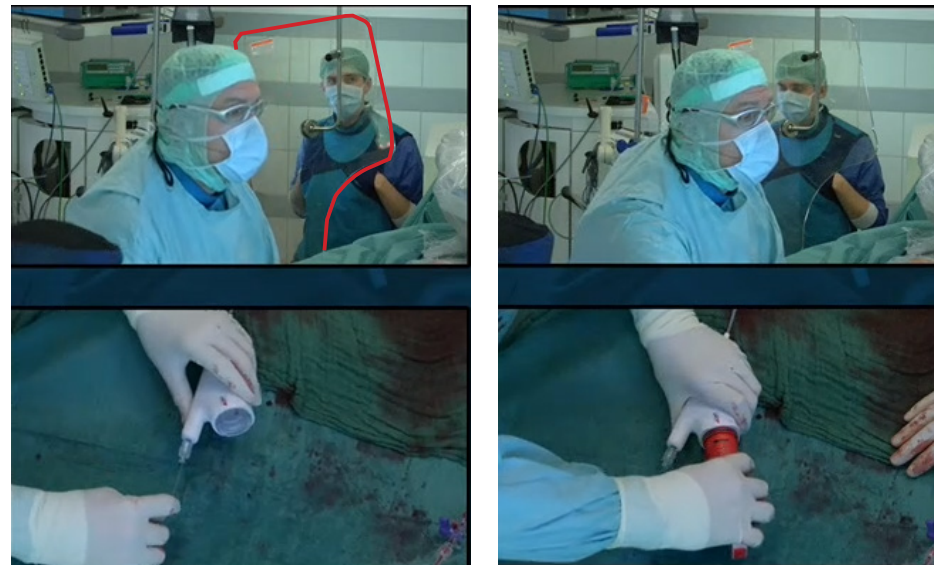

Figure 5.2 Shield protecting staff member - Video Stills 17m00 (Incathlab, 2018)

### Video 2. Aneurysm repair

The shield is placed in between the image sensor and the staff member in the background.

In its current position it is not meant for keeping the physician protected. The staff member moves the shield several times to better protect himself.

Procedure: EVAR  
 Hospital: St. Franziscus Munster  
 Date: 2018-01-17

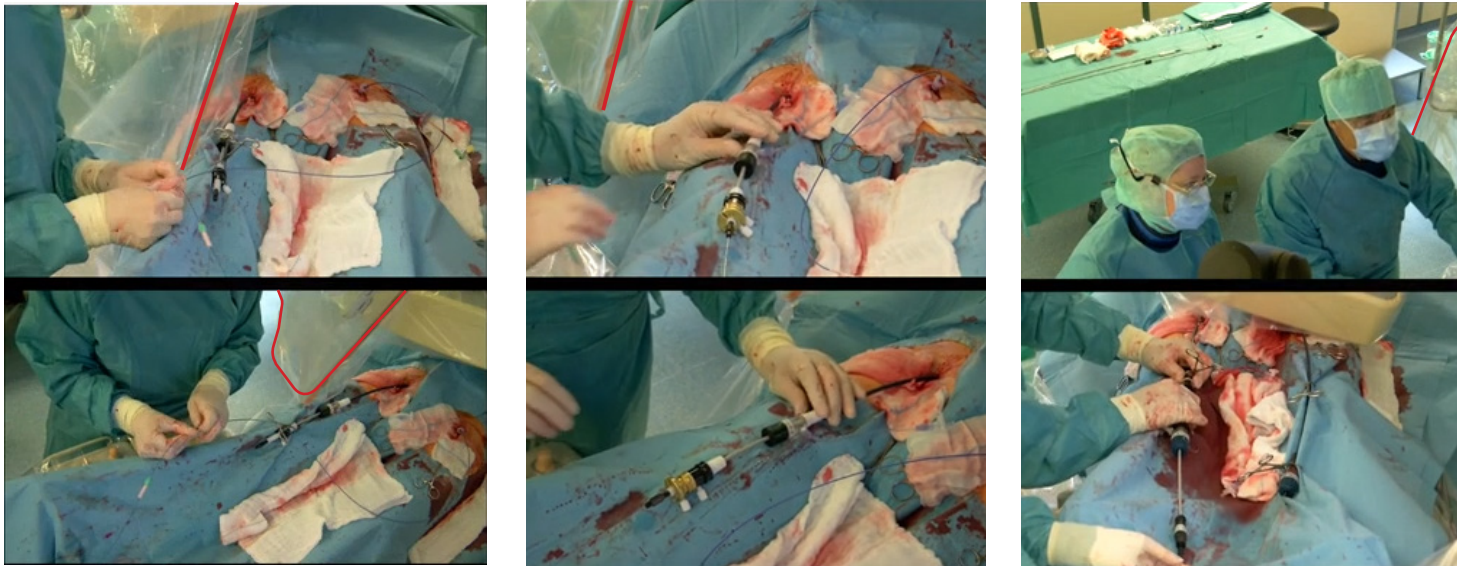

Figure 5.3 Shielding removed for catheter interaction - Video stills 15m15 (Incathlab, 2015)

### Video 3. Aneurysm repair

The shield is repositioned several times to access the catheter, which is almost below the image sensor.

Procedure: EVAR  
Hospital: Asklepios-Klinik St. Georg  
Date: 21/09/2015

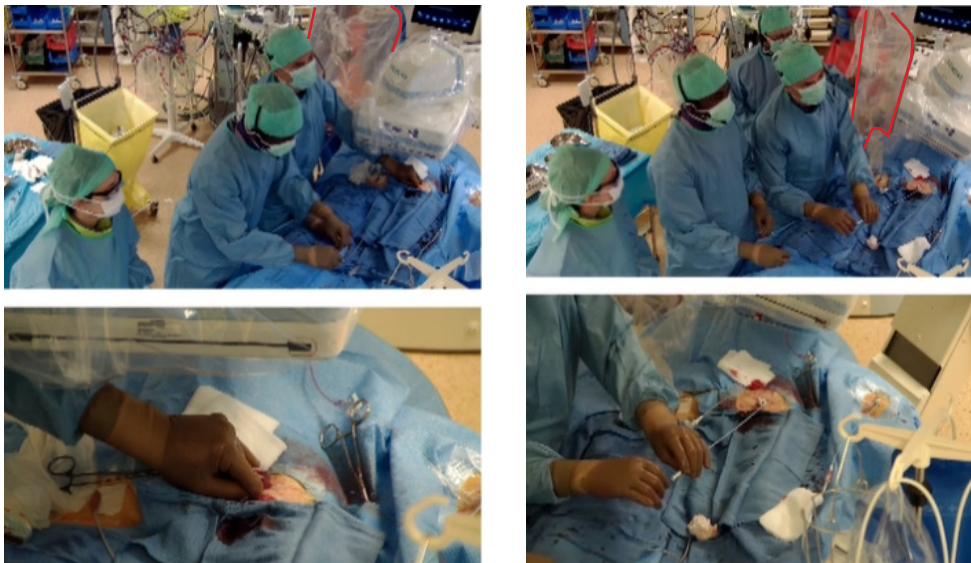

Figure 5.4 Incorrect placement of shield - Video stills -12m00 & 15m08 (MLSF, 2019)

### Video 4. Valve replacement

Without imaging, the shield is placed to create no obstruction. After this the procedure is continued with the imaging on, but the shield remains at the non obstructing position.

The shield is eventually repositioned by a support staff member after 3 minutes of x-ray being used. The staff member however positions the shield away from the patient body and towards

the image sensor. It appears as if he/she is protecting the physician from the wrong part of the setup; the sensor and not the source.

Procedure: TAVI  
Hospital: Arnault Tzanck Institute  
Date: 05/04/2019



During an orientation change, the machine itself pushes the shielding away.

Figure 5.5 Image sensor pushes shields away - Video stills -17m15 (MLSF, 2019)



In another instance, where a longitudinal translation is performed, the machine pushes the shield into the physician which is operating the catheter.

Figure 5.6 Image sensor pushes shield and operator handling the catheter away - Video stills -27m30 (MLSF, 2019)



Figure 5.7. Shield repositioning by physician- Video stills - 44m15 (MLSF, 2019)

The physician is closely monitoring the orientation change of the machine and adapting the shield accordingly.

Contrary to the repositioning of the staff member, the shield is placed onto the patient body.



Figure 5.8 Shield usage by physician - Video still - 13m45 (MLSF, 2019)

### Video 5. Femoral-artery intervention

A ceiling mounted shield with a patient cut-out is used. The physician has chosen to use the cut out for his arms instead of placing it onto the patient body.

Procedure: EVAR  
Hospital: Asan Medical Center, Seoul  
Date: 28/05/2016



Figure 5.9 Shield not touching the patient and machine rotation- Video still - 8m25 & 12m55 (University hospitals, 2017)

### Video 6. Valve replacement

The overhead mounted shield with patient cut-out is placed in a way where it does not touch the patient body.

The machine is rotated away from the physicians, which increases the scatter dose in their direction. The shield is also not repositioned from its initial position.

Procedure: TAVR  
Hospital: Cleveland Medical Center  
Date: 8/02/2017



Figure 5.10 Unused shield and machine rotation - Video still - 6m50 & 12m55 (Meet, 2010)

### Video 7. Artery stenting

The x-ray machine is rotated away from the physicians which increases the scatter towards them. No shielding is used in between them and the source.

It can be noticed that an unused Mavig Lead Acrylic Shield OT80001 is suspended in the background (Mavig, 2019).

Procedure: 3D Angiography and stenting  
Hospital: Clinique Louis Pasteur  
Date: 10/05/2010





### Video 8. Artery Stenting

The x-ray machine is rotated around the patient and the patient bed is translated laterally, yet all present shielding remains in the initial position during the whole procedure.

Procedure: Artery Stenting  
Hospital: IMC Jeddah  
Date: 18/01/2019

*Figure 5.11 Shield in initial position for whole procedure- Video still - 8m55, 29m00, 43m55 (IMC, 2019)*

## Conclusions from observations

Aneurysm repair procedures (EVAR, TEVAR) require the catheter to be handled closer to where shielding should be placed in comparison with valve replacement procedures (TAVI, TAVR). This creates a recurring scenario where the shield is removed to access the catheter and it not being replaced after the interaction.

During aneurysm repair procedures the shields that are present around the operating table are to protect the surrounding staff, hardly the physicians.

Proper knowledge from the scatter spread is useful for positioning the shields in an optimal way. The physicians know this better than the surrounding staff members.

Overhead mounted shields with a patient cut-out are often used in a way where the cut out does not touch the patient. This is done to accommodate hand movements closer to the patient (mainly during aneurysm repairs). This does not conform with Mavig's explanation of the optimal use of their shielding.

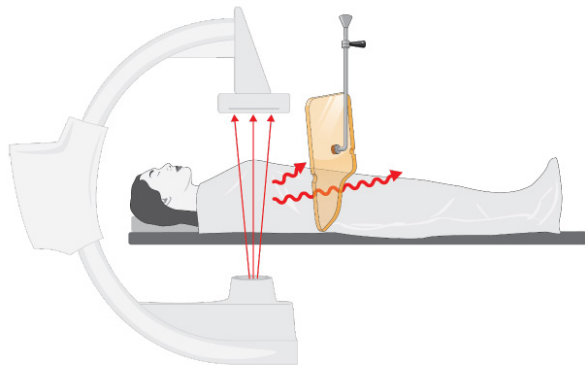

Figure 5.12 "Panels attached to the radiation protective shield should lay effectively on the patients body. Potential "leakages" for scattered radiation are then closed efficiently" (Mavig, 2019)

Imaging in a position where the machine is under an angle, is best done in a machine rotation where the imaging sensor is rotated towards the physicians. Although this is done in most case the orientation is sometimes causing higher scatter levels in direction of the physicians

The machine translations and rotations are forceful enough to move a shield and push a physician away.

When shielding is properly positioned when the procedure is started, it is in most cases not repositioned to accommodate for the scatter spread in a new machine orientation.

## 6 User awareness interviews

The aim of this study is to identify the knowledge regarding radiation and scatter radiation among medical staff which work in the field of radiation guided procedures.

Using images, such as indicated in figure 4.3.1, the participants were asked to identify the area's where scatter radiation can pose an danger to themselves or others.

The data acquired was then used to identify area's of increased danger, where for example scatter radiation is present but the participants were unaware of it.

The participants were first presented with a written questionnaire after which an interview followed.

### Participants

All participants have taken a course in occupational radiation training. All indicated to have acquired the 4M or 4A/B level (prior to 2018 renaming as discussed in section 2.7) and therefore having followed at least the course as explained in section 2.7 including practicum.

6 Doctors were interviewed in the St. Antonius Hospital Nieuwegein.  
(4 Interventional cardiologists, 2 electro-physiologists)  
3 Doctors were interviewed in the Amsterdam Medisch Centrum of which  
1 completed the interview with the questionnaire.  
(1 Interventional cardiologist)

#### Scenario introduction

You are performing your profession in a radiation guided intervention. You are wearing a lead apron, thyroid protector to protect yourself from the radiation. The system used is a C-arm x-ray machine. The C-arm is positioned as shown in figure 1.

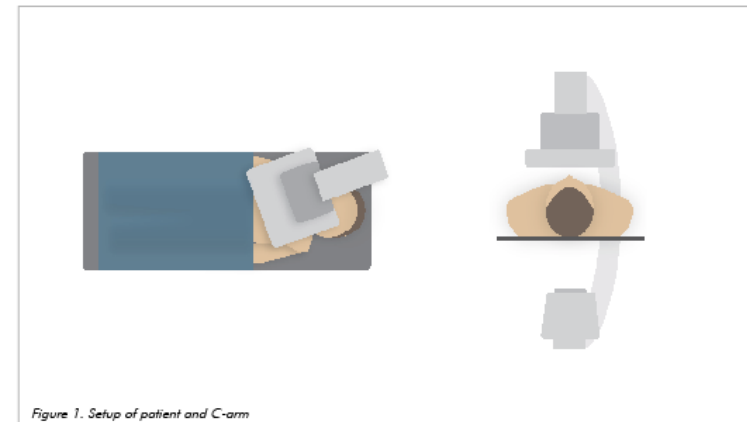

Figure 1. Setup of patient and C-arm

#### Question 1. Source of the hazard

Could you indicate in both figure 1 and 2 the source of the radiation, and the region where there is the most scatter radiation.

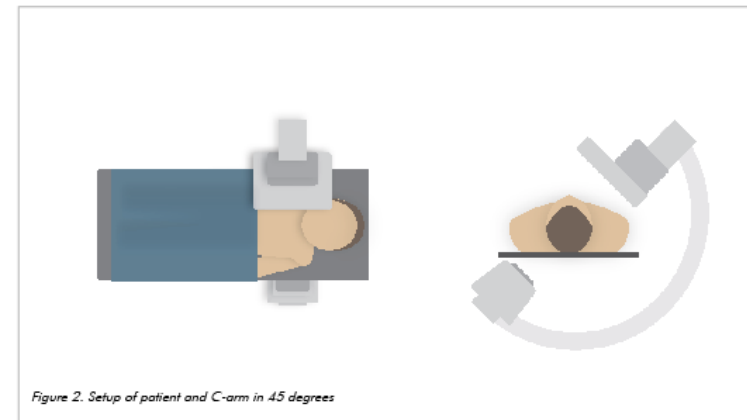

Figure 2. Setup of patient and C-arm in 45 degrees

Figure 6.1 Questionnaire questions regarding scatter knowledge.  
Full questionnaire in found in appendix 2.

## Results questionnaire + interview

### Scatter spread & Machine orientation

The image below is a collection of all responses. It shows a 'collective' understanding of interventional cardiologists towards the spread of radiation.

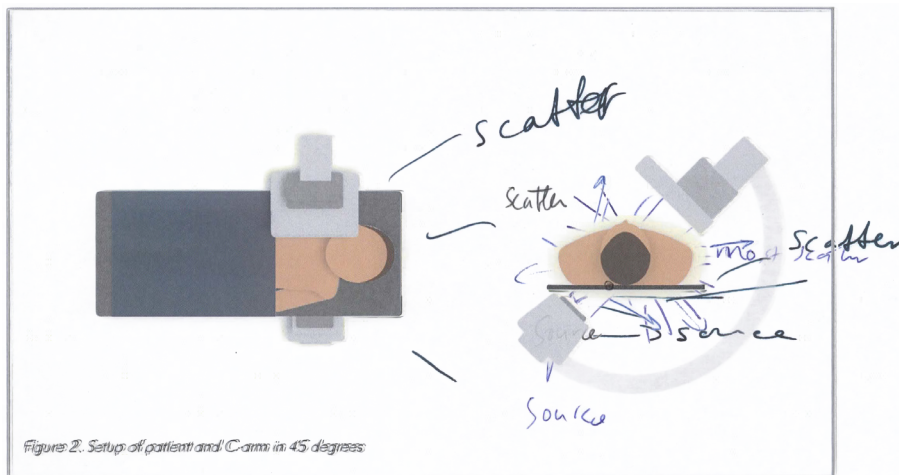
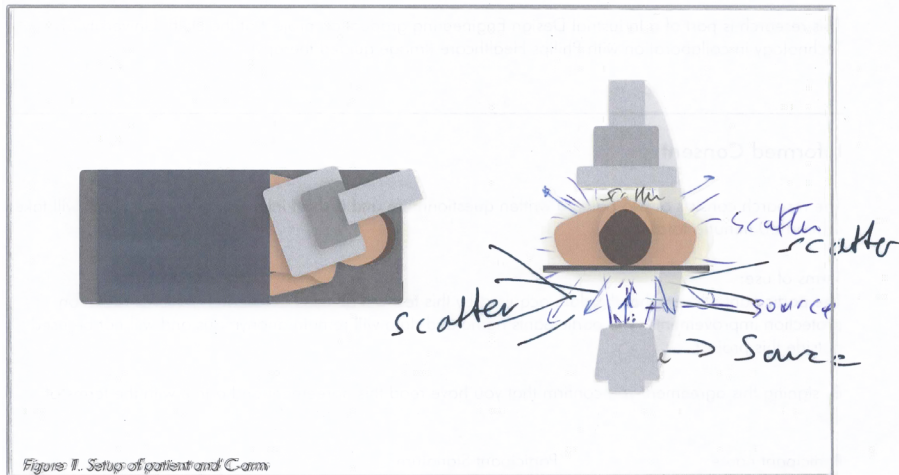

Figure 6.2 Combined results of radiation mapping among cardiologists

The combined results show that although the source is always indicated correctly as being the x-ray tube, there is no common ground on the exact spread of the scatter radiation.

Although every participant was asked to draw their perception of the radiation as detailed as possible, the individual entries from each participant do not feature a level of depth besides several arrows.

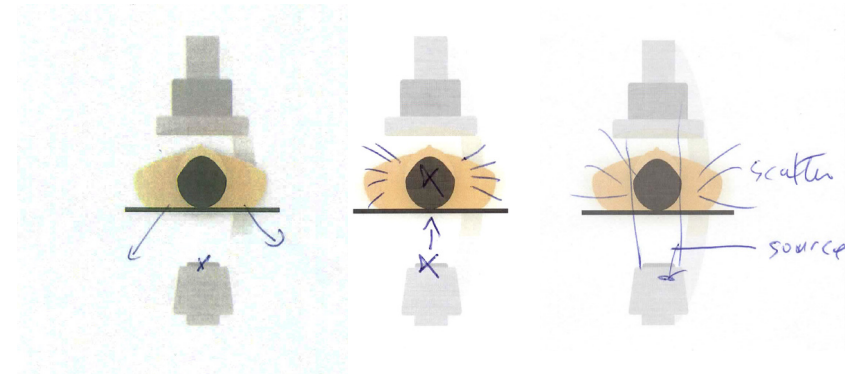

Figure 6.3 Level of detail in entries

The level of detail towards the spread of radiation might be a result of the training which focuses more on practical guidelines compared to hard theory. Also the removal of calculations from the course might influence their know-how for the spread of scatter (section 2.7).

Another interesting result was that few participants (3) included the backscatter directly below the patient, as can be seen in the drawings in figure 6.3.3.

When asked about his (correctly) drawn scatter spread, a participant indicated that he has had a discussion with his technician who claimed most scatter was present above the patient and not underneath, which had confused him.

As seen in figure 6.3.2, the situation where the c-arm is positioned under an angle also divided the participants in multiple directions.

The most notable error was in the direction in which the most scatter is projected; the participants (3) indicated this as where the x-ray tube is pointed towards. Also it was indicated that the orientation did not change the scatter compared to the vertical position.

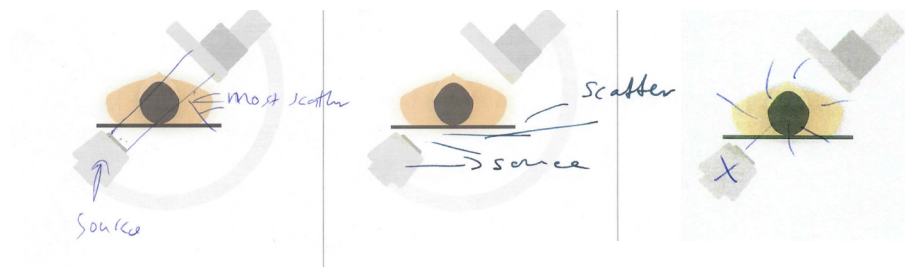

Figure 6.4 Incorrect scatter direction & absence of effect of orientation

### Radiation dose and feedback

Participants were asked to indicate how much radiation was 'too much' in their perception. All participants responded with the limit as set by the European union; the maximum allowed dose of 20mSv per year.

One participant indicated that he found the 20mSv bar too high already and proudly noted that he only accumulated 12mSv last year. Another mentioned that actually everything above the norm for normal people was already too much.

When asked the same question for a single procedure, only one gave an indication of too much, but it was related to the dose the patient would accumulate during the procedure. In that case more than 1 Gy was too much.

In both hospitals the personnel uses dosimeters. The participants mentioned that they do try to reflect on the data by paying extra attention to safe conduct when the values are higher than usual. That is however limited to when they are read out every 1 to 3 months. Therefore evaluation after each procedure is not possible.

### Use of protective measures

Both hospitals use the following set of protective shielding solutions.

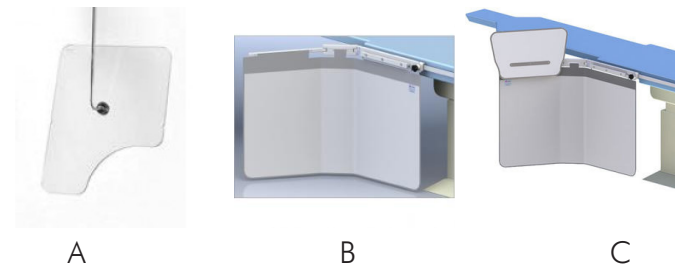

Here A (Mavig OT5003) combined with B (Kenex 312) or C (Kenex 312E) is always present in the OR.



D (Mavig WD304) or E (Kenex 317) and F (Infab 683461) are occasionally used in the St. Antonius when an echographer is present.

Most participants indicated that the present protective shields were used in an adequate way. However, in some specific operations the shielding could not be used properly.

During operations where a pacemaker was placed, the shields could not be used. This was due to the many rotations during this kind of procedure and the lateral/horizontal angle in which it would be positioned. Because of this the ceiling mounted shields were difficult to position. In the AMC the table mounted shields were even completely removed during pacemaker placement and PCI.

Another implication is the preference for using the radial artery instead of the femoral artery as entry point for the catheter (this is done to lower the chance of bleeding specifically for elderly). In this case the patient's arm has to be accessed.

This causes three issues. First, the arm is not included in the cut-out of the overhead mounted shield (A on the previous page). This gap was mentioned by a participant as being a problem. Second, the operator has to stand closer to the source and this makes the proper placement of shielding difficult. Third, sometimes the left arm of the patient is chosen for the procedure. The cut-out of the shield is not meant for this use and can not be placed.

The participants were asked whether they had ever felt vulnerable as a result of radiation. Only one participant answered that he felt vulnerable for a case unrelated to the issues mentioned above. It involved a procedure in Singapore where three operators were standing on the same side of the bed. He was not in control of the shield and had to rely on their knowledge of radiation, which he suspected was less than his.

When asked about their way for assessing proper placement of a shield the following two factors were mentioned by most.

- 1 Shield should be in between you and the patient/source
- 2 Shield cut-out should be fitted as close to the patient as possible

Some indicated that they were not quite sure about when it was correct due to the invisible nature of radiation. Using common sense for 1 was most applied.

As seen in figure 6.3.2, the majority of participants indicated a change in scatter direction in a non vertical orientation of the machine. But when asked if they alter the shield when changing the orientation of the machine, only two mentioned that they reposition the shield.

One of the two added to his response that these small alterations of the shield position became part of his routine over the years (27 years as interventional cardiologist).

All other participants mentioned that the shield was already in an optimal position before the rotation.

## Evaluation of radiation use in video cases

Video stills from three procedures (observation videos 3, 6 & 7 from section 6.1) were presented to the participant in which they were asked to comment on the procedure related to radiation.



All participants noticed the incorrect shielding position and indicated that it had to touch the patient body. 2 commented on the use of lead glasses for the main operator too.



All participants noticed that there was no shield in use. Only 1 however commented on the hazardous orientation of the x-ray tube.



Three participants commented on the shield not fitting properly onto the patient, two found the shielding situation adequate, one suggested lowering the image receiver and two suggested the use of lead glasses.

## Procedures

The participants were asked which procedure they performed most in their daily operations. TAVI, PCI, ablation & pacemaker placement were most common for them.

## Further remarks

The participants were asked if they would want to add anything to the OR regarding radiation protection improvements.

Almost all were interested in trying out Rad-Pads (A brand name for protective patient drapes as can be seen in figure 2.2.1) and several showed interest in using a suspended lead apron solution (e.g Zero-g apron). The use of last image hold software, as discussed in 2.2, was also mentioned.

One interesting suggestion was aimed at the monitors at which operators see the x-ray images. The participant said he always asks the staff to position them as much to the right of the table as possible. This to always avert his head from the radiation source to protect his eyes.

## Conclusions from interviews

There is a gap in knowledge to how scatter is distributed around the patient body. During the course in radiation safety the level of depth does apparently not include a detailed “map” of how scatter is present around the patient. Most participants do however indicate that the scatter is more present at the sides. Most absent was however the direct backscatter below the table.

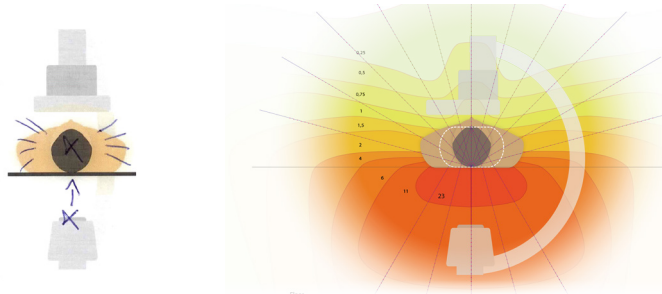

Figure 6.8 Cardiologist drawing vs actual spread at 0 degrees rotation

When the machine is orientated other than vertical, several participants indicated wrongly that the scatter was facing in the direction of the x-ray tube. This could be accounted to using common sense, where it would be logical that x-ray would continue from the source rather than reflect in the opposite direction.

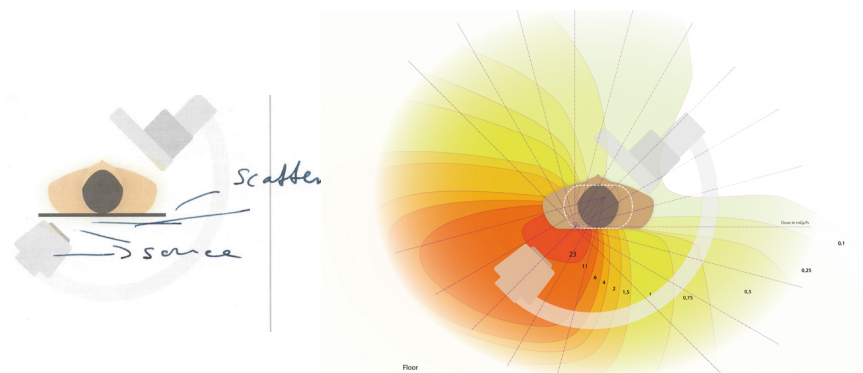

Figure 6.9 Cardiologist drawing vs actual spread at 45 degrees rotation

The levels of dose expressed in mSv might be somewhat unclear. All participants could quote the legal bar of 20mSv per year, but were unable to give an indication of how much radiation exposure during a single procedure would be too much. One mention was regarding patient dose but in a different unit, Gray (Gy).

The operators are able to read out their dosimeter data. It is however limited to three month intervals, which makes evaluating their behavior difficult. Especially reflecting on their conduct in a single operation is impossible because this data is not available.

The usage of shielding is limited to a few items compared to the whole range of products that are available on the market.

The preference for using the radial artery instead of the femoral artery as entry point for the catheter creates several issues including fitting and placement of shielding and potentially increases dose due to closer proximity to the x-ray tube.

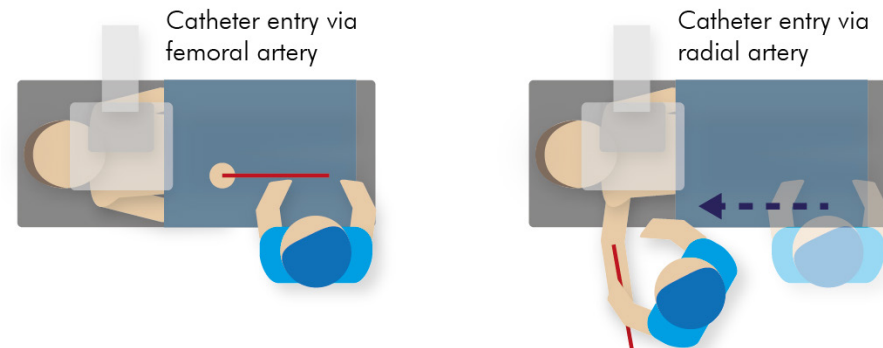

Figure 6.10 Different artery usage for catheter entrance and effect on operator position



Left sided procedures limit the shields that can be used due to misfits with the current cut-outs in the shields.

Orientation change of the machine was not considered a reason to change the position of shielding. Potentially exposing them to more radiation.

Although the participants mentioned various problems with the current situation, no one felt vulnerable in their line of work.

Only one participant mentioned the hazard of the orientation of the machine in the evaluation from the video stills.

Most participants were aware of the danger of a misfit of the cut-out and noted that the shield should be as close to the patient as possible.

This fitting of the cut-out in video still 3 was found adequate by the doctors with the least amount of years in the field. This would be an indication that such practice is learned and incorporated in their routine as mentioned in 2.7, where the years of experience lower the received dose.

# Combined Insights



## Products and training

Highly saturated market. Practically all major brands feature a similar product portfolio including a variety of different lead shields for both under and above the operating table. In practice however, only two or three products are in use in the Hybrid OR: the ceiling mounted shield with cut-out and table mounted curtains.

*(Appendix C2.3, C2.4, C6.3)*

Radiation protection training focuses on practical guidelines such as the ALARA principles. These are simple steps to limit exposure, such as doubling the distance with lower the dose by four. Real calculations or awareness of the actual radiation spread are limited.

*(Appendix C2.6, C2.7)*

Experienced interventionalists have a lower relative dose than fellow-interventionalists, per unit of radiation they use the dosimeters receive less.

*(Appendix C2.7)*

## Radiation

Scatter is not uniformly distributed around the patient. There is a significant difference in radiation intensity at different places surrounding the patient. Specifically the influence of backscatter (scatter in the opposite direction of the beam direction) is significant. Less than 1% actually reaches through the patient body due to attenuation in the tissue, where more than 5% of the beam is scattered back.

*(Sections 1.2, 1.3)*

The orientation of the C-arm has a crucial influence on the hazardous regions surrounding the patient. When the machine is oriented to a lateral (90 degrees) angle this high intensity beam of back scattered photons is directed directly at the operators and beamed into the room. In such an orientation it is safer for the operator to have the x-ray tube on the side where they are not standing.

*(Section 1.3)*

## User and operations

There is a large list of operational procedures that are image guided. The most prominent direction for the product lays in the cardiac interventions. Specifically PCI and TAVI/TAVR procedures.

*(Section 2.1)*

Certain procedures are more hazardous than others due to the location of the operator relative to the source. Aneurysm repair surgery for instance requires the operator to stand so close to the source that the placement of shielding is impossible. The same is achieved due to the trend of using the radial artery instead of the femoral artery to reduce bleeding.

*(Sections 5, 6)*

Shielding is often removed to give more space to the operator. It is afterwards not returned to a functional position.

*(Section 6)*

Shielding cannot always reach the desired location. This could be due to the position of the operator, e.g. on the other side of the operating table, or even due to collisions with another apparatus mounted from the ceiling.

*(Appendix D, Section 6)*

Shielding should be placed as close to the patient body as possible, a distance in-between the shield and the body is however not always detected or acted upon.

*(Section 5, 6)*

There is no common census for how scatter radiation is spread from the patient body. The operators are either unaware of the difference in intensity a different spots around the body or indicate more hazardous regions at the wrong locations.

*(Section 6)*

Operators are aware that the machine orientation causes a change in the scatter spread but mistake the direction of where the hazardous regions are formed as a result of it. Also shielding is hardly ever changed as a result of machine orientation changes.

*(Sections 5, 6)*

When asked to evaluate a certain case of malpractice regarding radiation safety, operators are critical about the placement of shields but ignore the machine orientation as a cause of increased risk.

*(Section 6)*

Active x-ray usage is sometimes difficult to detect. Not only due to the invisible nature of radiation but also due to the unclarity in displaying it. Next to this, the display of radiation in a unit (e.g. mGy) is practically unknown for the operator. Operators could not indicate how much radiation, in any unit of measurement, was considered a lot or too much. An arbitrary unit of measurement (e.g. colours or percentage) would be equally if not more effective.

*(Appendix D, Section 6)*



## Usage of shielding

Highly saturated market with variety of different lead shields. Only two products consistently used.



Shielding as close to the patient body as possible, distance between the shield and the body is not always detected.

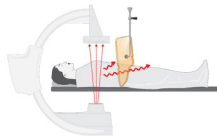

Shielding cannot always reach a location. Due to operator position or collisions with mounting beams.

Shielding gets removed to give more space to the operator. It is afterwards not returned to a functional position.



## Usage of radiation

Backscatter has a significantly greater (30 times more) impact than radiation on top of the patient body.

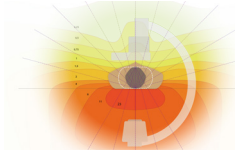

Orientation of the C-arm influences scatter and directs high energy back scatter at operators and into the room.

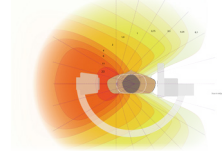

Procedures with entry for catheter closer to source are more dangerous. E.g. Radial artery use.

When displaying radiation in mGy, it is practically unknown for the operator what is a lot or not.



## Radiation Awareness

Training focuses on practical guidelines like the inverse square law. Limited awareness of the actual radiation.

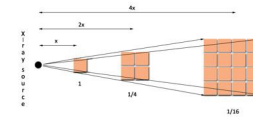

No common census about how scatter is spread (at an angle). Unaware or wrong about dangerous zones.

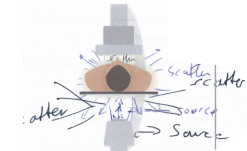

Operators are critical about the placement of shields but ignore the machine orientation.

Experienced interventionalists use more radiation but receive a lower dose relative to fellow-interventionalists.

# Ideation & Conceptualization

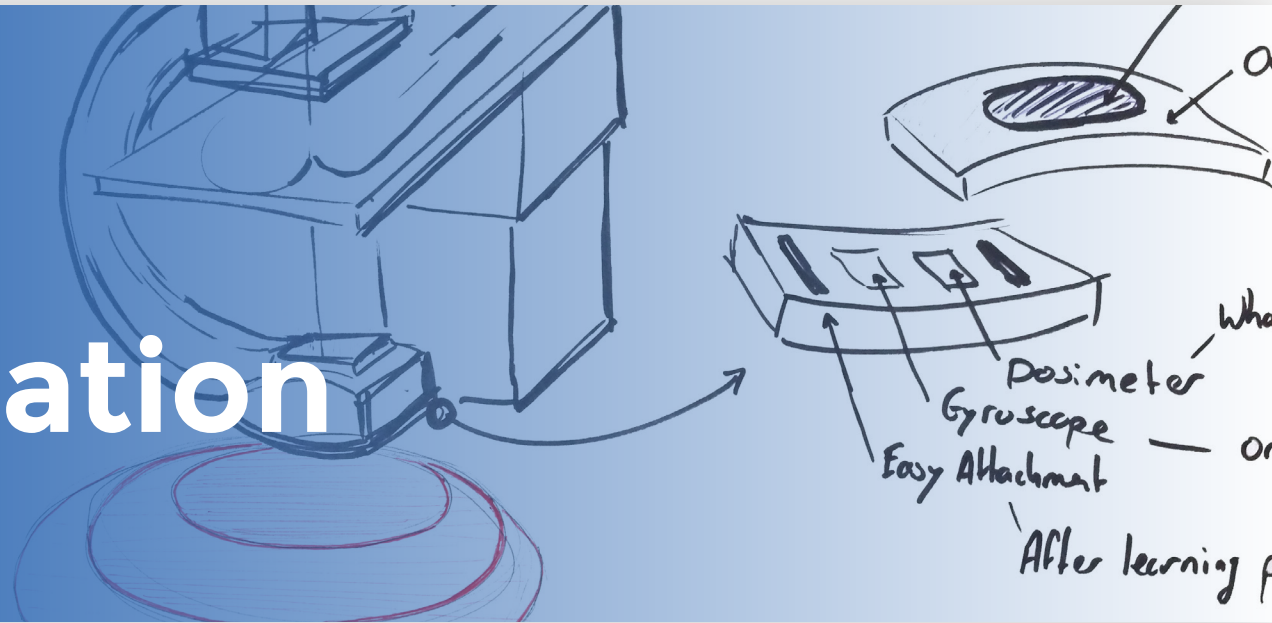

- 47** 8. Design direction
- 48** 9. Ideation
- 50** 10. Training direction
- 52** 11. Behavior change
- 55** 12. Concept directions

## 8 Design direction

### 8.1 Opportunity for product design

The previous sections created a clear insight into the current problematic points regarding radiation safety.

- Incorrect usage or placement of shielding
- Incorrect idea of radiation and where danger is present
- Incorrect indication of intensity for the user.

These problematic areas can create three opportunities, if the root of the problem is tackled. Then users can;

- Correctly place available shielding
- Easily identify radiation and avoid dangerous areas
- Evaluate how much dose they receive.

In order to accomplish this a single question has to be answered for the user: where is radiation? The main goal of this phase is therefore to solve the following problem statement:

**How can we clearly and effectively indicate radiation in the operation room**

### 8.2 Opportunity within Philips & the market

As seen in the competitors standpoints on radiation, there is an opportunity for Philips to provide a new type of protection in a way that communicates that Philips cares for the operators, compared to other C-arm suppliers. This is a good fit with their current strategy; the Quadruple aim. Here staff experience is one of the 4 pillars.

Within the market layers (section 4 and appendix C) this improvement in staff experience, aimed at radiation protection, is best translated in the 'individual protection' layer. This because of the need for proper education as seen in section 6.

An added benefit of the exploration of this particular layer is that, as discussed, no physical solutions are present here. Philips could therefore also get a unique selling point out of this as being the first supplier that also covers the whole spectrum of the occupational health strategy; from software-based source protection to shielding barriers and now also including training products.

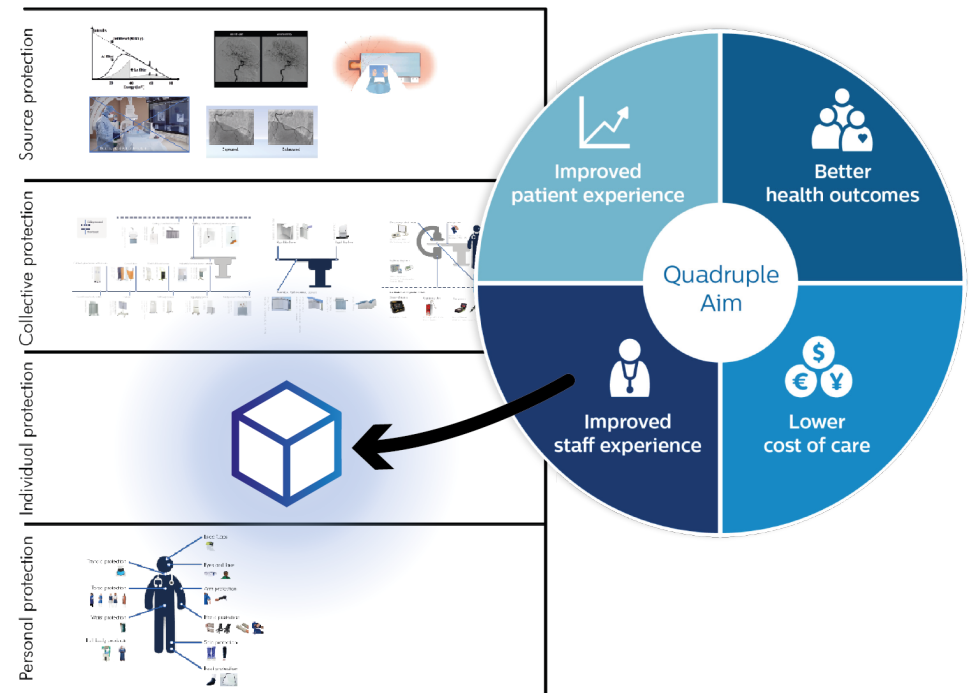

Figure 8.2.1 Quadruple aim posing product opportunity in individual layer of the OHS

## 9. Ideation

For the ideation phase 3 colours of post-its are used:

Purple: Ideation topic, Yellow: Idea, Green: Clarification of the idea above

### 9.1 Stakeholder brainstorm

Together with 4 stakeholders in the project a brainstorm was held to look for potential product directions. These stakeholders represented the Image Guided Therapy (IGT) and Healthcare Experience Systems (HES) departments within Philips.



Figure 8.2.1 Brainstorm in action. Left to right:

Jaap van der Voet (Flying quality squad, IGT)

Anke LeGuevel (Sr. Business development manager, HES)

Jan Jans (System designer/radiation expert, IGT)

Bert Bloemen (Development engineer, HES)

As stated in the design direction, the main goal of the brainstorm was to ideate on the problem statement: "How can we clearly and effectively indicate radiation in the operation room"

An update of the research was given after which an creative facilitation style brainstorm was held (the structure of the brainstorm can be found in appendix 6).

In order to loosen up the ideation the "Dark Side" method was used. The goal was now to; Mislead operators in receiving as much dose as possible. This created a variety of unethical ideas as can be seen in appendix 6.



Figure 8.2.2 Brainstorm presentation slide with Dark Side method

These were afterwards converted in ideas that aimed to solve the actual problem statement.

E.g. A dosimeter with inversed values (red) became a dosimeter with a royalty program for proper avoidance of radiation.

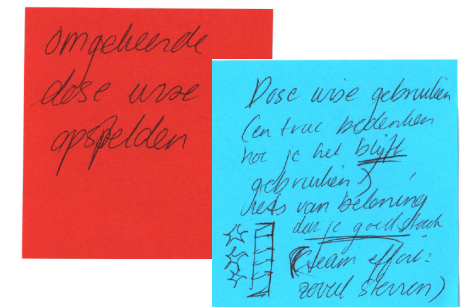



## 9.2 Results and Idea clusters

### 1. Focus on most dangerous area

- Visual indicators on x-ray tube
- Red Light on the back of the x-ray tube
  - Warns directly and reflects of the floor
- Colour difference between Fluo and Exposure usage

Gives a clear indication of where the most dangerous zone in the scatter area is. Takes away any doubt on what side is most safe. The usage of colour difference also is a clear indication for surrounding staff when higher intensity radiation is used.

### 2. Full potential Dose-Aware

- Real time position tracking via Dose-Aware
- Combine data generated by dose-aware and x-ray machine
  - Direct insight in who received too much at certain point
- Personalized report of radiation safety after each procedure

The dose-aware badges can be matched to a position in the scatter cloud if the x-ray machine data is used to match it. Quick warnings to staff at (non essential) dangerous positions. Insight afterwards to improve learning curve.

### 3. Training environment

- Augmented Reality glasses show live spread of radiation
  - Practice without radiation in safe learning environment
- Teach a mental map of scatter spread
- Philips sets colour range as maximum radiation instead of mGy units
  - Always stay below red

Train in a safe environment using AR technology to show the actual spread of scatter radiation with a working system but without the use of radiation. Use arbitrary units e.g. colour and learn to stay below a certain level. In real environment the mental map of scatter is known.

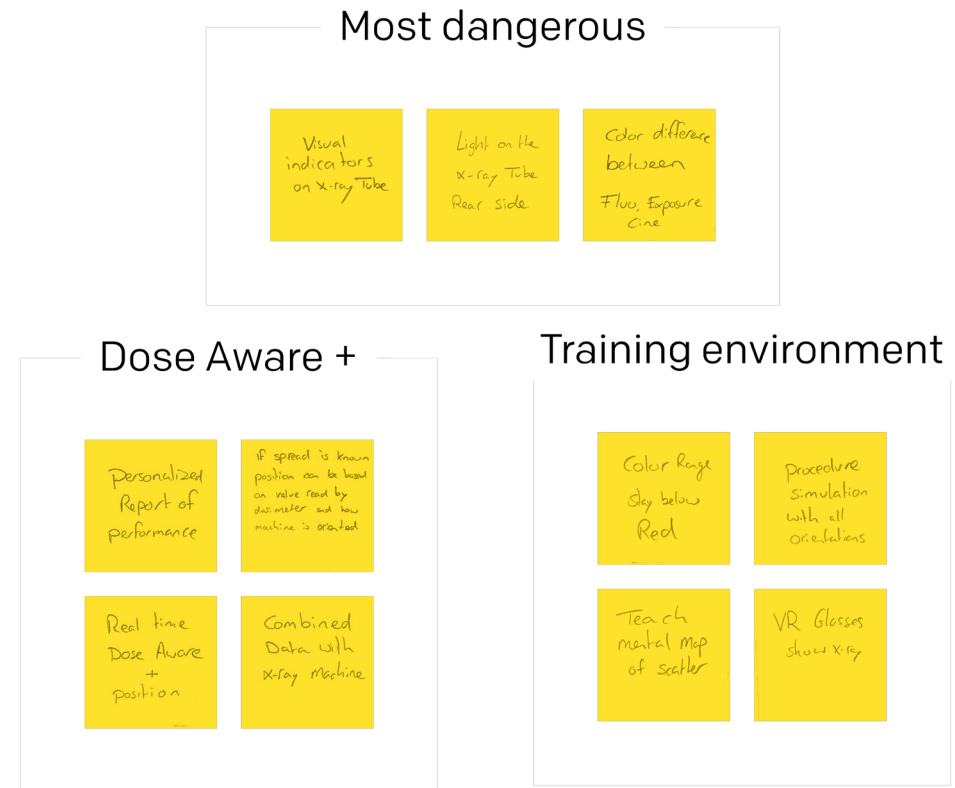

Figure 9.2.1 Idea clusters from brainstorm

# 10 Training as direction

Before the brainstorm the project was aiming towards a product specifically designed to be used during live procedures.

Together with the stakeholders we brainstormed towards solutions that were however more or less aimed at a training environment. Together with the realization that the mental picture of the scatter needs to be taught properly, a product aimed at training of new operators seemed a feasible directions.

Next to the brainstorm, the exploration of products within the occupational radiation safety layers (section 3 and appendix C) also showed that the market for products in the collective and personal layers is heavily saturated. The collective layer does involve products meant for the detection of radiation but little do give direct feedback.

The individual protection layer, where protocols and trainings are located, is however empty when it comes to (physical)products. If a product, perhaps derived from the collective layer, could be combined with a training it could provide an interesting opportunity for product design.

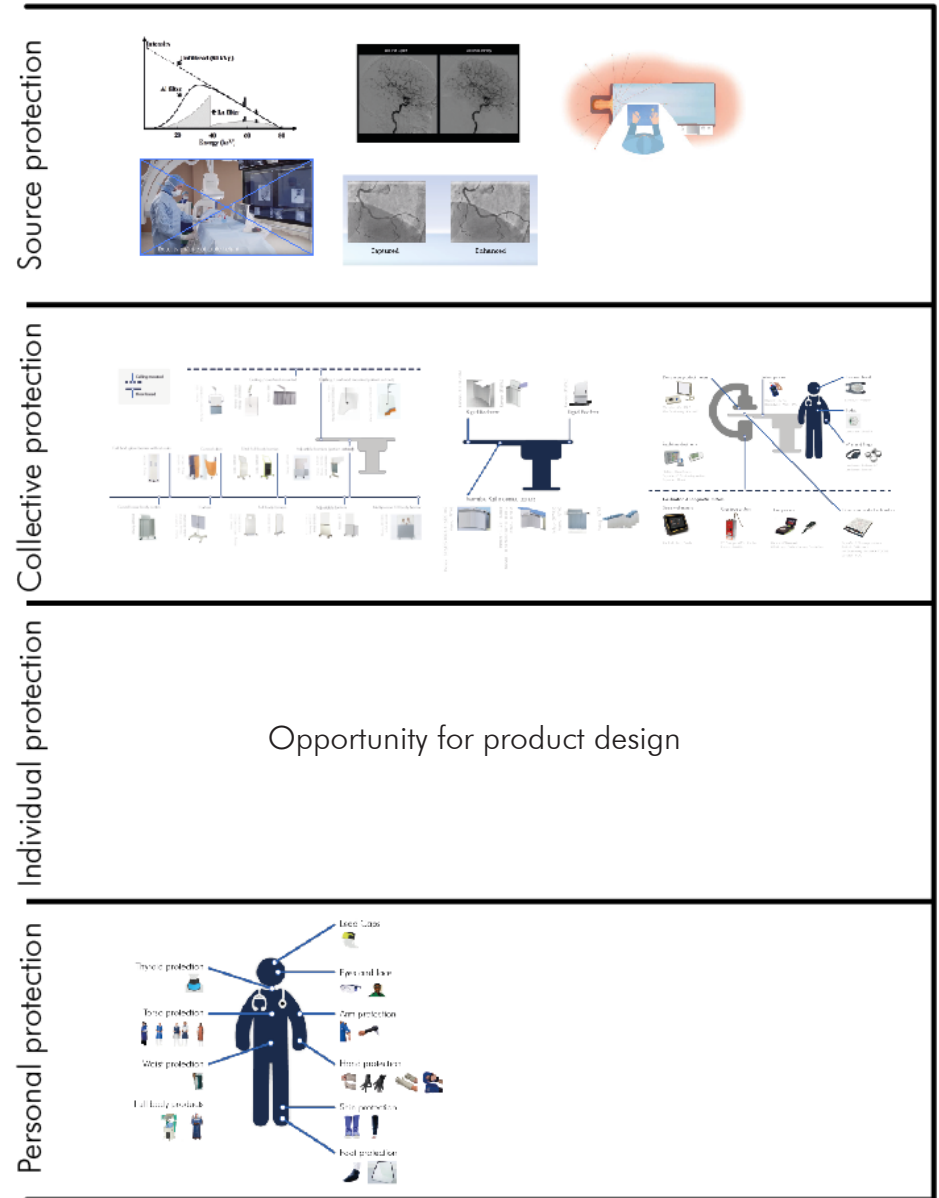

Figure 8.3.1 Products within the occupational radiation hygiene strategy. See appendix C2 for detailed overview.

## 10.1 Follow up with radiation coordinator

To verify whether or not a product in the direction of training could be implemented, Wout de Ruiter (Radiation safety coordinator at the Erasmus MC) was contacted again (appendix C 2.7).

De Ruiter explained that the Erasmus MC managed their available courses via the internal ZorgAcademy. They features several courses:

- Institutional course for new staff (Mandatory)

Introduces a new member to the rules and regulations. It is however a too broad course to include radiation safety for C-arm systems.

- Radiation safety training level 4A/B/M (Mandatory)

Mandatory for staff working with C-arm. Only for those without previously obtained certificate.

Focuses on health effects. Not only for the operator but also for the patient.

Includes a practical with the C-arm to identify the usage of shielding.

- Refreshment course in radiation safety (Optional)

Same content as mandatory course

In the current situation, the product would be most feasible in the radiation safety as this already includes a practical. This would not require big alterations to the existing course.

Ideally the product is introduced for all new staff that is working with a C-arm. This would require Philips to introduce a new training element when supplying their systems.

*“Ideally a transition period after placement (~1-2 months) of the new equipment is introduced where supervision or guidance from the supplier is present. Potentially in combination with a Dose Aware like product with which the staff can learn to properly use the equipment...*

*...The supplier should become aware of the hospital hierarchy to fully implement radiation safety. They should be in contact with the clinical physicists and the radiation coordinator.”*

*Wout de Ruiter - Radiation Coordinator Erasmus MC*

De Ruiter mentioned that he would be interested in a product that would increase the awareness of radiation that could be used during training and maybe also during regular procedures. As seen above he is aware of the Dose Aware system and likes how it lowers dose exposure to the staff. As radiation coordinator he is responsible for staff safety, where the medical physicist is mainly responsible for patient safety.

He acknowledges that the operators discontinue the use of the Dose Aware system as they assume they learned enough. If the product is used outside of the training environment it should therefore be taken into account that also its usage could be discontinued.

### Conclusion

A product aimed at the individual layer of the occupational radiation hygiene strategy could pose an opportunity due to the lack of products in the market. A product meant for training could be implemented in the mandatory radiation safety courses, but this only covers staff without a pre-obtained certificate. For full coverage of all users Philips should introduce a new type of training in cooperation with hospital staff.

Existing products such as Dose Aware are proven to be useful but are discontinued in use by the operators after a while. The product should accommodate for this.

# 11. Behavior change

## 11.1 Behavior theory

As seen from the interviews in section 6.3 a portion of the operators have a wrong conception regarding where radiation is present. As this idea is already present they could mistake their standing position as safe.

Also when repositioning around the table they do not pay attention when entering a more dangerous zone, as they don't experience this as present. This mindless repositioning around the operating table is beneficial to the procedure as it causes no loss of focus, but is a dangerous habit if their initial idea about safety is not properly set.

*"If the instinctive mind is not properly programmed for unsafe situations, the chance of unsafe behavior is higher despite conscious safe intentions."*

*Brain Based Safety p.34 (Daalmans, 2014)*

This could also be explained by the human behavior model by Rasmussen; Is the input known, then a automatic sensomotoric response is issued. This is why a wrong instinctive idea about radiation safety, as seen present in the user interviews, can lead to increased danger because the operators are convinced they are acting safely.

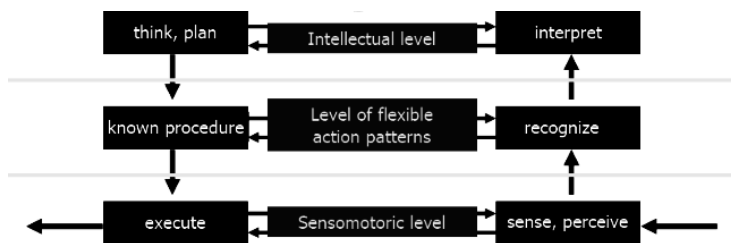

Figure 11.1 Rasmussen's SRK model of human behavior (Rasmussen, 1982)

Introduction of new trigger in existing chain interrupts the automated mind and introduces the conscious mind to the situation.

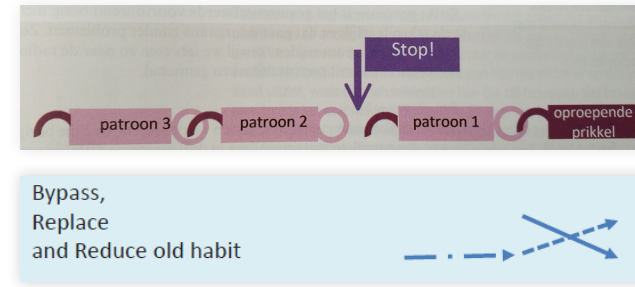

Figure 11.2 Conscious interruption (Daalmans, 2014, p.169) and Bypass technique

The bypass technique is a way to introduce a new trigger or cue to a situation to bypass the normal flow of the behavior (Visch, 2018). In the case of radiation safety the cue should interrupt the mindless or automatic position changing of the operator surrounding the patient bed. The behavior change should introduce an active consideration about where to stand. This consideration about standing position is probably a conscious effort in the beginning but could become an instinctive measure to avoid danger in the long run.

*"The automatized mind is very sensitive for the here-and-now situation. The current stimulations weigh higher than the stored stimulations. Behavior is opportunistic. Influencing behavior means also directing the current stimulations."*

*Brain Based Safety p.50 (Daalmans, 2014)*

A way to alter the mentioned here-and-now stimulations is conditioning. Most known for the experiments by Pavlov; Adding additional cues to a situation to link said cue to the situation. This could be applied in a training environment where the whole scatter spread is visible with additional cues such as minimalistic lighting. In the real situation the minimalistic lighting can trigger the operator to envision the scatter spread as a mental image and avoid dangerous regions.

*"When protocols are experienced as a pure formality, without knowing the underlying necessity or risks, the urge to follow protocols will fade when a situation deviates or when supervision is absent."*

*Brain Based Safety p.63 (Daalmans, 2014)*

Situations in an operation are variable. The chance of an incident is always present at which the main concern is to safe the patient. This does however create a tunnel vision which dismisses all protocols including those meant for personal safety. It is therefore vital to properly express the urgency of the risks to make sure that even in deviated situations the operator is aware of its own radiation exposure.

*"A small chance to a negative outcome is diminished to no chance at all. We assume it will not happen ... Humans have a polarized experience when it comes to risks. Damage does occur or does not occur."*

*Brain Based Safety p.62 (Daalmans, 2014)*

Exaggeration of the problem might be needed to create a stronger perception of risks. It also creates a greater perceived benefit of standing outside a dangerous zone.

## Main takeaways

Correct programming of the instinctive ideas of radiation safety.

In the live situation, where an elaborate map of the scatter spread is not present, the stimuli should be tailored to still trigger the correct behavior.

The danger or the probability of a dangerous outcome of the use of incorrect radiation safety should be made clear.

When the danger is known, protocol to avoid radiation exposure will be taken seriously.

## Concept direction

The concept is primarily meant to be used in a (safe) training environment.

The concept is aimed to facilitate the creation of a mental map of the scatter spread in the instinctive mind.

The concept emphasizes the most dangerous zone of the scatter spread.

The concept carries elements (cues) from the training environment to the live situation.

The concept polarizes (or slightly exaggerates) the danger of the scatter.

## 11.2 Ideation for behavior change

As mentioned in 9.1 the danger of the radiation should be made clear. This clear cue should however also corresponds with what the instinctive mind is taught using the new product in the training environment.

These cues should trigger the now instinctive behavior to avoid dangerous areas. Just like Pavlov's conditioning technique, a cue has to be introduced to link to the training environment.

### Clarify the danger

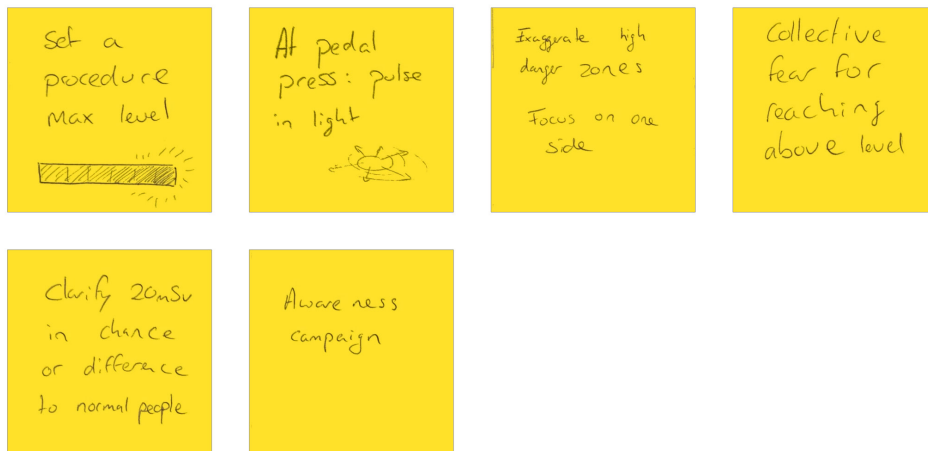

Figure 11.2.1 Ideation post its, How to clarify the danger of radiation

### Pavlov Cues



Figure 11.2.2 Ideation post its, How to create a cue to link the live situation to the trained instinct.

# 12. Concept directions

## 12.1 Clusters

The brainstorm clusters have been reduced to two concept directions as the training environment has become an important part of the product and is therefore integrated with the remaining two.

A new cluster for radiation information is introduced, called Radiation Know-How, that increases the significance of both directions. As explained in section 9 the danger of improper radiation safety behavior should be made clear for operators to take any product or protocol serious to begin with.

The focus on the most dangerous zone is renamed ScatterZone and features a live visualization of the scatter in the room.

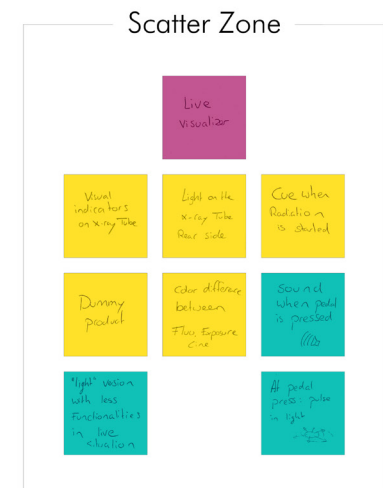
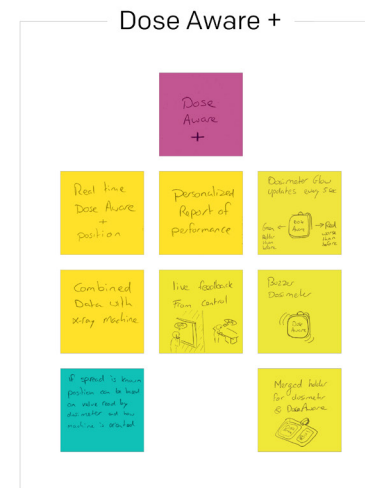
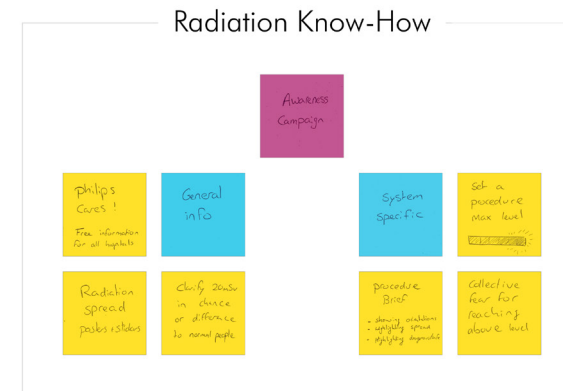

Figure 12.1 Concept direction clusters

## DoseAware+

The system is expanded with more ways to visualize or experience the radiation zones (1). This not only helps the operator wearing the badge but also gives surrounding staff the opportunity to call out when they see unsafe behavior.

In combination with the dose aware tracking system the control room could give live feedback to the operators (2).

To lower discontinued use of the Dose Aware badges, they are integrated with the mandatory dosimetry badges (3).



Figure 12.2 Cluster DoseAware+

## ScatterZone

As described in 9.1 the concept is aimed to be used during training with a short transition period with live usage. After this cues have to stay behind. A dummy version could solve this problem, which conveys a small portion of the functionalities of the training product to the live situation in order to trigger the learned behavior (1).

The danger should also be made clarified. A firm indication when radiation is initiated, when the operator pressed the pedal, in the form of sound of a pulse of light could draw attention to the now active scatter spread (2).



Figure 12.3 Cluster ScatterZone



## Radiation Know-how

The danger of improper radiation safety behavior should be made clear. This cluster enforces the use of the other clusters by integrating safe behavior in the instinctive mind.

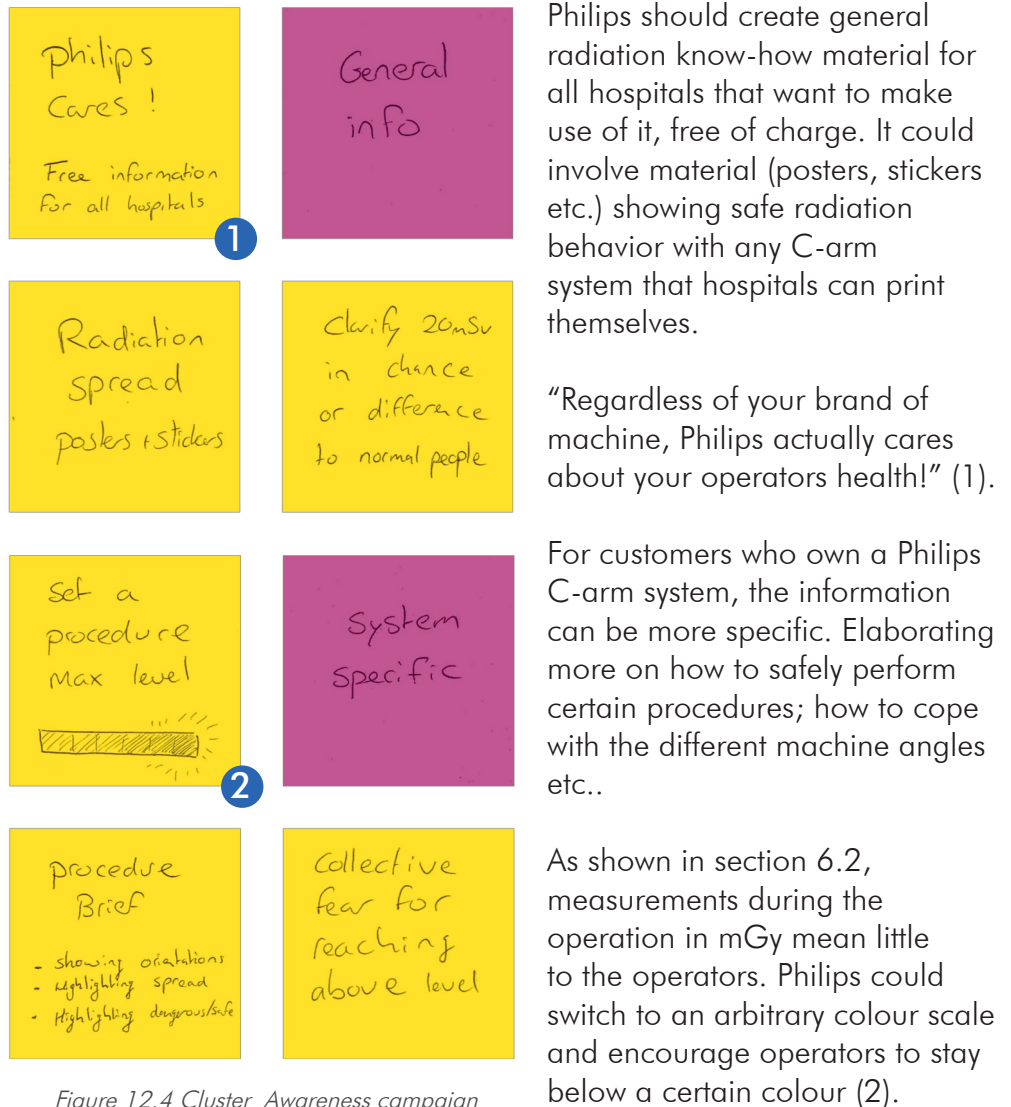

Figure 12.4 Cluster Awareness campaign

# Concept Exposure Prevention Package



- 59** 13. The Safe Hybrid OR
- 68** 14. ScatterZone elaboration
- 75** 15. DoseAware+ Philips design
- 77** 16. EPP in the Hybrid OR

## 13 The Safe Hybrid OR

### 13.1 : Exposure Prevention Package

In an ideal scenario all three directions would be integrated into the working environment of the Hybrid OR.

Philips is already create “package deals” (appendix 7) where not only the C-arm but also radiation shielding, lighting and monitors are supplied. This new way of radiation protection could be presented with the introduction of a new Philips Hybrid OR as the Exposure Prevention package (EPP)

The main goal of the EPP is to increase the sustainable deployment of staff by preventing unnecessary exposure.

Whether the staff is new or has been working with previous systems already, the introduction of the new OR comes with an introduction of safe conduct. It is of vital importance that all operators have a common census regarding radiation, as is not always the case (Section 6).

These wrong ideas about radiation can be dangerous in a hospital hierarchy. Here the main physicist is in charge and if not informed well enough, he/she also endangers fellow operators in the room. It is therefore vital that these misconceptions about safe conduct are removed.

For this the instinctive mind of the operators must be (re)programmed.

The EPP consists of three product solutions as cornerstones, which work together to create a clear insight for everyone in the room about radiation safety and to once and for all eliminate misconceptions. All together to achieve the goal of sustainable deployment.

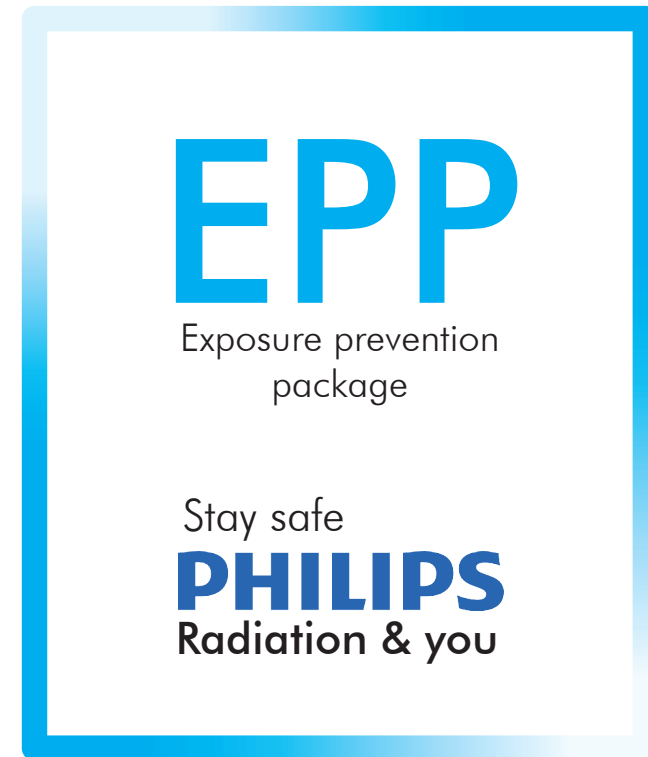



The three product cornerstones of the EPP together as they would be present during an operation.

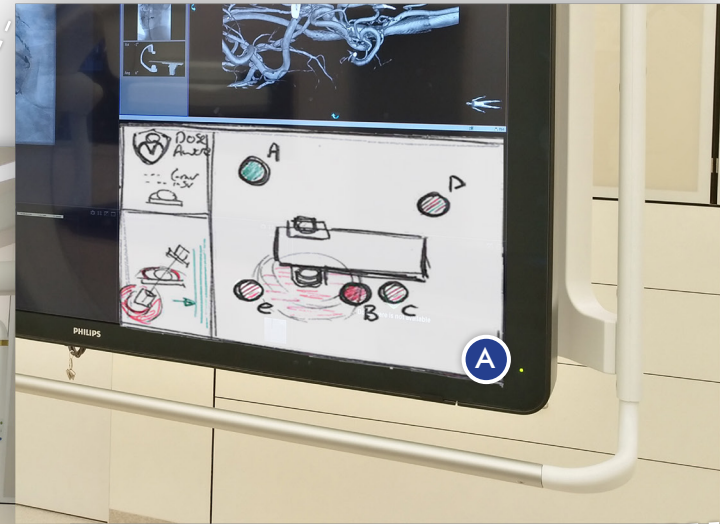
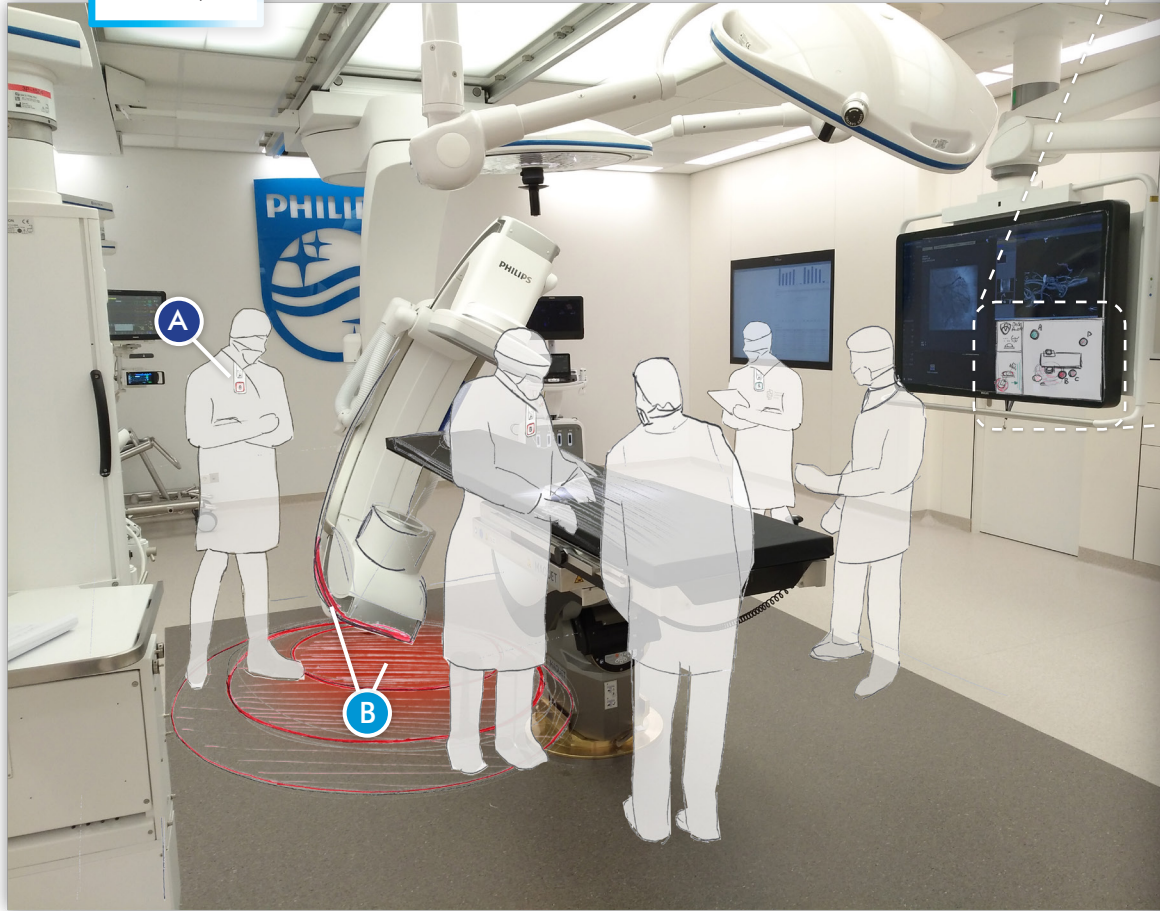
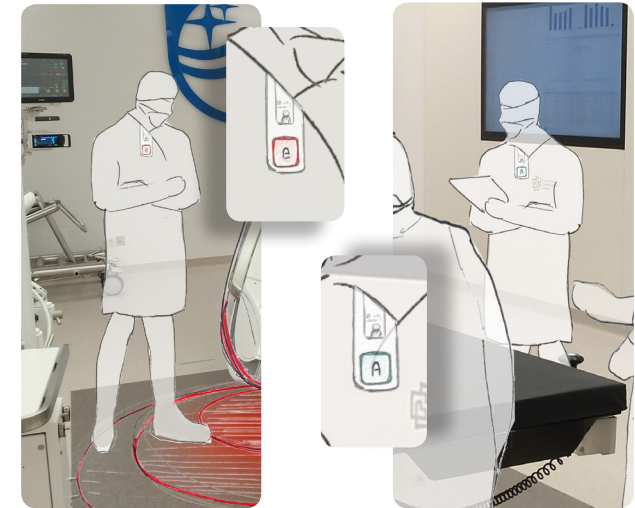
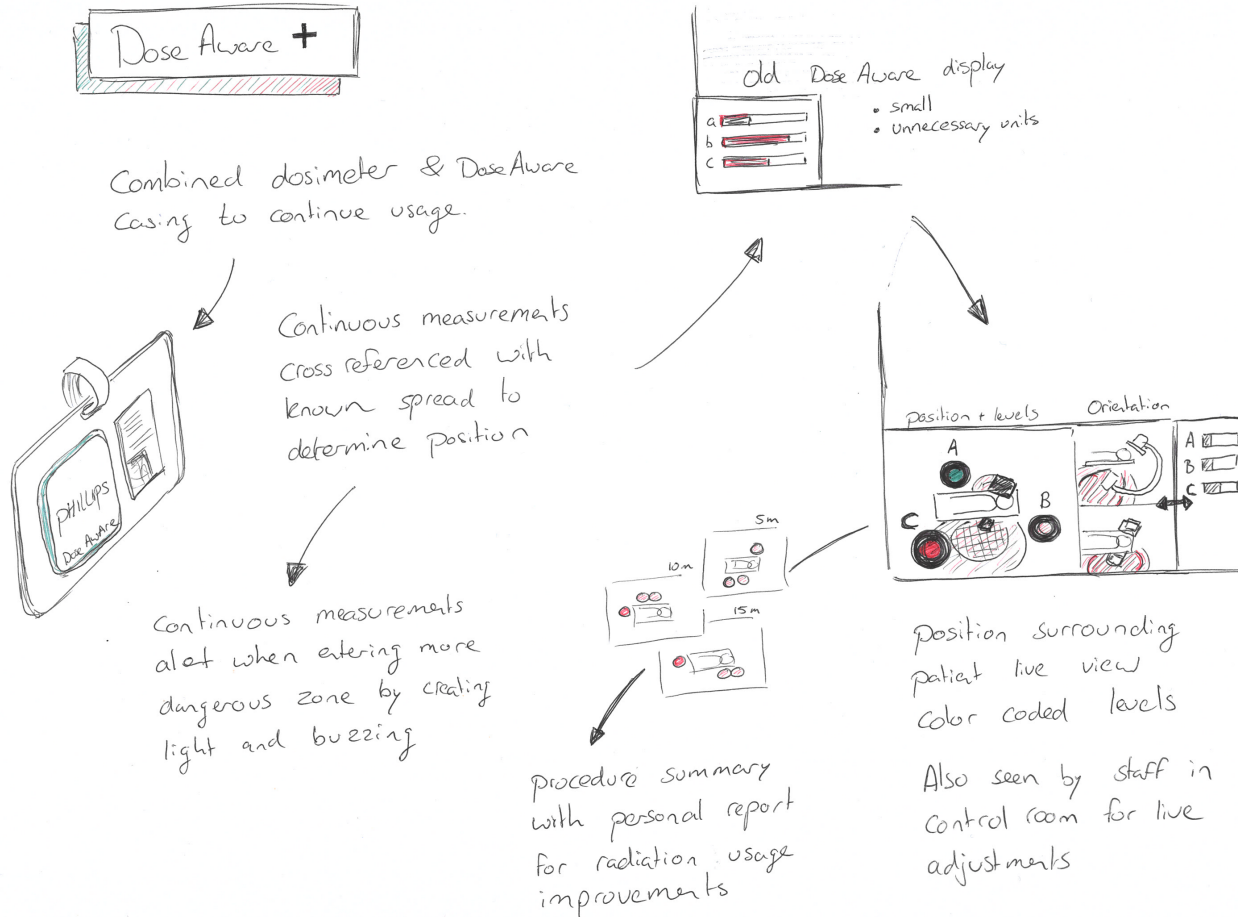

Figure 13.1.2 The safe Hybrid OR

# 13.1.1 Dose Aware+ A

## Improved insight and reflection



The combined dosimeter badges glow based on the exposure of the operator. Other operators can alert each other when they unnecessarily accumulate dose.

For instance the operator on the left could be warned that he is standing in a high dose area. This creates a mentality of social control.

A buzzer in the Dose Wise badge could also remind the operator when he enters a higher radiation zone.

### 13.1.2 ScatterZone



Clear marks where scatter is present

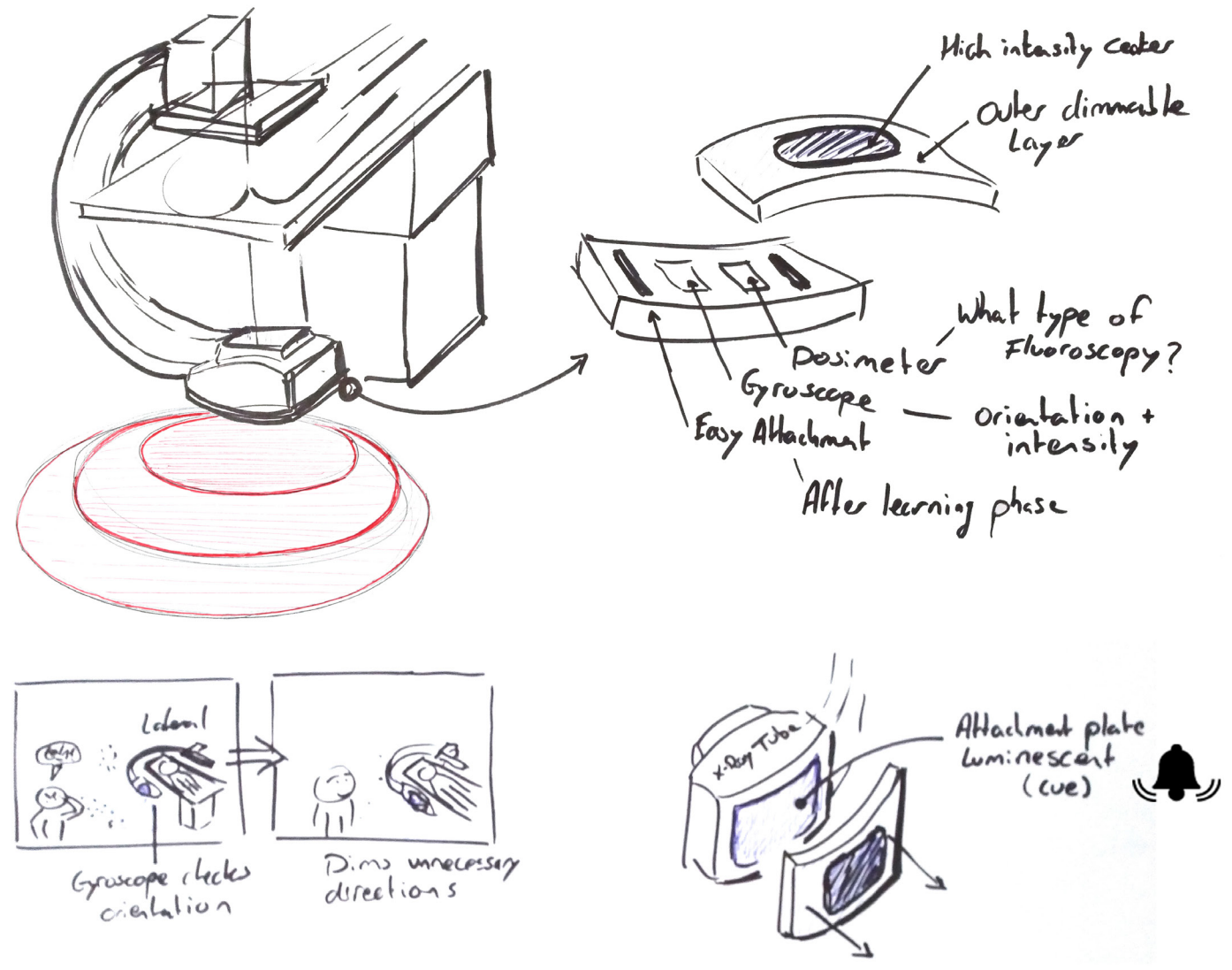

Tackles Operators that are not engaged with the catheter, and therefore could be (further) away from the table. It alerts these operators during their mindless wondering around, to rethink their position.

The visualization should not be annoying when at a higher rotation, where it shines into the room. The gyroscope inside always directs the light towards the floor.

The attachment of the product could be used to act as the dummy version and still give cues after the product is removed.

### 13.1.3 Radiation Know-how

Basic knowledge for operators radiation safety

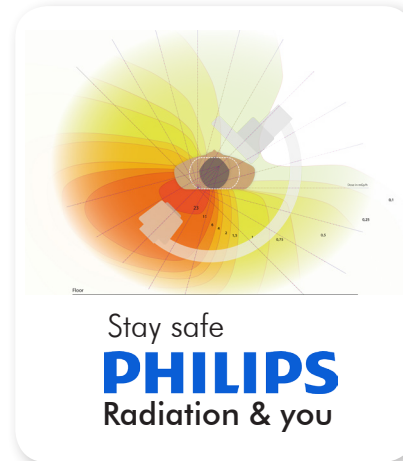
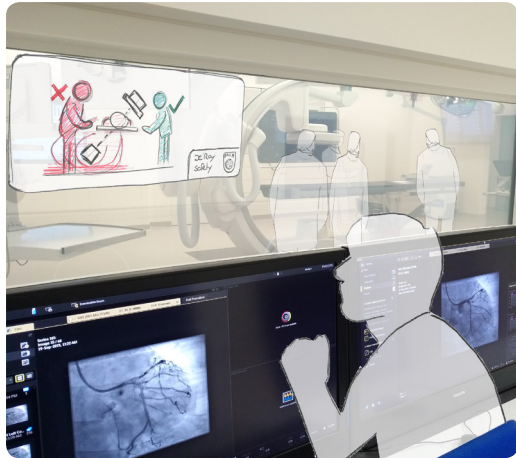

The information should tackle several points. The first being a basic understanding of the long term effects. This could be in flyer's or an information page on hospital websites.

The second is more specific to the C-arm systems, regardless of brand. Here the mental map of radiation comes in and the need to stand on the proper side of the table. This could be done via stickers that can be printed by the hospital and placed on strategic positions.

The stickers do not have to be highly detailed in terms of actual exposure. As seen in figure 11.3, the effect of standing on the x-ray tube side or the image intensifier side is significant regardless of the amount of mGy or mSv. It is therefore in everyone's best interest to imprint this importance by simple visualizations.

These could for instance be placed in the control room to give a quick reminder to the staff.

The mental map of course has to change as a result of the rotation, the easiest way is to make operators understand that the x-ray tube is the dangerous side. Warning symbols on the machine are a solution.

## 13.2 Exposure Prevention package in action

These three product solutions are present during three phases: Training, Live Procedures and Redundancy. Each phase will now be illustrated with the product solutions.

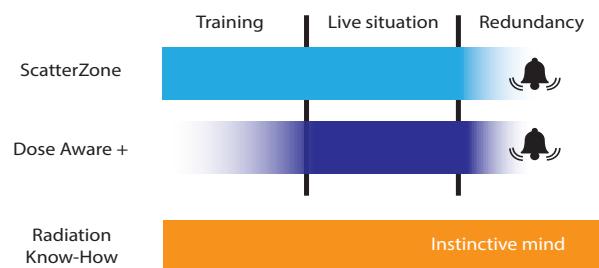

Figure 12.2.1 EPP in three phases

### Phase 1: Training

For future system deliveries, Philips should be working closely together with the hospital to reshape their radiation safety surrounding their systems, for now only focusing on the C-arm system.

Together with the clinical physicist and the radiation coordinator an introduction course is to be set up for all users of the new C-arm system. Similar to the existing mandatory training to receive the 4A/B/M level.

The main alteration is the introduction of a larger practical part. As mentioned by the radiation coordinator at the Erasmus MC, this currently focuses on shield placement (Section 2.8. , 7).

As observed in section 6, shielding is neglected for several reasons. The main problem presumably being an underestimation of the risk and as a result neglect of protocol for proper placement (section 9). This new practical will therefore focus on making the otherwise invisible risk of radiation actually perceivable.

The training will be done with a functional C-arm without radiation being used. As a “learning by doing” approach the operators are encouraged to orient the c-arm to every position and observe how this affects their exposure.

ScatterZone now illuminates the spread of scatter on the floor and gives clear feedback on their standing positions. The training should show the influence of the angle of the C-arm and the side on which operators can stand. Shielding still plays an important role. Just as it blocks the visible light from the ScatterZone visualization it would also block the actual radiation.

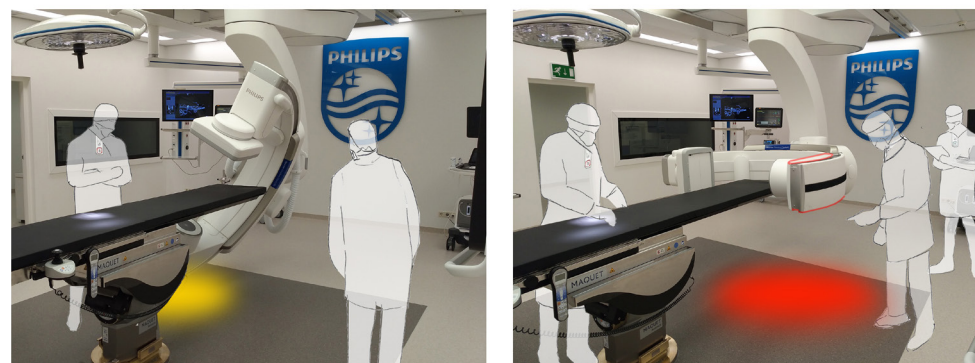

Figure 13.2.2 Operators playing with different orientations

Every time the pedal is pressed, a pulse of light is created. It indicates the ‘flow’ and direction of the scatter and serves as a clear signal for when the radiation is active.

The Dose Aware screen, although not actively tracking the radiation because none is used, shows the spread of scatter around the table to give a second indication close to where the operators are looking to follow the procedure on the screen.



Visual clues like stickers are placed on for instance shields and the machine displaying guidelines such as:

- Place the shield close to the patient (on the shield)
- Do not touch the patient (on the patient drape)
- Avoid the x-ray tube side (warning sticker on tube)
- Etc.



Figure 12.2.3 Example of training stickers with Radiation Know-How

They explain why a certain measure is necessary and how the spread of scatter is the source of this.

## Phase 2: Live operation

The DoseAware+ is now actively tracking the operators position based on their exposure. On the screen they can be seen as an indicator on their standing position. This indicator is glowing with a colour based on their current exposure, ranging from blue to red.

The operators wear a combined badge of the mandatory dosimeter and the Dose Aware badge. These badges glow based on their exposure. This encourages other operators to pay attention and correct each other from mindless wandering around the table.

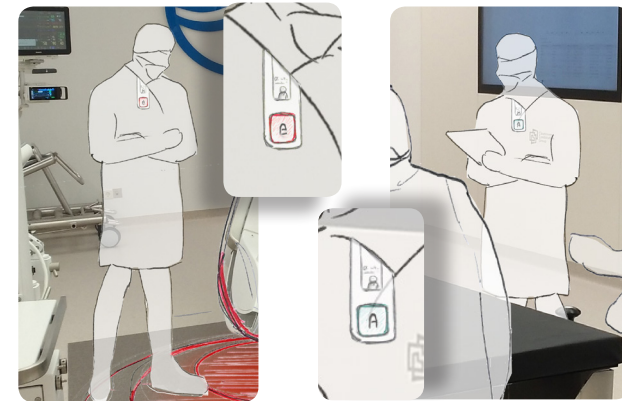

Figure 13.2.4 Glowing badges. Operator on the right can warn the left that he is standing in a high radiation zone

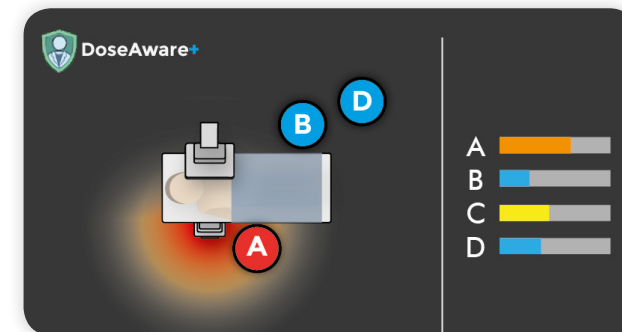

Figure 13.2.5 Simplified example for DoseAware+ display. Showing operator position & live exposure in colours on the left and accumulated exposure on the right

The ScatterZone is still actively showing the spread on the floor. It also shows the difference between “flavors” of exposure intensity by increasing or decreasing the glow on the floor. Pulses continue to give an indication when the main operator presses the pedal. The OR is now darker than during the training, to increase image quality and the glow will warn wandering operators even more clearly as a result of more contrast.

Stickers on points of interaction, such as the shields and the c-arm operating panel give guidelines like in the training. In this case the theoretic explanation is removed and simplified visuals are used.

After each procedure, the DoseAware+ system creates a personal reflection for each user of a badge. It shows their exposure in mSv over the duration of the procedure allowing them to have an reflection for themselves to see why they accumulate more than usual. Which is currently unknown to them (section 6.3).

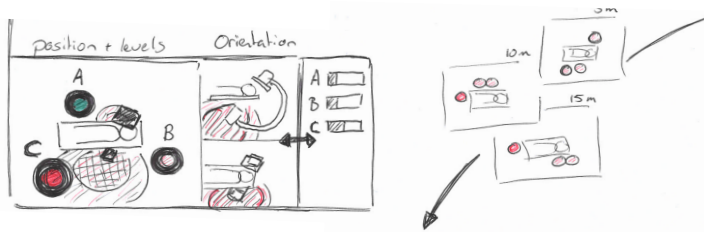

Figure 12.2.4 Overview of single procedure for personal reflection

As the radiation coordinator is responsible for the staff safety, the system forwards these reports to him/her after a period of time, e.g. every 2 months. This will allow the coordinator to have a feedback session with his staff members to evaluate and correct if necessary. "The report shows that every procedure you stand next too close to the x-ray tube, if you move a meter to the right it is much better".

### Phase 3: Redundancy

Ideally this phase will not be achieved and the EPP will continue to be used indefinitely to lower operator exposure. Judging from the current use of the Dose Aware system, operators do unfortunately discontinue the use of the badges when they have learned "enough". If this is indeed the case and the radiation coordinator agrees, The EPP can be set to the redundancy mode. It should however only be controllable by the radiation coordinator.

As can be read in section 6, the operators are probably not aware enough to judge for themselves as they underestimate the risks quite heavily.

The EPP will not disappear completely. If the coordinator determines it feasible to set it the system to redundancy mode, we can assume the mental model of the radiation is known to the operators. They can now instinctively avoid high radiation zones, but a little reminder is still advisable. As mentioned in section 9, the mind is highly influenced by the "here and now". Without a little cue they might fall back to their old behavior.

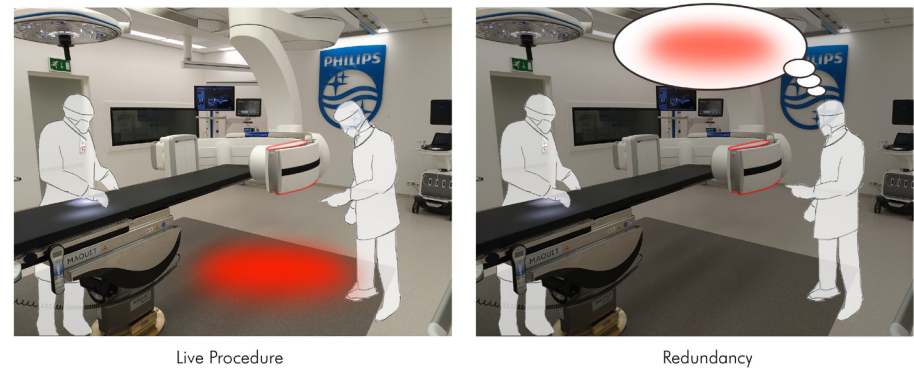

Figure 12.2.5 Pavlov cue for ScatterZone in redundancy phase

Here the Pavlov bells present themselves. The ScatterZone is removed and the active displaying of the spread will stop. Its mounting points on the x-ray tube however serve as a reminder of its former function, as a dummy product. Glowing at the slightest light exposure they act as a visible clue to trigger the mental model and still influence the behavior: "X-ray tube = Danger".

The DoseAware+ can be returned to its original smaller size on the screen. This gives the operators more space for the images of the procedure. The glow however will continue to give operators the chance to correct each other.

It also serves as a simple indication of the spread when they look around and see multiple glowing badges in different colours.

The DoseAware+ still feeds information to the operators and the radiation coordinator to allow them to continue the feedback sessions.

### 13.3 Timeline & Introduction

The Exposure Prevention package is ideally integrated into the C-arm and hybrid OR. This would be most feasible for a next generation of the C-arm. To still create an impact in the near future, the product could be introduced in steps and eventually as a package.

The first step would be to create a wake-up in awareness for the operators by reshaping the training by the introduction of the ScatterZone as an add-on to the existing system. This to lower the introduction time. The Dose Aware+ could be slowly introduced too with the first step being the integration with the mandatory dosimeter.

The Dose Aware+ can then be further developed to also include the position tracking. This allows the feedback sessions to be introduced. The system can run on an external screen such as the initial Dose Aware made by RaySafe (section 2.8).

After a period of time, a trial can be set up that compares the exposure levels of the group with the ScatterZone and the group without it.

If the data from this test is promising it might be valuable for Philips to start making claims about the product such as "lowers the exposure by 25% in the first year" and enter it for certification.

If this is successful the product could be integrated into the C-arm instead of being an external add-on. The next line of products after the Azurion would then include the ScatterZone as a core element.

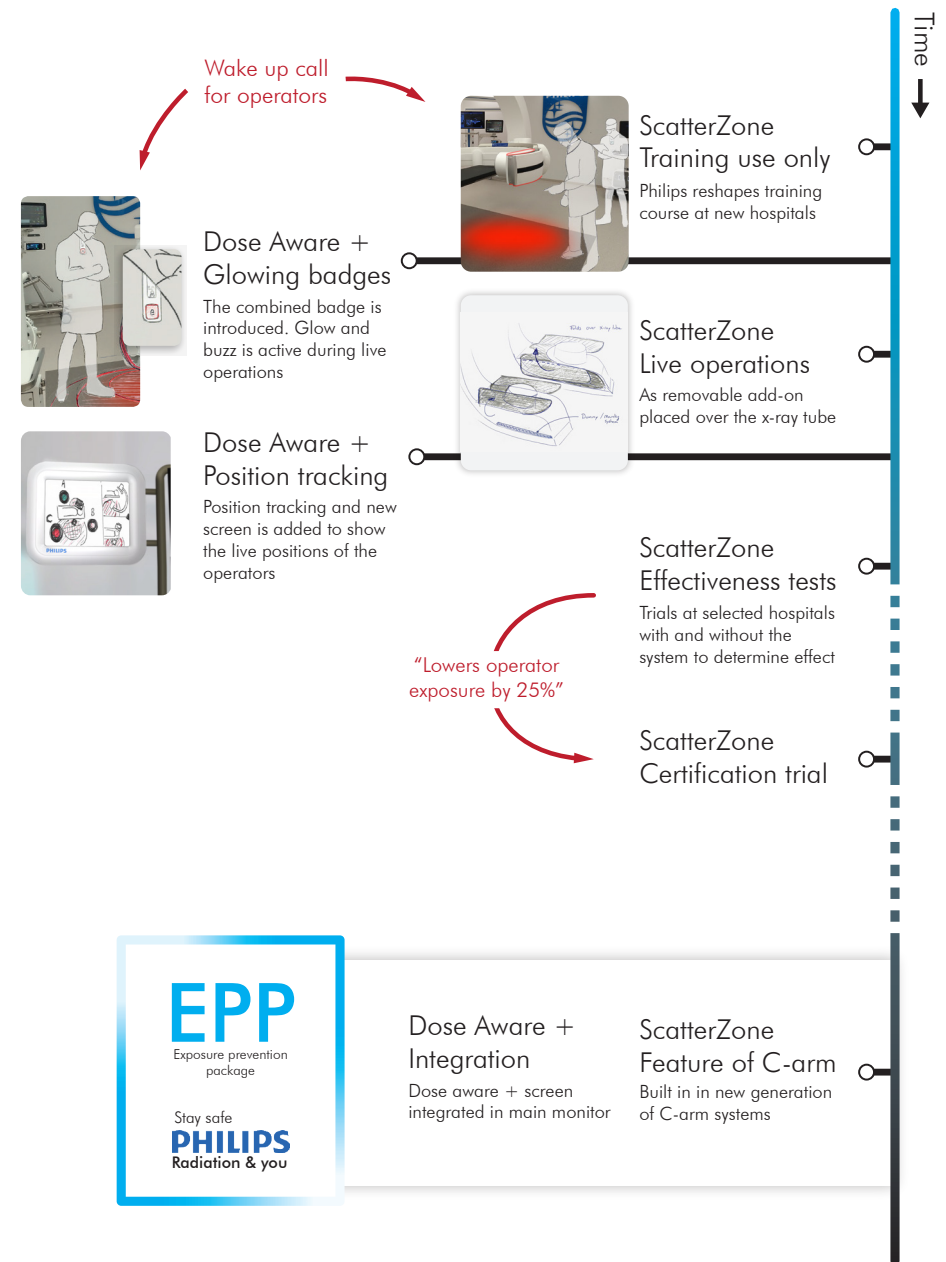
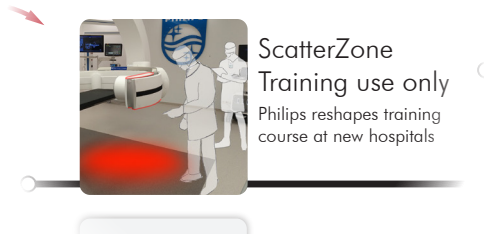

Figure 12.2.1 EPP introduction timeline

# 14 ScatterZone elaboration

The timeline on the previous page specifies the order of introduction of the parts of the EPP. The aim is for the shortest time to market of all these parts. The first step required is the wake up call in the form of the ScatterZone during training.



The following conceptualization is therefore focused on the design of an add-on to the current C-arm system to be used in training. This to remove the need for modifications to the system and to facilitate the quickest introduction in hospitals with existing (philips) systems.

This section will therefore take the current Azurion system, which is the newest C-arm version, into account as a base for the design.

## 14.1 ScatterZone clarification

There are several parts of the ScatterZone that need to be further elaborated in order to create a concept. These will be discussed below.

### 14.1.1 Spread projection

#### Spread calculation

As can be read in section 1.3 the largest contribution to the scatter is the result of backscatter. This as mentioned is regardless of patient torso height as the backscatter originates from almost entirely from the first 10 cm of tissue. As a result no attenuation calculations are necessary to deduct the spread.

Only the “base curve” of a 10cm torso is to be multiplied with the intensity of the incoming beam. For this two detectors are required, a dosimeter for intensity and a gyroscope for orientation. Based on the gyroscope the spread corresponding with the angle is taken from the base curve as in figure 1.4.3.

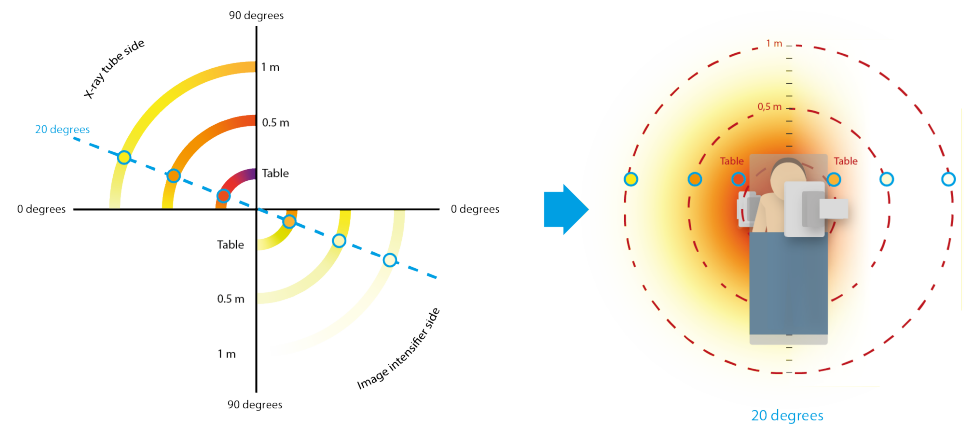

Figure 14.1.1 Spread determination from base curve and angle

## Visual style

The ScatterZone is based on projecting the spread onto the floor. The goal is to give a clear overview and catch the attention of the operator to trigger the instinctive mind.

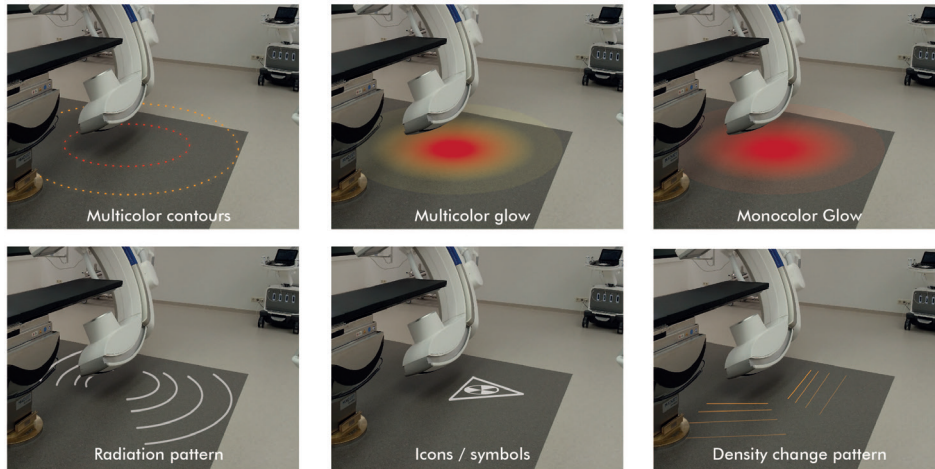

Figure 14.1.2 Spread visualization possibilities

This project started with the search for a non invasive solution that did not hinder the procedure. If the visualization is too distracting it would not fit in this search. A (multicolour) glow would therefore draw too much of attention. As icons do not give an indication of the intensity or direction, only patterned solutions would remain.

As stated in aim 15 of the List of Requirements (appendix K), the product should clarify the danger of the radiation. To achieve this the x-ray tube has to be seen as the source from which the harmful radiation waves emerge. The visualization could create a wave effect in its pattern pulsing outwards from the x-ray tube.

For the further development of this product an expert on behavior change or a short research has to be carried out on how to best indicate the spread.

Perhaps the operators benefit from a solution that also shows the radiation spread when no radiation is used. This to allow them to reposition to safety before the pedal is pressed again.

## 14.1.2 Training & live situation

As mentioned in section 11, the goal of this product is to serve its purpose during training and after redundancy mode is entered to leave clues behind. As the operators were triggered by the working principles of the original product, the clue should resemble it; A dummy product.

### Pavlov's bell

The goal of the product is essentially for operators to avoid standing around the x-ray tube, as this is where the spread is most present. The product shows this by illumination of the x-ray tube. The dummy should incorporate the same idea of x-ray tube illumination preferably without the use of electricity.

The dummy product should also remain when the actual product is removed from the x-ray tube. The dummy could be incorporated into the mounting mechanism for the actual product.

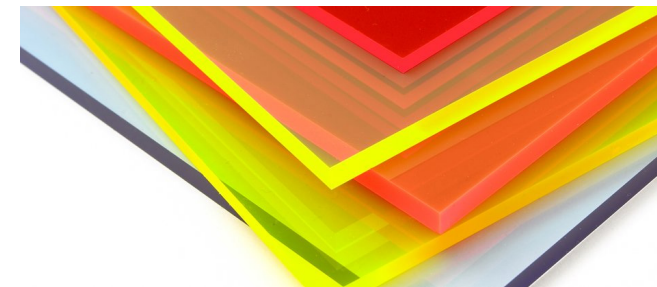

Figure 14.1.3 Fluorescent Plexiglas plates

A suitable material for this mounting dummy is fluorescent Plexiglas. This material illuminates its edges when the light shines on its surface, even in low light conditions. Drapes too cannot cover the full machine and therefore leave certain areas exposed for the product to be placed.

## 14.1.4 Physical barriers

### Sliding mechanism

The C-arm rotates over its back side. The machine can rotate to a point where the bottom of the X-ray tube is hidden inside the sliding mechanism. This blocks the most probable side for the product placement (figure 14.1.4).

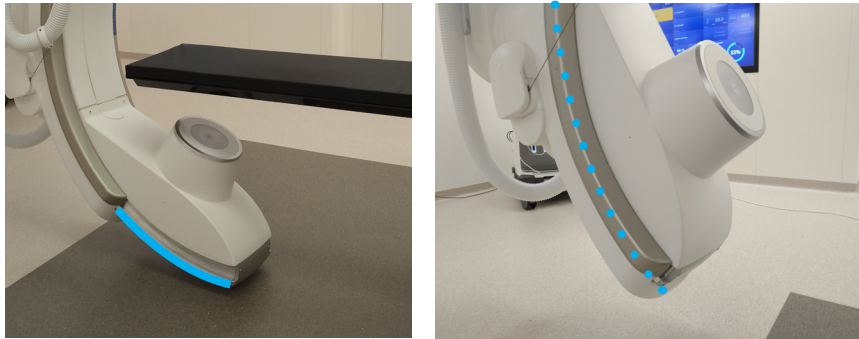

Figure 14.1.4 Sliding mechanism blocking the bottom side of the x-ray tube

### Draping

For the product to be usable in the live situation it is to be draped in most cases. A drape is a thin layer of plastic sheet to prevent contamination. When a drape is placed over the visualization actuator it would however blur the projection on the floor.

Based on an instruction video provided by drape manufacturer ECOLAB the C-arm drape meant for the x-ray tube side only covers the top and is attached by a self sticking layer on the drape (ECOLAB, 2014).

Drapes too cannot cover the full machine and therefore leave certain areas exposed for the product to be placed.

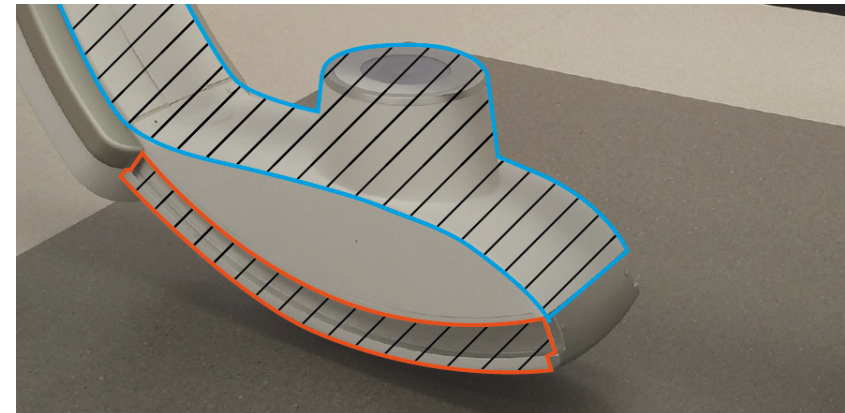

Figure 14.1.5 Area for product placement. Red: Unavailable due to sliding mechanism (Includes bottom side) Blue: Unavailable due to draping.

### Projection

The concerns for space on the x-ray tube do influence the way the radiation is projected. The spread visualization should regardless of the angle, and the orientation to achieve this angle (figure 14.1.5), remain the same as a difference in visualization could cause confusion.



Figure 14.1.6 Difference in machine orientation for same rotation angle. Rotation around central axis on the left and Sliding in the mechanism on the right.

As a result of the available area (figure 14.1.4), a projection from this area could not reach everywhere around the x-ray tube. For each orientation there is a different 'blind spot'.

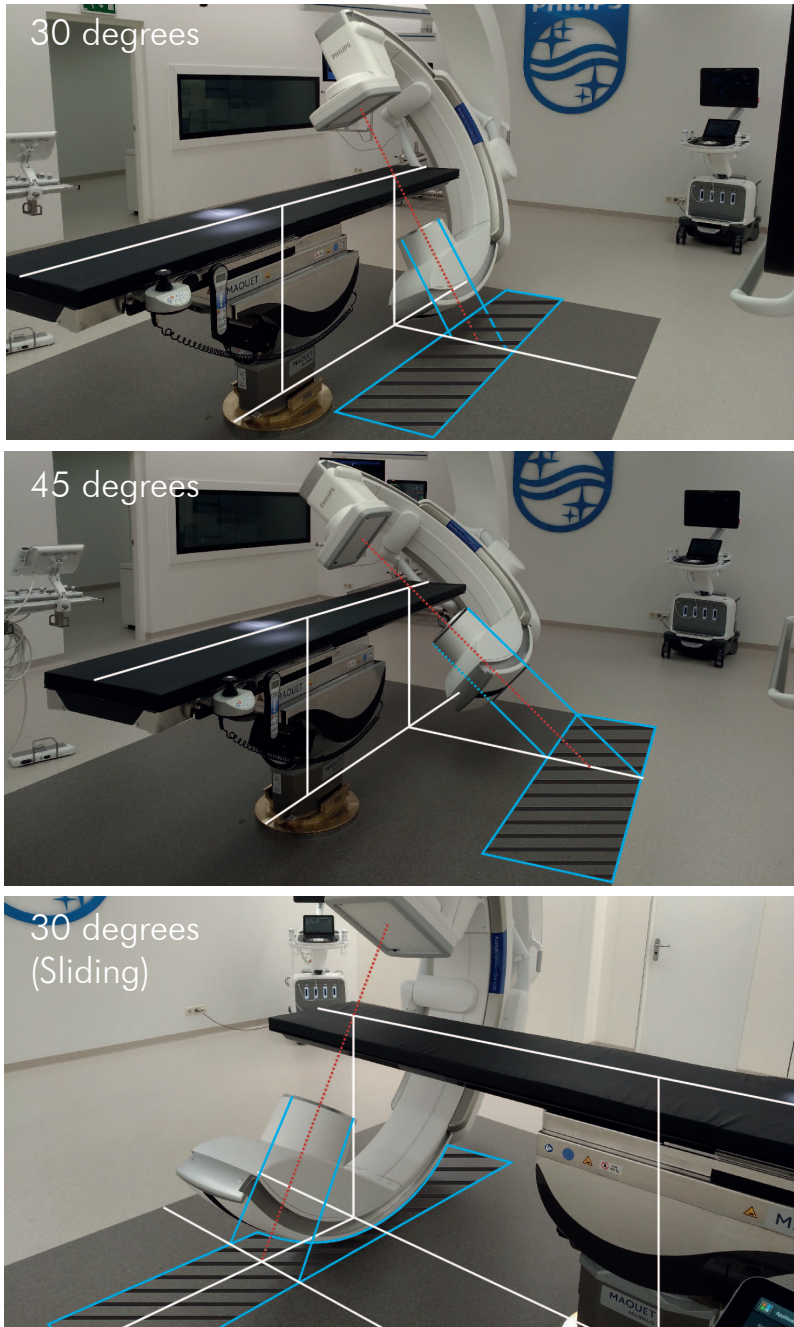

Figure 14.1.6 Blind spots for projection. White: perspective lines, Red: x-ray direction, Blue: edge of projection possibilities, Black striped area: blind spots for orientation.

## 14.2 Concept realization

### Projection directions

The biggest influence on the possible projection from the x-ray tube are the mentioned blind spots. To overcome this the projection has to include a 'shared projection' in which one side of the product also projects a part of the projection for the other side.

This can be accomplished by creating a filter that has multiple patterns on it and projects one of these patterns based on the direction of the light. How the individual patterns are shared over two sides is shown in figure 14.2.1. Here each side of the x-ray tube is equipped with a projector that has the possibility to project three patterns (A,B,C & X,Y,Z)

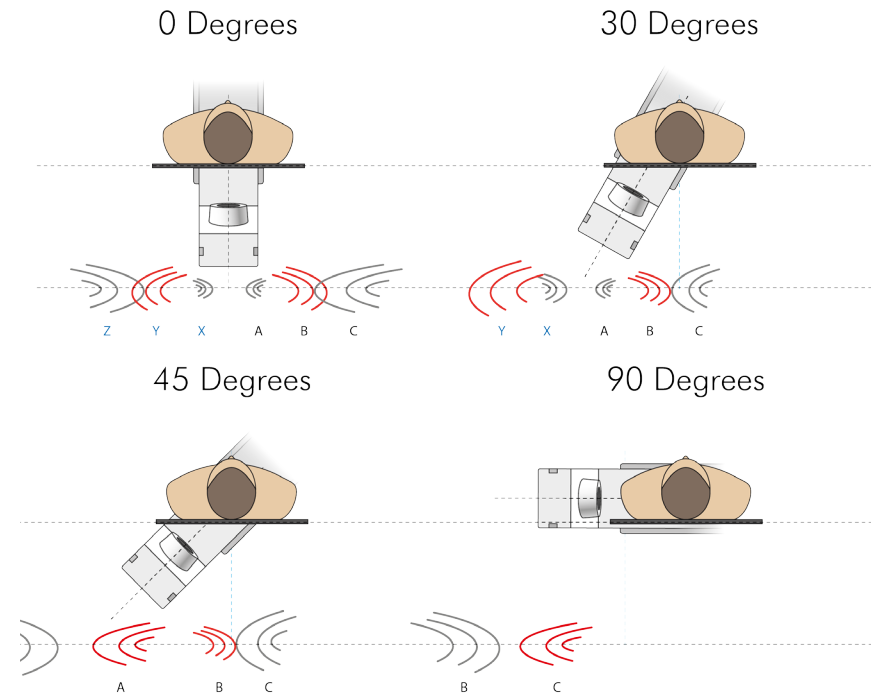

Figure 14.2.1 Shared projections from two sides of the x-ray tube. ABC and XYZ shift to maintain a constant display of the spread regardless of the orientations blind spots

Because the spread needs to be different based on the orientation, a single light would display an incorrect visualization. Instead a series of lights need to be turned on or off.

The working principle of a bright LED matrix would be ideal in combination with this filter. The filter would then be divided in the three patterns (A,B & C) as seen in figure 14.2.1. The same goes for the LED matrix which is divided in three parts to illuminate only one part of the filter at once.

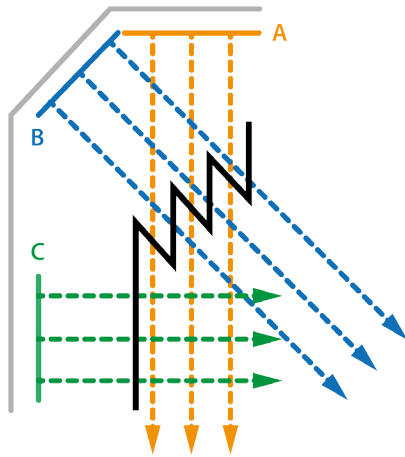

Figure 14.2.2 Three LED matrix parts and their light direction through a filter (black)

Figure 14.2.2 shows the three LED matrix parts A, B & C and how they cross a special filter (black) at specific positions to create the desired projections as seen in figure 14.2.1.

A model of the filter is shown in 3D in figure 14.2.3. Here the three projections are clearly visible on the filter segments in the form of slots where the light can penetrate.

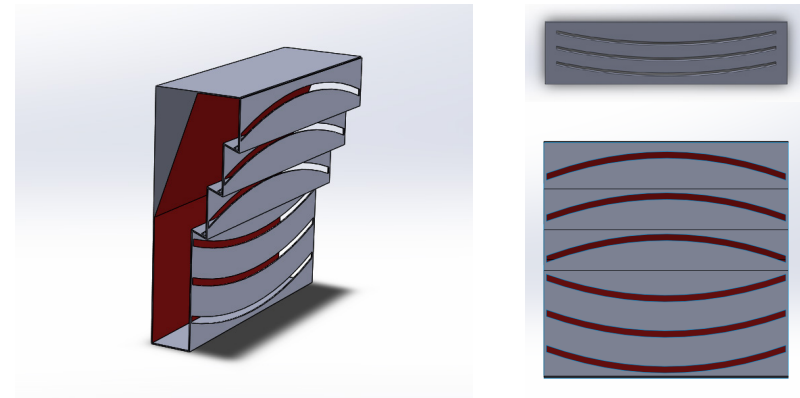

Figure 14.2.3 Filter in 3d. Projection directions are separated as in figure 14.2.2

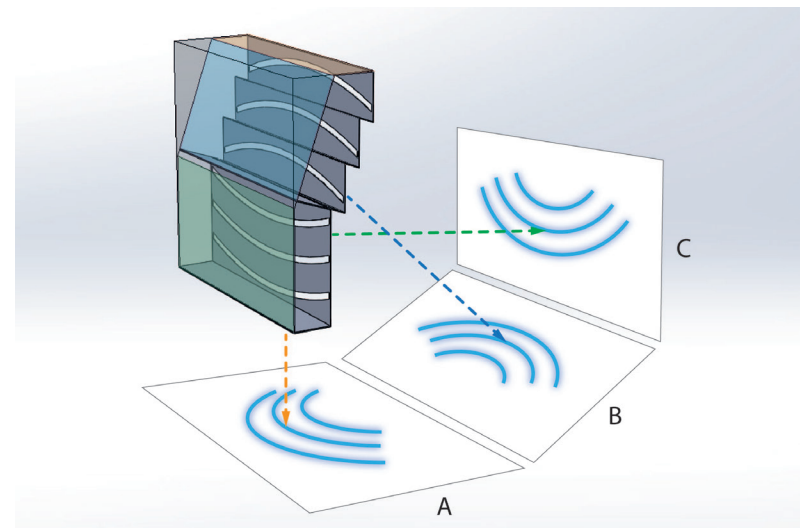

Figure 14.2.4 Projections from LED matrix through filter sections

Based on the orientation of the machine, one of the LED matrix parts is turned on and projects the needed pattern on the floor.

Section 12 and 13 mention a pulse of light as a reminder for wandering staff that the radiation is active. This would ideally resemble a wave traveling outward from the source.



This can be achieved with the filter too. The LED matrix can be programmed to make a gradient of LED's turning on and off from top to bottom, which will result in a pulse outward in the projection.

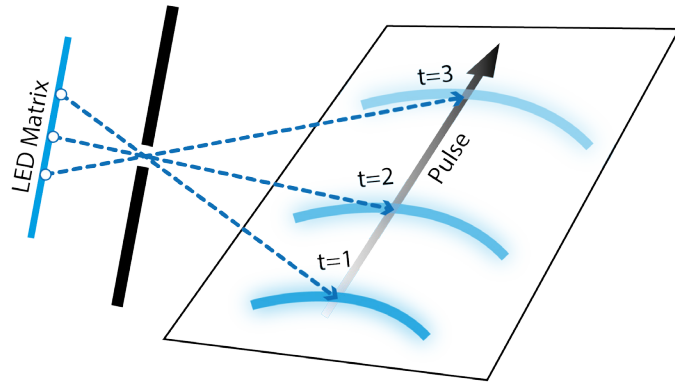

Figure 14.2.5 Pulse as a result of gradient programmed on the matrix to turn on LEDs from top to bottom

To also create a consistent projection in orientations where sliding is used instead of rotation (right example in figure 14.1.6) the projector must rotate in the opposite direction to remain facing down. This is managed the easiest by creating a circular filter and rotating it with gravity in order to keep it facing down.

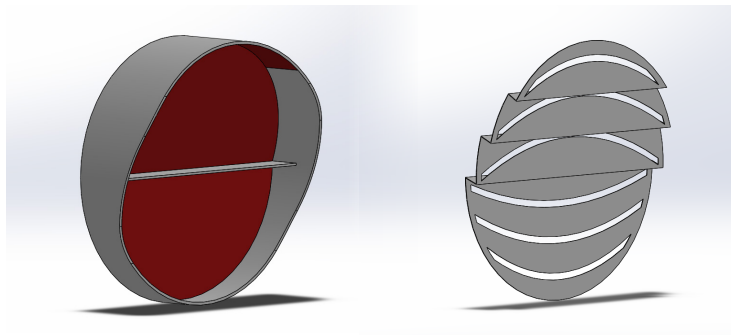

Figure 14.2.5 Circular filter to create a down facing projection when the C-arm is oriented using sliding instead of rotation

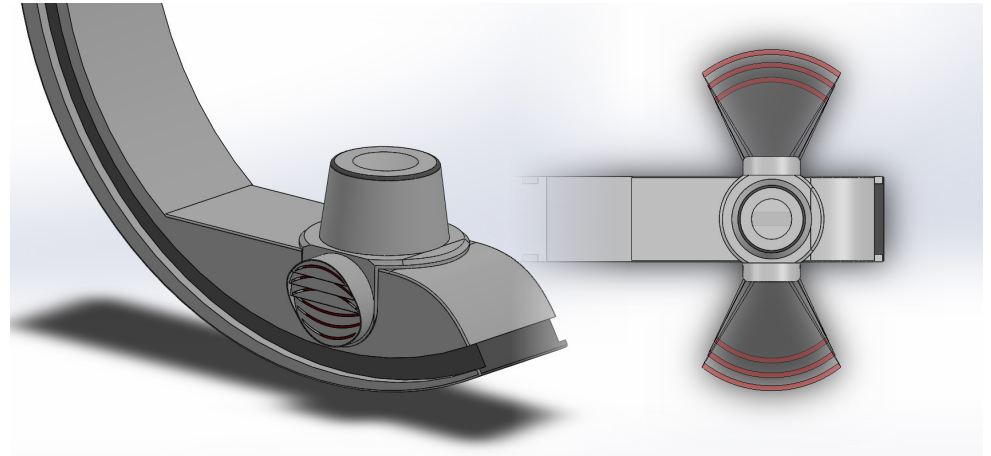

Figure 14.2.6 Mounting around the x-ray tube with a projector on each side

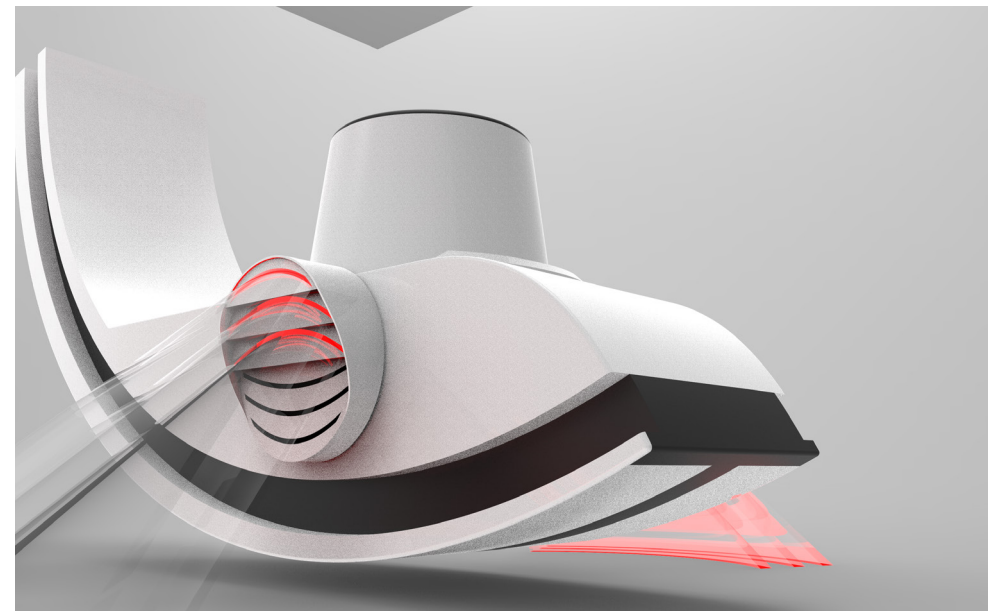

Figure 14.2.7 Projection of pattern B on each side of the x-ray tube

## 14.3 Colour scale for intensity

Previous chapters, including section 1.3 & 1.4, have shown the scatter intensity using a common 'hazard' colour scale ranging from yellow to red. In chapter 1.4 purple is even added as an upper limit above red to signify extreme dangerous radiation.

It is however difficult to use this colour scale in the OR environment due to its distracting nature. Besides distracting, the colour scale should not induce stress to operators unable to leave their position too. As stated in the project goal (p3) the product should not interfere or obstruct the operation.

A more 'friendly' colour-scale has to be used with a mere indicative nature. This also corresponds with feedback from Philips on the earlier 'hazard' colour usage. Here it was emphasized that when the product would involve softer colours it would be easier to introduce to the market. Because if it would only serve for indication purposes, it would not claim a certain working principle and be exempted from FDA approval to be used.

To still maintain a clear level of increasing intensity a colour scale has to be used that is similar to a 'hazard' scale but also blends into the OR environment.

Combined with glow intensity a colour scale was chosen from yellow-green to bright cyan.



Figure 14.3.1 Indicative colour scale from yellow-green to bright blue/cyan

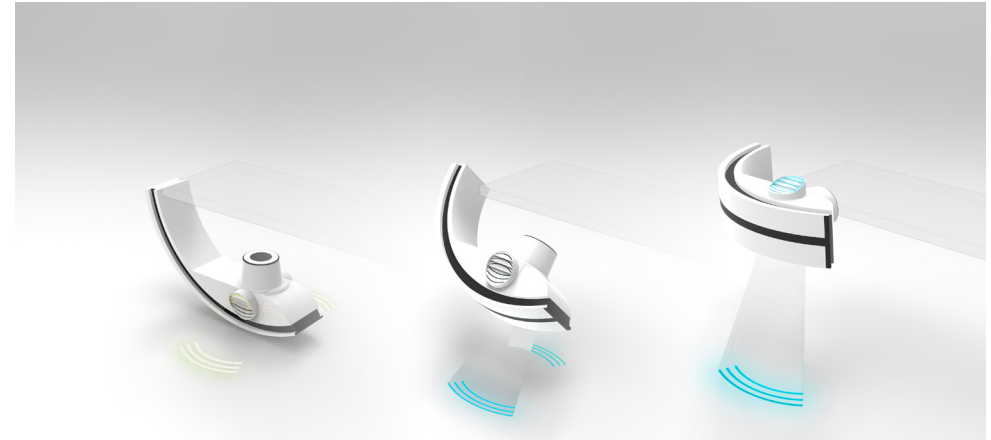

Figure 14.3.2 Colour scale on training visualization product in three orientations 0, 45 and 90 degrees

To create unity within the EPP other glowing products should also adhere to the same colour scheme. The DoseAware+ badges should therefore not still range from green to red as indicated before.

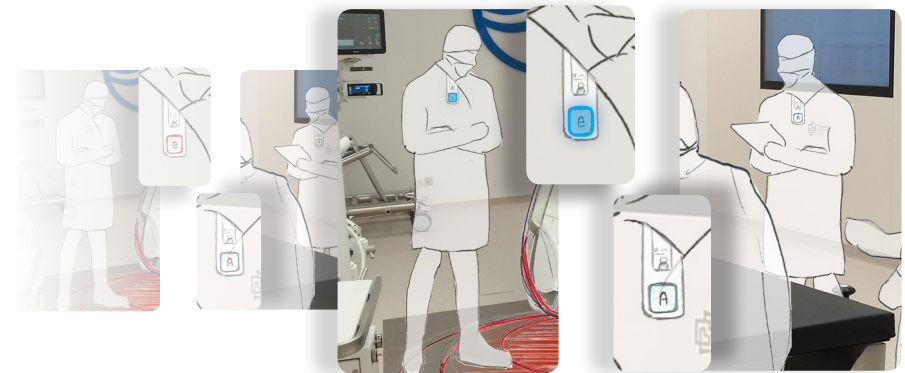

Figure 14.3.3 DoseAware+ badges glowing in the same colour scheme as the ScatterZone

## 15 DoseAware+ Philips design

Together with Dirk Vananderoye (Sr. Product Designer at Philips) the design of the DoseAware+ badge was evaluated.

Dirk suggested the unification of the EPP in terms of form language. The ScatterZone projects a circular pattern, as the radiation would, but the current DoseAware badges are rounded squares. His advise was to create one similar message from all products.

Dirk also listed several Philips style aspects which products in IGT feature:

Philips design has a preference for RVS as a detail material because of it's potential for engraving and gray-scale coloured plastics as a base.

A colour-scale from blue to yellow is used as an indicator for quality segments. Here blue is the highest. If the product would include exchangeable parts for these segments it makes implementation over all quality segments (and markets) easier.

### Redesign

The new badge redesign features a circular indication panel instead of the previous square one. To still include time to market into the design, the actual DoseAware badge is inside the design. As mentioned DoseAware is created by RaySafe and a redesign of their casing would be very complex as Philips is not the only buyer of their product.

The DoseAware is held in place by a mount on the main base, made from white plastic and the Dosimetry chip in a slot below it. On top of this a LED ring is placed as the actuator for the badge.

The conversion of DoseAware detected radiation to light output needs to be determined and probably requires involvement of Raysafe.

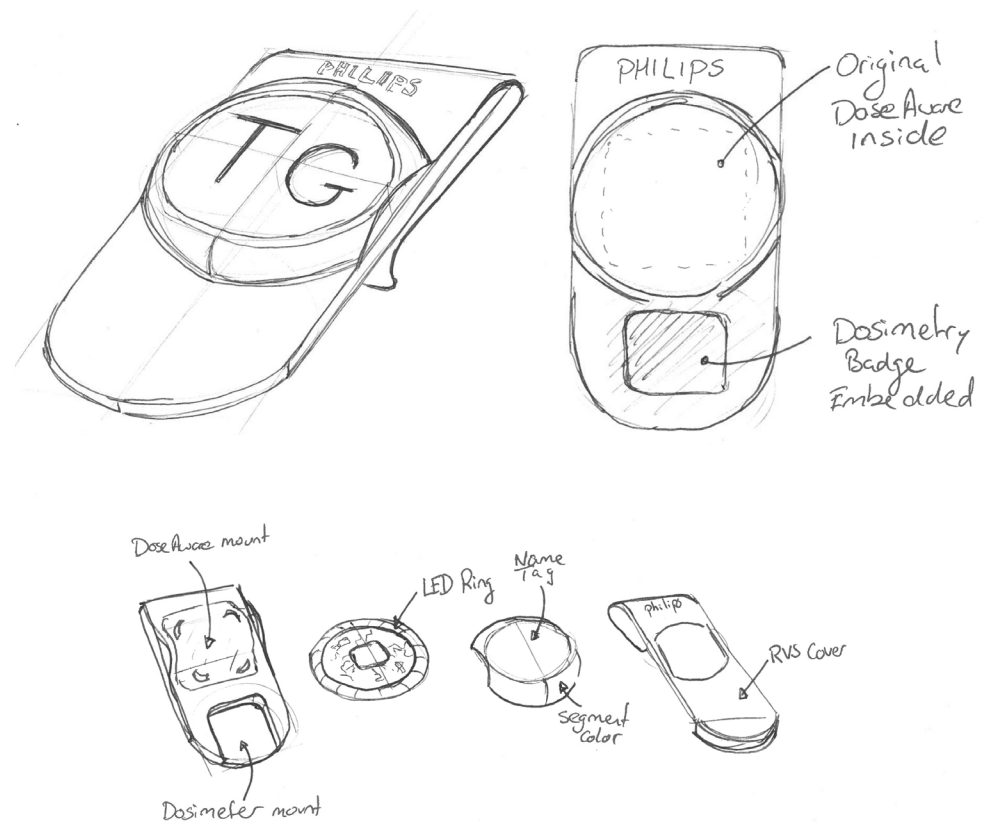

Figure 15.2.1 DoseAware+ badge redesign

To allow the differentiation between different market segments, the circular cover of the DoseAware badge is available in different colours. It can therefore be fitted to the desired product range.

On top of these segments, a RVS metal cover is placed to keep the system together and serve as a clip that can be placed on a lead apron. Ideally this clip would then fit onto a specific pocket on the apron.

The RVS is perforated where the dosimeter chip is placed. This perforation should be such that there is no difference in detection on the badge.

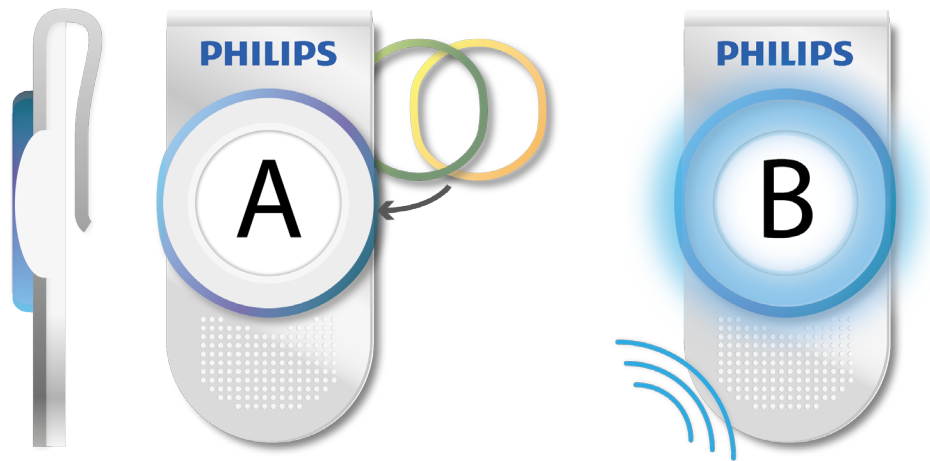

Figure 15.1 DoseAware+ badge design. Clip design and interchangeable rings to indicate segment. Glowing as radiation hits the badge.

# 15 EPP in the Hybrid OR

The working principles of the EPP have been explored in section 13. The following images are stills from the showcase video for the EPP which can be downloaded from the TU Delft repository:

Improving radiation safety for hospital staff during interventional surgery T.A.M. Gudde (4 Dec 2019)

## Training

Philips is involved in an introduction at the hospital of their newly installed system. The hospital Radiation Coordinator leads an interactive “learning by doing” style safety course.

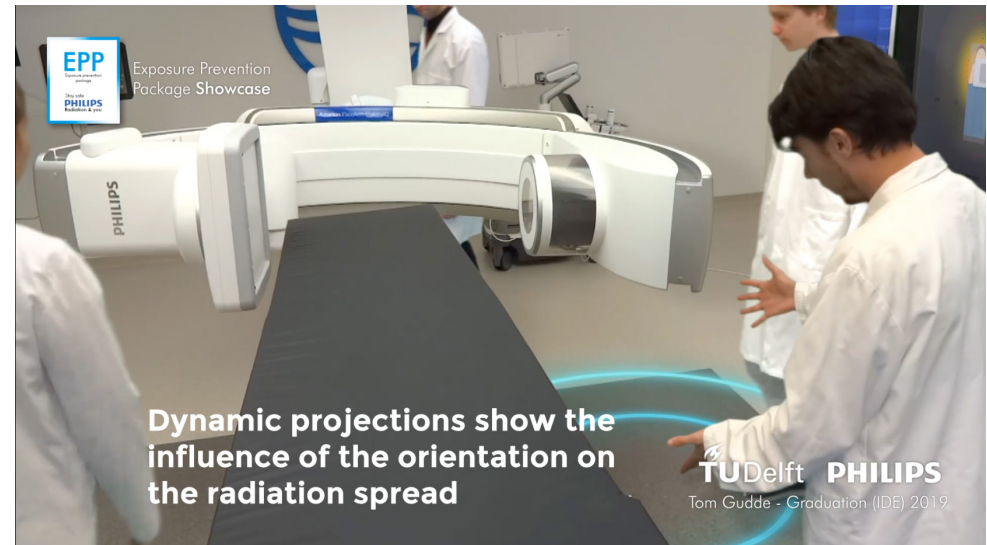
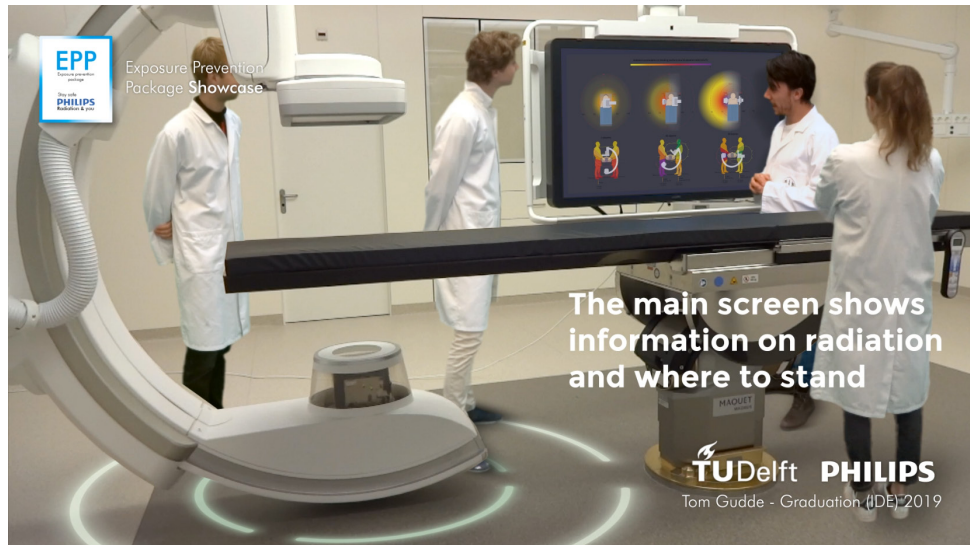

## Live Procedure

The system now shows a clear indication when radiation is active or not. DoseAware+ is activated and gives real time insights in radiation levels

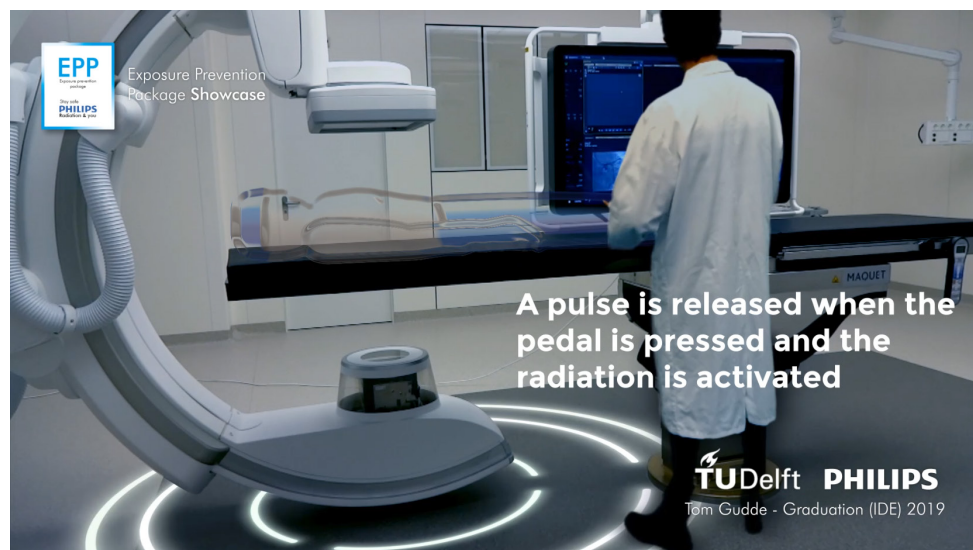
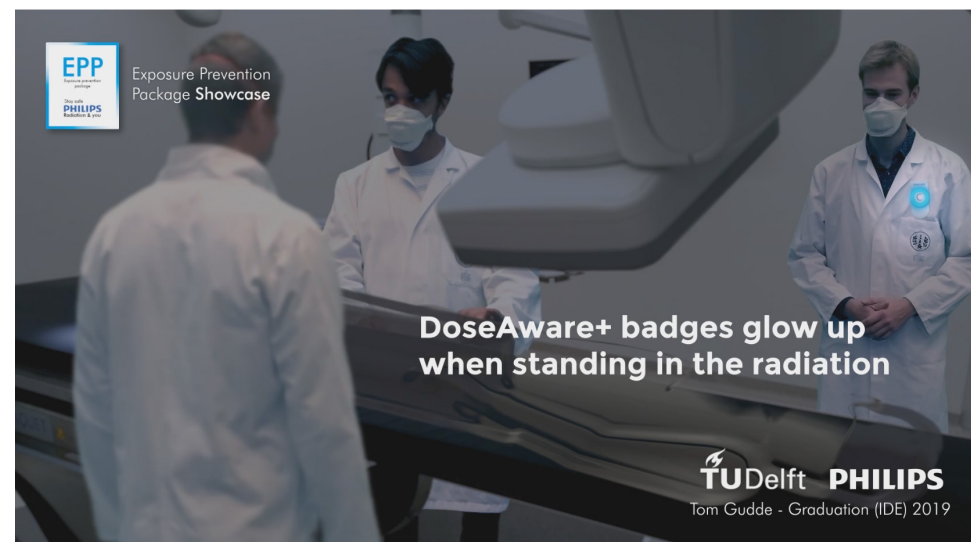
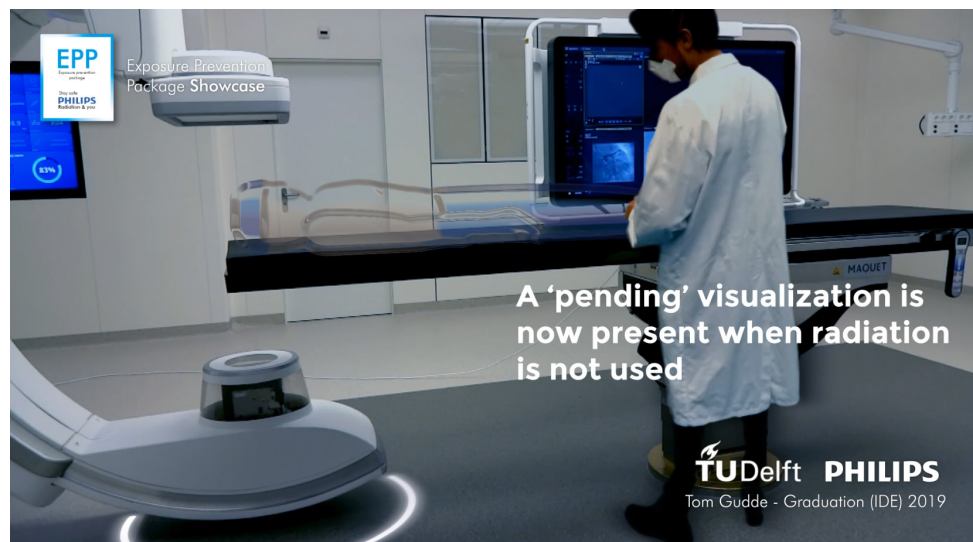



# Recommendations

- 4 16 Further concept development
- 5 17 Stakeholder evaluation
- 6 18 Training
- 7 19 Intensity of the EPP

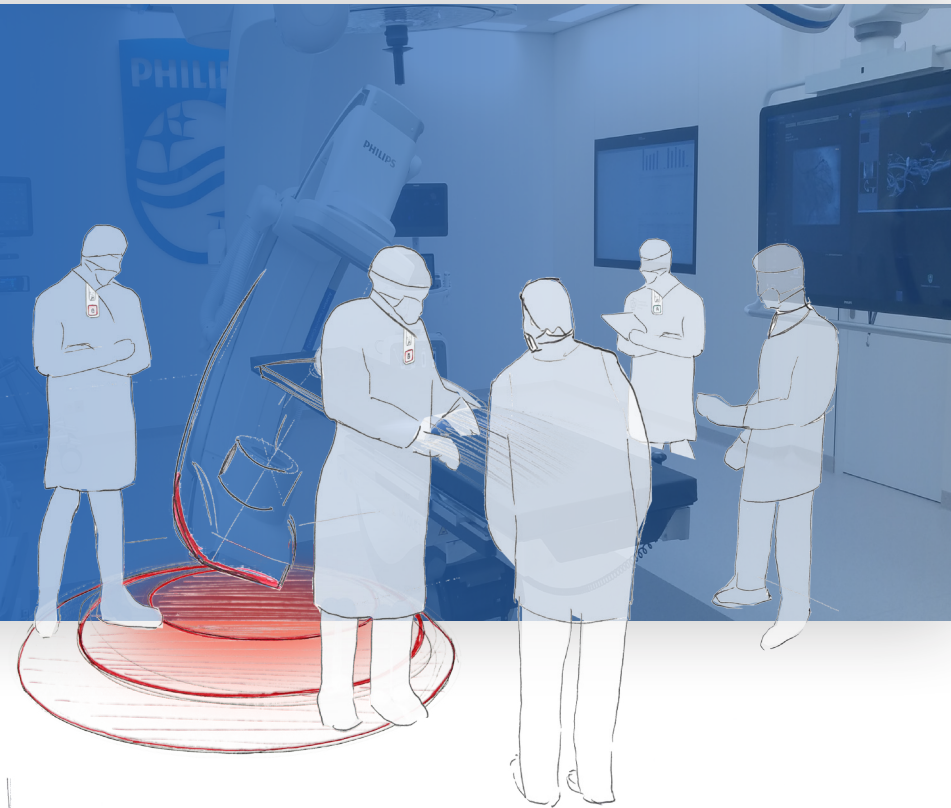



## 16 Further concept development

The EPP, in its current conceptual phase, still leaves some aspects undetermined. Besides further technical elaboration there are also several non physical and organizational points to be addressed for proper continuation of the project.

### 16.1 ScatterZone

#### Visual style for scatter projections

The current visualization is determined on personal associations with radiation, as explained, and has not been tested for efficiency yet. The same is true for the selections for the colour scale which is used to indicate the level of radiation at a certain orientation.

For the further development of this product an expert on behavior change, for example Juni Daalmans (section 11), will have to be involved and a short research has to be carried out on how to best indicate the spread in both visual style and usage of colours. An example setup for such a test is discussed in section 19.

#### Adjustability

The standard for radiation dose changes from year to year. Every hospital has their own target when it comes to operator exposure. To accommodate for this it would be useful for the product to be adjustable to these standards. This can be done by allowing the radiation coordinator for example to increase or decrease its intensity.

#### Product in live operation

The concept elaboration in section 14 focused on a uniform display of the dangerous zone and the quickest introduction for the training environment. The ScatterZone can however be tackled in multiple ways, also where a mounted product on the x-ray tube is not directly necessary. The solution should however not compromise the described "pavlov

cue" functionality in the redundancy mode. This is based on a similarity in displaying of the Scatterzone after it has been shifted to redundancy mode. This could be complicated by a projection from a vastly different source that from on the x-ray tube.

Other options for a similar projection include beamers at positions in the OR. For instance attached to the table and close to the floor. Here a short-throw projector could create a sharp image without the need of a large angle of projection.

The difficulty with projection is the chance of interference with objects or the operators them self which might block the light and lower the effectiveness of the product.

Next to this, a product that is not directly placed on the c-arm requires insight in the orientation via a link with the system. This might influence the introduction time.

Alternatively, the idea of projection could be exchanged for a floor based lighting system. Here LED matrices would be integrated into the floor and from there create a reliable display regardless of obstructions. Again a system link is required.

To prevent the requirement of a full floor replacement, a type of LED carpet could be created that can be placed around the table.

These have to be further explored to find the most promising solution. Here the introduction time and the system complexity, with regard to the required data from the system, should be taken into account in this exploration.

#### Medical accessory

The product will have the quickest time to market if it does not act as a medical device but as a medical accessory. This to prevent the need for medical trials. A medical device is also a product that alters the working principle of an existing system, such as the C-arm.

As a result the usage of an external powersource complicates this

because it requires cables on the C-arm which might have an effect on the machine itself.

Claims towards effects on health require testing. The product should therefore not aim to solve a SMART defined problem statement such as lowering operator exposure with 10mSv/year. Instead it should serve only as an indication of radiation. At least in marketing.

If the product is only used in training it might be able to be implemented without any scruteneering from the FDA or another validation institute.

## 16.2 DoseAware+

### Screen redesign

The current area where the Dose Aware bars are displayed are too small for a detailed display of the radiation spread in the room. It therefore needs to be expanded by one of two ways:

- Reorganize other information on existing screen
- Create a new screen for Dose Aware

Dose Aware is currently a third party product designed and programmed by RaySafe. The implementation would therefore also require their contribution. Alternatively an internal team from Philips could expand the current DoseAware package on their own. In a talk with Sr. Solutions developer (IGT) Mariana Koleva, she mentioned that her department was currently looking into this possibility.

### Reliable position tracking

Dosimeters are not 100% accurate which could create a problem with the position tracking of the individual operators. Next to this the spread is symmetrical in several directions, which means the operator can be on any position on a certain radius from the patient.

The PODIUM project funded by the European Union uses alternative

methods for position tracking to get digital feedback on how the ALARA principles are executed.

### PODIUM

“Personal Online Dosimetry Using computational Methods (PODIUM)” is a research project to improve occupational dosimetry by an innovative approach: the development of an online dosimetry application based on computer simulations, which will calculate individually the occupational doses, without the use of physical dosimeters.”

(Podium, 2018)

This could be an interesting project to use as the base of the technical part of the concept.

Other options include tracking using close range tracking sensors of which the Decawave MDEK is a suitable example for the deployment in the Hybrid OR. It takes measurements up to 10 meters with 1cm accuracy.

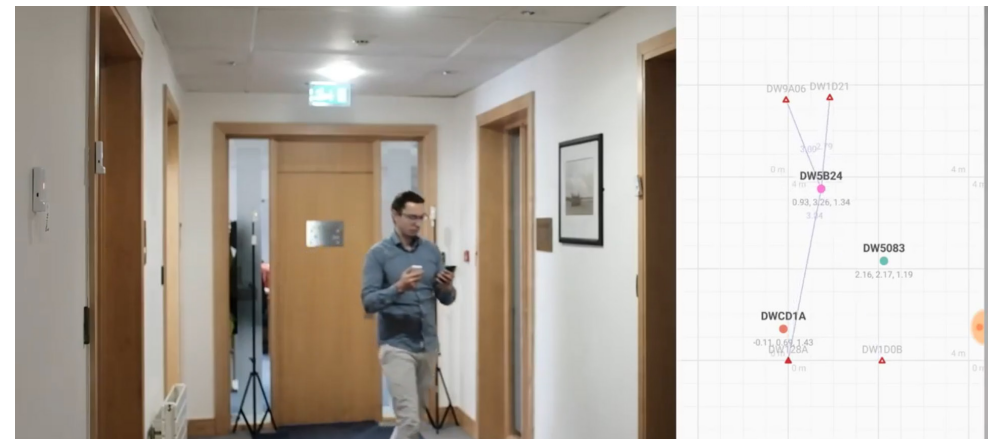

figure 16.2.1 Decawave tracking using 4 simple trackers in a small space. The data is logged as a coordinate on e.g. their android app. (Decawave, 2019)

## 16.3 Radiation Know-How

The material of the Radiation Know-How is in essence usable as a guide for the training itself. For this Philips needs to collaborate with the organization of an existing course to (re)shape the material. An example of such reshaping is shown in the showcase video (figure 16.3.1).

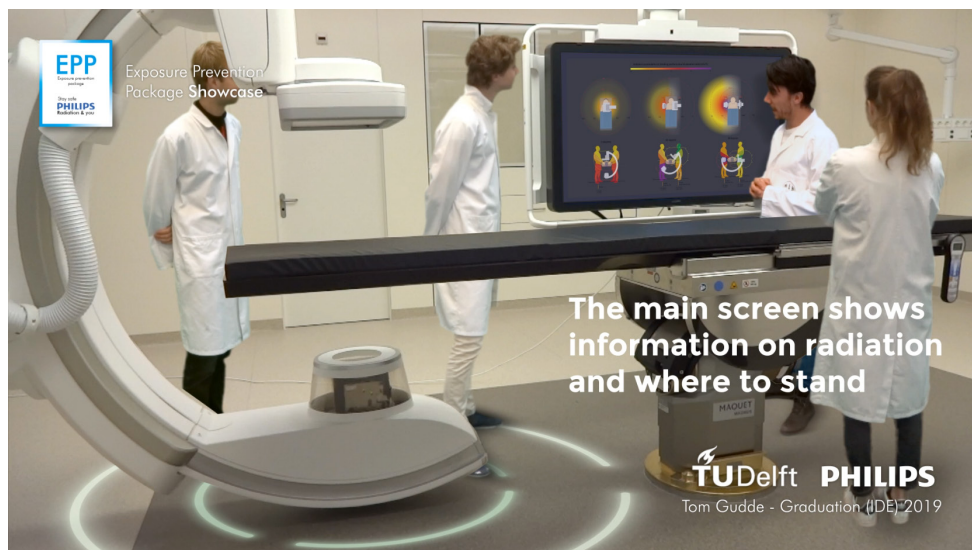

Figure 16.3.1 Showcase video still of training situation using Radiation Know-How

## 17 Stakeholder evaluation

### 17.1 Radiation coordinator

The radiation coordinator from the Erasmus MC was very interested in the EPP. He mentioned that he was mostly interested in the exploration of the DoseAware+ badge system on the short-term.

The evaluation of results from data generated by the DoseAware+ system would be most suitable to him for feedback on outliers compared

to individual evaluations with the whole staff, due to the time needed for such feedback sessions.

The DoseAware+ data therefore needs to accommodate for two scenario's:

- Personal reflection after each procedure (For the operator them self)
- Staff overview with outliers (For the radiation coordinator)

### Personal reflection

The personal reflection could be designed for an app of an added integration with the existing DoseWise portal, which currently focuses on patient exposure. Here clear markers for improvement on a single operation should be made clear.

The advanced tracking as mentioned in 16.2 could be converted into a path to allow the operator to see his/her behavior in the OR. Regions of bad practice can be highlighted here.

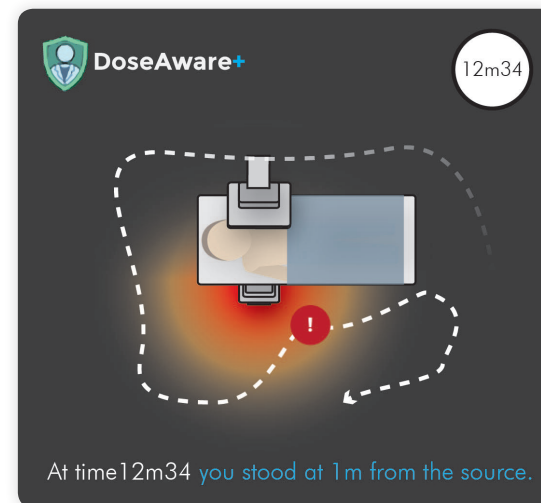

Figure 17.1 Example of personal feedback in an the DoseAware+ app or the DoseWise portal on behavior during a single procedure

## Staff overview

The interface should create a clear overview for the coordinator to tackle problems in behavior. It could give overall conclusions based on the data from the outliers. Ideally it would already suggest action points as seen in figure 17.2.

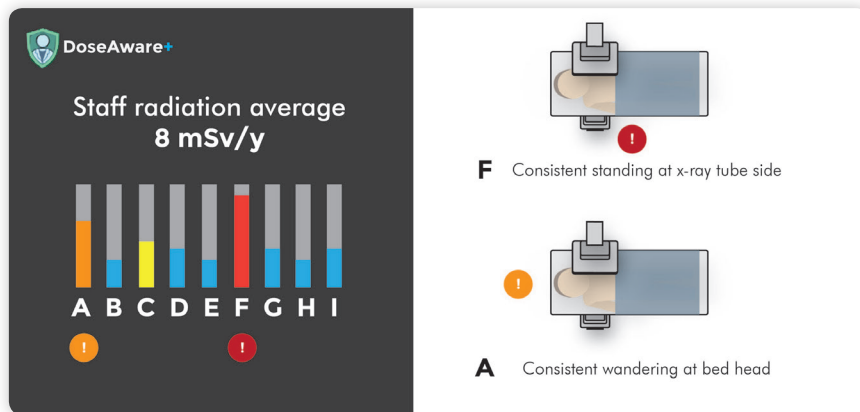

Figure 17.2 Staff overview interface with outliers and action points for improvement

The actual display and total list of features for this feedback app has to be designed by a professional application designer in combination with an expert on behavior change.

## 17.2 Cardiologist

In a follow-up with one of the cardiologists from the user test (section 6), the EPP system was shown with regard to the improvement over understanding the radiation spread.

The cardiologist was one of the subjects that had indicated an incomplete picture of the scatter spread during the test. During the evaluation, using the Radiation Know-How images, he was highly engaged with how the spread was actually much more a-symmetrical than he thought. He also mentioned that he was often not fully sure about the impact of radiation on his health.

He was sure that his team would benefit from an interactive solution where like the EPP. A follow-up meeting where these findings were presented to the whole staff was requested by the cardiologist.

## 17.3 Dose tracking & management

In a meeting with Mariana Koleva and Richard van den Bruggen, responsible for the “Dose tracking & management” module, the proposition of the EPP was presented.

They issued that their unit was looking into expansions of their current value proposition toward the clients. The clients were at the moment not motivated to expand their usage of Dose tracking beyond the DoseWise portal because of the increase in costs.

Based on the reaction of the cardiologist in the follow-up meeting (17.2) the EPP could potentially deliver this value for the “Dose tracking & management” module.

Koleva mentioned that she was interested in the EPP as a whole compared to the individual parts. This because the parts strengthen each others ability to warn the users and therefore the added benefit of introducing it.

The only obstacle at this point was the available manpower to execute the further development. Just as mentioned in section 16, the complexity of the solution (e.g. system integration to acquire data on rotation) influences its potential for being introduced in the short term. Based on a previous presentation within Philips, Sudeendra Chitta (see contact list) mentioned interest in the prototyping of the technical solution.

## 18 Training

The training should be designed by an expert on the field of radiation. Preferably Philips has to locate a person with the required knowledge on the topic within their own company. This person would have together with for example an clinical physicist to shape the required teaching material.

It has to be taken into account that the material is not just a simple slideshow, but instead a tool to lead an interactive session where the machine is the center of attention.

The session should also focus on the elimination of the hierarchy during an operation. Everyone should feel confident to correct each others behavior. This could prove difficult, as a nurse would currently not correct the head operator on his behavior. Especially in markets outside of the Netherlands, e.g. developing countries, this effect is more present.

An expert could be appointed to tailor the teaching material to fit best for the hospital where it is used. To better tackle the hierarchy issue and also to better suit the material for the performed surgeries within the hospital.

### **Radiation coordinator**

The EPP is based on an integration with the hospital structure where a radiation coordinator plays an important role. Some countries, for instance in developing countries, might not share the same system as in the Netherlands where a radiation coordinator is mandatory.

In some instances a coordinator is shared between multiple hospitals, which complicates deep insightful meetings to evaluate dose levels.

### **Training scenarios**

The training has to represent an actual procedure too besides featuring a system overview and radiation presence. It could be beneficial to

create several scenario's to allow the operators to get acquainted with the system in a relatable setting.

As mentioned in section 11, the operators might be tended to disregard the protocols in an emergency situation because the patient safety is more important. This puts the operators in danger and should be avoided.

To avoid the disregard for safety perhaps it could be an improvement to look at another profession where training via scenario's is present. Pilots, for example, learn how to create safe conduct in a variety of emergency procedures including engine failure and near crashes. In a guideline document by the Federal Aviation Administration (F.A.A.), this is referred to as scenario-based training (SBT) (F.A.A., nd). The F.A.A. stresses on the importance of reviewing the plan on how to act in such events before taking flight.

Scenario's where a patient is in danger but the operators are urged to take their own safety into account too, could become an interesting addition to the introduction course. This would however require an (external) expert on safety to properly set-up the protocol (e.g Juni Daalmans). Such a protocol would then be used during an emergency, much like a pilot would go through a checklist to avoid disaster.

Using emergency scenario checklists requires a change in the current work flow. Reviewing a checklist during an emergency could take important time and the influence of this has to be evaluated to determine its added benefit.

## 19 Intensity of the EPP

The EPP will create an extra set of elements which draw the attention from the operators. A study needs to be done on what the actual impact of the introduction would be on the working environment.

For instance the influence of the EPP on stress levels. Currently an operation could be hectic on it's own; now the operators are also warned about their own safety.

This should be delicately tackled by exploring how present the EPP should be to be noticed, but not to become distracting.

### 19.1 Intensity test during live procedure

For this a relatively simple physical test could be created. The goal would be to determine the intensity of the DoseAware+ badges and the floor projection of the ScatterZone.

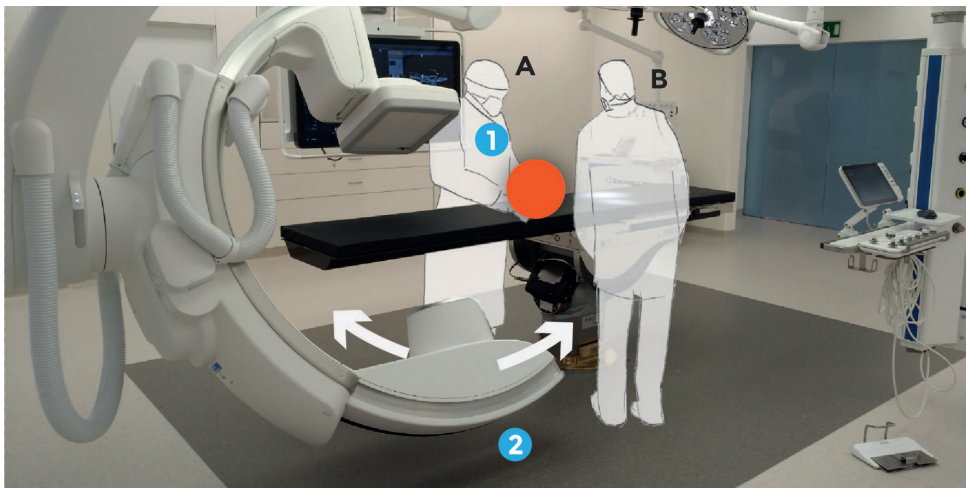

Figure 19.1 Intensity test setup. Two subjects unknown about the EPP perform a mentally and physically engaging task (orange) While the machine slowly changes orientation.

Two test subjects with no prior knowledge of the working principles of the EPP have to be asked to perform a physically and mentally demanding task (e.g. a puzzle or building a kit airplane).

The C-arm would rotate slowly to a predetermined orientation setup mimicking a live operation. This setup gives each of the test setup the same amount of 'exposure' time. No radiation is present in this test.

The test would have two parts. First part is meant for the determination of the **intensity of the DoseAware+ badges**. The badges will glow as a result of the machine orientation exposing the test subject.

The badges are programmed to slowly increase their intensity, the glow of the badge, over time.

Two effects will need to be determined:

- At what intensity does a test subject notice his/her own glowing badge
- At what intensity will a test subject notice the other badge and tell the other test subject about that discovery

In the second part the **ScatterZone intensity** is determined. The DoseAware+ badges will remain active.

Again the machine will slowly rotate in the predetermined setup and two effects can be determined:

- At what intensity does a test subject notice his/her standing position inside a glowing zone
- At what intensity will a test subject notice the others standing position inside a radiation zone and tell the other test subject about that discovery.

## 19.2 Redundancy mode visual style test

To determine the visual style of the redundancy mode the same setup as mentioned in 19.1 can be used.

In this case two directions can be chosen, a direction in which projections are still used, or one in which the mentioned Pavlov cue as a dummy product is present.

An option for the continued use of projections is to use a similar style to the pending visualization as seen in figure 19.2.1.

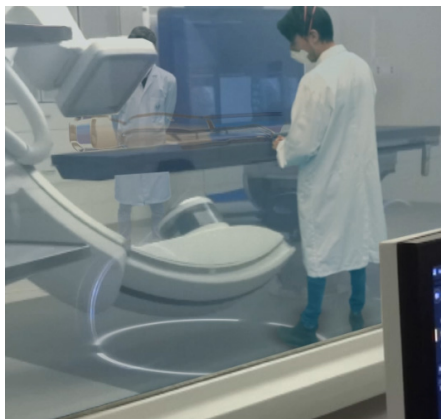

Figure 19.2.1 Pending visualization

Just as the previous test the intensity of the solution should increase to determine the first instance when the system is being noticed. In the case of the redundancy style it could be done by slowly increasing the size of the visuals. Which should be followed by a test to determine the intensity of the visuals.

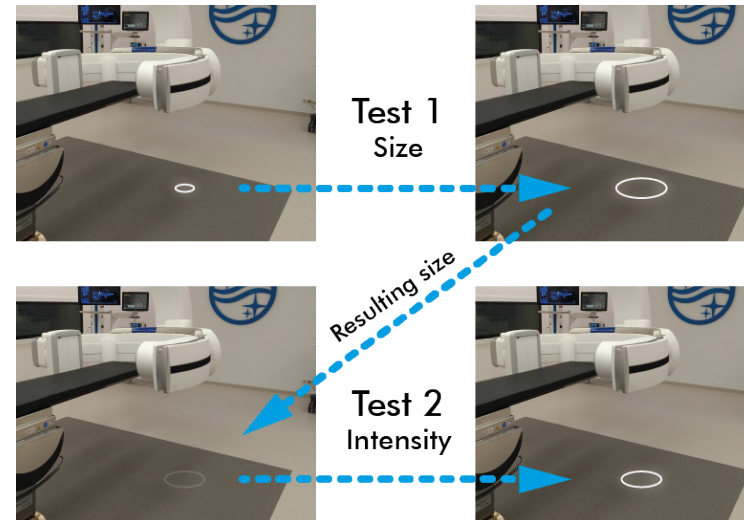

Figure 19.2.2 Redundancy mode test for projection style and intensity

If the dummy product is chosen as the direction for the redundancy mode, the same applies. In that case the test would determine the area on the x-ray tube that would be covered by the indicator.

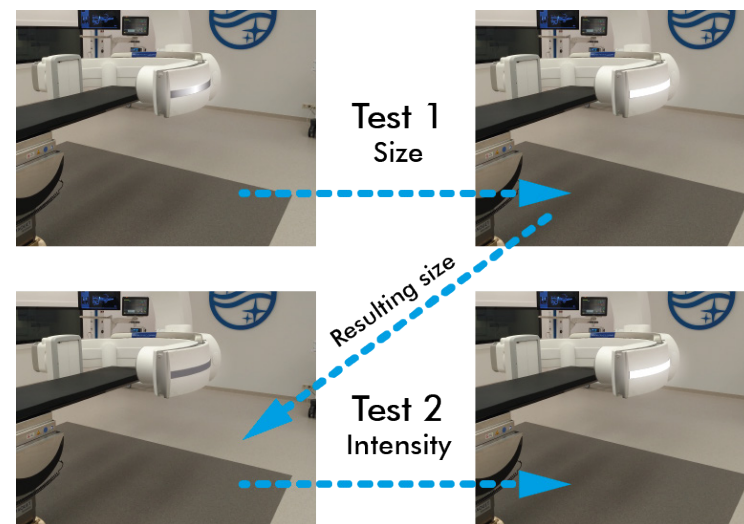

Figure 19.2.3 Redundancy mode test for dummy product size and intensity

# Contact list

Tom Gudde Student  
Master Integrated Product Design

TU Delft  
Faculty of Industrial Design Engineering  
+31642775572  
tomgudde@me.com

## Coaching team

Ruud van Heur (Chair at TU Delft) Design Engineering Department  
Margreet Beets (Mentor at TU Delft) Marketing & Consumer Research  
Bert Bloemen (Coach at Philips) Development engineer (HES)

R.J.H.G.vanHeur@tudelft.nl  
M.F.Beets@tudelft.nl  
bert.bloemen@philips.com

## Contacts within Philips

Anke LeGuevel Sr. Business development manager (HES)  
Siry Van Poppel Sr. Product manager (HES)  
Hans Ardon Product manager (IGT)  
Jan Jans Image quality specialist (IGT)  
Arjan Versluys Integral project manager (IGT)  
Jaap Van der Voet Flying quality squad (IGT)  
Bart Rem Department manager Mechatronics (IGT)  
Monique Weijers Clinical marketing specialist  
Dirk Vananderoye Sr. Product designer  
Sudeendra Chitta Mechanical designer (IGT)  
Mariana Koleva Sr. Solutions developer (IGT)  
Rick Bezemer Clinical scientist

anke.leguevel@philips.com }  
siry.van.poppel@philips.com } Further contact for exploring  
hans.ardon@philips.com } ScatterZone  
jan.jans@philips.com  
arjan.versluys@philips.com  
jaap.van.der.voet@philips.com  
bart.rem@philips.com  
monique.weijers@philips.com  
dirk.vananderoye@philips.com  
chitta.sudeendra@philips.com }  
mariana.koleva@philips.com } Further contact for exploring  
rick.bezemer@philips.com } DoseAware+

## Erasmus MC

Wout de Ruijter Radiation coordinator

w.a.deruiter@erasmusmc.nl



## References

2013/59/EURATOM Basic Safety Standards. (2018/06/02). Retrieved at 13/05/2019 from <https://www.arboportaal.nl/onderwerpen/ioniserende-straling/nieuws/2018/02/06/nieuwe-regelgeving-stralingsbescherming-van-kracht>

American heart association (n.d.). Angiogram. Retrieved at 26-08-2019 from <https://watchlearnlive.heart.org/index.php?moduleSelect=angiog>

American heart association (2017). Cardiac Procedures and Surgeries. Retrieved at 26-08-2019 from <https://www.heart.org/en/health-topics/heart-attack/treatment-of-a-heart-attack/cardiac-procedures-and-surgeries>

American heart association (2016). What is TAVR?. Retrieved at 26-08-2019 from <https://www.heart.org/en/health-topics/heart-valve-problems-and-disease/understanding-your-heart-valve-treatment-options/what-is-tavr>

American Society of regional anesthesia and pain medicine (ASRA)(n.d.) Radiation Safety Part 2. Retrieved at 1-07-2019 from <https://www.asra.com/page/220/radiation-safety-part-2>

Anderson, C.M., Leidholdt, E.M.Jr.(2013) An Introduction to Fluoroscopy Safety. Retrieved at 12-06-2019 from <https://www.mpcphysics.com/documents/IntroductiontoFluoroscopySafety8-20-13.pdf>

Antoni, R., Bourgois, L.(2013) Applied Physics of External Radiation Exposure: Dosimetry and Radiation Protection: 84-86.

Arbo (n.d). Arbeidshygiënische strategie. Retrieved at 20-06-2019 from <https://www.arboportaal.nl/onderwerpen/arbeidshygiënische-strategie>

Berger, M.J., Hubbell J.H.(2010) XCOM: Photon Cross-Sections Database, NIST Standard Reference Database 8 (XGAM) Retrieved at 11-06-2019 from <http://www.nist.gov/pml/data/xcom/index.cfm>.

Cardio Live (2019). TAVI: Dr Romain CADOR et Dr Saïd GHOSTINE [Video file]. Retrieved at 19-06-2019 from <https://www.incathlab.com/en/lives/18-structural-heart/58-tavi/2241-cardiolive-2019-tavi>

Cherry, S.R., Sorenson, J.A., Phelps, M.E.(2012) Radiation Safety and Health Physics: Physics in nuclear medicine 23:427-442. Retrieved at 11-06-2019 from <https://www.sciencedirect.com/science/article/pii/B978141605198500006X>

Cirsinc (2014) 3D Sectional Torso Phantom model 600. Retrieved at 11-06-2019 from <http://www.cirsinc.com/wp-content/uploads/2019/04/600-DS-120418.pdf>

Daalmans J. (2014). Veilig werkgedrag door brain based safety.. Journal of occupational accidents. Syntax Media (2017), 34-63

Dangal, S, Gudde T.A.M., Kamber F., Mane S.N., van Brouwershaven R.M. (2017). Workflow obstruction due to present x-ray protection during cardiac interventions.

Devawave (nd). MDEK deployment kit. Retrieved at 25-11-2019 from <https://www.decawave.com/product/mdek1001-deployment-kit/>

ECOLAB (2014). C-arm draping technique for the Philips Allura FD20 in the Hybrid OR. [Video file]. Retrieved at 18-10-2019 from <https://www.youtube.com/watch?v=WcDVnKwe1lw>

Etard, C., Bigand, E., Salvat C., Vidal, V., Beregi, J.P., Hornbeck, A., Greffier, J., (2017). Patient dose in interventional radiology: a multicentre study of the most frequent procedures in France. *European Radiology*(2017) 27: 4281. Retrieved at 24-06-2019 from <https://doi.org/10.1007/s00330-017-4780-5>

Federal Aviation Administration (nd). Emergency Procedures Training. Retrieved at 22-11-2019 from [https://www.faa.gov/news/safety\\_briefing/2018/media/SE\\_Topic\\_18\\_03.pdf](https://www.faa.gov/news/safety_briefing/2018/media/SE_Topic_18_03.pdf)

IAEA (2010). Radiation doses in interventional fluoroscopy. Retrieved at 24-06-2019 from <https://www.iaea.org/resources/rpop/health-professionals/interventional-procedures/radiation-doses-in-interventional-fluoroscopy>

IMC Live (2019). IMC LIVE 2019: Live Case #7 Dr Walid Hassan & Dr Masaaki Okutsu [Video file]. Retrieved at 19-06-2019 from <https://www.incathlab.com/en/videos/1-coronary/68-cto/2219-imc-live-2019-live-case-7?autoplay=1>

Incathlab (2015). EVAR with Cook Zenith Endograft [Video file]. Retrieved at 19-06-2019 from <https://www.incathlab.com/en/videos/2-peripheral/87-aorto-iliac/1097-evar-with-cook-zenith-endograft?autoplay=1>

Incathlab (2018). TEVAR of thoracic aneurysm close to the arch after debranching of left common carotid artery and left subclavian artery [Video file]. Retrieved at 18-06-2019 from <https://www.incathlab.com/en/videos/2-peripheral/87-aorto-iliac/1877-tevar-of-thoracic-aneurysm-close-to-the-arch-after-debranching-of-left-common-carotid-artery-and-left-subclavian-artery?autoplay=1>

Kenex (2019). X-Ray shielding products. Retrieved at 19-06-2019 from <http://kenex.co.uk/products/x-ray-shielding>

Kieranmaher [Public domain] (2001). The X-ray energy spectrum filtered by aluminium and lanthanum. Retrieved at 1-07-2019 from [https://en.wikibooks.org/wiki/Basic\\_Physics\\_of\\_Digital\\_Radiography/The\\_Source#/media/File:FilteredXraySpectrum.jpg](https://en.wikibooks.org/wiki/Basic_Physics_of_Digital_Radiography/The_Source#/media/File:FilteredXraySpectrum.jpg)

Linnet, M.S., Kim, K.P., Miller, D.L., Kleinerman, R.A., Simon S, Berrington de Gonzalez, A. (2010). Historical Review of Cancer Risks in Medical Radiation Workers. *Radiat Res.* 2010 Dec; 174(6): 793–808.

Lynskey GE, Powell DK, Dixon RG, Silberzweig JE. (2013). Radiation protection in interventional radiology: survey results of attitudes and use. *J Vasc Interv Radiol* 2013; 24:1547–1551

Mavig (2019). Lead Acrylic Shield OT80001. Retrieved at 19-06-2019 from <https://www.mavig.com/system-solutions/x-ray-protective-shields/ot80001/>

Medmastery (2015). Coronary angiography - image intensifier basics and nomenclature [Video file]. Retrieved at 11-09-2019 from <https://www.youtube.com/watch?v=CK98812F30Q>

Medical Imaging Tech (2018). ALARA - "As Low As Reasonably Achievable". Retrieved at 1-07-2019 from <http://www.medicalimagingtech.com/alaraachieve>

MEET: Multidisciplinary European endovascular therapy (2009). Complex Left Carotid Artery stenting Under 3D Rotational Angiography [Video file]. Retrieved at 19-06-2019 from <https://www.incathlab.com/en/videos/2-peripheral/34-carotid/74-complex-left-carotid-artery-stenting-under-3d-rotational-angiography?autoplay=1>

Miller, D. L. et al.(2003) Radiation Doses in Interventional Radiology Procedures: Part 1. *Journal of Vascular and Interventional Radiology*, Volume 14, Issue 6, 711 - 727. Retrieved at 24-06-2019 from [https://www.jvir.org/article/S1051-0443\(07\)60347-9/fulltext](https://www.jvir.org/article/S1051-0443(07)60347-9/fulltext)

MLSF (2019). Live Case 4 - Complex TAVI - access and implantation [Video File]. Retrieved at 18-06-2019 from <https://www.incathlab.com/en/lives/18-structural-heart/58-tavi/2243-mlsf-2019-live-case-4-complex-tavi-access-and-implantation?autoplay=1>

Morgan, D.E., Schueler B. (2010). Radiologic Issues and Radiation Safety during ERCP. Retrieved at 17-06-2019 from <https://abdominalkey.com/radiologic-issues-and-radiation-safety-during-ercp/>

National academy press. (2015). Radiation Physics Relevant to Advanced Imaging Technology Airport Passenger Screening Using Backscatter X-Ray Machines: Compliance with Standards (2). Retrieved at 11-06-2019 from <https://www.nap.edu/read/21710/chapter/4>

National Institute of Standards and Technology (n.d.). X-Ray Mass Attenuation Coefficients: Air, Dry (Near Sea Level). Retrieved at 11-06-2019 from <https://physics.nist.gov/PhysRefData/XrayMassCoef/ComTab/air.html>

Nederlandse vereniging voor stralingsbescherming (NVS). (2018). Deskundigheid en opleidingen stralingsbescherming. Retrieved at 17-06-2019 from <https://www.nvs-straling.nl/media/319940/schema-deskundigheid.pdf>

Niklason LT, Marx MV, Chan HP. (1993) Interventional radiologists: occupational radiation doses and risks. *Radiology* 1993; 187:729–733

Philips (2019). AlluraClarity with ClarityIQ technology. Retrieved at 2-07-2019 from <https://www.philips.nl/healthcare/product/HCNOCTN163/alluraclarity-low-dose-interventional-x-ray-system>

Philips (2019). Azurion 3 F 15 . Retrieved at 24-06-2019 from <https://www.philips.nl/healthcare/product/HCNVVD002/azurion-3-with-15-inch-detector>

Philips.(2014) Making the difference with Philips Live Image Guidance. Retrieved at 12-06-2019 from <https://philipsproductcontent.blob.core.windows.net/assets/20170523/fdee1fe9885c4a7d89f6a77c01514f63.pdf>

Philips (2019). Philips Azurion Biplane with Zero Dose Positioning [Video File]. Retrieved at 2-07-2019 from <https://www.youtube.com/watch?v=c6mtvgHnolo>

PODIUM (2018). Personal Online Dosimetry Using computational Methods. Retrieved at 18-11-2019 from <https://podium-concerth2020.eu/>

Radiopeadia (n.d.). Tissue Weighting Factor. Retrieved at 13/05/2019 from <https://radiopaedia.org/articles/tissue-weighting-factor>

Radiopeadia (n.d.). Inverse square law. Retrieved at 13/06/2019 from <https://radiopaedia.org/articles/inverse-square-law>

Rasmussen J. (1982). 'Human errors, a taxonomy for describing human malfunction in industrial installations'. *Journal of occupational accidents*, 4, 311-33

RIVM. (2014). Risicovolle medische technologie en specifieke eisen aan bekwaamheid. Retrieved at 17-06-2019 from <https://www.rivm.nl/bibliotheek/rapporten/080104001.pdf>

Schatzlein, D., Thomson, V., Mercurio, D..(2005) Spectroscopy: Tutorial: Attenuation of X-Rays By Matter. *Spectroscopy*; 20(6). Retrieved at 11-6-2019 from <http://www.spectroscopyonline.com/tutorial-attenuation-x-rays-matter>

Siemens (2019). CARE+CLEAR. Retrieved at 24-06-2019 from <https://www.siemens-healthineers.com/en-us/angio/innovations-technologies/care-clear/dose-reduction>

Siemens (2019). Health Management. Retrieved at 24-06-2019 from <https://new.siemens.com/global/en/company/sustainability/health.html>

Siiskonen, T., Ciraj-Bjelac, O., Dabin, J., Diklic, A., Domienik-Andrzejewska, J., Farah, J., Fernandez, J.M., Gallagher, A., et. al. (2018) Establishing the European diagnostic reference levels for interventional cardiology, *Physica Medica* 54(2018), 42-4. Retrieved at 28-09-2019 from <https://doi.org/10.1016/j.ejmp.2018.09.012>.

Sprawls, P. (n.d.) Radiation penetration. Retrieved at 11-06-2019 from <http://www.sprawls.org/ppmi2/RADPEN/>

Sprawls, P. (n.d.) Interaction of radiation with matter. Retrieved at 11-06-2019 from <http://www.sprawls.org/ppmi2/INTERACT/>

TCTAP (2016). [Endovascular Symposium] Live Case Session III. SFA Intervention [Video file]. Retrieved at 18-06-2019 from <https://www.youtube.com/watch?v=H4-V0d4B18Y>

Ubeda, C., Vano, E., Miranda, P., Aguirre, D., Riquelme, N., Guarda, E. (2015). COMPARISON OF TWO ANGIOGRAPHIC SYSTEMS IN PAEDIATRIC INTERVENTIONAL CARDIOLOGY. *Radiation Protection Dosimetry*: 1–4  
<http://repositorio.uchile.cl/bitstream/handle/2250/134658/Comparison-of-two-Angiographic-Systems.pdf?sequence=1>

Universtity Hospitals (2017). Watch a Trans-catheter Aortic Valve Procedure [Video file]. Retrieved at 18-06-2019 from <https://www.youtube.com/watch?v=JrrPwAs2pmM>

Vano, E., Sanchez, R., Fernandez, J.M. et al. (2009) *Cardiovasc Intervent Radiol* 32: 19. Retrieved at 27-06-2019 from <https://doi.org/10.1007/s00270-008-9439-9>

Wang, W., Zhang, M., Zhang, Y. (2013) Overall measurements of dose to patients in common interventional cardiology procedures, *Radiation Protection Dosimetry*, Volume 157, Issue 3, 348–354. Retrieved at 27-06-2019 from <https://doi.org/10.1093/rpd/nct147>

Ziehm (2016). Dose Management at Ziehm Imaging. Retrieved at 24-06-2019 from [https://www.ziehm.com/fileadmin/user\\_upload/row/04-clinical-evidence/03-the-right-dose/EN\\_Whitepaper\\_37\\_2016\\_DoseManagement.pdf](https://www.ziehm.com/fileadmin/user_upload/row/04-clinical-evidence/03-the-right-dose/EN_Whitepaper_37_2016_DoseManagement.pdf)

Zotova, R., Vassileva, J., Hristova, J., Pirinen, M., Jarvinen, H. (2012) A national patient dose survey and setting of reference levels for interventional radiology in Bulgaria. *Eur Radiol* (2012) 22:1240–1249. Retrieved at 27-06-2019 from <https://link.springer.com/content/pdf/10.1007%2Fs00330-012-2386-5.pdf>

# Improving radiation safety for hospital staff during interventional surgery

Tom Gudde

Graduation Project Integrated Product Design  
Faculty of Industrial Design Engineering (TU Delft)

## Appendices A-K

Please consider **not** printing this



- |              |                                 |              |                          |
|--------------|---------------------------------|--------------|--------------------------|
| <b>94</b> A  | Radiation from patient          | <b>132</b> G | Ideation process         |
| <b>101</b> B | Procedure Data                  | <b>140</b> H | ScatterZone drawings     |
| <b>103</b> C | Market & OHS                    | <b>141</b> I | Package deal examples    |
| <b>124</b> D | Flying Quality Squad            | <b>143</b> J | List of requirements     |
| <b>126</b> E | Cardiologist Interviews         | <b>145</b> K | Time to market selection |
| <b>131</b> F | Brainstorm schedule and results | <b>147</b> L | Graduation Brief         |

# Appendix A - Radiation from patient

To identify the most prominent area's for a design solution, the area's most dangerous to the operators must be identified. Scatter plots, or isodose plots, are commonly found on the Internet, but are specific to a certain case (e.g incoming radiation or patient thickness). To make predictions on the most dangerous area's a universal understanding of the behavior of scatter radiation is necessary.

## 4.1 Radiation intensity

Originating from a source, e.g. the x-ray tube of patient, radiation interacts with matter on its path. Based on the material, the radiation is weakened to a certain degree. Just like lead shielding the air itself also blocks a part of the radiation. The weakening of the radiation is called attenuation and can be defined as a function of the incoming radiation ( $I_0$ ), the material attenuation coefficient ( $\mu$ ) and the distance ( $x$ ) (Schatzlein et. al., 2005).

$$I = I_0 \exp(-\mu \cdot x)$$

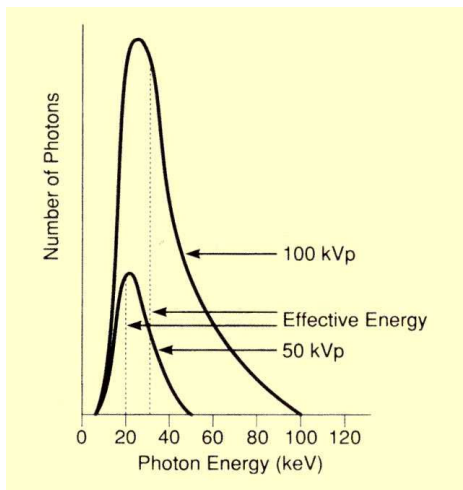

Based on the type of radiation used, the attenuation coefficient differs as a result of the photon energy. In the case of the Philips Allura Xper FD20, which operates at 100kV, photons with an effective energy of 35keV are created.

Figure 4.1.1 Effective Energy of X-Ray Spectra (Sprawls, n.d.).

Scatter however, which originates from collisions within the patient body and the operating table, has a lower photon energy level. This is the effect of Compton scattering.

These photons collide with a series of electrons as they pass through the solid matter (either the table or patient).

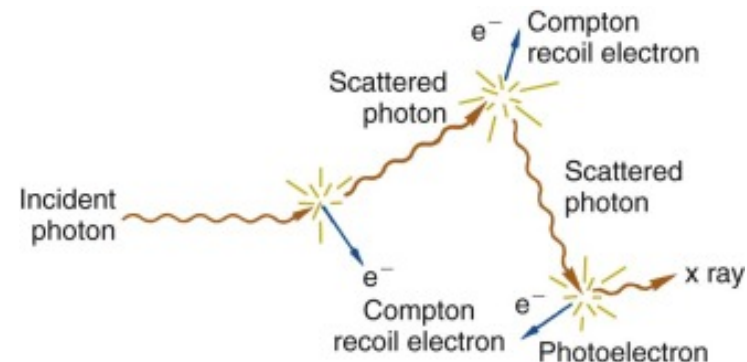

Figure 4.1.2 "Multiple interactions of a photon passing through matter. Energy is transferred to electrons in a sequence of photon-energy degrading interactions." (Cherry et. al., 2012)

A photon normally has a constant energy. When moving through an object they either pass through or don't. Compton scattering however consists of a series of collisions in which the photon transfers a part of its energy onto the recoil electrons while continuing in a different direction.

To calculate the difference in energy the energy transfer coefficient ( $\mu_{tr}$ ) is used. This coefficient is composed of the total mass energy absorption in the material ( $\mu_{en}$ ) minus the factor of other scattering effects such as the photoelectric effect ( $g$ ) (Antoni et. al., 2013).

$$\mu_{en} = \mu_{tr} (1 - g)$$

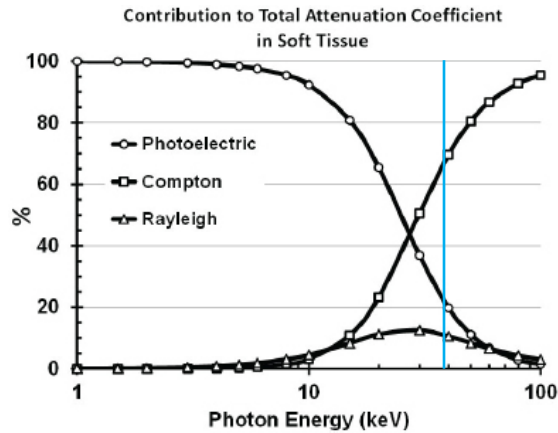

Figure 4.1.3 Contribution to total attenuation coefficient in soft tissue (N.A.P., 2015).

At 35 keV approximately 70% of the attenuation is accounted for by Compton scattering (N.A.P., 2015). This effect does not add to the creation of high energy photons but instead creates free electrons.

Therefore  $g=0.3$  for the not contributing 30% of the photo-electric effect).

For 35 keV the  $\mu_{en} / \rho$  equals 0,11 cm<sup>2</sup>/g (N.I.S.T., n.d.). After taking the 30% into account  $\mu_{tr}$  is set at **0,08 cm<sup>2</sup>/g**.

To find the difference in photon energy after passing through the body the following formula " $I = I_0 \exp(-\mu_{tr} * x)$ " as mentioned before was used in combination with the energy transfer coefficient.

The material attenuation for soft tissue at 35 keV can be added to the figure using the same equation now using the mass attenuation coefficient ( $\mu$ ) instead of  $\mu_{tr}$ . This value is approximately **0,3 cm<sup>2</sup>/g** (N.I.S.T., n.d.).

An average patient body is used with dimensions based on the Cirs torso phantom mentioned in section 2.5.

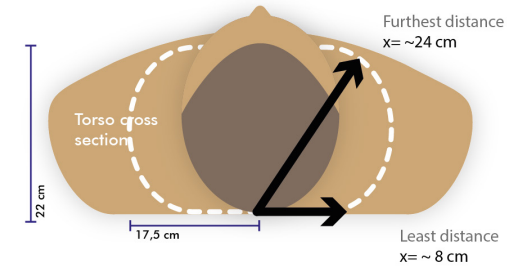

Figure 4.1.4 Travel distance for photons through patient body based on Cirs phantom. Average density at heart cross section = 0.81 g/cm<sup>3</sup> (Cirs Inc. 2014).

The two combined create a figure with the remaining beam percentage after attenuation and energy levels of the individual beam particles as a result of Compton scattering.

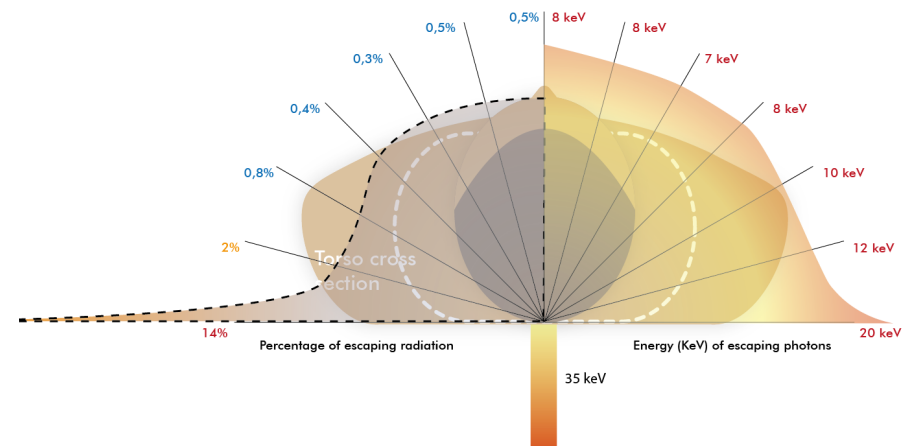
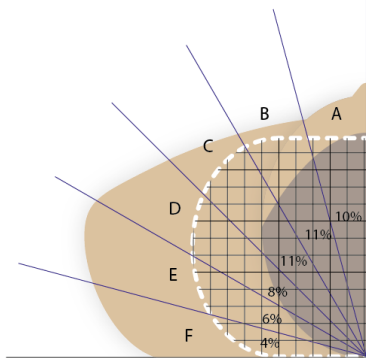

Figure 4.1.5 Attenuation effects of patient body on 35 keV beam. Remaining percentage of the beam and the energy of the photons on exit under an angle are shown.

## 4.2 Radiation at patient body

The Philips Allura Xper creates an incoming beam of photons at  $\sim 55$  mGy/min for the phantom thickness of 22cm (Philips, 2014)(Ubeda et. al., 2015)

We take that the incoming radiation is divided over the body equally and at random, as is the case with Compton scattering. When dividing the torso in 12 parts (6 per half) originating from the radiation beam, the percentual division as shown in the figure below is created.



When the percentual data is combined with the attenuation effects within the patient body the values of Gy/h can be calculated at the patient skin level.

Figure 4.2.1 Percentual division of torso in 12 pieces. Origin at x-ray beam

Section (Figure 4.2.1)	Percentage of section	Percentage after attenuation	Percentage of initial beam	Resulting dose (At patient skin level)
A	10%	0.5%	0.050%	1.5 mGy/h
B	11%	0.3%	0.033%	1.1 mGy/h
C	11%	0.4%	0.044%	1.4 mGy/h
D	8%	0.8%	0.064%	2.1 mGy/h
E	6%	2%	0.12%	4.0 mGy/h
F	4%	14%	0.56%	18.9 mGy/h

Table 4.2.1 Resulting dose at patient skin level

As the patient body is divided in 12 equal parts of 15 degrees, the resulting dose column is taken over the length of the patient. The radiation intensity as a function of distance will decrease with a factor 2 for every doubling of the area, and also for every doubling of the section length ( $d$  in figure 4.2.2).

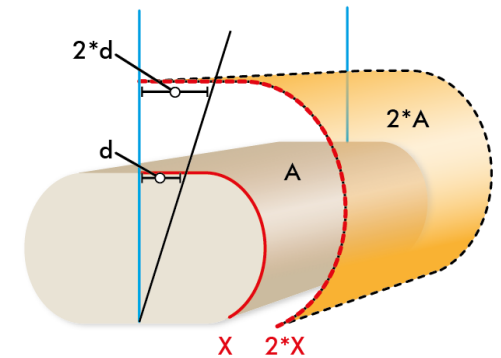

Figure 4.2.2 Area and section length

The doubling of the area for each section results in the dose levels as seen in figure 4.2.3.

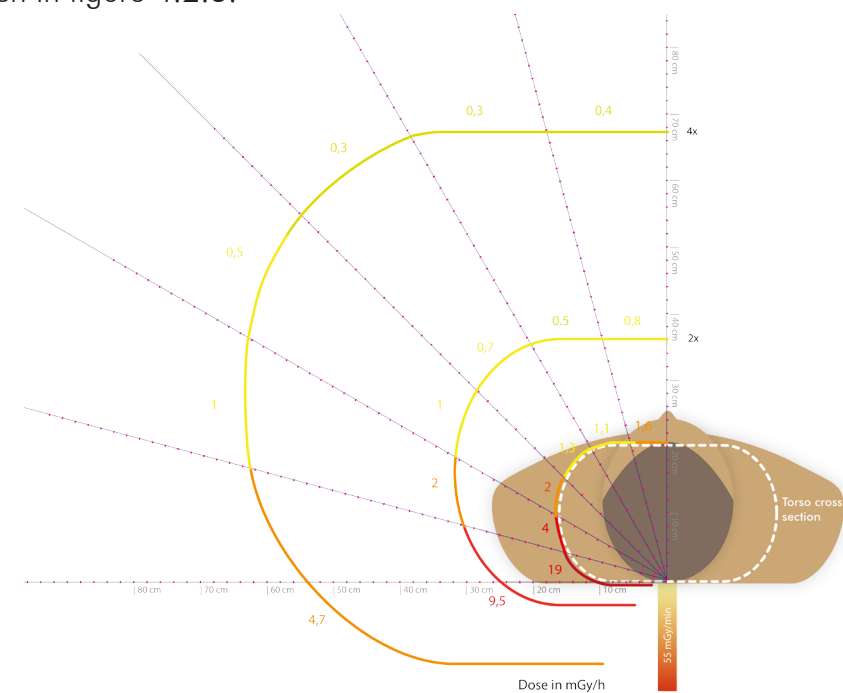

Figure 4.2.3 Scatter plot around patient body at  $2 \times X$  and  $4 \times X$  (mGy/h)



The following plots are only valid close to the operation table as it does not take the spread of the scatter into account in the longitudinal direction of the operation table, unlike the inverse square law. Therefore it only serves as an indication of the spread of radiation where the physicians are standing.

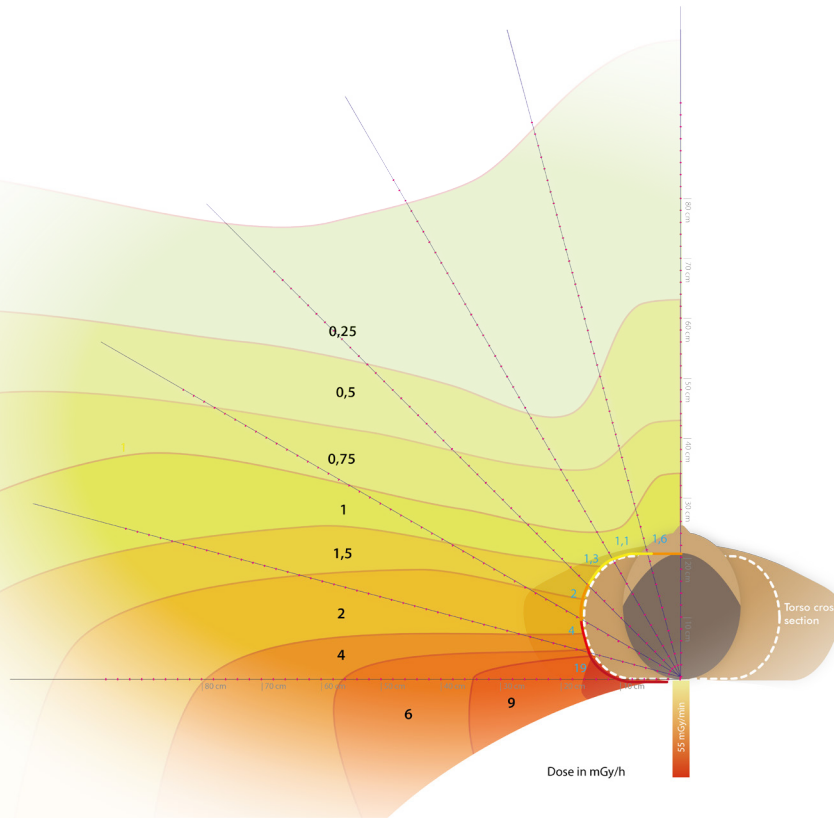
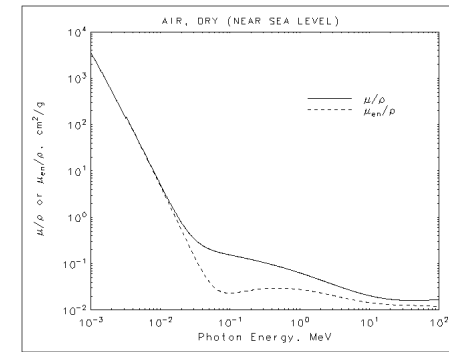

Figure 4.2.4 Near patient Isodose plot (mGy/h)

## Further remarks

The attenuation coefficient for air at 35 keV is 0.35 cm<sup>2</sup>/g. In this case, the half-value layer (HVL) for air is 1600 cm.

Figure 4.2.5 Air attenuation at different photon energy levels (N.I.S.T., n.d.).



Although the inverse square law reduces the amount of photons, the source radiation does not significantly weaken its energy within the hybrid OR. This could mean that for certain orientations of the machine personnel standing at the edges of the room, e.g. the entrance of the control room, still receive a considerable dose.

### 4.3 Back scatter & machine orientation

Underneath the patient, the influence of scatter is more difficult to calculate. This is due to the fact that the previous calculations are all based on protrusion through tissue which causes the decrease in intensity. The problem is the absence of the source; where does it emerge from to calculate this decrease as a function of tissue protrusion. For instance, a source at the center of the patient body ~10cm would result in only 5% compared to 22% if the source is at 5cm inside the patient body.

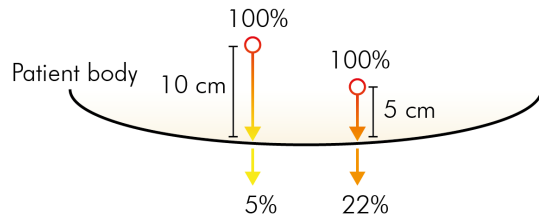

Figure 4.3.1 Back scatter source depth influence.

Instead the earlier discussed “random” distribution of Compton scattering has to be used. For a single collision however there is a probability of scattering at certain angles. For lower energy photons such as 35 keV, there is a high probability of 180 degrees back scatter.

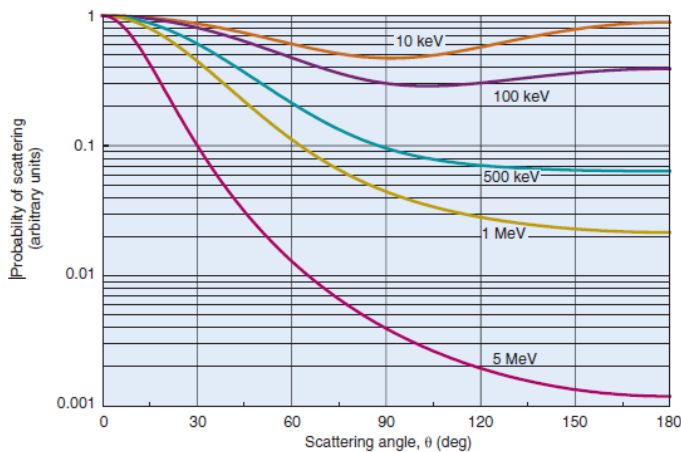

Figure 4.3.2 Scatter probability at different angles (Cherry et. al., 2012)

When the graph is adapted for a single collision the following probability in % regarding the exiting direction of the photon is created when we split it in 8 possible directions.

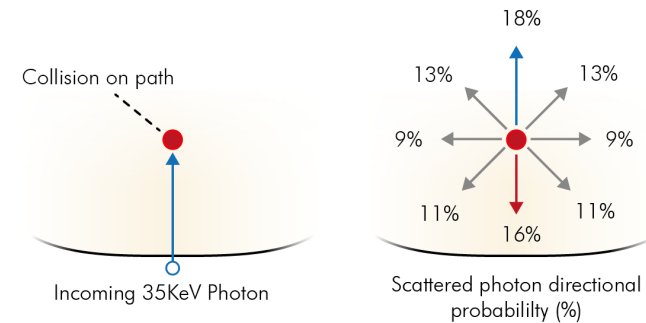

Figure 4.3.3 Individual photon collision and scattering angle probability

This does however not mean that 16% of all radiation that comes into contact with the patient body gets scattered back directly. This 16% only effects photons which actually interact with matter, hence the photons that are attenuated via Compton scattering. Both not 100% of the incoming beam; attenuation is a function of depth as indicated in figure 4.3.1 and the share of Compton scattering is around 70% of the attenuation in total for 35 keV.

Next to this a photon bundle which gets scattered back at depth x needs to continue back through this height x during which a % is attenuated again.

The total amount of backscatter is therefore sum of attenuated photons in a section of the torso ( $\Delta x$ ) at torso height x minus the attenuation that occurs on the way back through over said height x. Taken over the total height of the patient torso ( $0\text{cm} > x > 22\text{cm}$ ).

$$\int (\text{Attenuation at } \Delta x * 16\% * \text{Attenuation at depth } x) dx$$

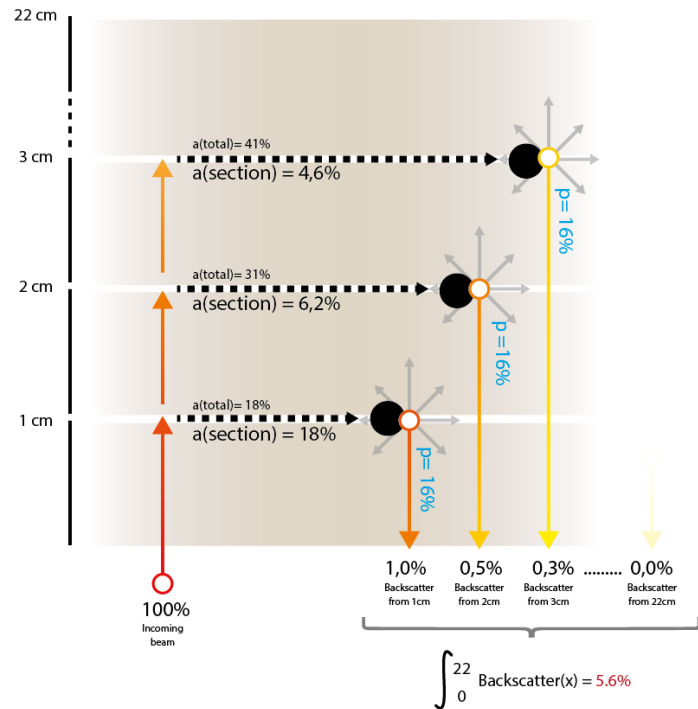

Figure 4.3.4. Black dot = collision with matter,  $a(\text{total})$  = attenuation in matter at height  $x$ ,  $a(\text{section})$  = attenuation over the section  $\Delta x$ .  $P$  = probability for backscatter in 180 degrees.

For example: At depth 2 cm ( $x$ ) the total attenuation is 31%, the section from 1 to 2 cm ( $\Delta x$ ) accounts for 6,2%. The probability of a photon scattering in a 180 degree direction is 16%, thus 16% of 6,2% (1%). These photons have to travel back over 2cm ( $x$ ) after which 0.5% remains. When  $\Delta x$  is reduced to 0, the integral from 0 cm to 22 cm accounts for a total of 5,6% back scatter.

It is worth mentioning that after penetrating more than 10cm, the radiation does not contribute to the backscatter anymore (Appendix 4. Backscatter calculations). Hence, for tissue thicker than 10 cm, which includes practically all patients, the backscatter is always the same amount of percentage of the incoming beam.

This also means that an orientation change, where the radiation sometimes passes through more tissue to reach the image sensor, does not influence the percentual amount of backscatter.

Using the same division as in figure 4.2.1, where the torso is divided in 12 parts, the bottom side of the patient body would be divided in 4 parts. Every segment would then account for 46 mGy/h at the patient skin level. When this is included into the previously shown plots (figures 4.2.3 & 4.2.4) the plot in figure 4.3.5 is created.

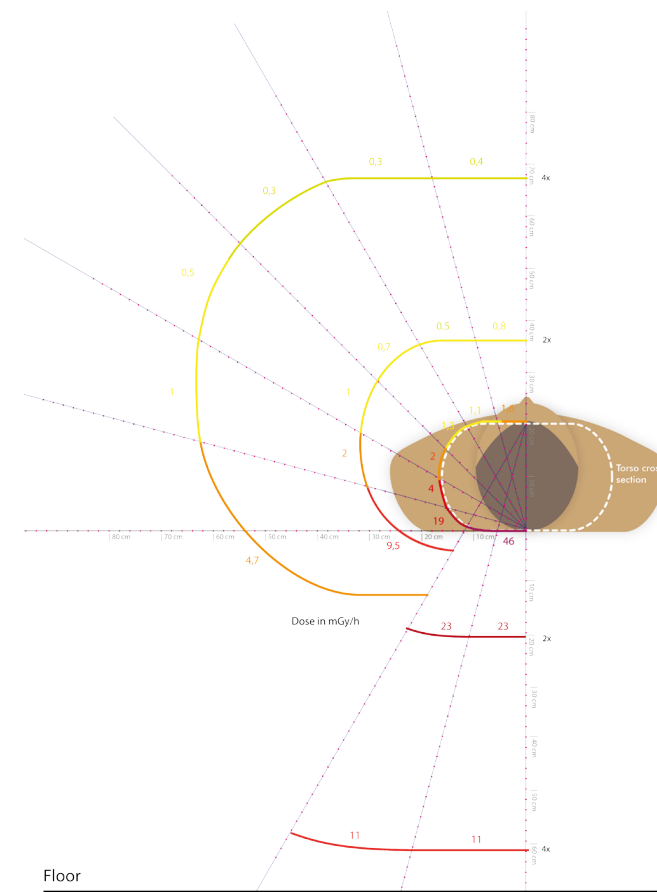

Figure 4.3.5 Scatter plot at doubled and quadrupled distance from source in mGy/h for an incoming beam of 55mGy/min at 35 keV

# Backscatter calculations

```

> restart;
> Attenuation := exp(-0.3·d)
Attenuation := e-0.3 d
> Compton := 0.7 - 0.7 Attenuation
Compton := 0.7 - 0.7 e-0.3 d
> Backscatter := 0.16 · Compton
Backscatter := 0.112 - 0.112 e-0.3 d
> Backsection := diff(Backscatter, d);
Backsection := 0.0336 e-0.3 d
> Backthrough := Backsection · Attenuation;
Backthrough := 0.0336 (e-0.3 d)2
> plot(Backthrough, d=0 ..22)

```

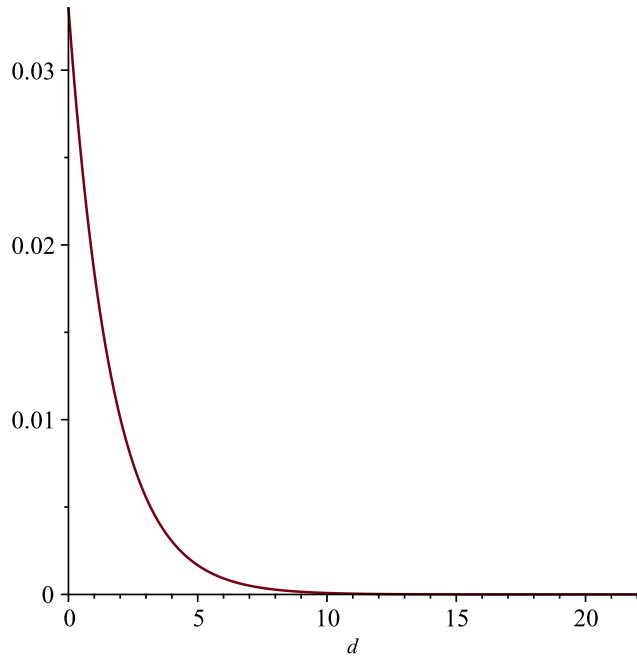

```

> BackI := int(Backthrough, d);
BackI := -0.05600000000 (e-0.3000000000 d)2
> plot(BackI, d=0 ..50)

```

(1)  
(2)  
(3)  
(4)  
(5)

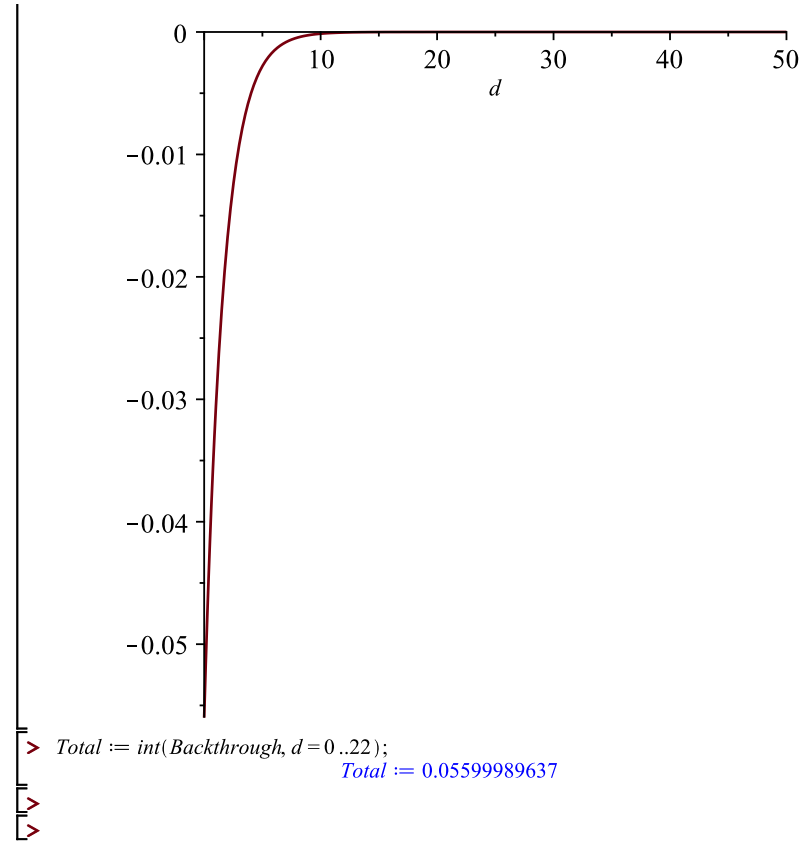

```

> Total := int(Backthrough, d=0 ..22);
Total := 0.05599989637
>
>

```

(7)

# Appendix B - Procedure data sets

## Cardiac procedures

Procedure	PSD (mGy)			DAP (Gycm <sup>2</sup> )			CD (Gy)			FT (min)		
	Mean	SD	Range	Mean	SD	Range	Mean	SD	range	Mean	SD	range
CAG	290	199	30–993	41.5	30.8	10.6–141.8	0.45	0.36	0.1–1.50	5.2	4.1	0.7–16
PTCA	1155	708	236–4302	115.5	58.0	32.5–225.0	1.35	0.66	0.23–3.19	16.2	9.0	3.1–47.0
RF ablation	725	611	88–3989	42.7	42.9	5.2–193.4	0.42	0.27	0.10–1.12	15.6	8.8	6.1–37.5

Radiation measurements during coronary angiography (CAG), percutaneous transluminal coronary angioplasty (PTCA) and radio frequency (RF) ablation (Wang et. al., 2013)

## Fluoroscopy procedures in general

Procedure	n	Max	Min	Mean	SD	Median	3rd quartile
Fistulography	180	83	0.6	9	13	5	12
Lower limb arteriography	685	608	2.4	58	53	44	73
Renal arteriography	55	397	7.7	75	85	43	89
Biliary drainage	205	428	0.6	61	81	23	80
Hepatic chemoembolization	151	830	27.4	216	176	161	289
Iliac stent	70	1136	14.1	91	148	53	94
Uterine embolization	45	677	26.6	170	154	103	236

Dose area product (Gy/cm<sup>2</sup>) for frequent fluoroscopy procedures (Vano et. al., 2009)

Procedure	PSD (mGy)			DAP (Gycm <sup>2</sup> )			CD (Gy)			FT (min)		
	Mean	SD	Range	Mean	SD	Range	Mean	SD	range	Mean	SD	range
CAG	290	199	30–993	41.5	30.8	10.6–141.8	0.45	0.36	0.1–1.50	5.2	4.1	0.7–16
PTCA	1155	708	236–4302	115.5	58.0	32.5–225.0	1.35	0.66	0.23–3.19	16.2	9.0	3.1–47.0
RF ablation	725	611	88–3989	42.7	42.9	5.2–193.4	0.42	0.27	0.10–1.12	15.6	8.8	6.1–37.5

Establishing the European diagnostic reference levels for interventional cardiology, *Physica Medica* 54(2018) (Siiskonen et. al., 2018)

Procedure	Sample size	No. units	Fluoroscopy time (min)	Number of images	Air kerma-area product $P_{KA}$ , Gy cm <sup>2</sup>			Cumulative dose (mGy)	
					Total	Cine	Fuoro		
Diagnostic procedures									
CA	409	10	Mean	5.1	594	30	17	17	417
			Median	3.5	542	21	14	8	321
			3rd quartile	6.2	718	34	20	18	461
			Range	0.1–46.2	141–2073	4–339	3–181	1–265	75–1322
CA (paediatric)	15	1	Mean	11.4	538	5	2	3	54
			Median	9.8	437	4	1	3	43
			3rd quartile	13.5	814	6	2	4	77
			Range	4.0–25.1	92–1118	1–16	0.1–9	0.3–8	11–130
LLA	182	6	Mean	2.4	204	37	28	8	123
			Median	1.7	164	24	20	4	83
			3rd quartile	2.9	267	47	35	8	141
			Range	0.2–16.0	37–710	0.2–288	2–202	0.3–87	20–986
BA	67	5	Mean	10.5	298	36	16	23	279
			Median	8.0	211	30	13	15	229
			3rd quartile	12.2	365	41	23	29	379
			Range	0.2–39.6	43–1513	6–152	1–87	1–111	104–465
PhG	41	4	Mean	0.7	247	11	10	1	129
			Median	0.3	205	5	5	0.1	129
			3rd quartile	1.1	326	12	11	1	130
			Range	0.03–4.0	51–640	0.3–60	0.4–48	0–13	126–131
MG	9	1	Mean	14.1	278	200	121	79	584
			Median	13.4	290	181	74	60	428
			3rd quartile	20.9	321	243	133	110	982
			Range	1.4–31.2	101–500	13–554	12–337	1–217	76–1098
Therapeutic procedures									
CA+PCI	181	10	Mean	16.2	1381	98	54	66	1672
			Median	11.8	1210	67	38	39	1244
			3rd quartile	19.9	1625	114	63	72	2108
			Range	1.7–70.3	398–3986	6–1003	8–303	1–701	207–4927
PTC	21	2	Mean	7.5	60	31	3	31	
			Median	6.3	56	27	3	26	
			3rd quartile	9.2	70	42	4	42	
			Range	1.7–20.9	15–138	3–92	1–6	4–87	
PTA	41	2	Mean	9.5	20	27	18	15	163
			Median	6.5	14	21	11	13	124

Dose area product for: CA coronary angiography, LLA lower limb arteriography, BA brain arteriography, PhG phlebography, MG mesentericography, CA + PCI coronary angiography + intervention, PTC biliary intervention, PTA stent placement, PhG + VCF phlebography + VC filter placement, RA + E renal arteriography + embolisation (Zotova et. al., 2012).

**Table 1** Number of procedures (N), number of departments (ND) and median value of the distributions of each dosimetric estimator (KAP, FT,  $K_{a,r}$  and NI) for the 15 types of procedure included in the survey

	N	ND	Median KAP (Gy.cm <sup>2</sup> ) (1st q.; 3rd q.)	Median $K_{a,r}$ (mGy) (1st q.; 3rd q.)	Median FT (min) (1st q.; 3rd q.)	Median NI (1st q.; 3rd q.)
Cerebral angiography	695	34	45.4 (23.1; 87.5)	312 (145; 628)	5.7 (3.2; 10.3)	256 (120; 389)
Spinal angiography	123	7	88.0 (39.6; 184.5)	639 (259; 1411)	15.1 (8.9; 25.5)	229 (101; 338)
Embolization in the head for aneurysm	427	19	130.8 (84.2; 186.5)	1718 (1048; 2763)	37.2 (23.9; 58.0)	610 (402; 1074)
Embolization in the head for AVM	239	13	169.9 (97.5; 280.5)	2019 (1166; 3224)	44.5 (25.8; 67.8)	577 (286; 963)
Lower limbs arteriography (without stenting)	193	11	38.1 (19.6; 72.0)	55 (8; 142)	2.2 (1.0; 5.2)	166 (89; 249)
Biliary drainage	307	20	14.2 (5.5; 33.5)	95 (27; 253)	9.1 (5.3; 15.7)	2 (0; 8)
Central line insertion	545	27	0.6 (0.2; 1.2)	2 (1; 4)	0.5 (0.2; 1.0)	1 (0; 1)
Implantable venous access port insertion	260	13	0.5 (0.2; 1.5)	2 (1; 5)	0.4 (0.2; 0.8)	1 (0; 2)
Hepatic chemoembolization	397	22	120.6 (58.0; 249.2)	520 (226; 987)	17.7 (11.2; 27.1)	105 (47; 197)
Bronchial artery embolization	163	10	68.7 (26.9; 131.4)	328 (149; 827)	25.0 (15; 37.4)	149 (63; 239)
Uterine fibroid embolization	242	15	73.7 (35.2; 174.4)	390 (155; 796)	20.3 (13.9; 28.7)	75 (33; 157)
Uterine artery embolization (postpartum haemorrhage)	142	12	145.5 (73.2; 251.1)	581 (300; 927)	15.8 (11.1; 24.4)	108 (17; 210)
Renal artery embolization	42	4	128.4 (66.0; 322.6)	750 (433; 1694)	14.3 (10.8; 21.6)	162 (97; 204)
Transjugular intrahepatic portosystemic shunt (TIPS)	181	11	99.3 (44.3; 185.8)	376 (171; 773)	24.1 (15.8; 38.5)	71 (30; 120)
Vertebroplasty	577	41	35.8 (17.4; 68.2)	370 (168; 762)	7.3 (4.8; 10.4)	10 (3; 320)

*Patient dose in interventional radiology of the most frequent procedures in France (Etard et. al., 2017).*

# Appendix C - Market & OHS

## 2.1 Layers of protection

As the need for protection from occupational radiation exposure is clear, it makes sense for a hospital or clinic to invest in this line of protective measures. Within radiation protection a division can be made into the “layers” of protection. For this assessment of existing measures a division is made following the “occupational health strategy” (OHS) guideline as set by the Dutch government (Arbo, n.d.).

This guideline is to be followed when employees are exposed to occupational hazards such as radiation. In this case the employer is obligated to minimize the hazards by taking measures in the following layers in ascending order:

OHS layer	Description
Source measures	Remove origin of hazard
Collective measures	Place protection
Individual measures	Set organizational rules
Personal measures	Provide personal protection

Table 2.1.1 Occupational health strategy

The OHC layers can be translated into categories for protection in the Hybrid OR. This creates the protection layers in table 2.

OHS layer	Protection in Hybrid OR	Description
Source measures	Source	Shielding at the source of the radiation
Collective measures	Room - Fixed	Present static shielding
	Room - Movable	Movable protection for all present staff
	Detection	Radiation detection for staff and equipment
Individual measures	Protocols	Staff interaction with radiation
	Awareness	Increase awareness via training
Personal measures	Personal	Wearable protection
	Individual	Measures bound to a single user

Table 2.1.2 Layers of protection in Hybrid OR environment

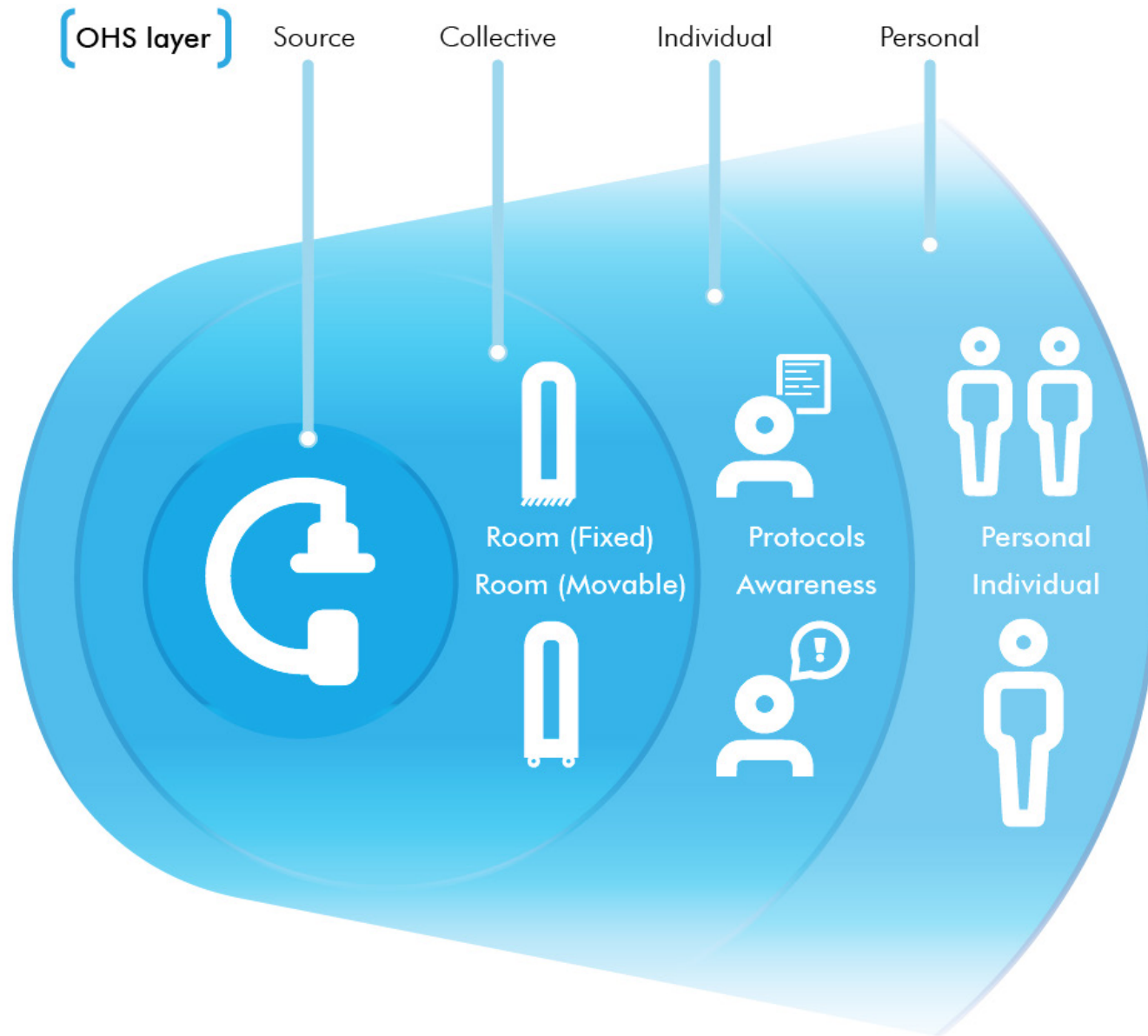



## 2.2 Source Measures

### Dose influencing techniques

Physical or computational tools within the source that lower received dose for patient and staff

### Protective patient drapes

The patient is exposed to radiation originating from underneath the body. From there the radiation passes through the body and scatters in contact with tissue. This is why the patient should be seen as the source of the scatter from which physicians want to protect themselves.

To limit the scatter on the patient body surface, the body can be covered with high density material drapes.

#### Scatter Armor Angiography Shield

Transfemoral Access: Angiography,  
Coronary Catheterization

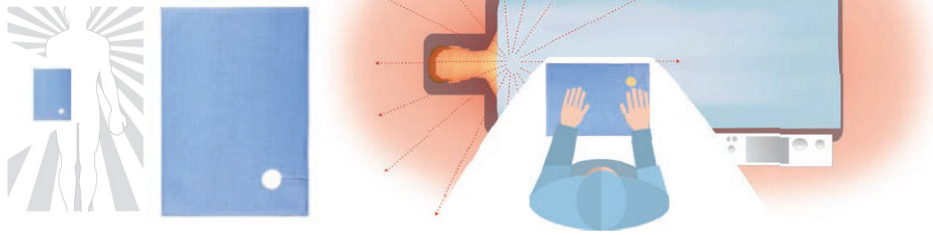

Figure 2.2.1 The usage of protective patient drapes (Infab Scatter Armor)

### X-ray filters

Most modern C arm systems are fitted with filters within the x-ray tube. These filters consist of a specific thickness of metal material which filter out the frequencies of radiation which are most probable to not penetrate the patient, and would therefore be attenuated by the patient body. In other words unnecessary dose for the patient. Also they can be optimized to filter out the high energy photons which might harm the operators. An example of the filtering effects of an Aluminium and Lanthanum filter are shown in figure 2.2.2.

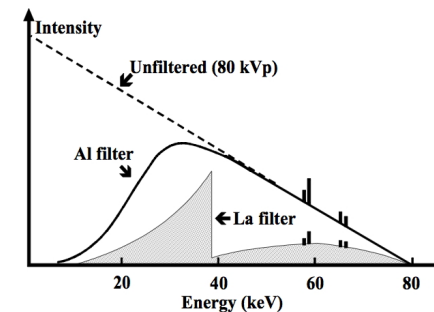

Figure 2.2.2 The X-ray energy spectrum filtered by aluminium and lanthanum. (Kieranmaher, 2001)

## Software- During procedure

Software can be used that enhances the images without the need for extra dose. Various techniques exist for this to be achieved. The Clarity system (Philips) makes use of the range of frequencies in the received image and filters out only the ones needed, where the veins are shown. It achieved this by lowering the contrast of frequencies that are absorbed by other soft tissue and bone while enhancing the contrast of the specific frequencies of the contrast liquid that is injected.

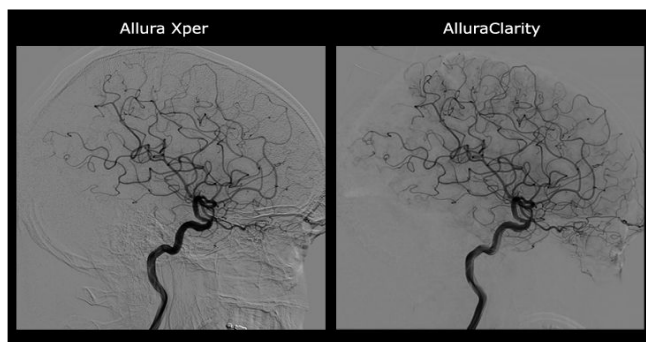

Figure 2.2.3 Example of Clarity system image where bone and soft tissue is 'removed' to achieve a clearer picture with less exposure. (Philips, 2019)

The Clear system (Siemens) uses an algorithm that among others identifies vessel structures in the image and enhances those artificially in the computer. This creates clearer pictures with less exposure.

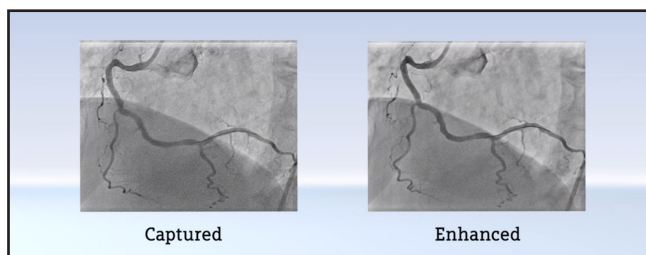

Figure 2.2.4 Example of CLEARvessel where a vessel is enhanced in sharpness by an algorithm. (Siemens, 2019)

## Software - In between procedures

Philips offers the Zero Dose Positioning system to make the use of radiation during machine or table positioning redundant. The software calculates and shows the 'live' position of the machine on the last image that is taken with radiation (LIH). This way the operator can move the system without using radiation (Philips, 2019)



Figure 2.2.5 The Zero dose positioning uses the last image and crops or pans the new position of the sensor over this, which is shown as a the cropped box.

## 2.3 Collective measures - Room (fixed)

Due to the similar nature of most solutions, only three main brands are taken into account for the assessment: Mavig, Kenex & Infab.

### Operation table mounted

Protective measures that are fixed to the operation table or movable in a limited way.

MAVIG

Kenex

INFAB

### Rigid shielding

Immovably fixed to a certain position on the operation table.

#### Head of the table

The shields provides protection from radiation originated from the x-ray tube and direct scatter.

It protects those at the head of the table (e.g. the anesthesiologist) close to the source.

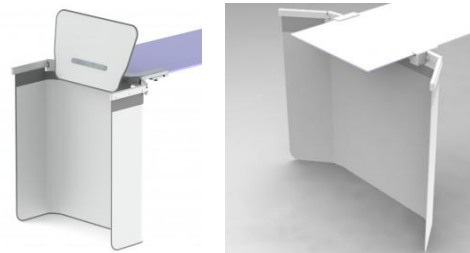

Figure 2.3.1 Head end table shields (Kenex 313/A2 & 313/A3)

### Adjustable shielding

Mounted on the side rail of the table. Adjustable by bending.

#### Bendable sheet/curtain

Moves over the side rail on the table and bends into an angle to allow the c-arm to maneuver.

Can be fitted with a top part which limits scatter from the patient sides towards the physicians.



Figure 2.3.3 Side rail shields (Kenex 312/DS-006, 312/E-012 & Infab 077035)

#### Foot of the table

Situated at the foot of the table, the shield protects catheter operators from scatter and potential blood splashes.



Figure 2.3.2 Foot end top side shield (Kenex 311/TC/004)

#### Side rail panels

Meant for operation tables which are not defined in shape (e.g. Magnus Maquet).



Figure 2.3.4 Side rail individual panels (Mavig UT30)

Kenex - 311/TC/004



Kenex - 313/A3



Kenex - 313/A2



Rigid Bedhead

Rigid Bedfoot

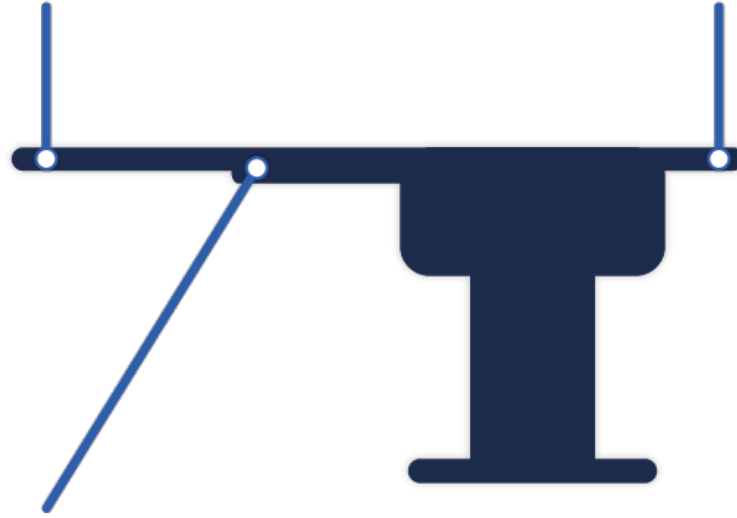

Movable Rail mounted panels

Kenex - 312/DS-006 & 312/DS-007  
Mavig - UT67



Kenex - 312 E - Range  
Mavig - UT6030/UT6031/UT6032  
Infab - 077036

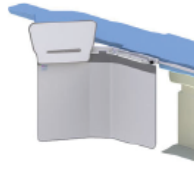

Infab - 077035  
Mavig - UT65



Mavig - UT65



## 2.4 Collective measures - Room (movable)

Due to the similar nature of most solutions, only three main brands are taken into account for the assessment: Mavig, Kenex & Infab.

### Ceiling / overhead mounted

Protective measures that are fixed to the ceiling via a beam system



#### Lead glass

Transparent shielding made from acrylic lead glass.

#### Patient body cut-out

Provides a fit to the patient body to shield from high energy scatter emitted on the side of the patient.

The Mavig OT54001 / OT94001 is combined with extra lead slabs to increase the seal on the patient body.



Figure 2.4.1 Lead glass with patient cut-out (Mavig OT50001/OT54001/OT94001)

#### Solid shape

Fully transparent glass plane. Can be used at every position within the range of the mounting beam system.



Figure 2.4.2 Solid shape lead glass (Mavig OT50002)

#### Lead curtain

Flexible leaded rubber curtains.

#### Flexible curtain

The flexible sheets can create a good fit to any shape to prevent escaping radiation.



Figure 2.4.3 Ceiling mounted lead curtain (Kenex 308)

#### Glass + flexible curtain

A solid shape combined with extra lead slabs to increase the seal on the patient body to prevent escaping radiation.



Figure 2.4.4 Side rail individual panels (Mavig UT30)

# Collective measures - Room (movable)

## Floor based / rollable

Protective measures that can be rolled around on the OR floor.

### Lead glass barriers

Rectangular barriers made from acrylic lead glass.

#### Barriers

A solid barrier for personnel that is not interacting with the patient. Ranges from a glass window to full glass barrier and single or multiple people sizes.



Figure 2.4.5 Lead glass & solid barriers (Mavig WD306, Infab 683492/683465)

### Adapted lead glass barriers

Adapted barriers made from acrylic lead glass.

#### Tilted barriers

A solid barrier with a tilted transparent lead glass top. Can feature an cut out for interaction with the patient



Figure 2.4.7 Lead glass & solid barriers (Infab 683461/683462)

### Interaction barriers

Fully transparent glass plane with cut-outs for interaction with the patient.



Figure 2.4.6 Barrier with cut-outs (Mavig WD300)

### Height adjustable barriers

A solid bottom with adjustable glass top. Can feature a bendable lead curtain side section.



Figure 2.4.8 Height adjustable lead glass (Mavig WD300)

# Collective measures - Room (movable)

## Floor based / rollable

Protective measures that can be rolled around on the OR floor.

### Patient interaction products

Rectangular barriers made from acrylic lead glass.

#### Curved cabin

A cabin to shield the lower half of the operator body. Flexible lead curtain on bottom to operate the x-ray machine with feet.



Figure 2.4.9 Lead glass & solid barriers  
(Mavig WD261, Infab 683495)

### Adapted lead glass barriers

Adapted barriers made from acrylic lead glass.

#### Adjustable height cut-out

A solid bottom with adjustable glass top with a patient body cut-out. Can feature a bendable lead curtain side section.



Figure 2.4.11 Lead glass & solid barriers  
(Infab 683461/683462)

#### Curved lead curtains

Barrier cabin with upper body part to shield scatter from the patient sides towards the physicians.



Figure 2.4.10 Barrier with cut-outs  
(Mavig WD260)

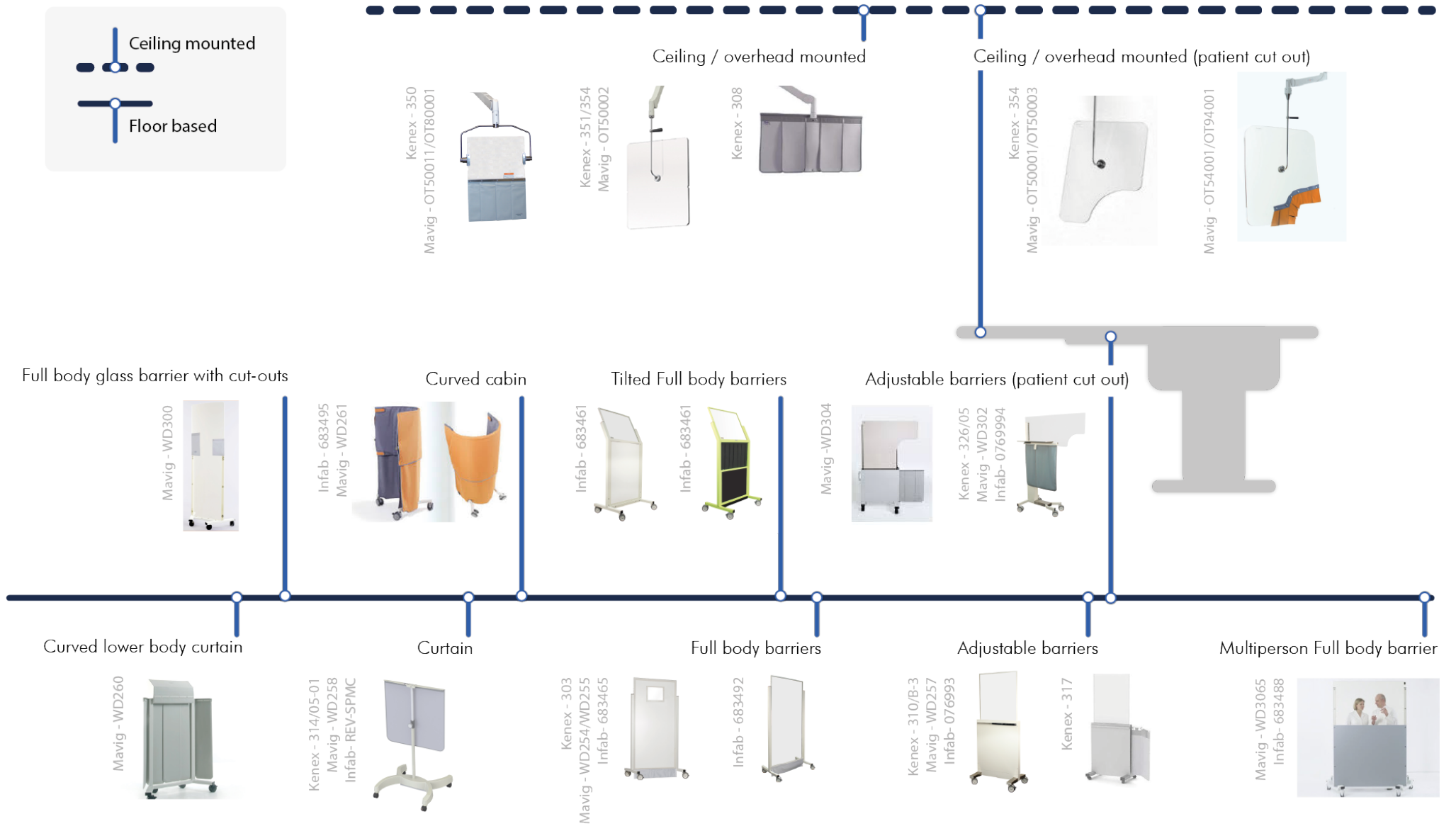
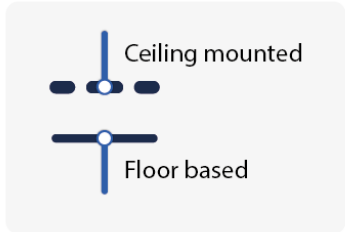



## 2.5 Collective measures - Detection

### During procedure / diagnostics

Radiation detection hardware

Due to the similar nature of most solutions only the following brands are shown.



### During procedure

Wearable detectors can give either live readouts, such as the DoseAware system (Philips) and Raysafe i3 (Raysafe), or accumulate the dose which is read out later via software, like radio-luminescent badges (Landauer).



Figure 2.5.1. Live feedback compared to cumulated read-outs after the procedure/day (Raysafe ThinX & Landauer Radwatch)

Radiation can also be measured during the procedure using probes or Dose Area Product (DAP) meters. The latter is mounted over the x-ray source to give accurate data on the current level of radiation in Gy/cm<sup>2</sup>.



Figure 2.5.2. Dose probes and DAP meter (Raysafe X2 & IBA Dosimetry KermaX)

### Diagnostics

Diagnostic tools include a variety of probes and detectors to give live feedback on the system parameters. These can be used to adjust, calibrate or optimize dose levels.

To prevent unnecessary exposure to test subjects/patients, products are designed to represent human anatomy. These density accurate human models are called phantoms.



Figure 2.5.3. Cardiac cross section phantom (Cirs Inc. model 300 Torso Phantom)

Dose area product meters



Vacutec - VacuDAP  
IBA Dosimetry - KermaX

Patient probes



Raysafe - X2 / Xi  
Radiadyne - AORTRAC

Eyes and head



Landauer - Vision®

Badge

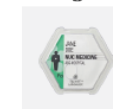

Landauer - Luxel®+

Wrist and finger



Landauer - Radwatch®  
Landauer - Saturn®

Real-time dosimetry



Philips - DoseAware  
Raysafe - i3 Dosimetry system  
Raysafe - ThinX

Calibration & Diagnostic meters

Dose multimeters



Radcal - Accu Gold+

X-ray tube probes



RTI Group - MAS-1 Probe  
Radcal - 90M10

Dose probes



Radcal - DDX6-WL  
RTI Group - Cobia Sense / Cobia Flex

Dose area product calibrators



Raysafe - P Fluoro phantom  
Radcal - DAPcheck  
IBA Dosimetry - MatriXX PT/ONE  
Vacutec - PDC

## 2.6 Individual measures - Guidelines

Avoiding exposure by following guidelines and knowledge of radiation to prevent unnecessary exposure.

### As low as reasonably achievable (ALARA)

As Low As Reasonably Achievable, is a term used to define best practice regarding the usage of radiation. The original guideline for ALARA, as set by the NCRP in 1987 includes three measures: (1) reducing exposure time, (2) increasing the distance from the source of radiation, and (3) shielding (ASRA, n.d.).

In the field of interventional surgery these can be translated into each of the defined OHS layers of protection.

Source measures
<ul style="list-style-type: none"> <li>- Maximize distance between x-ray tube and patient &amp; minimize Distance between detector and patient.</li> <li>- Reduce imaging area, focus solely on area of interest</li> <li>- Limit acquisition (high dose x-ray) to only the essential</li> <li>- Limit fluoroscopy time.</li> </ul>
Collective measures
<ul style="list-style-type: none"> <li>- Use mobile shielding devices</li> <li>- Apply radio-protective patient drapes</li> </ul>
Individual measures
<ul style="list-style-type: none"> <li>- Use dosimetry programs</li> <li>- Train staff in usage of radiation</li> <li>- Use Medical Physicist as overseer</li> </ul>

### Personal measures

- Wear leaded- aprons, glasses, thyroid shield, gloves

Table 2.6.1. ALARA guidelines (Medical Imaging Tech, 2018)

### Inverse square law

The simplest way of reducing the received dose is distancing yourself from the source, which is the patient body. Once the radiation escapes the patient body, the air does hardly change it's direction. Because of this the radiation spreads out as it distances it from the body and becomes less 'dense'.

The inverse square law dictates that when a cross section of a beam at distance  $X$  is taken the cross section at distance  $2 \cdot X$  is 4 times larger. Thus if you double the distance you reduce the dose by a factor of four.

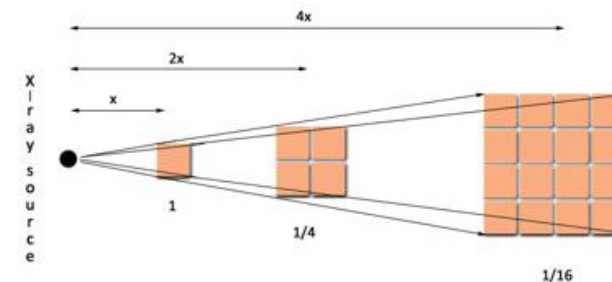

Figure 2.6.1. Inverse square law visualized (Radiopaedia, n.d.)

## Machine orientation influence

The orientation of the x-ray machine can also have a considerable impact on the radiation levels in the room.

Most interventional procedures are performed with a machine orientation where the x-ray tube is beneath the patient and the sensor above. This has been proven to drastically lower the scatter radiation in the direction of the physicians (Morgan et. al., 2010).

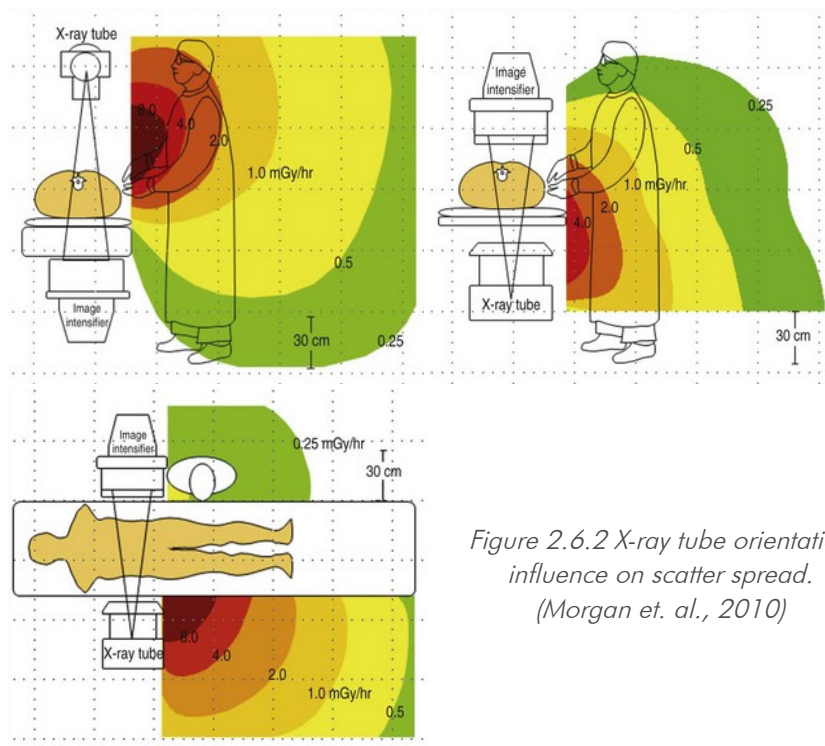

Figure 2.6.2 X-ray tube orientation influence on scatter spread. (Morgan et. al., 2010)

This is the result of a high number of scatter photons which immediately reflect of the patient without attenuating in the tissue.

In an lateral orientation (figure 2.6.2 right), where the x-ray tube and imaging sensor are positioned at a horizontal plane, these reflected high energy photons directly beam into the room towards the physicians.

## 2.7 Individual measures - Education levels

Protocols and (mandatory) training to allow individuals to work with occupational radiation.

Since 2018 the EU has set universal levels at which a medical professional can acquire training on to work with radiation or radioactive sources.

		Regeling basisveiligheidsnormen stralingsbescherming	voorheen
SBD	ACD	stralingsbeschermingsdeskundige op het niveau van algemeen coördinerend deskundige	2
	CD	stralingsbeschermingsdeskundige op het niveau van coördinerend deskundige	3
TMS	MT	medische toepassingen	5A/B cq 4A/B
	THKB	tandheelkunde basis	5AM
	TCB	tandheelkunde cone beam	4M_CBCT
	DG	diergeneeskunde	5A
	SC-B	splitstof cyclus niveau B	3
	SC-C	splitstof cyclus niveau C	
	VRS-B	verspreidbare radioactieve stoffen niveau B	3
	VRS-C	verspreidbare radioactieve stoffen niveau C	4B
	VRS-D	verspreidbare radioactieve stoffen niveau D	5B
	NORM	handelingen met van nature voorkomend radioactief materiaal	
	VER-B	versnellers niveau B	3
	VER-C	versnellers niveau C	4A/B
	VER-D	versnellers niveau D	5A/B
	IR	industriële radiografie	5A
M&R	meet- en regeltoepassingen	5A	
MRH	MS	medisch specialist bij gebruik röntgenapparatuur	4M
	RT	radiotherapeut-oncoloog	3M
	Rö	radioloog	3M
	IRö	interventie radioloog	3M
	NG	nucleair geneeskundige	3
MBB	MBB	medisch beeldvormings- en bestralingsdeskundige	4A/B

SBD	stralingsbeschermingsdeskundige
TMS	toezichhoudend medewerker stralingsbescherming
MRH	specialist bij medisch radiologische handelingen
MBB	medisch beeldvormings- en bestralingsdeskundige

The medical staff, such as nurses, is taught the basics of radiation at the “TMS-MT” level (Basic usage of radiation protection in Medical appliances).

Specialists and machine operators are taught a more advanced theory of radiation, specifically focusing on X-ray at the “MRH-MS” level (Specialist on medical X-ray usage).

Radio Cardiologists and interventional cardiologists are thought at the higher “MRH-IRö” level (Specialist in medical radiological procedures) (NVS, 2018). They are responsible for the radiation safety during a procedure.

To work with radiation in a Hybrid OR, a nurse has to achieve the TMS-MT basic level.

Table 2.7.1 Training levels in the Netherlands (NVS, 2018)

In an interview with the radiation coordinator at the Erasmus MC, Wout de Ruiter, the following structure and content is provided during this course as taught in their facility.

The course consists of half a day dedicated to theory, via an e-learning platform, followed by half a day of practicum.

The theoretical part includes (among others) the following relevant topics for protection in the Hybrid OR.

### **Basics or radiation**

- Patient is the source of scatter radiation
- Creating awareness of the hazards surrounding working with radiation.

### **Effects of radiation over longer exposure time**

- When and how to use personal and collective protection
- What to wear
- How to position shielding

### **How to avoid dangerous areas of the room during procedures**

- Where is scatter present.
- What influence has the rotation of the C-arm has on this
- Inverse square law, keep your distance.

### **Machine usage**

- As little radiation as possible
- Use aperture to only expose needed area
- Save previous images for replaying instead of new exposure

The practical part includes setting measurements in the room to not only show the scatter spread, but also to demonstrate the inverse square law in action. At the beginning of his career the practical also included calculations on radiation in the room, but this is no longer mandatory.

The theoretical and practical are very coherent with the ALARA principle as explained in 2.6.

According to de Ruiter, another aim of their training is the creation of a safety culture in which people correct each other and prevent hazards by social control. He mentioned "...it does not matter whether you are a doctor or a nurse, no-one should be afraid to correct each other to improve the safety of others, e.g. why is the aperture not focused...".

Although it could help to enforce this way of social control, the existing culture in hospitals, where hierarchy is still relatively in present (a doctor overrules a nurse as the responsible body in an operation), might make it difficult in practice to realize it. Specifically in countries other than the Netherlands e.g. India where this hierarchy is very present in daily life.

# Individual measures - Education levels

Protocols and (mandatory) training to allow individuals to work with occupational radiation.

A paper from 2019 showed that a large share of radiation safety comes with experience. Although newer cardiology-fellows are taught to work with minimal radiation, following the ALARA principle, more experienced interventional cardiologists expose themselves less (Vlastra et. al., 2019). The study mapped the usage of radiation, as received by the patient (DAP) during various procedures and the received dose (E) measured by personal dosimeters. Where the experienced cardiologists used ~50% more radiation, for every unit of used radiation (DAP) they received ~35% less (E).

Overall the experienced cardiologists therefore still receive more radiation compared to their fellows in training, but it shows that know-how on protecting oneself from radiation is a difficult aspect to teach. Where lowering the initial radiation is one of the best ways to decrease personal dose, this piece of experience could in theory lower the physician dose with another 35%.

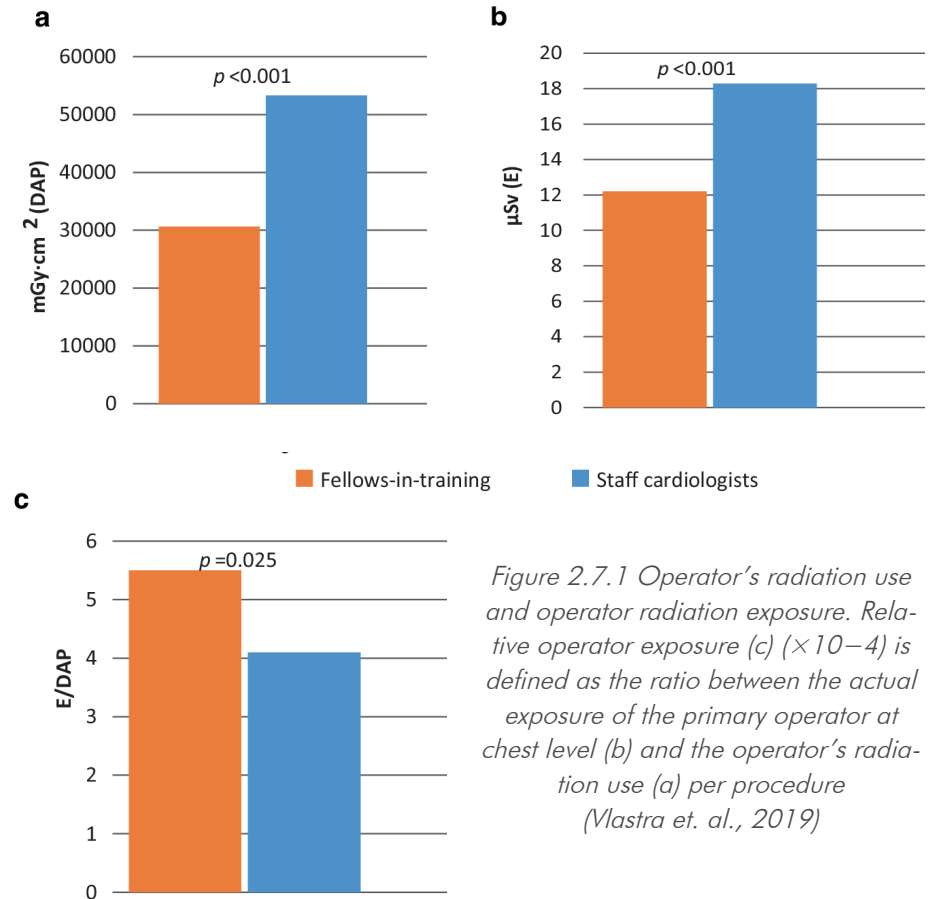

Figure 2.7.1 Operator's radiation use and operator radiation exposure. Relative operator exposure (c) ( $\times 10^{-4}$ ) is defined as the ratio between the actual exposure of the primary operator at chest level (b) and the operator's radiation use (a) per procedure (Vlastra et. al., 2019)





## 2.8 Personal measures

### Wearable protection

Protective measures that are worn by the staff

In the personal layer, where the protection is worn at a specific part of the body, the dose is measured differently compared to the whole body equivalent dose (Gy). The body is categorized into areas and graded a weighting factor which sums up to a total of 100% (table 2).

WT = 0.12	stomach, colon, lung, red bone marrow, breast, remainder tissues
WT = 0.08	gonads
WT = 0.04	urinary bladder, esophagus, liver, thyroid
WT = 0.01	bone surface, skin, brain, salivary glands

Table 2.8.1 Weighting factor per body part (Radiopeadia, n.d.)

The scale is set up to not only calculate the dose, but also to indicate an increased risk for exposure of certain body-parts. The thyroid for example accounts for 0.03% of bodyweight but the weighting factor is 4% (a factor 133) where the brain accounts for 1.75% and has a weighting factor of 1% (a factor 0.6).

That is why, along with organs such as the eyes and gonads, it needs more protection.



Figure 2.8.1 Organ specific shielding

Due to the similar nature of most solutions, no brands are mentioned.

### Available protection products per body part

**Head:** Lead caps

**Eyes & Face:** Glasses, Face guard

**Neck:** Thyroid protector

**Arms:** Shoulder pads, Upper & Lower pads

**Hands:** Open gloves, Surgical gloves, Thick gloves, Hand protectors

**Torso:** Lead apron (Front only, Segmental, Optimized sitting, Poncho)

**Waist:** Waist apron

**Legs:** Shin protector

**Feet:** Foot protector, Foot box (x-ray beam control)

These categories of products are features by almost every large manufacturer of protection.

Another way of personal protection is a full body product: e.g Zero-g apron (Biotronik) or Cathpax AF (LemerPax).

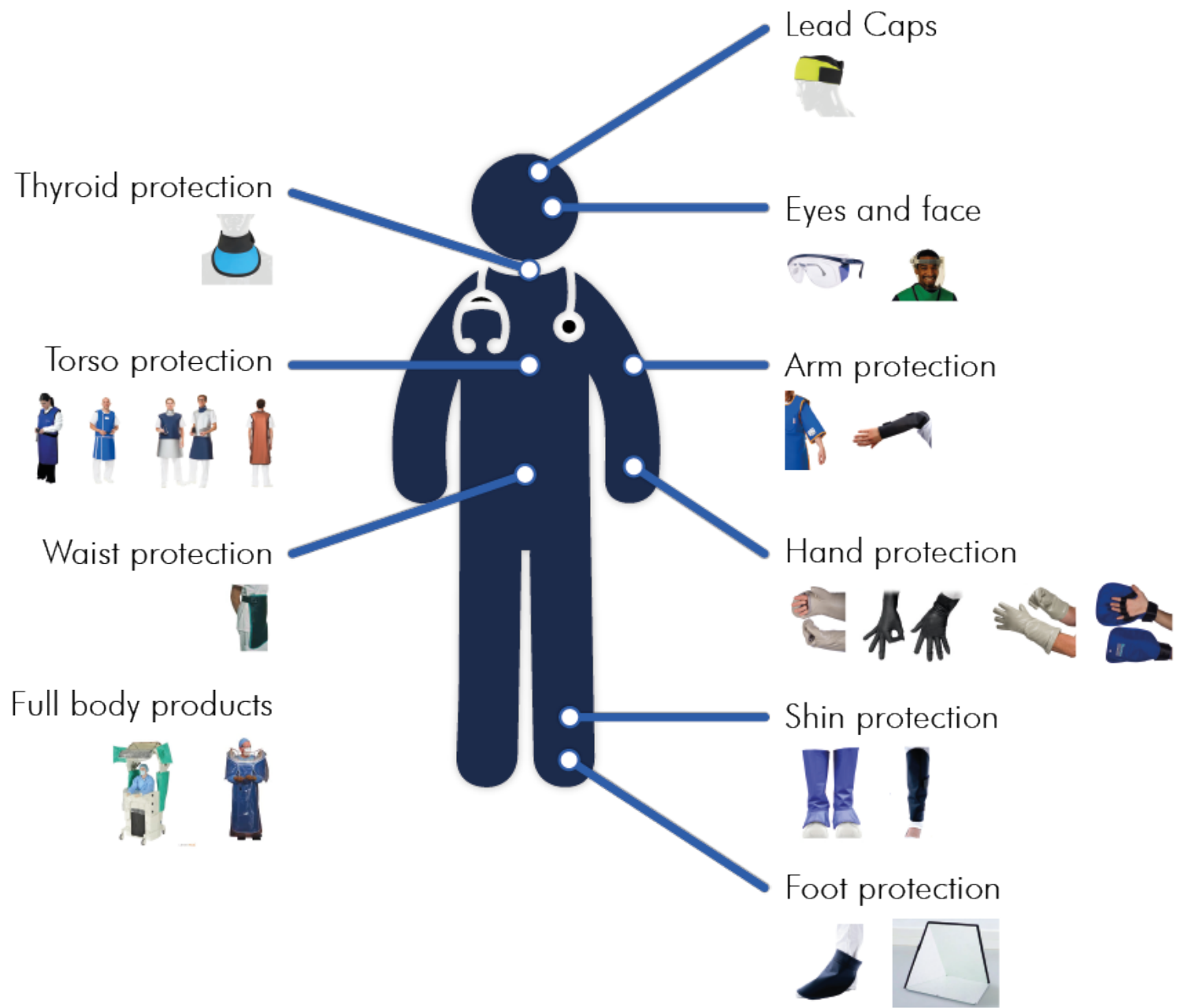

## Usage of personal protection

There has been a considerable increase in the usage of individual protection measures. Where a study from 1993 shows that only 10% uses lead glasses (Niklason et. al., 1993), a newer study conducted in 2013 already shows an increase to 54% (Lynskey et. al. 2013).

When we include the data from observation and a small survey (n=30, 11 Physicians & 19 Members of medical staff), this line is continued for the lead glasses (Dangal et. al., 2017). For the thyroid usage, a decrease is noticed but this could be an effect of the small sample size of only 11 physicians.

	1993	2013	2017 Physician/surgeon	2017 Medical staff
Lead apron	-	99%	100%	100%
Thyroid shield	47%	94%	81%	63%
Lead glasses	10%	54%	63%	16%

*Table 2.6.2 Use rate of personal protective gear*

A big difference however can be found in the difference between the usage among medical staff compared to the physicians. This could indicate that the medical staff (anesthesiologist and nurses) is in greater danger of radiation exposure.

## Appendix D - Flying Quality Squad

Philips Image Guided Therapy (IGT) uses a division to evaluate the usage of equipment and identify problems and opportunities with existing clients. This division, the Flying Quality Squad (FQS), keeps a record of all feedback. Within this feedback a part is directed at the usage of radiation shielding and awareness. The following quotes are a selection of all feedback regarding shielding in appendix 1.

### Prominent safety issues

**1: Unclearly about when x-ray is active** due to a lack of indication.

<p><i>Middlemore Hospital- Auckland - Otago-2016</i></p>	<p><b>1a</b> "One of the doctors mentioned to us that he is afraid that he gives too much radiation to the patient because he can't feel if the footswitch is pressed or not. If the pedals would be a bit higher from the ground then he would feel it and would not be afraid of activating xray by accident."</p>
<p><i>Caromont Regional Medical Center-Charlotte, NC-2014</i></p>	<p><b>1b</b> "The users told us that the radiation warning lamp at the outside of the door was confusing to them. This lamp goes on when the footswitch is pressed, even if X-ray is disabled. They don't understand this behavior and expect that the lamp only goes on if X-ray is enabled."</p>
<p><i>Tiantan Hospital- Beijing-2017</i></p>	<p><b>1c</b> "In this hospital a radiation overexposure incident had taken place. The table mounted lead shield was hanging on the footswitch, such that the footswitch was not seen by a nurse who entered the room after the case. She accidentally touched the lead shield such that the footswitch was activated, but she didn't notice this. As a result she was exposed to X-ray quite some time without knowing it."</p>

**2: X-ray indicators where disabled** because they were considered distracting for the staff.

<p><i>CHU Nîmes- Nîmes-2014</i></p>	<p><b>2a</b> "The speaker of the 5 minutes fluoroscopy buzzer was covered by tape, in order to get rid of the disturbing sound. We removed the tape after explaining that it is a regulatory requirement to have a sound signal after 5 minutes of fluoroscopy."</p>
<p><i>Hospital Infantil de Mexico- Mexico City-2019</i></p>	<p><b>2b</b> "A major annoyance for Dr. Harrigan is the 5 minutes fluo buzzer. The volume is so high and the sound is such that it's impossible to get used to it. When he is doing a neuro procedure and concentrating on his work with small microcatheters, it can be dangerous if suddenly the buzzer goes off. He understands the regulatory requirement for a warning signal, but would like to have the possibility to change sound type and volume, like other vendors."</p>

**3: Shielding cannot reach desired positions** due to placement on beam systems. These can collide with each other and limit the movement.

<p><i>National Heart Center Singapore-2015</i></p>	<p><b>3a</b> "The doctor explained that it is difficult to position the lead screen when the two Mavig arms are in line with each other"</p>
<p><i>Siloam Kebon Jeruk Jakarta-2015</i></p>	<p><b>3b</b> "The doctor finds the positioning flexibility of the ceiling mounted radiation shield too limited (mounted on the MCS rail). He can not use this shield when he works at the other side of the table."</p>

## Interpretation issues

**4: Different systems use different indicators** for dose (Accumulated dose, DAP, mGy vs Gy, % of maximum). Also the accuracy of the systems use different decimal places

<i>Hospital Britanico- Buenos Aires-2015</i>	<b>4a</b> "The DAP value on the Philips systems is in Gy $\cdot$ cm <sup>2</sup> while on Siemens it is in mGy $\cdot$ cm <sup>2</sup> . The doctor requested a formula to translate the values. The doctor received an instruction for this."
--	--

**5: Unclear for patient dose** in different body parts.

<i>Baroda Heart Vadodara-2015</i>	<b>5a</b> "The doctor wants to see, in real time, how much radiation the patient has received during the case. These dose values should be displayed for every body area on a separate monitor. This is available in high end Toshiba systems."
---------------------------------------	---

## Conclusions from FQS feedback

Ceiling mounted radiation shielding, the most used type, is sometimes unable to reach a required position due to collisions with other ceiling mounted equipment such as screens and lights.

During an intervention this could mean that only one side of the table can be properly protected using lead shielding.

There is unclarity about when x-ray is active or not. It was indicated that the x-ray trigger can be activated by accident. This can lead to unnecessary exposure due to a lack of indication.

Numerous reports also indicate that the used alarm/buzzer for over-exposure is disabled because it annoys or even startles the physicians mid operation.

Various reports also indicate that the displayed dose is different per system. This creates confusion and misconception about the dose levels. Dose can also be measured in different ways, patient dose, air kerma etc. which are easily confused when not focusing on the exact notation.

The indication of active x-ray is currently one of the focus-points for the Healthcare Experience Solutions (HES) department. One of the main obstacles is to produce a clear indicator that does not create a feeling of annoyance.  
*(Anke LeGuevel, 3/07/2019)*

# Appendix E- Cardiologist Interviews

## Research radiation protection

This questionnaire and the interview following it aims to gain insight in the usage of radiation protection by physicians and medical staff and their knowledge of radiation in general.

This research is part of a Industrial Design Engineering graduation project at the Delft University of Technology in collaboration with Philips Healthcare (Image guided therapy)

### Informed Consent

The research consists of two parts; a written questionnaire and a short interview afterwards. Both will take around 20 minutes total.

Terms of use:

The participant accepts that the data acquired by this test will be used in research towards radiation protection improvements. The participants name and data will remain anonymous and will not be used outside this project.

By signing this agreement you confirm that you have read this agreement and agree with the terms of use.

Participant name:

Participant Signature:

.....

.....

### Scenario introduction

You are performing your profession in a radiation guided intervention. You are wearing a lead apron, thyroid protector to protect yourself from the radiation. The system used is a C-arm x-ray machine. The C-arm is positioned as shown in figure 1.

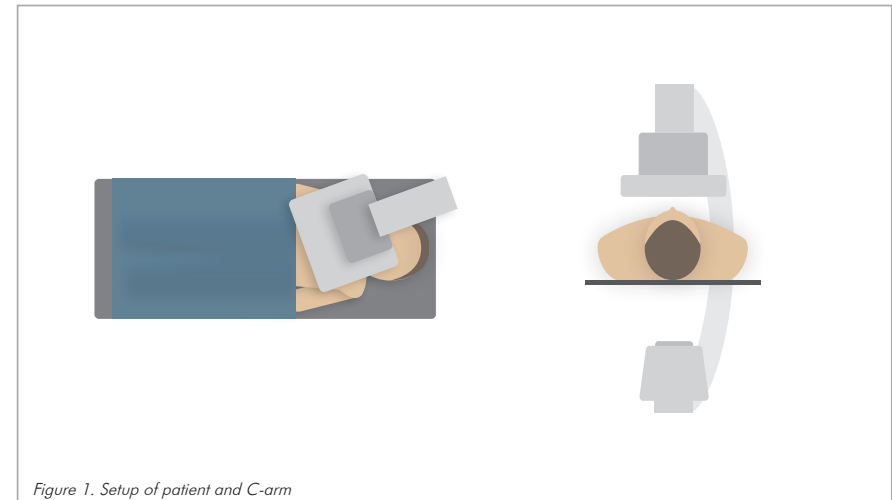

Figure 1. Setup of patient and C-arm

### Question 1. Source of the hazard

Could you indicate in both figure 1 and 2 the source of the radiation, and the region where there is the most scatter radiation.

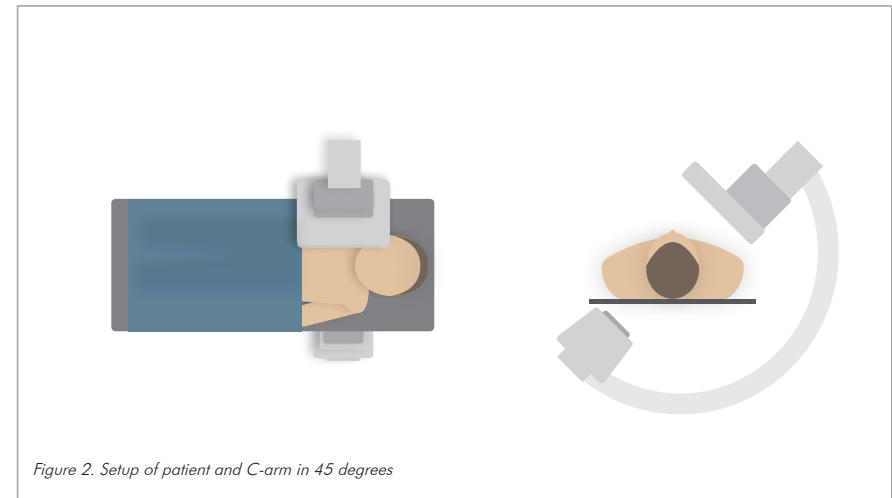

Figure 2. Setup of patient and C-arm in 45 degrees

## Question 2. Present protection

What protective measures are present in the operating room during an interventional procedure in your hospital? Please indicate which of the following products are used in the following 2 pages. Please indicate a number with each product as this will be used in the next question.

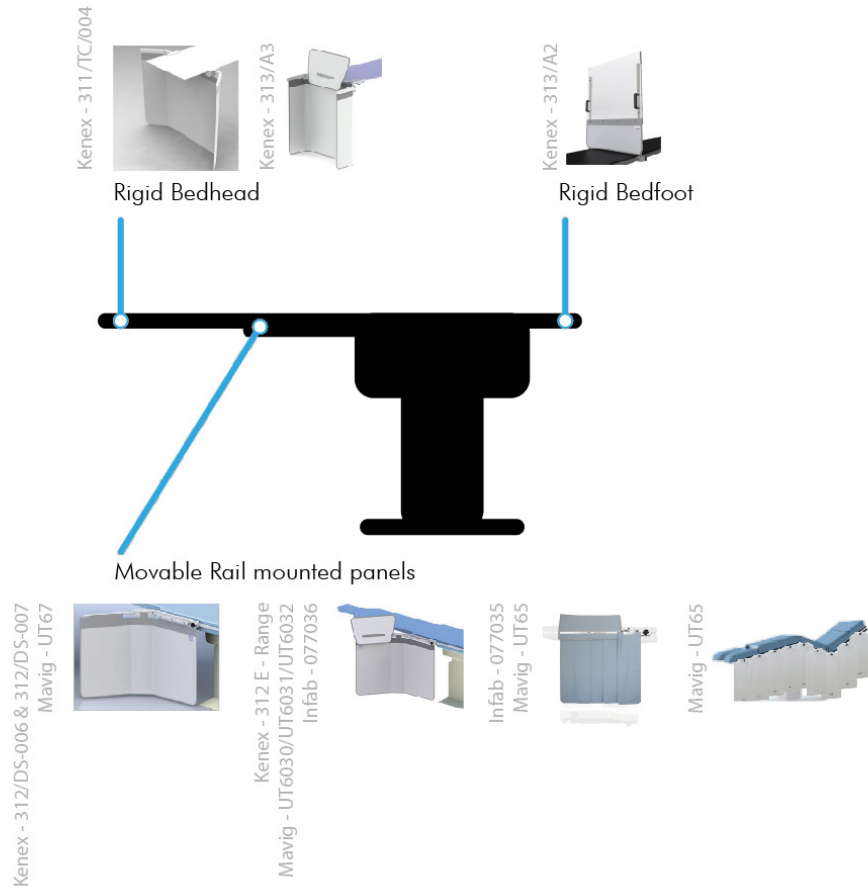

Figure 3. Table mounted protection

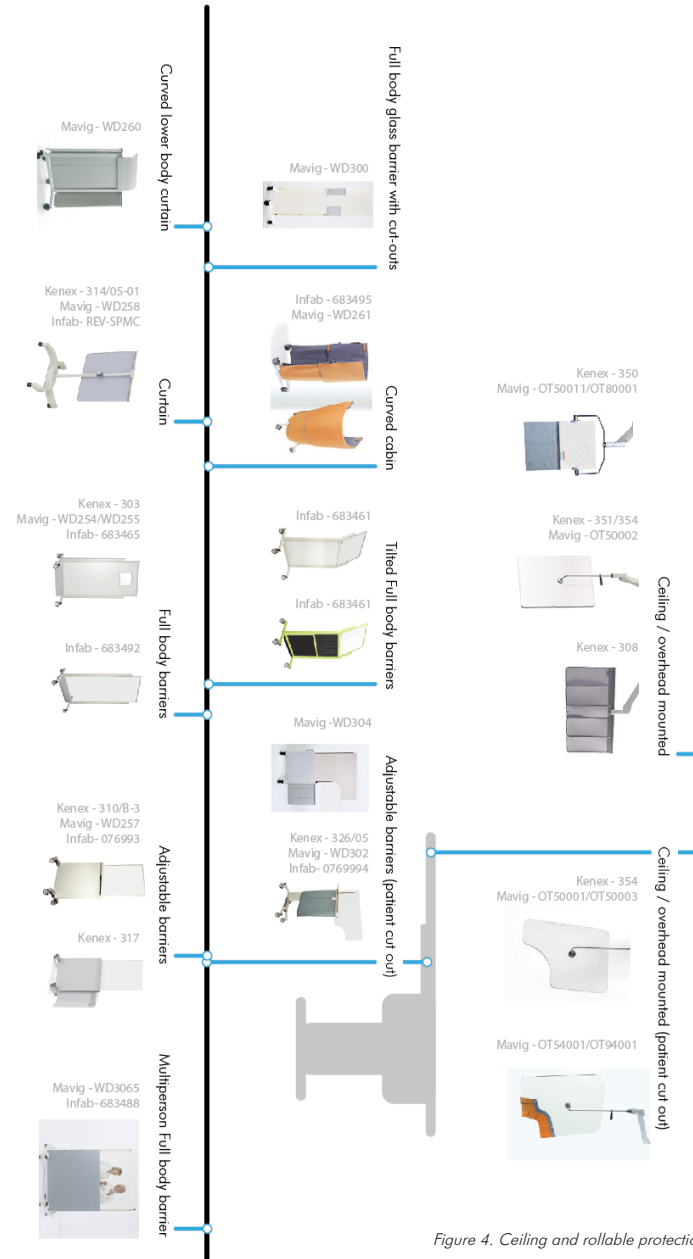
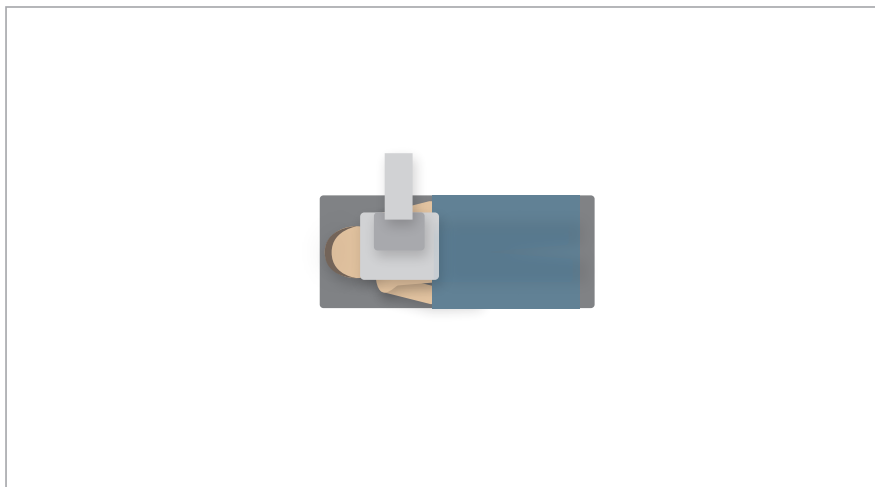

Figure 4. Ceiling and rollable protection

### Question 3. Present protection location

Could you indicate the position of the products that are present in your hospital in the box below?  
A simple line and the number, as asked in question 3, will suffice.



### Question 4. Usage of protection

In your personal opinion, is the provided protection used in a adequate way in most procedures?  
Does the (mis)placement of shields sometimes pose hazards for you or others? Please indicate these as  
area's in box above.

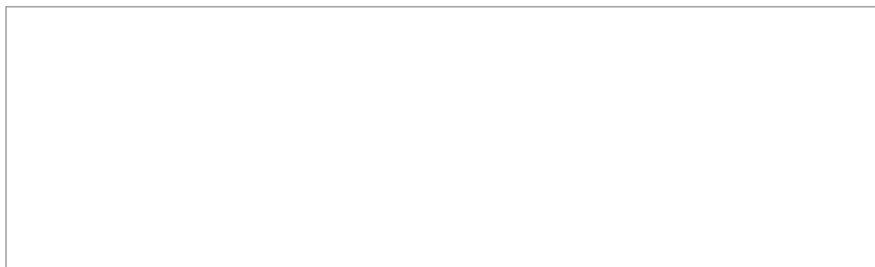

### Question 5. Reflection on procedures

Could you please reflect on the usage of protective shields and the way staff handles radiation in the  
following images?



Figure 5. Shield repositioning during TAVI procedure Video stills - 15m08 (MLSF, 2019)

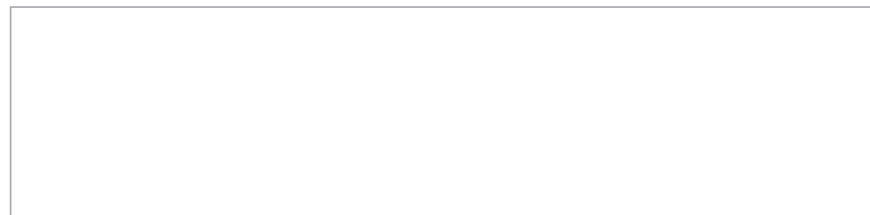
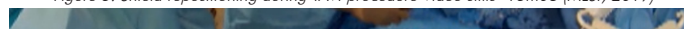



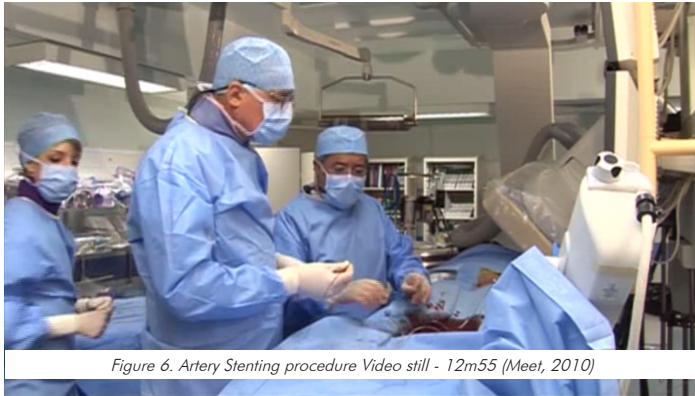

Figure 6. Artery Stenting procedure Video still - 12m55 (Meet, 2010)



Figure 7. TAVI procedure Video still - 8m25 (University hospitals, 2017)

## Occupational information

What is your profession and most performed procedure?

What is your age and how many years have you been working with radiation in your profession?

What level of training regarding radiation have you completed based on the levels defined by the Nederlandse vereniging voor stralingsbescherming (NVS) in the table below?

Regeling basisveiligheidsnormen stralingsbescherming			voorheen
SBD	ACD	stralingsbeschermingsdeskundige op het niveau van algemeen coördinerend deskundige	2
	CD	stralingsbeschermingsdeskundige op het niveau van coördinerend deskundige	3
TMS	MT	medische toepassingen	5A/B cq 4A/B
	THKB	tandheelkunde basis	5AM
	TCB	tandheelkunde cone beam	4M_CBCT
	DG	diergeneeskunde	5A
	SC-B	splijstof cyclus niveau B	3
	SC-C	splijstof cyclus niveau C	
	VRS-B	verspreidbare radioactieve stoffen niveau B	3
	VRS-C	verspreidbare radioactieve stoffen niveau C	4B
	VRS-D	verspreidbare radioactieve stoffen niveau D	5B
	NORM	handelingen met van nature voorkomend radioactief materiaal	
	VER-B	versnellers niveau B	3
	VER-C	versnellers niveau C	4A/B
	VER-D	versnellers niveau D	5A/B
	IR	industriële radiografie	5A
M&R	meet- en regeltoepassingen	5A	
MRH	MS	medisch specialist bij gebruik röntgenapparatuur	4M
	RT	radiotherapeut-oncoloog	3M
	Rö	radioloog	3M
	IRö	interventie radioloog	3M
	NG	nucleair geneeskundige	3
MBB	MBB	medisch beeldvormings- en bestralingsdeskundige	4A/B

SBD | stralingsbeschermingsdeskundige  
TMS | toezichhoudend medewerker stralingsbescherming  
MRH | specialist bij medisch radiologische handelingen  
MBB | medisch beeldvormings- en bestralingsdeskundige

Table 1. Stralingsdeskundigheid Nederlandse vereniging voor stralingsbescherming (NVS)

## Interview questions

How do you know when a shield is properly placed?

After the x-ray machine changes position, do you reposition the shield? Why?

Have you ever felt vulnerable during a procedure? During which procedure? Why and Where?

Do you have access to the data from your dosimeter? During the procedure and after the procedure?  
Can you reflect on this data to lower your dose?

How much dose is too much in your opinion?  
(Can be in any unit of measurement e.g. mGy, mGy/cm<sup>2</sup>, etc.)

If you could add something regarding radiation protection to the operating room, what would it be?  
Where would it be?

Further remarks

Participant	Adequate use	Misplacement	Foto 1	Foto 2	Foto 3	Beroep	Meeste Procedures
	Yes, no hazard		Schild aansluiten op patient	Schild niet in gebruik	Schild aansluiten op patient	Interventie cardioloog	PCI TAVI
	Yes, no hazard	Voor anderen	Schild aansluiten op patient	Schild niet in gebruik	Schild aansluiten op patient	Electrophysioloog	Ablation
	Not always but as good as it gets		Schild aansluiten op patient	Schild niet in gebruik	Correct	Interventie cardioloog	PCI
	Sometimes the below bed shield is placed too much towards the head. Shields can not always be placed fully towards the patient. Scatter can come from below		Schild te hoog. Tussen patient en operator	Schild niet in gebruik	Correct	Interventie cardioloog	PCI
	Yes		Schild te hoog. Tussen patient en operator	Schild niet in gebruik	Image receiver too far from body	Cardioloog Fellow electrophysioloog	Ablation + Pacemakers
	Yes		Schild te hoog. Tussen patient en operator. Gebruik lood bril	Schild niet in gebruik. Oriëntatie machine niet optimaal	Lood brillen	Interventie cardioloog	PCI TAVI
	Overhead shield least adequate. Radial artery approach left side hazard		Schild te hoog. Gebruik loodbrillen	Schild niet in gebruik. Loodbrillen	Schild aansluiten op patient en loodbrillen	Interventie cardioloog	Dotteren Mitraclip

Leeftijd	Jaren in vak	Training	Plaatsing	Oriëntatie verandering	Kwetsbaar	Dosimeter inzicht	Reflectie	Hoe veel is veel
56	21	4M	Aansluiting op patient. Zo dicht mogelijk bij de bron	Nee nooit	Nee	Maandlijks, Totaal 20mSv, Niet veel aan te doen.	Enkel mededeling	20mSv
46	10	4A/B	Niet zeker. Goede aansluiting op patient. Tussen bron en persoon	Nee staat al zo goed mogelijk	Bewust van risico. Moelijk om met schild te werken tijdens Biventriculaire ICB ivm bron naar je toe gericht	Jaarlijks		20mSv, zelf 12mSv
37	2	4M	Wordt gecorrigeerd door collegas. Straling is onzichtbaar dus zo goed mogelijk tussen jouw en patient	Ja	Nee	Maandlijks	Extra letten op gedrag	2mSv per maand
41	4	4M	Logisch nadenken. Schid volledig tussen patient en jezelf of staf	Nee staat al zo goed mogelijk	Ja als je met 3 operators naast elkaar staat. Weinig plaats. Andere operators dan jij met weinig kennis van straling (Singapore)	Maandlijks	Als fellow meer straling opgedaan dan nu. Routines aangeleerd	1mSv per maand
37	4	4M	Aansluiting op patient. Zo dicht mogelijk bij de bron	Nee niet vaak	Nee, maar schilden worden niet gebruikt bij pacemaker	Maandlijks	Minder doorlichten	20mSv
54	15	4M	Tussen patient (bron) en operator. Ook denken aan ander personeel	Kennis te gebrekkig over nut van repositioneren	Nee, bottom schilden niet gebruikt tijdens PCI ivm hoek machine	3 maanden	Aanvullende maatregelen of procedures vermijden	Alles boven normale bevolking.
61	27	4A/B	Niet zeker. Goede aansluiting op patient. Tussen bron en persoon	Ja want de bron verplaatst. Kleine correcties. Onderdeel van werkwijze	Nee	3 maanden	6mSv afgelopen jaar	10mSv per jaar

Per procedure	Suggesties nieuwe producten	Remarks
Geen idee	Automatische schilden. Hold op straling tot schilden correct staan	
	Zero gravity en rad pads	Schild soms niet correct op lichaam geplaatst. Flaps liggen verkeerd
	Rad pads	Technicus gaf aan scatter komt van boven.
meer dan 1 Gy voor patient	Lood flappen	Cut out van schilden moeilijk plaatsen over arm patient
	Rad pads + Adjustable barriers	Vorig ziekenhuis gebruikte rollable adjustable barriers
Geen idee	Arm bescherming en Zero gravity	Altijd aandringen op diafragma verkleinen
Onduidelijk	Lood flappen. Schermen meer naar rechts waardoor ogen minder in bron kijken. Licht in de ruimte donkerder ivm contrast	Echographist gebruikt kamerscherm. Procedures aan andere zijde van tafel gevaarlijk ivm moeilijke bereikbaarheid van schild. Schilden met cut-out past ook niet. Shift naar radial artery is gevaarlijker

# Appendix F - Brainstorm 10 September

## Setup and results

## Schedule - September 10th

### Brainstorm structure

1. Schedule for the brainstorm session
2. Presentation with research findings and objective
3. Warm Up exercises write or draw on post-it's:
  - a. Department superpowers
  - b. Assets & strengths
  - c. Collaborations between departments?
4. Present challenge to be tackled
5. Ideation sessions per challenge
  - a. Dark side exercise: How can we increase the problem
    - i. Shout out exercise
    - ii. Creates extreme versions of the problem
  - b. Ideation on how to solve said problems
    - i. Silent or shout out; depending on introvert/extrovert people
    - ii. Use warm up post-it's
  - c. Slide through drawings to next person
    - i. Create a collaborate ideation instead of "my idea"
  - d. Add limitations
    - i. e.g. how to use it without seeing or hearing or could a child use it
6. Evaluate ideas
  - a. Via feasibility or Effort vs Gain graph

Time	Duration	Phase	Technique	Requirements
14:15	15 min	Welcome	Waiting for attendees	
14:30	25 min	Presentation + Schedule		A4's with <u>main insights</u>
14:55	10 min	Questions		
15:10	15 min	Warming up	<u>Department superhero (5 min)</u> <u>Department / personal assets (5 min)</u>	Post-it's (Green) Pens for drawing
15:30	5 min	Present challenges		Flipchart with challenges
15:40	30 min	Ideation	<u>Dark side exercise (5 min)</u> <u>Solving dark side problems (5 min)</u> <u>Slide through to next person (5 min)</u> <u>Solve with added limitations (5 min)</u> <u>Discussion (5 min)</u>	Post-it's (Red) Post-it's (Blue) Pens for drawing
16:15	20	Evaluation	<u>Short discussion + select ideas (10 min)</u> <u>Effort vs Gain or Feasibility (10 min)</u>	Flip chart with "Winning" idea's and Feasibility chart
16:35		End of brainstorm		

IG &  
Physics!

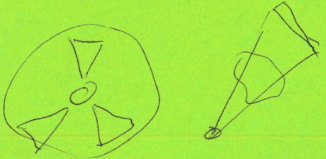

- geen lood glas
- geen schermen
- alleen exposure
- betere beeld kwaliteit
- meer data
- geen training

- lood glas
- scherm aan
- zoveel mogelijk filter
- ALARA beeld kwaliteit
- ALARA dose
- dedicated training

- visualize radium on screen
- Google Glass visualization
- "Leap eyes" VR-reading

Subject Matter Expert  
Network of experts  
IG &  
Dose  
Regulatory work

- monitoring of dose
- dose via portal
- dose aware
- personalized reporting

Interactive Leap sensitive screen!  
Can we do that??



- skin dose map
- visualize radium on screen
- on floor??



opstalende op  
oalige plekken

opstalende op  
ou veien plekken

St raken  
in de buiten-  
lucht.  
Kennis

167-nyntaan.  
in netto ruimte  
59-1.  
Rd duideljkheid

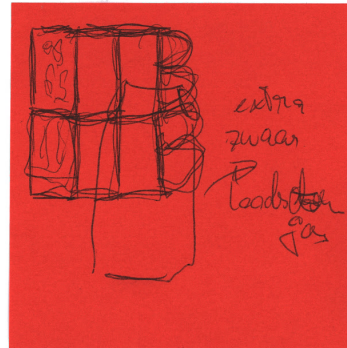
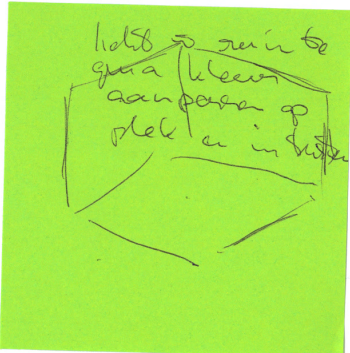

hal lichte loaden  
betrokkende lading  
organen

Mis information  
campagne via  
Trump etc

Wob site  
met  
conspirasies  
theorie

juiste info  
campagne  
publieklyk  
taagzaamheid

Altijd voor iemand  
blijven staan.  
Altijd achter iemand  
blijven staan

Altijd achter iemand  
blijven staan.

Handen onder  
de beam  
houden

Handen niets  
onder de beam  
houden

mentaal model van  
de 3D "cone"  
intrainen rook  
Coat met licht/licht  
visueel maken?

Trend ~~de~~  
Machio Compexen:  
wie heeft +  
minste haair?

cultuur verandering  
jonge artsen  
"slaving radiation"  
~~soortje you 24/7~~  
= stoer  
meuw  
STRESS  
ISSUE & RED JERZEL  
voor je je hand helpt  
- DATA / refereren cingrediss hospital

omgekeerde  
dose wroe  
opspelden

Dose wroe gebruiken  
Centraal beelden  
hoe je het blijft  
gebruiken  
iets van beloning  
dat je goed staak  
Steam effect:  
zoude sterven)

Zeggen dat  
achter de versterker  
de veilige kant is  
aangeven op de  
nabehure

Zeggen dat  
achter de deketer  
de veilige kant is  
dat visueel aangeven  
op de machine  
"visueel mentaal model

niets aangeven of  
wanneer /  
hoeveel gestraald  
wordt!

Duidelijk aangeven  
wanneer / hoeveel  
gestraald wordt  
bijv. met "lichtkop"  
zonder bij drempel.  
- Verschil fiso / andere  
- est dosis aangeven in "licht"  
of "sichtbaar voor hie  
skat"

Vertellen dat  
ze op de  
patient of  
op plek patient  
moeten liggen

vertellen dat je niet  
op patient of plek  
patient moet komen

### OR Moves

- verantwoordelijke  
spalning
- middelen om deze  
verantwoordelijk  
te nemen
- meelijken kneden  
(camera? "VAR")

- Philips's
- aanbieden team  
training voor optimum  
staff care "we care"  
of bevalde angle
  - bij deze training  
staff achten "food  
milieu/safe zone?"

Data analyse  
dese data  
in combinatie  
met posite  
& positieve arts.  
Reparatij.

Onderzoek op  
Azurion (credent)  
of in procedure  
cards  
"WE CARE" Azurion  
dose reference levels  
PHILIPS



FQS

Inzicht in  
klanten behoeften

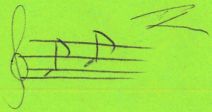

Gamification

Dareaware koppelen  
aan B warming  
signaal, bijv. op  
horloge.  
~~afh van pers~~

goede image moeding  
om met lagere  
doris zelfde IQ  
te bereiken

Visualiseren van  
stralingniveaus  
op de monitor  
afh. van cam oriëntatie

graf

goede loodjassen  
- verlagen van  
drempel om loodjas  
te dragen door deze  
op ~~de~~ te hangen aan  
een boom  
(gezien in Canada, 2019)

Duidelijke informatie  
over stralingniveaus  
op de monitor  
(real time plaatjes)  
- op vloer projectie  
- ook Dareaware  
→ personal report after case

training /  
education  
- vindbaar dat op  
ons eigen systeem  
- simulatie omgeving  
met gerimbeerde  
(holografie) x-ray (VR)

user warnings /  
guidance op het  
systeem ~~warnings~~  
voor laagst mogelijke  
doris

## Visual Clues

Visual clues

Directional Loos



Warning light



Shield shadow



Bed and Led + vibration



Dosimeter Glow updates every 5sec



Floor/wall Reflections

Like the bike lights with virtual lanes

Visual safe zones



Stand alone no connectors to system Gyroscope

Shield detector magnet below shield can be pulled up to also show shielded safe zone

Shield height known

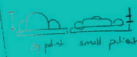

## Non visual clues

Non Visual clues

Buzzer Carpet



Buzzer Dosimeter



Sound Cancelling



Heat pads



Buzzer shoe soles

Different comfort levels

Merged holder for dosimeter & DoseAware



live feedback From control



## Spread In Space

Visualize spread in space

Projecties op muur



Hologram



3d printed hollow patterns



Lead points in floor



Scale model of spread inside casing

Scale model with light

## Brainstorm Ideas per topic

### Direct feedback

- Obstacles at dangerous places
- Skin dose projection
- Warning buzzers at dangerous orientations:
  - All non-essential personnel to the control room.
- Floor illumination with radiation intensity
- Smoke and holograms of radiation spread
- Radiation spread shown for short time
  - At begin of each pedal pressing and after a rotation change<sup>2</sup>
- Visual indicators on x-ray tube
- Red Light on the back of the x-ray tube
  - Warns directly and reflects of the floor
- Real time position tracking via Dose-Aware
- Combine data generated by dose-aware and x-ray machine
  - Direct insight in who received too much at certain point

### Intensity indicators

- Colour difference between Fluo and Exposure usage
- Philips sets colour range as maximum radiation instead of mGy units
  - Always stay below red
- Buzzers when entering a zone
- Haptic feedback
  - One buzz: safest, Three buzzes: most dangerous

### Feedback after procedure

- Responsible party is watching via video (VAR).
  - Live interrupts or feedback after the procedure.
- Personalized report of radiation safety after each procedure
- Dose-Aware royalty program. Dose levels as a team.
  - Internal staff reflections to keep dose as low as possible
- Hospital benchmarking
  - Received dose/Used dose

### Training

- App with clear information mandatory at on-boarding
- Information campaigns at hospitals
- Augmented Reality glasses show live spread of radiation
  - Practice without radiation in safe learning environment
- Spread the metaphor of the x-ray tube as a canon
- Teach a mental map of scatter spread
- Discourage contact with patient body

# Appendix H - ScatterZone drawings

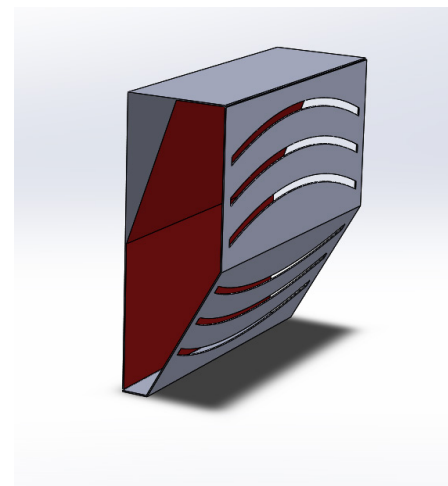
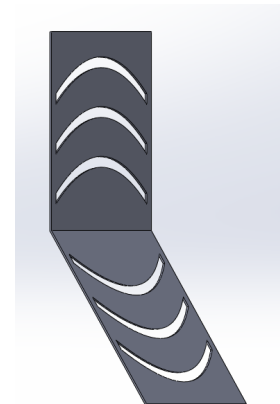
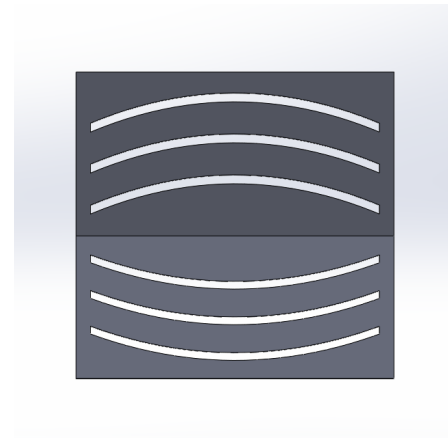
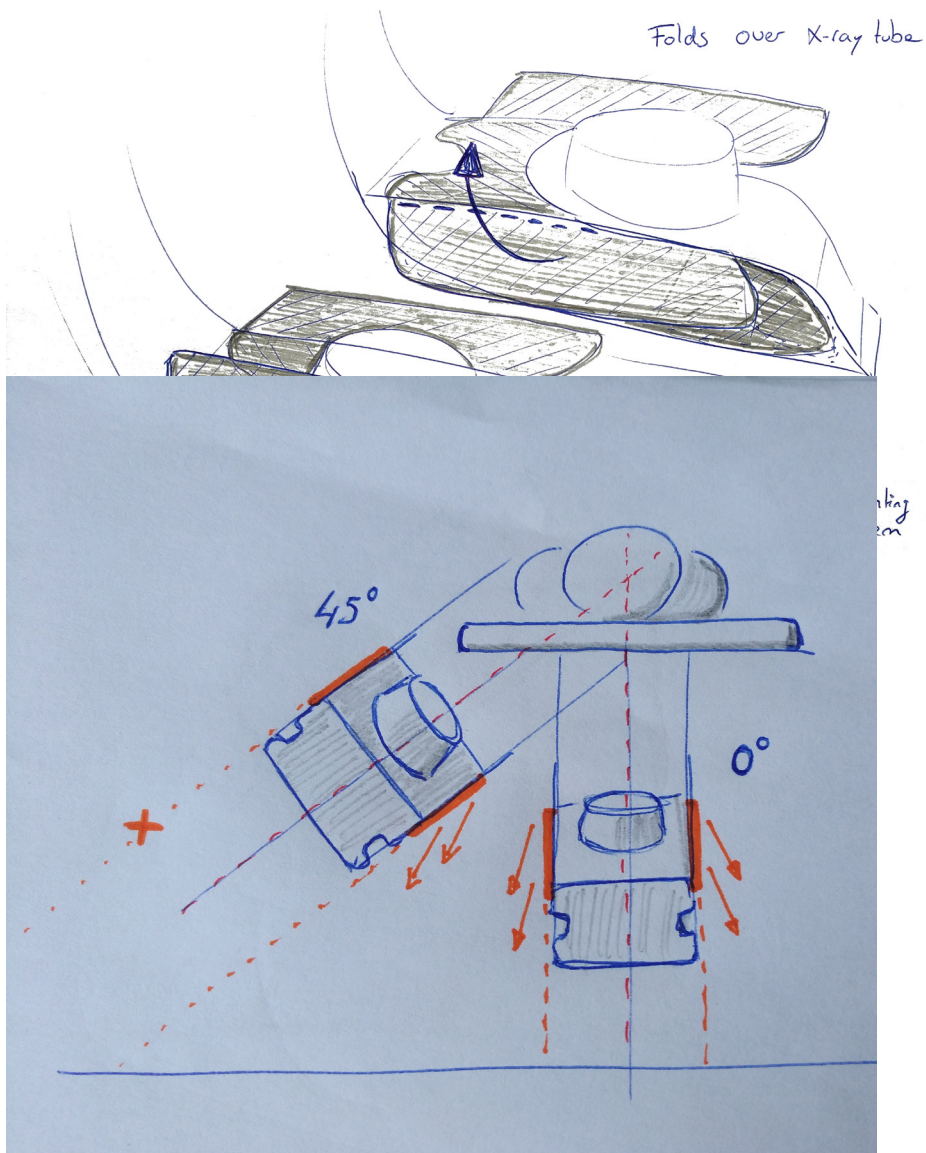

# Appendix I - Package deal example

## Interventional Radiology



## Interventional Radiology



Azurion 7 C20 & 7F20



Azurion 7 B20/15



Azurion 7 B20/12



## Lead Acrylic Shield Configurations

6

Figure A7.1 Example of “package deal” with Mavig for radiation shielding during interventional surgery for different OR styles and systems



Azurion 4F Monitor Ceiling Suspension



Table X-ray protection



Ceiling suspended radiation shield

\* In case of OR table other accessories may apply

### 1.3 Philips monitor ceiling suspension

The Philips monitor ceiling suspension allows flexible, freely rotating positioning of the monitors for an excellent viewing angle. A separate integration kit is available for third party monitor suspensions and ceiling booms. Standard, a 2 Fold MCS is delivered with two 27" full HD widescreen monitors.

#### Optional number of monitors

2 Fold MCS	2x 27" Full HD widescreen
4 Fold MCS	3 or 4x 27" Full HD widescreen.
6 Fold MCS	4x 27" Full HD widescreen + 1 or 2x 27" (top- or rear-viewing)
3 <sup>rd</sup> party boom (1,2 or 4 fold)	27" or 32" Full HD widescreen monitor
FlexVision MCS	1 x 58" XL screen
FlexVision MCS	1x 58" XL + 2x 27" Full HD widescreen (top- or rear-viewing)

#### MCS features

Rotation range	350°
Transversal movement	Over a distance of 300 cm (118.1 inch)
Longitudinal movement	Over a distance of 330 cm (129.9 inch)
Height movement	Motorized 32 cm (12.6 inch)

#### 1.4 Accessories

##### Standard accessories (patient table)

Mattress  
 Patient straps  
 Set of arm supports (if cradle option is chosen)  
 Drip stand  
 OP rail accessory clamps  
 Cable holders (15 pieces)

##### Optional accessories\*

Panhandle  
 Neuro Mattress (if Neuro tabletop)  
 Longer Cardio Mattress  
 Head support  
 Arm support, incl. arm pad  
 Neuro wedge  
 Table clamp  
 Set handgrips and clamps  
 Additional OP-rail with cable extension kit for control modules  
 Ratchet compressor  
 Additional OP-rail  
 Table base accessory rail  
 Examination light  
 Arm support (height adjustable)  
 Table X-ray protection  
 Peripheral X-ray filter  
 Pulse cath arm support  
 Ceiling suspended radiation shield

# 7 Room layout

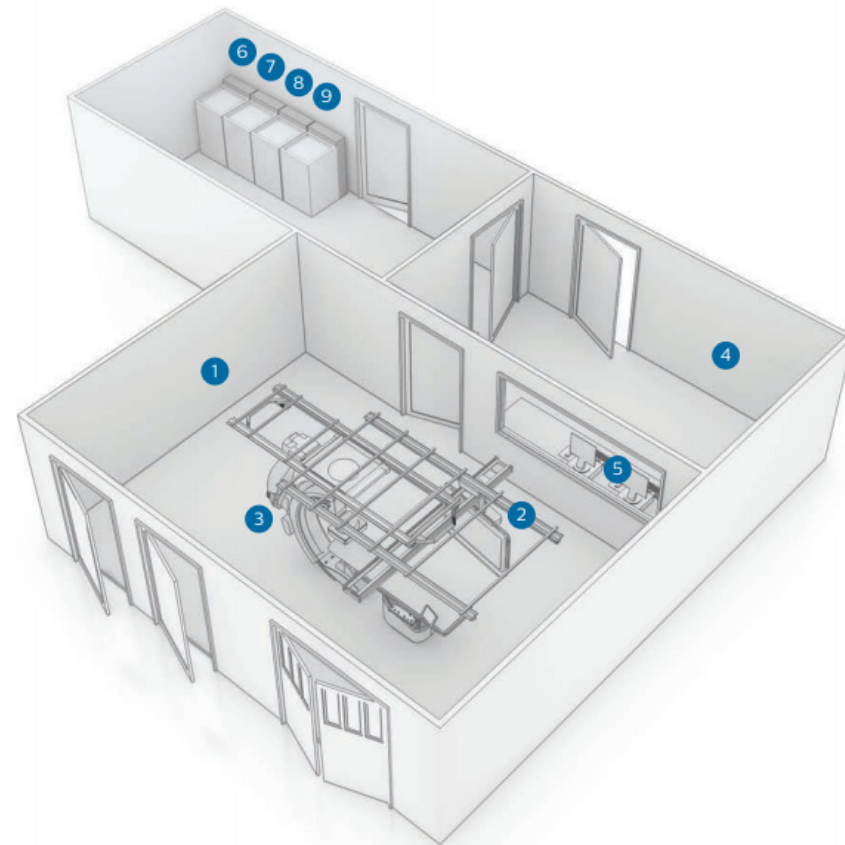

Conceptual drawing of a room layout

#### Top view

1. Examination room
2. LCD monitor ceiling suspension
3. Ceiling mounted C-arm stand
4. Control room
5. Xper Viewing console
6. Certeray generator
7. Geometry cabinet
8. System cabinet
9. FlexVision cabinet

Figure A7.2 Example of "package deal" for a whole OR to be designed by Philips. Including screens and shielding.

## Appendix K - List of requirements

Nr.	Requirement	Aim	Reference section
1		Product is placed in the individual layer of the occupational radiation hygiene strategy	2.3, 2.4, 6.3
2	The product increases the awareness of the scatter spread	The product aims to create a mental map of where the radiation is present	2.6, 2.7
3		The product aims to imprint this map in the instinctive mind	8
4		The product aims to achieve the radiation safety behavior of experienced operators for fellows	2.7
5	The products shows the difference in radiation intensity surrounding the patient		4.2, 4.3
6	The product removes doubt about the direction of the most scatter around the x-ray tube		4.3, 6.3
7	The product shows the influence of the rotation of the c-arm	At ~90 degrees rotation the product will alert surrounding staff about the increased radiation towards the room	4.3, 6.1, 6.3
8	The product is designed to improve radiation safety during PCI and TAVI procedures		5.1
9	The product uses arbitrary units to display intensity	The product creates a clear sense of intensity for the operators. The operators can indicate when too much was used during a single operation	6.2, 6.3
10	The product is an accessory and not a medical tool		
11		During a procedure the product does not require net power	
12	The product is meant to be used in a (safe) training environment.	The product will preferably also be used in a live operation	7.4

Nr.	Requirement	Aim	Reference section
13	The product emphasizes the most dangerous zone of the scatter spread.		7.2, 8
14		The product carries elements (cues) from the training environment to the live situation.	8
15		The product polarizes (or slightly exaggerates) the danger of the scatter.	8
16	The product does not pose a physical barrier to the procedure		
17		The danger or the probability of a dangerous outcome of the use of incorrect radiation safety should be made clear	8



# Appendix K - Time to market selection

The goal of this selection is not to eliminate a product from the EPP, but to select one for continuation within this project. The whole EPP system would unfortunately not be manageable to bring to a descent level of elaboration.

## 14.1 Criteria

### Short term effectivity

Degree of instant recognition of the scatter spread (shock effect).

### Mental model imprinting

Degree of creating a mental model of the scatter in the instinctive mind.

### Clarity of danger

Degree of recognition of the danger of standing at a specific position.

### Awareness for other staff

Degree to which staff members other than the operators / further from the table are made aware.

### Time to market

Product potential for quick introduction  
Does the product require integration with other systems or products

### Link/cue to training

Is there a cue (Pavlov bell) towards the training where proper protocol was taught

### Radiation cap clarity

Can operators identify when they accumulate too much radiation in a single procedure

## 14.2 Selection

Selection criteria	- / -- / = / + / ++	
	DoseAware+ Score	ScatterZone Score
Short term effectivity	=	++
Mental model imprinting	+	++
Clarity of danger	++	++
Awareness for other staff	-	+
Time to market	-	+
Link/cue to training	=	+
Radiation cap clarity	++	--
Overall score	3	7

Table 12.1 Criteria weighting for EPP products

The DoseAware+ concept has great potential for the Hybrid OR in terms of long term effectivity. When integrated into the system of the displays, the operators will always have a reliable source of information. The biggest issue is however this integration, as it involves the complete redesign of the screen information. It will require more screen space and therefore will either take it from other information displays or require a screen on its own. This would make a short term introduction of the product very difficult.

The concept for ScatterZone also requires no active link to the system or any of the screens making implementation significantly easier. The concept also scores better on instant awareness when compared to the DoseAware+. Even without proper training, operators can immediately see that they are standing in a radiation area. This creates a more relatable mental model as they can physically see where to be without

the help of a screen. The concept does however not give an indication of the amount of radiation the operators accumulate and can therefore not help them indicate when they receive too much.

The DoseAware+ concept would create too many aspects to tackle in the short window of time. A recommendation for further implementation is added to this report. The ScatterZone is a less technically integrated product and its complexity is manageable within the time-frame, including time for prototyping and testing.