



Alexander Feilmair

health
creation
campus

a new place
for health

What happens when we're too old to be 'useful'?

– BBC News, 22 Jan 2020

How a Vast Demographic Shift Will Reshape the World

– New York Times, 16 July 2023

The true costs of ageing – will it be possible to pay for the looming costs of an older society?

– The Economist, 21 Dec 2021

How should we prepare for an ageing global population?

– The Guardian, 24 Nov 2022



The Guardian – January 2023



Daily Express – February 2023

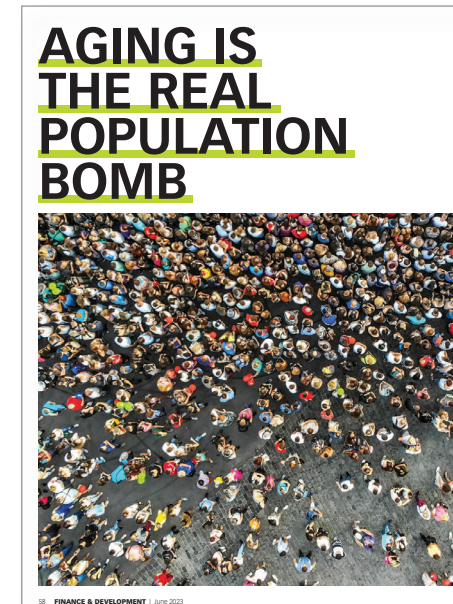

Finance and Development – June 2023

What Are The Long-Term Consequences Of Our Aging Population? It's All Guesswork

– Forbes, 26 May 2021

Ageing populations 'already hitting' governments' credit ratings

– Financial Times, 17 May 2023

Are We Ready to Care for Our Aging Population?

– Philadelphia Magazine, 28 April 2023

Ageing population is a long-term threat to economy

– The Telegraph, 9 July 2023

context

population distribution Netherlands

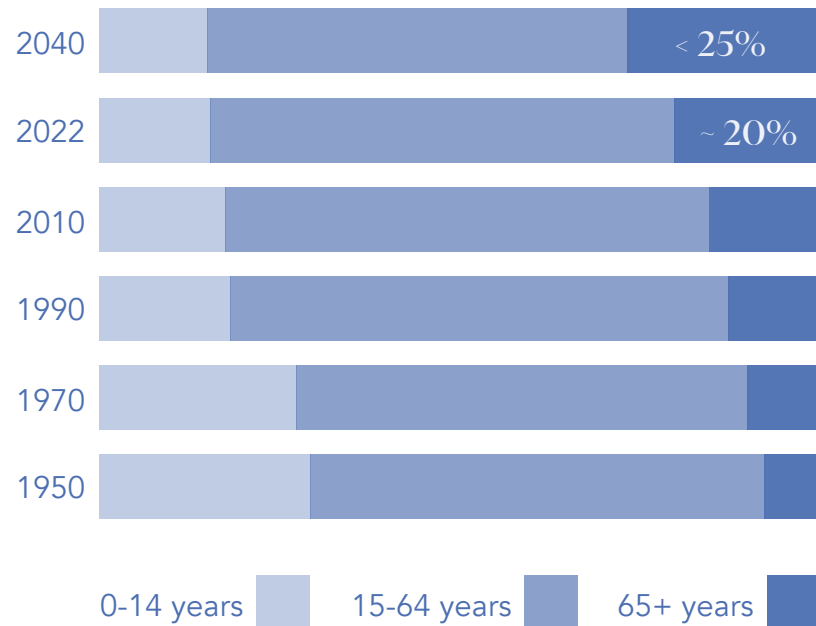

source: Statista, 2023

life span vs. health span

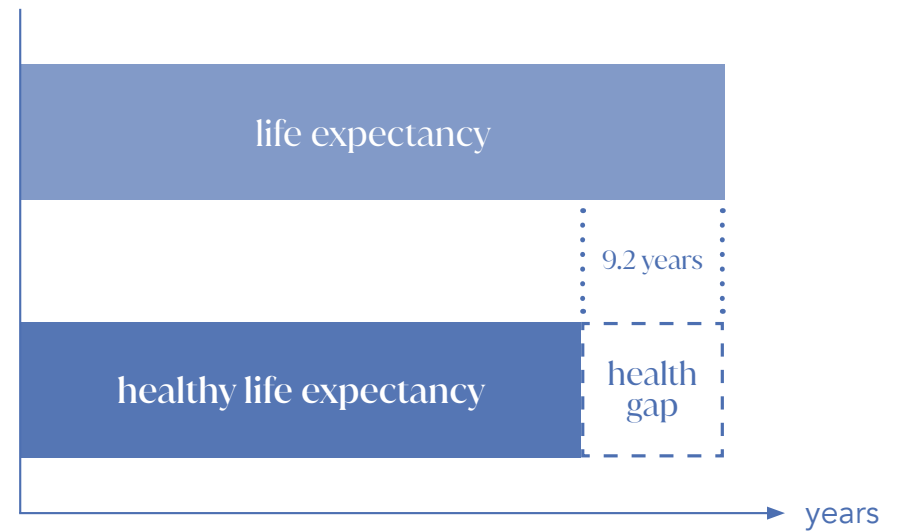

source: Garmany et al., 2021

context

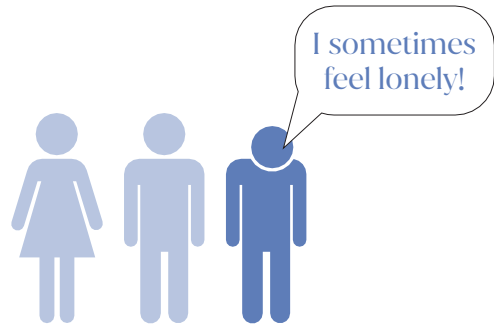

feeling of loneliness
among elderly people

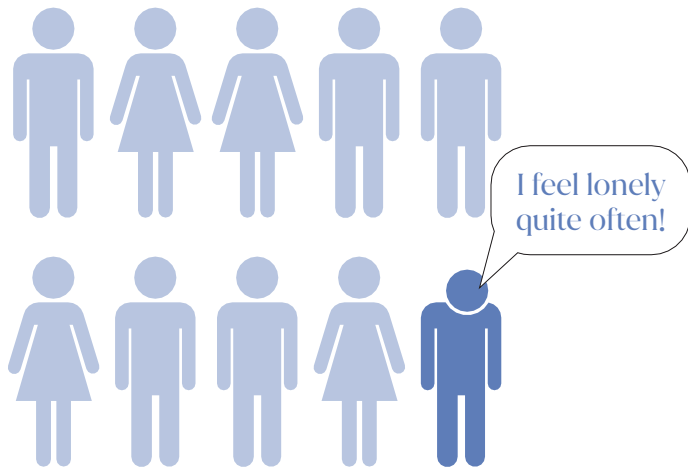

source: CBS, 2020

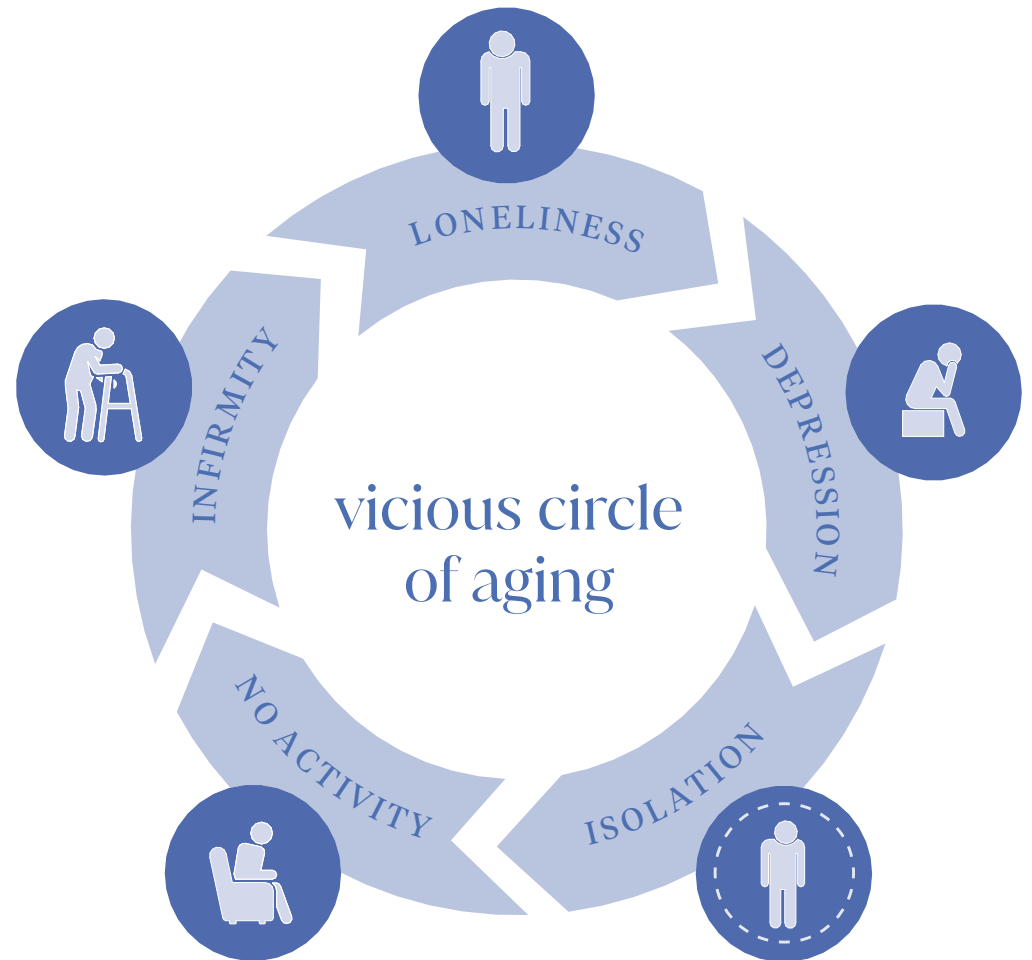

the challenges with health today

- health is seen merely as a physical state of condition

„Health is a state of complete physical, mental and social well-being and not merely the absence of disease or infirmity.“
(WHO, 1948)

- belief that health is primarily achieved through medical intervention
 - > importance of healthy lifestyle and health education
- inadequate access to healthcare
 - > the wealthier people are, the older they get!

HOW DO WE OVERCOME THESE CHALLENGES?

the potentials of Health Creation

- health as a holistic approach that goes beyond the mentality of “health is the absence of illness”
- Health Creation ≠ prevention
 - > prevention is still associated negatively („prevent to get sick“)

Health Creation is the process of individuals and whole communities gaining a sense of purpose, hope, and control over life and by doing so enhancing overall health and well-being.

(Health Creation Alliance, 2023)

- > reduce pressure on local health facilities (hospital, GPs)
- > a place that people associate positively with health
- > „social prescription“ instead of medical prescription

aim of research

health creation

Our shared societal aim should be towards implementing health-creating methods for (elderly) people from declining physical and mental conditions, keeping them active in society, and by doing so renewing in them a purpose in life.

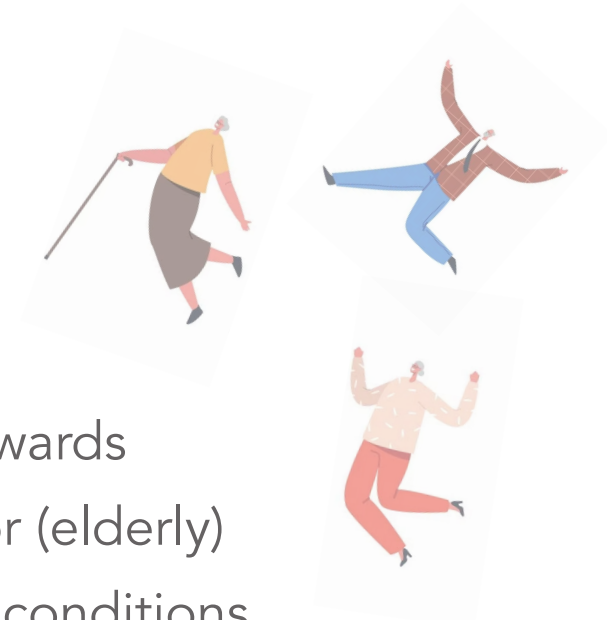

aim of research



aim of research

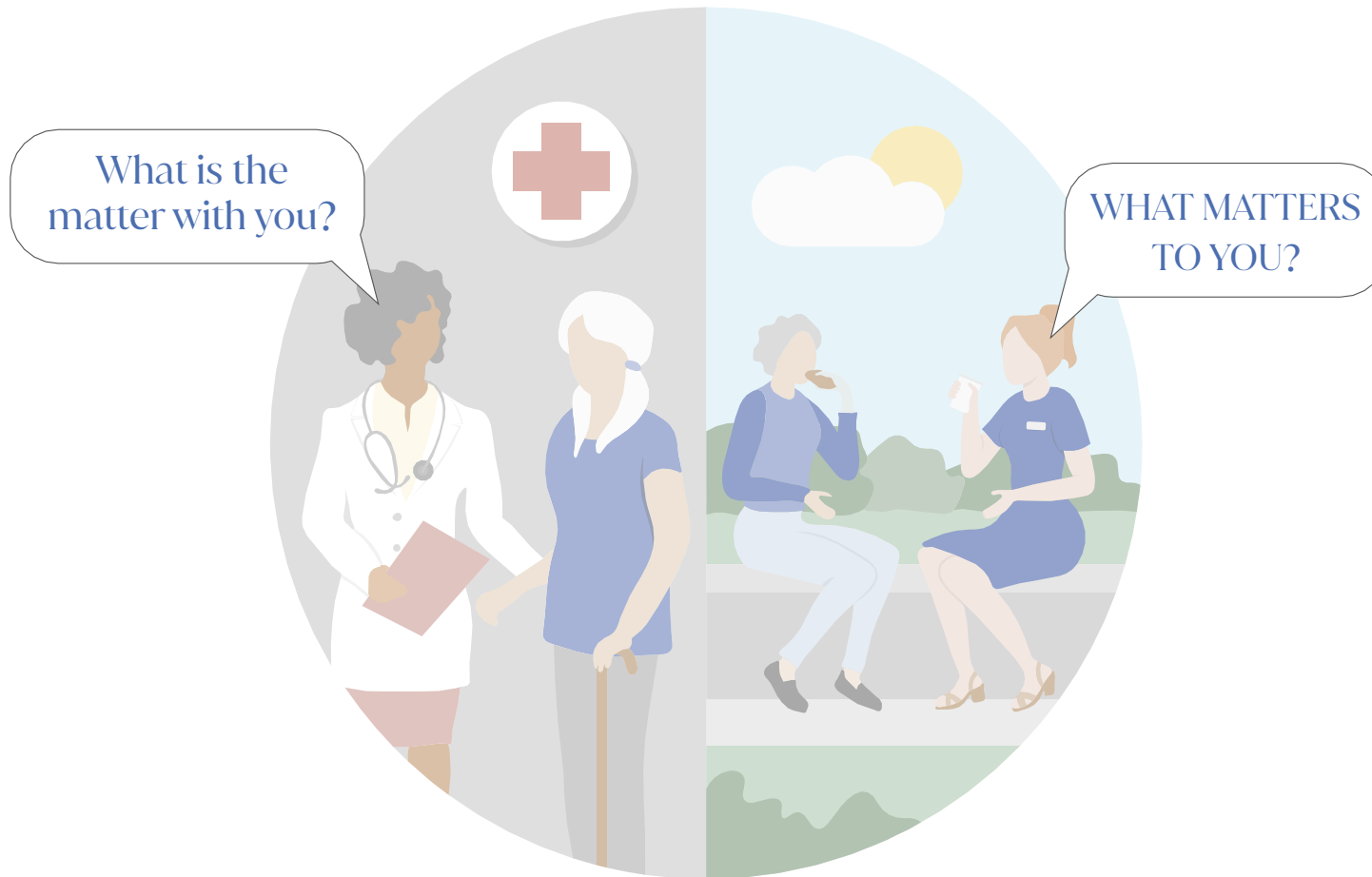

findings from the fieldwork

- independent living with nearby care
- public functions (library, café) close by
- desire for more interaction with people from the neighbourhood
- wish for (more) intergenerational interactions
- activities to keep themselves fit
- possibility of (informal) health checks

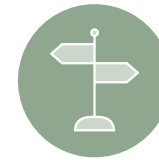

intergenerational interaction

- reducing age-related segregation
- beneficial for young and old
(improved cognitive/motor skills, social skills, mood boost)
- bringing back a purpose in life
- fighting against age-related poverty

intergenerational daycare



intergenerational café



architectural and programmatic guidelines

healthcare aspects



health checks



nearby care



relief for health institutions



caregivers' health



place of information



healthy nutrition

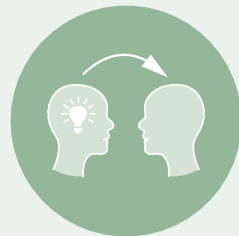

education about healthy life habits

mental aspects



learning of new skills



creation of purpose



mental health

architectural and programmatic guidelines

programmatic aspects



outdoor activities for all generations



community garden / garden of encounter



community kitchen



café as meeting point



increase of physical activity



shared activities



community spaces for gatherings / discussions



intergenerational interaction



public library in reachable distance



therapeutic climbing / bouldering

architectural and programmatic guidelines

architectural aspects



park / greenery space nearby



significance of natural ventilation



significance of color influence



group and individual areas



age-friendly stairs



access routes as communication zones



rounded design elements



importance of acoustics



use of natural materials

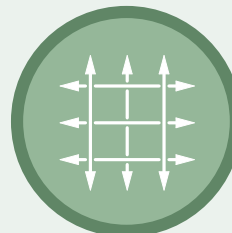

flexibility and adaptability of space

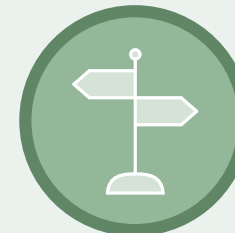

overview and wayfinding



importance of natural lighting

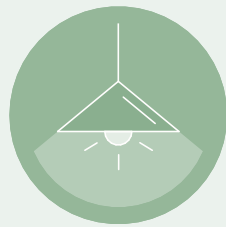

importance of the right illumination



natural elements and art as positive distraction

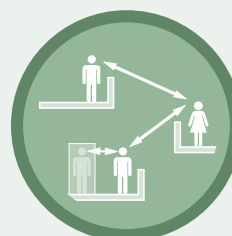

visual connections with other users / residents



sufficient seating and rest options

project brief

independent housing

public health creation
environment

- manageable apartments for elderly
- apartments for young professionals
- housing for young families
- student housing

- intergenerational daycare
- intergenerational café
- library with adjoining study spaces
- co-working spaces
- community kitchen
- health consultation
- workshop spaces
- activity spaces (sport classes, ...)
- gardening spaces
- outdoor sports equipment
- ...



site selection – Poptahof-Noord



ageing of the local population



around 60% feel socially lonely (Delft: ~40%)



around half with a low educational level



around 17% unemployment rate (Delft: 7%)

- plot size around 9.500m²
- existing built structure
- end of 2022: announcement of the demolition



Poptahof Noord

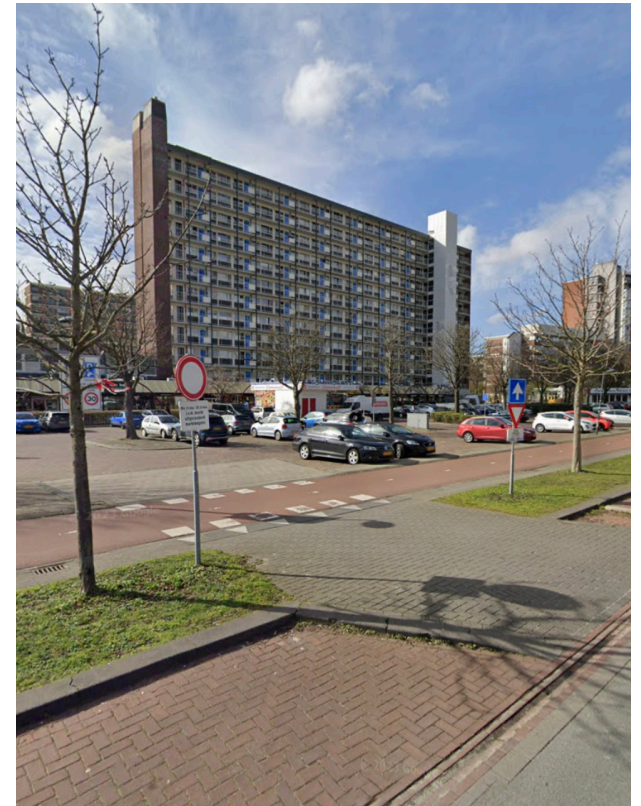

concept

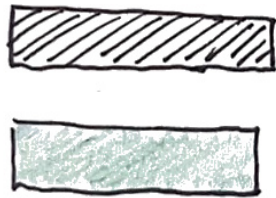

dwelling in
existing structure
+
new health creation
environment

concept

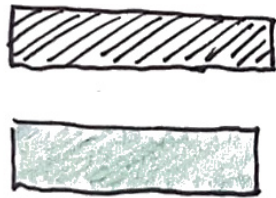

dwelling in
existing structure
+
new health creation
environment

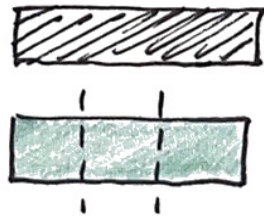

why forcing all functions
into one building?

concept

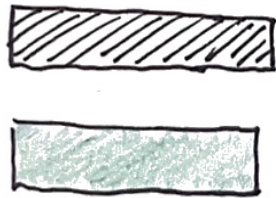

dwelling in
existing structure
+
new health creation
environment

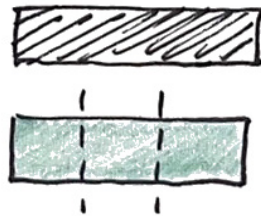

why forcing all functions
into one building?



Programmatically
harmonised structures

concept

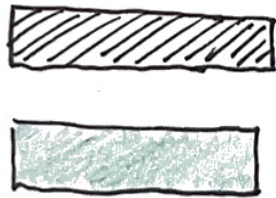

dwelling in
existing structure
+
new health creation
environment

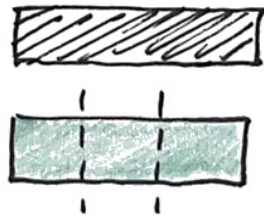

why forcing all functions
into one building?

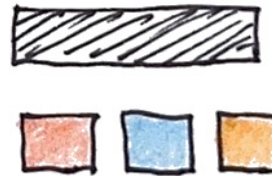

programmatically
harmonised structures

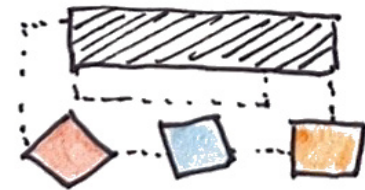

creation of unity through
a connecting platform

concept

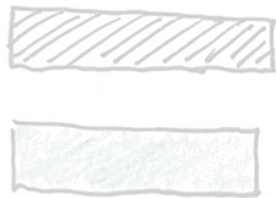

dwelling in
existing structure
+
new health creation
environment

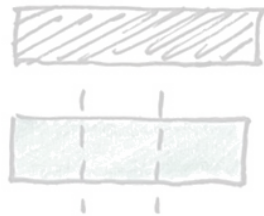

why forcing all functions
into one building?

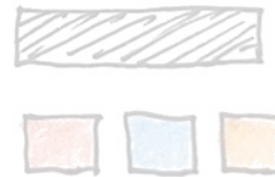

programmatically
harmonised structures

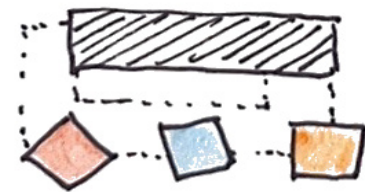

creation of unity through
a connecting platform



dwelling in existing structure

concept

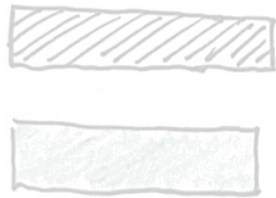

dwelling in
existing structure
+
new health creation
environment

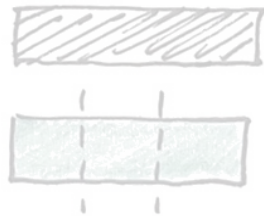

why forcing all functions
into one building?

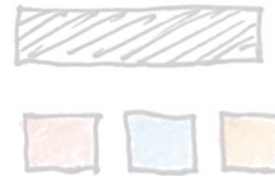

programmatically
harmonised structures

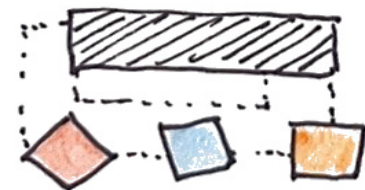

creation of unity through
a connecting platform



dwelling in existing structure
+
retail on high-rise ground floor

concept

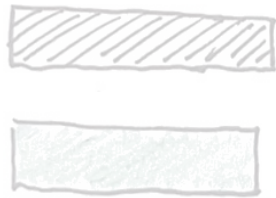

dwelling in
existing structure
+
new health creation
environment

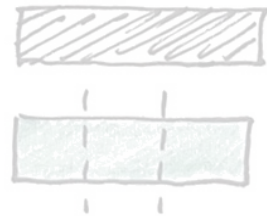

why forcing all functions
into one building?

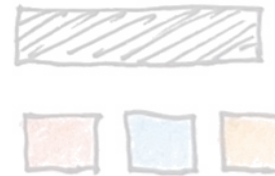

programmatically
harmonised structures

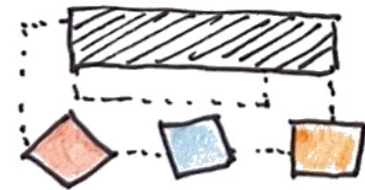

creation of unity through
a connecting platform



dwelling in existing structure
+
retail on high-rise ground floor
+
public health creation environment

concept

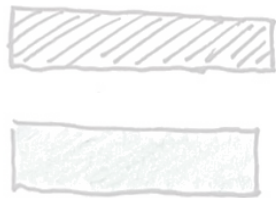

dwelling in
existing structure
+
new health creation
environment

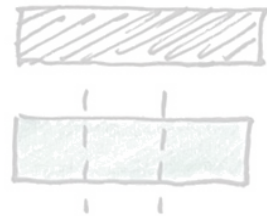

why forcing all functions
into one building?



programmatically
harmonised structures

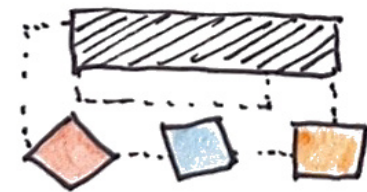

creation of unity through
a connecting platform



dwelling in existing structure
+
retail on high-rise ground floor
+
public health creation environment



health creation
campus

health creation campus

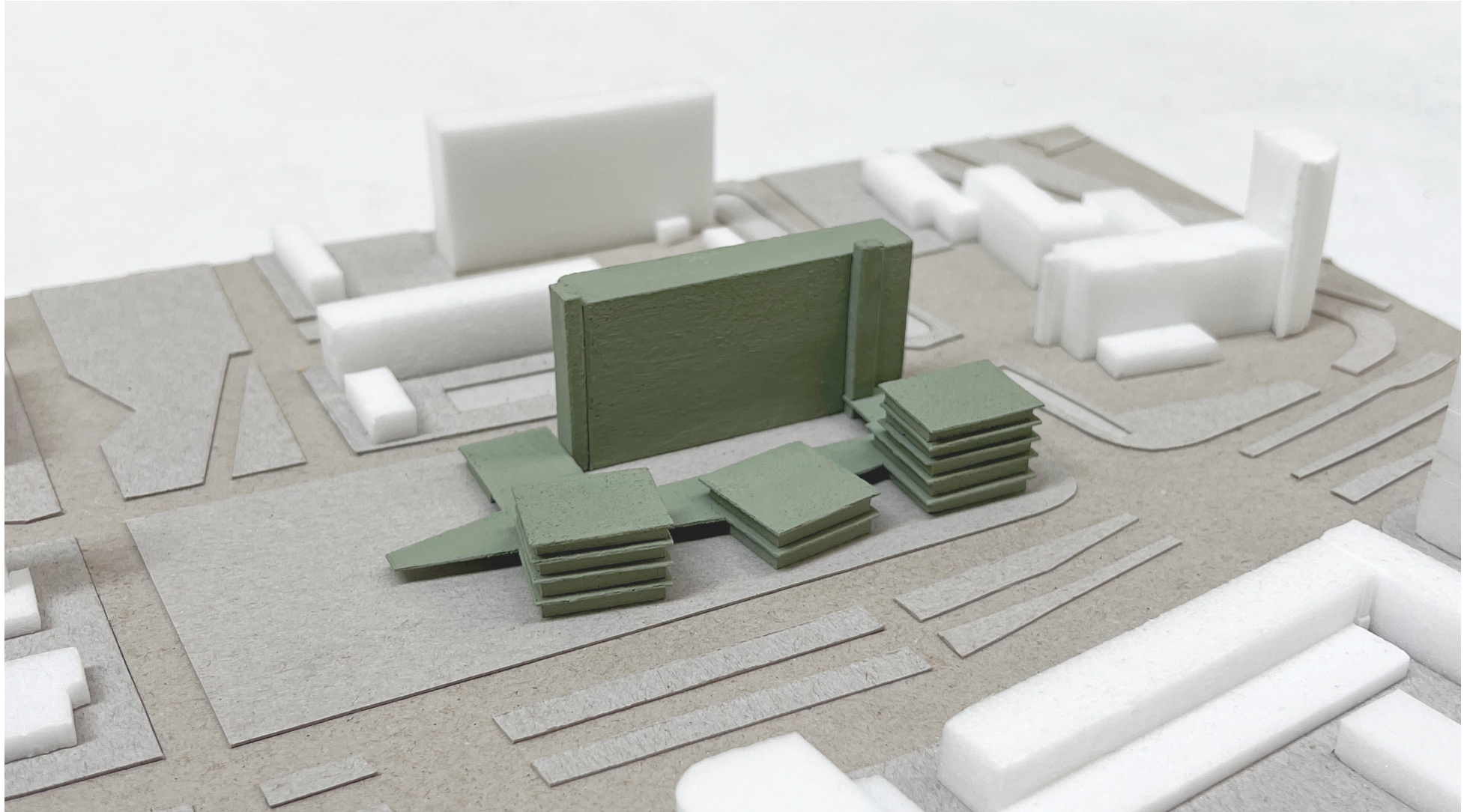

dwelling in existing structure

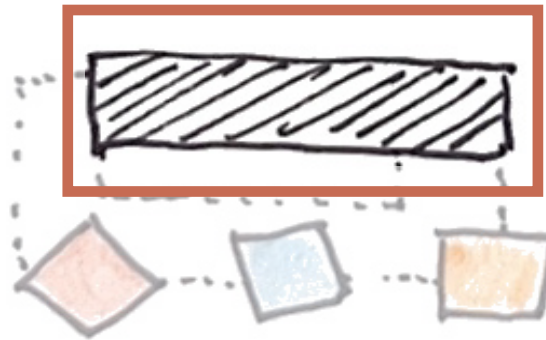

MuWi – Construction

- widespread building system in the post-war period
- more than 30.000 buildings in the Netherlands
- simple and flexible fundamental principle
 - > few qualified workers were required
 - > quick assembly on site

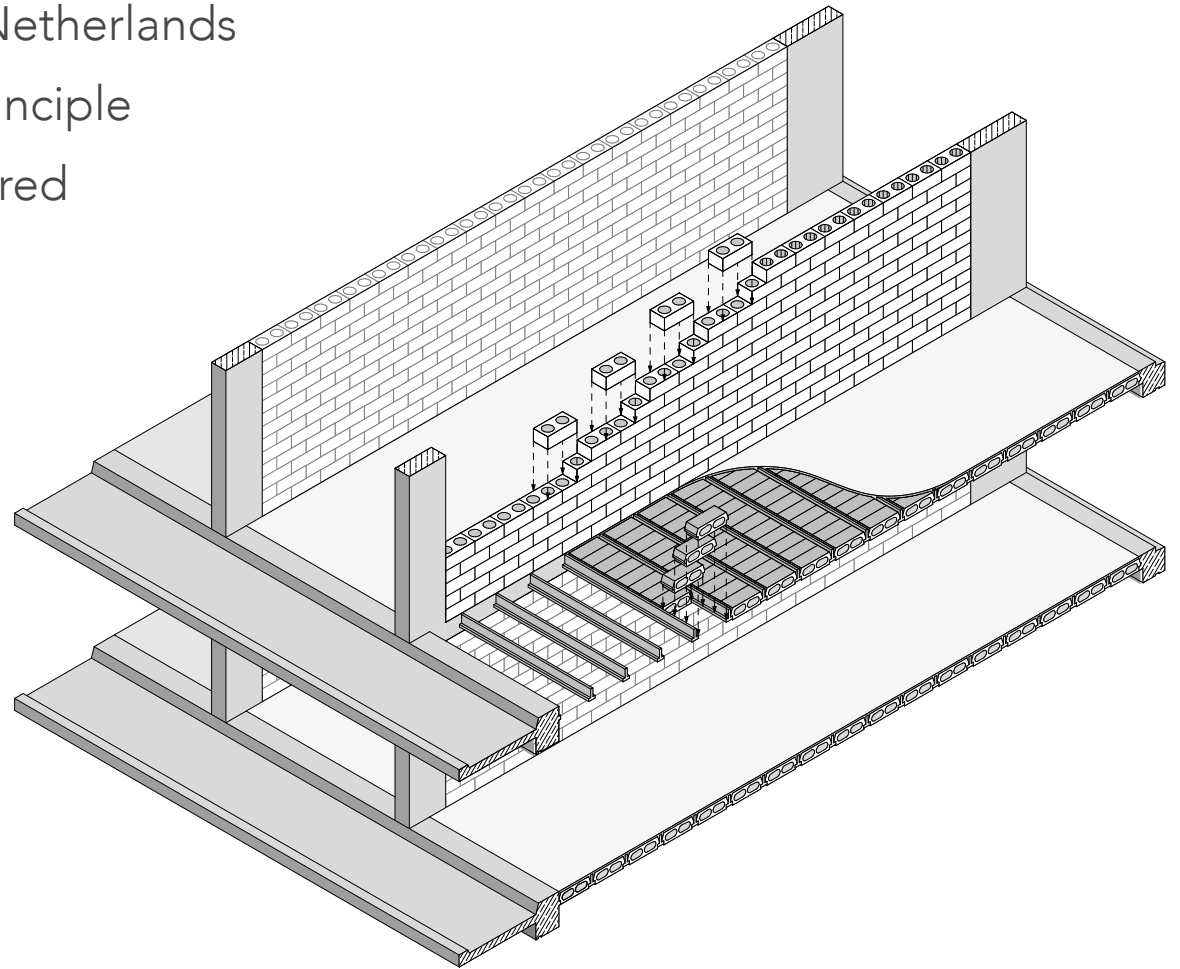
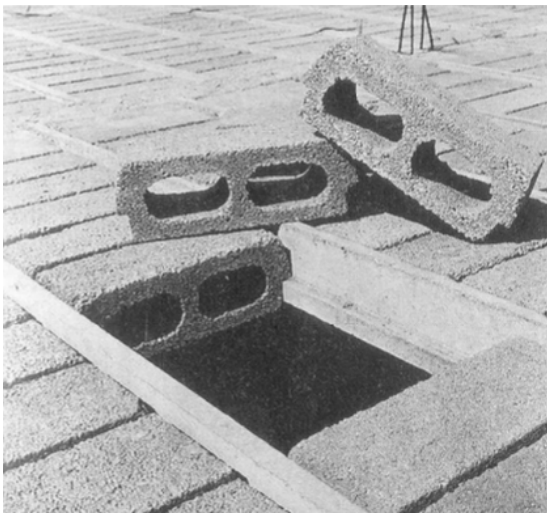

design principles

current situation



design principles

- removal of the interior walls and exterior skin
- removal of rundown galleries incl. stairwells and elevators

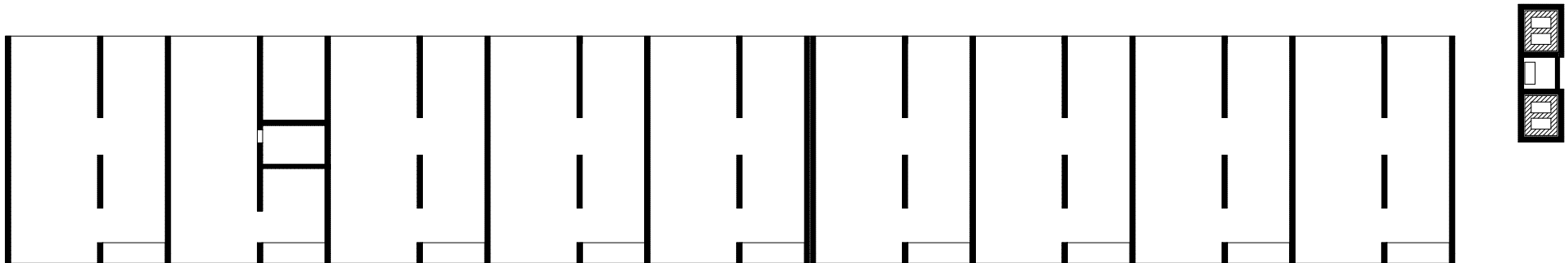

design principles

introduction of centrally positioned shafts for flexible floorplans

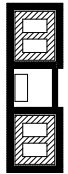
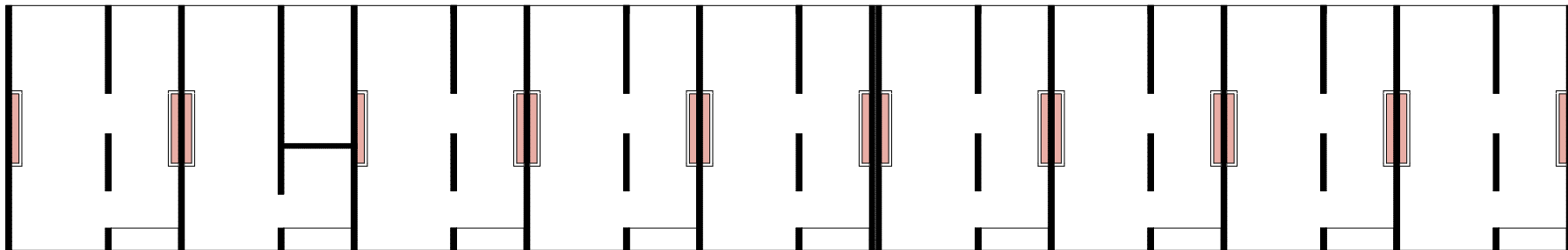

design principles

introduction of a new outer skin and offset gallery incl. new stairwells and elevators

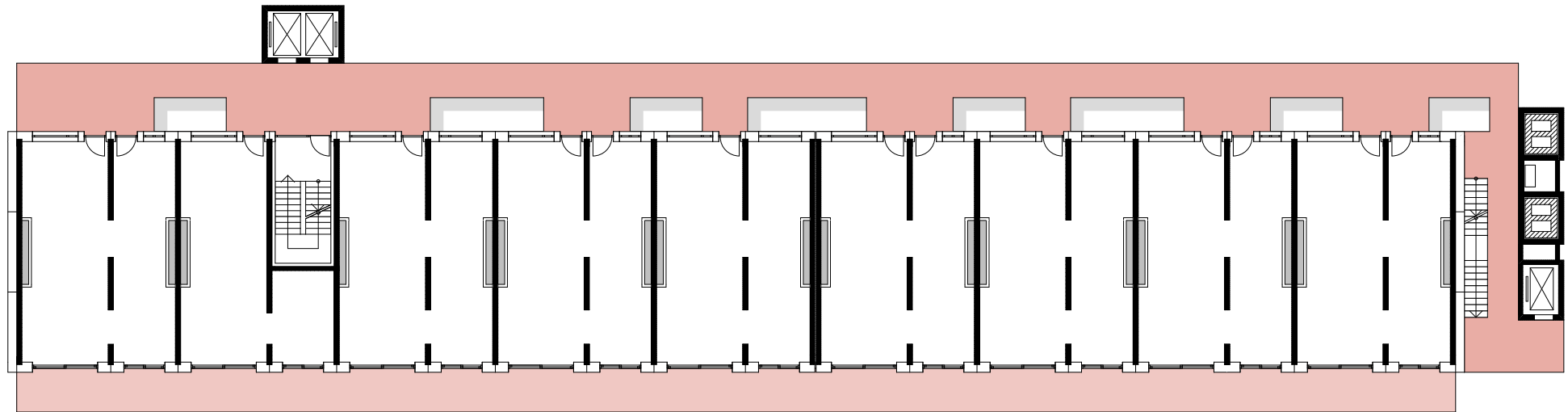

design principles

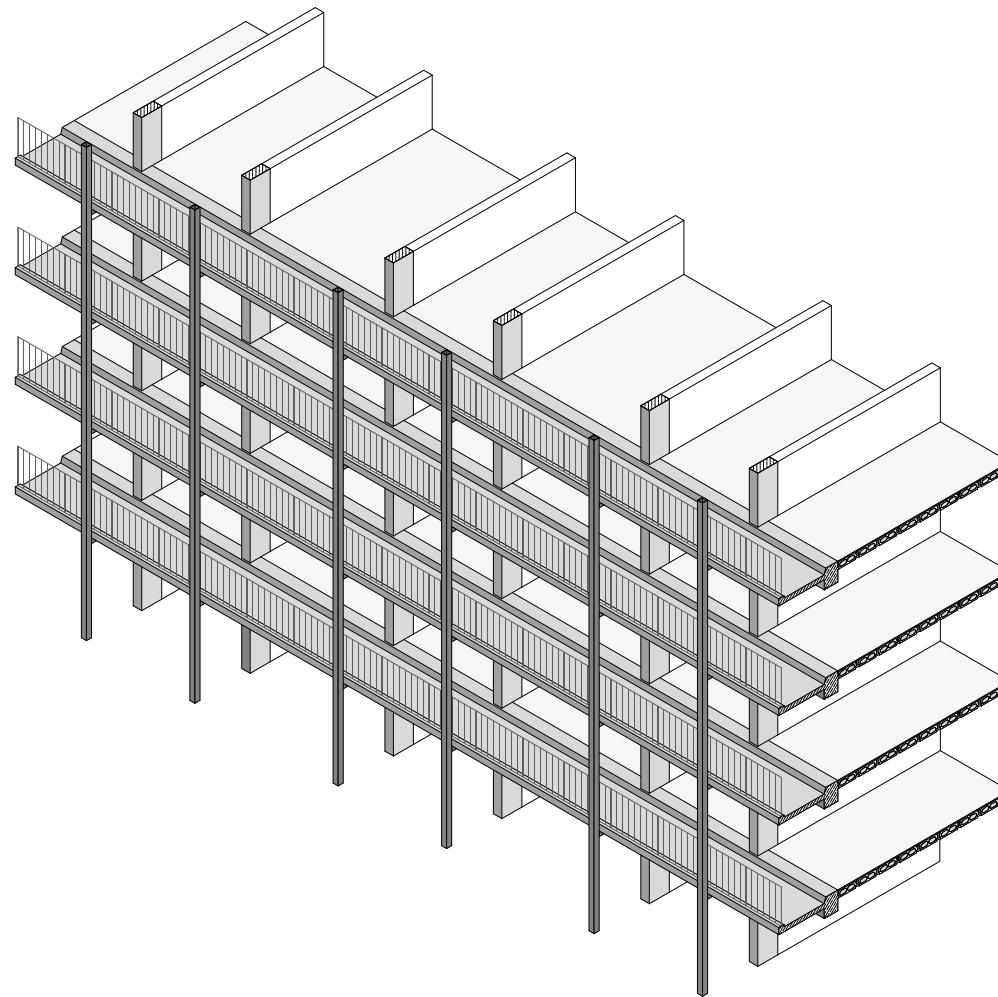

design principles

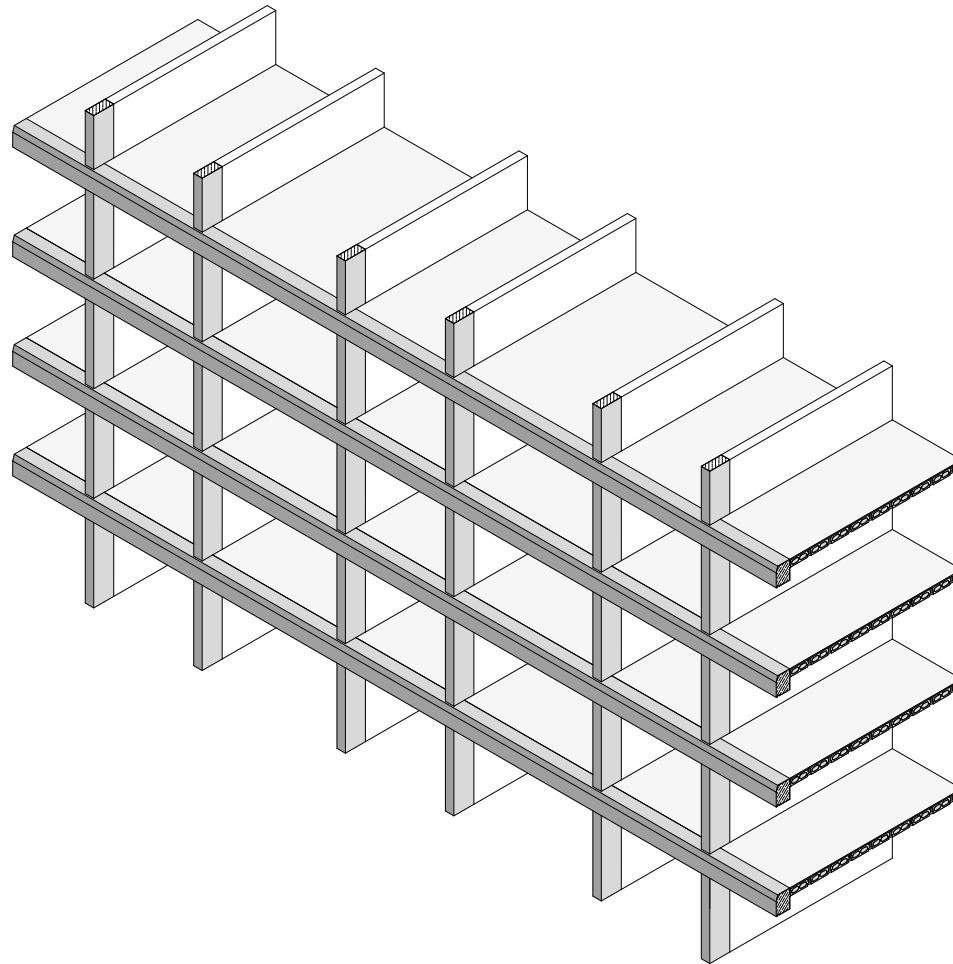

design principles

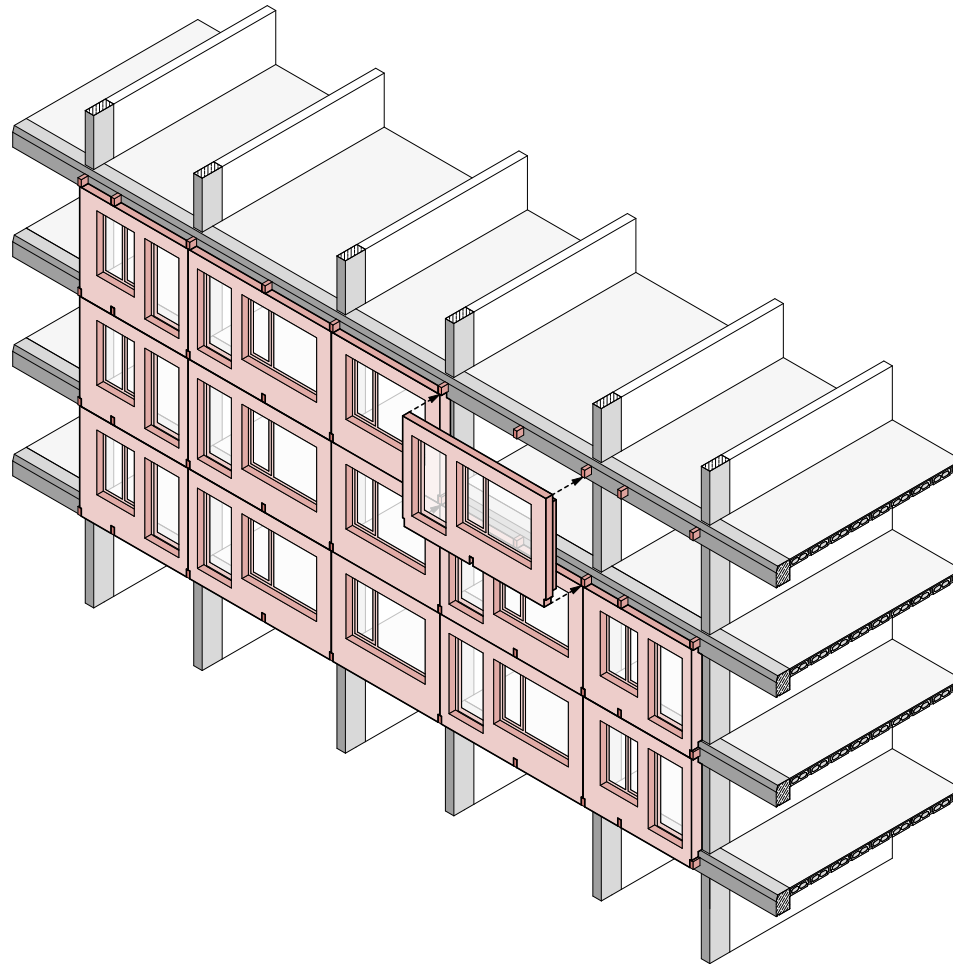

design principles

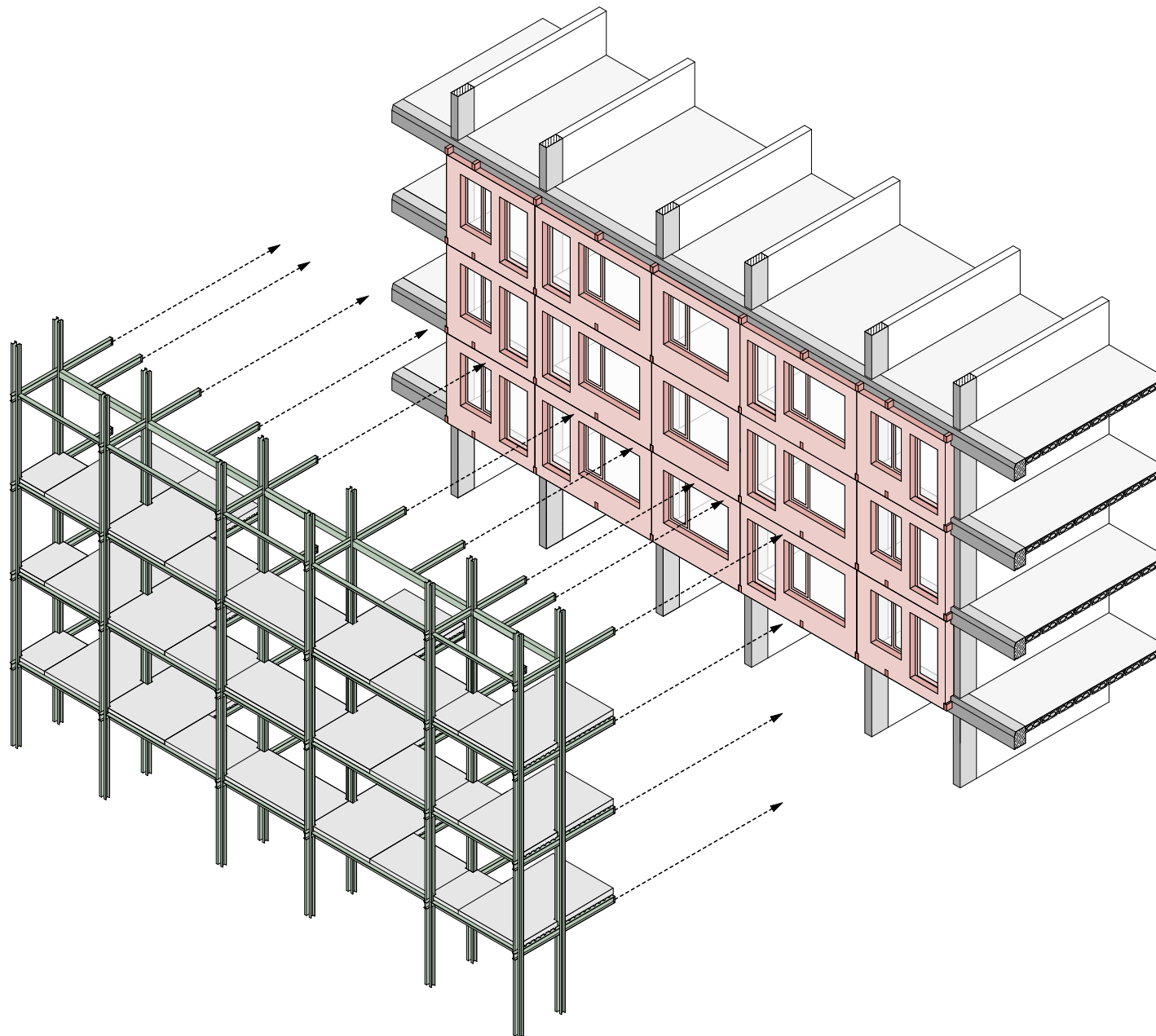



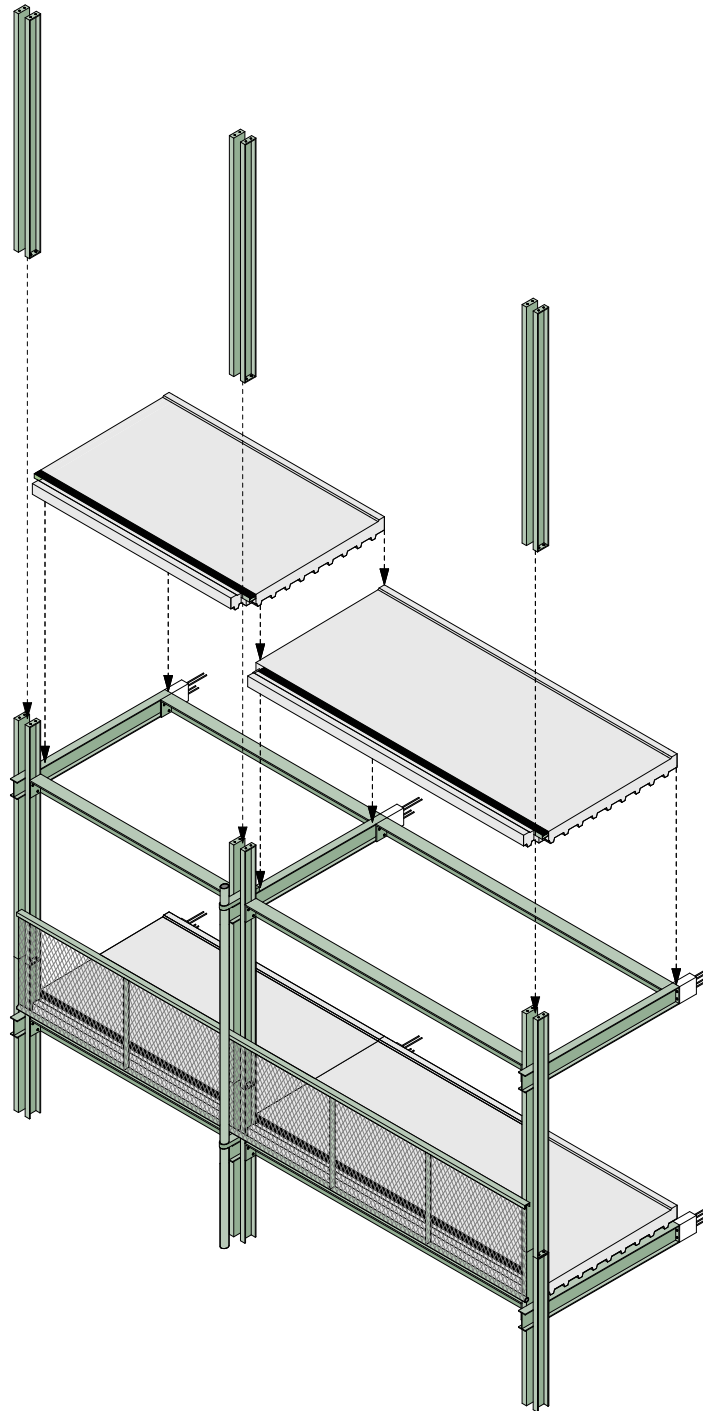

design principles



apartment layout

exemplary floor plan









-  student apartment (28m²)
-  starter apartment (38m² – young professionals, couples)
-  Maisonette apartment (60m² – couples / working + living)
-  elderly-friendly apartment (54m²)
-  young family apartment (70m²)

apartment layout

exemplary floor plan +1



- | | |
|--|--|
|  student apartment (28m ²) |  elderly-friendly apartment (54m ²) |
|  starter apartment (38m ² – young professionals, couples) |  young family apartment (70m ²) |
|  Maisonette apartment (60m ² – couples / working + living) |  shared living apartment (85m ²) |

diversity on all levels

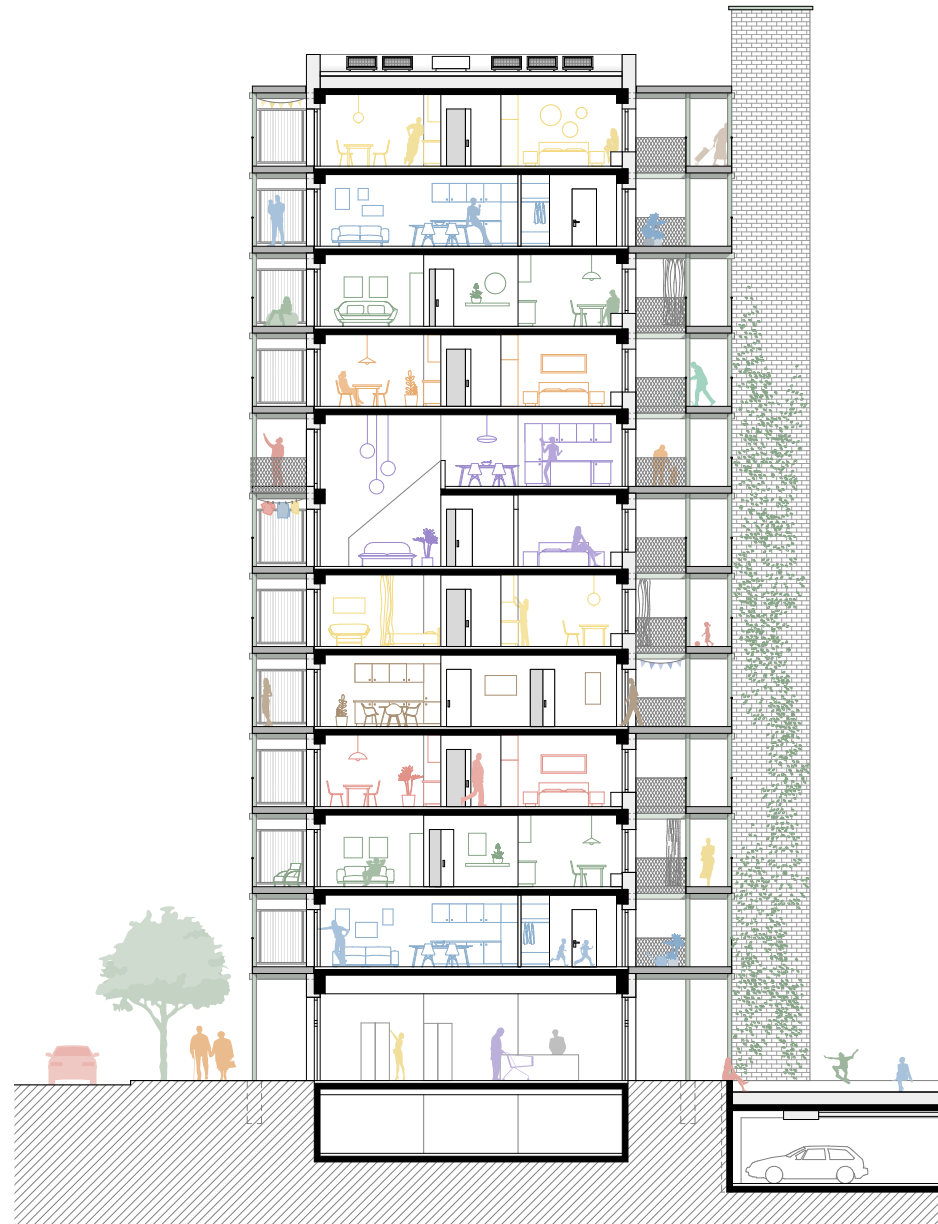

climate concept

1. passive climate measures

- 1.1 solar input at low sun position
- 1.2 shading at high sun position
- 1.3 green roof

2. active climate measures

- 2.1 floor heating
- 2.2 air extraction from internal bathrooms
- 2.3 decentralized ventilation units
- 2.4 clay building boards
- 2.5 underground car park ventilation

3. energy sources

- 3.1 district heating
- 3.2 exhaust air heat pump
- 3.3 PV system
- 3.4 geothermal wall panels in UG parking

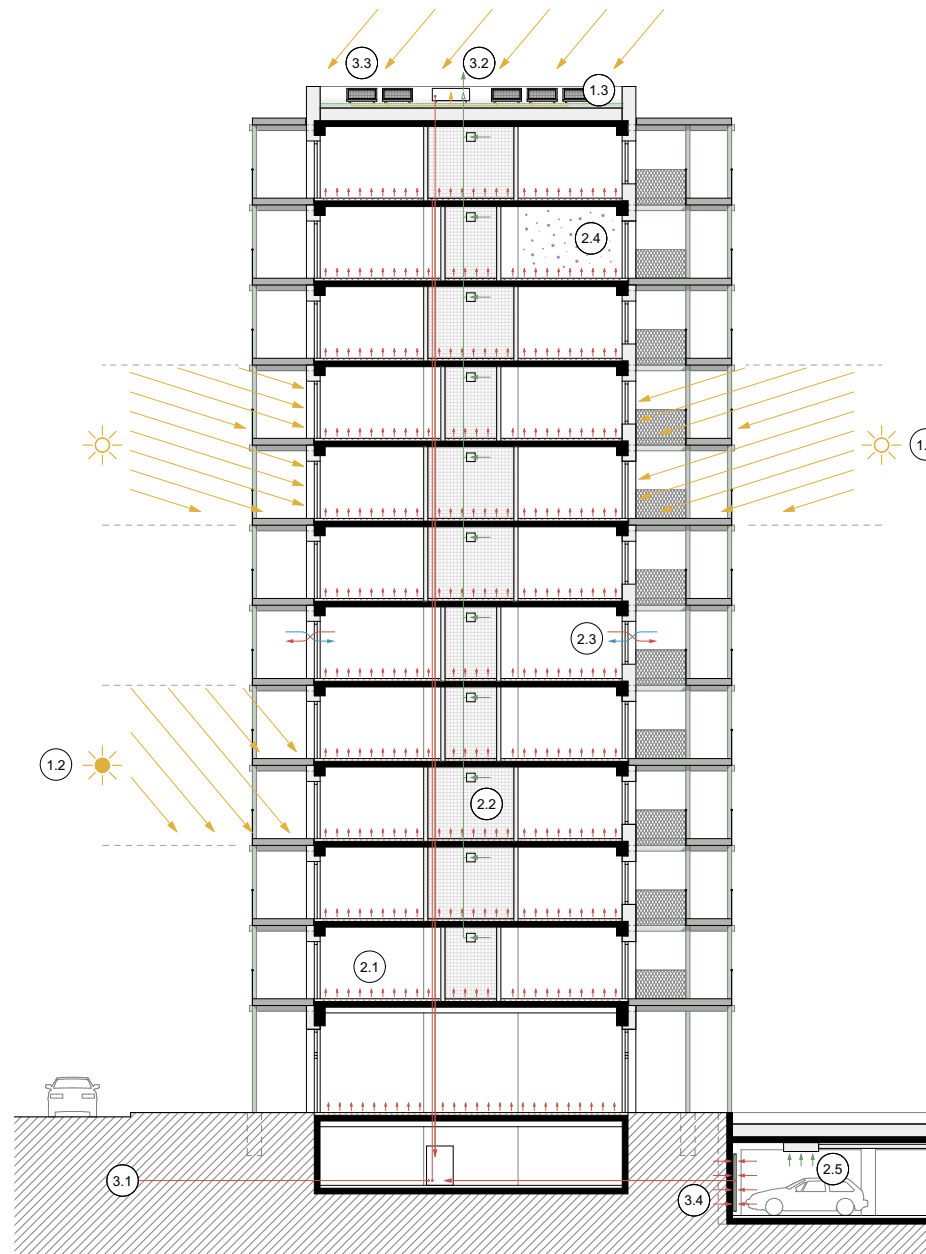

elderly-friendly apartment

flexibility as a guiding theme

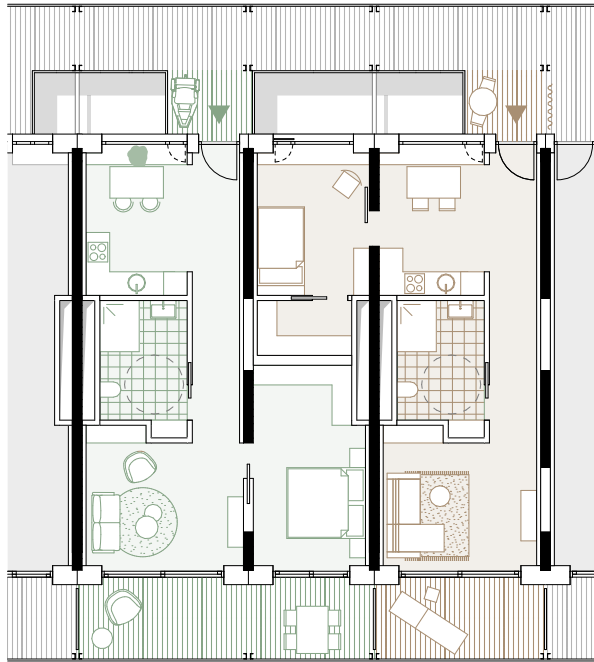

option 1

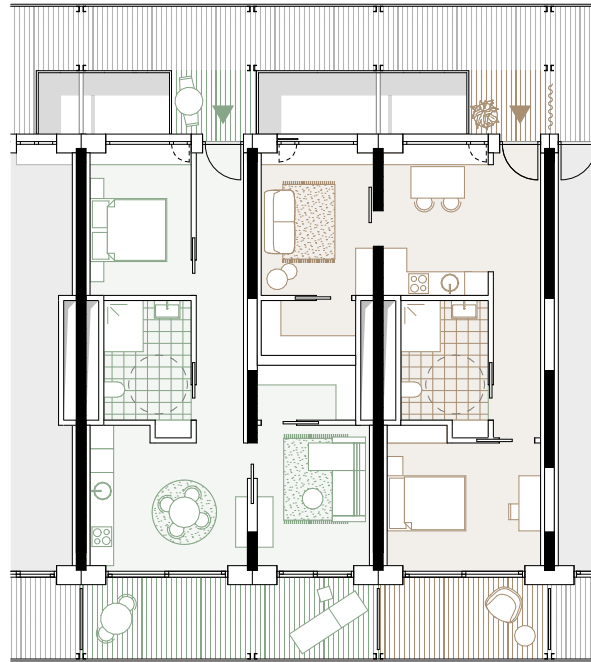

option 2

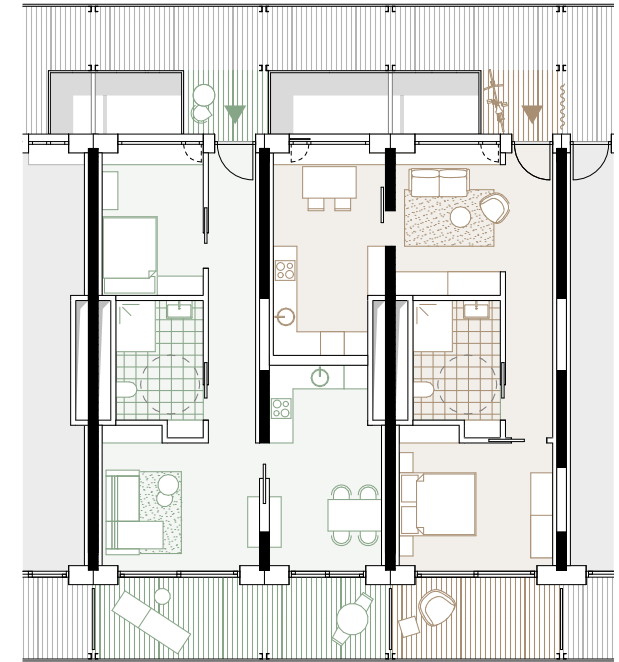

option 3



maisonette apartment

flexibility as a guiding theme



two into one – connecting apartments

flexibility as a guiding theme

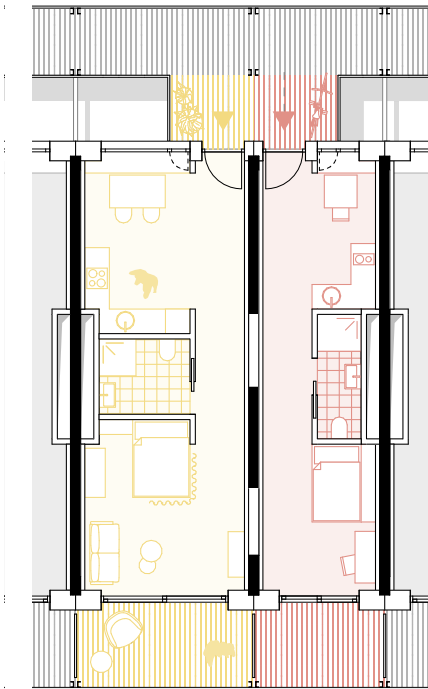

two separate apartments

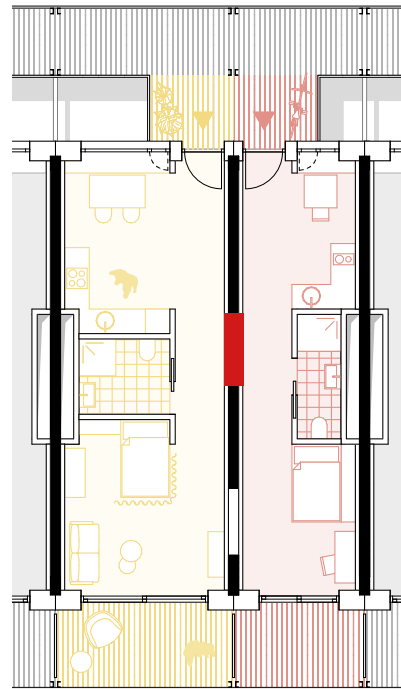

re-introduction of the wall opening

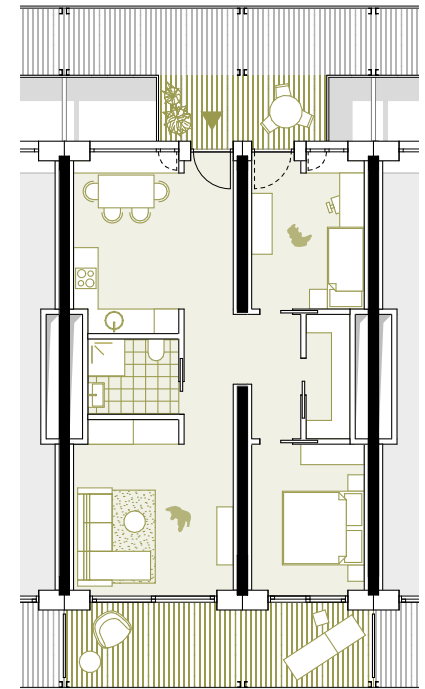

new layout



common rooms

8 common rooms for the „house community“

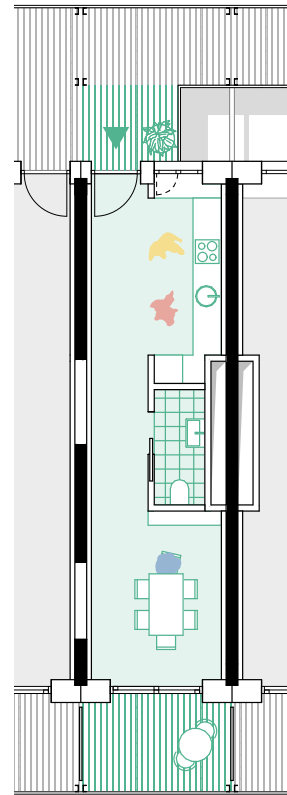
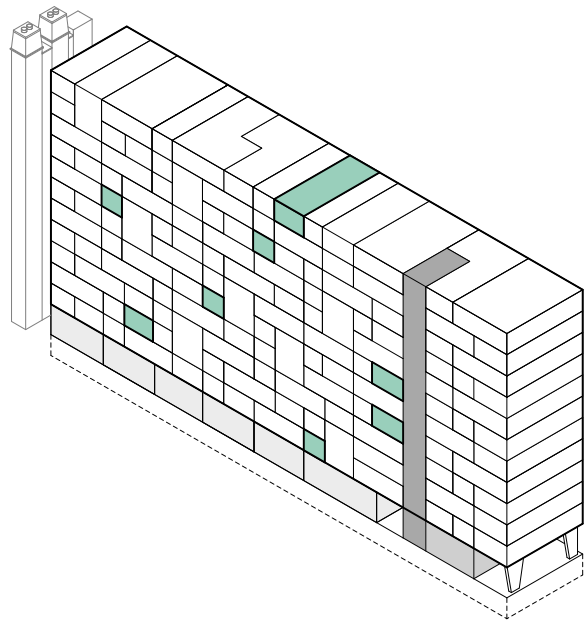

common room S

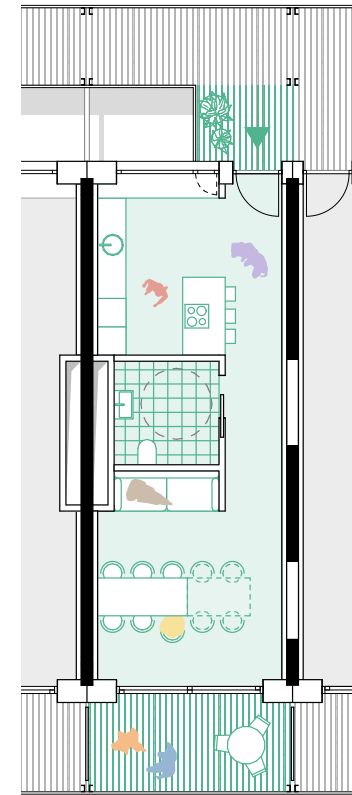

common room L



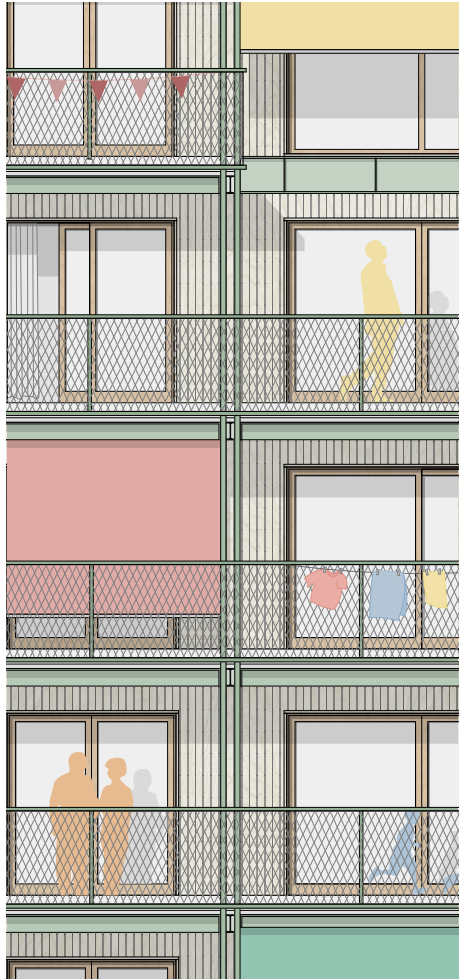

balconies

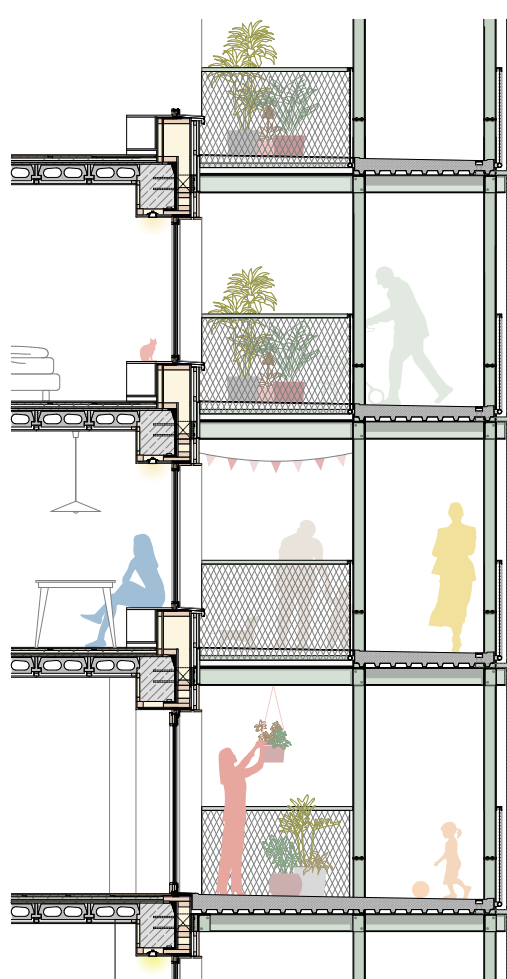
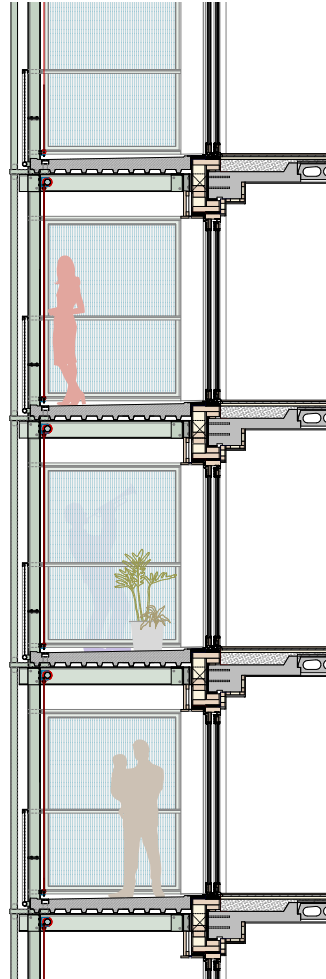

gallery accesses

from this...

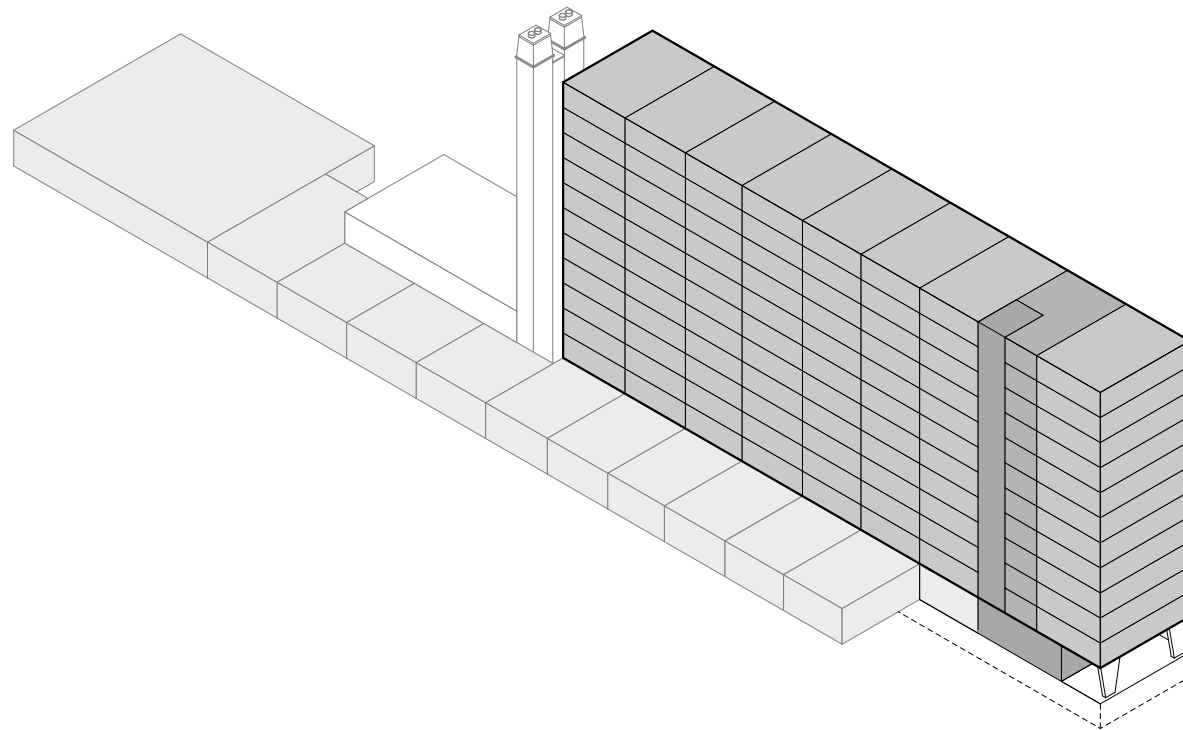

to this!

- student apartments: 40
- starter apartments: 18
- maisonette apartments: 8
- elderly-friendly apartments: 37
- young family apartments: 23
- shared living apartments: 4
- common rooms: 8
- small businesses (ground floor): 6

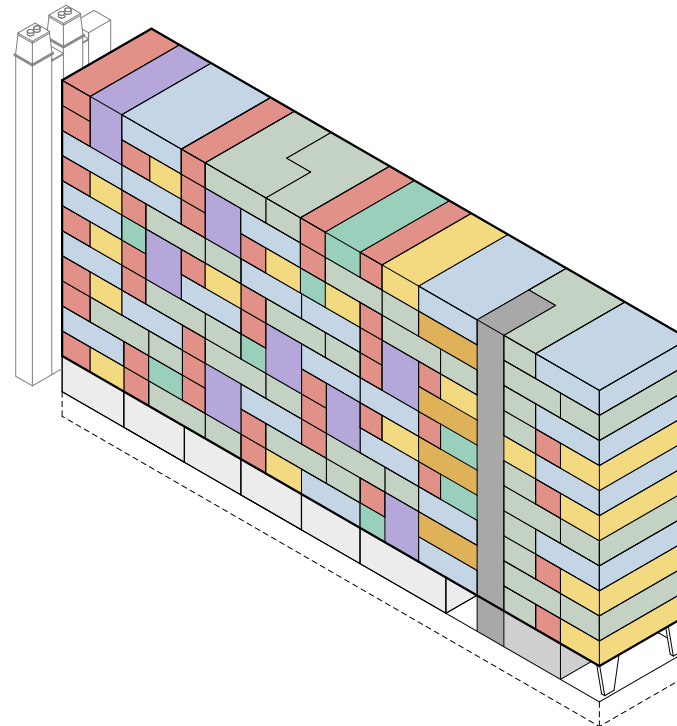

from this...

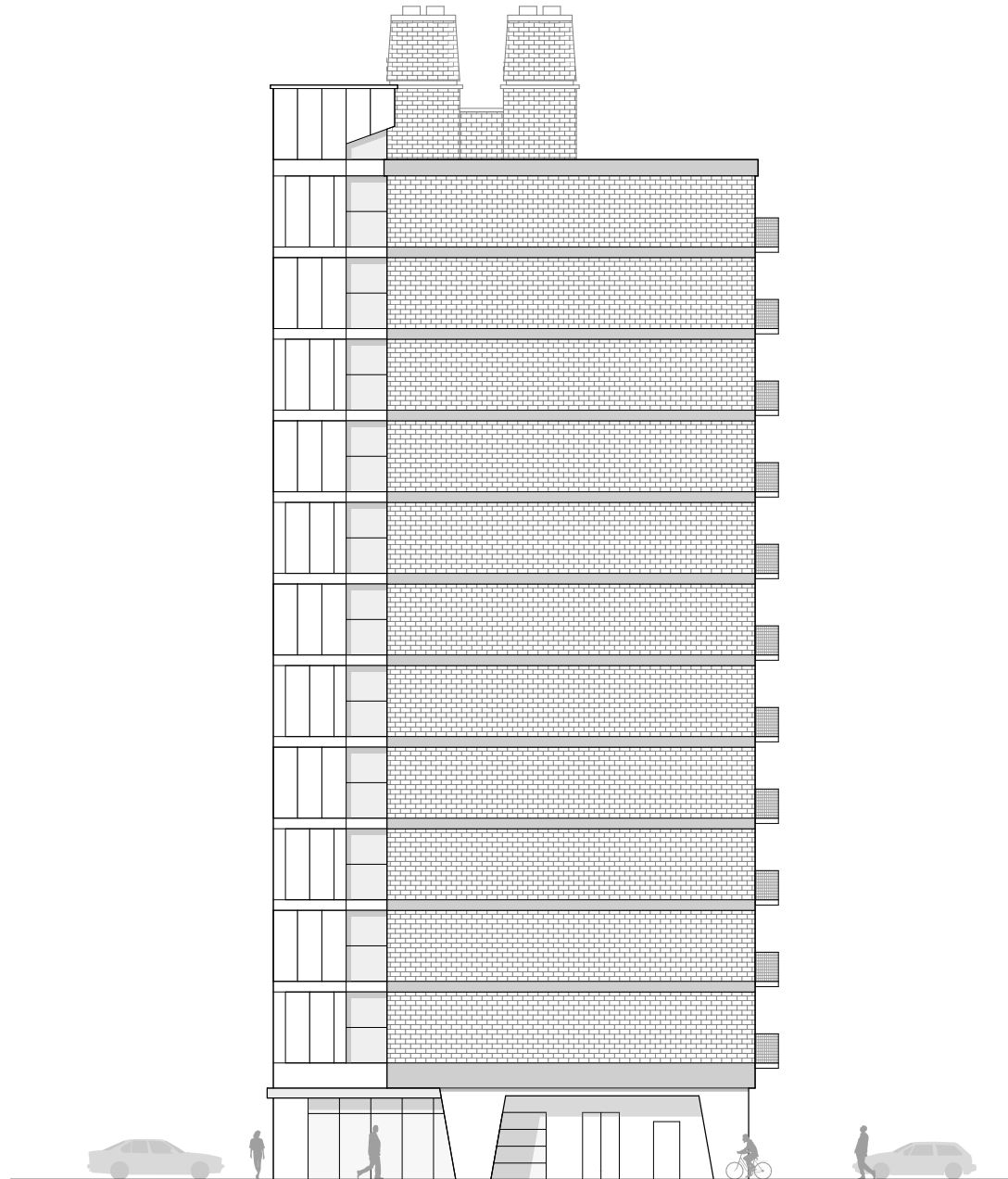

to this!

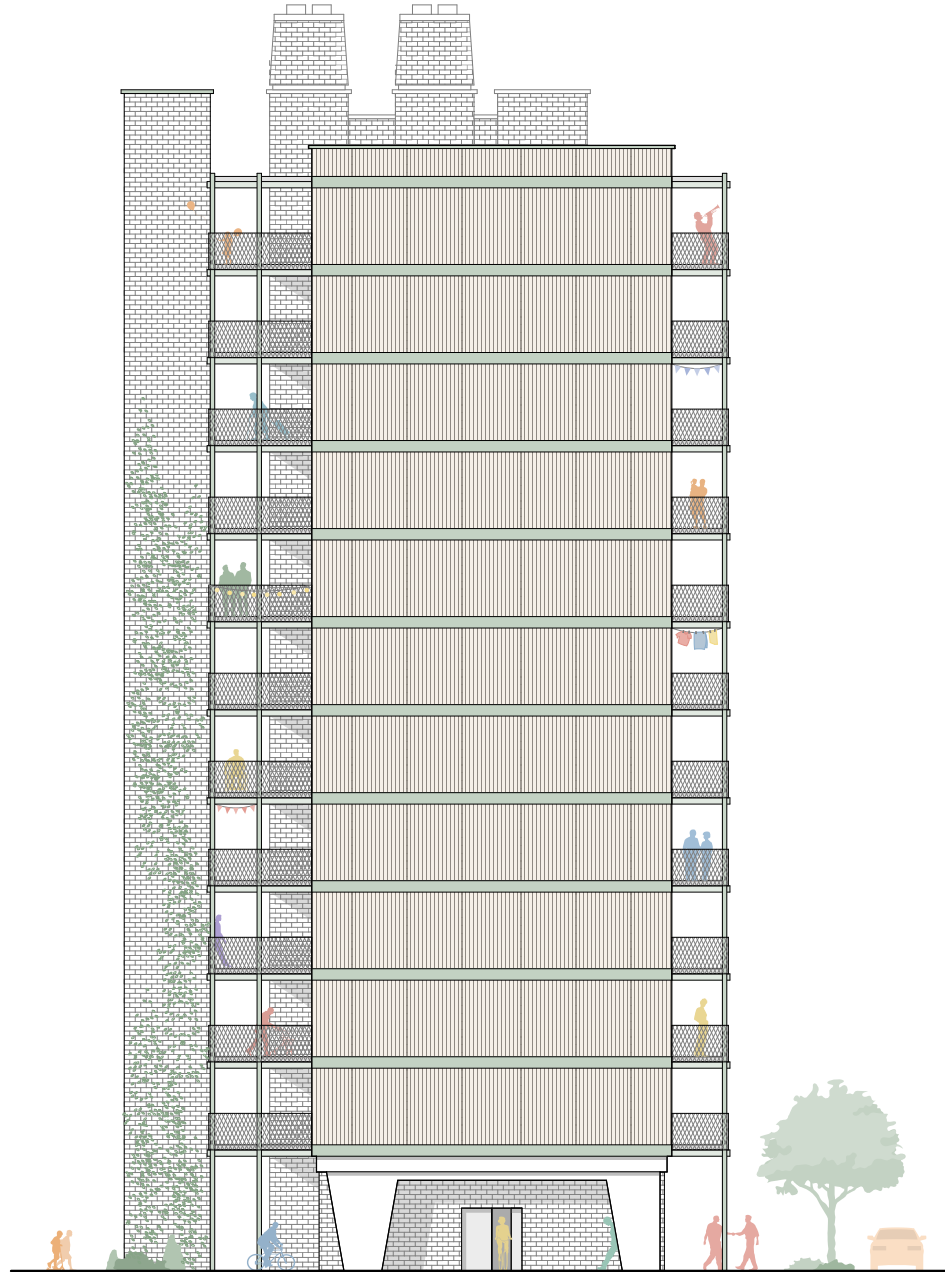

from this...



to this!



public health creation environment

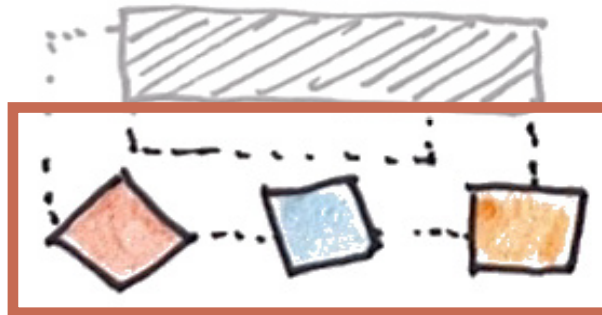

urban setting

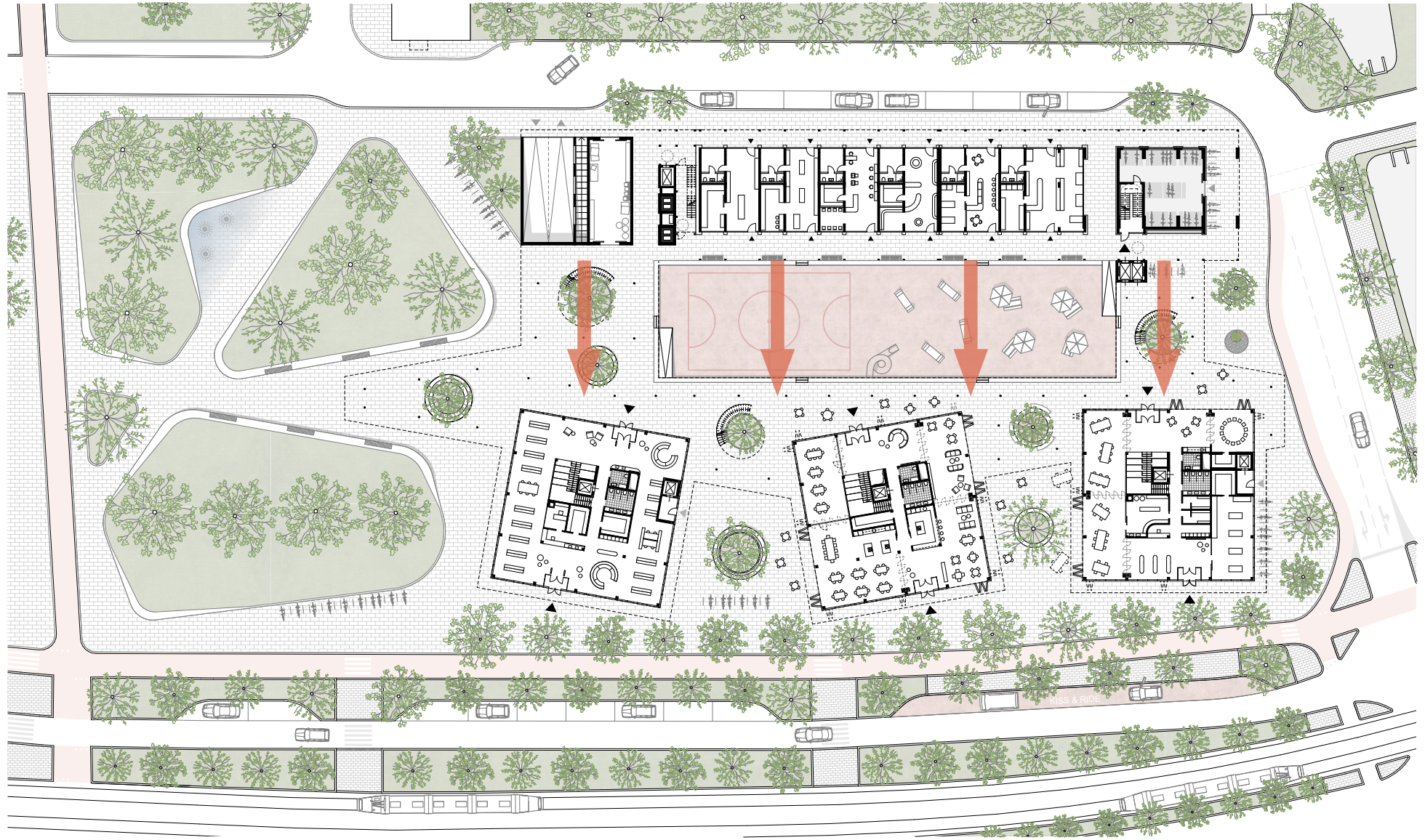

urban setting

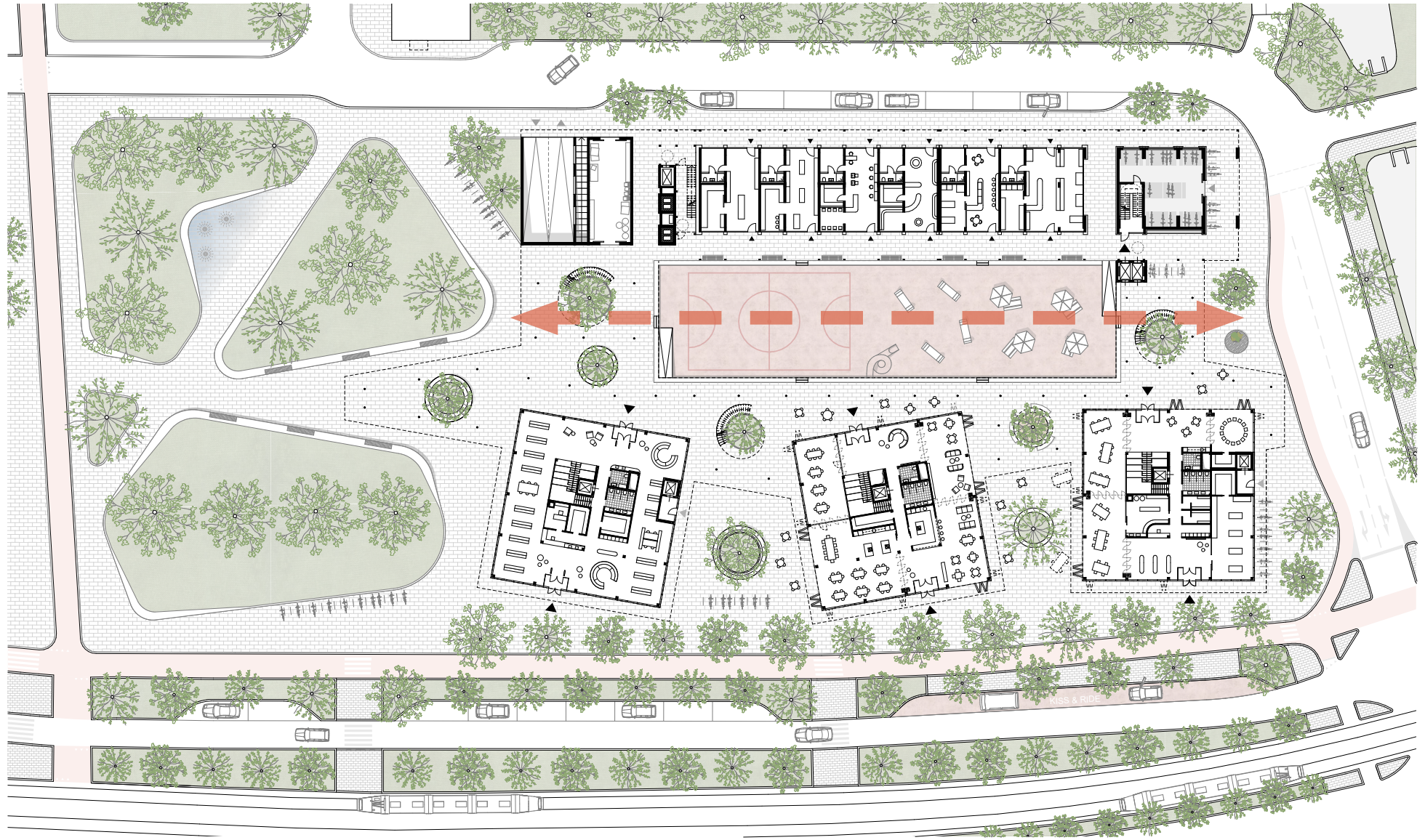

urban setting

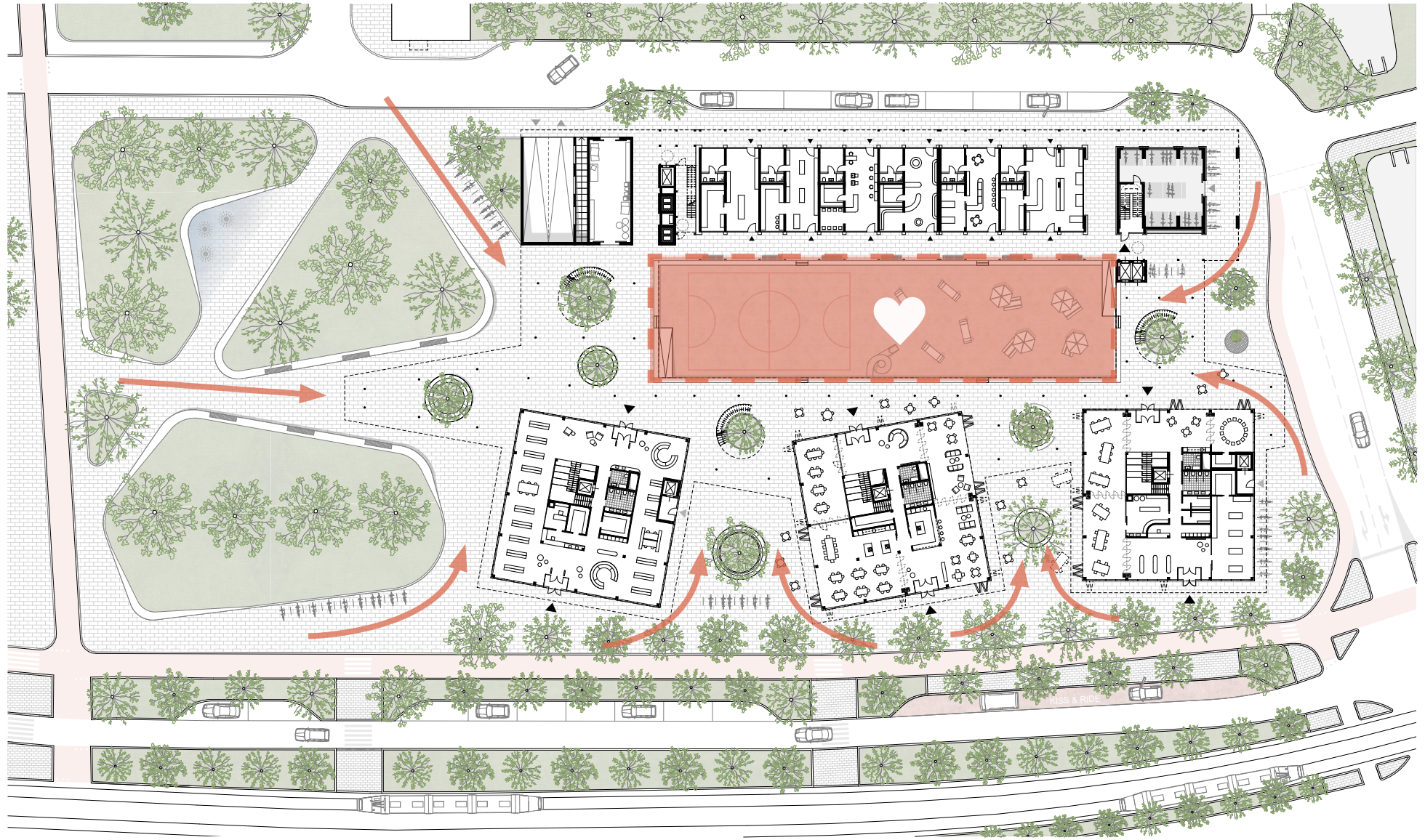

urban setting

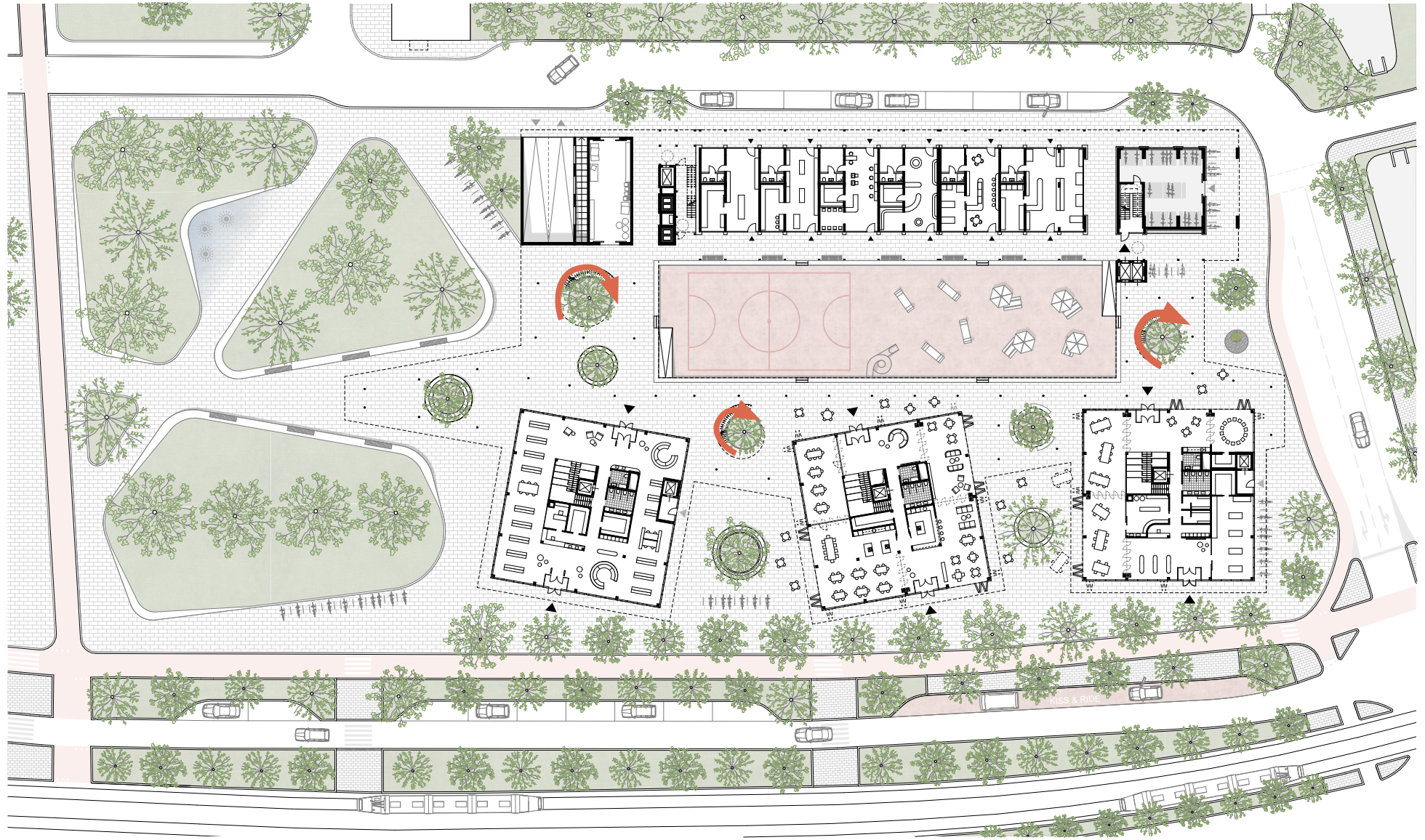

urban setting

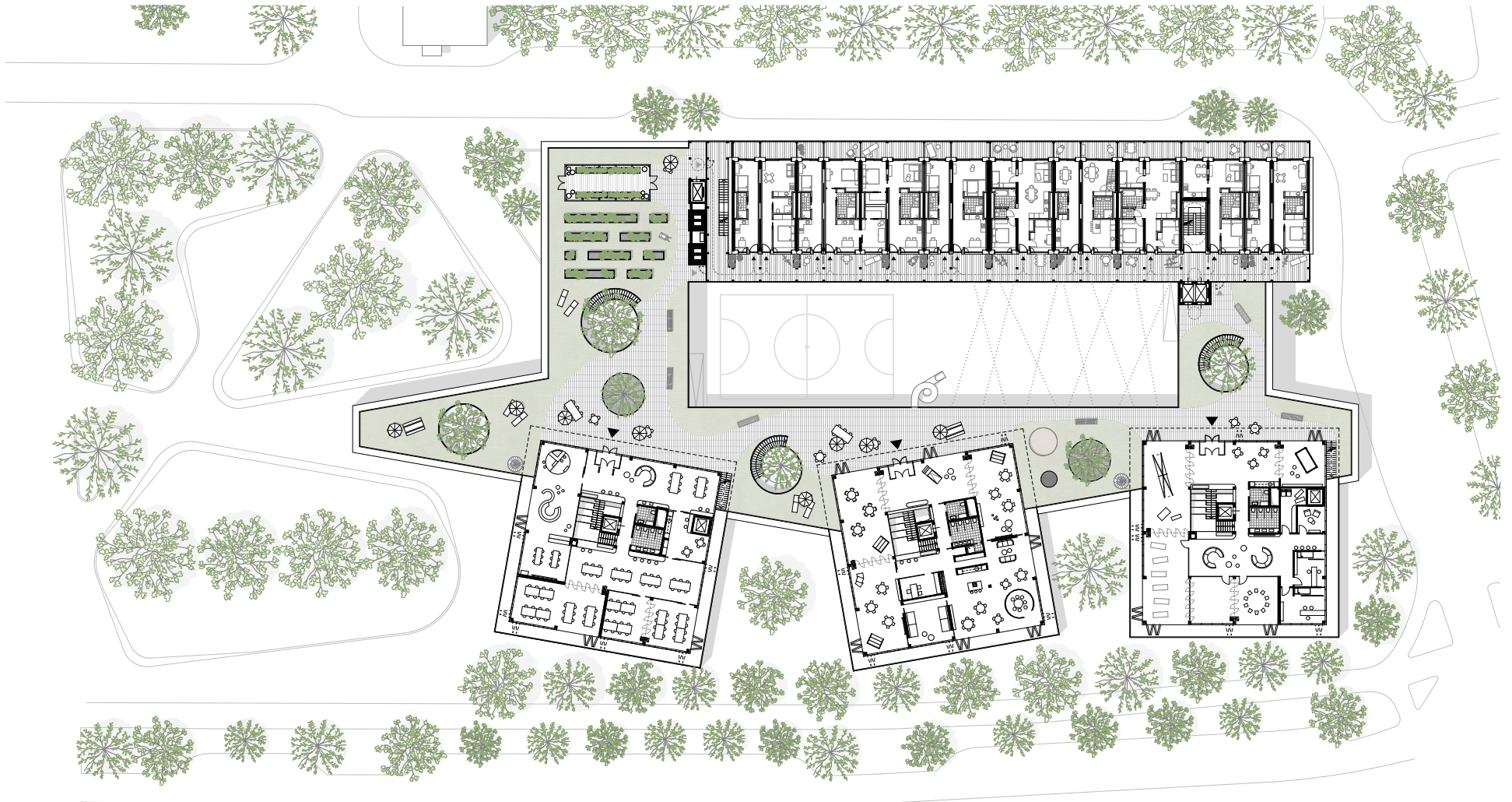

fundamental functions

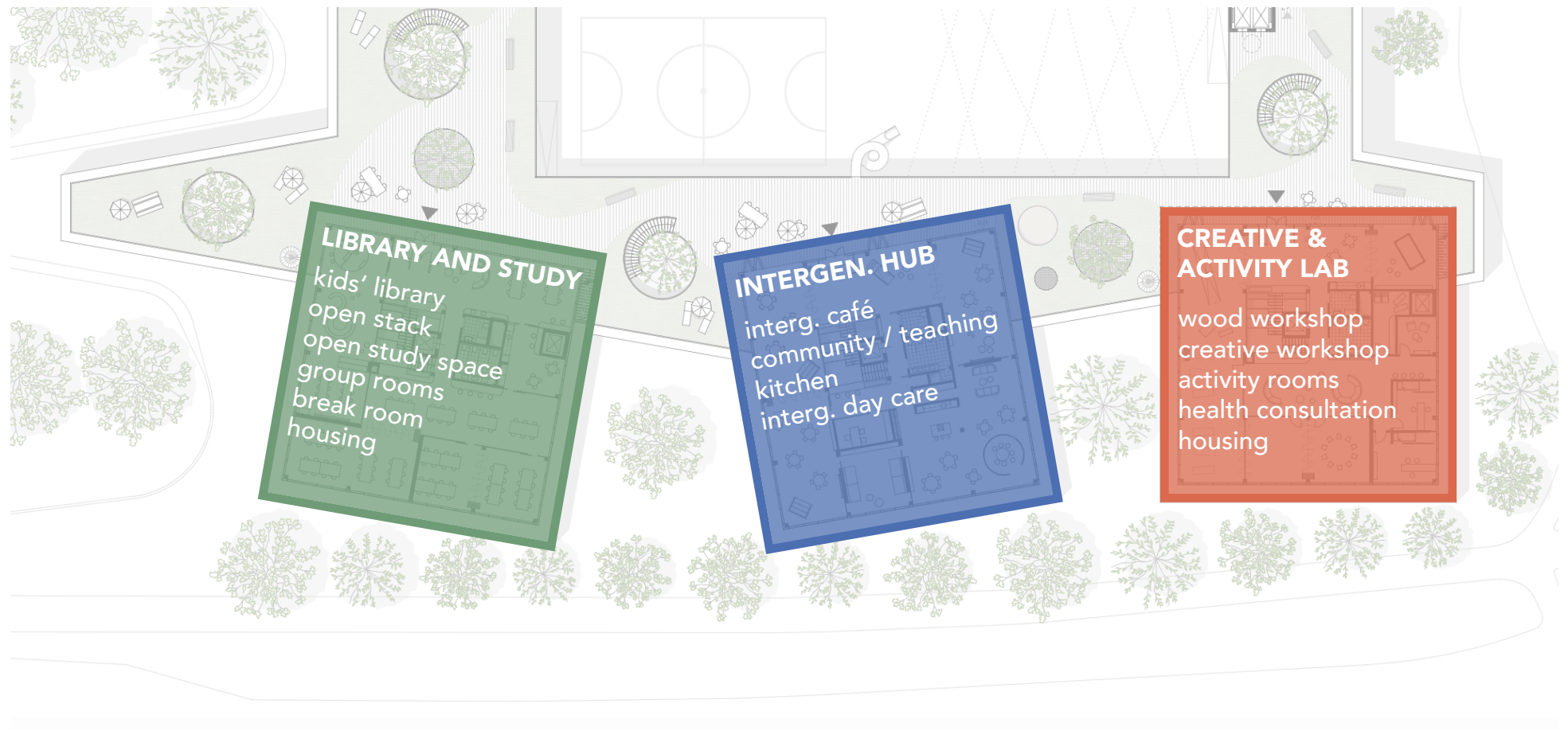

design principles

5x5m grid of underground parking as a guiding principle

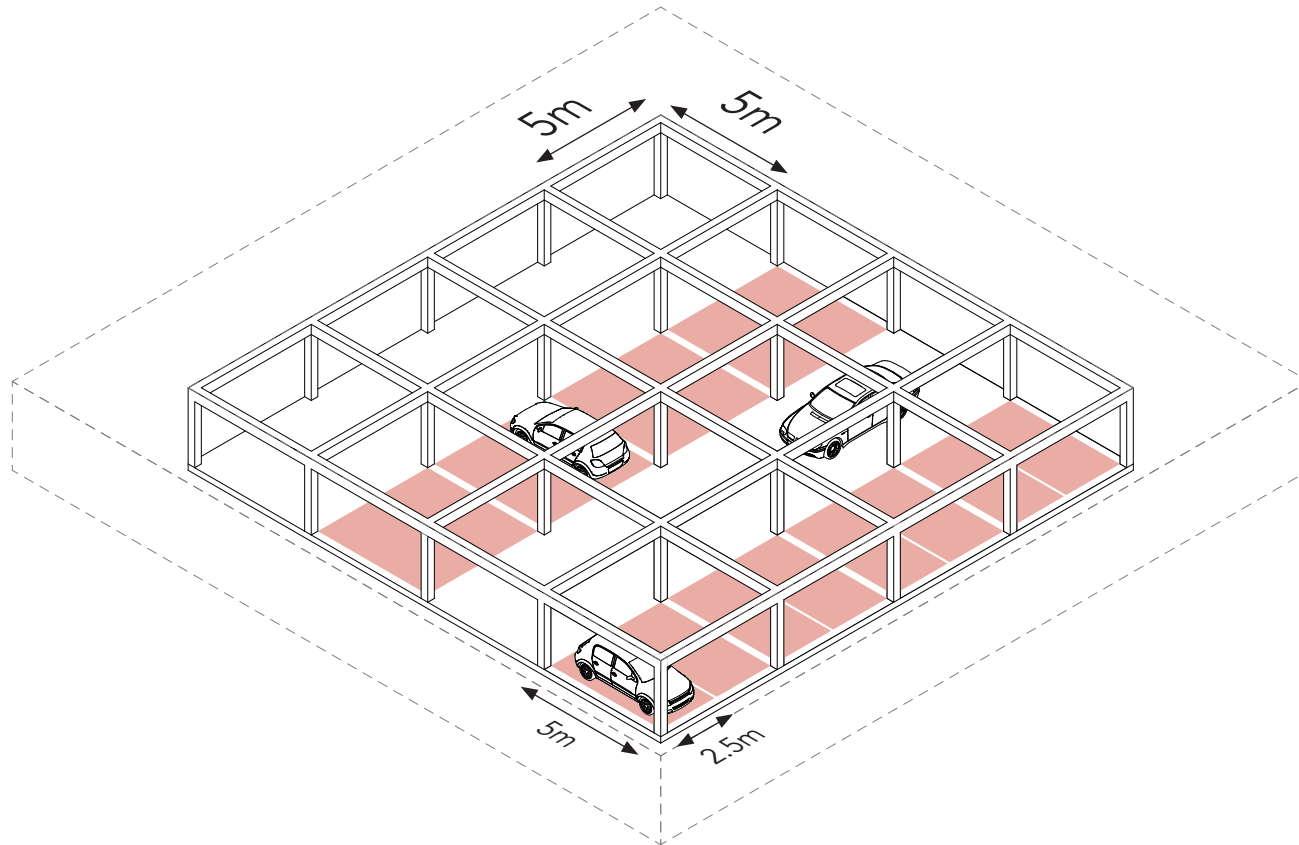

design principles

wooden structure above ground following the underground grid

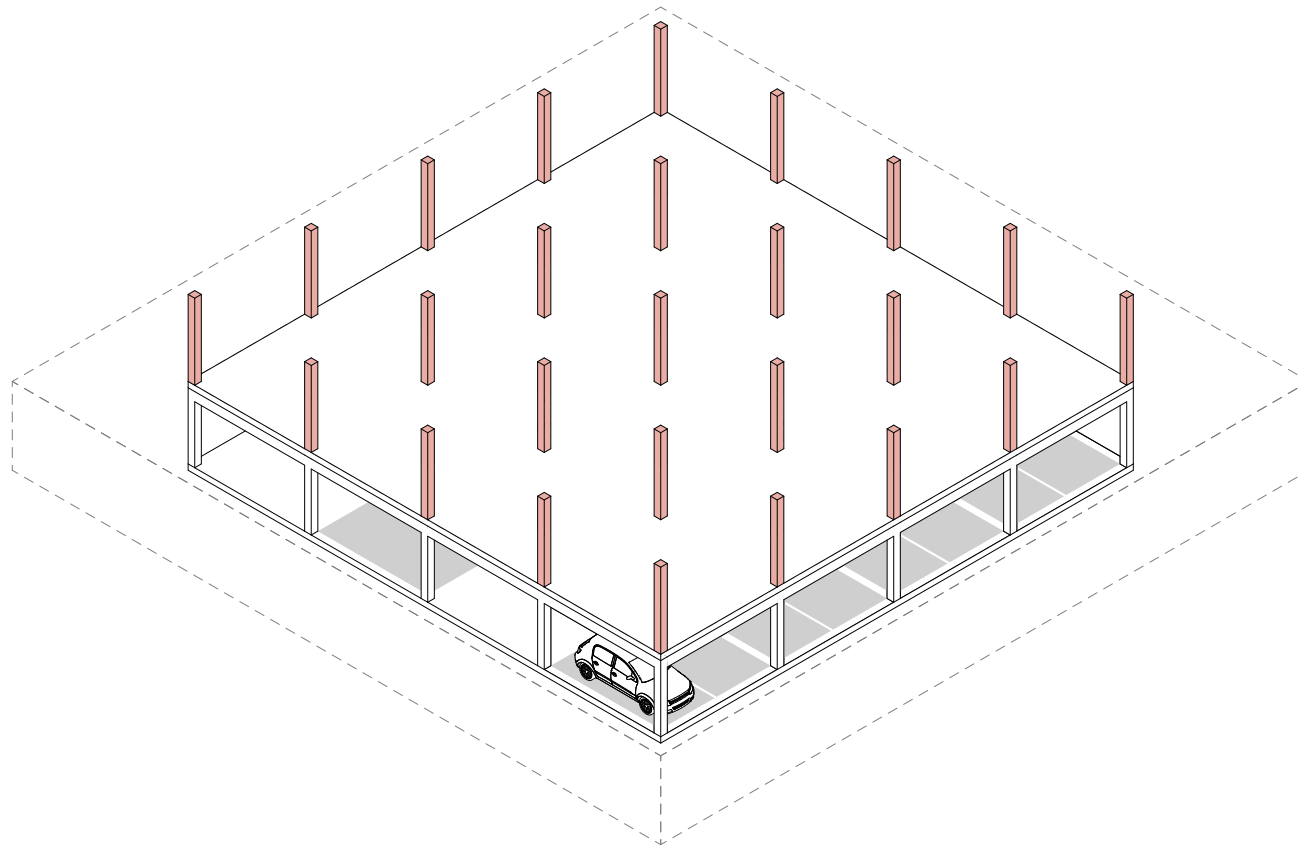

design principles

introduction of the „access package“

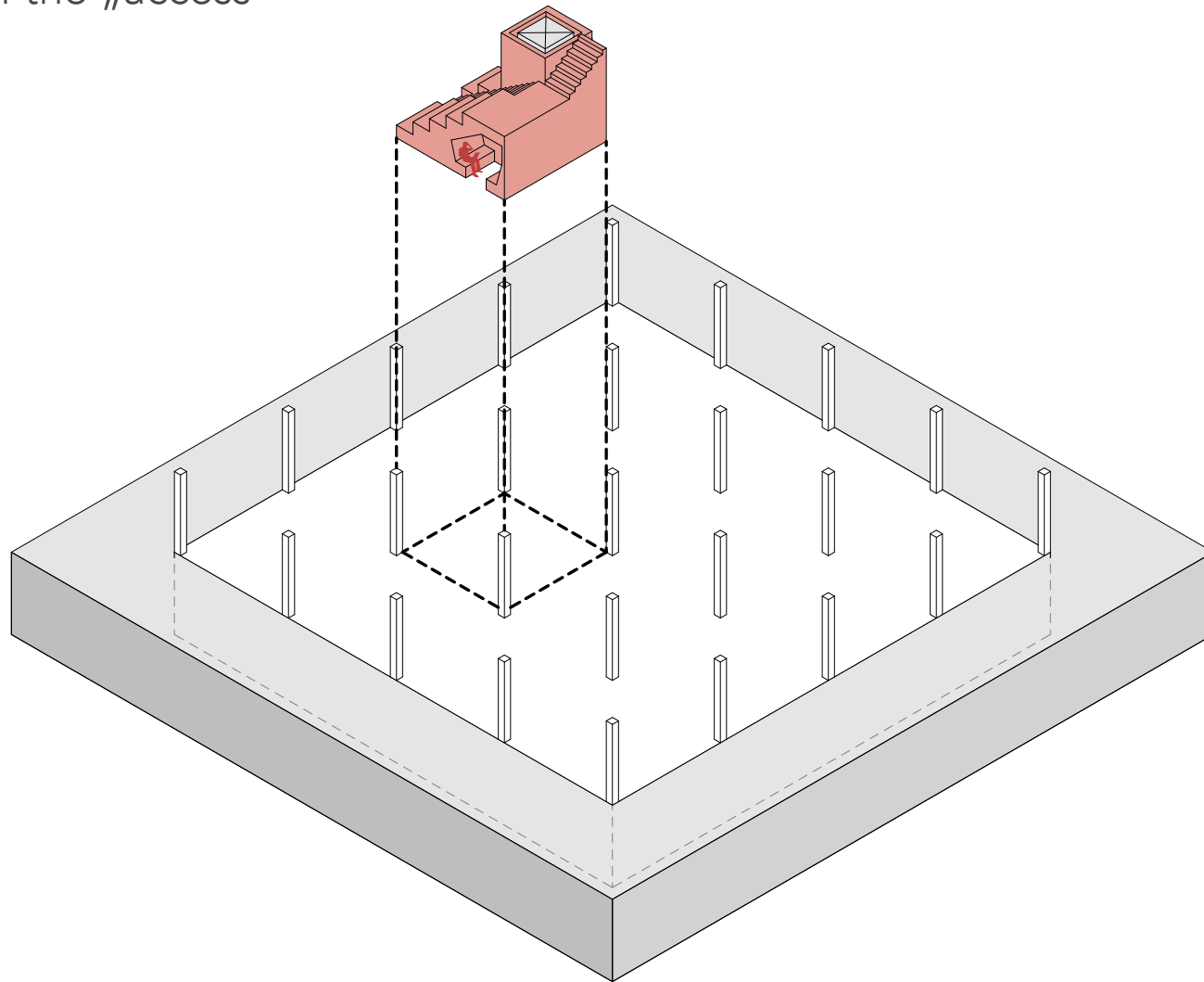

design principles

introduction of the „sanitary package“

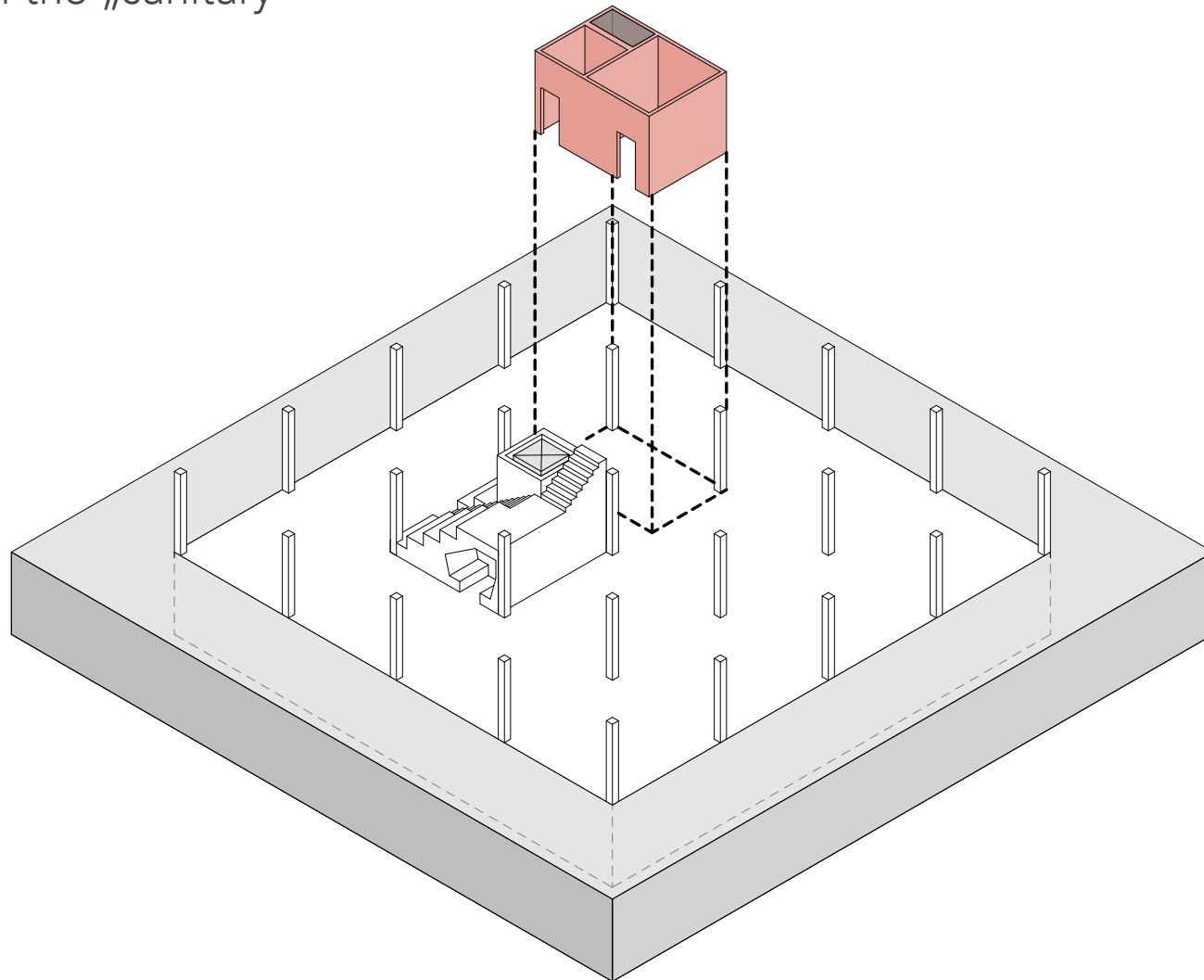

design principles

remaining core area reserved for diverse service functions

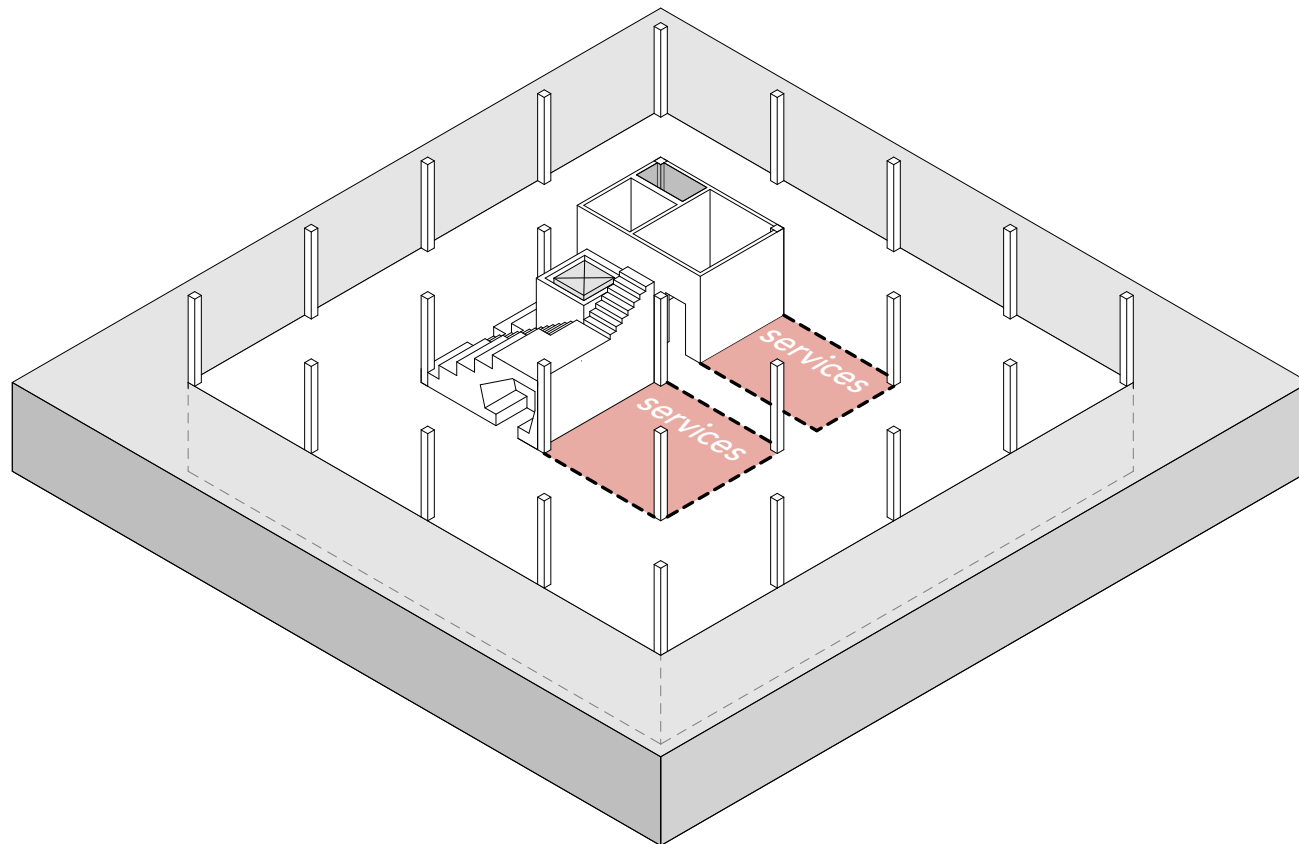

design principles

e.g. *InterGen Hub*: storage, community kitchen & serving counter

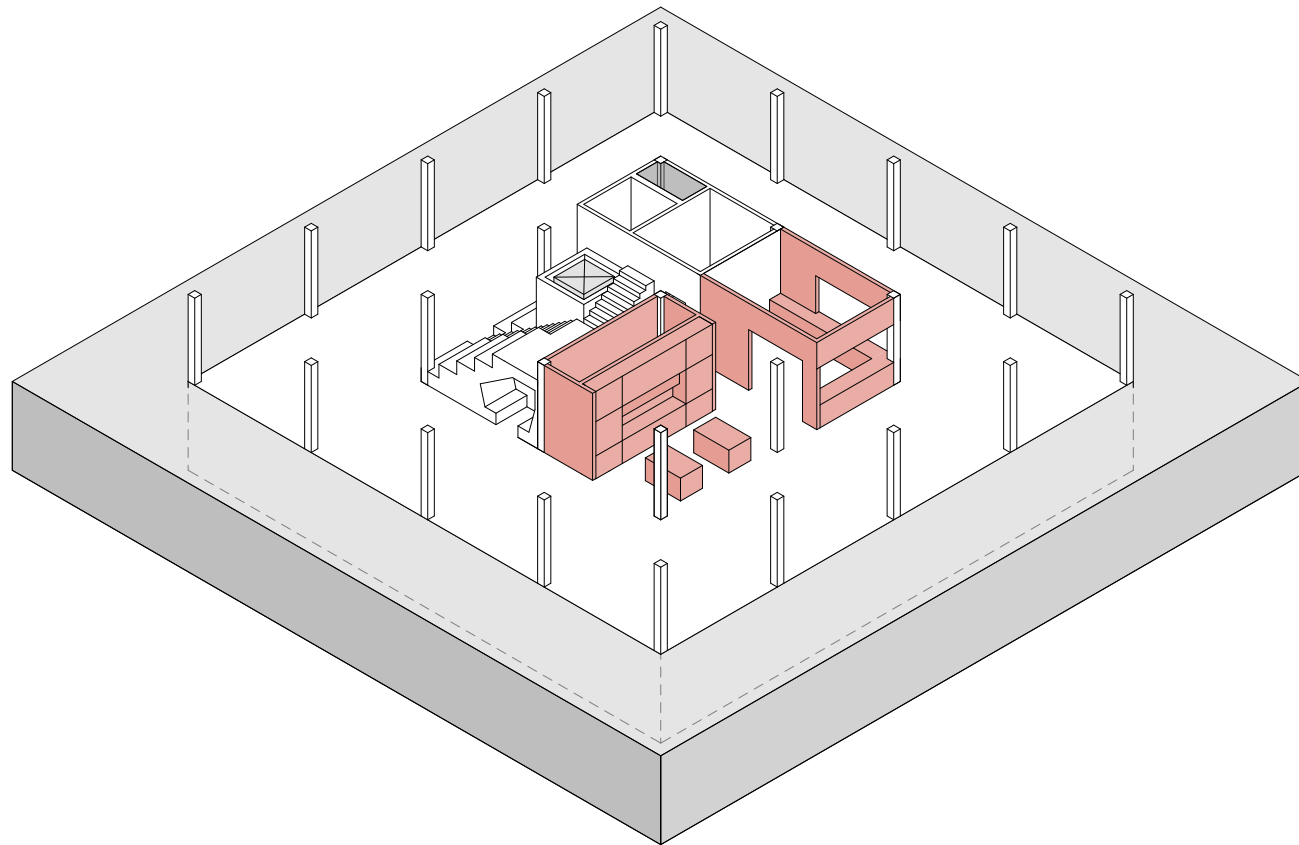

design principles

flexible spaces around the core functions

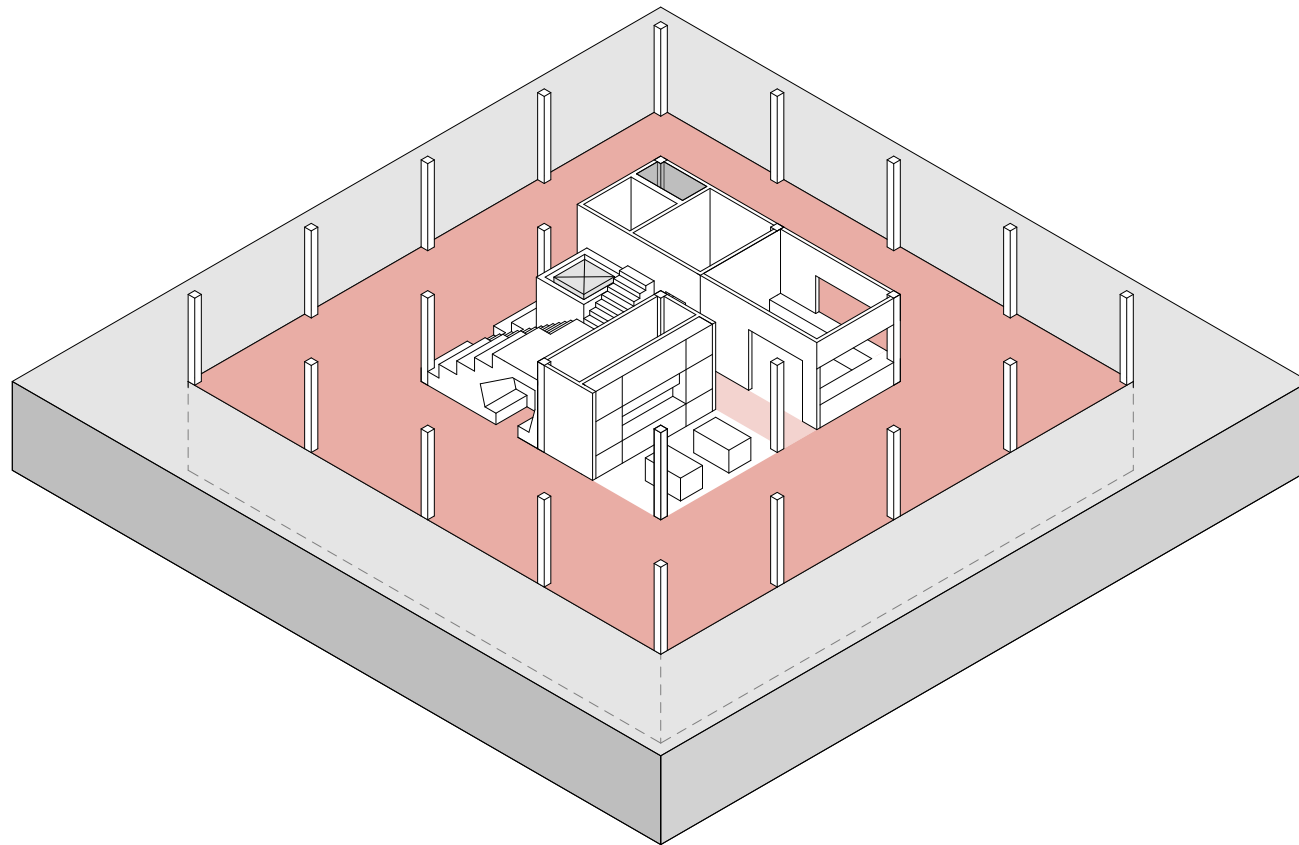

design principles

separability through mobile partition wall system

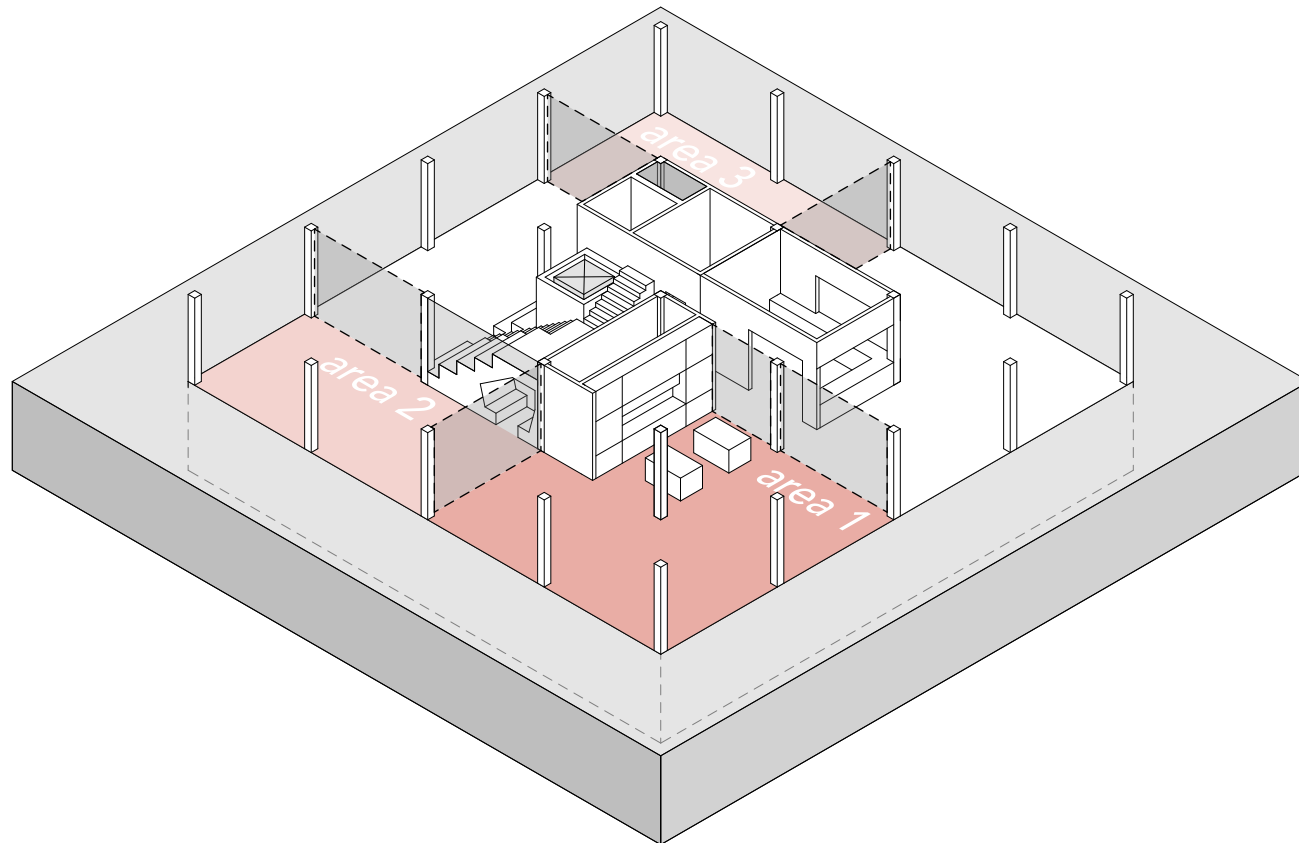

design principles

folding glass walls blur interior and exterior space

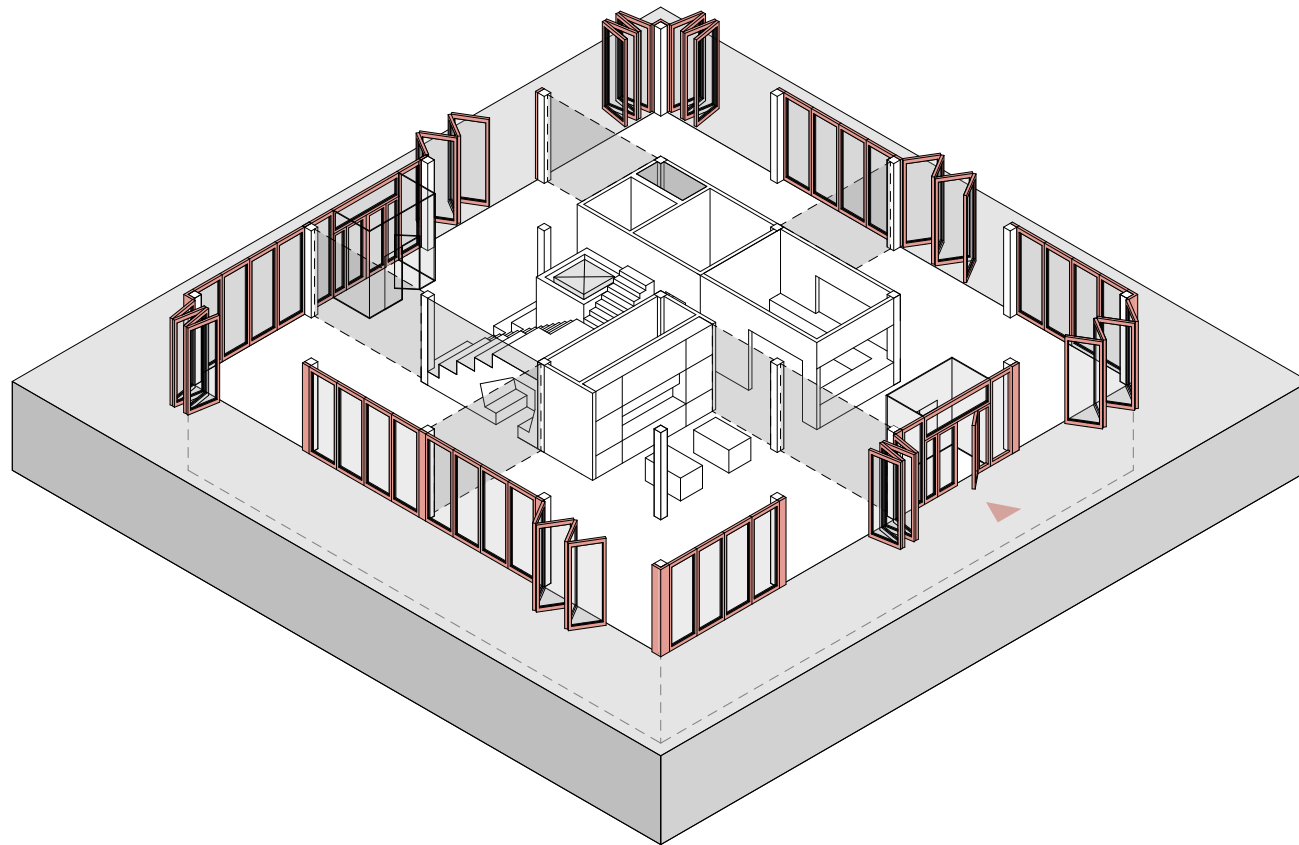

design principles

introduction of wooden ceiling system (Lignatur) with combined acoustic measures

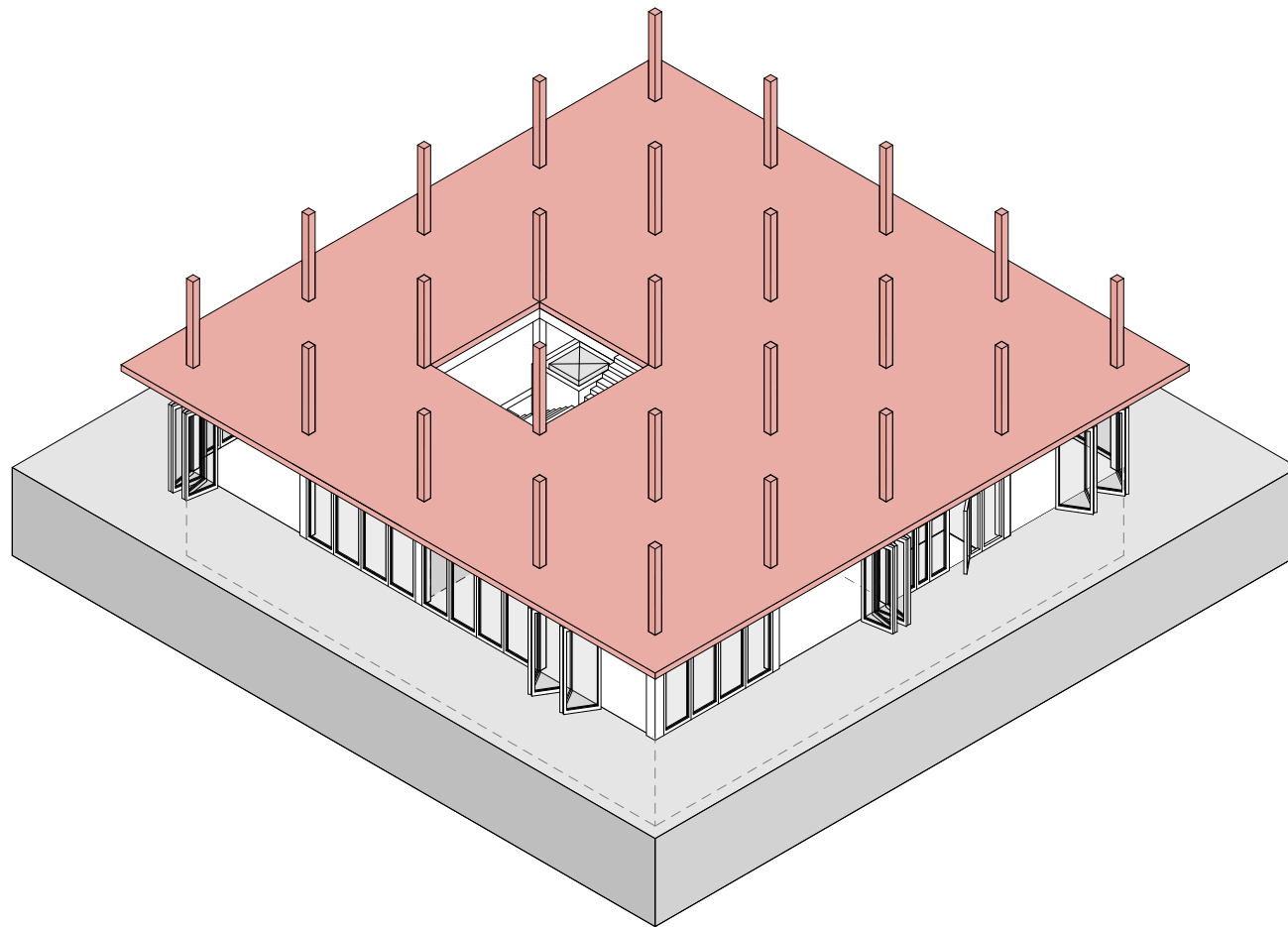

design principles

continuation of the elevator shaft and introduction of sanitary package

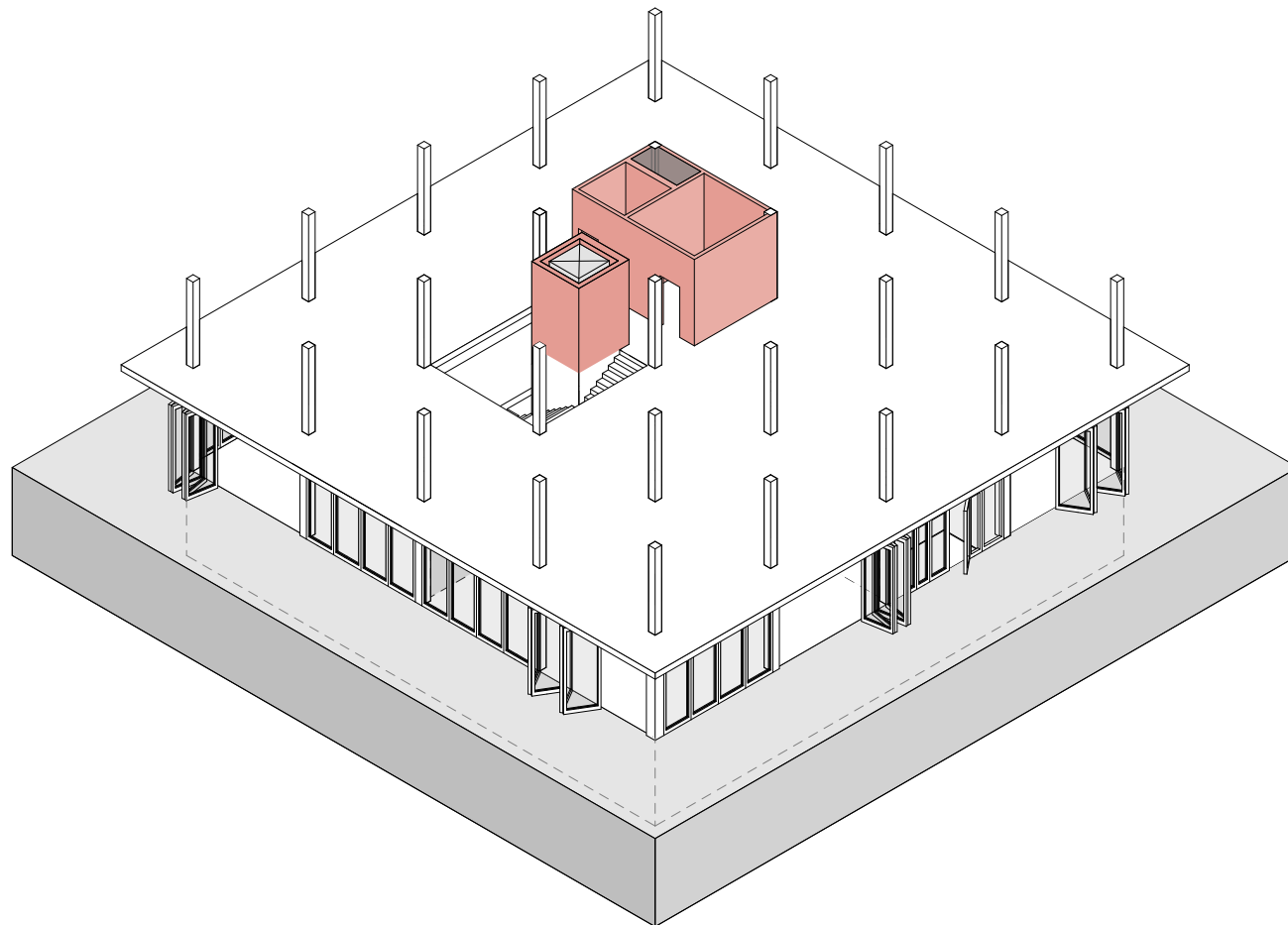

design principles

space-creating elements depending on the function

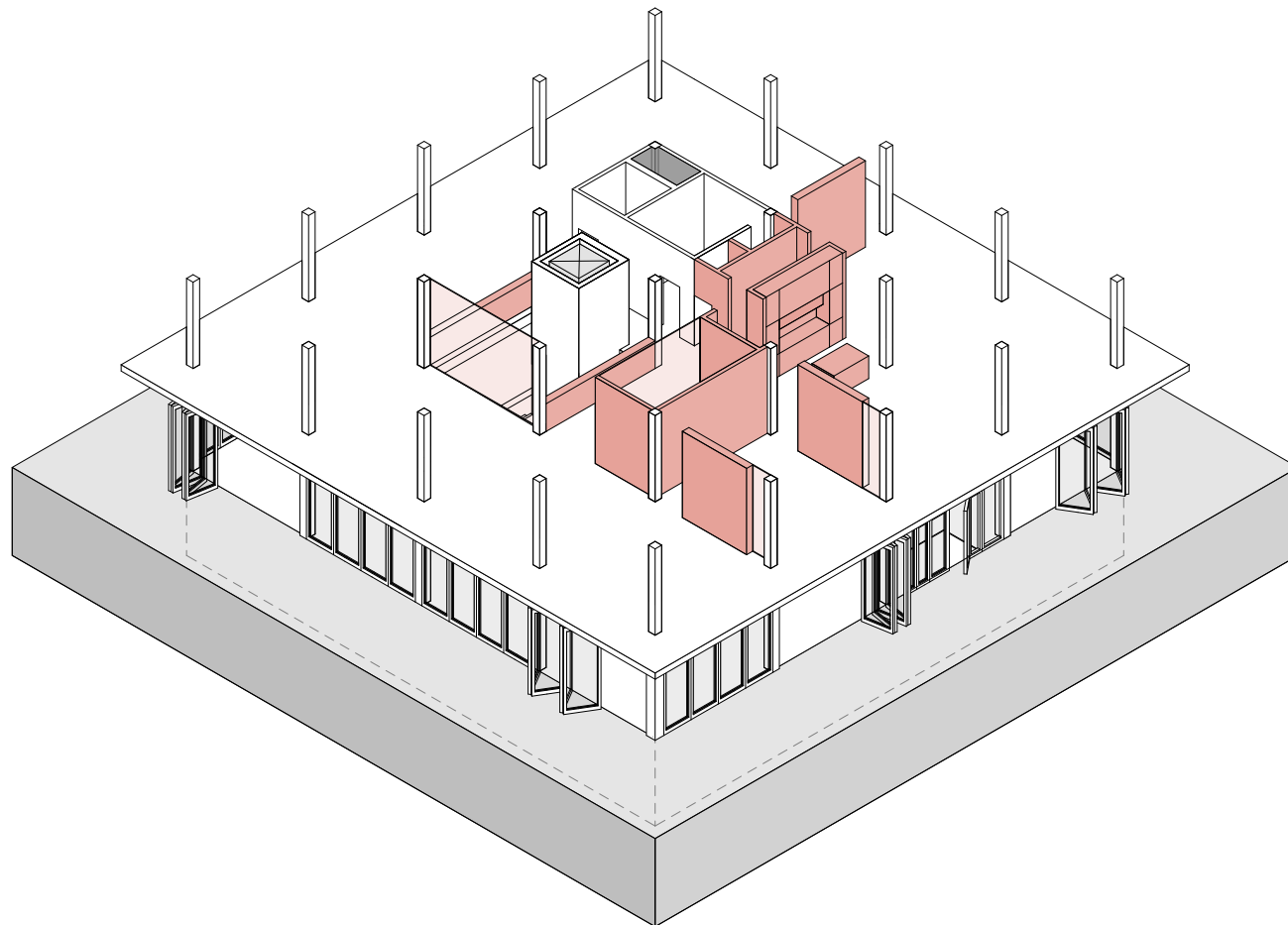

design principles

separability through mobile partition wall system

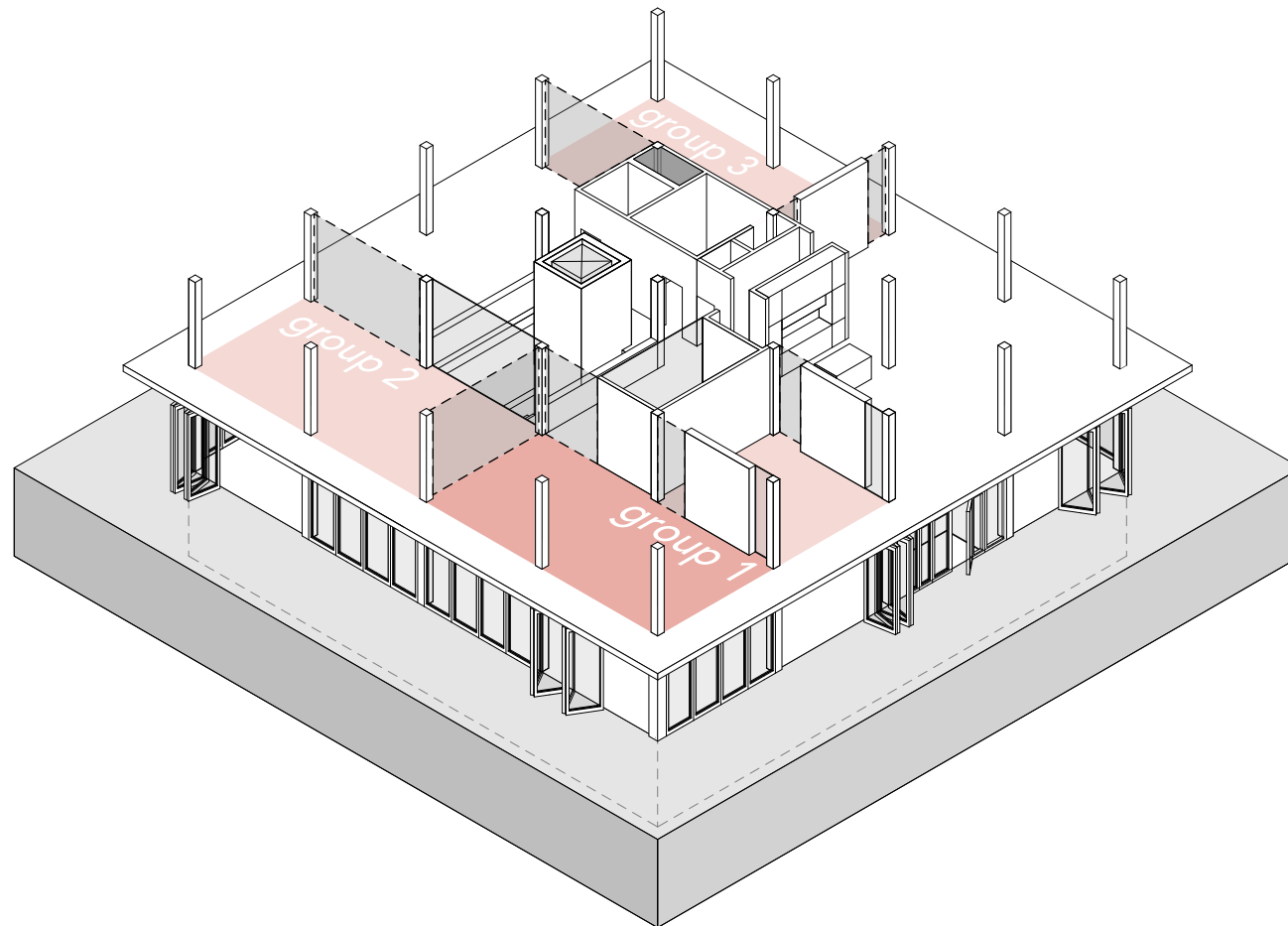

library & study

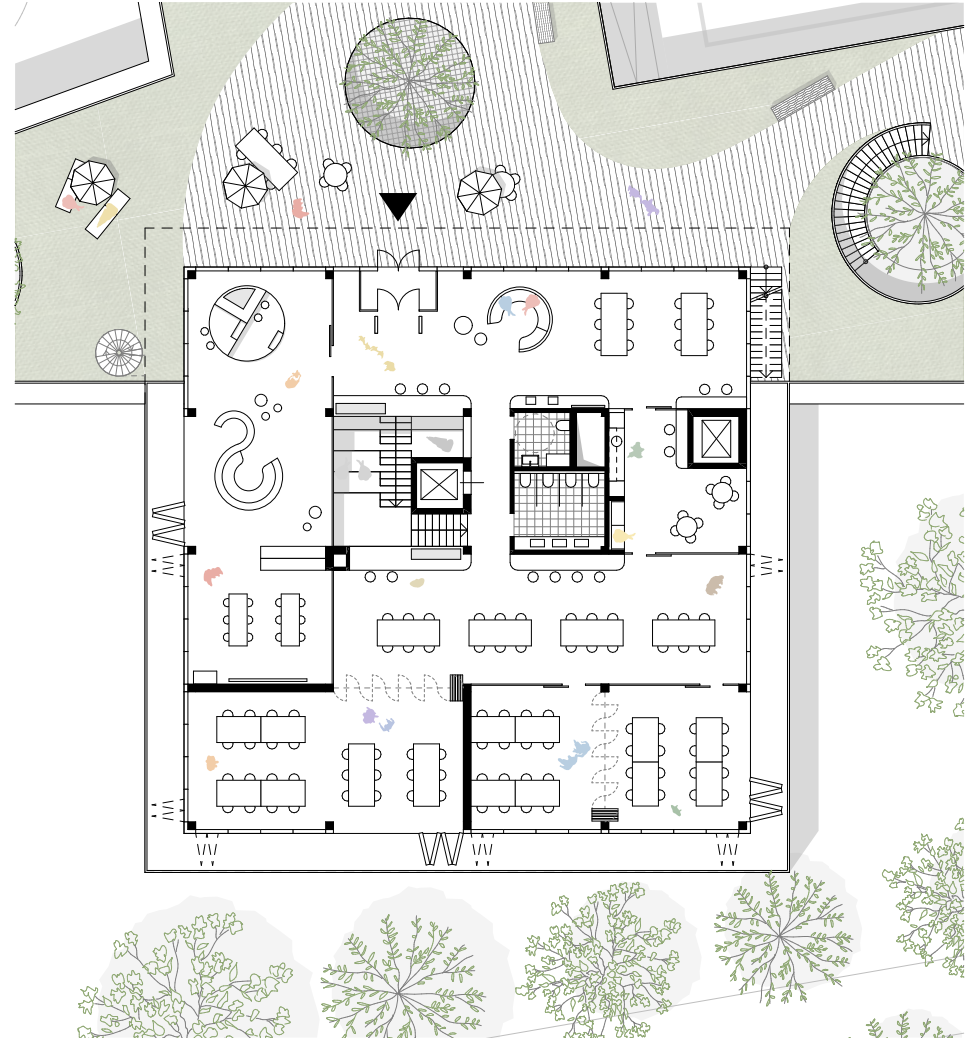
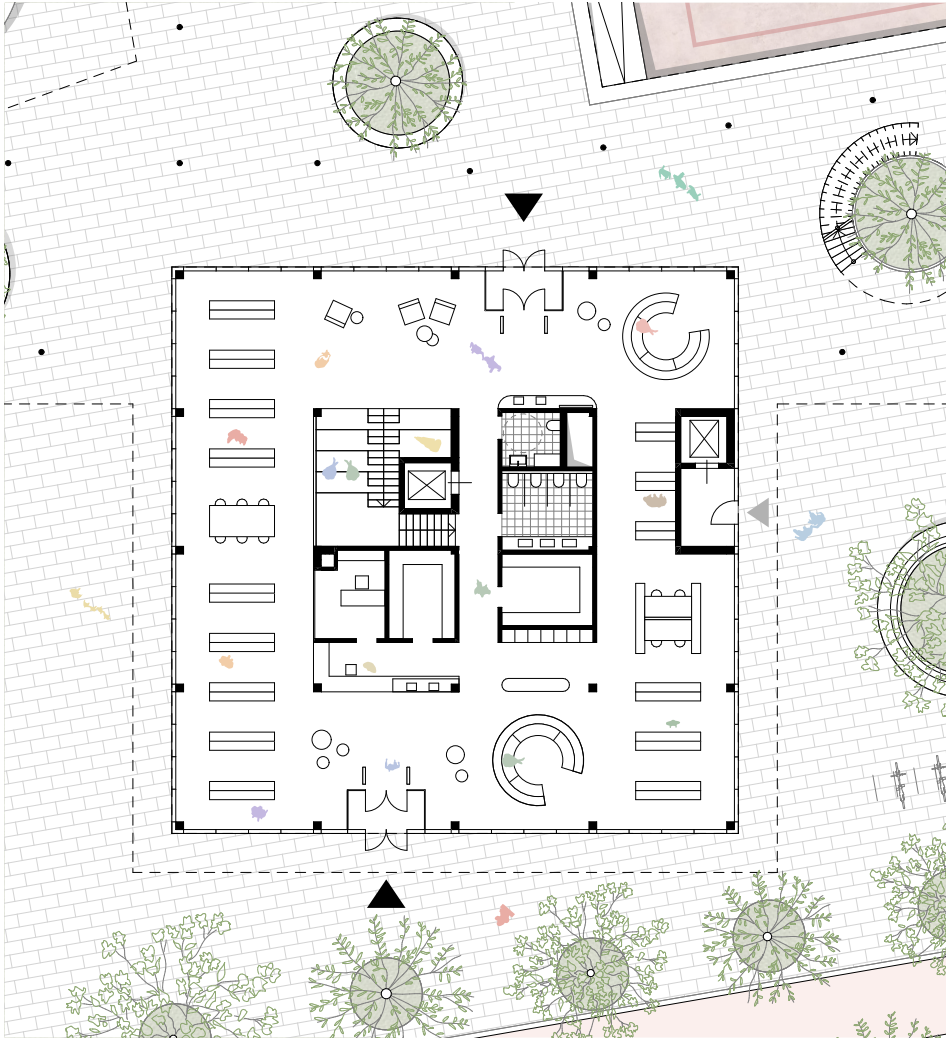
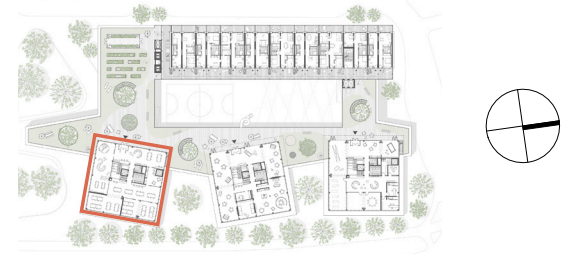

intergen. hub

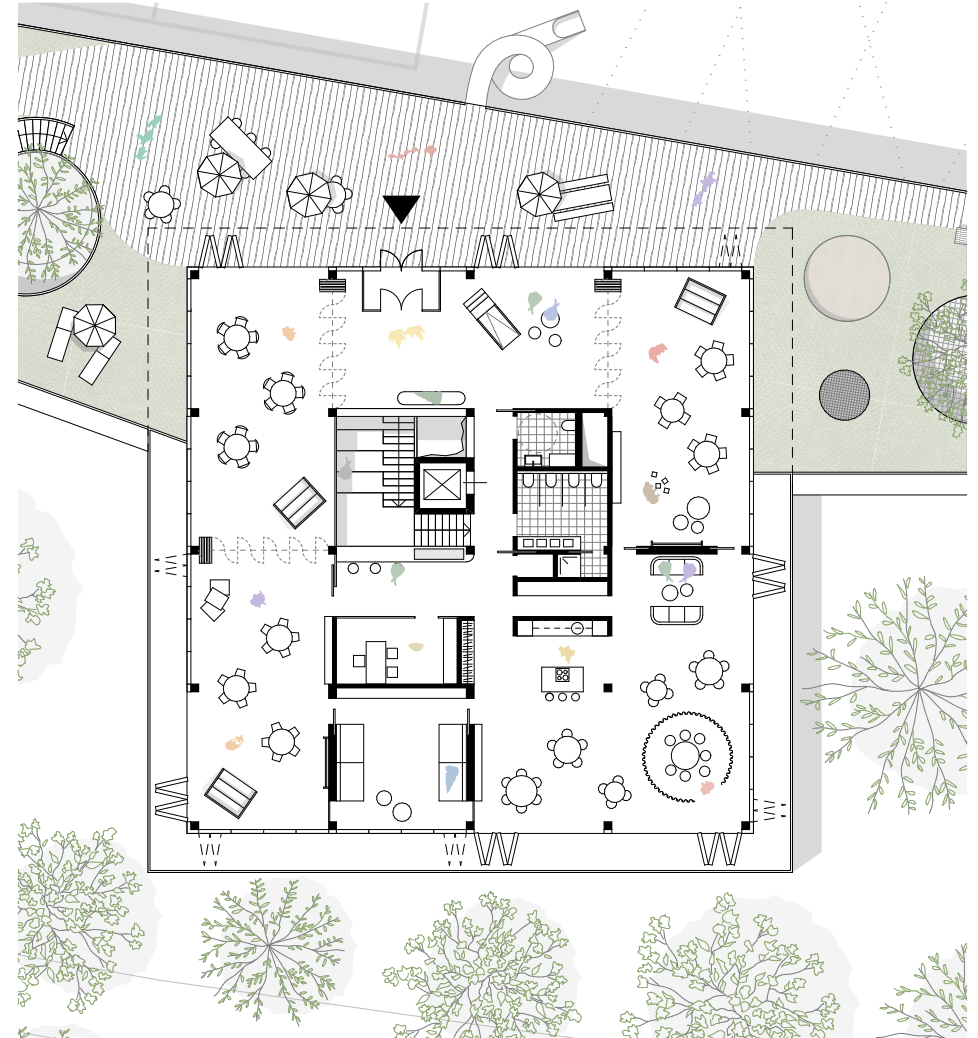
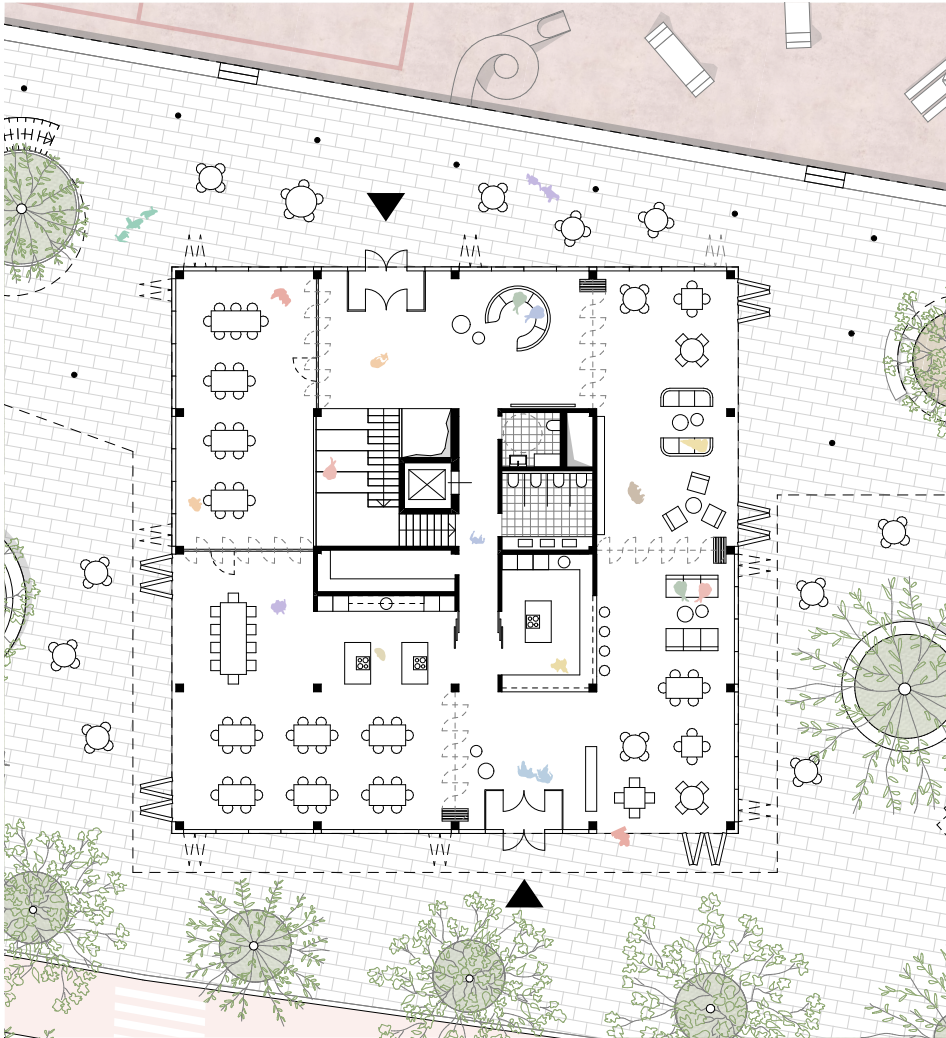
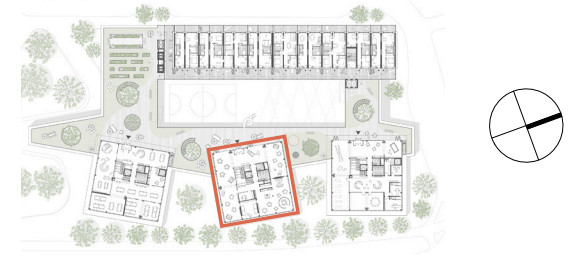

creative & activity lab

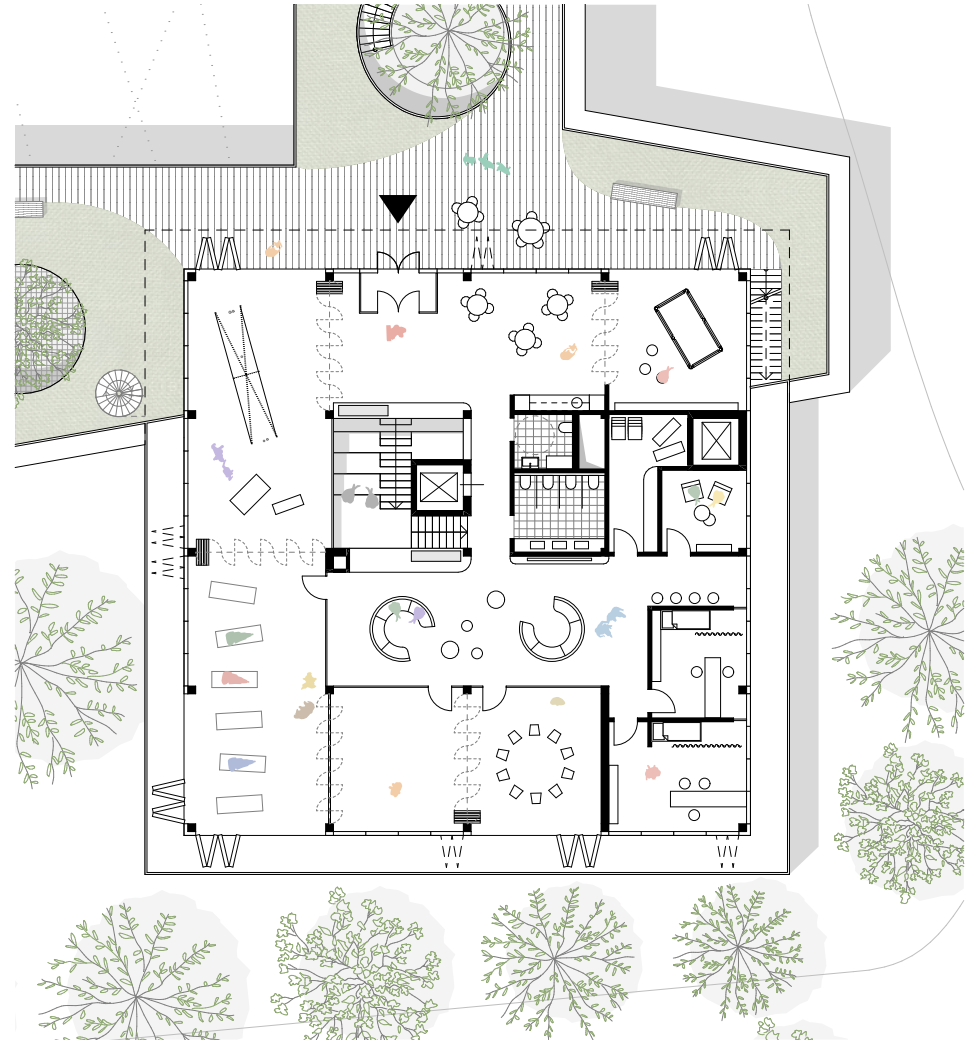
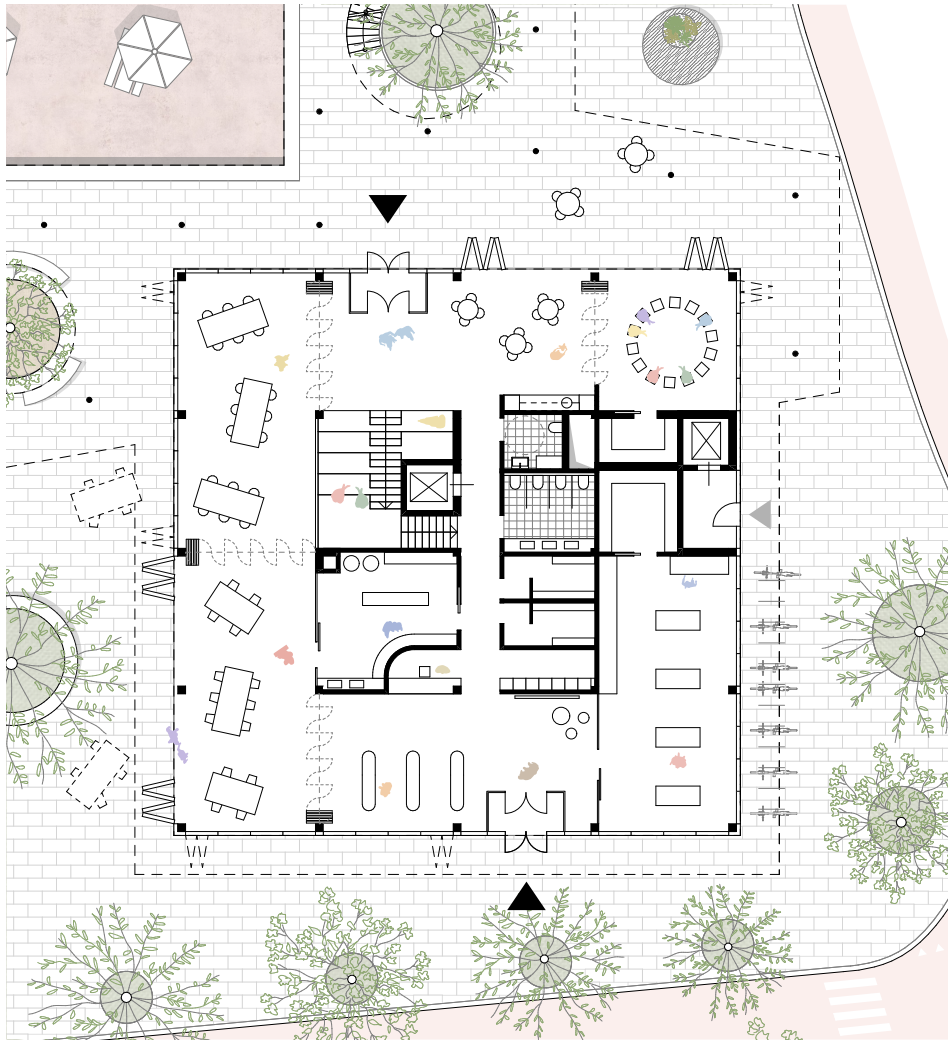
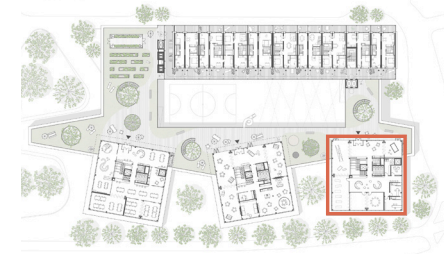

design impression



housing above public buildings

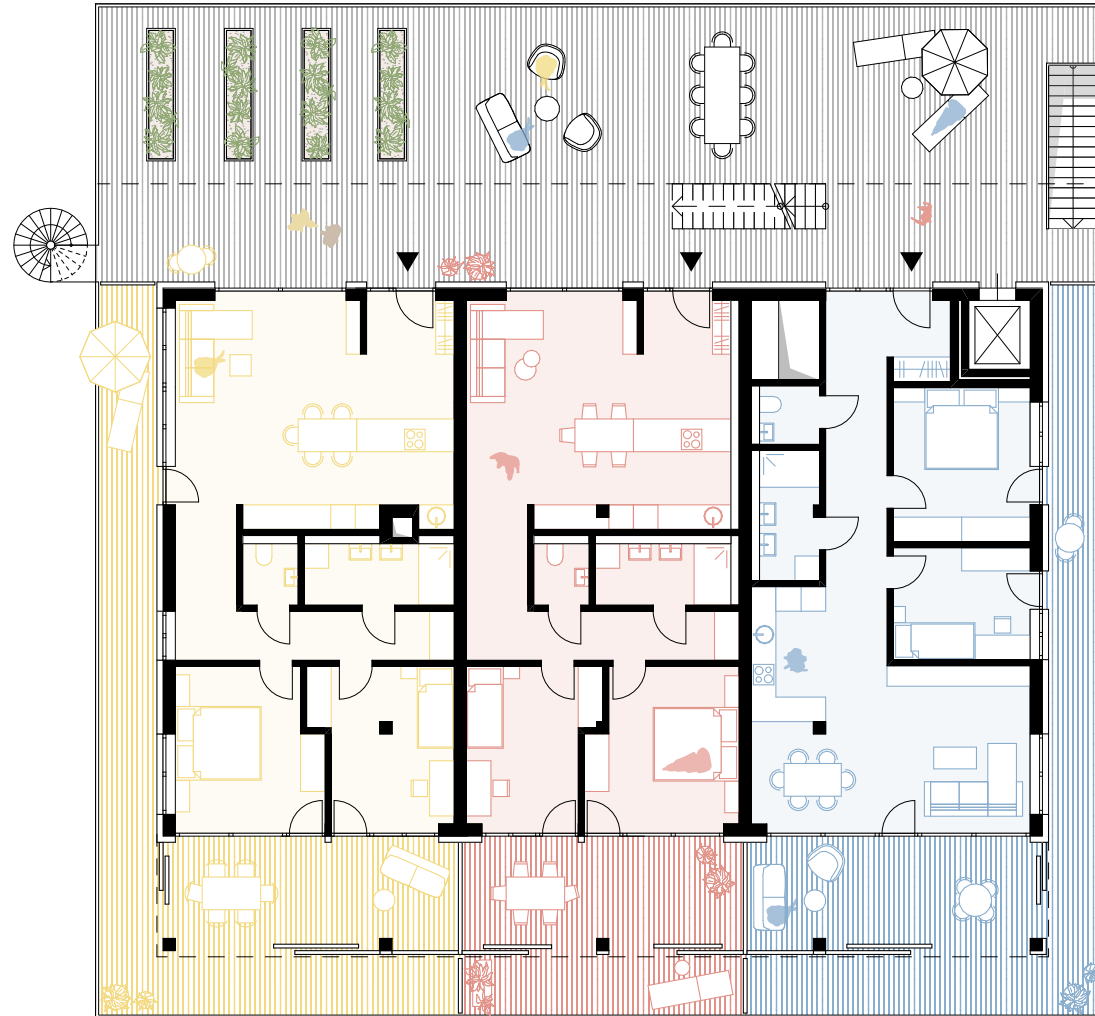

reflection

making a statement in the neighborhood

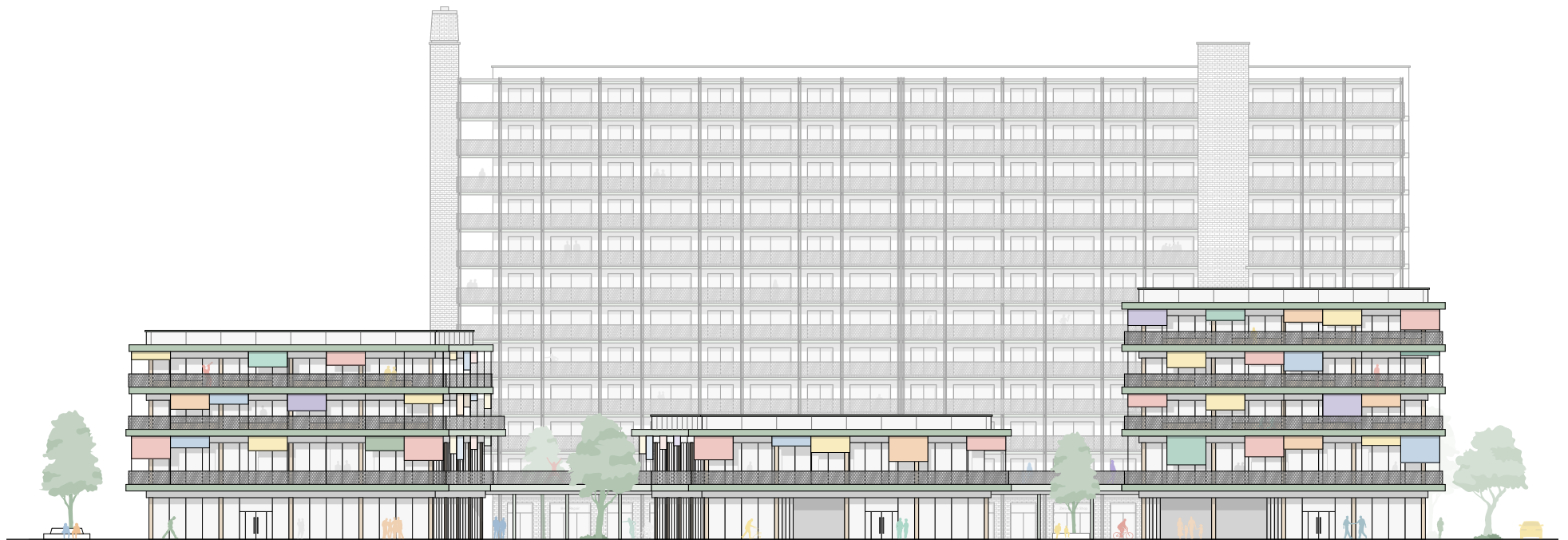



thank you :)

west façade



sun shading and privacy screen



underground car park

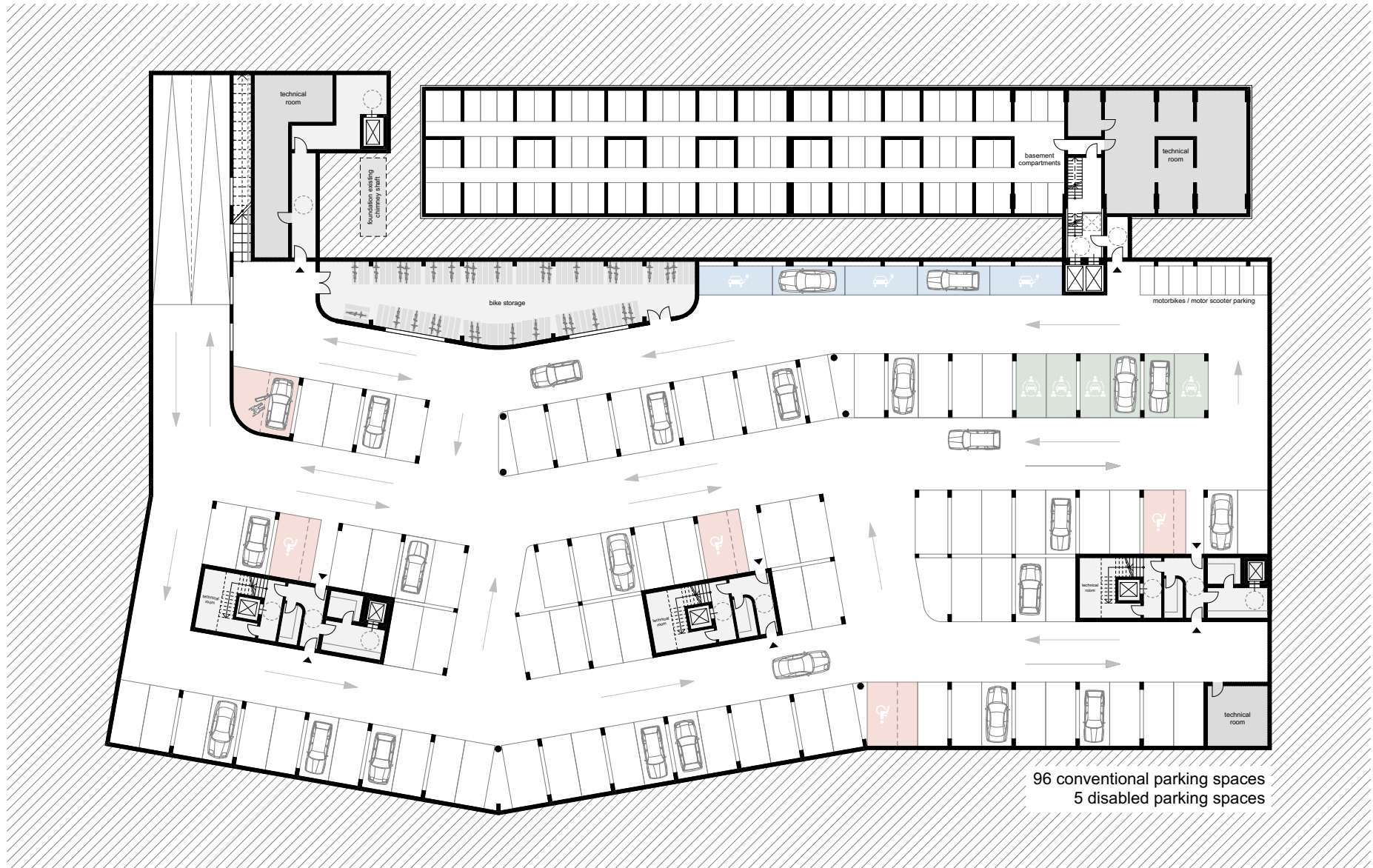

public space elements

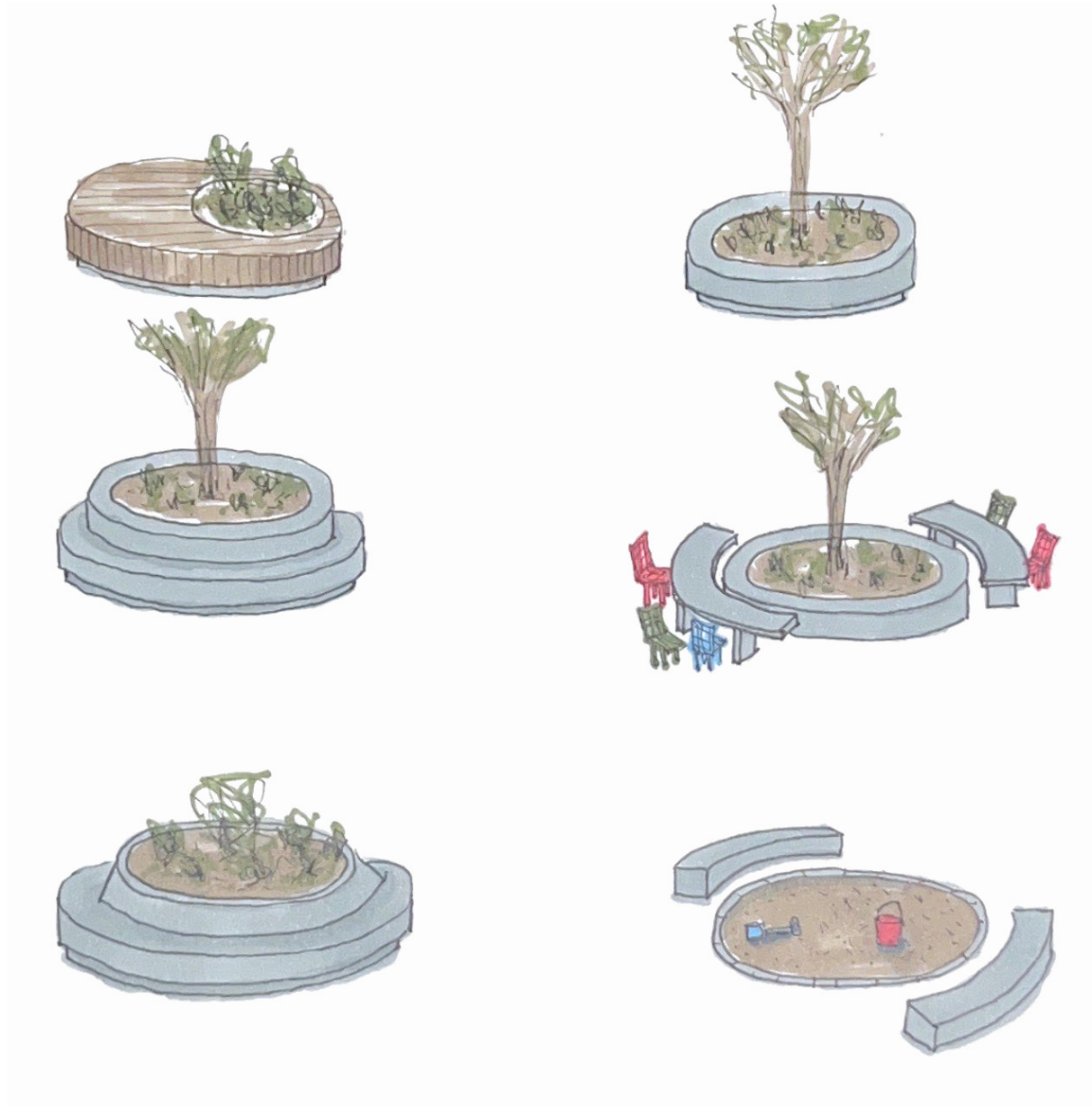

starter apartment

flexibility as a guiding theme

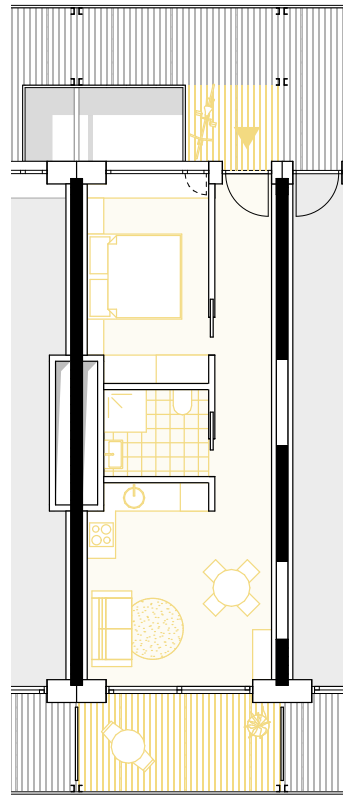

option 1

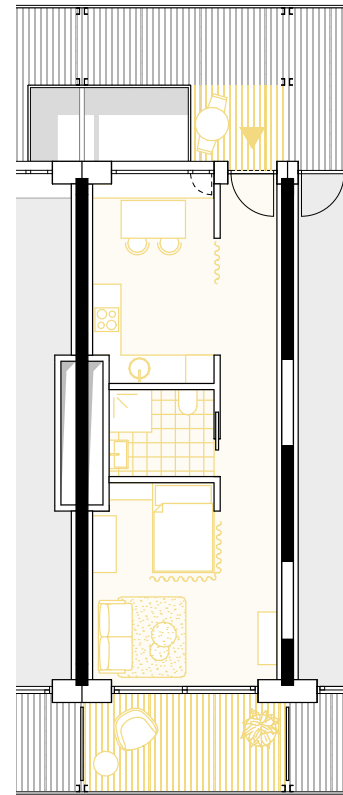

option 2

roof plan

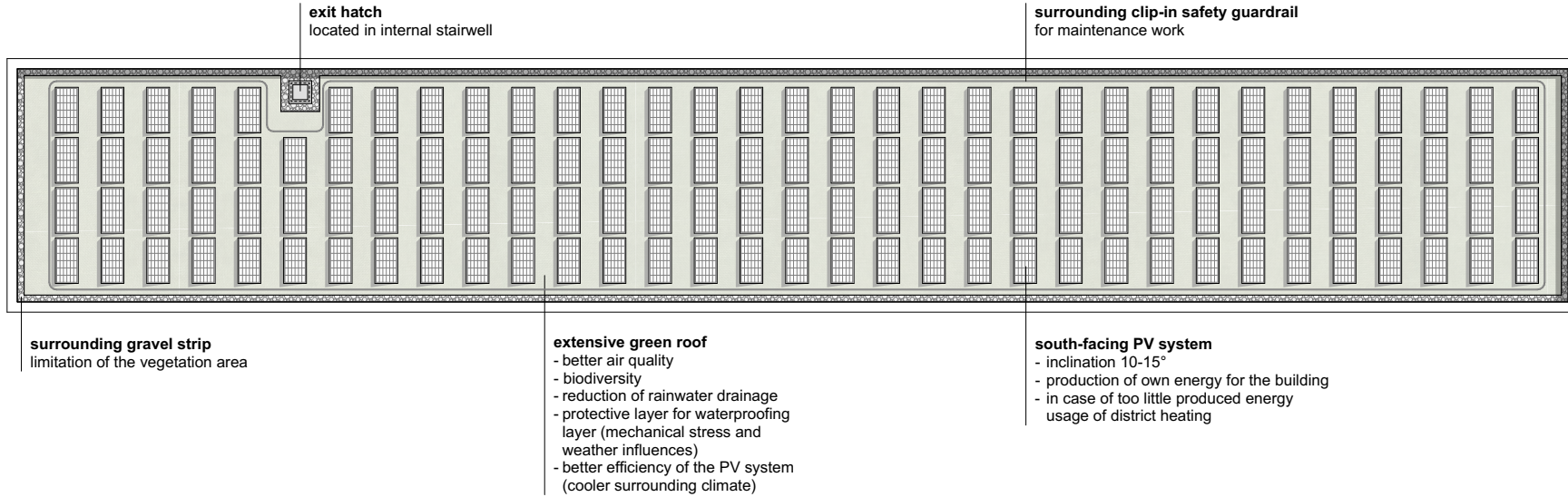
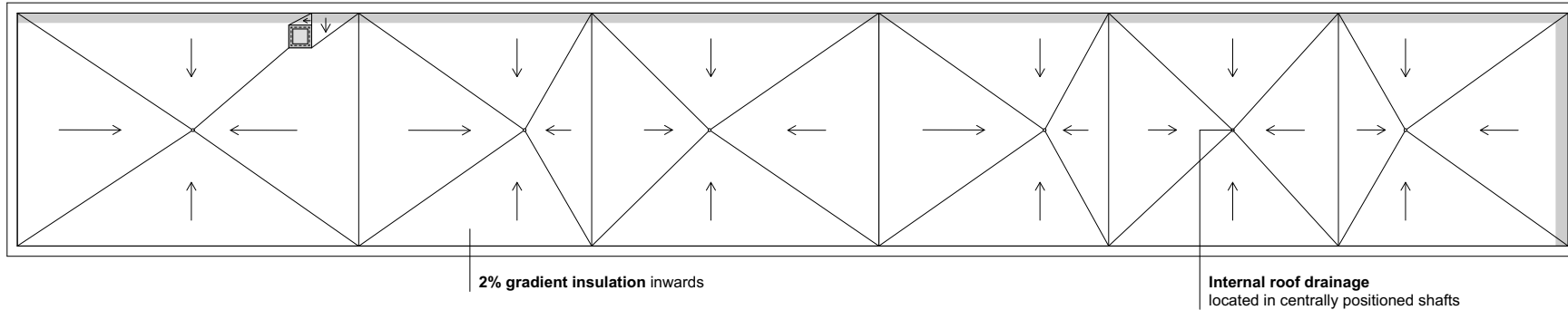

design principles

introduction of a variety of different types of dwellings

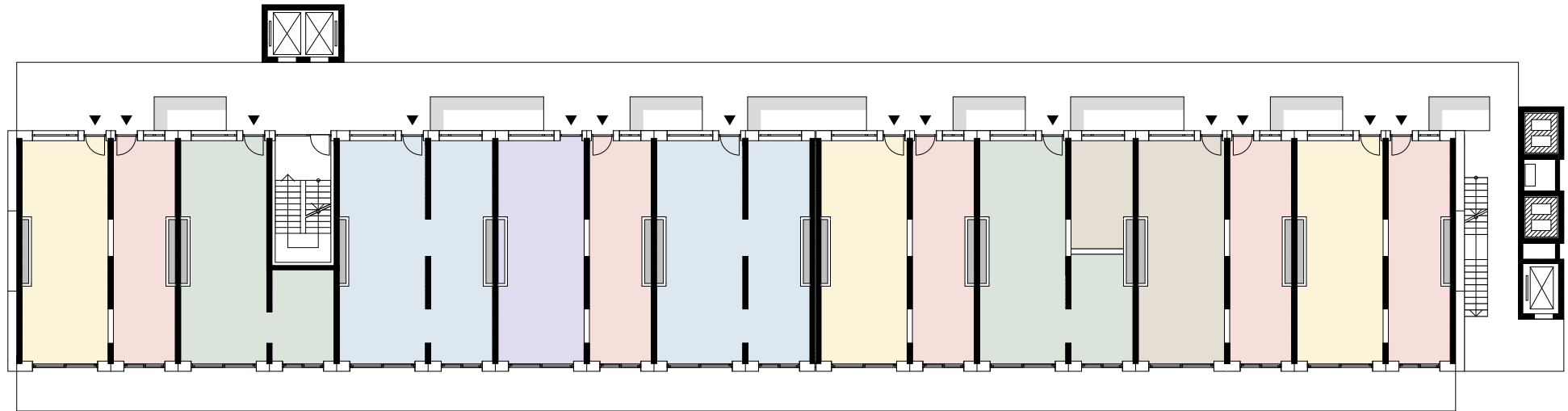

 student apartment (28m²)

 starter apartment (38m² – young professionals, couples)

 Maisonette apartment (60m² – couples / working + living)

 elderly-friendly apartment (54m²)

 young family apartment (70m²)

gallery drainage system

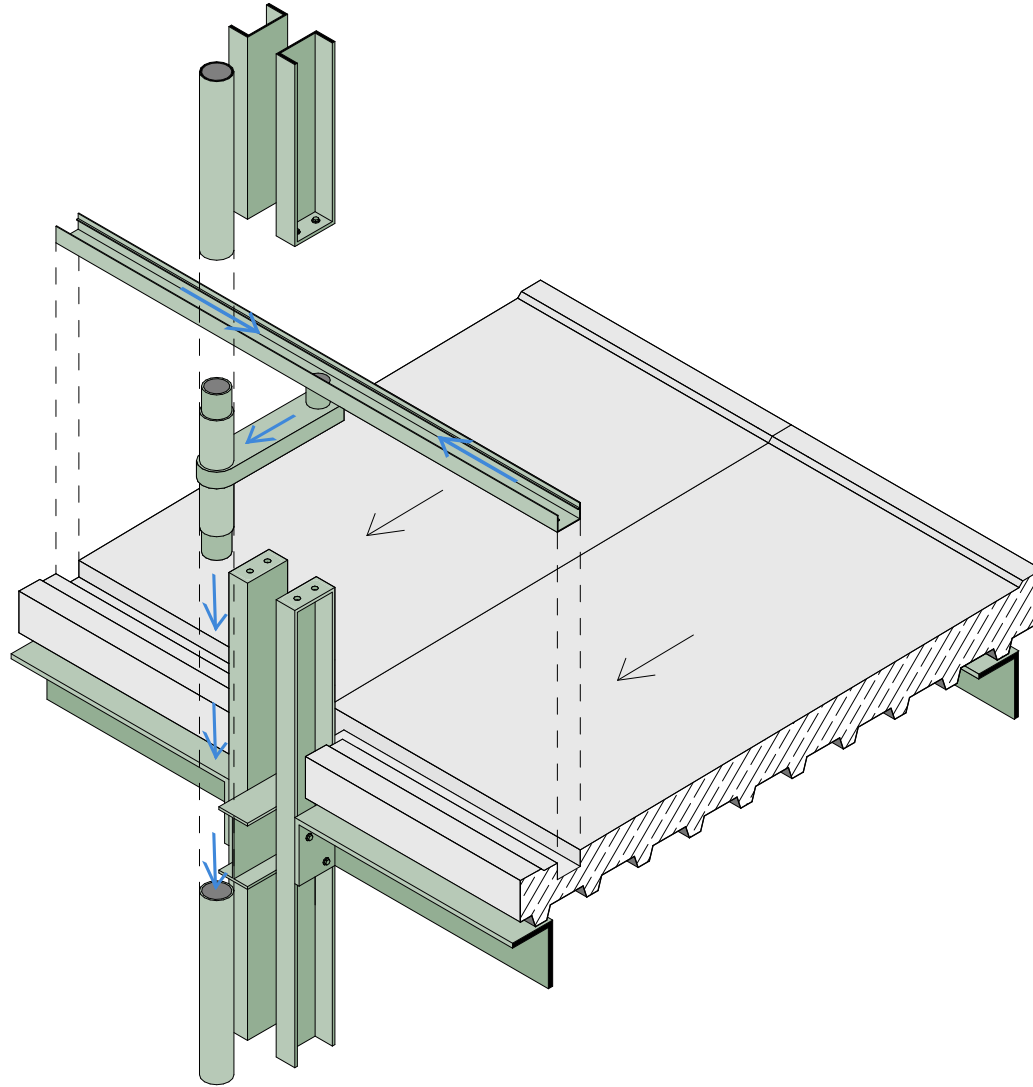

wood facade treatment

non-toxic flame retardant treatment

1. ACTIVE MODIFICATION

The biobased liquid reacts with OH-groups present in wood and reduces the water sensitivity significantly. This reaction increases the durability of the wood.

2. PASSIVE MODIFICATION

The biobased liquid forms a polymer that is reinforcing the wood which contributes directly to the strength and hardness of the wood and gives the brown colour.

Thanks to this unique dually modified™ process Kebony is able to replicate nature and produce wood with equal or superior performance of tropical hardwood, in a fast and sustainable way.

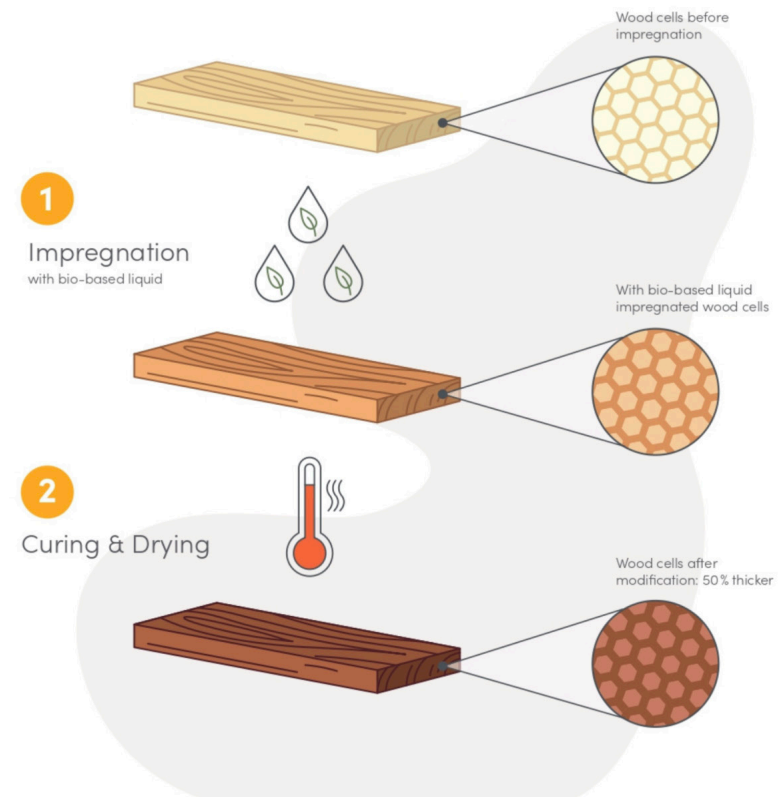

source: kebony.com