

**Technical feasibility of a Dutch radioactive waste repository in Boom Clay  
Plugs and seals**

Yuan, Jun; Vardon, Phil; Hicks, Michael; Hart, J; Fokker, PA

**Publication date**

2017

**Document Version**

Final published version

**Citation (APA)**

Yuan, J., Vardon, P., Hicks, M., Hart, J., & Fokker, PA. (2017). *Technical feasibility of a Dutch radioactive waste repository in Boom Clay: Plugs and seals*. Delft University of Technology.

**Important note**

To cite this publication, please use the final published version (if applicable).  
Please check the document version above.

**Copyright**

Other than for strictly personal use, it is not permitted to download, forward or distribute the text or part of it, without the consent of the author(s) and/or copyright holder(s), unless the work is under an open content license such as Creative Commons.

**Takedown policy**

Please contact us and provide details if you believe this document breaches copyrights.  
We will remove access to the work immediately and investigate your claim.

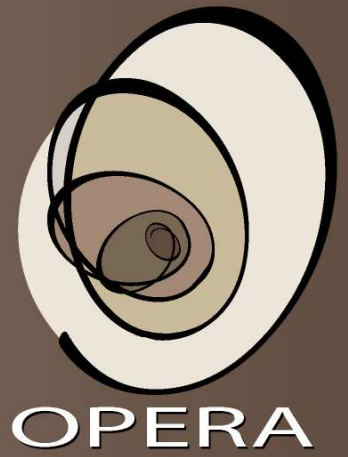

Technical feasibility of a Dutch  
radioactive waste repository  
in Boom Clay:  
Plugs and seals

Radioactive substances and ionizing radiation are used in medicine, industry, agriculture, research, education and electricity production. This generates radioactive waste. In the Netherlands, this waste is collected, treated and stored by COVRA (Centrale Organisatie Voor Radioactief Afval). After interim storage for a period of at least 100 years radioactive waste is intended for disposal. There is a world-wide scientific and technical consensus that geological disposal represents the safest long-term option for radioactive waste.

Geological disposal is emplacement of radioactive waste in deep underground formations. The goal of geological disposal is long-term isolation of radioactive waste from our living environment in order to avoid exposure of future generations to ionising radiation from the waste. OPERA (OnderzoeksProgramma Eindberging Radioactief Afval) is the Dutch research programme on geological disposal of radioactive waste.

Within OPERA, researchers of different organisations in different areas of expertise will cooperate on the initial, conditional Safety Cases for the host rocks Boom Clay and Zechstein rock salt. As the radioactive waste disposal process in the Netherlands is at an early, conceptual phase and the previous research programme has ended more than a decade ago, in OPERA a first preliminary or initial safety case will be developed to structure the research necessary for the eventual development of a repository in the Netherlands. The safety case is conditional since only the long-term safety of a generic repository will be assessed. OPERA is financed by the Dutch Ministry of Economic Affairs and the public limited liability company Electriciteits-Produktiemaatschappij Zuid-Nederland (EPZ) and coordinated by COVRA. Further details on OPERA and its outcomes can be accessed at [www.covra.nl](http://www.covra.nl).

This report concerns a study conducted in the framework of OPERA. The conclusions and viewpoints presented in the report are those of the author(s). COVRA may draw modified conclusions, based on additional literature sources and expert opinions. A .pdf version of this document can be downloaded from [www.covra.nl](http://www.covra.nl).

OPERA-PU-TUD321a

Title: Technical feasibility of a Dutch radioactive waste repository in Boom Clay: Plugs and seals.

Authors: Jiao Yuan, Philip J. Vardon, Michael A. Hicks, Jaap Hart and Peter A. Fokker

Date of publication: June 2017

Keywords: Boom Clay, feasibility, radioactive waste disposal, plugs, seals.

# Technical feasibility of a Dutch radioactive waste repository in Boom Clay: Plugs and seals

June 2017

Jiao Yuan<sup>1</sup>, Philip J. Vardon<sup>1</sup>, Michael A. Hicks<sup>1</sup>,  
Jaap Hart<sup>2</sup> and Peter A. Fokker<sup>3</sup>

<sup>1</sup> Delft University of Technology (TUD), Geo-Engineering Section, Delft

<sup>2</sup> Nuclear Research and consultancy Group (NRG), Petten

<sup>3</sup> Nederlandse Organisatie voor Toegepast Natuurwetenschappelijk Onderzoek (TNO), Utrecht

# Contents

Summary . . . . .	1
Samenvatting . . . . .	2
Notation . . . . .	3
1 Introduction . . . . .	4
1.1 Background and objectives. . . . .	4
1.2 Outline of the report . . . . .	5
2 Selected literature review . . . . .	6
2.1 Tunnel plugs . . . . .	6
2.2 Factors considered in repository plug design . . . . .	6
2.3 Review of national programmes' full-scale plug tests . . . . .	8
2.3.1 Plug studies in the Sweden . . . . .	8
2.3.2 Plug studies in Canada . . . . .	13
2.3.3 Plug studies in Belgium . . . . .	14
2.3.4 Plug studies in France . . . . .	15
2.4 Conclusions . . . . .	16
3 Plug system scoping design . . . . .	17
3.1 Requirement considered for the Dutch plug design . . . . .	17
3.1.1 The basic functions of the plug systems . . . . .	17
3.1.2 The components of the plug system . . . . .	18
3.1.3 Loads acting on the plug . . . . .	18
3.2 Design scenarios . . . . .	19
3.3 Conceptual design of the plug geometry . . . . .	21
3.3.1 Mechanical stability of the plug . . . . .	21
3.3.2 Constructability . . . . .	24
3.3.3 Hydraulic seal of the plug system . . . . .	25
3.4 Discussion . . . . .	32
4 Conclusions and recommendations. . . . .	34
References . . . . .	35

## Summary

The *Onderzoeks Programma Eindberging Radioactief Afval* (OPERA) is the third national research programme for the geological disposal of radioactive waste in the Netherlands, operating during the period 2011 to 2016. This document reports part of Work Package 3.2.1, where a number of aspects related to the technical feasibility were investigated.

Plugs and seals are an important aspect of a radioactive waste repository, isolating and containing sections of the repository during operation and the whole repository at closure. Plug systems typically have two roles: (i) to restrict material movement, and (ii) to control water flow. This report presents the outcome of a study to initially size the plug system.

The requirements for plug systems, with a focus on the Dutch situation, have first been derived. Following other international radioactive waste programmes, two components of the plug system have been considered: (i) a concrete plug to restrict material movement, and (ii) a bentonite seal to control water flow. The plug has been designed analytically using geometric and material strength considerations and the seal has been designed via use of a commercial finite element numerical model (PLAXIS).

Two designs for the mechanical plug have been made, with both based on unreinforced concrete. The first, which requires the local removal of the tunnel lining, yields a minimum plug length between 0.99 and 1.67 m (depending on the tunnel diameter), and the second, not requiring removal of the tunnel lining, yields a minimum length of 2.85 to 4.80 m. The addition of reinforcement may yield reduced lengths, but long term performance, e.g. corrosion, should be considered. The bentonite seal was shown to be able to restrict axial flow (in the direction of the tunnel) if it is between 0.5 and 1.0 m. Additionally, at these lengths, there was only a very limited pressure gradient in the backfill, reducing the chances of internal erosion. The swelling of the bentonite may reduce (locally) the impact of increased hydraulic conductivity in the excavated damaged/disturbed zone, however over-excavation may be required to eliminate preferential flow. The tunnel lining should be removed at the location of the bentonite seal to ensure a good hydraulic seal.

The results from this study are aimed to be an initial sizing, rather than a detailed design. This initial design should be converted into a detailed design and the performance tested robustly prior to construction in a repository. Confirmation of the ability of the seal in the plug system to provide swelling to reduce hydraulic conductivity in the excavated damaged/disturbed zone is needed.

## Samenvatting

*Onderzoeks Programma Eindberging Radioactief Afval (OPERA)* is het derde nationale onderzoeksprogramma naar geologische eindberging in Nederland, uitgevoerd in de periode tussen 2011 tot 2016. Dit document betreft werkpakket 3.2.1, waar een aantal aspecten gerelateerd aan de technische haalbaarheid zijn onderzocht.

Pluggen en afdichtingen zijn een belangrijk onderdeel van eindberging en worden gebruikt voor het isoleren van secties van de eindberging gedurende het gebruik en van de gehele eindberging na het afsluiten hiervan. Pluggen vervullen in het algemeen twee doelen: (1) het limiteren van beweging in van het materiaal, en (2) het controleren van grondwaterstroming. Deze rapportage presenteert de uitkomst van een studie naar de grootte van het benodigde plugsysteem.

Eerst zijn de vereisten aan het plugsysteem bepaald, met een focus op de Nederlandse situatie. In navolging van andere internationale eindbergingsprogramma's voor radioactief afval zijn twee componenten van het plugsysteem beschouwd: (1) een betonnen plug om verplaatsing van materiaal te beperken en (2) een afdichting van bentoniet om de waterstroming te beperken. De plug is analytisch ontworpen, gebruikmakend van geometrie en materiaalsterkte en de afdichting is ontworpen met behulp van een commercieel eindige elementen programma (PLAXIS).

Twee ontwerpen voor de mechanische plug zijn gemaakt, beide gebaseerd op ongewapend beton. Het eerste ontwerp, waar lokaal de tunnel lining verwijderd dient te worden, resulteert in een minimale plugafstand tussen de 0.99 en 1.67 m (afhankelijk van de tunneldiameter). Het tweede ontwerp, zonder verwijdering van de tunnel lining, geeft een minimale plugafstand van 2.85 tot 4.80 m. Extra versteviging kan leiden tot een verminderde tussenafstand, maar hierbij dient lange-termijnprestatie, d.w.z. corrosie, in beschouwing genomen te worden. Van de bentonietafdichting is aangetoond dat deze de axiale stroming (in lijn met de tunnel) verhindert als deze tussen de 0.5 en 1.0 m dik is. Bovendien, zijn bij deze lengtes de drukgradiënten in de opvulling gering. Dit reduceert de kans op interne erosie. Het zwellen van de bentoniet kan (plaatselijk) de impact van de verhoogde hydraulische doorlatendheid in de verstoringszone reduceren, alhoewel overgraven nodig kan zijn om preferentiële stroming te voorkomen. De tunnel lining dient verwijderd te worden ter plekke van de bentonietafdichting om zeker te zijn van een goede hydraulische isolatie.

De resultaten van deze studie zijn gericht op een initiële schatting van de dimensies, niet op een gedetailleerd ontwerp. Dit initiële ontwerp dient te worden omgezet in een gedetailleerd ontwerp en de prestatie van de eindberging dient grondig getoetst te worden voorafgaand aan constructie. Tevens dient het vermogen tot zwellen van het afdichting in het plug-systeem, om de hydraulische doorlatendheid in de verstoringszone rond de eindberging te reduceren, bevestigd te worden.

## Notation

This list contains definitions of acronyms and symbols including dimensions. All symbols are also defined in the text. The dimensions are defined in typical SI units.

Symbol	Definition	Unit
<b>Acronyms</b>		
EDZ	Excavated Damaged Zone	
FSS	Full-Scale Seal	
HADES	High Activity Disposal Experiment Site	
KBS-3	Kärnbränslesäkerhet-3, nuclear fuel safety - 3	
NRG	Nuclear Research and consultancy Group (NL)	
OPERA	Onderzoeks Programma Eindberging Radioactief Afval	
PRACLAY	Preliminary Demonstration Project for Disposal in Clay	
TNO	Nederlandse Organisatie voor Toegepast Natuurwetenschappelijk Onderzoek (NL)	
TUD	Delft University of Technology (NL)	
URL	Underground Research Laboratory	
WP	Work Package	
<b>Greek letters</b>		
$\alpha_{cc}$	Coefficient taking account of long-term effects on the compressive strength	[-]
$\sigma$	Total stress	[Pa]
$\sigma_b$	Bearing stress	[Pa]
$\sigma_p$	Punching shear stress	[Pa]
$\sigma_{cp}$	Compressive stress in the concrete from axial load or prestressing	[Pa]
$\sigma_n$	Confining stress	[Pa]
<b>Latin letters</b>		
$f_{cd}$	Design value of concrete compressive strength	[Pa]
$f_{ck}$	Characteristic compressive cylinder strength of concrete at 28 days	[Pa]
$f_{ctd}$	Design value of concrete tensile strength	[Pa]
$f_{cvd}$	Design value of concrete strength in shear and compression	[Pa]
$f_{yd}$	Design yield strength of reinforcement	[Pa]
$k$	Hydraulic conductivity	[m s <sup>-1</sup> ]
$l$	Length	[m]
$p_b$	Permissible bearing stress	[Pa]
$p_{pe}$	Permissible punching shear stress of the rock or concrete interface	[Pa]
$p_p$	Permissible punching shear stress	[Pa]
$r$	radius	[m]
$t$	thickness of tunnel lining	[m]
$v_{Rdi}$	Design shear resistance at the concrete to concrete interface	[Pa]



# 1 Introduction

This report is part of an investigation into the principle feasibility of a deep geological repository for radioactive waste in the Netherlands. This work is undertaken as part of the *Onderzoeks Programma Eindberging Radioactief Afval* (OPERA) research programme in Work Package (WP) 3.2.1. This report follows on from WP 3.1, where a number of additional aspects relating to the principle feasibility were identified for further investigation. The results of WP 3.2.1 are presented in the following reports:

- Yuan, J., Vardon, P.J., Hicks, M.A., Hart, J., Fokker, P.A. (2017) Technical feasibility of a Dutch radioactive waste repository in Boom Clay: Plugs and seals. OPERA-PU-TUD321a.
- Yuan, J., Vardon, P.J., Hicks, M.A., Hart, J., Fokker, P.A. (2017) Technical feasibility of a Dutch radioactive waste repository in Boom Clay: Tunnel crossings. OPERA-PU-TUD321b.
- Vardon, P.J., Buragohain, P., Hicks, M.A., Hart, J., Fokker, P.A., Graham, C.C. (2017) Technical feasibility of a Dutch radioactive waste repository in Boom Clay: Thermo-hydro-mechanical behaviour OPERA-PU-TUD321c.
- Li, Y., Vardon, P.J., Hicks, M.A., Hart, J., Fokker, P.A. (in prep) Technical feasibility of a Dutch radioactive waste repository in Boom Clay: Geomechanical validation. OPERA-PU-TUD321d.

The main objective of this report is to initially design the plug system for the proposed Dutch radioactive waste repository. The research was undertaken by *Delft University of Technology* (TUD), *Nuclear Research and consultancy Group* (NRG) and *Nederlandse Organisatie voor Toegepast Natuurwetenschappelijk Onderzoek* (TNO) during the period from 5-2015 till 6-2016.

## 1.1 Background and objectives

Storage and disposal of radioactive waste in deep geological formations is proposed as the most likely option for the Netherlands and worldwide. In this concept of the geological disposal system, Boom Clay is considered as a potential host rock in the Netherlands. To control water flow and restrict material movement in tunnels, such as mines, or in this case a repository, plugs and/or seals can be used. In the Dutch repository concept, plugs are proposed to be used to hydraulically seal off a disposal drift after emplacement of waste packages and to restrict movement of backfill. Plugs are also to be used to seal the shafts and ramp when the facility is closed (Verhoef et al., 2014a).

Regardless of the geologic medium and geometry selected, there will be a requirement for the access tunnels to remain open while repository operations are ongoing. The period of repository operation will be long, and therefore the plugs should be designed to function for about one century and their function should be maintained until the transport tunnels are backfilled and the natural geohydrological conditions have been recovered (Dixon et al., 2009).

In this report, scoping of the design requirements for plugs and seals and scoping calculations are carried out for the specific conditions expected in the Dutch geological context. It is intended to provide an initial design and approximate sizing, and a commentary on the key issues, so that a detailed design and performance assessment may be carried out. The generic term *plug system* is

used for a system which provides mechanical and hydraulic support, however where the functions are separated considered, a plug system provides *sealing* from hydraulic flow and *plugging* from mechanical movement. The impact of gas migration or chemistry on the plug system is not considered here, nor is detailed design.

## 1.2 Outline of the report

A selective review of literature is made in Chapter 2, beginning with an introduction to tunnel plugs in Section 2.1. In Sections 2.2 and 2.3, a review of the design of plugs and seals in other radioactive waste programmes has been made, incorporating a synthesis of the design requirements and considerations in Section 2.2. The scoping design is presented in Chapter 3. Firstly, the requirements for the design of the plug and seal for the proposed Dutch radioactive waste repository are contained in Section 3.1, including the functional requirements, the components, and loads applied on the components. Section 3.2 gives the scenarios and load combinations that the plugs are designed against. Section 3.3 contains the scoping calculations to provide the sizing of the components, including both mechanical stability and hydraulic sealing. The conclusions and recommendations are presented in Chapter 4.

## 2 Selected literature review

### 2.1 Tunnel plugs

Plug design in mines has been discussed by many researchers from the 1960's onwards. Auld (1983) reviewed generic issues about underground plug design and Kirkwood and Wu (1995) described the principles and approaches to plug construction in coal mines. Barcena et al. (2005) discussed the necessity of considering geological and hydrological assessment in plug design. Auld (1983) discussed a number of factors that need to be taken into account in the design of plugs, and presented eight generic plug types. The plug shapes described by Auld (1983) are illustrated in Figure 2.1.

The rock-plug interface is a key point in the plug design, in order to provide a frictional bond and to reduce the hydraulic gradient along the interface. The following five possible failure modes were stated to be needed to be resisted by the plug (Barcena et al., 2005):

- (i) Hydraulic jacking of rock surrounding the plug;
- (ii) Shear failure through the concrete, along the rock concrete contact or through rock alone;
- (iii) Deep beam flexure failure;
- (iv) Excessive seepage around the plug and possible backwards erosion;
- (v) Long term chemical/physical breakdown of concrete, grout, or surrounding rock.

The length of the plug was stated to be determined by the mechanical requirement and hydraulic leakage path, and the plug length should be the longer of the two obtained values. In order to reduce the leakage of the plug, the length of the plug should be proportional to the hydraulic head over the plug (Barcena et al., 2005). The plug length was stated to be often determined more by hydraulic rather than structural reasons (Garrett and Campbell Pitt, 1958).

### 2.2 Factors considered in repository plug design

In the underground repository application, the goal of the plug system is predominantly in controlling seepage and preventing backfill erosion and movement. In order to do this, the plug must resist external loads originating from the axial expansion of repository components, such as the backfill, and the water pressure. A repository would typically require plugs and seals at the ends of disposal galleries and zones of the repository, and in the shafts or ramps. A repository may also require the installation of plugs in locations where highly conductive joints or fissure are intersected, and must be isolated for safety and operational reasons (Dahlström, 2009; Malm, 2012). In addition, plugs may be required to limit radionuclide migration and to prevent inadvertent or unauthorised human access (White et al., 2014).

Plugging and sealing of excavations made in building and operating a deep geologic repository requires a level of engineering not typically required for plugging of underground structures. As described in the previous sections, in the mining industry and civil construction industry plugs are required to provide water control rather than near complete isolation and, in addition, the time scale of radioactive waste repository is significant longer. Furthermore, the movement of contaminants across the plug needs to be limited to diffusion-dominated rates (Dixon et al., 2009).

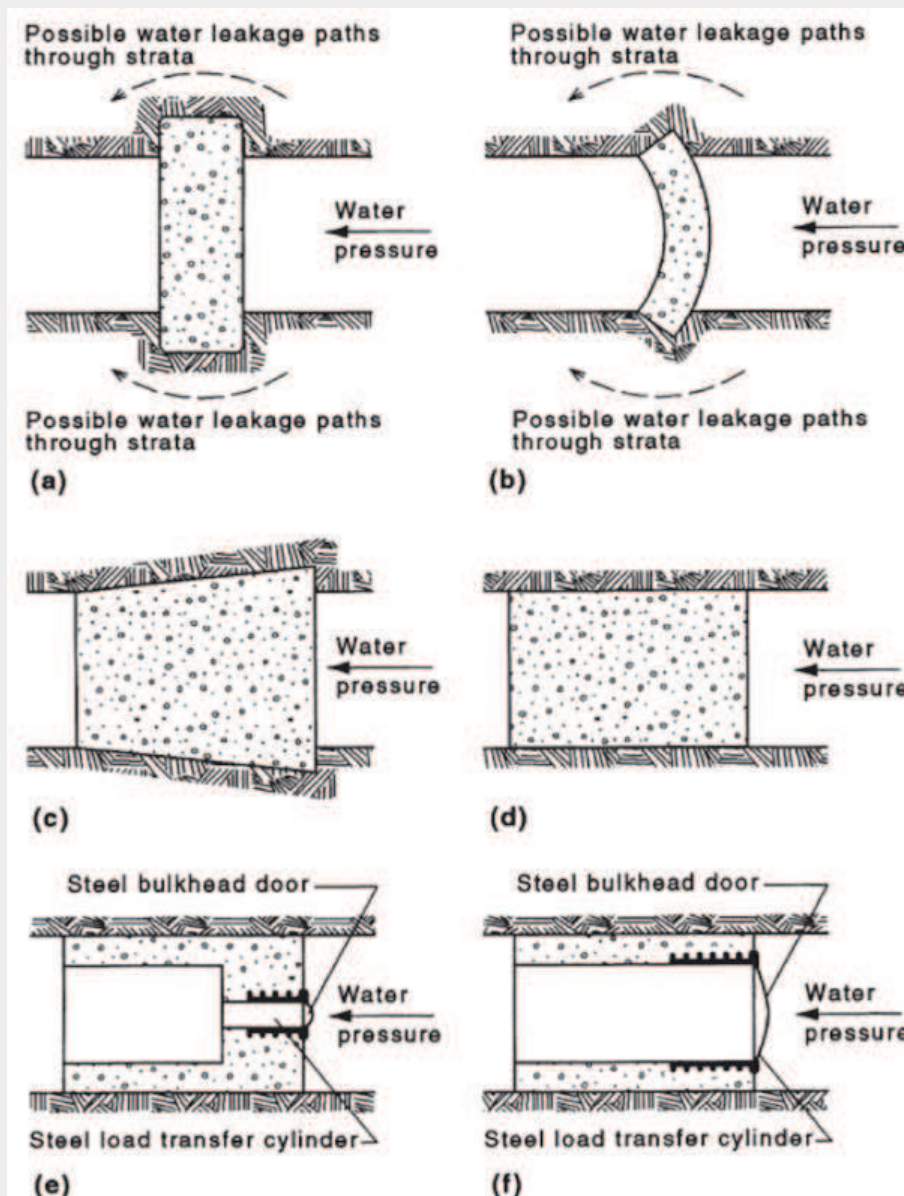

Figure 2.1: Generic plug shapes (Auld, 1983). (a) Reinforced concrete slab; (b) Unreinforced concrete arch; (c) Unreinforced concrete tapered plug; (d) Unreinforced concrete parallel plug; (e) Unreinforced concrete cylindrical parallel plug, with human access; (f) unreinforced concrete cylindrical parallel plug, with roadway access.

The type of host rock plays an important role in defining the design requirements for plugs. The requirements for the implementation would depend on the specific nature of the host rock and the disposal concept (White et al., 2014). Crystalline rocks are generally highly impermeable, but usually include a large amount of fractures that increase the overall hydraulic conductivity. The objective of plugging shafts and tunnels in crystalline rocks is to achieve a hydraulic conductivity comparable to that of the rock mass, ensuring a good contact is established between the plug material and the rock (IAEA, 1990). However, in many national programmes with crystalline rock disposal concepts, the canisters are well protected by the buffer and the backfill of the deposition tunnel, e.g. by using the *KBS-3* method. Therefore, a post-closure safety function is not a key issue for the plugs and their main role is to protect the bentonite buffer and backfill in the deposition tunnel from erosion and from piping (Malm, 2012).

Clay rocks usually have very low permeability, and can be plastic and soft (e.g. Boom Clay), or stiff (e.g. Opalinus Clay). The plasticity and self-healing properties of most clay rocks contribute to the self-healing of any cracks that may develop during tunnel construction operations (IAEA, 1990). The lining or mechanical stabilisation required in underground repositories located in clay rocks may need to be removed in a plug location to ensure a tight plug-rock interface. The objective of plugs in clay rocks is primarily to limit the flux of the groundwater by ensuring that very low permeabilities are reached (White et al., 2014).

Salt rocks generally have an extremely low hydraulic conductivity, and creep properties that can contribute to the closure of a repository. Some salt host rock may have to be backfilled in such a way that its containment function is not compromised due to fracture initiation and growth. The main safety function of plugs in this environment is to seal the deposition tunnel, such that groundwater flow into and out of the system is restricted (White et al., 2014).

## **2.3 Review of national programmes' full-scale plug tests**

Studies and tests on plugs and seals have been conducted at a number of underground research laboratories to provide information for the design of plugs and seals. In this section, various projects related to the plugging and sealing of underground repositories are reviewed.

### **2.3.1 Plug studies in the Sweden**

There are two types of plugs in the Swedish concept: “deposition tunnel plugs” and “plugs in other parts of the repository” (SKB, 2010b). Deposition tunnel plugs are used to close deposition tunnels during the operational phase of the repository, whereas plugs in other parts of the repository are constructions that provide mechanical restraint and hydraulic control functions at a particular place. The plug system is to provide the sealing against axial water flow and prevent erosion of bentonite from the deposition tunnel (Dahlström, 2009; Malm, 2012; SKB, 2010b). SKB has installed several full-scale plug tests at the STRIPA Mine (1980-1992) and the Äspö Hard Rock Laboratory (1995-present). These tests include the Tunnel Plugging Experiment, the Shaft Sealing Test, the Backfill and Plug Test and the Prototype Repository.

#### *Tunnel Plugging Experiment*

The tunnel plugging experiment was conducted in a 35 m long tunnel at the STRIPA Mine, at approximately 380 m depth from the ground (Gray, 1993; Pusch et al., 1987a,b). The tunnel plug design is shown in Figure 2.2. It was designed and constructed to allow passage past the plug via the axial access tube (Pusch et al., 1987b). The main objective of the tunnel plugging experiment was to evaluate the performance of the approximately 2.2 m long concrete concrete bulkheads together with the 0.5 m width and depth inset gaskets of highly compacted bentonite.

The tunnel plugging experiment demonstrated that it was possible to construct a composite concrete and highly compacted bentonite plug, and that the seepage can be substantially reduced by the highly compacted bentonite, vastly reducing seepage at the rock-concrete interface. There was no measure of mechanical stability of the plugs provided, and the duration of the test was short (a few months).

#### *Shaft Sealing Test*

The shaft sealing test was conducted in a 14 m long tapered shaft at the STRIPA Mine. The design of the shaft sealing test is shown in Figure 2.3. The shaft was 1.3 m diameter at its base and 1 m diameter at the top (Gray, 1993; Pusch et al., 1987a). The shaft sealing test comprised two tests; one test was to study the water flow around a concrete plug and the other was to study the

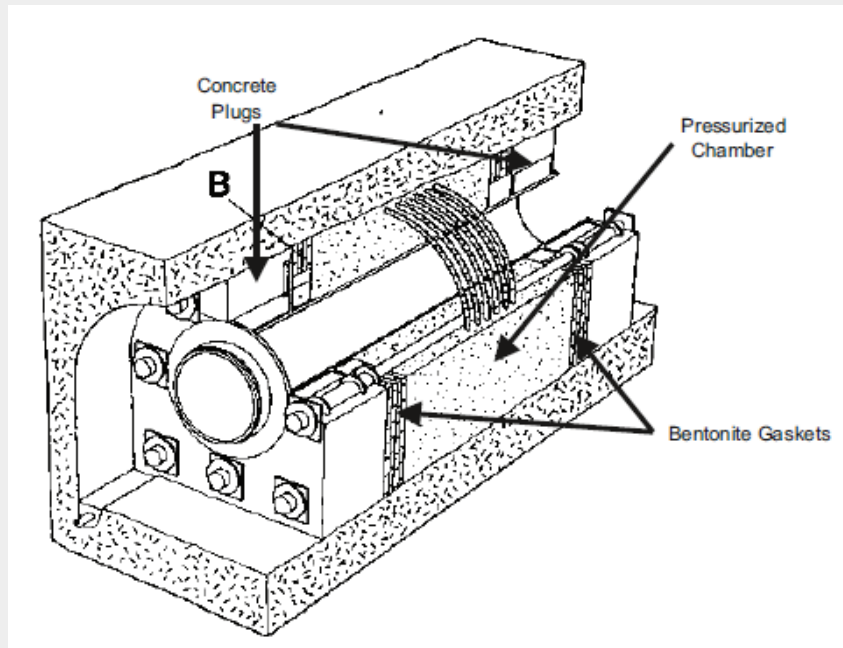

Figure 2.2: Design of the tunnel plugging experiment (Pusch et al., 1987b).

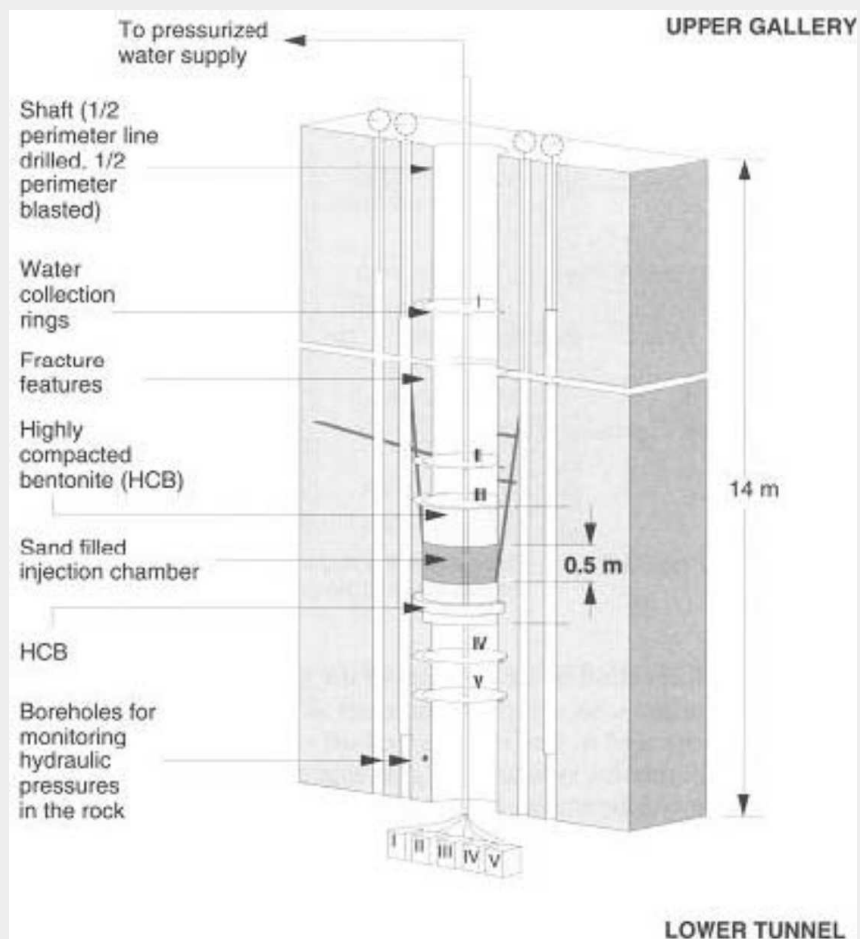

Figure 2.3: Design of the Shaft Sealing Test (Gray, 1993; Pusch et al., 1987a).



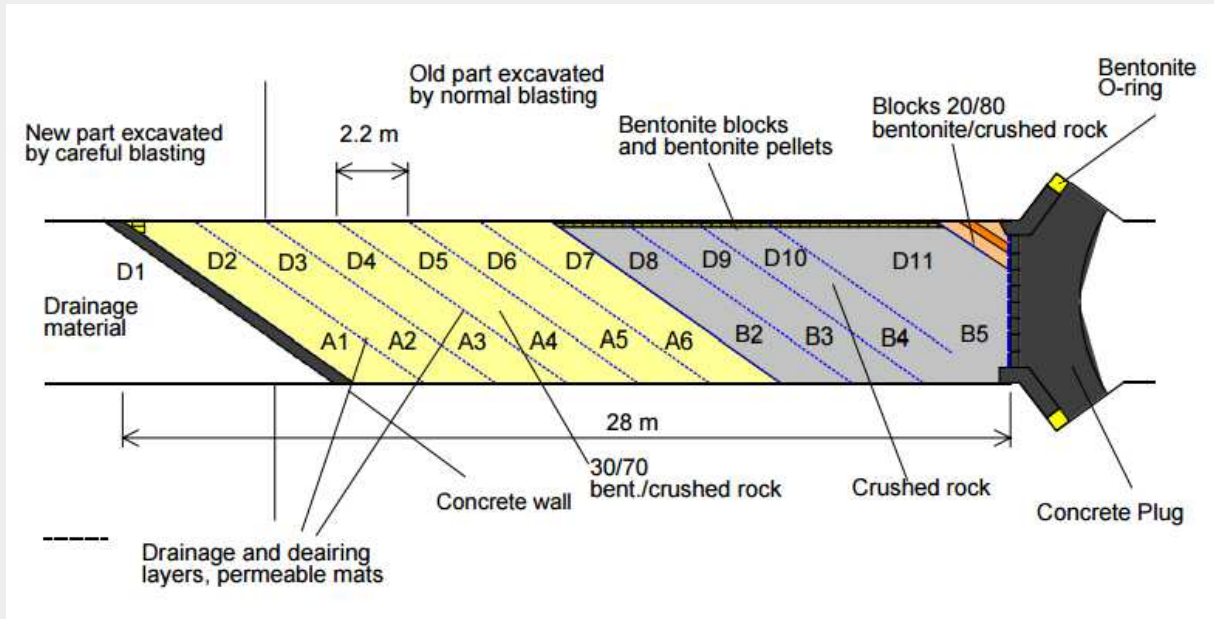

Figure 2.4: Layout of the backfill and plug test (Gunnarsson et al., 2001).

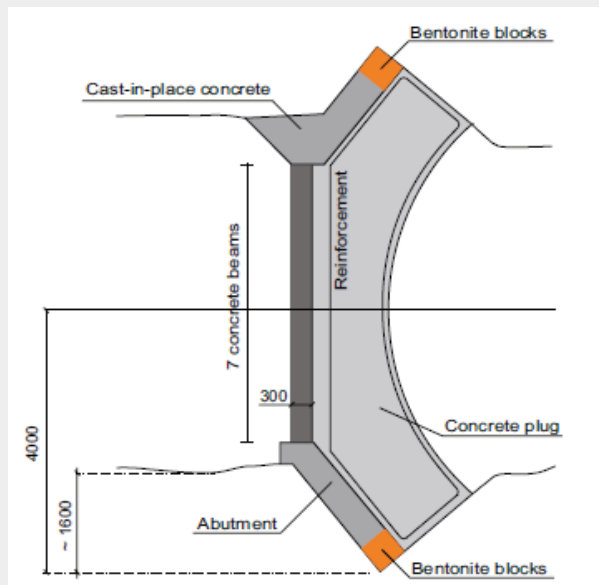

Figure 2.5: The plug design of the backfill and plug test (Malm, 2012).

seepage past the keyed and unkeyed sections of the shaft of the concrete plug. In order to cut off the excavated damaged zone (EDZ) that may have been developed during the tunnel excavation, highly compacted bentonite was used to fill a keyed lower section in the second shaft seal test (Dixon et al., 2009).

The shaft sealing test demonstrated that the bentonite was able to reduce the water flow along the hydraulically conductive features in the walls of excavation. The duration of shaft sealing test was also short, and interconnected hydraulic features would likely have been more important in determining the seepage than would occur in plugs of greater length (Dixon et al., 2009). The shaft sealing test also demonstrated the effectiveness of a composite system in reducing seepage through the tunnels.

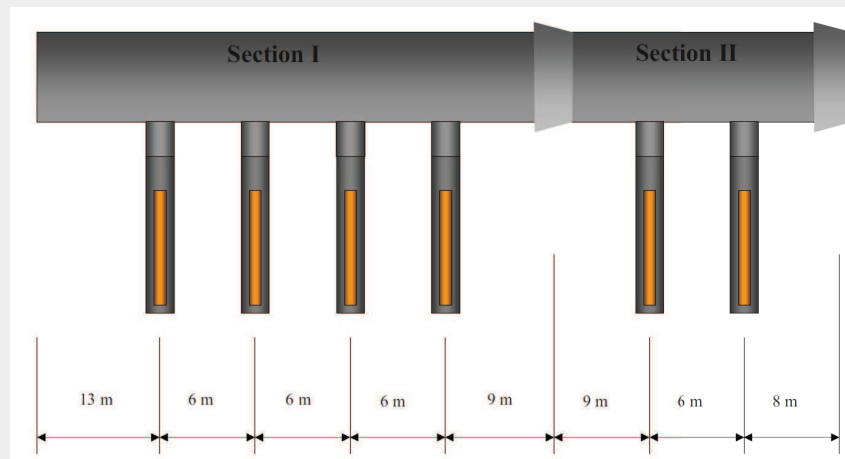

Figure 2.6: Layout of the prototype repository simulation (Dahlström, 2009).

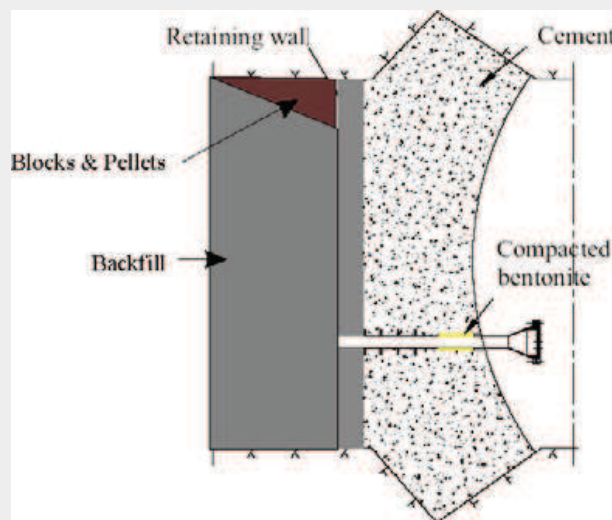

Figure 2.7: Design of the dome shape plug used in the prototype repository (Johannesson et al., 2004).

### *Backfill and Plug Test*

The backfill and plug test (Gunnarsson et al., 2001; SKB, 2008) was located at 420 m depth at the Äspö Hard Rock Laboratory. It consisted of a 28 m long installation in a blind drift and three major test sections as shown in Figure 2.4. The backfill and plug test was conducted to study different backfill materials, emplacement methods and full-scale plug design. The test was performed to study the concrete structure, that was designed to resist the swelling pressure from the backfill as well as the hydraulic pressure from the hydraulic head. The test was also designed to study the water seal's effectiveness in preventing seepage into the adjacent open area. The design of the concrete plug is shown in Figure 2.5, in which the concrete structure and highly compacted bentonite were installed together to achieve the mechanical and sealing function. This test was made as a preparation for the Prototype Repository test (Malm, 2012).

### *Prototype Repository*

The prototype repository is located at 450 m depth at the Äspö Hard Rock Laboratory, and the length of the tunnel used in the experiment was 65 m (Dahlström, 2009). In the floor of the tunnel, 6 full-scale emplacement holes were drilled and divided into two sections, as seen in Figure 2.6. Electrical heaters were installed in the emplaced canisters to simulate the heat generated by the



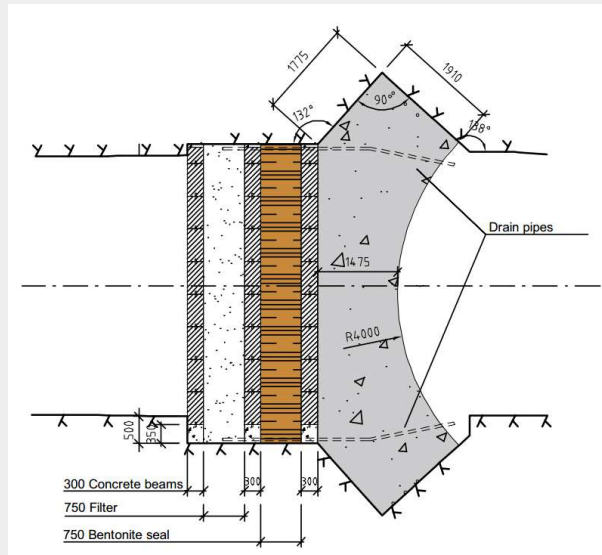

Figure 2.8: Layout of the KBS-3V reference plug design (Malm, 2012).

spent nuclear fuel, the canisters were surrounded by highly compacted bentonite, and the tunnel was filled with mixture of crushed rock and bentonite backfill material. The prototype repository was conducted to study the integrated function of the repository components under realistic conditions at full-scale. The prototype repository provided an opportunity to study the leakage control of the tunnel plugs and evaluate the plug design. A dome shaped plug was used in this test, as shown in Figure 2.7.

### *KBS-3 Repository*

Sweden has decided to build the final repository based on the KBS-3 method developed by SKB. For the deposition of spent nuclear fuel, the KBS-3 repository comprises the canister with spent fuel, placed in a system of either horizontal tunnels (KBS-3H) or vertical holes (KBS-3V) consisting of engineered barriers and the crystalline host rock (SKB, 2010a). The disposal tunnels will be approximately 30 m long, and they will be placed about 40 m apart. In the floor of the tunnels there will be deposition holes about 6 m apart.

In order to close the backfilled deposition tunnel, when all the canisters for spent fuel are deposited a plug is proposed. The reference design of the plug has continuously been developed based on the earlier constructed and tested plugs introduced in the above sections. The reference plug design has the following components: delimiter (wall of concrete beams), filter, bentonite seal and the concrete plug, as shown in Figure 2.8. A schematic of the reference plug system is shown in Figure 2.9. The delimiters were used to separated the different layers in the plug design. The filter, consisting of sand or gravel material, was designed to drain the tunnel until the concrete plug has gained full strength and to collect water leaking out from the backfill. The filter was also designed for controlled wetting of the bentonite seal. The bentonite seal consists of bentonite clay, and was designed to seal leakage paths and the interface between the host rock and the concrete, to ensure a watertight seal in the plug system. The concrete plug has a dome shape, and is designed to resist deformation and keep the bentonite seal, filter and backfill in place (Malm, 2012; SKB, 2010b).

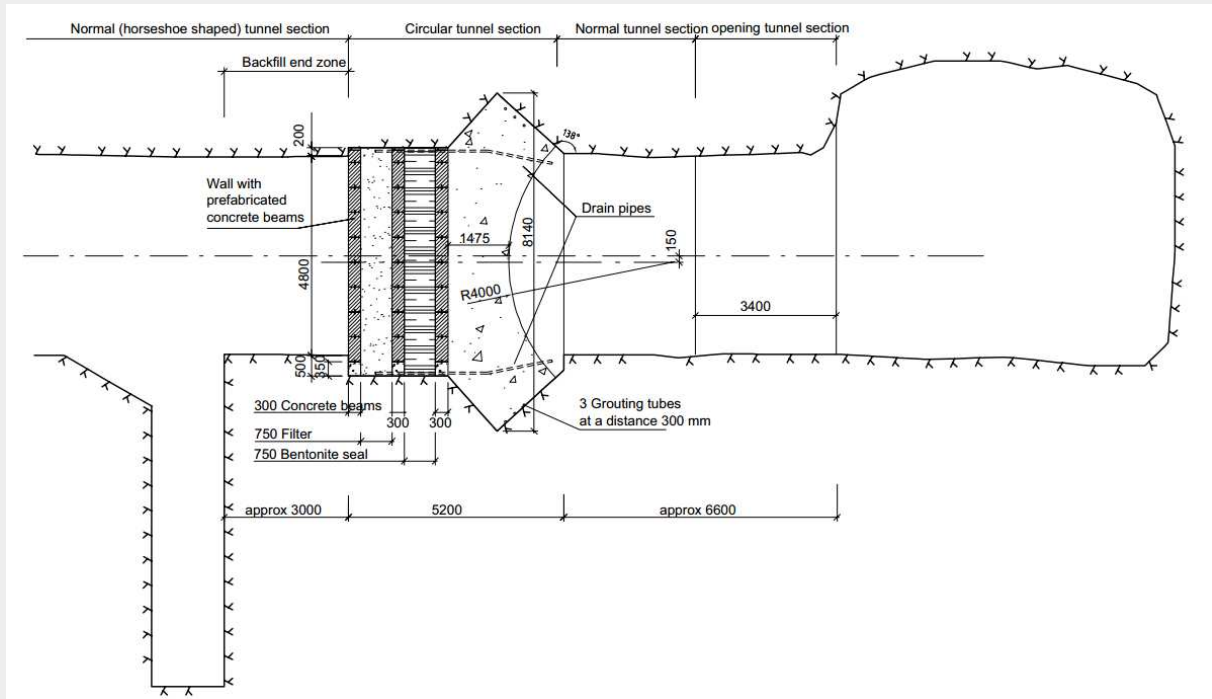

Figure 2.9: Schematic view of the KBS-3V reference plug system (Malm, 2012).

### 2.3.2 Plug studies in Canada

#### *Tunnel Sealing Experiment*

The tunnel sealing experiment was undertaken in Whiteshell Underground Research laboratory (*URL*) in Canada, in granitic rock. It was designed to study, at full-scale, an unreinforced concrete plug (Dixon et al., 2009; Malm, 2012). Two types of bulkhead (concrete plug and clay seal) were tested to characterise the sealing potential, the tunnel had an elliptical shape and was 4.4 m wide and 3.5 m high, and the layout of the test is shown in Figure 2.10. The objective of this plug test were: the assessment of technologies for the construction of practicable concrete and bentonite-based bulkheads; to evaluate the performance of each bulkhead; and to identify and document parameters that particularly affected performance (Chandler et al., 2002).

The tunnel sealing experiment illustrated that the concrete plug and the clay plug were both effective in cutting off the water flow from a tunnel in a granitic rock mass. It was also demonstrated that, during the pre-saturation stage, the clay component can provide a lower seepage rate than the concrete component. The test results led to the conclusion that a keyed composite seal, containing both clay and concrete components, would provide a means of cutting off flow along the tunnel axis, would have a self-sealing capacity, and would be mechanically stable (Chandler et al., 2002).

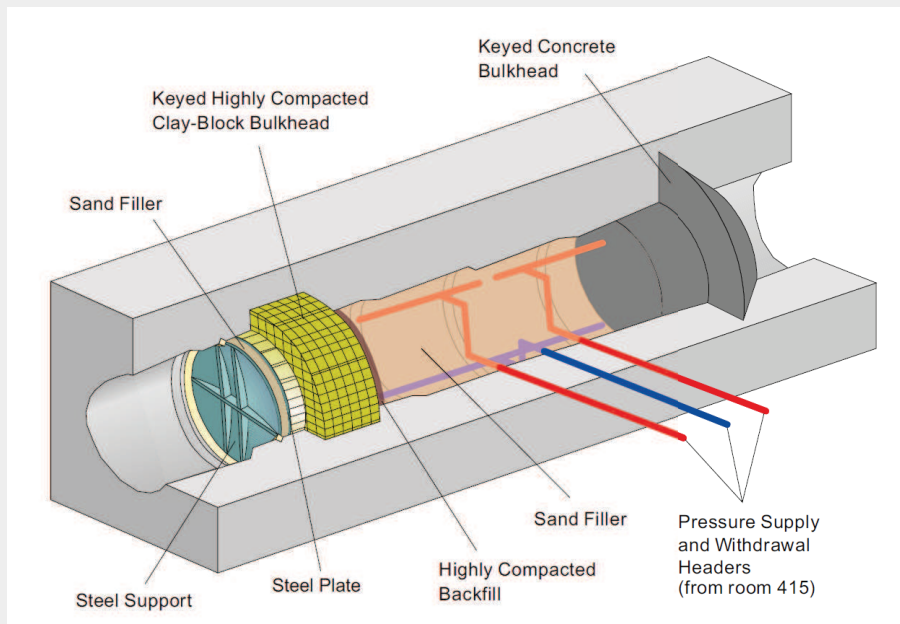

Figure 2.10: Layout of the tunnel sealing experiment (Chandler et al., 2002).

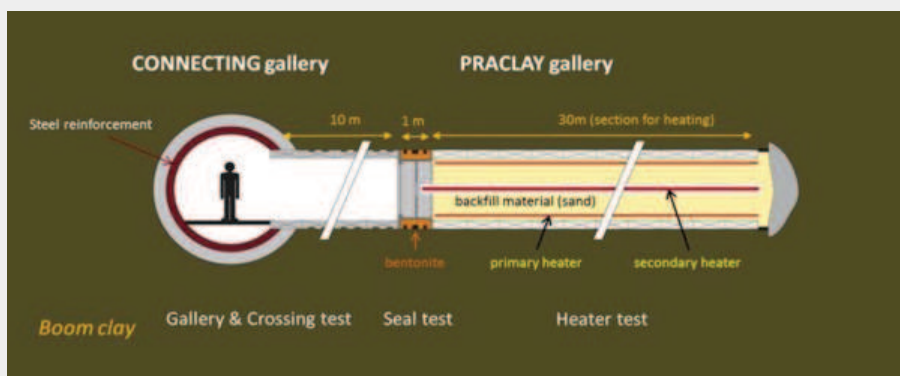

Figure 2.11: Layout of the PRACLAY experiment (Van Marcke et al., 2013).

### 2.3.3 Plug studies in Belgium

In Belgium, the Boom Clay has been selected as a potential host rock for the geological disposal of high-level and long-lived radioactive waste. The URL HADES, located at Mol, was constructed in the Boom Clay at 223 m depth to investigate the feasibility of geological disposal of radioactive waste in clay formations (Li et al., 2010, 2013).

#### *PRACLAY Experiment*

The PRACLAY project began in 1995, with the layout of this experiment shown in Figure 2.11. The main objective was to demonstrate the feasibility of constructing galleries using industrial techniques, achieved with the construction of the connecting gallery and the development of a large-scale demonstration of the reference design.

The PRACLAY in-situ experiment includes three tests: the heater test, the seal test and the gallery and crossing test. A hydraulic seal plug was installed in the PRACLAY gallery in 2010. The plug consists of a steel structure closing off the heated part of the gallery from the rest of the underground area, and an annular ring of compacted bentonite placed against the clay. Numerical simulation was used to determine the design of the plug, where scoping calculations proved that a

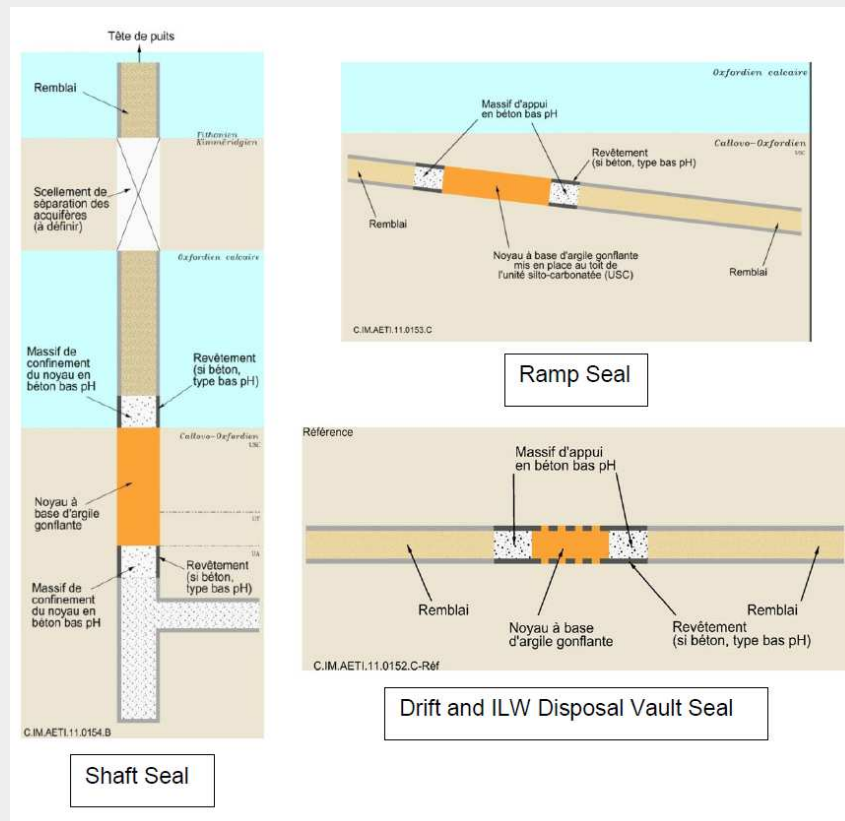

Figure 2.12: Conceptual designs for each type of seal (White et al., 2014).

seal length of 1 m was sufficiently effective and that no significant gain was obtained by any further increase in the length of the seal (Van Marcke et al., 2013).

### 2.3.4 Plug studies in France

In France, the 155 million year old Callovo-Oxfordian formation has been investigated as a potential host rock for the repository, which proposed to be located in the east of the Parisian Basin (République Française, 2011). The industrial repository project is referred as Cigeo. In the French concept, seals are defined as hydraulic components for closure of large diameter underground installations and infrastructure components such as shafts, ramps, drifts and intermediate level waste disposal vaults. The conceptual design for each type of seal is shown in Figure 2.12.

#### *FSS experiment*

The Full-Scale Seal (FSS) experiment is a reference drift and intermediate level waste disposal vault seal, being carried out in a hangar of a surface facility, in Saint Dizier, France. The FSS experiment consists of a swelling clay core and concrete containment walls, as shown in Figure 2.13. The design basis is to fulfil the safety function by limiting the groundwater flow. The main objective of the FSS experiment is to demonstrate the technical feasibility of constructing a full scale disposal seal. Technical feasibility includes demonstrating the ability of the approach used to emplace the swelling clay to be suitable for filling recesses in the clay host rock, and also the capacity to build large concrete containment walls with satisfactory mechanical properties. The experiment is focused on the construction of the seal, and the materials will not be saturated or otherwise pressurised (White et al., 2014).

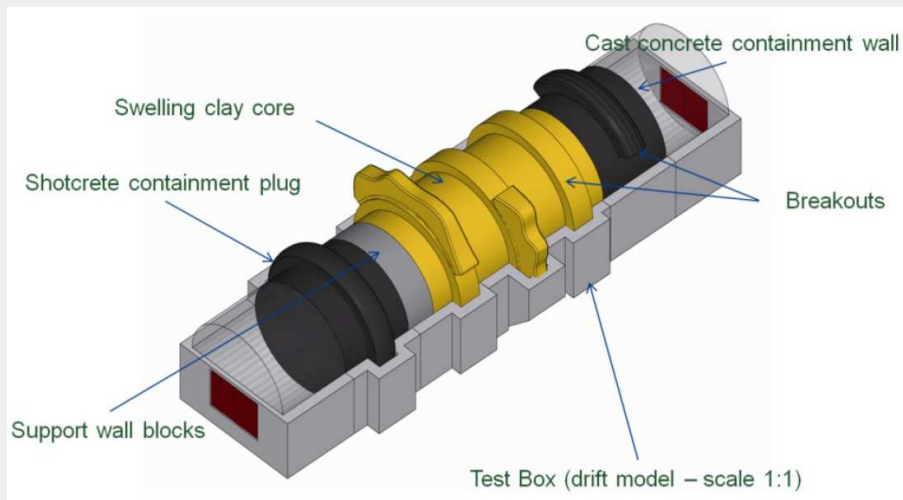

Figure 2.13: Layout of the FSS conceptual design (White et al., 2014).

## 2.4 Conclusions

Plug systems for repositories in various countries have been reviewed in this chapter. While it is clear that specific designs are due to specific geological conditions and the safety case, it was seen that for clay host rocks the main role is to limit the flux of groundwater, by being impermeable and also holding the material in place. The experiences of international research programmes and their designs has been discussed for various host rocks.

## 3 Plug system scoping design

### 3.1 Requirement considered for the Dutch plug design

#### 3.1.1 The basic functions of the plug systems

The most important functions of the repository plug system are that it should:

- (i) Keep the backfill in place;
- (ii) Be a watertight barrier limiting axial water flow and erosion of backfill from the deposition tunnel.

To achieve the second function the plug system must:

- (i) Reduce the hydraulic gradient in the backfill to reduce any possibility of erosion;
- (ii) Reduce flow, by ensuring low permeabilities.

This function requires that the plugs have low hydraulic conductivity, and that the interface between the concrete plug and the host rock must be effectively closed. The plugs also provide mechanical support for the backfill material.

In addition to the water flux requirement, the French guidelines include a general requirement for seals to play a major role in repository safety. Performance assessment modelling by Andra has indicated that radionuclide migration will be preferentially through the host rock provided the seals maintain a hydraulic conductivity of  $10^{-9}$  m/s or less (the actual requirement for the swelling clay core currently set in the Andra programme is  $10^{-11}$  m/s.). This hydraulic conductivity applies across the seal and must therefore be satisfied by all the components: the swelling clay core, any lining and the EDZ, and also the interface between these elements (White et al., 2014). However this aspect will be confirmed by performance assessment modeling for the Dutch case. Finally, when the transport tunnels are backfilled and saturated the function of the plug system has a more limited role. However, this is proposed to be around 100 years after construction (Verhoef et al., 2014a), so the plug system should be designed to function for at least this time scale.

The Dutch disposal system must allow for retrievability (Verhoef et al., 2014a), and therefore this must be a consideration in the design of the plug. Two implications may be derived; the first, that disposal galleries may be re-opened after closure, and the second, that access to sealed galleries may be required (prior to repository closure). The first implication will mean that sealing may be required for longer than 100 years, which means that a clay core becomes an essential component, as, due to concrete cracking and degradation, concrete is unlikely to provide such a seal. The second aspect could be addressed in a number of ways. As seen in Figure 2.2, an access tube could be installed through the plug system, sealed by a metallic access door, although this may, over time, corrode. Therefore, it is thought to be preferable not to have an access tube and to use engineering methods to access any disposal galleries already sealed.

The construction and other issues must also be practical. Therefore, in this work, as simple a design as possible has been considered. It is considered that altering the tunnel design, e.g. via tapered sections, is undesirable, as is the extensive removal of the tunnel lining, which may additionally affect the retrievability.

### 3.1.2 The components of the plug system

Based on the experiences in the previous sections, and the required functions of the plug system, two main components for a plug system in Boom Clay are summarised as follows: a concrete plug and a bentonite seal.

The concrete plug should mechanically support the bentonite seal and backfill, and transfer the loads into the surrounding host rock. The bentonite seal cannot prevent leakage unless it has reached sufficient saturation, so the concrete plug must prevent leakage until this time (Dahlström, 2009; Malm, 2012). After this point, the requirement of the concrete plug to be watertight is no longer necessary. The concrete plug must carry the hydrostatic water pressure as well as the effective stresses. Retrievalability means that each of the repository galleries should be isolated, and therefore plugs should be installed at the end of each disposal gallery.

The backfill is likely to provide a low permeability environment itself, but to reduce any risk of erosion of the backfill, the seal should create conditions that only allow a low hydraulic gradient to exist in the backfill. The backfill material is proposed to be foamed concrete (Verhoef et al., 2014b) in the Dutch disposal system.

The bentonite seal should prevent axial flow from the deposition tunnel, and can seal cracks in the concrete plug that may initiate on the upstream side of the plug, therefore preventing leakage (Malm, 2012). The seal must therefore be designed to have a low hydraulic conductivity, it must swell and seal, and it must be able to withstand a high hydraulic gradient. The seal must have good contact between the host rock and the bentonite. In order to reduce water flow through the EDZ, the bentonite seal can be inset into a slot in the host rock, or may be able to reseal the EDZ via swelling behaviour. The hydraulic cut off is achieved by the swelling pressure compressing the host rock, thus lowering the hydraulic conductivity of the clay around the seal to a value lower than the undisturbed in situ hydraulic conductivity (Van Marcke et al., 2013).

Concrete beams, such as shown in Section 2.3.1, or an additional concrete plug on the backfill side, such as shown in Section 2.3.4, may be used for ease of construction, but no filter is thought to be required to reduce flow during construction, as flow through the host rock would be small.

### 3.1.3 Loads acting on the plug

The expected load acting on the plug is summarised in this section. These loads are (Fälth and Gatter, 2009; Malm, 2012):

- (i) The water pressure (in the backfilled tunnel or elsewhere);
- (ii) The swelling pressure of the bentonite;
- (iii) The loads derived from the thermal load.

#### 3.1.3.1 Water pressure in the backfilled tunnel

The maximum unbalanced pore water pressure, i.e. the undisturbed ground water pressure, should be based on the vertical distance from the ground water level to the actual tunnel level. This gives the two worst case scenarios of shaft flooding (with an unsaturated or empty tunnel on the opposing side of the plug) as well as the scenario of a fully saturated and backfilled tunnel during the operation period. The ground water pressure will be affected by the surrounding tunnel, and thus lower than hydrostatic water pressures acting on the plug may be expected during the excavation period until pore water pressure recovery (Svensson, 2006). The hydrostatic pressure will also have a small variation over height of the concrete plug, but these variations are small compared to the total hydrostatic pressure. Due to retrievalability, the pore water pressure should be considered as a permanent load for the design of the concrete plug. In this case 5 MPa will be considered, which is equivalent to approximately 500m depth (see e.g. Arnold et al., 2015).



### 3.1.3.2 Swelling pressure of bentonite

The bentonite seal has been estimated to have a swelling pressure equal to 2 MPa (Fälth and Gatter, 2009; Malm, 2012). A higher density backfill of bentonite seal will introduce higher swelling pressures, but the density and therefore the swelling pressure can be controlled in the design process.

### 3.1.3.3 Thermal load

The decaying spent fuel will generate heat, which will cause a temperature increase in the surrounding rocks. This will induce thermal stresses in the rock mass and in the plug. Furthermore, the thermal expansion of the concrete plug will be different from the host rock, causing thermo-mechanical effects which could be considered in the plug design. However, as shown in Arnold et al. (2015), the temperature rise is likely to be limited due to the long period of interim storage.

### 3.1.3.4 Other loads

Besides on the loads summarised above, some other loads, such as lithostatic pressure, shrinkage and creep of the concrete plug and surrounding rock, and earthquakes, need to be incorporated in a detailed design of the plug system, but are not included in detail here. Compressive loads, i.e. those acting radially to the plug, will affect the contact of the plug with the tunnel lining or surrounding rock and, in general, will increase as time goes by (due to creep), thereby making the mechanical stability greater. Therefore, by not including these loads the initial design presented here is conservative. Concrete shrinkage may have the opposite effect, but it is strongly dependent on the detailed design and concrete mixture, and should therefore be taken into account in the detailed design stage; moreover, it is assumed that the additional displacement will be negligible compared to the overcut used in the tunnel excavation (Malm, 2012), and therefore rock stresses will only be negligibly altered. Settlements in the rock at the location of the plug, due to the higher volumetric weight of the concrete, could be expected. However, the additional load would be significantly lower than the in situ stresses and significantly lower the reduction in stress due to tunnel excavation, and therefore large plastic strains would not be expected.

## 3.2 Design scenarios

The disposal actions, such as the emplacement of the canisters into the deposition tunnels will go on for a few decades. After the waste packages (canisters, overpack, buffer) have been emplaced in their deposition tunnel, it has to be sealed from the main gallery. A plug system is needed to close the deposition tunnel and keep the backfill in place, as seen in Figure 3.3. Plugs are also needed to close the shafts and ramp after the disposal actions have been finished.



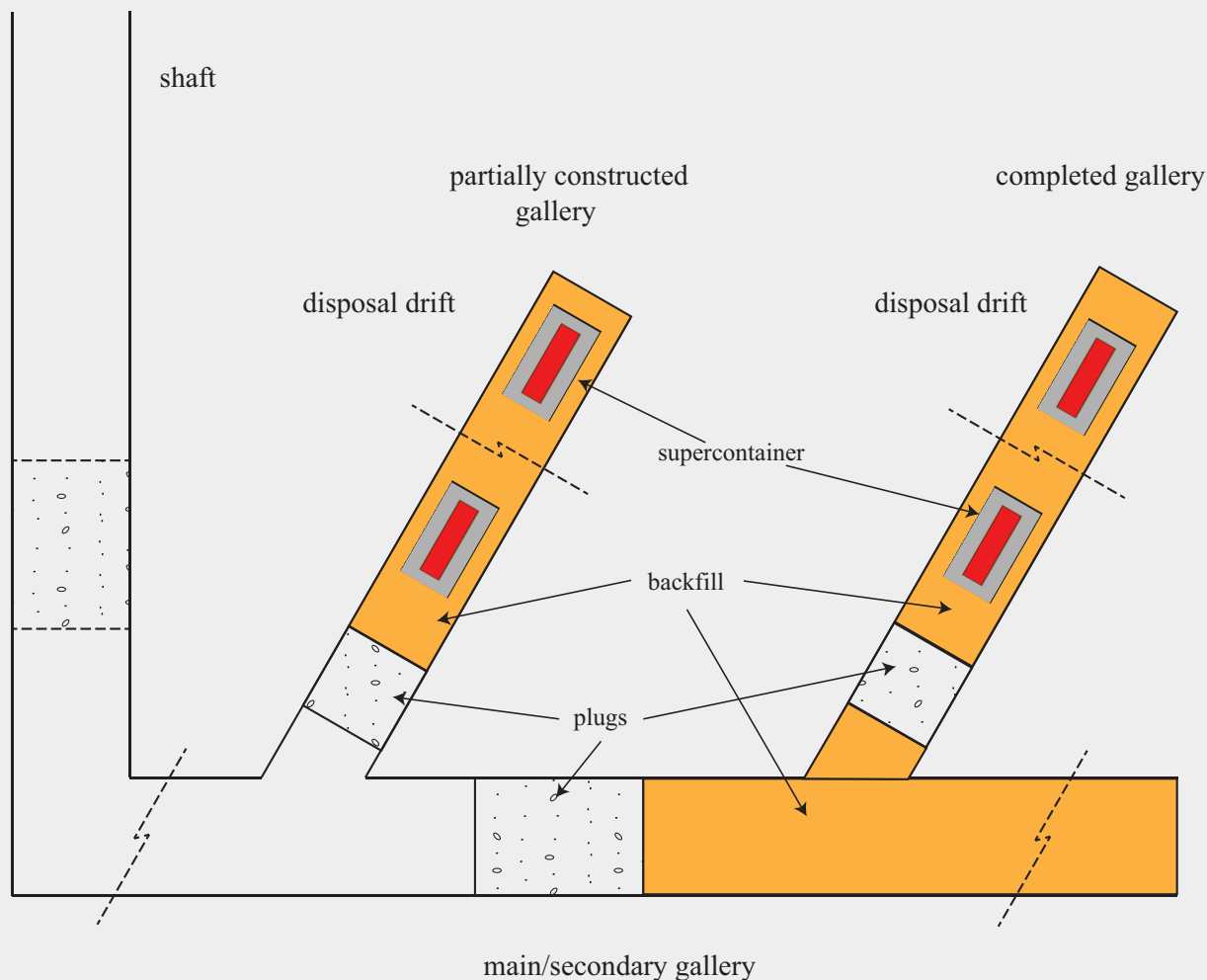

Figure 3.1: Schematic layout of plug locations in the repository concept. Main and secondary galleries are horizontal and the shaft is vertical.

During the operational period, the plugs for the disposal tunnel, shafts and ramps will face different kinds of load combinations. Based on different load combinations three types of design scenario are considered:

- (i) Shaft flooding;
- (ii) Partially constructed;
- (iii) Disposal actions completed and repository closed.

For the scenario of shaft flooding, there are two possible scenarios: (1) Where the hydrostatic pressure is acting on both sides of the plug and the swelling pressure of the bentonite come from the backfill direction. In this case, the only unbalanced external load acting on the plug is the swelling pressure. (2) The hydrostatic pressure has not recovered fully on the backfill side of the plug and therefore the swelling pressure has not developed. The maximum unbalanced external load is therefore the hydrostatic pressure.

For the scenario of a partially constructed repository, the greatest load is when the hydrostatic pressure and the swelling pressure of the bentonite are acting on the plug from the backfill direction and there is no load acting on the open side. In this case, the maximum unbalanced external loading acting on the plug is the hydrostatic pressure plus the swelling pressure.

For the scenario of construction completed, when both sides of the plug have been backfilled and the natural geohydrological conditions have been recovered, there will be only very limited unbalanced external load acting on the plug due to differences in saturation or swelling pressures.

The load combinations are summarised in Table 3.1.

Table 3.1: Summarised load combinations for scenarios

Scenario	Unbalanced load	Load ranges (MPa)
Shaft flooding	swelling pressure or hydrostatic pressure	2-5
Partially constructed	hydrostatic pressure + swelling pressure	7
Repository closed	none	0

### 3.3 Conceptual design of the plug geometry

The plug system initially sized here has two main components; a concrete plug for mechanical stability and a bentonite seal to control water flow. The bentonite seal should be in contact with the host rock, and therefore the tunnel lining should be locally removed. For the concrete plug to resist horizontal loads, mechanical support could be gained by also removing the lining locally, so that the plug can be supported by the lining. However, this may provide construction difficulties. Therefore, two types of conceptual plug design are studied in this section, with scoping calculations to initially determine the length of the plug components, from both the hydraulic and mechanical points of view. The systems are shown in Figure 3.2, where in Design A the concrete plug is installed inside the tunnel lining, whereas in Design B the tunnel lining is removed for the concrete plug to be installed. In both designs the tunnel lining is removed in the location of the bentonite seal, to ensure a good connection between the bentonite and the Boom Clay. It is anticipated that the EDZ would be able to be sealed via the swelling pressure of the bentonite, but local over-excavation in this area would allow an additional reduction of hydraulic conductivity.

#### 3.3.1 Mechanical stability of the plug

In Design A the mechanical loads must be resisted via friction between the tunnel lining and the plug, whereas in Design B the plug can transfer loads via compression into the lining (and subsequently the rock).

In both cases, the concrete is designed to be unreinforced to reduce the possibility of metal corrosion and, for the same reason, neither design has access tubes. Moreover, neither design requires alteration to the tunnel construction via tapering or substantial over-excavation.

The compressive strength of the concrete is considered to be significantly higher than the lithostatic pressures, and has therefore not been considered as a possible failure mechanism.

##### 3.3.1.1 Conceptual design A

For the first type of plug design (shown in Figure 3.2 as type A), the failure of this parallel-sided plug is governed by the interface shearing between the concrete plug and lining. The following equation can be applied to calculate the circular plug length, of (outer) radius  $r$  and length  $l$  (Auld, 1983),

$$\begin{aligned} \sigma \pi r^2 &\leq 2 \pi r l p_{pe} \\ l &\geq \sigma r / 2 p_{pe} \end{aligned} \quad (3.1)$$

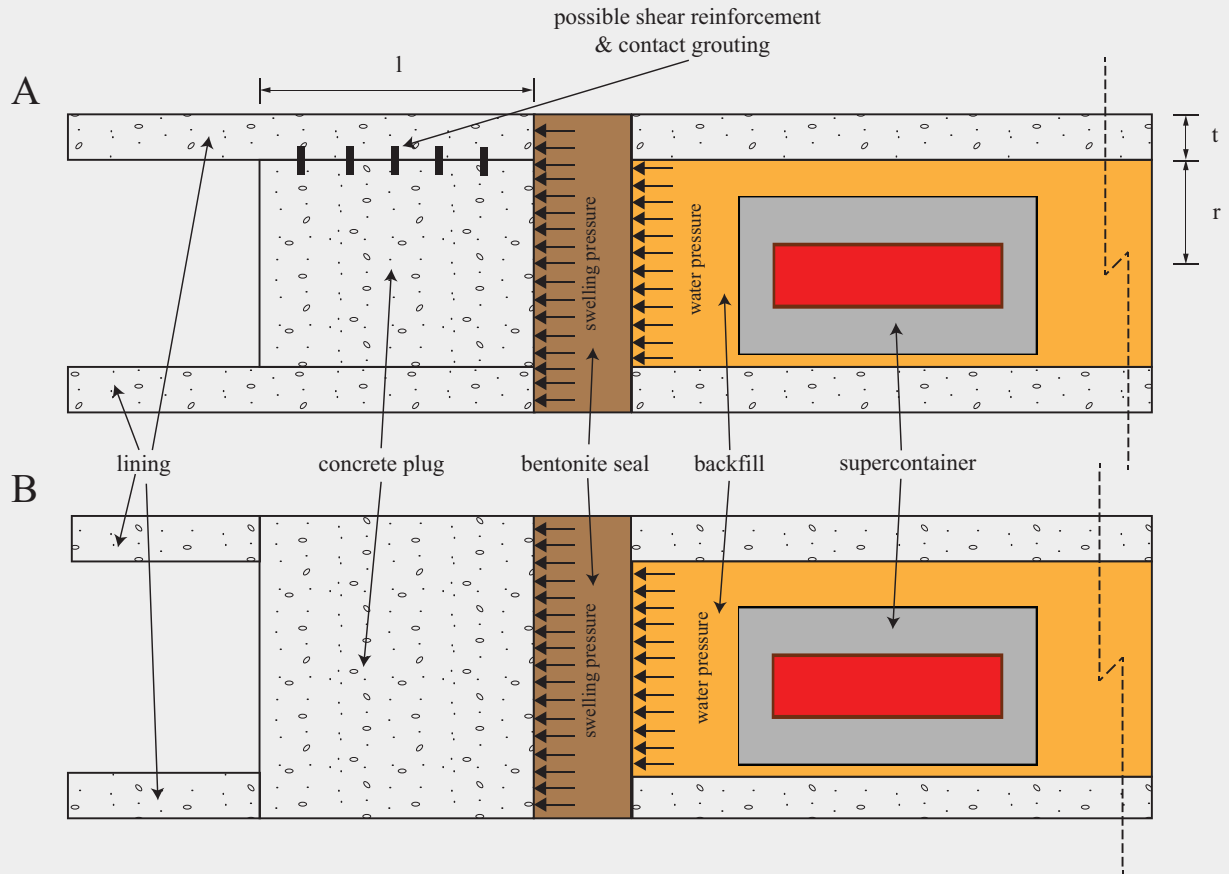

Figure 3.2: Two types of conceptual plug design, (A) with the concrete plug installed inside the tunnel lining, and (B) with the tunnel lining removed locally where the concrete plug is installed.

where  $\sigma$  is the applied stress, and, in this case, the total stress is assumed to be 7 MPa (see table 3.1). This is the sum of the estimated swelling pressure in the bentonite seal of 2 MPa (Fälth and Gatter, 2009) and a pore water pressure of 5 MPa at the depth of 500 m (Verhoef et al., 2014a). Also in the above equation,  $p_{pe}$  is the permissible punching shear stress of the rock or concrete interface.

### 3.3.1.2 Conceptual design B

For the design of plug B, the resistance force is provided by the interface shearing between the concrete plug and host rock, plus the support from the lining. Following Verhoef et al. (2014a) and Arnold et al. (2015), the lining is initially proposed to be 0.5/0.55 m thick, although, as noted by Arnold et al. (2015), there may be scope to reduce this during detailed design.

The load is partly transferred through friction between the host rock and plug, and partly through the lining, into the surrounding rock. The concrete plug must have sufficient strength at the interconnection between the plug and lining. The lining area must be sufficiently large to reduce the bearing stress imposed by the plug to a permissible value. Therefore, the concrete bearing stress of the lining is calculated by Auld (1983),

$$\sigma_b = \frac{\sigma \pi r^2 - 2\pi(r+t)lp_{pe}}{\pi((r+t)^2 - r^2)} \leq p_b \quad (3.2)$$

$$l \geq \frac{\sigma r^2 - p_b((r+t)^2 - r^2)}{2(r+t)p_{pe}}$$

where  $\sigma_b$  is the bearing stress,  $p_b$  is the permissible concrete bearing stress,  $t$  is the thickness of tunnel lining and  $r$ , in this case, is the inner radius.

The punching shear resistance of the concrete plug sitting against the concrete lining must also be adequate. The concrete punching shear stress (at the inner radius) can be calculated from:

$$\begin{aligned} \sigma_p &= \frac{\sigma \pi r^2}{2\pi r l} \leq p_p \\ l &\geq \frac{\sigma r}{2p_p} \end{aligned} \quad (3.3)$$

where  $\sigma_p$  is the punching shear stress,  $p_p$  is the permissible concrete punching shear stress and  $r$  is the inner radius here.

### 3.3.1.3 Concrete strength

According to SKB's designs (Malm, 2012), low-pH concrete is recommended for the plugs in order to prevent the erosion of the bentonite clay seals. Based on tests on low-pH concrete (Vogt et al., 2009), it can be assumed that the concrete complies with the strength class C55/67.

Concrete permissible stresses used by Auld (1983) are contained in Table 3.2. The values are derived based on the old UK codes of Practice (British Standards Institution, 1969, 1972). In this study, the concrete permissible stresses based on Eurocode 2, EN1992-1-1 (European Committee for Standardisation, 2004), are used. The values are all related to the concrete characteristic strength,  $f_{ck}$ , this being the strength below which 5 % of results may be expected to fall. Note that in this study a safety factor of 1 is considered to give an initial size.

#### *Compressive strength*

The design compressive strength of concrete,  $f_{cd}$  ( $p_b$  in Table 3.2), according to EN1992-1-1 (European Committee for Standardisation, 2004), Section 3.1.6, is taken as:

$$f_{cd} = \alpha_{cc} f_{ck} / \gamma_c \quad (3.4)$$

where  $f_{ck}$  is the characteristic cylinder compressive strength of concrete at 28 days,  $\gamma_c$  is the partial (safety factor for concrete) and  $\alpha_{cc}$  is a coefficient taking account of long-term effects on the compressive strength and of unfavourable effects resulting from the way the load is applied. In each case the material safety factor,  $\gamma_c$ , has been selected to be 1.0, although EN1992-1-1 recommend 1.5 so that overall safety levels can be considered. EN1992-1-1 recommends that  $\alpha_{cc} = 1$ .

#### *Shear strength*

The design strength in shear and compression of concrete,  $f_{cvd}$  ( $p_p$  in Table 3.2), according to EN1992-1-1 (European Committee for Standardisation, 2004), Section 12.6.3, is taken as:

$$f_{cvd} = \sqrt{f_{ctd}^2 + \sigma_{cp} f_{ctd}} \quad (3.5)$$

where  $f_{ctd}$  is the concrete design strength in tension and  $\sigma_{cp}$  is the compressive stress in the concrete from axial load or prestressing.

#### *Concrete to concrete interface shear strength*

The design shear resistance at the interface,  $v_{Rdi}$  ( $p_{pe}$  in Table 3.2), according to EN1992-1-1 (European Committee for Standardisation, 2004), Section 6.2.5, is given by:

$$v_{Rdi} = c f_{ctd} + \mu \sigma_n + \rho f_{yd} (\mu \sin \alpha + \cos \alpha) \quad (3.6)$$

where  $c$  and  $\mu$  are factors which depend on the roughness of the interface,  $f_{ctd}$  is the concrete design strength in tension,  $\sigma_n$  is the confining stress,  $\rho$  is the reinforcement ratio, and  $f_{yd}$  is the design yield strength of the reinforcement.

### 3.3.1.4 Results

Based on equation 3.4 and considering a safety factor equal to 1, the design compressive strength of concrete can be derived, giving  $f_{cd} = 55$  MPa (Table 3.1 from the European Committee for Standardisation, 2004).

For design A, the concrete to concrete interface shear strength is required to be calculated (equation 3.6). The concrete design strength against tension,  $f_{ctd}$ , again taking partial factors as equal to zero, is taken from Table 3.1 of the European Committee for Standardisation (2004), as 3 MPa. According to equation 3.6, with  $c = 0.45$  (rough interface, EN1992-1-1), and considering no reinforcement for the interface and no confining stress from the lining, the shear resistance at the concrete to concrete interface is  $v_{Rdi} = p_{pe} = 1.35$  MPa. Note that, if contact grouting is performed between the concrete to concrete interface, the shear resistance at the interface can be further improved; for long term storage a confining stress of 2 MPa can be considered equal to the confining pressure from the rock (however this has not been used here).

Then applying equation 3.1, and considering the inside radius of the tunnels as being  $r = 1.85$  m for the LILW and (TE)NORM disposal galleries, and  $r = 1.1$  m for the HLW/spent fuel disposal galleries (Verhoef et al., 2014a), gives plug lengths of 4.8 and 2.85 m, respectively. If using the concrete permissible stresses from Table 3.2, a permissible punching shear stress of 2.75 MPa is found, which would give plug lengths of 2.35 m and 1.4 m, respectively.

For design B, the concrete strength against bearing (i.e. the compressive strength, 55 MPa), the interface shear strength and the concrete strength in shear and compression (equation 3.5) are needed. The interface shear strength can be taken as the weakest of the rock or the concrete interface shear strengths. However, considering equation 3.2, and making the interface shear strength zero, the bearing strength required is 10.2 MPa, which is far below the 55 MPa compressive strength and satisfies the overall stability; therefore the punching resistance of the plug, equation 3.3, is more critical. To calculate the shear strength of the concrete, equation 3.5 is used. Following Arnold et al. (2015), the radial stress at the tunnel interface is between 2-10 MPa, and therefore the minimum value of 2 MPa is chosen for  $\sigma_n$ . This yields the concrete strength in shear and compression,  $f_{cvd} = 3.873$  MPa (used as  $p_p$  in equation 3.3). This compares to a value from Table 3.2 of 4.04 MPa. Using the design strength according to the Eurocode, gives plug lengths of 1.67 and 0.99 m for tunnel radii of 1.85 m and 1.1 m, respectively. Using Table 1 gives plug lengths of 1.60 and 0.95 m, respectively.

#### *Factor of safety*

As far as possible, the factor of safety is removed from the concrete strength calculation to allow for changes in construction methods and material changes. During the detailed design, factors of safety should be considered.

### 3.3.2 Constructability

As mentioned in the previous section, the tunnel lining at the location of the plug system may require additional treatment (e.g. local reinforcement) to provide support for the concrete plug. This additional treatment may lead to changes in the constructability.

For design A, contact grouting and reinforcement may be considered in order to increase the shear strength at the concrete to concrete interface. Steel (or other material) reinforcement can be introduced to improve the shear strength between the plug and lining (as shown in Figure 3.2 type

Table 3.2: Concrete permissible stresses (Auld, 1983).

Type of stress		Bending compression, $p_c$ (MPa)	Direct compression or bearing, $p_b$ (MPa)	Concrete to rock interface bearing <sup>1</sup> , $p_{be} = 3.75p_{pe}$ (MPa)	Punching shear $p_p = 0.2p_c$ (MPa)	concrete to rock interface punching shear <sup>1</sup> , $p_{pe}$ (MPa)
CP114:1969	value	$f_{cu}/2.73$	$0.75f_{cu}/2.73$	$0.75f_{cu}/4$		$0.2f_{cu}/4$
Grade	25	9.16	6.87	4.69	1.84	1.25
characteristic	30	10.99	8.24	5.63	2.20	1.50
strength,	35	12.82	9.62	6.56	2.56	1.75
$f_{cu}$	40	14.16	10.99	7.5	2.94	2.00
	45	16.48	12.36	8.44	3.30	2.25
	50	18.32	13.74	9.48	3.66	2.50
	55	20.15	15.11	10.31	4.04	2.75

A)). The reinforcement can be installed in pre-cast lining sections prior to installation or during the installation of the concrete plug.

In design B, the tunnel lining is removed, which will additionally affect the constructability considerably. As extensive removal of the tunnel lining will result in a tunnel stability problem, support may be needed after removing the tunnel lining and during the concrete plug construction.

The plug is a massive concrete structure; during concrete hardening heat will be generated and this will cause volumetric expansion and stresses. This expansion can create cracks. A cooling system may be needed, or special concrete to reduce the temperature or to ensure a relatively uniform temperature during the plug construction. Additionally, the hydrostatic pressure and the swelling pressure of the bentonite may rise gradually during the concrete plug construction, although this is likely to be limited by the low hydraulic conductivity of the Boom Clay. The level of pressure acting on the plug needs to be controlled during the construction of plug.

### 3.3.3 Hydraulic seal of the plug system

To substantially limit any possible water flow, a compacted bentonite seal is proposed. A rule of thumb has been used when tunnel plugs are constructed in conjunction with, for instance, water power dams, is that the plug length  $L$  is derived according to (Fälth and Gatter, 2009)

$$L = \alpha \cdot H \quad (3.7)$$

where  $\alpha$  is an empirical factor in the range 0.04-0.08 (Fälth and Gatter, 2009), and  $H$  is the water head drop over the plug. The reason for applying a length according to the above equation is mainly to seal the tunnel and reduce the leakage of the plug. The disposal concept assumed for OPERA has a repository depth of 500 m (Verhoef et al., 2014a). Applying the above equation gives a plug length of 20-40 m. A plug of that length would most likely be prohibitively expensive for the repository application. Therefore further calculations have been carried out to examine, in detail, the hydraulic performance.

<sup>1</sup>Based on a factor of safety = 4.



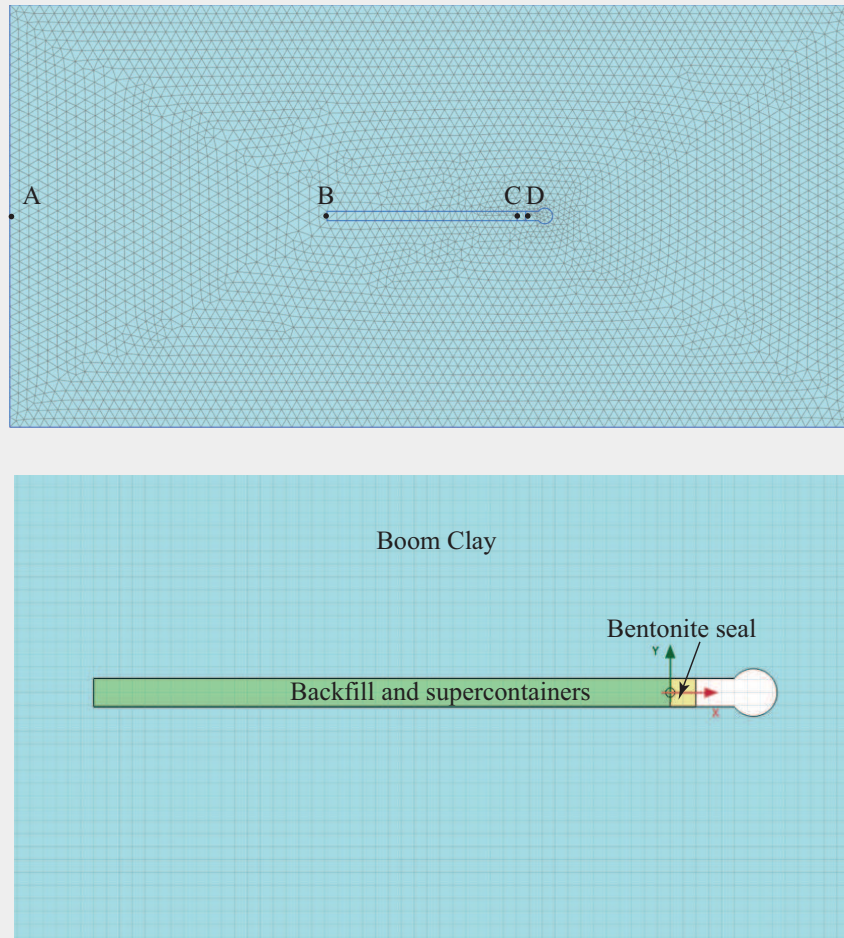

Figure 3.3: The mesh and details of the deposition tunnel and plug system used for the hydraulic simulation.

### 3.3.3.1 Numerical simulation

Numerical simulations have been performed to study the hydraulic function and sealing length of the plug and the axial flow in the backfill. A 2D geometry of a vertical section through the site has used to study the water pressure distribution and water flow of the plug seal system. A sensitivity analysis of the sealing length and hydraulic conductivity of the backfill has also been carried out.

#### *Model set-up*

The two-dimensional plane strain analyses have been performed with PLAXIS 2D AE (Plaxis, 2014). The simulation domain is approximately 200 m long and 100 m high, with the mesh and geometry near the deposition tunnel and plug system shown in Figure 3.3. The domain is discretised using 15-node triangular elements and refined in the close vicinity of the tunnel (Figure 3.3). The hydraulic boundary conditions are as follows: the water head at the outer Boom Clay boundaries are fixed to 500 m, the inner boundary of the open tunnel and the outer sealing boundary are free draining, i.e. fixed at 0 m head.

The domain is divided into 3 different property areas with different hydraulic properties: (i) those of the host rock (Boom Clay), (ii) backfill, tunnel lining and supercontainers (termed backfill herein), and (iii) the benonite seal (Figure 3.3). The fluid flow has been modelled here using a steady state Darcy flow equation. The mechanical behaviour and displacements in the domain have not been included in the simulations. The hydraulic conductivity of the backfill and supercontainers from installation until the post-closure period is uncertain. The hydraulic conductivity of foamed concrete

in a normal operation period (e.g. decades) is approximately  $1 \times 10^{-11}$  m/s (CUR, 1995), however, this does not include two aspects: (i) other materials in the tunnel, i.e. the supercontainers and tunnel linings, and interfaces between them; and (ii) material degradation. Both cases may lead to an increase in hydraulic conductivity. Therefore, to be conservative in the design, an increase in the hydraulic conductivity has been used in this work. Moreover, since the backfill material for the Dutch repository has not been fully specified (foamed concrete is proposed), this gives more flexibility in the selection of materials. Two values of hydraulic conductivity are used in the simulations, both higher than that of foamed concrete, representing the backfill, tunnel lining and supercontainers, including cracks or gaps within the foamed concrete. This also splits the functions of the material; the function of the backfill is then mainly to restrict movement of the supercontainers, and the function of the seal is to restrict movement of water. The hydraulic conductivity of the Boom Clay is approximately  $1 \times 10^{-12}$  m/s (Vis and Verweij, 2014). No changes in the hydraulic conductivity of the Boom Clay due to the EDZ have been included in the model due to lack of information. The hydraulic properties of the different materials are shown in Table 3.3. In order to find the optimal benonite seal length, the hydraulic response of five different length seals,  $L=\{0.1, 0.5, 1.0, 2.0, 5.0\}$  m, are studied.

Table 3.3: Hydraulic properties for different materials

Material	Hydraulic conductivity, $k$ (m/s)
Backfill	$10^{-9}, 10^{-10}$
Benonite seal	$10^{-13}$
Boom Clay	$10^{-12}$

### Numerical results

Figure 3.4 shows the pore water pressure head distribution in the calculation domain with backfill hydraulic conductivity,  $k = 10^{-9}$  m/s (left-hand side) and  $k = 10^{-10}$  m/s (right-hand side), for various seal lengths. An increase in seal length reduces the low pore water pressure head zone (Figure 3.4). The reduction in the backfill hydraulic conductivity also results in a reduction in the low pore water pressure head zone. Figure 3.5 shows the pore water pressure head profile along the line AD (see Figure 3.3), with backfill hydraulic conductivity  $k = 10^{-9}$  m/s and  $k = 10^{-10}$  m/s, for various seal lengths. As can be seen, the pore water pressure head at points B and C increases with increasing length of the benonite seal. Overall, the pore water pressure head gradient is mainly taken by the benonite seal, with only a small part taken by the backfill, which reduces the likelihood of erosion.

Figure 3.5 also shows that, with lower backfill hydraulic conductivity, the pore water pressure head gradient in the rock decreases, which indicates that a lower backfill hydraulic conductivity results in a better sealing effect; however the gradient in the backfill is greater, indicating a greater chance of erosion. Figure 3.6 shows the percentage of water head gradient taken by the benonite seal (Point C) relative to the water head at end of the disposal tunnel (point B) as a function of plug length, for different backfill hydraulic conductivities. These plots shows that, for different backfill hydraulic conductivities, the percentage of water head at B/C have similar trends with changes in plug length. The optimal seal length can be concluded to be between 0.5-1.0 m, since any further increase in the seal length only slightly increases the percentage of water head at B/C. Note that the pore water pressure head acting on the plug (Point C) varies in the range of 150-350 m, which means that the water pressure acting on the plug is much smaller than 500 m, the value of used in Section 3.3.1, increasing conservatism.

The maximum velocity in the domain against seal length is shown in Figure 3.7, with the velocity



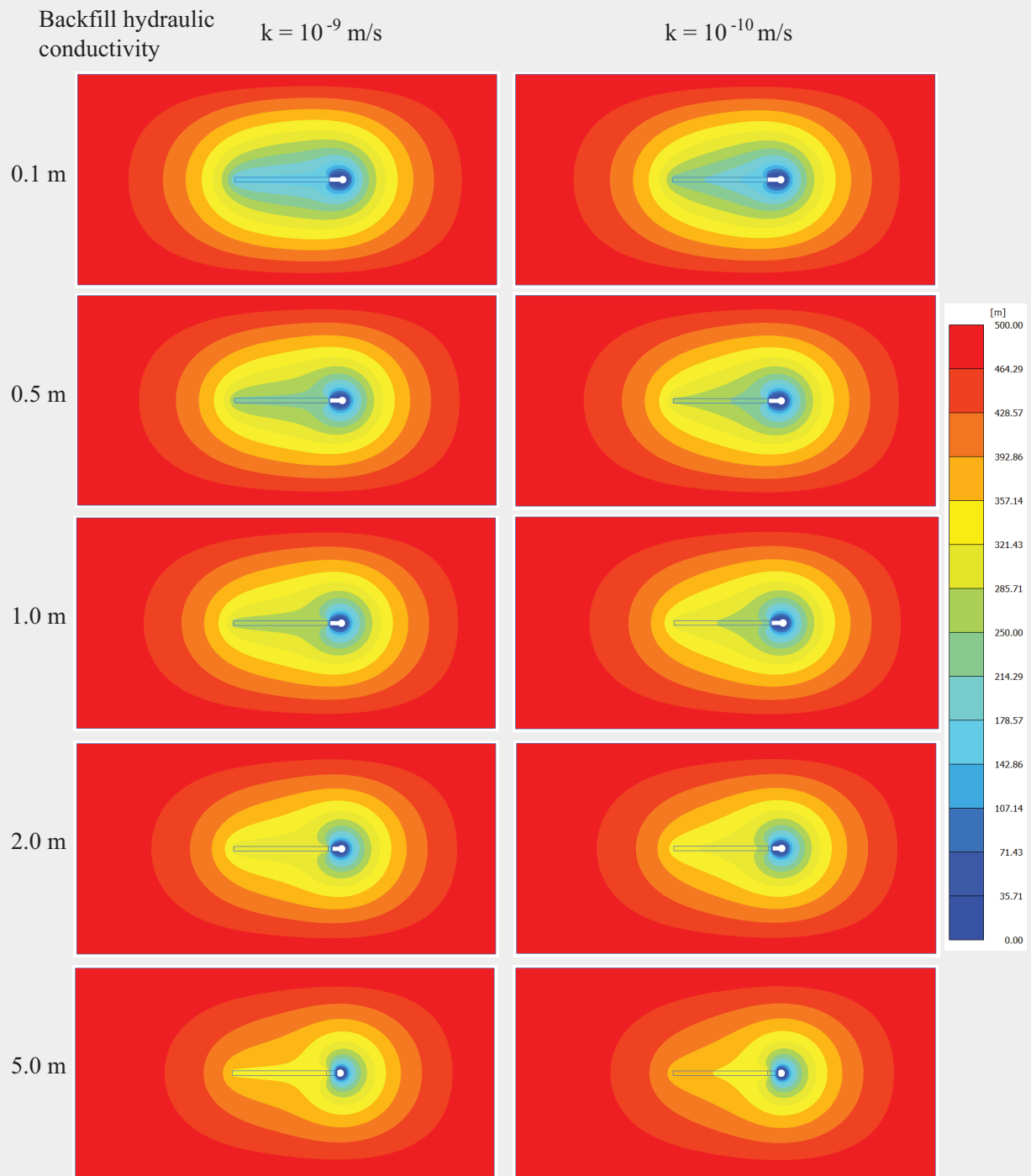

Figure 3.4: Pore pressure head distribution for different sealing lengths, left:  $k=10^{-9}$  m/s for the backfill hydraulic conductivity; right:  $k=10^{-10}$  m/s for the backfill hydraulic conductivity.

distribution of water flow close to the disposal tunnel and the plug system, for various seal lengths, shown in Figure 3.8, with backfill hydraulic conductivities of  $k = 10^{-9}$  m/s (left-hand side) and  $k = 10^{-10}$  m/s (right-hand side). The results from the calculations with  $k = 10^{-9}$  m/s and  $k = 10^{-10}$  m/s are similar, with the major flow paths in the host rock around the seal. In both cases, increasing the plug length results in decreasing the velocity around the plug system. As seen in Figure 3.8, the maximum flow velocity is located near the top and bottom of the plug, which indicates these areas may be critical, and further attention may be necessary, e.g. by extending the

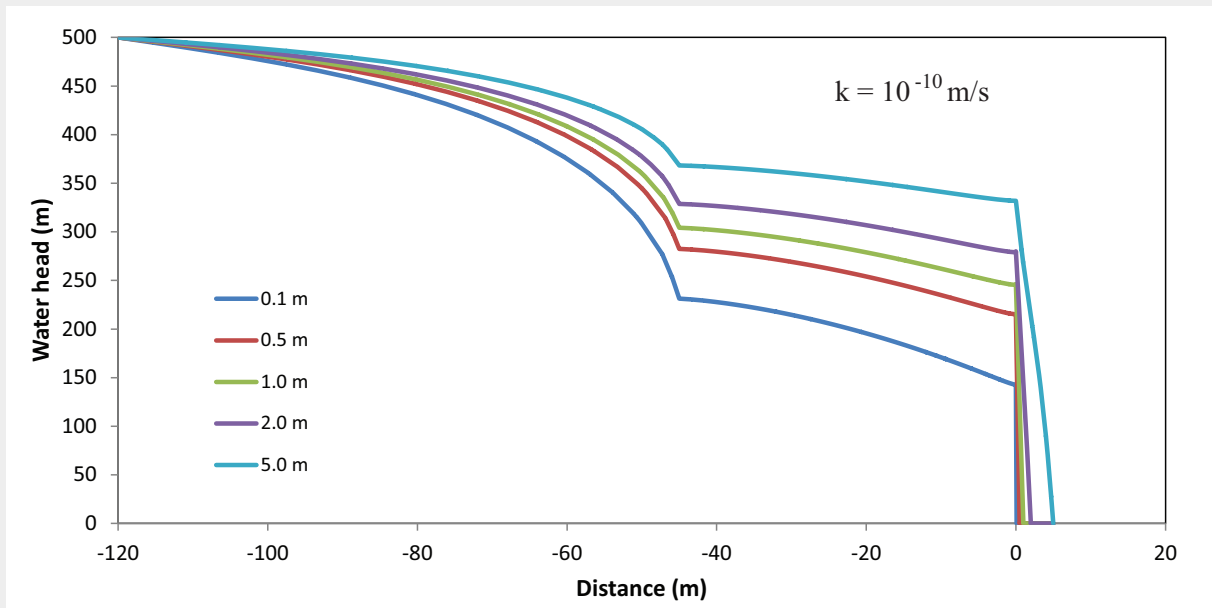
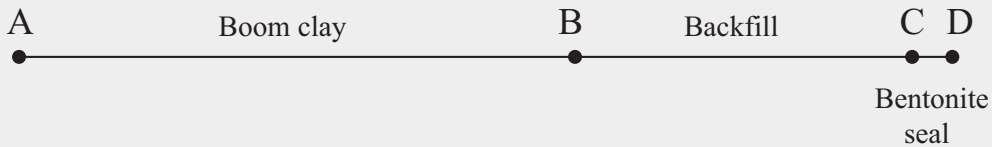
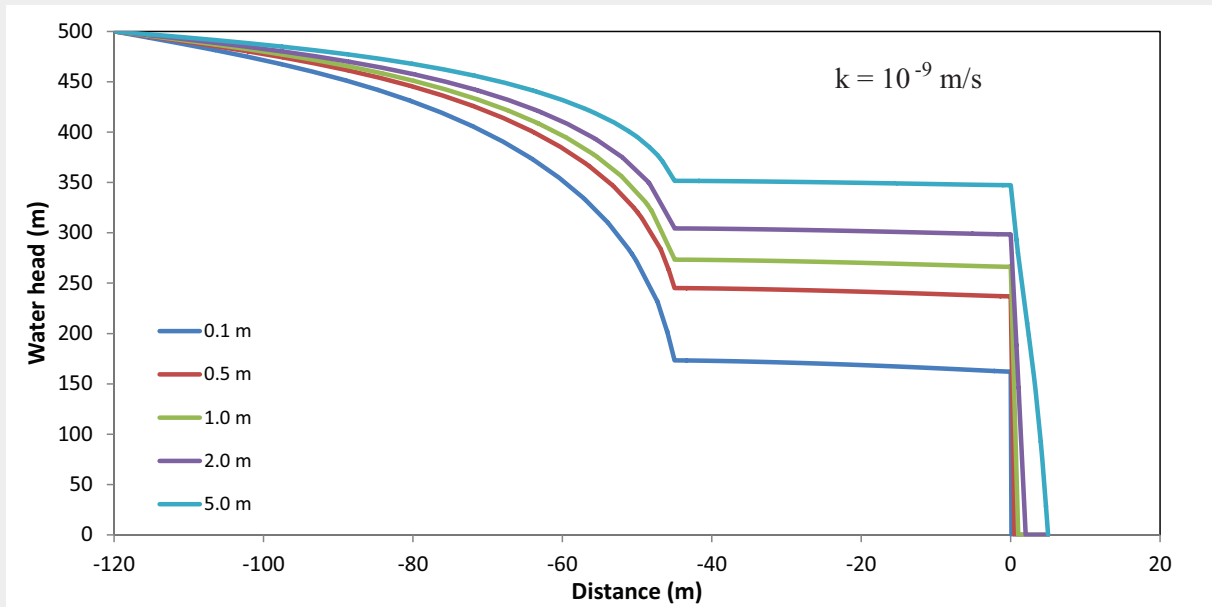

Figure 3.5: Pore pressure head distribution along the tunnel for different sealing lengths, top:  $k=10^{-9}$  m/s for the backfill hydraulic conductivity; bottom:  $k=10^{-10}$  m/s for the backfill hydraulic conductivity.

bentonite seal into the host rock. For a very thin seal (0.1 m) axial flow is seen in the disposal gallery, with large flows around the edges of the seal. At 0.5 m seal length, axial flows are reduced, although flows around the seal are still dominant. For seals over 1 m in length axial flow is virtually eliminated and almost no preferential flow around the seal is seen. This can be concluded to be the cause of the strong change in gradient of the velocity versus plug length plots in Figure 3.7, where the dominant flow path is around the plug on the left hand side ( $<0.5$ m) and through the plug on

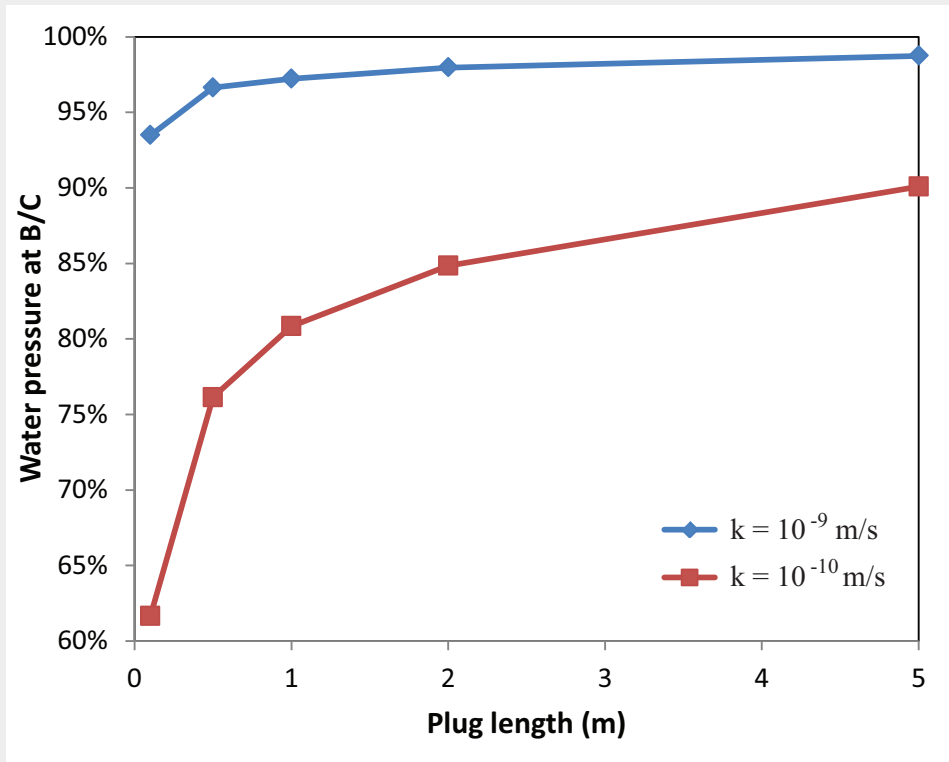

Figure 3.6: Percentage of water head taken by the plug versus sealing length, for different backfill hydraulic conductivities

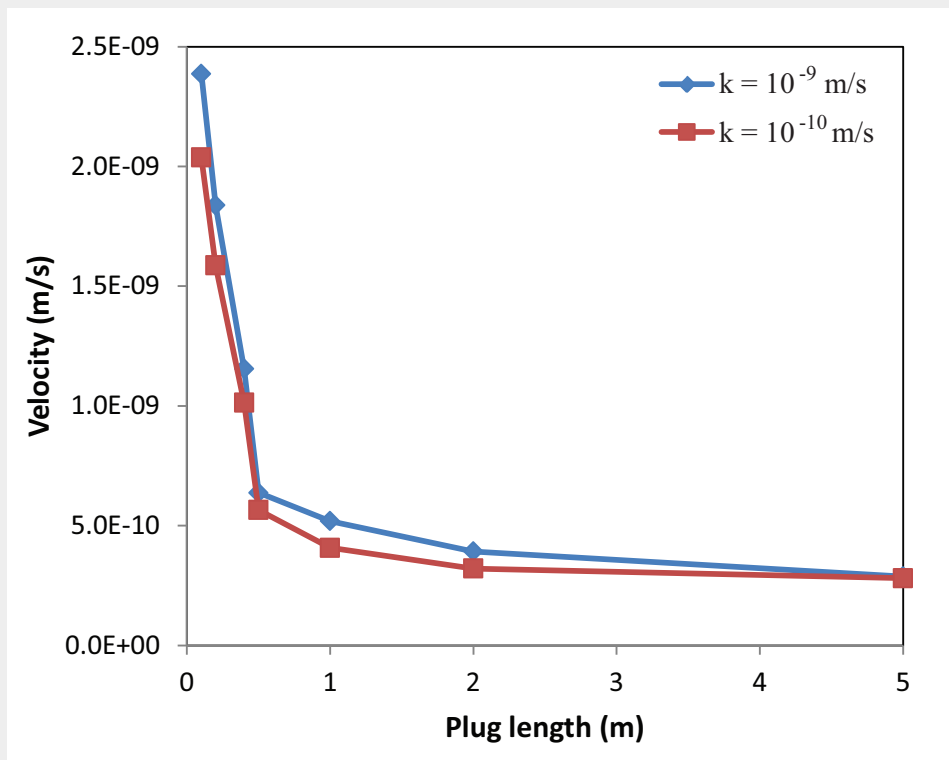

Figure 3.7: Maximum velocity in the domain versus sealing length for different backfill hydraulic conductivity (note: results for thicknesses of 0.2 and 0.4 m added for clarity).

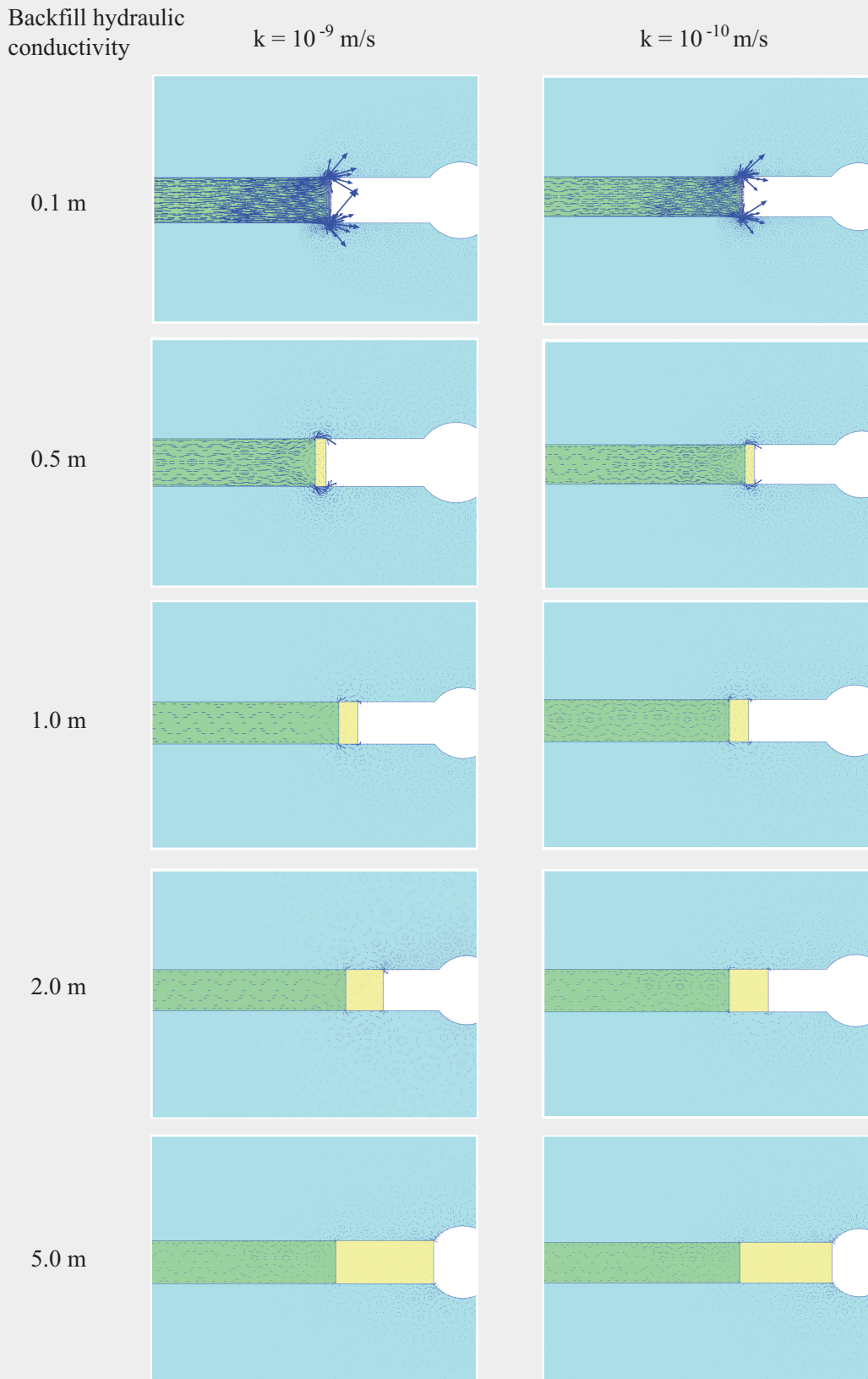

Figure 3.8: Velocity distribution near the plug for different sealing lengths, left:  $k=10^{-9}$  m/s for the backfill hydraulic conductivity; right:  $k=10^{-10}$  m/s for the backfill hydraulic conductivity.

the right hand side ( $>1$  m). It can be seen that it will be of benefit to over excavate the Boom Clay in the vicinity of the seal, to extend the seal into the Boom Clay, so that preferential pathways around the seal are cut off. It is seen that the optimal plug length is located between 0.5-1.0 m, with further increases in length not resulting in substantial decreases in flow.

Finally, from the numerical results presented above, the conclusion can be made that the optimal plug length is between 0.5-1.0 m, and sealing capabilities are not sensitive to the hydraulic conductivity of the backfill. However, this is reliant on the assumption that the backfill has a higher hydraulic conductivity than the seal. Further decreases in possible water velocities would be apparent if the hydraulic conductivity of the backfill was also lower.

### 3.4 Discussion

In this report the outline design of a plug system for the proposed Dutch radioactive waste repository has been undertaken. The purpose of such plugs and seals is to hydraulically seal repository sections and to mechanically hold other repository components in place.

The design method utilised is designed to give an initial sizing to the components of the plug system, to allow better sizing of the disposal galleries and an initial input into the performance assessment. More detailed structural analysis, material specification and detailed design to ensure good interface sealing is required prior to construction. However, due to the long interim storage planned in the Netherlands, it is thought that this approach is appropriate.

There are various possibilities to make a plug system; however, in most cases internationally a clay core is used to reduced flow and a concrete plug is used to provide mechanical constraint. This approach has also been followed here.

Retrievability and ease of construction have provided guidance where other design choices have been made. Retrievability implies that tunnels may be re-entered after backfilling. In the case of a single disposal gallery, it may be easier to include a steel access hatch, although this component may be susceptible to corrosion which may cause the sealing function to be compromised. Therefore, it is better to remove this feature and use excavation methods to enter a disposal gallery if needed. This would also mean that other disposal galleries which may not need to be entered would be more reliably sealed. In addition, the use of reinforced concrete has not been selected, firstly to remove further metallic components and secondly to increase the length of the seal which would improve the time period over which it is functional.

As far as possible, no modifications have been made to the tunnel geometry, to aid the construction process. Two options have been selected, one where the mechanical plug is installed inside the tunnel lining. In the second case the tunnel lining is removed, which results in a reduced length required for the plug. It is advised that a final decision on which method to use is based upon the constructability. Note that local reinforcement has not been taken into account. In principle, the concrete plug needs no reinforcement, but it is advisable to reinforce the concrete plug to reduce cracking and shear reinforcement, in particular, between the plug and the lining, would reduce the total length required. Contact grouting at the concrete lining interface would also improve the shear strength and hydraulic seal at the interface.

The concrete plug is required to provide sealing functionality prior to the saturation of the bentonite seal. Following this period this functionality is not required, although it will continue to provide this function for a period of time. This will further decrease flow through the repository.

The length of the hydraulic seal is much smaller than the simple rule of thumb, identified as being used in other engineering industries. This is in part due to the selection of compacted bentonite and secondly due to the detailed modelling undertaken. It is noted that this therefore becomes an engineered plug, rather than a more simple dam. The advantage is a substantial saving in space/tunnel length, at the cost of having to design and install a high quality and engineered plug system. It is expected that the bentonite Boom Clay interface, with an appropriate swelling pressure,

will be able to provide a good hydraulic seal, although confirmation of this assumption is needed. The length of the seal calculated here is also smaller than that proposed in the French concept (ANDRA, 2005), where the length was based upon chemical and mechanical modelling to maintain the swelling pressure. As there is substantial control over the installation density and chemical make up of the bentonite installed, these factors have not been included in the design here, but it is noted that the lengths calculated are dependent on the hydraulic conductivities given in Table 3.3.

In the case designed here, the bentonite buffer is installed against the backfill, depending on the material selected this may be practically difficult and may reduce the ability of the bentonite to reach the swelling pressure. This can be addressed via the installation of a concrete plug between the backfill and the bentonite, e.g. as in the FSS experiment (section 2.3.4). Of course, this would increase the total length of the plug system.

The detailed behaviour of the EDZ is at this time unknown. This will be affected by the construction method and the geology. The bentonite seal will swell during hydration, which will aid re-sealing of the EDZ; however, installing cut-offs (bentonite rings in local excavations into the Boom Clay) is likely to be able to provide additional sealing through the most damaged part of the Boom Clay local to the tunnel excavation. As shown, however, in Arnold et al. (2015), the EDZ will be a number of metres; therefore, cut-offs will not be able to be installed through the entire EDZ but could be through the most damaged part. This is in contrast to more stiff clay rock concepts, where the rock will be damaged, probably more substantially, in a more limited zone closer to the tunnel. The plastic Boom Clay will have a more extended damaged zone, but will benefit from increased sealing (and healing) capabilities.

Detailed design criteria have not been addressed in this report. Following White et al. (2014), materials and construction methods for the plug and seal should be selected based upon the ability to be installed with a high reliability, e.g. concrete should not excessively crack, and the durability of the systems should be ensured for the appropriate times of the repository evolution. Additionally, the behaviour of the plug should be such that other barrier functions should not be impaired. Therefore, material selection and the evolution should be considered, if appropriate, in the performance assessment.

This work should be reviewed in the light of performance assessment calculations to fully assess whether the initial designs presented here are appropriate.

## 4 Conclusions and recommendations

An evaluation of the use of plug systems in other national programmes has been presented and has led to two requirements for the Dutch repository: (i) a plug that keeps the backfill in place; and (ii) a seal that prevents axial water flow. The system shall prevent erosion of the backfill so that the backfill maintains its ability to prevent movement of the waste packages.

Two types of conceptual mechanical plug design have been studied. One is where the tunnel lining is locally removed and the second is where it is not. The plug lengths in all cases considered are thought to be reasonable, i.e. feasible, being in the order of the radius, with conceptual design A leading to a plug length of 2.85-4.80 m and conceptual design B leading to a plug length of 0.99-1.67 m. From the mechanical point of view, removing tunnel lining segments leads to reduced plug length (conceptual design B), but this may lead to a more difficult construction process.

A bentonite seal has been chosen to hydraulically seal the plug system. When bentonite is hydrated, the swelling pressure exerted against the clay will locally lower the hydraulic conductivity of the clay and close any cracks present around the bentonite seal and reduce the impact of the unloading due to the tunnel construction. An appropriate length was shown to be between 0.5 and 1.0 m. Close contact with the rock is required to ensure a good seal, and therefore the tunnel lining should be removed in this location. The bentonite seal could additionally be inset into a slot with a minimum depth larger than where damage to the host rock significantly changes the permeability, to ensure good sealing. This depth requires further investigation of the Boom Clay behaviour.

It is noted that a number of aspects require further detailed design and investigation to finalise a design, including the hydraulic conductivity of all components, and the swelling pressure of the bentonite seal due to a variety of aspects, e.g. geochemical evolution, concrete shrinkage and material creep.

## References

- ANDRA (2005). *Dossier 2005 Argile – Tome, Architecture and management of a geological repository*. Agence nationale pour la gestion des déchets radioactifs. URL: <http://www.andra.fr/international/download/andra-international-en/document/editions/268va.pdf>.
- Arnold, P., P. J. Vardon, M. A. Hicks, J. Fokkens and P. A. Fokker (2015). *A numerical and reliability-based investigation into the technical feasibility of a Dutch radioactive waste repository in Boom Clay*. OPERA-PU-TUD311. Centrale Organisatie Voor Radioactief Afval (COVRA N.V.)
- Auld, F. A. (1983). Design of underground plugs. In: *International Journal of Mining Engineering* 1 (3), 189–228. ISSN: 0263-4546.
- Barcena, I., B. Llamas, J. Bueno, J. L. Garcia-Sineriz and B. A. Suso (2005). Plug construction to isolate active zones of inactive zones in coal mine: WATERCHEM Project. In: *Proc. 9th International Mine Water Congress*.
- British Standards Institution (1969). *The Structural Use of Reinforced Concrete in Buildings*. British Standards Institution, London, UL.
- (1972). *The structural use of concrete, Part 1, Design, materials and workmanship*. British Standards Institution, London, UK.
- Chandler, N. A., A. Cournut and D. Dixon (2002). *The five year report of the Tunnel Sealing Experiment: an international project of AECL, JNC, ANDRA and WIPP*. Atomic Energy of Canada Limited, Pinawa, Manitoba (Canada).
- CUR (1995). *Werken met schuimbeton*. 181. Civieltechnisch Centrum Uitvoering Research en Regelgeving (CUR), Gouda, Netherlands.
- Dahlström, L. O. (2009). *Experiences from the design and construction of plug II in the Prototype Repository*. R-09-49. Stockholm, Sweden: Svensk Kärnbränslehantering AB (SKB).
- Dixon, D. A., L. Börgesson, D. Gunnarsson and J. Hansen (2009). *Plugs for deposition tunnels in a deep geologic repository in granitic rock, Concepts and experience*. R-09-50. Stockholm, Sweden: Svensk Kärnbränslehantering AB (SKB).
- European Committee for Standardisation (2004). *Eurocode 2: Design of Concrete Structures: Part 1: General Rules and Rules for Buildings*. EN 1992-1-1 :2004. European Committee for Standardization.
- Fälth, B. and P. Gatter (2009). *Mechanical and thermo-mechanical analyses of the tapered plug for plugging of deposition tunnels. A feasibility study*. R-09-33. Stockholm, Sweden: Svensk Kärnbränslehantering AB (SKB).
- Garrett, W. S. and L. T. Campbell Pitt (1958). Tests on an experimental underground bulkhead for high pressures. In: *JS Afr Inst Min Metallurgy Oct*, 123–143.
- Gray, M. N. (1993). *OECD/NEA International Stripa Project Overview Volume III: Engineered Barriers, Published by Swedish Nuclear Fuel and Waste Management Co.(SKB)*. Stockholm, Sweden: Svensk Kärnbränslehantering AB (SKB).
- Gunnarsson, D., L. Börgesson, H. Hökmark, L.-E. Johannesson and T. Sandén (2001). *Åspö Hard Rock Laboratory. Report on the installation of the Backfill and Plug Test*. IPR-01-17. Stockholm, Sweden: Svensk Kärnbränslehantering AB (SKB).
- IAEA (1990). *Sealing of Underground Repositories for Radioactive Wastes, Technical Reports Series 319*. Vienna, Austria: International Atomic Energy Agency.
- Johannesson, L. E., D. Gunnarsson, T. Sandén, L. Börgesson and R. Karlzén (2004). *Prototype Repository: Installation of buffer, canisters, backfill, plug and instruments in Section II. Åspo Hard Rock Laboratory*. IPR-04-13. Stockholm, Sweden: Svensk Kärnbränslehantering AB (SKB).
- Kirkwood, D. T. and K. K. Wu (1995). Technical considerations for the design and construction of mine seals to withstand hydraulic heads in underground mines. In: *SME annual meeting, Society of Mining Engineers of AIME*.



- Li, X. L., W. Bastiaens, P. Van Marcke, G. J. Verstricht J. and Chen, E. Weetjens and X. Sillen (2010). Design and development of large-scale in-situ PRACLAY heater test and horizontal high-level radioactive waste disposal gallery seal test in Belgian HADES. In: *Journal of Rock Mechanics and Geotechnical Engineering* 2 (2), 103–110.
- Li, X. L., G. J. Chen, J. Verstricht, P. Van Marcke and I. Troullinos (2013). The Large Scale In-Situ PRACLAY Heater and Seal Tests in URL HADES, Mol, Belgium. In: *ASME 2013 15th International Conference on Environmental Remediation and Radioactive Waste Management*. American Society of Mechanical Engineers.
- Malm, R. (2012). *Low-pH concrete plug for sealing the KBS-3V deposition tunnels*. R-11-04. Stockholm, Sweden: Svensk Kärnbränslehantering AB (SKB).
- Plaxis (2014). *PLAXIS 2D 2015.00 Beta complementary manual*. Delft, The Netherlands: Plaxis bv.
- Pusch, R., L. Börgesson and G. Ramqvist (1987a). *Final Report of the borehole, shaft, and tunnel sealing test—Volume II: Shaft plugging*. Stockholm, Sweden: Svensk Kärnbränslehantering AB (SKB).
- (1987b). *Final Report of the borehole, shaft, and tunnel sealing test—Volume III: Tunnel plugging*. Stockholm, Sweden: Svensk Kärnbränslehantering AB (SKB).
- République Française (2011). *Fourth National Report on Compliance with the Joint Convention Obligations, Joint Convention on the Safety of Spent Fuel Management and on the Safety of Radioactive Waste Management*. Nuclear Safety Authority (ASN). URL: <http://www.asn.fr/index.php/content/download/31730/226201/file/France+-+Joint+Convention+National+report+2012.pdf>.
- SKB (2008). *Åspö Hard Rock Laboratory. Annual report 2007*. TR-08-10. Stockholm, Sweden: Svensk Kärnbränslehantering AB (SKB).
- (2010a). *Design and production of the KBS-3 repository*. TR-10-12. Stockholm, Sweden: Svensk Kärnbränslehantering AB (SKB).
- (2010b). *Design, production and initial state of the backfill and plug in deposition tunnels*. TR-10-16. Stockholm, Sweden: Svensk Kärnbränslehantering AB (SKB).
- Svensson, U. (2006). *The Forsmark repository: modelling changes in the flow, pressure and salinity fields, due to a repository for spent nuclear fuel*. R-06-57. Stockholm, Sweden: Svensk Kärnbränslehantering AB (SKB).
- Van Marcke, P., X. L. Li, W. Bastiaens, J. Verstricht, G. J. Chen, J. Leysen and J. Rypens (2013). *The Design and installation of the PRACLAY In-Situ Experiment*. EIG EURIDICE.
- Verhoef, E., E. Neeft, J. Grupa and A. Poley (2014a). *Outline of a disposal concept in clay, OPERA-PG-COV008, First update*. Centrale Organisatie Voor Radioactief Afval (COVRA N.V.) URL: <http://www.covra.nl/cms-file/get/iFileId/2813>.
- Verhoef, E. V., A. M. G. de Bruin, R. B. Wieggers, E. A. C. Neeft and G. Deissmann (2014b). *Cementitious materials in OPERA disposal concept in Boom Clay, OPERA-PG-COV020*. Centrale Organisatie Voor Radioactief Afval (COVRA N.V.) URL: <http://www.covra.nl/cms-file/get/iFileId/2786>.
- Vis, G.-J. and J. M. Verweij (2014). *Geological and geohydrological characterization of the Boom Clay and its overburden, OPERA-PU-TNO411*. Centrale Organisatie Voor Radioactief Afval (COVRA N.V.) URL: <http://www.covra.nl/cms-file/get/iFileId/2785>.
- Vogt, C., B. Lagerblad, K. Wallin, F. Baldy and J. E. Jonasson (2009). *Low pH self compacting concrete for deposition tunnel plugs*. R-09-07. Stockholm, Sweden: Svensk Kärnbränslehantering AB (SKB).
- White, M., S. Doudou and F. Neall (2014). *DOPAS Work Package 2 Deliverable D2.1: Design Bases and Criteria*. URL: [http://www.posiva.fi/files/3564/DOPAS\\_Deliverable\\_D2\\_1\\_Design\\_Bases\\_and\\_Criteria\\_v1\\_1\\_2\\_final\\_SESAM.pdf](http://www.posiva.fi/files/3564/DOPAS_Deliverable_D2_1_Design_Bases_and_Criteria_v1_1_2_final_SESAM.pdf).

## **OPERA**

Meer informatie:

Postadres  
Postbus 202  
4380 AE Vlissingen

T 0113-616 666  
F 0113-616 650  
E [info@covra.nl](mailto:info@covra.nl)

[www.covra.nl](http://www.covra.nl)

