

Bus Network Design and Frequency Setting in the Post-COVID-19 Pandemic The Case of London

Filgueiras, Manuel; Gkiotsalitis, Konstantinos; Yap, Menno; Cats, Oded; Lobo, António; Ferreira, Sara

DOI

[10.1061/JTEPBS.TEENG-7176](https://doi.org/10.1061/JTEPBS.TEENG-7176)

Publication date

2023

Document Version

Final published version

Published in

Journal of Transportation Engineering Part A: Systems

Citation (APA)

Filgueiras, M., Gkiotsalitis, K., Yap, M., Cats, O., Lobo, A., & Ferreira, S. (2023). Bus Network Design and Frequency Setting in the Post-COVID-19 Pandemic: The Case of London. *Journal of Transportation Engineering Part A: Systems*, 149(4), Article 04023020. <https://doi.org/10.1061/JTEPBS.TEENG-7176>

Important note

To cite this publication, please use the final published version (if applicable).
Please check the document version above.

Copyright

Other than for strictly personal use, it is not permitted to download, forward or distribute the text or part of it, without the consent of the author(s) and/or copyright holder(s), unless the work is under an open content license such as Creative Commons.

Takedown policy

Please contact us and provide details if you believe this document breaches copyrights.
We will remove access to the work immediately and investigate your claim.

Green Open Access added to TU Delft Institutional Repository

'You share, we take care!' - Taverne project

<https://www.openaccess.nl/en/you-share-we-take-care>

Otherwise as indicated in the copyright section: the publisher is the copyright holder of this work and the author uses the Dutch legislation to make this work public.

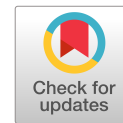

Bus Network Design and Frequency Setting in the Post-COVID-19 Pandemic: The Case of London

Manuel Filgueiras¹; Konstantinos Gkiotsalitis²; Menno Yap³; Oded Cats⁴; António Lobo⁵; and Sara Ferreira⁶

Abstract: A transit network design frequency setting model is proposed to cope with the postpandemic passenger demand. The multi-objective transit network design and frequency setting problem (TNDFSP) seeks to find optimal routes and their associated frequencies to operate public transport services in an urban area. The objective is to redesign the public transport network to minimize passenger costs without incurring massive changes to its former composition. The proposed TNDFSP model includes a route generation algorithm (RGA) that generates newlines in addition to the existing lines to serve the most demanding trips, and passenger assignment (PA) and frequency setting (FS) mixed-integer programming models that distribute the demand through the modified bus network and set the optimal number of buses for each line. Computational experiments were conducted on a test network and the network comprising the Royal Borough of Kensington and Chelsea in London. DOI: 10.1061/JTEPBS.TEENG-7176. © 2023 American Society of Civil Engineers.

Introduction

After the detection of the COVID-19 virus, the risks of transmitting the airborne infectious disease have had an enormous impact on global mobility (Zhou et al. 2020). The accelerated propagation of the virus is due to the extent of connections (Carteni et al. 2021), and the urgency to restrict contact forced many governments to implement travel limitations and lockdowns (Przybylowski et al. 2021). Although the epidemic situation still varies from region to region, as mentioned by Ghosh et al. (2020) and Carteni et al. (2021), cities with high access to public transport are prone to a higher transmission rate. In fact, the transportation sector is one of the most disrupted, due to implications such as reduced patronage, operational impacts, and emerging financial issues (UITP 2020b; Gkiotsalitis and Cats 2021c).

A sharp decline in public transport service is depicted in the statistics of almost every city (Cui et al. 2021). For example, in the early stages of the pandemic, cities such as London witnessed a passenger demand reduction of 85% in bus services and 95% in subway services (TfL 2020b). In New York, there was a 94% decrease in the subway's ridership, whereas in Budapest and Santander, there was a 90% and 93% reduction in public transport usage, respectively (Aloi et al. 2020; Bucsky 2020).

Regarding operational impacts, the decrease in ridership led operators to limit their service, close stations, and suspend routes (Gkiotsalitis 2021). In London, a reduction of the service frequency generated criticism because some bus lines had higher waiting times (UITP 2020b). Bus operators should not reduce bus frequencies on a whole network without referring to service standards or properly documented methods, because there are lines with different demands that may require a weighted allocation (Furth and Wilson 1981).

In addition to the reduced number of passengers, public transport operators had to comply with the health guidelines that introduced capacity restraints to the vehicles and requested operators to increase service frequency to ensure social distancing (UITP 2020a). For example, London and Beijing limited the number of available seats by 50% (TfL 2020a; UITP 2020b). In Poland, the public transport capacity changed according to the stage of spread by 100%, 70%, and 50% (Wielechowski et al. 2020). The rapid service adaptations in cities such as London have been formulated mainly with ad hoc knowledge (Gkiotsalitis and Cats 2021b), which leaves room for improvements and optimization in the postpandemic future.

Currently, public transport operators seek to revise their tactical plans to accommodate the near-future scenario in which the expected demand will grow. However, the predicted turnout still is lower than the prepandemic levels (Ratho and Johns 2020). Both the underground (tube) and the bus service usage in London remains below the prepandemic levels of January 2020 (Fig. 1). Despite recent increases in passenger demand, there still is a significant gap, and new developments, such as the Omicron variant of the virus, might postpone the passenger demand return to the prepandemic levels.

To adapt the tactical plans of public transport service providers to the new passenger demand levels without changing significantly

¹Research Associate, Centro de Investigação do Território Transportes e Ambiente (CITTA)-Research Centre for Territory, Transports and Environment, Faculty of Engineering of the Univ. of Porto, Porto 4099-002, Portugal. ORCID: <https://orcid.org/0000-0003-2704-433X>. Email: mcfilgueiras@fe.up.pt

²Assistant Professor, Dept. of Transport Engineering and Management, Univ. of Twente, Enschede 7522LW, Netherlands (corresponding author). ORCID: <https://orcid.org/0000-0002-3009-1527>. Email: k.gkiotsalitis@utwente.nl

³Postdoctoral Researcher, Dept. of Transport and Planning, Delft Univ. of Technology, Delft 2628 CD, Netherlands. ORCID: <https://orcid.org/0000-0002-0508-6064>. Email: m.d.yap@tudelft.nl

⁴Associate Professor, Dept. of Transport and Planning, Delft Univ. of Technology, Delft 2628 CD, Netherlands. Email: o.cats@tudelft.nl

⁵Senior Researcher, CITTA-Research Centre for Territory, Transports and Environment, Faculty of Engineering of the Univ. of Porto, Porto 4099-002, Portugal. ORCID: <https://orcid.org/0000-0001-7614-7605>. Email: lobo@fe.up.pt

⁶Assistant Professor, CITTA-Research Centre for Territory, Transports and Environment, Faculty of Engineering of the Univ. of Porto, Porto 4099-002, Portugal. Email: sara@fe.up.pt

Note. This manuscript was submitted on December 6, 2021; approved on November 14, 2022; published online on February 13, 2023. Discussion period open until July 13, 2023; separate discussions must be submitted for individual papers. This paper is part of the *Journal of Transportation Engineering, Part A: Systems*, © ASCE, ISSN 2473-2907.

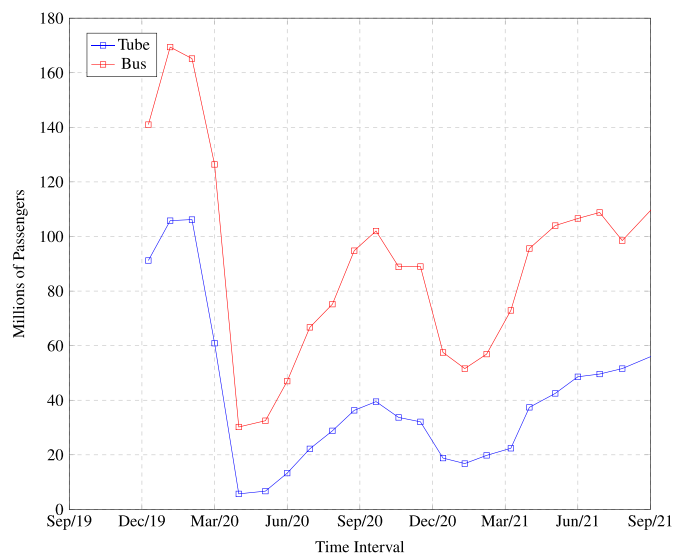

Fig. 1. London's bus and tube passenger ridership through the pandemic.

the existing public transport schedules, this study introduces a route design and a frequency setting (FS) model. The combined route design and frequency settings model optimizes the bus service by reducing the perceived travel time and incorporating the predicted passenger demand. The model is based on the presumption that a bus network exists, it has specific lines and service frequencies, and it can be redesigned based on passenger demand projections. The model redesigns the network to adapt without incurring massive changes to the current network's composition. The latter is addressed by adapting the existing routes to meet the demand and creating an extra set of new routes tailored to satisfy the origin-destination (OD) pairs with the highest demand. The frequency setting part of our model assigns vehicles to bus lines according to the distributed volume of passengers throughout the network. Meng et al. (2018) defined the perceived travel time as the duration that the passenger felt that he or she was spending between the departure and arrival.

The transit network design and frequency setting problem (TNDFSP) is an NP-hard problem in which every subproblem is hard to solve. To rectify this, our formulation separates the transit network design problem (TNDP) from the transit network frequency setting problem (TNFSP). The TNDP is addressed with a heuristic that generates extra lines based on the shortest paths of the highest-demand OD pairs. The output of the route generation model is used to solve the TNFSP. The TNFSP is composed of two integrated mixed-integer programs (MIPs) that are solved iteratively. The first MIP assigns passengers to service lines, and the second MIP determines the optimal line frequencies subject to the passenger volumes. Our approach can help public transport planners and service providers to reduce operational costs by removing low-frequency lines and altering routes without making radical changes to the pre-pandemic composition of the public transport network (i.e., altering the complete network plan and changing stop locations).

The proposed model was implemented in a test network, and then applied to an area of London comprising the Kensington and Chelsea borough. Transport for London (TfL) provided the supply data of this network. The remainder of this paper is structured as follows. The literature review is presented in the section "Literature Review." Sections "Solution Framework" to "Upper-Level Model:

Frequency Setting Model" introduce the solution framework and the formulation of the models. Section "Model Application" presents numerical experiments on different networks. Section "Concluding Remarks" concludes the paper and provides future research directions.

Literature Review

Public transport operators need to replan their services in order to meet passengers' requirements and regain their trust in the post-pandemic era. At the strategic level, replanning can include changes in routes and service frequencies (Guihaire and Hao 2008). Due to their computational complexity, most previous studies of bus service planning solved the following subproblems sequentially: transit network design (TND), frequency setting (FS), transit network timetabling (TNT), vehicle scheduling problem (VSP), driver scheduling problem (DSP), and driver rostering problem (DRP). These subproblems were discussed in detail in the survey study by Ibarra-Rojas et al. (2015).

Our literature review synthesizes studies that addressed the TNDFSP. TNDFSP studies range from formulations with exact solution methods to heuristics and metaheuristics. Oftentimes, studies used more than one solution strategy to reduce the computational costs. One example is the work of Szeto and Wu (2011), who aimed to reduce the passenger waiting, transfer, and travel times in the small area of Tin Shui Wai in Hong Kong. Szeto and Wu (2011) formulated the problem as a mixed-integer nonlinear program using a genetic algorithm (GA) hybridized with a neighborhood search heuristic to design the network and solve the frequency setting problem. Other examples are the works of Fan and Machemehl (2004) and Fan et al. (2016), who formulated multiobjective nonlinear mixed-integer models applying a genetic algorithm to solve the NP-hard problem. The metaheuristics involved prevent a guaranteed globally optimal solution in the context of several sources of nonlinearities and nonconvexities. In addition to the heuristics, they employed a neighborhood search, the simulated annealing algorithm, to minimize passenger, operator, and unmet demand costs.

Concerning mathematically formulated problems, Hasselstrom (1982) developed linear models for the TNDFS problems and solved them using mathematical programming approaches to maximize the total number of passengers. A set of routes was generated on a link-connected network, and the lines were selected by assigning the frequency using linear programming (LP). Ceder and Israeli (1998) proposed a nonlinear mixed-integer program that considered both passenger and operator costs. First, a set of feasible routes connecting all nodes was generated. Next, a set covering problem was solved by applying a multiobjective analysis to find the minimal subsets of routes from which the most suitable subset is selected. Wan and Lo (2003) examined modifying the routes and assigning frequencies, and developed a linear mixed-integer programming model to minimize operating costs. However, this mathematical approach has computational limitations, and it cannot be applied to large networks. Borndörfer et al. (2005) dealt with a line planning problem in public transport and formulated two multicommodity flow models to minimize the total passenger travel time and the operating costs. The developed linear model was examined using a commercial LP solver to create the lines dynamically, and then tested in the network of Potsdam, Germany. Ibarra-Rojas et al. (2014) presented two integer linear programming models for the timetabling and vehicle scheduling problems and combined them in a biobjective integrated model. Numerical experiments showed that the proposed approach can solve scenarios with as many as 50 bus lines.

Lampkin and Saalmans (1967) utilized heuristics in the TNDSP. They developed a skeleton method to obtain the transit routes iteratively by extending the routes to improve the trip directedness, and implemented a random greedy-based search method to obtain the frequencies. The latter was adjusted to minimize passenger trip times considering fleet size constraints and unlimited vehicle capacity. Silman et al. (1974) minimized the passengers' travel time and overcrowding discomfort. Their method was split into two phases: first, a candidate set of routes is selected based on the previously mentioned skeleton method, and then the optimal assignment of frequencies is performed under a fleet size constraint using the gradient descent method. Dubois et al. (1979) presented a TNDSP problem in three subproblems: determining the set of street selection, selecting routes, and assigning the optimal frequency. A heuristic method was proposed for determining the substantial subset of streets to minimize the passengers' journey time subject to a budgetary constraint. Moreover, the set of routes was selected from the generated subset of roads. The frequency was assigned using a gradient-based search heuristic to decrease the waiting time.

Mandl (1980) developed a two-stage approach: first, a feasible set of routes is created, and then heuristics are applied to improve the quality of the initial set of bus routes. Only in-vehicle travel costs are considered to evaluate route quality. In Mandl's pioneering work, a benchmark network of 15 Swiss cities was introduced. Lee and Vuchic (2005) tackled the TNDSP with a different methodology, considering variable transit demand. Moreover, network and operational specifications were included to minimize passenger travel time. Using a practical heuristic approach, Fusco et al. (2002) aimed to obtain the minimum overall system costs. Their heuristic approach was based on a genetic algorithm to select suboptimal routes or detours of the network. Their work considered and introduced different criteria to generate routes simultaneously, and generated a hierarchical transit network by easing the set of constraints to model the town's structure.

Chakroborty and Wivedi (2002) implemented a different technique relying on genetic algorithms to determine an optimal set of routes. Zhao and Gan (2003), Zhao (2006), and Zhao and Zeng (2007) tried a mathematical approach to solve large-scale network problems. They proposed a biobjective cost function minimizing passenger and operator costs. For larger problems, the search is conducted with a stochastic global search scheme that combines simulated annealing, tabu, greedy, and bisection search methods. Szeto and Jiang (2014) proposed a bilevel model that explicitly minimizes the total number of passenger transfers in the objective function of the upper-level problem and incorporates strict capacity constraints to address the in-vehicle congestion in the lower-level problem. They employed a hybrid artificial bee colony (ABC) algorithm to determine route structures and a descent direction search method to determine an optimal frequency setting for a given route structure. Arbex and Cunha (2015) formulated a multiobjective function to minimize passenger and operator costs by utilizing an alternating objective genetic algorithm. For each iteration, the objective function changes until it converges. Nikolić and Teodorović (2014) used the same objectives, applying a bee colony optimization approach.

López-Ramos et al. (2017) integrated the TNDSP in railway transit rapid systems with the dual objective of minimizing passenger riding time and operator costs. The solution method comprised a corridor generation algorithm to extend the current network or create lines, and a line-splitting algorithm to assign the train frequency and deal with multiple line construction. Ngamchai and Lovell (2003) optimized bus transit route design by manipulating genetic algorithms. They introduced seven genetic operators to incorporate unique service frequency settings for each route and

reduce the search time. Pattnaik et al.'s (1998) published benchmark network showed that their model is more efficient than binary-coded genetic algorithms. Pattnaik et al. (1998) developed a two-phase model, which generates a set of candidate routes competing for the optimum solution. The optimum set is selected by a genetic algorithm. This work was tested in Madras, India.

Zhao et al. (2015) employed the memetic algorithm, an evolutionary algorithm based on the genetic algorithm. The defined mathematical model minimized the passenger cost and unmet demand under route and capacity constraints. A trial-and-error procedure was introduced to verify the efficiency of the local search operator. Jha et al. (2019) presented a multiobjective approach to TDNFSP by solving the problem in two stages. First, the route design problem was handled using an initial route set generation combined with a genetic algorithm. Then the frequency setting problem was solved with multiobjective particle swarm optimization (MOPSO). The depicted solutions improved trip directedness, reduced transfers, and lowered the average travel time. Tom and Mohan (2003) minimized the total system cost, which includes the user and operator costs. Their integrated network design and frequency problem considered the frequency as a variable. Their method's structure is similar to that of Pattnaik et al. (1998). Afandzadeh et al. (2013) further investigated the TDNFSP by also considering an evaluation procedure, depot assignment, a penalty for empty seats, and unmet demand to consider fleet constraints. The work was tested on Mandl's benchmark network and gave promising results compared with other assignments.

Buba and Lee (2018) and Zhao et al. (2015) minimized passenger cost and unmet demand by testing differential evolution algorithms on Mandl's network and other generic networks from the literature. The results showed more-efficient searches than other metaheuristics, such as the previously mentioned genetic algorithm. Zhao (2006) defined a model that used a global search scheme based on simulated annealing and objective functions to minimize user costs and the unwillingness to make transfers. Fan et al. (2009) addressed the TNDSP using an evolutionary multiobjective approach to consider the trade-off between the user and operator costs. Their work structure had three phases: finding candidate solutions, generating feasible route sets, and a routine system for making smart neighborhood moves.

In summary, TNDSP formulations result in NP-hard problems due to their computational complexity (Guihaire and Hao 2008). Many studies considered iterative processes to obtain near-optimal solutions using heuristics and metaheuristics, given the difficulty of obtaining a globally optimal solution. The evaluation of candidate route sets can be challenging and time-consuming, and many potential candidate solutions are rejected due to infeasibilities (Fan et al. 2009; Arbex and Cunha 2015). Table 1 provides an overview of the aforementioned papers that approached the TNDSP, focusing on their objective functions and solution methods.

Contributions

The model presented herein differs from the existing TNDSP models because it emphasizes on replanning and does not permit radical line changes (i.e., altering the complete network plan and changing stop locations). It also considers the impact of postpandemic effects in the model formulation, expressed in the projected reduced number of passengers and negatively perceived in-vehicle crowding. We decompose the TNDSP into the transit network design and the TNFSP subproblems. The TNDP is solved using Dijkstra's algorithm to create shortest paths tailored to high-demand OD pairs. Subsequently, these paths generate lines for both

Table 1. Summary of TNDFSP literature

Authors	Objective	Solution method
Szeto and Wu (2011)	Minimize passenger costs	Metaheuristics (GA and NS)
Fan and Machemehl (2004)	Minimize passenger and operator costs	Metaheuristics (GA and NS)
Fan and Machemehl (2006)	Minimize passenger and operator costs	Metaheuristics (GA and SA)
Hasselstrom (1982)	Minimize passenger costs	Mathematical programming
Ceder and Israeli (1998)	Minimize passenger and operator costs	Mathematical programming
Wan and Lo (2003)	Minimize operator costs	Mathematical
Borndörfer et al. (2005)	Minimize passenger and operator costs	Mathematical programming
Ibarra-Rojas et al. (2014)	Minimize passenger and operator costs	Mathematical programming
Lampkin and Saalmans (1967)	Minimize passenger costs	Heuristic (GS)
Silman et al. (1974)	Minimize passenger costs	Heuristic
Dubois et al. (1979)	Minimize passenger costs	Heuristic
Mandl (1980)	Minimize passenger costs	Heuristic
Lee and Vuchic (2005)	Minimize passenger costs	Heuristic
Fusco et al. (2002)	Minimize passenger and operator costs	Metaheuristic (GA)
Chakroborty and Wivedi (2002)	Minimize passenger and operator costs	Metaheuristic (GA)
Zhao and Gan (2003)	Minimize passenger and operator costs	Metaheuristics (TS, SA, and GS)
Zhao (2006)	Minimize passenger and operator costs	Metaheuristics (TS, SA, and GS)
Zhao and Zeng (2007)	Minimize passenger and operator costs	Metaheuristics (TS, SA, and GS)
Szeto and Jiang (2014)	Minimize passenger costs	ABC
Arbex and Cunha (2015)	Minimize passenger and operator costs	Metaheuristic (GA)
López-Ramos et al. (2017)	Minimize passenger and operator costs	Heuristic
Ngamchai and Lovell (2003)	Minimize passenger costs	Metaheuristic (GA)
Pattnaik et al. (1998)	Minimize passenger and operator costs	Metaheuristic (GA)
Zhao et al. (2015)	Minimize passenger costs	Metaheuristic (MA)
Jha et al. (2019)	Minimize passenger costs	Metaheuristics (GA, MOPSO)
Tom and Mohan (2003)	Minimize passenger and operator costs	Metaheuristic (GA)
Tom and Mohan (2003)	Minimize passenger and operator costs	Metaheuristic (GA)
Afandizadeh et al. (2013)	Minimize passenger costs	Metaheuristic (GA)
Buba and Lee (2018)	Minimize passenger costs	Metaheuristics
Zhao et al. (2015)	Minimize passenger costs	Metaheuristics
Zhao (2006)	Minimize passenger costs	Metaheuristic (SA)
Fan et al. (2009)	Minimize passenger costs	Metaheuristics

Note: GA = genetic algorithm; NS = neighborhood search; SA = simulated annealing; GS = greedy search; TS = tabu search; and MOPSO = multiobjective particle swarm optimization.

OD pair directions. The bus network expands with the addition of these new lines, and the probability of having low-usage lines increases. Such lines will have a low frequency after solving the subsequent TNFSP model. Because of this, some of the lines generated during the TNDF stage might be eliminated. The TNFSP is solved by a two-stage model composed of two mixed-integer programs. In the first stage, the passengers are assigned to the network considering the crowdedness of each line segment and the bus frequencies (Spiess and Florian 1989). Frequencies are assigned optimally to the bus lines in the second stage, considering the fleet size and operational constraints.

Solution Framework

The modeling framework developed to deal with the transit network design and frequency setting problem is presented in this section. Due to the complexity of the problem, each subproblem is described individually. The description and assumptions are presented in each subsection, followed by a mathematical formulation.

The first model is the line generation model (section “Line Generation Model”) based on the works of Baaj and Mahmassani (1995). The model is based on a route generation algorithm (RGA) for the design of transit networks. The heuristic algorithm generates additional lines for the existing bus network to directly serve the OD pairs with the highest demand, thereby minimizing travel times. The second model is the passenger assignment (PA) model (section “Lower-Level Model: Passenger Assignment Model”). It was

adapted from the works of Spiess and Florian (1989) and complemented by a penalty for passenger transferring lines at a macrolevel. The overall objective aims to minimize the travel times of passengers considering a probabilistic assignment based on the frequency of the bus lines and the crowding of each line. The third model is the frequency setting model (section “Upper-Level Model: Frequency Setting Model”). The frequency setting model was developed in this study to consider new variables due to the influence of COVID-19. These variables consist mainly of the passengers’ negative perception of traveling in more-crowded buses. The output frequency minimizes travel times and optimizes the bus fleet’s deployment to meet the travelers’ demand. Further analysis of the assigned frequencies can be used to remove low-usage lines to reduce operational costs.

The second and third models, namely the passenger assignment (PA) and the frequency setting (FS) models, function as a combined bilevel model. The output from the passenger assignment model is the input of the frequency setting model, and vice-versa. The models iterate until convergence.

The input data consists of a network graph $G = (S, A)$ containing the existing stops S , the direct connections between them A with the respective length and travel time, the origin–destination matrix, the bus company fleet size, and the average bus capacity. Other parameters also can be adjusted, such as the convergence tolerance parameter δ , perceived travel and waiting times, and maximum distance travelled. Fig. 2 depicts the solution framework characterizing each model’s inputs, outputs, decision variables, and method used.

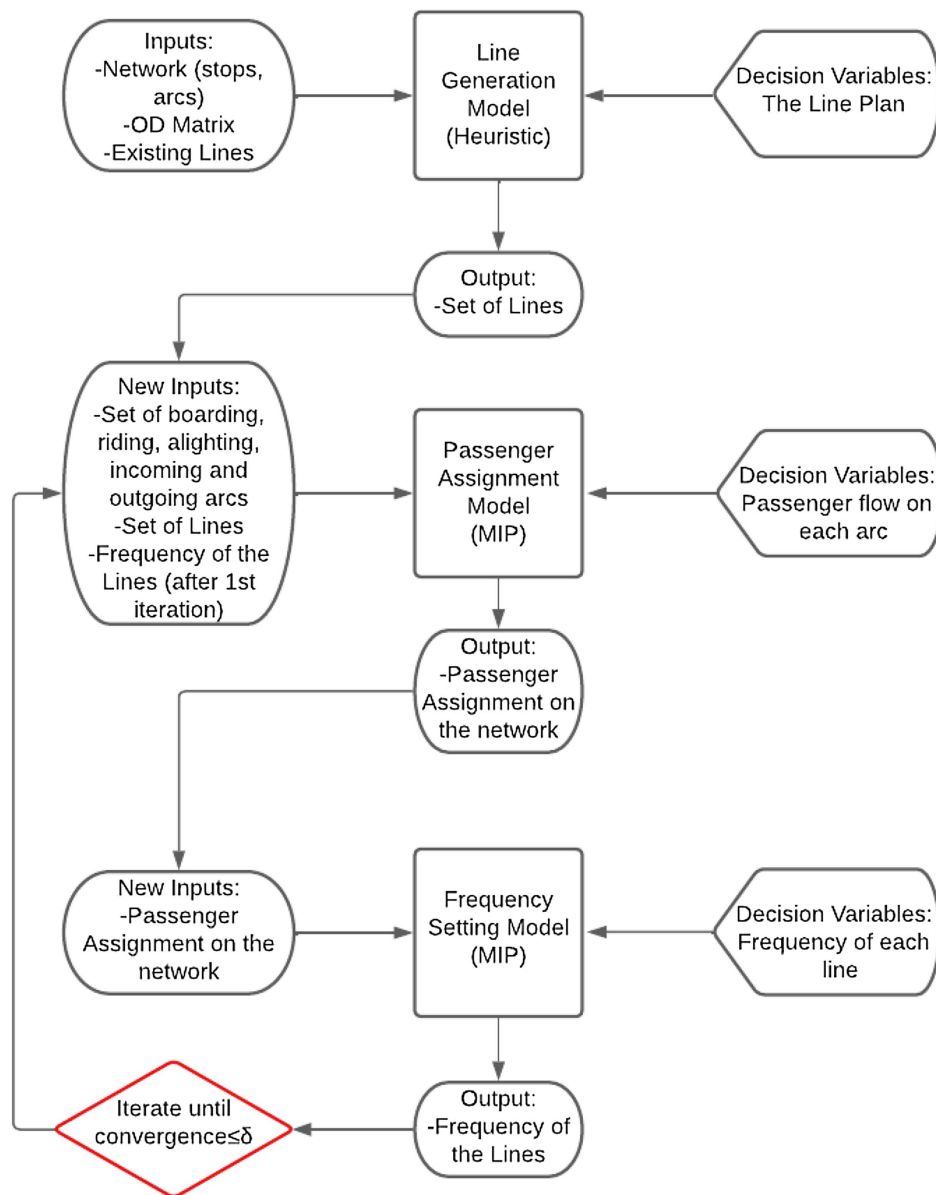

Fig. 2. Solution framework.

The solution framework integrates the three models to solve the TNDFSP. The line generation (LG) model runs independently, whereas the passenger assignment and frequency setting models iterate together to converge to the desired output. The structure of the algorithms starts with the LG model receiving the input data, which is used to generate additional direct bus lines. The generated lines do not change subsequently. Next, the pre-existing lines and new lines are combined, resulting in an extended network, and the algorithm proceeds to the bilevel passenger assignment and frequency setting model. A loop begins considering the initial frequencies f_o of all lines. The bilevel model runs iteratively until the minimal convergence tolerance is satisfied. The process starts with the lower-level passenger assignment model, considering the frequency of the lines to board, the in-vehicle travel time, the crowdedness of the lines, and an additional transfer penalty. The output from this model is used to readjust the frequencies of the upper-level model according to the in-vehicle crowding perception and boarding waiting times. The determined frequencies then are introduced to the lower-level model, and the process repeats. When the

difference between the previous assignment and the current assignment is less than the convergence tolerance, the iterative algorithm stops, and the output of the final bus frequencies is provided.

Line Generation Model

The line generation model extends the work of Baaj and Mahmassani (1995). Our line generation is complementary to the existing bus transit network in such a way as not to incur massive changes to the current network composition. In the scenario in which the disruption caused by COVID-19 in travel patterns leads to inefficiencies of the service, the model creates new lines tailored to the future travel demand. From the set of old and new lines, public transport service providers may choose the line plan to be established for their service according to the volume of passengers served. A line plan comprises the bus line routes and their respective frequencies.

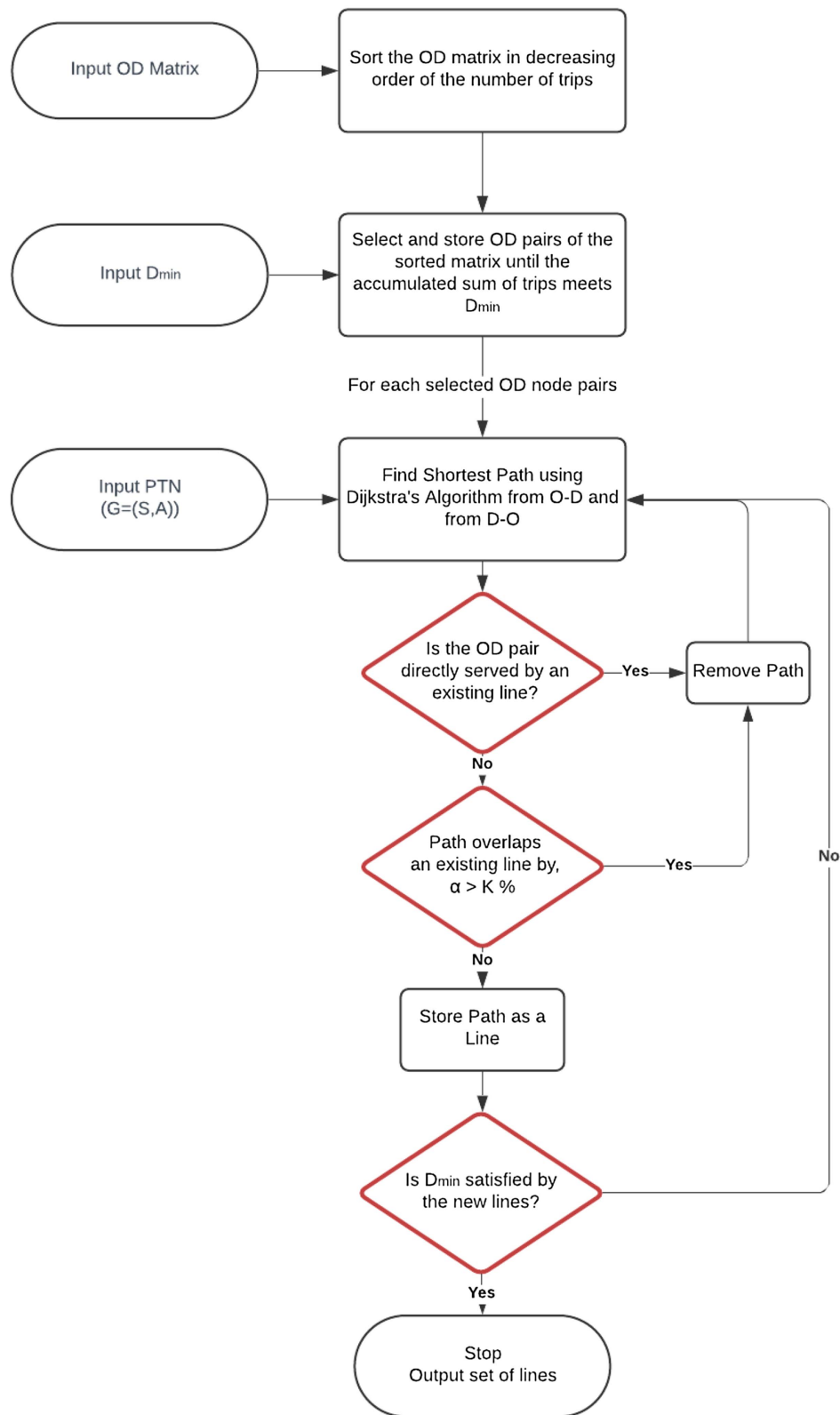

Fig. 3. Adapted route generation algorithm.

Given the OD matrix corresponding to a selected period of operation, a description of the node network specifies for each node (s)

- its neighboring nodes;
- the in-vehicle travel times on all connecting street links (PTN);
- the maximum load factor allowed on any bus route; and
- the seating capacity of the fleet's buses.

Then a route generation algorithm determines the sets of routes that correspond to different trade-offs between the user and operator's costs.

The RGA's overall structure is described in Fig. 3. It starts by sorting the OD pairs of the matrix in decreasing order of the number of trips into a new variable. Then, the first user input regarding the

trade-off between the user and operator costs is considered by introducing parameter D_{\min} . The value of D_{\min} specifies the minimum percentage of trips that are to be satisfied directly by the generation of the new routes by the RGA. The greater this percentage, the more lines are generated and, therefore, the greater are the operating costs, although the demand is served more directly and user costs are reduced.

Next, the algorithm sums the trips of the first sorted OD pairs until the accumulated sum, as a percentage, is higher than or equal to D_{\min} . The summed OD pairs are removed from the sorted OD and are selected to generate lines. They are considered to be the OD pairs with the highest demand. For each high-demand OD pair, the algorithm finds the shortest path using, for example, Dijkstra's algorithm from stop s to destination q , (s, q) , and from destination q to source stop s , (q, s) . These paths are concatenated and form a temporary line. The next steps filter the temporary line to check for overlapping. For example, if both stop s and destination q are already served directly by the bus network, the temporary line is removed to avoid redundant lines. Furthermore, overlapping filtering is applied. According to the requirements of the public transport service provider, one can introduce parameter K indicating the maximum percentage of overlapping links compared with an existing line. If this condition is not met, the temporary line is removed. Again, this is a trade-off between the operator's and users' costs, because a low value of K will generate fewer lines. The temporary line is stored as a new line of the bus network if the filtering steps do not remove it. After all high-demand OD pairs are checked, the algorithm outputs the set of generated lines.

Lower-Level Model: Passenger Assignment Model

The output of this lower-level model is the distribution of the demanded volume of passengers through the network composed of arcs (links) and stops (nodes). An arc a is a directed road connection between two bus stops. The arc contains information on the frequency of buses that travel the arc, the average travel time, and the respective length of the arc. The passenger assignment is a probabilistic assignment that depends on the frequency of the bus lines. As in Spiess and Florian (1989), we introduce a nonlinear term in the objective function to consider the perceived travel cost due to congestion. This aspect is incorporated here, but also is considered and explored further at the microlevel in the frequency setting model. One of the limitations of the model of Spiess and Florian (1989) is that it considers the general waiting time and not the passengers' perception of making a transfer to another bus. To rectify this, we introduce a fixed penalty to the volume of transfer passengers, which contributes to passengers opting more for direct lines when such an option is available.

Assumptions for the Passenger Assignment Model

Trip Components

The formulation of a traveler's trip is segmented into trip components that can be represented by the arcs $a \in A$ in a network $G = (S, A)$. These arcs can be boarding arcs, alighting arcs, and in-vehicle travel arcs. The stops, S , are nodes of the network with incoming and outgoing arcs. The set of outgoing arcs at a stop $s \in S$ is denoted A_s^+ , whereas the incoming arcs are denoted A_s^- . Spiess and Florian (1989) introduced the possibility of having more than one stop at the exact physical location to allow the construction of a network in which an arc corresponds to one and only one line (Fig. 7).

Information about the Arcs

Each arc has a given travel time t_a , a frequency $f_a \in [0, +\infty]$, and a waiting time $w_a \in [0, +\infty]$. Boarding and alighting arcs have a null value for travel time. Because boarding arcs imply waiting, the frequency needs to be greater than zero, i.e., $f_a \in \mathbb{R}_+$. In contrast, in-vehicle travel arcs have a frequency $f_a = +\infty$ and waiting time $w_a = 0$. To summarize, three types of trip components are considered

- waiting for boarding ($t_a = 0$, $f_a \in \mathbb{R}_+$, $w_a \in \mathbb{R}_+$);
- in-vehicle travel ($t_a > 0$, $f_a = +\infty$, $w_a = 0$); and
- alighting ($t_a = 0$, $f_a = 0$, $w_a = 0$).

Probabilistic Assignment

As mentioned previously, the assignment of passengers depends on the frequency. In a probabilistic model, this is done by considering at every stop a set of potential outgoing arcs A_s^+ . Let $x_{a,s} = 1$ if arc a is an outgoing arc of node s , and $x_{a,s} = 0$ otherwise. The probability of choosing an arc over another is given by

$$P_{a,s} = \frac{f_a x_{a,s}}{\sum_{a' \in A} f_{a'} x_{a',s}}, \quad \forall a \in A \quad (1)$$

where the denominator represents the sum of all other outgoing arcs $x_{a',s}$ multiplied by the respective frequencies $f_{a'}$. Probability $P_{a,s} = 0$ if a is not an outgoing arc of s , because $x_{a,s} = 0$. Following this method, the volume of passengers will be distributed more densely on high-frequency lines that also have reduced waiting times. The total passenger volume at a node (v_s) can be given by

$$v_s = \sum_{a \in A_s^+} v_a + d_s, \quad \forall s \in S \quad (2)$$

where d_s = predicted demand at node s from origins of OD matrix; and v_a = passenger volume of arc $a \in A_s^+$. Furthermore, the expected waiting time w_s at node s is expressed as

$$w_s = \frac{\theta}{\sum_{a \in A} f_a x_{a,s}}, \quad \forall s \in S \quad (3)$$

where $\theta \geq 0$ is a coefficient that can take the value of 1/2 if the arc is a high-frequency service, in which passengers arrive randomly at the station, or a value of 1 for a low-frequency service. In the case $\theta = 1$, the distribution of interarrival times is an exponential distribution of headways with mean $1/f_a$ and a uniform passenger arrival rate.

Bus Capacity

The bus capacity b^{cap} is assumed to be a constant value for the whole fleet; this is the average bus capacity. The previously mentioned in-vehicle crowding perception negatively impacts travel time as buses become overcrowded. For a network with a much-varying fleet size, some model development would be desired to adjust the crowding function of the travel time in order to consider different space areas within the vehicle. The equivalent is valid for the frequency setting model, in which another crowding function is considered.

Perceived Travel Cost due to Congestion

To consider the in-vehicle congestion on the passenger's path selection, the riding travel time of an arc t_a can be no longer immutable, but rather a continuous nondecreasing function of the corresponding arc flow $t_a(v_a)$. The function adopted to update the travel time was retrieved from the Bureau of Public Roads (BPR)

$$t_a(v_a) = \left(\frac{v_a}{f_a b^{\text{cap}}} \right)^\beta \quad (4)$$

where v_a = passenger volume of trip component a ; b^{cap} = nominal capacity of bus; and β = BPR function parameter that, in this case, takes the value of 2 and the function becomes quadratic to reduce the complexity of the optimization problem.

Transfer Waiting Time and Associated Penalty

The transfer waiting time for a complex network such as London's is hard to predict because it depends on at least two factors: the passenger arrival time at the transfer stop, and the frequency of the interchange bus line. The arrival time is considered to be random because the generation of lines and frequency settings are not formulated to coordinate the transfers. Coordination means that in a transfer stop, two or more lines meet simultaneously to reduce transfer waiting times. However, the transfer waiting time considers only the frequency of the transfer bus line, and it has the same formulation as the waiting time to board at a stop.

In this model, for simplification, the walking time is omitted if a transfer is conducted, because transfers can happen only at interchange stops. We aim to reduce the necessity of transfers to provide passengers with direct services, because in reality uninterrupted connections are preferable (Stradling et al. 2007). However, a journey might be incomplete without a transfer if there is no direct connection. In that case, the volume of transfers at a network level is accounted for and penalized by a fixed parameter β^{trans} . The value of β^{trans} is based on the work of Yap et al. (2020) in The Hague, in which a five-minute penalty was considered to be plausible.

To keep track of the volume of transfers, this term is considered at a network level. The formulation can be given by the difference between the sum of the outgoing volume of all boarding arcs and the original demand, i.e., the number of boarding passengers of the OD matrix (d)

$$v^{\text{transfer}} = \sum_{a \in B} \sum_{q \in Q} \tilde{v}_{a,q} - d \quad (5)$$

where $B \subseteq A$ = set of boarding arcs; and $\tilde{v}_{a,q}$ = flow in arc a of all passengers traveling to destination q .

Objective Function for the Passenger Assignment Model

The optimization model assigns passengers to their optimal paths considering all origins and destinations $q \in Q$. For this, it is defined as a subset $S_q \subseteq S$ containing all the stops before destination q . Additionally, variables $\tilde{v}_{a,q}$ and $w_{s,q}$, indicating, respectively, the flow in arc a and the total waiting time at stop s for passengers travelling to destination q are added

$$\begin{aligned} \min Z := & \sum_{a \in A} t_a^0 v_a + \sum_{q \in Q} \sum_{s \in S} w_{s,q} + \sum_{a \in A} t_a^0 \left(\frac{v_a}{f_a b^{\text{cap}}} \right)^\beta \\ & + \beta^{\text{trans}} v^{\text{transfer}} \end{aligned} \quad (6)$$

subject to

$$v_a = \sum_{q \in Q} \tilde{v}_{a,q} \quad \forall a \in A \quad (7)$$

$$\sum_{a \in A} \tilde{v}_{a,q} x_{a,s} - \sum_{a \in A} \tilde{v}_{a,q} y_{a,s} = d_{s,q}, \quad \forall s \in S_q, q \in Q \quad (8)$$

$$\tilde{v}_{a,q} x_{a,s} \leq f_a w_{s,q}, \quad \forall a \in A, s \in S, q \in Q \quad (9)$$

$$\tilde{v}_{a,q} \geq 0, \quad \forall a \in A, \quad \forall q \in Q \quad (10)$$

$$w_{s,q} \geq 0, \quad \forall s \in S, \quad \forall q \in Q \quad (11)$$

$$v^{\text{transfer}} = \sum_{a \in B} \sum_{q \in Q} \tilde{v}_{a,q} - d \quad (12)$$

where t_a^0 = average travel time of arc a without congestion; $d_{s,q}$ = demand of passengers travelling from s to q ; $x_{a,s}$ = binary dummy variable that checks if arc a is an outgoing arc of s ; $y_{a,s}$ = binary dummy variable that checks if arc a is an incoming arc of s ; d = total demand; and v_a = volume of passengers on arc a .

The model minimizes the total arc travel time and waiting time at nodes. Constraint Eq. (7) ensures that the volume of arc a is the sum of the volume that flows to all destinations q on arc a . Constraint Eq. (8) is the passenger flow conservation constraint, which ensures that the outgoing flow from all outgoing arcs from node s equals the incoming flow to node s plus the passenger demand. Constraint Eq. (9) ensures that the passenger volume v_a in the outgoing arc a of node s is lower than or equal to the frequency of that arc multiplied by the total waiting time for all trips at node s ; if a is not an outgoing arc of node s , constraint Eq. (9) is satisfied because the left-hand-side is equal to zero. Constraints Eqs. (10) and (11) ensure that the volume of passengers in an arc and the waiting time at a stop cannot be negative. Finally, constraint Eq. (12) results in the number of transfers at a network level. For a BPR parameter value $\beta = 2$, the objective function is quadratic, and the resulting mathematical program is an easy-to-solve inequality-constrained quadratic program (IQP) that can be solved with active set or interior point methods.

Upper-Level Model: Frequency Setting Model

The frequency setting model formulated as a mixed-integer linear program aims to attract more passengers by minimizing passenger costs. It utilizes the distribution of passengers and bus lines from the passenger assignment and line pool models output, respectively, as inputs.

The model adjusts the frequencies of the routes (bus lines) to meet the passenger demand. This adjustment ultimately alters the passengers' waiting time and in-vehicle travel time, which are addressed as passenger costs in this study. It follows the basic principles of frequency settings models expressed in the survey paper by Schöbel (2012). The waiting time is directly dependent on the frequency of a route at a given stop, because more-frequent routes have a lower time headway between vehicles, and therefore a reduced waiting time.

The in-vehicle crowding is related indirectly to the frequency, i.e., the frequency determines how many buses operate on a given route in a given period. Consequently, if the bus capacity is given and we multiply it by the number of buses, this indicates the maximum passenger flow possible to transport over that period. The crowding of each bus then is determined by the difference between the sum of the assigned bus capacity and the total demand if the demand is distributed evenly across a time interval. If the number of buses is underestimated, the model adds more frequency to routes to reduce the crowding perception and ultimately to reduce the in-vehicle travel time.

Assumptions for the Frequency Setting Model

In-Vehicle Travel Time and Crowding Time Penalty

The perceived in-vehicle travel time increases when there is crowding onboard. According to Pel et al. (2014), passengers start to experience a disutility for crowding when the demand exceeds 50%–70% of the

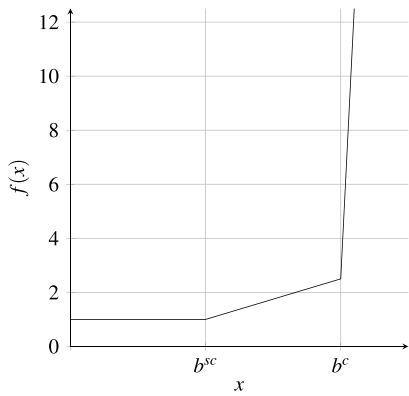

Fig. 4. In-vehicle crowding penalty function.

bus seat capacity. In our scope, even after COVID-19, people likely are reluctant to travel or relax in crowded public spaces. To consider such hesitation, the perceived in-vehicle travel time between two stops connected by an arc a of a given route r is given by the average road travel time $t_{r,a}$ multiplied by the in-vehicle crowding perception $\beta_{r,a}^{ivt}$. The crowding perception is formulated as a piecewise linear function of three conditionals

$$\beta_{r,a}^{ivt} = \begin{cases} M \cdot v_{r,a}^{ivt} & v_{r,a}^{ivt} > b^{cap} \\ \lambda - \frac{(\lambda - 1)(b^{cap} - v_{r,a}^{ivt})}{b^{cap} - b^{sc}} & b^{sc} < v_{r,a}^{ivt} \leq b^{cap} \\ 1 & b^{sc} \leq v_{r,a}^{ivt} \end{cases} \quad (13)$$

$$v_{r,a}^{ivt} = \frac{v_{r,a}}{f_r} \quad (14)$$

where $v_{r,a}^{ivt}$ = in-vehicle load per bus that runs on arc a of route r ; $v_{r,a}$ = passenger volume of arc a of route r over period T ; f_r = frequency on route r ; b^{cap} = total bus capacity; b^{sc} = bus seat capacity; M is a very large positive number; and λ = crowding parameter.

If the occupancy exceeds the total capacity b^{cap} , the multiplier takes a considerable value of M , making it infeasible to board the bus considering the resulting increase in in-vehicle travel time. If the occupancy is below b^{cap} , a linear interpolation is used on the second conditional between the seating capacity b^{sc} and the standing bus capacity scenarios b^{cap} . The penalty takes the value of 1, i.e., no liability, if the number of passengers is less than or equal

to b^{sc} . In the latter scenario, if it is impossible to board more passengers, the penalty takes another value according to a crowding parameter λ . Eq. (14) expresses the number of present passengers on every bus at an arc of a specific route. The passenger demand is assumed to be distributed evenly across the time horizon. The time horizon is one hour, because the frequencies also are defined per hour. The proposed piecewise linear (PWL) function that returns $\beta_{r,a}^{ivt}$ is depicted in Fig. 4.

Waiting Time and Associated Penalty

The waiting time w_s at a stop s is a feature that resembles the passenger perception of the bus service's reliability and efficiency. Passengers are more attracted to using public transport if the expected waiting time is low and consistent. Nowadays, more travelers arrive at the stations closer to the departure time due to technology that provides real-time service data (Lüthi et al. 2007). Because of this information, the waiting time at a stop in the frequency setting model no longer is based on a probabilistic assignment, but on two assumptions. The first considers a random arrival pattern if the stop is served by a high-frequency service, i.e., it has short interarrival times, and one does not need to check the schedule before arriving. The second is that travelers will plan their arrival closer to the departure of the vehicle if they wish to use a less frequent route. Regarding the former assumption's randomness, an average waiting time of half the time headway between successive vehicles was used, according to the literature (Gkiotsalitis and Cats 2021a). The latter assumption considers a fixed waiting time ξ when the time headway is longer, because passengers will coordinate their arrivals at the stops with the departure times of the vehicles (Liu et al. 2021). These two assumptions are depicted in Fig. 5.

The waiting time at any given stop for route w_r is expressed as a conditional function derived from the frequency of the route f_r

$$w_r = \begin{cases} \xi, & f_r < \omega \quad (\text{veh/h}) \\ \frac{1}{2f_r}, & f_r \geq \omega \quad (\text{veh/h}) \end{cases} \quad (15)$$

where ω = threshold service frequency that distinguishes high-frequency routes from low-frequency routes.

The waiting time at a station usually is perceived as costlier than the in-vehicle time. There are many studies of the waiting time multiplier, resulting in quite a range of values. Many authors determined different factors based on their research cases and local surveys. On average, passengers with no access to real-time information perceived the waiting time to be 0.83 min (multiplier = 1.15) longer in

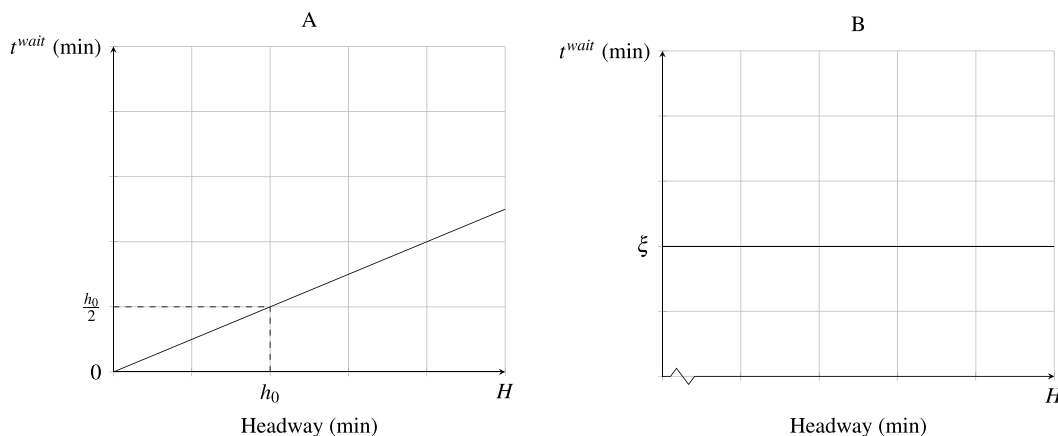

Fig. 5. Passengers' assumed waiting time versus vehicle time-headways.

the work of Watkins et al. (2011) and 0.84 min (multiplier = 1.21) longer in the work of Fan et al. (2016). These studies showed that passengers perceived the waiting time cost to be significantly less (about 30%) when they had access to real-time information. In our case study, we adopted a value of $\beta^{\text{wait}} = 1.2$. However, the parameter can be modeled and updated to a specific case study.

Reduced Traveled Length

Because of the financial strain that several transit operators face and the reduced ridership, a limit to the maximum hourly traveled distance is introduced in our model. Such a measure diminishes operating costs by limiting the frequencies and deploying fewer buses and drivers. The length of each bidirectional route r is calculated as the sum of each arc's length $l_{r,a}$. Thus, it is possible to calculate the distance per hour by multiplying the length of each route by the assigned frequency. The hourly covered distance of the network then can be given by

$$L = \sum_r \sum_{a \in r} l_{r,a} f_r \quad (16)$$

Objective Function for the Frequency Setting Model

The objective function is

$$\text{MIN: } Z = \sum_{r \in R} \sum_{a \in r} (\beta_{r,a}^{\text{ivt}} t_{r,a} + \beta^{\text{wait}} w_r g_{r,a}) v_{r,a} \quad (17)$$

For every route, r in the set of routes R and for all arcs a in the route r , the model is subjected to the following constraints:

$$\beta_{r,a}^{\text{ivt}} = \begin{cases} M \cdot v_{r,a}^{\text{ivt}} & v_{r,a}^{\text{ivt}} > b^{\text{cap}} \\ \lambda - \frac{(\lambda - 1)(b^{\text{cap}} - v_{r,a}^{\text{ivt}})}{b^{\text{cap}} - b^{\text{sc}}} & b^{\text{sc}} < v_{r,a}^{\text{ivt}} \leq b^{\text{cap}} \\ 1 & b^{\text{sc}} \leq v_{r,a}^{\text{ivt}} \end{cases} \quad (18)$$

$$v_{r,a}^{\text{ivt}} = \frac{v_{r,a}}{f_r} \quad (19)$$

$$w_r = \begin{cases} \xi, & f_r < \omega \\ \frac{1}{2f_r}, & f_r \geq \omega \end{cases} \quad (20)$$

$$N^{\text{buses}} = \sum_r \sum_{a \in r} \frac{t_{r,a}}{f_r} \quad (21)$$

$$N^{\text{buses}} \leq N^{\text{MAX}} \quad (22)$$

$$L = \sum_r \sum_{a \in r} l_{r,a} f_r \quad (23)$$

$$L \leq L^{\text{MAX}} \quad (24)$$

where $t_{r,a}$ = travel time of arc a of route r ; w_r = waiting time at any given stop for route r ; $\beta_{r,a}^{\text{ivt}}$ = penalty associated with in-vehicle crowding; β^{wait} = fixed penalty associated with perceived waiting time before boarding; $l_{r,a}$ = length of arc a belonging to route r ; N^{buses} = number of deployed buses in network; N^{MAX} = network's fleet size; L = traveled length in network per hour; L^{MAX} = maximum span travel length of network per hour; f_r = frequency of route r ; and B = set of boarding arcs.

The formulation minimizes the users' cost, which is related implicitly to the frequency of the routes. Similarly to the passenger assignment model, a journey is divided into trip components: boarding, riding, transferring, waiting, and alighting. The formulation

works on a network level as follows: the waiting time cost is employed if arc a is a boarding arc, and the in-vehicle time cost is applied for all arcs in A ; however, apart from the riding arcs, the travel times of boarding and alighting arcs are set to zero. Therefore only the riding arcs are penalized with the crowding perception.

Considering the objective function, in the case of a being an alighting arc, there is no associated cost. The first component regards the perceived in-vehicle travel time considering the crowding level of all buses and all arcs. The second component includes the waiting times of all passengers on arcs that are boarding arcs. Parameter $g_{r,a}$ is a binary parameter that takes the value of 1 if an arc is a boarding arc and zero otherwise. The last term, $v_{r,a}$, is the output of the passenger assignment model, and corresponds to the volume of passengers on every arc.

Constraint Eq. (18) is a piecewise linear function of $v_{r,a}^{\text{ivt}}$ ensuring that the in-vehicle crowding perception penalty is updated accordingly. Constraint Eq. (19) is a fractional constraint that calculates the number of passengers in a particular bus running on a specific arc of a route. Because each arc corresponds to one route only, if the total volume of the assigned passengers per arc $v_{r,a}$ is divided by the frequency of the operated buses of the route containing such arc, the average number of travelers per arc and per bus ($v_{r,a}^{\text{ivt}}$) is obtained. The waiting time to board a bus, if it is the first boarding or a transfer boarding, is given by the function in constraint Eq. (20). Constraint Eq. (21) calculates the number of buses deployed per route r with regard to the round trip time: this is the sum of the average time to ride each arc of the route. Furthermore, Eq. (22) constrains the maximum number of deployed buses according to the fleet size N^{MAX} .

Finally, constraints Eqs. (23) and (24) determine the distance traveled over the study period and limits it according to the maximum allowed traveled length and available resources from the operating company.

In this mathematical formulation, constraints Eqs. (19)–(21) are fractional (and thus nonlinear). These fractional constraints can be reformulated as quadratic equality constraints, which are supported by optimization solvers (i.e., Gurobi). We can introduce variable f'_r and add the quadratic equality constraint

$$f'_r f_r = 1 \quad (25)$$

This allows us to reformulate the fractional constraint Eq. (19) as the following linear constraint:

$$v_{r,a}^{\text{ivt}} = v_{r,a} f'_r \quad (26)$$

In addition, the fractional constraint Eq. (21) can be reformulated as the following linear constraint:

$$N^{\text{buses}} = \sum_r \sum_{a \in r} t_{r,a} f'_r \quad (27)$$

Finally, the conditional constraint Eq. (20) can be replaced by the following set of linear and quadratic equality constraints:

$$w_r = (1 - b_{in})\xi + \frac{1}{2} b_{in} f'_r \quad (28)$$

$$f_r \geq \omega - M(1 - b_{in}) \quad (29)$$

$$f_r \leq \omega + M b_{in} - \epsilon \quad (30)$$

where b_{in} = binary (0–1) variable; M = very large positive number (parameter); and ϵ = parameter that takes a small positive value to simulate constraint $f_r < \omega + M b_{in}$. If $f_r < \omega$ then b_{in} is forced to be equal to 0 to satisfy constraint Eq. (29), thus yielding $w_r = \xi$. On the other hand, if $f_r \geq \omega$ then b_{in} is forced to be equal to 1 to satisfy

constraint Eq. (30), thus yielding $w_r = (1/2)f'_r$ which is equivalent to $(1/2f_r)$.

Model Application

Case Study—Toy Network

The experiments with the bilevel model began with a test toy network, containing all the considered trip components. Fig. 6 illustrate the test network, and Fig. 7 depicts the different trip components of the same network.

In this example, there was a total of 14 nodes (4 stations and 10 auxiliary nodes) and 18 edges (6 boarding arcs, 6 riding arcs, and

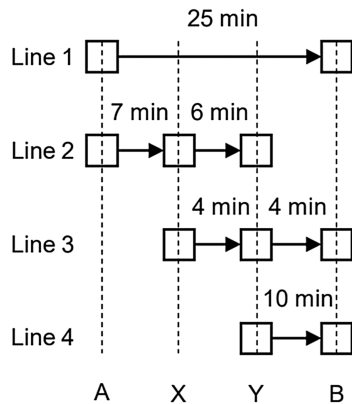

Fig. 6. Example test network.

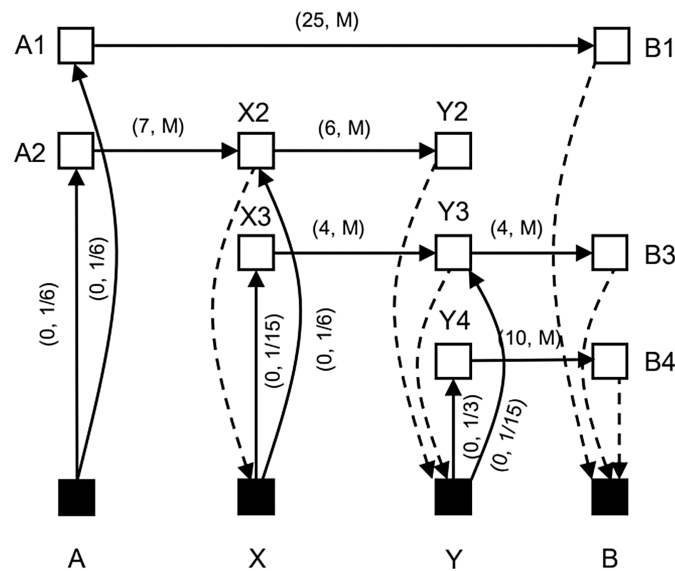

Fig. 7. Component representation of the test network.

Table 2. Example OD matrix for period of 1 h

O/D	A	X	Y	B
A	—	0	80	100
X	0	—	20	0
Y	0	0	—	0
B	0	0	0	—

6 alighting arcs). Table 2 presents an example OD matrix with the number of passengers traveling from an origin stop to a destination stop. The OD table also contains a demand with nondirect routes to destination vertexes, which was relevant for testing how the model processes the transfers.

Results from the Toy Network

The experiments started by verifying the implementation of the new transfer penalty in the passenger assignment model. The experiment was conducted by solving the lower-level model first using commercial solver Gurobi 9.1.2. The results of the different perceptions of the transfer penalty are depicted in Fig. 8.

The introduction of the transfer penalty reduced the number of transfers, which resembles the passengers' negative perceptions of transfers when a direct route is available. In this specific network, the effect was more evident when the transfer penalty was higher than 6 min (Fig. 8). It is expected that for a more extensive network, the transfer penalty will have an increased effect.

Furthermore, the bi-level optimization model was tested with the parameters in Table 3. The test results in Table 4 were obtained using different fleet sizes while keeping the other variables fixed. In this test, round trips were not considered for the bus assignment, so the frequency reflects the number of buses assigned to a route over 1 h. The output also gives the total volume of passengers that used at least one arc belonging to a route. A number of iterations was completed until the convergence tolerance of 1% was met.

The frequency assigned in the upper-level model also was optimized and validated by checking the passenger perception of the bus route. Under these circumstances, more vehicles will run on a higher-demand route so that the demand is satisfied and the vehicles are not overcrowded. As a consequence of assigning

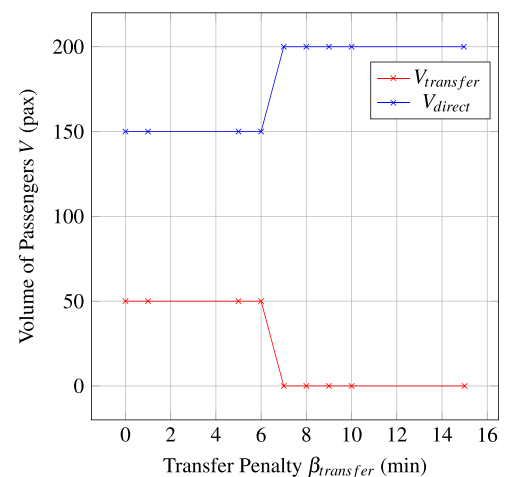

Fig. 8. Volume of direct and transfer passengers.

Table 3. Parameter values of test network of Fig. 6

Parameter	Value
b^{sc} (seats)	60
b^{cap} (seats)	87
λ (min)	2.5
ξ (min)	6
ω (bus/h)	10
β^{wait} (min)	1.2
β^{trans} (min)	5

Table 4. Output of bilevel optimization model in example network of Fig. 6 with different fleet sizes

Fleet size	Route	Passengers	Frequency
6	1	46	0.77
	2	153	4
	3	3	0.03
	4	72	1.2
7	1	100	1.67
	2	100	5.3
	3	0	0
	4	0	0
10	1	100	1.67
	2	100	8.3
	3	0	0
	4	0	0
15	1	100	7.5
	2	100	7.5
	3	0	0
	4	0	0

more buses, there is an increased chance of having more seats available. The waiting times also were generated according to the assigned frequency.

The computational time to solve the bilevel model depends on the size of the network, the size of OD demand, and the relative tolerance for convergence. The chosen convergence alters the number of iterations the model will perform. For the example network, with a relatively low value of 1%, the convergence was less than 30 s with three iterations when using a conventional computer with 8 GB RAM and a 2.1-GHz Ryzen 5 processor.

The results in Table 4 provide information on the number of passengers distributed on the existing four lines with the respective bus frequencies. As the fleet size availability increased, the model converged to an improved assignment of passengers, eliminating the number of subtours and unnecessary transfers. The assigned frequency also improved to reduce crowding. The model provides more-accurate results when the number of available buses provides more capacity than the OD demand requests.

Case Study—Area of the London Network

The scope of this case study was within the geographical area of Chelsea (within the Royal Borough of Kensington and Chelsea). The Borough of Kensington and Chelsea is one of the affluent areas in London, characterized by a high share of high-income residents. These residents opt more often for car usage, causing road traffic congestion and making it challenging to provide an attractive bus network with a reasonable cost recovery rate. TfL provided the supply data of this network. Considering the operational impacts of COVID-19, some parameters also were given by TfL (Table 5). The first experiments using the complete model were conducted using a reduced OD matrix that contained the 15 OD pairs with the highest demand.

Results from the London Network

The first experiments in the Borough of Kensington and Chelsea of the London Network began with programming and running the LG model in Python 3.8. Computational times differed according to the percentage of the total demand to be satisfied directly. That is, they increased as the number of considered OD pairs increased. The OD matrix input covered the complete area of the study comprising

Table 5. Parameter values for running bilevel model in Borough of Kensington and Chelsea

Parameter	Value
b^{sc} (seats)	60
b^{cap} (seats)	87
λ	2.5
ξ (min)	6
ω (bus/h)	10
β^{wait}	2
β^{trans} (min)	3.5
N^{MAX} (buses)	376
L^{MAX} (km)	2,932

Table 6. Number of lines created by line generation model with different percentages of demand to be served by direct connection

D_{min}	Overlap (%)	Number of additional generated lines
10%: complete OD matrix	70	12
25%: complete OD matrix	70	24
50%: complete OD matrix	70	40
60%: complete OD matrix	70	34
75%: complete OD matrix	70	31
100%: small OD matrix	100	9

thousands of OD pairs (7,077) at first. A small OD matrix comprising the 15 most-demanded OD pairs also was considered to demonstrate further the three models working together (LG, PA, and FS), because large networks cannot be solved to global optimality due to the NP-hardness of the subproblems. The latter OD matrix additionally was used to test different scenarios and the robustness of the three models. Table 6 depicts the percentage of D_{min} considered and the number of new generated lines.

The results show that for different values of D_{min} , the size of the constructed lines differed drastically. It is desirable to have a limited number of lines to reduce network complexity in practice, but also to serve the demand fast and directly. The LG heuristic model is capable of producing results in reasonable computational time. However, the output number of lines is substantially large, which is not optimal. The introduction of new constraints, such as the minimum number of stops for a path to be considered as a new line, helps to reduce the generated lines.

To implement the PA and the FS models, three line configurations were considered. These were the existing lines, the lines generated from the LG model, and a combination of both existing and generated lines. Table 7 presents the optimization of the existing lines.

The assignment employed 279 of a total of 376 buses, with a summed frequency of 124 buses/h. Lines with more passenger demand were prone to have higher frequencies. In contrast, lines with a null value represent lines that might be discarded because they serve little to no demand. This line elimination can be conducted manually or by implementing a line-elimination algorithm, such that presented by Gkiotsalitis et al. (2019). In addition to not meeting the demand, such lines do not generate revenue and should be reallocated or discarded in further analysis to cut users' and operators' costs.

Because the FS model was limited to 1 h, the results were obtained when running the first iteration. The total computational time for both models was 7 h. The models were run on a computer with 8 GB RAM and a 2.1-GHz Ryzen 5 processor. Although the OD

Table 7. Optimization of existing lines of Kensington and Chelsea network

Line	Frequency	Volume of boarding passengers
11	0	0
14	0	0
19	9	100
22	0	0
28	14.7	150.6
49	8.9	23.6
70	8.7	93.6
74	0	0
137	12.3	137.6
170	0	0
211	5	20
319	15	136.5
328	13	137
345	9	100
360	19.6	302
414	9.18	73.6
430	0	0
452	0	0
C1	0	0

Table 8. Optimization of generated network lines

Line	Frequency	Volume of boarding passengers
L1 Auxiliary	178	373
L2 Auxiliary	0	0
L3 Auxiliary	104	167
L4 Auxiliary	41.85	17
L5 Auxiliary	84	105
L6 Auxiliary	86	68
L7 Auxiliary	102.8	201
L8 Auxiliary	66.6	64
L9 Auxiliary	89.7	202

matrix was small, a solution was reached in a total of 19 lines. Including the auxiliary edges and vertexes needed to run, the network comprised over 1,800 stops and 3,800 arcs.

A test network was generated with the LG model to serve the 20 OD pairs with the highest demand. A broader number of OD pairs was considered to create a more diverse network without guaranteeing that all lines generated will be fully used. The results of the optimization after running the PA and FS models with the OD matrix are presented in Table 8.

The optimization for the generated network was completed within two iterations after setting the tolerance convergence of $\delta = 0.1$ between iterations. The running time was 4.5 min, which is considerably different from the previous computation using the existing lines. The number of buses used was 243, and the summed frequency was 753 buses/h. This is reflected in the reduced length of the generated lines. For this assignment, Line L2 Auxiliary may be discarded.

Finally, the optimization of the combined existing and generated routes is presented in Table 9. The results show that passengers used both the existing and the newly created lines. In terms of the number of boardings, 37% of the total demand boarded existing lines and 63% of the total demand boarded the generated lines. Although the generated lines were tailored to serve the 20 most demanding OD pairs, some existing lines still were in use, which is a vital indicator that the model can combine the old and new lines and provide a better solution. Lines that serve practically

Table 9. Optimization of combined existing and generated network lines

Line	Frequency	Volume of boarding passengers
11	0	0
14	0	0
19	0	0
22	0	0
28	14.4	77.7
49	0	0
70	7.7	49.2
74	0	0
137	16	87.6
170	0	0
211	0	0
319	12.2	37
328	8.4	50
345	0	0
360	14.4	111.1
414	9.7	55.6
430	0	0
452	0	0
C1	0	0
L1 Auxiliary	98.6	286
L2 Auxiliary	27	78.9
L3 Auxiliary	30.8	55.6
L4 Auxiliary	18.8	14.2
L5 Auxiliary	27.3	49.2
L6 Auxiliary	26.3	34
L7 Auxiliary	24	114.4
L8 Auxiliary	28.5	32
L9 Auxiliary	33.4	134.7

no demand should be discarded to avoid unnecessary operating costs. The number of buses used was 264, and the summed frequency was 362 trips/h. The model solved one iteration in 8 h 30 min. The convergence of the FS model depends on the number of linear variables and constraints. For this study, the FS model stabilized the convergence after 1 h.

Concluding Remarks

The replanning of a bus network is a continuous optimization process that requires attention in every stage. Because of the trade-off between operating and user cost changes, and because the passenger demand fluctuates over time, planners and public transport companies must embrace constant adaptations to new scenarios and prepare to mitigate disruptions, such as those caused by COVID-19. Concerning the effects of the pandemic, replanning bus service through modeling is essential to provide operators with an evidence-based tool that can deliver more-efficient solutions. The new plan should address the current problems, because many companies still are struggling to provide efficient service to the community (Tirachini and Cats 2020). To this end, our TND FS model optimizes the routes and frequencies of pre-existing public transport networks in the aftermath of the pandemic crisis considering the ensuing service disruptions. Our model considers several variables to regain passenger's trust in public transport, such as the in-vehicle crowding and the transfer penalties. Special consideration is given to the passengers' reluctance to gather in crowded vehicles by penalizing the perceived travel times of travelers. Further research on this subject, whether through literature studies or surveys, will help improve the realism of these penalties and better meet the passengers' requirements while maintaining low operational costs.

Data Availability Statement

All data, models, or code that support the findings of this study are available from the corresponding author upon reasonable request.

Acknowledgments

This work is a result of project DynamiCITY: Fostering Dynamic Adaptation of Smart Cities to Cope with Crises and Disruptions (NORTE-01-0145-FEDER-000073) supported by Norte Portugal Regional Operational Programme (NORTE 2020), under the PORTUGAL 2020 Partnership Agreement, through the European Regional Development Fund (ERDF). Dr. K. Gkiotsalitis was funded by the Dutch Organization for Health Research and Development (ZonMw) under the L4 project “COVID 19 Wetenschap voor de Praktijk” (10430042010018).

Notation

The following symbols are used in this paper:

- A = set of arcs;
- A^+ = outgoing arcs;
- A^- = incoming arcs;
- a = arc;
- B = set of boarding arcs;
- b^{cap} = bus capacity;
- b^{sc} = bus seat capacity;
- D_{min} = minimum percentage of OD pairs for LG model;
- d = passenger demand;
- f = frequency;
- f_0 = initial frequency;
- G = graphic network;
- g = boarding arc binary parameter;
- K = maximum percentage of overlapping arcs for LG model;
- L = covered distance of network;
- L^{MAX} = maximum network covered distance;
- l_a = length of arc;
- M = very large positive number;
- N^{MAX} = network's fleet size;
- $P_{a,s}$ = probability of choosing arc;
- Q = set of destinations;
- q = destination stop;
- r = bus line (i.e., route);
- S = set of stops;
- S_q = subset of all destinations before q ;
- s = stop or origin stop;
- T = period;
- t = travel time;
- $t(v)$ = travel time in function of passenger volume;
- t_a^0 = arc travel time without congestion;
- v = volume of passengers;
- $\tilde{v}_{a,q}$ = passenger volume for destination q on arc a ;
- v^{ivt} = in-vehicle volume of passengers;
- v^{transfer} = volume of transfers;
- w = waiting time;
- $w_{s,q}$ = passenger waiting time for destination q at stop s ;
- x = outgoing arc dummy variable;
- y = incoming arc dummy variable;
- β = BPR function parameter;

- β^{ivt} = in-vehicle crowding perception;
- β^{trans} = transfer penalty;
- β^{wait} = waiting time penalty;
- λ = crowding parameter;
- δ = convergence parameter;
- θ = frequency coefficient; and
- ξ = fixed waiting time.

References

- Afandizadeh, S., H. Khaksar, and N. Kalantari. 2013. “Bus fleet optimization using genetic algorithm a case study of Mashhad.” *Int. J. Civ. Eng.* 11 (1): 43–52.
- Aloi, A., et al. 2020. “Effects of the COVID-19 lockdown on urban mobility: Empirical evidence from the City of Santander (Spain).” *Sustainability* 12 (9): 3870. <https://doi.org/10.3390/su12093870>.
- Arbex, R. O., and C. B. Cunha. 2015. “Efficient transit network design and frequencies setting multi-objective optimization by alternating objective genetic algorithm.” *Transp. Res. Part B Methodol.* 81 (Nov): 355–376. <https://doi.org/10.1016/j.trb.2015.06.014>.
- Baaj, M. H., and H. S. Mahmassani. 1995. “Hybrid route generation heuristic algorithm for the design of transit networks.” *Transp. Res. Part C Emerging Technol.* 3 (1): 31–50. [https://doi.org/10.1016/0968-090X\(94\)00011-S](https://doi.org/10.1016/0968-090X(94)00011-S).
- Borndörfer, R., M. Grötschel, and M. E. Pfetsch. 2005. *A path-based model for line planning in public transport a path-based model for line planning in public transport*. Rep. No. 05-18. Berlin: Konrad-Zuse-Zentrum für Informationstechnik.
- Buba, A. T., and L. S. Lee. 2018. “A differential evolution for simultaneous transit network design and frequency setting problem.” *Expert Syst. Appl.* 106 (Sep): 277–289. <https://doi.org/10.1016/j.eswa.2018.04.011>.
- Bucsky, P. 2020. “Modal share changes due to COVID-19: The case of Budapest.” *Transp. Res. Interdiscip. Perspect.* 8 (Nov): 100141. <https://doi.org/10.1016/j.trip.2020.100141>.
- Carteni, A., L. Di Francesco, and M. Martino. 2021. “The role of transport accessibility within the spread of the Coronavirus pandemic in Italy.” *Saf. Sci.* 133 (Jan): 104999. <https://doi.org/10.1016/j.ssci.2020.104999>.
- Ceder, A., and Y. Israeli. 1998. “User and operator perspectives in transit network design.” *Transp. Res. Rec.* 1623 (1): 3–7. <https://doi.org/10.3141/1623-01>.
- Chakroborty, P., and T. Wivedi. 2002. “Optimal route network design for transit systems using genetic algorithms.” *Eng. Optim.* 34 (1): 83–100. <https://doi.org/10.1080/03052150210909>.
- Cui, Q., L. He, Y. Liu, Y. Zheng, W. Wei, B. Yang, and M. Zhou. 2021. “The impacts of COVID-19 pandemic on China's transport sectors based on the CGE model coupled with a decomposition analysis approach.” *Transp. Policy* 103 (Mar): 103–115. <https://doi.org/10.1016/j.tranpol.2021.01.017>.
- Dubois, D., G. Bel, and M. Llibre. 1979. “A set of methods in transportation network synthesis and analysis.” *J. Oper. Res. Soc.* 30 (9): 797–808. <https://doi.org/10.1057/jors.1979.190>.
- Fan, L., C. L. Mumford, and D. Evans. 2009. “A simple multi-objective optimization algorithm for the Urban transit routing problem.” In *Proc., 2009 IEEE Congress on Evolutionary Computation, CEC 2009*, 1–7. New York: IEEE.
- Fan, W., and R. B. Machemehl. 2004. *Optimal transit route network design problem: Algorithms, implementations, and numerical results 6. Performing organization code unclassified*. Rep. No. SWUTC/04/167244-1 Austin, TX: Univ. of Texas at Austin.
- Fan, W., and R. B. Machemehl. 2006. “Optimal transit route network design problem with variable transit demand: Genetic algorithm approach.” *J. Transp. Eng.* 132 (1): 40–51. [https://doi.org/10.1061/\(ASCE\)0733-947X\(2006\)132:1\(40\)](https://doi.org/10.1061/(ASCE)0733-947X(2006)132:1(40)).
- Fan, Y., A. Guthrie, and D. Levinson. 2016. “Waiting time perceptions at transit stops and stations: Effects of basic amenities, gender, and security.” *Transp. Res. Part A Policy Pract.* 88 (Jun): 251–264. <https://doi.org/10.1016/j.tra.2016.04.012>.

- Furth, P. G., and N. H. Wilson. 1981. "Setting frequencies on bus routes: Theory and practice." *Transp. Res. Rec.* 818 (1981): 1–7.
- Fusco, G., S. Gori, and M. Petrelli. 2002. "A heuristic transit network design algorithm for medium size towns." In *Proc., 13th Mini-Euro Conf.* Bari, Italy: Politecnico.
- Ghosh, A., S. Nundy, S. Ghosh, and T. K. Mallick. 2020. "Study of COVID-19 pandemic in London (UK) from urban context." *Cities* 106 (Jun): 102928. <https://doi.org/10.1016/j.cities.2020.102928>.
- Gkiotsalitis, K. 2021. "A model for modifying the public transport service patterns to account for the imposed COVID-19 capacity." *Transp. Res. Interdiscip. Perspect.* 9 (Mar): 100336. <https://doi.org/10.1016/j.trip.2021.100336>.
- Gkiotsalitis, K., and O. Cats. 2021a. "At-stop control measures in public transport: Literature review and research agenda." *Transp. Res. Part E Logist. Transp. Rev.* 145 (Jan): 102176. <https://doi.org/10.1016/j.tre.2020.102176>.
- Gkiotsalitis, K., and O. Cats. 2021b. "Optimal frequency setting of metro services in the age of COVID-19 distancing measures." *Transportmetrica A: Transp. Sci.* 18 (3): 807–827. <https://doi.org/10.1080/23249935.2021.1896593>.
- Gkiotsalitis, K., and O. Cats. 2021c. "Public transport planning adaption under the COVID-19 pandemic crisis: Literature review of research needs and directions." *Transp. Res.* 41 (3): 374–392. <https://doi.org/10.1080/01441647.2020.1857886>.
- Gkiotsalitis, K., Z. Wu, and O. Cats. 2019. "A cost-minimization model for bus fleet allocation featuring the tactical generation of short-turning and interlining options." *Transp. Res. Part C Emerging Technol.* 98 (Jan): 14–36. <https://doi.org/10.1016/j.trc.2018.11.007>.
- Guihaire, V., and J. K. Hao. 2008. "Transit network design and scheduling: A global review." *Transp. Res. Part A Policy Pract.* 42 (10): 1251–1273. <https://doi.org/10.1016/j.tra.2008.03.011>.
- Hasselstrom, D. 1982. *Public transportation planning: A mathematical programming approach*. Olney, UK: Bumpus, Haldane and Maxwell Limited.
- Ibarra-Rojas, O. J., F. Delgado, R. Giesen, and J. C. Muñoz. 2015. "Planning, operation, and control of bus transport systems: A literature review." *Transp. Res. Part B Methodol.* 77 (Jul): 38–75. <https://doi.org/10.1016/j.trb.2015.03.002>.
- Ibarra-Rojas, O. J., R. Giesen, and Y. A. Rios-Solis. 2014. "An integrated approach for timetabling and vehicle scheduling problems to analyze the trade-off between level of service and operating costs of transit networks." *Transp. Res. Part B Methodol.* 70 (Dec): 35–46. <https://doi.org/10.1016/j.trb.2014.08.010>.
- Jha, S. B., J. K. Jha, and M. K. Tiwari. 2019. "A multi-objective meta-heuristic approach for transit network design and frequency setting problem in a bus transit system." *Comput. Ind. Eng.* 130 (Apr): 166–186. <https://doi.org/10.1016/j.cie.2019.02.025>.
- Lampkin, W., and P. D. Saalmans. 1967. "The design of routes, service frequencies, and schedules for a municipal bus undertaking: A case study." *J. Oper. Res. Soc.* 18 (4): 375–397. <https://doi.org/10.1057/jors.1967.70>.
- Lee, Y.-J., and V. R. Vuchic. 2005. "Transit network design with variable demand." *J. Transp. Eng.* 131 (1): 1–10. [https://doi.org/10.1061/\(ASCE\)0733-947X\(2005\)131:1\(1\)](https://doi.org/10.1061/(ASCE)0733-947X(2005)131:1(1)).
- Liu, T., O. Cats, and K. Gkiotsalitis. 2021. "A review of public transport transfer coordination at the tactical planning phase." *Transp. Res. Part C Emerging Technol.* 133 (Dec): 103450. <https://doi.org/10.1016/j.trc.2021.103450>.
- López-Ramos, F., E. Codina, Á. Marín, and A. Guarnaschelli. 2017. "Integrated approach to network design and frequency setting problem in railway rapid transit systems." *Comput. Oper. Res.* 80 (Apr): 128–146. <https://doi.org/10.1016/j.cor.2016.12.006>.
- Lüthi, M., U. Weidmann, and A. Nash. 2007. "Passenger arrival rates at public transport stations." In *Proc., TRB 86th Annual Meeting Compendium of Papers*. Washington, DC: Transportation Research Board.
- Mandl, C. E. 1980. "Evaluation and optimization of urban public transportation networks." *Eur. J. Oper. Res.* 5 (6): 396–404. [https://doi.org/10.1016/0377-2217\(80\)90126-5](https://doi.org/10.1016/0377-2217(80)90126-5).
- Meng, M., A. Rau, and H. Mahardhika. 2018. "Public transport travel time perception: Effects of socioeconomic characteristics, trip characteristics and facility usage." *Transp. Res. Part A Policy Pract.* 114 (Aug): 24–37. <https://doi.org/10.1016/j.tra.2018.01.015>.
- Ngamchai, S., and D. J. Lovell. 2003. "Optimal time transfer in bus transit route network design using a genetic algorithm." *J. Transp. Eng.* 129 (5): 510–521. [https://doi.org/10.1061/\(ASCE\)0733-947X\(2003\)129:5\(510\)](https://doi.org/10.1061/(ASCE)0733-947X(2003)129:5(510)).
- Nikolić, M., and D. Teodorović. 2014. "A simultaneous transit network design and frequency setting: Computing with bees." *Expert Syst. Appl.* 41 (16): 7200–7209. <https://doi.org/10.1016/j.eswa.2014.05.034>.
- Pattnaik, S. B., S. Mohan, and V. M. Tom. 1998. "Urban bus transit route network design using genetic algorithm." *J. Transp. Eng.* 124 (4): 368–375. [https://doi.org/10.1061/\(ASCE\)0733-947X\(1998\)124:4\(368\)](https://doi.org/10.1061/(ASCE)0733-947X(1998)124:4(368)).
- Pel, A. J., N. H. Bel, and M. Pieters. 2014. "Including passengers' response to crowding in the Dutch national train passenger assignment model." *Transp. Res. Part A Policy Pract.* 66 (1): 111–126.
- Przybylowski, A., S. Stelmak, and M. Suchanek. 2021. "Mobility behaviour in view of the impact of the COVID-19 pandemic—Public transport users in Gdansk case study." *Sustainability* 13 (1): 364. <https://doi.org/10.3390/su13010364>.
- Ratho, A., and P. Johns. 2020. *Rethinking cities in a post-covid-19 world*. New Delhi, India: ORF and Global Policy Journal.
- Schöbel, A. 2012. "Line planning in public transportation: Models and methods." *OR Spectr.* 34 (3): 491–510. <https://doi.org/10.1007/s00291-011-0251-6>.
- Silman, L. A., Z. Barzily, and U. Passy. 1974. "Planning the route system for urban buses." *Comput. Oper. Res.* 1 (2): 201–211. [https://doi.org/10.1016/0305-0548\(74\)90046-X](https://doi.org/10.1016/0305-0548(74)90046-X).
- Spieß, H., and M. Florian. 1989. "Optimal strategies: A new assignment model for transit networks." *Transp. Res. Part B* 23 (2): 83–102. [https://doi.org/10.1016/0191-2615\(89\)90034-9](https://doi.org/10.1016/0191-2615(89)90034-9).
- Stradling, S., M. Carreno, T. Rye, and A. Noble. 2007. "Passenger perceptions and the ideal urban bus journey experience." *Transp. Policy* 14 (4): 283–292. <https://doi.org/10.1016/j.tranpol.2007.02.003>.
- Szeto, W. Y., and Y. Jiang. 2014. "Transit route and frequency design: Bi-level modeling and hybrid artificial bee colony algorithm approach." *Transp. Res. Part B Methodol.* 67 (Sep): 235–263. <https://doi.org/10.1016/j.trb.2014.05.008>.
- Szeto, W. Y., and Y. Wu. 2011. "A simultaneous bus route design and frequency setting problem for Tin Shui Wai, Hong Kong." *Eur. J. Oper. Res.* 209 (2): 141–155. <https://doi.org/10.1016/j.ejor.2010.08.020>.
- TfL (Transport for London). 2020a. "All London buses now taking payments as capacity limits are safely increased." Accessed July 13, 2020. <https://tfl.gov.uk/info-for/media/press-releases/2020/july/all-london-buses-now-taking-payments-as-capacity-limits-are-safely-increased>.
- TfL (Transport for London). 2020b. *Annual report and statement of accounts 2019/20*. Rep. No. 2019/20. London: TfL.
- Tirachini, A., and O. Cats. 2020. "COVID-19 and public transportation: Current assessment, prospects, and research needs." *J. Public Transp.* 22 (1): 1–21. <https://doi.org/10.5038/2375-0901.22.1.1>.
- Tom, V. M., and S. Mohan. 2003. "Transit route network design using frequency coded genetic algorithm." *J. Transp. Eng.* 129 (2): 186–195. [https://doi.org/10.1061/\(ASCE\)0733-947X\(2003\)129:2\(186\)](https://doi.org/10.1061/(ASCE)0733-947X(2003)129:2(186)).
- UITP (International Association of Public Transport). 2020a. *Knowledge brief*. Brussels, Belgium: UITP.
- UITP (International Association of Public Transport). 2020b. *Public transport authorities and COVID-19 impact and response to a pandemic*. Brussels, Belgium: UITP.
- Wan, Q. K., and H. K. Lo. 2003. "A mixed integer formulation for multiple-route transit network design." *J. Math. Modell. Algorithms* 2 (Dec): 299–308. <https://doi.org/10.1023/B:JMAA.0000020425.99217.cd>.
- Watkins, K. E., B. Ferris, A. Borning, G. S. Rutherford, and D. Layton. 2011. "Where is my bus? Impact of mobile real-time information on the perceived and actual wait time of transit riders." *Transp. Res. Part A*

- Policy Pract.* 45 (8): 839–848. <https://doi.org/10.1016/j.tra.2011.06.010>.
- Wielechowski, M., K. Czech, and Ł. Grzęda. 2020. “Decline in mobility: Public transport in Poland in the time of the COVID-19 pandemic.” *Economies* 8 (4): 78. <https://doi.org/10.3390/economies8040078>.
- Yap, M., O. Cats, and B. van Arem. 2020. “Crowding valuation in urban tram and bus transportation based on smart card data.” *Transportmetrica A: Transp. Sci.* 16 (1): 23–42. <https://doi.org/10.1080/23249935.2018.1537319>.
- Zhao, F. 2006. “Large-scale transit network optimization by minimizing user cost and transfers.” *J. Public Transp.* 9 (2): 107–129. <https://doi.org/10.5038/2375-0901.9.2.6>.
- Zhao, F., and A. Gan. 2003. *Optimization of transit network to minimize transfers*, 153. Gainesville, FL: Lehman Center for Transport Research, Florida Univ.
- Zhao, F., and X. Zeng. 2007. “Optimization of user and operator cost for large-scale transit network.” *J. Transp. Eng.* 133 (4): 240–251. [https://doi.org/10.1061/\(ASCE\)0733-947X\(2007\)133:4\(240\)](https://doi.org/10.1061/(ASCE)0733-947X(2007)133:4(240)).
- Zhao, H., W. Xu, and R. Jiang. 2015. “The Memetic algorithm for the optimization of urban transit network.” *Expert Syst. Appl.* 42 (7): 3760–3773. <https://doi.org/10.1016/j.eswa.2014.11.056>.
- Zhou, P., et al. 2020. “A pneumonia outbreak associated with a new coronavirus of probable bat origin.” *Nature* 579 (7798): 270–273. <https://doi.org/10.1038/s41586-020-2012-7>.