

# VOLUME 2

34<sup>th</sup> International Conference on  
Passive and Low Energy Architecture

Smart and Healthy  
Within the Two-Degree Limit

Edited by:

Edward Ng, Square Fong, Chao Ren

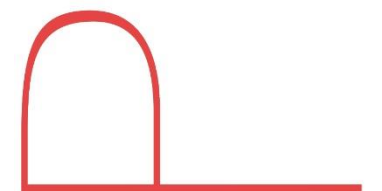
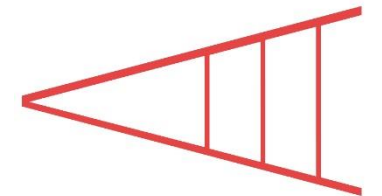
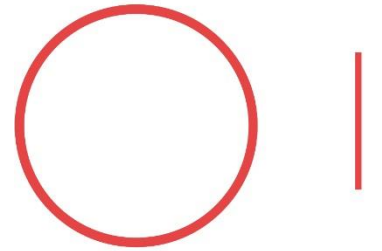
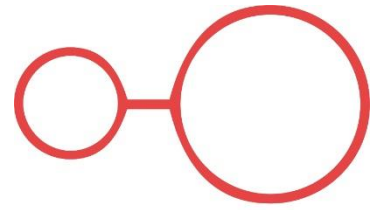

**PLEA 2018:**

**Smart and Healthy Within the Two-Degree Limit**

Proceedings of the 34<sup>th</sup> International Conference on  
Passive and Low Energy Architecture;

Dec 10-12, 2018

Hong Kong, China

Organised by:

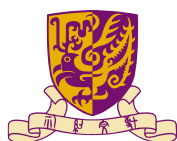

香港中文大學  
The Chinese University of Hong Kong



香港中文大學環境、  
能源及可持續發展研究所  
Institute of Environment,  
Energy and Sustainability, CUHK



PLEA

Conference Chair:

Edward Ng,

Yao Ling Sun Professor of Architecture,

School of Architecture,

The Chinese University of Hong Kong

Conference Proceedings Edited by:

Edward Ng, Square Fong, Chao Ren

**School of Architecture**

**The Chinese University of Hong Kong**

AIT Building

Shatin, New Territories

Hong Kong SAR, China

Copyright of the individual papers remains with the Authors.

Portions of this proceedings may be reproduced only with proper credit to the authors and the conference proceedings.

This book was prepared from the input files supplied by the authors. The editors and the publisher do not accept any responsibility for the content of the papers herein published.

Electronic version as:

ISBN: 978-962-8272-36-5

©Copyright: PLEA 2018 Hong Kong

# PLEA 2018

PLEA stands for Passive and Low Energy Architecture. It is an organisation engaged in a worldwide discourse on sustainable architecture and urban design through its annual international conference, workshops and publications. It commits to the development, documentation and diffusion of the principles of bioclimatic design and the application of natural and innovative techniques for sustainable architecture and urban design.

PLEA is an autonomous, non-profit association of individuals sharing the art, science, planning and design of the built environment. PLEA pursues its objectives through international conferences and workshops; expert group meetings and consultancies; scientific and technical publications; and architectural competitions and exhibitions. Since 1982, PLEA has organised conferences and events across the globe. The annual conference of PLEA is regarded, attracting academics and practicing architects in equal numbers. Past conferences have taken place in United States, Europe, South America, Asia, Africa and Australia.

It is the first time that the PLEA conference comes to Hong Kong in 2018. The juxtaposition of Hong Kong's compact and high-density living and scenic countryside makes it an intriguing case of urban sustainability and climate resilience. The urban and built environment represents both challenges and opportunities amid climate change. As the world approaches the 2-degree limit, living smart and healthy has become a priority in urban development. Smart cities are driven by science and technology but are meaningless without consideration for the people and community. Design and practice are essential in implementation, while education and training stimulate innovation and empower professionals and laymen alike.

With the theme **“Smart and Healthy within the 2-degree Limit”**, the conference strives to address the different facets of smart and healthy living and aims to bring together designers, academics, researchers, students, and professionals in the building industry in the pursuit of a better and more sustainable urban and built environment.

Edward Ng  
Conference Chair

## INTERNATIONAL ADVISORY COMMITTEE

Dr. Heide Schuster, BLAUSTUDIO - Sustainability in Architecture and Urban Design, Germany

Dr. Simos Yannas, Architectural Association School of Architecture, UK

Dr. Joana Carla Soares Gonçalves, The University of São Paulo, Brazil

Prof. Rajat Gupta, Oxford Brookes University, UK

Dr. Sanda Lenzholzer, Wageningen University, The Netherlands

Prof. Pablo La Roche, Cal Poly Pomona, United States

Arch. Mario Cucinella, Mario Cucinella Architects S.R.L., Italy

Prof. Sue Roaf, Retired, Centre of Excellence in Sustainable Building Design, Heriot-Watt University, UK

Prof. Alfredo Fernández-González, University of Nevada, United States

Dr. Paula Cadima, Architectural Association School of Architecture, UK

Prof. Brian Ford, Natural Cooling Ltd, UK

Prof. Christopher Webster, University of Hong Kong, Hong Kong, China

## ORGANISING COMMITTEE

Prof. Edward Ng, The Chinese University of Hong Kong, Hong Kong, China [Chairman]

Dr. Tin-Tai Chow, City University of Hong Kong

Prof. Jimmy Fung, Hong Kong University of Science and Technology

Prof. Yuguo Li, The University of Hong Kong

Dr. Shengwei Wang, The Hong Kong Polytechnic University

Mr. Tang Man Bun, Hong Kong Institute of Urban Design

Dr. Raymond Yau, Swire Properties

Mr. John Ng, The University of Hong Kong

Mr. M.K. Leung, Ronald Lu & Partners (Hong Kong) Ltd.

### Technical Sub-committee

Dr. Chao Ren, The University of Hong Kong

Dr. Kevin Lau, The Chinese University of Hong Kong

Dr. Chad McKee, The University of Hong Kong

Dr. Sunliang Cao, The Hong Kong Polytechnic University

Dr. Fong Kwong Fai, City University of Hong Kong

Mr. Tony Ip, Tony Ip Green Architects Ltd.

Mr. Ricky Li, Ove Arup & Partners (HK) Ltd.

## SCIENTIFIC COMMITTEE

Dr. Amal Abuzeinab  
Dr. Timothy Oluseun Adekunle  
Dr. Rajendra Singh Adhikari  
Dr. Avlokita Agrawal  
Prof. Sanyogita Manu Agrawala  
Prof. Khandaker Shabbir Ahmed  
Dr. Sura Al-Maiyah  
Prof. Jose Manuel Almodovar  
Dr. Hector Altamirano  
Prof. Hasim Altan  
Prof. Sergio Altomonte  
Prof. Servando Alvarez  
Prof. Massimo Angrilli  
Ms. Carmen Antuna Rozado  
Dr. Rigoberto Arambula Lara  
Dr. Michele arch. Manigrasso  
Prof. Shady Attia  
Dr. Rahman Azari  
Prof. George Baird  
Prof. Adolfo F. L. Baratta  
Mr. Enrico Baschieri  
Dr. Liliana Olga Beltran  
Dr. Umberto Berardi  
Prof. Susana Biondi  
Dr. Sahera Bleibleh  
Prof. Terri M Boake  
Dr. Paola Boarin  
Prof. Andrea Boeri  
Prof. Martha Christine Bohm  
Mr. Mehrdad Borna  
Dr. Helena Camara Lace Brandao  
Dr. Luisa Brotas  
Prof. Gian Luca Brunetti  
Dr. Neil Keith Burford  
Prof. Waldo E. Bustamante  
Dr. Paula San Payo Cadima  
Dr. Francesca Calarco  
Prof. Eliana Cangelli  
Dr. Gustavo Alexandre Cardoso Cantuaria  
Prof. Guedi Capeluto  
Prof. Paola Caputo  
Mr. Paul John Carew  
Dr. Kate Carter  
Dr. Szu-cheng Chien  
Dr. Joon-Ho Choi  
Dr. Roberta Cocci Grifoni  
Dr. Raphael Compagnon  
Prof. Manuel de Arriaga Brito Correia-Guedes  
Prof. Courtney Crosson  
Prof. Rolando-Arturo Cubillos Gonzalez  
Dr. Marwa Dabaieh  
Prof. Francesca De Filippi  
Prof. Robert Mark DeKay  
Prof. Claude Demers  
Prof. Gokay Deveci  
Prof. Branka Dimitrijevic  
Dr. Silvia Domingo-Irigoyen  
Dr. Samuel Dominguez-Amarillo  
Dr. Jiangtao Du  
Dr. Denise Helena Silva Duarte  
Dr. Meshack O Efeoma  
Prof. Soofia Tahira Elias-Ozkan  
Dr. Heba Elsharkawy  
Dr. Ihab Elzeyadi  
Prof. Rohinton Emmanuel  
Prof. Evyatar Erell  
Dr. Carlos Javier Esparza Lopez  
Dr. Kristian Fabbri  
Prof. Enrico Fabrizio  
Dr. Honey Fadaie Tamidjanie  
Dr. Juliana Felkner  
Ms. Jesica Fernandez Aguera  
Dr. Nisha A. Fernando  
Prof. Anderson Targino da Silva Ferreira  
Mr. Isak Worre Foged  
Prof. Brian Ford  
Mr. Andrea Fornasiero  
Prof. Robert Fryer  
Dr. Khaled Galal Ahmed  
Prof. Paola Gallo  
Prof. Susanne Gampfer  
Dr. Yun Gao  
Dr. Jose Roberto Garcia Chavez  
Dr. Veronica Garcia-Hansen  
Prof. Jacopo Gaspari  
Dr. Stephanie Gauthier  
Ms. Marjan Ghobad  
Prof. Aymeric Alain Girard  
Dr. Gabriel Gomez-Azpeitia  
Dr. Mehreen Saleem Gul  
Ms. Nidhi Gupta  
Prof. Rajat Gupta  
Ms. Mary Guzowski  
Prof. Emanuele Habib  
Prof. Annette Hafner  
Prof. Bruce T Haglund  
Dr. Muhannad J. A. Haj Hussein  
Prof. S Robert Hastings  
Mr. Navid Hatefnia  
Prof. Runa T. Hellwig  
Dr. Daniel Herrera  
Dr. Christina Hopfe  
Prof. Michaela Hoppe  
Dr. Nina Amor Hormazabal-Poblete  
Dr. Lingjiang Huang  
Dr. Guadalupe Huelsz  
Dr. Mehlika Inanici  
Dr. Vicky Ingram  
Dr. Saiful Islam  
Dr. Stoyanka Marinova Ivanova  
Prof. Usha Iyer-Raniga  
Dr. Beverley Lorraine James  
Ms. Gloria Cecilia Jimenez Dianderas  
Dr. Mohammad Arif Kamal  
Dr. Genku Kayo  
Prof. Greg Keeffe  
Dr. Inji Kenawy  
Prof. Nikolaus Knebel  
Dr. Roberta Consentino Kronka Mulfarth  
Prof. Alison Kwok  
Ms. Mili Kyropoulou  
Dr. Pablo Miguel La Roche  
Prof. Werner Xaver Lang  
Mr. Ping Hang (Benson) Lau  
Dr. Sanda Lenzholzer  
Dr. Fabrizio Leonforte

Prof. J Owen Lewis  
Mr. Florian Lichtblau  
Dr. Maria Lopez de Asiain Alberich  
Mr. Richard Lorch  
Dr. Yujie Lu  
Prof. Elena Lucchi  
Dr. Atefe Makhmalbaf  
Ms. Valentina Marincioni  
Mr. Keith McAllister  
Prof. Shannon Sanders McDonald  
Dr. Lori Barbara McElroy  
Dr. Grainne Marie McGill  
Prof. Christopher M. Meek  
Dr. Isaac A. Meir  
Ms. Rosalie Menon  
Ms. Ranny Loureiro Xavier Nascimento Michalski  
Dr. Mahta Mirmoghtadaee  
Ms. Anamika Vachaspati Mishra  
Prof. Jitka Mohelnikova  
Dr. Mahsan Mohsenin  
Dr. Marta Molina-Huelva  
Dr. Sameh Monna  
Dr. Azadeh Montazami  
Prof. Circe Maria Gama Monteiro  
Prof. Leonardo Marques Monteiro  
Mr. Martin Morelli  
Dr. Filbert Musau  
Prof. Emanuele Naboni  
Prof. Zoltan Nagy  
Prof. Leticia de Oliveira Neves  
Mr. Amir Nezamdoost  
Prof. Marialena Nikolopoulou  
Ms. Sarah O Dwyer  
Dr. Sonja Oliveira  
Dr. Mark Raphael Owor Olweny  
Ms. Sara Omrani  
Ms. Federica Ottone  
Dr. Massimo Palme  
Dr. Beta Paramita  
Prof. Ulrike Passe  
Mr. Nimish Bhupendra Patel  
Mr. Mic Patterson  
Prof. David Pearlmutter  
Dr. Sofie Pelsmakers  
Prof. Fernando Ruttkey Pereira  
Prof. Troy Nolan Peters  
Dr. Gloria Pignatta  
Prof. Adrian Pitts  
Dr. Andre Potvin  
Dr. Ash Ragheb  
Dr. Upendra Rajapaksha  
Mr. Bardhyl Rama  
Prof. Rajan Rawal  
Ms. Dana Raydan  
Dr. Andras Reith  
Ms. Valentina Resente  
Dr. Lucelia Taranto Rodrigues  
Dr. Jorge Rodriguez-Alvarez  
Prof. Jean-Francois RogerFrance  
Ms. Rosa Romano  
Mr. Flavio Rosa

Prof. Matthias Rudolph  
Dr. Masoud Sajjadian  
Prof. Marco Sala  
Prof. Ashraf Salama  
Dr. Aizaz Samuel  
Dr. Paola Sassi  
Dr. Kay Saville-Smith  
Dr. Rosa Schiano-Phan  
Prof. Marc Eugene Schiler  
Dr. Heide G. Schuster  
Prof. Subhashini Selvaraj  
Prof. Kelly Shannon  
Dr. Adil Sharag-Eldin  
Prof. Tim Sharpe  
Prof. Masanori Shukuya  
Prof. Cesarina Siddi  
Dr. Matthias Sieveke  
Dr. Joana Carla Soares Goncalves  
Ms. Maria Spastri  
Dr. Alessandro Speccher  
Prof. Malini Srivastava  
Dr. Thanos N Stasinopoulos  
Prof. Fionn Stevenson  
Prof. Vera A Straka  
Ms. Sadia Subrina  
Dr. Jae Yong Suk  
Dr. Tiziana Susca  
Prof. Kheira Anissa Tabet Aoul  
Dr. Abel Tablada  
Ms. Tasneem Tariq  
Ms. Leena Thomas  
Mr. Andrew Robert Toland  
Prof. Chiara Tonelli  
Dr. Eleni Tracada  
Dr. Maureen Eileen Trebilcock  
Dr. Antonella Trombadore  
Ms. Janine Tuechsen  
Ms. Samina Mazumder Tuli  
Prof. Brenda Vale  
Dr. Fan Wang  
Dr. Julian (Jialiang) Wang  
Dr. Yupeng Wang  
Dr. Paulina Wegertseder  
Dr. Andrea Wheeler  
Mr. Christopher James Whitman  
Dr. Jan Wienold  
Dr. Jin Woo  
Dr. Feng Yang  
Dr. Simos Yannas  
Dr. Fatih Yazicioglu  
Prof. Roshni Udyavar Yehuda  
Dr. Dongwoo Yeom  
Dr. Grace Yepez-Salmon  
Mr. Aram Krikor Yeretian  
Prof. Abraham Yezioro  
Dr. Chanikam Yimprayoon  
Dr. Chao Yuan  
Dr. Gökçen Firdevs Yücel  
Dr. Sahar Zahiri  
Prof. Nouredine Zemmouri



## SPONSORS & SUPPORTING ORGANISATIONS



Funding Support:

Q:

A: Social Science/CUHK

Wood Sponsor:

**L&O**  
ARCHITECTS

Bamboo Sponsors:

**AD+RG**  
architecture design and research group ltd  
建築設計及研究所有限公司

 **SWIRE PROPERTIES**

Sole Sponsor of Student Design Colloquium:

 **RONALD LU  
& PARTNERS**

## Supporting Partners:



## Supporting Organisations:



# **TABLE OF CONTENTS**

**Volume 1 – Long Paper**  
**(Science and Technology)**

**Volume 2 – Long Paper**  
**(Design and Practice, People and Community, Education and Training)**

**Volume 3 – Short Paper**

## **Volume 2 – Long Paper**

### **DESIGN AND PRACTICE**

1104	Is the Study of Thermal and Visual Comfort Enough? Case Study: Two Schools of the National Program of School Building in the Dominican Republic	495
1127	Environmental Performance of Abuja’s Low-Income Housing: Understanding the Current State to Inform Future Refinement	501
1145	Advanced Active Façades: The Construction of a Full-Scale Demonstrator for BIPV Architectural Integration	507
1170	The Resilience of Natural Ventilation Techniques in Myanmar’s Vernacular Housing	513
1190	Cooling Urban Water Environments: Design Prototypes for Design Professionals	520
1208	Urban Climate Evaluation for an Architectural Design Competition: A Best Practice Framework	526
1266	Assessment of ThermODrain System on Thermal Comfort: Study of a Multi-Storied Office Building in Nashik, India	531
1280	Hab-Lab: Development of a Light Touch BPE Methodology for Retrofit	537
1281	Low Budget Residential Building Façade Retrofit: Two Mediterranean Climate Prototype Case Studies	543
1282	The Thermal Environment in the High-Density Tall Building from the Brazilian Bioclimatic Modernism: Living in the COPAN building	548
1286	Passive Cooling Applicability Mapping: A Tool for Designers	554
1310	The Regenerative Sustainable Design of Modernist Nordic Houses. A Qualitative and Quantitative Comparison with Contemporary Cases.	561
1318	Strategic Design for the Urban Block of Buenos Aires: A Study of the Current Building Regulations Vs. The Actual Built Form	568
1324	Everyday House: Redesigning the Informal Housing in Subtropical Climates, the Case of Paraisópolis Favela in Sao Paulo	574
1326	Urban Climatic Application in City’s Master Plan: An Experience from China	580

1328	Rethinking Sustainability Towards a Regenerative Economy (RESTORE) within an Adaptive Neighbourhood Design	587
1381	Influence of Design-Decisions on the Energy Performance of Renovation Projects with Building-Integrated Photovoltaics: Results for a 1968 Residential Archetype in Neuchâtel (Switzerland)	594
1410	Adaptive Infill Living: Framework for an Alternative Housing Typology in London	600
1442	Passive Design for Managing Indoor Humidity: Creating Comfortable and Healthy Living Space in Hot & Humid Region	607
1503	Partial Shading Effects of Surrounding Obstacle Parameters on Building Integrated Photovoltaic (BIPV) System Efficiency in Thailand	613
1522	Climate-adaptive Facade Design with Smart Materials: Evaluation and Strategies of Thermo-Responsive Smart Material Applications for Building Skins in Seoul	620
1539	An Energy Efficiency Policy for Cambodia: Proposals for the Building Sector	627
1549	Developing a Sustainability Assessment Framework for Urban Developments in Hill Areas: A Case of New Tehri, Uttarakhand, India	632
1566	Free Running Office in Mexico City: Office Refurbishment Case Study.	638
1569	Sustainable Architecture and Social Engagement for Flooding and Drought Resilience	644
1581	Contemporary Review of the Regional Plan for Argentina's Countryside by Grupo Austral: Comparative Analysis between Typologies in 4 Different Climates	650
1589	New Daylight Breathable Façade with Miura DDC Surface (2). Setting Role of Design to Lead Technology: Test and Results	656
1595	Advanced Radiant Cooling System for the Office in Tropics: Relaxation of Thermal Comfort Criteria by Utilizing a Slight Airflow	663
1616	Kisekae House: Movable Building Devices and Lifestyle	670
1636	Design Criteria to Reduce Energy Demand and Improve Thermal Comfort in Desert-coastal Climate Office-building	676
1638	Passivhaus Lived Experience: More Than a Spreadsheet	682
1718	Rough Void: Translating Vernacular Microclimates into a Climate-Resilient, High-Density Urban Typology	688
1723	Delivering Sustainable Design Excellence: The Potential Role of Architectural Precedent	694
1734	Urban Connectivity as a Guideline for Sustainable Habitat Rehabilitation. A Study in Medellin, Colombia	701
1742	"A Material World": Study of a Circular Economy Approach in Architecture – Development of an Index for the Construction Industry	708
0746	A Roadmap to Design Zero Net Energy Buildings: Design and Performance Standards for the University of Hawaii	715
	Sustainable Architecture Design with Environmental Simulation: Introduction of Design Process with CFD	722

<b>Reinventing Wood: The Body, Materials and Their Relationship in Chinese Houses</b>	<b>726</b>
<b>Nostalgic Meets Contemporary Planning: Redevelopment of So Uk Estate</b>	<b>732</b>
<b>Building a Neighbourhood Friendly Community: Application of BEAM Plus Neighbourhood in Public Housing Development (Fat Tseung Street West)</b>	<b>738</b>
<b>Towards Environmental and Social Sustainability Through Design, Construction and User Experience: A School for Social Development for Girls at Choi Hing Road, Kwun Tong, Kowloon</b>	<b>744</b>
<b>Transformation of the Former Police Married Quarters into a Creative Industries Landmark: Showcase of a Successful Revitalization Project</b>	<b>748</b>
<b>Transformation of Sterile Space Underneath Flyover into a Arts, Cultural and Creative Hub: Fly and Flyover 023, Kowloon East</b>	<b>753</b>
<b>Meditation and Mediation: The West Kowloon Mediation Centre</b>	<b>758</b>

## **PEOPLE AND COMMUNITY**

<b>1123 Earth, Density and Form: The Role of New Housing Models in Building Sustainable Rural Communities</b>	<b>765</b>
<b>1130 Impact of Urban Air Pollution on Occupants' Visual Comfort, Alertness, Mood in an Office with Various Glazing Systems: An Investigation in Beijing</b>	<b>771</b>
<b>1168 Social Preference of Building Materials: Decision-Making towards Low Carbon Housing Constructions</b>	<b>778</b>
<b>1178 The Impact of Façade Renovation Strategies on User Satisfaction in Offices: Case Studies for Summer in the Netherlands</b>	<b>784</b>
<b>1347 LCZ in Metropolitan Regions: Surface Temperature in Urban and Rural Areas</b>	<b>790</b>
<b>1401 Gauging People's Perceptions of Reclaimed and Recycled Building Materials: A Pilot Study</b>	<b>796</b>
<b>1557 Sustainability: What We Need vs What We Think We Need. Change in Perception and Need with Socio-economic-cultural Conditions</b>	<b>802</b>
<b>1609 Two Degree Rise in Indoor Temperature: Energy Use Behaviour of British Asians</b>	<b>809</b>
<b>1645 Research Analysis of Urban and Social Patterns in the City: Shared Bicycles and Their Influence on Urban Fabric</b>	<b>815</b>
<b>1668 Analyze the Interaction between People's Perceptions of Interior Spatial Properties and the Opening Forms with Isovist Measures</b>	<b>821</b>
<b>1687 An Innovative Housing Model for Users Behavior Changes: From Informal Occupancy to Urban Regeneration.</b>	<b>827</b>
<b>1748 Community Energy Networks in the Making - Project SCENe, Nottingham</b>	<b>833</b>
<b>1759 Neighbourhood Environment and Walking Behaviour in High-density Cities</b>	<b>839</b>
<b>1762 Occupant Satisfaction in 60 Radiant and All-air Building: Comparing Thermal Comfort and Acoustic Quality</b>	<b>843</b>

<b>0422</b>	<b>The Elderly and Their Indoor Environment: Use of Thermal Comfort Models to Determine Occupant Satisfaction.</b>	<b>849</b>
	<b>Residual Thinking: Reclaiming Hong Kong's Lost Urban Spaces</b>	<b>855</b>
	<b>Architectural Interventions in the Informal City: On-site Upgrading Strategies for BaSECo Community</b>	<b>861</b>
	<b>EDUCATION AND TRAINING</b>	<b>867</b>
<b>1238</b>	<b>Learning about Building Technologies for Sustainability. Design Guidelines for a Nearly-Zero-Energy Residential Buildings in Barcelona: Case Study</b>	<b>868</b>
<b>1284</b>	<b>Field-Classroom Interactive Solar Education: The Interactive Satellite Solar Lab (ISSL)</b>	<b>874</b>
<b>1383</b>	<b>The Environmental Evolution of Urban Housing: Detailed Studies of London Residential Schemes</b>	<b>880</b>
<b>1484</b>	<b>Daylighting Education in Practice: Verification of a New Goal within a European Knowledge Investigation</b>	<b>886</b>
<b>1490</b>	<b>The Role of Planning, Urban and Building Design for Climate Adaptation in the Microscale: An Interdisciplinary Research Experience Empowering Architectural Education</b>	<b>892</b>
<b>1603</b>	<b>Teaching Natural Ventilation Using Water Table Apparatus: A Classroom Teaching, Simulation and Design Tool</b>	<b>898</b>
	<b>Architectural Design Education Based on Simulation tools: Retrofitting Design Improvement Approach in Tohoku University</b>	<b>904</b>



Volume 2

Long Paper

Design and Practice

People and Community

Education and Training

## **DESIGN AND PRACTICE**

Implementation of scientific and academic findings comes down to design and practice. This track looks into practical design options—both in theory and actual case studies—in smart, sustainable, and healthy urban development, for example:

- passive low energy design, eco-design and vernacular architecture
- low energy design tools for practice
- policies and government regulations on a low energy future
- professional practice and design of passive low energy architecture



## Is the Study of Thermal and Visual Comfort Enough?

### Case Study: Two Schools of the National Program of School Building in the Dominican Republic

LWIGINA RAMIREZ<sup>1</sup>, NEVEEN HAMZA<sup>2</sup>

<sup>1</sup>MSC Sustainable Buildings and Environments, Newcastle University, Newcastle Upon Tyne, United Kingdom.

<sup>2</sup>Programme Director in Sustainable Buildings and Environments, School of Architecture, Planning and Landscape, Newcastle University, Newcastle Upon Tyne, United Kingdom.

**ABSTRACT:** This study compares the thermal and visual comfort performance of the prototypical school classrooms design in two climatic regions in the Dominican Republic. Established metrics for thermal and visual indices combined with dynamic building performance simulations are carried out to assess the current performance and possible architectural interventions to improve the environmental performance of the classrooms. The PMV/PPD method with the ASHRAE scale, the adaptive comfort with the EN-15251 standard, the neutral comfort obtained with Kubota hot humid climate equations and the thermal sensation votes analysis underpins the conclusions. The prototypical classroom design was in the “comfortable” range in Santiago while “slightly cool” in Constanza School. Simulations were used to evaluate the daylight conditions and showed that Daylight Factor and Illuminance were within the acceptable ranges, but issues with glare and daylight uniformity arise. This study indicates that the use of light shelves do not improve the daylight conditions and suggests other architectural design interventions that are more effective in improving the indoor environment for students and teachers.

**KEYWORDS:** Thermal Comfort, Visual Comfort, Classrooms, Prototypical, Environment.

## 1. INTRODUCTION

Recognizing the importance of education to the country’s development, the Dominican Republic Government embarked on the ‘National Program of School Building’ [1]. During the design process, the environmental conditions for learning as thermal and visual comfort were not considered.

Increasingly, literature points out to the value of careful consideration of the classroom environmental design performance as a major factor in improving educational attainment, concentration, hearing and learning, [2,3]. However, due to the rapid deployment of the school’s building programme, the environmental conditions for learning such as thermal and visual comfort were not considered during the design process.

This research aims to assess the adequacy of the thermal and daylight conditions in the prototypical school design by integrating students’ and teachers’ perceptions through the analysis of two Prototypical schools in the Dominican Republic to improve the educational environment for learning.

## 2. CONTEXT

The first school ‘Eugenio de Jesus Marcano’ is situated in Santiago de los Caballeros, specifically in the Municipal District of Tamboril. The second school named ‘Gaston Fernando Deligne’ is located in Constanza city, representing the two dominant climate zones in the country (Figure 1), [4].

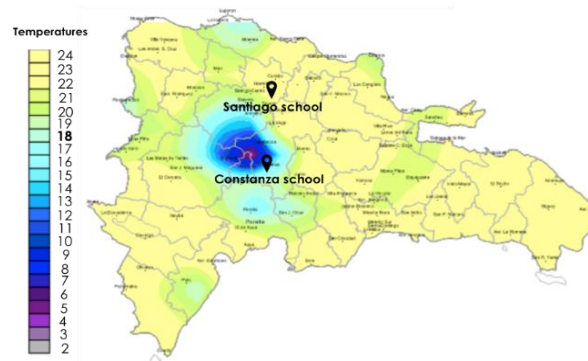

Figure 1: Map of Temperatures in °C with Case Studies Locations in the Dominican Republic [5].

Based on the Köppen classification, the specific climate type of Santiago is the tropical Savannah (AW) [6]. The orientation of the prototypical school in Santiago de los Caballeros follows established norms of building orientation, positioned Southeast and Northwest leaving the longer lengths of the buildings to the Northeast and to the Southwest. Due to site restrictions, the design marginally deviates from the orientation guidelines to avoid direct sunlight in the classrooms (Figure 2). However, the prototypical orientation guidelines fails to consider the different climatic characteristics in the School of Constanza City, that in Köppen classification is in the Oceanic type (Cfb) [6], where the corridor areas were located to the South and North façade leaving the

# PLEA 2018 HONG KONG

Smart and Healthy within the 2-degree Limit

services to the East and the West axis; this leads to reducing required direct solar gains in the classrooms as temperatures reach below 18°C (Figure 3).

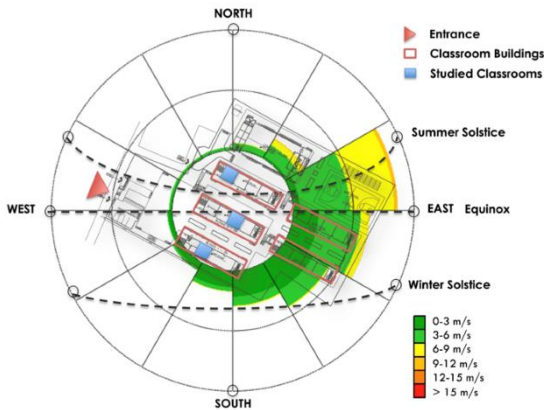

Figure 2: Context Analysis and Evaluated Classrooms in Santiago de los Caballeros School. (Tropical Savannah (AW) Climate Type). IESVE 2015.

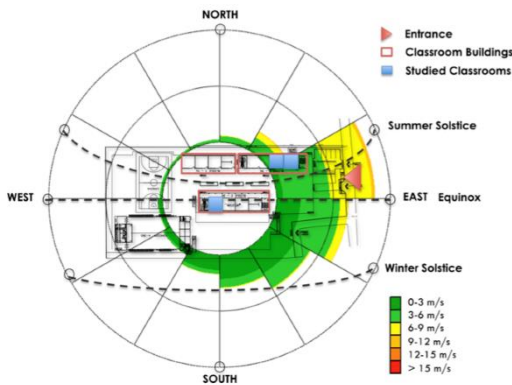

Figure 3: Context Analysis and Evaluated Classrooms in Constanza School. (Oceanic Climate Type (Cfb)). IESVE 2015.

During various visits to the schools, it was observed that the spaces between the school buildings are unused due to the high exposure to direct solar radiation, high glare and reflection from the light coloured building finishes encouraging students and teachers to meet and rest in the corridor areas where they find sheltered spaces (Figure 4).

### 3. THERMAL COMFORT ANALYSIS

The thermal comfort conditions were analysed using the Fanger seven-point scale to calculate the PMV/PPD method using the ASHRAE standard. The **PMV and PPD**, [7] calculates the average thermal sensation for a large group of people using a seven-point thermal sensation scale from Cold (-3) to Hot (+3) considering the values of air temperature, the relative humidity, the mean radiant temperature, air velocity, metabolic rate and clothing level.



Figure 4: Current Schools Courtyard Conditions and Exposure to Direct Sunlight. Site visit. April 2017, 11:00 a.m.

For the adaptive comfort calculation the EN-15251 standard was utilized and compared with the thermal sensation votes results from a field survey applied in the selected schools. The Kubota equation for hot-humid climates was used to determine the neutral temperature.

ASHRAE Standard 55 (Equation 1) and EN-15251 adaptive comfort equation (Equation 2) to calculate the neutral temperatures for naturally ventilated buildings are as follow:

$$T_{(conf)} = 31T_{(om)} + 17.8 \quad (1)$$

$$T_{(conf)} = 33T_{(rm)} + 18.8 \quad (2)$$

$T_{(conf)}$  is the indoor comfort operative temperature (°C).

$T_{(om)}$  is monthly mean outdoor air temperature (°C).

$T_{(rm)}$  is running mean outdoor air temperature (°C) [8].

The average air temperatures and relative humidity were measured in the classroom with Lascar EL-USB-1 USB Temperature Data Loggers in ten-minute intervals. These measurements were used to validate predicted indoor conditions from the building performance simulation model. The mean radiant temperature and the air velocity data were obtained from the dynamic modelling.

The ASHRAE standard 55 [9] established a metabolic rated between 1.0-1.3 met. However, Teli [10], applied the MET value for children and adults of 1.2 met. This study will be using Teli's value, as it is focus on teachers and students.

For the clothing levels the ASHRAE standard 55 Table was utilized (Table 1), a mean value was taken for each school considering that the clothing level were different by gender.

# PLEA 2018 HONG KONG

Smart and Healthy within the 2-degree Limit

Table 1: Clothing Combination Values for the Prototypical Schools Uniforms Based on ASHRAE Standard 55 [9]

Clothing Combination Values in the New Model Schools		Clo
Eugenio de Jesus Marciano School (Santiago de los Caballeros)		
For Boys and Girls		
Trousers, short sleeve shirt, socks and oxford shoes*		0.58
With their own long sleeve sweater*		0.78
Gaston Fernando Deligne School (Constanza City)		
For boys		
Trousers, long sleeve shirt, socks and oxford shoes*		0.66
With their own long sleeve sweater *		0.86
For Girls		
Knee length skirt, long sleeve shirt, knee high socks and pump shoes*		0.63
With their own long sleeve sweater *		0.83
*All Combinations Include Underwear		

The CBE Thermal Comfort Tool [11] was used to obtain the PMV and PPD values (based on equation (1) (Tables 2 and 3) and (Figures 5 and 6). Initially 3 classrooms of each school were measured, but one of the data loggers in Santiago school failed, providing non-accurate temperatures. For this reason it was discarded from the analysis.

Table 2: PMV and PPD values in Santiago de los Caballeros School

Santiago de los Caballeros School							
Mean Outdoor Temp.	26.26 (100% Mean Biometric Sensation Vote)						
WCI	1.2 (WCI: Metabolic Rate; PMV: Predicted Mean Vote)						
So	0.78 (So: Clothing insulation; PPD: Predicted Percentage Dissatisfied)						
Classroom	Air Temp. (monitors)	Humidity (monitors)	Mean Radiant Temp. Air Velocities	PMV	PPD	MTSV	
C1 (Basal floor)	24.5	41.1	26.46	1.82	-0.57	21.0	0.13
C2 (Basal floor)	26.75	66.66	27.6	1.82	-0.19	5.1	0.14
Mean Values					0.58	13.5	0.14

Table 3: PMV and PPD values in Constanza School.

Constanza School							
Mean Outdoor Temp.	17.5 (MTSV: Mean Biometric Sensation Vote)						
WCI	1.2 (WCI: Metabolic Rate; PMV: Predicted Mean Vote)						
So	0.84 (So: Clothing insulation; PPD: Predicted Percentage Dissatisfied)						
Classroom	Air Temp. (monitors)	Humidity (monitors)	Mean Radiant Temp. Air Velocities	PMV	PPD	MTSV	
C1 (Basal floor)	20.25	75	19.65	3.22	-2.1	20.0	-0.27
C2 (Basal floor)	20.17	73.72	19.65	3.22	-2.32	22.0	-0.26
C3 (Small floor)	20.6	67.92	19.65	3.22	-1.34	24.0	-0.25
Mean Values					4.2	76.7	-0.25

The mean PMV value for Santiago de los Caballeros school was -0.58 considered (slightly cool) and the PPD of 13.5%, over the ASHRAE range of 10%. The Constanza School PMV was of -2 (cool) and the PPD was of 75.7%, which can be considered distanced from the comfort zone following the ASHRAE standard, but the MTSV was of -0.25 (Comfortable). Zomorodian et al. [12] explains that the PMV and PPD methods can be precise for HVAC buildings, however for natural ventilated spaces it does not give accurate results.

The **adaptive thermal comfort** method provides more accurate results for natural ventilated buildings understanding the capacity to adjust to temperature changes. It uses the running mean outdoor temperature as the main parameter.

The EN-15251 Standard was used to calculate the adaptive thermal comfort utilizing the CBE Thermal Comfort Tool [11] based on the equation 2. The standard generates three classes of satisfaction limits of 90%, 80% and 65% in order of sensitive and expectation respectively. Because students are considered

vulnerable and with less control of the classroom environmental conditions each case will be employed in (class1). Santiago de los Caballeros classrooms has an operative comfortable temperature range between 25.4°C to 34.8°C. For Constanza it is between 20.6°C and 28.6°C (Figures 7 and 8).

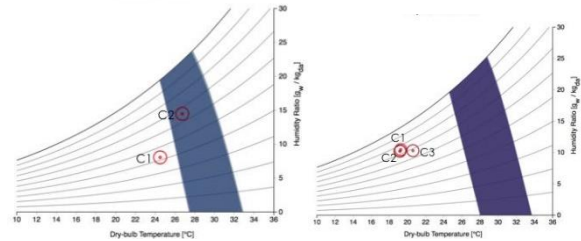

Figures 5 and 6: Psychrometric Chart of Santiago and Constanza School Classrooms from Left to Right

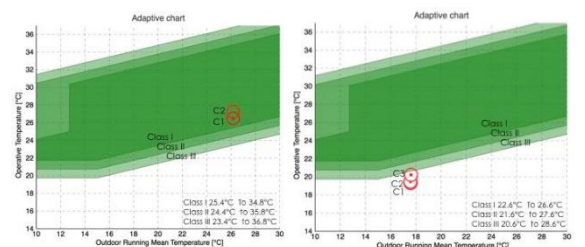

Figures 7 and 8: Adaptive Chart of Santiago and Constanza School Classrooms from Left to Right.

For Santiago de los Caballeros the indoor temperatures are normally inside the established range having comfortable conditions, while in Constanza School the temperatures are most of the time below the suggested limits, feeling normally cold, having discomfort sensation.

Compared to the ASHRAE Standard PMV and PPD results, Santiago de los Caballeros School is in comfort conditions. However, Constanza School indicates discomfort in both methods, presenting the need to consider a heating passive strategy to improve the current conditions.

Kubota et al [13], developed a study to calculate the adaptive comfort in hot humid climates, understanding that climate has a direct influence on the thermal adaptation of occupants in naturally ventilated buildings. This equations predict neutral operative temperatures of 24.9–31.2°C, and 19.0°C-24.7°C for hot-humid and moderate climates, respectively [13]. The equations to be utilized for hot humid climate (Equation 3) in the case of Santiago de los Caballeros School and moderate climate (Equation 4) for Constanza School calculations are:

$$T_{(neutop)}=0.57T_{(outdm)}+13.8 \quad (3)$$

$$T_{(neutop)}=0.22T_{(outdm)}+18.6 \quad (4)$$

$T_{(neutop)}$  is the indoor neutral operative temperature (°C) and  $T_{(outdm)}$  is daily mean outdoor air temperature (°C) [13].

# PLEA 2018 HONG KONG

Smart and Healthy within the 2-degree Limit

The ASHRAE equation considers the monthly mean outdoor air temperature (°C), the EN-15251 uses the running mean outdoor air temperature and Kubota's equation considers the daily mean outdoor air temperature (°C).

The comfort temperature results were different in each approach. With the ASHRAE standard the calculations were 25.9 °C and 23.24°C for Santiago and Constanza respectively. The EN-15251 standard results were of 27.4°C for Santiago and 24.6°C for Constanza and the Kubota equation gave the higher and lower value of 28.4°C for Santiago school and 22.9°C for Constanza school. The calculations are shown in Table 4 and 5.

Table 4.: Kubota's Adaptive Comfort in Hot Humid Climates Calculation for Santiago and Constanza School Classrooms.

Kubotas Formula	Santiago Temp.	Temperatures
$T_{neutop}=0.57T_{outdm}+13.8$	24.5	27.8
	26.73	29.0
	Mean Value	28.4
	Constanza Temp	
$T_{neutop}=0.22T_{outdm}+18.6$	19.26	22.8
	19.17	22.8
	20.6	23.1
	Mean Value	22.9

Table 5.: Comfort Temperature of Santiago de los Caballeros and Constanza School Classrooms.

City	Comfort Temperature		
	ASHRAE 55	EN-15251	Kubota et al. (2013)
Santiago	25.9	27.4	28.4
Constanza	23.24	24.6	22.9

The analysis was based on the number of occupancy hours (from 8:00 am to 5:00 pm) with the thermal comfort correspondent to each school zone. The measures were studied during the month of April as a period of average temperatures for the academic year. For Santiago the range of temperature was between 21.40°C-34.20°C. For Constanza the temperatures were between 12.10°C-22.20°C.

These values were used to assess the thermal conditions predicted by the base case building performance simulation runs. The construction model configuration was built with the exact specifications established from architectural drawings of the schools, to reflect the non-insulated building envelope, the window to wall ratios, and door openings.

The indoor temperatures present in Santiago de los Caballeros in the month of April were analysed and it was observed that temperatures remain within the defined neutral temperature and the adaptive comfort zone of 25.4°C to 34.8°C. (Figure 9). However, for Constanza the temperatures are predicted to be under the neutral line and below the adaptive comfort zone, between 20.6°C and 28.6°C. (See figure 10).

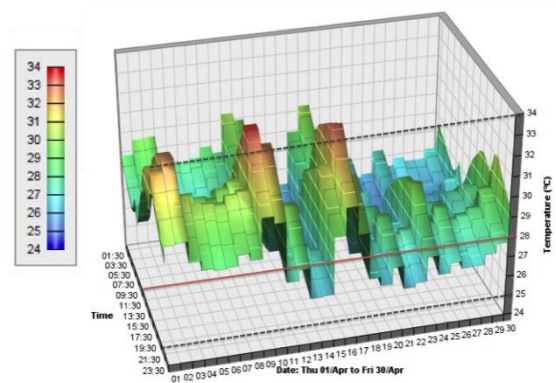

Figure 9: Santiago de los Caballeros Dry Resultant Temperatures During the Month of April.

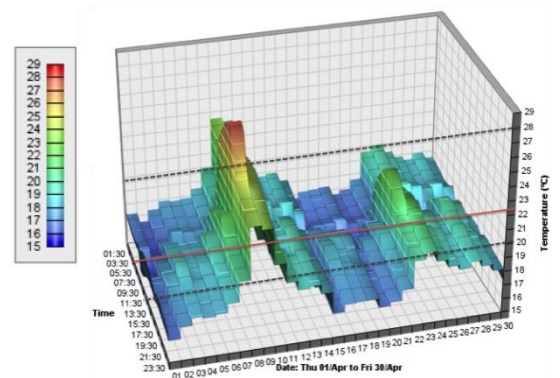

Figure 10: Constanza Dry Resultant Temperatures During the Month of April.

For the **Thermal Sensation Votes** analysis subjective surveys were applied in both schools. In Santiago de los Caballeros the sample was of 191 surveys (23 of teachers and 168 of students) and 119 for Constanza School (15 of teachers and 104 of students). The overall satisfaction of the individuals was evaluated by asking them if they felt comfortable or uncomfortable taking classes in their classrooms. For Santiago de los Caballeros School the predominant responses were of comfort and satisfaction while in Constanza School 47% felt comfortable, however 28% felt uncomfortable and very uncomfortable (Figure 11).

The ASHRAE scale based on the 7-point (cold, cool, slightly cool, neutral, slightly warm, warm, hot) was implemented. The thermal sensation votes results for Santiago school were 0.22 (comfortable) and -1.17 (slightly cool) for Constanza School. It was determined that Santiago School had better thermal comfort conditions and general satisfaction for teachers and students in classrooms than Constanza School. As a result, Constanza School needed to be improved.

The final outcomes from the calculations and the subjective analysis can take to similar conclusions perceiving that the school of Santiago de los Caballeros can be considered in comfort conditions for learning, excluding the ASHRAE Standard analysis, while

# PLEA 2018 HONG KONG

Smart and Healthy within the 2-degree Limit

Constanza School has slightly cool conditions and uncomfortable settings as a learning environment.

the design still needs to be improved to deliver better uniformity levels (Figure 15).

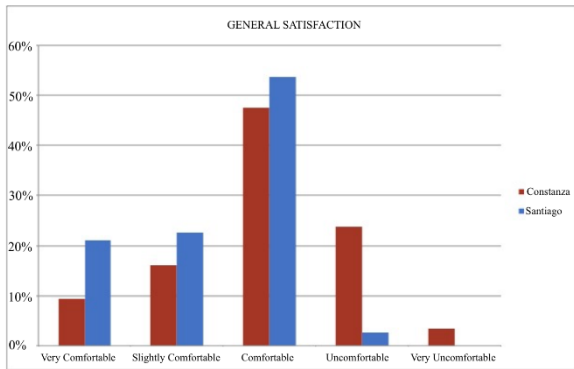

Figure 11: General Satisfaction Survey of Teachers and Students in Classrooms.

## 4. VISUAL COMFORT IN THE CLASSROOM

The daylight conditions were studied utilizing dynamic radiance analysis applying the IES-VE software 2015 version, reconstructing the schools' conditions to define the acceptable limit temperatures, Illuminance, daylight factor and uniformity in classrooms.

The Daylight factor (DF%) expresses the potential Illuminance inside a room in the worst possible scenario under overcast sky conditions [14]. The minimum and average daylight factors for classrooms have been defined as 2% and 5%, respectively [15].

The recommended average values in lux for visual tasks in classrooms, including reading and writing, respectively, are of 750, 500, 500 and 300-600 lux, [16,17].

Uniformity is defined as the ratio of the minimum daylight factor to the average daylight factor within the space creating a uniform distribution of Illuminance and luminance. Many lighting standards require a uniformity ratio of 0.8 (minimum/average) or 0.7 (minimum/maximum) [18]. The BREEAM UK suggests values over 0.3 [19].

The daylight analysis outcomes of the classrooms (Figure 12 and Table 6) indicated that the average Daylight Factor and Illuminance for the proposal were within the determined percentage, but the uniformity levels were below the recommended values.

The Light shelf intervention generates shadow in the nearest area to the window, as the sun in the tropics arises quickly and maintains in vertical angles for longer periods during most of the occupancy hours, reducing all values below the average (Figures 13-14).

The inclusion of a wall zone with a sitting area of 40cm width in the exposed façade combined with the increase of the window to wall ratio from 43% to 53%, serves as a visual transition for higher direct sunlight to enter, reducing intensity and at the same time allowing higher values to be reached by the variables. However,

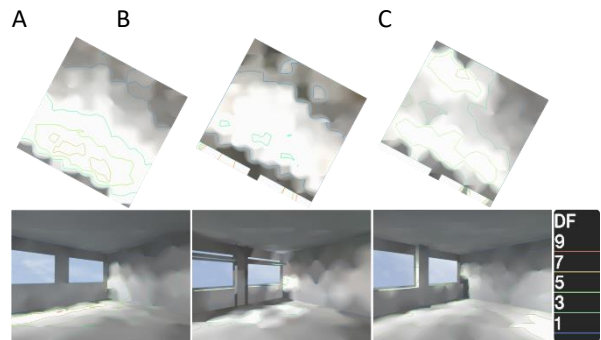

Figure 12: Classroom Daylight Factor Performance Plans and South Façade Perspectives of (A) Base Case (B) After the Implementation of Light Shelves (C) After the Addition of a Wall Zone. Simulated the 21st of April at 3:pm, 1.2mts height.

Table 6: Classroom Daylight Analysis.

	Minimum Daylight Factor	Average Daylight Factor	Uniformity	Average Illuminance (Lux)
Base Case	0.40	3.20	0.12	552
With Light Shelves	0.20	1.50	0.11	281
With Additional Wall Zone	1.00	4.00	0.14	565

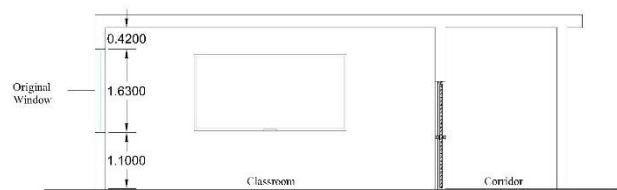

Figure 13: Schools Classroom Original Design Section Detail

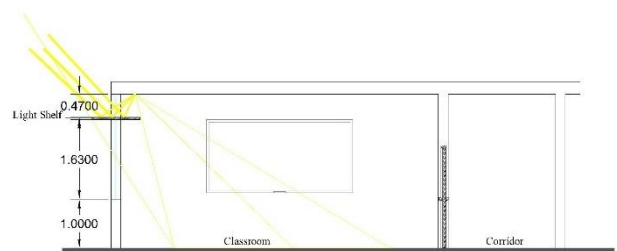

Figure 14: Schools Classroom Light Shelf Section Detail

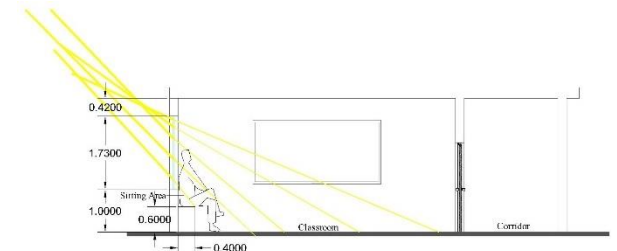

Figure 15: Schools Classroom Section Detail with Additional Wall Zone.

# PLEA 2018 HONG KONG

Smart and Healthy within the 2-degree Limit

By generating a separation of 2 meters between the existing corridor on the courtyard side and the building an enhancement of the Illuminance and Daylight Factor can be observed and also a sitting and recreational area can be generated (Figure 16).

However, the uniformity levels were not reaching the minimum requirements. The integration of skylights and the use of light ducts could be tools to improve the daylight conditions, most of all in the lower floors.

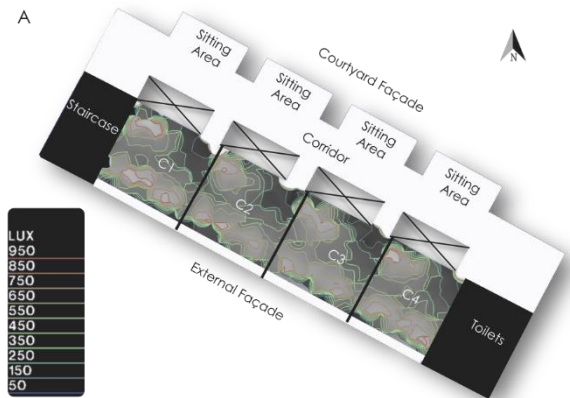

Figure 16: (A) Classroom Daylight Illuminance Performance Implementing 2mts Separation from the Corridor. Simulated the 21st of April at 3:pm, 1.2mts height.

## 5. CONCLUSION

The PMV/PPD method with the ASHRAE scale, the adaptive comfort with the EN-15251 standard, the neutral comfort obtained with Kubota hot humid climate equations and the thermal sensation votes analysis underpins the conclusions. The prototypical classroom design was in the “comfortable” range in Santiago while “slightly cool” in Constanza schools. Consequently, design interventions should be implemented to the buildings in accordance to the particular micro climatic location for each school utilizing building performance simulation tools. This paper suggests a feasible design alteration that can improve both the thermal and visual environments in other sub climatic classifications of the Dominican Republic.

Furthermore, thermal comfort and visual comfort analysis can be followed by an acoustics study, not measured in this project, to be able to provide a holistic design.

## 6. ACKNOWLEDGEMENTS

This publication has been possible thanks to the investment of the Dominican Republic Government and the collaboration of the chosen schools staff members and students together with Newcastle University research mentoring and facilities.

## REFERENCES

1. Medina, D. (2012). ‘Decreto 625-12’. Presidencia de la Republica Dominicana [Decree 625-12’. Presidency of the Dominican Republic]. D.R. pp. 1-6
2. Leiringer R& Cardellino, P (2010) Schools for the twenty-first century: school design and educational transformation, British Educational Research Journal, 37:6, 915-934
3. Cheryan, S., Ziegler, S., Plaut, V., and Meltzoff, A. (2014). ‘*Designing Classrooms to Maximize Student Achievement*’. Vol. 1.
4. Cucurullo, Jr, Oscar (1952). Una carta climática tentativa para la Isla de Santo Domingo. Revista de las Fuerzas Armadas, Año III, Núm. 13, Enero-Febrero 1952. pp. 21-30. Ciudad Trujillo [A tentative climatic chart for the Island of Santo Domingo. Magazine of the Armed Forces, Year III, No. 13, January-February 1952. pp. 21-30. Trujillo City].
5. (2018). ONAMET. <http://onamet.gov.do/m/pdto/04w-whidro/03w-wmapas-de-temperaturas.php> (Accessed: 31/05/2018).
6. (2017). Climate-Data.org.. <https://es.climate-data.org/location/764344/> (Accessed: 1/04/2018).
7. Fanger, P.O.(1970) *Thermal Comfort*. Danish Technical Press, Copenhagen.
8. Nicol, F. and Humphreys, M. (2010). ‘*Derivation of the adaptive equations for thermal comfort in free-running buildings in European standard EN1525*’. P. 15-16.
9. ASHRAE Standard 55 (2013). "Thermal Environmental Conditions for Human Occupancy".
10. Teli, D. Jentsch, M.F. & James, P.A.B. (2012). Naturally ventilated Classrooms: An assesment of existing confort models for predicting the termal sensation and preference of primary school children. Energy and Buildings.
11. (2017). CBE Thermal Comfort Tool <http://comfort.cbe.berkeley.edu>. (Accessed: 31/05/2018).
12. Zomorodian, Z. S. Tahsildoost, M. & Hafezi, M. (2016.a) 'Thermal comfort in educational buildings: a. review article'. Renewable and Sustainable Energy Reviews, Volumen 59, pp. 895-906
13. Toe and Kubota. (2013). Development of an adaptive thermal comfort equation for naturally ventilated buildings in hot-humid climates using ASHRAE RP-884 database. *Frontiers and Architectural Research* Volume 2, (Issue 3) Sept. 2013 P. 278-291.
14. Zomorodian, Z. S., Korsavi, S., Tahsildoost, M. (2016b). The effect of window configuration on daylight performance in classrooms: A field and simulation study. *Int. J. Architect. Eng. Urban Plan*, 26(1): 15-24, June 2016
15. Baker N, Steemers K. (2014). *Daylight design of buildings: a handbook for architects and engineers*. Routledge.
16. Othman AR, Mazli MAM. (2012). *Influences of daylighting towards readers" satisfaction at Raja Tun Uda public library*, Shah Alam, Procedia-Social and Behavioral Sciences. Vol. 68, pp. 244-257
17. Balocco C, Calzolari R. (2008). *Natural light design for an ancient building: A case study*. Journal of Cultural Heritage. No. 2, Vol. 9, pp. 172-178.
18. Cantin F, Dubois MC. (2011). *Daylighting metrics based on illuminance, distribution, glare and directivity*. Lighting Research and Technology, No. 3, Vol. 43, pp. 291-307
19. BRE Global Ltd. BREEAM UK—New Construction, Non-Domestic Buildings, Technical Manual; BRE Global Ltd: Watford, UK, 2014.

# Environmental Performance of Abuja's Low-Income Housing: Understanding the Current State to Inform Future Refinement

MAHMOOD ABDULKAREEM<sup>1</sup>, SURA AL-MAIYAH<sup>2</sup>

<sup>1</sup>Portsmouth School of Architecture, University of Portsmouth, Portsmouth, United Kingdom

<sup>2</sup>School of the Built Environment, University of Salford, Salford, United Kingdom

*ABSTRACT: In times of global ecological challenges, understanding building performance to improve occupants' comfort is becoming the norm in various climatic zones and locales. Any performance evaluation should account for occupants' demands for thermal and visual comfort. However, seeking to analyse the impact of design on the two aspects of comfort simultaneously can be complicated especially when a series of parametric changes with varying impacts on either is necessary. In the Nigerian context, assessing the environmental behaviour of existing residential properties to inform future refinement is becoming far more critical due to the vulnerability of the region to the changing climate, the ongoing issue with the energy supply and the housing shortage. The method adapted in this paper following previous research can be useful for the coinciding evaluation of the thermal environment and visual comfort. The environmental behaviour of two of Abuja's common housing types, in their current state and with the addition of multiple shading elements assessed using such methodological procedures to examine their suitability for performing a comprehensive analysis. The paper discusses the simplicity of the graphical representation utilised in displaying the changes in the cases' behaviour following the alteration. It also provides an insight into their current performance.*

*KEYWORDS: Housing, Comfort, Methodology, Nigeria*

## 1. INTRODUCTION

The 2014 IPCC report on climate change predicts that temperatures in Africa are to rise faster than the global average increase. By the end of this century, temperatures over West Africa are estimated to rise by 3°C to 6°C above the mean annual temperatures of the late 20th Century. Such a hasty increase in Africa's temperatures, which is likely to occur one to two decades earlier than the global average, is the result of the small natural climate variability in the region generating narrow temperature bounds that can be easily surpassed by small climate changes [1].

It is widely accepted that conventional sources of energy for mechanical cooling, heating, and artificial lighting are among the main contributors to greenhouse gas emissions causing global warming. In Nigeria, the housing sector alone has accounted for over 58% of the electrical energy consumed in the country [2]. This figure is already alarming given the lack of housing in the region, the issue of energy supply and the uncertainty associated with climate change.

Currently, the Nigerian housing market has a deficit of about 17 million units [3]. As a country, it is the most populous in Africa, but due to its speedy urbanisation, Nigeria is not only experiencing a severe housing shortage but also struggling to maintain a secure energy supply to the growing population. Over half of the households lack access to grid supply of electricity and for those already connected to the grid, the supply is unreliable [2]. Yet the contemporary design practice adopted in the country has contributed to inefficient

energy use in the building industry. Over the years, this has led to increasing demand for active energy through various devices for both cooling and lighting [4]. Therefore, investing in low energy passive design measures as a means for minimising the reliance on mechanical systems while meeting occupants' comfort, is key for the reduction of the present and future energy use in the country.

An increasing number of recent studies have examined energy use and occupants' comfort in buildings in Nigeria. A quick inspection of their contents reveals that most publications have mainly focused on the thermal aspect of indoor comfort [e.g. 5, 6]. Obviously, solar heating is rarely desired in tropical regions, hence the need to maximise the use of daylight in spaces often receives secondary consideration in comparison to controlling solar gain to improve comfort [7]. Nevertheless, achieving a balance between the prevention of heat gain and daylight penetration is crucial for the creation of a healthy living environment. In addition, the ability to effectively assess the trade-off between daylighting and thermal comfort is essential to improve the energy efficiency of buildings, by reducing lighting and cooling loads [5].

## 2. MEETING COMFORT REQUIREMENTS IN ABUJA'S HOUSING

Rising concerns over energy use in buildings, climate change, and occupants' well-being have resulted in an increasing number of studies exploring the thermal and visual aspects of indoor comfort in various climates. In

# PLEA 2018 HONG KONG

Smart and Healthy within the 2-degree Limit

general, there seems to be a separation between the metrics employed by scholars for examining the visual aspect of the indoor environment and those used for assessing the quality of the thermal environment. In an effort to close the gap between assessing the requirements of the two aspects of comfort separately, Sicurella and co-authors [8] presented a *statistical approach* that aimed at measuring the frequency and intensity of thermal and visual discomfort in certain settings by using two physical parameters; the *operative temperature* and *illuminance levels*. Although in the original study, the approach was tested to examine the impact of adjusting the design of building envelope of a notional space on the internal conditions, according to the current authors' knowledge it has not yet been applied to assess the environmental performance of real buildings, including those situated within the African context and climate zone. With the objective of thoroughly assessing the internal conditions of Abuja's existing dwellings and to explore opportunities for improving their performance, a joint approach that combines the two aspects of comfort seems necessary, particularly where there is an ever-rising demand for low-income affordable housing.

This paper presents the results of assessing the environmental performance of two of Abuja's common housing types adapting a similar method to Sicurella's et al. The aim is to discuss the application of such statistical approach for the simultaneous evaluation of daylighting and the thermal environment of Abuja's low-income dwellings. The influence of utilising various shading components on the indoor comfort in the case study buildings is examined based on the prediction of the values of operative temperatures and the levels of illuminance using validated simulation and measured data.

### 3. PERFORMANCE EVALUATION MODEL: INDICATORS

The method employed included a calculation of the following set of indicators:

*Hours of Thermal Discomfort (HTD), Frequency of Thermal Discomfort (FTD), the Intensity of Thermal Discomfort (ITD) (which is derived from the areas under the curve as illustrated in Fig. 1), Hours of Visual Discomfort (HVD), Frequency of Visual Discomfort (FTD), and the Intensity of Visual Discomfort (IVD).* A detailed description of each metric is given in [8]. Due to the lack of regional comfort guidelines, the ASHRAE standard 55-2013 adaptive model for thermal comfort in naturally ventilated buildings [9] is used to define the thermal comfort boundary in the study. Similarly, the evaluation of visual comfort is based on the recommended illuminance values given by the Illuminating Engineering Society of North America (IESNA) for generic types of activity in interior spaces [10].

HTD is a measure of hours within a given time period during which the indoor thermal comfort conditions are not accomplished. FTD is the percentage of time within a given period during which the indoor thermal comfort conditions are not accomplished [8]. The values of both metrics can be delineated by defining the upper and lower limits of the acceptable temperature range,  $T_{over}$  and  $T_{under}$ . A satisfactory level of comfort is to be achieved when the operative temperature in a room is greater than  $T_{under}$  and less than  $T_{over}$ . Temperatures greater than the upper limit  $T_{over}$  might cause occupants to suffer from hot sensation while those dropping below the lower limit  $T_{under}$  might cause a cold sensation.

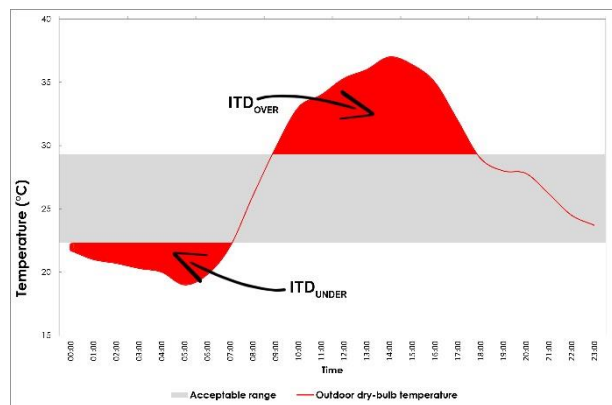

Figure 1: Definition of Intensity of thermal discomfort

The values for  $T_{over}$  and  $T_{under}$  are calculated in compliance with the adaptive thermal comfort criterion specified in section 5.4 of the ASHRAE standard-55, using the following equations:

$$T_{over} (°C) = 0.31 \times T_{pma} + 21.3 \quad (1)$$

$$T_{under} (°C) = 0.31 \times T_{pma} + 14.3 \quad (2)$$

Where:  $T_{pma}$  is the prevailing mean outdoor air temperature, which is the arithmetic mean of all the mean daily outdoor air temperatures for no fewer than 7 and no more than 30 sequential days prior to the day in question.

Typical daily tasks undertaken in a domestic setting are not limited to desks and display screens, therefore it should be noted that there is uncertainty regarding the preferred upper limits for thermal comfort in residential properties [11].

The traditional as well as the contemporary architecture of Nigeria favour limiting solar heat gain through windows over allowing higher levels illuminance indoors. Thus, the upper limit and lower limit for preferred daylight illuminance used for this research are 500lux (for the performance of visual tasks of high contrast and small size) and 100 lux (for spaces where simple visual tasks are performed), as prescribed by the IESNA standard [10]. Similar to thermal comfort,



# PLEA 2018 HONG KONG

Smart and Healthy within the 2-degree Limit

occupants are likely to feel visually comfortable when the average daylight illuminance across the working plane in the room is between the two limits.

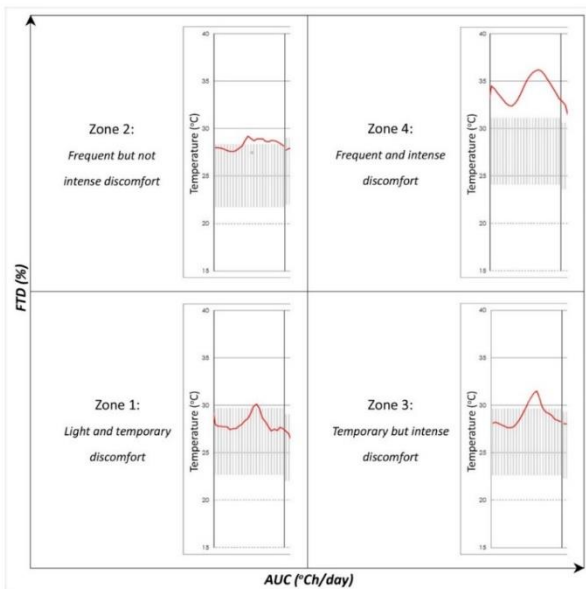

Figure 2: Zones of discomfort based on frequency and intensity

Depending on the quality of the indoor environment, an occupant's experience of comfort in a certain setting can be classified following Sicurella's et al approach into four categories. These are (a) a modest level of discomfort for a short period (b) a modest level of discomfort for a long period (c) intense discomfort for a short period and (d) intense discomfort for a long period. The zones were classified based on the severity of the conditions examined and for the ease of analysis and comparison are presented on a single graph as illustrated in Figures 2 and 8.

However, the paper by [8] did not define standard thresholds for each zone either in terms of the intensity of thermal or visual discomfort. Thus, in the current work, the threshold between temporary and frequent discomfort is 50% whereas the threshold between light and intense thermal and visual discomfort are 25°C•h/day and 12500Lux•h/day respectively. These thresholds are based on the examination of multiple buildings within the context of the study.

## 4. CASE STUDY BUILDINGS AND URBAN CONTEXT

The case study buildings selected for this study include a two-bedroom house in a four-storey block of flats and a four-bedroom detached house. The former was constructed in 1983 while the latter was constructed in 2003 (Fig. 3 and 4).

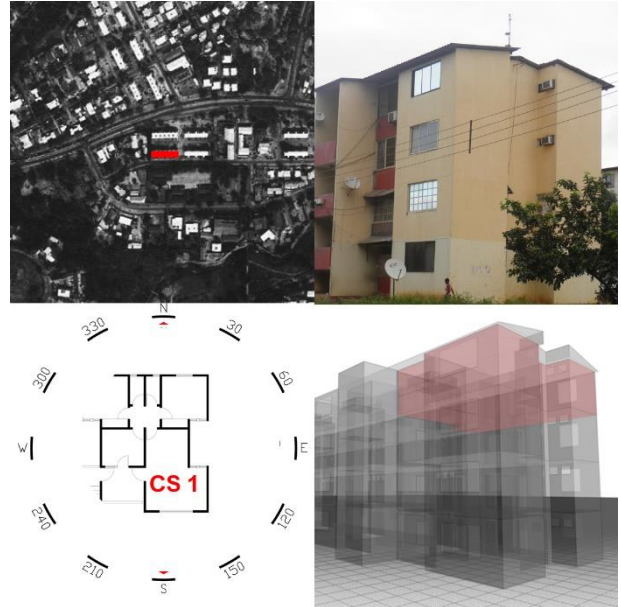

Figure 3: Location, photograph, plan of Cases study building 1 and the selected room (CS 1).



Figure 4: Location, photograph, plan of Cases study building 2 and the selected room (CS 2).

Both buildings are examples of the common prototypes for residential buildings developed by the government over the last three decades in Abuja. A room was selected from each house for the analysis presented in this paper. The physical attributes of the selected rooms and thermal transmittance of the buildings' materials that were collected during the fieldwork and utilised in the simulation modelling are given in Table 1. Even though both buildings were developed years apart they have similar materiality and internal finishes because their construction were carried out using the same style and standard that have been adopted for

# PLEA 2018 HONG KONG

Smart and Healthy within the 2-degree Limit

mass housing by the government in Nigeria for four decades.

Table 1: Physical characteristics of case study buildings

Room		CS 1	CS 2
Volume (m <sup>3</sup> )		54.5	66.4
Floor area (m <sup>2</sup> )		21.4	23.4
External wall area (m <sup>2</sup> )		34.2	31.6
Window area (m <sup>2</sup> )		3.8	3.6
Orientation		S	NE
U-value (W/m <sup>2</sup> K)	Wall	2.15	2.15
	Windows	5.22	5.22
	Roof	3.79	3.79
	Floor	2.38	2.38

## 5. CLIMATIC CONTEXT

The quality of the indoor environment of the rooms was evaluated during the Dry season, which is the hottest period of the year, normally extending from November to April. The midday sun is at its lowest angle in the south during the first three months of the season (around 57° in December) and there is often very little cloud cover over the city. Thus, the level of direct solar radiation reaching Abuja during this period is high. The average hourly solar radiation in the city in December is about 509 watts per hour per square metre (Wh/m<sup>2</sup>) leading to temperatures as high as 35°C [12]. The nearly vertical location of the sun in March combined with the absence of cloud cover further raises the average daytime temperatures to above 37°C [12]. However, over the course of the Dry season, the gap between the daytime and night-time temperatures in the city is wide, especially during the first three months. Temperatures around dawn can be 15-17°C lower than those recorded during the middle of the day [13]. This is the result of the dissipation of daily solar radiation beyond the atmosphere due to the lack of cloud cover [14].

Given the significance of the diurnal temperature change on the thermal experience of the occupants this paper reports the daily performance of the case studies. Consequently, the thermal and visual conditions in each room were assessed on the fifteenth day of each month during the Dry season. The operative temperatures in the rooms were simulated for 24 hours, and the illuminance levels between 7am and 6pm. On-site measured data was used in validating the simulated values, details of the validation method used were given in a separate publication [15].

## 6. THERMAL AND VISUAL PERFORMANCE ANALYSIS

According to the results (Fig. 5) it is anticipated that the frequency of thermal discomfort (FTD) in CS1 and CS2 will be 64% and 72% for the period assessed. Moreover, the ITD in both rooms are around 41°C•h/day and 45°C•h/day respectively. On other hand, the frequency of visual discomfort (FVD) in CS1 and CS2 will be 72% and

54% for the period assessed (see figure 6), while the IVD in the room is predicted to be 23032Lux•h/day and 14113Lux•h/day respectively.

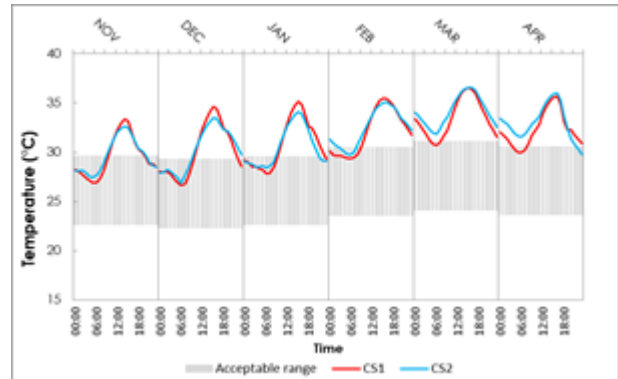

Figure 5: The acceptable temperature range and operative temperatures in CS1 and CS2 on the 15th of each month during the dry season

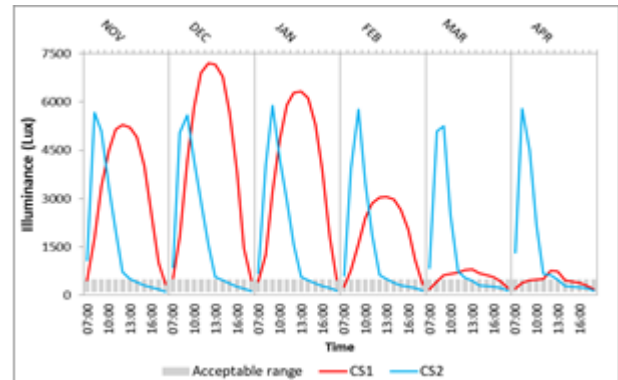

Figure 6: The acceptable illuminance range average daylight illuminance levels on the working plane of the living room in CS1 and CS2 on the 15th of each month during dry season

Based on the application of the four categories of assessment presented, the thermal discomfort conditions in both rooms can be described as frequent and intense (Fig. 8). On the days during the first three months of the Dry season the operative temperature in both rooms are within the acceptable range for a few hours in the morning but rise to about 35°C in the afternoon. By March 15th, the operative temperatures in the rooms are constantly above the acceptable range and the maximum temperatures are above 35°C. Likewise, on April 15th, there are only 4 hours in CS1 and 2 hours in CS2 during which the temperatures indoors are within the acceptable range.

The visual discomfort conditions in CS1 can also be categorised as frequent and intense due to the high illuminance levels (above 1000lux) that are expected to occur most hours on the days assessed during the first four months of the dry season. On the 15th of March and April the room receives minimal direct sunlight, thus there are 8 hours of visual discomfort on March 15th and only 3 hours of visual discomfort on April 15th.

# PLEA 2018 HONG KONG

Smart and Healthy within the 2-degree Limit

Moreover, the illuminance levels during these hours are below 1000lux. In contrast, the visual discomfort status of CS2 can be classified as light and temporary. This is the results of the eastern orientation of the room only receiving high levels of illuminance for a couple of hours around sunrise.

## 6. PARAMETRIC IMPROVEMENTS

Mapping the data on a single figure /sheet across the various zones, as stated above, is intended to assist with the visual inspection of the results providing a quick but an informative standardised way to compare and choose between various scenarios. Thus, the impact of adding two shading features on the rooms' as-built performance was examined for comparison. The composite shading devices used are 300mm and 900mm deep consisting of an overhang above the window and fins on either side of the window (Fig. 7).

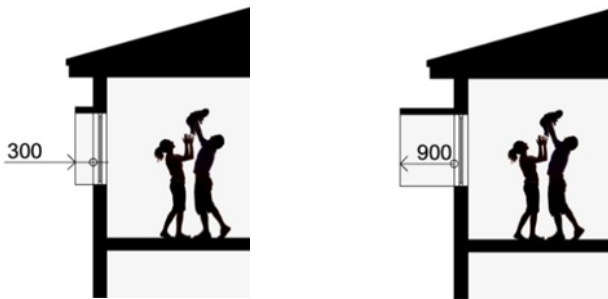

Figure 7: Composite window shading

As illustrated in Figure 8, the use of shading effectively reduces the frequency and intensity of thermal and visual discomfort. Although the thermal discomfort conditions for both rooms remain frequent and intense the FTD of CS1 and CS2 is reduced from 64% to 54% and 72% to 58% respectively with the 300mm shading components. The FTD with the 900mm shading components is about 52% and 56% in CS1 and CS2 respectively. Furthermore, the ITD in CS1 and CS2 is reduced from 41°C•h/day to 34°C•h/day and 45°C•h/day to 35°C•h/day respectively with the 300m shading components, while the 900mm shading reduces the ITD to 31°C•h/day and 32°C•h/day in CS1 and CS2 respectively. The results indicate that the addition of even minimal shading elements can be almost as effective as large shading elements for blocking unwanted solar radiation indoors in Abuja's climate. On the other hand, the increase in shading depth has a more significant impact on the visual environment in both cases. The FVD in CS1 and CS2 is reduced from 72% to 58% and 54% to 40% respectively with the 300m shading components. The FVD in CS1 and CS2 is further reduced to 13% and 25% with the 900m shading components added to the windows. Likewise, the IVD in CS1 and CS2 is reduced from 23032Lux•h/day to 16548Lux•h/day and 14113Lux•h/day to 6925Lux•h/day respectively with

the 300m shading components, while the values are about 563Lux•h/day and 1265Lux•h/day with the larger shading components.

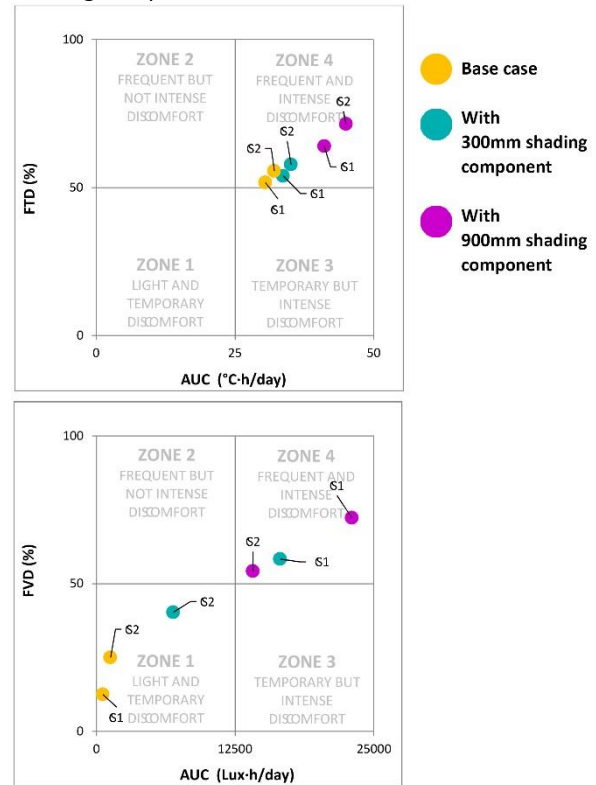

Figure 8: The zonal classification of the rooms assessed with shading (blue) and without shading (red) on the 15th of each month during the dry season

The impact of the shading elements on the zones of discomfort is illustrated in Figure 8. As clearly shown in the figure, the addition of shading elements is capable of changing visual discomfort from frequent and intense (zone 4) to light and temporary in both rooms (zone 1). Even though the frequency and intensity of thermal discomfort in both rooms are reduced the conditions in the rooms remain within zone 4. That said the zone diagram offers a simple and clear indication of the trend of discomfort with the addition of shading elements. Whereas the analysis presented in the paper is only limited to a few scenarios, the data mapping approach explained can be easily adjusted to identify the trend for other parameters or a range of multiple parameters.

## 7. OVERVIEW ON KEY FINDINGS

The evaluation tool adapted in this study following previous research work seems to offer an efficient informative way to assess buildings performance considering occupants' thermal as well as visual comfort demands. The simplicity of the data-mapping template presented can help designers quickly assess ways to optimise a building's design for comfort without sifting through cumbersome data. To manage such an analysis of the thermal and visual environments in residential

# PLEA 2018 HONG KONG

*Smart and Healthy within the 2-degree Limit*

settings, the tool only requires hourly operative temperatures and hourly average daylight illuminance. These data can be generated using reliable simulation packages or measured and collected on site. This can happen during the design phase for both new and existing buildings. However, the threshold for the zones established is dependent on the context of the study.

According to the results the two examined rooms are likely to be thermally uncomfortable for over half of the period assessed (64% and 72%) over the hottest part of the year. They are also expected to be visually uncomfortable for about 65% and 47% over the same period. Likewise, the intensity of thermal discomfort and visual discomfort are also high. With the exception of the visual condition in CS2, the visual and thermal conditions in the rooms can be classified as frequent and intense. However, it was found that the use of rigid shading components could potentially reduce the frequency of thermal discomfort in the rooms by 8.5-19.5%, as well as reducing the visual discomfort by 22-53%. In comparison to the as built-case, the intensity of thermal discomfort after the addition of shading devices reduced by as much as one-fifth and that of visual discomfort by as much as one tenth of the initial value. Shading devices (such as verandas) have long been recognised as the KEY design feature in the traditional residential architecture of Nigeria. Yet, most of Abuja's low-income contemporary dwellings are lacking the use of shading. Thus, responsive shading could not only act as a desired passive design measure but also as a cue bringing back some of the traditional architecture features to the image of the city.

## REFERENCES

1. Niang, I. et al (2014). Africa. In V. R. Barros, et al (Eds.), *Climate Change 2014: Impacts, Adaptation, and Vulnerability. Part B: Regional Aspects. Contribution of Working Group II to the Fifth Assessment Report of the Intergovernmental Panel on Climate Change*. Cambridge: Cambridge University Press.
2. International Energy Agency, (2014). *Africa Energy outlook – a focus on energy prospects in sub-Saharan Africa*. Paris: International Energy Agency.
3. Rahimian, FP., JS. Goulding, A. Akintoye, and SJ. Kolo, (2017). Review of motivations, success factors, and barriers to the adoption of offsite manufacturing in Nigeria. *Procedia Engineering*, 196:p. 512-519.
4. Hussaini, I. U., and N. H. Abdul Majid, (2015). Energy development in Nigeria and the need for strategic energy efficiency practice scheme for the residential building sector. *Management of Environmental Quality: An International Journal*, 26 (1): p. 21-36.
5. Irimiya, Y., I. A. Humphrey, and I. I. Aondover, (2013). Assessment of energy use pattern in residential buildings of Kano and Kaduna Northern Nigeria. *American Journal of Engineering Research*, 2(10): p. 271-275.
6. Lawal, A. F., and O. J. Ojo, (2011). Assessment of Thermal Performance of Residential Buildings in Ibadan Land, Nigeria. *Journal of Emerging Trends in Engineering and Applied Sciences*, 2(4): p. 581-586.
7. Lim, Y.M. (2014). Dynamic daylight and solar control in tropical climate. *American Journal of Applied Sciences*, 11 (10): p. 1766-1772.
8. Sicurella, F., E. Evola, and E. Wurtz, (2012). A statistical approach for the evaluation of thermal and visual comfort in free-running buildings. *Energy and Buildings*, 47: p. 402-410.
9. American Society of Heating Refrigerating and Air-conditioning Engineers [ASHRAE], (2013). *Standard 55-2013 -- Thermal Environmental Conditions for Human Occupancy*. Atlanta: ASHRAE.
10. Illuminating Engineers Society of North America [IESNA], (2000). *The IESNA lighting handbook: reference and application (9th ed.)*. New York: IESNA.
11. Mardaljevic, J., M. Andersen, N. Roy, and J. Christoffersen, (2011). Daylighting metrics for residential buildings. Paper presented at the 27th Session of the CIE, Sun City.
12. Nigerian Meteorological Agency [NIMET], (2010). *Nigerian climate review bulletin 2010*. [Online], Available: <http://www.nimetng.org/uploads/publication/2010%20Climate%20Review.pdf>
13. Adedaja, O. S., B. G. Ayantunji, U. A., Saleh and S. S. Jatto, (2015). Diurnal and Seasonal Variation of Global Solar Radiation at Anyigba, North-Central Nigeria. *International Journal of Engineering Science and Innovative Technology*, 4(4): p. 140-145.
14. Eludoyin, O. M., I. O., Adelekan, R. Webster, and A. O. Eludoyin, (2013). Air temperature, relative humidity, climate regionalization and thermal comfort of Nigeria. *International Journal of Climatology*, 34(6): p. 2000-2018.
15. Abdulkareem, M., S. Al-Maiyah, and M. Cook, (2018). Remodelling façade design for improving daylighting and the thermal environment in Abuja's low-income housing. *Renewable and Sustainable Energy Reviews*, 82(3): p. 2820-2833.

## Advanced Active Façades: The Construction of a Full-Scale Demonstrator for BIPV Architectural Integration

ANGELA CLUA LONGAS<sup>1</sup>, SOPHIE LUFKIN<sup>1</sup>, EMMANUEL REY<sup>1</sup>

<sup>1</sup>Laboratory of Architecture and Sustainable Technologies (LAST) of the Swiss Federal Institute of Technology Lausanne (EPFL), Switzerland

*ABSTRACT: In most European countries, new energy directives on building performance have been developed as a consequence of unsustainable greenhouse gas emissions. These norms promote active and passive energy strategies to lower the environmental impact of the building sector. Among the active strategies, building envelopes with Building Integrated Photovoltaics (BIPV) have a significant potential to generate clean electricity. However, despite the numerous advantages of BIPV products, diverse barriers are preventing their large-scale implementation. Many architects complain about their poor aesthetics as well as the lack of information on existing BIPV solutions, which leads to a generalized lack of interest on BIPV among building stakeholders. Aiming at overcoming these barriers, an interdisciplinary research team has designed and constructed the Advanced Active Façade (AAF) full-scale demonstrator. The mock-up integrates active and passive energy strategies such as BIPV and low-carbon construction principles, to meet the latest façade energy requirements. The AAF demonstrator approaches BIPV integration from an architectural perspective and showcases a new BIPV panel composition which widens the range of BIPV façade design opportunities. The ultimate objective of the AAF demonstrator is to generate an active façade architectural reference, while providing architects with an assessed low-carbon façade construction system.*

*KEYWORDS: BIPV, active façade, low-carbon façade, architectural reference*

### 1. RESEARCH CONTEXT

The European Union is committed to drastically reduce greenhouse gas emissions by 2050: levels should be 80-95% lower when compared to 1990 [1]. New energy directives regarding energy efficiency [2] and building performance [3] have been developed as a consequence of unsustainable greenhouse gas emissions and the undesired reliance on non-renewable resources. Based on these new European directives, a long-term energy policy has been developed in Switzerland under the name of 'Energy Strategy 2050' (ES 2050), which restructures the national energy system [4].

In this context of energy transition, the building sector aims at constructing energy neutral buildings, which requires on-site energy generation [5]. This goal increases the interest in the building skin, which can potentially become an active surface and generate clean, safe, affordable and decentralized electricity. This is possible through the integration of renewable energy generation systems such as solar energy generation systems [6]. Among them, the ES 2050 establishes that energy consumption from photovoltaic (PV) systems has to represent 20% of the total Swiss electricity consumption by 2050 [4].

A promising offer of PV technology consists in the architectural and constructive integration of PV elements: Building Integrated Photovoltaics (BIPV). The latter combines an architectural function with an electric generation capacity. BIPV systems also present

numerous advantages compared to a centralised PV power plant or a traditional building-attached PV installation since they reduce material use, initial investment costs and energy transportation losses [7]. Ten years ago, high costs of BIPV products were a strong integration barrier. However, BIPV prices have drastically dropped over the last decade. Today, BIPV prices can be compared to granite façade coatings or aluminium cladding [8], which are materials commonly used in public buildings.

Despite this favourable context, BIPV technology is not exploited to the best of its potential. Architects often justify the lack of PV use in their designs by the poor visual expression of existing BIPV solutions [9] and the lack of information regarding BIPV products and systems [10-12]. These facts are identified, among others, as architectural barriers for a widespread BIPV use and have been hindering its potential, revealing a real gap between technology and architecture in current practices.

PV integration is often found on the roof for performance and aesthetic reasons while BIPV façades are affected by the 'poor visual expression' barrier due to their significant impact on the public space. However, BIPV façade integration has some benefits over BIPV roof integration. To begin with, best oriented façades in Europe get about two thirds of the maximum annual solar input, and the higher the latitude, the higher the relative solar yield on facades [13]. Secondly, on average,

# PLEA 2018 HONG KONG

*Smart and Healthy within the 2-degree Limit*

buildings have more available façade surface than roofs, which can be solicited by building services or green surfaces [14]. Finally, a BIPV façade has a particular energy generation cycle, which better matches the residential energy demand than other building typologies [15]. Given that 50% of the building stock in Europe being residential [16], BIPV façade integration has a significant unattained potential.

## 2. RESEARCH APPROACH

Several authors state that the architectural design process relies on architectural references [17]. With this in mind, this research aims at developing a BIPV façade architectural reference integrated into contemporary architectural design practices. The research approaches the subject, from a design perspective, based on the collaboration of product developers, architects and scientists. The developed work aims at bridging the gap among these stakeholders to deal simultaneously with architectural, constructive and technological issues regarding BIPV integration on residential building façades.

The research approach is based on previous studies [18], which have determined that the current façade requirements are: low-carbon construction, high insulation, and energy generation. The Advanced Active Façade (AAF) concept was developed based on these three key requirements.

Based on these previous results, the paper presents the design, construction and assessment of a real-scale mock-up of the AAF, which aims to be an architectural reference for BIPV façades. The paper introduces the AAF concept and the project's objectives. After introducing the interdisciplinary research team, the paper explains the design process and the demonstrator's active and passive construction principles. Finally, the environmental impact assessment and transfer potential evaluation are presented.

## 3. THE ADVANCED ACTIVE FAÇADE (AAF) DEMONSTRATOR

The AAF demonstrator is a full-scale mock-up of the AAF construction system which combines passive and active energy design strategies to meet the latest façade energy requirements. The demonstrator is based on current façade composition strategies and integrates a combination of different BIPV products [19].

There is a number of existing BIPV façade researches that have already built prototypes to test different features of a BIPV façade [20-23]. However most of them monitor meteorological data, environmental influence and take electrical and thermal impact measurements. In other words, their reports provide very technical data, which has been identified as a BIPV barrier to integrate BIPV in the architectural design process [6]. The existing BIPV façade prototype reports do not refer to

architectural BIPV integration regarding composition and construction. For this reason, the current research has constructed the AAF demonstrator where architectural features such as construction processes and design practices have been tested and evaluated.

### 3.1 Objectives

As previously stated, the AAF demonstrator aims to join the architectural reference background of BIPV design. It aims at pushing BIPV research towards overcoming the identified barrier of *poor aesthetics*. The objective is to show that BIPV façade integration is attainable at a design and construction level, while being compatible with today's architectural taste in the Swiss context.

The construction of a real scale mock-up provides the research team with the experience of designing and constructing a BIPV façade. This facilitates the achievement of the second objective of the AAF demonstrator, which is overcoming the BIPV communication barrier. To do so, the research team has involved professionals to participate in the final assessment phase. This provides the authors with information about the level of BIPV comprehension, interest and design concerns among architects, which have an impact on the development of BIPV communication strategies.

### 3.2 Research team

The AAF demonstrator is designed by architects of the Laboratory of Architecture and Sustainable Technologies (LAST) of the Swiss Federal Institute of Technology Lausanne (EPFL). Throughout the design process, the research team collaborated with façade design and construction experts to verify that the AAF façade design met all norms and requirements regarding thermal and noise insulation targets, fire protection and substructure dimensioning. A second design assessment was carried out in collaboration with the construction company who evaluated the construction and transportation phases of the real-scale mock-up and recommended some modifications from the original designs to optimise the mounting and demounting processes.

The AAF demonstrator displays the latest's BIPV panels developed and manufactured by the research partner: CSEM (Swiss Centre for Electronics and Microtechnology) in Neuchatel. CSEM's team provided the BIPV technology that conforms the demonstrator's opaque façade cladding and dealt with the fixing system integration.

The Swiss PV producers H.Glass provided their translucent BIPV panel to be also integrated in the demonstrator. This way, the AAF demonstrator displays different types of BIPV technologies: opaque and translucent, which meet different façade requirements.

# PLEA 2018 HONG KONG

*Smart and Healthy within the 2-degree Limit*

The interdisciplinary design process has been an enriching research phase for all stakeholders, who have realised that compromises between efficiency, cost and aesthetics need to be made to design and construct a BIPV façade.

### 3.3 Design process

The design process is based on the development of the AAF construction system and the AAF design strategies [19]. The AAF real-scale mock-up represents a one storey angle of the building displayed in Figure 1 and integrates the AAF construction system.



Figure 1: Architectural visualization of a BIPV scenario integrating CSEM's BIPV façade cladding. Base for the AAF demonstrator (Source: LAST).

The objective of the demonstrator design was to represent a BIPV façade as an architectural object that could be visited, explored, analysed and assessed with an architectural perspective (Fig. 2).



Figure 2: The AAF demonstrator: Exterior view. A showcase for the AAF construction system and the latest BIPV panels produced by CSEM laboratory in Neuchâtel (Source: LAST).

This involves a complete façade construction to explicitly illustrate the different components of a BIPV façade and highlight potential issues related to architectural integration. This objective differs from other BIPV producers' demonstrators or prototypes, which are usually limited to the outermost active layer of the façade.

The interior of the AAF demonstrator is designed to give visitors information on the low-carbon principles

and the material choices taken (Fig. 3). On one wall, façade interior layers have been progressively removed to leave in sight every component of the AAF construction system: Interior coating, wood-fibre insulation, OSB (Oriented Strand Board) panels, wood-studs substructure, cellulose insulation, fibro-cement panels and air gap with BIPV substructure. The rear face of the BIPV panels is left visible, so that all the wiring and the simplicity of the fixation system can be appreciated and, in a way, demystified.



Figure 3: The AAF demonstrator: Interior view. A showcase of the AAF construction system and low-embodied carbon construction principles (Source: LAST).

### 3.4 Construction principles

In response to the latest façade energy requirements, the AAF mock-up's construction system incorporates low-carbon design principles, a very low transmittance value ( $U=0.094 \text{ W/m}^2\text{K}$ ) and energy generation by the integration of BIPV in its outermost surface. The AAF construction system is initially designed for the construction of new façades, which can be part of new edifices or existing buildings being fully refurbished. Due to its non-loadbearing design, it is compatible with a wide array of façade composition strategies as well as existing building structures.

#### Passive design strategies

With regard to low-carbon principles, the AAF construction system prioritizes the use of natural and locally sourced materials [24]. In addition, it is designed to be disassembled rather than demolished. This maximizes the reuse and recycling of materials while extending its life cycle. This design principle involves choosing mechanical fixations over adhesive materials due to the potential product damage as consequence of detachment. The AAF mock-up's construction system has also been designed to be prefabricated, which involves that in the building scale context, on-site waste can be reduced up to 50% [25]. These are the main principles that have guided the design team to develop a light

# PLEA 2018 HONG KONG

Smart and Healthy within the 2-degree Limit

wood-framed prefabricated façade, illustrated in Figure 4, with two layers of natural insulation: 35 cm of cellulose (5) and 5 cm of wood fibre (7), within a panel structure (4,6,8).

BIPV panels (1) are integrated with a ventilated-façade fixation system (2) with the particularity of respecting a minimum air gap of 80 mm (3). This distance guarantees the rear ventilation of BIPV panels, which lose efficiency when overheated [26]. BIPV panels can be fixed with regular ventilated glass-façade fixings. It shall be considered that glass perforated fixings increase complexity, due to the reorganisation of the PV cells, which are unperforated. Particularly, the AAF demonstrator displays an invisible fixation adhered at the rear of the panel. In this case, a compromise between aesthetics and carbon impact has been made in favour of the frameless panels, due to aesthetic and architectural requirements.

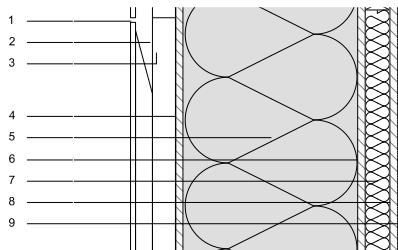

Figure 4. AAF façade. (Source: LAST)

## Active design strategies

The demonstrators' outermost layer and façade composition was designed to illustrate BIPV façade's flexibility. It integrates different types of BIPV panels, offering a variety of formats, textures, colours, light reflections and transparency. While the translucent panel is already market available, the façade cladding opaque panels are a brand-new production of CSEM's laboratory and were displayed for the first time on the AAF demonstrator. At the moment, these BIPV panels are at a research level and not market-ready.

Figure 5 shows the composition of the opaque panels, which are glass-glass BIPV panels.

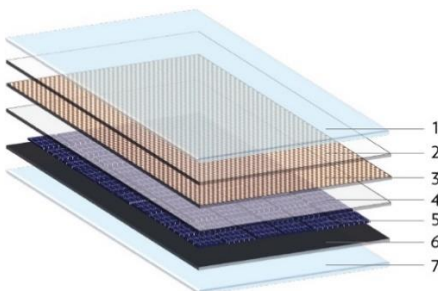

Figure 5: Panel composition: 1-Front Glass; 2-Clear interlayer; 3-Colour and texture filter; 4-Clear interlayer; 5-Monocrystalline PV cell matrix; 6-Back interlayer; 7-Back glass (Source CSEM).

These panels incorporate a filter, whose position is indicated by number 3 in the image. This filter can be of different nature, giving BIPV panels a wide variety of appearances regarding colour and texture (Fig. 6). According to CSEM's simulations, integrating these filters decreases the panel's efficiency. While a regular unfiltered BIPV panel's performance is around 18%, CSEM's BIPV panels achieve a performance between 11% and 15.5%. The difference in number can be accepted as a compromise between efficiency and a wider range of façade design options.

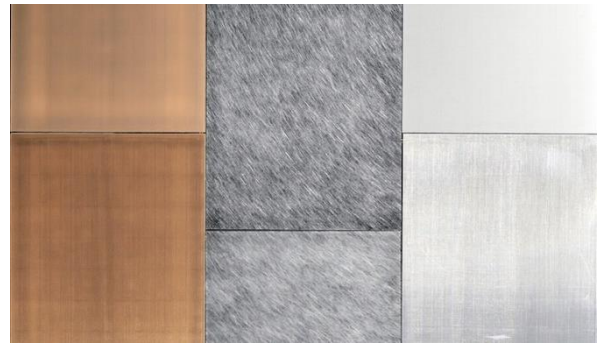

Figure 6: CSEM's BIPV panels. They integrate different filters and different glass treatments. From left to right: Copper metal mesh (can generate 110 W/m<sup>2</sup>), Fibreglass (can generate 155 W/m<sup>2</sup>) and Grey metal mesh (can generate up to 120 W/m<sup>2</sup>) (Source: LAST).

Different glass treatments have been tested with the aim of providing architects with a wider range of options when composing BIPV façades. The demonstrator displays regular tempered glass panels and sandblasted glass panels. However, the performance variations have not been tested yet. The embodied energy and life-span are currently being calculated by CSEM's team in collaboration with different experts from the University of Zurich.

## 3.5 Environmental assessment

In an integrated design process, the environmental impact of the AAF demonstrator has been assessed. Two simulations have been carried out:

Firstly, a calculation of the Life Cycle Assessment (LCA) of the AAF construction system. This assessment takes into account all the construction system components and their specific embodied energy, from the Swiss KBOB database [27]. To make the results understandable to non-specialised professionals, a comparative has been established between what could be considered as a basic commonly-used façade system and the AAF. The reference façade is taken from the Swiss Construction Catalogue and is composed of 12.5 cm bricks, 22 cm of polystyrene insulation and cement mortar finishing.

The LCA revealed that, at the substructure level, the AAF wood-panel substructure can reduce the façade's



# PLEA 2018 HONG KONG

Smart and Healthy within the 2-degree Limit

embodied carbon by around 70% compared to the reference brick façade. However, BIPV's embodied energy and energy generation must be taken into account. The final energy balance results comparative is displayed in Figure 7.

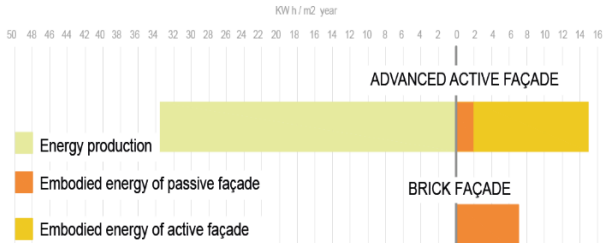

Figure 7: LCA results comparative. (Source : LAST).

Secondly, energy simulations were run with an energy building simulation tool: Design Builder. The AAF demonstrator was fully simulated at the building scale (fig.1). All three sorts of panels displayed on the demonstrator were simulated, and so was the energy demand of the building itself. The simulated building has a total heated surface of 2'244m<sup>2</sup> and, provided with the AAF construction system, consumes 113MWh/year, which is 15% less than the respective consumption when provided with a standard brick façade construction system. It can generate, depending on the installed BIPV variant: a) 60MWh/year (copper), b) 85MWh/year (fibreglass), and c) 66MWh/year (grey metal). This implies total annual energy savings, thanks to passive and active strategies, of respectively a) 38%, b) 42%, and c) 39%.

Due to the mismatch between residential buildings energy demand and BIPV energy generation, performances such as self-consumption, self-sufficiency and energy exceed were calculated. They are displayed in Figure 8.

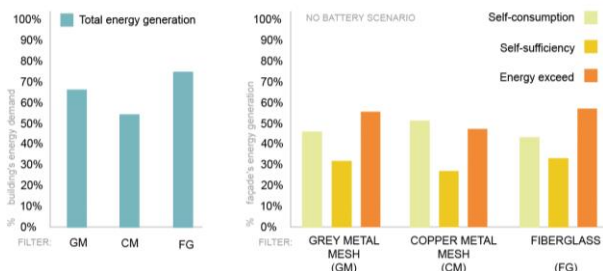

Figure 8: Building energy simulation results from different BIPV panels (Source : LAST).

### 3.6 Professional practice transfer potential

The transfer potential is evaluated through the qualitative assessment of architectural quality. This is one of the most difficult phases of the research due to the subjectivity it entails. It has been a motivation, from the beginning of this research, to find a solution to

architect's BIPV aesthetic claims, which has been identified as a barrier to the widespread use of BIPV.

It was decided during the development of this research – and based on other qualitative assessments [28] – to involve architecture professionals in the evaluation process.

After the demonstrator construction was completed, the AAF demonstrator was presented at a Swiss sustainable architecture forum with around 250 attendees[29], accomplishing a knowledge transfer objective. Right after this national event, an on-line survey was sent out to reach the latter attendees and find their opinion on the AAF demonstrator's architectural qualities. Due to the small response ratio (around 10%), individual presentations were subsequently organized, which allowed achieving almost 50 responses. 88% of the surveyed architects believed that the AAF is an effective construction system which can be applied to a large variety of façade projects. In addition, 79% of the respondents recognized its global energy efficiency virtues. Specifically, 58% had a positive opinion about the efficiency of the passive measures and 94% about the active ones. Also 94% of the AAF demonstrator visitors stated that the visit increased their interest in BIPV façades and 91% were motivated to start considering BIPV and low-carbon construction principles in future projects. Globally, architects had positive attitudes towards the AAF demonstrator and some of them have returned to visit it to implement the AAF principles in architectural competitions.

### 4. CONCLUSIONS

Motivated by current façade energy requirements, this research has developed a BIPV façade concept, which integrates a highly insulated core in a low-carbon construction system. The construction details developed show how the AAF can meet the required technical and architectural features as an active façade coating providing important energy savings to the building.

The construction of the AAF demonstrator has provided the research team with a real interdisciplinary experience of composing and constructing a BIPV façade. This experience is shared through papers, conferences and publications [18][19][29] with other building design professionals to motivate BIPV use in façade design.

This research has developed an active architectural reference (AAF demonstrator), inevitably based on existing ones (research team's architectural background). When this new reference was submitted to the professionals' opinion, most of them seemed interested on a technical and aesthetic level. The high percentage of acceptance shown in the final survey can be seen a promising sign for the AAF demonstrator to be taken as an architectural reference, when designing active façades. This would mean that BIPV research is advancing towards overcoming architectural barriers.

# PLEA 2018 HONG KONG

*Smart and Healthy within the 2-degree Limit*

## ACKNOWLEDGEMENTS

This research project is part of the National Research Programme "Energy Turnaround" (NRP 70) of the Swiss National Science Foundation (SNSF). Further information on the National Research Programme can be found at [www.nrp70.ch](http://www.nrp70.ch). As part of the joint research project PV2050 led by CSEM, the development of this research is based on an interdisciplinary collaboration between technology leaders (CSEM), architects (LAST) and PV building glazing firm (H.GLASS). The authors also thank the Swiss Federal Institute of Technology Lausanne for its support.

## REFERENCES

1. European Commission. (2012). Energy Roadmap 2050. European Commission.
2. Directive 2012/27/EU. Directive 2012/27/EU of the European Parliament and of the Council of 25 October 2012 on energy efficiency, amending Directives 2009/125/EC and 2010/30/EU and repealing Directives 2004/8/EC and 2006/32/EC. , Official Journal of the European Union (2012).
3. Directive 2010/31/EU. Directive 2010/31/EU of the European Parliament and of the Council of 19 May 2010 on the energy performance of buildings, Official Journal of the European Union (2010).
4. SFOE. (2014). Energy Strategy 2050. Swiss Federal Office of Energy (SFOE).
5. Hermelink, A., Schimschar, S., Boermans, T., Pagliano, L., Zangheri, P., Armani, R., ... Musall, E. (2013). Towards nearly zero-energy buildings. Definition of common principles under EPBD. Final report (No. BESDE10788). Ecofys.
6. Bonomo, P., Chatzipanagi, A., & Frontini, F. (2015). Overview and analysis of current BIPV products: new criteria for supporting the technological transfer in the building sector. *Vitruvio*, 0, 67–85.
7. SUPSI. (2015). Centre Suisse de compétence BIPV.
8. RIBA. (2009). Principles of Low Carbon Design and Refurbishment.
9. CSEM, LAST (EPFL), & G2E. (2015). PV2050 project. Photovoltaics into the built environment: from semitransparent PV glazing to high efficiency roof integrated solutions.
10. Jing Yang, R. (2015). Overcoming technical barriers and risks in the application of building integrated photovoltaics (BIPV): hardware and software strategies. *Automation in Construction*, 51, 92–102.
11. Jing Yang, R., & X.W. Zou, P. (2015). Building integrated photovoltaics (BIPV): costs, benefits, risks, barriers and improvement strategy. *International Journal of Construction Management*, 16(1), 39–53.
12. Azadian, F., & Radzi, M. A. M. (2013). A general approach toward building integrated photovoltaic systems and its implementation barriers: A review. *Renewable and Sustainable Energy Reviews*, pp. 527–538.
13. Gutschner, M., Nowak, S., Toggweiler, P., & Schoen, T. (2002). Potential for Building Integrated Photovoltaics. Achievable levels of electricity from photovoltaic roofs and façades: methodology, case studies, rules of thumb and determination of the potential of building integrated photovoltaics for selected countries. PVPS Photovoltaic Power Systems Programme.
14. Redweik, P., Catita, C., & Brito, M. (2013). Solar energy potential on roofs and façades in an urban landscape. *Solar Energy*.
15. Sanchez, E., & Izard, J. (2014). Performance of photovoltaics in non-optimal orientations: An experimental study. Elsevier.
16. Gutschner, M., Nowak, S., & IEA PVPS Task 7. (2001). Potential for Building Integrated Photovoltaics (No. IEA-PVPS T7-4: 2002 (summary)).
17. Rey, E. (2018, April 9). Du territoire au détail. Le projet architectural face aux défis de la transition vers la durabilité. Presented at the Leçon inaugurale EDAR / EPFL.
18. Clua Longas, A., Lufkin, S., & Rey, E. (2017). Towards Advanced Active Façades: Analysis of façade requirements and development of an innovative construction system. Presented at the PLEA 2017, Design to Thrive, Edinburgh.
19. Clua Longas, A., Lufkin, S., & Rey, E. (2017). Towards Advanced Active Façades. The development and assessment of a new façade concept, which combines passive and active design strategies. In *SDBE 2017* (pp. 526–537). Presented at the International Conference for Sustainable Design of the Built Environment, London.
20. Eder, G., Maul, L., Illich, P., & Folkerts, W. (2017). BIPV research teams & BIPV R&D facilities, an international mapping (No. IEA-PVPS T15-02:2017). IEA International Energy Agency PVPS.
21. Farkas, K., IEA - SHC, Maturi, L., Scognamiglio, A., Frontini, F., Munari Probst, M. C., & Roecker, C. (2013). Designing photovoltaic systems for architectural integration. Criteria and guidelines for product and system developers. (No. T.41.A.3/2: IEA SHC Task 41 Solar Energy and Architecture).
22. Gaillard, L., Ménézo, C., Giroux, S., Pabiou, H., & Le-Berre, R. (2014). Experimental Study of Thermal Response of PV Modules Integrated into Naturally-ventilated Double Skin Facades. *Energy Procedia*, 48, 1254–1261.
23. Loonen, R. C. G. ., Rico-Martinez, J. M., Favoino, F., Brzezicki, M., Menez, C., La Ferla, G., & Aelenei, L. (2015). Design for façade adaptability - Towards a unified and systematic characterization (pp. 1274–1284). Presented at the 10th Energy Forum - Advanced Building Skins, Bern, Switzerland.
24. Birgisdottir, H., Moncaster, A., Houlihan Wiberg, A., Chae, C., Yokoyama, K., Balouktsi, M., ... Malmqvist, T. (2017). IEA EBC annex 57 'evaluation of embodied energy and CO2eq for building construction.' *Energy and Buildings*, 154, 72–80.
25. Connaughton, J., Weight, D., Jones, C., & Moon, D. (2011). Cutting embodied carbon in construction projects. WRAP (Waste & Resources Action Programme).
26. Brinkworth, B. J., & Sandberg, M. (2005). Design procedure for cooling ducts to minimise efficiency loss due to temperature rise in PV arrays. *Solar Energy*.
27. KBOB. (2016). Données écobilans dans la construction 2009/1:2016. Conseil Fédéral Suisse.
28. Häkkinen, T., Kuittien, M., Ruuska, A., & Jung, N. (2015). Reducing embodied carbon during the design process of buildings. *Journal of Building Engineering*, 4, 1–13.
29. Clua Longas, A., Lufkin, S., & Rey, E. (2017, November). Concevoir des façades actives bas carbone. TRACÉS, 23–24(dossier), 20–22.

# The Resilience of Natural Ventilation Techniques in Myanmar's Vernacular Housing

MAY ZUNE<sup>1</sup>, THI HO VI LE<sup>1</sup>, LUCELIA RODRIGUES<sup>1</sup>, MARK GILLOTT<sup>1</sup>

<sup>1</sup>Department of Architecture and Built Environment, University of Nottingham, United Kingdom

**ABSTRACT:** Vernacular housing in tropical climates traditionally relies heavily on natural ventilation for comfort. However, global warming and climate change are threatening the efficacy of this technique. The study presented here explored two Myanmar housing types in the countries' three climate zones, and fifteen different ventilation regimes aiming to provide comfort to the occupiers with no reliance on energy. A comparative study was developed with a total of 444 dynamic simulations where orientation, window-to-wall-ratio, and infiltration rates were varied. The efficacy of single-sided and cross-ventilation, the relationship between local weather and the culturally acceptable time to allow the opening of the fenestration were also explored. The results using a typical weather year were then compared with three future climate change scenarios. The results confirmed that the current ventilation practices are not able to provide the required thermal comfort both for typical weather year and when considering future climate change scenarios. The authors concluded the study with suggestions to redesign the façades to improve the overall performances.

**KEYWORDS:** Natural ventilation, Thermal comfort, Climate change, Vernacular housing, Myanmar

## 1. INTRODUCTION

Consistently high humidity, high temperatures, and small diurnal temperature variation govern tropical climates. In response to this, natural ventilation is widely used to meet two requirements: a comfortable thermal environment and good indoor air quality.

According to Myanmar's 2014 Census data, only 15.9% of Myanmar houses' envelopes were built with brick and concrete; the rest was made of *Theke* (thatch), leaf, bamboo, and wood [1]. The majority of Myanmar houses were constructed vernacular construction practices [1], however affordable housing including the momentum of *Yangon Waterfront* projects [2] are into the modern method of construction. Myanmar, which was known as Burma, ranked second out of 183 countries in the long-term climate risk index from 2016 [3]. If the climate change predictions unfold, can Myanmar's housing provide the required thermal comfort? How does it respond to current and future climate conditions?

In order to answer these questions, the variety of ventilation practices in Myanmar's vernacular housing were identified and investigated. Opportunities to improve and the problems to address the required thermal comfort were explored from 15 ventilation regimes that based on typical weather and future climate scenarios of three climate zones, which resulted in 444 simulation models.

## 2. CLIMATE CONTEXT

According to the Koppen-Geiger climate classification for 2001-2025, Myanmar received subtropical highland climate (Cwb), a mixed humid subtropical climate (Cwa), equatorial winter dry climate (Aw), and tropical monsoon

climate (Am). All climates are varied due to her highlands and topography [4]. If the Koppen-Geiger climate shift A1F1 trajectory, which was commonly known as the high emission scenario introduced by the Intergovernmental Panel on Climate Change (IPCC) was referred, it could be seen in Figure 1 (left) that the climate *Cwa* and *Cwb* are disappearing in 2076-2100 [4, 5]. The southern and western parts of Myanmar are changing into the climate *Am*. The northern and eastern parts of Myanmar are changing into the climate *Aw* [4]. The changing climate is questioning the effectiveness of the vernacular practice of natural ventilation as a passive cooling strategy.

In this study, the three cities - *Yangon*, *Mandalay*, and *Myitkyina* - were selected to cover the three most significant climates of Myanmar. *Yangon* presents the climate *Am* that is influenced by the ocean. *Mandalay* presents climate *Aw* that is affected by its surrounding low mountain ranges. *Myitkyina* presents climate *Cwa* that is influenced by the surrounding high mountain ranges.

The climate study for this paper was used ASHRAE typical year weather files 22 years worth of data spanning 1991 to 2013 [6]. In Figure 1 (right), it was reported that the average temperature was above 22°C, and most of the daytime the temperature was above 27°C. In the hot season, especially from March to May, the temperature was above 33.5°C. The temperature dropped in the cold season; however, it remained above 15°C. The average daily relative humidity of the studied climates was above 70% for the whole year except the peak summer time. The average wind speed was 1.0m/s throughout a year in *Yangon*, 0.5m/s in *Mandalay* and 0.15 to 0.3m/s in *Myitkyina*. However, there was a strong

# PLEA 2018 HONG KONG

## Smart and Healthy within the 2-degree Limit

wind during the rainy season that is in the middle of a year in *Mandalay*. Basically, the wind speed in *Myitkyina*

was lower than the others. The south and north wind directions were dominant due to the trade winds.

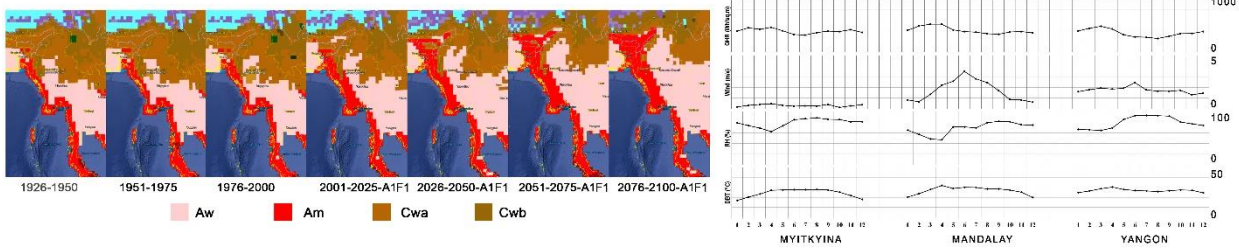

Figure 1: Koppen-Geiger climate shift: 1926-2100 for Myanmar [4, 7](left) and weather data of case study cities (right)[6]

### 3. HOUSING CONTEXT

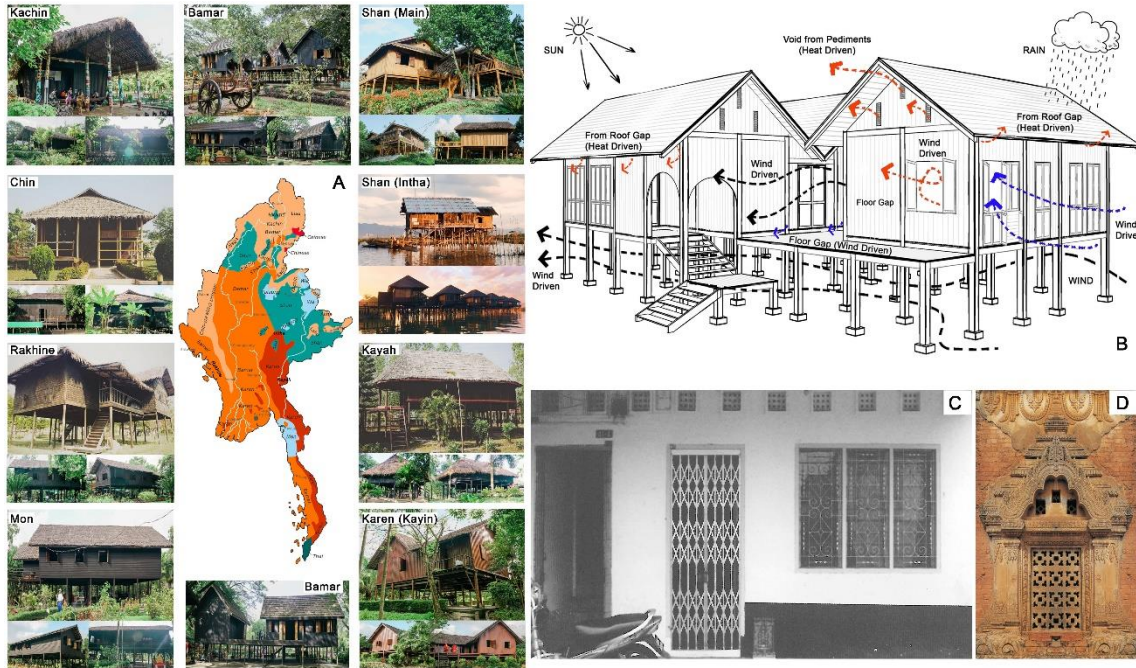

Figure 2: A. Myanmar National Race Houses [8]; B. Ventilation strategies in a Bamar house [9]; C. Casting used in Southeast Asia [10]; D. Ventilation block used in Myinkaba Kubyaukgyi temple, Bagan [11].

In order to understand the characteristics of Myanmar vernacular housing, the authors reviewed the eight significant races' vernacular houses [8] shown in Figure 2 (left). The pictures were taken from the Myanmar national race villages in *Yangon*, *Mandalay*, and *Naypyidaw*. Regardless of the variety of culture and traditions, most of the houses were very similar to each other. The main difference was the *Kachin* house and the *Chin* house which was because of their front open space. These two ethnic groups lived in the mountainous regions; therefore, these spaces were used for the wood burning fireplace in winter. Unless these slight built form differences, all Myanmar vernacular houses were built as a gable thatch roof was above, and either bamboo or wooden structure was below. Technically, the vernacular houses were loosely built; therefore, their air exchange rate through infiltration and exfiltration was very high.

Except for the breathable thatch roof that kept a building warm in winter and cool in summer, insulation was rarely used in walls and floor. The fresh cool air was supported by buoyancy air up from the raised floor, which was shaded under the dwellings. Ceilings were rarely built. The primary aim of the internal partitions was for privacy, and there were voids or gaps between the top of the wall and the base of the roof structure. The most important feature was the gable vent on the pediments of the roof, which promoted cooling. The hot air inside the house was easily and continuously removed from the roof utilize gable vent. The large eave provided a buffer zone; therefore the shaded interior space always behaved as a breathing and permeable space against the exterior.

From the post-independence period, Myanmar's vernacular housing construction was replaced with brick walls and either zinc or metal roofs due to the limitation

# PLEA 2018 HONG KONG

*Smart and Healthy within the 2-degree Limit*

of forest products and increased population. The raised floor level room was changed to the ground level room, and the elevated floor was altered to the sand, gravel, and concrete-filled floor. Regardless the building material and construction method changes, the built form and plans were not significantly changed. As a result, the infiltration rate in the masonry houses was reduced due to the material use and construction method. Unlike the vernacular houses, ceilings were added to the masonry houses to prevent the radiant heat gain from the zinc or metal roof. At first, the gable vent remained in the early brick housing. Although an opening was added to ceilings, the efficiency to facilitate the air change from the heat driven high-level ventilation was decreased. Therefore, the ventilation blocks were introduced above the window to increase the air change rate. The incorporation of ventilation blocks or casting architecture allowed not only facilitating air change but also providing some aesthetic detail for the walls. In fact, the ventilation blocks were not a new term for Myanmar. They were used in religious buildings since circa 1113, for example, *Myinkaba Kubyaukgyi* temple in *Bagan*. However, they became popular when the housing fabric was significantly changed from timber to brick.

## 4. METHODOLOGY

### 4.1 Benchmark and Future Weather Files

The primary six variables that affect the condition of thermal comfort are air temperature (AT), relative air velocity or air movement, water vapour pressure in ambient air, mean radiant temperature (MRT), activity level and the thermal resistance of clothing [12]. The first four variables are influenced by the environments that were the interest here to compare the overheating conditions for the defined housing scenarios. The last two variables are influenced by the personal factors and occupant's adaptable thermal comfort conditions that were left in this study. Although the ASHRAE comfort charts debate is on-going due to its databases, building classification and neutral temperature, the authors referred the mean monthly outdoor temperature up to 33.5°C, which was used as an acceptable adaptive thermal comfort limit proposed by de Dear and Brager [13]. It is important to note that the 33.5°C here was for comparison purpose, and it was not defined as a thermal comfort benchmark for the study climates. In this study, the comfort benchmark was set at 33.5°C for a total of 444 simulation runs and comparison. In the typical weather file, 5.7% of a year in *Yangon*, 12.66% in *Mandalay*, and 2.44% in *Myitkyina* were above 33.5°C.

The World Wild Life Fund and the Myanmar Climate Change Alliance reported in 2017 as the annual temperature of Myanmar can be increased 1.3°C to 2.7°C in 2041-2070 compared to 1980-2005 according to the NASA NEX-GDDP (2015) sources [14]. If only the summertime were considered, the prediction was that

the temperature could be increased up to 2.9°C [14]. It is obvious that there is a considerable change in the current weather and future weather condition. Technically, creating the future weather files requires expert knowledge of climatology. In this study, the authors created three future climate weather files by using a "shift" of a current hourly weather data parameter by adding increased value consistently to the typical weather file [15]. They were 1.3°C dry bulb temperature (DBT) increased case annually case, 2.7°C DBT increased case annually case and, 2.9°C DBT increased in the summertime case. The experimental investigation was aimed at observing the thermal performance of the defined fifteen scenarios in the future climate change conditions. A constraint was that the future weather files were limited to change in dry bulb temperature. Hence, further work is required to take into account other parameters, such as global radiation, relative humidity, and wind speed and wind direction.

### 4.2 Comparative Study

*Table 1: Location, building geometry, and material data*

Field	Description
Case study location	<i>Yangon</i> (16° 51' 0" N , 96° 11' 0" E) , <i>Mandalay</i> (21° 58' 30" N, 96° 5' 0" E), <i>Myitkyina</i> (25° 23' 0" N , 97° 24' 0" E)
Geometry	5m length, 5m width and 3m height room with 2m roof height.
Raised floor	1m height above the ground
Opening	Window: 2m x 1.5 m; Gable vent: 300mm x 450mm; Ventilation block: 200mm x 225mm each.
U value (W/m <sup>2</sup> K)	Floor: F1 = 2.6988, F2 = 0.7347; Wall: W1 = 3.3200, W2 = 2.0831; Roof: R1 = 0.4386, R2 = 4.2628; Window Pane: O1 = 2.8345, O2 = 5.8771 Ceiling: C = 1.2323
Roof Surface	Absorptivity = 0.9, Emissivity = 0.9
Opening time	06:00 am to 18:00 pm for the window; Others are continuously opened.
Internal Gain (W/m <sup>2</sup> )	Two occupants with 75 W/m <sup>2</sup> maximum sensible gains and 55 W/m <sup>2</sup> latent gain. Regardless of the size, the fluorescent lighting with 15 W/m <sup>2</sup> maximum sensible gains from 18:00 pm to 06:00 am. Equipment load with 15 W/m <sup>2</sup> maximum sensible gains from 06:00am to 18:00pm.
Infiltration	1.6ach for timber house (1) to (9), 0.4ach for brick house (10) to (15).

# PLEA 2018 HONG KONG

Smart and Healthy within the 2-degree Limit

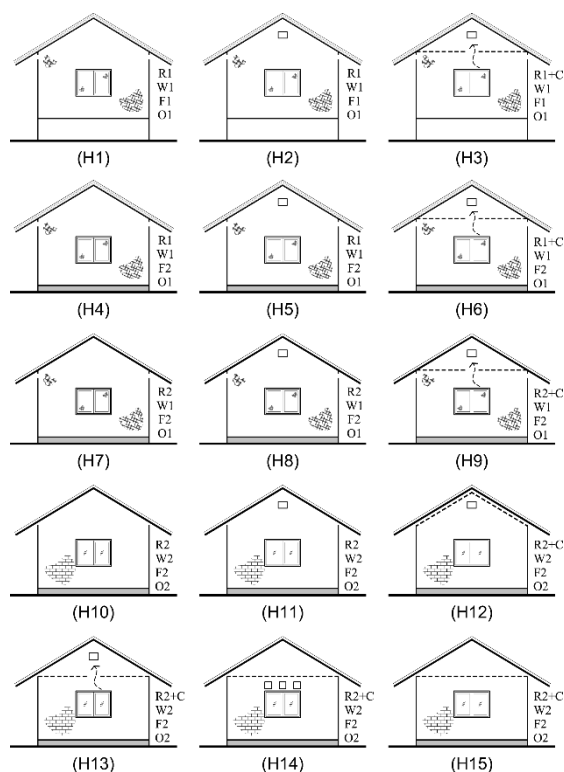

Figure 3: Model of ventilation scenarios in the study

Table 2: Ventilation scenarios in fifteen houses

House No.	House condition
H1 to H9	Included 25mm gap between the top of the wall and adjacent roof structure
H1, H4, H7, H10, H14, H15	Excluded gable vent
H3, H6, H9, H13	Included plywood ceiling and all-time opened void
H12	Included plywood ceiling below the roof
H14, H15	Considered sealed ceiling
H14	Included ventilation block

From the literature review of two vernacular housing, it was noted that ventilation practices in Myanmar housing were influenced by the relationship to the ground, the properties of materials, the introduction of a ceiling and ventilation blocks. Fifteen different models were generated for this study by varying ventilation scenarios shown in Figure 3. ApacheSim (IESVE) dynamic simulations were carried out to investigate the impacts of orientation, window-to-wall-ratio (WWR), infiltration rate, acceptable time to operate natural ventilation and efficiency of single-sided ventilation and cross ventilation. The results of three cities were compared for the typical weather condition and future climate change scenarios. In this study, the building materials adopted were timber and masonry. Material codes were represented as F1 for timber floors, F2 for concrete floors, W1 for timber walls, W2 for brick walls, R1 for thatch roofs, R2 for galvanized iron sheet roofs, O1 for

timber window pane, and O2 for glass window pane. The single-sided ventilation was tested from the southern direction. The cross-ventilation was tested from south and north direction, where the window area was increased as double. The gable vent was considered on the south-facing wall.

The total areas of ventilation block and the area of gable vent were treated as the same quantity. Four ventilation modes - daytime only, nighttime only, daytime with early night ventilation, daytime with early morning ventilation and full-day ventilation were tested. The fixed simulation data were presented in Table 1.

## 5. RESULTS AND DISCUSSION

The impacts of orientation, WWR and infiltration rate were firstly tested in the basic model H1 to understand the local climate contexts. There was a significant overheating hour reduction when the WWR% was increased from 5% to 30-35%, but gradually insignificant 30-35% onward. A similar study can be found in Ref [16]. Generally speaking, allowing the prevailing wind from the south, south-west and the north side is a priority to achieve much better thermal comfort. In contrast, the results showed insignificant differences in the eight principal winds. It could be because of the high diffuse radiation throughout the year and high infiltration rate. When the infiltration rate was increased from 0.3ach to 3.0ach, the overheating duration was decreased, but it was not as significant as increasing WWR%. The results from Figure 4 concluded that increasing fenestration size and allowing high infiltration could promote higher thermal comfort.

The results of single-sided and cross ventilation were compared in Figure 5. If H14 and H15 were compared, there was a slight overheating reduction although the ventilation block was added. Although the ceiling was added in H13 to prevent radiate heat gain, the possibility to remove the buoyant hot air was reduced. Therefore, the H13 was more overheated than H12. If the overheating above 33.5°C was considered, 41.36% of the percentile reference year in the single-sided ventilation and 33.69% in the cross-ventilation mode was found in *Mandalay's* H15, which means the cross-ventilation could reduce more overheating period. *Mandalay* housing was received longer overheating period than the others. Because of her dry summer and least humidity condition, *Mandalay* housing could reduce more overheating hours when the cross ventilation was added. Overheating hour reduction in *Yangon* was insignificant due to her high humidity condition throughout a year. *Myitkyina* receives the least overheating hours due to her lower exterior temperature compared to the other. Overheating hour reduction in *Myitkyina* was insignificant due to her given low wind speed.

The result of the AT and the MRT were compared for H3 and H15 in Figure 6. The AT in the H3 was found a

# PLEA 2018 HONG KONG

Smart and Healthy within the 2-degree Limit

similar pattern of the external air temperature although there was insulation effect from the thatch roof. The H15 received annually longer duration of overheating above 33.5°C but the intensity was lower than the H3, and the fluctuation was small. The impact of thermal mass from bricks in H15, and the capability to lose heat through the galvanized iron sheet roofs at night were a question.

The results of the window opening time were presented for the single-sided ventilated models in Figure 7. The results showed that the full-day opened ventilation could reduce more overheating hours. The efficient time to cool down the structure was the early night time. The early morning time was not a good option for the brick housing because the hot trapped air had extended the overheating period. The night-time cooling alone was technically not efficient because the hot air has been trapped in the building for the whole day.

The comparison of the overheating hours above 33.5°C was presented for typical weather year and three future climate scenarios in Figure 9. The single-sided ventilation types were considered. The 2.7°C DBT increased annually case was the worst case. A similar result was found in the 1.3°C DBT increased annually case and 2.9°C DBT increased in summer case. In the H15 of *Mandalay*, 67% of a year was above 33.5°C in the 2.7°C annually increased case, 46.78% of a year was above 33.5°C in the 2.9°C increased in summertime case, but there was only 41.36% in the typical weather year. In the same model, the peak summer temperature was 45.89°C in the typical weather year, but it was 48.95°C in the 2.9°C increased in summertime case.

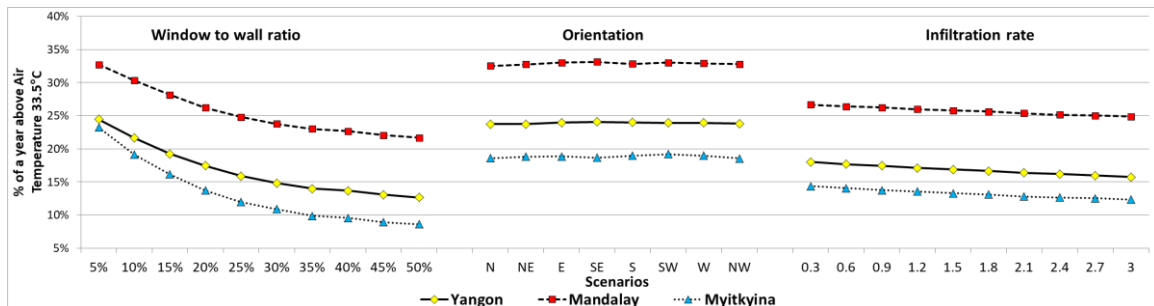

Figure 4: Comparison of overheating hours above 33.5°C for 5% to 50% WWR in the model (1), single-sided ventilated

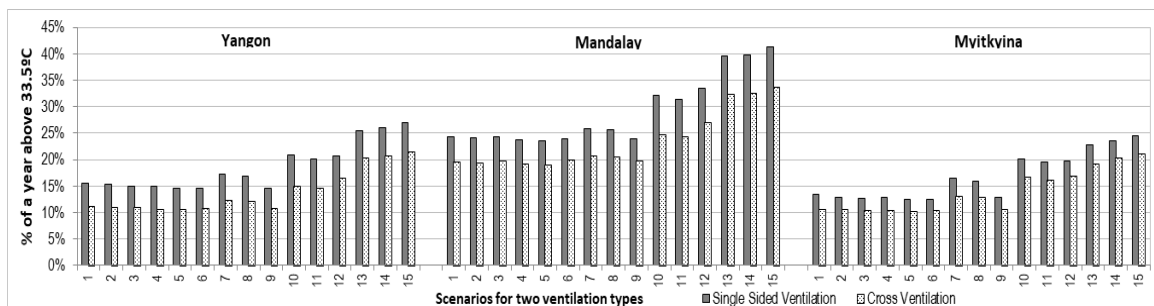

Figure 5: Comparison of overheating hours above 33.5°C for single-sided and cross-ventilation for a typical year

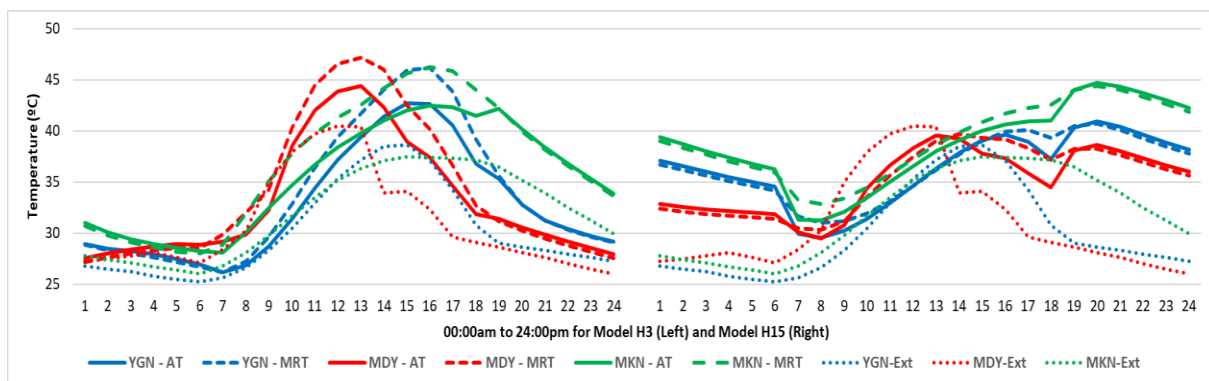

Figure 6: Comparison of AT and MRT in different cities for the hottest day, Single-sided ventilation

# PLEA 2018 HONG KONG

Smart and Healthy within the 2-degree Limit

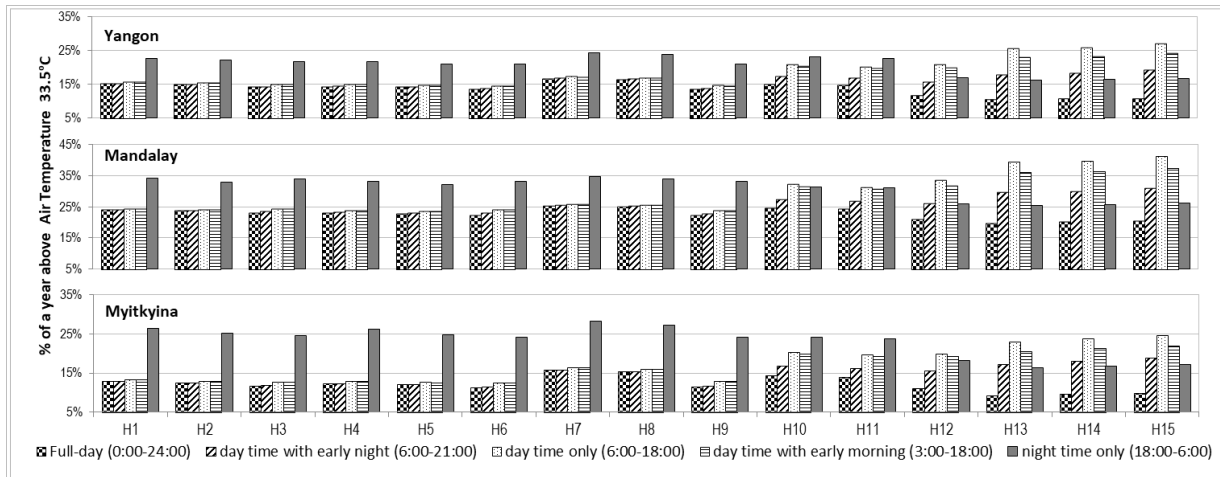

Figure 7: Comparison of overheating hours above 33.5°C for five window opening modes, Single-sided ventilation

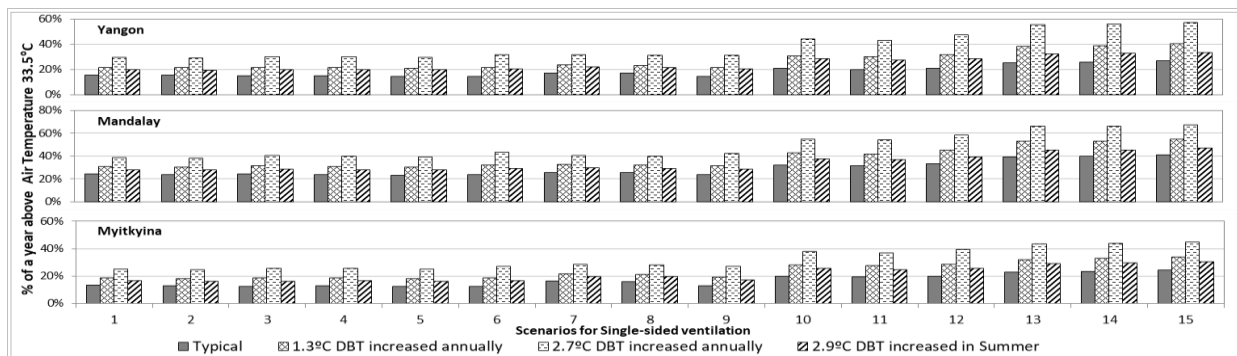

Figure 8: Comparison of the overheating hours above 33.5°C in the base case, 1.3°C dry bulb temperature annually increased case, 2.7°C dry bulb temperature annually increased case and, 2.9°C dry bulb temperature increased case in summer, Single-sided ventilation

## 6. CONCLUSION

The study presented here explored two Myanmar housing types in the countries' three climate zones, and fifteen different ventilation regimes aiming to provide comfort to the occupiers with no reliance on energy. The constraint of the research was its requirement of simplification in building geometry, and different building material uses for comparison. The challenge of the study was the accuracy of the typical year weather file and future weather files, and the threshold of the comparison. Therefore, the results of Figure 8 were questionable due to the use of the manual consistent offset method in future weather files creation, which was merely a "shift" of a current hourly weather data parameter [15].

The simplified case study confirmed that 10% to 40% of a year was overheated above 33.5°C in the defined housing regardless of the location differences in the typical weather condition [Figure 5]. The results confirmed that the current ventilation practices are not able to provide the required thermal comfort both for the typical weather year and the future climate change. The optimum fenestration could be approximately 30% of WWR. The full-day ventilation or extending the early-

night time ventilation was an option to reduce the overheating. The use of gable vent and gable roof was very significant to remove the hot air inside. The purpose of the ceiling could help to reduce the MRT but was a barrier to eliminate the buoyancy hot air. The overheating hours in the brick housing were increased due to their loss in the buoyancy-driven ventilation strategy. Even though the ventilation blocks were alternatively introduced to improve the air change rate, it was not as efficient as the vernacular buoyancy practices. In sum, it can be concluded that there is an urgent need to improve the thermal performance of the housing for future climate change scenarios in all climate zones of Myanmar due to the upcoming overheating risks and climate change.

The study presented the comparison of the typical weather year and predicted future weather years. The 'resilience' is about the understanding change and approach two actions: adaptability and transformability [17]. It is difficult to report which parameter was more sensitive for both actions because of building material differences and construction differences in this study. Moreover, the human factor was not considered in the study. Etymologically, 'resilience' comes from the Latin



# PLEA 2018 HONG KONG

*Smart and Healthy within the 2-degree Limit*

'*resilio*,' which means to 'jump back' [17]. It was difficult to set the stable reference point to jump back because of reliance on the unpredictable natural ventilation approach. One typical result was that the nocturnal ventilation could provide returning to the lower internal room temperature each day. In order to return to the lower AT was depended on the performance of the building envelope and the weather condition. It was thus questioned the use of thermal mass through the brick wall and the night cooling through the GI roof. It calls further studies to search the potential passive cooling approach especially for the northern Myanmar where the thermal mass is more appropriated.

The first step can be a general investigation of each characteristic of vernacular architecture in Myanmar such as envelop construction, roof material, ceiling structure, room structure, building shape, building story, infiltration, relationship to the ground, and shading [18]. The second step can be detailed researches for the adjustment of ventilation variables for better air exchange to remove internal hot air, the use of shading and exterior surface finish to avoid the direct solar heat gain and optimizing U-value and thermal mass. If a micro-climate of a building is ignored, even within the same humid regions, the climate responsive design for the hot and humid region will be slightly different to the warm and humid region. It is, therefore, necessary to understand the future climate variables and its impacts on the passive design strategies for different climate contexts of Myanmar. This paper is the first part of a much larger study project that intends to support the possibility to improve the thermal performance of the housing for the specific country.

## REFERENCE

1. Ministry of Labour (Immigration and Population), The 2014 Myanmar Population and Housing Census, The Union Report. (2015), Naypyidaw. p. 32.
2. Myint-U, T., et al., Yangon Heritage Strategy: Combining Conservation and Development to Create Asia's Most Liveable City. (2016), Yangon.
3. Kreft, S., et al., Global Climate Risk Index 2016. Who Suffers Most From Extreme Weather Events? Weather-related Loss Events in 2014 and 1995 to 2014., ed. G.K. Joanne Chapman-Rose, Daniela Baum. (2015), Bonn, Germany: Germanwatch e.V.
4. Rubel, F. and Kottek, M. Observed and projected climate shifts 1901-2100 depicted by world maps of the Köppen-Geiger climate classification. 2010 [7 August 2017], <http://dx.doi.org/10.1127/0941-2948/2010/0430>.
5. IPCC, Climate Change 2007: Impacts, Adaptation and Vulnerability. Contribution of Working Group II to the Fourth Assessment Report of the Intergovernmental Panel on Climate Change. (2007), New York: C.U. Press. p. 976, Figure TS.2.
6. White Box Technologies (2017), Weather Data for Energy Calculations, ASHRAE, Available from: <http://weather.whiteboxtechnologies.com/home>
7. Zune, M. (2017). Koppen-Geiger climate shift: 1901-2100 for Myanmar. Based on the Google Earth KMZ files provided by Koppen-Geiger Web Sources: <http://koeppen-geiger.vu-wien.ac.at/shifts.htm>
8. Zune, M. (2017). Vernacular houses in Myanmar, categorised by national races. Photography courtesy of May Zune, Aung Kyaw Min and Khaing Pwint Phyu,
9. Zune, M. (2017). Image. Illustrated by May Zune,
10. Schatz, F., Casting Architecture: Ventilation Block. (2014), National University of Singapore.: Architecture, Art and Design.
11. Falconer, J., et al., Burmese Design & Architecture (Photography by Luca Invernizzi Tettoni). (2000), Singapore: Petiplud Editions (HK).
12. Fanger, P.O., Thermal Comfort: Analysis and Applications in Environmental Engineering. (1970), Copenhagen: Danish Technical Press.
13. deDear, R.J. and Brager, G.S., Developing an adaptive model of thermal comfort and preference. UC Berkeley: Center for the Built Environment. ASHRAE Transactions. 104(1): (1998) p. 145-167.
14. Horton, R., et al., Assessing the Climate Risks in Myanmar, A contribution to planning and decision-making in Myanmar. (2017). p. 77.
15. Jentsch, M.F., Bahaj, A.S., and James, P.A.B., Climate change future proofing of buildings - Generation and assessment of building simulation weather files. Energy and Buildings. 40(2148): (2008) p. 2168.
16. Prianto, E. and Depecker, P., Optimization of architectural design elements in tropical humid region with thermal comfort approach. Energy and Buildings. 35(2003): (2003) p. 273-280.
17. Garcia, E.J. and Vale, B., Unravelling Sustainability and Resilience in the Built Environment. (2017), Oxon, New York: Routledge.
18. Zhai, Z.J. and Previtali, J.M., Ancient vernacular architecture: characteristic categorization and energy performance evaluation. Energy and Buildings. 42(2010): (2010) p. 357-365.

## Cooling Urban Water Environments: Design Prototypes for Design Professionals

JOÃO CORTESÃO<sup>1</sup>, SANDA LENZHOLZER<sup>1</sup>, LISETTE KLOK<sup>2</sup>, COR JACOBS<sup>1</sup>, JEROEN KLUCK<sup>2</sup>

<sup>1</sup>Wageningen University and Research, Wageningen, The Netherlands

<sup>2</sup>University of Applied Sciences Amsterdam, Amsterdam, The Netherlands

**ABSTRACT:** This paper presents five design prototypes for cool urban water environments developed in the 'Really cooling water bodies in cities' (REALCOOL) project. The REALCOOL prototypes address an urgent need: urban water bodies, such as ponds or canals, are often assumed to cool down their surroundings during days with heat stress, whereas recent research shows that this is not always the case and that urban water bodies may actually have warming effects too. There are, however, indications that shading, vaporising water, and proper ventilation can keep water bodies and their surroundings cooler. Yet, it is necessary to explore how these strategies can be optimally combined and how the resulting design guidelines can be communicated to design professionals. The REALCOOL prototypes communicate the spatial layout and biometeorological effects of such combinations and assist design decisions dealing with urban water environments. The micrometeorological simulations with Envi-met showed that the prototypes led to local reductions on daytime PET from 1 °C to 7 °C, upon introducing shade. Water mist and fountains were also cooling solutions. The important role of ventilation was confirmed. The paper discusses and concludes about the use of the prototypes as tools for urban design practice.

**KEYWORDS:** Urban Heat, Water bodies, Thermal sensation, Prototype, Research Through Design

### 1. INTRODUCTION

Urban water bodies such as ponds or canals are commonly believed to solve urban heat problems and improve human outdoor thermal sensation. This assertion is often based on the claim that urban water bodies necessarily have a cooling effect [1-3]. Recent research shows that the cooling effect of most common urban water bodies during warm summer periods is quite limited over day, in particular when perceived temperature is considered [4], and often induces a night-time warming effect [5-7].

Nevertheless, there are indications that under specific circumstances water can have a cooling effect during summer [7-9]. Shading, vaporising water (e.g. spraying), and proper natural ventilation might help to keep urban water bodies and their surroundings cooler [10-12]. Yet, it is necessary to explore how to combine these strategies in urban design and communicate the resulting design guidelines to design professionals.

The "Really cooling water bodies in cities" (REALCOOL) research project explores the most effective combinations of shading, water vaporisation and natural ventilation around urban water bodies, and makes them available to designers as design prototypes. The REALCOOL prototypes deal with keeping urban water environments as a whole — made up of water and other spatial features such as vegetation or ground cover — cooler during heat stress periods. The prototypes are animated 3D scenes depicting the layout and biometeorological effects of such combinations and work as evidence-based guidelines. The aim is to inform

design options targeted at improving outdoor human thermal sensation around urban water bodies.

This paper presents five of these prototypes. Light is shed on the micrometeorological processes and design principles behind the cooling effects of urban water environments.

### 2. METHODS

The REALCOOL team gathered experts in bioclimatic urban design, urban meteorology, water-atmosphere interaction, and 3D visualisations. The project followed a Research Through Designing (RTD) approach: an iterative process where the former iteration informs the latter [13]. In REALCOOL, quantitative and qualitative methods were combined and allocated in the different iterations. The REALCOOL RTD (Fig. 1) consisted of four iterations comprising designing and testing stages.

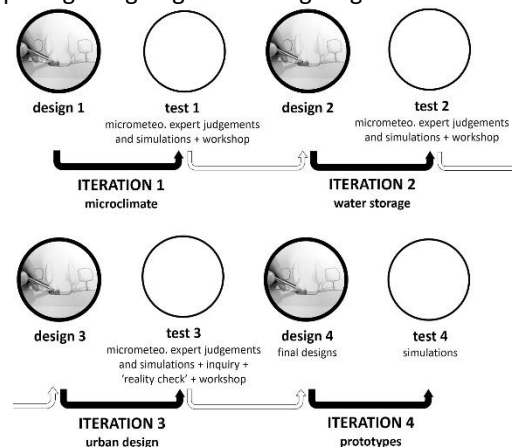

Figure 1: the REALCOOL RTD process.

# PLEA 2018 HONG KONG

*Smart and Healthy within the 2-degree Limit*

Designing involved experimenting with different combinations of shading, vaporisation and ventilation strategies around water. The overarching design aims were to reduce the thermal load placed upon people by increasing shading, cooling the air through water vaporisation and stimulating natural ventilation.

The design experiments (hereafter referred to as 'prototypes') were developed over 3D spatial reference situations — representative Dutch urban water bodies — that work as 'testbeds'. Working with these testbeds made the prototypes replicable. The testbeds were identified across nine cities on clay and peat soils (where most surface waters can be found) and with clear urban heat island effects. Eight types of water bodies were identified in four categories: canal, wide canal, ditch and pond. This number was doubled as to include east-west (EW) and north-south (NS) orientations. These resulting sixteen water body types were set as the REALCOOL testbeds.

Sketches, 2D drawings, 3D visualisations and physical models were used for producing the prototypes. A design matrix rated the efficiency of each design option in fulfilling the goal of the research. All design options addressed a typical Dutch heatwave day, with a maximum temperature higher than 30 °C. The chosen date was the 23<sup>rd</sup> of June, just after the summer solstice, thus, near the annual maximum of solar elevation. Wind direction was taken to be East as this is the predominant wind direction during heatwave days in the Netherlands.

Testing included expert judgments and micrometeorological simulations on the cooling effects of the prototypes, and their assessment by external practitioners on parameters commonly encountered in practice.

The expert judgements involved a close dialogue between urban designers and meteorologists on the most influential biometeorological issues of the prototypes. The prototypes were revised accordingly and the resulting biometeorological effects quantified through simulations in Envi-met software. The Envi-met Winter1617 (V4.1.3) release was applied as it enables simulation of turbulent mixing and transport in the water column and allows adjusting the light absorption characteristics of water. The main evaluation criteria for the simulations was the Physiological Equivalent Temperature Index (PET). The simulations were performed for 3.00 p.m. (when the maximum air temperature is reached) and 5 a.m. (when the minimum air temperature occurs).

The external assessment of the prototypes was made by representatives from consultancies, a health institute, municipalities and design offices during design workshops at the end of each iteration. Aesthetical appeal, functionality, costs, maintenance requirements and public health effects were the assessment criteria.

The results derived in design principles for refining the prototypes.

As shown in Figure 1, in iteration 1 designing dealt with exploring the maximum cooling potential possible. Testing involved expert judgements and Envi-met simulations. The bioclimatic design principles for the subsequent iterations were set and discussed during the design workshop.

In iteration 2, designing dealt with refining the cooling effects from iteration 1 and adding increase of rainwater storage as a design criterion. Testing quantified the resulting cooling effects (Envi-met simulations) and water storage increase (expert judgements), and finished with the design workshop.

In iteration 3, designing combined cooling effects and water storage with urban design criteria. Psychological cooling (enabling people to get closer to water) was added as a design criterion. Testing involved Envi-met simulations, expert judgements and design workshop. An online visual inquiry (to assess how attractive the general public would find hypothetical environments resulting from the prototypes) and a 'reality check' (to test the applicability of the prototypes to practice by applying them in real projects) were additionally used.

Iteration 4 dealt with setting the final prototypes and developing their 3D animated scenes, i.e. the REALCOOL final output. Envi-met simulations were used to quantify the final cooling effects.

## 3. RESULTS AND DISCUSSION

### 3.1. RTD process

The Envi-met simulations for the testbeds suggest that the cooling effect of small urban waterbodies on air temperature is quite small and often negligible — about 0.5 °C or less in air temperature and 1 °C or less in PET at 1.5m above the water surface. In pedestrian areas (e.g. quays), cooling effects were even smaller. These findings are in line with previous studies reporting the limited cooling effect of water [4, 14]. However, the prototypes led to reductions on PET from 1 °C to 7 °C at 15.00h, at 1.5 m above the water surface, locally, upon introducing shade.

These results suggest that there is little that can be done through design to cool down water and, thereby, make it cool its surroundings. What urban design *can* do is to create urban water environments — an ensemble of water, greenery, paving materials, etc. — offering improved conditions for human thermal sensation during heat stress periods by combining shading, vaporisation and ventilation strategies around water. Hardly any PET reduction in the pedestrian areas was due to cooling effects from water itself. The computed PET reductions were mainly due to the shading of trees. Water fountains and sprays also had significant local cooling effects. Furthermore, the simulations confirmed the important

# PLEA 2018 HONG KONG

*Smart and Healthy within the 2-degree Limit*

role of ventilation: openness enhances cooling by wind during hot periods.

Trees are vital cooling elements but may also hamper ventilation and, thus, increase PET. During heat stress periods, air should be able to flow over the water body as unobstructed as possible as to reduce PET. Finding the right balance between shading, vaporisation and ventilation appeared to be a major design challenge. Often, slight spatial changes can result in significant PET differences. The synergetic balance between the three strategies requires a holistic view on the biometeorological effects of design options.

The results from the simulations suggest that vaporising water from sprays and fountains can be a cooling solution. Locally, the cooling can be, typically, 3-5 °C in PET, with a spatial extent depending on wind speed and direction. Water mists are more effective than fountains. These results are also consistent with earlier reports in the scientific literature [11, 15, 16].

The outcomes of the design workshops indicated positive aesthetical qualities and functionalities to the prototypes. The former relates mainly to the diversity and excitement brought by vegetation and the latter to increased recreational activities near/at the water. However, the prototypes were considered more costly and requiring more maintenance than the testbeds. The prototypes were revised for reducing costs while maximising cooling effects. Regarding public health, the prototypes were considered to increase the chances for physical exercise and social cohesion, and to foster human encounters. Finally, the psychological 'cooling' from being close to water was seen as a relevant strategy.

These results show that creating cool water environments does not conflict with common urban design criteria and may even enhance them. Designers should articulate biometeorological effects with these criteria according to assignment, context and their own design 'signature'.

The online visual inquiry counted on the responses of 1210 people. The statistical analysis showed that 12 environments (Fig. 2) were perceived as more attractive than current situations (testbeds) and 4 as attractive as current situations. Beauty, harmony, excitement and height-to-width ratio were the main reasons. The results indicated, however, the need for design refinements on excitement and chances for interacting with water.



Figure 2: Example of environments depicted in the inquiry.

Regarding the reality check, the Envi-met simulations and the assessment matrices suggest that, overall, the prototypes lead to site-specific cooling effects and are suitable to practice.

### 3.2. The REALCOOL prototypes

Identifying testbeds and, afterwards, undertaking multiple designing and testing stages resulted in the REALCOOL prototypes. From the sixteen prototypes, five representative examples of each water body type will now be briefly described, focusing on the relationship between design options and microclimate.

#### Canal

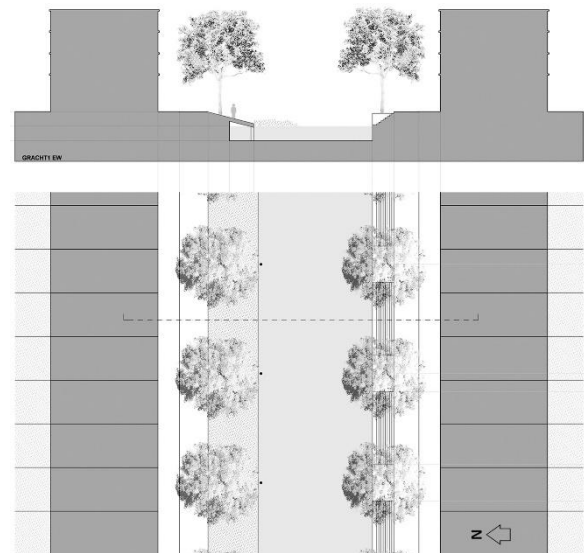

Figure 3: REALCOOL prototype CANAL1 EW.

CANAL1 EW (Fig. 3) is an averaged 40 m wide canyon with a central 20 m wide water body bordered by two symmetrical and high quays. The southern quay consists of steps towards the water whereas the northern is a grassed slope. This brings people closer to water and increases rainwater storage capacity by 275 m<sup>3</sup> (per 50 m).

# PLEA 2018 HONG KONG

Smart and Healthy within the 2-degree Limit

The 12 m wide tree crowns *shade* the intended sojourn locations, i.e. the areas near the water. On the southern quay, shade is provided throughout the day over the steps; on the northern quay, there is more exposure to sun since some people might prefer it.

Water *vaporisation* is provided as water mist along the northern edge and (well-kept and well-watered) grass provides evapotranspiration and a cool surface. This is aimed at offsetting the higher exposure to direct solar radiation by increasing evaporative cooling.

The shape and pace of trees (15 m) as well as the absence of further built obstacles allow wind to flow unobstructed along the canyon. *Ventilation* and nocturnal radiative cooling are, thus, enabled.

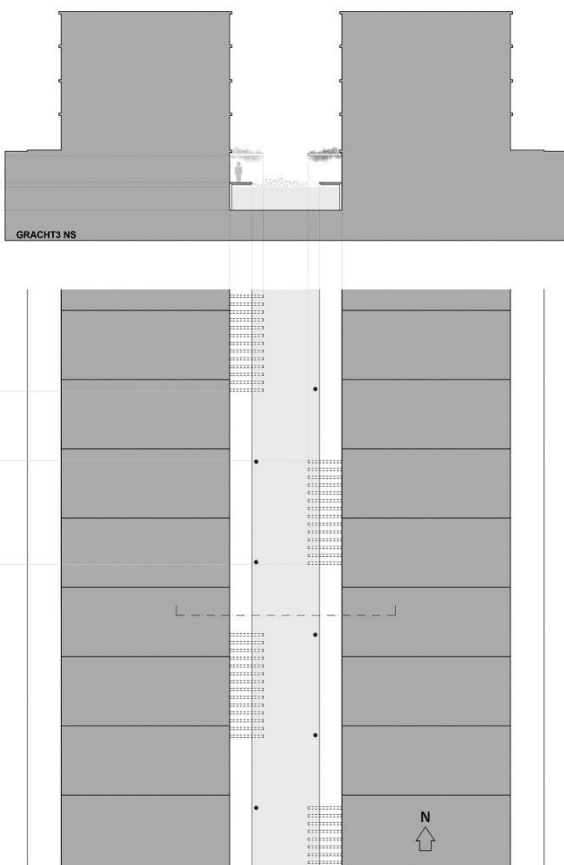

Figure 4: REALCOOL prototype CANAL3 NS.

CANAL3 NS (Fig. 4) is an averaged 10 m wide canyon where the water body is bordered directly by buildings. Pedestrian platforms (e.g. wooden deck) were installed on both sides to allow people to be closer to water. Rainwater storage was not a criterion suitable for this canal type due to its confined layout.

*Shade* is provided throughout the day by the buildings and, at heat peak hours, by green shading devices (e.g. pergolas) on both sides of the canal.

Water *vaporisation* is provided as water mist distributed on sunlit areas between the shading devices.

When made up of greenery, the shading devices also enable evapotranspiration.

Due to the high height-to-width ratio of the canyon, the design elements are not likely to have a large effect on wind flow. *Ventilation* is anyway allowed by interspersing the shading devices.

## Wide canal

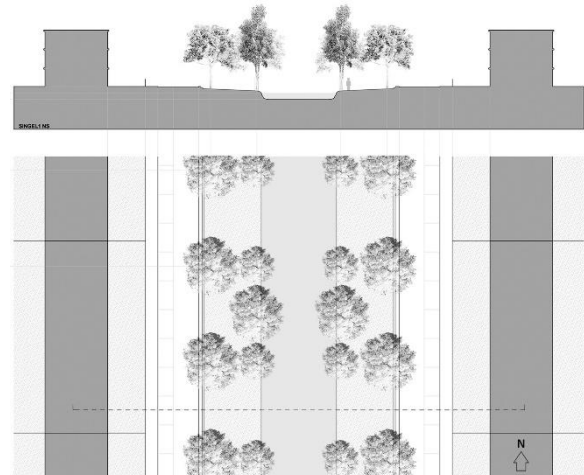

Figure 5: REALCOOL prototype WIDE CANAL1 NS.

WIDE CANAL1 NS (Fig. 5) is an averaged 62 m wide canyon with a central 12 m wide water body bordered by symmetrical, slightly sloped and easily accessible green areas. The green slopes along the water are lowered and, thereby, water storage capacity is increased by 250 m<sup>3</sup> (per 50 m).

The different crown shapes (8 m and 6 m wide) *shade* the sojourn locations throughout the day.

Water *vaporisation* was not included since from aesthetical and functionality viewpoints water features may not be desirable in this waterbody type.

*Ventilation* is enabled by the absence of further built obstacles and by the shape, pace (15 m) and distribution of trees. Smaller and larger trees are interspersed to avoid a continuous green cover. Moreover, trees are grouped to create wind flow channels.

Ditch

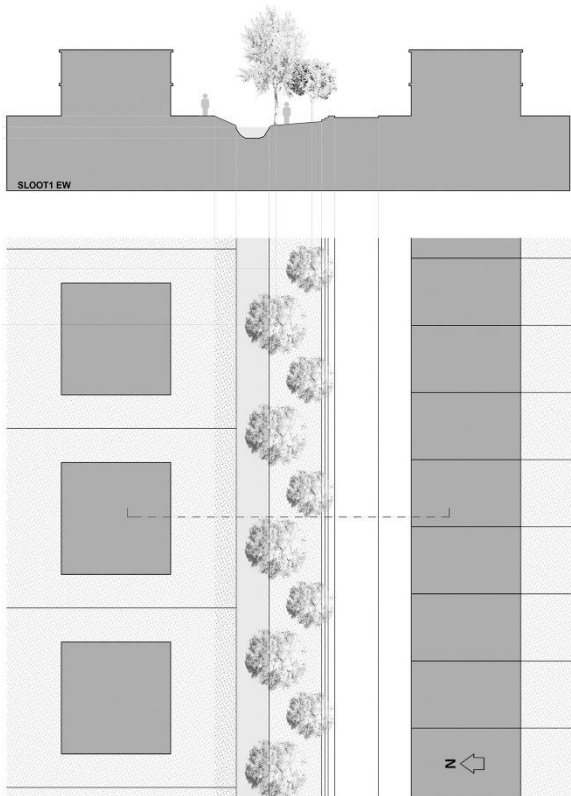

Figure 6: REALCOOL prototype DITCH1 EW.

DITCH1 EW (Fig. 6) is an averaged 22 m wide profile with a 3 m wide water body bordered, on one side by a sloped green area (public domain) and, on the other side, by private backyards (private domain). The green public area (southern side) has a formal character (alignment of trees and steps between the green area and the roads) and grants easy access to water. Together, green slopes and steps on the Southern side and slope on the Northern side increase water storage capacity by 350 m<sup>3</sup> (per 50 m).

The different crown shapes (5 m and 4 m wide) shade the sojourn locations on the southern side. Due to the low width of the water body, the northern side benefits from this shade.

Water vaporisation was not included for the same reason as for the two previous prototypes.

Ventilation is enabled by the absence of further built obstacles and by the shape and interspersed distribution of trees (spaced by 5 m) that allows wind to flow unobstructed along the canyon.

Pond

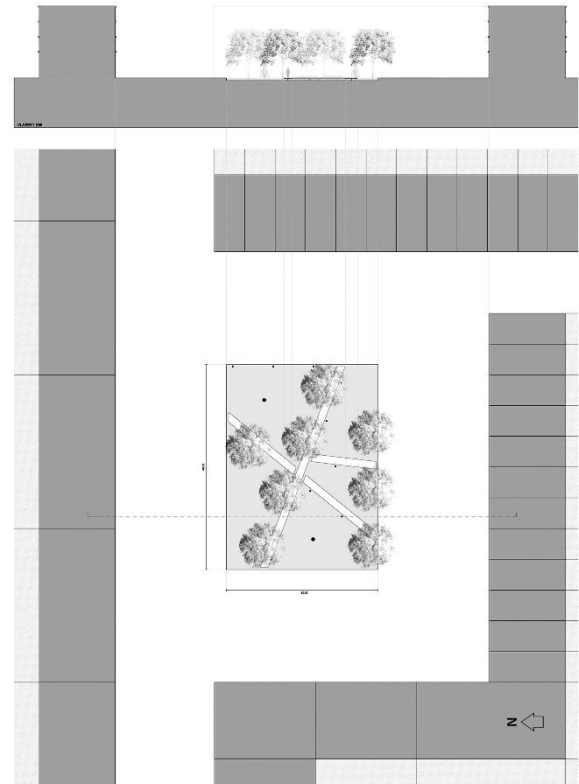

Figure 7: REALCOOL prototype POND EW.

POND EW (Fig. 7) is a shallow, averaged 30 m wide and 40 m long water body bordered by outdoor public spaces. Rainwater storage was not a criterion suitable for this water body due to its confined layout. The interaction people-water is enhanced by pedestrian platforms (e.g. wooden decks) following hypothetical desire lines (i.e. preferential crossing routes) over the water body.

Shade is casted over the sojourn locations by trees (8 m wide tree crowns) placed next to the platforms.

Water vaporisation is provided by water mist nozzles along the platforms and by fountains in sunlit areas. Additionally, trees provide evapotranspiration.

The spacing between trees and the absence of further built obstacles enable proper ventilation.

#### 4. CONCLUDING REMARKS

The REALCOOL prototypes can assist design professionals in creating urban water environments with improved thermal sensation during heat stress periods. Resulting from an RTD, the prototypes can help legitimising design decisions without the need to embark on further investigations on the topic.

Two remarks should be made about the micrometeorological data presented. Firstly, the assumptions on the cooling effects of water do not comprise large water bodies like rivers or lakes. Secondly, the prototypes are generic layouts and the results from

# PLEA 2018 HONG KONG

*Smart and Healthy within the 2-degree Limit*

the simulations indicate generic cooling effects that cannot be directly applied in specific situations — the magnitude and spatial pattern of cooling effects may be modified in specific situations (e.g. the ultimate cooling from the shading of trees depends on the exact location of the trees).

The prototypes work as ‘half-products’ between general design guidelines and site-specific solutions and should be regarded as conceptual frameworks rather than prescriptive tools. For example, the proper articulation of cooling principles with aesthetics, functionality, costs or maintenance can only be made for site-specific cases. It is up to designers to creatively translate the conveyed design principles into end-designs.

## ACKNOWLEDGEMENTS

This study is part of the research programme Research through Design with project number 14589, which is financed by the Netherlands Organisation for Scientific Research (NWO), the Taskforce for Applied Research SIA and the AMS Institute.

## REFERENCES

1. Rinner, C. and Hussain, M., (2011). Toronto’s urban heat island-exploring the relationship between land use and surface temperature. *Remote Sensing*, 3: pp. 1251-1265. DOI: 10.3390/rs3061251.
2. Kleerekoper, L., Van Esch, M. and Salcedo, T. B., (2012). How to make a city climate-proof, addressing the urban heat island effect. *Resources, Conservation and Recycling*, 64: pp. 30–38. DOI: 10.1016/j.resconrec.2011.06.004.
3. Oláh, A., (2012). The possibilities of decreasing the urban heat Island. *Applied Ecology and Environmental Research*, 10(2): pp. 173-183. ISSN: 1589 1623 (Print), ISSN: 1785 0037 (Online).
4. Broadbent, A., Coutts, A., Tapper, N., Demuzere, M. and J. Beringer, (2017). The microscale cooling effects of water sensitive urban design and irrigation in a suburban environment. *Theoretical and Applied Climatology*: pp. 1-23. DOI: 10.1007/s00704-017-2241-3.
5. Theeuwes, N., Solcerová, A. and Steeneveld, G., (2013). Modelling the influence of open water surfaces on the summertime temperature and thermal comfort in the city. *Journal of Geophysical Research Atmospheres*, 118(16): pp. 8881–8896. DOI: 10.1002/jgrd.50704.
6. Heusinkveld, B., Steeneveld, G., van Hove, L., Jacobs, C. and A. Holtslag, (2014). Spatial variability of the Rotterdam urban heat island as influenced by urban land use. *Journal of Geophysical Research: Atmospheres*, 119: pp. 677–692. DOI: 10.1002/2012JD019399.
7. van Hove, L., Jacobs, C., Heusinkveld, B., Elbers, J., van Driel, B. and Holtslag, A., (2015). Temporal and spatial variability of urban heat island and thermal comfort within the Rotterdam agglomeration. *Building and Environment*, 83: pp. 91-103. DOI: 10.1016/j.buildenv.2014.08.029.
8. Coutts, A., Tapper, N., Beringer, J., Loughnan, M. and M. Demuzere, (2013). Watering our cities: The capacity for Water Sensitive Urban Design to support urban cooling and improve human thermal comfort in the Australian context. *Progress in Physical Geography*, 37(1): pp. 2–28. DOI: 10.1177/0309133312461032.
9. Albers, R., Bosch, P., Blocken, B., van den Dobbelsteen, A., van Hove, B., Split, T., van de Ven, F., van Hooff, T. and V. Rovers, (2015). Overview of challenges and achievements in the climate adaptation of cities and in the Climate Proof Cities program. *Building and Environment*, 83: pp. 1-10. DOI: 10.1016/j.buildenv.2014.09.006.
10. Webb, B. and Y. Zhang, (1997). Spatial and seasonal variability in the components of the river heat budget. *Hydrological Processes*, 11(1): pp. 79–101. DOI: 10.1002/(SICI)1099-1085(199701)11:1<79::AID-HYP404>3.0.CO;2-N.
11. Nishimura, N., Nomura, T., Iyota, H. and S. Kimoto, (1998). Novel water facilities for creation of comfortable urban micrometeorology. *Solar Energy*, 64(4-6): pp. 197-207. DOI: 10.1016/S0038-092X(98)00116-9.
12. Yokohari, M., Brown, R., Kato, Y. and S. Yamamoto, (2011). The cooling effect of paddy fields on summertime air temperature in residential Tokyo, Japan. *Landscape and Urban Planning*, 53(1–4): pp. 17-27. DOI: 10.1016/S0169-2046(00)00123-7.
13. Nijhuis, S. and I. Bobbink, (2012). Design-related research in landscape architecture. *Journal of Design Research*, 10(4): pp. 239–257. DOI: 10.1504/JDR.2012.051172.
14. O’Malley, C., Poorang, P., Farr, E. and F. Pomponi, (2015). Urban Heat Island (UHI) mitigating strategies: A case-based comparative analysis. *Sustainable Cities and Society*, 19: pp. 222-235. DOI: 10.1016/j.scs.2015.05.009.
15. Gomez, F., Pérez Cueva, A., Valcuende, M. and A. Matzarakis, (2013). Research on ecological design to enhance comfort in open spaces of a city (Valencia, Spain). Utility of the physiological equivalent temperature (PET). *Ecological Engineering*, 57: pp. 27-39. DOI: 10.1016/j.ecoleng.2013.04.034.
16. Xue, F., Li, X., Ma, J. and Z. Zhang, (2015). Modelling the influence of fountain on urban microclimate. *Building Simulation*, 8(3): pp. 285-295. DOI: 10.1007/s12273-014-0210-7.

# Urban Climate Evaluation for an Architectural Design Competition: A Best Practice Framework

SEBASTIAN KUPSKI<sup>1</sup>, LUTZ KATZSCHNER<sup>2</sup>

<sup>1</sup>INKEK- Institute for climate and energy strategies, Lohfelden, Germany

<sup>2</sup>University of Kassel, Kassel, Germany

*ABSTRACT: During an architectural competition for a new neighbourhood in Frankfurt/Main, Germany microscale urban climate modelling was carried out to help decision makers to choose the best climate adapted design. Based on an climatic map of the city with ventilation modelling all designs were tested by the microscale model ENVI-met. They were evaluated through the thermal index PET which made it possible to judge ventilation and radiation processes. All results show a clear change in climate. The winning design significantly reduced the local heat load and created air paths for surrounding neighbourhoods.*

*KEYWORDS: urban climate, microclimate, architectural design*

## 1. INTRODUCTION

An increasing number of people worldwide lives in cities. To accommodate urban growth, it is necessary to intensify density in many inner cities. One of the consequences is that already existing urban heat islands (UHI) intensify. Climate change and the predicted increase of the air temperature add to the problem. This means that two of the most serious environmental issues of the 21<sup>st</sup> century, population growth and climate change, become evident in redensification projects[1]. This case study deals with designing climate-responsive as well as sustainable and energy efficient development. The aim is to combine high density and high quality.

In order to provide information for the planning institution and ultimately generate recommendations for urban planning and development under the conditions described above, the urban climate must be observed and evaluated to. To this end, many cities use urban climate maps [2]. They are generated using VDI standards. These describe how urban climate conditions can be cartographically presented, evaluated and used for planning with the help of reference maps.

One of the fastest growing cities as well as one of the big economic centers in Germany and Europe is Frankfurt/Main. The whole Rhine-Main area is characterized by high air temperature compared to other parts in Germany. Thus, the city has a long tradition of observing the local climate. This is illustrated by the detailed update of the urban climate map in 2016 [4] and a very interested urban population.

A new development area circling around the inner-city neighborhood is located in an important wind corridor. This means that a new high-density development in this area could lead to a high heat load for neighboring parts of the inner-city. It is therefore

vitaly important to ameliorate the negative effects to the whole city by using information about the urban climate and ventilation patterns. The new neighborhood is supposed to provide modern and urban residential and working areas with high ecological standards. In the urban and landscape design competition [3], proposals had to compare and evaluate the microclimate, depending on the mesoclimate knowledge at the same time. For this reason, professional support with regards to urban climate among other thematic fields like mobility, energy use, social integration etc. was needed (fig. 1).

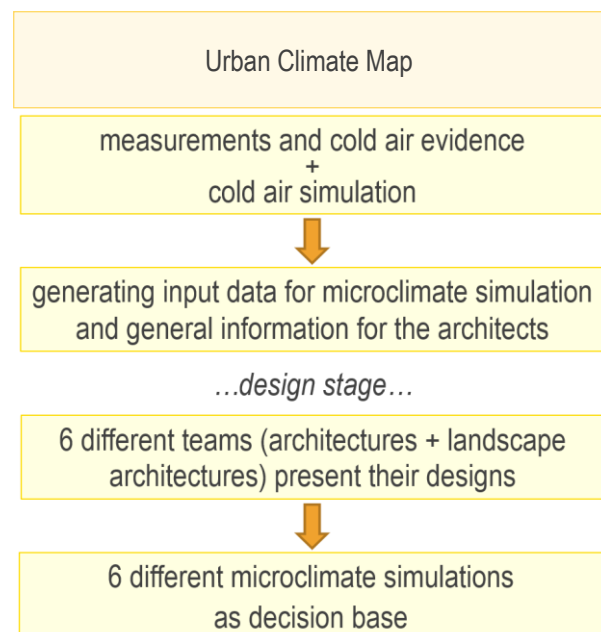

Figure 1: Flow chart of the described procedure.



# PLEA 2018 HONG KONG

Smart and Healthy within the 2-degree Limit

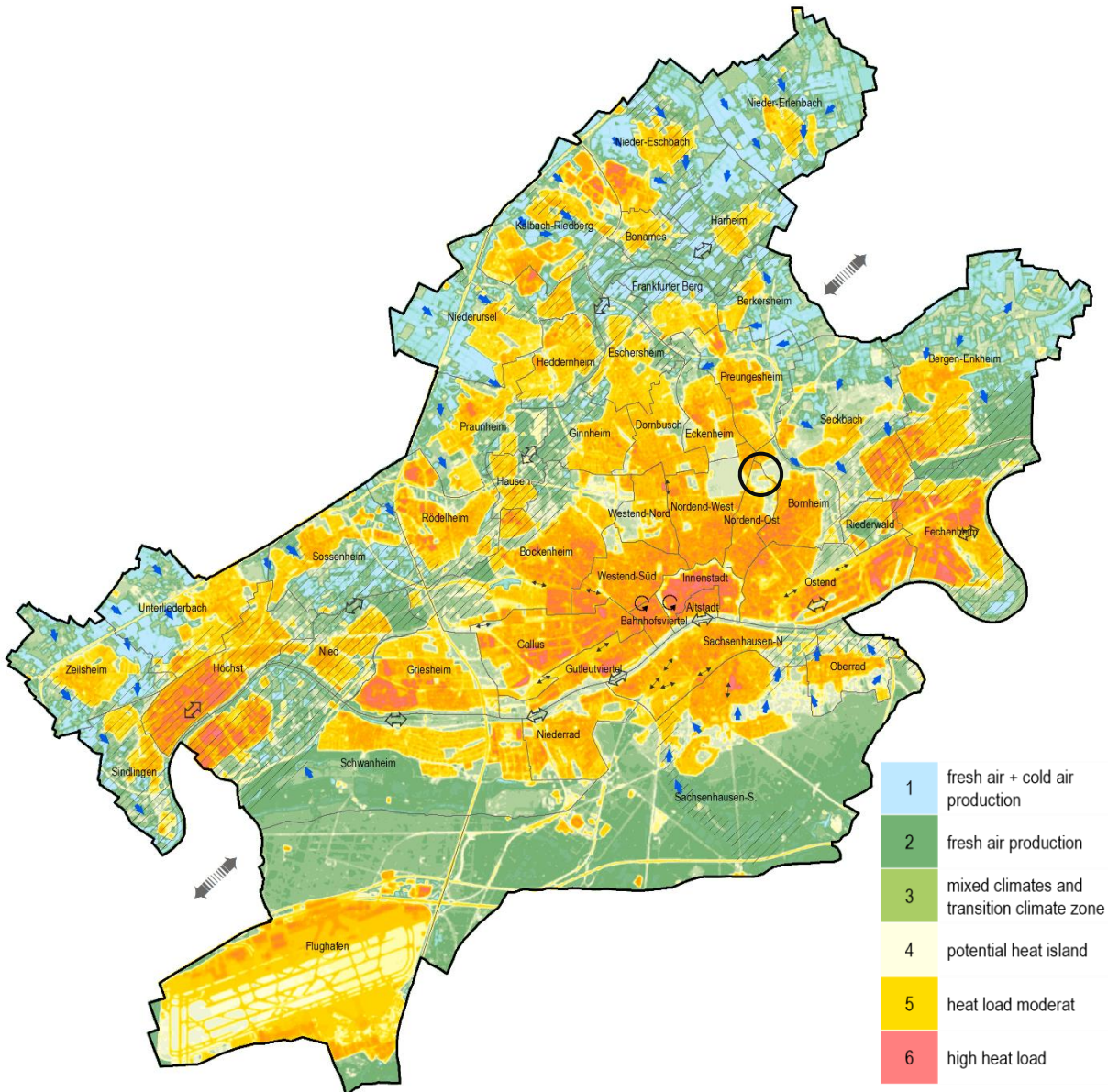

Figure 2: Urban climatic map of Frankfurt/Main, Germany [4] with legend and borders of the development area (black line).

## 2. METHODOLOGY

Based on the information retrieved from a mesoscale urban climate analysis (Urban Climate Map, UCM) (fig. 2), it was possible to deduce the conditions for a smaller area of the city.

Figure 2 shows the planned settlement area. Darker orange to red areas have high heat load conditions with weak ventilation. The area is affected by cold air flow from nearby mountains and can be characterized as a cold air production zone. The urban climate map indicates the thermal conditions using the thermal comfort index PET. This now has to be separated to see the effect of ventilation.

The aim in the case of Frankfurt was to create a new inner-city settlement in a climate sensitive way and to make sure climatic conditions in other parts of the city

characterized by higher heat load problems would not deteriorate .

After identifying the urban climate functions and interactions a cold air evaluation was carried out to obtain a more detailed information of the fragmented and sensitive cold air situation. The simulation model KLAM\_21 was applied to calculate cold air flows in an orographically structured terrain. This is used in urban and regional planning and facility siting. Quantitative statements on the cold air height and the volume flow in two meters above ground in a high spatial resolution were generated (fig. 3). At the same time, detailed climatic measurements and a cold air evidence (tracer gas method, pictures in figure 3) were carried out in two different spots so that the local picture could be described quite clearly.

# PLEA 2018 HONG KONG

Smart and Healthy within the 2-degree Limit

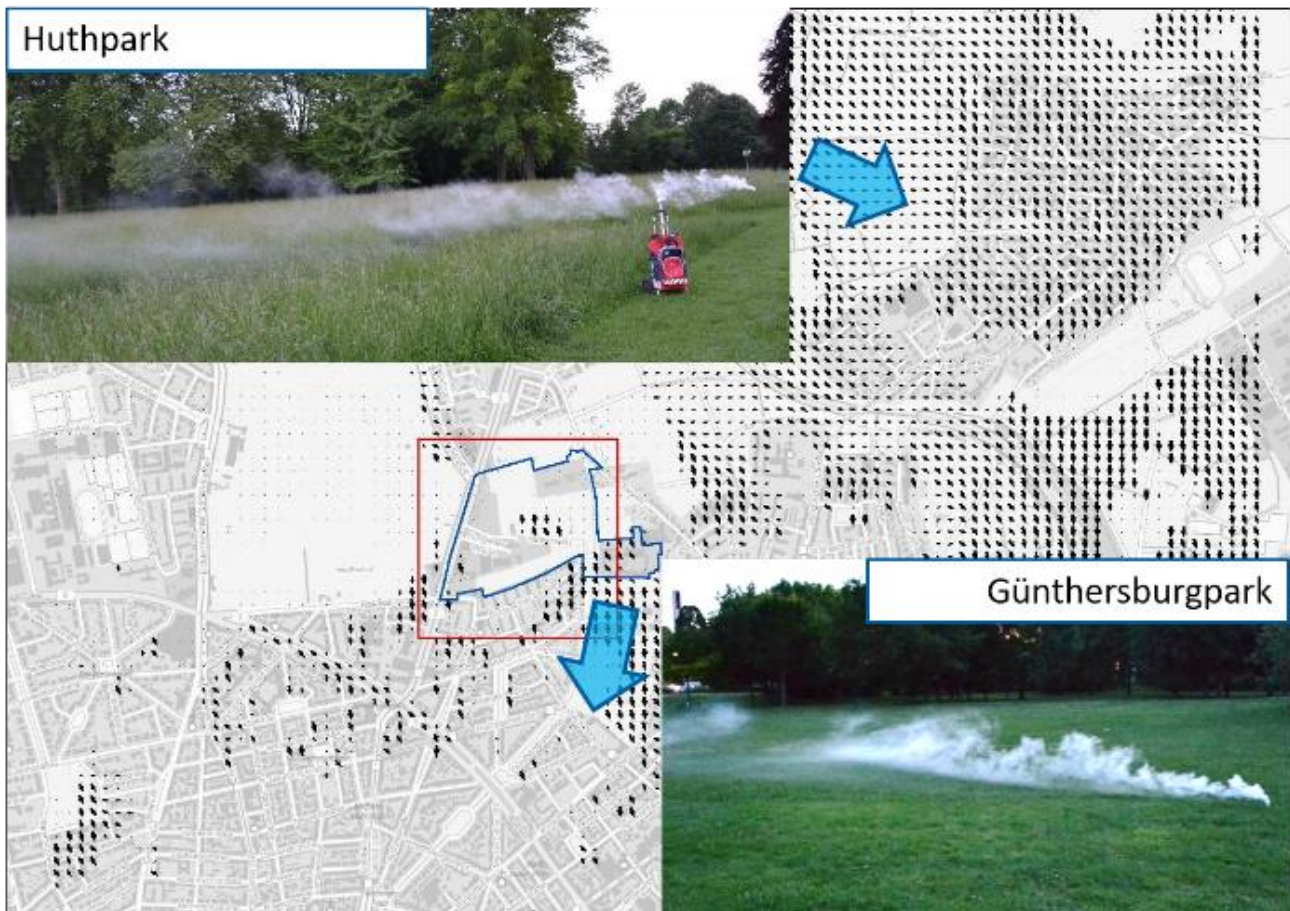

Figure 3: Cold air calculation, combined with near surface measurements and cold air evidence by smoke experiment.

Figure 3 shows the calculations with the KLAM\_21 model and the results of the measurements to ensure these results in the investigation area. The small black vectors show the cold air drain direction in a spatial solution of 40 meters as well as the velocity in three different categories. The large blue arrows represent the direction of the smoke experiment to visualize the atmospheric processes and to validate the calculation at the same time.

The case study was carried out with electronic sensors (Vaisala Weather Transmitter WXT530) and smoke pipes to visualize the nocturnal cold air drainage near the investigation area.

After collecting all these pieces of information, a short overview of the most important climatic processes was created and handed over to the planners in order to provide the knowledge needed to prepare the drafts.

The design stage went underway next. At the end, six drafts of the new settlement were selected and rated. With regards to the climate criteria, a comparable and transparent calculation of the microclimate was undertaken.

Based on that, an urban climate consideration was carried out with architects and climatologists. Some changes were made and the reviewed design proposals then simulated.

For this task, each draft was calculated by using the three-dimensional microclimate model ENVI-met (pro-version). The neighbourhood right beside the new development area was part of the simulation.

There was a reduction to two relevant parameters in order to not make the decisions more complicated than necessary. These two parameters were the PET (physiological equivalent temperature) value and the wind field two meters above ground. Focus was on avoiding weak ventilation and allowing wind to penetrate the city pattern. The jury can now easily use the climatic information to come to a decision and choose the winner of the competition (amongst others fig. 4).

### 3. RESULTS

The result at this stage was a decision, based on many different needs, but also influenced by an urban climate information to strengthen the climate sensitive development of the city. It is obvious that any changes in land use will change the microclimate. To develop a more satisfactory situation with regards to thermal comfort, it is necessary to manipulate especially the orientation of buildings, bearing in mind the wind direction and radiation balance.

# PLEA 2018 HONG KONG

*Smart and Healthy within the 2-degree Limit*

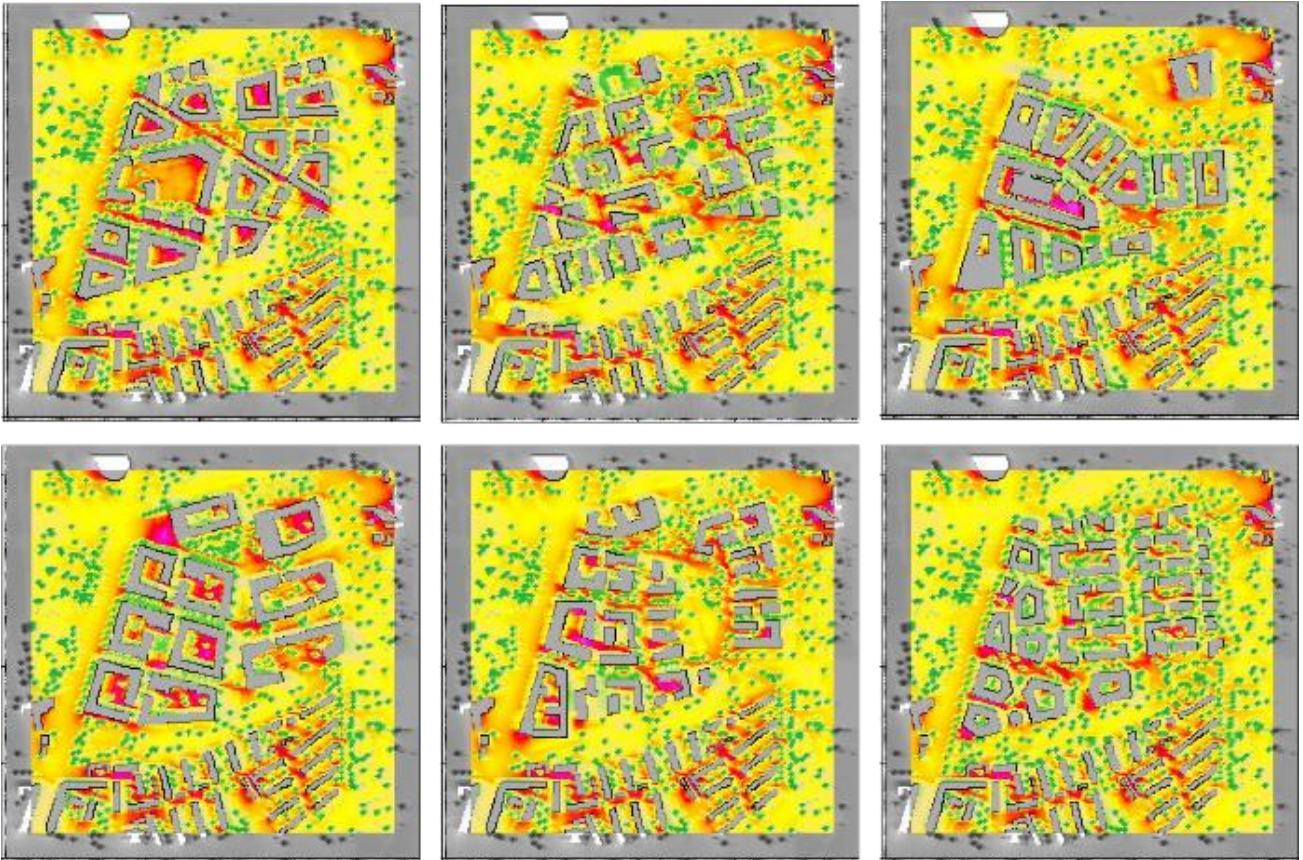

Figure 4: Finalized studies of the microclimate as decision base.

Each architectural team received an objective evaluation of their design based on the microclimate simulation results. Some had problems with heat load so that the recommendation was to improve the shadowing for example by planting more trees or to earmark another position. It was generally advised to stick to the albedo recommendations on colour sets or natural unsealed surfaces. A precise location of disadvantaged areas and situations with positive effects to the thermal comfort was prepared. In addition to that, the drafts should give an impression of the changes the new area will bring to the urban climate in the surrounding neighbourhoods. To answer this question, the wind field (wind speed and velocity in 2 meter height) was simulated. Looking to a heavy traffic road which tangent the development area in the west, e.g. the ventilation is able to reduce the emissions caused by the cars. In other areas the corridors to maintain the city ventilation were checked meticulously. Its mesoscale potential is high, we could therefore conclude that we have to prevent the air path from east to south west direction. This was then incorporated into most proposals. The winning project featured large green areas in the direct neighbourhood which could assist the local ventilation pathways and compensate some of the heat load. Another climate criterion was met by reducing the height of the buildings

and planting large trees in order to reduce the heat load in some of the court yards.

The next steps are already decided: The revised winning draft will be recalculated including the previously prepared climatic information to optimise the simulation base. This calculation can show in much more detail the effects of the new development and is as close to reality as possible.

## 4. CONCLUSION

If cities worldwide want to be well prepared for and resilient to climate change and its effects like the rise of air temperature, the increase of heavy precipitation events, the rise of the sea level etc. they need information in the form of the current analysis data to calculate their individual risk level today. After that each planning or land use change must be crosschecked to show the local effect so that an adaptation strategy to the future requirements can be developed. Planning needs to be aware of urban climate issues. Amelioration can only work if planning is based on a smart platform.

The procedure shows an effective way of proceeding in a process of densification. Urban climate information is needed beforehand, followed by the architecture design proposal, which is again cross-checked with microclimate modelling. This way, redensification in cities can be organized providing the highest possible

# PLEA 2018 HONG KONG

*Smart and Healthy within the 2-degree Limit*

thermal comfort. It is also in accordance with the current German guidelines (VDI 3787 Part 1 and 3787 Part 8 with the title: urban planning and climate change [5,6]).

This best practice framework should be part of each large inner-city development. The advantage is the objective and transparent approach. So it is very important to accompany the process with experts from the beginning. Many elementary requirements must be respected in the early process steps like main corridors and building structure. Other issues like local thermal hot-spots or wind discomfort can be solved later.

It is also very important to convince the planners, politicians and decision-makers as well as the population to support the process. They will be rewarded with a liveable city.

## **ACKNOWLEDGEMENTS**

We are thankful for the city of Frankfurt am Main to allow this project and to help on proceeding.

## **REFERENCES**

1. STEWART, D.; OKE, T. R. (2012) Local climate zones for urban temperature studies. American Meteorological Society. DOI:10.1175/BAMS-D-11-00019.1
2. NG, E.; REN, C. (2015) The urban climatic map: a methodology for sustainable urban planning. London, New York: Routledge.
3. Stadtbauplan Gmbh Darmstadt (2017) Auslobung eines Architektur Wettbewerbs, Innovationsquartier.
4. STADT FRANKFURT AM MAIN (2016) Klimaplanatlas Frankfurt am Main.
5. VDI (VEREIN DEUTSCHER INGENIEURE) (2015) VDI-Guideline 3787, Part 1: Environmental Meteorology - Climate and Air Pollution Maps for Cities and Regions. Berlin: VDI, Beuth Verlag.
6. VDI (VEREIN DEUTSCHER INGENIEURE) (2017). VDI-Guideline 3787, Part 8: Environmental Meteorology - Climate Change and Urban Development in press.

## Assessment of ThermODrain System on Thermal Comfort: Study of a Multi-Storied Office Building in Nashik, India

ROSHNI UDYAVAR YEHUDA<sup>1</sup>, DR. ARCHANA BHATNAGAR<sup>1</sup>

<sup>1</sup>Department of Resource Management, SNDT University, Juhu, Mumbai, India

**ABSTRACT:** A ThermODrain (TOD) is a system that uses water cooled by night sky to drain the radiant heat within a building. In office buildings, 'all air-cooled' systems are most prevalent. The study aimed to assess the thermal comfort of occupants in a ground and two storied naturally ventilated office building in the composite climate of Nashik in India where TOD system was installed. Assessment was conducted by taking hourly readings over a 25-hour period in peak summer of May 2017. Primary data collected included Dry Bulb Temperature (DBT) and Relative Humidity (RH) indoors, surface temperature of top and bottom of roof slab and Globe temperature within the office. Secondary data for the same period was obtained from the Indian Meteorological Department (IMD). Monthly electricity bills were used to measure the Energy Performance Index (EPI). The Tropical Summer Index (TSI), an index suggested in the National Building Code (NBC) 2016 of India, was calculated. Results show that the indoor operative temperature in the peak of summer with outdoor temperature of 36.30C was found to be close to the neutral temperature of 27.50C. The EPI of 26.5 kwh/m<sup>2</sup>/year falls within the BEE 5-star rating of below 40 kwh/m<sup>2</sup>/year.

**KEYWORDS:** ThermODrain (TOD) system, Thermal Comfort, Office Building, Tropical Summer Index (TSI), Energy Performance Index (EPI)

### 1. INTRODUCTION

A ThermODrain (TOD) system is not a common practice in modern office buildings where predominantly air-cooled systems prevail. Unlike radiant cooling systems with active coolants and pump, the ThermO-Drain system uses water cooled by night sky as a sink to drain radiant heat from the structure.

As per the data from the Indian Meteorological Department (IMD), the city of Nashik in Maharashtra located at an elevation of 700m above mean sea level, has a maximum Dry Bulb Temperature (DBT) of 37°C in April and May, while minimum temperatures can reach 10°C in January and February. Daily diurnal range of temperature is about 15°C. Average annual rainfall is about 705mm. Relative humidity fluctuates significantly in a single day.

The case study office building is a ground + 2 storied building with flat roof admeasuring 258.5 sq.m carpet area. The building is oriented north-south. Entrance is from the North while South wall is common to adjacent plot building. WWR (Wall Window Ratio) on North is 35%, East 20% and West 57%. Overall WWR is 30%. Windows are well shaded and have an overall equivalent SHGC of 0.66. Passive design strategies used in the building include appropriate orientation (South side is a common wall with neighboring building), use of double wall in the building envelope made of fly ash bricks and Gujarat brick cladding with air gap, use of turbo ventilators to facilitate stack ventilation and use of high albedo reflective paint with SRI>0.5 to reduce heat gain from horizontal surfaces. The plan and section of the building are shown in Figure 1a and b.

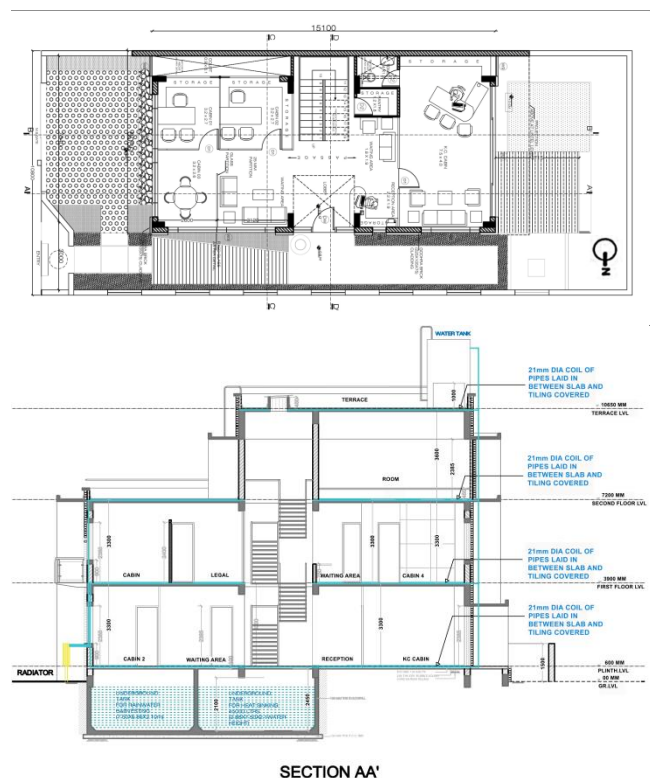

Figure 1: (a) Plan and (b) Section of the office building in Nashik

### 2. THERMO-DRAIN (TOD) SYSTEM

ThermODrain (TOD) system is a method based on the principal of removing heat from the floor and roof of the structure by laying a loop of plastic pipes between the

# PLEA 2018 HONG KONG

Smart and Healthy within the 2-degree Limit

slab screed and the tiling. Water from an underground water tank is circulated in the pipes that are cooled by a radiator that cools the water through night sky radiation. Figure 2a and b show the TOD system on terrace slab - during construction and post construction - the finished terrace slab.



Figure 2: Top (a) Laying out of the TOD system during construction and below (b) the finished terrace slab with the TOD system within

The TOD system installed at the office building in Nashik comprises of 21 mm diameter plastic pipes laid out in a grid at 0.3m center to center distance on the plinth of all floors. The system is designed to remove 242 Btu/ sq. ft. / hour (763 W/m<sup>2</sup>) of heat from the plinth mass of the structure. The thermal conductance of the pipe in the grid is 4.5 W/m<sup>2</sup>C. Thus heat removed by the pipe is 77 Btu/ Hr (22.56 W) for every 1 m of the pipe. The schematic layout of the system is shown in Figure 3.

The water picks up the roof heat (water absorbs 4100 joules per liter per Deg. C) and passes through a radiator which rejects most of it. Lukewarm water is stored in the tank and re-cycled through the radiator at night, when the cool night air absorbs the residual heat. The cycle starts again the next morning. Energy for the pump and the fan is supplied by solar PV system.

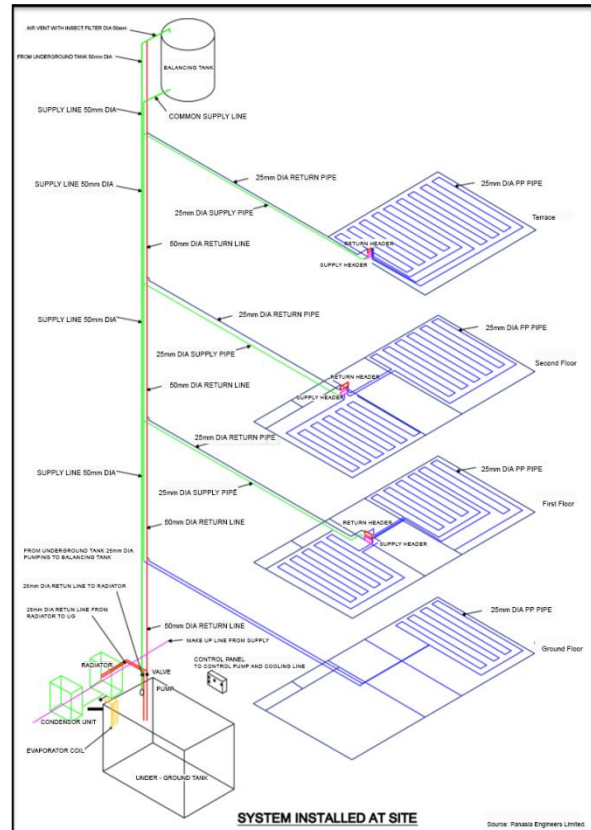

Figure 3: Schematic Layout of the ThermODrain (TOD) system used in the office building at Nashik, India

### 3. RATIONALE FOR TOD SYSTEM

Indoor Thermal comfort means that a body can effortlessly remove its metabolic heat from itself. Air conditioning uses chilled air in sufficient quantity to remove the heat and moisture gains from the space and maintain its temperature and humidity to specified values. It also provides treated outside air to maintain indoor air quality through ventilation. However, the assumption is that all solar gains, both direct and transmitted, are sensible loads to be absorbed by air and carried away before they reach the occupants.

This assumption is true in the Temperate zone. The houses are light-weight and insulated. They are designed to reduce the heating load during the cold winters by keeping the heat in. Summers are mild. So the cooling loads are low and so are the energy rates.

In India, we have hot summers and buildings are un-insulated. They absorb the solar heat and pass it inside. The interior surfaces get heated up and radiate heat. In a tropical country like India, the challenge is to keep the heat out. Instead conventional structures allow it to come in (through the structure) and then use an energy hungry technology of air conditioning to pump it out.

There is sufficient evidence today to show that un-insulated buildings in India have a typical thermal behavior pattern wherein they absorb solar radiation during the day and release it in the night [7]. Figure 4 indicates the typical pattern of temperature indoors and

# PLEA 2018 HONG KONG

Smart and Healthy within the 2-degree Limit

outdoors in naturally ventilated buildings. This affects the comfort level of occupants and the resulting energy usage to reduce the heat load.

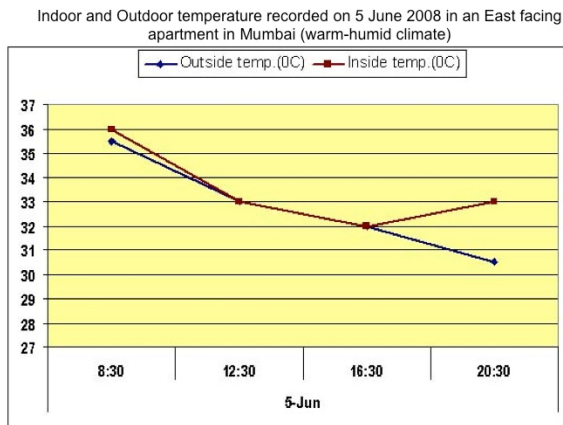

Fig. Xa: Indoor and outdoor DBT in a naturally ventilated residential building in June 2008 indicated higher indoor temperatures than outdoors

Figure 4: Indoor and outdoor DBT in a naturally ventilated residential building in Mumbai, June 2008 indicated equal or higher indoor temperatures than outdoors.

An ASHRAE study [1] conducted in 1938 shows that the ratio of radiant to evaporative cooling changes with the environment (Figure 5). At 90°F (32.2°C), about three quarters of the body heat is rejected as perspiration, which is easily absorbed by the low humidity in the room. The indoor building surface temperatures in summer are at or above the human skin temperature during the day. Under these conditions, a person sitting in still air will be sweating all the time. Since still air can carry very little convective heat, the person will be very uncomfortable. We can also conclude that if the structure is below the body temperature, it will absorb its heat. If it is above, then it transmits heat to the body through radiation.

The disadvantage in using air for cooling is that it has very low capacity for absorbing heat. One liter of air weighs one gram and can absorb only one Joule of heat per Kelvin. So to remove 150 watts (150 Joules/sec) would require  $150 \times 3600 = 540,000$  liters /hour of air per person. For 10 K rise, the required flow would be 54000 Lit/hour. This figure will increase due to low coefficient of convective transfer for air. While dry air does not need much energy to cool, the moisture in it condenses while chilling and releases its latent heat. Pumping this heat out through refrigeration requires tons of energy.

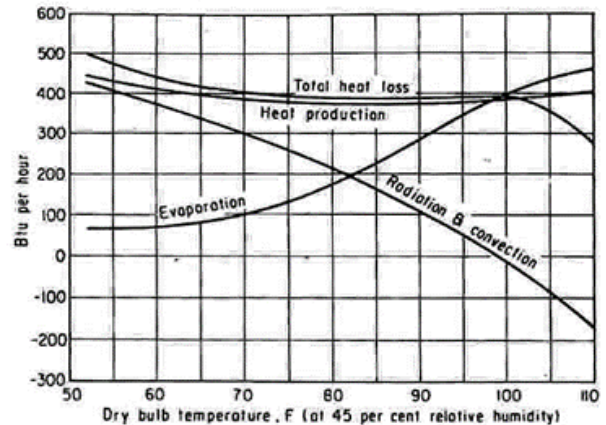

Figure 5: Body heat production and environmental heat exchanges for a healthy, young man seated at rest (Source: ASHRAE, 1938)

## 4. METHODS

The study used observation and instrumentation to record hourly data. Hourly surface temperature of top and bottom of the terrace slab with and without high albedo paint were measured using *Ambtronics T-800D* 8-channel calibrated data logger attached to K-type thermocouple sensors; Hourly indoor air temperature/dry bulb temperature (DBT) and relative humidity (RH) were measured using *EBRO BI 20TH1* temperature and humidity logger; Hourly radiant temperatures were manually recorded using *JRN 76mm black globe thermometer*. The measurements and observation were carried out over a period of 25 hours in May 2017 (peak summer). Hourly DBT and RH data for Nashik was obtained from the Indian Meteorological Department (IMD). Hourly Wet bulb temperatures were interpolated. Average wind speed for the two days was considered at 1.6m/s based on IMD data. Monthly electricity bills were obtained from the office to determine Energy Performance Index (EPI) and compared with prevailing benchmarks provided by the Bureau of Energy Efficiency.

## 5. THERMAL COMFORT STANDARDS

Since the office building under consideration is naturally ventilated day-time use building, the ASHRAE standard 55, 2013 and National Building Code (NBC) of India, 2016, were reviewed. The ASHRAE standard 55 defines thermal comfort as

That condition of mind which expresses satisfaction with the thermal environment and is assessed by subjective evaluation', while the National Building Code defines it as 'Thermal comfort is that condition of thermal environment under which a person can maintain a body heat balance at normal body temperature and without perceptible sweating'.

The 2013 version of ASHRAE standard 55 incorporates the model of 'Adaptive Thermal Comfort'

# PLEA 2018 HONG KONG

Smart and Healthy within the 2-degree Limit

especially in naturally ventilated spaces based on operative temperature range [2]. However, this standard is approved for a outdoor mean temperature range between 10°C and 30°C.

The National Building Code (NBC) 2016 India [3] refers to 3 thermal comfort indices that find applications for Indian climate viz. a) Effective temperature (ET), b) Tropical summer index (TSI), and c) Adaptive thermal comfort. Since Effective temperature or ET “appears to have an inherent error if used as an index of physiological strain, the error increasing with the severity of the environmental conditions” as per NBC, it was not considered. For IMAC standards, running mean outdoor temperature for 30 days is required. Hence Tropical Summer Index or TSI was used as a benchmark. Operative temperature was calculated using the formula below [4]:

$$\theta_c = \frac{\theta_{ai} \sqrt{10v} + \theta_r}{1 + \sqrt{10v}} \quad (1)$$

TSI is defined as the temperature of calm air at 50% relative humidity that imparts the same thermal sensations as the given environment. Mathematically, TSI (°C) is expressed as:

$$TSI = 0.745t_g + 0.308t_w - 2.06v(v+0.841) \quad (2)$$

Where  $t_w$  = wet bulb temperature, in °C;  
 $t_g$  = globe temperature, in °C;  
 and  $v$  = air speed, in m/s.

The thermal comfort of a person lies between TSI values of 25°C and 30°C with optimum condition at 27.5°C. As per the index, the warmth of the environment was found tolerable between 30°C and 34°C (TSI), and too hot above this limit. On the lower side, the coolness of the environment was found tolerable between 19°C and 25°C (TSI) and below 19°C (TSI), it was found too cold.

## 6. RESULTS AND DISCUSSION

### 6.1 Diurnal range of temperature

Outdoor diurnal range of Dry Bulb Temperature (DBT) was 14.7°C as compared to indoor DBT range of 3°C. Outdoor diurnal range of Relative Humidity (RH) was 71% in contrast to indoor RH range of 27.6%. The indoor RH is governed by the moisture content of the outside air that is drawn in by the toilet exhaust system. As dry outside air is drawn in by the ventilation system, it mixes with the room air, making it drier – reaching up to 30.4%. However, towards the evening, the outside RH increases resulting in increased room RH – up to 57% (Figure 6).

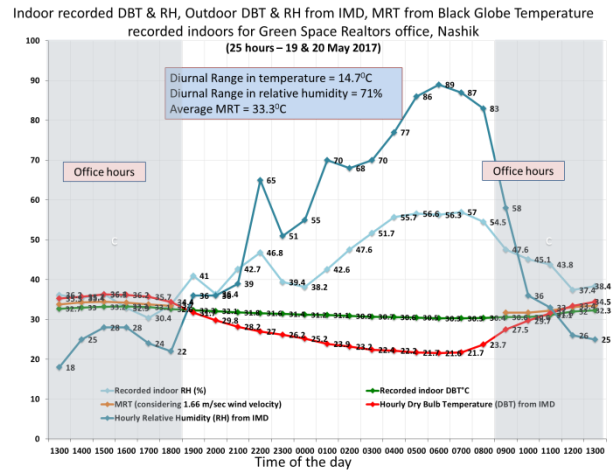

Figure 6: Diurnal range of temperature indoors is a mere 3°C as compared to diurnal range of temperature outdoors, which is nearly 15°C

### 6.2 Surface temperature of Terrace RCC slab

Surface Temperature of top of Terrace RCC slab with TOD system and high-albedo paint is found to be 3°C lower than the bottom of the slab for the 24-hour period. It is noted that slab bottom temperature is higher than slab top during day-time (office hours) by an average 1.3°C while slab bottom is lower than slab top by average 6°C during night-time (Figure 7).

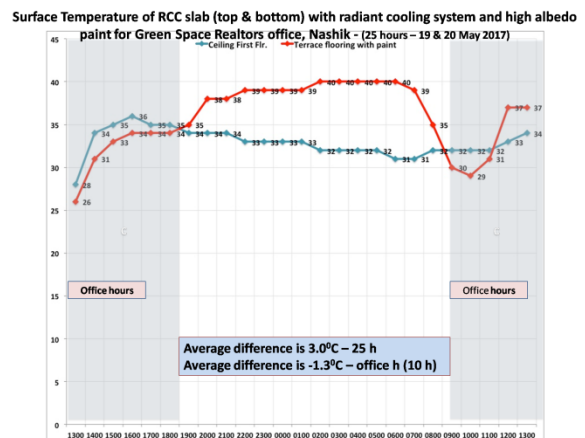

Figure 7: Comparison of top and bottom surface temperature of terrace slab with TOD system and high albedo paint

In the absence of high albedo paint, the slab bottom temperature is lower than slab top by an average 4.28°C during 24-hour period and an average 1.09°C during night-time.

Surface Temperature of top of Terrace RCC slab without high albedo paint is higher than the surface with paint by an average 1.280C throughout the day and an average and 2.10C during office hours (Figure 8).



# PLEA 2018 HONG KONG

## Smart and Healthy within the 2-degree Limit

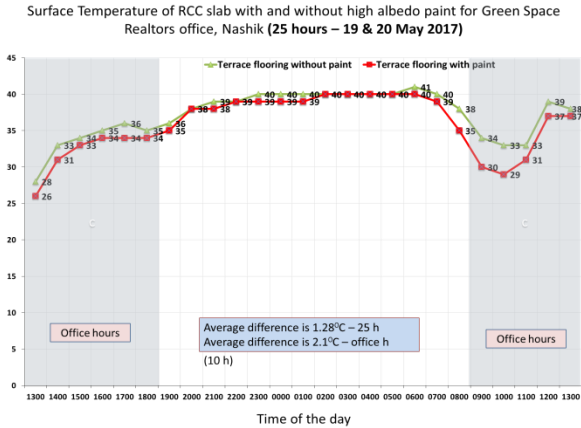

Figure 8: Surface temperature of Roof Slab without high albedo paint is higher than Roof slab with paint by an average 1.28°C

### 6.3 Tropical Summer Index

#### Comparison of indoor operative temperature with

**Tropical Summer Index:** Indoor operative temperature of Green Space Realtors in May 2017 at outdoor max.DBT of 36.3°C was found to be **27.4°C**, which is within the range of acceptable TSI values of 25°C and 30°C and close to optimum value of 27.5°C.

### 6.4 Energy Performance Index (EPI)

The EPI, an outcome-based metric for building energy performance, was calculated based on electricity bills obtained from the office administration from June 2016 to May 2017. The EPI for the office building in Nashik was calculated to be **26.5 kwh/m2/year**, which can be categorized under the BEE's voluntary 5-star benchmark for energy efficient buildings (less than 50% air-conditioned) for composite climate of <40 kwh/m2/year, and way below the national benchmark of 86 kwh/m2/year for commercial buildings in this climate zone [6]. Monthly electricity bills for the office building are shown in Figure 9.

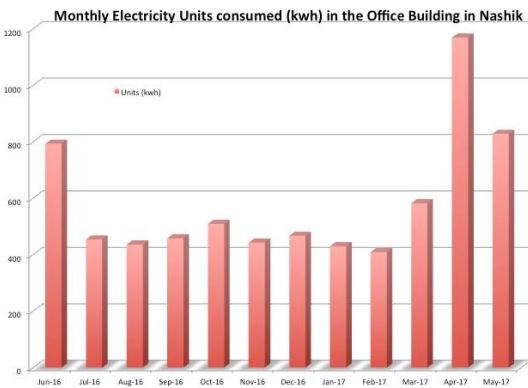

Figure 9: Average monthly electricity consumption in the office building in Nashik is 581.5 kwh

### 6.5 Envelope Thermal Transmittance

Thermal transmittance is a measure of the thermal effectiveness of the building envelope. It is an amalgamation of the thermal conductance of each material that is used in the building envelope. It is, however, calculated indirectly by finding out the thermal resistance of each layer including the air layer inside and outside. Cavity spaces or air gaps are also taken into consideration in the thermal transmittance calculations.

For the office building in Nashik, the U-value of roof and wall were calculated based on the cross section (Figure 10a and b) and available data on thermal conductivity from ECBC 2007 and CARBSE, Ahmedabad, India. The U-value of roof was calculated as 0.965 W/m<sup>2</sup>K and the U-value of wall was calculated as 1.85 W/m<sup>2</sup>K. Both of these do not meet the ECBC 2007 benchmarks of 0.409 and 0.44 W/m<sup>2</sup>K for roof and wall in composite climate.

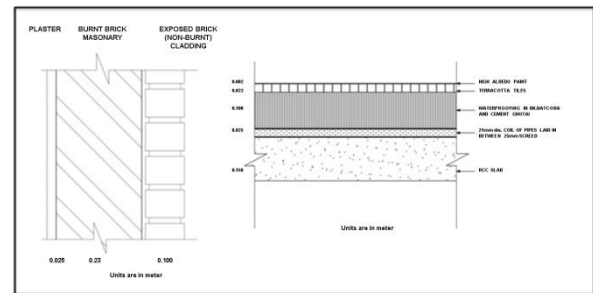

Figure 10: a. Cross section of Wall and b. Roof for calculation of Thermal Transmittance

### 7. CONCLUSIONS

The study shows that structural cooling system drastically reduced the diurnal range of temperature and relative humidity within the structure. With an average 4.28°C difference between slab top and bottom, the TOD system drains out radiant heat from the building that remains cools even when naturally ventilated. The indoor operative temperature in the peak of summer with outdoor temperature of 36.3°C, were found to be close to the neutral temperature of 27.5°C (Figure11) even though the thermal transmittance of roof and wall are much higher than prescribed national standards.

The system prevents the solar heat re-radiation from roof and floors by absorbing it before it adds to the sensible heat load and cause thermal discomfort to the occupants. Even in the hottest day of summer, the TOD system is able to maintain the floor temperature below human skin temperature, allowing a person to feel thermally comfortable sitting and walking on such floor with bare feet [5].

# PLEA 2018 HONG KONG

Smart and Healthy within the 2-degree Limit

Day-time Tropical Summer Index Values for Green Space Realtors office, Nashik  
(25 hours – 19 & 20 May 2017)

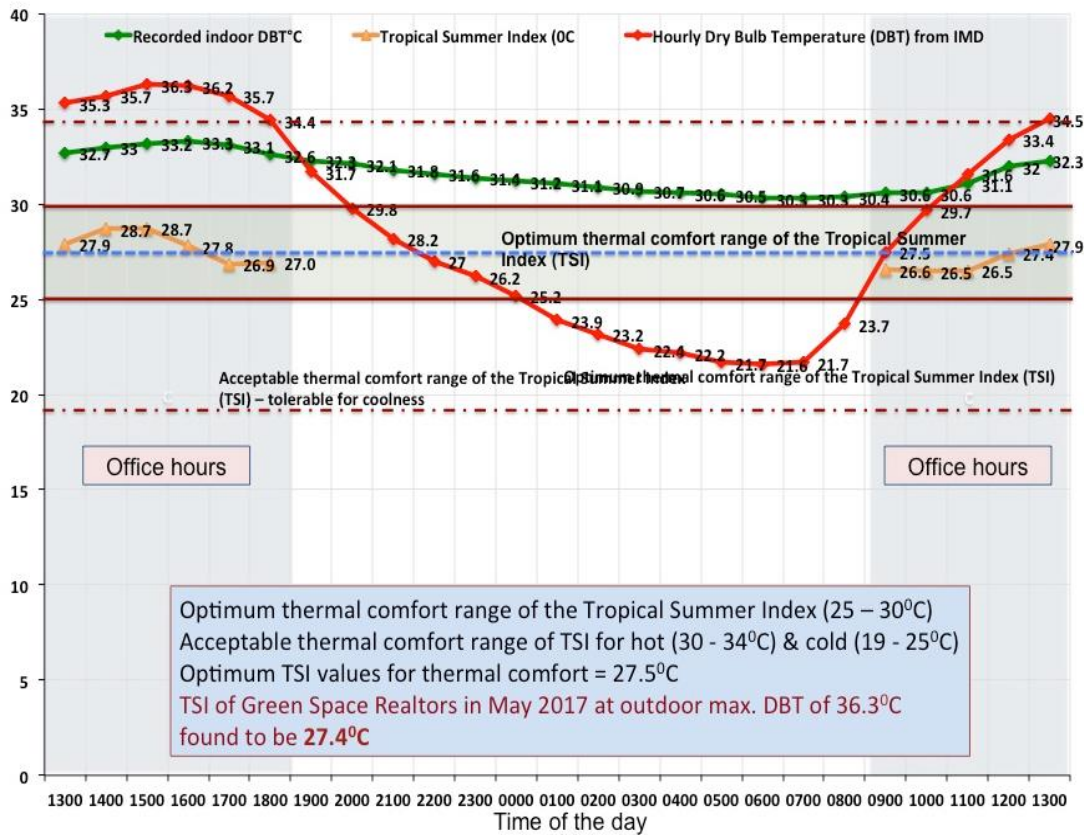

Figure 11: Indoor operative temperature within acceptable range of Tropical Summer Index (TSI)

In terms of capital cost, the structural cooling system is 50% less costly than a conventional HVAC system and the recurring energy cost is a mere 8.7% of a conventional system. The total life cycle costing (capital and running cost) of the TODsystem for a period of 10 years amounts to Rs. 6/ sq. ft./ year (US \$ 1 per sq. m) as compared to Rs. 30/sq. ft./year for a conventional HVAC system.

The system is passive except for 3 elements – Pump for the pipes grid, Fan for Radiator and Pump for Overhead Tank. The total energy consumption of these amount to 3000 kwh/ year as compared to 34,560 kwh/ year required for 12 Tr of conventional HVAC system (at 1.2kw/ Ton of refrigeration) required for the building. The difference in energy consumption is more than 10 times. The active components of the system are supplied energy primarily from solar PV panels.

### ACKNOWLEDGEMENTS

We gratefully acknowledge the cooperation extended to us by the owner of the Greenspace Realtors, Nashik, Mr. Kiran Chavan, Architect Sanjay Patil and structural cooling expert, Mr. Surendra Shah. We acknowledge the assistance of Dr. Ashok Joshi in validating the empirical set up for the research.

### REFERENCES

- Hopfe, C. J., & McLeod, R. S. (2015). *The Passivehaus Design Manual - A technical guide to low and zero energy buildings*. London & New York: Routledge, Taylor & Francis.
- Bureau of Indian Standards. (2016). *National Building Code of India 2016* (Vol. II). New Delhi.
- Sehgal, N. (2010). Analysis of Structural Cooling System in Energy Plus. *International Conference on Current Trends in Technology, NUICONE 2010*. Ahmedabad: Institute of Technology, Nirma University.
- United Nations Development Program. (2015). *Implementing Energy Efficiency in Buildings*. International Conference on Energy Efficiency in Buildings (ICEEB) (p. 6). New Delhi: UNDP.
- Yehuda, R. U. (2008). *Remodeling Building Design for Thermal Comfort and Low Energy Footprint*. Academy of Architecture, Postgraduate Department. Nashik: Yashwantrao Chavan Maharashtra Open University (YCMOU).
- ASHRAE. (1938). *Some Effects of Thermal Environment*. Heating, Ventilating and Air Conditioning Guide.
- Brager, G., & de Dear, R. (April 2001). *Climate, Comfort & Natural Ventilation: A new adaptive comfort standard for ASHRAE Standard 55*. Windsor, UK: Oxford Brookes University.

# Hab-Lab: Development of a Light Touch BPE Methodology for Retrofit

TIM SHARPE<sup>1</sup>, BARBARA LANTSCHNER<sup>1</sup>, CHRIS MORGAN<sup>1</sup>

<sup>1</sup>Glasgow School of Art, United Kingdom

*ABSTRACT: In the drive toward reduced energy consumption and consequent carbon emissions, and also reductions in fuel poverty and discomfort, the need to improve the performance of existing buildings, particularly housing is critical. To meet government targets some policy drivers are being implemented to improve the performance of existing building. In Scotland this has been through the Energy Efficiency Standard for Social Housing (EESH) which provides funding for retrofit measures. However, very little is known about the consequences of these measures. This project developed 'light-touch' building performance (BPE) approaches to undertake evaluation of retrofit measures examine their effectiveness and the paper identifies these techniques and reports on the findings. Whilst in general improvements led to reduced energy consumption, various unintended consequences were evident. These included issues of thermal bridging and poor detailing, and lack of improved ventilation provision led to issues of poor ventilation and indoor air quality and reinforces the need for wider evaluation of buildings in use.*

*KEYWORDS: Energy, Comfort, Retrofit, Building Performance Evaluation, Ventilation*

## 1. INTRODUCTION

In a drive toward carbon emission reductions the Scottish Government has introduced the Climate Change (Scotland) Act 2009 which aims for an 80 per cent reduction in carbon emissions by 2050 [1]. As domestic energy use represents 30% of total national energy use [2] this is clearly an important sector.

Whilst for new buildings this is being addressed through building standards [3], these regulations do not apply to existing buildings. Given estimates that over 75% of the 2050 building stock already exists [4], the need to undertake energy efficient and low carbon retrofit is self-evident.

Local authorities and housing associations have undertaken a number of measures to improve the thermal performance of their existing stock but more recently this has been driven the need to comply with the Energy Efficiency Standard for Social Housing (EESH) which has been introduced by the Scottish Government to address this issue [5]. EESH sets a minimum energy efficiency rating for landlords to achieve and requires improvements to insulation and heating systems. The new standard is based on minimum energy efficiency (EE) ratings calculated using the Standard Assessment Procedure (SAP) which produces an Energy Performance Certificate (EPC) and will mean that in the main no social property will be lower than a 'C' or 'D' energy efficiency rating

However, this represents a considerable challenge for landlords. Existing buildings are built to poorer thermal standards and improving these is hampered by the nature of the original construction which makes it harder to apply and less cost effective. In addition, the costs and

disruption associated with decanting tenants mitigates against deep retrofit and leads to piecemeal measures.

The other key issue that is emerging the lack of knowledge about the effectiveness and unintended consequences of such measures. There is a clear need to undertake Building Performance Evaluation (BPE) of retrofit measures to close this knowledge gap, but there are a number of barriers to this. Firstly BPE (despite being in the RIBA plan of work) is not a mainstream activity. Secondly, most projects do not have a budget or timescales to undertake BPE. Thirdly, the knowledge and skills to undertake BPE are not widespread. Whilst many valuable lessons have been learnt from research funded BPE projects, without a commercial footing and ready-made feedback loop into practice, the full potential for the industry to learn from these studies is not being fulfilled.

To address these issues a project was undertaken jointly by the Mackintosh Environmental Architecture Research Unit (MEARU) and John Gilbert Architects (JGA) to develop 'Hab-Lab' - a service that undertakes building performance evaluation of social housing in the west of Scotland that has either undergone or is due for refurbishment. The development of the service was supported by Knowledge Transfer Partnership (KTP) funding.

Social landlords are becoming increasingly aware of performance gaps between intended and actual performance and potential unintended consequences of retrofit measures. To investigate this, the Hab-Lab project formed a partnership with five council and housing association landlords to evaluate the actual thermal and environmental performance of a range of house and construction types. The Hab-Lab approach

# PLEA 2018 HONG KONG

*Smart and Healthy within the 2-degree Limit*

offers a range of possible processes dependant on the nature of the investigation ranging from assessment of compliance, testing of specific components (e.g. insulation systems), testing and monitoring of energy and environmental conditions in buildings, to handover and post-occupancy processes.

## 2. METHODOLOGIES

Conventional large scale BPE studies of retrofit are difficult for a number of reasons. As well as being time consuming, expensive and disruptive to occupants, the results are not available to inform design decisions. To address these issues the project has attempted to develop a 'light-touch' methodology. This attempts to gather a useful (if not comprehensive) dataset in a cost-effective manner as a means to mainstream the development of a more empirical understanding of the built environment. The key methodological ways in which the project seeks to address drawbacks of typical large scale BPE are as follows:

- Developing BPE services which are shorter in duration. This reduces disruption for residents and ensures that results are relatively quickly available for decision-making.
- Shorter BPE projects can be less expensive to undertake bringing them within acceptable likely budgets for housing associations and council housing departments.
- Ensuring that BPE is carefully tailored to the specific demands of the client – starting from their standpoint and ensuring that their initial brief is met, whilst introducing wider issues and deeper questions where appropriate.
- Providing a 'menu' of services allowing for shorter "snapshot" reporting on more straightforward technical issues but providing also longer term or more detailed studies to provide deeper understanding of the range of interrelated issues where time and budget allow.
- Developing a range of easier to understand, replicable, and often largely graphic techniques to explain issues and engage a variety of stakeholders.
- Initiating the idea of a partnership 'group' who agree to share findings and insights, thus increasing the impact and value of the learning amongst the group.
- 'Embedding' a Building Performance Specialist within an architectural practice ensuring that feedback loops are both formally and informally developed within the office, and drawing robust research methods directly into practice.
- Moving beyond simply monitoring and reporting into providing bespoke design and

intervention proposals based on evidence gathered and which are then themselves monitored.

- Explicitly introducing the potential for innovative solutions based on a limited scale of works and a reduced perception of risk due to monitoring regime.

From a methodological perspective, the approach suffers from a number of limitations which are hereby acknowledged. Firstly, projects tend to arise from a specific problem raised by the client which may not represent the totality of the issue. The risk is that a partial assessment only can be undertaken due to the limitations of the client's understanding of the issue, and willingness to pay for more extensive investigation. However, in each case where this has been the initial starting point, the Hab-Lab team have been able to demonstrate the wider issues and causes impacting on the more immediate effects.

Secondly, client priorities can change rapidly and, in some cases, the Hab-Lab team were not able to complete a full monitoring of the proposed and installed measures, and so have not been able to demonstrate empirically the benefits of the works undertaken.

Thirdly, when undertaking BPE on a commercial footing, there is the potential for pressure to deliver results according to certain pre-conceptions. In the project there was one example of this and although the veracity of the investigation was not compromised the reporting template was amended to comment only on the regulatory compliance issues, rather than speculating further on good practice and wider issues. To address this, issues of commercial and professional integrity are now explicitly addressed as part of the appointment documentation.

Lastly, detailed monitoring over at least a year is needed to obtain a detailed picture of energy use and environmental conditions, and to obtain annual energy consumption data, and shorter monitoring periods can only provide 'snapshots' of performance.

### 3.1 Data Collection

The service offers a range of services but in practical terms these fall into four categories.

1 Energy monitoring involves measuring electrical, gas or heat consumption in real time. With electrical monitoring, it can also be useful to monitor sub-circuits in order to establish the efficiency of certain equipment (MVHR systems, for example).

2 Building fabric and systems testing involves measuring in-situ performance of the building itself. Examples of this include U-value measurement, airtightness testing (pressure testing), thermography, as well as systems checks such as ventilation balancing and flow measurement, heating systems checks etc.

# PLEA 2018 HONG KONG

*Smart and Healthy within the 2-degree Limit*



Figure 1: Airtightness tests are included in the basic BPE methodology, to quantify the impact of air leakages in the building fabric.

3 Environmental monitoring normally involves measuring the temperature, relative humidity and CO<sub>2</sub> levels in specified spaces. It is common to also measure the external temperature and humidity levels for comparison, while a wide range of additional testing can be undertaken such as acoustic testing, VOC levels and mould testing. These tests establish the conditions within homes so that, for example, it is possible to corroborate lower gas consumption with maintained temperatures, showing that insulation measures have been effective. Monitoring may be undertaken for short (2-4 week) periods under specific seasonal conditions.

4 Finally, there are a range of strategies to engage people who occupy and use buildings, as well as those who commission, design, build and maintain them. A range of tactics allow 'hard' data gathered to be corroborated against 'soft' data about occupancy levels, habits, and behaviour generally. Different tranches of monitoring may be undertaken in varying seasons to examine effects of climate. Alternatively, some intervention studies may be undertaken (for example, asking occupants to change a particular behaviour).

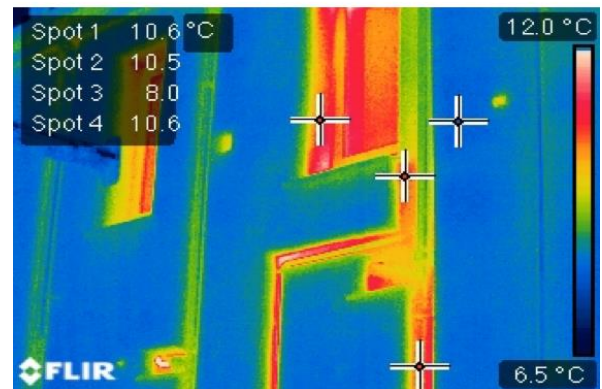

Figure 2: Thermographic images were used to highlight the gaps in external wall insulation due to poor detailing, leading to thermal bridges.

In general terms, the Hab-Lab process consists of a partnership with housing providers. In the first phase a range of different properties are studied in detail and findings reported to the clients. In a second phase, a series of innovative retrofit solutions are installed, which are drawn from the evidence created in phase 1. The retrofit measures can be monitored during the following winter season, in order to study and evaluate the efficiency of each proposal.

This knowledge is of significant value to landlords. Poor design and implementation would mean that they are failing to achieve the full potential of the retrofit works in terms of energy savings, but also creating significant problems related to resident's health and building maintenance.

## 4. CASE STUDIES AND IMPACT

In the last two years, the project examined 20 on-site monitored flats and the retrofit of 48 properties, but the potential benefits are applied to over 3000 similar flats managed by the partnering associations. Most had been refurbished and some were about to be retrofitted. The key case study examples include:

- Evidence based design advice for two flats in the East End of Glasgow – providing innovative retrofit solutions for traditional solid sandstone wall insulation and centralised demand

# PLEA 2018 HONG KONG

*Smart and Healthy within the 2-degree Limit*

controlled mechanical extract ventilation system,

- Technical evaluation of three different internal wall insulation systems, in order to find through in-situ u-value monitoring the most cost-effective solution for solid brick wall flats in Paisley,
- Best practice external wall insulation design advice for 12 no-fines flats in Bridge of Weir and 30 no-fines flats in Girvan, based on building performance evaluation evidence, taking into energy reduction, health and future-proof solutions,
- Optimized energy efficiency and indoor environmental quality design specification based on monitoring evidence, tackling fuel poverty, maximising comfort and minimising health risks in two Atholl Steel flats in Douglas.

To illustrate the methods and insights, two case studies are described below:

## 4.1 Case Study 1: Bluevale St, Glasgow

The client of this project signed up for the Hab-Lab partnership, for a period of 2.5 years with the aim of investigating and implementing innovative energy retrofit measures to improve the air permeability and indoor air quality of their traditional sandstone tenement building stock located in the East End of Glasgow. This allowed JGA to monitor several properties over different seasons and then develop energy retrofit solutions based on the building performance evaluation findings. During this period the Hab-Lab Partnership service also included regular workshops, trainings, occupant engagement programmes and complementary support. This project aimed to work as a pilot case study, to be implemented in the remaining stock and therefore the measures had to be scalable and replicable from a technical and in a financial point of view.

A combination of different energy retrofit measures were installed in a ground floor flat as following:

- Four different internal wall insulation systems
- Detailed and bespoke airtightness measures
- Suspended timber floor insulation
- Demand control centralized mechanical ventilation systems.

The application of external wall insulation was inappropriate as it could compromise the historic character of the traditional sandstone tenement building. The improvement works were therefore carried out internally using materials which were both natural and vapour permeable, to help maintain the performance of solid sandstone walls whilst still providing some hygroscopic capacity of the fabric. This case study therefore examined three measures of performance - the improvement in air permeability, the thermal properties, and the indoor environmental

quality and comfort for resident. Four carefully detailed insulation materials were used in the trial in order to provide comparative data to compare relative improvements in thermal performance and airtightness.



*Figure 3: Internal wood-fibre insulation, which aims to provide active moisture control working in combination with the demand control mechanical ventilation system.*

The building was originally constructed of sandstone masonry with solid brick internal partitions, and dates to around 1910. Due to general repairs the tenement was empty at the time the trials taking place. All internal wall linings had been stripped out and replaced with dry lining in a previous extensive refurbishment. This meant that there were no limitations regarding the retention of original wall linings or decorative cornices, which would be the case in many similar properties.

The retrofit specification was based on the pre-installation building performance evaluation conducted on the refurbished flat and in similar properties during the previous winter seasons which had measured actual u-values and thermal bridging and by-pass. The indoor environmental conditions (temperature, relative humidity and CO<sub>2</sub> levels) were monitored in a similar occupied flat for a period of five weeks. The air permeability was tested, the U-value of the existing walls was monitored and airflow at existing mechanical extract ventilation units was measured during the winter season. The pre-retrofit investigations also included internal and external thermographic surveys, and structured interviews with the residents.

The design advice for the energy refurbishment was therefore based on real evidence, gathered from existing building and from their occupants. The design advice was followed by building performance toolbox sessions with the housing association staff. General key learnings from the building performance evaluation were explained and discussed through repeated workshops over a 2-year period. This was also supported with toolbox sessions on site with housing associations installers along with best practice insulation, airtightness and ventilation suppliers discussed detailing and installation procedures. The specified retrofit proposals were consequently evaluated

# PLEA 2018 HONG KONG

*Smart and Healthy within the 2-degree Limit*

with on site monitoring to quantify the improvements and impacts of the measures.

The energy efficiency improvements can be summarised as following:

- Energy Performance Certificate rating increase of 25 points, EPC Band E (48) to EPC Band C (73).
- 49% reduction in space heating requirement.
- The pre-installation thermography showed extensive cold spots due to thermal bypass and thermal bridging at several points of the walls, floors and ceilings. This was mostly addressed with the upgrade works.
- The post installation airtightness test result of  $6.20 \text{ m}^3/\text{h}/\text{m}^2$  demonstrates an improvement of 53%.
- The post installation in-situ U-values and airtightness levels meet the recommended thresholds of the Building Standards for refurbished dwellings, whereas pre-installation values do not.

Interestingly, the results were not exactly what the client initially planned, but it helped them to better understand the complex building performance characteristics of traditional sandstone tenements and implement building performance evaluation and evidence base design into the standard energy retrofit specification. Thus, as well as a successful retrofit project, it was a key learning tool, based on empirical evidence, for the association.

## 4.2 Case Study II: Auchentorlie Quadrant, Paisley

Hab-Lab was engaged by a local Council to conduct a technical evaluation of three different internal wall insulation systems, installed in three flats, within an interwar solid brick tenement property located in Paisley. The purpose of this study was to:

- evaluate the cost-effectiveness of three different internal wall insulation systems,
- evaluate the detailing quality of the Council's contractors,
- understand the effectiveness of the governmental policy of financial incentives directed to energy retrofit actions in Scotland.

The original external wall consists of a solid brick wall, externally rendered and lath plastered internally. Three different insulation systems were installed as following:

- System 1: 62.5mm rigid phenolic boards bonded to plasterboard and mechanically fixed.
- System 2: 69.5mm PIR insulation, bonded to plasterboard and mechanically fixed.
- System 3: 85mm glass mineral wool insulation bats, fixed within a metal frame and finished with plasterboard.

Each insulation system was installed from floor to ceiling on the inside face of all external walls located within each flat. The same contractor appointed and

supervised by the Council, installed the three insulation types as per specification and recommendation of each manufacturer.

As requested by the client, the study pursued minimally invasive investigation methods to reduce time, costs and disturbance. The methods evaluated, internal environment, building fabric and installation quality. The evaluation methods employed were similar for all three flats and included U-value measurements of walls, temperature, relative humidity levels monitoring, thermography and energy modeling. The indoor environmental quality and the U-value was monitored for a period of four weeks. The monitoring results were compared to the modelled U-values and the manufacturer's installation values. The study also considered the installation costs, quality of the detailing and outlined watch points for future installations.

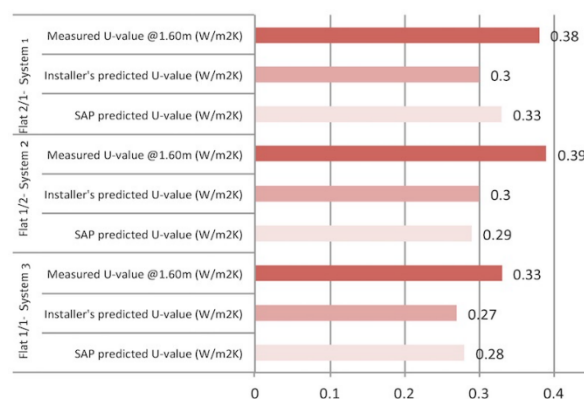

Figure 4: In-situ U-value measurement versus U-value calculation for three internal wall insulation systems.

All three systems performed similarly although less well than claimed, but the main problems were related to installation shortcomings, which increased heat loss and consequent condensation and mould growth risk in practice:

- System 1: 0.33 W/m2K, 22% more than the installer's prediction
- System 2: 0.39 W/m2K, 30% more than the installer's prediction
- System 3: 0.38 W/m2K, 27% more than the installer's prediction.

Although all systems comply with the recommended values for refurbished domestic buildings in Scotland, the thermographic imaging survey showed extensive cold spots at the base of the walls, against ceilings and around openings due to poor detailing. The quality of construction proved to have a higher impact on the post-retrofit performance of the flats than the different wall insulation performances.

The interesting aspect of this case study was that it highlighted the gap between predicted performance (as estimated by models) and actual performance (as installed and measured in the properties) without this

# PLEA 2018 HONG KONG

*Smart and Healthy within the 2-degree Limit*

being the original aim of study. This has obvious implications for energy efficiency and retrofit programmes. The results of the study have informed subsequent installation practice and procurement strategies within the Council.

## 4.3 General Findings

The performance gap between predicted and actual performance creates uncertainty concerning the full benefits of energy efficiency measures and BPE studies have the potential of identifying and closing these gaps.

In general, the BPE results highlight that the installed energy efficiency measures have benefited the occupants by reducing heating costs and increasing thermal comfort.

However multiple and diverse unintended consequences are apparent. For example, a restriction on the grant funding available for improvement measures has meant that they have significant limitations. For example, they do not include support for enhanced ventilation provision. A common finding is that air quality is not at recommended levels, often due to increased airtightness and almost always due to inadequate ventilation design, installation and equipment. High levels of relative humidity are common with increased risk of condensation and mould growth, as well as presence of dust mites and other allergens.

Common construction problems included thermal bridging due to poor detailing leading to heat loss and thermal bypass. With thermal bypass, cold air gets into the building fabric creating much greater heat loss without necessarily getting indoors.

## 4. CONCLUSIONS

The methodology has demonstrated some notable benefits. As well as bringing BPE to a wider range of clients and subsequent building projects, clients are educated about the benefits of BPE and become more knowledgeable about performance issues, more aware of what they are asking for, and more interested in developing a broader and deeper understanding of building performance.

This increase in knowledge also means that the future market for building performance evaluation grows and, in several instances, these clients have then commissioned JGA as architects to deliver buildings with more explicitly performance-based deliverables. Thus, better informed clients lead to better buildings and better performing buildings emit less carbon emissions, are more comfortable to be in and cost less to run.

The development of performance-based criteria has also had a knock-on effect on builders who have been obliged to work to more demanding detailing and specification, leading to an upskilling of the workforce more generally. Whilst there is no doubt that commercial pressures have forced down levels of quality in much

construction work, it has been especially heartening to see that when pressed, many in the industry quickly and readily adopt a far more conscientious and rigorous approach to construction, to the extent of feeding back to the designer's ways of improving things buildability.

As well as significantly increasing the knowledge base of JGA and the ability to undertake evidence-based design, the project has produced a new income stream for JGA to undertake BPE, and has raised profile with potential clients.

The impacts of these projects were not only beneficial to clients, they are a valuable set of operational data which have been included in presentations made to the Scottish Government on several occasions. The demonstration of effects of unintended consequences has been instrumental in informing changes in national energy efficient retrofit policies, for example to include the need to include improved ventilation measures in revised EESSH funding. They also provide a core knowledge of existing building stock in the UK, understanding the main issues, the performance of materials and specifying bespoke sustainable and ecological materials for each of the construction types.

## ACKNOWLEDGEMENTS

We would like to acknowledge the support received from Innovate UK for Knowledge Transfer Partnership funding.

## REFERENCES

1. Sullivan, L., (2007), *A Low Carbon Building Standards Strategy for Scotland*, Arcmedia, Scotland.
2. Shorrocks, L. D. and Utley, J. I., (2003) *Domestic Energy Fact File 2003*, BRE Bookshop, Watford, England
3. Scottish Government: Technical Handbook – Domestic: Section 6: Energy. Building Standards (Scotland) (2015).
4. Ravetz, J., (2008) "State of the stock—What do we know about existing buildings and their future prospects?." *Energy Policy* 36.12: 4462-4470.
5. Scottish Government Home Energy and Fuel Poverty, [Online], <https://beta.gov.scot/policies/home-energy-and-fuel-poverty/energy-efficiency-in-social-housing/> Available: <http://idmp.entpe.fr/> [15 Dec 2017].



## Low Budget Residential Building Façade Retrofit: Two Mediterranean Climate Prototype Case Studies

GALIT SHIFF<sup>1</sup>, YAEL GILAD<sup>1</sup>

<sup>1</sup>Department of Interior, Building and Environment, "Shenkar - Engineering, Design, Art", Ramat Gan, Israel

*ABSTRACT: The residential market in the Mediterranean climate as well as in other parts of the world has a large number of buildings that were built with a long lasting structure but limited consideration for energy efficiency and thermal comfort. Retrofitting the existing envelope can help reach national energy reduction goals while improving the living conditions and reduce energy expenses for the tenants. This study focuses on low budget retrofitting of old residential buildings in a Mediterranean climate with two applicative case studies already finished. The two buildings are of similar size but in different local climate settings. In both projects a similar analysis methodology was performed, that included structural, thermal and energy use inquiry. The analysis concluded in intervention strategies for each building, and despite the similarity in the buildings, the variations in the intervention strategies were essential. This paper focuses on the methodology to analyse existing structures in order to identify preferred renovation tactics, based on the knowledge of the executed case studies. The study was done in collaboration with Israeli housing companies and is meant to serve as a pilot for larger renovation projects of existing residential building stock.*

*KEYWORDS: Façade, Retrofit, Energy efficiency, Thermal-comfort, Residential buildings*

### 1. INTRODUCTION

The need to retrofit old buildings lies in the fact that buildings are responsible for the main energy use and CO<sub>2</sub> emission. For example, in North America, buildings' CO<sub>2</sub> emission is over 40% of the overall CO<sub>2</sub> emission. Research showed that existing old structures are more dominant in their effect on the environment than new energy efficient buildings (1). Yet, not every case of urban renewal that aims to replace old buildings with new neighbourhoods necessarily has a financial or sustainable justification. Façade design plays a vital role in the building's energy performance and the unit's comfort conditions. In residential buildings the envelope is responsible for 20%-30% of the total energy consumption (2). A significant amount of existing building stock in both North America and in Europe was constructed quickly after World War II. While the structure is still durable, the envelope is inefficient. As a result, instead of the use of passive design techniques (e.g., natural ventilation, daylight harvesting, and solar heat preservation or rejection) there is a strong reliance on new mechanical heating, air conditioning, and lighting systems (3,4). In addition to high levels of energy consumption and emissions, living conditions among low socio-economic groups, who cannot afford paying for the electricity and as a result suffer from thermal discomfort, are uncomfortable and unhealthy. The forecasts are not encouraging: local measurements show global warming has resulted in an increase of two degrees in the past thirty years. On the other hand, the advantages of a high-performance façade are numerous, far beyond the aesthetical renovation. It can separate the indoor environment from the outdoors, transmit daylight and solar heat, assist or replace oversized ventilation, heating

and cooling systems, adapt to changing climate conditions, as well as generate and store energy (5). Eventually, it can also increase economic value and appreciation of the property (6).

This research is a feasibility applicative study for retrofitting of residential façades. It has been carried out for the past four years, with two projects already fully renovated. The intention of this study is to serve as a case study for limited budget façade retrofits in Mediterranean climate urban areas. The added value of this study to previous more theoretical studies (7) is the accumulation of data gathered from the execution of actual projects with all the complexity real projects include. This paper focuses on one aspect of this topic. It demonstrates the methodology of analysing the existing conditions and design options in order to set priorities in a limited budget project, and help choosing an effective design approach. Extensive data and full assessment of those case studies are still under research.

### 2. CASE STUDY BUILDINGS

The two case study buildings are set in the same country, 220 km apart from each other. Officially, they share the same local climate (one of Israel's four climates zones). Nevertheless, their climatic conditions are different. The first is in the south of the country in the city of Sderot (referred to as Sderot Building) with only 500 heating degree days (HDD) and hot and very humid summers with up to 22 hours of heating loads during August. The second is in the north of the country in the city of Migdal Hahemek (referred to as Migdal Hahemek building) with around 900 heating degree days and moderate summers.

# PLEA 2018 HONG KONG

Smart and Healthy within the 2-degree Limit

Orientations are also different. The main façade of the Sderot project faces South-West while the main façade of the Migdal Hahemek project faces North-West. Each of the social housing building blocks includes around 19 residential units. Both have similar shape and proportions: three entrances in each block, 3-4 floors, flat roof, elevated first floor, etc. The budget of the projects is around \$14,000 per unit, and includes interventions at the buildings' envelope while tenants continue to live in the projects.



Figure 1: The Sderot building before renovation, south-west entrance façade



Figure 2: The Migdal Hahemek building before renovation, north-west entrance façade

## 3. METHODOLOGY

### 3.1 Analysis of existing conditions methodology

For the analysis of the existing conditions and setting the initial priorities, the following steps have been taken:

#### 3.1.1 Structure analysis

The building's components, materials and envelope sections were mapped, examined and compared with relevant updated standards.

#### 3.1.2 Radiation façade exposure

Solar radiation simulations for the buildings in their surroundings during winter and summer days were done using Ecotect Analysis software. The calculation considered mutual shading conditions. The simulations showed the accumulative radiation on each surface of the buildings' envelope. A comparative study of the results helped setting an initial priority of intervention between different areas of the building.

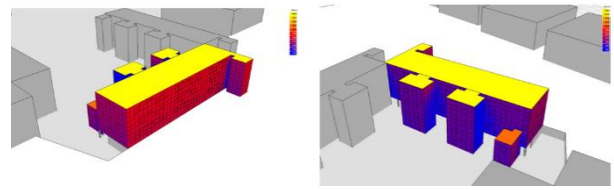

Figure 3: Solar radiation during a summer day on the north-east façade of the Sderot building (right) and on the south-west façade (left)

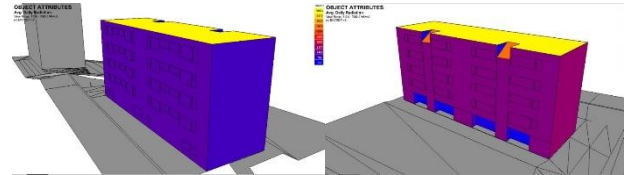

Figure 4: Solar radiation during a summer day on the north-west façade of the Migdal Hahemek building (right) and on the south-east façade (left)

### 3.1.3 Thermal analysis and Energy Code

The energy rate of each unit as well as the building as a whole was calculated according to a local Energy Code. The energy code is still a voluntary standard for existing buildings, but it is gradually becoming obligatory for new residential buildings with the enrooting of the local Green building standard. The Energy Code rate demonstrates the buildings' overall thermal condition. It can help with choosing the most problematic buildings within the urban context and it is also an effective tool for setting priorities within each building.

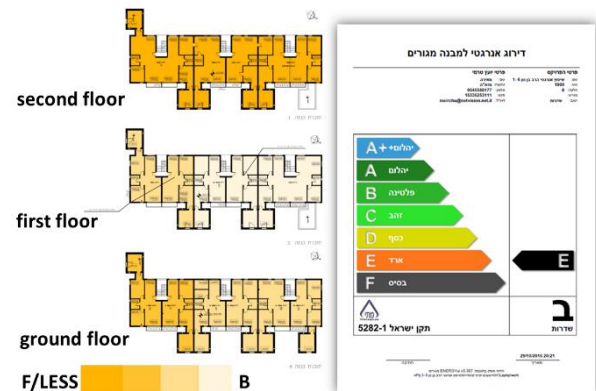

Figure 5: The energy code of the all Sderot buildings (right) and the energy code of each apartment (left) before renovation (photo: Meira Bet-El)

### 3.1.4 Thermal photos

The buildings' facades were documented with the use of a thermal camera during different hours of the day. The photos helped identify the thermal failures and gaps within the envelope.

# PLEA 2018 HONG KONG

Smart and Healthy within the 2-degree Limit

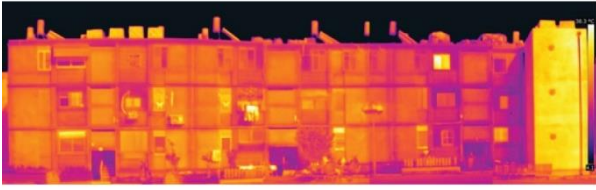

Figure 6: Thermal photo of the Sderot building at 15:00 on a winter day before renovation (photo: Wolfgang Motzafi-Haller)

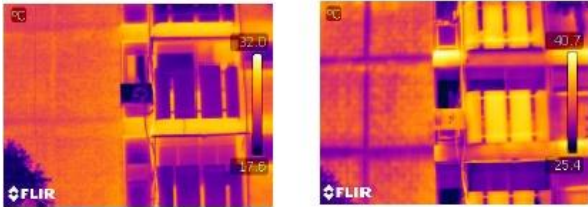

Figure 7: Thermal photo of the Sderot building at 13:00 on a winter day (right) and 19:00(left) before renovation (photo: Wolfgang Motzafi-Haller)

### 3.1.5 Collecting data from the residential units

Information regarding the electricity use and the thermal comfort of the units was assembled from electricity meters and thermometers that were installed in several units, along with tenants' electricity bills and a comprehensive survey of thermal comfort, apartment condition, electricity equipment and use.



Figure 8: Electricity meter (right) and thermometer (left); Collecting data from the residential units

### 3.2 Research and Design methodology

Similar tools were used to compare the effectiveness of different design options and to evaluate the chosen solutions. For example, the renovation of the south-west façade of the Sderot project was divided into two steps, in order to be able to take thermal photos and compare the results from before and after intervention, during the same thermal conditions.



Figure 9: Renovating the main facade of the Sderot building in two steps: in order to compare the results from before and after

renovation, during the same thermal conditions (photo: Wolfgang Motzafi-Haller)

Furthermore, data from the meters, thermometers and electricity bills is still being collected a year after the renovation is over.

### 4. LEARNING FROM THE TWO CASE STUDIES

The data showing the impact of the renovations on the thermal comfort and the energy use in the different units is still gathered and under research. Nevertheless, the methodology used in the two projects can already help the understanding of setting priorities in projects of low budget retrofitting of old residential buildings.

The tenants' survey and the Energy Code calculation showed clearly that in both projects the most problematic units in terms of thermal comfort were the ones below the roof and the ones on top of the elevated entrance floor. Old buildings tend to have poor insulation on those two horizontal surfaces and it is recommended to treat those surfaces even in very limited budget retrofit projects. In both projects polystyrene foam (and not polystyrene boards) was used on the roof, and rigid mineral wool boards on the elevated floor, for their suitability for existing complicated site conditions and high levels of insulation.



Figure 10: Insulating the elevated floor with rigid mineral wool boards (right) and polystyrene foam on the roof (left) of the Sderot building.

The solar radiation simulation and the thermal photos further helped understanding the priorities in the design of the facades and the openings. Different radiation levels and wall sections were found in the two projects and influenced the design strategies: In the Sderot project due to the orientation there was extreme difference in solar radiation levels between the main façade and the back elevation. When testing the effect of different solutions on the Energy Code, it was found that a better insulation on the main façade was essential, while treating the back façade was only obligatory. Eventually, it was decided to invest in insulating the main south-west façade and the side façades with the use of rigid mineral wool boards, leaving the back north-east façade almost untouched. Had it not been for the tight budget, the back façade would have been renovated as well. Due to different orientation, lower levels of

# PLEA 2018 HONG KONG

*Smart and Healthy within the 2-degree Limit*

radiation were found in the Migdal Hahemek project. The problem of the façades in this project was not high levels of radiation but thermal gaps in many areas of the two long façades. Therefore, a different tactic was required: a combination of basic thermal plaster insulation on all façades, together with intense treatment on areas of thermal gaps with the use of rigid mineral wool boards. It is also important to note that fire regulation, which changed during the time that had passed from the first Sderot building renovation to the Migdal Hahemek project, allowed using a thermal plaster, a cheaper insulation solution, in the Migdal Hahemek project, something that was impossible at the time the first project was renovated. Eventually, the plaster was not used for other reasons: First, the insulation for the thermal gap areas required shaping around the existing beams, which proved to be easier to do with the boards. Second, the cost difference between the two technologies proved to be smaller than initially expected. The decision regarding the treatment of the windows is also not one for all. While the Energy Code showed that the influence of replacing the windows is minimal, the input from the residents and the study on site of the Migdal Hahemek project proved that the windows suffer from poor execution of construction details and bad installation. Therefore it was required to replace all the windows in the Migdal Hahemek project. Differently in the Sderot project the windows were quite basic but in most cases sufficient; nevertheless the windows in the main façade were exposed to high levels of radiations. It was found that it is more essential to shade the windows than replace them. The challenge was then to find an effective shading solution that fits all of the different windows and can be added to the existing structure with minimal effort.



Figure 11: The south-west façade of the Sderot building after renovation: old windows with a uniformed shading system (photo: Lior Avitan)



Figure 12: The north-west façade of the Migdal Hahemek building after renovation: new windows and roller shutters

The budget of the two projects was similar in amount but was divided differently between the design strategies. The comparison is complicated since the costs were not always equal, even for similar intervention areas and same tactics (such as the renovation of the roof and the elevated floor). One of the main differences found, comparing the two budgets, was a larger investment in windows in the Migdal Hahemek project. This part of the budget was used in the Sderot project for replacing and enlarging the renewable energy and mechanical systems, which was hardly done in the Migdal Hahemek project.

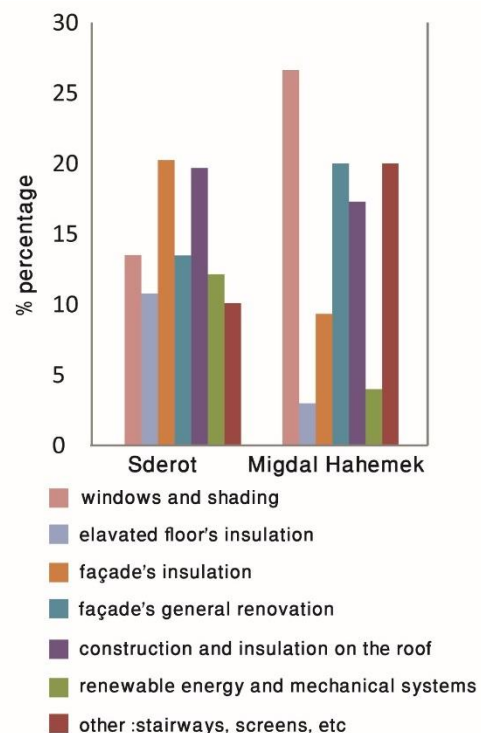

Figure 13: Comparison of the budget division in percentage in the two projects.

# PLEA 2018 HONG KONG

*Smart and Healthy within the 2-degree Limit*

## 5. CONCLUSION

Although the buildings and the construction typology chosen for this study are similar, the research shows that there are large differences due to variation in local conditions. Similar to previous studies in the region, it has been shown that orientation and design strategy are more dominant in their effect than local specific climate conditions (8). It is an on-going research but several rules of thumb for retrofitting old residential buildings in a Mediterranean climate, can already be concluded:

- It is very important to invest in insulating the roof and the elevated floor, if existing.
- It is important to take into consideration that a retrofit project deals with existing complicated site conditions and therefore to choose an intervention technology that can be easily adapted to those constraints.
- Basic windows can be sufficient if installed correctly. The need for shading is a matter of orientation.
- The amount and kind of insulation required on each facade is a matter of orientation together with shading from neighbouring buildings, specific wall sections and the existence of thermal gaps.

In order to reach a more wide-ranging systematic and cost-effective method of work, which will allow taking into account local conditions such as orientation and neighbouring buildings together with economic, legal and structural factors, a more extensive catalogue database is needed. Such a catalogue will enable public housing companies in a Mediterranean climate to promote massive projects of renovating existing old buildings, drawing on minimal analysis and planning processes.

## ACKNOWLEDGEMENTS

The two projects and the research were initiated and lead by the "Israel Energy Forum" and sponsored by "Keren Kayemeth Le Israel-Jewish National Fund" in the case of the Sderot project, and by "Amigour" company for social housing in the case of the Migdal Hahemek project, and supported by The Ministry of Construction and Housing, The Ministry of Energy, and the Ministry of Environmental Protection. The authors wish to thank Meira Beit-El for the thermal calculations and Prof. David Pearlmuter and Wolfgang Motzafi-Haller from Ben-Gurion University of the Negev for the thermal photos.

## REFERENCES

1. Voss, K. (2000). Solar energy in building renovation- results and experience of international demonstration buildings. *Energy and Buildings*, 32: p. 291-302.
2. Dall'O', G., Galante A, Pasetti G. (2012) A methodology for evaluating the potential energy saving of retrofitting residential stocks. *Sustain Cities Soc*, 4: p. 12-21.
3. Lechner, N. (2004). Heating, Cooling, Lighting. *Sustainable methods for architects*. New Jersey, The USA: Wiley.
4. Martinez, A., Patterson M., Carlson, A., & Noble, D. (2015). Fundamentals in Façade Retrofit Practice. *Procedia Engineering*, 118, 934-941. [Online], Available: <http://dx.doi.org/10.1016/j.proeng.2015.08.534>
5. Quesada, G., Rouse, D., Dutil, Y., Badache, M., & Halle, S. (2012). A Comprehensive review of solar facades. Opaque solar facades. *Renewable and sustainable Energy Reviews*, 16(5) : p. 2820-2832. [Online], Available: <https://doi.org/10.1016/j.rser.2012.01.078>
6. Popescu, D. Bienert, S., Schutzenhofer, C., Boazu, R. (2012) Impact of energy efficiency measures on economic value of buildings. *Applied Energy*, 89: p. 454-463.
7. Capeluto, G. Ochoa, C. (2014) Simulation-based methods to determine climatic energy strategies of an adaptable building retrofit façade system. *Energy*, 76: p. 375-384.
8. Shaviv, E. Capeluto, G. Yezioro, A. Becker, R. Warszawski, A. (2002). Thermal Performance of Buildings and the Development of Guidelines for Energy Conscious Design Part I: Design Guidelines for Residential Buildings. *Final report, First Year 2000/ 01 ENERGY RESEARCH for Ministry of national Infrastructures, Division of Research and Development, Israel.*

# The Thermal Environment in the High-Density Tall Building from the Brazilian Bioclimatic Modernism: Living in the COPAN building

JOANA CARLA S. GONÇALVES<sup>1</sup>, MONICA DOLCE<sup>1</sup>, ROBERTA MULFARTH<sup>1</sup>, EDUARDO GASPARELO  
LIMA<sup>1</sup>,  
AMANDA FERREIRA<sup>1</sup>, RANNY NASCIMENTO MICHALSKI<sup>1</sup>

<sup>1</sup>University of São Paulo, Faculty of Architecture and Urbanism, Department of Technology, São Paulo, Brazil

*ABSTRACT: Looking back to the glory years of Brazilian bioclimatic modernism between 1930 and 1964, the country's architectural heritage reveals a design approach still highly relevant today. Building design of those days paid heed to solar orientation and the consequent need for solar protection. The COPAN is the tallest residential buildings in South America until today, with 42 floors being 38 residential and 120 thousand square meters of total built space. The long "S" shape form creates variations in the orientation, resulting in one side of the building facing north and northwest whilst the other faces south and southeast. This research work about the thermal performance of the Copan building was developed based on fieldwork including measurements in loco of environmental variables and interviews with occupants. The effect of thermal inertia coupled with external shading that characterizes buildings built during the times of the Brazilian bioclimatic modernist, resulting in steady thermal conditions during warm and cold days, favorable to the comfort of the occupants, with temperature figures oscillating between 24°C and 26°C.*

*KEYWORDS: Compact housing, Thermal inertia, Thermal response, Measurements*

## 1. INTRODUCTION

Looking back to the glory years of Brazilian bioclimatic modernism between 1930 and 1964, the country's architectural heritage reveals a design approach still highly relevant today. Building design of those days paid heed to solar orientation and the consequent need for solar protection. Horizontal and vertical *brise-soleils*, external movable wooden shutters and perforated ceramic blocks were typical shading elements of curtain wall façades, whilst the common concrete structures of modern architecture add thermal inertia to internal spaces [1].

The distinguishable and creative manner by which principles of environmental design were introduced in referential buildings from the Brazilian modernism produced during between 1930s and 1960s, made the architecture from period known as the "*Brazilianbioclimatic modernism*".

In the city of São Paulo (latitude 23°S) the modernist architecture was widely applied to residential tall buildings of various heights starting from 9 story-high with the tallest ones reaching more than 30 stories, most of them built in the city centre and in the surrounding neighbourhoods. One of the most iconic residential buildings of the apogee of Brazilian Modernism is the COPAN building, located in the heart of the city centre of São Paulo, designed by Oscar Niemeyer and Carlos Alberto Cerqueira in 1950s and completed in 1966. This iconic modernist residential tower is recognized by its 140 metres-high curvilinear concrete structure (of a

gentle "S" shape), shaded towards north and northwest orientations by horizontal concrete *brise-soleils* and opened with a single glazed curtain wall on the south and southeast.

This work is based on the premise that the architectural features of the modernist bioclimatic residential tall building in São Paulo hold thermal qualities still valid for today's architecture, which have not yet been characterized and quantified. Hence, the objective of this technical study is the assessment of the thermal performance of selected residential units in the COPAN building by means of empirical and analytical work carried out by means of thermodynamic computer simulations.

With regards to the climate, the city of São Paulo (latitude 23.85°S; longitude 46.64°W; altitude 792m) is located in a subtropical region, characterized by warm-humid summer days with predominantly partially cloudy sky, cool and drier winter days with predominantly sunny sky, with prevailing wind directions being Southeast and South during summer months and Northeast during winter. Air temperatures are moderate for most of the year with an annual average of approximately 19°C.

In typical warm days with clear sky, temperatures can reach figures above 30°C in the beginning of the afternoon. On the other hand, under a cloudy sky, air temperatures in a warmday stay around 20°C. In typical cooler days air temperatures can go as high as 24°C, due to the impact of solar radiation, whereas in a cooler

# PLEA 2018 HONG KONG

*Smart and Healthy within the 2-degree Limit*

cloudy day, air temperatures struggle to get above 15°C[2].

## 2. THE CASE-STUDY BUILDING

The COPAN is the tallest residential buildings in South America until today, with 42 floors being 38 residential and 120 thousand square meters of total built space (figures 1, 2). Commissioned by and named after the Pan American Company of Hotels (*Companhia Pan Americana de Hotéis*), the building is currently occupied by 5.000 people living in 1.160 residential units of various types of studio flats (kitchenettes) alongside one, two and three bedroom apartments distributed across six blocks of independent vertical accesses [3, 4].

The studios are concentrated on block B, with the shallower in depth but wider facade ones at the north side with 30 m<sup>2</sup>, and the deeper and narrower ones at the south side with 25 m<sup>2</sup>. The variety of units has resulted in a diversified socioeconomic profile of the buildings' population.

The long "S" shape form creates variations in the orientation, resulting in one side of the building facing north and northwest whilst the other faces south and southeast. The long north and northwest facade is protected from the direct solar radiation by 1.5 meters deep horizontal concrete shading structure. The south and southeast side, where most of the studio flats are located, has an unprotected curtain wall. Also on the south side, in blocks C and D the facade was closed by a vertical perforated concrete block wall (name in Portuguese as *Cobogó*), designed to allow air and daylight through but provide shading and partially blocking views.



Figure 1: The residential tall building COPAN, 1966, in the city centre of São Paulo, North and Northwest orientations.

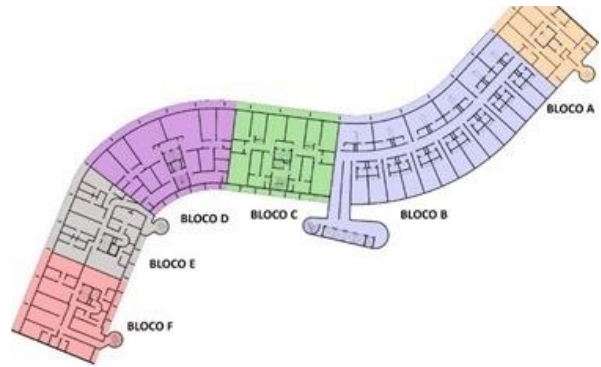

Figure 2: Plan of the typical floor of the COPAN building and its six blocks.

## 3. RESEARCH METHODS

This research work about the thermal performance of the Copan building was developed based on fieldwork including measurements in loco of environmental variables and interviews with occupants. The measurements recorded values of dry bulb air temperature, globe temperature, air movement and humidity taken with data loggers in four selected residential units of different architectural features to be compared, during two different times of year: a warmer during the month of March and a cooler period during the month of August in 2016. Measurements of external temperatures and humidity levels were registered at the rooftop of the 42 floor tall building of Copan, with a weather station from Campbell.

For the warm period, measurements were taken during the first two weeks of March 2016, from which a period of three days between the 6th and the 8th was selected for the purpose of this analysis. For the cooler period, measurements were taken during the second half of August of the same year, from which the period of three days between the 18<sup>th</sup> and the 20<sup>th</sup> of August was selected.

In order to capture the perception of occupants from studio flats in the Copan building about their overall environmental conditions, a questionnaire about thermal and acoustic comfort as well as daylight and their satisfaction with the buildings' location and general architectural image was submitted to a group of 100 occupants being 60 women and 40 man living in studio flats of block B (southeast and northwest facing), where most of the kitnets are relocated. The questionnaires were reapplied during April, 2016. For the sake of this analysis, only the questions regarding thermal comfort are discussed in this paper.

### 3.1 Measurements in loco

The measurements in loco were carried out in four studio flats of different floor plans and located in various orientations. The case-studies and their location are: Kitnet 1 - block B, 27<sup>th</sup> floor, southeast facing; kitnet 2 - block E, 27<sup>th</sup> floor, northwest facing; kitnet 3 - block F, 6<sup>th</sup>

# PLEA 2018 HONG KONG

*Smart and Healthy within the 2-degree Limit*

floor, southeast facing and; kitnet 4 - block F, 9<sup>th</sup> floor, southeast facing (Figures 3, 4).

The different case-study flats have different solar exposure throughout the year due to the differences in orientation as well as in facade treatment. Kitnet 1, oriented southeast, has a curtain wall facade; kitnet 2, towards northwest is protected by the 1.5 meter- deep horizontal shading device; kitnets 3 and 4, on the southeast orientation, are protected by the external perforated block wall (Figures 5, 6).

Differently from the first three, kitnet 4 had half of the internal curtain wall changed into a solid brick one. It should be mentioned that all flats are naturally ventilated, with opening areas been regulated according to the occupants' habits. In this respect, it was confirmed during the technical visits that in the warm periods that, with the exception of kitnet 2 where windows are kept closed, all residents keep windows opened to different degrees during day and night. The resident from kitnet 1 declared to open the windows to its maximum capacity (half of its area) in warm days and nights, but in the other selected kitnets windows are opened to a minimum. In the cooler days, the common behaviour is to keep windows opened to a minimum during the day and closed at night.

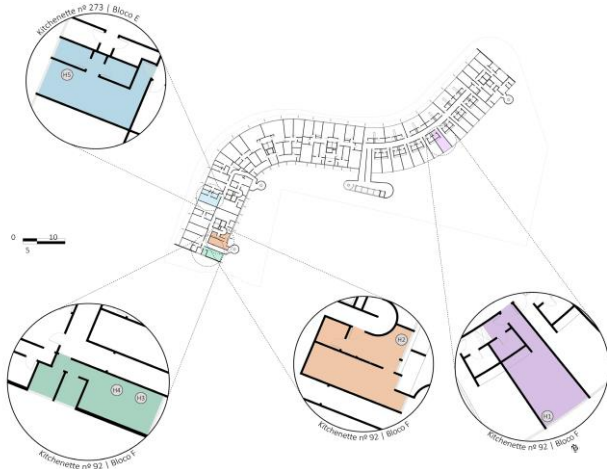

Figure 3: Plan of the typical floor of the COPAN building, with highlighting the plans of the four case studies studio flats.

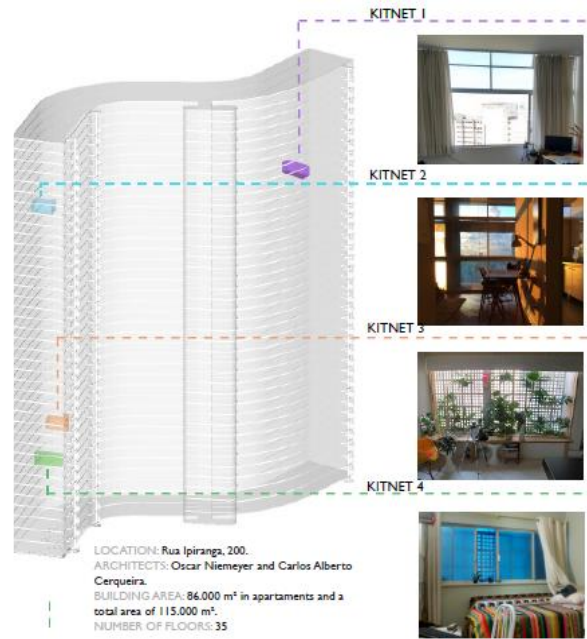

Figure 4: Diagram of the COPAN with the location and internal views of the four case-study flats, named between 1 and 4.



Figure 5: On the left close view of northwest facade, on the centre closer view of southeast facade, on the right the perforated concrete wall (cobogó).

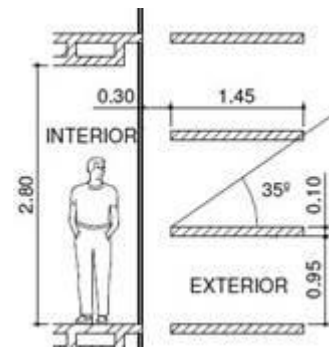

Figure 6: Schematic section of COPAN through north and south orientations.

As seen in Figures 7 to 9, in both warmer and cooler periods, the measurements show a more significant constancy in flats 3 and 4, both on the southeast orientation (originally exposed to direct sun during the morning hours in March, whereas in August the exposure is only to diffuse radiation), showing values between 24°C and 26°C in the warmer period when external temperatures can be as high as 30°C (see Figures 7 and 8) with the exception of few hours in the entire period



# PLEA 2018 HONG KONG

*Smart and Healthy within the 2-degree Limit*

when the temperature raised to 28°C; and between 20°C and 21°C in the cooler period when external temperatures vary between 14 at night and 26°C during the day (see Figure 9).

The stability in the internal air temperatures in these two cases is explained by the joint effect of significant solar protection and the thermal inertia provided by the internal solid brick walls and concrete structure. It is worth noticing that both shading strategies (external concrete horizontal *brise soleil* and the perforated block wall) add external thermal mass to the building.

Kitnet 1 (unprotected curtain wall facade) and 4 (curtain wall protected by the vertical perforated block), both facing southeast, are the ones with the most distant performance as a consequence of its different facade treatment. The thermal response of the two flats during the warm period is presented in more detailed in figure 7, with dry bulb airtemperatures, globe temperatures and air velocity at 1,5 meters from the window.

Given the impact of thermal mass and consequent internal surface temperatures lower than air temperature, the measurements show globe temperatures constantly below the curve of dry bulb air temperatures in both flats, varying between 0,5°C to 1°C, which is positive for the thermal comfort of the occupants, especially during warm days.

With respects to air velocity, kitnet 1 has the windows close during the whole period of the measurements with resulting air velocities close to zero. Hence, the lowering of internal air temperatures at night getting close to the external ones can only be associated with the heat losses through the unprotected curtain wall facade.

Due to the lack of external solar protection, diurnal internal temperatures raise close to the outside temperatures. On the other hand, kitnet 4 has the window opened all the time and experiences occasionally higher recordings with figures reaching 1,2 m/s at its peak, causing internal temperatures to soon fall by approximately 2°C. Air and globe temperatures in kitnet 4 are constant as a function of thermal mass coupled with the external heavy mass facade treatment.

Because of access restrictions, kitnet 2 could only be measured during the warm period. In kitnet 2, internal air temperatures are constantly higher than in all the others, with slight increases in the afternoon as seen in Figure 7. Facing northwest, kitnet 2 is the one that receives the greatest amount of solar radiation, being most of it in the after period when its horizontal shading device cannot effectively block the low-angle sun rays.

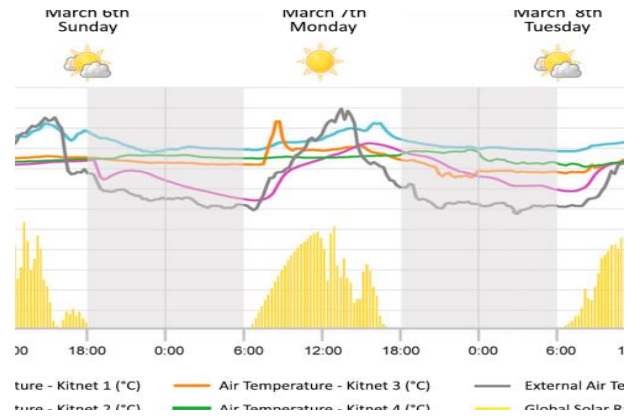

Figure 7: Measurements of dry bulb air temperature during warm days (March 2016) in the four case-studies with external temperatures.

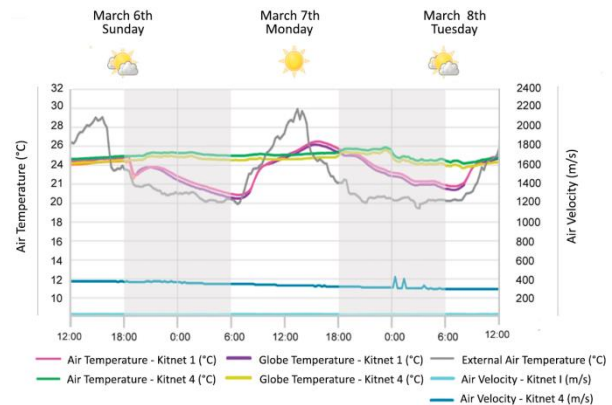

Figure 8: Measurements of dry bulb air temperature, globe temperature and air velocity in kitnets 1 and 4 during the warm period (March 2016).

Despite the afternoon solar gains, air temperatures do not go above 28°C, even when external ones are higher than this. The differences found between the air temperatures in kitnet 2 and the other three cases can be interpreted a matter of the amount of air changes due to different opening areas for natural ventilation.

Nevertheless, as also shown in the measurements, kitnet 1 is the one with the wider internal temperature oscillation, surpassing the external peak temperatures on the warm days reaching 32°C when external temperatures are around 28°C, due to the lack of shading and the consequent impact of direct as well as diffuse solar radiation.

During the night of a warm day, the impact of natural ventilation coupled with the exposed single glass facade, allow air temperatures drop to around 20°C, staying close to external figures. During typical sunny winter days (as the 18th of August 2016), the unobstructed glass wall provides relatively higher air temperatures during the day. In all cases, keeping the windows closed during the cooler nights help to keep temperatures at around 20°C (Figure 9).

# PLEA 2018 HONG KONG

## Smart and Healthy within the 2-degree Limit

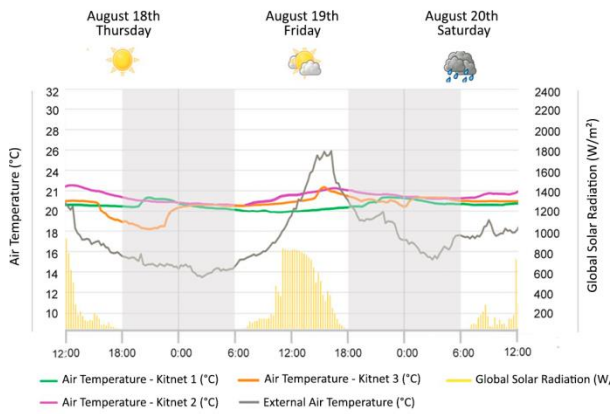

Figure 9: Measurements of dry bulb air temperature during cool days (August 2016) in the case studies with external temperatures and global solar radiation on the horizontal surface.

### 3.2 People’s perception

A questionnaire was applied to a group of 100 occupants living in studio flats of the block B (southeast and northwest facing), where most of Copan’s kitnets are located, in order to capture their perception about the environment they live in, with particular focus on the thermal conditions.

For the warm period, the questions contemplated the occupants’ satisfaction with the internal air temperatures and the effectiveness of natural ventilation as well as about the means used to cool the internal spaces and how quickly these get cooled to comfortable levels (Figures 10, 11). For the cooler period, the questions were about the occupants’ satisfaction with the internal temperatures, whether they experience overheating or the use artificial means to heat up their internal spaces (Figure 12).

The answers presented in Figure 10 show that a great majority (68,6%) is satisfied with the thermal conditions in the warm periods of the year and with the natural ventilation (72,7%), stating that for their perception, when necessary the room is quickly cooled by means of natural ventilation and fans (85,6%).

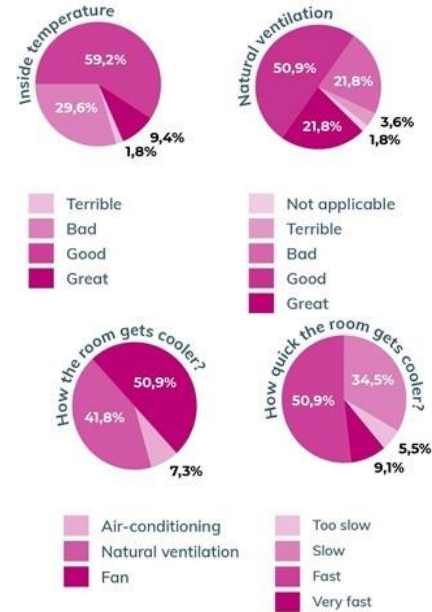

Figure 10: Responses from occupants of studio flats in Copan to questions regarding their thermal comfort during warm periods of the year.

Nevertheless, it should be observed that the percentage of people dissatisfied with their thermal environments in the warm periods is not insignificant (31,4 %) and to the lack of effectiveness of natural ventilation (21,8%), indicating a problem associating with excessive solar gains in those cases. A small percentage (7,3 %) has introduced artificial cooling means to achieve comfort.

When questioned about the manipulation of windows’ openings for natural ventilation during warm days, almost all occupants keep their windows opened during mornings (90,7%), with this percentage reducing gradually towards the afternoon (83,4%), evening (77,8%) and early hours of the day (53,7%), following a natural decrease of the external temperatures, as shown in Figure 11. In addition to that, internal curtains and similar devices are mainly used at night (48,2 %) and early mornings (63%) for privacy purposes, and not during the day, when solar gains might be undesirable.

The perception of thermal comfort in the cooler days is less positive than in the warm days. As shown in Figure 12, the percentage of people satisfied with their thermal environments in the cooler days is just above the average (56,4%) and a small percentage use artificial heating to compensate the discomfort (21,8%), whilst overheating in winter is pointed out by a minority (18,2%).

# PLEA 2018 HONG KONG

Smart and Healthy within the 2-degree Limit

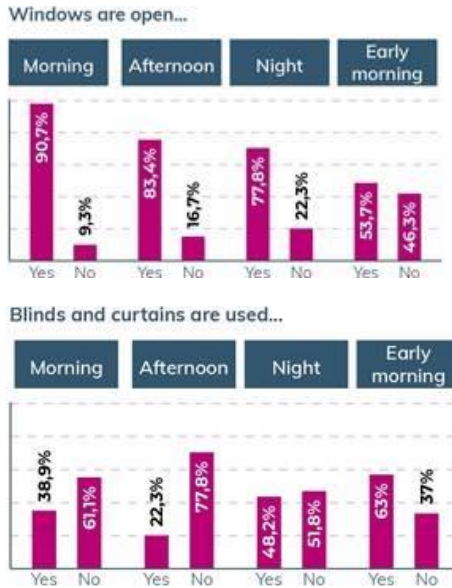

Figure 11: Responses from occupants of studio flats in Copan to questions regarding the manipulation of adaptive opportunities during warm periods of the year.

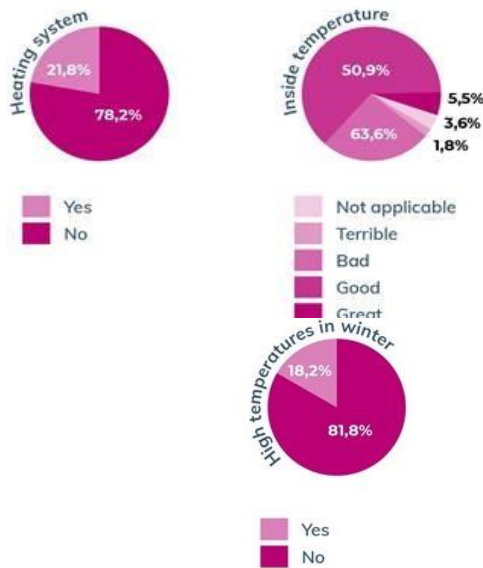

Figure 12: Responses from occupants of studio flats in Copan to questions regarding their thermal comfort during cooler periods of the year.

## 4. CONCLUSION

One of the main conclusions about the research on the thermal response of the Copan building was the effect of thermal inertia coupled with external shading, that characterizes buildings built during the times of the Brazilian bioclimatic modernist, resulting in steady thermal conditions during warm and cold days, favorable to the comfort of the occupants, with temperature figures oscillating between 24°C and 26°C.

In addition to that, it was verified that reducing window apertures during the cooler nights allowed

internal temperatures to stay as high as daytime figures around 20°C.

According to occupants' opinions, thermal discomfort during the cooler periods appeared to be a problem for more people than during the warmer periods, with 43,6% of interviewers dissatisfied with their thermal conditions in the cooler days against 31,4 % in the warm days. Most occupants (more than 90%) declared that natural ventilation is widely used throughout day and night to cool the internal spaces and enhance comfort conditions. On the other hand, the dissatisfaction with the thermal comfort in the warm periods points out to the problem of excessive solar gains, leading to the increase of internal temperatures, as seen in the unit without external shading towards southeast.

Concluding, it is worth noticing that the fieldwork in the studio flats of the Copan building revealed that the single curtain glass facade does not compromise the internal thermal conditions in warm days as long as shading and thermal mass are provided. For the cooler days, the single curtain glass facade can become a problem, especially if the unit does not benefit from passive solar heating. Nonetheless, it should be considered that when the curtain wall facade is not a problem for the internal thermal conditions (as seen in a number of scenarios for studio flats in the Copan building), in general, this remarkable architectural feature from the residential modernist buildings in Brazil, is associated with benefits of views, daylight access and open-space perception, aggregating environmental quality to the compact living units.

## ACKNOWLEDGEMENTS

The authors would like to thank the Brazilian federal funding agency CNPq (Conselho Nacional de Pesquisa, current Conselho Nacional de Desenvolvimento Científico e Tecnológico) and research funding agency from the State of São Paulo, FAPESP (Fundação de Amparo à Pesquisa no Estado de São Paulo). Thanks also to the residents of COPAN that opened their homes to this research Project.

## REFERENCES

1. Yannas, S; Corbella, O. (2003). Em Busca de uma Arquitetura Sustentável para os Trópicos.
2. Roriz, M. (2012). Arquivos climáticos em formato EPW. São Carlos, Brazil.
3. Lemos C.; Cerqueira, A. (2014). Trilogia do Copan: a história do edifício Copan. Vol. 1. São Paulo.
4. Galvão, W. J. F. (2008). COPAN/SP: A trajetória de um megaprojeto, da concepção ao uso.

## Passive Cooling Applicability Mapping: A Tool for Designers

JUAN VALLEJO<sup>1</sup>, BRIAN FORD<sup>1</sup>, ROSA SCHIANO-PHAN<sup>2</sup>, PABLO APARICIO RUIZ<sup>3</sup>

<sup>1</sup>NaturalCooling Ltd, UK

<sup>2</sup>University of Westminster, London, UK

<sup>3</sup>University of Seville, Spain

*ABSTRACT: The applicability of passive cooling methods has been a recurring subject in architectural engineering science. The integration of these methods in architecture often requires feasibility studies and, in most cases, a deep knowledge of the climatic conditions is required to succeed in this task. The number of parameters to be evaluated will depend on the complexity of the cooling system, the physics involved and the context. This paper addresses the climatic applicability of convective and evaporative cooling systems in the context of United States (US) through the creation of a series of applicability maps deriving from processed climate data. This work is a revision of the climatic maps for draught cooling developed in Europe and in China with an extension to evaluate the opportunity for natural ventilation. More specifically, the studied cooling solutions are: Natural Convective Cooling (NCC), Passive Evaporative Cooling (PEC), and Active Draught Cooling (ADC). The maps obtained demonstrate the strong potential for the use of passive evaporative and convective cooling solutions in the US to overcome the current dependency on mechanical systems.*

*KEYWORDS: Passive Cooling, Applicability, Mapping*

### 1. INTRODUCTION

Global demand for cooling is increasing at a spectacular rate. In 2010-11 world sales of air-conditioning went up by 13% [1]. Data from 2016 [2] indicates that in the US 87% of all buildings are air-conditioned, and that air conditioning represents 42% of the peak load. In India and China, summer demand for power outstrips supply, resulting in rationing and the closure of factories and offices. Investment in renewables is increasing, but new fossil fuel power stations are still coming on stream every year.

Alternatives to conventional air-conditioning are needed urgently. The rise in demand for air-conditioning in the US, and the current dependency on it, is unsustainable. And yet the natural environment of the US is not as inhospitable as one might think. This paper presents results from an investigation into both the demand for cooling and the applicability of a range of passive cooling techniques across the whole of the country.

### 2. BACKGROUND

At early stages in the design process, speedy and robust assessments of feasibility are enhanced by reference to reliable sources of weather data and an understanding of the building use. Weather data plotted on psychrometric charts can promote rapid interpretation to support strategic decision making. Such plots can help to define both the need for cooling and the opportunity for different passive cooling strategies. The combination of 'need' and 'opportunity' can provide the

basis for determining 'applicability' of a specific passive cooling technique.

Interactive psychrometric charts are accessible through web and desktop tools, mostly part of climate analysis software packages like Climate Consultant, Climate Tool or Ladybug Tools. By integrating the theory of psychometrics using Szokolay's [3] methods, these tools compare the climatic data against an 'extended' comfort zone for environments with evaporative cooling systems.

Applicability maps, instead, allow the evaluation of passive cooling techniques at a larger geographical scale without the need of accessing multiple weather data. Previous work has published maps which have been constructed to communicate both the 'need' for cooling and the 'opportunity' for different climatic regions. A group at the University of Seville, Department of Energy Engineering, pioneered the definition of these maps, initially for Spain [4] and subsequently for the whole of Europe [5]. A similar approach has also been applied to map the applicability of different draught cooling options in China [6] and recently in the US [7], but these applied the original methodology and did not consider convective cooling.

In the US, the application of passive evaporative cooling methods in contemporary architecture is not new, and the design integration and performance evaluation of a series of built precedents have already been explained [4], [8]. The assessment and mapping methodology previously used has been revisited and expanded in this work to allow a full applicability

# PLEA 2018 HONG KONG

*Smart and Healthy within the 2-degree Limit*

evaluation of NCC, NEC and ADC. The entire process was taken to a higher degree of resolution, now dealing with hourly data instead of daily average data by means of big data processing techniques.

The third generation of Typical Meteorological Year climate data (TMY3), which derives from the 1961-1990 and 1991-2005 National Solar Radiation Data Base (NSRDB) archives, was obtained for 1020 locations in the US and post-processed to generate the applicability maps. The applicability in counties without climate data is determined using an interpolation methodology [9] by means of the geographical distance between the closest meteorological stations, latitude, altitude and proximity to the sea.

### 3. THE MAPPING METHODOLOGY

The 'need' (or demand) for cooling is based on a combination of climatic factors, and building design characteristics (uses, occupancy density, equipment & lighting). Preliminary assessments of cooling needs are often simply related to climatic factors and can be expressed as the number of cooling hours (CH) for a location. The number of cooling hours represent the number of hours when cooling might be needed and can be determined directly from hourly weather data for the location, or from maps for the region.

Assessment of the 'opportunity' of applying different passive cooling options strategies in a specific location will be determined by climatic factors alone (including dry and wet bulb temperatures and inside-outside temperature difference). The opportunity of a passive cooling strategy for a location can be expressed in terms of a temperature difference 'range' ( $\Delta T$ ).

The 'need' for cooling in a location may be 'low' or 'high', just as the 'opportunity' for a particular passive cooling technique may be 'low' or 'high'. The 'applicability' of a particular technique can therefore be considered to be a multiple of 'need' and 'opportunity', and this is the basis for the mapping of the applicability of cooling by natural convection, evaporation and active draught described in this paper. Essentially:

$$\text{APPLICABILITY} = \text{NEED (CH)} \times \text{OPPORTUNITY (\Delta T)} \quad (1)$$

### 4. NATURAL CONVECTIVE COOLING (NCC)

Natural ventilation is a recurrent strategy to provide healthy and comfortable internal environments. Its capacity to reduce indoor temperature through convection (convective cooling) is also widely appreciated and presents significant benefits against mechanical systems: reduced carbon emissions (mechanical ventilation can represent 25-35% of electrical energy use in buildings), reduced capital cost (mechanical ventilation can add 10% to the capital cost) and reduced maintenance cost (mechanical ventilation can double lifecycle costs) [10].

Assuming a design indoor temperature of 26°C, equal to the upper limit of a thermal comfort zone for indoor environments with elevated high humidity and air velocity [11], the climatic applicability of convective cooling can be directly determined by the indoor-to-outdoor temperature depression, 26°C-DBT. This index derives from the sensible cooling equation [12], which determines the amount of energy needed to reduce the temperature of a volume of air keeping its moisture content constant. The equivalent cooling is thus directly proportional to the indoor-to-outdoor air temperature difference and responds to the question: *how much cooler is the climate with respect to indoor temperature?* 26°C-DBT has been determined for each hour of the analysis period and the average values are mapped in Fig. 1. The map suggests a prevailing range of indoor-to-outdoor air temperature depression between 3°C and 9°C, with cooler areas referring to the Northern counties and high altitudes. The displayed scale responds to the following criteria:  $\Delta T < 3$  (low),  $3 < \Delta T < 6$  (medium-low),  $6 < \Delta T < 9$  (medium-high) and  $\Delta T > 9$  (high).

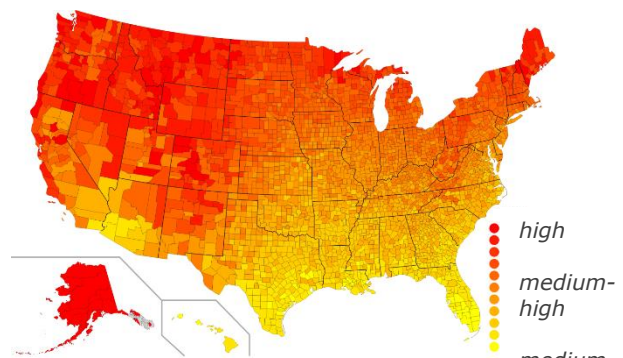

Figure 1: Natural convective cooling applicability. Determined from 26°C-DBT.

In addition to the above index to evaluate the NCC applicability, a second index determining average daily temperature fluctuation was obtained to complement it. Night ventilation is a recurring strategy to release the heat received and often absorbed by the building mass, and a higher temperature drop at night increases convective heat exchange and internal heat losses. Fig. 2 maps the average day-to-night temperature depression  $DBT_{max} - DBT_{min}$  and suggests the opportunity for night ventilation as well as a good potential for thermal mass (when coupled with night ventilation) as a strategy to reduce indoor peak temperatures. The results suggest a good opportunity for night ventilation in most counties, presenting a mean range of  $DBT_{max} - DBT_{min}$  between 10°C and 20°C with high applicability in Western counties where altitude is typically higher than 1000 meters above the sea level. The displayed scale responds to the following criteria:  $\Delta T < 5$  (low),  $5 < \Delta T < 10$  (medium-low),  $10 < \Delta T < 15$  (medium-high) and  $\Delta T > 15$  (high).

# PLEA 2018 HONG KONG

Smart and Healthy within the 2-degree Limit

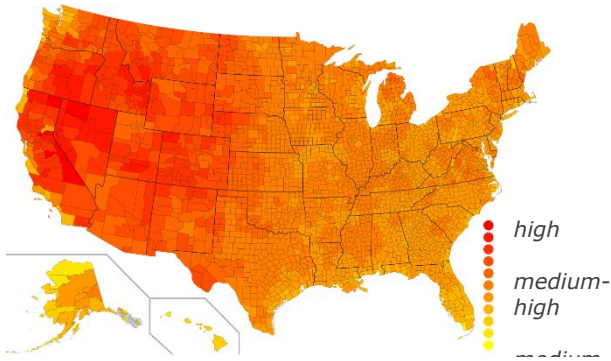

Figure 2: Opportunity for night ventilation. Determined from average DBTmax-DBTmin.

The above maps provide sufficient information to evaluate convective cooling methods. The outcome from these maps is promising and concludes that 70% of the counties in US (presenting high applicability) could overcome overheating problems in buildings with a good natural ventilation strategy and without the need of mechanical systems.

## 5. PASSIVE EVAPORATIVE COOLING (PEC)

Assuming the same design indoor temperature, the need for cooling can be determined by the number of hours (h) when DBT>26°C for a theoretical warm period from June to September (presenting a maximum number of hours of 2928). The results for each county is mapped in Fig. 3. The map suggests a higher demand in areas with lower latitudes and altitudes, in other words, the Southeast counties from Texas to Florida, Southern California and Arizona. The displayed scale responds to the following criteria:  $h < 750$  (low),  $750 < h < 1500$  (medium-low),  $1500 < h < 2250$  (medium-high) and  $h > 2250$  (high).

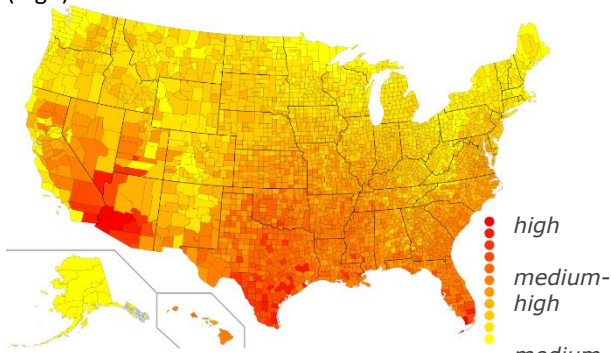

Figure 3: Passive evaporative cooling need. Determined from DBT>26°C.

The opportunity or efficiency of an evaporative cooling method derives from the wet bulb temperature depression and responds to the question: how dry is the climate? This question has been addressed in three different approaches that adapt to different contexts.

- The first approach determines DBT-WBT for each hour of the analysis period and the average values are mapped in Fig. 4. The results obtained

broadly represent the humidity of the climate with no differentiation between day a night. The map also suggests a prevailing range of DBT-WBT between 3°C and 6°C, with dryer areas referring to the Western counties, and highlighting an evident relation with the altitude above the sea level. The displayed scale responds to the following criteria:  $\Delta T < 3$  (low),  $3 < \Delta T < 6$  (medium-low),  $6 < \Delta T < 9$  (medium-high) and  $\Delta T > 9$  (high).

- The second approach determines DBT-WBT when DBT>26°C. This index represents the maximum opportunity by mapping the wet bulb depression at the warmer hours of the day. It is indeed addressing PEC opportunity in the outdoor environment when most needed. The results mapped in Fig. 5 extends the high opportunity also to Eastern counties and the prevailing range of DBT-WBT at the warmer hours now increases from 4°C to 8°C. The displayed scale responds to the following criteria:  $\Delta T < 4$  (low),  $4 < \Delta T < 8$  (medium-low),  $8 < \Delta T < 12$  (medium-high) and  $\Delta T > 12$  (high).
- The third approach considers the previously used design indoor temperature of 26°C to determine the wet bulb depression. As with the maps created for Europe and China, 26°C-WBT indicates the opportunity to reduce cooling demand in indoor spaces with a PEC system that theoretically could supply air at wet bulb temperature. The results mapped in Fig. 6 suggest that PEC opportunity could be extended even in the colder and more humid regions of North-eastern US when a theoretical indoor temperature is achieved as a result of the internal and solar gains. The displayed scale responds to the following criteria:  $\Delta T < 3$  (low),  $3 < \Delta T < 6$  (medium-low),  $6 < \Delta T < 9$  (medium-high) and  $\Delta T > 9$  (high).

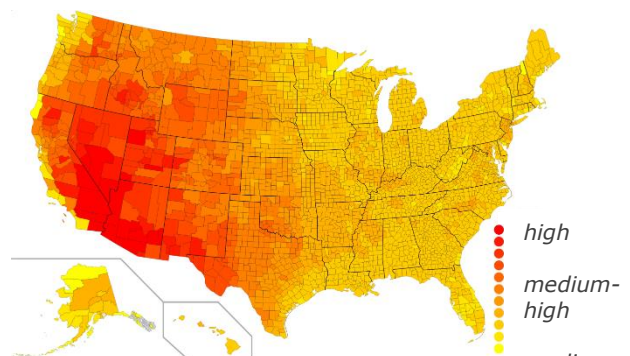

Figure 4: Passive evaporative cooling opportunity (I). Determined from DBT-WBT.

# PLEA 2018 HONG KONG

Smart and Healthy within the 2-degree Limit

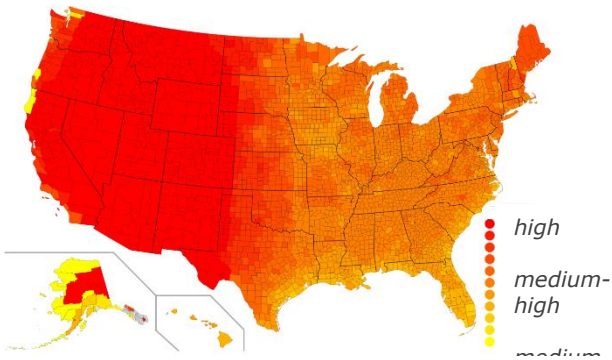

Figure 5: Passive evaporative cooling opportunity (II). Determined from DBT-WBT when DBT>26°C.

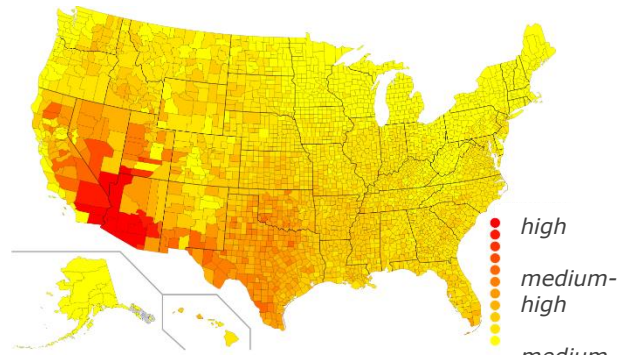

Figure 7: Passive evaporative cooling applicability (I). Determined from CH x [DBT-WBT].

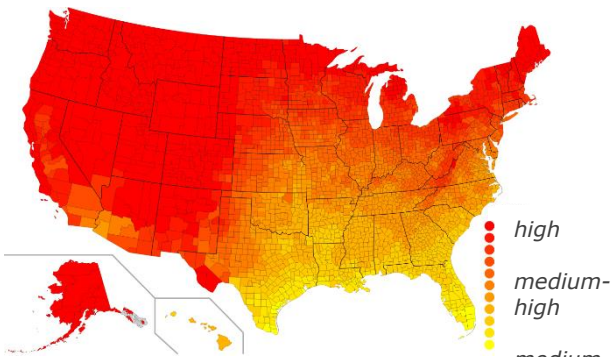

Figure 6: Passive evaporative cooling opportunity (III). Determined from 26°C-WBT.

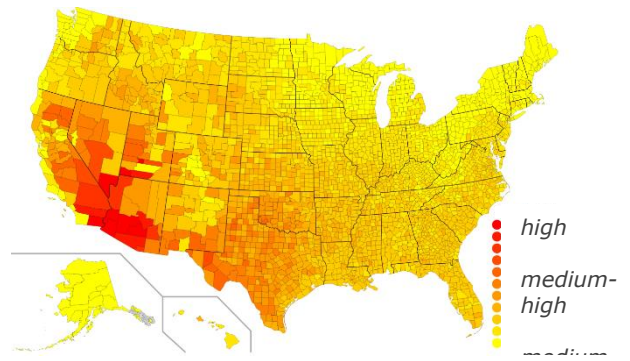

Figure 8: Passive evaporative cooling applicability (II). Determined from CH x [DBT-WBT when DBT>26°C].

The above maps provide sufficient information to evaluate separately need and opportunity for PEC systems in early stages. As both indexes are equally important, higher number of warm hours (demand) and higher wet bulb temperature depression (opportunity) yield high applicability. The maps shown in Figs. 7-9 combine PEC demand with each of the opportunity indices above described to determine PEC applicability as in Equation (1), equivalent to the cooling degree-hours [hours x°C]. It is important to look at the three maps for a better understanding of PEC viability under different contexts. The combined results suggest a medium to high applicability in South and Southwest regions in the US for outdoor spaces and extended high applicability region towards the North for indoor spaces. The maps conclude that 30% of the US counties present optimal climatic environmental conditions for the integration of passive evaporative cooling systems in architecture. These results are satisfactory and confirm that alternative passive methods to the 'default' use of mechanical systems are very valid and present a huge potential for expansion to overcome the recurring increase in greenhouse gas emissions during the last decade [13].

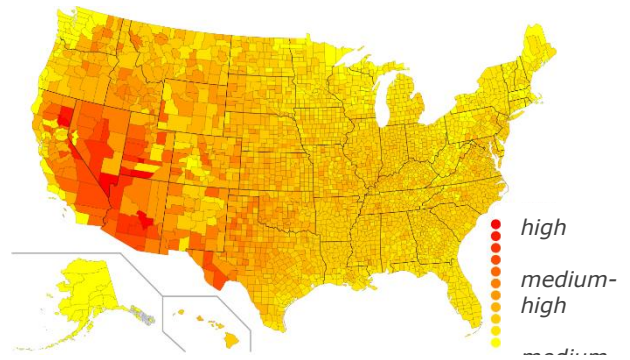

Figure 9: Passive evaporative cooling applicability (III). Determined from CH x [26°C-WBT].

## 6. ACTIVE DOWNDRAUGHT COOLING (ADC)

Active draught cooling becomes an environment-friendly solution to climates with warm and humid conditions presenting low PEC applicability. It is achieved by using chilled water cooling coils or panels exposed to a warm internal environment, thus inducing a natural indoor air movement (downdraught). Although it relies on mechanical cooling, it avoids the need for fans, which can represent an energy saving of 25–35% of the electrical load in non-domestic buildings. [14].

Cooling in ADC systems is achieved by convective heat exchange and no evaporation takes place. Although ADC is applicable for both humid and dry climates and air

# PLEA 2018 HONG KONG

*Smart and Healthy within the 2-degree Limit*

moisture content does not have a significant impact on the cooling delivered, the applicability assessment proposed in this paper prioritises passive systems over active systems. In other words, ADC applicability is inversely proportional to PEC applicability.

The need for active draught cooling is determined as with PEC, thus by defining the number of hours (h) when  $DBT > 26^{\circ}\text{C}$  for a theoretical warm period from June to September. The results for each county are mapped again in Fig. 10 and the same graphical interpretation and scale criteria applies as with PEC applicability.

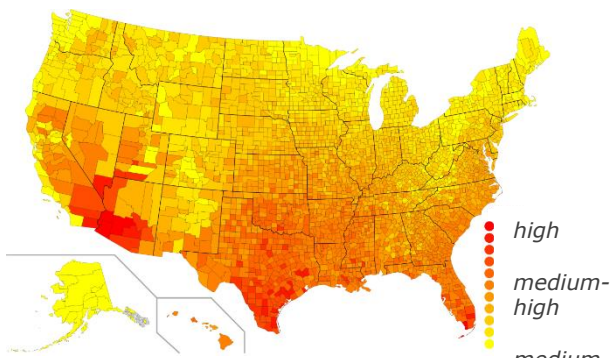

Figure 10: Passive evaporative cooling need. Determined from  $DBT > 26^{\circ}\text{C}$ .

The opportunity or efficiency of an active draught cooling method is directly proportional to the temperature difference between the room and the coil temperature for a convective heat exchange. This characteristic makes ADC methods less coupled to climate and reaffirms its potential applicability for both humid and dry environments. To evaluate ADC opportunity the index coil-to-room temperature depression is determined together with a complementary index to prioritise ADC opportunity on humid climates. This second index responds to the question: *how humid is the climate?*

- The first index determines a potential maximum coil-to-room temperature depression. The room temperature is the design indoor temperature equal to  $26^{\circ}\text{C}$ . The coil temperature is set to the minimum temperature at which condensation on the coil surface won't happen. In theory, the on-coil water temperature should be slightly above the dew-point temperature (DPT), but for simplicity it is considered equal to DPT. This first opportunity index is thus determined from  $26^{\circ}\text{C}-\text{DPT}$  and results are mapped in Fig. 11. The map suggests a mean range of coil-to-indoor air temperature depression between  $10^{\circ}\text{C}$  and  $15^{\circ}\text{C}$ . It is by about 4 degrees higher than PEC opportunity (III) index ( $26-\text{WBT}$ ) and its opportunity extends to most US area. The displayed scale responds to the following

criteria:  $\Delta T < 3$  (low),  $3 < \Delta T < 6$  (medium-low),  $6 < \Delta T < 9$  (medium-high) and  $\Delta T > 9$  (high).

- The second index is determined from  $DBT-\text{WBT}$  as in PEC opportunity index (I). In this case, and in order to prioritise ADC opportunity in humid climates, lower wet bulb temperature depressions are associated to high ADC opportunity. As in Fig. 4, the results obtained and mapped in Fig. 12 illustrate the average humidity of the climate represented in the inverse ranking of opportunity. The map also suggests a prevailing range of  $DBT-\text{WBT}$  between  $3^{\circ}\text{C}$  and  $6^{\circ}\text{C}$ , highlighting more humid areas in Eastern counties with lower altitudes. The displayed scale follows the criteria:  $\Delta T < 3$  (high),  $3 < \Delta T < 6$  (medium-high),  $6 < \Delta T < 9$  (medium-low) and  $\Delta T > 9$  (low).

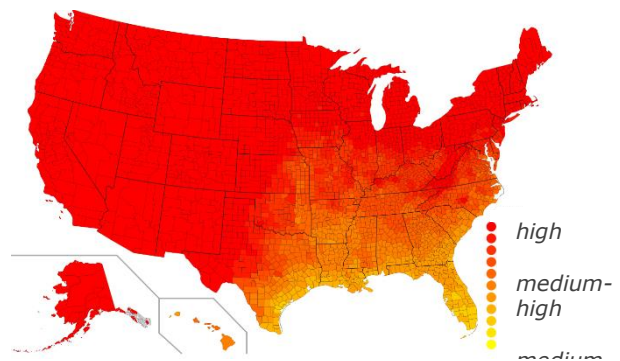

Figure 11: Active draught cooling opportunity (I). Determined from  $26^{\circ}\text{C}-\text{DPT}$ .

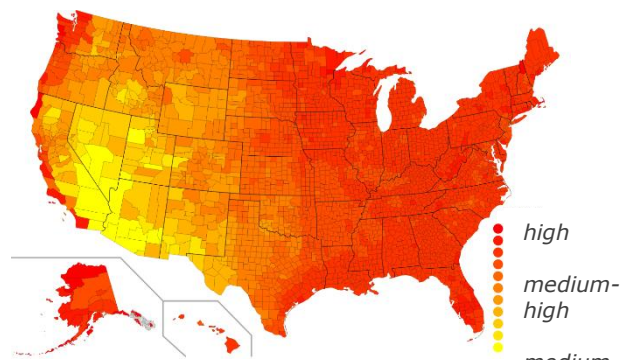

Figure 12: Active draught cooling opportunity (II). Determined from  $DBT-\text{WBT}$ .

The above maps provide relevant information to evaluate separately demand and opportunity for ADC systems in early design stages. Demand and opportunity (I) indices are directly proportional to ADC applicability: higher number of warm hours (demand) and higher coil-to-indoor temperature depression (opportunity) yield to high applicability. ADC opportunity (II) is, however, inversely proportional to ADC applicability as lower wet bulb temperatures depression yields to higher applicability in order to promote the use of PEC methods in dryer climates. The maps shown in Fig. 13 and Fig. 14



# PLEA 2018 HONG KONG

*Smart and Healthy within the 2-degree Limit*

combine ADC need with each of the opportunity indexes above described to determine ADC applicability from Equation (1) and Equation (2):

$$\text{APPLICABILITY} = \text{NEED (CH)} \div \text{OPPORTUNITY (\Delta T)} \quad (2)$$

The combined results suggest that in principle, ADC is applicable in most US, presenting the highest applicability in South and Southwest regions in the US (Fig. 13). However, this strategy should be prioritised over PEC methods only in South-eastern regions as suggested in Fig. 14.

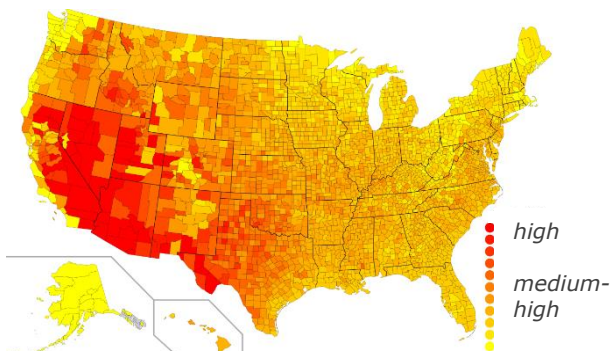

Figure 13: Active draught cooling applicability (I). Defined from  $CH \times [26^{\circ}\text{C}-\text{DPT}]$ .

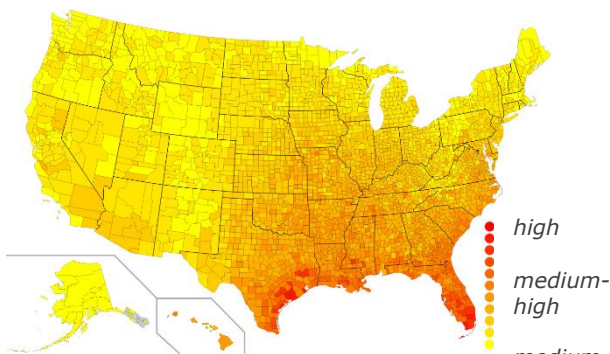

Figure 14: Active draught cooling applicability (II). Defined from  $CH \div [\text{DBT}-\text{WBT}]$ .

## 7. CONCLUSION

The proposed method and its application provide a reliable set of maps to determine the applicability of Natural Convective Cooling, Passive Evaporative Cooling and Active Drought Cooling systems in the USA at early design stages. The work also defines a methodology to assess the applicability of each cooling method with the highest rigour through a series of indexes that derive from the physics involved during the cooling process and adapt to different contexts. This methodology can be applied to any location in the world and aims to set the base for a future standardised method to assess the applicability of passive cooling techniques in architecture in a simple and accurate manner.

Hence, these maps target architects and product designers with limited knowledge in this field to, for

instance, suggest the most suitable cooling strategy to overcome overheating problems or evaluate the market opportunity of a novel evaporative cooling product.

The results obtained are promising and suggest a large potential for the use of passive evaporative (PEC) and convective cooling solutions in the US. In fact, from the climatic data available it can be concluded that more than 50% of the counties in the US are eligible for the application of PEC methods and more than 70% of the counties could overcome overheating problems in buildings with a good natural ventilation strategy and without the need of mechanical systems. Although the presented methodology does not include all the related criteria for applicability (i.e. building geometry, internal heat gains, water availability, etc), the maps are still a robust and useful tool that supports the development of alternative evaporative and convective cooling systems for architecture, demonstrating the high potential of these systems for improving comfort conditions and overcome the current dependency on mechanical systems.

## REFERENCES

1. Cox, S. (2010). *Losing our Cool*; The New Press, NY.
2. Commercial Buildings Energy Consumption Survey (CBECS). Metadata update 2017 (Aug).
3. Szokolay, S. V. (2008). *Introduction to architectural science: the basis of sustainable design*. Amsterdam; London, Architectural.
4. Ford, B., Schiano-Phan, R. & Francis, E. (2010). *The Architecture & Engineering of Drought Cooling: a design sourcebook*, PHDC Press.
5. Salmerón, J. M., Sánchez, F. J., Sánchez, J., Álvarez, S., Molina, J. L. & Salmerón, R. (2012). Climatic applicability of drought cooling in Europe. *Architectural Science Review*, 55, 259-272.
6. Xuan, H. & Ford, B. (2012). Climatic applicability of drought cooling in China. *Architectural Science Review Special Issue*.
7. Aparicio-Ruiz, P., Schiano-Phan, R. and Salmeron-Lissen, J.M. 2018. Climatic applicability of drought evaporative cooling in the USA. *Building and Environment*. 136, pp. 162-176.
8. Schiano-Phan, R. (2012). Post-occupancy evaluation of non-domestic buildings using passive drought evaporative cooling in south-west USA. *Architectural Science Review* 55(4): 320-340.
9. De La Flor, F. J. S., Domínguez, S. Á., Félix, J. L. M. & Falcón, R. G. (2008). Climatic zoning and its application to Spanish building energy performance regulations. *Energy and Buildings*, 40, 1984-1990.
10. K. J. Lomas, M. J. Cook & C. A. Short (2009) Commissioning hybrid advanced naturally ventilated buildings: a US case study. *Building Research & Information*, 37:4, 397-412.
11. Givoni, B. (1994). *Passive and low energy cooling of buildings*, New York, Van Nostrand Reinhold.
12. ASHRAE (2013). *ASHRAE Handbook: Fundamentals 2013*. American Society of Heating, Refrigerating and Air-Conditioning Engineers.

# PLEA 2018 HONG KONG

*Smart and Healthy within the 2-degree Limit*

13. IPCC (2014). Climate Change 2014: Synthesis Report. Contribution of Working Groups I, II and III to the Fifth Assessment Report of the IPCC.
14. Short, C.A. and Cook, M.J. (2005). Design guidance for naturally ventilated theatres. Building Services Engineering Research and Technology, Hodder Arnold, 26 (3), September, pp. 259-270.

# The Regenerative Sustainable Design of Modernist Nordic Houses. A Qualitative and Quantitative Comparison with Contemporary Cases.

EMANUELE NABONI<sup>1</sup>

<sup>1</sup>Institute of Architectural Technology, The Royal Danish Academy (KADK), Denmark

*ABSTRACT: This research presents a study of Functionalistic Nordic housing by appraising the Regenerative Sustainable Design qualities of four projects built before the energy crisis of the 1970s and by comparing them to four projects created after the year 2000 when Sustainable Design became an explicit target, and the concept of Regenerative Design was not widespread. The functionalist projects are Erskine's Box, Aalto's Helsinki House, Jacobsen's, Gotfred Rodes Vej House, and Korsmo's Planetveien House. The recent case studies selected are AART Architects' Home for Life, Henning Larsen's Adaptable House, Rune's Tind Prefabricated House and Kaminsky Architecture's Villa Nyborg. The Regenerative Design Sustainable Features of the case studies are studied qualitatively considering aspects such as Biophilia, Salutogenesis, Human Centric Design and quantitatively analysing Daylighting Distribution, Operational and Embodied Energy. Site visits, literature review, and computer simulation are the used methods.*

*KEYWORDS: Energy, Houses, Functionalism, Modernism, Regenerative Design, Sustainable Design*

## 1. DEFINING THE REGENERATIVE HOUSE

The research seeks to identify how functionalist architects on the one hand, and a more recent generation of architects on the other, consciously or unconsciously have implemented Regenerative Design. Regenerative Design scopes focus less on doing less damage to the environment and participate in restoring the ecosystems to a healthy state while providing human wellbeing (1). Five foundational aspects of regenerative design are considered.

-Biophilia suggests a deep, innate affinity between humans and nature (2).

-Salutogenesis (3) means 'generation of health'. The shift is from minimising the impact on people's health, to improving peoples' health.

-Human-Centric based design. Thermal and Visual delight focus on a simple interaction with environmental controls (e.g., blinds, openings).

- Bioclimatic Design. While one approach is the one of conserving energy with hyper-insulated buildings and mechanical systems (non-bioclimatic solution), the focus is on maximising the relation to the cycle of nature with less reliance on equipment.

## 2. COMPARISON OF CASES

The selected buildings share their location in the Nordic geographical context, and prominent architects designed them. Four of the buildings were designed before the '60. They are identified as "modernist". These are Ralph Erskine's Box (Sweden); Aalto's Helsinki House (Finland); Jacobsen's Gotfred Rodes Vej House (Denmark); and Korsmo's, Planetveien House (Norway) (Fig.1). They are "low-tech" homes, made of locally

sourced materials, and use natural forces to provide a comfortable internal environment (e.g. harvesting sun and light) with limited use of energy.

The "new" case studies are Home for Life Future Active House (Denmark); Adaptable House by Henning Larsen (Denmark); Tind Prefabricated House by Claesson Koivisto Rune (Sweden); Villa Nyborg by Kjellgren Kaminsky Architecture (Sweden) (Fig.1). All cases incorporate performance-based design concepts. The active house "thinks", "learns" and "anticipates" users' behaviour to minimise the use of energy. Tind House is unbuilt, and it features solutions to reduce embodied energy. Villa Nyborg was designed according to principles of biological shape, combining natural flows and sun position to reduce energy consumptions. The "Home for Life" is shaped to adaptable to a Danish family life-path.

## 3. QUALITATIVE AND QUANTITATIVE METHODS

The analysis of the case studies is filtered by the qualitative and quantitative targets regarding regenerative design. The analysed qualitative factors are Biophilia, Salutogenesis, Human Centric Design, Bioclimatic Design, as well as to the "ephemeral" characteristics of the spaces. The analysis is based on the study of drawings, published reviews, field visits, and interviews with experts. Quantitative consideration of how buildings are related to daylighting, operational and embodied energy, yet a qualitative look is on how performance is achieved by establishing a relationship with the ecosystems, the climatic context and the site.

The performance were calculated with the use of a (BIM) Building Information Modelling-based workflows (Fig.2). (Fig.3). The geometrical analysis was based on the

# PLEA 2018 HONG KONG

## Smart and Healthy within the 2-degree Limit

3D models. The BIM models were used imported for energy calculations in EnergyPlus, Daylighting Calculation in Radiance, and Embodied Energy calculations in Tally.



Figure 1: The 8 cases. Clockwise from upper left: Jacobsen's Gotfred Rodes Vej House; Aalto's Helsinki House; Korsmo's Planetveien House; Erskine's Box; Kaminsky Architecture's Villa Nyberg; Rune's Tind Prefabricated House; Henning Larsen's Adaptable House; AART Architects' Home for Life.

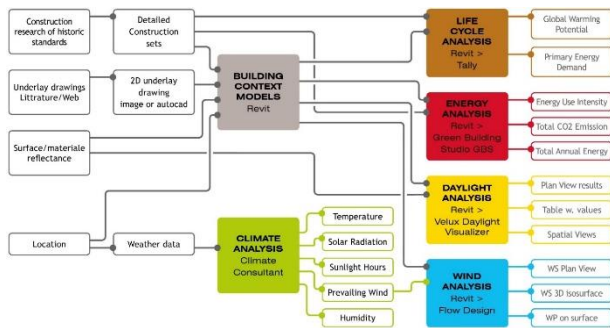

Figure 2: The workflow charts from construction research to building simulation (and related outputs)

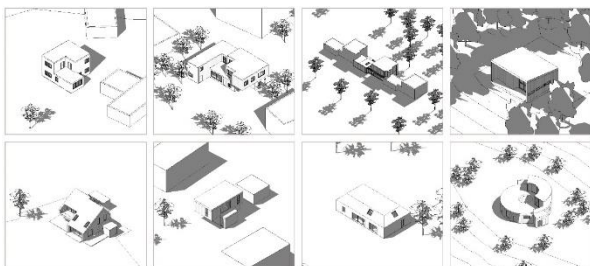

Figure 3: BIM models of the 8 case studies (order of Figure 1)

### 4. THE ANALYSIS OF REGENERATIVE FACTORS

#### 4.1 Size, Form and Compactness

The eight buildings (Fig.4) present distinct forms. Except for the Box, the old cases are two-storey-high structures with living on the ground floor. The older cases feature patios and upstairs decks to benefit from direct solar gain (Fig.5). The forms create exterior "rooms" exposed to sunlight and protected from winds. The elevated terraces allow for extended views, giving the users the opportunity to relate to nature. Seasonal occupancy of outdoor spaces adjacent is key. The older cases have fragmented perimeters that interlock with the surrounding natural systems.

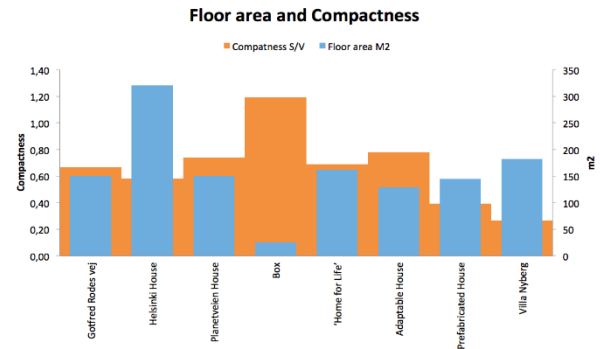

Figure 4: Floor area and Compactness (expressed as Surface to Volume ratio; lower value = more compact).

The recent projects enclose the occupied space within a tight thermal envelope. The separation between interior and exterior is a dominant formal characteristic of the recent projects. Home for Life and Villa Nyborg are oriented to optimise solar gain. The form of the Home for Life is a roofline that slopes to the south for optimal integration of solar technologies. Villa Nyberg (Fig.7) is a round toroid-shaped building that optimises passive solar heat gain. The Adaptable House has an upper level that shades the lower floor from the direct solar gain. The Prefabricated House has a similarly dominant sloping profile that refers to the traditional Swedish roof.

In the functionalist cases, the shape is impacted by a pure bioclimatic approach that increases thermodynamic exchanges with climate while connecting occupants to the surroundings with a biophilic approach. The paradigm of "forms follows energy" of the most recent cases leads to a more "introvert" approach with compact thermodynamic shapes, which often leads to a separation between the occupants and the surroundings.



Figure 5: Outdoors living space for seasonal use, Helsinki house terrace (photo: Anders Bengtsson)

# PLEA 2018 HONG KONG

*Smart and Healthy within the 2-degree Limit*



Figure 6: A local rock crosses the Helsinki house (photo: Alix Henry)



Figure 7: Villa Nyberg exterior; central courtyard brings light and heat into the building (photo credit: Kjellgren Kaminsky Architecture)

## 4.2 Heat Gains and Thermal Delight

In all cases, the Window to Wall Ratios on the south and west are higher than on the north and east. Windows are mostly located at the south (except the Adaptable House) allowing for winter direct solar gain.

The modernist case studies are oriented with airlock entries on the “coldest” side of the building (Fig.8) while living spaces are located on the “warm” side. There are more individual rooms in these buildings, thus offering the opportunity to close off areas, thermally isolating them, and allowing for seasonal uses. Insulating blinds and draperies control heat gain/ heat loss through openings. These are manually operated and add to the texture, colour and language of the spaces. In both Erskine (Fig.9) and Jakobsen House functional closets are located in the northerner side thus adding further insulation.

The more recent buildings have mixed-used living kitchen/dining areas, and – except Villa Nyberg –there are no airlock entry systems. Views of a lake nearby Villa Nyberg contributed to the design and the orientation of windows. The design of Home for Life integrates an “impressive array of technologies” with intelligent control systems. The building automatically adjusts operations of windows, shades and lighting; without the occupant’s direct control (8).

In the functionalist concept, openings are multi-layered and operable according to the user’s ever-changing relation to climate, light and outside views. In the contemporary cases, windows are conceived as large

openings of limited operability. Their orientation is driven by the concept of a solar machine.

## 4.3 Thermal Aesthetic, breathability and materials

In the modernist buildings, there is a designed integration between heating bodies and architecture, a feature that could be defined as “Thermal Aesthetics”. The fireplace is a prominent architectural element (Fig.9); these are focal points. These buildings have hydronic heaters (radiators) placed underneath the operable windows. In the Gotfred Rodes Vej Home and Helsinki House, plant trays are positioned on the deep window sills, so that live plants contribute to a biophilic design. Nature is brought inside the spaces and part of the thermal regulation of openings. In the cases with radiators under windows, the sill is deep so that the light can be reflected back into the living space, improving upon efficiency and also creating a functional “shelf”. The Planetveien building was originally designed with “warm floors”, a new technology at the time, although the architect regretted not putting radiant heating pipes in the stem wall underneath the windows (Tostrup).

The recent case studies use solar heating, active heat recovery and renewable energy systems combined with super-insulated, tight building envelopes that reduce heat losses. The heaters are embodied into floor and hidden from the occupants (Fig.10). In the Home for Life, the iconic solar heaters are integrated into the façade of the home and collect energy for whole house heating and domestic hot water.

The functionalist cases contribute to the generation of health with the breathability of spaces and the envelope. Such cases use natural ventilation driven by operable windows, ventilation shafts and tubes to facilitate air exchange. Wall sections are designed to “breathe” (Fig.10). Chosen materials are not harmful according to the Red List compiled by the International Living Future Institute (ILFI) as part of the Living Building Challenge.

Conversely, airtightness objective of some of the newer buildings. The latter use a combination of passive gain and mechanical heating recovery ventilators (HRV). In order to conserve energy, they aim at providing the minimum air change per hours by norms that facilitate the dispersion of indoor-generated pollutants. The newest cases adopt finishes and specifically insulation materials that are “less bad”, for occupants health, but some of the used materials are under the lenses of indoor environmental quality experts for their possible impacts on people health.

# PLEA 2018 HONG KONG

Smart and Healthy within the 2-degree Limit



Figure 8: AirLock of Jacobsen's Gotfred Rodes Vej House (photo credit: Authour)



Figure 10: Simple and operable Vents contributes to wall breathability in the Helsinki House (photo: Alix Henry)



Figure 8: Noth Wall of Erskine House is further insulated by a closet (photo credit: Authour)



Figure 9a: Fireplace is a prominent architectural element in the Planetveien home



Figure 9b: Radiant floor and fix large windows used in the Adaptable House

## 4.4 The relation to Daylighting

In the modernist architecture daylighting is a material. Living spaces have the large windows facing south and the west. There is a distinct relationship between the location of windows/skylights and the program. The Planetvein house is in a site with limited daylight. Korsmo designed large glass panes to distribute natural light deep into the building. A stepping garden on the west side allows daylight into the basement/studio. The Box has easterly windows adjacent to the working/living space at table height so that the illumination of working surfaces is well calibrated. In the kitchen, light is indirect (Fig.11). The Helsinki house has a quality of lighting that is ideal for working conditions in the studio, whereas the living rooms have south-facing windows that allow for bright light levels and sun can heat the occupants bodies. At the same time, skylights allow spaces in the centre of the building to access natural light. The daylight simulation that included overhangs, vegetation and the set of translucent curtains, showed vibrant environments with uneven yet calibrated distribution of light. There are daylighting transition area from the outside to the inside: eyes do not experience a sudden change of light. Jacobsen house is an exception, with a more distributed and uniform distribution of light that recalls of the contemporary cases.



Figure 11: Indirect Lighting in the kitchen of Erskine House. The perforation of the upper panel allows to diffuse light and avoid contrasts.

# PLEA 2018 HONG KONG

*Smart and Healthy within the 2-degree Limit*

The newer cases have white brightly coloured interiors to reflect and bounce around natural light admitted through large windows and skylights. Sections are derived from sun angles graphical studies and daylighting simulations. What strikes from the daylighting analysis of the most recent cases is that they have an extreme control that limits extreme daylighting conditions. The analysis of winter illuminance and luminance levels, lead to the identification of a trend when comparing the older and newer cases (Fig.12).

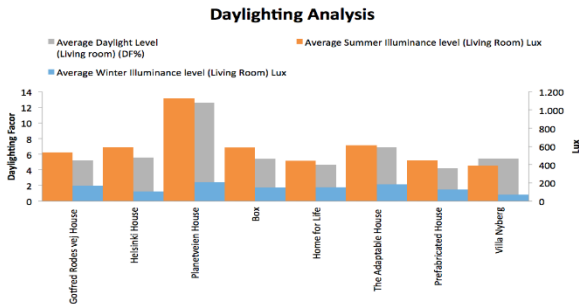

Figure 12: Simulated daylighting factors (above) and illuminance levels for living spaces at 12 o'clock the 21 of June and 21 of December and Lighting Loads.

In the modernist cases, light creates a variety of daylighting zones or atmospheres. The use of spaces varies during the day, following light penetration. It is abundant in colours via the reflection operated from the outside and the interiors. It impacts the circadian system positively. Daylight is rhythmic in both intensity and colour over a day and season. Access to daylight in earlier cases also often comes with the added benefit of being coupled with a view, leveraging the innate desire to be tied to the natural world.

The newer cases have a safe approach to daylighting that is aimed at having a uniform and sufficient distribution of illuminance level, this to increase metrics such as the daylight autonomy and glare index. An effect is that spaces have less light variations and rhythm (Fig. 13).

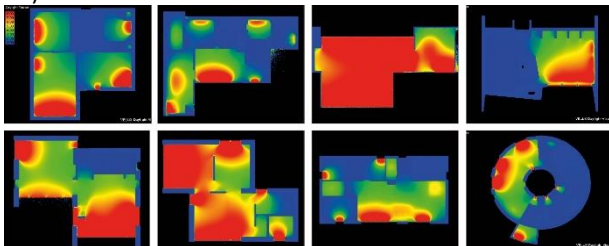

Figure 13: Daylighting Analysis (order of Figure 1)

## 4.5 Thermal delight

Modernist buildings place outdoor courtyards on the south side and let the winter sun in. They are all built on south, southeast, or southwest slopes. The site presence of trees is minimised on the south. Storage spaces, staircases, and kitchens are located on the northern sides. The buildings employ thermal mass to absorb and

store solar radiation and use pavements, or surfaces and furniture to play with thermal radiation exchanges. They have sunny but wind-protected outdoor spaces and utilise ground, plants, shaded outdoor spaces, such as porches and terraces, and integrate vines on walls and trellises for shading. All of the buildings use natural ventilation for summer cooling with a series of windows details that allow controlling breezes.

The more recent cases studies have clear ambitions to minimise energy use and achieve uniform and fixing temperature in every room. The focus on efficiency via mechanically controlled climates automated systems may at times result in spaces that do not seem to pay heed to the creation of building atmospheres and cultural links to heat and lights.

## 4.6 Operational Energy Demand

The simulation data indicates that the older cases do not demand significantly more energy to operate per square meter than the newer cases (Fig. 14).

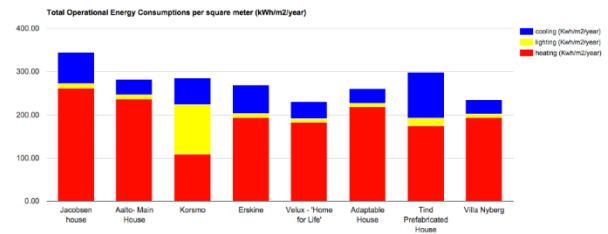

Figure 14: Simulated Operational Energy Use Intensity.

The functionalist cases, except the Box, have been renovated to improve energy efficiency and increase comfort. The Helsinki House was connected to district heating when it became available in the 1980s. The Planetveien home was connected to a geothermal heating system recently. Both projects, therefore, have improved the efficiency of the existing heating systems by connecting to more efficient technologies, thereby reducing their carbon footprint. However, the simulation here performed refer to the original construction drawings. In order to compare the efficiency of design across the different cases, only the energy demand was calculated, excluding the bias of considering the efficiency of mechanical systems.

In the case of the Planetveien house, "the entire building got very hot." (Tostrup) Because there were no operable windows upstairs; the building was thus rapidly adapted with operable panes to improve upon this. The exterior wall sections of the Aalto house were designed to buffer the harsh winter winds with lapping wood that allows for a breathable façade. "It is a breathing structure; the wood-based layers make no direct route for the air" (Pöyhkä). Alvar Aalto House and Erskine House are designed with strong reference to the site, being today two references in bioclimatic design.

The newer projects have tighter envelopes with lower U-value in the walls, roofs, floors and windows.

# PLEA 2018 HONG KONG

*Smart and Healthy within the 2-degree Limit*

Villa Nyberg set a record for airtightness and insulation in Sweden, which combined with a very compact shape determines a very low energy need.

The functionalist architects achieve thermal comfort by collaborating with nature. These buildings, based on intuitive knowledge of the environment and the climate, show a thermodynamic integration with the microclimate. The newer concepts rely on optimised compact shapes, thermally isolated from the outside and optimised by an energy simulation tool.

## 4.7 Materials and Embodied Energy Demand

The windows are a special double pane in the Korsmo house, which was built post-war when there was “heavy rationing of materials and the state institute of housing recommended how to build; use as little material as possible.” (Tostrup). The Box uses minimal materials due to the frugality required during World War II. It is constructed of wood sourced from the forest that surrounds the house. Bricks were reused from a falling apart building. The Helsinki house includes portions of a wall composed of brick, concrete and layered wood. The wall insulation was sawdust; the roof insulation was made of cork. In general, the older projects are achieving the goal of reducing carbon emissions and operational energy; as compared to the newer cases.

The Adaptable house uses a thermal mass concrete block base with Rockwool insulated frame construction above. The newer houses are optimized to retain heat with highly insulated walls and roof assembly with high impact on the primary energy needed for construction. Figure 15 shows in red the primary energy needed for construction per square meters over a theoretical lifespan of 50 years. To offer a full overview in blue is reported the operational energy demand.

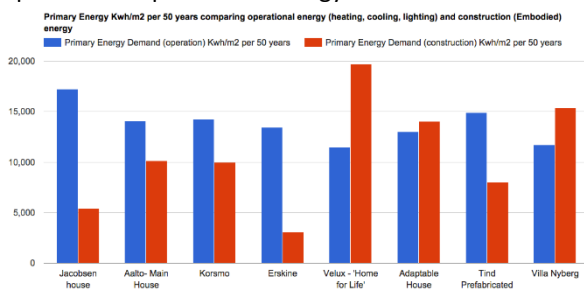

Figure 15: Used materials Primary Energy Demand (PED) in operation and for construction.

## 5. CONCLUSIONS

The functionalist master architect designed their houses as a continuum with nature and with a deep comprehension of the rhythm of climate, the flows of materials and the human physiology and health. These houses demonstrate an implicit understanding of the effect of climate on the spaces for living as demonstrated by the architectural form and relation to environmental factors. They used local, reused and natural material and

these houses have all been well maintained. Health is generated by the vegetation integrated into the interiors and exteriors, varying daylighting levels, and dynamic variations of temperatures. The occupants are engaged in the operation of the internal environment, and the buildings are not as automated as the contemporary cases.

The modernist houses could access limited technologies. However, they show sophistication in their design experimentation and regenerative approach. When these buildings were built, requirements regarding insulating materials, codes, standards, energy-conscious architectural design, etc. did not exist. They demonstrate value through their biophilic features, their salutogenic approach, the human-centric design, and the bioclimatic approach did not compromise operational energy performances, and they have low embodied energy.

The contemporary cases served well as a benchmark to highlighted that contemporary design should refer to the body of Regenerative theory and practice accumulated during the Nordic modernist period (1930-1970).

## ACKNOWLEDGEMENTS

This article is based upon work from COST Action RESTORE CA16114, supported by COST (European Cooperation in Science and Technology). I would like to thank Alix Henry for her work in the research, Daniel Nielsen for his support with the BIM Modelling, Sergio Altomonte and Toni Kotnik for their advice on the contents shape, Martin Brown for the discussion about Regenerative Design.

## REFERENCES

1. Martin Brown, Edeltraud Haselsteiner (2018) Sustainability, Restorative to Regenerative.
2. Wilson, Edward O. Biophilia. Harvard University Press, 1984.
3. Antonovsky, A., Health, 1979. Stress and Coping, San Francisco, Jossey-Bass Publishers
4. Reed, B., (2007). "Shifting from 'sustainability' to Regeneration." Building Research & Information 35 (6):674–80.
5. Mang P. and Reed B., (2012). Regenerative Development and Design, vol. Springer Encyclopedia of Sustainability Science and Technology. Regenes Group and Story of Place Institute, p. 14.
6. Alto, Alvar, Göran Schildt. (1998). Alvar Aalto in His Own Words. New York: Rizzoli, 1998. Print. p. 107.
7. Thule K., (2008). Peter. Gotfred Rodes Vej 2: Arne Jacobsens Eget Hus. Odense: Realea A/S, 2008. Print.
8. Hansen, Ellen Kathrine. "Denmark's Net-Zero-Energy Home." N.p., n.d. Web. 25 Apr. 2015.
9. Malmberg, Jonas; Architect / Aalto Foundation "Aalto's Main House." Personal interview. 7 Aug. 2013.
10. Pallasmaa, Juhani: Professor/ Architect 8/6/13 "Aalto's Architecture." Personal interview. 6 Aug. 2013.
11. Pöyhkä, Tuula; Architect / Building Heritage, Alvar Aalto Foundation. "Aalto's Main House." Personal interview. 7 Aug. 2013.
12. Thule Kristensen, Peter. Gotfred Rodes Vej 2: Arne Jacobsens Eget Hus. Odense: Realea A/S, 2008. Print.



# PLEA 2018 HONG KONG

*Smart and Healthy within the 2-degree Limit*

13. Troelsen, Per. "Arne Jacobsen Own House on Gotfred Rodes Vej 2." Message to the author by Alix Henry. 27 Aug. 2014. E-mail.

# Strategic Design for the Urban Block of Buenos Aires: A Study of the Current Building Regulations Vs. The Actual Built Form

ANGELA DUB<sup>1</sup>, SIMOS YANNAS<sup>2</sup>

<sup>1,2</sup>Architectural Association School of Architecture, London, UK

<sup>1</sup>Facultad de Arquitectura, Diseño y Urbanismo, Universidad de Buenos Aires, Buenos Aires, Argentina

**ABSTRACT:** The City of Buenos Aires lies on a regular grid of square blocks, following the traditional 'Law of Indies'. Due to large immigration waves from Europe during the 20<sup>th</sup> century, the city went through a very rapid densification process leading to constant changes in the building regulations to meet housing needs. Therefore, the city is currently composed by a mix of buildings responding to all different regulations, resulting in a very irregular urban landscape. By contrast, the current building regulation proposes an extremely regular model, by limiting buildable heights according to zoning and plot dimensions. This paper is a simulation-based study that explores the environmental performance of the 'irregular' actual built form and the 'regular' model following current building regulations. The method consists of three main steps: firstly, the city's urban layout is studied, identifying the most common block orientation. Secondly, analytic studies are carried out to evaluate the performance of typical 'regular' and 'irregular' blocks. Lastly, a redesign for the current urban block is proposed, engaging in reducing energy consumption per block and focusing specially on outdoor variety and comfort. This results in an effective 'generic' morphologic model, to be applied in the growth of low and mid-density blocks.

**KEYWORDS:** Strategic design, urban block, densification, climate-responsive design, mid-latitude city

## 1. INTRODUCTION

The City of Buenos Aires (34.6°S, 58.4W), is located at the northern edge of the flat plain known as the 'Pampas', bordered on its Eastern limit by the 'Río de la Plata' estuary. It has a population density of 13,800 inhabitants per km<sup>2</sup> [2]. 3 million people live in the city, and another 4 million commuters enter on a daily basis.

Due to large immigration waves from Europe during the first half of the 20<sup>th</sup> century, the city went through a very rapid densification process leading to constant changes in building regulations to meet housing needs. This process is visible in the city's urban landscape, characterized by extreme *irregularity*, especially in terms of height variations. By contrast, current building regulations propose an extremely *regular*, constrained and uniform model, by limiting the buildable volume according to zoning and plot dimensions. In addition, environmental regulations are scarce and outdated.

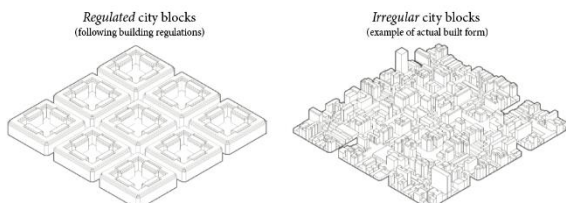

Figure 1: 'Regulated' and 'Irregular' urban morphologies [1]

This paper is a simulation-based study that explores and compares the environmental performance of the 'irregular' and the 'regulated' models, leading to an inhabitant-centered proposal for the redesign of the

urban block, engaged in reducing energy consumption per block and focusing specially on outdoor variety and comfort.

## 2. CONTEXT

### 2.1 Layout and grid orientation

Buenos Aires is laid on a regular grid of square blocks, following the 'Laws of Indies' of traditional Spanish colonies. Two prevailing orientations for these blocks are identified: 0° due North and 45° due North (considering a ±10° tolerance). The remaining blocks don't present a predominant orientation. They act as 'adjustments' or 'transitions' along the grid.

The city blocks orientated due North (0°) correspond most commonly to the historical neighbourhoods, where the city was first settled. These blocks are the most consolidated and represent 18% of the building stock. Furthermore, the 45° rotated block is the most repeated across the city, representing 32% of the building stock and the remaining 'transitional' blocks represent 21.8%. The remaining buildings (28.2%) are located across blocks that do not have a predominant orientation [1, 5].

### 2.2 Typical block

Buenos Aires has a very systematic block and plot formation (Fig.2), modulated by the 'vara' unit of measurement, inherited from the 'Laws of Indies': all blocks are 155 by 155 varas big (130m x 130m), typical streets are 20 varas wide (17m) and plots are 10 varas wide (8,66m) by varying lengths.

# PLEA 2018 HONG KONG

Smart and Healthy within the 2-degree Limit

The urban block that has the greatest potential is the one rotated 45° from North. It is the most widely spread and is most predominant on low and medium density buildings, which have a great potential to grow and have an impact on the larger number of people [5].

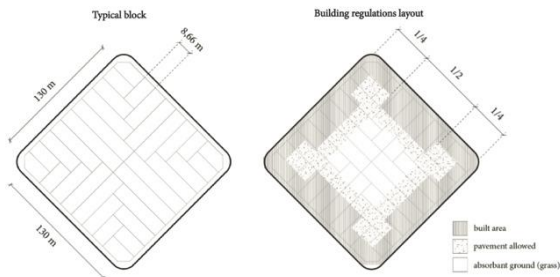

Figure 2: Typical block and plot layout, and building block formation according to building and planning regulations [6]

### 2.3. Typical urban canyon

Streets, generally, respect the original layout (17,50m wide), except for Avenues which are in general 25m wide. For the purpose of this study, the original measurement is considered as a standard.

Consequently, typical H/W ratios are identified, in correspondence to the three main building densities, according to building regulations:

- High: 15 storey buildings, H/W=2,3
- Medium: 6-8 storey buildings, H/W=1,6
- Low: 4 or less storey buildings H/W=0,57

## 3. ANALYTIC STUDIES

The environmental attributes and microclimatic features of the city's urban block types are evaluated through simulations for both *regulated* and *irregular* blocks, in all predominant layouts and orientations, and for the predominant urban canyons. Particular attention is given to daylighting, solar access and solar radiation for passive solar gains in the cool period.

### 3.1 Solar radiation and thermal comfort

Solar radiation is taken as the main parameter in order to assume units have the potential to be free-running. Figure 3 [3] shows thermal performance of a North-oriented flat in winter, according to its position within the urban canyon. It can be observed that as from the 9<sup>th</sup> floor onwards, indoor temperature is within the comfort band. This corresponds to values of 140KW/m<sup>2</sup> of solar radiation, and above. This value is taken as a target, considering the units where this is achieved as free-running and that adequate solar control strategies are implemented in order to avoid overheating.

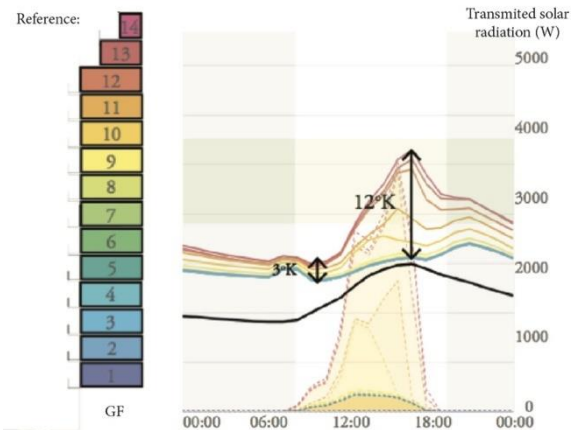

Figure 3: Performance of North oriented apartments on a typical winter day in Buenos Aires (Source: Collo, 2016). [3]

Furthermore, solar radiation is observed for all predominant block layout orientations (0° or 45° from due North) and building densities (low, medium and high), for the cool period (June, July and August) and the warm period (December, January and February). (Figure 4).

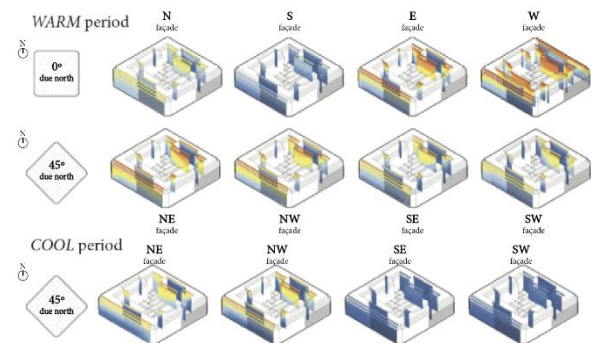

Figure 4: Extract from an extensive solar radiation analysis through different block orientations, densities and configurations (both regulated and irregular), for Buenos Aires, during warm and cool periods (Source: HoneyBee). [1]

In terms of block orientation, the 45° block presents a more even distribution of solar radiation in all orientations for the warm period in comparison to the 0°, where North and West orientations are completely overexposed and the South façade receives very low levels of solar radiation. During the cool period behaviour is similar: the 45° is slightly more favourable but receives low levels of solar radiation in the SW and SE facades; the cardinal block receives insufficient solar radiation in all façades except in the Northern one.

Courtyard and canyon façades of the *irregular* block behave similarly and generally 1/3-1/2 of the built form acts as unobstructed in all orientations and all densities. In the *regulated* block, courtyard façades are much more unobstructed than canyon façades, hence receiving more solar radiation.

# PLEA 2018 HONG KONG

Smart and Healthy within the 2-degree Limit

During the cool period, canyon façades in the higher density are obstructed almost completely until the 6th floor. This corresponds to an obstruction as of  $H/W=0.95$ .

For the warm and cool periods, the extreme cases are the following: the 0° block due West is the most exposed to solar radiation, and 0° due South is the least exposed.

### 3.2 Solar Access

Sun access in the main outdoor spaces of both block typologies for the medium building density are analyzed. Both the warm (December, January, February) and cool periods (June, July, August) are explored, during a 10am to 6pm interval.

Solar access in the main courtyard of both the *regulated* and *irregular* blocks is abundant during the warm period, where most of the area is exposed to 5 or more hours of sun. However, during the cool period only 15% receives up to 4 hours of sun in the *regulated* block's courtyard, corresponding to its southernmost corner, meaning there is very little to no potential use for the courtyard during the coldest months. Due to vertical irregularity, the *irregular* block has areas exposed to 5 hours or more of sun, and a distributed proportion of 50-50% of shadowed and sunny areas, a much better situation than for the *regulated* block. Nevertheless, the great disadvantage is that not all buildings in the block have access to the favorable patches of land (Figure 5).

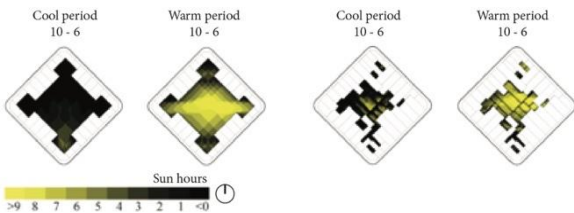

Figure 5: Solar access in regulated and irregular blocks (Source: Ladybug) [1]

### 3.3 Daylighting

The base-case apartment in Figure 3 is studied for the Southern and Northern orientations considering a Target of 300 lux between the occupied hours of 9am to 5pm (Figure 6). Flats oriented both North and South and located between  $H/W$  ratio=1,4 or lower have a DA of more than 50%. Top floors have over 75% of Daylight Autonomy, so their performance can be considered as independent from orientation. In higher  $H/W$  ratios there is a great difference between Northern and Southern-oriented flats: DA=40% and 27.3%, respectively.

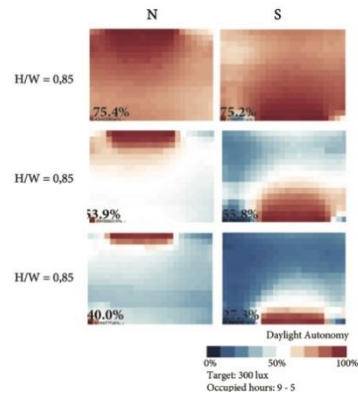

Figure 6: Daylight Autonomy according to  $H/W$  ratios (Source: DIVA for Rhino)

### 3.4 Air Temperature & Surface Temperature

Figure 7 illustrates Air Temperature and ground floor Surface Temperature variations in the *regulated* and *irregular* blocks from 10am to 4pm during the warm period.

For the constrained block, ground floor materiality was taken as what is allowed by the building regulations: the centre of the block is grass, while the surrounding area is covered by concrete. During the morning and at 7pm, Air Temperature is 1.5K higher than Surface Temperature. In addition, the effect that materiality has on Surface Temperature is very clear at 7pm, where the block's centre is 1.5-3K lower than the concrete perimeter. At midday and at 4pm ST is 1.5K higher than AT°.

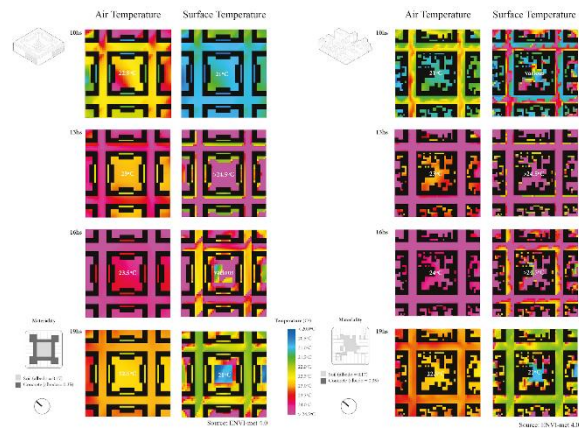

Figure 7: AT° and ST° in the regulated and irregular block throughout a day (Source: ENVI-met 4.0) [1]

In the *irregular* block, temperature differences between Air and Surface are not as pronounced as in the *regulated* block, and all surfaces are considered as grass. During the morning, ST° varies greatly across the block, ranging from 20.5-25°C, while AT° is stable. At midday, ST° is 1.5K higher than AT°, and are equal again by 4pm.

# PLEA 2018 HONG KONG

Smart and Healthy within the 2-degree Limit

The evening presents a lower  $ST^o$  of 21°C, thus decreasing 3K in 3hs.

### 3.5 Air movement

Air movement in the enclosed courtyard typology is very low, thus creating a very protected, yet poorly ventilated, central area. Only the top 2-3 floors are exposed to wind. The opposite takes place in the actual built form, where ventilation potential is much greater, and can be very beneficial for pollutant dispersion and urban air quality [6] as well as for outdoor comfort during the warm period.

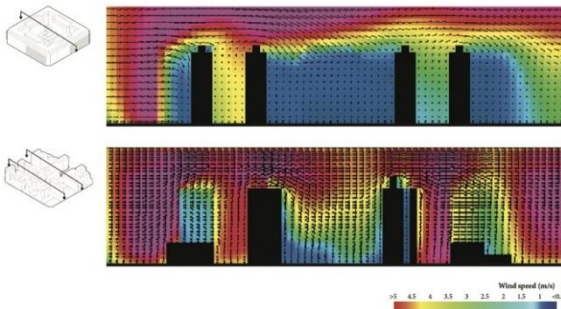

Figure 8: Air movement for the regulated and irregular blocks on a typical summer day (Source: ENVI-met 4.0) [1]

## 4. THE NEW URBAN BLOCK

The proposal for the design of a 'New Urban Block' is a holistic approach, responding to social, economic and contextual aspects, and informed by the performance of the *irregular* and *regulated* blocks. Special attention is paid to outdoor spaces in order to provide varied options for use in every season, for urban outdoor life is a very important characteristic of the local culture.

### 4.1 Objectives

Lead by the idea of improving life quality within the city, the main objectives that guide the proposal are the following:

#### Environmental objectives

- Achievement of sufficient solar gains in units in order to guarantee free-running potential.
- Daylight Autonomy of over 60% in all residential units.
- Cross-ventilation potential in all residential units.
- Large outdoor areas to receive 4+ hours of sun during the cool period, in order to accommodate all inhabitants and their activities.
- Natural ventilation to be enhanced through building morphology yet protecting outdoor spaces from winds when needed.
- Scalability of the environmental impact.

#### Socio-cultural objectives

- Replicability, adaptability and flexibility of the urban block for the city's expansion, compliance and future use, respectively.
- Maintain urban forms which are established symbols and characteristics of the local identity, such as the central courtyard in blocks.
- Access to the sky and life in outdoor spaces should play a leading role due to their importance for local culture.

### 4.2 Generic site and typology

The generic site for the proposal is a regular block in a medium density area of Buenos Aires. The City's general layout is respected; therefore block, street and plot dimensions remain the same. This establishes a realistic scenario, in order to focus on how the present urban morphology could eventually evolve into this *generic* model without suffering extreme modifications (otherwise, leading to a very lengthy and slow transformation). The block orientation is 45° from due North, being this the most common case.

A maximum target resident population of 1,000 people is suggested (20% more than that proposed by current regulations), distributed between residential (60%), work (30%), cultural/leisure (3%) and retail (7%).

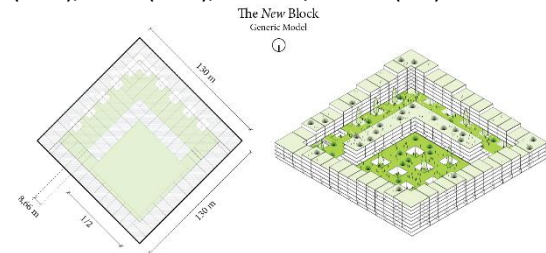

Figure 9: New Block configuration and generic model [1]

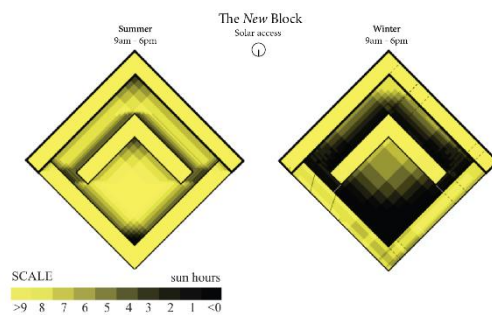

Figure 10: Solar access in the New Block (Source: Ladybug) [1]

The typical central Spanish courtyard, which is an established urban symbol for locals, is relocated to the block's Northern edge, maintaining its proportions (1/2x1/2 of the total length of the block) and multiplying its use by proposing densification strategies for different scenarios. For this scheme, the courtyard is elevated to the 2<sup>nd</sup> floor terrace, thus locating uses that do not

# PLEA 2018 HONG KONG

*Smart and Healthy within the 2-degree Limit*

require direct light, such as work and retail spaces, on the first two floors, and maximising solar access on the courtyard (4 hours+ p/day is achieved on over 65% of the courtyard in the cool period between 10am and 6pm) (Figure 9).

Outdoor spaces are located in 3 floors: Ground Floor (+0m), 2nd floor (+ 6m) and terraces (+15 to +27m). In addition, every unit also has a potential for a North-oriented private open space (balconies or small gardens). In the densest scheme, a podium occupies the GF and 1st floor of the building, to be occupied at street level by retail towards the street and by work spaces towards the inside of the block. Additionally, at +6m it can be used as a garden for residents, with occasional light-well perforation that add ventilation, illumination and outdoor areas for the users of the floors below (Figure 11).

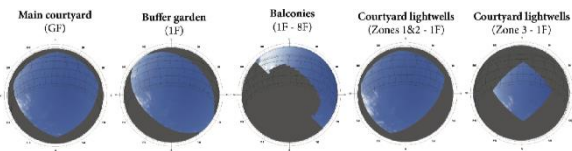

Figure 11: Shadow mask variation/sky framing for all proposed outdoor spaces (Source: Ladybug). [1]

This layout promotes community living and connectivity within the block without affecting privacy and intimacy for residents as it offers different gardens for the distinct types of users.

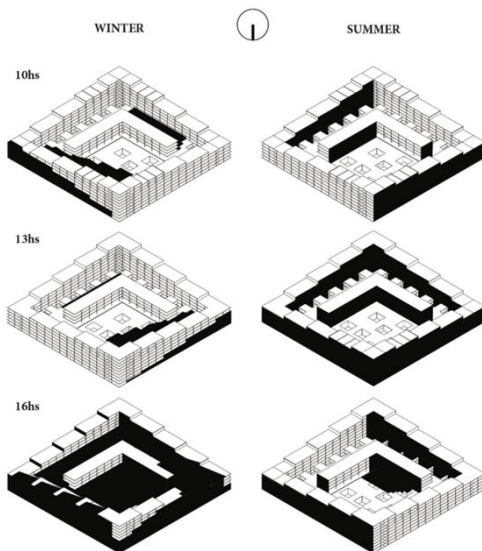

Figure 12: Sun access on façades (Source: Sketchup PRO) [1]

## 4.3 Adaptation and growth

For lower and medium density existing blocks, the generic model will serve also as an *adaptation* model,

constraining buildable heights for new buildings and adding new floors where the generic volume allows it.

For blocks that are located on wider canyons, higher volumes can be considered in the N and S corners, as long as it does not have a negative effect on solar access on the ground floor and façades). Standards achieved by the generic block should be maintained in new configurations of this kind.

For all configurations, and as informed by outdoor thermal comfort studies, horizontal porosity should be considered in order to improve outdoor conditions in the heart of the block during the warm period. This is key specially for the densified courtyard model, to ensure that light-wells are ventilated. NE façades are considered more porous, to allow summer prevailing winds to flow through the building into the courtyard (buffer courtyards are always protected from wind, in case of mild/cool summer days). In addition, porosity is greater in the lower floors for it coincides also with areas of low solar radiation, thus removing units with no potential for free-running. Different porosity thresholds informed by this were adopted for the top floors (10%) and the lower floors (20%).

## 5. CONCLUSIONS

Simulation studies and fieldwork have shown that the current city's irregular conformation has a lot of benefits in comparison to the constrained block morphology driven by the current building regulations. *The New Urban Block* pretends to tackle the city's housing deficit, by adding density without losing good life quality standards, and intends to homogenize environmental standards so that everyone in the block has similar benefits.

Buildings within the *New Urban Block* incorporate passive and active design strategies such as optimal building orientation for daylight and solar access, North facing orientation of all modules to ensure direct solar exposure (to be controlled), narrow plans to maximise daylight and natural ventilation and very efficient lighting and ventilation systems. It is based on reducing energy demand per block and it was designed to be responsive to people. In addition, the *Generic Model* provides a large typological variation in the building scale, not present in the city today.

Irregularity in the urban landscape is promoted, which enhances air movement for pollutant dispersion at the urban scale.

All strategies applied on the design of the *New Urban Block* were guided by considering its potential of being a replicable model that cuts across all levels and sets the stage for systemic change and environmental prosperity within the City of Buenos Aires.

# PLEA 2018 HONG KONG

*Smart and Healthy within the 2-degree Limit*

## **ACKNOWLEDGMENTS**

The authors would like to acknowledge that the lengthy solar radiation study at the urban scale was done together with Msc.Arch.Florencia Collo as part of a joint investigation at the Architectural Association School of Architecture in London, UK.

## **REFERENCES**

1. Dub, A. (2017). Redefining urban living: Strategic design for the urban block of Buenos Aires, Argentina. Architectural Association School of Architecture.
2. INDEC, National Institute of Statistics and Census of Argentina (2010).
3. Collo, F. (2016). Solar urbanism and building design in Buenos Aires. Architectural Association School of Architecture.
4. Oke, T.R. (1988) Street design and urban canopy layer climate. *Energy and buildings Journal* 11, No 1-3, p.103-113, Elsevier Science.
5. CIUDAD AUTÓNOMA DE BUENOS AIRES. Código de Planeamiento Urbano y de Edificación.
6. Ng, E. (Ed. 2009). *Designing High Density Cities*. Earthscan.
7. de Schiller, S. y Evans, J. M. (2000) *Urban Climate and Compact Cities in Developing Countries*, in Jenks, M. y Burges, R., Spon Press, London and New York.

## Everyday House: Redesigning the Informal Housing in Subtropical Climates, the Case of Paraisópolis Favela in Sao Paulo

EDUARDO PIMENTEL PIZARRO<sup>1</sup>, JOANA CARLA SOARES GONÇALVES<sup>1</sup>

<sup>1</sup>Faculty of Architecture and Urbanism, University of Sao Paulo, Sao Paulo, Brazil

*ABSTRACT: The favela is a pressing reality in the city of Sao Paulo, Brazil, concentrating around 10% of its population. Despite the public investments and its higher consolidation status, the favela still lacks some urban infrastructures and services. In addition to that, housing is a key topic both due to the social dynamics embedded and to the poor environmental conditions found indoors, mainly caused by overexposure, under performative building fabric and inefficient openings. From this context, how would it be possible to develop practical and replicable design strategies for the self-built houses' facades, environmentally informed in favelas in Subtropical Climates? The method articulates fieldwork, analytical simulations and prospective exercises that culminate on the construction of a 1:1 prototype entitled "Everyday House", in the second largest favela in the city of Sao Paulo, "Favela de Paraisópolis", with the aim of evaluating the strategies' impact and promoting its replication within and outside of the local community, showcasing the real application of the design proposal.*

*KEYWORDS: Favela; Housing; Thermal Comfort; Design; Brick;*

### 1. INTRODUCTION

Among over 12 million people in the city of Sao Paulo [1], 3 million live in informal settlements, of which 1,6 million live in favelas [2].

The second largest favela in the city started to be settled in the 60s within a wealthy area and nowadays concentrates around 100.000 inhabitants [3]. Its name is Paraisópolis (Fig. 1), which is translated as City of Paradise.



Figure 1: Favela de Paraisópolis' selfbuilt houses.

Despite the remaining infrastructure shortages, Paraisópolis is indeed a consolidated urban reality [3] and its buildings are continuously self-built following poor informal standards that lead dwellings to either solar overexposure or lack of it, besides insufficient natural ventilation and consequent poor indoor air

quality. As a result, thermal conditions in homes are also critical mainly during the warm periods of the year [4].

Through this research pro-design exercise, environmental guidelines and design strategies for enhancing thermal conditions in buildings from the favela in São Paulo were developed, following the logic of the favela's morphological existing built mass and building materials. Architecturally, the research is focused in the redesign of the dwellings' facades, which were previously identified as the main influencing factor of the performance of internal thermal environments [3, 4].

In this context, the ultimate objective is to build a house extension in the Paraisópolis Favela as a 1:1 prototype that applies the guidelines and design strategies developed in this research applying ordinary materials as solid brick blocks and perforated ceramic blocks. The project for the dwelling extension is entitled "Everyday house" and it has been developed within the context of an university initiative, including design and construction.

#### 1.1 Climate in Sao Paulo

The city of São Paulo is located in the latitude 23°24'south, with a tropical climate subjected to the effects of altitude (approximately 800 metres above sea level) where thermal comfort is likely to be achieved for approximately 70% of the year [5]. According to Köppen [6], Sao Paulo's climate is classified as warm temperate, hot summer (Cfa). The climate offers sunny winter days, when direct solar radiation is a key factor for thermal comfort, especially in outdoor spaces, and partially cloudy days in summer, when the main strategy for



# PLEA 2018 HONG KONG

Smart and Healthy within the 2-degree Limit

thermal comfort is solar protection combined with natural ventilation. The mean air temperature in the summer months stays at around 23°C, whilst humidity can easily reach 80 per cent and above (Fig. 2). However, it is worth highlighting that in the hot periods of the year, thermal comfort indoors and outdoors is highly dependent on shading strategies and proper ventilation. Winters are mild, with mean air temperatures between 16°C and 18°C, though even in winter relative humidity stays high. The heating demand is small and for short periods of the year, being easily solved by passive means as solar gains and occupation (internal gains).

In addition to the characteristics of the natural climate, the city presents a huge variety of urban microclimates, influenced by the multiple aspects of the urban form and human activities and characterized by problems with air quality, urban heat islands, poor urban ventilation, urban noise, among others, which affect the quality of both open spaces and buildings, typical in the slums [7].

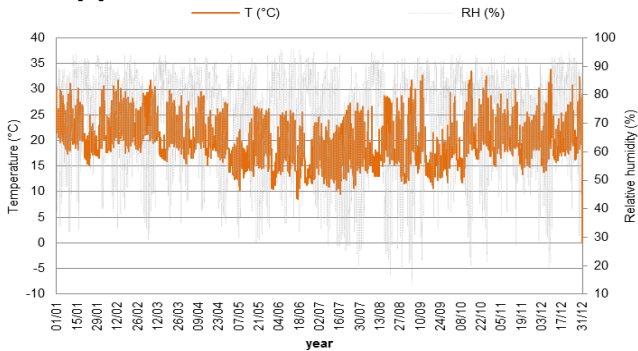

Figure 2: Annual distribution of dry bulb temperatures and relative humidities in Curitiba, Sao Paulo and Porto Alegre, based on Roriz [8].

Furthermore, it is important to consider that, in the residential units, high occupation density coupled with insufficient air changes, due to small windows, compromise the internal environmental conditions in the warm days of the year.

## 1.2 Favela's logics

Besides some well-known urban characteristics of the favela as such as its multifunctionality, diversity, gradual and organic growth and lively open spaces, it is important to highlight the social dynamics and values embedded on its selfbuilt housing typology.

First, in the favela, in contrast with the formal city, the boundaries between private and public realm are blurred. Second, each floor of a favela building is treated as a separate property in which several uses, construction techniques and building types and components are found/allowed, and this is combined with different means of access that can be horizontal or vertical. In other words, a multi-storey building in the favela works as a set of overlapped and inter-connected

independent houses built separately and constantly over time.

On this scheme, the rooftop (called “laje”, in Portuguese, “slab” in English) plays a very important role, both as a physical structure standing-by for the building’s verticalization (Fig. 3) and also in everyday life for the development of individual and collective activities in semi-open spaces, ranging from hanging clothes to a barbecue and other activities at different times of the week including weekends.

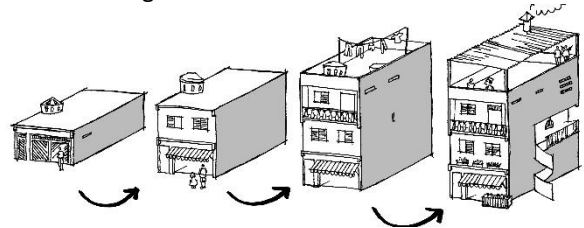

Figure 3: Building verticalization in the favela.

## 2. METHOD

From the environmental perspective, the method follows the one presented by Yannas [9], and is also based on Evidence Based Design approaches [10]. In addition to that, the methodological approach adopts bottom-up strategies closely developed with the local community, highlighting cognitive knowledge and “learning by doing” [11].

The research method encompasses by three complementary phases: empirical and analytical work followed by a prospective design phase, involving fieldwork, computer simulations and a design proposal, with the perspective of real life construction (Fig. 4). From a base case informed by fieldwork, the analytical work defined a few scenarios featuring facades with different materials and openings, which were simulated [12] and compared. The first two phases when empirical and analytical procedures were carried out were described in detail in the PLEA Conference of 2014 in Ahmedabad [4]. This paper focuses on the presentation and discussion of phase three: the prospective design phase.



Figure 4: Method.

## 3. RESEARCH PRECEDENT

From phase one, measurements of thermal conditions of an internal space taken in one of the houses facing North-West along the main street showed that the exposure to solar radiation coupled with the concentration of internal gains and insufficient ventilation rates resulted in air temperatures as high as 40°C in the living space (bringing together living and kitchen in one area) at 4 pm of a week day, when outdoor temperatures oscilated around 33°C [4].

# PLEA 2018 HONG KONG

Smart and Healthy within the 2-degree Limit

In the sequence, thermal dynamic simulations of phase two showed that changing one single standard facade into a 100% shaded and naturally ventilated membrane would decrease the peak temperature in a typical warm/hot day by 3°C (Fig. 5), bringing internal temperatures closer to external ones, therefore, improving thermal comfort. The impact is smaller in the scenario of simply replacing the existing window for a new one with 100% ventilated span. Here, it is worth noticing that the main local climatic issue is global radiation and not external air temperatures.

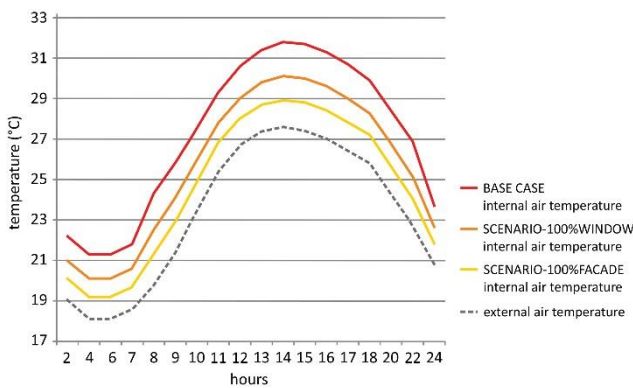

Figure 5: Air Temperature in a sunny summer day, comparing different scenarios: base case internal temperature; proposed scenario 01 (replacing window) internal temperature; scenario 02 (room with new facade) internal temperature; and external temperature.

## 4. DESIGN APPLICABILITY

Based on the analytical results, the prospective step of the work develops three different outcomes: the first one is a set of design strategies for solar shading and permeable facades for natural ventilation, featuring ordinary materials as different kinds of concrete and ceramic blocks assembled according to the facades' solar orientation and exposure (Fig. 6); secondly, these design strategies are then translated into easily replicable schemes which are shared with the community through participatory workshops, printed-out booklets and "lambe-lambe" (wheat-paste posters in public spaces) (Fig. 7), promoting DIY interventions (Fig. 8); and in third place the last outcome is the construction of the facades' 1:1 prototype in the community, in other words, a real case scenario (Fig. 9-12), in order to evaluate the strategy's feasibility and its local environmental and social impacts, whilst stimulating its replicability among the *favela's* inhabitants.

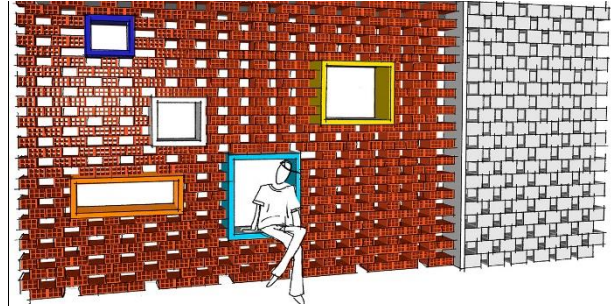

Figure 6: (First outcome) development of design strategies for different facades' orientation, besides creating physical structures to support social structures.

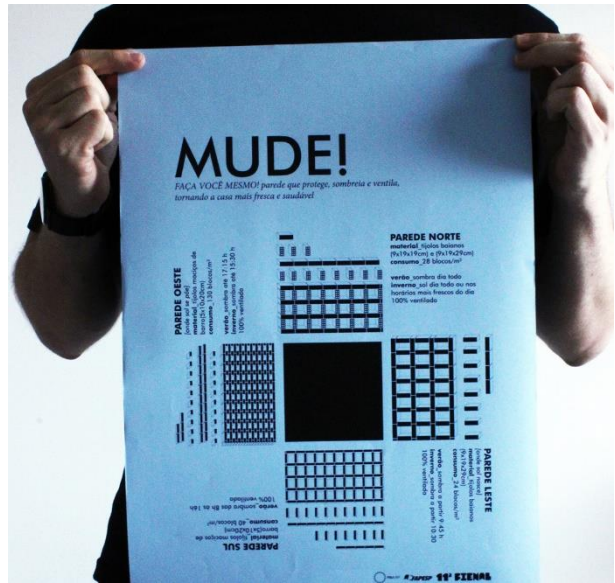

Figure 7: (Second outcome) "MUDE!", or CHANGE! is a "Lambe-lambe" poster to environmentally inform self-built construction in the community with DIY schemes for different facades' orientation.



Figure 8: (Second outcome) Environmental DIY facades started spontaneously being built in Paraisópolis. Picture taken in April 2018.

# PLEA 2018 HONG KONG

Smart and Healthy within the 2-degree Limit

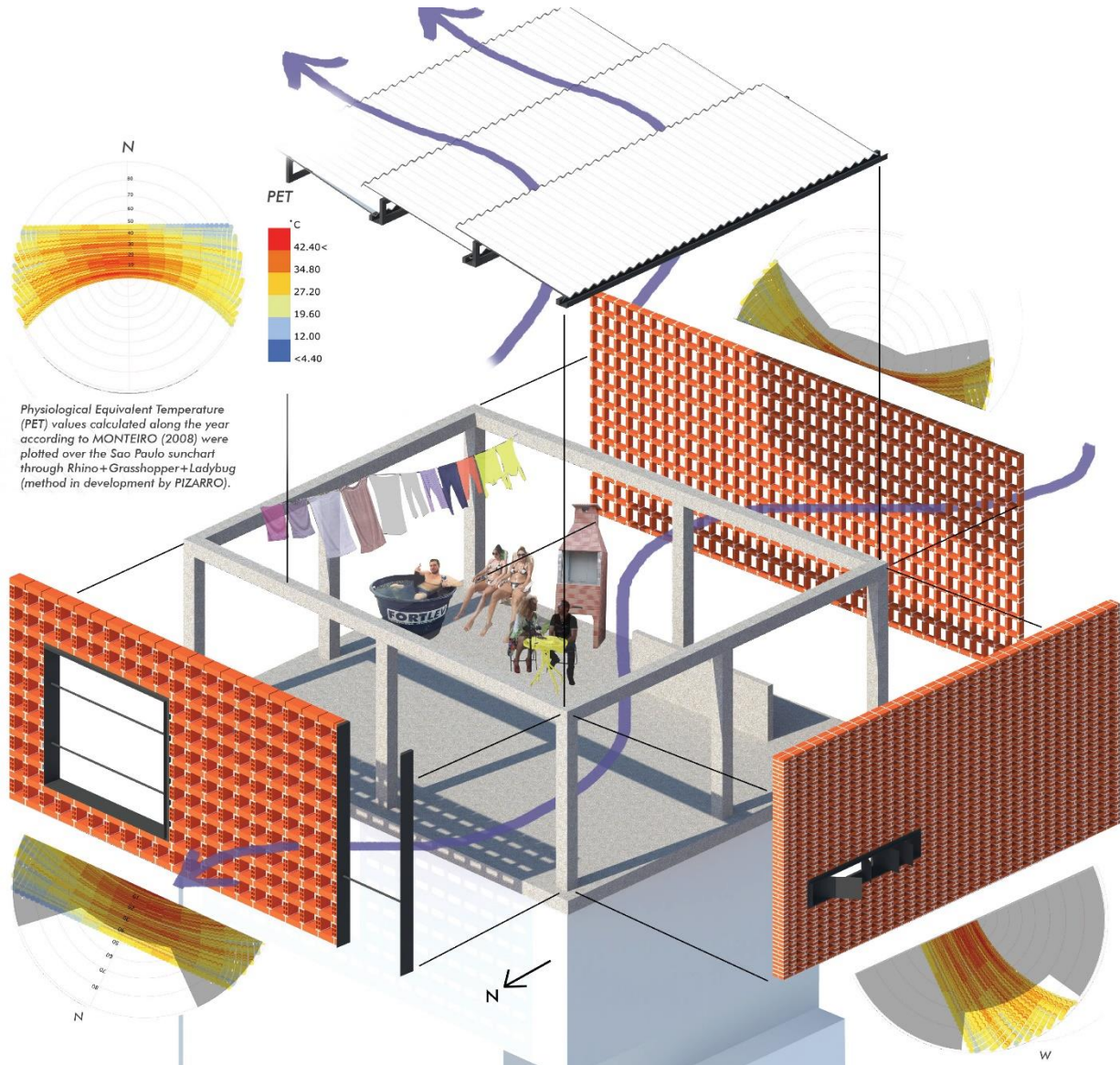

Figure 9: (Third outcome) Exploded Axonometric Perspective of the 1:1 Prototype, highlighting sun masks of different orientations.

The 1:1 prototype (Fig. 9-12) is entitled “Everyday House”, in the sense that keeps and reinforces the role played by the rooftop in promoting fundamental everyday dynamics for the houses in the favela. It is composed by three facades with different perforated brick works based on their solar orientation (Northern, Western and Southern) besides a light roof following a shed typology and painted in white. The facades and roof are structured by a concrete skeleton built over an existing slab on the fourth floor of a building in the center of Paraisópolis. The prototype was designed as an open plan that permits the development of multiple activities by the dwellers and even their neighbours.

The shading masks (Fig. 9) show how the brick assemblage blocks direct solar radiation during the

warmer periods at the same time that lets it in when the temperatures are expected to be milder or colder.

The facades’ pattern is disrupted by steel structures that both frame the landscape or the sunset and address the dwellers’ needs, for example hanging birdcages, plant pots and wet clothes.

In order to keep this rooftop as a semi-open space, the prototype has no Eastern facade and the light roof doesn’t cover the entire space.

In the case that, in the future, the dwellers decide to turn this rooftop into a new independent house, it would be required to install an internal skin made of glass or polycarbonate in order to permit users’ adaptability for the colder days when natural ventilation could be excessive in indoor spaces as a bedroom.

# PLEA 2018 HONG KONG

*Smart and Healthy within the 2-degree Limit*

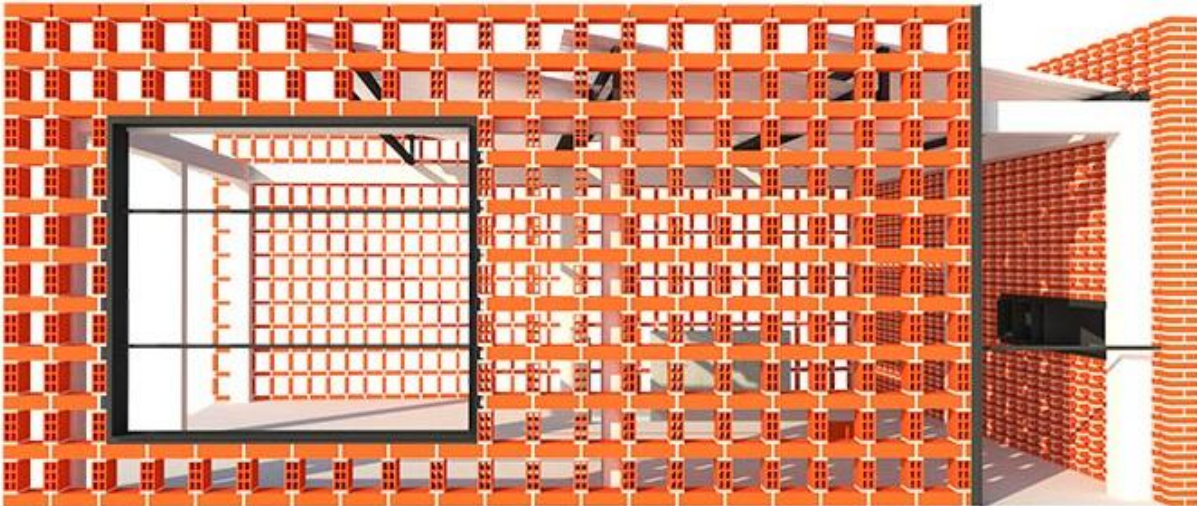

Figure 10: (Third outcome) Digital model of the 1:1 prototype, featuring the Northern façade.

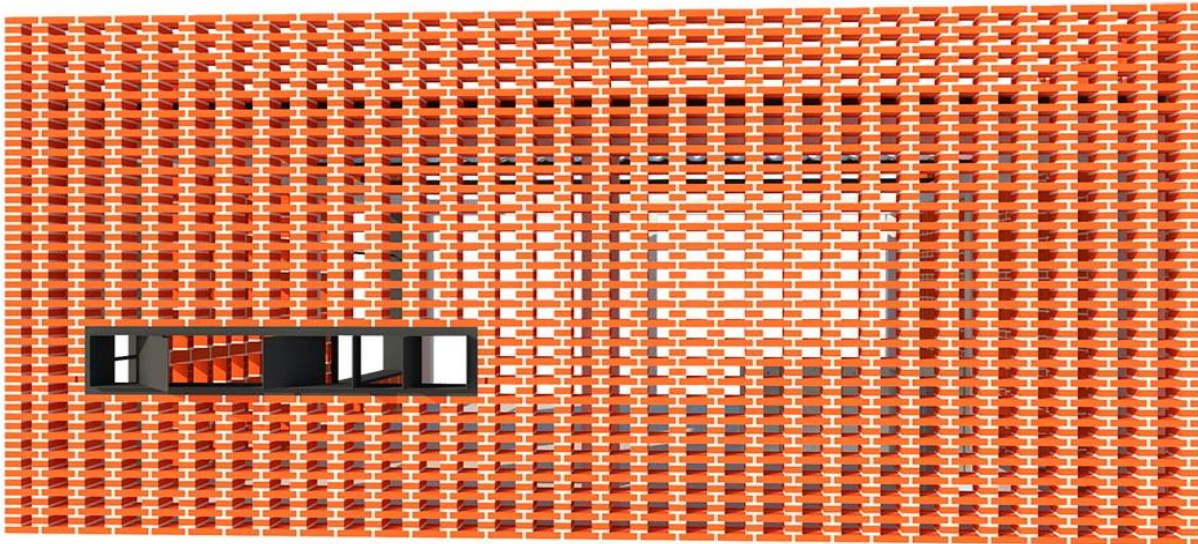

Figure 11: (Third outcome) Digital model of the 1:1 prototype, featuring the Western façade.

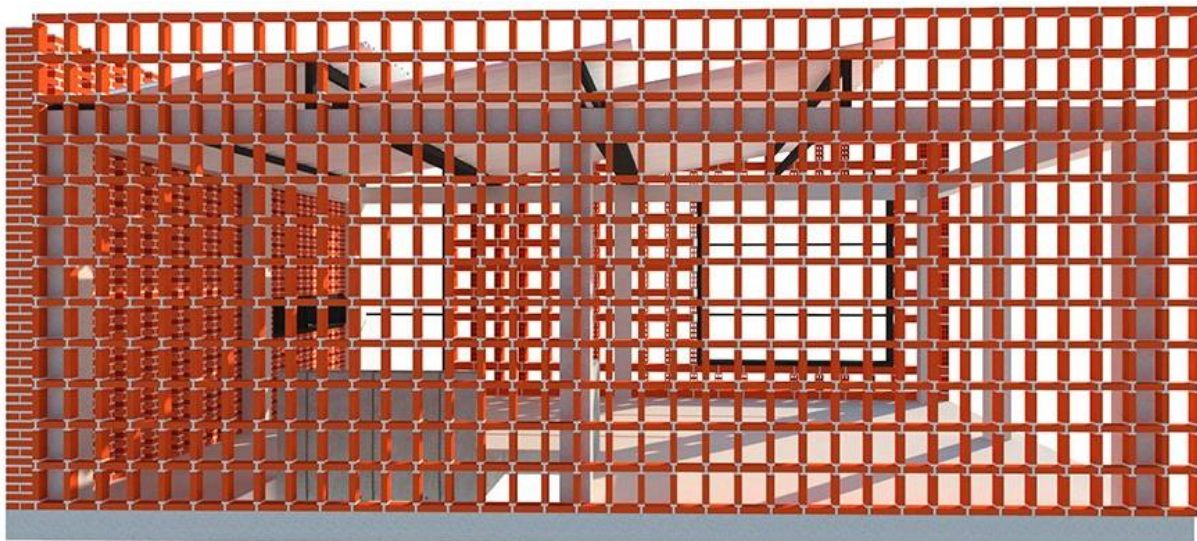

Figure 12: (Third outcome) Digital model of the 1:1 prototype, featuring the Southern façade.

# PLEA 2018 HONG KONG

*Smart and Healthy within the 2-degree Limit*

The construction of the “Everyday House” will be completed by the end of 2018. Meanwhile, the design strategies have been shared within the community and applied in “Design and Build” workshops involving undergraduate Architecture students in Brazil (Fig. 13).



Figure 13: Design and Make Workshop held with Architecture students.

## 5. CONCLUSION

This research pro-design exercise showcases the potential impact of ordinary, practical and localized strategies informed by environmental guidelines in the design of new future possibilities to the informal city in subtropical climates. It's also worth noting that these strategies shall apply to many other self-built neighborhoods in the city of Sao Paulo, and not just deprived communities.

In addition to that, this approach questions the self-built housing *status quo*, which is arbitrarily replicated, of poor environmental performance and therefore showing a negative impact the overall livability in the informal city, both indoors and outdoors.

There are still a few challenges to be considered as such as: how to effectively convince the favela's inhabitants about their primary right for environmentally responsive houses/shelters and the simple strategies to address that; which would be the best model for applying these environmental strategies in the favela? DIY schemes and open source design? Technical assistance? Or social entrepreneurship? Most likely, the way to the future of the quality of housing in the favela is a combination of all the above alternatives.

This paper focuses the design and construction phases of a real case building, following the previous fieldwork and analytical phases that have already been published [4]. The next step would be to assess in loco the environmental performance of the built prototype in typical days of different seasons of the year.

Ultimately, the research process here presented represents an effort in stretching the academic discourse boundaries and applying the research outcomes directly to the existing reality. Moreover, it highlights the

importance of articulating research and design activities benefiting from local knowledge, in order to both enrich academic experience and improve the reality of the built environment in the informal city.

## ACKNOWLEDGEMENTS

To the State of São Paulo Research Foundation (FAPESP) and to the University of Sao Paulo (USP) and its Faculty of Architecture and Urbanism (FAUUSP) for respectively supporting the research project and the prototype construction. Also to the Favela de Paraisópolis' inhabitants for embracing both research and design project.

## REFERENCES

1. Brazilian Institute of Geography and Statistics, [Online], Available: <https://cidades.ibge.gov.br/brasil/sp/sao-paulo/panorama> [21 November 2017]
2. Brazilian Institute of Geography and Statistics, Aglomerados Subnormais, Informações Territoriais, [Online], Available: [https://biblioteca.ibge.gov.br/visualizacao/periodicos/552/cd\\_2010\\_agrn\\_if.pdf](https://biblioteca.ibge.gov.br/visualizacao/periodicos/552/cd_2010_agrn_if.pdf) [14 August 2013]
3. Pizarro, E. P., (2014). Urban interstices and interfaces as latent opportunities: the case of the Paraisópolis Favela, Sao Paulo. Master Thesis, University of Sao Paulo, Sao Paulo.
4. Gonçalves, J. C. S., Pizarro, E. P., Mulfarth, R. K. and Carunchio, C., (2014). Examining the Environmental and Energy Challenges of Slums in São Paulo, Brazil. In Proceedings PLEA 2014, Ahmedabad. [Online], Available: [http://www.plea2014.in/wp-content/uploads/2014/12/Paper\\_6C\\_2745\\_PR.pdf](http://www.plea2014.in/wp-content/uploads/2014/12/Paper_6C_2745_PR.pdf) [20 June 2017]
5. ASHRAE, American Society of Heating, Refrigerating and Air Conditioning (2009). *Climate Design Data. ASHRAE Handbook*. ASHRAE, Atlanta: ASHRAE.
6. CIBSE. Buildings for extreme environments. Tropical. UK: CIBSE.
7. CETESB - Companhia de Tecnologia de Saneamento Ambiental (2008). Resolução CONAMA nº 03 de 28/06/90. Disponível em: [http://www.cetesb.sp.gov.br/Ar/ar\\_indice\\_padroes.asp](http://www.cetesb.sp.gov.br/Ar/ar_indice_padroes.asp).
8. Roriz, M. (2012). Arquivos climáticos em formato EPW. São Carlos, Brazil.
9. Yannas, S. (2015) Pesquisa arquitetônica para o projeto ambientalmente sustentável. In: Gonçalves, J. C. S. Edifício Ambiental. São Paulo: Oficina de textos.
10. Yannas, S. (1989). Physics and architecture; issues of knowledge transfer and translation in design. Solar and wind technology. Vol.6, pp.301-308.
11. Parekh, H. (2015). Dweller's perceptions and development of built environment: learning through interaction with a chawl community near KeshavNagar, Ahmedabad. Undergraduate thesis, CEPT University, Ahmedabad.
12. Roriz, M., (1995). Software Arquitrop 3.0, [Online], Available: <http://www.labee.ufsc.br/antigo/software/arquitrop.html> [13 April 2014]

## Urban Climatic Application in City's Master Plan: An Experience from China

CHAO REN<sup>1,2</sup>, XIAOYI FANG<sup>3</sup>

<sup>1</sup>The Institute of Future Cities, The Chinese University of Hong Kong, Hong Kong, China

<sup>2</sup>Faculty of Architecture, The University of Hong Kong, China

<sup>3</sup>Beijing Meteorological Service, China

*ABSTRACT: Although research in the field of urban climatology has greatly expanded in the last two decades, the impact of urban climate knowledge on the urban planning and design practice remains very low. This is particularly the case in developing countries such as China, which faces a series of environmental problems. The paper looks at the ways urban climatic evaluation and application are incorporated into the master urban plan. It introduces the newly developed China National Guide—'Technical specification for climatic feasibility demonstration in urban master plan (QX/T 242-2014)', which aims to assist practitioners and policymakers to respect the natural environment and climate, and to adopt the concept of eco-protection. They can then carry out the overall urban planning climate feasibility evaluation from a climate perspective, so the city's development will follow a rational planning program based on scientific evidence that will lead towards the goals of urban liveability and sustainable development. It also provides suggestions on data collection, methodology, planning implementation and technology report preparation. In this paper, the Tongzhou wind corridor plan is selected as a case to demonstrate the adoption of this Guide in real planning and design scenarios.*

*KEYWORDS: Thermal Comfort, Urban Planning and Design, Urban Climatic Application, Wind Corridor*

### 1. INTRODUCTION

The study of urban climate was first developed in the nineteenth century in response to anthropogenic climate modification in cities caused by global industrialisation and urbanisation. The investigation focuses on urban climatic phenomena, such as urban heat island, urban energy budget, air pollution dispersion and urban ventilation[1, 2]. The urban climate has great impacts on cities and their populations in the areas of thermal comfort, air quality and the wind environment. Although research in the field of urban climatology has significantly expanded in the last two decades, the impact of urban climate knowledge on the urban planning and design practice remains very low[3], especially in developing countries such as China[4].

The paper looks at the application of urban climatic strategies and methodology of urban thermal and wind environment evaluations, especially how urban corridors are incorporated into urban policy and planning. A recent effort on developing a national technical guide from China is introduced.

### 2. NATIONAL TECHNICAL GUIDE ON URBAN CLIMATIC CONSIDERATION IN CITY MASTER PLAN IN CHINA

Since 2006 more than half of the world's population have become urban dwellers [5]. Furthermore, by 2030, nearly 60% of humanity will live in cities and almost 9% of the world's population will be living in just 41 megacities[6]. The rise of mega- and high-density compact cities are now irreversible trends of human urban development, especially in Asian countries, such as

China and India[7]. While Megacities and high-density urban living may make lives more convenient and society more economically efficient [8, 9] they pose a range of environmental challenges. In particular, increasingly dense, complex and interdependent urban systems leave cities vulnerable[10, 11] and sensitive to climate variability and change[12].

China is still in the process of urbanisation. The central government's 13th five-year plan predicts that the country's urbanisation level will reach 70% in 2050. Thus, the greatest challenge for China is to find a balance between economic growth and keeping carbon dioxide and greenhouse gas emission rates at a manageable level[13]. Cities in China play a key role in the implementation of the central policies and make concrete actions in response to climate change.

Climatic factors are important in the overall planning and construction of the city. Changes in human activities and underlying surfaces in cities, and the differences in the layout of buildings can all affect the urban meteorological elements in varying degrees, thus changing the microclimate of urban areas. Urban construction and building development should respect the city's natural climate. That requires consideration of climate factors in urban planning and future urban development, stronger planning management, and rational distribution. The Meteorological Law of the People's Republic of China explicitly states that "the competent meteorological departments at all levels should organize feasibility studies on climate feasibility for such projects as urban planning, key national

# PLEA 2018 HONG KONG

*Smart and Healthy within the 2-degree Limit*

construction projects, major regional economic development projects and large-scale solar energy and wind energy development and utilization projects." The Regulations on Meteorological Disaster Prevention stipulates that in major construction projects, major economic development projects and urban and rural planning, all regions shall consider the feasibility of climate and the risk of meteorological disasters in an integrated manner. These measures demonstrate the great importance China's central government attaches to cities' climatic and environmental conditions. Since the beginning of 2017, researchers from Beijing Climate Centre of China Meteorology Administrative, China Academy of Urban Planning and Design, The Chinese University of Hong Kong and The University of Xiamen have worked together to develop a new national guide: 'Technical specification for climatic feasibility demonstration in urban master plan(( QX/T 242-2014))'. It is based on 10 years of collaboration experience with planning departments and the lessons learnt from actual urban climatic application projects in 60 cities in more than 20 provinces in China.

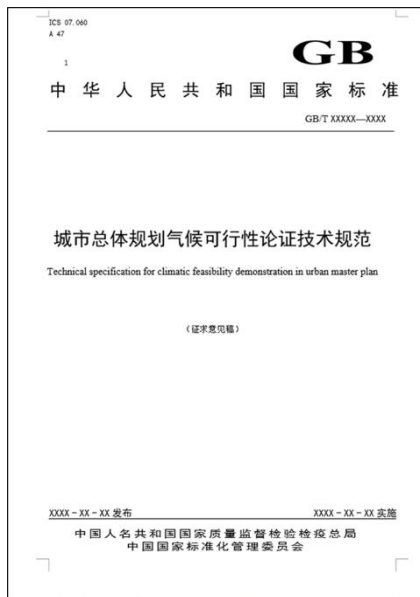

Figure 1: China National Technical Guide (under preparation)

## 2.1 Study objectives

This new national technical guide aims to assist practitioners and policymakers to respect the nature and to follow the concept of ecological protection. They can then carry out the overall urban planning climate feasibility evaluation from a climate perspective, so the city's development will follow a rational planning program based on scientific evidence that will lead towards the goals of urban liveability and sustainable development.

## 2.2 Seven Focuses

The guide has seven focuses including (Figure 2):

- 1) Master layout plan and urban ventilation;
- 2) Greenery master layout and thermal environment;
- 3) Allocation of industrial areas and intensive factories areas;
- 4) Urban renewable energy and energy structure;
- 5) Rainfall, sponge city development and urban flooding management;
- 6) Extreme weather and risk management;
- 7) Integrated meteorological evaluation for liveable cities.



Figure 2: Content of China National Technical Guide

## 2.3 Evaluative Aspects and Analysis Contents

The corresponding evaluative aspects and contents of analysis of these seven focuses are (Figure 3):

- 1) Thermal environment: analysis of the spatiotemporal pattern of urban heat island and evaluation of the evolution of greenery areas, woodlands and other major vegetated areas to develop corresponding mitigation measures and actions;
- 2) Wind environment: analysis of the wind speed distribution patter of cities and drawing of air pollution index map, so local planners and policy makers can have a better understanding and information of air pollution control and land use management;
- 3) Potential wind dynamics: evaluation of wind dynamics at the city level and development of corresponding map, so local wind corridor plan can be developed;
- 4) Boundary conditions: urban boundary conditions analysis, including calculation of its vertical wind profile and mixing of layer height, so frequency of inversion layer and its height can be calculated and estimated, which is useful for local air pollution control.
- 5) Rainfall and precipitation: analysis of the spatiotemporal pattern of city rainfall, so local policy makers and professionals can develop the city's drainage system and other basic facilities of sponge city development and urban flooding management more easily;

# PLEA 2018 HONG KONG

Smart and Healthy within the 2-degree Limit

6) Extreme weather events and hazards: analysis of a series of extreme weather events and hazards, such as fog, haze, lightening, sandstorm etc to assist local transportation plan and city electric grid network;

7) Wind energy and solar energy: observation of local wind and solar energy potentials and consideration for corresponding areas in local land use plan for building energy saving.

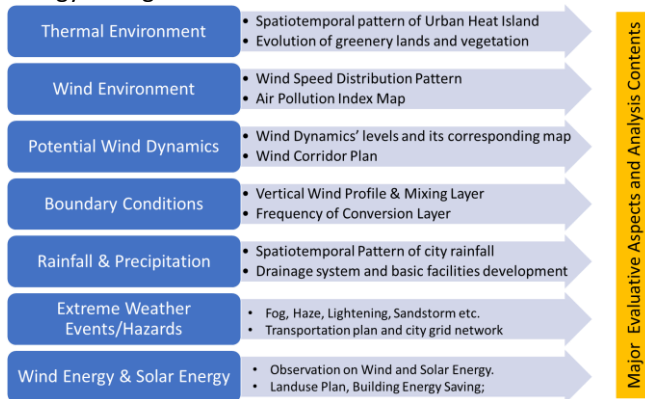

Figure 3: Major Evaluative Aspects and Analysis Content of China National Technical Guide

## 3. KEY ASSESSMENT FACTORS AND THEIR CALCULATIONS

### 3.1 Human Thermal Comfort

$$ET = T_d - 0.55(1 - r)(T_d - 58)$$

ET: Human Thermal Comfort, unit: °C ;

$T_d$ : dry bulb Temperature, unit: °C ;

$r$ : Relative Humidity, unit : %.

\*the ratio of the area with the ET value is less than 75 °C (most people may feel 'comfortable') over the simulated area for evaluation human thermal comfort (P)

Table 1: Human thermal comfort levels

Level of ET	Ratio (%)
1	P ≤ 20
2	20 < P ≤ 40
3	40 < P ≤ 60
4	60 < P ≤ 80
5	P > 80

### 3.2 Urban Heat Island Intensity (UHII)

$$H_t = T_c - T_s$$

$H_t$  : Urban Heat Island Intensity, unit: °C ;

$T_c$ : Urban Temperature, unit: °C ;

$T_s$ : Rural Temperature, unit: °C ;

\*There are five categories of urban heat island intensity based on the value of  $H_t$

Table 2: UHII classifications

UHII Classification	Intensity Level	Intensity °C
1	No	$H_t \leq 0.5$
2	Minor	$0.5 < H_t \leq 1.5$
3	Medium	$1.5 < H_t \leq 2.5$
4	Strong	$2.5 < H_t \leq 3.5$
5	Very Strong	$H_t > 3.5$

### 3.3 Weak Wind Area

At the level of 1.5m above the ground, the ratio of the area with average wind speed less than 1m/s is observed over the simulated area. The weaker the wind, the more difficult it is for air pollution to disperse and dilute. Therefore this indicator shows the city's ability of mixed air pollution dispersion. Table 3 shows the weak wind areas' classifications.

Table 3: Classifications of Weak Wind Area

Classification of Weak Wind Area	Ratio %
1	R > 80
2	60 < R ≤ 80
3	40 < R ≤ 60
4	20 < R ≤ 40
5	R ≤ 20

### 3.4 Inversion's intensity

$$C = (T_1 - T_2) / H$$

$C$  Inversion's intensity, unit: °C/m ;

$T_1$  : Inversion's top roof temperature, unit: °C ;

$T_2$  : Inversion's bottom temperature, unit: °C ;

$H$  : Inversion's height, unit: m;

Table 4: Levels of Inversion's intensity

Level	Inversion Intensity
1	$C > 1.0$
2	$0.7 < C \leq 1.0$
3	$0.4 < C \leq 0.7$
4	$0.1 < C \leq 0.4$
5	$C \leq 0.1$

### 3.5 Mixing Layer Height (MLH)

The mixing layer height (p) characterizes the extent to which the contaminants are diluted by turbulence in the vertical direction and can be obtained by the normal method of calculating the MLH (e.g. dry adiabatic curve method, atmospheric stability method and etc) and mixed layer height evaluation. The criteria for classifying MLH's levels are shown in Table 5.



# PLEA 2018 HONG KONG

Smart and Healthy within the 2-degree Limit

Table 5: Levels of MLH

Level	MLH
1	$p \leq 150$
2	$150 < p \leq 350$
3	$350 < p \leq 600$
4	$600 < p \leq 900$
5	$p \leq 900$

### 3.6 Total Amount Control Rate of Annual Runoff (TACRAR)

Total Amount Control Rate of Annual Runoff = 100% - (annual discharge rainfall / total annual rainfall) \* 100%. The TACRAR can be calculated based on daily rainfall statistics, and its results can be converted into design rainfall. The process involves selecting daily rainfall (excluding snowfall) data of at least the past 30 years (showing long-term rainfall patterns and climate change in recent years), deducing those rainfall events with less than 2mm rainfall (generally does not generate any runoff), sorting daily rainfall from small to large, and counting the total amount of rainfall that is smaller than a certain amount of rainfall (less than the total amount of rainfall that is calculated as the actual rainfall, but greater than the ratio of the amount of rainfall to the total amount of rainfall). The rainfall (day value) corresponding to this ratio (ie, annual runoff total amount control rate) is the designed amount of rainfall.

The design rainfall is the specific amount of annual runoff total control implemented by each city. Considering the different rainfall distribution characteristics of different cities in China, the design rainfall value of each city should be calculated separately. When data is lacking, the design rainfall values of cities with similar long-term rainfall patterns can be referred to based on the local long-term rainfall patterns and recent changes in climate.

### 3.7 Assessment Factor's Index Calculation

Based on all assessment factors, the Linear Interpolation method is adopted to calculate each factors' index:

$$I_i = I_{i,(j-1)} + (C_i - C_{i,(j-1)}) / (C_{i,j} - C_{i,(j-1)})$$

$I_i$  is the integrated index of the  $i$ th assessment factor (rounding to 2 decimal places);

$I_{i,(j-1)}$  is the  $i$ th assessment factor at  $(j-1)$ th class;

$C_i$  is the mode calculation value of  $i$ th assessment factor;

$C_{i,j}$  is the upper threshold value the  $i$ th assessment factor at  $j$ th class;

$C_{i,(j-1)}$  is the lower threshold value the  $i$ th assessment factor at  $j$ th class;

$i$  the  $i$ th assessment factor. Here, it can be those above the first assessment factors including human thermal comfort, urban heat island, weak wind area, inversion's intensity, mixing layer height ;

$j$  is the  $j$ th class;

### 3.8 Weighting Factor Calculation

(for factors of higher scores that indicate better environmental quality) :

$$W_i = (C_1 - D_i / C_{i,3}) + 1$$

(for factors of higher scores that indicate worse environmental quality) :

$$W_i = (D_i / C_{i,3}) + 1$$

$W_i$  is the  $i$ th weighting factor;

$C_1$  is the threshold of the  $i$ th first-class standard values;

$D_i$  is the  $i$ th observed value;

$C_{i,3}$  is the threshold of the  $i$ th third-class standard values;

### 3.9 Integrated Evaluation

Based on the calculation results of the assessment factors' Index and weighting factor, the below equation can be used to evaluate the planning proposal's integrated climatic performance. The higher the score, the better is the integrated climatic performance of the proposed master plan.

$$I = \sum_{i=1}^m (I_i \times W_i) / \sum_{i=1}^m W_i$$

$I$  is the integrated evaluation result;

$m$  is the number of assessment factors;

$I_i$  is the integrated index of the  $i$ th assessment factor (rounding to 2 decimal places);

$W_i$  is the  $i$ th weighting factor;

## 4. CASE STUDY: WIND CORRIDOR PLAN OF TONGZHOU NEW TOWN, BEIJING

### 4.1 Study Area and Background

Tongzhou District is located in southeast Beijing and will be a sub-centre of Beijing capital (Fig. 4). Given its central location, it will serve as a key node for the coordinated development of this Jing-Jin-Ji mega-urban region. The Central Government of China has thus attached great importance to its master town plan and development. One of its master plan objectives is to

# PLEA 2018 HONG KONG

Smart and Healthy within the 2-degree Limit

adopt climatic evaluation for better land use and layout plan.



Figure 4: Map of Tongzhou, Beijing(left) and the study area in Tongzhou District (right)(Source from Beijing Academy of Urban Planning and Design)

## 4.2. UHI Intensity Evaluation

Liu et al used NOAA/AVHRR and Landsat-TM Landsat 5 satellite images between 1987-2012 to detect the spatial distribution of surface urban heat island (SUHI) and evaluated the UHI intensity based on local observed temperature results of 1987-2012[14]. In this study, their method is adopted and applied to UHI intensity detection of 2015. Seven levels of SUHI are classified. Fig 5 shows that for Tongzhou district, the surface temperature of the eastern and northern parts are very high. These are the extension urban areas of Shunyi, Chaoyang and Daxing districts under fast urbanization; vast agriculture land show no UHI effect and major cool areas can be found in the woodlands and water bodies.

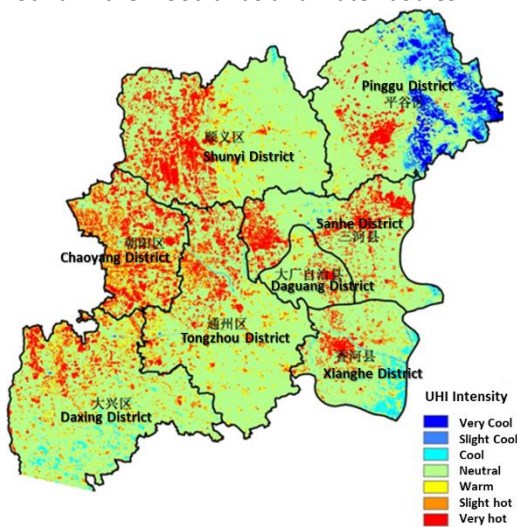

Figure 5: Surface UHI Detection Map with UHI intensity levels

## 4.3 Wind Environment Evaluation and Potential Wind Dynamics Detection

Based on the meteorological wind records from 20 ground observatory stations over the last 30 years, it is found that the annual prevailing winds are mainly from the southern and northern directions. The wind evaluation results show that the wind environment of Beijing, Tongzhou district included, is influenced by the topography, surface roughness of urban morphology, and prevailing wind conditions. The prevailing wind directions in Tongzhou are mainly from the SE and E

under both annual prevailing wind condition and weak wind condition.

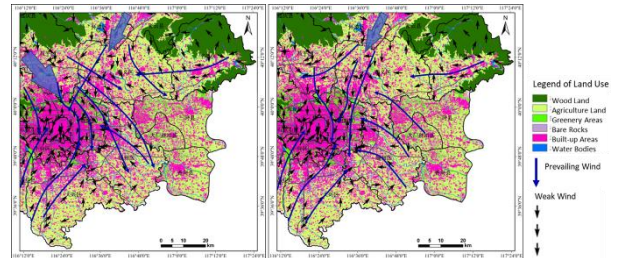

Figure 6: Wind Environment Evaluation Map of Beijing and Tongzhou district under annual prevailing wind condition (left) and weak wind condition (right) (black arrows are the wind directions captured by ground observatory stations)

Following the proposed National Guide, the degree of openness was used to classify the levels of potential wind dynamics (Fig 7) based on the integrated evaluation of sky view factor and roughness length. Those areas with high and very high wind dynamics levels can be considered wind corridors in local master plan.

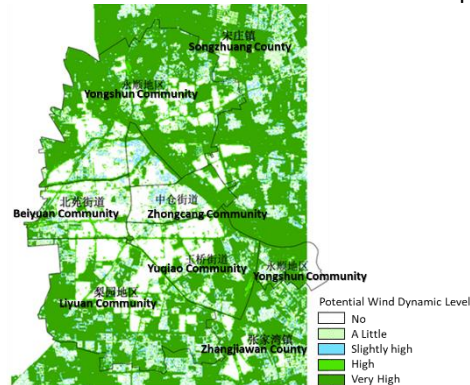

Figure 7: Potential Wind Dynamics Detection Map of Tongzhou District

## 4.4 Planning Implementation

Following discussion with local planners and government officials, four Wind Corridor's development principles are defined:

1. Follow the annual prevailing wind directions in the planning of wind corridors and obstacles along them should be minimal or absent;
2. Respect locally detected wind dynamics and natural resources in future new town development;
3. Mitigate UHI effect by inserting greenery and avoiding the extension of continuous large built-up areas;
4. Use river channels, greenery systems and road networks to create wind corridors to improve weak wind situations instead of demolishing existing built-up areas;

# PLEA 2018 HONG KONG

Smart and Healthy within the 2-degree Limit

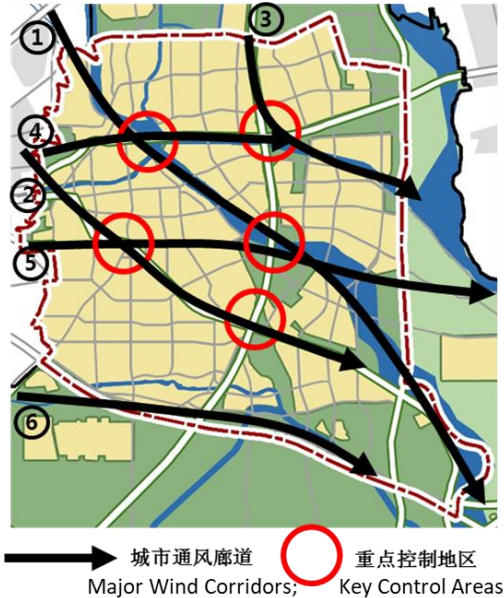

Furthermore, for better management of wind corridor development, design actions are also defined:

1. The designed direction of wind corridors: follow annual prevailing wind directions, ie. Mainly NW-SE with consideration of the E wind direction under weak wind conditions;
2. Elements of Wind Corridor: areas with low roughness, long and narrow areas with high to very high potential wind dynamics; apart from creating new wind corridors, existing wide roads, urban parks, river channels and low rise low density built-up areas can also be used;
3. Control measures and design actions: width>100m, length>1000m; if there are any obstacles in the wind corridor, its width should be less than 10% of the wind corridor's;

## 5. CONCLUSION

Although research in the field of urban climatology has greatly expanded in the last two decades, the impact of urban climate knowledge on the urban planning and design practice remains very low. This is particularly the case in developing countries such as China. Rapid urbanisation in China makes urban climatic consideration in the planning practice ever more important. In local governments, subjective judgements are being replaced by scientific-evidence-based decisions. They have also started taking concrete actions in line with the new policy direction of the central government and working towards sustainable urban development and ecological recovery.

This paper presents the recent efforts in urban climatic application in China. It highlights two trends: (1) a cross-disciplinary impact assessment on climatic performance in urban planning and (2) dynamic understanding and information of urban climatic conditions.

The paper also provides the much-needed standardisation of format, process, and methodology of data needed for urban climatic studies in Chinese cities; it also demonstrates the fundamental principles of urban climatic application and climatic-sensitive design actions for planners and policy makers at the urban master plan level.

## ACKNOWLEDGEMENT

The study is supported by The Vice-Chancellor's Discretionary Fund of The Chinese University of Hong Kong and GRF14643816. Authors appreciate the help from planners from China Academy of Urban Planning and researchers from China Meteorology Administrative and Xiamen University who provide the technical supports in developing this National Guide.

For the Tongzhou case study, the authors would like to thank Chen Cheng, Pei Xing, Shuo Zhang and Yonghong Liu for their help in data analysis and evaluation. The authors also appreciate the assistance from Beijing Meteorology Bureau, which provides their meteorological records, and Beijing Academy of Urban Planning and Design, which helps in the planning implementation part of the study.

## REFERENCES

1. Landsberg, H.E., *Man-Made Climatic Changes*. Science 1970. **170**(3964): p. 2-14.
2. Oke, T., *Urban Climate Zone - Simplified classification of distinct urban forms arranged in approximate decreasing order of their ability to impact local climate*, 2004.
3. Eliasson, I., *The use of climate knowledge in urban planning*. Landscape and Urban Planning, 2000. 48: p. 31-44.
4. Ng, E. and C. Ren, *China's adaptation to climate & urban climatic changes: A critical review* (in press). Urban Climate, 2017.
5. UNFPA, *State of world population 2007: Unleashing the Potential of Urban Growth, 2007*, United Nations Population Fund.
6. UN, *State of the World's Cities 2008/2009 - Harmonious Cities 2008*, United Nations Human Settlements Programme (UN-HABITAT): London, Sterling, VA.
7. UNFPA, *The State of World Population*. United Nations Population Fund. 2009.
8. Ng, E., *Policies and technical guidelines for urban planning of high-density cities - air ventilation assessment (AVA) of Hong Kong*. Building and Environment, 2009. **44**(7): p. 1478-1488.
9. Ng, E., *Towards Planning and Practical Understanding of the Need for Meteorological and Climatic Information in the Design of High-density Cities: A Case-based study of Hong Kong*. International Journal of Climatology, 2012. **32**(4): p. 582-598.
10. WMO, *WMO/IGAC Impacts of Megacities on Air Pollution and Climate*, 2012, WMO: Geneva, Switzerland.
11. WMO and WHO, *Heat Waves and Health: Guidance on Warning System Development*, WMO-No. 1142, G. McGregor, et al., Editors. 2015, WMO, WHO.
12. Grimmond, C.S.B., et al., *Climate and More Sustainable Cities: Climate Information for Improved Planning and*

# PLEA 2018 HONG KONG

*Smart and Healthy within the 2-degree Limit*

- Management of Cities (Producers/Capabilities Perspective).  
Procedia Environmental Sciences, 2010. **1**: p. 247-274.
13. Zeng, N., et al., *Climate Change-the Chinese Challenge*.  
Science, 2008. **319**: p. 730-731.
14. Liu, Y., et al., *Quantitative Assessment and Planning  
Simulation of Beijing Urban Heat Island*. Ecology and  
Environmental Sciences, 2014. **23**(7): p. 1156-1163.

## Rethinking Sustainability TOwards a Regenerative Economy (RESTORE) within an Adaptive Neighbourhood Design

MIHAELA HĂRMĂNESCU<sup>1</sup>, SILVIA COCCOLO<sup>2</sup>, EMANUELE NABONI<sup>3</sup>, PREBEN HANSEN<sup>4</sup>

<sup>1</sup>Ion Mincu University of Architecture and Urbanism, Bucharest, Romania

<sup>2</sup>École Polytechnique Fédérale de Lausanne, Switzerland

<sup>3</sup>The Royal Danish Academy of Fine Arts - Schools of Architecture, Design and Conservation, Copenhagen, Denmark

<sup>4</sup>Stockholm University - Department of Computer and Systems Sciences, Stockholm, Sweden

*ABSTRACT: The current paper presents the activities carried out by a Working Group (WG2) within the frame of the COST Action CA16114 'RESTORE: Rethinking Sustainability Towards a Regenerative Economy'. The content is divided into two parts: a brief overview of the ongoing work within RESTORE, and a detailed analysis of the tasks performed in the Working Group tackling the Regenerative Design Process (RSD). With the term "Restorative Design", is identified the activities of design, construction and building operation to regenerate the local natural systems to a healthy state and supporting their capability for self-organization and regeneration. The objective is thus to improve the built environment restorative quality, considering current and future climatic scenarios, focusing on the revision of the energy demand, and on the outdoor human comfort. The paper presents a series of urban methods and design cases studies that engages in newer, continuous and healthy, relationship with the unique 'place' of intervention in light of climate adaptation. The envisaged results direct a change on the path of "to perceive" "to adapt" and "to develop" the urban environment and to define recommendations for science based interdisciplinary design processes.*

*KEYWORDS: COST Action, Urban design, Human comfort, Greening, Climate change, Restorative, Regenerative*

### 1. INTRODUCTION

We are living in an urban world [1], and since 2015 more than half of the human population is living in cities, which consume 75% of global energy and are responsible for 50% to 80% of CO2 emissions [2]. To face climate change and all the problems related to it, we should rethink the concept of sustainability, going beyond current practice. Current understanding of the term sustainability, introduced in the Brundtland Report [3], is characterised by three interconnected dimensions: society, economy and environment [4]. This term can be defined in several definitions, but how we can overpass the current paradigm, going deeper and further?

The objective of this paper is to present the contribution currently performed within on-going COST Action CA 16114 RESTORE 'REthinking Sustainability TOwards a Regenerative Economy', started in May 2017. The purpose of this COST Action is to go beyond the current practice of sustainable design, from the reflection on the restorative or regenerative concepts. Firstly, the terms "Sustainable", "Restorative" and "Regenerative" are defined [5]. The term "Sustainable" means to limit the damage we cause. "Restorative" means to restore the capability of social and ecological systems to a healthy state. "Regenerative" is related to the capacity of regen the local relationship of social and ecological systems, evolving continuously [5].

The RESTORE COST Action, composed of an interdisciplinary and international team, brings together over 140 sustainability researchers, experts, and practitioners across a wide spectrum of disciplines, in order to create a unique and collaborative knowledge-based community from 37 European countries. The network crosses typical academic networks and professional's association, providing a transversal and potentially exponential impact and is subdivided into 5 working groups (WG):

- WG1 Restorative Sustainability, with the focus on defining the influence of the built environment as a contributing cause/factor but also as a potential solution to facing climate change and on creating the Language of Sustainability as a reference for RESTORE working groups.
- WG2 Restorative Design Process, with the objective of bringing the research into practice and underlining the tools and processes to adapt to climate change.
- WG3 Restorative Building and Operations, providing the impact and innovations for a restorative approach for construction and operation (facilities management).
- WG4 Rethinking Technology, to explore the implementation of systems and technologies in new and existing buildings.

# PLEA 2018 HONG KONG

*Smart and Healthy within the 2-degree Limit*

- **WG5 Scale Jumping**, with the objective of connecting the output provided by the previous working groups, and adapting them from the building to the city scale.

The WGs are developed in different phases of the Action's lifetime and implementation, starting from the WG1 activity, which explores the key issues of sustainability in the built environment. WG1 establishes the theoretical foundation for the other working groups to build upon and further elaborate, cooperating with each other. This WG is focusing on the new knowledge (theoretical and applied), the skills, and the competence that support new sustainability models. The proposed models look beyond the frame of static assessment methods, leading to 'Evidence-based' Restorative Design solutions, characterized by a wider range of integrated qualitative and quantitative restorative sustainable performances [6]. The main objective of this work is to enhance human health and wellbeing in the urban built environment. Considering the RESTORE objectives, this paper presents the multidisciplinary research challenge, objectives and methods work we are performing within this COST Action, underlying our purposes, as well as the problems we are facing. A further focus of the paper is to address the thematic developed by WG2, concentrating on the Adaptive Neighbourhood Design.

## 2. RESTORATIVE DESIGN PROCESS

The term *Restore*, according to the Cambridge and Oxford dictionaries, underlines the need of bringing back or re-establish a right, a situation or practice. We can *restore* a building, a work of art, but we can also *restore* a right. Consequently, this term has several connotations, from art and architecture to the humankind. The objective of this COST action is to expand our knowledge on sustainability, and re-design the current practice by projecting it into the future.

### 2.1 A conscious worldview approach – from sustainability to restorative and regenerative sustainability

As previously started, the WG1 core activity is related to the glossary definitions. Another important issue is the so called Regenerative Economics, with the objective of understanding how the design can truly meet the human needs within ecological limits, in a social just and culturally rich economy. If by sustainable design we understand a green design with an emphasis on reaching a point of being able to sustain the health of the planet's organisms and systems over time, Restorative Design is about using the activities of design and building to *restore* the local natural systems to a healthy state and supporting their capability of self-organization [8,9] (Figure 1).

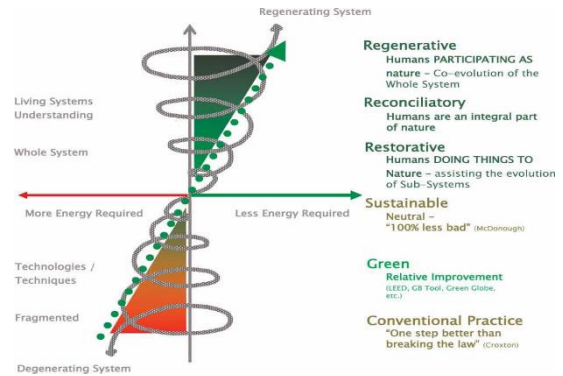

Figure 1: Trajectory of Environmentally Responsible Design [8]

Thus, restorative design starts with the concept of a place-based design. By engaging all the key stakeholders and acknowledging the place – humans, earth systems and the consciousness that connects and energizes them – the design process builds the capability of people to engage in a continuous and healthy relationship with their environment. There are continuous learning and feedback loops; consequently, all aspects of the system are integrated into the process, also known as co-evolution [7].

Beyond restorative, *regenerative design* is defined as the holistic approach, which supports the co-evolution of humans and natural systems, in a partnered relationship, repositioned from an ego-centred position to understanding that we are inherently a part of, and fully dependent on the web of life on the planet [7].

Regenerative Design applies to community planning and building design. It is not the building that is "regenerated" in the same sense as the self-healing and self-organizing attributes of a living system, but building become a catalyst for positive change within the unique 'place' in which it is situated [10, 7]. As Commoners, in *The Closing Circle*, summarized the basics of ecology into four Laws, with a profound reference to designing with nature: i) everything is connected, ii) no waste in nature; iii) nature already has a solution and iv) there is no free lunch [11]. This last is important as every design; action that is not regenerative is only 'borrowing' from nature, which at some point we have to pay back (e.g. by the problems related to climate change).

Within the regenerative development paradigm, built projects, stakeholder processes and inhabitation are collectively focused on enhancing life in all its manifestations – human, flora and fauna, and ecological systems – through an enduring responsibility of stewardship [12].

### 2.2 Collaborative interdisciplinary process

The main purpose of restorative design is to restore social and ecological systems to a healthy state. In this context, WG2 Restorative Design Process focuses particularly on the role played by the place-based design. Indeed, it is essential to understand how the design of

# PLEA 2018 HONG KONG

*Smart and Healthy within the 2-degree Limit*

the built environment impacts the health, wellbeing, quality of life and productivity of its users. In this respect, WG2, comprising an interdisciplinary team of researchers, architects, urban and landscape planners, aims to understand how the outputs from university research can be applied in real practice. The WG2 activity is subdivided into four main groups, passing through several scales: (a) neighbourhood, (b) building, (c) materials, and (d) human. The work of the group is based on the interconnection and discussion between the members (Figure 2).



Figure 2: Keywords and interconnection within WG2

Thus, the frame of the WG2 is developed from an object design to a process design, focusing on the interactions between the energy demand of building and the urban environmental conditions. A barrier or enabler to a collaborative interdisciplinary process is the sustainability certification scheme. As an example, the Living Building Challenge [13] certification is only granted after 12 months of proven design intent. Consequently, a very different collaboration between disciplines, design, construction and operation is needed.

### 3. ADAPTIVE NEIGHBOURHOOD DESIGN

Within the frame of WG2, the subgroup working on the Adaptive Neighbourhood Design focuses its attention on three main aspects: human perception, the energy demand of buildings and greening. The paper refers to the neighbourhood scale as an urban area that is connected by people and consists in buildings, public and private space with various functions and infrastructure. It is not defined by limits or visible boundary, but by people's fluxes. Underlining that regeneration is about the whole system and *to regenerate* means to give new life and energy to, which can only happen to the whole system [14].

Consequently, the adaptive neighbourhood is an adaptive system, which responds to and explores the continuous environmental changes.

The objective of the work is to investigate old and new processes, guidelines and tools, analogue and computational, which support regenerative, creative and innovative solutions. The work is performed from the urban to the neighbourhood scales. In order to understand the urban exposure and sensitivity to a given set of climatic impacts, and to develop responsive design strategies that address these vulnerabilities, the focus is

primarily targeted to adaptation to climate change. The adaptive capacity is the ability to adjust to climate change (including climate variability and extremes) to moderate potential damages, to take advantage of opportunities, or to cope with the consequences (in relation to climate change impacts) [15].

Figure 3 summarises the expressed concepts, behind the adaptive neighbourhood design processes. The energy demand, pedestrian perception and greening are analysed within the urban environment.

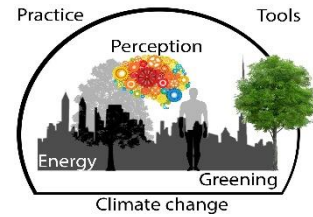

Figure 3: Keywords and interconnection within the adaptive neighbourhood design.

### 3.1 Methodology

Our objective is to underline the use of the research into practice, providing a new direction to impact the change on the path of "to perceive" "to adapt" and "to develop" the built environment. Given the established concepts of on place-based design [16, 17]; genius loci [18] and the aim of reconnecting to place [7], which would help foster the shift from sustainable design to restorative and regenerative design [8], the WG explores design methods and tools that sustain urban adaptations.

The further and current challenges in urban climate adaptation are related to the fact that each urban area/city has its specificities and unique setting exposed to environmental transformation. The interactions of neighbourhood systems are complex and it important to be able to:

- 1) predict the future state of a complex climatic adaptive system with accuracy [14]
- 2) find viable computational methods to understand how the neighbourhood evolves over time.

When focusing on sustainable neighbourhood regenerative design approaches, the WG activities explores existing climatic research able to relate, at the level of neighbourhood, the qualitative and quantitative relations between the system of outdoor spaces and the indoor environments, in light of climate change.

Study the problem of microclimate and comfort condition and energy systems in a separate manner, within take into account the influence that outdoor have on indoor space, and vice versa is found the most common case. This study plans on testing the concept of thermally and visually interlaced indoor and outdoor environments. Indeed, a first attempt in this direction was the work performed on the EPFL campus, focusing on the impact of the microclimatic conditions on the

# PLEA 2018 HONG KONG

*Smart and Healthy within the 2-degree Limit*

energy behaviour of buildings, in current and future climatic scenarios [19] (Figure 4).

## 3.2 Human perception

The human perspective includes a viewpoint that encompasses human activities, which are embedded into their surrounding context. This embeddedness could be both implicit and explicit, and the presence of humans and their activities are today concerned as part of both physical and digital contexts [20]. The human today moves and acts between different spaces and these needs to be designed for [16, 21].

To restore the neighbourhood sustainability, the focus is on improving the urban microclimatic conditions, the pedestrian perception (both thermal and visual).

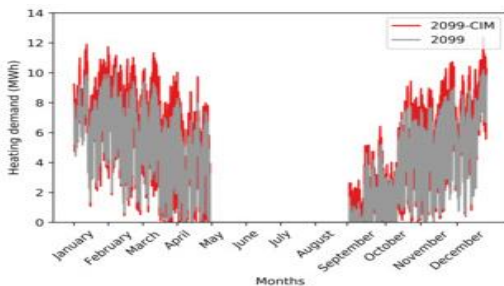

Figure 4: Cumulative heating demand of the EPFL campus in future climatic conditions (2099) with and without considering the microclimatic urban conditions [19]

It is also important to acknowledge the users engagement, e.g. empowerment, education and recognition. For example, recognition is a critical concept since people are more engaged when they see the impact of their actions [27][36].

A first step is to understand how people live the space, the experience of the place [17] monitoring their movements [22], through tools that became drivers for urban analysis. Research conducted in the WG focuses on how social media can prove useful for guiding and gathering data relating to human behaviours, and their patterns of spaces and building uses. This includes the use of innovative artificial intelligence methods and technologies [23, 20].

Having understood the users, we should model their physical, physiological and psychological adaptation within the urban environment. Human centric design is related to wellbeing and welfare, thus, the place experience and the comfort are strongly connected to restorative design. The available tools [24] are analysed in the WG, underlying their applicability in the practice: how we should implement a human-centric design, in the planning design process? A first step in this direction was the definition of the so called “thermal comfort maps”, able to describe, visually, the human thermal perception within the urban environment. Several studies were already performed, in the hot arid climatic conditions of

Dubai, as well as in the temperate Swiss climate, both in current and future climatic conditions.

Furthermore, when we have understood the users and users needs and context, we may define, develop and implement tools that then continuously adapt to human and contextual changes. As such the tools should not only monitor, but also adapt to changing circumstances in order to actually react on the users needs in space and time.



Figure 5: Comfort Map of the EPFL campus in 2100. Total comfort hours during the summer season. [25]

## 3.3 Energy demands of buildings

The WG assumes that the scientific developments and the design ideas will have to go beyond the energy-driven focus that often has led to the retrofit of the built environment. Creative solutions should aim at radically transforming site shape, the materials and the uses, whereas the boundaries are defined by thinking of an intervention that is based on the principles of circular design (and consideration of environmental impact throughout the whole building life cycle). However it is recorded that building energy performance is currently understood as dependent upon urban geometry, building design, systems efficiency and users behaviour [26]. Through the urban geometry, the buildings energy behaviour is transferable to the neighbourhood scale, where the building has a large impact by changing the microclimate and urban environment. Buildings are also connected to larger systems through an exchange of resources, waste [9], land-use and urban morphology.

The improvement of the energy demand of buildings, the integration of renewable energy sources and the optimization of the energy systems is essential in order to improve the sustainability of a city. In the optic of climate change, it is also essential to understand what will be the future thermal behaviour of buildings, knowing that, e.g. in a temperate climate, we will face a reduction of the heating demand and an increase of the cooling demand.

## 3.4 From design to process

All the theoretical aspects defined in the previous part of the paper should be brought into practice. Integrative modelling techniques and collaborative processes could help in planning the limitation of the impacts of climate change, enhance biodiversity and



# PLEA 2018 HONG KONG

*Smart and Healthy within the 2-degree Limit*

improve environmental quality while contributing to economic activities and social well-being. Various types of adaptation to climate change can be distinguished, including: i) *anticipatory* through the role of simulation, prediction of future climatic file, and outdoor to indoor relation; ii) *autonomous* adaptation as welfare in the human system and iii) *planned* adaptation based on the awareness of the people to achieve a desired state.

Different methodologies exist, such as top-down and bottom-up approaches. The top-down approaches are based on policies and regulations. The bottom-up approaches are based on individual efforts [27] and initiatives through persuasive design, in order to change behaviours. In the frame of this project, we will work in contact with planning offices, in order to apply the proposed directions into practice. Additionally, a training school happening in Malaga this fall will focus on an ethnographic study, looking for how each design team integrates the regenerative knowledge and the tools provided to their design proposals. This study comprises the recording and observation of team interactions.

Table 1 summarizes the research axes that are currently developing, focusing on the jump from the sustainable to the regenerative design.

*Table 1: From Sustainable to Regenerative Design*

	<b>Sustainable</b>	<b>Regenerative</b>
<b>Outdoor Micro-climatic Adaptation</b>	Punctual strategies	Integrated within the project design
<b>Greening and Nature Based Solutions</b>	Integrated within the city	Biophilic design, urban mitigation strategy
<b>Indoor Adaptation / Carbon Emission</b>	Zero carbon emission	Oxygen generation
<b>Behaviour Adaptive Design Processes</b>	Attention Imitation	Everyday life Integration Perception Reconnection
<b>Adaptive Design Tools</b>	Lighthouse projects	Integrated within the project loop

All the previous aspects are addressed focusing both on: i) onsite monitoring and questionnaires; ii) simulations; iii) applied projects and iv) training schools.

### 3.5 Focus on Solutions: Greening

The research and design project represent, in this regard, an opportunity for enhancing life in all its manifestations. This presumes shifting the focus from a solely based human-centred design process into a nature-centred one, where “people and buildings can commit to a healthy relationship with the environment where they are placed”. A further focus is thus addressed by Greening. Whereas landscape is perceived as an area by people, whose character is the result of the action and interaction of natural and/ or human factors’ [28], as

being external to the building. In our work we are concerned with bringing nature elements outside and into the building, including the benefit of biophilic design [29]. The ideas is to understand how greening impacts the microclimatic conditions, and consequently the energy demand of buildings, the absorption of pollutants and the outdoor comfort. Additionally, what is the intrinsic implication of greening in people’s urban perception?

In order to create “comfortable” spaces, as well as reducing pollution harm, a further focus is addressed to the greening design process. Indeed, we should understand how nature (of the place) works before starting the design. Indeed, the question is how the technological intervention inspired or supported by nature (so-called “nature-based solutions (NBS)”) impacts the microclimatic conditions, the energy demand of buildings, the human comfort and health [30]. A sound urban greening landscape design has several positive implications, being able to i) mitigate the urban microclimate, ii) improve the energy efficiency of buildings and iii) influence human thermal perception and iv) the social benefits [31]. Indeed, several studies (both simulations and monitoring) were already conducted on this topic, underling how a sound landscape design can decrease the mean radiant temperature, improving the microclimatic conditions [32]. This behaviour is more evident in future climatic conditions, as the natural areas appear to be less impacted by the climate change (e.g. heat waves phenomena during the summer time) in the next fifties to one hundred years.

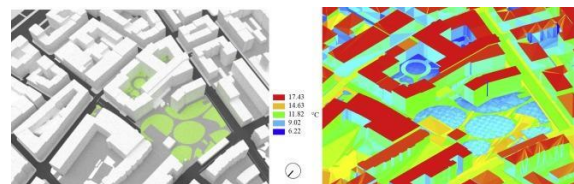

*Figure 6: Urban mitigation by greenings. Geneva case study [32]*

On the other hand, NBS is considered as intervention that change or enhance the function of the area/structure, addressing societal, environmental and economic challenges and supported by or copied from nature’ [34]. Thus, NBS promote nature and include solutions to climate mitigation and adaptation challenges, to improve health, happiness and wellbeing of the population, focusing on the environmental and urban design, restoring the existing spaces. According to the Urban Nature Atlas (a database of NBS across 100 European cities) [35] almost half of the NBS are at the neighbourhood or district-level, with almost 40% on a street or building-scale. NBS and indigenous vegetation can decrease resource demand through energy and matter-efficient processes, as well as by using of

# PLEA 2018 HONG KONG

*Smart and Healthy within the 2-degree Limit*

the natural properties of ecosystems together with technological innovation to provide more restorative responses and to enhance the storage of carbon and additional heat stress reduction.

## 4. CONCLUSION

The proposed paper presents the conceptual developments behind the COST Action RESTORE, Rethinking Sustainability TOwards a Regenerative Economy through the interdisciplinary research-working group on the Adaptive Neighbourhood Design, which is the focus of a specific working group.

## ACKNOWLEDGEMENTS

This article is based upon work from COST Action RESTORE CA16114, supported by COST (European Cooperation in Science and Technology). More information can be found at [www.eurestore.eu/](http://www.eurestore.eu/). Many thanks to Martin Brown, RESTORE WG1 coordinator for the contribution on regenerative sustainability.

## REFERENCES

1. ONU, (2014). "World Urbanization Prospects," New York, United. p. 32.
2. UN HABITAT, (2012). "Sustainable urban energy. A Sourcebook for Asia." p. 203.
3. United Nations, (1987). "Report of the World Commission on Environment and Development: Our Common Future."
4. Theis, T and Tomkin, J., (2013) Sustainability: A Comprehensive Foundation, Rice Univ.
5. Brown, M., (2016). FutuREstorative: Working Towards a New Sustainability. RIBA Publishing.
6. COST Action CA 16114 RESTORE, (2016)., Memorandum of understanding for the implementation of the COST Action 'REthinking Sustainability TOwards a Regenerative Economy' (RESTORE). Bruxelles: COST Association.
7. Brown, M., Haselsteiner, E., Apró, D., Kopeva, D., Luca, E., Pulkkinen, K., Vula Rizvanolli, B., (Eds.), (2018). Sustainability, Restorative to Regenerative. COST Action CA16114 RESTORE, Working Group One Report: Restorative Sustainability [Online].
8. Reed, B., (2007). Shifting from 'Sustainability' to Regeneration. *Building Research & Information*, 35(6), 674-680.
9. 7group and Reed B., (2009). The Integrative Design Guide of Green Building. Redefining the Practice of Sustainability, New Jersey: John Wiley&Sons, Inc.
10. Cole, R., J., (2012) Regenerative design and development: current theory and practice *Building Research & Information*, 40:1, 1-6; DOI: 10.1080/09613218.2012.617516
11. Commoner, B. (1971). *The Closing Circle. Nature, Man, and Technology*, New York: Knopf Press.
12. Mang, P and Reed, B., (2011). Designing from place: a regenerative framework and methodology, *Building Research & Information*, 40:1, 23-38. DOI: 10.1080/09613218.2012.621341
13. Living Building Challenge <https://living-future.org/lbc/>
14. Colchester, J. (2016). Complexity theory. *Systems + Complexity. An Overview*.
15. European Environment Agency, (2016). „Urban adaptation to climate change in Europe 2016. Transforming cities in a changing climate“, EEA Report No 12/2016.
16. McHarg, J. L. (1969). *Design with Nature*, Garden City, N.Y.: Natural History Press.
17. Tuan, Yi-Fu. (1987). *Space and Place: The Perspective of Experience*. London: Arnold.
18. Norberg Schulz, C. (1971), *Existence, space and architecture*, Studio Vista Limited.
19. Mauree, D., Coccolo, S., Perera, A.T.D., Nik, V., Scartezzini, J.-L., Naboni, E., (2018). A new framework to evaluate urban design using urban microclimatic modelling in future climatic conditions. *Sustain.* 10. <https://doi.org/10.3390/su10041134>
20. Sonetti, G., Naboni, E., Brown, M. (2018). Exploring the Potentials of ICT Tools for Human-Centric Regenerative Design. *Sustainability* 10, no. 4: 1217. DOI: [10.3390/su10041217](https://doi.org/10.3390/su10041217)
21. Hărmănescu, M. and Enache, C. (2016). Vernacular and Technology. In *Between. Procedia Environmental Sciences*, Volume 32, 2016, Pages 412-419, <https://doi.org/10.1016/j.proenv.2016.03.047>.
22. Kung KS, Greco K, Sobolevsky S, Ratti C, (2014). Exploring Universal Patterns in Human Home-Work Commuting from Mobile Phone Data. *PLoS ONE* 9(6): e96180. <https://doi.org/10.1371/journal.pone.0096180>
23. Chokhachian, A., Ka-Lun Lau, K., Perini, K., Auer, T., (2018). Sensing transient outdoor comfort: A georeferenced method to monitor and map microclimate, *Journal of Building Engineering*, Volume 20/2018, Pages 94-104, <https://doi.org/10.1016/j.jobeb.2018.07.003>.
24. Naboni, E., Meloni, M., Coccolo, S. Kämpf, J., and Scartezzini, J.-L., (2017). "An Overview of Simulation Tools for Predicting the Mean Radiant Temperature in an Outdoor Space Setting," in CISBAT International conference.
25. Coccolo, S., (2017). Bioclimatic Design of Sustainable Campuses using Advanced Optimisation Methods. EPFL Thesis n.7756
26. Steadman, P., Hamilton, I., and Evans, S., (2013). Energy and urban built form: an empirical and statistical approach. *Building Research & Information*, 42(1), 17–31. <https://doi.org/10.1080/09613218.2013.808140>
27. Parviainen, E., Lagerström, E., and Hansen, P., (2017). "Composting as Interior Design – Encouraging Sustainability throughout a Participatory Design Process," In: ACM DIS '17 Proceedings. DOI: [10.1145/3064857.3079139](https://doi.org/10.1145/3064857.3079139)
28. EC, (2001). European Landscape Convention. *European Treaty Series*, 176. [Online], Available: [https://rm.coe.int/1680080621\\_23](https://rm.coe.int/1680080621_23) [23 May 2018].
29. Browning, WD, CO Ryan & J Clancy (2014), 14 Patterns of Biophilic Design, Improving Health & Well-Being in the Built Environment. New York: Terrapin Bright Green. [Online], Available: <https://www.terrapinbrightgreen.com/reports/14-patterns/> [26 July 2018]
30. Hărmănescu, M. & Popa, A. (2013). "A New Landscape Perspective - Human Exercises through Time in Environmental Perception." *Procedia* 92(Lumen):385–89.
31. Kellert, S. and Calabrese, E. (2015). The Practice of Biophilic Design. [Online] Available: [www.biophilic-design.com](http://www.biophilic-design.com) [26 July 2018]]
32. Coccolo, S. Kaempf, J. Mauree, D. and Scartezzini, J.-L. (2018). "Cooling potential of greening in the urban environment, a step further towards practice," *Sustain. Cities Soc.*, vol. 38, pp. 543–559.
33. IUCN, (2012). The IUCN Programme 2013–2016. IUCN, Gland.

# PLEA 2018 HONG KONG

*Smart and Healthy within the 2-degree Limit*

34. EC, (2015). In: Innovation, D.-G.F.R.A. (Ed.), Towards an EU Research and Innovation Policy Agenda for Nature-based Solutions & Re-naturing Cities - Final Report of the H2020 Expert Group. European Commission: Directorate General for Research and Innovation, Brussels.

35. Dora Almassy, D et al., (2018). Urban Nature Atlas: a database of Nature-Based Solutions across 100 European cities. Nature-based urban innovation project NATURVATION.

36. Parviainen, E., Lagerström, E. and Hansen, P. (2017). Transform Your Kids Into Self Sustainable Power Plants – Teaching Sustainable Behaviour to Young Users. In: ACM DIS'17 Proceedings. DOI: [10.1145/3064857.3079137](https://doi.org/10.1145/3064857.3079137)

# Influence of Design-Decisions on the Energy Performance of Renovation Projects with Building-Integrated Photovoltaics: Results for a 1968 Residential Archetype in Neuchâtel (Switzerland)

S. AGUACIL<sup>1</sup>, S. LUFKIN<sup>1</sup>, E. REY<sup>1</sup>

<sup>1</sup>Laboratory of Architecture and Sustainable Technologies (LAST), School of Architecture, Civil and Environmental Engineering (ENAC), Ecole polytechnique fédérale de Lausanne (EPFL), Switzerland.

*ABSTRACT: The renovation of existing buildings is one of the priorities of western countries and needs to be promoted to increase the current low renovation rate, estimated to be of 0.6% per year in the European and Swiss contexts. In parallel, the implementation of building-integrated photovoltaic (BIPV) elements during the renovation process can provide a crucial response to achieve the 2050 targets in terms of greenhouse gas (GHG) emissions and energy savings. In this context, architects, designers and engineers have a key role in achieving these objectives, mainly because they are responsible for the design decisions during the development of the projects, especially during the early-design phase when the most influential decisions are taken. Through a real-case study built in 1968, this research shows how certain design-decisions in renovation processes can affect or compromise the final performance of the building from a global life-cycle and multi-criteria approach. Life-Cycle Analysis (LCA) and Cost (LCC) results show the importance of not losing the opportunity to go beyond current practices when a building needs to be renovated and highlight the necessity to take into consideration BIPV strategies to guarantee both economic and environmental targets.*

*KEYWORDS: Integrated design, Building renovation, Building-Integrated Photovoltaics, Life-Cycle Analysis, Life-Cycle Cost*

## 1. INTRODUCTION

The renovation of buildings is one of the priorities of western countries, where regulatory frameworks are becoming increasingly demanding in terms of energy performances. For instance, Switzerland has an ambitious target for 2050, year at which primary energy consumption and greenhouse gas (GHG) emissions must be reduced by 45% and 76% respectively compared to 2005 [1]. However, with the current renovation rate of 0.6% per year [2], it is impossible to achieve the 2050 targets. The implementation of building-integrated photovoltaic (BIPV) systems during the renovation process can provide a crucial response to the Swiss energy turnaround challenges [3]. Functioning both as envelope material and on-site electricity generator, they can simultaneously reduce the use of fossil fuels and GHG emissions, and promote energy efficiency renovation projects [4]. In this context, architects have a key role in achieving these objectives, mainly because they are responsible for the design decisions that are made in the energy renovation projects of existing buildings [5]. They have the opportunity to convince owners to implement more energy-efficient solutions. This article shows how certain design decisions during renovation projects' processes can affect the final energy performance of a building while simultaneously showcasing new BIPV products available, therefore promoting high quality architecture with active elements. Through a real-case study built in 1968, results show the Life-Cycle Analysis (LCA) and Life-Cycle Cost (LCC) performance of different

renovation design scenarios, and different energy use scenarios studied in an iterative process between the design and simulation phases.

## 2. LITERATURE REVIEW

This section presents a concise literature review to contextualise this research. There are recent publications about how to help designers in decision-making during the design process for new buildings [6–8], using multi-criteria assessment [7]. However, there is lack of studies convening renovation, residential buildings and BIPV in the same study. The originality of this study lies in this combination, focusing on helping decision-makers to better deal with the renovation projects of existing residential buildings integrating photovoltaic energy from the early design stages.

## 3. METHODOLOGY

The research involves four main phases: **1)** identification of five residential archetypes taking Neuchâtel as a representative city in Switzerland; **2)** detailed analysis of a real case study per archetype; **3)** implementation of design scenarios embodying BIPV solutions and different levels of intervention; **4)** multi-criteria assessment of the scenarios. While further details on the methodology can be found in [4,9], emphasis here is placed on the results obtained after the implementation of each design scenario, to analyse how the design decisions condition the LCA and LCC performances. Our calculation takes into account the

# PLEA 2018 HONG KONG

*Smart and Healthy within the 2-degree Limit*

whole renovation process, including operational energy as well as the embodied energy from construction materials, BIPV elements, and heating, ventilation and air-conditioning (HVAC) system improvement. After the selection of a real case study, five renovation scenarios are defined from an architectural point of view. The **E0-Current status** scenario reflects the actual situation of the building. The **S0-Baseline** scenario – without BIPV – aims at achieving at least the current legal requirements SIA 380/1:2016 [10], in accordance with current practice. The last three scenarios incorporate BIPV strategies. **S1-Conservation** aims to maintain the expression of the building while improving its energy performance (at least up to current legal requirements). **S2-Renovation** has as purpose to maintain the general expressive lines of the building while reaching high energy performance (at least *Minergie*<sup>®</sup> standard). For **S3-Transformation**, the goal is to achieve the best energy performance (at least the Swiss targets for 2050 [1]) with aesthetic and formal coherence over the whole building.

These general design concepts are implemented taking into account the specific characteristics of each building. Consequently, the strategies are adapted to each case study to provide the most adequate means for achieving the design objectives. The results of the design scenarios implementation, described in the following section, allow to define constructive details and identify all possible active surfaces on roof and façades, which will be considered to substitute traditional inert construction elements by BIPV elements permitting to produce electricity. During this phase, an iterative process between design and energy simulation is conducted using DesignBuilder v.5 [11] and DIVA v.4 [12] via the Grasshopper graphical algorithm editor integrated with the Rhino 3-D modelling tool [13].

All data are saved in an Excel database, allowing to create an in-house assessment tool allowing to easily compare between scenarios and extract results.

This paper shows two kinds of results. First, the range of results obtained according to the design parameters (Table 1), using an online application to generate parallel coordinate plots (PCP) [14]. The use of PCP allows users to detect which are the key parameters to be able to reach one or several pre-set objectives. Second, we present the detailed results of the LCA and LCC for the scenarios that allow reaching a higher level of performance compared with the Swiss objectives for 2050 (Fig. 6 and 7).

Table 1 presents the different design parameters used in this study. In terms of inputs we propose five options: 1) design concept (or renovation design scenarios), 2) active strategy (maintaining the existing gas-boiler or replacing it by an electric heat-pump), 3) using active elements or not (to compare with a non-active renovation option and highlight the benefits of including BIPV elements), 4) three possible energy-use

scenarios: (*A-100%*) using all possible active surfaces detected in the design process, (*B-Selection*) making a selection according to the energy demand of the building or (*C-Batteries*) including batteries [9], 5) with or without the possibility to inject the overproduction into the grid, and 6) taking into account or not the public subsidies (for BIPV, HVAC and improvement of the thermal envelope).

The selection of the façade elements that would be active – versus “dummies” or “inert” modules – depends on an optimisation process between on-site production and building consumption to maximise self-consumption and self-sufficiency ratios (corresponding to the energy-use scenario named *B-Selection*).

In addition, our holistic approach also considers the integration of batteries (*C-Batteries*) with an adapted sizing method based on the cost-effectiveness of this additional investment, to guarantee the optimum size of the storage system according to the lifespan of the existing products on the market, specifically lithium-ion batteries technology [15–17].

Table 1: Input-Output design parameters.

Input parameters	Values
Design Concept	E0, S0, S1, S2 or S3
HVAC	Gas-Boiler or Heat-Pump
Active elements	Active or Non active
Energy-use scenario	A, B or C
Injection	Yes or No
Subvention	Yes or No
Output parameters	Units
Total PV production	MWh/year
Self-consumption (SC) ratio	%
Self-sufficiency (SS) ratio	%
Electricity consumption	kWh/m <sup>2</sup> .year
Gas consumption	kWh/m <sup>2</sup> .year
Cumulative energy demand	kWh/m <sup>2</sup> .year
Global warming potential	kgCO <sub>2</sub> /m <sup>2</sup> .year
Net investment cost	CHF
Energy bill	CHF/year
Payback period	Years
Internal Rate of Return	%

For example, implementing the scenario S3-transformation including the replacement of the exiting HVAC system and an optimization of the actives surfaces, the storage system (sized for a mean daily electricity demand of capacity) presents about 1100 discharge cycles per year. Thus, if batteries could support about 7500 cycles at 80% depth of discharge (DOD)[16], that means about 7 years of life span.

The output parameters correspond to the multi-criteria evaluation process based on the LCA and LCC approach. These parameters and the methodology used in this research are fully described in [4,9].

## 4. RESULTS

The case study presented in this paper corresponds to a residential archetype built in 1968 (Fig. 1) of 7 stories, 48 apartments and 4'415 m<sup>2</sup> of total floor area. It has a poorly insulated envelope, its façades are made of

# PLEA 2018 HONG KONG

Smart and Healthy within the 2-degree Limit

perforated brick with a 4 cm air gap and double-glazed windows, and it has a flat roof with 6 cm of expanded polystyrene (EPS) insulation and 5 cm of gravel. In terms of active systems, this building has a central gas boiler covering heating and domestic hot water (DHW) needs.



Figure 1: Scenario E0 - Current Status. Image and construction detail of the existing façade.

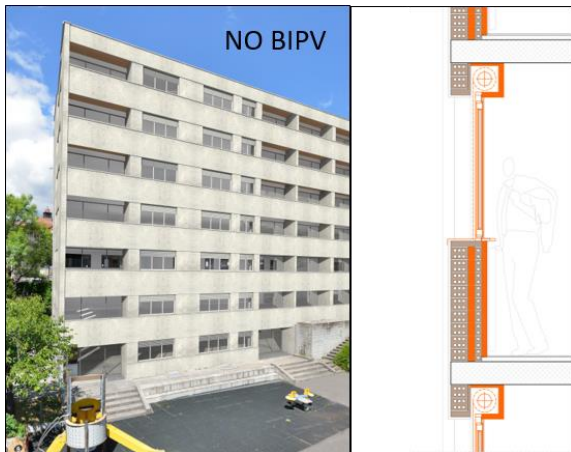

Figure 2: Scenario S0 - Baseline.

The results presented here correspond to the implementation of the renovation design scenarios into concrete strategies for the present case study. For **S0** (Fig. 2), only passive strategies are applied to reduce the energy demand. The performance of the envelope is improved by adding internal insulation (filling the air gap of the existing façade) and by substituting the windows to achieve the current legal requirements.

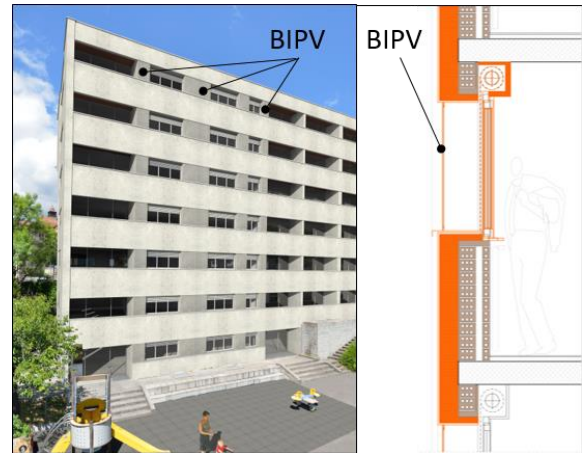

Figure 3: Scenario S1 - Conservation.

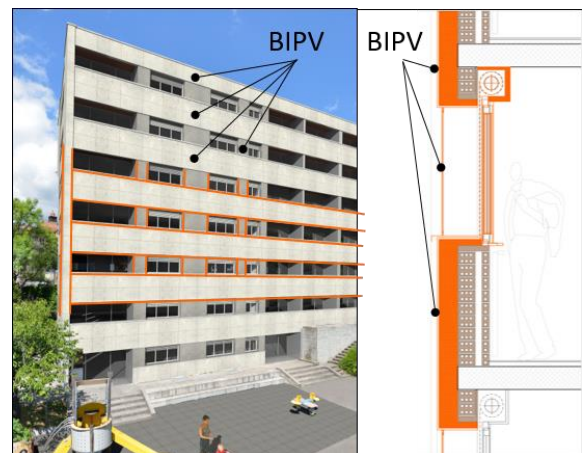

Figure 4: Scenario S2 - Renovation.

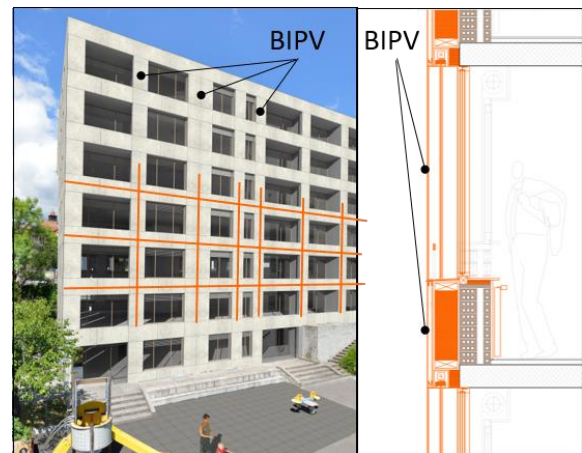

Figure 5: Scenario S3 - Transformation.

For **S1** (Fig. 3), we propose an external insulation façade system and the replacement of existing windows (frame and glazing). Moreover, the space between the windows is covered with custom sized coloured BIPV elements, maintaining the original aspect of the building.

For **S2** (Fig. 4), in addition to S1 strategies, active elements are installed over the long horizontal bands between floors with standard-size coloured BIPV panels, respecting the main expressive lines of the building's

# PLEA 2018 HONG KONG

Smart and Healthy within the 2-degree Limit

architecture while accepting visible joints between panels and completing the rest of the surfaces with non-active panels with the same appearance.

Finally, for **S3** (Fig. 5), we propose a prefabricated low-carbon façade system to plug directly onto the existing façade, including insulation (ventilated facade), new windows, and BIPV elements covering all opaque surfaces. Standard-sized panels are used to modulate the entire façade, accepting visible joints and a new aspect of the building.

An optional active strategy for the S1, S2 and S3 scenarios regarding the HVAC system (for heating and DHW) is proposed: substituting the existing gas-boiler by an electricity-based system using an air-water heat-pump (AWHP) to increase the energy efficiency of the HVAC system and the self-consumption (SC) ratio (by using more intensively the BIPV installation).

As defined in Table 1, three energy-use scenarios are tested (*A-100%*, *B-Selection* and *C-Batteries*). These are defined in three sequential design phases using parametric simulations, as further detailed in [9].

By conducting hourly simulations with a 3D model generated according to the above mentioned design scenario implementation, taking into account the urban context, we obtain the global warming potential (GWP) expressed in GHG emissions and non-renewable cumulative energy demand (CEDnr) results shown in Fig. 6.

We observe that for **S0** (Fig. 2), the design concept remains too conservative with only passive strategies implemented, thus limiting (for the operational phase) the energy savings to 47% and the GHG to 51%.

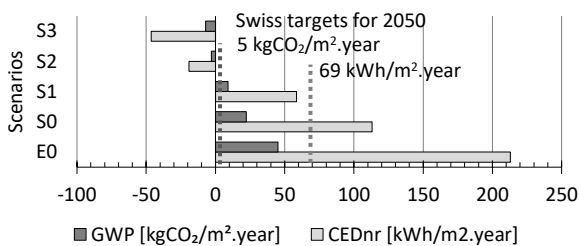

Figure 6: Results for the operational phase (use of building).

The **S1** design concept allows to achieve 72% of savings. This scenario requires fully customized BIPV elements, but it does not take advantage of the improvement potential of the building. For **S2** and **S3** the building produces more energy than it consumes, thus meeting the Swiss targets for 2050.

The implementation of the **S2** design concept, which allows visible joints without disturbing the horizontal expression of the building, enables the building to achieve 109% of energy savings. **S3** reaches 122% of energy savings, while ensuring an aesthetic and formal coherence of the completely active façade using standard-size BIPV element. Moreover, the change in the

proportion of windows allows increasing the daylighting potential (results not shown here).

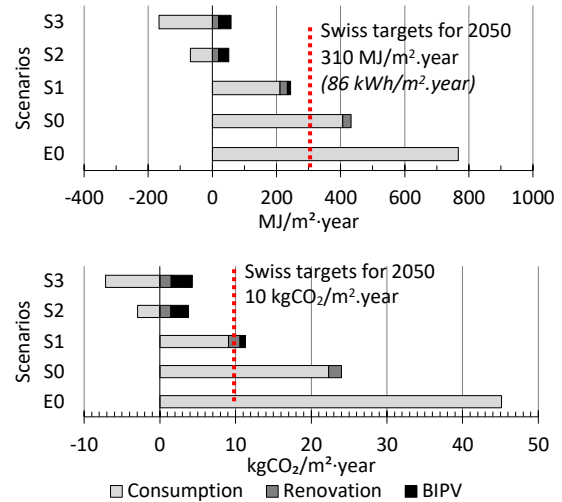

Figure 7: Life-Cycle Analysis (LCA) results in terms of CEDnr (top) and GWP (bottom).

In order to highlight the improvement potential of this real case study from 1968, Fig. 7 shows the most energy performing cases, which correspond to BIPV scenarios with the replacement of the existing gas-boiler by an AWHP, with the possibility of injecting the overproduction into the grid.

The results are for the whole LCA, considering CEDnr and GWP for both the operational phase (use of building) and construction materials (including BIPV elements). The savings needed to achieve the 2050 targets are of 59% (for CEDnr) and 77% (for GWP). It is important to highlight that all scenarios including BIPV elements achieve the CEDnr target, but only **S2** and **S3** achieve both the CEDnr and GWP targets.

In terms of LCC, Fig. 8 shows the payback time (PBT) resulting of the application of the different design scenarios, using three distinct energy-use options and with the possibility of injecting the electricity overproduction into the grid.

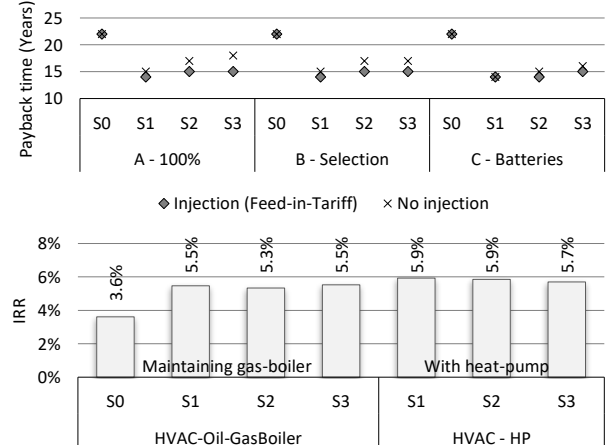

Figure 8: Life-Cycle Cost analysis (LCC) results in terms of payback time (top) and internal rate of return (IRR) (bottom).

# PLEA 2018 HONG KONG

Smart and Healthy within the 2-degree Limit

We observe that BIPV scenarios have a lower PBT, thus are significantly more cost-effective than the S0 (current renovation practice). As mentioned in [2], current practices in renovation projects like the S0 scenario make it difficult to achieve cost-effectiveness objectives such as an internal rate of return (IRR) of 4% or more, where 4% corresponds to a typical value used in economic analysis for private construction investors.

These results indicate that renovation with BIPV scenarios could help to overcome this economic barrier. Fig. 8 also shows the results in terms of the annual financial viability of the investment, using economic savings due to both energy consumption reduction and energy efficiency increase. It is important to highlight

that the best results correspond to BIPV scenarios, achieving between 5.3% and 5.9% of annual profitability.

Considering the amount of data generated in this study, as mentioned in the methodology section, the objective is to help architects, engineers and stakeholders involved in renovation processes to explore the whole range of solutions and highlight the influence of the different design decisions according to the parameters of Table 1. Fig. 9 shows, through a PCP, the range of solutions and highlights the design parameter combinations that allow to achieve CEDnr and GWP targets. It is possible to explore the results of this case study by following this link: <https://goo.gl/JspwGL>.

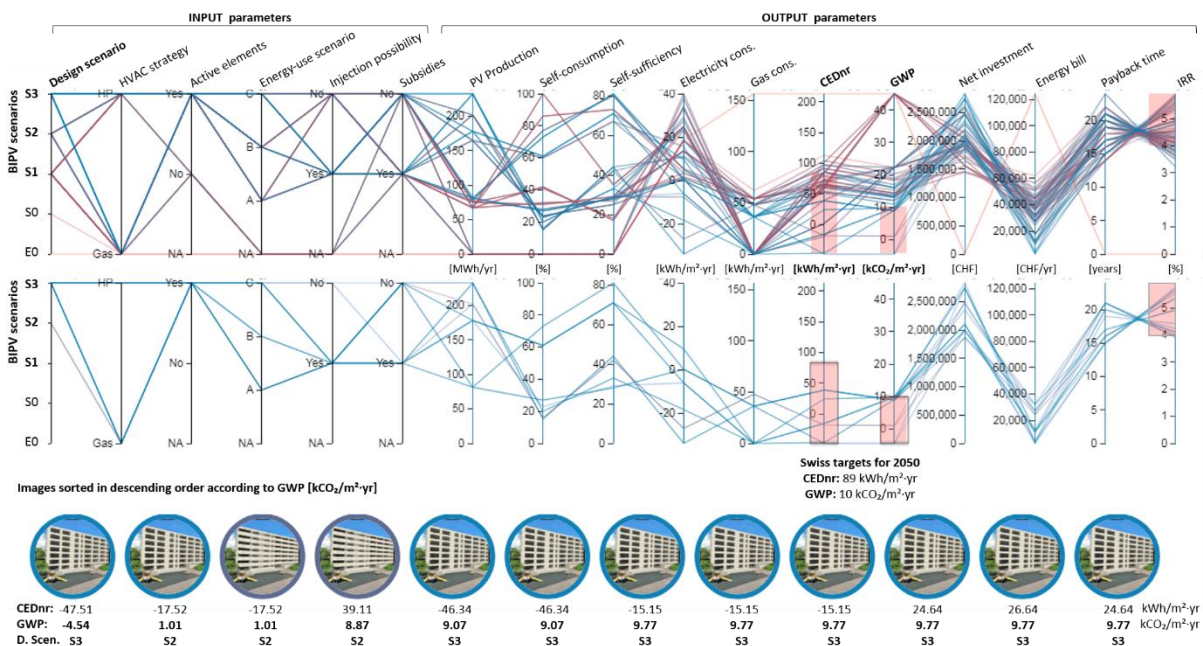

Figure 9: Parallel coordinate plot (PCP) with all design variants (top) and filtering results according to the Swiss targets for 2050 (bottom). Visualisation data using the Design Explorer online application [14].

## 5. CONCLUSION

In light of our results, it is important not to miss the opportunity and to carry out a detailed analysis considering BIPV strategies when planning the renovation of a building, instead of settling for a superficial renovation. Likewise, this study highlights the necessity to take into consideration BIPV strategies to guarantee both economic and environmental targets.

It is important to conduct these variations in terms of energy-use scenarios (A-100%, B-Selection and C-Batteries) to ensure a better integration of BIPV elements not only from a construction point of view, considering BIPV as a new construction material, but also from an operational and exploitation approach.

By exploring results using PCP, it is possible to highlight the range of strategies that helps to achieve

certain objectives and to check the compatibility between other strategies.

For example, filtering results with the 2050 targets (CEDnr = 86 kWh/m<sup>2</sup>.year; GWP = 10 CO<sub>2</sub>/m<sup>2</sup>.year) and a typical profitability objective (IRR = 4%), only two BIPV scenarios (S2 and S3) remain possible. The range of valid scenarios includes variants without necessity of subsidies, which means that the results of this study can be used to more effectively manage the economic resources allocated to subsidies, prioritizing for instance projects with more difficulties to obtain an acceptable profitability.

These results should motivate the use of BIPV elements in renovation projects, accelerating the renovation rhythm of the building stock. They also provide valuable information to make new guidelines to



# PLEA 2018 HONG KONG

*Smart and Healthy within the 2-degree Limit*

be included for example in masterplan developments to ensure the realisation of high quality active renovation projects.

Through a design-driven approach, the use of BIPV elements can be promoted as a new construction material for facades and roof, as it allows great variety of formal solutions.

Finally, results show that if a greater degree of intervention is permitted, without compromising the architectural quality, the necessary levels of energy performance can be achieved, significantly reducing the environment impact, increasing indoor comfort and the value of the existing building stock.

## ACKNOWLEDGEMENTS

This research is part of the Active Interfaces research project of the National Research Program "Energy Turnaround" (NRP 70) of the Swiss National Science Foundation (SNSF). Further information on the National Research Program can be found at [www.nrp70.ch](http://www.nrp70.ch). The authors also thank the Ecole polytechnique fédérale de Lausanne (EPFL) for its support.

## REFERENCES

1. SIA (2011). SIA 2040 - La voie SIA vers l'efficacité énergétique, [Online], Available: <http://www.2000watt.ch/> [16 May 2018].
2. Jad, K., (2014). Rénovation énergétique des bâtiments résidentiels collectifs : état des lieux, retours d'expérience et potentiels du parc genevois, Université de Genève, doi:10.13097/archive-ouverte/unige:48085.
3. Lufkin, S., Rey, E., Wuestenhagen, R., Wittkopf, S., Bacher, P., (2015). Building integrated photovoltaics. ACTIVE INTERFACES, NRP 70 (Energy Turnaround) and NRP 71 (Managing Energy Consumption), Kick-off Meeting Luzern, 24 April, Luzern, <http://www.activeinterfaces.ch/>.
4. Aguacil, S., Lufkin, S., Rey, E., (2016). Architectural design scenarios with building-integrated photovoltaic solutions in renovation processes: Case study in Neuchâtel (Switzerland). In PLEA 2016 Los Angeles - 36th Int. Conference Passive and Low Energy Architecture, Cities, Buildings, People: Towards Regenerative Environments. Los Angeles, USA, July 11-13.
5. Aguacil, S., Lufkin, S., Rey, E., (2017). Stratégies de rénovation active pour le parc bâti Suisse. In 9e Édition Du Forum Ecoparc. Potentiel solaire des territoires urbains : vers de nouveaux paradigmes ?. Neuchâtel, Switzerland, September 8.
6. Jusselme, T., Rey, E., Andersen, M., (2018). An integrative approach for embodied energy: Towards an LCA -based data-driven design method. Renewable and Sustainable Energy Reviews, 88: p. 123–132.
7. Jusselme, T., Cozza, S., Hoxha, E., Brambilla, A, Evequoz, F., Lalanne, D., Rey, E., Andersen, M., (2016). Towards a Pre-Design Method for Low Carbon Architectural Strategies The case of the smart living building in Fribourg, Switzerland. In PLEA 2016 Los Angeles - 36th Int. Conference Passive and Low Energy Architecture, Cities, Buildings, People: Towards Regenerative Environments. Los Angeles, USA, July 11-13.
8. Röck, M., Hollberg, A., Habert, G., Passer, A., (2018). LCA and BIM: Visualization of environmental potentials in building construction at early design stages. Building and environment, 140: p. 153–161.
9. Aguacil, S., Lufkin, S., Rey, E., (2017). Influence of energy-use scenarios in Life-Cycle Analysis of renovation projects with Building-Integrated Photovoltaics – Investigation through two case studies in Neuchâtel (Switzerland). In International Conference for Sustainable Design of the Built Environment. London, UK, December 20-21.
10. SIA (2016). SIA 380/1:2016 - Besoin de chaleur pour le chauffage.
11. DesignBuilder (2018). DesignBuilder software v.5, [Online], Available: <http://www.designbuilder.co.uk/> [23 February 2018].
12. Solemma LCC (2018). DIVA for Rhino. Environmental analysis for buildings, [Online], Available: <http://diva4rhino.com/> [15 April 2018].
13. Davidson, S., (2018). Grasshopper for Rhino, [Online], Available: <http://www.grasshopper3d.com/> [29 May 2018].
14. CORE studio, Thornton, T., (2017). Design Explorer v.2 for multi-dimensional parametric studies, [Online], Available: <http://tt-acm.github.io/DesignExplorer/> [29 May 2018].
15. McManus, M.C., (2012). Environmental consequences of the use of batteries in low carbon systems: The impact of battery production. Applied Energy, 93: p.288–295.
16. Vandepaer, L., Cloutier, J., Amor, B., (2017). Environmental impacts of Lithium Metal Polymer and Lithium-ion stationary batteries. Renewable and Sustainable Energy Reviews, 78: p. 46–60.
17. Stenzel, P., Baumann, M., Fleer, J., Zimmermann, B., Weil, M., (2014). Database development and evaluation for techno-economic assessments of electrochemical energy storage systems. In Energy Conference (ENERGYCON), 2014 IEEE International, Cavtat, Croatia, May 13-16.

## Adaptive Infill Living: Framework for an Alternative Housing Typology in London

WAN FONG WU<sup>1,2</sup>, PAULA CADIMA<sup>1</sup>

<sup>1</sup>Architectural Association School of Architecture, London, UK

<sup>2</sup>ZGF Architects, Seattle, USA

**ABSTRACT:** London's increasing housing demands and land scarcity impose a creative way of finding spaces for well-connected, sustainable housing development. Airspaces, above low-traffic connector roads, in between blind walls (windowless) of terraced houses were found numerous and identified as exploitable spaces. This paper illustrates a framework design that aims to have a contextually sensitive application that provides quality atmospheres for a modern live-work lifestyle, with flexible spatial layouts and adaptive passive features to help achieve desirable comfort. The project employs a modular construction system, for efficient and affordable delivery, where design strategies are transferable and adaptable on sites with different dimensions and microclimates. The outcome is an optimized prototype that demands 30% less energy per sqm annually compared to the UK Zero Carbon Dwelling standard.

**KEYWORDS:** infill terraced houses, sustainable housing, passive adaptive strategies, live-work lifestyle

### 1. INTRODUCTION

Increasing housing demands and land scarcity in London call for research into utilizing untapped areas. Referencing London's organic infill history, this paper explores the potential of building in the airspace between terraced house blind walls, that are windowless, above connector roads, with low traffic, Fig. 1. This is an idea that decouples development from land value. It encourages local authorities that own the airspaces above the roads to build a socially and financially beneficial scheme with interested developers or social housing builders.



Figure 1: Site criteria and an example infill site. Source [1]

This study is based, in part, on observational research in central London—Camden and Islington neighborhoods, specifically—which confirmed that the local architecture and infrastructure offer sizeable development opportunities above connector roads. Site explorations within these neighborhoods provided a sample size for a statistical inference, calculating to an estimate of 1,296 units, each with 100-160m<sup>2</sup> of potential provision within Central London's existing urban fabric.

This paper presents the outcome of a design research which aimed at validating this infill housing typology as a viable sustainable option that fosters community building. It illustrates the development of a prototype

design that combines contextual proportions, a modern aesthetic, and improved environmental performance, arriving at an enhanced lifestyle (Fig. 2). The research aim was to: 1) strategically densifying London to reduce housing and energy demands in less intrusive ways; 2) cultivate public awareness of energy consumption; 3) support the pursuit of a modern lifestyle with live-work environments in desirable locations with access and connection to the outdoors.

### 2. CLIMATE CHANGE

Historical air temperature data indicates that current monthly diurnal averages for the project site can reach 31.2°C maximum and 10.8°C minimum in the summer, and 15°C maximum and -2°C minimum in the winter [2]. For the future picture, the UK Climate Impacts Programme (UKCIP) published four climate change scenarios in early 2002, which in sum suggested that by the 2080s, the UK annual average temperature may rise 2°C to 3.5°C [3]. While the project uses a predicted 2050 weather data for simulations, which show an average of 1°C rise compared to the current annual average, 2°C to 3.5°C rise may cause overheating issues. With this in mind, various adaptive strategies are studied to ensure the ability to maximize airflow for natural ventilation as well as potential for simple retrofitting, such as adding internal blinds to prevent extra solar heat gains during the warm period.

In a broader sense, studies have shown that 21% of greenhouse gas emissions worldwide came from ground transportation [4]. Private automobiles account for two times more pollutants compared to a bus ride per passenger mile, and three times more

# PLEA 2018 HONG KONG

## Smart and Healthy within the 2-degree Limit



Figure 2: View from neighbor's balcony, showing features such as the pedestrianized street, roof garden, solar panels. Source [1]

than by rail [5]. Therefore, focusing housing developments in centralized areas, in proximity to public transportations or within walking distance to workplaces, addresses the root of the problem by reducing greenhouse emissions from ground transportation with the minimized commuting distance between home and work.

### 3. METHODOLOGY

The Class II London Georgian Terraced House was identified, through context research, as having the most blind side façades where non-major roads cut through the housing blocks [6]. In addition, site explorations showed that blind façades are commonly found at six different urban configurations. These urban forms were modeled to generate solar radiation simulations for comparison to narrow down the analytical scope to a manageable set of case studies. (*This paper will not discuss the details of the orientation and solar comparison studies.*) This led to selecting a prototype site, representative of a prevailing urban configuration (20° East of due South) and a 1.35 street width-to-height (W/H) ratio for detail analytical studies.

Working with all the constraints that come with compact sites while aiming at maximizing flexibility, analytical studies were carried out to test different façade configurations while respecting the classical proportion of the adjacent terraced houses and staying with the recommended W/F ratios per learnings from previous studies in the London climate [8]. Different case studies were modeled in Rhino and Open Studio and simulated with DIVA for Rhino, Grasshopper, and Energy

Plus to assess daylighting and thermal performance assuming the following:

**Summer strategies:** shading typologies per parametric analysis using two thresholds (daylight level at 300 lux and incident solar radiation on glazing at 400 Wh/m<sup>2</sup>) along with different percentages of window aperture for ventilation studies.

**Winter strategies:** lower U-value glazing, wool curtains, insulated night shutters, additional insulation on exterior walls and exposed floor, improve airtightness, and possibly adding MVHR.

### 4. DESIGN CONSIDERATIONS

#### 4.1 Targeted occupants

Since the building will be raised, it is not accessible to people requiring wheelchairs. It is impractical and cost prohibitive to install a lift for this 1-2 units, low-rise dwelling. This however, does not limit, for example, older occupants who have the physical strength to climb a flight of stairs to these units. In a socially responsible scheme, an older couple, which may have higher financial capacity, can share the flat with younger professionals or students, where the younger occupants can provide company and exchange more manual labor household chores for a reduced rental rate. However, with the concept of designing for a live-work lifestyle, the most suitable occupants would be younger in age, consisting of residents who can be a combination of students, young professionals and/or young families. Thus, the proposed design focuses on this occupant type with the proposed live-work occupancy pattern of working from home 24/40 hours per week.

# PLEA 2018 HONG KONG

*Smart and Healthy within the 2-degree Limit*

## 4.2 Accessibility and spatial layout

There are two options for accessing this raised infill building. The preferred option is to connect to the adjacent building's shared staircase with access from its side door. This is economically efficient and encourages neighbor encounters and interactions. Some incentives for the neighbor is that they will have better winter performance with reduction of exposed blind façade, access to the shared roof garden, and usage of surplus PV energy generated from the roof (Figs. 2, 9). The other option is to install an external staircase at the widened sidewalk in the back. Figure 4 illustrates these two access options as well as the flexible spatial layouts. The diagram also shows that only small changes are needed to adjust for the two different access strategies.

With a live-work lifestyle as a design case, the internal spaces were conceived to be flexible with several choices of work locations, such as the dining room, the study upstairs or within the bedrooms. As some direct sun will be able to penetrate through the southern windows, the work space was placed on the northern side where more diffused light is available and desirable. Lower internal gain rooms such as the bedrooms are prioritized to be placed on the southern side. The kitchen and living room are in an open plan for cross ventilation. In addition, the outdoor patio garden is placed at the northern orientation to avoid the south and southwest winter prevailing wind to minimized increased heat loss.

## 4.3 Façade modular system

18<sup>th</sup> Century terraced houses are typically tall and narrow with a long narrow garden in the back. Their façades are uniform, with careful attention to symmetry and proportion (Fig. 2). The challenge lay in how to infill here while not being intrusive and adding value to the community. The obvious option of extending or mimicking the adjacent façades may be the least disturbing contextually, but it is also the least visually interesting. Alternatively, modular insulated timber wall panels were proposed. Figure 5 shows the proposed panels having minimal size variations, with two sizes of extruded plugin modules, each having two types of window sizes. This limits construction variations and respects the contextual proportions while still allowing a flexible and dynamic configuration on the façade based on daylighting and shading requirements of the different rooms.

In addition, the units were designed to have dual aspect to allow cross-ventilation. Top and bottom hopper windows were tested for stack effect potential as well. It is possible to add openable panels above the doors of rooms to enhance cross-ventilation in the future if temperature exceeds the 2050 predictions.

Moreover, with the extruded plugins, raising the windows to seat height can create seat ledges, making the walls more functional and versatile, while creating

more usable spaces. Daylight simulations informed that the part of a window below desk height would not contribute much to daylighting and that extra glazed surface could increase heating/cooling loads. Consequently, in the proposed design prototype the windows were raised to start at a height of 0.45 to 0.85 meter and extend close to the ceiling. Daylight visualizations for different times and periods confirmed good distribution of daylight with these strategies. Figure 3 shows example results for an overcast sky and a clear sky with sun on June 21st.

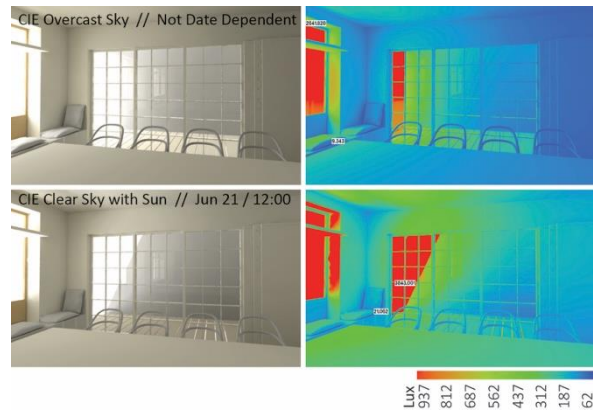

Figure 3. Illuminance image-based and false color visualizations for the Dining-Study space. Source [1].

## 4.4 Adjustable lightshelf and nightshutter

The angled extruded window plugins add a playful dynamism to the façade while the proportions are respecting the terraced block context as well as fitted for the recommended W/F ratios. Additional adjustable devices such as the lightshelf-nightshutters give occupants full adaptability to achieve thermal and visual comfort passively. Daylight simulations show that the addition of the lightshelf improves daylighting distribution in the southern rooms by 8% compared to having no lightshelves. While the lightshelves do very little in terms of daylight distribution for the northern rooms, since these are also insulated nightshutters, they are proposed on the northern rooms as well to keep to one system. Figure 5 illustrates the dual to triple functionality of the folded lightshelf, which allows, during cold winter nights, the occupant to pull down the folded panel, lift the horizontal sill panel, and then fasten the two pieces together to form an insulated night shutter. Simulations results show an increase up to 1K indoor temperature during the cold period with this feature, helping to bring rooms into the comfort band for most of the winter time. The adjustable lightshelf-nightshutter is a convenient strategy of combining both nightshutters and lightshelf while also being able to adjust them to a certain degree for additional shading needs. This allows the users to control the amount of daylight and solar gains that enter the space as well as improve privacy.

# PLEA 2018 HONG KONG

Smart and Healthy within the 2-degree Limit

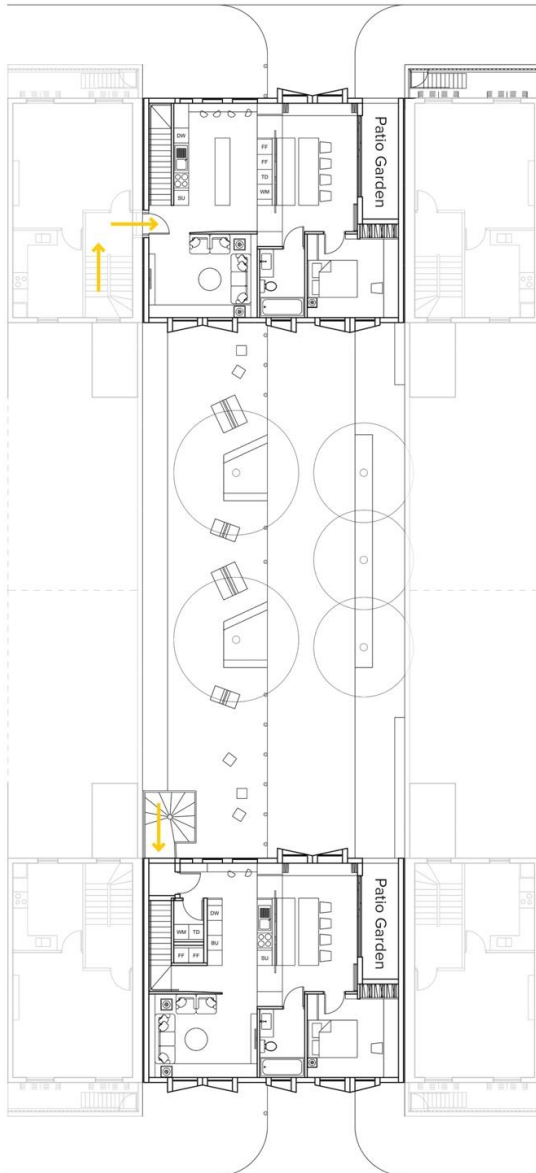

Figure 4: Spatial layout of two units (10.5m wide by 9.0m deep) with two options for accessing (illustrated with arrows) at the prototype site, with a pedestrianized connector road as community space. Source [1].

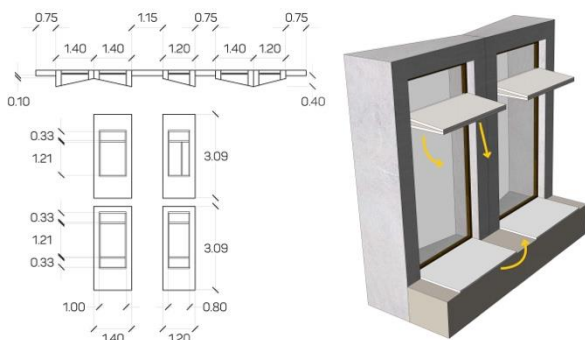

Figure 5: (left) shows the modular insulated timber panel system and window layout; (right) shows the adjustable lightshelf and nightshutter design. Source [1]

## 5. THERMAL SIMULATIONS

Thermal simulations were performed to test the initial building envelop design and the influence of the proposed occupancy internal heat gains. This provided a base case for further studies to assess various summer and winter strategies. Figure 6 summarizes the conditions used for the base case simulations. Room dimensions for the model were established based on previous studies [7], along with the London Housing Design Space Standards [8].

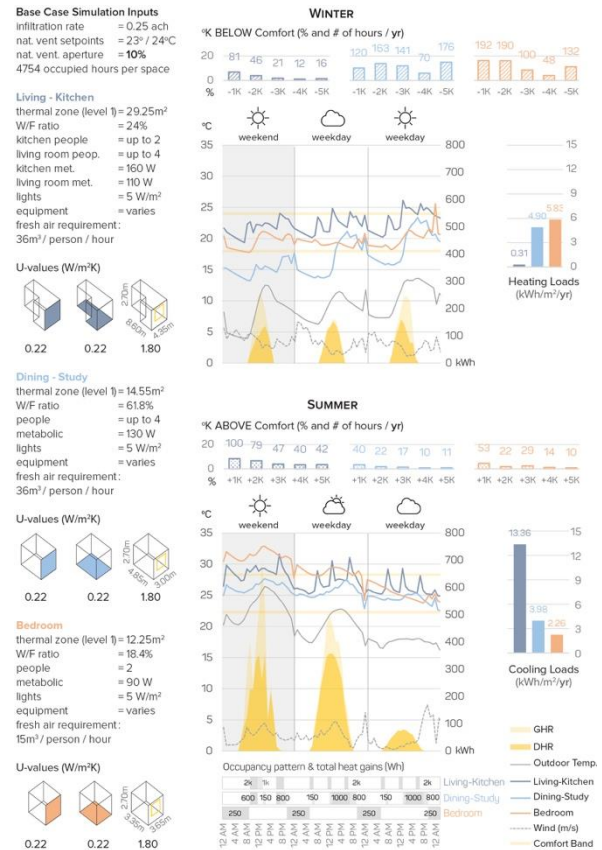

Figure 6: Base case thermal analysis results and energy loads from the infill prototype. Source [1].

### 5.1 Summer strategies: comparative shading studies

The base case showed 100-300 hours annually or 2.0-6.5%, depending on the space, of the occupied hours to remain above comfort. To improve on this, parametric shading studies were performed using the Galapagos plugin considering two thresholds: daylight at 300 lux and incident solar radiation at 400 Wh/m². The latter was assumed with no shading but which, according to simulations, remained within comfort (base case), Fig. 6. Despite the solar angle study showing that a minimum of 1.03-1.06m depth of horizontal shading would be needed to shield from the summer sun, parametric studies revealed that a 0.4m depth would provide an appropriate balance between desirable daylight and solar radiation. It was hypothesized that having a 0.4m shading depth, with the provision of natural cross

# PLEA 2018 HONG KONG

Smart and Healthy within the 2-degree Limit

ventilation, indoor temperatures could be maintained within comfort range in the summer while maximizing daylight.

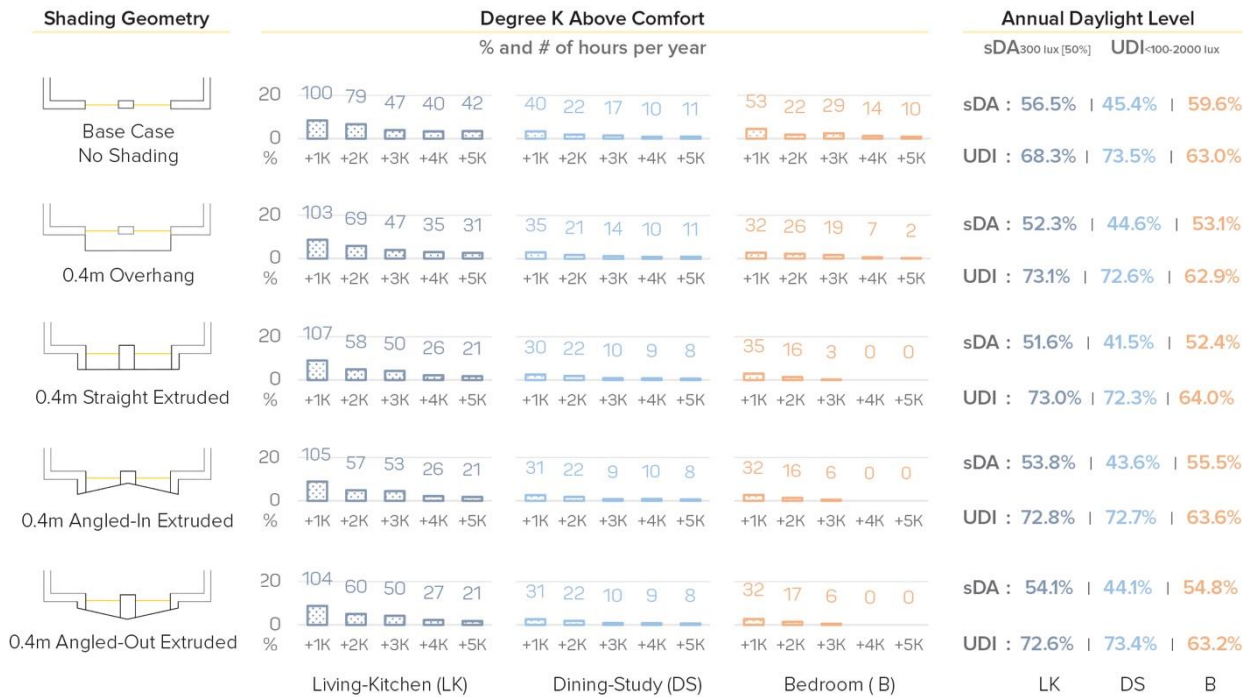

Figure 7: Comparing degree K above comfort and daylight level of the five shading geometries. Source [1]

levels. To verify this, 5 variations of shading devices with the 0.4m optimized depth were studied (blinds were not being considered). The comparison between these shading devices demonstrated that the angled extruded windows can provide a good balance between required daylight levels and hours in comfort during the summer (Fig. 7) at the prototype site (SE 20°). The differences are small, which were expected since the shading depth was already optimized. However, the slight differences support choosing the angled extruded shading for aesthetic and visual reasons.

## 5.2 Summer strategies: natural ventilation

Natural ventilation was studied to compare the effects of different aperture openings: 10%, 30%, 50%, and 70%. According to CIBSE Guide A, the setpoint for window opening for natural ventilation is 23° for bedrooms and 24° for other rooms. For the study, 10% apertures were left opened from 8:00pm to 8:00am for summer night time ventilation. Table 2 shows the comparison of ventilation potential (ach), between the base case vs. the proposed shading case, with various aperture sizes for the different spaces in the summer.

Table 2: Ventilation potential (ach): base case vs. proposed shading case with varying aperture sizes

Apertures	10%*	10%	30%	50%	70%
Living-Kitchen	4.5	4.0	6.4	8.3	10.0
Dining-Study	6.5	7.2	12.0	20.4	26.7
Bedroom	2.5	2.1	2.9	3.4	3.7

\*Base case with no shading

Simulations show that the bedroom and Dining-Study would be in comfort with 30% aperture openings, and the Living-Kitchen would require 50% aperture openings. Although, it is not recommended to increase the aperture of the Dining-Study space more than 30%, as a higher than 12 ach would cause discomfort [9]. But, occupants can increase the size of apertures for a quicker, full room 'purge' ventilation during peak hot days, when outdoor temperature is lower than indoors.

## 5.3 Winter optimization

The base case with the recommended summer strategies yields 87% in comfort for the Living-Kitchen, 70% for the Dining-Study, and 73% for the bedroom. With these results, step by step optimization of the winter strategies were simulated to attain a desirable combined case: 1) improving U-value of double glazed windows; 2) adding wool curtains; 3) adding 50mm night shutters; 4) adding 45mm of extra insulation to exterior walls and exposed floor. The studies show that adding

# PLEA 2018 HONG KONG

Smart and Healthy within the 2-degree Limit

more insulation, improving infiltration, and adding MVHR did not improve overall thermal comfort. The improved winter performance was negated by overheating in the summer.

## 5.4 SUMMARY OF FINDINGS

Figure 8 illustrates that to sufficiently address London winter conditions within these infill sites, the necessary performance strategies should include: improving the double glazing U-value for the Dining-Study and Bedrooms from 1.80 to 1.40 W/m<sup>2</sup>K, adding wool curtains, night shutters, and additional 45mm insulation to the external walls and exposed floor. Combining with the proposed summer strategies (30% apertures at the Dining-Study and Bedrooms for natural ventilation and 50% for the Living-Kitchen), the Living-Kitchen would be in comfort 93% of the occupied time, 88% for the Dining-Study, and 85% for the bedrooms. The remaining low heating demand can be provided by small, energy efficient radiators.

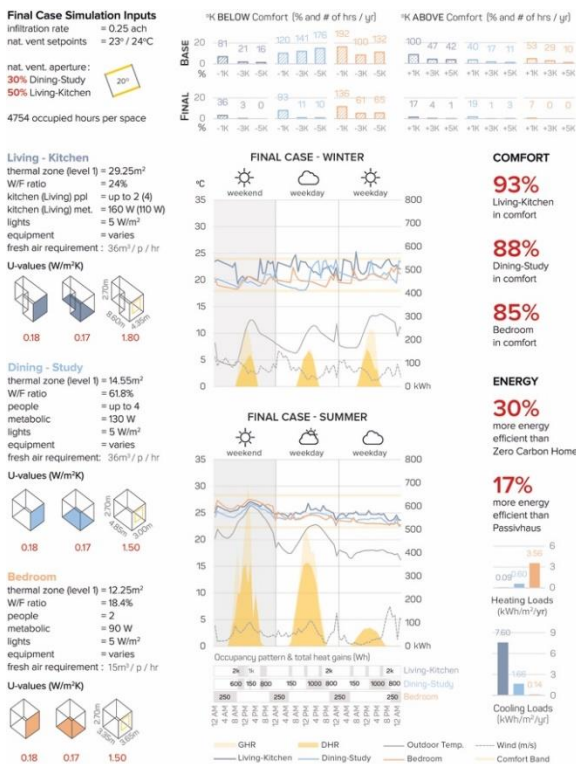

Figure 8: Final case thermal analysis results and energy loads from the infill prototype. Source [1].

Figure 9 shows all three spaces having good daylight levels, which allows occupants to work in different rooms if needed. With the proposed building envelope, strategic but flexible spatial layout, passive adaptive measures, and energy efficient appliances, each unit's electricity demand is 100 kWh/m<sup>2</sup>/year. As a result, the project offers an economically preferred scheme for

addressing both housing shortages and the 2-degree limit.

## 6. CONCLUSION

London's increasing housing demands and land scarcity require creative methods to develop well-connected, sustainable housing. Airspaces in between windowless terraced house walls and, above low-traffic connector roads, were found numerous and identified as exploitable spaces. The research proves that infill sites, compact forms, and flexible live-work environments can make positive impacts to a sustainable future. It concludes with an infill residential prototype averaging 89% in comfort when the proposed passive adaptive measures are applied. The outcome is an optimized prototype that demands 30% less energy per sqm annually compared to the UK Zero Carbon Home Standard.

As cities continue to become digitized, more urban spaces and building typologies will become underutilized or obsolete. These can become infill opportunities where this research/design framework can be applied to ensure sustainable developments.

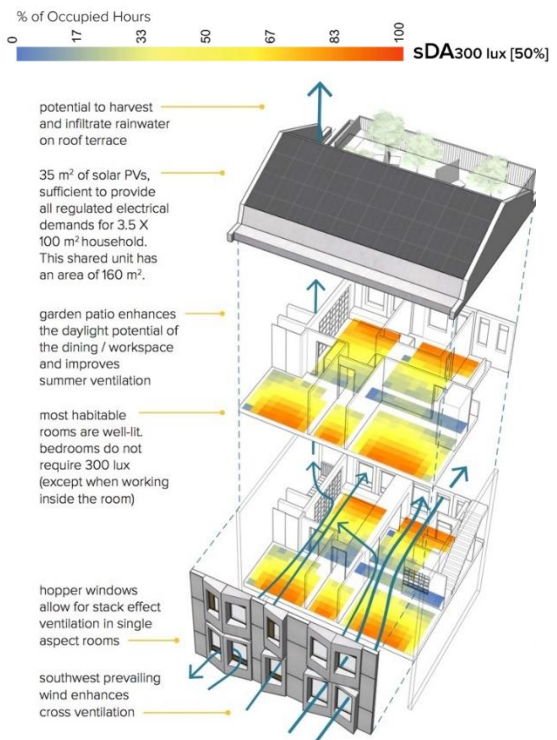

Figure 9: Exploded diagram showing façade dynamism, spatial layout, daylight and passive ventilation potential; 72% of the space has 100-2000 lux useful daylight illuminance during 1/2 of the occupied time. Source [1].

## REFERENCES

1. Wu, W.F., (2017). *Urban Synergy: Adaptive Infill Living*. MArch Dissertation Project, Architectural Association School of Architecture, Unpublished.

# PLEA 2018 HONG KONG

*Smart and Healthy within the 2-degree Limit*

2. EPW weather data from London Weather Central Station using Meteonorm 7.0
3. UK Climate Impacts Programme (UKCIP)., (2002).
4. Garham, R., (2002). Air pollution from Ground Transportation, United Nations, [Online], Available: <http://www.un.org/esa/gite/csd/gorham.pdf> [5 May 2018].
5. Hodges, T., (2010). Public Transportation's Role in Responding to Climate Change, [Online], Available: [www.transit.dot.gov](http://www.transit.dot.gov) [15 May 2018].
6. Muthesisus, S., (1985). The English Terraced House, Yale University.
7. Wu, W.F., V. Jarunyaraj, M.K. Alvarez, T. De Los Santos. (2016). *Diespecker Place*. SED Term 2 Project, Architectural Association School of Architecture, Unpublished.
8. London Housing Design Space Standards., (2016).
9. Baker, N., (2016). *Natural Ventilation*. Lecture to MSc & MArch Sustainable Environmental Design, Architectural Association School of Architecture, [10 Nov. 2015]



# Passive Design for Managing Indoor Humidity: Creating Comfortable and Healthy Living Space in Hot & Humid Region

VARUNA JARUNYAROJ<sup>1,2</sup>, PAULA CADIMA<sup>1</sup>

<sup>1</sup>Architectural Association School of Architecture, London, UK;

<sup>2</sup>ONG&ONG Group, Bangkok, Thailand

**ABSTRACT:** In the tropical environment, air conditioning has become a popular yet high-energy-consuming solution for interior cooling in urban households. With the rising trends in global warming, continued increase in air-conditioners usage has been serious environmental concerns over the past decades, calling for the need to rethink of more sustainable resolutions. While heat is alleged to be the main reason that creates discomfort, humidity also furtively plays a significant role. Sweaty and sticky feeling caused by humid environment deceive people to feel hotter than it truly is. As a matter of fact, rather than the heat itself, the discomfort triggered by humid environment could be the actual root for the high demand of air-conditioners in the tropic. This paper discussed the undesirable effects of humidity on people's sensation and health which subsequently leads to the introduction to awareness of benefits of humidity control. The paper results in suggestions of how architectural design could take parts in controlling indoor moisture level by proposing a sustainable, energy-efficient, free-running design solutions to help people stay drier and cooler indoor. The research features materiality research and design experimentation regarding key humidity management strategies.

**KEYWORDS:** *Tropic, Hot and Humid, Humidity, Passive Dehumidification, Moisture Control*

## 1. INTRODUCTION

Air-conditioners, despite their wastefulness, have become a common solution for indoor cooling, especially in tropical regions. Nevertheless, with the rising numbers of evidences that verify the global warming crisis, the upward trend of air conditioning is undoubtedly one of the most serious environmental concerns. Although the demand for air-conditioners (AC) in most parts of the world is declining, the amount of demand in some tropical area is going contrary to the trend. A study clearly shows that numbers of household which own AC in South East Asia keep growing over time. A survey in 2002 by Hill T. [1] pointed out that the majority of the survey responders in Thailand, Malaysia, and Singapore view AC as a necessity with 50% or over of the surveyed households maintaining at least one AC. While the circumstances in other countries in the same region are better comparatively, but the tendency of sales and usage of AC in this section is predicted to remain upward.

In cities located closer to the equator, despite the mild temperature, the humidity level could reach a substantially high peak. The combination of warm and humid environment creates discomfort as heat triggers the body's mechanism to perspire in order to shed body heat; however, the atmospheric air is saturated with moisture. Subsequently, this condition prevents the sweat from evaporating; leaving people to feel hot and sweaty. Indeed, the combination of heat and humidity could be misleading as it tricks people to feel certain degrees hotter than it actually is. The article by Australian Bureau of Meteorology confirms that people may start experiencing discomfort of the clammy weather when

the dew point temperature is as low as 24°C. These effects caused by humidity may be the reason why people feel the need to find active solutions and easily turn to the convenience of AC to help them stay cooler and drier indoor as the passive mean such as natural ventilation is unpredictable and might not always be reliable.

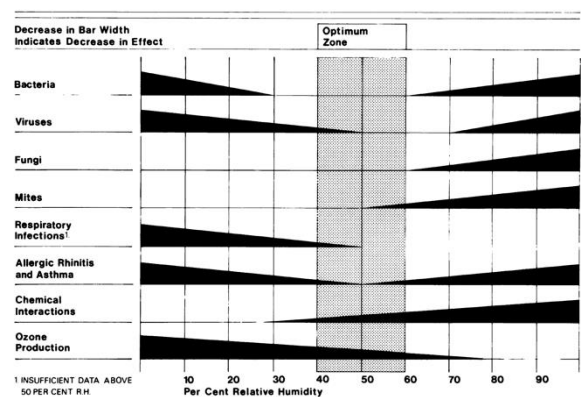

Figure 1: Healthy indoor relative humidity range  
Source: Arundel et al., 1986 [2]

Besides, relative humidity does not only affect the body's comfort, but it also does harmful effects on people's health. A Research [2] suggested that the optimum healthy relative humidity range should be around 40 - 60% (fig.1) while outdoor relative humidity in some tropical cities always stays around 80% with occasional 90-100% peak. Although AC may help getting rid of indoor moisture which is a cause of negative health

# PLEA 2018 HONG KONG

*Smart and Healthy within the 2-degree Limit*

issues but they are also a known probable cause of adverse health problems [3].

The overuse of AC in the tropic did not go unobserved. A study regarding thermal comfort [4] reported that people in the tropical region are able to adapt and develop the tolerant to warm and humid weather conditions which make their thermal comfort range broader than those from different climates. Andamon M. [5] suggested that the adoption of AC system creates a contradiction between the sensational thermal comfort and preference to have the cooler setting when a choice of AC is available. Even though AC could make building more habitable, it also brings numbers of negative impacts which includes the urban heat island issue currently occurring worldwide. The undesirable consequences per chance are too high of the price to pay for temporally improvement of indoor condition.

Therefore, to create sustainable yet comfortable and healthy living space in the tropics, the factor of relative humidity shall not be overlooked; passive humidity control strategies could be the key for more sustainable and healthier substitute to AC.

## 2. METHODOLOGY

As previously stated, humidity plays a major role affecting people's comfort in the hot and humid zone. This research studied passive design solutions based on theoretical studies and supporting empirical experiments. The study proposed the design of two passive humidity control equipment founded on the result of experimentation. The paper also extensively explored alternative humidity control techniques involving the conception of material properties which will lead to the selection of appropriate materials to deliver positive effects on indoor humidity condition and the durability of building elements. The study of the humidity management strategies was divided into two parts:

- **Equipment Design**  
This section uses the knowledge base from experiment regarding the understanding of the effectiveness of the humidity control solutions which utilised local organic and affordable materials. The study led to the design applicability of two moisture control equipment.
- **Materiality**  
This section comprises majorly literature reviews which focused on the comprehension of properties and capabilities to interact with liquid substance of several building materials. The study also call attention to the methods to employ these materials to help regulating indoor moisture content.

## 2.1 Experiment

The objective of the experiment is primarily to explore the effectiveness of selective materials which potentially could be implemented into the design.

The experiments were conducted using an insulated control chamber (Fig.2,3) with heat and humidity sources to raise the temperature and humidity level to a tropical range. After that, two identical boxes with the same opening size were placed inside, one was a controlled subject box which was empty, and another box was used for test subjects. Three data loggers were appointed to keep records of temperature and relative humidity in the control chamber, the controlled subject box, and the test subject box for comparison.

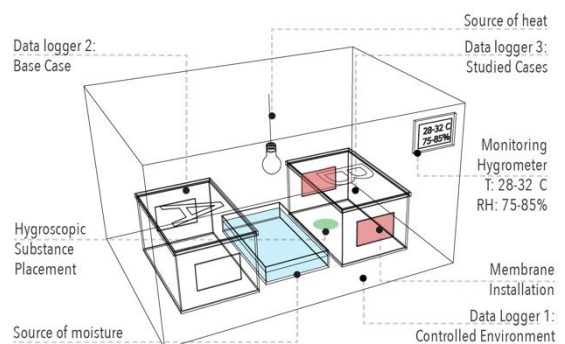

Figure 2: Experimentation set-up diagram [6]



Figure 3: Images of experimentation set-up [6]

## 3. EQUIPMENT DESIGN

Rationally, in order to control indoor humidity, two main strategies should be applied. Firstly, the method which could get rid of the excess moisture built up by internal factors such as people and their activities. Secondly, to prevent moisture from external sources. The before-mentioned humidity controlling devices which are called "Moisture Membrane" and "Passive Salt Dehumidifier"; both were created based on the straightforward strategies. The effectiveness of the two devices was primarily tested through the experimentation which the result would be discussed further.

# PLEA 2018 HONG KONG

Smart and Healthy within the 2-degree Limit

### 3.1 Moisture Membrane

The Fog Catcher Project [6] originated in the region where water resources are scarce and rain rarely falls, while, on the other hand, mist occurs constantly. Mesh structures are installed where the mist occurs to trap the airborne moisture. The water yielded from the device, is initially not potable without treatment; however, it could still be stored for other purposes. The fog catcher project verified that mesh surfaces can extract small particles of water from the environment.



Figure 4: Fog Catcher [7]

When the outdoor humidity level is high, utilizing natural ventilation can become a problematic strategy for the reason that as the outdoor humidity level is higher, the moisture content is, without restrictions, let in along with the fresh air. By means of the idea of the fog catcher, applying mesh surfaces on windows or ventilators openings can thus prevent the incoming moisture content while still allowing acceptable ventilation rate.

Table 1: Mesh Screen Experimentation Result [6]

Subject	Material	Mesh Size (mm)	Wind flow (2.5m/s @source)	RH Difference (%)
Bamboo Screen	Bamboo Skin	2	1.2 m/s	-9%
Cotton Mesh A	Cotton	1	0.8 m/s	-4%
Cotton Mesh B	Cotton	1.5	1.5 m/s	-6%

Several test subjects which are organic and can be found inexpensively and locally in the tropics were tested, namely, cotton meshes and handed-woven bamboo mesh. The result in Table 1 shows that the bamboo mesh works the best by decreasing the humidity by 9% while slowing down the wind speed only by half.

Figure 5 exhibits the application of mesh surface on openings. The mesh can be applied both as fixed elements on the ventilator usually being opened continuously to slowly ventilate and cool down spaces

while the adaptive type membrane screen can be applied to the operable windows.



Figure 5: The Design of the Moisture Membrane [6]

### 3.2 Passive Salt Dehumidifier

Hygroscopic substances can absorb water from the surrounding atmosphere. This ability sometimes extends to drawing water out of sources through the surrounding air without a direct contact. People use hygroscopic materials widely for different purposes. For example, salt is normally used to preserve food, and charcoal is used to keep inside of shoes dry.

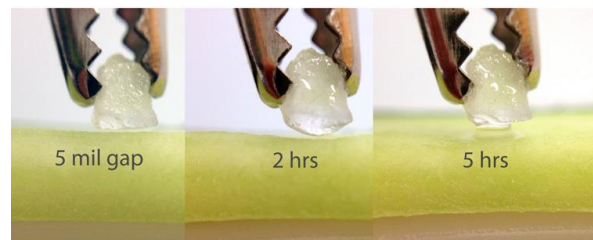

Figure 6: Hygroscopicity demonstration with a grain of salt [8]

Table 2: Hygroscopic Substance Experimentation Result [6]

Subject	Material	RH Difference (%)	Soluble	Recycle-able
Fine Salt	Salt	3 - 5%	Yes	Yes
Coarse Salt	Salt	3 - 5%	Yes	Yes
Fine Crushed Charcoal	Charcoal	0.5 - 0.7%	No	No
Crushed Charcoal	Charcoal	0.4 - 0.5%	No	No
Uncooked Rice	Rice grain	0 - 0.1%	No	No

The researcher tested several known local affordable hygroscopic materials such as rice and crushed charcoal along with salt. However, salt was selected for its outstanding performance and the reasons that it is easy to maintain as well as reusable. The proposed device (fig.7) can be implemented into a stand-alone device or embedded into building elements.

# PLEA 2018 HONG KONG

Smart and Healthy within the 2-degree Limit

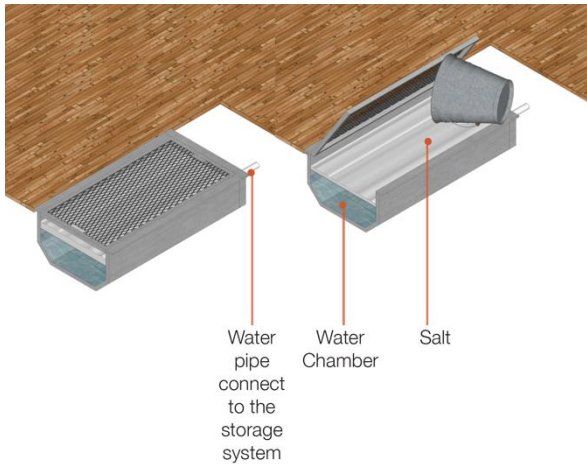

Figure 7: The Design of the Passive Salt Dehumidifier [6]

The “Passive Salt Dehumidifier” mechanism consists of a salt chamber and a water chamber divided by a fine mesh surface in the middle. The lid is an aluminium grate which people can step and walk over. When the salt absorbs the water, it will get saturated and become smaller until it falls through the divider and dissolves into the water. The water chamber should connect to a sewage pipe which convey to a separated water storage. The cumulated salt water can be used for various purposes; for example, watering plants, by diluting it at 1:15 ratio with clean water or flushing. They can also be sent to re-dehydrate at the salt manufacture facilities to be reused.

## 4. MATERIALITY

Building materials play part in the fluctuation of indoor humidity as well. Building envelopes absorb and release moisture from the air all the time. By doing so, the endurance of material with poor moisture transfer property could be reduced as well as causing another problem like mould, which could harmfully affect people health. Material choices can also affect the dampness of the indoor atmosphere as different materials absorb and release vapour at different rates. This section explores the possibility of integrating building material properties as a mean of managing humidity indoor.

### 4.1 Breathable Material

Material breathability defines how and how well moisture content moves through the substances' bodies. Gaining good comprehension of breathability property could be a crucial key to maximize material durability and maintaining a comfortable indoor condition. Breathability is defined by;

- Hygroscopicity: the ability to absorb and release moisture content.
- Vapour Permeability: the ability to let the vapour move through.
- Capillarity: the ability to transfer and release water in liquid form.

Different building elements need different breathability characteristic. Structures, floors, and ceilings require less permeability and capillarity as possible while hygroscopicity is desirable. To be precise, if these building elements get in contact with the water in any form, the transfer of moisture content would be slow or halted; however, in the case that parts have absorbed water, it should better if they could release the water quickly. Next, it is preferable for typical internal walls to have high hygroscopicity while moderate to low capillarity and permeability are acceptable as their chances of exposure to water are considerably low. To be more specific, the interior wall should be able to dry quickly while the ability to absorb and let water through should be kept to the minimum.

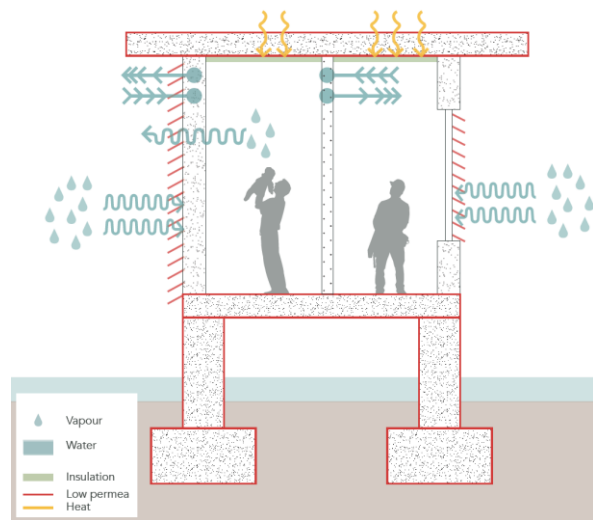

Figure 8: Breathable Material Diagram [6]

Finally, the breathability requirement for external walls is ideally unique. Initially, they should have high hygroscopicity which means they would be able to dry quickly but also have low capillarity so that when it rains, they will not absorb water. High permeability is highly required so the walls can let the vapour through. This property can be an advantage when there are differences between humidity levels on both sides of the walls. However, the ideal aspect of the exterior walls' property is that it should only operate one-way. When the humidity level inside is higher, the walls should transfer moisture content from inside to outside, on the other hand, the property ought to shift and stop the transfer when the condition is reversed.

Although the effect of moisture transfer on indoor humidity level could be minor in most cases but using suitable types of porous material and cladding or render may help boosting the process to the evident outcome.

### 4.2 Humidity Buffering

In addition to breathability, the material property mentioned in the previous section can perform another

# PLEA 2018 HONG KONG

*Smart and Healthy within the 2-degree Limit*

function to help stabilize indoor humidity. The stabilization of the interior climate by moisture-active building materials and furnishing is called Humidity buffering. Humidity Buffering happens when porous, absorbent materials release water vapour into the air when the relative humidity declines and re-absorbed from the air when the relative humidity rises.

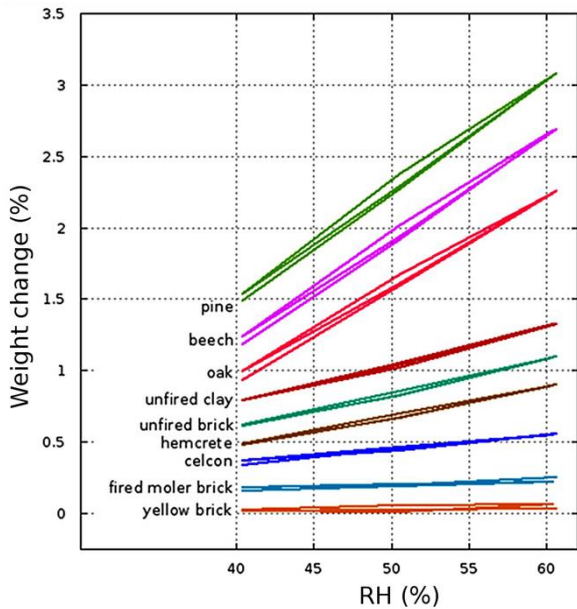

Figure 9: Humidity buffering for different materials [10]

Numbers of materials were tested in a research done by Padfield T. [11]. The moisture buffer capacity of wood cut across grain perform the best; however, the limitation of the use of porous organic materials as building materials might lead to other issues as they could quickly degrade. Unfired clay and unfired clay brick are the next best options to use as a wall material which could perform adequately to moderate the progression of the relative humidity in a living space which is influenced by moisture from the outside and by vapor released from normal household activities.

### 4.3 Meteorological Responsive Material

Meteorological responsive Materials change shapes or properties regarding the condition of its environment. The idea of utilizing these materials has been widely explored leading to the result of more auto-adaptive control opportunities to maintain comfortable indoor condition. Some of these designs involve man-made systems which involve sensors and control module to command the mechanisms to adapt to the change of their environment. However, this paper discussed another distinctive material which owns an organic mechanism to change shape without the help of any control system.

Hygro-skin allows the possibility to create the ideal property for external walls as mentioned in section 4.1 or

even assisting the “Moisture Membrane” mechanism introduced in section 3.1.

Hygro-skin (fig.10) is a climate responsive material researched by a team from The ICD from the University of Stuttgart in 2013 [12]. The way hygro-skin works is simply by using the unique property of a thin layer of wood which has a natural mechanism to react and absorb or release moisture. These reactions cause the material to quickly changes its shaped in response to the humidity level. This property in a natural setting is not rare; for example, it could be seen in pine cones which could change their outer skin shape according to the dampness in the air as shown in Figure 10.



Figure 10: How Hygro-Skin Work [12]

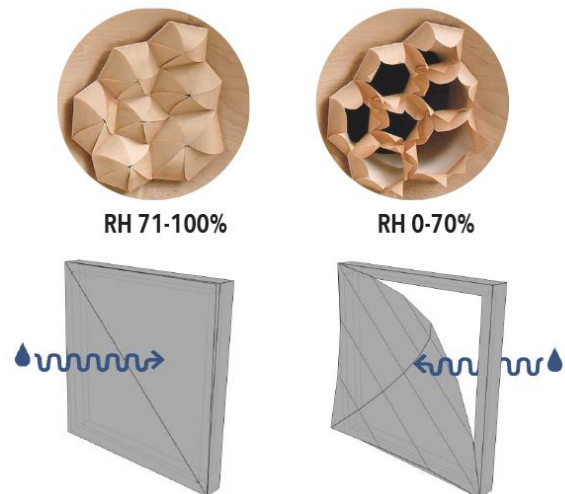

Figure 11: Hygro-Skin [12,6]

The application of hygro-skin on the external walls or on openings as seen in Figure 11 would create an automatic adaptability to slow down or stop moisture buffering or transferring when there are differences between humidity on the inside and the outside.

### 5. CONCLUSION

High level of humidity can clearly cause direct and indirect unwelcome effects on people’s health and wellbeing. It also compromises building material

# PLEA 2018 HONG KONG

*Smart and Healthy within the 2-degree Limit*

endurance, reducing the building's useful life and creating unnecessary waste to restore in undue time. As a common mean to reduce interior humidity in residential buildings, modern architecture relies heavily on air-conditioning to provide interior cooling.

This research aimed to deliver alternate sustainable solutions to support healthy and comfortable indoor living space. The solution could reduce the dependency on energy consumption and minimizes the environmental footprints. The design leverages the strategies to control humidity level to provide a semi-cooling effect. It features the guideline for applications of several moisture management techniques. The proposed humidity control consists of three main strategies that can be further explained as follows:

- **Moisture Membrane:** The bamboo-weaved screen applied to the opening to trap moisture content and prevent moisture from coming in.
- **Passive Salt Dehumidifier:** The passive dehumidifier which uses the hygroscopic property of salt to draw moisture out of the damp indoor atmosphere.
- **Materiality:** The combination of suitable breathable materials will create positive effects on the indoor humidity level.

The stated humidity control strategies were validated using research methodologies which included both literature reviews and empirical experiments.

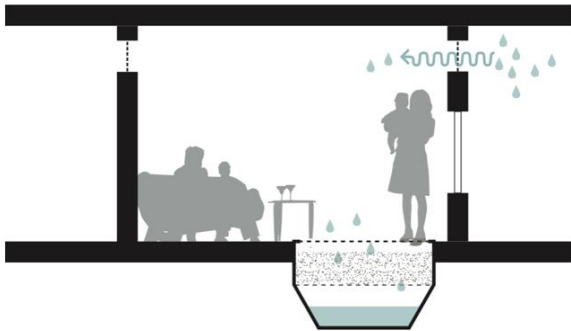

Figure 12: Diagram of moisture control devices [6]

Additionally, using combinations of low-energy consumption methods; for instance, natural ventilation, exhaust fan, and electric fan to circulate indoor air movement can also help to dry off perspiration; making people feel cooler which could further enhance the effectiveness of the strategies suggested in this paper.

In closing, this study on humidity control on this paper, although proposed only preliminary aspects of humidity control through architectural design, should be open doors to the possibilities of more researches on passive dehumidification and moisture control solutions as they have proven to be significant drivers in achieving indoor comfort in the tropical environment. To the

greater extent, it is also my hope to educate and influence general public and specialized agents such as our fellow architects to recognize the importance of architectural design and choices of design standards that directly and indirectly affect the environment and the world we live in.

## REFERENCES

1. Hill, T. (2018). *Freezing in the tropics: Asean's air-con conundrum*. [ebook] Singapore: Eco-Business PTE Ltd. Available at: [http://www.eco-business.com/media/uploads/freezing\\_in\\_the\\_tropics.pdf](http://www.eco-business.com/media/uploads/freezing_in_the_tropics.pdf) [Accessed 24 May 2018].
2. Arundel, A.V., Sterling, E.M., Biggin, J.H. and Sterling, T.D. (1986) 'Indirect health effects of relative humidity in indoor environments', *Environmental Health Perspectives*, 65, p. 351. doi: 10.2307/3430203.
3. Rossi, G.L., Corsico, A., Roggeri, A., & Moscato, G. (1991) 'Human health and air conditioning systems'. *Giornale Italiano di Medicina del Lavoro*, 13(1-6): p. 51-54.
4. Busch, J. (1992). A tale of two populations: thermal comfort in air-conditioned and naturally ventilated offices in Thailand. *Energy and Buildings*, 18(3-4), pp.235-249.
5. Andamon, M. (2004). 'Thermal comfort in Philippine office buildings: the Coolth\* preference'. In: *Contexts of architecture*. Launceston: The 38th International Conference of Architectural Science Association.
6. Jarunyaroj, V. (2017) *Rethinking HDB Flat: Applicable Design of Public Housing in Singapore*. March Dissertation. Architectural Association School of Architecture.
7. Lavars, N. (2015) *How Chile's fog catchers are bringing water to the driest desert on earth*. Available at: <http://www.cda.uc.cl/how-chiles-fogcatchers-are-bringing-water-to-the-driest-desert-on-earth/> (Accessed: 26 January 2017).
8. Blonder, G. (2011) *Follow the Salt: Salt diffusion*. Available at: <http://www.genuineideas.com/ArticlesIndex/diffusion.html> (Accessed: 26 January 2017).
10. Padfield, T. (1999). *Humidity Buffering of Interior Spaces by Porous, Absorbent Insulation: Part of Hygrothermal Properties of Alternative Insulation Materials*. The Technical University of Denmark.
11. Padfield, T. and Jensen, L.S. (2010) 'Humidity buffering by absorbent materials'. Available at: [www.conservationphysics.org/wallbuff/buffer\\_performance.pdf](http://www.conservationphysics.org/wallbuff/buffer_performance.pdf) (Accessed: 23 January 2017)
12. Menges, A., Krieg, O.D.K. and Reichert, S. (2013) *HygroSkin: Meteorosensitive Pavilion*. Available at: <http://www.achimmenges.net/?p=5612> (Accessed: 26 January 2017).

# Partial Shading Effects of Surrounding Obstacle Parameters on Building Integrated Photovoltaic (BIPV) System Efficiency in Thailand

NUTTASIT SOMBOONWIT<sup>1</sup>, AMON BOONTORE<sup>2</sup>

<sup>1</sup>Design and Construction Division, Department of Health Service Support, Ministry of Public Health, Thailand

<sup>2</sup>Faculty of Architecture, King Mongkut's Institute of Technology Ladkrabang (KMITL), Bangkok, Thailand

*ABSTRACT: This study aims to explore the comparative effects between Obstacle's Distance and Obstacle's Orientation parameters that cause partial shading effect (PSE) and influence the potential solar power generation of a building integrated photovoltaic (BIPV) system. An automatic collaboration between Building Information Modelling (BIM) software and a cloud-based building performance analysis tool were used to simulate the annual cumulative insolation obtained from rooftop BIPV surfaces of sixteen different Obstacle's Orientations and forty-three different distances between the BIPV and building obstacles—Obstacle's Distance. The case study are two axis-aligned public healthcare buildings; an outpatient department (OPD) building and a ward building that are widely established throughout Thailand. This study also explores the notion that Obstacle's Orientation and Obstacle's Distance of a surrounding obstacle are both important parameters that influence the annual cumulative insolation of PV surfaces but in the different contexts. The findings of this study also support decision making for BIPV designers and planners to select which the BIPV and the obstacle placement is highly effective, especially BIPV application on lower-rise buildings in dense urban environments, such as healthcare facilities.*

*KEYWORDS: Surrounding Obstacle, Partial Shading Effect, Building Integrated Photovoltaic, Obstacle's Orientation, Obstacle's Distance*

## 1. INTRODUCTION OF THE PROBLEM: PARTIAL SHADING EFFECTS (PSE)

The potential for solar energy to make a significant contribution to global electricity demand has been widely recognized and solar photovoltaic (PV) is considered as a major contributor to solar energy supply [1-2]. A Building integrated photovoltaic (BIPV) system directly converts sunlight into electricity so it is sensitively affected with the change in the intensity of solar radiation. These fluctuations cause discrepancies between demand and supply and reduce the power quality [1].

Environmental and surrounding factors, namely surrounding-reflected radiation and shading effects of the environmental obstacles significantly affect PV system performance [3-4]. Practically, BIPV performance estimation is significantly affected by partial shading effect (PSE) on PV modules due to the surrounding obstacles including surrounding buildings, trees, the BIPV itself and so on. Partial shading plays an important role in the efficiency of PV systems by their complex, non-uniform and dynamic conditions, especially when the PV system is located in a dense urban environment. Partially shaded PV modules receive less solar radiation than the unshaded PV modules and partial-shading effects may cause irreversible damage to the module due to the hot spot effect [5-8].

### 1.1 Components of Partial Shading Effects

There are three main conceptual parameters of the shadow that project on a PV surface which are including solar properties, surroundings, and related-BIPV [3,5-6]. The parameter of solar properties includes the sun altitude, azimuth angle, and solar irradiation [9]. The parameter of surroundings consists of two subcategories; the parameter of surrounding-reflected radiation and surrounding obstacle. The parameter of surrounding-reflected radiation includes reflectance, absorptance, emittance and transmittance, while the parameter of a surrounding obstacle comprises of obstacle's location, obstacle's shape, and obstacle's orientation. The surrounding obstacles block and eliminate the beam element of the solar radiation from fully hitting on a PV surface.

The parameter of related-BIPV consists of two subcategories: the parameter of a PV surface geometry includes PV surface orientation, PV surface tilt angle, PV surface shape, and PV surface location. The parameter of PV module properties comprises of PV materials, BIPV product type, and BIPV system type [10].

The projection of shadow on PV modules directly determines the shaded PV surfaces. The shift of projected shadow significantly changes the level of received solar irradiation of the associated PV surfaces [11]. The impacts of PSE on the potential of power generation of a PV system can be calculated using the parameters of solar properties, surrounding and PV

# PLEA 2018 HONG KONG

Smart and Healthy within the 2-degree Limit

modules. The result is the effective irradiance over a time period called the solar insolation over PV surfaces.

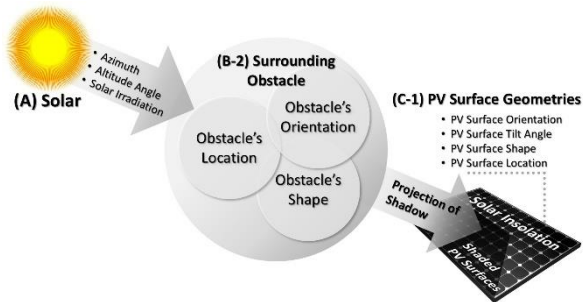

Figure 1: Parameters related to partial shading effects.

## 1.2 Scope and Objective of the Study

It can be seen from Figure 1 that such effect is principally influenced by two groups of parameters: surrounding obstacle and PV surface geometries. Numerous studies have examined the parameter of PV surface geometries while the investigations of the parameter of surrounding obstacles are still meager [12]. When considering surrounding obstacles, they are normally also not available for major alteration of their shape due to their variety of functions and aesthetic reason, not to mention the case that such building is not under the BIPV owner's authority.

The projected shadow on BIPV obtained as shaded PV surfaces is determined in terms of the solar azimuth, altitude angles and surrounding obstacle's location and orientation that dynamically change all the time during day. Obstacle's location is assumed to be composed of point particles (three-dimensional coordinates) interacting with a BIPV, i.e., through the proxy of distance between two buildings—Obstacle's Distance. Besides, Obstacle's Orientation refers to both the direction that BIPV faces towards and the location of building obstacle in relationship with the BIPV in terms of compass direction.

Therefore, this leads to the research question: of how the distance between building obstacle and BIPV, the orientation of BIPV and the orientation between building obstacle and BIPV affect the potential to generate power of a BIPV. The conceptual framework of the study can be established and illustrated in Figure 2. This study aims to explore the comparative effects between Obstacle's Distance and Obstacle's Orientation parameters that cause PSE and influence the potential solar power generation of a building integrated photovoltaic (BIPV) system.

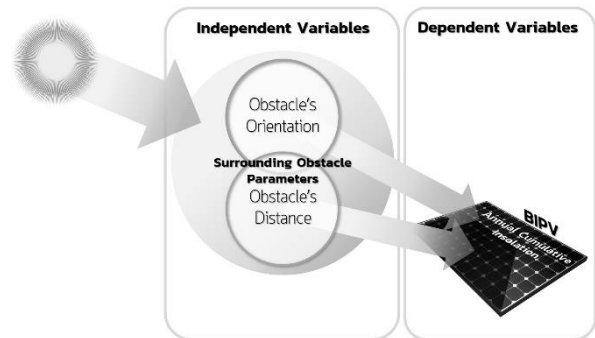

Figure 2: Conceptual framework of the study.

## 1.3 BIM and Automated Simulation of PSE

An intelligent approach to better deal with deficiencies in manual Building Performance Simulation (BPS), from the time-consuming, cumbersome and error-prone of manual data generation and use of improvised defined data that may invalidate the results, is the automation of BPS input data acquisition and transformation, it has been a goal of the buildings industry for decades [13–15]. Reuse of existing data by interoperable processes would significantly reduce the time and overhead associated with the creation of simulation models [14,16]. An interoperable, intelligent and object-oriented simulation model would enable bi-directional data exchange with a Building Information Modelling (BIM) authoring applications, reuse of geometric and other data from different models significantly reduces the overhead associated with the definition of input data and has the potential to eliminate error-prone manual processes [11,16].

With the growing adoption of Building Information Modeling (BIM) in the Architecture, Engineering, Construction, and Operations (AECO) industries. A BIM is an extensible approach to virtual design and construction involving the generation and management of digital representations of physical and functional characteristics of a facility which creates and uses the coordinated, consistent, and computable information of the 3D models of the project components interconnect with the holistic information that conceived as a source of shared knowledge to support decision-making, through the life cycle of the building [17–22]. The integration of a BIM and a BPS tools is fundamentally transforming building design into a faster, performance-aware and more flexible process, which eases the production of multiple design alternatives that provide model foundations for BIPV design optimization [11,23]. Furthermore, many buildings have already been modelled with BIM authoring tools, in which the features of most building components, e.g. shape, size, materials, locations as well as building's environment, have been accurately described [11].



# PLEA 2018 HONG KONG

*Smart and Healthy within the 2-degree Limit*

## 2. METHODOLOGY

The research approach is through an automatic collaboration of a BIM authoring software—Autodesk Revit, and Autodesk Insight 360—a cloud-based building performance analysis tool embedded within a BIM authoring software which is able to relieve energy modelers from necessity in setting up hardware and software infrastructures. It aims to explore the most critical parameters of PSE on PV surfaces caused by surrounding obstacles, namely the Obstacle's Orientation and the Obstacle's Distance that affect the annual cumulative insolation on photovoltaic modules that are attached to roof surfaces.

### 2.1 Case Study

In Thailand, most of the government healthcare facilities have been developed and administered using Generalizable Building Designs (GBDs), i.e. cookie-cutter healthcare building designs, from the concept of “one size fits all” for universal application on healthcare facilities design which list down the types, functions, sizes and work load capacities. The GBDs also minimize time and resources consumed during new building design processes and to be flexible to accommodate the healthcare construction projects in Thailand, especially in the rural and remote areas [12,24]. The case study comprises of two selected GBDs which are (1) an outpatient department (OPD) building was chosen as a case study to be the BIPV, where PV modules have been installed on the OPD's sloped roofs, and (2) a ward building was chosen as a case study to be the obstacle. These two GBDs are widely established in the community hospitals that provide secondary level of Thailand's healthcare services that serve more than 20 million of the population [24].

The physical settings of the case study are those of typical cost-control public health facilities: the structural construction is in situ reinforced concrete, the exterior opaque walls are of plastered brick walls, the glazing for windows is 6-millimeter clear float glass, and the roofs are made of fiber-cement roof tiles. The first building of the case study, an OPD building (Figure 3), this two-story building has an irregular-shaped footprint with gross floor area of 1,125 m<sup>2</sup> which contains functional areas to be fully operational outpatient department. The sloped roofs of the OPD building are three rectangle-based hipped roofs with 20° roof pitches. Total area of the sloped roof surfaces is 712 m<sup>2</sup>, the surfaces of these roofing systems have been used to mount PV modules. The total cumulative solar insolation on the surfaces of the solar PV modules has been examined for estimating solar potential and output energy of the PV systems. The height from the ground level to the highest point of the roof is approximately 10 meters.



Figure 3: A photograph of the OPD building.

The second building is a ward building which is a five-story rectangle shaped building with 21.00 meters wide, 46.50 meters long and 24.00 meters high. This ward building has been usually placed near the OPD building. The minimum distance equals to 6 meters, it is the minimum distance of separation between buildings in public healthcare facilities, from the outmost edge of a building to the outmost edge of another building with vertical clearance that is required along the buildings for fire safety and circulation routes. The maximum distance between an OPD building and a ward building is not greater than 48 meters. The axis of the OPD building has been aligned with the axis of the ward building, center to center of the two buildings. These aligned axes which are the representation of the interaction between geometries of the two buildings is kept stationary to maintain the consistency of the simulations.

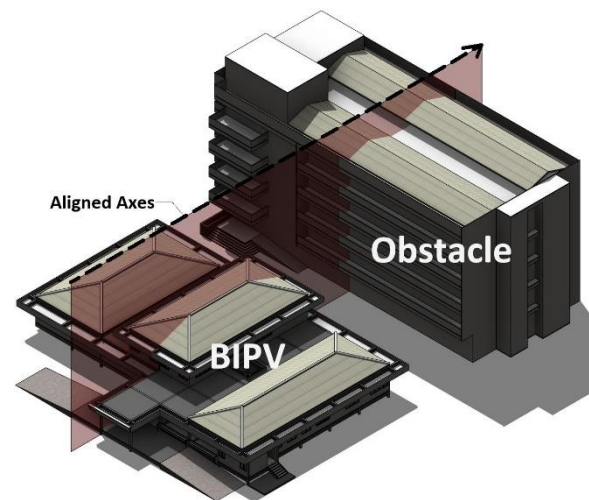

Figure 4: An illustration of the aligned axes of the BIPV and the obstacle.

To complete the case study, setting the orientation of the axis-aligned buildings to face south: true north-based azimuth (AZ) of 180°. The nearest distance between the two models has been set to 6 meters—the 6-meter Obstacle's Distance (Figure 4). Then, setting a BIM project to create a digital environment for solar insolation simulation.

# PLEA 2018 HONG KONG

*Smart and Healthy within the 2-degree Limit*

## 2.2 Steps of Automated BPS

BIM models of the case study have been developed using Autodesk Revit. The BIM model of the OPD building, has been developed at LOD 300. Otherwise, the development of the ward building's BIM model is at LOD 200. LOD (Level of Development) is concept to describe information richness of BIM objects, ranges from LOD 100 (basic/conceptual) to 500 (highly detailed/precise). LOD 300 is the Model Elements is graphically represented within the model as a specific system, and non-graphic information may also be attached to the Model Element [25–27]. The OPD has been chosen to be a BIPV, thus a development of its BIM model requires details and functionalities with a certain accuracy, information richness and actuality of the underlying data to support further design and modeling processes of PV systems (Figure 5).



Figure 5: The LOD-300 BIM model of the OPD building.

Otherwise, the development of the ward building's BIM model is at LOD 200, it has been utilized to be a building-surrounded obstacle, thus, its important BIM parameters are the obstacle's location and geometry that have been derived into three-dimensional coordinates that used to determine the projection of shadow on PV modules by the dynamic change of solar azimuth and altitude angles. That is very important to limit the LOD of the model to the minimum, due to more-detailed modeling needs more time and effort that ranging from doubling the effort to eleven folding them, and more computational power of the building performance simulation to acquire the results is also needed [28].

The location to simulate the annual cumulative insolation is Bangkok, Thailand. Its global coordinates are 13°N 100°30'E. The next step is to simulate the annual cumulative insolation on the PV surfaces of the BIM model of the OPD building using Autodesk Insight 360. To discover the influence of Obstacle's Distance, the baseline models which both buildings facing south (AZ = 180°) is 0° CW (Clockwise) rotation angle—the 0° Obstacle's Orientation, the simulations of annual cumulative insolation simulation at 1-meter intervals of the distance from 6 meters to 48 meters between the axis-aligned buildings have been performed. There are 43 simulations completed for 0° CW models.

To explore the comparative influence of Obstacle's Distance parameter and Obstacle's Orientation parameter, annual cumulative insolation simulations of

0° CW have been performed against fifteen other orientations which are: seven other major orientations clockwise (CW), i.e. 45° (AZ = 225°), 90° (AZ = 270°), 135° (AZ = 315°), 180° (AZ = 0°), 225° (AZ = 45°), 270° (AZ = 90°), and 315° (AZ = 135°) to explore the PSE impacts (Figure 6), and eight minor orientations clockwise, i.e. 22.5° (AZ = 202.5°), 67.5° (AZ = 247.5°), 112.5° (AZ = 292.5°), 157.5° (AZ = 337.5°), 202.5° (AZ = 22.5°), 247.5° (AZ = 67.5°), 292.5° (AZ = 112.5°), and 327.5° (AZ = 157.5°) to examine the transformation of the PSE impacts over those major orientations. There are total 688 annual cumulative insolation simulations have been performed in this study.

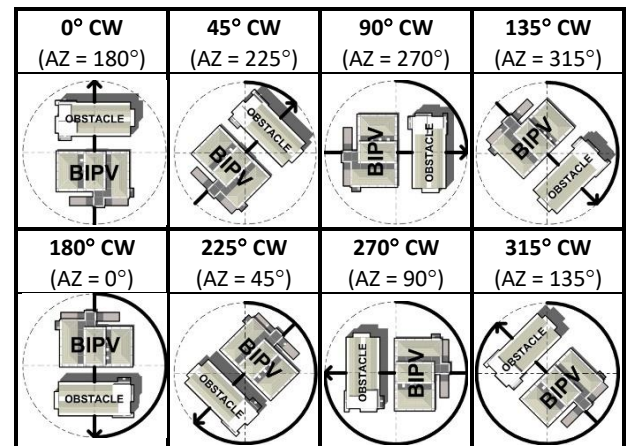

Figure 6: Eight major Obstacle's Orientations of the case study—the axis-aligned buildings.

## 3. RESULTS AND ANALYSIS

Once a simulation has been performed, the results are displayed automatically within the BIM authoring platform. Individually, each simulation provides a result of solar analysis—total cumulative insolation (kWh), as shown in Figure 7.

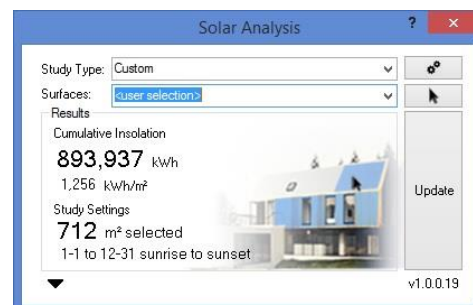

Figure 7: Solar Analysis results of the 0°CW at 6-meter Obstacle's Distance.

The analysis tool also provides graphical results within the BIM models as shown in Figure 8. The annual cumulative insolation on the PV surfaces of the eight major Obstacle's Orientations is presented in Figure 9.

# PLEA 2018 HONG KONG

Smart and Healthy within the 2-degree Limit

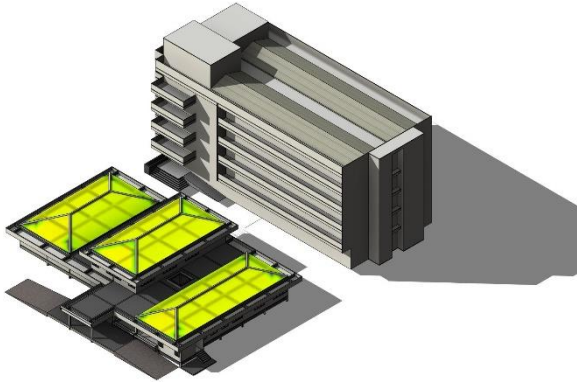

Figure 8: The graphical results of a solar analysis.

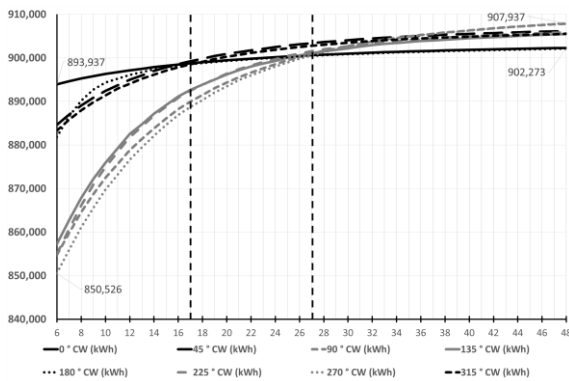

Figure 9: Annual cumulative insolation of the eight major Obstacle's Orientations and 43 Obstacle's Distance.

The annual cumulative insolation on the PV surfaces of all simulations is presented in Figure 10. The simulation results of every Obstacle's Orientations shared one thing in common; their curves are logarithmic shaped with periods of rapid increase at first, followed by periods where the gains increase slowly then reach the plateaus at their farthest distances.

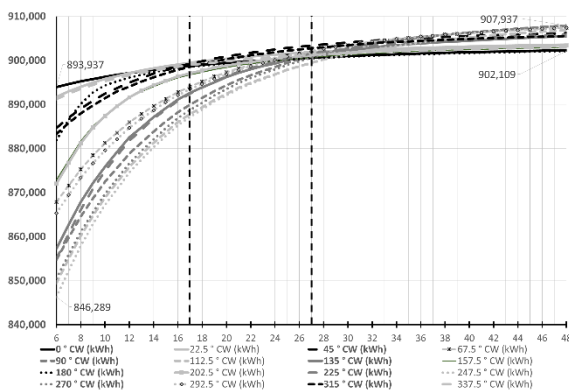

Figure 10: Annual cumulative insolation of all 688 Simulations; 16 Obstacle's Orientation, and 43 Obstacle's Distance.

Using general equation of a straight line (1),  $m$ , to analyze the partial slopes of each 1-meter intervals and the overall slopes of all sixteen curves between 6-meter and 48-meter Obstacle's Distance.

$$m = \Delta y / \Delta x \quad (1)$$

where  $m$  – slope of a curve

$\Delta y$  – the difference of amount of the annual cumulative insolation between 6-meter and 48-meter Obstacle's Distance

$\Delta x$  – the difference of distance between 6-meter and 48-meter Obstacle's Distance

There is a distinctive difference to separate the eight curves of the eight major Obstacle's Orientations into three groups: the first group (Group A<sub>1</sub>) is only 0°CW Obstacle's Orientations, the curve is almost linear that starts at the highest annual cumulative insolation and increases at very slow rate while the distance is increasing, its overall slope ( $m$ ) is 198.48; the second group (Group A<sub>2</sub>) consists of curves that start at slightly lower annual cumulative insolation than Group A<sub>1</sub> but increase at a faster rate while the distance is increasing than Group A<sub>1</sub>, the curves of Obstacle's Orientations in the Group A<sub>2</sub> are 45°CW ( $m = 512.48$ ), 180°CW ( $m = 482.05$ ) and 315°CW ( $m = 530.60$ ) (Figure 11); and the third group (Group B) that start at lower annual cumulative insolation than both Group A<sub>1</sub> and Group A<sub>2</sub> but increase at much faster rate, which consists of 90°CW ( $m = 1,265.07$ ), 135°CW ( $m = 1,148.60$ ), 225°CW ( $m = 1,211.79$ ) and 270°CW ( $m = 1,366.93$ ) Obstacle's Orientations (Figure 12).

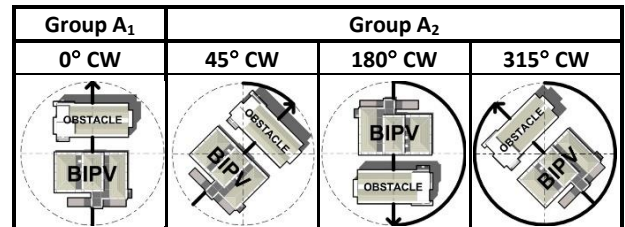

Figure 11: The first group (Group A<sub>1</sub>) and the second group (Group A<sub>2</sub>).

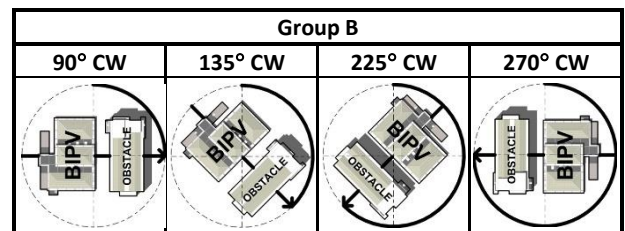

Figure 12: The third group (Group B).

At the 6-meter Obstacle's Distance, the compared potential solar power between 0°CW (Group A<sub>1</sub>) and 270°CW (Group B) is dramatically different, it is 43,411 kWh or 5.1040% with 0°CW performing better than 270°CW. Contrarily, at 48-meter Obstacle's Distance, 0°CW obtains less annual cumulative insolation than 270°CW does by 0.6277%.

# PLEA 2018 HONG KONG

*Smart and Healthy within the 2-degree Limit*

Additionally, at 48-meter Obstacle's Distance, 0°CW gains more annual cumulative insolation than it does at the 6-meter Obstacle's Distance by just 0.93%. Despite the fact that at 48-meter Obstacle's Distance, 270°CW obtains more annual cumulative insolation than its 6-meter Obstacle's Distance does tremendously at 6.7501%. At 17-meter Obstacle's Distance, all curves of Group A<sub>2</sub> surpass A<sub>1</sub> as well as at 27-meter Obstacle's Distance all curves of Group B surpass Group A<sub>1</sub>, as shown in Figure 9. Thus, it can be concluded that the effects of the Obstacle's Orientation are high from 6-meter Obstacle's Distance and become ineffective at 17-meter Obstacle's Distance. In different, the Obstacle's Distance affected the solar insolation on the BIPV in just some Obstacle's Orientations, especially, Group B. The Obstacle's Distance also becomes ineffective when the Obstacle's Distance exceeded 27.00 meters.

Results from this study show that at such Obstacle's Orientations of Group A<sub>1</sub> and Group A<sub>2</sub>, the potential PV power generation of the BIPV is high since the nearest distance and almost consistent until the farthest distance between the BIPV and the obstacle. They are also the recommended BIPV placement for BIPV application on lower-rise buildings in urban environments, such as healthcare facilities, as they steadily receive solar irradiation with less sensitive to the Obstacle's Distance. That means the lower-rise BIPVs with these locations are capable of generating solar energy to reach their nearly full potential, no matter how far they are from a much-taller surrounding obstacle. On the conditions of the placement that define Obstacle's Orientations are not optimal, such as Group B, placing the two buildings farther from each other will enhance the energy output from the PV system, especially farther than 27.00 meters.

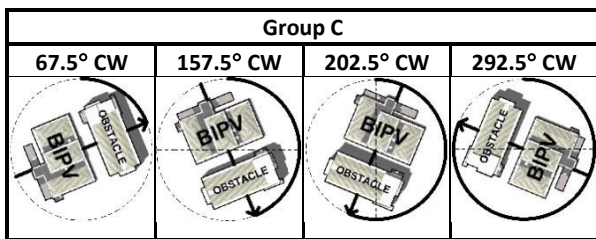

Figure 13: The fourth group (Group C).

For the other eight minor Obstacle's Orientations, there are two Obstacle's Orientations that share the same characteristics with Group A<sub>1</sub>; 22.5°CW ( $m = 282.52$ ) and 337.5°CW ( $m = 280.21$ ), as well as 122.5°CW ( $m = 1,367.07$ ) and 247.5°CW ( $m = 1,441.90$ ) which their slopes are similar to the curves in Group B. On the other hand, there are curves that have distinctive slopes which are able to be categorized into a new group: the fourth group (Group C) including 67.5°CW ( $m = 941.95$ ), 157.5°CW ( $m = 715.05$ ), 202.5°CW ( $m = 747.07$ ) and 292.5°CW ( $m = 1,001.69$ ) (Figure 13). It can clearly be

seen that Group C is intermediate between Group A<sub>2</sub> and Group B, as shown in Figure 10, and Group C diminishes the clear distinction between them.

## 4. CONCLUSION

This study found that the Obstacle's Orientation parameter immensely affected solar insolation on the BIPV, especially the near distances of Obstacle's Distance parameter. The effect of Obstacle's Orientation is very high when the Obstacle's Distance is low in some Obstacle's Orientations, especially Group B—the Obstacle's Orientations that the obstacle located on the east, southeast, west, and southwest of the BIPV. The findings of this study also support decision making for BIPV designers and planners to select which the BIPV and the obstacle placement is highly effective, Group A<sub>1</sub> and Group A<sub>2</sub>—the Obstacle's Orientations that the obstacle located on the north, northeast, northwest, and south of the BIPV, are suitable to be applied in dense urban environments. On the other hand, Group B is advisable to be applied in facilities with sufficient space. The proposed methodology is based on the simulated annual cumulative insolation obtained from rooftop PV surfaces through an automatic collaboration of a BIM software—Autodesk Revit, and a cloud-based building performance analysis tool—Autodesk Insight 360. BIM models of the case study have been built at different LODs to provide a suitable level of details and functionalities while maintaining the simplicity of computational processes. The BIM-based automated simulations have been substantiated its usability that removed the deficiencies; time-consuming, cumbersome and error-prone of the non-automated processes.

## REFERENCES

- Ekici, B. B., (2014). A least squares support vector machine model for prediction of the next day solar insolation for effective use of PV systems. *Measurement*, 50: p. 255–262.
- Yang, R. J., (2015). Overcoming technical barriers and risks in the application of building integrated photovoltaics (BIPV): hardware and software strategies. *Automation in Construction*, 51: p. 92–102.
- Yoo, S-H., (2011). Simulation for an optimal application of BIPV through parameter variation. *Solar Energy*, 85(7): p. 1291–1301.
- Celik, B., Karatepe, E., Silvestre, S., Gokmen, N., Chouder, A., (2015). Analysis of spatial fixed PV arrays configurations to maximize energy harvesting in BIPV applications. *Renewable Energy*, 75: p. 534–540.
- Celik, B., Karatepe, E., Gokmen, N., Silvestre, S., (2013). A virtual reality study of surrounding obstacles on BIPV systems for estimation of long-term performance of partially shaded PV arrays. *Renewable Energy*, 60: p. 402–414.
- Masa-Bote, D., Caamaño-Martín E., (2014). Methodology for estimating building integrated photovoltaics electricity production under shadowing conditions and case study. *Renewable and Sustainable Energy Reviews*, 31: p. 492–500.

# PLEA 2018 HONG KONG

*Smart and Healthy within the 2-degree Limit*

7. Frontini, F., Bouziri, S. M., Corbellini, G., Medici, V., (2016). S.M.O Solution: An Innovative Design Approach to Optimize the Output of BIPV Systems Located in Dense Urban Environments. *Energy Procedia*, 91: p. 945–953.
8. Zomer, C., R  ther, R., (2017). Simplified method for shading-loss analysis in BIPV systems – part 1: Theoretical study. *Energy and Buildings*, 141: p. 69–82.
9. Garner, R., Solar Irradiance [Online], Available: [http://www.nasa.gov/mission\\_pages/sdo/science/solar-irradiance.html](http://www.nasa.gov/mission_pages/sdo/science/solar-irradiance.html) [3 April 2015].
10. Shukla, A. K., Sudhakar, K., Baredar, P., (2017). Recent advancement in BIPV product technologies: A review. *Energy and Buildings*, 140: p. 188–195.
11. Ning, G., Junnan, L., Yansong, D., Zhifeng, Q., Qingshan, J., Weihua, G., et al., (2017). BIM-based PV system optimization and deployment. *Energy and Buildings*, 150: p. 13–22.
12. Somboonwit, N., Boontore, A., (2017). Identification of Building-Surrounded Obstacle Parameter Using Automated Simulation to Support Building Integrated Photovoltaic (BIPV) Layout Planning in Thailand. *Asian Social Science*, 13(12): p. 142-159.
13. Clarke, J. A., Hensen, J. L. M., (2015). Integrated building performance simulation: Progress, prospects and requirements. *Building and Environment*, 91: p. 294–306.
14. Bazjanac, V., Maile, T., Rose, C., O’Donnell, J. T., Morrissey, E., Welle, B. R., (2011). AN ASSESSMENT OF THE USE OF BUILDING ENERGY PERFORMANCE SIMULATION IN EARLY DESIGN. In: *Proceeding of Building Simulation 2011*. Sydney, Australia: International Building Performance Simulation Association; p. 1579–1585.
15. Hitchcock, R. J., Wong, J., (2011). TRANSFORMING IFC ARCHITECTURAL VIEW BIMS FOR ENERGY SIMULATION: 2011. In: *Proceeding of Building Simulation 2011*. Sydney, Australia: International Building Performance Simulation Association; p. 1089–1095.
16. O’Donnell, J., See, R., Rose, C., Maile, T., Bazjanac, V., Haves, P., (2011). SIMMODEL: A DOMAIN DATA MODEL FOR WHOLE BUILDING ENERGY SIMULATION. In: *Proceeding of Building Simulation 2011*. Sydney, Australia; p. 382–9.
17. Krygiel, E., Nies, B., (2008). *Green BIM: Successful Sustainable Design with Building Information Modeling*. Alameda, CA, USA: SYBEX Inc.
18. Kymmell, W., (2007). *Building Information Modeling: Planning and Managing Construction Projects with 4D CAD and Simulations (McGraw-Hill Construction Series): Planning and Managing Construction Projects with 4D CAD and Simulations*. McGraw Hill Professional; 297 p.
19. Eastman, C., Teicholz, P., Sacks, R., Liston, K., (2011). *BIM Handbook: A Guide to Building Information Modeling for Owners, Managers, Designers, Engineers and Contractors*. John Wiley & Sons; 648 p.
20. Aguiaro, G., (2016). Energy planning tools and CityGML-based 3D virtual city models: experiences from Trento (Italy). *Applied Geomatics*, 8(1):41–56.
21. Kuo, H.-J., Hsieh, S.-H., Guo, R.-C., Chan, C.-C., (2016). A verification study for energy analysis of BIPV buildings with BIM. *Energy and Buildings*, 130: p. 676–691.
22. Somboonwit, N., Boontore, A., Rugwongwan, Y., (2017). Obstacles to the Automation of Building Performance Simulation: Adaptive Building Integrated Photovoltaic (BIPV) design. *Environment-Behaviour Proceedings Journal*, 2(5): p. 343–354.
23. Negendahl, K., (2015). Building performance simulation in the early design stage: An introduction to integrated dynamic models. *Automation in Construction*, 54: p. 39–53.
24. Somboonwit, N., Sahachaisaeree, N., (2012) Healthcare Building: Modelling the Impacts of Local Factors for Building Energy Performance Improvement in Thailand. *Procedia - Social and Behavioral Sciences*, 50: p. 549–562.
25. Volk, R., Stengel, J., Schultmann, F., (2014). Building Information Modeling (BIM) for existing buildings – Literature review and future needs. *Automation in Construction*, 38: p. 109–27.
26. BIM Forum. LOD | BIMForum [Online], Available : <http://bimforum.org/lof/> [2017].
27. Autodesk Sustainability Workshop. Project Phases & Level of Development | Sustainability Workshop [Online], Available: <https://sustainabilityworkshop.autodesk.com/buildings/project-phases-level-development/> [20 May 2018].
28. Leite, F., Akcamete, A., Akinci, B., Atasoy, G., Kiziltas, S., (2011). Analysis of modeling effort and impact of different levels of detail in building information models. *Automation in Construction*, 20(5): p. 601–9.

# Climate-adaptive Facade Design with Smart Materials: Evaluation and Strategies of Thermo-Responsive Smart Material Applications for Building Skins in Seoul

JUNGWON YOON<sup>1</sup>

<sup>1</sup>Department of Architecture, University of Seoul, Seoul, Republic of Korea

*ABSTRACT: Smart materials are often studied in architecture due to their internal changeable properties stimulated by various material-specific input or operating factors. Meanwhile, climate-adaptive facades have been investigated for design and simulation to achieve dynamic aesthetics satisfying environmental performance for energy efficiency and indoor comfort. This paper presents a design exploration framework for climate-adaptive facades with thermally responsive smart materials, limiting the scope of study to a pilot study of facades in Seoul, South Korea. The proposed smart material building skins are discussed for further simulation and validation to assess multiple criteria to verify their environmental performance and implementation for practical use. The paper is concluded by providing selected thermo-responsive smart material facade types and directions for future work.*

*KEYWORDS: Climate-adaptive, Thermo-responsive, Smart Material, Building Skin, Facade*

## 1. INTRODUCTION

Adaptive facades play a critical role in high performance building design [1]. Smart materials exhibiting changeable properties that respond to environmental changes can offer radical shifts to the built environment and its aesthetic design paradigm in architecture [2]. For architects and academic scholars in architecture, Addington and Schodek's publication [3] has become a groundbreaking reference for a theoretical approach to smart materials. Globally, many research groups at universities, such as MIT, IAAC, Stuttgart University, and TU Eindhoven, have been accelerating research on smart materials and presenting various applications. Sung [4], Decker [5], Sabin [6], and Menges [7] demonstrated a new understanding of specific material responses by adopting the biological patterns of transformation to detect environmental changes and to react intrinsically in built structures. However, only two research trends related to smart materials in architecture have been discovered at the national level. One trend is to focus on shape memory alloy (SMA) for kinetic installations, and another is to highlight phase change material (PCM) and its latent heat capacity for energy-efficient building systems.

The adaptive facade strategy would allow design with smart materials to produce an environmentally responsive system linking the formal behavior with its climate-related performance. Currently, adaptive building skins are variably defined, often related to the ways the building skin reacts to weather conditions or users. Loonen [8] defined the climate adaptive building shell as a building skin that can adapt itself as a function of the users' needs and the climatic conditions, aiming to reduce the overall energy demand. Clifford [9] viewed

the climate adaptive building facade as a self-organizing operable filter responding to differences between interior and exterior environments by adjusting or attuning surfaces to climatic changes. Al-Obaidi [10] defines the adaptive building skin as a morphogenetic evolution and real-time physical adaptation of a design in relation to its surrounding environment to achieve a symbiotic energy-efficient design solution, seeking optimization of energy consumption with availability of material resources. However, most dynamic systems utilizing mechanical actuators for automatic control require maintenance and energy consumption [8]. Therefore, a new system should be developed for future adaptive building skins [10]. From this perspective, an important aspect of a climate-adaptive facade with a smart material is the hygroscopic intrinsic property of the material, which includes the ability to change physical properties or shape without any energy source [10]. In addition, smart materials can perform reversible shape variations triggered by external stimuli, such as heat [1], which was referred to as adaptive response by Lurie-Luke [11]. Therefore, sensing and actuating functions could be integrated into a single facade element [12].

This paper accepts thermal responsiveness as the central impetus for performance of efficient energy strategies [13], and this aspect of the study is different from other researchers in proposing a responsive building facade strategy. The review of adaptive strategies in selected references is complemented by an overview of key measures relating to input, output, and component types of smart material applications. The aim would be achieved by integrating findings with design propositions in a critical discussion on adaptive facade strategies and their validations.

# PLEA 2018 HONG KONG

Smart and Healthy within the 2-degree Limit

## 2. OBJECTIVES AND METHODOLOGY

This paper is a part of the research: A Study on a Sustainable Energy-efficient Envelope Applying Thermo-responsive Smart Materials that aims to develop a smart material facade as a concept to combine active and passive measures supporting an energy-efficient building technology. A design exploration framework for climate-adaptive facades is presented with a focus on thermal responsiveness of smart materials. The research aimed to propose a new prospective for building skin design strategies by fostering application of thermo-responsive smart materials. The long-term objective is to provide pathways for wide use of thermo-responsive smart materials in energy-efficient, climate-adaptive facades and to develop integrated prototypes to improve the performative and dynamic aspects of material and system development for building skins [14].

When designing adaptive building systems, materials are investigated in the research-driven process of design, material selection, and material processing [15]. The design process includes defining a design concept and adaptive components, while the research of material selection and processing involves analysis, experimentation, validation, evaluation, and implementation. This paper focuses on the design process of adaptive components in this type of research methodology scheme and provides directions for analysis and validation for future work.

This research is based on analysis of the state-of-the-art responsive facade design precedents integrating thermally sensible or interactive technologies. Reviews of case-studies provide lessons on how smart buildings perceive varying environmental stimuli and perform transformation of internal properties, thus helping to understand how to apply the theoretical principles in different facade typologies and to pinpoint predictive design hypotheses. The paper explores the research topics in four key stages: 1) selection of possible thermo-responsive smart materials to the temperature changes in Seoul, 2) classification of thermally active facade design strategies, 3) identification of thermo-responsive smart materials for classified facade strategies, and 4) development of scenarios for climate-adaptive facade design with smart materials.

## 3. EVALUATION

### 3.1 Material Selection

To select adequate thermo-responsive smart materials for applications, several criteria including environmental conditions, critical material properties, strain rate, temperature ranges for transformation, cost, and manufacturing processes are reviewed, classified, and categorized. This study starts by focusing on thermobimetal, shape memory alloy (SMA), shape memory polymer (SMP), phase change material (PCM), and thermochromic material, which morph or transform

their colors and transparency. By examining manufacturers and smart material products, thermo-responsive smart material information was collected, documented, and sorted. Thermo-responsive smart materials are produced in specific advanced countries, such as the USA, Germany, and Japan (Fig. 1). Also, unit prices of all the materials are acquired from price quotes (Fig. 1), showing that the unit price of SMA is incomparable to that of other materials. While smart materials other than SMA can be applied in volume or surface, SMA should be used relatively sparingly at the minimum amount for equal economic feasibility.

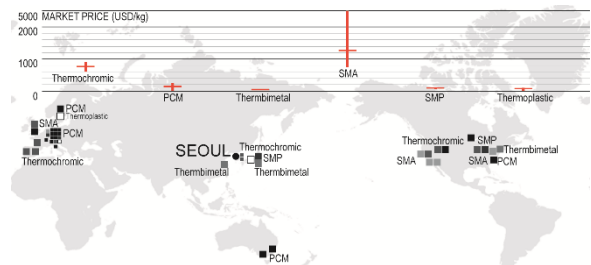

Figure 1: Mapping thermo-responsive smart material origins and comparison of market prices

The material properties are derived from extensive references for comparative analysis. The latent energy, specified reaction temperature, repeatability of cycles, strain, actuation stress, and two-way behavior availability are reviewed to evaluate practical applicability of the discussed smart materials in climate-adaptive facades, as is shown in Table 1. PCM expresses a phase change as a result of energy exchange. Thermobimetal, SMA, and SMP possess strain and stress to present their dynamic transformation, as well as to activate and deform connected components of the system by morphing their shapes. However, thermobimetal deforms steadily in a broad temperature range from -20 to 200 °C with the maximum deformation between 10 and 93 °C in the case of the alloy type with the biggest bending strain. In addition, 2-way SMA and SMP have been produced in the laboratory for research [16], showing two-way morphing behavior by reversing the activation stimulus [17].

Table 1: Comparison of thermo-responsive smart materials (Temp. Spec. means temperature specified for activation of response. In this study, the reaction temperature was expected to be 25 °C) [7, 17-18]

Material	Energy (KJ/kg)	Temp. Spec.	Cycle	Strain	Stress	2-way
Energy-exchange	PCM	37-45	varies	*		
		100-110				
		200				
Property-changing	Thermobimetal		*	+	+	
	SMA		*	++	++	*
	SMP		*	+++	+	*
	Thermochromic		*	*		

# PLEA 2018 HONG KONG

Smart and Healthy within the 2-degree Limit

Based on the properties and behaviors of thermo-responsive smart materials, their application, morphology, format, control of responses operated by temperature, usability as actuators, and output from responses are listed in Table 2. Thermobimetal, SMA, and SMP can be applied as individual components of facade systems in sheets, wires, and any manufactured formats as well as actuators, resulting in dynamic movements and deformations. PCM and thermochromic material can be added to and mixed with other materials or be provided in containers, while transforming transparency or color as per temperature changes. By focusing on shape-morphing dynamism of a climate-adaptive facade system, PCM is excluded from the following study.

Table 2: Comparison of smart materials

Material	Morphology	Format	Control	Actuator	Output
PCM		Powder Liquid	Phase		Transparency
Thermobimetal		Sheet	Expansion Curvature	●	Movement Opening
SMA		Wire/Spring Sheet	Contraction Relaxation	●	Movement
SMP		Sheet Free-form	State Transition	●	Deform Elasticity
Thermochromic		Powder Liquid	Internal Order		Color

## 3.2 Facade Design Classification

From the literature review [2, 3, 8, 17, 19-22] and a web search for adaptive, responsive, and active building skins, 76 cases of responsive facade design in buildings, installations, components, and systems are collected, as listed in Table 3.

Table 3: List of case studies

Building	Installation	Component & System
Gustavo Capanema Palace	Institut du monde arabe	Flectofin Ceramic
Milwaukee Art Museum	Museum of Paper Art	REEF Enteractive
Galleria Department Store	Housing for Elderly	Hylozoic Soil Pixel Skin02
Monte Verde Building	Shanghai Qizhong Centre	Raspberry Fields Nano Vent-skin
Media-TIC	iCon Innovation Centre	Lotus Living Glass AIR Flow(er)
Q1 Headquarters	Torre de Especialidades	Windscreen Super cilia skin eskin
Kieffer Technic Showroom	Dubai Da Vinci Tower	kinetic artwork for HelloTrace System iConic
One Ocean Pavilion	EWE Arena	Brisbane Airport Homeostatic Façade Translated Geometries
Towers (REX)	Soft House	Windswept Aldar Central Market (Permea)
POLA	Hotel Habitat	Bloom Nasher Sculpture Center (surya shading screen)
Lumenhaus	Sliding House	HygroSkin BIQ house (solar leaf)
BIQ House	Delfts Blauw	Exo Campus of Justice (Strata)
Cyclebow	Heliotrop	Breathing Skin KAFD spas (Tessellate)
Chanel Ginza	Chabot College	Al Bahr Towers Structure with PBR Façade
Al Bahr Towers	Allianz Arena	Grunewald Manufacturing Facilities Dynamic Aperture - Pivot (study)
Univ of Washington-Seattle		Syddansk Universitet Communications and Design Adaptive Fritting in GSD
Xicui Entertainment Complex		Charles Sturt Univ Thurgooona campus Shutter Project
		Solar black and white house
		Passive Cooling System from Hydrogel and water driven-breathing skin

All the cases are analyzed and sorted into three types to derive methods to apply thermo-responsive smart materials to building skins: 1) active type, 2) heat-sensing type, and 3) smart material type. In addition, the relationship between facade design and heat can be defined according to inputs and outputs. After excluding examples that do not have a strong relationship with heat or aesthetic appeal, 64 cases resulting in heat control as the outcome are selected, as shown in Table 4.

Table 4: Quantity of facade design types having heat as input and output

Façade Design Type	Input	Output	Input	Output
	Others	Heat Control	Heat Temperature	Heat Control
Active	25		-	
Smart	9		14	
Active + Heat-sensing	-		8	
Active + Smart	5		1	
Heat-sensing + Smart	-		1	
Active + Heat-sensing + Smart	-		1	

The key features in smart material facades are input controls as sensing and actuating mechanisms for heat and the output as a scenario in which building envelopes transform. Adaptability of facades can be established by intrinsic, behavioral, and performative properties of smart materials to enable property change in response to temperature change [23]. To gain insight into the practical application of smart material systems for climate-adaptive facades, the input, output, and component types of 64 examples are analyzed and summarized, as shown in Table 5.

Table 5: Summary of input, output, and component types

Input	Output	Component
Temperature / heat / weather	Movement	Panel
Light		Radial
Sun location		Displacement
Solar radiation		Retracting
Relative humidity / moisture		Deploying
Wind	Deformation	Membrane
Sound		Folding
Carbon dioxide		Bending / twisting
Electricity	Inflation	Multi-layer membrane
Occupant / user	Transparency	Cell
Programmed / hour	Color	Skin
	Energy exchange	Structure

Heat control is implemented by movement, deformation, transparency, and color change, with sensing input of temperature, light, sun location, solar radiation, moisture, wind, sound, carbon dioxide, electricity, occupant, and program in case-studies. Multiple movement types are discovered including rotation, radial, displacement, retracting, and deploying. Deformation is categorized into folding, bending/twisting, and inflation in this paper. Depending on the form, operation, scale, and scope, facade components are classified into panel, lamella/brise-soleil, fin/blade, aperture, membrane, multi-layer membrane, cell, skin, and structure. The responsive facade design types of 64 cases are sorted according to their heat-control principles as shown in Fig. 2. Movement is the most frequent output principle in all the facade design types analyzed in this study. This strategy relates to key measures of the facade system: natural ventilation, thermal quality, daylight quality, integrated technologies, and materials and energy performance [24].



# PLEA 2018 HONG KONG

Smart and Healthy within the 2-degree Limit

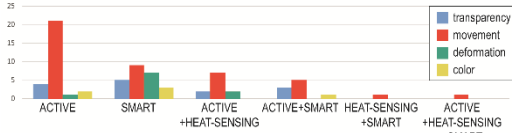

Figure 2: Quantity of different heat-control output principles as per facade design types

The analysis results of input, output, and component types are then synthesized in the form of mapping (Fig. 3), highlighting the distinguished relationships between input and output and output and component, and resulting in selected outputs and components for thermo-responsive building skin concepts. Self-adjusting facades with intrinsic temperature controls are characterized by adaptive capacity as an inherent feature of the components of the building skins, automatically triggered by environmental stimuli of temperature by using smart materials [3,8,25-26]. The finally selected components and outputs (Fig.3) are considered as major elements to extract principles for climate-adaptive facades utilizing thermal-responsive smart materials in the basic design approach. The selected outputs can be defined in two different mechanisms: 1) movements and 2) surface appearances. The following design exploration will focus on the former mechanism. Selected components would represent varying smart material application scales from small to large unit types, which are directly proposed as types in this study.

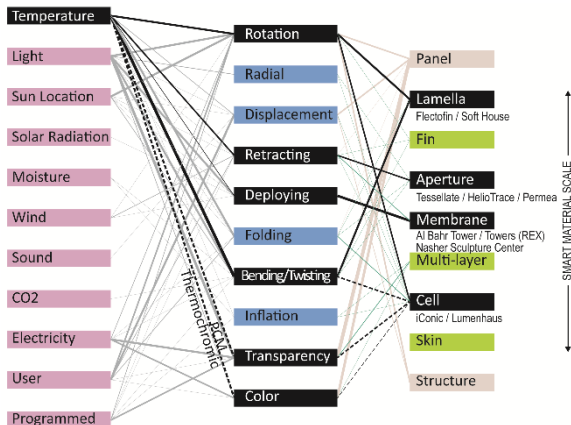

Figure 3: Mapping facade input, output, and component to select adaptive facade strategies

## 4. STRATEGIES

### 4.1 Identification of Materials for Adaptive Strategies

The design approach by imitation and application of borrowed material technologies is adopted to create scenarios for smart material applications in building skins. Lopez et al. [27] also introduced a model for adaptive walls using adaptive materials based on dynamic mechanisms and static strategies and classified the materials into four areas: temperature reactive materials, light reactive materials, humidity reactive materials, and carbon dioxide reactive materials.

However, this study focuses on temperature responsive materials. From the previous section, four different components are classified. By reviewing selected projects: iConic, Lumenhaus, Tessellate, HelioTrace, Permea, Al Barh Tower, Nasher Sculpture Center, Towers, Flectofin, and Soft House, for all the component types, the mechanisms of the shading devices are defined and specified with smart materials [1].

In identifying adequate thermo-responsive smart materials for selected adaptive facade strategies, specific changes inherent to smart materials provide a possibility to extend the performance in relation to how the dynamic characteristics of materials are reflected in the design and how the change can be perceived and performed. For selected adaptive facade strategies, smart materials can be identified based on the interrelation of material morphology and format with facade component types, material controllability, actuating capacity, and output, in addition to processing methods and performative appearances as shown in Table 6.

Table 6: Identification of materials for adaptive strategies

No.	Component	Mechanism	Smart Material
1	Cell	Rotating	SMP
			SMA
2	Aperture	Retracting	SMA
3	Membrane	Deploying	SMP
4	Lamella	Rotating	SMA
		Bending/twisting	SMP

In this study, four different facade design strategies are prepared and presented in Fig. 4 for the possible scenarios of climate-adaptive facades utilizing the properties and technology of the thermo-responsive smart materials, in differentiated component types with varying movement and deformation mechanisms. All the presented adaptive strategies exhibit the desired movements between open and closed modes [1, 16]. To be responsive to external conditions, modulation also needs to be taken into consideration, and opening ratios at the component scale according to the different shapes are considered for variations for all the types [1]. The proposed component sizes vary due to the discrete sizes and capabilities of smart materials as actuators as well as the developed facade systems [1]. However, color changing can be added to any strategy due to the wide compatibility of thermochromic material.

TYPE	T < 25°C	T ≥ 25°C	Ref
Type 1 Cell			
Type 2 Aperture			Permea Heliotrace Tessellate  Institut du Monde Arabe
Type 3 Membrane			Al Bahr Tower  Surya shading screen
Type 4 Lamella			Softhouse  Flectofin

Figure 4: Adaptive strategy types

The aim of this proposition is to observe how heat can affect building skin morphologies in relation to shape changing and, consequently, shading, air flow, daylight, and visual openness. Identified smart materials become the receptors and effectors of the environmental stimuli, while the processing is triggered by inherent properties and morphological configuration. In this sense, the design-driven process negotiates material thresholds and capacities and is calibrated by evaluating the outcome of modulation [28] and permeable openness.

## 4.2 Scenarios

The climate-adaptive facade with selected smart materials could be used in innovative material techniques and dynamic visual impacts for environmentally-friendly design. This study proposes an architectural envelope system to apply thermo-responsive smart materials in Seoul. The local climate features extreme temperatures between 38 °C and -23 °C. From May to September, the average high temperature ranges from 23 °C to 30 °C. As the pilot study, scenarios are studied for the south facade of an office building.

Analysis of the psychrometric chart and adaptive comfort from the Climate Consultant software demonstrates that sun shading of windows and adaptive comfort ventilation can be adopted as key measures to achieve strategic indoor climate control. The adaptive comfort analysis is based upon the acceptable comfort ranges according to the ASHRAE 55 Adaptive Comfort Model. Comfort is a complex perception based on the interactions between physical stimuli and cognitive processes, and it is connected to user satisfaction through adaptation to the surrounding environment by behavioral adjustment, physiological adaptation, and psychological adaptation [1].

In this study, shading devices are proposed to be linked to the materials' intrinsic behaviors instead of the

occupants' behaviors. Therefore, it is important to study how the autonomous shading devices can affect the building performance, provide adaptation to the environment, and play a central role in building energy optimization as the design research progresses. Finally, four facade strategy types are employed in pilot facade design studies (Fig. 5) as not only devices for shading, but also for daylight and natural ventilation. In-depth studies of each facade type would be developed with applicable smart materials for system developments in the continuing further study.

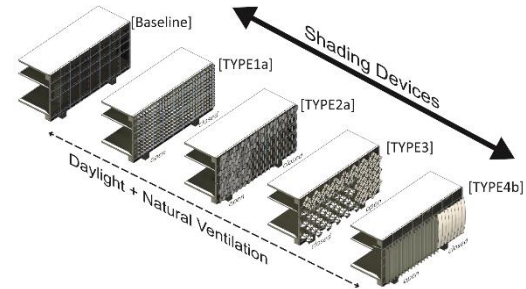

Figure 5: Four facade strategy types in pilot studies

## 4.3 Multi-Criteria Assessment and Validation

By applying the performance simulations, multi-criteria assessment can validate the effectiveness of proposals, allowing design strategies to be drawn with improved direction of methods in the research processes of material selection and processing. Computational tools can be explored to evaluate the thermal, lighting, and airflow properties during the design process for performance simulations. The biggest challenge would be to determine the computer design strategy through the setting of the variables and rules and to physically convert the characteristics of the material through computer software, verifying its effectiveness and ensuring quantitative energy efficiency as well as qualitative aesthetic performance. The objective of the energy performance analysis and the parametric studies is to investigate the proposed adaptive strategies regarding energy saving potential and impact on thermal comfort [24].

The building energy simulation concerns implementation of the facade model, taking into consideration the compatibility and flexibility with the software for the design study. In addition, the parametric optimization and generative algorithms required for smart material facades limit the available software for performance analysis.

In our study, the smart material information including the physical properties and behavioral parameters is simplified after hands-on, scaled-down model experimentation to comparatively analyze [29] the efficacy of all the prototypes and scenarios, as shown in Fig. 6. In addition, parametric algorithms are scripted to simulate the transformative mechanism using Rhinoceros with its plug-ins, such as Grasshoppers and

# PLEA 2018 HONG KONG

Smart and Healthy within the 2-degree Limit

Kangaroo, to include the programmed and activated conditions. Solar radiation and thermal effect simulations are carried out in this study using Ladybug, Radiance, and Honeybee [30-32] for analysis of dynamic shadings [29].

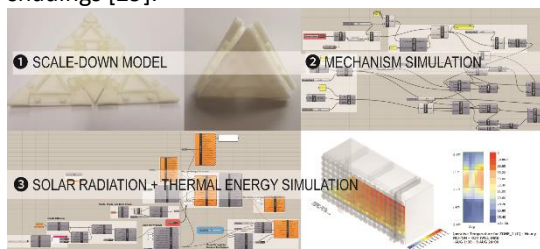

Figure 6: Smart material application simulation for Type 1

However, while conducting the simulation and assessing the environmental effects of smart material applications, unknown property values, such as light transmission value, recovery force, and behavioral fatigue, are required for a deeper understanding of the energy efficiency. Therefore, it would be challenging to test and survey all the demanded values in further assessment and validation processes. To overcome the limitations of the facade strategy selection process, a building performance assessment and an evaluation of indoor comfort quality and economic benefits should be investigated in a later stage as the succeeding protocol of the long-term research.

## 5. CONCLUSION

This study demonstrated that the comparative and holistic analysis of available thermo-responsive smart materials and their intrinsic properties, performative properties, and physical properties enable application as adaptive building facade components. The detailed analysis of responsive systems regarding sensing inputs, controlling outputs, and component morphology classification led to the development of design strategy concepts for climate-adaptive building skins using smart materials. The variety and dynamics of thermo-responsive smart materials and adaptive facade strategies promote a wide range of design scenarios and prototype developments. Despite the design-driven nature of this research, by limiting the scope of smart material selection and facade design strategies based on the site-specific climate criteria, four different key strategies with SMA, SMP, and thermochromic materials were defined for pilot studies and further exploration of simulations to assess energy and daylight effects. Scaled-down prototype models were proposed to validate the dynamic mechanisms. The results of this paper and the future study can provide findings transferrable to manifold design research processes of similar materials, design strategies, and climates for adaptive facade potential by gaining insights into material capacities for

architectural applications and experimental design approaches.

## ACKNOWLEDGEMENTS

This research was supported by the Basic Science Research Program through the National Research Foundation of Korea (NRF) funded by the Ministry of Science, ICT, and Future Planning (NRF-2017R1C1B5015080).

## REFERENCES

1. Fiorito, F., Sauchelli, M., et al. (2016). Shape morphing solar shadings: A review. In *Renewable and Sustainable Energy Reviews*, 55: p.864-884. <https://dx.doi.org/10.1016/j.rser.2015.10.086>
2. Aksamija, A. (2016). Innovative Materials. In *Integrating Innovation in Architecture: Design, Methods and Technology for Progressive Practice and Research*. Chichester, UK: John Wiley and Sons, Inc: p. 20–59 <https://doi.org/https://doi.org/10.1002/9781119164807.ch1>
3. Addington, M., & Schodek, D. (2005). *Smart Materials and New Technologies - For architecture and design professions*. New York, USA: Routledge.
4. Sung, D. (2016). Smart Geometries for Smart Materials: Taming Thermobimetal to Behave. *Journal of Architectural Education*, 70(1): p. 96–106.
5. Decker, M. (2013). Emergent Futures: Nanotechnology and Emergent Materials in Architecture. In *Tectonics of Teaching – Building Technology Educators Society (BTES) Conference*. Newport, USA: Building Technology Educators Society: p. 217-223
6. Sabin, E., Lucia, A., et al. (2014). Prototyping Interactive Nonlinear Nano-to-Micro Scaled Material Properties and Effects at the Human Scale. In *SimAUD 2014 Spring Simulation Multi-Conference*. Tampa, USA: Article 11
7. Menges, A. & Reichert, S. (2012). Material capacity: embedded responsiveness. *Architectural Design*, 82(2): p.52-59
8. Loonen, R. C. G. M., Trčka, M., Cóstola, D., & Hensen, J. L. M. (2013). Climate adaptive building shells: State-of-the-art and future challenges. *Renewable and Sustainable Energy Reviews*, 25: p. 483–493. <https://doi.org/10.1016/j.rser.2013.04.016>
9. Clifford, D., Zupan, R., Brigham, J., Beblo, R., Whittock, M., & Davis, N. (2017). Application of the dynamic characteristics of shape-memory polymers to climate adaptive building facades. In 12th Conference of Advanced Building Skins. Bern: Advanced Building Skins GmbH: p. 171-178
10. Al-Obaidi, K. M., Azzam Ismail, M., Hussein, H., & Abdul Rahman, A. M. (2017). Biomimetic building skins: An adaptive approach. *Renewable and Sustainable Energy Reviews*, 79(June): p.1472–1491. <https://doi.org/10.1016/j.rser.2017.05.028>
11. Lurie-Luke, E. (2014). Product and technology innovation: What can biomimicry inspire? *Biotechnology Advances*, 32(8): p. 1494–1505. <https://doi.org/10.1016/j.biotechadv.2014.10.002>
12. Knaack, U., & Klein, T. (2008). *The future envelope 1, A multidisciplinary approach*: Amsterdam, The Netherlands: IOS press BV.
13. Fernández-Galiano, L. (2013). Architecture and life. In W. W. Braham & D. Willis (Eds.), *Architecture and Energy: Performance and Style*. New York, USA: Routledge: p.27
14. Favoino, F., Goia, F., Perino, M., & Serra, V. (2016). Experimental analysis of the energy performance of an ACTIVE, RESponsive and Solar (ACTRESS) façade module. *Solar Energy*, 133(2016): p. 226–248.

# PLEA 2018 HONG KONG

*Smart and Healthy within the 2-degree Limit*

<https://doi.org/10.1016/j.solener.2016.03.044>

15. Moavenzadeh, F. (1990). Design and Materials Selection and Processing. In *Concise Encyclopedia of Building and Construction Materials*. Cambridge, MIT Press: p. 23–28. <https://doi.org/10.1080/10464883.2016.1122479>
16. Boldini, A., Colangelo, M., Pilla, A., et al. (2017). Metereosensitive user-controllable skin for dynamic façades. In *12th Conference on Advanced Building Skins*. Bern: Advanced Building Skins GmbH: p. 740–832
17. Lelieveld, C. M. J. L. (2013). Smart Materials for The Realization of An Adaptive Building Component. <https://doi.org/10.1017/CBO9781107415324.004>
18. Coelho, M., & Zigelbaum, J. (2011). Shape-changing interfaces. *Personal and Ubiquitous Computing*, 15(2): p.161–173. <https://doi.org/10.1007/s00779-010-0311-y>
19. Brownell, B., & Swackhamer, M. (2015). *Hypernatural: Architecture's New Relationship with Nature*. Princeton Architectural Press
20. Brownell, B. (2017). *Transmaterial Next: A Catalog of Materials that Redefine Our Future*. Princeton Architectural Press
21. Kolarevic, B. & Parlac, V. (2015). *Building Dynamics: Exploring Architecture of Change*. Routledge
22. Mazzoleni, I. (2017). *Architecture Follows Nature- Biomimetic Principles for Innovative Design*. CRC Press
23. Ng, R. (2010). Something Borrowed: Defining an Emerging Covenant between Architecture and Materials, In *ARCC/EAAE Proc. of International Conference on Architectural Research*
24. Gosztonyi, S., Stefanowicz, M., Bernardo, R., & Blomsterberg, Å. (2017). Multi-active façade for Swedish multi-family homes renovation: Evaluating the potentials of passive design measures. *Journal of Facade Design & Engineering*, 5(1): p. 7–21. <https://doi.org/10.7480/jfde.2017.1.1425>
25. Klooster, T. (2009). *Smart surfaces: and their application in architecture and design*. Basel: BIRKHÄUSER.
26. Ritter, A. (2007). *Smart materials in architecture, interior architecture and design*. Basel: Birkhauser.
27. Lopez, M., Rubio, R., Martin, S., Croxford, B., & Jackson, R. (2015). Adaptive architectural envelopes for temperature, humidity, carbon dioxide and light control. In: *Proceedings of the 10<sup>th</sup> conference on Advanced Building Skins*. Bern: Switzerland
27. Doumpiotti, C., McGee, W., & Ueno, M. (2011). Responsive and Autonomous Material Interfaces. *Integration through Computation: Proceedings of the 31st Annual Conference of the Association for Computer Aided Design in Architecture (ACADIA)*: p. 318–325, [Online], Available: [http://cumincad.architecturez.net/doc/oai-cumincadworks.id-acadia11\\_318](http://cumincad.architecturez.net/doc/oai-cumincadworks.id-acadia11_318)
28. Elzeyadi, I. M. K., Abboushi, B., Hadipour, H., & Rivera, I. (2016). High-performance façades: measuring the impacts of dynamic shading prototypes on indoor environmental quality Using Yearly Simulations and Field Tests. In *PLEA 2016 32nd International Conference on Passive and Low Energy Architecture*, Vol. II. Los Angeles, California: p. 0–9.
29. Gonzalez, N., & More, S. (2015). Self-adaptive Membrane: A Passive Kinetic System, [Online], Available: [http://www.iaacblog.com/programs/self-adaptive-membrane-\\_a-passive-kinetic-system/](http://www.iaacblog.com/programs/self-adaptive-membrane-_a-passive-kinetic-system/)
30. Mokhtar, S., Leung, C., Chronis, A., & Kingdom, U. (2017). Geometry-Material Coordination for Pasive Adaptive Solar Morphing Envelopes. *SimAUD 2016: Symposium on Simulation for Architecture and Urban Design*: p.211–218.
31. Merla, M., Diaferia, R., & Dibari, G. (2016). Application of parametric study and generative algorithms to optimize building physics analyses. In *PLEA 2016 32nd International Conference on Passive and Low Energy Architecture*, Vol. I, Los Angeles, California: p. 23–28.

# PLEA 2018 HONG KONG

*Smart and Healthy within the 2-degree Limit*

## An Energy Efficiency Policy for Cambodia: Proposals for the Building Sector

ROBERT LIMANEK<sup>1</sup>

<sup>1</sup>Faculty of Architecture, Zaman University, Phnom Penh, Cambodia

*ABSTRACT: This paper describes a project to propose a National Energy Efficiency Policy for Cambodia. The project was initiated by the Ministry of Industry, Mines and Energy of Cambodia (MIME). The European Union Energy Initiative Professional Dialogue Facility (euei pdf) provided funding and Integration Consulting Group management. The policy was written by a team of five experts who met in Cambodia over a period of eight months (2012-2013). The areas of expertise comprised energy efficiency in industry, consumer goods, biomass, rural electrification, and buildings. This paper will describe the author's contribution as building expert, and will therefore focus on energy efficiency in buildings. Its purpose is to share experience with other developing countries, to solicit helpful suggestions from those with similar experience and expertise, and to promote this on-going effort.*

*KEYWORDS: Energy, Policy, Cambodia*

### 1. INTRODUCTION

Cambodia relies heavily on expensive imported oil and gas for electricity. The government of Cambodia sees the demand for energy increasing and sensibly initiated this energy efficiency policy project.

During the project term the author visited government officials, toured new large buildings, talked with architects and engineers, observed construction in Phnom Penh, and reviewed the available literature. It is apparent there is a rapid growth in the number of buildings, particularly in the major cities and coastal areas. Most recent construction is without regard or knowledge of energy efficiency. There is no building code in Cambodia. There is very little data available on the energy intensity of existing buildings. The author found some general papers discussing energy efficiency policy in developing countries which are reviewed below.

This paper will outline what is known and what is lacking in energy efficiency in buildings in Cambodia and will conclude with a proposed policy.

### 2. BACKGROUND

This section is a review of what was found by the author in Cambodia and any available papers on related topics.

#### 2.1 Existing building regulations

The Ministry of Urban Planning, Land Management and Construction (MUPLM&C) of Cambodia is the organization which issues building permits. However, there is no building code. Local developers typically rely on foreign building codes while foreign developers usually rely on building codes from their own country. MUPLM&C is not aware of, nor is in the process of drafting any type of energy efficiency or green building regulations.



Figure 1: typical new construction in Phnom Penh

#### 2.2 Growth mode

Cambodia is currently experiencing a rapid growth in building construction. This is made clearly evident by looking at the skyline in Phnom Penh to see the many new high-rise projects and going to outlying areas to see expansion in the suburbs. Furthermore, there is rapid development in Sihanoukville on the coast and in the tourist mecca of Siam Reap. An interview with the MUPLM&C confirmed this impression.

#### 2.3 Misguided construction techniques

Generally it was found that new construction in Cambodia is not well adapted to the warm and humid climate. Particularly there is a lack of use and understanding of heat avoidance strategies such as proper building orientation (east-west with major opening on the south and north), effective sunshading of windows, and use of light colored materials. Often buildings are built with large plate glass windows, without sunshading, which contribute large heat gain in

# PLEA 2018 HONG KONG

*Smart and Healthy within the 2-degree Limit*

the building and load on the air conditioning (and almost always the curtains are drawn in an unsuccessful attempt to keep heat from the sun out). See Chapter 17 “Tropical Architecture” in Heating, Cooling, Lighting [1] for additional sustainable building strategies.

## 2.4 Review of papers

There are a number of international organizations involved in energy efficiency advocacy, but little written on how countries can develop their own policy. This is surprising given the fact that every developed country has gone through this process. It seems that each country has struggled with it over long periods. Of course, every country is different in how institutions are organized and governed.

A review of papers highlights the advantages of building energy efficiency codes and other measures in developing countries:

Mandatory building energy efficiency codes (BEECs), when practically formulated, continuously updated, and actually enforced, are both effective and economic in overcoming persistent market barriers and delivering more energy-efficient buildings.

Price incentives and market information, such as charging users for energy services based on consumption and at cost-recovery prices and providing cost-benefit analysis of energy efficiency improvements, are essential to achieving energy savings afforded by BEEC compliant buildings.

Adoption of enforceable BEECs is essential at the beginning of the process of transforming a country’s construction sector toward delivering increasingly energy-efficient buildings. It is important for developing countries to start with realistic goals and to be conscious about the compliance cost implications. A practical and mandatory BEEC will initiate a positive feeding loop of enforcement, supply of technologies and materials, development of compliance capacity, and expanded enforcement that is reinforced over time.

Successful implementation of BEECs is a multifaceted and resource-intensive process that can take many years to achieve. Government interventions and persistency are critical to making energy efficiency a pillar of building construction. Enforcement failures may be directly attributed to the lack of indigenous technical, institutional, and market capacities. But the fundamental issue often is the lack of necessary government support and commitment to enable the development of those capacities. Such political and organizational mobilization has to be country-driven and supported by champions at local, regional, and national levels.

The main challenge for middle-income developing countries is the political commitment to adopting and enforcing broad-based BEEC compliance. The incremental cost financing for compliance with their

BEECs can and should be largely borne by the building/home owners.

International assistance should be primarily targeted at strengthening the enforcement and compliance infrastructure.

Development and implementation of BEECs in low- and lower-middle-income countries should be selective and initially targeted at the market segment where economic benefits are great and enforcement is most likely to succeed. In many of these countries, government oversight of urban building construction is often hampered by an inefficient or inadequate construction permit system and a large informal construction sector.

International assistance will need to first focus on enabling the government to effectively manage the construction sector.

Greater attention should be given to development and implementation of appropriate BEECs in warm-climate developing countries. There is a large gap in the adoption of BEECs between cold-climate and warm-climate developing countries.

New approaches must be adopted to make carbon financing and other international clean technology financing mechanisms useful for mainstreaming BEECs in developing countries.

International experience shows that 20% or more energy savings can be achieved in buildings by using energy efficient building materials, energy efficient equipment, and passive design principles.

[2-3]

## 2.5 Codes in the region

Some of Cambodia’s neighbours have adopted energy efficiency codes, with Singapore being the strongest example (perhaps too complex for Cambodia’s purposes). In particular, codes from countries in the same climate zone, i.e. warm and humid, were chosen for study. Note that most of these codes go beyond energy efficiency to include “green” features such as water conservation and recycled materials.

*Table 1: Building energy codes in the region.*

Country	Year	Description
Indonesia	1992	voluntary
Thailand	1995	commercial, government
Viet Nam	2005	commercial
Philippines	2005	voluntary
India	2007	commercial
Malaysia	2008	energy management
Singapore	2008	residential, commercial

Adopting foreign energy codes can be difficult because they are linked to other codes such as general building codes, electrical, and mechanical codes. However, many of the general principles are helpful. Uniformity in codes throughout the region would be

# PLEA 2018 HONG KONG

*Smart and Healthy within the 2-degree Limit*

helpful to policy makers, builders, and building product manufacturers.

## **3. THE POLICY FOR CAMBODIA**

At the end of the project term, an energy efficiency policy was proposed to the Ministry of Industry Mines and Energy. The following is the portion addressing the building sector. It is divided into of four sectors: energy efficiency in new buildings, existing buildings, government buildings, and awareness through education.

### **3.1 New buildings**

Establish a building energy efficiency code (BEEC) for new buildings. A BEEC is widely regarded as the most effective way to reduce energy consumption in buildings. There is lower cost to improve the design of new buildings, before they are built. This avoids costly retrofits and makes buildings inherently energy efficient for their entire lifespan. Once construction begins, changes become more difficult and expensive. A BEEC specifies these energy efficient designs. Buildings can choose those which are most relevant for their projects. A stock of energy efficient buildings will be established in Cambodia over time.

A BEEC would include a checklist of energy saving building techniques, such as sun shading and building orientation. It is a subset of a general building code and applies to new buildings and major additions. Building developers are required to achieve a passing score for approval of a building permit the BEEC applies to all building types with air-conditioned floor area greater than 2,000 meters square, and connected to the public utility grid. Field inspection occurs during the issuing of a certificate of occupancy.

Stakeholders include the Institute of Standards, Construction Association, Board of Architects, and Ministry of Vocational Training. Completion of general building code, for which the Ministry of Land Management, Urban Planning and Construction (MOLMUP+C) has begun a draft, is a prerequisite of establishing a BEEC in Cambodia. Good cooperation between MOLMUP+C and MIME is established for the purpose of using data on existing buildings to update the energy efficiency building code. An EE building code is written in consultation with MOLMUP+C and a steering committee of building professionals. Training of field inspectors is established. The timeframe is medium to long term. Monitoring would include regular surveys by MIME under an Energy Manager Program (outlined below).

A short-term alternative for new buildings is energy efficiency building requirements are attached to large developments and luxury hotels which currently enjoy a tax holiday in Cambodia. Compliance with energy efficiency standards is made a prerequisite for tax reliefs

applicable to large developments and luxury hotels in Cambodia. The developer is encouraged to use energy efficiency standards from his home country if they are equivalent or better than those being developed in Cambodia. Requirements include cooperation with the Council for the Development of Cambodia (CDC). The implementing Agencies are MOLMUP+C and CDC. Stakeholders include foreign trade organizations, and the hotel association. Monitoring is accomplished by regular reporting to MIME.

### **3.2 Existing buildings**

An Energy Manager Certification program is established for existing buildings. The logic is that substantial improvement can be made to existing buildings without expensive changes to its infrastructure which most owners would not be willing or able to make. Energy efficiency of existing buildings can be improved in a cost effective manner by careful attention to the operation of the building. An onsite energy manager can monitor building equipment, such as air-conditioners and boilers, and manage the habits of building occupants e.g. turning off lights when not in use. Furthermore, the building energy manager can record and report energy data and energy saving strategies that are valuable for policy making.

An energy manager (or person responsible for energy) is designated on the staff of large buildings with energy use above a certain number of kWh/year

A document containing energy use data and proposals for reducing energy consumption is periodically prepared by the energy manager

Initial energy audits are encouraged to establish a baseline for energy saving strategies and measures.

Stakeholders include the Electricite du Cambodge (EDC), Hotel Association, ASEAN Center for Energy. The time frame for this measure is medium to long term. Monitoring is accomplished by the energy managers trained by MIME.

### **3.3 Public Buildings**

A green standard is applied to all new public buildings. Government can easily dictate a higher standard for its own buildings. Furthermore, the standard could address more than energy efficiency alone and generate good examples. It could include wider environmental concerns, such as building waste in landfills and water consumption. These standards have the advantage that they are already written, such as LOTUS in Viet Nam, and thus can be implemented relatively quickly. A model program is the United States' General Service Administration (GSA) which has made the Green Building Council's LEED green standard a requirement for all federal government buildings.

# PLEA 2018 HONG KONG

*Smart and Healthy within the 2-degree Limit*

## 3.4 Education and awareness

Education of professionals and the public is the best way to instill a long-term desire for energy efficiency and the knowledge to implement changes. Programs could include energy labelling of buildings, an Energy Efficiency Information Resource Center, and Energy in Buildings Research Laboratory, and classes and information for building professionals and the public.

An Energy labelling program for buildings involves rating buildings from 1 to 100 in energy efficiency. A label is attached to the building which informs buyers, renters and public. Further details about the building are available on a website. This is similar to the Energy Star program in the United States. It could include reporting to MIME which would help to establish an energy database. The public becomes informed so that they demand energy efficient buildings as clients.

A National Energy Information Center is established to promote energy efficiency in buildings. The Center is a division of MIME that is responsible for promoting energy efficiency awareness and information to building owners. It complements the Energy Manager Program by providing useful information to building managers.

A relatively easy action is to establish a portal on MIME's website offering technical manuals (e.g. the Guidelines on Energy Conservation for Commercial Buildings) and energy management information (e.g. Energy Management Handbook) in pdf format is created. A database of private service providers and products is included along with information on best practices for efficient buildings and factories.

MIME staff provides assistance with energy audits and lends equipment such as data loggers. An example of such a program is Efficiency Vermont (<http://www.encyvermont.com/>). This is a crosscutting measure that includes industry and consumer goods.

The expected result is that practical information on energy efficiency in buildings is made available to the public. MIME would take the initiative to establish the information center and gets financial support from government and international donors. The time frame is short to medium term.

Education of architecture students in energy efficiency is improved by introducing into the curriculum knowledge of energy efficiency in buildings as a core competency for architecture students. A pilot project consists of a two-term course on Environmental Control Systems co-taught by an outside expert and an existing faculty member in order to transfer knowledge to both faculty and students. Expected results are that students have the necessary background to be aware of and understand energy efficiency issues when in professional practice. Implementing Agency is the Ministry of Education, Youth and Sport (MOEYS) and the Royal University of Fine Arts (RUFA) or other universities.

Stakeholders include the Board of Architects, Cambodia Society of Architects, and MIME. Architecture students are provided the necessary fundamentals to understand energy efficiency issues when in professional practice. Professional architects have the training and information needed to improve energy efficiency in building designs.

Education of architects and planners in energy efficiency is enhanced through a certification course. IT addresses basic issues of energy efficiency in buildings and is taught by an expert in evening or weekend courses. Certificates are issued to improve the applicant's status in public tendering processes. Expected Results are that energy efficiency in buildings becomes common knowledge among architects and is increasingly applied in the construction of new buildings. Requirements include qualified trainers and adequate training programs are available and that architects are willing and motivated to participate in the training courses and certification process. The implementing agency is the Board of Architects of Cambodia. Stakeholders involved include MIME and Universities.

An Energy in Buildings Research Laboratory is established at a University. The Lab develops energy efficient building technology such as wall and roof construction, and daylight modelling. The research is specific to warm and humid climates. The lab advises MIME to improve policy and takes on projects for private building sector.

Study tours for architects and students to exemplary energy efficient buildings in the region are conducted. For example, a tour to Malaysia could be organized that includes the Diamond building, the Low Energy Office, and the Green Energy Office, all located in the Kuala Lumpur area. These buildings are well documented in terms of energy use and cost. Expected Results are that Cambodian officials and developers will see the practicality of energy efficient buildings. It fosters cooperation between neighboring energy ministries. MIME is the Implementing Agency in cooperation with the Board of Architects and universities. The time frame is short term.

## 4. CONCLUSION

There are many challenges to implement such policies. Not least of these is a lack of political will among many government officials which makes the effort somewhat like "pushing a wet noodle." However, there is a hopeful tradition of great, climate-sensitive modern architecture in Cambodia from the 1960s [5], namely New Khmer Architecture (see figure 2).

These policy ideas are now in the hands of MIME. They will decide which measures to pursue. They will need the help and encouragement of organizations in the international community. It will be a long and gradual process. Please contact the author at the above e-mail



# PLEA 2018 HONG KONG

*Smart and Healthy within the 2-degree Limit*

address if you have ideas or resources for assisting in this effort.

## ACKNOWLEDGEMENTS

The project was initiated by the Ministry of Industry, Mines and Energy of Cambodia (MIME). The European Union Energy Initiative Professional Dialogue Facility (euei pdf) provided funding and Integration Consulting Group management. The policy was written by a team of five experts who met in Cambodia over a period of eight months (2012-2013). The areas of expertise comprised energy efficiency in industry, consumer goods, biomass, rural electrification, and buildings. The organizer of our team was Andy Schroeder of Sunlabob Renewable Energy in Laos.



Figure 2: 'New Khmer Architecture' in Phnom Penh

## REFERENCES

1. Lechner, Norbert, Heating, Cooling, Lighting; Sustainable Methods for Architects (4th edition), Wiley, 2015.
2. Lui, Feng, A. Meyer, and J. Hogan. 2010. Mainstreaming Building Energy Efficiency Codes in Developing Countries: Global Experiences and Lessons from Early Adopters, World Bank Working Paper No. 204.
3. Schwarz, Virgine. 2010. Promoting Energy Efficiency in Buildings: Lessons Learned from International Experience, United Nations Development Programme.
4. Anonymous. 2009. Building Energy Codes: Best Practices Report for APEC Economies, Building Codes Assistance Project of the Alliance to Save Energy.
5. Helen Grant Ross & Darryl Leon Collins, Building Cambodia: 'New Khmer Architecture'1953-1970, The Key Publisher Company Limited, 2006.

## Developing a Sustainability Assessment Framework for Urban Developments in Hill Areas: A Case of New Tehri, Uttarakhand, India

HARSIMRAN KAUR<sup>1</sup>, PUSHPLATA GARG<sup>1</sup>

<sup>1</sup>Department of Architecture and Planning, Indian Institute of Technology, Roorkee, India

*ABSTRACT: The urban sustainability assessment is the key to evaluate environmental, social and economic issues at various levels. The objective of this paper is to develop the transportation connectivity index to assess the urban development in hill areas. Since transportation connectivity index cannot be developed in isolation to measure the sustainability in an integrated manner, this paper also devises a set of sustainability indicators to assess the overall impacts of urban development on Indian hill settlements. New Tehri Township in Uttarakhand is taken as a case study for the analysis, that was planned to resettle the residents of settlements affected by Tehri dam. Qualitative content analysis (QCA) method have been employed in the study to select the sustainability indicators for proposing a sustainability framework and performing spatial analysis using a GIS-based tool. Previous scholarly literature has shown that a set of indicators are very useful for developing qualitative and quantitative variables of urban environments. The analysis has shown that topography, the climate of the place, appropriate urban layout, transportation and connectivity, extent of open spaces and adequate solar exposure play a major role in promoting sustainable development and ensuring a better quality of life in a hill settlement. Also, a conceptual sustainability assessment framework provides an indexing model to the planners and designers to be used as a decision support tool in curbing the negative consequences of development in environmentally sensitive hill areas.*

*KEYWORDS: sustainable urban development, sustainability indicators, hill towns, spatial indexing, geographic information system (GIS)*

### 1. INTRODUCTION

Though the need for sustainability has been recognized as a primary goal of urban development since 1970's, inability of prevalent planning and design practices not only result in the high consumption of energy, waste production, high levels of pollution and urban heat island; but also add burden on existing infrastructure aggravating environmental problems, reflecting their inappropriateness without considering the geo-environmental context. Even the practices related to sustainable urban development focus primarily on generation and optimization of energy; waste and water management and their monitoring; and public transportation; whereas, other aspects affecting sustainability of urban development such as intensity of development, open spaces and their treatment, vegetation, land use patterns, and networks for bicycle and pedestrians – all related to site planning, design and development are not considered to the desired extent. Not only this, sustainable urban development is viewed at from different and narrow perspectives, depending upon the role played by the professionals and the agencies involved in the process of planning, design, and implementation of urban development.

Further, the impact and hence the significance, of these vary considerably in different contexts. For example, the climate and topographical location of an area play a major role in the assessment of urban

sustainability. Planning as well as monitoring of sustainable urban development requires not only understanding the-state-of-the-art urban planning and design practices adopted in cities considered to be sustainable, but also a comprehensive understanding of the tools and techniques for integrated assessment of the sustainability of urban development.

This paper aims to devise and assess a set of sustainability indicators for measuring the sustainable urban development, applicable to Indian hill settlements. The study is limited to test and develop the transportation connectivity index only. New Tehri Township in Uttarakhand is taken as a case study for the survey and analysis using GIS-based tools. GIS is the powerful software tool for geospatial data management and urban spatial analysis in the urban planning [1-2].

### 2. METHODOLOGY

The method used for the analysis of the urban sustainability is qualitative content analysis (QCA) of relevant documents, books, journal papers, websites relevant to the sustainable urban development and the manuals of six selected sustainability assessment tools such as CASBEE-UD, BREEAM Communities, GBI Township, LEED-ND, IGBC Green Townships and GRIHA-LD. For the QCA analysis, the data was coded in NVivo (version 12) under more general terms, including "dimensions", "categories", "criteria" and "indicators".

# PLEA 2018 HONG KONG

*Smart and Healthy within the 2-degree Limit*

The coding of the literature identified a significant set of categories with relevant criteria that correlates with the sustainable urban development.

Urban sustainability indicators used in the study were selected on the basis of relevance (relevant to the important aspects of sustainability), measurability, validity, representativeness (focus on key indicators), comparability (over time), accessibility, policy sensitiveness (that can be tested to frame policies) and predictability (to forecast the policy impact) [3-5].

## 2.1 Identification of spatial aspects of urban sustainability

Total 252 sustainability indicators have been compiled from the literature relevant to urban sustainability and sustainability assessment tools. The three main categories have been formulated from the literature: natural environment, built environment and transportation connectivity. These categories are then divided into relevant criteria. For each criteria, context specific and mostly used sustainability indicators are being added into the proposed structure, given in Table 1 [6-9].

Sustainable urban development is essential for protecting the natural environment as well as the well-being of people and the society at large. *Natural environment* includes the environmental sensitivity, microclimate, visual aesthetic perception as criteria. Topography, vegetation, drainage, water sources are the important indicators in determining the environment sensitivity of the hills. Microclimate is very crucial in the varying climates of hills, not only for the comfort and health point of views but also from sustainability aspect, where energy consciousness in planning and design is a prime consideration. Exposure to the sun is the most important parameter for site selection of new development in hilly areas. The development should be such that the buildings and open spaces should have maximum solar exposure and minimum wind exposure. The appearance of hill towns and compatibility of built forms to the landscape character is one of the key concerns of hill towns. The parameters include the visual prominence of the site by its topographic location, visibility of site from important tourist/public areas and main roads in terms of their slope gradient [10].

Table 1: list of categories as well as their respective indicators and units.

Category	Criteria	Indicator
Natural environment	Environmental sensitivity	Topography
		Vegetation
		Drainage

Microclimate	Water sources	
	Solar access	
	Exposure to winds	
	Rainfall and humidity	
	Heat island effect	
Visual aesthetic perception	Visual prominence of site	
	Visibility of site from important tourist/public areas/roads	
	Soil/rock and vegetation contrast	
Built environment	Availability of view, vistas	
	Land use and density	Land size (ha)
		Population density (ppha)
		Mixed Land use (Index value)
		Housing and jobs proximity (%)
	Urban form	Internal street connectivity (Index value)
		Traffic calming (%)
		Non-motorised Transport (%)
		Open space (%)
		Transportation connectivity
Access to public transport (%)		
Proximity to school (%)		
Proximity to Recreational Spaces (%)		
Proximity to Local services (%)		

The concepts of sustainable neighbourhood design are primarily based on walkability, pedestrian friendliness, mixed land use, appropriate densities and compact development [11]. Mixed land use and density play a significant role in the *built environment* and affects the environmental and social sustainability. Mixed uses include food retail, financial, administration, welfare, medical, educational and cultural. The internal street system is the important parameter of the built environment that promote walking and discourage the use of private vehicles within the neighbourhoods of town. Open space comprised of parks and the other related recreational spaces for the inhabitants of the neighbourhood unit. Variations in the optimum distances to various services and community facilities are related to the accessibility and availability of mixed land uses and the methods used for counting them.

Proximity to various community facilities (such as schools, hospitals, markets, recreational areas, etc.),

# PLEA 2018 HONG KONG

*Smart and Healthy within the 2-degree Limit*

work centers, town centers and its accessibility in terms of pedestrian paths, vehicular roads are the most important factors determining the sustainability of the development. The walking distance of community facilities from dwelling units varies in different sustainability tools. According to the studies done in the US on walkable neighbourhood and cities specify that “the walking distance to the destination should be a quarter of a mile” which is equivalent to 400m or 15minute [12]. LEED-ND and IGBC Green Townships also consider 400m as a comfortable walking distance within the sector with the provision of basic amenities as well as transit stops [14-15]. Though the walking distances in CASBEE-UD and BREEAM Communities vary for different facilities with 300m and 500m respectively [16-17].

### 3. ANALYSIS OF NEW TEHRI TOWN

The new hill township of Tehri is taken as a case study as it is the only planned town of Uttarakhand with a 24,014 population as per census 2011 completed in 1993 [18]. It was developed to accommodate the people of the old town, who were displaced from the construction site of the Tehri dam on the river Bhagirathi. This township has also been awarded Prime Minister's national award for excellence in planning and design in hills in 2000. It is located at 30° 22' N, 78° 26' E in the middle lands of Lesser Garhwal Himalayan belt on a ridge at a height of 1750m above mean sea level. Town has warm and temperate climate, varies from minimum of 11°C to a maximum of 19.7°C.



Figure 1: a) Location and b) Site View showing low-rise development in Tehri Township, Uttarakhand, India.

The mountain hamlet of Baurari was chosen as the site for the development of a new town shown in Figure 1 (a & b). It offered the planners 200 acres (80 ha) of the naturally terraced eastern and south-east slopes of the ridge, valleys and dome-shaped formations cascading down to a large flat terrace. Planning for the new town entailed the integration of several diverse and sensitive issues like: a high sense of responsiveness to people's need; respect for the holding capacity and natural systems of the land; sustainability of the environment; and equal opportunities for all [19].

The town is divided into thirteen wards with various functions being planned at different levels. Central administrative and community functions are on the lower terraces, relatively flat areas; plotted and other

kinds of residential development are on the middle terraces; while educational and institutional functions have been organized on the higher terraces, away from the residential clusters with reserved forest area on the north and north-west terraces (refer Fig. 2).

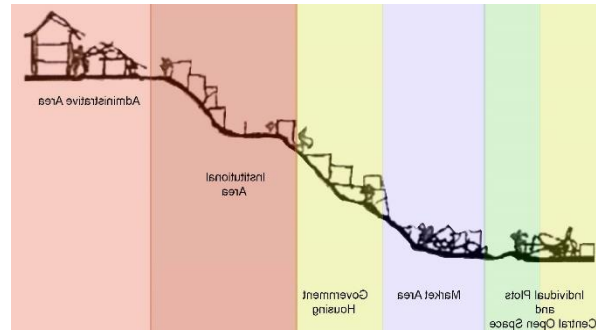

Figure 2: Land Use Pattern at different terraces.

The residential development has taken primarily on the east, south and /or south-eastern slopes to maximize penetration of sunlight and offer protection from cold winds. The entire township has been perceived as a series of cascading clusters of buildings linked by roads, pedestrian paths and open spaces.

A circular system of the road network and pedestrian linkages (pathways, steps and ramps) were established to provide access for each parcel of developable land. As far as possible, roads have been planned along the natural contours to reduce construction cost and the adverse environmental impact caused by excessive cutting of slope that can lead to landslides and soil erosion. The pedestrian system has been designed as an integral part of the new community. Primary paths have been planned at strategic locations to connect important activity nodes. These linear spaces traverse through activity areas, such as local shops, religious complexes, and play areas. Footpaths have also been designed as a part of all the vehicular roads. These provide direct access to individual plots or residences where it has not been possible to create direct or individual vehicular access.

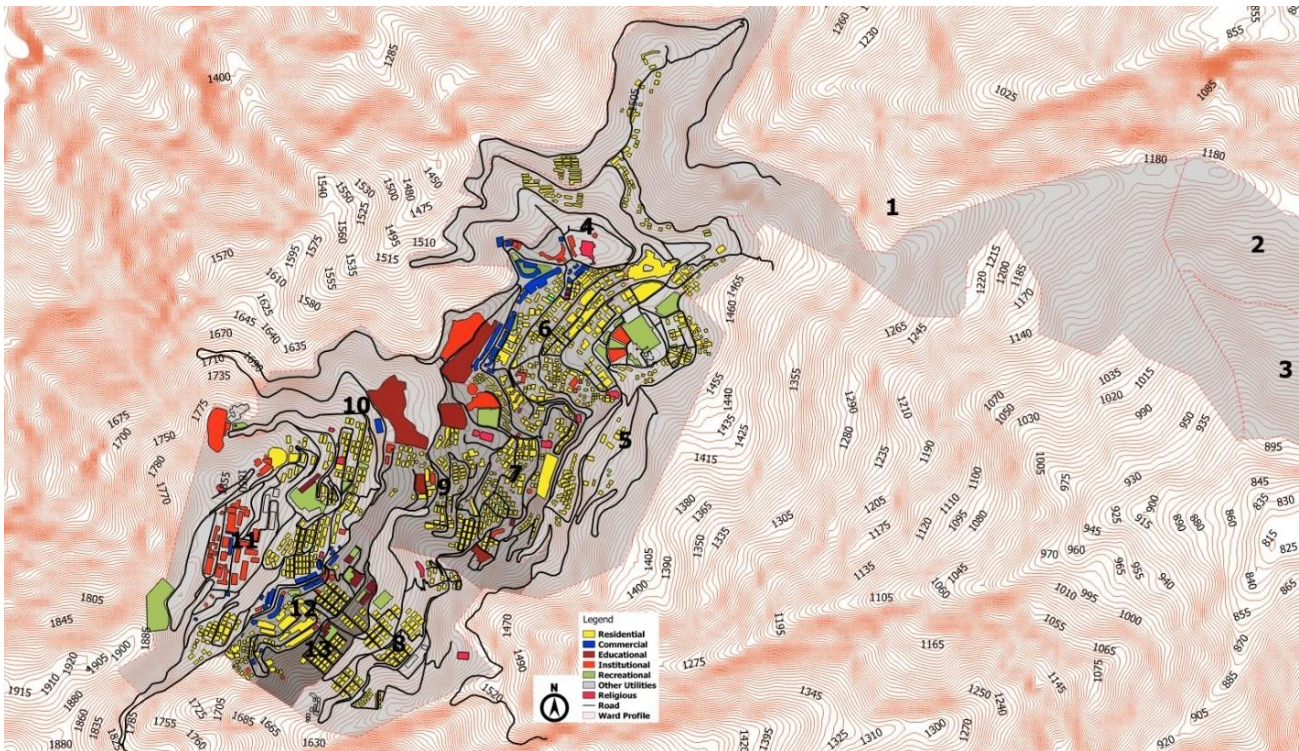

Figure 3: Tehri Town, Uttarakhand, India.

### 3.1 Assessment of Neighbourhood in New Tehri Town (Uttarakhand, India)

Neighbourhoods in new Tehri town was assessed based on indicators grouped in three categories with six criteria, which evaluate the environmental sensitivity, micro-climate, visual and aesthetic perception, land use and urban form and transportation connectivity.

All the thirteen wards have been considered within the study area for spatial analysis of the devised indicators to evaluate the overall sustainability of the development of the town. In this paper, the only transportation accessibility to community facilities composite index has been developed for analysis of New Tehri town using GIS. It is developed by adding the scores of each indicator together as follows in Equation (1):

$$CTCI = \sum PTI + PSI + PRSI + PLSI \quad (1)$$

where *CTCI* - composite transportation connectivity index;

- PTI* - public transport indicator;
- PSI* - proximity to school indicator;
- PRI* - proximity to recreational spaces indicator;
- and
- PLSI* - proximity to local services indicator.

For preparing a composite index map, each indicator map, indicator sets map, and indicator categories map were prepared using various data sources collected from New Tehri's Rehab. Division (master plan), District Economics and Statistical Office Tehri Garhwal (population data), Municipal Corporation Board, New

Tehri (ward map) and further updated using the geo-referencing plugin in GIS mapping on with google map to be embedded in the GIS software and then analysed in GIS by applying near distance feature on ArcMap. Fig. 4 shows the composite indexing model prepared in the GIS based tool [20].

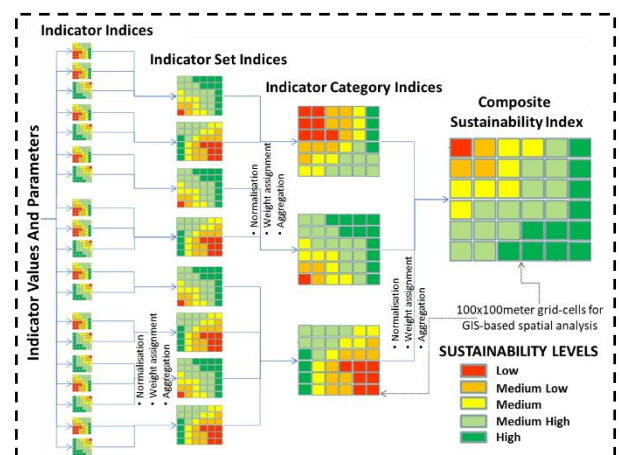

Figure 4: Basic composite sustainability indexing structure. Source: Yigitcanlar and Dur (2010, p. 332).

The entire data is converted to 10X10m lattice grid by using GIS tools for the analysis of the study area. Each indicator is classified into five-point scale by assigning Likert scale values for each indicator between the value of 0 and 5 as follows:

- Low (0.0 – 1.0): extremely low level of sustainability,

# PLEA 2018 HONG KONG

*Smart and Healthy within the 2-degree Limit*

- Medium-low (1.0 – 2.0): representing to not suitable-but not as severe as low level,
- Medium (2.0 – 3.0): discrete level of sustainability,
- Medium-high (3.0 – 4.0): satisfactory level, and
- High (4.0 – 5.0): extremely high sustainability level.

## 4. RESULTS

This section presents the results of sustainability assessment of New Tehri town based on the accessibility aspects of public transport and proximity to various community facilities by taking different wards (1 to 13) for the purpose of analysis. The below listed steps have been followed to assess the urban sustainability of town:

- measuring the urban sustainability performance with a set of sustainability indicators
- Aggregation of all the sustainability indicators to form a composite index

Once the data collection and indicator analyses was done, each indicator was assigned a value ranging from high to low level on a Likert scale.

The findings suggest that ward 13 has the highest density of 290.83 persons per hectare (ppha). ward 6, ward 7, ward 9 and ward 12 have densities between 100 to 145 ppha. ward 3, ward 4, ward 5, ward 8 and ward 11 have a population density of around 45 to 75 ppha, thereby falling under the acceptable range of densities in URDPFI guidelines, 2014, applicable for hill towns in India [21]. Rest ward 1 and ward 2 have the lowest densities with 10 to 20 ppha (refer Fig. 4a). A higher density reflects better sustainability in terms of efficient use of infrastructure, housing affordability, reducing car dependency, improving social interaction and enhancing walking and cycling [22]. But in this case, ward 13 does not have any other land use except residential land use. In terms of sustainability, ward 3, ward 4, ward 8 and ward 11 are performing better with the availability of mix land-use except for ward 5 which does not have accessibility to public transport and local services within the walkable distances.

In Fig. 4 (b,c & d), it is clearly visible that the areas near to public transport stops, community facilities and local services are awarded high value. For instance, ward 6, ward 8, ward 10 to ward 13 have public transport stops and commercial shops given high value, but the areas located in the ward 1 to ward 5, ward 7, ward 9 have low transport index values due to very less or non-availability of services such as public transport stops, local shops, recreational spaces, schools and so on.

In the composite index for transport category (refer to Fig. 5), it can be seen that great part of the area is performing better in terms of transportation accessibility to various community facilities such as school, recreation areas, local services and availability of public transport. Other performance values can also be seen in the study

area, ranging from medium-high to low. This analysis shows that the study area is achieving an average level of sustainability. The areas located at the upper and lower terraces of the hill have the highest values as compared to the middle terraces with dominating residential areas only.

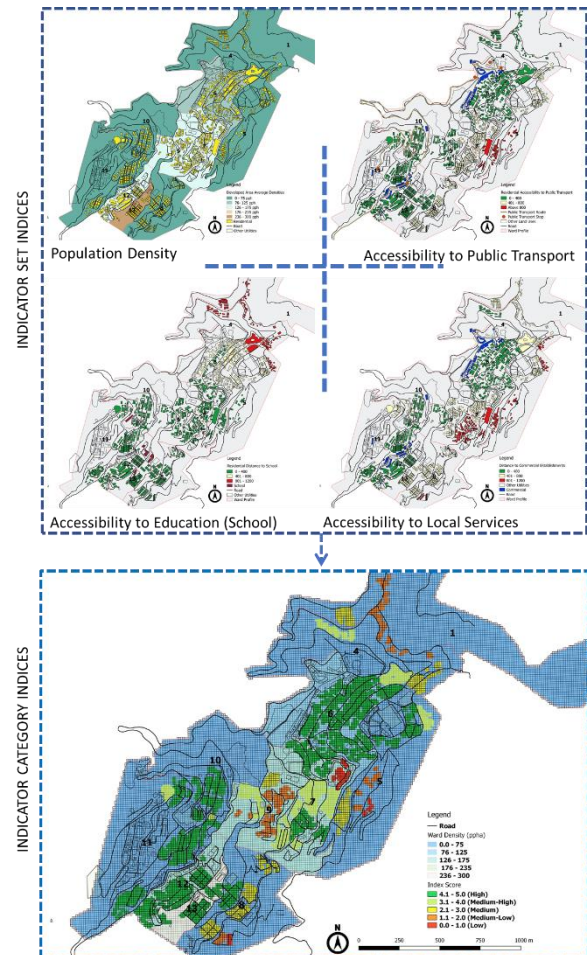

Figure 5: Composite index for transport category

It is also observed that topography, the climate of the place, appropriate urban layout, transportation and connectivity, extent of open spaces and adequate solar exposure play a major role in promoting sustainable development and ensuring a better quality of life in a hill settlement. Certain aspects are frequently neglected in policy guidelines and buildings/site regulations that results in unsustainable urban development in hill towns.

## 5. CONCLUSION

The study is employed on New Tehri Town to understand the interrelationship between the spatial and measurable indicators of urban sustainability, mainly focussed on the parameters of land use, density and accessibility. It is found that the areas with better accessibility and mixed land use proportions are performing better at sustainability levels than the areas with only one or two land use.

# PLEA 2018 HONG KONG

*Smart and Healthy within the 2-degree Limit*

The study was limited to develop the transportation connectivity index only. The area with different performance values in terms of connectivity might bring out different results if linked with the other natural and built environment categories. Therefore, a conceptual urban sustainability assessment framework and the indicators found in this study can be further used to develop a sustainability composite index for hill settlements using GIS based tool. The framework will assist planners and designers in reduce the negative consequences of urban planning and development by providing a spatial indexing model to formulate locally adoptable sustainability policies.

## ACKNOWLEDGEMENTS

The authors would like to thank Public Works Department, Infrastructure Rehab. Division, New Tehri and Municipal Corporation Office, Barari, Uttarakhand for providing access to maps and related information about the New Tehri Township. The authors also thank department of architecture and planning for providing infrastructural support and MHRD for financial assistance.

## REFERENCES

1. Benenson, I. and Torrens, P.M., (2004). *Geosimulation: Automata-Based Modeling of Urban Phenomena*. John Wiley and Sons Ltd, Chichester.
2. Paez, A. and Scott, D., (2004). *Spatial Statistics for Urban Analysis: A Review of Techniques with Examples*. *Geo Journal*, 61: p. 53-67.
3. Dur F., Yigitcanlar T. and Bunker J. (2011). "Measuring neighbourhood sustainability performance: An indexing model for Gold Coast City, Australia,". In: *19th International Conference on Geoinformatics*, Shanghai. p. 1-6.
4. Fowler K.M. and Rauch E.M., (2006). "Sustainable building rating systems—summary." (The Pacific Northwest National Laboratory) operated for the U.S. Department of Energy by Battelle, PNNL-15858.
5. Lautso K., Spiekermann K., and Wegener M. "Modelling policies for urban sustainability," unpublished.
6. Cervero R., and Kockelman K., (1997). "Travel demand and the 3Ds: density, diversity, and design," *Transportation Research Part D: Transport and Environment*, vol. 2(3), p. 199-219.
7. Handy S., Cao X., Buehler T. J., and Mokhtarian P., (2005). "The link between the built environment and travel behavior: correlation or causality," *Presented at 2005 Annual Transportation Research Board Meeting*, on TRB CD-ROM.
8. Litman T., (2007). "Developing indicators for comprehensive and sustainable transport planning," *Journal of the Transportation Research Board*, vol. 2017, pp. 10-15.
9. Newton P., Flood J., Berry M., Bhatia K., and Brown S., (1998). "Environmental indicators for national state of the environment reporting-human settlements," <http://www.environment.gov.au/soe/publications/indicators/pubs/settlements.pdf>.
10. Pushplata, (2000). *Urban Design Matrix for Hill Towns*, PhD thesis, Department of Architecture and Planning, Indian Institute of Technology Roorkee, India, unpublished.
11. CHARTER OF THE NEW URBANISM, (2018). *Livable New York Resource Manual*. [online] Available at: <https://aging.ny.gov/LivableNY/ResourceManual/PlanningZoningAndDevelopment/II1f.pdf> [Accessed 1 May 2018].
12. Duncan D. T., Aldstadt J., Whalen J., Melly S. J. and Gortmaker S. L., (2011). Validation of Walk Score® for Estimating Neighborhood Walkability: An Analysis of Four US Metropolitan Areas. *International Journal of Environmental Research and Public Health*, vol. 8, no. 11, p. 4160-4179.
13. Congress for the New Urbanism, Natural Resources Defense Council, the US Green Building Council, (2011).
14. *LEED 2009 for Neighborhood Development Rating System*. revision of 2011 ed. Washington DC: US Green Building Council.
15. Indian Green Building Council, (2010). *IGBC Green Townships Rating System - Abridged Reference Guide*. Pilot Version ed. Hyderabad: IGBC, Confederation of Indian Industry.
16. CASBEE, (2014). CASBEE for urban development. *Comprehensive Assessment System for Building Environmental Efficiency*. Technical Manual 2014 Edition.
17. BREEAM Communities, (2012). *SD202 Technical Manual*. [www.breeam.org](http://www.breeam.org)
18. Tehri City Population Census—Uttarakhand, (2011) [Online].
19. DKS, (2000). New Tehri Town, Baurari, UP. *Spatio-Economic Development record*, 7(2): p. 11-14.
20. Yigitcanlar, T. and Dur, F. (2010). Developing a Sustainability Assessment Model: The Sustainable Infrastructure, Land-Use, Environment and Transport Model. *Sustainability*, 2(1), p.321-340.
21. URDPFI guidelines, Draft Report Version1, (2014). *Urban Regional Development Plans Formulation and Implementation Guidelines – Volume 1*. 1st ed. [ebook]. New Delhi: Government of India, Ministry of Urban Development. Available at: [http://www.mpurban.gov.in/Pdf/URDPFIGuidelinesVol\\_IDraft\\_1.pdf](http://www.mpurban.gov.in/Pdf/URDPFIGuidelinesVol_IDraft_1.pdf).
22. Kamruzzaman M., Washington S., Baker D. and B., (2014). "Built environment impacts on walking for transport in Brisbane, Australia," *Transportation*, vol. 43, no. 1, p. 53-77.

## Free Running Office in Mexico City: Office Refurbishment Case Study.

DANIEL IBARRA FLORES<sup>1</sup>, PAULA CADIMA<sup>1</sup>

<sup>1</sup>The Architectural Association School of Architecture, London, UK

**ABSTRACT:** *This study challenges the misperception that natural ventilation cannot be used as a passive cooling means in Mexico City due to the air pollution and demonstrates that free running conditions can indeed be achieved by passive design strategies. These were tested in a refurbishment project of a brutalist office building in the city, where the high thermal mass of the building was exposed, while natural and night ventilation as well as exterior solar control were implemented as the most relevant passive strategies. As thermal comfort and ventilation was achieved by passive means, electric energy used for this purpose was reduced up to 98% dispensing the need for an HVAC system; in addition, after enhancing daylight, installing LED lighting, and substituting inefficient appliances the total electric energy consumption dropped up to 46%, from 114KWh/m<sup>2</sup> to 61KWh/m<sup>2</sup>. Finally, the relationship between indoor air quality, human comfort, and passive strategies was investigated, correlating the outdoor air quality with the climate. The study revealed that it's possible to integrate natural ventilation strategies without compromising the interior air quality if the diurnal Ozone trend is followed and enabled between 8pm and 11am when the air quality tends to be classified as "Good".*

**KEYWORDS:** *Passive Design, refurbishment, natural ventilation, air pollution, free-running office*

### 1. INTRODUCTION

Mexico City Metropolitan Area (MCMA), one of the world's megacities, with an estimated 20 million inhabitants, is one of the most dynamic regions in Mexico, concentrating industrial, commercial, cultural and social activities.

Despite the temperate climate that prevails in the city, office buildings have been relying on mechanical cooling devices to achieve thermal comfort and ventilation. The common perception is that interior air quality can be compromised if natural ventilation is implemented due to air quality issues, even though Ozone levels have been reported to be dropping since the 90's [2].

This paper looks into Mexico City climate and the daily distribution of the Ozone (O<sub>3</sub>) concentration levels and explores the potential of passive cooling strategies. Night ventilation, solar control and high thermal mass, were investigated in order to achieve thermal comfort while challenging the need for electric energy consumption for cooling and lighting without compromising the interior air quality. The paper reports on a case study of a recently refurbished office in Mexico City carried out during a research aiming at developing a design project in Mexico [1]. It was estimated that around 30% of the annual electric energy is needed for cooling and lighting purposes.

The case study, which involved fieldwork and analytic studies, demonstrated that thermal comfort in office buildings can be achieved in Mexico City without mechanical cooling and without compromising the

interior air quality, if appropriate passive design strategies and ventilation schedule are implemented.

### 2. CASE OF STUDY

The refurbishment of an office in a brutalist building in Mexico City (Canoa 521, Fig. 1), the design project of which was developed by the author (2012-13), was studied to assess the impact of the passive design strategies implemented to improve the working environment and the energy performance of the existing space.



Figure 1: Canoa 521 building, Mexico City. On the right the concrete structure building which was analysed.

#### 2.1 Refurbishment Design Intentions

The concrete structure of the brutalist building where the office is located was originally designed as an



# PLEA 2018 HONG KONG

## Smart and Healthy within the 2-degree Limit

enclosed and controlled environment with a central ventilation and cooling system as shown in Fig. 2.

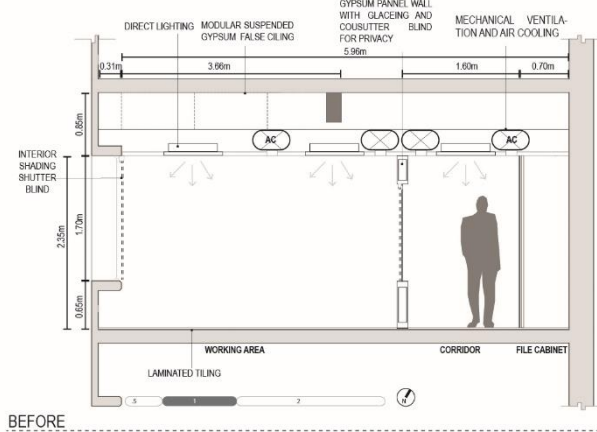

Figure 2: Typical section of studied floor - general construction details before the refurbishment.

The refurbishment scheme included passive design strategies and adaptive opportunities for the occupants, (Fig. 3).



Figure 3: Photograph taken from the corridor of the analysed layout after the refurbishment - general construction details, passive strategies and design intentions are shown.

Operable windows were installed enabling natural ventilation, the slabs were uncovered to increase the height, volume and expose the thermal mass. Ceilings were painted white and mid-high glazed internal partitions were included in the working areas and circulations to improve daylighting. Visual and thermal comfort was expected to be achieved with considerable reduction of artificial lighting and no mechanical ventilation, (Fig. 4).

As the maximum distance from windows located at the perimeter towards the central core is 6 meters, the potential to achieve good daylight was estimated, the strategy to potentialize it apart from what is described above and shown on Fig. 3, consisted in using glazed walls as partition elements in combination to mid high walls perpendicular to the window. All the storage area and circulations were placed close to the central core to locate the working area near the daylight source as shown on the image in Fig. 5.

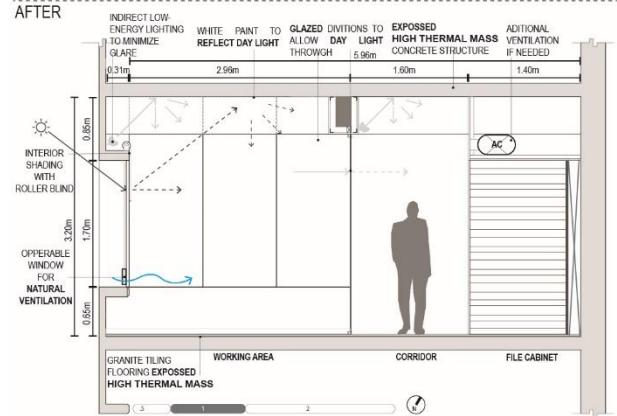

Figure 4: Typical section of studied floor - general construction details and passive strategies and design intentions after refurbishment (existing scenario). The section can be contrasted with the previous scenario show on figure 2.



Figure 5: Photograph of the typical private or working station showing the placement near the window to enable daylight and views. The mid high walls and the glazed internal partitions are shown.

## 2.2 Climate and Air Quality in Mexico City

Ozone is the main trigger of the atmospheric environmental contingencies in Mexico City [2]; the concentration in the air (O<sub>3</sub>) distribution tends to be higher during day time when solar radiation is present and the air temperature increases. It is lower when relative humidity is higher, usually at night and during the rainy season. It reaches its maximum level during the hot and dry season when cooling is most needed [3], (Fig. 6).

Despite the average trend remains in a "good" air quality range [3], the data shown on Fig.6 helps to understand the common belief that natural ventilation is not a reliable passive strategy to ventilate or dissipate heat in office buildings in the city.

# PLEA 2018 HONG KONG

Smart and Healthy within the 2-degree Limit

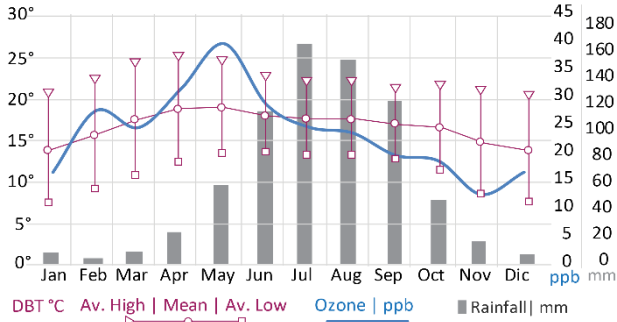

Figure 6: Monthly average Ozone concentration "ppb" (right axis), Dry Bulb Temperature DBT °C" (left axis) and Rainfall "mm" (extreme right). Sources: Meteonorm and [3].

However, if the O3 annual trend is taken into account in a 24-hour chart (Fig.7), data shows that the highest levels of O3 occur between noon and 7pm, with peaks at 4pm. The lowest levels take place in the morning period, just before sunrise. This coincides with a similar trend for the air DBT hourly fluctuation. As shown in Fig. 7, natural ventilation for cooling and fresh air can therefore be achieved between 8pm and 11am, when the air quality tends to be "Good" and the DBT tends to be lower than the comfort band (20-25°C), while also taking advantage of the high diurnal temperature variation (11.4K year average) for convective cooling of the thermal mass present on the building structure.

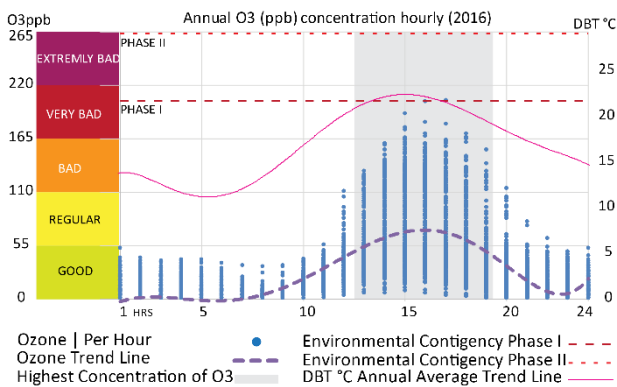

Figure 7: Annual Ozone (ppb) levels concentration in 2016, during 24-hour period analysis.

## 2.3 Post-Occupational Survey & Monitoring

The post-occupational survey revealed that visual comfort and daylight were perceived as satisfactory, though 65% of the interviewees expressed some level of thermal dissatisfaction during spring (hottest season).

Air temperature measurements were undertaken in the open plan private office on the 6th floor during a 20 days free running period (01-18/08/2017), (Fig.8). The DBT data collected and the electric energy consumption and information on the occupational patterns shared by the office administration were used to develop a calibrated thermal model (OpenStudio + Energy Plus, software) to be used for analytic studies.



Figure 8: Existing layout of the 6th floor (after refurbishment), showing placement of dataloggers to record air DBT.

Fig. 9 shows the data recorded during the second week. In both spaces DBT remained in comfort, despite the outdoor fluctuation, while the O3 ppb trend reached "Regular" conditions at noon during working hours on Monday, Tuesday and Friday, maintaining "Good" conditions during mornings and at night time on Wednesday and Thursday. This indicates that natural ventilation strategy can follow what was suggested on section 2.2, as it matches what was analysed for sunny or partially sunny days, with solar radiation influencing DBT and O3 levels, tending to be higher than cloudy or rainy days.

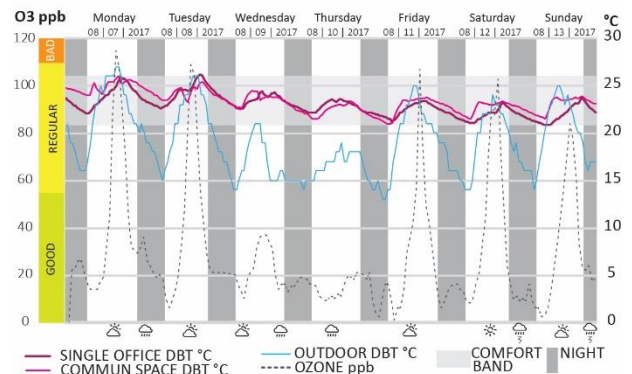

Figure 9: Air temperature data gathered at the 6th floor during one week (07/08/2017 to 13/08/2017), showing the interior DBT in relation to the outdoor DBT and the O3ppb levels. The chart also shows graphic representation of the relevant meteorological events.

# PLEA 2018 HONG KONG

## Smart and Healthy within the 2-degree Limit

### 3. ANALYTIC STUDIES

Thermal simulations were carried out to assess the impact of specific passive strategies on comfort and estimate the energy consumption. The following scenarios were tested (Fig. 10):

- A - Base Case (before refurbishment)
- B - Existing scenario (data gathered)
- C - Night ventilation (convective cooling of thermal mass)
- D - Solar Control (exterior shading devices).

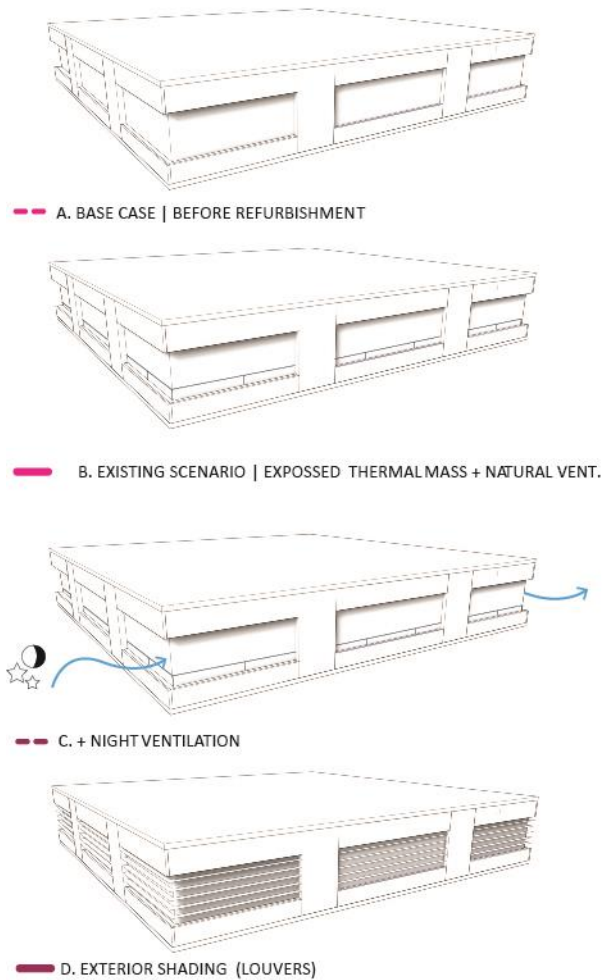

Figure 10. Perspective illustrating scenarios A to D as described in text.

Fig. 11 shows the thermal performance for a typical hot and cold week. Results support that thermal comfort can be achieved for most of the working hours when applying the passive design strategies described above (D scenario). DBT drops up to 6K on the cooler week and up to 7K on the hottest one.

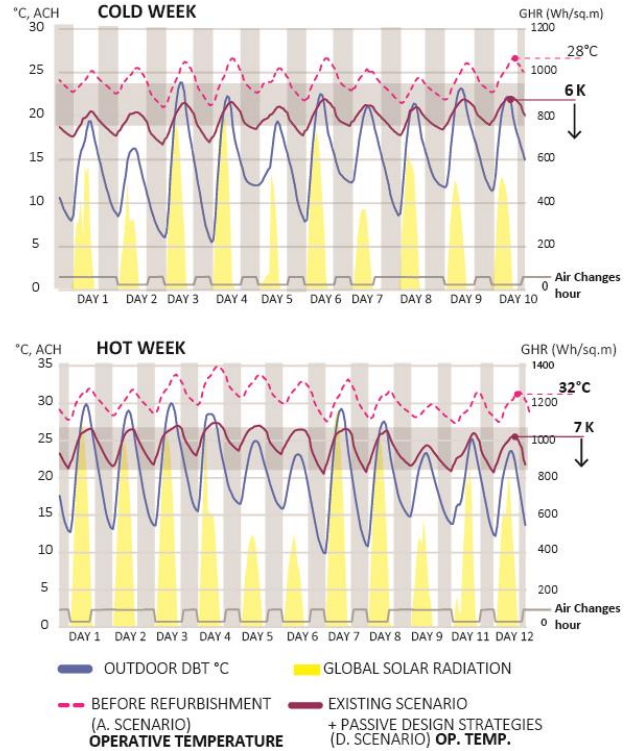

Figure 11. Comparison of thermal performance between scenario A (before the refurbishment) and D (after passive design strategies) under free running conditions for a typical hot and cold week. (After OpenStudio and Energy Plus)

Fig. 12 shows that after the refurbishment the energy consumption was reduced by approximately 42%. The percentage of electric energy used for cooling was reduced from 28% to 8%, and a greater reduction was estimated with adding night ventilation and solar control (scenarios C and D, respectively).

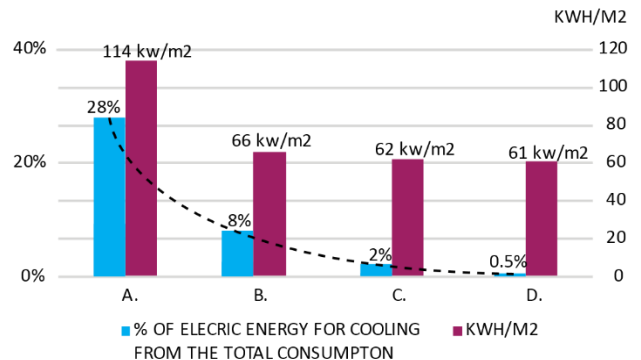

Figure 12. Annual electric energy consumption and cooling percentage for the various scenarios described above. The percentage of electric energy for cooling from the total consumption dropped up to 98% (scenario D.) - the total electric energy consumption was reduced up to 46% (Scenario D.). (After OpenStudio and Energy Plus)

External solar control was estimated to be an effective passive design strategy reducing direct solar radiation on the slab by 54% (shading the thermal mass) and improving 10% the average Useful Daylight

# PLEA 2018 HONG KONG

Smart and Healthy within the 2-degree Limit

Illuminance (UDI). This was probably due to glare being reduced on the perimeter areas close to the windows (Fig. 13), eliminating the need for blinds and therefore allowing unobstructed views at all time. It had little impact however on the cooling loads due to the geometry of the building and the window to wall ratio. Therefore, night ventilation (scenario C) appears to be the best option, should costs be a constraint. This scenario was further analysed.

Fig. 14 shows that in a cooler month there may be some occupied hours below comfort during the morning and above comfort during the afternoon in a warmer month, when natural ventilation is restricted (between 11am and 8 pm) due to potential lack of good air quality and mechanical ventilation for fresh air is implemented.

While this may be seen as a small improvement, if aiming for free running conditions, additional adaptive opportunities can be implemented in order to achieve thermal comfort. These are described in Table 1. thermal sensation could be increased by up to 2K in the cooler period and decreased by up to 8K for the warmer period [4], suggesting that comfort could be achieved with such adaptive changes (Fig. 14).

Table 1. Comfort temperature increase / decrease on standard comfort zone after adaptive opportunities. [4]

Adaptive Opportunity	Increase / Decrease of Standard Comfort Zone (Kelvin)
<b>Personal</b>	
1 Free dress code	
1.0 – 0.3 Clo	+ 2.5
1.0 – 1.2 Clo	- 1.5
2 Non - upholstered chair	+ 0.5
3 Access to cold/hot drinks	+ 0.75 ( - 0.5)
4 Metabolic rate and posture	+ 1.0 ( - 0.5)
<b>Building</b>	
5 Desk fan or ceiling fan	+ 2.5
6 Openable window	+ 1.5
7 Operable blinds	+ 1.0
8 Spatial variation	+ 1.25

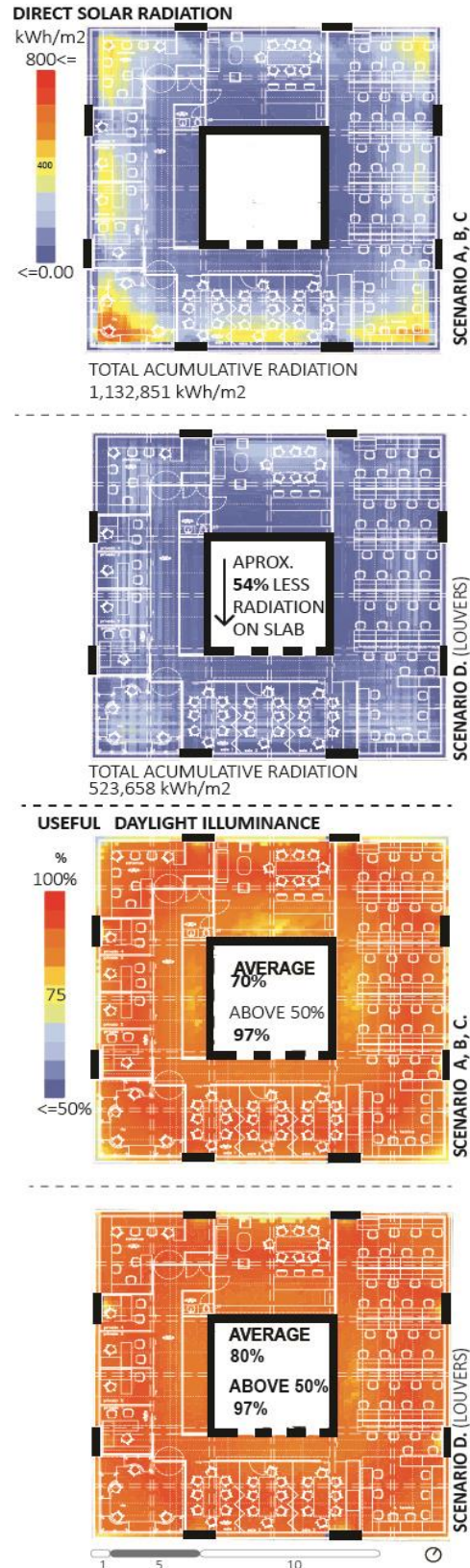

Figure 13. Comparative diagrams of 6<sup>th</sup> floor showing the effects of external solar control "louvers" on the transmitted direct solar radiation hitting the slab (thermal mass), upper diagrams, and on the UDI, lower diagrams. (after grasshopper, ladybug and radiance)

# PLEA 2018 HONG KONG

*Smart and Healthy within the 2-degree Limit*

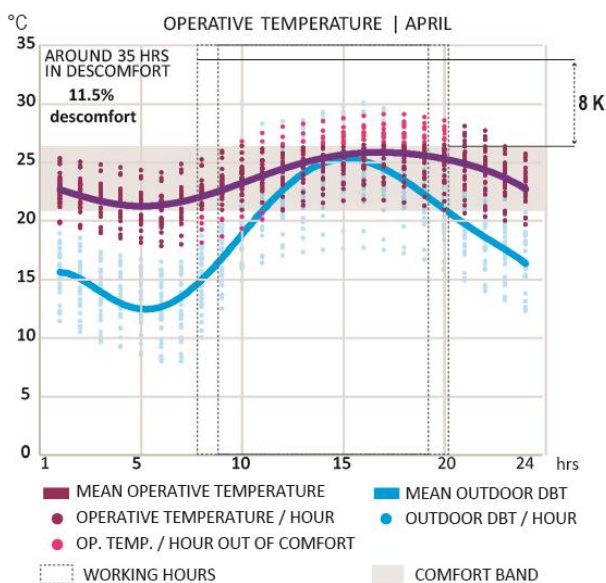
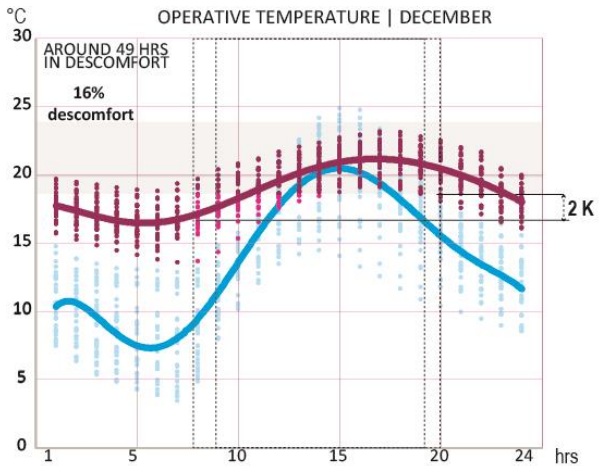

Figure 14. Monthly indoor operative temperature and outdoor DBT during 24-hour period for December (cooler month) and April (warmer month) and comfort hours with potential comfort band extension with adaptive opportunities.

As the interior operative temperature does not exceed the upper comfort limit by more than 3K nor does it drop by less than 2K from the lower limit, implementing adaptive opportunities, such as the free dress code and enabling occupants with access to hot or cold drinks, comfort can be reached during most of the working hours.

## 4. CONCLUSION

The study challenged the wrong perception that natural ventilation in Mexico City is unhealthy and demonstrated that thermal comfort can be achieved in free running mode for most of the year in office buildings in Mexico City during the occupied hours by passive means without compromising interior air quality if appropriate ventilation strategies are in place.

This research demonstrated that the integration of passive design strategies in the refurbishment of

buildings with concrete structures, such as night ventilation, solar control and the use of thermal mass, in combination with adaptive opportunities, can reduce the energy consumption and improve the working environment.

A further post-occupational analysis should take place after implementing the passive strategies as suggested to validate the potential found after the simulations; feedback on the users and the practicality of the implementation would be useful for tuning the proposed strategies and improve future proposals.

## ACKNOWLEDGMENTS

I would like to thank the SENER and the CONACYT for granting me the sponsorship that enabled me to develop most of the research here presented.

Also, everyone at Murguía Consultores and O’Gorman&Hagerman, particularly to Juan Pablo Murguía, Juan O’Gorman and Jose Carlos Serrano for facilitating me to conduct the post-occupational analysis and for trusting me with the refurbishment project and construction of their office on which this research is based on.

Finally, all the tutors at the Architectural Association School particularly to Paula Cadima and Simos Yannas as they were my mentors during the master’s degree during which the research was done.

## REFERENCES

1. Ibarra, D. (2018), *Passive Design for Multiple-Use Buildings in Mexico Hot and Dry Climate*, MArch Dissertation, Architectural Association School of Architecture, London.
2. Molina, L. (2009). Air quality, weather and climate in Mexico City. *WMO*, [online] (Bulletin 58), pp.49-51. Available at: <https://public.wmo.int/en/bulletin/air-quality-weather-and-climate-mexico-city> [Accessed 9 Apr. 2017].
3. Aire.df.gob.mx. (2017) *Dirección de Monitoreo Atmosférico*. [online] Available at: <http://www.aire.df.gob.mx> [Accessed 20 Apr. 2017].
4. Baker, N. (2015). Environmental Comfort. Lecture delivered to SED MSc & MArch Sustainable Environmental Design, Architectural Association School of Architecture, 18 Oct. 2016.

## Sustainable Architecture and Social Engagement for Flooding and Drought Resilience

PEPE PUCHOL-SALORT<sup>1</sup>, ROSA SCHIANO-PHAN<sup>2</sup>

<sup>1</sup>Puchol Architects, United Kingdom & Spain

<sup>2</sup>University of Westminster, London, UK

*ABSTRACT: Climate change is disrupting our planet's natural cycles and the steep socio-economic growth together with rapid urbanisation are increasing the uncertainty of its effects. During the last decades, frequency and impact of flash floods and droughts in Mediterranean and Middle-East regions has substantially increased and will continue to rise due to these new variations. Therefore, buildings and local architecture in these areas must be adapted to avoid future damages. However, disaster prevention will not be truly effective until the 'human factor' is considered, based on actual evidence instead of theoretical assumptions. Better research into how communities are affected by disasters and how they re-act with new architectural solutions is urgently needed.*

*In 2007, one Spanish town was tragically affected by the Girona River flash-floods and its population and buildings were severely disrupted. This case study was chosen as the main testing ground within this research, whose main aims were: a) to identify environmental retrofit strategies to increase resilience and adaptation to flooding, while improving comfort and living conditions; and, b) to present the proposed strategies to the affected local population. The project revealed insights in the increased level of acceptance and understanding of innovative solutions by local inhabitants when greater communication and participation is achieved.*

*KEYWORDS: Sustainable-architecture, social-engagement, communities, floods, resilience*

### 1. INTRODUCTION

Architecture is fundamentally about people. Being architects, university teachers or researchers, some questions about the role of place and design in human life should be central to our work.

Few architecture books today focus on people and communities; although in many design schools, social design is a distant third after sculptural expression and green technologies [12].

Simultaneously, there are more people today under natural hazards threat compared with 50 years ago, and building in floodplains and other high-risk areas has increased the likelihood that a periodic natural disaster will become a major catastrophe [3].

Flooding has caused the majority of disasters between 1994 and 2015, accounting for 43% of all recorded events and affecting nearly 2.5 billion people. Similarly, droughts affected more than one billion people between the same period, despite the fact that droughts accounted for just 5% of disaster events happening during this time [3].

At the same time, across the world many governments have invested significant resources in trying to raise awareness not only of flooding, but many other natural hazards, to make populations understand the importance of adaptation to future scenarios; however, these initiatives are rarely as effective as hoped [2].

This research paper is focused on one Mediterranean town located in the Valencian Community (Spain) and called El Verger. It was severely affected by flash-flooding

in October of 2007 and almost ten years later it was taken as a case study to develop strategies for sustainable architecture [6].

Additionally, these methods and their results were approached in 2017 to the affected citizens during an important and successful social event; in order to make them understand the actual threat of the situation and also observe their actual response.

### 2. FLOODS & DROUGHTS

Every year more and more areas are adversely affected by changes in their hydrological cycle and precipitation patterns, resulting in serious droughts and flooding. Also, it is a fact that climate change will certainly exacerbate these adverse impacts in the near future across Europe and its neighbouring countries [5].

#### 2.1 Flash flooding

Flash flooding is one of the worst natural hazards which causes catastrophic damage and reduces income and economic opportunities in many countries around the world. And, while most of the fundamental causes lie beyond human control, decisions on where to locate houses and businesses or how to build them, can reduce significantly the loss of property, income, and even lives [6].

# PLEA 2018 HONG KONG

Smart and Healthy within the 2-degree Limit

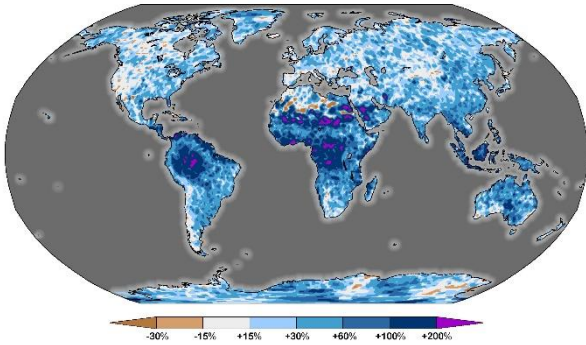

Figure 1: Change from the late 20th to the late 21st century in the average amount of precipitation occurring during the five wettest six-hour intervals (equivalent to the worst flash floods) in reference 47-year periods. Source: European Centre for Medium-range Weather Forecasts (ECMWF) (based on the A1b Scenario of the IPCC)

## 2.2 Droughts

On the other hand, every year more and more areas are adversely affected by serious droughts. Over the past thirty years, droughts have dramatically increased in number and intensity in Europe and Middle-East regions. Reduced water availability has a direct negative impact on citizens and essential economic sectors such as agriculture, tourism, industry and transport, affecting its internal market's competitiveness [3].

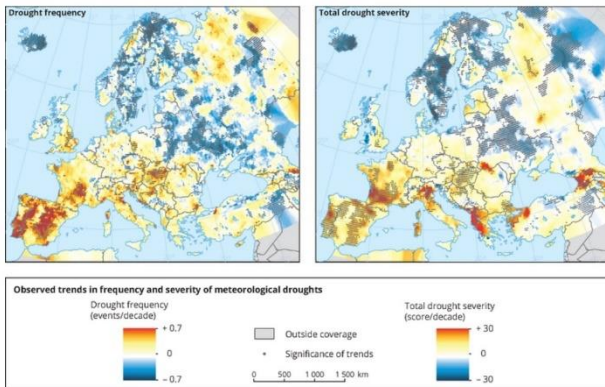

Figure 2: Trends in frequency and severity of meteorological droughts between 1950 and 2015 (accumulated over 12-month periods). Source: European Environment Agency

## 3. SOCIAL ENGAGEMENT THEORY

Social or public engagement is widely interpreted as any opportunity for the public to be exposed to, become aware of and appreciate architecture, and even contribute to any architectural project as much as possible [11].

At the same time, sustainable architecture involves a balance of three primary aspects: economic, environmental and socio-cultural. Although there is minimal current action being taken to address the socio-cultural aspects.

The concept which comprehend all these aims is participatory design, which can be defined as an

approach that attempts to engage everyone in the process and also ensures that everyone in the community can transform their environment [6].

This methodology entails that when the necessary studies and their outcomes are obtained, a pre-planning and design-stage consultation (often known as *charrette*) will be conducted. Other alternatives are organisation of pre-testing and larger social events, as it was the case conducted in this particular occasion.

The main goal in all cases will be to hammer out acceptable solutions which satisfy the local community, but also influence the design of the final architectural solutions.

## 4. ARCHITECTURAL TECHNIQUES EXPOSED

### 4.1 Introduction: the Girona River Case Study

As already introduced above, very strong and torrential rain fell into the upper parts of the Girona river basin (East of Spain) due to the Cold Drop phenomenon in October 2007. The river overflowed in the floodplain area where El Verger is located [7].

This town is positioned very near to the river mouth and the consequences were catastrophic. In total, more than 1,500 houses were severely damaged, one person was killed, and the water level rose to 3 m height in most cases. Physical and personal damages were countless, and hundreds of people lost their homes [7].



Figure 3: Pictures of Girona river's floods: river overflowed (left) and citizens' damaged belongings outside the houses after the catastrophe (right). Source: Author's pictures.

In 2016 a postgraduate research project showed how to retrofit and adapt the houses affected by this flash flooding from a sustainable perspective [6]. After complex analysis and simulations applied to the most representative building typologies, this research developed two main design strategies: a) Flood Resilience and b) Flood Resistance. Very briefly, these two strategies are explained on the following sections.

### 4.2 Flood Resilience Strategy

This technique is advised for those high-risk flooding zones, which might encounter flood water levels of 1.5-3.0 m height. In this case, the water is allowed to come inside the buildings GF, which functions as a multi-functional semi-open space during the period when there is not any flooding event.

Permeability of the ground will be considerably increased again if all houses inside these zones would

# PLEA 2018 HONG KONG

*Smart and Healthy within the 2-degree Limit*

apply a gravel drainage system. Additionally, all the interior courtyards, which most of them are currently paved, will be converted into green areas with gravels or natural ground too.

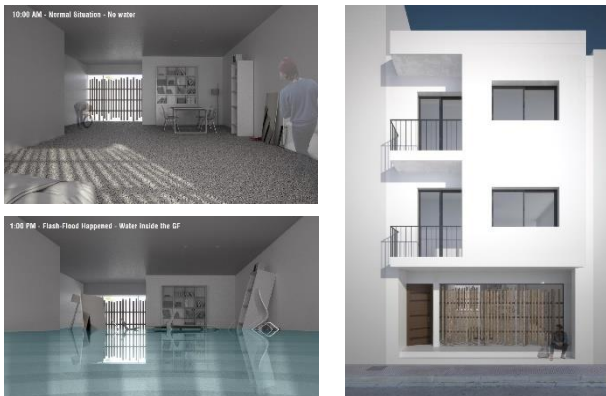

Figure 4: Virtual images of flood resilience design applied into a terraced apartment building, with and without flood water. Source: Final MSc Thesis Project, Puchol-Salort, Jose.

## 4.3 Flood Resistance Approach

This option is suitable for those cases with 1.5 m flood water height or less, otherwise water pressure might be so strong and endanger the structural stability of the building. The main strategy on this occasion is to create a shell around the house and raise the GF level by two steps into a suspended floor.



Figure 5: Long section of a single-family house with flood resistance design applied and 1 m flood water height. Source: Final MSc Thesis Project, Puchol-Salort, Jose.

## 5. LOCAL COMMUNITY EVENT

Close to the completion of the MSc thesis research at the end of 2016, the author aimed to approach all this technical knowledge and outcomes to the inhabitants of the affected area. In October 2017, 10 years would have passed since the Girona River floods and it seemed the perfect occasion to organise a commemorative event to remind what happened 10 years earlier, but also to offer new solutions and, more importantly, approach all these new techniques to all affected citizens.

This event was called the 10<sup>th</sup> Anniversary of the Girona River Floods.

### 5.1 Promotion Methodology

Nowadays, one of the most important procedures to achieve a truly successful event and consequently get a good social engagement, is to promote it in all social media and inside as much means of communication as possible [8].

Approximately three months before the date of the event, several local and national newspapers as well as radio networks were contacted and several articles were published before and after the event.

In parallel, a group of graphic designers from El Verger agreed to altruistically collaborate and created a logo and a distinctive image for the event campaign. They were consistently used for all signs and leaflets, as well as Facebook, Twitter and Instagram posts.



Figure 7: Model of the main sign used to promote the event campaign with its logo in the middle (language: Valencian (most spoken language in the area)). Source: Author's data.

### 5.2 Process Description

The organisation of this event to disseminate the results of the research to the local population started in large advance. Once a specific date was agreed (the closest weekend to the floods day) a complex process involving many agents was developed.

The next figure shows step by step how this process was conducted by the author:



# PLEA 2018 HONG KONG

*Smart and Healthy within the 2-degree Limit*

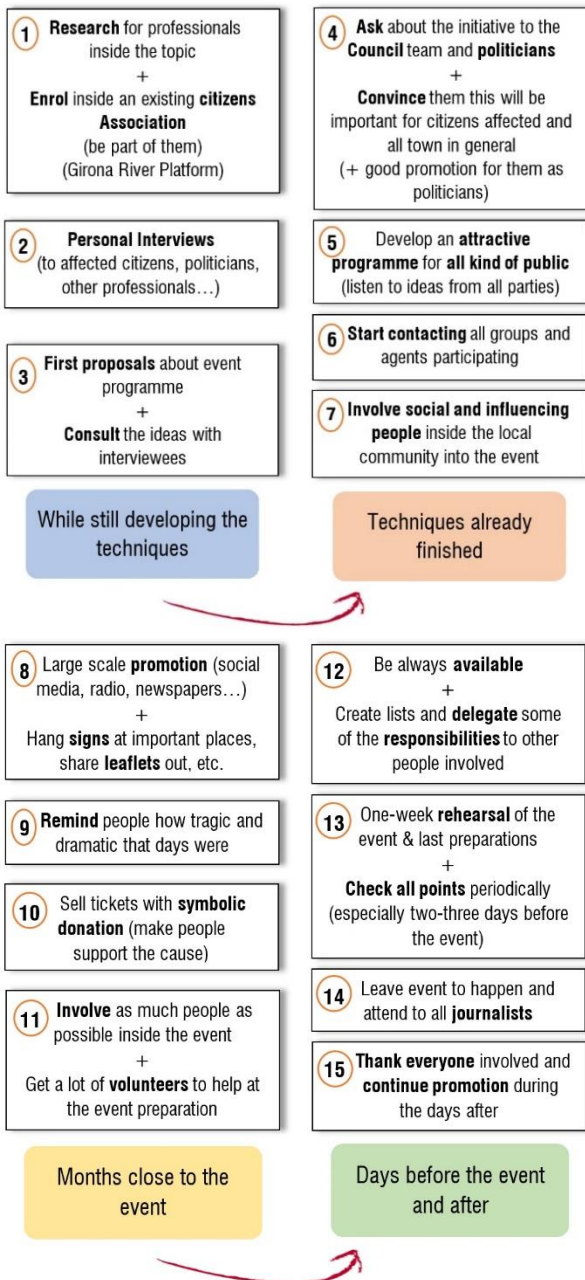

Figure 6: Diagram of the process followed to create the 10<sup>th</sup> Anniversary of the Girona River Floods. Source: Author's data.

It is important to highlight that, as it can be seen from Figure 6, the process started with actions which involved a few people, but it gradually ended up by a complex system of activities which concerned a lot of agents or stakeholders, all of them acting altruistically.

### 5.3 Activities Developed & Groups Involved

The event was performed over a full-day in October 14<sup>th</sup> 2017, with a very wide programme. It involved Government and military authorities, politicians, engineers, geographers and many other professionals. It was divided in two parts, one more technical with lectures and round tables during the morning time and a

second with a more social approach, with theatre plays, poetry, videos, citizens interviews, etc. during the afternoon.

Morning time had a great opening conducted by the Spanish Army Emergency Services (UME) together with the Red Cross, Firefighters, Police, Spanish Civil Guard and two important representatives of the Valencian Central Government.



Figure 8: Photos of the morning session of the 10<sup>th</sup> Anniversary Girona River Floods. Source: Author's pictures.

Afternoon time started with a poetry recited by one well-known young citizen from El Verger and followed by a short play represented by the local theatre group. Together they were the perfect introduction to catch all audience's attention.



Figure 9: Photos of the evening session of the 10<sup>th</sup> Anniversary Girona River Floods. Source: Author's pictures.

Just on the middle of the session, one introductory and emotional video was projected and it was directly followed by the author's lecture. In there, all studied new techniques were explained in as much plain and easy to understand way as possible. This was accompanied by a temporary exhibition which include panels, models and hard-copies of all this material. It was opened to the public during two weeks.

### 5.4 Analysis of Audiences

Survey questionnaires and public opinion collection data are very important in participatory and community co-design [1]. At the 10<sup>th</sup> Anniversary, it was possible to analyse the audience received based on a very easy collection data method carried out during the day of the

# PLEA 2018 HONG KONG

*Smart and Healthy within the 2-degree Limit*

event. The data gathering followed ethical protocols and all the information was kept completely anonymous.

From early stages, the main intention of the event was to attract as much people as possible and coming from all kind of backgrounds. However, data revealed that around 70% of the audience was people affected or in some way related to any of the participants of the event and only 30% of the public had no connection to the incident.



Figure 10: Graph which shows the audiences relationship to the catastrophe happened in 2007. Source: Author's data.

Regarding the audience ages (see Figure 11), the most predominant age group was from 35 to 55 years old, followed by more than 55 years old band. Even trying to attract as much young people as possible (inviting a singer of a local fashionable rock music band or promoting it in social media such as Instagram or Twitter) unfortunately all of this was not enough to attract more citizens inside the 18 to 25 years old range, which only accounted by 6-8% of the total audience.

This point reflects that audiences are one of the main objectives in order to get a constructive result and it must to be taken into further consideration for future similar events.

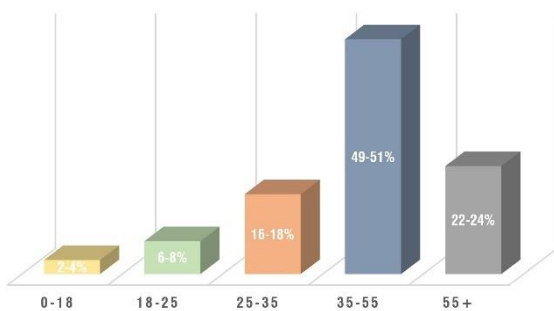

Figure 11: Graph which shows the audiences ages and the different percentages. Source: Author's data.

## 5.5 Event Final Outcome

This event shaped a new community framework inside the Valencian region, combining anthropology and activism in a way never seen before.

Overall, more than 2,000 people attended along the day and it was published in lots of newspapers during the days and weeks after. Approximately, there were counted around 800 people during the morning session

and 1,200 during the afternoon, though it is difficult to identify who was present at both congregations.

One of the direct outcomes of this public engagement was that it opened a previously non-existing link between citizens and Administrations. Authorities came already with positive ideas and proposed some measures such as reducing Council Tax or removing Planning Application fees to those who choose to build based on the sustainable alternatives presented.

This event demonstrated that it is possible to bring technical knowledge to people who is not very used to listen to technical vocabulary and, at the same time, it brought citizens and authorities closer.

## 6. ARCHITECTURE SIGNIFICANCE

Built places inside the cities tell stories in various forms and can emphasize different elements such as place, concept, people or action [12].

The 10<sup>th</sup> Anniversary event can be considered the first attempt to place contemporary design and sustainable architecture inside a Spanish rural area. It was the perfect example of how to approach technical and architectural knowledge to all kind of publics, although it needs to be studied further in order to improve its real implications, repeat it quite periodically (every one or two years) and increase its global impact.

During the event's research process, the Valencian Community's neighbouring region of Catalonia was identified as having a high level of public engagement in architecture, despite a less well-developed support infrastructure compared with other countries such as the UK or Holland, where there are architecture specific centres. In this Spain's northern region, architecture-related exhibitions and conferences are held in many public buildings on a very regular basis at more than 18 locations throughout the province. This was taken as a primary example into our case and demonstrated that we still need to promote many more events like the 10<sup>th</sup> Anniversary to be truly effective in the Valencian Community.

In our case, some aims of good public engagement were achieved, such as: foster sustainability in design and acknowledge in the field of architecture and the built environment, deliver broader social and economic policy goals, promote resilient and sustainable architecture inside of a regional culture, stimulate a bottom-up learning in order to create a more vibrant and democratic city and, encourage greater interest and community involvement in matters of local built environment.

## 7. FUTURE SCOPE OUTSIDE SPAIN

Some areas around the Mediterranean basin and the Middle-East, especially found around the 36° to 39° North latitude, have been recently severely affected by flash floods despite the fact that rains are well below the annual average.

# PLEA 2018 HONG KONG

Smart and Healthy within the 2-degree Limit

The studied Valencian region is not an isolated case and other zones around the Mediterranean basin and beyond are under very similar circumstances.

In August 2001, the worst flash flooding event of the Caspian Sea region in over two centuries claimed over 300 lives after a weekend of heavy rainfall and brought a devastating disaster in the province of Golestan, Iran [9]. This is a very dry and hot area too, which experiences periods of difficult droughts during summer months. Again: water scarcity intersected with flooding.

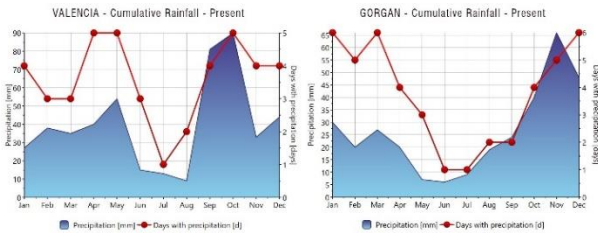

Figure 12: Two graphs of the present cumulative rainfall in two of the studied regions: Valencia, Spain (left) and Gorgan, Iran (right). See the “dangerous torrential peak” in both cases. Source: Meteonorm software v.7.0.

Parallely, the city of Mersin in South Turkey presents a very similar situation. It is built on a coastal floodplain and uncontrolled and illegal urbanization process has been causing degradation of agricultural areas and river basins, also causing flooding in the city and its vicinity during the last decades [4].

The most dramatic regions where these same phenomena have occurred in the last twenty years are: 1) the Valencian Community in Spain, 2) the Peloponnese region in Greece, 3) the Mersin Province in Turkey and 4) the Golestan Province in Iran.

The next steps inside this research would be to find the existing connection among all these four areas and see how they can be compared with the Girona River floods case. Some sustainable and adaptative techniques should be developed and applied to its architecture and also social events relevant to their particular societies must be organised too.

## 8. FINAL CONCLUSION

This experience shows that it is necessary to find more efficient strategies to approach and engage communities affected by natural disasters. Events like the 10<sup>th</sup> Anniversary of the Girona Floods proved to be very effective in raising awareness on the scale of the local and global problem and move towards the implementation of technical solutions which require public acceptance and government support.

## ACKNOWLEDGEMENTS

I would like to give my gratitude to all the MSc AED team from University of Westminster who impeccably guided me during the first stage of this research. Also, I

would like to thank all El Verger Council team as well as every agent involved in the 10<sup>th</sup> Anniversary celebration. All of them together with tens of volunteers acted in the best altruistic way and made possible this wonderful event.

## REFERENCES

1. Aravena, Alejandro and Lacobelli, Andres (2012), *Elemental. Incremental Housing and Participatory Design Manual*. 1<sup>st</sup> Edition. Published by Hatje Cantz. ISBN 978-3-7757-3460-8
2. Booth, J.E., C.A., Hammond, F.N. & Proverbs, D.G. (2011), *Flood Hazards: Impacts and Responses for the Built Environment*. CRC Press - Taylor and Francis Group, London.
3. Centre for Research on the Epidemiology of Disasters (2015), *The human cost of natural disasters 2015: a global perspective*. UN International Strategy for Disaster Reduction – Executive Summary
4. Duran, Celalettin; Sandal, Ersin Kaya (2012), *Effects of urbanization on agricultural lands and river basins: Case study of Mersin (South of Turkey)*. Journal of Environmental Biology 33, 363-371. ISSN: 0254-8704
5. Gasparinetti, W. M. and Faergemann, H. (2012), *Water Scarcity & Droughts – 2012 Policy Review – Building blocks*. European Commission - Directorate-General Environment - Water, Chemicals & Biotechnology.
6. Poiani, Aldo (2006), *Floods in an Arid Continent*. Advances in Ecological Research, Vol. 39. 1<sup>st</sup> Edition. Published by Elsevier Ltd. ISBN-13: 9780123736307
7. Puchol-Salort, Jose (2016), “Sustainable Retrofit for Flooding Resilience: Houses Close to the Girona River, Spain”. Final Thesis project, AED MSc, University of Westminster.
8. Pulizzi, Joe (2015), Content Inc.: How Entrepreneurs Use Content to Build Massive Audiences and Create Radically Successful Businesses. 1<sup>st</sup> Edition. Published by Content Marketing Institute. ISBN: 978-1-259-589652
9. Sharifi, F., Samadi, S.Z. & Wilson, C.A.M.E. (2012), *Causes and consequences of recent floods in the Golestan catchments and Caspian Sea regions of Iran*, Nat Hazards 61: 533. DOI:10.1007/s11069-011-9934-1
10. Sinha, Sumita (2012), *Architecture for Rapid Change and Scarce Resources*. 1<sup>st</sup> Ed. Routledge, Taylor and Francis Group.
11. Wakely, Richard and Mee, Alan (2008), *Public Engagement with Architecture in the Republic of Ireland*, 1<sup>st</sup> Ed. by Mullan Consulting.
12. Young, Jenny and Coffin, Christie Johnson (2017), *Making Places for People: 12 Questions Every Designer Should Ask*, 1<sup>st</sup> Ed. by Routledge ISBN: 978-1-138-86063-6

# Contemporary Review of the Regional Plan for Argentina's Countryside by Grupo Austral: Comparative Analysis between Typologies in 4 Different Climates

FLORENCIA COLLO<sup>1</sup>, SIMOS YANNAS<sup>2</sup>

<sup>1</sup>Atmos lab, London, UK

<sup>2</sup> Architectural Association, School of Architecture, United Kingdom

*ABSTRACT: This paper presents 4 rural housing typologies designed by Grupo Austral in 1939 for the countrymen of Argentina. Each dwelling was adapted to a different climatic region of the country, ranging from warm subtropical to cold desert. The designs represent an outstanding start in environmental awareness in Argentina, though ignored by the community of architects and any of the government plans for housing. In this paper the design features of these housing designs are evaluated using contemporary simulation tools and the original specifications are compared to current building practices. Comparison with contemporary housing projects by government agencies shows the Grupo Austral's design to be superior in all environmental aspects.*

*KEYWORDS: Rural Housing, Modern Architecture, Grupo Austral, Argentina's Countryside, Comfort Analysis,*

## 1. INTRODUCTION

"Grupo Austral" was an association of architects founded from within Le Corbusier's studio in 1938. They aimed at translating the European avant-garde discourse into a rapidly modernizing Argentina whilst revalorizing the local imprint (1). Rural urbanism was the topic of their second manifesto, published in 1939 in "Nuestra Arquitectura", a wide spread magazine of the time (2). It presented a regional plan and four dwelling typologies for the countryside of Argentina. Each one corresponded to a different climatic region, ranging from warm regions in the North to desert cold zones in the South. They were designed with prefabricated materials to enable the supply of houses to a larger number of families in less time. Design variations responded solely to climatic adaptations.

The current situation of the rural dwellings of Argentina is critical as social housing plans impose generic solutions without responding to local conditions.

Even though the designs by Grupo Austral were not carried out and their plan faded into oblivion, their sensitivity to climatic adaptation was never achieved again nor picked up in any subsequent plan for housing. This paper will present a critical review of the four designs using the theoretical knowledge acquired since as well as advanced simulation tools. A comparison will also be drawn with current housing typologies to assess the relevance of the Grupo Austral's proposals today. The aim of this research is to contribute to a future housing plan aimed at designing dwellings that are environmentally conscious and energy efficient.

## 2. METHODOLOGY

Weather data were obtained from Meteororm 7.0. The Grupo Austral design typologies were assessed using geometric criteria, solar radiation data processed by Ladybug, daylight analysis carried out with Radiance through Honeybee, thermal simulations performed with Energy Plus, and wind simulations performed with Butterfly and OpenFOAM. Simulated free-running zone operative temperatures were evaluated against the adaptive comfort zone based of EN 15251 (category III). The annual number of hours with indoor temperatures within the comfort range were estimated as weighted averages of living room and bedroom temperatures.

## 3. THE REGIONAL PLAN

The initiative was issued from a public competition for rural housing (3). The objective was to provide to the countrymen with a new home with a contemporary, economic and easy-to-implement design approach. They studied the landscape, techniques, lifestyle and climates of the different areas. The focus was on prefabrication, as any element manufactured "cleverly and scientifically". Material selection was based on criteria such as durability, thermal properties, maintenance, waste reduction, cost, execution time, ease of construction, local availability and local workforce.

## 4. THE CLIMATES

The climatic regions considered represent the entire spectrum of Argentina's climates, ranging from warm subtropical to desert cold. The data employed by Grupo Austral are presented in Table 1 together with contemporary information. Tucuman is the representative city for the warmer climate, with an

# PLEA 2018 HONG KONG

Smart and Healthy within the 2-degree Limit

annual average temperature of 19.8°C. 9 de Julio in Buenos Aires was picked by Grupo Austral for both temperate climates. However, to get more distinctive results, Oliveros in Santa Fe was considered as Temperate-warm -annual average of 17.9 °C- and 9 de Julio as temperate-cool -annual average of 16.2°C-. Colonia Sarmiento was the original choice for cold climate, but due to the lack of an appropriate weather file, data for Paso de los Indios was used instead, which has an annual average temperature of 10.6 °C.

Although standard procedures to represent climatic data did not exist at the time, the sunpath and wind rose diagrams employed by Astral appear to be accurate. Temperature data show a variation with more recent historical data.

## 5. REVIEW OF BUILDING TYPOLOGY

Design typologies, geometric analysis and simulation results are summarised Domus 1-4 in Table 2.

Grupo Austral described Domus 1 as: "Open towards the fresh winds and eternally in the shade. The house is on pilotis as the solution for the warm region. In the semi-outdoor space formed a large part of domestic life will take place during spring, summer, and autumn." Elevating the house is justified by the shaded space generated below. The house itself is also shaded by the slab projections, and the living room allows cross ventilation. The larger openings are facing south to prevent the sun from reaching the interior. The design relies on wind, shade, and thermal mass to cool down temperatures during the hottest periods.

Domus 2 and 3 are described as: "The courtyard as the main element. The house as the extension of the courtyard. On it, the larger number of hours elapses. Space open to the sky but limiting the horizon." Both typologies are adapted to seasonal variations, with outdoor spaces for summer and sunny living rooms for winter. Extended walls protect both indoor and outdoor spaces from prevailing winds. Even if the main concept is the same, design variations show that each house is tailored either to warmer or colder conditions. The one in the warmer climate is split, to make room for more outdoor space, allow more heat losses, and a better ventilation. Also, living room and bedroom are protected from the west sun through the kitchen and barn respectively. The Domus 3 is much more compact, and fully open to the north to allow solar access.

Domus 4 was conceived by Grupo Austral as: "Compact house. The southern climate turns fire into a vital element of the house. The entire household takes place around it." The kitchen is placed in the centre, as a heat source for the whole house. Windows of the living room are north oriented, without any element causing shade. Also, there is a large clerestory facing west, which has multiple functions: it captures the highest amount of solar radiation, but its height prevents the occupants from suffering from glare and from the chilly effect of the strong prevailing wind.

The four designs are simple, austere, sensitive, in line with the modern movement philosophy, and also deeply rooted in their respective climate.

Table 1: Climate analysis by Grupo Austral and contemporary correlation

	1. WARM	2. TEMPERATE-WARM	3. TEMPERATE-COOL	4. COLD
Reference city / latitude	Tucumán 27°	Oliveros 32.5°	9 de julio 35°	C. Sarmiento 45° Paso Indios 44°
Sun Path solar angles				
Wind Rose average speed				
Annual Temperatures	Average temperatures January: 32° July: 6° avg year 19.8°C	Average temperatures January: 32° July: 3° avg year 17.8°C	Average temperatures January: 32° July: 3° avg year 16.2°C	Average temperatures January: 25° July: 1° avg year 10.6°C

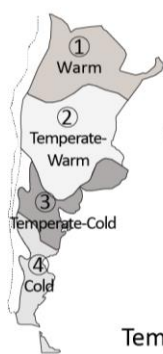

Climate division given by Grupo Austral

# PLEA 2018 HONG KONG

Smart and Healthy within the 2-degree Limit

Table 2: Comparative environmental analysis of the 4 houses in their respective climate

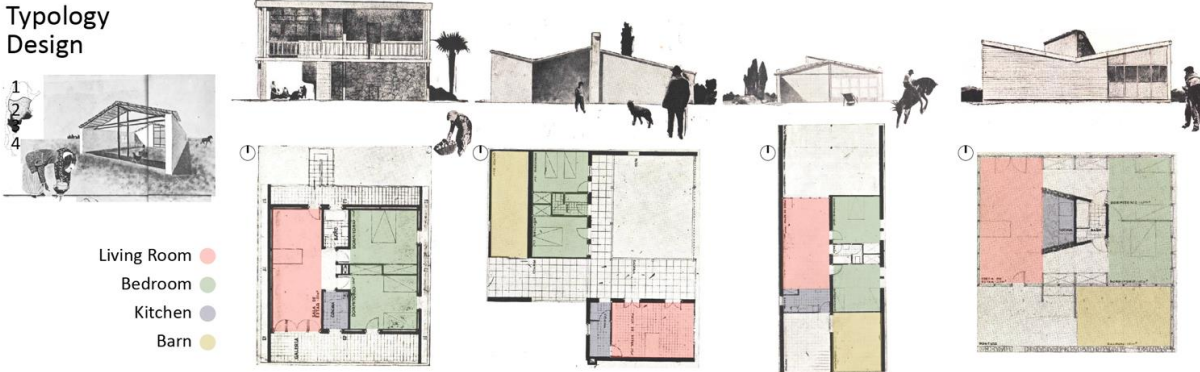
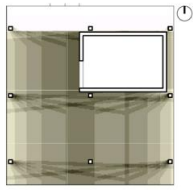
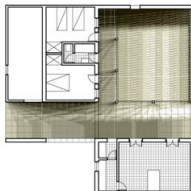
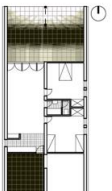
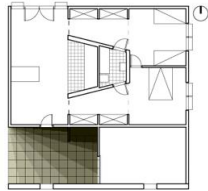
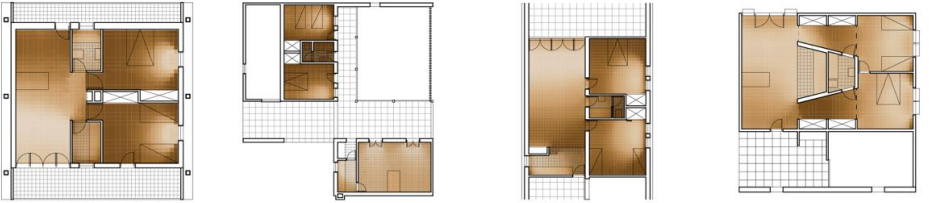
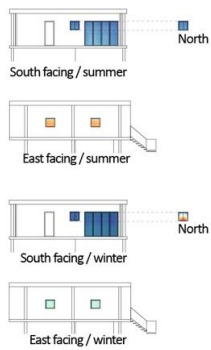
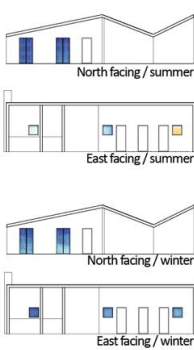
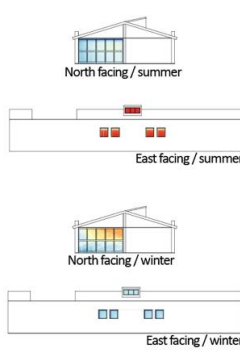
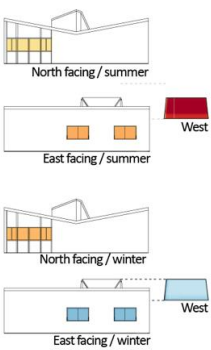
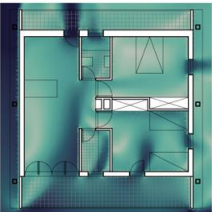
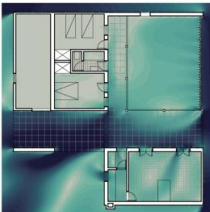
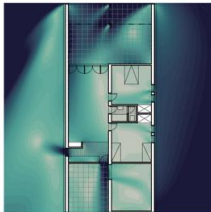
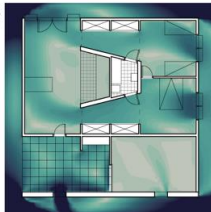
	1. WARM	2. TEMPERATE-WARM	3. TEMPERATE-COOL	4. COLD
<b>Typology Design</b>  <ul style="list-style-type: none"> <li>Living Room (Red)</li> <li>Bedroom (Green)</li> <li>Kitchen (Blue)</li> <li>Barn (Yellow)</li> </ul>				
<b>Compacity ratio</b> (floor area/exposed envelope)	0.31	0.32	0.48	0.44
<b>Outdoor space</b> (enclosed outdoor/floor area)	1.85	1.8	0.88	0.25
<b>Sun Hours</b> over a typical day (21st of September)				
<b>W/F ratio</b> <b>Daylight levels</b> Useful Daylight Illuminance	12%	11%	15%	16%
				
<b>W/W ratio</b> by orientation	N 2.5% S 27.5% E 6.2% W 0%	N 13.4% S 0% E 3.5% W 4.8%	N 33.6% S 0% E 10.9% W 2.8%	N 12.5% S 0% E 17.6% W 14.1%
<b>Solar Radiation</b> falling on windows				
<b>Warm period</b> <b>Cold period</b>				
<b>Wind exposure</b> (exposed area to prevailing wind)	3.2m <sup>2</sup> , living room	5.9m <sup>2</sup> , living room	4.2m <sup>2</sup> , living room	0
<b>Breeze</b>				

# PLEA 2018 HONG KONG

Smart and Healthy within the 2-degree Limit

## 6. COMPARATIVE ANALYSIS

In general, compacity ratios increase gradually as climates become colder. The largest ratio difference lies in between the two designs for the temperate climates owing to the split plan in the warmer one. The area for controlled outdoor spaces increases as climates become warmer, indicating a more intensive use.

Living rooms are located in the most advantageous area of the plan, whilst bedrooms always face east to receive morning sun. The barn and the kitchen are used to protect main rooms from the worst orientations, preventing either from high incident solar radiation or excessive heat loss. In the colder climates, the kitchen is incorporated to the living room to benefit from its heat. Window-to-floor ratios increase as latitudes increment. Useful Daylight Illuminance calculations show that daylighting patterns are consistent across the different climates, as smaller window-to-floor ratios are compensated with more sky illuminance.

Windows and walls become more shaded as climates become warmer, which is explicit in the original drawings. Solar radiation simulations falling on the windows show a clear gradation, from the ones of the warmest climate that barely receive sun across the year, to the ones of the coldest climate that receive high amounts both in summer and winter. Results prove that the designs were fully thought according to solar considerations, compensating orientation and shading for adequate solar control.

Looking at wind exposure, windows of the living rooms of the 3 warmer climates are facing prevailing winds. Simulations show how breeze easily flows on the living rooms, whereas bedrooms remain protected. Whereas the house of the warmest climate is fully exposed, the 2 temperate are protected by extended walls. The design of the coldest climate has no window at occupant height facing prevailing winds, and breeze barely penetrates, even if winds are much stronger.

## 7. THERMAL PERFORMANCE

Thermal simulations were performed under free-running conditions and with uniform materials, as specified by Grupo Austral:

- Walls: double layer of bricks. U value: 0.7 W/m<sup>2</sup>K
- Roof: 20 cm of thatch. U value: 0.8 W/m<sup>2</sup>K
- Floor: Pine wood elevated with bricks. U= 2.34 W/m<sup>2</sup>K
- Single glazing. U value= 5.7 W/m<sup>2</sup>K

All the elements employ air as insulation: in between the layers of exterior walls, separating the floor from the ground through an air chamber, and inside the straws of the thatch roof. Despite the lack of technology, the resulting U values are rather low. An additional iteration was carried out adding layers of insulation to reach nowadays common transmittances (see following section for reference) and to validate the performance of the designs with contemporary standards. The final U-values were as follows:

- Walls of the 3 warmer climates: 0.44 W/m<sup>2</sup>K
- Walls of the coldest climate: 0.32 W/m<sup>2</sup>K
- Roofs: 0.29 W/m<sup>2</sup>K
- Floors: 0.68 W/m<sup>2</sup>K
- Windows:

warm: single glazing, U=5.7 W/m<sup>2</sup>K, SHGC= 0.9

temperate: double glazing, U=2.7 W/m<sup>2</sup>K, SHGC= 0.73

cold: double glazing low-e, U=2.3 W/m<sup>2</sup>K, SHGC= 0.65

Results of both cases are summarised in Table 3.

The typology of the warmest climate reaches 72.6% of time in comfort, with only 3.2% overheating. During a typical summer day, while outdoor temperatures rise to 33-34°C from 12pm to 19pm, temperatures inside remain in comfort for most of the time. The thermal mass of the bricks lags and reduces overheating inside to later in the afternoon (3pm, 32 °C), when the shaded and ventilated area below the house can be enjoyed. It is to be noted also that indoor temperatures never rise above outdoors. Adding insulation brings the number of hours in comfort to 91.4%, an improvement of 26%. On cold days temperatures stay inside the comfort band, falling

Table 3: Thermal performance of the 4 typologies with the original materials and with added insulation to reach contemporary standards

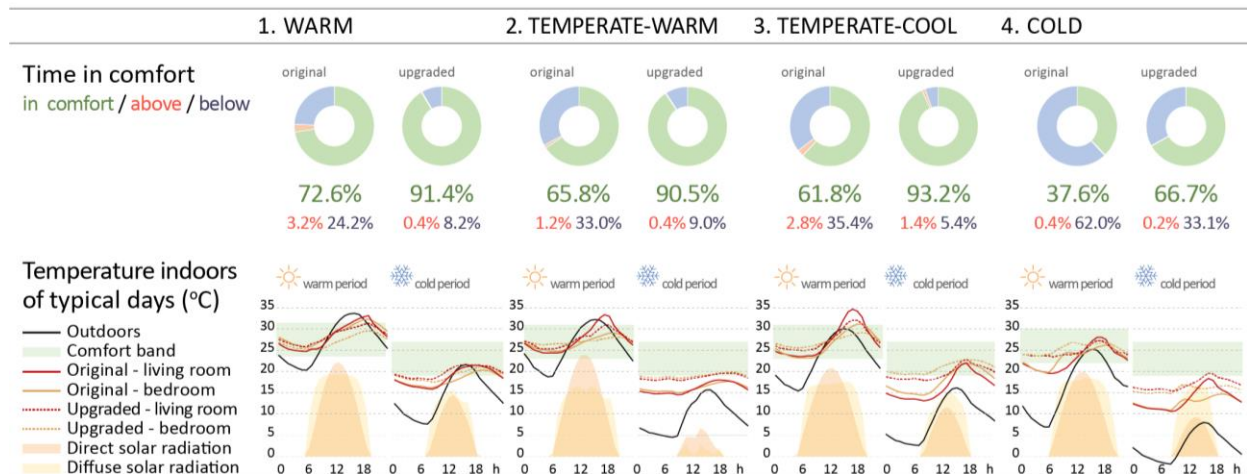

# PLEA 2018 HONG KONG

*Smart and Healthy within the 2-degree Limit*

below it only at night. Insulation helps to raise indoor temperatures by 1-3°C.

The houses of the temperate climates achieve similar performances. The temperate-warm reaches 65.8% of time in comfort: the split plan, shading elements, and covering of main rooms from the western sun by service functions help to minimize overheating to 1.2% of time. Temperature patterns during summer days are similar to the warm climate case. During the cold period, the house suffers from a higher-than-expected amount of time underheated (33%), with temperatures falling 1 to 4°C below the comfort band across the day. Low levels of radiation and abundant solar control prevent the space from raising its temperature naturally. Adding extra insulation brings the house to 90.5% of time in comfort reducing by 2/3 time above and below it. It maintains indoor temperatures of the hottest days in comfort and rises them 1 to 3°C in the coldest days, touching the lower bound of the comfort band.

The compactness of house in the temperate-cool climate and the adequately controlled sun and wind add up to bring the temperatures of the house in comfort for 61.8% of time. In the warm period, during the 2.8% of time that the house is overheated, occupants can also be outside in the small patio. During the cold period, temperatures are comfortable during daytime, but fall below the comfort band at night. Adding insulation is highly beneficial, making the house attain the best performance overall: 93.2% of time in comfort. Time above comfort is cut by half, whereas time below comfort is reduced by 85%. Additionally, the bedroom seems to be inside comfort even at night, which may almost suppress the need for heating.

The large gap of design intentions in between these two houses is manifested in the small differences of percentage of time underheated, in the higher percentage of time below comfort of the house in the warmer climate (with extra insulation), and in the higher percentage of time overheated of the house in the cooler climate (both with and without insulation).

The house in the coldest climate attains 37.6% of time in comfort, which is relatively high considering the very cold temperatures, little insulation, and single glazing. During the warm period, temperatures during the day remain in comfort, whereas during the night, they fall below as outdoors reach 7°C. It is clear in all the cases how the morning sun helps the bedrooms rise their temperature before the living-room does. During the coldest period, temperatures fall below the comfort band by 1-8°C across the house. Nevertheless, the big windows of the living room north and west oriented help to rise the temperature considerably compared to the bedrooms, when outside is only 8°C. Adding insulation is naturally highly beneficial, doubling the time in comfort, and rising temperature during the coldest period by 1-5°C.

In general, bedrooms are cooler than living rooms, due to the reduced size of windows. Adding insulation helps in all the cases to attain very high percentages of time in comfort. Thermal performances result solid and flawless, even considering the constraints of the time and exposure to open weather. Passive strategies adopted have proven to be well chosen, properly calibrated and remarkably efficient.

## 8. COMPARISON WITH CONTEMPORARY HOUSING

Even if similar programs of single rural houses have not been released, the government has constantly built social housing in the city suburbs across the country. The most recent plan dates from 2015. Information was provided by the National Innovation Directory for Sustainable Development (4). The program distinguishes the “regular” prototypes, which were designed by the Housing Provincial Institutes (IPV) and are regularly built in the area; and the “environmental” prototypes, which were ameliorated by environmental consultants. Orientations of the former are generally randomly decided, whereas the latter are oriented according to the most advantageous situation. To carry out the simulations, the most advantageous orientation was always chosen. Plans, thermal properties, simulation results and comparative performance with Grupo Austral are summarised in Table 4.

The designs by Grupo Austral largely outperform the ones proposed by the IPVs. The disparity in between extreme climates is not large whereas the gap in the temperate climates is very wide, with a difference of up to 26.0% of time in comfort, which signals an evident lack of climate capitalisation. Both temperate typologies have a similar percentage of time underheated as the coldest climate -20.1%, 26.1%, and 36.3%-. Taking into consideration how much colder the latter is, this indicates clearly a loss of the sun’s warming benefits.

The performances of Grupo Austral also exceed the ones supervised by environmental consultants, but by a smaller margin. In the 3 warmest climates, all the contemporary designs seem to have too much time above comfort: the minimum attained -1.4%- corresponds to the maximum obtained by Grupo Austral. The excessive overheating results from the lack of suitable shading elements. Overall, recent designs are missing an adequate strategy of solar control.

Considering the leverage of the acquired knowledge in environmental design, progress in scientific research and material quality, and the advantage of pairing the houses, the efficiency of the designs achieved by Grupo Austral is astounding.

## 9. DISCUSSION

Environmental design concepts for the Regional Plan are remarkably well founded and adapted to their respective climate, even if the science was not yet



# PLEA 2018 HONG KONG

Smart and Healthy within the 2-degree Limit

developed. Layouts are optimised for each situation, passive strategies are adequately chosen, and houses harness optimally sun and wind in all the cases. This translates into sound thermal performances, that become optimal when nowadays common practice insulation is added. Designs of the warm and temperate climates reach very high percentages of time in comfort, ranging from 90.5 to 93.2%, whereas the house in the desert cold climate attains 66.7%. Furthermore, performances of Grupo Austral surpass by 1.1 to 26% all of the contemporary ones analysed, both the traditional typologies built by the government as well as the revised versions by well-known environmental consultants.















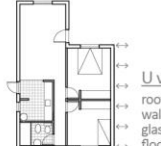
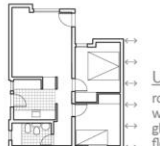

## 10. CONCLUSION

Environmental design in Argentina is nowadays far behind the world's standards, and there is no build-up of valid references. Housing plans carried out by the government do not rely on vernacular learnings neither on up-to-date simulation tools. It is most relevant to bring back to light projects such as Grupo Austral's that perform exceptionally well and set precedents. It is most important that these typologies become a flawless starting point of a work tradition that builds up with new solutions, and in which any new project can bank on.

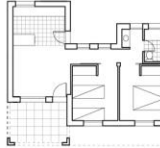
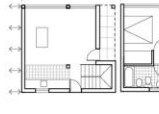
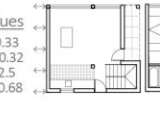
## REFERENCES

1. León, A. 2016, 'Grupo Austral (1939–1950)' in Routledge Encyclopedia of Modernism, Taylor and Francis
2. Bonet, A., Kurchan, J., Ferrari Hardoy, J., (1939). Austral 2: Plan Regional, Urbanismo Rural y Vivienda. *Nuestra Arquitectura*, 122, Buenos Aires, Argentina.
3. Banco de la Nación Argentina (1939), Concurso Nacional de Anteproyectos para Viviendas Rurales, in Concursos 1825-2006
4. Author's visit to the "Dirección de Innovación para el Desarrollo Sustentable - Ministerio de Ambiente y Desarrollo Sustentable de la Nación"

Table 4: Thermal performance of contemporary typologies built by the government and comparison with Grupo Austral's performance

	1. WARM	2. TEMPERATE-WARM	3. TEMPERATE-COOL	4. COLD
<b>Time in comfort achieved by Grupo Austral</b> in comfort / above / below	 91.4% 0.4% 8.2%	 90.5% 0.4% 9.0%	 93.2% 1.4% 5.4%	 66.7% 0.2% 33.1%
<b>Regular prototypes built by the IPVs</b> (provincial housing institutes)	 U values roof: 0.62 walls: 1.47 glass: 5.7 floor: 0.68	 U values roof: 0.62 walls: 1.47 glass: 5.7 floor: 0.68	 U values roof: 0.62 walls: 1.47 glass: 5.7 floor: 0.68	 U values roof: 0.41 walls: 0.42 glass: 2.3 floor: 0.68
<b>Time in comfort and efficiency vs. G.A.</b> in comfort / above / below	 85.8% 4.6% 9.6% -6.1% +4.2% +1.3%	 70.5% 3.4% 26.1% -22.1% +3.0% +17.1%	 67.2% 1.9% 30.9% -27.9% +0.5% +25.5%	 63.7% 0.1% 36.3% -4.6% -3.1% -0.1% +3.2%
<b>Environmental prototypes designed by the IPVs with consultants</b>	 U values roof: 0.33 walls: 0.32 glass: 5.7 floor: 0.68	 U values roof: 0.33 walls: 0.32 glass: 2.5 floor: 0.68	 U values roof: 0.33 walls: 0.32 glass: 2.5 floor: 0.68	 U values roof: 0.39 walls: 0.42 glass: 2.3 floor: 0.68
<b>Time in comfort and efficiency vs. G.A.</b> in comfort / above / below	 89.8% 3.8% 6.4% -1.7% -1.6% +3.4% -1.8%	 89.5% 2.7% 7.9% -1.2% -1.1% +2.2% -1.1%	 89.2% 1.4% 9.4% -4.3% -4.0% +0.1% +3.9%	 60.6% 0.4% 39.0% -9.1% -6.1% +0.2% +5.9%

# New Daylight Breathable Façade with Miura DDC Surface (2): Setting Role of Design to Lead Technology: Test and Results

YUSHI UEHARA<sup>1</sup>

<sup>1</sup>Faculty of Art and Design, University of Toyama, Toyama, Japan

**ABSTRACT:** This research is showing the result of tests of new façade geometry. The model is a conclusion of a search path to find façade with osmosis effects of lights: more surface area that allow penetration of 'cool' daylight. With the system new building will benefit roughly twice as much as use of daylight in comparison to any other existing system. The façade system is considered as a mean to soften harsh climate such as desert. It is expected to create soft northern Europe like light condition.

**KEYWORDS:** Daylight Active Façade System, Miura DDC, Tachi-Miura-Polyhedra, Energy, Comfort

## 1. INTRODUCTION

In 2013 the International Energy Agency addressed the building sector the compelling importance for changing the mode of energy and climate control [1]. In seeking the contribution to this issue, this research frames the moral and the vocabulary of functionalism architecture, that values a simple flat square façade, has reached the limit for this quest and made tests to formulate an alternative ground where new set of rules and technology might appear. This research seeks answers in three-dimensionally formed façades that create shades. Historically building façades are equipped by shades and its modes are ruled by tectonics. This paper seeks to innovate this approach and seeks façade system that is an autonomous construction that fits on to any modern architecture. Constructively three hinged system is known to be firm and efficient. This paper seeks answer in façade system with a folding geometry that the façade seals in- and outside and to have the property that its own part to give shade to itself. Miura DDC surface seemed to satisfy all demands set by this research.

The purpose of this paper is to test new model of façade that are aimed to utilize daylight more effectively. In doing so the paper aims to utilize the façade for a building that makes harsh climate for habitation habitable. This façade is based on the idea that Austrian light engineer firm BARTENBACH has introduced in late 1990's: shuttering of direct ray of sun lights and penetration of daylight as reflection. This aimed to eliminate heat that sunlight transmit and take only its flux of luminous. This paper explores new façade geometry to achieve higher results. This paper introduces application of new façade based on the Tachi-Miura-Polyhedra [2].

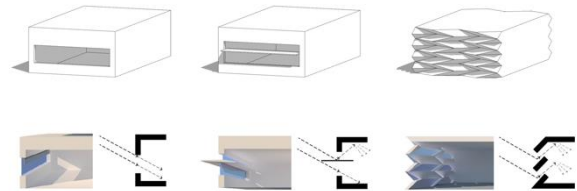

Figure 1: Diagram showing the three models that this paper tests. From left to right: Standard model, System with Reflection inspired by BARTENBACH, MIURA DDC. The paper develops variations of MIURA DDC geometry by changing dimensions and direction.

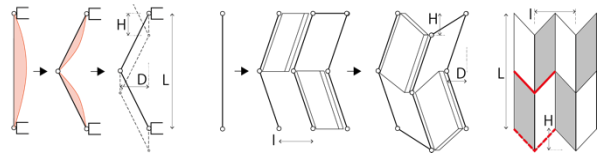

Figure 2: Diagram showing the parameters of MIURA DDC geometry.  $D$  is depth of fold,  $L$  is Interval,  $A$  is the height of  $V$ .

### 1.1 Miura Deployable Double Corrugated geometry

Tachi-Miura-Polyhedra is based on the folding method developed for packaging and deployment of large membranes in space. The method is reported by Koryo Miura [3]. Besides its intentions that aimed to deploy solar panel in space, the geometry allows larger surface area for a volume, which can be applied to increase surface area to shutter, reflect and transmit daylight towards its interior. The application of this façade to a building on the earth signifies new building morphology that creates more shades. It therefore may have impact in reducing urban micro climate issue such as heat island phenomenon.

### 1.2 Parameters to control DDC geometry

This paper tests 59 variation of this geometry. The original geometry is described by its isometric folding characteristic that are described by the angles of parallelogram and the length of its sides. Because this paper does not aim to fold and deploy façade in full, it

# PLEA 2018 HONG KONG

Smart and Healthy within the 2-degree Limit

instead defines the geometry by means of simple three sets of parameters: The interval distances of the 'V' shaped folding peaks in two directions, i.e. width and the length of this V, and the folding depth of mountain-and-valley-folds of two V-s. The width of V and the interval of V is identical. This paper further introduces arrangements not only in horizontal but also in vertical direction on a building façade. The depth are arranged in 300, 600, 750 and 900mm. The building dimensions such as the distances between the party walls and floor heights defines the intervals and the length of V.

The building volume we test are fairly conventional which have 2.7 ceiling height, 7.2m heart to heart between the party walls and 12m between the two facades. This dimension dictates, for a vertical façade arrangement 750 or 1500mm of the length of V, while the intervals are set as 600, 900 and 1200mm; while 900 or 1800 mm of length and 600, 750, 1000, 1500 and 3000mm intervals for a horizontal arrangement. From here, 21 variants of vertical variants and 38 variants of horizontal variants are created, which in total counts 59 variants to be tested.

Façade panelling have two variations: the upward looking closed panels and downward looking glass panels. This test applies a mat plastic material for all closed panels and glasses of 68% transparency by having idea to use hi-performance heat reflective Low-E glass.

### 1.3 Altered conditions from the previous tests

The tests are altered from the previous report published on the bulletin of University of Toyama No.12 pp58-69, with the distances between the facades. While I defined the distances of outer perimeter to outer perimeters between the facing façades as the constant, this paper reports the results accumulated by defining internal distances between the interior of facing façades.

The motif of the previous paper derives from the convention to quantify building including the façade thickness. This allows to fins all variants in the identical footprint which confirms convention to design building according to the perimeter of a specific site. This paper focused on a conventional utilitarian demand to provide equal usable floor plan. This results in diverse building footprint which may or may not allow the application of a deeper façade on a site with limited size.

The façade heights of the variants are further lowered by 300mm in respect to the last tests. This is done because glass opening at the higher level is an advantage that might gave advantage to the horizontal variant performed so highly at the previous test. By lowering the façade both versions are to have sorted the condition of the effect caused by highest part of window.

Table 1: The list of variants showing its parameters specifications on I, D and H.

Variant	Interval	Depth	Height	Variant	Interval	Depth	Height
V01	600	300	750	V23	600	300	900
V02	600	300	1500	V24	600	300	1800
V03	600	600	750	V25	600	600	900
V04	600	600	1500	V26	600	600	1800
V05	600	750	750	V27	600	750	900
V06	600	750	1500	V28	600	750	1800
V07	900	300	750	V29	600	900	900
V08	900	300	1500	V30	600	900	1800
V09	900	600	750	V31	750	300	900
V10	900	600	1500	V32	750	300	1800
V11	900	750	750	V33	750	600	900
V12	900	750	1500	V34	750	600	1800
V13	900	900	750	V35	750	750	900
V14	900	900	1500	V36	750	750	1800
V15	1200	300	750	V37	750	900	900
V16	1200	300	1500	V38	750	900	1800
V17	1200	600	750	V39	1000	300	900
V18	1200	600	1500	V40	1000	300	1800
V19	1200	750	750	V41	1000	600	900
V20	1200	750	1500	V42	1000	600	1800
V21	1200	900	750	V43	1000	750	900
V22	1200	900	1500	V44	1000	750	1800
				V45	1000	900	900
				V46	1000	900	1800
				V48	1500	300	1800
				V49	1500	900	900
				V50	1500	600	1800
				V51	1500	600	900
				V52	1500	900	1800
				V53	1500	900	900
				V54	3000	300	1800
				V55	3000	900	900
				V56	3000	600	1800
				V57	3000	600	900
				V58	3000	900	1800
				V59	3000	900	900

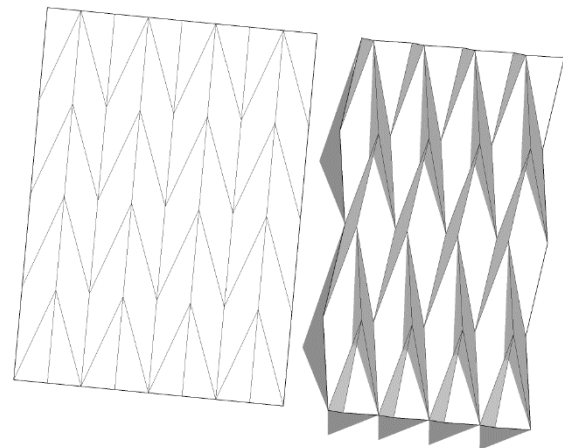

Figure 3: Diagram showing the folding pattern of the MIURA DDC geometry. The right side is a 3D illustration of its shape. This figure shows what this paper calls a vertical arrangement.

## 2 METHODOLOGY

This paper designs the method to test the variants in order to select one or two high performance variant(s) that could improve the daylight use capacities of current building facade. It aims collecting data to accumulate knowledge for actual application a building project.

The tests are run on the three methods: Daylight penetration visualization by means of ray tracing simulation on the V-Ry software; Daylight Factor simulation and flux of illumination simulation made on VELUX Daylight Visualizer software. It produces floor plans, interior visualization, the ISO contour, the False colour indication and the grid measurements in a fairly easy operation. The dates of tests are set as according to

# PLEA 2018 HONG KONG

Smart and Healthy within the 2-degree Limit

the convention of the Daylight Factor simulation on the March 21<sup>st</sup> at 12:00 unless otherwise there is other notices. The sensors are placed also according to the convention, 850mm above the floor level looking upwards on the grid of 100mm in x-y directions and recessed 500mm inside the interior perimeter.

## 2.1 The design of tests

The tests are designed to select variants that provides higher flux of luminosity than a standard façade as well as a modelled system of original BARTENBACH with horizontal reflection panels. The tests aim to identify variants with even but not peaky light distributions.

Tests are designed in four stages:

The first tests simulate Daylight Factor and flux of luminous in perspective. This aims to confirm the rudimental significance of these new series of façades.

The second tests simulate daylight factor; eliminate 1/4 of variants. The test chooses variants with higher area with Daylight Factor between 4 to 8.

The third test simulates flux of luminous. The test focuses variants with flux illumination between 320 to 1000 lux. It chooses variants with even illumination. Eliminates 1/4

The fourth tests simulate flux of luminous with a preliminary thickness of closed façade panels. The façade at the fourth test adds thickness of 100mm materialized as a high-performance isolated sandwich panel with U value of 0.22W/m<sup>2</sup>K as the starting point. The tests eliminate 1/4 with lower flux of luminous. The façade applies 2 thresholds and introduces 4 models. The test calculates surface area above and under the thresholds. It selects four variants. Among them the test chooses variants that bring most gradual light distribution by considering uniformities.

The best option simulates thicker wall thickness that considers preliminary construction thickness. Comparison between a standard façade with 30% window opening and System with reflection panel.

The site situates at the geographical coordination W54.54 N24.41 with 13-degree clockwise rotation from the north. No effects of ground plane have been considered.

## 3. RESULTS

### 3.1 The first test

The first tests simulate the experience to inhabit the interior. One variant is selected randomly from the all variations. The test results below show they are at least equal in spatial experiences therefore enough to convince the significance of the tests.

### 3.2 The second test

The first tests examine all 59 variants with Daylight Factor simulation. The positioning of the sensors confirms convention, mounted 850mm above the floor

at 100mm interval in both x and y directions 500mm off the walls. The results of the tests are documented in numeric data on the values such as: mean, median, minimum, maximum, uniformity1 (min/mean), uniformity2 (min/max). The results are also accumulated in false colour representation and ISO contours. The results recorded on ISO contour as well as false colour graphs are visually evaluated and compared with the numeric data.

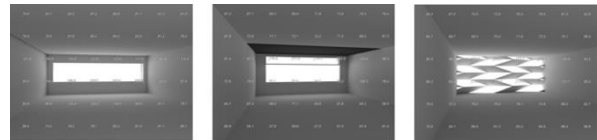

Figure 4: The result: the average grades of ISO grid reading are: Standard 98.7, the system-R 72.5 and Miura DDC 79.6

Table 2: Showing the result of the second test.

Model	Daylight Factor						Model	Daylight Factor					
	Mean	Median	Min.	Max	Uniformit y 1	Uniformit y 2		Mean	Median	Min.	Max	Uniformit y 1	Uniformit y 2
V01	8.45	7.09	4.15	24.26	0.49	0.17	V23	7.11	6.59	3.54	17.20	0.46	0.21
V02	8.81	7.01	3.87	25.97	0.44	0.15	V24	7.82	7.03	3.82	14.61	0.49	0.26
V03	7.97	6.96	3.18	18.82	0.40	0.17	V25	7.21	6.56	3.55	17.20	0.48	0.24
V04	7.11	6.11	3.08	19.94	0.46	0.17	V26	7.11	6.51	3.73	12.61	0.53	0.30
V05	7.75	6.88	4.05	16.87	0.52	0.24	V27	7.66	6.72	3.73	14.47	0.49	0.26
V06	7.75	5.68	3.24	17.75	0.50	0.14	V28	7.21	6.82	3.66	17.19	0.35	0.31
V07	8.43	7.09	2.09	24.54	0.25	0.09	V29	7.47	6.62	3.66	14.27	0.49	0.26
V08	9.04	7.18	3.91	26.93	0.43	0.15	V30	6.78	5.53	2.88	16.35	0.70	0.22
V09	8.24	7.15	3.21	20.25	0.39	0.16	V31	7.17	6.48	3.17	19.23	0.41	0.25
V10	8.05	6.64	4.01	21.30	0.48	0.17	V32	7.80	6.94	3.71	16.16	0.48	0.23
V11	8.14	7.14	4.15	18.26	0.51	0.23	V33	7.74	6.74	3.64	15.67	0.47	0.23
V12	7.08	6.34	3.55	19.43	0.47	0.17	V34	7.46	6.75	3.79	13.94	0.51	0.27
V13	8.16	7.21	4.22	16.83	0.52	0.25	V35	7.69	6.73	3.69	15.48	0.48	0.24
V14	7.31	6.02	3.30	17.40	0.47	0.17	V36	7.45	6.74	3.79	13.97	0.51	0.27
V15	8.41	7.11	4.15	23.70	0.50	0.18	V37	7.62	6.67	3.67	14.74	0.48	0.25
V16	9.11	7.24	3.96	27.18	0.43	0.15	V38	2.50	2.15	0.90	5.83	0.76	0.15
V17	8.30	7.20	4.16	20.17	0.50	0.21	V39	7.21	6.50	3.30	16.16	0.45	0.19
V18	8.41	6.91	3.42	22.54	0.41	0.15	V40	7.77	6.82	3.65	17.24	0.47	0.21
V19	8.29	7.24	4.18	19.19	0.50	0.22	V41	7.75	6.66	3.31	16.91	0.43	0.20
V20	8.04	6.69	3.37	20.43	0.42	0.16	V42	7.77	6.93	3.81	14.78	0.49	0.26
V21	8.19	7.19	3.00	17.67	0.37	0.17	V43	7.77	6.70	3.68	16.26	0.46	0.22
V22	7.08	6.36	3.30	18.55	0.48	0.17	V44	7.56	6.77	3.68	14.00	0.49	0.26
							V45	7.72	6.66	3.63	17.19	0.47	0.23
							V46	7.31	6.57	3.70	13.63	0.51	0.27
							V48	7.58	6.49	2.69	21.25	0.36	0.13
							V49	8.09	6.73	3.80	23.36	0.47	0.16
							V50	8.43	7.46	4.09	16.87	0.49	0.24
							V51	8.28	7.04	3.87	20.24	0.47	0.19
							V52	6.41	5.77	3.10	11.59	0.52	0.29
							V53	8.28	7.10	3.92	17.56	0.47	0.22
							V54	8.31	6.91	2.95	24.73	0.36	0.12
							V55	8.38	6.82	3.82	25.85	0.46	0.15
							V56	8.34	7.09	3.93	20.83	0.47	0.19
							V57	8.3	6.86	3.83	23.65	0.46	0.16
							V58	8.37	7.16	4.01	17.43	0.48	0.23
							V59	8.19	6.82	3.81	22.41	0.47	0.17
							Av	7.76	6.67	3.50	18.19	0.45	0.20

The variants are examined by the hands of the minimum value of the Daylight Factor as the criteria in combination with the uniformity2 (min/max). Confirming the aim to find variants that satisfy the criteria of Daylight Factor between 4 to 8, the test identified only 9 variants that its minimum Daylight Factor is above 4: V05, V11, V13, V15, V17, V19, V50, V58. The average value of the minimum Daylight Factor is 3.5. The variants that recorded the values that is lower than average in both minimum Daylight Factor and uniformity2 are eliminated unless it performed above average in the mean value. The results are visually compared with the graphs and found coherent.

# PLEA 2018 HONG KONG

Smart and Healthy within the 2-degree Limit

This resulted in excluding 15 variants out of 59 from the next tests: V04, V06, V10, V12, V14, V22, V23, V25, V28, V30, V31, V38, V39, V45 and V52.

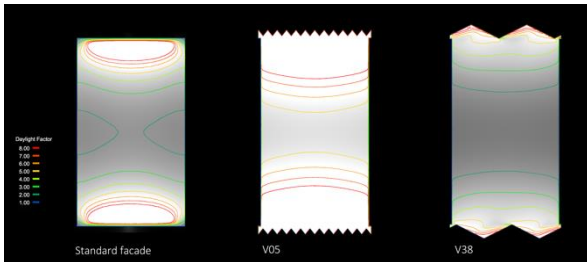

Figure 5: the result of the second test of Standard façade, V05 (passed the test) and V38 (failed the test).

### 3.3 The third test

With the knowledge that the most gl Table 3: Showning the result of the third test.

ass surfaces of the variants are shaded and shutter intrusion of direct sun light the glass surfaces are kept in 50% for the third test.

The 44 variants remained from the first tests are put to simulate on the flux of illuminance. The results are documented in numeric data collecting information on mean, median, minimum, maximum, uniformity1 (min/mean), uniformity2 (min/max). The results are also accumulated in false colour representation and ISO contours by the bands of luminosities: 250 lux to 500 lux, 100 lux to 800 lux and 300 lux to 1000 lux. The variants were tested by means of visual analysis of the false colour as well as ISO contour graphs.

The most excluded variants were confirmed with the below average performance on the maximum flux of illuminance. The selected variants were further analysed by means of thresholds found within the ISO contour graphs that separate variants with lower performances: 321 lux and 357 lux. The variants were formed in one group with area lower than 321 lux stretching from one party wall to the other like a band. The second group has area lower than 321 lux split in two parts positioned separately on the tow party walls. The third group has area lower than 357 lux split in two parts.

As the façade has no thickness, further reduction in brightness is certain. The 14 variants that has the area lower than 321 lux across the full width, from one party wall to the other has been eliminated from the further examinations.

### 3.4 The fourth test

The closed panels are given 100mm thickness for the third tests with the idea that panels be materialized as a high performance isolated sandwich panel with U value of 0.22W/m2K as the starting point.

Table 3: Showning the result of the third test.

S4.54E 24.41N Mch 21 103degree						Uniformity 1	Uniformity 2	Uniformity 3	A>500 lux	A<357 Lux
	Mean (average)	Median (middle value)	Min	Max		(min/mean)	(min/max)	max/mean	area	
V01	621.34	544.94	329.73	1699.82	0.53	0.19	2.74	23.0	2.55	
V02	448.40	313.24	184.52	1831.44	0.41	0.10	#REF!	22.6	4.18	
V03	591.82	532.93	321.19	1326.88	0.54	0.24	2.24	22.7	4.16	
V04	456.85	386.81	213.33	1202.47	0.47	0.18	2.63			
V05	569.72	518.12	313.80	1156.47	0.55	0.27	2.03	22.0	12.92	
V06	399.18	342.05	187.85	950.20	0.47	0.20	2.38			
V07	642.91	562.49	247.18	1764.92	0.38		2.75	24.6	0.51	
V08	665.95	542.24	304.22	1964.61	0.46	0.15	2.95	23.1		
V09	629.29	565.02	337.27	1383.37	0.54	0.24	2.20	24.6	0.87	
V10	570.00	485.65	277.69	1394.89	0.48	0.20	2.45			
V11	624.54	562.89	333.54	1288.14	0.53	0.26	2.06	24.4	1.80	
V12	531.21	453.04	260.15	1237.62	0.49	0.21	2.33			
V13	623.65	562.14	323.75	1241.21	0.52	0.26	1.99	24.2	1.44	
V14	490.94	421.09	169.74	1109.45	0.35	0.15	2.26			
V15	651.52	569.75	254.02	1783.39	0.39	0.14	2.74	25.0	0.23	
V16	699.25	568.24	319.32	2007.73	0.46	0.16	2.87	24.2		
V17	649.18	580.26	344.46	1468.10	0.53	0.23	2.26	25.2	0.30	
V18	636.49	534.22	291.89	1589.48	0.46	0.18	2.50	25.3		
V19	650.40	583.21	344.38	1373.21	0.53	0.25	2.11	25.3	0.34	
V20	600.45	509.43	205.83	1412.30	0.34	0.15	2.35	25.5		
V21	650.90	584.27	346.18	1313.88	0.53	0.26	2.02	25.3	0.33	
V22	569.83	486.45	277.06	1291.16	0.49	0.21	2.27			
V23	505.97	452.68	255.26	1121.05	0.50	0.23	2.22			
V24	434.09	408.25	176.64	796.18	0.41	0.22	1.83			
V25	506.91	465.85	257.85	949.26	0.51	0.27	1.87			
V26	361.35	349.41	217.45	575.05	0.60	0.38	1.59			
V27	475.36	38.72	258.83	859.76	0.54	0.30	1.81			
V28	349.45	339.79	234.72	538.55	0.67	0.44	1.54			
V29	454.71	421.02	254.87	806.79	0.56	0.32	1.77			
V30	257.88	251.36	174.24	389.77	0.68	0.45	1.51			
V31	542.56	478.07	266.96	1442.59	0.49	0.19	2.66			
V32	492.02	454.09	257.63	1088.30	0.52	0.24	2.21			
V33	510.09	453.55	253.07	1133.33	0.50	0.22	2.22			
V34	437.66	415.57	251.12	825.65	0.57	0.30	1.89			
V35	531.02	480.19	275.31	1067.17	0.52	0.26	2.01			
V36	437.06	414.43	251.91	827.77	0.58	0.30	1.89			
V37	521.17	473.36	274.64	1001.92	0.53	0.27	1.92			
V38	357.04	342.09	113.87	628.15	0.32	0.18	1.76			
V39	584.85	505.54	202.30	1898.22	0.35	0.11	3.25			
V40	545.51	492.32	275.16	1276.09	0.50	0.22	2.34			
V41	584.10	515.48	288.76	1308.76	0.49	0.22	2.24	21.5		
V42	525.14	486.40	281.17	1012.89	0.54	0.28	1.93			
V43	583.25	516.64	292.04	1200.07	0.50	0.24	2.06	21.6		
V44	501.67	467.10	276.19	927.89	0.55	0.30	1.85			
V45	578.14	513.10	292.08	1147.58	0.51	0.25	1.98	21.5		
V46	469.83	439.65	268.93	843.57	0.57	0.32	1.80			
V48	597.04	523.12	202.48	1563.65	0.34	0.13	2.62	22.0		
V49	625.70	528.49	295.73	1758.60	0.47		2.81	22.2		
V50	599.73	537.49	269.67	1193.52	0.45	0.23	1.99	22.7		
V51	622.15	535.03	297.49	1506.82	0.48	0.20	2.42	22.5		
V52	581.41	525.69	292.30	1070.31	0.50	0.27	1.84			
V53	618.13	534.29	292.17	1269.14	0.47	0.23	2.05	22.5		
V54	653.69	549.04	308.36	1737.60	0.47	0.18	2.66	23.1		
V55	669.96	550.08	310.78	1791.10	0.46	0.17	2.67	23.3		
V56	638.51	545.55	307.01	1430.24	0.48	0.21	2.24	23.2		
V57	656.97	545.96	308.97	1625.40	0.47	0.19	2.47	23.1		
V58	609.16	523.63	289.04	1290.90	0.47	0.22	2.12	21.9		
V59	645.38	539.34	300.16	1574.08	0.47	0.19	2.44	22.8		
AV To	552.39		269.18							

  tiny 357 lux  
  split 357 lux  
  presence of area lower than 321 lux  
  presence of area lower than 300 lux

The 30 variants remained from the first tests are tested by means of the simulation on flux of illuminance. The results are documented in numeric data collecting information on mean, median, minimum, maximum, uniformity1 (min/mean), uniformity2 (min/max), uniformity3 (max/mean). The results are also accumulated in false colour representation and ISO contours by the bands of luminosities: 250 lux to 500 lux, 100 lux to 800 lux and 300 lux to 1000 lux.

30 variants are grouped by applying the identical thresholds of flux of luminosities; 300 lux, 321 lux, 357 lux and 500 lux. Visual consultation of ISO graphs created subgroups by separating a group into two; the area lower than the threshold being stretched from one party wall to the other, or split into two areas. For the thirty variants the surface area above 500 lux and the area lower than 357 lux were calculated. The value above 500 lux varies from 21.5 m<sup>2</sup> to 25.5m<sup>2</sup>. The variants with presence of

# PLEA 2018 HONG KONG

## Smart and Healthy within the 2-degree Limit

the area with lower than 321 lux was excluded, through which all 13 horizontal variants were excluded from further tests.

For the remaining last 11 variants, which all of them had the area under 357 lux split in two parts, the surface area under 357 lux were calculated. The value spreads from 0.23 m<sup>2</sup> to 4.18 m<sup>2</sup>. There were four variants with the area lower than 10%, from 0.23 m<sup>2</sup> to 0.34 m<sup>2</sup>. The test recognized these four variants and further examined the results.

V15, V17, V19 and V21 all had quite similar mean value stretching from 649.18 lux to 651.52 lux. The minimum value of V15 was 254.02 lux, which is significantly lower than the other three that range from 344.38 lux to 346.18 lux. The uniformity1 (min/mean) of V17, V19 and V21 were identical at 0.53. V21 has lowest uniformity3 (max/mean) at 2.02 by which the test concluded that the V21 as the best performed variant.

### 3.5 Comparison

V21 is a vertical variant which has the interval of the 'V' fold at every 1200mm, the height of 'V' 900mm and the depth of fold 750mm. From the horizontal variants V55 and V56 seem to perform at nearly identical level. V21 performed better than V22, which has identical spec except the depth being 1500mm. V20 differ from V21 only with its interval being 750. From this I can assume that depth of the fold has optimal point at around 1/4 of floor to ceiling heights. The test confirmed that the daylight penetration via this new façade geometry can be proportionate with the relation of the three parameters.

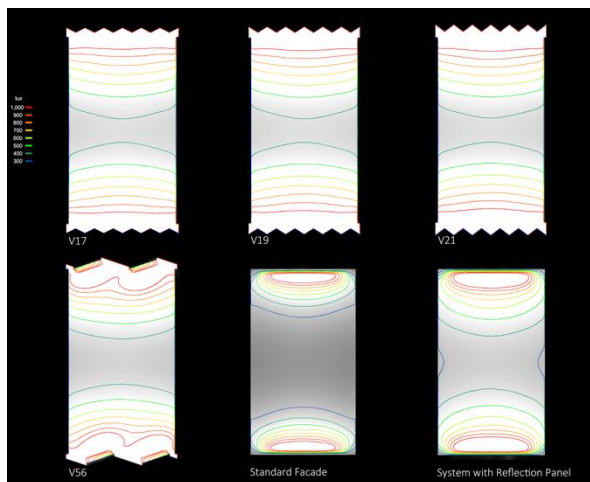

Figure 6: Showing the result of the fourth test of variants V17, V19 and V21 (above three). V56, Standard Façade and the façade with system of reflection plate on the lower three.

Table 4: Showing the result of the fourth test

CRITERIA Re SufiteTest 4 t-100mm / Illuminance									
S4.54E 24.41N Mrch 21 103degree					Uniformity 1 min/mean	Uniformity 2 min/max	Uniformity 3	A>500 lux	A<357 Lux
	Mean (average)	median (middle)	Min	Max	(min/mean)	(min/max)	max/mean	area	
V01	621.34	544.94	329.73	1699.82	0.53	0.19	2.74	23.0	2.55
V02	448.40	313.24	184.52	1831.44	0.41	0.10	#REF!	22.6	4.18
V03	591.82	532.93	321.19	1326.88	0.54	0.24	2.24	22.7	4.16
V04	456.85	386.81	213.33	1202.47	0.47	0.18	2.63		
V05	569.72	518.12	313.80	1156.47	0.55	0.27	2.03	22.0	12.92
V06	399.18	342.05	187.85	950.20	0.47	0.20	2.38		
V07	642.91	562.49	247.18	1764.92	0.38		2.75	24.6	0.51
V08	665.95	542.24	304.22	1964.61	0.46	0.15	2.95	23.1	
V09	629.29	565.02	337.27	1383.37	0.54	0.24	2.20	24.6	0.87
V10	570.00	485.65	277.69	1394.89	0.48	0.20	2.45		
V11	624.54	562.89	333.54	1288.14	0.53	0.26	2.06	24.4	1.80
V12	531.21	453.04	260.15	1237.62	0.49	0.21	2.33		
V13	623.65	562.14	323.75	1241.21	0.52	0.26	1.99	24.2	1.44
V14	490.94	421.09	169.74	1109.45	0.35	0.15	2.26		
V15	651.52	569.75	254.02	1783.39	0.39	0.14	2.74	25.0	0.23
V16	699.25	568.24	319.32	2007.73	0.46	0.16	2.87	24.2	
V17	649.18	580.26	344.46	1468.10	0.53	0.23	2.26	25.2	0.30
V18	636.49	534.22	291.89	1589.48	0.46	0.18	2.50	25.3	
V19	650.40	583.21	344.38	1373.21	0.53	0.25	2.11	25.3	0.34
V20	600.45	509.43	205.83	1412.30	0.34	0.15	2.35	25.5	
V21	650.90	584.27	346.18	1313.88	0.53	0.26	2.02	25.3	0.33
V22	569.83	486.45	277.06	1291.16	0.49	0.21	2.27		
V23	505.97	452.68	255.26	1121.05	0.50	0.23	2.22		
V24	434.09	408.25	176.64	796.18	0.41	0.22	1.83		
V25	506.91	465.85	257.85	949.26	0.51	0.27	1.87		
V26	361.35	349.41	217.45	575.05	0.60	0.38	1.59		
V27	475.36	38.72	258.83	859.76	0.54	0.30	1.81		
V28	349.45	339.79	234.72	538.55	0.67	0.44	1.54		
V29	454.71	421.02	254.87	806.79	0.56	0.32	1.77		
V30	257.88	251.36	174.24	389.77	0.68	0.45	1.51		
V31	542.56	478.07	266.96	1442.59	0.49	0.19	2.66		
V32	492.02	454.09	257.63	1088.30	0.52	0.24	2.21		
V33	510.09	453.55	253.07	1133.33	0.50	0.22	2.22		
V34	437.66	415.57	251.12	825.65	0.57	0.30	1.89		
V35	531.02	480.19	275.31	1067.17	0.52	0.26	2.01		
V36	437.06	414.43	251.91	827.77	0.58	0.30	1.89		
V37	521.17	473.36	274.64	1001.92	0.53	0.27	1.92		
V38	357.04	342.09	113.87	628.15	0.32	0.18	1.76		
V39	584.85	505.54	202.30	1898.22	0.35	0.11	3.25		
V40	545.51	492.32	275.16	1276.09	0.50	0.22	2.34		
V41	584.10	515.48	288.76	1308.76	0.49	0.22	2.24	21.5	
V42	525.14	486.40	281.17	1012.89	0.54	0.28	1.93		
V43	583.25	516.64	292.04	1200.07	0.50	0.24	2.06	21.6	
V44	501.67	467.10	276.19	927.89	0.55	0.30	1.85		
V45	578.14	513.10	292.08	1147.58	0.51	0.25	1.98	21.5	
V46	469.83	439.65	268.93	843.57	0.57	0.32	1.80		
V48	597.04	523.12	202.48	1563.65	0.34	0.13	2.62	22.0	
V49	625.70	528.49	295.73	1758.60	0.47		2.81	22.2	
V50	599.73	537.49	269.67	1193.52	0.45	0.23	1.99	22.7	
V51	622.15	535.03	297.49	1506.82	0.48	0.20	2.42	22.5	
V52	581.41	525.69	292.30	1070.31	0.50	0.27	1.84		
V53	618.13	534.29	292.17	1269.14	0.47	0.23	2.05	22.5	
V54	653.69	549.04	308.36	1737.60	0.47	0.18	2.66	23.1	
V55	669.96	550.08	310.78	1791.10	0.46	0.17	2.67	23.3	
V56	638.51	545.55	307.01	1430.24	0.48	0.21	2.24	23.2	
V57	656.97	545.96	308.97	1625.40	0.47	0.19	2.47	23.1	
V58	609.16	523.63	289.04	1290.90	0.47	0.22	2.12	21.9	
V59	645.38	539.34	300.16	1574.08	0.47	0.19	2.44	22.8	
AV To	552.39			269.18					

■ tiny 357 lux  
■ split 357 lux  
■ presence of area lower than 321 lux  
■ presence of area lower than 300 lux

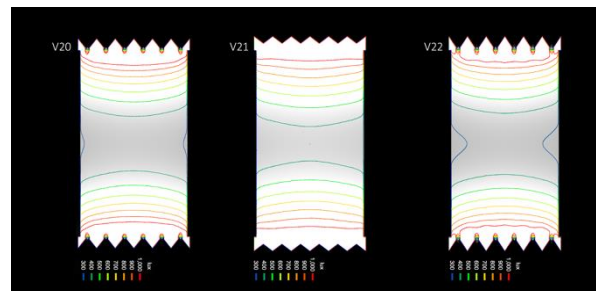

Figure 7: Showing the result of the fourth test V20 on the left, V21 in the middle and V22 on the right. At 750mm folding depth the V21 is not a shallow façade. This test also tested the fold from 300 mm onwards. The deeper façade folding, as much as 1500, creates less penetration of daylight.

### 4. CONCLUSION

The façade thickness of the V21 is increased to 150mm with the idea to use construction frame of section dimension 120 x 70mm. V21 has the minimum

# PLEA 2018 HONG KONG

## Smart and Healthy within the 2-degree Limit

value of illuminance at 329.93 lux. this is formidable result as under the condition the building needs no artificial lights. The mean value V21 is 621.92 lux, which is 1.6 times improvement in respect to a standard façade with a conventional 400mm thickness. The minimum illuminance of V21 is 2.8 times higher than the same standard façade. In terms of Daylight Factor, the minimum value of Daylight Factor of V21 is 3.88, that quite close to the initial target to achieve a variant with the Daylight Factor of all area higher than 4. A standard 400mm façade has 1.78 which is 1.4 times smaller. In comparison to a model that assimilates the BARTENBACH's system with reflection, V21 performed 1.7 times better in mean value of the flux illuminance. With reflective aluminium applied on BARTENBACH's V21 still performed 1.1 times better. In terms of Daylight Factor the performance is similar.

The BARTENBACH's variant that makes the condition of reflection closer to its intention improves its daylight penetration performances. With the application of aluminum as the reflective material, the system with reflection reduces its shortcomings to V21 from 3.1 times to 1.3 times. V21 covers entire floor area with the illumination above 300 lux, while system with reflection covers its 98% yet 1.4 times darker at the area with the lowest illumination. The standard façade can only cover 45% of its entire floor above 300 lux and it is 2.2 times darker at the area with the lowest illumination.

In theory the façade with twice Daylight emitting capacity can support building with twice as deeper floor plan as the current model. An office floor plan can be a large single 70m square. This may beneficial to reduce energy consumption to heat or to cool building due to its smaller external surface area. I add sketch of such building.

### ACKNOWLEDGEMENTS

This paper forms a part of the KAKEN (JSPS) research on a new building that support human habitation in the extreme life environment.

Table 5: Comparison between standard model, System with reflection, System with Reflection with Aluminium and V21. (lux) x S-4 f400 stands for comparison against Standard-4 façade depth 400mm. SB stands for System with reflection, SB\_alu-4 stands for System with reflection with aluminium.

Model	Illuminance				Uniformity 1 (min/mean)	Uniformity 2 (min/max)
	Mean	Median	Minimum	Maximum		
Standard-4_f400	383.35	272.74	116.01	1207.51	0.3	0.1
SystemB-4_f400	373.45	300.33	177.32	988.54	0.47	0.18
SystemB_alu-4_f400	561.38	472.35	214.7	1296.46	0.38	0.17
V21(f150)-4	621.92	589.14	329.93	1215.43	0.53	0.27
x S-4 f400	1.6	2.1	2.8	1.0		
x SB-4 f400	1.7	1.9	1.9	1.2		
x SB_alu-4 f400	1.1	1.2	1.5	0.9		

Model	Daylight Factor				Uniformity 1 (min/mean)	Uniformity 2 (min/max)	A>500 lux	300<A<500
	Median	Minimum	Maximum					
274>	4.47	3.17	1.78	14.01	0.4	0.13	19.079	18.1529
	4.32	3.48	2.01	11.46	0.47	0.18	15.8163	25.6987
	6.53	5.5	2.77	15.03	0.42	0.18	37.0769	44.0658
	7.25	6.51	3.88	14.42	0.53	0.27	48.3795	34.4205
	1.6	2.1	2.2	1.0			2.5	1.9
	1.7	1.9	1.9	1.3			3.1	1.3
	1.1	1.2	1.4	1.0			1.3	0.8

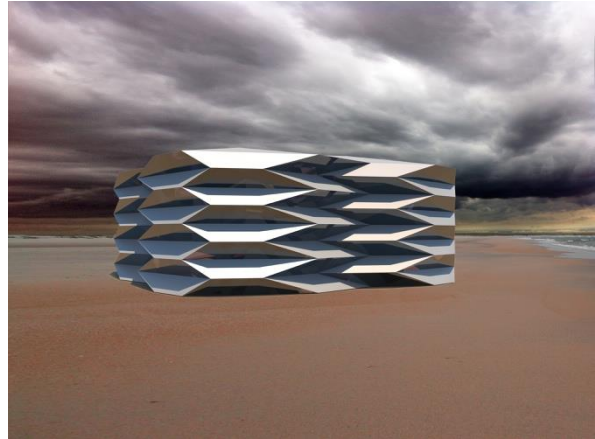

Figure 8: A tentative design of a shelter, exterior view impression.

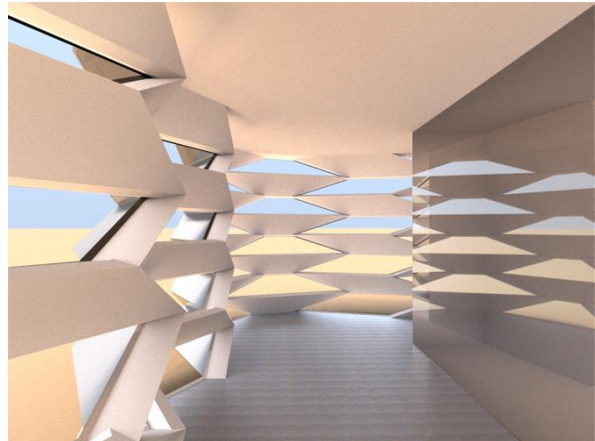

Figure 9: A tentative design of a shelter, interior View.



Figure 10: An imaginary tower with small floor/façade ratio.

### REFERENCES

1. Transition to sustainable building Strategy and Opportunities – EXECUTIVE SUMMARY, 2013, p3
2. Miura, K. and T. Tachi, (2010). SYSTHESIS OF RIGID-FOLDABLE CYLINDRICAL POLYHEDRA. *Symmetry: Art and Science Gmuend Austria*.

# PLEA 2018 HONG KONG

*Smart and Healthy within the 2-degree Limit*

3. Miura, K., (1985). Method of Packaging and Deployment of Large Membranes in Space. *The Institute of Space and Astronautical Science Report No.618*, December 1985.



# Advanced Radiant Cooling System for the Office in Tropics: Relaxation of Thermal Comfort Criteria by Utilizing a Slight Airflow

MASAYUKI ICHINOSE<sup>1</sup>, MIDORIKO KINOSHITA<sup>2</sup>, KITARO MIZUIDE<sup>3</sup>,  
TARO HONGO<sup>3</sup>, KAZUKI YAMADA<sup>4</sup>

<sup>1</sup>Tokyo Metropolitan University, Tokyo, Japan

<sup>2</sup>Kajima Corporation, Tokyo, Japan

<sup>3</sup>Nikken Sekkei Ltd., Tokyo, Japan,

<sup>4</sup>Tonets Corporation, Tokyo, Japan

**ABSTRACT:** The YKK 80 building located in central Tokyo aims to realise better energy saving and thermal comfort compared to a conventional radiant cooling system by utilising a slight airflow to improve comfort criteria and relaxation. This paper presents the actual performance of an advanced radiant cooling system based on a mock-up experimental study and on-site investigations into the occupied building. As a result of investigations, the actual performance of the system is verified.

The YKK 80 building was awarded first place in the ASHRAE Technology Award 2017[1] and was certificated as LEED CS Platinum in 2016.

**KEYWORDS:** Air conditioning for tropic climate, Radiant cooling system, Slight airflow assist, Expansion of comfort criteria, Energy conservation

## 1. INTRODUCTION

One focussed energy conservation method for air-conditioning systems against humid tropic summers in Japan is the radiant cooling system because it allows for a higher temperature chilled water supply and the utilisation of desiccant dehumidification that contribute to the high efficiency of a comprehensive air-conditioning system and better thermal comfort at the same time. The YKK 80 building project, shown in Fig. 1, by utilising the effect of a slight airflow aims to save more energy and realise better thermal comfort than a conventional radiant cooling system.

Fig. 2 shows the design concept for a slight airflow combined radiant cooling system. The target design temperature is as following; ceiling surface temperature is 23°C (chilled water temperature is 17°C), air temperature is initially 28°C. One of the most important hypotheses in this system is that the slight airflow under the radiant cooling environment enhances the thermal comfort while a conventional radiant cooling system strictly avoids air drafts. To verify and realise this concept, we have conducted a long-term study on the actual performance of this system during a mock-up, both before and after occupation, as shown in Table 1.

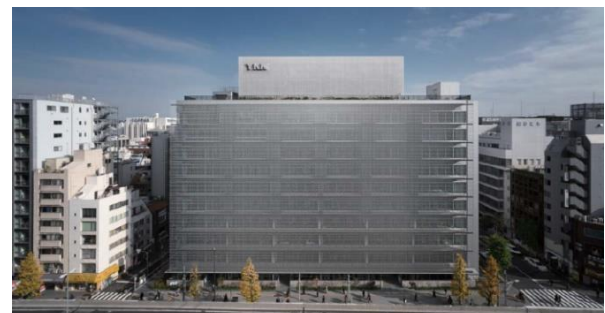

Figure 1: The YKK80 Building located in central Tokyo (completed in July 2015)

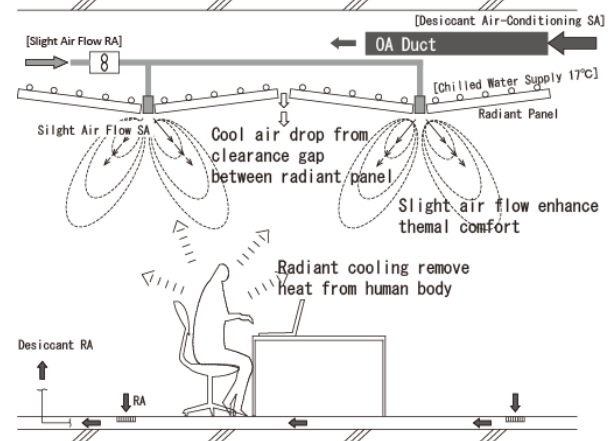

Figure 2: Diagram of slight airflow assisted radiant cooling

# PLEA 2018 HONG KONG

## Smart and Healthy within the 2-degree Limit

Table 1. Investigation phases of the entire project

Phase	Construction	Operation				
Target	Mock-up	Before occupied	After occupied			
Season	Summer*	Summer	Winter	Intermediate	Summer	Winter
Date	2014.11	2015.7	2016.1	2016.4	2016.7	2017.1
Content	Experimental study on slight air flow effect	Comparative study on different set point temperature	Study on initial operation situation	Study on normal operation situation under different season		

## 2. METHODOLOGY

### 2.1 Mock-up experimentation

To identify the effect of a slight airflow on the thermal comfort, a mock-up building was built as shown in Fig. 3. This building was built in a storage facility in Tokyo and had three separate rooms; anterior chamber, room for conventional air conditioning and room for radiant cooling. The anterior chamber was to buffer and neutralise the different thermal environments. The conventional air-conditioning room was equipped with a package air-conditioning unit. The radiant cooling room was equipped with a chilled water piped radiant ceiling panel and a slight air diffuser. Ventilated fresh air was supplied to each room through an air handling unit.

The experimental studies included the comparison of conventional/radiant cooling, different set points of temperature/humidity, different air volumes for the slight airflow and so on. 150 cumulative total number of people attended this study and answered a questionnaire related to thermal comfort. Fig. 4 shows an example of the schedule for an experimental study on different air volumes for the slight airflow that is supposed to enhance thermal comfort under the radiant cooling system. Before entering the target air-conditioned room, occupants stay in the anterior chamber space for 30 minutes and answer an initial questionnaire, followed by a second questionnaire in the air-conditioned room.

### 2.2 Before and after occupation

The YKK 80 building has 10 stories, is 39.5 m in total height and has a total floor area of 22,574 m<sup>2</sup> and typical floor area of 1,960 m<sup>2</sup> on each floor. After completion, before and after occupation measurements were conducted on one of the typical floors, as shown in Fig. 5. The main façade shown in Fig. 1 is facing directly west and measurement points are located in the north part of the floor. Sectional distribution was measured at point A and radiant panel temperature was measured at point B. The vertical air temperature (T-CC thermocouple), globe temperature (75mm sphere), relative humidity (T&D, TR-74Ui), air velocity (KANOMAX, 6501), radiant panel temperature (T-CC), sectional temperature(T-CC)/air velocity distribution (KANOMAX) at each point were measured.

Measurements were conducted by an automated sensor and data logger, but some of the elements were measured manually. Fig. 6 shows the methodology of the sectional distribution for temperature and air velocity recorded manually. The trolley shown on the left side of Fig. 6 is equipped with several thermocouples at 50 mm vertical intervals and moves in one direction to measure the two dimensional temperature distribution in the space. For the air velocity, the mesh wire shown on the right side of Fig. 6 was prepared to identify measurement points for the anemometer.

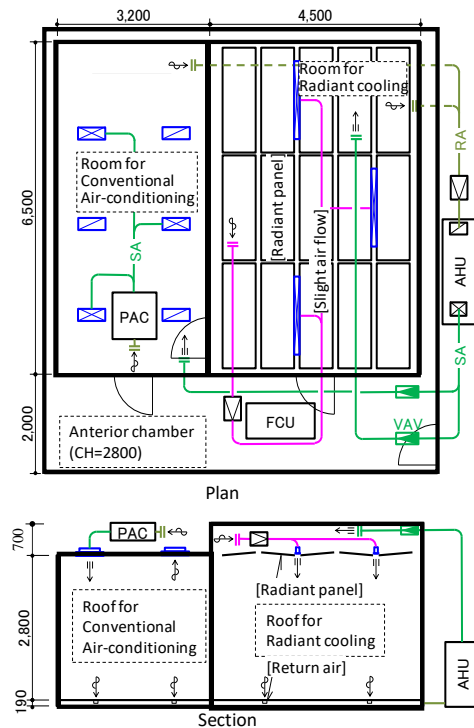

Figure 3: Diagram of mock-up experimental room

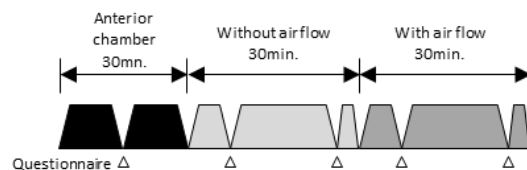

Figure 4. Schedule of experimental study

# PLEA 2018 HONG KONG

Smart and Healthy within the 2-degree Limit

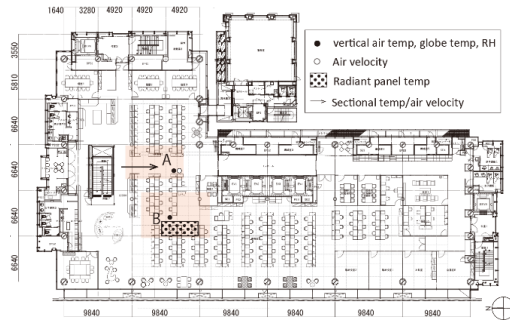

Figure 5: Plan for typical office floor with measurement points and items

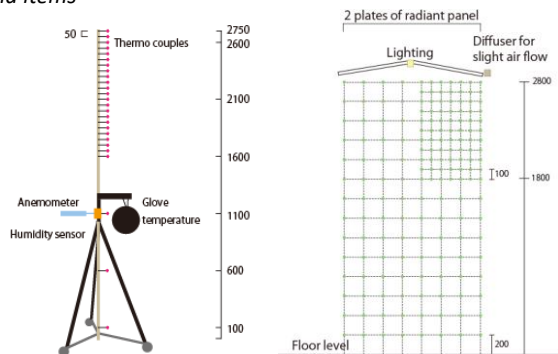

Figure 6: Methodology of manual measurements for spatial distribution in the office

## 3. THERMAL ENVIRONMENT

### 3.1 Effect of a slight airflow on comfort criteria

To ensure and confirm our hypothesis; a slight airflow may relax the thermal comfort criteria in a radiant cooling environment, an experimental mock-up study of 150 cumulative total number of people was conducted in 2013 [2]. The comparative case study was configured at different set points of air temperature, humidity, radiant panel temperature and air velocity (low, intermediate and strong).

In this paper, the results of the intermediate air velocity for slight airflow assisted air conditioning will be discussed because the low and strong air velocity situations showed less correlation to other indices. Table 2 shows a summary of the conditions and results under a radiant cooling system with intermediate air velocity (around 2 m/s near the occupants) with a slight airflow. The air temperature, operative temperature and humidity represents the measured averaged value over 30 min during each case. As shown in Fig. 4, all examinees stayed in the anterior chamber for 30 min before entering the radiant cooling room.

Fig. 7 displays the temperature and humidity points on the psychrometric chart that is based on the results in Table 2. The coloured area shows that 75% of subjects reported a comfort response under the radiant cooling condition with a medium rate of slight airflow. This result shows an expansion of the comfort area that supports

the hypothesis of a relaxation effect of a slight airflow under radiant cooling.

### 3.2 Comparative study on set point temperature

After the building was completed, on-site measurements before occupation were conducted. The main purpose of this phase was to verify the appropriate operation of the radiant cooling system and study the set point temperatures for the occupied operation phase [3]. The different set points were tested on different operation days and the measurements were based on point B in Fig. 5.

Fig. 8 shows the vertical temperature distribution when the room temperature became stable at the different set point (SP) temperatures. A larger temperature difference can be observed in the case of SP: 28°C, but there was less than 0.5K difference between heights of 100 to 1600mm that represent the occupied zone. This result reflects the typical effect of a radiant cooling system.

Fig. 9 shows the fundamental surface temperatures (radiant panel and wall surface) and mean radiant temperatures (MRT). In each case, the MRT is less than or equal to the SP temperature (except SP 28°C) because of the effect of cooler radiation from the ceiling or due to other surface temperature reductions.

Table 2. Summary of the conditions and results from the experimental study under radiant cooling with a slight airflow

Temp	OT	Abs Humidity	Examinee		Rate of comfort
			Male	Female	
[°C]	[°C]	[kg/kg(DA)]	[-]	[-]	[%]
26.9	26.7	0.01036	3	1	100
27.0	27.1	0.01343	3	2	50
28.2	27.4	0.01335	2	3	100
27.5	27.4	0.01181	5	1	100
27.6	27.5	0.01205	3	3	75
28.1	27.6	0.01010	2	3	33.3
28.1		0.01161	2	3	66.7
27.8	27.6	0.01050	3	1	100
27.9	27.7	0.01147	6	0	50
27.3	27.8	0.01281	3	2	66.7
27.9	27.8	0.00989	3	2	100
28.0	27.9	0.01207	5	1	75
28.0		0.01336	5	1	100
28.0	27.9	0.01261	6	0	100
28.0	28.0	0.01101	5	0	100
28.4	28.3	0.01199	1	4	100
28.4		0.01306	1	4	0

# PLEA 2018 HONG KONG

## Smart and Healthy within the 2-degree Limit

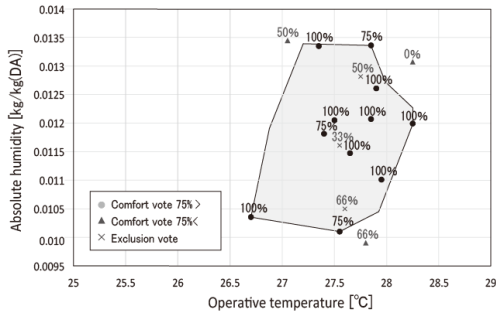

Figure 7: Expanded comfort areas based on 75% of the subjects

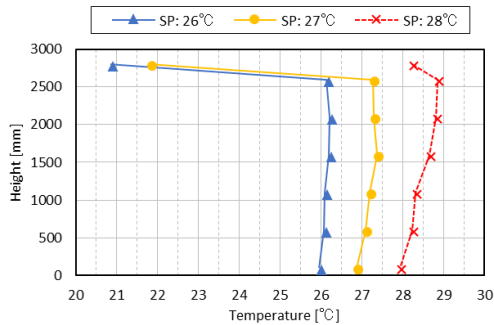

Figure 8: Vertical temperature distribution at the different set point temperatures before occupation.

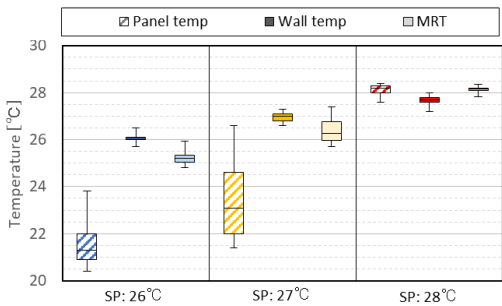

Figure 9: Surface temperature and MRT in the different set point temperature before occupied

Fig. 10 describes the air temperature and humidity distribution on the psychrometric chart using the thermal comfort criteria of ASHRAE [4] and the expanded criteria shown in Fig. 7. SP:27°C is inside of the expanded comfort area while SP:26°C is inside of the ASHRAE criteria. However, SP:28°C cannot satisfy the expanded comfort area despite the initial results. According to the result of the satisfaction of the comfort criteria, the SP for the operation phase was chosen to be 27°C.

### 3.3 Detailed thermal environment under operation

Following the initial investigation, measurements after occupation were conducted to evaluate and verify the detailed thermal environment. The results in this section are also based on point B in Fig. 5.

Fig. 11 shows the fluctuation in the air temperature, relative humidity, MRT and PMV on a typical summer day. The air temperature fluctuated largely during the initial operation but stabilised around 27°C after that. The MRT fluctuated in a similar fashion to the air temperature

because of the effect of the radiant cooling panel. As a result, PMV (under the conditions of  $clo = 0.5$  and  $met = 1.1$ ) was less than 0.2 during all of the day.

Fig. 12 describes the sectional spatial distribution of the air velocity recorded by the manual measurement equipment as previously shown in Fig. 6. The left side shows the air velocity without airflow and the right side shows it with airflow, that is the regular operation of the radiant cooling system. By applying a slight airflow diffuser, the air velocity in the occupied space increased to around 0.2 m/s, that is the target air velocity according to the mock-up experimental study.

Fig. 13 also shows the sectional spatial distribution of air temperature with and without any airflow. The distribution of air temperature is very small but there is a more prevalent cool air down flow in the case of a slight airflow. This slight airflow also assists in cooling the air temperature with minimal fan utilisation.

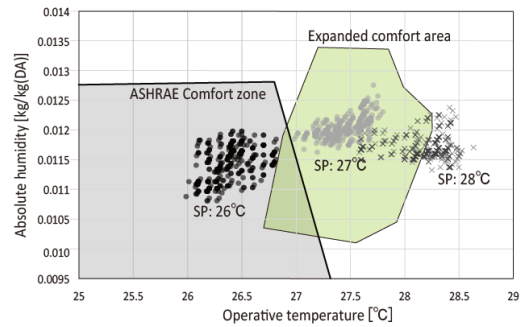

Figure 10: Surface temperature and MRT at the different set point temperatures before occupation.

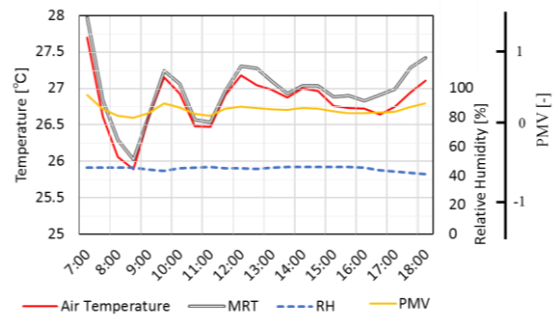

Figure 11: Fluctuation of the thermal environment in the interior space on a typical summer day ( $Clo = 0.5$ ,  $Met = 1.1$ )

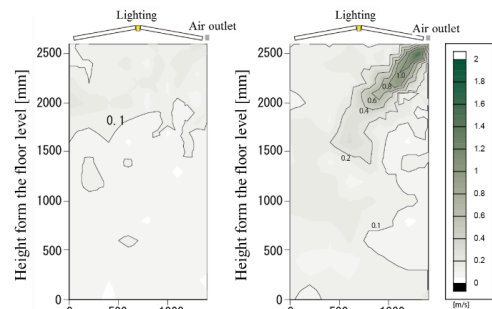

Figure 12: Sectional spatial distribution of air velocity in the interior space (Left: w/o airflow, Right: w/ airflow)

# PLEA 2018 HONG KONG

Smart and Healthy within the 2-degree Limit

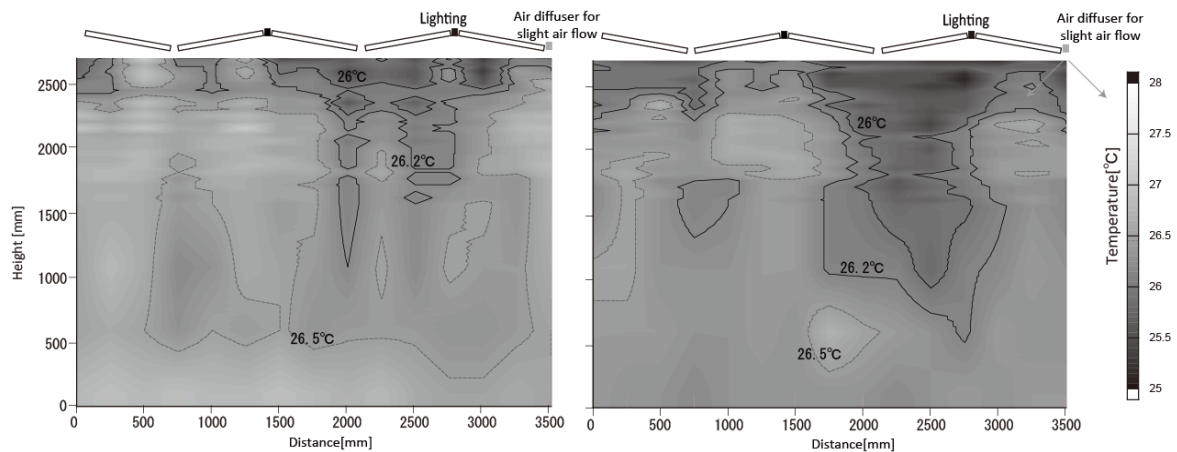

Figure 13: Sectional spatial distribution of air temperature in the interior space (Left: w/o airflow, Right: w/ airflow)

### 3.4 Thermal sensation vote of occupants

To understand the occupants' sensation and satisfaction to the thermal environment derived by the radiant cooling system with a slight airflow, a questionnaire survey was conducted after the occupied situation. The contents of the questionnaire included; 9 items of personal information, 4 items on the thermal sensation, 10 items on thermal comfort and satisfaction and 4 items on aeroscepsy. The occupants gave answers on a paper sheet by ticking on the points of a scale bar [5]. The number of subjects was 85. Subjects in their 30's accounted for 42%, in their 40's accounted for 34% and female subjects accounted for 42% of the total.

Fig. 14 displays the thermal sensation votes for each part of the body. Because of the application of a continuous sensation scale, the vote was classified into seven sections by referring to the PMV  $\pm 0.5$ , recommended by ISO7730 [6]. Due to the observed small differences between each part of the body, occupants may feel the superiority of the radiant cooling system over a small spatial temperature distribution. From the result of the total thermal sensation that is hotter than 19% and cooler than 35%, the operational SP air temperature of 27°C can satisfy a cooler environment.

Fig. 15 shows the correlation between the clothing ratio and the thermal sensation vote by gender. The clothing ratio is estimated by referring to ISO9920 [7]. The average thermal sensation vote for females was  $-0.39$  and for males was  $+0.24$ . There is a strong relationship between the clothing ratio and the sensation vote in females but not in males.

Fig. 16 shows the correlation between the thermal comfort sensation and the airflow comfort sensation. Airflow has a strong relationship to the thermal comfort. Fig. 17 displays the relationship between aeroscepsy and the strength / temperature of the airflow sensation. A slight airflow of this system is accepted by occupants because a neutral sensation for strength accounts for 63% and the temperature accounts for 78%.

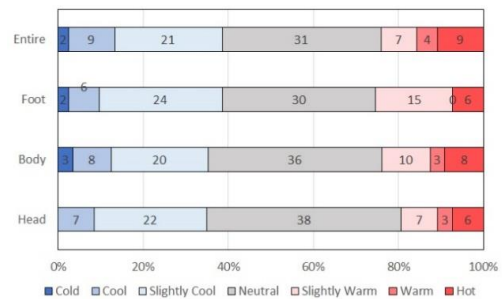

Figure 14: Thermal sensation vote

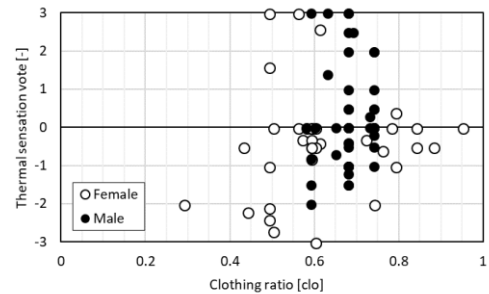

Figure 15: Correlation between clothing ration and thermal sensation vote

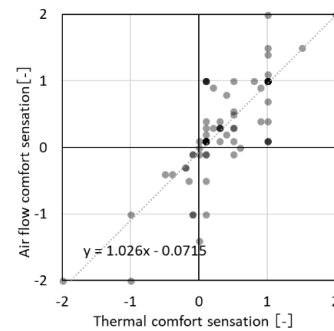

Figure 16: Correlation between the thermal comfort and aeroscepsy

# PLEA 2018 HONG KONG

Smart and Healthy within the 2-degree Limit

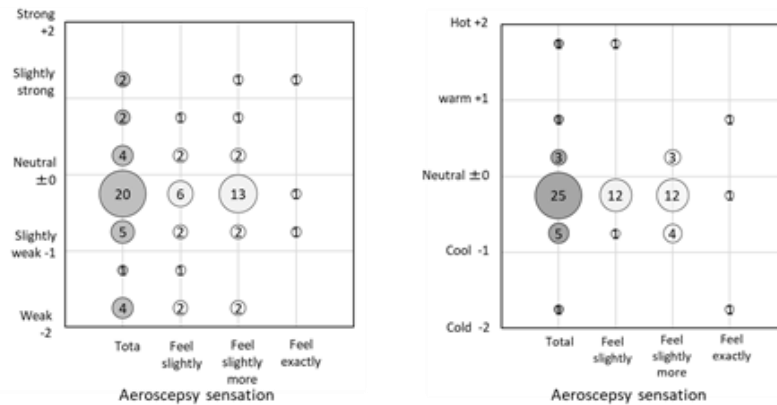

Figure 17: Correlation between aeroscepsy and strength / temperature of airflow sensation

## 4. ENERGY PERFORMANCE

### 4.1 Comparison to the different system

To clarify the energy conservation effect of the suggested radiant cooling system, an energy simulation study was conducted. In this simulation, heat load and system simulation were conducted separately by using a LCEM tool [8] developed in Japan. The building was assumed to be a typical office building that is almost the same scale as the YKK 80 building.

Fig. 18 shows a comparison of the estimated energy consumption between different types of air-conditioning systems for cooling during June to September in Tokyo. The energy consumption was broken down into use by the chiller, desiccant, pump and fan. In comparison to the general radiant cooling system, fan energy increased because of the slight airflow, but due to the relaxation of the SP temperature it resulted in a 7.4% total energy reduction. Compared to the conventional air conditioning, a 39.4% reduction in energy consumption is possible.

### 4.2 Baseline, proposed and actual

Fig. 19 shows the monthly energy consumption for an office space by comparing the ASHRAE Baseline, the proposed consumption in the design phase and the actual consumption after completion of the YKK 80 building because of the relaxation in the SP air temperature and humidity, a higher chilled water supply and utilisation of desiccant dehumidification, the efficiency of the comprehensive air-conditioning system is quite high and the energy conservation effect is 40 to 50% compared to the baseline.

## 5. CONCLUSION

The high efficiency of this advanced radiant cooling system is verified through on-site measurements. A 0.2m/s slight airflow expanded the thermal comfort criteria and 60% of the occupants' thermal sensation vote was neutral/cool even if the SP air temperature was 27°C. The actual energy consumption realised a 40%–50% reduction compared to the ASHRAE Baseline.

The concept of this radiant cooling system has potential for higher energy efficiency and better thermal environment in the tropics Asia.

## ACKNOWLEDGEMENTS

The authors would like to thank YKK real estate, YKK and YKK AP Corporation for cooperation.

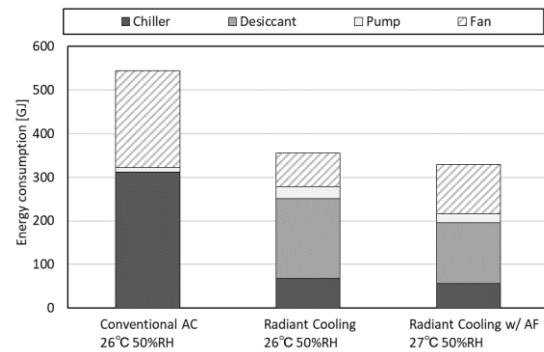

Figure 18: Comparison of estimated energy consumption between different type of air-conditioning system for the cooling in Tokyo

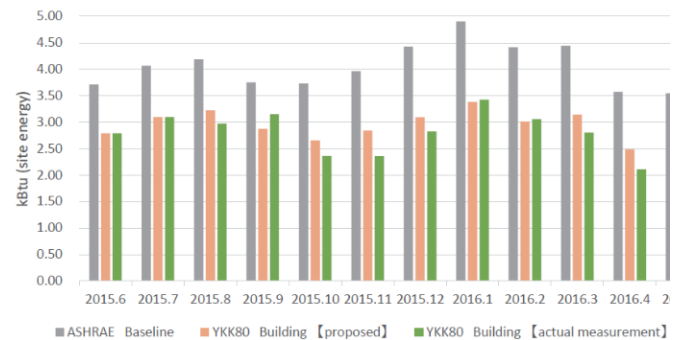

Figure 19: Monthly energy consumption for office space of baseline, proposed and actual measurement

## REFERENCES

- [1] S. Horikawa, K. Mizuide, T. Hongo, Cool Radiant Design – Inside and Out, High Performing Buildings Magazine, Vol.10, No.3, pp. 6-17, Summer 2017

# PLEA 2018 HONG KONG

*Smart and Healthy within the 2-degree Limit*

- [2] K. Mizuide, M. Ichinose, et al., Validation about the environmental efficiency of the radiative cooling and heating system assisted by a slight air flow on urban environmental building, Part1 - 4, Proceedings of annual conference of SHASE, Sep., 2016 (Japanese)
- [3] K. Mizuide, M. Ichinose, et al., Experimental Study on radiative cooling and heating system assisted by a slight air flow, Part1 - 5, Proceedings of annual conference of SHASE, Sep., 2014, 2015 (Japanese)
- [4] ASHRAE, Thermal environmental Conditions for Human Occupancy, ANSI/ ASHRAE standard, 2013, 55 - 2013
- [5] M. Haneda, N. Nishihara, G. Kawaguchi, S. Tanabe, Productivity in Office with Elevated Preset Temperature in Summer – Improvement of thermal satisfaction by cooling methods and its effect on performance and fatigue, J. Env. Eng., AIJ, Vol.74 No. 646, 1329-1337, Dec., 2009
- [6] ISO7730 Ergonomics of the thermal environment - Analytical determination and interpretation of thermal comfort using calculation of the PMV and PPD indices and local thermal comfort criteria
- [7] ISO9920 Ergonomics of the thermal environment - Estimation of thermal insulation and water vapour resistance of a clothing ensemble
- [8] S. Tokita et al., Development of HVAC System Simulation for Life Cycle Energy Management, Annual Conference of SHASE, 1957-1960, 2005

## Kisekae House: Movable Building Devices and Lifestyle

TOMOKO UNO<sup>1</sup>, JUNKO MORIMOTO<sup>1</sup>, SHIGEYUKI OKAZAKI<sup>1</sup>,  
AYA YAMAGUCHI<sup>1</sup>, KEISUKE INOMATA<sup>1</sup>

<sup>1</sup>Mukogawa Women's University, Nishinomiya, Japan

**ABSTRACT:** Kisekae House is a net zero energy house, which the total energy consumption is covered by natural energy. The students and teachers of Architecture Major in Mukogawa Women's University proposed the house. The high thermal performance of the house and the high efficient equipment keep the room condition comfortable, as well as reduction of the energy consumption. In addition, ideas based on the Japanese traditional system and devices are adopted. The residents can control the environment by adjusting spaces and device conditions by themselves. According to the results of the measurement of the energy consumption and thermal environment in November 2017, the total zero energy were achieved on the house.

**KEYWORDS:** ZEH, Japanese traditional system, movable device, adjusting device, low energy house

### 1. INTRODUCTION

"Kisekae House" (Figure 1) is a Net Zero Energy House, which was proposed to the competition of ENEMANE House 2017<sup>Note1</sup>) by students and teachers of the Architecture Major of Mukogawa Women's University <sup>Note2</sup>). Students in the 2nd and 1st grades of the master course joined the competition and conducted the primary design, detail design, and surveillance, evaluation of thermal performance, measurements of thermal environment, public exhibition and demolition.

The concept of the Kisekae House is creations of the communication with surrounding environment and with neighbours by several Kisekae devices which the residents can control or change by themselves. The residents can create comfortable condition by adjusting these Kisekae devices.

The house was completed in November 2017, and the several environmental factors and energy consumption were measured to evaluate the performance.

### 2. DESIGN CONCEPT

#### 2.1. Plan of Kisekae House

Table 1 and Figure 2 show the plan of Kisekae House and the general information. The Kisekae House has two different spaces; one is open to the outside called "EN" in Figure 3, the other is the space of stable condition called "KURA" in Figure 4.

Table 1: General information of Kisekae House.

Location	Osaka, Japan (35.7° N, 135.5° E)
Floor area	66.25m <sup>2</sup>
Eave height	FL+2.210mm
Building use	Model house
Energy source	All electric

The design concept of the EN refers "Engawa" which is a traditional Japanese semi-open space like terrace. People commonly use the Engawa spaces for enjoying cooling breezes in summer, or taking in the sunshine. This EN is placed inside the Kisekae House, which is usually open to the outside.



Figure 1: South facade of Kisekae House.

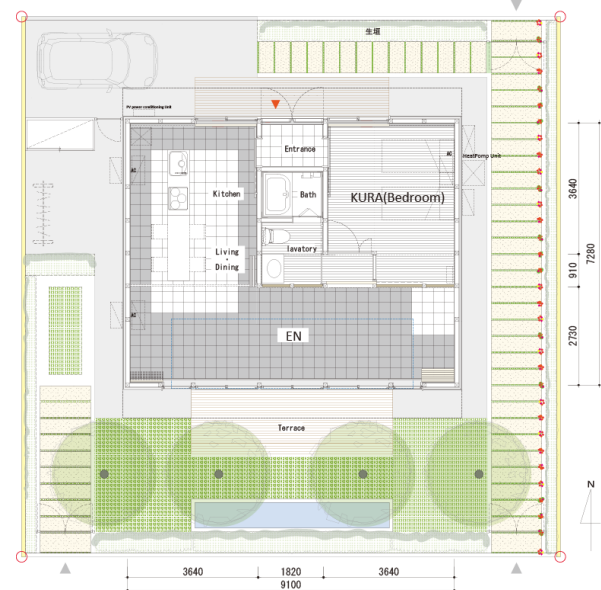

Figure 2: Plan of Kisekae House.



# PLEA 2018 HONG KONG

Smart and Healthy within the 2-degree Limit

The EN obtains much of the solar energy through the large windows in the south (Figures 1 and 3) and large skylights (Figures 3 and 5), to reduce the energy for heating. While, because the much solar radiation leads to increase of cooling load in summer, it can be controlled by the movable high-insulated shadings and roll blinds in Kisekai House (Figures 5, 9, and 10).

The other space, "KURA", which is used as a bedroom (Figures 2 and 4), the space is isolated from surrounding rooms by the high insulated partition walls, in terms of thermal environment. In addition, it can keep a very stable environment by the high thermal mass of clay partition wall.

In the EN and KURA, its spaces and sizes can be changed by partitions depending on the resident's situations. By this, the size or characteristics of the private and public spaces are also changed. Figure 15 shows an example of plan changed responding to the change of the family structure.

The new systems are adopted in Kisekai House, which are arranged the Japanese traditional system such as changing the type of the sliding doors or partitions, which are suited to the season condition.

The residents can control the movable inside doors or devices to suit their desirable condition or their life styles. The ideas of several movable devices are showed in section 4.

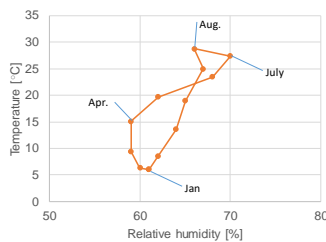

Figure 6: Climograph in Osaka<sup>1)</sup>.

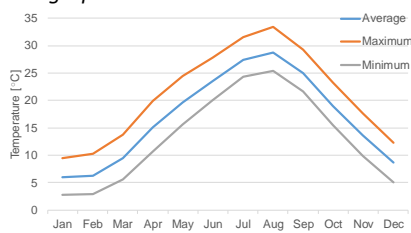

Figure 7: Monthly maximum, average, and minimum temperatures in Osaka<sup>1)</sup>.

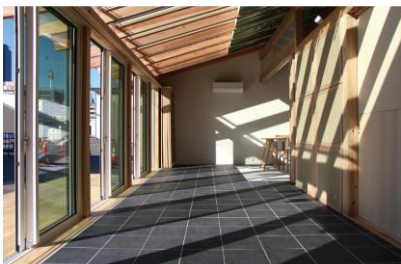

Figure 3: Inside of EN: Natural solar energy can be obtained through the skylights to create bright and warm open space for public.



Figure 4: Inside of KURA: The space is isolated from surrounding room by the high-insulated partitions, to create stable private space.



Figure 5: High-insulated shadings under skylights. They can be moved up and down manually and electric-powered.

## 3. SITE CLIMATES

Figure 6 and 7 show the climograph and monthly temperature of the average, maximum and minimum values in Osaka which is a construction site of Kisekai House.

Osaka has relatively temperate climate. The average temperature of the year is 16.9°C, the average relative humidity is 64% (Figure 6). The monthly average temperature changes between 6.0°C in January and 28.8°C in August. The average of monthly lowest temperature becomes lower 0°C in winter. Maximum temperature is between 10 and 34°C. Recently the maximum temperature in summer occasionally is over 37°C. The monthly average relative humidity changes between 59% in April and May and 70% in July. Osaka has hot and high humidity in summer and dry and sunny days in winter.

## 4. DETAIL OF KISEKAI DEVICES

### 4.1 Movable high-insulated shadings under skylights

Movable and high-insulated shadings are installed under the skylight windows (Figure 5), to control solar heat gain. Roll blinds are also installed to shade the solar radiation and control the lighting condition (Figure 9).

The energy consumptions for heating and lighting can be kept low by utilizing solar energy and daylights obtained through the skylight, when the high-insulated shadings and roll blinds are opened in the daytime in winter.

The high-insulated shadings also prevent the heat loss through the windows during nighttime in winter. Furthermore, it can shade the solar radiation in summer daytime, when the insulated shading devices are closed.

The flat rails attached to the both sides of the high-insulated shadings slides on the flat rail attached to the roof barks. Because there are no spaces between the rails, air leakage through devices can be limited.

The high-insulated shadings can be controlled by hand in Figure 10. An electrical opening system is also programmed to control the shadings, and the open/close schedule is able to be decided depending on room air temperature, floor surface temperature, or heat flow through.

# PLEA 2018 HONG KONG

Smart and Healthy within the 2-degree Limit

## 4.2. Movable inner doors inside windows

The two types of window systems are adopted. In order to increase the thermal resistance of the windows, the high-insulated inner doors are installed (Figure 11). The ventilation inner doors are used in summer or internal seasons (Figure 12). These systems are created by referring to the Japanese traditional partition doors. These doors are placed on the both side of the room (Figure 1 (point A)). When these are placed on the spaces, the whole windows are open like Figure 3.

The ventilation inner doors are made by bamboo blinds to control shading and ventilation. The outside bamboo shadings are installed on the outside of the windows for shading (Figure 8).

## 4.3 Floor and wall with thermal mass

The solar radiation through the skylights and south windows irradiate the floor in EN or inside walls (Figure 3). So the black tile which the emissivity is high are used for the tile of EN where the solar radiation irradiates, while the white tiles are used at the place of no heat gain to increase the daylight factor (Figure 13).

In order to increase of the thermal mass of the floor, the mortar (80mm-thick) are installed on the floor. The clay wall (24mm-thick and 26mm-thick clay panel<sup>Note3</sup>) with large thermal mass are used for the partition walls between EN and KURA at point B in Figure 2. The clay wall has the large moisture capacity to control the air humidity of the connected rooms. It is expected that the room humidity condition is stable when the temperature changes rapidly.

## 4.4 High-insulated partition walls

The high-insulated partition walls are adopted to create the thermal boundary between air conditioned and non-air conditioned spaces. It can reduce excess

energy consumption and efficient control of the air conditioned room by reduce the air conditioning spaces.

## 4.5 Space changing depending on seasons

The residents can control their spaces and thermal conditions by the Kisekai devices, depending on the seasons. Figure 14 shows the example of these devices in winter and summer.

## 4.6 Space changing depending on lifestyle

The residents also change the partitions which can be moved easily. The spaces and size of EN and KURA are changed depending on their lifestyle (Figure 15).



Figure 13: Inside of Kitchen and living room.

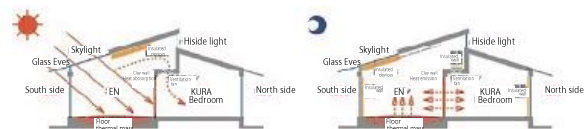

(a) Winter (left: daytime, right: night-time)

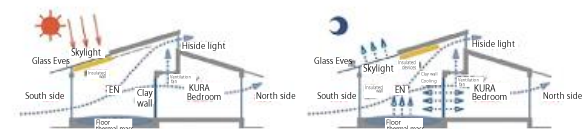

(b) Summer (left: daytime, right: night-time)

Figure 14: Seasonal environmental control by Kisekai devices.

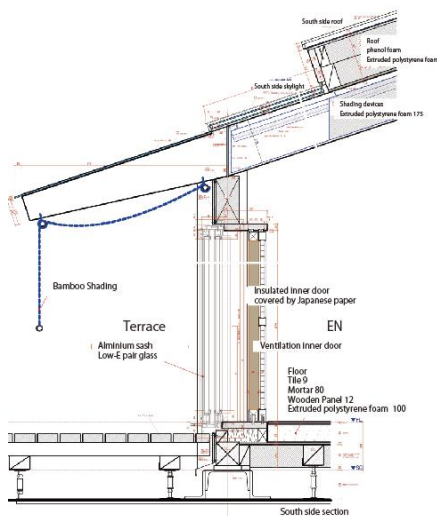

Figure 8: Detail of the top light windows and other devices.



Figure 9: Shades under sky light.



Figure 10: Shades under sky light.



Figure 11: Windows systems installed inside windows for insulation.



Figure 12: Windows systems for ventilation and shading solar radiation.

# PLEA 2018 HONG KONG

Smart and Healthy within the 2-degree Limit

The kitchen also can be rearranged. For this, flexible facility systems are developed. The more than one water supply and drainage systems are installed in EN or living spaces and IH system which is unconstrained by the exhaust fan are adopted.

## 5. ENVIRONMENTAL PERFORMANCE

### 5.1. Thermal Performance

Table 2 shows the heat transmission coefficient of each element of the house. The detail of section is showed in Figure 8. The average of the heat transmission coefficient ( $U_A$  value [ $W/m^2K$ ]) of the house is  $0.45W/m^2K$ .

The Low-E pair glasses are used in the skylight. The polyethylene foam (thick-175mm) are used for the insulation of high-insulated shadings under the skylights. The U value of glass roof considering the low-E pair glass and the insulated device is  $0.20W/m^2K$ .

The low-E pair glasses and the high-insulated internal doors are used for the windows on the south and north. The internal doors were made by polyethylene foam (thick-40mm), which heat thermal resistance is  $0.683m^2K/W$ . The total heat thermal resistance was  $1.46m^2K/W$  and it is three times of the resistance of the low-E pair glass only. U value is  $0.68W/m^2K$ .

The air exchange ratio was 0.2 times/hours, which was calculated from the decreasing of measured  $CO_2$  concentration.

### 5.2. Lighting Performance

The low energy consumption for lighting was achieved in Kisekae House. The size of the skylights and the interior materials are simulated to obtain over 2% daylight factor at the backside of the living room. The white colour floor tiles are used in the living room where the direct solar radiation does not irradiate. The measured daylight factor was over 10%.

### 5.3. Equipment and appliances

In Kisekae House, 3.5kW photovoltaic generation of PV is installed, which the conversion efficiency from direct current to alternate current is 96%.

Three air conditioners are installed in EN, living room and KURA (bedroom). A heat pump water heater is used for hot water supply. All lights of the house are LED. Table 3 shows the equipment and appliances and its energy performance.

### 5.4. Energy consumption

The primary energy consumption of the Kisekae House is shown in Table 3<sup>Note 4</sup>. The results include the reduction by changing the high-insulated shadings under skylights in summer and winter. The energy consumption for heating and cooling account for 30% of the total energy. The reduction of the energy consumption of the

hot water supply was 27% comparison with the basic energy consumption.

Total energy consumption is 29.4GJ/year, which is 72% of the basic energy consumption. The annual electric generation by photovoltaic (36.9GJ) exceeds the annual primary energy consumption.

## 6. MEASUREMENT RESULTS

### 6.1. General information of measurement

The thermal environment and other environmental factors were measured and the energy consumption was recorded. The moment was conducted for 9 days from 18<sup>th</sup> to 21<sup>st</sup> and from 24<sup>th</sup> to 28<sup>th</sup> in November 2017.



Figure 15: Example of partitions change depending on the family size. (a) Planning when the family has one child. The child room is placed at EN within eyeshot of parents. (b) Planning when the family number increase. Child rooms are placed in EN in order that neighbours can follow the children growth. (c) Planning after retired. The EN are opened to the neighbours to create the good relationship with community.

Table 2: Thermal performance of building elements.

	U value [ $W/m^2K$ ]
Wall	0.18
Roof (North side)	0.17
Roof (South side)	0.18
Sky light and movable devices	0.20
Windows	2.2
Movable elements	0.2

Table 3: General information of Equipment and Appliances.

Air conditioner	DAIKIN (S22UTAXS-W) APF 6.7
Hot water supply	Panasonic (HE-JPU37HQ) Heat pump water heater
Lightings	LED lights
Photovoltaic generation	Panasonic (VBHN250WJ01) 3.5 kW

Table 4: Annual primary energy consumption [ $GJ/year$ ]  
The values are calculated by the program<sup>2</sup>.

	Kisekae House	Basic energy consumption
Heating	7.1	10.3
Cooling	3.1	4.4
Ventilation	1.0	2.5
Hot water supply	9.2	16.4
Lighting	1.8	6.4
Total Energy consumption [ $GJ/year$ ]	29.4	40.0
Photovoltaic generation	39.6	

# PLEA 2018 HONG KONG

## Smart and Healthy within the 2-degree Limit

Because of the competition of the energy performance of ZEH, it was required that several environmental factors should be controlled in the target ranges in Table 5. The globe temperatures in living room and bedroom are controlled by the air-conditioners to realize the required value.

In the measurement period, the thermal performance of the skylights and thermal mass of the inside walls were measured.

The 3 women lived in the daytime during the measurement.

Table 5: Measurement factors and target range.

Factor	Place	Range
Globe temperature	Living room	23.2±1°C
Humidity	Bedroom	40-70%RH
	Bath room	
Illuminance on the living room	Living room	> 4%
CO2 concentration		< 800ppm
Lighting	Living room	> 200lx (15:00 ~)

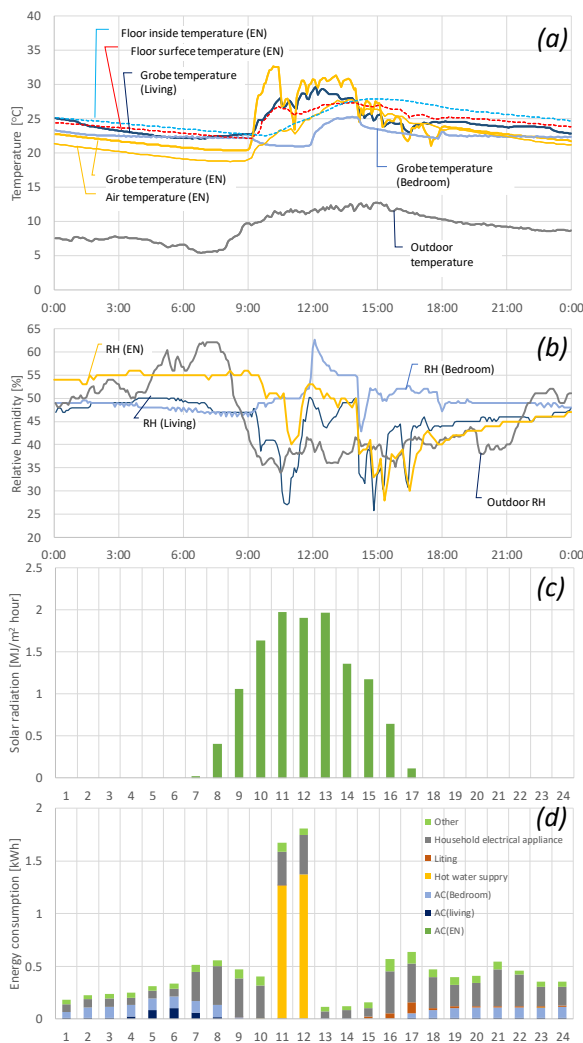

Figure 17: Results of environmental factors and electric consumption on 24<sup>th</sup> November, a sunny day. (a) Globe, air and surface temperatures, (b) relative humidity, (c) solar radiation and (d) energy consumption.

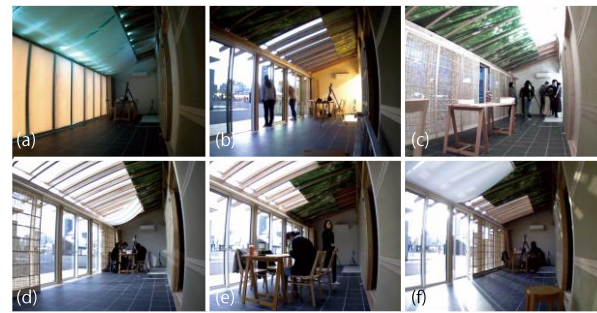

Figure 16: Photos of easements periods.

(a) All insulated inner doors and the devices under the skylights are closed during night time. (b) The students open the inner doors after sunrise in the morning. (c) Before sunset, the students close the insulated devices under skylights. Sometimes, they use inner ventilation windows for privacy. (d) On a sunny day, they control the solar gain by the shading devices and ventilation windows. Because of the high temperature and strong sunshine, they stay in a shaded place for comfortable. (e) On a cloudy day, they stay in a sunny and warm place. (f) They controlled the Kisekae items as they like.

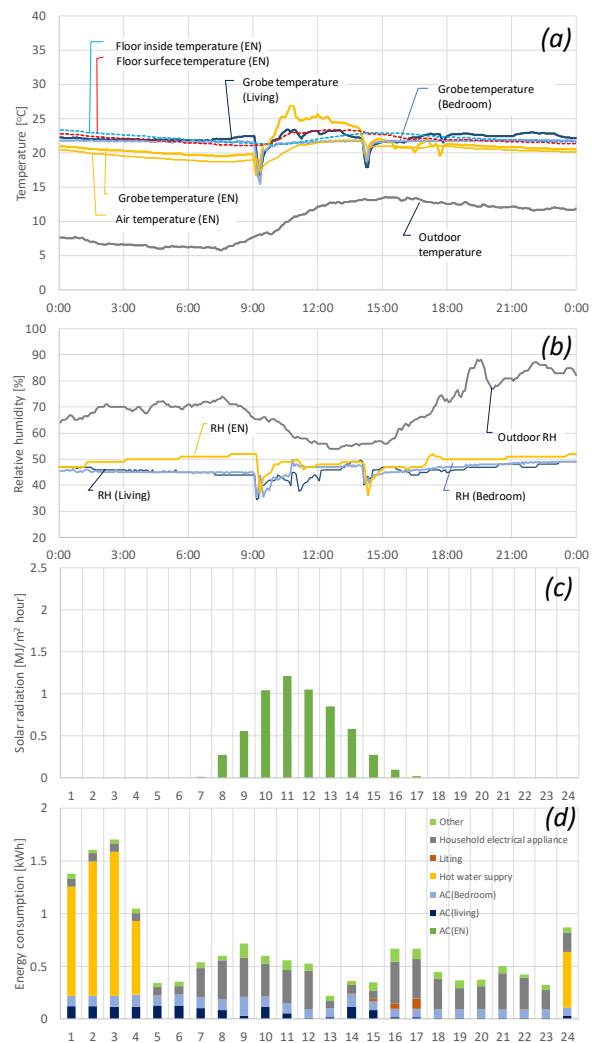

Figure 18: Results of environmental factors and electric consumption on 26<sup>th</sup> November, a sunny day. (a) Globe, air and surface temperatures, (b) relative humidity, (c) solar radiation and (d) energy consumption.

# PLEA 2018 HONG KONG

*Smart and Healthy within the 2-degree Limit*

## 6.2. Temperature and humidity, and energy consumption

Figures 17 and 18 show the measured *globe, air and surface temperatures*, relative humidity, solar radiation and energy consumption on 24<sup>th</sup> and 26<sup>th</sup> November in the house.

It was sunny on 24<sup>th</sup> (Figure 17), and enough solar energy was obtained. While cloudy on 26<sup>th</sup> (Figure 18), the power generation amount was only 5kWh/day, which is one-third of that on 24<sup>th</sup>.

The air conditioner in bedroom and living room were used during night time on 24<sup>th</sup>, and the air conditioner in the bedroom was used through a day on 26<sup>th</sup>.

The globe temperature in EN increased up to 33°C on 24<sup>th</sup>, and that in the living room also increased up to 28°C. Even though the students suit the Kisekae items to control the environment, because of the direct radiation irradiated to the measured point, the globe temperatures in the living room and bedroom exceeded the target range.

In the night, they closed the inner insulated doors and high-insulated shadings under skylights. The outdoor temperature falls down to 5°C in the early morning, it kept the air temperature in the non-air conditioned EN over 18°C. Because of the thermal mass of the floor and it gained solar heat during daytime, the globe temperature did not fall below 20°C.

## 6.3. Energy consumption

During evaluation term, the effective electrical load management was tried depending on the power generation by the photovoltaic. We simulated amount of the power generation based on the amount of the solar radiation by the weather forecast of following days, and programmed to conform the peak load, which depends on the hot water supply, with the peak generation time. Then the natural energy by PV was used efficiently. The maximum of the self-consumption of the solar energy on sunny day exceeded up to 95%.

The average amount of the electric consumption without household electric consumptions was 8.6kWh/day. The amount of power generation by PV was 14.6kWh/day on a sunny day, and the average value was 9.0kWh/day, which was over the energy consumption.

The results show that the adequate thermal environment was kept with low energy consumption during the measurement. The total solar electric generation exceeded the electric energy consumption for 9 days.

The detail of the electric consumption shown in Figure 19. The category of other included the energy consumption of the communication devices such as router, Wi-Fi, and so on. The energy for heating account for 23%, that for the hot water supply does 25% of the total energy consumption. The household consumption accounts for a large portion of energy consumption, 39%.

The communication devices to control and monitor the system need a certain level of energy.

## 7. CONCLUSION

In this paper, Kisekae House project, which is net zero energy house, was introduced. The house has very high thermal performance and the high efficiency equipment were installed. The energy consumption was totally covered by the natural energy.

The results show that adequate thermal environment was controlled by the residents using the Kisekae devices. It can keep the low energy consumption. The electric energy consumption was covered by the natural energy in the Kisekae House.

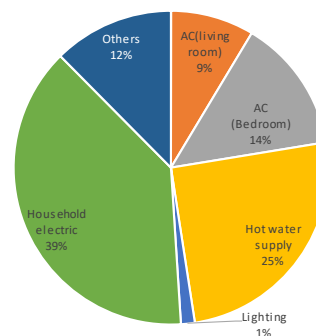

Figure 19: Break down of energy consumption.

## Note

1) This ENEMANE HOUSE competition project was hosted by ENEMANEHOUSE 2017. The aim of the project was to popularize ZEH, zero energy house.

It was required to propose advantaged technologies and lifestyle in cooperation with universities and private companies. Five teams passed a preliminary selection by the proposal documents built a model house of Zero Energy House (ZEH) and evaluated the performance of the house.

2) Architecture Mayer and Department of Architecture in Mukogawa Women's University promotes a practical education and six-year consistent curriculum according to the UNESCO-UIA Charter for Architectural Education.

3) Arakabe Panel is a clay panel for foundation layer of clay wall.

4) The household energy consumption is not included here.

## REFERENCES

1. Average year value in Osaka, [Online] <http://www.jma.go.jp/jma/index.html>, Japan Meteorological Agency [31 May 2018]
2. Energy consumption calculation program for house, <https://www.kenken.go.jp/becc/>, Building Research Institute [December 2018]

# Design Criteria to Reduce Energy Demand and Improve Thermal Comfort in Desert-coastal Climate Office-building

CRISTOPHER MATIAS TAPIA-MAUREIRA<sup>1</sup>, MARIA BEATRIZ PIDERIT MORENO<sup>1</sup>

<sup>1</sup>Department of Design and Theory of Architecture, University of Bio-Bío, Concepción, Chile

*ABSTRACT: The improvement in the thermal and energy performance of an office building project, located in the city of Antofagasta, is analyzed, upon incorporating passive strategies oriented towards the thermal and light comfort in its design. A "base case" of the building was prepared and simulated for this, where climate-based design strategies were incorporated. The assessment is made on two of its floors: a compartmentalized floor, where the office with the most unfavorable orientation was analyzed, and an open-plan floor which was completely assessed. It was possible to determine through the simulation that the incorporation of passive strategies reduced the thermal discomfort period by an average of 80% versus the base case. In addition, on integrating the thermal comfort strategies with the natural lighting ones, energy demand was reduced by 90%. The criteria applied to the building's design will be presented, where the shape strategies, envelope optimization, solar control, ventilation and natural lighting are included, revealing how the building's final shape was nothing more than the result of the passive strategies integration process.*

*KEYWORDS: Coastal desert climate, passive design strategies, office building, thermal comfort, energy demand.*

## 1. INTRODUCTION

This work has been carried out in the context of integrating tools and criteria in the building design process, using a methodology which integrates the analysis of thermal comfort, lighting and energy efficiency. It has been done starting from the elaboration of a reference case following current energy standards, which was then optimized by incorporating passive strategies that involved thermal and lighting aspects.

The project was carried out in the climatic context of the city of Antofagasta, Chile (23° 38' 0" S, 70° 24' 0" W), located on the coast of the Atacama Desert. It has a coastal desert climate, characterized by a pronounced annual thermal amplitude, with annual temperatures between 13°C and 20°C [1]. It has a low rainfall and abundant humidity thanks to the coastal fog or *camanchaca*. The predominant winds come from the south, with an average speed of 12 m/s. According to the Chilean standard's climate zoning, it is in Zone 1 - Northern Coast (1NL) [2], where the highest radiation levels are found in Summer, with a sun altitude of 87°. It has 45° in winter and 66° in the intervening seasons. It was possible to determine that the thermal discomfort period is produced during the summer because of the articulation between high temperatures and high levels of incident radiation, which would extend into intermediate seasons where, although the temperatures are lower, a lower altitude of the sun produces higher solar incidence "s", increasing the direct gains.

An analysis run using the Climate Consultant software indicates that the following passive strategies must be used: Natural ventilation for cooling in summer; Higher north-facing glazing to increase direct gains in winter. Solar control for avoid these in summer; High insulation

and airtightness in the envelope to take advantage of internal gains and to reduce heating in winter. Antofagasta has clear skies, 30% of the year, mainly seen in Summer, with 28% intermediate skies in the rest of the year [3].

Using this information as a starting point, the goal of designing an office building is set out. The goal is a performance where the discomfort during the occupation period (Mon-Fri: 8am-5pm) is less than 1% without using HVAC. The idea is to investigate which criteria reduce the demand of the office buildings in Chile [4], while approaching an evaluation about whether Chile's northern climate makes the incorporation of the Nearly Zero Energy Building or Net Zero Energy Building possible [5].

The article is structured to show how the methodology allowed achieving the architectonic shape, responding to the incorporation of passive strategies, aiming at improving the user's comfort in office environments.

## 2. METHODOLOGY

The impact of the strategies on the building's energy and thermal performance was assessed comparatively between the results of a reference case and an improved case.

# PLEA 2018 HONG KONG

## Smart and Healthy within the 2-degree Limit

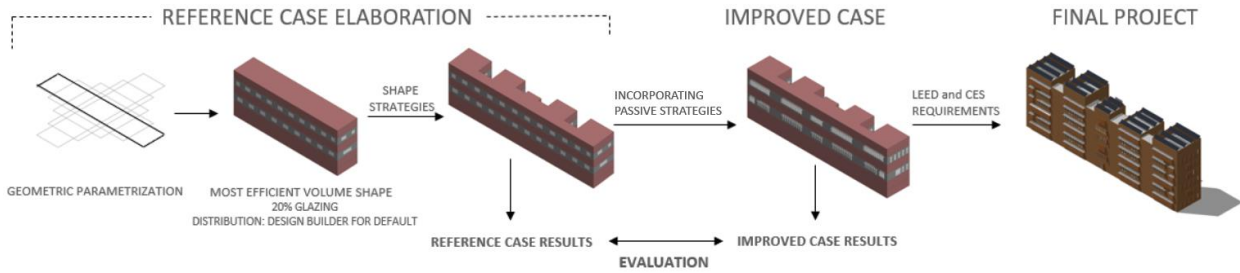

Figure 1: Methodology Diagram used (Source: Author)

The reference case is made with the following design conditions: six-floor building, each floor with 500 m<sup>2</sup>. Three of these are open plan and three are compartmentalized. The design process began with the identification of a volume with the shape, window percentage and the most efficient orientation regarding the climatic context, determining the optimal shape with lowest electricity demand, to which design strategies are included to support its performance. This building is assessed for thermal comfort, energy demand and natural lighting [6] on one of its open floors and in the most unfavorable office position, which in this case was north-west facing.

The improved case is developed starting from the base case with the incorporation of passive strategies, looking to improve its thermal, energy and light performance as a whole, following the UNE-EN-1525 standard's adaptive comfort model [7]. The simulation's results correspond to the evaluation of the same premises evaluated in the reference case. To evaluate the effectiveness of the strategy, the goal was set to reduce the energy demand and increase the thermal comfort hours, using the Design Builder software. Regarding the visual comfort, the goal was to improve the illuminance (lux) and luminance (cd/m<sup>2</sup>) levels using the Velux Daylight Visualizer and Daylight Glare Probability (DGP) software, using the Radiance software.

### 3. PREPARATION OF REFERENCE CASE

#### 3.1 Shape optimization

The optimization of the building's shape was done using a geometric parametrization based on three variables: the shape itself, the glazing % and the orientation regarding North.

As can be seen in Fig.2, the result of the process is that the shape with the lowest energy demand is that of a 1:5 ratio, perpendicular to the North, with 20% glazing and an approximate energy demand of 8.30 kW/m<sup>2</sup> a year.

Given the climatic conditions, with strong solar radiation, a north-sided circulation corridor is set as a design strategy, looking to avoid the generation of a "solar damping" space, keeping sunlight from coming into the offices. A first comfort analysis was made using

this first internal distribution. It produced a 93% comfort level over the year during occupation hours, with the highest energy demands being for cooling and artificial lighting.

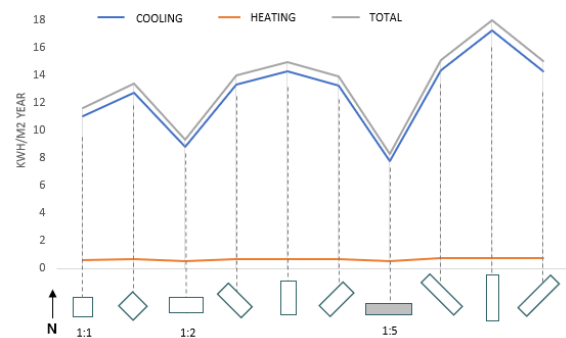

Figure 2: Energy demands for volumes with different shapes and orientations (Source: Author)

The first passive strategy incorporated was to avoid overheating, where from the building shape obtained, the envelope's surface is modified to increase the area and have higher calorific losses through it. Figure 3 shows the increase of the envelope's surface through cavities on the Southern façade, which also increases the possibility of naturally lighting the offices.

The shape chosen has over 92% comfort hours during occupation schedules following the UNE-EN-1525 adaptive comfort model. The highest % of discomfort hours is associated to overheating, totaling less than 300 hrs./year. Likewise, these 5m wide concavities also allow ventilating the spaces using the city's predominant southern winds.

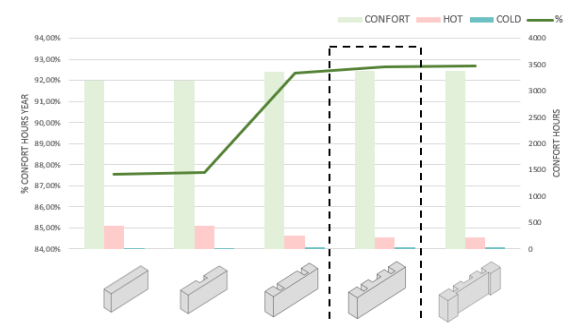

Figure 3: Evaluation of building's shape optimization during thermal comfort times (source: Author)

# PLEA 2018 HONG KONG

*Smart and Healthy within the 2-degree Limit*

The methodology used to determine the building's volume [Fig. 1] was an integrated methodology, which covered thermal comfort, light comfort and passive ventilation aspects.

## 3.2. Evaluation of Reference building

An adaptive comfort analysis was made via thermal-energy simulation, using the border conditions of Table 1 and considering an office occupation schedule of 3,650 hrs./year. The different U-values of Table 3 are used. Higher discomfort periods caused by overheating of the internal spaces were determined, mainly during Summer and Autumn months where discomfort hours reached 16% of the total for the office in the most unfavorable situation and 10% for the open floor. The discomfort percentage related to low temperatures does not reach 1% of all hours for either of the two cases.

Table 1: Border Conditions for simulation

	Unit	Value
Occupation Load	W/m <sup>2</sup>	6
Heat. / Cooling record	°C	20/25
Equipment Load	W/m <sup>2</sup>	4.5
Lighting Load	W/m <sup>2</sup>	16
Heat. / Cooling Energy	Electricity	

For the lighting comfort analysis, a South-facing office was used as the most unfavorable case, where the illuminance in the work plane is under 500 lux. There is a poor luminance distribution which could cause glare and contrast with the background during the Winter period due to a higher solar incidence. Likewise, it was determined that the window distribution on the façade causes a low illuminance uniformity on internal spaces. Strategies are proposed which improve the lighting without compromising an increase of the direct gains.

The energy demand is calculated over the air-conditioned spaces of the two floors. In line with the thermal analysis, the total electricity demand was determined by the cooling and lighting loads, with the open-plan office having a slightly higher demand in both aspects. There are no loads associated to heating internal areas for either level. The results are summarized on Table 2. It is worth highlighting that the lighting demand comprised 75.6% of the total demand, thus determining that the passive strategies must be focused on increasing natural lighting, increasing the demands by HVAC. These strategies will also be supported by optimizing the envelope looking to reduce the overheating periods.

## 4. DESIGN OPTIMIZATION

### 4.1. Strategy 1: Solar Control

Solar control strategies are incorporated by integrating natural lighting strategies. The percentage glazing on the North façade was increased by 30%, looking to increase the inside lighting and take advantage of the direct gains during Winter. On the South side, it

was reduced by less than 20% to avoid the loss of internal gains for the offices. On the east and west façade, it was kept by 20%. High light transmittance windows were chosen. The implementation of 3.6 mm double Low E glazing was assessed, glazing which implies an increase in the window's U-value (Table 2), a modified solar factor (FSM) that is reduced regarding the base case and a luminous transmittance of 76%.

Fig. 6 shows that solar control is achieved via eaves and latticework designed as per the orientation. Eaves and latticework are applied towards the North. The former protects against the high Summer radiation, while the latter provides controlled protection in Winter to have moderate direct gains. Vertical latticework is provided to the West for a strong solar control, to avoid radiation in the afternoon and visual discomfort. However, these are distanced from the windows to let natural light in. The East-facing windows have an eave which would protect against excessive radiation during Summer mornings. The Southern facade has relatively little control, mainly with side protections to avoid incidental radiation during Summer.

The incorporation of these solar and natural lighting control strategies meant an increase in the discomfort hours due to cold, but with a general increase in the comfort hours, which demonstrates that the natural lighting strategies will not increase overheating hours.

### 4.2. Strategy 2: Optimization of the envelope

Starting with the reference case's envelope, the target was to completely reduce the discomfort hours due to cold, which was achieved reducing the U-value to 1.5 W/ (m<sup>2</sup>-K), by increasing the insulation and incorporating traditional techniques.

First, the base case's wall section was increased from 15 to 20 cm. A 5 cm thick cover comprising what is known as "improved wattle and daub" or "improved quincha" is installed [8]. Between the wall and the wattle and daub and *quincha* an insulation layer of 2 cm of cellulose was provided. A 12mm thick cardboard plastic layer is applied on the inside as an acoustic solution [Fig 4]. 10 cm H. A. walls are used for the vertical partitions, with a 3 mm cork plate covering the inside

When the first thermal comfort evaluations were made for this solution, discomfort periods due to cold were produced during the Winter that could not be resolved by reducing transmittance, which forced checking the envelope's airtightness values. It was determined that the value used corresponded to low quality constructions, so it was adjusted to one that was representative of the area (Table 3). Antofagasta has the best airtightness levels in the country [9]. This correction balanced out the temperatures, providing results that were more coherent with the city's climatic setting.



# PLEA 2018 HONG KONG

## Smart and Healthy within the 2-degree Limit

Table 2: Values for reference and improved case.

	Unit	Ref. [1]	Case	Imp Case
U-value walls	W/m2-K	2		1,51
U-value windows	W/m2-K	5,7		2,47
Infiltration [3]	n50	10		7

The incorporation of this construction solution and the correction of the envelope managed to completely resolve the discomfort hours due to cold. However, there was a high impact on the increase of discomfort hours from overheating.

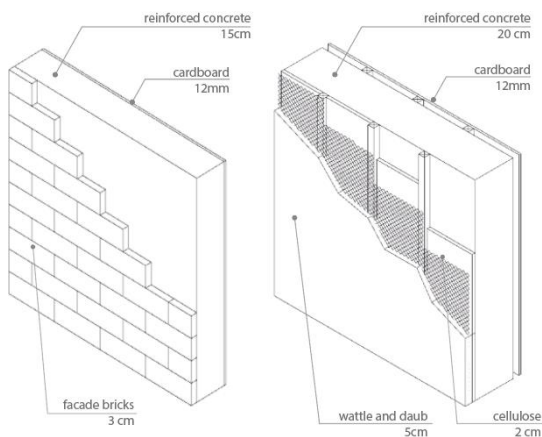

Figure 4: Left: Envelope for reference case ( $U=2$ ) / Right: improved case with cellulose insulation ( $U=1.5$ )

### 4.3. Strategy 3: Natural Ventilation

The period with highest overheating is between December and April, from 1 to 4pm. With this, it was possible to determine the wind speed available. It was determined that the most efficient strategy was supporting the natural ventilation strategy with an auxiliary cooling system [10], which would start when the wind speed is not enough to generate the air flows needed to reach thermal comfort. Due to the building's morphology, it was determined to use crossed ventilation [11].

The goal is that the building does not just depend on the natural cooling strategy to maintain the comfort hours in Summer, as this is relative and depends on external factors. A simulation in Design Builder for ventilation calculated in mixed mode was made for this, so that the cooling system is only activated when the ventilation is not capable of maintaining the temperature below 26°C.

Considering that the upper limit of the comfort band in Summer is approximately 27°C, the supporting cooling system is calculated with a setpoint of 24°C for the activation of the natural cooling and 26°C for the activation of mechanical cooling.

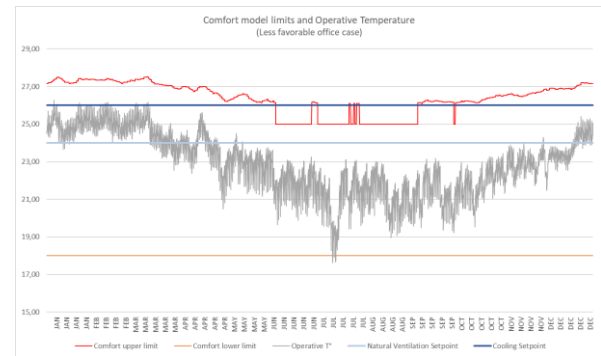

Figure 5: Graph of operating temperature and adaptive comfort limits in least favorable office (Source: Author)

### 4.4. Natural Lighting Strategies

Their purpose is taking maximum advantage of the light contribution of the North façade's window, increasing the direct gains to avoid overheating. Strategies should also be included to improve illuminance and their uniformity. Two main strategies were used which can be seen integrated to those of the solar control in Fig. 6:

(1) In order to avoid excessive direct gains through the North façade, the window is divided into two parts. The lower part is for ventilation, generating views and contributing with direct gains during Winter. The upper one is for lighting purposes. Solar shelves are installed in this upper window which are articulated with ceilings formed by semi-shiny surfaces, which act increasing the illumination level inside the offices and particularly in the central part.

In the compartmentalized floor, a variation of the solar shelf is considered which is called "reflective chamber", where a chamber with highly reflective inside surfaces is built on the corridor's ceiling, transporting the light falling on the upper window of the Northern façade directly to the office.

(2) To improve the luminance distribution inside the compartmentalized floor's offices, glazing on the inside partitions is provided. All the North-facing partitions receive 70% glazing, which also takes advantage of the direct gains. The separations between offices with 30% are located on the upper and side edges to take advantage of the ceiling reflections and the window's contribution. Side windows, which light the rear of the offices are distributed, reducing the contrast of the work areas regarding the North face. All the analyses of the illuminance and average uniformity have been made for the most critical period of winter, with Antofagasta's predominant skies. The illuminance and average uniformity analysis was done on two offices of the compartmentalized floor, one South-West facing, where the rear is darker than the front of the office, as the Southern windows do not provide as much as the others. And the other orientated towards the North-East, where there may be glare issues in the afternoon. A lighting

# PLEA 2018 HONG KONG

*Smart and Healthy within the 2-degree Limit*

control system is incorporated as artificial lighting control, which measures the illuminance inside working spaces to aid in the reduction of the annual demand. This incorporation had a great impact on the increase of discomfort hours due to cold during the year for the two premises studied. However, an important reduction of 90% in the total annual electricity demand versus the base case was produced. A reduction in the lighting demand shows the effectiveness of the natural lighting strategies.

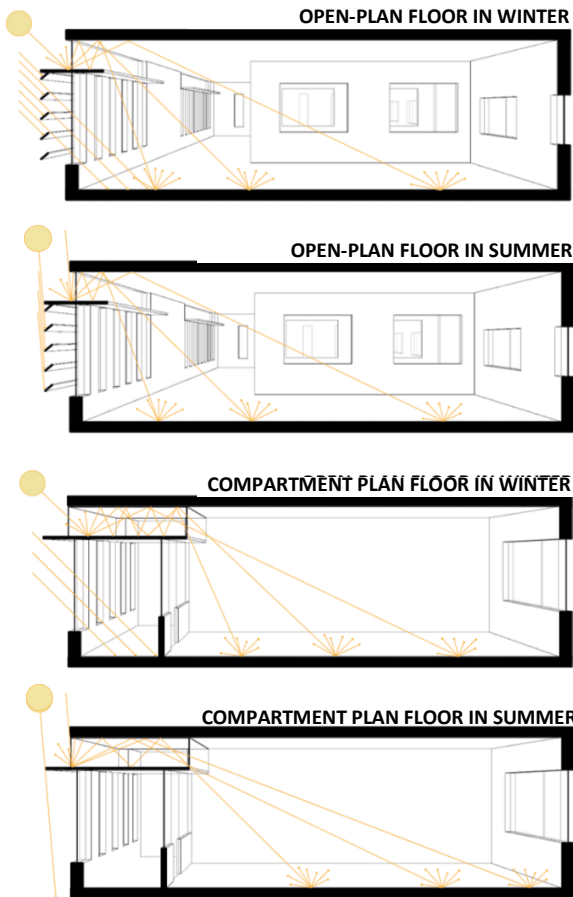

Figure 6: strategies for natural lighting and solar control (Source: Author)

## 5. RESULTS

In general, the incorporation of passive strategies had a strong impact on the three settings studied in the project. It must be considered that the reference case already had a good % of comfort hours, but these were increased by 15% in both floors during occupation hours, complying with the goal of being under 1%.

It was key to have an envelope which met the thermal amplitude, to take advantage of the internal loads in Winter, and ventilation is used in summer as a means of passive cooling and solar control to avoid the excessive impact of radiation. The remaining discomfort hours are due to cold and are generated in the first hours of

occupation in Winter, when the building comes out of a nighttime low temperature running. It has a moderately insulated envelope ( $U=1.5$ ), a high level of airtightness to reduce leaks in the mornings. All its openings are protected from the sun but are designed to ventilate during hotter periods. It also has an auxiliary mechanical cooling system, which is the one that causes demand in the compartmentalized floor.

Table 3: Improved Case and ref. case energy thermal results

	Unit	Reference Case	Improved Case
<b>Open Plan Demand</b>			
% Comfort*	%	89.45	99.91
Heating Demand	KWh year	0	0
Cooling Demand	KWh year	5653.57	0
Lighting Demand	KWh year	15849.81	2151.17
<b>Unfavorable office of Compartmentalized Demand</b>			
% Comfort *	%	83.67	99.86
Heating Demand	KWh year	0	0
Cooling Demand	KWh year	4265.66	264.79
Lighting Demand	KWh year	14897.19	1772.76

\*Calculated in freecooling over 3650 hrs. of annual occupation

As it was possible to reduce the lighting demand via natural lighting strategies, an important reduction in the artificial lighting total demand was produced. It was possible to increase the illuminance levels of the most unfavorable offices of the compartmentalized floor, from 550 to 640 lux at 12:00 on July 21<sup>st</sup>, and on the open floor, from 230 to 610 lux, for the same period [Fig. 7], without compromising the thermal comfort.

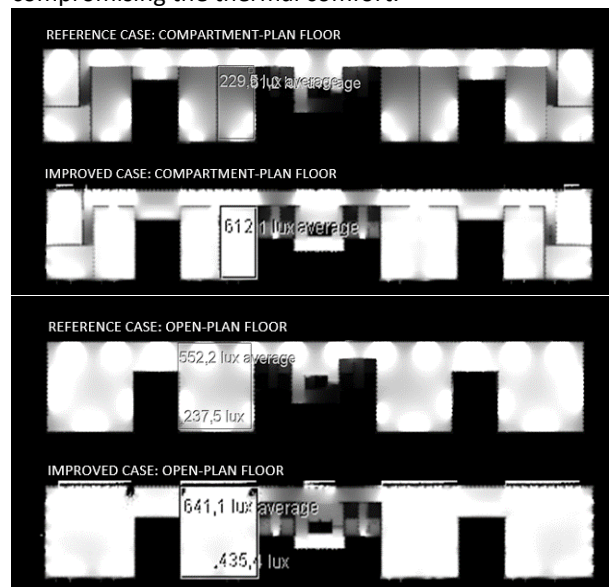

Figure 7: Illuminance Levels for improved and reference case (Source: Author)

In architectural terms, the result is a building with a compact north façade and a separated south façade. It proposes construction systems that are typical in the

# PLEA 2018 HONG KONG

*Smart and Healthy within the 2-degree Limit*

north of Chile, like the “*improved quincha*” and native wood loam, which apart from having a low environmental impact, give it a quaint appearance which contrasts with the contemporary elements that have been included, like photovoltaic panels, reaching a tension between the temporalities of the integrated technologies. Considering the desert context, the use of xerophilous and endemic landscaping is considered, to give the project water efficiency.

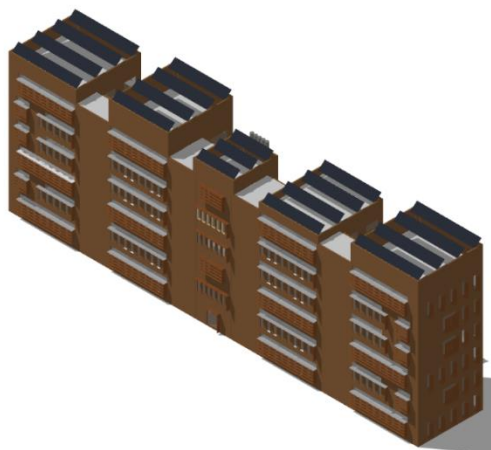

Figure 8: Project's northern façade (Source: Author)

## 6. CONCLUSIONS

It was possible to design a building with a low energy demand and with indoor thermal and visual comfort in a desert-coastal climate. It is possible that this low demand can be satisfied with the incorporation of photovoltaic panels, taking advantage of the available radiation and resulting in a building with zero demand. This could indicate that the climate context in the North of Chile is favorable to design buildings with nZEB or ZEB standard.

On combining thermal comfort strategies with natural lighting strategies, it is possible to increase the average inside illuminance over 500 lux for half the day in the most critical period of Winter, with a predominantly clear sky [2]. This was possible without causing discomfort periods due to overheating.

It is concluded that, in this climatic setting, it is essential to integrate natural lighting strategies with thermal comfort strategies so that, on one hand, it does not cause a risk of overheating in Summer periods; and on the other, visual discomfort problems are generated on trying to avoid solar penetration. It was possible through this design methodology to complement both types of strategies, increasing visual and thermal comfort levels with a reduction in the energy demand.

The city's temperate climate greatly influenced these results, which made it possible from the reference case onwards to have a level of comfort hours over 80% during occupation times, which could be increased to 99%. This methodology can be used to support decision-making in the early design stages of office buildings to determine the most efficient volume and to incorporate

passive design strategies, which would contribute to the increase of the building's indoor comfort and move towards a reduction of the electricity demands of office buildings in Chile.

## ACKNOWLEDGEMENTS

This research was carried out in Master program of Sustainable Habitat and Energy Efficiency of the University of Bio-Bío. The studies of the master program were funded by a grant awarded for CONICYT Chile. CONICYT-PHC / Magister para Funcionarios del Sector Público / 79170103 - 2017.

Special thanks to Grupo de investigación Arquitectura y Construcción Sustentable, GI 171902/VC.

## REFERENCES

1. PUC, Cartografía interactiva de los climas de Chile [http://www7.uc.cl/sw\\_educ/geografia/cartografiainteractiva/](http://www7.uc.cl/sw_educ/geografia/cartografiainteractiva/)
2. MOP, 2011, TDR: Términos Ref. Estandarizados con Parámetros Efic. Energética y Confort Ambient. para Lic. Diseño y Obra la Dir. Arquitectura, Según Zo. Geográficas del País y Según Tipología Edif., 2011.
3. <http://iluminachile.ubiobio.cl/freqsky.php?c=antofagasta>
4. Bustamante, W., A. de Herde, and F. Encinas. 2011. Análisis de Comportamiento térmico de Edificios de Oficinas En Comunas de La Región Metropolitana, Chile.” *Revista de La Construcción* 10 (1):64–77. <https://doi.org/10.4067/S0718-915X2011000100007>.
5. Karlessi, Theoni, Nikos Kampelis, Denia Kolokotsa, Mat Santamouris, Laura Standardi, D. Isidori, and C. Cristalli. 2017. “The Concept of Smart and NZEB Buildings and the Integrated Design Approach.” *Procedia Engineering* 180. The Author(s): 1316–25. <https://doi.org/10.1016/j.proeng.2017.04.294>.
6. Pei, Zufeng, Borong Lin, Yanchen Liu y Yingxin Zhu. “Comparative Study on the Indoor Environment Quality of Green Office Buildings in China with a Long-Term Field Measurement and Investigation”. *Building and Environment* 84 (2015): 80-88. doi: 10.1016/j.buildenv.2014.10.015.
7. CEN. 2007. EN 15251. Indoor Environmental Parameters for Design and Assessment of Energy Performance of Buildings: Addressing Indoor Air Quality, Thermal Environment, Lighting and Acoustics. Brussels: Comité Européen de Normalisation.
8. Fernández, José Esteban, Alfredo Esteves, Gustavo Oviedo, and Fernando Buenanueva. 2005. “La Quincha, Una Tecnología Alternativa Eficiente Para La Autoconstrucción. Aspectos Educativos.” *Avances En Energías Renovables y Medio Ambiente* 9:25–29.
9. CITEC U. Bio-Bío, 2012, Manual de hermeticidad al aire de las edificaciones.p.47
10. Bajenaru, Nicolae, Andrei Damian, and Rodica Frunzulica. 2016. “Evaluation of the Energy Performance for a NZEB Office Building under Specific Climatic Conditions.” *Energy Procedia* 85 (November 2015). Elsevier B.V.:26–34. <https://doi.org/10.1016/j.egypro.2015.12.271>.
11. CITEC U. Bio-Bío. 2012. Manual de Diseño Pasivo y Eficiencia Energética En Edificios Públicos.

## Passivhaus Lived Experience: More Than a Spreadsheet

KATE CARTER<sup>1</sup>, JILL ZHAO<sup>2</sup>

<sup>1</sup>Edinburgh School of Architecture and Landscape Architecture, University of Edinburgh, UK

<sup>2</sup>School of Architecture and the Built Environment, University of Lincoln, UK

*ABSTRACT: The ideology of Passivhaus is clear. It is a building standard associated with a really well insulated and airtight building that saves energy – in both hot and cold climates. There is evidence from that shows how important this approach to building is in achieving carbon reduction targets. Passivhaus is a credible way for large scale energy reduction in the built environment and has gained in popularity with policy makers tasked with meeting the internationally agreed climate change targets. The reality of living in a Passivhaus is not so clear. There is evidence of some Passivhaus projects using much more energy than the design models anticipate. There is also emerging evidence of the difficulties some people face in living in a Passivhaus. Issues of air quality, systems control problems, inadequate technical knowledge and skills. While the overall picture is positive there are clearly issues to be overcome in the delivery of a promising carbon reduction strategy for the built environment. This research explores the limitation of the PHPP software in addressing the lived experience of Passivhaus. The emerging issues with some PH projects suggest a better understanding of the interactions between people and the building is required.*

*KEYWORDS: Energy, Comfort, Passivhaus, People*

### 1. INTRODUCTION

The ideology of Passivhaus is clear. It is a building standard associated with a really well insulated and airtight building that saves energy – in both hot and cold climates. There is evidence from [1] that shows how important this approach to building is in achieving carbon reduction targets. Passivhaus is a credible way for large scale energy reduction in the built environment and has gained in popularity with policy makers tasked with meeting the internationally agreed climate change targets.

The reality of living in a Passivhaus is not so clear. There is evidence of some Passivhaus projects using much more energy than the design models anticipate. There is also emerging evidence of the difficulties some people face in living in a Passivhaus. Issues of air quality, systems control problems, inadequate technical knowledge and skills [2],[3]. While the overall picture is positive there are clearly issues to be overcome in the delivery of a promising carbon reduction strategy for the built environment.

While not exclusively a residential standard the majority of projects are dwellings [4]. The emerging issues with some PH projects suggests a better understanding of the interactions between people and the building is required. Understanding how people engage with a Passivhaus, will reveal some of the complexity of the lived experience of a Passivhaus.

### 2. PASSIVHAUS LIVED EXPERIENCE

Passivhaus is a standard for high-performance, low-energy sustainable buildings. It embraces a new level of

comfort, based on providing stable temperatures with minimal need for energy input. Passivhaus is based on a system of post heating and cooling of air, achieved through a system of air heat recovery. This finely tuned system is designed to work optimally without human interaction. In order to understand how people engage with living in this 'new' type of housing the social grounding of the typology needs to be considered. If Passivhaus can be considered as a typology, then the preconceptions and prior knowledge of the typology are likely to affect how a person will respond to what is a slightly different way of living.

#### 2.1 Passivhaus – A Paradigm Shift for the Home?

This raises the question – is a Passivhaus so very different from a 'normal' house? And what does it take to live in one 'well'? The Passivhaus epitomises the relationship between the building fabric, the technical systems and the people within it. However this is not a new relationship. The hearth as a central focus of the home demonstrates the cultural and physical significance of the inter-related nature of systems, people, and buildings in the ideology of the home.

Passivhaus has emerged as a successful method for creating low energy homes that use significantly less energy than most housing built to national codes. Comfort is characterised by thermal consistency achieved through minimal amount of energy. This is defined at the design stage, and has been shown to be reasonably accurate. Evidence from the first Passivhaus project built in Darmstadt-Kranichstein, Germany, shows consistently low energy consumption across heating, hot

# PLEA 2018 HONG KONG

*Smart and Healthy within the 2-degree Limit*

water, cooking and ventilation [4]. This performance is well documented and is famously occupied by its designer and the inventor of the Passivhaus methodology, Wolfgang Feist. The project has been constantly monitored and maintained or improved to keep this performance. The one thing that is often overlooked is the engaged and committed participation of the occupant.

The ability to understand and then fine tune the building has been invaluable in testing and proving the Passivhaus approach. Since the first Passivhaus project in 1991, 60,000 Passivhaus now exist [4]. The majority of these are houses. As a typology it does not require any particular change to current housing design practice for either layout or spatial configuration. Where the main difference lies is in the careful balance of energy that is determined by a fabric first approach closely coupled with a finely tuned heat recovery ventilation system. Occupant response to this and the potential to achieve comfort in a Passivhaus is the subject of this research.



Figure 1: Air conditioner advertisement (model IT & T Coolerator, 1953)

## 2.2 Comfort and Evolution of the Home

The hearth is a central concept of the home, and its relationship with comfort. The physical placing of the fireplace was always inter-related with the social condition in the home, and by extension comfort. The compact form of the Rumford stove was designed to enable a social space around the hearth which had previously been inhibited by the egress of smoke from earlier broad and open fireplaces. This both changed the way in which a room might be used, and the efficiency of the system in providing heat. In the early 20th century, the service system gained even more attention in architecture with the escalating role played by technology in the philosophy of design and the process

of architectural form-making. Introduction of air-conditioning is not such a modern concept as perceived by many. In a house designed in 1839 in Edinburgh, flues were built into gable walls, openings were hidden behind cornices and empty spaces were left between the ceilings of the attic space so that fresh, warm air could continuously circulate throughout the six-storey house [5]. From the early 19th century in Europe, ongoing trials of central heating using warm air, hot water and steam were performed with the aim of finding the safest and most efficient way of providing thermal comfort. Old-fashioned fireplaces gradually came to be replaced by gas-powered central heating systems.

Each evolution of technical system is coupled with a change in the social dimensions of comfort and the expectations of householders. This suggests that Passivhaus is likely to require an evolutionary step in the idea of comfort in the home.

## 2.3 Achieving Passivhaus 'The PHPP Spreadsheet'

The use of a spreadsheet to evaluate the design of a Passivhaus results in an emphasis on quantitative measures of achieving the low energy standard. The realisation of Passivhaus buildings is determined through close control of energy balance, achieved through thermal performance of the fabric and controlled ventilation strategies coupled with solar gain. The role of human behaviour is often overlooked by assumptions that are built into the spreadsheet. This research is important in exploring the links between the design of Passivhaus projects and the people that move into them. Positive linkages will lead to energy reductions, but also a wider acceptance of a more sustainable lifestyle. Where there are negative links, these can be counter-productive to the Passivhaus ideology, in terms of a gap between predicted and actual energy use, but more widely a rejection of a way of building, proven to reduce carbon emissions

PHPP stands for Passivhaus Planning Package. It is a rigorous and evolving software that is used to define if a design will achieve Passivhaus standard. The approach has been used since the first Passivhaus, albeit the software has been developed and improved in response to its use. The PHPP methodology requires designers to incorporate robust building fabric, and evaluation of window orientation and shading strategies to enable meeting exacting standards for heating, cooling, primary energy and airtightness.

# PLEA 2018 HONG KONG

Smart and Healthy within the 2-degree Limit

Specific building demands with reference to the treated floor area		
	Treated floor area	351.4 m <sup>2</sup>
Space heating	Annual heating demand	14 kWh/(m <sup>2</sup> a)
	Heating load	9 W/m <sup>2</sup>
Space cooling	Overall specific space cooling demand	kWh/(m <sup>2</sup> a)
	Cooling load	W/m <sup>2</sup>
	Frequency of overheating (> 25 °C)	0.0 %
Primary Energy	Space heating and cooling, dehumidification, household electricity, DHW, space heating and auxiliary electricity	kWh/(m <sup>2</sup> a)
	Specific primary energy reduction through solar electricity	kWh/(m <sup>2</sup> a)
	Airtightness	Pressurization test result n <sub>50</sub>
		0.6 1/h

Figure 2: PHPP excerpt

The Five basic principles of Passivhaus are: Thermal Insulation with a max 0.15W/(m<sup>2</sup>K); high performance windows; ventilation heat recovery; airtight construction; and absence of thermal bridges. These are built into the PHPP and so designers can test design iterations within the spreadsheet. The results are based on numerical evaluation. This creates the real benefit of PHPP in terms of the architectural resolution. There are no perceived design limitations for Passivhaus beyond the five basic principles set out above.

Really interesting modulation of the data within PHPP can be used to create multiple design solutions that fulfil the PHPP requirements for Passivhaus. The optimum wall to window ratio can be calculated for particular climates [10].

## 2.4 Comfort in Passivhaus

The concept of comfort is closely aligned to the primary benefit of Passivhaus. The ability to retain heat and maintain a constant temperature with minimal energy. This key characteristic of the Passivhaus building typology adopts a systemic view of comfort, and the scope is limited to a thermally empirical view.

There is increasing concern about overheating of Passivhaus in summer periods [6], and this is set to worsen with global warming. The methodology for Passivhaus confines allowable overheating to only

Meanwhile, distinct from the learning process, home occupants will develop habitual strategies for using the controls as part of their daily routine. In learning to use the Passivhaus system, the occupants develop an understanding of the control panels and the principles of MVHR. However, the Passivhaus system needs to be fine-tuned to be compatible with individual's needs. A fine-tuned system can only be achieved through daily interaction and adaptations in habitual strategies. Those strategies include changes in household behaviour such as laundry schedules and thermostat settings, as well as psychological changes such as the increased awareness of energy use. Behavioural change has been recorded in previous research on Passivhaus occupants. For instance, due to the presence of large south-facing windows, behavioural change occurred whereby the occupant participants either stayed away from windows or used

curtains. Participants' ventilation habits also changed, with a shift from them manually operating windows to using programmable controls [7] Another study comparing feedback from three pairs of occupants of both Passivhaus and conventional houses suggested that the Passivhaus occupants tended to behave with greater regard for the environment and have greater control and awareness of their energy use [8].

## 3. RESEARCHING THE LIVED EXPERIENCE

This research examines the scope of the PHPP in achieving Passivhaus and builds an argument that the spreadsheet alone cannot lead to a comfortable home. A careful understanding of and sensibility to the human experience is required for success in the uptake of Passivhaus projects. Case study analysis using a primary study of UK projects, and secondary case studies from International context are used to develop the findings. Research has tended to focus on the achievement of energy savings, but this work represents a departure from this technical grounding into a broader social anthropological study. The work is underpinned by a traditional framework for comfort in the home and widens the focus from thermal comfort to issues that frame a broader concept of social comfort. This paper presents part of a PhD study on the lived experience of Passivhaus.

### 3.1 Research methodology

The PHPP framework is evaluated to identify the key characteristics that define a Passivhaus. This is then used to evaluate case study projects. The architectural features in the project that were closely related to receiving or reconciling comfort are examined in the context of the transitions made by people moving into Passivhaus projects.

Research with ten households living in UK Passivhaus projects was carried out to understand the perception and experience of comfort in these houses. This case study analysis informed the development of new understanding in the lived experience of Passivhaus. The research moved beyond technical achievement of standards to an anthropological interpretation of comfort in the Passivhaus.

Working with households that had moved into a Passivhaus home in the last three years, research was undertaken to understand their a priori knowledge, engagement with and adaptation to the building, and the relationship this has with energy consumption. The work developed an understanding of comfort and how people came to receive and reconcile comfort in the their Passivhaus homes. It explores prior knowledge and perceptions with the physical interactions people made with the buildings to attain comfort. The participants were surveyed on their understanding of Passivhaus prior to moving in, and then their experience of comfort

in their current home [9]. Exploration of the adaptations made by people moving into a Passivhaus reveals a strong connection between the comfort and physical interaction and the mental image held of Passivhaus.

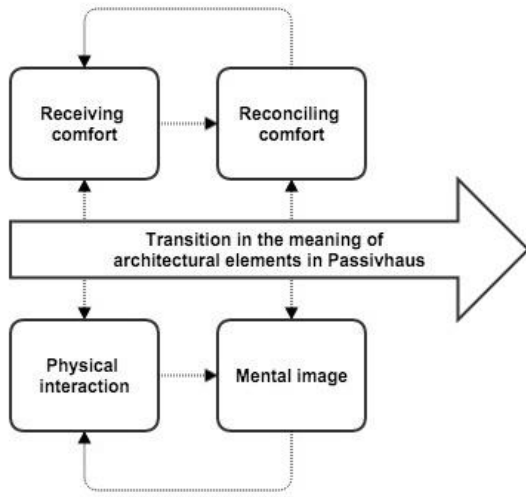

Figure 3: Adapting to a Passivhaus

Further examination of Passivhaus projects in light of these findings reveals a strong relationship between technical systems, human interactions and energy consumption. The case study analysis shows emerging themes that connect architectural features with the concept of comfort as it evolves in a Passivhaus.

The variables that are included and excluded from the PHPP software are examined in relation to the narratives of lived experience in Passivhaus. This provides insight into the process of designing a Passivhaus that is cognisant of how people may live within the typology. The analysis highlights features that are more likely to impact on the comfort of occupants. The analysis focuses on ten UK Case study examples, then further explores this in the context of some international examples.

### 3.2 The role of occupants in low-energy housing

Ten case studies (15 households) participated in the research. Seven were privately commissioned and owned (Projects B-H). Eight were social housing tenants (Projects A, J & K). Interviews explored their attitudes and expectations of Passivhaus [11]. Health, energy efficiency and heat+air+light were perceived as the most positive aspects of their Passivhaus. Occupants were asked about their knowledge of Passivhaus before moving in, and their experience of living in one. 14 of 15 households were confident in operating the Passivhaus, including four social housing tenants with no a-priori knowledge of Passivhaus. Of those with prior awareness of Passivhaus, five (3 Private, 2 Social) had equal prior knowledge and confidence in operating their Passivhaus. Of the remaining six households, four became more confident, and two less so. This demonstrates the

importance of learning by experience. Most occupants were given training to control the technology, but more than half would call an engineer to get assistance if something went wrong. Compared with other low-energy housing, one distinct feature of the Passivhaus is its MVHR system. This mechanical ventilation heat recovery systems provides warm fresh air without the need to manually operate windows. This new system, along with other technologies in a Passivhaus, requires a certain understanding and technical knowledge on the part of occupants. Occupants will develop habitual strategies for using the controls as part of their daily routine. A fine-tuned system can only be achieved through daily interaction and adaptations in habitual strategies. Those strategies include changes in household behaviour such as laundry schedules and thermostat settings, as well as psychological changes such as the increased awareness of energy use.

Not only do home characteristics have a direct impact on energy requirement, they also indirectly affect household energy behaviour. Lindén et al. [12] found that occupants of detached houses used lower thermostat settings than occupants in a multi-family flat. Another study comparing the experiences of occupants in a conventional building with those of the occupants of a green building suggested that the occupants in a green building tended to be more aware of environmental issues and behave in a pro-environmental manner [8]. The more a building is insulated, the more the lifestyle proportionally influences the heating loads'[13]. That is to say, highly insulated low-energy buildings are more sensitive to household behaviour in terms of energy performance. In one case study house the relationship with external conditions became more important – “so it's a question of changing your lifestyle really according to the weather”. They also noticed that internal temperatures were sensitive to activity levels – “if the kids do exercise the whole house would be roasting. I told them if they get cold, go do some exercise”.

### 3.3 Architectural Features

In the Passivhaus design guide, several design features are highlighted as being the most important in terms of their effect on the performance of the Passivhaus. These are: **building form factor**; **orientation**; and **U-value**. Each of these features was examined in the case studies and correlated with the lived experience of occupants. These are all variables within the PHPP that are defined numerically. This research tries to understand the relationship that these features have on the lived experience of occupants.

Building form factor is used to optimise the floor area, the footprint of the building, the plot ratio and other parameters. A smaller ratio of external envelope area to the volume of the building (A/V ratio) indicates a lower heat loss. A favourable compactness ratio is considered

# PLEA 2018 HONG KONG

*Smart and Healthy within the 2-degree Limit*

to be where the A/V ratio  $\leq 0.7\text{m}^2/\text{m}^3$ . The form factor is established by dividing the exposed surface area by Total Floor Area (TFA) with a benchmark of 3.

*Table 1: Exposed Area to Volume Ratio of Case Studies*

Project code	A/V	A/TFA	Experience+
Project A (4 houses)	<b>0.70</b>	<b>2.57</b>	<b>3,5,3,5</b>
Project B	<b>0.80</b>	<b>3.46</b>	<b>5</b>
Project C	<b>0.76</b>	<b>2.94</b>	<b>5</b>
Project D	<b>0.80</b>	<b>2.35</b>	<b>5</b>
Project E	<b>0.71</b>	<b>2.75</b>	<b>5</b>
Project F	<b>0.73</b>	<b>3.28</b>	<b>1</b>
Project G	<b>0.71</b>	<b>2.96</b>	<b>5</b>
Project H	<b>0.76</b>	<b>2.16</b>	<b>3</b>
Project J (2 houses)	<b>0.58</b>	<b>2.42</b>	<b>5,3</b>
Project K (2 houses)	<b>0.60</b>	<b>2.23</b>	<b>5,1</b>

With the exception of the Projects B and F, the case studies have all achieved the benchmark of 3 for the form factor. In terms of the A/V ratio, the three multi-family projects, A, J and K, achieved a ratio of no more than  $0.70\text{m}^2/\text{m}^3$ , whereas the single-family projects all scored slightly above the average A/V ratio, with the largest occurring in Projects C and G, a reflection on the client wishes at odds with the PHPP guidance. The form factor does not seem to have a direct bearing on physical comfort, probably as they all achieve the Passivhaus standard. Table 1 shows a rating from 1 to 5 of comfort experienced by occupants. It is notable that the greatest incidence of poor comfort was experienced by the social housing. Perhaps due to less familiarity with the concept of Passivhaus. However the layout and orientation of homes is clearly linked to the satisfaction of occupants. Correlational examination between these properties and occupants' comfort evaluation revealed strong relationships between orientation and occupants' perception of certain comfort values such as heat+air+light and the energy efficiency of their houses, increasing when the house faces south.

To maximise solar gain, the main façade is oriented within 30 degrees south. Poor orientation can increase annual heating demand by 30% to 40% [14]. The majority of the projects (6 houses) are oriented due south. The remainder, with the exception of the Projects H and K, are oriented within 30 degrees south. Project H and the K face 57.7 degrees and 46.6 degrees southwest respectively. Both these projects have higher energy use. Very few of the projects have any natural shading from vegetation or adjacent buildings. 11 of the 15 case studies experience overheating in summer months. This was frequently experienced in upstairs bedrooms. PHPP calculates heat distribution across the whole building, and does not allow for differential heat gradients. When evaluating the floor to window ratio in these projects it was much higher for the rooms experiencing

overheating. The design to maximise solar gain has influenced by the requirement specified in the Passivhaus design guide.

*Table 2: U Values of the Case Study Houses in W/m<sup>2</sup>K*

Project code	Wall	Ground	Roof	Energy kWh/m <sup>2</sup>
Project A	<b>0.120</b>	<b>0.110</b>	<b>0.120</b>	<b>23.4</b>
Project B	<b>0.094</b>	<b>0.075</b>	<b>0.099</b>	<b>14.02</b>
Project C	<b>0.100</b>	<b>0.100</b>	<b>0.080</b>	<b>36.7</b>
Project D	<b>0.145</b>	<b>0.088</b>	<b>0.121</b>	<b>30.45</b>
Project E	<b>0.097</b>	<b>0.094</b>	<b>0.077</b>	<b>16.93</b>
Project F	<b>0.116</b>	<b>0.125</b>	<b>0.115</b>	<b>27.14</b>
Project G	<b>0.100</b>	<b>0.090</b>	<b>0.090</b>	<b>21.34</b>
Project H	<b>0.123</b>	<b>0.090</b>	<b>0.064</b>	<b>30.43</b>
Project J	<b>0.120</b>	<b>0.140</b>	<b>0.098</b>	<b>28.07</b>
Project K	<b>0.110</b>	<b>0.080</b>	<b>0.110</b>	<b>54.74</b>

The external envelope in Passivhaus design must achieve U-values of  $\leq 0.15\text{W}/\text{m}^2\text{K}$ . When correlating with energy consumption of the studied cases, it can be seen that houses with the best U-values – projects B, E and G - are also the projects with the best energy performance. However, project H which has a similarly low U-value, consumes much more energy than the other cases.

In examining the relationship between comfort traits and architectural design, these quantifiable factors have been taken into consideration. A quantitative correlational analysis carried out separately [11] has revealed two clusters of factors between the occupants' evaluation of comfort and their lifestyle change, ideology and knowledge of Passivhaus. These two clusters of factors are: 'physical interaction' and 'mental image' of Passivhaus living. Figure 3 shows the relationship between these two clusters and achieving comfort. The Lived Experience of Passivhaus involves more complexity than the PHPP approach incorporates, and while this tool is valuable in defining a well-balanced design, it is important to understand the wider context of comfort for a Passivhaus home. These two strands of investigation are needed to study the lived experience of Passivhaus occupants. Moreover, the correlation between energy consumption and the occupants' evaluation of comfort, knowledge and ideology revealed even more interesting connections. It can be concluded that the deviation in energy consumption of the studied cases needs to be examined with a holistic consideration of occupants' experience and architectural design. The specified features in Passivhaus design guide are able to direct a satisfactory and qualified Passivhaus building, however, in order to ensure a high energy performance, other design features as well as occupants' behaviour and comfort need to be taken into consideration in the design of Passivhaus.



# PLEA 2018 HONG KONG

*Smart and Healthy within the 2-degree Limit*

## 4. CONCLUSION

It can be observed that the majority of single family projects are detached, two storey houses with three or four bedrooms. Project B is single storey. One major observation made during the study of the layouts is that for most of the houses with two storeys, bedrooms are placed on the upper level as per conventional housing layout. However, for projects E, F, and H, the bedrooms are designed to be on the ground or lower ground level. Correlating with the evaluation of the layout in the comfort value for Projects J and K 2 (households) occupants expressed dissatisfaction with their house layouts. One thing the three households had in common was that they all moved into a ready-built Passivhaus without any participation in design or construction process. It can be understood that this was perhaps the reason why the layout was not to their satisfaction. On the other hand, comparing with other social tenants (in Project A) and J1 household, who were content with the layout of their houses, J2, K1 and K2 households also share a relatively short period of occupation time. This could also suggest that occupation time plays a role in the evaluation of the layout of Passivhaus dwellings. During the period of occupation, it is likely that the residents make adaptations or adjustments to the layout of their houses to suit their preference.

People are an important part of the Passivhaus ideology. The PHPP is a robust and seemingly accurate way of predicting energy use in many PH projects. There remains a potential area for unpredictable energy performance associated with people and their interaction with the system of Passivhaus. As demonstrated above the interaction between comfort and physical interactions, has a relationship with the acceptance of Passivhaus as a housing typology. This requires much deeper longitudinal research to be better understood.

## ACKNOWLEDGEMENTS

The researchers are grateful to the research participants for sharing the Lived Experience of Passivhaus vital to improved understanding.

## REFERENCES

1. Dequaire, X. Energy Efficiency (2012) 5: 377.
2. Foster, J.; Sharpe, T.; Poston, A.; Morgan, C.; Musau, F (2016). Scottish Passive House: Insights into Environmental Conditions in Monitored Passive Houses. Sustainability 2016, 8, 412.
3. Sharpe, T.; Farren, P.; Howieson, S.; Tuohy, P.; McQuillan, J. (2015) Occupant Interactions and Effectiveness of Natural Ventilation Strategies in Contemporary New Housing in Scotland, UK. Int. J. Environ. Res. Public Health 2015, 12, 8480-8497.
4. Passiv House Database [www.passivhausprojekte.de/](http://www.passivhausprojekte.de/)
5. J.C.Loudon (1842) First Additional Supplement to Loudon's Encyclopedia of Cottage, Farm and Villa Architecture. London: Longman, Brown, Green and Longmans.
6. Tabatabaei S, Gaterell M, Montazami A Ahmed A. (2015) Overheating investigation in UK social housing flats built to the Passivhaus standard. Building and Environment 2015) vol 92.
7. Brunsgaard, C., Knudstrup, M.-A. & Heiselberg, P. (2012) Occupant Experience of Everyday Life in Some of the First Passive Houses in Denmark. Housing, Theory and Society, 29(3), 223-254
8. Zalejska-Jonsson, A. (2012) Evaluation of low-energy and conventional residential buildings from occupants' perspective. Building & Environment. Dec2012, 58, 135
9. Zhao J and Carter K (2015) Perceived Comfort and Adaptive Process of Passivhaus 'Participants' Energy Procedia Volume 83 Dec 2015 pp 121-129.
10. Lavafpour, Y. and Sharples, S. (2017) The influence of façade design on the optimum window to wall ratio and overheating rate in UK Passivhaus dwellings for current and future climates: A Parametric Design Method. In: Passive Low Energy Architecture (PLEA), Edinburgh, Scotland, 3-5 July 2017.
11. Zhao J and Carter K (2018) Lived Experience of Passivhaus. Forthcoming.
12. Lindén, A.-L., Carlsson-Kanyama, A. & Eriksson, B. (2006) Efficient and inefficient aspects of residential energy behaviour: What are the policy instruments for change? Energy Policy, 34(14), 1918-1927.
13. de Meester, T., Marique, A.-F., De Herde, A. & Reiter, S. (2013) Impacts of occupant behaviours on residential heating consumption for detached houses in a temperate climate in the northern part of Europe. Energy and Buildings, 57, 313-323
13. Nikolaidou, E, Wright, J.A. and Hopfe, C.J., (2015). Early and detailed design stage modelling using Passivhaus design; what is the difference in predicted building performance? IN: Proceedings of BS2015: 14th International Conference of Building Performance Simulation Association, Hyderabad, India, 7th-9th December 2015, pp.2166-2173
14. McLeod, R. S., Hopfe, C. J. & Kwan, A. (2013) An investigation into future performance and overheating risks in Passivhaus dwellings. Building and Environment, 70, 189-209

## Rough Void:

# Translating Vernacular Microclimates into a Climate-Resilient, High-Density Urban Typology

ANDREW HEID<sup>1</sup>, CHRISTOPHER PURPURA<sup>1</sup>, THEO DIMITRASOPOULOS<sup>1</sup>

<sup>1</sup>NO ARCHITECTURE, New York City, USA

**ABSTRACT:** Since 2015, the New York-based design studio NO ARCHITECTURE (NOA) has researched the history of vernacular and pre-industrial built environments in order to better understand indigenous strategies for climate-resilient development. Spatial and ecological performance analysis of our findings initially led to a catalog of vernacular outdoor microclimate morphologies, which we then translated into a higher-density proposal for an ecodistrict located in Portland, Oregon's (Csb) Mediterranean climate. The interdisciplinary study includes examinations of several dimensions of the early stages of a design process, including: underlying theoretical and historical frameworks; simulations of solar isolation and wind flow; and the elaboration of a set of flexible principles which can be adapted throughout climates with dry summer conditions. This proposal for a new "Rough Void" typology anticipates an alternate, climate-resilient trajectory for urban development.

**KEYWORDS:** Microclimate, Vernacular, UTCI, Design Process, Mediterranean climate

## 1. INTRODUCTION

Although density is championed by environmentalists over sprawl, by many measures, our cities have exacerbated their local climates by overheating—creating the "urban heat island" effect where freeways, high-rise towers, minimal canopy coverage, and exhaust from air conditioning threaten our ability to live in close proximity [1-2]. To elaborate this paradox at the scale of housing and habitat is to question the specific configurations, the forms and fabrics of our cities today, and how they can adapt and mitigate for tomorrow. Founded in 2009, NO ARCHITECTURE (NOA) is a New York-based design studio dedicated to the radical exploration of ecology and urbanism through innovative architecture. Since 2015, we have researched the history of vernacular and pre-industrial built environments in order to better understand indigenous strategies for climate-resilient housing. Spatial and ecological performance analysis of our findings initially led to a catalog of passive design strategies, which we then implemented to generate a flexible urban geometry—the "Rough Void" typology—that anticipates a climate-resilient trajectory for urban development.

## 2. REPRESENTING THE VERNACULAR

In the influential photographic survey *Architecture Without Architects*, Bernard Rudofsky argues, perhaps naively, that indigenous architecture achieved the comforts of floor heating and air conditioning, the efficiencies of prefabrication and standardized building components, without today's destructive reliance on fossil fuels [3]. Despite an inspiring proliferation of images, Rudofsky's survey reduces these settlements into aesthetic objects, therefore, eliding the contextual

and cultural particularities of each site's builders and inhabitants. In retrospect, Rudofsky falls into the "Traditional Technology Trap," which Susan Roaf warns relies on stereotypical assumptions that vernacular builders "optimized" their design decisions for climate performance—a mistake that too often obscures the "fundamental interconnectedness that exists between technical, social, economic, and political decisions in reality" [4].

Holding both this critique and appreciation for *Architecture Without Architects*, the architectural historian Paul Oliver gave substance to Rudofsky's sketch by devoting a career's worth of rigorous scholarship to vernacular settlements. After ten years of research, Oliver and 650 contributing authors published the landmark *Encyclopedia of Vernacular Architecture* [5]. Amidst this abundant scholarship, however, there remain opportunities for further visual and quantitative supporting material. This encyclopedia, moreover, largely overlooks the relationship between vernacular settlement and the theory and practice of contemporary architecture.

Intended as a supplement to Rudofsky and Oliver, the scope of our catalog is the performance of outdoor microclimates at vernacular settlements through a methodology defined by architectural representation and climate simulation. Whereas Rudofsky and Oliver argue for Western architectural practice to respect and learn from indigenous innovations, our project reinforces their position by compiling spatial and climactic analyses to visualize and quantify the performance of pre-fossil fuel economy habitat and settlement.

# PLEA 2018 HONG KONG

*Smart and Healthy within the 2-degree Limit*

## 2.1 Cataloging Microclimates

We have amassed twenty case studies into a catalog that cuts across climates and cultures: from the semi-private courtyards and alley ways ventilating Beijing hutongs to the shared walls mitigating solar heat gain in North African medinas. From mudbrick wind towers in Iran to stepped terraces in Greece, the catalog focuses on the outdoor microclimate between buildings as a climate positive indicator for not only outdoor space but also passive cooling and ventilation within buildings.

To avoid the “Traditional Technology Trap,” Roaf advocates for methods that enable us to systematically test the actual performance of vernacular settlements, specifically citing in situ monitoring, infrared thermography, as well as thermal and daylight simulations [6]. Therefore, in compiling this catalog, our methodology included architectural drawings and 3-D modeling that simulate, quantify, and analyze for surface and ambient temperature, natural ventilation, gross floor area, and density.

We experimented with mapping climate data onto site models to produce axonometric drawings that visualize outdoor microclimate performance. As an adaptive model of thermal comfort, Universal Thermal Climate Index (UTCI) accounts for how users’ thermal expectations and preferences are modified by psychological adaptation and behavioral adjustment. In addition to its integrated and holistic consideration of both thermal history and contextual factors, UTCI involves standard requirements for weather input parameters: temperature, humidity, radiative exposure, and wind speed [7]. However, current analytical methods to assess outdoor comfort based on UTCI, such as ENVI-met and CitySim, proved too computationally heavy and time intensive for the resources of our studio, a hurdle frequently faced by designers and students [8]. Therefore, in line with this project’s resources, we selected a composite or hybrid strategy to visualize the effect of urban form on outdoor comfort. For each site, we ran simulations for solar insolation and wind flow with Computational Fluid Dynamics (CFD) to achieve a partial representation of the built environment’s impact on outdoor comfort.

With limited time during early design stages to perform advanced simulations, designers often rely on broad or inaccurate assumptions on the passive heating and cooling effects of built form. Although not a full picture of UTCI variables, coupling visualizations of solar insolation and wind flow is an efficient preliminary method for critically and quantitatively assessing outdoor comfort. Since passive design principles are most effectively implemented in the early stages of design [9-10], it is important to continue to rethink and streamline climate simulations that are not only reliable, but also accessible for designers and students without specialized training.

## 3. High-Density Translation

With an FAR of 3.45, the 16<sup>th</sup> century walled city of Shibam, Yemen achieves a similar built density to the Downtown Manhattan condition typified by Greenwich Village, which Jane Jacobs influentially championed as a model for urbanism [11]. Reviewing our existing catalog, it was surprising to learn that several additional case studies achieved a built density comparable to modern urban development, including the Medina of Marrakesh, Morocco; Cerro San Cristobal in Lima, Peru; and Sana’a also in Yemen. Although simulations of these case studies confirmed that built form can enhance outdoor comfort and, in some cases, achieve density—as is, these vernacular settlements are not solutions for our current climate crisis. Culturally-speaking, the inhabitants of 21<sup>st</sup> century urban centers have different programmatic requirements for the use of outdoor public space, and expectations around comfort. Economically, developers and home-owners understandably prefer to invest in housing built with modern comforts including electrical lighting, plumbing, and indoor climate control. Therefore, the problem remains: How can these vernacular passive design strategies be translated to serve the realities of our increasingly overpopulated and overheating urban centers in the 21st century?

To demonstrate this process of translation, below is a review of our studio’s early design stages for a high-density ecodistrict in Portland, Oregon intended to achieve carbon-neutrality. As one of the last underdeveloped contiguous parcels within Central Portland, the six-acre industrial site interrupts the fine-grained street pattern of two residential neighborhoods to the north and south with 2.5 FAR. Time-specific temperature readings collected at Portland State University indicate that the proposed ecodistrict’s site trends 1.6 to 1.8°C warmer, according to the Sustaining Urban Places Research Lab [12-13]. In Oregon, the hottest days in the 2000s approximately tripled the rate of heat-related illness compared with days 12.2°C cooler (Dalton et. al). Furthermore, the ecodistrict’s mission to mitigate the Urban Heat Island Effect via comfortable outdoor microclimates intends to positively effect social equity by increasing access to green spaces [14] and potentially create safer and healthier neighborhoods [15]. All day and year-round, a core aspiration for the ecodistrict is the design of public green spaces that define places to gather for work and leisure not only for the district’s tenants and residents but also surrounding communities.

# PLEA 2018 HONG KONG

*Smart and Healthy within the 2-degree Limit*

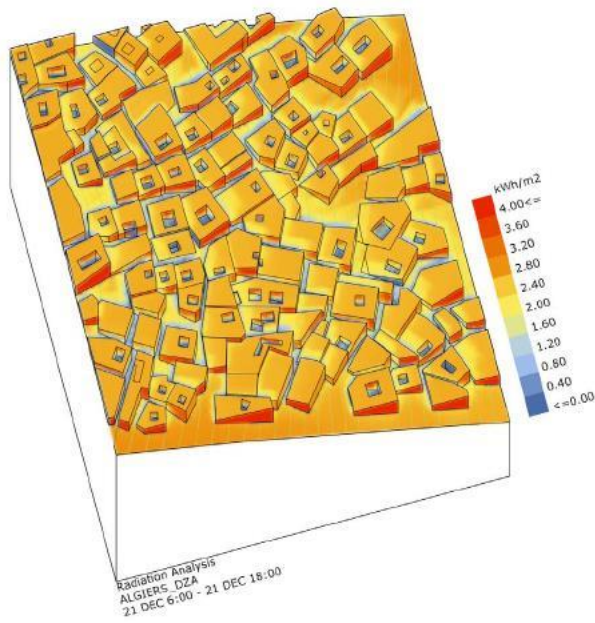

Figure 1: Casbah of Algiers: winter solar insolation analysis.

In the Willamette Valley 80 miles west of the Pacific Ocean, Portland receives summer breezes from the northwest, downstream from the Columbia River and winter winds from the east up the Columbia River Gorge [16]. The Koppen-Geiger climate classification for Portland is Csb: a Mediterranean climate with a cool dry-summer that receives almost all precipitation during the mild winter season. In Portland, the average temperature is 19.3°C in summer, and 5.9°C winter. Due to high ambient temperature and strong solar radiation, the most challenging issue for Mediterranean climates is cooling buildings. During summer months, there is considerable potential for night-time ventilative cooling due to the large daily temperature fluctuation [17]. In combination with interior thermal mass and decreasing heat losses, the most relevant passive design strategies for this location are aimed at increasing natural ventilation in warmer months and solar gains in cooler months.

### 3.1 Mediterranean Vernacular

From our existent catalog, five vernacular case studies share Portland's classification under the Koppen-Geiger's parameters of a Csb "cool dry-summer" climate: the Algerian Casbah of Algiers; the Greek island of Hydra; and the Italian towns of Alberobello, Anticollo Corrado, and Positano. The five case studies share a network of narrow pedestrian streets and self-shading alleyways punctuated by open public plazas, creating a hierarchy of outdoor public space diverse in not only scale and geometry, but also program. While framing culturally-specific activities—mosques in Algiers, Orthodox

churches in Hydra, Catholic in Italy—these plazas feature an additional dimension of flexibility: time. Marketplaces, for example, convert easily into formal civic centers on days of public celebration. At all five sites, a collection of diverse and flexible plazas hosts comfortable microclimates for public gathering.

Unlike Portland's classic street grid, all five settlements feature an irregular street pattern rotated off the north-south axis. Urban microclimate

depends not only on the type of city (in regards to size, geographic location, density, and land use) but also street design features, including the height of buildings, street widths and orientation [18]. A study conducted in Ghardaia, Algeria concluded that pedestrian comfort conditions are indeed improved by rotating the street to a northeast-southwest or northwest-southeast orientation [19]. In summer, our catalog's solar insolation simulations showed an increase in the shading effects of walls in comparison to east-west oriented streets; while in winter, an increase in solar access in comparison to north-south oriented streets (Fig. 1).

Deliberately integrated topographic conditions benefit microclimate performance at each of the five sites, which are all elevated on sloping hillsides and oriented to capture sea breezes. For example, in the case of Algiers, the orientation of the Casbah stimulates natural ventilation in summer by capturing the prevailing northeast summer winds. In winter, the Bouzareah massif blocks the prevailing northwest winds, mitigating their intensity [20]. At all five locations, variations on a dominant housing flex with the terrain [21], compounding the urban fabric's distinctive quality of roughness in both plan and section. This intimate integration with the landscape further stimulates natural ventilation since building facades align with the sites' contour lines, allowing fresh air to stream through the street pattern. It is important to note, however, that these vernacular strategies likely respond not only to the natural topography or local geomorphology, but also to considerations including local building skills and traditions as well as the social, economic, and historical evolution of each settlement (Roaf, 2008).

Whereas the twin conditions of proximity to the sea and mountainous topography benefit these case studies' natural ventilation performance, East Portland is inland and relatively flat. The process of translating passive design techniques into the proposed ecodistrict, therefore, calls for the innovation of a new urban typology that increases the urban fabric's degree of roughness in plan and section via its intrinsic built form. In other words, an example of "landform building," which Stan Allen suggests, "no longer occupy a given site but instead, construct the site itself" [22]. This new typology will examine the multiple intersections of landscape and ecology in contemporary architectural practice as a

# PLEA 2018 HONG KONG

Smart and Healthy within the 2-degree Limit

source for new formal strategies and design techniques applicable for Mediterranean climates.

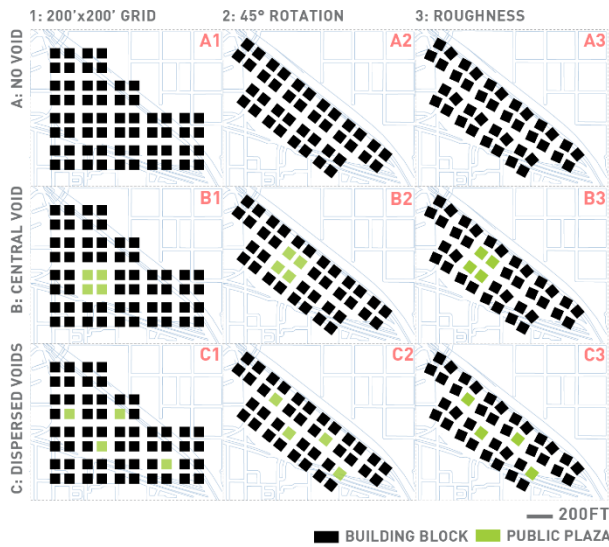

Figure 2: Above spatial operations each tested at both uniform and varied building heights for a total of 18 design iterations.

### 3.2 Simulations

We arrived at the Rough Void typology through an iterative testing of three design principles: street rotation, void condition, and volumetric roughness. The principles were tested in isolation and combination on an abstracted base model derived from Portland's 200'x200' cartesian street grid with uniform building massing (GFA: 1,260,000sf) at 3.5 FAR. The street rotation principle relies on a solar access angle adjustment determined by latitude: in the case of Portland, 45° NW-SE. Void condition was tested in two applications: 1) a single 279x279' central plaza; 2) four 145x145' dispersed plazas. Two applications also tested the principle of volumetric roughness: 1) rotating the 70x70' building footprints 2) varying building heights. In total, eighteen iterations of proposed urban morphologies were modelled and simulated (Fig. 2).

Drawing on discussions for generating faster microclimate maps, this study approached UTCI from its two most important parameters—sky heat exchange and wind speed—simulating each individually [23]. Maps generated in Grasshopper simplified UTCI by privileging sky heat transfer, or the spatial effect of sun on outdoor comfort. Sunrise to sunset on the summer equinox (June 21) represented summer daytime conditions: air temperature (Ta) at 19.21°C, mean radiant temperature (Tmrt) at 35.32°C and relative humidity at 59.73%. As spatial maps of UTCI, the simulations only describe thermal diversity driven by the presence of direct sun or shade. These maps account neither for spatial differences in surface temperature across the urban area nor for spatial differences in wind speed.

The study accounts for the effect of urban form on wind speed with CFD simulations run in ANSYS Fluent. Portland TMY data provided the summer average wind speed and direction (3.4m/s at NNW 112.5°). An SST  $k-\omega$  turbulence model replaced the  $k-e$  model. No-slip conditions were used to simulate wind tunnel walls. Chamber dimensions were  $x=2090.6m$ ,  $y=776.6m$  and  $z=65.0m$  with resolutions  $dx = dy = dz = 1.98m$  in space. This domain grid resolution was adequate for the required scale, namely the interaction of wind patterns between 70x70ft building volumes.

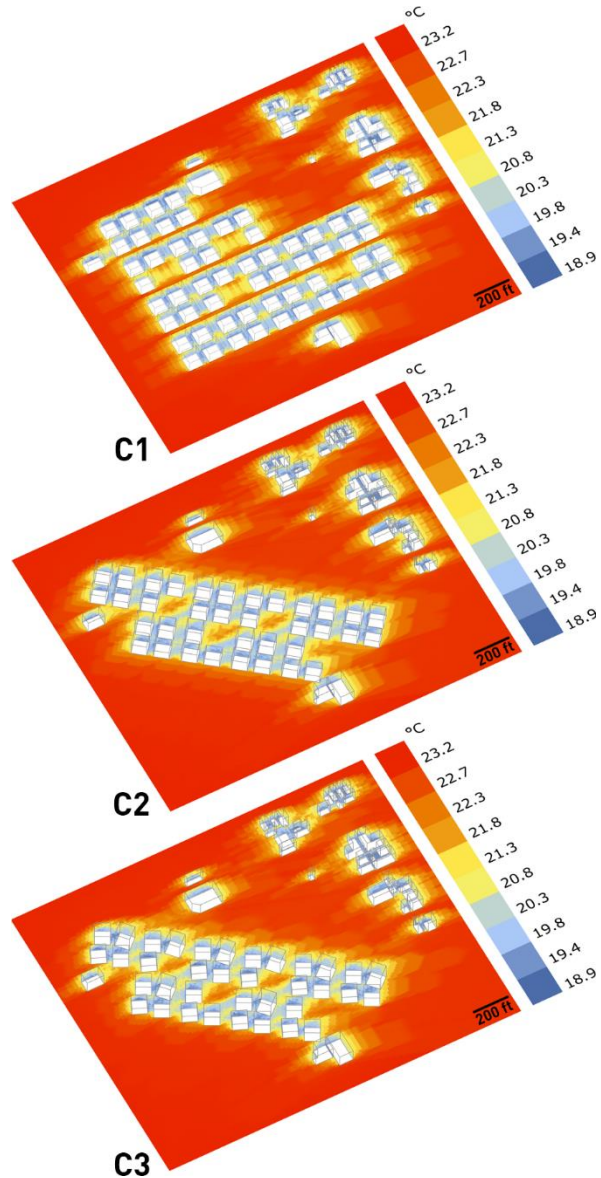

Figure 3: Sky Heat Transfer spatial maps of UTCI for three iterations of spatial operation series C—dispersed voids—with NS aligned grid (C1); with 45° grid rotation (C2, C3); and rotated building footprints (C3). All three iterations tested with varied building heights.

# PLEA 2018 HONG KONG

Smart and Healthy within the 2-degree Limit

Table 1: Comparison of wind effects within dispersed plazas.

Design Iteration	Plaza 1			Plaza 2			Plaza 3			Plaza 4		
	C1	C2	C3	C1	C2	C3	C1	C2	C3	C1	C2	C3
Avg UTCI: (°C)	22.1	22.9	22.0	22.6	22.7	22.0	23.2	22.7	23.0	21.9	23.4	23.1
Avg Vorticity Magnitude	0.12	0.15	0.80	0.45	0.24	0.35	0.63	0.72	0.68	0.98	0.47	0.47

Results from the Sky Heat Transfer simulations confirmed that grid rotation increases an urban fabric’s self-shading properties. For example, whereas the main east-west thoroughfares are exposed to the sun in iteration C1, every street canyon receives shade in iterations C2 and C3 (Fig 3). By rotating the grid, shaded areas along plaza perimeters widened and cooled  $\cong 1.5^{\circ}\text{C}$  along the eastern plaza boundaries. By rotating building footprints, thermal contrast between the center and periphery of plazas increased by  $\cong 1^{\circ}\text{C}$ . Although the plazas in iteration C3 were the hottest (22.7°C) of all iterations, its street canyons were also the coolest, reaching a low 18.2°C UTCI absent from plaza iterations without both grid and building rotations. In future design iterations, land- and water-scaping can mitigate the relative heat stress observed at the centers of the plazas (Fig. 6). Landscape designs need not only respond to and learn from the completed simulations, but also be subject to subsequent sky heat transfer and CFD analysis that weigh the shade benefits of tree canopy coverage against potential negative effects on wind turbulence.

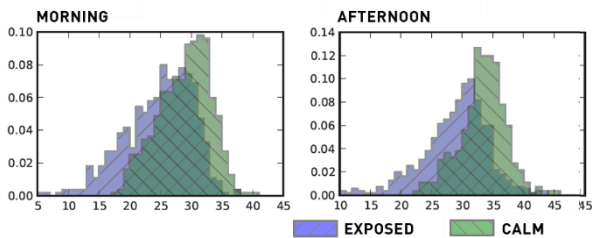

Figure 4. Frequency of UTCI with and without wind in Portland during summer months (source: klimaat.ca).

CFD results met expectations on the degree to which wind benefits UTCI, coinciding with Portland TMY data, and both suggesting an  $\cong 7^{\circ}\text{C}$  UTCI difference between calm and exposed wind conditions (Fig. 4). Although average wind speeds for the plaza iterations demonstrated a surprisingly thin variance (1.1-1.6m/s), results confirmed that increasing volumetric roughness by rotating building footprints dramatically increased wind turbulence (Table 1). For example, the vorticity magnitude increased 433% from C2 to C3 in the case of Plaza #1, and thus, is model on which to refine the geometries of iteration’s other plazas (Figure 5). The effect of wind turbulence on outdoor comfort deserves closer study under a CFD method that accounts for “air

age” pattern and distribution, which is a relative indicator of outdoor air quality [24]. With results firmly within the UTCI “no heat stress” category, the C3 morphology now becomes the base for further study.

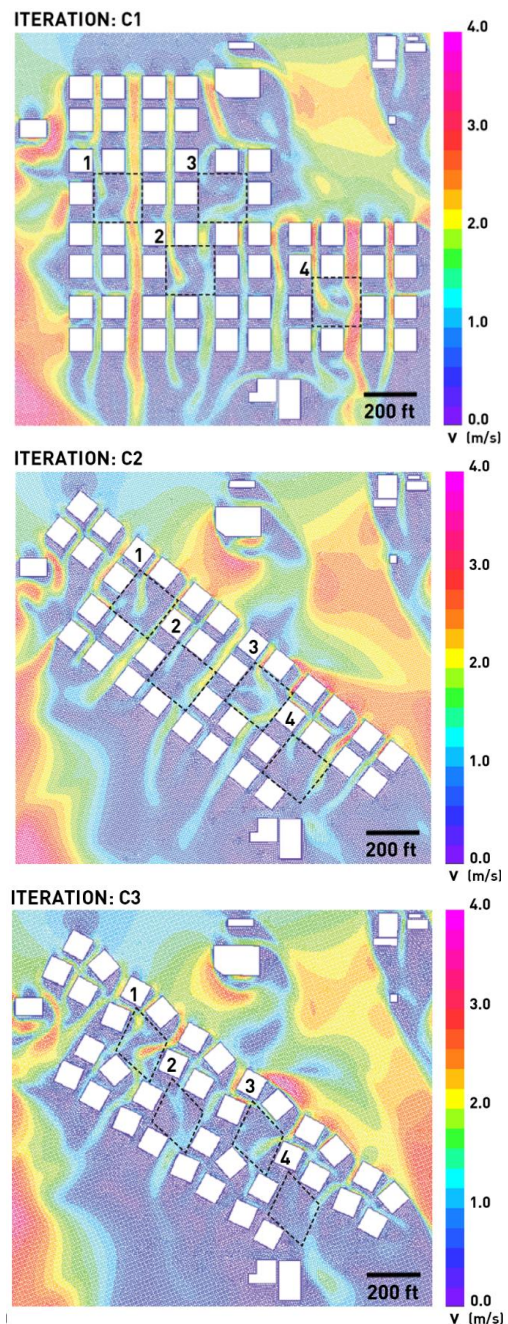

Figure 5: CFD simulations for spatial operation series C, iterations C1-C3 with dispersed courtyards outlined and numbered in black.

# PLEA 2018 HONG KONG

*Smart and Healthy within the 2-degree Limit*



Figure 6. Rendering of plazas with tree canopy coverage.

## 4. CONCLUSION

Advancing the trajectory pioneered by Rudofsky and Oliver, this study corroborates indigenous precedents as both inspiring and useful in practice, yet at the same time, insists that quantitative methods are critical for moving beyond the assumption that form follows climate in the traditional and vernacular. Our process demonstrates how a hybrid approach to UTCI, where sky heat transfer and wind velocity are simulated independently, provides time- and cost-efficient results for students and architects who wish to integrate climate analysis into the early stages of their design process. Emerging from a series of flexible principles intended to scale and re-program according to local constraints, the Rough Void is a typology that is at once site-specific and replicable.

## REFERENCES

1. Oke, T., (1988). Street design and urban canopy later climate. *Energy and Buildings*, 11: p. 103-113.
2. Santamouris, M., (2014) On the energy impact of urban heat island and global warming on buildings. *Energy and Buildings*, 82: p. 100-113.
3. Rudofsky, B., (1964). *Architecture Without Architects: A Short Introduction to Non-Pedigreed Architecture*. New York: The Museum of Modern Art.
4. Roaf, S., (1990). The traditional technology trap. *Trialog*, 25: p. 26-33.
5. Oliver, P., ed (1996). *The Encyclopedia of Vernacular Architecture*. Cambridge: Cambridge University Press.
6. Meir, I. and S. Roaf, (2006). The future of the vernacular: towards new methodologies for the understanding and optimization of the performance of vernacular buildings. In *Vernacular Architecture in the 21<sup>st</sup> Century*. Abingdon, Oxon: Taylor & Francis.
7. Jendritzky, G., de Dear, R., & Havenith, G., (2012). UTCI—Why another thermal index? *Int J Biometeorol*, 56: p. 421-8.
8. Hatefnia, A. and M. Ghobad, (2015) Analytical method to assess outdoor comfort based on universal thermal climate index (UTCI). In *31<sup>st</sup> Conference of Passive and Low Energy Architecture*. Bologna, Italy.
9. Lechner, N., (2009). *Heating, cooling, lighting: sustainable design methods for architects*, Hoboken, N.J., Wiley.
10. Olgyay, V., (1963). *Design with climate: bioclimatic approach to architectural regionalism*. New Jersey: Princeton University Press.
11. Jacobs, J., (1992). *The Death and Life of Great American Cities*. New York: Vintage Books.
12. City of Portland (2015). *Climate Action Plan*, [Online], Available: <https://www.portlandoregon.gov/bps/64076> [14 August 2018].
13. Gordon, K., (2018). *Pacific Northwest: Risks and Opportunities in a Changing Climate*. Olympia, WA: Passive House Northwest.
14. Pincetl, S. and E. Gearin, (2013). The reinvention of public green space. *Urban Geography* 26(5): p. 365–384.
15. Abrahams, P., (2010). Stakeholders' Perceptions of Pedestrian Accessibility to Green Infrastructure: Fort Worth's Urban Villages. University of Texas, Arlington.
16. Sharp, J. and F. Clifford, (2004). Columbia Gorge Gap Winds: Their Climatological Influence and Synoptic Evolution. *Wea. Forecasting* (19): p. 970-992.
17. Causone F., (2016). Climatic potential for natural ventilation. *Architectural Science Review*, 59(3): p. 212-228.
18. Givoni, B., (1998). *Climate considerations in buildings and urban design*. New York: Van Nostrand Reinhold.
19. Ali-Tourdet, F. and H. Mayer, (2004). Planning-oriented assessment of street thermal comfort in arid regions. In *21<sup>st</sup> Conference on Passive and Low Energy Architecture*. Eindhoven, Netherlands.
20. Karabag, E. and N. Fellahi, (2017). Learning from Casbah of Algiers for more Sustainable Environment. In *Climamed 2017 – Mediterranean Conference of HVAC*. Matera, Italy.
21. Michaelides, C., (1967). *Hydra: A Greek Island Town: Its Growth and Form*. Chicago: The University of Chicago Press.
22. Allen, S., (2011). *Landform Building: Architecture's New Terrain*. Zurich: Lars Muller.
23. Mackey, C., T. Galanos, L. Norford, & Roudsari, M., (2017). Wind, Sun, Surface Temperature, and Heat Island: Critical Variables for High-Resolution Outdoor Thermal Comfort. *Proceedings of the 15<sup>th</sup> IBPSA Conference*. San Francisco, USA.
24. Ramponi, R., B. Blocken, L. de Co, Janssen, D., (2015). CFD simulation of outdoor ventilation of generic urban configurations with different urban densities and equal and unequal street widths. *Building and Environment*, p.152-166.

## Delivering Sustainable Design Excellence: The Potential Role of Architectural Precedent

JULIE AMANDA GWILLIAM<sup>1</sup>, SARAH O'DWYER<sup>1</sup>

<sup>1</sup>Cardiff University, Cardiff, United Kingdom

**ABSTRACT:** *This paper aims to explore the role that critical engagement with precedent might play in the delivery of architectural Sustainable Design Excellence. It is argued here that there are currently two divergent core paradigms in the field of architectural design: one based upon a conceptually underpinned process of Conjecture and Analysis, termed here Architectural Design Excellence; while the second, termed Sustainable Performance Excellence, seeks its delivery through a process termed by Bamford, Analysis and Synthesis, of constituent problem fragments. The central role of precedent in architectural design processes is acknowledged in both contexts, and as such it is argued that critical engagement from a sustainable performance perspective with case studies that demonstrate architectural design excellence may provide an effective route for achieving their synthesis. Online coverage of the 21 Stirling Prize winners, 1996 – 2016 (as a proxy for Architectural Design Excellence) were evaluated using a framework for holistic sustainability and the results presented in summary here. It was found that sustainable performance was largely ignored in the available critique, despite some performing well within the narrow measure of energy performance as evidenced through DEC's, thus limiting precedents' potential role within the delivery of a future synthesised sustainable design excellence paradigm.*

**KEYWORDS:** *Architecture, Design, Sustainability, Precedent,*

### 1. INTRODUCTION

Sustainability is now well established as a global driver for action across industry and politics [1]. However, there are concerns associated with the increasingly narrow focus on low carbon presenting a barrier to the pursuit of holistically sustainable architecture, responding to environmental, economic and social sustainability. Although, Environmental Assessment methods have had some impact in encouraging engagement with these wider themes [2]. Additionally, holistic sustainability is rarely found to coincide with architectural design excellence; as indicated both by sustainability's relative deficiency in architectural awards such as the Stirling Prize and in the ongoing professional debate regarding the poor quality of sustainable building design [3].

This paper explores the hypothesis that the sustainable building design process - and in particular the role that precedent plays in this - lies at the heart of this otherness; seeking to consider precedent's role, as a generative tool, in a future synthesis of architectural and sustainable design processes; in order to enable the delivery of smart, healthy and *sustainable architectural design excellence*.

### 2. ARCHITECTURAL DESIGN PROCESSES

The Architectural design process has been the subject of much research, leading to a breadth of typically iterative and cyclical models. Although not a wholly rational practice, the processes described each have structure, components and procedures [4].

#### 2.1 Design Process: Architectural Excellence Lens

It can be argued that at the heart of design processes associated with architectural excellence, lies the generation of a concept: *"Nowadays, a building is appreciated because of its concept, its meaning, its underlying and integrating idea..."* [5]. Where such design concept(s) work to provide the constraining variables that inform the functions and aesthetics of the design, *"structural integrity, clarity of circulation, appropriateness of proportions, and so on."* [6]. The generative process for such concepts is relatively individual, and typically stems from the client, the site and its context, the design team, experience, knowledge and architectural precedent [7]: the latter defined as *"...a culturally approved building that lends authority to new designs based on it."* [8]. Bamford [9] argued that this is largely a descriptive integrative and holistic process, that ultimately relies on a process of Conjecture and Analysis (C/A). Whereby the design generating ideas are *"...quickly tested against constraints and there is enormous value in making mistakes."* [10].

#### 2.2 Design Process: Sustainable Performance Lens

While, for the sustainable design process, it is argued that the pursuit of sustainable performance, rather than a project derived concept, lies at the heart of the design process; indeed that the theoretical concept or driver is itself sustainability. One of the most pertinent problems is therefore the focus on building performance and energy use, whereby sustainability begins to be perceived as a linear end point and not a process [11]. There is thus, perhaps, a contradiction between



# PLEA 2018 HONG KONG

Smart and Healthy within the 2-degree Limit

architects working with dynamic knowledge as in the (C/A) process above, relating to imagination, intuition and experience and the need for sustainable buildings to achieve static benchmarks and legal standards. This might best be identified as Bamford's Analysis and Synthesis (A/S) [9], whereby, "design starts by dismantling problems into fragments, synthesising and evaluating possible solutions..." [10].

## 2.3 Working Towards a Synthesis

What is clear is that both design paradigms, architectural (C/A) and sustainable (A/S) are striving for excellence, but are applying different lenses to its meaning; inhabiting mutually exclusive camps with distinct processes, languages and design tools, including precedents. It is argued here that a synthesis of thinking should enable their integration, and thus effective delivery of healthy and design-excellent buildings. Two approaches towards this synthesised future, can be proffered: one, which requires a wholesale change in the judging of architectural excellence, perhaps "a new measure of beauty" [3]; a second, that effectively enables a synthesis of the two design approaches and ensures that the qualities of each might be brought together. The latter scenario is considered here to be optimal in achieving a paradigm shift towards built environment sustainable design excellence. Of course, such changes might be achieved through a range of actions, not least, in the long term, through interventions in the education of Architects and associated professionals [9]. However, the larger and more pressing challenge is to influence the actions of those already educated and practicing, indeed, who set current architectural culture.

First, it is argued that the re-sequencing of the design process, as inferred by the Integrated design process (IDP) [9] is paramount. Sustainability must be integrated into the very essence of the design; becoming integral to the overarching design concept itself, from the earliest inception phases; thus overcoming problems associated with current widespread late adherence to assessment tools, whereby sustainability is diminished to "an endless series of checklists, spreadsheets and credits" [12]; and placing a strong, project specific, conceptual generator, beyond sustainable performance, at the heart of this new design process. This requires a valuing and retention of the C/A based design process and the derivation of a design concept that is itself informed both qualitatively and quantitatively, but not dominated by, sustainability. Second, timely access to appropriate information, tools, simulations and advice that can appropriately inform design will be required [10]. Here lies the potentially transformative role that precedent could play in delivering sustainable architectural design excellence.

Lawson [13] suggests the development of design expertise moves through 3 phases: "...acquisition of the design domain schemata..."; "...development of a

growing pool of precedent..." and; "...the identification of ... guiding principles which develop over time and further structure and filter the continued acquisition of precedent...". Therefore, where sustainable thinking has been integral to the process of achieving design maturity, one might argue that sustainable precedents will have informed this development and where not, a more individual architectural design sense might have developed.

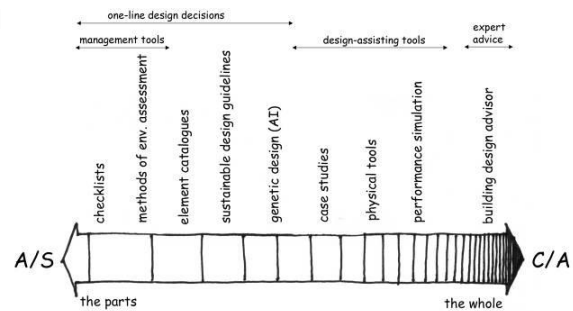

Figure 1: Position of tools according to A/S and C/A paradigms [10].

A synthesised future design paradigm, will require access to precedents that are critically evaluated in terms of both architectural design excellence and sustainable performance: that meet both the Architectural professions' current criteria for excellence (as represented by Architectural media and winners of prestigious prizes); as well as those that meet sustainable design, construction and performance criteria. Rather than mutually exclusive pools of precedent, architectural precedent analysis could also present critical evaluation of building performance, and where buildings do not perform, critique might proffer informed debate over alternative solutions to stimulate professional debate, and feed-forward learning.

## 3. ARCHITECTURAL PRECEDENT: THE STIRLING PRIZE

In order to begin to inform this debate and to evaluate the current relationship between Architectural design excellence and sustainable performance, the Stirling prize winners (1996 – 2016) were selected as a coherent set of building precedents, where the Prize was deemed a proxy measure for Architectural Design Excellence.

This work therefore seeks to explore the potential for typical Architectural Design Precedent to inform sustainable architectural design excellence. It should be noted that future work is required whereby buildings hailed for their sustainable design excellence are analysed for their architectural design excellence. However, although some definitions exist, the latter is much more difficult to characterise as clearly as sustainable design currently is [15].

# PLEA 2018 HONG KONG

*Smart and Healthy within the 2-degree Limit*

Table 1: Stirling Prize Winners: Buildings and Design Teams 1966 – 2016 [14]

YEAR	BUILDING	DESIGN TEAM
1996	The Centenary Building	Hodder Associates
1997	The Music School, Stuttgart.	Michael Wilford & Partners
1998	American Air Museum in Britain	Foster and Partners
1999	NatWest Media Cntr, London,	Future Systems
2000	Peckham Library & Media Centre	Alsop & Störmer
2001	Magna Science Adv. Centre	Wilkinson Eyre
2002	Gateshead Millenium Bridge	Architects
2003	Laban	Herzog & de Meuron
2004	30 St Mary Axe	Foster and Partners
2005	The Scottish Parliament	EMBT/RMJM
2006	New Area Terminal-Barajas Airport	Richard Rogers Partnership Estudio Lamela
2007	Museum of Modern Literature	David Chipperfield Architects
2008	Accordia	Feilden Clegg Bradley Studio Maccreanor Lavington Alison Brooks Architects
2009	Maggie's London, Charing Cross Hospital	Rogers Stirk Harbour + Partners
2010	Museo Naz. d.Arta d.XXI Secolo	Zaha Hadid Architects
2011	Evelyn Grace Academy	Architects
2012	Sainsbury Laboratory, University of Cambridge	Stanton Williams
2013	Astley Castle	Wetherford Watson Mann Architects
2014	Everyman Theatre	Haworth Topkins
2015	Burntwood School	Allford Hall Monaghan Morris
2016	Newport Street Gallery	Caruso St John Architects

This paper will summarise the evaluation of the winning buildings against holistic sustainability criteria, presenting a first step in understanding the potential for current Architectural Precedent to inform the proposed new Paradigm of *Sustainable Design Excellence*.

### 3.1 Method

In order to evaluate this Prize winning Architecture, it was first necessary to establish the phase of their development that would be assessed. While, it is valid to argue that true sustainability, and even architectural excellence, cannot be evaluated until a building has been occupied for a number of years, such in-use data is largely either non-existent or inaccessible beyond the building users or immediate building development team, as this results from additional investment of time and money in Post Occupancy Evaluation (POE) [16]. Therefore, as a proxy for POE, where available, Display Energy Certificate (DEC) data was sought. These standards provide benchmarks against average performance for building typologies [17]. This represents a significant gap in precedent knowledge for the appropriate and informed application of precedents in future projects which must be tackled in future work. As

a result the *design & construction phase* is the focus of this work.

In order to undertake an evaluation of these buildings for their sustainable design, it was then necessary to identify an appropriate framework. Existing sustainability assessment tools are widely applied across the industry to assess buildings during this phase. Such tools came into prominence in the 1990's (Cole, 1998) and although there are many methodologies available on the market, BREEAM (established in UK in 1990) and LEED (established in USA in 2000) are the most commercially successful, well established and international of these. Indeed 2 of the Stirling prize winners have been BREEAM Assessed: 2012, Sainsbury Laboratory, received an interim certification of 75.59%, Excellent; while the 2014, Everyman Theatre received a final certification of 70.19%, also excellent. However, it must be noted that such tools typically focus on environmental aspects of sustainability and no widely applied, universal tool presently exists for the holistic evaluation of sustainability.

The European project, "Openhouse" aimed 'to develop and implement a common European transparent building assessment methodology' [18]. The resulting assessment tool, based upon a study of existing initiatives and their synthesis produced 56 indicators, across 6 categories. This was selected as a key source for the assessment framework applied here. Some alterations to the open house methodology were however, deemed necessary: removal of those factors that were considered to be beyond the control of the architect; as well as those that were typically addressed through legislation, (e.g. access to potable water). Finally, comparison of this theoretically derived framework was undertaken against those factors broadly acknowledged elsewhere to be representative of holistic sustainable design excellence, a proxy for which was provided by Sassi's Strategies for Sustainable Architecture [19]; providing a sense check to pragmatic realised case studies.

Table 2: Themes, indicators & No. of Criteria for Literature Based Sustainability Design Assessment

No. of Indicators	Social	8
<b>Environmental</b>	24	Accessibility
Energy	4	Education
Lighting	3	Community
Materials	5	Health & Comfort
Water	4	<b>Economic</b>
Site Design	4	Building Costs
Waste	3	Performance Management
Climate Change Adaptation	1	Employment Opportunities

Finally, the framework was employed in assessing published material typically accessed by architectural designers when informing architectural precedent studies during the design process. These included:

# PLEA 2018 HONG KONG

Smart and Healthy within the 2-degree Limit

architectural and wider traditional and online media sources; websites of the RIBA, architectural and other built environmental professionals associated with the completed buildings; and the websites for the buildings' owners / occupants. In terms of content analysis, these were simply assessed through the application of a qualitative indicative scale of 0 to 2 for each indicator, whereby: 2 was awarded where design was evidenced to be fully responsive to an indicator; 1, where there was partial evidence of compliance and 0 where no evidence was found.

### 3.2 Findings: Energy Performance

As already stated DEC's were sought as a proxy for POE: calculated using actual annual energy consumption in comparison to building typology benchmarks. Their availability is however, limited as in the UK only public authority buildings require publication of DEC's where they are: "at least partially occupied by a public authority"; they have a "total floor area of over 250 square metres"; and "it's frequently visited by the public" [20]. Private organisations are not required to have a DEC calculated but "may still need an Energy Performance Certificate if the building is sold or rented". As such, where DEC's were not available, Energy Performance Certificates (EPC's) were sought as an alternative: although these are based upon theoretical performance of buildings and as such are less indicative of building performance in reality. "All domestic and commercial buildings in the UK available to buy or rent must have an [EPC]" [21].

Using the UK government's Non Domestic energy performance register [22] 8 valid DEC's were found, calculated between 2016–18 and 4 further EPC's were found for buildings that had been bought or sold during this period. An EPC was reviewed for the Scottish Parliament, as DEC's are not required in Scotland.

Table 3: Building Energy Performance Summary

YEAR	BUILDING	YEAR	DEC
1996	The Centenary Building	2015	57 C
1997	The Music School <sup>1</sup>	N/A	
1998	American Air Museum in Britain	2016	15 A
1999	NatWest Media Center <sup>2</sup>	N/A	
2000	Peckham Library and Media Center	2016	90 D
2001	Magna Science Adventure Centre	2015	13 A
2002	Gateshead Millenium Bridge <sup>2</sup>	N/A	
2003	Laban <sup>2</sup>	N/A	
2004	30 St Mary Axe <sup>3</sup>	2011 (EPC)	138 F
2005	The Scottish Parliament <sup>4</sup>	2009 (EPC)	30 B
2006	New Area Terminal- Barajas Airport <sup>1</sup>	N/A	
2007	Museum of Modern Literature <sup>1</sup>	N/A	
2008	Accordia <sup>2</sup>	(EPC)	79 C
2009	Maggie's London, C. Cross Hospital <sup>2</sup>	N/A	
2010	Museo Nazionale d. Arti d. XXI Secolo <sup>1</sup>	N/A	
2011	Evelyn Grace Academy	2017	117 E
2012	Sainsbury Laboratory	2016	351 G
2013	Astley Castle <sup>4</sup>	N/A	
2014	Everyman Theatre	2016	32 B
2015	Burntwood School	2017	177 - 179 G
2016	Newport Street Gallery	2015 (EPC)	52 C

<sup>1</sup> Not in England/Wales - DEC Unavailable <sup>2</sup> Does not meet requirements for DEC  
<sup>3</sup> For the Sterling Restaurant @ St. Mary Axe <sup>4</sup> Domestic Property

For ease of interpretation an EPC or DEC of 100 is considered to be typical for any building typology in the UK stock. It would therefore be reasonable to expect buildings considered as excellent in their field to at least perform above this baseline, while excellence could be interpreted as achieving an A rating (0-25). Based upon those buildings for which this data was found and including both EPC's and DEC's: 17% achieved an A rating (0-25), synonymous with excellence; 50% a rating 26<100, synonymous with good performance; and 33% a rating of >100 below average. This finding could therefore be interpreted as suggesting that many of these projects have fallen short, and in some cases very short, of excellence in terms of energy performance.

### 3.4 Findings: Environmental

As has already been reported, 24 indicators for Environmental aspects were applied within the analysis (Table 4):

Table 4: Environmental Theme Assessment Indicators

<b>Energy:</b>	<b>4</b>
Inc. fabric thermal efficiency, air tightness, passive design strategies, efficient systems & renewable energy systems.	
<b>Lighting:</b>	<b>3</b>
Including daylighting strategies, avoidance of light pollution and efficiency lighting systems.	
<b>Materials</b>	<b>5</b>
Inc: their dimensions, building small, renewable, certified and low impact materials and role in 'design for delight'.	
<b>Water</b>	<b>4</b>
Inc: minimising use (efficient systems design & education); alternative sources and consideration of waste treatment.	
<b>Site Design</b>	<b>4</b>
Inc: design to promote sustainable transport; ecological value: appropriate density & incorporation of SuDs.	
<b>Waste</b>	<b>3</b>
Including reuse of buildings / materials, minimisation during construction and design for deconstruction.	
<b>Consider Climate Change Adaptation</b>	<b>1</b>
Design to consider climate change adaptation	

Overall for the Environmental assessment: the maximum was 50% in 2009; the minimum was 0% in 1997; with an average of 28% (Fig 2).

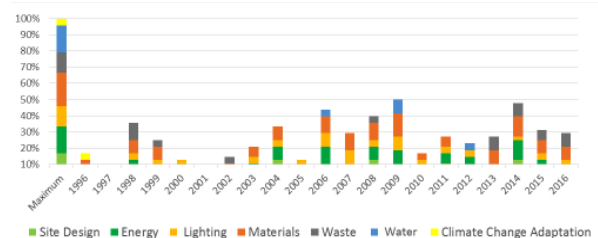

Figure 2: Annual Environmental Indicator Assessment

It can be seen that the consideration of environmental factors is relatively sporadic; with no identifiable trend towards attention to environmental

# PLEA 2018 HONG KONG

Smart and Healthy within the 2-degree Limit

sustainability, and with no apparent improvement, even incrementally, in recent years.

In terms of coverage of particular environmental themes (Table 5) there are buildings that haven't addressed any of these factors (Min = 0%). While, those aspects that appear to be considered relatively consistently, (comparing Figure 2 & Table 5) include Site Design and Energy. Lighting and Materials are fairly consistently addressed, with waste to a lesser extent. Finally, Water aspects are rarely considered and Climate Change Adaptation, never.

Table 5: Average Environmental Themes Assessment

Environmental	Indicators	Average	Max	Min
	24	28%	50%	6%
Site Design	4	38%	75%	0%
Energy	4	36%	88%	0%
Lighting	3	35%	100%	0%
Materials	5	34%	70%	0%
Waste	3	25%	83%	0%
Water	4	5%	50%	0%
Climate Change Adaptation	1	0%	0%	0%

### 3.5 Findings: Social

For the social aspects of sustainability 16 indicators were applied within the analysis (Table 6):

Table 6: Social Theme Assessment Indicators

<b>Community</b>	<b>3</b>
Inc: Participation: identify and engage stakeholders / encourage ownership / design to enhance identity & quality of life & for provision of and access to facilities.	
<b>Accessibility</b>	<b>1</b>
Inclusive barrier free access	
<b>Education</b>	<b>1</b>
Promotion of sustainable lifestyles: Including ease of operation	
<b>Health &amp; Comfort</b>	<b>3</b>
Inc: Design to promote Health; Minimise noise & internal air pollution; & promote a restorative environment.	

It can be seen in Figure 3, that the overall level of achievement in this pillar was much higher than for the environmental and economic pillar: average of 63%; maximum of 100%, again in 2009; while, the minimum was again 0% in 1997; and 81% achieving an assessment over 50% (the maximum achieved for the environmental assessment). As such, the consideration of social factors across the Stirling Prize winners can be seen to have been reasonably consistent over the years.

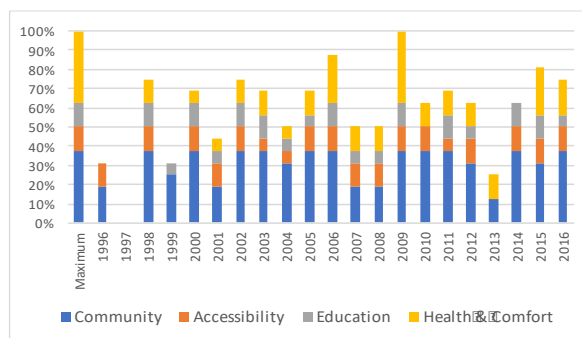

Figure 3: Annual Social Indicator Assessment

While, in terms of coverage of particular social themes, Table 7 illustrates that some cases have not addressed themes associated with accessibility, education or health & comfort (Min = 0%). While, those aspects that have been considered relatively consistently include Community, Accessibility and Education, (comparing Figure 3 and Table 7); while Health and Comfort is least well addressed.

Table 7: Average Environmental Themes Assessment

Social	Indicators	Average	Max	Min
	16	63%	100%	25%
Community	6	84%	100%	33%
Accessibility	2	82%	100%	0%
Education	2	68%	100%	0%
Health & Comfort	6	35%	100%	0%

### 3.6 Findings: Economics

Finally, just 7 indicators were applied within this phase of the analysis (Table 8):

Table 8: Economic Theme Assessment Indicators

<b>Employment Opportunities</b>	<b>2</b>
Inc: Consider mixed use development & Promote opportunities for local employment	
<b>Building costs</b>	<b>3</b>
Inc: Life cycle costs vs capital cost / Design for Maintenance, Longevity & Flexibility	
<b>Building Performance management</b>	<b>2</b>
Inc: Effective building handover & Setting building performance targets	

It can be seen that the overall level of achievement in this pillar of sustainability was very low (Table 9 & Figure 4): an average of 18%; a maximum awarded of 36%, in 2006 and 2012; and a minimum of 0%, in 1997, 1999, 2005; and there was again no trend towards improved engagement.

Table 9: Average Environmental Themes Assessment

Economic	Indicators	Average	Max	Min
	14	18%	36%	0%
Employment Opportunities	4	33%	100%	0%
Building costs	6	17%	67%	0%
Building Performance Management	4	4%	50%	0%

# PLEA 2018 HONG KONG

*Smart and Healthy within the 2-degree Limit*

In terms of coverage of particular economic themes it can be seen in Table 9 that some cases have not addressed any of the indicators associated with economics (Min = 0%). Where only Employment Opportunities and Building Costs appear to have been reasonably consistently considered.

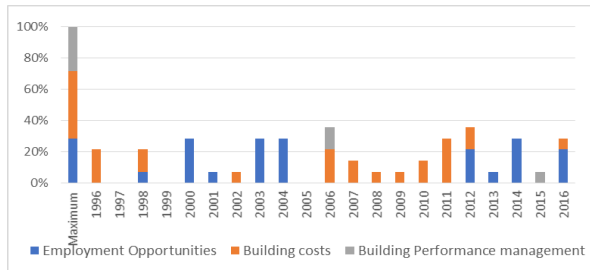

Figure 4: Annual Economic Indicator Assessment

While the low level of engagement with Building Performance Management speaks of the lack of commitment to Post occupancy evaluation, and the industry's lack of self-reflection, on how buildings actually perform versus how they were designed, as suggested above in Section 3.2.

## 4. CONCLUSION

Results presented here suggest that while Stirling prize winning buildings are exemplars of architectural design excellence, they perform weakly against indicators of holistic sustainable design excellence. It is the exception that a number of buildings performed reasonably well across the three pillars, where this sporadic approach suggests a lack of understanding, rigour and structure in the implementation of sustainability in building design. When analysed both collectively and in detail, Social sustainability is predominant in all years: perhaps not surprising as this is the area of sustainability that architects have traditionally addressed; while, environmental and economic indicators of excellence are much less well understood or widely applied.

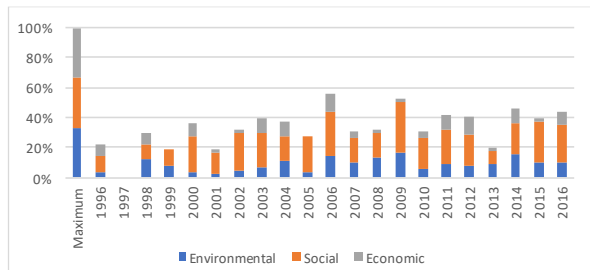

Figure 5: Annual Pillar Assessment

It is acknowledged that there are limitations to this research. Firstly, the analysis relies on publicly available data: although, arguably this speaks to how architects and media are electing to describe projects; indicating the need for wider discussion of sustainable

performance in the critical evaluation of buildings, perhaps as much as of their actual performance. Secondly, that a consistent application of sustainability indicators across such various projects may have skewed results, where some may have little relevance in particular contexts. Thirdly, the lack of POE data to inform this work; where, engagement with project stakeholders: owners, occupiers, users and design teams, to verify these initial results will now be sought. Finally, engagement with other, accessible published project documentation, including planning applications and building regulations submissions will be used to inform the next phases of this work. In conclusion, we propose that it is through the development and publication of a *combined* architectural and sustainable critique of precedents, in a manner accessible to all Architects, that both architectural sensibilities and sustainable performance might be promoted and achieved as we work towards the delivery of Sustainable Design Excellence

## REFERENCES

1. UNGC & RIBA (2015). UN Sustainable Development Goals in Practice, [online]. Available: <https://www.architecture.com/-/media/gathercontent/un-sustainable-development-goals-in-practice/additional-documents/unsustainabledevelopment-goalsinpracticepdf.pdf> [11 January 2018]
2. Häkkinen, T & Belloni, K (2011). Barriers & drivers for sustainable building. *Building Research & Information*, 39:3.
3. Barry, B (2018). Energy and Design Criticism: Is It Time for a New Measure of Beauty? *Architectural Design*, Vol88, 1.
4. Stolterman, E. (2008). The nature of design practice and implications for interaction design research. *International Journal of Design*, 2, 55-65.
5. Heylighen, A & Neuckermans, H. (1999). Walking on a thin line - between passive knowledge and active knowing of components and concepts. *Design Studies*, 20, 211 – 235.
6. Askin, O (2002). Case-based instruction strategies in architecture. *Design Studies*, 23, 407 – 431.
7. Eckert, C & Stacey, M (1999). Sources of inspiration- a language of design. *Design Studies*, 21, 523 – 538.
8. Goldschmidt, G (1998). Creative architectural design: reference versus precedence. *Journal of Architecture and Planning Research*, 15, 258–270
9. Bamford, G (2002). From analysis/synthesis to conjecture /analysis: a review of Karl Popper's influence on design methodology in architecture. *Design Studies*, 23, 245-61.
10. Trebilcock, M (2009). Integrated Design Process: From analysis/synthesis to conjecture/analysis. In PLEA2009 - 26th Conference on Passive and Low Energy Architecture, Quebec City, Canada, 22-24 June 2009.
11. WAHL, D. C. & BAXTER, S. 2008. The Designer's Role in Facilitating Sustainable Solutions. *Design Issues*, 24, 72-83.
12. Hartman, H. et al (2012). Is Sustainability Just Another "Ism"? *Architectural Design*, July, Vol. 82(4),
13. Lawson, B, (2004). Schemata, gambits and precedent. *Design Studies* Vol 25 No. 5. 09/2004
14. RIBA, Stirling Prize Winners:

# PLEA 2018 HONG KONG

*Smart and Healthy within the 2-degree Limit*

- <https://www.architecture.com/awards-and-competitions-landing-page/awards/riba-stirling-prize> (Accessed:01.06.17)
15. Gwilliam, JA & O'Dwyer, S (2018) "Architectural Design and / or Sustainable Building: A Question of Language?". SArch (5), 22- 24 May 2018, Venice.
  16. RIBA (Various). Resources for POE. Accessed: <https://www.architecture.com/knowledge-and-resources/resources-landing-page/post-occupancy-evaluation#available-resources> (12.04.18)
  17. DCLG, (2008). The Government's methodology for the production of Operational Ratings, Display Energy Certificates and Advisory Reports (Online): Accessed: [https://assets.publishing.service.gov.uk/government/uploads/system/uploads/attachment\\_data/file/7806/998942.pdf](https://assets.publishing.service.gov.uk/government/uploads/system/uploads/attachment_data/file/7806/998942.pdf) (15.04.18)
  18. Openhouse (2011). <http://openhouse-fp7.eu/> (01.06.17)
  19. Sassi, P (2006). Strategies for Sustainable Architecture. Taylor & Francis, Oxford.
  20. UK Gov. <https://www.gov.uk/check-energy-performance-public-building> (Accessed 12.05.18)
  21. EST. <http://www.energysavingtrust.org.uk/home-energy-efficiency/energy-performance-certificates> (Accessed 12.05.18)
  22. Ministry of Housing, Communities & Local Government. <https://www.ndepcregister.com> (Accessed 12.05.18)

## Urban Connectivity as a Guideline for Sustainable Habitat Rehabilitation.

### A Study in Medellin, Colombia

VERÓNICA LOPERA AGUIRRE<sup>1</sup>, ALEXANDER GONZÁLEZ CASTAÑO<sup>2,3</sup>

<sup>1</sup>Grupo de investigación Escuela del Hábitat - CEHAP, Facultad de Arquitectura, Universidad Nacional de Colombia, Medellín, Colombia

<sup>2</sup>Grupo de investigación EMAT, Facultad de Arquitectura, Universidad Nacional de Colombia, Medellín, Colombia

<sup>3</sup>Grupo de Investigación en Arquitectura, Urbanismo y Paisaje, Universidad Pontificia Bolivariana, Medellín, Colombia

*ABSTRACT: In Medellin, as in most Colombian cities, self-construction and self-management were the main drivers of urban development in the periphery areas, through informal settlements. The generation of cableway systems has improved connectivity with the rest of the city, but in terms of housing, there are still many sectors with poor residential habitat, in terms of habitability, well-being and eco-efficiency. This research focuses on making a diagnosis of the area near the Metrocable Line H, seeking to establish the necessary factors to improve the liability of people in the sector, having as base the experiences of the two previous cableway in the city, evaluating the processes of consolidation and adaptation that are generated, the way in which these impulse interventions by the State. The results conclude that although there is a positive connection between the neighbourhood and the city, reducing marginality, it is necessary to connect it inside, and although there is a first approach to improving the public space, it doesn't work as expected, resulting in an incentive for informal development.*

*KEYWORDS: Urban connectivity, Habitat rehabilitation, Sustainability, Housing, Informality*

#### 1. INTRODUCTION

In Colombia, Article 51 of the Political Constitution determines that: "All Colombians have the right to decent housing. The State will establish the necessary conditions to make this right effective and will promote housing plans of social interest, adequate systems of long-term financing and associative forms of execution of these housing programs"[1], where reference is made to the quantitative factor and housing is assumed as a commitment of the State with the citizen.

However, with actions such as the transfer of social responsibility of the State, to private entities such as banks and real estate developers, for the development of social housing, the problem of housing in Colombia does not reach a fundamental solution, because the performance of this model on quantitative indices generates residential units by coverage, but which are lacking in factors of habitability, well-being and efficiency. This problem is widespread throughout the national territory due to the lack of a public policy effective on housing and habitat, which can offer low-income communities, both the acquisition of the property and material good, as well as a healthy and sustainable environment.

In contrast then, among the actions proposed by the State and facing the current urban reality of the country, the expectation for nearly six million people in Colombia is a model of self-construction that lacks professional technical assistance, minimum conditions of safety,

habitability and eco-efficiency, in response to the need to build shelters, badly called housing and that has a background of segregation, when it is determined by the management of the urban land in the cases that these are destined for social housing [2].

#### 2. THEORETICAL ARGUMENT

Informal settlements are common in Latin American cities, driven by the need for shelter, by occupying low-cost land or by the opportunities that irregular land subdivision represents, in the absence of coverage by the State, and the growing housing deficit. In Colombia, more than 75% of the population lives in cities, and within that percentage, between 20 and 30% live in precarious settlements, being one of the two Latin American countries with the highest rate of urban inequity and insecurity [3].

The lack of technical knowledge in the construction of housing, the appearance of an organic urbanism of irregular streets, narrow and without continuity in many cases, the scarcity or absence of public spaces and equipment, makes the conditions of habitability in these neighbourhoods are not adequate, because in addition, the constructions in these contexts, rarely cover the sanitary requirements of security and habitability that indicate the current regulations [4].

In Medellin, as in most Colombian cities, self-construction and self-management were the main drivers of urban development in the periphery since the

# PLEA 2018 HONG KONG

*Smart and Healthy within the 2-degree Limit*

1960s, often with low technical levels, in response to the large displacements of the countryside to the city and inter-cities that the country has had during the last decades, in the search for refuge, security and well-being.



Figure 1: Esfuerzos de Paz neighborhood, Commune 8, Medellín.

But the precarious settlements of Medellín have the particular condition of being located on the hillside, which hinders its accessibility and increases its segregation, because they are built apart from the urban planning of the State and the ideals of the modern and safe city, being organized by its inhabitants under a model of self-construction, understood as that process that starts directly from the interest of the owner before of their particular need for shelter and with scarce economic resources, where the workforce comes directly from them or from their neighbours, relatives or friends. This informality is a common and current element in residential urban development and is seen as a problem of the city, from social, economic, urban and environmental perspectives, but at the same time it's presented as the only alternative, given the ineffectiveness of the solutions offered in a legal and orderly manner, as well as the lack of financial means to propose new and better solutions.



Figure 2: Location commune 8 on the map of Medellín

Much of the commune 8 Villa Hermosa, of the city of Medellín (figure2), was developed and built spontaneously, mainly in the hillside areas where the low cost of the land is justified in some way, and that still continues with a process of expansion and consolidation

of informal housing, resulting in few access routes, insufficient public space and minimal connections for coverage of basic public services, such as sanitation, water, energy and communications.

But since 2016, with the construction and commissioning of metro-cableway H line in this area, connectivity with the rest of the city has been improved through a semi-massive electric and integrated transportation system, situation that also involves new dynamics to the neighbourhood as the arrival of other people from the city and tourists. This situation allows to perceive a contrast with the basic needs that are still unsatisfied, to such a point that some of the private spaces that should be covered in the houses become part of the public space. It is therefore noteworthy that near the upper stations, sanitation conditions are poor, public spaces or recreation are limited and housing is precarious to a large extent.



Figure 3: View from the access platform, Las Torres station.

Line H is an engineering work that, due to the topographic characteristics of the terrain with slopes of hillside, the narrow roads and the existence of a single main road both to enter and to leave the neighbourhood required great efforts. The connection with the massive transport system occurs in its first station, Oriente, where it is linked to the Ayacucho tram. Then there is the Las Torres intermediate station, close to the green belt of Pan de azúcar hill and ends at Villa Sierra Station, [5] as shown in Figure 4.



Figure 4: Implementation Linea H of the Metrocable (cableway), Medellín



# PLEA 2018 HONG KONG

*Smart and Healthy within the 2-degree Limit*

Medellín, was a pioneer in the use of the cableway system as a means of transport, to respond to the mobility needs of hillside areas, with steep slopes and difficult vehicular access, which made it a world reference in this area, breaking paradigms of marginality and violence, thus establishing a state presence. But the greatest success of the system is its connection with the city's mass transportation means, the Metro de Medellín, with integrated payment formats, where transitions between various means of transport (cable, tram, metro) doesn't represent a greater cost on basic transportation fee, allowing greater agility and economy with a daily movement of close to 1 million passengers.



Figure 5: Line K of Metrocable sistem, Medellín.

The central-eastern commune, one of the densest areas of the city, strongly stigmatized as a marginal, poor, violent and out-of-control sector, for its urban growth by self-construction and informal urbanization processes, with complicated topographical conditions, that hindered the generation of infrastructure, with few access roads, and where in addition to providing public services the state presence was low, receives inside Line K of the metro system. It was an attractive idea, little invasive, that solves issues of accessibility and mobility, proposing an integration with the Metro system, despite the difficulties that the inclination of the terrain generated; and that could have a positive impact on the social problems of the sector, "Talking about socio-spatial justice obliges us to evoke the planning of the territory, the intervention of the State in the life of a social formation to modify more or less in a profound way the distribution of equipment and activities in the territory" [6]

The incursion of the metrocable in the city, allows to minimize the times of displacement, reducing, almost completely, the idea of periphery, understanding this as the geographical condition of distancing or obstacle temporary space, where neighbourhoods difficult to access, or inaccessible in terms of infrastructure, by topographic conditions, begin to be part of the city to be articulated with the mass transport system. In addition, a series of urban interventions are carried out to improve local integration, generating expectations as opposed to the capacity to promote other forms of economic and social integration; because improving mobility generates

better connectivity, it is not simply moving, it is positively influencing accessibility conditions, it is generating connections between housing and workplaces, sources of income. Having greater connectivity can mean having better job opportunities, more participation in the cultural and civic life of the city. "In principle, the Metrocable constitutes a vehicle towards the 'right to the city' and greater participation of marginalized sectors in full urban life." [7]

And it is also the letter of entry to start looking at how to meet the Sustainable Development Goals (SDG) [8] within these territories: guarantee a healthy life and promote well-being for all; guarantee the availability of water and its sustainable management and sanitation for all; guarantee access to affordable, safe, sustainable and modern energy for all; promote sustained, inclusive and sustainable economic growth; reduce inequality; reduce poverty; and make cities and human settlements inclusive, safe, resilient and sustainable.

Colombia is one of the most unequal countries in terms of poverty, where around 25% of the population lives in inadequate conditions, and where the progress to reduce poverty is minimal, [9] where, in addition, urban development has generated low habitability environments with high environmental, social and economic costs. But activities such as the construction of buildings and infrastructure contribute a high percentage in the mitigation of these impacts, therefore, the introduction of sustainability criteria to urban development, not only proposes solutions to existing problems, it also implies new opportunities and implies new challenges for cities.

It is also important to consider, as each of the interventions that have been raised around metrocable systems may be triggering positive changes in other indicators, if the criteria of the international smart city standard are taken into account, where the positive impact on any of the indicators of urban services and quality of life, enhances a broader and more complete development together with the other factors of this emerging urban model of sustainability:



Figure 6: Standard UNE - ISO 37120 indicators of urban services and quality of life for Smart Cities

# PLEA 2018 HONG KONG

*Smart and Healthy within the 2-degree Limit*

## 3. METHODOLOGY

This research focuses on making a diagnosis of the area near the Metrocable Line H, seeking to establish the necessary factors to improve the liability of people in the sector, taking into consideration its recent level of connectivity with the city, in its state still in consolidation and with a focus on sustainability, to prioritize them and project their intervention, through the State, public-private partnerships, or even, that motivates the community organization, through self-management and self-construction, of which they have already demonstrated knowledge in their homes, to generate, through social construction, an adequate habitat.

The methodology used was to consider the influence zone of the metrocable H line as a case study, where the current status of the common and access spaces was analysed, In addition to some houses, supported by a documentary analysis of the experiences lived in the cables of the lines K and J, where the consolidation process is more advanced, and the real impacts on the mobility, habitability and quality of life of the inhabitants of the surrounding sectors can be perceived.

The experience of the previous cableway metro lines serves to evaluate the processes of consolidation and adaptation to the new dynamics that the cables generate, the way they promote interventions by the State, equipment, infrastructure, public space, and sometimes the improvement of housing and neighbourhoods; but in the same way to make visible that the majority of the interventions that are proposed, are clearly in the physical, leaving the social and human component aside, which then represents new intervention approaches.

In a previous investigation, lighting, natural ventilation and spatial quality were identified, as the main strategies to intervene, as they are the main problems presented in the homes analysed. a list of strategies was developed, based on the proposals for rehabilitation of the case studies, classified according to their possible impact on each of the potential rehabilitation factors. This information was organized in a table that indicates to which factors each strategy responds to, selecting the 10 strategies that respond to major factors and that respond specifically to the most recurrent needs of the houses, were filtered to develop a cost analysis. In this way, the strategies that have the greatest potential of implementation for the rehabilitation of the dwellings were identified, according to their impact on several factors of habitability, defined internationally and established in the Public Policy of Sustainable Construction of the Aburrá Valley, having high capacity of response to identified needs and with lower costs.

Table 1: Habitability factors and rehabilitation actions

Rehabilitation actions	USD	Units	Habitability factors				
			Hot	Light	Air Hygiene	Noise	Ergonomics
Replacement of Lighting (bulbs)	\$ 3,7	Un	x	x			x
Redistribution of spaces	\$ 196,8	m <sup>3</sup>	x	x	x	x	x
Creating windows	\$ 31,3	Un	x	x	x		
Finishes	\$ 14,8	m <sup>2</sup>	x	x	x	x	x
Change of materiality cover	\$ 78,0	m <sup>2</sup>	x	x		x	
Extension	\$ 144,6	m <sup>3</sup>	x	x	x		x
Privacy in rooms	\$ 23,3	Un				x	x
Skylight	\$ 86,7	Un	x	x	x		
Creation of interior patio	\$ 6,0	m <sup>2</sup>	x	x	x		
Accessibility	\$ 240,3	m <sup>3</sup>					X

## 4. RESULTS

The process of integration of cable-type transportation systems, used in this way by the topography of the city's slopes, as a viable alternative to reach urban neighbourhoods, had two important antecedents, the first of these is the opening of the Line K in 2004, in the Santo Domingo Savio neighbourhood of communes 1 and 2, a marginal zone that has been consolidated, and to which the commissioning of the metro cable system projected, with the construction of equipment and improvement of public transport routes and routes integrated into the system through collective transport. The second with equal conditions was given in the commune 13 of San Javier west of the city, a sector marked by violence, where the Line J was put into operation in 2008. These neighbourhoods have improved their conditions of connectivity and services, but in terms of housing, they still conserve many sectors with a deficient residential habitat, in aspects of habitability, well-being and eco-efficiency.



Figure 7: Line J of Metrocable system, Medellín.

An analysis of the place in the area of direct influence of Line H, allows to identify how the generation of metrocable stations drives a change in road infrastructure in the first place, in the beginning to be able to access with the materials and construction

# PLEA 2018 HONG KONG

*Smart and Healthy within the 2-degree Limit*

machinery to the places chosen for its implementation, but that in the end they become improvements for the mobility of the sector, either by public or private transport, see figure 8.

However, not all access roads to the neighbourhood have this condition, in the case of pedestrian paths, only those that are immediate to the metro cable stations have been improved, in the other sectors, these have been self-built by the inhabitants with rubble and leftover materials from other works, placing them more by a sense of logic and necessity, than by some ergonomic or normative criteria, partially improving access to housing.



Figure 8: Improvement of the road in the Esfuerzos de Paz neighbourhood, Commune 8, Medellín

Another of the aggravating conditions of the sector is the lack of public sanitation services, something that is evident in the main access road, where the houses are next to, drain mainly in the pipe that accompanies the stairs, generating bad smells, paths wear, and worrying health conditions.



Figure 9: Pedestrian access to the Esfuerzos de Paz neighbourhood, Commune 8, Medellín

In the middle landscape of the neighbourhood it is possible to perceive a permanent transformation of the city, passing precarious materials of wood and brass, to concrete and brick structures, as a sign of progress, to such an extent that people aspire to build their homes in "material" with reference to it, with the idea of solidity, security, and permanence, the brick being the

predominant material of the informal settlements of Medellín.

In this scenario of urban transformations one of the positive impacts of interventions on informal neighbourhoods, is the generation of equipment and recreational spaces, as in the case of the Tinajas Ecopark, a place of meeting, recreation and education, which is linked to the Circumvalar Garden of Pan de Azúcar hill, frequented and appropriated by the community, where a large retaining wall allows to control the slope topography to guarantee the operation of a sports plaque, playgrounds and a building where a children's garden is housed.



Figure 10: Housing in constructive process, Esfuerzos de Paz neighbourhood, Commune 8, Medellín.



Figure 11: Tinajas Ecopark, Commune 8, Medellín.

If each of the interventions that were made or would have to be considered in the metro cable insertion area are analysed, under the indicators of urban services and quality of life described in the Smart Cities methodology, according to the UNE - ISO 37120 - 2014 standard [10], the impacts could be quantified, and the way in which it contributes to improving the sustainability of the city and what the future intervention approaches should be if one wishes to comply with said indicators, see table 1.

This analysis of urban interventions promoted directly by Line H, from the perspective of a conceptual framework of sustainability indicators, allows to validate in a qualitative and quantitative way, how the actions of improvement of habitability of a neighbourhood, despite being focused on particular issues such as transportation, they can have collateral impacts that justify the physical and economic magnitude of this type of intervention.

# PLEA 2018 HONG KONG

*Smart and Healthy within the 2-degree Limit*

Table 1: Indicators of urban services and quality of life described in the Smart Cities methodology, and their relationship with interventions. Own elaboration.

Indicators of Smart cities	Actions																
	Economy	Education	Energy	Environment	Finance	Emergencies	Government	Health	Recreation	Security	Habitat	Solid waste	ICT innovation	Transport	Planning	Water resources	Environmental impacts
Cable stations	x						x			x	x			x	x		x
Equipment		x					x	x	x	x	x		x				
Adequacy of roads	x					x					x	x		x			x
Generation of public space				x				x	x	x	x						x
Housing rehabilitation	x		x	x				x		x	x					x	x

If these positive impacts of urban intervention are also contrasted, with the SDG in relation to Smart cities indicators, common points are found, which contribute to the compliance of 7 objectives: healthy life and well-being, sustainable water management, access to energy, economic growth, employment, reduction of inequality, end to poverty and generation of inclusive, safe, resilient cities and sustainable.

Although it isn't a complete contribution in each of the objectives, it's a substantial approach to the progressive improvement of informal neighbourhoods, given the possibility of promoting this type of intervention by the State, with indicators that exceed the net economic value of the projects, to involve aspects of urban sustainability, habitat improvement.

Likewise, the proposed methodology makes it possible to demonstrate that the aspects of urban sustainability that have no relation whatsoever, with the interventions proposed to the cable lines, they could be considered as future centres of strategic intervention and therefore complementary to improving mass transport system.

## 5. CONCLUSION

The challenges of informality in the construction of urban periphery, continue to be complex and although its planning is technical and economic, there is evidence of a positive connection of the neighbourhood with the city, through the metro-cable stations, which reduces marginality and promotes the necessary connection with the interior of each neighbourhood of the commune that is located in its area of influence. But although there is a first approach to the improvement of public space through the green belt Garden circumvallation, the condition of city edge and growth limit, does not work in the expected way in front of the containment of the

expansion phenomenon by self-construction. Even the possibility that these improvements and impacts result in an incentive for the informal development of new settlements in their vicinity is considered, revealing that there is a need for greater urban control and community management.

## ACKNOWLEDGEMENTS

To the collective Casa Diversa of the Esfuerzos de paz neighbourhood in the Commune 8, for allowing us to enter their neighbourhood and to know better how they live, and their plans to improve the conditions of life in the place.

## REFERENCES

1. Corte Constitucional de Colombia. (1991). Artículo 51 (p. art. 51).
2. Lopera, V., & González, A. (2016). Housing rehabilitation as Strategy for Sustainable Urban Regeneration. In PLEA. Los Angeles.
3. ONU-Hábitat. (2009). Global Report on Human Settlement. Planning Sustainable Cities. Reino Unido.
4. Abramo, P. (2012). La ciudad com-fusa: mercado y producción de la estructura urbana en las grandes metrópolis latinoamericanas. EURE (Santiago), 35–69.
5. Metro de Medellín. (2016). Metrocable línea H: para integrarnos más y volar alto. Retrieved from <https://www.metrodemedellin.gov.co/al-dia/noticias-metro/artmid/6905/articleid/104/metrocable-l205nea-h-para-integrarnos-m193s-y-volar-alto>
6. Reynaud, A. (1981), cited by Leibler, L., & Brand, P. (2012). Movilidad e inclusión social : la experiencia desde la periferia de Medellín y el primer Metrocable. Bulletin de l'Institut Français d'études Andines, (32).
7. Leibler, L., & Brand, P. (2012). Movilidad e inclusión social : la experiencia desde la periferia de Medellín y el primer Metrocable\*. Bulletin de l'Institut Français d'études Andines, (41 (3)), 363–387
8. Organización de Naciones Unidas. (2017). Objetivos de desarrollo sostenible. Retrieved from

# PLEA 2018 HONG KONG

*Smart and Healthy within the 2-degree Limit*

<https://www.un.org/sustainabledevelopment/es/objetivos-de-desarrollo-sostenible/>

9. Vergel Tovar, E. (2010). Asentamientos precarios Una aproximación para su mejoramiento integral y prevención. DEARQ.

10. ISO. (2014). ISO 37120:2014 - Sustainable development of communities -- Indicators for city services and quality of life.

## “A Material World”:

### Study of a Circular Economy Approach in Architecture – Development of an Index for the Construction Industry

ANOUK GODELET<sup>1</sup>, HEIDE G. SCHUSTER<sup>2</sup>

<sup>1</sup>Frankfurt University of Applied Sciences, Frankfurt, Germany

<sup>2</sup>BLAUSTUDIO, Waging am See, Germany

*ABSTRACT: Globally, the construction industry is the single largest consumer of resources and raw materials. It consumes 3 billion tonnes of raw materials to manufacture building products each year and relies mostly on a linear building construction process. Not only materials and building elements must be demolished and disposed at the end of the life cycle of a building, but also a considerable amount of valuable raw materials, therefore, is lost. Due to a worldwide increasing need for construction activities, the construction industry is more and more under pressure. Counteracting would result in a new approach - the model of the circular economy - and the design of circular buildings. But, how do we create circular buildings and which requirements have to be incorporated? The paper summarises a study on the integration of the circular economy approach into architecture and presents a first tool to support the circular economy design in early planning stages.*

*KEYWORDS: Circular Economy, circularity, materials, evaluation, architectural design process*

#### 1. INTRODUCTION

Based on estimates from the United Nations, the world population is reaching 9.8 billion in 2050 [1]. The annual global extraction of materials grew from 22 billion tonnes in 1970 to around 70 billion tonnes in 2010 [2]. With current urbanization and population growth rate, not only the consumption of energy and material, but also construction activities and thus the amount of waste will further rise. Therefore, it is not only necessary to reduce the energy demand but furthermore to rethink the handling of all resources.

In Europe, the building and construction sector is one of the most revenue-generating sectors. At the same time, it is with 40% the largest energy consumer and causes about 50% of raw material dismantling [3].

But the building sector accounts also the largest source of waste (34%). In some EU Member States, such as Luxembourg, major mineral waste sums up to 84%, which is higher than average [4]. With the introduction of the Waste Framework Directive 2008/98/EC in 2008 recycling industries have been developed across Europe [5]. Since then, an increase of recycled building materials has been noted. However, there is still a lack of concepts in the design of recyclable buildings.

Nowadays the construction industry relies on a linear building construction process. More specifically, the building is understood as a “final product” [6] where materials and building elements must be demolished and dumped at the end of the life cycle of a building. A considerable amount of valuable raw materials, therefore, is lost. Taking this into account, the construction sector is increasingly under pressure. If no countermeasures are taken, raw materials, such as sand

or gravel, could become scarcer and more expensive [7] and waste streams will rise rapidly in the future.

Given in the wide range of materials, construction methods, building regulations, etc. the industry has become increasingly complex in recent years and has become more challenging for the planners. Nevertheless, neither qualities nor quantities of building materials are accurately documented according to current building standards.

In the first part of this paper the general circular economy model is transferred to the construction industry and planning approaches of buildings. The paper is based on a literature review of existing evaluation and certification systems and their handling of material and waste production. The second part presents a newly developed instrument to assess the circularity of buildings in early planning stages demonstrating its applicability in practice through demonstration of a constructed building.

#### 2. TECHNICAL BACKGROUND

##### 2.1 The principals of the “Circular Economy”

The model of the circular economy is currently the subject of discussion worldwide - a new economic model in which resources and products are used in continuous loops and will serve as a source of raw materials in the future. Industrial systems should be designed in such a way that resources become no longer waste but a resource again. The continuous circularity of materials improves the product quality, minimizes the extraction of raw materials and thus achieves positive effects in economic, ecological and social ways [8, 9].

# PLEA 2018 HONG KONG

*Smart and Healthy within the 2-degree Limit*

This approach creates a new way of thinking away from a linear attitude and leads, instead, to the point of a value creation concept with closed material loops: "Reuse - Repair - Refurbish" [10]. It is also a way of thinking that can be transferred to the construction industry.

In the 1950s, the term "Circular Economy", or CE for short, appeared for the first time in scientific literature to describe the nutrient recycling of sustainable agriculture and fish aquaculture in China [11]. After about 30 years, first practical applications of the circular economy took place through "schools of thought". A well-known example is the Cradle to Cradle® design concept (C2C). The concept was developed in the 1990s by the German chemist Michael Braungart, the American architect William McDonough and the Environmental Protection Encouragement Agency (EPEA) [12]. It is based on the idea of a circular economy, in which raw materials are not consumed, but continue to be used without any loss of quality [9, 13]. Cradle to Cradle® thus forms the basis for new qualities in many industries and it aims for a circular economy.

## 2.2 Evaluation and certification of sustainable buildings

Sustainable buildings are defined in the ISO 15392 standard, forming the basis for building certification systems and environmental product declarations. International building certifications are, for example, in the USA "Leadership in Energy and Environmental Design (LEED)" [14], in the UK "Building Research Establishment Environmental Assessment" (BREEAM) [15] and in Germany the DGNB System by the "German Sustainable Building Council" [16]. In particular, they consider amongst other criteria also technical and ecological qualities looking at health aspects as well as the choice of materials. Apart from whole building certification systems also systems for the evaluation of building materials have been developed. Below a selection of systems currently used in the construction industry is presented.

1. BREEAM/ LEED and other systems: The first generation of certification systems, BREEAM (1990) and LEED (1998), focused mainly on environmental aspects such as regional products, conservation of resources, increasing energy efficiency, etc. The systems originally assessed the phases from planning to implementation to building use. Those certifications are classified based on points awarded for individual criteria [14, 15].

2. DGNB and other systems: Within the development of the "second generation" of evaluation systems the whole life cycle of buildings has been integrated into a performance based evaluation and complex weighting across topics. These include criteria such as "risks to the local environment", "flexibility" or "dismantling and reuse" and the analysis of buildings along the whole life cycle [16].

3. Cradle to Cradle®: The product evaluation according to C2C design considers sustainability aspects already in an early product development phase. All substances are selected on a non-toxic basis and can be demounted into its components. As a result, no waste should arise. In addition to the environmental product declaration (EPD), the C2C design gives further insights into the recyclability of a material. However, the combination with the construction is missing [13].

4. "The 25 Principles of Building Biology" (Institute of Building Biology): With a holistic, sustainable and ecological approach to buildings, this program shows another aspect to evaluate building materials. Many of these principles follow the principles of the circular economy, such as rule No. 1 "Use natural and unadulterated building materials" or rule No. 15 "Prefer regional building materials" [17].

Whole building assessments analyse the building with its construction but do not necessarily conform to the principles of a circular economy. As an example, at the material level, it is important to make the ingredients recognizable, e.g. on the basis of a product declaration in order to identify the proportion of pollutants. Furthermore, the way of thinking of those models is particularly relevant for the conception of a circular building.

## 2.3. Circular architecture

Circular designed buildings should not only ensure easy disassembly and adaptability; they also should ensure a healthy choice of building materials, e.g. materials from renewable raw materials - organic substances from agriculture and forestry that substitute fossil raw materials. Such building materials or elements can be mainly made from wood, corn, rape, but also hemp, flax or others. Depending on the composites they are free of pollutants and therefore reduce the negative impact on health and nature. In addition, these materials can be reintroduced to the biosphere. They can be used as load-bearing structure (wood) or as insulation material (cellulose).

In theory, circular materials and building elements can be easily integrated into buildings nowadays. There are numerous options available on the market substituting conventional building materials. However, particular attention has to be taken to supplements which can worsen a natural resource in terms of recyclability and emissions. In addition, special emphasis must be placed on the construction, securing the disassembly and recyclability of each material.

Furthermore, there are interdependencies which are not necessarily considered at once. The external thermal insulation composite system - extensively used in moderate and cold climates such as Germany, especially for refurbishment - is a good example of building materials which have positive effects on the energy

# PLEA 2018 HONG KONG

*Smart and Healthy within the 2-degree Limit*

demand of buildings but are difficult or impossible to separate after the life cycle of the building. Figure 1 shows, for example, a wall with an external thermal insulation composite system and a solid wood wall.



Figure 1: Wall with external thermal insulation composite system (left); solid wood wall (right)

The research project "Buildings as Material Banks" (BAMB), established in 2015 and funded by the European Union, develops a methodology for a systemic shift in the building sector. The aims of BAMB are not only to reduce construction and demolition waste but rather to develop new construction typologies with used and re-used materials. Within the project, several tools, such as the so-called "Material Passport", are developed for further implementation of the circular economy principals and their application in practice. Essential to the electronic Material Passport is the accumulation of information about the material composition, the absence of pollutants or the circularity of building materials. This documentation can later be transferred to BIM (Building Information Modelling) systems. The overall project aim is to simplify the (whole) construction process, create the necessary transparency and thus advance the circular economy [18].

### 3. METHODOLOGY

The understanding of the CE approach and the knowledge of the importance of a circular designed building leads to three questions: 1. Which requirements a circular building has to fulfil? 2. How could this building be evaluated? 3. How can this be done already in early planning stages when decisions have to be made?

The analysis of the assessment and certification systems earlier in this paper exhibits several advantages for the construction sector: the principle of new ideas and qualities, the circularity of materials, building elements and whole buildings, systems for assessing building sustainability, and the focus on health and the environment. But they also show disadvantages: the challenges of feasibility especially in early planning stages, partly no clear assessment of the circularity and a rather complex application. The requirements for the circularity of a building and its materials during an early planning stage seems to be the most incisive topic. Through the synthesis of the above models, the authors worked out a method to evaluate the circular economy

approach for the early building planning process. Thus, a "Circular Economy Index" (CEI) was developed.

The tool serves as a guide for planners and builders taking into account the criteria of the circular economy and contributing to the future-oriented planning of circular buildings. It does not represent or even replace a certification system, but merely give support for the evaluation of building materials, components and constructions according to the CE principles. The simple handling of the tool and the least supposable effort also allow a quick result and early detection of optimisation potential.

#### 3.1 Core of the Circular Economy Index (CEI)

First, the framework of the CEI was developed. Based on the so-called building structure [19] which is assembled hierarchically, the index is subdivided into building outlines with three levels: materials 'm', components 'c' and assembly 'a'.

Level 1: Building materials consist of different raw materials and complex composite materials (such as metals or polymer, and building products as floor coverings, insulation or sealing).

Level 2: Components are either functional elements which differ in their geometric shape (wall, column and ceiling) or elements such as windows.

Level 3: A group of components or elements, such as an exterior wall, is called an assembly.

The following criteria are therefore used in the CEI: renewable raw materials, the absence of pollutants, local origin, circularity, the connection of system components (techniques like clamping connection, magnet, click and screw connection) and dismantling.

Table 1 describes the criterion "circularity" with its five different evaluation levels as an example of the full matrix. In addition to the use of circular building materials, the possibility for reuse of each building material is another prerequisite for a circular designed building. It is important that the product, according to the CE principles, returns to its original loop without being mixed with other substances. A building material which can be reused after installation without any effort is rated 100%. However, if the building material can only be thermally reused or even is hazardous waste, it will receive a rating of 25% or 0%.

Table 1: Scoring system, criterion Nr. 4 "circularity"

#	Material	Rating
4	Circularity	
	Building material can be reused without any effort. Upcycling.	100 %
	Building material can be recycled with effort.	75 %



# PLEA 2018 HONG KONG

Smart and Healthy within the 2-degree Limit

	Building material can be recycled at great expense. Downcycling.	50 %
	Thermal recovery.	25 %
	Deposting.	0 %

Finally, the key aspect of the CEI is the assessment matrix (Table 2) which considers the three building outlines (levels) and six criteria. For the overall rating of a building element (e.g.: exterior wall or roof), first, the mass of all related materials are averaged. Then their mass will be weighted and at last evaluated for the final percentage.

Table 2: Overview of the Circular Economy Index (CEI)

Criteria	Material selection				Construction	
	Renew. raw materials	Absence of pollutants	Local origin	Circularity	Structural connections	Dis-mantling
<b>Building outlines</b>						
<b>Materials 'm'</b>						
m 001	... %	... %	... %	... %		
m ...	... %	... %	... %	... %		
<b>Components 'c'</b>						
c 001	... %	... %	... %	... %	... %	... %
c ...	... %	... %	... %	... %	... %	... %
<b>Assembly 'a'</b>						
a 001	... %	... %	... %	... %	... %	... %
a ...	... %	... %	... %	... %	... %	... %

All criteria are weighted equally. The index is awarded in percentages and will be evaluated from 0% (minimum) to 100% (maximum). The exemplary construction of a solid wood wall can, therefore, be evaluated as follows: First, the percentage portion of each building material and the component of the wall, such as wood, insulation, etc. will be calculated, followed by their evaluation criterion by criterion. This process applies for each assembly of the building.

## 4. APPLICATION OF THE CIRCULAR ECONOMY INDEX

In the following, the CEI is applied to a sample building with a high degree of renewable materials in comparison to a standard building construction. As a result, the CEI indicates the percentage of circularity of each building showing the possible need for optimization.

### 4.1 Description of the pilot project

The authors selected the pilot project "Tennis Club Lorentzweiler", as it is the first building in Luxembourg constructed with miscanthus wall elements. It aims to counter current environmental problems and to create a positive footprint. With a particular focus on healthy and regional building materials as well as on the demountability of the building, this project shows the principles of a circular designed building.

On completion, the building will offer changing rooms and sanitary facilities for 12 tennis players with a total of 77 sqm floor area. Rooms will be accessed via a wooden covered arcade. In addition, vertical wooden slats create

a smooth transition between the facade, the roof and the accessibility (see Figures 2 and 3).



Figure 2: Tennis club Lorentzweiler in Luxembourg, completion in September 2017

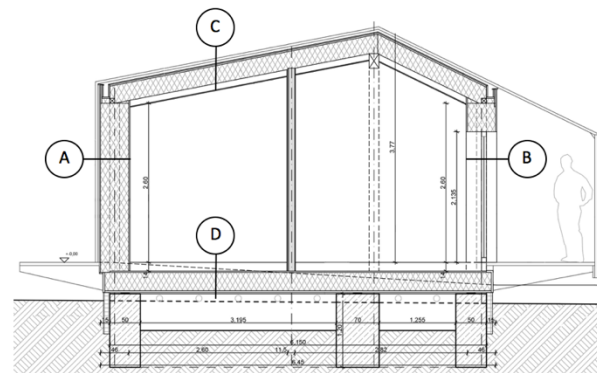

Figure 3: Building section of the Tennis club Lorentzweiler in Luxembourg

The Grand Duchy of Luxembourg, one of the smallest states the European Union (EU-28), is located in North-western Europe and enjoys a temperate climate without extremes and is influenced by the humid air mass of the Atlantic. The annual average temperature is 9.1 °C and the annual rainfall is 831 mm [20]. Due to its location, a heat insulation of the building envelope is needed.

Through consideration of climatic influences and sustainability, the architects used "Miscanthus x giganteus" as a novel insulation. Miscanthus is highly-insulating, pollution-free and renewable, and offers an alternative to conventional insulating building materials. Therefore, the building is characterized by the media in Luxembourg for its "miscanthus dress" [21]. Laboratory research shows, that Miscanthus has a cellular structure similar to Styrofoam - a conventional insulation material - and thus demonstrates the properties of an excellent insulating material [22].

The solid wall consists of 46 cm thick prefabricated miscanthus elements with a U-value of 0,16 W/m<sup>2</sup>K (see Figures 3 and 4). The U-value corresponds to current EU-Directive for Energy Efficiency [23]. These serve as heat storage mass and ensure at the same time the load transfer by an internal wooden frame construction.

Table 3 shows the materials of the building envelope.  
Table 3: Materials used for the building envelope

# PLEA 2018 HONG KONG

Smart and Healthy within the 2-degree Limit

Envelope	Materials
<b>A. Facade / solid walls</b>	<b>Outside:</b> Lime-cement <b>Insulation:</b> Prefabricated miscanthus elements <b>Inside:</b> Wood, lime-cement
<b>B. Windows</b>	Aluminium
<b>C. Roof</b>	<b>Outside:</b> Polymer film <b>Insulation:</b> Paper (cellulose). Installation of Oriented Strand Boards (OSB) with cellulose has a stiffening function as well as a heat and sound insulating function.
<b>D. Foundation</b>	<b>Ceiling timbers:</b> Wooden beam ceiling, OSB panels <b>Insulation:</b> Paper (cellulose)

## 4.2 Evaluation within the CEI

The evaluation according to the CEI is based on simple Excel Sheets. Results are shown by a “spider network diagram” showing at a glance to which extent buildings correspond to the circular economy approach.

The Tennis Club is compared with a reference building - a virtual standard building that is recreated each time the energy pass according to the European Directive for Energy Efficiency in Germany is calculated. This reference building is identical to the new design except for the choice of material of the building envelope and the technical equipment, which will not be part of this paper. Figure 4 illustrates the two different wall constructions. The precast wall of the example building made of a miscanthus-cement mixture and the reference building with a simplified external thermal insulation composite system (no moisture proof or windproof film).

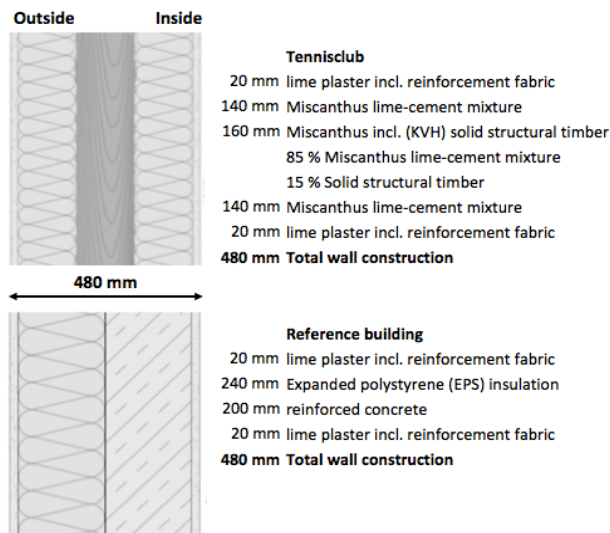

Figure 4: Wall construction of the Tennis Club and the reference building

The following diagram (Figure 5) shows the two wall construction typologies shown in Figure 4 according to the CEI. The wall of the Tennis Club performs significantly better than the reference building wall. Five criteria of the Miscanthus wall reach a value over 92%. But it became apparent, that the construction of the wall is only about 90% recyclable when installed. This is due to the addition of other building materials such as lime

plaster. Due to the use of concrete and polyurethane insulation in the reference building, only one of the six criteria reaches a value of over 85%. Neither the concrete nor the insulation consists of renewable raw materials and is therefore rated at 0%. With the external thermal insulation composite system, a non-destructive dismantling is hardly possible and the reuse rather difficult. Therefore, these criteria reach just 25%.

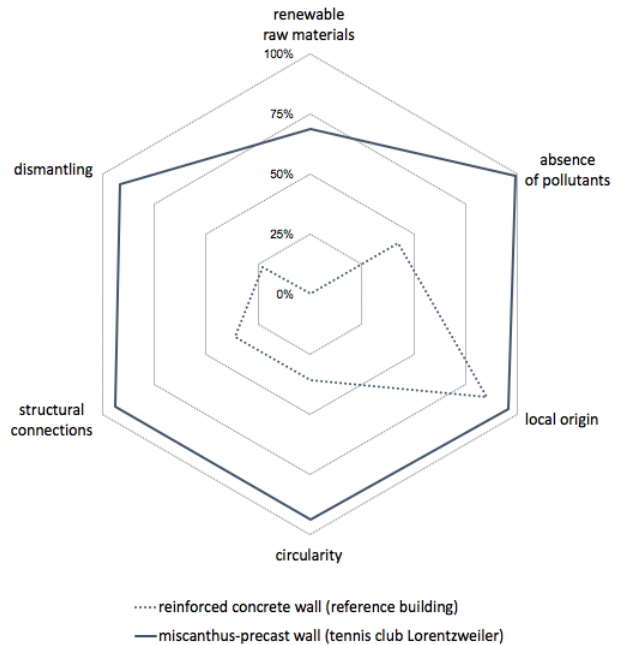

Figure 5: The “spider network diagram” compares a miscanthus-precast wall with a concrete wall

The diagram represented in Figure 6 illustrates that, in total, only 35% of the building materials used in Lorentzweiler are made from renewable raw materials such as the Miscanthus lime-cement mixture and the solid structural timber. About 80% of the building can be dismantled without any problems. Exceptions are e.g. the lime-cement and polymer film. The building envelope can be demounted separated by material to an extent of 90%. The criteria for the use of renewable raw materials and absence of pollutants show optimization potential.

# PLEA 2018 HONG KONG

## Smart and Healthy within the 2-degree Limit

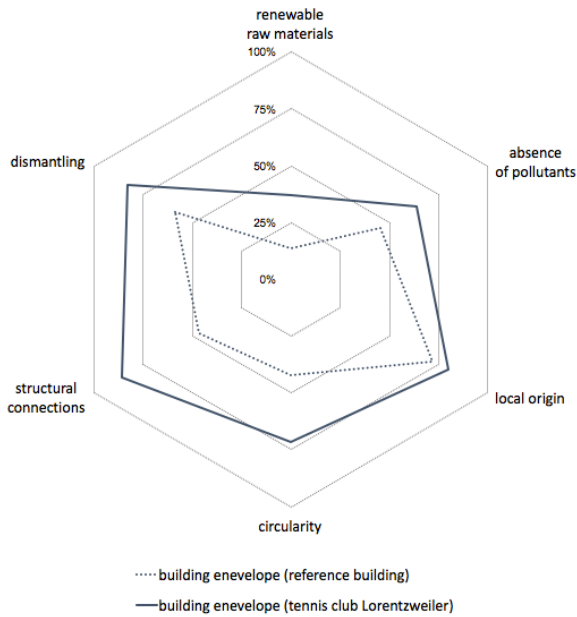

Figure 6: The “spider network diagram” compares the whole building envelope of the tennis club with the reference building envelope

As shown on the diagrams (Figures 5 and 6) the Tennis Club is not 100% circular, but compared to the reference building, all criteria are rated significantly better. Furthermore, both projects still show considerable scopes for improvement.

#### 4. CONCLUSION AND DISCUSSION

As discussed in the sections above, the key indicators for a circular designed building at the material level according to the CEI/taken into account in the CEI can be shortened into the use of pollution-free building materials and products from renewable raw materials. In contrast, at the construction level, the easy disassembly and abstinence of connections with adhesion are crucial aspects.

The exemplary application of the CEI on a real rather circular and a corresponding conventional reference building shows the potential of considering circular economy aspects already in the early architectural planning process. The simple and clear handling of the tool, as well as a low effort, allows quick results which can be detailed more and more during the advancing project. Ideally, the CEI will be applied very early in the planning process taking into account the whole building with the relevant qualities. Possible optimisation can then be identified at an early planning stage and measures be applied to get closer to a circular building.

The study contributes to a future-oriented design of buildings taking into account not only the material but also the construction of a building. In order to support the results, complementary research on the practical feasibility of the Circular Economy Index should be carried out. Durability and embodied energy are other

important factors which should be integrated into the CEI in further research.

#### ACKNOWLEDGEMENTS

This paper is based on a master’s thesis carried out in the programme of “sustainable structures” at the Frankfurt University of Applied Sciences, Germany. Special acknowledgements to the professors and to the experts from the Circular Economy in Luxembourg for their supervision.

#### REFERENCES

1. United Nations, [Online], Available: <https://www.un.org/development/desa/en/news/population/world-population-prospects-2017.html> [02 Febr 2018].
2. UNEP, (2016). Global Material Flows. Assessment Report for the UNEP International Resource Panel.
3. European Commission, (2016). Putting energy efficiency first: consuming better, getting cleaner, MEMO/16/3986.
4. Eurostat Waste statistics, (2018). [Online]. Available: [https://ec.europa.eu/eurostat/statistics-explained/index.php?title=Waste\\_statistics](https://ec.europa.eu/eurostat/statistics-explained/index.php?title=Waste_statistics) [02 Febr 2018].
5. European Parliament Brussels, (2008). Richtlinie des Europäischen Parlaments und des Rates vom 19. November 2008 über Abfälle, 2008/98/EG.
6. Bergmann, C., (2013). Prozessneugestaltung im Bauen - eine Strategie. Institut für Leichtbau Entwerfen und Konstruieren der Universität Stuttgart, p. 147.
7. CTMC, (2016). A statistical overview of sand demand in Asia and Europe.
8. Bundesministerium für Wirtschaft und Energie, (2017). Bundesregierung schlägt G20 Ressourcenpartnerschaft vor.
9. Griefahn, M. and Rydzy E., (2013). Der Grundwiderspruch der deutschen Nachhaltigkeitsstrategie. Freie Universität Berlin, p. 282-286.
10. Ellen MacArthur Foundation, (2015). Towards a Circular Economy: Business rationale for an accelerated transition.
11. EPEA, (2014). Luxembourg as a knowledge capital and testing ground for the Circular Economy, Hamburg and Luxembourg.
12. EPEA "Cradle to Cradle®", [Online], Available: <http://epea.com/de/content/cradle-cradle> [01 Apr 2017].
13. M. Braungart, (2008). Die nächste industrielle Revolution: die Cradle to Cradle-Community. Hamburg: Europ. Verl. Anst., pp. 27.
14. LEED - Leadership in Energy and Environmental Design, [Online], Available: <http://www.usgbc.org/> [17 May 2017].
15. BREEAM - Building Research Establishment Environmental Assessment, [Online], Available: <http://www.breeam.com> [17 May 2017].
16. DGNB GmbH, [Online], Available: <http://www.dgnb.de/de/system/kriterien/> [17 May 2017].
17. Institute of Building Biology + Sustainability, [Online], Available: <https://buildingbiology.com/principles-of-baubiologie/> [18 May 2017].
18. BAMB 2020, [Online], <https://www.bamb2020.eu/about-bamb/> [02 April 2018].
19. V. Brenner, (2010). Recyclinggerechtes Konstruieren., Universität Stuttgart, Germany.

# PLEA 2018 HONG KONG

*Smart and Healthy within the 2-degree Limit*

20. Climate-data, [Online], <https://de.climate-data.org/location/984/> [15 May 2018].
21. Fwa, (2017). Garderobe im Chinaschilf-Kleid, Luxemburger Wort. No. 08.05.2017, Luxembourg, p. 37.
22. U. Freudiger and R. Auderset, (2016). Verfahren für den Einsatz einer Nutzpflanze als Baustoff, Kerzers.
23. European Commission Buildings, [Online], Available: <https://ec.europa.eu/energy/en/topics/energy-efficiency/buildings> [12 Aug 2018].

# A Roadmap to Design Zero Net Energy Buildings

## Design and Performance Standards for the University of Hawaii

IBONE SANTIAGO TROJAOLA<sup>1</sup>, SUSAN UBBELOHDE<sup>1,2</sup>, GEORGE LOISOS<sup>1</sup>

<sup>1</sup>Loisos + Ubbelohde, Alameda, CA, United States

<sup>2</sup>University of California, Berkeley, University, Berkeley, CA United States

*ABSTRACT: Setting Zero Net Energy Performance goals for large building stocks such as University Campuses can have a great effect on mitigating climate change impact, especially in locations such as Hawai'i, where resources and energy are limited. This paper describes the content and the methods used to develop the Building Design and Performance Standards for the University of Hawaii at Manoa (UHM BDPS). They help achieve this goal and other building performance and energy use related State mandates while responding to the climate and environmental priorities of the region of Hawaii. The UHM BDPS are based on a location-specific set of sustainable goals extracted from current industry standard documents along with the results of extensive performance simulations. They address the project phases and teams involved, and include pre-design information to develop procurement documentation, design strategies and requirements for building performance, water conservation, and other principles of sustainable operational models. These Standards also address the building operation phase and describe the framework to provide real-time information to document the progress in achieving the ZNE and other progressive campus sustainability goals overtime, in addition to identifying operation and maintenance issues.*

*KEYWORDS: ZNE, Hawaii, Standards, Benchmarking, Performance Metrics*

### 1. INTRODUCTION

Most Zero Net Energy (ZNE) design efforts are based on single new construction building projects. Property owners such as Universities face a large and dated building stock. At the same time, Governments aspire to move buildings towards Zero Net Energy performance to help mitigate climate change effects. This paper presents a roadmap toward ZNE in this particular context. The University of Hawai'i Building Design and Performance Standards (UH-BDPS) were developed to assist design and construction teams and University staff to achieve goals set by State and University policies, including net zero performance by 2035 (ACT 99), while responding to the climate, culture and energy context of the region of Hawai'i.

### 2. LOCAL CONTEXT: STATE REGULATIONS, UNIVERSITY POLICIES AND EXISTING BUILDING STOCK

Hawai'i is one of the most oil dependent states in the US and has the highest electricity price in the nation [1]. Climate change is now increasing the strain on electricity supplies necessary to meet the demand for air conditioning during the hottest times of the year.

In 2015, State Of Hawai'i HB 1509 (ACT 99) [2], required the University of Hawai'i (UH), one of the largest consumers of energy in the State, to establish a goal of zero net energy by 2035 across all campuses.

The local professional community is key to achieving these goals but currently lacks the expertise and experience to do so. The University of Hawai'i Standards help to build this technical capacity by providing a

detailed roadmap specifically tailored to the climate and University building types. Additionally, the UH student community can be trained in the analysis and data collection process as part of graduate research programs.

Similar to many institutions, the largest campus in the UH system, Manoa, was built in the 1960s, before the energy crisis. With limited availability for expansion, most efforts and resources for the Manoa campus and others will be on retrofit projects rather than new buildings. The UHM Facility Condition Analysis, released in 2011, indicated for half of the buildings reviewed (60 of the approximately 300 buildings that make up the Manoa campus, representing nearly 4 million square feet) that "major renovation is required", which is in line with other documents concerning deferred maintenance backlog (about \$503 million in 2016 [3]).

The UHM campus is served through one electrical distribution system. In spite of the significant air conditioning load, the campus does not have a central plant for chilled water. Cooling is primarily performed by local centrifugal chillers in individual buildings. Some of these have been tied together to form virtual chilled water loops, while other buildings have package unit air conditioning, in some cases relying on dozens of window air conditioning units (See figure 1). With Mechanical systems accounting for 62% of "total deficiencies" [4], new opportunities present themselves for implementation of integrated passive strategies into the design of major renovations.

Since 2011, lighting retrofits have been implemented through the Campus Lighting Upgrades (De-lamping)

# PLEA 2018 HONG KONG

*Smart and Healthy within the 2-degree Limit*

Project to replace the fluorescent light sources, but there are still minimal occupancy sensor or daylight harvesting controls for lighting” [4].



Figure 1: Exterior View of Kuykendall Hall Showing Window Air Conditioning Units in Professor Offices.

### 3. LIMITATIONS IN EXISTING STANDARDS

Industry Standards or certification methods based on regulatory energy models (usually ASHRAE 90.1) do not address strategies that are critical for human comfort in tropical climates. These include shading from surrounding landscape (trees or buildings), air motion (ceiling fans or natural ventilation) and clothing levels. Schedules for internal loads are determined by building type and do not correspond to actual operation. As a consequence, there is a disconnect between modeling results and actual performance, even in LEED Platinum certified projects. UH has been facing a steep learning curve in maintenance of facilities with new sustainable technologies such as green roofs, etc. These have added to a general dissatisfaction with sustainable efforts that the new Standards begin to address.

### 4. DESIGN AND PERFORMANCE STANDARDS TAILORED TO THE HAWAIIAN CLIMATE

The UH Building Design and Performance Standards establish performance criteria woven from a wide range of industry standards, including LEED, CHPS, IECC and ASHRAE 189.1. In addition, we adopted the “best suite” of approaches for this campus by studying other campus sustainability efforts in the United States and abroad (such as University and California at Merced and University of Singapore). Recognizing that national and international codes and criteria are often inappropriate

for Hawai'i, the UH Standards include goals and benchmarks that were developed with extensive new performance modeling focused on local climate and campus building types.

The modeling process and results are included in a “pre-design information package” for design teams. This information is grounded in scientific principles and sophisticated simulation. They offer a more robust starting point for the design teams than general guidelines often employed at these early project stages [5]. This pre-design package (named the Modeling Addendum) includes local climate analysis, studies for daylighting and shading, lighting design, HVAC autonomy and thermal comfort, and ZNE performance. These also provide a model for design teams to pursue similar analysis, and confirms that the metrics required in these Standards are both achievable and reasonable in Hawai'i locations.

#### 4.1 Local Microclimate and Weather Data Comparison

Climatic conditions have a strong influence on the optimal design of a high performance building and can reveal potential design opportunities and limitations. Temperature affects the comfort of the occupants, and is directly related to the potential performance of natural ventilation to provide comfort, as well as to the demand on the cooling system.

Culturally, local climate knowledge such as seasonal winds is already used in everyday decision-making. Temperature in Hawaii is strongly correlated to elevation, distance from the coast and the influence of trade winds. The diurnal temperature change is fairly consistent among locations and is generally limited to a 10F swing. In choosing the most appropriate weather data to predict actual building performance, design teams are urged to review any available site-specific data from the weather stations installed on campus to determine if adjustments from airport data are required to account for differences in microclimate, especially regarding wind conditions and opportunities for naturally ventilated spaces. In addition, in order to simulate conditions under actual peak conditions (such as heat waves), it is critical to compare building performance under a typical meteorological data set (TMY) to an actual meteorological year (AMY) data that might be more representative of the future conditions buildings will need to endure in the next 20 years due to climate change.

As a summary of the weather description included in the UH BDPS pre-design package, design teams for buildings in UH Campuses are made aware of the following:

1. Mixed mode conditioning strategies are critical. Thermal comfort is achievable: being outdoors, sitting on the shade and having a 1m/s air movement, provides comfort during most of the year, but not all year.

# PLEA 2018 HONG KONG

Smart and Healthy within the 2-degree Limit

2. Sky and wind conditions change frequently throughout the day, impacting daylighting and shading designs.

3. Building types or designs with intense internal loads require careful analysis to identify potential energy efficiencies.

## 4.2 Building Performance Simulations

Shading and daylighting are both primary tools to increase occupant comfort and lower energy use, but they are often in conflict. In order to determine the potential for maximizing visual comfort, lighting levels and solar control while reducing use of electric lighting, daylight studies focused on a typical existing classroom and generated balanced design solutions that then served as input in terms of shading strategies (recommended profile angles) and window sizes (minimum and maximum window to wall ratio) for the thermal comfort and energy models.

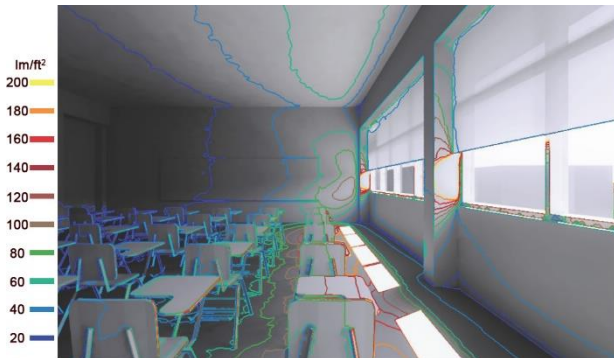

Figure 2: Illuminance levels shown as contour lines in perspective view of typical existing classroom on March 21st at 2pm, with shades lowered for sky brightness.

The passive potential for each building type in each orientation was the next step towards understanding the potential for existing or new buildings on UHM campus to reduce energy use.

The goal of zero-net-energy performance requires maximum hours of comfort delivered passively through building envelope design and control without mechanical conditioning. Using comfort load factor diagrams (Figure 3) and parametric simulations, we identified suites of passive strategies that minimize need for mechanical conditioning. Simulations of various envelope configurations quantify the impact of natural ventilation, thermal mass, roof and wall insulation, glazing specification, efficient lighting design and daylighting controls on both the annual energy use and the hour-by-hour thermal comfort of occupants.

Once a set of suites for building envelopes was identified, a mechanical conditioning system was included in the models, with assumptions for ceiling fans and smart controls. Energy use was then studied and compared between the different suites of design

strategies. A preliminary net zero performance analysis for a typical Photovoltaic panel then determined the energy production potential for arrays on the UHM campus.

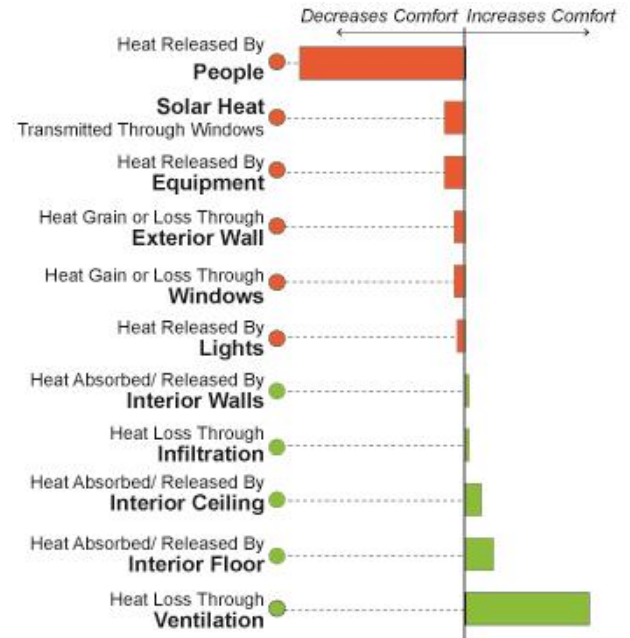

Figure 3: Comfort Load Factors (Degree To Which A Particular Load Is Pushing The Temperature Of A Space Towards The Middle Of The Comfort Zone Or Away From It ) For Bottom Floor Classroom with Suite of Improvements

## 5. DESIGNING FOR, ACHIEVING AND MAINTAINING ZNE PERFORMANCE

A primary strategy for achieving high performance buildings in UH campuses is to program, design and construct new buildings to use as little energy as possible. However it is also crucial to ensure that facilities work as expected and are operated properly when occupied. Three main approaches address this goal [5].

### 5.1 Benchmarking

The potential for design teams to predict the actual energy performance in future projects is limited by existing load data and valid benchmark energy usage in UH campuses. As a priority, the University of Hawaii needs to update the available energy benchmarks (provided in the UHM Strategic Energy Plan 2011). While these data are being collected, results from the extensive building simulations included in the Modeling Addendum (Table 1) provide targets for maximum energy budgets in typical spaces (classrooms, offices and laboratories) found on campus.

# PLEA 2018 HONG KONG

*Smart and Healthy within the 2-degree Limit*

*Table 1: Benchmarks for Existing Buildings Energy Use Intensity (EUI) in KWh/sqft/yr and Target Energy Use for UHM Projects*

Building Use	Strategic	UHMBDPS
	Energy Plan 2011	Modeling Results
CLASSROOM	34.6	35.8
OFFICE	30.6	25.6
LABORATORY	35.6	83.7

For retrofits (even partial renovations or upgrades to single systems with an energy impact), energy auditing and monitoring studies before beginning the design process are key in strategically determining how to reduce the University's building energy consumption.

Future assessments should push for a significant metering effort to collect useful benchmarking data for energy use broken down into major end uses, such as HVAC, lighting and equipment.

## 5.2 Predictive Building Performance Modeling

In order to assist project teams in creating high performing designs, the Standards identified different levels of building energy, lighting and comfort modeling for new buildings and major renovations.

In whole building projects, predictive performance modelling that reflects the actual expected use of the building is included as part of the design team responsibility, in addition to compliance modeling for LEED Certification. Predictive performance modeling to achieve benchmark-based targets considers all facility systems, and allows for all potential passive approaches to be employed to meet the targets (such as trees, automated shading, thermal mass and natural ventilation [6]). This modeling is based on anticipated equipment loads and operating conditions (schedules and occupancies).

As a starting point for the required analysis that will be developed by the design teams, the Modeling Addendum provides a process model, modeling assumptions, methodology and result visualization examples.

## 5.3 On-Going Performance Monitoring

UH must review and monitor performance data over time and re-assess performance targets to progressively achieve the ACT 99 carbon neutrality goal. This also helps UH to learn from its experience with each building. Comparing energy use predictions to monitored post-occupancy energy-use data can provide modeling assumption feedback and early opportunities to troubleshoot maintenance issues. This information will be especially useful when further construction of the same type is contemplated by UH.

On a monthly basis during the first year of occupancy, and quarterly after that, UH staff are asked to create building performance reports including energy and water

peak demand, total energy and water consumption and the total energy end use for HVAC, lighting and plug loads and compare it with the data for the previous month and the same month from the previous year. These reports will include outdoor conditions from weather stations on campus.

A set of initial performance assessments will also be completed quarterly during the first year of occupancy. These assessments include visual and thermal comfort performance evaluations and will be reviewed by the whole project team (Design, Construction and Operation/ Maintenance) during a performance review held one year after the building is occupied.

## 6. STANDARDS FOR BOTH PARTIAL RETROFITS AND WHOLE BUILDING (NEW AND EXISTING) PROJECTS

These Standards apply to all projects, from new buildings to partial retrofits, and recognize the time and budget constraints of smaller projects. Consequently, they provide an appropriate set of design requirements for each project type.

### 6.1 Project Requirements Overview: Certification, Performance and Design

For all new buildings and major renovations, the Standards include specific credits from LEED version 4. This provides a path to achieve Silver and strive for Gold Certification as required by the UH Executive Policy on System Sustainability EP.4.202.

Furthermore, new construction and major renovation projects are required to achieve holistic performance goals that go beyond Silver/ Gold Certification. These include performance metrics for thermal comfort and lighting quantity and quality.

The standard also defines the level of analytics and modeling methods required throughout the design process to achieve these specific building performance goals. A prescriptive approach based on the pre-design simulation results compiled in the modeling Addendum is included for teams without simulation expertise. This consists of following specific design recommendations for envelope (windows, shading and opaque surfaces) and additional design requirements for interior finishes, space planning and electric lighting design as an alternate path to fulfilling performance requirements.

Other design requirements that respond to critical needs for either the Hawaiian climate or the University are also included in this document. They refer to topics that cannot be evaluated with performance metrics or that are not specifically required to achieve LEED Certification. These include aspects of Indoor Environmental Quality, Energy, Water, Site and Building Materials.



# PLEA 2018 HONG KONG

Smart and Healthy within the 2-degree Limit

## 6.2 Integrated Design Process

In order to assist project teams in setting sustainability goals and implementing the requirements included the UH BDP Standards, the document identifies appropriate levels of formal integrated design requirements for projects depending on their scope of work. These include Strategic Performance Meetings and following a thorough commissioning process to ensure an optimal result.

## 7. ROADMAP IMPLEMENTATION: CONTENT ORGANIZATION AND PROJECT DELIVERABLES

A roadmap to successfully deliver a Zero Net Energy Building needs to address the different project phases and teams involved in each of them. To that goal, these Standards are organized in three volumes.

### 7.1 Volume 1: “Project Definition”: Pre-Design and Analysis Phases

Volume 1, “Project Definition”, focuses in pre-design information to be mostly used by the University staff as a resource to define and develop procurement documentation for new projects.

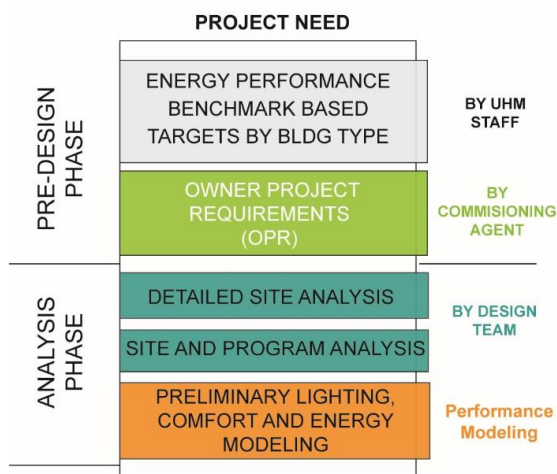

Figure 4: Project Milestones and Deliverables During Pre-Design and Analysis Phases

The University first identifies the need for a project on the basis of quantifiable requirements for space and budgetary capacity to meet them with a holistic, iterative and integrated approach. The Owner Project Requirements (OPR) articulate the project’s goals, constraints, program and requirements, and include clear reference to the aspects of the Standards the design is expected to meet.

Pursuant to the OPR, UH will engage the architect or other prime consultant who will oversee the design process and its final implementation. Criteria for selection include the provider’s experience with sustainability requirements and a candidate’s ability to achieve high environmental performance in existing,

historic or new buildings. Specifically mentioned in the contract for the design team is the performance evaluation post-occupancy.

During the analysis phase, the design team creates the preliminary site, program and climate analysis that focus on the features that impact building performance, as described in the Modeling Addendum (Climate and Weather Data Analysis).

### 7.2 Volume 2: “Design +Construction”

Volume 2, “Design + Construction” includes a specific set of requirements depending on the scope of work. It articulates building design strategies and includes standards for building performance, water conservation, environmentally responsible material choices, and other principles of sustainable operational models.

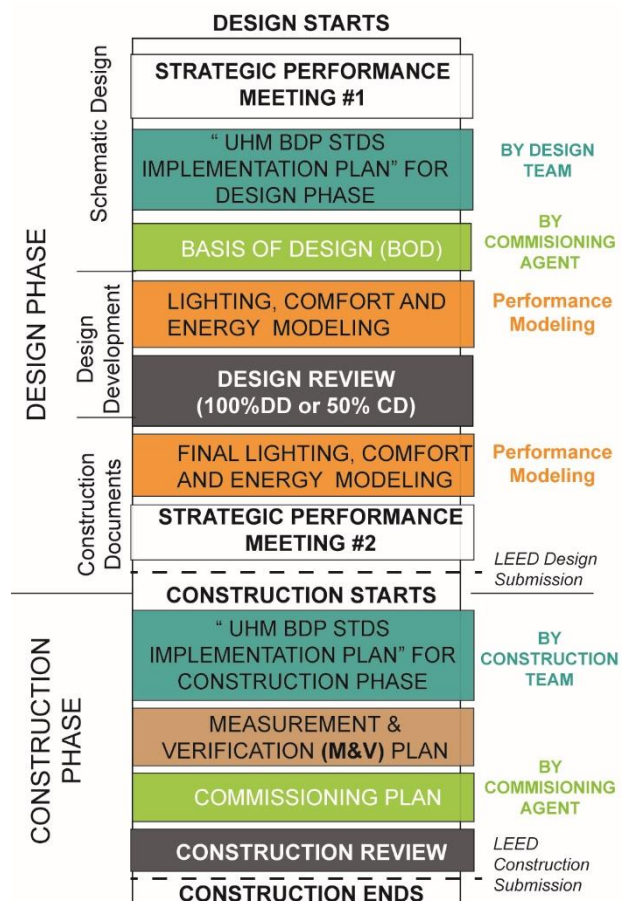

Figure 5: Project Milestones and Deliverables During Design and Construction Phases

Schematic designs show site location and organization, general building shape, distribution of program, and an outline of components and systems to be designed and/or specified for the final result. If applicable, initial performance model results are developed for energy, daylight, electric lighting and thermal comfort with sensitivity or comfort load analysis.

# PLEA 2018 HONG KONG

*Smart and Healthy within the 2-degree Limit*

During Design Development, greater detail is developed for all aspects of the building, and the collaborative process continues with the architect or prime consultant facilitating the various contributors. If applicable, multiple parametric runs (energy, daylight, electric lighting and thermal comfort) compare options of systems and strategies. Quantitative analysis is not required for the project teams involved in partial retrofits or system upgrades, when performance (thermal comfort and lighting) modeling is not within the scope of the project.

The University will conduct a “Design Review” to track the design team’s progress towards meeting these Standards and fulfilling all the necessary requirements.

The Construction Document phase translates the Design Development information into formats suitable for pricing, permitting, and construction. If applicable, complete design and base case models used for actual energy performance prediction and LEED and/or code compliance verification are submitted.

The construction phase begins after the general contractor has begun physical work on the project. Designers and other members of the team must remain fully involved. Decisions previously made may require clarification, suppliers’ information must be reviewed for compliance with the Contract Documents, and substitutions must be evaluated.

Once construction is completed, UHM performs a “Construction Review” to check implementation of all the building features and systems anticipated by the design team. The design team is responsible for assuring the building meets the requirements of the Contract Documents. Meanwhile, success at meeting the requirements of the original program is assessed by a third party during the Commissioning process, evaluating the full range of functions in the building.

### 7.3 Volume 3 “Post-Occupancy”

Volume 3, “Post-Occupancy”, forms the basis for performance diagnostic information and ongoing achievement of the expected project performance.

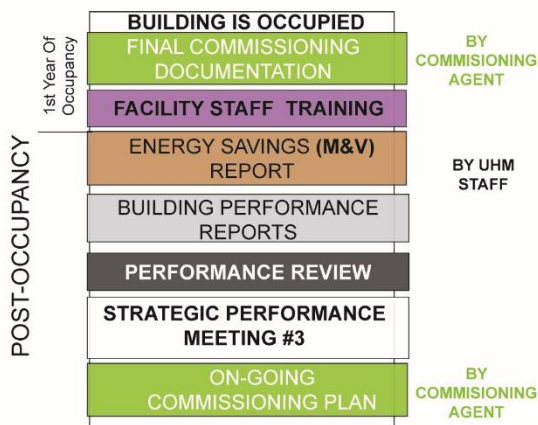

Figure 6: Project Milestones and Deliverables During Post-Occupancy Phase

This volume addresses the building operation phase and describes the framework to provide real-time information to document the progress in achieving the progressive campus sustainability goals overtime once the building is occupied, in addition to identifying and troubleshooting operation and maintenance issues. This feedback from performance measurement is then compared against the set of benchmark-based energy performance targets enforced by “Volume 1- Project Definition” of these Standards, providing an early opportunity to mitigate potential issues post-occupancy.

After the building is fully operational, a “Performance Review” is conducted to assess the building’s adherence to the performance goals. This is when the building’s performance is assessed and compliance with the contract’s goals is evaluated.

### 8. CONCLUSION

When following these Standards, University projects will fulfill the required energy use targets established by the State of Hawai’i, and will also deliver superior indoor environmental quality for University occupants.

Providing the design team with detailed analysis of the energy potential of the climate and program allows them to move in a direction conducive to passive strategies immediately in their design process.

In most integrated, sustainable design practices, energy analyses beyond a baseline model do not come into the process until after an initial design has been proposed. Working without a preliminary design and instead using conceptually defined “ideal” design characteristics for repeated units on campus sets a high bar for the design teams. This strategy is well suited to any program with repeated or dominant elements.

While UH Campuses are physically only a percentage of the Hawaiian islands, the University aspirations are influential and actions taken by the University of Hawai’i are intended to ripple throughout the State.

### ACKNOWLEDGEMENTS

These Standards would not have been possible without the support of the University of Hawaii Staff, especially Steve Meder and Sharon Williams, that provided the resources and local knowledge for this project.

### REFERENCES

1. U.S. Energy Information Administration (EIA), State Energy Production Estimates 1960 Through 2015.
2. State of Hawaii House Bill 1509 (Act 99) 2015, Legislation Relating to Energy.
3. University of Hawai’i Office of Capital Improvements, UH Strategic Directions, 2015-2021 Report.
4. University of Hawai’i Strategic Energy Plan 2011
5. Brown, Karl. 2002. “Setting Enhanced Performance Targets for a New University Campus: Benchmarks vs. Energy Standards

# PLEA 2018 HONG KONG

*Smart and Healthy within the 2-degree Limit*

as a Reference?" Proceedings of the 2002 ACEEE Summer Study of Energy Efficiency in Buildings.

6. Philip, Santosh; Shameson, Abe; Brown, Nathan; Loisos, George; and Ubbelohde, Susan "Design And Modeling Strategies For Retrofit To Natural Ventilation". 2014 ASHRAE/IBPSA-USA Building Simulation Conference Atlanta, GA

# Sustainable Architecture Design with Environmental Simulation: Introduction of Design Process with CFD

HIROKAZU SUEMITSU<sup>1</sup>

<sup>1</sup>SUEP., Tokyo, Japan

**ABSTRACT:** SUEP. is a Japanese architectural design firm, design organic architecture to co-exist with nature with digital simulational method such as CFD and thermal simulation. The target of these works is not only to satisfy the specification of energy-saving, but also to realize comfortability using natural energy like daylights, natural wind, water, and so on. These trials have a potential to lead new Asian style architecture design with semi-outdoor space in tropical climate.

**KEYWORDS:** Environmental simulation, CFD, thermal analysis, semi-outdoor space, tropical climate

## 1. HOUSE IN AWAJI ISLAND

The house is built on a hill with good view to Akashi Kaikyo Bridge which is near to the shore at the north end of Awaji island. The client requested ZEH(zero energy house) which used a natural energy and local material to the maximum at a place in proximity to the city and nature. A digital technology using the environmental simulation and the order made Kawara louver by the collaboration with the local Awaji Kawara craftsman create rich semi-outdoors space covered in the shade. We investigated various energy to be underlying around air-conditioning which circulated geothermal energy of 50m below ground and hot water supply using the solar energy which gathered in the pool and realized zero energy by using them to the maximum.



Photo 1: 2F terrace (credit: Kai Nakamura).

## 2. PREPARING THE MANUSCRIPT

The outer wall of the first floor is an earth wall made by Awaji soil and we planned the appearance that accorded with the climate of this ground which harmonized with the bare rock of the shore with a Kawara. The building has high insulation performance, the skeleton performance with the high-performance sash. In addition, energy of all air-conditioning is served using geothermal energy of 50m below ground. Full hot

water energy is covered with solar heat using difference of temperature of the pool water of the warming sea side. We plan it so that annual consumption amount of energy of the whole building becomes zero by acquiring a natural energy positively.

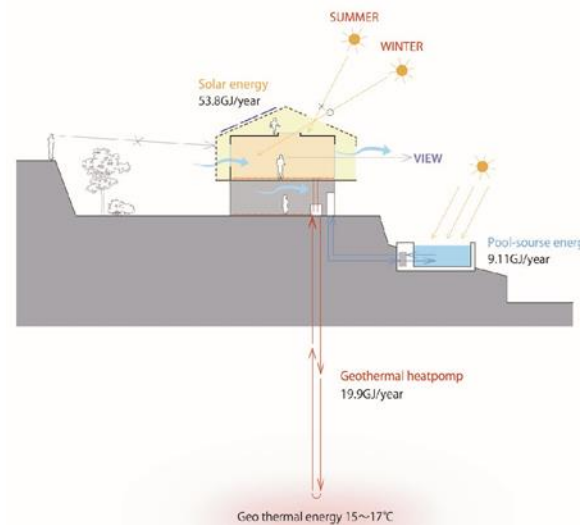

Figure 1: Diagram

Because the sea is a strange of enormous cool energy, it makes a cool and comfortable semi-outdoor environment with low temperature sea breeze in approximately 4 degrees Celsius. The crust of double skin is formed by the order made Awaji Kawara (roofing tile).



# PLEA 2018 HONG KONG

Smart and Healthy within the 2-degree Limit

## 2. HOUSE OF CAVE

The Ground's Attributes Vary By Depth. This project's sloping, bared ungraded site is located in a residential district in central Fukuoka. By digging "caves" to serve as the house's living spaces, we were able to make the most of the site's scenic views and to incorporate its ungraded topography into our design. We constructed the house's "caves" (its three primary living spaces) with retaining walls that double bearing walls in the house's structure. The house's living spaces are connected via an underground stairway.



Photo 2: Exterior (credit: Kai Nakamura).

The ground stays cool in summer and warm in winter. Buildings that are integrated into the ground can therefore maintain a stable, comfortable indoor environment year round and do not require air conditioning.

A semi-outdoor space with a dirt floor path leads from the house's main entrance to the garden. This path creates a connection with the outdoors and allows residents to pass through the house without removing their shoes. On the house's exterior, we used a soil finish that matches with the ground.



Figure 6: Plan (wind simulation).

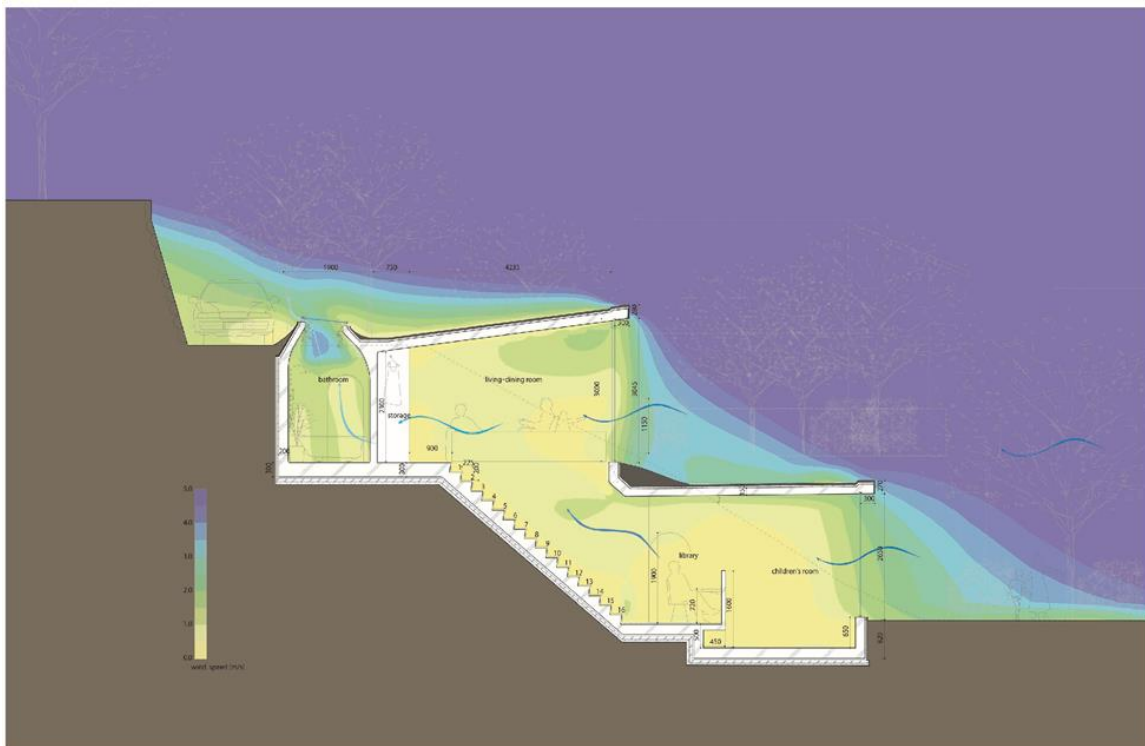

Figure 7: Section (wind simulation).

# PLEA 2018 HONG KONG

Smart and Healthy within the 2-degree Limit

## 3. OFFICE OF WICKERWORKS

The office of a company running recycling business in Fukuoka. Office space using a natural energy and the recycling material that expanded the image of the company of the recycling business was requested and suggested work space of the natural day-light.



Photo 3: 1F work space (credit: Kai Nakamura).

Although 40% of the energy used in the office in general is a lighting energy, in this office, the roof has a transparent polycarbonate roof of the entire surface, by spreading in wickerwork the light through the insulation with a light-transmitting performance and meets a soft natural light inside.

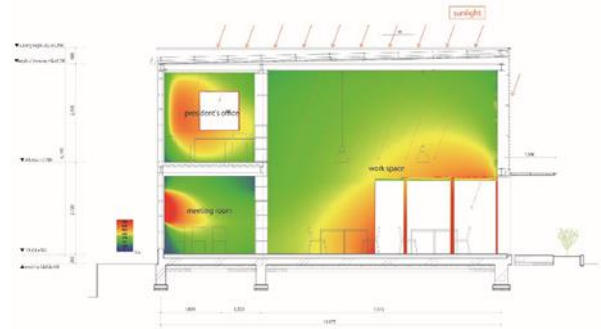

Figure 9: Section (light environment simulation).

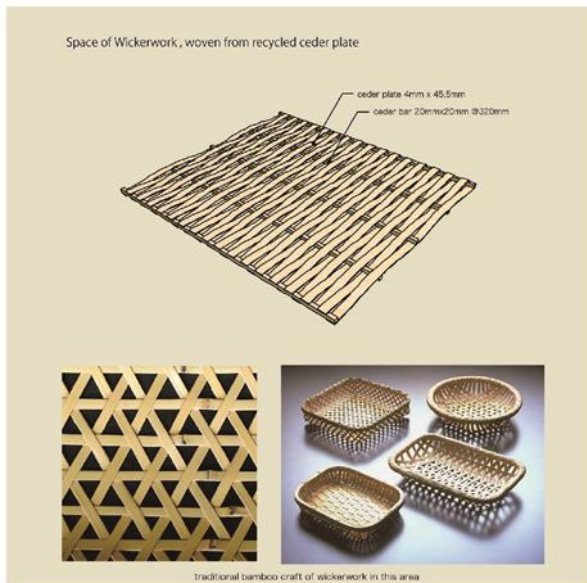

Figure 8: Concept image.

The office uses translucency material for all of the roof and an southern outer wall to make lighting. The work space can keep illumination only in soft natural light in the daytime by scattering it by a wickerwork(-formed basket)without depending on artificial illumination. The outer wall uses hollow materials of polycarbonate with the insulation performance, the roof uses an insulation material of the translucency under the transparent halving roof. They reduce thermal load to the building inside while making lighting. The weaving like a wickerwork pattern assumes the bamboo work which is a local traditional craft in this area a motif. The wickerwork recycles the old cedar which was unexploited in the warehouse of the builder firm which runs the wood business and begins to slice and knit it.

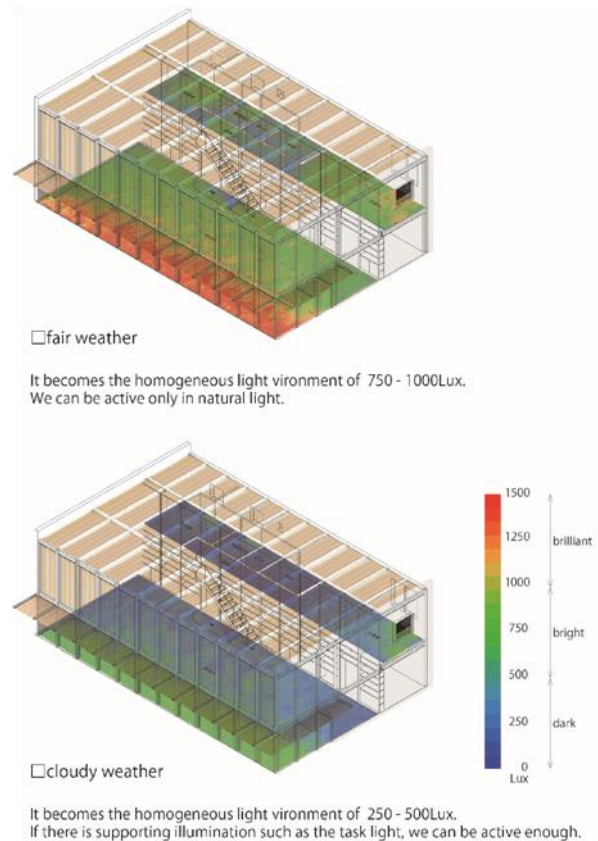

Figure 10: light environment simulation - illuminance distribution (June.21tt pm0:00) -

## REFERENCES

1. Hirokazu Suemitsu and Yoko Suemitsu/SUEP.,(2015). Form of Wind, Form of Heat, Form of Architecture. Shinkenchiku-sha.

## Reinventing Wood: The Body, Materials and Their Relationship in Chinese Houses

JING LUO<sup>1</sup>, PETER. W. FERRETTO<sup>1</sup>

<sup>1</sup>School of Architecture, The Chinese University of Hong Kong, Hong Kong

**ABSTRACT:** *The DNA of Chinese houses is embodied in the way we used to treat wood. To be specific, the concept of vernacular dwelling in China, are perfectly represented by the long history of utilizing wood as the principal building material for the Chinese houses. Moreover, it reveals the basic principle of being in harmony with nature, which proved through the relationship between the human body and wood. More than a material, wood was a metaphor of a living body with its own soul in the eyes of Chinese people, presenting the value of the Chinese dwelling traditions. Although few wooden houses could be found in today's China, the first impression of the Chinese house is still characterized by its wooden structures with the joint system. We have to admit that the historical wooden houses no longer fit in the present situations because of the deforestation and increased living demands under the modern conditions. However, the potential of the wood as a sustainable building material should never be underestimated. Since the severe shortage of wood resources has been relieved, the value of wood is worthy to be reinvented through reconnecting the relationship with the human body in the context of modern China.*

**KEYWORDS:** Wood, Body, Chinese House, Material, Sustainable Design

### 1. INTRODUCTION

#### 1.1 The human body is surrounded by wood

If we consider the clothes as the second skin of the human body made by fabric, the third skin must be the houses which constructed by building materials. The great elegance of the traditional Chinese house relied on neither its outer appearance nor the indoor spaces, but the complex structure well accomplished only by a single natural material, which was the wood during the long ancient period of Chinese history.



Figure 1: Typical Ancient Timber Architecture (Image downloaded from website <http://www.tooopen.com/view/491313.html>)

For most Chinese people in the past, wood was not only the principal material for housing construction but indispensable in their everyday life. The Chinese used to dwell in the wooden houses, sit around the wooden table, sleep on the wooden bed and eventually be placed in a wooden coffin when reaching the end of the life. From the day of birth to the day of death, the physical body of the Chinese people was always surrounded by

wood in every possible way of living. It is clear to state that the wood not only played an important role for traditional housing constructions but also has been strongly bonded with the everyday life of the Chinese people over thousands of years (Fig 1).

#### 1.2 The wood connects to the human body

Although wood is less durable than stone, it was highly appreciated and popularly employed by the Chinese people. The reason for it was because the natural quality of the wood made it the best building material representing the value of traditional Chinese dwelling, which pursuing the unity of the human and nature. According to the Taoism, the human being should dwell in harmony with nature rather than conquer nature. Therefore, the original intention for the Chinese people to build their own house was to dwell in an ambiguous atmosphere which was capable of integrating the body with the surrounding environment.

As one of the most fundamental five elements including metal, water, fire and earth which shaping the form of the universe under the belief of the ancient Chinese people, wood has shown close connections with the human body and nature (Fig2). On the one hand, the natural quality of the wood reminds us of the human body; on the other hand, wood was considered as the metaphor of the living organism mediating the human body with nature. Compared to other materials, wood is "alive" as the human body. Every piece of wood will be always in changes from the moment you have it.



# PLEA 2018 HONG KONG

Smart and Healthy within the 2-degree Limit



Figure 2: The ancient Chinese people lived with the wood  
(Image from website  
[https://www.16pic.com/photo/pic\\_5722021.html](https://www.16pic.com/photo/pic_5722021.html))

It is well known that wood has played a very important role in the history of Chinese architecture over 7000 years. Even though many scholars and historians have provided us with a sweeping view of the glory of ancient wooden structure in Chinese houses. However, the reason why wood was so important for the Chinese people and how does it relate to the human body in Chinese houses, have never been fully described. This article will analyze the relationship between the wood and the human body in the transitional Chinese houses from the past, looking at the current situations of the houses in the rural areas of China, and discussing how to reinvent the hidden potential of the modern wood material for rural housing constructions in the future of China.

## 2. THE HISTORICAL RELATIONSHIP BETWEEN WOOD AND THE HUMAN BODY IN CHINESE HOUSES

### 2.1 Wood is a metaphor for the human body

The Taoists believe that wood is the origin of life (Zhao, 2001). The five elements including wood make up everything in the world. According to Taoist cosmology, the human body is a small system belongs to the whole universe as a large system (Fig3). Therefore, wood as one of the five elements forms not only the natural phenomena but also the human body (Reninger, 2017). In the theory of traditional Chinese medicine (TCM), wood is matched up with human liver (Fig 4), shaping the human body with other four elements together. In a larger perspective, the definition of wood in the notion of five elements refers to the trees, showing the growing energy in the spring (Xu & Ding, 2008). Like a new tree grows from the earth in the spring, it also indicates the birth of a human child. Extended from the material quality, wood was regarded as the perfect symbol of human spirit, representing the classic virtue of human honesty and moderate which highly appreciated by the Chinese people. As a Chinese proverb says 'The growth of a tree costs ten years, but the growth of a man

needs a hundred years'. Hence, the growth of the tree is equally important than the growth of a human being, and the body of wood could be extended to the human body as well (Xu & Ding, 2008).

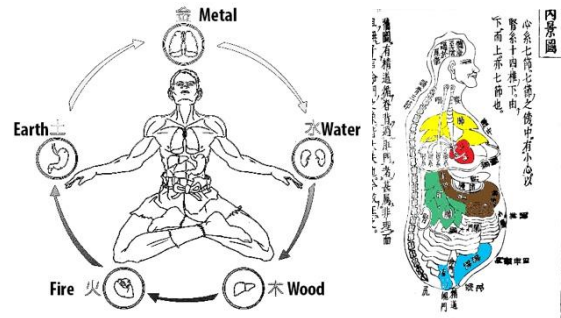

Figure 3 (Left): The Wu Xing (Chinese: 五行), also known as the Five Phases (Image from website)

Figure 4 (Right): The system of five phases was used for describing the human organs in traditional Chinese medicine (Image from website)

When one piece of wood was taken away from its mother trees, it stops growing but starts aging. The color of the wood will be gloomier after exposing under the sun and its skin texture will gradually be rough through the time. Each piece of wood has a particular function within the whole building system and requires regular maintenance. If we consider the wooden structure as the skeleton of a standing human body, the function of those wood joints situated in between two columns will play the same role as human knees. Like the human body needs be healed by the doctors sometimes, the wooden components in the Chinese houses require the regular maintenance as well. Sooner or later, the wooden structure will be in the need of repairing or replaced by the fresh wood under the effect of decay. As a result, the body of a standard Chinese house which composed of wood is always in the condition of changes like a living organism. Unless destroyed by the natural or man-made forces, the wooden structure lives together with the human body in the historical Chinese houses and shares the life with its dwells during the process of natural decay (Fig. 5).

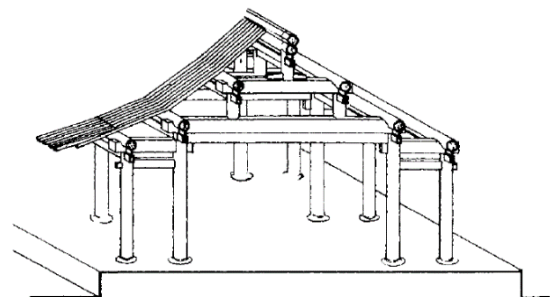

Figure 5: Typical Ancient Timber Architecture

# PLEA 2018 HONG KONG

Smart and Healthy within the 2-degree Limit

(Image from *Ancient Chinese Timber Architecture. I: Experiment Study* by D. P. Fang,<sup>1</sup> S. Iwasaki,<sup>2</sup> M. H. Yu,<sup>3</sup> Q. P. Shen,<sup>4</sup> Y. Miyamoto,<sup>5</sup> and H. Hikosaka<sup>6</sup> (Fang et al., 2001)

## 2.3 Wooden structure is a metaphor of a living organism

A complete wooden structure for the ancient Chinese house is made of the column, beams with wooden brackets. Each of architectural terms in the structure was created for a specific building element according to its specific functions. Therefore, every architectural term is a carrier of distinctive concepts (Feng, 2012, p. 139). The wooden bracket arms that protrude from the wooden column or from the wall plane, were called Hua Gong 华拱 in Chinese which literally means "flower arms" in the earliest Chinese dictionaries (Feng, 2012, p.140). The architectural scholar Feng Jiren argued in his book *Chinese Architecture and Metaphor: Song Culture in the Yinzan Fashi Building Manual* that, 'a systematic architectural metaphor underlies these distinctive bracketing elements generally are likened to "flowers," "branches," "flower sprays," "leaves," or "petals"; and, a bracket set as a whole is likened to a flower and counted in one cluster or more' (Feng, 2012, p. 160) (Fig. 6).

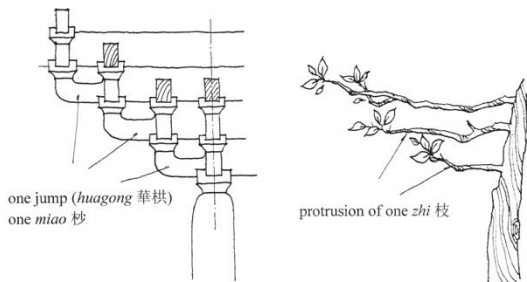

Figure 6: Protruding arms likened to branches (Image from Feng, Jiren. *Chinese Architecture and Metaphor: Song Culture in the Yinzan Fashi Building Manual*, University of Hawaii Press, 2012(Feng, 2012))

Following this imagery, the name of the wooden joints and protruding bracket on top of the columns were indicated as 'cluster of flowers' and 'tree branches'. It clearly shows that the wooden structure is the metaphor of living plants since the tenth century. As the logic further interpreted by Feng, the form of the whole wood structure in the Chinese houses, could be seen as many flowering trees standing in rows (Feng, 2012, p. 145), which establishing a feeling that boundary between the interior and exterior becomes blur and integrated to each other (Fig7). According to this metaphorical thinking, the human body dwells as part of nature and is in perfect accordance with the value of Taoism, which pursuing the unity of human and nature.



Figure 7: Sketch of bracket sets on columns likened to rows of flowering trees (Image from Feng, Jiren. *Chinese Architecture and Metaphor: Song Culture in the Yinzan Fashi Building Manual*, University of Hawaii Press, 2012 (Feng, 2012))

## 3. WOOD IN LOST

### 3.1 The deforestation and policies

Wood which was the principal building material has been employed by the Chinese for thousands of years. As the foremost concerns of the craftsman, it was not only widely applied to the Chinese rural houses but also imperial temples and palaces. However, the mass building constructions and wars eventually resulted in the over-exploitation of the forests (Zwenger, 2006, p. 20). During the 1950s, the shortage of wood resources became much more serious than before after huge amounts of forests have been intentionally destroyed for enlarging the cultivated land area (Fig8). Consequently, the estimated coverage of forests in China has been declined from 15% in 1949 to 12% at the end of the 1970s. The abuse of natural environment led to widespread deforestation in China (Tian & Chao, 2010). Until 2006, China is one of the most forest-deficient countries in the world, with only 0.1 hectares of forest per person as compared with the world average of 0.6 hectares (Tian & Chao, 2010).



Figure 8: Excessive logging of forests during the Great Leap Movement in China (Image from website: [http://www.sohu.com/a/218889688\\_692749](http://www.sohu.com/a/218889688_692749))

The severe deforestation resulted the wood became too precious to widely be used. In addition, the overwhelming growth of the population resulted in a huge pressure on the housing supply. Since the People's

# PLEA 2018 HONG KONG

*Smart and Healthy within the 2-degree Limit*

Republic of China was founded after ending with the national war in 1949, the population of China rapidly increased from 583 million in 1953 to 1.2 billion at the end of the 20th century (Knapp, 2000, p. 319). With the passion for the national movement of modernization, the Chinese people were eager to relocate the increasing family members and improve the living standards. Facing these critical problems, the Chinese government began to initiate policies that advocated the application of prefabricated concrete as building material for housing constructions. It was not until the late 1980s, 85 percent of new rural housing in China was constructed by the concrete material. Moreover, the deforestation in China even further encouraged material transformations in most of the rural areas in China (Knapp, 2000, p. 320).

### 3.2 The concrete houses

With the consequence of wood shortage and encouraged by the government policies, the Chinese craftsman and households have accepted the use of reinforced concrete to build their new houses. During the period of the 1980s, China carried on a great building boom with massive new housing construction took place in the most rural areas (Knapp, 2000, p. 3). As a result, the pattern and scale of the rural housing in China were reformed to adapting the quality of the new material and demands of industrial productions. In order to show the strong impression of modernism, the newly-built rural houses in China were sooner presented with standard two or three-story concrete blocks with flat roofs and regular windows (Zwerger, 2006)(Fig9). Meanwhile, the reinforced concrete has taken the place where wood was exclusively used in the past, and become the dominant building materials for rural housing constructions in China. With the rapid development of industrialized production, the traditional techniques and experiences of wooden carpentry were regarded as old conventions and no longer been used. One the one hand, the good quality of wood became hard to get from the market due to the deforestation; on the other hand, the building process of wooden structure costs much more time and labors compared to the concrete block. As a result, the single-story wooden structure was not the first priority for housing constructions anymore and widely replaced by the multi-stories concrete structure.



Figure 9: Concrete rural houses in China (Image from website)

### 3.3 The human body in concrete houses

The houses in today's rural China, generally built by bricks and concrete. Unlike wood, concrete is durable material like stone and lasts for centuries. The quality of concrete is different from the wood. As an industrial product, it doesn't have any connections or interactions to either nature or the human body. Those load-bearing concrete walls are built in mold and each piece of concrete unite could be precisely built through the industrial techniques. The key difference between the traditional wooden structure and modern concrete structure relies on the attitude to the wall. The wooden structure is a load-bearing structure without the enclosure, while the concrete structure creates an enclosed space divided by heavy settled walls. Rather than creating fluid spaces inside the house, the boundary of interior and exterior in concrete blocks were violently defined by the walls in dimensions. With the solid concrete walls, the relationship between the human body and nature has been changed(Fig10). In the traditional wooden houses, the human body integrated into nature in an ambiguous condition. However, the relationship between nature and the human body was broken in the concrete houses by the solid walls. Therefore, the building material has lost the original contacts with the human body under the impact of modern building form and characteristics of the concrete as an industrial material.

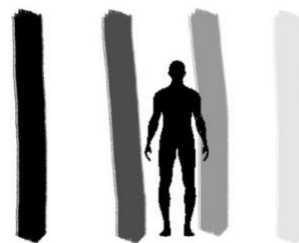

Figure 10:  
Interior space of wooden houses is in gradient



Interior space in the concrete house is divided by wall

## 4. REINVENTED WOOD

### 4.1 Wood returns to the Chinese market

On one side, the new form of rural settlement has been created through widespread applying the reinforced concrete structure; on the other side, the traditional relations to the human body has been lost in the concrete monstrosities. It seems impossible to make a balance between architectural traditions and modernism. However, the shortage of wood resources has been relieved during the past decades because of the

# PLEA 2018 HONG KONG

*Smart and Healthy within the 2-degree Limit*

effect of global trading. To meet the increasing demand for wooden resources, China has been keeping expanding its wood imports annually from more than 80 different countries, making it the world's second-largest timber importer behind the U.S (Lague, 2003). Meanwhile, we have witnessed a rapid improvement of wood-based products in the field of industrialized production during the recent decades. One of the most impressive improvement is that the conventional timber construction was transformed to engineered timber structures combined with steel components, which made it as economical to build as equivalent reinforced concrete designs (Jeska & Pascha, 2014, p. 6). Based on the rapid developments of techniques, wooden structural houses started returning to the market and attract the intentions of the Chinese architects with brand new appearances (Fig11).



Figure 11: Glued laminated timber and structure (Image from website <http://www.glulamstructuralwood.com/>)

## 4.2 Hybrid strategies for Reinventing wood

We have to admit the ancient Chinese wooden structure is no longer acceptable to the modern industry. In addition, the traditional craft skill for wood carpentry is in danger of extinction. The development of the wood industry as well as the training for wood-frame construction in China, has been far behind the western countries for almost 20 years. Therefore, most of the newly-built wooden houses in China were designed and imported directly from Canada or other countries (Ren, Jiang, Fei, & Zhou, 2006).

However, some Chinese young architects started to pay attention to reinventing the wooden structure for rural housing constructions in recent years. To improve the material properties and make it adapt to industrial productions, the traditional wooden structural form was simplified and combined with concrete walls in hybrid design strategies. Taking the “Λ House” as the example, the architect reconstructed the wooden structure and integrated the new structure into the reserved brick houses. *‘On the first floor, a traditional column-and-tie construction is continued to use to support the floor plate. While on the second floor, employing Skeuomorphism, the wood structure roof is made a smart cantilevered crown-shape to cover and protect the old wall’* (“Λ House,” 2018). Through rising up the wooden roof, the interior space became an intermediate space in the second floor,

which preserving the nature of wooden structure by connecting the inside to the outside(Fig12). With the gap between the wooden roof and brick walls, the villagers could enjoy the view of the natural environment when sitting in the houses. Also, the ancient wooden joint has been simplified in a minimum manner, looking like tree branches and successfully bridging the sense of old with new. As it says’ *This architecture adopts such a way of “renewing the old architecture with new technology, vest the newly built house with old look” to achieve a delicate reconciliation of the sense of locality and modernity’*(“Λ House,” 2018).

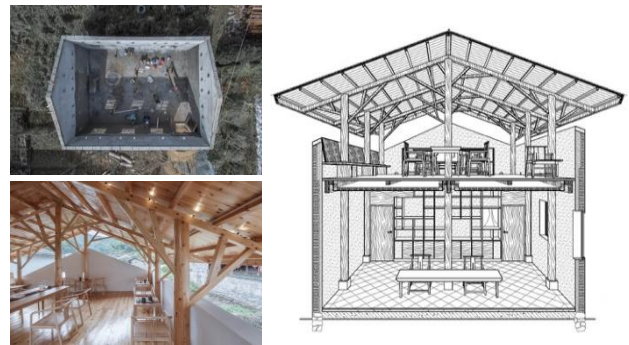

Figure 12:  
(Right): The section of the “Λ House”  
(left bottom): The second floor has left a gap due to the rise of the roof  
(Left top): The preserved brick walls  
(Image from website: <https://www.goood.cn/house-qimen-black-tea-house-in-taoyuan-village-shanli-anhui-province-china-by-su-architects.htm>)

## 4.3 Integrating the concrete with the wooden structure

The vernacular dwellings in southern China have the building traditions that combining wooden structure with brick walls. Typically, the white plaster walls of brick are filled into the wooden frame in order to save the wooden material and improving the durability of the houses(Knapp, 2000, p. 98). This type of material combination has a long history of use in southern China, and become even popular in the construction of dwelling houses in recent years. Generally, the brick walls elevate the wooden frame above the level ground and build the first-floor space on the bottom of the wooden structure(Fig13). The ground level enclosed by the solid walls is usually used to storage or stable animals such as cattle and horses; while the second floor or above which built by wood, are the real living areas for the villagers. Either integrated to bricks or concrete, the living traditions of dwelling with wood has been preserved. Besides, as the wooden material has been saved through replacing other material to build the enclosed walls for the ground floor, it will reduce the cost of the building materials and labor forces compared with the traditional way of housing constructions.

# PLEA 2018 HONG KONG

*Smart and Healthy within the 2-degree Limit*



Figure 13: Vernacular house in Guizhou province (Image from website: <http://lvyou.baidu.com/pictravel>)

6. Reninger, E. (2017). The Taoist Five Elements. Retrieved October 28, 2018.
7. Tian, D., & Chao, C.-C. (2010). The Communication Model and the Nature of Change in Terms of Deforestation in China Since 1949. *Applied Environmental Education & Communication*, 9(2), 122–130.
8. Xu, X. Z., & Ding, H. J. (2008). The Notion of Wood in Theory of Five Phases. *Journal of Hezhou University*, 24(2).
9. Zhao, G. C. (2001). *Buzhi Zhongguo Mu Jianzhu* [Not only Chinese Wooden Architecture] (In Chinese). Shanghai Scientific and Technical Publishers..
10. Zwerger, K. (2006). *Vanishing Tradition: Architecture and Carpentry of the Dong Minority in China*. Orchid Press.
11. *A House: QiMen Black Tea House in Taoyuan Village, Shanli, An'Hui Province, China* by SU Architects (2018). [Design].

## 5. CONCLUSION

Chinese dwelling culture has shown a steady preference for wood. Just like snowflakes, every piece of wood is distinctive with its unique mother nature fingerprints, expressing the beauty of nature. Because of the material quality of the wood, it makes the house connect our body as well as sensory to the nature in the built environment. Moreover, the essence of the ancient Chinese house could be understood as a sculptured expression of the relationships between the human body and nature, which achieved by building materials. If the culture of traditional Chinese dwelling could be considered as a culture of wood, the DNA of Chinese houses is applying wood.

Compared with concrete and steel, wood is renowned for its sustainability as an eco-friendly, lightweight material. Therefore, wood is not only essential for the ancient Chinese dwelling, but for modern architectural practice in China. With the increasing crisis of pollution, it is clear to recognize that the value of wood still exists and even more important than before. As a country has a long history of applying wood, the potential of wood is worthy to be rediscovered for Chinese housing construction and the ancient connections between the human body and building material are urgent to be reinvented under the modern age of China.

## REFERENCES

1. Feng, J. (2012). *Chinese architecture and metaphor: Song Culture in the Yingzao Fashi building manual*. University of Hawai'i Press.
2. Jeska, S., & Pascha, K. S. (2014). *Emergent Timber Technologies: Materials, Structures, Engineering, Projects*. Birkhäuser.
3. Knapp, R. G. (2000). *China's Old Dwellings*. University of Hawai'i Press.
4. Lague, D. (2003, December 23). *Asia's Forests Head to China; Beijing's Logging Ban Sparks Fears of Deforestation Abroad*. *Wall Street Journal*, Eastern Edition; New York, N.Y., p. A.10.
5. Ren, H. qing, Jiang, Z. hui, Fei, B. hua, & Zhou, H. bin. (2006). *Future Development Path of Modern Wood Frame Housing in China*. *China Wood Industry*, 20(2).

## Nostalgic Meets Contemporary Planning: Redevelopment of So Uk Estate

JULIAN HO<sup>1</sup>

<sup>1</sup>Hong Kong Housing Authority, HKSAR, China

**ABSTRACT:** Residential design is always about people and their interpretation of a place for living. We were taught in architectural school about design principles that put people first. In practice it becomes more complicated when unit cost and time pressure become exerting an ever greater influence on all our design decisions. In the process of planning and designing for the So Uk Estate redevelopment, we had an blessed opportunity to re-examine what are important for people in the process of transformation to a new community. We have tried to put people first and worked within a very limited budget; experimenting with methods of social engagement, old-fashioned passive design, and hopefully retained something that are precious to generations of people growing up there in close to 50 years of the estate's history and also the community at large.

**KEYWORDS:** Design Practice, People and Community, Connectivity, Microclimate, Cultural Heritage

### 1. THE SITE

When it was first completed in 1960, the old So Uk Estate became famous as one of the earliest and largest public housing developments in Asia. Built on a steep hillside and incorporating some distinctive architectural features, So Uk Estate posed a number of challenges for the Housing Authority in its redevelopment efforts (Figures 1-3).



Figure 1: The old and new So Uk

The goal was to redevelop this very special public housing site into a harmonious contemporary living environment, while retaining some of its distinctive original characteristics. In order to maximize the site's development potential and retaining some of the old structures, most of the existing road and terrain were retained, whilst some other parts were re-aligned or re-formed for optimizing the development potential and flat production.

The project mainly comprises fourteen domestic blocks ranging from 21 to 41 storeys, with 6,985 rental flats. Retail and social welfare facilities are spread among

the podium floors as well as the community facilities block (Figure 4).

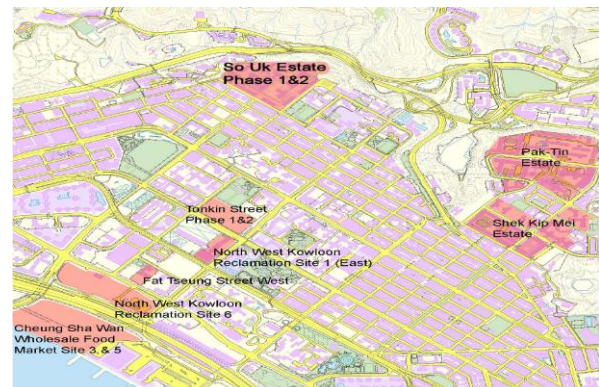

Figure 2: Location of So Uk Estate in Sham Shui Po



Figure 3: So Uk Estate

# PLEA 2018 HONG KONG

Smart and Healthy within the 2-degree Limit

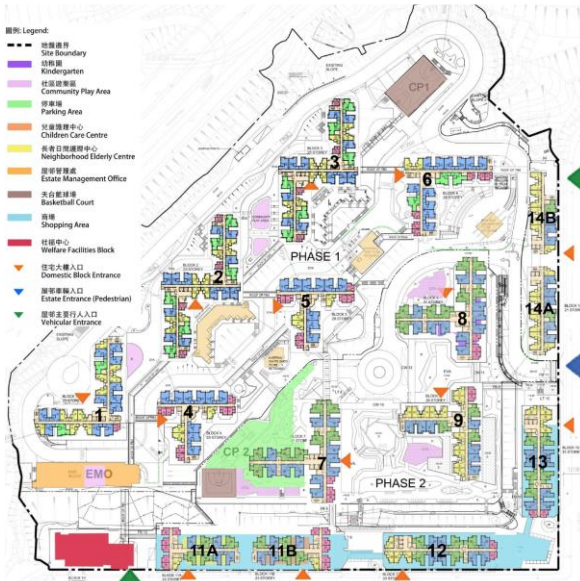

Figure 4: Estate Facilities and Layout

## 2. THE CONTEMPORARY -LAYOUT PLANNING

### 2.1 Retaining the Social Tie

The main themes of the design were ‘care for the community’ and ‘revitalisation for a sustainable and healthy living environment’. The strategically phased redevelopment plan meant that residents of the old estate could be rehoused in newly completed estates nearby, and thus stay connected with their familiar neighbourhood and social networks. People could still shop in their familiar shops, eat in their favourite restaurants and students going to the same nearby schools without disruption (Figure 5).



Figure 5: Community Engagement Timeline

### 2.2 Microclimate and Connectivity

The project design respects the urban contexts with visual corridors and breezeways created across the site (Figure 6). Through contemporary practice of planning and microclimate studies, the building disposition were carefully considered with passive design in mind, allowing air paths and view corridors to penetrate through the estate amongst buildings. Microclimate studies were carried out to assist the planning and design

of the site for improving air flow permeability, solar comfort and disposition of open space to complement sun paths and shading.

View corridors towards crest of Eagle’s Nest and wind corridors of Hing Wah Street and Ming Wah Street were open up with the new building alignments (Figure 7). The corner of Po On Street and Cheung Fat Street now serve as an inviting entrance to the retail podium floors. Main pedestrian circulation towards the upper platforms is now enhanced with elevator tower at both East and West corners of the site (Figure 8).

Building blocks are aligned with the existing urban fabrics, with stepping heights to echo the topography. The lower blocks are located along street frontage to improve visual and wind permeability from adjacent streets.

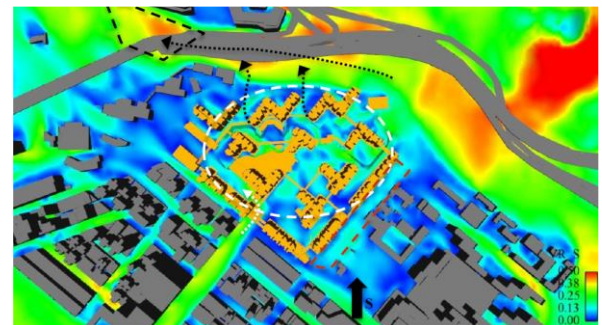
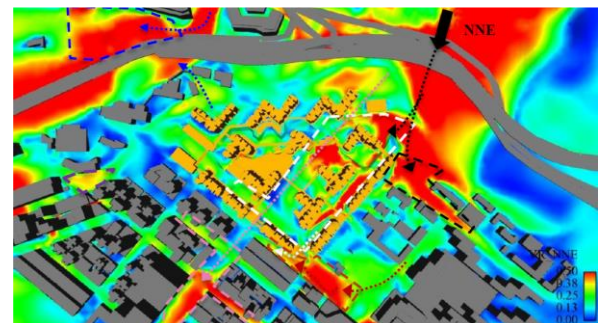
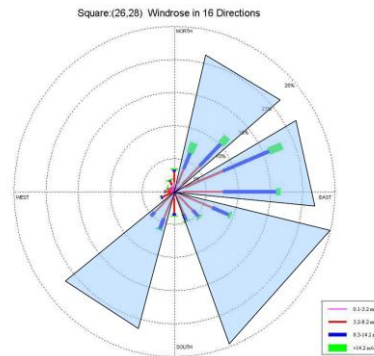

Figure 6: Wind Rose and air ventilation assessment

# PLEA 2018 HONG KONG

Smart and Healthy within the 2-degree Limit



Figure 7: View Corridors and Breezeways

strategically located; providing the residents and estate goers a safe, convenient and barrier free network between upper platforms of So Uk Estate and the major entrance hubs at Po On Road and Cheung Fat Street (Figure 9). Pocket spaces for sitting and leisure are provided along pedestrian path to bring back the intimate social spaces of the old So Uk Estate. Buildings along Po On Road are set back to provide a spatial pedestrian zone with retail, amenity and green features for enhancing the streetscape.



Figure 8: Enhanced Connectivity to the neighbourhood



Figure 10: View towards crest of Eagle's Nest behind is preserved



Figure 9: All building terraces are well connected with lift towers, escalators and footbridges. There are altogether 11 footbridges and 10 lift towers all subtly integrated with the buildings and the overall layout

### 3. The Nostalgic- Heritage Preservation

As part of the overall design and planning process, we conducted a community engagement exercise with residents of the old estate and other locals. We were particularly interested in obtaining some consensus on which of the structures of the old So Uk Estate should be retained, due to their distinctive architectural style or because of the powerful collective memories generated through an existence as part of the estate's setting for over 50 years. At the top of this list was the "Three Precious" of So Uk (Figures 11-12).

The new community is also tightly connected with the district. A network of covered pedestrian walkway, elevator towers, footbridges and escalators are



# PLEA 2018 HONG KONG

## Smart and Healthy within the 2-degree Limit

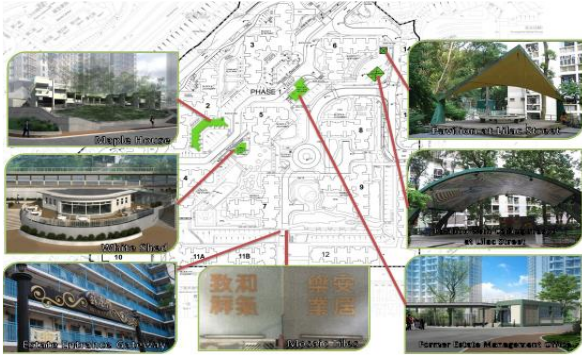

Figure 11: Location of Heritage items



Figure 13: Little white Shed



Figure 12: Heritage and Greening



Figure 14: One of the Swallow Pavilion

### 3.1 The “Three Precious” of SO UK

**Little White Shed** - This little white building next to now Willow House was originally a kerosene store. Kerosene was a common fuel for cooking back in the 60s. It was preserved and will be let out for retail/ food and beverage use. The rehabilitated building will also be integrated with the new deck and plaza to form a civil open space for the residents upon completion of phase 2 redevelopment in 2018 (Figure 13).

**The Swallow Pavilions** – next to Cherry House is 2 pavilions with curvy roofs. Around the early 1980s, a mural was painted on the soffit of one the pavilion depicting a view towards the sky from the estate open space (Figure 14); capturing the estate’s architectural characters and also doves under a blue sky and an overall harmonious living environment. The original artist of the painting, Mr. Mak Wing, was commissioned again to revive the old painting. These pavilions were and will continue to be the most popular open space for the residents and also for hosting community events.

The **old entrance portal**, with So Uk estate painted in gold Chinese character on a black background, signifying one’s arrival at So Uk was an undeniable landmark of the old estate. This portal will be re-installed at open space of phase 2.

Apart from the “three precious”, the following was also retained:

- Maple House- In the process of the redevelopment, we collected a large number of artifacts from families moving out- household items that filled 2 containers to the brim. A curator was employed to select and restore these items for exhibition. Part of the ground and first floor of old Maple House was retained and restored for exhibition purpose, showing the typical unit decorations in the 60s and 70s (Figures 15-18).
- The structure of former estate management office was retained and restored. The rehabilitated building has now become a post office.
- Princess Tree- Next to the old estate management office is one of the oldest trees in the estate, known locally as the Princess Tree, which was planted by Princess Alexandria when she visited the newly completed So Uk in November 1961.

# PLEA 2018 HONG KONG

Smart and Healthy within the 2-degree Limit



Figure 15: Maple House retained for Exhibition

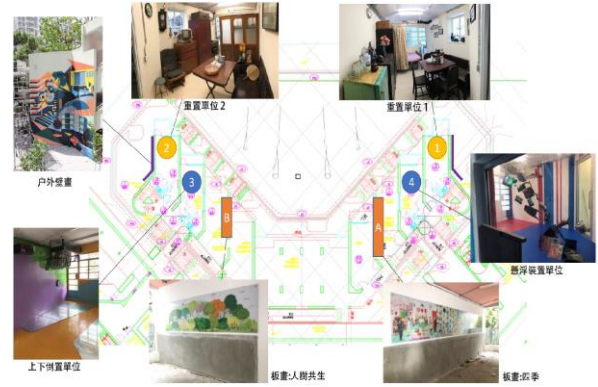

Figure 17: Exhibits in Maple House



Figure 18: Hong Kong Homes of the 60s and 70s



Figure 16: Art installation making use of artifacts collected

### 3.2 Rehabilitation of old buildings

These old structures were all structurally appraised; some had their roof or floor slab recast or their spalled concrete repaired, and all were redecorated. Together, these retained features combine to form a pleasant 'heritage trail' giving visitors nostalgic glimpses of old times as they walk around the new estate. The new residential blocks bear the old block names but exist in a completely contemporary estate setting, except for the occasional old retaining walls that sit seamlessly alongside new ones (Figures 19-23).

# PLEA 2018 HONG KONG

Smart and Healthy within the 2-degree Limit



Figure 19: Old estate office now serves as Post Office



Figure 22: Old Block names retained

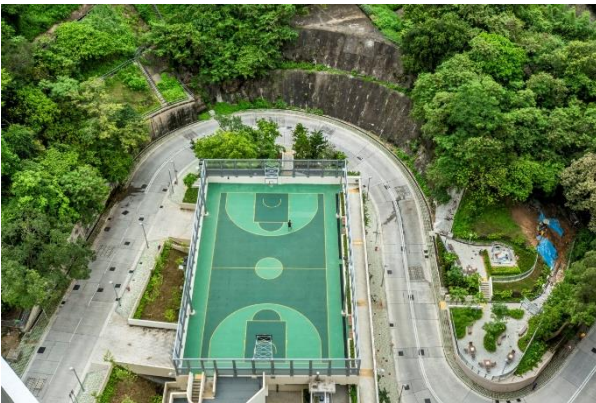

Figure 20: Over 200 trees of the old estate were retained



Figure 21: Greening of over 27% of site area

## 4. CONCLUSION

The Hong Kong Housing Authority has a very strong public housing programme, providing dwellings for over one third of people in Hong Kong since the 1950s up to present.

There are scores of building configurations and estate layouts throughout these years and ever evolving methods of planning and design. One aspect that remains unchanged is our vision for people-oriented design and processes. In the process of planning and designing for the So Uk Estate redevelopment, we had an blessed opportunity to re-examine what are important for people in the process of transformation to a new community. We have tried to put people first and worked within a very limited budget; experimenting with methods of social engagement, old-fashioned passive design, and hopefully retained something that are precious to generations of people growing up in the 50 years of the estate's history and the community at large.



Figure 23: Community event under the old pavilion

## Building a Neighbourhood Friendly Community: Application of BEAM Plus Neighbourhood in Public Housing Development (Fat Tseung Street West)

MAX WONG<sup>1</sup>

<sup>1</sup>Hong Kong Housing Authority, HKSAR, China

*ABSTRACT: The Hong Kong Housing Authority (HKHA) adopts a people-centred approach to provide quality homes for people in need. When designing new public housing developments, HKHA is committed to build for the future by taking into account quality, comfort, sustainability, as well as neighbourhood friendliness. The introduction of BEAM Plus Neighbourhood provides a valuable reference for HKHA to enhance the design of public housing in a wider community scale, as demonstrated by its pilot project of the Subsidised Sale Flats Development at Fat Tseung Street West.*

### 1. INTRODUCTION

BEAM Plus Neighbourhood is the first local tool to address various sustainability issues at early planning stage of a project. Besides saving resources in the long run through effective planning at early stage and demonstrating their commitment to urban sustainability, project proponents may use the tool to engage the community and major stakeholders to create a sustainable neighbourhood with vibrant public realm, as well as promoting the project through third-party verification. The assessment tool was launched by the Hong Kong Green Building Council (HKGBC) in December 2016.

To ensure relevance, user-friendliness and smooth operation of the tool in the local context, HKGBC engaged three live projects, including HKHA's Subsidised Sale Flats Development at Fat Tseung Street West (FTSW), to undergo pilot-testing conducted prior to recalibrating the launch version of the tool.

The HKHA started preparing for the submission in September 2015 and maintained close communication with HKGBC along the process. The first submission was made in January 2016 and after a further round of revision, the assessment was completed in June 2016. The overall score for FTSW is 76.9 and the project managed to attain the "Platinum" rating.



Figure 1: The HKHA project team received the "Platinum" Certificate from the former Secretary for Development Mr Paul Chan (third left) at the BEAM Plus Neighbourhood V1.0 Launching Ceremony on 6 December 2016.

In this Paper, the notion of BEAM Plus Neighbourhood, its relevance to the Hong Kong context and its insight to the urban sustainability will be demonstrated throughout the assessment process of the Fat Tseung Street West Development.

### 2. PROJECT OVERVIEW

The FTSW Development comprises a 41-storey domestic block providing 814 flats, estate management facilities, a semi-basement car park and associated external works. The planning and design of the FTSW Development aims to create a sustainable, cost effective and healthy living environment while taking into account the integration with the surroundings, optimization of environmental qualities and enhancement of greening opportunities.

# PLEA 2018 HONG KONG

Smart and Healthy within the 2-degree Limit



Figure 2: Subsided Sale Flats Development at FTSW

## 2.1 Master Layout

The project site situates in the Sham Shui Po District, bounded by Sham Mong Road, Fat Tseung Street West, Ying Wah Street and an adjoining school. The overall design aims to maximize the development potential with a balanced solution to meet various design requirements under site specific and development constraints. The project design satisfies the Sustainable Building Design guidelines with enhanced quality and sustainability of the built environment.



Figure 3: The Master Layout

## 2.2 Building Design

To optimize the utilization of land resources for flat production, we have adopted noise responsive and site specific design for the domestic block. Along Sham Mong Road, where there is heavy vehicular traffic, we have adopted acoustic windows to combat the traffic noise. Along Fat Tseung Street West, where there are fixed noise sources in the opposite industrial building, we have purposely designed and orientated the flats away to meet the stringent noise requirements.

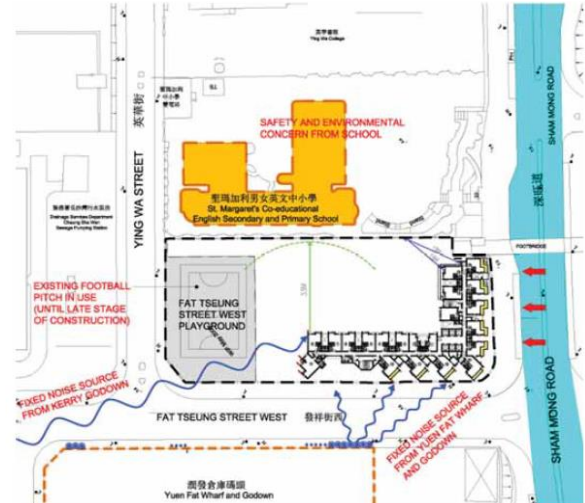

Figure 4: Site specific design of FTSW Development

## 2.3 Site Design

To enhance wind environment of the neighbourhood, a three-storey entrance void is designed to enhance wind penetration to the neighbourhood, in particular during summer time. We have also taken the advantage of the level difference between surrounding roads to design a semi-basement carpark with its roof levelled with Sham Mong Road. This facilitates convenient connection between Sham Mong Road and the entrance lobby at Upper Ground level, and minimizes bulk excavation for the carpark block. The roof deck of the semi-basement carpark also forms part of the landscape area and serves to link the rear entrance of the development to the domestic block.



Figure 5: Three-storey entrance void for enhancement of visual linkage and wind permeability to the neighbourhood



Figure 6: Roof deck of semi-basement carpark serving as landscaped amenity area

# PLEA 2018 HONG KONG

*Smart and Healthy within the 2-degree Limit*

## 3. BEAM Plus Neighbourhood Assessment

When HKGBC first launched the pilot scheme of BEAM Plus Neighbourhood, HKHA showed support and nominated its Fat Tseung Street West Development to participate in the pilot assessment. It was also our intention to test out the urban sustainability and neighbourhood-friendliness performance of typical public housing projects. We started preparing for the submission in September 2015 and maintained close communication with HKGBC. The first submission was made in January 2016 and after a further round of revision, the assessment was completed in June 2016.

The assessment under BEAM Plus Neighbourhood mainly covers the following performance aspects of the project –

- (a) **Community Aspects** – community engagement, sustainable lifestyle, placemaking and local character, corporate social responsibilities etc.
- (b) **Site Aspects** – the neighbourhood facilities, pedestrian-oriented and low carbon transport, ecological value and cultural heritage and quality open space etc.
- (c) **Material Aspects** – cut and fill minimization, integrated waste management etc.
- (d) **Energy Aspects** – sustainable buildings and passive design, energy-efficient infrastructure etc.
- (e) **Water Aspects** – water environment and stormwater management etc.
- (f) **Outdoor Environmental Quality** – outdoor thermal comfort and urban heat island effect, daylight access and visual quality, acoustics and air qualities of open spaces etc.
- (g) **Innovations and Additions** – innovative techniques and performance enhancements etc.

### 3.1 Community Aspects

Community engagement was part of our master planning process. To build for the community effectively, it is vital to engage the stakeholders with inclusiveness, transparency and creativity. We have conducted rounds of community engagement workshops and district council consultative sessions during the early planning and design stages of FTSW. Comments received were considered and has been reflected in the revised master layout plan of the project.



Figure 7: Community Engagement Workshop with District Council members, local concern groups, adjacent school communities and residents of neighbouring public housing estates and private residential developments.

Subsequent to a series of community engagement events and our internal review, the original two single aspect domestic blocks were transformed to one site specific block with specially designed flats to combat surrounding fixed plant noise constraints. The project design was tactfully revised to enhance the ventilation and visual link to the neighbourhood without reducing flat production.

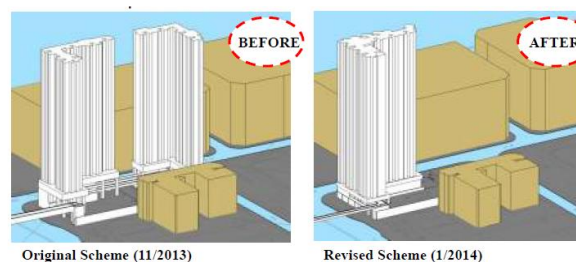

Figure 8: Revised development proposal with enhanced ventilation and visual link to the neighbourhood.

Besides, the location of the building block enabled deferred closing of the existing public soccer pitch within site boundary for construction at later stage and hence the disruption to public services could be minimized.



Figure 9: Construction of FTSW development with deferred closing of the existing public soccer pitch to minimize disturbance of its use by the community.

As this subsidised sale flats development mainly provides one-bedroom and two-bedroom units, the

# PLEA 2018 HONG KONG

Smart and Healthy within the 2-degree Limit

performance under the credits for “Diversity of Housing Type” could be enhanced if it is a public rental housing development providing domestic flats ranging from 1/2-person units to two-bedroom units. Furthermore, the scores in “Existing Community and Economy” could be higher if the development could include more retail and community facilities.

### 3.2 Site Aspects

Given the advantages of its siting, the FTSW Development was designed in conjunction with HKHA’s adjacent comprehensive public housing developments. It will provide convenient access to public open spaces, sports centre and public library, welfare facilities, retail facilities and transportation hubs including a public transport interchange and the adjacent Nam Cheong MTR Station. The covered pedestrian network serves the community at both the pedestrian and podium levels promoting a vibrant neighbourhood.



Figure 10: Comprehensive planning with other adjacent HKHA developments enhances the connectivity of the community at both street and podium levels.

The site abuts public road and streets on three sides while the vehicular access is segregated from the pedestrian route. Residents can access the development conveniently with the covered walkway system and enjoy vehicle-free pedestrian environment. Covered walkway system is provided from Ying Wah Street entrance to the domestic tower entrance which serves as the all-weather path throughout different activity zones in the landscape area.



Figure 11: Residents can access their homes from entrances at different sides of the site under vehicle-free and weather-protected environment.

As more than 10 basic services are located within 500m from the site, including recreation facilities, schools, churches and community centre, the project attained high scores in neighbouring amenities.

On the other hand, the performance in Site Aspect is constrained by the late availability of the open spaces at the opposite North West Kowloon Reclamation Site 6 which is to be completed more than one year after FTSW, as such open spaces cannot be considered for credits on “Accessibility to Neighbourhood Open Spaces”.

### 3.3 Material Aspects

For material aspect, only the credit of “Shared Facilities to Reduce Waste” is applicable to this project. We encourage the community to reduce waste generation and promote waste separation at source. Refuse storage and material recovery rooms are conveniently provided at each domestic floor for residents to separate recyclable materials from household waste, while at ground floor, refuse storage and material recovery chamber with vehicular access is provided for handling of refuse in an enclosed environment to minimize nuisance caused to the surrounding. We have conducted detail waste estimation to ensure the area of the waste handling facilities is adequate for separate storage of recyclable and non-recyclable wastes, as well as accommodating on-site personnel to oversee the smooth implementation of the refuse collection and material recovery operations.

### 3.4 Energy Aspects

We have demonstrated HKHA’s commitment for effective energy use in our developments as we have introduced Client’s Requirement and Contract Specifications to ensure that all its new projects would be “BEAM Plus ready” with Gold Rating starting from 2013. Uses of materials, energy and water etc. have all been optimized in the design and construction stages to reduce the carbon footprint and future energy consumption of the development.



Figure 12: The FTSW Development attained the Provisional Gold of BEAM Plus V1.2 for New Buildings.

While this subsidised sale flats development does not provide for renewable energy system on estate management considerations, the performance in this

# PLEA 2018 HONG KONG

Smart and Healthy within the 2-degree Limit

aspect could be enhanced for public rental housing developments where renewable energy systems such as photovoltaic panels contributing to the electricity consumption in common areas are always provided.

### 3.5 Water Aspects

We have conducted Flood Risk Assessment which demonstrated that the development would not cause adverse impact to the local drainage system.

For the criteria of “stormwater management”, although we could not score on the provision of stormwater retention tank due to site constraints, we did provide Zero Irrigation System (ZIS) as an alternative irrigation source. For upcoming HKHA developments, we may consider adopting ZIS to a larger extent such that more than 75% of the potable water demand for irrigation could be saved and the corresponding credit under “Alternative Irrigation Source” could be attained.

### 3.6 Outdoor Environmental Quality

Same as all other HKHA projects since 2004, we applied micro-climate studies to the FTSW Development in early planning and design stages to ensure environmental-responsive project design and healthy living of the future occupants. The study attained credits which include “Outdoor Thermal Comfort Study”, “Urban Heat Island Study”, “Neighbourhood Daylight Study” and “Solar Reflectivity Study”.

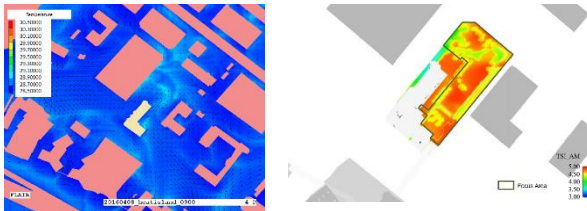

Figure 13: Micro-climate studies were conducted throughout feasibility study, scheme design and detail design stages to ensure sustainable built environment and healthy living of future occupants.

Environmental Assessment Study was also conducted for the development in close liaison with the Environmental Protection Department. The study indicated that the majority of traffic noise sources came from the West Kowloon Highway and Sham Mong Road. Apart from traffic noises, fixed plant noise sources from adjacent industrial buildings along Fat Tseung Street West were identified. To address the noise impact, mitigation measures such as vertical acoustic fins, acoustic windows and specific oriented flats were proposed.



Figure 14: Vertical acoustic fins and acoustic windows were adopted to mitigate surrounding traffic noises according to the extent at respective locations.

### 3.7 Innovations and Additions

For Innovations and Additions, our four credits attained reflected our efforts in

- the review of master plan to address the concerns of the community;
- full achievements of criteria under the credit of “Pedestrian-oriented transport planning”;
- submission of assessment reports in accordance with Nature Conservation Policy; and
- engagement of BEAM Professional in the project.

### 3.8 Overall Assessment Rating

Concluding all aspects of assessment, the overall score for FTSW was 76.9 which exceeded the threshold for “Platinum” of 75. We managed to obtain the overall “Platinum” rating as the scores in individual aspects also passed individual thresholds for “Platinum” rating.

Table 1: Credits attained under each assessment criteria and the overall score

Category	Applicable Credits	Achievable Credits	Achievable Percentage	Weighting Factor	Weighted Achieved Credits
Community Aspect (CA)	7	4	57%	20%	11.4
Site Aspects (SA)	17	13	76%	25%	19.1
Materials Aspects (MA)	1	1	100%	10%	10.0
Energy Aspects (EA)	13	10	77%	16%	12.3
Water Aspects (WA)	3	1	33%	9%	3.0
Outdoor Environmental Quality (OEQ)	14	12	86%	10%	17.1
Innovation (IA)	6	4	4	100%	4.0
				Overall Score	76.9 (>75) Platinum Rating

Table 2: Scores attained and grading thresholds under each assessment criteria

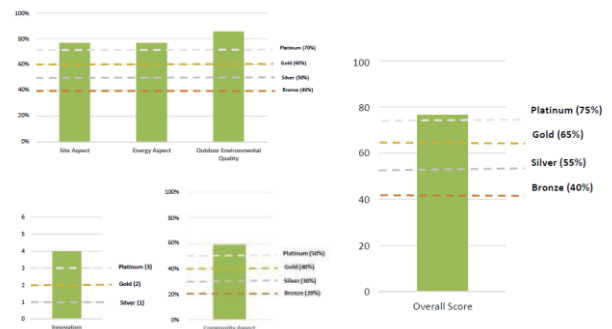



# PLEA 2018 HONG KONG

*Smart and Healthy within the 2-degree Limit*

The “platinum” rating acknowledges HKHA’s exemplary achievements not only in terms of green and sustainable design, but also the efforts in building neighbourhood-friendly communities.

in the BEAM Plus Neighbourhood assessment process and their joint effort in making this project a sustainable and neighbourhood-friendly one.

## 4. CONCLUSION

The Subsidised Sale Flats Development at Fat Tseung Street West is scheduled to complete in mid-2020 and will form part of the vibrant community together with other new public housing developments in the Sham Shui Po district.



*Figure 15: The award of the highest “Platinum” rating in BEAM Plus Neighbourhood recognized HKHA’s effort in building a sustainable and neighbourhood-friendly community.*

The “Platinum” rating in BEAM Plus Neighbourhood recognized every effort of the project team in the pursuit of urban sustainability and demonstrated HKHA’s core value of “4Cs” - Caring, Customer-focused, Creative and Committed in the delivery of public housing.

The introduction of BEAM Plus Neighbourhood provides a valuable reference for HKHA to enhance the design of public housing in a wider community scale. With the accomplishment and recognition of this pilot project in the BEAM Plus Neighbourhood assessment, HKHA shall continue to build for the community with holistic considerations of urban sustainability and neighbourhood friendliness, and enhance the planning and design of public housing developments with reference to the guidelines and good practices promulgated in the BEAM Plus Neighbourhood assessment tool.

## ACKNOWLEDGEMENTS

Special thanks to HKGBC for inviting us to participate in the BEAM Plus Neighbourhood pilot testing process, in which we have gained valuable insights in the design and planning of future public housing estates. We also acknowledge project team members’ active participation

# PLEA 2018 HONG KONG

*Smart and Healthy within the 2-degree Limit*

## **Towards Environmental and Social Sustainability Through Design, Construction and User Experience: A School for Social Development for Girls at Choi Hing Road, Kwun Tong, Kowloon**

VIVIEN FUNG<sup>1</sup>, MIFFI CHENG<sup>1</sup>, KELVIN TAM<sup>1</sup>

<sup>1</sup>Architectural Services Department, HKSAR Government

*ABSTRACT: With a brief calling for a boarding school for female students who have moderate to severe behavioural and emotional difficulties, this project aims to create a closely knitted community for the students, and create an environment that students can feel at "HOME", such that they can experience and adapt to a socially and environmentally sustainable way of living. Moreover, the building is meticulously designed such that it will operate in a low-carbon way from day to day. During construction, this project also introduced to the contractors and workers some ways to carry out works sustainably.*

*KEYWORDS: Environmental and Social Sustainability, Behaviour Change, Green Site Office*

### **1. INTRODUCTION**

With a view to providing general education and residential services for female students who have moderate to severe behavioural and emotional difficulties, the brief calls for a boarding school to accommodate 202 nos. of boarders and an 18-classrooms school, with several career training rooms and a school hall, at a 7000 m<sup>2</sup> site at Kwun Tong. The School Sponsoring Body will provide intensive counselling and educational guidance for students to help them tide over their transient development difficulties before resuming to mainstream education.

The design aims to create a closely knitted community for the students, and create an environment that students can feel at "HOME", such that they can experience and adapt to a socially and environmentally sustainable way of living which can carry through the rest of their lives.

### **2. ARCHITECTURE AS A CATALYST FOR BEHAVIOR CHANGE**

Well-designed built environment shapes behaviour. With user experience in mind, the project intends to create a suitable environment which attracts the students to engage in social activities and experience of green living.

#### **2.1 Creating High Quality Social Space with Low-Energy Thermal Comfort**

A variety of communal space are provided on all floors for the student's enjoyment and gathering. The design offers the students choices of outdoor, semi-open space and indoor activity space to socialize at all weather conditions.

The open terraces at various floors and ball court invites the students to move from a solitary pattern at air-conditioned space to enjoying the sunlight and engaging in sports and communal activities.

The covered playground catered with benches provides low energy thermal comfort to the students and staff, and encouraged interactions.



Figure 1: Terrace for picnic and group study.



Figure 2: Covered playground connected with amphitheatre for dancing, practising public speaking, drama, etc.

# PLEA 2018 HONG KONG

*Smart and Healthy within the 2-degree Limit*



Figure 3: Greening at Strata.

## 2.2 Green Living as Part of Daily Lives

The landscape design plays an important part of the students' daily lives. At each level, greening is the communal space, engaging the students to enjoy and explore the nature as part of their daily activities, e.g. stargazing and bird watching have become the girls' newest "curriculum" at the school lately.

A variety of vegetation types are planted at the landscape areas, including flowers, shrubs, bamboo, trees, etc. The growth of the vegetation throughout the year provides constant stimulus to the students, inviting them to discover and learn about nature in this outdoor "class-room". Growing up with such an engaging green living experience, the students are envisaged to carry on with life having a love for nature and an inquisitive mind even after they graduated from this school.

Moreover, the green roofs reduce temperature of the roof surface and the surrounding air through evapotranspiration, which helps to reduce energy consumption and improve air quality.



Figure 4: Terrace with diverse vegetation types inviting students to discover and learn about nature.

## 2.3 Opening Up for a Sustainable Future

Some study area such as Home-Economics Room, Library and Visual Arts Room are designed in a way that it can be opened up fully to the external. The idea is to extend from indoor to outdoor, so that these rooms have a better environmental attribute to the students and teachers.

By opening up the study area, the students can enjoy natural ventilation at the same time as sharing their creative works and new things they learned with other students. Such an openable setting encouraged a behaviour change, shifting from staying in airconditioned rooms to a more sustainable way, and achieving thermal comfort through natural ventilation.

Moreover, this design allows for user-building interaction, so that the user can learn to be more responsive to the weather, and to be engaged in decision makings for choosing the configurations of the fenestrations. This is considered as a learning process and to stimulate the users' experience.



Figure 5: Home Economics Room can be opened up for natural ventilation and for nurturing a sharing culture.

# PLEA 2018 HONG KONG

*Smart and Healthy within the 2-degree Limit*

## 3. SUSTAINABLE ARCHITECTURAL AND BUILDING SERVICES DESIGN

The building is meticulously designed such that it will operate in a low-carbon way from day to day.

### 3.1 Choosing Low Emissivity Colour and Material in Building Envelope

The external surfaces of the complex are largely painted in white, which signifies purity, as well as having low emissivity.

Moreover, more than 50% of the total roof area is provided with high emissivity roofing (emissivity of at least 0.9) material or vegetation roof covering for better microclimate around the building.



Figure 6: The external surfaces of the complex are largely painted in white – a low emissivity colour

### 3.2 Natural Ventilation

Most of the circulation area of the building is designed as open corridors and open staircases to maximize natural ventilation.

Moreover, the layout is carefully designed and generously provided with windows at strategic locations to enable cross ventilation at the rooms.



Figure 7: Open corridors with natural ventilation.

### 3.3 Responsive Design

The building is designed to respond to the weather/environmental conditions and occupancy in various aspects to minimize energy consumption:

#### Weather/Environmentally-Responsive Design

- On-off controls of mechanical ventilation (MV) systems for plant rooms are determined by the sensed temperature of temperature sensors, so that the MV systems are only put into operation when the room temperature reaches pre-determined settings.
- Daylight sensors dims down the illumination from luminaires in classrooms under high intensity daylight.

#### Occupancy-Responsive Design

- Occupancy sensors are provided at staircases for lighting control. A lower illumination level is being kept in a vacant situation, and a higher illumination level is triggered upon activation by occupancy sensor.
- Automatic on/off switching of lighting and ventilation fan is installed inside the lift. When the lifts are not occupied, the ventilation fans inside will be turned off automatically to save energy consumption.

### 3.4 Reducing Energy and Water Consumption

Fresh Air Pre-conditioners (FAP) are installed in classrooms and staff rooms to reclaim waste energy. The principle of energy conservation is to use the difference in temperature between “outdoor air” and “indoor exhaust air” to cool the hotter “outdoor air” with colder “indoor exhaust air” through heat exchange equipment (i.e. FAP), thereby reducing the use of cooling energy from the air conditioner.

Rain water recycling system is also installed to reduce water consumption for irrigation. The rain water recycling system is equipped with tank, pump, filtration and disinfection facilities.

### 3.5 Renewable Energy

A Photovoltaic (PV) System, consisting of monocrystalline PV panels and of 2.7kW capacity, is installed at roof of the school part. This system has been connected to the electrical supply grid and supplies electricity in parallel.

The lifts are equipped with Elevator Power Regeneration System. When the elevator drive is in the “gravity drive” mode of operation, the energy it generates will be converted into electrical energy for use by the lift, thereby reducing the power consumption of the lift.

Solar Hot Water Supply System equipped with evacuated tube solar collectors is installed to preheat the

# PLEA 2018 HONG KONG

*Smart and Healthy within the 2-degree Limit*

incoming water for showers at the boarding part. This type of solar collectors is compact in size and can maintain a high level of solar energy absorption without the need of a separate solar tracking device. The pre-heated water would be fed to centralized town gas-fired water heaters for further heat-up to the setting temperature. The temperature of incoming water can be substantially raised by the solar heat so that total energy demands by the heating system of this project is much less than the traditional water heating system.

## 4. GREEN CONSTRUCTION PROCESS

The project acted as a testing ground for various green construction measures and methods, with an aim to showcase to the industry, and to encourage contractors and workers to devote more environmental considerations during their construction process.

### 4.1 Green Site Office

A green site office was constructed using second/third-hand construction materials. Organic farm, vegetable garden and vertical greening were incorporated in this site office, creating a desirable environment for the workers. The workers were also invited to manage these green facilities, and a green community was thus formed on site. The green site office and the vegetable garden were opened for the students' visits during the construction period, and were highly appraised by the visitors.



Figure 8: Green site office using second/third-hand construction materials.

### 4.2 Bolt and Nut Hoarding

Bolt and nut hoarding was used as part of the site hoarding to test out the feasibility of this prefabricated modular hoarding system before widely adopted at other sites of the Architectural Services Department. Instead of disposing the hoarding materials, the bolt and nut hoarding was dismantled and reused as the hoarding of another site. This modular system extends the life-span of hoarding materials and minimizes waste created during construction.



Figure 9: Bolt and nut hoarding – a reusable modular hoarding system.

### 4.3 Aquaponics Ecosystem

An aquaponics ecosystem was made by assembling waste materials during construction. The creation and accommodation of this ecosystem on site set a good example for workers to learn how to make good use of waste materials.

## 5. CONCLUSION

As a whole, the project creates a soft and green environment for the students. Through teaching, care and guidance, it is hopeful that the students can gain the right experience and knowledge to face the outside world with the right attitude. Through design, construction, and user experience, the students, teachers, as well as the workers during construction and all involved in this project are encouraged to live an environmentally and socially sustainable life.

## ACKNOWLEDGEMENTS

Development Bureau, HKSAR Government  
Education Bureau, HKSAR Government  
Caritas-Hong Kong  
Fook Lee Construction Company Limited

# Transformation of the Former Police Married Quarters into a Creative Industries Landmark: Showcase of a Successful Revitalization Project

WILLIAM TSANG

Architectural Services Department, HKSAR Government

**ABSTRACT:** The project showcases how to revitalise a site that itself had been a transformational place since the earliest days of Hong Kong into a creative industries landmark. It conserves the heritage of the site and merges with urban landscape to provide a public open space for the community. The site of the former Police Married Quarters is a constant catalyst for change. It has been instrumental in three (and now a fourth) key socio-economic revolutions that have shaped the identity of Hong Kong people since the British era. The design concept is to build upon and enhance these historical foundations and layers with a vision to transform the site into a new zone for creative industries. The design included a number of key interventions to enhance the understanding and usability of the site. It has now become open and usable by the community as never before, providing a resource and incubator for the creative talent of local designers while making reference to and revealing the layers of historical significance.

**KEYWORDS:** Revitalization, Intervention, Public-private partnership, Adaptive reuse, Catalyst

## 1. INTRODUCTION: CULTURAL SIGNIFICANCE

The former Police Married Quarters lies physically and figuratively at the heart of Hong Kong's story of public education and social progress. The importance of the site to the people of Hong Kong resides in its contextual, historic, social, architectural and aesthetic significance; and the layers of history that it embodies.

## 2. SITE PLANNING, CITYSCAPE & NEIGHBOURHOOD

It is important for visitors to understand the site settings, in particular the 4-plateau arrangement stepping down from Staunton Street to Hollywood Road (Fig. 1 and Fig. 3). The general setting of these and their spatial relationship was essential to preserve. Retaining and restoring this site arrangement in the form of its original boundary walls, connecting steps and entrances were seen as the best way of expressing its relationship with the surrounding urban fabric, and enhancing understanding of the design and layout of the former Central School (Fig. 2). A key technical challenge for the project was to identify and differentiate the different structural, architectural and material elements. This required a detailed and verifiable understanding of which of these elements belonged to the Central School, which to the former Police Married Quarters and which parts were modern additions. The existing buildings including the Quarter Blocks and the Junior Police Club (JPC) House were refurbished with minimum interventions for adaptive re-use.

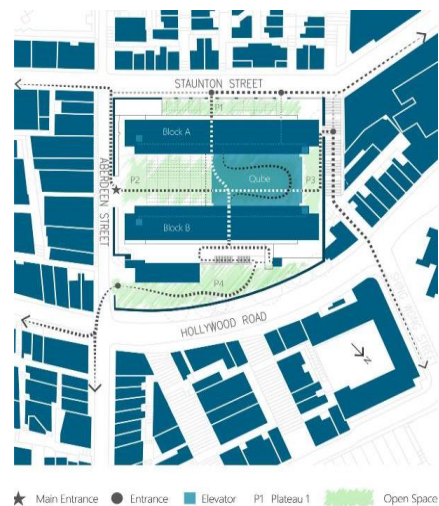

Figure 1: Figure-ground plan showing the locations of the four plateaus.

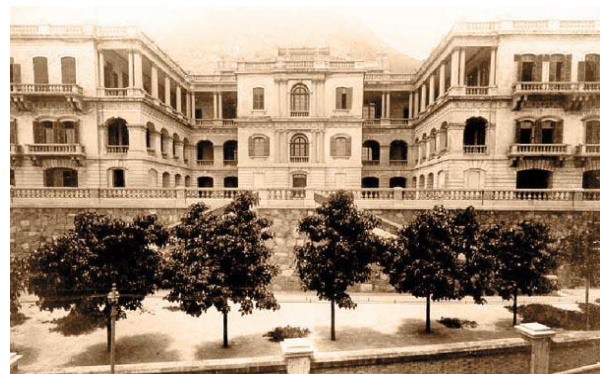

Figure 2: A photograph of the site from 1889-1948, when it was occupied by the former Central School.

# PLEA 2018 HONG KONG

Smart and Healthy within the 2-degree Limit

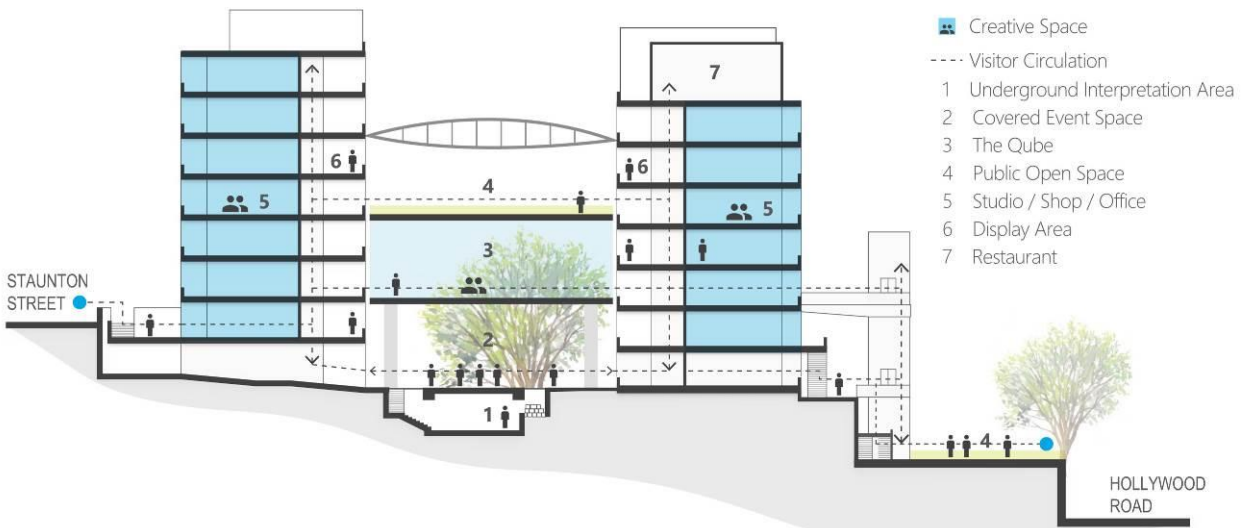

Figure 3: Section showing the step-down arrangement from Staunton Street to Hollywood Road

### 3. INTERVENTION & CONSERVATION

Retaining the existing structures, building elements and key architectural features was essential. The reconstruction, rebuilding or demolition of the existing structures were carefully planned as much as possible (Fig. 4). It was important to reveal, build upon and enhance the site's historical foundations and layers, the overall appearance, as well as the streetscape nearby. Facilities and access across the site are needed to be brought up to the modern standards for public health and safety. Other interventions had to be carefully managed to fulfil the project's brief without diminishing visitors' ability to understand the historical layers of the site.

#### 3.1 The QUBE

New building structures providing various event spaces were carefully integrated to the existing Quarter Blocks to fulfill the functional requirements as well as respect, complement and enhance the inherent character and spatial quality of PMQ. Among one of them is the QUBE, which is a multifunctional hall between the two Quarter Blocks (Block A and B) equipped with crystal clear low-iron glass panels that allow greater appreciation of the internal facades between Block A and B (Fig. 5 and Fig. 6). This double volume, fully enclosed multifunction hall is used for creative industry events. A landscaped roof has been provided at the rooftop of the QUBE.

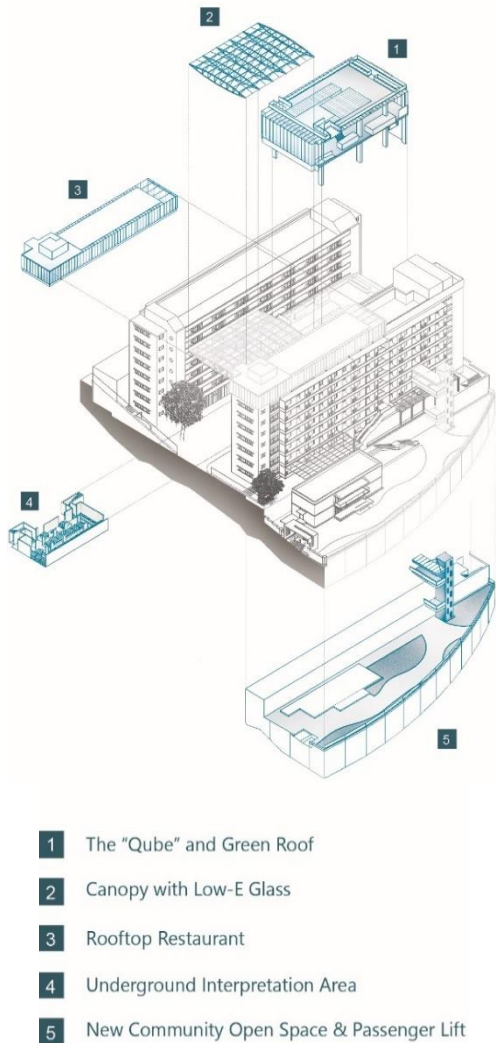

Figure 4: Isometric diagram showing the location of new elements in the site.

# PLEA 2018 HONG KONG

Smart and Healthy within the 2-degree Limit



Figure 5: A view of the two Quarter Blocks through the crystal clear low-iron glass panels of the QUBE.

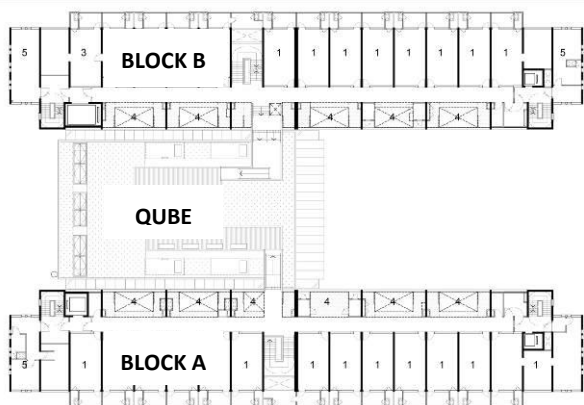

Figure 6: Plan showing the two Quarter Blocks and the QUBE bridging between them.

### 3.2 Underground Interpretation Area (UIA)

Usually in projects involving heritage sites, historical relics would be disturbed due to construction works. For this project, the Architect decided on a more challenging and creative approach – the former Central School's foundations were preserved in-situ. This was a major technical challenge during construction. First, the area for the UIA construction was surrounded by a pipe pile wall in order keep excavation works stable. Then lateral support was installed gradually from top to bottom as the excavation went deeper. To avoid damaging valuable

historical works, excavation near the stone relics needed to be conducted by hand held tools. Large boulders at UIA passages were carefully removed by hydraulic coring to minimize impact to the building stability due to vibrations. The parapet wall and floors around the relics were constructed as a huge U-channel floating on top of unexcavated soil. This allowed the historical foundations to be viewed from above through a tempered glass platform built over the UIA, or closely seen by walking through the underground passage (Fig. 7).



Figure 7: Viewing corridor of the UIA showing preserved historical foundations.



# PLEA 2018 HONG KONG

Smart and Healthy within the 2-degree Limit



Figure 8: Precast steel truss members span across Block A and Block B to maintain a column-free courtyard.

### 3.3 The Grand Canopy

To maintain the spatial integrity in the courtyard, prefabricated steel truss members were directly fixed onto the uneven parapet wall surfaces of Block A & B. There are no supporting columns inside the courtyard to minimize visual obstruction (Fig. 8 and Fig. 9). A major technical challenge was that the physical constraints of the site and the limits on floor loading capacity prohibited the use of a tower crane, so a mobile crane was required to operate at a distance. Careful crane operation and on-site supervision was required to eliminate any chance of damaging the heritage properties.



Figure 9: The Grand Canopy viewed from below.

1. 10mm thk. T-Shape Steel Mullion
2. 6mm thk. Tempered Glass Panel
3. 3mm thk. Steel Window Frame
4. 3mm thk. Steel Window Grill Frame
5. 34 x 34 x 3mm thk. U-Channel Steel Transom
6. 9mm thk. Steel Intermediate Horizontal Window

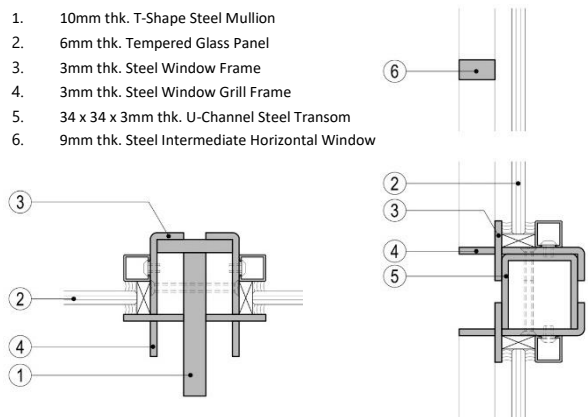

Figure 10: Reconstruction of featured steel window frame.

### 3.4 Restoration of Significant Architectural Elements

The Conservation Management Plan and Conservation Guidelines were used as a guide and reference throughout the construction. Local materials were employed as far as possible. Good examples include the steel windows and the terrazzo flooring. Terrazzo and steel windows were very common materials/components in the older public housing buildings of Hong Kong. The steel windows that give the PMQ façade elevation its distinctive 1950s style were found to be in a state of deterioration that meant they did not meet modern performance or safety standards. However factories no longer manufacture steel windows in Hong Kong. The Architect revised the details using only

# PLEA 2018 HONG KONG

*Smart and Healthy within the 2-degree Limit*

typical steel sections to reconstruct the evocative windows instead of simply replacing with the modern days aluminium windows (Fig. 10 and 11). In the case of the terrazzo flooring which adds a nostalgic feel to the environments, experienced older workers in the construction industry who still remembered how to make, repair and lay this were gathered for this project (Fig. 12).



Figure 11: Before (top) and after (bottom) of steel window details.



Figure 12: Experienced terrazzo artisans hand-trowelled terrazzo walls and floors.

## 4. SOCIAL BENEFITS

In the past the site has been an area closed to the public. But it also occupied a large area of Mid-Level district. It acted as a block and obstruction to neighbourhood traffic flow and was an obstacle that

people had to pass around. The PMQ now connects the existing urban fabric to make the district permeable and connected. The original small scale domestic units of the block buildings were refurbished to provide much needed affordable workshop and retail spaces to the local young artists and artisans. Event spaces, leisure and dining opportunities are also provided for locals and tourists (Fig. 13).

PMQ has lived up to its promise as a place for the exchange of ideas and is now a fully functioning creative hub. A strong mix of creative design talent has created its own creative ecosystem on the site, cross-fertilizing ideas, influences and practical expertise from fashion to household products to food and beverage. This model of proactive nurturing of talent and deliberate encouragement of positive interaction between tenants and visitors creates its own momentum and an in-built engine for continued success.



Figure 13: Courtyard acts as a community event space.

## 5. CONCLUSION: SUSTAINABILITY OF REVITALIZATION PROJECT

This revitalization project forms part of the “Conserving Central” programme to tell the story of urban development in the area. It is also the first Public-Private Partnership (PPP) project completed in the specified time frame that demonstrates the viability and sustainability of PPP involvement in a revitalization project. Other heritage revitalization projects will have an opportunity to learn from the experience of certain breakthrough project management and structural arrangements that ensure its long-term sustainability. For the delivery and future operation of the revitalized facilities at the site, and the operator has committed to ploughing back its share of the net operating surplus into the operation of the creative industries landmark.

## ACKNOWLEDGEMENTS

PMQ Management Company Limited  
Techoy Construction Company Limited  
Development Bureau, HKSAR Government

# Transformation of Sterile Space Underneath Flyover into a Arts, Cultural and Creative Hub: Fly and Flyover 023, Kowloon East

CHAN TSZ-KIN<sup>1</sup>

<sup>1</sup>Architectural Services Department, HKSAR Government

**ABSTRACT:** This project successfully redefine the unused spaces and transform into vibrant leisure open space by connecting the inner part of the city to the sea. Three key elements was employed in the architectural and facilities design for the Site: Containers (Industrial), Artistic, Creative Art and Green Living. By adoption of passive building design, as well as the low life cycle energy, the project successfully integrated with the surrounding development in Hoi Bun Road and turns it into a place for integration, co-creation, enjoyment for the artists, locals and visitors. By application of a series of integrated green and sustainable building strategies such as “upcycling” of used containers and installation of bamboo façade, offer lower carbon footprint than the traditional one. The design concept also tally with the operator’s mission, i.e. to cultivate creative processes by means of arts, culture, green living and community engagement, and making the City more livable, productive and innovative.

**KEYWORDS:** Upcycling, Low life cycle energy, bamboo, containers

## 1. INTRODUCTION

In the old days, the waterfront facing the Kwun Tong Typhoon Shelter was occupied by Cargo Working Area and not accessible by the public. The area along the waterfront was used as a zone for barges, lorries, freight containers and cargoes. The Kwun Tong Bypass is genuinely forming an edge to cutting the waterfront away from the centre part of Kwun Tong and Ngau Tau Kok and the waterfront. So, “Site 2 & 3 of Fly the Flyover Operation” (FF023) was launched with the concept of redefining unused spaces beneath the flyover and transforming into vibrant leisure open space by connecting the inside part of the city to the sea.



Figure 1: Sterile space underneath Kwun Tong Bypass in the old days.

A total of two pocket sites, namely FF02 and FF03, under Kwun Tong Bypass along Hoi Bun Road, were built

for creativity, arts and cultural uses. Facilities included exhibition gallery, dance studios, artists-instudio, practice rooms, workshops, performance stage, food kiosks, café, urban farms and ancillary office were constructed. A series of integrated green and sustainable building strategies are adopted with a view to establish a green community in Kowloon East. In this paper, section 2 is going to introduce the architectural features of the site. Section 3 will illustrate the energy efficient installations, green construction and procurement method will be discussed in section 4. The sustainability design and public participation will be illustrated in Section 5 & 6 respectively and Section 7 concludes this paper.

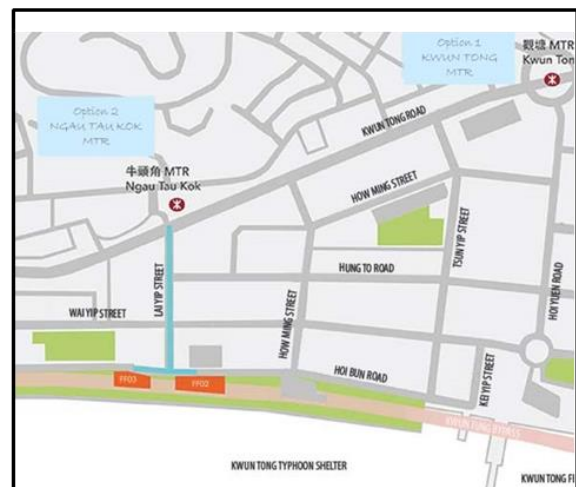

Figure 2: Location Plan of FF023.

# PLEA 2018 HONG KONG

Smart and Healthy within the 2-degree Limit

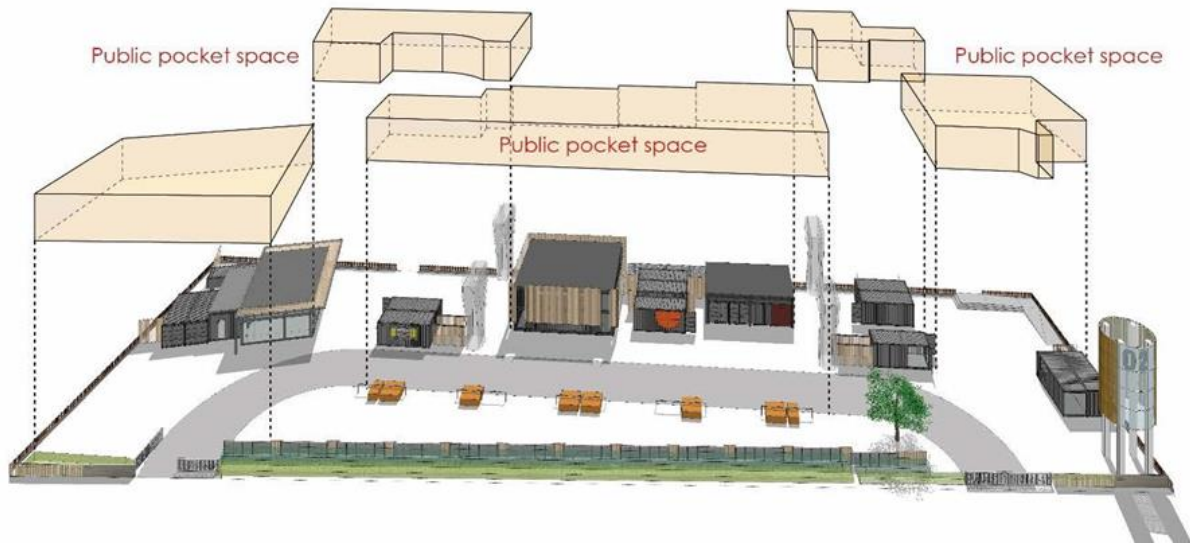

Figure 3: Stitching of exterior public pocket spaces.

## 2. ARCHITECTURAL FEATURES

### 2.1 Building Disposition

Although the site area of the project is 6,000 square meters, there are many pre-dominant constraints within two sites including drainage reserves, underground high voltage power cables, and highway structure reservation zones. In order to fully utilize the limited buildable areas, the project team carefully studied the buildable areas with the combination of basic module of 20-foot containers. Architectural volume of different building blocks are generated by putting together side by side, staking up, taking out, extruding, subtracting and rotating. We intentionally stitch the separated outdoor rooms together. Through the mediation of the outdoors and the indoors, ones can submerge into different “rooms” and celebrate the variation of architectural volumes and environment.

Used cargo containers is one of the key architectural features of the site, which is compatible to the existing Energizing Kowloon East Office (EKEO) building and surrounding industrial building and as a celebration to the success of the shipping and logistic sections of Hong Kong. Therefore, the site utilizes used cargo containers to create robust and energy efficient design for Kwun Tong Waterfront. A total of 23 nos. 20-foot and 1 no. 40-foot recycled freight containers were “upcycled” and reused in FF023. Re-functioned container architecture not only offers low carbon footprint (Robinson & Swindells, 2012), but also achieves a lesser carbon dioxide emission throughout building cycle comparing with concrete structure. These cargo containers can be easily dismantled and reused elsewhere at the end of the building’. Besides, the lean construction methods with standardized used freight containers minimized excavation and underground works and alleviate the pollution due to excessive excavation.



Figure 4: A view of upcycled container.



Figure 5: A view of upcycled container.

# PLEA 2018 HONG KONG

*Smart and Healthy within the 2-degree Limit*



Figure 6: Bamboo Façade.

## 2.2 Passive Building Design

Despite low carbon dioxide emission throughout construction stage, studies indicated steel container structure has a higher energy consumption and carbon dioxide emission than concrete structure during operation phase due to the low insulation property. Passive building design, based on site features, was adopted in FF023. Passive building can operate using 75%-95% less energy compared to traditional power methods (Tobias, 2016). In FF023, all the buildings are deliberately located beneath the Kwun Tong Bypass. The flyover shades the southwest façade of buildings until late afternoon so that the solar heat gain to the buildings could be drastically minimized. Also, the flyover could serve as rain and sun shade to arts and cultural facilities underneath, creating a pleasant comfortable environment.

## 3. LEAN CONSTRUCTION AND GREEN PROCUREMENT METHOD

All the building systems and components were designed to enhance buildability by adopting modular and standardised components. Lean construction with standardised used containers, modular structural steel members and precast cable draw pits were used. This construction improve the quality, enhance the site safety, shortened construction period, less construction waste, less disturbance and nuisance to the neighbourhood, etc. which contribute to a more sustainable built-environment.

Eco-friendly materials were chosen in FF023. With the purpose of minimizing embodied energy<sup>1</sup> throughout the building life cycle, the project team sourced materials which were manufactured in nearby regions around South China areas to promote short-haul logistic and maximized the use of reused / recycled / recyclable materials. This could save energy in both transportation and manufacturing process of materials.

## 4. SUSTAINABILITY DESIGN

On building façades, bamboo was selected in lieu of aluminium fins for decorative features. As one of the most sustainable natural building materials, bamboo has an extremely low carbon footprint and short maturity time of 3 to 5 years. Its high strength-weight ratio could give a resistant, light and permeable exterior to the building. Instead of adding to the problems of polluting land-fills like conventional building waste, any part of the bamboo that is not used can be recycled back into the earth as fertilizer or processed as bamboo charcoal.



Figure 7: Light Weight Hydrophobic Cementitious Acoustic Board.

<sup>1</sup> Embodied energy is the total energy consumed to manufacture any goods or services from acquisition of natural resources to product delivery, as well as the energy used during construction process

(Harvey, 2006). It gives an indication of the overall environmental impact of a building.

# PLEA 2018 HONG KONG

Smart and Healthy within the 2-degree Limit

In this project, “Light Weight Hydrophobic Cementitious Acoustic Board” was adopted. It is a trail scheme under Innovation and Technology Fund to provide an acoustic barrier alongside Hoi Bun Road.

The visual appearance was further improved by insertion of plants into the holes at the acoustic barrier to create a green fence wall along the perimeter of the sites. Together with urban farm and herb garden, these greenery not only act as a traffic noise buffer zone to the buildings, but also mitigate urban heat island, lower greenhouse gas emission and improve roadside air quality.

## 5. ENERGY EFFICIENT INSTALLATIONS

### 5.1 High Thermal Performance Building Envelope

To reduce cooling demand, the casing of steel containers were modified by using rock wool as insulation. The high thermal performance envelope can achieve 77% reduction in heat transmission. The thermal transmittance coefficient (U-value)<sup>2</sup> of insulated envelope is calculated to be 0.86 W/m<sup>2</sup>/K which is 4 times less than the baseline suggested by Hong Kong Green Building Council for green building assessment. Low thermal conductivity not only enhances energy efficiency, but also protects the environment by reducing energy demand and greenhouse gases emissions.

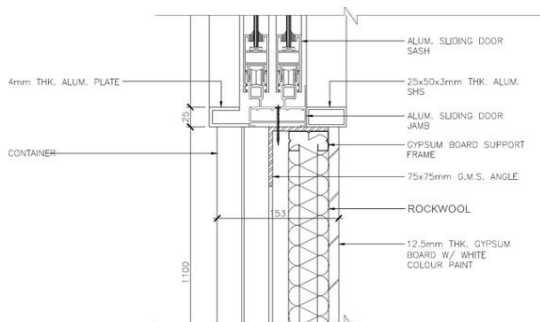

Figure 8: Sectional details of the thermal insulation of the building envelope.

### 5.2 High Efficiency HVAC System

In pursuance of sustainable living, high efficiency HVAC system using Variable Refrigerant Volume (VRV) units was adopted.

This air-conditioning system alternates the refrigerant volume to match users' cooling requirements so that least possible amount of energy is needed for the system to keep set temperatures. Comparing with conventional window type and split type air-conditioners which have Coefficient of Performance (COP) of approximately 3.0, VRV system can achieve COP up to

3.8. The overall energy consumption of air-conditioning as well as maintenance cost could be significantly reduced with more than 26% increase in energy efficiency.



Figure 9: Adoption of VRV system.

### 5.3 LED Lighting

Added to suitably planned building disposition, light-shelf effect was also designed to maximize the use of natural daylight. The underside of the Bypass, painted white, is used as a light-shelf to reflect daylight to the buildings and reduce the lighting consumption. Moreover, high efficacy LED lighting was chosen for indoor lighting, which demands less power and lasts much longer than traditional fluorescent tubes. The project team also installed additional task lights with a control system for switching off or dimming the output of lighting installations to cater for ad-hoc operation needs.

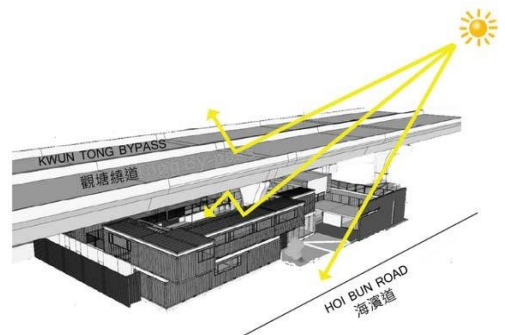

Figure 10: Concept (Top) & Actual (Bottom) Light-Shell effect.

<sup>2</sup> The thermal transmittance coefficient (U-value) is a measure of the heat that is transmitted from the front side of a façade to the inside, assuming an area of 1m<sup>2</sup> and a temperature difference of 1K

(Kaltschmitt, et al., 2007). The lower the U-value of a building's fabric is, the better the material acts as heat insulator.

# PLEA 2018 HONG KONG

*Smart and Healthy within the 2-degree Limit*



Figure 11: Urban Farm and Herb Garden.

## 6. PUBLIC PARTICIPATION

Partnership approach was adopted between EKEO and the operator who is responsible for managing, operating and maintaining the creativity, arts and cultural facilities for the public to enjoy. The operator organized various activities, such as annual festival for clothing, eating, housing and mobility, regular art and living fair, workshops, urban farming and herb garden, etc. , aiming at build a space combining elements of creative arts and green living. In the Fly-the-Flyover Programme, the site provide a platform for young talents to showcase their non-mainstream art forms, such as street dance, indie music, circus and clown theatres, etc. "Project C", an annual commissioning project by inviting creative art talents to create a space with temporary structure or re-designed cargo containers, that is best conducive for communication, contemplating and imagination.

Through collaboration of professional, talents, amateurs and general public in arts and green living, the site can be transformed into an environment that is conducive for creativities and imagination.



Figure 12: Art & Cultural Creative Hub.

## 7. CONCLUSION

In conclusion, FF023 is an exemplary demonstration of sustainability using a set of integrated green and sustainable building strategies, such as adoption of lean construction methods and selection of low embodied energy materials. We have turned the sterile spaces beneath Kwun Tong Bypass into a charming green-blue gem and leisure hotspot for both locals and visitors.

## REFERENCES

1. Harvey, L. (2006). A Handbook on Low-Energy Buildings and District-Energy Systems: Fundamentals, Techniques and Examples (1st ed.). London: Routledge.
2. Kaltschmitt, M., Streicher, W., & Wiese, A. (2007). Renewable Energy: Technology, Economics and Environment (1st ed.). Berlin Heidelberg New York: Springer Science & Business Media.
3. Olivares, A. A. (2010). Sustainability in prefabricated architecture: A comparative life cycle analysis of container architecture for residential structures. Wellington, New Zealand: Victoria University of Wellington Faculty of Architecture and Design School of Architecture.
4. Robinson, A., & Swindells, T. (2012). Customized Container Architecture. pp. 64-69.
5. Tobias, M. (2016, 10). Green Building Trends: Pros & Cons of Passive House Construction. New York, US: New York Engineers.

# PLEA 2018 HONG KONG

Smart and Healthy within the 2-degree Limit

## Meditation and Mediation: The West Kowloon Mediation Centre

WILLIAM TSANG<sup>1</sup>, CHIU NING<sup>1</sup>

<sup>1</sup>Architectural Services Department, HKSAR Government

**ABSTRACT:** The West Kowloon Mediation Centre is located next to the Law Courts Building in Shum Shui Po, which offers an alternative means to resolve disputes for early settlement and provides public education at the community level. The composition of the architecture is unique and truly reflects the mediation procedure. The architect reinterprets the mediation space and brings the users closer to nature. Courtyard spaces, greenery and natural lights are brought into the premises. The humanistic approach and harmony in materials result in tranquillity in space. This one-storey building is constructed entirely with steel structure and dry wall system which makes construction fast, easy, and within budget. **KEYWORDS:** Courtyard, Colour, Modular, Steel, Small-scaled

### 1. BACKGROUND OF PROJECT

The project starts with an impossible mission: To construct a mediation centre next to an existing law court building within a year and under a budget of HK\$30M. It has to be equipped with mediation rooms, toilet facilities, staff office and a big multi-purpose room for public events. Circulation within the premises needs to be carefully planned to ensure the confidentiality during the mediation process. (Fig. 1).

The design tactically balance the aesthetics, functions as well as construction method and brings surprises to this alternative legal procedure.

### 2. REDEFINITION OF MEDIATION SPACE

Mediation is a process conducted confidentially, in which a neutral person assists the parties in working towards a negotiated agreement of a dispute or difference [1]. In this project, the architect redefines mediation space and changes people's perception towards this intense process by simple architectural languages.

Architecture is perceived as a mediation between the world and our minds [2]. People's behaviours is often influenced by the spatial quality around us. In this building, natural elements such as light, air and greenery are used to shape user's experience and bring out a moment of peace and calmness.



Figure 1: Ground floor plan of the West Kowloon Mediation Centre



# PLEA 2018 HONG KONG

*Smart and Healthy within the 2-degree Limit*

## 2.1 Form and Function

The form and composition of this one-storey building is unique and truly reflect its function. To fulfil the privacy and acoustic requirements, all mediation rooms are segregated from each other by courtyard spaces. Each room in the premises is like an individual entity projecting from the public circulation, which creates an interesting in-and-out rhythm on the façade(Fig. 2).



Figure 2: Aerial photograph of the Mediation Centre.

Public and private spaces are clearly defined in relationship with the common lobby area (Fig. 3). Two separate entrances are created along streets and

independent access is provided to link up the adjacent Law Courts Building. Public functions such as multi-purpose room, locker space and working counter are arranged around the entrance foyer with skylight above. Light shedding down the foyer space brings a calm and airy environment to the user before the mediation begins (Fig. 4).

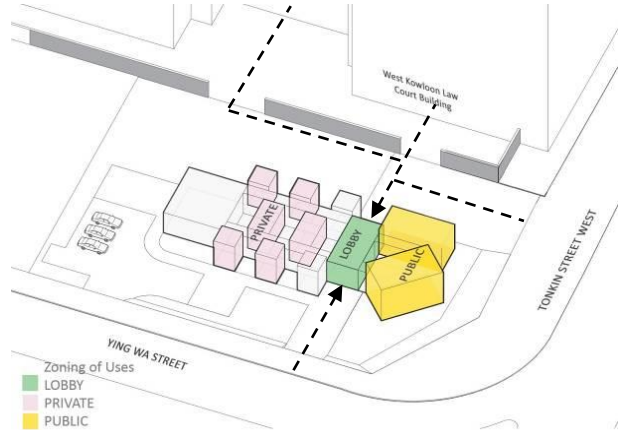

Figure 3: Diagram showing the zoning of uses.

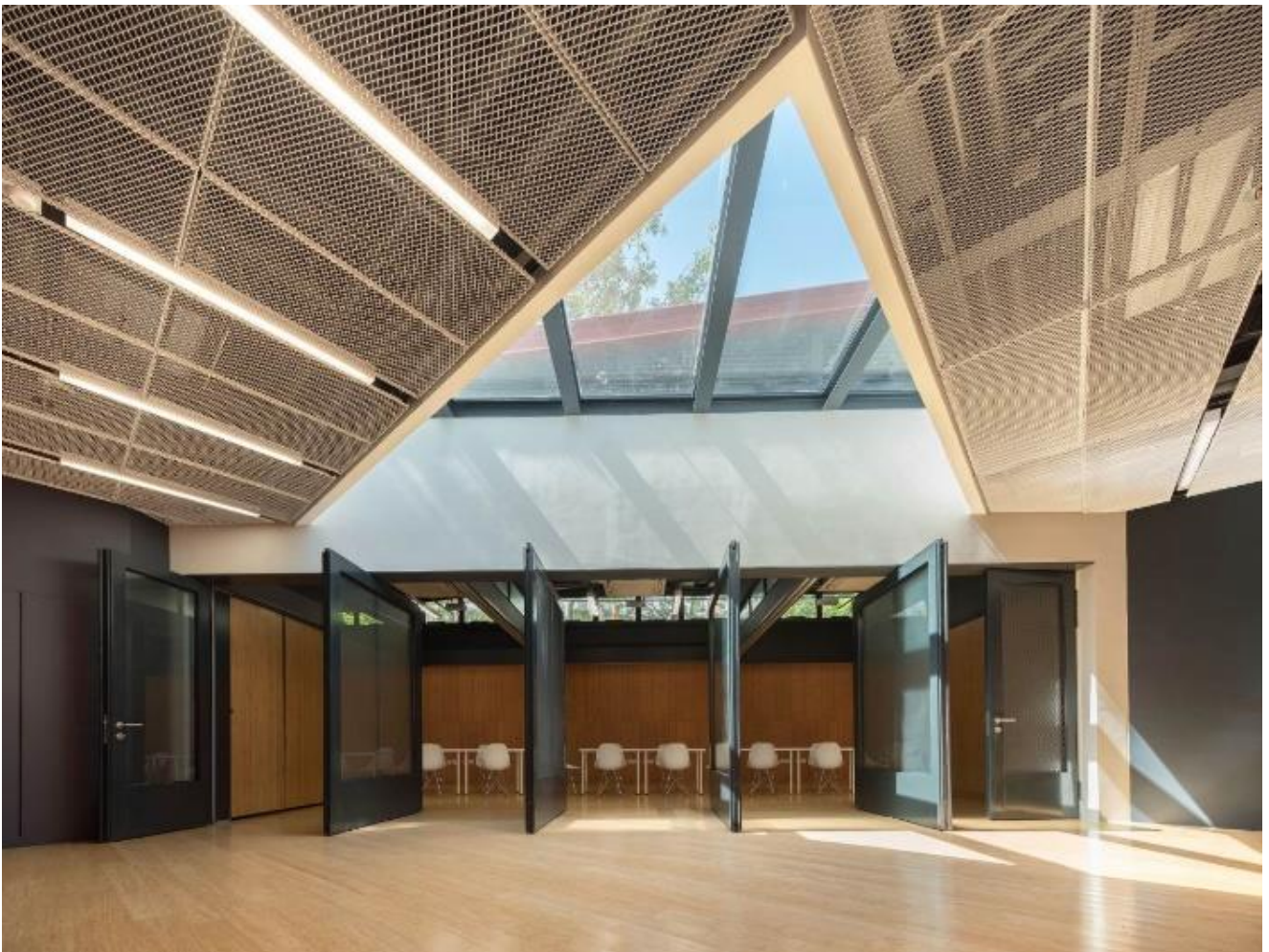

Figure 4: Photograph of the skylight at the foyer.

# PLEA 2018 HONG KONG

*Smart and Healthy within the 2-degree Limit*

To enter the mediation rooms, users from different parties are provided with designated routes in order to protect their privacy and ensure confidentiality. Two separate entrances are found in each mediation room to allow individual access after their private discussion in the break out rooms. (Fig. 5) This arrangement is reflected on the overall massing and results in a solid-void configuration.

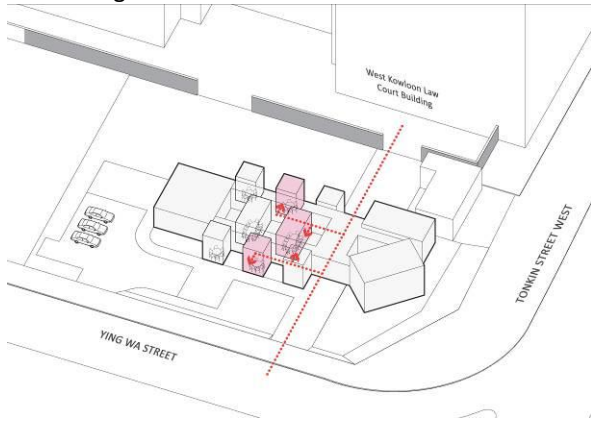

Figure 5: Diagram showing access routes from mediation room to breakout rooms, main lobby and streets.

## 2.2 Courtyard: Meditation & Mediation

Three courtyard spaces are placed strategically between the mediation rooms and the public area. They punctuate alternately within the building and blur the distinction between inside and outside. (Fig. 6) This setting allows each mediation room to have its own private garden. Full height slide-folding window is there

to allow complete openness to the outside greenery. (Fig. 7) Within the courtyard, bamboo, sand and stone are arranged like a traditional Japanese Zen garden, which offer the users a contemplative moment during the mediation process and serve as natural acoustic buffers between rooms. The large opening of mediation room frames the courtyard view and the users are embraced by the greenery during their mediation process.



Figure 7: Full height slide-folding window opened.

The spatial arrangement facilitates natural ventilation and lighting penetration. Natural breeze flows to indoor through courtyard spaces. High window at break-out rooms bring in natural light while minimizes heat gain in summer. The interior spaces are flooded with natural lighting from corridor, skylight and courtyard.

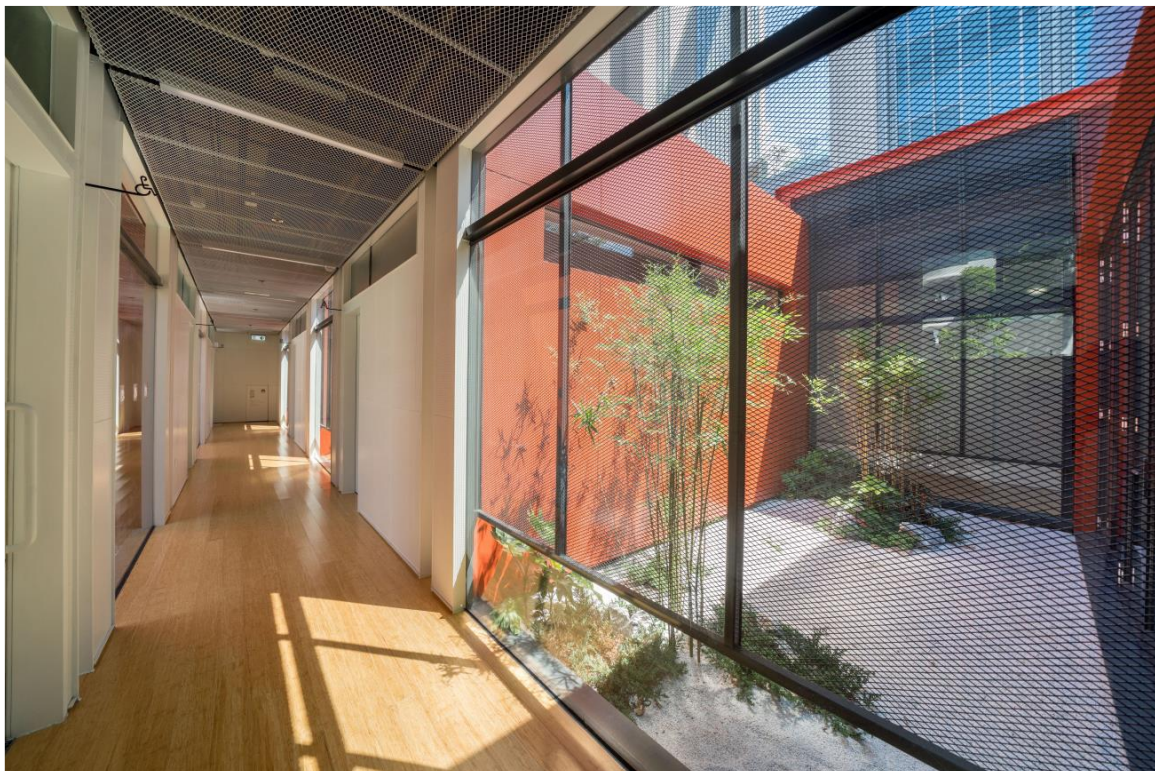

Figure 6: Photograph showing the connection between interior corridor and exterior courtyard.

# PLEA 2018 HONG KONG

Smart and Healthy within the 2-degree Limit



Figure 9: Photograph of building façade and landscaping.

## 2.3 Colour and Materials

Color is an integral element in architecture: it is not only aesthetically important, but also has a great psycho-sensory effect on perceivers [3]. In this project, the reddish colour on the façade make this piece of architecture stand out even by far despite of its tiny scale.

The overall metallic look challenges the traditional image of a judicial building, which is usually clad with masonry stone or heavy materials. Nevertheless, the colour of the external aluminium corrugated sheet has a subtle relationship with the nature of premises. The red colour is selected to represent the red paste called Vermillion (in Chinese: 朱砂 zhūshā) and the sealing wax in western culture (Fig. 8). They are commonly used in lieu of signatures in personal documents, contracts, art, or any item requiring authorship or acknowledgement [4]. The colour symbolizes solemnity and authority in the legal procedure and at the same time commensurate with the surrounding greenery. (Fig. 9) This chemical is



Figure 8: Vermillion stamp and wax seal.

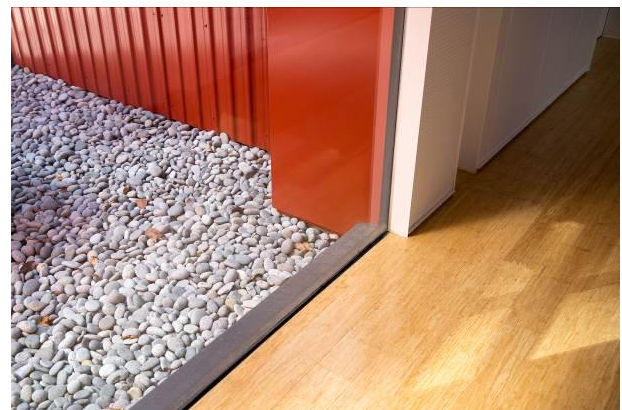

Figure 10: Indoor/outdoor material palette and detail.

also widely used in Chinese medicine for calming the body and mind, which also correlates to the theme of meditation in this project.

To ensure the confidentiality during the mediation process, acoustic performance is the first priority of the client. Cross-talking and background noise has to be kept to a minimum. As a result, acoustic wall panels and insulated Glass Units (IGU) are used for all walls facing corridor and between rooms. Bamboo flooring and white panels are used throughout the interior space to give light and peaceful atmosphere. The interior materials are kept minimal and natural contrasting to the metallic look of the building envelope. (Fig. 10)

## 2.4 External Landscape

Along the perimeter of the site, bamboo planting screen is chosen to replace the typical solid fence wall which is found commonly in most of the judicial

# PLEA 2018 HONG KONG

Smart and Healthy within the 2-degree Limit



Figure 11: View from the street to the building through low fence wall.

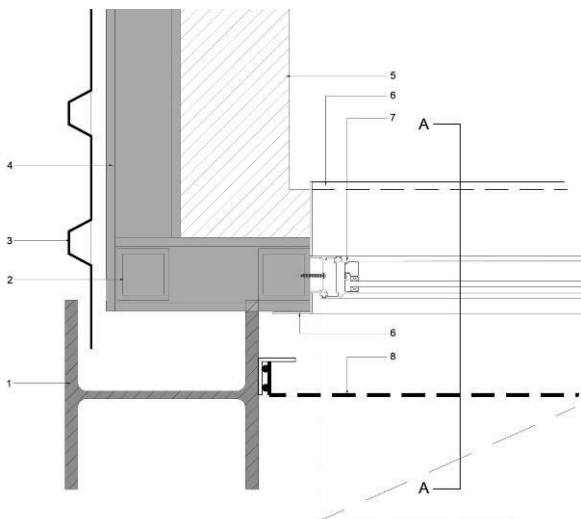

Figure 13: Wall detail drawing.



Figure 12: Steel frame erected during works.

buildings. This humanized treatment reinforces the image of openness and collaboration which the client wishes to promote to the public. Greenery around the building and the site acts as the last element in the external palette to contrast the red aluminium sheet and grey metal mesh.

Low fence walls with facing brick define the two entrances and form a poetic picture along the streets (Fig. 11). Around the building envelope, small pockets of green are found at the alcove space bringing the greenery into interior through the full height window.

### 3. DRY CONSTRUCTION

Innovative construction is the coming trend and the method to be explored in the construction industry of Hong Kong where labour cost is high and sites are mostly congested. This particular project adopted dry construction method for the whole building structure and its envelope.

This one-storey building is constructed entirely with steel members (Fig. 12). Waterproofing cement board system with aluminium corrugated sheet are used as partitions and external walls. (Fig. 13) Also, all the rooms and courtyards are laid out according to typical modules, which also makes construction fast, easy, and economical.

The dry construction method and off-site fabrication reduced overall construction time as different trades could be carried out in parallel. The overall programme is advanced and project could be completed within one-year time.

### 4. THE FUTURE OF SMALL-SCALED PROJECTS IN HONG KONG

It is always fulfilling for an architect to design a small-scaled project as time could be focused on user's

# PLEA 2018 HONG KONG

*Smart and Healthy within the 2-degree Limit*

experience and details rather than the resolution of complicated technical issues. Also, we are able to see the final outcome in a short period of time. However, it is also a challenging task as there are always restrictions, e.g. time, money, space etc. In a built environment like Hong Kong with scarcity of land resources, small-scaled projects are playing an increasingly important role in shaping people's living environment, e.g. pavilion, pop-up store, public toilets, temporary exhibition space or even a street furniture. Regardless of their format or function, the impacts brought to our urban environment could be huge and tremendous.

## REFERENCES

1. CEDR Model Mediation Procedure, Available: [https://www.cedr.com/about\\_us/modeldocs/?id=21](https://www.cedr.com/about_us/modeldocs/?id=21) [Online].
2. Pallasmaa, J., Interview: Art and Architecture from Louisiana Channel.
3. Pereira, M., The Role of Color in Architecture: Visual Effects and Psychological Stimuli.
4. Wikipedia Seal (East Asia), Available: [https://en.wikipedia.org/wiki/Seal\\_\(East\\_Asia\)](https://en.wikipedia.org/wiki/Seal_(East_Asia)) [Online].

## ACKNOWLEDGEMENTS

Special thanks to the following parties for their efforts and support to this project:

Client: Department of Justice

Project Administrator: K&W Architects Ltd.

Building Contractor: Cheung Hing Construction Ltd.

## **PEOPLE AND COMMUNITY**

Cities are primarily about people. Smart and healthy cities are nothing but buzzwords without considering the need and wish of the communities within. This track connects science, technology and research with people and their everyday lives, for example:

- human behaviour, design for behaviour change
- user-building interaction and post occupancy evaluation
- passive energy neighbourhood, community and city development
- low energy thermal comfort, public health and wellbeing

## **Earth, Density and Form: The Role of New Housing Models in Building Sustainable Rural Communities**

NEIL BURFORD<sup>1</sup>, CAROL ROBERTSON<sup>2</sup>

<sup>1</sup>School of Architecture Planning & Landscape, Newcastle University, Newcastle upon Tyne, UK

<sup>2</sup>Architecture and Urban Planning, University of Dundee, Dundee, UK

*ABSTRACT: The driver behind the need for sustainable development is to mitigate the impact that predicted climate change will have on our cities, land uses and infrastructural systems. This paper explores new spatial forms of sustainable housing in Scotland where the demand for new housing in accessible rural areas is predicted to increase due to pressure from nearby urban centres. Historically, rural building forms were largely influenced by immediately available materials, climate and specific use, resulting in regionally identifiable typologies. However, changes in the way we live, proximity to place of work, and the relationship between home, community and land-use have resulted in rural domestic buildings losing specific regional distinctions. The primary house type on offer through the volume house building market is homogenised materially, structurally and spatially, lacking any relationship to place. The aim of this research was to generate new spatial models of autarkic housing and alternative massing arrangements that responded to land-use, density, energy, landscape and Scottish policy frameworks. The main objective in the study was to generate alternative, semi-quantifiable models that integrated the above requirements within holistic conceptual frameworks for rural sustainable living and which could then be used as a primer for further research and development.*

*KEYWORDS: Architecture, Autarky, Rural, Regional, Low-energy*

### **1. INTRODUCTION**

The design and form of housing and its relationship to people, place and work, is key to creating sustainable low-carbon communities. Appropriate housing is an intrinsic component in the establishment of an integrated economic and sustainability framework that is needed to achieve low carbon regions, as first proposed by urban planner and sociologist Patrick Geddes in The Regional Plan in 1909 [1]. The domestic sector also accounts for nearly one third of all energy consumption and consequently has a significant role to play in reducing reliance on carbon-intensive generation while sustaining living standards and managing the protection of natural resources if climate change targets are to be met [2].

With the aim of mitigating the impact that predicted climate change will have on our cities, land uses and infrastructural systems, more robust planning legislation governing the quality of our built environments and more onerous energy efficiency standards are making incremental improvements to new and existing building stock. To date much of this focus has been on technical improvements to building fabric efficiency and the adoption of Low and Zero Carbon Generating Technologies (LZCGTs) [3]. However, material and technical design considerations are only one aspect of resource efficiency.

The majority of housing in the UK is driven by speculative development led by commercial sector developers and volume house builders, resulting in

largely standardised housing models and development morphologies. Housing shortages have led to increasing pressure to develop agricultural land in accessible rural areas. However, the physical outcomes are similar irrespective of place and the broader socio-economic, sustainability and local energy contexts. There is an urgent need to rethink current practices due to the disconnect between planning, carbon abatement, energy efficiency and design quality policies at regional, local and applied scales. A step change would require alternative development practices, new housing typologies and development morphologies in order to fully integrate buildings and people within a regional low-carbon strategy and deliver the equitable and sustainable low-carbon neighbourhoods and communities that we need to take us through the 21st century.

This paper explores these issues through the examination of a conceptual case study for a new autarkic rural community at Cottown in the Carse of Gowrie, Scotland. The architectural designs propose new typological models and alternative sustainable spatial arrangements for low-energy rural housing that respond to higher density planning, creating hybrid land-use, innovative housing models, integrated renewable energy provision and new formal regional languages.

# PLEA 2018 HONG KONG

*Smart and Healthy within the 2-degree Limit*

## 2. SUSTAINABLE PLACE-MAKING AND SELF-SUFFICIENCY

In June 2014 the Scottish Government published its National Performance Framework 3 (NPF3) [4] and updated Scottish Planning Policy (SPP) [5] documents which set out the spatial development priorities and the policies to deliver them over the next 20 – 30 years. The outcomes are designed to deliver a “more successful country, with opportunities for all of Scotland to flourish, through increasing sustainable economic growth” [4]. The development outcomes to help realise this ambition, are stated as being: a successful, sustainable place; a low carbon place; a natural, resilient place and a more connected place. In all of these outcomes, ‘place’ is the key recurring development theme. Good quality places, in their widest sense, are the foundation to our well-being on both a societal and individual level. Scotland’s population is predicted to increase by 5.3% from 5.40 million in 2016 to 5.69 million in 2041, meaning the solutions for meeting housing demand need to be integrated with alternative approaches to land use and public space to correspond with the aims for successful places [6].

While previous studies have assessed built form through analysis of specific formal attributes, for the purposes of this study there is a need to consider the relationship between built form and landscape in terms of its integration of land-use, its formal reading in the landscape, passive design approaches and renewable energy generating technologies [7].

In FARMAX: Excursions on Density (1998) [8] Koek, Maas and Rijs proposed new models and forms of development based on Floor Area Ratio (FAR): the maximisation of the ratio of gross floor area of a building to the total size of its plot thereby unlocking a site’s potential through releasing plot area for other economic, social or sustainability enterprises. These models rely on increased density, concentrated land use with mixed economics and in some cases new hybrid-typologies of urban and agricultural zoning, offering the possibility for communities to be self-sufficient in their resources and needs.

Recently emerging from central Europe, autarky, the quality of being self-sufficient, potentially provides a new sustainable, economic model for rural living that could reverse recent high-carbon settlement practices and the associated costs of rural home ownership through the development of settlements which integrate living and working practices for the benefit of the individual and the wider community [9]. Energy balancing through local renewable energy generation and storage is central to the concept as it provides the economic means for building community resilience and provides limitations to sustainable growth based on energy availability.

## 3. RESEARCH AIMS AND METHODS

The aim of this research was to generate new spatial models of autarkic housing and alternative massing arrangements that responded to land-use, density, energy, landscape and Scottish policy frameworks. The main objective in the study was to generate alternative, semi-quantifiable models that integrated the above requirements within holistic conceptual frameworks for rural sustainable living and which could then be used as a primer for further research and development. The methodology is based on work by RIBA/CABE in their study of future housing predictions ‘Housing Futures 2024’ [10]. The research has been a mixed methods approach with the design process forming a major part of the research method. It is informed by quantitative data and provides the means by which data was generated for analysis. Design is an iterative process in which the implications of different decisions are weighed against each other in an informal evaluation process, until an optimum solution is arrived at. The criteria used in design development are typically both quantitative and qualitative in nature and the relative importance of each issue is often open to the personal bias of the designer. In light of this inherent subjectivity the designs were tested against specific quantifiable measures to give resistance to the decision-making process, which included energy performance, density and floor areas. The scope of the research, developed in collaboration with industry stakeholders and specialist consultants, addresses the relationships between affordability, energy security, food cultivation, sustainable construction techniques, regional identity and spatial quality.

### 3.1 Research Context

The Carse of Gowrie is an area of low lying agricultural land, small towns and hamlets sitting along the banks of the River Tay between the cities of Dundee and Perth. Classed as Accessible Rural, the Perth & Kinross region is expected to encounter an increase of 18% in the number of households by 2039, which will have significant implications for housing demand and type in this area as the need for large family homes decreases [11]. The Carse of Gowrie has a long history of being self-sustaining through thriving agriculture, renowned orchards and locally sourced materials, its southern aspect and low rainfall offering ideal growing conditions making it prime high value agricultural land. The Local Development Plan identifies potential development sites for the provision of housing and employment through expansion of existing settlements to strengthen infrastructure and networks. Development sites have been identified which reinforce the ribbon development which forms the village of Cottown, a small collection of houses distributed along two minor roads approximately 8 miles to the east of Perth. The larger of the development sites,



# PLEA 2018 HONG KONG

*Smart and Healthy within the 2-degree Limit*

at approximately 0.9 hectares, is located to the north west of the village, with existing houses to the east and agricultural land typical of the area to the west. Orchards were first planted in the area by Cistercian monks in the 12th century with production from over 50 commercial orchards reaching its peak in the early 19th century. There is a particularly high concentration of surviving mud wall structures in the area due to the drier climate on the east of Scotland. The success of local industries brought an influx of workers and their families to the area, resulting in an urgent need for housing, the solution being to use locally sourced clay, timber and Tay River reed thatch, a sustainable method of construction which is synonymous with the Carse of Gowrie. The Old Schoolhouse, one of the surviving mud wall structures in the area, influenced research into the development of contemporary sustainable communities which address land-use as well as built form, assessing local planning policies in relation to housing with the aim of developing strategies for the hamlet based on autarkic principles.

## 4. RESULTS

### 4.1 Energy Generation

Research into existing Scottish Government legislation regarding fuel poverty and micro generation identified a secure, renewable strategy for the Cottown proposals through establishment of a low carbon community energy generation structure. Research led to a micro CHP plant using local reeds as a fuel source as the most appropriate low-carbon option in that it offered economic and social benefits in addition to efficient energy generation. The Tay Reed Bed is home to rare species of birds and insects, and requires cropping annually to sustain this fragile ecosystem. Each hectare of reeds can produce 5 tonnes of dried matter annually, which provides a potential energy content of 21MWh/t/Ha, making the potential for reeds as a fuel source for a CHP plant in conjunction with thermally efficient housing a viable proposition [12]. Bailing the reeds, as opposed to transporting the reeds to England for compaction into pellets, would reduce carbon emissions, promote local employment and contribute further to the local economy. By sizing the CHP plant to meet the heat demand of the proposed housing, a surplus in electricity is generated which can be exported to the National Grid and could generate up to £12,000 per annum in Feed-In Tariffs. This sum could be used for community use, in employing a manager to run the CHP system, reducing bills, or reinvesting in community facilities. Three standards of fabric efficiency were analysed: Code for Sustainable Homes Level 6 at 46 kWh/a m<sup>2</sup>; Code for Sustainable Homes Level 6 + Mechanical Ventilation and Heat Recovery (MVHR) with airtightness to Passivhaus standard at 34 kWh/a m<sup>2</sup>; and Passivhaus at 15 kWh/a m<sup>2</sup>, which was used to calculate

the number of units/developments that could be supplied with sustainable energy.

### 4.2 Procurement

The number of dwellings and their energy efficiency was determined to establish the total energy demand and having confirmed housing density through contextual analysis of existing housing developments in the local area, the plot density of 40 dwellings per hectare was adopted as an economically viable model. Evaluating the site to keep the total number of units constant but using this urban density of 40 dwellings per hectare facilitated a reduced development footprint which provided the opportunity to release land for other community purposes such as subsistent farming practices and shared facilities (Figure 1).

**PRIORY GRANGE DEVELOPMENT**  
Year: 2006-2014  
Developer: Muir Homes / Barratt Homes  
No. of Houses: 200  
Area of Site: 9.6Ha.  
Dwellings per hectare (DPH): 20  
House Types: Detached houses  
Typical market price: 3 bed £139,995

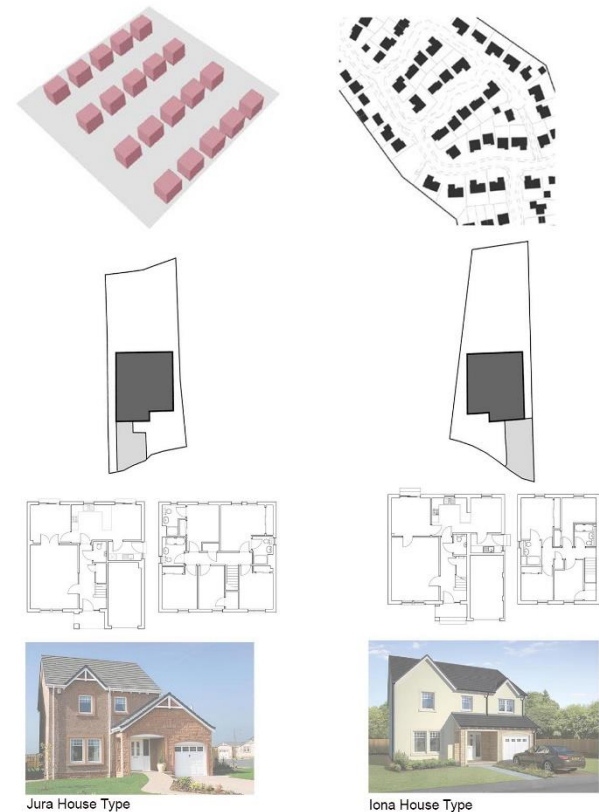

Figure 1: Typical mass market rural housing types and development morphology

The strategic proposals investigated the possibility for like-minded individuals to lead housing procurement as a group, thereby directing funds into raising spatial design quality rather than forming the developer's profit and through shared facilities reduce the costs of essential services. Alternative procurement methods were

# PLEA 2018 HONG KONG

*Smart and Healthy within the 2-degree Limit*

investigated which allowed the opportunity to re-evaluate the relationships between public and private realms, shared/community spaces and private gardens with all the proposed house types offering defined, private external space as well as access to shared areas. This approach inevitably led to considerations of how to resolve the massing, formal and spatial issues of developing to urban densities in a rural location of high aesthetic landscape value and creating an identity for the development that responded to and intensified the intrinsic aesthetic relationships between built form and landscape particular to the Carse of Gowrie context.

## 4.3 Identity

Historically, rural building forms were largely influenced by immediately available materials, climate and specific use, resulting in regionally identifiable typologies. Maudlin noted that in Scotland traditional single storey dwellings with walls of mud or stone and roofs of thatch or turf were "integrated structures within the landscape" in that they were directly connected to the land through material, orientation and form [13]. More recently, however, characteristics of rural domestic buildings have lost specific regional distinctions due to the mono-cultural suburban residential model currently implemented by volume house-builders in Scottish rural areas. Unlike the regional characteristics apparent in traditional rural buildings, suburban development follows an essentially predefined development strategy irrespective of where it is implemented geographically. This type of development is having a detrimental impact on areas such as the historically significant Carse of Gowrie, where existing characteristics are at risk of being lost as housing development follows a generic architectural language.

As well as over 40 examples of mud wall construction in the Carse of Gowrie area, more recent typologies with specific rural characteristics include the range of buildings which characterise large country estates and farms. The farm typology is a hybrid of key buildings of different scale and hierarchy, with particular relationships to the form of the landscape in terms of topography and orientation. The detached farm house, steading clusters protecting working courtyards, walled gardens, row housing, agricultural barns and silos all retain particular architectural qualities representative of their location and use.

## 4.4. Design Proposals

Research and analysis of existing types in the Cottown area, specifically the agricultural barn, walled garden and farm steading, was carried out to identify key characteristics and principles for use in generating place-specific proposals in response to generic volume house development. Taking inspiration from the regional sustainable building traditions exemplified by the

existing mud wall and thatch Schoolhouse and the key characteristics of existing rural building types, the research led to three spatially differentiated concepts integrating energy autarkic solutions, with higher density planning and new regional languages that respond to the unique landscape of the Carse of Gowrie: Skinny Barn; Community Farm; Walled Garden (Figure 2).



Figure 2: Vernacular rural farm infrastructure and new development forms

### Skinny Barn

The Skinny Barn proposal investigates the typology of the regionally identifiable agricultural barn, allowing for higher housing density to be achieved while maintaining a recognisable rural language. The built form is located to the west of the site, releasing land for cultivation towards the east. A protected, car-free, courtyard forms a series of controlled spaces between the varied house types, offering shared greenhouses, raised planters, seating, play areas, tool storage and main entrances to all houses. These pockets of external space relate to activities in the different house types forming the perimeter - the living spaces of the 3 and 4 bedroom types, and the shared facilities located at the entrances to the courtyard. Vehicular access is limited to the north and south edges of the development, with car parking located below maisonettes, maximising pedestrian ownership of the site. Pows, drainage ditches common to the area, define the built form in the landscape and separate public and semi-public areas. The land released to the east of the development site as a result of the higher density approach offers allotments and tool storage for use by the existing Cottown community as well as those living in the new development, connecting the existing and new communities (Figure 3a).

### Community Farm

The Community Farm proposal integrates housing with glasshouses, the built forms protecting and defining areas for cultivation of food. The u-shape forms repeated across the site create a more private courtyard for family use with a direct relationship to ground floor living

# PLEA 2018 HONG KONG

*Smart and Healthy within the 2-degree Limit*

spaces, while the spaces between the built forms frame the areas for growing crops. Lean-to glasshouses sit at the gable ends of the housing, inspired by traditional Edwardian and Victorian examples in using the thermal mass of the supporting wall to contribute to sustaining higher temperatures for growing. The glasshouses have several key purposes: the annual growing period is extended, and crops which may not survive outdoors can be cultivated for home consumption; the intakes for the MVHR system are located in the glasshouses, so pre-heating the air and reducing the amount of energy required to get the air to ambient temperature; and semi-outdoor spaces are offered as an extension to the living spaces, offering an alternative 'winter garden' for the inhabitants. Vehicular access is limited to the edges of the development, keeping the family courtyards and growing areas car-free. The pitched roof forms reference agricultural buildings in the area, with pows reinforcing the reading of each form in the landscape, ensuring the mass is comparable with existing buildings in the area (Figure 3b).

## Walled Garden

The Walled Garden proposal is directed by one of the characteristic elements of landed property in the Carse of Gowrie, forming a contemporary reinterpretation of the walled garden typology. Substantial country estates in the area included various forms of enclosed gardens for cultivation, social activities and education. As country estates have diversified and reduced in scale, new buildings have been located within walled gardens to accommodate a range of private or commercial uses while the perimeter wall remains a constant, recognisable element in the landscape. The proposal places individual houses in a row to generate the perimeter wall, the collective mass forming a recognisable form in the landscape, enclosing and protecting a secluded space for subsistent living, community use and the reintroduction of the orchards which were historically prevalent in the Carse of Gowrie. The envelope formed by the row houses conceals the garden at the heart of the development, from which the natural horizon is only glimpsed at specific points. The enclosed garden becomes the primary focus, an external room of a different scale to the rural landscape. Vehicular access is limited to the external perimeter of the wall, with each house having an associated parking area on the bridge crossing the pow, adjacent to the main entrance. Pows running round the perimeter of the boundary wall emphasise the reading of the wall as an object in the rural landscape, giving the development identity and mass when viewed from a distance to relate to existing rural forms (Figure 3c).

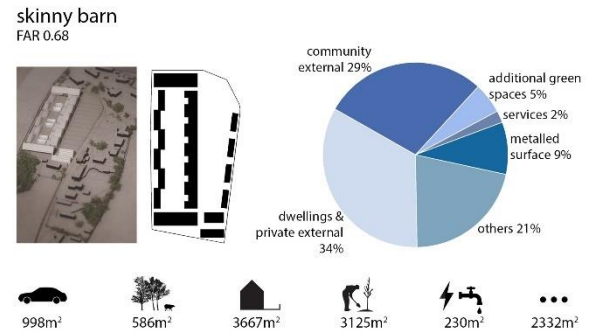

Figure 3a

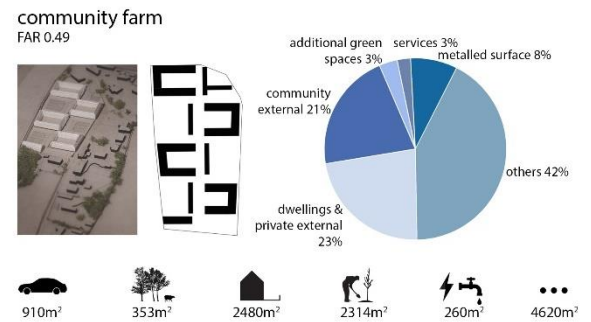

Figure 3b

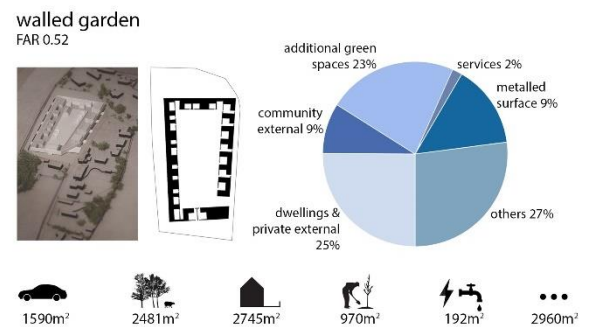

Figure 3c

Figure 3: (3a) Skinny Barn, (3b) Community Farm and (3c) Walled Garden landscape infrastructure analysis

## 5. CONCLUSION

With the built environment contributing to 37% of carbon emissions, fuel poverty in rural Scotland reaching up to 40% in some areas, and a net annual shortfall of 574 affordable houses in the Perth and Kinross area alone, there is an urgent need for more innovative solutions to the problem of housing provision. The future sustainable, equitable, low- and zero-carbon communities that will be required to deliver this need alternative forms of housing of all tenures with mixed land uses and economies that are simply not provided by the current mass-market housing mix. A deeper understanding at regional and individual levels of the underlying cultural, environmental and economic requirements of communities may generate more appropriate development frameworks and architectural responses to low-carbon rural living. Autarky principles emerging from central Europe offer a possible answer to

# PLEA 2018 HONG KONG

*Smart and Healthy within the 2-degree Limit*

the challenge of rural housing in that low-carbon energy self-sufficiency can catalyse sustainable economic development providing resilience and the necessary economic means for inward investment in local community infrastructure whilst contributing to regional energy generation requirements through renewable energy exports. However, this will require reconsideration of policy and regulation at national and regional levels across planning, building regulations and procurement policy.

Changes in some areas are being made, and the presented research supports recent changes in Government legislation which cater for an alternative market to developer-led speculative development. Scottish communities now have the opportunity to use the Community Right to Buy process under the Community Empowerment (Scotland) Act 2015 [14] to form a collective body and apply to develop land, buildings and spaces to meet the needs of local inhabitants. As communities rather than individuals or companies begin to buy larger pockets of land for development, procurement methods and forms of housing will need to diversify. These changes offer a people-led alternative, similar to more established central European examples such as the German Baugruppe model where like-minded individuals form 'building groups' to develop community-orientated housing with shared facilities. These are inherently more sustainable in use of material resources and land use, and the community-led approach can offer ownership of public space with the potential to create the successful places Scottish government policies intend.

Whilst the proposals for this small development site at Cottown in the Carse of Gowrie take different formal approaches, a number of common architectural issues have emerged from the study. Density and intensive use of land are needed to create clearly defined hierarchies and high quality external spaces. In all schemes, clustering of the built fabric allows very precisely defined public space with clear boundaries and thresholds whilst achieving higher densities than suburban models. The perception of enclosure (and therefore density) is generated by the boundary walls and drainage pews. A more intensive use of land pockets relieves pressure on remaining land which can be released for alternative uses: green-space; wildlife corridors; swales; waterways; farming and allotments. An ordered landscape framework, based not on the primacy of the car but on alternative land uses can achieve a scale of association with the existing rural landscape with built densities more in-keeping with the existing village and surrounding non-domestic agricultural infrastructure, and offer sustainable ways of living and working.

## REFERENCES

1. Mellor, H., (1990). Patrick Geddes: Social Evolutionist and City Planner, Routledge, USA, p156-157
2. Department of Energy and Climate Change, (2014), Energy Consumption in the UK, London, p5
3. The Scottish Government, (2013), Building Standards Technical Handbook (Scottish Government 2013), Edinburgh
4. The Scottish Government (2014), National Performance Framework 3, Edinburgh: APS Group
5. The Scottish Government (2014), Scottish Planning Policy, Edinburgh: APS Group
6. National Records of Scotland (NRS), (2017a), Projected Population of Scotland 2016-based, Edinburgh, p2, accessed 02.06.2018:  
<https://www.nrscotland.gov.uk/files//statistics/population-projections/2016-based-scot/pop-proj-2016-scot-nat-pop-prob.pdf>
7. Steadman, P., Bruhns, H.R., Rickaby, P.A. & Brown, F.E., A (2000), *Classification of Built Forms, Environment and Planning B: Planning and Design 2000*, volume 27, p73-91, Pion, UK.
8. Koek, R., Maas, W., & Van Rijs, J., (1998), *FARMAX: Excursions on Density*, MVRDV and 010 publishers, Rotterdam, p1-10
9. Zammer, J., (2005), *Voralberg, Austria: the Land of a New Alternative Development*, Conf. Proc., PLEA 2005, The 22nd Conference on Passive and Low Energy Architecture, Beirut
10. Worthington, J. (2004). *Housing Futures 2024: A Provocative Look at Future Trends in Housing, Building Futures*, CABE / RIBA, London, England
11. National Records of Scotland (NRS), (2017b), *Household Projections for Scotland 2014-based*, Edinburgh, p22, accessed 02.06.2018:  
<https://www.nrscotland.gov.uk/files//statistics/household-projections/2014-based/2014-based-household-projections.pdf>
12. Komulain, K., Simi, P., Hagelberg, E., Ikonen, I., Lyytinen, S., (2008), *Reed Energy: Possibilities of using the Common Reed for energy generation in Southern Finland*, Turku University of Applied Sciences, Finland, p17
13. Maudlin, D., (2009), *The Legend of Brigadoon: Architecture, Identity and Choice in the Scottish Highlands*, TDSR Volume XX Number II, p2
14. The Scottish Government (2015), Community Empowerment (Scotland) Act 2015, ASP6, Edinburgh, accessed 06.06.18, Available at:  
[http://www.legislation.gov.uk/asp/2015/6/pdfs/asp\\_20150006\\_en.pdf](http://www.legislation.gov.uk/asp/2015/6/pdfs/asp_20150006_en.pdf)

\*All figures authors' own.

# Impact of Urban Air Pollution on Occupants' Visual Comfort, Alertness, Mood in an Office with Various Glazing Systems: An Investigation in Beijing

XIAODONG CHEN<sup>1</sup>, XIN ZHANG<sup>1</sup>, JIANGTAO DU<sup>2</sup>

<sup>1</sup>School of Architecture, Tsinghua University, Beijing, China

<sup>2</sup>School of Built Environment, Liverpool John Moores University, Liverpool, UK

**ABSTRACT:** Urban air pollution is currently one of the top 10 worst pollution problems in China. It can not only worsen indoor air quality but also substantially reduce daylight availabilities in buildings, both of which are directly linked to occupants' health and well-being. This article presents results of a winter experiment focusing on testing human performances in a daylit office room with three various glazing systems in Beijing. The impact of external air pollution on occupants' visual comfort, alertness and mood is the research focus. Some important findings can be achieved as follows: 1) Urban air pollution can significantly reduce the indoor daylighting availability; 2) Urban air pollution would significantly affect occupants' performances. 3) The impact varies in window glazing type and colour. Most importantly, it seems that a properly selected glazing system could mitigate the negative impact of urban air pollution on human performances.

**KEYWORDS:** Air pollution, Visual comfort, Alertness and mood, Glazing systems, Office

## 1. INTRODUCTION

Several surveys have exposed that there is a substantial link between daylighting and visual performance, alertness, and mood in offices [1-4]. Based on subjective assessments, two studies showed that the glazing systems may have a significant effect on visual and non-visual performances of office workers [5-6]. Figueiro & Rea [2] pointed out that more investigations would be required in order to further clarify how daylight regulates sleep and mood, especially in working places. Currently, urban air pollution is the world's top 10 worst pollution problems, especially in China [7]. It can not only worsen indoor air quality, but also significantly reduce daylight availabilities in buildings, both of which can affect occupants' health & well-being.

This study presents results of a winter experiment focusing on testing human performances (visual and non-visual aspects) in a daylit office room with various glazing systems in Beijing. The effect of external air pollution on occupants' visual comfort, alertness and mood is the research focus.

## 2. METHODS AND MATERIALS

Three parts were included in this section, such as room description and glazing types, subjective assessment, as well as lighting measurement and the approach used for displaying external air quality in urban areas.

### 2.1 Office room and glazing types

From 17th November 2016 to 11th January 2017, the experiment was conducted in an office of the School of

Architecture at Tsinghua University in Beijing. On average, this city has the annual sunshine hours of 2707. Figure 1 shows room plan and dimensions, window, and sitting positions. This room has a dimension of 6.3 × 3.2 × 3.6 m and its surface reflectances are: 0.3 (floor), 0.88 (wall), and 0.88 (ceiling). Two spaces are separated as one testing room (length 4.6m) and the preparation room (length 1.7m). This office has only one side window facing south, and several sitting positions including A1 & A2 (working places for participants), B (for the person who conducted measurements and controlled the experiment). Three types of glazing were individually applied at the window, including clear, bronze and blue. Their visual transmittance (VT) values are 0.92, 0.37 and 0.55 respectively.

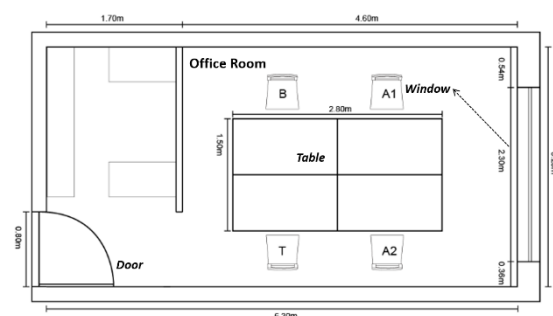

Figure 1: Room plan and dimension, window, and sitting positions.

### 2.2 Participants and subjective assessments

Seventeen participants were recruited from the university students and staffs (mean age: 22.68 ±1.8

# PLEA 2018 HONG KONG

*Smart and Healthy within the 2-degree Limit*

years). No participants should have medical and psychiatric diseases and sleep disorders. All participants were required to attend the experiment during a normal work schedule (8:30 – 16:00). The daily experiment was divided into two time-slots: 08:30-11:30 and 13:00-16:00, with a 1.5 hours lunch break in between. In order to control prior light exposure, each participant was asked to start his/her sleep earlier than 23:00 at the night before the testing day. During the experiment, the participants were just allowed to carry out regular office work in the office room, such as reading, writing, typing, etc. No food and drinks with caffeine or similar content can be taken on the testing day.

Two VAS (visual analogue scale [8], 0-100mm) questionnaires were adopted to assess visual and non-visual performances. The questions for visual performance are: VQ1, Room lighting is comfortable? (0mm, extremely uncomfortable; 100mm, extremely comfortable); VQ2, Room is bright? (0mm, very bright; 100mm, OK); VQ3, Room is dark? (0mm, very dark; 100mm, OK); VQ4, Glare? (0mm, intolerable; 100mm, Imperceptible); VQ5, Light colour is comfortable? (0mm, extremely uncomfortable; 100mm, extremely comfortable); VQ6, Colour appearance is proper? (0mm, absolutely not; 100mm, perfect). These questions were suggested and/or applied in two field surveys of lighting and human performances [4, 9]. In addition, four questions were used for assessing non-visual aspects: NVQ1, Alertness (0mm, extremely sleepy; 100mm, extremely alert); NVQ2, Mood (0mm, very bad; 100mm, very good); NVQ3, Physical well-being (0mm, very uncomfortable; 100mm, very comfortable); NVQ4, Relaxation (0mm, very tense; 100mm, very relaxed). Their applications were also reported in the study [4]. The use of such questions to investigate self-reported satisfaction of psychological and physiological well-being was supported by another study [10]. Each participant was asked to complete the two questionnaires every 45 minutes.

### 2.3 Lighting measurements and air quality index

The daylighting conditions were measured by a portable Illuminance Colour Spectral meter (SPIC-200). Each meter reading was recorded every 10 minutes. Three key values were available in this investigation: illuminances at the table and near the participant’s eyes (lux), and correlated colour temperature (CCT) near the eyes (K). No artificial lighting can be used in the experiment, even if the daylighting level was insufficient to meet the lighting standard at the working plane (e.g. late afternoon).

At the same time, a six-level air quality index (AQI) was used to justify the external air pollution level [11], such as excellent, good, lightly polluted, moderately polluted, heavily polluted, and severely polluted.

In addition, the indoor temperature and humidity were measured as a reference of thermal conditions.

### 3. RESULTS AND DISCUSSIONS

IBM\_SPSS (v23) was the data analysis package (measurement and questionnaire feedback). ANOVA and *Post Hoc* test were the main statistical approaches in terms of various analyses. The significance was achieved when  $p < 0.05$ .

#### 3.1 Measurement: Illuminance and CCT

Table 1 shows mean daylight illuminances and CCT measured near participants’ eyes and their standard error of the mean (SEM). Apparently, there were differences of illuminance and CCT between the three glazing systems. The largest illuminance was found with the clear glazing, whilst the blue glazing can bring in the highest CCT.

Table 1: Mean and standard errors of the mean of Illuminance and CCT at eyes

Mean ± SEM		
Glazing type	Illuminance_eye (lux)	CCT_eye (K)
Clear	1045.32 ±202.18	4472.23 ±26.85
Bronze	602.10 ±88.88	4007.39 ±59.36
Blue	711.03 ±102.90	5376.40 ±33.95

Figure 2 gives distributions of mean illuminance near eyes in terms of AQI levels. Based on one-way ANOVA analysis, it can be found: the indoor daylight illuminance received notable impact from AQI ( $F(5, 673)=8.94, p < 0.01$ ).

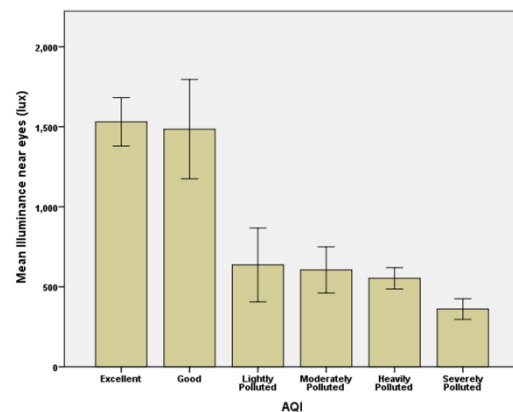

Figure 2: Mean illuminance values and external air quality.

Due to the unequal sample size of AQI, a *Post Hoc* test (Scheffe [12]) was conducted to compare various groups. Only the significant differences are reported in Table 2. ‘Excellent’ AQI had a significant difference in

# PLEA 2018 HONG KONG

Smart and Healthy within the 2-degree Limit

illuminance levels from ‘Severely Polluted’ & ‘Heavily Polluted’ conditions ( $p < 0.01$ ). There were also significant differences between ‘Good’ and ‘Heavily Polluted’ AQI ( $p < 0.05$ ). The measured illuminances between the groups without pollutions, and between the groups with pollutions, however, displayed no significant differences ( $p > 0.05$ ). The heavy air pollutions can significantly reduce the indoor daylighting levels near the eyes.

Table 2: Significant differences of mean illuminance between AQI groups (Post Hoc) ( $p < 0.05$ )

AQI(I)	AQI(J)	Mean Difference (I-J)	Std. Error	Sig.
Excellent	Heavily Polluted	977.10	197.23	0.00
Excellent	Severely Polluted	1169.83	245.27	0.00
Good	Severely Polluted	1124.43	330.04	0.04

### 3.2 Subjective feedback: visual effects

The feedback of six visual performance questions was assessed based on three types of glazing in this section (only significant main effects or differences are presented in figures and tables).

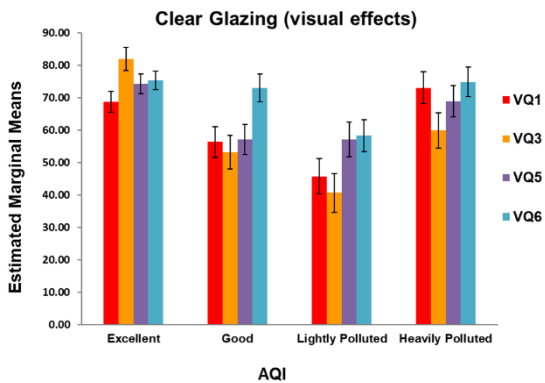

Figure 3: Mean values and standard errors of the mean of feedback of visual questions (clear glazing). ( $p < 0.05$ )

Table 3: Post Hoc test of mean differences of AQI groups (visual, clear glazing). ( $p < 0.05$ )

Q	AQI(I)	AQI(J)	Mean Difference (I-J)	Std. Error	Sig.
VQ1	Excellent	Lightly Polluted	22.97	6.32	0.01
VQ1	Lightly Polluted	Heavily Polluted	27.39	7.38	0.00
VQ3	Excellent	Good	28.78	6.29	0.00
VQ3	Excellent	Lightly Polluted	41.30	6.91	0.00
VQ3	Excellent	Heavily Polluted	21.98	6.46	0.01
VQ5	Excellent	Good	17.22	5.59	0.03
VQ6	Excellent	Lightly Polluted	17.08	5.73	0.03

With the clear glazing (Figure 3), significant main effects of four AQI levels (Excellent, Good, Lightly Polluted, and Heavily Polluted) can be found on four aspects of visual performance ( $p < 0.05$ ), including ‘Lighting Comfort’ (VQ1,  $F(3, 124)=6.42$ ); ‘Darkness’ (VQ3,  $F(3, 124)=15.38$ ); ‘Colour comfort’ (VQ5,  $F(3, 124)=4.56$ ); ‘Colour appearance’ (VQ6,  $F(3, 124)= 3.17$ ). There were no significant main effects on the ‘Brightness (VQ2) & Glare (VQ4)’ ( $p > 0.05$ ). As shown in Table 3, pairwise comparisons using Scheffe model demonstrated the differences. For VQ1, first, significant differences can be found between ‘Excellent’ and ‘Lightly Polluted’, and between ‘Lightly Polluted’ and ‘Heavily Polluted’ ( $p < 0.05$ ). The excellent air quality could make occupants feel more comfortable than the slightly polluted condition. The heavy pollutions did not bring in significant differences from the conditions of good & excellent air quality based on this issue ( $p > 0.05$ ). Second, the feedback of darkness (VQ3) was significantly different between ‘Excellent’ and ‘Good’ ( $p < 0.05$ ), and between ‘Lightly Polluted’ and ‘Heavily Polluted’ ( $p < 0.05$ ). For colour comfort and appearance (VQ5 & 6), third, the feedback with excellent air quality was significantly different from that with ‘Good’ ( $p < 0.05$ ) or ‘Lightly Polluted’ ( $p < 0.05$ ), and had no significant difference from ‘Heavily Polluted’ ( $p > 0.05$ ).

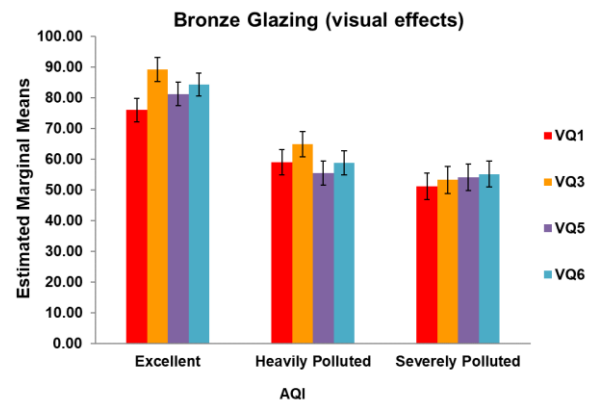

Figure 4: Mean values and standard errors of the mean of feedback of visual questions (bronze glazing). ( $p < 0.05$ )

Table 4: Post Hoc test of mean differences of AQI groups (visual, bronze glazing). ( $p < 0.05$ )

Q	AQI(I)	AQI(J)	Mean Difference (I-J)	Std. Error	Sig.
VQ1	Excellent	Heavily Polluted	17.00	5.58	0.01
VQ1	Excellent	Severely Polluted	24.79	5.82	0.00
VQ3	Excellent	Heavily Polluted	24.23	5.64	0.00
VQ3	Excellent	Severely Polluted	35.82	5.89	0.00
VQ5	Excellent	Heavily Polluted	25.77	5.52	0.00
VQ5	Excellent	Severely Polluted	27.15	5.76	0.00

# PLEA 2018 HONG KONG

Smart and Healthy within the 2-degree Limit

VQ6	Excellent	Heavily Polluted	25.43	5.45	0.00
VQ6	Excellent	Severely Polluted	29.13	5.68	0.00

For the bronze glazing, in Figure 4, only three AQI levels were available during the test: Excellent, Heavily Polluted and Severely Polluted. Similarly, the main effects of AQI on four visual aspects have been found as significant ( $p < 0.05$ ), such as 'Lighting Comfort' (VQ1,  $F(2, 121)=9.85$ ); 'Darkness' (VQ3,  $F(2, 121)=19.95$ ); 'Colour comfort' (VQ5,  $F(2, 121)=15.11$ ); 'Colour appearance' (VQ6,  $F(2, 121)=16.54$ ). It seems that no significant links can be observed between 'Brightness (VQ2) & Glare (VQ4)' and external pollution levels. Given Scheffe pairwise comparisons (Table 4), 'Excellent' air condition led to significantly different feedback from both 'Heavily and Severely Polluted' conditions in terms of VQ1, 3, 5 and 6 ( $p < 0.05$ ). In general, higher comfort levels of both lighting and colour (VQ1 & 5), fewer complaints of darkness (VQ3), more acceptance of light colour (VQ6) can be found with 'Excellent' AQI than the heavy pollution conditions ( $p < 0.05$ ). However, there were no significant differences of these issues between the two pollution conditions ( $p > 0.05$ ).

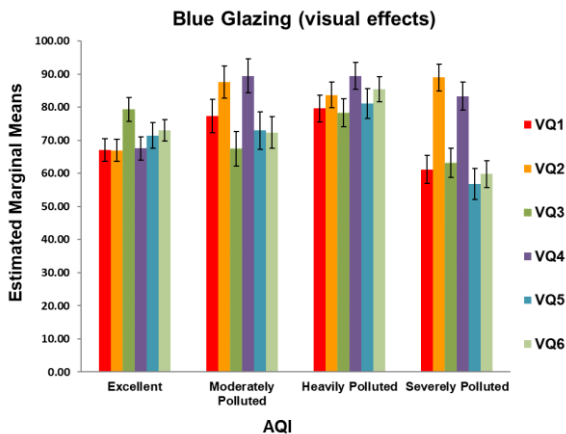

Figure 5: Mean values and standard errors of the mean of feedback of visual questions (blue glazing). ( $p < 0.05$ )

Table 5: Post Hoc test of mean differences of AQI groups (visual, blue glazing). ( $p < 0.05$ )

Q	AQI(I)	AQI(J)	Mean Difference (I-J)	Std. Error	Sig.
VQ1	Heavily Polluted	Severely Polluted	18.46	5.85	0.02
VQ2	Excellent	Moderately Polluted	-20.59	5.86	0.01
VQ2	Excellent	Heavily Polluted	-16.72	5.11	0.02
VQ2	Excellent	Severely Polluted	-22.01	5.25	0.00
VQ3	Excellent	Severely Polluted	16.22	5.69	0.05

VQ4	Excellent	Moderately Polluted	-27.66	6.17	0.00
VQ4	Excellent	Severely Polluted	-23.15	5.53	0.00
VQ5	Heavily Polluted	Severely Polluted	24.31	5.70	0.00
VQ6	Heavily Polluted	Severely Polluted	25.64	5.84	0.00

When using the blue glazing, four AQI levels were available: Excellent, Moderately Polluted, Heavily Polluted and Severely Polluted. In Figure 5, significant main effects of AQI were found for all six questions ( $p < 0.05$ ): 'Lighting Comfort' (VQ1,  $F(3, 129)=4.27$ ); 'Brightness' (VQ2,  $F(3, 129)=7.85$ ); 'Darkness' (VQ3,  $F(3, 129)=3.61$ ); 'Glare' (VQ4,  $F(3, 129)=10.35$ ); 'Colour comfort' (VQ5,  $F(3, 129)=6.21$ ); 'Colour appearance' (VQ6,  $F(3, 129)=6.44$ ). Furthermore, the *Post Hoc* (Scheffe) test in Table 5 displayed some results different from the clear and bronze glazing. For the feedback of lighting and colour comfort (VQ1, 5) and colour appearance (VQ6), there were no significant differences between 'Excellent' AQI and the three pollution conditions ( $p > 0.05$ ), while 'Heavily Polluted' significantly receives higher acceptance rates than 'Severely Polluted' ( $p < 0.05$ ). Normally, the feedback of 'Brightness & Darkness (VQ2 & 3)' showed 'Excellent' brought in a brighter lighting environment than other pollution conditions ( $p < 0.05$ ). Therefore, the pollutions (moderate & severe) conditions might deliver a lower possibility to get glare problem (VQ4) ( $p < 0.05$ ).

### 3.3 Subjective feedback: non-visual effects

The feedback of four non-visual questions was evaluated with three types of glazing as follows (only significant main effects or differences are presented in figures and tables).

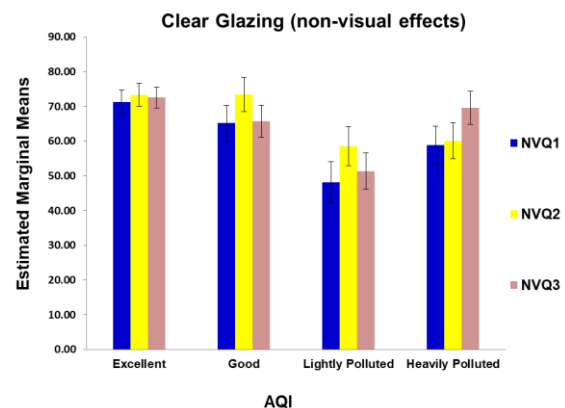

Figure 6: Mean values and standard errors of the mean of feedback of non-visual questions (clear glazing). ( $p < 0.05$ )



# PLEA 2018 HONG KONG

Smart and Healthy within the 2-degree Limit

Table 6: Post Hoc test of mean differences of AQI groups (non-visual, clear glazing). ( $p < 0.05$ )

Q	AQI(I)	AQI(J)	Mean Difference (I-J)	Std. Error	Sig.
NVQ1	Excellent	Lightly Polluted	23.07	6.91	0.01
NVQ3	Excellent	Lightly Polluted	21.17	6.05	0.01

As regards the clear glazing (Figure 6), significant main effects of four AQI levels (Excellent, Good, Lightly Polluted, and Heavily Polluted) can be observed on three aspects ( $p < 0.05$ ): 'Alertness' (NVQ1,  $F(3, 124)=4.09$ ); 'Mood' (NVQ2,  $F(3, 124)=2.97$ ); 'Physical well-being' (NVQ3,  $F(3, 124)=4.20$ ). The 'Relaxation (NVQ4)' was not significantly affected by AQI ( $p > 0.05$ ). The pairwise comparisons using Scheffe model (Table 6) supported that significant differences were only found for 'Alertness' and 'Physical well-being' between 'Excellent' and 'Lightly Polluted' conditions ( $p < 0.05$ ). It is normal that 'Excellent' AQI led to a more positive feedback on alertness and physical well-being. Similar to the visual feedback analysis above, there were no significant differences between 'Excellent' or 'Good' AQI and 'Heavily Polluted' condition for all the four aspects ( $p > 0.05$ ).

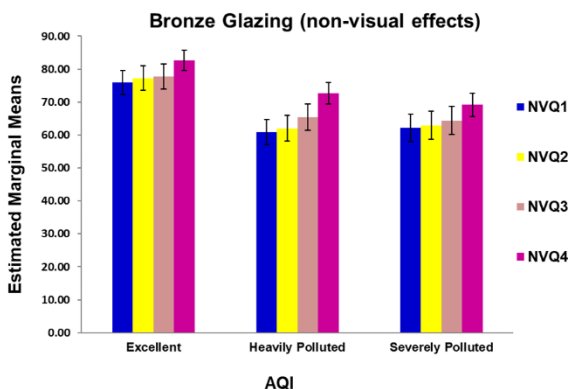

Figure 7: Mean values and standard errors of the mean of feedback of non-visual questions (bronze glazing). ( $p < 0.05$ )

Table 7: Post Hoc test of mean differences of AQI groups (non-visual, bronze glazing). ( $p < 0.05$ )

Q	AQI(I)	AQI(J)	Mean Difference (I-J)	Std. Error	Sig.
NVQ1	Excellent	Heavily Polluted	14.99	5.31	0.02
NVQ1	Excellent	Severely Polluted	13.78	5.53	0.05
NVQ2	Excellent	Heavily Polluted	15.24	5.47	0.02
NVQ2	Excellent	Severely Polluted	14.32	5.70	0.05
NVQ4	Excellent	Severely Polluted	13.47	4.67	0.02

For the bronze glazing (Figure 7), significant main effects of AQI were found for four non-visual aspects as follows ( $p < 0.05$ ): 'Alertness' (NVQ1,  $F(2, 121)=4.90$ ); 'Mood' (NVQ2,  $F(2, 121)=4.85$ ); 'Physical well-being' (NVQ3,  $F(2, 121)=3.54$ ); 'Relaxation (NVQ4,  $F(2, 121)=4.67$ ). Three AQI levels (Excellent, Heavily Polluted and Severely Polluted) were available for this test. In Table 7, the Scheffe process displayed that significant differences between 'Excellent' and 'Heavily Polluted' or 'Severely Polluted' occurred at the questions of NVQ1, 2 and 4 ( $p < 0.05$ ). For occupant's alertness and mood, normally, excellent air quality will achieve more positive feedback than seriously polluted air conditions. In addition, occupants will feel less stressful with the improved air quality than the conditions of heavily polluted air. However, the NVQ3 'Physical well-being' did not see significant differences between various AQI levels ( $p > 0.05$ ).

In Figure 8, the experiment using the blue glazing has four AQI levels available: Excellent, Moderately Polluted, Heavily Polluted and Severely Polluted. Similar to the bronze glazing, significant main effects of AQI were found at four non-visual questions ( $p < 0.05$ ): 'Alertness' (NVQ1,  $F(3, 129)=4.93$ ); 'Mood' (NVQ2,  $F(3, 129)=5.0$ ); 'Physical well-being' (NVQ3,  $F(3, 129)=5.16$ ); 'Relaxation (NVQ4,  $F(3, 129)=3.37$ ). As the pairwise comparisons (Scheffe) in Table 8, for 'Alertness & Mood', there were significant differences between 'Excellent' and 'Heavily Polluted' ( $p < 0.05$ ), and between 'Moderately Polluted' and 'Heavily Polluted' ( $p < 0.05$ ). In comparison to excellent and moderately polluted air, interestingly, the heavy pollution conditions would significantly get participants' feedback of alertness and mood moving towards the positive side. For 'Physical Well-being & Relaxation', significant differences can be found between 'Moderately Polluted' and 'Heavily Polluted' ( $p < 0.05$ ). The heavy pollution could achieve more positive feedback than moderate pollution condition based on the two aspects. However, 'Severely Polluted' level can give rise to a significantly lower score on 'Mood and Physical well-being' than 'Heavily Polluted' condition ( $p < 0.05$ ). Generally, for all non-visual aspects, the effects of excellent air quality were similar to moderately polluted air quality ( $p > 0.05$ ).

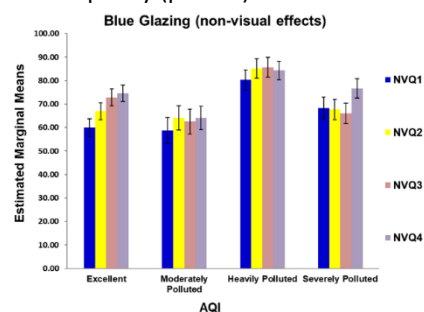

Figure 8: Mean values and standard errors of the mean of feedback of non-visual questions (blue glazing). ( $p < 0.05$ )

# PLEA 2018 HONG KONG

*Smart and Healthy within the 2-degree Limit*

Table 8: Post Hoc test of mean differences of AQI groups (non-visual, blue glazing). ( $p < 0.05$ )

Q	AQI(I)	AQI(J)	Mean Difference (I-J)	Std. Error	Sig.
NVQ1	Excellent	Heavily Polluted	-20.24	5.81	0.01
NVQ1	Moderately Polluted	Heavily Polluted	-21.51	7.03	0.03
NVQ2	Excellent	Heavily Polluted	-18.19	5.51	0.01
NVQ2	Moderately Polluted	Heavily Polluted	-21.06	6.67	0.02
NVQ2	Heavily Polluted	Severely Polluted	17.44	6.05	0.04
NVQ3	Moderately Polluted	Heavily Polluted	-23.10	6.72	0.01
NVQ3	Heavily Polluted	Severely Polluted	19.61	6.10	0.02
NVQ4	Moderately Polluted	Heavily Polluted	-20.20	6.42	0.02

### 3.4 Discussions

Results above could be explained based on psychological adaptation [13], daylight illuminances, and light colour (CCT). Participants easily noticed any change of external air quality through the clear and blue glazing (reflected by atmospheric visibility [14]). Given the finding of air pollution adaptation [15], visual detection of air pollution is a complex problem, and the perceptual sensitivity of air pollution would tend to decrease with the increasing exposure time. The lightly pollution situation was newly developed from the stage of good air quality, while the heavy pollution was the pollution accumulation across a period. In addition, heavily polluted external air might influence participants' perceptions and cognitions so that they might feel more satisfied with staying indoors. The bronze glazing delivered low mean illuminances and CCT to participants' eyes (Table 1). In a relatively darker space, participants might be highly sensitive to the incident daylight. Since the higher external air quality can lead to higher daylighting availability (Figure 2), excellent AQI would improve participants' satisfaction via increasing the daylight illuminances [1]. The blue glazing brought in a higher CCT (5300K) (Table 1). It has been found that the dominant short-wave stimulus would enhance sensitivities of visual functions (brightness, glare), and improve the alertness and mood [16]. Even with the heavy air pollutions, CCT above 5000k would keep participants with higher alertness and good mood in the working space.

Limitations: The impact of weather conditions on daylight illuminance was not fully considered in the discussion. The measures used for non-visual feedback could be relatively simple.

### 4. CONCLUSION

Several findings can be drawn as follows: 1) Urban air pollutions can reduce indoor daylight availability. Significant reduction could be only found with the heavy air pollution. 2) Urban air pollution would significantly impact on occupants' visual performance, alertness, physical wellbeing, and mood in offices. The effects vary in the window glazing type and colour. With the clear glazing, significant effects on comfort, mood, and alertness were only observed when the lightly polluted air occurred. However, the heavy air pollution combined with the bronze glazing would bring in significant detrimental effects on occupants' visual performances. Interestingly, the blue glazing might mitigate the negative effects of heavy urban air pollution on occupants' performances, especially in terms of comfort, alertness and mood.

### ACKNOWLEDGEMENTS

The authors would thank NSFC (National Science Foundation of China) for the funding support through a project of 'Fundamental studies of non-visual and biological effects of daylight on the sleeping and alertness in young and middle-aged adults' (no. 51778322).

### REFERENCES

1. Aries, M.B.C., Aarts, M., Hoof, J., (2015). Daylight and health: A review of the evidence and consequences for the built environment. *Lighting Research & Technology*, 47: p. 6-27.
2. Figueiro, M.G., Rea, M.S., (2016). Office lighting and personal light exposures in two seasons: Impact on sleep and mood. *Lighting Research & Technology*, 48(3): p. 352-364.
3. Figueiro, M.G., Kalsher, M., Steverson, B.C., Heerwagen, J., Kampschroer, K., Rea, M. S., (2018). Circadian-effective light and its impact on alertness in office workers. *Lighting Research & Technology*, 0: p. 1-13.
4. Borisuit, A., Linhart, F., Scartezzini, J-L., Munch, M., (2015). Effects of realistic office daylighting and electric lighting conditions on visual comfort, alertness and mood. *Lighting Research & Technology*. 47(2), 192-209.
5. Arsenaault, H., Hébert, Marc., Buboiss, M-C., (2012). Effects of glazing colour type on perception of daylight quality, arousal, and switch-on patterns of electric light in office rooms. *Building and Environment*. 56: p. 223-231.
6. Zhang, X., Chen, X., Du, J., (2017). A Pilot Study of Effects of Coloured Glazing Systems in a Daylit Office: Visual Comfort, Alertness, Mood and Wellbeing. In *The 33th Conference of Passive and Low Energy Architecture*. Edinburgh, July 03-05.
7. He, K.B., Huo, H., Zhang, Q., (2002). Urban air pollution in China: current status, characteristics, and progress. *Annual Reviews of Energy and the Environment*. 27(1):397-431.
8. Monk, T.H., (1989). A visual analogue scale technique to measure global vigor and effect. *Psychiatry Research*, 27, 89-99.
9. Akashi, Y., Boyce, P.R., (2006). A field study of illuminance reduction. *Energy and Buildings*, 38: 588-599.

# PLEA 2018 HONG KONG

*Smart and Healthy within the 2-degree Limit*

10. Ryan, R.M., Frederick, C., (1997). On energy, personality, and health: Subjective vitality as a dynamic reflection of well-being. *Journal of Personality*, 65(3): 529–565.
11. Air Pollution in World: Beijing [Online], Available: <http://aqicn.org/city/beijing/cn/> [17 Nov 2016].
12. Ruxton, G.D., Beauchamp, G., (2008). Time for some a priori thinking about post hoc testing. *Behavioral Ecology*. 19(3): 690-693.
13. Schmitt, D.P., Pilcher, J.J. (2004). Evaluating Evidence of Psychological Adaptation. *Psychological Science*. 15(10): 643-49.
14. Malm, W. C., (1999). Introduction to Visibility. Colorado State University. USA. Available: [www.epa.gov](http://www.epa.gov). [20 April 2018].
15. Evans, G.W., Jacobs, S.V., Frager, N.B. (1982). Adaptation to air pollution. *Environmental Psychology*. 2: 99-108.
16. Kuller, R., Wetterberg, L., (1993). Melatonin, cortisol, EEG, ECG and subjective comfort in healthy humans: Impact of two fluorescent lamp types at two light intensities. *Lighting Research and Technology*. 25: 71–81.

## Social Preference of Building Materials: Decision-Making towards Low Carbon Housing Constructions

RODRIGO ALBA KRASOVSKY<sup>1</sup>, SEBASTIAN BOBADILLA SUAREZ<sup>2</sup>, DIETRICH SCHWARZ<sup>1</sup>

<sup>1</sup>Institute of Architecture and Planning, Universität Liechtenstein, Vaduz, Liechtenstein

<sup>2</sup>Department of Experimental Psychology, University College London, London, UK

*ABSTRACT: Material considerations are essential while trying to achieve low energy and carbon constructions. According to our preliminary findings, decisions regarding materials in new buildings are mostly done by clients or by self-builders often without the aid of an architect or planner. Therefore, community studies are important to understand today's building dynamics. In this exploratory study - carried out in USA and Mexico - we analysed the public's preferences for building materials for the exterior of dwellings and the factors that have more influence over their decisions while choosing the materials. We also studied the update in the subjects' preference after receiving certain information concerning the materials. We wanted to know if the environmental factors play an important role in today's public preference in the building sector and what type of information could greater affect their beliefs. Preliminary results for Mexico and after a follow up analysis for USA show that acknowledging unfamiliar information (e.g. carbon emissions or price) might have a greater influence on the public's update of preference of materials. This could have implications for the construction market dynamics in the usage promotion of low carbon building materials.*

*KEYWORDS: Building materials, decision-making, low carbon, social cognition*

### 1. INTRODUCTION

To achieve a low energy and carbon construction, there are several considerations to take into account. One, which has an important influence on the total energy consumption and carbon emissions during the building's lifecycle, is the use of building techniques suited to locally resourced materials [1-2]. Research regarding this topic is usually carried out from an objective perspective underlining the benefits of using low energy and low carbon materials, but studies on consumers and users' cognition are generally not considered [3].

As architects and planners, we are usually confronted during the building design process with the actual needs and preferences of the potential users and clients. Therefore, we should consider the social preference of such techniques and materials, and the reasons behind it. A number of studies have addressed the issue by analysing cases where the architects or designers have primary decision-making authority for material selection [4]. Nevertheless, there is a great proportion of constructions worldwide that are done by self-builders or only with the aid of contractors, and therefore the user or developer mainly takes the decisions. In developing countries like Mexico, this phenomenon grows proportionally with the informal settlements; while in countries with developed economies like the USA, self-builders emerge looking for alternatives to the mainstream market [5-6].

Decisions about characteristics of materials such as: physical properties, costs, cultural context and appearance among others are regularly present during

the design process while choosing the materials to be used [4]. However, other environmental factors should be considered; specifically those related to building materials' life cycle, such as embodied energy and carbon emissions.

In this study, we carried out online questionnaires based on the hypothetical case of building a new housing construction. We assessed real behaviour through a speculative scenario, a common methodology in decision research [7]. We aimed to answer mainly two questions: (1) Which factors most influence the decision-making process of people while choosing building materials? (2) How do people update their preferences after acknowledging facts about the chosen materials?

### 2. THE STUDY

100 participants living in the United States of America (USA) and 100 living in Mexico partook in the study. The participants were recruited through the crowdsourcing online platform Clickworker ([www.clickworker.com](http://www.clickworker.com)). Internet-based studies have demonstrated to be as accurate as laboratory experiments in behavioural research, plus it allows access to a large volume of subjects [8]. Our sample is limited to the users of this platform, which are mainly economically active adults. We decided not to exclude any participant based on previous knowledge, location or other demographic factors since these variables could not correlate with the randomized conditions by design (see below). The survey took approximately 5 minutes to complete and we set the minimum time threshold for valid results in 2 minutes (participants who completed the study in less than 2

# PLEA 2018 HONG KONG

*Smart and Healthy within the 2-degree Limit*

minutes were excluded from analyses). The study was carried out between the 25th of January and the 28th of February 2018. EUR 0.30 were paid to each participant after completion.

After a series of demographic questions, participants were asked to give information about their type and condition of dwelling and if they would rely on an architect, a contractor, family or just on their own while building a new house or building. For the next phase, preferences regarding different materials that are commonly used on the building's substructure and in the shell as exterior and interior finishes were elicited. Regardless of the configuration, a building's embodied impact concentrates on the materials of the substructure and the cladding of the shell [9]. Depending on the country, ratings for the most commonly used materials according to their census were elicited, respectively. Participants were asked to rank these materials in order of preference for the exterior of their dwelling. They were also asked to rank the four factors that affect their choice of material the most; these factors were physical properties, costs, cultural context, appearance, and environmental factors. The study then included an experimental section. After indicating their choice, the participants were randomly assigned to one of four groups. A standard construction of one square foot/meter of the shell of a building was compared based on four factors: typical durability (physical property), price (costs), trend (cultural context) and embodied carbon emissions (environmental factors). The four factors can be seen in fig. 1-4. The information showed to the participants in Mexico, changed for trend and price based on data collected specifically for that country. After receiving the information, the participants were finally asked once again to rank the materials according to preference to measure their update in preferences after seeing the information provided to them in each condition.

Our objective was to determine which of the facts would have a greater effect on the participants' update of material preference. Based on a previous study (see [10]), we entered the results into an analysis of variance (ANOVA) with fact type as a between-subjects factor with four levels (trend, durability, price, and carbon emissions) with participants' update as the dependent measure. Update was defined as: 1-(Pearson correlation of the first rating with the second rating). We also included as a covariate the nuisance variable of estimation errors, which is necessary for the effect of updates being greater for the sole reason of being farther away from the presented fact.

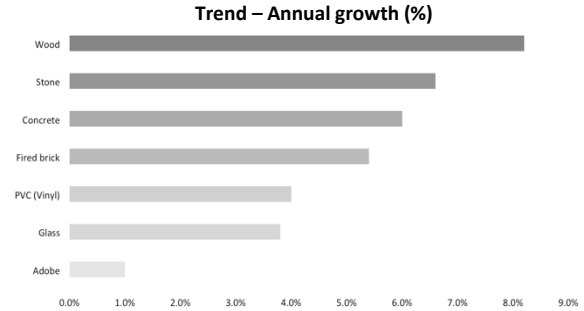

Figure 1: Trend – Annual growth of material sales within the building sector, which can be an indicator of a current popular trend. Graph made by authors with information taken from GrowthBuilder [11].

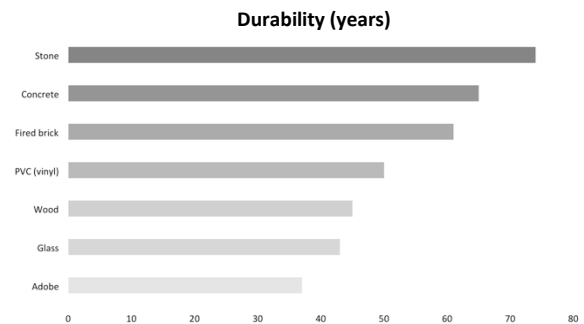

Figure 2: Durability, which can be an indicator of a desired physical property. Graph made by authors with information taken from eTool [12].

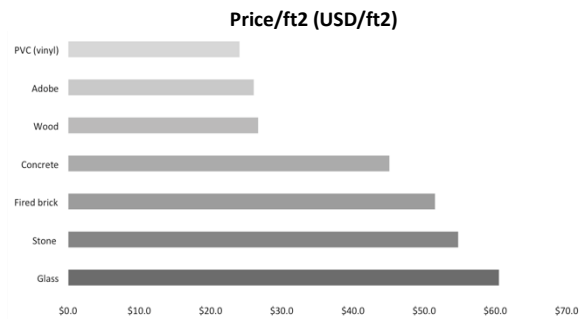

Figure 3: price per square foot. Graph made by authors with information taken from RS Means [13].

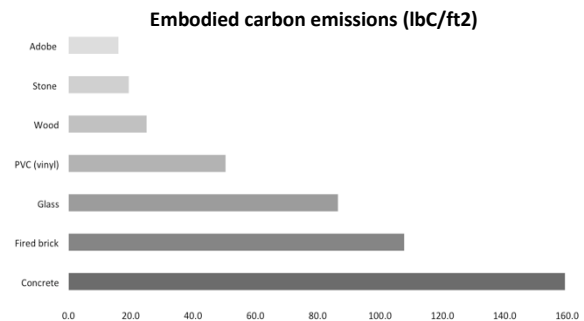

Figure 4: Embodied Carbon emissions per material per square foot, which can be an indicator of an environmental factor. Graph made by authors with information taken from the Inventory of Carbon and Energy [14].

# PLEA 2018 HONG KONG

*Smart and Healthy within the 2-degree Limit*

The estimation errors were defined as: 1-(Pearson correlation of first estimate with the presented fact in each condition). We also analysed how the influencing factors are related to other covariates such as gender, age, and income level with a follow up analysis based on multiple linear regression.

The reason for choosing two different countries for the study is to understand the differentiation of building dynamics and update of preferences depending on the culture and to analyse if the study can be replicated by adapting the variables to a specific context. The statistical classification and the information showed to the participants were based on data collected per country and therefore the surveys slightly differed from one another. Thus, even though the methodology is the same, the context and the results will be presented separately. Further on, both countries will be compared to evaluate results of the dependent variable.

## 2.1 Study in Mexico

### 2.1.1 Context

According to INEGI (Mexico's census authority), detached single-family houses accounted for 92.2% of the total housing constructions, followed by apartment units with 5.2% and units in a *vecindad* with 2%. The materials that are used the most in new constructions are: 1.concrete 2.burned brick 3.stone 4.adobe 5.wood 6.bamboo or straw [15]. Even though glass is not included in the census as a building material, it has earned popularity as a main façade element, causing an important repercussion in the building's costs, durability and carbon emissions and it was therefore considered for the surveys.

In Mexico, 65% of the total housing constructions are done by the residents themselves. From that number, around 50% is self-construction and the other 50% is done with external aid and the other 35% of the total is usually built by developers [16]. This reflects the great social division that exists in the country, but it also shows that the decision-making process in the construction sector in the country falls on a greater proportion on the residents of the houses.

### 2.1.2 Participants

The specific characteristics of the participants living in Mexico were as follows: gender: 68 males and 32 females; age: 54 were 18-29 years old, 42 were 30-49 years old, and 4 were 50-64 years old; occupation: 20 were employed in education or health, 32 in technical or professional services, 3 in farming, fishing or forestry, 7 in sales or tourism, 11 in construction or maintenance, 3 in production or transportation, 4 in the government, 2 worked as freelancers, 23 were students and 4 were unemployed; household monthly income: 4 earned less than MXN 2K, 4 earned MXN 2K-3.9K, 6 earned MXN 4K-5.9K, 22 earned MXN 6K-9.9K, 28 earned MXN 10K-

\$19.9K, 26 earned MXN 20K-\$49.9K and 9 earned more than MXN 50K; type of home: 69 were living in a single family-house detached, 19 were living in an apartment in a multi-storey building, 7 were living in a multiplex house (row house, duplex, triplex, etc.) and 4 were living in a *vecindad*. The average household size reported by the participants was 3.37 persons per unit.

### 2.1.3 Material preference

When hypothesizing about building a new house or building, 63 participants reported that decisions regarding building materials would solely be taken by their own or a family member, 19 would also include an architect or a contractor in the decision-making process and only 18 would leave the decision exclusively to the architect or contractor.

When ranking the materials of preference that they would use the most on the shell of their dwelling, these were: 1.Concrete ( $\bar{x}$  2.31,  $s$  = 1.79) 2.Fired brick ( $\bar{x}$  2.9,  $s$  = 1.79) 3.Stone ( $\bar{x}$  3.26,  $s$  = 1.4) 4.Wood ( $\bar{x}$  3.83,  $s$  = 1.38) 5.Adobe ( $\bar{x}$  4.49,  $s$  = 1.75) 6.Glass ( $\bar{x}$  5.13,  $s$  = 1.67) 7.Bamboo/Straw ( $\bar{x}$  5.82,  $s$  = 1.55). When ranking the factors that affected their decision the most, these were: 1.Physical properties ( $\bar{x}$  1.91,  $s$  = 1.15) 2.Costs ( $\bar{x}$  2.61,  $s$  = 1.28) 3.Appearance ( $\bar{x}$  2.64,  $s$  = 1.25) 4.Environmental factors ( $\bar{x}$  3.57,  $s$  = 1.08) 5.Cultural Context ( $\bar{x}$  4.14,  $s$  = 1.13).

### 2.1.4 Update in preference

We conducted a one-way ANOVA (see Fig. 5). For this model, the between-subjects factor of fact type was significant ( $F(3, 95) = 5.108, p = 0.003$ , partial eta squared = 0.139) and so was the estimation error nuisance variable ( $F(1, 95) = 8.132, p = 0.005$ , partial eta squared = 0.079).

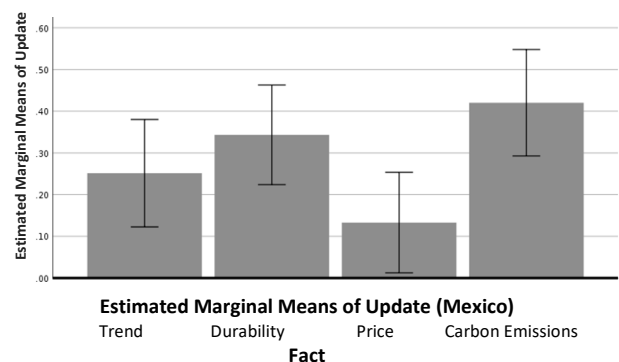

Covariates appearing in the model are evaluated at the following values:  
estimation error = .7746 Error bars: 95% CI

Figure 5: The estimated marginal means of update for each condition given by fact type (trend, durability, price, and carbon emissions) for the Mexican survey data. The error bars are 95% confidence intervals of the marginal means.

To follow up on these results, we conducted a series of multiple linear regressions implemented with the backward elimination method (see [17]) in SPSS. The full

# PLEA 2018 HONG KONG

*Smart and Healthy within the 2-degree Limit*

model included as predictors the estimation error nuisance variable, gender, age, income level, the five influencing factors (i.e., physical properties, costs, cultural context, appearance, environment), and three of the four independent variables (i.e., durability, price, carbon emissions) using the trend variable as a baseline for the model. The best performing model resulted in one with age ( $B = 0.01, t = 3.063, p = 0.003, 95\% \text{ CI} = [0.004, 0.017]$ ), price ( $B = -0.255, t = -3.85, p < 0.001, 95\% \text{ CI} = [-0.387, -0.124]$ ), and estimation error ( $B = 0.267, t = 5.026, p < 0.001, 95\% \text{ CI} = [0.162, 0.373]$ ), as predictor variables. Care should be taken when interpreting these effects due to the multiple comparisons nature of the backward elimination method.

## 2.2 Study in USA

### 2.2.1 Context

By 2011, detached single-family houses accounted for 62.7% of the total housing units in the United States followed by apartment units with 24.6%, mobile homes with 6.8% and multiplex attached houses with 5.9%. The percentage of single-family detached homes has remained similar over the past 70 years [18]. The type of home preference is expected to change in USA, mainly due to a demographic shift that will lower the average household size, and therefore the market will prefer smaller units in apartments and attached houses [19].

According to the 2016 Census, the preference of building materials for new single-family detached constructions on the shell of the building were: 1.vinyl (PVC) 2.stucco 3.brick 4.concrete/fiber cement 5.wood 6.stone [20]. Stucco was not considered in the survey as it is a material that can be implemented in many surfaces and therefore the values for carbon emissions, price and durability are not representative. Adobe, even though it is not considered in the U.S. Census, is gaining interest in North America and has started to be introduced in the building codes [21], therefore it was included.

### 2.2.2 Participants

The specific characteristics of the participants living in the United States were as follows: gender: 47 males and 53 females; age: 32 were 18-29 years old, 56 were 30-49 years old, 11 were 50-64 years old and 1 over 64 years old; occupation: 25 were employed as managers or professionals, 13 in services, 3 in farming, fishing or forestry, 12 in sales or office, 5 in construction or maintenance, 7 in production or transportation, 5 in the government, 8 worked as freelancers, 10 were students, 4 were retired and 15 were unemployed; household yearly income: 23 earned less than USD 20K, 21 earned USD 20K-39K, 24 earned USD 40K-59K, 15 earned USD 60K-79K, 5 earned USD 80K-99K, 10 earned USD 100K-149K and 1 earned more than USD 150K; Type of home: 54 were living in a single family-house detached, 33 were living in an apartment in a multi-storey building, 8 were

living in a multiplex house (row house, duplex, triplex, etc.) and 4 were living in a mobile house. The average household size reported by the participants was 2.8 persons per unit.

### 2.2.3 Material preference

When hypothesizing about building a new house or building, 37 participants reported that decisions regarding building materials would solely be taken by their own or by a family member, 46 would also include an architect or a contractor in the decision making process and only 17 would leave the decision exclusively to the architect or contractor.

When first ranking the materials of preference that they would use the most on the shell of their dwelling, these were: 1.Stone ( $\bar{x} 2.44, s = 1.36$ ) 2.Fired brick ( $\bar{x} 2.51, s = 1.47$ ) 3.Wood ( $\bar{x} 3.42, s = 1.64$ ) 4.Concrete ( $\bar{x} 3.46, s = 1.68$ ) 5.PVC ( $\bar{x} 5.17, s = 1.73$ ) 6.Glass ( $\bar{x} 5.25, s = 1.60$ ) 7.Adobe ( $\bar{x} 5.72, s = 1.35$ ). When ranking the factors that affected their decision the most, these were: 1.Physical properties ( $\bar{x} 1.94, s = 1.35$ ) 2.Costs ( $\bar{x} 2.66, s = 1.27$ ) 3.Appearance ( $\bar{x} 2.68, s = 1.22$ ) 4.Environmental factors ( $\bar{x} 3.42, s = 1.28$ ) 5.Cultural Context ( $\bar{x} 4.30, s = 0.9$ ).

### 2.2.4 Update in preference

As we did with the Mexican survey data, here we also conducted a one-way ANOVA (see Fig. 6). For this model, neither the between-subjects factor of fact type was significant ( $F(3, 95) = 0.672, p = 0.571, \text{partial eta squared} = 0.021$ ) nor was the estimation error nuisance variable ( $F(1, 95) = 0.172, p = 0.679, \text{partial eta squared} = 0.002$ ).

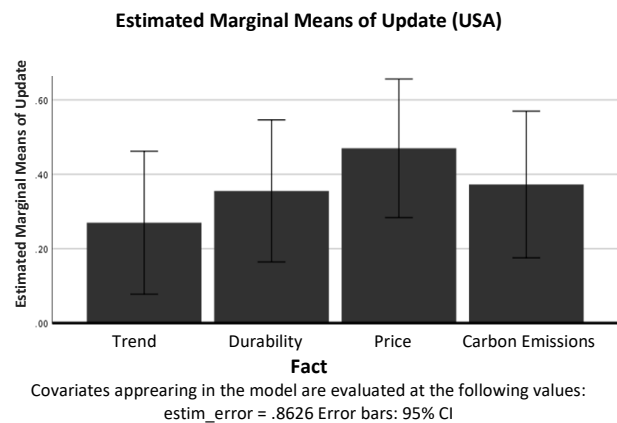

Figure 6: The estimated marginal means of update for each condition given by fact type (trend, durability, price, and carbon emissions) for the survey data from U.S.A. The error bars are 95% confidence intervals of the marginal means.

Consistent with the follow up analysis done for the sample from Mexico, we also conducted a series of multiple linear regressions implemented with the backward method in SPSS. The best performing model resulted in one with the physical properties influencing variable ( $B = 0.088, t = 2.464, p = 0.016, 95\% \text{ CI} = [0.017, 0.159]$ ) and gender ( $B = 0.151, t = 1.872, p = 0.064, 95\%$

# PLEA 2018 HONG KONG

Smart and Healthy within the 2-degree Limit

CI = [-0.009, 0.312]). Only the physical properties variable has a significant effect. As above, care should be taken when interpreting this effect due to the multiple comparisons nature of the backward elimination method.

## 2.3 Comparison between Mexico and USA

To compare the survey data between Mexico and USA, we ran a two-way between-subjects ANOVA (see Fig. 7) with one factor being the same as in the above ANOVAs (fact type) and another factor being country (either Mexico or USA). However, the fact type for this analysis was reduced to only two levels of interest: price and carbon emissions. The reduction in levels was a decision made post hoc, after observing the main results reported above. This means this analysis is done for exploratory purposes only and care is advised when making inferences here. For this model we also included the estimation error nuisance variable.

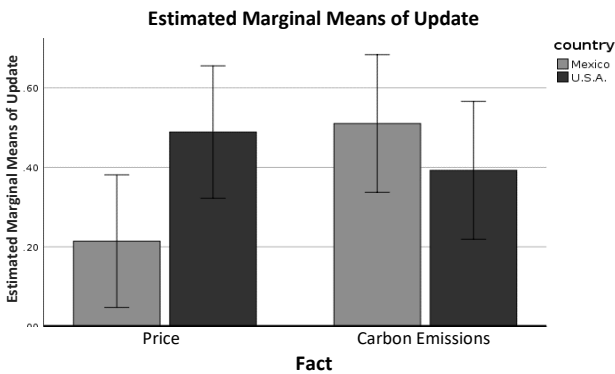

Covariates appearing in the model are evaluated at the following values:  
estim\_error = 1.2048 Error bars: 95% CI

Figure 7: The estimated marginal means of update for price and carbon emissions levels of fact type for both countries; Mexico and U.S.A. These are marginal means since they account for the effect of the estimation error nuisance variable. The errors bars are 95% confidence intervals of the marginal means.

In this analysis we do not observe a significant effect of estimation error ( $F(1, 95) = 0.069, p = 0.794$ , partial eta squared = 0.001), fact type with only price and carbon emissions as levels of interest ( $F(1, 95) = 1.359, p = 0.247$ , partial eta squared = 0.014), nor main effect of country ( $F(1, 95) = 0.836, p = 0.363$ , partial eta squared = 0.009). However, we do observe the crossover interaction between fact type and country ( $F(1, 95) = 5.259, p = 0.024$ , partial eta squared = 0.052). As mentioned before, this post hoc analysis should be interpreted with care given that the significance value does not survive Bonferroni correction assuming that all six possible pairs of levels from fact type would have been compared in the same way; the corrected significance value in such a case would be  $p = 0.05/6 = 0.0083$ .

## 3. CONCLUSIONS

This exploratory study was focused on potential decision-makers in the building industry, regardless of occupation or previous knowledge, and their update of preference after receiving certain information. Our preliminary findings show that most of the participants would rely on their own decisions while choosing materials to build a new housing construction. The presented materials were taken based on representative values from the national census from the two countries where the surveys were conducted. These results can provide initial guidance when evaluating current preferences and use of materials. However, we wanted to assess the factors that might greater influence future decisions within consumers. Even though our results might have limitations because they are based on verbal reports and a hypothetical scenario, we expect a correlation with real behaviour.

We found out that physical properties, such as durability, were the most influential factors reported by the participants. Nevertheless, the update in preference was influenced more by other factors. For example, in Mexico, acknowledging evidence concerning carbon emissions of materials can have a greater influence on the update of preference in comparison to other types of evidence like durability, trend or price. The latter had almost no influence on the participants' update of preference in Mexico, whereas in USA, this was the information that affected their update the most. These results could be explained by a confirmation bias, since recognizing information about an existing belief generates less influence on our change of mind than on receiving information about which we know less [22]. This was probably the case with environmental awareness, which is directly related to the economic level of the population [23], which could mean that there is less knowledge in Mexico about this topic than in USA. The converse could be true for building material pricing, as there is a bigger rate of self-construction in Mexico, people are more familiarized with costs there than in USA.

## 4. EXPECTED CONTRIBUTIONS

With this research, we want to dig into the challenges for low energy and low carbon constructions while trying to overcome social barriers in the building sector. This study could serve as a basis for material producers to understand the factors to focus on while developing a sustainable product. Our findings show that focusing on information that is not common for the decision-makers might result in a higher influence for the update of preferences. This might also have implications for policy makers, to know on what factor to focus to promote the use of low carbon materials or products.

Nowadays, a great proportion of the constructions worldwide are done by self-builders and therefore many



# PLEA 2018 HONG KONG

*Smart and Healthy within the 2-degree Limit*

of the decisions are taken by the population in general. Nevertheless, There are many cases where architects and planners are involved in the decisions. In that sense, this research is useful to have a better understanding of the clients' needs and preferences and to know what type of information has more influence over the clients' decisions. We think that architects have a crucial role in the influence over clients and users to promote building techniques suited to locally resourced materials.

The update of preference was the main variable to test in this study within a national context, thus, location within each country was considered random. However, future studies regarding the use of building materials are needed within a more local context. There are also other variables that could be considered depending on what is measured, like supply and availability of materials, aesthetic attributes, or specific building regulations, as consumers' choice may vary greatly depending on the location. Yet, we think that this study can serve as a reference, which takes us one step forward in understanding behaviour within decision-makers, and therefore brings us closer to have a greater influence towards low energy and carbon constructions.

## REFERENCES

1. Venkatarama Reddy, B. V., & Jagadish, K. S. (2003). Embodied energy of common and alternative building materials and technologies. *Energy and Buildings*, 35: p. 129–137.
2. Morel, J. C., Mesbah, A., Oggero, M., & Walker, P. (2001). Building houses with local materials: means to drastically reduce the environmental impact of construction. *Building and Environment*, 36: p. 1119–1126.
3. Zhao, D.-X., He, B.-J., Johnson, C., & Mou, B. (2015). Social problems of green buildings: From the humanistic needs to social acceptance. *Renewable and Sustainable Energy Reviews*, 51(Supplement C): p. 1594–1609.
4. Wastiels, L. & Wouters, I. (2009). Material Considerations in Architectural Design: A Study of the Aspects Identified by Architects for Selecting Materials. In: *Proceedings of the Undisciplined! Design Research Society Conference 2008*: p. 1-379
5. Jeffreys, P., Lloyd, T., Argyle, A., Sarling, J., Crosby, J., & Bibby, J. (2014). *Building the homes we need*. London: KPMG
6. Benson, M., Hamiduddin, I. (2017). *Self-Build Homes: Social Discourse, Experiences and Directions*. London: UCL Press.
7. Kühberger, A., Schulte-Mecklenbeck, M., & Perner, J. (2002). Framing decisions: Hypothetical and real. *Organizational Behavior and Human Decision Processes*, 89(2): p. 1162–1175.
8. Crump, M. J. C., McDonnell, J. V., & Gureckis, T. M. (2013). Evaluating Amazon's Mechanical Turk as a Tool for Experimental Behavioral Research. *PLoS ONE*, 8(3): p. 1-18
9. Basbagill, J., Flager, F., Lepech, M., & Fischer, M. (2013). Application of life-cycle assessment to early stage building design for reduced embodied environmental impacts. *Building and Environment*, 60: p. 81–92.
10. Sunstein, Cass R., Bobadilla-Suarez, S., Lazzaro, S. & Sharot, T. (2016). How People Update Beliefs about Climate Change: Good News and Bad News. Available at SSRN: <http://dx.doi.org/10.2139/ssrn.2821919>
11. Principia Consulting, L. (2017). *GrowthBuilder*. Retrieved November 14, 2017, from <https://www.principiaconsulting.com/research/building-materials-forecasting/>
12. eTool. (2017). *Typical Life Expectancy of Building Components*. Retrieved November 14, 2017, from <http://etoolglobal.com/wp-content/uploads/2015/10/BuildingComponentLifeExpectancy.pdf>
13. RS Means (2017). *RS Means online data*. Retrieved November 13, 2017, from <https://www.rsmeansonline.com/SearchData>
14. Hammond, G., & Jones, C. (2008). *Inventory of carbon & energy (ICE)*
15. INEGI. (2010). *Encuesta Nacional de Vivienda 2010*. Retrieved May 24, 2018, from [http://www.inegi.org.mx/lib/olap/consulta/general\\_ver4/MDXQueryDatos.asp?proy=cpv10\\_viviendas](http://www.inegi.org.mx/lib/olap/consulta/general_ver4/MDXQueryDatos.asp?proy=cpv10_viviendas)
16. Softec S.C. (2016). *Mexican housing Overview 2016. Mexico*. Retrieved February 27, 2018, from [https://www.softec.com.mx/web/images/demos/DEMO\\_MH\\_O\\_2016.pdf](https://www.softec.com.mx/web/images/demos/DEMO_MH_O_2016.pdf)
17. Draper, N. R., & Smith, H. (1966). Selecting the “best” regression equation. *Applied Regression Analysis*, Third Edition, p. 327-368.
18. U.S. Census Bureau (2013). *American Housing Survey for the United States: 2011*. Retrieved May 24, 2018, from <https://www.census.gov/content/dam/Census/programs-surveys/ahs/data/2011/h150-11.pdf>
19. Nelson, A. C. (2009). The New Urbanity: The Rise of a New America. *The Annals of the American Academy of Political and Social Science*, 626. P. 192-208.
20. U.S. Census Bureau (2015). *Characteristics of New Housing*. Retrieved May 24, 2018, from [www.census.gov/construction/chars/completed.html](http://www.census.gov/construction/chars/completed.html)
21. Windstorm, B., Schmidt, A. (2013) A Report of Contemporary Rammed Earth Construction and Research in North America. *Sustainability*, 5, p. 400-416
22. Nickerson, R. S. (1998). Confirmation Bias: A Ubiquitous Phenomenon in Many Guises. *Review of General Psychology*, 2(2), 175–250.
23. Rohracher, H., Ornetzeder, M. (2002). Green buildings in context: improving social learning processes between users and producers. *Built Environment*, 28, p. 73-84.

# The Impact of Façade Renovation Strategies on User Satisfaction in Offices:

## Case Studies for Summer in the Netherlands

MINYOUNG KWON<sup>1</sup>, HILDE REMØY<sup>1</sup>, ULRICH KNAACK<sup>1</sup>

<sup>1</sup>Faculty of Architecture and the Built Environment, Delft University of Technology, Delft, The Netherlands

**ABSTRACT:** Many offices have been renovated to improve building performance. However, the user's perception after renovation has not been evaluated. This paper presents user satisfaction with indoor environmental quality in façade renovated offices in the Netherlands. The study explored the correlation between facade renovation strategies and indoor climate on the one hand and on the other hand user satisfaction and user preferences. Data were collected in four renovated offices in the Netherlands, which were adapted using different façade renovation strategies. The case study consisted of conducting online surveys and indoor climate monitoring for 2 weeks with loggers. Statistical results demonstrate that design factors such as desk location, workplace orientation, and layout have a strong correlation with user satisfaction of IEQ, unlike window types. The suggested essential design factors for user satisfaction can guide architects and designers to better understand users' preferences and to reflect on office design.

**KEYWORDS:** User satisfaction, Office renovation, Façade renovation, Indoor climate

### 1. INTRODUCTION

Refurbishing façades is an essential building renovation solution for reducing energy demand. Often, the objective of the building renovation is to reduce energy demand with low investment costs. However, next to economic and environmental impacts of energy renovation, social impact is also important [1] to encourage energy renovation. However, the energy renovation should not only consider the energy performance but also user satisfaction, as higher user satisfaction increases the value of buildings [2]. Although we expect that renovated office buildings will provide improved building conditions in various perspectives, there are a few cases reported with low levels of indoor environmental satisfaction in energy efficient buildings [3].

The facade quality strongly relates to indoor climate, since the façade controls the amount of light, ventilation and temperature. Moreover, indoor climate has high impact on thermal comfort. The thermal comfort is one of the important parameters in the building design [4] that mainly contributes to increase user satisfaction. For this reason, this paper compares the indoor climate of renovated offices, which applied different renovation strategies to user satisfaction. This leads to the following research question: how does the façade strategies affect user satisfaction?

### 2. METHODS

To conduct this study, five renovated office buildings were studied, from which three types of datasets were collected. The degree of renovation was classified by [5-7] The methodological approach was developed based

on [8]. First, technical information related to façade renovation was collected. Second, monitoring actual indoor climate was conducted during summer (e.g., temperature, relative humidity (RH), and illuminance). Last, a user satisfaction survey was distributed to the office occupants by online and paper means. SPSS was used to scrutinise the correlation between façade types on user satisfaction and understand the correlation between indoor climate and user satisfaction.

There were three conditions to select the case studies. The selected five offices are located in the Netherlands, originally built in the 1960s to 1980s. The energy label of these buildings improved from F or G to A after renovation. Different façade strategies were applied to the offices, from passive to active. All the case studies were occupied at least over a couple of years after renovation, thereby they can provide one-year energy use data.

Renovated offices have climate ceiling for heating, cooling, and ventilation with central control mechanical system. In addition, each workplace has thermostat. Non-renovated office has decentralised heating system and no ventilation system is installed.

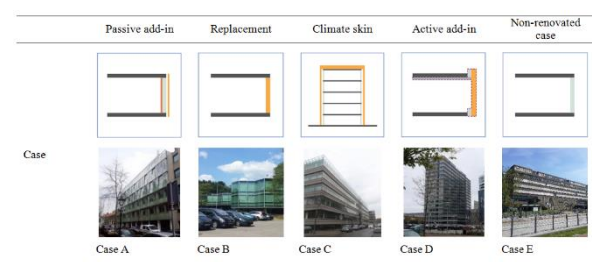

Figure 1: Different scale of façade renovation strategies

# PLEA 2018 HONG KONG

Smart and Healthy within the 2-degree Limit

## 2.1 Indoor climate measurements

Indoor climate was monitored for two weeks in July to avoid significant climate variations during summer. Measurement time was started and ended at the same time and date. HOBO loggers, which monitor temperature, RH, and illuminance were placed in workplaces with different orientations. The devices were positioned to collect the data at 0.9m height desks from the floor. Table 1 shows the placed location of devices in five case studies. One logger was placed in each orientation. Outdoor climate was taken from local meteorological stations near the buildings.

Table 1: Measurement locations in five cases

Renovation strategies	Orientations			
	N.E	N.W	S.E	S.W
Passive add-in	*	*	*	*
Replacement	*			*
Climate skin	*	*	*	*
Active add-in	*			*
Non-renovated case		*	*	

## 2.2 User satisfaction survey

A modified questionnaire is developed based on literature [9-11]. The modified version has 38 questions consisting of three chapters: general information, indoor environmental quality, and functional quality and user perception. In this paper, we only focused on user perception about indoor comfort. The questionnaires consist of three parts: general information, indoor environmental quality, and user's perceptions. Each option was allocated a score: 1= extremely dissatisfied, 2= somewhat satisfied, 3= neither dissatisfied nor satisfied, 4= somewhat satisfied, and 5= extremely dissatisfied. Respondents were asked to rate their satisfaction on a five-point Likert scale regarding environmental variables such as temperature, air quality, humidity and overall comfort.

Only 14 (2.2%) people have their own room. Among cellular office rooms, sharing workplace with 2-3 people was common type with 93 (14.6 %). 53 people (8.3%) of total participants shared the workplace with 4-6 colleagues. Majority of people (56.2%) work in open space with over 10 colleagues.

## 2.3 Analysis

IEQ data were stored in SPSS Statistics 24.0 and examined using descriptive statistics showing minimum, maximum, mean value and standard deviation (SD). The characteristics of indoor climate of each office were summarized. After that, the data were compared to outdoor climate information to check how well each office has managed indoor climate quality.

To examine the relationship between design factors and user satisfaction of indoor comfort, statistical analysis was performed. The dependent variable was user satisfaction, and independent variable was design

factors. The selected significance level was  $p = 0.05$ . The measurements were ordinal level, and the values were not equally distributed. Thus, Spearman's correlation coefficient, which is for nominal variables, was used to determine correlations between variables regarding user satisfactions and design factors. The test shows both frequency of votes and rates for each office and makes it easy to compare the satisfaction level. Multi linear and binary logistic regression were performed to sort out which of the predictor variables do have an impact on the dependent variable, and which factors matter the most.

## 3. Results

### 3.1 Indoor climate data

The measured indoor climate data represent temperature, RH, and lighting of workplaces located in different orientations and offices (Fig. 1). These data were collected to compare indoor environmental quality of different orientations in a building and the same orientations of different office buildings. The orange colour in figure 2 pictures comfort zone recommended by the NEN 15251 standard. The result shows that the non-renovated office (Case E) has poor indoor environmental quality, and the temperature is quite high compared to renovated offices. In case C, workspace with a south-east orientation was cooler than set by the guideline. Nevertheless, the RH (%) values of five buildings are in the comfort zone except for the S.E workplaces from case C. Workspace on the north side was tending to be warmer than on the south side.

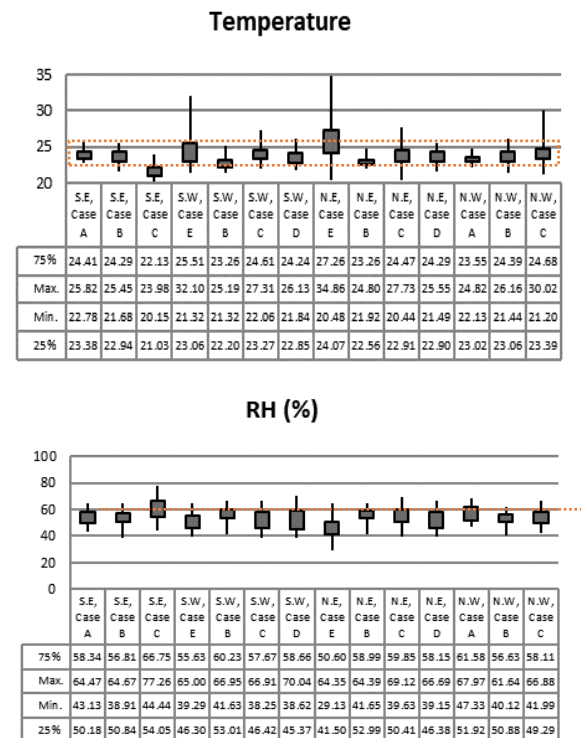

Figure 2: Comparison of the measured indoor climate (temperature, relative humidity) in five offices

# PLEA 2018 HONG KONG

Smart and Healthy within the 2-degree Limit

## 3.2 User perception about indoor climate

Figure 3 illustrates a comparison of how occupants perceive the temperature. The perception was marked with five options: cold, cool, comfortable, warm and hot. Over 60 percent of the occupants from the A, B, and C offices indicated that they felt comfortable with the temperature and feeling warm was the second most frequent answer. Although case D had a well-controlled indoor climate, around 30 percent of the users answered they felt cold in summer. In case E, people tended to feel warmer and hotter, and few people answered they felt cold. This shows that the percentage of temperature within the guideline range is not the only factor that influences user perception, and it is risky to say that people working in recommended/guideline climate zone always feel comfortable. Especially, in case of the D office, it is important to do further research by considering other variables such as how far the occupants sit from a window, orientation of workspaces, and office layouts etc.

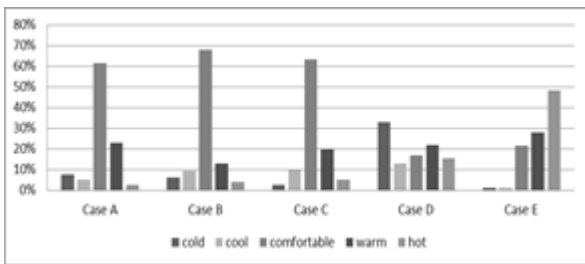

Figure 3: User perception of indoor temperature for five cases

## 3.3 User satisfaction in summer

738 occupants from 5 buildings responded to the user satisfaction survey. The occupants consist of around 70% full-time and 30% part-time employees. 549 of total respondents completed the survey.

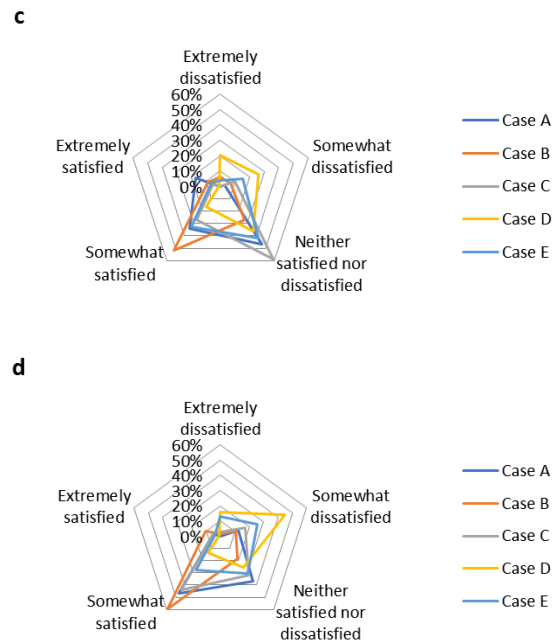
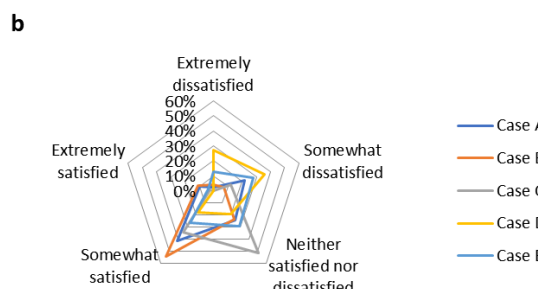
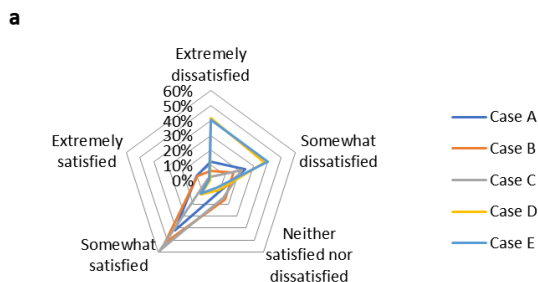

Figure 4: Comparison of user satisfaction in five cases a. Temperature, b. Air quality, c. Humidity, and d. Overall comfort.

In order to compare user's perception and actual indoor climate, the survey included to what extent people were satisfied with the following categories (e.g., temperature, air quality, humidity and overall comfort) in summer. Overall, occupants working in case A and B were more satisfied in terms of temperature, air quality, humidity and overall comfort than in case C, D, and E (Figure 4). Only in case of humidity, most people from case A were neither satisfied nor dissatisfied. People from case C, D, and E had more neutral satisfaction. At the same time, case C and E showed high percentage of dissatisfaction with the temperature. Thus, it is evident that people are more satisfied with indoor climate in case A, B, and C than D, and E. Moreover, case E provided unpleasant indoor environmental quality.

Table 2: Density of workplace of each case

	Office					Total
	A	B	C	D	E	
Number of colleagues sharing the room	7	2	0	2	3	14
Alone	17.9%	1.5%	0.0%	0.8%	4.0%	2.6%
2-3 people	29	2	13	11	38	93
	74.4%	1.5%	31.7%	4.2%	50.7%	16.9%
4-6 people	1	4	13	12	23	53
	2.6%	3.0%	31.7%	4.6%	30.7%	9.7%
7-9 people	0	1	6	19	5	31
	0.0%	0.8%	14.6%	7.3%	6.7%	5.6%

# PLEA 2018 HONG KONG

*Smart and Healthy within the 2-degree Limit*

over 10	2	124	9	217	6	358
	5.1%	93.2%	22.0%	83.1%	8.0%	65.2%
Total	39	133	41	261	75	549

Results of the Spearman correlation indicated that there was a moderate correlation between different façade strategies and satisfaction of indoor climate in summer. Desk location and user satisfaction with temperature, air quality, humidity and overall comfort were significantly correlated. In other words, desk location is an important factor to increase occupants' satisfaction. On the contrary, there was a weak positive correlation between orientation and temperature. Window types affected most user satisfaction variables except for satisfaction with humidity. Office layout only affected user satisfaction of temperature and overall comfort. Although we could find the correlation between dependent and independent variables, the precise information such as in which design options people were highly satisfied within those independent variables need to be analysed further.

*Table 3: Correlation between design factors and user satisfaction on indoor climate*

		Temperature	Air quality	Humidity	Overall comfort
Desk location	CC	0.135**	0.133**	0.138**	0.175**
	p-value	0.001	0.001	0.001	0.000
Facade types	CC	0.110**	0.086*	0.043	0.113**
	p-value	0.009	0.040	0.302	0.007
Orientation	CC	0.089*	0.057	0.028	0.072
	p-value	0.032	0.168	0.494	0.084
Layout	CC	0.142**	0.065	0.057	0.112**
	p-value	0.001	0.129	0.184	0.008

\*p <.05; \*\*p <.01; \*\*\*p <.001.

CC: Correlation Coefficient

A multiple linear regression analysis was performed to determine the orientation of workspace, desk location, window types, and layout to predict the user satisfaction with IEQ. Preliminary analyses were performed to ensure whether the assumption of normality and multicollinearity were validated.

In order to conduct the regression analysis, non-parametric measures were translated to dummies. The last dummy was a standard for each variable group (desk location over 4m, over 70% of glazing area, north-west orientation, and Flex-office layout).

Table 4 represents influential variables mathematically sorted out for satisfaction with indoor climate. Variables with over 10 of Variance Inflation Factor (VIF) were eliminated due to multicollinearity. R<sup>2</sup> explains estimation of the strength of the relationship between the model and the response variables. The

regression models with sorted independent variables satisfied p-value < 0.05, which means statistically significant. Orientation only affected temperature satisfaction. The results from multi-linear regression demonstrated that desk location is the only factor influencing satisfaction on air quality and humidity. In detail, people who sit far away from windows were inclined to be satisfied with IEQ. A desk location of 0-2m away from windows had a strong negative impact on user satisfaction in terms of temperature, air quality, humidity and overall comfort, while, people sitting over 4m away from windows were significantly satisfied with the indoor climate. Facades with 30 % of glazing area were eliminated due to high p-value.

People sitting on the south-west side were the most dissatisfied with the temperature followed by workplaces on the north-east side. People working in open plan offices represented a strong dissatisfaction with temperature and overall comfort. On the other hand, people working in flexible offices were more satisfied. Therefore, a desk location over 4 m away from windows, north-west oriented workspace, and flexible office layout could be an optimal design to increase user satisfaction on indoor climate.

# PLEA 2018 HONG KONG

Smart and Healthy within the 2-degree Limit

Table 4: User satisfaction with indoor environmental parameters and building features that correlated based on from multi linear regression analysis

Satisfaction	Independent variable	B	$\beta$	p-value	VIF	Durbin-Watson	R <sup>2</sup>
Temperature	Constant	3.101		0.000		1.513	0.043
	Desk location 0-2m	-0.770	-0.307	0.000	2.290		
	Desk location 2-4m	-0.757	-0.279	0.000	2.290		
	Constant	1.806		0.000		1.487	0.014
	Façade (50% glazing)	-0.222	-0.113	0.008	1.045		
	Constant	3.074		0.000		1.577	0.055
	Orientation S.E	-0.430	-0.122	0.000	1.631		
	Orientation S.W	-0.809	-0.317	0.000	2.079		
	Orientation N.E	-0.752	-0.270	0.000	1.965		
	Constant	2.910		0.000		1.483	0.033
	Cellular	-0.518	-0.157	0.002	1.478		
	Open	-0.572	-0.227	0.000	1.616		
	Combi	-0.490	-0.112	0.019	1.282		
Air quality	Constant	3.329		0.000		1.639	0.035
	Desk location 0-2m	-0.646	-0.278	0.000	2.290		
	Desk location 2-4m	-0.624	-0.249	0.000	2.290		
	Constant					1.648	0.033
	Orientation S.W	-0.502	-0.211	0.000	1.369		
	Orientation N.E	-0.352	-0.136	0.005	1.369		
Humidity	Constant	3.367		0.000		1.697	0.025
	Desk location 0-2m	-0.515	-0.241	0.000	2.290		
	Desk location 2-4m	-0.428	-0.185	0.003	2.290		
	Constant	3.197		0.000		1.667	0.022
	Orientation S.W	-0.362	-0.166	0.001	0.731		
	Orientation N.E	-0.307	-0.129	0.007	0.731		
Overall comfort	Constant	3.380		0.000		1.547	0.041
	Desk location 0-2m	-0.655	-0.305	0.000	2.290		
	Desk location 2-4m	-0.519	-0.223	0.000	2.290		
	Constant	3.009		0.000		1.386	0.018
	Façade (50% glazing)	-0.318	-0.136	0.001	1.045		
	Constant	3.238		0.000		1.434	0.031
	Cellular	-0.320	-0.113	0.028	1.478		
	Open	-0.480	-0.222	0.000	1.616		
	Combi	-0.438	-0.116	0.015	1.282		

To summarise, optimal user satisfaction value for the statistic model follows the formula below:

### Temperature

$Y = 3.101 - 0.770*(\text{Desk location 0-2m}) - 0.757*(\text{Desk location 2-4m})$

$Y = 1.806 - 0.222*(\text{Façade (50% glazing)})$

$Y = 3.074 - 0.430*(\text{S.E}) - 0.809*(\text{S.W}) - 0.752*(\text{N.E})$

$Y = 2.910 - 0.518*(\text{Cellular}) - 0.572*(\text{Open}) - 0.490*(\text{Combi})$

### Air quality

$Y = 3.329 - 0.646*(\text{Desk location 0-2m}) - 0.624*(\text{Desk location 2-4m})$

### Humidity

$Y = 3.367 - 0.515*(\text{Desk location 0-2m}) - 0.428*(\text{Desk location 2-4m})$

# PLEA 2018 HONG KONG

*Smart and Healthy within the 2-degree Limit*

## Overall comfort

$Y = 3.380 - 0.655 * (\text{Desk location } 0-2\text{m}) - 0.519 * (\text{Desk location } 2-4\text{m})$

$Y = 3.009 - 0.318 * (\text{Window types } 50\%)$

$Y = 3.238 - 0.320 * (\text{Cellular}) - 0.480 * (\text{Open}) - 0.438 * (\text{Combi})$

## 4. CONCLUSION

This study investigated the impact of façade strategies on user satisfaction during summer in the Netherlands. First, an indoor temperature according to the guideline (NEN 15251) did not always result in higher user satisfaction. For example, the office with active façade renovation/high-tech renovation (case D) was qualified comfortable indoor environment according to the guideline. The occupants were, however, considerably dissatisfied with the indoor climate. There was a big difference in satisfaction with temperature between the non- renovated case and the renovated office cases in this study. The occupants were more sensitive to temperature than to relative humidity (see Fig. 4-c). Furthermore, people had more complaints about temperature than other indoor climate factors. Still, there may be more reasons why people feel dissatisfied with the indoor climate next to temperature, air quality and RH.

Second, we could find correlations between each variable group through the Spearman test. The regression analysis, however, showed slightly different results than the correlation results. In the Spearman test, orientation was the relatively less important factor for user satisfaction among the four categories. In contrast, orientation was an influential factor to air quality and humidity as well as temperature in the multi-linear regression analysis. South-east variable was automatically eliminated from the independent variables during the analysis, as the orientation was not statistically significant. On the other hand, desk location was the most influential factor for user satisfaction according to the both analysis methods. Different glazing area of façade was correlated to temperature and overall comfort.

Lastly, we could assume the tendency of user satisfaction with different design factors. People tended to be more satisfied when they sit far away from window and with large glazing area in north-west orientation in flexible office layout.

Nevertheless, finalising a decision for the façade renovation needs to include various factors, not only techniques but also the design quality and the way of use. The next step of the study will deal with visual-related variables such as the view to the outside, daylighting, and artificial lighting, and will include the data about winter and moderate seasons.

## ACKNOWLEDGEMENTS

This project is supported by TU Delft in the Netherlands and SangLimWon CO., Ltd. which is a landscape architecture/construction company in South Korea. This research is a part of scientific and technical activities in the company. The paper was made possible with the support of architects and facility/asset managers of office buildings: KCAP, MVSA, Fokkema & Partners Architecten, Royal HaskoningDHV in Amersfoort, DGMR, CAK, and The Ministry of Finance.

## REFERENCES

1. Lucuik, M., *A Business case for Green Buildings in Canada*, Canadian Green Building Council. Copyright March, 2005.
2. Shafaghat, A., et al., *Methods for adaptive behaviors satisfaction assessment with energy efficient building design*. Renewable and Sustainable Energy Reviews, 2016. 57: p. 250-259.
3. Ornetzeder, M., M. Wicher, and J. Suschek-Berger, *User satisfaction and well-being in energy efficient office buildings: Evidence from cutting-edge projects in Austria*. Energy and Buildings, 2016. 118: p. 18-26.
4. Boerstra, A.C., J. van Hoof, and A.M. van Weele, *A new hybrid thermal comfort guideline for the Netherlands: background and development*. Architectural Science Review, 2015. 58(1): p. 24-34.
5. Ebbert, T., *Integrated refurbishment planning for sustainable office buildings*. Proceedings of the ICE-Structures and Buildings, 166 (2), 2012, 2012.
6. Konstantinou, T., *Facade Refurbishment Toolbox*. 2014.
7. Rey, E., *Office building retrofitting strategies: multicriteria approach of an architectural and technical issue*. Energy and Buildings, 2004. 36(4): p. 367-372.
8. Šeduikyte, L. and V. Paukštys, *Evaluation of indoor environment conditions in offices located in buildings with large glazed areas*. Journal of civil engineering and management, 2008. 14(1): p. 39-44.
9. Bluysen, P.M., *The Healthy Indoor Environment: How to assess occupants' wellbeing in buildings*. 2013: Taylor & Francis.
10. D'Oca, S., et al. *Introduction to an occupant behavior motivation survey framework*. in *Clima*. 2016.
11. Nicol, F., M. Humphreys, and S. Roaf, *Adaptive Thermal Comfort: Principles and Practice*. 2012: Taylor & Francis.

## LCZ in Metropolitan Regions: Surface Temperature in Urban and Rural Areas

ALESSANDRA RODRIGUES PRATA SHIMOMURA<sup>1</sup>, ANDERSON TARGINO FERREIRA<sup>2</sup>

<sup>1</sup>Faculty of Architecture and Urbanism, The University of Sao Paulo, Brazil

<sup>2</sup>Universidade Guarulhos, Brazil

*ABSTRACT: In this article, the WUDAPT methodology was applied to Metropolitan Regions (RM) in the state of São Paulo/Brazil. The objective was to identify the influence of the typologies of urban versus rural occupation for a region with predominantly agricultural characteristics. The state of São Paulo/Brazil has six Metropolitan Regions and the choice of these regions was due to their socioeconomic and technological importance and because there is a concentration of agroindustrial and urban areas. The scarcity of data on urban form/occupation and on the function of cities makes it difficult to understand the climatic conditions of occupied space. Analyses were carried out, based on mappings developed by supervised classification and by treatment of MODIS satellite images. These resulted in the LCZ - Local Climate Zone classification; the mapping of the annual average Land Surface Temperature and the Surface Heat Island, all for the year 2016. Significant differences in surface temperature were found in the RM of São Paulo and Ribeirão Preto, mainly due to the type of LCZ class, soil type, solar incidence and topographic differences. Thermal images can serve as indicators of anomalies present in the analyzed areas and, associated with the LCZ classification, can support the formulation of spatial planning guidelines.*

*KEYWORDS: Local Climate Zone (LCZ) Classification, World Urban Database and Access Portal Tools (WUDAPT), Metropolitan Regions (RM), agricultural areas, Surface Temperature(ST), Surface Heat Island (SHI)*

### 1. INTRODUCTION

In this paper, the WUDAPT methodology was applied to Metropolitan Regions (RM) in the state of São Paulo/Brazil [1, 2, 3].

Research that detects the thermal field based on Orbital Remote Sensing in urban areas has been developed, among other purposes, to detect the spatial variation of Surface Temperature (LST) and its relation to land use, urban / rural vegetation and the heat island in urban areas [4, 5, 6, 7, 8, 9, 10, 11]. Understanding the LST data is of fundamental importance for Urban Climatology, since it modulates the air temperature in lower layers of the urban atmosphere, allowing an analysis of the influence on the comfort of users of urban and rural areas [12].

Satellite thermal images identify the different Surface Temperatures in urban and rural areas, highlighting - mainly - the different behaviors regarding the emission of heat or infrared radiation from objects [12, 13, 14]. It, thus, presents an important correlation with the land use, revealing areas with greater or lesser vegetation; as well as identification of the constructed elements [15, 16, 17]. The use of thermal imagery is an important and efficient tool for analyzing the distribution and influence of natural and constructed elements in cities and rural areas.

In this context, the objective was to identify the influence of the typologies of urban versus rural occupation for these regions with predominantly agricultural characteristics and to verify the prevailing surface temperatures in these areas.

### 2. THE METHODOLOGY AND PROCEDURES

The methodology adopted in this article consisted of the following steps: 1. Identification of the study area; 2. Mapping of Local Climate Zones (LCZ); 3. Land Surface Temperature (LST) identification; and, 4. Surface Heat Island classification.

#### 2.1 Study Area

The state of São Paulo/Brazil has the Macrometrópole Paulistana (MMP), one of the largest urban agglomerations in the Southern Hemisphere. MMP is home to the Metropolitan Region of São Paulo (RMSP), among the six largest in the world, according to the United Nations), in addition to 5 other RMs and the Urban Agglomerations of Jundiaí (AgU\_Jnd) and Piracicaba (AgU\_Pcb). The choice of these regions was due to their socioeconomic and technological importance and because there is a concentration of agroindustrial and urban areas of regional and national importance.

Fig. 1 shows the regions comprising this paper: Metropolitan Region of Ribeirão Preto (RMRP), Metropolitan Region of Santos (RMS), Metropolitan Region of São Paulo (RMSP), Metropolitan Region of Campinas (RMC), Urban Agglomerations of Piracicaba (AgU\_Pcb), Urban Agglomerations of Jundiaí (AgU\_Jnd) and São Carlos and Pirassununga Connection (Cnx\_SC\_Ps), [18], totalling about 40,695 km<sup>2</sup>.



# PLEA 2018 HONG KONG

Smart and Healthy within the 2-degree Limit

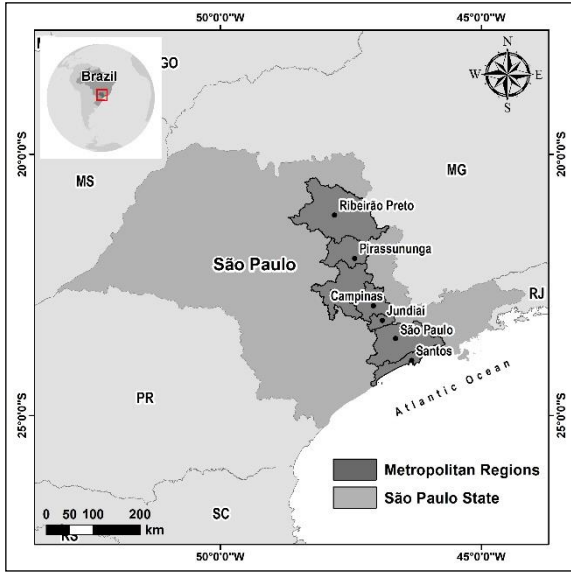

Figure 1: Metropolitan Regions, Urban Agglomerations and Connections of the State of São Paulo: study area.

The RMSP is home to the main national metropolis and almost 50% of the state population live in this territory, approximately 21.4 million inhabitants, according to estimates by the Brazilian *Instituto Brasileiro de Geografia e Estatística* (IBGE) for 2017. The RMSP and RMS have characteristics of urban areas and industrial areas, and still have densely vegetated areas that are protected in conservancy areas (for example Serra do Mar / Santos and Cantareira State Park and Mantiqueira / São Paulo). These areas preserve potential characteristics regarding the maintenance of environmental services of regulation of temperature and humidity of the air, due to their location in hills and marshland areas.

The RMSP holds the largest urban area in metropolitan regions, followed by the metropolitan region of Campinas. The RMs of Campinas, Jundiaí and Piracicaba, also, have industrial areas with characteristics of rural occupation with predominant use of monoculture (sugar cane). In the areas of Pirassununga and the RMRP there is a predominance of rural / agriculture areas, mostly sugar cane culture.

The forest fragments in some areas of the RMs only exist because they are areas denominated Legal Reserve within the properties. They correspond to 30% of the total area of each property and are intended for the preservation of species of fauna and flora and may sometimes be turned into Permanent Preservation Areas (PPA), if they are close to rivers, and to protect springs [19].

## 2.2 Mapping of Local Climate Zones (LCZ)

The mapping of Local Climate Zones used the classification proposed by Stewart & Oke [1], generated by means of a Geographic Information System (GIS),

SAGA 2.2 software, as proposed by Bechtel et al. [2] and [20]. The training samples were those representative of the 17 types of geometric pattern (volume and height) of soil cover, as well as their combination [1].

The classification was based on multispectral orbital images, corresponding to the band ranging from visible to thermal infrared, from Landsat-8 (2016) for the scenes highlighted in Figure 2.

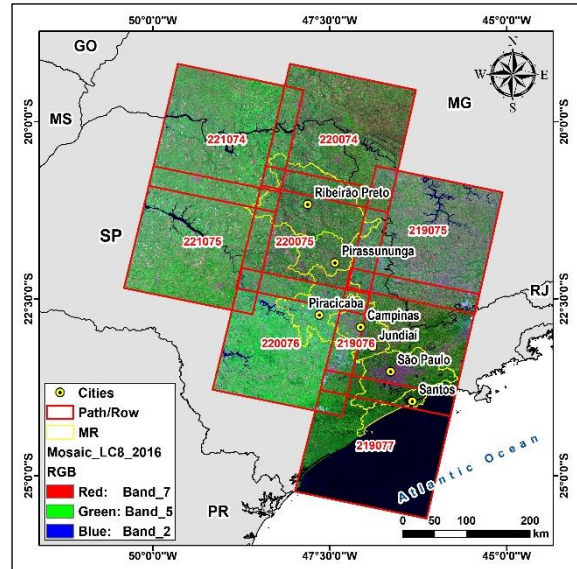

Figure 2: Image mosaic of Landsat-8 satellite of 2016, for the following scenes (path/Row) and dates: 219/075, 219/076 and 219/077 – July 07; 220/074, 220/075 and 220/075 – April 09; 221/074 and 221/075 - May 02 [21].

The evaluation of the accuracy of the soil cover map classification was performed using the kappa (k) index analytical technique, Equation (1), which, from reference areas ( $n$ ) randomly distributed in the image, calculates the measurement of the difference and the probability of agreement between the reference values and the classification [22].

$$k = N \sum X_{ii} - \sum X_{i+} X_{+i} / N^2 - \sum X_{i+} X_{+i} \quad (3)$$

Where,  $X_{ii}$  is the observed agreement;  
 $X_{i+}$  and  $X_{+i}$  (product of the marginal ones) is the expected agreement, and  
 $N$  is the total of elements observed.

As reference areas, at least 50 representative polygons of each mapped class observed in the high spatial resolution images from Google Earth Pro software will be used [23, 20].

The distinction between urban and rural areas was made using the criteria of form, function and location defined by Stewart & Oke [1]. The urban areas are represented by the LCZ classes "1 - 8" and "10 and E"; with rural areas defined as LCZ classes "A - D" and "F and G".

# PLEA 2018 HONG KONG

*Smart and Healthy within the 2-degree Limit*

It is worth noting that, due to the high dynamics of the sugarcane crop, dominant from the RMC to the RMRP, only those images taken within the shortest possible satellite transition dates were used.

For the LCZ classification, the WUDAPT methodology was adopted, using multispectral images from the LandSat-8 satellite for three different dates over a reference year. In this process, the trainings are defined according to the occupation typologies of the study areas [1, 3, 24]. When defining the training areas for the RMs and routing the mapping, it was observed that since this region has a predominantly agricultural occupation characteristic, the LCZs did not represent the occupation accurately.

As a result of the classification, it was observed that in the predominantly agricultural regions (sugarcane, eucalyptus, soybean and peanut), the classification of LCZs overestimated urban areas (eg LCZs 8 - Large Low-Rise and 10 - Heavy Industry), mainly due to the high turnover of these crops (classes D - Low Plants and F - Bare Soil or Sand), not allowing the correct mapping of these typologies. For example, sugar cane has several stages of development from grass size up to a height of 2 meters, not configuring a shrub and/or a tree species.

Thus, to overcome this problem, an adaptation was made in the WUDAPT methodology with the objective of improving the classification capacity in these areas. The training areas were surveyed using a high spatial resolution image from the Google Earth Pro software, taken on a given date and chosen as the base-image. Subsequently, images taken immediately before and after the base-date were verified for significant changes in morphology. In order to assist in the selection of training areas, a color composition (RGB - R7, G5 and B2 of Landsat 8) was used in the Google Earth Pro software, which covered practically all the infrared range (electromagnetic spectrum provided by the satellite) of the LandSat-8 reference image itself.

The integration of the information layers (satellite images and classes of use and ground cover) and calculation of the surface temperature averages for the year 2016 was carried out in a Geographic Information System (GIS) environment in the ArcGIS software v. 10.1.

## 2.3 Land Surface Temperature (LST)

The MODIS - Moderate - resolution Imaging Spectroradiometer images, present on the TERRA and AQUA satellites, have a spatial resolution of 1km and are made available online, by the United States Geological Survey at \*.HDF [25].

The images were acquired daily – Dec. 21, 2015 to Dec. 21, 2016 at 13:30 a.m. - and were converted into an annual average for the year 2016. The use of the MODIS satellite has advantages; because it covers areas of great extension and has an adequate temporal resolution. Surface Temperature (TS °C) images were derived from

the MODIS MYD11A1 (AQUA), channel 32 (11.770 - 12.270  $\mu\text{m}$ ) products with heliosynchronous orbit, together with the quality band [26]. Each image has, in its composition, original pixel values (Digital Numbers) that were converted to values of Surface Temperature (TS °C), according to Equation (1) [27] and depending on the Quality Control (QC) band of the image.

$$TS = (ND * 0,02) - 273,15 \quad (1)$$

Where, the ND is the "Digital Number" referring to the pixel of the image.

## 2.4 Surface Heat Island classification (SHI)

To allow the identification of Surface Heat Island (SHI), as well as the comparison of thermal patterns throughout the year, [28] suggested normalizing the surface temperature value of a given site (LST) in relation to the average of all sites, for the period of observation, (LST mean) and the respective standard deviation (LST std) as per Equation (2):

$$SHI = (LST - LST_{\text{mean}}) / LST_{\text{std}} \quad (2)$$

This methodology allows identification of anomalies in relation to the average of a given region. It also enables verification of areas with higher or lower temperature in relation to this given average, in the period of observation.

## 3. RESULTS AND DISCUSSION

The assessment of the LCZ accuracy score resulted in a Kappa (k) coefficient of 0.88, representing an excellent assessment according to the reference table [29]. The Kappa index encompasses all classes - urban and rural.

In Table 1 the classes LCZ 1 – Compact High-Rise, 2 – Compact Mid-Rise, 3- Compact Low-Rise, 4 – Open High-Rise, 5 - Open Mid-Rise, 6 - Open Low-Rise, 8 – Large Low-Rise, 10 – Heavy Industry and E – Bare Rock or Paved are grouped as the urban portion of the study area, according to the type of soil cover [1]. Already the classes LCZ 9 –Sparsely Built, A – Dense Trees, B – Scattered Trees, C – Bush, Scrub, D – Low Plants, F – Bare Soil or Sand and G – Water are grouped in the rural portion. In general, urban areas comprise 13% of the total area of study and rural areas 87%.

For the urban areas, the most representative classes were the LCZ classes "3" and "6", which together totaled about 7% of the entire study area. In these, mean surface temperatures exceeded 30°C for the analyzed period (Table 1).

# PLEA 2018 HONG KONG

Smart and Healthy within the 2-degree Limit

Table 1: Classes of LCZ and their respective areas and average surface temperatures (°C), for urban and rural areas.

LCZ	km <sup>2</sup>	%	LST °C Mean	LCZ	km <sup>2</sup>	%	LST °C Mean
1	634	1,6	31,0	9	3542	8,7	29,3
2	143	0,4	33,2	A	7329	18,0	28,4
3	1397	3,4	32,9	B	7304	17,9	29,6
4	328	0,8	31,6	C	3150	7,7	29,7
5	316	0,8	31,3	D	8858	21,8	29,6
6	1479	3,6	30,8	F	4805	11,8	30,4
8	236	0,6	31,3				
10	479	1,2	30,9	G	383	0,9	28,9
E	312	0,8	32,5				

However, the class that represented the largest portion of the territory was LCZ "D", occupying about 22% of the total area (Table 2). In this class, sugarcane cultivation predominated, extending from the Metropolitan Region of Campinas (RMC) to the Metropolitan Region of Ribeirão Preto (RMRP) in the NW portion of the study area (Fig. 3).

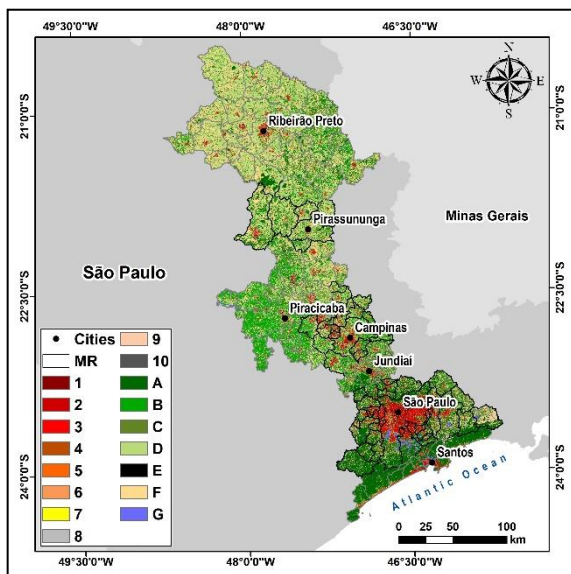

Figure 3: Local Climate Zone (LCZ) - Metropolitan Regions, Urban Agglomerations and Connections of the State of São Paulo.

In large urban areas, such as RMSP, the degree of surface transformation, materials used, permeability, roughness, density, quantity of heat generating sources - among others - are variables which influence the amount of heat that will be reflected, absorbed or stored in these areas. This effect causes differences in temperature between urban and rural environments, evidenced by the highest standard deviation found (Std = 3.4 °C) among the RMs (Table 2).

Table 2: Surface temperatures (°C) averages by regions and standard deviation, according to LCZ classification - urban and rural areas.

Regions	Mean	Std
RMRP - Metropolitan Region of Ribeirão Preto	31,6	1,9
RMC - Metropolitan Region of Campinas	31,1	2,2
AgU_Pcb - Urban Agglomerations of Piracicaba	30,9	1,5
RMSP - Metropolitan Region of São Paulo	28,0	3,4
RMS - Metropolitan Region of Santos	26,8	2,1
AgU_Jnd - Urban Agglomerations of Jundiaí	28,5	2,4
Cnx. SC_Psg - São Carlos and Pirassununga Connection	30,8	1,3

However, in the RMRP, the urban area is significantly smaller than its rural area (7% urban / 93% rural). This region has the highest LST of the entire study area (Table 1). This is due mainly to three factors: 1. the type of soil cover; 2. the annual average global solar incidence, and 3. type of soil.

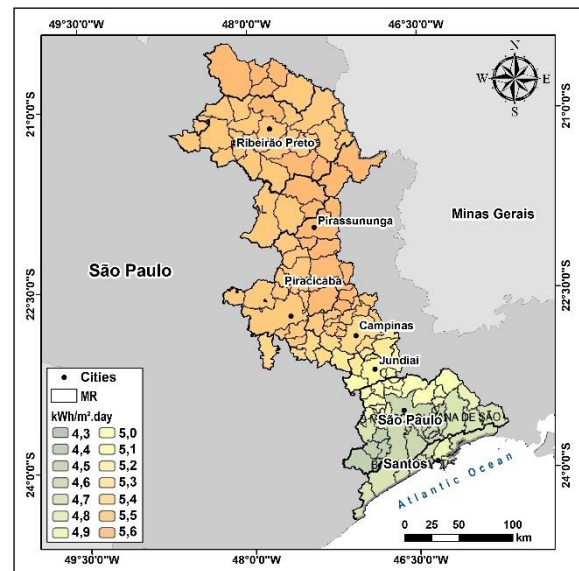

Figure 4: Annual average global solar incidence - Metropolitan Regions, Urban Agglomerations and Connections of the State of São Paulo. Source: adapted from Governo do Estado de São Paulo [30].

When analyzing the LST data between the RMRP and the RMSP and Santos, we can verify that the surface temperature difference can be related to factors such as: 1. altitude and morphological conformation; 2. annual average global solar incidence; 3. Local conditions such as vegetated areas (dense vegetation "LCZ-A"), which can absorb less heat than unvented areas such as urban (1 - 8 and 10) and rural LCZ classes "D, E and F"; among other factors [31].

Inserted in a zone of tectonic depression, the RMRP has about 60% of its territory covered by classes of LCZ "D" and "F". The alternation between soil preparation for planting (LCZ "F") and sugarcane harvest (LCZ "D"), exposes rocky soils created by volcanic spills (basalt)

# PLEA 2018 HONG KONG

Smart and Healthy within the 2-degree Limit

during the formation of *Serra Geral* [32]. Due to its mineralogical composition (dark color), highest annual mean solar area incidence in the state (Fig. 4) and the type of management promoted by sugarcane farming practices such as: compaction, increase of density and decrease of porosity; these soils can store or release heat at rates similar to those of urban areas (Fig. 6).

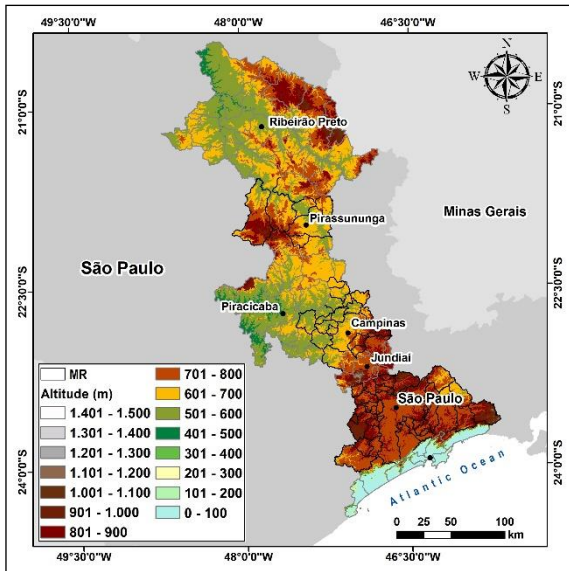

Figure 5: Morphological and altimetric description - Metropolitan Regions, Urban Agglomerations and Connections of the State of São Paulo.

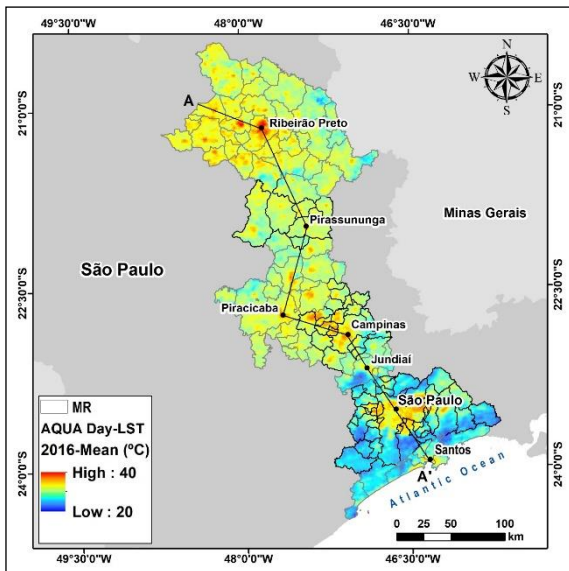

Figure 6: Mean Land Surface Temperature (°C) - Metropolitan Regions, Urban Agglomerations and Connections of the State of São Paulo.

In this sense, Surface Heat Island (SHI) of up to 4°C could be observed in the urban portion of the RMRP. That is, 1°C higher than the one observed in the RMSP, which has a larger and more diverse urban area in terms of geometry and materials (Fig. 7). It is observed that,

although the RMRP has an urban area smaller than the RMSP, the LST were 2.5°C higher than the RMSP, according to the factors mentioned.

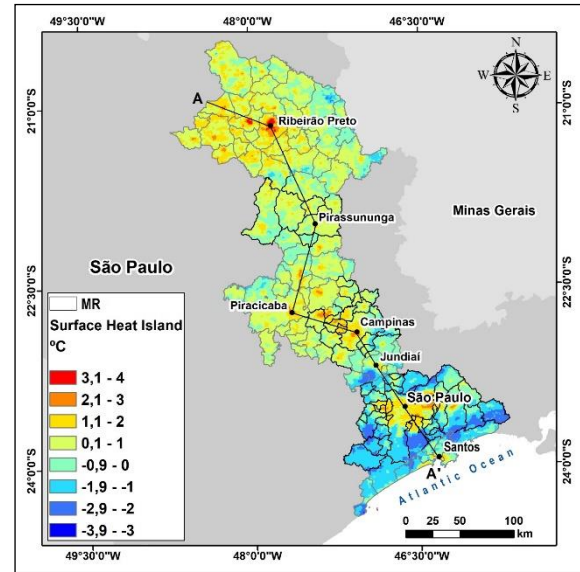

Figure 7: Surface Heat Island (SHI) (°C) - Metropolitan Regions, Urban Agglomerations and Connections of the State of São Paulo.

## 4. CONCLUSION

The need for studies applied to urban planning for tropical climate regions is of great importance for the verification of aspects related to Surface Temperature (LST) and Surface Heat Island (SHI) conditions.

The lack of information on the constructive aspects of cities hinders the development of standards and the creation of master plans; demanding hard work by technicians for the production of this information. Brazilian cities, in most cases, lack digital information in the administration of the use and occupation, height and design of buildings, size of occupied areas (green areas, paved areas, etc.).

Factors such as soil cover, higher mean solar incidence, morphological conditions of relief and soil type; can identify larger and smaller LST changes in a given area. For example, for RMRP, these conjugated factors made this region have LST higher than in the metropolitan region of São Paulo, although São Paulo has a larger portion of urban area.

## REFERENCES

1. Stewart, I. D. & Oke, T. (2012). Local Climate Zone for urban temperature studies. *Bulletin of the American Meteorological Society*, 93, 1879 – 1900.
2. Bechtel, B.; Alexander, P. J.; Böhner, J.; Ching, J.; Conrad, O.; Feddema, J.; Mills, G.; See, L.; Stewart, I. (2015). Mapping Local Climate Zones for a Worldwide Database of the Form and Function of Cities. *ISPRS Int J Geo-Inf* 4:199–219.
3. Mills, G., Ching, J., See, L., & Betchel, B. (2015). An introduction to the WUDAPT project. In 9th International Conference on Urban Climate.

# PLEA 2018 HONG KONG

*Smart and Healthy within the 2-degree Limit*

4. Kim, H. H. (1992). Urban heat island. *International Journal of Remote Sensing*, v. 13, p. 2319–2336.
5. Shoshany, M., Aminov, R., & Goldreich, Y. (1994). The extraction of roof tops from thermal imagery for analyzing the urban heat island structure. *Geocarto International*, v.4, p. 61–69.
6. Aniello, C., Morgan, K., Busbey, A., & Newland, L. (1995). Mapping micro urban heat islands using Landsat TM and a GIS. *Comparative Geoscience*, v. 21, p. 965–969.
7. Weng, Q., Lu, D., & Schubring, J. (2004). Estimation of land surface temperature – vegetation abundance relationship for urban heat island. *studies. Remote sensing of Environment*, v. 89, n. 4, p. 467–483. doi:10.1016/j.rse.2003.11.005.
8. Chen, X. L., Zhao, H. M., Li, P. X., & Yin, Z. Y. (2006). Remote sensing image-based analysis of the relationship between urban heat island and land use/cover changes. *Remote Sensing of Environment*, 104 (2), 133–146. doi:10.1016/j.rse.2005.11.016.
9. Li, W.; Bai, Y.; Chen, Q.; He, K.; Ji, X.; Han, C. (2014). Discrepant impacts of land use and land cover on urban heat islands: A case study of Shanghai, China. *Ecological Indicators*, v. 47, p. 171–178. doi:10.1016/j.ecolind.2014.08.015.
10. Lin, W.; Yu, T.; Chang, X.; Wu, W.; Zhang, Y. (2015). Calculating cooling extents of green parks using remote sensing: Method and test. v. 134, p. 66-75. doi:10.1016/j.landurbplan.2014.10.012.
11. Mohan, M.; Kandy, A. (2015). Impact of urbanization and land-use/land-cover change on diurnal temperature range: A case study of tropical urban airshed of India using remote sensing data. *Science of The Total Environment*. v. 506–507, p. 453–465. doi:10.1016/j.scitotenv.2014.11.006.
12. Voogt, J.A.; Oke, T.R. (2003). Thermal remote sensing of urban climates. *Remote Sensing of Environment*. v. 86, p. 370–384. doi:10.1016/S0034-4257(03)00079-8
13. Weng, Q. (2009). Thermal infrared remote sensing for urban climate and environmental studies: Methods, applications, and trends. *ISPRS Journal of Photogrammetry and Remote Sensing*, v. 64, n. 4, p. 335–344. doi:10.1016/j.isprsjprs.2009.03.007
14. Gartland, L. (2001). Cool Roof Energy Savings Evaluation for City of Tucson. Thomas O. Price Service Center Administration Building One. Tucson, AZ, City of Tucson, 117p.
15. Li, J.J., Wang, X.R., Wang, X.J., Ma, W. C. & Zhang, H. (2009). Remote sensing evaluation of urban heat island and its spatial pattern of the Shanghai metropolitan area, China. *Ecol. Complex*. v. 6, p. 413–420. doi:10.1016/j.ecocom.2009.02.002
16. Zhou, W., Huang, G., & Adenasso, M. L. (2011). Does spatial configuration matter? Understanding the effects of land cover pattern on land surface temperature in urban landscapes. *Landscape and Urban Planning*, v. 102, n. 1, 54–63. doi:10.1016/j.landurbplan.2011.03.009.
17. Deng, C., & Wu, C. (2013). Examining the impacts of urban biophysical compositions on surface urban heat island: A spectral unmixing and thermal mixing approach. *Remote Sensing of Environment*, 131, 262–274. doi:10.1016/j.rse.2012.12.020
18. IBGE - Instituto Brasileiro de Geografia e Estatística (2017), Available: 01 July 2017, <www.ibge.gov.br>.
19. Código Florestal. LEI Nº 12.651, DE 25 DE MAIO DE 2012. [Online]. Available: [http://www.planalto.gov.br/ccivil\\_03/\\_ato2011-2014/2012/lei/l12651.htm](http://www.planalto.gov.br/ccivil_03/_ato2011-2014/2012/lei/l12651.htm) [31 May 2018].
20. Ferreira, L. S., Shimomura, A. P., Ferreira, A. T. & Duarte, D. H. S. (2017). Mapping Local Climate Zones for São Paulo Metropolitan Region: a comparison between the local climate zone map and two other local maps. *Proceedings of 33rd Plea International Conference – Design to Thrive*, download online [www.nceub.org.uk](http://www.nceub.org.uk), NCEUB 2017 – Network for Comfort and Energy Use in Buildings, Volume II, pages 1725 to 1732, Ed. Luisa Brotas, Susan Roaf and Fergus Nicol, ISBN 978-0-9928957-5-4
21. USGS - United States Geological Survey. Aquisição de imagens orbitais do satélite Landsat-8. Acesso em: 08 dec. 2017b. [Online]. Available: <<http://earthexplorer.usgs.gov>>.
22. Congalton, R. & Green, K. (2009). *Assessing the Accuracy of Remotely Sensed Data*. 2nd ed. Boca Raton: CRC Press, 200p.
23. Congalton, R. G. (1991). A review of assessing the accuracy classifications of remotely sensed data. *Remote Sensing Environment*, v. 37, p. 35-46, 10.1016/0034-4257(91)90048-B.
24. Prata-Shimomura, A. R. & Ferreira, A. T. (2018). Local Climate Zone Classification adapted for mapping agricultural áreas in Metropolitan Areas. 10th International Conference on Urban Climate and 14th Symposium on Urban Environment – ICUC 2018. City College of New York, NY – 6-10 august/2018. Download online - [https://ams.confex.com/ams/ICUC10/meetingapp.cgi/Day/Program1243\\_2018-08-10](https://ams.confex.com/ams/ICUC10/meetingapp.cgi/Day/Program1243_2018-08-10)
25. USGS - Geological Survey. Aquisição de imagens orbitais digitais gratuitas dos satélites Terra/Aqua (MODIS). Available: 12 08 dec. 2017 <<http://mrtweb.cr.usgs.gov>>.
26. Justice, C. O.; Townshend, J. R. G.; Vermote, E. F.; Masuoka, E.; Wolfe, R. E.; Saleous, N.; Roy, D. P.; Morisette, J. T. (2002). An overview of MODIS land data processing and product status. In: *Geoscience and Remote Sensing Symposium*. Sydney, Australia, IGARSS, p 1454-1457.
27. Wan, Z. *Collection-6 MODIS Land Surface Temperature Products Users' Guide*. ERI, University of California, Santa Barbara, 2013, 33 p. [Online]. Available: 08 mai <https://ices.eri.ucsb.edu/modis/LstUsrGuide/usrguide.htm>
28. Alcoforado, M. J.; Andrade, H.; Lopes, A. S.; Vasconcelos, J. (2009). Application of Climatic Guidelines to Urban Planning. The example of Lisbon (Portugal). *Landscape and Urban Planning*. n. 90, p. 56-65. Doi: 10.1016/j.landurbplan.2008.10.006.
29. Landis, J. R. & Koch, G. G. (1977). The measurement of observer agreement for categorical data. *Biometrics*, v. 33, p. 159-154.
30. Governo do Estado de São Paulo. *Energia solar paulista: levantamento do Potencial* (2013). Portal do Governo do Estado de São Paulo, Available: 02/Aug./2018, [http://dadosenergeticos.energia.sp.gov.br/portalcev2/intranet/BiblioVirtual/renovaveis/atlas\\_energia\\_solar.pdf](http://dadosenergeticos.energia.sp.gov.br/portalcev2/intranet/BiblioVirtual/renovaveis/atlas_energia_solar.pdf)
31. Ynoue, R. Y.; Reboita, M. S.; Ambrizzi, T.; Silva, G. A. M. (2017). *Meteorologia: noções básicas*. São Paulo : Oficina de Textos, 184 p.
32. SÃO PAULO. (2014). *Unidades Básicas de Compartimentação do Meio Físico (UBC) do Estado de São Paulo*. Instituto Geológico/Coordenadoria de Planejamento Ambiental, Secretaria do Meio Ambiente do Estado de São Paulo.

# Gauging People's Perceptions of Reclaimed and Recycled Building Materials: A Pilot Study

ZAHRA BALADOR<sup>1</sup>, MORTEN GJERDE<sup>1</sup>, NIGEL ISAACS<sup>1</sup>

<sup>1</sup>Victoria University of Wellington, Wellington, New Zealand

*ABSTRACT: Construction activities can lead to detrimental environmental effects and the industry is recognised as a high polluter. Adopting more sustainable construction practices should be the mission of all stakeholders. One way of decreasing negative environmental impacts is to enhance the lifecycle of building materials. The construction sector can considerably enhance its sustainability quotient by fostering more sustainable practices around the use of building materials. From another point of view, construction is responsible for a large amount of waste, since it utilizes energy and materials. The construction sector is by nature fragmented and diverse, so involves many different stakeholders with different abilities to influence outcomes. As there is much to be gained by a more effective and coordinated construction industry, this paper reports on an investigation into the roles different stakeholders can play in bringing about change. This paper addresses this complexity and tries to clarify roles and responsibilities of stakeholders.*

*KEYWORDS: Building materials, recycling, reuse, sustainability, and stakeholders.*

## 1. INTRODUCTION

One of the consequences of ongoing growth of economies and population is degradation of the environment. The construction industry has the reputation of being one of the industries that creates the most detrimental environmental effects. As the worldwide population continues to grow, the construction sector is also undergoing a surge, which means more building materials are being used, many of which have an adverse impact on the environment. Adopting more sustainable construction practices would include enhancing the life cycle value of building materials. As a rule of thumb, one square meter of a completed building requires up to 2.3 tonnes of 100 different building materials. Each of these materials needs to be extracted and processed [1].

While past practices have largely considered the cost, availability, and aesthetics of building materials, we are now at a point where attention should also be paid to sustainability indicators. Using reclaimed and recycled building materials (RRBM) has the potential to mitigate the adverse effect of materials production process by reducing extraction of more raw materials. Other than saving the cost of extraction, recycled materials can save between 12% and 40% of the total energy needed for the production phase [2].

From another perspective, construction activities can generate large amounts of waste. As well as other areas of society, the building industry is shifting towards reducing ecological impacts by using, on the one hand, more natural and local materials and on the other hand, using wastes or producing less waste to close the life cycle loop of buildings [3].

## 2. OBJECTIVES

This research examines people's perceptions of the role of different stakeholders in specifying, manufacturing, regulating, installing and maintaining RRBMs in the construction process. People's positive and negative perceptions of these materials are also gauged along with their environmental activities. The paper reports on the results from a pilot study, which is already indicating clear patterns. Along with reporting on these early findings, the paper discusses the effectiveness of the research method. The survey has proven effective at collecting the perceptions of people in the field of RRBMs and finding the gaps and opportunities to improve the use of these materials.

### 2.1. Pilot study

Pre-testing the appropriateness of survey design is indispensable and yet has been discussed in the literature more in theory than practice. Before launching the survey to collect data, a pre-testing or pilot study can be undertaken to identify different possible problems on similar population. Issues that may arise in such a pilot study include respondents having difficulty in understanding or interpreting questions or missing the intended meaning or reference with the way questions are stated [4]. Wording and ordering the questions and procedural issues all matter in the communication to respondents.

It is also important to experiment with analysis of the data collected in a pilot study; it means that we can prepare dummy tables for expected results. Another useful test is to write up the results of the pilot study. However, it is inadvisable to place too much weight on

# PLEA 2018 HONG KONG

*Smart and Healthy within the 2-degree Limit*

these initial results, as the number of respondents may not be statistically relevant or they might not be good representative of the target population. Nevertheless, some differences may appear. These interpretations can help in rephrasing or eliminating the questions [5]. There are inconsistencies among these methods for evaluating a pilot study, so we should find which method is appropriate for a specific circumstance and purpose. If problematic items are seeking to shed light on underlying theoretical domains it is important that they be retained [6]. Researchers should look to examine the data collected from the pilot study in the same manner of the main survey; accordingly, raw data should be prepared as an initial step, including editing and coding [7].

## 3. ONGOING DIALOGUE

Studies related to this topic can be divided into two main categories: first, RRBMs, possibilities and processes through which they can be used in building construction; second, roles of different stakeholders in the market of building materials. Most of the studies in this section investigate the environmental performance of companies or buying behaviour of consumers.

### 3.1 Reuse and recycling

According to the New Zealand Waste Strategy, two main goals are set out to reduce the harmful effects of waste and to increase the efficiency of resource use. In order to take action, there are different hierarchical steps based on their importance: reduce, reuse, recycle, recover, residual disposal. In order to have a waste management plan in the project, the team should gain the client commitment and select materials and systems wisely [8].

The idea of reuse emerged in the early 1970s in the U.S., in order to reduce negative environmental impacts. Projects are different in terms of possibility of reusing different materials and component. Planning to have unitised and removable parts such as partitions, services, fittings, and fixtures can certainly help increase this possibility. These decisions often depend on availability; ease of refurbishment; product liability; and environmental benefits and costs [9].

Superuse is another kind of reusing but one in which the element or material is reused with a different purpose through adaptation for the new task. Discarded oil drums reused to make a big wall, packaging foil redeployed as insulation, and airplane fuselages reused, as buildings are examples of this approach. Superuse does not need energy for grinding or scraping components, but give a different architectural role to them [10].

Challenges of deciding whether to adopt a reuse and recycling strategy of raw materials involve weighing up different factors such as initial investment, maintenance, replacement, demolition, and disposal energy. For

example, a material with more energy consumption in manufacture may be more durable and easily recyclable, and an expensive one may require less maintenance or vice versa [11]. An example of this is steel, which has a 24 MJ/kg embodied energy characteristic and will have the same performance, even after being recycled many times. Concrete, on the other hand, having an embodied energy value of 1 MJ/kg can only be turned into aggregate when it is recycled, not reused. Steel, aluminium, and copper have very good histories of being recycled; PVC-U and plastics can be turned into new products after recycling; glass can be used for thermal insulation or as aggregates for concrete [12].

### 3.2 Stakeholders

There is sufficient evidence to suggest that stakeholders improve decision-making process by adding new information, ideas, and analysis. The large number of actors and their interests make it complex and sometimes unclear when it comes to choosing materials but it is vital. Although this brings non-scientific knowledge to the decision-making process, it is practical knowledge and experience [13, 14].

The cooperation of multiple stakeholders is one of the factors that can be studied more specifically for the development of new sustainable products [15]. Freeman defined stakeholder as “any group or individual who can affect or is affected by the achievement of the organization’s objective” [16]. Main stakeholders include regulators, consumers, manufacturers and suppliers, NGOs and environmental activists, builders, architects and designers.

Government can take a leadership role in the uptake of new technologies; as facilitator, stimulator, controller, and director. In other words, government agencies could become involved in creating boundaries for the market and more directly stimulating experiments and developing new partnerships. External factors, political structure and socio-cultural factors influence the extent to which governments become involved in such programmes [17]. Governments take action through waste reduction policies, and production schemes which are encouraging directly or indirectly [15].

Communities of environmental activists can have influence on changing public attitudes and persuading consumers towards using more environmentally sustainable materials, promoting recycling, reuse, composting, waste reduction, and waste education [18, 19]. To date however, there is greater emphasis on other green products and reducing the general waste and not as much yet on building materials [15].

Architects and designers have the responsibility of specifying and selecting construction materials in connection with having their design proposal considered by their client and are therefore prime candidates to help initiate change. Hence, they should have the

# PLEA 2018 HONG KONG

*Smart and Healthy within the 2-degree Limit*

understanding of the importance, advantages and disadvantages of utilising RRBMs. Personal interest and the ideas that are driven by the design team and clients can be the main impetus in the first stages of design [9]. From the point of view of materials production processes, studies of purchasing behaviour suggest that it is the consumers who dictate (or define) the values of the market [20].

Many manufacturing industries have become more conscious of future limits on natural resource availability and this has led some to increase the percentage of recycled content in their products. Current trends toward more socially and environmentally behaviours by manufacturers are largely an ethical approach by the businesses, driven in part by their perceptions of stakeholder expectations [21-23].

## 4. RESEARCH DESIGN

The overall research methodology seeks to collect quantitative data through an anonymous survey and qualitative data through focus group discussions. This paper reports on the findings based on the analysis of the quantitative data. Specifically, it reports on the results of a pilot study run to pre-test the research methods. The survey is an online questionnaire, conducted on the Qualtrics platform. Five-point Likert scale, multiple choice, and dichotomous questions have been utilised to gauge people's perceptions and preferences. The main categories in the first part of the questionnaire are classifying respondents based on their demographics, their environmental attitudes, and their knowledge about environmental issues. The second part is focused on their perceptions and understanding about RRBMs; their experience of using these materials; and finally, their knowledge about their role in this area and others' roles.

Analysis of the collected data follows several steps, including: preparing the data for analysis, exploring the data to developing broad trends, appropriate statistical tests to address the research question, using figures to present, interpretation, validating to check meaningful indicators and conclusions. The analytical tool, SPSS, was used to identify frequencies, mean response values and correlations between responses. This research is anonymous and has been approved by the Victoria University of Wellington Human Ethics Committee.

### 4.1 Data collection

Some studies recommend between 12-50 cases as a sufficient sample size to discover flaws in the survey depending on the study [25]. Other studies suggest 12 as the minimum sufficient number per group or 10% of the expected sample size, as a general rule [26]. This pilot study collected responses from 27 people, which coincidentally is 10% of the expected total sample size of 270 participants. While this sample was limited to a

particular demographic – students in the Victoria University postgraduate student body – this group could more readily provide constructive feedback on the questionnaire and survey process when asked. One of the other reasons behind choosing this sample of postgrad students was that they were all experienced architects or civil engineers as well, so they can be partly representative of the target population. It was also expected that this demographic group would have a relatively high response rate (77% in this study), enabling a more effective pilot study. The average duration for answering this online questionnaire was 23 minutes.

### 4.2 Limitations

Some studies suggest such research should be conducted anonymously in order to achieve more reliable results because people may want to show themselves environmentally and socially responsible [27]. Other obstacles can be the complexity of the business environment and society such as bureaucracy, greenwash, and scepticism [28, 29].

## 5. RESULTS AND DISCUSSION

Descriptive statistics are useful for describing the basic features of data. In this study, 12 men and 15 women participated. Most of the respondents (21) claimed that their occupation is not related to reclaimed and recycled building materials, while 11 respondents have related occupations (they chose one of the occupations in the list like architect). This suggests that many people will be unaware of the direct role they play in promoting the use of materials in the building process.

The New Environmental Paradigm (NEP) scale, which is proposed, by Dunlap and Van Liere has been most widely used to assess environmental attitudes, and it is recommended to use it as a single dimension and calculate the total score. Each item has a mean Likert score, and the average of all of these scores is the total score. A short version of this scale has been used in this research, which is a set of six items (two with original wording and four revised items). In this study, the total score of respondents is 3.97 (Table 1) which is similar to the result of another study in New Zealand. In that study, the score of respondents (No=226) with tertiary education level was 3.84 in 2008 [30]. However, measuring the consistency of this scale shows that Cronbach alpha is 0.567 (Table 2) which is higher than consistency of Thomson's study. However, we should have in mind that the number of respondents of a pilot study is so much lower than the main survey study, and consistency will probably increase in the main survey. In addition, researchers seem willing to acknowledge that for measuring the environmental attitudes we can accept a Cronbach's  $\alpha$  as low as 0.693 [31].



# PLEA 2018 HONG KONG

*Smart and Healthy within the 2-degree Limit*

Table 1: NEP item mean scores

New Environmental Paradigm scale	Score
1. The balance of nature is very delicate and easily upset by human activities	4.45
2. The earth is like a spaceship with only limited room and resources	4.48
3. Plants and animals do not exist primarily to be used by humans	3.74
4. Modifying the environment for human use seldom causes serious problems	3.63
5. There are no limits to growth for nations	3.40
6. Mankind is created to rule over the rest of nature	4.12
Total score	3.97

Table 2: Consistency of NEP scale

Cronbach's Alpha if Item Deleted						Cronbach's Alpha
1	2	3	4	5	6	Total
.57	.56	.39	.57	.45	.51	.56

Respondents' attitudes towards the environmental building construction is measured by asking 6 items about sustainable buildings and reclaimed and recycled building materials in Likert Scale. Results indicate that although most people have a positive attitude toward these approaches, higher scores were registered in relation to sustainable building than against sustainable uses of materials. While the differences are not great in the present study, they suggest that people are not aware of the impact of materials in the life cycle of the whole building. If we consider a total score for all of the six items, the mean score will be 4.23, which shows the acceptance of sustainability in building construction among respondents (Table 3). The dispersion of respondents indicates that people are not aware that construction is one of the most a polluting industry. However, still there is no certain pattern.

Table 3: Measurement of attitudes towards sustainability in building construction

Item Dimension						Score
1	2	3	4	5	6	Total
4.37	4.23	4.37	4.12	4.15	4.12	4.23

Results show that based on the perception of respondents, people are more concerned about environmental issues and recycling these days (67%); interestingly, they agreed that people usually buy environmentally friendly products for self-satisfaction and feeling good about themselves (81%), however price plays an important role in this purchase (96%).

Almost half of the samples were not sure whether they would be able to find reclaimed and recycled building material suppliers in nearby stores. Also 55% of them think that advertisement has some influence on buying reclaimed and recycled building materials,

although 63% of them say that required information and specifications of reclaimed and recycled building materials are not easily accessible. If this pattern remains the same for the bigger sample size in the main survey, it can be interpreted that people need more information and it is beneficial that building material manufacturers advertise and show more transparency to their potential consumers. About 70%, or 19 respondents, agreed that the benefits of using reclaimed and recycled building materials are more than their drawbacks.

Table 4: Kruskal-Wallis test relationship between attitude of people and their practice

	benefit	N	Mean Rank
practice	1.00	18	15.19
	2.00	7	9.14
	3.00	1	13.50
	Total	26	

A Kruskal-Wallis test was conducted to determine whether there were any relationship between attitude of people about benefits of using these materials and the number of environmental practices they do. It shows a relationship which is not reliable yet but can turn into a strong relationship in a bigger sample size (Table 4). The most frequent practices were recycling paper, plastics etc. with 23, repairing items with 21, buying energy-efficient products with 20 responses.

Results of the comparison of respondents' attitude towards the importance of using reclaimed and recycled building materials from environmental, economic and social point of view reveals that environmental is the most important aspect (4.5 average point), and economical and social are on the same level (with average point of 3).

Although most of the respondents agreed that the public and environmental image of the manufacturers of environment friendly products are important (mean score 4), 63% of respondents think that there is a gap between manufacturers' claim and performance (mean score 4). If this attitude holds true in the main study it can create challenges for any campaigns for change, as it shows people may not trust manufacturers' information or their advertisements (Fig. 1).

Respondents' answers to questions about related regulations and certificates indicated that mostly they do not have knowledge about them. The most frequent category showed: 46% said they are not aware whether there are enough regulations related to reclaimed and recycled building materials, 31% said that they do not have knowledge about them, 50% said that they are not sure whether there is any related building certificate and 44% said that they are not sure whether there is any related building material certificate. Evaluation of the

# PLEA 2018 HONG KONG

Smart and Healthy within the 2-degree Limit

importance of different specifications of reclaimed and recycled building materials when buying indicated that, health is the most important factor, and durability is the least important, although differences are small, it may show a pattern in the larger sample.

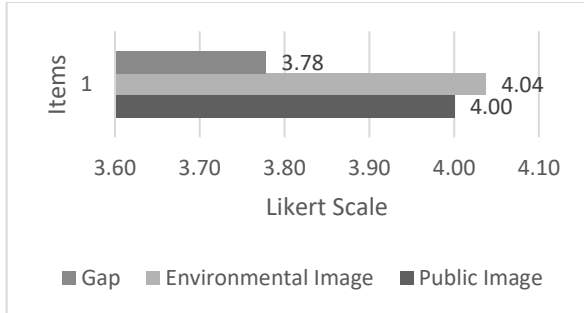

Figure 1: Measurement of attitudes towards the manufacturers of environment friendly products

Based on the perceptions of respondents, consumers and regulators have the most influential roles in enhancing reuse and recycling of building materials (each category attracted a 26% response frequency); and regulators (with 27% response rate) are seen as the stakeholder group most capable to change attitudes about recycling; regulators at 35% and architects at 31% are perceived to be the most capable of implementing recycled materials into projects; regulators at 46% have the greatest influence in checking the safety and performance of these materials and architects with 52% response rate are seen as the group most likely to include consumers' ideas for recycled material usage in the built environment. With this background, we would argue that architects' role, although indirect, is the most influential (Fig. 2).

Most of the respondents (70%) believe they have no role in enhancing reuse and recycling of building materials, and 82% lack awareness about others' roles. 82% of respondents are unaware of any regulations around reclaimed and recycled materials that are related to their occupation; however, 56% of them think that their occupation has an effect on increasing the use of reclaimed and recycled building materials. Interestingly, 82% of respondents believe that they should advocate for using reclaimed and recycled building materials according to their professional responsibilities, and 89% of them would suggest others to use them too. Therefore, it seems that most of them think that they do not have a role to improve this situation, but when they are asked in detail, they understand that they can have a role, personally and professionally.

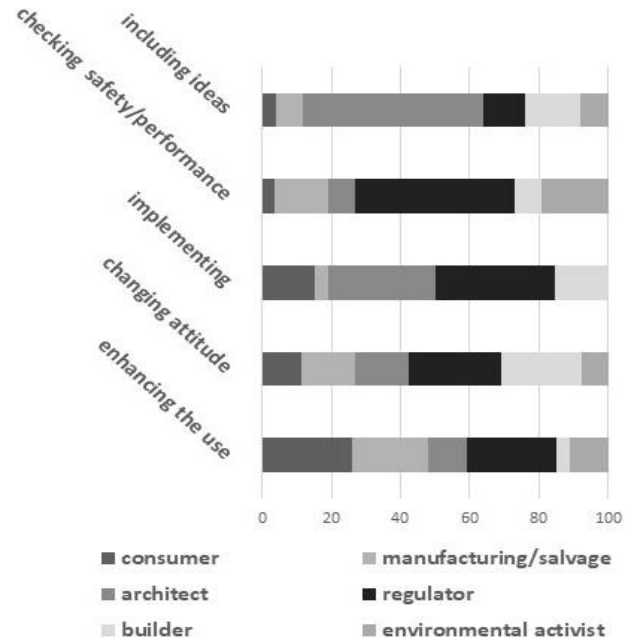

Figure 2: The importance of stakeholders' role based on participants' perceptions

## 6. CONCLUSION

Earlier research has clearly established that construction is responsible for a large amount of waste. To help mitigate the potentially adverse effects and consequences for all stakeholders there are opportunities to bring about change. In order to clarify the complexity of these opportunities and challenges, studying the perceptions of stakeholders is essential. As this paper is concerned with a pilot study, the primary purpose is to check the effectiveness of the methods, not only to collect data but also for those data to be analysed. To test whether the questions measure what they are meant to measure, we evaluate the results to check if they are meaningful and indicate any patterns that align with contemporary literature in the field. In the process, several changes were made to the wording and type of questions before the main survey is conducted.

The responses indicate that people are concerned about environmental issues and having a sustainable building construction sector. However, when it comes to the use of reclaimed and recycled building materials, they are not familiar with current policies. From the literature we understand that government has a leading role to play. This is also confirmed in the results of this pilot study but it is less clear whether people are aware of relevant regulations and certification regimes around the use of recycled materials. In terms of the influence of environmental communities, it seems that they do not promote reclaimed and recycled building materials as it is needed and still they are in the early stages of promoting the reduction of general waste. The architect is the stakeholder who has the responsibility of specifying materials and interpreting clients' needs and expectations into a project and can therefore play an

# PLEA 2018 HONG KONG

*Smart and Healthy within the 2-degree Limit*

important role. This is also confirmed by the results of this study. Marketing studies show that consumers can define values of the market and manufacturers in order to keep up with future limits of natural resources and satisfying consumers have to update themselves by communicating with consumers and understanding their needs. Findings of this pilot study present the same results as well. Most of the respondents think that they do not have a role to boost the use of reclaimed and recycled building materials, but when they are asked in detail, they understand that they can have a role, personally and professionally. By conducting a pilot study and interpreting the results, the research team is well placed to probe more deeply into stakeholders' perceptions of recycled materials in the building industry.

## REFERENCES

1. Khatib, J., Sustainability of construction materials. 2016: Woodhead Publishing.
2. Calkins, M., Materials for sustainable sites: a complete guide to the evaluation, selection, and use of sustainable construction materials. 2008: John Wiley & Sons.
3. Balador, z., et al. Research hotspots on agro-waste based building insulation products \_ a meta-review. in International Conference on Advances on Sustainable Cities and Buildings Development. 2017. Porto, Portugal: Green Lines Institute.
4. Kumar, R., Research Methodologies: a step-by-step guide for beginners. 2nd. 2005: London: SAGE Publications Ltd.
5. Oppenheim, A.N., Questionnaire design, interviewing and attitude measurement. 2000: Bloomsbury Publishing.
6. Rattray, J. and M.C. Jones, Essential elements of questionnaire design and development. *Journal of clinical nursing*, 2007. 16(2): p. 234-243.
7. Srinivasan, R. and C. Lohith, Pilot Study—Assessment of Validity and Reliability, in *Strategic Marketing and Innovation for Indian MSMEs*. 2017, Springer. p. 43-49.
8. Jaques, R., Building basics: Minimising waste. 2013: BRANZ.
9. Addis, B., Building with reclaimed components and materials: a design handbook for reuse and recycling. 2012: Routledge.
10. Van Hinte, E., C. Peeren, and J. Jongert, Superuse: constructing new architecture by shortcutting material flows. 2007: 010 Publishers.
11. Conder, T., Materials. 2008: BRANZ.
12. Lyons, A., Materials for architects and builders. 2014: Routledge.
13. Rotmans, J., Methods for IA: The challenges and opportunities ahead. *Environmental modeling and assessment*, 1998. 3(3): p. 155-179.
14. Sandhu, S., et al., Consumer driven corporate environmentalism: Fact or fiction? *Business Strategy and the Environment*, 2010. 19(6): p. 356-366.
15. Balador, Z., et al., Thermal and Acoustic Building Insulations from Agricultural Wastes, in *Handbook of Ecomaterials*, L. Martínez, O. Kharissova, and B. Kharisov, Editors. 2018, Springer, Cham. p. 1-20.
16. Freeman, R.E., Strategic management: A stakeholder approach. 2010: Cambridge University Press.
17. Rotmans, J., R. Kemp, and M. Van Asselt, More evolution than revolution: transition management in public policy. *foresight*, 2001. 3(1): p. 15-31.
18. Community Recycling Network, Mission. 2017, Community Recycling Network: New Zealand.
19. NZAIA, Aims. 2016, New Zealand Association for Impact Assessment New Zealand.
20. Bendell, J. and A. Kleanthous, Deeper luxury: Quality and style when the world matters. 2008: WWF-UK.
21. Slaughter, G., Construction of New Zealand's First 100% Recycled Road. Fulton Hogan Ltd, New Zealand, 2005.
22. Rodriguez-Melo, A. and S.A. Mansouri, Stakeholder Engagement: Defining Strategic Advantage for Sustainable Construction. *Business Strategy and the Environment*, 2011. 20(8): p. 539-552.
23. Albino, V., A. Balice, and R.M. Dangelico, Environmental strategies and green product development: an overview on sustainability-driven companies. *Business Strategy and the Environment*, 2009. 18(2): p. 83-96.
24. Kurisu, K., Pro-environmental Behaviors. 2015, Department of Urban Engineering, The University of Tokyo, Tokyo, Japan: Springer.
25. Presser, S., et al., Methods for Testing and Evaluating Survey Questions. *Public Opinion Quarterly*, 2004. 68(1): p. 109-130.
26. Johanson, G.A. and G.P. Brooks, Initial scale development: sample size for pilot studies. *Educational and Psychological Measurement*, 2010. 70(3): p. 394-400.
27. Grimmer, M. and T. Bingham, Company environmental performance and consumer purchase intentions. *Journal of Business Research*, 2013. 66(10): p. 1945-1953.
28. Lemke, F. and J.P.P. Luzio, Exploring Green Consumers' Mind-Set toward Green Product Design and Life Cycle Assessment. *Journal of Industrial Ecology*, 2014. 18(5): p. 619-630.
29. Tilikidou, I., et al., Pro-Environmental Purchasing Behaviour during the economic crisis. *Marketing Intelligence & Planning*, 2014. 32(2): p. 160-173.
30. Thomson, J., New Ecological Paradigm Survey 2008: Analysis of the NEP results, W.R. Council, Editor. 2013, Waikato Regional Council.
31. Lovelock, B., Disability and going green: a comparison of the environmental values and behaviours of persons with and without disability. *Disability & Society*, 2010. 25(4): p. 467-484.

## Sustainability: What We Need vs What We Think We Need. Change in Perception of Need with Socio-Economic-Cultural Conditions

AMAN BATISH<sup>1</sup>, AVLOKITA AGRAWAL<sup>1</sup>

<sup>1</sup>Department of Architecture & Planning, Indian Institute of Technology, Roorkee, India

*ABSTRACT: A lot has been written about sustainability and sustainable development in the recent times, but a clear meaning of the term still remains elusive. Socio-economic-cultural factors such as the prevalent world-view in a society greatly influence environmental behaviour of people. Materialistic consumer culture and the urge to consume resources without restraint to gratify personal desire have a negative correlation with pro-environmental behaviour. It is therefore, important to understand how socio-economic-cultural factors influence the need to consume resources. This study aims to assess the intensity of perception of needs in people in the context of their socio-economic-cultural conditions. Primary data was collected through a survey conducted in several cities, towns and villages in India across different socio-economic-cultural scenarios. The respondents were asked to rate the intensity of needs in various categories (adopted from Maslow's need hierarchy) on a five-point scale ranging from very strong need to not essential. Scores for intensity of perceived need were calculated for each respondent for each need type. An analysis of variance (ANOVA) was done to see if the different settlement types and economic classes showed statistically significant variance in the intensity of needs. Significant variance was observed between different settlement types and economic classes.*

*KEYWORDS: Sustainability, Need perception, Environmental behaviour, Attitudes, Value*

### 1. INTRODUCTION

Since a definition was first published in Brundtland report, Our Common Future[1], a lot has been said and written about Sustainability and Sustainable development. In fact a recent study cites the existence of some 21,500,000 documents with the theme of sustainability[2]. Many scholars and practitioners have articulated and promoted their own definitions: yet a clear, fixed and immutable meaning remains elusive[3].

It is often beneficial in such situations to rise above the rhetoric and go back to the basics to explore the origins of a problem. From this perspective it would be interesting to note the views of eminent historian Lynn White, Jr. that, "Human ecology is deeply conditioned by beliefs about our nature and destiny –that is by religion." [4]. As a matter of fact, the world-view prevalent in any society has a deep relation with the culture/religion practised in that society and this world-view greatly influences the treatment of its environment by its members.

The current scientific approach towards understanding the idea of sustainability involves identifying 'indicators', representing measurable phenomena. However, "an emphasis on the scientific foundation of indicators risks becoming an overstatement that communicates a message that sustainability is primarily a scientific problem rather than a moral or ethical choice." [5] It is therefore important that, 'the field of sustainability science recognises the important contributions that understanding social values can make to the development of indicators'. [5] In fact, philosophies of the orient, sharing common roots,

emphatically express the need for a symbiotic, need based relationship between man and his environment, where avoiding excesses to gratify human desire and hankering for more is strongly advocated.

#### 1.1. Trends in Environmental Psychology Studies

Recent studies in environmental psychology have presented a strong evidence that, materialistic values may be negatively related with and dissuade pro-environmental attitudes and behaviours [6],[7]. The roots of Environmental problems like global warming and air pollution etc. have been shown to lie in human behaviour [8]. Concerns have also been expressed regarding the role of consumer culture and materialistic way of life in promoting environmentally unfriendly behaviour [9].

It has been suggested that, 'the effects of contextual factors on environmental behaviour needs to be examined in more detail' [8]. It is therefore, important to take into account the effects of socio-economic-cultural factors on the environmental attitudes of people, particularly in relation to their perceived need to consume resources.

#### 1.2 The present study

In the light of these facts, this study aims to form an understanding about how intensely people feel about the satisfaction of their needs in relation to their socio-economic-cultural context—do they adapt and modify their needs according to these contextual conditions or according to the availability and accessibility of resources.

# PLEA 2018 HONG KONG

*Smart and Healthy within the 2-degree Limit*

The objectives include: a) to identify a set of measurable indicators to assess the intensity of perception of need in people and b) to observe any correlation, through these indicators, between the intensity of perception of needs in people and their socio-economic-cultural context.

## 2. METHODOLOGY AND APPROACH

A pilot study was conducted with the help of 4<sup>th</sup> year students of the Bachelor of Architecture course at IIT, Roorkee to collect primary data in the following villages, towns and cities of India:

*Table 1: List of settlements covered in the study*

SETTLEMENT TYPE	CITY/ VILLAGE NAME (NO.)	SAMPLE SIZE	REMARKS
Tier 1	Delhi, Mumbai (2)	36	Metropolitan cities; population >10,000,000 ; easy access to resources & facilities
Tier 2	Gurgaon, Jaipur, Ghaziabad (3)	25	Large cities; population >1,000,000 ; good access to resources & facilities
Tier 3 & 4	Roorkee, Tehri, Rishikesh, Angul, Ghansali, Kaza (6)	26	Small cities & towns; population <300,000; fair access to resources & facilities
Villages	*Ghuttu, *Gangi, Saidpura, Kasol, *Nako, Chitkul (6)	43	Villages (* remote Himalayan); population <15,000; limited access to resources & facilities
<b>TOTAL</b>		<b>130</b>	

The students were provided with a schedule containing qualitative questions about perception of various types of human needs, structured on the basis of Abraham Maslow's hierarchy [10], and asked to interview respondents to fill the schedule. The categories of need assessed are listed in Table 2.

The questionnaire was designed to assess the intensity of need felt by respondents using a Likert type scale. The questions could be answered expressing the intensity of need felt in 5 degrees varying from very strong, strong, neutral, weak, not essential.

On the basis of the responses, scores were worked out for intensity of perception of need in each category for each respondent. Average scores were then worked out for each category of city/village i.e. Tier-1, Tier-2, Tier-3&4 and Villages and also for the various economic categories (based on monthly household income i.e. E1, E2 and E3 as shown in Table 3).

*Table 2: List of Needs and related indicators.*

S.NO.	NEED TYPE/ HIERARCHY	INDICATORS/ NEED SUB-TYPE
1	PHYSIOLOGICAL AND BODILY COMFORT	Basic Food, Fast Food, Packed Food, Fruits, Restaurant, Water, Cleaning, Health, Grooming, Clothing, Fashion, Sleep/Work/ Leisure, Furniture, Power/Energy, Domestic Help/Workers, Machines/ Appliances, Vehicles
2	SAFETY AND SECURITY	Home (Rented Or Owned), Education, Removal from Danger (Physical), Money
3	BELONGING	Love, Friends, Social Groups, Entertainment, Communication, News & Information
4	SELF ESTEEM	Approval, Recognition, Self Image

A comparison of the average scores was done to analyse the differences. Each category of settlement has a heterogeneous mix of income categories (see Table-3) and any differences in need perception between settlement types can be attributed to limits of access to resources and socio-cultural factors.

### 2.1 Distribution of respondents in collected data

The collected data was categorised on the basis of settlement type and economic class. The breakup is presented below:

*Table 3: Categorical Distribution of respondents*

ECONOMIC CLASS (AS/ MONTHLY INCOME)	TIER				TOTAL
	TIER 1	TIER 2	3&4	VILLAGES	
E1 (<Rs15000 pm)	2	6	5	22	35
E2 (Rs15000-30000 pm)	8	9	10	15	42
E3 (>Rs30000 pm)	26	10	11	6	53
<b>TOTAL</b>	<b>36</b>	<b>25</b>	<b>26</b>	<b>43</b>	<b>130</b>

27% of the respondents had a **monthly household income** of less than Rs15000 (class E1), 32% between Rs15000-Rs30000 (class E2) and 41% above Rs30000 (class E3). 28% of the respondents were from Tier-1 cities/settlements, 19% from Tier-2 cities, 20% from Tier 3&4 towns and 33% from villages. Villages had the max. number of respondents from lower economic class E1, while Tier-1 cities had the max. respondents from the higher income class E3.

The demographic distribution (age, gender etc.) across groups was even. Max. numbers of respondents were in the age group 21-30 years (34 No.); followed by age group 31-40 years (33 No.) and age group 41-50 years (25 No.). 2 respondents were less than 10 years and 7 were more than 60 years old. 97 respondents were male and 33 female. 116 respondents were Hindus, 6 Muslims & 8 were affiliated to other religions. However, a recent study conducted on EU citizens [11] indicates that, the environmental behaviour of people is affected more by the subtle differences in attitudes and

# PLEA 2018 HONG KONG

Smart and Healthy within the 2-degree Limit

motivations (psychographics) than by the gross differences of gender, age, education, etc. (socio-demographics). Also, it would be worth mentioning here that, the **focus of this study is on the pattern of variance in the intensity of perception of needs rather than on the cause of this variance** (scope for future study).

### 3. KEY FINDINGS AND OBSERVATIONS

A pattern was observed in the variation in intensity of perception of needs with the socio-economic-cultural conditions of respondents (living in different locations in India) suggesting a possible correlation. The intensity of perceived needs of respondents showed a reduction from Tier-1 cities to villages as the access to resources and facilities became more difficult (Fig.1). The only exception to this was observed in the perception of safety and security needs, where the intensity of need was found higher for villages. This is attributable to proneness of villages towards natural disasters and calamities.

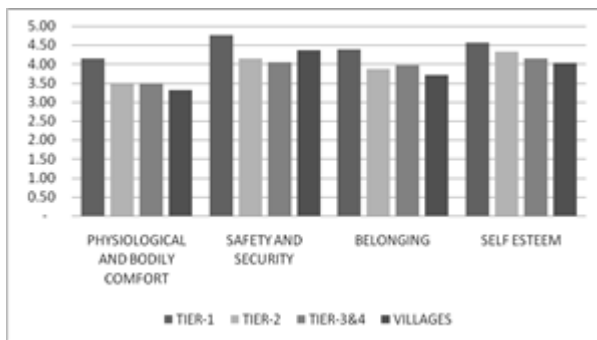

Figure 1: Intensity of perception of needs (averaged) across various types of settlement (categorized as/population size)

A similar pattern was observed across income categories. The intensity of perception of need increased from lower income category E1 to the higher income category E3 across all need categories (Fig.2).

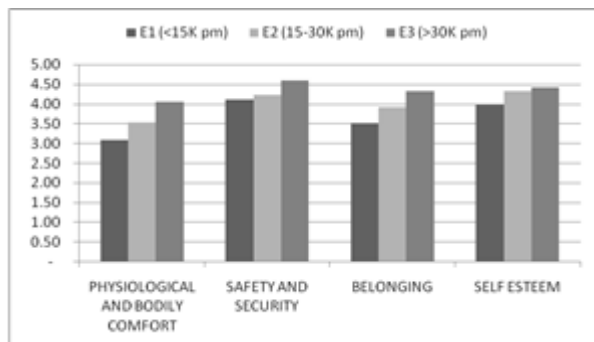

Figure 2: Intensity of perception of needs (averaged) across income classes (categorized as/monthly household income)

The variance in mean scores of settlement types and economic categories was analysed using ANOVA technique to assess if the observed variance across categories was statistically significant or not. ANOVA is a

procedure for testing the difference among different groups of data for homogeneity [12].

The results were found to be highly significant ( $p$ -values  $< 0.05$ ) for all need categories across settlement types and also economic class (Table 4). A similar analysis was done for all the need sub-types/indicators across the settlement types and also the economic categories. The general observation is that, the intensity of perception of needs is more pronounced in cities as compared to villages where the opportunities for the same are less easily available. Also, the intensity of perception of needs is more pronounced in upper income category E3 as compared to lower income category E1 as the financial opportunities for access to resources are reduced.

Table 4: ANOVA results (analysis of variance between category means across settlement types and economic class);  $\alpha = 0.05$

NEED CATEGORY/ HIERARCHY	ANALYSIS OF VARIANCE			
	BETWEEN SETTLEMENT TYPES		BETWEEN ECONOMIC CLASSES	
	F	P-value	F	P-value
PHYSIO. & BODILY COMFORT				
COMFORT	19.217	<b>0.000</b>	49.489	<b>0.000</b>
SAFETY AND SECURITY				
SECURITY	10.529	<b>0.000</b>	7.628	<b>0.001</b>
BELONGING	9.729	<b>0.000</b>	12.776	<b>0.000</b>
SELF ESTEEM	8.962	<b>0.000</b>	6.606	<b>0.002</b>

An analysis using ANOVA technique was also performed for all need sub-types included in each need category/ hierarchy.

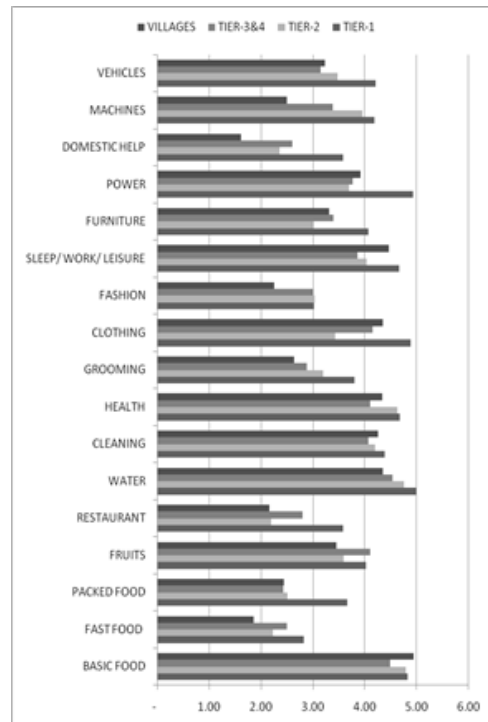

Figure 3: Intensity of perception of specific need sub-types in the need category 'physiological & bodily comfort' across various types of settlement (categorized as/population size)

# PLEA 2018 HONG KONG

Smart and Healthy within the 2-degree Limit

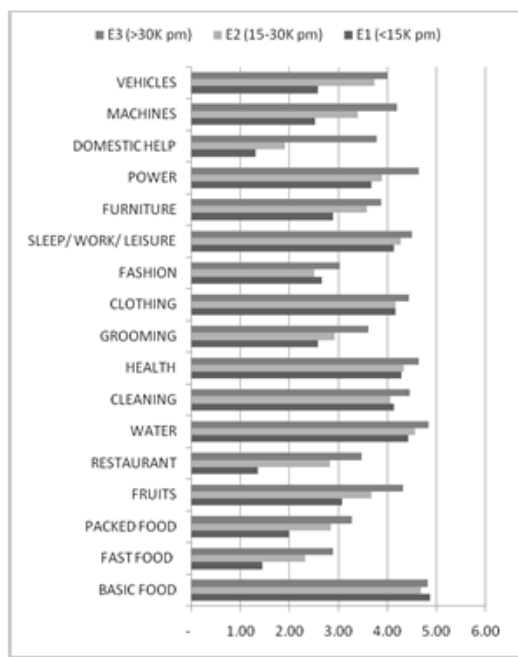

Figure 4: Intensity of perception of specific need sub-types in the need category 'physiological & bodily comfort' across various types of economic classes.

Significant variance (p-values <0.05 marked in bold) was found in most cases in the need category of 'Physiological & bodily comfort' across settlement types (Table 5) except for the need sub-types 'Cleaning' and 'Fruits'.

Table 5: ANOVA results (between category means across settlement types and economic class) for need sub-types in the need category 'physiological and bodily comfort';  $\alpha=0.05$

NEED SUB-TYPE (IN THE CATEGORY PHYSIOLOGICAL & BODILY COMFORT)	ANALYSIS OF VARIANCE			
	BETWEEN SETTLEMENT TYPES		BETWEEN ECONOMIC CLASSES	
	F	P-value	F	P-value
BASIC FOOD	3.138	<b>0.028</b>	1.071	0.346
FRUITS	2.364	<b>0.074</b>	13.398	<b>0.000</b>
RESTAURANT FOOD	8.799	<b>0.000</b>	34.316	<b>0.000</b>
FAST FOOD	3.433	<b>0.019</b>	13.091	<b>0.000</b>
PACKED FOOD	6.930	<b>0.000</b>	9.579	<b>0.000</b>
WATER	6.352	<b>0.000</b>	3.938	<b>0.022</b>
CLEANING	0.665	<b>0.575</b>	2.736	0.069
HEALTH	4.101	<b>0.008</b>	3.164	<b>0.046</b>
GROOMING	6.292	<b>0.001</b>	8.160	<b>0.000</b>
CLOTHING	17.641	<b>0.000</b>	1.504	0.226
FASHION	3.259	<b>0.024</b>	1.902	0.153
SLEEP/ WORK/ LEISU	7.148	<b>0.000</b>	2.295	0.105
FURNITURE	4.743	<b>0.004</b>	7.818	<b>0.001</b>
POWER	13.504	<b>0.000</b>	12.642	<b>0.000</b>
DOMESTIC HELP	11.587	<b>0.000</b>	48.725	<b>0.000</b>
MACHINES	18.303	<b>0.000</b>	26.149	<b>0.000</b>
VEHICLES	4.197	<b>0.007</b>	12.647	<b>0.000</b>

The variance between economic categories was not significant in some need sub-types under this need category. This suggests that difference in settlement type

induces greater variance in intensity of need perception in comparison to economic class.

It may be noted that, needs in the category 'physiological and bodily comfort' require material resources for fulfilment and are, therefore, directly associated with resource consumption. On the other hand, need sub-types in the other categories can also be psychological or emotional.

Results for other need sub-types (in other need categories) across settlement types and economic classes are presented in Figures 5-10 and Tables 6-8.



Figure 5: Intensity of perception of need sub-types in need category 'safety and security' across settlements types.

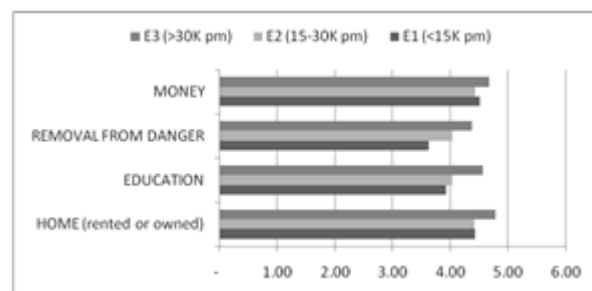

Figure 6: Intensity of perception of need sub-types in the need category 'safety and security' across economic classes.

Table 6: ANOVA results (between category means across settlement types and economic class) for need sub-types in the need category 'safety and security';  $\alpha=0.05$

NEED SUB-TYPE (IN THE CATEGORY SAFETY & SECURITY)	ANALYSIS OF VARIANCE			
	BETWEEN SETTLEMENT TYPES		BETWEEN ECONOMIC CLASSES	
	F	P-value	F	P-value
HOME (rented or owned)	6.624	<b>0.000</b>	3.769	<b>0.026</b>
EDUCATION	7.671	<b>0.000</b>	6.388	<b>0.002</b>
REMOVAL FROM DANGER	6.667	<b>0.000</b>	5.310	<b>0.006</b>
MONEY	4.410	<b>0.006</b>	1.436	0.242

The variance in scores was found to be statistically significant in case of all the need sub-types in the need category 'Safety & security' across settlement types and economic categories (except need sub-type 'Money' in case of economic categories).

# PLEA 2018 HONG KONG

Smart and Healthy within the 2-degree Limit

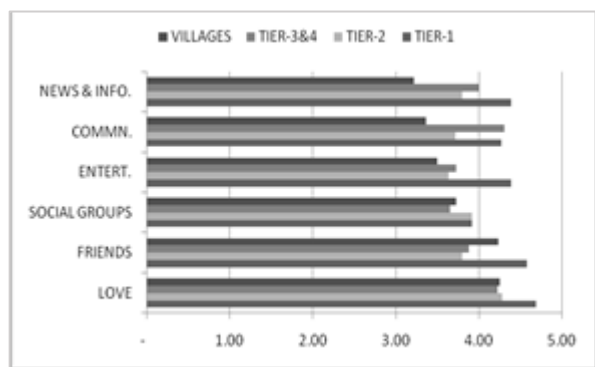

Figure 7: Intensity of perception of specific need sub-types in the need category 'Belonging' across various types of settlements.

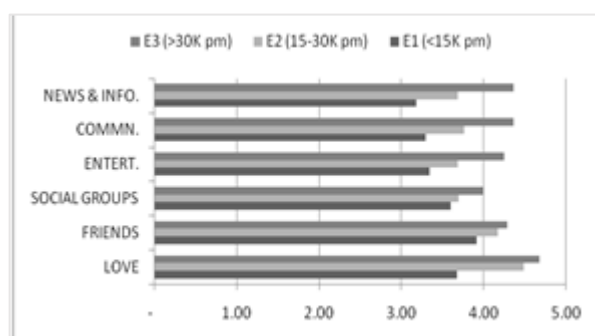

Figure 8: Intensity of perception of need sub-types in the need category 'Belonging' across economic classes.

Table 7: ANOVA results (between category means across settlement types and economic class) for need sub-types in the need category 'Belonging';  $\alpha=0.05$

NEED SUB-TYPE (IN THE CATEGORY BELONGING)	ANALYSIS OF VARIANCE			
	BETWEEN SETTLEMENT TYPES		BETWEEN ECONOMIC CLASSES	
	F	P-value	F	P-value
LOVE	2.342	0.077	15.286	<b>0.000</b>
FRIENDS	4.872	<b>0.003</b>	1.279	0.282
SOICAL GROUPS	0.493	0.688	1.726	0.183
ENTERTAINMENT	5.798	<b>0.001</b>	9.552	<b>0.000</b>
COMMUNICATION	7.999	<b>0.000</b>	13.832	<b>0.000</b>
NEWS & INFO.	10.357	<b>0.000</b>	18.447	<b>0.000</b>

The results for the need category 'Belonging' were found to be significant except in the case of need sub-type 'Love' and 'Social groups' in settlement types and sub-type 'Friends' and 'Social groups' for economic categories (Table-7).

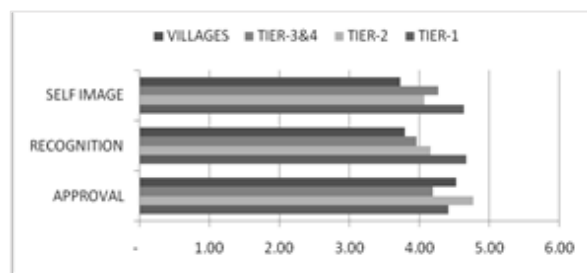

Figure 9: Intensity of perception of specific need sub-types in the need category 'Self Esteem' across settlement types

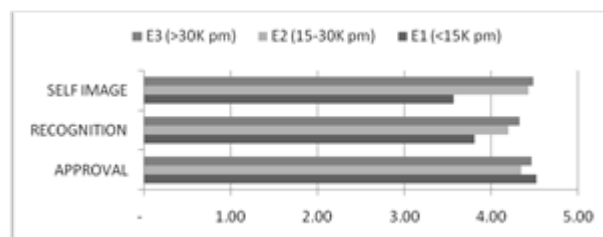

Figure 10: Intensity of perception of specific need sub-types in the need category 'Self Esteem' across economic classes.

Table 8: ANOVA results (between category means across settlement types and economic class) for need sub-types in the need category 'Self Esteem';  $\alpha=0.05$

NEED SUB-TYPE (IN THE CATEGORY 'SELF ESTEEM')	ANALYSIS OF VARIANCE			
	BETWEEN SETTLEMENT TYPES		BETWEEN ECONOMIC CLASSES	
	F	P-value	F	P-value
APPROVAL	1.782	0.155	0.382	0.684
RECOGNITION	6.307	<b>0.001</b>	2.703	0.072
SELF IMAGE	6.043	<b>0.001</b>	11.267	<b>0.000</b>

The results for the need category 'Self esteem' were found to be significant only in the case of need sub-type 'Recognition' and 'Self image' in settlement types and sub-type 'Self image' for economic class.

## 4. INTERPRETATION OF RESULTS

The results indicate that, type of settlements and economic conditions both produce a significant variance in the intensity of perception of needs in people in case of the broader categories of need hierarchy. That is not so in case of need sub-types, where settlement type produced significant variance in more need sub-types in comparison with economic class. While in most cases, the variance is more significant between types of settlements in comparison to economic categories, it is the other way round in some cases. Never-the-less, both these factors contribute significantly towards variance in intensity of need perception.

The pattern of variance indicates that, there is a positive correlation between the scale of settlement and the intensity of perception of needs. Apart from the differences in accessibility of resources, this can also be attributed to a greater exposure to consumer culture in



# PLEA 2018 HONG KONG

*Smart and Healthy within the 2-degree Limit*

larger cities. A positive correlation was also observed between income and perception of needs.

This suggests that, the more accessible and approachable the resources for gratification of needs (in terms of finances as well as availability), greater is the intensity of perception of need in people. This finding relates with studies which have shown that households with higher income generate greater amounts of Green House Gas (GHG) emissions [13].

The intensity of perception of need ultimately compels people to indulge in resource consumption to satisfy their perceived needs (higher the intensity, greater the compulsion to gratify a desire). It is the mechanism through which attitudes, values and behaviour of people are manifested in action.

## 5. CONCLUSION & SCOPE FOR FUTURE STUDY

The findings of the study are in line with other studies which suggest that resource consumption is related to differences in people's attitudes and values. Values (such as 'self enhancement') have been shown as an important part of psychological construct for studying environmental issues[14].

A correlation was observed between intensity of perceived needs and socio-economic-cultural factors. While, economic classes (based on household income) show significant variance among them due to financial accessibility, the variance between settlement types could be due to differences in physical accessibility of resources or due to socio-cultural factors (like prevalent world-views and environmental values). The extent to which each of these factors may contribute towards variance in need perception between settlement types needs to be explored further through more detailed research to establish a distinction between these two factors.

Studies on relation between materialistic attitudes and environmental concerns and behaviours of people have also suggested that, 'the cultural context is likely to have a strong influence on what will be sought for by materialists'[15]. Also[16] cited in [17] suggest that, attitudes about environmental issues are the result of more general underlying values such as 'self-enhancement' (general orientation towards self benefit), 'self-transcendence' (degree to which a person values goals and ideals not related to self) and 'biospheric' (environmental concerns).

Future studies would do well to establish the link between socio-cultural values and pro-environmental concerns/behaviours in people through the mechanism of intensity of need perception by clearly discriminating between and quantifying the effects of other underlying factors/values that make up the socio-cultural dimension.

## ACKNOWLEDGEMENTS

We express our gratitude towards the 4<sup>th</sup> year students of the Bachelor of Architecture course at IIT Roorkee for their efforts in conducting the primary survey and collecting the data for this study.

## REFERENCES

1. G. H. Brundtland, "Our Common Future: Report of the World Commission on Environment and Development," *United Nations Comm.*, vol. 4, no. 1, p. 300, 1987. doi: 10.1080/07488008808408783
2. L. M. A. Bettencourt and J. Kaur, "Evolution and structure of sustainability science," *Proc. Natl. Acad. Sci.*, vol. 108, no. 49, pp. 19540–19545, 2011. doi: 10.1073/pnas.1102712108
3. R. W. Kates, T. M. Parris, and A. A. Leiserowitz, "What is sustainable development? Goals, indicators, values, and practice," *Environment*, vol. 47, no. 3, pp. 8–21, 2005. doi: 10.1080/00139157.2005.10524444
4. L. White, Jr., "The Historical Roots of Our Ecologic Crisis," *Science*, vol. 155, no. 3767, pp. 1203–1207, 1967.
5. S. F. McCool and G. H. Stankey, "Indicators of sustainability: Challenges and opportunities at the interface of science and policy," *Environ. Manage.*, vol. 33, no. 3, pp. 294–305, 2004. doi: 10.1007/s00267-003-0084-4
6. M. Hurst, H. Dittmar, R. Bond, and T. Kasser, "The relationship between materialistic values and environmental attitudes and behaviors: A meta-analysis," *J. Environ. Psychol.*, vol. 36, pp. 257–269, 2013. doi: 10.1016/j.jenvp.2013.09.003
7. B. Banerjee and K. McKeage, "How Green is My Value: Exploring the Relationship Between Environmentalism and Materialism," *Adv. Consum. Res.*, vol. 21, no. eds. Chris T. Allen, and Deborah Roedder John, Provo, UT: Association of Consumer Research, pp. 147–152, 1994.
8. L. Steg and C. Vlek, "Encouraging pro-environmental behaviour: An integrative review and research agenda," *J. Environ. Psychol.*, vol. 29, no. 3, pp. 309–317, 2009. doi: 10.1016/j.jenvp.2014.01.002
9. W. Unanue, V. L. Vignoles, H. Dittmar, and M. Vansteenkiste, "Life goals predict environmental behavior: Cross-cultural and longitudinal evidence," *J. Environ. Psychol.*, vol. 46, pp. 10–22, 2016. doi: 10.1016/j.jenvp.2016.02.001
10. A. H. Maslow, "A THEORY OF HUMAN MOTIVATION," *Psychol. Rev.*, vol. 50, no. 4, pp. 370–396, 1943.
11. J. M. Ortega-Egea, N. García-de-Frutos, and R. Antolín-López, "Why do some people do 'more' to mitigate climate change than others? Exploring heterogeneity in psycho-social associations," *PLoS One*, vol. 9, no. 9, 2014. doi: 10.1371/journal.pone.0106645
12. C. R. Kothari, *Research Methodology: Methods & Techniques*, Second. New Delhi -110002: NEW AGE INTERNATIONAL (P) LIMITED, PUBLISHERS 4835/24, Ansari Road, Daryaganj, New Delhi - 110002, 2004.
13. J. Nässén, D. Andersson, J. Larsson, and J. Holmberg, "Explaining the Variation in Greenhouse Gas Emissions Between Households: Socioeconomic, Motivational, and Physical Factors," *J. Ind. Ecol.*, vol. 19, no. 3, pp. 480–489, 2014. doi: 10.1111/jiec.12168
14. T. L. Milfont and J. Duckitt, "The structure of environmental attitudes: A first- and second-order confirmatory factor analysis," *J. Environ. Psychol.*, vol. 24, no. 3, pp. 289–303, 2004. doi: 10.1016/j.jenvp.2004.09.001

# PLEA 2018 HONG KONG

*Smart and Healthy within the 2-degree Limit*

15. D. Andersson and J. Nässén, "Should environmentalists be concerned about materialism? An analysis of attitudes, behaviours and greenhouse gas emissions," *J. Environ. Psychol.*, vol. 48, pp. 1–11, 2016. doi: 10.1016/j.jenvp.2016.08.002
16. P. Stern and T. Dietz, "The Values Basis of Environmental Concern," *J. Soc. Issues*, vol. 50, no. 3, pp. 65–84, 1994. doi: 10.1111/j.1540-4560.1994.tb02420.x
17. P. Wesley Schultz, "The structure of environmental concern: Concern for self, other people, and the biosphere," *J. Environ. Psychol.*, vol. 21, no. 4, pp. 327–339, 2001. doi: 10.1006/jev.2001.0227

## Two Degree Rise in Indoor Temperature: Energy Use Behaviour of British Asians

SATISH BK<sup>1</sup>

<sup>1</sup>School of Art, Design and Architecture, The University of Plymouth, Plymouth, UK

*ABSTRACT: The understanding of households' socio-economic characteristics and their behaviour has been acknowledged as a key factor while assessing the energy demands. There is considerable research in the area of building simulation and energy modelling; however, the representation of occupants and their behaviour needs further work. For instance, every degree rise in internal temperature settings will increase the household energy consumption by 10 %. This research investigates the energy use behaviour of a specific demographic and ethnic group, the British Asian households. A large-scale housing survey is used to gather self-reported information about the British Asian households' energy use behaviour, for instance, heating patterns, appliances use, ventilation behaviour, as well as other socio-economic characteristics. Data collected will be transformed into energy models, which includes Space heating behaviour models, electrical appliances and lighting use models, and Ventilation behaviour models. The outcome of this research demonstrates how social perception and economic aspirations limit the acceptability of sustainable design and construction strategies. This research involves active community participation and engagement; a major part of the dissemination will aim at communicating the research findings to the British Asian households, which will have a direct impact of energy reduction by informed behaviour choice.*

*KEYWORDS: Energy, Comfort, Energy behaviour, British Asian, Sustainable housing*

### 1. INTRODUCTION

The domestic sector alone contributes about 27% carbon emission and it is critical to address while resolving the UK commitment of 80% reduction in CO<sub>2</sub> emission by 2050 against the 1990 baseline [1]. Though government legislation addresses the mitigation strategies by setting stricter regulations for the new build, it is very difficult to upgrade the existing housing stock. Due to the very slow replacement cycles and long physical lifetimes, attention must also be placed upon the existing housing stock, which is expected to make up at least 70% of the UK's total housing by 2050 [2]. Among the factors affecting the energy consumption, Occupants behaviour plays a pivotal role. Underprediction of energy saving from the thermal upgrade is evident from the recent research. Further, the lack of understanding of the households' behaviour has led to assumptions which mostly predict higher energy saving compared to the actual saving [3].

There is a difference between the occupants' behaviour and assumptions at different stages and it is attributed as the prime reason for the performance gap [4]. There is considerable research to demonstrate the predicted and measured energy consumption and relate it to performance gap [5, 6]. For instance, de Wilde (2014) in a review of the core reasons behind the performance gap and the implications thereof has identified three types of performance gap; predictions vs. measurement, machine learning vs. measurement, and prediction vs. displayed energy performance.

However, there is limited research to explore the correlation of the performance gap to the households' socio-economic characteristics. While building simulation has made significant progress, the representation of occupants and their behaviour needs further work.

Lack of knowledge and household behaviour has been identified as the main reason for the gap between the energy reduction prediction to actual savings despite awareness of the climate change and increasingly stringent regulations [7]. Building users were considered as passive recipients of thermal stimuli to maintain the thermal balance reflecting the Fanger's model [8]. Recent studies have linked occupants' thermal experiences and expectations to the indoor conditions and to the climatic condition [9] and researchers have argued for understanding households' expectations and satisfying their desire for thermal comfort as one of the key drivers to reduce energy use [9].

In the domain of sustainable housing, both a qualitative approach and quantitative strategies are essential to the understanding of social and cultural dynamics as well as to measure and benchmark performance. Most of the process, from the beginning, including the Club of Rome, has relayed heavily on quantitative mathematical methods [10]. Most of the studies evaluating the performance of the energy efficient homes or refurbishment design process are quantitative and measure empirical data and most of the

# PLEA 2018 HONG KONG

*Smart and Healthy within the 2-degree Limit*

qualitative factors like, individual comfort variation, occupants' energy behaviour is generalised [11, 12].

Until recently, house-building targets and neighbourhood planning lacked a clear strategy to understand households energy behaviour while developing sustainable communities [13]. Many energy efficiency initiatives including net-zero energy homes have been adopted as a financially viable, energy reduction models [14]. However, households, their expectations and its impact on energy usage are hardly considered in these models. The hierarchical approach to reducing energy consumption in buildings includes building envelop, energy-efficient equipment and renewable power. However, none of these approaches acknowledges the behaviour of households and its influence on the operation of buildings while reducing the energy consumption [15].

The implication of behaviour pattern is further complicated when energy reduction runs contrary to the prevailing practices or encouraged logical solutions. For instance, the average temperature maintained in the UK household is around 18 degree Celsius in winter [16]. All the energy prediction is calculated based on this fact; whereas expatriates from the tropical countries prefer to keep their homes warm and at 21.4 degree Celsius [17]. The difference in internal temperature of the average UK households to that of British Asians is significant as every degree of higher internal temperature will increase the household energy consumption by 10 % [18]. British Asians, also referred as South Asians in the United Kingdom, Asian British people or Asian Britons, are persons of Asian descent who reside in the United Kingdom [19] and they constitute about 5 percent of the UK population [20] and hence their behaviour pattern would have a enormous impact on the energy consumption.

For British Asians, though it appears to be way higher compared to UK average, it is perceived as a positive move to not bring down the temperature drastically and align themselves in reducing energy. In this context, this paper explores the behaviour pattern of the British Asian households, their socio-economic characteristics and its impact on the energy behaviour.

There is a strong relationship between the social-cultural practices and energy consumption behaviour of the homeowners. In particular, the way in which a homeowner perceives their residence as a vehicle for the display and maintenance of status can impact on the energy use characteristics of a home (Satish and Brennan, 2015, Satish et al., 2011). Furthermore, whilst acknowledging the role of technology, emphasis needs to be placed on the importance of lifestyle and social change (Skea and Nishioka, 2008).

## 2. METHODOLOGY

This research builds on the previous research and aims to test the energy use behaviour of a specific demographic and ethnic group, the British Asian households, in the UK and compare with that of the Indian homeowners. This work builds on the extensive research conducted in India [21, 22], and a large-scale, citywide, socio-technical survey conducted as part of the EnerGAware project in Plymouth, the UK [23, 24]. wherein the homeowners' aspirations are mapped to the energy demand in Mysore, India and Plymouth, the UK.

This research targets the Asian diaspora and the questionnaire forms are delivered to British Asians. The contact list of British Asians is developed through snowball sampling or chain-referral sampling and by approaching various cultural and community organisations and societies. The survey questionnaire is carefully developed to overlap with the EnerGAware project and the field works carried out in India. A small-scale housing survey was conducted to gather self-reported information about the British Asian households' energy use behaviour, as well as other socio-economic characteristics. The survey questionnaires were collected from 40 households, who are British Asians living in Plymouth, the UK. Questionnaires are collected from homeowners settled in the UK from different Asian ethnic background. While distributing the questionnaires among owner-occupiers, special care was taken to ensure that different neighbourhoods were represented. This included the city central area, neighbourhoods around Derriford hospital and neighbourhoods in the villages near Plymouth. The respondents social, economic and educational background is mapped to a similar representation of respondents in India. A wide spectrum of respondents was shortlisted to reflect the occupation, different age group and 'length of residence' of the households.

Stratified Random Sampling technique was adopted to include proportional representation of sample from different age group, background and location from within Plymouth. This technique enables to achieve a higher statistical precision and hence smaller sample yields significant results [25, 26].

The outcome of the questionnaire survey triangulated with the literature studies and the surveys conducted in India on one hand and the survey outcome of the EnerGAware project on the other. More than 200 homeowners were surveyed in a South Indian city, Mysore and the same questionnaire with modification to reflect the climatic and socio-cultural conditions is used as part of this questionnaire. Similar questions to relatively similar demographics have enabled to compare the survey outcomes. On the similar lines, part of the questionnaire of the EnerGAware project is used to compare the feedback of respondents of British households and British Asian households. Respondents

# PLEA 2018 HONG KONG

*Smart and Healthy within the 2-degree Limit*

have reflected various energy-related issues including household preferences, ventilation, energy-related habits and energy consumption. This paper focuses on socioeconomic preferences and energy behaviour for further analysis and discussion.

## 3. FIELDWORK ANALYSIS AND DISCUSSION

### 3.1 Socio-economic preferences

The traditional housing typology was reflective of the social and cultural values of the homeowners. In the revised model, households' aspirations and their reflections were examined by asking them about their preferences and choices specifically related to house selection process. Asian homeowners tend to give higher priority to the family and friends, Plot size, amenities, cost and proximity to the city centre compared to their counterparts living in Plymouth, UK. However, British Asians living in Plymouth prioritise good neighbourhood, location, and school while finalising their house location.

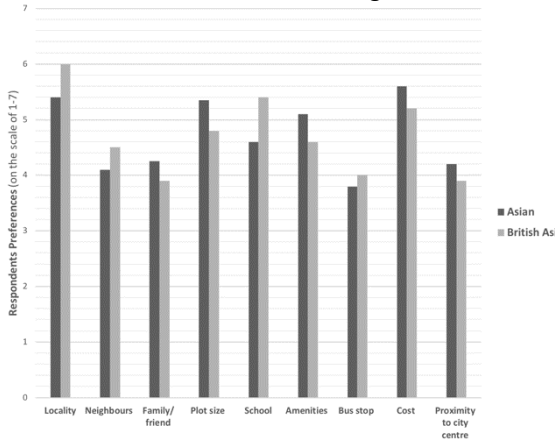

Figure 1: Respondents preferences for their house location

The distinctiveness of the new class structure has rested on a range of representational practices centred around particular characteristics of consumption, style and social distinction [27]. These have their ramification on the spatial reorganisation of neighbourhoods within cities and small towns. In this reorganisation, households have developed new suburban aesthetic identities and lifestyles that seek to change the visual signs of public spaces [27]. As scholars like Fernandes have argued, expression of the economic mobility and demonstration of newfound wealth is a key dimension of the homeowners in the emerging world [28, 29]. Whereas, living in relatively established residential suburbs, British Asians are not as keen as Asians in case of amenities, plot size and proximity to the city centre. Migrated households tend to give importance to the social and cultural values and are conscious of the cultural background as a mechanism to develop the family cultural values and explore socio-cultural activities [30]; hence they are keen of compatible neighbours and the locality while choosing their house location (Figure 1).

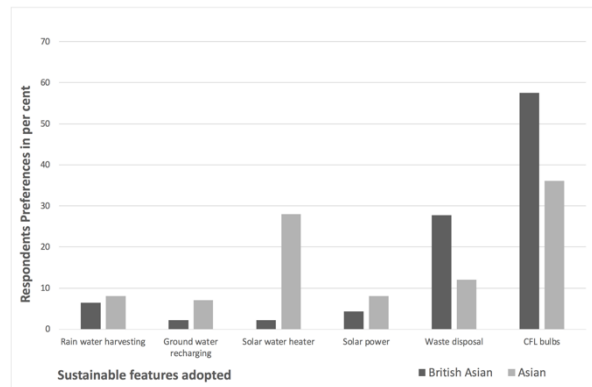

Figure 2: Sustainable features adopted

There is an acknowledgement of climate change and societies are contributing to reducing energy consumption and carbon emission. Societies tend to adapt to the local government, regulations, policy and the sustainable features they adopt would depend on a combination of government policy on one hand and cultural and social values and responsibility of the individual on the other. When asked about the sustainable features adopted, nearly 30 % of the Asians have made provision for solar power, compared to less than 3 % of British Asians. Further, a greater number of Asian households have implemented rainwater harvesting and groundwater recharging compare to their counterparts in Britain (Figure 2). Though the Indian government has put forth these in its national agenda [31], most of these initiatives are voluntary and despite the support from the government or agencies [32].

Whereas, in a regulated economy like the UK with clear top-down guidelines towards addressing climate change, When the same question was asked to British Asians, their alignment with the government policy is evident with nearly 60 percent of the households using energy saving lighting fixtures and more households are sensitive towards waste disposal compare to Asian counterparts (Figure 2).

Comparative study of Asian and British Asian households' selection process suggests a consistency in the preference for values and aspirations demonstrates, how households tend to carry the cultural values and recreate them in the migrated place.

# PLEA 2018 HONG KONG

Smart and Healthy within the 2-degree Limit

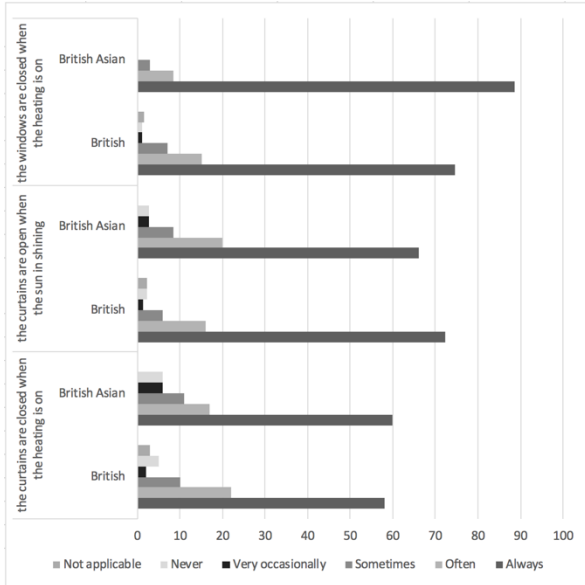

Figure 3: Respondents window usage practices.

## 3.2 Energy Behaviour

One of the key differences for British Asians born and raised in Asia would be to acclimatise to the UK climate and hence understand the difference in the energy consumption in the homes. This section analyses the energy behaviour of the British Asians in Plymouth and compare with the similar survey of British (White British) household conducted by the EnerGAware project [24].

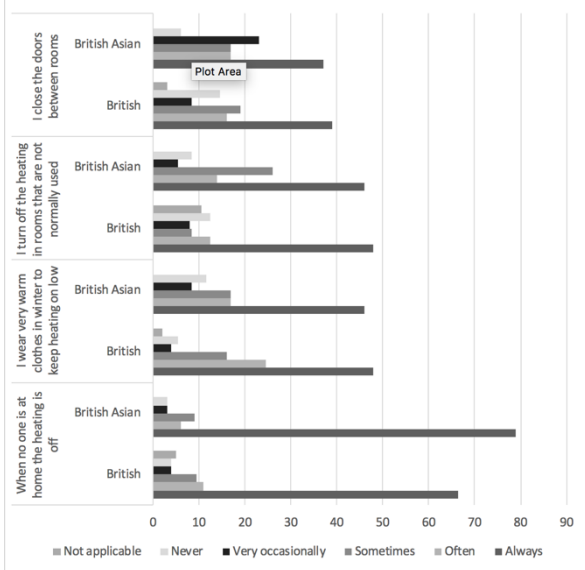

Figure 4: Respondents heating practices.

To understand the energy consumption of the households, their behaviour pattern related to energy consumption and their preferences are elicited through a series of questions. The British and British Asians tend to exhibit similar sensitivity when it comes to window opening preferences during winter. However, British Asians tend to be more sensitive to the heat loss and most of them tend to close the windows when the heating is on (Figure 3). A similar trend can be observed

in their spatial usage pattern as well, wherein more than twice the number of British tend to keep the door open between the rooms while heating is on (Figure 4). Further, a higher number of British Asians tend to shut down heating when no one at home (Figure 4).

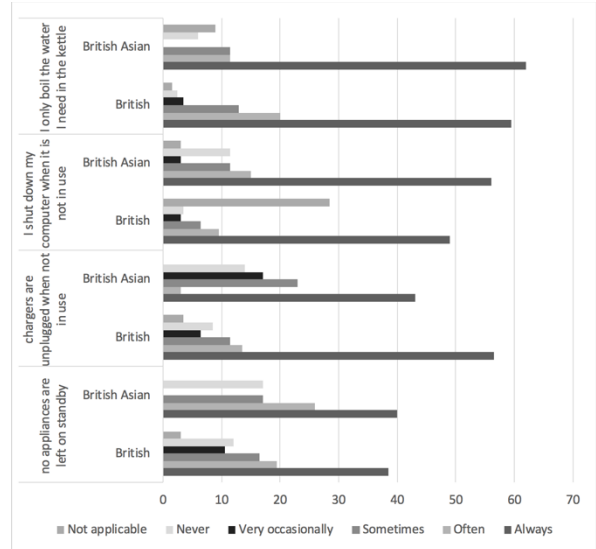

Figure 5: Respondents usage pattern.

Though there are similarity and consistency in terms of usage of electrical appliances, British Asians have shown relatively more sensitivity and inclination towards saving energy (Figure 5), which underpins the earlier research of correlation between cultural values and sustainable housing features [33]. Correlation of values and energy behaviour is further evident when nearly half of the British Asians use energy saving modes on their appliances compare to only 29 % of British use energy saving mode (Figure 6).

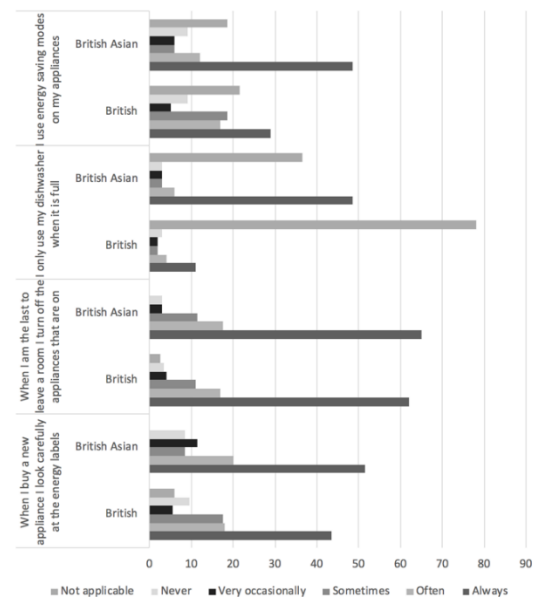

Figure 6: Energy saving measures in appliances.

# PLEA 2018 HONG KONG

*Smart and Healthy within the 2-degree Limit*

## 4. CONCLUSION

### 4.1 Applications for the research

The results of this study will be of key interest to government policymakers and building industry stakeholders. The study identifies the specific areas where homeowners' preferences can be aligned with sustainable elements. While tackling the climate change, all the countries are committing for carbon reduction and this research provides a bottom-up solution as to how to achieve these targets.

### 4.2 Limitation and further research

From the outcome of the questionnaire survey, this paper examined two key aspects of Socio-economic preferences and energy behaviour. Further studies with the ethnographic survey and interview of households triangulated with environmental analysis would be helpful to further develop this research.

The research has shown that there is a direct correlation between the social and cultural values and energy behaviour of households. Further examination of specific aspects like ventilation, heating would provide greater insight into the extent of the impact of behaviour on energy consumption and would go a long way in reducing the carbon emission and develop sustainable communities for the future.

### 4.3 Summary

While acknowledging the role of policy guideline, emphasis needs to be given to the importance of lifestyle and social change. This research focuses on the sustainable built environment as social and cultural phenomena that can allow insights in the effective formulation of localised and relevant low carbon strategies and thus provide a bottom-up tool to implement the policies and targets set by the professional bodies and the UK government.

The study in this paper, using a literature review and survey fieldwork, has highlighted the similarity and differences in the perception and socio-cultural value system of British and British Asian households. From the outcome of the questionnaire survey, this paper examined two key aspects of Socio-economic preferences and energy behaviour.

The particular points are as follows:

1. Social perception and economic aspirations limit the acceptability of sustainable design and construction strategies. Questionnaire survey both in India and the survey conducted in Plymouth, the UK, clearly demonstrate that it is crucial to align the household's aspirations in the process of developing sustainable housing strategies.
2. The difference in behaviour pattern in a regulated and unregulated economy: there is a

striking difference between the behaviour pattern of respondents in India and the UK. For instance, most of the sustainable features adopted by households in India were voluntary, whereas households in the UK had engaged in the features promoted by the policy or government in the UK.

3. Some consistency in the preferences for cultural values: one of the key findings is that social and cultural values scaffold the decision-making process and households tend to emulate those preferences in migrated places.

The research has shown that there is a direct correlation between the social and cultural values and energy behaviour of households. Further examination of specific aspects like ventilation, heating would provide greater insight into the extent of the impact of behaviour on energy consumption and would go a long way in reducing the carbon emission and develop sustainable communities for the future.

## ACKNOWLEDGEMENTS

This paper is part of the ongoing research and continuation of the paper presented during the International Conference for Sustainable Design of the Built Environment, Dec 2017, The Crystal, London.

## REFERENCES

1. DECC and H. Treasury, Policy paper - 2010 to 2015 government policy: greenhouse gas emissions. 2015, <https://www.gov.uk/government/publications/2010-to-2015-government-policy-greenhouse-gas-emissions/2010-to-2015-government-policy-greenhouse-gas-emissions>: Committee on Climate Change, Department of Energy & Climate Change.
2. SDC, Climate Change – The UK Programme 2006: SDC response. 2006, sustainable development commission: <http://www.sd-commission.org.uk/>.
3. Tahir, F. and I. Walker, Review of potential for carbon savings from residential energy efficiency. 2013, The Committee on Climate Change, Energy Saving Trust: Cambridge.
4. de Wilde, P., The gap between predicted and measured energy performance of buildings: A framework for investigation. *Automation in Construction*, 2014. 41: p. 40-49.
5. Khoury, J., Z. Alameddine, and P. Hollmuller, Understanding and bridging the energy performance gap in building retrofit. *Energy Procedia*, 2017. 122: p. 217-222.
6. Menezes, A.C., et al., Predicted vs. actual energy performance of non-domestic buildings: Using post-occupancy evaluation data to reduce the performance gap. *Applied Energy*, 2012. 97: p. 355-364.
7. Pan, W. and H. Garmston, Compliance with building energy regulations for new-build dwellings. *Energy*, 2012. 48(1): p. 11-22.
8. Fanger, P.O., *Thermal comfort : analysis and applications in environmental engineering*. 1972, New York: New York : McGraw-Hill.
9. erry, S., et al., Near zero energy homes – What do users think? *Energy Policy*, 2014. 73: p. 127-137.

# PLEA 2018 HONG KONG

## *Smart and Healthy within the 2-degree Limit*

10. Danilov-Danil'yan, V., K. Losev, and I. Reyf, Sustainable Development and the Limitation of Growth: Future Prospects for World Civilization. Future Prospects for World Civilization. 2009, Berlin, Heidelberg: Springer Berlin Heidelberg, Berlin, Heidelberg.
11. Thomas, W.D. and J.J. Duffy, Energy performance of net-zero and near net-zero energy homes in New England. *Energy & Buildings*, 2013. 67: p. 551-558.
12. Konstantinou, T. and U. Knaack, An approach to integrate energy efficiency upgrade into refurbishment design process, applied in two case-study buildings in Northern European climate. *Energy & Buildings*, 2013.
13. Power, A., Does demolition or refurbishment of old and inefficient homes help to increase our environmental, social and economic viability? *Energy Policy*, 2008. 36(12): p. 4487-4501.
14. Berry, S. and K. Davidson, Zero energy homes – Are they economically viable? *Energy Policy*, 2015. 85: p. 12-21.
15. Maslesa, E., P.A. Jensen, and B. Astmarsson, Sustainable renovation of residential buildings and the landlord/tenant dilemma. *Energy Policy*, 2013. 63: p. 355-362.
16. Waters, L., Energy Consumption in the UK: Overall energy consumption in the UK since 1970, E.I.S. Department for Business, Editor. 2017.
17. Satish, B.K. Modelling energy use behaviour of British Asian households. in *Sustainable Earth 2017: A global forum for connecting research with action*. 2017. Plymouth, UK: Plymouth University.
18. Trust, E.S. Save energy at home. 2017 [cited 2017 15 Nov 2017].
19. Smith, T., *Asians in Britain*. 2004, Stockport: Stockport: Dewi Lewis.
20. White, E., *Ethnicity and National Identity in England and Wales: 2011*. 2012, <https://www.ons.gov.uk/peoplepopulationandcommunity/culturalidentity/ethnicity/articles/ethnicityandnationalidentityine nglandandwales/2012-12-11>: Office for National Statistics.
21. Satish, B. and J. Brennan, Significance of boundary conditions towards sustainable housing strategies: a case study of Mysore, India. *IAFOR Journal of Sustainability, Energy and the Environment*, 2015. 2(1): p. 21-40.
22. Satish, B., J. Brennan, and R. Pedreschi, Influence of affluence on sustainable housing in Mysore, India. *Proceedings of the Institution of Civil Engineers, Engineering Sustainability*, 2011. 164(4): p. 249–260.
23. Jones, R.V., A. Fuertes, and P. de Wilde, The gap between simulated and measured energy performance: A case study across six identical new-build flats in the UK. 2016, Hyderabad, India;Hyderabad, India;Hyderabad, India;Hyderabad, India;Hyderabad, India;Hyderabad, India.
24. EnerGAware. EnerGAware project. <http://www.energaware.eu/> 2017 10 June 2017].
25. Bryman, A., *Social research methods* / Alan Bryman. 2008: Oxford, [England] ; New York, N.Y. : Oxford University Press, 2008. 3rd ed.
26. Groat, L.N. and D. Wang, *Architectural research methods*. 2002, New York: J. Wiley. xvii, 389 p.
27. Fernandes, L., Restructuring the new middle class in Liberalizing India. *Comparative studies of South Asia, Africa and Middle east*, 2000. 20(1 & 2): p. 88-104.
28. Fernandes, L., Nationalizing 'the global' media images, cultural politics and the middle class *India. Media, Culture & Society*, 2000. 22: p. 611-628.
29. Fernandes, L., *India's new middle class: democratic politics in an era of economic reform*. 2006, Minneapolis, Minn.: University of Minnesota Press. xxxix, 289 p.
30. Castles, S., *Citizenship and migration : globalization and the politics of belonging*, ed. A. Davidson. 2000, Basingstoke: Basingstoke : Macmillan.
31. NAPCC, *India: National action plan on climate change*, G.o.I. Prime Minister's Council on Climate Change, Editor. 2008: New Delhi.
32. Varma, P.K., *The great Indian middle class*. 2007, New Delhi: Penguin. xiv, 232 p.
33. Satish, B.K., *Sustainable housing futures for a growing middle class: a contextual study of Mysore, India*, in Ph.D. thesis. 2013, The University of Edinburgh.



## Research Analysis of Urban and Social Patterns in the City: Shared Bicycles and Their Influence on Urban Fabric

GONÇALO ARAÚJO<sup>1</sup>, MANUEL CORREIA – GUEDES<sup>1</sup>; ERCUMENT GORGUL<sup>2</sup>

<sup>1</sup>Instituto Superior Técnico, Universidade de Lisboa, Lisboa, Portugal

<sup>2</sup>CAUP, Tongji University, Shanghai, China

*ABSTRACT: Shared bicycles have been around for a while and growing steadily in China. Recently, concept and volume of this new form of shared transportation vehicles captured a widespread attention and usage. This study is focused in two areas known as former French concession in Shanghai and in Xintiandi. Using one of the popular bicycle sharing app “Mobike” location and number of available bicycles is captured during a period of one week, three times a week, and every eight hours. Furthermore, this data is correlated with the existent urban framework by analysing certain aspects such as proximity to building services and daily life of locals. Allowing a quantitative and comparative evaluation with other sites regarding predictors of urban development, cyclers safety and urban quality. Then a proximity factor is introduced measuring the distance to key services, such as supermarkets, restaurants or office buildings, that impact life in the area. Finally, it will be possible to determine the comparative quality of these areas and take conclusions regarding future area studies and comparisons.*

*KEYWORDS: Transportation, Urban quality, Shared Bikes, Social Patterns, Urban Planning*

### 1. INTRODUCTION

The main goal of this research is to map and analyze the dispersion of available shared bicycles in Xintiandi, Shanghai, and apply the results to a macroscale event, establishing correlations between the position of these bicycles, their availability, their location and proximity to different services and various infrastructures of the city. Throughout this study, one will try to understand and answer questions that are of crucial importance to urban development of a city and try to identify cores of economic and urban development. It is important to mention that this is a hypothesis-oriented study and will follow accordingly, establishing questions and trying to answer them through data gathering and analysis.

First, start with identifying and understanding what is a social phenomenon and the inherent questions that relate it to shared bicycle usage. Secondly, tracing what is called key services. In this study, key services are designation given to services and infrastructure typologies that are considered relevant for shared bicycle usage and play a major role in their dispersion. Following identification, explanation and calculation of what is called “proximity factor”, which translates the relevance of each service and the role it plays in the positioning of *Mobike*, one of the most popular shared bicycle brands, further allowing to make assumptions over the relevance of these services and understanding the scope of urban development with new and innovative transportation models, which are recently booming all over China.

### 2. METHODOLOGY

The data gathering was done simply by using the *Mobike* app, through screening positions of available

bikes in aforementioned area every morning, afternoon and night, over a week period. Screening of selected key services was made using an altered variation using map services of *Baidu* that allows to identify and locate all type of infrastructure typology of an area.

After these predefined settings (choosing key services and brand of bikes to study), the only thing left to do would be to map these services, and cross reference this data with the *Mobike* data. To do that, it would be necessary to scale both areas of the application map and the *Baidu* Map variation into same scale, and then overlap them [Fig.1,2].

By mapping with points in an xyz-coordinate system, both bicycles and existing services in the perimeter would allow us to have a common quantifiable vector system that may, or may not, soon prove accurate.

All this data, after being gathered, will need a significance test, to see if any error implied by this cross referencing would be of a large importance that would influence and turn the future results obsolete. Consequently, the most suitable test would be a comparison using heatmap between available *Mobike* density over time, and position of these defined key services [Fig.3,4]. This will lead to ideas about whether if this study is worth conducting and take primary conclusions over the importance of it.

Understandably, there are some quantifiable relations between these parameters in several images where the heat pattern of bike distribution relates similarly to the position of residences and office buildings in the area.

# PLEA 2018 HONG KONG

Smart and Healthy within the 2-degree Limit



Figure 1: Mobike on one morning and office buildings



Figure 2: Residences (Blue) and Supermarkets (Red)

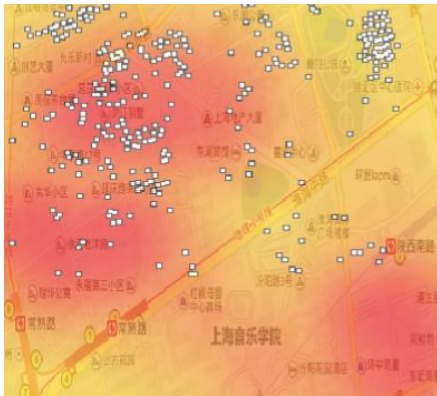

Figure 3: Heatmap of bikes and residences (White) in one night

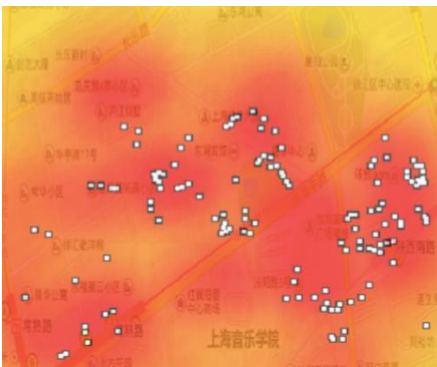

Figure 4: Heatmap of bikes and office buildings in one morning

### 3. FIRST HYPOTHESIS AND BASIC SOCIAL ANALYSIS

With these gathered insights, definitions of proximity factor and key services, as well as the raw analysis of the data gathered, one can already draw some basic information and hypotheses, that must be proven in the next steps.

At this stage, one can logically assume by sociological experience that, for example, there are more bikes with a lower proximity factor, meaning that, there will be more bikes close to key services, than further away, counting for the total of Mobikes registered in the study. This might look like a basic assumption, but if true, it can have several different influences in urban fabric, arguably directing city's development in a way that implies a cordiality and symbiosis between urban fabric, various layers of infrastructure, influencing the flow of shared bicycles all over the area of study and, therefore, the flow of people, life and image, in the city.

Another assumption or hypothesis that one can make is that there is a higher number of available bikes during weekdays, though, this hypothesis is exclusive to the area of interest, since analysis of the urban framework at that scale, describes and shows the area of Xintiandi as a large and famous touristic, retail and office area. This will imply that more people will move from their houses to the area, leaving a trace of bikes. Consequently, exists a larger offer of available bikes in that area during the weekdays, since weekends consist of non-working days. Thus, by observing data, it should be noticed a lower number of bikes during weekends.

Finally, during these weekends, it is probable that the user's commute to office and work, transfer to other areas, namely residential areas of Shanghai, which retail and general office workers can afford. These residential areas obviously have a minor density of services (such as retail, office buildings, restaurants or malls) than the same service fabric of the perimeter of Xintiandi. Thus, by analysing this information, it is implied that the calculated proximity factors for all the available Mobikes during the weekend will be, overall, bigger than the one calculated during weekdays. Meaning that there will be an inferior overall number of available bicycles and that these will be more scattered through areas, further away from some critical key services, such as shopping centres, subway stations, office buildings and so on.

However, this may seem like a logical and unimportant hypothesis, yet it is of major importance to understand the implication and the significance of the singular content of the key services, and in the end, will allow to study, and filter the critical key services that have a general influence in the city and not in specific districts. Thus, the next stage would be to verify and determine the value of significance of each key service, by testing how many bikes have each service as their closest one.

# PLEA 2018 HONG KONG

Smart and Healthy within the 2-degree Limit

## 4. PROXIMITY FACTOR

The proximity factor described during this paper, works to evaluate the quality of versatility in building typologies that surround the area of study, meaning that a constant and averagely lower proximity factor for most of the sessions and bikes accounted would indicate that most available bikes are dropped in places: a) With good urban quality and versatility; b) Very possible of being picked up, since services that promote mobility and interactions would be constantly nearby.

More information we gather from the analysis of the proximity factor for each bicycle are patterns of bike distribution during the week. We can analyse and compare the weekend record to the week and with enough resources, one can compare areas of development in between zones of city and lower the average proximity factor in the area which would eventually need improvement. Also, by reading high constant values on a specific site, it is indicative of a necessity for an urban requalification, meaning there are not enough key service infrastructures around the area.

### 4.1 Accuracy tests, closest key services and overview

Analysis of such data and tests might allow a deeper study of urban framework and lifestyle, optimizing the streets, facilities and services in regard of user experience. Instead of conditioning user experience to urban framework, it is possible to adapt the urban framework to user experience. Thus, proportionating a better symbiosis between systems. Subsequently, to narrow down the most significant key services, correlation with the number of closest key services is necessary.

As observed in Fig. 5, there is a natural and sociological correlation between restaurants and office buildings in urban fabric and daily lifestyle of people. It is visible in mapping graph that, there are usually more available bicycles closer to restaurants. But most interesting part is the chronological proportionality between these two, as the variation of bikes close to each service develop almost identically, at a given time. This is helpful as a condition for future development of areas, as it arguably can show strategies for planning.

It is interesting to compare the results obtained in the figures 5 and 6 as both pairs of key services present a hand in hand variation over time. It is uttermost important to understand the influence and significance that each key service prints in daily lifestyle of locals, so it can be assumed that services can have different values of significance in the quantification of proximity factor. Furthermore, by looking at the graphs, we can already assort natural relation existing between some services, providing a reliable pattern studying over time. The same can be pictured in Fig. 6, related to supermarkets and residences, but in this situation, the difference between the number of bicycles that are closer to residences and

supermarkets is much higher than the one observed in Fig. 5. This is probably due to the massive domain of housing and residence-oriented areas, that exist in specific areas on sight.



Figure 5: Correlation between closest restaurants (blue) and office buildings (grey) to each bike over time.



Figure 6: Correlation between closest supermarkets (green) and residences (orange) to each bike over time.

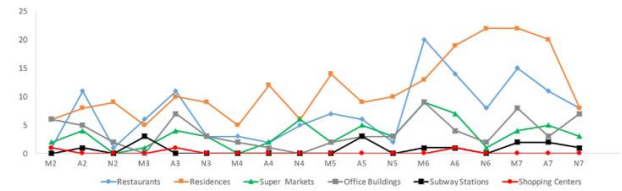

Figure 7: Correlation of all closest key services (red – shopping centres, black - subway stations) over time.

Finally, by reading and overlapping closest key services to each Mobike over time [Fig. 7], it is easily understandable how to filter key services and select the most significant ones in the area being studied. It was decided to exclude the embedded key services within the residential areas, due to the overwhelming concentration of this typology in area of research as well as difficulties to extract this embedded information within the fabric of residential lanes. Also shopping centres usually do not have nearby bicycle parking lanes, since most of them have a big pedestrian plaza, landscaping, sculptures or monumental entrances. These steps lead to a data deviation in favour of other services nearby, indicating the shopping centres as elements of intensification on proximity factor calculation. Subway stations are obvious drop off points for Mobike. This also means that the data gathered from these might be corrupted since they had no influence in the studied social phenomenon. Finally, for reasons stated above it is down to three most significant services: Restaurants, office buildings and supermarkets. They represent the most balanced distribution among all the services.

Consequently, after the filtering of these significant services, it is important to understand if this data is accurate and therefore ready to be used. This results in the need of proceeding to a hypothesis null test against these services. In other words, this means that a way to

# PLEA 2018 HONG KONG

Smart and Healthy within the 2-degree Limit

see in a large scale if parking users are actually going to the service registered in the session and not to other services around must be found. Fortunately, there is a simple test to be done to verify if there is any major error in the methodology applied. Simply by calculating the number of second closest key services to all the bikes, and determine their building typology, and then, correlate it with the number of closest services of the same building type [Fig 8, 9, 10, 11].

For a simpler explanation, it is interesting to look at the phenomenon of picking or dropping a bike of one individual, and then apply this logic to a large-scale event. Imagining that someone would park the bicycle in a specific location, it does not mean that this person would obligatorily move to the closest key service in the area. This happens because of several conditions: either for parking spots available, or just individual commodity, just the thought of a person always going to the closest service to where they park their bicycle sounds illogical. What happens is that this person would probably go to the second or third closest key service, and with our current data it would be unclear what the actual destination is. This implies that in one recording session at an individual scale, the unity representing this person's Mobike would disappear from the closest key service and instead be added in the list of the second closest key service. If we multiply this event to a group of people, what we would see in the data would be a different value between the closest and second closest key service, meaning that people who were originally parking closer to a restaurant, maybe would go to the nearest supermarket, and the number corresponding to these people, would shift to another key service on the second closest service list [Fig. 9].

This implies a change in the slope of the graphs of the closest and second closest key services. Consequently, to verify if this large-scale shift of the numbers occurs, the only thing to do is to correlate the same graphs with the closest service and the second closest, and if there is a massive deviation of the pattern of the graph, it means that this test model is not accurate for a large-scale study of this phenomenon, while if the graphs have a similar slope over time, it means that the distribution is even and at a large scale. These errors either end up compensating and cancelling each other out or the number of people that are not going to the closest key service does not represent a significant percentage of the studied population. [Fig. 9, 10, 11] Either way, it ends up safe proving the reliability of the test model that is ideal for this study.

	A	B	C	D	E	F	G
1	Closest S.	Restaurants	Office	Super	Shopping	Subway	
2	M2	1	11	2	1	1	
3	A2	14	7	7	0	1	
4	N2	1	7	6	0	0	
5	M3	8	4	2	0	3	
6	A3	14	12	7	1	0	
7	N3	4	10	4	0	0	
8	M4	2	4	2	1	0	
9	A4	9	2	5	0	0	
10	N4	8	2	7	0	0	
11	M5	12	4	9	0	0	
12	A5	9	7	7	0	3	
13	N5	3	5	9	0	0	
14	M6	26	11	13	0	1	
15	A6	19	13	12	1	1	
16	N6	15	11	9	0	0	
17	M7	20	19	10	0	2	
18	A7	19	8	12	0	2	
19	N7	13	8	3	0	3	
20		197	145	126	4	17	489
21	2nd closest	Restaurants	Office	Super	Shopping	Subway	
22	M2	1	10	2	1	1	
23	A2	12	6	7	2	2	
24	N2	4	7	6	0	0	
25	M3	4	4	3	0	4	
26	A3	11	10	10	2	0	
27	N3	4	8	6	0	0	
28	M4	3	5	2	0	0	
29	A4	7	4	5	0	1	
30	N4	2	5	9	0	1	
31	M5	9	4	12	0	1	
32	A5	8	7	7	0	4	
33	N5	5	6	6	0	0	
34	M6	16	17	14	0	3	
35	A6	18	14	10	1	3	
36	N6	9	11	12	2	1	
37	M7	11	24	14	0	2	
38	A7	11	13	14	1	2	
39	N7	8	10	5	0	3	
40		143	165	144	9	28	489

Figure 8: Table of closest services registered for each bike



Figure 9: Correlation between closest and 2nd closest restaurants over time

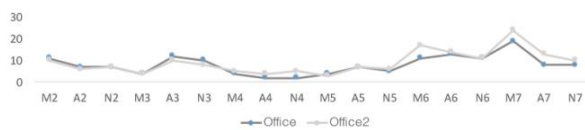

Figure 10: Correlation between closest and 2nd closest office buildings over time



Figure 11: Correlation between closest and 2nd closest supermarkets over time

## 4.2 Proximity factor supported calculation and methodology

Now that the accuracy of the test model is proven, there is only one step missing to completion and final reading of the studied data. The calculation of the Proximity factor tuned according to area specifics, and in this case, Xintiandi.

Our data: the total amount of bikes accounted for closest key services; and the total amount of closest services by category, will allow us to establish three constants in the calculation of our proximity factor.

These appear from the percentage model [Fig. 12], by calculating the number of restaurants, supermarkets and office buildings that are closest to Mobikes and

# PLEA 2018 HONG KONG

Smart and Healthy within the 2-degree Limit

dividing it by the total number registered, we now have a percentage constant, attributed to each significant key service. This constant is area specific and must be calculated again, in order to proceed to the calculation of the proximity factor in another site, since, as explained before, other areas have further or different preponderance to infrastructure typologies and therefore, the results or the significant services might change. In this case it was office buildings, supermarkets and restaurants, in other cases it might be industry, residences, green public spaces or every other significant building typology that is present in the study.

Simple things that we can read from the graph below are, for example, that office buildings have a higher percentage of closest services during weekdays while restaurants appear to have a higher number during afternoon sessions. It is important to notice the different percentages during morning, afternoon and night, according to the service and lifestyle of the users.

Finally, the proximity factor is represented by equation (1), which represents the sum of the distance of one available *Mobike* to the closest service multiplied with the respective significance factor, with the distance of the same bicycle to the closest supermarket multiplied with the significance factor of supermarkets in the area and so on, for every significant building typology on the site. This results in an accurate split of the overall distance to the selected key services with the respective significance factor applied in a percentage model.

It is also important to mention that weather and other conditions that influence bicycle usage in the city should be accounted for. In this case, it was planned to be used as a binary exclusion factor, when accounted for rain or other events in the area that would incapacitate or influence the use of bikes, but since the data was only recorded for one week, and no such event or weather-related condition occurred during the week of data collection, it was not necessary. This will finally lead to our tuned data graphs and will allow us to further analyse the results and draw the necessary information about the specific area's social activity.

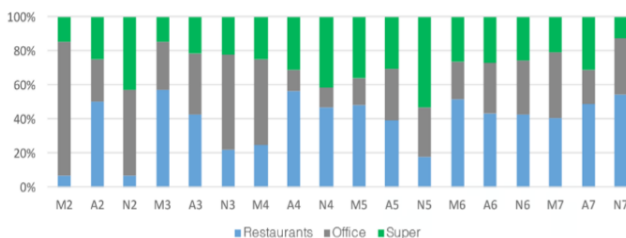

Figure 12: Percentage model of the number of bikes with closest services and their typology

$$P = \sum_{i=1}^n D_i \times F_i \quad (1)$$

Where:

- P = Proximity factor for one registered bicycle
- $D_i$  = Distance of bicycle to closest indexed service
- $F_i$  = Significance of indexed service
- n = Number of correspondent key services

### 4.3 Final results analysis

With the proximity factor calculated for all the bicycles recorded, it is possible to visualize the data in a heat graph and verify the previously stated hypothesis [Figure 13]. As seen previously, the weekend starts at Morning 4 (M4 in the x axis) and a large decrease of available bikes from the night before is visible. Xintiandi is a very well-known night-life area in Shanghai and this observation supports that statement, seeing as almost half of the available bicycles in N3 (Friday night) were taken from outside the area of study, to other areas.

On the other hand, M5 (Monday morning) presents almost 50 available bikes in the area with very low average proximity factor (below 0.4 average). This can be read as a successful distribution of the bicycles and that they are reasonably close and accessible to any city user in the area, indicative of a good urban efficiency and quality.

Overall, in the Xintiandi area, bicycle proximity factors seem generally low, which is good, because considering overall range to services and infrastructures one can assume an urban quality that regulates accordingly to the city life, except maybe, at night where some records tend to demonstrate less available bikes and higher proximity factors.

One of the next interesting steps to take would be to compare it with other Shanghai areas and other cities similar zones and determine which areas might need urban requalification or improvement in service and building quality, by estimating an adaptive model that falls between the standards of city regulation and classification.

Another optional interesting step is to automate this analysis with a computer and use a machine learning approach to be constantly evaluating and analysing the data, allowing a more accurate result with less intervals between periods of screenings and new evaluation, intervention and analysis methodologies.

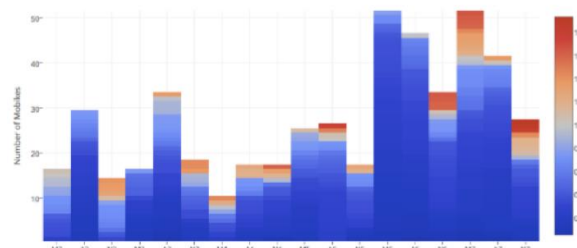

Figure 13: Heatmap of proximity factor for registered bicycles over time.

# PLEA 2018 HONG KONG

*Smart and Healthy within the 2-degree Limit*

## 5. CONCLUSION

After this thorough analysis and test model tuning and development, some basic but interesting facts that support the hypothesis can be assumed. In the night, records tend to register less available bicycles in the Xintiandi area. This is important, since Xintiandi is also a famous night-life area, with several night facilities and the fact that less bikes are available during night time, means that people using nocturnal facilities will not have access to such a big offer of available bicycles. Although, this does not happen in late morning records and afternoons. This occurs due to the registered increased tendency of available bicycles in the residential area. Also, offices and restaurants register their highest peaks on mornings and in afternoons. This translates the normal people working routine and strengthens the bond between urban fabric and daily life. It can be deduced that the influence of the urban fabric in people's lives is enormous and implies a direct **one-way influence of the urban fabric**. The final outcome should not be this one, but one where user experience and building typologies have a reciprocating influence on the co-existence of people and buildings.

This will allow a more efficient urban planning process, over the master plan of the area, and its respective function and services. Furthermore, with this new accurate test model, there are several things that can be improved in the scope of urban planning, among them are:

- The providing of a better insight under which areas should suffer future redevelopments. Ultimately, would increase the area life-style efficiency;
- The improvement of cyclers safety, by adding or restructuring the bike lane frameworks in the existent streets;
- Allows to establish common grounds and predictors, between city mapping, Urban mobility and future development in a large scale.

## ACKNOWLEDGEMENTS

This research was partially supported by Tongji University, Tecnico Lisboa and Disney Research Lab in Shanghai. We thank our colleagues from Tongji university who provided insight and expertise that greatly assisted the research, although they may not agree with all the interpretations/conclusions of this paper.

My friends Jonas Herzer, MBS, Phillips-Universitat Marburg; Hejia Jin, Student, TU Berlin and Andrea Grossi, Urban Planner, Politecnico di Milano for comments that greatly improved the manuscript.

We would also like to show our gratitude to the "anonymous" reviewers for their so-called insights. We are also immensely grateful to Carmo Cardoso, Architect; Sheryl Shen, Student and Alexandra Erfort, Student for their comments on versions of the manuscript, although

any errors are our own and should not tarnish the reputations of these persons.

## REFERENCES

1. Brennan, Matthew (May 2017). "Bike Sharing and the City, 2017 White Paper". China Channel. Retrieved May 17, 2017.
2. Andrews-Speed, Philip (November 2014). "China's Energy Policymaking Processes and Their Consequences". The National Bureau of Asian Research Energy Security Report. Retrieved May 20, 2017.
3. Russel, John, (January 2017) "China's Mobike raises \$215M led by Tencent for its bicycle sharing service". Techcrunch.com. Retrieved May 20, 2017.
4. Hersey, Frank, (May 2017) "China's bike rental startups are learning a lot about how people spend their free time". Techcrunch.com. Retrieved May 21, 2017.
5. "China's electric vehicles to hit 1 million by 2020: report". Reuters. 2010-10-16. Retrieved 201705-10.
6. The High Road; "If China steers its auto industry toward hybrids and perhaps hydrogen cars, the world may have no choice but to follow."(Cover Story), Newsweek International. Retrieved May 10, 2017.

# Analyze the Interaction between People's Perceptions of Interior Spatial Properties and the Opening Forms with Isovist Measures

XUFENG ZHANG<sup>1,2</sup>, WEI YOU<sup>2</sup>

<sup>1</sup>Ningbo Institute of Technology, Zhejiang University, Ningbo, China

<sup>2</sup>School of Architecture and Urban Planning, Nanjing University, Nanjing, China

*ABSTRACT: The opening form of building façade has a strong influence on people's perceptions of interior spatial properties. However, architectural designers usually pay attention to aesthetics aspect of building façade and neglect the influence of changing the opening form on the people's perceptions of interior space. Furthermore, the isovist is a quantitative method that describes space from a visual observing perspective including 2D and 3D measures. But most isovist studies investigate the visual experience of interior space only in two dimensions. Besides, the opening can also influence the daylighting performance, and the daylighting performance can impact the interior perception as well. In response, this paper presents the results of a study involving 52 participants who assessed 29 perspective views of virtual interiors with different opening forms for feelings of spaciousness. Firstly, these results are compared with isovist measures, including 2D and 3D, to examine which isovist measure is more effective. Secondly, these results are compared with daylighting measures to find out which openings can possess both spacious feeling and nice daylighting performance.*

*KEYWORDS: Opening forms, Interior perception, Spacious, Isovist measures, Daylighting measures*

## 1. INTRODUCTION

People are sensitive to metric properties and that perceptual responses to a space can be linked to its actual geometric properties [1, 2, 3, 14, 15]. The perception of spaciousness is the center of several major applications of behavioural research in interior design. Joedicke (1985) describes spaciousness as a major component of the emotional experience of architecture while other researchers confirm a strong correlation between spaciousness and perceptions of beauty [11, 22].

With the rise of interest in testing environmental preference theory in architecture, an alternative tradition has arisen which tests these spatial properties mathematically or computationally. For example, past research has used isovist polygons and visibility graphs (derived from isovists) to examine the spatio-visual properties of environments [2, 3]. An isovist is 'the set of all points visible from a given vantage point in space'. Isovists change their shape and size depending on the chosen observation point within an environment, which allows them to reveal location-specific patterns of visibility [3]. In an architectural context, they allow for the interrelation of space, light, and visibility to be measured [3].

However, very few studies test, in a controlled way, the relationship between actual spatial properties and how they are perceived. One rare exception (Dosen and Ostwald, 2017) confirms that some human spatial perceptions reflect the properties of a room's actual geometry [10], and some metric and isovist measures can legitimately be used to model or predict relative

spatial perceptions. Specifically, they grouped the isovist area in plan view, in section view and by their sum (plan and sectional isovists) as a simple means of approximating a three-dimensional isovist, and proved that isovist area indicates a high, positive correlations with perceptions of exposure for a simple living room with different opening types. Although they are examined in both plan and section, for examining internal prospect, three-dimensional isovist or spatial salience measures may be more useful [10, 13].

In parallel, daylighting environment is an important element on the perception of spaciousness in interior design. Past researches confirm that the integration of design elements such as the shape, volume, color, and light can alter our perception of how spacious a room is. The level of lighting, both natural and artificial, plays a major role in the creation of spaciousness awareness. Openness of views emerged as the most important factor for room satisfaction. It would be best then to optimize window views to improve openness feeling and provide a spacious environment. So, for design purposes, we will study the daylighting performance of the test rooms to examine which possess spacious feeling can have nice daylighting performance as well.

This paper presents the results of a study involving 52 participants who assessed 29 perspective views of virtual interiors with different opening forms for feelings of spaciousness. Firstly, these results are compared with isovist measures, including 2D and 3D, to examine which isovist measure is more effective. Secondly, these results are compared with daylighting measures to find out

which opening can possess both spacious feeling and nice daylighting performance.

## 2. 3D ISOVIST CALCULATION

Recently, there has been a revival of interest in visibility analysis of architectural configuration and various attempts have been made to develop automated tools for assistance in architecture and urban research and plan development. Benedikt was the first to introduce the 'ISOVIST', the area visible directly from any location within the space [3]. He developed a set of analytic measurements of ISOVIST properties to be applied to achieve quantitative descriptions of the built environment.

All the visual analysis methods and automated models mentioned above are based on a two-dimensional visual analysis. Very few attempts have been made to capture and respond to the three-dimensional urban environment. Teller introduced a spherical metric for field-oriented analysis relating to the urban open spaces [20]. The mathematical modeling technique is capable of mapping the variation of sky visible from points distributed throughout the space. Fisher-Gewirtzman et al suggested a 2D visual analysis looking at every level of the built volume, from street level and up. This method could be described as a multi-level ISOVIST. Similarly, Dosen and Ostwald (2017) grouped the isovist area in plan view, in section view and by their sum (plan and sectional isovists) as a simple means of approximating a three-dimensional isovist [10]. The spatial openness index (SOI) suggests a 3D visibility analysis for the urban open spaces and for the private spaces, within the built volumes, looking out [13]. In this way, this visual analysis model relates to the 3D urban situation. We feel this should be the path to solve the visibility analysis in the 3D urban environments. Both models are described below.

A 2D visual analysis cannot capture the whole 3D situation and get close to the human perception. In this paper, we will discuss two view-oriented visual analysis methods that aim at capturing the 3D urban structure. The first is a quantitative method for visual openness by summing the plan and sectional isovists (figure 1. b) which was used by Dosen and Ostwald (2017) [10]. The second method discussed in this paper is the 'spatial openness index' (SOI) that enables the calculation of the volume of space potentially seen from a given point of view (figure 1. c). Viewpoints are dispersed throughout the built volumes and the space between the surfaces. The SOI can also be described as 3D ISOVIST. Both methods can support a comparative evaluation between alternative interior configurations. In this paper, we will compare these two isovist calculations.

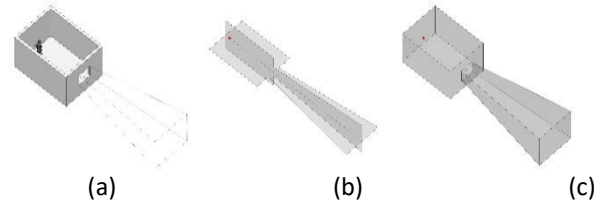

Figure 1: Isovist of the basic room shape. (a) tested room; (b) the sum of plan and sectional isovists; (c) 3D isovist.

## 3. EXPERIMENT 1

The method adopted in this paper combines an empirical survey with a mathematical and computational approach (isovist analysis) to test the relationship between perceptual responses and actual properties of virtual interiors (geometric space). In the online survey, 52 participants rated 29 fixed-viewpoint perspectives of virtual rooms with varying opening forms for their feelings of spaciousness. As the stimuli in this study are the varying views from a room, isovist properties were derived from the room geometry as a measure for the spatio-visual dimension of each space. The survey results were then compared with commonly used isovist measures (e.g. isovist area and volume). Isovist area is derived from both plan and section based isovists. All isovists were constructed with a uniform view limit of 20 meters from the observation point. Decisions about the view limits used in isovist analysis must balance the fact that longer limits inflate many calculated measures – they increase isovist area and volume – without adding any additional benefit to the calculations and complicating comparisons using non-ratio-based measures. A practical view limit must also extend beyond the immediate environment being analysed but not so far that it includes distant objects. The chosen 20-metre view limit balances these factors and reinforces the notion that the interior and its general relationship with the exterior are the focus, and not any distant views.

### 3.1 The test environment

For this study, an interior was modelled which represents a habitable domestic room. Each virtual room has a  $3.6 \times 5$  metres wide plan and a standard ceiling height of 3.6 metres. 29 rooms have different forms of façade openings with same open area (table 1). That means the wall-to-window-area ratio of all test rooms is identical. Each room has one of three opening types: square opening (type: A; size:  $1.2\text{m} \times 1.2\text{m}$ ), horizontal bar opening (type: B; size:  $3.6\text{m} \times 0.4\text{m}$ ), and vertical bar opening (type: C; size:  $0.4\text{m} \times 3.6\text{m}$ ). These openings were then divided by different positions (1-15), including from top to down and from side to centre.



# PLEA 2018 HONG KONG

Smart and Healthy within the 2-degree Limit

Table 1: Stimuli by opening type (A–C) and position (1–15) with same opening area.

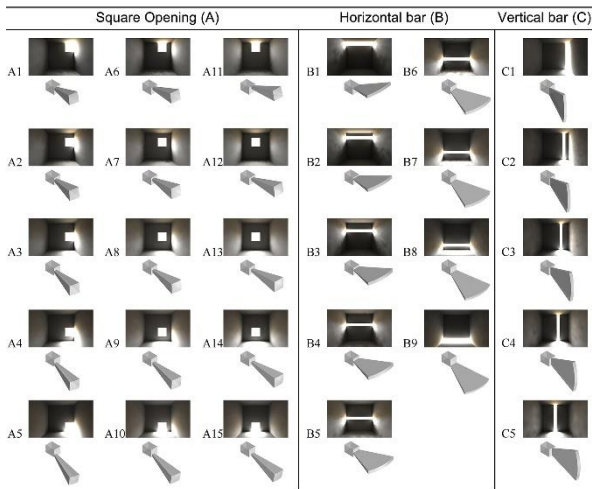

### 3.2 The result of isovist volume

It is clear from the line graph (Figure 2) that the value of isovist volume fluctuates according with the type and position of openings. The highest value is B5 ( $v=262.9\text{m}^3$ ), and the value of A13 ( $v=257.7\text{m}^3$ ) is quite close to it. The lowest value is C1 ( $v=160.6\text{m}^3$ ), and then B1 ( $v=165.8\text{m}^3$ ). As we can see, the openings located at the central area occupy the line peak points (A3 and A4, A8 and A9, A13 and A14, B5, C5), while the openings at the corner or near the side (A1, A5 and A6, A10 and A11, B1, B9, C1) distribute at the bottom of the line. And the trend of line indicates that the same type of openings from side to central area will produce a bigger value of isovist volume which tally with what we observe. Additionally, the square openings possess a higher mean value than bar openings. Most of square openings are over the value  $200\text{ m}^3$  except A1 ( $v=194.5\text{m}^3$ ), while only the central bar openings (B and C) can reach above the value of  $200\text{ m}^3$ .

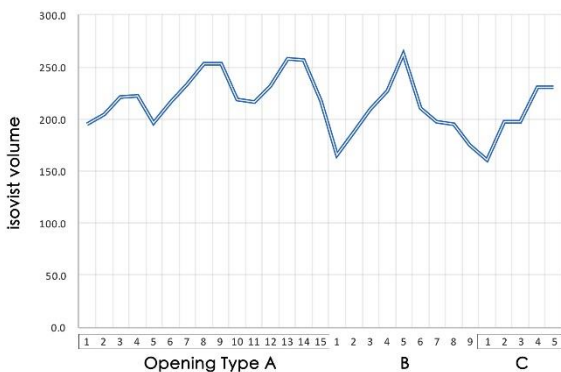

Figure 2: The isovist volume by opening type (A–C)

### 3.3 The result of isovist areas sum

As we can see (figure 3), the line graph is made of two flat lines with little fluctuation. The lower line is square

openings whose value are around  $129\text{ m}^2$ , and the other one is vertical bar and horizontal bar openings, their value are floating at  $188\text{ m}^2$  level. Firstly, it indicates that vertical bar and horizontal bar openings possess a higher value than square openings. Secondly, the factor of position has little influence when we use the calculation of sum the plan and section isovist areas.

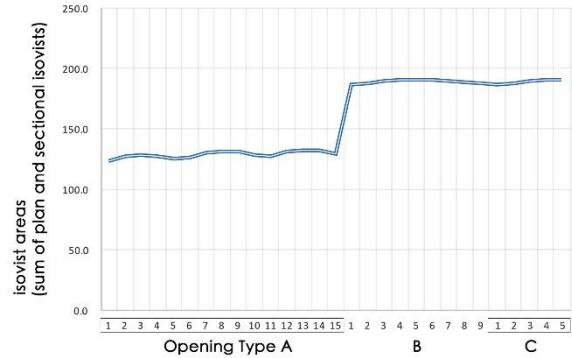

Figure 3: The sum of plan and sectional isovist areas by opening type (A–C)

### 3.4 The result of Survey

Staff and students from Nanjing University will be invited to take part in the study. Participants took part in an online questionnaire, which was accessible for a period of 4 weeks. Seven demographic questions followed an initial agreement on reading the information statement, asking for age, gender, experience, current location (country) and local background. Thereafter, a short description of the terminology used and three example images (Figure 4) were shown before the first stimuli. The 29 stimuli were then presented in the order shown in Table 1, varying by opening type and position. While ordered stimuli can influence the assessment, it can also be argued that a fixed structure aids the overall understanding of the rating task.



Figure 4: three test room images

For the result, the highest value is A13 ( $r=4.85$ ), and the lowest value is C1 ( $r=1.83$ ). As we can see, the openings located at the central area occupy the line peak points (A3, A8, A13, B5, C5), while the openings at the corner or near the side (A1, A5 and A6, A10 and A11, B1, B9, C1) distribute at the bottom of the line. And the trend of line indicates that the same type of openings from side to central area will produce a bigger value of isovist volume, which is quite similar with the graph line of isovist volume.

# PLEA 2018 HONG KONG

## Smart and Healthy within the 2-degree Limit

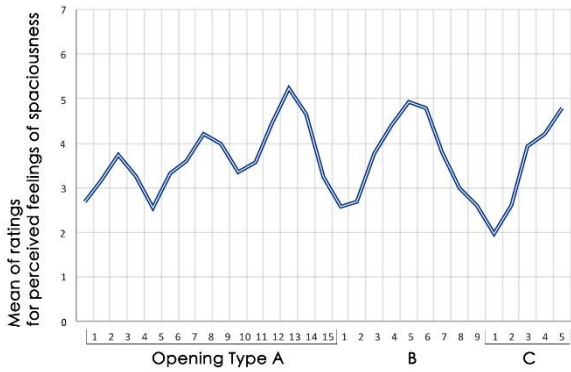

Figure 5: Mean of ratings for perceived feelings of enclosure by opening type (A–C)

### 3.5 Analysis

The figure 6 describes the trend of isovist volume (blue line) and the mean of ratings for perceived feelings of spaciousness (dark line). As we can see, the fluctuation of these two lines is quite similar. Specifically, A3, A8, A13, B5 and C5 reach the peak level, and A1, A5, A10, B1, B9 and C1 lie the bottom of the lines. It indicates that the calculation of isovist volume can well describe the feeling of spaciousness of 29 test rooms, the value of their correlation coefficient is 0.67.

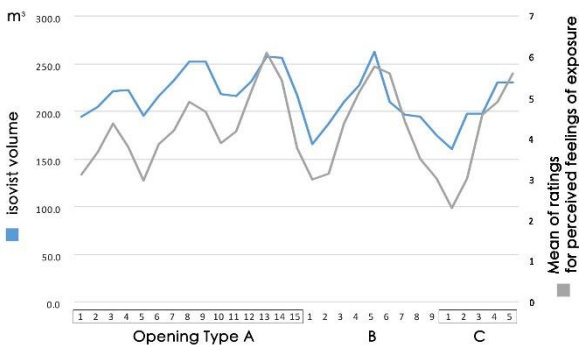

Figure 6: The correlation between isovist volume and the mean of ratings for perceived feelings of spaciousness by opening type (A–C)

Meanwhile, as we can see from the figure 7, there is little correlation between isovist areas sum and mean of ratings for perceived feelings of enclosure by opening type (A–C). It indicates that the calculation of summing the plan and sectional isovist areas cannot well describe the feeling of spaciousness of 29 test rooms.

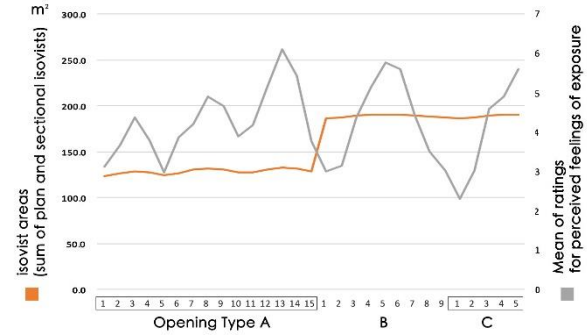

Figure 7: The correlation between isovist areas sum and mean of ratings for perceived feelings of enclosure by opening type (A–C)

## 4. EXPERIMENT 2

The opening can also influence the interior daylighting performance. We calculate the daylight factor of these test rooms to find which rooms possess well feeling of spaciousness, and nice daylighting performance as well. This can make a good sense for architectural design.

### 4.1 Calculation for daylighting performance

Daylight factor (DF) is defined in more conventional residential rooms, serving as a reference for window design in architecture in order to. The daylight factor (DF) was conceived as a means of rating daylighting performance independently of the actually occurring, instantaneous sky conditions. Hence it was defined as the ratio of the internal horizontal illuminance  $E_{in}$  at some arbitrary point in a space to the unobstructed (external) horizontal illuminance  $E_{out}$  from a hemisphere of sky. Light from the sky can arrive at a point in a space directly if any sky is visible from that point, and also indirectly following one or more reflections from surfaces inside and outside of the space. The daylight factor is usually expressed as a percentage, equation (1):

$$DF = E_{in} / E_{out} \quad (1)$$

where  $E_{in}$  - the internal horizontal illuminance at some arbitrary point in a space;

$E_{out}$  - the unobstructed (external) horizontal illuminance  $E_{out}$  from a hemisphere of sky.

### 4.2 Calculation conditions

Daylight simulations were conducted with two room surface average reflectances. The inner surfaces of the room were assumed to display Lambertian reflectances. The luminous intensity of reflected light was therefore directly proportional to the cosine of the angle between the observer's line of sight and the surface normal. All variables of the calculation model are shown in Fig. 8.

The main location of the room model corresponds to Beijing under predominantly overcast skies. All trials relating to shape, size and position of the window are developed under these weather conditions. The window

# PLEA 2018 HONG KONG

Smart and Healthy within the 2-degree Limit

orientation used for all calculation models and locations is south. And the test room is on 7<sup>th</sup> floor (20 meters high) with no cover around it.

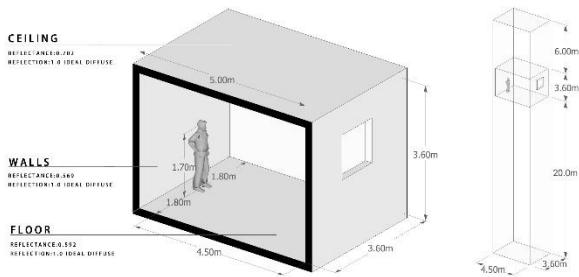

Figure 8: The model of test room

### 4.3 Calculation and analysis

As we can see (Figure 9), the openings located at upper area occupy the line peak points (A1, A6, A11 and B1), while the openings near the bottom of the wall (A5, A10, A15 and B9) distribute at the bottom of the line. In addition, the square openings possess a higher mean value of DF than bar openings. In this research, we find that A13 (the square opening in the centre of the wall) and C5 (the vertical bar opening in the centre of the wall) possess well feeling of spaciousness, and nice daylighting performance as well. Two main factors could account for the result. Firstly, the bigger value of isovist means more chance for the observer to get attach to outside environment. And this allows more outside lighting-rays reach the observing point directly. So, A13, B5 and C5 could properly possess a nice daylighting performance. Secondly, the position of opening will exert remarkable effect on the daylighting performance. Measurements revealed that a densely overcast sky exhibits a relative gradation from darker horizon to brighter zenith; this was recorded in 1901. With improved, more sensitive measuring apparatus, it was shown that the zenith luminance is often three times greater than the horizon luminance for some of the most heavily overcast skies. So the higher opening (A13, C5) will better enhance the efficiency and effectiveness of daylighting performance. These findings can make a good sense for architectural design.

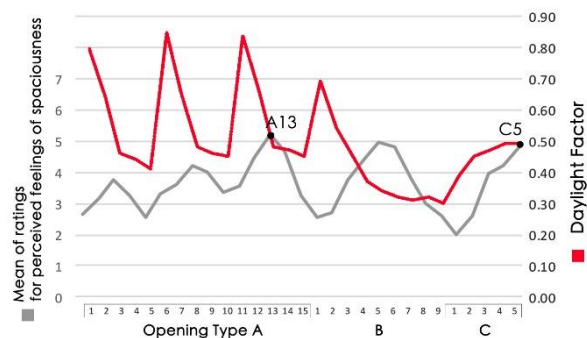

Figure 9: The study of daylight factor and the mean of ratings for perceived feelings of enclosure by opening type (A–C)

### 5. CONCLUSION

In total, for 29 different spaces, the paper studies isovist and daylighting measures in three opening variations, with ratings for perceived spaciousness and daylighting factor, providing a rich, detailed and methodical analysis of a basic assumption in design psychology and architectural science.

The results of isovist volume presented in this paper indicate a high positive correlation with the mean results of perceived spaciousness. While the sum of plan and section isovist area indicate little correlation with the perceived result. Past research has generally noted the usefulness of isovist analysis for predicting experiential qualities of space, but only isovist area has previously been identified as a dominant factor [16,22]. Dosen and Ostwald [10] grouped the isovist area in plan view, in section view and by their sum (plan and sectional isovists) as a simple means of approximating a three-dimensional isovist, and proved that isovist area indicates a high, positive correlations with perceptions of exposure for a simple living room with different opening types. But the opening areas of three types is arranged from small size to large size. The isovist area can definitely distinguish bigger opening from small ones. In this paper, we test 29 openings with same opening area, and compare isovist volume and isovist area (plan and sectional sum). As we can see, the result indicates that isovist volume appear to be more effective or useful. In further, the opening can also influent the interior daylighting performance. In this research, we find that A13 (the square opening in the centre of the wall) and C5 (the vertical bar opening in the centre of the wall) possess well feeling of spaciousness, and nice daylighting performance as well. This can make a good sense for architectural design.

However, there are limits to the present research that must also be taken into account when interpreting the results. Firstly, only static stimuli are used for the survey, which might limit the experiential assessment of a three-dimensional space. Secondly, the number of participants is not equally divided across all demographic groups and so detailed conclusions or inferences cannot be drawn about all of the sub-groups who participated. Finally, this paper is only concerned with the properties of fixed isovist viewpoints, not isovist fields or paths. The extent of its analysis of isovists is also limited to their potential correlation with human perceptions.

The present research confirms that, for a simple room and a graduated series of variations, basic human spatial perceptions do correlate to the metric properties of a space. For practical purposes, it does suggest that some human spatial perceptions reflect the properties of a room's actual geometry, and some isovist and daylighting measures can legitimately be used to model or predict relative spatial perceptions.

# PLEA 2018 HONG KONG

*Smart and Healthy within the 2-degree Limit*

## REFERENCES

1. Augustin, Sally, (2009). *Place Advantage: Applied Psychology for Interior Architecture*. London: John Wiley & Sons.
2. Batty, Michael, (2001). Exploring Isovist Fields: Space and Shape in Architectural and Urban Morphology. *Environment and Planning B: Planning and Design*, 28 (1): p. 123–150.
3. Benedikt, Michael L, (1979). To Take Hold of Space: Isovists and Isovist View Fields. *Environment and Planning B: Planning and Design*, 6 (1): p. 47–65.
4. Bhatia, Shashank, Stephan K. Chalup, and Michael J. Ostwald, (2013). Way finding: A Method for the Empirical Evaluation of Structural Saliency Using 3D Isovists. *Architectural Science Review*, 56 (3): p. 220–231.
5. Christenson, Mike, (2010). Registering Visual Permeability in Architecture: Isovists and Occlusion Maps in AutoLISP. *Environment and Planning B: Planning and Design*, 37 (6): p. 1128–1136.
6. Dawes, Michael J., and Michael J. Ostwald, (2013). Using Isovists to Analyse Prospect-Refuge Theory: An Examination of the Usefulness of Potential Spatio-Visual Measures. *The International Journal of the Constructed Environment*, 3 (1): p. 25–40.
7. Dawes, Michael J., and Michael J. Ostwald, (2014a). Testing the ‘Wright Space’: Using Isovists to Analyse Prospect-Refuge Characteristics in Usonian Architecture. *Journal of Architecture*, 19 (5): p. 645–666.
8. Dawes, Michael J., and Michael J. Ostwald, (2014b). Prospect-Refuge Theory and the Textile-Block Houses of Frank Lloyd Wright: An Analysis of Spatio-Visual Characteristics Using Isovists. *Building and Environment*, 80: p. 228–240.
9. Dosen, Annemarie S., and Michael J. Ostwald, (2013). Methodological Characteristics of Research Testing Prospect-Refuge Theory: A Comparative Analysis. *Architectural Science Review*, 56: p. 232–241.
10. Dosen, Annemarie S., and Michael J. Ostwald, (2017). Lived space and geometric space: comparing people’s perceptions of spatial enclosure and exposure with metric room properties and isovist measures. *Architectural science review*, 60(1): p.62-67
11. Dzebic, Vedran, (2013). Isovist analysis as a tool for capturing responses towards the Built Environment. Master’s thesis (Psychology), University of Waterloo, Canada. Available: <http://hdl.handle.net/10012/7511>.
12. Fisher-Gewirtzman, Dafna, (2016). The Association Between Perceived Density in Minimum Apartments and Spatial Openness Index Three Dimensional Visual Analysis. *Environment and Planning B: Planning and Design*, 1–32.
13. Fisher-Gewirtzman, Dafna, Michael Burt, and Yigal Tzamid, (2003). A 3-D Visual Method for Comparative Evaluation of Dense Built-up Environments. *Environment and Planning B: Planning and Design*, 30 (4): p. 575–587.
14. Kellert, Stephen R. , (2005). *Building for Life: Designing and Understanding the Human-Nature Connection*. Washington, DC: Island Press.
15. Lidwell, William, Kristina Holden, and Jill Butler, (2003). *Universal Principles of Design*. Beverley, MA: Rockport Publishers.
16. Meilinger, Tobias, Gerald Franz, and Heinrich H. Bühlhoff, (2012). From Isovists via Mental Representations to Behaviour: First Steps Toward Closing the Causal Chain. *Environment and Planning B: Planning and Design*, 39 (1): p. 48–62.
17. Montello, Daniel R., (2007). The Contribution of Space Syntax to a Comprehensive Theory of Environmental Psychology. *Proceedings of the 6th international space syntax symposium*. Istanbul.
18. Morello, Eugenio, and Carlo Ratti, (2009). A Digital Image of the City: 3D Isovists in Lynch’s Urban Analysis. *Environment and Planning B: Planning and Design*, 36 (5): p. 837–853.
19. Stamps, Arthur E., (2005). Isovists, Enclosure, and Permeability Theory. *Environment and Planning B: Planning and Design*, 32 (5): p. 735–762.
20. Teller J., (2003). A spherical metric for the field-oriented analysis of complex urban open spaces. *Environment and Planning B: Planning and Design*, 30: p. 339-356.
21. Turner, Alasdair, Maria Doxa, David O’Sullivan, and Alan Penn, (2001) From Isovists to Visibility Graphs: A Methodology for the Analysis of Architectural Space. *Environment and Planning B*, 28 (1): p. 103–121.
22. Wiener, Jan, Gerald Franz, Nicole Rossmannith, Andreas Reichelt, Hanspeter A. Mallot, and Heinrich H. Bühlhoff, (2007). Isovists Analysis Captures Properties of Space Relevant for Locomotion and Experience. *Perception*, 36 (7): p. 1066– 1083.
23. Yang, Perry P., Simon Y. Putra, and Wenjing Li, (2007). Viewsphere: A GIS- Based 3D Visibility Analysis for Urban Design Evaluation. *Environment and Planning B: Planning and Design*, 34 (6): p. 971–992.

## An Innovative Housing Model for Users Behavior Changes: From Informal Occupancy to Urban Regeneration.

CHIARA TONELLI<sup>1</sup>, ILARIA MONTELLA<sup>1</sup>, BARBARA CARDONE<sup>1</sup>, NICOLA MOSCHENI<sup>1</sup>

<sup>1</sup>Department of Architecture, Roma Tre University, Rome, Italy

*ABSTRACT: This paper considers both the housing emergency and unused building stock as part of "People and Community" and shows how, by recovering unused buildings in metropolitan areas for residential use and through conscious management by the inhabitants, the energy-hungry building stock can be upgraded and mitigate the housing emergency. The Case Study reported here is the "Spin Time Labs" building in the heart of Rome, a former office building squatted by 180 homeless families (323 inhabitants) since 2013 that has become an urban regeneration laboratory and creator of economic value and social redemption.*

*KEYWORDS: Housing model, Urban regeneration, Building occupancy, Squatting of buildings, User Behaviour.*

### 1. INTRODUCTION

The current technological revolution has shaped society and defined a new concept of comfort. The change in social morphology, characterized by strong heterogeneity due to continuous migratory flows, and the new economic models influenced by the economic crisis have changed our relationship with residential spaces.

The reference scenario features demographic growth (and the related need for housing), climate change, resource scarcity and the effects of land abuse. All these factors have created a need for new land administration models to mitigate the impact of massive human presence, favouring new lifestyles that are more energy responsible and that meet the needs of a different demographic and social order.

### 2. GENERAL REFERENCE CONTEXT

In Italy, the demographic growth of the last few years, fed by migratory flows, is creating a serious housing emergency in a context of institutional stasis unable to provide adequate responses. Currently, Public Housing serves only a tiny portion of the population, managing just 4% of the entire Italian residential stock.

To this context we must add the changing social morphology, affecting both the traditional family and alternative households (single, elderly, city-users, single-parent households, etc.). The new societal models create new lifestyles shaping a different use and distribution of homes' spaces.

The main critical point of the existing housing stock is functional: lack of flexibility, large size, and oversized common spaces on ground floor and roofs that are difficult to manage.

To all this, we must add the economic crisis that has led the middle class to no longer be able to afford housing on the free market.

In the absence of public responses, this situation has led to the development of informal settlement. Such situations are becoming common in Italy, with consequences on health, safety and the possibility of integration and social redemption. In the 2011 ISTAT census, over 70,000 people stated they lived in slum areas. To this number we must also add people evicted for unpaid rent, who numbered close to 80,000 in 2014 [4].

Then, there is inadequate existing building stock of which a large proportion of energy consumption is attributed to the residential sector. Despite national measures adopted in 2015, the energy demand trend has been reversed with respect to 2014, with primary energy demand actually rising by 4%. In particular, the residential sector saw a 2.7% uptick in final energy consumption, equal to 116.4 Mtoe in 2015 compared to the previous year.

Representing 10% of final uses, 27.9% of energy uses are for residential buildings (approximately 24 Mtoe/year), compared with 34% for transport and 22.3% for industry.

The real estate market is turning to small home sizes to meet the new user profile needs from numerical, construction, technological, typological, and energy points of view.

The reference context represents a good fit with directives for land use and resource conservation. It researches the need to rethink housing standards and processes to ensure they are adequate in terms of size and methodology for current flexibility needs and that they favour reduced consumption and adaptation to climate change and innovative forms of living.

# PLEA 2018 HONG KONG

*Smart and Healthy within the 2-degree Limit*

## 3. THE "SPIN TIME LABS" CASE STUDY: FROM SQUATTING IN AN ABANDONED PUBLIC BUILDING TO AN URBAN REGENERATION LABORATORY

There are vast numbers of unused public buildings in Italy. The possibility of recovering and reusing them as housing can become a field of experimentation into new living models based on shared spaces and services established in a blue economy perspective.

Through the user-building interaction, both in the construction process and management, these types of models trigger behaviour changes in inhabitants toward "smart" energy models with a greater propensity for adaptation.

Precisely in this perspective, housing movements ("Movimenti di lotta per la casa") in large cities like Rome have been fighting for the past several years to occupy and recover unused buildings, proposing an informal cohabitation model that is self-managed and based on shared spaces and services and the creation of economic value by offering activities open to the city.

We chose one of these as a case study. "Spin Time Labs" was an abandoned building in the heart of Rome (Fig.1) that had formerly been used for offices and has been illegally occupied since 2013 by 180 families of various nationalities. The occupants have transformed the offices into private apartments of various sizes (Fig.2). They have also created shared places such as corridors, kitchens, bathrooms and distribution spaces that they rendered liveable through equipment and facilities provided by the inhabitants themselves (Fig. 3, Fig. 4).

The first two floors of the building have been converted into spaces open to the public in which meetings, workshops, courses and schools (Fig. 5) are held, generating micro-economies aimed at self-sufficiency and creating conditions to allow a public asset in disuse to become a "common good" once more (Fig. 6).



Figure 1: Exterior of the Spin Time Labs building, Rome, Photo: Giovanni Barba.



Figure 2: Interior of one of the housing space, Photo: Giovanni Barba.



Figure 3: Shared kitchen, Photo: Giovanni Barba.



Figure 4: Shared laundry, Photo: Giovanni Barba.

With the collaboration of teachers who are experts in the field, doctoral students, researchers and architecture students, our research group promotes a process that moves away from the informal system, and borrows good and replicable practices in order to propose a formal urban regeneration pilot model.

# PLEA 2018 HONG KONG

*Smart and Healthy within the 2-degree Limit*



Figure 5: Space reused for a dance course, Photo: Giovanni Barba



Figure 6: Spaces open to the public: the tavern, Photo: Giovanni Barba

Starting with the squat, we developed a recovery model for the building by sharing the project with the occupants. The project aims to convert the upper floors into residential spaces, increasing the occupational capacity from 300 to 500 inhabitants. It also plans to create a new economy for the building by formalising the already active microeconomies and establishing new services open to the neighbourhood on the ground floor and in the basement.

At the same time, using the conversion as an opportunity to retrofit the building, the entire building will undergo energy upgrading, not only through the contribution of specialised companies but also that of the occupants themselves through guided self-building.

They will receive training so that, not only will these new professionals participate actively in upgrading the building, but their new technical skills may also help them find employment.

In order to understand the needs, characteristics and residential possibilities of a community, we mapped profiles and skills through structured interviews, questionnaires, meetings and collective assemblies.

The project strategy was developed in two phases:

- Phase 1: definition of a new residential and functional set-up;
- Phase 2: development of the energy upgrading project.

## **3.1 Phase 1: The new residential and functional set-up**

Phase 1 was defined through:

- indirect discovery phase, through a census of the settlement;
- direct discovery phase, through interviews and a photographic report;
- consultation phase, through the questionnaire;
- preparation phase of the new residential areas and neighbourhood services.

### **3.1.1 Indirect discovery phase**

The census of the Spin Time Labs occupants collected information on each household. The largest one consists of persons from up to 25 foreign countries such as South America, North Africa and Eastern Europe. Analysis of the age-group distribution of the occupants shows that 67% are adults (19-60 years) and 18% are children (0-12). In terms of education, some of the occupants have university degrees, secondary school diplomas or professional certificates.

Since most of the adults are unemployed, this datum leads us to hypothesise that their skills could be used to improve the building and contribute to their economic independence.

### **3.1.2 Direct discovery phase**

Through one-to-one interviews, we reconstructed a mapping of the nationalities present and determined whether the occupants' ethnic origin influenced the arrangement of the families on the various storeys in some way and led to phenomena of marginalisation. We discovered that, indeed, various ethnic backgrounds had grouped together based on shared customs and timetables, in part hindering the integration process, which is desirable in this type of cohabitation.

We were assisted in the direct discovery phase by a professional photographer who joined the community to document lifestyles inside the building, the transformation of the spaces as an expression of need and the microeconomies of already active services.

### **3.1.3 Consultation phase**

Again through interviews, we studied social aspects in order to understand the problems and conflicts arising in the community.

The questions were structured with the support of an anthropologist and sought to understand the dynamics within the organisational hierarchy of the Movimento di lotta per la casa, the criteria for acceptance in the association, time spent in the occupancy, any payment of rent, the composition of the households, the condition

# PLEA 2018 HONG KONG

*Smart and Healthy within the 2-degree Limit*

and the perception of environmental comfort and relational aspect within the community. Although some dissatisfaction was expressed with regard to living conditions, the interviews highlighted an overall positive assessment.

## 3.1.4 Preparation phase

The preparation phase for the new residential and service areas was based mainly on co-housing and experimentation of new living standards.

Using the results of the previous phases, which identified three main categories of inhabitants (singles, couples and families), we structured the various types of accommodations in order to favour optimisation, flexibility and multi-functionality.

The Singles category was assigned two types of "model cell", one with a private kitchen created using a gas cylinder, the other with a common kitchen. For both types, the offices' old bathrooms were shared. The Couples category was assigned two types of accommodations: a single cell and a double cell, with a division between the living and sleeping areas.

The Families category received more than two cells structured in two ways: one with a private kitchen and the other with a common kitchen. The ground floor and basement already house services offered by the community for the neighbourhood (leisure and exercise classes, training and entertainment, free professional training courses, catering, handicrafts, conferences and cultural meetings). So, the project considered formalising the existing services and adding new ones not present in the neighbourhood. These were defined as "hot", "warm" and "cold" services according to the level of profitability. Hot services are ones that can be entirely self-financed and that generate income (restaurant, room rental, bike sharing etc.). Warm services are those that can be self-financed in part but have significant social potential (auditorium, co-working, study rooms, etc.). Cold services are those whose management costs are greater than revenues but have high and indispensable social potential (assistance services, after-school care, grass-roots school, etc.).

These services were born to generate an economic return to cover building maintenance. And by providing useful public services, they also represent an opportunity for residents to free themselves of their illegal status.

## 3.2 Phase 2: Energy upgrade

According to the 2011 ISTAT census, about 50% of the Italian building heritage was built between 1946 and 1981. The Spin Time Labs building dates back to the 1960s and 1970s, and has a reinforced concrete and brick masonry construction. The presence of thermal bridges, inadequate window and door fittings and outdated systems make the building's energy conditions critical,

with 70 kWh/sqm/year of losses relating to the plant and 250 kWh/sqm/year of losses attributable to the shell.

Converting the building for residential purpose provides an opportunity to promote its energy conversion.

## 3.2.1 Analysis of microclimatic data and morphology

A necessary step in defining possible energy upgrade scenarios was the microclimatic and morphological analysis of the building, crucial for defining the comfort criteria to be guaranteed in the living spaces. Located in a densely urbanized area of the city, the structure, which was initially intended for offices, is impacted by air and noise pollution. The spaces have exposure in all directions, with variable conditions of illumination and irradiation.

Interior lighting is poor, especially on the lower floors facing the courtyard, with an average daylight factor of 0.4%.

The steel and glass door and window fittings provide no thermal break and are unsuitable for residential use. The sun screens are inadequate or absent, with cumulative solar irradiance of 1 000 kWh/sqm/year

The residences established in the offices overlook only the courtyard and have no cross ventilation. This problem is aggravated by the absence of air handling mechanisms.

No thermal bridges were found and there is no air conditioning in the summer or rainwater collection installations.

## 3.2.2 Preparation phase: energy audit

Given the building's climatic conditions and its morphological and construction characteristics, we were able to use specific software to calculate energy requirements, quantify thermal dispersions and estimate management costs.

The results showed that the building is especially energy hungry:

- The energy need for winter heating is 631 733.1 kWh generated by an electric furnace, 671 534.3 kWh of non-renewable energy is used, with management costs of €172 584.31/year.
- The energy requirement for domestic hot water is 624 339.0 kWh generated by an electric boiler, 1 101 774.6 kWh of non-renewable energy is used, with management costs of €283 156.07/year.

Overall, the building has class D energy efficiency, with consumption of 165 08 kWh/sqm/year.

## 3.2.3 Three scenarios for energy upgrades

Three different upgrade scenarios were proposed following the analysis of the critical aspects of the building. The first two aim to legalise the intervention, by proposing an energetic upgrade together with a new



# PLEA 2018 HONG KONG

*Smart and Healthy within the 2-degree Limit*

residential and economic definition. The third scenario represents an immediate response to the housing emergency, with very limited self-building interventions aiming at improving the comfort of the current situation.

## ▪ Scenario 1: Sustainability

The aim of the first scenario is to create a hygienic building with a low environmental impact through the total demolition and reconstruction of the outer shell, redistribution of the internal spaces, replacement of doors and windows, construction of a solar greenhouse and installation of Smart Home systems.

To improve interior lighting, the project proposes enlarging the glazed surfaces and painting the exterior walls in the courtyards with ultra-reflective white paint.

To promote natural ventilation, the central staircase and the two courtyard walls would be demolished and the permeability of the main floor base would be improved.

Rainwater collection tanks would be installed for use in toilets, irrigation and cleaning of communal areas.

Electricity would be generated by a renewable source through the installation of photovoltaic panels. Heating and cooling would be provided by in-floor panels in the lodgings and fan coils for the service areas, supplied by a heat pump. Domestic hot water is produced by the heat pump. A controlled mechanical ventilation system provides air treatment for comfort inside the lodgings, while an AHU is installed for the service areas.

This scenario would improve the building's energy class from D to A4 (2.09 kWh/sqm/year), with a 92% reduction of energy consumption for winter heating and 77% for domestic hot water (DHW). 62% of electricity would be generated by renewable sources and 4% would be provided by the grid. With an investment of €1 153.50/sqm and considering the economic return of the services added, management costs would fall from €455 740.38/year to €2 483.42/year. The restructuring investment would therefore be amortized with management cost savings and expected income from services by €1 589 220.00/year. The time of return on investment would be 9.5 years.

## ▪ Scenario 2: Efficiency

This scenario would improve the energy efficiency of the existing shell by replacing windows and doors, installing sun shades, EPS external insulation, a ventilated wall and systems.

As in the first scenario, glazed surfaces would be enlarged and the exterior walls in the courtyards painted with ultra-reflective white paint to improve interior lighting.

This scenario also involves the installation of rainwater collection tanks for toilets, irrigation and cleaning of communal areas.

As for the previous scenario, electricity is generated by renewable sources through photovoltaic panels. Heating and cooling would be provided by in-floor panels in the lodgings and fan coils for the service areas, supplied by a heating/cooling system. DHW is produced by the solar thermal system and a gas-fired boiler. A controlled mechanical ventilation system provides air treatment for comfort inside the lodgings, while an AHU is installed for service areas.

This scenario would improve the building's energy class from D to A (30.43 kWh/sqm/year), with a 43% reduction of energy consumption for winter heating and 74% for DHW. Sixty-three percent of the electricity and 25% of the thermal energy would be generated using renewable sources. Twenty-four percent of the electricity and 75% of heat would come from the grid. An investment of €953.09/sqm would generate management cost savings of €390 552.21/year. The time of return on investment would be eight years.

## ▪ Scenario 3: Self-building

This scenario aims to improve the current state immediately, keeping the original shell. Energy efficiency would be improved from the inside by the inhabitants. This type of self-production and self-help housing uses the residents' skills and can involve complete or partial self-building and even self-maintenance and self-restructuring. However, this type of participatory process poses a wide range of problems, due primarily to a lack of knowledge of the community with respect to construction and energy issues, but also in terms of management of the intervention once the squatting phase has ended. For this reason, the third scenario foresees training courses and upgrading done through self-building.

At the design level, this scenario involves the installation of internal insulation and repair of the existing doors and windows. Shielding is provided by self-produced curtains.

DHW is produced by a thermal system with an accumulator and solar panels. The winter heating system is composed of an electric infrared radiant panel system.

This scenario would improve the building's energy class from D to C (62.62 kWh/sqm/year), with a 66% reduction of energy consumption for winter heating and 82% for DHW. Fifty-three percent of the electricity would be generated using renewable sources. The remaining 47% would come from the grid. An investment of €132.54/sqm would generate management cost savings of €388 358.12/year. The time of return on investment would be 1.5 years.

## 4. CONCLUSION

The project's aim—to upgrade and legalize the building—is based on a desire to transform the existing informal good practices model to a formal model aimed

# PLEA 2018 HONG KONG

*Smart and Healthy within the 2-degree Limit*

at rethinking uses and spaces, while also ensuring long-term economic feasibility and inclusiveness.

Since top-down projects are imposed on the needs of the internal community and usually have inauspicious outcomes, this work aimed to maintain a constant dialogue between designers and occupants through a participatory sharing process.

The study of similar occupancy cases in Italy and in Europe, the use of interviews, the census and the market analysis of the services present in the neighbourhood were an essential resource that helped us understand the dynamics of the internal operation of the community of occupants and their needs.

Upon completion of the building, it would be interesting to plan for autonomous consumption management. The possibility of providing each household with its own renewable energy production plant would increase awareness of energy consumption management in the home. Furthermore, through the use of home automation systems, inhabitants could be involved in the energy management of their own home and share the positive outcomes achieved in the network.

The experimental phase is still ongoing and some of its objectives are the housing solution itself and, most important, the hope that an innovative housing model based on a function-user mix and on active participation of inhabitants could lead to social, energy, environmental and economic sustainability.

In a segment of the population living in hardship, the concept of "smart and healthy" takes on new meanings. Sharing practices are meant as a tool for reducing construction and management costs. The reuse of existing buildings located in strategic parts of the city close to economic centres are opportunities for energy recovery with less costly operation. Users are trained and involved, managing their home daily and responsible for its energy consumption. The creation of economic and social value is a vehicle for liberation and social inclusion, generating virtuous micro-economies.

The future intent is to develop a generalizable and replicable model to be applied in other Italian or European contexts.

## 5. ACKNOWLEDGEMENTS

The research team includes: Università degli Studi Roma Tre<sup>1</sup>, Università Tor Vergata<sup>2</sup>, Università del Salento<sup>3</sup> – Italy.

Coordinator: Chiara Tonelli<sup>1</sup> (Academic Professor in Architecture Technology).

Collaborators: Ilaria Montella<sup>1</sup> (Research Fellow in Architecture Technology), Barbara Cardone<sup>1</sup> and Nicola Moscheni<sup>1</sup> (Ph.D Students in Architecture Technology).

Scientific Committee: Francesco Careri<sup>1</sup> (Professor in Architectural Design), Giovanni Caudo<sup>1</sup> (Professor in Urban Studies), Luigi Corvo<sup>2</sup> (Researcher in Business

Economics), Roberto D'Autilia<sup>1</sup> (Researcher in Math Models), Raffaele Di Raimo<sup>3</sup> (Professor in Civil Law and Financial Market), Silvano Falocco (Expert in Green Economy), Fabrizio Finucci<sup>1</sup> (Researcher in Quantity Survey), Angelo Romano (Researcher in Sociology).

Master degree students: Sara D'Arcangeli, Lorena Di Bari, Marco Gesmini, Ilaria Grossi, Cecilia Mattera, Matteo Molinari, Andrea Piattella, Gulia Zambon.

A special thanks to professional photographer Giovanni Barba © <http://www.giovannibarba.org> and to the Spin Time Labs occupants.

## REFERENCES

1. ENEA, Analisi e risultati delle policy di efficienza energetica del nostro paese, (ENG: Analysis of the energy efficiency policies of our country) [Online], Available:<http://www.enea.it/it/seguici/publicazioni/pdf-volumi/raee-2017.pdf> [1 June 2017].
2. ISTAT, Indicatori demografici, (ENG: Demographic indicators) [Online], Available: [https://www.istat.it/it/files/2017/03/Statistica-report-Indicatori-demografici\\_2016.pdf?title=Indicatori+demografici++06%2Fmar%2F2017++Testo+integrale+e+nota+metodologica.pdf](https://www.istat.it/it/files/2017/03/Statistica-report-Indicatori-demografici_2016.pdf?title=Indicatori+demografici++06%2Fmar%2F2017++Testo+integrale+e+nota+metodologica.pdf) [6 March 2017].
3. FEDERCASA, L'edilizia residenziale pubblica. Elemento centrale della risposta al disagio abitativo e all'abitazione sociale, (ENG: Public housing. Central element to solve housing problems and social housing) [Online], Available: [http://www.federcasa.it/wp-content/uploads/2017/03/Edilizia\\_Residenziale\\_Pubblica\\_dossier\\_05\\_2015.pdf](http://www.federcasa.it/wp-content/uploads/2017/03/Edilizia_Residenziale_Pubblica_dossier_05_2015.pdf) [7 May 2015].
4. ISTAT, XV Censimento generale della popolazione e delle abitazioni, (ENG: general census of population and housing) [Online], Available: [https://www.istat.it/it/files//2012/12/volume\\_popolazione-legale\\_XV\\_censimento\\_popolazione.pdf](https://www.istat.it/it/files//2012/12/volume_popolazione-legale_XV_censimento_popolazione.pdf) [9 October 2011]

## Community Energy Networks in the Making Project SCENE, Nottingham

LUCELIA RODRIGUES<sup>1</sup>, MARK GILLOTT<sup>1</sup>, JULIE A. WALDRON<sup>1</sup>, LEWIS CAMERON<sup>1</sup>,  
RENATA TUBELO<sup>1</sup>, ROB SHIPMAN<sup>1</sup>

<sup>1</sup>Department of Architecture and Built Environment, The University of Nottingham, Nottingham, United Kingdom

**ABSTRACT:** 'Community Energy' refers to people working together to reduce and manage energy use, and increase and support local energy generation. It can help promote the infrastructural, social and cultural changes we need to reduce the impact of climate change and increase energy security. The core part of community energy initiatives is people, and therefore engagement is essential. In this work, the authors appraised three innovative mechanisms used to engage residents in Project SCENE (Sustainable Community Energy Networks), an ongoing research and development community energy scheme in a real-world setting involving 31 homes in its first phase along the banks of Nottingham's River Trent. New tools for improving crucial consumer and citizen engagement, participation, co-production and demand-side management were used and their efficacy analysed. These included a user engagement platform, an energy interaction model and in-home smart technology. The findings presented here epitomise the centrality of social-technological interdependencies and the importance of social and collective processes throughout these. It was concluded that civil society were essential actors in the services used and shaped through the passive and active processes that underpin what we do and why, and that utilising these in interrelated methods supports the development and outcomes of such projects.

**KEYWORDS:** Energy, User Engagement, Smart Technology, Community, Socio-technological

### 1. INTRODUCTION

Energy systems are at the cusp of a vital transformation due to the evolution of technology, the regulatory landscape and interdisciplinary influences. Prime components of this include UK obligations to generate 30% of its energy from renewable sources by 2020 [1], developments in battery storage, smart technology and independent power production policy, and UK ambitions to optimise this [2,3]. Uniting these components is the Sustainable Community Energy Network (SCENE) Project (Figure 1), a pioneering model involving industry, academia and society to demonstrate how community-scale systems can accelerate low-carbon energy, housing, resilience and sustainability goals [4]. In this paper, the project is introduced and the importance of community engagement is discussed.

Project SCENE is a real-world research and development model involving a new housing development in Nottingham, UK. Renewable energy is generated and stored in the housing site using solar photovoltaic panels and Europe's largest community battery. Storage at this scale (2.1MWh) makes community energy a game-changing option as it diversifies and enhances income streams through providing grid services, optimising the retailing of locally produced energy and facilitating power and heat arbitraging to further decarbonise the energy system. It also helps to reduce costs for consumers by contributing to the significant heat component of domestic energy use and costs.

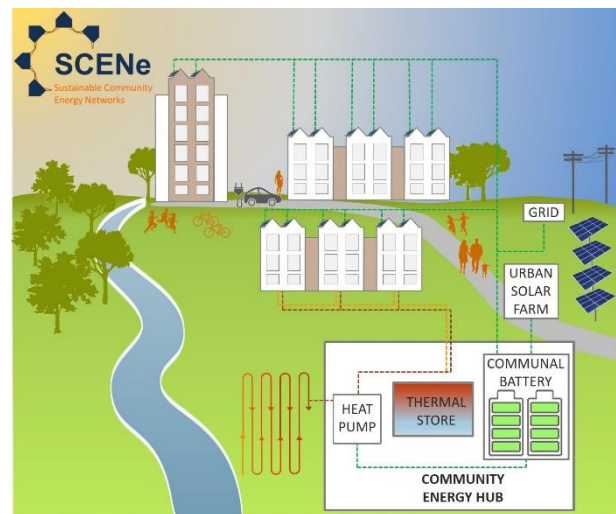

Figure 1: Project SCENE's components

Because the housing development is new, one of the aims of Project SCENE is to support the creation of social networks in order to increase participation [5]. The authors accordingly present here three methods developed to better influence these processes and outcomes, and build community in sustainable energy systems. These three methods are: i) user engagement platform, ii) energy interaction model and iii) in-home smart technology. These methods were outlined in Section 2, followed by an appraisal of their effectiveness in Section 3 and an overview of resulting key lessons and implications in Section 4.

# PLEA 2018 HONG KONG

Smart and Healthy within the 2-degree Limit

## 2. CO-DESIGNING A COMMUNITY ENERGY SCHEME

According to Knudsen et al. [6], the acceptance of renewable energy structures in a community requires: democracy and control, fair distribution of the costs and benefits and a decision-making power shared between the partners. This suggests a partnership where the end user is able to participate, benefit and contribute with the generation and consumption of renewable energy. This project integrated different strategies to educate and engage residents about the community energy scheme, influence their behaviour in order to improve the way they manage their energy and provide reliable data and feedback based on their energy management.

### 2.1 Participatory User Engagement

In order to advance user influences and its impact, a two-way online interaction platform was designed using Stickyworld [7]. Its unique value is that it provides an interactive space to organise and stimulate engagement and consultations upon specific matters; can do so in either private or public rooms; and allows anyone to be invited to be a co-developer for specific rooms. These three attributes can be used effectively for enhancing engagement of various sorts. Here we briefly explained why this is the case, followed by outlining how our approach built-upon these principles to maximise our impact with it.

Engagement is key to influencing the impact society has on projects. In the case of community energy schemes, it helps to prioritise local needs and strengthen the relationship with the community [8]. This includes how much people use, shape and reuse something, their influence on others, levels of understanding and contributions, and how it relates to other actions and effects. Yet engagement is multifaceted, being cognitive, emotional, behavioural, and thus related to complex and embedded domains (e.g. cultural, structural, subconscious) [9, 12]. Engagement methods must thus relate to these, and also relate to action and ends. Stickyworld facilitates such ‘purposeful engagement’ and tenants of social science and engagement theory in various ways [11].

Firstly, it supports organising engagement and interactions in a clear, consistent and simple to use way, key to enhancing their effect [10]. One way it facilitates this is by allowing individual rooms to be created within a project’s overall portal with clear, succinct markers of their purpose and commands. These markers increase in depth, enabling essential information to be gleaned immediately, optimising the vital window of initial attention time, and coupling this with markers of and links to increasingly higher-levels of engagement. This is enhanced by the markers following a recognisable format throughout the platform, such as of title sub-sections for ‘Home’, ‘Welcome’ or ‘About’, ‘Slides’ (for most in-depth information), ‘Comments’ or ‘Questions’,

‘Location’, ‘Action’ (to highlight a specific action from them). This is exemplified in Figure 2.

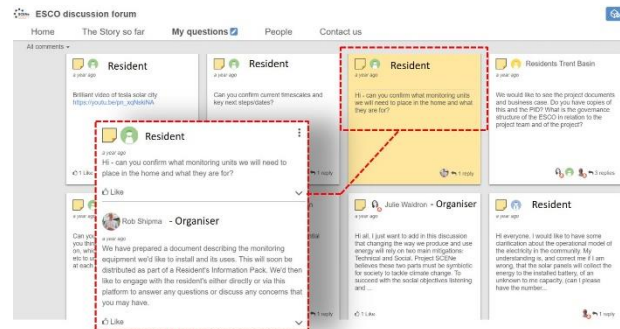

Figure 2: One of the pages on Project SCENE’s Stickyworld portal for questions and answers. Each box contains the question made by a resident and the answer or following comments made by other participants or organisers.

This successional approach stimulates deeper and more purposive participation. This occurs as participants become increasingly involved with the content and its links to action as they are subtly guided, or nudged, through the process. Throughout this journey, interactions and contributions are encouraged in multiple complimentary ways. This includes positive reinforcement from our project team as well as their community through the use of ‘like’, ‘share’ and ‘comment’ functions, and the ability for organisers to put time-lines on rooms, summarise rooms and to thank everyone publicly for their inputs and insights.

In so doing, the method utilises the strengths of self-led yet supported discovery on a focused topic, as well as relationship building, collective learning, socialisation and a shared sense of mutually generated progress and connections. These attributes are reinforcing, normalise the process of using or doing something, and in such a way that accords with the collectively developed ensemble of ideas, intentions, understandings, skills, commitments, and bonds that enable and embed new ways of doing things.

The platform thus affords a key tool to build ‘community’ linked to shared behavioural drivers. This is invaluable for stimulating engagement, as well as for actions and impacts from these that are typically more extensive and inclusive [11].

The second core aspect of Stickyworld advances this further by enabling both private and public rooms within the same overarching project. This enhances purposive engagement through the complimentary yet often opposed pathways of exclusivity and specificity, and linking these with larger, globally resonant themes and practices, such as using sustainable energy routines and smart technology [11, 12, 13, 14].

The third key attribute of Stickyworld is that a developer can invite anyone to be either a ‘participant’

# PLEA 2018 HONG KONG

*Smart and Healthy within the 2-degree Limit*

or 'organiser'. Both allow projects to extend interaction and development capabilities to new audiences. This facilitates potentially invaluable co-design, co-production, co-value and 'community' building [6, 15, 16].

## 2.2 Energy Interaction Model: Environmental Measurement and Data Visualisation

The community energy scheme was monitored with the aim of generating an energy community dataset, informing the energy use across the community to help the operation of the scheme and also the residents to better understand their energy expenditure to make future informed decisions about their consume. The initial stage of the monitoring system consisted of data acquisition of environmental variables at building and community use levels.

The selected buildings for monitoring were the show apartment and show home of the community. They were selected for their availability, occasional occupancy and lack of data protection restriction. The monitoring of these buildings was experimental and intended to give indications of potential improvements to be considered on the monitoring system before the real monitoring started in the community homes. The data collection included variables such as air temperature, relative humidity, Carbon dioxide (CO<sub>2</sub>), total energy consumption and total electricity consumption.

At community use level, the data collection consisted of environmental variables that mainly feeds the local weather station and also data of Photovoltaic (PV) panels' farm (average and total energy generation) and battery (level of charge, discharge and time to charge). The last stage of the monitoring system consisted of the acquisition of data of the community houses and this is preceded for legal agreements. The monitoring of the community homes required an effective engagement of the community residents.

The Community Information Model (CIM), was created to display energy data of the community. The CIM is an interactive 3D platform (Figure 3), developed by Integrated Environmental Solutions (IES) Company with the collaboration of the University of Nottingham (UoN) [4, 17, 18]. The main aim of this visualisation tool was to engage the residents of the community, informing them of the local energy consumption and generation. It also aimed to promote public engagement of the community energy schemes and disseminate the results of the project.

One of the main features of the CIM was the ability of the user to actively interact with the model through a multiple-touch screen system. It also allowed multiple users to interact with the tool at the same time. The platform was displayed on a wall screen located at the community energy hub, measuring 3.2m length by 1.8m of height. It was designed to be inclusive and self-

explanatory, allowing children and people with reduced mobility to also interact as the dashboards were designed to be easily accessible (Figure 3).

The platform was a visualisation tool showing the community energy data and renewable production, which displays historical-community level data in terms of the energy consumed and generated, respectively. The model also displayed general information of each house, such as the area and number of bedrooms (Figure 4).



Figure 3: Sketch of the data visualisation tool - IES study of the CIM platform. Source: IES, 2017 [17, 18]



Figure 4: Snapshot of the CIM platform displaying community energy data and community house data.

The model had also the ability to show real-time community level data for the monitored show apartment and show house. For these buildings, a set of measured environmental variables were displayed in graphs along simulated data for comparison purposes (Figure 5).

# PLEA 2018 HONG KONG

*Smart and Healthy within the 2-degree Limit*



Figure 5: Examples of the dashboards of real-time data collection of the show apartment and show home.

## 2.3. Smart Technology: Digital Assistant

The use of voice controlled assistants has gained significant momentum in recent years. Initially these assistants were services delivered via smartphones in the form of Apple's Siri and the Google Assistant. However, their embodiment in smart speakers has been a catalyst for more widespread adoption spearheaded by Amazon's Echo suite of devices. This emerging trend provided an additional method of interacting with residents within the Trent Basin community to provide information required to better understand energy usage and to potentially influence behavioural changes to encourage energy efficiency for the benefit of residents and the wider community.

In order to achieve this aim a Skill was written for the Amazon Echo Spot device that allowed users to enquire about the environmental conditions within their home such as temperature, relative humidity and CO<sub>2</sub>, electricity usage of the overall home and disaggregated circuits such as lighting together with the status of heating controls via a smart thermostat that was installed as part of the project. The core functionality of the skill was to provide answers to questions such as "How much electricity did we use yesterday?" or "What is the temperature in the bedroom?" However, this core functionality was extended in 2 key ways; 1. *Behavioural nudging*; in addition to factual answers the skill also delivers comparative data on the integrated Echo Spot screen so that a resident can see how they compare to others; and 2. *Automation*; when answering a question relating to temperature, a user is given the option of allowing the digital assistant to take action on their behalf where appropriate. For example, when the temperature is high the user is asked if they would like to reduce the thermostat temperature, which is chosen automatically by the assistant based on recommended

ranges. An aim of this research was to explore the effectiveness of these techniques in encouraging more energy efficient behaviour, their acceptance and adoption by residents.

## 3. CRITIQUE OF THE ENGAGEMENT METHODS

As the use of these methods increases, so too are their anticipated success. This section summaries their success to date, which is early-stage and ongoing.

### 3.1 Participatory User Engagement

The effectiveness of the bespoke online portal developed to boost meaningful user engagement and wider impacts can be attested in 4 main ways: the number of users/viewers, the number of users inputting (often defined as active users or contributors), the progression of these inputs, and the outcome of these actions. For the overall project portal, the number of views is 2,787 (as of 11.05.18). Inputs are typically questions or opinions. In addition to these are 'likes', 'shares' and 'replies'. All of which bolster and give an indication of levels of active engagement. It indicates that engagement varies considerably according to topic and that this correlates positively with the degree participants expect to benefit from their involvement, providing further empirical exemplification of this influential relationship [7, 15]. Engagement by these metrics was greatest for instance in the ESCO rooms in which participants could co-design how they wanted to divide potential surplus from the Project SCENE model. The economic, social and environmental value of the surplus according its design, such as to incentivise collective rather than individual changes to energy behaviours, is significant and was clear to the participants. The forum and subsequent exchanges facilitated this clarity, and thereby further reinforced interactions and engagement.

This high-level of engagement volume also correlates with high interaction progression and outcomes, becoming increasingly consensual and in-depth, resulting in an inclusively co-designed direction for how to divide the ESCO surplus. To support this enhanced user-engagement, the rooms have increased in number over time, increasing by 12 or 300% from the end of 2017 to 16, and becoming increasingly focused per topic and action, such as moving from the ESCO concept, to co-designing the share method for it, to adopting the in-home energy kit. Finally, the total number of views per rooms has increased relative to the time rooms have been published, suggesting that such methods, as with innovations in general, become increasingly used and effective with their increasingly familiarity [12, 19]. For this and the link between engagement and action, engagement is likely to notably increase with more in-person activities [11, 12, 15].

# PLEA 2018 HONG KONG

*Smart and Healthy within the 2-degree Limit*

## 3.2 Energy interaction model and Digital Assistant

This has proved a powerful tool for engaging publics and influencing consumption behaviour by making energy more visible, social and interactive. In the case of the Community Information Model, the replication of this tool may be limited at present as it is time-consuming and requires technical skills to be fully designed and implemented.

Despite the fact that the Digital Assistant and the CIM are tools not been fully implemented yet, it has a great potential to disseminate community energy data and engage the residents as the interfaces are simple to use and interactive. The users are able to learn about the community energy scheme and it is likely to be an effective way to inform community residents about their own energy consumptions against the overall community energy expenditure. In the case of the CIM, the tool has also a potential to be transferable for use in different contexts, such as city-level modelling and analysis of building, electricity, EV, among others.

## 4. CRITICAL LESSONS AND IMPLICATIONS

Engagement and community are key behavioural drivers. The experience from Project SCENE and the three user-centric methods signifies that these are dynamic states best approached as a multifaceted and variable and uncertain process and best optimised by approaches that reflect this and tap into the social nature of behavioural drivers and actions.

This was most effective when co-designed with the end users, iteratively discussed and shaped, highly contextualised and specific to the community and sub-groups therein, yet linked to collective actions and broader scales of importance and contextualisation. Multi-dimensional interactions were essential for this. Examples include the virtual space for ongoing multimedia, private and shared content and actions on Stickyworld; the highly visual and intuitive 3D model; and the digital assistant that afforded in-home energy audio and visual feed-back and interactions with a recognised brand and community-specific capabilities.

Moreover, through having these also set-up in the community hub these methods were all compatible with individual, in-home, family and community-level use. The multi-user touch-screen further accentuated these interactive, multidimensional and multi-scale qualities of the engagement approach by allowing people to collectively see, use, discuss and play with the Stickyworld platform and digital assistant.

The suitability of using these things in conjunction with other activities and existing routines further enhanced their effectiveness. This is because the engagement methods could slot into existing patterns of behaviour rather than conflict with them by educating, supporting consumers' choices and capturing behavioural data (Figure 6). Using Stickyworld, for

instance, whilst online and perhaps reading and communicating anyway, and the use of the digital assistant when doing everyday things in the house. This complementarity to existing norms and routines supports the uptake and regular use of innovations, and the impact of engagement [7, 15].

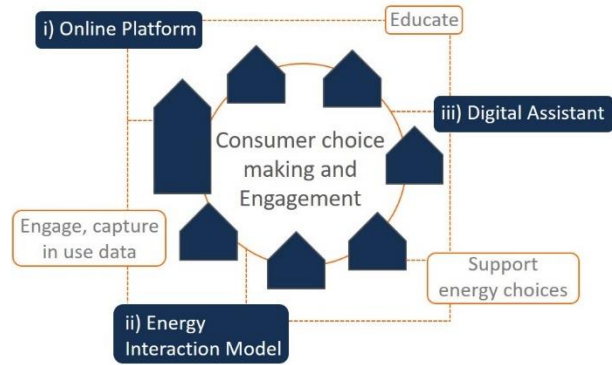

Figure 6: Diagram of engagement strategies and the overlapped aims

Finally, the community building experience of Project SCENE to date evidences these are most significant and effective when linked to clear and contextualised actions. The Stickyworld rooms for the tour, in-home kit, digital assistant and ESCO surplus share attests this most clearly, reinforces others evidencing the highly experiential and subjective nature of engagement [15, 16]. Yet the more they were collectively used, discussed and otherwise experienced, the more routine and effective they were. The sum is to link engagement with actions through the multiplicities of everyday actions, and to facilitate this through relational, multi-dimensional and contextualised methods. This paper reveals three methods for this.

## 5. CONCLUSION

This paper presents three methods used to engage residents of a community energy project and through this improve the outcomes of the project. It showed that this occurs through enhancing processes of co-design, socialisation, normalisation and routinisation. These methods and processes can relate to different aspects of a scheme and that engagement and community are broader processes that provide prime drivers of behaviour. The methods presented for energy-related behaviours are thus instructive far beyond the energy sector. It suggests that methods are most effective when relational, multidimensional and linked to specific contexts and actions.

These findings are of increasing significance as technology and services become increasing 'smart' and digitalised and risk marginalising users and publics and our need to visualise, feel, and variously interact with what and how we consume. This paper suggests,

# PLEA 2018 HONG KONG

## *Smart and Healthy within the 2-degree Limit*

however, the central importance of engaging with such stakeholders and processes and that doing so remains dependent on deep-rooted 'non-technological' factors. How these socio-technological factors interplay and the long-term impact of such methods outlined thus offer significant avenues for future research and development.

### ACKNOWLEDGEMENTS

Project SCENE was funded by Innovate UK and the Energy Research Accelerator (ERA). The partners of the project are: The University of Nottingham, Blueprint, ATKearney, Smartklub, Stickyworld, Solar Ready, Loughborough University, Slam Jam, Urbed and Siemens.

### REFERENCES

1. HM Government, (2009). The UK Renewable Energy Strategy. [Online]. Available: <https://www.gov.uk/government/pub>. [30 Jan 2018].
2. HM Government, (2017). The Clean Growth Strategy: Leading the way to a low carbon future 2017. [Online]. Available: <https://www.gov.uk/government/pub>. [30 Jan 2018]
3. HM Government, (2017). Autumn budget 2017. [Online]. Available: <https://www.gov.uk/government/pub>. [16 May 2018].
4. Project SCENE. Sustainable Community Energy Networks Project Website. <https://www.projectscene.uk/> [30 Jan 2018].
5. Alvarez, L., Borsi, K. & Rodrigues, L. (2017). The role of social network analysis on participation and placemaking. *Sustainable Cities and Society*, Volume 28, 118-126.
6. Knudsen, J. K., Camilla, L., Aas, Ø., Jacob, J., Haug, K., Batel, S., Devine-Wright, P., Qvenild, M. & Jacobsen, G. B. (2015). Land Use Policy Local perceptions of opportunities for engagement and procedural justice in electricity transmission grid projects in Norway and UK. *Land Use Policy*, 48, 299–308.
7. Stickyworld: Homepage [Online]. Available: <http://info.stickyworld.com/>. [16 May 2018].
8. Kiamba, L., Rodrigues, L.T. & Marsh, J. (2017). Community energy schemes: the role of public participation and engagement. In: *Passive and Low Energy Architecture (PLEA) 2017*, 3-5 July 2017, Edinburgh, UK
9. Fredricks, J. A. (2011). Engagement in school and out-of-school contexts: A multidimensional view of engagement. *Theory into practice*, 50(4), 327-335.
10. Sheppard, S. R., Shaw, A., Flanders, D., Burch, S., & Cohen, S. (2011). Future visioning of local climate change: a framework for community engagement and planning with scenarios and visualisation. *Futures*, 43(4), 400-412.
11. Parra, D., Swierczynski, M., Stroe, D.I., Norman, S.A., Abdon, A., Worlitschek, J., O'Doherty, T., Rodrigues, L.T., Gillott, M.C., Zhang, X., Bauer, C. & Patel, M.K. (2017). An interdisciplinary review of energy storage for communities: challenges and perspectives. *Renewable and Sustainable Energy Reviews*, 79, 730-749.
12. Cameron (2018) Approaches to modern energy services. Doctoral thesis. [Online]. Available: <http://etheses.whiterose.ac.uk/18337/>
13. Brodie, R. J., Hollebeek, L. D., Jurić, B., & Ilić, A. (2011). Customer engagement: Conceptual domain, fundamental propositions, and implications for research. *Journal of service research*, 14(3), 252-271.
14. Banks, S., et al. (Eds.). (2013). *Managing community practice: Principles, policies and programmes*. Policy Press.
15. Ramaswamy, V. (2009). Leading the transformation to co-creation of value. *Strategy & Leadership*, 37(2), 32-37.
16. Nambisan, S., & Baron, R. A. (2009). Virtual customer environments: testing a model of voluntary participation in value co-creation activities. *Journal of product innovation management*, 26(4), 388-406.
17. IES, 2018. Webpage. Integrated Environmental Solutions (IES) [Online]. Available: <https://www.iesve.com/> [30 Apr 2018]
18. IES, 2017. Touch Screen Wall Study. Integrated Environmental Solutions (IES). Glasgow.
19. Rogers, E. M. (2010). *Diffusion of innovations*. S. & S.



# Neighbourhood Environment and Walking Behaviour in High-density Cities

KEVIN KA-LUN LAU<sup>1,2,3</sup>, ZHENG TAN<sup>1</sup>

<sup>1</sup>Institute of Future Cities, The Chinese University of Hong Kong, Hong Kong

<sup>2</sup>CUHK Jockey Club Institute of Ageing, The Chinese University of Hong Kong, Hong Kong

<sup>3</sup>Institute of Environment, Energy and Sustainability, The Chinese University of Hong Kong, Hong Kong

*ABSTRACT: Pedestrian environment is the key to walking in the neighbourhood. Complex settings in Hong Kong creates both opportunities and challenges to walkability in urban areas. Urban planning and neighbourhood design are important elements to support walking as a means of active transportation. It therefore requires better understanding of the relationship between walking behaviour and the built environment in order to improve the walkability in Hong Kong. The present study examined the effect of built environment on walking behaviour at both neighbourhood and district levels. Initial findings showed that the number of walk trips is associated with road density, land use mix and the level of PM2.5. At district level, walking behaviour, in terms of walking time and percentage of long walking trips, is associated with road density and land use mix respectively. It suggests that neighbourhood characteristics are influential to walking behaviour and the design of neighbourhood environment can potentially promote active transportation. Further studies will focus on including more factors related to walking environment and behaviour. Studies with finer spatial scales will also be important for the design of the street environment which promotes walking and healthier lifestyle in high-density cities.*

*KEYWORDS: Walking behaviour, neighbourhood environment, road density, land use mix, high-density cities*

## 1. INTRODUCTION

Pedestrian environment is important for promoting walking activities which improve physical and mental health [1]. It also facilitates social engagement and improves the sense of belonging to the community [2]. Previous studies suggested that health behaviour such as walking and vehicle use is associated with influential factors at different levels such as individual, social, environmental and political levels [3,4,5].

The complex urban settings in Hong Kong creates both opportunities and challenges to walkability in urban areas. Urban planning and neighbourhood design are important elements to support walking as a means of active transportation [6]. To improve the walkability in Hong Kong, there is a need for more comprehensive understanding in the relationship between walking behaviour and the built environment, which contributes to better design of the walking environment.

The present study aims to investigate the effect of built environment on walking behaviour at both neighbourhood and district levels. Findings of the present study are useful for urban designers to consider the relevant features of the built environment in the design of walking environment. They can potentially be used for understanding the relationship between walking and physical and mental health.

## 2. METHODOLOGY

### 2.1 Data

Information about walking behaviour was obtained from the *Travel Characteristics Survey 2011* commissioned by the Transport Department. Two sets of walking data were used in this study. The first data set (the main survey) contains territory-wide responses from 2,363,300 households and a population of 6,881,900. The number of walk trips were extracted from this dataset and used in subsequent analysis for the relationship with environmental factors. Due to the variations in responses obtained from each of the tertiary planning units (TPUs), the resultant data were weighted based on the TPU-level population (Figure 1).

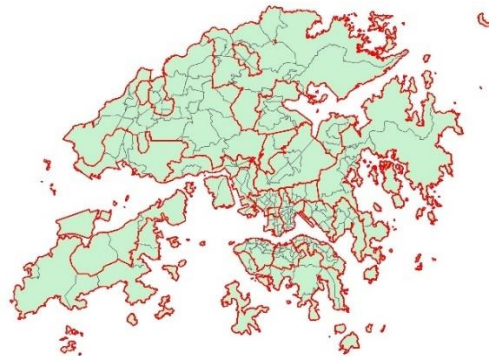

Figure 1: The boundary of tertiary planning unit (TPU; delineated in black lines) and 26 districts (red lines).

The second dataset is based on an attachment survey which specifically address the characteristics of walking

# PLEA 2018 HONG KONG

Smart and Healthy within the 2-degree Limit

behaviour for walk-only trips and walk trips connecting to other modes of transport. 5,600 responses were collected in 26 districts during the survey conducted between 2010 and 2011. Average walking time and the proportion of trips with walking time over 10 minutes at district level were extracted for subsequent analysis.

Environmental characteristics concerned in the present study include road density, land use mix, sky view factor (SVF), air temperature and air quality (PM<sub>2.5</sub> and PM<sub>10</sub>). Road network and land use data were acquired from the Planning Department while building shapefiles with height and footprint were obtained from the Lands Department. The density of pedestrian road network and the percentage of open space were calculated for each of the TPUs and the 26 districts for comparing to the data of the main and attachment survey respectively. Average sky view factor, an indicator of urban morphology and compactness, was also calculated from the building shapefiles.

Entropy Index is a measure of land use mix which incorporates the relative proportion of two or more land use types within an area [7]. It is defined by the following equation:

$$\text{Entropy} = \sum_j P_j \times \frac{\ln(P_j)}{\ln(J)}$$

where  $P_j$  refers to the proportion of total land area of  $j$ -th land-use category found in the tract being analysed and  $J$  is the total number of land uses considered in the study area. Its value ranges from 0 to 1 with higher levels of Entropy inferring greater diversity of land use mixture.

Air temperature was obtained from a spatial interpolation of ground-level observational data [8]. PM<sub>2.5</sub> and PM<sub>10</sub> data were obtained from a land-use regression model which incorporates urban morphological parameters into the calculation of the concentration of the two air pollutants [9]. The average values of both TPUs and districts were calculated for subsequent statistical analysis.

## 2.2 Statistical analysis

Multiple linear regression was used to determine the relationship between average walking behaviour and the characteristics of the built environment. The model can be described as follows:

$$Y_i = \beta_0 + \sum_{k=1}^p \beta_{ik} \cdot x_{ik} + \varepsilon$$

where  $Y_i$  and  $x_i$  are dependent and independent variables respectively,  $\beta_i$  is the regression coefficient,  $\beta_0$  and  $\varepsilon$  are the intercept and error terms respectively. Significant built environmental factors (independent variables), which fulfil the criteria of least significance in the correlation with walking behaviour, were identified with P-values smaller than 0.05 considered as significant.

## 3. RESULTS AND DISCUSSION

### 3.1 Correlations among variables

After excluding entries with missed values, there are 154 TPUs included in the multiple linear regression analysis. Table 1 shows the correlation matrix of the dependent (weighted number of walk trips) and independent variables (built environmental factors). The number of walk trips is significantly correlated with SVF, PM<sub>2.5</sub> and PM<sub>10</sub>, with correlations of -0.303, 0.473 and 0.447 respectively). Among the independent variables, road density is significantly correlated with SVF, PM<sub>2.5</sub>, PM<sub>10</sub> and Entropy Index. It implies the inter-relationships between built environmental factors. It was also found that Entropy Index is significantly correlated with SVF, PM<sub>2.5</sub> and PM<sub>10</sub>, suggesting the influence of the diversity of land use on environmental conditions.

Table 1: Correlation matrix of the dependent and independent variables.

	Road	SVF	T <sub>a</sub>	PM <sub>2.5</sub>	PM <sub>10</sub>	Entro
Road	/					
SVF	<b>0.469</b>	/				
T <sub>a</sub>	-0.037	0.060	/			
PM <sub>2.5</sub>	<b>-0.396</b>	<b>-0.751</b>	0.085	/		
PM <sub>10</sub>	<b>-0.387</b>	<b>-0.748</b>	0.086	<b>0.863</b>	/	
Entro	<b>-0.278</b>	<b>-0.807</b>	0.135	<b>0.715</b>	<b>0.731</b>	/
WT	0.122	<b>-0.303</b>	0.133	<b>0.473</b>	<b>0.447</b>	<b>0.477</b>

### 3.2 Number of walk trips at TPU level

The result of the regression model for the number of walk trips is presented in Table 2. The overall R<sup>2</sup>-value is 0.327 (P-value < 0.001). Road density, land use mix and PM<sub>2.5</sub> are found to be significant variables in the regression model. As indicated by the positive coefficients, road density and land use mix have a positive effect on the number of walk trips. Road density is widely proved to be associated with walkability [10]. High road density provides more diverse choices of walking routes so that pedestrians can avoid less favourable environmental conditions and adjust their routes according to their needs. It also facilitates active travel in the neighbourhood and improves the environmental support for physical activity [11].

Land use mix, as indicated by Entropy Index, is another significant factor in the multiple linear regression analysis. Higher number of walking trips is associated with higher diversity of land use in the local area. Previous studies suggested that higher land use mix encourage active transportation in terms of both walking and cycling, compared to a homogeneous land use [12]. The proximity to destinations or local attractions can also affect the influence of land use diversity on walking behaviour, which can be included in further studies [13]. On the other hand, results show that PM<sub>2.5</sub> has a positive effect on the number of walk trips. It could be possibly due to the correlation with road density as the presence of major transportation corridor and heavy traffic are the

# PLEA 2018 HONG KONG

Smart and Healthy within the 2-degree Limit

primary contributing factor to high level of PM<sub>2.5</sub> concentration.

Table 2: Results of Model 1 on the number of walk trips at TPU-level.

<b>Model 1</b>		Number of Walk Trips	
<i>R Square</i>	0.327	<i>P-value</i>	0.000
<i>Predictors</i>			
<i>included</i>	<i>Coefficient</i>	<i>t-stat</i>	<i>P-value</i>
Road density	0.441	5.755	0.000
Entropy	0.311	3.425	0.001
PM <sub>2.5</sub>	0.381	4.041	0.000
<i>Predictor</i>			
<i>excluded</i>	<i>Coefficient</i>	<i>t-stat</i>	<i>P-value</i>
T <sub>a</sub>	0.058	0.865	0.389
PM <sub>10</sub>	0.175	1.336	0.184
SVF	0.147	1.153	0.251

### 3.3 Average walking time at district level

Table 3 shows the results of the multiple linear regression. Average walking time was found to be significantly related with road density ( $R^2$ -value = 0.292,  $P$ -value = 0.004). However, land use mix, percentage of open space and SVF were not included in the model due to the statistical insignificance. Four districts were found to have average walking time over 20 minutes per day. Three of them are dense urban areas with relatively higher level of retail and commercial activities. Road density in these districts is the highest in Hong Kong due to the compact and regular urban form and heavy pedestrian and road traffic (Figure 4). The remaining district is located in southwestern part of Hong Kong and outlying islands where road traffic is limited. Walking is therefore the dominant mode of transport for residents living there.

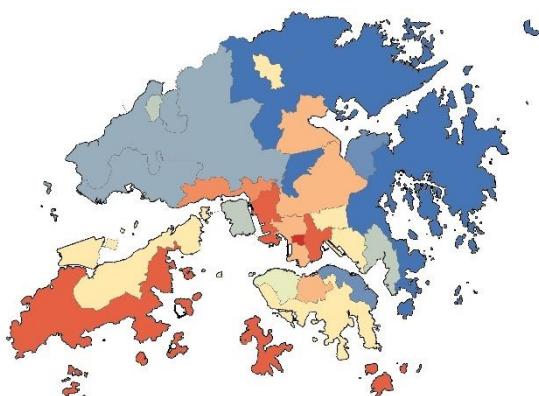

Figure 2: Spatial pattern of the average walking time of the 26 districts. Maximum (in red) and minimum (in blue) values are 22.15 and 14.50 minutes respectively.

In contrast, lower average walking time was observed in new towns. These new towns are often designed for self-sustained purpose that residents can obtain their everyday needs and services within their residential estates. In addition, the longer distance between different residential estates and the availability of public transport discourage residents to travel between estates by walking.

Table 3: Results of Model 2 on average walking time at district level.

<b>Model 2</b>		Average Walking Time	
<i>R Square</i>	0.292	<i>P-value</i>	0.004
<i>Predictors</i>			
<i>included</i>	<i>Coefficient</i>	<i>t-stat</i>	<i>P-value</i>
Road density	115.464	3.148	0.004
<i>Predictor</i>			
<i>excluded</i>	<i>Coefficient</i>	<i>t-stat</i>	<i>P-value</i>
Entropy	-0.102	-0.256	0.800
% Open space	-0.115	-0.495	0.625
SVF	0.345	1.151	0.262

Longer walking trips were found to be associated with land use mix, as indicated in the Model 2 with a  $R^2$ -value of 0.195 and a  $P$ -value of 0.024 (Table 4). Higher percentage of walking trips over 10 minutes was found in the peripheral areas around urban cores where residential areas, retail industry and open spaces are commonly found. It promotes walking within the districts by multiple purposes. On the other hand, new towns are characterized by less longer walking trips due to the single-use and self-sustained communities where walking is generally limited within the estates.

Table 4: Results of Model 3 on percentage of trips longer than 10 minutes at district level.

<b>Model 3</b>		Percentage of trips > 10 minutes	
<i>R Square</i>	0.195	<i>P-value</i>	0.024
<i>Predictors</i>			
<i>included</i>	<i>Coefficient</i>	<i>t-stat</i>	<i>P-value</i>
Entropy	0.129	2.409	0.024
<i>Predictor</i>			
<i>excluded</i>	<i>Coefficient</i>	<i>t-stat</i>	<i>P-value</i>
Road density	-0.437	-1.054	0.303
% Open space	-0.207	-0.735	0.470
SVF	0.608	2.010	0.056

# PLEA 2018 HONG KONG

Smart and Healthy within the 2-degree Limit

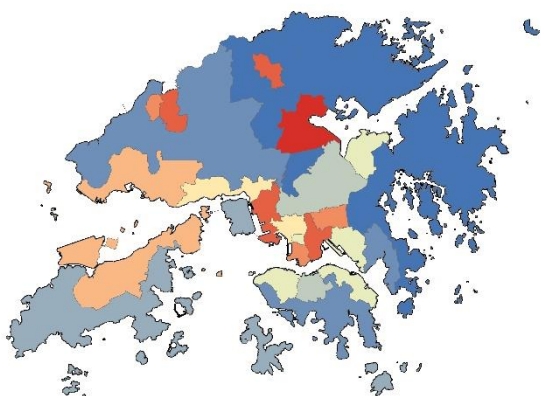

Figure 3: Spatial pattern of the percentage of trips longer than 10 minutes of the 26 districts. Maximum (in red) and minimum (in blue) values are 18.63% and 0.53% respectively.



Figure 4: Compact and regular urban form in Mong Kok, one of the districts with higher average walking time.

## 4. CONCLUSION

The present study examined the effect of built environment on walking behaviour at both neighbourhood (TPU) and district levels. Initial findings showed that the number of walk trips is associated with road density, land use mix and the level of PM<sub>2.5</sub>. At district level, walking behaviour, in terms of walking time and percentage of long walking trips, is associated with road density and land use mix respectively. It suggests that neighbourhood characteristics are influential to walking behaviour and the design of neighbourhood environment can potentially promote active transportation. Further studies will focus on including more factors related to walking environment and behaviour. Studies with finer spatial scales will also be important for the design of the street environment which promotes walking and healthier lifestyle in high-density cities.

## ACKNOWLEDGEMENTS

This study is supported by the Vice-Chancellor Discretionary Fund, The Chinese University of Hong Kong.

## REFERENCES

1. Hirsch, J.A., Moore, K.A., Clarke, P.J., Rodriguez, D.A., Evenson, K.R., Brines, S.J., Zagorski, M.A. and A.V. Diez Roux, (2014). Changes in the built environment and changes in the amount of walking over time: Longitudinal results from the multi-ethnic study of Atherosclerosis. *American Journal of Epidemiology*, 80(8): p.799-809.
2. Yip, C., Sarma, S. and P. Wilk (2016). The association between social cohesion and physical activity in Canada: A multilevel analysis. *SSM - Population Health*, 2: p.718-723.
3. Sallis, J. and N. Owen (2015). Ecological models of health behaviour. *Health Behaviour: Theory, Research and Practice*. pp. 43-64.
4. Ham, S.A., Yore, M.M., Kruger, J., Heath, G.W. and R. Moeti (2007). Physical activity patterns among Latinos in the United States: putting the pieces together. *Preventing Chronic Disease*, 4(4): p.A92.
5. O'Brien, M.J., Davey, A., Alos, V.A. and R.C. Whitaker (2013). Diabetes-related behaviors in Latinas and non-Latinas in California. *Diabetes Care*, 36 (2): p.355-361.
6. Dannenberg A.L. and A.M. Wendel (2011). *Measuring, assessing, and certifying healthy places*. A.L. Dannenberg, R.J. Jackson (Eds.), Making Healthy Places, Island Press, Washington.
7. Turner, M.G., Gardner, R.H. and R.V. O'Neill (2001). *Landscape ecology in theory and practice: Pattern and process*. Springer, New York.
8. Cai, M., Ren, C., Lau, K.K.L., Xu, Y. (2017). Spatial analysis on intra-urban temperature variation under extreme hot weather by incorporating urban planning and environmental parameters: A pilot study from Hong Kong. *Proceedings of the Passive & Low Energy Architecture Conference 2017 (PLEA2017)*, 3-5 July 2017, Edinburgh, UK.
9. Shi, Y., Lau, K.K.L., Ng, E. (2017). Incorporating wind availability into land use regression modelling of air quality in mountainous high-density urban environment. *Environmental Research* 157: p.17-29.
10. Grasser, G., Van Dyck, D., Titze, S., Stronegger, W. (2013). Objectively measured walkability and active transport and weight-related outcomes in adults: a systematic review. *International Journal of Public Health*, 58: p.615-625.
11. Koohsari, M.J., Mavoa, S., Villanueva, K., Sugiyama, T., Badland, H., Kaczynski, A.T., Owen, N., Giles-Corti, B. (2015). Public open space, physical activity, urban design and public health: concepts, methods and research agenda. *Health and Place*, 33: pp. 75-82.
12. Cerin, E., Sit, H.P.C., Cheung, M.C., Ho, Y.H., Lee, L.C., Chan, W.M. (2010). Reliable and valid NEWS for Chinese seniors: measuring perceived neighborhood attributes related to walking. *International Journal of Behavioral Nutrition and Physical Activity*, 7: p.84.

## Occupant Satisfaction in 60 Radiant and All-air Building: Comparing Thermal Comfort and Acoustic Quality

CAROLINE KARMANN<sup>1,2</sup>, STEFANO SCHIAVON<sup>1</sup>, LINDSAY GRAHAM<sup>1</sup>,  
PAUL RAFTERY<sup>1</sup>, FRED BAUMAN<sup>1</sup>

<sup>1</sup>University of California, Berkeley, Center for the Built Environment, Berkeley, USA  
<sup>2</sup>ARUP, London, United Kingdom

*ABSTRACT: Radiant heating and cooling systems have the potential to save energy and are widely used in zero net energy buildings. Their positive and negative impacts on indoor environmental quality and, in particular, thermal comfort compared to all-air systems are still debated in the literature. This paper presents indoor environmental quality survey results from 3,892 respondents in 60 office buildings located in North America. 34 (2,247 respondents) of these buildings utilized all-air systems and 26 (1,645 respondents) utilized radiant systems as primary conditioning system. Our results indicate that radiant and all-air buildings have equal indoor environmental quality, including acoustic performance, with a tendency towards improved temperature satisfaction in radiant buildings.*

*KEYWORDS: Occupant satisfaction, Indoor Environmental Quality, Radiant systems, Post-occupancy evaluation, Thermal comfort*

### 1. INTRODUCTION

U.S. adults are estimated to spend nearly 87% of their lives indoors (Klepeis et al. 2001). This long exposure to indoor conditions has the potential to affect the well-being, performance and health of the occupants residing within those spaces. Design and operation of these spaces also impacts building energy use, which accounts for 40% of U.S. primary energy use (US DOE 2011). With these dual challenges, researchers and building professionals seek design strategies to simultaneously address both indoor environmental quality (IEQ) and energy use.

Building designers motivated to include radiant heating and cooling systems for energy efficiency considerations (Babiak et al. 2009; Feustel et al. 1995; Thornton et al. 2009; Thornton et al. 2010; Leach et al. 2010) are often concerned about how these systems might impact various aspects of indoor environmental quality, such as thermal comfort, indoor air quality, and acoustics. We completed a critical literature review to learn if spaces using radiant system provide a better, lower or equal thermal comfort compared to those spaces using an all-air system (Karmann et al. 2017). Among the eight conclusive studies we identified, five could not establish a thermal comfort preference between all-air and radiant systems, and three studies showed a preference for radiant systems. Considering the limited number of studies available, we could not establish a definitive statement on the effectiveness of radiant systems for thermal comfort. The same review revealed a lack of studies based on occupant's perception. Aside from thermal comfort, little is known about the ways in which radiant systems affect space acoustics. Radiant systems are commonly installed on

large surfaces (e.g., ceilings or floors) that are kept uncovered to allow thermal radiation. In practice, exposed concrete surfaces used for massive in-slab systems can lead to lower acoustic satisfaction (Bauman et al. 2012). The use of radiant systems may also indirectly affect other aspects of a building's design, such as its envelope or the integration with air systems that provides ventilation.

The goal of this study is to compare IEQ - in particular, thermal comfort and acoustic quality- as reported by occupants within a large set of buildings using radiant and all-air systems.

### 2. METHODS

#### 2.1 Occupant IEQ Survey database

The Center for the Built Environment (CBE) at the University of California Berkeley has developed a web-based survey in order to assess occupant satisfaction with IEQ (Zagreus et al. 2004). The current database provides an opportunity to investigate what building features correlate with higher satisfaction in the workplace from an occupant's perspective. The survey asks a set of basic questions about occupant demographics followed by a series of questions addressing nine indoor environmental quality core categories including thermal comfort, air quality, acoustics, lighting, cleanliness/maintenance, spatial layout, office furnishing, and general building and workspace satisfaction. The survey uses a 7-point Likert scale to evaluate occupant satisfaction with answers ranging from 'very satisfied' (+3) to 'very dissatisfied' (-3), with a 'neutral/ neither satisfied nor dissatisfied' midpoint (0). The database currently includes over 1,000 buildings (e.g., commercial buildings, healthcare

# PLEA 2018 HONG KONG

*Smart and Healthy within the 2-degree Limit*

facilities, laboratories, educational buildings, libraries, etc.) and 100,000 individual occupant responses obtained over a period of more than fifteen years, mainly in North America. These buildings involve all types of conditioning systems, including traditional all-air and radiant systems.

## 2.2 Selection of buildings

For this study, we considered the following three types of systems ‘radiant systems’: embedded surface systems (ESS), thermally activated building systems (TABS), and radiant ceiling panels (RCP). As of March 2017, the CBE Occupant IEQ Survey database included 26 surveys completed in radiant buildings that presented the following characteristics: (1) use radiant systems as a primary conditioning type, (2) involve active radiant cooling (only or in addition to radiant heating), (3) are located in the U.S. and Canada, and (4) involve a minimum of 15 non-transient occupants working within a regular ‘office’ environment (e.g., building type includes offices, higher education, learning centres, libraries, and government buildings). For buildings using mixed conditioning strategies, we made sure that the workstations for the surveyed occupants were in a radiantly conditioned area. We considered both new and renovated construction.

The all-air building data came from a subset of the CBE survey database consisting of commercial buildings surveyed up until 2010 and whose building characteristics we verified (Altomonte et al. 2013). We wanted our all-air subset to conform with the characteristics of the radiant buildings collected. This included buildings that use active all-air mechanical cooling systems, were of similar types and locations as the radiant subset, were no older than the oldest radiant building of the subset, and were of comparable size (building area) to the radiant subset (range of minimum and maximum area based on the radiant building subset).

## 2.3 Description of the dataset

The dataset used for this study is detailed in Table 2. Our study involved 26 radiant surveys and 34 all-air buildings, with 1,645 and 2,247 occupant responses, respectively.

*Table 1: Survey count (occupants and buildings) for the dataset used for the analysis of this paper*

	Radiant subset	All-air subset	Total
Survey count			
Occupant responses (% of total)	1,645 (42%)	2,247 (58%)	3,892 (100%)
Buildings count (% of total)	26 (43%)	34 (57%)	58 (100%)

*Table 2: Detailed description of the radiant and all-air subset*

	Radiant subset	All-air subset	Total
<b>Radiant type</b>			
Radiant panels	478 (12%)	-	478 (12%)
In-slab (TABS & ESS)	1,167 (30%)	-	1,167 (30%)
Non-radiant	-	2247 (58%)	1,978 (58%)
<b>Ventilation systems</b>			
Mechanical ventilation (MV)	1,038 (27%)	1,185 (30%)	2,036 (57%)
Mixed-mode ventilation (MM)	607 (16%)	969 (25%)	1,487 (40%)
NA	-	93 (2%)	234 (2%)
<b>Climates</b>			
Cold (ASHRAE 6A, 7)	55 (1%)	395 (11%)	450 (12%)
Cool (ASHRAE 5, 5A, 5B)	384 (10%)	477 (12%)	861 (22%)
Mixed (ASHRAE 3C,4A,4C)	813 (21%)	803 (21%)	1,616 (42%)
Warm (ASHRAE 3A, 3B)	393 (10%)	572 (16%)	965 (25%)
NA	-	-	-
<b>Type of offices</b>			
Cubicles w/ high partitions	157 (4%)	336 (9%)	493 (13%)
Cubicles w/ low partitions	665 (18%)	974 (25%)	1639 (42%)
Enclosed private office	256 (7%)	547 (14%)	803 (21%)
Enclosed shared office	80 (2%)	173 (4%)	253 (7%)
Open office w/ no partitions	295 (8%)	35 (1%)	330 (8%)
NA	192 (5%)	182 (5%)	374 (10%)
<b>Year of occupancy</b>			
1 <sup>st</sup> Quartile	2010	2005	2006
2 <sup>nd</sup> Quartile (median)	2012	2006	2008
3 <sup>rd</sup> Quartile	2013	2008	2012
Max	2015	2009	2015
<b>Building size (m<sup>2</sup>)</b>			
1 <sup>st</sup> Quartile	5,574	2,764	4,095
2 <sup>nd</sup> Quartile (median)	16,020	6,132	6,763
3 <sup>rd</sup> Quartile	18,860	7,990	16,350
Max	20,440	17,190	20,440

## 2.4 Statistical analysis methods

We used occupants’ individual responses as the main unit of our analysis. The use of individual responses has the advantage of correctly accounting for the number of people that have answered the survey and it prevents one from artificially reducing the variance. We used R v.3.3.2 (R Development Core Team 2017) for all statistical analysis.

# PLEA 2018 HONG KONG

*Smart and Healthy within the 2-degree Limit*

We compared both mean and median values. We tested the statistical significance of the difference between independent groups using the Wilcoxon rank test, where  $p$ -value  $< 0.05$  is considered statistically significant.  $P$ -values are sensitive to sample size and larger samples can lead to possible over-interpretation of the results. Therefore, we complement our results with effect sizes that reflect practical significance (Kraemer et al. 2003). Effect size is a quantitative measure of the strength of a phenomenon (in our case the strength of a relationship between conditioning type and satisfaction). Because of the ordinal structure of our data, we used the two following effect size metrics:

- (1) Spearman's  $\rho$  that describes the correlation between variables. It is by itself a measure of effect size. Spearman's  $\rho$  is kept within the interval  $[-1, +1]$  with 1 (and -1) indicating a perfect positive (and negative) association, and a 0 indicating no association.
- (2) Cliff's  $\delta$  that explains the probability of superiority of one variable against the other (i.e., for this study,  $\delta = P(\text{radiant} > \text{all-air}) - P(\text{all-air} < \text{radiant})$ ) (Cliff 1996). Cliff's  $\delta$  is a non-parametric test; it is not affected by the distribution of the dependent variable. Cliff's  $\delta$  is kept within the interval  $[-1, +1]$  with 0 indicating equal distributions.

Finally, our statistical analysis includes linear models with mixed effects to determine the correlation between conditioning type and acoustic satisfaction. Mixed effects recognize the relationship between serial observations scaled on the same unit. We used 'type of office' as the random effect and report between-group variability for acoustic satisfaction.

## 3. RESULTS

### 3.1 IEQ satisfaction in radiant and all-air buildings

Table 3 and Table 4 show the results of the comparison between radiant and all-air buildings. All IEQ satisfaction categories are reported. For each question, we provide: the mean, the median (Mdn) and standard deviations (SD) of scores for occupants of radiant and all-air buildings; the difference in mean ( $\Delta M$ ) and median ( $\Delta Mdn$ ) between the two groups; the statistical significance of the difference ( $p$ -value), and the effect sizes Spearman's  $\rho$  and Cliff's  $\delta$ .

The largest difference across all measures was found for temperature satisfaction in favour of the radiant subset ( $\Delta M=0.51$ ,  $p<0.001$ ,  $\Delta Mdn=1$ ,  $\rho=0.14$ ,  $\delta=0.16$ ). Although the Spearman's  $\rho$  effect size was larger for temperature satisfaction than the other survey categories, it could be considered as either negligible or small depending on the reference used (Cohen 1988; Ferguson 2009). We further develop this analysis in section 3.2. The second largest difference in means was found for satisfaction with perceived amount of space,

but with no difference in median values ( $\Delta M=0.35$ ,  $p<0.001$ ,  $\Delta Mdn=0$ ,  $\rho=0.1$ ,  $\delta=0.12$ ). Aside from these two categories, the differences observed between the radiant and all-air groups are very small, with no difference in median, and negligible effect size. Acoustic satisfaction (noise and sound privacy) did not show statistically significant and practically relevant differences between the two groups.

*Table 3: Results of statistical analysis for the radiant and all-air groups*

Satisfaction with: <sup>(a)</sup>	Radiant group			All-air group		
	M	Mdn	SD	M	Mdn	SD
building cleanliness	1.77	2	1.29	1.57	2	1.43
ease of interaction	1.74	2	1.26	1.46	2	1.46
building maintenance	1.67	2	1.29	1.38	2	1.5
amount of light	1.48	2	1.53	1.42	2	1.6
workspace cleanliness	1.44	2	1.48	1.41	2	1.54
comfort of furnishing	1.6	2	1.28	1.31	2	1.53
building	1.54	2	1.35	1.28	2	1.5
amount of space	1.58	2	1.57	1.23	2	1.72
colours and textures	1.42	2	1.35	1.27	2	1.59
workspace	1.33	2	1.37	1.15	2	1.47
air quality	1.27	2	1.56	1.13	2	1.59
adjust. of furniture	1.19	2	1.56	1.08	2	1.65
visual comfort	1.08	2	1.63	1.04	2	1.69
visual privacy	0.5	1	1.78	0.38	1	1.96
<b>temperature</b>	<b>0.56</b>	<b>1</b>	<b>1.71</b>	<b>0.05</b>	<b>0</b>	<b>1.82</b>
noise	0.14	0	1.79	0.22	0	1.82
sound privacy	-0.66	-1	1.83	-0.64	-1	1.94

<sup>(a)</sup> We ordered the results by mean satisfaction score for each category based on the full database. We indicate in bold the variable for which there is the largest difference between the two groups

*Table 4: Results of statistical analysis between the radiant and all-air groups (comparison)*

Satisfaction with:	Comparison <sup>(a)</sup>			
	$\Delta M$	$\Delta Mdn$	$p$ -value	Effect size ( $\rho$ )
building cleanliness	0.20	0	$<0.001^{***}$	0.06
ease of interaction	0.28	0	$<0.001^{***}$	0.09
building maintenance	0.29	0	$<0.001^{***}$	0.09
amount of light	0.06	0	0.552	0.01
workspace cleanliness	0.03	0	0.977	0
comfort of furnishing	0.29	0	$<0.001^{***}$	0.08
building	0.26	0	$<0.001^{***}$	0.08
amount of space	0.35	0	$<0.001^{***}$	0.10
colours and textures	0.15	0	0.146	0.02
workspace	0.18	0	0.001 **	0.06
air quality	0.14	0	0.002 **	0.05
adjust. of furniture	0.11	0	0.095	0.03
visual comfort	0.04	0	0.732	0.01
visual privacy	0.12	0	0.19	0.02
<b>temperature</b>	<b>0.51</b>	<b>1</b>	<b><math>&lt;0.001^{***}</math></b>	<b>0.14</b>
noise	-0.08	0	0.223	-0.02
sound privacy	-0.02	0	0.876	0

<sup>(a)</sup> Metrics used for comparison include: difference in mean ( $\Delta M$ ) and median ( $\Delta Mdn$ ); statistical significance of the difference ( $p$ -value), and effect size Spearman's  $\rho$

# PLEA 2018 HONG KONG

Smart and Healthy within the 2-degree Limit

## 3.2 Temperature satisfaction in radiant and all-air buildings

In Figure 1, we show the distribution of occupant responses for temperature satisfaction. This graph does not consider the difference between buildings but aggregates all individual responses. If we cluster positive votes, we observe that the 58% of the occupants are satisfied with radiant systems vs. 45% with all-air systems. If we add neutral votes, we reach 69% satisfied occupants with radiant systems vs. 62% with all-air systems. In Figure 2, we show boxplots of temperature satisfaction for radiant and all-air systems. Both mean and median are higher in the case of occupants exposed to radiant systems.

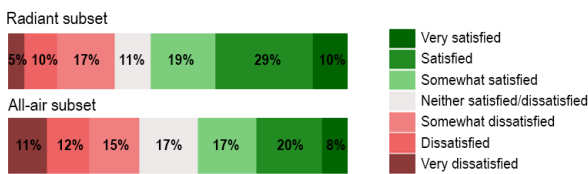

Figure 1: Bar chart showing the distribution of temperature satisfaction for the radiant and all-air subset

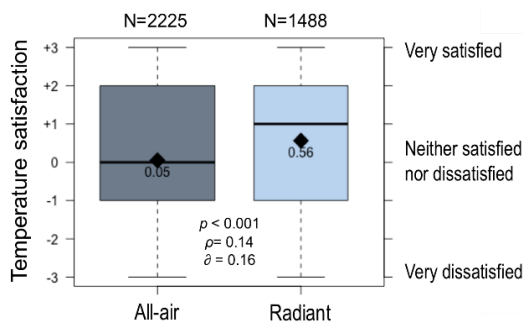

Figure 2: Boxplot of temperature satisfaction (diamond dots represent mean values)

We looked to the literature to find guidance on the interpretation of effect sizes. Cohen (Cohen 1988) was the first to propose thresholds. He used 0.1, 0.3 and 0.5 to define ‘small’, ‘medium, and ‘large’ effects, respectively. Cohen’s values have been later increased by Ferguson (Ferguson 2009) to more conservative thresholds of 0.2, 0.5 and 0.8, respectively, to prevent over-interpretation of effects (see Figure 3). Both authors commonly warn about the challenge of interpretation of effect sizes, which vary from one field to another. There are no interpretation schemes of effect sizes commonly used in our field.

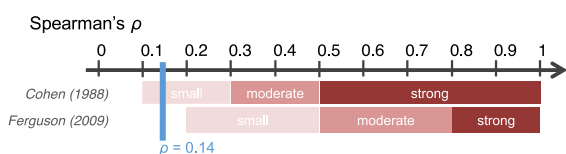

Figure 3: Spearman’s  $\rho$  effect size for the radiant vs. all-air comparison plotted against the interpretation thresholds according to Cohen and Ferguson

To address this limitation and to keep the assessment and discussion into the context of buildings and occupant satisfaction, we decided to compare the effect size obtained for conditioning type (radiant/all-air) to the effect size obtained for other binary variables of our survey: type of ventilation (mixed-mode/mechanical), gender (male/female), distance to window ( $\leq$  or  $>$  4.6 m.), and type of office (enclosed/open). Table 5 presents these results. The largest difference in effect size for temperature was found for gender ( $\rho=0.2$ ), followed by conditioning type ( $\rho=0.14$ ). The other variables showed low effect size comparatively. Karjalainen (Karjalainen 2012) conducted a meta-analysis to determine the impact of gender on thermal comfort. His results showed that females were more likely than males to express thermal dissatisfaction (odd ratios (OR): 1.74, 95% confidence interval: 1.61–1.89). He concluded that there was a statistical difference based on p-value, but did not comment on effect size thresholds for practical significance. If we apply to Karjalainen’s results the threshold proposed by Ferguson (where  $OR \leq 2$  is a ‘negligible’), then the effect of gender within his analysis remains below the minimum recommended value for a practically significant effect size. For our sample, gender just reaches the threshold of ‘small’ practical significance according the Ferguson’s scale for Spearman’s  $\rho$ ; and the outcome for conditioning (radiant vs. all-air) is below gender ( $0.14 < 0.2$ ). As with gender, we can conclude that there is a tendency toward higher temperature satisfaction for radiant systems, but with either a negligible or small practical significance.

Table 5 : Comparison of effect size for satisfaction with temperature for different subgroups

Variables and sub-groups	$\Delta M$	$\Delta Mdn$	p-value	Effect size ( $\rho$ )
Gender				
- male / female	0.74	1	<0.001***	0.2
Conditioning				
- radiant / all-air	0.51	1	<0.001***	0.14
Ventilation strategy				
- MM / MV <sup>(a)</sup>	0.09	1	0.139	0.02
Distance to window				
- close / far away <sup>(b)</sup>	0.05	1	0.535	0.01
Type of office				
- enclosed / open	-0.02	0	0.898	0

<sup>(a)</sup> MM: mixed-mode and MV: mechanical ventilation;

<sup>(b)</sup> Close: window  $\leq 4.6$  m.; and far away: window  $> 4.6$  m.

In this study, the Cliff’s  $\delta$  explains the probability that a randomly selected observation from the radiant group has higher satisfaction than a randomly selected observation from the all-air group, minus its reverse probability (i.e.  $P(\text{all-air} < \text{radiant}) - P(\text{radiant} > \text{all-air})$ ). We decomposed this equation. Compared to a space



# PLEA 2018 HONG KONG

*Smart and Healthy within the 2-degree Limit*

using an all-air building, a person in a space using a radiant system has:

- 50% chance of having a higher temperature satisfaction rating
- 16% chance of having an equivalent rating
- 34% chance of having a lower temperature satisfaction rating.

Figure 4 displays the distribution of these three probabilities. The Cliff's  $\delta$  associated with this analysis is 0.16 (16% probability of higher temperature satisfaction for occupants exposed to radiant systems). We could not find references for interpretation for Cliff's delta values, and therefore this analysis should be viewed only as a useful means of interpreting the survey results.

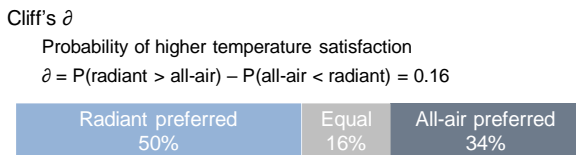

Figure 4: Probability of higher temperature satisfaction for the radiant and all-air conditioning subsets

### 3.3 Acoustic satisfaction in radiant and all-air buildings

Buildings using radiant systems are associated with lower acoustical quality; this is particularly the case for radiant in-slab systems (ESS and TABS types) due to large exposed acoustically reflective (i.e., 'hard') surfaces (Bauman et al. 2011). Based on Table 4, neither of the two acoustic categories (noise and sound privacy) showed statistically significant and practically significant differences in satisfaction ratings between the radiant and all-air subsets. Previous occupant satisfaction studies have shown that the type of office has a major impact on acoustic satisfaction (Frontczak et al. 2012; Kim et al. 2013). To address this complexity, we used a mixed-effect model with 'type of office' (cubicles with high partitions, cubicles with low partitions, enclosed private office, enclosed shared office, open office with no partitions) as the random effect. We also distinguished in-slab (ESS & TABS) from panel (RCP) types of radiant systems. The output for noise satisfaction was not statistically significant between the two groups. Satisfaction with sound privacy showed a weakly significant regression coefficient (+0.17,  $p=0.02$ ) in favour of in-slab radiant systems compared to all-air systems. The random effect reached 21% suggesting that the large spread in the variance can be described by 'between office type' differences. Overall these results reveal that acoustic satisfaction categories are comparable across the two conditioning types. This outcome is relevant because it provides evidence disproving common biases against radiant systems specifically. Acoustic satisfaction appears as the most

challenging aspect in regard to occupant satisfaction in buildings, for both radiant and all-air systems.

### 4. STUDY LIMITATIONS

The buildings used for this study were selected following the methodology detailed in section 2.2. Yet, the data available for the radiant subset was limited due to the general lack of buildings with radiant systems in North America. We sampled the all-air buildings data from a larger dataset based on characteristics that followed the radiant building's demographical and physical characteristics. Overall, the buildings of this study (both conditioning types) show a higher IEQ than the average building of the CBE survey database. As a reference, the mean overall workspace and overall building satisfaction ratings considering the entire CBE database are 0.93 (N=76,598) and 1.06 (N=80,869), respectively, while they reach 1.22 (N=3,573) and 1.38 (N=3,574), respectively, for all the buildings of this study. This study involved 26 radiant buildings and 34 all-air buildings, with 1,645 and 2,247, occupant responses, respectively. While this is a large sample size, it is not a randomized statistically-representative sample, which is a limitation of the study.

We could not find effect size interpretation thresholds that were representative of our field in existing publications. Our paper includes an analysis on effect size interpretation thresholds. This analysis should be seen as a precedent for discussion. Further research in this area can yield a different conclusion as to the practical significance of the observed and reported effect sizes.

### 4. CONCLUSION

We used the CBE IEQ occupant survey to compare occupant satisfaction in radiant and all-air conditioned buildings. This comparison involved 1,645 respondents from 26 buildings with radiant systems and 2,247 respondents from 34 buildings with all-air systems. The analysis showed that radiant and all-air conditioned spaces have equal IEQ, including acoustic satisfaction, with a tendency towards improved temperature satisfaction in radiant buildings. From this dataset, a person has a 50% chance of experiencing higher temperature satisfaction in a space using a radiant system compared to an all-air system. The reverse probability reaches 34%, and there is a 16% chance for the two systems to bring equal satisfaction. We observed equal acoustic satisfaction (noise and sound privacy) in radiant and all-air systems, disproving some commonly held biases against radiant systems. Acoustic quality remains the most challenging aspect in regard to occupant satisfaction in buildings (lowest scores from all the categories surveyed).

# PLEA 2018 HONG KONG

*Smart and Healthy within the 2-degree Limit*

## ACKNOWLEDGEMENTS

This work was supported by the California Energy Commission (CEC) Electric Program Investment Charge (EPIC) (EPC-14-009) "Optimizing Radiant Systems for Energy Efficiency and Comfort." The authors would like to thank Cathy Higgins and Kevin Carbonnier from NBI, Gwelen Paliaga from TRC for their support with this study.

## REFERENCES

1. Klepeis, N. E., Nelson, W. C., Ott, W. R., Robinson, J. P., Tsang, A. M., Switzer, P., ... others. (2001). The National Human Activity Pattern Survey (NHAPS): a resource for assessing exposure to environmental pollutants. *Journal of exposure analysis and environmental epidemiology*, 11(3), 231–252.
2. US DOE. (2011). Quadrennial Technology Review report, vol. II Technology Assessments. Washington, DC, USA: US Department of Energy.
3. Babiak, J., Olesen, B. W., & Petras, D. (2009). REHVA Guidebook No 7: Low Temperature Heating and High Temperature Cooling (1st ed.). Belgium: Federation of European Heating and Air-conditioning Associations. Available: <http://cds.cern.ch/record/1433801>
4. Feustel, H. E., & Stetiu, C. (1995). Hydronic radiant cooling—preliminary assessment. *Energy and buildings*, 22(3), 193–205.
5. Thornton, B. A., Wang, W., Lane, M. D., Rosenberg, M. I., & Liu, B. (2009). Technical Support Document: 50% energy savings design technology packages for medium office buildings (No. PNNL-19004). Pacific Northwest National Laboratory, Richland, WA, USA. Available: <ftp://cert.ncat.edu/Files/EERE%20on%20Offices.pdf>
6. Thornton, B. A., Wang, W., Huang, Y., Lane, M. D., & Liu, B. (2010). Technical Support Document: 50% energy savings for small office buildings (No. PNNL-19341). Pacific Northwest National Laboratory, Richland, WA, USA. Available: [http://www.pnl.gov/main/publications/external/technical\\_reports/PNNL-19341.pdf](http://www.pnl.gov/main/publications/external/technical_reports/PNNL-19341.pdf)
7. Leach, M., Lobato, C., Hirsch, A., Pless, S., & Torcellini, P. (2010). Technical Support Document: Strategies for 50% energy savings in large office buildings (No. NREL/TP-550-49213). Golden, CO, USA: National Renewable Energy Laboratory. Available: <http://www.bluevantage.net/userdata/userfiles/file/Technical%20Library%20Docs/49213.pdf>
8. Karmann, C., Schiavon, S., & Bauman, F. (2017). Thermal comfort in buildings using radiant vs. all-air systems: A critical literature review. *Building and Environment*, 111, 123–131.
9. Bauman, F., Webster, T., Zhang, H., & Arens, E. (2012). Advanced Design and Commissioning Tools for Energy-Efficient Building Technologies (California Energy Commission No. CEC-XXX-2012-XXX). Center for the Built Environment. Available: <https://escholarship.org/uc/item/9pc6t4s3>
10. Zagreus, L., Huizenga, C., Arens, E., & Lehrer, D. (2004). Listening to the occupants: a Web-based indoor environmental quality survey. *Indoor Air*, 14(s8), 65–74.
11. Altomonte, S., & Schiavon, S. (2013). Occupant satisfaction in LEED and non-LEED certified buildings. *Building and Environment*, 68, 66–76.
12. R Development Core Team. (2017). R: The R Project for Statistical Computing. Retrieved February 21, 2017, from <https://www.r-project.org/>
13. Kraemer, H. C., Morgan, G. A., Leech, N. L., Gliner, J. A., Vaske, J. J., & Harmon, R. J. (2003). Measures of clinical significance. *Journal of the American Academy of Child & Adolescent Psychiatry*, 42(12), 1524–1529.
14. Cliff, N. (1996). Answering ordinal questions with ordinal data using ordinal statistics. *Multivariate Behavioral Research*, 31(3), 331–350.
15. Cohen, J. (1988). *Statistical power analysis for the behavioral sciences*. Hillsdale, NJ: Lawrence Earlbaum Associates.
16. Ferguson, C. J. (2009). An effect size primer: A guide for clinicians and researchers. *Professional Psychology: Research and Practice*, 40(5), 532–538.
17. Karjalainen, S. (2012). Thermal comfort and gender: a literature review. *Indoor air*, 22(2), 96–109.
18. Bauman, F., Webster, T., Dickerhoff, D., Schiavon, S., Feng, D., & Basu, C. (2011). Case study report: David Brower Center. UC Berkeley: Center for the Built Environment. Available: <https://escholarship.org/uc/item/7tc0421f.pdf>
19. Frontczak, M., Schiavon, S., Goins, J., Arens, E., Zhang, H., & Wargocki, P. (2012). Quantitative relationships between occupant satisfaction and satisfaction aspects of indoor environmental quality and building design. *Indoor air*, 22(2), 119–131.
20. Kim, J., & de Dear, R. (2013). Workspace satisfaction: The privacy-communication trade-off in open-plan offices. *Journal of Environmental Psychology*, 36, 18–26.

## The Elderly and Their Indoor Environment: Use of Thermal Comfort Models to Determine Occupant Satisfaction.

CAROLINE ELIZABETH HUGHES<sup>1</sup>, SUKUMAR NATARAJAN<sup>1</sup>

<sup>1</sup>University of Bath, Bath, United Kingdom

*ABSTRACT: In the winter of 2014-15 an estimated 43,900 excess winter deaths occurred, 85% of which were in older people. There is a clear link between cold homes and poor health, especially in older people, as sub-optimally heated homes increase the risk of health problems that are particularly prevalent in this demographic. By 2050 a quarter of the UK population will be aged 65 and over, with the greatest population increases being seen in the octogenarian and older categories. Investigating thermal comfort in the over 65 demographic is key to ensuring that older people are able to stay healthy and comfortable in their homes. To date, thermal comfort models are based on working age populations habiting office buildings throughout a working day. This paper seeks to validate how suitable current thermal comfort models are in predicting comfort levels of older people in their homes. In this study indoor temperature data from 30 homes occupied by people aged 65 and over, together with thermal comfort data was collected during the measurement period November 2016 to March 2017. This data enabled the theoretical outputs from Fanger's model to be correlated with the measured temperatures to validate the model.*

*KEYWORDS: Ageing Population, Thermal Comfort, Fanger, Temperature Monitoring*

### 1. INTRODUCTION

By 2050 a quarter of the UK population will be aged 60 and over, with the greatest population increases being seen in the octogenarian and older categories [1]. Currently, older person households account for 27% of total households, but this is predicted to rise to 48% within the next decade [2]. This anticipated demographic shift causes concern for a number of reasons. Firstly, the UK housing stock is notoriously inefficient and despite a relatively mild climate, excess winter mortality figures are higher than in other countries with similar or colder climates [3]. This is frequently attributed to the poor thermal insulation, single glazing and draughts in much of the existing stock [5]. Much research has focused on investigating the thermal comfort of people on lower incomes and in social housing as it is often assumed that it is these people who are most at risk of suffering cold homes. However, there is no clear link between cold homes and deprivation [5], as social houses tend to be well insulated and warm. In reality, the most adversely affected homes tend to be large owner-occupied houses that are difficult to heat. These homes are often occupied by older people. Furthermore, it is common for older people to spend large amounts of time in their home. It is estimated that 60 year olds spend over 85% of their time at home, which rises to over 95% once people reach 85 years of age and above [2]. This is concerning as there is a clear link between cold homes and poor health, especially in older people, as sub-optimally heated homes increase the risk of circulatory and respiratory health problems that are particularly prevalent in this demographic [4]. But most shocking of all is the link between cold homes and excess winter deaths, in the

winter of 2014-15 an estimated 43,900 excess winter deaths occurred, most of which were in older people [6].

Investigating thermal comfort in the over 65 demographic is crucial to ensuring that older people are able to stay healthy and comfortable in their homes. 'Thermal Comfort' is the term used to describe a balance of environmental and personal factors that lead to a person feeling satisfied and comfortable in their thermal environment [11]. It is inextricably linked with health, and the World Health Organisation, UK Government and The British Geriatric Society recommended internal temperatures of 21° C in living rooms and 18° C in all other rooms for older people, to ensure their health is maintained. Use of Fanger's PMV-PPD model is the most commonly used method to measure thermal comfort within UK buildings in winter periods. However, this model is based on working age populations habiting office buildings throughout a working day, not domestic buildings resided in by over 65 year olds. This paper seeks to validate how suitable current thermal comfort models are in predicting comfort levels of older people in their homes.

### 2. METHODS

This study involved a monitoring programme of internal temperatures, humidity and heating patterns of a sample of 43 households with occupants aged over 65, between November 2016 and March 2017.

To measure internal temperatures and relative humidity, Thermocron iButton sensors, with a manufacturer reported accuracy of +/-0.5°C, were placed in three locations in the home - the living room, the radiator in the living room and the bedroom, with

# PLEA 2018 HONG KONG

Smart and Healthy within the 2-degree Limit

measurements being recorded every 90 minutes. Use of iButton sensors is highly practical in this type of study as they are small and unobtrusive, so do not cause interruption in participating homes. During the first measurement phase additional spot measurements were taken measuring air temperature, mean radiant temperature and air velocity using the industry standard Swema Thermal Comfort equipment. This paper correlates the measured data from the industry standard Swema equipment and the iButton sensors to determine how accurate the measured data from the iButtons are in calculating PMV and PPD. To calculate PMV and PPD requires the measurement of six variables – four environmental and two personal – including air temperature, mean radiant temperature, air velocity, relative humidity, metabolic rate (the activity level of the participant) and clothing insulation (Clo value). Typically, measurement of these variables is in office buildings which is less invasive and inconvenient than in domestic homes, and the Swema equipment is large and so could not reasonably be expected to stay in people’s homes for prolonged periods, hence why smaller sensors such as iButtons are commonly used instead. This paper aims to determine whether iButtons are suitable in providing a less intrusive alternative to the Swema equipment whilst maintaining accuracy of the measured data.

Additionally, an initial comprehensive survey was collected, intended to provide a thorough demographic profile of each participant and to provide information about housing characteristics, thermal comfort, heating and health followed by shorter questionnaires disseminated monthly, with the aim of capturing changes in thermal comfort and health.

Of the 43 homes studied, 30 were selected for inclusion in this paper, details of which are given in Table 1.

Table 1: Demographic Profile of Participants in measurement Phases 1 and 3 (November 2016 - March 2017 and November 2017 - March 2018).

ID	Occupant Age	House Type	Income
1	65	SD	Low
2	76	D	High
3	66	T	Low
4	71	T	High
5	66	SD	Low
6	89	SD	Med
7	72	F	Low
8	75	D	High
9	79	D	Low
10	69	T	Low
11	86	SD	Med
12	91	F	Low
13	73	SD	Low
14	85	D	Med
15	90	D	High
16	71	SD	Med
17	84	D	Med

18	69	T	Low
19	91	B	Med
20	86	D	Low
21	77	D	Med
22	69	D	High
23	74	F	Med
24	65	T	Low
25	75	F	High
26	69	D	Low
27	80	SD	Med
28	72	D	Low
29	80	D	High
30	74	T	Med

### 3. RESULTS

The first section of results report on how suitable iButtons are for use as an alternative to the industry standard equipment in thermal comfort data collection. The second section reports on the findings of the internal temperatures and comfort of participants in Phase 1 of the project.

#### 3.1 Validation of iButton sensors for use in thermal comfort models

The following graphs show the correlations between the measured variables using the Swema equipment and the iButtons.

##### 3.1.1 Air Temperature

Figure 1 shows a strong positive correlation ( $R=0.86$ ) between the air temperature measured by the iButtons and the Swema equipment. On average the iButton sensors overestimated the temperature by  $0.46^{\circ}\text{C}$ , but the accuracy of the sensors is  $\pm 0.5^{\circ}\text{C}$ , so up to  $\pm 1^{\circ}\text{C}$  of difference is anticipated. The mean temperature recorded by the iButtons was  $19.74^{\circ}\text{C}$  and SD  $2.3^{\circ}\text{C}$ , whereas the mean temperature recorded by the Swema equipment was  $19.28^{\circ}\text{C}$  and SD  $2.17^{\circ}\text{C}$ .

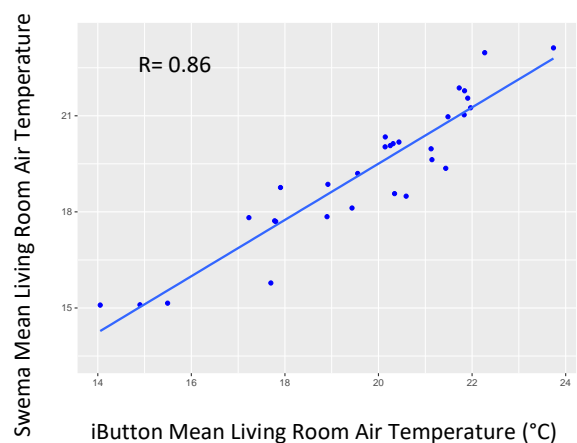

Figure 1: Regression of indoor mean living room air temperature measured using the iButtons and industry standard Swema equipment, measured in November 2016. With trend line and 95% confidence interval (shaded blue area).

# PLEA 2018 HONG KONG

Smart and Healthy within the 2-degree Limit

This shows that iButtons are capable of measuring indoor temperatures as accurately as the industry standard equipment and are therefore suitable as a substitute where it is considered impractical to use the Swema equipment in domestic homes.

### 3.1.2 Relative Humidity

Figure 2 shows a very strong positive correlation ( $R=0.92$ ) between the relative humidity measured by the iButtons and the Swema equipment. The average relative humidity measured by the iButtons was 57.98% with a SD of 7.85%, whereas the Swema equipment measured an average relative humidity of 58.1% and standard deviation of 6.97%. These differences are very minimal and lead to the conclusion that iButtons are a suitable alternative to industry standard monitoring kits, when the necessity for discreet sensors is a key factor.

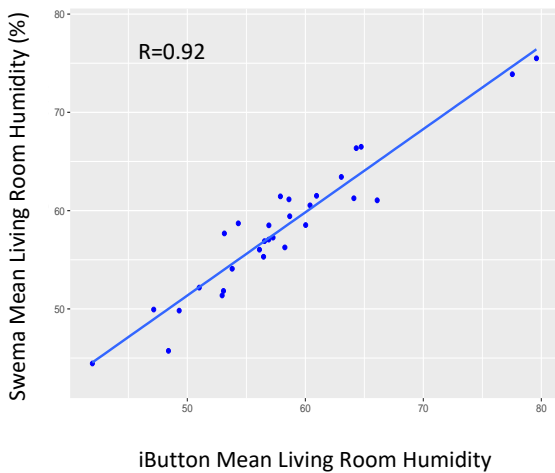

Figure 2: Regression of relative humidity measured using the iButton sensors and industry standard Swema thermal comfort equipment, measured in the 30 participating homes in November 2016. With trend line and 95% confidence interval (shaded blue area).

### 3.1.3 Mean Radiant Temperature

The iButton sensors are only capable of recording air temperature, not mean radiant temperature, so consequently it is common to use air temperature as a proxy for mean radiant temperature. Figure 3 shows the correlation between the air temperature and mean radiant temperature measured by the Swema equipment. The correlation is very strong ( $R=0.96$ ), meaning that it is perfectly acceptable to use air temperature in place of mean radiant temperature without losing reliability in the PMV-PPD calculations.

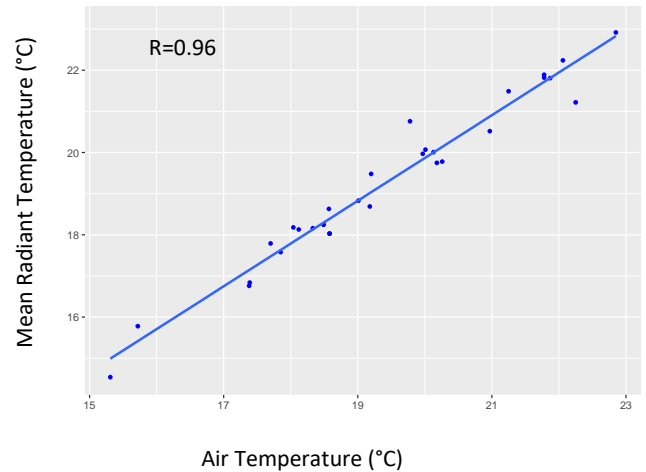

Figure 3: Correlation between air temperature and mean radiant temperature, measured by the industry standard Swema thermal comfort equipment. With trend line and 95% confidence interval (blue shaded area).

### 3.1.4 Air Velocity

In typical PMV-PPD calculations the air velocity is assumed to be  $0.1\text{ms}^{-1}$ . Figure 4 shows that in 10% of homes ( $N=3$ ), the air velocity was higher than  $0.1\text{ms}^{-1}$ . As the majority of homes were below or equal to the assumed value of  $0.1\text{ms}^{-1}$  it is reasonable to assume a value of  $0.1\text{ms}^{-1}$  for all homes. Additionally, the calculation of PMV-PPD, discussed later in the paper, shows that air velocity has a relatively small impact on the calculated PMV and PPD outputs.

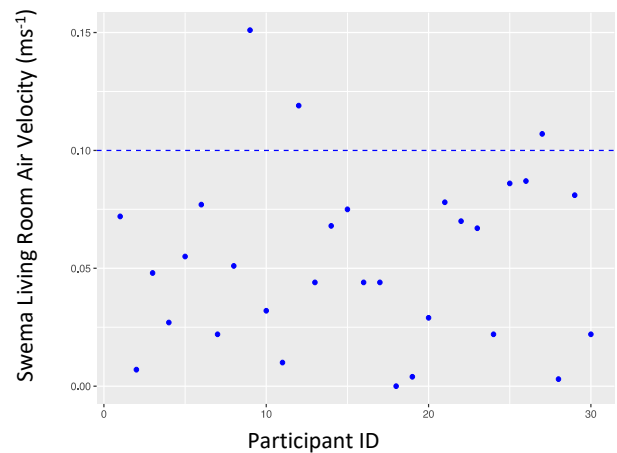

Figure 4: Air Velocity in each participating home ( $N=30$ ) measured using the industry standard Swema equipment and the value of  $0.1\text{ms}^{-1}$  (blue dashed line) typically used as an assumed value in PMV-PPD calculations.

### 3.1.5 Personal Variables

The personal variables, metabolic rate and clo value, were assumed or self-reported in the questionnaire. The metabolic rate was assumed to be 60 met per person, in accordance with the average sedentary older person [10]. The Clo value was self-reported in the

# PLEA 2018 HONG KONG

Smart and Healthy within the 2-degree Limit

questionnaire, in accordance with the Dukes-Dubos clothing ensemble conversion tables [10].

### 3.1.6 Predicted Mean Vote (PMV)

PMV values calculated by using both the measured data from the iButtons and measured data from the Swema equipment are correlated and shown in Figure 5. A strong correlation of 0.93 was observed between both data sets, suggesting that overall the less invasive use of iButtons for domestic environments, where it is impractical to use the Swema equipment does not significantly detrimentally impact the PMV results.

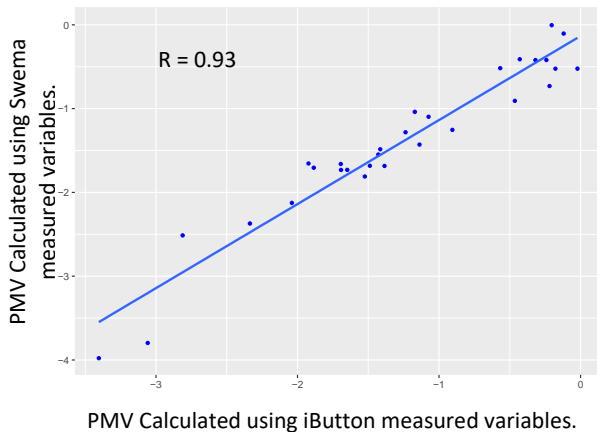

Figure 5: Regression of the PMV calculated using the measured data from iButton sensors and PMV calculated using measured data from Swema equipment. With trend line and 95% confidence interval (blue shaded area).

### 3.1.7 Percentage of People Dissatisfied (PPD)

PPD values were also calculated using data measured by the iButtons and the Swema equipment (Figure 6). There is a very strong correlation between the two data sets ( $R=0.95$ ), so it is evident that use of iButton sensors does not affect PPD results.

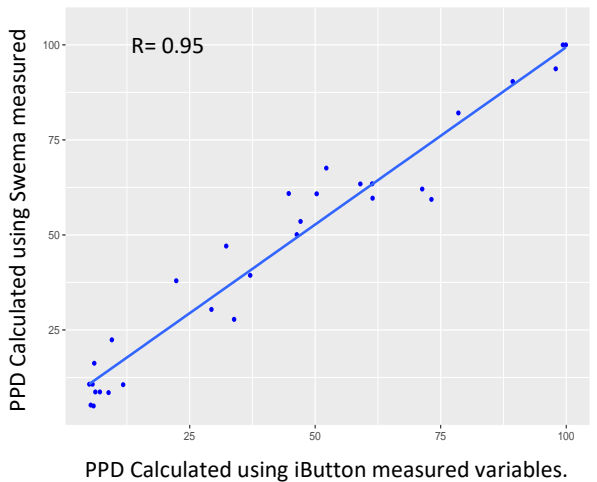

Figure 6: Regression of the PPD calculated using the measured data from iButton sensors and PMV calculated using measured data from Swema equipment. With trend line and 95% confidence interval (blue shaded area).

### 3.2 Mean Internal Temperature

The average mean internal living room temperature of the measured data from the iButtons between November 2016 and March 2018 was calculated and is shown in Figure 7, for each of the 30 participating homes. The average mean internal temperature of all homes was 18.9°C, which is below the World Health Organization's (WHO) and British Geriatric Society recommended internal temperature of 21°C [7, 8].

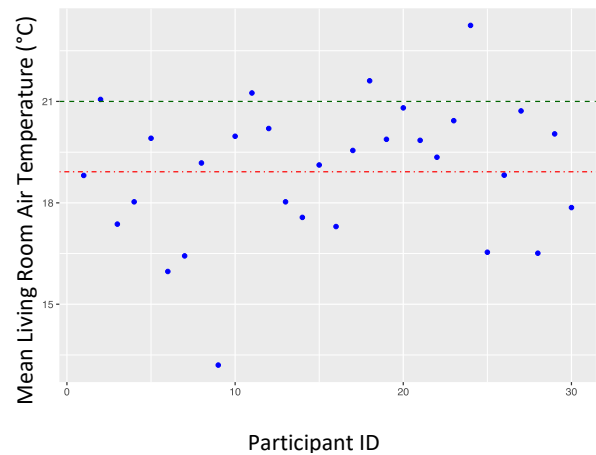

Figure 7: The Mean Internal Air Temperature (°C) from November 2016 until March 2017 in each of the 30 participating homes, the World Health Organisation's recommended internal temperature of 21°C (green dashed line) and the mean internal air temperature of all 43 homes (red solid line).

Measured data from the iButtons during November 2016 were used as inputs to calculate Fanger's predicted mean vote (PMV) for each of the 30 homes in accordance with BS EN ISO 7730 [9]. The thermal sensation vote (TSV) was self-reported by participants in the November questionnaire, through answering how comfortable they were in their home at that time, and numerically converted using the Bedford scale of thermal comfort (Table 2).

Table 2: Bedford 7-point Thermal Comfort Scale.

Question Response	Scale
Much too warm	3
Too Warm	2
Comfortably Warm	1
Neither warm nor cool	0
Comfortably Cool	-1
Too Cool	-2
Much too Cool	-3

Figure 6 shows a very weak correlation between the PMV and TSV ( $R^2 = 0.00061$ ). The TSV was higher than the PMV for 93% of homes, which shows that a significant proportion of participants were more comfortable than the PMV predictions suggest.

# PLEA 2018 HONG KONG

Smart and Healthy within the 2-degree Limit

These results show that Fanger's thermal comfort model consistently underestimates occupant thermal comfort in the over 65 demographic.

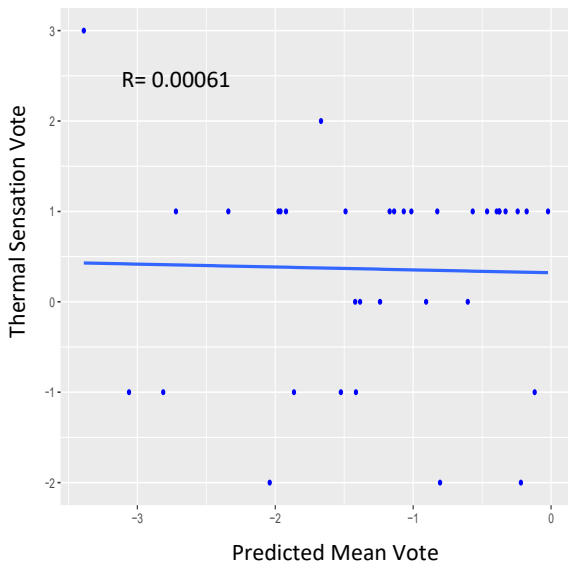

Figure 8: Correlation and 95% confidence interval between the Predicted Mean Vote (PMV), calculated using measured data from the iButton sensors, using Fanger's method in accordance with BS EN ISO 7730, and the participant thermal sensation vote (TSV) self-reported in the questionnaire sent in November 2016.

## 4. DISCUSSION

The correlations shown in figures 1,2,3,5 and 6 all show very strong positive correlations. It is therefore evident that accuracy and reliability of the measured data is not compromised through use of alternative sensors, such as the iButtons, in comparison to the industry standard thermal comfort equipment. The iButton sensors are smaller, less obtrusive and cheaper than industry standard equipment. This paper has shown that it is possible to use a practical type of sensors without compromising the accuracy of the data collected, when conducting temperature monitoring studies.

This paper has also shown that the majority of participants (86%) did not achieve the WHO or British Geriatric Society's recommended internal temperature of 21°C, which is concerning as this is likely to be detrimental to their health. Nonetheless, when comparing PMV outputs to the participants self-reported TSV, there was no correlation with participants reporting to be more comfortable than the PMV outputs suggest. This lack of correlation shows that Fanger's model does not accurately predict the thermal comfort of over 65 year olds in their home and may also signify that the WHO and British Geriatric Society recommended internal temperatures are unrealistic for the majority of homes.

## 5. CONCLUSION

This paper has shown that use of alternative measuring equipment, such as iButton sensors, which are more suited to domestic homes, in comparison to industry standard equipment, does not have a negative impact on the accuracy of the data measured, it is therefore clear that when conducting temperature monitoring studies it is possible to use sensors such as iButtons without compromising the quality of the PMV-PPD outputs.

This paper has also shown that Fanger's thermal comfort model is not suitable for determining occupant thermal comfort in the over 60 demographic, as for the majority of participants the model did not accurately predict their comfort levels. These results have demonstrated that older people are comfortable at lower temperatures than are recommended for their sustained health, which has significant wider implications, as it is known that low temperatures are detrimental for the health of older people. This paradoxical situation could result from a number of factors including the desire for past ways of living, the reticence to adapt to modern levels of comfort, or use of alternative methods to stay warm, such as additional clothing. Further research is required to investigate these possibilities.

## ACKNOWLEDGEMENTS

This project is financed by an EPSRC funded University of Bath Studentship.

## REFERENCES

1. Wouters, E., (2017). Demographic Trends: Why We Need Smart Solutions. In: van Hoof, *et al.* ed. *Handbook of Smart Homes, Health Care and Well-Being*: Switzerland: Springer: p. 13-22.
2. Hamza, N. and Gilroy, R., (2011). The challenge to UK energy policy: An ageing population perspective on energy saving measures and consumption. *Energy Policy*, 39: p. 782 – 789.
3. Rudge, J. and Gilchrist, R., (2005). Excess winter morbidity among older people at risk of cold homes: a population-based study in a London borough. *Journal of Public Health*, 27 (4): p. 353 – 358.
4. Liddell, C. and Morris, C. (2010). Fuel poverty and human health: A review of recent evidence. *Energy Policy*, 38: p. 2987-2997.
5. Hajat, S. *et al.* (2007). Heat-related and cold-related deaths in England and Wales: who is at risk? *Occupational Environmental Medicine*, 64: p. 93-100.
6. ONS. (2016). Excess Winter Mortality in England and Wales. *Statistical Bulletin*. England.
7. Ormandy, D. and Ezratty, V., (2012). Health and thermal comfort: From WHO guidance to housing strategies. *Energy Policy*, 49: p. 116-121.
8. Burholt, V. and Windle, G., (2006). Keeping warm? Self-reported housing and home energy efficiency factors

# PLEA 2018 HONG KONG

*Smart and Healthy within the 2-degree Limit*

impacting on older people heating homes in North Wales. *Energy Policy*, 36: p. 1198 – 1208.

9. British Standards Institution. (2005). BS EN ISO 7730: Ergonomics of the thermal environment – Analytical determination and interpretation of thermal comfort using calculation of the PMV and PPD indices and local thermal comfort criteria. London: BSI.

10. Parsons, K. (2002). *Human Thermal Environments*. 3<sup>rd</sup> Edition. (London: Taylor and Francis).

11. Nicol, F. and Roaf, S. (2017). Rethinking Thermal Comfort. *Building Research & Information*, 45 (7): p. 711-716.



## Residual Thinking: Reclaiming Hong Kong's Lost Urban Spaces

PETER. W. FERRETTO<sup>1</sup>

<sup>1</sup>School of Architecture, The Chinese University of Hong Kong, Hong Kong

**ABSTRACT:** *Hong Kong is an extreme city: extreme consumerism set against intense urban inhabitation, radical authenticity juxtaposed to severe topography, whichever way you read Hong Kong there are never any half measures. Compiled to this vertiginous density, Hong Kong is an amalgam of conditions, that came into existence due to a hostility settlement between China and Britain over the trading of narcotics, and developed from a "barren rock", into a 7 million plus metropolis with the 8th largest trading economy in the world. Throughout its history, Hong Kong has always adapted, mitigating territorial as well as political situations to produce a concentrated and vertical city. Residual thinking relates to interpreting our present urban environment for what it really is, vis-à-vis the convergence of natural and artificial forces that jostle for control. From the Latin "residuus", meaning left over, the word residual has become synonymous with a number of terms that describe the status of our contemporary city: non-spaces, anti-spaces and vacant spaces. The residual condition, it can be argued, has become the common lexicon through which we discuss and read our urban environment, a different form of waste that relates to the opportunities, not problems.*

**KEYWORDS:** *Hong Kong, Urban Conditions, Residual Urban Spaces, Background Architecture, Urban Prototypes.*

### 1. INTRODUCTION



Figure 1: Book Tree Prototype, Mei Foo Estate, Hong Kong.  
Photo P.W. Ferretto

This paper focuses on the lost urban spaces of Hong Kong, circumstantial spaces that were neither planned nor designed but simply arose due to a complex array of overlapping reasons. Their status has always been ambiguous, with ownership, management and governing regulations frequently varying. What appears, on the surface, as a public domain is, in reality, a highly controlled space with blurred ownership, governed by an intricate web of independently acting institutions.

Many of the conditions within Hong Kong, are a derivative of a highly engineered city, where adaptive solutions generate an invisible background. Through the insertion of design prototype this paper seeks to demonstrate how such leftover spaces can be inhabited by temporary architectural insertions that foster awareness, community participation and importantly

work within a different time frame from traditional architectural projects that are typically too static, expensive and non-flexible.

#### 1.1 Defining the Residual

*"On the most physical level, the environment prompts people to think of the public domain as meaningless"* (Sennett, 2002, p. 12)

In the opening chapter of the "The Fall of Public Man" Richard Sennett makes reference to the idea of "Dead Spaces", disengaged spaces with a meaningless public domain and no diversity of activities, "a space that you move through, not a space to be in". Although Sennett does not refer to the notion of the residual, the isolation and disconnection he alludes to has direct parallels with the urban by-product spaces we discuss in this paper.

In the present academic and professional debate, the word residual has multiple disguises (Abandoned, By-product, Buffer, Detached, Dual Use, Empty, Fringe, Hidden, Incoherent, Intermediate, Infrastructural, Left-over, Lost, Neglected, Remainder, Surplus, Vacant, Undesirable and White spaces) that have come to define the urban architectural zeitgeist. However, the underlying connotations of the term revolves around two distinct positions, one theoretical and the other practical, that allow us to differentiate between how we should interpret and react to transitional urban zones.

The theoretical position as argued in the 90's by the Catalan architect and urbanist Ignasi de Sola-Morales who defines such spaces as the "Terrain Vague" (Sola-Morales - Rubio, 1995) of our cities, indispensable buffer zones that allow cities to breathe, expand and contract,

# PLEA 2018 HONG KONG

*Smart and Healthy within the 2-degree Limit*

through a membrane of heterogenous locations that accommodate unpredictability. In other words, indeterminate areas that our cities need to be able to adapt and survive the straight jacket of modern planning and building regulations – an inbuilt tolerance system to allow freedom.

The counter position, instigated by performance artists such as Gordon Matta-Clark, who in the 1970's explored how vacant plots in New Jersey could be reclaimed and appropriated has today evolved to an consolidated architectural position initiated by socially motivated architectural practices such as Raumbaum (Austria) who see the issue in reverse. Rather than constituting an breathing gap within the city, these plots offer a unique opportunity for the community to challenge the planning status quo.

## 1.2 Learning from Hong Kong

Ever since moving to Hong Kong, I have been struck by how, due to the city's urban density, the city seamlessly inhabits its urban infrastructure. The examples are multiple, ranging from domestic workers colonizing the elevated pedestrian walkways every Sunday in Central to the illegal gambling stations located below concrete bridges in the Newtown of Tin Shui Wan. In a similar manner as "Learning from Las Vegas" (Venturi, Scott Brown, & Izenour, 1972) which famously postulated a reading of the city (non-city in their case) through a taxonomy of mundane conditions: casinos, hotels, churches and parking lots, Hong Kong's residual spaces offer an altogether new reading of our present Asian city. To demonstrate the case we use three examples that represent the tip of the iceberg, regarding how we can learn from Hong Kong's "second-hand spaces".

The first example relates to an interstitial forgotten slot located in the heart of Tsim Sha Tsui, one of Hong Kong's busiest commercial districts in Kowloon. The plot is wedged between a high-way flyover (Kowloon Park Drive) and the end of a dense urban block, where the awkward geometry of the site prevents any profitable development of the land, hence this in-between situation is transformed into a stealth den of heterogenous activities amalgamated under an ingenious light roof structure.

Diverse programmes that require flexible, temporary and low rental conditions to survive are able to colonize the space and coexist with each other. The Haiphong Road Temporary Market includes a Hallah meat market adjacent to a whole sale flower stall, jammed against a cluster of Dai Pai Dong (street food stalls) structures combine to create an authentic atmosphere straight out of a scene from a Wong Kai Wan film.



*Figure 2: Hill Road Viaduct, Sai Ting Pun, Hong Kong. Photo P.W. Ferretto*

The second example is a cathedral like space situated in Pok Fu Lam, where a vertiginous elevated Hill Road highway meanders perilously through a cluster of residential buildings, perched on a steep terrain. The resulting by-product void is left vacant for 50/52 week of the year – literally a wasted space. However in early February, for a fortnight, the site is metamorphosed into a temporary spiritual festival housing a Chinese theatre, various temples and a shrine all built out of bamboo. The beauty of this intervention demonstrates how a mistaken situation, allows the traces, history and memories of the site to survive. Even with the advent of modernization and technology, local rituals survive and adapt.

Hong Kong is not renowned for its urban grid, unlike Manhattan or Barcelona, its urban fabric is conceived as an organic reaction to the surrounding topography, where urban zones are tailored to the existing uneven landscape, generating a highly bespoke engineered territory. Ensnared within this hectic infrastructural framework lies the Sham Shui Po grid and its associated urban block, is our third example.

Built in the 1920's by the British, this 50x 100m block was conceived as a strategic network to facilitate the transport of military ammunition, becoming over the years the home of the city's textile trade. Rather than the block being an example of a residual type, it represents a system of interconnected micro residual moments. The void beneath the stairs becomes a watch repair shop, roof terraces turn out to be occupied fringes, a standard family apartment is subdivide to a cluster of micro units, the back alley doubles up as electronic workshops, every space have at least three indenteties.

# PLEA 2018 HONG KONG

*Smart and Healthy within the 2-degree Limit*



Figure 3: Sham Shui Po Urban Block, Axonometric. Drawings by Carol Wong, CUHK Masters Student.

These examples, and there are many more in Hong Kong, represent the resilient city that fights back, episodes where marginal sites generate bespoke informal solutions. Such meta-spaces, light and temporary everyday structures are inexpensive, adaptable and easily demountable. They operate as a system, are extremely organized and mutate to the complex contemporary urban issues.

Each example alludes to an alternative urban metabolism that is frequently ignored but is critical to how Hong Kong operates. Specifically, in the context of this sustainability conference, it allows the discourse to run off-piste and digress, addressing environmental issues from an altogether alternative perspective to the prevalent concern to minimizing human environmental impact. Paradoxically the discussion here becomes about maximizing the potential of given urban conditions to achieve a form of ecological balance that has long eluded the city. At a time when Hong Kong is confronted by the spectre of the generic, when most of the city's recent developments seem to segregate rather than unite communities, the residual offers an alternative form of urban inhabitation.

## 2. THE MEI FOO PROTOTYPE

To demonstrate how this residual latent energy can be transformed into customized temporary public spaces, our research team (with the funding of a research grant from Research Grant Council of Hong Kong, titled "Urban Pauses: Reclaiming Hong Kong's Residual Urban Spaces" grant number 14611017) embarked on designing and building an urban prototype that would allow us to better understand how such potential spaces could be inhabited.

### 2.1 Urban Prototype

The architectural prototype is a vessel to test and to challenge conventional readings. In the context of this paper the prototype is conceived as an architectural organism: object, event, regulation that reacts to a given context, relying importantly on a feedback mechanism to evolve into a given proposal. As adaptive structures,

prototypes respond to specific conditions, using materials that may not necessarily be meant for final production and complete designs. The role of the prototype is to be unique and test original ideas, a design fragment which challenges preconceived thinking and leading to a radical change of position.

Contrary to conventional architecture, the prototype relates to temporary and adaptive design solutions. In this respect, they are similar to the idea of "Magnet" (Price, 2012) coined by the British architect Cedric Price, vis-à-vis Price's theoretical position relies on magnets being facilities with inherent possibilities of change, growth and adaptability compared to buildings. Price argues that architects often see buildings as a cure for social problems, a role he believes they are singularly ill-suited to, as they are: too slow, too solid and too late. The architectural prototype, as a context-sensitive design, serves as a working model for the implementation in numerous analogous situations. The prototype as a paradigm encourages a rethinking of existing ecosystems in order to incorporate novel expressions as well as new performances.



Figure 4: Mei Foo Estate, Aerial View. Image taken from Google Earth.

### 2.2 The Mei Foo Estate

The Mei Foo estate built in phases between the late 60s and 70's is the first private housing estate in Hong Kong, accommodating between 70,000 – 80,000 residents in 99 identical towers with 13,500 apartments. The complex entirely built on reclaimed land from the harbour, embodies many of the ideas put forward by French architect and urbanist Le Corbusier who in 1925 presented his "Plan Voisin" vision, a radial proposal (never built) to demolish a vast area of central Paris and replace it with a new high density city.

What is striking about the Mei Foo estate, contrary to the Plan Voisin position, is how, due to the extreme density and tropical climate of Hong Kong, it is not the vast expanses of open green space "where the air is clear and pure" to quote Le Corbusier, that public engage with but paradoxically the underside of the Kwai Chung flyover. A space that normally would be considered as a negative and redundant space is transformed into an asset for the whole community.

# PLEA 2018 HONG KONG

*Smart and Healthy within the 2-degree Limit*

To understand the importance public space plays for the people of Hong Kong, one has to know that the average living area per person in Hong Kong is 4.5m<sup>2</sup>. In this perspective, the notion of rethinking the city's residual spaces takes on a new dimension. They are no longer wasted spaces but become imminent opportunities for transformation, public assets latent with potential energy to change. 80,000 people require a multitude of public amenities, which due to Hong Kong's chronic lack of space, are situated directly into the underside of the elevated flyover, converting a 1km stretch of infrastructural space into the heart of the neighbourhood. A wet market, medical clinic, community centre, bus depot, flower whole seller and public toilet are all housed here. The resulting public space defies conventional classifications, primarily because the space was not designed as a public event space but arose out of a derivative situation, an adaptive situation. Every programme sets up an artificial relationship with the context a form of interior urbanism.



Figure 5: Mei Foo Municipal Wet Market. Photo P.W.Ferretto.

## 2.3 Book Tree Prototype

Book Tree is a research project conceived by Associate Professor Peter W. Ferretto at the School of Architecture at The Chinese University of Hong Kong, in collaboration with the Mei Foo District Counsellor Ambrose Cheung. The objective of the project is twofold: to inhabit a lost urban space and simultaneously to create a new type of reading experience for children within the Mei Foo neighbourhood.

Due to its high density and unique topography, Hong Kong has a high concentration of residual urban spaces, spaces that are not planned and typically occur by accident. These lost spaces have become invisible to local people who usually dismiss them as mundane background places devoid of purpose.

Our research started from the notion that through design, such spaces can be activated and transformed into inhabitable places. Rather than design being a high-end service, the predominant case in Hong Kong, design here becomes a tool to transform a neglected corner beneath a flyover into a real open community space.



Figure 6: Book Tree Prototype, August 2018. Photo P.W. Ferretto

Libraries are typically associated with quiet and studious spaces. The idea behind the "Book Tree" is to install a structure where children can play while reading, rather than a chore reading books becomes a fun experience. The temporary installation is composed of two elements, an open timber landscape to sit down and a tree structure that holds books. The structure was conceived as a tree where the different branches each house books for different ages. The structure was built from untreated timber as to reconnect children to the warmth of natural materials contrasted to the mineral and hard materiality of the surrounding infrastructure.

The manner in which the "Book Tree" operates is unique in Hong Kong. Books are not registered nor borrowed, they are simply donated by the community for the community to take freely. There is no trading, no promise to return, the tree acts as a temporary deposit for the many books Mei Foo households can no longer store.

This dynamic sharing system creates a sense of pride in an otherwise transitional space between A and B. The Mei Foo estate built in phases between 1968 and 1978, comprises 99 residential towers housing more than 70,000 residents within 13,500 apartments. It is one of Hong Kong's first private housing estates and is bisected by Kwai Chung Road. It was selected as the site for our first prototype due to its unique inhabitation of residual spaces below the highway, which include a community centre, a clinic and wet market.

## 2.4 Book Tree Description

The "Book Tree" occupies 25 m<sup>2</sup>, consisting of a tree structure of bookshelves surrounded by an undulating interactive sitting and reading platform. The tree structure is made of pre-fabricated timber components that are assembled and dismantled by students in 1-2 days, while the platform consists of 50 (600x600 mm) timber boxes of different height. The tree structure is lined with a waterproof fabric, which provides sun and

# PLEA 2018 HONG KONG

*Smart and Healthy within the 2-degree Limit*

rain protection. It is equipped with LED lighting for reading.



Figure 7: Book Tree Prototype, Children interacting with the Structure. Photo P.W. Ferretto

## 2.5 Design, Fabrication and Planning Process

Potentially the most valuable lesson and source of knowledge the “Book Tree” generated relates to the uncovering of the implementations process behind the realization of a project of this kind. So called residual spaces in Hong Kong are highly regulated spaces governed by specific government departments who follow strict rules as to their use and programme. In the case of the Mei Foo viaduct, the site is controlled by the Lands Department of Hong Kong, who in turn have to consult several other departments such as the Police, Community Groups, Health and Safety Department before consenting approval for the installation of a temporary structure.

The fabrication of the prototype had to follow one very important constraint, the whole structure had to be built and erected for less than 50,000 HKD (the project was self-financed by the team, with no outside funding). For these reasons we opted for a timber structure that could be erected by students, rather than contractors, and we sourced the timber pieces from a timber merchant in Dongguan, Mainland China, who helped cut to size all the pieces.

The design process relied on a series of workshops with the District Council and presentations to the Local Leaders and community representatives. What was evident was the how all parties responded to the physicality of the project and immediately understood the project idea through a model. To be noted also was the importance of the “tree” metaphor that enabled all parties to identify with the story and understand how children would respond.



Figure 8: Study model used to explain the Design. Photo P. W. Ferretto

## 5. CONCLUSION

In an article titled “Alternative Urban Design Strategies” the sociologist Saskia Sassen (2006) relates her informal economic theory “Novel Assemblage” directly to the city pointing out that architecture needs to engage directly with unforthcoming spaces, elaborating a “another architecture” to occupy today’s massive urban infrastructures. Large cities, in her view, contain a diversity of under-used spaces, which often lie outside today’s logical spatial frames.

It is exactly these spaces that this paper believes are an essential part of the interiority of the city and that any proposal to reactivate or inhabit them has got to avoid, the predictable Hong Kong developer mindset, which only seeks to maximize their real estate value. New practices have to be sought out, steering away from an architecture of permanence, towards a temporary architecture of interventions that subvert and reactivate abandoned public spaces, to borrow Sassen’s analogy, barefoot architects working like China’s barefoot doctors. We do not aim to present one solution to one specific site, rather present a spectrum of possibilities in the form of architectural prototypes exploit the potential conditions of existing residual spaces.

The cultural identity of a place from an anthropological perspective, as argued by the Hong Kong based anthropologist Gordon Matthews, has historically been associated with the “way of life of the people”. In this context, Hong Kong’s cultural identity is, and one can argue has always been, in a state of flux, neither cultural ‘pure’ nor culturally ‘free’. Hong Kong is a city that lies between extreme polarities: political, national, economic and architectural. In architectural terms: extremely formal (designed and branded architecture) contrasted with the informal unplanned organic city (adaptive, temporary and spontaneous architecture), between these two architectural positions lie the conditions of Hong Kong.

Condition is a word with multiple readings; as a noun it relates the state of something, vis-à-vis its appearance,

# PLEA 2018 HONG KONG

*Smart and Healthy within the 2-degree Limit*

quality and circumstances. While as a verb it implies: influence, constraint and control. These two understandings are critical in/to the thesis of this article; on the one hand the urban condition narrates the physical characteristics of our city, what I describe in the first part of the article as the situations that belong to the “background city” and how everyday practices of inhabitation, the hyper local, establish a form of “urban dialect” which in the most part remains extraneous to the authorities that plan our cities. The second position, the notion that reflects the meaning associated with influence and control, relies on observation and interpretation, though schematization/modelling.

Most of the conditions highlighted in this article would not typically be associated with an /the recognized identity of Hong Kong, they represent a taxonomy of the ‘other’ Hong Kong to borrow the concept coined by Foucault (Foucault, 1984). In-between worlds, neither here nor there, that belong somewhere between utopia and dystopia, the heterotopia of Foucault, act as vessels connecting the city to its roots, to the memories of a world not so far away, that has evolved into the present condition. Foucault remarks that the perfect example of heterotopia is a boat, a floating piece of space that belongs to no fixed place except the infinity of the sea.

To conclude, as several hundred million more people are expected to move to cities in East Asia over the next 20 years as economies shift from agriculture and manufacturing to services, when the China’s Pearl River Delta has overtaken Tokyo to become the world’s largest urban area in both size and population, Hong Kong is in a strategic position both geographically and politically to examine the role of what our cities are, rather than what they might become. Understanding urban conditions as a set of relationships, places of deviations, where the real life, which today seems so incompatible with our/the prescribed social needs of the people, actually takes place.

Architecture has a fundamental role to help society, it is our ambition that this humble insertion can rekindle a sense of pride and joy for the children of the neighbourhood.

## REFERENCES

1. Abbas, A. (n.d.). Building Hong Hong: from Migrancy to Disappearance. In S. Cairns, *Drifting: Architecture and Migrancy* (pp. 129-141). London: Routledge.
2. Cecla, F. L. (1993). *Mente Locale*. Milan: Eleuthera.
3. Certeau, M. d. (2006). *The Practice of Everyday Life*. Berkeley: University of California Press.
4. Chase, J., Crawford, M., & Kaliski, J. (2008). *Everyday Urbanism*. New York: The Monacelli Press.
5. Christ, E., & Gantenbein, C. (2010). *Hong Kong Typologies*. Zurich: ETH-DARCH.
6. Herzog, J., & de Meuron, P. (2015). How do Cities Differ. In J. Herzog, R. Diener, M. Meili, P. de Meuron, M. Herz, C. Schmid, & M. Topalovic, *The Inevitable Specificity of Cities* (pp. 15-19). Zurich: Lars Muller Publishers.
7. Mathews, G. (2013). Cultural Identity in the Age of Globalization: Implications on Architecture. In S. Lee, & R. Baumeister, *The Domestic and the Foreign in Architecture* (pp. 47-54). Rotterdam: 010 Publisher.
8. Price, C. (2012, 01 31). Cedric Price: Magnet. Retrieved from Architectural Foundation: <http://www.architecturefoundation.org.uk/programme/1997/magnet-cedric-price>
9. Sennett, R. (2002). *The Fall of Public Man*. London: Penguin Books.
10. Sola-Morales - Rubio, I. (1995). *Terrain Vague*. In *AnyPlace* (pp. 118-123). Cambridge, Massachusetts: MIT Press.
11. Tieben, H. (2010). The Origin of Hong Kong Building Types. In C. & Gantenbein, *Hong Kong Typologies* (pp. 33-55). Zurich: ETH-DARCH.
12. Venturi, R., Scott Brown, D., & Izenour, S. (1972). *Learning from Las Vegas*. Cambridge, Massachusetts: MIT Press.

## Architectural Interventions in the Informal City: On-site Upgrading Strategies for BaSECo Community

FRANCESCO ROSSINI<sup>1</sup>

<sup>1</sup>School of Architecture, The Chinese University of Hong Kong, Hong Kong, China

*ABSTRACT: As Architects we have the opportunity to work in different spatial contexts and urban environment. Since ancient times the search of the genius loci, or spirit of place constitute an essential aspect to create meaningful buildings and places inspired by cultural, climatic, geographical, political, and topographical conditions.*

*Often these local conditions could be difficult to interpret requiring additional efforts to understand a particular urban context, as is the case of informal settlements where the organic pattern of their urban structure is based on several social actions and spontaneous processes.*

*The scope of this article is to describe the preliminary stage of a research project focused on the upgrading strategy of the informal community of BaSECo in Manila. The information derived from this research seeks to understand the ways in which this informal settlement works so as to establish an alternative urban regeneration strategy which is socially, economically and environmentally sustainable, offering a model for other informal settlements in the Philippines.*

*KEYWORDS: Informal Settlements, Incremental Interventions, Architectural Prototypes, On-site Upgrading, Manila*

### 1. INTRODUCTION

Informal settlements, slums, favelas, shacks, bidonville, shanty towns, and squatters, are all terms which connote negative characteristics and precarious living conditions such as the lack of basic services and infrastructure, high population density, unhealthy living environments, poverty and high levels of crime [1].

These organic and often illegal forms of inhabitation, which are considered parasitic compared to the areas developed according to a formal planning process, may presents similar characteristics of the vernacular architecture. According to Pietro Belluschi [2, p.132] the architecture in the past was “a communal art, not produced by a few intellectuals or specialists but by the spontaneous and continuing activity of a whole people with a common heritage, acting under a community of experience.” In his 1964 exhibition ‘Architecture without architects’, Bernard Rudofsky showed a series of examples where it was possible to appreciate the beauty of this accidental architecture and the talents and achievements of anonymous builders “...whose concepts sometimes verge on the utopian, whose aesthetics approach the sublime” [3, IV].

These types of informal or spontaneous architectures are often the result of participatory processes where the project, conceived as a determining phase for the conception of an architectural artefact, resides in the construction techniques often transmitted through a hundred generations.

In informal settlements, as remarked by Dovey [4] the constructions transgress some definitions of architecture, requiring new modes of architectural practice and ideology. (Fig.1)



Figure 1: Spontaneous constructions in the informal district of BaSECo.

Working in such dynamic context requires thinking of innovative spatial strategies where architecture and urban design could play a critical role in addressing the challenge of urban informality.

### 2. MANILA: CONFLITS OF A TWIN CITY

In Metro Manila, rapid changes of the urban structure have led to an explosion of two opposite yet related phenomena: the development of high-density clusters of high-rise buildings and the formation of dispersed patterns of informal settlements.

Over the years, Manila has undergone alternate phases of crisis and economic growth, but the urbanisation of its territory has continued uninterrupted,

# PLEA 2018 HONG KONG

*Smart and Healthy within the 2-degree Limit*

following no specific spatial order. Rather, urban growth has been marked by highly volatile and chameleon-like configurations [5].

This urban explosion does not mean however that there has been a general improvement in citizens' living conditions; quite the contrary, it has accentuated existing inequalities. Despite the fact that the rate of urbanisation is comparable with other countries of the Asia Pacific Region, the city has not experienced the same level of development that usually follows increased urbanisation.

Large areas of the city, especially in the downtown area, are occupied by informal communities that will be affected by the city's undergoing redevelopment. The Pasig River Rehabilitation Program, a long-term plan to improve water quality and to promote urban renewal, will bring dramatic shifts in the spatial pattern of the urban structure, resulting in the relocation of large sectors occupied by informal communities. Under this program the district of BaSECo, one of the densest informal settlements in Manila, was selected as a priority area for substantial urban renewal (Fig. 2).



Figure 2: The dense carpet of houses delineates the cityscape of BaSECo.

Although this government-lead project is aiming to resettle the residents on-site instead of relocating them outside the city, it's vital that the revitalisation strategy take into consideration the mutual, interconnected needs of both the local community and city administration, which may at times appear to be at odds.

The name BaSECo, (an acronym for Bataan Shipyard and Engineering Corporation) was established in 1964, and over the last 10 years the district, has suffered the effects of natural disasters; because of its proximity to Manila Bay it is particularly vulnerable to river flooding and storm surges.

BaSECo has also endured high levels of crime and poverty, further complicating matters for residents, and despite the support of NGOs and the local government, is still an extremely problematic area in which a number of difficulties must be solved.

There is considerable attention being paid to future of this strategic area, and both community organisations and local NGOs are quite active in negotiating with different stakeholders and facilitating the empowerment of local residents.

### 3. ON-SITE UPGRADING STRATEGIES, A METHODOLOGICAL APPROACH

In the late 1970s, the British architect John Turner promoted a new approach based on the view that self-help settlements assisted by NGOs had to be perceived as a potential solution for improving the slums. Turner's pioneering efforts led to the rethinking of urban regeneration policies in informal settlements, generating various upgrading programmes in different developing countries [6].

The on-site upgrading approach demands effective engagement and communication with different members of the community. Recent on-site schemes not only focus on improving housing conditions but also on developing open spaces and community facilities.

A participatory process focused on promoting open spaces as social integrators can have "a strong reliance on the role that public space can play in bringing people together stressing the importance of quality design and architecture" [7, p.527]. According to Jáuregui [8], planting the 'seeds of urbanism' in the heart of the community may contaminate it in a positive way, improving the physical and social dimension of the informal district.

This alternative approach will be tested in the informal district of BaSECo with the aim to generate two main consequences: the first is to provide more open spaces in the dense and intricate urban tissue and the second is to implement the provision of infrastructure and services that are missing or deficient in the community.

Incremental interventions and on-site upgrading approaches rely on a sophisticated understanding of informal settlement forms, as well as their spatial and social structure. As Such, the process of mapping is essential in order to understand the physical context and the sociocultural environment and becomes a vital tool for discussing and planning the revitalisation of the informal community [9; 10].

The methodology of this research is structured into three interrelated phases, entitled 'Spatial Analysis', 'Participatory Process' and 'BaSECo Incremental Plan' (BIP). The preliminary stage of this study examined three areas of the district that feature different urban



# PLEA 2018 HONG KONG

*Smart and Healthy within the 2-degree Limit*

conditions and spatial organisation: Dubai Site (DS), Gawad Kalinga (GK), and New Site (NS) (Fig. 3).

Urban morphology, typological elements, living conditions and open spaces were analysed using quantitative and qualitative methods in order to gain a comprehensive understanding of the context, identifying tangible and intangible urban phenomena.

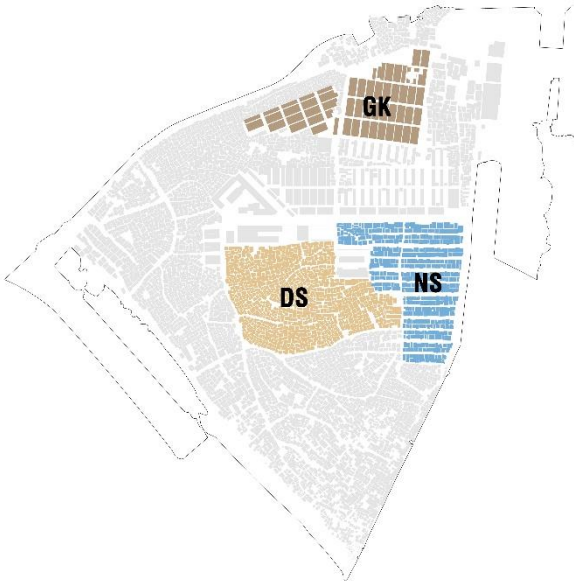

Figure 3: The three areas of Gawad Kalinga (GK); Dubai Site (DS) and; New Site (NS) in the district of BaSECo

### 3.1 Preliminary Analysis

At first sight BaSECo presents all the typical characteristics of any informal community such as congestion, poor hygiene conditions, misaligned street spaces and lack of urbanity. The district covers a surface area of approximately 52 hectares; the analysis of the spatial pattern shows a complex urban form where it is possible to identify a critical mass of housing occupying more the 80% of the entire area.

The main street network, which has enough space to allow for the circulation of people and vehicles, covers approximately 100,000 m<sup>2</sup>, which corresponds to 19% of the entire surface area (Fig. 4, a). Public facilities, such as markets, schools, the evacuation centre and the church are located almost in the central area of BaSECo (Fig. 4, b).



Figure 4: Figure ground analysis of the district.

The analysis revealed that 65 % of the spatial pattern in BaSECo has an organic configuration. The areas organised in a more regular pattern are the result of a series of fires arose in the past and are located near the port shoreline and close to the main facilities of the district. (Fig. 4, c-d).

In details, the three districts analysed present substantial differences in terms of urban form, social activities and use of living and open spaces. The different spatial patterns and urban forms also influence societal relationships and the way in which open spaces are used (Fig. 5).



Figure 5: The social use of open spaces in Dubai Site.

In GK and NS, a regular layout has fomented the development of linear communities, in that this type of

# PLEA 2018 HONG KONG

*Smart and Healthy within the 2-degree Limit*

organisation facilitates social interactions in the streets, thereby consolidating a sense of belonging in the residents.

By contrast, in the organic pattern of DS, neighbourhood relations are not so clearly defined, and social interaction occurs among small groups of families essentially because of proximity

In all the areas analysed, the lack of open space and community facilities is a serious issue to be addressed. In most cases, the unplanned and irregular structure, typical of informal settlements, generates dynamic spaces where distinctions between public and private are not clearly defined.

The proximity of people and open space in informal settlements generates a specific relationship, 'because they are socially produced and constructed' [11, p. 5].

Such intermediate open spaces are not simply vital to the effective functioning of settlements, but rather, offer a place where social relationships and productive activities can flourish, providing what perhaps is the greatest value to informal communities.

### 3.2 Architectural Prototypes and Incremental Interventions

The implementation of architectural prototypes, focused on the provision of open spaces and community facilities, aims to interpret the composite DNA of the urban environment in order to celebrate the diversity and the dynamism of the informal district (Fig. 6).

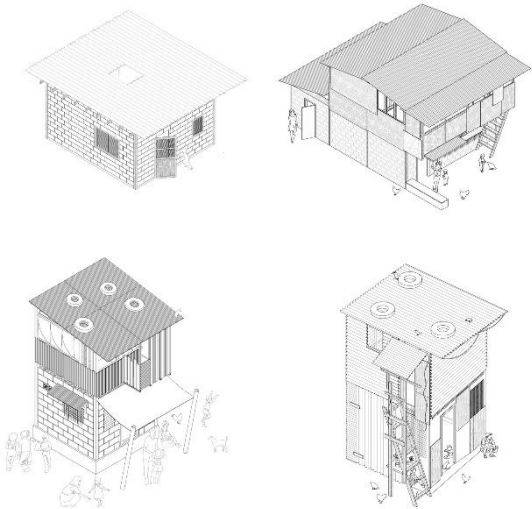

Figure 6: The different typologies of housing in Dubai Site.

The insertion of these seeds of architecture seeks to respond to the needs of the community in order to foster a more effective and sustainable on-site upgrading strategy.

The notion of the 'prototype' here is primarily interesting as a process rather than the prototype itself

as a product. The involvement of the local residents in all the stages of the design process will be crucial to create a sense of ownership and is a pre-condition of successful use, care and maintenance [12].

Inserting seeds of architecture in the informal settlements means to rethink the role of the design process, moving from object-oriented models towards new understandings of complex integrations of formal and informal conditions [4].

These architectural prototypes aim to generate a strategy for incremental change, but at the same time, to make use of sustainable technologies to face the conditions of the tropical climate. The use of lightweight materials and passive cooling strategies will be adopted to limit the use of energy and to increase the thermal comfort.

Our prior pilot studies into the district helped us to engage the local community and NGOs. The implementation of the Waste Management and Recycling Centre and the Learning and Cultural Centre, has been previously discussed during the summer workshop 'Mapping the Informality' held in BaSECo in June (Fig. 7).



Figure 7: The engagement of the local community during the workshop 'Mapping the Informality'.

This preliminary analysis and the engagement with different stakeholders gave us a significant insight on key issues and problems that this district faces, providing key background knowledge for ways to identify prototypes and determine appropriate areas and methods of intervention.

The implementation of these community facilities will be comprehensively studied in order to translate the community's ideas into potential projects.

The study will offer practical recommendations to identify core components and elements of these

# PLEA 2018 HONG KONG

*Smart and Healthy within the 2-degree Limit*

incremental interventions such as, construction materials, project dimensions, type of structure and any other suggestions that have support from all stakeholders.

### 3.2.1 Learning and Culture Center

In Dubai Site, Kabalikat (one of the most active community organizations in BaSECo) owns a small one story construction in where the community organise various social activities and which often serves as a meeting place for the district's decision-making. (Fig. 8)

The project is going to replace the existing learning centre which is not in condition to be upgraded due to structural problems. The new learning centre composes of a children library, a multipurpose room, a hand-craft centre, a small office, a kitchen and a dining area. Hence, the building will scale approximately 2-3 storeys with a total functional area of 150 m<sup>2</sup>.



Figure 8: The existing learning Centre own by Kabalikat.

### 3.2.2 Waste Management and Recycling Centre.

At first sight BaSECo presents all the typical characteristics of any informal community such as congestion, misaligned street spaces and lack of urbanity. In many areas of the district is possible to see any types of waste products which are dumped along the streets deteriorating the urban environment. The lack of any management and organisation of the waste in BaSECo is crucial in the development of this new architectural prototype.

The new Waste Management and Recycling Centre will provide an important and urgent infrastructural element as well as a place where the resident can experiment composting as a method to dispose food waste and recycle organic matter to improve soil structure and fertility.

## 4. CONCLUSION

As previously described, BaSECo district is affected by structural weaknesses that must be addressed with a comprehensive upgrading strategy.

The need for housing as well as the extremely high population density have put incredible pressure on basic infrastructure and community services, leading to an overcrowded and unsustainable urban area.

This preliminary stage of the research demonstrated the need to develop a comprehensive analysis of informal settlements will be crucial in developing a clear picture of the urban structure, helping to gain insight into residents' needs and motivations. Moreover, this understanding of how informal settlements work is key in developing more effective on-site upgrading strategies with the aim of addressing the community's needs. (Fig. 8)

Since conditions will differ from place to place, engagement calls for forms of practice where research takes a much more integral role in the design process, incorporating morphological and diagnostic mapping and modelling [4].

By analysing the BaSECo compound, this research will provide a general reflection on the conditions of the informal settlements in Manila in order to propose a methodological and analytical approach that will help implement long- and short-term actions and to support the decision-making processes at different stages of the revitalization process. (Fig.9)



Figure 9: The potential site for the construction of the Waste Management and Recycling Centre.

The implementation of architecture prototypes in BaSECo will be the first community facilities realized through a participatory process with the direct engagement of the local residents.

# PLEA 2018 HONG KONG

*Smart and Healthy within the 2-degree Limit*

These proposed projects will help to improve also the condition of the open spaces surrounding the buildings in order to generate a contamination process that can allow BaSECo districts to evolve into a more sustainable settlement. (Fig. 10)



Figure 10: The poor conditions of the open spaces in the district.

The impact of this research can be measured by the improvement of the condition of excluded or disadvantaged groups. Through the upgrading strategy the aim is to create an alternative urban model of development that can be applied in the revitalisation of informal settlements and underprivileged communities.

The key task of this process is to incrementally change the status of negative perception associated with informal settlements in order to reduce the physical and social segregation of these districts with the city.

## ACKNOWLEDGEMENTS

This work derives from a project funded by the Social Science Panel, The Chinese University of Hong Kong. (Direct Grant for Research), to whom thanks and acknowledgement are given.

I would also like to acknowledge the students of the School of Architecture of the Chinese University of Hong Kong, who participated at the summer elective course 'Mapping the informality' held in Manila last June 2018. The students spent more than one week working in the district of BaSECo engaging local residents and realising maps, graphics and drawings that have contributed to the development of this research.

## REFERENCES

1. UN-Habitat. (2003). The Challenge of Slum: Global Report on Human Settlements 2003. London and Sterling, VA.
2. Belluschi, P. (1955). Regionalism in Architecture. *Architectural Record*, 118(6), 131-139.

3. Rudofsky, B. (1964). *Architecture without Architects*: Museum of Modern Art; distributed by Doubleday, Garden City, N.Y.
4. Dovey, K. (2013). Informalising Architecture: The Challenge of Informal Settlements. *AD Architectural Design*, 83(6), 82-89. doi:10.1002/ad.1679
5. Ortega, A. A. C. (2014). Mapping Manila's Mega-Urban Region. *Asian Population Studies*, 10(2), 208-235.
6. Turner, J. F. C. and Fichter, R. (Eds) (1972) *Freedom to Build*. New York: Macmillan.
7. Riley, E., Fiori, J., & Ramirez, R. (2001). Favela Bairro and a new generation of housing programmes for the urban poor. *Geoforum*, 32(4), 521-531.
8. Jáuregui, J. M. (2011). A project for the favelas of Rio de Janeiro. *Archphoto*.
9. Carracedo, O. (2016). *Ibid./In the same place*. Singapore: ORO.
10. Kamalipour, H. (2016). Forms of Informality and Adaptions in Informal Settlements. *Archnet-IJAR International Journal of Architectural Research*, 10(3), 60-75.
11. Hernández-García, J. (2013). *Public Space in Informal Settlements: The Barrios of Bogotá*: Cambridge Scholars Publishing.
12. Blundell-Jones, P., Petrescu, D., & Till, J. (2013). *Architecture and Participation*: Taylor and Francis.

## **EDUCATION AND TRAINING**

Inspiration, knowledge, and innovation come with education and training. They empower professionals, practitioners and even laymen to play a part in future city development. Opportunities and issues related to the dissemination of knowledge are discussed in this track, for example:

- architectural education for low energy and sustainable design
- professional development, training and certification for a low energy future
- innovative methods, experiences and teaching techniques on passive low energy design
- lifelong learning and continue education for sustainable architecture and low energy design

# Learning about Building Technologies for Sustainability. Design Guidelines for a Nearly-Zero-Energy Residential Buildings in Barcelona: Case Study

EZEQUIEL USON GUARDIOLA<sup>1</sup>, JOSEP VIVES REGO<sup>2</sup>, ISABEL CASTILLO LEMA<sup>1</sup>, DIANA USON MAIMO<sup>1</sup>

<sup>1</sup>School of Professional & Executive Development, Polytechnic University of Catalonia (UPC), Barcelona, Spain

<sup>2</sup>Universidad de Barcelona (UB), Barcelona, Spain

*ABSTRACT: There is an increasingly urgent need to cut global CO2 emissions and thereby avoid the most catastrophic effects of climate change. In the EU construction sector, action has already begun to help minimise carbon emissions and reverse their current negative impact on the environment. These initiatives have so far been based on introducing the mandatory construction of “Nearly-Zero-Energy Buildings” (NZEBs) from 2018 onwards, in compliance with an EU Directive on the Energy Performance of Buildings (2010/31/EU) [1]. The NZEB project not only constitutes a technical challenge but also a challenge for the design process. It must be accompanied by the introduction of new, specialised programmes at Schools of Architecture. This article points out how this quest for design strategies to produce NZEBs has been converted into pedagogical content in the Polytechnic University of Catalonia’s (UPC) MSc in “Architecture & Sustainability: Design Tools & Environmental Control Techniques”. As an example of the work done and the results obtained, we present a project designed for a residential building in Barcelona, Spain. This was developed by a team of students from the MSc course and presented as their final project.*

*KEYWORDS: NZEB, MSc Architecture & Sustainability: Design Tools & Environmental Control Techniques, Master’s Degree Final Project, Software tools*

## 1. INTRODUCTION

Learning programmes for sustainable design are based on approaches that allow students to analyse complex systems in order to achieve concrete learning outcomes. One of these complex systems is the built environment and its associated CO2 emissions. One increasingly common objective for sustainable architecture is how to produce a Nearly-Zero-Energy Building (NZEB) and thereby minimise emissions of greenhouse gases (GHG) during the working life of the building. The MSc programme entitled “Architecture & Sustainability: Design Tools & Environmental Control Techniques” [2] has been designed to promote learning related to sustainable design and it clearly focuses on this objective. [3] The strategies proposed for this architectural project can be grouped around the two main goals established for NZEBs: reducing energy consumption and producing energy from renewable sources. In accordance with EU Directive (2010/31/ EU), the embodied energy is not taken into account. When establishing the balance between the energy consumed from fossil sources and that produced from renewable sources, only the energy consumption in the basic operations of the building is taken into account. It therefore incorporates integrated energy design into all the different phases of the project, as explained in detail in the following chapters.

## 2. THE MSc in ARCHITECTURE & SUSTAINABILITY: DESIGN TOOLS & ENVIRONMENTAL CONTROL TECHNIQUES

### 2.1 Pedagogical objectives

This Master’s Degree started from the premise that architecture is now subject to two important types of influence: Ecology and High Technology. This Master’s Degree provides training in sustainable architecture and urbanism. It is structured into four learning modules. The MSc programme has been designed to increase students’ comprehension, improve their capacity to solve problems and, most importantly, to improve their ability to apply the principles learned in the design of NZEBs.

### 2.2 Structure and Methodology

The MSc provided by the School of Professional & Executive Development of the Polytechnic University of Catalonia (UPC) of Barcelona, Spain, is divided into two post-graduate degree programmes. Each of these consists of two modules, with each module being subsequently divided into different subjects.

- MODULE A: Bioclimatic design: passive Techniques.
- MODULE B: Energy efficiency: active techniques and renewable energy.
- MODULE C: Control and regulation: home automation and smart buildings.
- MODULE D: Studio project: Nearly Zero Energy Buildings (NZEBs).

# PLEA 2018 HONG KONG

*Smart and Healthy within the 2-degree Limit*

This module will include a workshop on projects. This will be aimed at getting participants to apply all of the knowledge that they have previously obtained in an architectural project. The methodology used is based on three main design considerations:

- Site and micro-climate analysis  
Design with climate
- Energy efficiency: passive techniques  
Minimising energy demand by applying passive strategies: increasing insulation, improving solar radiation control, natural lighting, and heat recovery ventilation.
- Energy efficiency: active techniques.  
Increasing the energy efficiency of the building systems and the building management systems. Replacing conventional energy sources with renewable sources, as much as possible.

Students use a wide variety of software tools which provide information about the best strategies to employ. These include: Meteonorm, Climate Consultant, Archiwizard and Design Builder.

- GREEN TOUR: A study trip to a European city to visit buildings and ecological neighbourhoods constructed using sustainable strategies.

On finishing the programme, students who complete all of the tests to a satisfactory level will receive a diploma accrediting their Master's Degree in Architecture and Sustainability, which will be awarded by the Polytechnic University of Catalonia: Barcelona Tech (UPC).

### 3. CASE STUDY: A RESIDENTIAL BUILDING IN BARCELONA (SPAIN)

For the MSc course taught in 2016-17, the theme of the final project was a draft design for a residential building located in the Plaza de las Glorias, Barcelona (Spain) (Fig.1). Sustainable strategies of the MSc methodology were implemented via an Integrated System Design to achieve the goals associated with the Nearly-Zero-Energy Building (NZEB) standard. The aim was therefore to reduce the building's CO<sub>2</sub> emissions through systems that would reduce its energy consumption by around 50% and leave only a minimal environmental footprint. This aggregation process simultaneously incorporated: passive design and highly efficient active systems for taking advantage of renewable energy sources. For the Design Guidelines, Standard Passive House requirements for Mediterranean climatic conditions were followed. The design was phase was carried out focussing on the passive strategies outlined in the previous section; the aim was to reduce the building's heating and cooling loads to near zero levels (Table 1).

*Table 1: Passive House Requirements*

Passive House Requirements
Heating Demand: 15kW/h/m <sup>2</sup> /a
Cooling Demand: 15kWh/m <sup>2</sup> /a
Total Primary Energy Demand (for heating, hot water, and electricity): 120kWh/m <sup>2</sup> /a
Air Leakage: 0.6 Air changes per hour @ a pressure of 50 Pascal

It is planned to connect the building to the local district heating system. This already exists in the neighbourhood and supplies both hot and cold water. The photovoltaic roof will provide the building all, or almost all, of its energy needs; this will cover the energy demands of typical services used in the building. The design also incorporates water management, waste management and greenery services.



*Figure 1: Site: Plaza de las Glorias; Barcelona, Spain, latitude 41° 23'N, longitude 2° 11'E, altitude above sea level 13m.*

#### 3.1. Functional Programme and Design Intentions

The programme involved a residential building of 30,000m<sup>2</sup> and 300 units on a 4737m<sup>2</sup> plot, located on the perimeter of the Plaza de las Glorias square. The site occupies a full block (Fig. 2). The set of buildings has formal independence and constitutes a reinterpretation of the historical block of Barcelona's "Eixample", dating from the 19<sup>th</sup> century, but with the requirements of the 21<sup>st</sup> century. It has been conceived as a NZEB building, expressing its contemporaneity through a dialogue with the rest of the buildings that form part of the square. The dwellings are organised around an open central courtyard. The accesses to the apartments are via elevated streets that encourage relations among neighbours and help to create a sense of community. These buildings are two-, three- and four-bedroom apartments, with an average size of between 70 and 80m<sup>2</sup> (Fig. 3).

# PLEA 2018 HONG KONG

Smart and Healthy within the 2-degree Limit



Figure 2: Typical floor plan of the residential building



Figure 3: detail of the housing units

## 4. SITE AND MICRO –CLIMATE ANALYSIS: THE IMPACT OF LOCAL CLIMATE

Based on the Köppen-Geiger climate classification, Barcelona, like other cities located in the Mediterranean basin, would correspond to climate zone Csa: with mild, rainy winters and hot dry summers. The climatic data and diagrams were obtained using the Meteonorm, Weather Tool and Climate Consultant programmes. These made it possible to obtain precise data about temperature, humidity, precipitation, wind and solar radiation and to produce a psychometric chart showing the boundary of the city's comfort zone (Fig. 4). A series of different passive design strategies were proposed to achieve an average of 58.8 % of comfort hours. A plot of local climatic data revealed that the local DBT ranged from 6 to 27°C for different periods of the year. The amount of solar radiation received is relatively high (2628Kwh/m<sup>2</sup> per year); this made it easy to generate electric power from photovoltaic systems.

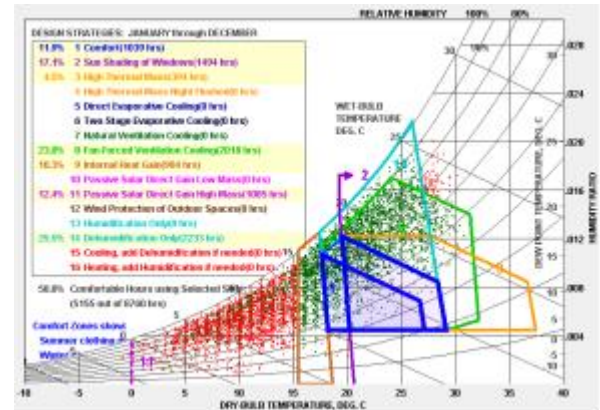

Figure 4: Psychometric chart analysis (Source: Climate Consultant, Meteonorm and Autodesk Weather Tool 2011 Analysis)

## 5. ENERGY EFFICIENCY: PASSIVE TECHNIQUES

It would probably be rather unrealistic to consider completely replacing active systems with climatic controls on a case-by-case basis [4]. Even so, using passive systems can notably improve their energy behaviour. In the design of the project using passive strategies, the aim was to increase indoor comfort and to reduce the demand for cooling, heating, ventilation and electric light. There is, however, a potential drawback in using Passive House design, resulting from the thermos effect created by the envelope around the building, which implies the risk of overheating. In order to ensure a no-risk situation, both mechanical ventilation with heat recovery and natural ventilation were proposed, but as part of a holistic approach that could simultaneously address not only the question of ventilation, but also that of sun shading, lighting and finishing (or their absence in order to permit slab cooling). The passive climatic control systems proposed were: 1) Control for solar radiation, 2) Vegetation, 3) Passive cooling, 4) Reducing airflow, 5) Insulating the building, and 6) Renewing the internal air with heat recovery.

### 5.1. Building Form, Orientation and Building Envelope

The shape of a building has a critical impact on the welfare of its users, the use of its resources and its consumption of water and energy. The positioning of its built mass is the product of multiple considerations, with the passive issue being only one of them. In this case, the design decisions were based on the volume determined by the Master Plan. The envelope is the main interface between a building and its external environment. In the case of the Mediterranean climate of Barcelona, when applying passive design, it was particularly important to prevent external solar heat gain (Fig. 5). The transitional spaces, terraces and access hallways were therefore dimensioned to regulate solar radiation. The design solution adopted on the facades and the roof achieved very favourable transmittance values. The U-value



# PLEA 2018 HONG KONG

Smart and Healthy within the 2-degree Limit

(W/m<sup>2</sup>/°K) of the building's fabric was 0.22W/m<sup>2</sup>/°K and the U-value of the windows was 0.6W/m<sup>2</sup>/°K.

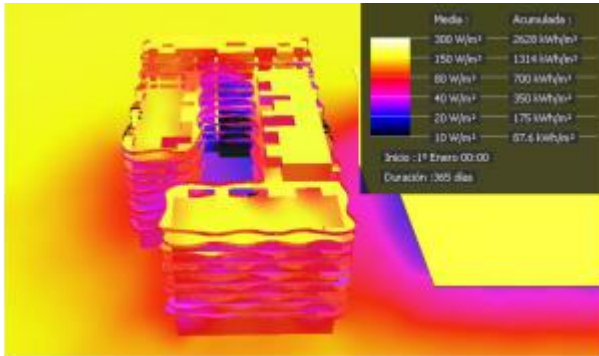

Figure 5: Solar Radiation at the Summer Solstice (source: Archiwizard Analysis)

The building's elongated shape and limited floor depths allow natural daylight to penetrate deeply into the flats (Fig. 6). Every room has access to nearby opening windows in order to permit a current of fresh air from outside the building. Naturally, night-time cooling strategies guarantee an optimum regulation of cooling/heating (Fig. 7).

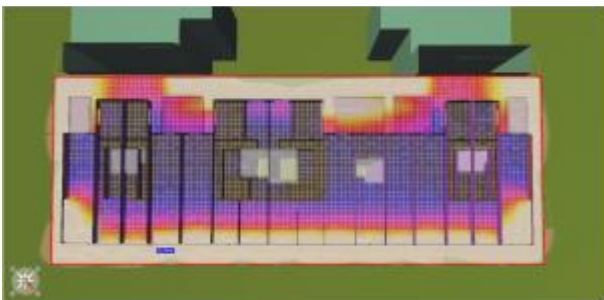

Figure 6: Natural lighting simulation: day.light factor (source: Archiwizard Analysis)

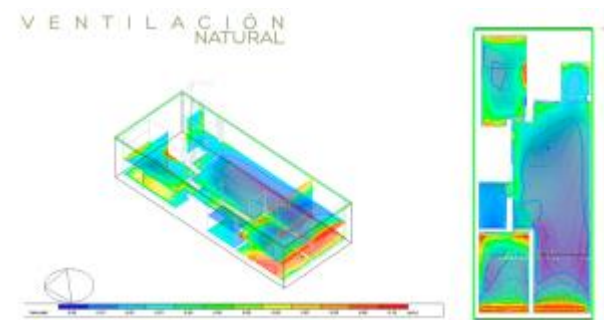

Figure 7: Natural ventilation: indoor air speed (source: Archiwizard Analysis)

## 6. ENERGY EFFICIENCY: ACTIVE TECHNIQUES

Active climate control systems include: 1) Production systems, 2) Means of distribution, 3) Methods of distribution, and 4) Recovery systems. To reduce dependency on sources of fossil fuels, the building will be connected to the local district heating supply system, which produces both heat and cold, using renewable

energy generated by a plant that incinerates urban waste. This system provides a guaranteed supplementary power supply which is needed to achieve thermal comfort and which complements the passive systems and systems for recovering heat and cold (Fig. 8 and Fig. 9).

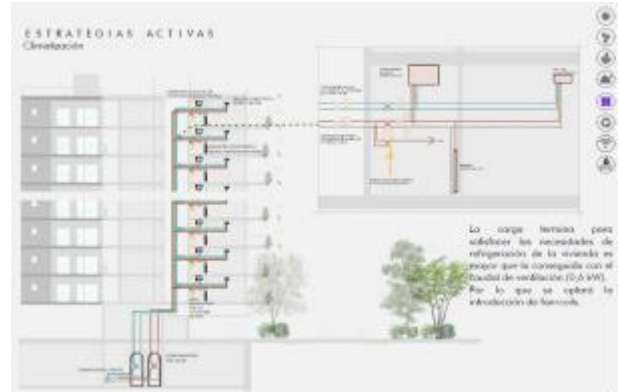

Figure 8: Extra support of an energy supply from the district heating system.

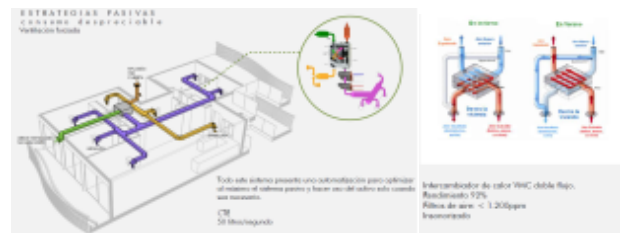

Figure 9: System for recovering heat energy through ventilation with a VCM Heat Exchanger, with a dual flow system and an efficiency level of 92%.

### 6.1. Renewable Energy

Fossil fuels are not renewable as they are based on finite resources that will, eventually, become exhausted. The draft project considered the contribution of the local district heating system to the supply of both hot and cold water. The photovoltaic roof will cover the energy demands of the typical services used in the building.

### 6.2. Results of calculations

As far as the consequences of using passive or active strategies are concerned, In this project after the simulations made with the design builder programme it was shown that it would be possible to reduce its energy consumption by more than 50% in relation to the average consumption of equivalent buildings in Barcelona (Fig. 10).

# PLEA 2018 HONG KONG

Smart and Healthy within the 2-degree Limit

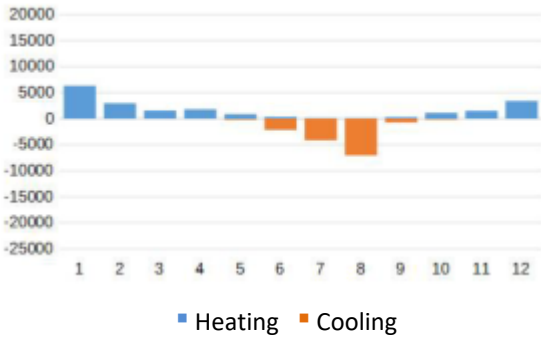

Figure 10: Monthly energy demand expressed in kWh. Heating demand: 12,47kWh/m<sup>2</sup> year. Cooling demand: 10,34kWh/m<sup>2</sup> year.

## 7. SYSTEM OF INFRASTRUCTURES FOR TELECOMMUNICATION CONTROL AND AUTOMATION

For the telecommunications system, it was decided to have a rack on each floor in order to centralise all of the systems for the different flats/rooms. The corresponding wiring would then lead out of each apartment to the different supply, data, Wi-Fi, telephone and security camera connection points. In turn, these racks would be interconnected from flat to flat throughout the building (Fig. 11).



Figure 11: System of Infrastructures for Telecommunication control and automation

### 7.1 Control Systems

Users often inadvertently overuse electrical devices and the effects of this are often significant in terms of energy consumption; as a result, control and regulation systems are of crucial importance (Fig.12).

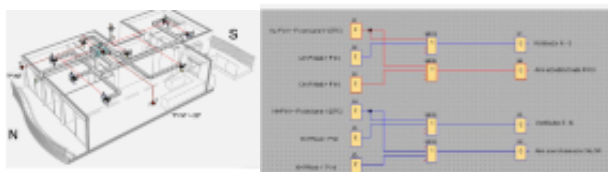

Figure 12: Automation of cooling control

### 7.2 Lighting Systems

Artificial lighting is one of the biggest internal demands. Optimising the design of the building envelope in order to improve the level of natural lighting may help to reduce the demand for indoor lighting. High-efficiency lighting systems, such as LEDs with integrated lighting controls, reduce energy consumption by half in comparison with traditional luminaries. Advanced lighting controls include occupancy sensors and daylight sensors.

## 8. WATER EFFICIENCY AND VEGETATION

Another fundamental component of the building is the water management system. Fresh drinking water is a limited resource and must be treated and reused before it is disposed of via sewers or storm drains. In this case, the project reduced the total demand for potable water by half and complemented the other half with the reuse of grey water and/or rainwater in order to achieve an almost zero net demand for potable water for irrigation. Green roofs on building tops provide pleasant views, serve for relaxing activities and help to mitigate the urban heat island effect. Green roofs can also help to reduce storm water runoff from buildings. In this project, the vegetation was located on the covers and terraces of the apartments. Native species of vegetation typical of Mediterranean climates were used for this purpose. Irrigation was applied using rainwater that had been collected and stored in the same building for this specific purpose.

The UNE-ISO14001 environmental management system was used for the management of waste.

## 9. INTEGRATED SYSTEM DESIGN

In the final NZEB project of the MSc in Architecture & Sustainability: "Design Tools & Environmental Control Techniques" described in this paper, sustainable strategies were implemented via an Integrated Design System. The aggregation process used simultaneously incorporated: climate analysis, passive design and the optimisation of the building envelope, highly efficient building systems, renewable energy sources, control and regulation, the water cycle, waste management and vegetation.

## 10. DISCUSSIONS AND CONCLUSIONS

In current architectural practice, incorporating sustainable strategies should form a key part of the process of designing a building. To achieve this objective, it is necessary to follow an integrated design approach from the very start of the design process. The project presented here was drawn up in line with a specific educational programme that had been taught as part of the Master's Degree course delivered at the UPC's School of Professional & Executive Development. This programme was designed to teach graduates, with first

# PLEA 2018 HONG KONG

*Smart and Healthy within the 2-degree Limit*

degrees in architecture and engineering. the basic concepts and strategies required for sustainable design and particularly those needed for designing NZEBs. The result is presented in this paper in the form of a specific project designed by students. The design of this residential building was conditioned by a previously defined volume set with a precise orientation that had been determined by an earlier Master plan. Even so, the whole planning process was followed.

Briefly stated, the project outlined described a step-by-step pedagogical programme designed to teach basic resource conservation and the main concepts to consider when designing NZEBs. The design process began with the students considering the climatic environment in order to establish the most appropriate design strategies and passive design concepts. Starting from the pre-determined orientation, the interior space was first distributed. The design of the envelope then made it possible to regulate the solar radiation and incorporate vegetation. Materials and technical solutions were efficiently used to obtain the degree of air tightness and insulation required by the passive house principles. The HVAC system consisted of an air renewal system fitted with an exhaust air heat exchanger and supported by the district heating system. Mechanical ventilation with heat recovery is also proposed, but within a holistic vision that simultaneously addresses not only the use of ventilation, but also sun shading, lighting and finishes. However, management by regulation and control systems provided a high degree of thermal comfort. The district system was able to supply additional hot water throughout the year without generating any GHG emissions. In order to produce electricity from a renewable source, a photovoltaic canopy was integrated into the roof of the building. The final simulation of the energy balance carried out using the Design Builder programme enabled us to check that the building met the Nearly-Zero-Energy-Building objectives. The energy demand was reduced to levels below those required of the standard Passive House model for a Mediterranean climate. Under these conditions, a very important percentage of the resulting energy consumption is provided from renewable sources, whether on-site, using photovoltaic panels, or off-site, through district heating. Vegetation was incorporated into the green roof while the facades of the building were used to collect rainwater and to recycle grey water for irrigation. A plan was also established for managing waste in line with ISO 14000 environmental management norms [5]. The use of a comprehensive package of software programmes was also a determining factor, as this made it possible to add greater rigour to the process of passive design and permitted the assessment of energy behaviour within an active system. As in other instruction methodologies for building design [6], when using software tools, the design solutions adopted made a significant contribution to energy

saving. From a pedagogical point of view, perhaps the most effective contribution was the integration of building technology and design into architectural education [7]. As a result of this process, it was made evident that incorporating sustainability into architectural practice should not be an obstacle to design but, instead, should offer an opportunity for greater creativity (Fig.13).



*Figure 13: Render showing the project for a NZE Residential Building in Plaza de las Glorias, Barcelona.*

## ACKNOWLEDGEMENTS

The project was presented with different design phases and was developed under our leadership by Team nº 2. This was formed by MSc students Isabel Castillo, Angela Ponzoa, Itxiar Mendizabal, Amanda Padilla, Astrid Diesel and Jaqueline Memmel.

## REFERENCES

1. All new buildings to be nearly zero energy from 2019 (2012). Retrieved from <http://www.europarl.europa.eu/sides>
2. MSc Architecture & Sustainability: Design Tools and Environmental Control Techniques Retrieved from <http://www.arquitecturaysostenibilidad.com>
3. VOSS, K., SARTORI I., LOLLINI, R., (2012) "Nearly-zero, NetZero and Plus Energy Buildings-How definitions & regulations affect the solutions." REHVA journal- December, p.24, retrieved from <http://task40.lea-shc.org/publications.pdf>
4. Vives-Rego, J., Uson, E., Fumado, J., (2015) Passive Designed Buildings for active citizens became schools of sustainability: a proposal for sustainable architecture. Journal of Green Building, volume 10, number 1, (2015) pp. 85-96.
5. ISO 14000-Environmental management retrieved from <http://www.iso.org/iso14000>.
6. Vassigh, S., Ozer, E., Spiegelhalter, T., (2012). Best Practices in Sustainable Building Design, J. Ross Publishing, Fort Lauderdale, Har/DVD first edition
7. Schlaich, J. (1991). Practices Which Integrate Architecture and Engineering, In Bridging the Gap: Rethinking the Relationship of Architect and Engineer, Webster, A. (Coord. Ed), Van Nostrand Reinhold, New York, p. 122.

## Field-Classroom Interactive Solar Education: The Interactive Satellite Solar Lab (ISSL)

JONG-JIN KIM<sup>1</sup>

<sup>1</sup>University of Michigan, United States of America

**ABSTRACT:** This paper presents a prototype classroom-field interactive teaching and research tool, named *Interactive Satellite Solar Lab* (ISSL) that *transcends the physical boundary of conventional classrooms and expands the venue of teaching and learning to out-of-doors*. Tethered wirelessly to the classroom, the satellite lab empowers students to examine real-time performance of solar systems in real world settings. While experiments are conducted in remote settings by a team of students, their experiments and collected data are communicated instantly to the classroom instructor and students. The visual images and collected data from field experiments are simulcast in the classroom where the instructor and other students are viewing them. The data gathered from the field *are* transmitted to the instructor's and students' PCs or cellular phones. Activities of onsite experiments can be recorded and projected in the classroom. The field team and the classroom students are able to assess field conditions, make decisions, and perform experiments together. The ISSL was developed by a multidisciplinary team of faculty and students in an effort to transform the environmental dimension of architectural education, and to explore and promote a next generation pedagogic paradigm for science and engineering.

**KEYWORDS:** solar energy, action-based learning, field-classroom communication, teaching tool, renewable energy

### 1. INTRODUCTION

Solar energy is one of the most promising energy technologies for enhancing a building's energy sustainability. However, in current architecture education as well as professional practice, solar energy generation is estimated based on solar availability data that were measured at relatively remote airport weather stations, with little or no obstructions, while real buildings are typically shaded by adjacent buildings or vegetation. Consequently, solar energy production from buildings in typical urban settings is often vastly overestimated [1].

Student interest in learning about sustainability, renewable energy technologies is higher than ever. However, their interest in sustainability and motivation to gain hands-on knowledge and technologies dissipates quickly when they are confronted by abstract, concept-dominant modes of learning. Their motivation further diminishes with the realization that they are unable to engage the actual site and the site-specific context, which is essential to solar energy design. Even the high resolution solar radiation data published by NASA are insufficient and unsatisfactory for predicting onsite energy production from solar collectors surrounded and shaded by adjacent buildings and other obstructions [2]. Teaching tools that increase students' hands-on experience in sustainability and the application of renewable energy technology in real physical settings can greatly narrow this gap. Palpable, first-hand, live experience promotes greater curiosity and interest in understanding and designing solar energy systems.

This paper presents a classroom-field interactive teaching and research tool, named *Interactive Satellite Solar Lab* (ISSL). Tethered wirelessly to the classroom, the satellite lab empowers students to examine real-time performance of solar systems in real world settings.

### 2. NEW MODE OF TEACHING AND LEARNING

The ISSL is an action-based learning tool that is used to analyze a building site's potential for solar energy generation from active and passive systems. To design an energy-producing building, architects and engineers need to evaluate three variables: 1) the seasonal and diurnal cycles when direct solar radiation is available on the building site, 2) the intensities of solar radiation, and 3) the energy production from onsite renewable technologies. The ISSL mobile lab is capable of real-time sensing and transmitting of solar radiation and PV system performance data to multiple remote monitoring stations wirelessly. Using this experimental learning tool with a two-way video and audio communication capabilities, students in the field and in the classroom can simultaneously engage in real world problems. Transforming the mode of teaching and of learning from traditional classroom lectures to field actions, and expanding the realm of learning beyond the classroom are the pedagogical underpinning for the development of the Interactive Satellite Solar Lab.

### 3. ASSEMBLY

The ISSL is made up as a kit of three parts: the solar panel frame, the wood platforms, and the table. The solar panel frame is comprised of five 10-Watt solar

# PLEA 2018 HONG KONG

Smart and Healthy within the 2-degree Limit

panels mounted onto an aluminium pipe frame. Internal to the frame is a shelf where electric signal sensing and transmission chips and wiring are organized. The entire frame was designed to be disassembled from the rest of the ISSL, for ease of transport between testing locations. The platform is made of three wooden disks stacked on top of each other. The solar panel frame is attached to the top circular platform, which rotates to simulate different orientations. The bottom disc functions as a shelf to hold PV system components: charge controller, inverter, and battery. Below the wood discs is the table where the laptop and other data collection instruments can be placed.

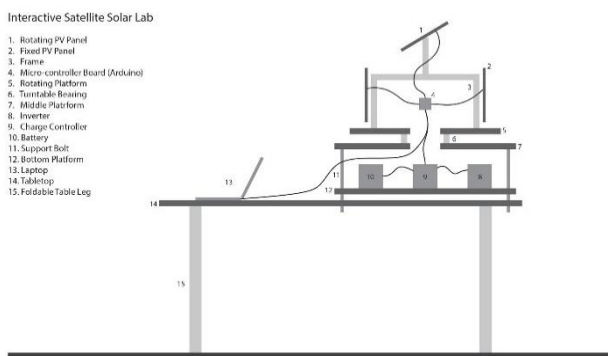

Figure 1: Diagram of the Interactive Satellite Solar Lab.

## 4. DATA COLLECTION AND TRANSMISSION

The ISSL was designed to continuously monitor and transmit solar irradiances and energy production from PV panels. A real-time data transmission system was set up in the station to transmit, manage, and display the collected data. A set of voltage, current, and pyranometer sensors are attached to each of the five solar panels, and send the signals from the sensors to a laptop computer through a USB connection. The laptop computer saves the signal data in a local database server. Using the internet, the data are displayed on a webpage which is published online through an HTTP server. The network connection is provided by a mobile hotspot device. The data collection and transmission software of the ISSL consist of four main programs: 1) Arduino, a C-based control code running in an embedded controller, 2) a Python-based data transmission interface between PC and Arduino, 3) third-party server software and DNS service, and 4) a PHP-based data display webpage. Figure 2 that shows the data communication platform of the ISSL.

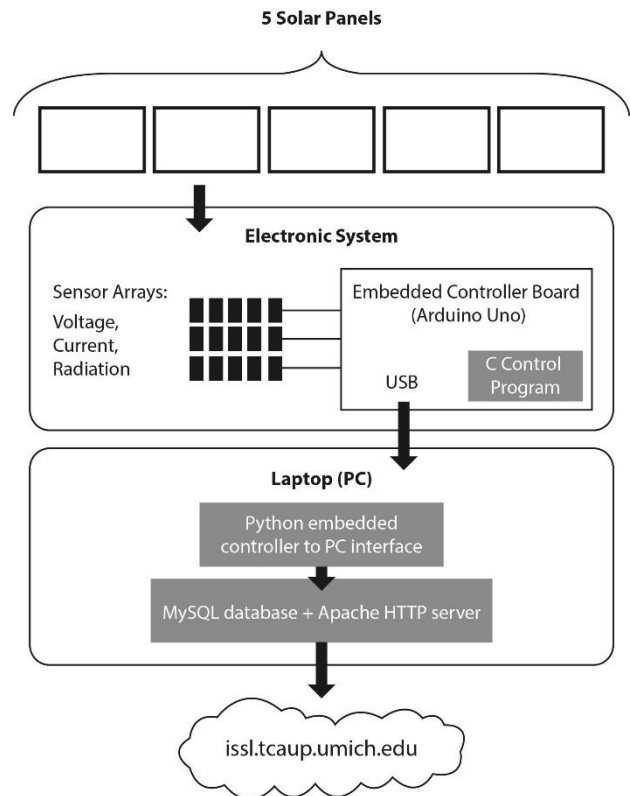

Figure 2: Solar access analysis by overlay of a fisheye image and a sun path diagram.

### 4.1 Embedded micro-controller board

Arduino UNO is used as an embedded micro-controller board to collect the signals from sensors, and to transmit the digitalized solar signals to the laptop. Five sets of voltage and ampere sensors are connected to a multiplexer board, which is wired to 5 analog input pins of the Arduino GPIO port. Arduino contains an onboard six-channel 10-bit analog-to-digital (A/D) converter to interpret the analog signals read from each pin into 10-bit digital data. The communication between Arduino and the laptop is based on USB serial protocol, whose baud rate is 9600 bits per second.

### 4.2 Data transmission from the ISSL to classrooms

The data acquisition laptop at a field test site is connected to the internet wirelessly by “tethering.” A smart-phone can be used for setting up a mobile Wi-Fi hotspot. The video teleconferencing and the transmission of real-time data collected from the field are continuously transmitted to the classroom via the internet. Most cell-phones today have a built-in mobile Wi-Fi function that allows a laptop to connect to the internet. All four major carriers, including AT&T and Verizon, provide this service. A Verizon Jetpack MiFi device serves as a wireless router and provides a Wi-Fi hotspot for the data collection laptop.

# PLEA 2018 HONG KONG

*Smart and Healthy within the 2-degree Limit*

## 4.3 Control codes

The control codes are executed repeatedly in the embedded micro-controller, cycling all five sets of the sensors. The control codes are written in the language of C. In each cycle, the digitized voltage, current, and solar irradiance signals are read from the GPIO port and stored in appropriate data structures. The program converts each measurement signal to a calibrated physical value based on the formula specified in the sensor data-sheets. The calibrated values of a single measurement are combined and encoded into a 95-byte data segment. The segments are then sent to the laptop through the USB connection.

## 4.4 Micro-controller to PC interface

The micro-controller to PC interface program written in Python language runs on the PC. It performs three main functions: 1) allows the laptop to read the data segments from Arduino through USB serial communication; 2) decodes the received data, and 3) saves the data into a local MySQL database. The interface implements the PySerial python module to communicate with the USB data buffer. Each execution cycle reads 95 bytes. The communication between Arduino and the laptop is based on simplex protocol, which allows it to initiate a message only while the laptop acts as a blind receiver. This approach reduces the waiting time in duplex systems, which is desirable in real-time data transmission. It is important to have a mechanism to check the integrity and sequence of data after receiving. Each transmitted data segment is encoded in a consistent 95-byte convention, and each value embedded in the segment uses a unique alphabet. The length and head byte "a" of a received data segment are checked first to verify and further decode each value by detecting which alphabet is used by the segment. With decoded current and voltage values corresponding to each solar panel, the power, a product of current and voltage, is calculated. Before receiving the data, a connection between the python program and the local MySQL database must be established. The MySQL connector python module saves the decoded values into the database after processing.

## 4.5 Database and HTTP server

The database and HTTP server are set up in the local laptop by installing an XAMPP open source package, which contains Apache HTTP server software, MySQL database software, and a PHP compiler. The Apache HTTP server software is an open-source implementation of an HTTP protocol based (web) server [3]. This web server establishes a foundation of data communication between the local system and the internet. Specifically, the local server can map URL requests from a web client, typically a remote browser, to a local resource that handles the request and return a response to the client.

MySQL database software is a cluster of open source codes establishing a relational database management system [4] that uses standard query language (SQL) for data storage and retrieval. The measured data are stored locally in a MySQL database named "python\_mysql." Remote clients' requests are answered by a local server's website displaying the data on the client's computer.

XAMPP provides an integrated development and management environment for Apache and MySQL. It has a graphical control panel for turning each program on or off, and also offers a PHP-based GUI as an alternative for SQL programming for database modification.

## 4.6 Data display on remote devices

The measurement data are presented in a webpage generated by PHP codes at the request of remote clients. Fig. 10 shows the webpage showing all the measurement data. The display refreshes every 3 seconds to load new data.

Panel ID	Name	Voltage (V)	Current (A)	Power (W)	Radiation (W/m <sup>2</sup> )	Efficiency (%)	Capacity (W)
1	South	20.81	0.04	0.83	417.48	0.0336969354464	1.98811919134
2	East	20.07	0.04	0.8	498.05	0.0272248208692	1.60826443128
3	North	20.44	0.02	0.41	173.34	0.0400897227551	2.36529364255
4	West	20.59	0.02	0.41	155.03	0.0448245664863	2.64464942269
5	Top	20.73	0.11	2.28	784.91	0.0492337564773	2.90479163216

Figure 3: Display of measured data in a tabular format.

## 5. TEACHING APPLICATION OF THE ISSL

The analysis of solar energy production potential of a given building site is conducted for two aspects: 1) solar access analysis and 2) directional solar energy availability measurements. The solar access analysis evaluates the time when direct sunlight is accessible or obstructed by surrounding buildings and/or other obstructions at the test site. The directional solar energy availability measurements tests provide both the solar irradiances and energy produced from PV panels on building surfaces facing various orientations.

### 5.1 Solar Access Analysis

A fisheye lens and sun path diagram is employed to conduct the analysis (See Figure 4). After the hemispherical image was produced, the sun path diagram of the test site was overlaid. The overlay of the sun path diagram onto the fisheye image indicates when obstructions affect the solar access of the site throughout the year.

# PLEA 2018 HONG KONG

Smart and Healthy within the 2-degree Limit

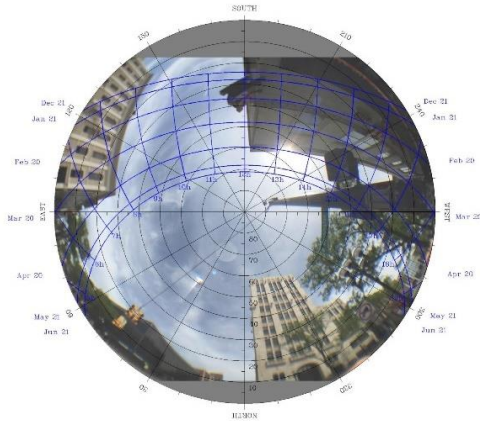

Figure 4: Solar access analysis by overlay of a fisheye image and a sun path diagram.

## 5.2 Field-classroom interaction

The solar lab was used in teaching solar energy to the students in building technology courses. While experiments are conducted in remote sites by a team of students, their actions and collected data were communicated instantly to the classroom instructor and students. The visual images and collected data from field experiments were simulcast in the classroom where the instructor and other students are viewing them. The data gathered from the field are transmitted to the instructor's and students' PCs or cellular phones. Activities of onsite experiments were recorded and projected on the classroom screen (See Figure 5). The field team and the classroom students are able to assess field conditions, make decisions, and perform experiments together interactively.

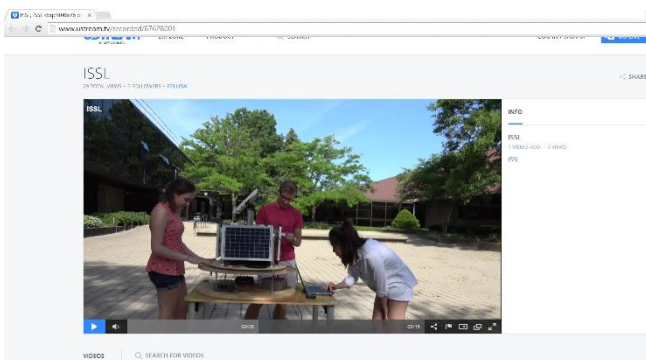

Figure 5: Projection of data collected from a field test on a classroom screen.

## 6. Teaching Effectiveness Evaluation

Teaching effectiveness surveys were conducted. The survey questionnaire consisted of four categories of questions with thirteen five-level Likert scale questions and two comment questions. The four categories of the questionnaire were to assess students' understanding in:

- Principles of solar energy technology
- Building and facade design implication
- Field-classroom communication

- Overall teaching effectiveness

Category 1 questions, Questions 1 to 9, were intended to assess the ISSL's effectiveness in creating understanding of physical principles of solar energy and PV energy production technology. The student response indicates that the ISSL helped them to understand the functions and performance of the components in a PV system. All of the Likert scale questions showed high responses. Student comments revealed that the field experiment increased their interest in solar energy production. Twelve of the thirteen questions received an average response of 4 or higher. The only question with response lower than 4 points was at 3.95.



Figure 6: Projection of data collected from a field test on a classroom screen.

Most of the Likert scale questions showed high responses. Eight of the nine questions received an average response of 4 or higher. The lowest score, 3.95, was reported in Question 7, which asked the students about their understanding of the method of calculating energy conversion efficiency of PV panels. A worksheet to address this issue was developed and will be used in future classes.

Category 2 questions, Questions 10 and 11, were intended to gauge 1) student understanding of the thermal and solar energy impact of climate and physical constraints on buildings and facades and 2) their ability to apply what they have learned from the ISSL to PV integrated building and facade designs. Student responses to Questions 10 and 11 were generally high, 4.1 and 4.2 respectively, but further improvements can and will be made in this category. Exercise problems to address these issues will be developed and used in future field experiments.

Category 3 question, Question 12, asked the students about the effectiveness and usefulness of the communications between the field and classroom. The real-time data, voice and image communications were designed to allow in-class students to be interactively engage with students in the field. The students marked that the two-way communications between the ISSL and

# PLEA 2018 HONG KONG

*Smart and Healthy within the 2-degree Limit*

the classroom created greater interest in the course topic, and increased their propensity to apply what they gained from the field-tests to the designs of their studio projects and future practice. This kind of transfer from technical to design courses is a perennial challenge in architectural pedagogy and of great significance when achieved.

Category 4, Question 13, asked students about the overall teaching effectiveness of the ISSL. This question recorded the highest response average with 4.904, indicating that the students found the ISSL to be very useful as a teaching tool. 90% of students who took the survey responded that they strongly agree with question and the other 10%, somewhat agreed. The students commented that they learned and understood solar energy production technology and methods through student run experiment and how to study the subject on their own. During the in-class demonstration, students stayed engaged and came up with their own questions and inquiries instead of blindly following the instructor's testing procedure.

In response to Question 14 (What are improvements to be made on the ISSL? Please comment), student comments provided valuable insights on specific improvements that could be made in the revision of the ISSL. Responses to Question 14 can be summarized in three main categories: design improvements, capability of multiple readings, and teaching application.

Concerns with physical designs with respect to the structural stability and mobility were raised. This issue was addressed by redesigning the structural base of the ISSL station. Originally three tripod legs were attached to support the upper parts. This caused the upper parts to be unsteady when movement or weight was applied. A new rectangular base-table was designed with four foldable legs and two handles for transport. Bolts on the ISSL secure the PV panel frame and wood platforms housing electrical components into the tabletop.

Students also suggested more variation in the tilt angle. The redesign of the station was made to allow two axis angle adjustment; The top panel can be tilted to any desired direction allowing to examine the effect of orientation on the energy output from a PV panel. The north, south, east, and west panels are fixed in their 90° vertical orientation, but they can be spun to any azimuth orientations.

Next, students asked for the ability to view data from all panels at the same time, including power output, and the panel tilt angle and direction. The new data table on the ISSL website displays real-time voltage, current, power, solar irradiance, and conversion efficiency of each of the five panels. This table organizes all of the five panels' performance next to each other for easy comparison. Additional graphs show volts, amps, wattages, and efficiencies of each of the panels. These graphs show the real-time data from all five panels

simultaneously and the previous several minutes' data. These time series data address student suggestions on understanding historical (continuous?) performance of the solar panels.

Student surveys also revealed their desire for being able to evaluate how different building sites affect PV system performance. This issue can be addressed in two ways: by building multiple ISSLs or by transporting the ISSL within short span of time to different sites. Ideally, having multiple systems at multiple test sites simultaneously is a solution. However, this solution is costly. Therefore, although the simultaneousness is sacrificed, the second alternative is a more practical resolution for the students' interest in comparatively evaluating different sites. Because the ISSL is a compact mobile system, it can be easily moved to the different site areas within reasonably short time.

Students also asked for calculation worksheets to get hands-on experience and understanding of how the system works in the production of solar energy. A worksheet was developed, and will be used in future class instructions and field tests of the ISSL.

Responses to Question 15 give additional insight into what the students learned from the ISSL. The responses showed that, through the ISSL field tests, students gained a better understanding of PV systems as well as new ideas for incorporating solar technology in building enclosures. They indicated their motivation to apply the principles learned from ISSL field tests to their building designs in studio. The ISSL increased not only their understanding of energy producing buildings but also willingness to enhance the sustainability in buildings.

*Table 1: Teaching Evaluation Survey Questionnaire*

No.	Question	Score
1	The interactive satellite solar lab (ISSL) helped me understand the availability of solar radiation on various building orientations.	4.3
2	The ISSL was effective in enhancing my understanding the functions of various components of PV systems.	4.5
3	The ISSL helped me understand the impact of a solar panel's orientation on its energy production.	4.8
4	The ISSL helped me understand the impact of a solar panel's angle of tilt on its energy production.	4.9
5	The ISSL helped me understand the difference between direct solar radiation and diffuse solar radiation.	4.0
6	The ISSL helped me understand the impact of adjacent obstructions (buildings, trees, etc) on onsite solar energy production.	4.0
7	The ISSL helped me understand the energy conversion efficiency of PV panels.	4.0



# PLEA 2018 HONG KONG

*Smart and Healthy within the 2-degree Limit*

8	The ISSL helped me understand how onsite solar production systems should be designed.	4.57
9	I found the experimental and interactive features of the ISSL useful for improving my understanding of the theory underlying solar energy systems.	4.6
10	The ISSL helped me understand the impact of climatic and physical contexts surrounding a building site.	4.6
11	The ISSL helped me create insights on how to design a building and its facade.	4.2
12	The ability of the ISSL for real-time interactive communication was effective at directly engaging me with the material.	4.6
13	Overall, the interactive satellite solar lab (ISSL) is an effective teaching tool.	4.9
14	What are improvements to be made on the ISSL? Please comment.	NA
15	Besides the areas mentioned above, are there other ideas or skills you learned from the ISSL? If so, please identify these here.	NA

## 7. CONCLUSIONS

The teaching effectiveness evaluation revealed that the field-classroom interactive learning was highly effective in motivating student interest in solar energy and in creating understanding on solar energy design. The ISSL can serve as a model to transform the environmental dimension of architectural education, and to explore a next generation education tool for science and engineering. Transforming the mode of teaching and of learning from traditional classroom lectures to field actions, and expanding the realm of learning beyond the classroom were the educational goals in the development of the Interactive Satellite Solar Lab.

## ACKNOWLEDGEMENTS

Funding for this project was provided by the Transforming Learning for a Third Century (TLTC), Third Century Initiative, University of Michigan.

## REFERENCES

1. National Renewable Energy Laboratory, Solar Radiation Data Manual for Buildings, Available: <http://idmp.entpe.fr/> [16 June 2008].
  2. NASA., (2018). Surface Meteorology and Solar Energy, <https://eosweb.larc.nasa.gov/sse/> [16 December 2017].
  3. Apache Group (1995). Apache HTTP Server Project, Available: [https://httpd.apache.org/ABOUT\\_APACHE.html](https://httpd.apache.org/ABOUT_APACHE.html)
  4. SiteGround Web Hosting (2010), What Is MySQL? Available: <https://www.siteground.com/tutorials/php-mysql/mysql.htm>
  5. National Renewable Energy Laboratory, Solar Radiation Data Manual for Buildings, Available: <http://idmp.entpe.fr/> [16 June 2008].
- Renewable Energy Laboratory, Solar Radiation Data Manual for Buildings, Available: <http://idmp.entpe.fr/> [16 June 2008].

## The Environmental Evolution of Urban Housing: Detailed Studies of London Residential Schemes

JORGE RODRÍGUEZ-ÁLVAREZ<sup>1,2</sup>, SIMOS YANNAS<sup>1</sup>

<sup>1</sup>Architectural Association School of Architecture, London, UK

<sup>2</sup>Universidade da Coruña, A Coruña, Spain

*ABSTRACT: This paper reviews sixteen residential schemes that represent the range of urban typologies encountered around London, UK. Fieldwork and detailed analytical studies conducted on each scheme provided insights on environmental performance and the connections between type, architectural design and performance. The study demonstrates the potential for passive design to lead to free-running buildings that do not require conventional space heating while also highlighting an increasing problem with overheating that is affecting smaller, highly insulated dwellings of recent construction.*

*KEYWORDS: Space heating energy, thermal comfort, urban housing typologies*

### 1. INTRODUCTION

In recent years, a number of measures and programmes have been implemented to improve the energy efficiency of British homes. These have included regulatory guidance as well as financial incentives (e.g. Green Deal, Code for Sustainable Homes). However, despite all such efforts domestic energy use keeps increasing year after year (1). It is clear that underlying constraints are preventing more sustainable buildings from becoming standard practice. The hypothesis that inspired the present research is that part of the problem is due to lack of feedback available to architects on the performance of their designs after completion and occupation of their buildings. The research follows building case studies conducted over several years as part of the Environment & Energy Studies Programme at the Architectural Association School of Architecture in London. Some fifty residential schemes were studied around London with the help of over two hundred postgraduate students specialising in the area of sustainable environmental design. The aim of this investigation was to acquire performance feedback from existing buildings, in the form of practical information that can be applied by practitioners toward imaginative adaptation and reuse of buildings and outdoor urban spaces. The results have provided univocal insights on practical aspects that can now inform design decisions for the delivery of more sustainable buildings. This paper presents a summary of the results with the aid of comparative graphics and numerical data.

### 2. METHODOLOGY

The original building studies included on-site visits to conduct personal interviews with inhabitants, designers and facility managers, as well as data collection on key environmental parameters. Fieldwork was followed by calibration and running of computer models (Ecotect,

Radiance, EDSL TAS, Openstudio and Energyplus) aimed at testing current performance and exploration of alternative scenarios and design hypotheses. Measurements, occupancy patterns and simulation results (encompassing daylighting, airflow, and thermal studies) were recorded, mapped and interpreted to illustrate the temporal and spatial variations in the dwellings' environmental performance and how these related to the buildings' architectural features.

#### 2.1 Case study selection

For the present investigation, 16 out of the 50 original cases studies were selected to represent a cross section of London housing schemes under the following groupings (Fig. 1):

**-Modernist Estates.** The residential block was an innovative solution to acute housing shortage in the interwar period and especially after World War II, when the most representative examples were built. Highpoint I (Architect: Tecton, 1935) Hallfield Estate (Architect: Tecton, 1955), Keeling House (Architect: Denys Lasdun, 1958) and Robin Hood Gardens-RHG (Architect: Alison and Peter Smithson, 1972) were selected for this study.

**-Terraced Housing.** The first standardised housing typology built in the city after the great fire of the 17th Century was the Georgian terrace. Notwithstanding variations of the type due to class, time and location it presents many consistent features and solutions. The Victorian terrace is the quintessential housing type of London's great expansion in the 19th Century. Suburban boroughs were colonised and populated mostly with the repetition of a uniform model with minor variations. Recent adaptations of the terrace can be found in Murray Mews (Architect: Foster & Partners, 1966) and the Slip House (Architect: Carl Turner, 2012).

# PLEA 2018 HONG KONG

*Smart and Healthy within the 2-degree Limit*

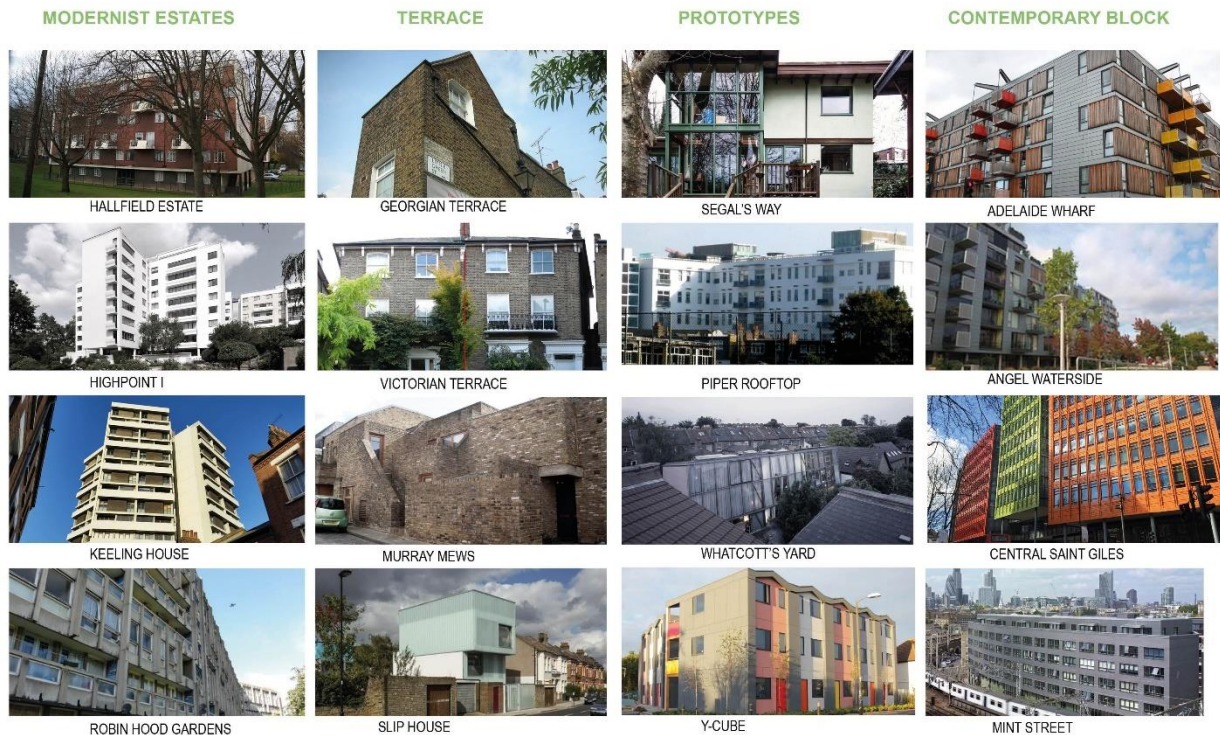

Figure 1: Selected London residential case studies

**-Prototypes.** Housing shortage has been a recurrent issue in London history. A diverse range of solutions have been tested over the years to provide innovative and affordable accommodation. Walter's Way was an original self-built scheme (Architect: Walter Segal, 1977). Piper Rooftop (Architect: Pierre D'Avoine, 2003) involved the addition of two housing pods on the roof of a former British Gas office building. Whatcott's Yard, (Architect: Ullmayer Sylvester Architects, Annalie Riches, Barti Garibaldi, 2004) has three self-built dwellings erected on a leftover backyard space. Finally, the Y-Cube is a modular building designed as accommodation for the homeless (Architect: Rogers Stirk Harbour and Partners, 2015).

**-Contemporary Housing Blocks** had to reverse the negative perception of collective housing, very often associated with deprivation and decay. Recent examples have proved not only that it is possible to create a high quality environment with diverse amenities, but also provide efficient, low energy accommodation in these urban dwellings. The schemes presented here are all award winning projects: Adelaide Wharf (Architect: Allford Hall Monaghan Morris, 2007), Angel Waterside (Architect: Pollard Thomas Edwards, 2008) Central Saint Giles (Architect: Renzo Piano Building Workshop with Fletcher Priest Architects, 2010) and Mint Street (Architect: Pitman Tozer, 2014).

The wide range of designs and constructions (see Table 1) will provide insights about the connection between design, material and performance.

## 2.2 Case study analysis

Each case study was analysed under the following main subjects:

**-Site.** The site analysis assessed the influence of the surrounding urban fabric. Solar and wind analysis, conducted as part of field measurements, were followed by calibrated computational studies.

**-Building Form and Dwelling Layout.** The study of floor plans, sections and elevations was also used in defining geometry and spatial zoning for thermal simulations.

**-Construction.** Building details, elemental specifications and material properties were compiled from architectural documents and verified on site.

**-Environmental Modelling and Performance Assessment.** Spot measurements taken during visits provided a sense of thermal and visual variations between spaces. Datalogger readings over periods of a week or longer revealed the dynamic attributes of the buildings.

Dynamic thermal and daylighting models were applied to all-year simulations evaluating each scheme under different conditions. Measured data, collected during fieldwork, were used to calibrate the computer models. The behaviour of the buildings was tested for typical winter and summer periods. Thermal performance was analysed under free-running conditions (i.e. no mechanical control on indoor temperature) as well as with thermostatic control to predict heating loads. An adaptive model (2) was used to

# PLEA 2018 HONG KONG

*Smart and Healthy within the 2-degree Limit*

define the upper and lower limits of thermal comfort and the set point temperatures.

**-Sustainable design potential.** Finally, a series of measures aimed at improving the buildings' initial environmental performance were modelled and simulated. The results from this parametric exercise are summarised and illustrated below.

### 3. RESULTS

As expected, buildings dating from similar periods shared certain characteristics such as material specifications and constructive solutions. Newer dwellings tended to be smaller and better insulated while older housing was typically larger and characterised by high air infiltration rates as well as higher heat losses by conduction through the building envelope (table 1). Among the buildings discussed in this paper, some of the large older houses had been converted into flats with little spatial modification though serving substantially different occupancy patterns. Some of the smaller dwelling units had also undergone interventions involving changes in their thermal and/or daylighting conditions. For example, the Georgian terraced house was completely renovated, but its walls remain uninsulated. Hallfield, Highpoint and the Keeling House had also been subject to refurbishments for aesthetic or purely reparative purposes. Robin Hood Gardens (RHG) was studied in its original condition; the building is currently being demolished. Some of the other modernist blocks, which were originally designed as affordable solutions for the working classes, are now fashionable icons currently occupied by a diverse range of well-to-do individuals, couples and families (3).

The Window-to-floor (WFR) ratios range between 10% and 50%. There is no firm correlation between this parameter and building form or construction date. However, four out of the six case studies that have WFR values below 20% can be classified as being contemporary "energy conscious" schemes (Adelaide, Angel, Mint and Y-Cube). By contrast, some other recent projects were designed with much larger openings: St Giles (WFR 44%) Piper (WFR 50%) and Whatcotts (WFR 42%).

The Heat Loss Coefficient (sum of heat loss by conduction through the external building envelope expressed per square metre of occupied floor area) values were found to range from 0.32 W/m<sup>2</sup>K for Angel Waterside to 4.19 W/m<sup>2</sup>K for Highpoint. The very high value for the latter is due to its uninsulated concrete external walls and large single glazed windows. By contrast, most recent schemes (Adelaide, Mint, and Angel Waterside) feature improved glazing and frames on windows and incorporate 20cm or more of thermal insulation in external walls. They result in window U-values below 2.0 W/m<sup>2</sup>K and external wall U-values

below 0.15 W/m<sup>2</sup>K yielding HLC values around 0.35 W/K per m<sup>2</sup> dwelling floor area.

Heat loss by air exchange is associated with unintended infiltration on the one hand, and on the other, with the necessary provision of fresh air to occupants to ensure indoor air quality. Due to the impracticality of conducting blower door tests on all the case studies, starting values for infiltration and ventilation were assumed as reported in the literature and were subsequently refined in the process of model calibration. As expected, contemporary housing schemes, which are tested for airtightness, featured values around 0.4 W/m<sup>2</sup>K whereas older buildings had considerably higher infiltration rates. Whatcotts Yard, a self-built scheme which features a large open volume, experienced very high infiltration rates.

The field studies reported here were conducted on different years but always during late autumn. They provided essential data for model calibration and for the assumption of realistic operational scenarios.

*Table 1: Summary of thermal properties and performance of the 16 case studies. Area: total dwelling floor area (m<sup>2</sup>). WFR: Window to floor ratio (%). HLC: Conductive Heat Loss Coefficient (W/m<sup>2</sup>K). VLC: Ventilation Loss Coefficient (W/m<sup>2</sup>K). HL: Space Heating Load (kWh/m<sup>2</sup> per year). OR: Overheating risk (% of hours of the year above the upper limit of the adaptive thermal comfort band assumed at 28°C). In bold the cases discussed in the next sections.*

Case	Area	WFR	HLC	HLC+VLC	HL	OR
<i>Hallfield</i>	74	10	3.40	4.37	119	0.56
<b>Highpoint</b>	<b>113</b>	<b>24</b>	<b>4.19</b>	<b>5.16</b>	<b>168</b>	<b>1.63</b>
<i>Keeling</i>	93	22	2.67	3.36	75	0.24
<b>RHG</b>	<b>72</b>	<b>29</b>	<b>2.56</b>	<b>3.93</b>	<b>157</b>	<b>1.92</b>
<b>Adelaide</b>	<b>85</b>	<b>13</b>	<b>0.36</b>	<b>1.01</b>	<b>2</b>	<b>24.00</b>
<i>Angel</i>	72	15	0.32	0.79	6	3.60
<i>Mint</i>	68	18	0.36	0.82	7	12.75
<b>St Giles</b>	<b>57</b>	<b>44</b>	<b>1.25</b>	<b>1.64</b>	<b>27</b>	<b>5.53</b>
<i>Y Cube</i>	27	19	0.47	1.12	8	4.93
<i>Piper</i>	158	50	3.42	3.95	56	4.50
<i>Whatcotts</i>	114	42	1.57	4.76	191	0.65
<i>Walter's</i>	149	35	3.05	3.87	106	4.43
<i>Murray</i>	170	35	3.95	4.62	174	0.30
<i>Slip</i>	175	32	0.87	1.25	27	2.10
<i>Georgian</i>	184	22	3.09	3.68	111	1.04
<b>Victorian</b>	<b>216</b>	<b>18</b>	<b>3.12</b>	<b>3.84</b>	<b>118</b>	<b>0.21</b>

### 3.1 Daylight studies

A comparative daylighting analysis was conducted across the selected case studies. Daylight Factors (DF) were calculated and compared for living rooms and kitchens. A comparison was also drawn between observed and calculated DF values (Fig. 2). Values for the former were extracted from the field studies. Calculated DF were obtained from simulations performed with Radiance and Honeybee.

# PLEA 2018 HONG KONG

## Smart and Healthy within the 2-degree Limit

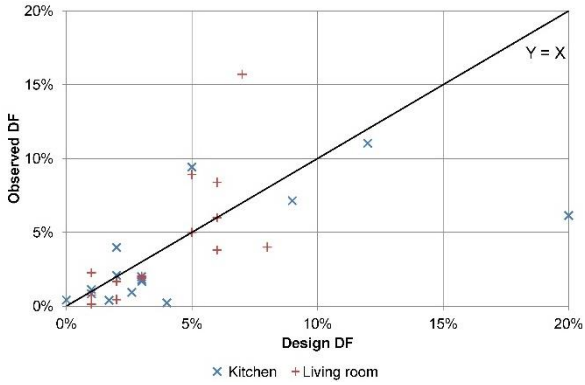

Figure 2: Scatter plot showing Design Values DF vs. Observed DF in kitchens and living rooms of the sixteen case studies

The analysis revealed a discrepancy between estimated and observed daylight performance. In most cases the actual DF tends to be lower than the design value. This difference can be mostly attributed to the use of curtains and other measures taken by occupants for solar protection and/or privacy. This was most evident at Robin Hood Gardens, where large windows facing toward the external corridors were kept covered with curtains at all times. The average observed DF was 3.3% in the kitchens and 4.1% in the living rooms; whereas the average design DF was 4.4% and 6% respectively (Fig. 3). The highest observed values were found at Central Saint Giles (15%) and the Slip House (11%). The most dramatic difference between observed and measured was encountered at Murray Mews, where a large rooflight was obscured with blinds reducing the mean DF from 35% to less than 1%.

### 3.2 Thermal studies

The thermal performance of every scheme was monitored with spot measurements and dataloggers. The former highlighted spatial variations of air and surface temperatures while the latter provided records of the daily cycles of air temperature and relative humidity. In some of the buildings, heating systems were operated during the site visits, as part of arrangement with occupants to follow their daily routines as usual (Fig. 4).

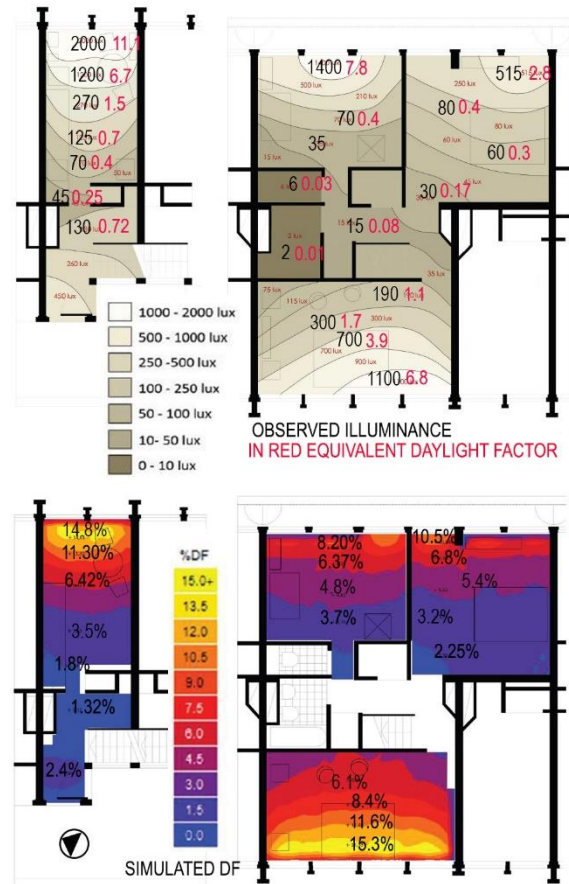

Figure 3: Robin Hood Gardens. Top: Indoor illuminance spot measurements taken on 16<sup>th</sup> October 2010 at 12:00. Outdoor Illuminance: 18000Lux. Intermediate sky. Bottom: Daylight Factors from Radiance simulation (4)

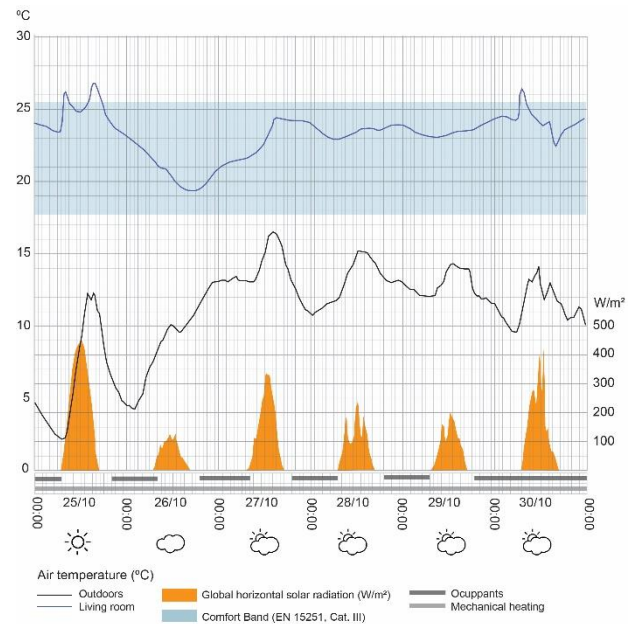

Figure 4: Datalogger results from Highpoint I. The dwelling was monitored during October 2010. The heating system was in intermittent operation (after 5).

# PLEA 2018 HONG KONG

*Smart and Healthy within the 2-degree Limit*

Other dwellings reached high enough indoor temperatures for comfort without needing to use the heating system during the monitored period. In some cases, occupants had simply adapted to lower indoor temperatures wearing heavier clothing. An example of this was the Keeling House, where temperatures were continuously below 17°C. At the opposite end, living room temperatures above 23°C were observed at the Angel Waterside, Adelaide Wharf, Central St Giles and Mint Street schemes without use of conventional heating while outdoor temperature varied between 7 and 10°C.

In order to extend the analysis to the whole year, the thermal models were run in OpenStudio and Energyplus for all the selected cases. Each case was simulated under the same weather data (London Gatwick station) but with their own operational characteristics. Figure 5 illustrates simulation results for a typical winter week for four of the schemes (Adelaide Wharf, Central St Giles, Highpoint and Victorian) operating as free-running. These four schemes are representative of the four categories described in section 2. The figure compares the simulated operative temperature in the living rooms of the four schemes, The Highpoint dwelling, which has the highest HLC is shown to be penalised by its poor thermal properties being unable to achieve a meaningful temperature rise above the outdoor. By contrast, the simulation results for the Adelaide Wharf living room show a very regular temperature with mild daily fluctuation rising to fairly warm levels without mechanical heating in mid-winter. According to interviews with the occupants, the heating system is used very rarely in this scheme.

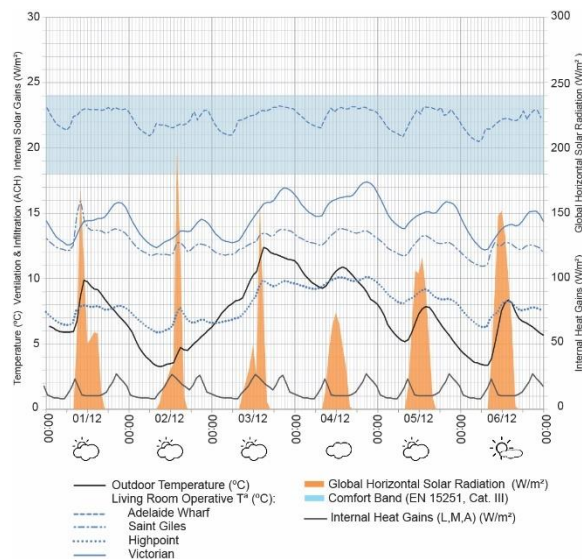

Figure 5: Thermal simulation results comparing living room operative temperatures under free-running conditions for four of the selected schemes over a typical winter week.

The differences between these four schemes were smaller on the typical summer week (Figure 6) with

fluctuations occurring mostly within the thermal comfort band. In order to portray a realistic operational scenario for the summer period, the natural ventilation regime was increased when internal temperatures reached the upper limit of the comfort band. This was adapted to the opening characteristics of the dwellings (single or cross ventilation). On schemes completed before the year 2000, additional ventilation was not necessary as the indoor temperatures barely rose to the overheating threshold. By contrast, the compact and highly insulated dwellings of recent construction struggle to dissipate excess heat. This is illustrated by Adelaide Wharf (Fig. 6) where single aspect layout precludes higher air exchange rates.

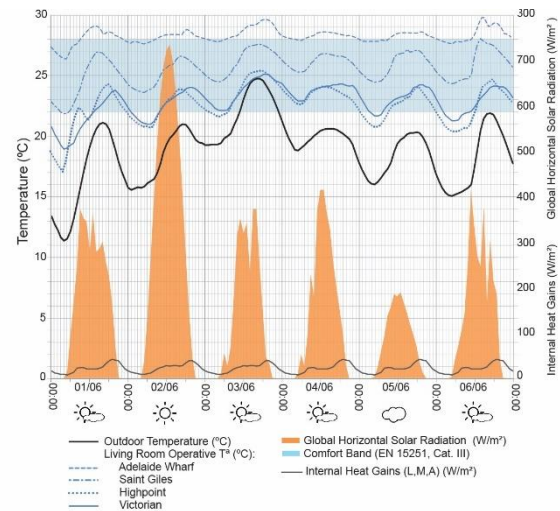

Figure 6: Thermal simulation results comparing living room operative temperatures under free-running conditions for four of the selected schemes over a typical summer week.

### 3.3 Performance Studies

The final stage of the research was aimed at identifying potential improvements for each of the housing typologies considered, presenting the results in the form of environmental performance indicators encompassing heating loads and overheating hours. Annual heating loads were obtained from thermal simulations performed with heating setpoint temperatures derived from the adaptive comfort model (2) and input into OpenStudio/Energyplus. The overheating risk was determined as the percentage of hours over the year that the indoor temperatures were predicted to rise above the upper comfort limit. A higher air exchange rate was assumed for heat dissipation and summertime cooling. The results are summarized in table 1.

As expected there is a strong correlation between the dwellings' HLC and their space heating loads. The highest estimated heating load was for Whatcotts Yard (191 kWh/m<sup>2</sup> per year), followed by Murray Mews (174 kWh/m<sup>2</sup>). Both these buildings have highly exposed envelopes and large glazing areas. In addition, the former

# PLEA 2018 HONG KONG

Smart and Healthy within the 2-degree Limit

was self-built and has been observed to experience high air infiltration rates. The lowest heat demands correspond to the most recent buildings: Adelaide Wharf, Angel Waterside, Mint and the Y-Cube. On these buildings use of conventional space heating has been negligible.

The environmental improvements considered included:

- Addition of thermal insulation to external walls (50mm and 100mm) and roofs (100mm). T

- Window upgrades. Single glazed windows upgraded to low-emissivity double glazing; new frames assumed to reduce air infiltration. Glazing over balconies tested on the Hallfield, Highpoint and Piper case studies.

- Night Shutters. Applied internally on windows to reduce night-time winter heat losses.

- Solar control. External blinds and overhangs were tested to reduce solar gains.

- Increased night-time ventilation tested in combination with higher thermal inertia on cases with the highest overheating risk.

- Lower ventilation threshold. Instead of applying natural ventilation whenever indoor temperature reaches the limit of comfort, it is applied 3 degrees below that limit, thus making it more effective.

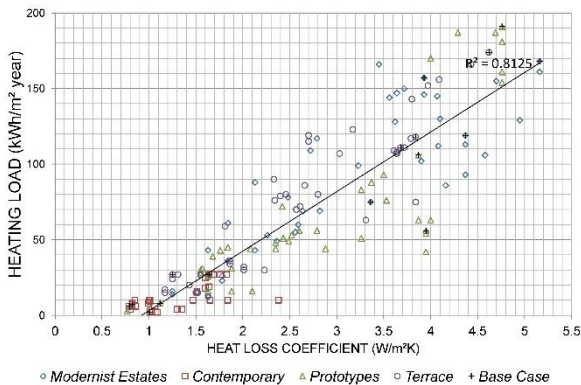

Figure 7: Scatter plot showing the relationship between HLC and Heating Load for all case studies.

The effects of all these measures on space heating loads and hours of overheating are plotted on figures 7 and 8 as a function of the respective heat loss coefficient HLC, showing the strong effect that the latter exerts on thermal performance. HLC values of 1.0W/m²K or less suggest that the building can be potentially free-running all-year (Fig.7). At the same time it can be seen that values of HLC below 1.5W/m²K lead to exponential increase in overheating risk (Fig. 8). Clearly, designers should consider adaptive measures by which the HLC, and especially the VLC, of dwellings can be varied by occupants at different times of the day and year. In this respect, it is interesting to note on Fig. 7 that although there is a clear correlation between HLC and heating load, there are other factors, such as solar and casual

gains that influence thermal performance so that a higher HLC does not necessarily imply a higher heating load.

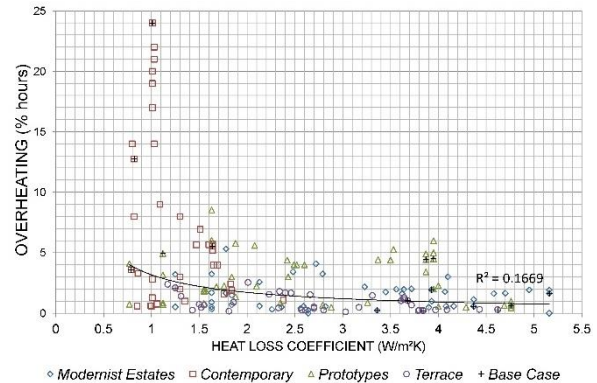

Figure 8: Scatter plot showing the relationship between HLC and overheating for all case studies (the cross indicates base case)

## 4. CONCLUSION

This paper summarised findings of an extensive study of the environmental performance of London housing encompassing a wide range of the city's characteristic urban typologies. The buildings were analysed and monitored to realistically define and describe their daylight and thermal performance. The potential for free-running thermal performance was demonstrated with data from measurements as well as simulations. A surprising finding is the increasing risk of overheating that appears to become endemic, even during winter months, owing to highly insulated envelopes stipulated by Regulations, and the nature of contemporary dwelling design following current socioeconomic trends.

## ACKNOWLEDGEMENTS

The paper is based on research conducted over the last decade for the MArch/MSc in Sustainable Environmental Design at the Architectural Association School of Architecture, London. Part of the study was supported by a RIBA Research Trust Award.

## REFERENCES

1. Palmer, J., & Cooper, I. (2013). *United Kingdom housing energy fact file 2013*. Department of Energy & Climate Change
2. Brager, G. S., & De Dear, R. J. (1998). Thermal adaptation in the built environment: a literature review. *Energy and Buildings*, 27(1), 83-96.
3. Orazi, S. (2015) *Modernist Estates. The buildings and the people who live in them*. Frances Lincoln Adult
4. Calleja, H. Czech, N. Hepner, A. & A. Tziastoudi (2011) Robin Hood Gardens. Term 1 Building Study. MArch/MSc Sustainable Environmental Design. Architectural Association School of Architecture. London
5. Bryan, D.N. Cala, S. Rizkallah, M. Vlachos, E. (2011) Highpoint I. Term 1 Building Study. MArch/MSc Sustainable Environmental Design. Architectural Association School of Architecture School of Architecture. London

## Daylighting Education in Practice

### Verification of a New Goal within a European Knowledge Investigation

FEDERICA GIULIANI<sup>1</sup>, NATALIA SOKOL<sup>2</sup>, VALERIO R.M. LO VERSO<sup>3</sup>,  
FEDERICA CAFFARO<sup>4</sup>, AICHA DIAKITE<sup>5</sup>, RAQUEL VIULA<sup>6</sup>, BERNARD PAULE<sup>7</sup>

<sup>1</sup>Faculty of Architecture, Sapienza University of Rome, Rome, Italy

<sup>2</sup>Faculty of Architecture, Gdansk University of Technology, Gdansk, Poland

<sup>3</sup>Department of Energy, Polytechnic of Turin, TEBE Research Group, Turin, Italy

<sup>4</sup>Department of Life Sciences and Systems Biology, University of Turin, Turin, Italy

<sup>5</sup>Department of Lighting Technology, Technische Universität Berlin, Germany

<sup>6</sup>Delft Technical University, Delft, The Netherlands

<sup>7</sup>Estia SA, Lausanne, Switzerland

*ABSTRACT: Two independent surveys were conducted in 2017 and in 2018 among architecture students across Europe to investigate their knowledge on daylighting and the impact of that knowledge on the visual perception of daylit spaces. A total of 600 responders were involved. This paper presents findings from the second survey, which was distributed in six European countries. Based on the findings from the first survey, a new goal was set for the second survey: to examine how daylighting knowledge may influence the visual perception of it and how the perception of a daylit space by a student population and by experts compare to each other. Three main findings were observed: i) the perceived comfort shows a better agreement with mood than with sky condition; ii) the judgments expressed by the experts and by non-experts are consistent with each other, confirming an outcome of the earlier study and iii) there is a lack of knowledge about daylighting metrics and regulations as well as a difficulty in implementing daylighting into the design process. These outcomes highlight the relevance of reconsidering the way daylighting education is delivered in current architectural programmes.*

*KEYWORDS: Survey among students; Experts vs. Non-Expert; Knowledge on daylighting, Perception of daylit spaces; European education.*

#### 1. BACKGROUND

Daylight is widely considered as a strategic resource towards a human-centred and energy efficient approach to the design of the built environment. Linked to both visual performance and comfort, daylight fosters attentiveness, interaction and communication. It stimulates mood and well-being via image forming and non-image forming processes and given its impact on the human circadian rhythm, is it also regarded as an important resource for the creation of healthy indoor environments. Often regarded as a design driver [1], daylighting can also lead to optimal solutions regarding form, function and usage of technology in building design [2]. The importance of rethinking the role of daylighting in building regulations and practice is furthermore demonstrated by the work of the Comité Européen de Normalisation (CEN) (Technical Committee CEN/TC 169) on the new European Standard on *Daylight of Buildings* [3, 4].

However, despite all the benefits, many building practitioners are still unable to optimise daylighting in their projects. According to a study by the International Energy Agency (IEA) [5], the practical application of the latest daylighting assessment methods and metrics remains quite limited. There is a tendency to rely on

simplified calculations, experience, and rules-of-thumb in the early design stages [6, 7].

Within this context, this paper presents a selection of the results from DAYKE (DAYlighting Knowledge in Europe), a project aimed at exploring the knowledge on daylighting and its impact on the visual perception of spaces. Two independent surveys were conducted in 2017 and in 2018 among architecture students, 600 participants in total. This paper focuses on how daylighting knowledge of architecture students is manifested:

- (a) by the perception of the daylighting conditions in their classrooms;
- (b) in their education and implementation in the design process.

#### 2. THE DAYKE PROJECT

The motivation behind DAYKE is a belief that a better awareness of daylighting should result in smarter and healthier buildings. Based on that, DAYKE investigates the current level of daylighting knowledge among students and practitioners of architecture across Europe.

The DAYKE framework is composed of six areas of investigation. There are three main areas: i) perception of the daylit space; ii) knowledge about daylighting



# PLEA 2018 HONG KONG

*Smart and Healthy within the 2-degree Limit*

standards and regulations and iii) preferences; and three secondary areas: iv) educational offer; v) professional training and vi) cultural aspects.

Overall, DAYKE is meant to provide an-overview of the daylighting knowledge and training to all building sector stakeholders in Europe.

## 2.1 The DAYKE toolkit

According to the conceptual design of the research, a set of tools was created to investigate selected topics at different stages. These tools have specific goals and target different categories of respondents:

- **Stage 1:** Questionnaires A (Q-A and later Q-AR) targeted architecture students. They were designed to assess students' ability to observe and describe daylight conditions in a given space (*perception*). The questionnaires also investigated cultural preferences and knowledge about daylight metrics/indicators and regulations.
- **Stage 2:** Questionnaire B (Q-B) will be directed to university students and practitioners. The goal will be to evaluate the daylighting preferences and corresponding design practice.
- **Stage 3:** Questionnaire C (Q-C) will aim at evaluating the daylight educational programmes and training courses across Europe.

## 3. FIRST STAGE: ARCHITECTURE STUDENTS' DAYLIGHT PERCEPTION AND KNOWLEDGE

Stage 1 consists of two different surveys carried out in 2017 and 2018. The first survey, which used questionnaire A (Q-A), was a pilot study and involved 250 people from architecture schools in five countries (Germany, Italy, The Netherlands, Poland and Spain). The method and the main results were presented in detail in [8].

The second survey, which used a revised version of questionnaire A (Q-AR), is run in two sessions: spring and fall 2018. Nine countries are involved (Denmark, France, Germany, Italy, The Netherlands, Poland, Spain, Switzerland and the United Kingdom) with approximately 1000 subjects.

This paper presents the results of Q-AR from the spring session, with 350 people of seven schools of architecture from six countries (France, Germany, Italy, The Netherlands, Poland, Switzerland).

### 3.1 Survey Q-A: a preliminary study

The first survey was as a preliminary enquiry to confirm literature findings and to test the research protocols. The Q-A covered three areas of investigation: i) *perception*; ii) *preferences* and iii) *knowledge* (Fig. 1). The *perception* evaluation was based on a benchmark method that compares the judgments of "experts" (lecturers, PhD students and professionals) and "non-experts" (students) [9]. The investigation on *perception*

relied on 5-point scales whereas open or multiple answers questions were used to investigate *preferences* and *knowledge*. Illuminance values were also measured during the questionnaire to investigate potential correlations with the subjective judgments.

The first outcomes of the survey were presented in [8] while the complete results of the Q-A survey are the subject of a future publication. As a summary, four major tendencies have emerged from the analysis of Q-A:

**T1.** Significant differences of knowledge per country were observed regarding the daylighting design know-how, preferences and expectations. Students from different countries also paid a different degree of attention to distinct aspects of daylighting design. However, no major differences in subjective preferences on daylighting were found between southern and northern countries.

**T2.** There were no substantial differences regarding the perception of the daylight quality of the classrooms between students and experts.

**T3.** A distinctive influence of the educational programme on the students' responses was found.

**T4.** Most of respondents had no knowledge about daylight standards and regulations.

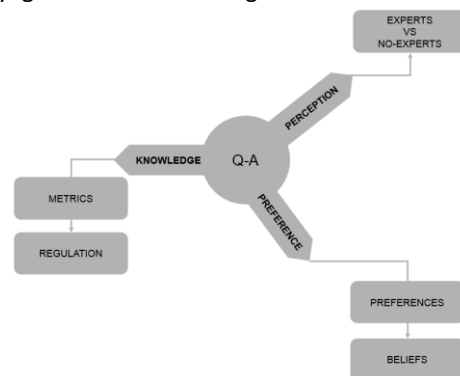

Figure 1: Areas investigated in Q-A.

### 3.2 Q-AR survey: a targeted study

Based on the experience gained from the first survey, the questionnaire was revised to improve its effectiveness and interpretation as well as to expand the areas of investigation. In this way, Q-A served as an instrument to understand the main tendencies, while the Q-AR served to verify research goals derived from Q-A.

### Evolution from Q-A to Q-AR

The main strengths of Q-A turned out to be: i) the simplicity of the tool; ii) a great interest and response from architecture tutors and iii) the cross-national character of the research. On the other hand, the weaknesses were: i) problems with data collection and cataloguing of open answers; ii) the rudimentary in-situ measurement method and the difficulty in using illuminance data for non-homogeneous sky conditions

# PLEA 2018 HONG KONG

Smart and Healthy within the 2-degree Limit

and iii) the generic character of the questions on preferences.

To improve the procedure, Q-AR was amended in: i) use of simpler and more effective data collection procedure, including a limited use of open answers; ii) introduction of respondents' subjective appraisals to describe the daylighting in a space (e.g. daylight quantity, view to the outside, position in relation to the windows) in replacement of measures; iii) more in-depth questions on cultural issues, daylighting tools and educational training.

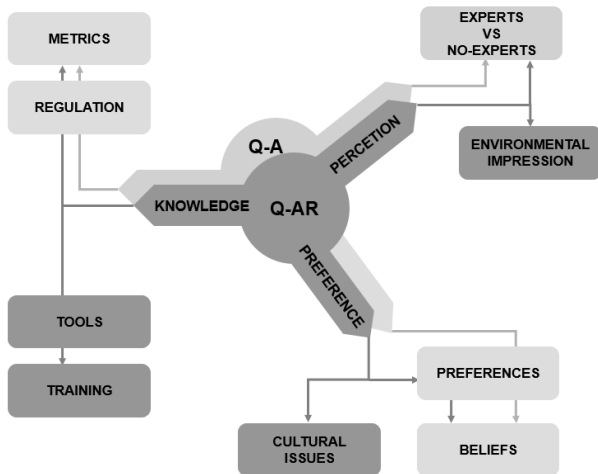

Figure 2: Expansion of the investigation areas from Q-A (light grey) to Q-AR (dark grey).

## Definition of a new research goal

A new research objective was defined based on trends T2 and T4 from Q-A (see 3.1). Given the complexity of T1 and T3 findings, their analysis will be the subject of a dedicated publication.

According to T2, there was not a noticeable difference in daylighting perception between the experts and non-experts. The level of daylighting knowledge (trend T4) was low among the non-expert respondents. It hence appears that the perception of daylighting is not influenced by knowledge on the subject. To investigate this issue further, the following main changes were implemented in Q-AR (Fig. 2).

- The *perception* section was extended with a new part called *environmental impression*, to obtain subjective information about the weather, users' comfort within the space, perceived environmental comfort and occupants' mood.
- New questions about educational programmes and training were added in the *preferences* and *knowledge* sections.

## Structure of Q-AR

The new questionnaire Q-AR follows the structure of Q-A's with three sections but introduces the revised

content and different assessment scales (Fig. 2). The additions are:

- *Perception*: a set of multiple choice answers (*environmental impression*) and a list of 5-point unipolar and bipolar scales (*daylight perception*). The 5-point scale was used to assess participants' mood, impressions about the weather, location and daylight conditions in the classroom, e.g. «The daylight control by shading system is: (1) very low to (5) very high» or «Obstructions out of the windows are: (1) absent to (5) very high. This section was filled out simultaneously by experts and non-experts.
- *Preference*: sets of multiple answers designed to investigate preferences, beliefs and cultural issues.
- *Knowledge*: sets of multiple answers designed to investigate the knowledge on metrics and standards, and the use of design tools and regulations.

The participants' socio-demographic and daylighting education information are also collected.

## 4. Q-AR RESULTS FROM THE SPRING SESSION

The questionnaire was filled by undergraduate and graduate students during their lectures, through an online platform. Consistently with the new research goal (see 3.2), the data regarding the relationship between *perception* and *knowledge* was analysed using descriptive statistics.

### 4.1 Perception I: Environmental impression

This section aims at understanding how daylight/sky conditions and respondents' proximity to the windows may influence their general impression of a space as well as their mood.

#### Weather and mood

The analyses showed that higher scores of perceived comfort (visual and thermal) corresponded to sunny sky conditions (Fig. 3). However, this trend does not seem to match a similar growth of good mood (*positive* and *very positive*) (Fig.4).

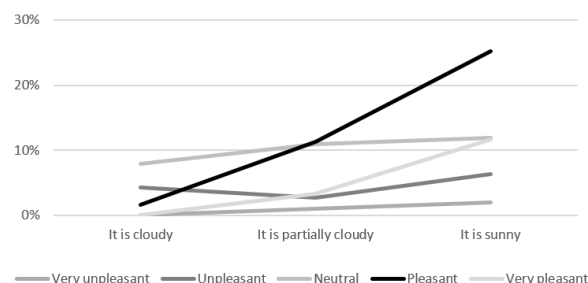

Figure 3: Comparison between weather (Question: «What is the weather like?») and comfort («For your comfort related to daylighting (visual and thermal), how do you describe the weather?»).

# PLEA 2018 HONG KONG

## Smart and Healthy within the 2-degree Limit

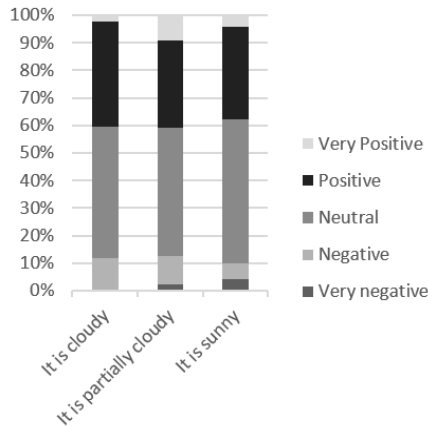

Figure 4: Comparison between weather conditions (Question as in Fig.3) and mood («Please describe your current mood»).

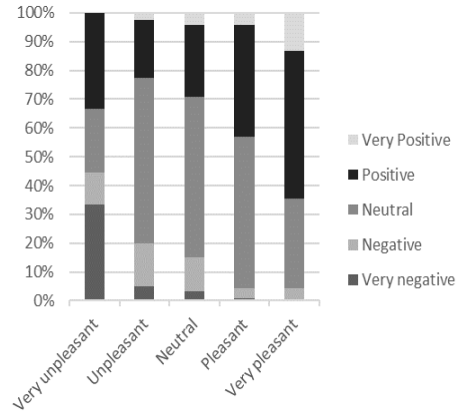

Figure 6: Comparison between comfort and mood (questions are reported in captions of previous figures).

### Comfort and position within the space

A change of comfort related to the users' sitting position in relation to the windows was noted (Fig. 5). The main findings were:

- the respondents who expressed higher comfort (from *neutral* to *very pleasant*) were close to the windows (*neither near, neither far or close*).
- more than 1/3 of students who were sitting *far away* from the windows described their comfort as *unpleasant*.

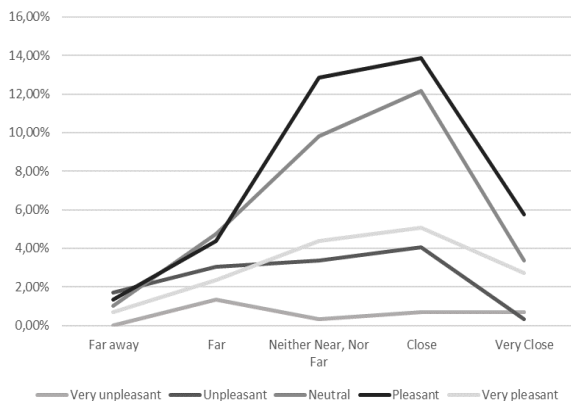

Figure 5: Comparison between comfort (question as in Fig. 3) and position in relation to the windows («What is your position in relation to the window/s?»).

### Comfort and mood in relation to the weather

The data analysis highlighted two main tendencies (Fig. 6). The findings were:

- almost half (45%) of the respondents who reported a condition of *unpleasant comfort*, have simultaneously declared a *negative* or *very negative mood*;
- more than 2/3 of the respondents that reported *very pleasant* comfort, have simultaneously declared a *positive* or *very positive* mood.

### Sitting position and mood

By cross-examining the data on position and mood, the following trends were observed (Fig. 7):

- more than 1/3 of the respondents who were sitting *far away* from the windows reported *negative* or *very negative mood*;
- almost 1/2 of the respondents who were sitting in a *very close* position to the windows declared a *positive* or a *very positive mood*;
- the lowest scores on mood (*negative* or *very negative*) were reported by respondents who were sitting close to the windows;
- there was not a single (*very*) *negative* mood for positions *very close* to the windows.

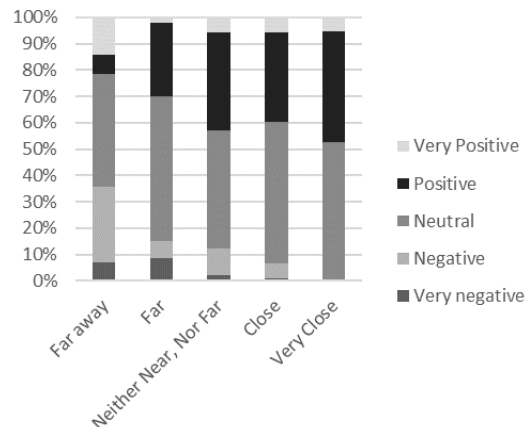

Figure 7: Comparison between position and mood (questions as in previous figures).

### 4.2 Perception II: Experts versus Non-Experts

For the explicit investigation of the objective defined for QA-R (see 3.2), four macro-categories concerning key aspects of daylighting were defined: i) amount of daylight, ii) quality of daylighting, iii) quality of the view out and iv) quality of windows. Each category includes several sub-topics, or indicators as shown in Fig. 8.

# PLEA 2018 HONG KONG

Smart and Healthy within the 2-degree Limit

## QUANTITY OF DAYLIGHT

1. Quantity
2. Number of windows
3. Glazed area
4. Dark zones
5. Glazing cleanliness

## QUALITY OF DAYLIGHTING

1. Pleasantness of the overall daylight
2. Contribution of daylight to create a stimulating environment
3. Concentration due to the overall daylight
4. Overall comfort due to daylight

## QUALITY OF THE VIEW OUT

1. Obstructions out of the windows
2. Distractions due to the view out
3. Pleasantness of the view out

## QUALITY OF WINDOWS

1. Daylight control by shading system
2. Shading system maintenance
3. Glazing cleanliness

Figure 8: The selected macro-categories to analyse the Q-AR research goal in perception II section.

The judgments expressed by non-experts and experts were found to be in good agreement with regard to the *quantity of daylight*, *quality of the windows* and *quality of view out* (fig. 9a-9c). However, the *quality of daylighting* was judged as being higher by the non-experts than by the experts, for all the investigated indicators (Fig. 9d).

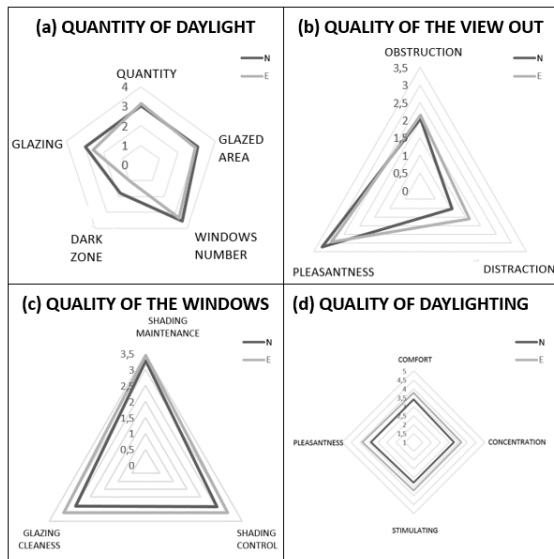

Figure 9: Comparison between experts (E) and non-experts (N) on: quantity of daylight (a); quality of the view out (b); quality of the windows (c); quality of daylighting (d).

### 4.3 Knowledge and Training

Although over half of the students declared to know one or more daylighting metrics or indicators, only 1/5 of them used such metrics in their projects. The number of students who reported to use computer software for daylighting modelling and calculation was greater (1/4) than those who worked on a project that involved daylighting assessment (Table 1). Only 10% of respondents knew about European regulations

concerning daylighting, while 16% declared to know national daylighting standards. Only 7% of the students knew other regulations (e.g. building, energy efficiency) that included daylighting, solar gain and/or shading system recommendations (Table 2).

Over 67% of respondents attended classes on daylighting analysis and/or calculations during their studies. Less than 6% of them participated in extra-curricular lectures on daylighting subjects (Table 3).

Table 1: Students' declared knowledge on daylighting metrics, their use in design projects and the use of software for daylighting modelling and calculation.

Topic	YES	NO	No answer
METRICS	<b>54.5%</b>	43.6%	1.9%
PROJECTS	<b>20.3%</b>	76.5%	3.2%
SOFTWARE	<b>25.5%</b>	73.8%	0.7%

Table 2: Students' declared knowledge of EU, national and other regulations regarding daylighting.

Regulation	YES	NO	No answer
EUROPEAN	<b>10.0%</b>	90.0%	0.0%
NATIONAL	<b>16.2%</b>	83.8%	0.0%
OTHERS	<b>7.4%</b>	92.6%	0.0%

Table 3: Students who declared participation in classes addressing daylighting analysis and/or calculations.

Classes	YES	NO	No answer
REGULAR	<b>68.4%</b>	31.6%	0.0%
EXTRA	<b>5.7%</b>	94.3%	0.0%

## 5. DISCUSSION

The following considerations may be derived from the results of the present study and in comparison to the findings of the earlier survey [8].

### Environmental impression and mood

The highest appraisals of comfort (related to daylight) by the respondents occurred in the presence of sunny skies. However, a relevant relation between weather and mood was not detected, while a good relation was detected between high levels of comfort and the proximity to the windows. This trend was observed for positions close to the window but not for positions very close to the window.

Similarly to other research [10,11], a relevant correlation between very positive and positive moods and comfort (due to daylight) was detected. The worst mood reports (negative and very negative) occurred in positions far away from the windows.

### Congruence of judgments on perception

The congruence of judgements between experts and non-experts on the environmental perception seems to demonstrate that the interpretation regarding the quantity of daylighting is similar for the two groups. The more negative judgments expressed by the students

# PLEA 2018 HONG KONG

*Smart and Healthy within the 2-degree Limit*

regarding daylighting quality can be interpreted in two ways:

- The experts were able to detect subtle aspects of comfort more easily; this seems to lead them to more positive judgments regarding the quality of daylighting (*pleasantness, stimulation, concentration, overall comfort*).
- The students had a more difficult visual (and cognitive) task to perform, this leading to higher expectations regarding the lighting.

These observations need to be further confirmed by more in-depth studies.

## Knowledge and Training

67% of the interviewed students declared to have received lectures on daylighting and stated to know at least one daylighting indicator or metric. However, only 25% of them had used daylighting modelling and calculation tools in their projects. Such a lack of knowledge regarding norms and requirements may therefore lead to a limited implementation of daylighting in a practical architectural design process, or to non-conscious design strategies, which do not exploit the potential of daylighting. The daylighting skills learned in class seem to remain at a theoretical stage and with limited implementation in the design process.

## Verification of the new goal research

Although the basis of investigation for *perception* skills was extended and refined, the first findings of Q-AR seem to confirm the trends that have been observed in the earlier Q-A survey (tendency T2). In short, during this new investigation it was noted that: i) there are similarities regarding the evaluations expressed by experts and non-experts and ii) there is a low level of daylighting knowledge and use of daylighting skills. Both trends are in line with findings from Q-A. Hence, the assumption that the perception is not influenced by individual knowledge on this matter, seems to be confirmed.

## 6. CONCLUSIONS

So far, the new DAYKE survey has shown 3 main trends:

1. It seems that the mood related to daylight depends on the direct benefit (comfort or sitting position) rather than on its simple presence.
2. The congruence between the judgments of the experts and non-experts, already observed in the earlier study, seems to be confirmed, except for the quality of daylighting, which deserves further study.
3. In comparison to the previous survey, a better understanding of the students regarding daylighting was noted. However, it is noted that there is still a significant lack of general knowledge regarding metrics and regulations.

## 7. FUTURE STEPS

The Q-AR survey data collection and analysis is an ongoing process. The findings from Q-A helped to reconsider the methodology and to define a standard protocol for future research stages (Q-AR).

The gathered data so far highlight the need for improvement of current daylighting education. The specific aspects of that education are in part dependent on professional requirements and practice. Studies involving architecture professionals are currently being planned (DAYKE stage 2).

It is hoped that the results from the DAYKE project will provide a better understanding regarding daylighting design education and practice in Europe. The obtained data should help to formulate a set of recommendations for improvement and better knowledge exchange platforms between European countries.

## ACKNOWLEDGEMENTS

The authors wish to thank all the students and volunteers involved in the DAYKE project. Raquel Viula is funded by FTC Portugal under POCH, with grant n. SFRH/BD/93536/2013.

## REFERENCES

1. Lam W. M. C. (1986), *Sunlighting as Formgiver for Architecture*. Van Nostrand Reinhold, New York.
2. Mardaljevic, J. And G. M. Janes, (2012). Multi-scale Daylight Modelling for Urban Environments, in "Solar Energy at Urban Scale", Backers B., Ed. John Wiley & Sons, p.159-190.
3. Deroisy, B. (2017). A new standard for daylight: Towards a daylight revolution?, in *Lux Europa 2017*. Ljubljana, SLO, September 18-20.
4. Mardaljevic, J. and Christoffersen, J. (2013). A roadmap for upgrading national/EU standards for daylighting in buildings, *CIE conference*, Paris, FR, April 12-19.
5. Kaempff, J., Paule, B. et al. (2016). Lighting retrofit in current practice. A Technical Report of IEA SHC Task 50.
6. Galasiu, A.D., Reinhart, C.F., (2008). Current daylighting design practice: a survey. *Build. Res. Inf.*, 36: p. 159–174.
7. Reinhart, C.F., and V.R.M. Lo Verso, (2010). A rules of thumb-based design sequence for diffuse daylight. *Light. Res. Technol.*, Vol. 43: p. 55–72.
8. Giuliani, F., Sokol, N., Viula, R., Lo Verso, V.R.M., Coch, H., Caffaro, F., (2017). First outcomes of an investigation about daylighting knowledge and education in Europe, in *Lux Europa 2017*. Ljubljana, SLO, September 18-20.
9. Fornara, F., Bonaiuto, M. and Bonnes M., (2006). Perceived hospital environment quality indicators: A study of orthopaedic units. *J. Environ. Psychol.*, vol. 26, no. 4: p. 321–334.
10. Galasiu, A.D., Veitch, J.A., (2006). Occupant preferences and satisfaction with the luminous environment and control systems in daylight offices: a literature review. *Energy Build.*, 38: p. 728–742.
11. Wang, N., Boubekri, M., (2010). Design recommendations based on cognitive, mood and preference assessments in a sunlit workspace. *Light. Res. Technol.*, Vol. 43: p. 55–72.

# The Role of Planning, Urban and Building Design for Climate Adaptation in the Microscale: An Interdisciplinary Research Experience Empowering Architectural Education

DENISE HELENA SILVA DUARTE<sup>1</sup>, FÁBIO LUIZ TEIXEIRA GONÇALVES<sup>2</sup>

<sup>1</sup> School of Architecture and Urbanism, University of São Paulo, FAUUSP, São Paulo, Brazil

<sup>2</sup> Institute of Astronomy, Geophysics and Atmospheric Sciences, University of São Paulo, IAGUSP, São Paulo, Brazil

*ABSTRACT: The world's cities are growing in size and number. At the same time, the global climate change rise global average temperatures as well as increase weather extreme events. Sao Paulo, the 5<sup>th</sup> urbanized region in the world, has currently more than 21 million inhabitants and recent studies alert for the increased frequency of extreme climate events in the city. In this context, this work presents an ongoing interdisciplinary research experience, based at the Architecture and Urbanism school in partnership with the Atmospheric Sciences' Department, approaching the interdependencies between urban morphology, green infrastructure and microclimate in São Paulo, aiming to discuss planning, urban and building design alternatives to counterbalance urban warming effects in a subtropical changing climate. The research team, led by an architecture researcher and an associate researcher from atmospheric sciences, includes a post-doc researcher, graduate and undergraduate students, engaging architecture, urban planning and meteorology, dealing with the role of planning, urban and building design for climate change adaptation in the microscale. This paper briefly summarizes what we have learnt with remote sensing, measurements and numerical simulation in the metropolitan, local and building scales and discuss the ongoing results of an interdisciplinary research empowering architectural education in different levels.*

*KEYWORDS: architectural education; interdisciplinary research; urban climate adaptation, urban design, building design*

## 1. INTRODUCTION

This paper describes an ongoing interdisciplinary research experience based at the Architecture and Urbanism school in partnership with the Atmospheric Sciences' Department, empowering architectural education. The research scope approaches the interdependencies between urban morphology, green infrastructure and microclimate in São Paulo, Brazil, aiming to discuss planning, urban and building design alternatives to counterbalance urban warming effects in a subtropical changing climate. The research team, led by an architecture researcher and an associate researcher from atmospheric sciences, includes a post-doc researcher, graduate and undergraduate students from the architecture school.

## 2. THE RESEARCH CONTEXT

In 2016 [1], 54.5% of the world's population lived in urban settlements. The world's cities are growing in size and number. In 2016, there were 31 megacities globally and their number is projected to rise to 41 by 2030.

At the same time, the global climate change is a phenomenon of shift in global climate patterns, rising global average temperatures as well as increasing weather extreme events. The Intergovernmental Panel on Climate Change - IPCC, an international body that compiles worldwide studies on climate change, indicates,

in its five previous reports [2], both the climate change intensification as well as the increasing certainty about the human actions' role.

In a clear sign of continuing long-term climate change, 2015, 2016 and 2017 have been confirmed as the three warmest years on record, being 2017 the warmest year without an El Niño, 1.1° Celsius above the pre-industrial era. Seventeen of the 18 warmest years on record have all been during this century, and the degree of warming during the past three years has been exceptional [3]. The warming pattern has changed, not just globally, but also at the regional scale, including South America [4].

In urban areas, the land use and the heat residues emissions by mechanical systems are playing a more significant role in ongoing warming trends than greenhouse gas emissions [5]. Heat islands in relatively hot climates or seasons can increase discomfort and potentially raise the threat of heat stress and mortality, and heighten the cost of air conditioning and the demand for energy [6]. In certain cities, there are thermal increases similar to the expected in the global scale for several decades [7].

Taking into account the climate scenario, for the urban scale the increase of urban vegetation cover is seen as a powerful strategy to cooling cities and save energy. Urban growth typically decreases space for green

# PLEA 2018 HONG KONG

*Smart and Healthy within the 2-degree Limit*

areas and urban environment creates obstacles to planting of new trees. These include soil compaction, lack of space for roots, overhead (and underground) provision of services and the lack of adequate management of trees. Consequences of neglecting green and water infrastructure - factors that modulate urban climate - are evident: recurrent and severe flooding, excessive heating of urban surfaces, low air quality and increase in urban heating, even daytime urban heat island in the tropics, among other factors [8]. The situation is worse in high-density cities, where land is scarce and there is little provision of space for the incorporation of urban greenery such as urban parks and landscaping. Land-use pressures and overheated property markets limit the potential for large-scale green infrastructure [9]. The integration of greenery in buildings and dense urban spaces faces many constraints [10], in spite of some cases of success, such as Singapore, with the adoption of Green Plot Ratio by local legislation [11].

In addition, both global and local urban heating phenomena can potentially influence the thermal building performance. The associated urban heat island and the global warming increases the cities surface temperature, which is responsible for serious consequences in city energy, environmental and social balance [12], as well as human health and comfort.

## 2.1 Climate and urban context in Sao Paulo

São Paulo is a sprawling megacity with 39 municipalities. It is the 5<sup>th</sup> urbanized region in the world with more than 21 million inhabitants, the biggest Latin-American megacity [1]. Sao Paulo is located at 46.6°W longitude and 23.5°S latitude, characterized by a subtropical climate, with mild temperatures, hot and wet summers and milder and drier winters.

Recent studies alert for the increased frequency of extreme events in the city such as heat waves [13], [14], [15]. The overtime data observation reveals the progressive temperature rising: from the measuring start in 1933 there was an increase in annual average temperature of approximately 3°C and respective relative humidity reduction. There were heat wave events in January and February during the years 2014 and 2015, being the absolute maximum 37,2°C occurred in October 2014 [16].

In 2016, excepting June, all other months presented monthly average higher than the Normals (1933-1960, 1961-1990) and the climatological mean (1933-2016) since measurements began in the city at the IAG/USP Meteorological Station. In 2016, there were 100 days with temperatures higher than 30°C (the average is 49 days). In 2015, there were 86 days and in 2014, there were 109 days, being this the warmest year since 1933. Concerning the minimum temperature, in 2017 average

values for all months were above the climatological mean (1933-2016) [16].

Sao Paulo is characterised by a heterogeneous urban structure, caused by the rapid growth of the city during the 20<sup>th</sup> century. High-rises are found everywhere in the city and contrasts with poor informal settlements, spread all over the metropolitan area. In Sao Paulo deforestation has occurred since the early stages of urban development due to illegal and legal allotments, however no updated official monitoring is available. The lack of information about the vegetation dynamics in SPMR can be related both with technical restrictions and with suspicious political and economic interests [17].

Besides the urban scale, the Brazilian Panel on Climate Change - PBMC states that the building sector is increasing its energy consumption both in Brazil and all around the world [18] so that they can respond for a significant carbon dioxide emission share.

According to data from the Brazilian Energy Research Company, energy consumption in buildings is responsible for a significant portion of the energy generated in Brazil: approximately 14% of total energy consumption and 47% of electricity consumption [19]. In the global scenario, buildings account for about 32% of global energy demand from a variety of sources, which has motivated cities worldwide to adopt more rigorous urban and building regulations, as well as more efficient energy consumption policies. In Brazil, unlike countries in higher latitudes, the cooling demand is significantly higher than the heating one, and the energy consumption for air conditioning accounts for approximately 20% of the total in residential buildings and 47% in commercial buildings [20].

During the heatwave events, the energy demand tends to be even greater. An example is the heatwave that took place in São Paulo in January and February 2014, when there was a 4.9% energy consumption increase during January and 8.6% during February, if compared to the same months in 2013. Great part of it was due to the intensification of the air conditioning use in that period, especially by the residential sector [21], [22]. Once installed, the equipment will be used whenever there is a temperature increase [23], which means that consumption patterns probably will not return to what they used to be previously.

It was verified that, for the São Paulo weather conditions, residential buildings that use traditional construction systems and were built around the 1970's tend to respond reasonably well to the current and projected future climate changes, operating in passive mode and keeping most of the year under comfortable conditions, according to the ASHRAE 55: 2013 [24] adaptive comfort model. The gradual increase of hours in warmer conditions, out of the comfort zone, and the discomfort intensity can be considered unavoidable and

# PLEA 2018 HONG KONG

*Smart and Healthy within the 2-degree Limit*

it was simulated around 270% discomfort increase in the housing units studied, highlighting the summer period and the heat waves [25].

In addition to the traditional residential buildings, there is a large stock of new residential ones in São Paulo, especially built from 2007 to 2014 due to a real estate market boom in the city. Being driven by market issues, the real estate production is remarked by the distance between professional practice and architecture research and it over values the aesthetic while other issues, as functionality and performance, do not play such an important role. Glass façades, less thermal mass and poor natural ventilation design reached wealthy and fancy high-rise residential buildings, which are followed by middle-class buildings, and are spreading very fast.

The city of Sao Paulo has in force three laws for its urban planning and development: The Master Plan (2014), the Zoning Law (2016) and the Building Code (2017) [26]. As recently updated texts, it was expected that they could express the integration of its contents pointing at contemporary urban issues such as managing energy efficiency and providing buildings with quality and comfort to the users. What happens instead are several mismatches between their contents. On the opposite of the worldwide trend, São Paulo city laws have been losing, over the last century and in the update process, almost all the performance construction requirements, which influence the environmental quality of buildings.

### 3. THE TEAMWORK AND RESEARCH METHODS

Under this theoretical framework and local context, this project deals with the role of planning, urban and building design for climate change adaptation in microscale, including occasional heat waves or for the projected IPCC AR-5 scenarios.

For this purpose, a research team was based at the Architecture and Urbanism school in partnership with the Atmospheric Sciences' Department approaching the interdependencies between urban morphology, green infrastructure and microclimate in São Paulo, aiming to discuss urban and building design alternatives to counterbalance urban warming effects in a subtropical changing climate.

The research group encompasses a principal investigator at the Architecture and Urbanism school, an associate researcher from the Atmospheric Sciences Department, a post-doc researcher and Architecture students from different levels, being 4 PhDs and 2 Master candidates, 4 Diploma students and 6 undergraduates as scientific initiation researchers, from 2<sup>nd</sup> to 5<sup>th</sup> year students.

The research group is formed aiming to involve Architecture students in different levels of their education and training around common themes. All

research topics involve graduates and undergraduates working together, in theoretical, experimental, public policies and/or design issues. In some cases, the undergraduates started as scientific initiation in the laboratory, continued for the Diploma and later apply for the graduate courses. In this particular case, the 4 PhD candidates did the Master in the same group, as well as the post-doc researcher for Master and PhD, consolidating a long-term research involvement with environment and energy issues.

The research topics are organized in three different scales: 1) *metropolitan scale*, mainly studying the impact of vegetation suppression in land surface temperature in temporal and spatial scales, combining satellite thermal images from 2002 to 2017 (Modis), vegetation indices and mapping techniques, exploring daytime and nighttime effects and relating this results to the urban morphology, feeding other ongoing investigations in the group; 2) *local scale*, subdivided in 2.1) the impact of vegetation in urban microclimate, encompassing urban parks, street trees and green walls; and 2.2) the role of built density in local microclimate, concerning urban geometry and materiality; 3) *building scale*, regarding building thermal performance and comfort, highlighting the new stock of residential buildings emerged during a real estate boom in the last years in Sao Paulo. The local and building scales are carried out through local measurements and numerical modelling, mainly with ENVI-met and TAS/EDSL.

Besides measurements and modelling studies, part of the team is directly focused on public policies, for urban and building scale, aiming application strategies of this project results, e.g. green infrastructure plans, green indicators, environmental off-set mechanisms, mobility innovations resulting in more space for public amenities in the city, and, last, but not least, the São Paulo building code review in a changing climate.

Vertical interactions in the group are encouraged, e.g. green issues are addressed in metropolitan, local and building scales (green walls), besides public policies, encompassing researchers and students in all levels of formation.

Horizontal interactions among different themes are encouraged also, e.g. the density studies group discussing with the green infrastructure group, aiming to counterbalance built density with green amenities in the city.

The on-site urban climate and building performance measurements are planned in a comprehensive way, as far as possible, aiming to optimize human and equipment resources and to enable a longer period of measurements. At urban scale, on-site measurements are more complicated, and for security reasons also, the teamwork is imperative to make it feasible and successful (Fig.1).



# PLEA 2018 HONG KONG

*Smart and Healthy within the 2-degree Limit*



Figure 1: Microclimate monitoring in two nearby locations: inside an urban park and in the courtyard of an urban block downtown, in a densely built and high-rise area.

Simultaneously, as far as possible, depending on climate stability, instruments and people availability, parallel measurements (fig.2) are carried out to raise local data related to: 1) surface temperature with a thermographic camera, at the same time Landsat pass, for comparison; 2) leaf area index of local species; 3) building façades, paving and vegetation surface temperature, to be compared with ENVI-met modelling results; 4) indoor measurements of air temperature and humidity, wind speed and globe temperature in buildings, to calibrate a building energy simulation model, in this particular case, TAS/EDSL, etc.



Figure 2: Fieldwork to measure surface temperature with a thermographic camera, air and surface temperature and air humidity in different locations and leaf area index with the canopy analyser.

In a regular basis, smaller groups' meetings are carried out for discussing theoretical issues, for training features of new software versions, for planning common activities including workshops and fieldwork, and for presentation and discussion of partial results, most of the times, feeding each other research.



Figure 3: Intermediate presentations and software seminar in the laboratory to explore the features of a new version.

For urban and building scales, the research methods encompass: 1) data raising and/or mapping to identify study areas; 2) development of fieldwork plans according

to the resources and constraints of the models adopted; 3) primary data collection in urban scale for soil, vegetation and atmosphere at ground level and in the top of the model, to be obtained by surface microclimatic measurements coupled with remote sensing (RS) data and geographic information systems (SIGs), and also by measurements on building scale; 4) modelling of the study areas; 5) calibration of the models between measured and simulated data; 6) development of parametric studies and selection of the best strategies from simulation results for current and future climate scenarios.

Therefore, starting from mesoscale information, using thermal satellite images and other available mapping techniques, besides microclimate data at pedestrian level, the purpose is to focus in interest areas and develop parametric studies to select the best strategies using model simulation. Expected results include the impact's quantification of density, vegetation and urban surfaces in microclimate, as well as the effects of adaptation strategies to climate change for urban areas and buildings, in current and future climates.

## 5. PARTIAL RESULTS

### 5.1 Metropolitan scale

Partial results are shown starting from the metropolitan scale, aiming to quantify the impact of vegetation loss in the urban microclimate and to contribute for public policies in the São Paulo Metropolitan Region (SPMR).

Temporal variations of the land surface temperature and vegetation indices, obtained by MODIS satellite images from 2002 to 2017, are under evaluation. Urban morphology was mapped using the WUDAPT-Local Climate Zones (LCZ) approach. LCZ maps for 2003 and 2017 were generated in order to verify whether changes in LST and/or vegetation cover can be explained by changes in urban morphology. The year 2016 were chosen as a testbed year for the entire procedure. Daytime and nighttime land surface temperature (LST) and the Normalized Vegetation Index (NDVI) derived from 2016 Aqua/MODIS satellite images were computed for the SPMR.

There is a strong negative linear correlation between LST and NDVI, both for daytime and nighttime. LST-NDVI correlation is strongest during summer, when LSTs are higher and the vegetation cover more vigorous. During daytime LCZ 1 showed lower temperatures than LCZ 3. Since NDVI values of these two zones are similar, shadows may have lowered LST. The combination of vegetation cover shaded by buildings may explain the lowest daytime LST of LCZ 4. The open arrangement of LCZ 4 and 6 also enables urban ventilation, which may have an influence both in diurnal and nocturnal LST. During nighttime the daily heat storage and the lack of

# PLEA 2018 HONG KONG

*Smart and Healthy within the 2-degree Limit*

open spaces may contribute to LCZ 1 higher LST values. Results suggest that ventilation, building shadows and vegetation cover have a key role in LST for SPMR.

## **5.2 Local scale: green infrastructure and built density**

Concerning green, studies on ENVI-met V.4 Science model were intensified including the Albero tool. The full-forcing feature was important to better calibrate São Paulo's microclimatic conditions. A 3D parametrization of Brazilian trees was carried out based on leaf density in local field measurements. Different scenarios were simulated, considering an urban park and its surroundings. The new areas with vegetation were incorporated gradually in order to verify the local microclimatic effect including street trees, green walls and trees inside the blocks.

Regarding the urban form, both geometry and urban materials are being investigated. Initial results suggest that urban geometry is predominant in this climate, but surface finishes raise questions for the conflict between more reflective materials for the inside of buildings and the outside urban environment.

One of the main aims of São Paulo Masterplan and its current land-use regulation is to guide urban densification next to the city main transport axes, optimizing the occupation of the areas around the train stations, subway lines and bus corridors. At the same time, there are no predictions of the real impact of the proposed densification over the urban microclimate.

In principle, densifying affects the climate within the Urban Canopy Layer - UCL by the accumulation of sensible heat in the urban fabric during nighttime. This accumulation depends on the materiality of urban surfaces, urban geometry and the SVF. On the other hand, during daytime, mutual shading of buildings can play an important role in decreasing surface temperatures. Preliminary simulation results show the low impact of the proposed densification in the SVF and consequently in the phenomenon of heat trap during nighttime.

## **5.3 Building scale**

The building scale studies are supported by two main issues: the real estate housing typical production (multifamily apartment buildings from 2005 to 2014, the Real Estate boom period, and the changing warming climate. The current stage focus on the building thermal performance simulation looking for the assessment of the different weather scenarios and the parameters related to construction and use influencing building thermal performance and human comfort. Measurements were carried out simultaneously in apartment buildings. Substantial differences in thermal performance were found, due to the building design as well as to the occupation pattern, especially regarding

ventilation rate. Preliminary results suggest that: a) more space or more openings do not guarantee a better thermal performance; b) balcony glazing can be positive or negative, depending on solar orientation and opening hours; c) thermal performance depends in large amount of the user operation of openings.

Another challenge is the consideration of the UHI, taking into account both the climate change and the local urban warming. For this purpose, an UHI effect [27], locally measured, was coupled to the climatic data in the current and future scenarios, IPCC RCP 8.5 AR-5, for the simulation with TAS/EDSL.

## **6. CONCLUSIONS**

This paper summarizes an ongoing interdisciplinary research between architecture and atmospheric sciences empowering architectural education in different levels. Teamwork dynamics were detailed, exemplifying vertical and horizontal interactions among different scales, themes and students' formation levels. Research methods were briefly presented, as well as partial results on what we have learnt with remote sensing, microclimatic measurements and numerical simulation in the metropolitan, local and building scales.

Experiencing everyday life in a sprawling megacity, density seems to be a better solution, but it is possible only side by side with urban amenities, including a paradigm shift in mobility, creating small oasis spread all over the city, in transition spaces, taking the benefits of green, cool surfaces, weak winds and mutual building shading. For now, São Paulo is going to the opposite direction, more and more air conditioning dependent, with a local building code failing to establish any thermal and energy performance requirement and lacking good quality urban spaces in most parts of the city. Results can subsidy proposals for future revisions of the local building code, that should be more aligned with overheating issues, related to climate change and urban heating phenomena, as many other building codes in different cities and climates.

At the same time research goes forward, exploring remote sensing, mapping, urban and building on-site measurements and modelling techniques, building and urban design proposals are developed by the Diploma students, informed by the latest research developments in the group.

## **ACKNOWLEDGEMENTS**

To all the researchers, graduate and undergraduate students involved in this project. This research was supported by FAPESP (Grants #2016/02825-5, #2014/50978-0 #2016/01204-7, #2015/17360-5, #2016/20433-7, #2016/21884-2 and #2017/12816-6), by the National Council for Scientific and Technological Development – CNPq (Productivity Grant 309669/2015-4, Master and

# PLEA 2018 HONG KONG

*Smart and Healthy within the 2-degree Limit*

PIBIC Scholarships), by Capes Master Scholarship and by the University of Sao Paulo PUB undergraduate scholarship.

## REFERENCES

1. UNITED NATIONS, Department of Economic and Social Affairs, Population Division (2016). The World's Cities in 2016 – Data Booklet (ST/ESA/SER.A/392).
2. IPCC (Intergovernmental Panel on Climate Change). Climate Change 2014. Geneva: IPCC, 2014.
3. WMO. WMO confirms 2017 among the three warmest years on record. January 18<sup>th</sup> 2018.
4. SÁNCHEZ E. et al. Regional climate modelling in CLARIS-LPB: a concerted approach towards twenty first century projections of regional temperature and precipitation over South America. *Climate Dynamics*, v. 45, p. 2193-2212, 2015.
5. STONE, B. The city and the coming climate. *Climate Changes in the Places we live*. New York: Cambridge, 2012.
6. STEWART, I, OKE, T. Local climate zones for urban temperature studies. *Bulletin of the American Meteorological Society* v. 93, p. 1879-1900, 2012.
7. GRIMMOND, C. S. B. Progress in measuring and observing the urban atmosphere. *Theoretical and applied climatology*, n. 84, p. 3-22, 2006.
8. EMMANUEL, R. *An Urban Approach to Climate-Sensitive Design. Strategies for the Tropics*. New York: Spon Press, 2005.
9. ONG, B. L. et al. Green Plot Ratio - Past, Present and Future. In: *Tropics 2050. iNTA 2012 - 4th International Network for Tropical Architecture*. 2012.
10. CHEN, Y., WONG, N.H. Thermal benefits of city parks. *Energy and Buildings* 38, 2006, p.105–120.
11. ONG, B. L. Green Plot Ratio: An Ecological Measure for Architecture and Urban Planning. *Landscape and Urban Planning*, vol.63, p.197-211, 2002
12. SANTAMOURIS, M. On the energy impact of urban heat island and global warming on buildings. *Energy and Buildings*, v. 82, p. 100-113, 2014.
13. BATISTA R, GONÇALVES F, PORFIRIO DA ROCHA R. Present climate and future projections of the thermal comfort index for the metropolitan region of São Paulo, Brazil. *Climatic Change*, v. 137, p. 439-454, ago. 2014.
14. NOBRE, Carlos A. et al. *Vulnerabilidade das Megacidades Brasileiras às Mudanças climáticas: Região metropolitana de São Paulo*. Sumário executivo. 2010.
15. MARENGO, José A. *Mudanças climáticas globais e seus efeitos sobre a biodiversidade: caracterização do clima atual e definição das alterações climáticas para o território brasileiro ao longo do século XXI*. Ministério do Meio Ambiente, Brasília, Distrito Federal, Brasil, 2006.
16. IAG/USP (2016/2017). *Boletim climatológico anual da estação meteorológica do IAG/USP – 2016/2017*.
17. FERREIRA, L. S. (2015). *Vegetation Management in São Paulo, Brazil: Clearing of Urban Vegetation and Environmental Compensation*. In: *Trees. People and the Built Environment II*, 2015, Birmingham. *Proceedings...* Birmingham: ICF. p. 32-42.
18. PBMC (2016): *Mudanças Climáticas e Cidades. Relatório Especial do Painel Brasileiro de Mudanças Climáticas*.
19. BRASIL. Ministério de Minas e Energia - MME (2016). *Demanda de Energia 2050*. Rio de Janeiro: Empresa de Pesquisa Energética – EPE.
20. LAMBERTS, R et al. *Eficiência energética na arquitetura*. 3ed., 2007.
21. BRASIL. Ministério de Minas e Energia (MME). *Resenha mensal do mercado de energia elétrica*, v. 77. Rio de Janeiro: Empresa de Pesquisa Energética (EPE), fevereiro, 2014.
22. BRASIL. Ministério de Minas e Energia (MME). *Resenha mensal do mercado de energia elétrica*, v. 78. Rio de Janeiro: Empresa de Pesquisa Energética (EPE), março, 2014.
23. WU, A, PETT, J. Cold comfort for Kyoto? Carbon implications from increasing residential cooling demand. A scoping report. ACE: London: 2006.
24. ASHRAE 55-2013: *Thermal Environmental Conditions for Human Occupancy*. Atlanta: ASHRAE, 2013.
25. ALVES, C, DUARTE; D; GONÇALVES, F. Residential Buildings' Thermal Performance and Comfort for the Elderly under Climate Changes Context in the city of São Paulo, Brazil. *Energy and Buildings*, v.114, p. 62-71, 2016.
26. Prefeitura de São Paulo (2016). *Municipal Ordinance*. Available: <http://www.prefeitura.sp.gov.br> [07 January 2018].
27. CRAWLEY, D B. Estimating the impacts of climate change and urbanization on building performance. *Journal of Building Performance Simulation*, v 1:2, p. 91-115, 2008

## Teaching Natural Ventilation Using Water Table Apparatus: A Classroom Teaching, Simulation and Design Tool

MONISHA EDWINA ROYAN G<sup>1</sup>, PRASAD VAIDYA<sup>2</sup>, POOJA MUNDHE<sup>2</sup>

<sup>1</sup>C.A.R.E School of Architecture, Tiruchirapalli, India

<sup>2</sup>CEPT University, Ahmedabad, India

*ABSTRACT: The building sector amounts to about 40% of the world's total energy consumption. In tropical countries like India naturally ventilated or mixed mode ventilated buildings would contribute in the reduction of energy consumption used for cooling the buildings. It is necessary for the architecture schools to educate the students on understanding the principles of natural ventilation and applications of various strategies in the design decisions. This paper summarizes the development of a water table apparatus for testing architectural design for natural ventilation, validation of its results, and its utilization in the classroom as a design evaluation tool for architecture students. The water table was constructed, and its performance was validated and simple metrics for evaluating natural ventilation performance were developed at CEPT University. A refined water table was constructed later to be used for classroom instruction at the C.A.R.E School of Architecture. The workshop there provided hands-on experience to test various design parameters, qualitative and quantitative analysis in design projects. The paper demonstrates the ease with which students are able to visualise and understand the effectiveness of natural ventilation and make the necessary design modifications.*

*KEYWORDS: natural ventilation, simulation, water table, passive design, visualization*

### 1. INTRODUCTION

For effective low energy cooling design of buildings, the study of natural ventilation in design schools needs to be taken beyond a theoretical approach of understanding simple flow patterns or rules of thumb given in the literature. It is necessary for students of architecture to visually understand the performance of natural ventilation in their design projects. Most analytical tools that are used for studying natural ventilation flows for real buildings with elaborate geometry are too complex to be accessible for students in architecture schools. The water table apparatus however, is an affordable tool that can be used to simulate air movement and visualize performance for such an audience.

This paper summarises the construction and validation of the water table constructed and at CEPT University. A revised water table was used as for classroom instruction at C.A.R.E School of Architecture. A five-day workshop was conducted on the use of water table apparatus for about 20 students. The students were first introduced to the basic principles of natural ventilation, after which they conducted hands-on experiments. Scaled models of two residential buildings were studied with parametric variations. The students were able to visualise and understand the air movement within and outside a building. It deepened their understanding of the principles of natural ventilation as they could readily visualize the effects of their design decisions. It reinforced their ability to understand, predict and test the possible wind pattern movement in

a building through hands-on exploration using the water table apparatus.

### 2. BACKGROUND

Buildings amount to 33% of total energy consumption in India, of which 25% is by the residential sector and 8% is by commercial sector (ECBC 2009). In India, there has been a recent sustained growth in the construction industry. Installation of air-conditioning equipment is rising rapidly in the country. The government will facilitate the construction of 20 million affordable new housing units until 2022 with its Housing for All scheme. Residential buildings in India are largely of the multifamily multi-story typology. These buildings, with their high envelope to floor-area ratios have potential for natural ventilation during certain times of the year. For residential buildings, this represents an enormous opportunity for low energy mixed mode cooling solutions.

The undergraduate curriculum in architecture schools in India typically ignores building energy efficiency and building science. Only a handful of institutes cover these topics in any depth along with the principles of natural ventilation (Manu et al., 2010). However, without the ability to test the effectiveness of natural ventilation and air movement as a result of their design decisions, students assume performance based on simplistic principles. This is seen to result in an incorrect understanding of the actual performance (Toledo & Pereira 2005). CFD modelling and wind tunnel testing are too complex or expensive to be accessible to

# PLEA 2018 HONG KONG

*Smart and Healthy within the 2-degree Limit*

most architects and architecture students. A more affordable and accessible alternative is the water table, which can provide useful results for natural ventilation and inform the design decisions for residential buildings in India. This paper summarizes the development, construction, validation of the water table, as well as its use in the classroom for teaching natural ventilation.

This water table is limited to wind induced natural ventilation in a building and does not simulate temperature induced stack ventilation. Nevertheless, it is likely to be applicable to most of the multifamily residential construction in India.

## 3. WATER TABLE DEVELOPMENT

### 3.1 Construction

The water table apparatus (Figure 1) constructed at CEPT University had dimensions of 1155mm x 750mm working base plane (with a 30 mm water depth), 180mm x 750mm (95mm deep) input tank and 140mm x 750mm (95mm deep) output tank. Two types of 5mm thick acrylic sheet were used as a waterproof layer on 18mm thick commercial plywood which was used as the basic formwork. A 0.5 HP self priming mini monoblock water pump was used to supply dyed water from a 225 liter PVC reservoir. The fixtures such as control valves, inlet nozzles, PVC piping and bends used are from reverse osmosis water treatment systems. The cost of the materials and equipment was Rs. 20,000 (Royan & Vaidya, 2017).

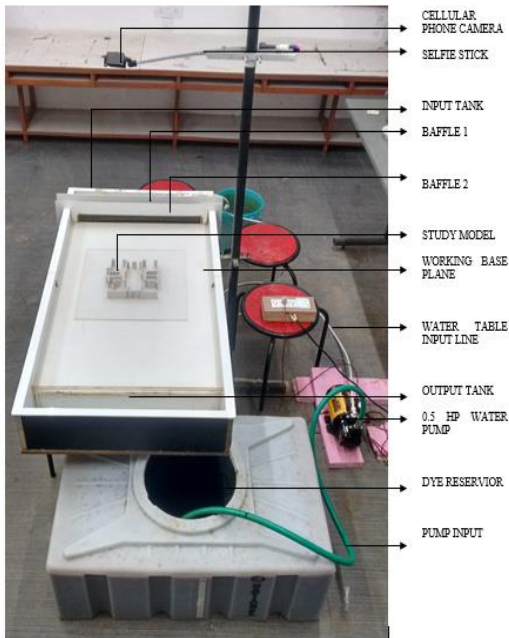

Figure 1: Water table apparatus experimental set-up at CEPT University (Royan & Vaidya, 2017)

### 3.2 Fluid velocity calculation

Reynolds number can be used to calculate the velocity of air (simulated) relative to that of water (in the experiment) (Royan & Prasad Vaidya, 2017).

$$Re = \frac{\rho v l}{\mu} \quad (1)$$

Where, Re = Reynolds Number,  $\rho$  is the density of the fluid,  $v$  is the velocity of the fluid,  $l$  is the length or diameter of the object in the fluid,  $\mu$  is the dynamic viscosity of fluid.

$$Re_{(Air)} = Re_{(Water)} \quad (2)$$

When,  $Re_{(Air)}$  is the Reynolds number of air,  $Re_{(Water)}$  is the Reynolds number of water  
And  $Re_{(Air)}$  and  $Re_{(Water)}$  are assumed to be equal,

$$\left( \frac{\rho v l}{\mu} \right)_{Air} = \left( \frac{\rho v l}{\mu} \right)_{Water} \quad (3)$$

$$v_{(Air)} = \left( \frac{\rho v l}{\mu} \right)_{Water} * \left( \frac{\mu l}{\rho l} \right)_{Air} \quad (4)$$

Using Equation 4, the velocity of the air was calculated at 0.0013 m/s (Royan & Vaidya, 2017).

### 3.3 Experimental Procedure

The experiment is run by initially filling the water table with clear water. Then, the pump introduces the dyed water via the input tank. The dye water uses Potassium Permanganate ( $KMnO_4$ ) at a concentration of 1 g/litre. Baffles in the input tank are used to introduce the dyed water uniformly in to the working base plane. The experiment runs through the initial stages and then reaches steady state in about 6 minutes. The total experiment run lasts for about 20 minutes, after which the pump is switched off. To prepare the water table for the next run, all the water from it is drained and a squeegee is used to clean the working base plane. This preparation time is about 30 minutes, and the entire process of experimentation and setup takes about 1 hour per run. See Vaidya (2018).

### 3.4 Validation

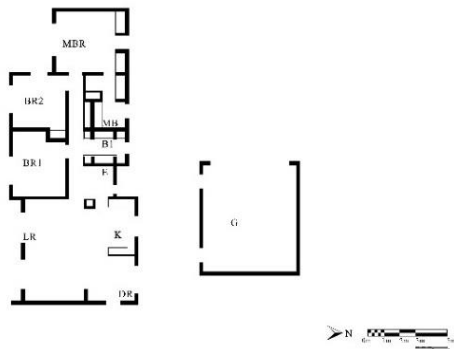

Figure 2: Residence plan for validation

The flow pattern results derived from testing of the residential building in the water table were validated with the results obtained from the smoke chamber testing documented by Boutet (1987).

The resultant flow in the water table run exhibited a pattern similar to that in the smoke chamber test for most spaces. The flow patterns were observed to have a slight deviation in two rooms, the passages inside the building, and the exterior space between the residence and garage (Figure 3).

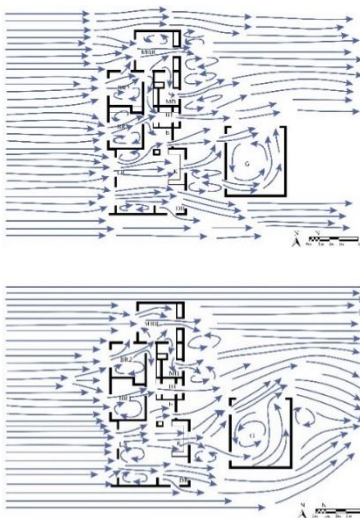

Figure 3: Top: Flow diagram from smoke chamber test from Boutet (1987). Bottom: Flow diagram from water table experiment



Figure 4: Water table image from the validation run

### 3.5 Development of Metrics

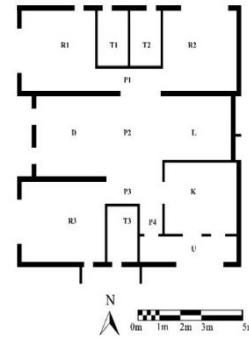

Figure 5: Plan of a residential building for experimentation

A typical apartment design of area 716 sqm was considered for the experiment trials along with various parametric such as change in orientation, sizes of openings and interior obstructions. The simulations were recorded on videos with a cell phone camera, and a set of key frames were saved for additional image analysis. See Vaidya (2018). This analysis is done in Photoshop and AutoCAD.

The steady state of the experiment run, when the flow patterns were observed to be repetitive for an extended duration, was used for the analysis. It was possible to differentiate between the results between the parametric runs with qualitative description of the flow. In addition, two metrics for quantitative analysis were formulated: percentage of apartment area with good access to ventilation and percentage of room area with dead spots. These metrics show adequate difference between the runs and matched the visual observations of the experiments.

## 4. WATER TABLE USE IN EDUCATION

### 4.1 Construction

Subsequently another water table was constructed at the C.A.R.E School of Architecture (see figure 6 and 7) with a 1066mm x 750mm (30 mm deep) working base plane, 100mm x 750mm (50mm deep) input tank and 100mm x 750mm (50mm deep) output tank (figure 6). The formwork was of 12 mm thick marine plywood with 3mm thick acrylic sheets as the waterproof layer. Two PVC reservoirs of 100 liters each were used for clear water and dyed water supply. The pump size was not modified. The piping and controls valves were modified to allow dyed water and clear water to be run alternately. The cost of the materials and equipment was Rs. 30,000. To put this in perspective, this cost is a fraction of the cost of a heliodon that is used for sun-angle studies during classroom instruction.

# PLEA 2018 HONG KONG

*Smart and Healthy within the 2-degree Limit*

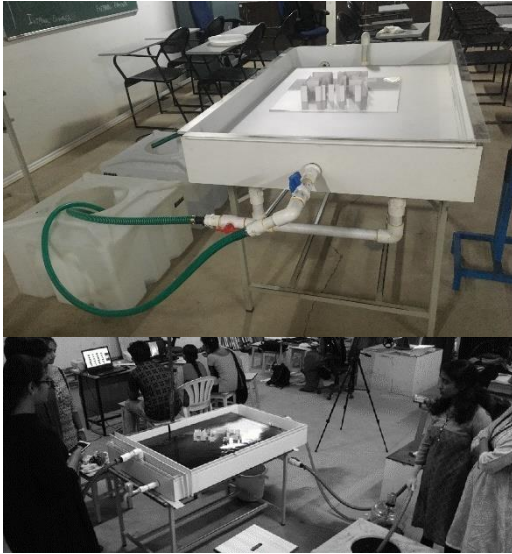

Figure 6: View of Water table from output tank



Figure 7: View of the water table from inlet tank

## 5. NATURAL VENTILATION WORKSHOP

A five-day workshop with two sections was conducted in 2017. In the first section of two days, the students were introduced to basic theory of natural ventilation. They were given readings on principles of natural ventilation and factors that affect it. The students experimented with a simple room of 1:2 aspect ratios, and proposed a variety of natural ventilation options for positions of the openings. Each case was analyzed for

effectiveness of natural ventilation using the metrics developed earlier. Results for ventilation access and uniformity reinforced the qualitative observations and the students were easily able to determine which options had better performance.

In the second section of three days, two buildings designed by a local architect were studied for the effectiveness of natural ventilation. In this paper, only one building is discussed. This was a residential apartment of 173 sqm. First, the students made drawings of the anticipated air movement pattern for the building with their knowledge about natural ventilation. Then they simulated the building using the water table for the baseline case for different wind incident angles (WIA). After analyzing the air movement and discussing the findings, the students made design modifications to increase the effectiveness. These modifications included addition of wing walls, changing sizes or location of openings, and removal of interior walls. Each modification was simulated in the water table and the qualitative and quantitative analyses were carried out. See figures 8 through 11 for the qualitative analysis of the building. Figures 12 and 13 show the quantitative analysis results.

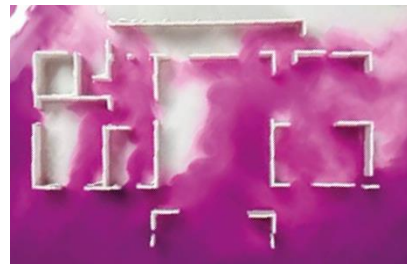

Figure 8: Experiment - SW baseline run



Figure 9: Wind pattern - SW WIA Baseline run

# PLEA 2018 HONG KONG

Smart and Healthy within the 2-degree Limit

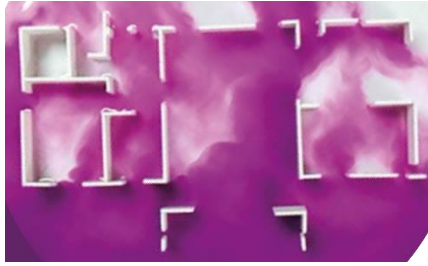

Figure 10: Removal of north wall - SW WIA



Figure 11: Wind Pattern - Removal of north wall - SW WIA

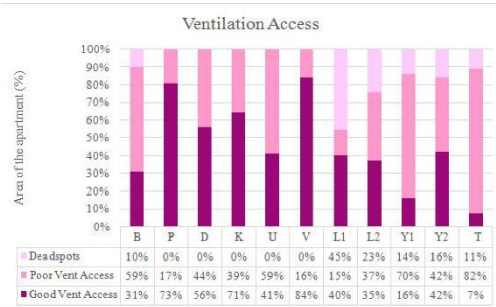

Figure 12: Ventilation access- SW Baseline

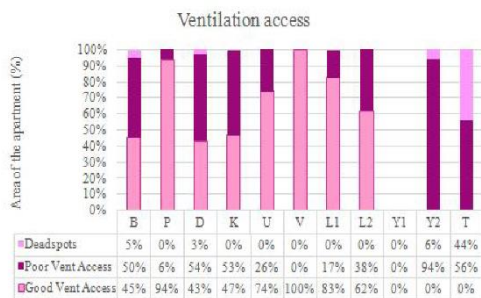

Figure 13: Ventilation Access –Removal of north wall – SW orientation

Introduction to theories of natural ventilation along with experimentation of a single space to experimentation of residential spaces enabled the students to understand how design elements impact air movement in a space. The simple practical exploration reinforced their theoretical knowledge in understanding of principles of natural ventilation. The students expressed more interest in testing the principles of natural ventilation through their study models. During their analysis, a few spaces exhibited inadequate natural

ventilation. They understood the behavior of the wind movement and principles, through observations and discussions. This helped them to take design decisions and propose design modifications such as introduction of wing walls, removal of wall, increase in window opening, etc. The cycle of design, experimentation and observation during the run improved their understanding through continuous feedback on performance. Since each experiment takes less than 30 minutes to run, they were able to test the workability through a number of iterations. They were exposed to both qualitative and quantitative analysis of primarily visual data.

## 6. CONCLUSIONS

The water table has been demonstrated as a useful tool for design analysis of natural ventilation. The results obtained are visual, similar to false color monochrome imaging. These results allow both qualitative and quantitative analysis for the effectiveness of air movement. A water table can be to study performance of designs for effective natural ventilation, calculate the percentage area of space that is well ventilated, and identify dead spots those are not ventilated. (Kimura)

The water table is an effective education tool for natural ventilation because:

1. It is more accessible than CFD simulation, to students of architecture. The apparatus is affordable, the investment is one time for colleges, the physical models of their own designs can be built using cheap waterproof materials within a few hours, and the experiment takes about 30 minutes to run. Visual information that engages the students is continuously available during the experiment run.
2. It allows the students to understand that fluid flows in natural ventilation are complex, and designs need to be tested. It aids in the understanding of metrics for effectiveness of natural ventilation, and helps them assess the performance of design alternatives.
3. Students get hands-on experience with simulation and the ability to make live observations during the run allows them to generate solutions through an iterative design process. A combination of the qualitative and quantitative results along with the rich visual information makes the analysis actionable for design.
4. The results are visual, and easy for them to understand, only need some basic image processing and area calculation skills, which they already have. Most importantly, the visual feedback makes the results very actionable for design changes.

The water table can thus serve to be a suitable tool for architecture students in design schools and perhaps in an architect's office to study natural ventilation and make design decisions.



# PLEA 2018 HONG KONG

*Smart and Healthy within the 2-degree Limit*

## ACKNOWLEDGEMENTS

We would like to acknowledge the following: Prof. Michael Apte, Prof. Rashmin Damle, Prof. Tushar Bose, Prof. Dipsha Shah from CEPT University and Prof. Malcolm Cook from Loughborough University for their guidance during the development process; Mr. Ramalingam who recommended the workshop for students at C.A.R.E School of Architecture; Mr. Vidyashankar who shared the plans of two projects for testing natural ventilation in the apparatus; Mr. Murali for his technical support. We the management and the department at C.A.R.E School of Architecture for supporting the workshop; all the students who contributed in the workshop, especially Abishek Raj V, Arul Karthika G, Arun Kumar G, Deepti J B M, Gayathri Devi K, Harini M, Maheshware C K who volunteered in documenting the workshop proceedings.

## REFERENCES

1. A.M. Toledo, F. P. (2005). Natural ventilation due to wind action: practice knowledge against experimental airflow visualization. *International Conference "Passive and Low Energy Cooling for the Built Environment*, (pp. 1009 -). Santorini, Greece.
2. Andersen, A., Bjerre, M., Chen, Z. D., Heiselberg, P. K., & Li, Y. (2000). *Experimental Study of Wind-Opposed Buoyancy-Driven Natural Ventilation*. Denmark: Aalborg: Dept. of Building Technology and Structural Engineering, Aalborg University.
3. Boutet, T. S. (1987). *Controlling Air movement*.
4. Cunningham, D. (2012). Investigating the effects of resistance pathways on air flow through naturally ventilated buildings. *First Building Simulation and Optimization Conference* (pp. 132 - 140). England: IBPSA.
5. Dockery, D. S. (1981). *Indoor - outdoor relationships of respirable sulfates and particles 15:335-343*. Elsevier Science B.V. , Atmos Environ.
6. (2009). *ECBC*. New Delhi: Bureau of Energy Efficiency.
7. Foundation, C. W. (2010). *Reducing GHG Emissions in the Building Sector in India: A Strategy Paper*.
8. Ismail, I. M. (2007). Simulation of natural ventilation on scale model of a livestock house: Determination of airflow pattern in a water table . *Journal of Tropical Agriculture and Food Science*, 341-349.
9. Koenigsberger, O. H. (1975). *Manual of tropical Housing and Building*. Orient Longman Private Limited.
10. Lechner, N. (2015). The Water Table for Ventilation Studies. In *Heating, Cooling, Lighting, Sustainable Design Methods for Architects 4th edition* (pp. 659 - 660). New Jersey: Published by John Wiley & Sons, Inc., Hoboken, New Jersey.
11. Linden, P. F. (1999 ). *The Fluid Mechanics of Natural Ventilation*. Annual Reviews.
12. Manu, S., Bajpai, A., Kumar, S., Narayan, S., Tulsyan, A., Rawal, R., & Shetty, S. (2010). Architectural Curriculum Enhancement for Promoting Sustainable Built Environment. In 2010 ACEEE Summer Study on Energy Efficiency in Buildings (pp. 196–212). Pacific Grove, California: American Council for an Energy-Efficient Economy.
13. Rajan Rawal, Y. S. (2014). *Residential Buildings in India: Energy Use Projections and Savings Potentials, GBPN, 2014*". Global Buildings Performance Network (GBPN).
14. Robert W. Fox, A. T. (2004). *Introduction to fluid Mechanics, sixth edition*. John Wiley & Sons, INC.
15. Royan, M. E., & Prasad Vaidya, R. D. (2017). Simulating natural ventilation in residential buildings using water table apparatus. *INSPIRE* (pp. 159 - 167). Jaipur: Alliance for an Energy Efficient Economy.
16. Sharif, M. Simulation of natural ventilation on scale model of a livestock house: Determination of airflow pattern in a water table. In *J. Trop. Agric. and Fd. Sc.* 35(2)(2007) (pp. 341–349).
17. Steve Irving, P. B. (2005). *Natural Ventilation in non-domestic buildings*. Norwich: CIBSE.
18. Tantachamroon, P. R. (2015). The Water Table for Ventilation Studies. In N. Lechner, *Heating Cooling Lighting Sustainable Design Methods for Architects* (pp. 659-660). New Jersey: John Wiley & Sons, Inc., Hoboken.
19. Vaidya, P. (2018). *Videos of water table experiment for natural ventilation*. Retrieved May 10, 2018, from <http://bit.ly/watertable-nv>.
20. Zulfikar A.Adamu, A. P. (2015). The Design and Simulation of Natural Personalised Ventilation (NPV) System for Multi - Bed Hospital Wards. *MDPI Buildings* , 381-404.

# Architectural Design Education Based on Simulation tools: Retrofitting Design Improvement Approach in Tohoku University

TOSHIKAZU ISHIDA<sup>1</sup>, MUNENORI INOUE<sup>2</sup>, MAMIKO FUJIYAMA<sup>2</sup>

<sup>1</sup>Professor, Department of Architecture and Building Science, Tohoku University, Japan

<sup>2</sup>Assistant Professor, Department of Architecture and Building Science, Tohoku University, Japan

**ABSTRACT:** This paper explicates development efforts in Tohoku University that are necessary for high capability architect education using versatile simulation tools. In this paper, we first explain the social change toward architectural design in the “Era of Digitalization” and needs transformation for Architects today especially in Tohoku region after having the experiences of March 11th 2011 disaster. We then introduce a study environment and curriculum for Design education from undergraduate to master level program in Tohoku University. Thus, an effort will be exemplified taking a case study of each student’s design project of an adequate improvement process using CASBEE index and simulation tools that can facilitate effective communication and interaction between junior architect (Design Laboratory students) and junior engineer (Sustainable Engineering Laboratory students). The relevancy of so-called Retro-fitting Improvement Approach will be exemplified based on different building types and various simulation index of each student’s design projects. Such developments are expected to achieve new levels of architect education standard and connectivity between designers and the engineers for wide range of sustainable design project. The outcome will serve as a solid basis for the primary design training to larger urban scale of high performance Smart City design project in the future.

**KEYWORDS:** Digitalization, Design Education, Simulation Tool, Retrofitting Design Improvement

## 1. INTRODUCTION

This paper explores new standard in digitalization era of architectural design education in university to enhance the knowledge and skill related to the versatile simulation tools.

It proposes a set of potential architectural design education method in Tohoku University for new generation of student with expanded possibilities for

interactions between designers and engineers.

While evolved IT society today would offer feasible, less expensive, and widely applicable simulation tools and software for Green Building and sustainable environmental design in the business scene, it could be said that an interdisciplinary knowledge and integrated skill education for architectural design student in the university have not been properly explored.

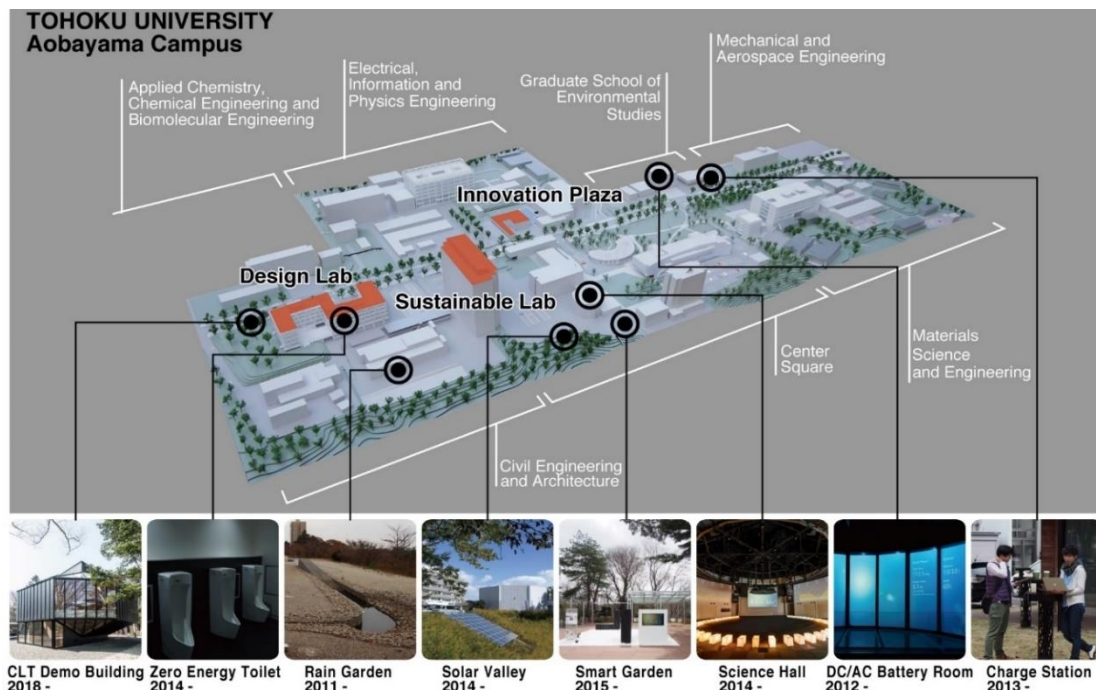

Figure 1: Smart & Sustainable Project in Aobayama Campus

# PLEA 2018 HONG KONG

*Smart and Healthy within the 2-degree Limit*

Architect capability for simulation tools can significantly affect both communication with engineer and building performances. Nonetheless, relatively few efforts have been made to build up a design education based on versatile simulation tools.

In this paper, we first explain the change of social and profession for Architects in the Era of Digitalization and, especially energy issues in Tohoku region having the experiences of March 11th 2011 disaster. We then introduce a study environment and curriculum for Design education in Tohoku University. Thus, an effort will be exemplified taking a case study of each student's design project of an adequate improvement process using CASBEE index and CFD simulation tools that can facilitate effective communication and interaction between junior architect in design and junior engineer in Engineering. The relevancy of Retro-fitting Improvement Approach will be exemplified by different building types and various simulation index of each student's design projects.

Such developments are expected to achieve new levels of architectural design education basis and connectivity between designers and the engineers for wide range of project. The outcome will serve as a solid basis for the primary design training to larger urban scale of Smart City design project in the future.

## 2. Background

There have been numerous of books and papers published on design education in architectural school. Disclosure of simulation tools to architects in the field of architectural and urban design date back more than decades ago. William. J. Mitchel, founder of MIT Media Lab, made a whistling arrow by pioneering works together with the emergence of impressive Apple Macintosh's GUI in the late 70's.

Two books Computer-Aided Architectural Design in 1977 [1] and The Logic of Architecture: Design, Computation and Cognition in 1990 [2] inscribed the mile stone for Era of digitalization in architecture design and

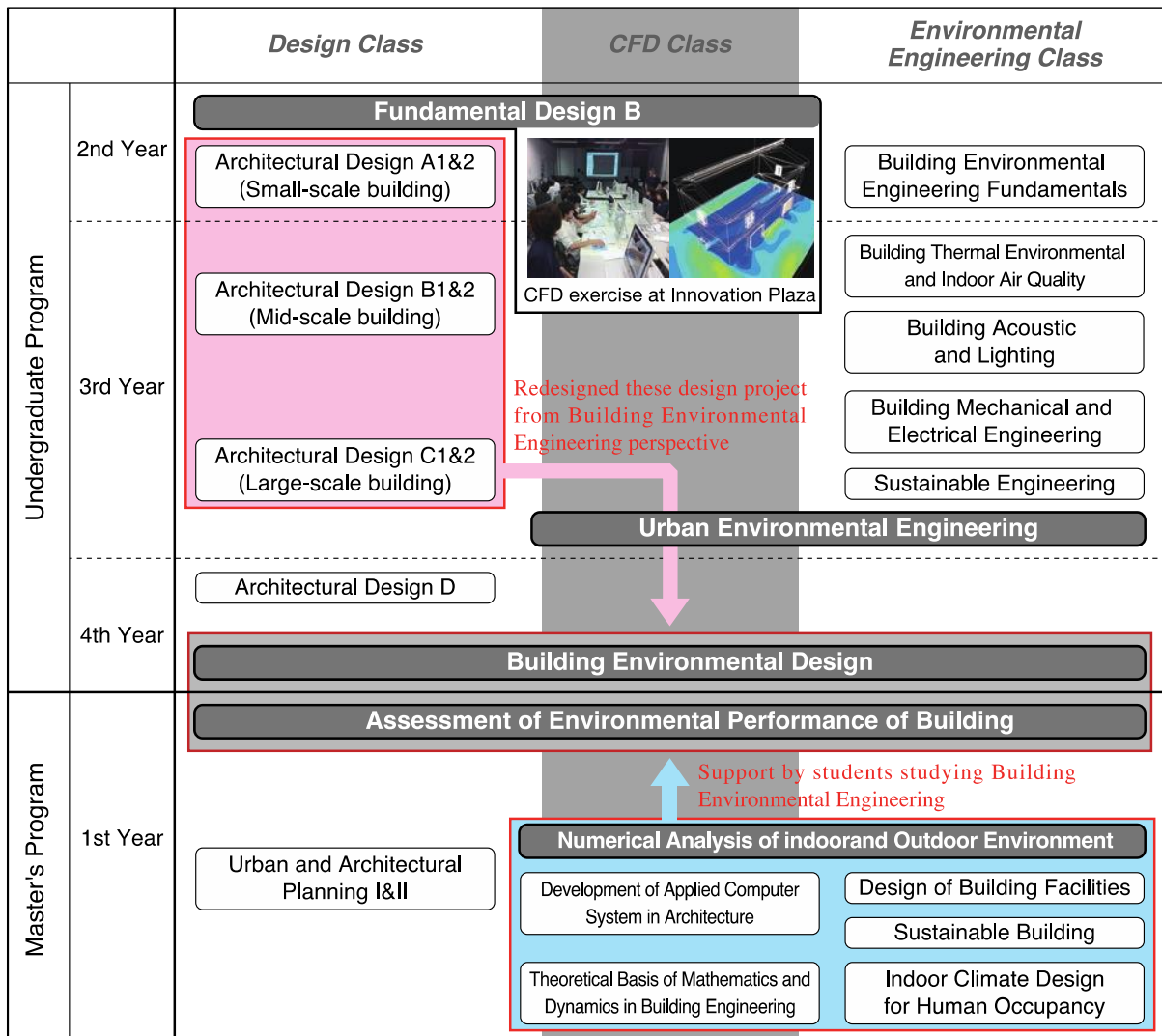

Figure 2: Curriculum of Design /CFD/ Environmental Engineering Class/ Undergraduate to master program in the department of architecture and building science, school of engineering

# PLEA 2018 HONG KONG

*Smart and Healthy within the 2-degree Limit*

profoundly changed the way architects approached building design. Today development of versatile and less expensive simulation tools not only for energy, thermal and lighting optimization but also for wind environment are getting popular for BIM (Building Information Modelling) users collaterally affected the insight of Design Education in the University. However, design education in the architecture schools mostly have not been refined sufficiently updating the evolution of digitalization era.

In Tohoku University we have recognized the significance of simulation tools on design education and have started primary development efforts since 2010, a year before mega-quake disaster of 2011.

### 3. Study Environment and Curriculum

Aftermath of March 11th disaster in Tohoku University included striking demolition of architecture department building. Author, as a director of Campus Reconstruction Architect Office of Aobayama East Campus, engaged in enormous number of reconstruction design from scratch situation.

Beside rapid dismantling and reconstruction work for the damaged campus facilities, new insights were simultaneously discussed, i.e. establishment of energy wise and resilient Smart Campus design. Thus, initial Test-bed project by reconstruction support fund were planned and implemented in the Campus.

#### 3.1 Testbed for Smart projects in Campus Recovery

Figure 1 shows Test-bed projects map inside Aobayama East Campus. All projects are done by interdisciplinary collaboration of mechanical, electric information and civil engineers professors with experts eventually that gave us a clue for potential vision of future architectural design paradigm. Here explains three of Test-bed projects briefly where function as venue of design education field for students.

##### 3.1.1 ZET: Zero Energy Lighting System in Lavatory

Under the emergency evacuation situation after the disaster, maintaining normal state of toilet is indispensable however after mega disaster toilet often becomes malfunction. The demonstration on resilient lighting system by micro water DC generator was successfully implemented without AC electricity by the collaboration with sustainable engineering professor and water closet company engineer [3].

##### 3.1.2 DC/AC Battery Room : Energy Visualization

Storage battery/machine control room for DC/AC hybrid electricity system was designed. Ambient signage gives visitor an immersive experience for renewable energy information. Integrating projection image, sound and lighting through the motion sensor by visitor's

interaction, renewable electricity energy information is multilaterally brought to visitor.

Collaborators: Environmental studies professor and electric information company engineer [4].

##### 3.1.3 Rain Garden : Storm Water control Green-Infra

Surprisingly given its unpredictable magnitude caused all city life infrastructure into standstill condition including swage system. Test-bed project of small rainwater harvesting gardens for dense urban context has the potential to function as an emergency drinking water reservoir, and work as storm water runoff reservoirs to prevent urban inundation. The rain garden also operates as counter figure to urban structure and serves as recreational gathering places throughout the city. Collaborators: civil engineering professor and environmental ecology engineer [5].

Throughout the design and implementation process of Test-bed projects, author was exposed to the outside of architectural education fields and required the technical direction of interface design between architecture and others domain.

### 3.2 Design Education based of CFD

Department of Architecture and Building Science has started primary training of CFD simulation tools at the specialized programs a decade ago. Figure 2 shows Curriculum from undergraduate to master program. In *Fundamental Design B* (2<sup>nd</sup> year), the students engaged in the measurement work of building details of traditional Japanese building by hands and CAD, making 3D model, having a basic CFD and structural analysis. There includes both *Building Environmental Design*(4<sup>th</sup>) and *Assessment of Environmental Performance of Building*(M1<sup>st</sup>). The features of these classes represent the following features.

1<sup>st</sup>: Consistent curriculum from undergraduate to graduate students. 2<sup>nd</sup>: Retrofitting improvement approach for the architectural design by the students themselves based on environmental engineering. 3<sup>rd</sup>: Re-designing project by team of both design and environment engineering laboratory students. The knowledge and skills gained are utilized for a master's design and thesis work by design lab's students.

### 3.3 Research Oriented Application by Design lab.

Recently in the master's thesis research project, design theory student has started to use CFD simulation for reinterpretation of modern architecture. For example, one of the students have been examining the environmental effect of "New Khmer architecture" in Cambodia (Figure 2: master thesis). Potential analysis for a new interpretation on modern architectural form is expected to give a new horizon by adding viewpoint of building environmental engineering.

# PLEA 2018 HONG KONG

*Smart and Healthy within the 2-degree Limit*

The significance of “Retrofitting Design Improvement” approach using CFD simulation tools by design laboratory student is that before having re-evaluation of design work, they never aware the indoor, outdoor climate factors and building envelope specification consciously, however through the entry program to higher integration class of *Building Environmental Design* under the supervision of hybrid discipline professors from design and engineering field, design laboratory student’s design work becomes to be continued and visions are optimized not only for aesthetical concerns but also for the needs of holistic sustainability design.

## 4. Retrofitting Design Improvement Approach

In this regard so-called “Retrofitting Design Improvement Approach” based on CFD simulation for design students are quite positive to widen the existing design theory basis. The results of the *Building Environmental Design* and *Assessment of Environmental Performance of Building* have shown various developments in recent years. Thus, enhancing motivations are given to students improving the original design concept into sustainable green building details.

In these classes, opposition are often observed between concept design making and the optimization proposition by engineering side, thus always heated up. For example, Figure 3 was an art museum project with concept of U-shaped open space receiving the flow of people, but retrofitting evaluation revealed that the wind environment of the open space and the light environment of the entrance hall gallery deviated from the space quality that he wanted achieve.

To improve the original closed space disposition into more comfortable venue having natural moderate speed of wind blow, he re-examined the proper site layout of building and changed the entrance hall into semi opened passage venue. In addition he also investigated the sky lighting as an environmental device that integrates vista of installation art work, consequently sublimated the original space idea into the revisional proposition integrating inside outside zone and opened to the surrounding urban area.

“Retrofitting Design Improvement Approach” for design and engineering laboratory students having a supervision both from design and engineering experts with active discussion is one of the distinctive feature regarding development effort on design education in Tohoku University, gaining a higher reputation in the environmental design competition entry for students’ original design with simulation projects.

## 5. Recent Students Projects: Sound, Water, Smell and Wind Simulation with Design Improvement

Currently, in the *Building Environmental Design* class, there are various types of design proposal that is not only for the purpose of raising the score of CASBEE but also the factors out of existing CASBEE score index. Then interesting and critical aspects that identifies the needs of improvement and additional index of CASBEE evaluation have been brought. Here, efforts and relevancy of design education so-called “Retro-fitting Improvement Approach” are exemplified taking a case study of each student’s different building types of design projects in recent years.

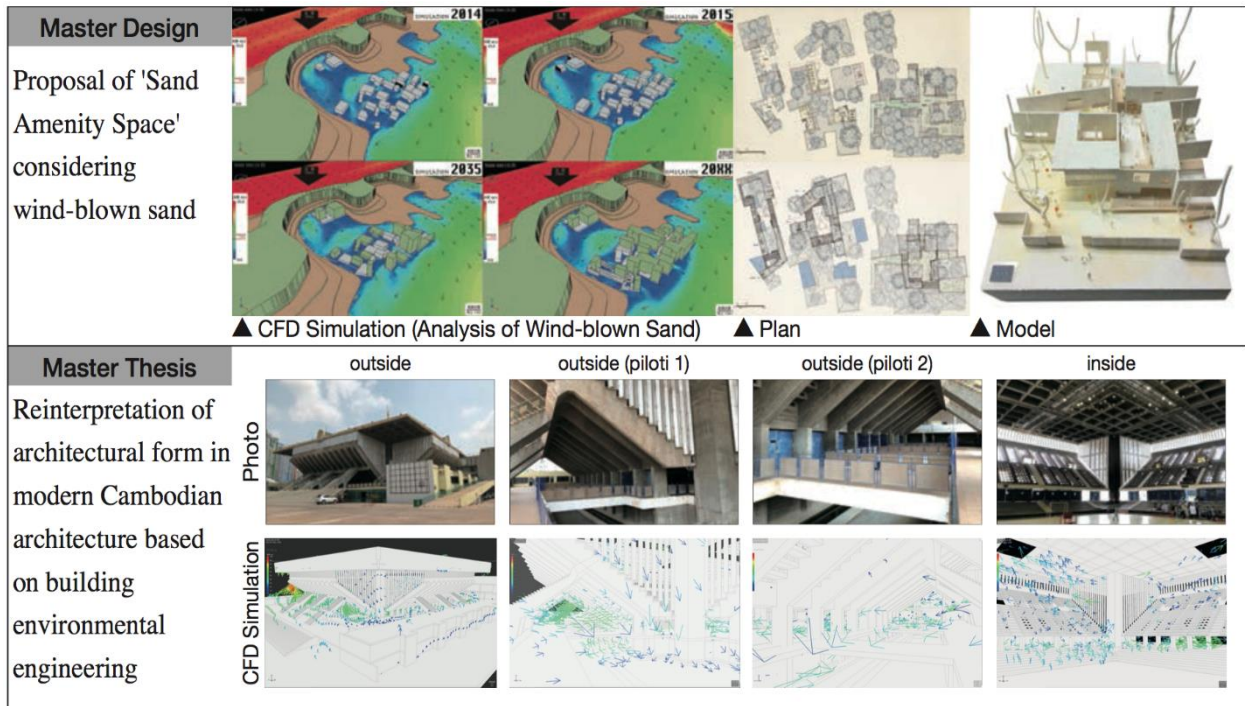

Figure 3: CFD application for Master Design and Thesis village near the sand dunes to the satellite campus (above). Thesis research for New Khmer Architecture and Formal analysis based on CFD simulation (bottom)

# PLEA 2018 HONG KONG

Smart and Healthy within the 2-degree Limit

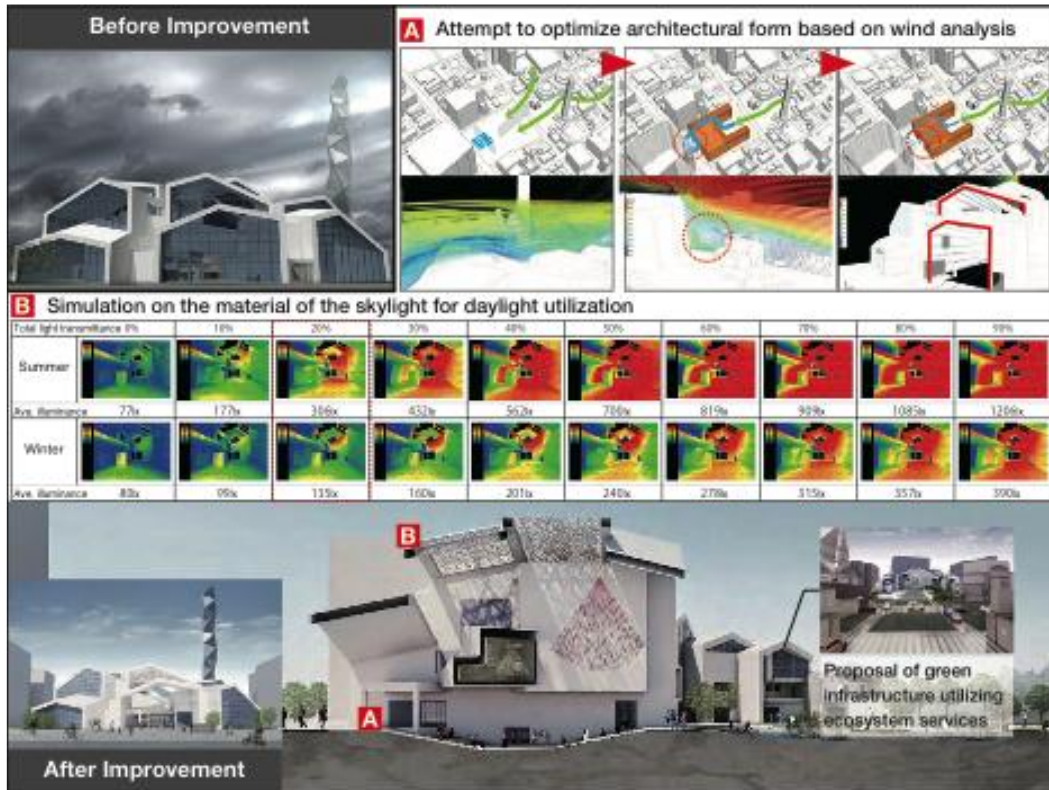

Figure 4: Simulation of Sound Environment for Interior Design case study in Building Environmental Design class.

## 5.1 Sound Environment Improvement case study

Figure 5 shows Simulation of Sound Environment for Interior Design case study in *Building Environmental Design* class. The original design was made for Primary School building in the relatively high dense urban context with local community facility in the 2nd year architectural design studio. Throughout the improvement discussion within design and engineering laboratory's student members, found that not only indoor thermal environment but also sound environment were critically low CASBEE scores because of immense square meters of glass façade of all orientation, proposed the optimum partition layout targeting each decibel(db) environment for different room.

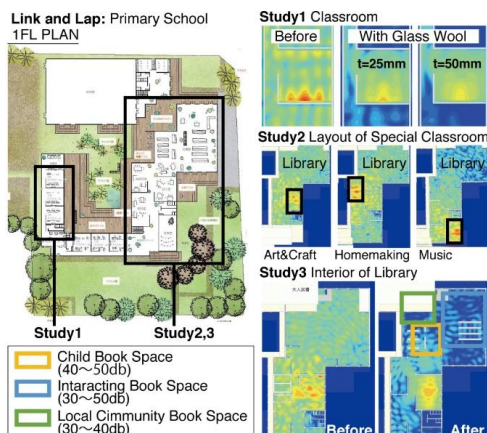

Figure 5: Simulation of Sound Environment for Interior Design

## 5.2 Light Environment Improvement case study

Figure 6 shows Simulation of Light Environment case study made for Nursery School and Kids Café Complex in the 4th year architectural design studio. Simulation result indicates not well-balanced lighting environment, so that concept of "Jumble 10 Boxes" was revised into articulated space with optimally well-organized lighting environment design.

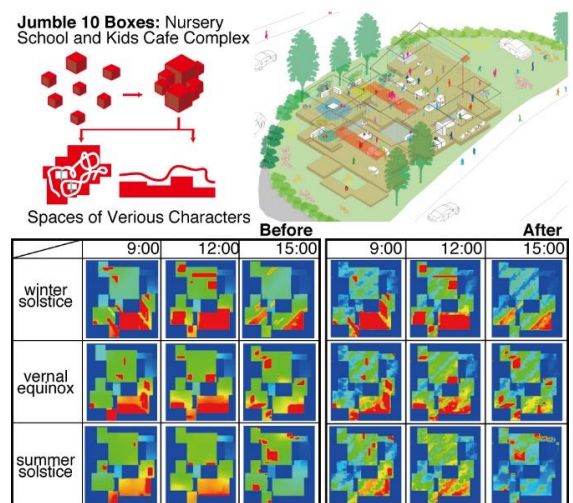

Figure 6: Simulation of Light Environment of Each Specific Space

## 5.3 Smell Environment Improvement case study

Figure 7 shows Simulation of Smell (Scent of Coffee) environment case study. The concept was space zoning

# PLEA 2018 HONG KONG

Smart and Healthy within the 2-degree Limit

using good smell of coffee for adult users in café without implementing real physical partition between Kids café however due to lack of adequate ventilation engineering, relevant zoning with / without coffee scent made impossible, thus revisional improvement were done for horizontal and vertical disposition.

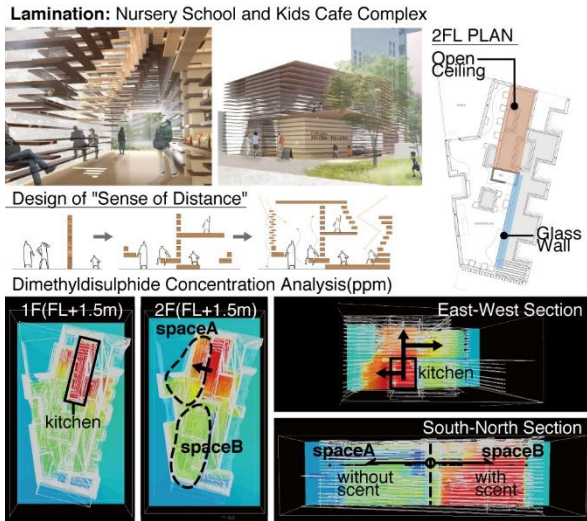

Figure 7: Simulation of Smell Environment by Scent of Coffee

## 5.4 Smell Environment Improvement case study

Figure 8 shows Simulation of Rain flow for Roof Design and Landscape case study, design proposal for Fabrication Laboratory in the high dense urban context. The concept is roof and surrounding landscape that are functioning as Green Infrastructure purifying and storing rainwater. Simulation for the original design proved not smooth rainwater flow, led change of roof plan and grade to realize stable rain water flow control.

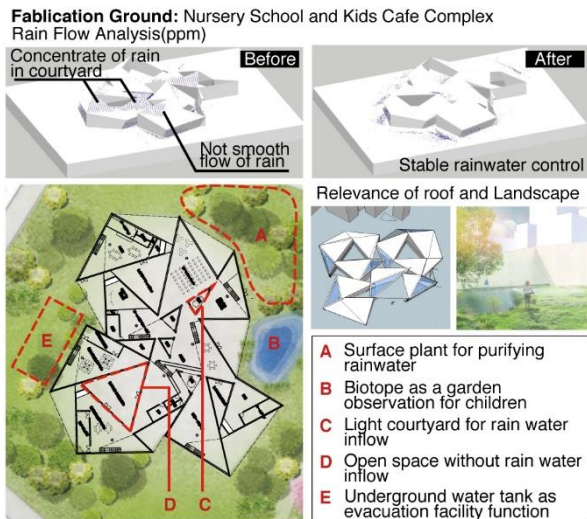

Figure 8: Simulation of Rainflow for Roof Design and Landscape

## 5.5 Wind Environment Improvement case study

Figure 9a/b shows Simulation of Wind Environment case study, for Housing Complex. Both projects pursued

the improvement design of building pilotti layout and room partition disposition by CFD.

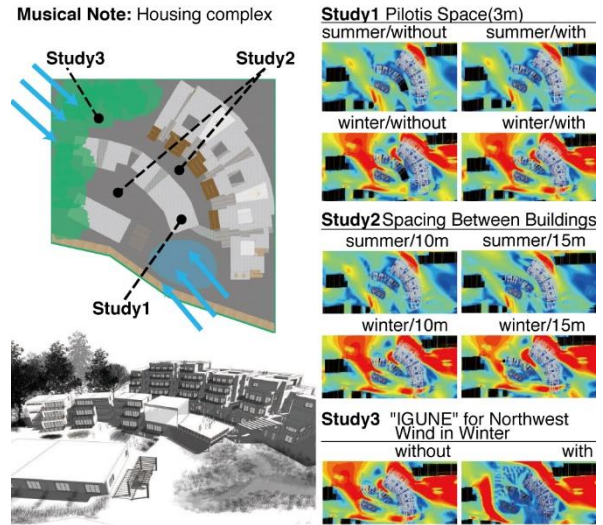

Figure 9a: Simulation of Wind Environment by Block Planning

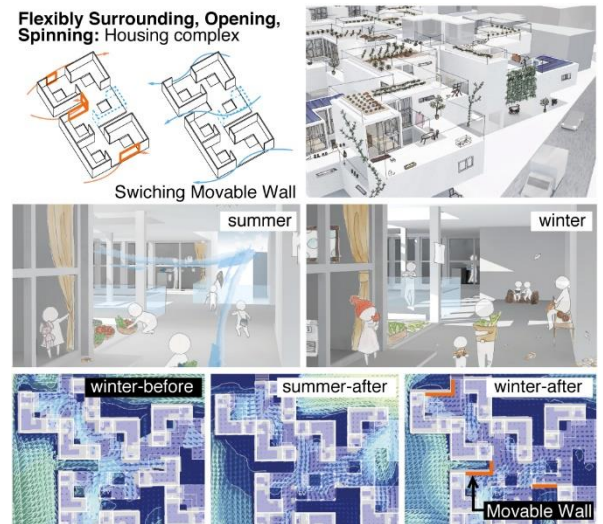

Figure 9b: Simulation of Wind Environment Control by Partitions

## 6. Conclusion

Through a decade training of "Retrofitting Design Improvement Approach" in Tohoku University, it could be pointed out that such developments are expected to achieve new levels of education standard and connectivity between designers and the engineers. The outcome will serve as a solid basis for primary design training to larger urban scale of high performance Smart City design project in the future.

## Acknowledgements

Building Environmental Design in Tohoku University are instructed by visiting prof. T. Ikaga (Keio University) and collaborative tutorial work of prof. A. Mochida, assoc.prof. H. Kobayashi, assoc.prof. T. Goto and research assoc. Y. Ishida with former assist. Prof. T. Okaze

# PLEA 2018 HONG KONG

*Smart and Healthy within the 2-degree Limit*

(Tokyo Institute of Technology) in the Sustainable Engineering laboratory.

## References

1. Mitchell, J. William, (1977). John Wiley & Sons, Inc. NY,
2. Mitchell, J. William, (1990). MIT Press Cambridge, MA,
3. M. Fujiyama, T. Ishida. (2016) Architectural Institute of Japan, Journal of Technology and Design, Vol.22, No.51,
4. M. Fujiyama, T. Ishida. (2016) Architectural Institute of Japan, Journal of Technology and Design, Vol.22, No.50, 281-284, [published in Japanese]
5. T. Ishida, (2014) POST 311/ Sendai OASIS, Water Urbanism East 2, 64-69, Kelly Shannon ed. Zurich, CH,