

Novel intensified process for ethanolamines production using reactive distillation and dividing-wall column technologies

Devaraja, Devnarayan; Kiss, Anton A.

DOI

[10.1016/j.cep.2022.109073](https://doi.org/10.1016/j.cep.2022.109073)

Publication date

2022

Document Version

Final published version

Published in

Chemical Engineering and Processing - Process Intensification

Citation (APA)

Devaraja, D., & Kiss, A. A. (2022). Novel intensified process for ethanolamines production using reactive distillation and dividing-wall column technologies. *Chemical Engineering and Processing - Process Intensification*, 179, Article 109073. <https://doi.org/10.1016/j.cep.2022.109073>

Important note

To cite this publication, please use the final published version (if applicable). Please check the document version above.

Copyright

Other than for strictly personal use, it is not permitted to download, forward or distribute the text or part of it, without the consent of the author(s) and/or copyright holder(s), unless the work is under an open content license such as Creative Commons.

Takedown policy

Please contact us and provide details if you believe this document breaches copyrights. We will remove access to the work immediately and investigate your claim.



Contents lists available at ScienceDirect

Chemical Engineering and Processing - Process Intensification

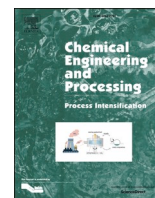
journal homepage: www.elsevier.com/locate/cep

Novel intensified process for ethanolamines production using reactive distillation and dividing-wall column technologies

Devnarayan Devaraja^a, Anton A. Kiss^{a,b,*}^a Centre for Process Integration, Department of Chemical Engineering, The University of Manchester, Sackville Street, Manchester, M13 9PL, UK^b Department of Chemical Engineering, Delft University of Technology, Van der Maasweg 9, 2629 HZ, Delft, the Netherlands

ARTICLE INFO

Keywords:

Process intensification
Process design
Process simulation
Optimization
Energy savings

ABSTRACT

Monoethanolamine is an essential chemical used as feedstock in the production of detergents, emulsifiers, pharmaceuticals, polishes, corrosion inhibitors, and chemical intermediates. It is produced industrially by treating ethylene oxide with aqueous ammonia, but the reaction also leads to di- and tri-ethanolamine as less desired by-products.

This study is the first to propose an intensified process for the production of ethanolamines combining reactive distillation (RD) and dividing-wall column (DWC) technologies. The process was optimized to maximize the MEA selectivity (over 71%), as the ratio of the products can be controlled by the stoichiometry of the reactants. Rigorous process simulations and sensitivity analysis of key process parameters have been carried out using Aspen Plus, for a plant with a production capacity of 11.5 ktpy ethanolamines. The overall process has been designed to produce ethanolamines with minimal energy utilization and reduced capital cost. Economic and sustainability analysis have been carried out showing the key benefits of the proposed process as compared to the conventional one used in industry: CapEx reduction of 7.3%, OpEx savings of 42%, and TAC improvements of 31.3%.

1. Introduction

Several environmental regulation policies and laws (e.g. Kyoto protocol, Paris agreement, REACH in Europe, TSCA amended by Lautenberg Chemical Safety Act in USA) have led to the demand for more sustainability to reduce fossil-based energy use and transition to renewable sources [22]. This has called for improvements to be made to the chemical operations and developments of newer approaches for sustainable engineering designs that prioritize cost-effectiveness, efficient operability, and reduces carbon footprint. In this respect, process intensification (PI) techniques can be employed to many chemical processes to make them more efficient, leading to energy and cost savings as well as less negative impacts to the environment [23].

Ethanolamines (EA) belong to a class of organic compounds, which are predominantly used as intermediated in a wide variety of chemical application [20]. It is forecasted that the ethanolamines market will

grow at a CAGR of 5% and become a \$5 BN market by 2030 [30]. But this growing demand requires key changes to the conventional production process in order to make it more sustainable, eco-efficient and cost effective. The reaction of ethylene oxide (EO) and ammonia (NH₃) catalyzed by water (H₂O) produces a mixture of mono-di- and tri-ethanolamines (MEA, DEA, TEA). Conventionally, the reactions occur in a series of tubular reactors, followed by a number of distillation columns performing separations of each of the remaining reactants (which are recycled) and the products formed.

The conventional process for producing ethanolamines has improved very little historically. Vamllng et al. [41] reported experiments on solid catalysts which can be used instead of H₂O for achieving better selectivity of MEA (e.g. zeolites and ion-exchange resins). MEA is the desired product as it has properties of both amines and alcohols and it is useful in many applications such as detergents, personal care, agrichemicals, CO₂ capture, etc. [10]. All the experiments were performed at lab-scale,

Abbreviations: CAGR, Compounded annual growth rate; CapEx, Capital expenditure; DEA, Di-ethanolamines; DWC, Dividing-wall column; EA, Ethanolamines; EO, Ethylene oxide; GHG, Greenhouse gas emissions; HP, High pressure; MEA, Mono-ethanolamines; MP, Medium pressure; OpEx, Operating expenditure; PI, Process intensification; RD, Reactive distillation; SP, Side product; TAC, Total annualized cost; TEA, Tri-ethanolamines; VLE, Vapor liquid equilibrium; HTP, Human toxicity potential.

* Corresponding author.

E-mail address: TonyKiss@gmail.com (A.A. Kiss).

<https://doi.org/10.1016/j.cep.2022.109073>

Received 21 April 2022; Received in revised form 18 July 2022; Accepted 23 July 2022

Available online 26 July 2022

0255-2701/© 2022 The Authors. Published by Elsevier B.V. This is an open access article under the CC BY license (<http://creativecommons.org/licenses/by/4.0/>).

but the results could be used as a basis for preliminary reactor designs. Nippon Shokubai [25] reported the solid catalyst development using rare earth elements for the production of ethanolamines. This was very promising as it gave an 81% mass fraction of MEA product when the molar ratio of NH_3 to ethylene oxide was fixed at 12.5 and the reactor pressure at 14.5 MPa.

In 2006, BASF patented the improved selectivity of MEA by increasing the molar ratios of reactants (NH_3/EO), but no information was given on the effects of other parameters such as water feed rate, temperature, etc. [10]. A later patent from 2010 by Sulzer ChemTech reported experiments on understanding the distribution of MEA, DEA and TEA by varying molar ratios of NH_3 to ethanolamines [8]. Zahedi et al. [45] reported an industrial ethanolamines production plant optimized to get maximum yield. However, the study did not include energy reduction and only focused on improving MEA selectivity. To be fair, all these patents only focused on improving the conventional production approaches.

This particular approach has disadvantages which can be addressed with PI techniques to achieve higher selectivity towards MEA to make the process economical and energy efficient.

This research study is the first to propose a combination of PI technologies for ethanolamines production in a new process implementing reactive distillation (RD) and dividing-wall column (DWC) technologies. RD takes advantage of the synergy developed by combining two operations (reaction and separation) into a single unit [17], leading to higher selectivity, better conversion of reactants, less energy use, no need for solvents, etc. [14,38]. A recent publication by Liu et al. [20] explored the production of ethanolamines in a single RD column, but the downstream separation part (and recycles of reactants) was completely neglected despite being very important [1], and no data was provided in terms of improvements as compared to the classic production (e.g. carbon emissions, energy intensity, etc.). Notably, a DWC combines the operation of two distillation columns in one shell, in an efficient way that allows energy and capital savings of 25–30% or even more [34,43]. Such a DWC could be used for the downstream processing of the ethanolamines mixture, but this idea has not been explored yet. There are also no patents published on the separation of ethanolamines using a DWC. This work proposes a new intensified process for the production of ethanolamines, with an annual production capacity of 11.5 ktpy (operated for 8760 hr per annum).

2. Problem statement

The current state of the art production of ethanolamines takes place in several tubular reactors followed by a series of distillation columns for separation of ethanolamines, an approach that is inspired by a patent from BASF [10]. However, there are several disadvantages of this process, such as low selectivity towards MEA, requirements of large excess amounts of NH_3 , high energy use for separation (and recycle) of unreacted reactants, high catalyst to feed ratio, inefficient heat recovery and high complexity of reactor control [2,20,39].

To solve these problems, this study proposes a new intensified process that combines RD and DWC technologies to achieve an innovative, energy efficient approach that allows high MEA selectivity and significant cost savings. Note that RD is typically used for equilibrium limited reactions, but this is not the case here. In this particular process, there are three chemical reactions taking place consecutively leading to MEA, DEA and TEA (as described later). RD can help here, by recycling the reactants in a more efficient manner (total ammonia reflux) and removing the MEA product as soon as it is formed, thus not allowing it to react further to form DEA or TEA (the less desired by-products) – which is not the case in traditional PFRs.

3. Basic data (thermodynamics & kinetics)

Understanding the properties of the chemicals involved in a chemical

system is crucial in order to choose the best operating conditions. The main physical properties of the components involved in the ethanolamines production are listed in the Appendix (in Table A1).

Vapor liquid equilibrium (VLE) data is essential in order to design accurate separation schemes for getting high purity MEA, DEA and TEA. Park et al. [29] determined the VLE for a wide range of temperatures which was not available previously in the literature. Activity coefficient models (such as NRTL and UNIQUAC) can be used for the simulation of the process, validated using the previously reported experimental data [29]. For this work, UNIQ-RK property model has been employed in Aspen Plus V8.8, as the chemical system involves non-ideal polar components having varying molecular sizes and operating at high pressures. This is consistent with the literature, as Liu et al. [20] used the same thermodynamic package for the simulation of an RD column.

Note that ethanolamines are color sensitive chemicals when exposed to high temperatures, but it should be colorless for commercial applications. Yue et al. [44] reported experiments about the heat sensitivity of ethanolamines. MEA is the most color sensitive to temperature followed by TEA, while DEA is the least effected and acts as a protective blanket for MEA and TEA from changing color. However, the authors were not able to explain the protective mechanism of DEA. From this research, one could infer that having some DEA in the product streams can help in countering the colouring problem at high temperatures. Alternatively, it is better to avoid exposing the ethanolamines at high temperatures for prolonged times.

The main reactions that take place for the production of MEA, DEA and TEA are:

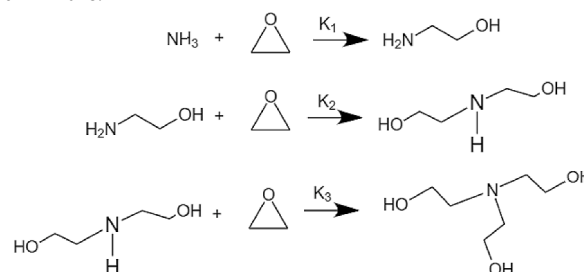

The reaction rates are a function of concentration of reactants, as follows:

$$r_1 = k_1 C_{\text{NH}_3} C_{\text{EO}} \text{ where } k_1 = 7845 \times \exp(-11500 / RT) \quad (4)$$

$$r_2 = k_2 C_{\text{MEA}} C_{\text{EO}} \text{ where } k_2 = (8.151 - 0.051C_w) \times k_1 \quad (5)$$

$$r_3 = k_3 C_{\text{DEA}} C_{\text{EO}} \text{ where } k_3 = (14.81 - 0.196C_w) \times k_1 \quad (6)$$

where r_1 , r_2 and r_3 represent the reaction rates and k_1 , k_2 , and k_3 are the kinetic rate constants., and the activation energy is $48.185 \text{ kJ mol}^{-1}$.

The reaction between ammonia and ethylene oxide does not take place without the presence of water to catalyze the reaction [19]. Moreover, the reaction rate constants are a function of the concentration of water [24]. Over the years, several studies have been conducted to achieve accurate kinetic data for these reactions. The kinetic constants are a function of several parameters such as water concentration, residence time, molar ratios of feed, equipment type and size of equipment [2]. The reaction mechanism has been studied and reported by Park et al. [28]. The experiment has been carried out by assuming irreversible consecutive second order reactions. This work adapts the kinetic data from Park et al. [28], as the reaction temperatures and molar compositions of the reactants are quite similar. Table A1 provides the kinetics parameters. Note that the publication of Cheng et al. [2] summarizes all the reaction kinetics data from other researchers, and confirms that the values reported by Park et al. [28] are closer to the actual values when the temperature is between 30 and 140 °C and the concentration of ammonia is between 30 and 99 wt%. The side reactions involving the formation of ethylene glycol have not been considered as they are insignificant [31], especially in a reactive distillation process with short

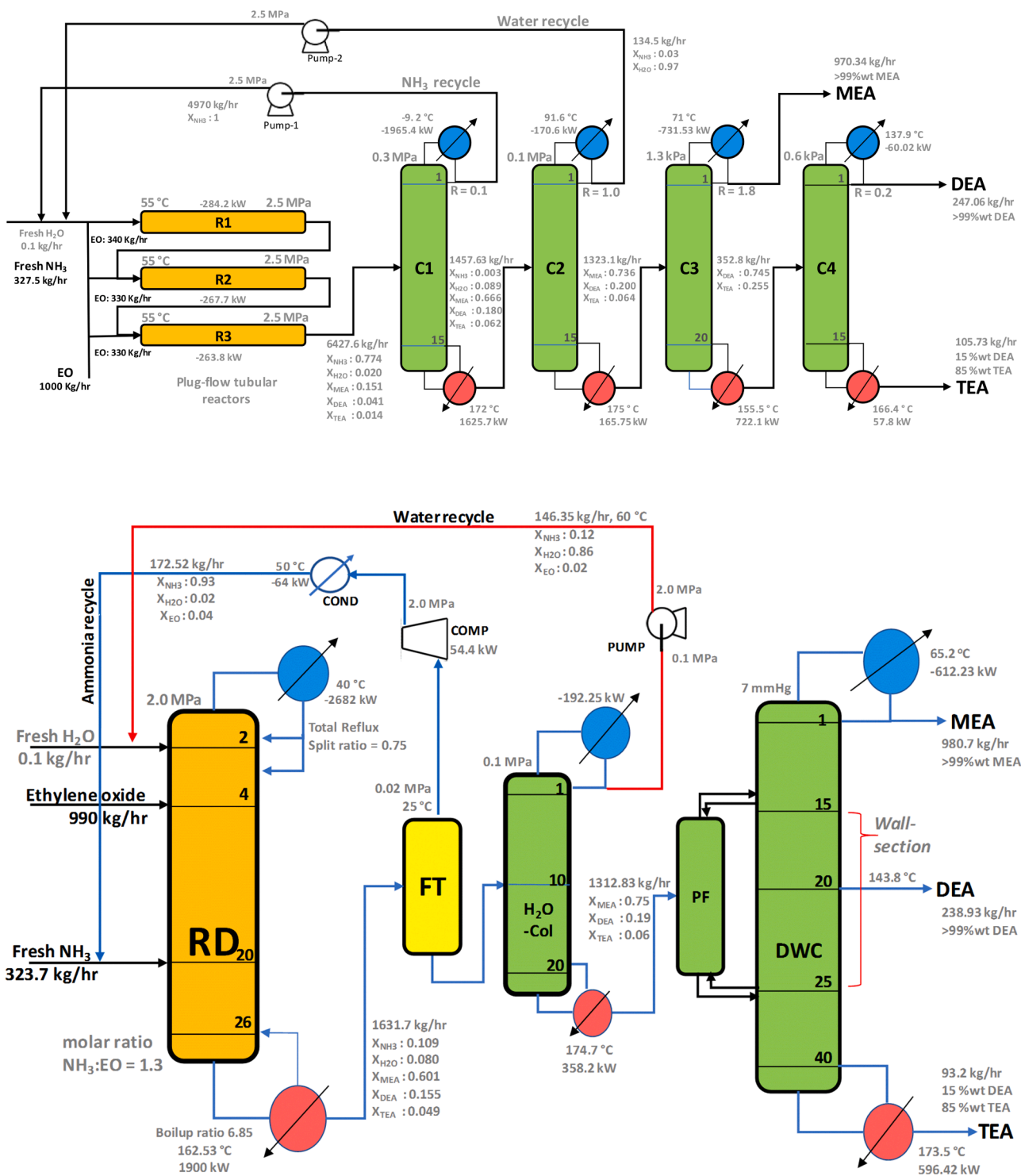

Fig. 1. Top: Conventional process for ethanolamines production (adapted from [20]). Bottom: Flowsheet of a new intensified process for ethanolamines production.

residence time and continuous removal of products.

4. Process description and simulation approach

The conventional process for ethanolamines production is depicted in Fig. 1 (top). The simulation of the conventional process is adapted from the work of Liu et al. [20], in which the conventional model is developed based on the patent by BASF [12]. A multi-tubular reactor system (consisting of 3 reactors) is employed for carrying out the desired reactions, followed by a series of distillation columns for separating

unreacted reactants from products. In the conventional process, the reactors are operated at a pressure of 25 bar and a temperature of 55 °C, the EO is introduced into the 3 tubular reactors in the ratio of 0.34:0.33:0.33 in order to minimize EO concentration, catalyst feed rate of 130 kg/hr, the unreacted NH₃ and water are recycled back, and the distillation columns are operated in such a way that the reboiler temperatures do not exceed 180 °C.

Fig. 1 (bottom) depicts the proposed flowsheet for the intensified ethanolamines production process. It consists of an RD column where production of ethanolamines takes place, followed by a separation

Table 1
Optimized design parameters of the RD column after performing sensitivity analysis.

Parameters	Results
Pressure	20 bar
No. of stages	26
No. of reaction stages	22
Reaction zone starting stage	4
Reaction zone ending stage	25
Reflux ratio (kg/kg)	0.8
Boilup ratio (kg/kg)	6.85
EO feed rate	1000 kg/hr
NH ₃ feed rate	501.70 kg/hr
Molar ratio (NH ₃ :EO)	1.3
Water feed rate	130 kg/hr
Temperature of distillate	49.51 °C
Temperature of bottom product	162.4 °C
Condenser duty	-2682 kW
Reboiler duty	1900 kW
Product composition mass fraction	
- Ammonia	0.109
- Water	0.080
- MEA	0.601
- DEA	0.155
- TEA	0.049
EO conversion	99%
Ammonia conversion	64.5%
MEA selectivity	71.5%
Column diameter	0.67 m
Residence time per stage	40 s

scheme to separate the unreacted reactants from the products. The products (MEA, DEA and TEA) are further separated using a DWC. The separation scheme consists of a flash tank to recover unreacted NH₃ followed by a H₂O recovery distillation column. The flash tank is operated at a pressure of 0.23 bar and a temperature of 25 °C in order to achieve >90% recovery of the unreacted ammonia. The water recovery column is operated at a pressure of 1 bar such that the reboiler temperature does not exceed 180 °C. The unit will recover 99.9% of H₂O and the remaining unreacted ammonia from the product stream. The recovered reactants are recycled back to the RD column. The bottom product of the H₂O recovery column is sent to the DWC where ternary separation takes place to recover MEA as distillate, DEA as side product and TEA as bottom product.

4.1. RD column simulation

RADFRAC unit in Aspen Plus was used to simulate the RD column. The proposed RD column has 3 feed inlets and the top product (NH₃) is fully refluxed back into the column for achieving maximum conversion. The initial parameters for the simulation are adapted from the work of Liu et al. [20] and the patent of Garg et al. [11]. It should be noted that the results of Liu et al. [20] are rather questionable due to some unrealistic assumptions, e.g. a specific reactive zone instead of considering all trays reactive (as water is a homogeneous catalyst that is removed in the bottom stream), very low liquid hold-up per tray meaning less than 1 s residence time (insufficient for reaction), errors / typos in the kinetics, mismatch of mass and molar fractions, and inaccuracies in the temperature vs pressure in the columns. In this work, further optimization of the parameters is carried forward by sensitivity analysis for achieving maximum selectivity of MEA. A total of 26 stages are present in the RD column. NH₃ is fed to the column at stage 20, while liquefied EO is fed to the column at stage 4 and water is fed at the top of the column to ensure uniform concentration in the bulk reacting phase for catalyzing the ethanolamines reaction. The concentration of water is a function of the amount of catalyst introduced in the RD column. The molar ratio of NH₃ and ethylene oxide is set at 1.3 and the flowrate of ethylene oxide is fixed at 1000 kg/hr. For this molar ratio the concentration of water is 0.72 mol.L⁻¹. These operating variables are chosen for

a fair comparison of the results with the conventional process, which is adapted from the paper of Liu et al. [20] considering similar flowrates of EO and molar ratios for the ethanolamines production. The temperature of the reactive section of the column is maintained between 40 and 60 °C for favorable kinetics. This temperature range agrees to the publication of [20] and the reaction kinetics experiments reported [24,28]. The reboiler temperature of the column does not exceed 180 °C as to avoid color deterioration of ethanolamines and less expensive utilities can be utilized. Cooling water is used as the cold utility in the condenser, and MP steam as the hot utility in the reboiler.

High pressure is maintained in the RD column for the reactions to surface. The RD column is operated at a pressure of 19 bar, maintaining high pressure is conducive to better conversion of reactants. In addition to high pressure and favorable temperature, we also need to provide sufficient residence time in each tray of the RD column for the desired reactions to occur. A residence time per stage of 40 s is set for the ethanolamines reactions to occur. Sensitivity analysis on the effects of pressure, molar ratio of NH₃ to ethylene oxide, catalyst flowrate, residence time, boilup ratio, reactant feed stage has been performed to achieve the best operating conditions for achieving maximum selectivity.

4.2. DWC simulation

Simulation of DWC requires solving mass, energy and momentum balance equations simultaneously [33]. Designing a DWC is challenging due to the complex internal structures and additional degree of freedom such as number of stages in each section of the DWC, reflux ratios, operating pressures, liquid and vapor split ratios, side product flowrate etc. [5]. Aspen Plus does not provide readily available DWC models which can be utilized for performing simulations. Hence, two RADFRAC units which are thermally coupled (a Petlyuk setup) was employed for performing the DWC simulations as the Petlyuk is the thermodynamic equivalent of a DWC [16]. In this setup, the prefractionator column performing a non-sharp split is thermally coupled with a main column where a sharp split between the components takes place [36].

For the initial design of the DWC, the heuristics of designing and simulating a DWC adapted from the publications of [5] is followed. Firstly, a conventional 2 column direct sequence setup is simulated for achieving the desired separation. The number of stages for the DWC is 80% of the total number of stages required for a 2-column conventional sequence. The wall is placed approximately in the middle of the column. Equal split ratios are provided for both the vapor and liquid splits. 70% of the total duties of the condenser and reboiler in the conventional approach have been taken for the DWC [5]. The heuristics followed lead to the initial design but this is not an optimal design. The optimal design in terms of energy use is achieved by performing sensitivity analysis. The effects of the side product flowrate, operating pressure and vapor and liquid split ratios have been evaluated to estimate the best operating conditions for achieving the desired separation.

5. Results and discussion

This section of the paper provides results related to the design of the RD and DWC in terms of optimal operating conditions for achieving maximum selectivity of MEA, desired degree of separation of ethanolamines and minimum energy use. Economic and sustainability analysis was also performed to allow a fair comparison to the conventional industrial process.

5.1. RD column design

Sensitivity analysis have been performed on the RD column for obtaining optimal conditions of operations for higher MEA selectivity. Table 1 provides the RD column design based on the results of the sensitivity analysis. The optimization resulted in 99% conversion of EO

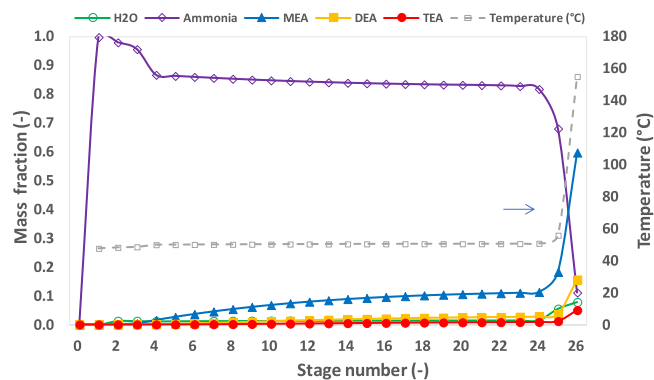

Fig. 2. Composition and temperature profiles along the RD column.

Table 2

Results of sensitivity analysis performed for the RD column.

Parameters (RD)	MEA (Kg/hr)	DEA (Kg/hr)	TEA (Kg/hr)	Tcond (°C)	Treb (°C)
Pressure (MPa)					
1.8	934.64	264.68	93.66	45.52	144.46
1.9	972.05	253.86	81.03	47.56	155.31
2.0	1005.39	242.02	70.16	49.51	164.71
2.1	1035.33	229.77	60.82	51.40	173.20
NH₃/EO					
1.1	966.52	263.89	83.38	47.56	197.57
1.2	969.00	259.16	82.38	47.56	174.82
1.3	972.05	253.86	81.03	47.56	155.32
1.4	973.07	250.81	80.21	47.56	142.93
Reboiler Duty					
1900	946.84	263.28	92.00	47.56	152.78
2000	957.33	259.43	87.36	47.56	153.83
2100	967.27	255.69	83.06	47.56	154.84
2200	976.70	252.06	79.08	47.56	155.79
2300	985.67	248.54	75.38	47.56	156.69
Water Feed Rate					
110	970.19	254.04	81.46	47.56	152.25
120	971.10	253.97	81.26	47.56	153.84
130	971.94	253.88	81.11	47.56	155.31
140	972.99	253.74	80.83	47.56	156.76
Residence time per reactive stage (sec)					
30	954.09	246.56	75.34	47.56	149.00
35	965.56	251.57	78.68	47.56	152.97
40	972.05	253.86	81.03	47.56	155.32
45	975.82	254.90	82.86	47.56	156.10

and 64.5% conversion of ammonia. Overall, a MEA selectivity of 71.5% is achieved which is higher than reported in previous studies, e.g. 70.3% reported by Liu et al. [20] and 52.1% achieved by Garg et al. [11]. Compared to previous work, the key parameters and design differences are higher boilup ratio allowing the unreacted EO and NH₃ to recirculate in the column for further reactions to take place, which lead to higher MEA selectivity according to the reaction kinetics and reactants ratio. In addition to this, the reflux stream containing predominantly ammonia is split into two streams (75% of the reflux being returned to the top stage of the column), which helps increasing of the concentration of NH₃ in the reaction bulk phase. Moreover, the residence time per stage chosen in such a way to maximize the MEA selectivity by avoiding subsequent chain reactions that forms DEA + TEA.

In another design arrangement which was considered, the EO feed was split into 3 feed streams and introduced into the column at 3 different sections (top, mid section and bottom) with the objective to increase the concentration of EO in the reaction bulk phase. This helped in increasing the selectivity of MEA. However, it reduced the conversion of EO due to the low residence time per stage. This meant that the unreacted EO in the product stream would further react in the subsequent units, auxiliary components and pipes which cannot be controlled.

Due to this disadvantage, this particular design was not considered for the intensified process. The RD column could be further improved by implementing catalyst for anhydrous operations which has the potential to further increase MEA selectivity.

Fig. 2 shows the composition and temperature profiles of the RD column. It is clear that ammonia is predominant because of the total reflux conditions and high boilup ratio. There is also a sharp rise in temperature in the stripping section which is due to the enrichment of heavy components present in the product mixture during separation.

5.2. Sensitivity analysis for the RD column

5.2.1. Effect of the catalyst flowrate

Water is utilized as catalyst so it is crucial to understand the effects of water concentration in the reacting bulk phase on the selectivity of MEA. From the adapted reaction kinetics, water concentration plays a major role in the selectivity and distribution of ethanolamines. According to the literature, higher concentrations of water in the reacting bulk phase are beneficial to MEA selectivity and lower concentrations favors higher TEA selectivity [24,28]. However, higher catalyst flow rate increase the concentration of water in the reboiler causing the energy use to increase. Lower feed rates of water help in reducing the energy requirements, but the reaction kinetics of MEA is disadvantaged. Hence, an optimum water feed rate has to be set in order to optimize the energy use and MEA selectivity. For the sensitivity analysis, the water feed rate is varied from 110 to 140 kg/hr and its effects on various parameters are studied.

The sensitivity analysis revealed that MEA selectivity tends to increase with increase the catalyst flow rate, TEA and DEA selectivity reduces with changing water concentration (see Table 2). This trend is similar to the ones reported in literature [19,24]. The top product temperature remains the same as water concentration in the top product is unchanged since the top product is predominantly ammonia. However, the bottom temperature increases at higher water (catalyst) concentration in the reboiler. It also influences the reactive stages, as increasing the water concentration enables faster reaction rates for MEA thus lowering the EO concentration in the reactive section. This results in fewer stages where the ethanolamines reaction takes place. After performing the analysis and considering the benefits and drawbacks, a feed rate of 130 kg/hr water is used for operating the column.

5.2.2. Effect of the operating pressure

Pressure is a key parameter that determines the conversion of the reactants into ethanolamines as it sets the temperature of the reboiler and condenser (and along the column) and ultimately the operating costs [4,18,39]. In RD, pressure influences the reaction temperatures thus it influences the kinetics that govern the reactions. The pressure of the RD column was varied in the range 18 to 21 bar. An increase in pressure increases the selectivity of MEA as it increases the reaction rates for producing ethanolamines as the temperature of the column is raised. It also increases the temperature of the reboiler, thus suitable operating pressures have to be selected for ensuring high quality products (avoiding thermal degradation). The selectivity of MEA increases in this analysis and a decrease in TEA formations can be observed as shown in Table 2. This is because the reaction rates of MEA is relatively higher compared to the rates of DEA and TEA as the pressure (and temperature) is increased. Considering the energy use (energy cost) and optimal MEA selectivity, the RD column should be operated at a pressure of 20 bar.

5.2.3. Effect of the reboiler duty

The RD column operates under total reflux conditions, hence for optimizing the column performance, the reboiler duty is used as an operating variable instead of the reflux ratio. Reboiler duty has direct effects on the boilup ratio of the column. Boilup ratio is amount of liquid that is boiled and returned to the column and plays an important role in RD processes because it can influence both separations as well as the reactions in the column [9]. Increasing the reboiler duty helps

Table 3

Optimized design parameters of the DWC after performing sensitivity analysis. Tabulation also specifies design parameters adopted for the separation of ethanalamines for a 2-column direct sequence system.

Parameters	Optimized Data/results
Prefractionator (PF)	
No. of stages (wall height)	10
Feed stage	5
Operating pressure	9.33 mbar
Main Column	
no. of stages	40
vapor feed stage (from pf)	15
Liquid feed stage (from PF)	25
Side product stage	20
Liquid and vapor split ratio	0.5 0.5
Side product flowrate	2.27 kmol/hr
Operating pressure	9.33 mbar
Reflux ratio	1.3 kg/kg
Distillate rate	16.06 kmol/hr
Reboiler type	Kettle
Top product temperature	65.2 °C
Side product temperature	143.77 °C
Bottom product temperature	173.53 °C
Reboiler duty (DWC)	596.42 kW
Reboiler duty (conventional system)	779.9 kW
MEA purity	99 wt%
DEA purity	99 wt%
TEA purity	85 wt%
DWC column diameter	3.0 m
Direct Sequence (two-column approach)	
Number of stages (C1 C2)	20 15
Feed stage	5 9
Operating Pressure	13.33 6.66 mbar
Reflux ratio	1.8 0.2 kg/kg
Reboiler duty	722.072 57.76 kW
Reflux rate	28.6 0.47 kmol/hr
Boilup rate	32.68 2.43 kmol/hr
MEA purity	99 wt%
DEA purity	99 wt%
TEA purity	85 wt%

increasing the separation in the reboiler, meaning that the unreacted NH_3 in the bottom product can be separated and further sent to the reactive section of the RD column which leads to increasing the selectivity of MEA. However, increasing the reboiler duty above a certain limit leads to a very high boilup ratio causing the drying up of stages which translates to insufficient liquid holdup on trays for the reactions to occur. This would negatively influence the residence time per tray. Hence, an optimum reboiler duty needs to be set for achieving maximum selectivity with minimum energy use. For the sensitivity analysis, the reboiler duty was varied from 1900 to 2300 kW. The increase in reboiler duty aids in the increase in the boilup ratio. High reboiler duty is beneficial to MEA selectivity due to increased ammonia concentration in the reaction bulk phase. However, reboiler duty above 2300 kW causes the stages in the column to dry up due to the high boilup ratio (vapor flowrate). Note that the distillate temperature does not change with an increase in reboiler duty as NH_3 is the dominant component in the top. However, the temperature of the reboiler increases as the high boiling components are enriched, resulting in increased energy use. For the optimal design, the RD column should be operated with a reboiler duty within the range of 1900–2100 kW such that maximum conversion of NH_3 and MEA selectivity can be achieved.

5.2.4. Effect of molar ratio of reactants

Molar ratio of NH_3 to EO is a crucial parameter which governs the selectivity of MEA. According to the literature, higher ratio of the reactants favors MEA selectivity and lower ratios help in increasing the concentration of TEA in the product stream [27]. This reactants ratio was varied from 1.1 to 1.4. Higher molar ratios are beneficial to MEA selectivity, while lower ratios favor TEA formation. It has no effect on the top product temperature, but the reboiler temperature reduces

considerably as the excess unreacted ammonia ends up into the reboiler. Compared to conventional tubular reactor models the molar ratio of NH_3 to EO is significantly low in the RD column, due to the total reflux of unreacted NH_3 . In the publication of Liu et al. [20], the authors mention that for a molar ratio of 0.9:1 in the feed, the total reflux conditions help the molar ratio to increase to 40:1 in the column. The RD column being operated under total reflux conditions and high boilup ratios helps amplifying the molar ratios of reactants which is a primary reason for high MEA selectivity. These conditions actually help increase the concentration of NH_3 in the reactive section compared to the concentration of EO. A ratio of 1.3 would also favor an easy separation of ammonia in the downstream units without excess energy usage.

5.2.5. Effect of EO feed stage

The feed stage of NH_3 and H_2O are fixed in order to maintain a uniform concentration of these components in reactive section of the column. The EO feed stage directly affects the number of stages in the reaction and stripping zone. MEA selectivity is reduced slightly as the EO feed stage is moved downwards as this can reduce the molar ratio of NH_3 to EO in the reaction stages, but does not show significant variation as compared to the other effects discussed previously. Moving the EO feed stage further down the column also impacts the conversion of EO. Although it has an effect on the MEA selectivity, the influence is reduced as compared to the influence shown by other parameters discussed earlier. Moving the feed stage of EO away top of the column can reduce the duties of the condenser and reboiler as the concentration of EO reduces in the condenser and the reboiler. For the optimal design, EO is introduced to the column on stage 4.

5.2.6. Effect of the residence time per stage

As a crucial parameter which can significantly affect the reactions which occur in a RD column. Residence time can be defined as the contact time between the reactants and the catalyst per reactive stage in the RD column [42]. Liquid residence time and its distribution per tray are very important for modeling RD [37], as it influences the column dimensions for any system. A higher residence time increases the tray size leading to a column with larger diameter thus no reduction in CapEx. Also, a larger residence time would mean a very high liquid holdup which can affect the hydraulics of the column. Thus, an optimum residence time has to be chosen to achieve the desired conversion and selectivity of the product. Sensitivity analysis was performed by varying the residence time in the range of 30 to 45 s per stage.

Note that increasing the residence time per tray is not beneficial to MEA selectivity, as the MEA formed can further react with EO to produce DEA and TEA. Also, reducing the residence time will impact the conversion of EO. For a residence time above 60 s, the liquid height on the tray becomes higher than a typical side weir height of 0.45 m. Conversely, for a residence time of 10 s, the liquid height on the tray becomes 0.05 m, and due to the large flow rates of vapor through the trays, a problem of foaming can occur. Residence time does not have effects on the top product temperature but increasing residence time increases the reboiler temperature, due to the reduced concentrations of EO and NH_3 in the reboiler and increased concentrations of heavy boiling components. A residence time per stage of 40 s is considered the best trade-off for acceptable EO conversion and MEA selectivity.

5.3. Dividing-wall column design

DWC has been employed in the proposed process for the separation of ethanalamines with a primary objective of reducing energy use and overall OpEx and CapEx. The use of DWC is advantageous as ternary separations can be performed in a single unit that replaces a series of distillation columns performing binary separations [43]. Sensitivity analysis have been performed on three main parameters (operating pressure of the column, side draw flowrate, and liquid split ratio) for obtaining the optimal design to achieve the desired degree of separation.

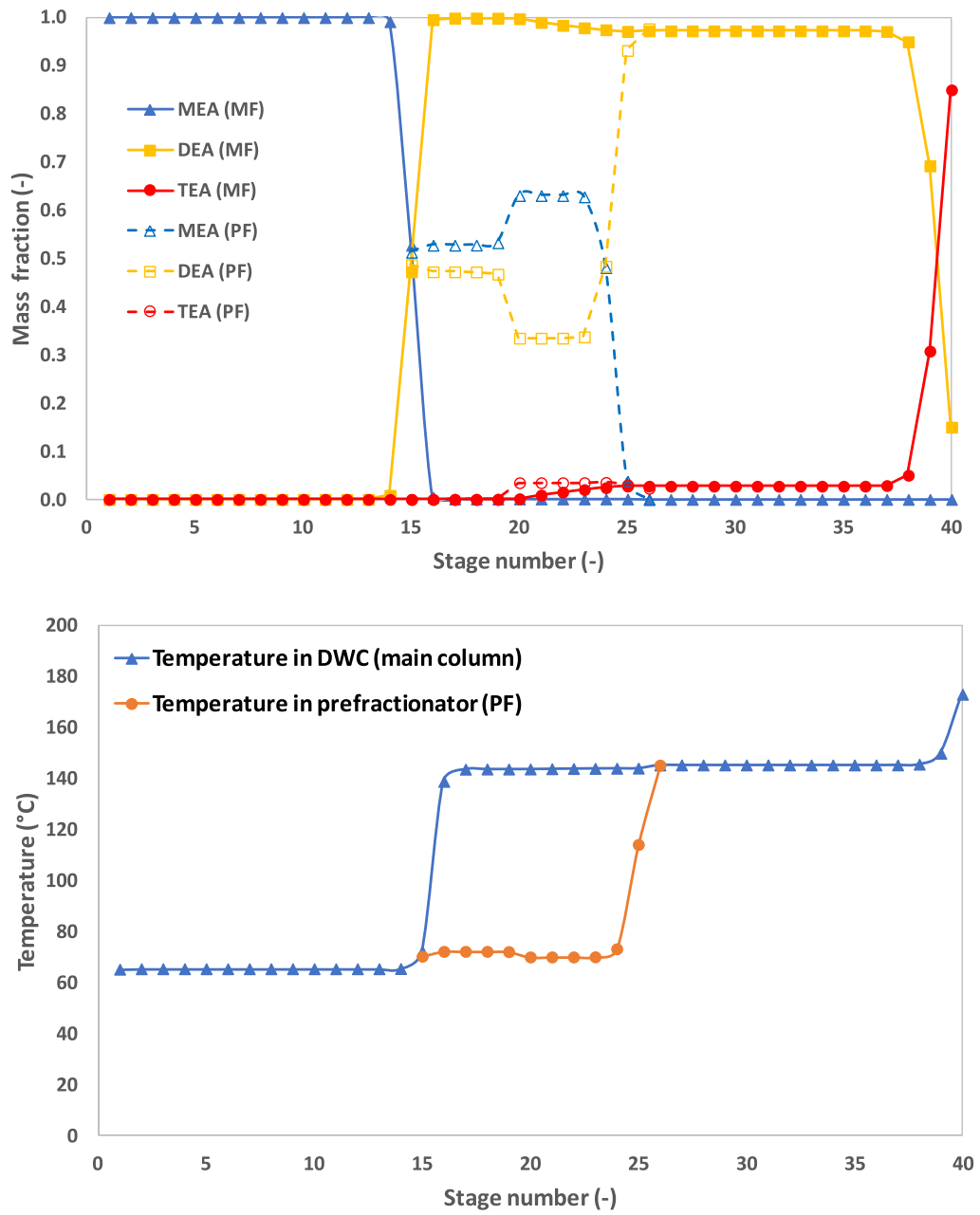

Fig. 3. Composition (top) and temperature (bottom) profiles along the DWC.

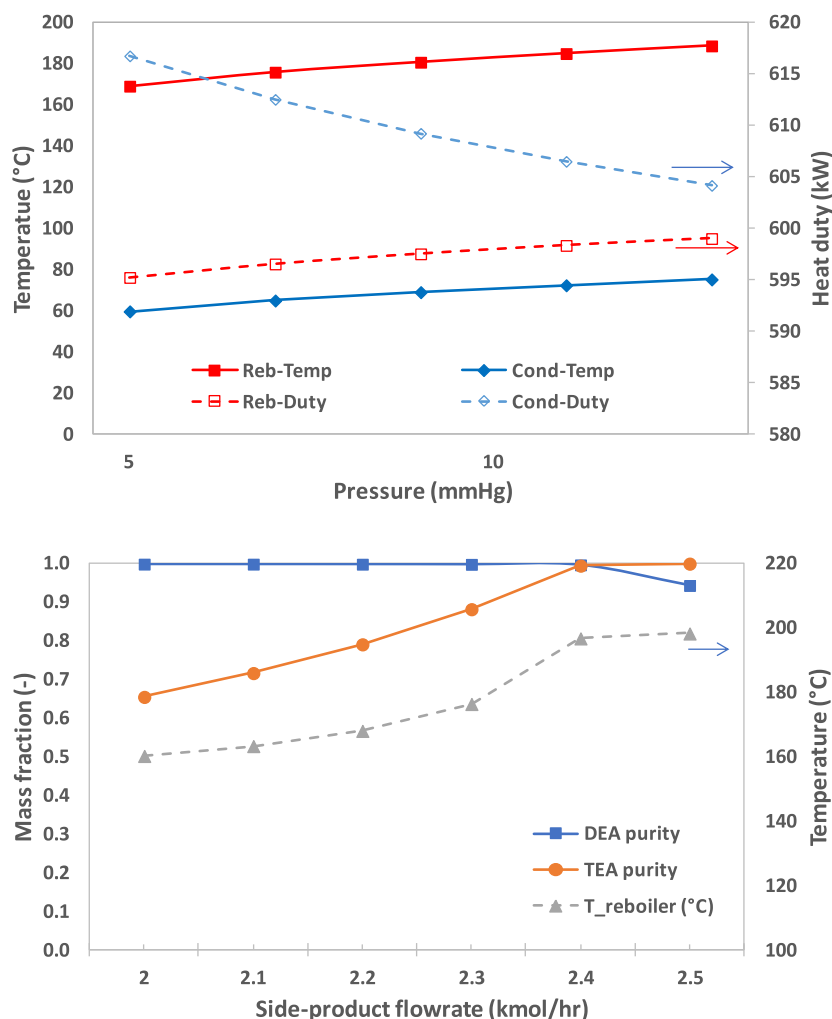

Fig. 4. Sensitivity analysis for DWC: effect of the operating pressure (top) and effect of the side product flowrate (bottom) on product purities, temperature and duties.

Table 4

Comparison of energy consumption in conventional and intensified approach for ethanolamines production.

Conventional Process	Energy use (kW)	Intensified Process	Energy use (kW)
<i>Tubular Reactors</i>			
Cooling duty	-815.7	RD column	
Heating duty	N/A	Condenser duty	-2682
<i>NH₃ separation</i>			
		Reboiler duty	1900
<i>Column</i>			
Condenser duty	-1965.4	NH ₃ Flash tank	
Reboiler duty	1625.7	Cooling duty	N/A
<i>Water Separation</i>			
		Heating duty	N/A
<i>Column</i>			
Condenser duty	-170.6	Water Separation Column	
Reboiler duty	165.75	Condenser duty	-192.3
<i>MEA separation</i>			
		Reboiler duty	358.2
<i>Column</i>			
Condenser Duty	-731.5	DWC (PF & MF)	
Reboiler Duty	722.1	Condenser duty	-612.23
<i>Auxiliary Component</i>			
		Reboiler duty	596.42
<i>Column</i>			
Condenser Duty	-60	Auxiliary Component	
		Compressor inter-stage cooling (NH ₃ recycle)	-46.5
Reboiler Duty	57.8	Compressor Work	54.4
<i>Auxiliary Component</i>			
		NH ₃ recycle heater	471.2

Table 5

Comparison of the intensified and conventional processes for ethanolamines production in terms of economic performance, energy use and sustainability metrics.

Parameter (unit)	Conventional process	Intensified process
CapEx (\$10 ³)	1919	1779
OpEx (\$10 ³)	1437	833
TAC (\$10 ³)	2076	1426
Total Cooling Duty (kW)	3743.3	3536.4
Total Heating Duty (kW)	2571.3	2854.6
Total CO ₂ emissions (tonne/yr)	9773.0	6884.5
CO ₂ emission (kg of CO ₂ / tonne of product)	853.5	598.5
Energy intensity / heating (MWh/tonne of product)	1.958	2.184
Specific cooling duty (MWh/tonne of product)	2.851	2.705
Human Toxicity Potential (tonne of DCB eq./f.u)	1.35	1.35

Parameters such as wall height, number of stages in the main fractionator and the feed stage is kept constant as no significant influence on the energy consumption is observed. Table 3 summarizes the optimized parameters for the DWC designed for obtaining 99 wt% MEA, 99 wt% DEA and 85 wt% TEA [45], as well as the results of the conventional

direct sequence separation scheme. Employing a DWC for the separation of ethanolamines can reduce energy use by 23.5% in comparison to the traditional two-column system. One of the reasons being the capabilities of performing the desired degree of separation by employing less auxiliary equipment (one pair of condenser-reboiler) compared to the conventional two column sequence. In a DWC (thermodynamic equivalent of a Petlyuk setup), the energy use is reduced as the operating conditions are provided in such a way that reduces remixing effect [5, 43].

The composition and temperature profiles (see Fig. 3) of the DWC (simulated as a Petlyuk setup) show that the prefractionator does not perform sharp splits and aids in separating the light key and heavy key components. Separation of DEA and TEA takes place in the stripping zone. The temperature profiles show a temperature difference of more than 30 °C across the wall [15], thus the dividing wall should be insulated in practice (in a DWC implementation) such that no heat transfer occurs across in order to avoid any significant effect on the energy demand and product purities [7].

5.4. Sensitivity analysis for the DWC

5.4.1. Effect of the side product flowrate

The side product flowrate is a key parameter that affects the energy use. Sensitivity analysis was performed by varying the SP flowrate from 2 to 2.5 kmol/hr for achieving 99 wt% of MEA in the top product, 99 wt % of DEA in the SP and 85 wt% of TEA in the bottom product. Increasing the SP flowrate causes the rise in reboiler temperatures. The side product mainly consists of DEA and TEA, but increasing the SP flowrate would increase the concentration of DEA in the SP. This would imply the bottom product being heavily concentrated with TEA, causing a rise in duty and temperature of the reboiler (due to the higher boiling point of TEA). TEA purity rises and DEA purity drops as the SP flowrate is increased. Increasing the SP flowrate leads to rise in concentration of TEA and MEA in the side draw causing the drop in purity of DEA. The SP flowrate has no influence on the condenser duties and top product temperature as there is no effect on MEA concentration in top product, and the concentration of DEA or TEA does not increase in condenser when the SP flowrate is increased. The influence of SP flowrate was significantly on DEA and TEA, as illustrated by Fig. 4 that shows the trend of purity and temperature on varying side product flowrate. For optimal design, a SP flowrate of 2.27 kmol/hr is used for getting the desired purity maintaining the reboiler temperature below 180 °C for avoiding thermal degradation and color deterioration of TEA.

5.4.2. Effect of DWC operating pressure

Separation of ethanolamines in the DWC is performed under vacuum condition due to its high boiling points and color sensitive nature. Sensitivity analysis is performed for pressures in the range of 5–13 mmHg. This parameter influences the reboiler and condenser duties along with their respective temperatures. However, varying the pressure does not show any influence on the purity of ethanolamines. Increasing the pressure above 9 mmHg raises the reboiler temperature above 180 °C which is not desirable. This temperature constraint is put in place to avoid decolorization of ethanolamines [44]. Fig. 4 shows the graphical trends on the duties and temperature of the condenser and reboiler on varying operating pressures. For optimal design, an operating pressure range between 5 and 9 mmHg is chosen. Pressure drop was not considered when building the thermally coupled model in Aspen Plus, as the packing selected for the simulation (MellapakPlus 252Y) has a high capacity and very low pressure drop, which is practically negligible.

5.4.3. Effect of split ratio

Liquid and vapor split ratios are two additional degrees of freedom that can be manipulated for achieving minimal energy usage [3]. Liquid split can be controlled with ease with the aid of collectors and distributors [32]. However, vapor split cannot be easily controlled due to

constraints such as cross-sectional area of the trays as well as the pressure drops between the partitions [15]. Controlling liquid split can also aid in restricting the amount of heavy key component which comes out as top product of the prefractionator [15]. For the operation of the DWC, a equimolar vapor split (vapor from the reboiler is directed equally to the prefractionator and main fractionator of the simulated Petlyuk) at the dividing wall junction is assumed and sensitivity analysis is done for a liquid split ratio of 0.4 to 0.6.

This range is chosen because exceeding the upper bound leads to drying up of the wall-section of the column due to excess vapor, while setting the liquid split ratio below the lower bound leads to excess load on the reboiler which increases its duty. The variation in liquid split ratio showed no significant influence on the purities of DEA and TEA in the side draw and bottom product, and it had no influence in the duties of the condenser and reboiler as well as the temperatures. Therefore, an equimolar liquid split is used for operating the DWC (Table 3).

5.5. Energy analysis

A fair comparison is made between the proposed intensified process and the conventional production scheme adapted from the work of Liu et al. [20]. The classic process has been developed with the aid of the patent by Frauenkron et al. [10]. The amount of reactants (flowrates) and catalyst introduced is the same and the reaction temperatures and pressures are similar, so comparable EO conversion and MEA selectivity is obtained. However, downstream separation of the reactants and products are different as compared to the intensified process. Table 4 compares the energy use of the conventional scheme and the proposed intensified process. In the conventional scheme, tubular reactors do not require supplementary heating as the reactions are exothermic. However, they need to be cooled in order to maintain the reactor temperatures favorable for kinetics, e.g. temperature range of 20–125 °C [2]. High molar ratios of EO and NH₃ are used (approximately 10 times higher than in the intensified process). Due to the temperature constraints and large flowrates the duties of the column for NH₃ separation are very high.

Table 4 shows that the duty of condenser of the RD column is high as the column is operated under total reflux conditions and high boilup ratios, it increases the molar flowrates of unreacted NH₃ in the column. This explains the high duties of the condenser and reboiler in the RD column. No direct comparison can be made with the heat requirements of the reactors in the conventional process, as the heat generated in the exothermic reactions are used in the tubular reactors and no additional heating requirements are needed. In the conventional process, the reactor temperatures are maintained by the circulation of cold utility in the jacketed reactors. The RD column heating requirements account to 66.56% of the total process heating, due to the need to circulate the unreacted ammonia back to the column, which does not happen in the conventional process. However, due to the large recycle of ammonia in the classic process, the heating requirement of the ammonia recovery column accounts for 63.2% of the total heating needed in the process. Thus, using an RD column does not offer significant energy reductions in recovering the unreacted ammonia. Due to total reflux condition and high boilup ratio the cooling requirements of the RD column accounts for 75.84% of the total cooling needed. In the conventional process, the cooling requirements of the reactors account for 21.8% of the total cooling needed. Hence, from an energy perspective, the RD column does not offer significant benefits due to the high cooling requirements when compared to the conventional reactors. However, the use of RD column enables the production of ethanolamines with much higher MEA selectivity at reduced molar ratios of reactants.

Using a DWC offers benefits in energy savings as compared to the conventional downstream separation in a two-column direct sequence, namely the heating and cooling requirements are reduced by 23.5% in the DWC. When the total energy use in the intensified process is considered, the intensified process does not offer benefits in energy

savings due to the high heating and cooling requirements of the RD column compared to the tubular reactor approach.

Table 4 provides information on the overall heating and cooling duties incurred by both processes for a direct comparison (while the Appendix gives a visual representation).

5.6. Economic analysis

An economic analysis has been performed to establish the feasibility. The comparison of the RD based approach and plug flow tubular reactor model is done on the TAC basis. All the operations and equipment used have been considered for calculating TAC. TAC is estimated as a function of capital cost, operating cost and payback period [6].

$$TAC = \frac{\text{Capital Cost}}{\text{Payback Period}} + \text{Operating Cost} \quad (7)$$

where a payback period of 3 years is assumed [46]. The operating period of the plant is 8760 hr, as the economic data gathered for the conventional model is also calculated with the same operating period. Operating cost is a function of utility cost and energy used. The capital cost of the columns, heat exchangers and compressors employed are estimated using correlations adapted from the work of [40]. The cost of utilities is adapted from [21] as follows: cooling water (CW) = 0.354 \$/GJ, LP Steam = 7.78 \$/GJ, MP Steam = 8.22 \$/GJ, HP steam = 9.98 \$/GJ, Refrigerant at $-20\text{ }^{\circ}\text{C}$ = 7.89 \$/GJ and electricity = 0.0775 \$/kW.hr. The economic analysis of the conventional model in the paper also uses the same correlations and utility pricing for cost comparison purpose. The cost of utilities and correlations employed for CapEx and OpEx estimations are provided in the Appendix (Table A2). Table 5 illustrates the operating and capital cost incurred in the intensified process. The OpEx and CapEx of the conventional process is also calculated in similarly to the intensified process. The correlations used for calculating CapEx for the conventional model is the similar to the ones used for the intensified process. The reduction in OpEx can be explained due to the difference in ammonia recycle flowrate and use of DWC for EA separation. The use of refrigerant for ammonia recovery contributes to the high OpEx incurred in the conventional process. The use of RD helps in reducing the overall CapEx due to the substitution of the series of tubular reactors with a single RD column achieving the same conversion of EO and higher MEA selectivity. In terms of OpEx, the RD column does not contribute to significant reductions. Substituting the two-column direct sequence for separating ethanolamines with a DWC, and replacing the ammonia recovery column with a flash tank also contributes to the reduction in CapEx. Due to the lack of internal recycle in the conventional tubular reactors, the amount of unreacted NH_3 is significantly high in the outlet stream, as compared to the RD process. This cannot be completely separated using a flash unit hence a simple flash tank cannot be used for the separation of NH_3 in the classic process. Overall, the intensified process reduces the CapEx by 7.3%, OpEx by 42%, and TAC by 31.3% in comparison to the classic process for EA production (as depicted in Fig. A1).

5.7. Sustainability analysis

The sustainability of the process can be evaluated using several metrics proposed by industrial experts such as material and energy intensity, water consumption, toxic and pollutant emissions, GHG emissions – with lower values meaning better performance. Table 5 summarizes the results of the performed sustainability analysis.

- **Material intensity** expresses the mass of wasted materials per unit of output. In the new process proposed here all the material is either recycled or completely converted into the desired products, so the material intensity is 0 kg / kg EA product.

- **Energy intensity** represents the primary energy consumed per unit of output. The total heating is considered, provided by hot utilities (such as LP, MP and HP steam) which also contribute to the carbon footprint. Overall, 2.18 kWh of thermal energy is used to produce a kg of EA product as compared to 1.95 kWh/kg in the conventional process, thus the energy intensity of the intensified process is 11.5% higher as compared to the classic process due to the additional thermal requirements for the RD column.
- **Water consumption** expresses the amount of water used per unit of output. In this study water is used as a catalyst and is completely recycled. The amount of fresh water introduced into the RD column is very little (0.1 kg/hr) as all of the water is recycled back into the RD column. However, cooling water is used as cold utility in all the condensers in the process. The temperature range from process to cooling tower is $10\text{ }^{\circ}\text{C}$, from $25\text{ }^{\circ}\text{C}$ to $35\text{ }^{\circ}\text{C}$. The cooling capacity of water is 4.17275 kJ/kgK. The flowrate is then derived from the total cooling duty as follows: $(3536.4\text{ kW} / 4.17275\text{ kJ/kg}) \times 3600\text{ s/hr} / 1000\text{ kg/m}^3 = 3051\text{ m}^3\text{ h}^{-1}$. As water cooling is obtained by evaporation, this must be compensated by a make-up with fresh water. Following the 7% rule [35], the loss is $0.07 \times 3051 = 213.57\text{ m}^3\text{ h}^{-1}$.
- **Greenhouse gas (GHG) emissions** expresses the total GHG emitted per unit of output. Table 5 provides the carbon footprint in terms of CO_2 emissions, human toxicity potentials, energy intensity, etc. Overall, 598.5 kg of CO_2 is emitted per tonne of EA product (implies total ethanolamines). Similarly, the GHG emissions per unit of output was calculated for the conventional process. In the conventional process, apart from the heating requirements which contributes to the GHG emissions, refrigerants are also used for cooling purpose which also contributes to the CO_2 emissions. 853.5 kg of CO_2 is emitted per tonne of EA in the conventional process. Table 5 provides details on the total heating requirements in the conventional process. Based on the calculations a reduction of 29.9% in CO_2 emission is achieved in the intensified process as compared to the classic one.
- **Toxic emissions** include toxics and hazardous materials for the operating personnel. Toxicity is expressed in terms of HTP. According to [13] HTP is an index which reflects the potential harm of a unit of chemical when released in the environment and is evaluated in terms of tonne of 1,4 dichlorobenzene (DCB) equivalents per functional unit. The functional unit is 1 tonne of ethylene oxide processed. DCB is a known pesticide which is used to normalize the toxicity of other substances [26]. CCalC2 software package (developed by the University of Manchester) was used to calculate the HTP of the analysed system. For this model, a HTP of 1.35 tonne DCB eq./f.u is recorded and the raw materials used contribute to the HTP of the system. HTP is calculated as a function of the amount of reactants used. As the same amount of reactants is used as in the conventional process, the HTP is the same. As 99% conversion of EO (per pass) is obtained and full recycle of the unreacted reactants is used, there is no wasted materials in the proposed scheme.
- **Pollutant emissions** express the amount of pollutants produced per unit of output. In this process there are no toxic pollutants emitted.

6. Conclusions

A novel intensified process for ethanolamines production has been proposed and successfully simulated using Aspen Plus. The optimal design and operating conditions for the RD column and DWC have been obtained by sensitivity analysis. Economic and sustainability analysis were performed to demonstrate the economic feasibility and environmental advantages of the proposed process. The key findings of this study are as follows:

- Employing a reactive distillation column for the production of EA results in a high conversion of EO (>99%), 64.5% conversion of NH_3 and 71.5% selectivity of MEA.

- Using total reflux in the RD column reduces the molar ratio of NH_3/EO to almost a tenth of the value in comparison to the conventional scheme (molar ratio of 13.71).
- The use of DWC for the separation of ethanolamines reduces the energy usage by 23.5% as compared to the direct sequence of two-columns used conventionally.
- Overall, the intensified process does not benefit in terms of energy use as compared to the classical process due to the higher heating and cooling requirements of the RD column. However, the use of a DWC contributes to the reduction of energy usage as compared to the conventional two column separation of ethanolamines. The OpEx benefits are also significant due to the ability to use inexpensive utilities instead of refrigeration. The CO_2 emissions of the intensified process are also reduced by 29.9%.
- The intensified process allows CapEx savings of 7.3%, OpEx savings of 42%, and 31.3% reduction in the TAC (for a payback period of 3 years).

The use of process intensification techniques (such as RD and DWC) is beneficial from an eco-efficiency perspective, and these techniques show promising applications in the industry. Further improvements such as using heterogeneous catalysts for reactions, can lead to savings in OpEx and CapEx as no additional equipment for water separation would be required, resulting in further reduction of TAC as compared to the classic process.

Data availability

Data will be made available on request.

Author statement

All persons who meet authorship criteria are listed as authors, and all authors certify that they have participated sufficiently in the work to take public responsibility for the content, including participation in the concept, design, analysis, writing, or revision of the manuscript. Furthermore, each author certifies that this material or similar material has not been and will not be submitted to or published in any other publication.

CRediT authorship contribution statement

Devnarayan Devaraja: Conceptualization, Methodology, Software, Data curation, Validation, Visualization, Writing – original draft, Writing – review & editing. **Anton A. Kiss:** Conceptualization,

Methodology, Formal analysis, Investigation, Resources, Visualization, Validation, Supervision, Project administration, Writing – original draft, Writing – review & editing.

Declaration of Competing Interest

The authors declare that they have no known competing financial interests or personal relationships that could have appeared to influence the work reported in this paper.

Acknowledgment

AAK gratefully acknowledges the Royal Society Wolfson Research Merit Award (No. WM170003).

All persons who have made substantial contributions to the work reported in the manuscript (e.g., technical help, writing and editing assistance, general support), but who do not meet the criteria for authorship, are named in the Acknowledgements and have given us their written permission to be named. If we have not included an Acknowledgements, then that indicates that we have not received substantial contributions from non-authors.

Appendix

Fig. A1 and Tables A1 and A2

Table A1

Physical properties of the chemicals and kinetics parameters.

Chemical	Molecular formula	Mol. Weight	Boiling Point ($^{\circ}\text{C}$)	Density (kg/m^3) at 25°C
MEA	$\text{C}_2\text{H}_7\text{NO}$	61.23	172.3	1020
DEA	$\text{C}_4\text{H}_{11}\text{NO}_2$	105.2	268.61	1060
TEA	$\text{C}_6\text{H}_{13}\text{NO}_3$	149.56	359.98	1120
EO	$\text{C}_2\text{H}_4\text{O}$	44.05	10.45	870
Ammonia	NH_3	17.12	-33.54	0.771
Water	H_2O	18.02	100	998.08

Reaction	Kinetic constant ($\text{L}\cdot\text{mol}^{-1}\cdot\text{min}^{-1}$)	Activation energy ($\text{kJ}\cdot\text{mol}^{-1}$)
$\text{NH}_3 + \text{EO} \rightarrow \text{MEA}$	$k_1 = 7845\exp(-11,500/\text{RT})$	48.185
$\text{MEA} + \text{EO} \rightarrow \text{DEA}$	$k_2 = (8.151 - 0.051C_w) \times k_1$	48.185
$\text{DEA} + \text{EO} \rightarrow \text{TEA}$	$k_3 = (14.81 - 0.196C_w) \times k_1$	48.185

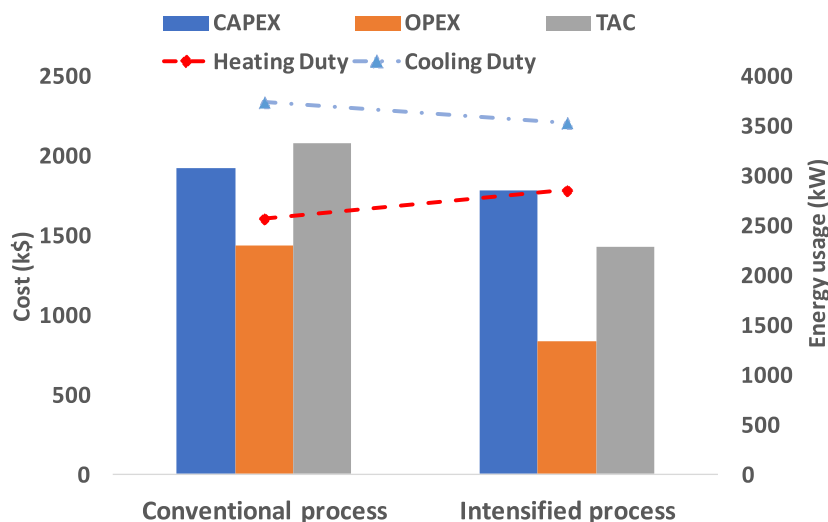

Fig. A1. Comparison of cost and energy usage for the conventional vs intensified process.

Table A2

Utility cost for estimating OpEx and correlations used for CapEx calculations.

Utilities	Cost per unit
Cooling Water (CW)	0.354 \$/GJ
LP Steam	7.78 \$/GJ
MP Steam	8.22 \$/GJ
HP steam	9.98 \$/GJ
Electricity	0.0775 \$/kWhr
Refrigerant (−20 °C)	7.89 \$/GJ
Cost correlations	
Column (shell) cost	$= (M\&S/280) \times (957.9 \times D^{1.066} \times H^{0.82}) \times (2.18 + Fc)$ $M\&S = 1716.2$ (end of 2019) D: Diameter of the vessel (m) H: Height of the vessel (m) $Fc = Fm \times Fp$, $Fm = 1$ (carbon steel), $Fp = 1 + 0.0074 \times [P(\text{bar}) - 3.48] + 0.00023 \times [P(\text{bar}) - 3.48]^2$ $H = 0.6 \times (NT - 1) + 2$ (m), NT (Number of trays) Cost of Tray $= NT \times (M\&S/280) \times 97.2 \times D^{1.55} \times (Ft + Fm)$ $Ft = 0$ (sieve trays) and $Fm = 1$ (carbon steel) Cost of HX / Rex $= (M\&S/280) \times (474.7 \times (A^{0.65}) \times (2.29 + Fm(Fd + Fp)))$ A = Area of the HX/Rex (m ²) $Fm = 1$ (carbon steel), $Fd = 0.8$ (fixed tube), $Fp = 0$ (less than 20 bar) Cost of compressor $= (M\&S/280) \times (664.1 \times Hp^{0.82} \times Fc)$ HP: horsepower (kW), $Fc = 1$ (centrifugal (motor), 1.07 (reciprocating / steam), 1.15 centrifugal (turbine), 1.29 and 1.82 reciprocating (motor and gas engine)

References

[1] M. Blahusiak, A.A. Kiss, K. Babic, S.R. Kersten, G. Bargeman, B. Schuur, Insights into the selection and design of fluid separation processes, *Sep. Purif. Technol.* 194 (2018) 301–318, <https://doi.org/10.1016/j.seppur.2017.10.026>.

[2] H.N. Cheng, Q.S. Liu, B.Q. Wang, S.Q. Zheng, Reaction kinetics of ethanolamines with water catalysis, *Adv. Mat. Res.* 233-235 (2011) 95–100, <https://doi.org/10.4028/www.scientific.net/AMR.233-235.95>.

[3] C. Cui, Q. Zhang, X. Zhang, J. Sun, Eliminating the vapor split in dividing wall columns through controllable double liquid-only side-stream distillation configuration, *Sep. Purif. Technol.* 242 (2020), 116837, <https://doi.org/10.1016/j.seppur.2020.116837>.

[4] C. Cui, S. Liu, J. Sun, Optimal selection of operating pressure for distillation columns, *Chem. Eng. Res. Des.* 137 (2018) 291–307, <https://doi.org/10.1016/j.cherd.2018.07.028>.

[5] I. Dejanović, L. Matijašević, Ž. Olujić, Dividing wall column - A breakthrough towards sustainable distilling, *Chem. Eng. Process.* 49 (6) (2010) 559–580, <https://doi.org/10.1016/j.cep.2010.04.001>.

[6] J.M. Douglas, *Conceptual Design of Chemical Processes*, McGraw-Hill, USA, 1988.

[7] C. Ehlers, M. Schröder, G. Fieg, Influence of heat transfer across the wall of dividing wall columns on energy demand, *AIChE J.* 61 (5) (2015) 1648–1662, <https://doi.org/10.1002/aic.14747>.

[8] Fassler, P. (2010), Method and plant for the production of ethanol amines, Patent No. EP2177501.

[9] V. Feyzi, M. Beheshti, Exergy analysis and optimization of reactive distillation column in acetic acid production process, *Chem. Eng. Process.* 120 (2017) 161–172, <https://doi.org/10.1016/j.cep.2017.06.016>.

[10] Frauenkron M., Müller U., Harder W., Unger J., Melder J.P., Meier A. and Himmel W. (2006), Method for producing alkanolamines, Patent No. US7119231.

[11] [11]Garg D., Navin S.S., Matthew J., Okasinski, A.S. (2005), Process for producing alkanolamines, Patent No. US 6846959.

[12] Hammer H., Reutemann W. (1996), Production of ethanolamines, Patent No. US5545757.

[13] E.G. Hertwich, S.F. Mateles, W.S. Pease, T.E. McKone, Human toxicity potentials for life-cycle assessment and toxic release inventory risk screening, *Environ. Toxicol. Chem.* 20 (4) (2001) 928–939, <https://doi.org/10.1002/etc.5620200431>.

[14] R. Hiwale, N. Bhate, Y. Mahajan, S. Mahajani, Industrial applications of reactive distillation: recent trends, *Int. J. Chem. Reactor Eng.* 2 (1) (2004), <https://doi.org/10.2202/1542-6580.1109>.

[15] A.A. Kiss, C.S. Bildea, A control perspective on process intensification in dividing-wall columns, *Chem. Eng. Process.* 50 (3) (2011) 281–292, <https://doi.org/10.1016/j.cep.2011.01.011>.

[16] A.A. Kiss, M. Jobson, Taking reactive distillation to the next level of process intensification, *Chem. Eng. Trans.* 69 (2018) 553–558, <https://doi.org/10.3303/CET1869093>.

[17] A.A. Kiss, M. Jobson, X. Gao, Reactive distillation: stepping up to the next level of process intensification, *Ind. Eng. Chem. Res.* 58 (15) (2019) 5909–5918, <https://doi.org/10.1021/acs.iecr.8b05450>.

[18] H.Z. Kister, *Distillation Design*, 1, McGraw-Hill, USA, New York, 1992, p. 340.

[19] L. Knorr, P. Rössler, Zur Kenntniss des Aethanolamins, *Ber. Dtsch. Chem. Ges.* 36 (1) (1903) 1278–1283.

[20] D. Liu, Z. Lin, W. An, R. An, H. Bie, Simulation and energy consumption evaluation of reactive distillation process for ethanolamine production, *Chem. Eng. Process. - Process Intensification* 153 (2020), 107930, <https://doi.org/10.1016/j.cep.2020.107930>.

[21] W.L. Luyben, I.L. Chien, *Design and Control of Distillation Systems For Separating Azeotropes*, John Wiley & Sons, 2011, <https://doi.org/10.1002/9780470575802>.

[22] A.F. Martínez, J.S. Rodríguez, C.A. Sánchez, A. Orjuela, G. Rodríguez, Isobutyl acetate by reactive distillation. Part III. Conceptual design, simulation and optimization, *Chem. Eng. Process. - Process Intensification* 155 (2020), 108059, <https://doi.org/10.1016/j.cep.2020.108059>.

[23] F. Meyer, J. Johannsen, A. Liese, G. Fieg, P. Bubenheim, T. Waluga, Evaluation of process integration for the intensification of a biotechnological process, *Chem. Eng. Process. - Process Intensification* 167 (2021), 108506, <https://doi.org/10.1016/j.cep.2021.108506>.

[24] M. Miki, T. Ito, M. Hata, T. Okabe, Reaction of ethylene oxide with active hydrogen. I. Reaction of ethylene oxide with ammonia, *J. Jpn. Oil Chemists' Soc.* 15 (5) (1966) 215–220, <https://doi.org/10.5650/jos1956.15.215>.

[25] Moriya A., Tsuneki H. (1995). Process for preparation of alkanolamine, catalyst used in the process and process for preparation of the catalyst, Patent No. EP0652207.

[26] Oliveira, L., Messagie, M., Rangaraju, S., Hernandez, M., Sanfelix, J. and Van Mierlo, J. (2017). Life cycle assessment of nanotechnology in batteries for electric vehicles. In Rodriguez-Martinez L. M. and Omar N. (Eds.), *Emerging Nanotechnologies in Rechargeable Energy Storage Systems*, a volume in *Micro and Nano Technologies*, 231–251. doi:10.1016/B978-0-323-42977-1.00007-8.

[27] E.F. Osborn, *Evolution of the Igneous Rocks*. Chapter 5. The reaction Principle, Princeton University Press, 1979, <https://doi.org/10.1515/9781400868506-006>.

[28] K.Y. Park, T.K. Park, B.K. Lee, A study on the reaction kinetics for ethanolamines synthesis, *Korean Chem. Eng. Res.* 23 (6) (1985) 409–409.

[29] S.J. Park, H.Y. Shin, B.-M. Min, A. Cho, J.S. Lee, Vapor-liquid equilibria of water+monoethanolamine system, *Korean J. Chem. Eng.* 26 (1) (2009) 189–192, <https://doi.org/10.1007/s11814-009-0031-z>.

[30] Presswire, Ethanolamines Market Outline to 2022 | Potential Growth Rate (CAGR), Business Strategies, Industry Trend, Analysis, Opportunity Assessment, M2 Presswire (2018). Link, <https://www.proquest.com/docview/2056374057>.

[31] T. Prihatin, S. Mahadzir, M.I.A. Mutalib, Modeling and optimization of water-based polygeneration system, *Comput. Aided Chem. Eng.* 31 (2012) 1427–1431.

[32] M.G. Ramapriya, M. Tawarmalani, R. Agrawal, Thermal coupling links to liquid-only transfer streams: a path for new dividing wall columns, *AIChE J.* 60 (8) (2014) 2949–2961, <https://doi.org/10.1002/aic.14468>.

[33] V.K. Sangal, V. Kumar, I.M. Mishra, Optimization of structural and operational variables for the energy efficiency of a divided wall distillation column, *Comput. Chem. Eng.* 40 (2012) 33–40, <https://doi.org/10.1016/j.compchemeng.2012.01.015>.

[34] M.A. Schultz, D.G. Stewart, J.M. Harris, S.P. Rosenblum, M.S. Shakur, D.E. O'Brien, Reduce costs with dividing-wall columns, *Chem. Eng. Prog.* 98 (5) (2002) 64–71.

[35] J. Schwartz, B. Beloff, E. Beaver, Use sustainability metrics to guide decision-making, *Chem. Eng. Prog.* 98 (7) (2002) 58–63.

[36] R. Smith, C. Triantafyllou, Design and optimisation of fully thermally coupled distillation columns, *Chem. Eng. Res. Des.* 70 (A2) (1992) 118–132, <https://doi.org/10.1205/026387601753192037>.

[37] R. Taylor, R. Krishna, Modelling reactive distillation, *Chem. Eng. Sci.* 55 (22) (2000) 5183–5229, [https://doi.org/10.1016/S0009-2509\(00\)00120-2](https://doi.org/10.1016/S0009-2509(00)00120-2).

[38] Y. Tian, I. Pappas, B. Burnak, J. Katz, E.N. Pistikopoulos, Simultaneous design & control of a reactive distillation system - a parametric optimization & control approach, *Chem. Eng. Sci.* 230 (2021), 116232, <https://doi.org/10.1016/j.ces.2020.116232>.

[39] H. Tsuneki, A. Moriya, Analysis and modeling of adiabatic reactor for monoethanolamine selective production, *Chem. Eng. J.* 149 (1–3) (2009) 363–369, <https://doi.org/10.1016/j.cej.2008.12.031>.

[40] R. Turton, R.C. Bailie, W.B. Whiting, J.A. Shaeiwitz, *Analysis, Synthesis and Design of Chemical Processes*, 3rd edition, Prentice Hall, USA, 2009. Appendix A.

[41] L. Vamllng, L. Cider, Comparison of some solid catalysts for the production of ethanolamines from ammonia and ethylene oxide in the liquid phase, *Ind. Eng. Chem. Prod. Res. Dev.* 25 (3) (1986) 424–430, <https://doi.org/10.1021/i300023a010>.

[42] P. Yang, X. Li, H. Li, H. Cong, A.A. Kiss, X. Gao, Unraveling the influence of residence time distribution on the performance of reactive distillation - Process optimization and experimental validation, *Chem. Eng. Sci.* 237 (2021), 116559, <https://doi.org/10.1016/j.ces.2021.116559>.

[43] Ö. Yildirim, A.A. Kiss, E.Y. Kenig, Dividing wall columns in chemical process industry: a review on current activities, *Sep. Purif. Technol.* 80 (3) (2011) 403–417, <https://doi.org/10.1016/j.seppur.2011.05.009>.

[44] J.C. Yue, N. Li, L.Q. Kong, S.Q. Zheng, Study on ethanolamine heat sensitivity and separation process, *Adv. Mat. Res.* 233-235 (2011) 165–170, <https://doi.org/10.4028/www.scientific.net/AMR.233-235.165>.

[45] G. Zahedi, S. Amraei, M. Biglari, Simulation and optimization of ethanol amine production plant, *Korean J. Chem. Eng.* 26 (6) (2009) 1504–1511, <https://doi.org/10.1007/s11814-009-0254-z>.

[46] T. Zhao, J. Li, H. Zhou, Z. Ma, L. Sun, A thermally coupled reactive distillation process to intensify the synthesis of isopropyl acetate, *Chem. Eng. Process.* 124 (2018) 97–108, <https://doi.org/10.1016/j.cep.2017.12.001>.