

Implementation of Ship Hybridisation Sizing a Hybrid Crew Transfer Vessel Considering Uncertainties

Karagiorgis, S.; Nasiri, S.; Polinder, H.

DOI

[10.24868/10643](https://doi.org/10.24868/10643)

Publication date

2022

Document Version

Final published version

Published in

Proceedings of the International Naval Engineering Conference

Citation (APA)

Karagiorgis, S., Nasiri, S., & Polinder, H. (2022). Implementation of Ship Hybridisation: Sizing a Hybrid Crew Transfer Vessel Considering Uncertainties. *Proceedings of the International Naval Engineering Conference*, 16, Article 49. <https://doi.org/10.24868/10643>

Important note

To cite this publication, please use the final published version (if applicable).
Please check the document version above.

Copyright

Other than for strictly personal use, it is not permitted to download, forward or distribute the text or part of it, without the consent of the author(s) and/or copyright holder(s), unless the work is under an open content license such as Creative Commons.

Takedown policy

Please contact us and provide details if you believe this document breaches copyrights.
We will remove access to the work immediately and investigate your claim.

Implementation of Ship Hybridisation: Sizing a Hybrid Crew Transfer Vessel Considering Uncertainties

Savvas Karagiorgis^a, Saman Nasiri^{a*}, and Henk Polinder^a

^a*Department of Maritime and Transportation Technology, Delft University of Technology, The Netherlands*

*Corresponding author. Email: S.Nasiri@tudelft.nl

Synopsis

Interest in ship hybridization has increased as a result of policies to combat climate change and boost energy independence. However, designing and optimizing hybrid propulsion systems is a challenging task. The availability of numerous power, propulsion, and energy system topologies with different energy storage and conversion technologies presents a significant challenge. In this paper, the optimum sizing of various components and systems in a CTV is thoroughly investigated. The appropriate sizing of a maritime vessel depends on energy management and control, making optimization and retrofitting a complex problem. Thus, this paper develops a method to select a power, propulsion, and energy system architecture and optimize the power and energy ratings of the components. The operational profile and various system structures make up the system's input. The technique provides optimized system architecture and contains the data required for vessel retrofitting. Optimization criteria include cost, fuel volume, propulsion system rating, and other sustainability factors. The proposed approach incorporates the price of fuel and electricity as an uncertainty element. As a result, the developed strategy can assist ship owners in deciding whether and when to retrofit their vessels as well as the optimum design for doing so at the chosen moment. In addition, it takes into account the effects of the GHG emission reduction measures, which can lead to a more practical solution.

Keywords: Ship hybridisation; Marine power system; Offshore support vessel; Power system sizing; Design uncertainty

1 Introduction

Recently, the International Maritime Organization (IMO) established a new climate change plan, posing a significant challenge to the shipping industry. In order to contribute to the targets of the Paris agreement, the shipping sector needs to reduce its total annual GHG by 50% before 2050 and Carbon dioxide (CO₂) emissions by 40% before 2030, and 70% before 2050. Thus, a substantial change in ships design and operation is required to achieve the IMO ambitious goals. The benefits of hybrid propulsion for de-carbonization of the shipping sector have been studied in recent years, with hybrid propulsion being popular in the automotive industry as an example. Hybrid propulsion systems have been deployed by naval vessels, yachts, harbor tugs, and supply vessels, and their classification, benefits, obstacles, and opportunities have been evaluated in a review of developments for smart ships by Geertsma et al. (2017); Nasiri et al. (2021a). It is found that offshore and passenger ships have the most significant potential for fuel savings from hybridization, diesel-electric propulsion, or energy storage, as they spend a significant fraction of their total operational time in part-load where the fuel efficiency is sub-optimal (Jafarzadeh and Schjøberg, 2018).

A ship design challenge has several objectives and includes topology, sizing, control, and energy management. These constraints necessitate a multidisciplinary, multi-objective approach. Due to the popularity of hybrid propulsion in the automotive industry, optimization methodologies have been thoroughly researched and applied to electric vehicle applications. Several studies have examined optimization problems associated with ships' hybrid power systems employing automotive design and control knowledge. Furthermore, some studies have attempted to incorporate the environmental impact of ships (Trivyza et al., 2018) and partial or full decarbonisation of the maritime industry is explored as an objective in the design process in Baldi et al. (2019); Wang et al. (2021). An investigation on hybrid renewable energy on ships and its challenges can be found in Huang et al. (2021); Nasiri et al. (2022a). The impact of uncertainty at all stages of ship design, as well as its implications in optimization studies, have been widely investigated in the literature (Nikolopoulos and Boulougouris, 2020; Ebrahimi et al., 2020; Priftis et al., 2020; Nasiri et al., 2021b,c). Uncertainty needs to be incorporated into the solution of the ship design optimization problem, as it dramatically influences ship design. Traditional optimization techniques that ignore uncertainty result in over-optimized, unrealistic designs that are

Authors' Biographies

Savvas Karagiorgis is currently a MSc student at Faculty of Mechanical, Maritime and Materials Engineering, Delft University of Technology. His research interests are ship electrification and maritime design optimization.

Saman Nasiri is currently Postdoc Researcher at Faculty of Mechanical, Maritime and Materials Engineering, Delft University of Technology. His research interests include transportation electrification, ship hybridization, and maritime power system control and stability.

Henk Polinder has been an Assistant/Associate Professor with the Delft University of Technology since 1996, working in the field of electrical machines and drives. His main research interests include electric drive and energy systems for maritime applications and offshore renewables.

not robust. The required error margin that develops during the design process can be minimized if these uncertainties and their impacts are promptly captured (Priftis et al., 2020; Nasiri et al., 2022b).

Considering the aforementioned challenges and to provide decision-makers with a more realistic picture of the solution space, this paper proposes integrating uncertainties introduced by the physical and financial environments into a multi-objective double-layer optimization methodology. A Crew transfer vessel (CTV) is a good option for a hybrid propulsion system. Hence, a CTV is examined in this paper, and the sizing and control of a proposed hybrid propulsion powertrain are optimized based on its specific measured operational profile. Then, according to the results, an optimal cost-effective and emission-free power plant for retrofitting the vessel is obtained. Based on forecast reports provided by experts, various scenarios are developed to represent the impact on design and sizing of the uncertainties related to fuel costs, regulations, CO₂ prices, and technology advances. In each scenario, consequences of hybridization on the CTV are analysed. The results are a set of optimum hybrid propulsion system layouts, an analysis of the expenses of each configuration over the span of a ship's life, retrofitting costs, and projected emission reductions.

The rest of the paper is organized as follows. In section 2, a conventional propulsion system and the proposed hybrid topology are described. Section 3 describes the optimization methodology that is utilized in this paper. The studied scenarios are explained, and the outcomes of the simulation experiments are presented in section 4. In addition, the analysis of the optimized hybrid electric propulsion system layouts are discussed in this section. Finally, conclusions are drawn in section 5, and suggestions for future works are presented.

2 Hybrid propulsion system and operational profile of the vessel

A CTV with 19.5 meter length is considered for this study. The fixed pitch propellers are powered by two 720 kW diesel engines. The propulsion power is the primary load since it has major power consumption. Thus, the shipbuilder does not change/retrofit the power system for the auxiliary loads. The Capital Expenditures (CAPEX) of the mechanical propulsion system is estimated to be \$432000, with the diesel engines costing \$300/kW based on Stapersma (2002); Livanos et al. (2014); Zhu et al. (2018). It should be noted that in most cases, just the power sources are considered in the CAPEX calculation. The assumed crew transfer vessel goes through different phases during its operation. Figure 1 depicts typical operation profiles of the vessel's power demand as measured by the main diesel engines during two different operations. The journey takes about 12 hours. The CTV travels to its destination in 1.5 hours and stays there for roughly 7 hours. The return journey also takes 1.5 hours. The fuel consumption for one operation is estimated to be 1.050 tons of diesel fuel. Further details about the presumed CTV and its operation profile can be found in Wang et al. (2021). Without losing generality, the analysis in the paper does not take into account the dynamic properties on the time scale of a few seconds. The measured operational profiles are therefore condensed to the operational profile shown in Figure 2.

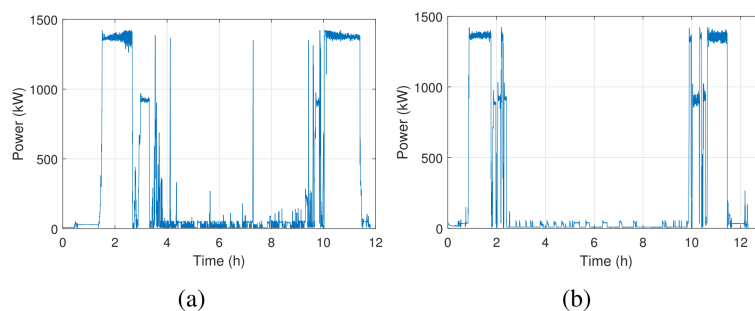

Figure 1: Measured operational profiles in the measured operating scenario

It is assumed that the CTV is retrofitted and its propulsion system is transformed to hybrid for reducing emissions and costs. Therefore, a powertrain topology with diesel engines, batteries, and fuel cells is considered for the vessel's structure. The scheme of the considered ship power system is shown in Figure 3. Since Li-ion batteries have higher power/energy density, they are used in this configuration. Moreover, the batteries are supposed to be charged by on-shore electricity. Proton Exchange Membrane Fuel Cell (PEMFC), which is in its advanced stages of development, are chosen for this study. They can run at low temperatures and have the lowest cost per installed power (Van Biert et al., 2016).

3 The proposed optimization strategy

This section provides an overview of the double-layer optimization method along with the description of the goals and constraints for the optimization problem. Moreover, the evaluation method for analysing the costs of hybrid propulsion system layouts over its remaining life of the CTV are described. A multi-objective double-layer

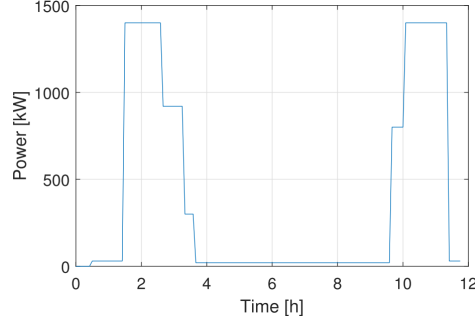

Figure 2: Simplified operational profile in the measured operating scenario

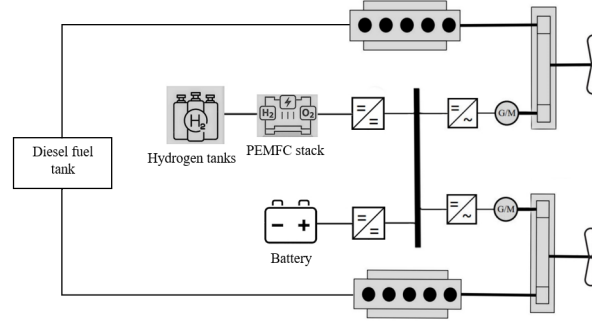

Figure 3: The proposed hybrid propulsion system structure

optimization methodology is employed in this paper based on the strategy presented in Wang et al. (2021). The technique is a nested architecture combining plant sizing with control design optimization. The control design (the inner layer) is nested within the plant design (the outer layer). The operational profile of the vessel is given as an input together with the quantity, initial suggested power/energy rating, cost of investment per kW/kWh of the components, the purchase price of fuels, and cost of on-shore electricity. Operational restrictions, such as the state-of-charge (SOC) of the battery and the fuel cell operation range, are included to form the constraints of the problems. The optimization problem has three objectives: 1) Capital Expenditures (CAPEX), 2) Operating Expenditures (OPEX), and 3) weight of diesel fuel consumed (W_{DF}). Three objective functions of the outer layer are given by equations 1, 2 and 3. In these equations, P_{DE}^r , E_{Bat}^r , and P_{FC}^r are power/energy rating of the components. Furthermore, N_{DE} , N_{Bat} , and N_{FC} are the number of the power sources.

$$OF_1^{GA} = CAPEX(P_{DE}^r, E_{Bat}^r, P_{FC}^r, N_{DE}, N_{Bat}, N_{FC}), \quad (1)$$

$$OF_2^{GA} = OPEX(W_{DF}, V_{H_2}, C_{CO_2}) + OPEX_{Bat} \quad (2)$$

$$OF_3^{GA} = W_{DF}(P_{DE}, N_{DE}, X_{DE}) \quad (3)$$

In addition, in this paper, a CO_2 tax per ton of diesel fuel consumed (C_{CO_2}) is also added as an extra costs in the objective function of OPEX in the outer layer by equation 4. This equation's objective is to take emission reduction policies into account. In this equation, V_{H_2} is the volume of the consumed H_2 .

$$OF^{LP} = OPEX(W_{DF}, V_{H_2}, C_{CO_2}) \quad (4)$$

The CAPEX and OPEX formulations are represented in 5 and 6, respectively. A mixed integer linear programming (MILP) algorithm is used in the inner layer of optimization and has a single objective to minimize the OPEX given by 6. The non-dominated sorting genetic algorithm II (NSGA-II) is used to find Pareto optimal solutions for this multi-objective problem. Further details about the constraints of this optimization problem can be found in Wang et al. (2021).

$$CAPEX = C_{DE}N_{DE}P_{DE}^r + C_{Bat}N_{Bat}E_{Bat}^r + C_{FC}N_{FC}P_{FC}^r \quad (5)$$

$$OPEX = \sum_{t=0}^H \left(C_{DF} \sum_{i=1}^{N_{DE}} W_{DF}^i(t) + C_{H_2} \sum_{k=1}^{N_{FC}} V_{H_2}^k(t) + C_{CO_2} \sum_{i=1}^{N_{DE}} W_{DF}^i(t) \right), \quad (6)$$

In this paper, the Total Cost of Ownership (TCO) is proposed as 7. This formula is used to assess the investment and operation costs of the optimal hybrid propulsion designs under various conditions.

$$TCO = CAPEX + C_{OP} \cdot OPEX \cdot Y \quad (7)$$

In 7, C_{OP} is the number of days per year that the vessel operates. C_{OP} is assumed 300 days in this study. Additionally, Y is the estimated lifespan of the vessel in years once it has been modified with a new propulsion system, which is presumed 15 years. As mentioned, this study proposes a strategy to incorporate uncertainty in the ship design optimization to derive robust and future-proof guidelines for the retrofitting of CTVs. The optimal designs from the multi-objective double-layer optimization methodology vary according to CAPEX, fuel and electricity prices and the introduction of new regulations such as a carbon tax. Available reports are used to get different predicted values of the uncertain parameters to be included in a multi-objective double-layer optimization methodology DNV-GL Maritime (2019), PwC (2020), BloombergNEF (2019), Man Energy Solutions (2019). By employing the proposed approach, the optimization can be carried out repeatedly with various parameters, returning designs that are optimum and representative of all potential scenarios (possible futures). The next section presents different scenarios used to evaluate the advantages of the proposed approach.

4 Simulations

This section explains how the multi-objective double-layer optimization methodology determines the uncertainty parameters. Then, two future scenario trajectories that differ in the penetration of renewable energy sources in the energy generation supply are investigated.

4.1 Scenarios

Stakeholders are searching for projections that can tell them what the future will look like or methods to lessen uncertainty in order to assist them in making smart decisions. In these tables, the investment price per kW for diesel engines is assumed to be constant through the years due to the technological maturity (Stapersma, 2002; Livanos et al., 2014; Trivyza et al., 2018; Zhu et al., 2018). In addition, price projections for marine fuel cells and lithium batteries can be found in the tables (DNV-GL Maritime, 2019; DNV-GL, 2021). Due to mass production and consumer demand, battery prices are falling significantly. The total cost of the battery system, which includes the cost of system integration, module fabrication, battery control hardware and software, power electronics, thermal management, and testing, is anticipated to be 600\$/kWh in 2020 (DNV-GL Maritime, 2019). It is 90% of the cost in 2019. Prices between 2022 and 2035 are expected to be 70%, 60%, 52%, 47%, 42%, 38%, 34%, 32%, 29%, 28%, 27%, 26%, 25%, 24% lower than its price in 2019, respectively DNV-GL Maritime (2019). The prices for PEMFC are following the same projections. Adopting from Battelle Memorial Institute (2017) and TNO (2020), a total price of 2000\$/kW is considered for the fuel cell system, which is 65% of 2018 price. The prices between 2023 and 2035 are anticipated to be 63%, 61%, 60%, 58.5%, 58%, 57%, 56%, 55.5%, 54.5%, 54%, 53%, 52.5%, 52% lower than 2018 price. According to the average of recent prices in The Netherlands, the diesel fuel price are set at \$2.20 per litre, and the prices for 2023 and 2024 are modified Trading Economics (2022). Due to the unpredictability of fuel prices, a constant increase of 5% has been assumed for the ensuing years. The costs of H₂ per litre used in this research are based on PwC study for the Netherlands' cost-development of renewable hydrogen. Standards for a carbon tax on shipping emissions are escalating. The Marshall and Solomon Islands are one of the first nations to propose a landmark carbon shipping tax, calling for a levy of \$100 per ton of CO₂ in early 2021 (Metzger, 2022). A carbon price is added to the study after 2025 according to these costs. The carbon tax is consequently 300 per ton of diesel fuel, assuming a 3 ton CO₂-eq (GWP-20 well to wake) per ton of diesel fuel. In addition, an increase of \$90 per ton of diesel per year is assumed.

Using two alternative estimates for onshore electricity costs, two possible future trajectories are generated. Increased use of renewable energy sources (RES) in power systems will result in more hours of cheaper electricity. In the first future scenario, from 2026 onward, it is presumed that the penetration of renewable energy sources is sufficient to lower electricity prices. Between 2026 and 2030, a 10% decline each year is predicted, followed by a 20% decline per year between 2031 and 2035. Prior to the penetration of RES in 2026, it is estimated that the energy price rises by 5% per year, establishing the price of electricity for 2022 by recent prices for business in The Netherlands. The assumption used to create the second future path is that prior to 2035, the penetration of RES in the power systems is insufficient to significantly impact the distribution of electricity prices. As a result, a constant increase of 5% per year is implemented. The input parameters for the two pricing scenarios represent plausible futures paths, as well as the variance in the parameter determining electricity price development, are shown in Tables 1 and 2. In this study, the input parameters are adapted from technical reports.

Table 1: The optimization problem's input parameters in the first scenario

	2022	2023	2024	2025 ^a	2026 ^b	2027	2028	Source
Diesel engine C_{DE} [\$/kW]	300	300	300	300	300	300	300	(Stapersma, 2002; Livanos et al., 2014; Zhu et al., 2018)
Batteries C_{Bat} [\$/kWh]	466.67	400	346.67	313.33	280	253.33	226.67	(DNV-GL, 2021)
Fuel cells C_{FC} [\$/kW]	2000	1938.46	1876.92	1846.15	1800	1784.62	1753.85	(DNV-GL Maritime, 2019)
Diesel Fuel C_{DF} [\$/L]	2.2	2.86	3.05	3.20	3.36	3.53	3.71	(Trading Economics, 2022)+Assumed based on accessible data
Hydrogen price C_{DF} [\$/L]	0.141	0.131	0.131	0.121	0.121	0.111	0.111	(PwC, 2020)
Onshore Electricity price C_e [\$/kWh]	0.239	0.251	0.263	0.277	0.249	0.224	0.202	Assumed based on accessible data
CO ₂ price C_{CO_2} [\$/tonDF]	0	0	0	300	390	480	570	Assumed based on available data

	2029	2030	2031	2032	2033	2034	2035	Source
Diesel engine C_{DE} [\$/kW]	300	300	300	300	300	300	300	(Stapersma, 2002; Livanos et al., 2014; Zhu et al., 2018)
Batteries C_{Bat} [\$/kWh]	213.33	193.33	186.67	180	173.33	167.67	160	(DNV-GL, 2021)
Fuel cells C_{FC} [\$/kW]	1723.08	1707.69	1676.92	1661.54	1630.77	1615.39	1600	(DNV-GL Maritime, 2019)
Diesel Fuel C_{DF} [\$/L]	3.89	4.09	4.29	4.51	4.73	4.97	5.22	(Trading Economics, 2022)+Assumed based on accessible data
Hydrogen price C_{DF} [\$/L]	0.101	0.101	0.101	0.091	0.091	0.091	0.081	(PwC, 2020)
Onshore Electricity price C_e [\$/kWh]	0.182	0.163	0.131	0.105	0.084	0.067	0.054	Assumed based on accessible data
CO ₂ price C_{CO_2} [\$/tonDF]	660	750	840	930	1020	1110	1200	Assumed based on available data

^aCarbon tax implementation

^bImplementing RES penetration

Table 2: The optimization problem's input parameters in the second scenario

	2022	2023	2024	2025 ^a	2026	2027	2028	Source
Diesel engine C_{DE} [\$/kW]	300	300	300	300	300	300	300	(Stapersma, 2002; Livanos et al., 2014; Zhu et al., 2018)
Batteries C_{Bat} [\$/kWh]	466.67	400	346.67	313.33	280	253.33	226.67	(DNV-GL, 2021)
Fuel cells C_{FC} [\$/kW]	2000	1938.46	1876.92	1846.15	1800	1784.62	1753.85	(DNV-GL Maritime, 2019)
Diesel Fuel C_{DF} [\$/L]	2.20	2.86	3.05	3.20	3.36	3.53	3.71	(Trading Economics, 2022)+Assumed based on accessible data
Hydrogen price C_{DF} [\$/L]	0.141	0.131	0.131	0.121	0.121	0.111	0.111	(PwC, 2020)
Onshore Electricity price C_e [\$/kWh]	0.239	0.251	0.263	0.277	0.291	0.305	0.320	Assumed based on accessible data
CO ₂ price C_{CO_2} [\$/tonDF]	0	0	0	300	390	480	570	Assumed based on available data

	2029	2030	2031	2032	2033	2034	2035	Source
Diesel engine C_{DE} [\$/kW]	300	300	300	300	300	300	300	(Stapersma, 2002; Livanos et al., 2014; Zhu et al., 2018)
Batteries C_{Bat} [\$/kWh]	213.33	193.33	186.67	180	173.33	167.67	160	(DNV-GL, 2021)
Fuel cells C_{FC} [\$/kW]	1723.08	1707.69	1676.92	1661.54	1630.77	1615.39	1600	(DNV-GL Maritime, 2019)
Diesel Fuel C_{DF} [\$/L]	3.89	4.09	4.29	4.51	4.73	4.97	5.22	(Trading Economics, 2022)+Assumed based on accessible data
Hydrogen price C_{DF} [\$/L]	0.101	0.101	0.101	0.091	0.091	0.091	0.081	(PwC, 2020)
Onshore Electricity price C_e [\$/kWh]	0.336	0.353	0.371	0.389	0.409	0.429	0.451	Assumed based on accessible data
CO ₂ price C_{CO_2} [\$/tonDF]	660	750	840	930	1020	1110	1200	Assumed based on available data

^aCarbon tax implementation

4.2 Results

The optimization is executed multiple times with various inputs based on the parameters of the two projected future trajectories. The optimization algorithm returns several optimal hybrid designs on the Pareto front according to the three objectives set in its last generation. The TCO approach is then used to identify the optimum hybrid system structure.

4.2.1 First scenario

The power/energy ratings of the optimal designs for the first future path after applying the TCO approach are given in Figure 4. According to the results, the designs with the lowest TCO have the smallest diesel engines and zero diesel fuel usage. Therefore, batteries and fuel cells are considered according to their power schedules and the diesel engines are constantly off. The installation of a hybrid system based entirely on batteries and fuel cells results in a long-term cost-effective design when operational expenses are incorporated into the TCO.

In addition, it is depicted that the optimal battery rating is within the range of approximately 2100 and 2700 kWh until 2031 and that fuel cells are between 400 and 600 kW. The results of the optimal ratings of the components are less subject to changes between 2022 and 2031. Therefore, choosing a battery and fuel cell rating within these ranges is recommended if retrofitting the CTV is intended to be completed before 2031. After 2032, the size of batteries and fuel cells is impacted by the sharp decline in electricity. The outcomes of optimization are closer to the maximum value specified for the battery energy rating variable due to the low cost of electricity. The fuel cell optimal power rating values are less than half the size of the average of the previous years. If replacement is required due to the batteries and fuel cells deterioration, these rating ranges can be installed as the new batteries and fuel cells. Figure 5 shows the total cost of ownership of optimal hybrid layouts. Moreover, the TCO of the conventional propulsion system is depicted in this figure for a better comparison. The introduction of carbon tax in 2025 is taken into account for the calculation of the operational expenses of the conventional

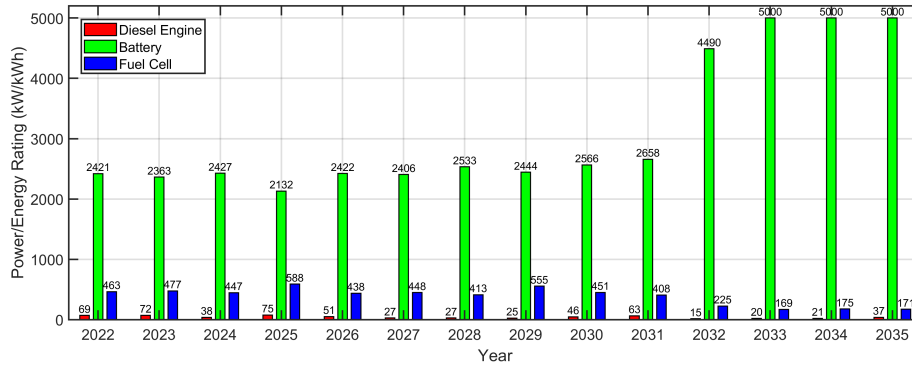

Figure 4: Optimal power/energy rating considering the lowest TCO in the first scenario

system. It can also be seen in figure 5 that the optimal design capital expenses are decreasing each year. It is expected based on the adopted battery and fuel cell investment costs trends in the scenarios. Although the capital costs are three times higher than those of the conventional system, it can be predicted that over time, the operational costs and TCO of the optimal solutions will differ significantly from those of the conventional system. It highlights the cost-effectiveness of a hybrid propulsion system that only uses batteries and fuel cells. This analysis can determine if and when to invest in retrofitting the ship as well as how much money will be saved relative to the current propulsion system over the ship's remaining usable life.

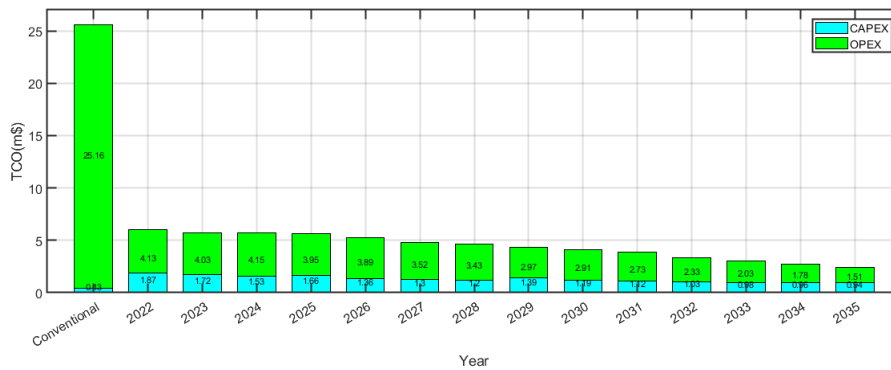

Figure 5: Total cost of ownership in optimal solutions in the first scenario

This scenario is also looked into from a different perspective. In this assessment, the design among the Pareto optimal solutions that gives a 50% emission reduction is adopted, as opposed to using the lowest TCO as the criterion to find one optimal hybrid system layout per year. The results of this analysis for the first future path are shown in Figure 6 and Figure 7. It can be seen that diesel engines are included in the solution of the optimal hybrid configurations this time. The results are less subject to changes between 2022 and 2029. Figure 7 shows that the TCO is increasing through the years. Despite the fact that capital costs are decreasing as previously mentioned, the implementation of the carbon tax and the consistent annual increase in the price of diesel fuel have an impact on the operational costs over the long term because diesel engines and their emissions are a part of the solution. This leads to the conclusion that, in order to make a more cost-effective choice, the vessel should be retrofitted as soon as possible in the upcoming years if the objective is to reduce the emission in half. In addition, the power/energy ratings of the components should be first within the ranges of the produced solutions between 2022 and 2029. Additionally, the evaluation depicts how the sharp decline in electricity by 2030 affects the size of batteries and fuel cells, leading to predictions of larger batteries and smaller fuel cells. The diesel engine size is decreasing after 2030, approximately half of the average rating of the preceding years' optimal ratings. Thus, size ranges from the optimal solutions after 2030 serves as a guide for a future replacement of the battery and the fuel cell. If two small diesel engines are installed for the hybrid propulsion configuration, one of them can be removed.

4.2.2 Second scenario

The power/energy ratings of the optimal designs for the second future path after applying the TCO approach are given in Figure 8. Similar conclusions regarding the cost-effectiveness of a hybrid propulsion system using solely

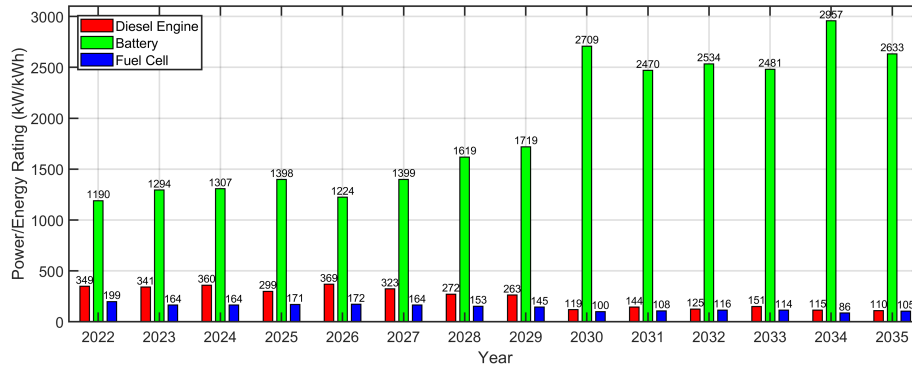

Figure 6: Optimal power/energy rating based on 50% emission reduction in the first scenario

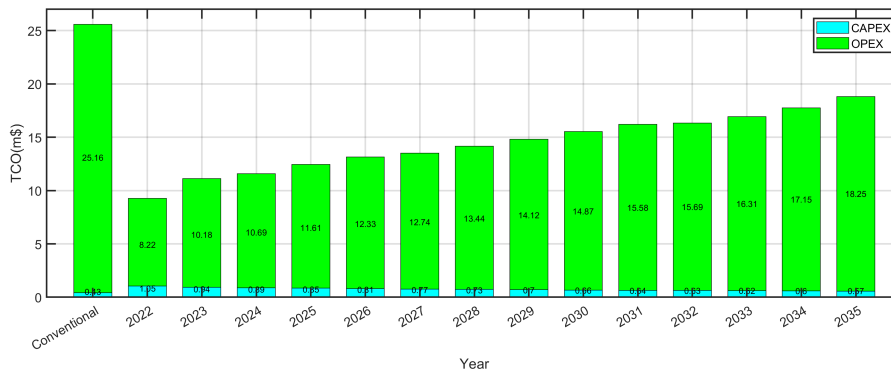

Figure 7: Total cost of ownership of optimal solutions based on 50% emission reduction in the first scenario

batteries and fuel cells can be drawn as the optimal design with the lowest TCO have zero fuel consumption and the smallest diesel engines possible. In this scenario, the results of the components optimal ratings are less subject to changes between 2022 and 2028. The battery rating for the optimal designs is within the range of approximately 2100 and 2450 kWh until 2028, and that fuel cells are between 450 and 600 kW. This concludes that if the CTV is to be retrofitted before 2028, a battery and fuel cell rating within these ranges is recommended. The steady increase in electricity price impacts the size of batteries and fuel cells after 2029. According to the optimization results, the batteries optimal energy rating values are decreasing from 2029 to 2035 rapidly, and the power demand is covered by the simultaneous increase of the fuel cell ratings. Suppose replacement is necessary after 2029 due to the degradation of the batteries and fuel cells over time. In that case, the average values of the optimal ratings between 2029 and 2035 can be installed as the new batteries and fuel cells estimated at around 830 kWh and 1140 kW, respectively.

Figure 9 shows that the capital expenses are initially decreasing for the optimal designs annually until 2028. However, the CAPEX starts to rise in 2029. Although the optimal rating of batteries is declining and the predicted installation cost per kW/kWh adopted is on the decline, the growth in the optimal fuel cell ratings has a considerably more significant influence on the investment costs. Until 2029, operating costs are about the same. After that, they start to decrease annually. In comparison to the steadily rising cost of electricity price, the decline in the optimal battery ratings and hydrogen prices substantially influence operating expenses. The TCO is marginally declining annually, and operational expenditures account for a higher portion of the total TCO. The ship owner can determine whether and when to invest in ship retrofitting based on this information.

The next assessment aims to determine the optimal hybrid system among the Pareto optimal solutions that reduces 50% emission. The results are shown in Figure 10 and Figure 11. Similar conclusions can be drawn as with the case of the first future path analysis. The diesel engines are also included in the solution. The TCO is increasing through the years in this case too. The steady increase of electricity prices results in higher operating costs and thus higher TCO than the first scenario. The power/energy ratings of the components should be first within the ranges of the produced solutions between 2022 and 2029. In this instance as well, retrofitting the vessel as soon as possible is a cost-effective choice based on the TCO development of the optimal designs. In contrast to expectations, the optimal battery size tends to increase through the years, especially after 2028. It is important to

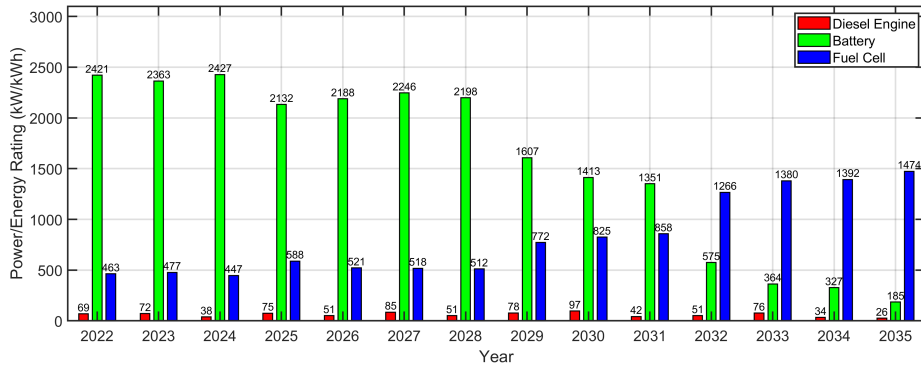

Figure 8: Optimal power/energy rating based on the lowest TCO for the second scenario

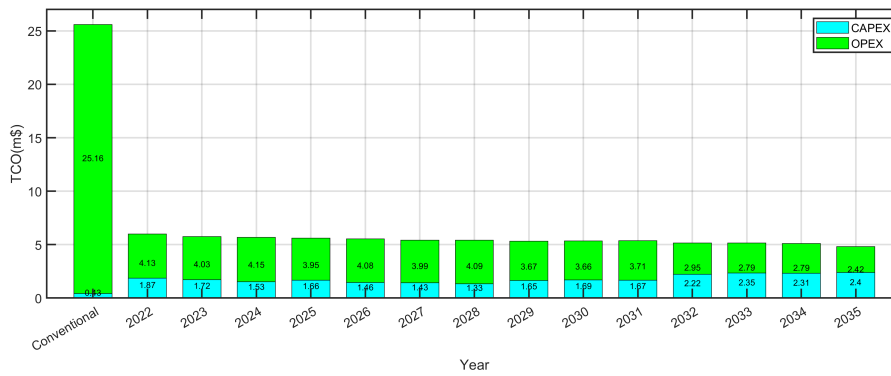

Figure 9: Total cost of ownership of optimal solutions in the second scenario

note that even though the electricity price is steadily increasing, the predicted decrease in battery cost investments has a more considerable impact on the optimization problem. The fuel cell rating has been within the range of 100 to 200 kW. Thus, it is the size for the retrofit and a potential replacement for this trajectory. If the retrofit is intended to occur before 2028, the battery size should be 1200-1700 kWh and the diesel engine between 250 to 360 kW. A larger battery should be installed as a replacement according to the solutions after 2028 and a smaller engine within the range of 100 to 270 kW. It should be noted that the first future trajectory is the more likely to occur and that out of the two alternative future trajectories, RES will most likely penetrate the energy supply.

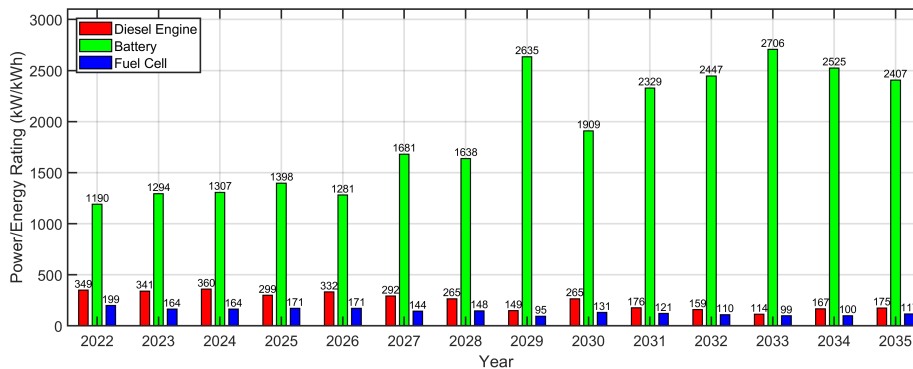

Figure 10: Optimal power/energy rating based on 50% emission reduction in the second scenario

5 Conclusions

This paper presents a straightforward approach to including uncertainty factors into an optimization methodology for identifying the optimal sizing of a proposed hybrid propulsion topology. This approach can be used to determining the potential retrofitting of a vessel. Various future trajectories have been constructed by

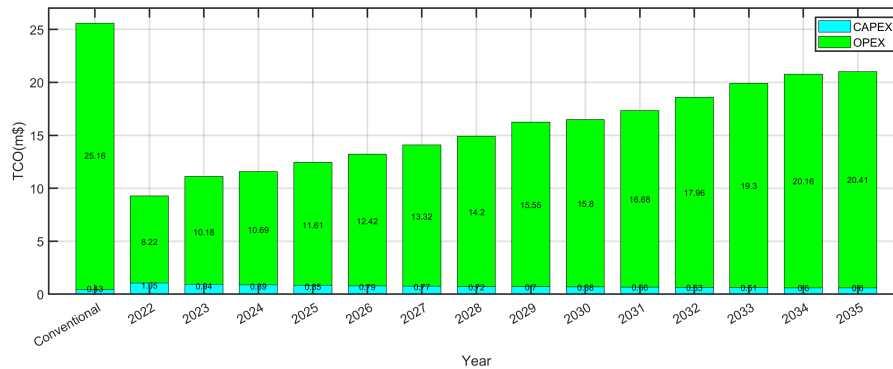

Figure 11: Total cost of ownership of optimal solutions based on 50% emission reduction in the second scenario

adopting future projections from technical reports. Then, the most cost-effective optimal results produced by the optimization methodology are identified and the results are compared for the developed future paths. Two scenarios for the future prices are defined and the advantageous of the proposed strategy is evaluated in these conditions. Furthermore, the optimal designs that reduce the propulsion system emissions by 50% are evaluated for each scenario. According to the results the benefits of the proposed strategy is discussed. The analysis of two future scenarios reveals that their eventual conclusions are rather close to one another. In addition, the analysis revealed that the study's vessel should be retrofitted as soon as possible in the coming years if halving emissions is the target in order to avoid incurring excessive operational expenditures. Additionally, it is demonstrated that, despite the fact that electricity prices are continually rising in the second scenario, the optimization problem is more significantly impacted by the anticipated decline in battery cost investments. It is shown the proposed method's design recommendations consider a certain degree of uncertainty and can be beneficial for the stakeholders. For future works, the optimization process will be enhanced by considering component replacement costs and maintenance. In addition, the sensitivity of the outcomes to the operational profile will be investigated.

Acknowledgement

This work is supported by the Interreg 2 Seas Mers Zeeën Cross-Border Cooperation Program "Implementation of Ship Hybridisation (ISHY)" under Project 2S06-015.

References

- Baldi, F., Brynolf, S., Maréchal, F., 2019. The cost of innovative and sustainable future ship energy systems, in: Proceedings of the 32nd International Conference on Efficiency, Cost, Optimization, Simulation and Environmental Impact of Energy Systems, Wrocław, Poland, pp. 23–28.
- Battelle Memorial Institute, 2017. Manufacturing cost analysis of 100 and 250 kw fuel cell systems for primary power and combined heat and power applications. . URL: https://www.energy.gov/sites/default/files/2018/02/f49/fcto_battelle_mfg_cost_analysis_100_250kw_pp_chp_fc_systems_jan2017.pdf.
- BloombergNEF, 2019. A behind the scenes take on lithium-ion battery prices. . URL: <https://about.bnef.com/blog/behind-scenes-take-lithium-ion-battery-prices/>.
- DNV-GL, 2021. Technology progress report – a guide to 10 key energy transition technologies. . URL: <https://www.dnv.com/energy-transition/technology-progress-report-2021.html>.
- DNV-GL Maritime, 2019. Assessment of selected alternative fuels and technologies in shipping. . URL: <https://www.dnv.com/maritime/publications/alternative-fuel-assessment-download.html>.
- Ebrahimi, A., Brett, P.O., Erikstad, S.O., Asbjørnslett, B.E., Garcia Agis, J.J., 2020. Ship design complexity, sources, drivers, and factors: A literature review. *International Shipbuilding Progress* 67, 221–252.
- Geertsma, R., Negenborn, R., Visser, K., Hopman, J., 2017. Design and control of hybrid power and propulsion systems for smart ships: A review of developments. *Applied Energy* 194, 30–54.
- Huang, M., He, W., Inecik, A., Cichon, A., Królczyk, G., Li, Z., 2021. Renewable energy storage and sustainable design of hybrid energy powered ships: A case study. *Journal of Energy Storage* 43, 103266.
- Jafarzadeh, S., Schjøberg, I., 2018. Operational profiles of ships in norwegian waters: An activity-based approach to assess the benefits of hybrid and electric propulsion. *Transportation Research Part D: Transport and Environment* 65, 500–523.

- Livanos, G.A., Theotokatos, G., Pagonis, D.N., 2014. Techno-economic investigation of alternative propulsion plants for ferries and ro-ro ships. *Energy Conversion and Management* 79, 640–651.
- Man Energy Solutions, 2019. Batteries on board ocean-going vessels. . URL: <https://static1.squarespace.com/static/5f0d42f16639a745affd633e/t/5ffac248fb26793593c04d70/1610269269784/batteries-on-board-ocean-going-vessels.pdf>.
- Metzger, D., 2022. Market-based measures and their impact on green shipping technologies. *WMU Journal of Maritime Affairs* 21, 3–23.
- Nasiri, S., Parniani, M., Blaabjerg, F., Peyghami, S., 2022a. Analysis of all-electric ship motions impact on pv system output power in waves, in: *2022 IEEE Transportation Electrification Conference Expo (ITEC)*, IEEE. pp. 450–455.
- Nasiri, S., Peyghami, S., Parniani, M., Blaabjerg, F., 2021a. A comprehensive theoretical approach for analysing manoeuvring effects on ships by integrating hydrodynamics and power system. *IET Electrical Systems in Transportation* 12, 89–101.
- Nasiri, S., Peyghami, S., Parniani, M., Blaabjerg, F., 2021b. Modeling in-and-out-of-water impact on all-electric ship power system considering propeller submergence in waves, in: *2021 IEEE Transportation Electrification Conference Expo (ITEC)*, pp. 533–538.
- Nasiri, S., Peyghami, S., Parniani, M., Blaabjerg, F., 2021c. An open-water efficiency based speed change strategy with propeller lifespan enhancement in all-electric ships. *IEEE Access* 9, 22595–22604.
- Nasiri, S., Peyghami, S., Parniani, M., Blaabjerg, F., 2022b. Power management strategies based on propellers speed control in waves for mitigating power fluctuations of ships. *IEEE Transactions on Transportation Electrification* , 1–1.
- Nikolopoulos, L., Boulougouris, E., 2020. A novel method for the holistic, simulation driven ship design optimization under uncertainty in the big data era. *Ocean Engineering* 218, 107634.
- Priftis, A., Boulougouris, E., Turan, O., Atzamos, G., 2020. Multi-objective robust early stage ship design optimisation under uncertainty utilising surrogate models. *Ocean Engineering* 197, 106850.
- PwC, 2020. The green hydrogen economy - predicting the decarbonisation agenda of tomorrow. . URL: <https://www.pwc.com/gx/en/industries/energy-utilities-resources/future-energy/green-hydrogen-cost.html>.
- Stapersma, D., 2002. Diesel engines, volume 1: Performance analysis. Royal Netherlands Naval College .
- TNO, 2020. Power-2-fuel cost analysis. . URL: https://smartport.nl/wp-content/uploads/2020/09/Cost-Analysis-Power-2-Fuel_def_2020.pdf.
- Trading Economics, 2022. Netherlands gasoline prices. . URL: <https://tradingeconomics.com/netherlands/gasoline-prices>.
- Trivyza, N.L., Rentizelas, A., Theotokatos, G., 2018. A novel multi-objective decision support method for ship energy systems synthesis to enhance sustainability. *Energy Conversion and Management* 168, 128–149.
- Van Biert, L., Godjevac, M., Visser, K., Aravind, P., 2016. A review of fuel cell systems for maritime applications. *Journal of Power Sources* 327, 345–364.
- Wang, X., Shipurkar, U., Haseltalab, A., Polinder, H., Claeys, F., Negenborn, R.R., 2021. Sizing and control of a hybrid ship propulsion system using multi-objective double-layer optimization. *IEEE Access* 9, 72587–72601.
- Zhu, J., Chen, L., Wang, B., Xia, L., 2018. Optimal design of a hybrid electric propulsive system for an anchor handling tug supply vessel. *Applied energy* 226, 423–436.