

## Shape sensing of morphing-wing sections using fibre optic sensors

Nazeer, N.; Groves, R.M.

**Publication date**

2021

**Document Version**

Final published version

**Citation (APA)**

Nazeer, N., & Groves, R. M. (2021). *Shape sensing of morphing-wing sections using fibre optic sensors*. Poster session presented at Precision Fair 2021 , 's-Hertogenbosch, Netherlands.

**Important note**

To cite this publication, please use the final published version (if applicable). Please check the document version above.

**Copyright**

Other than for strictly personal use, it is not permitted to download, forward or distribute the text or part of it, without the consent of the author(s) and/or copyright holder(s), unless the work is under an open content license such as Creative Commons.

**Takedown policy**

Please contact us and provide details if you believe this document breaches copyrights. We will remove access to the work immediately and investigate your claim.

# Shape sensing of morphing-wing sections using fibre optic sensors



Nakash Nazeer (n.nazeer@tudelft.nl), Roger M. Groves (r.m.groves@tudelft.nl)

## Fibre Bragg grating (FBG) sensing

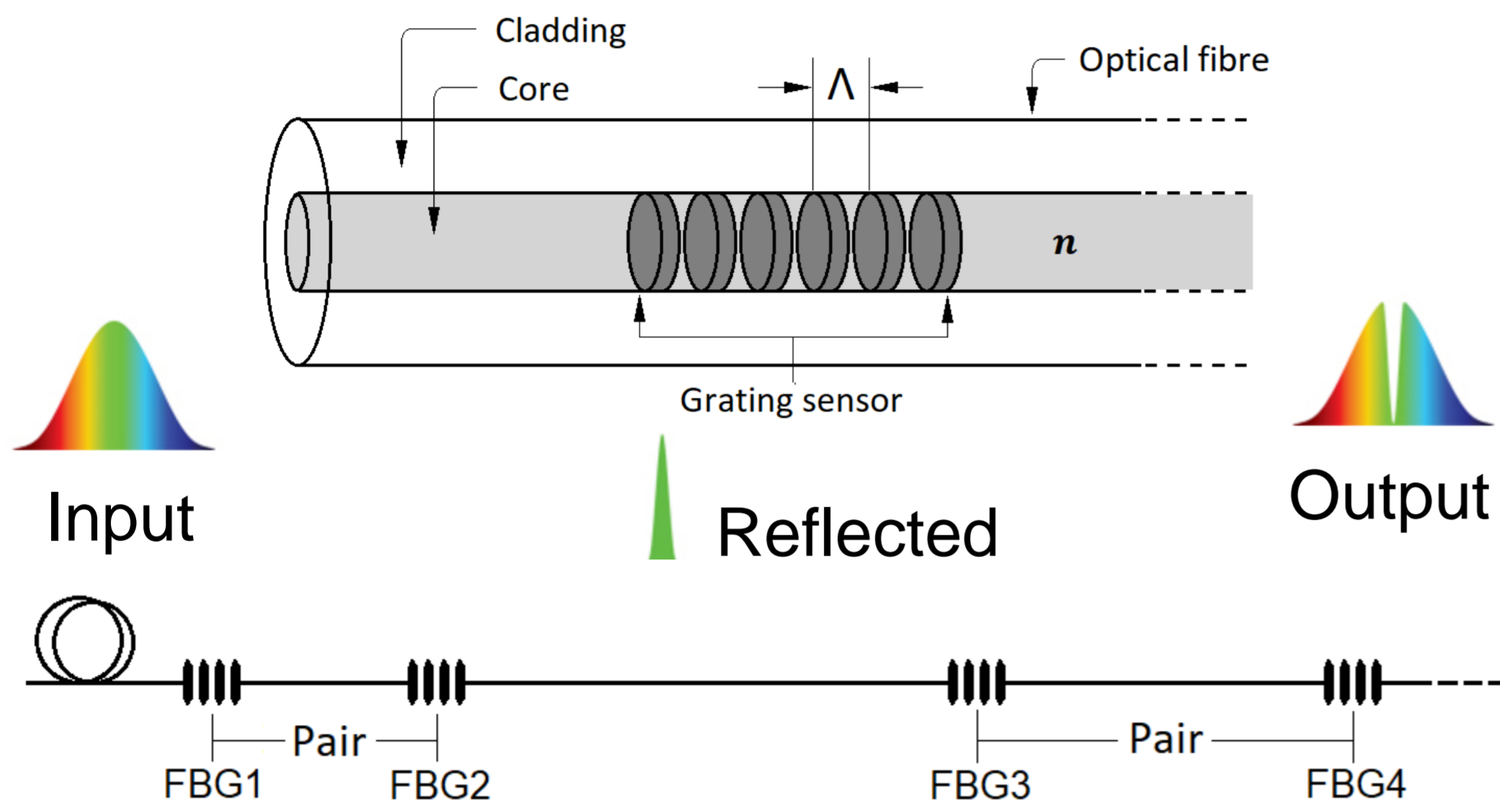

Measuring local strain at each grating and the displacement between each grating pair

## Wing sensor layout

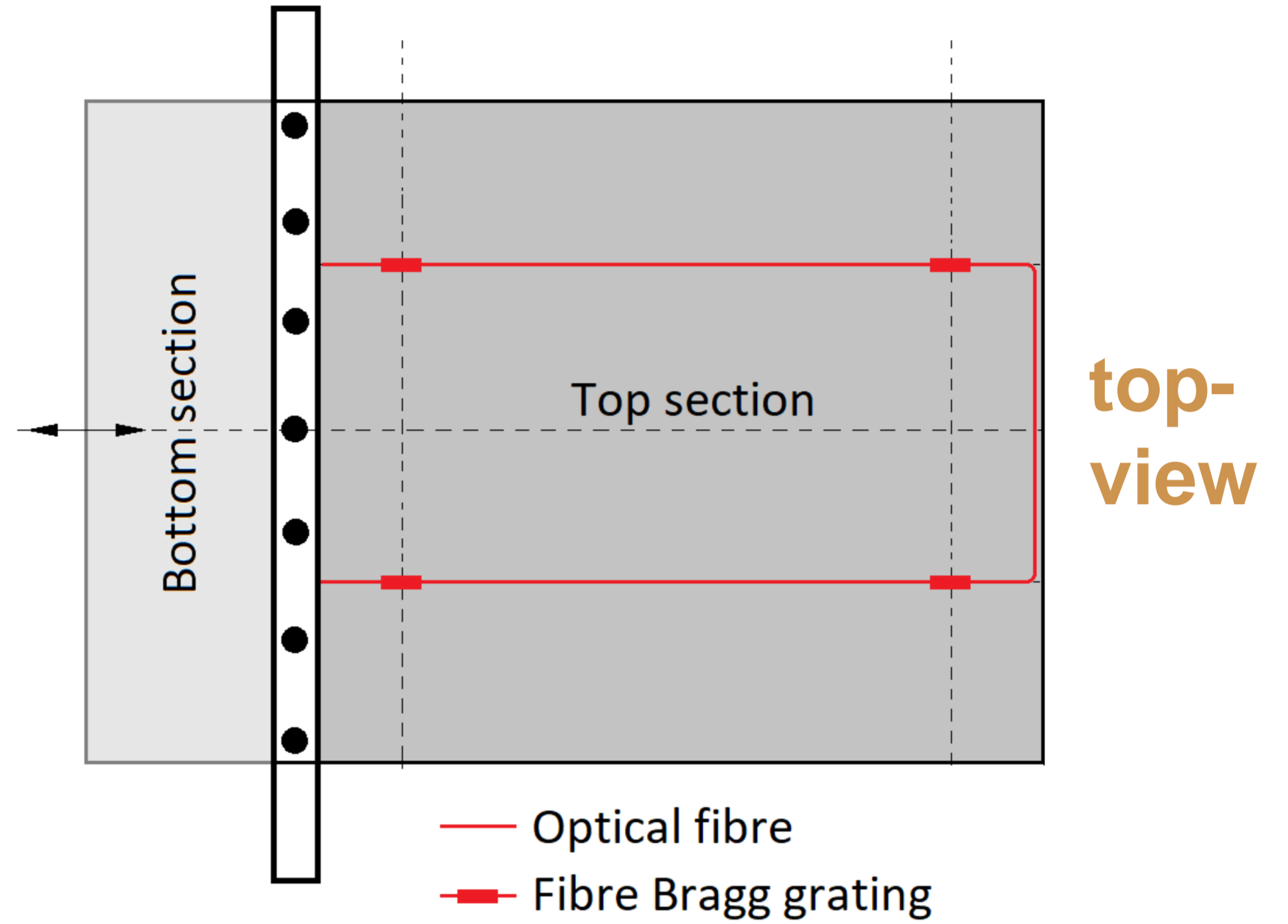

## Morphing sequences

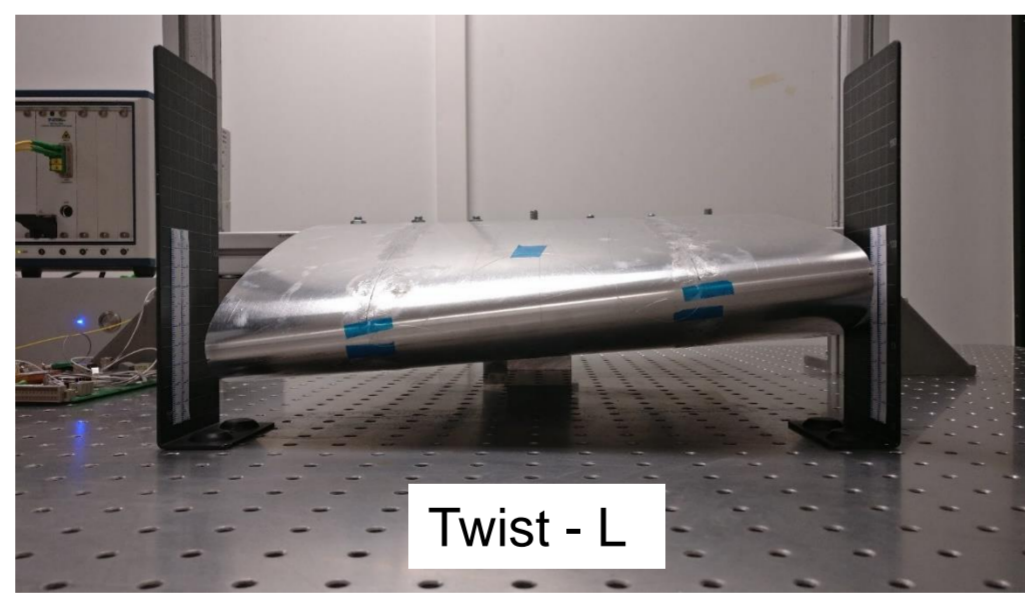
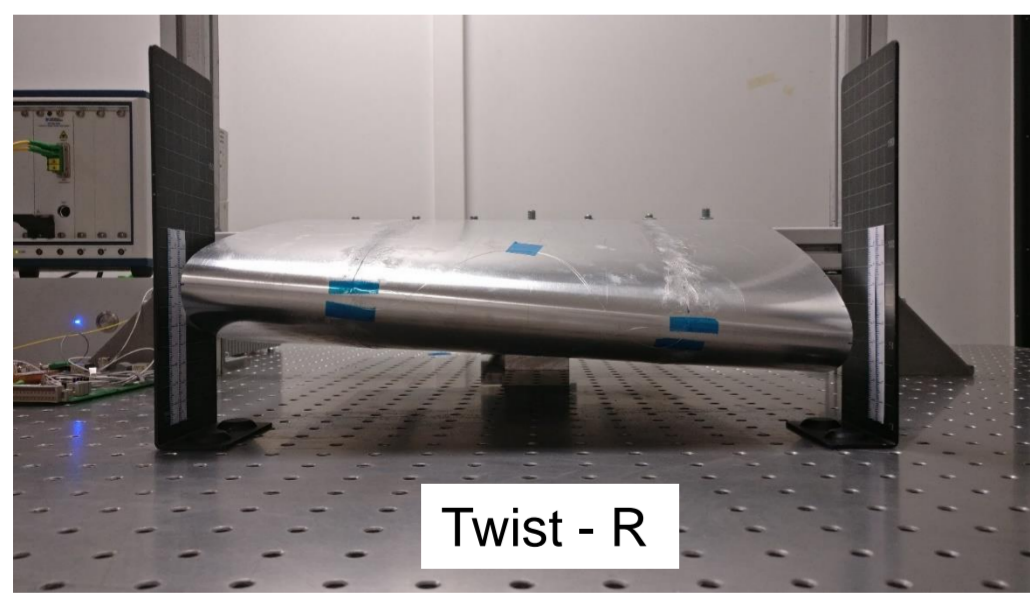
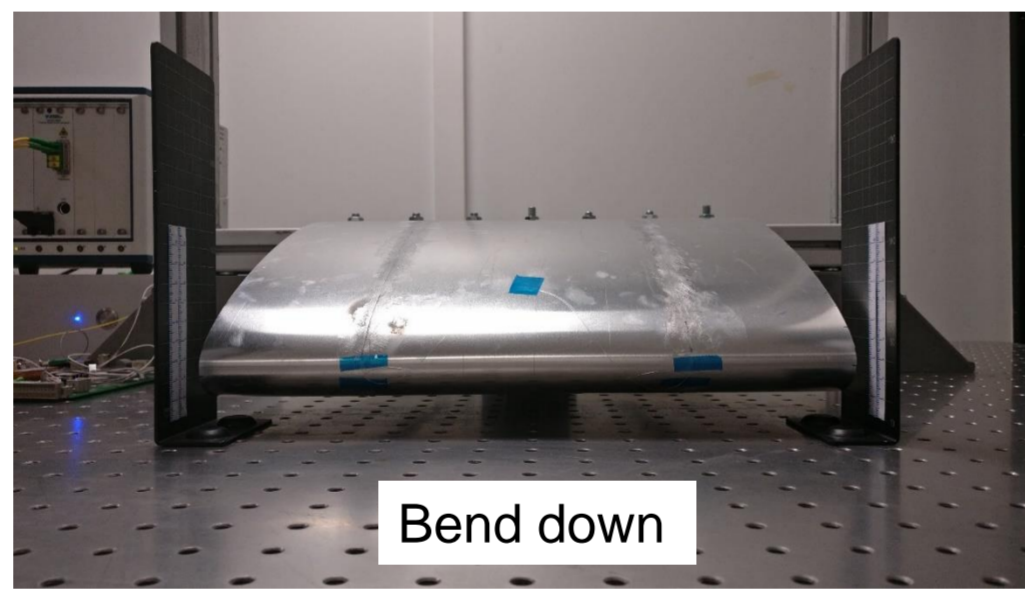
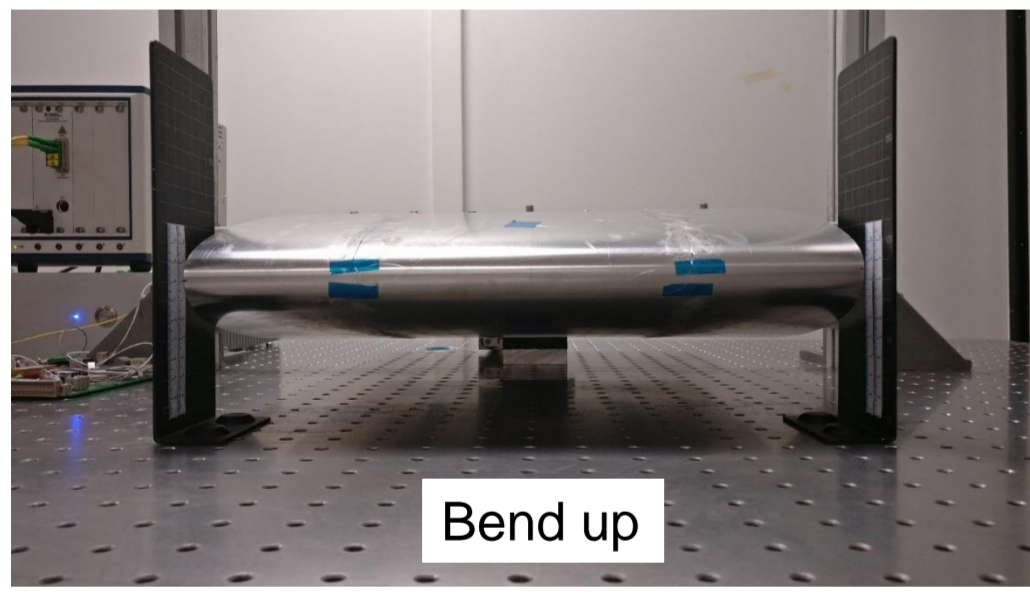
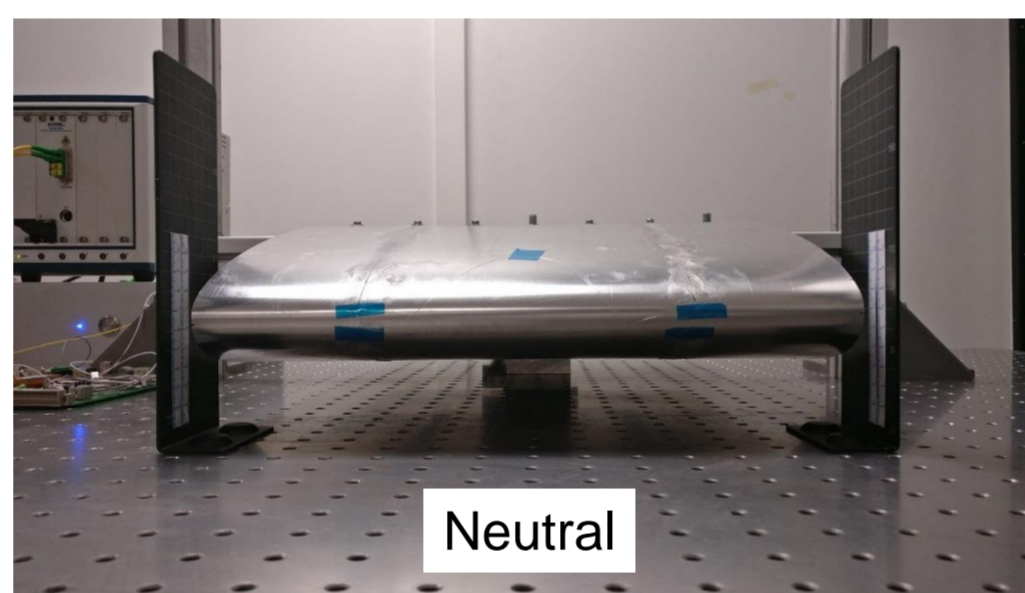
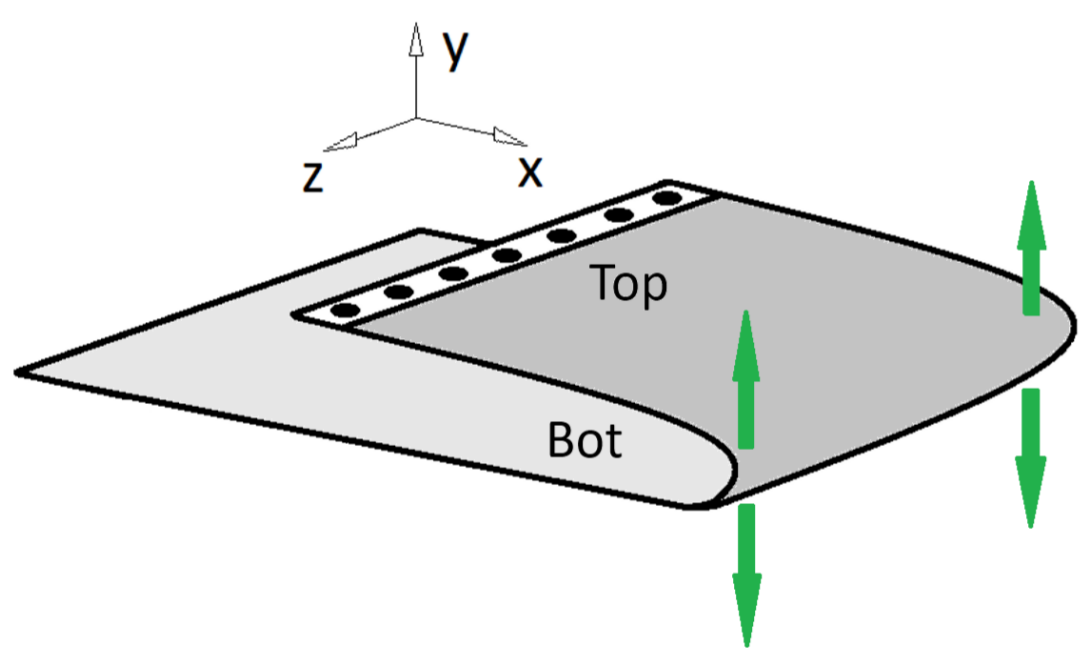

The wing is monitored while it adapts its shape to achieve ideal aerodynamic and structural performance during different flight regimes

## Test setup

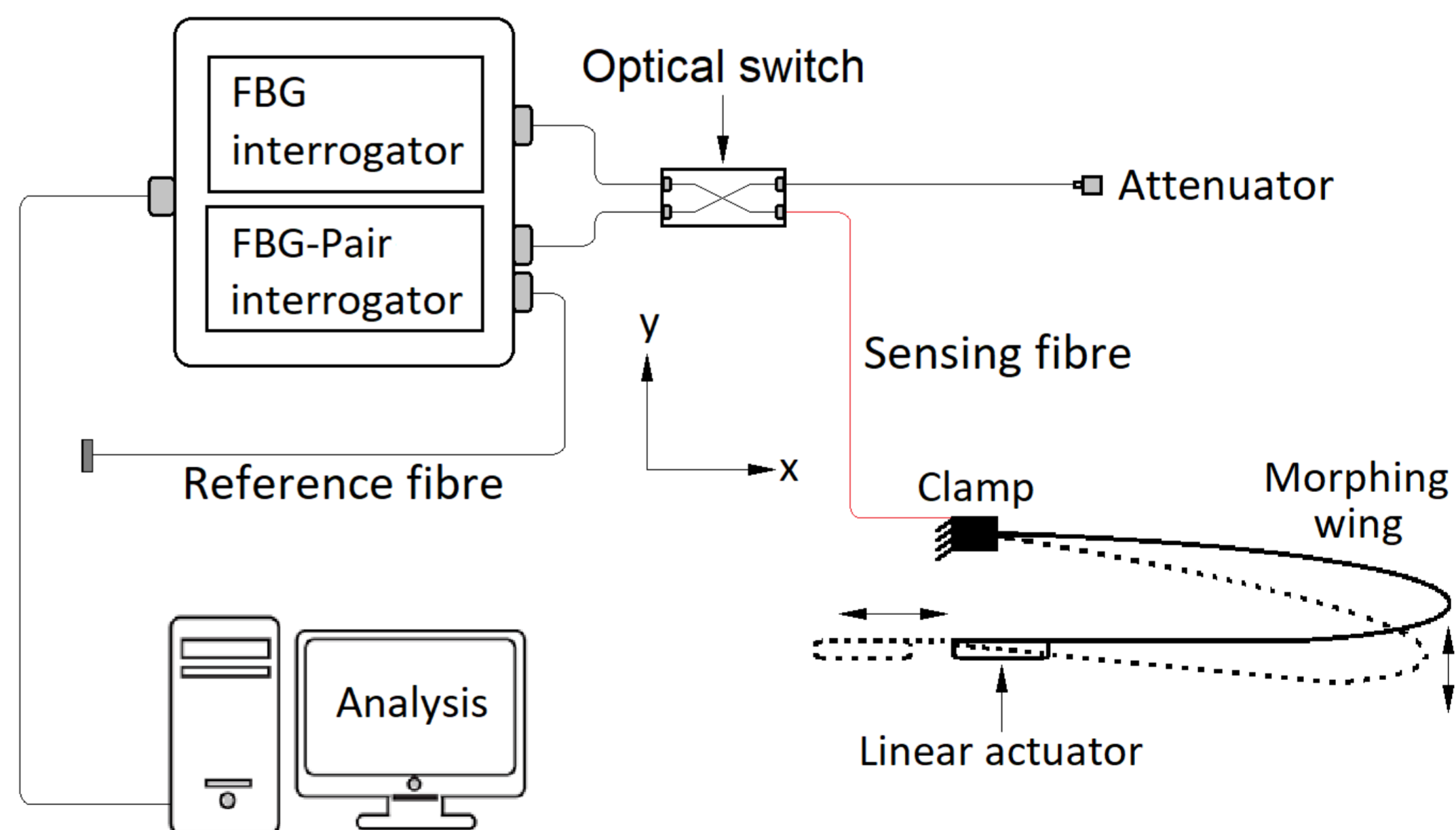
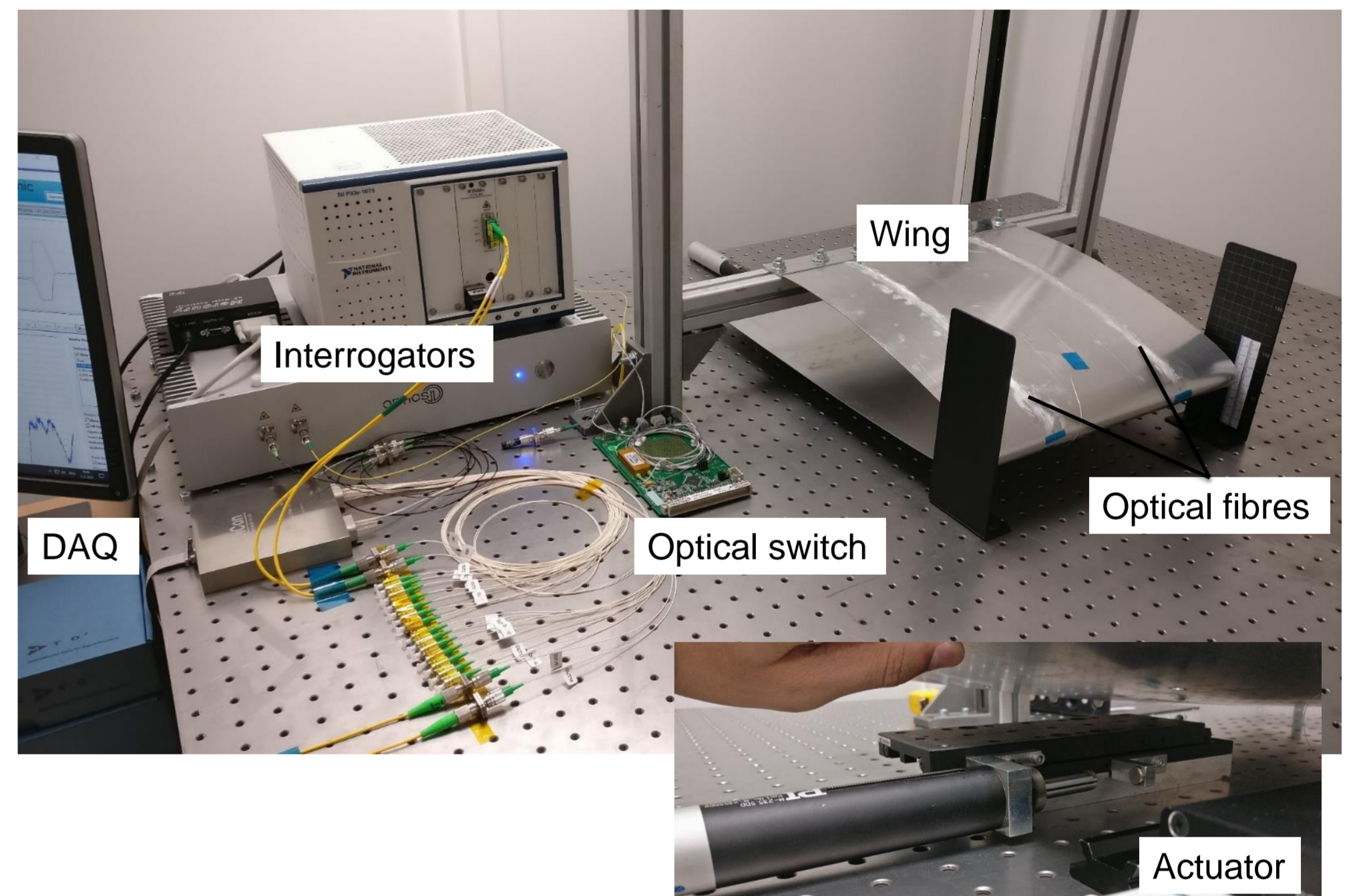

Feel free to contact us for updates or additional information