

Master Thesis

The development and evaluation of a modular well intervention business concept.

D.A. (Dominique) Smit

Supervised by:
Ir. J.W. Frouws
Dr. Ir. E.B.H.J. van Hassel
Ir. R. de Nie

SDPO.19.015.m



Master Thesis

The development and evaluation of a modular well intervention business concept.

by

D.A. (Dominique) Smit

to obtain the degree of Master of Science
at the Delft University of Technology,
to be defended publicly on Friday July 3, 2019 at 14h00.

Student number: 4183754
Report number: SDPO.19.015.m
Project duration: November 12, 2018 – July 3, 2019
Thesis committee: Prof. Ir. J.J. Hopman, Section Ship Design, Production and Operations, 3ME
Ir. J.W. Frouws, Section Ship Design, Production and Operations, 3ME
Dr. Ing. S. Schreier, Section Ship Hydromechanics and Structures, 3ME
Dr. Ir. E.B.H.J. van Hassel, Section Ship Design, Production and Operations, 3ME
Ir. R. de Nie, Damen Shipyards Group

This thesis is confidential and cannot be made public until July 3, 2024.

An electronic version of this thesis is available at <http://repository.tudelft.nl/>.

Preface

Dear reader,

The report which lies in front of you is my final work as student in Marine Technology at the Delft University of Technology. This work marks the end of an exciting career as student and the beginning of a new and even more exciting chapter in my personal and professional life.

The subject of this thesis is the product of a combination of my personal interest in Asia and the commercial aspect of the maritime industry, and the continuing drive of Damen to investigate and pursue new markets and business opportunities. I would like to express my sincere gratitude towards Damen Shipyards Group, namely my daily supervisor Ruben de Nie, for offering me this interesting and enriching opportunity. Ruben, your guidance throughout my research period was both supportive and challenging. To the colleagues of Business Development & Market Intelligence, thank you for the motivating surrounding and wise words, especially during lunch, which should always take place at 11h45 and no later.

The swift completion of this thesis would have not been possible without the academic guidance from my supervisors at Delft University of Technology. Koos Frouws and Edwin van Hassel, thank you for your time and critical but constructive feedback, and your availability for meetings and explanation. I would also like to thank Prof. ir. Hopman for his guidance at the beginning of my thesis period which has helped me get off in the right direction, and for chairing my graduation committee.

The process of writing a master thesis has proven to be an emotional roller coaster. From diverging through literature studies to converging towards the research goal, many emotional states were encountered. Not knowing where to start, having it all figured out and high and low levels of motivation are just a few of them. An additional amount of personal circumstances have had a significant contribution to this emotional roller coaster too. Luckily the presence and help of several people have made me safely cross the finish line. To my father and Francis, thank you for your unlimited willingness to listen and motivate, and for your gentle, yet important reminders to focus on the objective of graduating. To Chris †, thank you for reminding me to challenge myself, to confront problems and to take care of myself and those dear to me. And finally to my best friends, thank you for ensuring there was no lack of fun and excitement after long weeks at the office.

Best regards,

*D.A. (Dominique) Smit
Delft, June 2019*

Summary

The subject of this thesis is the development and evaluation of a modular well intervention business concept. The concept aims to bridge the gap between surface and subsea well intervention markets, currently served by different vessel types, using a platform vessel and equipment modules. The regional scope is South-East Asia, due to its low subsea intervention demand making it difficult for dedicated subsea intervention vessels to operate all-year round. The concept is evaluated from the point of view of the vessel owner and is limited to light and medium well interventions.

The thesis consists of concept development and concept evaluation phases. In the concept development phase, the technical requirements to perform well intervention are analysed. Also, a reference vessel analysis is done in order to understand which vessel dimensions are required. Next, the technical requirements are translated to a modular solution. The required equipment modules are investigated and their mobilisation complexity and lease costs estimated. Two vessels are initially chosen as module platform, both Damen Off-shore Carriers. The first has a deadweight of 5000t and a length of 100m, the second a deadweight of 8400t and a length of 125m. Both vessels are equipped with a helicopter deck, sufficient deck space to carry all modules and a moonpool amongst other specifications. An operability study has shown that the bigger vessel has no operability advantage over the smaller in this region, resulting in the consideration of the smaller vessel only for the business case evaluation due to its lower acquisition cost.

Before evaluating the business case, the concept's cost and pricing level are determined. Total costs include capital expenses (loan amortisation, interest), running costs (maintenance, repairs, insurance, crew) and voyage costs (fuel consumption, module mobilisation and lease costs). The cost level calculation and subsequent comparison with competing vessels have shown that the modular concept has the potential to be competitive. This does however depend on individual contract conditions and require specific market scenario evaluations.

In order to evaluate the concept and to understand in which market conditions this concept is profitable, market scenarios have been generated. This is done using the field data of four large field operators which is analysed and translated to intervention demand using an intervention policy. The rules and assumptions of this policy include that the first well intervention after going on stream takes place after 7 years and subsequent interventions take place every 5 years.

These market scenarios, consisting of well intervention contracts, form the basis for the financial evaluation of the business concept. In each scenario, the concept's payback time, net present value (NPV) and internal rate of return (IRR) have been calculated. The discount rate of the NPV calculation is 10%. In the first place a base case scenario, formed by the combination of intervention demand from all four operators has been evaluated. Moreover, the evaluation of operator-specific scenarios, together with a sensitivity analysis, have helped to understand the impact of different market conditions on the business case. The parameters which have been varied are the concept's pricing level (from -30% to +30%), module mobilisation time (5, 7 and 9 days) and well intervention duration (5, 7 and 9 days per well). The financial evaluation of the base case scenario results in a positive overall business case with a payback period of 9 years, €1.5M NPV and 11% IRR. The analysis of operator-specific scenarios have however shown, at the calculated cost and pricing levels, that subsea intervention contracts can hardly generate profit due to the high module lease and mobilisation costs involved. Surface intervention contracts do generate profit and play an important role in the overall success of a market scenario.

In conclusion, when operating at the given pricing level, the concept requires a market in which it is able to execute around three times as many surface contracts as subsea contracts to maintain a break-even point. In order for the concept to operate profitably in subsea interventions, the subsea modules' lease and mobilisation costs need to be reduced or the concept's price level increased which goes hand in hand with a reduction in competitiveness.

Contents

Preface	iii
Summary	v
List of Figures	xi
List of Tables	xiii
1 Introduction	1
1.1 Damen Business Development and Market Intelligence	1
1.2 A modular well intervention approach	1
1.3 Research gap	3
1.4 Research objective and questions	3
1.5 Research methodology and outline	3
I Business concept development	5
2 Market introduction	7
2.1 Offshore oil and gas production	7
2.1.1 Surface wells	7
2.1.2 Subsea wells	7
2.2 Oil & gas fields in South-East Asia	7
2.3 Well life cycle phases and well intervention	8
2.4 Well intervention drivers	9
2.4.1 Growing energy consumers	9
2.4.2 Demand and opportunities in Asia Pacific	10
2.4.3 Oil price and contracting trends	12
3 Well intervention technical requirements	15
3.1 Surface intervention	16
3.2 Subsea intervention	16
3.3 Intervention techniques	17
3.3.1 Slickline and wireline	17
3.3.2 Coiled tubing	18
3.4 Light intervention	18
3.5 Medium intervention	18
3.6 Reference vessel analysis and general vessel requirements	19
3.7 Requirements summary	19
3.8 Modularity suitability	20
4 Conceptual design of platform and modules	21
4.1 Concept design philosophy	21
4.2 Module platform	21
4.2.1 Damen Offshore Carrier	21
4.2.2 Platform concepts	22
4.3 Equipment modules	22
4.3.1 Module description format	22
4.3.2 Mobilisation complexity and cost	23
4.3.3 Accommodation	23
4.3.4 Module Handling Tower	24
4.3.5 Motion-compensated gangway	24
4.3.6 Wireline (light intervention)	24

4.3.7	Coiled tubing (medium intervention)	24
4.3.8	ROV Expansion	25
4.3.9	Cargo tanks	26
4.3.10	Module overview.	26
4.4	Operability	26
4.4.1	Method	27
4.4.2	Regional weather data	28
4.4.3	Operational limits	28
4.4.4	Results	29
4.4.5	Limitations.	29
5	Concept cost, competitiveness and pricing	31
5.1	Modular concept cost level	31
5.1.1	Capital expenses	32
5.1.2	Running expenses	34
5.1.3	Voyage expenses	34
5.1.4	Cost summary and utilisation rate dependency	34
5.2	Competitiveness and pricing	35
5.2.1	Subsea intervention competition	36
5.2.2	Surface well intervention competition	36
5.2.3	Comparison and conclusion	36
II	Business concept evaluation	39
6	Market scenarios	41
6.1	Methodology	41
6.2	Operators and field characteristics	41
6.3	Intervention policy rules and demand	42
6.4	Market scenarios	42
6.4.1	Assumptions	44
6.4.2	Scenario description framework	44
6.4.3	Market scenarios and utilisation rate.	45
7	Financial evaluation	47
7.1	Evaluation method	47
7.1.1	Cash flow	47
7.1.2	Payback period.	47
7.1.3	Net present value	48
7.1.4	Internal rate of return	48
7.1.5	Sensitivity analysis	49
7.2	Base case: combined market scenario	50
7.2.1	Standard situation	50
7.2.2	Sensitivity to pricing	50
7.2.3	Sensitivity to module mobilisation time	50
7.2.4	Sensitivity to well intervention duration	51
7.3	Operator-specific scenarios	53
7.4	Discussion	53
7.4.1	The cost of modularity	53
7.4.2	Pricing level	53
7.4.3	Mobilisation time	54
7.4.4	Well intervention duration	54
7.4.5	Utilisation rate	54
7.4.6	Operator demand and combined campaigns	55
7.4.7	Conclusions on required price level and contract conditions	55
7.5	Alternative business case: vessel and module ownership	56

8	Conclusion and recommendations	57
8.1	Conclusion	57
8.2	Recommendations	58
	Bibliography	61
A	Appendix	63
A.1	Modularity decision tree	63
A.2	Reference vessel analysis	63
A.3	Weather characteristics South-East Asia	64
A.4	Day rate analysis	66
A.5	Scrap value	68
A.6	Market scenarios	69
A.7	Operator-specific results	72
A.7.1	Murphy	72
A.7.2	Petronas	74
A.7.3	Chevron	76
A.7.4	Shell	78

List of Figures

1.1	A simple visualisation of well intervention demand and supply	2
1.2	A visualisation of the modular business concept and the different players that are involved . . .	3
1.3	Parts and contents overview	4
2.1	Offshore platform	8
2.2	Subsea wells	9
2.3	Fields containing operational subsea wells	10
2.4	Fields containing operational surface wells	10
2.5	Field analysis graphs	11
2.6	Field production over time	12
3.1	Two-layer intervention capabilities. The bottom layer is that of the vessel capabilities, the second is that of the intervention equipment.	15
3.2	FTAI Pride	16
3.3	Intervention stack	17
3.4	Helix Well Enhancer	18
3.5	Subsea impression of intervention operation	18
3.6	Modularity decision tree outcome	20
4.1	Damen Offshore Carrier	22
4.2	Damen Offshore Carrier range	22
4.3	Existing Damen Offshore Carrier vessels	23
4.4	The two concept platforms	24
4.5	PRT Offshore module handling tower	25
4.6	Ampelmann A Type EP	25
4.7	IHC Coiled tubing equipment	26
4.8	Operability calculation overview	27
4.9	Operability calculation of DOC 2 (8400 DWT) in winter conditions	30
4.10	Operability calculation of DOC 1 (5000 DWT) in winter conditions	30
4.11	Equipment limits	30
5.1	Total cost breakdown into capital, running and voyage expenses	31
5.2	Breakdown of building cost financing	32
5.3	Profit differences between day rate pricing and competition cost level pricing	35
6.1	Market generation method	41
6.2	Market generation methodology extensions	43
7.1	Cash flow in standard base case scenario	50
7.2	Cash flows of base case at different pricing levels	51
7.3	Cash flows of base case with different mobilisation times	51
7.4	Cash flows of base case with different well intervention durations	52
7.5	Profit share and module lease cost of surface and subsea interventions	53
7.6	Profitability per well intervention contract type. The base case scenarios contains no 'surface light' contracts so only three percentages are shown.	54
7.7	Cost per well intervention type as function of contract size (amount of wells) for a utilisation rate of 75%	55
A.1	Modularity decision tree	63
A.2	Subsea well intervention vessel analysis	63

A.3	Wave scatter diagram of Area 62 (part 1)	64
A.4	Wave scatter diagram of Area 62 (part 2)	65
A.5	Day rates graph	66
A.6	Drilling rig day rates	67
A.7	Cash flow of normal Murphy scenario	72
A.8	Cash flow of Murphy scenario at different price levels	73
A.9	Cash flow of Murphy scenario with different mobilisation times	73
A.10	Cash flow of Murphy scenario with different well intervention durations	73
A.11	Cash flow of normal Petronas scenario	74
A.12	Cash flow of Petronas scenario at different price levels	75
A.13	Cash flow of Petronas scenario with different mobilisation times	75
A.14	Cash flow of Petronas scenario with different well intervention durations	75
A.15	Cash flow of normal Chevron scenario	76
A.16	Cash flow of Chevron scenario at different price levels	77
A.17	Cash flow of Chevron scenario with different mobilisation times	77
A.18	Cash flow of Chevron scenario with different well intervention durations	77
A.19	Cash flow of normal Shell scenario	78
A.20	Cash flow of Shell scenario at different price levels	79
A.21	Cash flow of Shell scenario with different mobilisation times	79
A.22	Cash flow of Shell scenario with different well intervention durations	79

List of Tables

3.1	Slickline, wireline and coiled tubing capability comparison	18
3.2	Significant dimensions of reference vessels	19
3.3	Summary of all intervention requirements per type	19
3.4	Summary of all required equipment required to operate in subsea and surface, light and medium intervention market	20
4.1	Specifications of existing DOC platforms Nexus and Connector	23
4.2	Module capabilities overview	26
4.3	Lease and (de)mobilisation costs per intervention type	27
4.4	Seakeeping performance criteria for human effectiveness - limiting criteria with regard to accelerations (vertical and lateral) and roll motion	28
4.5	General operability limiting criteria for ships	29
4.6	Operational limits of equipment modules	29
5.1	DOC 5000 cost estimation process based on cost breakdown and analysis of Nexus and Connector building costs.	33
5.2	Capital expenses of the DOC5000 concept	33
5.3	Running expenses of the DOC5000 concept	34
5.4	Fuel consumption of the DOC5000 concept	34
5.5	Cost level summary and comparison of modular concept and subsea and surface competition vessels.	37
6.1	Operational wells and wells under development (UD) per operator	42
6.2	Well intervention contract types	42
6.3	Well intervention demand per year for the four biggest operators in South-East Asia	43
6.4	Combined well intervention demand of the four biggest operators in South-East Asia per year	44
6.5	Technical well intervention contract requirements per contract type	45
6.6	Business concept utilisation rate in each scenario	45
7.1	Payback time, NPV and IRR for standard base case scenario	50
7.2	Payback time, NPV and IRR of base case at different pricing levels	51
7.3	Payback time, NPV and IRR at different module mobilisation times	51
7.4	Payback time, NPV and IRR at different well intervention durations	52
7.5	Utilisation rate versus NPV comparison	55
7.6	Dayrate increase (in the first year) as a consequence of purchasing the equipment modules for several cost and utilisation rate combinations.	56
A.1	Day rates table	66
A.2	Scrap value of both existing and conceptual DOC 5000 vessels	68
A.3	Yearly depreciation calculation of DOC 5000.	68
A.4	Combined market scenario	69
A.5	Petronas market scenario	70
A.6	Murphy market scenario	70
A.7	Chevron market scenario	71
A.8	Shell market scenario	71
A.9	Murphy scenario results	72
A.10	Petronas scenario results	74
A.11	Chevron scenario results	76
A.12	Shell scenario results	78



Introduction

1.1. Damen Business Development and Market Intelligence

Damen Shipyards, a leading global shipbuilding company, operates in every market where it sees an opportunity to improve, innovate or invest. One of Damen's departments playing a vital role in identifying such opportunities is the Business Development and Market Intelligence department. This department was formed in 2015 with the following announcement: "With the formation of this dedicated department, Damen puts a strong focus on the search for new markets and further developing existing markets. By aligning with the Damen company plan, analysing market intelligence, and putting forward business leads the Business Development & Market Intelligence department will provide strategic information to weigh sales opportunities and vessel portfolio development. To ensure long-term growth of the Damen Shipyards Group, this department will work in close collaboration with the Damen Management, Area Groups and Product Groups." The subject of this thesis, introduced in the next section, originates from this important department within Damen Shipyards Group.

1.2. A modular well intervention approach

The goal of this thesis is to develop and evaluate a new business concept which will be introduced in this section by answering the questions: 'what?', 'why?', 'how?' and 'who?'.

The business concept is a modular approach to the well intervention market. Well intervention consists of any operation that involves penetration of an offshore oil or gas well for inspection, maintenance, repair or plugging. The business concept aims to operate in both surface and subsea well intervention market segments, traditionally served by differing vessels. The business concept relies on a module platform vessel and compatible equipment modules instead of a vessel with permanently installed equipment. The platform vessel has capabilities which are useful in both subsea and surface well intervention operations, whereas the modules add specific capabilities according to the requirements of the operation. The modularity of this vessel theoretically allows it to operate in other markets in the region too, although that is not the main focus of this research. The module platform is a vessel from the Damen Offshore Carrier design range which will be introduced in chapter 4.

The reason why Damen Shipyards sees potential in this concept can be explained as follows. There exists demand for both subsea and surface well intervention in the region. This will be elaborated upon in the market analysis in chapter 2. Due to the specific complexity of subsea well intervention, dedicated subsea well intervention vessels (SWIV) are normally used for such intervention operations in other regions in the world such as the North Sea or the Gulf of Mexico. However, in order for any dedicated vessel to operate profitably in the market it is designed for, there need to be sufficient contracts to occupy the vessel all year round. In case of the South East Asian region, the number of subsea wells is too limited for a dedicated vessel to operate profitably all year round. Therefore a vessel that can perform both subsea and surface well intervention would be useful. If this vessel were to be robust (not modular) it would need to carry all necessary capabilities

for both market segments permanently on deck. This would lead to very high investment cost for the owner, as well as high operational costs. As a result, the vessel cannot presumably be competitive in the dominating surface well intervention market in which it competes with cheaper platform support vessels (PSVs). An example of a failed attempt to operate in a limited subsea market exists. Namely, Marine Subsea tried to step into the subsea well intervention market of Angola. It constructed two subsea intervention vessels, 'Sarah' and 'Karianne', and signed a contract with Sonangol, a parastatal company overseeing national oil and gas production, to perform well intervention campaigns on a ten year horizon. However, this deal fell apart as Sonangol did not have enough subsea wells to make the contract financially viable. Marine Subsea went on and tried to save their existence by taking on subsea work from other operators in the region, but failed to do so. The company subsequently filed for bankruptcy and sold both subsea intervention vessels.[14]

Moreover, the reason Damen wants to investigate this concept is of course to sell a vessel to a potential client. This will only happen when Damen can demonstrate that the well intervention concept is a profitable investment. In order to do so the point of view of the vessel owner is taken during the business concept development and evaluation phases. There are two important factors at stake to assess the investment. First, it has to be made sure that the concept's pricing level is competitive compared to existing alternatives in order to win contracts. Secondly, the business concept should generate a profit at the given price level.

This leads to how the modular approach intends to achieve serving both market segments whilst being competitive. The financial advantage should result from lower capital and operational expenses for the vessel in comparison to a robust multifunctional vessel. Next, the technical requirements for executing well intervention contracts are met by mobilising and demobilising modules on and off the platform between contracts. The well intervention market, like any other 'market' in its simplest form, consists of demand and supply. The compatibility between well intervention demand and supply is in fact defined by the technical capabilities that are at play. On one hand, contracts require capabilities in order to be executed according to the intervention objectives, and on the other the well intervention solution (in this case the platform and equipment modules) provides these capabilities. This is represented by figure 1.1.

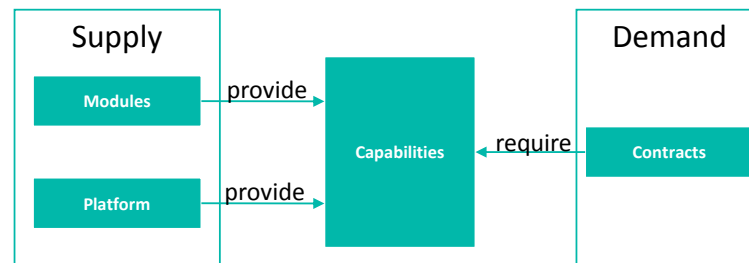

Figure 1.1: A simple visualisation of well intervention demand and supply

The modules are assumed to be available for lease by an equipment partner. In this manner, modules are paid for by the vessel owner only when they are required. The modules are located on shore at unspecified locations and the mobilising and demobilising costs will be taken into account in the operational expenses.

The module platform is to be built by Damen Shipyards Group for the vessel owner. The modules are owned and leased to the vessel owner by a well intervention equipment manufacturer of which several exist. This however is an assumption, there is no specific agreement about the availability of such modules yet. Depending on the outcome of the concept analysis however, there is a possibility that this agreement will be sought. The vessel owner owns the modular well intervention solution, and uses this to compete and operate in the well intervention market either directly (as service provider) or through an external service provider who charters the vessel. The market is created by field operators who request quotations from service providers for well intervention. The business concept and the players involved are visualised in figure 1.2.

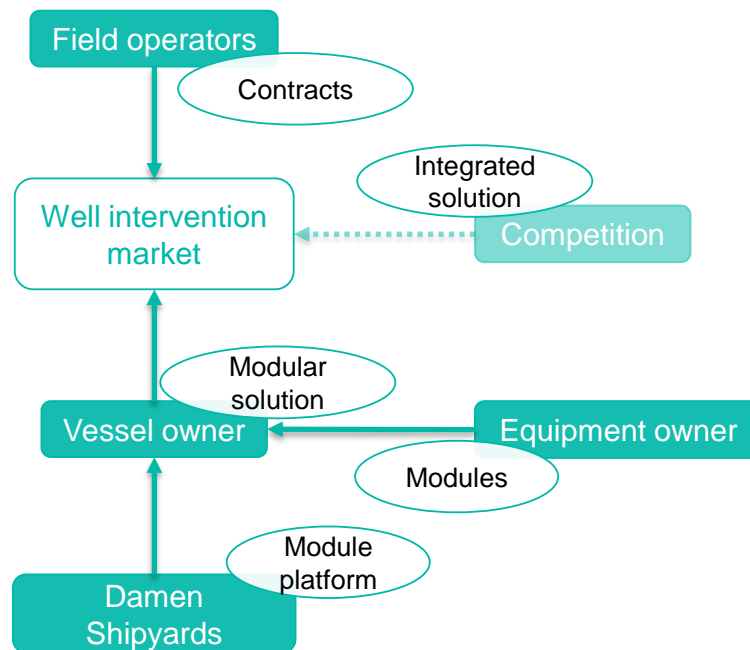

Figure 1.2: A visualisation of the modular business concept and the different players that are involved

1.3. Research gap

Although modular equipment is deployed on multifunctional vessels for well intervention already, no vessel has been specifically designed for the business concept highlighted. Neither has it, to the best of my and Damen's knowledge, been publicly researched before.

1.4. Research objective and questions

The objective of this thesis is to develop and evaluate the business concept of a modular well intervention approach. This should lead to an indication of the financial viability of the business concept. The research questions which will be answered in this thesis are:

1. What are the technical requirements to perform subsea and surface well intervention?
2. How can the technical requirements be translated to a modular solution?
3. Is the business concept financially viable?
 - (a) Does the base case scenario form a positive business case?
 - (b) How do market and intervention assumptions affect the business case's financial success?
 - (c) In which market conditions is the concept a good business case?

1.5. Research methodology and outline

In order to structure the research process this thesis consists of two parts. Firstly the concept development phase includes an analysis of the well intervention market and technical requirements, the introduction of a conceptual design and the determination of its cost and pricing level. Secondly, the business concept is evaluated in specific market scenarios. This is done using an evaluation model which calculates the vessel's revenue in a market scenario whilst taking into account all operational expenses and contract requirements.

To increase the report's clarity, the parts contain several chapters. The following overview introduces the role that each chapter plays in achieving the goal of this thesis. It is visualised in figure 1.3.

- Part 1: Business concept development
 - Chapter two is a market introduction and analysis which contains information essential to understanding the market dynamics and complexities.
 - Chapter three contains a thorough analysis in which technical requirements of well intervention are determined.
 - Chapter four focuses on the conceptual design, including the platform capabilities and equipment modules.
 - Chapter five establishes the concept's cost and pricing level.
- Part 2: Business concept evaluation
 - In chapter five the contract scenarios are defined in which the business concept is evaluated.
 - Chapter six presents the market scenario evaluation model and describes the assumptions and constraints of the model.
 - Chapter seven describes and analyses the results of the evaluation model.
 - Chapter eight draws conclusions on the concept's financial viability.

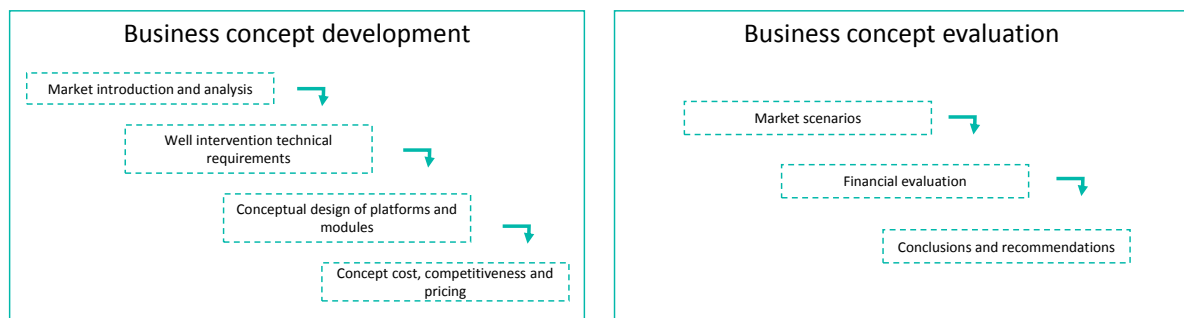

Figure 1.3: Parts and contents overview

I

Business concept development

2

Market introduction

This chapter has an introductory purpose and aims to give some important background information on well intervention and to describe the general context of the well intervention market in South-East Asia.

2.1. Offshore oil and gas production

Offshore oil and gas wells are artificially drilled borings in the earth with the purpose of bringing petroleum oil, hydrocarbons and natural gas to the surface. They are drilled at sea by drilling rigs. Once the wells are drilled, a set of valves and pipes (better known in the industry as the 'christmas tree' or XMT in short) is installed to control the outflow of substances. Usually a blowout preventer (BOP) to prevent oil spills from happening in case of well failures is installed too. In this report two types of wells are differentiated, namely surface and subsea wells. The following sections explain the difference.

2.1.1. Surface wells

Wells are preferably drilled in shallow waters (up to 100m of water depth) enabling their exploitation from a platform at the water surface. Such a surface platform commonly stands on a rigid structure (also known as a jacket) on the seabed for depths up to 100m, an example of which can be seen in figure 2.1 Above 100 meters of water depth floating platforms exist in the form of a semi-submersible or Floating Production, Storage and Offloading (FPSO) vessels. In any case, the oil and gas can be extracted, stored and processed in dry conditions at the surface. Another advantage of surface wells is that because the XMT is placed on the platform, its inspection, repair and maintenance (IRM) is easier and can be done routinely. Surface wells are the most common type of well (98% of all wells) in South East Asia because the majority of oil and gas fields are in water up to around 80m in depth.

2.1.2. Subsea wells

However, new field developments are targeting areas in deeper water. The increased water depth (above 100 meters) does not allow the use of a rigidly connected platform, and thus a subsea well infrastructure is used. A subsea well is defined as a well that has the so-called XMT installed on the seabed rather than on the platform. This gives rise to challenges particularly with regards to the maintenance and intervention of the well, as the well has to be accessed remotely and under water. Oftentimes, a group of wells is interconnected subsea using a hub-like network leading the products (oil or gas) towards more shallow waters and a common collection platform, or directly towards shore. Figure 2.2 gives an impression of subsea wells.

2.2. Oil & gas fields in South-East Asia

The scope of this thesis is limited to the region of South-East Asia as explained in section 1.2. The area of South-East Asia is limited by the the China Sea on the North, the Indian Ocean on the South, the Andaman



Figure 2.1: Offshore platform
Source: <http://www.emis-bv.com/>

sea on the West and the Pacific Ocean on the East. According to market research of Infield Data [14], South-East Asia counted 7679 operational surface wells and 151 operational subsea wells producing oil and gas in November 2018. These wells are divided over several fields across the region. Figure 2.3 shows the location of all the fields in the region containing subsea wells, whereas figure 2.4 shows all fields with surface wells. At the same time, 22 subsea wells and 219 surface wells were under construction.

2.3. Well life cycle phases and well intervention

Well intervention is a general term used for any type of work that takes place on an existing well. Wells go through three phases during their lifetime, each requiring different kinds of well intervention. The three phases are:

1. Completion Phase: Once a well is drilled, product transfer between the reservoir and well has to be stimulated. This is often accomplished by pumping acids into the well bore. Figure 2.5a shows the amount of fields that went and continue to go on stream per year. From the graph can be seen that 17, 31 and 42 fields will go through their completion phase in years 2020, 2021 and 2022 respectively. This amount per year remains stable until around 2025 and then diminishes from 20 to zero in 2037, based on the information known in 2019.
2. Production Phase: Once a well starts producing oil or gas, the well requires inspection and maintenance to protect the integrity and production level, which take place approximately every 5 years. This can include anything from inspection to repairs to more advanced hydraulic interventions. Figure ?? shows the age distribution of all fields in South-East Asia as calculated in 2019. The wells in these fields can require intervention during their production phase for up to 50 years.
3. Decommissioning phase: At the end of a well's life cycle, the integrity of the well needs to be checked and completely restored in preparation for a plug and abandonment campaign. This happens when the well's field is depleted. Figure 2.5b shows the amount of fields that reach their estimated depletion age per year. In 2020 an estimated 52 fields reach their depletion year, and this number stays within the 26 to 46 range until 2035.

As illustrated per production phase above, the amount of well intervention required in the 15 years ahead knows no reduction. The amount of active oil and gas fields per year can be seen in figure 2.5c. This number hovers around 400 fields until 2030.

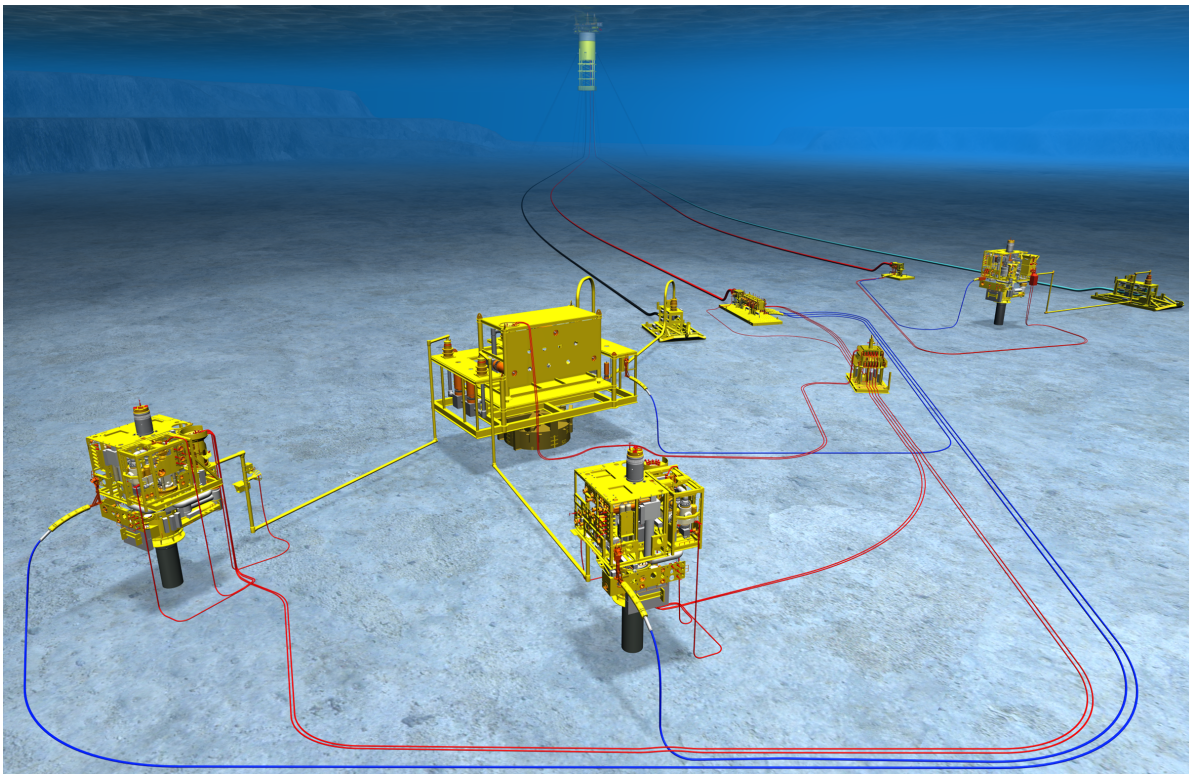

Figure 2.2: Subsea wells
Source: www.drillingcontractor.org

The production volume of a well increases after the extraction starts, until it reaches a rate of maximum output. When this peak or plateau is reached, the well enters into a phase of irreversible production decline, generally estimated to be 7-10% per year [18]. This is caused by depletion of the well and the deteriorating state of the infrastructure. However, well intervention can extend the production levels over time. A graphical representation of well production over time is drawn in figure 2.6. This figure shows the general idea of declining well production over time and the possible effect of well intervention. It is not based on any specific measured data and is in no way representative of all wells.

2.4. Well intervention drivers

2.4.1. Growing energy consumers

The Asian region has found itself playing an ever increasing role in both the supply and demand of offshore oil and gas. It is no surprise that the new levels of growth are tied to the emergence of China along with India as growing energy consuming markets. The growth from these two huge markets, coupled with demand from Japan means that Asia contains three of the world's top five energy important nations. Japan has always been an energy dependant state, however, in 2011 after the devastating effects of the Fukushima Daiichi nuclear disaster, the country started to look to increase its dependency on imported energy, specifically LNG, and the country is now the world's largest importer, ahead of China.

While this energy dependence exists, countries within the region will increasingly look to develop and discover new supplies of oil and gas in order to meet their insatiable appetite for resources. Indonesia and Malaysia are the largest energy exporting nations in the region, with the majority of offshore reserves found around the South East Asian area, or in Russia in Sakhalin. However production rates in both Malaysia and Indonesia have been dropping in recent years as fields in mature basins begin to run dry. In an effort to address this decline, operators working in Asia have been looking to new areas in deeper water in an attempt to find new discoveries that they hope will help to offset this decline in production and meet the region's demand for energy. The majority of production in Asia is centred around shallow water fixed platform developments and,

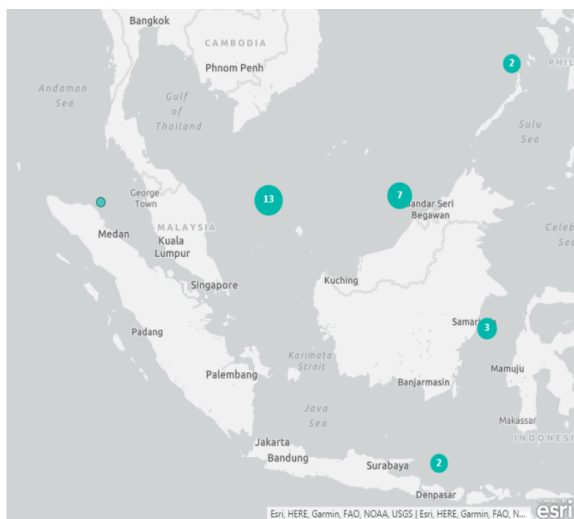

Figure 2.3: Fields containing operational subsea wells

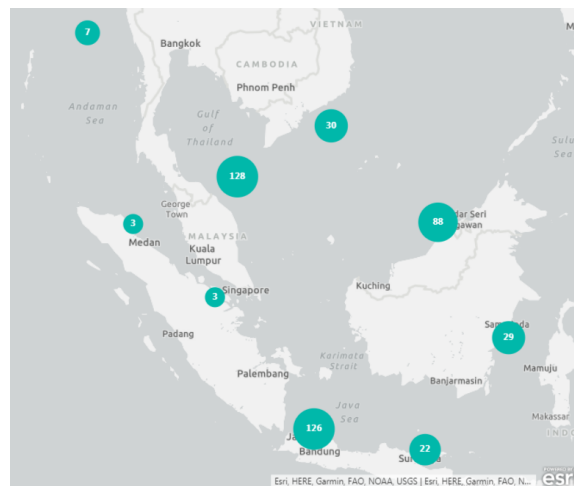

Figure 2.4: Fields containing operational surface wells

as such, Asia is not really a major subsea region, when compared to other regions globally. However, it is a market where major deep water development continue to be realised and expected. This could help to build momentum and increase the number of subsea installations, and thus the possible need for well intervention services.

Specifically, according to market research of Infield Systems [14], Asia saw the largest growth in subsea intervention demand over the past decade compared to any other region, as subsea activity was set to increase in India, China, Malaysia and Indonesia, raising the need for intervention services.

2.4.2. Demand and opportunities in Asia Pacific

According to Offshore Network [27], the market developments mentioned before will lead to a global market growth from an estimated USD 8.18 billion in 2017 to USD9.85 billion by 2022. The Asia Pacific region is said to be the region to benefit the most from this wave of activity as it combines all 3 factors driving upsurge: a rise in energy demand, an increase in oil and gas production and a need to revitalise ageing fields.

Furthermore, energy consultant Wood Mackenzie estimates that offshore operators in Asia Pacific could face a total decommissioning bill of over \$100 billion with nearly 2600 platforms and 35000 wells needing to be abandoned in the near future. [2] These market developments specifically lead to an increased demand in well intervention on wells in production and decommissioning phases. In this section we zoom in on the opportunities that arise specifically in several countries in Asia Pacific.

Malaysia

The government's main focus has long been on offsetting production declines from mature assets such as larger shallow water fields in the offshore Peninsular Malaysia by opening up new investment opportunities through enhancing output from existing wells and developing new fields in deep water areas offshore. A proactive regulatory environment and declining production in ageing fields therefore offer huge opportunities for well service contractors capable of offering uplift services to Malaysian operators. [27]

Indonesia

According to a report from BCG [1], Indonesia's existing oil and gas fields are aging. More than 60% of oil production and more than 30% of gas production come from late-life-cycle resources. Indonesia needs to take a combination of actions in response, including developing more from proven reserves, exploring for and developing new reserves, and using advanced recovery technologies, such as enhanced oil recovery (EOR), on mature fields to slow or reverse production declines. However, EOR requires major capital investment as well as advanced technologies and expertise that aren't available locally. In addition, current regulations in Indonesia don't encourage partnerships with international EOR service providers, which could facilitate the outside-in transfer of technology and knowledge.

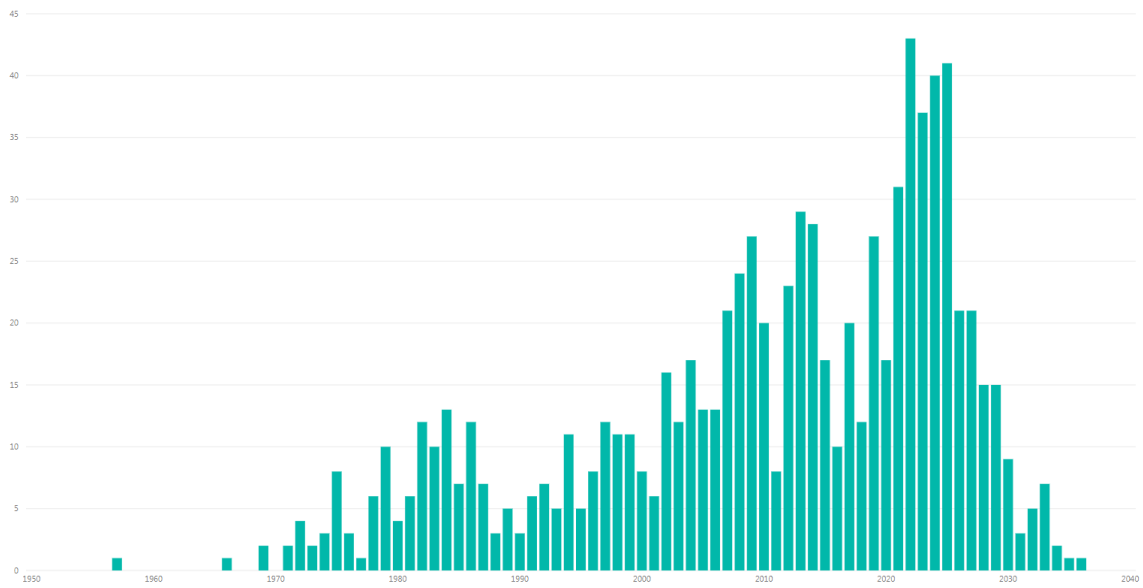

(a) New fields going on stream per year

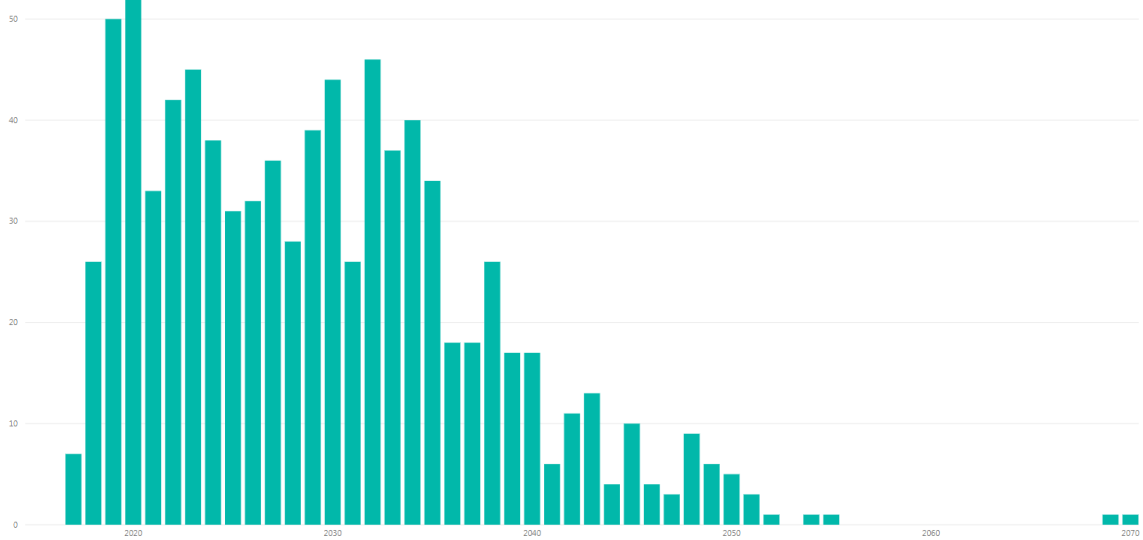

(b) Fields reaching their estimated depletion age per year

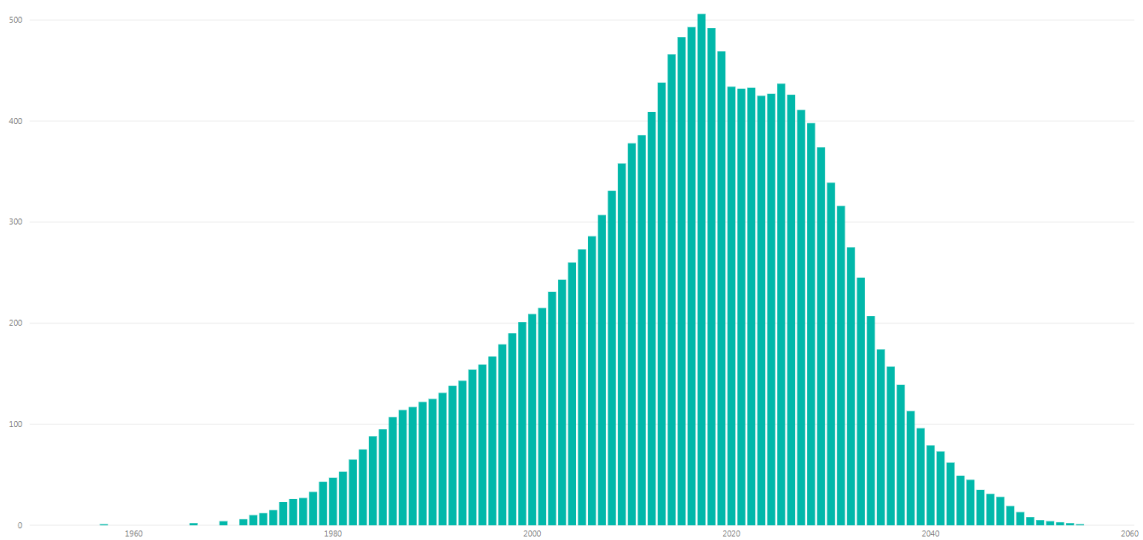

(c) Total amount of fields on stream per year based on available data in 2019

Figure 2.5: Field analysis graphs

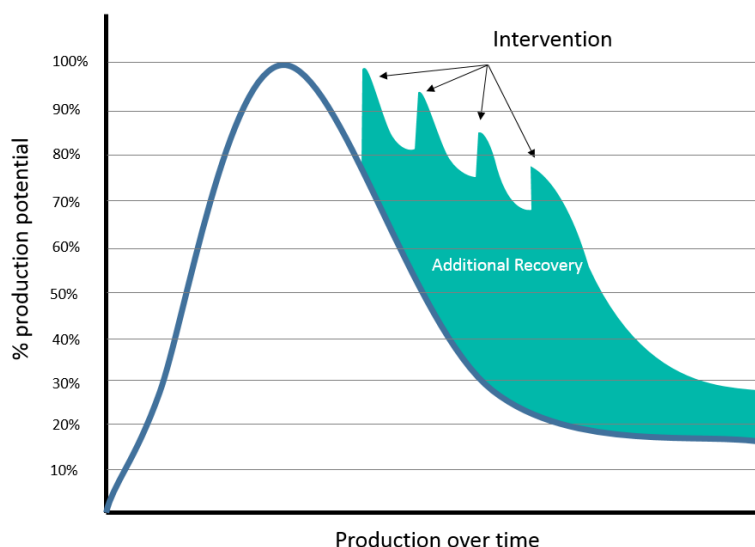

Figure 2.6: Field production over time

Vietnam

Vietnam's oilfields are maturing and crude oil production capability is forecast to decline significantly from 2019. Some assets such as the White Tiger field have been producing for over 30 years and have been declining since 2005, according to a market report from BMI Research. This leads to continuing opportunities for well interventions.

Conclusion

In conclusion, Asia Pacific is at the forefront of big increase in well intervention operations across the entire region. Taking into account that most wells are surface operated, as well as the continuing deepwater subsea developments, the market is suitable for smart and flexible intervention solutions suitable for both surface and subsea well intervention in production and decommissioning phases.

2.4.3. Oil price and contracting trends

Well intervention demand is strongly linked to the trading rate of oil. In this section we take a look at the general market development over the years and forecast for 2019.

Until 2014 the majority of well intervention activities centred around the first and second phases mentioned in section 2.3, as the business was heavily focused on identifying big discoveries, bringing them online and then uplifting production as quickly as possible. During this period the oil business was an Exploration and Production business (E&P). [18]

However, since 2015, the oil market has been and continues to be a bearish market. Industry operators have been moving back into healthier profits since the 2008 financial crash after effectively lowering their cost base to support production operation in the \$50 oil environment, and they continue to focus on bringing the cost base down as much as possible. This means CAPEX budgets had massive and immediate reductions globally, and although impacted too, OPEX budgets remained a necessity as revenue came from the existing assets and extending, uplifting and optimising production wells became critical for the industry. During this period, operators essentially shifted from E&P businesses to just P, increasing demand for well intervention.[18]

Moreover, since 2017, global regulatory bodies such as Malaysia's MPM created new guidelines and regulations regarding Plug & Abandonment (P&A). Idle wells have to be either abandoned or brought back into production. This further pushes the business model of operators towards one that is reliant on extending the life of economic production fields and removing idle or non-profitable wells from the portfolio. Oil prices are predicted to remain in the mid-\$60 area in 2019 [3]. If a field is profitable in the \$50 oil environment, workovers can generate a lot more value in a \$60-\$70 oil environment in 2019. Alternatively if wells are cost negative at \$60-\$70 oil it is likely they are P&A candidates as the regulatory environment will no longer allow

them to be suspended until markets improve to make them economic again.

Additionally, since 2015, Petronas (Malaysia's national oil company and of Asia's biggest players in the oil and gas market) has adapted a new form of well intervention contracting. Named 'Integrated Idle Wells Restoration' (IIWR), this contracting form is an integrated provision that leverages on a risk sharing mechanism between operator and service provider to drive operational efficiency and improve success rate. It implies that the service provider gets paid based on performance instead of duration, leading to an increased incentive to maximise cost-efficiency of the intervention equipment used. This form of contracting will continue to be adapted in similar forms throughout the well intervention market in Asia Pacific and globally.

3

Well intervention technical requirements

The well intervention demand that has been laid out in the previous chapter can be performed by a number of globally operating vessels that are equipped with specialised intervention systems. Before diving in the conceptual design of the modular well intervention approach in the next chapter, it is important to understand how different well intervention operations differ and how existing solutions execute intervention contracts both on subsea and surface wells. Therefore this chapter aims to describe the vessels and equipment used in intervention operations and to lay the foundations for the concept design of the modular approach. This chapter also serves to answer the first research question: "What are the technical requirements to perform well intervention?".

On top of the differences in well type introduced in section 2.1, there also exist different intervention types according to a gradation in complexity. Defining intervention types into light, medium and heavy is the traditional approach to classifying intervention activity depending on the activities expected to be carried out. [14] These are generic terms that capture the range of intervention services. Because heavy intervention generally requires greater free deck space than monohulls can offer, mobile offshore drilling units (MODU's) serve this segment. A unit that is able to perform heavy interventions should also be able to perform all the services that a light intervention vessel can provide. It makes however no sense to perform a light intervention with a heavy intervention unit due to higher costs and lower efficiency. For this reason, heavy intervention falls outside the scope of this thesis.

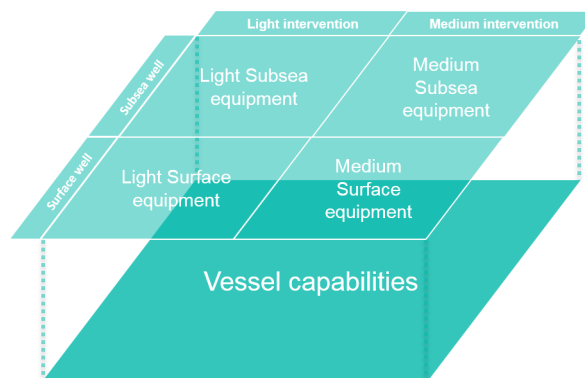

Figure 3.1: Two-layer intervention capabilities. The bottom layer is that of the vessel capabilities, the second is that of the intervention equipment.

A well intervention vessel's capabilities can be seen as the addition of the base vessel's capacities and the equipment installed on board. This is visualised in figure 3.1 which shows the separation of vessel and equipment capabilities. In case of a dedicated intervention vessel, there is no decoupling between the vessel and equipment layers because all equipment is installed permanently on board. In case of the modular approach, this decoupling exists as much as possible. The equipment layer is divided in four quadrants. These result from combining well types (surface and subsea) with intervention types (light or medium). Each situation is different and required a different combination of equipment.

The following sections will dive into the different intervention types in order to determine which equipment is required to operate in the well intervention market. This is done by looking at each well type and intervention type separately, before summarising which equipment is required in each of the four intervention situations. Later on, 3.8 will determine to which extent vessel (or module platform) capabilities and intervention equipment can be decoupled by means of modularity.

3.1. Surface intervention

Surface well intervention activities take place from the surface platform's topside itself. In South East Asia, 75% of platform wells are unmanned [14]. This implies that they have no accommodation for crew and limited available space for intervention equipment. This needs to be provided by the well intervention vessel. Surface intervention requires deck space to carry the necessary intervention equipment. This equipment is then fed to the platform's topside using a crane and straight into the well bore using a catenary injector tool which is a piece of equipment used to guide the intervention cable or tube into the well. Moreover, surface intervention requires dynamic positioning capabilities for station keeping next to the platform and a motion-compensated gangway for crew transfer between vessel and platform. A crane to transfer intervention equipment (such as the catenary injector tool) and other supplies to the platform is also required. The cranes on board intervention vessels are usually heave-compensation abilities to compensate for ship motions. Such cranes are called Active Heave Compensation (AHC) cranes.

Figure 3.2 shows vessel 'Pride' of FTAI Offshore performing platform intervention. In this figure the intervention equipment mentioned above is highlighted.

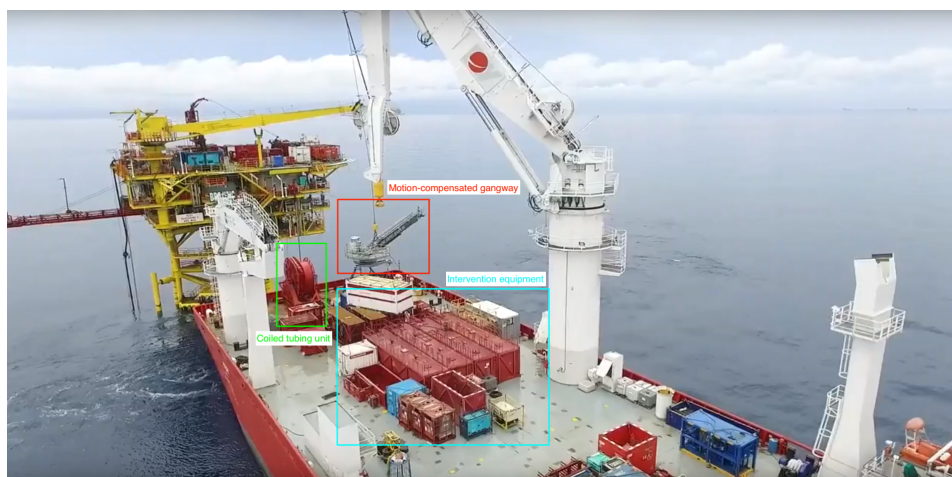

Figure 3.2: FTAI Pride
Source: www.ftaioffshore.com

3.2. Subsea intervention

A dedicated subsea intervention vessel is one that is equipped for underwater operations. An impression of a subsea intervention operation can be seen in figure 3.5. It is able to perform subsea well intervention using dynamic positioning level 3 capabilities and the possibility to deploy an intervention stack through its moonpool or over the side of the vessel. An intervention stack is a piece of equipment that allows a riserless connection between the well at the seabed. It is a long and slender piece of equipment which needs to be build up from parts and can reach 10 to 30 meters in height. An example is shown in figure 3.3. This intervention stack is used by vessel Island Performer and consists of four main components. [32]. The pressure control head (PCH) creates a dynamic grease seal around the moving wireline. There are two mono-ethylene glycol (MEG) injection points for hydrate prevention and a tool catcher to prevent tool drop. The upper lubricator package (ULP) is the connection point for the PCH and has a wireline cutting valve, which acts as a secondary barrier element. The ULP also contains the circulation outlet. The ULP includes the lubricator tubular that provides the pressure lock for the wireline tool and carries the grease system for the PCH. The lower lubricator

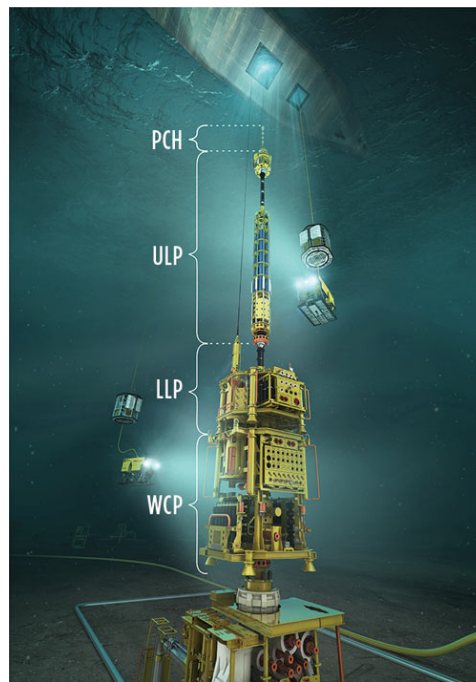

Figure 3.3: Intervention stack
Source: <https://bit.ly/2KjQ0Bd>

tor package (LLP) is the connection point for the well control package (WCP) and provides a safety joint to prevent overload of the wellhead and tree. It also contains the controls equipment. The WCP is the main well barrier. It can shear the wireline toolstring and coiled tubing. The WCP enables the hydrocarbons to flush back into the well and provides hydraulic energy to operate the WCP and subsea tree valves, as well as communication with the subsea tree functions. Equipment on the topside includes the ROV type umbilical reel, the umbilical clamp and a chemical injection unit. Dedicated vessels have intervention stack permanently installed on board. Modular intervention stacks do however exist such as the Well Ops Subsea Intervention Device (SID) [24], although these are not used in the context of modular well intervention approach as will be developed in this thesis.

To build up the stack a Module Handling Tower (MHT) is required on deck, positioned over the moonpool. The tower can easily reach 30 meters in height depending on the length of the stack which is used. Such a tower can be seen in figure 3.4 and in figure 4.5. Riserless intervention means the intervention is executed from a vessel not rigidly connected to the platform, rather than a traditionally used semi-submersible drilling rig which uses a vertical train of pipes to connect to the well.

Subsea intervention also requires the use of remotely operated vehicles (ROVs). These serve to transmit images to the intervention operator and to physically open and close valves. They are launched and recovered with a Launch and Recovery System (LARS) which is thus also required.

3.3. Intervention techniques

Having introduced two types of intervention, light and medium, it is necessary to discuss the different techniques that exist before continuing with the explanation of light and medium intervention. In this thesis we take into account the following three main packages when intervening with wells.

3.3.1. Slickline and wireline

Slickline is the most basic form of equipment used for well intervention. It consists of a single steel cable used to lower tools into the wellbore. The cable is rolled onto a slickline unit, meaning a combination of a powered drum and a control area. It has only pulling capabilities, meaning it can pull the tool up from



Figure 3.4: Helix Well Enhancer
Source: www.fleetmon.com

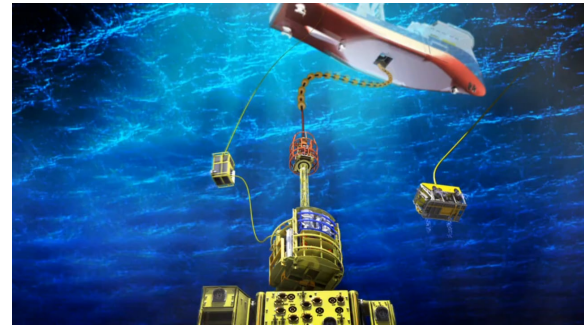

Figure 3.5: Subsea impression of intervention operation
Source: <https://vimeo.com/125658756>

the wellbore. Wireline is a multistrand cable for mechanical conveyance of tools into the wellbore (similar to slickline), as well as providing an electrical/fibre optic combination path to the operator. Hence wireline has pulling and communication capabilities. With the continuing development of wireline capacities and the increasing complexity of well intervention, wireline is nowadays the most common tool for light well intervention.

3.3.2. Coiled tubing

Coiled tubing is a rolled and welded continuous length of steel tubing which is used to convey tools, provide communication paths as well as provide fluid flow paths. It is spooled on and off a reel utilising an injector system. Coiled tubing can have integrated wireline. This gives coiled tubing pulling, communication pushing and pumping capabilities.

Table 3.1 summarises the difference in capabilities between slickline, wireline and coiled tubing.

Table 3.1: Slickline, wireline and coiled tubing capability comparison

	Pulling	Communication	Pushing	Pumping
Slickline	X	-	-	-
Wireline	X	X	-	-
Coiled tubing	X	X	X	X

3.4. Light intervention

Light well intervention is usually carried out using wireline and slickline or through ROVs. The vessels that make up this sector of supply are involved with logging the diagnostics of the well, lift perforating, zone isolation and plug setting. The work involved in this sector does not necessitate the presence of a highly specialised intervention vessel, in the majority of cases the work can be carried out by a barge, or multifunctional support vessel (MSV) mobilised with portable intervention equipment. Although useful, light subsea intervention does not necessarily require a moonpool if intervention tools can adequately be launched and operated from the side of the ship. The majority of tools used for well intervention nowadays contain sensors and data used by operators during the operation. Therefore, going forward into this thesis, exclusively wireline will be used for light intervention operations.

3.5. Medium intervention

Medium well intervention can utilise the same wire- and slickline processes as light intervention but can require the additional presence of coiled tubing. Included within the scope of work associated with medium intervention is commissioning, flow line intervention, well abandonment, water shut offs, casing repairs and

sand clear-outs. These requirements represent a more specialist scope of work, and thus demand the presence of a higher specification vessel. A moonpool is a definite requirement. The vessels chartered to carry out such medium intervention work will usually be dedicated intervention vessels with the necessary equipment installed on a permanent basis.

3.6. Reference vessel analysis and general vessel requirements

Within the light and medium intervention market operate vessels which are based on the same principal. Namely, providing a platform from which the (subsea) intervention takes place. Higher end assets provide support activities to intervention activities by means of offshore cranes, moon pools, ROVs, fluid handling and accommodation for specialist crew.

There is a clear split in the market between specialised vessels and those that have been constructed with additional capabilities to tender for a wider scope of demand. Instead of a dedicated vessel, multifunctional assets (MSVs, DSVs) can be deployed and used to perform services such as subsea installations as well as IMR of offshore infrastructure. More information on these vessels is provided in section ???. These vessels have become prominent in the market as a result of the fact that well intervention is still an emergent market and demand is yet to become substantial. [14]

In order to get an clear image of the design requirements of a well intervention vessel, a selection of 18 reference vessels are analysed which have been or are active in the light and medium subsea intervention markets. The subsea requirements are more specific than surface intervention and thus more relevant to analyse. The list can be found in appendix A.2. A summary of the vessel specifications can be seen in table 3.2. This information will be used in the design philosophy of the modular concept (section 4.1).

Table 3.2: Significant dimensions of reference vessels

	Min	Average	Max
Length (m)	85	115.83	157
Beam (m)	19	23.75	32
DWT (t)	2953	6723	10826
Deck space (m ²)	300	1165	2210

On top of the equipment requirements related to the intervention type and well type, there are additional general vessel requirements. The vessel needs to have appropriate capacity for crew (minimum 90 and maximum 130 for more complex operations), and a helicopter deck for their transportation. In all intervention situations dynamic positioning is required, and a certain amount of free deck space is required to position the equipment and move around components. Lastly the vessel should have sufficient tank volume to store intervention fluids.

3.7. Requirements summary

The above analysis has touched upon the different vessel capabilities which are required for each intervention type. They are summarised in table 3.3.

Table 3.3: Summary of all intervention requirements per type

Surface	Subsea	Light	Medium	General
Gangway	Moonpool	Wireline	CT	Accommodation
AHC Crane	MHS			Helideck
Catenary injector tool	Intervention stack			Dynamic positioning
	ROV			Deck space
	LARS			Tank volume

It is these capabilities that define a vessel's position in the well intervention market. Recalling figure 1.1, the supply side of the market provides these capabilities in order to meet market demand (contract require-

ments). As explained in figure 3.1, these capabilities are provided on one hand by the equipment which is installed on board, and on the other hand by the vessel itself.

A modular well intervention concept has the same set of capabilities as its well intervention counterparts to provide. However, the modularity aspect of the concept implies that the capabilities of the vessel change according to contract requirements. It is therefore important to establish a clear framework to classify how each module platform and equipment module contributes to the overall (combined) capabilities. These frameworks are introduced for the module platforms, module data and contract scenarios in their respective chapters in the next part of this report, but they will all revolve around the same capabilities summarised in the list in table 3.4.

The list contains the 11 requirements involved with well intervention. Behind each requirement is indicated whether its expression is quantitative or binary. Quantitative means the requirement is expressed with a number such as tons crane lifting capacity (t) or number of persons on board (POB) for accommodation. Binary means the requirements exists (one) or it does not (zero). Both the vessel and module capabilities are expressed in the same manner.

Table 3.4: Summary of all required equipment required to operate in subsea and surface, light and medium intervention market

1	Crane capacity	[t]
2	Accommodation	[POB]
3	ROV + LARS	[binary]
4	Moonpool	[binary]
5	Deck space	[m ²]
6	Dynamic positioning	[level]
7	Gangway	[binary]
8	MHS (tower)	[binary]
9	Tank volume	[m ³]
10	Light intervention	[binary]
11	Medium intervention	[binary]

3.8. Modularity suitability

In anticipation of the conceptual platform and module design, the technical requirements which have been highlighted in the above equipment analysis can be qualified according to their modularity suitability. Although for most technical requirements straight-forward, the following modularity decision tree allows to consistently classify vessel specifications in one of three categories: modular, platform-integrated or partly integrated with modular expansion. The decision tree is based on three critical questions and leads to the correct outcome for each specific technical requirement which has been encountered in the well intervention analysis. The decision tree can be seen in appendix A.1. The outcome for each capability or requirement can be found in figure 3.6. The modularity decision tool and its outcome form the basis for the concept design phase (chapter 4) in which all required modules will be presented.

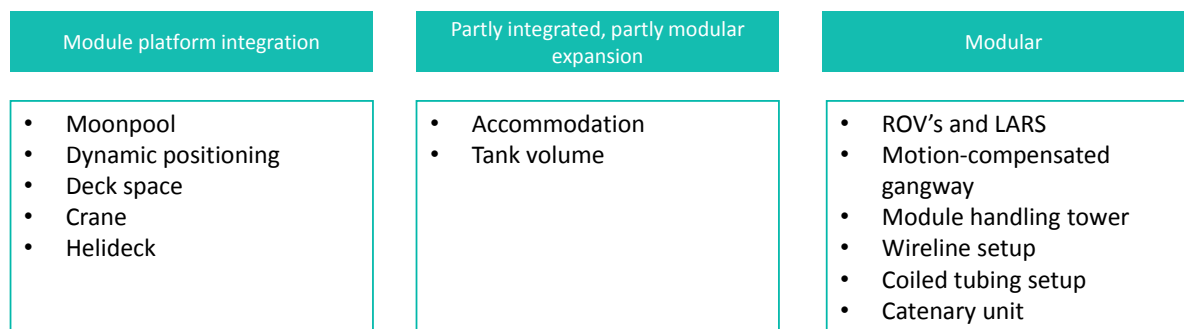

Figure 3.6: Modularity decision tree outcome

4

Conceptual design of platform and modules

This chapter intends to answer research question 2: "How can the technical requirements be translated to a modular solution?".

4.1. Concept design philosophy

Based on the analysis of the reference vessels in section 3.6, well intervention vessels do not come in one specific size. Current vessels fit in a wide range of main dimensions as seen in the analysis of reference vessels. Additionally, it is generally known that the main dimensions of a vessel have a direct impact on its ship motions, its operability within certain sea state limits and thus its utilisation rate. It also has an impact on the required installed power and thus fuel consumption. Because no specific dimension requirements other than sufficient deck space (for the modules it intends to carry) exist but rather a dimensions range, there is an opportunity to compare differing concept designs and investigate the balance between operability and costs.

Therefore it is chosen to compare two concept designs: one on the bottom end of the reference vessels analysis' deadweight range and the other at the top. Deadweight is used as initial indicator, and other dimension such as length, breadth and draught are to be determined according to the design of the Damen Offshore Carrier range, introduced in the next section.

In the following section, the Damen Offshore Carrier range is introduced before presenting the two platform concepts which will be compared in the business concept evaluation.

4.2. Module platform

4.2.1. Damen Offshore Carrier

The Damen Offshore Carrier (DOC) range offers a platform for transportation and installation works in various markets to ensure high flexibility for year round utilisation. Damen set out to create a vessel that is able to carry modules and cargo on the open deck for long distances. The DOC design thus lends itself perfectly for the purposes of the modular well intervention approach. An impression of the vessel's design is given in figure 4.1.

The Damen Offshore Carrier series compromise a range of vessel dimensions instead of discrete vessels designs. This allows for many combinations of vessel parameters. The range can be seen in figure 4.2. The flexibility in its design enables this range to be widely applicable in different offshore markets with different purposes. Damen Shipyards has built two variations of the Damen Offshore Carrier at the time of writing. Both vessels are cable installation vessels and can be seen in figure 4.3.

The main dimensions of both existing Damen Offshore Carriers are shown in table 4.1.



Figure 4.1: Damen Offshore Carrier
Source: [7]

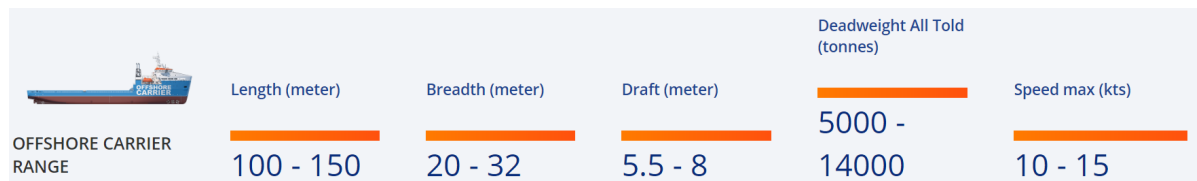

Figure 4.2: Damen Offshore Carrier range
Source: [7]

4.2.2. Platform concepts

Based on the reference analysis in section 3.6, the DOC design range, existing DOC vessels and internal discussion with Damen stakeholders, two platforms with respectively 5000t and 8400t are considered. The latter is basically the same as the Van Oord Nexus introduced in the previous section. The main dimensions of both concept platforms are presented in figure 4.4. The modularity decision tool in section 3.8 has dictated some essential features required by each module platform: a moonpool, DP level 3, free deck space, main crane and helicopter deck. Accommodation for 90 people (elaborated upon in section 4.3.3) and storage tank volume depending on the vessel size are also standard features but can be expanded using modules. Both vessels have enough deck space to carry all modules (defined in the following section) at once if required. The advantage of a bigger vessel should only be seen in its operability advantage as explained in section 4.1. Section 4.4.3 will determine whether there is real advantage or not.

4.3. Equipment modules

As opposed to dedicated well intervention vessels which have their intervention equipment installed permanently on board, the modular concept relies on equipment modules which can be (de)mobilised according to contract requirements. In this section, the required intervention modules are defined.

4.3.1. Module description format

In order to consistently compare the capabilities and cost of each module, and in order to provide a generic model to allow future expansion, a specific format for module classification is proposed in this section. The following sections describe for each module its specifications according to this format. As described in section 1.2, capabilities form the interface between well intervention demand and supply. By mobilising modules, capabilities are added to the vessel. The capabilities have already been introduced in section 3.7.



(a) Maersk Connector
Source: <https://magazine.damen.com/>



(b) Van Oord Nexus
Source: www.vanoord.com

Figure 4.3: Existing Damen Offshore Carrier vessels

Table 4.1: Specifications of existing DOC platforms Nexus and Connector

	Van Oord Nexus	Maersk Connector
Delivered	2015	2016
Length	122m	138m
Breadth	27m	27m
DWT	8400t	9300t
Deck area	2000m ²	2310m ²
Accommodation	90	90
DP	2	2

The module description includes estimated lease cost per day, mobilisation complexity (defined in the next section) and resulting configuration and removal cost, the contribution to each of the predefined capabilities and the module weight.

In the following sections all modules will be defined and classified according to the above format. Afterwards an overview will be presented of the capabilities list above showing each module's contribution.

4.3.2. Mobilisation complexity and cost

The platform returns to port every time it has to mobilise or demobilise modules in preparation for the next well intervention contract. The time it takes to mobilise the modules depends on the complexity involved which influences the cost. Not every module has the same complexity: container-like modules need to only be lifted on board, whereas others may require electrical and mechanical connections to the platform. In order to take into account the differences in mobilisation complexity, three classifications are suggested: simple, medium and complex. Simple mobilisation is assumed to take up to one day, medium mobilisation is assumed to take two days and complex mobilisation 6. The module's day rate is then used to calculate the mobilisation cost.

4.3.3. Accommodation

The vessel's base accommodation capacity is 90 persons for each platform. This is the minimum amount of people on board during each operation and therefore a permanent feature on the vessel. Some intervention operations however may require additional people, up to about 40 extra. This information is based on inside information obtained from the captain of the Helix Well Enhancer (figure 3.4) during a visit on board whilst the vessel was docked at facilities of Damen Shiprepair Rotterdam. The extra people may be required during more complex interventions (medium intervention) or subsea operations (well intervention, dive support). Modular accommodation units designed for the offshore industry exist. After some market research, one option has been chosen as a reference from H2M [8]. One 33ft container can accommodate 4 people and is 10.28m long, 3.22m wide. Ten units would be required to house 40 people. When stacked one row of 5 on top

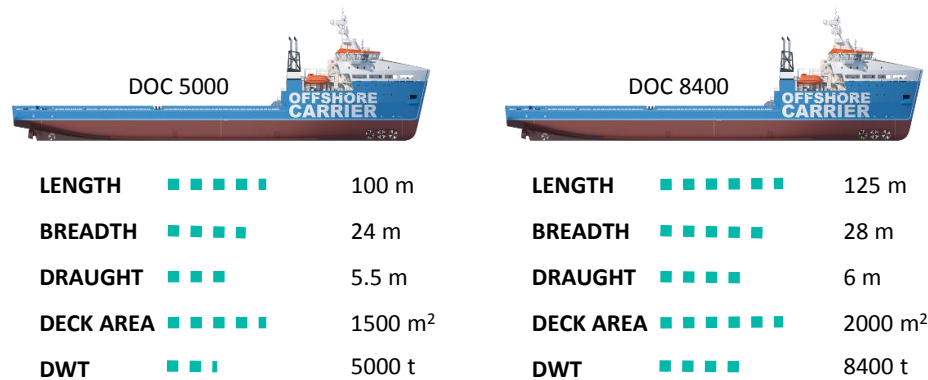

Figure 4.4: The two concept platforms

of another, this would require a total of 165 m^2 and weighs a total of approximately 90t. The cost to lease 1 unit for one day is approximated to be €500. Leasing 10 units on a daily basis would thus cost €5.000. The (de)mobilisation is simple and thus costs €5000.

4.3.4. Module Handling Tower

A module handling tower (MHT) is necessary only in case of subsea intervention. They are used to guide subsea well intervention equipment such as an intervention stack through the moonpool down to the subsea well. An impression can be seen in figure 4.5. Traditionally, MHT's consist of a tower and winches for lifting. In case of the modular concept they are not integrated. The permanently installed crane rests its lifting end on the modular MHT, forming the equivalent of a permanently installed MHT. This concept has been designed by, amongst others, Seasonics [28] and PRT Offshore [23]. It is however difficult to estimate the lease cost of such a tower. Based on information from Damen colleagues, it can be assumed a comparable tower costs €15.000.000 in acquisition. Assuming a breakeven horizon of 10 years with 70% utilisation rate, a day rate of €5.900 results. Its weight is approximately 100t. Mobilisation of this module is complex and thus mobilisation and demobilisation costs €35.400. A comparable module handling system built by IHC [9] has an operational limit of 5m significant wave height.

4.3.5. Motion-compensated gangway

In case of platform intervention, the vessel needs to have a motion-compensated gangway to provide easy and safe crew transfer between vessel and platform. A popular gangway used in the industry is built by Ampelmann. Their A-type EP model shown in figure 4.6 has a footprint of 45 m^2 and weighs 39t [4]. Ampelmann's gangways are only available for lease (according to Damen colleagues) and the approximate day rate is €2.000 for this type. Its mobilisation is of medium complexity and thus costs €4.000. Moreover, this module has an operational limit of 3.5m significant wave height according to its specification sheet.

4.3.6. Wireline (light intervention)

As described in section 3.4, light intervention requires a wireline setup. Offshore wireline units exist and are fairly compact. As a reference setup is chosen for a wireline solution of Koller Solutions [29]. Its footprint is around 12.75 m^2 and weighs around 8.5t. The leasing cost is estimated to be €2.900 a day. Mobilisation is considered of medium complexity and thus costs €5.800.

4.3.7. Coiled tubing (medium intervention)

A coiled tubing module as seen in figure 4.7 includes the reel, injector head, power pack, control cabin, high pressure pump unit and power hose reel. As an example, this coiled tubing unit from IHC is shown. Such units are actually available for lease and thus integrate perfectly with the modular well intervention approach. The leasing cost is estimated to be €4.300 a day. The mobilisation is also considered of medium complexity and



Figure 4.5: PRT Offshore module handling tower
Source: PRT Offshore [23]



Figure 4.6: Ampelmann A Type EP
Source: www.ampelmann.nl

thus costs €8.600. The approximated weight of the entire module is 10t.

4.3.8. ROV Expansion

Subsea operations may require support from remotely operated vehicles (ROVs) in the form of communication (imaging and sensing) or physical help. ROVs are stored on deck and are deployed using a launch and recovery system (LARS). The ROV expansion module consists of both the ROV and LARS. Both can be lifted on board as a whole and placed near the side of the deck. The leasing cost is estimated to be €6.700 a day based on the information presented in the Investor Presentation of Oceaneering [20]. Mobilisation is complex and thus costs an estimated €1.900. The operational limit for launching and recovering ROVs is assumed to be 3.9m significant wave height and the deck space it takes around $30m^2$ [31].



Figure 4.7: IHC Coiled tubing equipment
Source: <https://www.royalihc.com/>

4.3.9. Cargo tanks

In case there is a need to carry specific chemicals in separate tanks instead of the tanks of the vessel itself, standardised containerized tank can be placed on deck. One such tank has a capacity of 8300 liters, weighs maximum 16t and occupies around $7m^2$ on deck. The leasing cost is estimated to be €700 per day and its simple mobilisation the same amount.

4.3.10. Module overview

The overview in table 4.2 shows the cost and capabilities associated with each module introduced in the previous sections.

Table 4.2: Module capabilities overview

	#	Day rate	Complexity	Mobilisation	Weight (t)	Capabilities											
						1	2	3	4	5	6	7	8	9	10	11	
Accommodation module	1	€ 5,000	Simple	€ 5,000	90	0	40	0	0	-165	0	0	0	0	0	0	0
MHT	2	€ 5,900	Complex	€ 35,400.00	100	0	0	0	0	-100	0	0	1	0	0	0	0
Motion-comp. gangway	3	€ 2,000	Medium	€ 4,000	39	0	0	0	0	-46	0	1	0	0	0	0	0
LI	4	€ 2,900	Medium	€ 5,800	8.5	0	0	0	0	-50	0	0	0	0	0	1	0
MI	5	€ 4,300	Medium	€ 8,600	10	0	0	0	0	-50	0	0	0	0	0	1	1
ROV expansion	6	€ 6,700	Complex	€ 1,900.00	20	0	0	1	0	-12	0	0	0	0	0	0	0
Cargo tank	7	€ 700	Simple	€ 700	16	0	0	0	0	-7	0	0	0	0	8300	0	0

Now that these costs are known, it is also possible to determine the lease cost per intervention type. Each intervention type requires a different combination of modules, resulting in the lease cost presented in table 4.3. When switching from one type of intervention to another type, some or all modules need to be demobilised and others mobilised. The costs of demobilisation between types are also shown in table 4.3. It can be seen that subsea interventions require far more expensive modules than surface intervention.

4.4. Operability

Vessel operability is the percentage of uptime during a season or year given specific operational limits. These limits vary from vessel to vessel as its dimensions and other characteristics such a centres of gravity and

Table 4.3: Lease and (de)mobilisation costs per intervention type

Type	#	Dayrate	Mobilisation
Light Subsea	1	€ 20,500	€ 48,100
Light Surface	2	€ 4,900	€ 9,800
Medium Subsea	3	€ 22,600	€ 51,600
Medium Surface	4	€ 12,000	€ 18,300

	1	2	3	4
€	-	€ 46,300.00	€ 15,100.00	€ 54,500.00
		€ -	€ 61,400.00	€ 24,100.00
			€ -	€ 41,300.00
				€ -

buoyancy differ. A rule of thumb states that a vessel with twice the length of another experiences half the motions such as roll and heave. Operability differences between the two concepts are important to take into account because operability can have a direct effect on a vessel’s utilisation rate. This is the case when a vessel has to decline or pause the execution of a contract due to weather conditions leading so unsafe operation. The higher the operability, the more unlikely this will happen. The larger of the two concepts, although more expensive, might have an operability advantage over the smaller concept leading to a stronger financial business case. In the following sections will be explained how the vessel uptime is determined and which conclusions can be drawn.

4.4.1. Method

The operability method, visualised in figure 4.8, is explained in this section. Calculating vessel operability starts with the vessel drawings. Together with the R&D department of Damen, the existing DOC drawings have been scaled to the dimensions of each concept in Rhino [26]. For the DOC8400 the original drawing of the Nexus could be used, for the DOC5000 scaling was done. Then the ship motion calculations were performed with QShip [15]. This is an hydrodynamic suite, created by Marin, for seakeeping calculations and workability analysis of ships in waves. The hydrodynamic suite contains (depending on the selected version) two potential flow methods; the strip theory code SHIPMO [15] and the panel code PRECAL [15]. In this case, SHIPMO was used. SHIPMO is the MARIN implementation of strip theory. It is the fastest way to obtain a first reliable impression of the ship motions. SHIPMO gives an answer in a few minutes, depending on the number of headings, speeds, frequencies and hull lines. Using this theory, QSHIP calculates motions like ship motions, velocity accelerations and relative wave elevation of the ship in waves. Based on this QSHIP can calculate the uptime based on exceedance of defined criteria like illness rating or local accelerations. For the post-process of the information, WASCO (Workability Analysis of Ships and Constructions) was used, also developed by Marin. In the WASCO code of QSHIP the significant numbers for a range of signals can be calculated for any sea state. In the operability viewer, these are combined with actual wave statistics to evaluate the time that a criterion is exceeded in that specific location. This includes the calculation of comfort indicators such as MII, MSI and local accelerations but also relative wave elevation. When SHIPMO is used, these relative wave elevations are based on the undisturbed waves. Lastly, the Operability viewer gives easy access to the operability data, showing downtime/uptime in polar plots or lines in wave scatter diagrams showing the limiting wave height. [15] For ease of understanding, the operability calculation method above is visualised in figure 4.8.

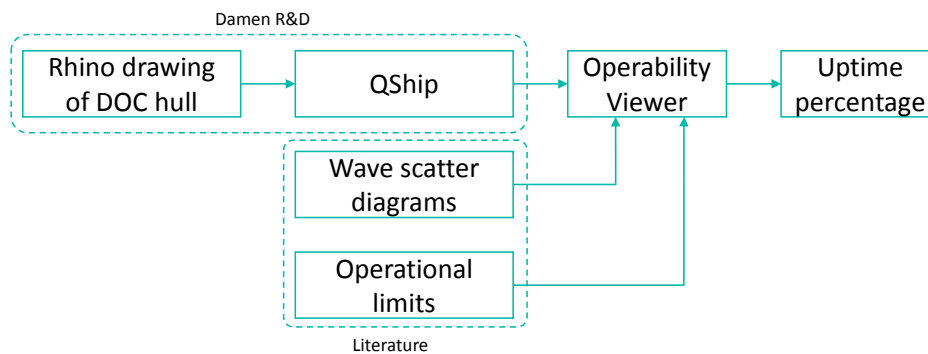

Figure 4.8: Operability calculation overview

4.4.2. Regional weather data

The scope of this thesis is limited to South-East Asia. The weather data for this region can be seen in appendix A.3. This data represents for each combination of significant wave height and zero-crossing period the corresponding amount of occurring waves per 1000 waves in each season. This serves as input for the vessel uptime calculation in WASCO. The region of South East Asia knows calm seas due to its relatively small surface area closely surrounded by land which limits the build up of high waves. Also wind conditions are less rough in comparison to for example the North Sea. There are however more geographical and meteorological reasons which explain the accessible conditions in the part of the world.

4.4.3. Operational limits

Vessel operability is limited by three factors: the human experience on board, the operational limits of the hull structure and the operational limits of deck equipment. In the first case, certain sea states may lead to ship motions that cause seasickness or dangerous situations where the people on board can hurt themselves. In the second, heavy sea states may cause forces and impacts (slamming) on the vessel that may hurt its integrity. Lastly equipment on board often has a maximum significant wave height above which safety cannot be guaranteed or the equipment simply does not function properly. All three need to be taken into account.

Both human and vessel limits have been established in the book called 'Assessment of ship performance in a seaway' by Nordforsk [19] which Damen R&D recommended to use. It represents acceleration and roll angle criteria in different directions and at different locations on the ship. Due to time restrictions of this thesis however only the 'RMS vertical acceleration' limit is taken into account.

Seakeeping performance criteria for human effectiveness are summarised in table 4.4. In this table the relevant criteria can be found on the Intellectual Work line. This limit is chosen because well intervention operations require equipment operators and DP officers to work precisely and concentrated in control rooms and on the bridge. This gives a limit of 0.10g or $0.98m/s^2$.

General operability limiting criteria for vessels can be found in table 4.5). The relevant limits for the modular well concept are found in the 'Merchant Ships' column because a DOC is not a navy vessel nor a fast small craft. This gives a limit of 0.12g.

The limit for intellectual work is thus stricter than that of the general ship criteria, thus 0.10 g is taken as RMS vertical acceleration criteria.

Table 4.4: Seakeeping performance criteria for human effectiveness - limiting criteria with regard to accelerations (vertical and lateral) and roll motion

Criteria for Accelerations and Roll (NORDFORSK, 1987)			
Description	RMS Vertical Acceleration	RMS Lateral Acceleration	RMS Roll Motion
Light Manual Work	0.20 g	0.10 g	6.0°
Heavy Manual Work	0.15 g	0.07 g	4.0°
Intellectual Work	0.10 g	0.05 g	3.0°
Transit Passengers	0.05 g	0.04 g	2.5°
Cruise Liner	0.02 g	0.03 g	2.0°

Source: NORDFORSK, 1987

Some equipment modules defined in chapter ?? come with operational limits in terms of significant wave height with their specification sheet. These modules are the ROV's Launch and Recovery System (LARS), the motion-compensated gangway and Module Handling Tower (MHT). Because their limit is dependent on the sea state and not of the vessel's characteristics, the operability limit is the same for every concept. The percentage of exceedance can be derived from the wave scatter diagrams by counting the number of waves that exceed the given significant wave height for all periods. The maximum significant wave height and their

Table 4.5: General operability limiting criteria for ships

General Operability Limiting Criteria for Ships (NORDFORSK, 1987)			
Description	Merchant Ships	Navy Vessels	Fast Small Craft
RMS of vertical acceleration at FP	0.275 g ($L \leq 100$ m) 0.050 g ($L \geq 330$ m)	0.275 g	0.65 g
RMS of vertical acceleration at Bridge	0.15 g	0.20 g	0.275 g
RMS of lateral acceleration at Bridge	0.12 g	0.10 g	0.10 g
RMS of Roll	6.0 deg	4.0 deg	4.0 deg
Probability of Slamming	0.03 ($L \leq 100$ m) 0.01 ($L \geq 300$ m)	0.03	0.03
Probability of Deck Wetness	0.05	0.05	0.05

Source: NORDFORSK, 1987

Module	Limit	Exceedance percentage			
		Spring	Summer	Fall	Winter
Gangway	3.5m Hs	1.9%	3.1%	5.3%	13.5%
LARS	3.9m Hs	0.9%	1.5%	3.1%	8.9%
MHT	5m Hs	0.0%	0.2%	0.8%	3.0%

Table 4.6: Operational limits of equipment modules

corresponding level of exceedance per module have been summarised in table 4.6 and the limits drawn in the wave scatter diagram can be seen in figure 4.11. It can be seen that the highest level of exceedance occurs in winter. This can cause a downtime of up to 13.5%

4.4.4. Results

In subsea operation conditions, the vessel has no speed and lies in head waves (180 degrees). This is used as input for the operability analysis. The result obtained for both vessels are shown in figures 4.9 and 4.10. The calculated uptime based on the human limit is 100% in winter conditions for both vessels. The equipment operational limits are thus governing. This also means that there is no point of comparing the two vessels in the financial evaluation, because since there is no operational advantage the cheaper of the two vessels has the upper hand when it comes to costs. This thesis thus continues with the DOC5000 as platform vessel.

4.4.5. Limitations

The operability conclusions require two points of attention. Firstly, the higher the waves, the higher the inaccuracy of QShip due to the use of linear strip theory. Above 2-3 meters, forces start getting nonlinear and QShip doesn't accurately calculate the response. Damen R&D seakeeping experts have explained that exact calculations are complex and time-consuming. They trust the QShip results up to around 4m wave height. If the curve would cut the wave scatter below this wave height, it would be visible in the graph. So the actual curve might be lower than shown in the graph, but still not below 4m, and definitely not below the equipment limits.

Secondly, the equipment limits indicated by their manufacturer are given as a function of the significant wave height only. In reality however, the wave period and vessel dimensions also play a role in the operational limits of equipment. A straight line through the wave scatter diagram therefore is not a representation of reality, but due to a lack of time and the complexity of the matter, these limits are taken as given.

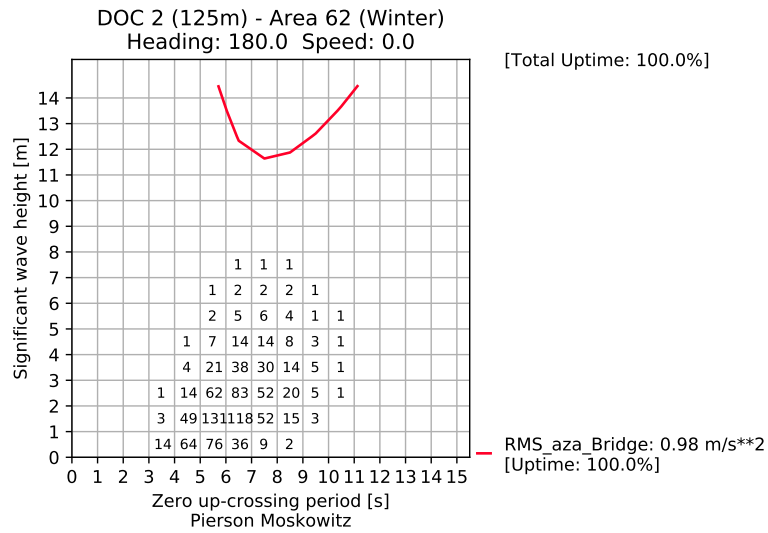

Figure 4.9: Operability calculation of DOC 2 (8400 DWT) in winter conditions

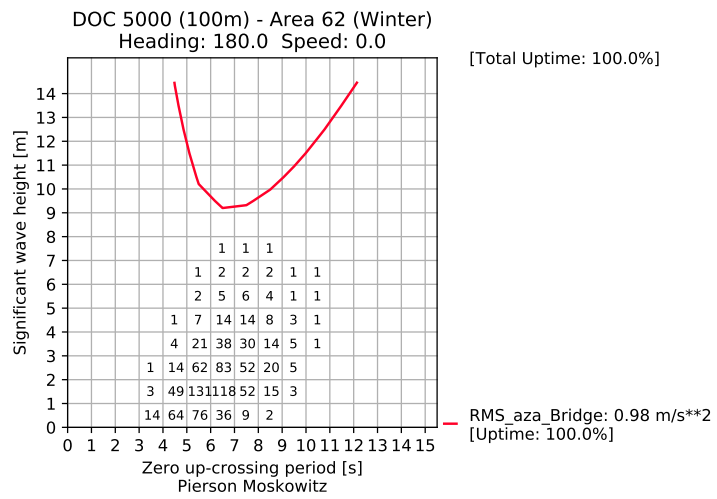

Figure 4.10: Operability calculation of DOC 1 (5000 DWT) in winter conditions

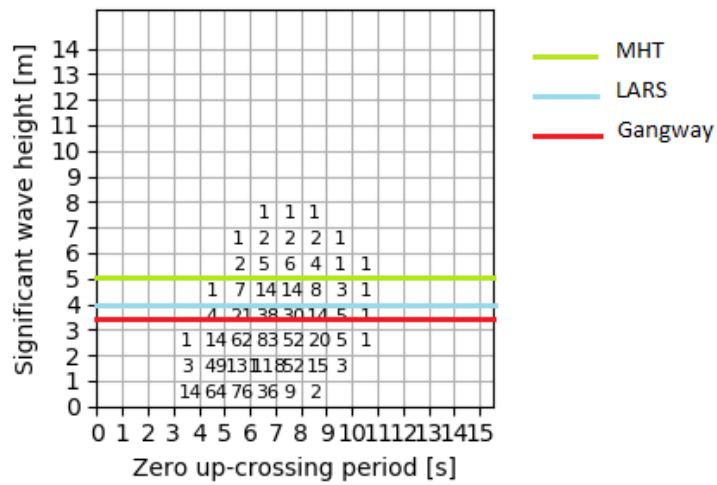

Figure 4.11: Equipment limits

Concept cost, competitiveness and pricing

The purpose of this chapter is to define and establish the concept's cost and pricing level. Cost level is determined by calculating the expenses the vessel owner encounters, whereas pricing level is the amount which is charged to the client. The difference between the two drives the concept's profit or loss. Pricing is dependent on external factors such as competitor's cost level and market day rates. Both cost and pricing are required for the financial evaluation of the concept. In this chapter, first the cost level of the modular well intervention concept will be determined. Afterwards, the concept's competitiveness will be investigated by estimating the competitor's cost level. Finally the concept's pricing level is determined.

5.1. Modular concept cost level

The cost level of the concept is determined by the addition of its capital expenses, operational expenses and voyage expenses. Capital expenses consist of different costs related to the financing of the vessel and the value of the asset. Operating expenses, also called running expenses, consists of constantly incurred cost to keep the vessel working such as crew, maintenance and insurance. Voyage costs are those costs incurred due to execution of contracts. This includes fuel and module lease and mobilisation. Figure 5.1 visualises the breakdown of total vessel cost. Each cost component will be elaborated upon in the following sections.

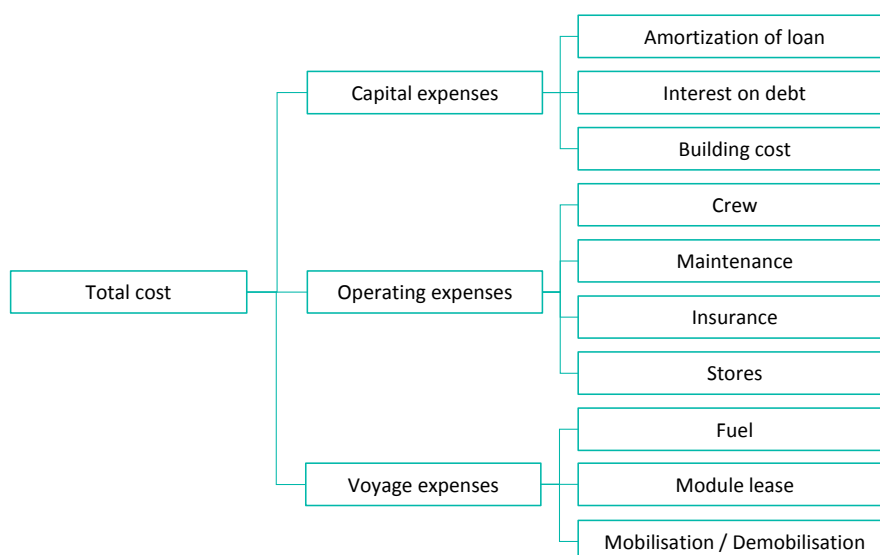

Figure 5.1: Total cost breakdown into capital, running and voyage expenses

5.1.1. Capital expenses

Capital expenses (CAPEX) result from the financing of the vessel, meaning the purchasing or building cost of the asset. Vessels are often financed by two parties: the vessel owner and a bank who gives out a loan to the owner. In university courses in shipping finance it has been taught that the vessel owner usually finances around 30% to 40% of the total himself (equity). The other part is financed by the bank in the form of a loan (debt). The expenses related to taking a loan are two-fold: its yearly amortisation has to be paid over the payback period which has been agreed upon, and interest has to be paid over the outstanding amount of debt. The capital expenses just named are visualised in figure 5.2.

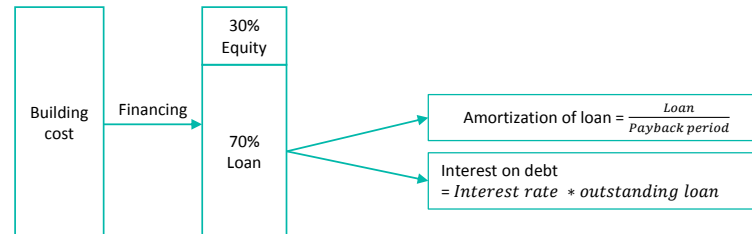

Figure 5.2: Breakdown of building cost financing

The following assumptions are made with regards to the calculation of capital expenses:

1. The vessel is financed with 30% equity and 70% debt.
2. Amortisation is assumed to be paid in equal instalments over the course of 20 years.
3. The interest rate on the outstanding debt is assumed to be 2.5%. The total amount of interest to be paid decreases on a yearly basis as the loan is paid off.

Amortisation is thus calculated as shown in formula 5.1.1 and the total interest as shown in formula 5.1.2.

$$\text{Yearly amortisation} = \frac{\text{Building cost} * 70\%}{\text{Pay back time [years]}} \quad (5.1.1)$$

$$\text{Total interest paid after } n \text{ years} = \sum_{n=1}^n (\text{Outstanding loan} - (\text{Amortisation})^{n-1}) * \text{interest rate} \quad (5.1.2)$$

The capital expenses above depend however on the building cost of the vessel which is still to be determined.

Since the concept platform introduced belongs to the DOC family of which two have been constructed, its building costs can be estimated using known building costs. Total vessel building cost at Damen are broken down in several categories according to their work scope. There are 10 categories:

1. Shipbuilding (hull and outfitting)
2. Main machinery
3. Primary ship systems
4. Electrical systems
5. Deck equipment
6. Secondary ship systems
7. Joinery, accommodation, nautical and communications
8. Navigation
9. Special equipment
10. General costs and engineering

Table 5.1: DOC 5000 cost estimation process based on cost breakdown and analysis of Nexus and Connector building costs.

Vessel	Constant Cost	+	Variable Cost			=	Total cost	Difference
			€/L*B*D	€/DWT	€/SW			
1	Connector original	€ 6,920,454.00	+ € 2,208.83	€ 5,530.97	€ 12,487.99	=	€ 58,358,473.00	
	Nexus original	€ 6,875,684.00	+ € 1,948.32	€ 4,446.59	€ 10,375.37	=	€ 44,227,012.00	
2	Average	€ 6,898,069.00	+ € 2,078.57	€ 4,988.78	€ 11,431.68			
3	Connector verif.	€ 6,898,069.00	+ € 2,078.57			=	€ 55,302,786.63	-5.24%
	Connector verif.	€ 6,898,069.00	+	€ 4,988.78		=	€ 53,293,706.50	-8.68%
	Connector verif.	€ 6,898,069.00	+		€ 11,431.68	=	€ 53,121,810.52	-8.97%
4	Nexus verification	€ 6,898,069.00	+ € 2,078.57			=	€ 46,746,516.19	5.70%
	Nexus verification	€ 6,898,069.00	+	€ 4,988.78		=	€ 48,803,806.10	10.35%
	Nexus verification	€ 6,898,069.00	+		€ 11,431.68	=	€ 48,648,545.21	10.00%
5	DOC 5000	€ 6,898,069.00	+ € 2,078.57			=	€ 34,335,203.63	

The costs for both existing vessels have been analysed based on internal documents at Damen. Using expert knowledge of Damen colleagues at the Offshore and Transport department, corrections have been made to normalise both vessel costs and to adapt to the modular well intervention approach. This has been done by adding the same helicopter deck costs of the Maersk Connector to the Van Oord Nexus, and by multiplying categories 2, 3 and 4 by 1.5 to upgrade the dynamic positioning system to level 3. After the costs correction and further analysis, it can be noted that the costs categories can be split in two groups: on hand the cost categories that scale with the vessel's dimensions (1, 2, 4 and 10) and those that can be assumed to be constant over the entire DOC range (3, 4, 5, 8 and 9). The constant cost are approximately €6.900.000.

The variable costs can be scaled using different units of measurement to obtain a cost estimation for the DOC 5000 concept platform. Which variable yields the most accurate cost scaling? Three different variables are compared and their accuracy verified using the known vessel cost:

- the multiplication of length times breadth times draft (LBD)
- deadweight tonnage (DWT)
- steel weight (SW)

The process and resulting numbers is visualised in table 5.1. In step 1 the original vessel prices are broken down using the different variable cost estimators. The variable cost is obtained by dividing the total variable cost by each of the three variables introduced above for each vessel. In step 2 the average between the two vessels is calculated for each unit of measurement. Next, in step 3 and 4 the prices of the original vessels (Connector and Nexus) have been calculated using these averages to verify the accuracy which is shown as a percentage of the original price. The most accurate of the three proved to be LBD with a 5% margin between the estimated and actual cost prices. Using LBD to determine the cost of the DOC5000 results, in step 5, in a total estimated cost of €34.335.203 for the DOC5000 concept platform.

Now that the building cost of the DOC5000 has been calculated, the resulting capital expenses can be calculated as explained above. They can be These are shown in table 5.2.

Table 5.2: Capital expenses of the DOC5000 concept

New build price	€ 34,335,203.00
Loan percentage	70%
Loan amount	€ 24,034,642.10
Pay back period	20 years
Amortization	€ 1,201,732.11 [€/yr]
Interest on debt	2.5%
Total interest	€ 6,309,093.55

5.1.2. Running expenses

Running expenses of a vessel consist of all costs incurred to keep the vessel running. This includes crew, stores, maintenance, insurance and administration.

To estimate these costs, a tool by thesis supervisor Ir. Koos Frouws named 'Conceptual Design and Financial Evaluation' has been used which contains cost calculation parameters based on literature, such as a book named Maritime Economics by Martin Stopford [30].

Table 5.3 contains the total running cost per year for the DOC5000 concept.

Table 5.3: Running expenses of the DOC5000 concept

	DOC 5000	
New build price	€ 34,335,203.00	
Crew (€60k/yr)	€ 8,100,000.00	[€/yr]
Stores (€70/crew/day)	€ 975,250.00	[€/yr]
Maintenance (0.5% NB)	€ 171,676.02	[€/yr]
Insurance (1% NB)	€ 343,352.03	[€/yr]
Administration (0.5% NB)	€ 171,676.02	[€/yr]
Total	€ 9,761,954.06	[€/yr]

5.1.3. Voyage expenses

On top of the capital and running expenses there are voyage expenses (VOYEX) related to the execution of contracts. These consist of fuel cost, module lease and module mobilisation and demobilisation costs.

Fuel consumption is an import voyage expense to take into account. An accurate estimation is therefore no unnecessary luxury. It is however difficult to calculate the fuel consumption for a vessel which operates mostly in dynamic positioning (during interventions), of which the fuel consumption is very dependant on the strength of wind, current and sea state. Due to time restrictions it is chosen to estimate the fuel consumption using two reference vessels of vessel owner FTAI Offshore of which the average fuel consumption in transit and dynamic positioning are available. These are vessel Pioneer [21] and Pride [22]. Based on their specification, it is estimated that the DOC5000 concept consumes $13m^3$ and $24m^3$ of fuel per day in DP and transit respectively. Using the actual bunker price of approximately 360 €/ton [5] and fuel oil's specific density of $0.89\text{ ton}/m^3$ [25] this results in the fuel consumption per day shown in table 5.4.

Table 5.4: Fuel consumption of the DOC5000 concept

Fuel consumption (DP)	13 m ³ /day	4165.2 €/day
Fuel consumption (transit)	24 m ³ /day	7689.6 €/day

The modular well intervention concept is designed to operate in its target area of South-East Asia all year round. The physical mobilisation costs of the vessel thus only consist of its movement between port of origin and oil fields when it has to mobilise and demobilise equipment modules. Considering the field locations in South-East Asia (see in figures 2.3 and 2.4), it is assumed the vessel executes contracts from within 100 nautical miles (approximately 200km) of the fields.

It is also assumed that all modules are available for lease and mobilisation in the said port of origin. When the modular concept changes contracts and requires module (de)mobilisation, the said distance of 100 nm is taken into account. Module lease, mobilisation and demobilisation costs have been calculated previously and are presented in table 4.2. These depend on the intervention type.

5.1.4. Cost summary and utilisation rate dependency

The capital and running expenses are expressed in €/year. These costs are incurred the moment the vessel is operational, whether the vessel is under contract or not. Their contribution to the concept's day rate depend on the utilisation rate of the vessel. Utilisation rate is the measure of time the vessel spends under contract and thus in revenue-generating conditions. It is during these days that the vessel generates income, in the

first place to compensate for its expenses and secondly for profit. A vessel with higher utilisation rate thus has more time to generate income and a higher chance of profit. The utilisation rate of the modular well intervention concept is dependant on the market scenario it operates in and will be calculated in the market scenario generation section of chapter 6. The resulting minimum day rate to charge to contractors in order to achieve break even revenue can then be calculated as follows:

$$\text{Day rate} = \frac{\text{Capital exp.} + \text{Running exp.}}{\text{Utilisation rate} \times 365} + \frac{\text{Voyage exp.}}{\text{Contract duration}} \quad (5.1.3)$$

A cost summary of the DOC5000 is shown in table 5.5 and has been converted to its corresponding day rate with an assumed 75% utilisation rate. This is however subject to change according to each market scenario as explained above.

5.2. Competitiveness and pricing

Now that the business concept's cost level is determined, the focus of this section shifts to the concept's income. The price a vessel owner charges for chartering out his vessel depends on several factors. Two different approaches can be considered: pricing based on market day rates or pricing based on competition and competitiveness. The first assumes that the vessel executes a contract at the given market day rate in that period. Deducting the vessel's daily cost results in profit. This can be seen in figure 5.3a. The second approach is dependent on the competitor's cost level. When a competitor wants to make sure he wins a contract, he will bid lower than the market day rate. In this case, the lowest a competitor will go in order to win a contract is determined by its cost level. Operating at cost level might be necessary to avoid losses which would have occurred if it didn't execute a contract at all. This may be the case when a vessel hasn't met its desired utilisation rate yet and needs to fill in the contractless periods. Operating at a price below voyage cost leads to losses in which case skipping the contract makes more sense. The worst case scenario for the modular well intervention approach is thus the market in which it has to compete with competitors operating at their cost level. Assuming the cost level of the modular concept is lower than that of a competitor's vessel, and their cost level defines the modular concept's price level, the resulting profit can be visualised as in figure 5.3b. If the modular well intervention concept is indeed able to make profit even when operating at (or below) the cost level of the competition, then it has a competitiveness margin. The difference between the concept's cost level and that of the competition ultimately is the most direct measure of competitiveness that exists.

Pricing based on a market day rate assumption is not a reliable way to evaluate the financial success of the concept. It is however interesting to have an indication of the gap between cost and market pricing. It is therefore chosen to include the market day rate analysis in the appendix of this thesis (section A.4). In the following sections however, the competitor's cost level will be determined in order to measure the concept's competitiveness and to obtain the concept's pricing level.

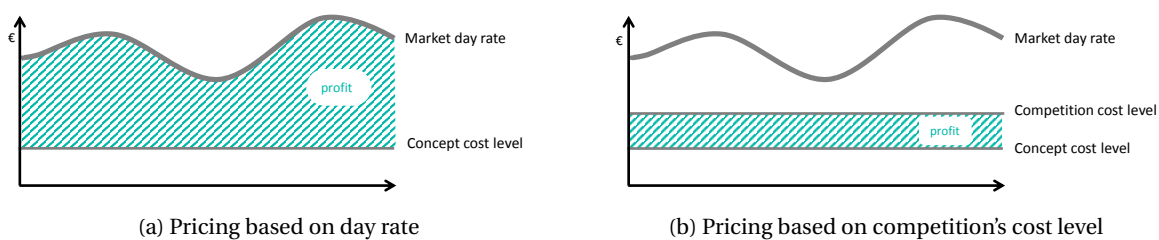

Figure 5.3: Profit differences between day rate pricing and competition cost level pricing

The modular well intervention approach aims to operate in both subsea and surface well intervention markets in which it competes with different vessel types (as explained in section 3.6). Therefore it is necessary to take into account the difference in cost level of vessels in these markets. Precise capital and operational expenses are unavailable for most vessels due to confidentiality reasons. Therefore their expenses are estimated the same way as the modular well intervention concept. It is important to have a measure of their building cost which leads to capital expenses according to the same assumptions as mentioned in section 5.1.1. Also based on building costs the running expenses (stores, maintenance, insurance and administration) are estimated using the same percentages as with the modular concept. In order to estimate the building cost of the competing vessels, Clarkson's World Fleet Register [6] is consulted which contains new build prices of some

vessels. This method is chosen over a cost estimation as done for the DOC5000. The reason is two-fold. First, neither subsea or surface intervention vessels have been constructed by Damen nor have they been designed as a module platform, and secondly because they are equipped with dedicated equipment of which the acquisition price is difficult to estimate but required to add to the DOC cost estimation. Since the assumption of new build price has a big impact on the cost level and thus the concept's competitiveness, the cost level of competition will be subject to a sensitivity analysis. It is however important to realise the building costs thus used in the cost calculation of the competition were subject to the market demand and supply at the time of contracting which may result in a less accurate comparison to the new building cost of the DOC5000.

5.2.1. Subsea intervention competition

The new build prices of two dedicated well intervention vessels, both capable of light and medium intervention, have been found in the World Fleet Register [6]: Aker Wayfarer and CSS Derwent. The second vessel is a compact semi-submersible vessel designed for well intervention. This vessel was under consideration by Petronas for its next well intervention campaign. It was however not chosen because it was considered too expensive, which underlines the relevance of determining its cost level. The concept's cost level would have to be lower in order to be considered for contracting by Petronas.

As explained in the introduction, no dedicated subsea well intervention vessels currently operate all year round in the Asian market. Therefore a competitor who decides to compete for contracts would need to mobilise its vessel from Africa or Europe where relevant vessel currently operate. Aker Wayfarer is at the time of writing under contract with Petrobras in Brasil. Moving into the Asian market would require a voyage of around 8000 nautical miles, taking around 27 days at its design speed of 12 knots. Consuming an estimated $32m^3/day$ of fuel at design speed leads to an expense of nearly 550k€ for a return trip excluding other operational expenses. CSS Derwent is currently in West India, requiring a mobilising trip of around 2400 nautical miles one way, leading to costs of approximately 180k€ for a return trip to the South-East Asian region given a transit speed of 10 knots and a fuel consumption of $28m^3/day$. The operational expenses are calculated using an assumed utilisation rate of 75%. Assuming a different utilisation rate will result in a different cost level, therefore this assumption will be subject to a sensitivity analysis too be presented with the results of this thesis. The CSS Derwent is the cheapest of the two, this will thus be used as reference vessel for subsea intervention. The calculated costs of this vessel is shown in table 5.5.

5.2.2. Surface well intervention competition

No dedicated surface well intervention vessels exist, however multipurpose vessels are often equipped with the necessary equipment to perform well intervention. Particularly in Asia, MV Pride of FTAI Offshore has done well intervention campaigns for Malaysian field operator Petronas. Therefore it is a good benchmark to determine the pricing level for the surface intervention contracts. According to the World Fleet Register, vessel Pride has been built for 132.6 million dollars. Its fuel consumption is $30m^3/day$ at transit speed (12 knots) and $16m^3/day$ in DP3 mode according to its technical specifications [22]. The vessel is currently in Singapore thus no mobilisation trips are required towards the region of interest. The expenses are calculated similarly to the subsea vessels and are presented in table 5.5.

5.2.3. Comparison and conclusion

Based on the cost calculations of the DOC5000 and the reference vessels of the subsea and surface intervention markets, summarised and compared in table 5.5, it can be said that the modular concept has the potential to be competitive. Its capital and running costs are less than both reference ships. This comparison does however not include the cost of equipment modularity which the reference vessels don't have, and which are dependent of the market scenarios. Also, the amount of interest is only valid in the first year, after which this amount decreases.

The pricing level of the concept is now determined too: for subsea interventions the concepts charges just below €64k/day and an additional €179.000 for each time the reference vessel would have to mobilise to the region and return back if it were to execute the same contract. The pricing level for surface intervention is just beneath €70k/day without additional mobilisation costs. As said before, these numbers are valid for the first year only due to the variable interest amount. If no more interest is due when the loan is paid off, the cost level of the competing vessels would be just below €58k/day and just above €62k/day for subsea and surface

Table 5.5: Cost level summary and comparison of modular concept and subsea and surface competition vessels.

	Surface intervention			Subsea intervention	
	DOC 5000	FTAI Pride	CSS Derwent		
New build price	€ 34,335,203.00	€ 118,747,280.00	€ 98,315,000.00	Source: WFR	
Loan amount (@70%)	€ 24,034,642.10	€ 83,123,096.00	€ 68,820,500.00	total	
Amortization (20yrs)	€ 1,201,732.11	€ 4,156,154.80	€ 3,441,025.00	per year	
Interest (@ 2.5%)	€ 600,866.05	€ 2,078,077.40	€ 1,720,512.50	in first year	
Crew (€60k/yr)	€ 8,100,000.00	€ 8,100,000.00	€ 8,100,000.00	per year	
Stores (€70/crew/day)	€ 975,250.00	€ 975,250.00	€ 975,250.00	per year	
Maintenance (0.5% NB)	€ 171,676.02	€ 593,736.40	€ 491,575.00	per year	
Insurance (1% NB)	€ 343,352.03	€ 1,187,472.80	€ 983,150.00	per year	
Administration (0.5% NB)	€ 171,676.02	€ 593,736.40	€ 491,575.00	per year	
Subtotal per year	€ 11,564,552.22	€ 17,684,427.80	€ 16,203,087.50	per year	
Utilisation rate	75%	75%	75%	assumption	
Dayrate	€ 42,244.94	€ 64,600.65	€ 59,189.36	per day	
Fuel consumption (DP)	€ 4,165.20	€ 5,127.15	€ 4,806.70	per day in operation	
Subtotal per day	€ 46,410.14	€ 69,727.80	€ 63,996.06	ex. vessel mobilisation	
Vessel mobilisation	€ -	€ -	€ 179,450.21	per round trip to Asia	

intervention respectively. As this decreases the competitiveness and forms the lowest possible pricing level, these numbers will be used in the revenue calculation of each market scenario.

The financial evaluation of the concept in different market scenarios will point out whether or not the cost of the concept's modularity is low enough to take advantage of the initial competitiveness. Additionally, the assumptions made regarding the cost calculation of the competing vessels have a direct impact on the financial evaluation. Therefore a sensitivity analysis will be done to demonstrate the effect of lower and higher pricing levels.

II

Business concept evaluation

6

Market scenarios

6.1. Methodology

The modular well intervention concept aims to operate in both subsea and surface well intervention market segments in the region of South-East Asia. In order to get an idea whether or not this concept is financially feasible and has an advantage over alternatives, the concept should be simulated in certain market scenarios. The goal of this chapter is to generate market scenarios containing realistic well intervention contracts based on the characteristics and requirements of fields in the region of South East Asia. In order to do so, the field characteristics of the four biggest operators in the region are analysed and translated into contracts which form the foundation of the financial evaluation of the modular concept. The field characteristics first need to be translated into well intervention demand according to an intervention policy. The type of intervention demand depends on the field age and well type. The demand is subsequently translated into contracts forming market scenarios. The global methodology of this chapter is visualised in figure 6.1.

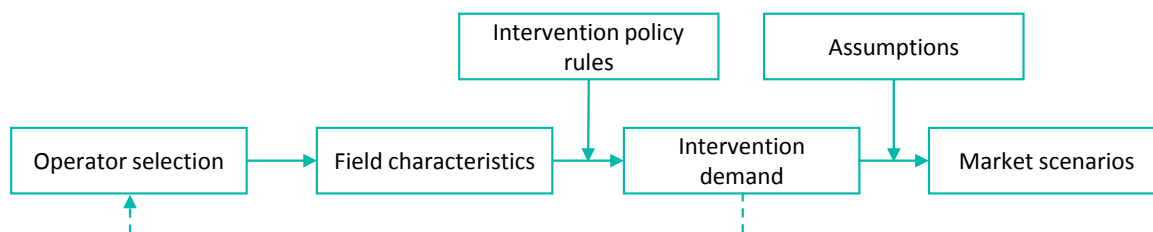

Figure 6.1: Market generation method

6.2. Operators and field characteristics

As basis for the creation of market scenarios four big operators active in the region of South East Asia are chosen. These are Chevron, Murphy, Petronas and Shell. Together they run almost 2300 oil and gas wells. Infield Research [14] has a database containing information of each field. Damen has access to this database and all information regarding the wells are sourced therefrom. The field characteristics which are observed are the year of going on stream, field age, expected depletion year and number of wells per field. The amount of subsea and surface wells per operator are shown in the following table 6.1.

Some observation can be made. A mere 3% of these wells are subsea wells, most of them run by Murphy and Shell. This is in line with the market analysis which stated the market for subsea intervention in Asia is small. There is also a big segregation between subsea and surface well operators. Murphy and Shell have nearly all subsea wells, and no to relatively little surface wells in comparison to Petronas and Chevron, who run more than thousand surface wells each.

Table 6.1: Operational wells and wells under development (UD) per operator

Operator	Subsea wells		Surface wells		Total
	Operational	UD	Operational	UD	
Shell	28	0	176	8	212
Murphy	38	0	0	0	38
Petronas	0	7	1032	66	1105
Chevron	0	4	1523	0	1527
					2882

6.3. Intervention policy rules and demand

Intervention demand can arise reactively when urgent problems occur or consistent production decrease is noted, or proactively according to a specific intervention policy. Although usually proactively organised, however, based on inside information at Damen, few operators have such policies and when they do, they are not publicly available. Therefore, this section first proposes intervention policy rules used to translate operator-specific field characteristics into intervention demand.

As said before, The field characteristics which are taken into account are the number of wells, their type and age, and estimated depletion time. Based on these characteristics it can be estimated which intervention and thus contract types are required. The intervention policy consists of a set of rules and assumptions. These rules are based on literature research, presentations given at conferences by companies active in well intervention campaigns and inside information available within Damen. They are:

1. A well's first intervention takes place 7 years after the field goes on stream.
2. After the first intervention, subsequent interventions take place every 5 years.
3. The previous rule is true unless the estimated depletion year is within 7 years from the last intervention. In this case, the intervention is delayed until the depletion year.
4. Interventions types (light or medium) are allocated randomly with a 50% chance on either outcome.
5. The last intervention is a plug and abandonment operation, classified as medium intervention.

Recalling the four types of well intervention taken into consideration in this thesis, well intervention demand can be classified according to their type. Four contract types are introduced and their classification as seen in table 6.2

Type	Intervention
1	Subsea Light
2	Surface Light
3	Subsea Medium
4	Surface Medium

Table 6.2: Well intervention contract types

The analysis has been done for a scope of 15 years ranging from 2020 until 2034. Based on the rules above, the intervention demand for each operator can be seen in figure 6.3. Taking into account the possibility of performing well intervention campaigns for a combination of operators, the combined demand of all operators is shown in table 6.4. Some observation can be made regarding the required amount of well interventions per year. The amount necessary per year varies enormously from year to year: 2023 requires one subsea well intervention in comparison to 58 in 2029. Surface interventions vary between 50 in 2034 up to 914 in 2020. Choices will have to be made regarding the allocation of well intervention operations to the intervention vessel taking into account its yearly capacity.

6.4. Market scenarios

This section introduces the assumptions and rules used for translating the intervention demand into market scenarios in which the modular concept will be evaluated. The vessel's operability limits and resulting yearly

Table 6.3: Well intervention demand per year for the four biggest operators in South-East Asia

Year	Subsea		Surface		Total
	Light	Medium	Light	Medium	
2020	0	2	175	344	521
2021	0	0	0	54	54
2022	2	2	78	224	306
2023	0	0	40	46	86
2024	0	0	14	44	58
2025	0	4	175	181	360
2026	0	0	0	63	63
2027	1	1	75	75	152
2028	0	0	18	412	430
2029	0	0	0	0	0
2030	0	2	0	0	2
2031	0	0	2	2	4
2032	7	7	75	75	164
2033	4	4	6	6	20
2034	2	2	0	40	44

Chevron demand

Year	Subsea		Surface		Total
	Light	Medium	Light	Medium	
2020	7	7	8	8	30
2021	3	3	0	0	6
2022	0	0	3	3	6
2023	0	0	0	8	8
2024	0	38	26	42	106
2025	0	0	0	7	7
2026	0	0	0	4	4
2027	3	3	0	14	20
2028	2	2	5	41	50
2029	6	6	1	1	14
2030	0	0	0	0	0
2031	1	5	1	3	10
2032	8	8	0	0	16
2033	1	1	7	7	16
2034	1	12	2	3	18

Murphy demand

Year	Subsea		Surface		Total
	Light	Medium	Light	Medium	
2020	16	16	44	44	120
2021	0	0	0	0	0
2022	4	4	21	31	60
2023	0	0	3	21	24
2024	0	0	14	14	28
2025	17	17	50	62	146
2026	0	0	0	0	0
2027	0	8	15	29	52
2028	0	0	0	85	85
2029	4	4	6	14	28
2030	16	16	6	18	56
2031	0	2	0	0	2
2032	0	0	9	21	30
2033	2	2	0	0	4
2034	4	4	0	0	8

Shell demand

Year	Subsea		Surface		Total
	Light	Medium	Light	Medium	
2020	0	3	133	158	294
2021	5	5	96	122	228
2022	0	0	149	275	424
2023	0	1	50	156	207
2024	0	0	50	68	118
2025	0	0	54	288	342
2026	6	6	39	82	133
2027	0	0	11	266	277
2028	0	0	48	62	110
2029	15	23	4	107	149
2030	0	0	15	23	38
2031	0	4	7	139	150
2032	0	0	6	11	17
2033	1	1	2	32	36
2034	16	16	1	4	37

Petronas demand

capacity need to be taken into account all the while maximising the vessel’s utilisation rate. Several market scenarios are made: operator-specific scenarios where the vessel is contracted by one operator and performs interventions only on its own wells, and a combined scenario where the four operators form a whole. This is an important assumption: operators don’t usually sit around the table and combine their intervention demand, but it is not an impossible scenario either. This will be further elaborated upon in the results and conclusions. When the market scenarios are determined, a theoretical utilisation rate is obtained. This utilisation rate reflects the vessel’s activity in each scenario. The utilisation rate has a direct influence on the concept’s cost level in that specific scenario, as explained in section 5.1.4. This is important to know for the cost level of the concept as seen in chapter 5. In combination with concept’s pricing level determined in section 5.2.3, the financial evaluation can take place. The interaction between this and the following chapters of this thesis are visualised in figure 6.2.

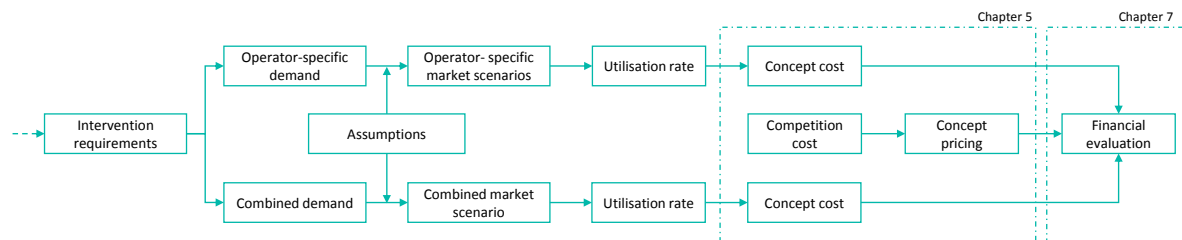

Figure 6.2: Market generation methodology extensions

Table 6.4: Combined well intervention demand of the four biggest operators in South-East Asia per year

Year	Subsea		Surface		Total	Subsea total	Surface total
	Light	Medium	Light	Medium			
2020	23	28	360	554	965	51	914
2021	8	8	96	176	288	16	272
2022	6	6	251	533	796	12	784
2023	0	1	93	231	325	1	324
2024	0	38	104	168	310	38	272
2025	17	21	279	538	855	38	817
2026	6	6	39	149	200	12	188
2027	4	12	101	384	501	16	485
2028	2	2	71	600	675	4	671
2029	25	33	11	122	191	58	133
2030	16	18	21	41	96	34	62
2031	1	11	10	144	166	12	154
2032	15	15	90	107	227	30	197
2033	8	8	15	45	76	16	60
2034	23	34	3	47	107	57	50

6.4.1. Assumptions

The assumptions for well intervention selection are introduced in the following list:

1. Subsea well intervention has priority over surface well intervention.
2. Medium intervention has priority over light intervention because these are likely to influence the well's production output the most.
3. When the intervention capacity of one year is reached, the remaining subsea wells are rescheduled to the following year according to the two previous rules.
4. Each intervention is assumed to take 7 days with 100% vessel uptime. This assumption is subject to a sensitivity analysis later on. This is based on literature and expert knowledge within Damen. The duration is extended in relation with the vessel's operability limits presented in section 4.4.3.
5. There is a one week module (de)mobilisation period between contract types during which the vessel changes its modules according to the requirements of the next contract. This assumption will be subject to a sensitivity analysis.

6.4.2. Scenario description framework

A market scenario is defined as a selection of well intervention contracts. A contract is defined by certain characteristics. These characteristics are presented in the following list:

- Contract number (for indexing purposes)
- Year of execution
- Start week: indicates the starting week of the contract
- Contract duration expressed in weeks
- Contract type
- Number of wells
- Revenue (according to section 5.2.3)

The contract type defines which technical requirements need to be met by the vessel in order to successfully execute the contract. There 11 contract requirements have been introduced in 3.7. Additional requirements can be defined if different markets want to be simulated too. The intervention and well type requirement both influence the parameters for the 11 technical requirements. Because both well types can require both intervention types, there are four possible combinations of technical requirements as shown in table 6.2. The requirements for each contract type (combination of well type and intervention type) can be seen in table 6.5.

Table 6.5: Technical well intervention contract requirements per contract type

	1	2	3	4	5	6	7	8	9	10	11
	Crane lifting	Accommodation	ROV Operation	Moonpool	Deck space	DP level	W2W	Tower	Tank volume	Light intervention	Medium intervention
Subsea Light	150	110	1	1	0	3	0	1	500	1	0
Subsea Medium	150	90	0	0	0	3	1	0	500	1	0
Surface Light	150	130	1	1	0	3	0	1	1500	0	1
Surface Medium	150	120	0	0	0	3	1	0	1500	0	1

6.4.3. Market scenarios and utilisation rate

The market scenario generation is done by a script written in Matlab [17]. It analyses the field characteristics, applies the intervention policy rules and assumptions, and creates a market scenario creating contracts. These contracts have a start time, duration, type, amount of wells and revenue. The resulting market scenarios for each operator and the combined market scenario containing all intervention contracts can be seen in appendix tables A.4 (combined), A.5 (Petronas), A.6 (Murphy), A.7 (Chevron) and A.8 (Shell). The resulting utilisation rate in each scenario is also calculated and they are summarised in table 6.6.

Table 6.6: Business concept utilisation rate in each scenario

	Chevron	Murphy	Shell	Petronas	Combined
Utilisation rate (15 years)	100%	41%	75%	98%	96%

7

Financial evaluation

This chapter contains the financial evaluation of the business concept. The goal of the evaluation is to establish whether or not the business concept is a financially viable investment and in which market conditions it remains so by analysing some financial indicators such as payback time, cash flow, Net Present Value and Internal Rate of Return. This is done to answer research question 3a: "Does the base case scenario form a positive business case?". Additionally, the business case's sensitivities to some of the assumptions made throughout the concept development and evaluation phases are tested. This should help to determine what the most important success factors are for the concept's success and to answer research question 3b: "How do market and intervention assumptions affect the business case's financial success?" and 3c: "In which market conditions is the concept a good business case?". First the evaluation method is introduced, after which the base case and sensitivity analysis results are presented and lastly the observations and conclusions regarding the required market conditions.

7.1. Evaluation method

The financial evaluation of the market scenarios is done by means of a cash flow analysis, Net Present Value calculation and Internal Rate of Return calculation. These will be explained in the following subsections. It is chosen to analyse one base case scenario, which is the combined well intervention scenario of all four operators. The individual cases will be referred to as required in the analysis of the results.

7.1.1. Cash flow

Cash flow over the duration of a project is a summary of all the revenue the vessel received and the expenses it has to pay. The difference between the two leads to profit or loss. A company's cash flow statement or prediction is necessary to understand where money is made or lost, and to ensure whether a company can pay its financial obligations. A cash flow statement is easiest to analyse when visualised, which will thus be done for each market scenario.

The cash flow includes all incoming and outgoing movements of cash. The initial investment is an outgoing cash flow and sets the starting point for the cumulative cash flow curve. As the project advances in time, profit or loss is added to the cumulative cash flow and the curve evolves. In case of profitable market scenario, the curve will cross from negative to positive cumulative cash flow in the payback year. The curve continues until it reached the end of the project, marked by a peak in cash flow caused by the sale of the vessel at its residual value at that point in time. In order to correctly calculate the residual value of the vessel, its scrap value has to be calculated. This is done with an estimation method presented in appendix A.5.

7.1.2. Payback period

The payback period refers to the amount of time it takes to recover the cost of an investment. Simply put, the payback period is the length of time an investment reaches a breakeven point. The payback period, though, disregards the time value of money, unlike other methods of capital budgeting such as net present value

(NPV) and internal rate of return (IRR). It is determined by counting the number of years it takes to recover the funds invested. For example, if it takes five years to recover the cost of the investment, the payback period is five years. [13]

7.1.3. Net present value

Net present value (NPV) is the difference between the present value of cash inflows and the present value of cash outflows over a period of time. NPV is used in capital budgeting and investment planning to analyse the profitability of a projected investment or project.[12]. The following formula is used to calculate NPV:

$$NPV = -I + \sum_{t=1}^n \frac{FV_t}{(1+k)^t} \quad (7.1.1)$$

Where:

FV = Future cost of the cash inflows,

I = Initial Investment,

k = Discount rate,

t = The number of time periods.

A positive net present value indicates that the projected earnings generated by a project or investment - in present euros - exceeds the anticipated costs, also in present euros. It is assumed that an investment with a positive NPV will be profitable, and an investment with a negative NPV will result in a net loss. This concept is the basis for the Net Present Value Rule, which dictates that only investments with positive NPV values should be considered.

What is the appropriate discount rate to use for an investment or a business project? While investing in standard assets, like treasury bonds, the risk-free rate of return is often used as the discount rate. On the other hand, if a business is assessing the viability of a potential project, they may use the weighted average cost of capital (WACC) as a discount rate, which is the average cost the company pays for capital from borrowing or selling equity. In either case, the net present value of all cash flows should be positive to proceed with the investment or the project.[10]. After consulting both supervisors Frouws and De Nie it is chosen to assume a 10% discount rate in the financial evaluation of this project.

7.1.4. Internal rate of return

The internal rate of return (IRR) is a metric used in capital budgeting to estimate the profitability of potential investments. The internal rate of return is a discount rate that makes the net present value (NPV) of all cash flows from a particular project equal to zero.[11] IRR calculations rely on the same formula as NPV does:

$$0 = NPV = -I + \sum_{t=1}^n \frac{FV_t}{(1+IRR)^t} \quad (7.1.2)$$

Where:

FV = Future cost of the cash inflows,

I = Initial Investment,

IRR = Discount rate for which NPV=0,

t = The number of time periods.

To calculate IRR using the formula, one would set NPV equal to zero and solve for the discount rate (r), which is the IRR. Because of the nature of the formula, however, IRR cannot be calculated analytically and must instead be calculated either through trial-and-error (iterative process) or using software programmed to calculate IRR such as Excel. [11] Excel is used to calculate IRR as well as the other measures named above. When the cash flows throughout a project are all negative, the IRR cannot be calculated. This is indicated in the results as not applicable (n.a.) wherever necessary.

7.1.5. Sensitivity analysis

During the concept cost and pricing calculation (chapter 5) and market scenario generation (chapter 6) assumptions had to be made which can influence the outcome of the financial evaluation. These assumptions carry a degree of uncertainty which needs to be accounted for. It is therefore important to investigate the potential impact these assumptions have on the financial evaluation of the concept. In this section the assumption which are subject to a sensitivity analysis are recalled.

First of all, the revenue of the modular well concept is dependent of the chosen pricing level. The pricing level in its turn was decided to be based on the cost level of the competition as discussed in chapter 5. It is therefore of importance to determine the sensitivity of the business concept's results to the pricing level. The concept's pricing level has been both decreased and increased by 10%, 20% and 30% to account for this uncertainty.

Secondly, in the base case scenario it is assumed that both the mobilisation time windows of modules between contracts and the intervention time per well is 7 days. This assumption influences the planning of the vessel and the amount of wells that can be serviced per year. Therefore both assumptions have separately been decreased and increased by two days in comparison to the base case.

7.2. Base case: combined market scenario

The base case is formed by the combined market scenario introduced in section 6.4. For this scenario all results will be presented in this section. This section serves to answer research questions 3a: "Does the base case scenario form a positive business case?", and 3b: "How do market and intervention assumptions affect the business case's financial success?".

7.2.1. Standard situation

In the standard situation the modular concept's pricing level is just below €58k/day and just above €62k/day for subsea and surface intervention respectively. The cash flow in this situation is shown in figure 7.1. The payback time, NPV and IRR in this situation are shown in table 7.1.

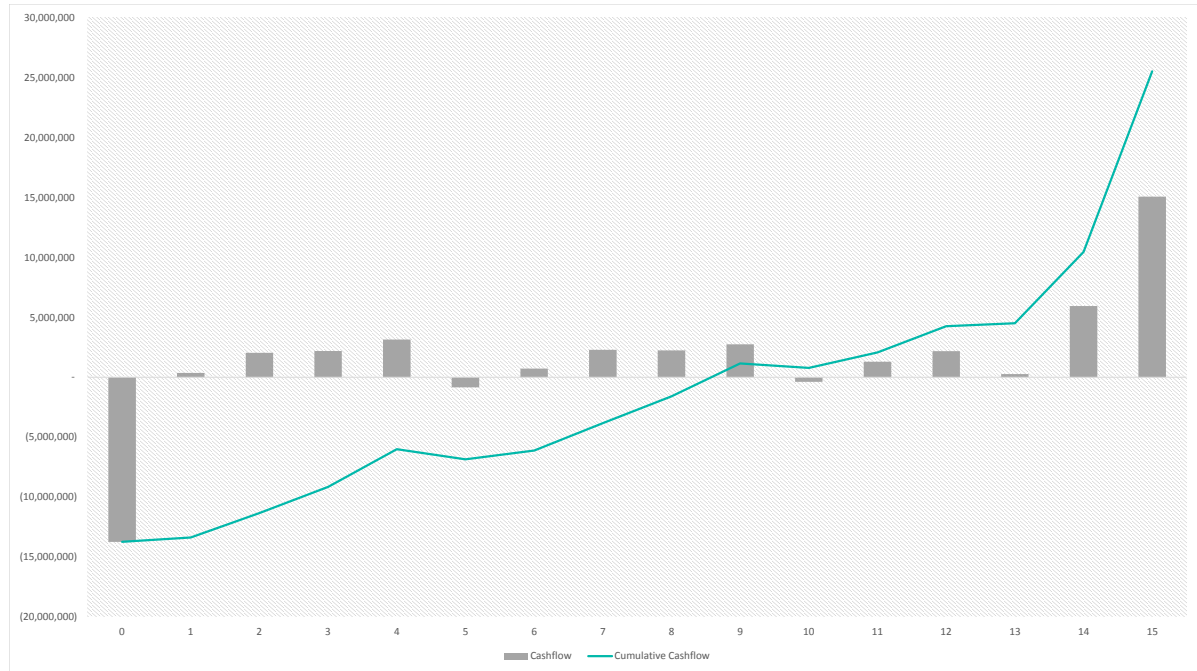

Figure 7.1: Cash flow in standard base case scenario

Table 7.1: Payback time, NPV and IRR for standard base case scenario

	Base case
Payback time	9 years
NPV	€ 1,593,173.03
IRR	11%

7.2.2. Sensitivity to pricing

The cash flows at each pricing level are shown in figure 7.2. The payback time, NPV and IRR in this situation are shown in table 7.2. As explained, the IRR calculation is not applicable (n.a.) for cases with all negative cash flows.

7.2.3. Sensitivity to module mobilisation time

The cash flows at different module mobilisation times is shown in figure 7.3. The payback time, NPV and IRR in this situation are shown in table 7.3.

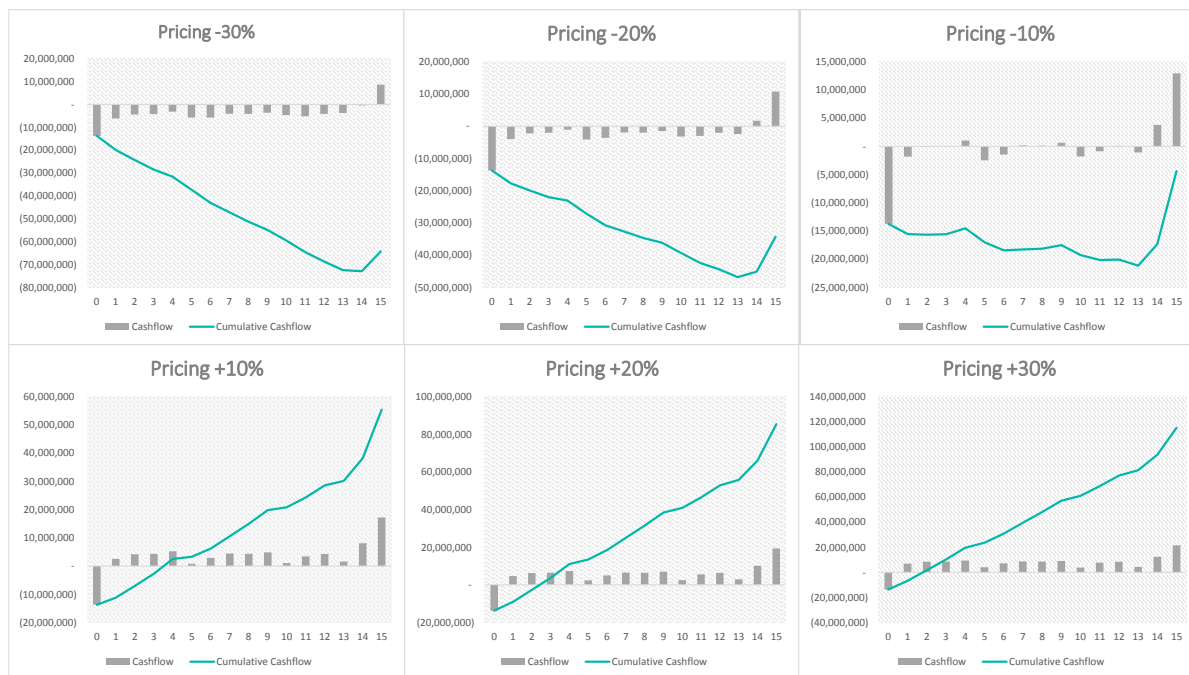

Figure 7.2: Cash flows of base case at different pricing levels

Table 7.2: Payback time, NPV and IRR of base case at different pricing levels

Base case pricing sensitivity							
	-30%	-20%	-10%	Standard	+10%	+20%	+30%
Payback time	n.a.	n.a.	n.a.	9 years	4 years	3 years	2 years
NPV	€ (44,550,698.98)	€ (29,169,408.31)	€ (13,788,117.64)	€ 1,593,173.03	€ 16,974,463.70	€ 32,355,754.37	€ 47,737,044.80
IRR	n.a.	-14%	-2%	11%	26%	41%	56%

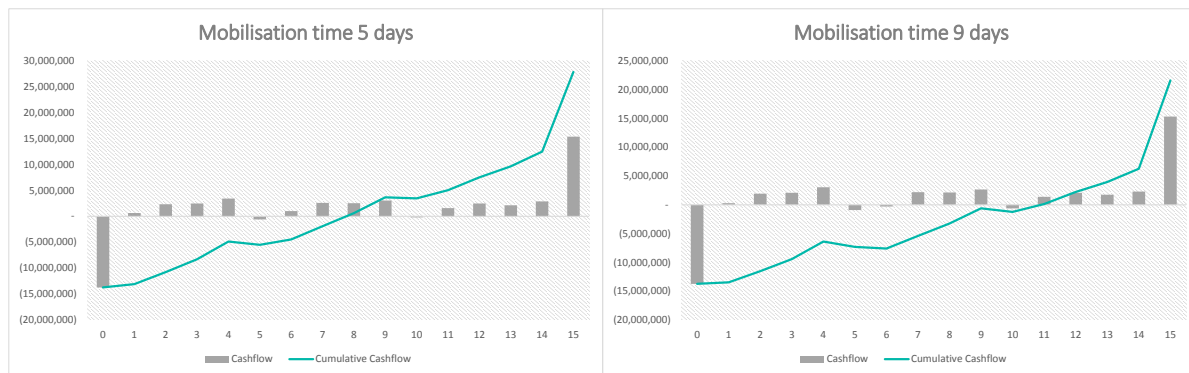

Figure 7.3: Cash flows of base case with different mobilisation times

Table 7.3: Payback time, NPV and IRR at different module mobilisation times

Mobilisation time			
	5 days (-2)	7 days	9 days (+2)
Payback time	8 years	9 years	11 years
NPV	€ 3,247,003.65	€ 1,593,173.03	€ (39,200.14)
IRR	13%	11%	10%

7.2.4. Sensitivity to well intervention duration

The cash flows at different well intervention durations is shown in figure 7.4. The payback time, NPV and IRR in this situation are shown in table 7.4.

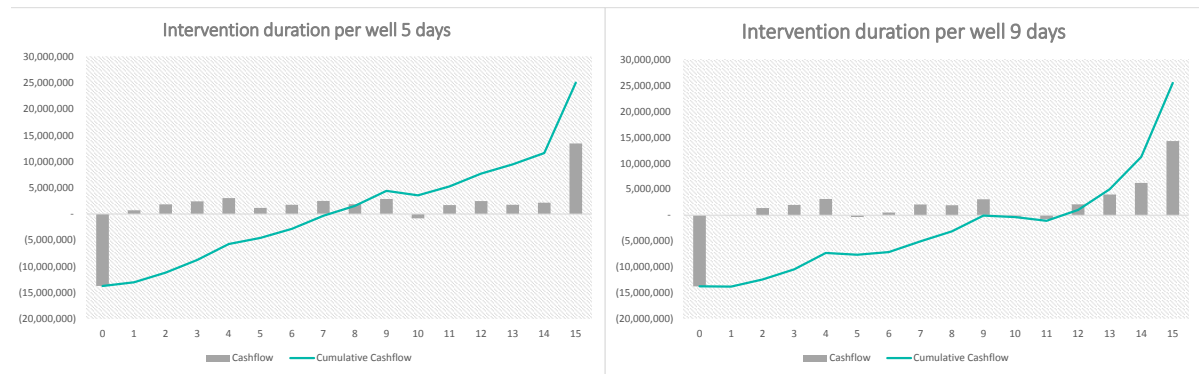

Figure 7.4: Cash flows of base case with different well intervention durations

Table 7.4: Payback time, NPV and IRR at different well intervention durations

	Intervention duration per well		
	5 days (-2)	7 days	9 days (+2)
Payback time	8 years	9 years	12 years
NPV	€ 2,738,582.42	€ 1,593,173.03	€ 843,968.86
IRR	13%	11%	11%

7.3. Operator-specific scenarios

In order to maintain the readability of the report, the results of the operator-specific scenarios are included in the appendix of this report in section A.7. The results are however observed and used to draw conclusions presented in the next section.

7.4. Discussion

In this section the results of the base case and operator-specific scenarios are analysed, discussed and used to draw conclusions on the required market conditions for which the business concept is a positive investment. This section serves to answer research question 3c: "In which market conditions is the concept a good business case?".

7.4.1. The cost of modularity

There is a significant difference in profit generation between surface and subsea intervention. Figure 7.5 shows the profit share of surface and subsea intervention for the base case scenario. This is due to the difference in module lease cost as seen in table 4.3 which translates to high VOYEX for subsea intervention contracts. As a matter of fact, subsea intervention contracts account for 67% of the vessel's total VOYEX and generates only 22% of the profit in the base case scenario.

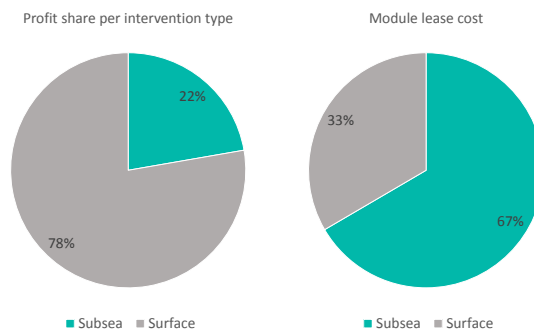

Figure 7.5: Profit share and module lease cost of surface and subsea interventions

Whenever a contract is executed, the required modules need to be mobilised. The module mobilisation costs are always incurred, whether the contract contains one well or ten. In case of subsea intervention, this can cost up to around €52k (see table 4.3). Does every type of intervention contract in the market scenarios generate enough profit to compensate for these module costs? As a matter of fact, they do not, as seen in figure 7.6 which shows the percentage of contracts which is profitable per contract type. Only 25% of subsea medium contracts are profitable, compared to nearly 60% of subsea light contracts and 100% of surface medium contracts. Why are some contracts of the same type profitable and other are not? This has to do with the contract size and the additional module mobilisation and demobilisation costs dependent on the succeeding contract type.

It is of interest to know under which market conditions all contracts are profitable, especially subsea medium contracts which have the lowest percentage of profitability. The sensitivity analyses which have been done on each market scenario help to answer this question. The effect of each assumption will be discussed in the following sections.

7.4.2. Pricing level

The pricing level of the concept has been decreased and increased from -30% to +30% in each market scenario. Continuing on the thought process of the previous section, it is desired to know at which price level all contract types are profitable. At 130% of the original pricing level, just above 90% profitability is reached for both types of subsea intervention contracts. On the other hand, 'surface medium' intervention contracts are still all profitable at 80% of the pricing level, but only 9% are profitable at 70% of the pricing level. So

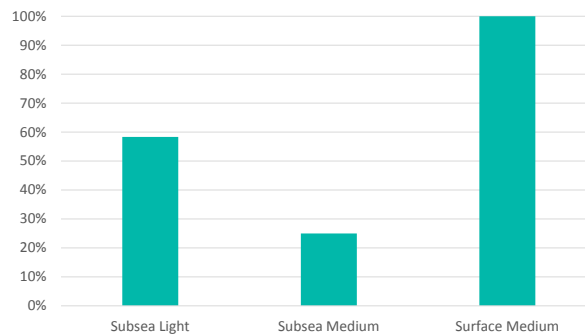

Figure 7.6: Profitability per well intervention contract type. The base case scenarios contains no 'surface light' contracts so only three percentages are shown.

somewhere between these two pricing levels lies the average break even point for surface intervention contracts. This means that the concept is very competitive against a vessel such as the FTAI Pride in the surface intervention market.

7.4.3. Mobilisation time

The concept's response to changes in module mobilisation time indicate that module mobilisation time has influence on the financial success. An increase of two days in module mobilisation time, without a change in module mobilisation cost, affects the vessel's planning in such a way that the payback time increases by two years and its NPV just drops below zero at a discount rate of 10%. A decrease in module mobilisation time can however double the project's NPV and bring the payback time back one year.

7.4.4. Well intervention duration

The concept's response to changes in well intervention duration indicates that it has influence on its financial success too. An increase of two days in intervention duration per well affects the vessel's planning in such a way that the payback time increases by three years and its NPV is decreased but remains positive. A decrease in well intervention duration however increases the project's NPV and bring the payback time back one year.

7.4.5. Utilisation rate

By creating and evaluating market scenarios based on four different operators and a combined scenario, the importance of utilisation rate can be investigated. The utilisation rate of each scenario results from the concept's operation in the given market only, so not executing any other contracts but those defined in each scenario. The resulting utilisation rates vary from 41% in the Murphy scenario, to 100% in the Chevron scenario.

It is interesting to see that the utilisation rate of the vessel in the combined scenario is lower than that in operator-specific scenarios of Chevron and Petronas. This can be explained by logic reasoning and recalling the market generation assumptions. The combined scenario contains all the subsea intervention demand of all operators. Subsea intervention has priority in its execution according to the market generation assumptions. This translates to the market scenarios in the form of a higher amount of contracts (40 in the combined scenario, 30 with Chevron and Petronas), and thus more time spent on mobilising and demobilising modules. Time spent on (de)mobilisation does not qualify as billable work (because non-modular solutions do not require equipment mobilisation time) and thus does not contribute to the concept's utilisation rate.

The utilisation rate of the concept does however influence its cost level as seen in chapter 5. Having analysed the concept's NPV time in each scenario, conclusions can be drawn on the required utilisation rate at the given pricing level. This is compared in table 7.5.

From the table above can be seen that at the given pricing level, the concept's utilisation rate in the combined scenario is closest to a NPV of zero. This indicates that the required utilisation rate for a positive NPV lies around 95%. This is however a questionable conclusion. With a two percent increase in utilisation rate (Petronas), the NPV increases by nearly as much as the NPV decreases in case of the Shell scenario with a 21%

Table 7.5: Utilisation rate versus NPV comparison

	Murphy	Shell	Combined	Petronas	Chevron
Utilisation	41%	75%	96%	98%	100%
NPV	€ (55,941,066.54)	€ (12,822,294.34)	€ 1,593,173.03	€ 13,927,995.50	€ 17,083,211.23

lower utilisation rate. The lower the utilisation rate, the higher the vessel's CAPEX and OPEX. Does increasing the price level then compensate for these higher cost and bring the NPV to a positive level in the Murphy and Shell scenarios? It does for the Shell scenario as can be seen in table A.12. An increase of 10% in the pricing level brings the project's NPV nearly to zero. In case of the Murphy scenario however, no pricing increase can create any positive cash flows at all, as can be seen in figure A.8. How can this be explained?

7.4.6. Operator demand and combined campaigns

The Murphy scenario (section A.7.1) is not one the investor wants to end up in with this business concept. With no positive NPV, not even with a 30% increase in pricing, this scenario has no potential. It is however interesting to understand why this is the case. None of the adjustments in assumptions have a positive impact, so the reason must lie at the source of this market scenario: the well intervention demand of Murphy. Indeed, the amount of wells of each operator is shown in table 6.1 and Murphy has with 38 subsea wells (the highest amount of subsea wells of all operators) and no surface wells the smallest total well intervention demand. This is in essence a scenario in which a dedicated well intervention vessel would operate. Based on comparison with Shell's demand, consisting of 28 subsea wells and 176 surface wells, which has a positive NPV from slightly higher pricing levels onward, it can be concluded that the concept can only be profitable in a combined market and not in a subsea intervention market only. Two conclusions can be drawn from this. Firstly it is interesting for operators such as Murphy to combine well intervention campaigns together with other operators in order to attract competitively priced intervention solutions. Secondly, the modular concept does not just have the ability to cross over between surface and subsea market, but it requires surface intervention campaigns in order to remain a profitable concept. If subsea demand were to increase significantly and allow dedicated vessels to operate all year round in the region, this concept would not be competitive anymore.

7.4.7. Conclusions on required price level and contract conditions

In this section the observations and conclusions from the previous sections are used to draw the limits of the market conditions in which the concept is profitable. The concept's daily cost level depends on different factors as seen before, such as its utilisation rate, the module mobilisation cost, modules lease cost and contract size. The following graph 7.7 shows the concept's cost level for different contract sizes (amount of wells) and intervention types. In this situation a utilisation rate of 75% and module mobilisation from an empty deck is assumed.

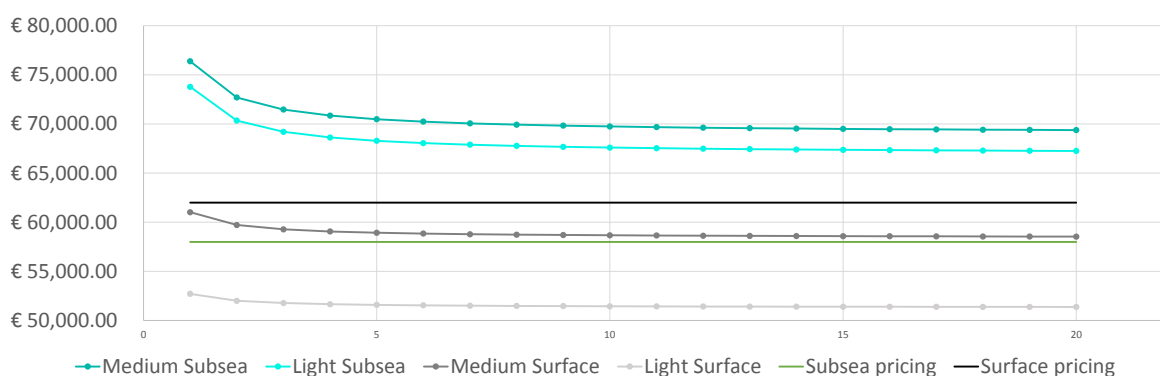

Figure 7.7: Cost per well intervention type as function of contract size (amount of wells) for a utilisation rate of 75%

This graph indicates for each contract size what the vessel's minimum day rate should be in order to

compensate for its expenses. This is about €68k per day for subsea contracts, €58.5k for medium surface intervention contracts and €51.5k for light surface intervention contracts. In comparison, the pricing levels based on the competition's cost level are indicated too. These were used in the financial evaluation and clearly show that subsea intervention contracts are not profitable, whereas surface intervention contracts are. The main difference is the module lease cost which is a lot lower for surface intervention modules. Subsea contracts (containing more than 5 wells) generate a loss of around €10k per day, whereas medium surface intervention contracts generate a profit of around €3400 per day based on price levels used in the base case. This means that at the given price and cost levels and with a utilisation rate of 75%, market scenarios need to contain around 3 times as many surface intervention contracts as subsea intervention contracts in order to prevent operating at an overall loss. A reduction in costs, be it caused by lower module lease or mobilisation costs, a higher utilisation rate, lower capital or running expenses, or an increase in pricing can reduce the concept's dependency on surface intervention contracts to obtain a positive business case.

7.5. Alternative business case: vessel and module ownership

The business concept as evaluated before was based on the assumption that the required equipment modules are always available for lease from a third party. This assumption arguably contains a contradiction. If the modules are always available, they must actually be owned by the vessel owner himself. If they are owned by a third party, they are not always available because they might be leased out to someone else. What is the effect on the modular business concept if the vessel owner also owned the equipment modules?

If the owner were to purchase and own all modules, the total capital expenses of the concept would increase. This would translate to a higher dayrate, reducing the competitiveness of the concept in comparison to dedicated solutions. The advantage though is that the vessel owner always has the right equipment available to execute intervention contracts. In general it is also cheaper in the long run to purchase instead of lease equipment. The increase in day rate depends on the total equipment cost and utilisation rate. Table 7.6 below shows the increase in day rate for different combinations of said variables. This is based on a financing rate of 30%/70% (equity/debt) with a 20 year amortisation period and 2.5% interest on outstanding debt, which is the same financing construction as the vessel itself. The values shown in the table are calculated for the first year. The values decrease as the loan is paid off and the interest on the outstanding loan decreases.

Table 7.6: Dayrate increase (in the first year) as a consequence of purchasing the equipment modules for several cost and utilisation rate combinations.

		Utilisation Rate			
		25%	50%	75%	100%
Equipment cost	€ 15,000,000.00	€ 8,054.79	€ 4,027.40	€ 2,684.93	€ 2,013.70
	€ 20,000,000.00	€ 10,739.73	€ 5,369.86	€ 3,579.91	€ 2,684.93
	€ 25,000,000.00	€ 13,424.66	€ 6,712.33	€ 4,474.89	€ 3,356.16
	€ 30,000,000.00	€ 16,109.59	€ 8,054.79	€ 5,369.86	€ 4,027.40

The difference in dayrate between the modular concept (excluding modules) and the dedicated subsea reference vessel is around €13500 as calculated in chapter 5. This is the competitiveness margin of the bare vessel compared to the subsea intervention competition. If the vessel owner purchases the modules, the resulting vessel day rate would only exceed the margin of €13500 in case of a €30M investment and low UR of 25%. Although no more module lease costs need to then be paid during operations, module mobilisation and demobilisation costs of the modules which were already proven to be significant still remain. Continuing on the idea of module ownership by the vessel owner, it could become the case that the vessel owner has two vessels. In this case the additional capital expenses of the equipment modules are divided over two ships, decreasing its effect on the vessel dayrate by half or even more with more vessels. Having two or more vessels use the modules can also significantly increase the utilisation rate of the modules, further decreasing the day rate.

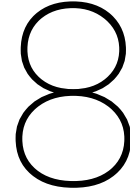

Conclusion and recommendations

This chapter concludes this thesis by recalling the research goals and their answers, followed by recommendations regarding further research into the development and evaluation of a modular well intervention concept.

8.1. Conclusion

This research into a modular well intervention business concept was guided by three research questions inquiring firstly into the technical requirements of subsea and surface well intervention, secondly into how these requirements can be translated to a modular solution, and lastly into the financial viability of the business case. These questions have been answered in different steps.

In the concept development phase the technical requirements for subsea and surface well intervention have been investigated. The required equipment for each type of intervention was analysed, and a reference vessel analysis provided information regarding the required vessel dimensions.

This knowledge has subsequently been translated to a modular concept by splitting the equipment and vessel requirements into modules where possible and platform specifications otherwise. Two module platforms were initially chosen. These vessels were based on the Damen Offshore Carrier range and had a deadweight of 5000 and 8400 ton respectively. An operability study has shown that the bigger of the two vessels (150m in length) did not have an operability advantage over the smaller vessel (100m in length) in the region of South-East Asia. Based on this outcome, it was chosen to go forward with the smaller vessel concept as its building cost are lower.

Its cost level has been determined using estimation methods based on existing DOC vessels. The total concept cost includes capital expenses (loan amortisation, interest), running costs (maintenance, repairs, insurance, crew) and voyage costs (fuel consumption, module mobilisation and lease costs). The cost level calculation and subsequent comparison with competing vessels have shown that the modular concept has the potential to be competitive, although depend on the type of intervention and market conditions which required to market scenarios to investigate. Its pricing level has been based on the cost level of competing vessels in both surface and subsea markets.

Subsea and surface interventions require different module packages requiring mobilisation and demobilisation of modules between different contracts. Although modularity allows the vessel to cross over between two otherwise separate markets and generate extra revenue compared to a dedicated solution, modularity does come at a cost. This has been investigated in the financial evaluation of different market scenarios.

Market scenarios were generated based on the field data of four big operators in the region. An intervention policy was proposed to translate the field characteristics into well intervention demand. This resulted in operator-specific scenarios and a combined scenario consisting of all the fields of the four operators.

In each scenario, the concept's payback time, net present value (NPV) and internal rate of return (IRR) have been calculated. The discount rate of the NPV calculation is 10%. In the first place a base case scenario, formed by the combination of intervention demand from all four operators has been evaluated. Moreover, the evaluation of operator-specific scenarios, together with a sensitivity analysis, have helped to understand the impact of different market conditions on the business case. The parameters which have been varied are the

concept's pricing level (from -30% to +30%), module mobilisation time (5,7 and 9 days) and well intervention duration (5, 7 and 9 days per well).

The financial evaluation of the base case scenario results in a positive overall business case with a payback period of 9 years, €1.5M NPV and 11% IRR. The analysis of operator-specific scenarios have however shown, at the calculated cost and pricing levels, that subsea intervention contracts hardly generate profit due to the high module lease and mobilisation costs involved. Surface intervention contracts do generate profit and play an important role in the overall success of a market scenario.

In conclusion, when operating in the price, cost and market conditions laid out in this research, the concept requires a market in which it is able to execute around three times as many surface contracts as subsea contracts to maintain a break-even point. In order for the concept to operate profitably in subsea intervention contracts, the subsea modules' lease and mobilisation costs need to be reduced or the concept's price level increased which goes hand in hand with a reduction in competitiveness.

8.2. Recommendations

Throughout the concept development and evaluation phases of this thesis, assumptions had to be made where time restrictions of this thesis or lack of data didn't allow a thorough investigation. These are however interesting and important to investigate at a later stage, especially if it is chosen to move forward with this business concept and more accurate predictions are required. The recommended points to investigate are presented per topic.

Vessel design

In the concept development phase two initial designs were chosen of the Damen Offshore Carrier (DOC) range. These were based on the main dimensions of the reference vessels, the limits of the DOC design range and existing DOC vessels. It should however be more thoroughly investigated exactly what the minimum design requirements are for a well intervention vessel. This can include the exact required deck space taking into account not only modules but also working and 'moving around safely' space, required deadweight and required cargo volume beneath deck. With this knowledge can be determined how small the vessel can be, in order to minimise the building cost and increase competitiveness with a tailored solution.

Module cost and modularity

The module lease and (de)mobilisation costs have played a significant role in the financial evaluation of the business concept. The costs of these modules have however been estimated and are not based on actual quotations from equipment providers. Together with the equipment provider it can also be determined exactly how much time the mobilisation and demobilisation of each module requires, leading to more accurate cost calculations.

Operability

As explained in section 4.4, the operability method used to compare the two initial DOC concepts has its own limits with regards to accuracy. First of all specific limiting criteria for well intervention operations should be determined by talking with experts in the field and secondly the equipment operability limits should be defined as a function of vessel dimensions and motions. Both can lead to a more accurate prediction of the concept's operational profile.

Cost and pricing

The financial evaluation of the business concept relies on the determined cost and price level of the concept. As shown in the sensitivity analysis, both can have a big impact on the outcome of the business case. It is therefore important to increase the accuracy of the cost components, especially building cost and fuel consumption. The price level, based on the estimation of two competing vessels' cost level, can also benefit from more reference points (more reference vessels).

Intervention demand

The market scenarios in which the business concept has been evaluated are based on a self-made intervention policy method based on literature research. It should however be investigated with oil & gas field operators whether this intervention policy aligns with their view on the market and should subsequently be fine-tuned and expanded to obtain a more realistic representation of reality.

Market cross-over opportunities

Lastly, the modularity of the business concept allows it to cross-over into additional markets apart from well intervention. Examples of such markets are dive support operations, pipe-laying or platform supply. The concept can maximise its utilisation rate by picking contracts in more than one market as long as it has the required modular equipment to satisfy the operational requirements. It is recommended to analyse the potential extra revenue the concept can generate from doing so.

Bibliography

- [1] Indonesia's \$120 billion oil and gas opportunity, November 2017. URL <https://www.bcg.com/publications/2017/upstream-oil-gas-energy-environment-indonesia-billion.aspx>.
- [2] Decommissioning asia pacific on a budget, January 2018. URL <https://www.woodmac.com/reports/upstream-oil-and-gas-decommissioning-asia-pacific-on-a-budget-11831>.
- [3] Kimberly Amadeo. Oil price forecast 2019-2050, December 2018. URL <https://www.thebalance.com/oil-price-forecast-3306219>.
- [4] Ampelmann. Ampelmann a-type enhanced performance, April 2019. URL <https://www.ampelmann.nl/systems/a-type-enhanced-performance>.
- [5] Ship & Bunker. Bunker prices, May 2019. URL <https://shipandbunker.com/prices>.
- [6] Clarkson's. World fleet register, May 2019. URL <https://www.clarksons.net/wfr/>.
- [7] Damen Shipyards Group. Offshore carrier range, April 2019. URL <https://products.damen.com/en/ranges/offshore-carrier/offshore-carrier-range>.
- [8] H2M. Offshore accommodation units, April 2019. URL <https://www.h-2m.com/download/33ft-sleeper-leaflet.html>.
- [9] Royal IHC. Module handling system, April 2019. URL https://www.royalihc.com/-/media/royalihc/products/motion-control-and-automation/mission-equipment-control/d1_leaflet_module_handling_system.pdf.
- [10] Investopedia. Discount rate, 2019. URL <https://www.investopedia.com/terms/d/discount-rate.asp>.
- [11] Investopedia. Internal rate of return, 2019. URL <https://www.investopedia.com/terms/i/irr.asp>.
- [12] Investopedia. Net present value, 2019. URL <https://www.investopedia.com/terms/n/npv.asp>.
- [13] Investopedia. Payback period, 2019. URL <https://www.investopedia.com/terms/p/paybackperiod.asp>.
- [14] Infield Systems Limited. *Subsea Well Intervention Market Report to 2017*. Infield Systems Limited, 2012.
- [15] MARIN. Qship hydrodynamic suite, May 2019. URL <https://www.marin.nl/storage/uploads/3609/files/QSHIP%20Hydrodynamic%20Suite.pdf>.
- [16] IHS Markit. Offshore rig day rate analysis, April 2019. URL <https://ihsmarkit.com/products/oil-gas-drilling-rigs-offshore-day-rates.html>.
- [17] Mathworks. Matlab, May 2019. URL <https://www.mathworks.com/products/matlab.html>.
- [18] Offshore Network. 2018 market forecast: What does the oil price mean for well intervention? Technical report, April 2018.
- [19] Nordforsk. *Assessment of Ship Performance in a Seaway: The Nordic Co-operative Project: "Seakeeping Performance of Ships"*. Nordforsk, 1987. ISBN 9788798263715. URL <https://books.google.nl/books?id=hdaQ0gAACAAJ>.
- [20] Oceaneering. Investor presentation march 2019, March 2019. URL http://s22.q4cdn.com/369103554/files/doc_presentations/2019/03/Q4-IR-Presentation-FINAL.pdf.

- [21] FTAI Offshore. M/v pioneer, May 2019. URL https://www.ftaioffshore.com/offshore-vessels/mv-pioneer/_res/id=Attachments/index=0/MV%20Pioneer%20Specifications.pdf.
- [22] FTAI Offshore. M/v pride, May 2019. URL https://www.ftaioffshore.com/offshore-vessels/mv-pride/_res/id=Attachments/index=0/MV%20Pride%20Specifications.pdf.
- [23] PRT Offshore. Intervention work tower, May 2019. URL <https://prtoffshore.com/intervention-work-tower/>.
- [24] Well Ops. Specialist subsea intervention device, May 2019. URL <http://www.helixesg.com/default/energyservices-wellops/downloads/sid.pdf>.
- [25] Anton Paar. *Marine fuel density*. 2019. URL <https://wiki.anton-paar.com/en/bunker-oil-marine-fuel-oil/>.
- [26] Rhino. Rhino 3d software, May 2019. URL <https://www.rhino3d.com/6/features>.
- [27] sam Scarpa. 2018 market forecast: Well services demand and opportunities in the asia pacific. Technical report, June 2018.
- [28] Seasonics. Module handling towers, April 2019. URL <https://www.seaonics.com/module-handling/>.
- [29] Koller Solutions. Offshore wireline unit, April 2019. URL https://www.koller-celle.com/en/offshore-wireline-unit.html?file=tl_files/kma_downloads/wireline_units/A2-001-Offshore-Wireline-Unit.pdf.
- [30] M. Stopford. *Maritime Economics*. Routledge, 2009. ISBN 9780415275576. URL <https://books.google.nl/books?id=tfsC6RUDn2QC>.
- [31] Tech Safe Systems. Mk2 a-frame lars, April 2019. URL <https://www.techsafe.co.uk/machine/mk2-a-frame-lars/>.
- [32] WorldOil. Introducing riserless light well intervention stack, systems to monitor subsea production, April 2015. URL <https://www.worldoil.com/magazine/2015/april-2015/technology-at-otc/introducing-riserless-light-well-intervention-stack-systems-to-monitor-subsea-production>.

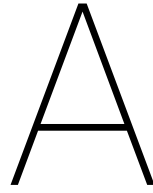

Appendix

A.1. Modularity decision tree

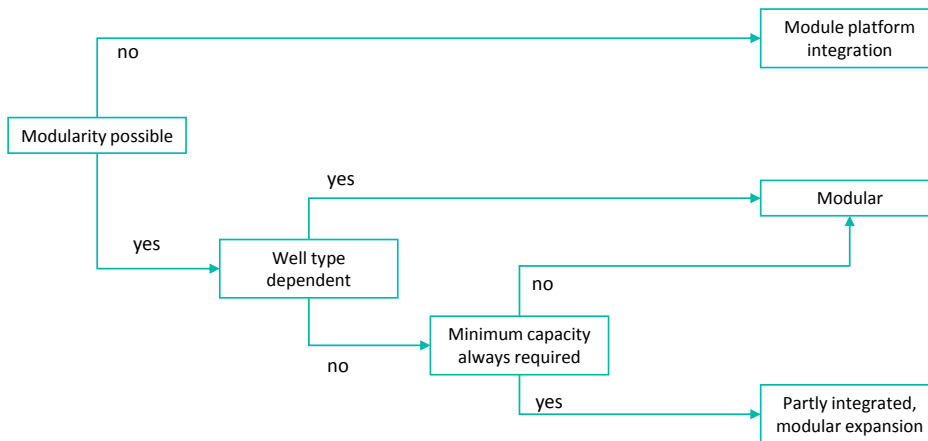

Figure A.1: Modularity decision tree

The modularity decision tree can be seen in figure A.1.

A.2. Reference vessel analysis

See figure A.2.

Vessel name	Intervention	Length (m)	Beam (m)	GT	Main Crane (t)	AHC	Secondary Crane (t)	AHC	Accommodation (POB)	ROV support	Moonpool size (m2)	Deck Space (m2)	DP level	MHT (t)	Tank volume (m3)
FTAI Pride	Medium	130	28	10000	250	1	35	0	n.a.	1	n.a.	2000	3	0	3460
Well Enhancer	Medium	132	22	9383	100	0	5	0	n.a.	1	49	1100	3	150	5510
Seawell	Light	114	22.5	9158	45	1	5	0	n.a.	n.a.	35	600	2	150	2430
Aker Wayfarer	Medium	157	27	16697	400	1	100	1	n.a.	1	52	1850	3	n.a.	3900
Skandi Santos	Medium	121	23	9074	0	1	0	0	n.a.	1	125	n.a.	3	125	1930
Akofs Seafarer	Medium	157	27	16942	400	1	50	1	n.a.	1	52	2210	3	450	5190
Island Constructor	Light	120	25	11602	140	1	40	1	n.a.	1	64	1470	3	0	0
Island Frontier	Light	106	21	6834	130	1	0	0	n.a.	1	50	946.4	3	70	7924
Island Wellserver	Light	116	25	12223	150	1	0	0	n.a.	1	60	1150	3	100	0
Island Intervention	Light	120	25	11572	250	1	15	0	100	1	n.a.	1500	3	0	3711
Havila Harmony	Light	93	20	4724	150	1	0	0	n.a.	1	31	816	2	0	5037
Havila Phoenix	Light	110	23	10599	250	1	20	1	140	1	0	1100	2	0	2600
Fugro Synergy	Medium	104	20	6543	250	1	15	1	n.a.	0	52	n.a.	2	84	4124.5
Norshore Atlantic	Light	115	22	8200	140	1	0	0	n.a.	1	52	300	3	98	1950
CSS Derwent	Medium	85	32	11561	150	1	5	1	152	1	58	1330	3	200	2304
Skandi Constructor	Light	120	25	11572	140	1	0	0	100	1	64	1400	2	115	6830
Olympic Intervention IV	Light	95	21	5974	150	1	25	0	100	1	52	940	3	0	7100
Ocean Intervention III	Light	90	19	4202	150	1	0	0	n.a.	1	50	770	2	0	3420

Figure A.2: Subsea well intervention vessel analysis

A.3. Weather characteristics South-East Asia

See figures A.3 and A.4.

March to May, area 62 (Malaysia)

All directions

Significant wave height (m)	total	186	366	286	120	34	7	2	0	0	0	0	1001
	>14	0	0	0	0	0	0	0	0	0	0	0	0
	13-14	0	0	0	0	0	0	0	0	0	0	0	0
	12-13	0	0	0	0	0	0	0	0	0	0	0	0
	11-12	0	0	0	0	0	0	0	0	0	0	0	0
	10-11	0	0	0	0	0	0	0	0	0	0	0	0
	9-10	0	0	0	0	0	0	0	0	0	0	0	0
	8-9	0	0	0	0	0	0	0	0	0	0	0	0
	7-8	0	0	0	0	0	0	0	0	0	0	0	0
	6-7	0	0	0	0	0	0	0	0	0	0	0	0
	5-6	0	0	0	0	0	0	0	0	0	0	0	0
	4-5	0	1	2	2	1	0	0	0	0	0	0	6
	3-4	1	5	9	7	3	1	0	0	0	0	0	26
	2-3	5	28	40	25	9	2	1	0	0	0	0	110
1-2	40	137	133	58	16	3	1	0	0	0	0	388	
0-1	140	195	102	28	5	1	0	0	0	0	0	471	
	<4	4-5	5-6	6-7	7-8	8-9	9-10	10-11	11-12	12-13	>13	total	
Zero crossing period (s)													

June to August, area 62 (Malaysia)

All directions

Significant wave height (m)	total	91	292	333	190	69	19	4	0	0	0	0	998
	>14	0	0	0	0	0	0	0	0	0	0	0	0
	13-14	0	0	0	0	0	0	0	0	0	0	0	0
	12-13	0	0	0	0	0	0	0	0	0	0	0	0
	11-12	0	0	0	0	0	0	0	0	0	0	0	0
	10-11	0	0	0	0	0	0	0	0	0	0	0	0
	9-10	0	0	0	0	0	0	0	0	0	0	0	0
	8-9	0	0	0	0	0	0	0	0	0	0	0	0
	7-8	0	0	0	0	0	0	0	0	0	0	0	0
	6-7	0	0	0	0	0	0	0	0	0	0	0	0
	5-6	0	0	0	1	1	0	0	0	0	0	0	2
	4-5	0	1	2	3	2	1	0	0	0	0	0	9
	3-4	0	4	12	13	7	3	1	0	0	0	0	40
	2-3	3	27	58	48	22	7	2	0	0	0	0	167
1-2	23	124	167	94	31	7	1	0	0	0	0	447	
0-1	65	136	94	31	6	1	0	0	0	0	0	333	
	<4	4-5	5-6	6-7	7-8	8-9	9-10	10-11	11-12	12-13	>13	total	
Zero crossing period (s)													

Figure A.3: Wave scatter diagram of Area 62 (part 1)

September to November, area 62 (Malaysia)

All directions

Significant wave height (m)	total	57	238	336	229	98	31	7	1	0	0	0	997
	>14	0	0	0	0	0	0	0	0	0	0	0	0
	13-14	0	0	0	0	0	0	0	0	0	0	0	0
	12-13	0	0	0	0	0	0	0	0	0	0	0	0
	11-12	0	0	0	0	0	0	0	0	0	0	0	0
	10-11	0	0	0	0	0	0	0	0	0	0	0	0
	9-10	0	0	0	0	0	0	0	0	0	0	0	0
	8-9	0	0	0	0	0	0	0	0	0	0	0	0
	7-8	0	0	0	0	0	0	0	0	0	0	0	0
	6-7	0	0	0	1	1	0	0	0	0	0	0	2
	5-6	0	0	1	2	2	1	0	0	0	0	0	6
	4-5	0	1	4	5	4	2	1	0	0	0	0	17
	3-4	0	4	14	18	12	5	2	0	0	0	0	55
2-3	2	20	53	52	28	10	2	0	0	0	0	167	
1-2	11	86	151	105	40	11	2	1	0	0	0	407	
0-1	44	127	113	46	11	2	0	0	0	0	0	343	
	<4	4-5	5-6	6-7	7-8	8-9	9-10	10-11	11-12	12-13	>13	total	
Zero crossing period (s)													

December to February, area 62 (Malaysia)

All directions

Significant wave height (m)	total	18	132	300	297	166	66	18	4	0	0	0	1001
	>14	0	0	0	0	0	0	0	0	0	0	0	0
	13-14	0	0	0	0	0	0	0	0	0	0	0	0
	12-13	0	0	0	0	0	0	0	0	0	0	0	0
	11-12	0	0	0	0	0	0	0	0	0	0	0	0
	10-11	0	0	0	0	0	0	0	0	0	0	0	0
	9-10	0	0	0	0	0	0	0	0	0	0	0	0
	8-9	0	0	0	0	0	0	0	0	0	0	0	0
	7-8	0	0	0	1	1	1	0	0	0	0	0	3
	6-7	0	0	1	2	2	2	1	0	0	0	0	8
	5-6	0	0	2	5	6	4	1	1	0	0	0	19
	4-5	0	1	7	14	14	8	3	1	0	0	0	48
	3-4	0	4	21	38	30	14	5	1	0	0	0	113
2-3	1	14	62	83	52	20	5	1	0	0	0	238	
1-2	3	49	131	118	52	15	3	0	0	0	0	371	
0-1	14	64	76	36	9	2	0	0	0	0	0	201	
	<4	4-5	5-6	6-7	7-8	8-9	9-10	10-11	11-12	12-13	>13	total	
Zero crossing period (s)													

Figure A.4: Wave scatter diagram of Area 62 (part 2)

A.4. Day rate analysis

The following dayrate and utilisation analysis is based on market research into subsea well intervention by Infield Systems [14]. The day rates presented in their report are drawn from historical contract analysis for the years between 2008 and 2012 and are forecast post 2012 until 2017. Actual dayrate after 2012 is not publicly available. The following dayrate table A.1 and figure A.5 reflect an average figure across the length of a contract and include mobilisation and demobilisation from within the region of operation. The numbers are expressed in thousand of US Dollars.

Work Scope	2008	2009	2010	2011	2012
IRM	78	70	67	67	84
Subsea Construction	115	111	110	111	111
Pure Well Intervention	219	212	211	216	228
Intervention Vessel Average	138	131	129	131	141

Work Scope	2013	2014	2015	2016	2017
IRM	88	90	118	108	101
Subsea Construction	113	116	151	129	128
Pure Well Intervention	244	244	268	305	314
Intervention Vessel Average	148	150	179	181	181

Table A.1: Day rates table
Source: [14]

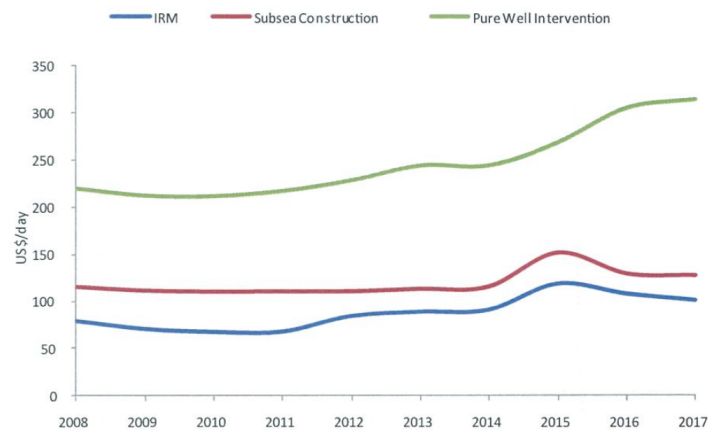

Figure A.5: Day rates graph
Source: [14]

It has been noted that the offshore market is not at the same level of activity in 2019 as it was in 2012. According to sources within Damen, day rates have dropped up to 50%. For this reason the predicted day rates of Infield Systems presented in table A.1 are reconsidered. Actual day rates of well intervention vessels are not available but an estimate can be made based on the drilling rig day rates. Based on the day rates analysis of Infield Systems [14], well intervention vessel day rates equalled approximately 50% of those of drilling rigs. The current day rates for drilling rigs are published by IHS Markit in their Offshore Rig Day Rate Index [16] and can be seen in figure A.6. Their day rate currently hovers around USD275,000, which leads to an estimated day rate for well intervention vessels of USD137,500 or approximately €125,000 per day. This is however a very rough estimation and subject to very complex market dynamics. Using this number as a basis for the concept's financial viability would carry a big uncertainty factor making the financial evaluation close to useless. It is therefore chosen not to take this number into account in the evaluation in the next chapter. Taking the competitor's cost level as benchmark scenario in which the modular concept should still be profitable is a more reliable approach; It is also direct measure of the concept's competitiveness.

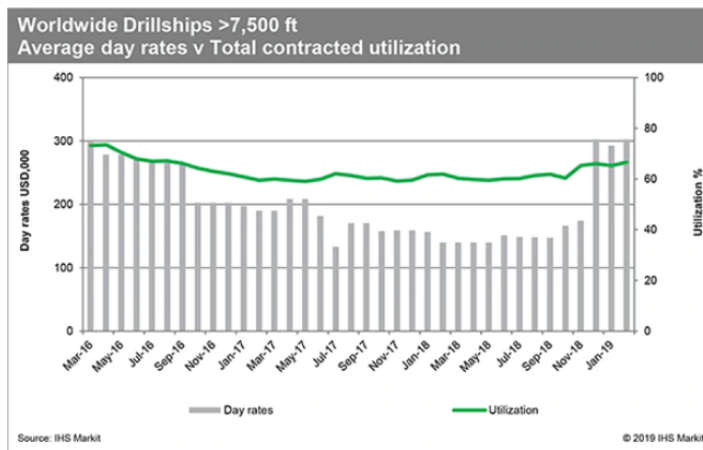

Figure A.6: Drilling rig day rates
Source: [16]

A.5. Scrap value

To calculate the residual value of the vessel after 15 years, its scrap value has to be estimated. The scrap value of a vessel is measured by the value of the steel used in its construction, the weight of which is generally approximated by the ship's lightweight (LDT). However, because two DOC platforms have been built, there is a precise indication of the amount of steel in both vessels. These have been obtained at the Offshore and Transport product group within Damen, who were responsible for DOC designs and construction. For the DOC 5000 the ratio between deadweight and steel weight is used as estimation method. Summarised in table A.2, the ratio between dead weight and steel weight is 2.33 and 2.25 for Nexus and Connector respectively. Using their average (2.29) to estimate the steel weight of the DOC 5000 concept, this results in 2183t. The scrap rate (or second hand value) per ton steel is around €385.00/ton.

	DOC 5000	Nexus	Connector
DWT (t)	5000	8400	9300
Steel weight (t)	2183	3600	4119
Ratio (DWT/LDT)	2.29 ↑ average	2.33	2.25
Scrap value (€)	826.180	1.386.000	1.585.815

Table A.2: Scrap value of both existing and conceptual DOC 5000 vessels

Now that both the scrap value and building cost (determined in chapter 5) of the DOC5000 are known, linear yearly depreciation is obtained by dividing the difference between building cost and scrap value by 25 years. This is summarised in table A.3. Using the yearly depreciation, a ship's value at each year can be estimated. This however represents a ship's bookvalue, which can be different from the market value.

Table A.3: Yearly depreciation calculation of DOC 5000.

	DOC 5000
Building cost (€)	€34.335.203
Scrap value (€)	€826.180
Total depreciation	€ 33.509.024
Yearly depreciation (25 years)	€ 1,340,360.95

A.6. Market scenarios

Table A.4: Combined market scenario

Contract ID	Year	Week	Duration	Type	Wells	Revenue
3	2020	1	30	3	28	€ 11,995,094.00
4	2020	32	23	1	21	€ 9,686,201.01
5	2021	56	9	3	8	€ 3,427,169.71
6	2021	66	11	1	10	€ 4,612,476.67
7	2021	78	33	4	31	€ 13,280,282.64
8	2022	112	7	3	6	€ 2,570,377.29
9	2022	120	7	1	6	€ 2,767,486.00
10	2022	128	40	4	37	€ 15,850,659.93
11	2023	169	2	3	1	€ 428,396.21
12	2023	172	51	4	48	€ 20,563,018.28
13	2024	224	41	3	38	€ 16,279,056.14
14	2025	266	23	3	21	€ 8,996,320.50
15	2025	290	19	1	17	€ 7,841,210.34
16	2025	310	12	4	11	€ 4,712,358.36
17	2026	323	7	3	6	€ 2,570,377.29
18	2026	331	7	1	6	€ 2,767,486.00
19	2026	339	40	4	37	€ 15,850,659.93
20	2027	380	13	3	12	€ 5,140,754.57
21	2027	394	5	1	4	€ 1,844,990.67
22	2027	400	35	4	33	€ 14,137,075.07
23	2028	436	3	3	2	€ 856,792.43
24	2028	440	3	1	2	€ 922,495.33
25	2028	444	48	4	45	€ 19,277,829.64
26	2029	493	35	3	33	€ 14,137,075.07
27	2030	529	20	3	18	€ 7,711,131.86
28	2030	550	17	1	16	€ 7,379,962.67
29	2030	568	16	4	15	€ 6,425,943.21
30	2031	585	12	3	11	€ 4,712,358.36
31	2031	598	2	1	1	€ 461,247.67
32	2031	601	40	4	37	€ 15,850,659.93
33	2032	642	16	3	15	€ 6,425,943.21
34	2032	659	16	1	15	€ 6,918,715.01
35	2033	677	9	3	8	€ 3,427,169.71
36	2033	687	9	1	8	€ 3,689,981.34
37	2033	697	35	4	33	€ 14,137,075.07
38	2034	733	37	3	34	€ 14,565,471.28
39	2034	771	16	1	15	€ 6,918,715.01

Table A.5: Petronas market scenario

Contract ID	Year	Week	Duration	Type	Wells	Revenue
3	2020	1	4	3	3	€ 1,285,188.64
4	2020	6	49	4	46	€ 19,706,225.85
5	2021	56	6	3	5	€ 2,141,981.07
6	2021	63	6	1	5	€ 2,306,238.34
7	2021	70	42	4	39	€ 16,707,452.35
8	2022	113	52	4	49	€ 20,991,414.50
9	2023	166	2	3	1	€ 428,396.21
10	2023	169	51	4	48	€ 20,563,018.28
11	2024	221	52	4	49	€ 20,991,414.50
12	2025	274	52	4	49	€ 20,991,414.50
13	2026	327	7	3	6	€ 2,570,377.29
14	2026	335	7	1	6	€ 2,767,486.00
15	2026	343	40	4	37	€ 15,850,659.93
16	2027	384	52	4	49	€ 20,991,414.50
17	2028	437	52	4	49	€ 20,991,414.50
18	2029	490	25	3	23	€ 9,853,112.93
19	2029	516	16	1	15	€ 6,918,715.01
20	2030	533	25	4	23	€ 9,853,112.93
21	2030	559	16	2	15	€ 6,918,715.01
22	2031	576	5	3	4	€ 1,713,584.86
23	2031	582	48	4	45	€ 19,277,829.64
24	2032	631	52	4	49	€ 20,991,414.50
25	2033	684	2	3	1	€ 428,396.21
26	2033	687	2	1	1	€ 461,247.67
27	2033	690	50	4	47	€ 20,134,622.07
28	2034	741	17	3	16	€ 6,854,339.43
29	2034	759	17	1	16	€ 7,379,962.67
30	2034	777	19	4	17	€ 7,282,735.64

Table A.6: Murphy market scenario

Contract ID	Year	Week	Duration	Type	Wells	Revenue
3	2020	1	8	3	7	€ 2,998,773.50
4	2020	10	8	1	7	€ 3,228,733.67
5	2020	19	9	4	8	€ 3,427,169.71
6	2020	29	9	2	8	€ 3,689,981.34
7	2021	53	4	3	3	€ 1,285,188.64
8	2021	58	4	1	3	€ 1,383,743.00
9	2022	105	4	4	3	€ 1,285,188.64
10	2022	110	4	2	3	€ 1,383,743.00
11	2023	157	9	4	8	€ 3,427,169.71
12	2024	209	41	3	38	€ 16,279,056.14
13	2024	251	12	4	11	€ 4,712,358.36
14	2025	264	41	4	38	€ 16,279,056.14
15	2026	313	5	4	4	€ 1,713,584.86
16	2027	365	4	3	3	€ 1,285,188.64
17	2027	370	4	1	3	€ 1,383,743.00
18	2027	375	15	4	14	€ 5,997,547.00
19	2028	417	3	3	2	€ 856,792.43
20	2028	421	3	1	2	€ 922,495.33
21	2028	425	44	4	41	€ 17,564,244.78
22	2029	470	7	3	6	€ 2,570,377.29
23	2029	478	7	1	6	€ 2,767,486.00
24	2029	486	2	4	1	€ 428,396.21
25	2029	489	2	2	1	€ 461,247.67
26	2031	573	6	3	5	€ 2,141,981.07
27	2031	580	2	1	1	€ 461,247.67
28	2031	583	4	4	3	€ 1,285,188.64
29	2031	588	2	2	1	€ 461,247.67
30	2032	625	9	3	8	€ 3,427,169.71
31	2032	635	9	1	8	€ 3,689,981.34
32	2033	677	2	3	1	€ 428,396.21
33	2033	680	2	1	1	€ 461,247.67
34	2033	683	8	4	7	€ 2,998,773.50
35	2033	692	8	2	7	€ 3,228,733.67
36	2034	729	13	3	12	€ 5,140,754.57
37	2034	743	2	1	1	€ 461,247.67
38	2034	746	4	4	3	€ 1,285,188.64
39	2034	751	3	2	2	€ 922,495.33

Table A.7: Chevron market scenario

Contract ID	Year	Week	Duration	Type	Wells	Revenue
3	2020	1	3	3	2	€ 856,792.43
4	2020	5	50	4	47	€ 20,134,622.07
5	2021	56	52	4	49	€ 20,991,414.50
6	2022	109	3	3	2	€ 856,792.43
7	2022	113	3	1	2	€ 922,495.33
8	2022	117	48	4	45	€ 19,277,829.64
9	2023	166	52	4	49	€ 20,991,414.50
10	2024	219	52	4	49	€ 20,991,414.50
11	2025	272	5	3	4	€ 1,713,584.86
12	2025	278	48	4	45	€ 19,277,829.64
13	2026	327	52	4	49	€ 20,991,414.50
14	2027	380	2	3	1	€ 428,396.21
15	2027	383	2	1	1	€ 461,247.67
16	2027	386	50	4	47	€ 20,134,622.07
17	2028	437	52	4	49	€ 20,991,414.50
18	2029	490	52	4	49	€ 20,991,414.50
19	2030	543	3	3	2	€ 856,792.43
20	2030	547	50	4	47	€ 20,134,622.07
21	2031	598	52	4	49	€ 20,991,414.50
22	2032	651	8	3	7	€ 2,998,773.50
23	2032	660	8	1	7	€ 3,228,733.67
24	2032	669	38	4	35	€ 14,993,867.50
25	2033	708	5	3	4	€ 1,713,584.86
26	2033	714	5	1	4	€ 1,844,990.67
27	2033	720	44	4	41	€ 17,564,244.78
28	2034	765	3	3	2	€ 856,792.43
29	2034	769	3	1	2	€ 922,495.33
30	2034	773	48	4	45	€ 19,277,829.64

Table A.8: Shell market scenario

Contract ID	Year	Week	Duration	Type	Wells	Revenue
3	2020	1	17	3	16	€ 6,854,339.43
4	2020	19	17	1	16	€ 7,379,962.67
5	2020	37	19	4	17	€ 7,282,735.64
6	2021	57	29	4	27	€ 11,566,697.78
7	2022	105	5	3	4	€ 1,713,584.86
8	2022	111	5	1	4	€ 1,844,990.67
9	2022	117	33	4	31	€ 13,280,282.64
10	2022	151	11	2	10	€ 4,612,476.67
11	2023	163	23	4	21	€ 8,996,320.50
12	2023	187	15	2	14	€ 6,457,467.34
13	2024	209	15	4	14	€ 5,997,547.00
14	2024	225	15	2	14	€ 6,457,467.34
15	2025	261	19	3	17	€ 7,282,735.64
16	2025	281	19	1	17	€ 7,841,210.34
17	2025	301	16	4	15	€ 6,425,943.21
18	2026	318	50	4	47	€ 20,134,622.07
19	2027	369	9	3	8	€ 3,427,169.71
20	2027	379	31	4	29	€ 12,423,490.21
21	2027	411	13	2	12	€ 5,534,972.00
22	2028	425	52	4	49	€ 20,991,414.50
23	2029	478	5	3	4	€ 1,713,584.86
24	2029	484	5	1	4	€ 1,844,990.67
25	2029	490	44	4	41	€ 17,564,244.78
26	2030	535	17	3	16	€ 6,854,339.43
27	2030	553	17	1	16	€ 7,379,962.67
28	2030	571	19	4	17	€ 7,282,735.64
29	2031	591	3	3	2	€ 856,792.43
30	2031	595	11	4	10	€ 4,283,962.14
31	2032	625	23	4	21	€ 8,996,320.50
32	2032	649	10	2	9	€ 4,151,229.00
33	2033	677	3	3	2	€ 856,792.43
34	2033	681	3	1	2	€ 922,495.33
35	2034	729	5	3	4	€ 1,713,584.86
36	2034	735	5	1	4	€ 1,844,990.67

A.7. Operator-specific results

A.7.1. Murphy

The cash flow plot of the normal Murphy scenario and its NPV, IRR and payback period can be seen in figure A.7 and table A.9 respectively.

The cash flow plot of the Murphy scenario at different pricing levels can be seen in figure A.8 and its NPV, IRR and payback period in figure A.9.

Base case	
Payback time	n.a.
NPV	€ (55,941,066.54)
IRR	n.a.

Base case pricing sensitivity							
	-30%	-20%	-10%	Standard	+10%	+20%	+30%
Payback time	n.a.	n.a.	n.a.	n.a.	n.a.	n.a.	n.a.
NPV	€ (75,028,407.58)	€ (68,665,960.57)	€ (62,303,513.56)	€ (55,941,066.54)	€ (89,057,305.84)	€ (43,216,172.52)	€ (36,853,725.51)
IRR	n.a.	n.a.	n.a.	n.a.	n.a.	n.a.	n.a.

Mobilisation time			
	5 days (-2)	7 days	9 days (+2)
Payback time	n.a.	n.a.	n.a.
NPV	€ (55,941,066.54)	€ (55,941,066.54)	€ (55,941,066.54)
IRR	n.a.	n.a.	n.a.

Intervention duration per well			
	5 days (-2)	7 days	9 days (+2)
Payback time	n.a.	n.a.	n.a.
NPV	€ (67,615,968.93)	€ (55,941,066.54)	€ (52,093,339.17)
IRR	n.a.	n.a.	n.a.

Table A.9: Murphy scenario results

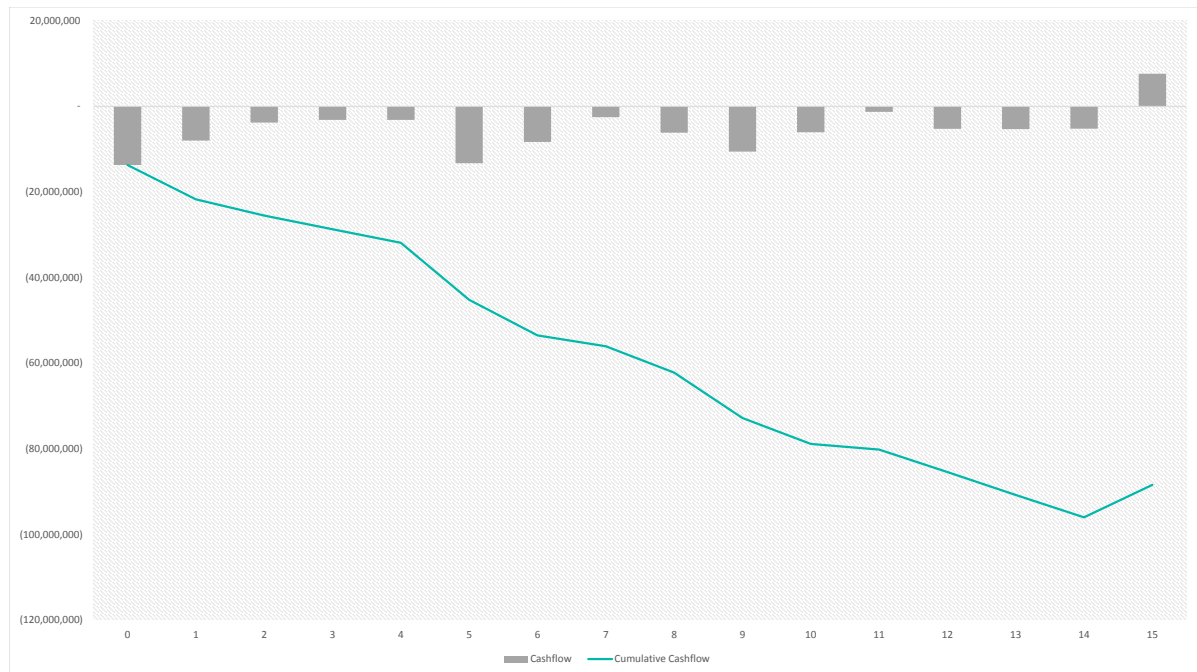

Figure A.7: Cash flow of normal Murphy scenario

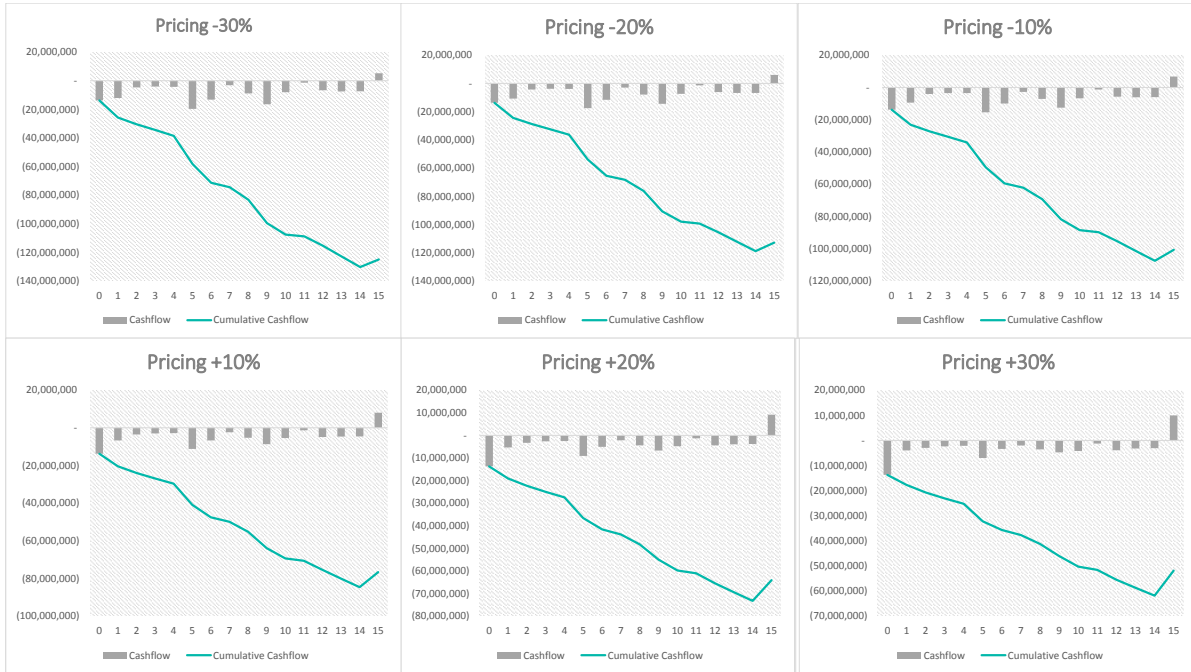

Figure A.8: Cash flow of Murphy scenario at different price levels

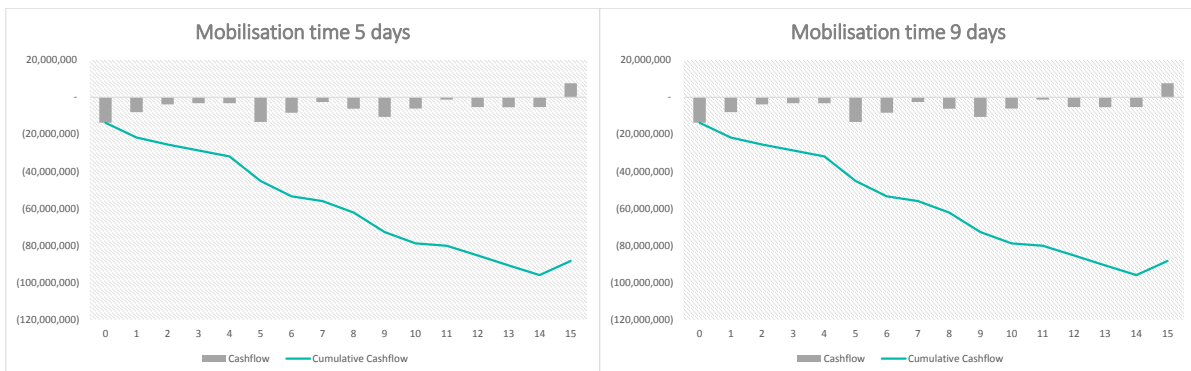

Figure A.9: Cash flow of Murphy scenario with different mobilisation times

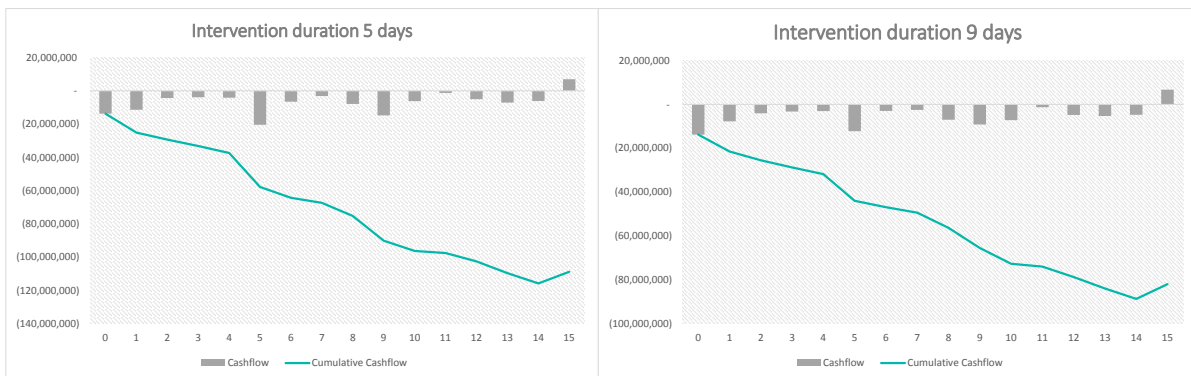

Figure A.10: Cash flow of Murphy scenario with different well intervention durations

A.7.2. Petronas

The cash flow plot of the normal Petronas scenario and its NPV, IRR and payback period can be seen in figure A.11 and table A.10 respectively.

The cash flow plot of the Petronas scenario at different pricing levels can be seen in figure A.12 and its NPV, IRR and payback period in figure A.10.

Base case	
Payback time	5 years
NPV	€ 13,927,995.50
IRR	23%

Base case pricing sensitivity							
	-30%	-20%	-10%	Standard	+10%	+20%	+30%
Payback time	n.a.	n.a.	13 years	5 years	4 years	2 years	2 years
NPV	€ (33,150,396.56)	€ (17,457,599.21)	€ (1,764,801.85)	€ 13,927,995.50	€ 13,345,410.23	€ 45,313,590.21	€ 61,006,387.57
IRR	n.a.	-7%	8%	23%	25%	54%	69%

Mobilisation time			
	5 days (-2)	7 days	9 days (+2)
Payback time	5 years	5 years	5 years
NPV	€ 13,927,995.50	€ 13,927,995.50	€ 12,279,397.54
IRR	23%	23%	22%

Intervention duration per well			
	5 days (-2)	7 days	9 days (+2)
Payback time	5 years	5 years	5 years
NPV	€ 13,504,106.74	€ 13,927,995.50	€ 13,155,661.66
IRR	23%	23%	22%

Table A.10: Petronas scenario results

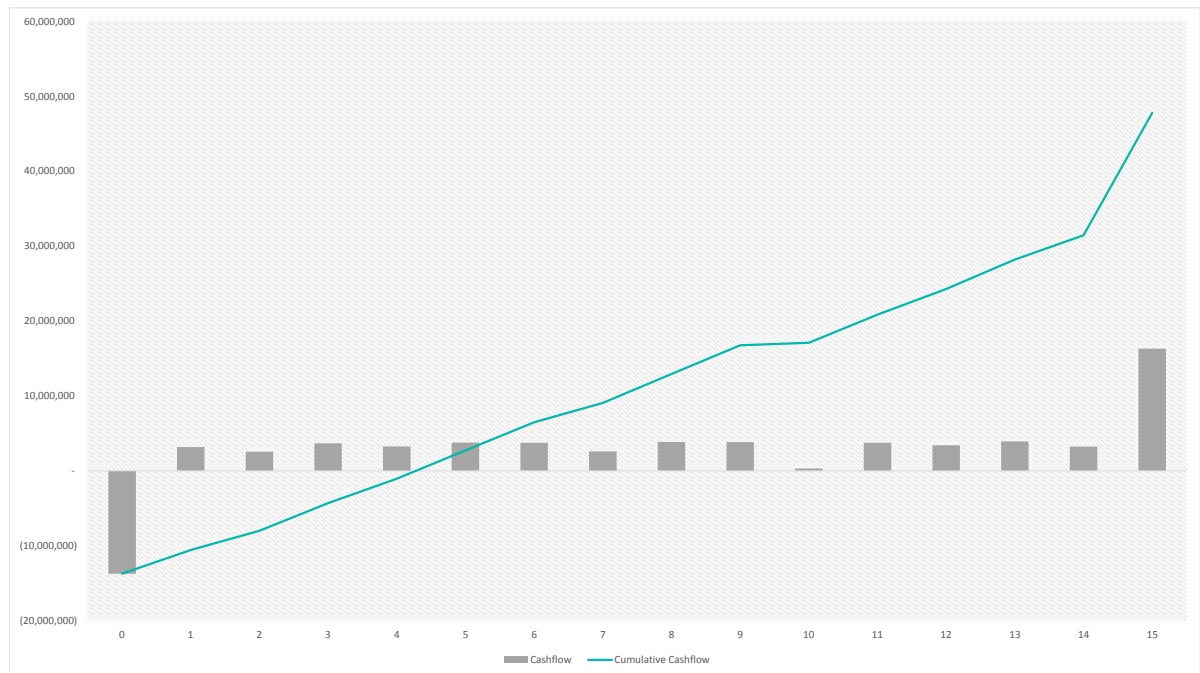

Figure A.11: Cash flow of normal Petronas scenario

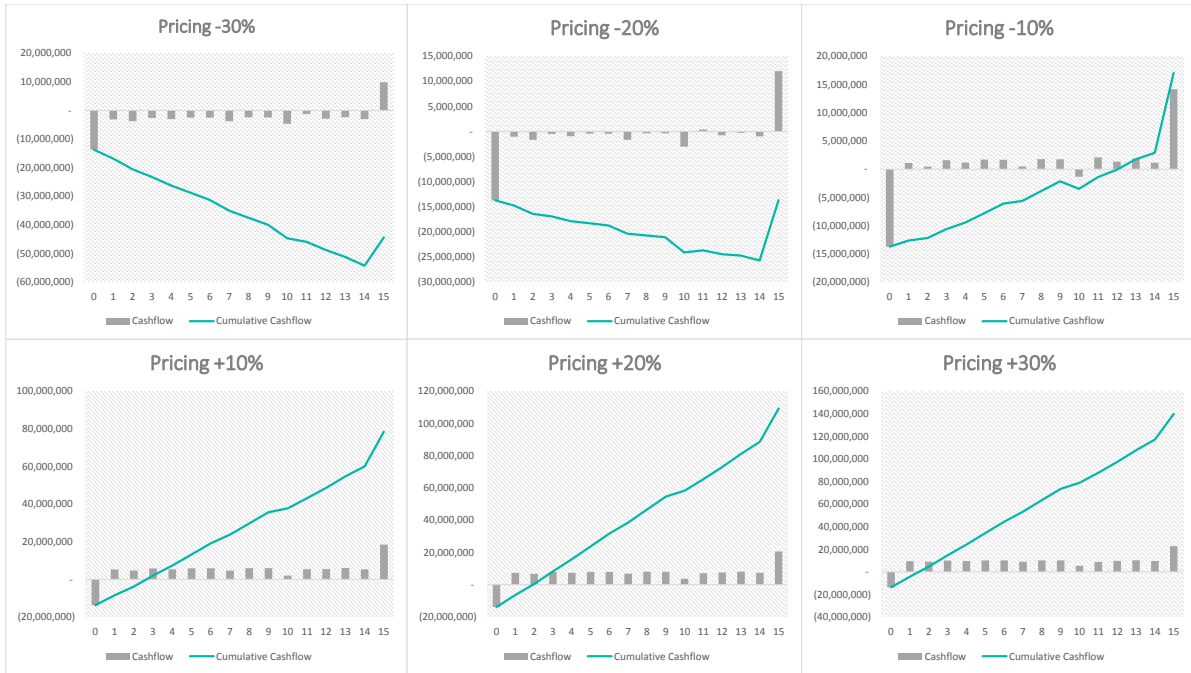

Figure A.12: Cash flow of Petronas scenario at different price levels

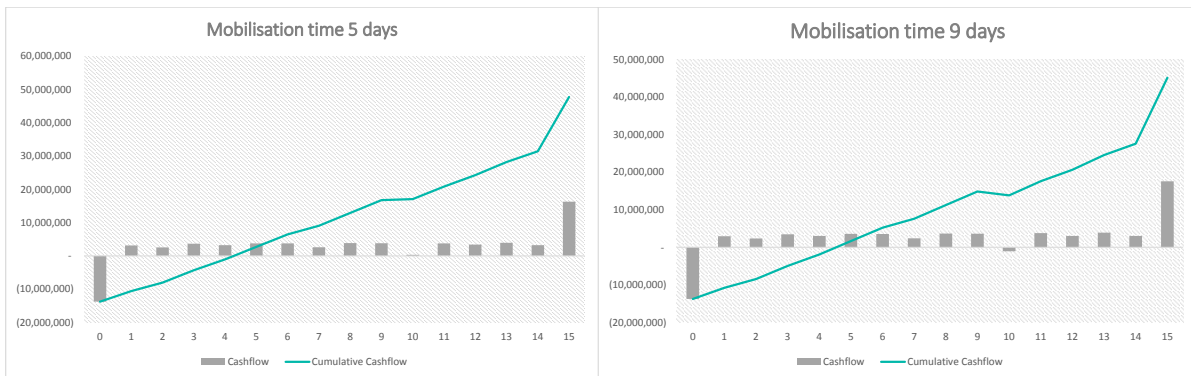

Figure A.13: Cash flow of Petronas scenario with different mobilisation times

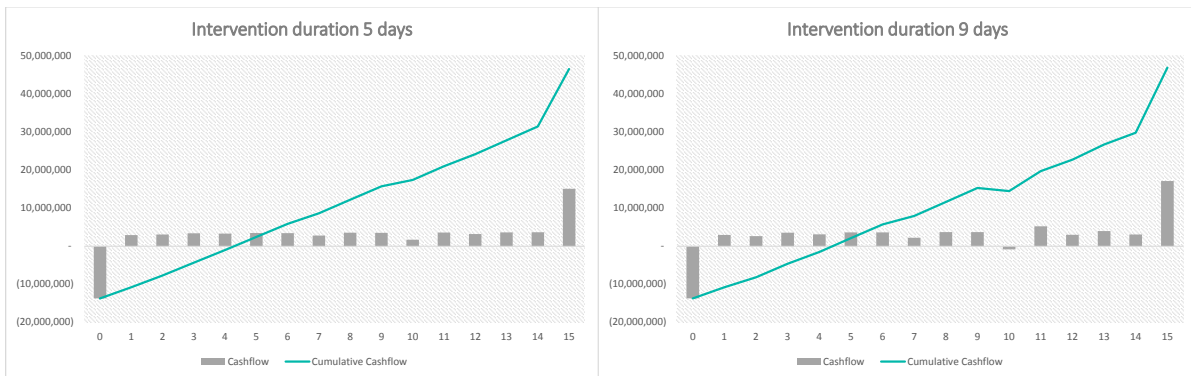

Figure A.14: Cash flow of Petronas scenario with different well intervention durations

A.7.3. Chevron

The cash flow plot of the normal Chevron scenario and its NPV, IRR and payback period can be seen in figure A.15 and table A.11 respectively.

The cash flow plot of the Chevron scenario at different pricing levels can be seen in figure A.16 and its NPV, IRR and payback period in figure A.11.

Base case	
Payback time	4 years
NPV	€ 17,083,211.23
IRR	26%

Base case pricing sensitivity							
	-30%	-20%	-10%	Standard	+10%	+20%	+30%
Payback time	n.a.	n.a.	9 years	4 years	4 years	2 years	2 years
NPV	€ (30,869,988.74)	€ (14,885,588.75)	€ 1,098,811.24	€ 17,083,211.23	€ 16,620,992.67	€ 49,052,011.21	€ 65,036,411.20
IRR	n.a.	-4%	11%	26%	27%	57%	72%

Mobilisation time			
	5 days (-2)	7 days	9 days (+2)
Payback time	4 years	4 years	5 years
NPV	€ 17,083,211.23	€ 17,083,211.23	€ 9,201,635.90
IRR	26%	26%	19%

Intervention duration per well			
	5 days (-2)	7 days	9 days (+2)
Payback time	4 years	4 years	4 years
NPV	€ 17,120,873.82	€ 17,083,211.23	€ 16,978,755.55
IRR	26%	26%	26%

Table A.11: Chevron scenario results

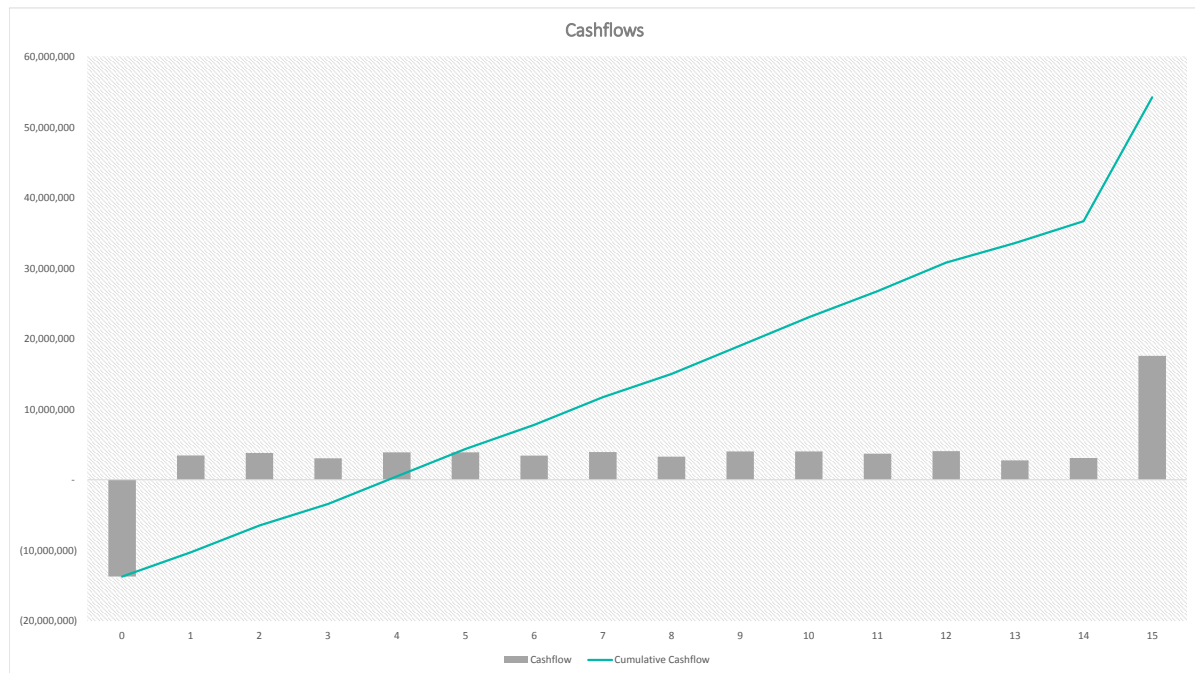

Figure A.15: Cash flow of normal Chevron scenario



Figure A.16: Cash flow of Chevron scenario at different price levels

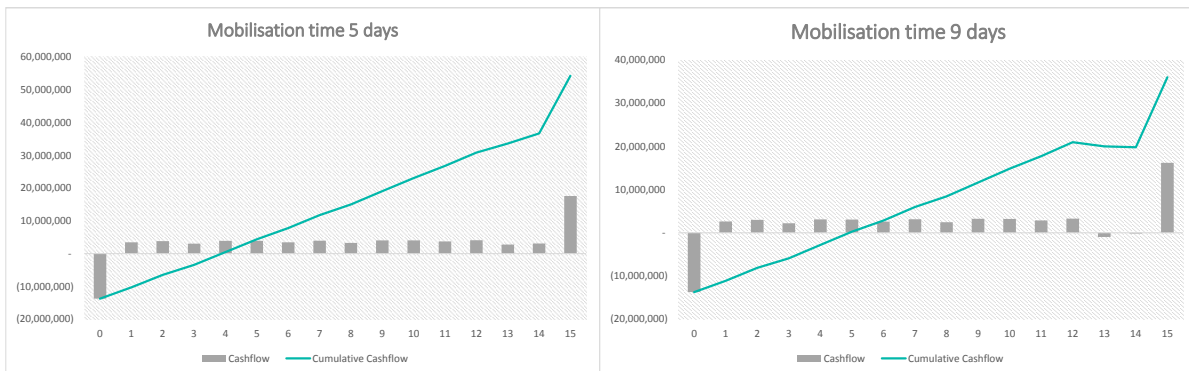

Figure A.17: Cash flow of Chevron scenario with different mobilisation times

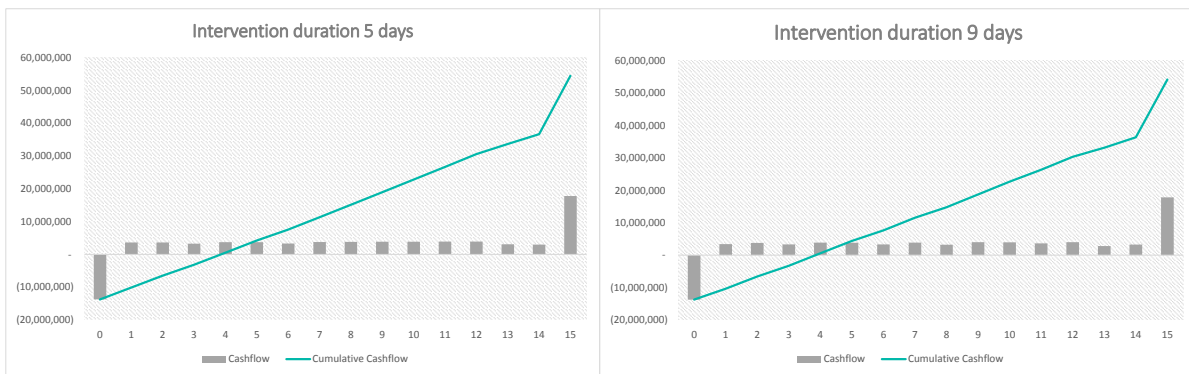

Figure A.18: Cash flow of Chevron scenario with different well intervention durations

A.7.4. Shell

The cash flow plot of the normal Shell scenario and its NPV, IRR and payback period can be seen in figure A.19 and table A.12 respectively.

The cash flow plot of the Shell scenario at different pricing levels can be seen in figure A.20 and its NPV, IRR and payback period in figure A.12.

Base case	
Payback time	n.a.
NPV	€ (12,822,294.34)
IRR	-3%

Base case pricing sensitivity							
	-30%	-20%	-10%	Standard	+10%	+20%	+30%
Payback time	n.a.	n.a.	n.a.	n.a.	8 years	5 years	3 years
NPV	€ (51,028,302.34)	€ (38,292,966.34)	€ (25,557,630.34)	€ (12,822,294.34)	€ (86,958.33)	€ 12,648,377.67	€ 25,383,713.67
IRR	n.a.	n.a.	-14%	-3%	10%	23%	36%

Mobilisation time			
	5 days (-2)	7 days	9 days (+2)
Payback time	n.a.	n.a.	n.a.
NPV	€ (12,822,294.34)	€ (12,822,294.34)	€ (17,421,014.09)
IRR	-3%	-3%	-8%

Intervention duration per well			
	5 days (-2)	7 days	9 days (+2)
Payback time	n.a.	n.a.	n.a.
NPV	€ (36,392,577.19)	€ (12,822,294.34)	€ (11,248,848.57)
IRR	n.a.	-3%	-1%

Table A.12: Shell scenario results

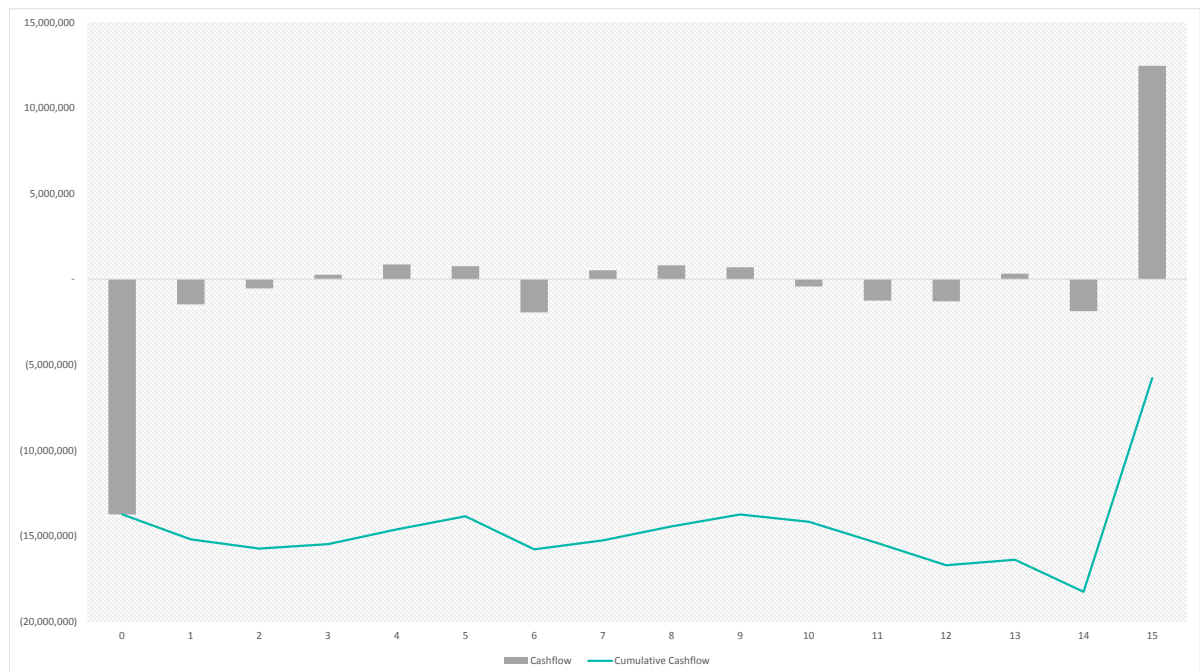

Figure A.19: Cash flow of normal Shell scenario

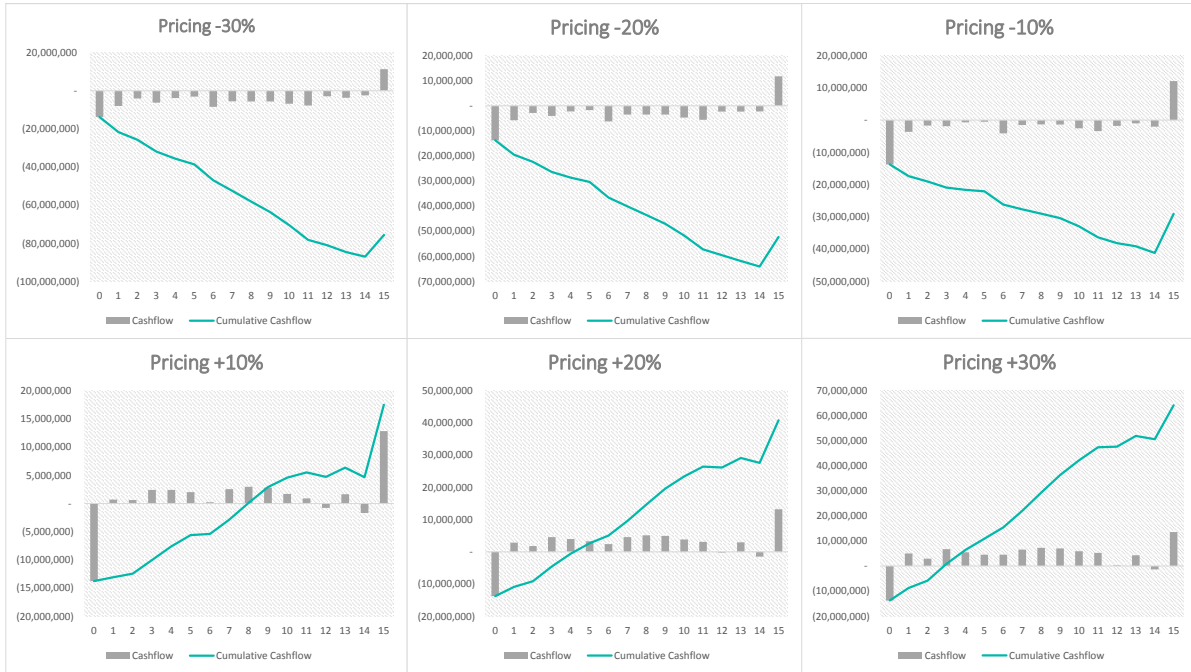

Figure A.20: Cash flow of Shell scenario at different price levels

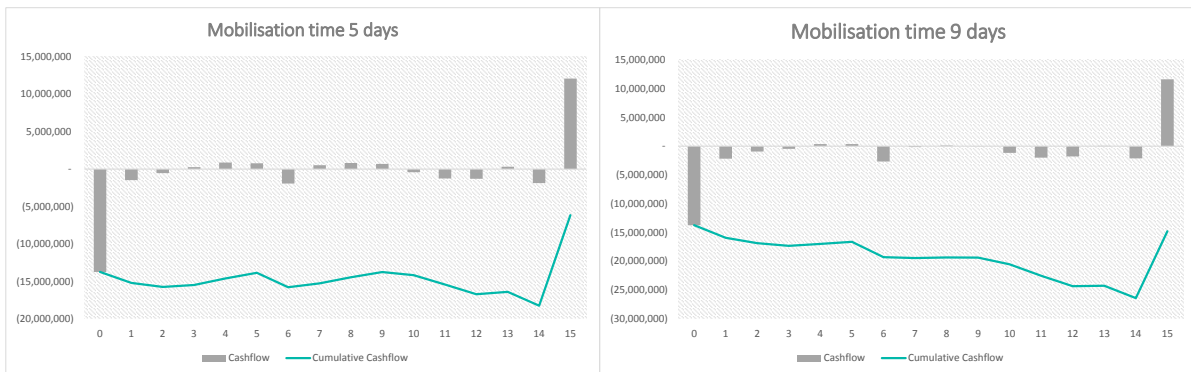

Figure A.21: Cash flow of Shell scenario with different mobilisation times

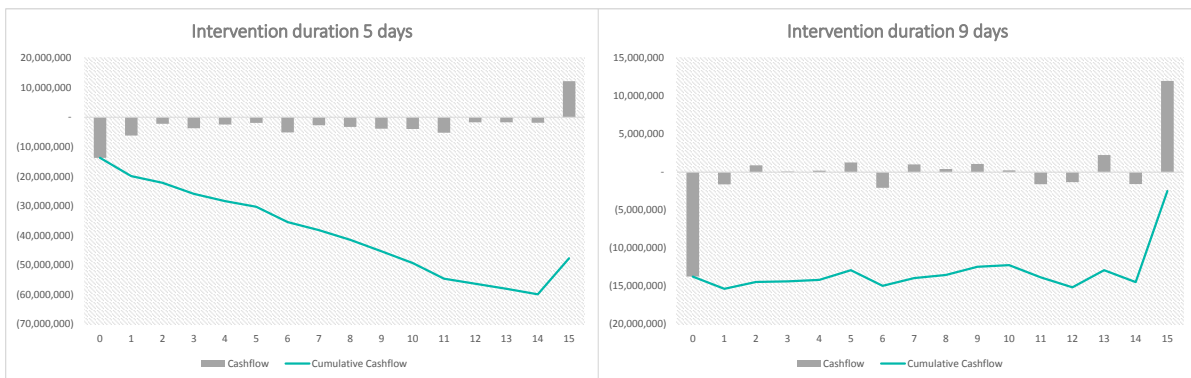

Figure A.22: Cash flow of Shell scenario with different well intervention durations