

## Peak Load Shaving of Air Conditioning Loads via Rooftop Grid-Connected Photovoltaic Systems

### A Case Study

Bakhshi-Jafarabadi, Reza; Seyed Mousavi, Seyed Mahdi

**DOI**

[10.3390/su16135640](https://doi.org/10.3390/su16135640)

**Publication date**

2024

**Document Version**

Final published version

**Published in**

Sustainability (Switzerland)

**Citation (APA)**

Bakhshi-Jafarabadi, R., & Seyed Mousavi, S. M. (2024). Peak Load Shaving of Air Conditioning Loads via Rooftop Grid-Connected Photovoltaic Systems: A Case Study. *Sustainability (Switzerland)*, 16(13), Article 5640. <https://doi.org/10.3390/su16135640>

**Important note**

To cite this publication, please use the final published version (if applicable). Please check the document version above.

**Copyright**

Other than for strictly personal use, it is not permitted to download, forward or distribute the text or part of it, without the consent of the author(s) and/or copyright holder(s), unless the work is under an open content license such as Creative Commons.

**Takedown policy**

Please contact us and provide details if you believe this document breaches copyrights. We will remove access to the work immediately and investigate your claim.

## Article

# Peak Load Shaving of Air Conditioning Loads via Rooftop Grid-Connected Photovoltaic Systems: A Case Study

Reza Bakhshi-Jafarabadi <sup>1,\*</sup>  and Seyed Mahdi Seyed Mousavi <sup>2,†</sup> <sup>1</sup> Faculty of EEMCS, Delft University of Technology, Mekelweg 4, 2628CD Delft, The Netherlands<sup>2</sup> Department of Mechanical Engineering, Mashhad Branch, Islamic Azad University, Mashhad P.O. Box 91735-413, Iran; sm\_smoosavi@mshdiau.ac.ir

\* Correspondence: reza.bakhshi@tudelft.nl

† These authors contributed equally to this work.

**Abstract:** Over the past few decades, grid-connected photovoltaic systems (GCPVSS) have been consistently installed due to their techno-socio-economic-environmental advantages. As an effective solution, this technology can shave air conditioning-based peak loads on summer days at noon in hot areas. This paper assesses the effect of solely rooftop GCPVSS installations on the peak load shaving of commercial buildings in arid regions, e.g., the Middle East and North Africa. To this end, the load profile of a large building with 470 kW of unshaved peak power in Mashhad, Iran (36.2972° N, 59.6067° E) is analyzed after commissioning an actual 51 kW GCPVSS. The results of this experimental study, exploiting 15 min resolution data over a year, endorse an effective peak shaving of the GCPVSS without employing a battery energy storage system, with 12.2–18.5% peak power shaving on a summer day at noon. The monthly GCPVSS self-sufficiency is also 10.2%, on average. In accordance with the studied case's results, this paper presents valuable insights and recommends actionable policies to regions with similar solar potential and electricity supply challenges, aiming to expedite GCPVSS development.

**Keywords:** air conditioning system; arid area; grid-connected photovoltaic system; peak shaving



**Citation:** Bakhshi-Jafarabadi, R.; Seyed Mousavi, S.M. Peak Load Shaving of Air Conditioning Loads via Rooftop Grid-Connected Photovoltaic Systems: A Case Study. *Sustainability* **2024**, *16*, 5640. <https://doi.org/10.3390/su16135640>

Academic Editors: Yuanda Cheng and John Bell

Received: 17 April 2024

Revised: 5 June 2024

Accepted: 23 June 2024

Published: 1 July 2024



**Copyright:** © 2024 by the authors. Licensee MDPI, Basel, Switzerland. This article is an open access article distributed under the terms and conditions of the Creative Commons Attribution (CC BY) license (<https://creativecommons.org/licenses/by/4.0/>).

## 1. Introduction

The global energy demand has grown steadily over the past few decades due to population growth and economic development [1]. According to the International Energy Agency (IEA), this trend will see a sharper increase in the next few years, with an average of 3.4%/year [2]. Especially in arid areas with a hot summer noon, the growing utilization of air conditioning systems in large buildings is the main reason for this substantial rise. Also, while a cooling system requires a large amount of electricity for several hours on a summer day around noon, this usage does not persist in winter, changing the electricity profile of the residential and commercial sectors [3]. Therefore, the peak load supply at the summer noon becomes a challenge in hot countries. The construction of large fossil-fuel power plants is not a technically and economically feasible solution, as there is no need for their full power generation in winter.

To meet the growing electricity demand, renewable energies such as grid-connected photovoltaic systems (GCPVSS) are being markedly developed worldwide [4], even during the COVID-19 pandemic: e.g., 124.4 and 138.5 GW global installations in 2020 and 2021 [5]. Clean energy generation, simple operation, low maintenance costs, and modular installation are a few motivations behind this trend [6]. In addition, a GCPVSS has the inherent ability to generate high levels of power on a summer day at noon due to the substantial level of solar irradiance received [7]. Residential and commercial buildings in urban areas can benefit from this opportunity, smoothing their domestic peak load by using a GCPVSS. It is worth noting that the significant penetration of GCPVSSs may pose control and protection challenges for distribution networks, e.g., anti-islanding protection [8], protection

miscoordination [9], and overvoltage [10]. However, some of these challenges would not occur in urban areas due to the strong inter-connected grid.

The effect of a GCPVS on peak load shaving has been analyzed for various locations, mainly in non-arid regions. In these regions, which mainly suffer from electricity support challenges in cold winters, peak demand and maximum GCPVS generation do not occur simultaneously. Thus, most experts presently propose combining a battery energy storage system (BESS) and a GCPVS, where the BESS is charged during off-peak timeframes and supports the GCPVS during peak times. The existing literature on GCPVS peak shaving can be categorized into three main groups.

The first group of studies determined a cost-optimized GCPVS and BESS combination to support a given load. In addition to peak load shaving, various other objectives have been defined, including maximum GCPVS self-sufficiency (i.e., minimum dependency of a given load profile on the grid) [11–13], power quality enhancement, and contributing to the grid's frequency regulation [14]. Silva and Hendrick demonstrated a nearly 30% GCPVS self-sufficiency for Belgian household demand [11]. This energy support could be augmented by 10% with the deployment of a BESS; nevertheless, the extra cost would jeopardize the project's economic viability. Qiu et al. optimized the BESS charging and discharging processes, supported by a GCPVS, over daily and intra-day timeframes [14]. In addition to peak load shaving, frequency regulation of the grid has been formulated as an objective function. The aforementioned authors discovered that the peak load would be significant, even with the BESS discharging at noon. Thango et al. conducted a comprehensive review of BESS and PV applications in South Africa [15]. Their study investigated several areas of interest, such as mitigating power quality problems, optimally controlling a power system, and shaving the peak demand. From the perspective of peak shaving, their results highlight that lithium-ion batteries are more economical than lead-acid ones for the studied country.

The second group analyzed the GCPVS and BESS combination from an economic perspective under the studied sites' incentive policies [16–22]. The outcomes of such studies provide valuable feedback for policymakers, enabling them to adopt the same or a modified form of supportive policy. Jankowiak et al. adopted the combination of a GCPVS and a BESS for the peak load shaving of a 4044 kWh/year household load in the United Kingdom [17]. Their techno-economic analysis highlighted that a 2 kW GCPVS with a 15 kWh BESS would shave this load fully. However, this would only be economically feasible when the energy cost at peak hours is greater than 0.24 GBP/kWh. In [18], an optimum BESS capacity was determined in order to minimize its annual cost and loss and maximize its lifetime within a combined system with a GCPVS. The MATLAB-based simulation results found that a 19.2 kWh optimum capacity would allow the BESS to reach the mentioned goals. However, this project would only be economically feasible when the energy sold at peak hours is more expensive than the grid's purchased energy. Dufo-López and Bernal-Agustín proposed a GCPVS and BESS for shaving the peak demand of Spanish residential, commercial, and industrial loads [19]. The BESS is charged during the night and discharged at peak times, supported by the GCPVS. The results revealed that the combined system could effectively shave the peak demand. However, it is not economically viable under the current electricity tariff and equipment costs.

Finally, a few scholars have investigated the effect of a GCPVS alone on peak load shaving [23–27]. However, most studies lack reliable analyses (i.e., outdoor long-term measurement or accurate GCPVS/load modeling) and practicability (i.e., GCPVS design and layout), and do not cover air conditioning-system-based demand in hot areas. For example, Alkelbi et al. explored the effect of a GCPVS on peak load shaving for bulk customers in Riyadh from an economic standpoint [23]. The authors employed a dynamic tariff regarding the load profile in Saudi Arabia. The result unveiled a significant shaving of the peak day load. However, the high expected energy from GCPVSs requires a substantial development of this technology in the studied country, indicating the necessity of a well-defined incentive to motivate investors. The study in [24] included four rooftop GCPVSs with 117.5 kW nominal power for Andalas University, Indonesia. In addition to the site's



- Presenting a peak shaving assessment of a GCPVS (without BESS integration) in an arid area, which has rarely been reported in the literature [23];
- Exploiting the high-resolution one-year recorded data of a 51 kW real GCPVS, raising the results' reliability;
- Considering the GCPVS electrical design and site limitations, ensuring the study's practicability, unlike other studies [23,25,26] that have not taken into account such constraints.

The rest of this paper is structured as follows: Section 2 elaborates on the supportive policy and details of the 51 kW GCPVS in the studied case. Section 3 presents peak power shaving and self-sufficiency indicators to quantify the effect of the installed GCPVS on the domestic load. Afterwards, the effect of this GCPVS on the load's peak shaving and supported energy is assessed in Section 4. Concluding remarks and a few suggestions for future studies are finally presented in Section 5.

## 2. Description of Case Study

### 2.1. Photovoltaic Incentives in Iran

Iran is a Middle Eastern country with a dominantly arid and semi-arid climate in the center, south, and east. Similar to most countries of the region, it benefits from abundant fossil-fuel resources, i.e., it is among the top four countries with the greatest oil and natural gas reservoirs [29]. In addition, it is located in the Earth's sunbelt, benefiting from high solar potential in those arid/semi-arid regions (Figure 2). Nevertheless, less than 0.6% of the country's electricity is generated by GCPVSs due to unstable economic conditions and social concerns [30].

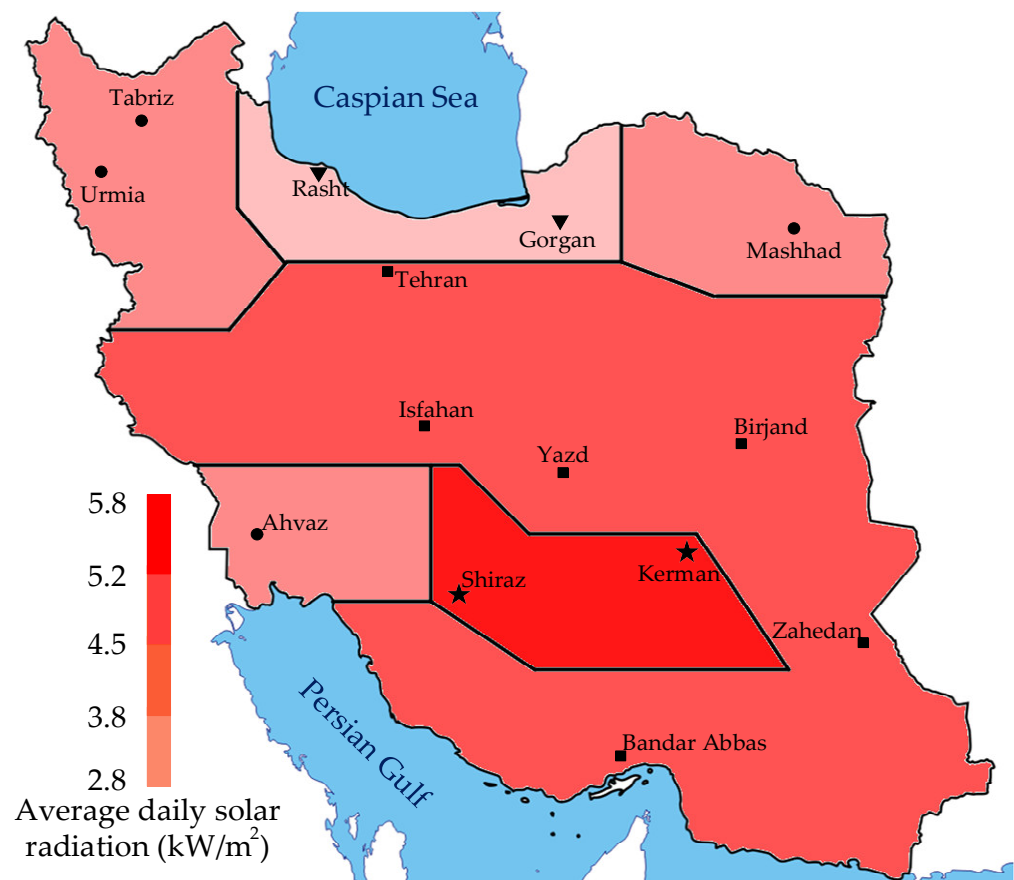

**Figure 2.** High solar potential in the arid/semi-arid areas of Iran.

According to the existing subsidies for fossil-fuel-based power plants, the electricity price is low, resulting in a sharp rise in demand. The situation is even worse in summer around noon due to the significant utilization of air conditioning systems [31]. In this

regard, Figure 3 illustrates the peak loads in summer and winter, shown by H1 and H2, for 2018–2022. It is seen that the summer's peak demand is ~42% greater than the winter's. This energy supply in summer at noon has become more severe since 2021. The investment in constructing new power plants has been reduced due to economic challenges; thus, the rising demand now surpasses the country's total delivered power. Several planned power cuts have been executed for residential and commercial facilities, three times a week with a ~2 h duration, to avoid large blackouts. At noon in the summer days of 2022 and 2023, distribution system operators exploited an energy management approach, i.e., the power of private companies was restricted to around 10% of their nominal demand. This led to adverse consequences on the economy, as companies had to reduce/stop the generation of their products from May to September.

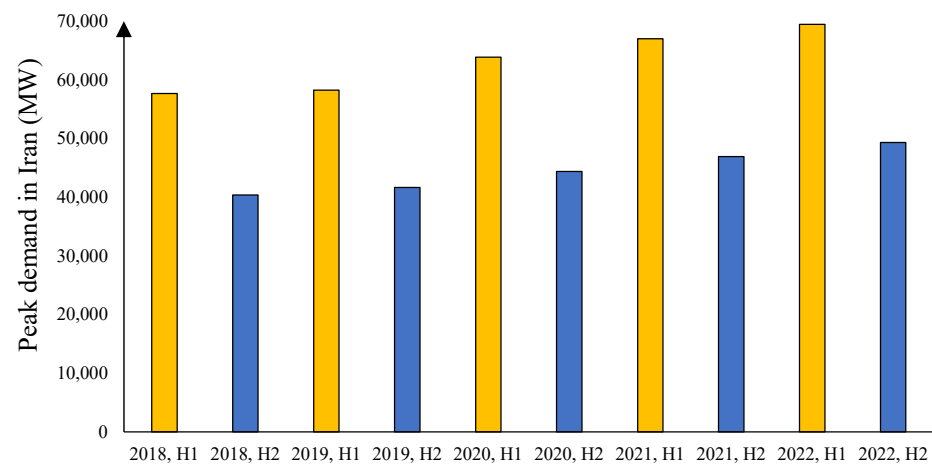

**Figure 3.** Iran's peak loads during summer and winter periods.

Fossil-fuel-based power plants and renewable energies can resolve the challenge of peak load in the summer at noon. The construction of new fossil-fuel-based power plants causes several issues, such as a cost burden, air pollution, and great transmission and distribution losses. Since this peak load challenge persists in summer at noon and not in cold weather, these units should also operate at low generation levels in winter, leading to several issues during operation (e.g., low efficiency) and maintenance. Therefore, this approach is not technically and economically feasible in such applications. Focusing on renewable energies, wind turbines and GCPVSs are widely employed among the existing technologies [32]. Due to the lack of high wind potential in arid/semi-arid areas, this resource cannot be extensively employed. Also, wind turbine generation relies on the wind regime and may not coincide with the peak load. Another solution is GCPVS technology, which contributes highly to supporting the peak demand at noon in summer.

The Iranian Ministry of Energy has legalized several supportive policies to encourage private and government-based individuals to construct GCPVSs. Figure 4 illustrates these incentives and their effects on the installed GCPVS capacity in this country. After an unsuccessful net metering experience during 2012–2014, a feed-in-tariff (FiT) framework was established where private investors could purchase all of a GCPVS's generated electricity for twenty years. Furthermore, the FiT rate increases annually regarding inflation and currency exchange rates. This FiT raise ensures project profitability under unstable economic conditions, as detailed in [33]. This promising policy has motivated the private sector, such that the total installed capacity jumped from 40 MW in 2014 to more than 600 MW at the end of 2022 [30].

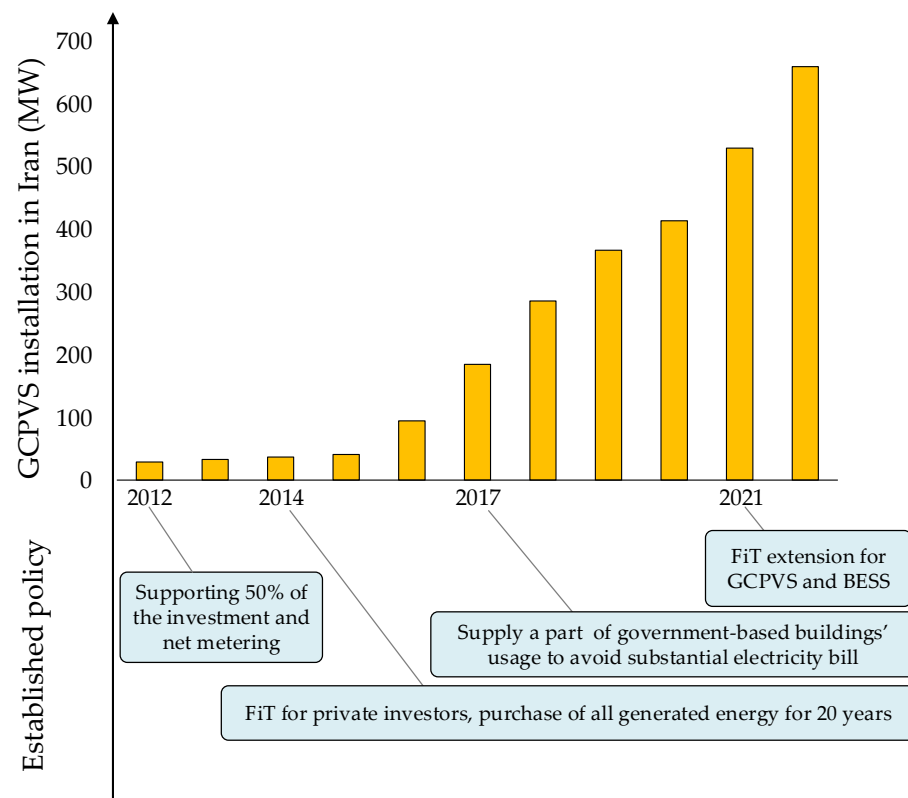

**Figure 4.** Incentive policies and their effects on GCPVS development in Iran.

Due to several (un)planned grid disconnections in summer around noon, the FiT policy was extended to hybrid systems in 2021, incorporating GCPVSs and BESSs [34]. Thus, the system owner benefits from purchasing the GCPVS yield under the FiT in grid-tied operation and supporting the domestic load through GCPVSs and BESSs when the grid is out of service.

Besides private investors, the integration of GCPVSs into government-based buildings has also been considered. In this perspective, the existing FiT is developed for government-based facilities, i.e., large buildings should support some of their electricity usage through GCPVSs. Otherwise, the tariff of this energy (up to 20% of last year's unshaved demand) is computed based on the GCPVS FiT, being almost ten times greater than the grid's purchased electricity. For the cases with limited space, the owner should install the maximum possible capacity considering the existing technologies in the market. This policy encourages various government-based facilities to adopt an energy management approach (i.e., reduce their electricity usage) and construct rooftop GCPVSs (i.e., peak load shaving). Moreover, the capacity is limited to avoid technical risks, e.g., to avoid disturbing the protection coordination and causing overvoltage.

## 2.2. Mashhad City Hall Building's Grid-Connected Photovoltaic System

The Mashhad Municipality is the largest organization in Mashhad city ( $36.2972^{\circ}$  N,  $59.6067^{\circ}$  E), with more than 100 buildings. According to the existing policy, this government-based facility installed rooftop GCPVSs on some buildings to avoid high electricity bills. The project's first phase was performed in 2020, where several 15 and 30 kW GCPVSs were commissioned at 11 sites. After this promising experience, the Municipality constructed several GCPVSs with larger nominal powers, i.e., around 20, 25, 50, and 100 kW, in the second phase. One of the ~50 kW projects was constructed on the Mashhad City Hall building and commissioned in May 2022. The capacity of this GCPVS was determined based on the available space on the rooftop.

The Mashhad City Hall project exploits 136 pcs of monocrystalline domestic solar modules with 375 W power under standard test condition (STC). These solar modules are then connected to two 25 kW grid-tie Fronius inverter units with single maximum power point tracking (MPPT). Table 1 presents the technical data of the solar module and inverter employed in the electrical design process. Further, Figures 5 and 6 depict the system's layout, including four parallel strings with seventeen series solar modules (per inverter) and an aerial view. The GCPVS contains DC and AC enclosures to protect the inverter and solar modules against overcurrent and overvoltage. Since the generation may exceed the demand at weekends, a bi-directional digital meter is used, i.e., the facility benefits from net metering.

**Table 1.** Detailed information on the PV module and inverter of the studied GCPVS.

TBM72-375M [35]		Fronius Eco 25.0-3-S [36]	
MPP power	375 W	MPP voltage range	580–850 V
MPP voltage	39.79 V	Maximum input voltage	1000 V
MPP current	9.43 A	Maximum input current	44.2 A
Open-circuit voltage	48.18 V	Maximum PV power	37.5 kW
Short-circuit current	9.91 A	Number of MPPT	1
Temperature coefficient of voltage	0.06%/°C	Maximum number of strings	6
Temperature coefficient of current	−0.30%/°C	Maximum output power	25 kW
Temperature coefficient of power	−0.39%/°C		

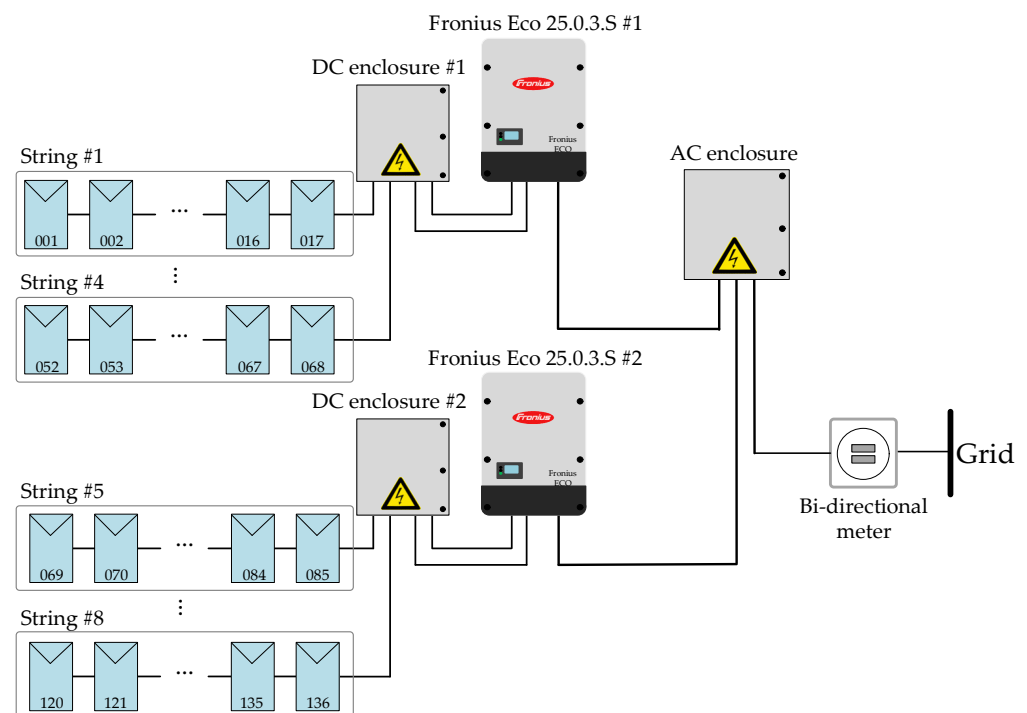

**Figure 5.** Electrical layout of the 51 kW GCPVS on the Mashhad City Hall building.

In addition to electrical design, the PV tables are oriented south with a 30° tilt to ensure maximum annual yield. The distance between the existing tables is large enough to minimize shading, i.e., only unavoidable shading at sunrise and sunset occurs. The AC output of the solar inverters is recorded with a 5 min resolution through an online Fronius platform. Also, the building demand is recorded every 15 min via the bi-directional meter. These data are used to assess the effect of the constructed GCPVS on the facility's demand.





**Figure 6.** Aerial view of the 51 kW GCPVS on the Mashhad City Hall building.

### 3. Peak Load Shaving Indicators

According to the recorded data of solar inverters and an electrical meter, the amount of shaved peak power ( $P_{SH}$ ) can be computed as follows:

$$P_{SH} = \frac{P_{L,max} - P_{GCPVS}}{P_{L,max}} \quad (1)$$

where  $P_{L,max}$  is the unshaved load's peak power. The GCPVS-generated power during this interval is also shown by  $P_{GCPVS}$ . It is evident that a greater  $P_{SH}$  leads to a higher shaved peak load (Figure 7). Also, the time resolution of the inverters' data recording (5 min) differs from that of the bi-directional meter (15 min). Hence, three consecutive samples of the inverters' power are averaged to align the time resolution.

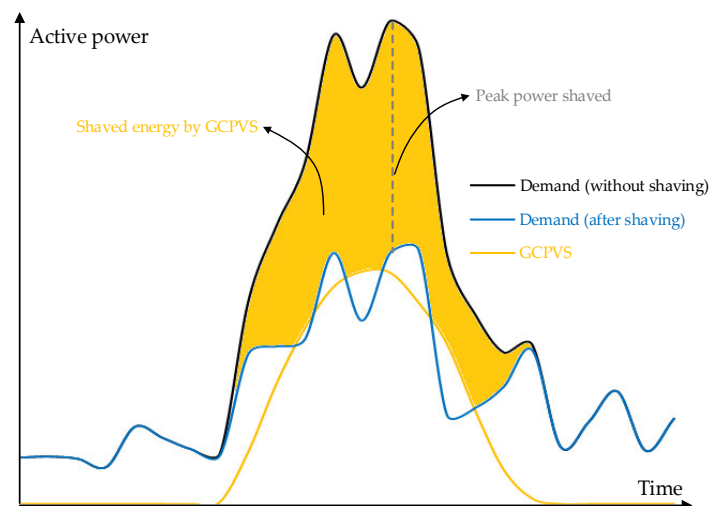

**Figure 7.** Peak power shaving and daily photovoltaic self-sufficiency concepts.

In addition, the photovoltaic self-sufficiency ( $PVSS$ ) can be determined as follows:

$$PVSS = \frac{E_L - E_G}{E_L} = \frac{E_{GCPVS}}{E_L} \quad (2)$$

where  $E_L$ ,  $E_G$ , and  $E_{GCPVS}$  are the daily/monthly/annual unshaved load energy, imported energy from the grid, and GCPVS-generated yield, respectively. This indicator demonstrates the GCPVS-supported energy in the desired time interval, e.g., daily, as shown in Figure 7.

Based on these two indicators, the effect of the constructed 51 kW GCPVS on the self-sufficiency and peak shaving of the Mashhad City Hall building's demand is evaluated in the next section.

#### 4. Experimental Results

This section assesses the effect of the 51 kW GCPVS on the peak shaving of the domestic demand. In this regard, the load profile of the case study building is analyzed for one year, i.e., after project commissioning. In addition to the peak power shaving of the building's load, the daily, monthly, and annually supported energy from the GCPVS are also studied.

##### 4.1. Peak Power Shaving

As noted earlier, the main gain of GCPVS construction in arid/semi-arid areas is peak load shaving in the summer at noon. Figure 8 demonstrates this impact, where the shaved peak load is shown for 22 June–22 September 2022, excluding the weekends and holidays.

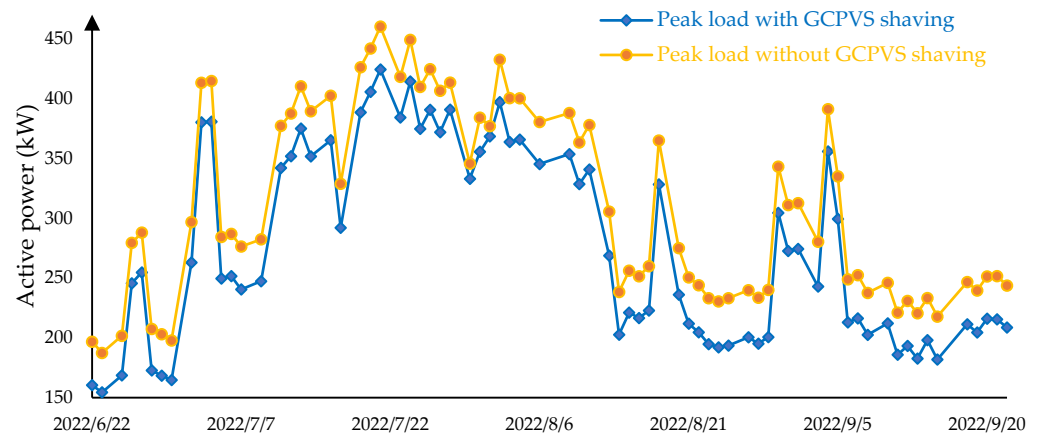

**Figure 8.** Shaved peak power of the studied building in summer at noon.

The outputs highlight that the maximum peak power is cut off by 18.48% at noon in the summer, while the average peak power shaving is 12.17%.

Focusing on the daily load profile, Figure 9 shows the effect of the installed GCPVS on the grid's supported power for a few working days in different seasons. The waveforms indicate the high active power of the studied building in summer at noon, as seen for, e.g., 22 August. The GCPVS shaves ~39 kW of the ~405 kW peak load, highlighting its notable contribution due to the great amount of received solar irradiance.

##### 4.2. Self-Sufficiency

According to the existing policy for government-based facilities and available space, GCPVSs can supply some part of the domestic usage of such buildings. Thus, the amount of imported energy from the grid and the energy yield of the 51 kW GCPVS are considered within monthly and yearly timeframes. Figure 10 displays the outputs for the monthly GCPVS self-sufficiency. It is readily seen from these outputs that the maximum monthly GCPVS yield occurs on August 2022, with 9.99 MWh and 8.9% self-sufficiency (111.71 → 101.725 MWh). The monthly GCPVS self-sufficiency is 7.5–14.2%, 10.2% on average.

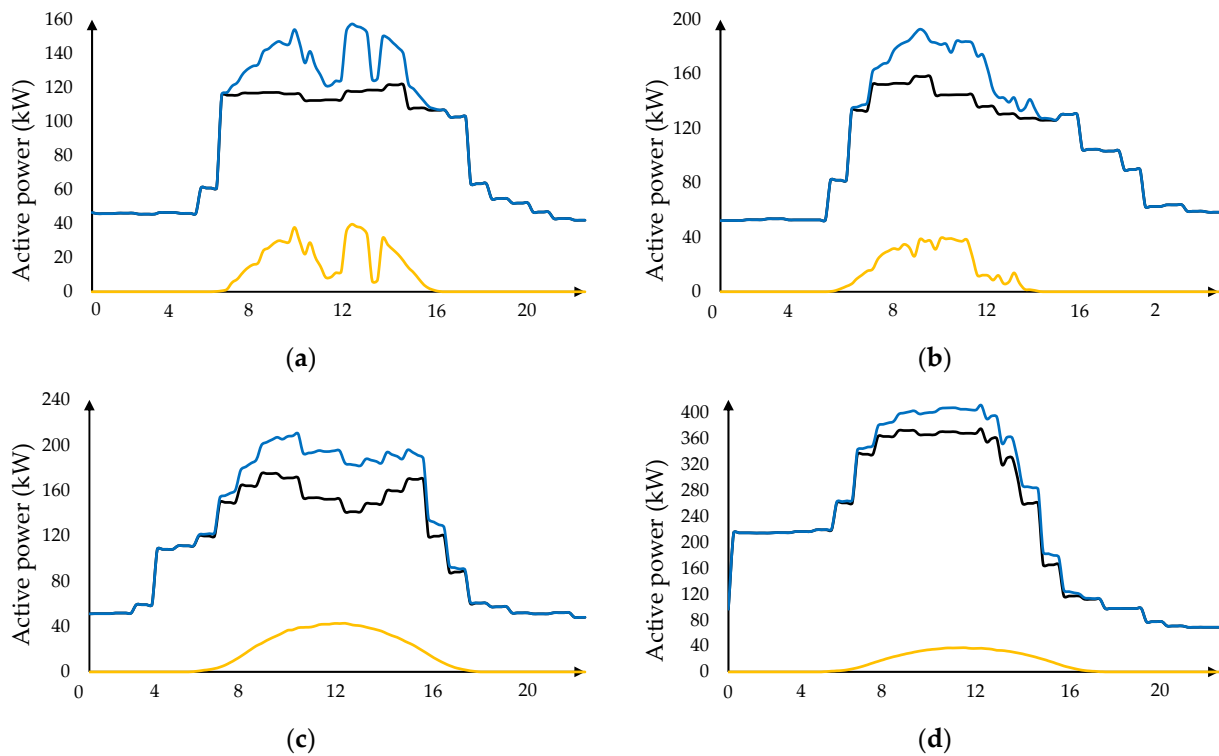

**Figure 9.** Effect of the installed GCPVS on the daily load profile (GCPVS generation is shown by the orange line, the unshaved demand is shown with the blue line, and the shaved load is shown with the black line): (a) 23 October 2022, (b) 22 January 2023, (c) 22 April 2023, and (d) 22 August 2022.

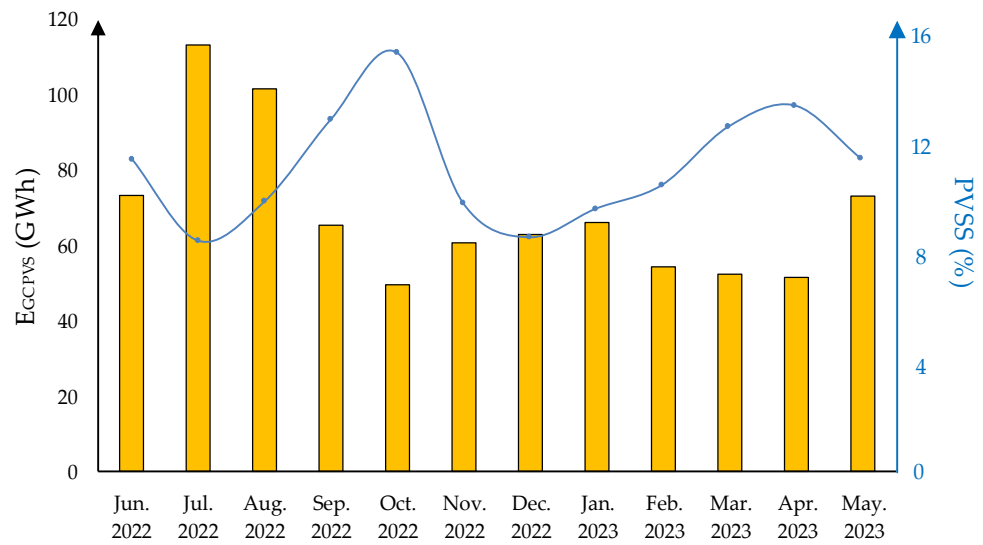

**Figure 10.** GCPVS energy generation and self-sufficiency.

In addition, an analysis of the one-year recorded data demonstrates that the GCPVS generates 90.694 MWh in this measurement timeframe, representing 10.99% self-sufficiency of the 825.251 MWh domestic load.

What stands from the presented analysis is that this GCPVS effectively shaves the peak load profile with reasonable self-sufficiency. Thus, this technology can solely be used in arid areas without necessitating a BESS. To this end, the outputs can be extrapolated for other arid regions, depending on the local economy, solar potential, and electricity rate. Table 2 presents the suggested policies (i.e., net metering, fixed FiT, and dynamic FiT) for a few arid countries. According to this table, we can see the following:

**Table 2.** Proposed policies for a few arid countries regarding constructing GCPVSS for peak load shaving.

Country	Economic Condition [37] <sup>1</sup>	Solar Potential (kWh/kWp) [38]	Household Electricity Rate (Cent EUR/kWh) [39]	Proposed Policy
Qatar	Stable (−2.5 to 5.0%)	4.8–4.9	3.0	Fixed FiT
UAE	Stable (−2.1 to 4.8%)	4.9–5.1	7.4	Fixed FiT
Saudi Arabia	Stable (2.5 to 3.4%)	4.9–5.1	4.4	Fixed FiT
Oman	Stable (−0.6 to 2.5%)	4.9–5.1	2.4	Fixed FiT
Bahrain	Stable (−2.3 to 3.6%)	4.7–4.9	4.4	Fixed FiT
Iraq	Stable (0.6 to 4.0%)	4.5–5.1	1.4	Fixed FiT
Egypt	Unstable (4.5 to 24.4%)	5.0–5.5	1.6	Dynamic FiT
Spain	Stable (0.5 to 10.8%)	4.1–4.6	22.0	Net metering
Turkey	Unstable (11.4 to 85.5%)	4.0–4.7	4.7	Dynamic FiT
Australia	Stable (0.9 to 6.6%)	4.9–5.3	26.0	Net metering
Mexico	Stable (3.4 to 7.9%)	4.4–5.4	10.0	Fixed FiT

<sup>1</sup> Inflation rate range during 2020–2023 [37].

- The fixed FiT policy can be adopted for countries with stable economic conditions and a low electricity rate, e.g., most Middle Eastern countries located in the south of the Persian Gulf. Therefore, the owner sells the GCPVSS's generated energy at an interesting price (i.e., greater than the electricity rate).
- An increasing FiT rate over the contract term, named a dynamic FiT, can be used for countries with unstable economic conditions and a low electricity rate. In countries such as Turkey and Egypt, the net present value of the future incomes drops notably. Thus, this FiT rate increase covers the drop in the income's net present value [33].
- Finally, countries with a high electricity rate can adopt the net metering approach so that GCPVSSs supply some/all of the domestic load. Hence, the owner benefits from reduced electricity bills.

## 5. Conclusions

The increasing deployment of air conditioning systems in summer at noon has become a challenge in hot regions. This peak power, which does not persist in winter, should be supplied to avoid blackouts in the power system. As a practical solution, GCPVSSs can solely shave the peak load due to the tremendous solar potential of arid areas at noon in summer. To this end, this paper deals with a peak load shaving assessment of residential and commercial buildings in arid areas by employing a GCPVSS. The details of the studied building with 470 kW peak power and a 51 kW installed GCPVSS are initially described. Contrary to the existing works, the presented study exploits one-year high-resolution recorded data to boost the results' reliability. The outputs reveal effective peak power shaving in the studied case, reaching up to 18.45% in the summer at noon, supporting nearly 11% of the annual demand.

According to the outputs of this case study, valuable insights and recommendations are presented for regions with the same challenge (i.e., peak power in summer at noon) and opportunities (high solar potential). To this end, the effective peak load shaving of successful projects, such as in the presented study, can motivate other individuals to construct GCPVSSs. According to the results, policymakers can also legalize an actionable incentive for encouraging private and government-based investors to construct GCPVSSs. In addition to the economic conditions of the location, the electricity rate and solar potential should be considered in the regulation of incentive policies.

This paper can be enhanced in several aspects by future work. Future work could analyze the GCPVSS from socio-economic-environmental standpoints. Hence, further merits of this technology would be highlighted, motivating more private and government-based

individuals to act. Optimization can also be performed in future studies to find the optimum GCPVS size (e.g., number of inverters and PV modules), design (e.g., number of strings and series PV modules per string), and layout (e.g., azimuth and tilt angles of the PV tables) for the maximum peak load shaving. In addition to the characteristics of the GCPVS's components and site, the load profile is expected to affect the optimum solution.

**Author Contributions:** Conceptualization, R.B.-J.; methodology, R.B.-J. and S.M.S.M.; validation, R.B.-J. and S.M.S.M.; resources, S.M.S.M.; writing—original draft preparation, R.B.-J.; writing—review and editing, S.M.S.M.; supervision, R.B.-J. All authors have read and agreed to the published version of the manuscript.

**Funding:** This research received no external funding.

**Institutional Review Board Statement:** Not applicable.

**Informed Consent Statement:** Not applicable.

**Data Availability Statement:** The data presented in this study are available on request from the corresponding author.

**Conflicts of Interest:** The authors declare no conflicts of interest.

## References

1. Bollino, C.A.; Asdrubali, F.; Polinori, P.; Bigerna, S.; Micheli, S.; Guattari, C.; Rotili, A. A note on medium- and long-term global energy prospects and scenarios. *Sustainability* **2017**, *9*, 833. [CrossRef]
2. World Energy Outlook 2023. 2023. Available online: <https://www.iea.org/reports/world-energy-outlook-2023> (accessed on 16 April 2024).
3. Space Cooling. Available online: [www.iea.org/energy-system/buildings/space-cooling](http://www.iea.org/energy-system/buildings/space-cooling) (accessed on 4 April 2024).
4. Minoofar, A.; Gholami, A.; Eslami, S.; Hajizadeh, A.; Gholami, A.; Zandi, M.; Ameri, M.; Kazem, H.A. Renewable energy system opportunities: A sustainable solution toward cleaner production and reducing carbon footprint of large-scale dairy farms. *Energy Convers. Manag.* **2023**, *293*, 117554. [CrossRef]
5. Cumulative Installed Solar PV Capacity Worldwide from 2000 to 2022. Available online: <https://www.statista.com/statistics/280220/global-cumulative-installed-solar-pv-capacity/> (accessed on 16 April 2024).
6. Bakhshi-Jafarabadi, R.; Sadeh, J.; Serrano-Fontova, A.; Rakhshani, E. Review on islanding detection methods for grid-connected photovoltaic systems, existing limitations and future insights. *IET Renew. Power Gener.* **2022**, *16*, 3406–3421. [CrossRef]
7. Mohajer, F.; Kargar, H.K.; Salemnia, A.; Sadeh, J. Setting groups-based overcurrent relays coordination considering distributed generations uncertainties. In Proceedings of the 2023 International Conference on Protection and Automation of Power Systems (IPAPS), Tehran, Iran, 24–25 January 2023; pp. 1–6.
8. León, L.F.; Martinez, M.; Ontiveros, L.J.; Mercado, P.E. Devices and Control strategies for voltage regulation under influence of photovoltaic distributed generation. a review. *IEEE Lat. Am. Trans.* **2022**, *20*, 731–745. [CrossRef]
9. Cucchiella, F.; Rotilio, M.; Capannolo, L.; De Berardinis, P. Technical, economic and environmental assessment towards the sustainable goals of photovoltaic systems. *Renew. Sustain. Energy Rev.* **2023**, *188*, 113879. [CrossRef]
10. Khourchid, A.M.; Al-Ansari, T.A.; Al-Ghamdi, S.G. Cooling energy and climate change nexus in arid climate and the role of energy transition. *Buildings* **2023**, *13*, 836. [CrossRef]
11. de Oliveira e Silva, G.; Hendrick, P. Photovoltaic self-sufficiency of Belgian households using lithium-ion batteries, and its impact on the grid. *Appl. Energy* **2017**, *195*, 786–799. [CrossRef]
12. Kelepouris, N.S.; Nousedilis, A.I.; Bouhouras, A.S.; Christoforidis, G.C.; Yerasimou, Y.; Chatzigeorgiou, N.G.; Georghiou, G.E.; Celli, G.; Mocci, S.; Gal, E.; et al. Impact of demand side management on the self-sufficiency and self-consumption of buildings with photovoltaic and storage systems. In Proceedings of the 2021 9th International Conference on Modern Power Systems (MPS), Cluj-Napoca, Romania, 16–17 June 2021; pp. 1–6.
13. Pater, S. Increasing energy self-consumption in residential photovoltaic systems with heat pumps in Poland. *Energies* **2023**, *16*, 4003. [CrossRef]
14. Qiu, Z.; Luo, Y.; Wang, Y.; Wang, Y.; Mao, Y.; Li, C. Battery energy storage application: Regulation and peak shaving for a photovoltaic-equipped community. In Proceedings of the 2022 IEEE 6th Conference on Energy Internet and Energy System Integration (EI2), Chengdu, China, 11–13 November 2022; pp. 2089–2094.
15. Thango, B.A.; Bokoro, P.N. Battery Energy Storage for Photovoltaic Application in South Africa: A Review. *Energies* **2022**, *15*, 5962. [CrossRef]
16. Schram, W.L.; Lampropoulos, I.; van Sark, W. Photovoltaic systems coupled with batteries that are optimally sized for household self-consumption: Assessment of peak shaving potential. *Appl. Energy* **2018**, *223*, 69–81. [CrossRef]
17. Jankowiak, C.; Zacharopoulos, A.; Brandoni, C.; Keatley, P.; MacArtain, P.; Hewitt, N. Assessing the benefits of decentralised residential batteries for load peak shaving. *J. Energy Storage* **2020**, *32*, 101779. [CrossRef]

18. Abul'Wafa, A.R. Energy storage sizing for rooftop grid-connected PV system. *Electr. Power Compon. Syst.* **2017**, *45*, 331–343. [CrossRef]
19. Dufo-López, R.; Bernal-Agustín, J.L. Techno-economic analysis of grid-connected battery storage. *Energy Convers. Manag.* **2015**, *91*, 394–404. [CrossRef]
20. Worighi, I.; Geury, T.; El Baghdadi, M.; Van Mierlo, J.; Hegazy, O.; Maach, A. Optimal design of hybrid PV-battery system in residential buildings: End-user economics, and PV penetration. *Appl. Sci.* **2019**, *9*, 1022. [CrossRef]
21. Díaz-González, F.; Chillón-Antón, C.; Llonch-Masachs, M.; Galceran-Arellano, S.; Rull-Duran, J.; Bergas-Jané, J.; Bullich-Massagué, E. A hybrid energy storage solution based on supercapacitors and batteries for the grid integration of utility scale photovoltaic plants. *J. Energy Storage* **2022**, *51*, 104446. [CrossRef]
22. Ashoornezhad, A.; Falaghi, H.; Hajizadeh, A.; Ramezani, M. Feasibility study on the integration of residential PV-battery systems in system peak load shaving: A case study in Iran. *IET Gener. Transm. Distrib.* **2023**, *17*, 3100–3113. [CrossRef]
23. Alkelbi, A.M.; Abbas, M.; Eltamaly, A.M. Economical study on load shaving by PV implementation for bulk customers in Riyadh. In Proceedings of the 2021 6th International Conference on Renewable Energy: Generation and Applications (ICREGA), Al Ain, United Arab Emirates, 2–4 February 2021; pp. 237–242.
24. Syafii; Zaini; Juliandri, D.; Akbar, Y. Design of PV system for electricity peak-shaving: A case study of faculty of engineering, Andalas university. In Proceedings of the 2018 International Conference on Computing, Power and Communication Technologies (GUCON), Greater Noida, India, 28–29 September 2018; pp. 294–298.
25. Wang, R.; Lam, C.M.; Alvarado, V.; Hsu, S.-C. A modeling framework to examine photovoltaic rooftop peak shaving with varying roof availability: A case of office building in Hong Kong. *J. Build. Eng.* **2021**, *44*, 103349. [CrossRef]
26. Ceran, B.; Jurasz, J.; Mielcarek, A.; Campana, P.E. PV systems integrated with commercial buildings for local and national peak load shaving in Poland. *J. Clean. Prod.* **2021**, *322*, 129076. [CrossRef]
27. Jurasz, J.; Campana, P.E. The potential of photovoltaic systems to reduce energy costs for office buildings in time-dependent and peak-load-dependent tariffs. *Sustain. Cities Soc.* **2019**, *44*, 871–879. [CrossRef]
28. Bakhshi-Jafarabadi, R.; Sadeh, J.; Soheili, A. Global optimum economic designing of grid-connected photovoltaic systems with multiple inverters using binary linear programming. *Sol. Energy* **2019**, *183*, 842–850. [CrossRef]
29. Aien, M.; Mahdavi, O. On the way of policy making to reduce the reliance of fossil fuels: Case study of Iran. *Sustainability* **2020**, *12*, 606. [CrossRef]
30. Mehrsun National Platform. Available online: [www.solar.meedc.ir/cp/home](http://www.solar.meedc.ir/cp/home) (accessed on 28 March 2024).
31. Asadi, M.; Larki, I.; Foroootan, M.M.; Ahmadi, R.; Farajollahi, M. Long-term scenario analysis of electricity supply and demand in Iran: Time series analysis, renewable electricity development, energy efficiency and conservation. *Sustainability* **2023**, *15*, 4618. [CrossRef]
32. IEA. *Renewables 2023*; IEA: Paris, France, 2024.
33. Bakhshi, R.; Sadeh, J. Economic evaluation of grid-connected photovoltaic systems viability under a new dynamic feed-in tariff scheme: A case study in Iran. *Renew Energy* **2018**, *119*, 354–364. [CrossRef]
34. Bakhshi-Jafarabadi, R.; Keramatpour, A. Economic assessment of residential hybrid photovoltaic-battery energy storage system in Iran. In Proceedings of the 2022 9th Iranian Conference on Renewable Energy & Distributed Generation (ICREDG), Mashhad, Iran, 23–24 February 2022; pp. 1–5.
35. TBM72-375M Datasheet. Available online: [www.tabanenergy.ir/wp-content/pdf/catalogue5BB-Mono-Feb2019.pdf](http://www.tabanenergy.ir/wp-content/pdf/catalogue5BB-Mono-Feb2019.pdf) (accessed on 29 March 2024).
36. Fronius Eco 25.0-3-S Datasheet. Available online: [www.fronius.com/en/solar-energy/installers-partners/technical-data/all-products/inverters/fronius-eco/fronius-eco-25-0-3-s](http://www.fronius.com/en/solar-energy/installers-partners/technical-data/all-products/inverters/fronius-eco/fronius-eco-25-0-3-s) (accessed on 29 March 2024).
37. International Monetary Fund Inflation Rate, Average Consumer Prices. Available online: [https://www.imf.org/external/datamapper/PCPIPCH@WEO/WEO\\_WORLD](https://www.imf.org/external/datamapper/PCPIPCH@WEO/WEO_WORLD) (accessed on 30 May 2024).
38. Global Solar Atlas. Available online: <https://globalsolaratlas.info> (accessed on 30 May 2024).
39. Global Petrol Prices Electricity Prices for Households. Available online: [https://www.globalpetrolprices.com/electricity\\_prices](https://www.globalpetrolprices.com/electricity_prices) (accessed on 30 May 2024).

**Disclaimer/Publisher's Note:** The statements, opinions and data contained in all publications are solely those of the individual author(s) and contributor(s) and not of MDPI and/or the editor(s). MDPI and/or the editor(s) disclaim responsibility for any injury to people or property resulting from any ideas, methods, instructions or products referred to in the content.