

Unit exergy cost and specific CO₂ emissions of the electricity generation in the Netherlands

Silva Ortiz, Pablo; Flórez-Orrego, Daniel; de Oliveira Junior, Silvio; Maciel Filho, Rubens; Osseweijer, Patricia; Posada, John

DOI

[10.1016/j.energy.2020.118279](https://doi.org/10.1016/j.energy.2020.118279)

Publication date

2020

Document Version

Final published version

Published in

Energy

Citation (APA)

Silva Ortiz, P., Flórez-Orrego, D., de Oliveira Junior, S., Maciel Filho, R., Osseweijer, P., & Posada, J. (2020). Unit exergy cost and specific CO₂ emissions of the electricity generation in the Netherlands. *Energy*, 208, Article 118279. <https://doi.org/10.1016/j.energy.2020.118279>

Important note

To cite this publication, please use the final published version (if applicable).
Please check the document version above.

Copyright

Other than for strictly personal use, it is not permitted to download, forward or distribute the text or part of it, without the consent of the author(s) and/or copyright holder(s), unless the work is under an open content license such as Creative Commons.

Takedown policy

Please contact us and provide details if you believe this document breaches copyrights.
We will remove access to the work immediately and investigate your claim.

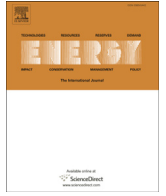

Unit exergy cost and specific CO₂ emissions of the electricity generation in the Netherlands

Pablo Silva Ortiz^{a, b, *}, Daniel Flórez-Orrego^{c, d}, Silvio de Oliveira Junior^c,
Rubens Maciel Filho^a, Patricia Osseweijer^b, John Posada^b

^a Laboratory of Optimization, Design and Advanced Control, School of Chemical Engineering, University of Campinas, Campinas, Brazil

^b Faculty of Applied Sciences, Department of Biotechnology, Delft University of Technology, Delft, the Netherlands

^c Laboratory of Environmental and Thermal Engineering, Department of Mechanical Engineering, Polytechnic School, University of São Paulo, São Paulo, Brazil

^d Bioprocesses and Reactive Flow, Faculty of Minas, National University of Colombia, Medellin, Colombia

ARTICLE INFO

Article history:

Received 9 December 2019

Received in revised form

30 May 2020

Accepted 29 June 2020

Available online 7 July 2020

Keywords:

Exergy analysis

CO₂ emissions

Renewable exergy cost

Non-renewable exergy cost

Dutch electricity mix

ABSTRACT

Exergy and environmental analyses have been developed to determine the performance of the electricity generation in the Dutch mix. A comparative assessment of diverse technological routes, including fossil and renewable energy resources consumption, is carried out in terms of the exergy costs and specific CO₂ emissions. Hence, an exergoeconomy methodology is used to properly allocate the renewable and non-renewable exergy costs and specific CO₂ emissions among the various products of the polygeneration energy systems. By using a suitable methodology, the distribution of irreversibility throughout the different steps of the energy conversion processes of the Dutch electricity mix is characterized in the light of the Second Law of Thermodynamics. The results may help to propose performance indicators that support the Dutch government and research institutions. To identify sustainable energy planning strategies and fairly comparing electricity generation and end-use processing stages with other types of energy resources, such as fuels used in transportation, residential and industrial sectors. In brief, the weighted average of the renewable and non-renewable unit exergy costs and the specific CO₂ emissions of the electricity generated in each route of the Dutch mix is calculated and compared to another electricity mix with a higher share of renewable energy resources. The weighted average renewable and non-renewable unit exergy costs of the electricity generated in the Netherlands are calculated as $c_R = 0.8375$ kJ/kJ_{E/W} and $c_{NR} = 1.7180$ kJ/kJ_{E/W}, respectively ($c_R/c_{NR} = 0.49$). Furthermore, the specific CO₂ emissions in the Dutch electricity generation achieve 373.21 gCO₂/kWh_{E/W}.

© 2020 The Authors. Published by Elsevier Ltd. This is an open access article under the CC BY license (<http://creativecommons.org/licenses/by/4.0/>).

1. Introduction

According to the International Energy Agency, the share of electricity in the final energy consumption is foreseen to rapidly grow in the next decades, going from a global electricity consumption of 26,615 TWh in 2018 up to an expected consumption of 42,500 TWh by 2040 [1]. Nevertheless, electricity is not a primary energy source, and its generation efficiency and emissions should

be assessed in the conversion process to allow fair comparisons with other kinds of energy resources. In fact, in the case of fossil energy-based power generation systems, it is evident that the direct greenhouse gas (GHG) emissions are inherent to their operation. However, technologies such as renewable energy-based plants may still be responsible for a considerable amount of indirect CO₂ emissions, which encourages strategies for improving the energy conversion efficiencies of these routes, especially at the upstream and downstream processes [2]. Hence, it is essential to appropriately assess the costs and impacts of the energy resources used in electricity generation, aiming to identify and pursue the most sustainable energy alternatives.

Some authors have studied the electricity generation for several countries applying the Life Cycle Analysis (LCA) approach. For instance, Turconi et al. [3] carried out a critical review of 167 case

* Corresponding author. Laboratory of Optimization, Design and Advanced Control, School of Chemical Engineering, University of Campinas, Campinas, Brazil.

E-mail addresses: p.silvaortiz@tudelft.nl, pabloaso@unicamp.br (P. Silva Ortiz), daflorezo@usp.br, daflorezo@unal.edu.co (D. Flórez-Orrego), soj@usp.br (S. de Oliveira Junior), rmaciel@unicamp.br (R. Maciel Filho), p.osseweijer@tudelft.nl (P. Osseweijer), j.a.posadaduque@tudelft.nl (J. Posada).

| Nomenclature | | | |
|-------------------------------|--|------------------------------------|--|
| <i>Acronyms/Abbreviations</i> | | E | energy rate or flow rate (kW) |
| bcm | billion cubic meters | E/W | electricity (kWh) or power (kW) |
| Const. | construction step | I | fuel carbon content (% weight) |
| CExC | cumulative exergy consumption | m | direct CO ₂ emissions (g _{CO2} /s) |
| CHP | combined heat and power | r | exergy consumption (kJ/kJ) |
| EEA | extended exergy accounting | Rc | CO ₂ to elemental carbon molecular weight ratio |
| LCA | life cycle analysis | T | temperature (C, K) |
| LCI | life cycle inventories | <i>Subscripts and superscripts</i> | |
| LNG | liquefied natural gas | CH | chemical exergy |
| GE&UK: | German and English electricity mixes | Cons | consumed fuel |
| GHG | greenhouse gas emissions | CO ₂ | carbon dioxide emission |
| TPES | total primary energy supply | en | energy |
| MtCO ₂ | metric tons of carbon dioxide equivalent | ex | exergy |
| Mtoe | million tonnes of oil-equivalent | F | processed fuel |
| <i>Latin symbols</i> | | <i>i</i> | <i>i</i> -th step |
| c | unit exergy cost (kJ/kJ) | <i>n</i> | <i>n</i> -th step |
| B | exergy rate or flow rate (kW) | NG | natural gas |
| b | specific exergy (kJ/kg) | NR | non-renewable |
| | | R | renewable |
| | | T | total |

studies involving the LCA of electricity generation based on hard coal, lignite, natural gas, oil, nuclear, biomass, hydroelectric, solar photovoltaic, and wind. Direct emissions from plant operation represented the majority of the life cycle emissions for fossil fuel technologies. In contrast, fuel provision represented the largest contribution for biomass technologies and nuclear power, whereas infrastructures provided the highest impact for renewables. Similarly, Itten et al. [4] reviewed a series of Life Cycle Inventories (LCI) for electricity mixes of selected countries. The inventories are based on data of the Swiss electricity grid using the Eco-points indicator. More recently, Rugani et al. [5] describe the progress towards consensus building in the LCA domain regarding the assessment of anthropogenic impacts on ecosystems and their associated services for human well-being. Meanwhile, Kiss et al. [6] presented a method for linking a detailed economic model and LCA to evaluate both intra-annual and long-term variations in the environmental impact of grid electricity. The model was applied for the case study of Hungary for three future scenarios. The “Decarbon” and “Delayed” scenarios include an emission reduction target of 94% for 2050 compared to 1990 for the EU with less intensive support of renewables until 2035 in the “Delayed” scenario.

A limitation inherent to the previous analyses lies in the thermodynamic energy quality, *i.e.*, when the value of the electric energy must be compared with thermal energy [7]. In order to deal with this problem, some energy forms, such as electricity, are often converted into ‘equivalent primary energy’ by using conversion factor-based procedures. This approach does not represent a severe inconvenience when only one input and one output, such as fuel and electricity, are considered. On the other hand, few studies have used the renewable and non-renewable unit exergy costs and specific CO₂ emissions as appropriated indicators for energy conversion systems, let alone the characterization of the Dutch electricity mix. In the following section, the particularities of each allocation method are briefly discussed to shed light on the advantages of the exergy costing method.

1.1. Mass-based allocation

Agricultural and industrial processes have ever dealt with the

problem of allocating the energy expenditure and atmospheric emissions among the various products of a polygeneration plant, especially when a residue can be considered either as feedstock, byproduct, or final product [8]. However, due to the unevenly distributed mass yields, along with radically different energy contents of products and by-products (*e.g.*, biodiesel and glycerol; also vinasse, bagasse, sugar, and ethanol), mass-based methodologies may fail to rationally apportion the energy intensity and the environmental burden, more specifically, among the bulkiest co-products of the polygeneration facilities [9]. Additionally, certain co-products may not be fully available to be commercialized, needing further processing before it could be capitalized on them. It renders mass-based allocation an unsuitable criterion to elucidate the underlying relationships between products and co-products from efficiency and economic point of view. Other authors observed that mass allocation is unsuitable for non-mass products like electricity [10]. Some authors also consider mass allocation as deprecated to allocate emissions between co-products, *e.g.*, biogas and digestate, as long as it draws more attribution to the digestate as the by-product than on energy as the primary product [11]. In contrast, in the surplus methods, co-products are thought of as burden-free and, therefore, regarded as waste, which contrasts with the variety of applications of some material and energy effluents [10].

1.2. Energy-based allocation

There have been several attempts to apportion the energy costs among the different products of the cogeneration plants by using methods based on the First Law of Thermodynamics [12]. As it concerns the bare cost formation for power and thermal energy generated at a combined heat and power (CHP) plant in Denmark, two approaches are reportedly used [13]. On the one hand, there is an economical approach, which relies on the comparison of alternative schemes for the production of thermal energy and electricity. The second one is based on the fact that electrical power decreases when there is a transition from condensing operation mode to a steam extraction mode. Thus, the latter approach uses the derating factor of the steam turbine for calculation of cost

indicators. Other approaches consider that the heat generated at a CHP is energetically equal to the heat produced at a boiler house. In other words, the specific fuel consumption at CHP and boiler house is set as equal regarding the thermal energy, whereas the remainder fuel consumption is charged to the electrical energy, such as that adopted in Russia [14].

However, those accounting methodologies reportedly ignore the versatility (*i.e.*, higher quality) of more ordered energy forms, such as power, concerning those related to low-grade waste heat transfer at lower temperatures [15]. For instance, by considering average efficiencies of both electricity generation (25–50%) and steam production in fired boilers (50–90%), some studies have assumed that the amount of fuel required to generate each unit of electricity is as much as twice the required to generate each unit of heat [16]. Consequently, the carbon intensity of electricity is fixed at twice that of steam, which clearly misleads purchasers of steam, electricity, or even of CO₂ captured to wrongly believe they are acquiring much lower or higher carbon-intensive supplies. Other authors consider that energy allocation is judged not appropriate when fuels, energy, and chemicals are produced at the same time, as well as when not all products may be energy products [17]. For example, without further assumptions, the energy allocation would not work for non-energy products that do not have a heating value [10]. Also, in the substitution methods, energy credits are assumed to be equal to the energy required to produce a substitute for the co-products [18], which depends on the particularities of the alternative production routes.

Meanwhile, based on the effort of the natural environment in providing resources for human activities to reach the societal well-being, the energy accounting suggested the relevance of allocating the biophysical consumption along the energy supply chains [19]. Emergy, measured in solar emjoules (*sej*), is defined as the available energy used up, directly and indirectly, to make a service or product [20]. In contrast, the emissions released into the environment by the whole productive process are reported in kg_{CO₂eq} (*i.e.*, a stream-wise allocation of emissions is not performed) [20]. Unfortunately, the obtainment of the variables required by the traditional emergy approach may turn into a difficult task due to the lack of trustable and complete statistical databases [19].

1.3. Exergy-based allocation

As it has been shown, the apportioning of costs and environmental burdens, based solely on the First Law considerations, may be misleading because the scale of quality of the energy can be only quantified by means of an entropy analysis. For instance, as pointed out by Szargut et al. [21], unreasonable results could be obtained if the apportioning of the exergy consumption over the useful products in complex processes is performed on a mass or energy basis. It could be argued that this approach would be acceptable if the products were similar (*e.g.* hydrocarbons distilled from crude oil), although some derivatives are more energy and, thus, emissions-intensive than others. Some authors arbitrarily recommend allocating 65% of the total refinery process energy to gasoline production, 20% to diesel production, and the remaining to the production of other refining products, without providing detailed analysis to support this adjustment [22]. However, inasmuch as heating values of refining products deviate slightly from that of crude oil, unexpected results may arise from inaccurate stream composition and heating content for intermediate streams [22]. Meanwhile, the allocation of the energy intensity and environmental impacts on the basis of market value is subject to volatility in product prices [17], political influences through subsidies [11], and other assumptions, such as weighing factors and similarity of some products with other commodities [22]. Thus, although it

considers the market drivers, the economic allocation, falls short of being universally applicable to systems where by-products do not yet have a market or prices rapidly fluctuate [23].

On the other hand, exergy costing brings about useful re-interpretations to basic economics engineering to include new terms in the economic balance. At the same time, it evaluates the energetic flows in light of the Second Law of Thermodynamics [24]. Thus, several authors have proposed a series of methodologies for rationally allocating the exergy consumption and the irreversibility arisen from industrial systems to the different streams of a multi-product process. Valero et al. [25] proposed the Exergy Cost Theory (*ECT*), a mathematical formalism that evaluates the costs of all internal flows of an energy system, either in exergy or monetary units, by using auxiliary allocation criteria. On the other hand, the Thermo-economic Functional Analysis (*TFA* [26]) also considers the role of the environment in which the energy system settles and the cost of the exergy losses arisen from dissipative equipment (negentropy) from an economic point of view. Other allocation methods based on the exergy concept include the Exergy Economics Approach (*EEA* [27]) and the Engineering Functional Analysis (*EFA* [28]), and the Structural Theory ([29]). More lately, the Specific Exergy Costing methodology (*SPECO* [30]) aimed to account for the net contributions and the net extractions from the exergy content in the mass and energy flow along with the industrial processes. In this way, the exergy contributions and extractions are parts of the fuel and product, respectively. All in all, none of the aforementioned methodologies accounts separately for the renewable and non-renewable exergy cost and specific CO₂ emissions. The first attempts date back to the works of Silva et al. [31] and Flórez-Orrego et al. [32] for the production of petroleum derivatives, biofuels, chemicals and electricity. More recently, Nascimento-Silva et al. [33] used this methodology to calculate the extended exergy cost and specific CO₂ emissions of the various products in offshore production platforms including enhanced oil recovery. Also, Silva-Ortiz et al. [34] present the process design and assessment of a bioenergy system that combines the usage of mass and heat integration strategies based on the exergy metric to enhance the process efficiency and renewability performance. The key performance indicators (KIPs) comprise the average unitary exergy cost (AUEC) and the exergy-based CO₂ emissions. Ptasinski et al. [35] evaluated the (i) *exploitation*, (ii) *transformation*, and (iii) *distribution of energy sub-sectors* by using performance indicators focused on energy, exergy and Cumulative Exergy Consumption (*CExC*) via the Extended Exergy Accounting (*EEA*) method for the Dutch energy sector. Finally, Iora et al. [36] presented a novel exergy loss based allocation method for the electricity produced in hybrid renewable-fossil power plants. Silva et al. [37] compared five allocation techniques commonly applied in the LCA approach with three thermo-economic allocation methods for pollutants and resources (fuel consumption). The comparison revealed that usually applied techniques for the allocation of emissions in LCA provided a wide variation between results (over 88%). In contrast, Thermo-economic methods provided less variation and yielded a more rational approach as the multi-product processes was disaggregated into its subsystems. Hence, the authors showed that merging thermo-economics and LCA methodologies provide a more in-depth and rational perspective for complex systems via an integrated analysis.

Accordingly, in this work, the exergy concept is used to properly split the unit exergy costs and CO₂ emissions among the energy resources involved in the Dutch electricity mix (namely, natural gas, oil-derived products, coal, nuclear, and renewables). Since some resources and the electricity itself are consumed in previous energy conversion steps, the exergy expenditure, as well as the direct and indirect CO₂ emissions can be iteratively calculated for all

the streams involved. This allows mapping the cost formation along the conversion processes composing the electricity mix. In this context, this work aims to assess the exergy and environmental performance of the electricity mix in the Netherlands vis-à-vis other reportedly cleaner electricity mixes, such as the Brazilian electricity mix, by using energy resources with different characteristics [38].

1.4. Overview of the Dutch energy sector and electricity mix

The Dutch strategy aims to ensure energy security and reduce emissions from the domestic energy sector. To this end, a mandatory target, recently introduced in the Netherlands, has encouraged the use of renewables, so that the contribution of those energy resources to the final energy consumption achieves 16% by 2023 [39]. A breakdown of the renewable and non-renewable energy consumption in the Dutch energy mix is shown in more detail in Fig. 1. As it can be seen, the total primary energy consumption in the Netherlands amounted to 84.8 million tonnes of oil equivalent (Mtoe) in 2018, primarily dominated by fossil energy resources [40]. It explains the fact that, despite the continuous reduction of the Dutch CO₂ emissions in the last years, the domestic emissions still represents almost 6% of the total emissions in the European Union (EU), according to the comparative evolution of the overall CO₂ emissions from the Netherlands, the EU and the World economic activities from 2010 to 2018 shown in Table 1 [40,41]. In this context, the goal of the *Dutch Operational Energy Strategy* is to reduce the dependency on fossil fuels and the associated CO₂ emissions by 20% in 2030 [42].

1.5. An overview of the Dutch electricity mix

According to Table 2, the electricity generation in the Netherlands attained 118 TWh in 2018, which represents a reduction of 3.3% compared to 2010 and stands for one of the most significant annual contraction over the last decade [40]. Table 2 also shows the evolution of the contribution of renewable energy resources to the Dutch electricity generation [40,41]. Following the global trend, in both the European Union and the Netherlands, renewable energy resources have increased their participation in power generation applications, partly motivated by the commitment to climate change mitigation protocols. Notwithstanding, further efforts must be focused on the transition towards a more diversified and clean electricity mix.

Fig. 2 presents the breakdown of the Dutch electricity mix by energy source, which evidences the dominance of fossil fuels (e.g., natural gas and coal), partially explained by the successful national oil and gas industry. Other sources include the pumped hydro and

non-renewable waste energy, solar energy, wind farms, and biomass-based plants. According to this figure, natural gas accounted for 48.8% (57.3 TWh) of the electrical energy generation in 2018, while coal achieved 25.5% (30 TWh). As for the former, the electricity generated has experienced only a marginal growth of 0.5% since 2002, while electricity from coal and oil has decreased by 5.9% and 51.5%, respectively [43]. Nuclear energy achieved 3.0% (3.5 TWh) of the overall electricity generation also in 2018, a share that has slightly reduced from 4.1% in 2002. Over the last decade, there has been a shift towards the use of more renewable energy resources, accompanied by a reduction from 90.3% in 2002 to 85% in 2018 of the total share of fossil fuels in the electricity mix.

The share of electricity generation of renewable energy has increased from 5.7% up to 15.8% over the period 2002–2018 [43]. In fact, in 2018, the share of renewables composed of solar and biomass energy as well as wind farms accounted for 18.6 TWh, whereas pumped hydro, non-renewable waste and fuel cell systems together played a smaller role 7.4 TWh [44]. Onshore and offshore wind farms have experienced the fastest growth over the decade [45]. Moreover, electricity from biofuels and waste has more than doubled, passing from 3.1 TWh in 2002 up to 6 TWh in 2018.

Table 3 shows some features of the power plants and the properties of the fuels used in the assessment of the performance of the Dutch electricity mix. Further details on the various electricity generation routes are presented in the following sections.

1.5.1. Coal supply route

The total supply of coal and derivatives was 8.2 Mtoe in 2018, representing 9.70% of the total primary energy in the country [40]. This resource consists mainly of hard coal, with negligible levels of lignite. The main uses of imported coal remain the power and steam cogeneration, as well as the iron and steel industry, which consume coking coal. Rankine cycles fuelled with coal are among the leading technologies for electricity generation. Actually, 70% of the total coal supply is employed in electricity plants and combined heat and power (CHP) systems [45], which is imported from Colombia (53%), South Africa (21%), and Indonesia (7%) [49]. This distribution is used in the calculation of the energy consumption in the coal supply chain, especially at it concerns the transportation supply stage.

1.5.2. Oil supply route

Oil plays an essential role in the Dutch energy mix, accounting for 48.2% of the total primary energy. In 2018, the total supply of oil (including crude oil and derivatives) was 40.9 Mtoe [40]. Despite the new field exploration and development, particularly offshore fields, oil production has declined by 50% since 2002. Notwithstanding, the Netherlands has a strategic position in the European

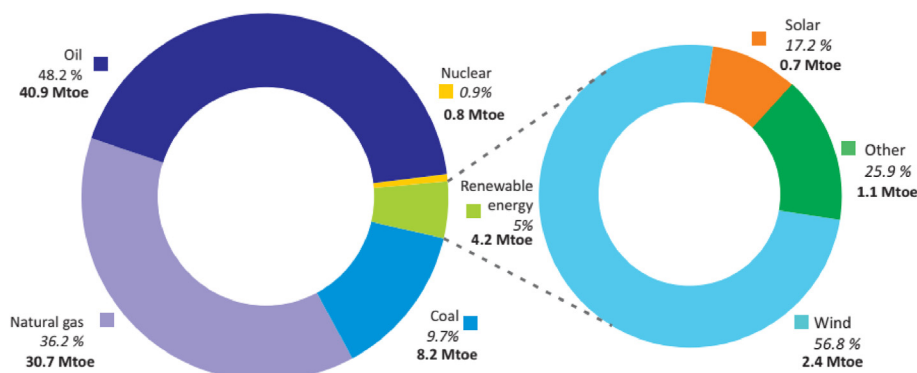

Fig. 1. Total primary energy consumption and the renewable energy percentages contribution in the Netherlands in 2018. Adapted from Ref. [40].

Table 1Evolution of the CO₂ emissions in the Dutch, European Union, and World energy mixes between 2010 and 2018. Adapted from Refs. [40,41].

| Year | 2010 | 2011 | 2012 | 2013 | 2014 | 2015 | 2016 | 2017 | 2018 |
|---|--------|--------|--------|--------|--------|--------|--------|--------|--------|
| CO₂ emissions from fuel combustion (Mt) | | | | | | | | | |
| World | 31,058 | 31,978 | 32,317 | 32,800 | 32,845 | 32,804 | 32,914 | 33,243 | 33,891 |
| EU | 3,941 | 3,812 | 3,754 | 3,665 | 3,458 | 3,502 | 3,514 | 3,550 | 3,479 |
| Netherlands | 232 | 224 | 217 | 212 | 201 | 209 | 213 | 206 | 203 |

Table 2

Evolution of the electricity generation and the share of renewable energy share in the Dutch, European Union, and World energy mixes between 2010 and 2018. Adapted from Ref. [40,41].

| Year | 2010 | 2011 | 2012 | 2013 | 2014 | 2015 | 2016 | 2017 | 2018 |
|--|--------|--------|--------|--------|--------|--------|--------|--------|--------|
| Electricity Generation (TWh) | | | | | | | | | |
| World | 21,574 | 22,259 | 22,808 | 23,450 | 23,915 | 24,287 | 24,957 | 25,677 | 26,615 |
| EU | 3,365 | 3,299 | 3,295 | 3,270 | 3,188 | 3,237 | 3,260 | 3,290 | 3,282 |
| Netherlands | 118 | 113 | 103 | 101 | 103 | 110 | 115 | 117 | 118 |
| Share of renewables in electricity generation (%) | | | | | | | | | |
| World | 3.5 | 4.0 | 4.6 | 5.3 | 5.9 | 6.7 | 7.4 | 8.4 | 9.3 |
| EU | 9.0 | 11.1 | 13.1 | 14.9 | 16.4 | 18.4 | 18.5 | 20.5 | 21.5 |
| Netherlands | 9.4 | 10.9 | 12.1 | 12.0 | 11.2 | 12.4 | 12.7 | 14.8 | 15.8 |

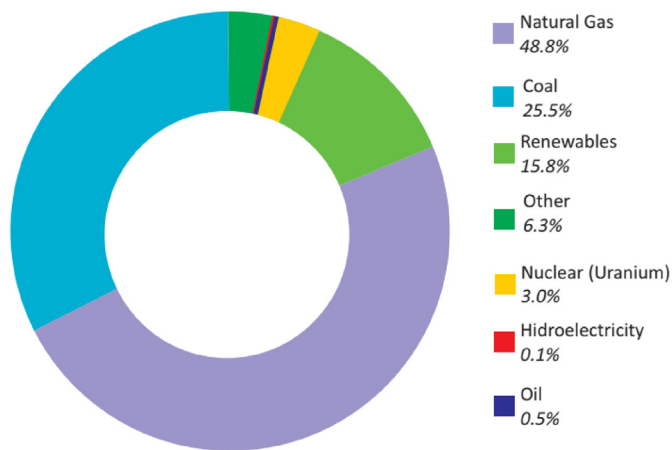
**Fig. 2.** Electricity generation supply by source in the Netherlands in 2018. Adapted from Ref. [40].

oil supply chain, as a leading importer, as well as exporter of oil products (63%) and refiner of crude oil, hosting the most significant oil storage capacity in the region. Nowadays, Rotterdam has become the energy hub of Europe, with oil refineries and storage services, the Gas Access to Europe (GATE) terminal of liquefied natural gas (LNG), and extensive coal import facilities. In this region, it is also located a significant power generation and chemical industries, which use oil and natural gas as feedstock materials

[45]. Domestic oil production accounts for 2.2% of intake in refineries, rendering the country depends heavily on crude oil imports. In 2015, according to *Statistics Netherlands*, the leading suppliers of crude oil were Russia 29%, Norway 14%, Saudi Arabia 12%, the United Kingdom (UK) 10%, and Nigeria 9%. The Netherlands also exports a small amount of crude oil to Germany, the UK, Sweden, and Denmark [50]. According to Nakashima et al. [51], a fraction of the produced natural gas is consumed in the primary separation stage ($0.006\text{kJ}/\text{kJ}_{\text{Oil}}$ and $0.025\text{kJ}/\text{kJ}_{\text{NG}}$); thus, the exergy consumption and CO₂ emissions per unit of exergy of crude oil and natural gas produced can be calculated. The exergy consumption in oil transportation from sea to land is calculated assuming the use of a shuttle tanker Suezmax-type. By considering a travelling route of 10959 km at a speed of 13 knots and a load capacity of 155,000 tons, as well as the offloading operations of platform and tanker, it is possible to calculate the exergy consumption of bunker fuel and the direct CO₂ emissions as $42.32\text{ kJ}/(\text{km}\cdot\text{t}_{\text{Oil}})$ and $3.06\text{ gCO}_2/(\text{km}\cdot\text{t}_{\text{Oil}})$ [31]. The oil transportation from land base to the refinery is performed through pipelines by consuming electricity from the national electric grid. Thus, from the pressure drop calculation in the petroleum pipeline and assuming a pumping efficiency of 60%, the exergy consumption is estimated as $100.3\text{kJ}/(\text{km}\cdot\text{t}_{\text{Oil}})$. It is worthy to notice that since electricity consumed in land oil transportation comes from the national grid, the unit exergy costs and CO₂ emissions of transported oil will depend on the whole electricity mix. Finally, the refining plant data is based on a typical petroleum refinery as studied by Silva and Oliveira Jr [31] with a cracking-coking scheme.

Table 3

Characteristics of the power plants and fuels used in the assessment of the Dutch electricity mix.

| | Power plant efficiency (%) | LHV (MJ/kg) | $\Phi = b^{CH}/LHV^a$ | Fuel carbon content – I (%C _{mass}) | Direct specific emissions (gCO ₂ /kJ) |
|----------------|----------------------------|--------------------|-----------------------|---|--|
| Coal | 46.0 | 30.08 ¹ | 0.927 ^b | 59.50 | 0.0783 |
| Oil products | 40.0 | 42.00 | 1.066 | 86.73 | 0.0710 |
| Natural gas | 46.0 | 47.34 | 1.032 | 75.30 | 0.0565 |
| Nuclear | 32.0 | 1,016,952 | 0.950 ^c | – | – |
| Wind | 45.0 | – | 0.927 | – | – |
| Biomass (wood) | 30.0 | 9.30 | 1.188 | 22.40 | – ^d |

^a Φ represents the ratio between the specific chemical exergy (b^{CH}) and the lower heating value (LHV) of the resource [21].

^b Refs. LHV [46], Colombian coal [47].

^c Ref. [48], Borssele Nuclear Power Plant, 485 MW.

^d Release and capture of carbon by direct burning are supposed to occur in a closed natural cycle of biomass growth.

1.5.3. Natural gas supply route

The Netherlands remains the second-largest gas producer in Europe, and it is a net exporter of natural gas and refined oil products. This resource dominates the electricity supply, domestic heating, and industry feedstock, such as in the petrochemical sector [45]. Natural Gas (NG) is the largest source of energy in this country, mainly due to the production in the Groningen basin, which accounted for 36.2% of the total primary energy supply in 2018 when the natural gas energy amounted 30.7 Mtoe [40]. The first LNG terminal, GATE, came into operation in 2011 at the Maasvlakte facility in Rotterdam with a capacity of 12 billion cubic meters (bcm) of natural gas [45]. In 2017, total production in all Dutch gas fields decreased by 13%, while imports increased. The growing demand for foreign gas was mainly met by Norway (56%) and British gas (44%) [52]. As for gas transportation, it was considered pipeline transportation of 1344 km. Thus, it is possible to determine the exergy consumption and CO₂ emissions related to natural gas transportation as 1.063 kJ/(km.t_{NG}) and 58.2 g_{CO2}/(km.t_{NG}), respectively [32]. According to Pereira [53], an exergy consumption of 0.0180 kJ of natural gas and 0.0039 kJ of electricity per kJ of processed NG is estimated to treat natural gas.

1.5.4. Nuclear fuel mining and enrichment

Nuclear plays a small but steady role in the Dutch energy supply, constituting about 1% of the total power generation capacity. In 2018, the only nuclear power plant in operation produced 4 TWh, providing about 0.8% Mtoe of the total primary energy [40]. Thus, throughout the operation, the nuclear power station has generated about 132 TWh of carbon-free baseload electricity [45]. The nuclear plant is located in Borssele (province of Zeeland) in the south-west of the country. The pressurized water reactor (PWR), constructed by Siemens, is fuelled with enriched uranium fuel (UOX). In 2006, following an upgrade of the turbine, the net electrical capacity was increased by 7%, to the current level of 482 MW [45].

1.5.5. Renewable energy harvesting

According to the IEA, the Netherlands has renewed its ambitions to support the cost-effective deployment of renewable energy sources as a pillar of its 'National Energy Agreement for Sustainable Growth.' In 2017, the Dutch government had set a target of 49% GHG emission reduction in 2030, mainly through solar and wind energy (10 times more) and also doubling the share of bioenergy [39].

1.5.5.1. Wind and solar energy. Currently, onshore wind turbines hold a capacity of 2,000 MW, providing only 4% of the total Dutch electricity [54]. Meanwhile, the existing offshore wind farms have an installed capacity of approximately 1,000 MW. The first two wind farms built in the North Sea off the coast of the Netherlands are the offshore *Egmond aan Zee-OWEZ* Wind Farm (at 10–18 km), and the *Princess Amalia* Wind Farm (at 23 km) [54]. In 2018, both onshore and offshore wind farms and solar (*PV and thermal*) energy sources contributed with 56.8 % and 17.2%, respectively, to the electricity generation in the country.

1.5.5.2. Biomass. In 2016, biomass energy contributed to 75% of the renewable energy in the total primary energy, which can be further divided among the use of mostly solid biomass by waste incineration plants, industrial boilers and furnaces, co-firing power plants, and the use of liquid biofuels and biogas [55]. The platform Bio-Energie reports that the total use of woody biomass increased from 1.2 Mt (million metric tons) in 2014 to 1.70 Mt in 2017. This growth consists mainly of wood chips, supported by increased domestic production of chips and imports, mainly from Germany and Norway.

Considering the whole route of the biomass conversion to

products (*i.e.*, electricity, fuels, or chemicals), several processing stages at diverse locations along the route could be defined. For instance, if the large-scale biomass plant station is installed in the Netherlands, the required biomass can be imported as raw matter (wood logs and chips) or as intermediate sources (pellets, pyrolysis slurry, torrefied wood, pellets), depending on the desired final product (methanol, diesel, chemicals, SNG, LNG) [56]. The biomass production is assumed to occur in the Baltic States, and the Rotterdam harbour is considered as the final destination. The harvested biomass is naturally dried in the forest before transported to a pre-treatment plant [56]. The domestically-sourced chips originate from the management of forests, parks/agricultural land, and the wood processing industry. Another type of biomass imported is sawdust and wood scrap, which in 2018 comprised about 270,000 metric tons [57].

2. Methodology

The present methodology relies on previous thermoeconomy approaches [30,58–60], adapted by Flórez-Orrero et al. [38] in order to calculate the renewable and non-renewable unit exergy costs and specific CO₂ emissions of the streams composing the Dutch electricity mix. The cost balances for each of the main energy conversion processes are based on the initial identification and classification of each stage into supply, transformation, and end-use stages (Fig. 3). This classification allows for making suitable simplifying assumptions that still satisfy the exergy analysis, especially of upstream supply stages without the need for performing an explicit energy balance. However, this classification also suggests the need for a more disaggregated level of analysis, such as in the case of the transformation stages, which include complex polygeneration refineries and biorefineries.

In fact, in the coal-based power generation route, the specific exergy consumption either diesel or electricity at the coal transportation (supply stage) could be recognized as the only energy resource effectively consumed for achieving the transportation service of the coal useful exergy, which is eventually consumed in the thermoelectric plant (end-use stage). In other words, the coal fed (useful exergy) to the power unit remains basically unaffected along the transportation stage. Likewise, the useful exergy of the sugarcane that reaches the biorefinery and the petroleum components extracted from the well that enter into the refinery is fundamentally not affected by the harvesting, extraction, and transportation stages.

Certainly, the specific consumption in each supply stage must already include the actual amount of energy used up in order to deliver the fuel or exergy flow to the power plant plus the amount needed to compensate the whole process irreversibility and losses (*e.g.*, the actual amount of diesel due to the inherent losses of the engine, friction losses and exhaust gases ejection). In this way, a direct calculation of the exergy destruction rate in the supply stage will bring about fairly the same results, as long as the only useful exergy recoverable from those supply stages will be the useful exergy of the fuel fed at the transformation and end-use stages. Meanwhile, the total emissions associated with the supply stages can be suitably accounted for by the emission intensity thereof, characterized by the composition of the energy resources consumed in the respective stage, the reported efficiency of the supply stage, and the presence of non-renewable CO₂-emitting reactions. These specific consumptions are obtained from the open literature and simulations of refineries, biorefineries, and typical cogeneration plants, as well as from the life cycle analysis databases, which were adjusted for representing exergy indicators.

Depending on the need for refining the various fuels (exergy flows) comprised in the Dutch electricity mix, and whenever more

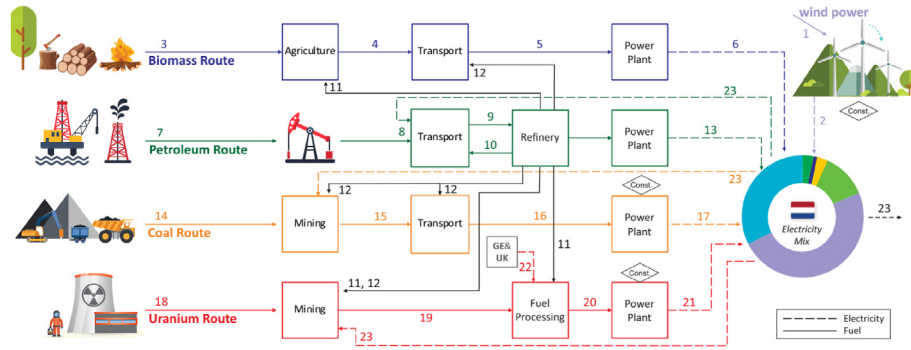

Fig. 3. Schematic of the interrelationships between the fuel and exergy flows used for allocation of the unit exergy costs and specific CO₂ emissions in the Dutch electricity mix.

complex energy conversion systems were involved (transformation stages), more detailed simulations of the chemical and industrial plants are obviously necessary [32,61]. For instance, when light hydrocarbons and other petroleum derivatives are distilled, a detailed exergy analysis must incorporate the entire petroleum refinery [31]. As a final remark, aside from the useful fuel and exergy flow rates, obtained and processed along the upstream supply and transformation stages of the electricity production routes, no other energy resources are fed the downstream end-use stages (i.e., thermoelectric and nuclear power units, hydroelectric and wind farms). Thus, the associated exergy consumption is inversely proportional to the power unit efficiency (see Table 3). In contrast, the specific CO₂ emissions in the end-use stage can be divided into indirect (associated with the upstream obtainment stages of the fuel consumed) and direct emissions (resultant from the direct combustion of carbon-containing fuels). In the following, the mathematical formulation that relates the cost balances of the different stages is described. This strategy has been successfully implemented to calculate the cumulative exergy consumption of fuels, chemicals and transportation services [62], petrochemical refineries, biorefineries (associated ethanol, sugar and electricity biorefineries; as well as biodiesel production units) [32], fertilizers complexes [61] and the Brazilian electricity mix [38].

Fig. 3 shows the interrelationship between fuel and exergy flows in the Dutch electricity mix. As it can be seen, the energy resources as present in the environment (e.g., petroleum and gas from wells, coal and uranium ore, biomass, and wind) enter productive macro-control volume. Henceforth, as the natural resources go through a series of processing stages (e.g., extraction, mining, agriculture, transportation, fuel processing, and end-use), the inefficiencies and CO₂ footprint associated with the successive energy conversion processes are accumulated along the power generation routes [38]. In order to map the most significant contributors in terms of exergy destruction and environmental impact, a rational distribution of the exergy costs and CO₂ emissions among the various streams of each route represented in Fig. 3 will be performed. As it has been discussed, this exergoeconomy approach is preferable than other energy or mass-based allocation methods, as it takes into account the quality of the energy conversion processes, regardless of the nature of either material or energy flows, as well as the energy technologies involved, such as combined heat and power generation, kinetic and potential energy harvesting, and transformation of biomass or fossil energy resources into electricity.

Fig. 4 shows the schematics used to perform the allocation of the unit exergy costs and CO₂ emissions of each one of the supply, transformation, and end-use stages in the Dutch electricity mix shown in Fig. 3. From Fig. 4a, it is worthy to notice that the useful exergy ($B_{F,s}$) that enters the supply (SS) stage (k) has the same numerical value of the useful exergy that leaves ($k+1$) the supply

stage, as it will be discussed in the next section. Meanwhile, Fig. 4b shows the useful exergy fed to ($B_{F,t}$) and exiting from ($B_{P,t}$) the transformation (TS) stages. Additionally, one or more consumptions must be provided ($Cons$), such that supply and transformation stages can be executed. On the other hand, as it has been implied earlier, the supplied or transformed substances or exergy flows ($B_{F,n}$ or $B_{P,n}$) finally enters the end-use stage (ES) in order to generate the electricity in each route ($B_{E,W}$). In this methodology, the non-renewable unit exergy cost (c_{NR}) is defined as the amount of non-renewable exergy required to produce one unit of exergy of substance or flow (e.g., water, wind, biomass, nuclear, natural gas, coal, oil, heat or electricity), expressed in [kJ/kJ]. Analogously, the renewable unit exergy cost (c_R) is defined as the amount of renewable exergy required to produce one unit of exergy of substance or flow; whereas the sum of the two previous costs is equal to the total unit exergy cost (c_T).

Meanwhile, the specific CO₂ emissions (c_{CO_2}) are defined as the quantity of CO₂ emitted to obtain one unit of exergy of a given substance or exergy flow rate (g_{CO_2}/kJ). Finally, it is important to notice that, since the processed streams leaving certain processing stages are consumed in other stages. Some processing stages also consume the electricity from the interconnected mix; an iterative calculation approach must be applied to estimate the unit exergy costs and specific CO₂ emissions of the various streams and the electricity generated involved in the Dutch electricity mix (Fig. 3). Hereafter, the formulation of the particular exergoeconomy balance for each type of stage, used for calculating the exergy costs and specific CO₂ emissions of the different streams going through each type of processing stage, is described.

2.1. Exergy cost balances

In this section, the formulation of the unit exergy costs balance of the supply, transformation, and end-use stages is briefly described. The simplifications applicable to each type of stage are also discussed.

2.1.1. Supply stage

The supply stage comprises the activities intended to extract, mine, harvest, transport, treat, and distribute the processed streams. Moreover, since the exergy consumption in construction, operation, and decommissioning stages can be amortized along the lifetime of the plant, those stages could be also considered analogous to supply stages. As earlier explained, the useful exergy of the product $B_{F,s}^{k+1}$ leaving a given supply stage (Fig. 4a) can be considered as basically the same useful exergy of the substance or exergy flow $B_{F,s}^k$ entering the referred stage (i.e., $B_{F,s,useful}^k = B_{F,s}^{k+1,useful}$, for a supply stage), since no complex transformations are carried out upon the useful exergy flow, which is later supplied to the

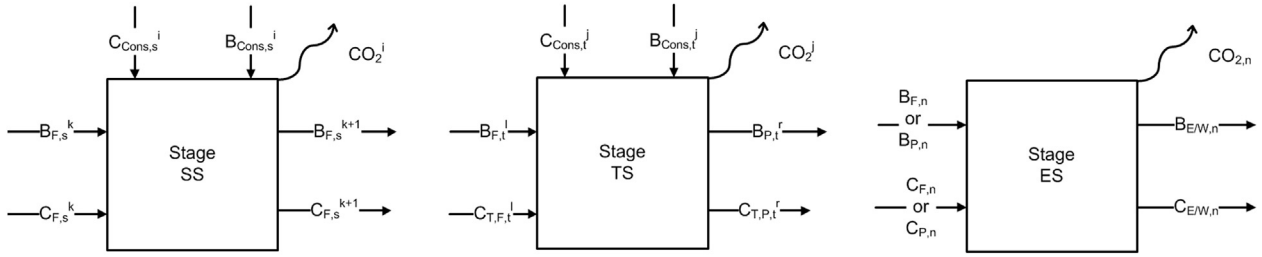

Fig. 4. Schematics of the supply (SS), transformation (TS), and end-use (ES) stages, considered in the allocation of the unit exergy costs and specific CO₂ emissions.

downstream transformation and end-use stages.

Nevertheless, the unit exergy cost of $B_{F,s}^{k+1}$ does increase due to an additional exergy consumption $B_{Cons,s}^i$ used to displace, extract, harvest, in brief, to supply $B_{F,s}^k$ to become $B_{F,s}^{k+1}$ at the exit of the respective supply stage. Thus, the cost balance can be written as in Eq. (1):

$$c_{F,s}^{k+1} B_{F,s}^{k+1} = c_{F,s}^k B_{F,s}^k + \sum_{i=1}^{Ks} c_{Cons,s}^i B_{Cons,s}^i \quad (1)$$

Or equivalently, Eq. (2):

$$c_{F,s}^{k+1} = c_{F,s}^k + \sum_{i=1}^{Ks} c_{Cons,s}^i r_{Cons,s}^i \quad (2)$$

where $r_{Cons} = B_{Cons}/B_{F,s}^{k+1}$ in $\text{kJ}_{Cons}/\text{kJ}_F$ is the specific consumption of a set Ks required to supply a unit of substance or exergy flow ($B_{F,s}^{k+1}$). As for the initial supply stage (i.e., the stage at which the natural resources firstly enter the macro-control volume of the Dutch electricity mix), the initial unit exergy costs (c_F) are considered as 1 kJ/kJ_F since it is assumed that the original resources come directly from the environment. Inasmuch as the productive chain incorporates more energy conversion stages, the unit exergy costs of the inputs $B_{F,s}^k$, consumptions $B_{Cons,s}^i$ and, consequently, of the products of the supply stages $B_{F,s}^{k+1}$ also increase.

2.1.2. Transformation stage

The transformation stage corresponds to a complex facility responsible for transforming the supplied fuels or substances into value-added products, such as refineries, biorefineries, chemical plants, and so forth. The transformation stage can be thought as composed of subsystems, which, in turn, can be classified into supply stages (preparation, transportation, etc.), transformation stages (reactors, distillation, fermentation, polygeneration units, carbon capture systems, etc.) and end-use stages (CHP generation systems, boilers, etc.) inside the battery limits of the industrial facility. In this type of stage, multiple exergy inputs (Qt) and consumptions (Kt) can be considered as feedstock and utility streams consumed to produce a variety of products and by-products (It). Thus, transformation stages must be further disaggregated into more sub-stages, which are modelled and simulated in detail, in order to increase the accuracy of the exergy costing process, expressed by the cost balance in Eq. (3):

$$\sum_{r=1}^{It} c_{P,t}^r B_{P,t}^r = \sum_{l=1}^{Qt} c_{F,t}^l B_{F,t}^l + \sum_{j=1}^{Kt} c_{Cons,t}^j B_{Cons,t}^j \quad (3)$$

Unlike the supply stage, performing simplifications upon the previous equation is not straightforward due to the interrelations of the components and subsystems of the transformation stage, as graphically represented by Fig. 5.

2.1.3. End-use stage

In the end-use stage, the main energy input is assumed to be the substance or exergy flow rates, either transformed or supplied ($B_{F_oP,n}$), which is also responsible for the direct CO₂ emissions (m_{CO_2}) in the power plant, provided that the consumed fuel(s) contain(s) carbon [38]. The desired output is the electricity generated ($B_{E/W,n}$). Thus, the mathematical representation of the cost balance is given by Eq. (4):

$$c_{E/W,n} B_{E/W,n} = \sum_{f=1}^{Qn} c_{F_oP,n}^f B_{F_oP,n}^f \quad (4)$$

By considering an end-use stage (Fig. 4c) where only one exergy input F is fed to produce one good or service, the Eq. (4) can be written as in Eq. (5):

$$c_{E/W,n} B_{E/W,n} = c_{F_oP,n} B_{F_oP,n} \rightarrow c_{E/W,n} = \frac{c_{F_oP,n}}{\eta_{end-use}} \quad (5)$$

Although this expression is seemingly straightforward and expresses the inversely proportional relationship between the unit exergy cost of the product of the end-use stage and the efficiency thereof, the difficulty relies on the determination of the end-use efficiency, as explained by several authors [32,63,64]. Defining the efficiency of service (electricity generation, heating, transportation, or refrigeration, etc.) is seldom straightforward, since it depends on the nature of the system in which the energy conversion occurs. For instance, the energy conversion in transportation is not limited to the efficiency of the engine (i.e., a mere fuel to shaft power analysis), since from shaft to wheels and from wheels to achieve the displacement, there is still room for a large number of inefficiencies [62]. On the other hand, the fuel consumption indicator (in km/L) is not an exergy measurement, and it depends on the type of vehicle. Even more challenging is comparing different sectors, such as transportation and residential sectors as the efficiency concept is not always interchangeable or univocally defined for all the sectors and applications in the industry and, in general, in society.

2.2. Specific carbon dioxide emissions balances

In this section, the mathematical formulation of the carbon dioxide (CO₂) emission balance is briefly presented. Some important differences in the approach for CO₂ emissions allocation, compared to the procedure for the unit exergy costs allocation (Section 2.1), are also highlighted.

2.2.1. Supply stage

By applying the same assumptions that in the cost balance, in the case of the supply stage (Fig. 4a), the CO₂ emissions balance can be written as in Eq. (6):

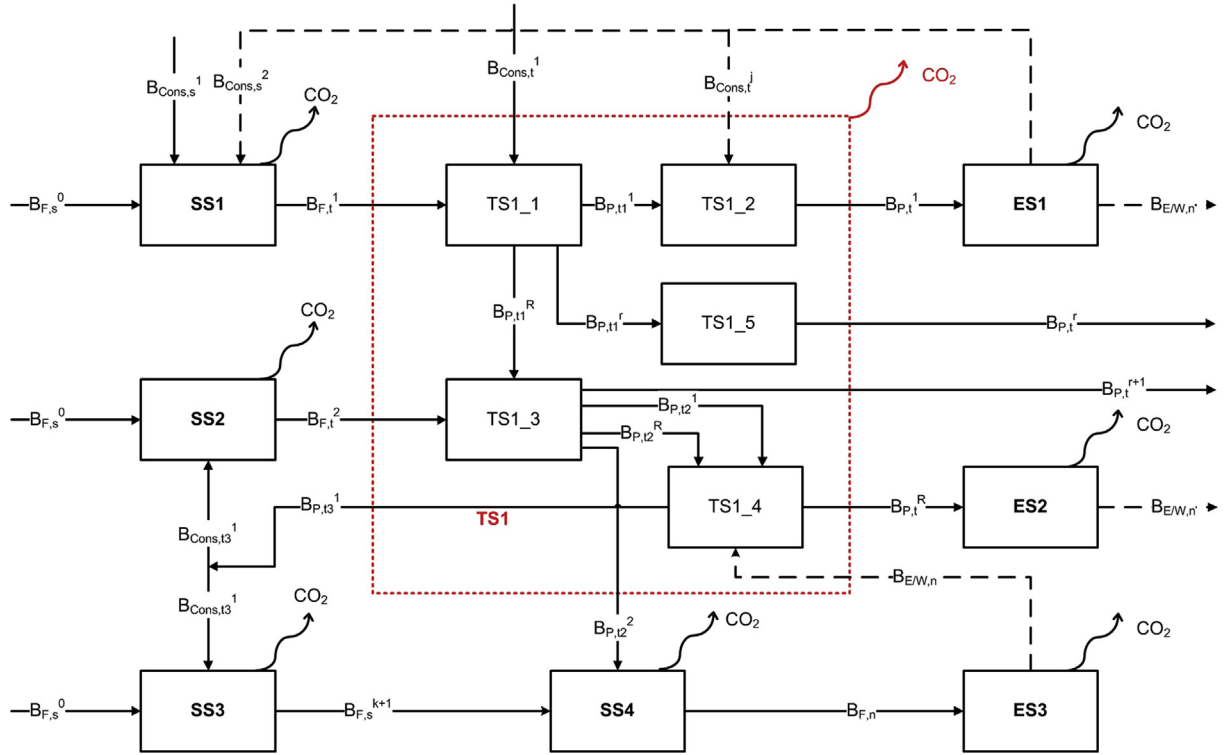

Fig. 5. Disaggregation of a transformation stage (TS1, enclosed in dashed line) and its relationship with the supply (SS) and end-use (ES) stages. Adapted from Ref. [32].

$$c_{CO_2,F,s}^{k+1} B_{F,s}^{k+1} = c_{CO_2,F,s}^k B_{F,s}^k + \sum_{i=1}^{K_s} (c_{CO_2,Cons,s}^i B_{Cons,s}^i + m_{CO_2,Cons,s}^i) \quad (6)$$

where the terms $c_{CO_2,Cons,s}^i$ and $c_{CO_2,F,s}^k$ are, respectively, the specific CO₂ emissions calculated from the analysis of the upstream supply stages, as long as the ‘current’ stage is not the very first supply stage (i.e., whereby the natural resources enter the macro-control volume). Meanwhile, the term $m_{CO_2,Cons,s}^i$ stands for the direct CO₂ emissions produced by burning the specific exergy consumptions Cons required to perform the supply stage.

the consumption, and $b_{Cons,s}^{CH,i}$ in $\text{kJ}_{Cons}/\text{kg}_{Cons}$ is the specific chemical exergy thereof.

As it concerns the first supply stages (i.e., whereby the natural resources enter each route of the macro-control volume), the initial specific CO₂ emissions ($c_{CO_2,F,s}$) are considered as 0 $\text{g}_{CO_2}/\text{kJ}_F$, because it is assumed that the original resources come directly from the environment. Hence, as the number of supply stages increases, the specific CO₂ emissions are accumulated, increasing the c_{CO_2} value of the downstream inputs, consumptions and, consequently, the products. In fact, the additional exergy consumption brings about more CO₂ emissions in the supply stage, which are allocated to the stage product. When only one consumption ($B_{Cons,s}$) inputs the SS in order to supply a single substance or exergy flow rate ($B_{F,s}^k$), Eq. (6) can be simplified as in Eq. (8):

$$c_{CO_2,F,s}^{k+1} = \frac{c_{CO_2,F,s}^k B_{F,s}^k + c_{CO_2,Cons,s} B_{Cons,s} + m_{CO_2,Cons,s}}{B_{F,s}^{k+1}} = \frac{c_{CO_2,F,s}^k B_{F,s}^k}{B_{F,s}^{k+1}} + \frac{c_{CO_2,Cons,s} B_{Cons,s}}{B_{F,s}^{k+1}} + \frac{m_{CO_2,Cons,s}}{B_{F,s}^{k+1}} \quad (8)$$

$$= c_{CO_2,F,s}^k + c_{CO_2,Cons,s} r_{Cons,s} + \frac{I_{C,Cons,s} R_C r_{Cons,s}}{b_{Cons,s}^{CH,i}} \times 1000$$

$$m_{CO_2,Cons,s}^i = \frac{I_{C,Cons,s} R_C B_{Cons,s}^i}{b_{Cons,s}^{CH,i}} \times 1000 \quad \left[\frac{\text{g}_{CO_2}}{\text{s}} \right] \quad (7)$$

where, $I_{C,Cons,s}$ in kg_C/kg_F is the carbon content in the fuel (see Table 3); R_C in $\text{kg}_{CO_2}/\text{kg}_C$ is equal to 44/12 (the molecular weight ratio of CO₂ to carbon); $B_{Cons,s}^i$ in $\text{kJ}_{Cons}/\text{s}$ is the exergy flow rate of

where, $r_{Cons,s}$ ($= B_{Cons,s}/B_{F,s}^{k+1}$ in $\text{kJ}_{Cons}/\text{kJ}_F$) has been defined as the specific consumption required to supply a unit of exergy of substance or exergy flow. This indicator is commonly found in literature as the specific consumption for providing a substance or fuel (e.g., coal, sugarcane, crude oil, gas, uranium) to the downstream transformation stages, normally given in $\text{kJ}_{electric}$ or $\text{kJ}_{thermal}$ per

unit of energy of substance or exergy flow supplied.

2.2.2. Transformation stage

The CO₂ emissions balance of the transformation stage is analogous to the cost balance, except for two additional terms that aim to include the emissions produced by direct burning ($m_{CO_2, Cons}$) or chemical reactions ($m_{CO_2, Reac}$) between the fuel and other inputs, as expressed in Eq. (9):

$$\sum_{r=1}^{\Pi t} c_{CO_2, P, t}^r B_{P, t}^r = \sum_{l=1}^{\Omega t} c_{CO_2, F, t}^l B_{F, t}^l + \sum_{j=1}^{Kt} (c_{CO_2, Cons, t}^j B_{Cons, t}^j + m_{CO_2, Cons, t}^j) + m_{CO_2, Reac} \tag{9}$$

where $m_{CO_2, Cons, t}^i$ has been defined in Eq. (7), and the terms $c_{CO_2, Cons, t}^i$ and $c_{CO_2, F, t}$ are once more calculated from the upstream supply

$$c_{CO_2, E/W, n} = \frac{c_{CO_2, F \circ P, n} B_{F \circ P, n} + m_{CO_2, F \circ P, n}}{B_{E/W, n}} = \frac{c_{CO_2, F \circ P, n} B_{F \circ P, n}}{B_{E/W, n}} + \frac{m_{CO_2, F \circ P, n}}{B_{E/W, n}} \tag{12}$$

$$= \frac{c_{CO_2, F \circ P, n}}{\eta_{ex, end-use}} + \frac{m_{CO_2, F \circ P, n}}{B_{E/W, n}} = \frac{c_{CO_2, F \circ P, n}}{\eta_{ex, end-use}} + \frac{I_{C, F \circ P, n} R_C}{b^{CH}_{F \circ P, n} \eta_{ex, end-use}} \times 1000$$

stages. Meanwhile, the term $m_{CO_2, Reac}$, or equivalently, the net CO₂ yield or capture in a variety of chemical reactions (e.g., reforming, fermentation, shift, and other CO₂ producing applications different from combustion) is calculated according to the particular operating parameters that govern the equilibrium and kinetic reactions.

2.2.3. End-use stage

The CO₂ emission balance of the end-use stage considers both the indirect and direct CO₂ emissions, associated to the obtainment of the upstream supply stages ($c_{CO_2, F}$), and the burning of the fuel (c_F) consumed in the respective stage, as given in Eqs. (10) and (11):

$$c_{CO_2, E/W, n} B_{E/W, n} = \sum_{f=1}^{\Omega n} (c_{CO_2, F \circ P, n}^f B_{F \circ P, n}^f + m_{CO_2, F \circ P, n}^f) \tag{10}$$

$$m_{CO_2, F \circ P, n}^f = \frac{I_{C, F \circ P, n}^f R_C B_{F \circ P, n}^f}{b^{CH}_{F \circ P, n}^f} \times 1000 \left[\frac{g_{CO_2}}{s} \right] \tag{11}$$

where $I_{C, F \circ P, n}^f$ in kgC/kg_F is the amount of carbon content in the fuel (see Table 3); $B_{F \circ P, n}^f$ in kJ_F/s is the chemical exergy flow rate of the fuel; $b^{CH}_{F \circ P, n}$ in kJ_F/kg_F is the specific chemical exergy of the plant

fuel. Meanwhile, if only one exergy input ($B_{F \circ P, n}$) is considered to feed the end-use stage, the specific CO₂ emissions associate to its product ($c_{CO_2, E/W, n}$), i.e., the electricity generated in a power plant, can be calculated as in Eq. (12).

3. Results and discussion

Table 4 summarizes the total, renewable, and non-renewable unit exergy costs and specific CO₂ emissions calculated when the cost and CO₂ emissions balance (Eqs. (1)–(12)) are applied to the supply, transformation, and end-use stages displayed in Fig. 3. It is worthy to notice that, in Table 4, streams 8a and 8b denote the crude oil and natural gas produced in offshore platforms, respectively. Stream 9a is related to the crude-oil and 9b to the natural gas

transported to the refinery, whereas the electrical energy generated in the oil-fired plant and the natural gas-fired power station corresponds to stream 13a and 13b.

Meanwhile, Table 5 summarizes the main results for the total, renewable, and non-renewable unit exergy costs and specific CO₂ emissions for the power generated in the Netherlands in each pathway presented in Fig. 3. By considering the contribution of each route to the Dutch electricity mix, a weighted average for the renewable and non-renewable unit exergy cost of the whole Dutch electricity mix are calculated as $c_R = 0.8375$ kJ/kJ_{E/W} and $c_{NR} = 1.7180$ kJ/kJ_{E/W}. Meanwhile, the specific CO₂ emissions are estimated as 373.21 g_{CO2}/kWh_{E/W}. This value agrees with data reported specifically for the Netherlands in 2013 (351 g_{CO2}/kWh) [65]. It must be pointed out that the average CO₂ emission intensity for the power generation decreased sharply (16%) between 1990 and 2016. For instance, the Netherlands reported 505.2 g_{CO2}/kWh_{E/W} related to CO₂ emissions per kWh generated in 2016, which are calculated as the ratio of CO₂ emissions from public electricity production (as a share of CO₂ emissions from public electricity and heat production related to electricity production), and gross electricity production [66]. This reduction in the CO₂ emissions for electricity generation was driven by the replacement of coal by

Table 4
Total, renewable, and non-renewable unit exergy costs and specific CO₂ emissions for each stream in the Dutch electricity mix represented in Fig. 3

| Streams | 1 | 2 | 3 | 4 | 5 | 6 | 7 | 8a | 8b |
|-------------------|-----------|-----------|-----------|-----------|-----------|------------|------------|-----------|-----------|
| c_{NR} (kJ/kJ) | 1.0000 | 0.0344 | 0.0000 | 0.0167 | 0.1715 | 0.5716 | 1.0000 | 1.0060 | 1.0250 |
| c_T (kJ/kJ) | 1.0000 | 2.2589 | 1.0000 | 1.0167 | 1.1721 | 3.9071 | 1.0000 | 1.0060 | 1.0250 |
| c_{CO_2} (g/kJ) | 0.0000 | 0.0008 | 0.0000 | 0.0009 | 0.0120 | 0.0398 | 0.0000 | 0.0006 | 0.0006 |
| | 9a | 9b | 10 | 11 | 12 | 13a | 13b | 14 | 15 |
| c_{NR} (kJ/kJ) | 1.0262 | 1.0550 | 1.0693 | 1.0550 | 1.0568 | 2.8620 | 2.3848 | 1.0000 | 1.0158 |
| c_T (kJ/kJ) | 1.0305 | 1.0550 | 1.0737 | 1.0550 | 1.0612 | 2.8767 | 2.3994 | 1.0000 | 1.0196 |
| c_{CO_2} (g/kJ) | 0.0019 | 0.0023 | 0.0042 | 0.0023 | 0.0048 | 0.2048 | 0.1328 | 0.0000 | 0.0010 |
| | 16 | 17 | 18 | 19 | 20 | 21 | 22 | 23 | |
| c_{NR} (kJ/kJ) | 1.0167 | 2.0627 | 1.0000 | 1.0380 | 1.0573 | 3.1389 | 2.4026 | 1.7180 | |
| c_T (kJ/kJ) | 1.0206 | 2.0733 | 1.0000 | 1.0478 | 1.0674 | 3.1689 | 2.5519 | 2.5555 | |
| c_{CO_2} (g/kJ) | 0.0011 | 0.1609 | 0.0000 | 0.0024 | 0.0036 | 0.0107 | 0.1490 | 0.1037 | |

Table 5Total, renewable, and non-renewable unit exergy costs and specific CO₂ emissions of the electricity generated in each route and in the overall Dutch electricity mix.

| Power plant | Share (%) | c_{NR}^a (kJ/kJ _{E/W}) | c_R^b (kJ/kJ _{E/W}) | c_T^c (kJ/kJ _{E/W}) | $c_{CO_2}^d$ (gCO ₂ /kWh _{E/W}) | c_R/c_{NR} ratio |
|------------------------------|---------------|------------------------------------|---------------------------------|---------------------------------|--|--------------------|
| Coal-fired | 23.70 | 2.0627 | 0.0106 | 2.0733 | 579.11 | 0.01 |
| Oil-fired | 2.54 | 2.8620 | 0.0147 | 2.8767 | 737.18 | 0.01 |
| Natural gas-fired | 40.72 | 2.3848 | 0.0145 | 2.3994 | 478.22 | 0.01 |
| Biomass-fired | 14.54 | 0.5716 | 3.3355 | 3.9071 | 143.40 | 5.84 |
| Nuclear power | 3.09 | 3.1389 | 0.0299 | 3.1689 | 38.53 | 0.01 |
| Wind farms | 15.41 | 0.0344 | 2.2245 | 2.2589 | 3.00 | 64.70 |
| Dutch Electricity mix | 100.00 | 1.7180 | 0.8375 | 2.5555 | 373.21 | 0.49 |

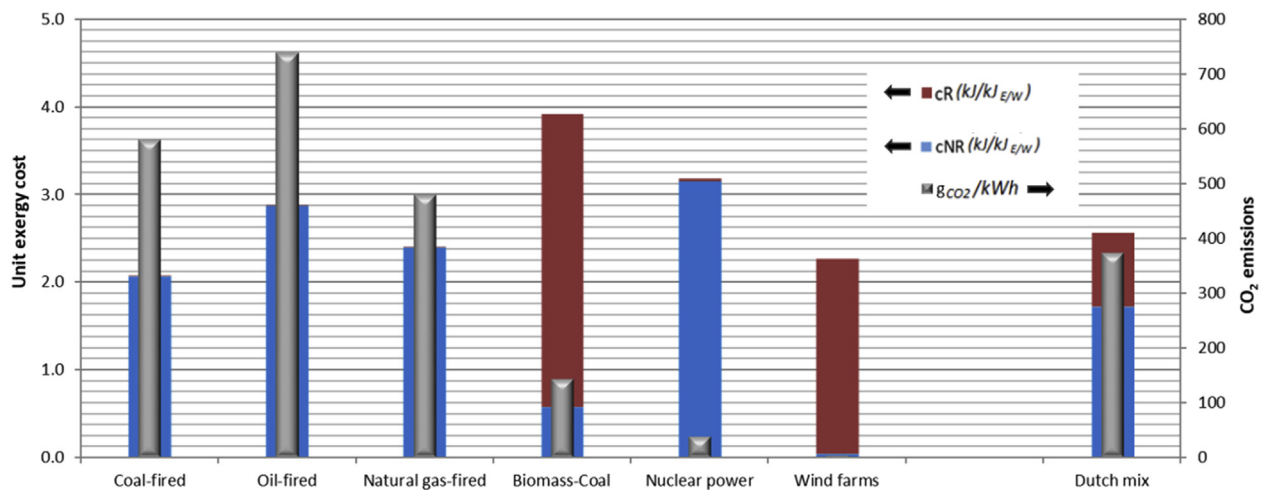
^a c_{NR} : Non-renewable unit exergy cost^b c_R : Renewable unit exergy cost^c c_T : Total unit exergy cost^d c_{CO_2} : Specific CO₂ emissions**Fig. 6.** Unit exergy cost and CO₂ emissions of the electricity generation in the Netherlands.

natural gas, as well as the rapid development of renewables, primarily wind and biomass resources.

Furthermore, according to Table 5, the renewable to non-renewable c_R/c_{NR} ratio of the exergy invested in the electricity generation routes is not necessarily equal to zero, especially in the case of the fossil-based electricity generation routes, due to the slightly renewable amount of renewable exergy consumed with the use of electricity, which is, in turn, partially produced by using alternative power generation routes, such as wind farms and biomass-based power plants.

Consequently, the intricacies of the integrated Dutch electricity mix evinced in Fig. 3 can be better understood when an iterative calculation process of the unit exergy costs and the specific CO₂ emissions is considered. Even though the highest c_R/c_{NR} ratio corresponds to the biomass-fired and wind power plants, the associated CO₂ emissions due to the indirect consumption of fossil resources, such as diesel or the non-renewable fraction of the Dutch electricity in the upstream supply and construction stages, it ends up affecting the overall CO₂ emissions accounting, regardless of the so-called 'green' characteristics of the alternative electricity generation routes. This result represents a fair level playing field for comparison purposes between diverse technological solutions and energy resources consumption for power generation.

Fig. 6 graphically compares the unit exergy cost and specific CO₂ emissions of the different electricity generation routes with that of the overall Dutch electricity mix. As it can be seen, among the facilities fuelled by non-renewable energy resources, the highest unit exergy costs of the electricity generated correspond to the nuclear

and oil-fired power stations, mainly explained by the low average exergy efficiencies considered (32% and 35%, respectively).

As it concerns the atmospheric CO₂ emissions, the highest emitting technologies are expectedly the oil-fired plants, followed by the coal-fired ones. On the other hand, the CO₂ emissions for natural gas-fired power plants are much lower due to higher hydrogen to carbon ratio of the fuel and the higher efficiency related to the combined power cycles.

These results can be compared to those for the integrated Brazilian electricity mix with a larger participation of renewable resources, mainly dominated by hydroelectricity (81.9%) and biomass cogeneration plants (6.6%), followed by natural gas (4.4%), nuclear (2.7%) and oil products (2.5%), with coal products playing a much smaller role (1.4%) [67]. Wind power still represents only 0.5% of the electricity mix. According to Ribeiro et al. [68], the primary hydropower in Brazil (Itaipu plant) is responsible for producing 23.8% of Brazilian electricity consumption. Despite some controversies about the amount of emissions from the water reservoir, hydropower is often considered the lowest emitting technology [69,70]. Dones et al. [71] reported two research studies from Brazil and Canada in which the influence of the world region (ecosystem) in the intensity of CO₂ emissions is compared when flooding the soil in order to produce electricity. The determination of such emission levels depends on the decay rates, specific localization, and types of cultures, which carries a large amount of uncertainty [70].

Furthermore, the efficiency of hydroelectric power stations is high because losses result only from hydraulic friction in water

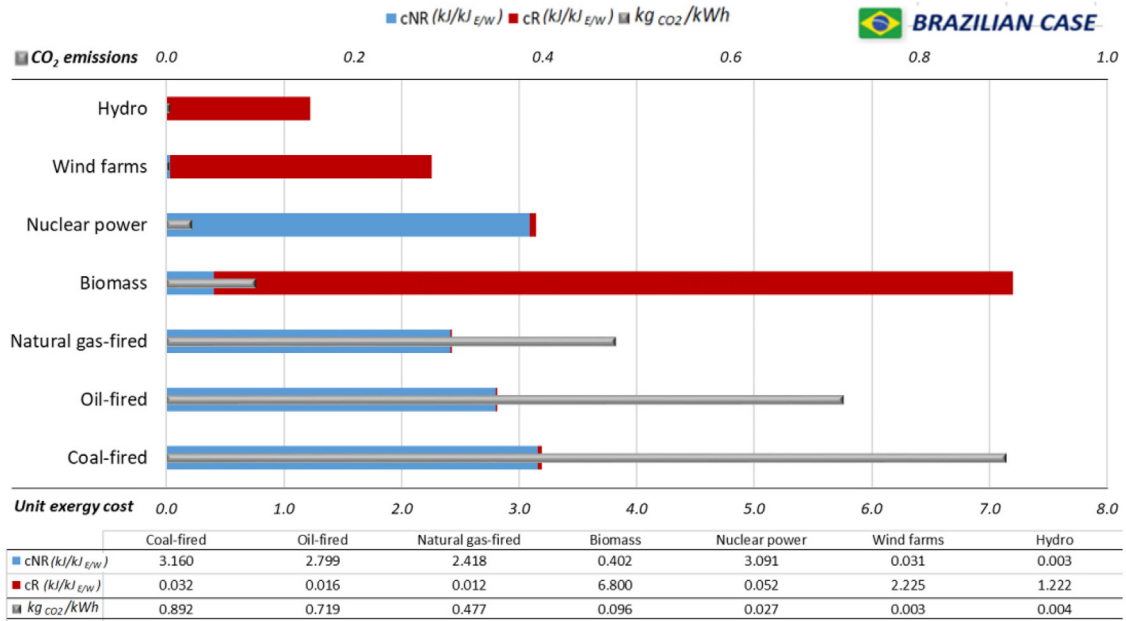

(a) Brazilian scenario. Adapted from Flórez-Orrego et al. [37].

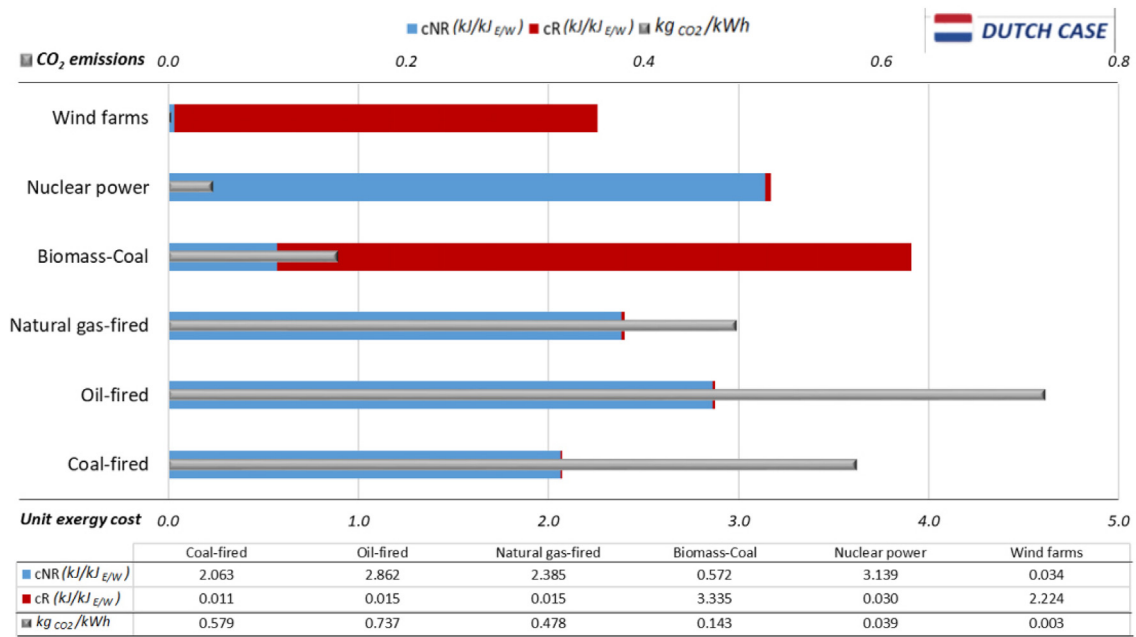

(b) Dutch scenario.

Fig. 7. Comparison between the unit exergy cost and specific CO₂ emissions of the Dutch and Brazilian electricity mix per route.

channels and the passage through turbine blades, as well as from mechanical friction and other irreversibilities in the hydroelectric generator. As pointed out by Szargut et al. [21], the electricity generation efficiency ranges between 70% and 90% for one-fourth of load and full load, respectively. Also, the CO₂ emission intensity of 4.33 g_{CO2}/kWh_{E/W} for hydroelectricity, as reported by Ribeiro et al. [68], encouraged the comparison between the Dutch and Brazilian electricity mixes. Accordingly, the renewable and non-renewable unit exergy costs of the electricity generated in each route in the Brazilian case achieved $c_R = 1.4631$ kJ/kJ_{E/W} and $c_{NR} = 0.3329$ kJ/kJ_{E/W}, respectively (see Fig. 7a) [38]. Additionally,

the specific CO₂ emissions attained 62.09 g_{CO2}/kWh_{E/W}, or almost sixfold lower than the emission intensity found for the Dutch electricity (see Fig. 7b).

These results point towards important differences between the Dutch and the Brazilian electricity mixes. Among the most interesting facts is the difference between the overall exergy efficiency of the power generation in both countries, namely 39.13% and 55.68% for the Dutch and Brazilian cases, respectively. This value can be calculated as the inverse of the total unit exergy cost of the overall power generated in each electricity mix. On the other hand, since the electricity mix in Brazil is primarily dominated by

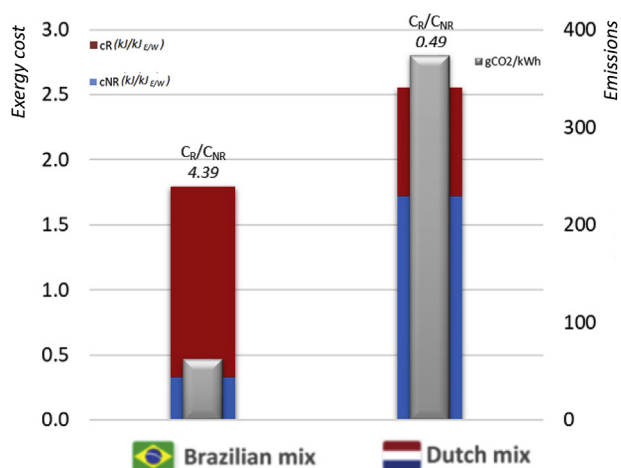

Fig. 8. Comparison between the Dutch and Brazilian electricity mix in terms of the total, renewable, and non-renewable unit exergy costs and specific CO₂ emissions.

renewable resources (e.g., hydroelectric, 81.9% and biomass-based power plants, 6.6%), the renewable to non-renewable exergy cost ratio C_R/C_{NR} ratio achieves 4.39 [38] (see Fig. 8), almost 9 times higher than the renewable to non-renewable exergy cost ratio obtained in the case of the Netherlands ($C_R/C_{NR} = 0.49$).

Indeed, any comparative assessment based solely on aspects related to the Second Law of Thermodynamics without including other economic, geographic, or even societal criteria may leave aside some essential dimensions of the energy sector planning and decision making, particular to each country. Notwithstanding, the presented results represent a valuable preliminary insight for aiding institutions and energy market agents to issue recommendations for rationally distributing the energy expenditure and environmental burdens. Actually, the applied methodology highlights the pervasive nature of electricity in the residential, industrial, and agricultural activities, responsible for manufacturing various goods and services, in turn showing how its consumption affects directly or indirectly the different actors of the economic sectors.

Hence, the exergy analysis is a practical approach that can be used to evaluate the merit of the energy conversion systems and distribution processes, regardless of the nature of the energy resources and technologies considered. Exergoeconomic analysis complements and enhances traditional energy analysis, as it also assesses the quality of the energy resources. Since it is based on the Second Law of Thermodynamics, it bounds the maximum potential for work that can be produced from a substance or exergy flow. In other words, it compares the actual performance of the processes to the maximum theoretical efficiency for all the studied energy conversion technologies in a level playing field, regardless of the mass or energy nature of the resource used. In this way, exergoeconomic analyses allow for issuing recommendations that prioritize the development and upgrade of the technologies embedded in the domestic electricity mix or, in the broader sense, the domestic energy mix, looking for more sustainable routes for power generation and supply chains.

Thus, the first and most evident recommendation is the need for embracing the use of the Second Law of Thermodynamics to properly compare different energy technologies by using objective allocation methods that account for both the irreversibilities inside the economic process as well as for the associated CO₂ emissions of each power generation route. This new approach may allow issuing more objectively future carbon taxation policies.

Furthermore, it is demonstrated that, although renewable energy resources, such as biomass cogeneration systems, may be integrated or further expanded to diversify the electricity mix and reduce the share of non-renewable energy resources in the nationwide energy mix, the inefficient and unsustainable use of those resources may threaten their a priori admitted renewability and offset the advantages of the alternative energy technologies, at the expense of an increased fossil fuel consumption and indirect emissions occurring in their upstream supply stages. In this way, a more rational assessment of the novel technology developments and applications may be quantified to reflect the actual impact of the so-called renewable electricity generation pathways in the potential of decarbonisation of the economic sectors and, specifically, highly non-renewable national grids.

4. Conclusions

An exergy-based allocation procedure accounting for exergy costs and specific CO₂ emissions of the electricity mix in the Netherlands was carried out based on the representative routes of electricity generation. The methodology of analysis identifies and classifies the different stages into supply, transformation, and end-use stages, and allows differentiating between total, renewable, and non-renewable unit exergy costs. Thus, the contribution of renewable exergy in the total exergy expenditure can be calculated. An iterative approach is also applied to determine the unit exergy costs of the intermediate substances and exergy flows before reaching the power generation unit. In this way, the feedback calculation of the indirect and direct CO₂ emissions of the technological configurations in the upstream and downstream fuel processing stages can be determined. As a result, the significant role that the indirect emissions play in the renewable-based pathways is evidenced, such as in the case of the consumption of the CO₂-intensive Dutch electricity mix, six fold more emitting than the Brazilian mix, highly reliant on hydropower and used for comparison purposes.

In fact, the weighted average renewable and non-renewable unit exergy costs of the electricity generated in the Netherlands results in $C_R = 0.8375$ kJ/kJ_{E/W} and $C_{NR} = 1.7180$ kJ/kJ_{E/W}, respectively. In contrast, the specific CO₂ emissions in the electricity generation achieve 373.21 gCO₂/kWh_{E/W}, equivalent to a renewable to non-renewable exergy consumption ratio of $C_R/C_{NR} = 0.49$. This result is a consequence of the lower efficiency of the biomass-based power generation systems, compared to the higher average 80% efficiency of hydropower, which represents only a small fraction in the Dutch electricity sector. Although only 14.6% of the total unit exergy cost of the biomass-fired power plants is owed to non-renewable energy resources, those technologies still present the highest unit exergy cost among all the routes of the electricity generated. Furthermore, due to the reduced participation of renewable resources, around 67% of the total unit exergy cost of the Dutch electricity mix is non-renewable cost, dominated by fossil resources (nuclear, natural gas, coal, and oil-fired). Finally, unlike the energy-based analysis, these figures may help assess and compare the effect of the electricity generation and consumption with other types of exergy sources and power technologies in a more rational manner and shed light on new approaches for defining proper taxation policies.

Declaration of competing interest

The authors declare that they have no known competing financial interests or personal relationships that could have appeared to influence the work reported in this paper.

Acknowledgments

The authors acknowledge the São Paulo Research Foundation (FAPESP) for grants 2017/03091-8 and 2017/16106-3. In addition, this work was carried out within the framework of a FAPESP-BIOEN thematic research project, process 2015/20630-4. Daniel Flórez-Orrego would like to acknowledge the Brazilian National Agency of Petroleum, Gas, and Biofuels (ANP) and its Human Resources Program (PRH/ANP grant 48610.008928.99), and the Colombian Administrative Department of Science, Technology, and Innovation (COLCIENCIAS 646/2014). Lastly, Silvio de Oliveira Junior also acknowledges the Brazilian National Research Council for Scientific and Technological Development, CNPq (grant 304935/2016-6).

References

- [1] IEA. Electricity generation by fuel and scenario, 2018–2040. 2019. <https://www.iea.org/data-and-statistics/charts/electricity-generation-by-fuel-and-scenario-2018-2040>. [Accessed 25 April 2020].
- [2] Fragkos P, Kouvaritakis N. Model-based analysis of intended nationally determined contributions and 2 °C pathways for major economies. *Energy* 2018;160:965–78. <https://doi.org/10.1016/j.energy.2018.07.030>.
- [3] Turconi R, Boldrin A, Astrup T. Life cycle assessment (LCA) of electricity generation technologies: overview, comparability and limitations. *Renew Sustain Energy Rev* 2013;28:555–65. <https://doi.org/10.1016/j.rser.2013.08.013>.
- [4] Itten R, Frischknecht R, Stucki M. Life cycle inventories of electricity mixes and grid. Version 1.3. Switzerland: ESU-services Ltd., Paul Scherrer Institut (PSI); 2014.
- [5] Rugani B, Maia de Souza D, Weidema BP, Bare J, Bakshi B, Grann B, Johnston JM, Pavan ALR, Liu X, Laurent A, Verones F. Towards integrating the ecosystem services cascade framework within the Life Cycle Assessment (LCA) cause-effect methodology. *Sci Total Environ* 2019;690:1284–98. <https://doi.org/10.1016/j.scitotenv.2019.07.023>.
- [6] Kiss B, Kácsor E, Szalay Z. Environmental assessment of future electricity mix – linking an hourly economic model with LCA. *J Clean Prod* 2020;264:121536. <https://doi.org/10.1016/j.jclepro.2020.121536>.
- [7] Hohenwarter D, Heindler M. Net power and energy output of the German LWR nuclear power system. *Energy* 1988;13:287–300. [https://doi.org/10.1016/0360-5442\(88\)90023-0](https://doi.org/10.1016/0360-5442(88)90023-0).
- [8] Ahlgren S, Björklund A, Ekman A, Karlsson H, Berlin J, Börjesson P, Ekvall T, Finnveden G, Janssen M, Strid I. Review of methodological choices in LCA of biorefinery systems – key issues and recommendations. *Biofuels, Bioproducts and Biorefining* 2015;9:606–19. <https://doi.org/10.1002/bbb.1563>.
- [9] González-García S, Lacoste C, Aicher T, Feijoo G, Lijó L, Moreira MT. Environmental sustainability of bark valorisation into biofoam and syngas. *J Clean Prod* 2016;125:33–43. <https://doi.org/10.1016/j.jclepro.2016.03.024>.
- [10] Djomo SN, Knudsen MT, Parajuli R, Andersen MS, Ambye-Jensen M, Jungmeier G, Gabrielle B, Hermansen JE. Solving the multifunctionality dilemma in biorefineries with a novel hybrid mass–energy allocation method. *GCBB Bioenergy* 2017;9:1674–86. <https://doi.org/10.1111/gcbb.12461>.
- [11] Timonen K, Sinkko T, Luostarinen S, Tampio E, Joensuu K. LCA of anaerobic digestion: emission allocation for energy and digestate. *J Clean Prod* 2019;235:1567–79. <https://doi.org/10.1016/j.jclepro.2019.06.085>.
- [12] Leprince P, Arlie J, Raimbault C. How to calculate the energy content of oil-origin products and their substitutes vegetable and coal-origin. *Rev Inst Fr Petrol* 1981;36:81–90.
- [13] Sultanov M. Optimization of CHP operating modes in regards to energy efficiency. Ph.D. Thesis in Engineering Sciences. Moscow Power Engineering Institute; 2010.
- [14] Sukhareva E, Fedyukhin AV, Kikot EA, Matisov BG, Nikitkov NV, Izrantsev VV, Knorring VG, Kondrashkova GA, Akhmetov TR, Sinitsyn AA. Flexible allocation of costs between electricity and heat as a factor for improving the CHP competitiveness. *IOP Conf Ser Earth Environ Sci* 2019;337. <https://doi.org/10.1088/1755-1315/337/1/012079>.
- [15] El-Nashar AM. Cost allocation of electricity and water in a cogeneration plant. *Desalination* 1992;85:197–212. [https://doi.org/10.1016/0011-9164\(92\)80005-T](https://doi.org/10.1016/0011-9164(92)80005-T).
- [16] DEFRA. Guidelines to defra/DECC's GHG conversion factors for company reporting. London: Department for Environment, Food and Rural Affairs; 2012. <https://www.gov.uk/environment/greenhouse-gas-emissions>. [Accessed 20 January 2019].
- [17] Righi S. Life cycle assessments of waste-based biorefineries—a critical review. In: Basosi R, Cellura M, Longo S, Parisi ML, editors. Life cycle assessment of energy systems and sustainable energy technologies: the Italian experience. Cham: Springer International Publishing; 2019. p. 139–54. https://doi.org/10.1007/978-3-319-93740-3_9.
- [18] Shapouri H, Duffield J, Wang M. The energy balance of corn ethanol: an update. United States: United States Department of Agriculture - USDA; 2002. <https://grist.files.wordpress.com/2006/02/265.pdf>. [Accessed 20 January 2019].
- [19] Agostinho F, Sevegnani F, Almeida CMVB, Giannetti BF. Exploring the potentialities of energy accounting in studying the limits to growth of urban systems. *Ecol Indic* 2018;94:4–12. <https://doi.org/10.1016/j.jecolind.2016.05.007>.
- [20] Marinho Neto HF, Agostinho F, Almeida CMVB, Moreno García RR, Giannetti BF. Activity-based costing using multicriteria drivers: an accounting proposal to boost companies toward sustainability. *Front Energy Res* 2018;6:36. <https://doi.org/10.3389/fenrg.2018.00036>.
- [21] Szargut J, Morris D, Steward F. Exergy analysis of thermal, chemical, and metallurgical processes. New York: Hemisphere Publishing Corporation; 1988.
- [22] Wang M, Lee H, Molburg J. Allocation of energy use in petroleum refineries to petroleum products. *Int J LCA* 2004;9:34–44. <https://doi.org/10.1007/BF02978534>.
- [23] Wang M, Huo H, Arora S. Methods of dealing with co-products of biofuels in life-cycle analysis and consequent results within the U.S. context. *Energy Pol* 2011;39:5726–36. <https://doi.org/10.1016/j.enpol.2010.03.052>.
- [24] Sciubba E. From engineering economics to extended exergy accounting: a possible path from monetary to resource-based costing. *J Ind Ecol* 2004;8:19–40. <https://doi.org/10.1162/1088198043630397>.
- [25] Valero A, Lozano M, Muñoz M. A general theory of exergy saving. I. On the exergetic cost. In: Gaggioli R, editor. Computer-aided engineering and energy systems. Second Law Analysis and Modelling; 1986. p. 1–8.
- [26] Frangopoulos C. Thermoeconomical functional analysis: a method for optimal design or improvement of complex thermal systems. PhD Thesis. Georgia Institute of Technology; 1983.
- [27] Gaggioli RA. Second Law analysis for process and energy engineering. In: Efficiency and costing. American Chemical Society; 1983. p. 3–50. <https://doi.org/10.1021/bk-1983-0235.ch001>.
- [28] Von Spakovsky M. A practical generalized analysis approach to the optimal thermoeconomic design and improvement of real-world thermal systems. PhD Thesis. Georgia Institute of Technology; 1986.
- [29] Serra L. Exergoeconomic optimization of thermal systems. PhD Thesis. University of Zaragoza; 1994.
- [30] Lazzaretto A, Tsatsaronis G. SPECO: a systematic and general methodology for calculating efficiencies and costs in thermal systems. *Energy* 2006;31:1257–89. <https://doi.org/10.1016/j.energy.2005.03.011>.
- [31] Silva JAM, Flórez-Orrego D, de Oliveira S. An exergy based approach to determine production cost and CO₂ allocation for petroleum derived fuels. *Energy* 2014;67:490–5. <https://doi.org/10.1016/j.energy.2014.02.022>.
- [32] Flórez-Orrego D, Silva JAM, Velásquez H, de Oliveira S. Renewable and non-renewable exergy costs and CO₂ emissions in the production of fuels for Brazilian transportation sector. *Energy* 2015;88:18–36. <https://doi.org/10.1016/j.energy.2015.05.031>.
- [33] Nascimento Silva FC, Alkmin Freire RL, Flórez-Orrego D, de Oliveira S. Comparative assessment of advanced power generation and carbon sequestration plants on offshore petroleum platforms. *Energy* 2020;117737. <https://doi.org/10.1016/j.energy.2020.117737>.
- [34] Silva Ortiz P, Maciel Filho R, Posada J. Mass and heat integration in ethanol production mills for enhanced process efficiency and exergy-based renewability performance. *Processes* 2019;7(670). <https://doi.org/10.3390/pr7100670>.
- [35] Ptasinski KJ, Koymans MN, Verspagen HHG. Performance of the Dutch energy sector based on energy, exergy and extended exergy accounting. *Energy* 2006;31:3135–44. <https://doi.org/10.1016/j.energy.2006.03.010>.
- [36] Iora P, Beretta GP, Ghoniem AF. Exergy loss based allocation method for hybrid renewable-fossil power plants applied to an integrated solar combined cycle. *Energy* 2019;173:893–901. <https://doi.org/10.1016/j.energy.2019.02.095>.
- [37] Silva JAM, Santos JCS, Carvalho M, de Oliveira S. On the thermoeconomic and LCA methods for waste and fuel allocation in multiproduct systems. *Energy* 2017;127:775–85. <https://doi.org/10.1016/j.energy.2017.03.147>.
- [38] Flórez-Orrego D, Silva JAM, de Oliveira S. Renewable and non-renewable exergy cost and specific CO₂ emission of electricity generation: the Brazilian case. *Energy Convers Manag* 2014;85:619–29. <https://doi.org/10.1016/j.enconman.2014.04.058>.
- [39] IEA Bioenergy. Country report The Netherlands, Task42 biorefining in a future BioEconomy. EIA; 2019. <http://task42.ieabioenergy.com/>. [Accessed 20 June 2019].
- [40] BP. Statistical review of world energy 2019. BP Global; 2019. <https://www.bp.com/en/global/corporate/energy-economics/statistical-review-of-world-energy.html>. [Accessed 1 May 2020].
- [41] Enerdata. Enerdata EnerOutlook. 2018. <https://eneroutlook.enerdata.net/>. [Accessed 5 March 2020].
- [42] van de Ketterij RG. Emissions reduction at The Netherlands ministry of defence: potential, possibilities and impact. In: Proceedings of the International Naval Engineering Conference & Exhibition. Glasgow, UK: INEC; 2018.
- [43] Commercial Service US. Netherlands country commercial guide. 2018.
- [44] U.S. Energy Information Administration (EIA). International energy Statistics-The Netherlands. IEA; 2019. <https://www.eia.gov/beta/international/data/browser/>. [Accessed 30 October 2019].
- [45] IEA. Energy policies of IEA countries-The Netherlands 2014 review. OECD/IEA International Energy Agency; 2014. www.iea.org. [Accessed 10 September 2019].
- [46] Kotas TJ. The exergy method of thermal plant design. London-UK:

- Butterworths; 1985.
- [47] Lora E, Nascimento M. *Geração Termelétrica Planejamento. Projeto e Operação*. 2014. Editora Interciência.
- [48] EPZ. *Borssele nuclear power plant*. 2018.
- [49] Environment and Development Service. *A Burning Issue - the global footprint of coal-fired energy in The Netherlands, Both Ends briefing paper*. Bothends; 2011. <https://www.bothends.org/en/>. [Accessed 23 September 2019].
- [50] CBS-Statistics Netherlands. *Crude oil imported by The Netherlands*. CBS; 2015. <https://www.cbs.nl/en-gb/news/2011/11/russia-largest-oil-supplier-for-the-netherlands>. [Accessed 3 October 2019].
- [51] Nakashima CY, de Oliveira S, Caetano EF. Subsea multiphase pumping system x gas lift: an exergo-economic comparison. *Revista de Engenharia Térmica* 2004;3:107–14. <https://doi.org/10.5380/reterm.v3i2.3531>.
- [52] Reuters. *Dutch become net importer of gas as Groningen production cuts bite*. Reuters; 2019. <https://www.reuters.com/article/netherlands-gas-imports/dutch-become-net-importer-of-gas-as-groningen-production-cuts-bite-idUSL8N1RW38L>. [Accessed 10 February 2020].
- [53] Pereira Hill M. *Energy use in transport: comparative analysis of energy efficiency between compressed natural gas and gas-fired electricity at the end use in light vehicles*. Federal University of Rio de Janeiro; 2010.
- [54] Ogg F. *Policy paper series-The Netherlands*. WWEA-World Wind Energy Association; 2018.
- [55] IEA Bioenergy, *Country Reports. The Netherlands – 2018 update, Bioenergy policies and status of implementation*. 2018.
- [56] Zwart R. *Report on BUS-ticket E3 - import of biomass: logistic advantages of overseas pre-treatment*. BUS Biomass-Upstream Stuurgroep; 2006.
- [57] Flach B. *The Dutch industrial market for biomass*. USDA Foreign Agricultural Service; 2019.
- [58] Tsatsaronis G. *Design optimization using exergoeconomics*. In: *Thermodynamic optimization of complex energy systems*. Springer-Science+Business Media; 1999.
- [59] Lozano MA, Valero A. *Theory of the exergetic cost*. *Energy* 1993;18:939–60. [https://doi.org/10.1016/0360-5442\(93\)90006-Y](https://doi.org/10.1016/0360-5442(93)90006-Y).
- [60] Torres C, Valero A, Rangel V, Zaleta A. *On the cost formation process of the residues*. *Energy* 2008;33:144–52. <https://doi.org/10.1016/j.energy.2007.06.007>.
- [61] Flórez-Orrego D, de Oliveira S. *On the efficiency, exergy costs and CO₂ emission cost allocation for an integrated syngas and ammonia production plant*. *Energy* 2016;117:341–60. <https://doi.org/10.1016/j.energy.2016.05.096>.
- [62] Flórez-Orrego D, Silva JAM, de Oliveira S. *Exergy and environmental comparison of the end use of vehicle fuels: the Brazilian case*. *Energy Convers Manag* 2015;100:220–31. <https://doi.org/10.1016/j.enconman.2015.04.074>.
- [63] Dewulf J, Van Langenhove H, Muys B, Bruers S, Bakshi BR, Grubb GF, Paulus DM, Sciubba E. *Exergy: its potential and limitations in environmental science and technology*. *Environ Sci Technol* 2008;42:2221–32. <https://doi.org/10.1021/es071719a>.
- [64] Bejan A, Tsatsaronis G, Moran M. *Thermal design and optimization*. N.Y.: John Wiley & Sons Inc.; 1996.
- [65] Enerdata-ABB. *The Netherlands-Energy efficiency report, Enerdata-ABB. Netherlands-Country reports 2013*.
- [66] EEA. *Overview of electricity production and use in Europe*. Copenhagen, Denmark: European Environment Agency; 2018. <https://www.eea.europa.eu/data-and-maps/indicators/overview-of-the-electricityproduction-2/assessment-4>. [Accessed 10 December 2019].
- [67] MME. *Brazilian energy balance/balanço energético nacional 2019, ano base 2018*. Rio de Janeiro, Brazil: EPE; 2019. <https://ben.epe.gov.br/>. [Accessed 20 February 2020].
- [68] Ribeiro F de M, da Silva GA. *Life-cycle inventory for hydroelectric generation: a Brazilian case study*. *J Clean Prod* 2010;18:44–54. <https://doi.org/10.1016/j.jclepro.2009.09.006>.
- [69] Gagnon L, Bélanger C, Uchiyama Y. *Life-cycle assessment of electricity generation options: the status of research in year 2001*. *Energy Pol* 2002;30:1267–78. [https://doi.org/10.1016/S0301-4215\(02\)00088-5](https://doi.org/10.1016/S0301-4215(02)00088-5).
- [70] Raadal HL, Gagnon L, Modahl IS, Hanssen OJ. *Life cycle greenhouse gas (GHG) emissions from the generation of wind and hydro power*. *Renew Sustain Energy Rev* 2011;15:3417–22. <https://doi.org/10.1016/j.rser.2011.05.001>.
- [71] Dones R, Gantner U, Hirschberg S. *Greenhouse gas total emissions from current and future electricity and heat supply systems*. In: *Proceedings of 4th International Conference on Greenhouse Gas Control Technologies*. Interlaken (Switzerland): Pergamon; 1999.