

KATOENVEEM

FUNCTION vs. AESTHETICS

P1 Research Report

Heritage & Architecture
MSc3 'Rotterdam Harbour Heritage'
TU Delft

March 16-2017
Charlotte de Boon / 4005430

Tutors:
Lidy Meijers
Suzanne Fischer
Frank Koopman

Preface

As a part of the Heritage & Architecture MSc3 'Rotterdam Harbour Heritage' graduation studio at the TU Delft, I have been analysing the heritage value of an old, concrete warehouse building in Rotterdam named the Katoenveem.

This paper will elaborate on the research, observations and analysis I have done, regarding the aesthetics of the Katoenveem.

Doing this research helped me understand the reasons behind the appearance of the Katoenveem, which will be a guideline throughout the design process in the second part of my graduation studio.

Content

Introduction	7	Conclusion	37
1. The definition of aesthetics	8	Age Value Assessment	38
<i>What are aesthetics</i>	8	<i>Façades</i>	39
<i>Function of the ornament</i>	8	<i>Floor plans</i>	40
<i>Aesthetic value</i>	9	Heritage Value Assessment	42
2. The function of the Katoenveem	11	<i>Terrain</i>	43
<i>Function of the Katoenveem</i>	11	<i>Façades</i>	44
<i>Development of the Rotterdam Harbour</i>	12	<i>Floor plans</i>	46
<i>Development of the Warehouses and Veemen in Rotterdam</i>	13	Value Assessment	48
<i>Time line of the Rotterdam Harbour</i>	16	<i>Value Table</i>	48
<i>Influence of function on appearance of the Katoenveem</i>	18	Starting Points	50
<i>Conclusion of the function of the Katoenveem</i>	19	<i>Design</i>	50
3. Aesthetic discussion at the time	21	Bibliography	52
<i>Discussion about exposed concrete architecture</i>	21	<i>Literature</i>	52
<i>Historic Surface Finishes</i>	22	<i>Articles</i>	53
4. Aesthetics of the Katoenveem	25	<i>Websites</i>	53
<i>Influence of discussion on the aesthetics of the Katoenveem</i>	25	<i>Archives</i>	53
<i>Used surface treatment</i>	27	Attachments	55
<i>Exterior aesthetic detail</i>	30	<i>Position paper</i>	55
<i>Interior aesthetic detail</i>	31		
<i>Details pumping station</i>	33		
<i>Details terrain</i>	34		
5. Reasons for aesthetic Katoenveem	35		
<i>Influences</i>	35		



12 July 1949 - Photo: KLM Aerocarto / Aviodrome (copyright)

Introduction

The Katoenveem, as its name already suggests in Dutch, was a specially designed warehouse built for one specific function, the storage of cotton bales. Designed in 1920 by architect Jan Jeronimus Kanters, the Katoenveem has stood solidly at the end of the pier next to the Keilehaven located in the Vierhavens, Rotterdam. It was a revolutionary building completely designed to optimize the transshipment of the cotton bales and at the same time it assured that the cotton stored in the storehouse wouldn't lose its value. To do so, the building was constructed completely out of concrete and was divided into five different fire compartments to keep the cotton safe from unexpected fires.

Interestingly enough, around the time of the realization of the Katoenveem, there was a discussion going on in the Netherlands about the aesthetics of exposed concrete architecture. Exposed concrete was considered dull and expressionless and was usually disguised with traditional materials such as brick or natural stone. However in the early years of concrete, the aesthetic quality of the concrete surface being exposed to the public was accepted for industrial buildings. So how did architect J.J. Kanters react to this discussion when designing an industrial building constructed completely out of reinforced concrete? Was he influenced by the discussion, did he want to make the building appealing to the public or did he consider it a normal concrete industrial building and left it untreated. The question of this research report is therefore as follows:

To what extent did the architect of the Katoenveem combine the function of the concrete building with the aesthetics of exposed concrete architecture?

The first chapter of this research report will focus on the definition of aesthetics and the function of the ornament. The second chapter will explain the function of the Katoenveem and how the function has influenced the appearance of the Katoenveem. The third chapter will explain the reason of the discussion and what was considered appealing concrete architecture. The fourth chapter will investigate if and how the Katoenveem has been influenced by this discussion and the last chapter will explain the reason why the Katoenveem has been influenced or not by the discussion on exposed concrete architecture.

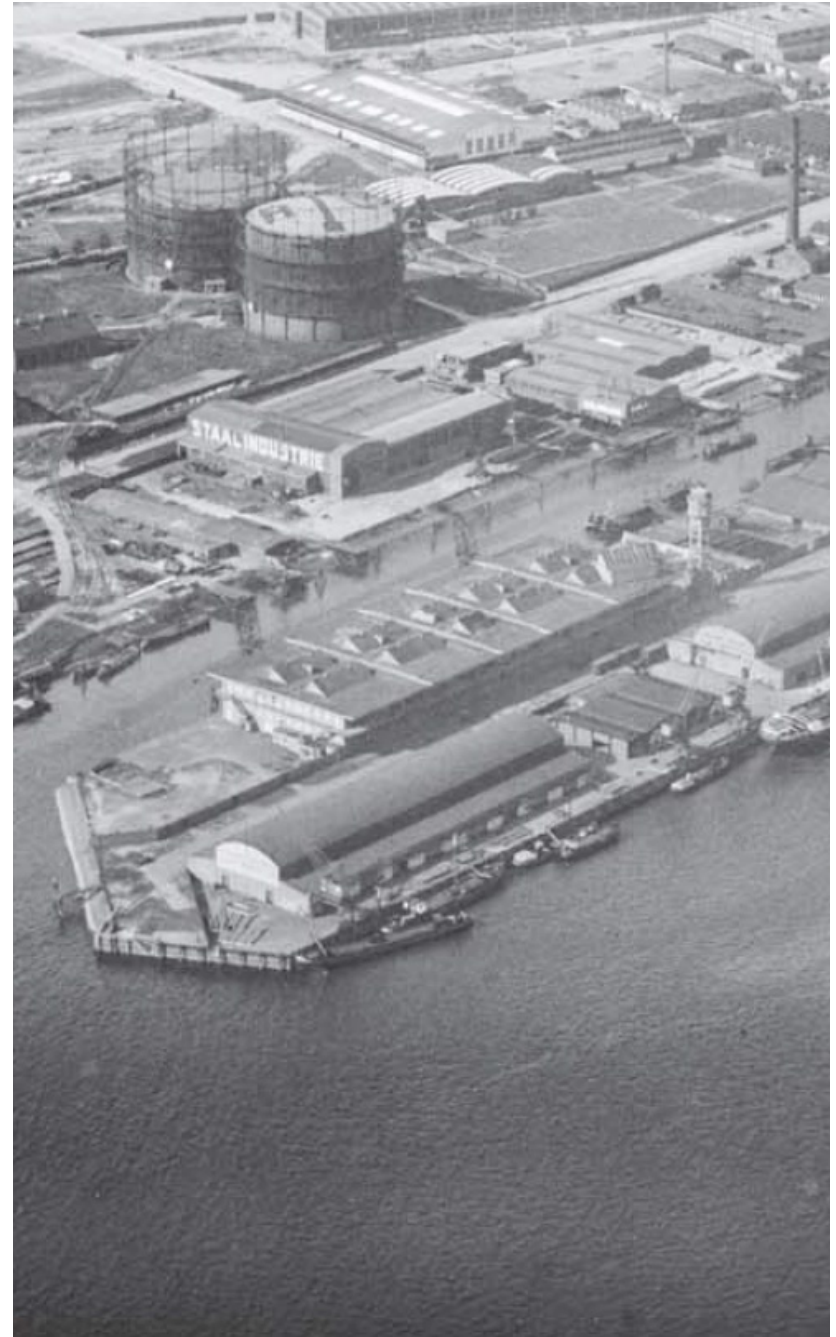

1. The definition of aesthetics

What are aesthetics

Since the beginning of the Roman times there has been a proceeding discussion about the aesthetics of architecture. Philosopher Vitruvius already defined beauty (venustas) together with firmness (firmitas) and utility (utilitas) as one of the three essential qualities of architecture. He described beauty as: “the appearance of the work is pleasing and in good taste, and its members are in due proportion according to correct principles of symmetry.” (Roth, 2007) This definition is still considered correct today, but not everyone may agree as taste may vary per person.

So how can we define aesthetics nowadays? According to Jon Lang in his book ‘Creating Architectural Theory’ written in 1987, he describes that the science of aesthetics is concerned with two things: “(1) identifying and understanding the factors that contribute to the perception of an object or a process as a beautiful or, at least, a pleasurable experience, and (2) understanding the nature of the human ability to create and to enjoy creating displays that are aesthetically pleasing.” (Lang, 1987) He describes beauty as something that has to be pleasing and creating a pleasurable experience to whomever observes it. But creating such experience means understanding the nature of the human ability to create an enjoyable experience. This is difficult because each human has a different understanding of what is beautiful. So how can aesthetics be justified and how can we find out if something will be considered beautiful? Buildings can create a pleasurable experience to the individual through the message they want to give to their observers. One way or another, a building can communicate a message from one person or group to another, but it depends on the observer how this message is perceived. Ornamentation has been a tool used in architecture for decades to sent out a message to its observer.

Function of the ornament

Throughout the decades, opinions about the use of ornamentation have continuously been changing. From Gottfried Semper’s theory of ornament to Adolf Loos’s opposition to it; “for Semper, the functional and structural requirements of a building were subordinate to the semiotic and artistic goals of ornament. For Loos, on the other hand, ornamentation was a crime. In his view, ornament was used in traditional societies as a means of differentiation; modern society needed not to emphasize individuality, but on the contrary, to suppress it. Hence for Loos, ornamentation had lost its social function and had become unnecessary.” (Moussavi & Kubo, 2006) Opinions of the use of ornamentation changed with style. For example the modernist style which was obsessed with transparency to make architecture more ‘sincere’. According to the modernists, the architecture of a building was supposed to make its function visible. Buildings had to be readable and therefore any type of ornamentation was unnecessary. Compared to the postmodern approach where the modernist style was critiqued as ‘cynical and dull’ and transparency was replaced with décor to “integrate



buildings within the urban realm and give them meaning in the eyes of the public.” However, according to Moussavi & Kubo in their book ‘The function of ornament’ ornamentation these days should “become an “empty sign” capable of generating an unlimited number of resonances.” Concluding that the function of ornament depends on the message it wants to give to the observer, from a clear functional message in the modernist style, to a specific message in the post-modernist style, or an open message used in current days which leaves the message up to the observer to decide.

Aesthetic value

Last of all the aesthetic value of the building refers to the visual qualities of heritage. “Aesthetic value is a strong contributor to a sense of well-being and is perhaps the most personal and individualistic of the sociocultural value types.” (Mason, 2002) According to Jon Lang in his book ‘Creating Architectural Theory’ written in 1987, he describes that the science of aesthetics is concerned with two things: “(1) identifying and understanding the factors that contribute to the perception of an object or a process as a beautiful or, at least, a pleasurable experience, and (2) understanding the nature of the human ability to create and to enjoy creating displays that are aesthetically pleasing.” (Lang, 1987) Lang also describes beauty as something that has to be pleasing and creating a pleasurable experience to whomever observes it. But creating such experience means understanding what leads to such enjoyable experience. This therefore makes the aesthetic value of a building difficult to determine because beauty is in the eye of the beholder.

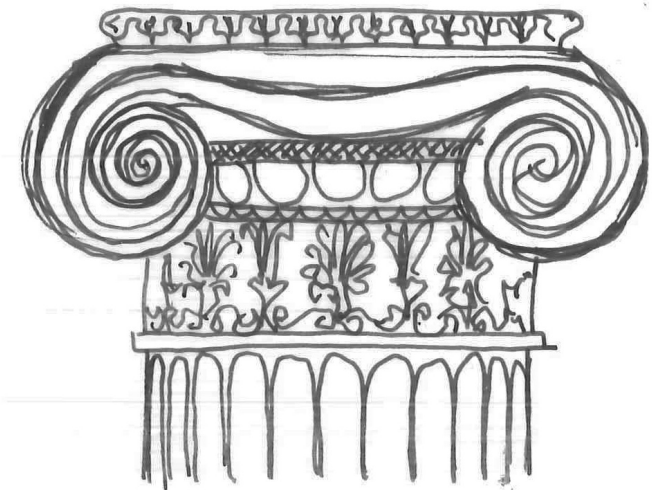



The Katoenveem on the Keilestraat, Fototechnische Dienst Rotterdam (Gemeentewerken, Openbare Werken), 1919, Rotterdam Stadsarchief.

2. The function of the Katoenveem

Function of the Katoenveem

The Katoenveem was the first establishment in Rotterdam specially built for the import and storage of cotton bales. The name Katoenveem is translated to “cotton storehouse company”. A storehouse company is a building which contains an enterprise which is specialized in temporarily storing goods for another enterprise. It functioned as a third party between the seller and the buyer of the goods with the aim to keep the goods safe until they could be sent off to their final destination on a later date. (Winter & Jong, 1982)

In the beginning of 1915 hopes had arrived to start a cotton trade in Rotterdam. For this to be successful, the harbour of Rotterdam had to be equipped with a warehouse for the cotton trade facilities. (Dam, 1919) A number of different storehouse companies decided to join partnership to start the cotton trade in Rotterdam. Joining together would mean that the companies could split the high insurance costs. The insurance companies demanded high insurance costs for the storage of cotton bales, because the cotton dust that came free from the bales was highly flammable. On November 20th 1915, the Katoenveem Joint Stock Company was established, a partnership between six different storehouse companies; Blaauwhoedenveem, Handelsveem, Hollandsveem, Leydsche Veem, Nederlandsche Veem, and Pakhuismeesteren. The Blaauwhoedenveem held the most shares out of all six different storehouse companies with 10 out of the 25 shares. (Dam, 1919)

A specially built cotton storehouse such as the Katoenveem was of great importance for the cotton trade. Cotton bales would lose weight upon arrival due to the drying of the cotton. At temperatures $> 25^{\circ}\text{C}$ and too much direct light, cotton will dry out and causes it to become hard, brittle and lose its elasticity. (www.tis-gdv.de) The drying of the cotton bales was a disadvantage for the cotton traders as the buyers would buy the cotton by weight. As a result, the cotton traders would use heavy packaging around the cotton bales to take advantage and gain more profit. To keep both parties happy, measures were taken for the storehouse companies to assure that the climate conditions within the storehouse would not cause the cotton bales to dry out and therefore keep a fair trade. (Rotterdamsch Nieuwsblad, 08/07/1926) Not only was the drying of the cotton bales a problem, the bales had to also be stored in an area which would prevent the bales from rotting. The optimum temperature for mold development is $25 - 35^{\circ}\text{C}$. At temperatures $< 0^{\circ}\text{C}$ there is no risk of wet bales rotting, since this process stops at low temperatures. (www.tis-gdv.de) Therefore it was important to store the cotton bales in cool climate conditions without direct sunlight to prevent the cotton bales from rotting and drying out.



A packed Katoenveem, 1952, photograph by F.H. (François Henry) van Dijk, Rotterdam Stadsarchief.

Development of the Rotterdam Harbour

In the 16th century, Rotterdam had become the second largest port city in the country, besides Amsterdam. Following into the 17th century, Rotterdam underwent a period of great prosperity which ended due to the general depression in the Netherlands. In 1820 the trade started to pick up again due to the import of colonial goods from the Dutch East Indies. The harbour started to react on this development in 1847 with the construction of 'het eerste nieuwe werk' (first new work), the Willemsskade. In 1852 'het tweede nieuwe werk' (second new work) was realized, the Westerskade. It wasn't until the 1870's that the port started to develop on the southern riverbanks. Important for the trade on the southern riverbanks was the development of the 'nieuwe waterweg' (new waterway) developed in 1872. The new waterway connected the port to the open sea and allowed all the large ships to directly enter the port. This made Rotterdam the main port city for the German Ruhr area. The Willemss bridge was constructed in 1878 to connect the north and the south river banks. From this moment on, Rotterdam continued to develop from an old-fashioned emporium to a modern transit port. (Winter & Jong, 1982)

The harbour of Rotterdam developed further in 1887 with the construction of the Rijnhaven (1887-1895) together with the construction of the Maashaven (1898-1905). Both harbours were meant for transshipment of bulk goods like stone coal, grain and fruits. The construction of the Vierhavens from (1912-1916) moved the harbour further along towards the North sea. This harbour was built as a cargo port with harbour basins and long quays. From 1915-1920 one of the piers of the Vierhavens, in between the Keilehaven and Lekhaven, made room to built the Katoenveem. (see the star in image to the left) The harbour of Rotterdam got its general shape with the completion of the Eemhaven constructed between 1946-1965. The Eemhaven was originally constructed as a cargo port, but since 1966 the port is dominated by container storage. The harbour still keeps developing till this day, but the area of the Stadshavens has for the most parts remained the same since 1970. (Gemeente Rotterdam, 2010)

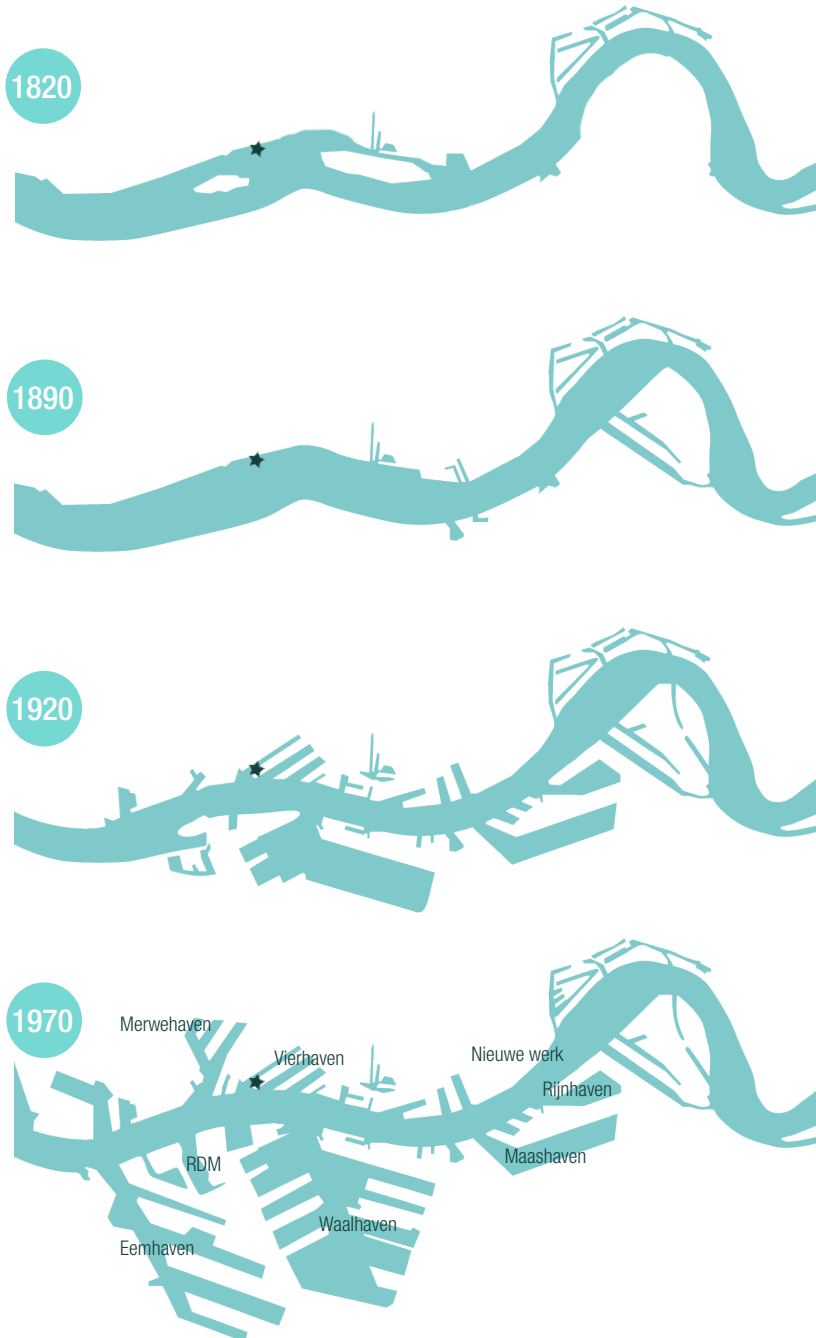

Development of the Warehouses and Veemen in Rotterdam

Warehouses came to development when the harbour shipping and commerce rapidly expanded and the ports couldn't distribute the amounts of goods imported. The goods had to be stored somewhere before they could be sent off to their final destination and so warehouses were built. In the past, the goods would be stored in the cellars or attics of large merchant houses. (Winter & Jong, 1982) When the ports started to grow, storage and transshipment had to be handled more efficiently and so did the warehouses. As a result, warehouses designed for specific types of storage started to develop. According to de Winter & de Jong, the most important aspects which a warehouse architect had to keep in mind were: to maximize the investable surface space, realize an efficient transfer technique, and the independence of weather conditions. (Winter & Jong, 1982)

A veem, or storehouse company is an example of such a warehouse designed for a specific type of storage. It wasn't just a normal warehouse, a veem stored the goods under warranty and made sure that the stored goods didn't lose its value. Therefore a veem had to have the right knowledge about the products and know how they had to be stored. (Rotterdamsch Nieuwsblad, 08/07/1926) Different companies would even sometimes use a veem to store their already paid for products so they wouldn't have to worry about their products losing its value. (Rotterdamsch Nieuwsblad, 29/07/1926)

The veemen only started to develop in Rotterdam at the end of the 19th century. They originate from the 'Waagdragersgilde' (weigh house carrier guild) in Amsterdam, a group of carriers who would carry the goods from the ships to the Waag (weigh house) and further onto the warehouses. The Dutch word 'veem' actually meant alliance and refers to the cooperation between the storehouses and the carriers. The carriers and storehouses were subjected to strict regulations and rates by the city's authority. Therefore it was almost impossible to work without cooperation. This resulted in many different storehouse companies such as the Blaauwhoederveem, Klappmutsenveem, Groenhoeden, Roodhoeden etc. (Rotterdamsch Nieuwsblad, 17/06/1926) One reason to explain the late development of the veemen in Rotterdam could be the value of the goods that arrived in the harbour. Valuable goods had to be able to be traded without having to constantly be moved. For this reason it was best to store them under warranty in a veem. Rotterdam had a lot less import of valuable goods to place in storage. Therefore the banks wouldn't give away warranty on these less valuable goods. It is therefore logical that the veemen only started to develop when more valuable goods entered the port of Rotterdam and the banks started to give out warranty on these imported goods. (Rotterdamsch Nieuwsblad, 02/07/1926)

The development of both 'nieuwe werken' stimulated the construction of the warehouses, by prohibiting factories and companies to establish on these newly developed pieces of land. Also the warehouses had



Automatic transport system to lift barrels. Rotterdamsch nieuwsblad (05/08/1926)

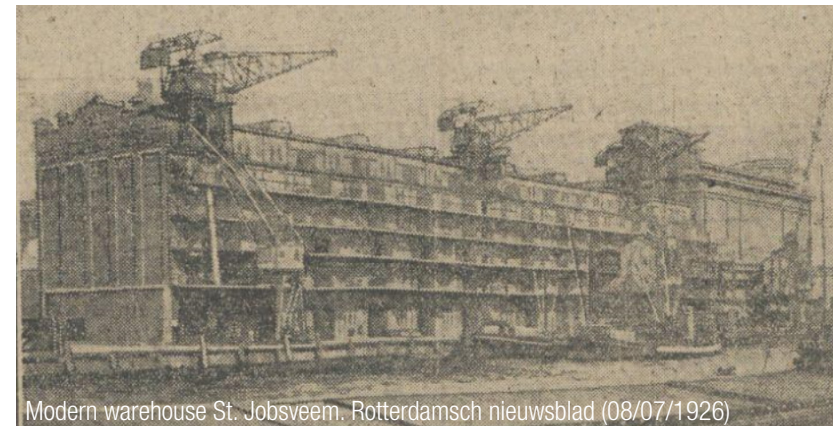

Modern warehouse St. Jobsveem. Rotterdamsch nieuwsblad (08/07/1926)



Katoenveem located on the Keilestraat. Rotterdamsch nieuwsblad (01/09/1926)



Warehouse located at the first new work



Warehouse Leidsche veem



Het Vrije Entrepot de Vijf Werelddeelen



Santos, own image



St Jobsveem. Groenendijk, P., & Citroen, H. (2008)



Katoenveem, own image

to follow strong building regulations restricting the nature and form of the buildings.(Winter & Jong, 1982) Further development of the veemen shows the importance of efficiency. The hauling and moving of the goods had to be improved. There was no time and money to do everything manually anymore. New machines were added to the veemen such as an automatic transport system to bring barrels up and down from the basements. Warehouse 'Het Vrij Entrepot de Vijf Werelddeelen' built in 1879 was the most modern warehouse in the world at the time and had all the characteristics of a commercial building from the 19th century. It was divided into five different warehouses which were each named after a specific continent. In 1898 the warehouse 'Leidsche veem' was built which continued the idea of multiple different warehouse placed next to each other which could later be extended. In 1903 the tallest warehouse Santos appeared in the Rijnhaven. This six storey high building was the tallest warehouse found in Rotterdam and the goods were lifted up with the use of winches. In 1914 a revolutionary veem was designed, St. Jobsveem which was fully designed to optimize the transshipment of the goods. St. Jobsveem was also six storeys tall and had a flat roof on which three cranes were situated to hoist the goods into the warehouse and keep the quay area free. This meant the building could be placed closer to the quay. With this innovation together with the design of partially offset loading balconies the building fully optimized its transshipment techniques. In 1920 the Katoenveem follows which is a strong example of a tailor made building designed for storing one specific product. Eventually with the further growth of the ports and the need for rapid processing of the goods, the development of the warehouses changed from the use of traditional warehouses to an expansion of stevedoring operations in low sheds. (Winter & Jong, 1982)

Santos 1903



St. Job 1914

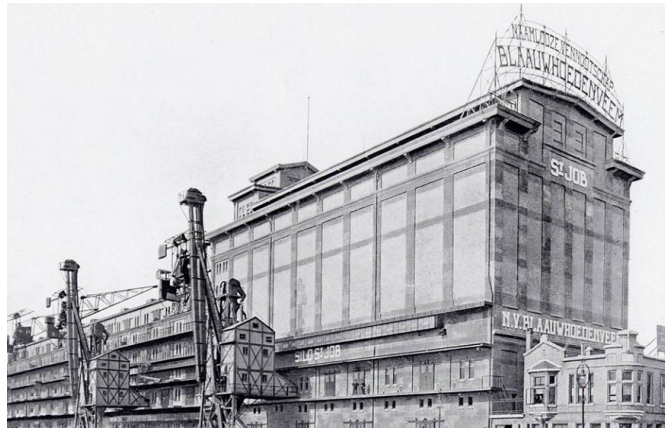

Katoenveem 1920

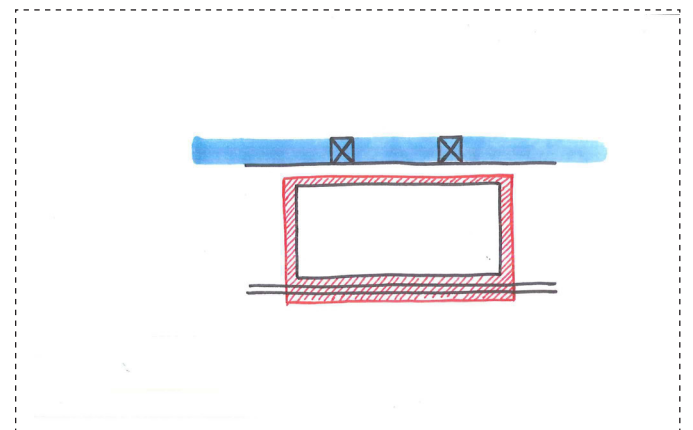
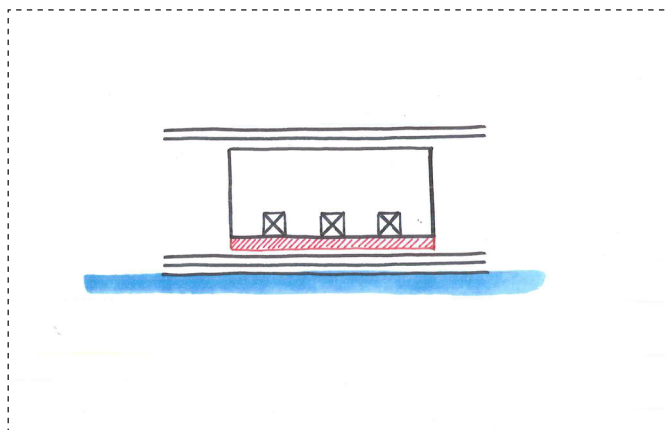
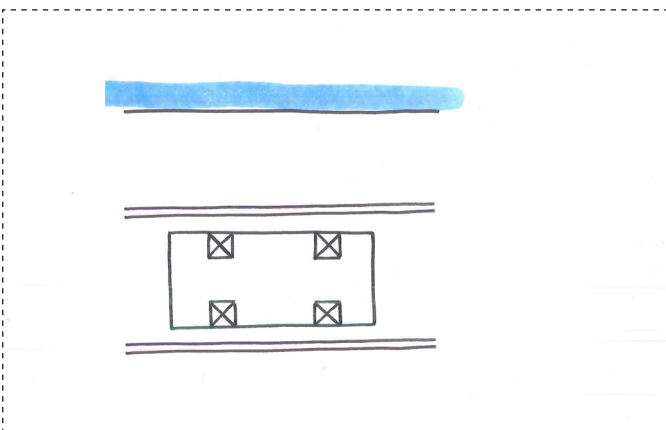
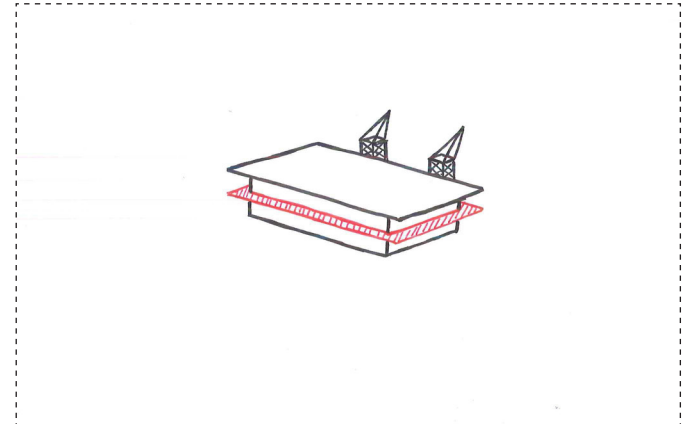
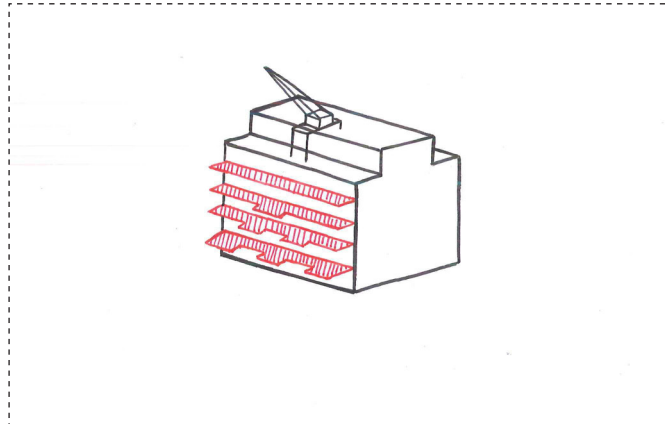
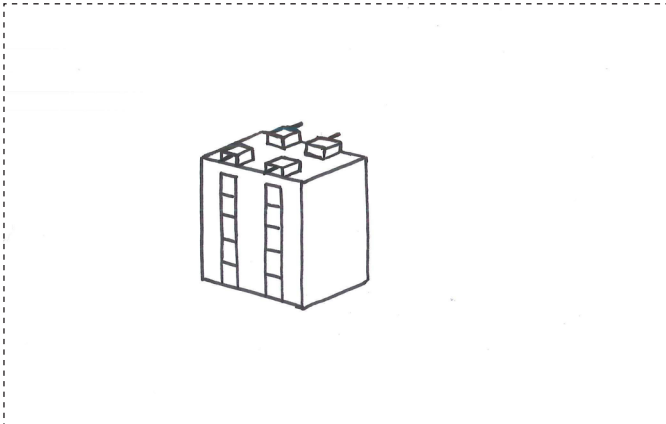

Time line of the Rotterdam Harbour

The construction of 'de Nieuwe Waterweg' in 1872 was a decisive impulse for Rotterdam to become the largest Port. Harbours and quays were enlarged and surrounding municipalities like Feijenoord (1869), Delfshaven (1885), Kralingen (1894), Charlois and Katendrecht were annexed.

At the end of the 19th century a lot of commercial buildings were developed, like 'het Witte Huis', the office of the Holland-America line, the Hulstkamp building and luxurious buildings in the Scheepvaartkwartier.



The construction of the Katoenveem is completed in 1920

Construction of the quarantine terrain (1930-1933). The terrain has never been used as a quarantine area.

Construction of the Merwehaven (1932-1933). Similar to the Vierhavens, constructed as cargo port with harbour basins and long quays. The plans had been ready since 1916 (then known as the 'driehavengebied'), but the building site was located in the municipality Schiedam. Therefore a change of the municipality borders was required.

The construction of Maashaven (1898-1905). The harbour mainly served, just like the Rijnhaven, for the transshipment of bulk goods like stone coal, grain and fruits

Construction of the Vierhavens (1912-1916). The harbour was built as a cargo port with harbour basins and long quays.

City architect Rose drew the first plans for the southern part of Rotterdam in 1858. The construction on the left riverbank of the Maas started in 1875 (Noordereiland, Katendrecht and Feijenoord).

1880

Construction of the Rijnhaven (1887-1895). The harbour was meant for transshipment of bulk goods like stone coal, grain and fruits. Together with the Maashaven the use of the riverbanks was striking; at the northern side lower storage sheds were built and the ships did not require quays.



First connection made with the southern river banks with the completion of the Willemsbrug in 1878.

Around 1900, Rotterdam was the economic heart of the Netherlands. Employment grew causing the population to grow. This caused uncontrolled residential growth, failing to meet the requirements of the national 'woningwet'.

1900

Construction of the Waalhaven (1908-1931). The harbour was constructed in phases and served for the transshipment of bulk goods.

The economic growth of the city early twentieth century was stimulated by the construction of new harbours and quays.

The RDM terrain was constructed in 1902 and was expanded during the following half century. The RDM terrain as an important shipyard for building and repairing ships and machines.

1920

From 1916 on Auguste Plate became the director of the Municipal housing services (gemeentelijke woningdienst). He focused on proper housing for the working class. Therefore Michiel Brinkman designs the Justus van Effencomplex near Spangen and 'de Stijl' architect J.J.P. Oud designs several residential areas including 'de Kiefhoek'.





1953 Groot Handelsgebouw by Huig Maaskant. The building is iconic for the reconstruction of the city. Maaskant also designed the Euromast which was built between 1958 and 1960.

Construction of the Eemhaven (1946-1965) Originally constructed as cargo port, but since 1966 the port is dominated by container storage.

In the early eighties small residential projects like the Cubic houses by Piet Blom were developed. At the end of the eighties architects modernism is reintroduced by architects like Carel Weeber and Jan Hoogstad and buildings like the 'Nationale Nederlanden'.centraal

Preparations are made to transform the Vierhavens and Merwehavens into a fruit port.

Due to the construction of the Kop van Zuid the city centre of Rotterdam transition towards the waterfront with the Erasmusbridge (1996) as contemporary city mark. The riverbanks of the Maas are an attractive location for residential buildings. The water also provides a new manner of transport via water-taxies and fast ferries.



Markthal by OMA (2014)

1960

From the fifties on, harbour activities translocated towards the west.

After the bombing in 1940 the City Council decided to part with tradition. They decided upon a spacious city plan with modern architecture. The new city center, a car less shopping zone, called 'de Lijnbaan' was designed by Broek en Bakema (continuing the firm of Brinkman and v/d Vlugt).

The new subway system in 1968 provides large parts of Rotterdam South with public transport.

Due to the uprise of synthetic fabrics and the decrease in textile demands, the Katoenveem closed its doors as a cotton storage warehouse in 1964.

1980

Due to the transition of the harbour activities towards the sea (Europoort and the Maasvlakte) and the relocation of industries towards the city borders (Brainpark, bedrijvenpark Noord-West) the riverbanks previously used by the harbours and industries were available for residential use.

2000



Central Station by Benthem Crouwel Architecten (2014)

2020

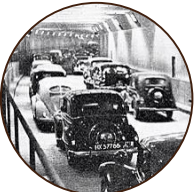

The Maastunnel is realized in 1941 to support the traffic load of the Willemsbridge.



In this period 'Het Nieuwe Bouwen' evolves in Rotterdam. The 'van Nellefabriek' by Brinkman & van der Vlugt is one of the most striking buildings from this period. Kromhout establishes 'de Opbouw' a society for architects in Rotterdam.



Erasmusbrug by Ben van Berkel (1996)

Influence of function on appearance of the Katoenveem



Katoenveem, 1933, photo by Gemeente werken, Rotterdam Stadsarchief.



Katoenveem, 1920, photo by Gemeente werken, Rotterdam Stadsarchief.

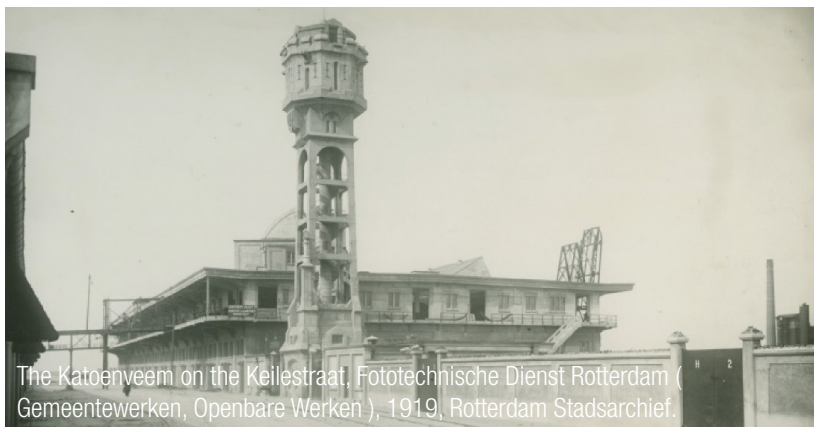

The Katoenveem on the Keilestraat. Fototechnische Dienst Rotterdam (Gemeentewerken, Openbare Werken), 1919, Rotterdam Stadsarchief.

Analysing the Katoenveem compared to the three aspects which de Winter & de Jong mentioned to keep in mind when designing a warehouse; to maximize the investable surface space, realize an efficient transfer technique, and the independence of weather conditions. We can link each aspect to the appearance of the Katoenveem.

Starting off with the realisation of an efficient transfer technique. To fully optimize the transshipment of the cotton, the building was equipped with a specially designed transit system which could easily transfer the cotton bales from the ship into the storehouse and later from the storehouse into the trains to send them off to their final destination. The system consisted of “hanging rails and switches, along which the bales are moved by automatic electric trucks at a rate of 200 feet per minute.” (Dam, 1919) The system was connected to two warehouses, Galveston and New Orleans, across the street and offered great advantage concerning practical and economical aspects as only a few employees were needed to transfer the bales in and out of the storehouse. The system is attached to the roof of the structure and runs along the entire building and even along the outside balconies. The whole structure of the Katoenveem is adapted to this system to assure that the system could work as efficiently as possible. Extra beams were placed in the ceiling structure to be able to hang the system from the roof and openings were made in the facade to allow the bales to be transferred in and out of the building. The transit system had to be especially designed together with the design of the building as it was not possible at that time to drill holes through the concrete after it had hardened. During construction, steel tubes would be placed in the concrete where the transit system would later be hung from. To do so, the transit system had to be designed together with the building to know where these steel tubes had to be placed.

To maximize the investable space, the Katoenveem was split into two levels; the ground floor was used to store the cotton bales and the first floor to control the transit system. The cotton bales would arrive by boat, would then be hauled off the ships by cranes and transferred into the building with the transit system on the first floor. Voids in the floor would allow the bales to be lowered down to the ground floor where they were stored. The Katoenveem was equipped with balconies on all four sides to be able to easily transfer the bales horizontally before they were placed inside for storage. This meant the roof had to be extended over the balcony to attach the transit system above.

The main reason to store goods in a veem was to assure that the value of the goods remained the same. This meant that the Katoenveem had to protect the cotton bales from any types of weather. First of all it was important to keep the cotton dry. Cotton has a strong hygroscopic behaviour (tendency to absorb water from the air) and must therefore be protected from the sea, rain, condensation water and high levels of humidity

to avoid decay, discolouration, mold, mildew stains and rot. Even at a relative humidity of 95%, cotton may increase its water content to 25 - 27% without feeling wet. (www.tis-gdv.de) Therefore the extended roof above the balcony didn't only function to attach the transit system, it was also intended to keep the cotton bales dry from the rain. As an added bonus it would also keep the workers dry.

Secondly another weather condition concerning the value of the cotton bales was that the bales could dry out. The bales would be sold depending on their weight. The drying of the bales would mean a disadvantage for the seller versus an advantage towards the buyers. At temperatures $> 25^{\circ}\text{C}$ and too much direct sunlight, cotton will dry out and causes it to become hard, brittle and lose its elasticity. (www.tis-gdv.de) Therefore it was important to store the cotton bales in cool climate conditions without direct sunlight to prevent the cotton bales from drying out. This might be a reason why the windows in the façades are small and the main light source is the diffused light that comes from the skylights above. This cool climate was also an advantage to prevent the cotton bales from rotting. The optimum temperature for mold development is $25 - 35^{\circ}\text{C}$. At temperatures $< 0^{\circ}\text{C}$ there is no risk of wet bales rotting, since this process stops at low temperatures. (www.tis-gdv.de) Not only were the cotton bales sensitive to drying out and mold development, the cotton dust that came free was also highly flammable. This meant that the Katoenveem had to be completely fireproof. Therefore the entire building was constructed out of reinforced concrete. Not even wooden window frames were used to assure that the building would not burn down if a fire would erupt. Reinforced concrete succumbs less fast than steel when admitted to heat stress and was therefore more appropriate to use. For this same reason the building was also equipped with a modern sprinkler system and divided into five different fire compartments. Each compartment was separated from the other with a firewall and expansion joints to keep the rest of the cotton safe if a fire would start in one of the other compartments.

Conclusion of the function of the Katoenveem

As a conclusion, the function of the Katoenveem has indeed influenced its appearance. First of all, the building was adapted to the specially designed transit system which would optimize the transshipment of the cotton bales. Secondly the organization of the Katoenveem is also adapted towards the functioning of the transit system, storing the cotton on the ground floor and using the first floor to control the system. This also resulted in a balcony which wraps around the entire building and a roof which extends above the balcony to assure an optimized transshipment of the bales as well as preventing the bales from getting wet. Last of all, the entire building is constructed out of concrete to assure a safe fireproof storage building, and the small windows and diffused light which enters from above to assure that the cotton bales would not dry out or develop mold and lose value.

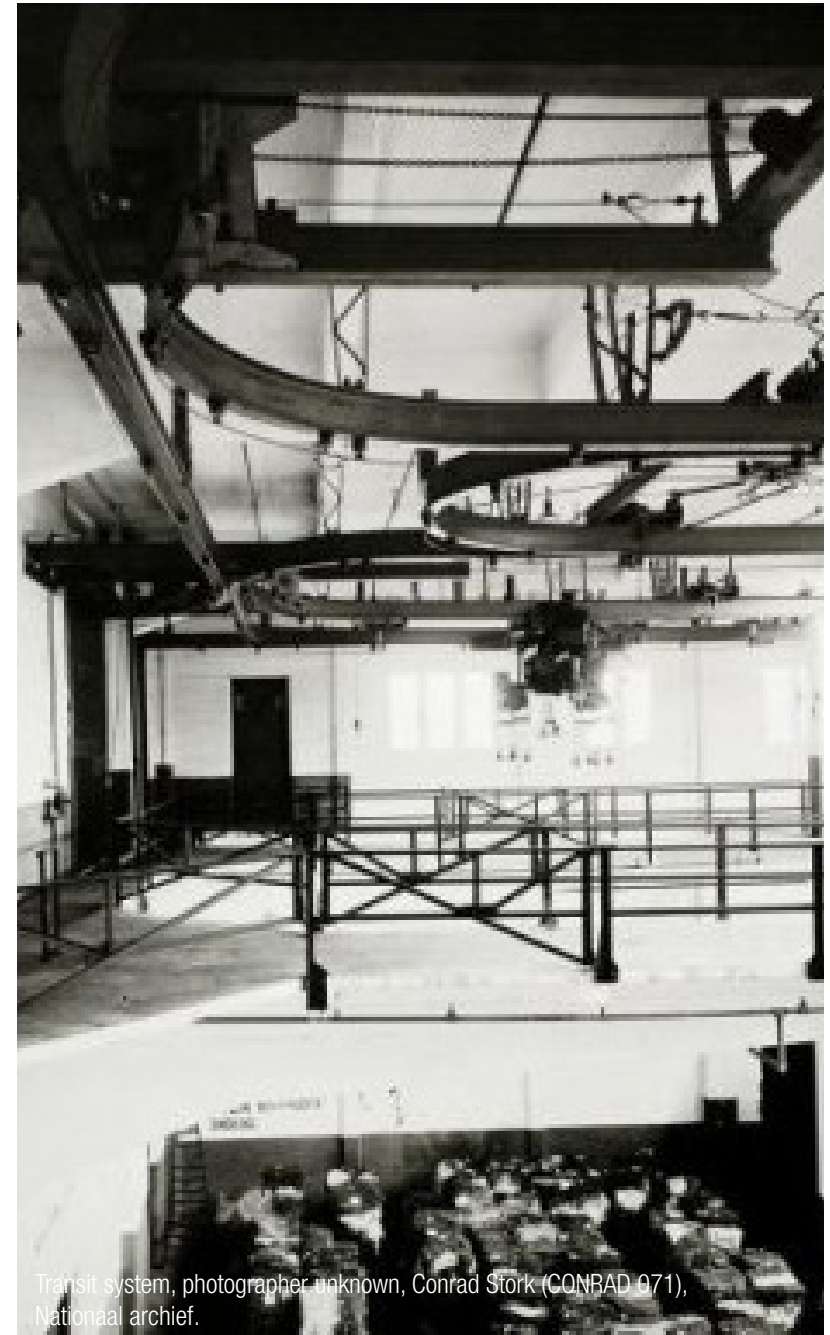

Transit system, photographer unknown, Conrad Stork (CONRAD 071), Nationaal archief.

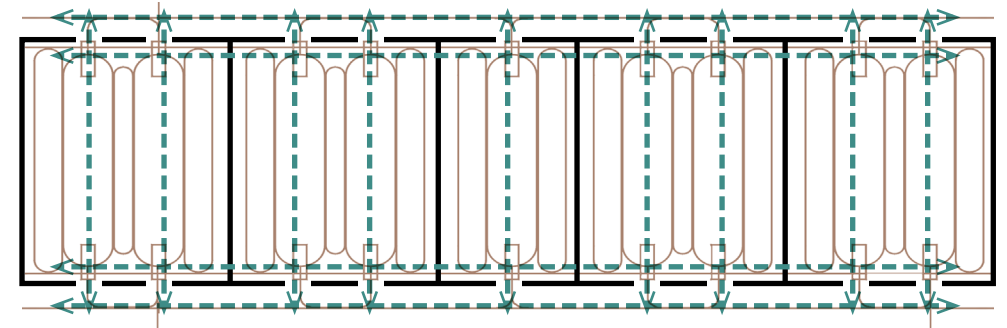
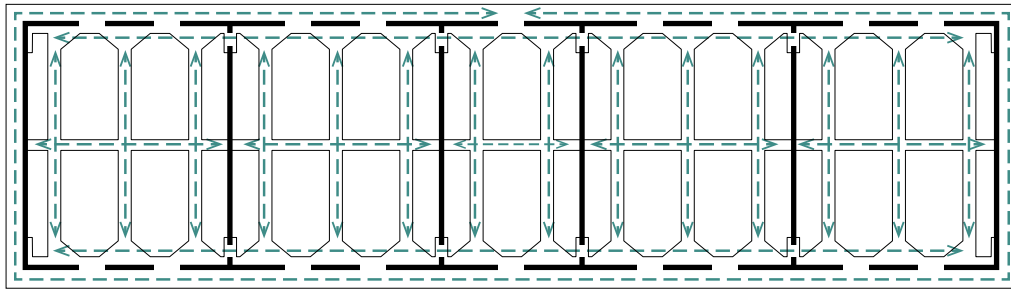
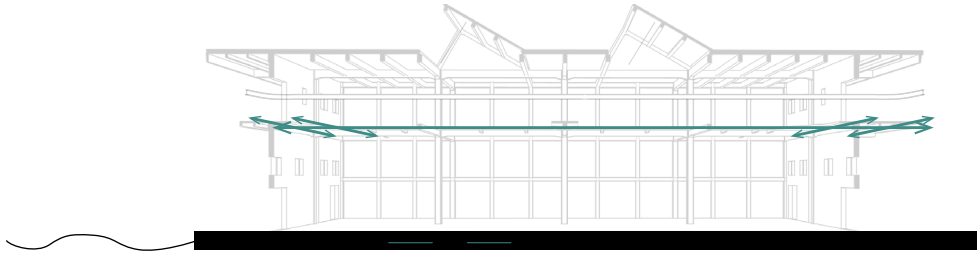

Movement of the people, illustrated by Jelmer van der Poel

Movement of the cotton bales, illustrated by Jelmer van der Poel



Outside balconies first floor, own image 27 oct 2016



Ground floor storage space, own image 20 sept 2016

3. Aesthetic discussion at the time

Discussion about exposed concrete architecture

An interesting discussion to consider when analysing the Katoenveem is the discussion about the aesthetics of concrete architecture. In the late 19th century, the use of concrete in architecture was mainly used for structural elements such as columns and beams. The concrete was commonly disguised either by plastering or cladding with traditional materials such as brick or natural stone. For example the former bank building Rijkspostspaarbank in Amsterdam built between 1899-1901 and even the Town Hall in Rotterdam built around the same time as the Katoenveem between 1914-1920. Both buildings are constructed out of reinforced concrete but have a brick or natural stone facade. Occasions where the concrete was exposed were usually only found on façades with a low aesthetic requirement such as industrial buildings. Traditionally timber was used to form the formwork for the concrete. Unfortunately the texture and the unavoidable blemishes due to the formwork construction methods, were not acceptable and seen as an aesthetic problem. (Heinemann, 2013) Besides the texture of the exposed concrete, it's grey colour was considered dull and expressionless and had a lack of character opposed to the traditional materials such as brick and natural stone. (Heinemann, 2013)

From the 20th century and onwards, the use of concrete increased and a growing interest to find an appropriate aesthetic appearance for exposed concrete is noticeable. Architects and engineers worldwide started to realize that concrete could indeed create its own architectural surface style and it was no longer necessary to cover it with other materials. (Heinemann, 2013) But the problem was still the appearance of the exposed concrete. As a result exposed concrete surface finishes were being developed to make the exposed concrete more appealing. The six surface finishes used on historic concrete are rendering, painting, tooling, sand blasting and washing out, polishing and rubbing down, and metallisation. (Heinemann, 2013)

In the Netherlands, the development of exposed concrete in architecture took a longer time to develop compared to other countries. According to architect J. Gratama, in the Dutch magazine 'Bouwkundig Weekblad' he describes that the Dutch architects were too conservative and cautious of the new material. Concrete had not developed its own architectural surface style yet and thus the Dutch architects were hesitant to use the new material. They were waiting to see what this material could offer and left it to the civil engineers to find out as they were already familiar with the material. (Gratama, 1912)



1. Rendering:

There were two ways the exposed concrete surface could be rendered. (1) With a kunstzandsteenpleister (“artificial sandstone render”) which included adding ground natural stone to the mortar to imitate the colour of natural stone. (2) By applying a beton-emaille which is a special plaster type applied to walls. Beton-emaille was commonly used for interior spaces exposed to wear and moisture, such as bathrooms and stairwells. Surfaces could be rendered to improve its water-tightness, smooth the surface or to improve the aesthetics of the exposed concrete.(Heinemann, 2013)



Reinforced concrete rendered with a tooled kunstzandsteen, (Heinemann, 2013).

2. Painting:

Painting concrete surfaces was technically not easy until the development of special cement paints in the 1930's. Traditional oil-based paints could not be used without any pretreatment of the surface. A more traditional method was to lime wash the surface with the option to add pigments or to use cement instead of lime, known as 'grijzen'.(Heinemann, 2013)



Remains of a green paint, (Heinemann, 2013).

3. Tooling:

Tooling is one of the earliest surface finishes of concrete. The technique removes the undesired grey cement film of the hardened concrete through mechanical techniques such as bush-hammering, point-tooling and chiselling. In the process the colour and texture of the aggregates were exposed. This technique was often combined with coloured aggregates or cement to alter the grey appearance of the concrete.(Heinemann, 2013)



Bush hammered surface with chiselled margins, (Heinemann, 2013).

4. Sand blasting and washing out

Sand blasting or washing out is a technique which exposes the coarse aggregates of the concrete. It removes the outermost cement paste after its hardening. This technique differs from the tooling technique because it also takes away the cement in between the aggregates (see image ...).(Heinemann, 2013)



5. Polishing and rubbing down:

Another surface finish technique is to polish or rub the surface down, which results in a very smooth concrete surface. Due to the rubbing, the outer cement film is removed causing the coarse aggregates to become visible through a polished surface. Unfortunately it was a labour intensive treatment and rather expensive which limited its practical application. (Heinemann, 2013)

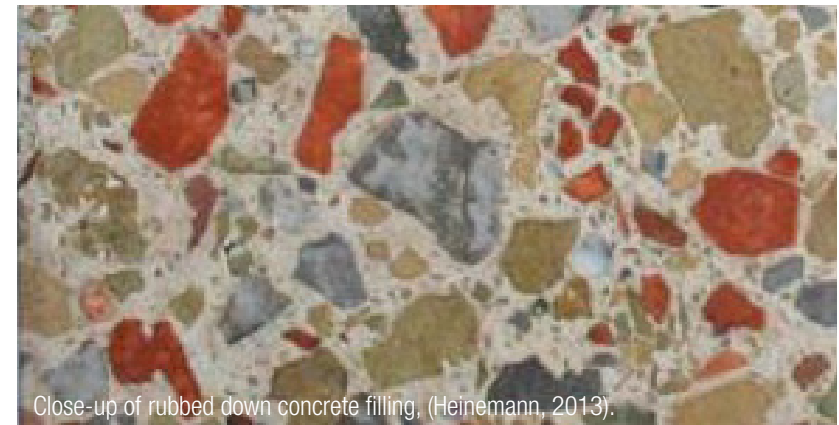

6. Metallised concrete:

Metallizing the concrete was used to alter the colour of the concrete and was mostly used in the Netherlands between 1910-1930. During this time the grey colour of the concrete was not yet appreciated and specific concrete paints had not been developed yet. By applying a solution of metal salts (sulphates, acetates, chlorates, nitrates or chlorides) onto the hardened concrete with a brush, a reaction of the salts with the cement caused a colour change. A range of 35 colours could be obtained. Metallizing the concrete was a very Dutch surface finish and was patented by the Dutch brothers L. A. Sanders and A.J. Sanders in 1917. (Heinemann, 2013)





West facade of the Katoenveem, own image 20 sept 2016

4. Aesthetics of the Katoenveem

Influence of discussion on the aesthetics of the Katoenveem

Interesting is to see how this architectural discussion has influenced a building which is completely constructed out of concrete, such as the Katoenveem. In the early years, the aesthetic quality of the concrete surface being exposed to the public, showing the imprint of the timber formwork, was considered only for industrial buildings. Considering the Katoenveem being an industrial building it would be likely if the Katoenveem was not treated with a surface finish. When observing the Katoenveem it appears that the building has a brownish colour. At first glance it is uncertain if this is a surface finish, if it's the original colour or if it is discolouration. Observing the surface closer up by investigating the damages we can clearly state that the exterior surface of the Katoenveem has indeed been treated with a surface finish. The damages reveal a very coarse concrete underneath two layers of cement. The first bottom layer is assumed to be added to smooth down the coarse concrete of the construction and the second thin layer above is assumed to be added to add colour to the building. A possible reason for the two separate layers could be financial as it was expensive to add coloured supplements to the cement. This way less coloured cement was needed.



Images of the brown facades of the Katoenveem, own image 27 okt 2016



Used surface treatment

Considering the possible historic concrete surface finishes, we can make an assumption which surface finish has been used on the exterior of the Katoenveem. Having already observed that the exterior of the Katoenveem has been treated with two layers of cement, we can assume that the Katoenveem has been treated with an artificial sandstone render.

An artificial sandstone render applied on the concrete surface was usually based on Portland cement, unless the binder of the concrete was not Portland based, then a render using the same binder as the cement was advised. Lime renders were used to improve the workability of the render. However the adhesion of a lime based render was weaker therefore a thin layer of mortar made from Portland cement had to be applied first. Considering the two layers of the exterior of the Katoenveem, this might also be a reason why two layers of cement have been applied. (Heinemann, 2013)

Two earlier examples for the application of an artificial sandstone render in the Netherlands are both found in Rotterdam. The first example is the Hofplein railway viaduct built between 1905 and 1908 and designed by civil engineer Alphons van Hemert. The viaduct was attached to the former Hofplein station designed by architect J.P. Stok in 1908, an old companion of J.J. Kanters. (www.retours.eu) The second example is the plinth of the warehouse St. Jobsveem, also designed by J.J. Kanters in 1914. Both buildings/structures were treated with the same technique, imitating the appearance of a tooled sandstone facade with or without imitation joints. (see images on the right)





Keilestraat, 1920, photographer unknown, Historisch Centrum Overijssel.

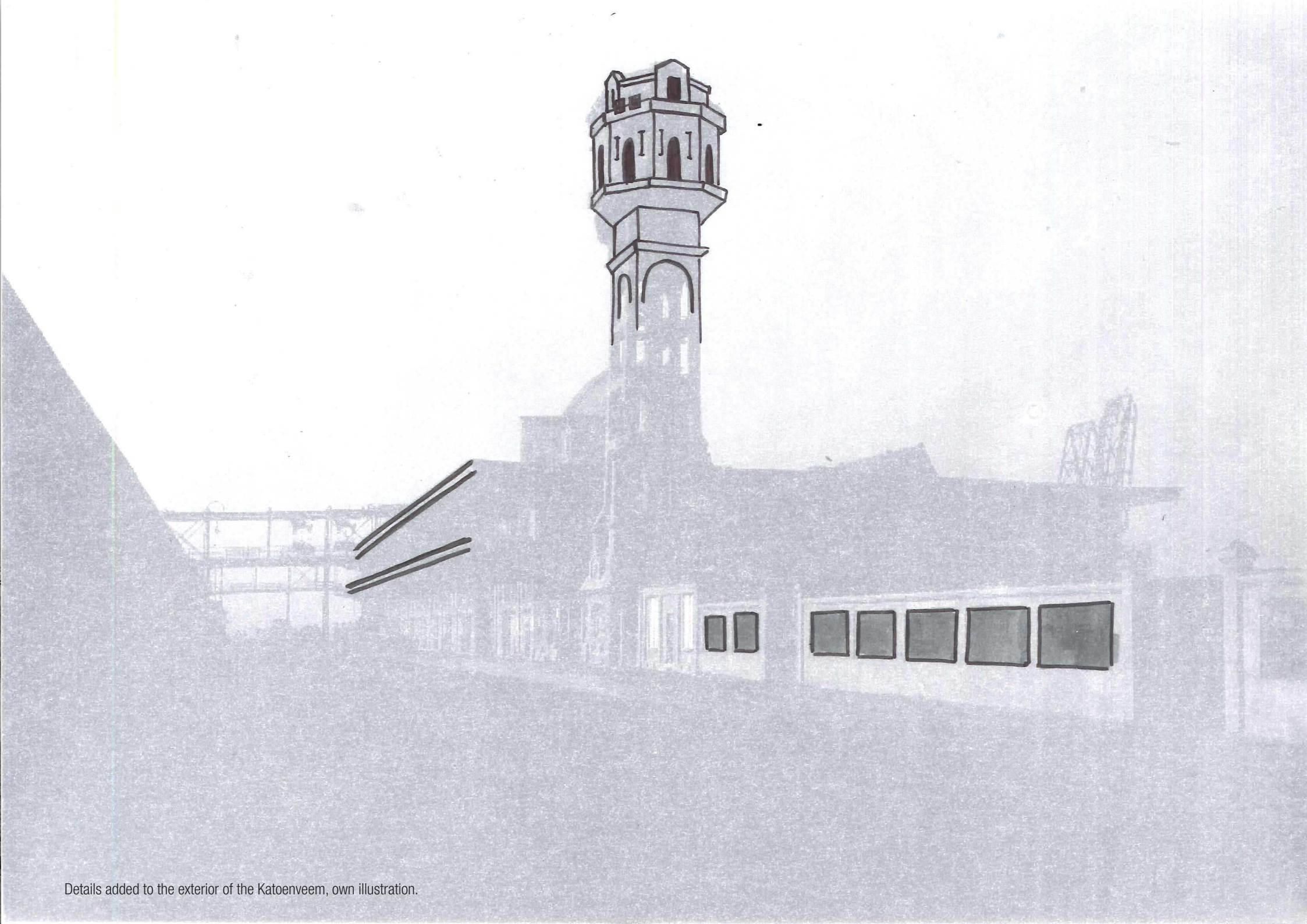

Details added to the exterior of the Katoenveem, own illustration.

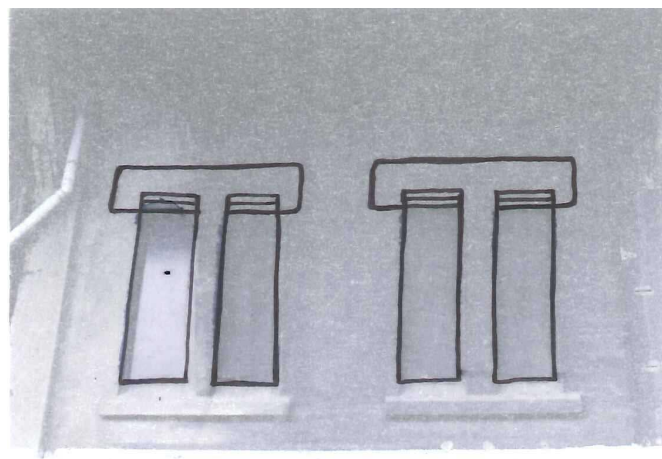
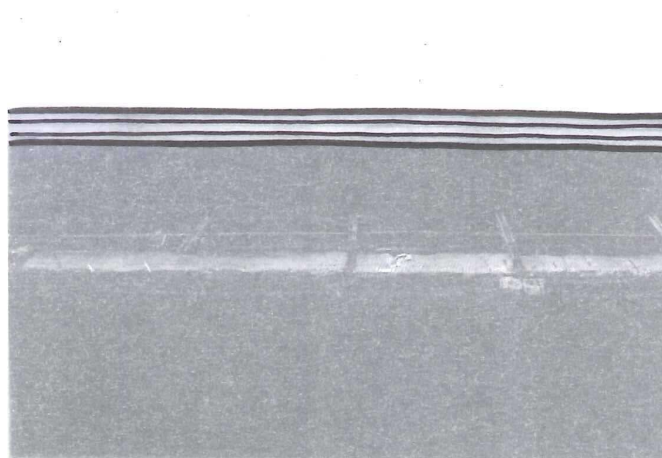
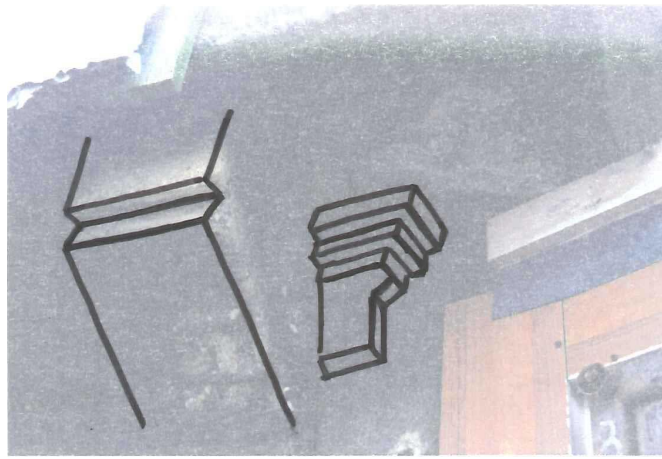

Exterior aesthetic detail

Exploring the exterior of the Katoenveem, it appears that a lot of detail has been added onto its exterior. Starting with the details around the windows imitating a natural stone lintel, the detailed cornice which suggests a natural stone roof edge and most off all the details used in the water tower which is most detailed of all and instantly makes it the focal point of the entire building. Unfortunately the water tower was demolished in 1966 due to its bad concrete conditions.

The used artificial sandstone render surface finish gave architect J.J. Kanters the opportunity to add more detail to the facade. The thicker bottom layer of cement provided thickness to add grooves into the cement to create the detail around the windows. Therefore, another assumption is that the bottom layer could have also been used to add aesthetic details. (see detail below)

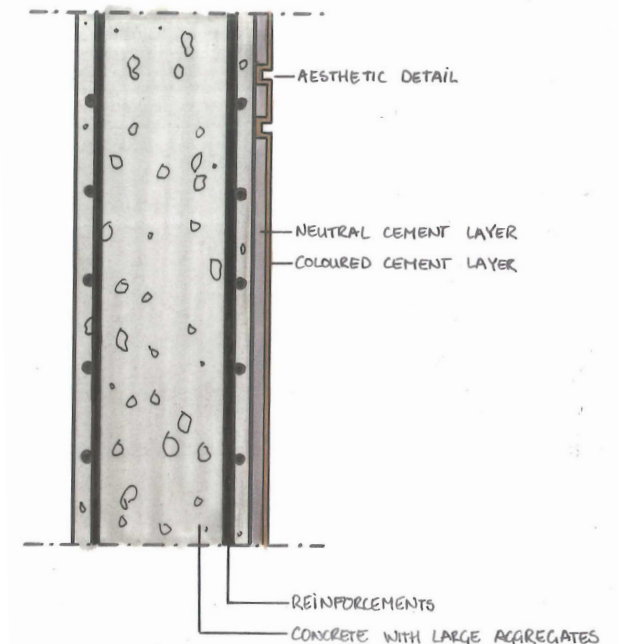

Interior aesthetic detail

When we compare the exterior of the Katoenveem to its interior we find out that they are very contradictory to each other. While the exterior has been treated with a surface treatment and details, the interior is the complete opposite. The walls are left untreated, the formwork is highly visible on all the walls, beams, columns and roof and the concrete still has its normal grey colour. Compared to the window details on the exterior, the interior windows have no detail at all. Also the detailing elements such as the railings along the walkways on the first floor and hooks to hang up the transit system are just designed to function.

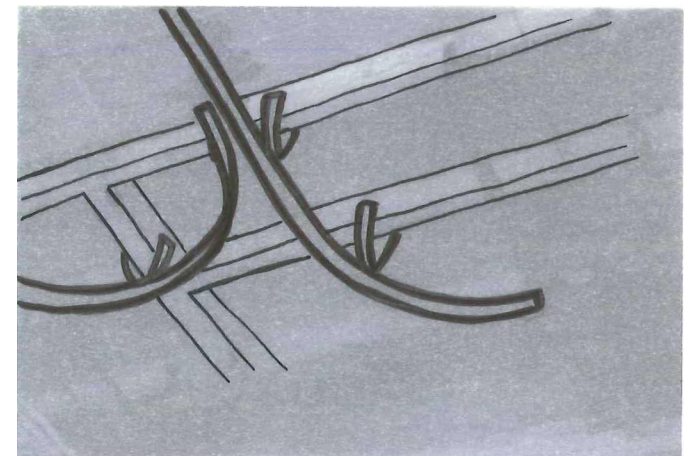
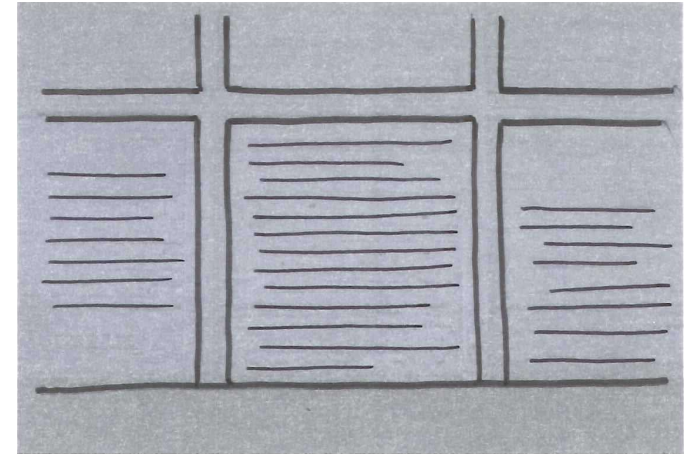
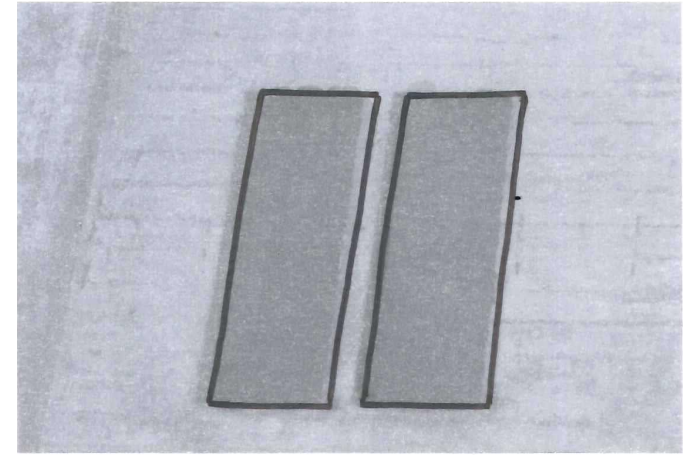

FACADE INTERIOR

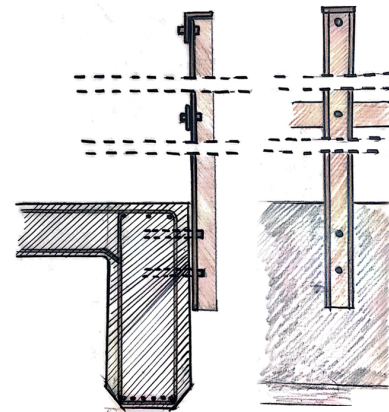
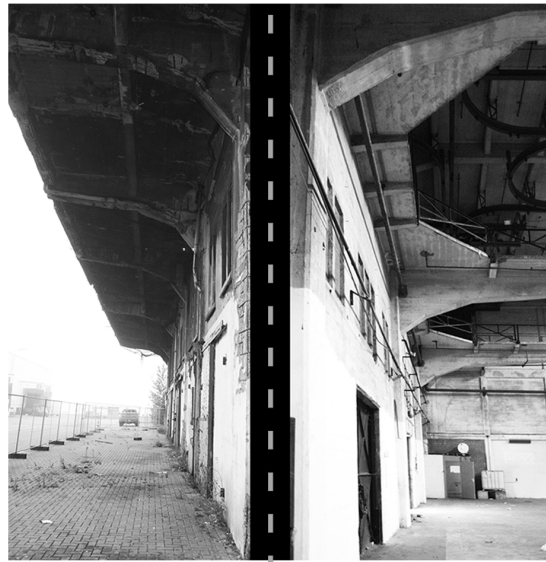
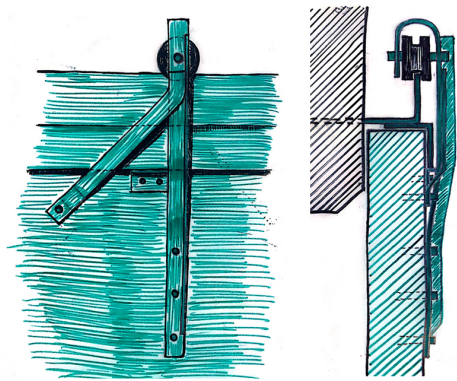
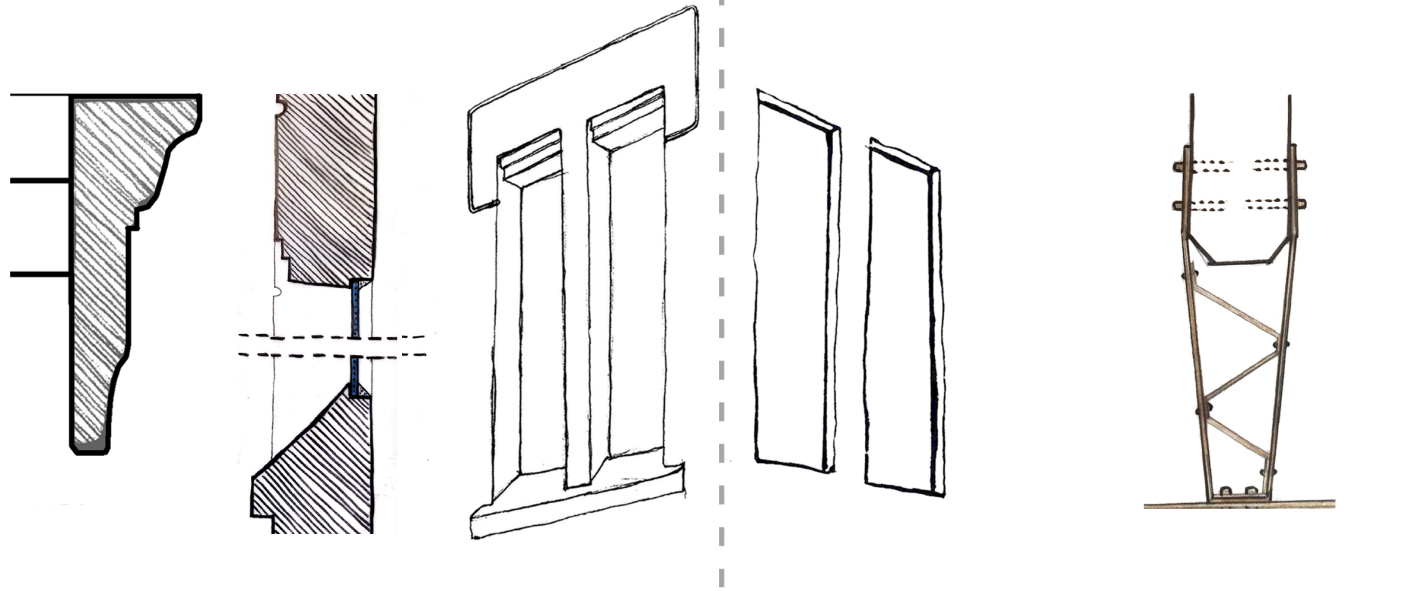

Details pumping station

Part of the Katoenveem complex is the pumping station located on the North-East side of the building. This building was originally used to pump the water from the city's water network up into the water tower which would then be used to supply the sprinkler system in case of a fire. Therefore the pumping station was of high importance for the functioning of the Katoenveem to assure that the cotton would stay safe.

Knowing the importance of the pumping station it is interesting to see that it was treated with presumably the same artificial sandstone render surface finish as the exterior of the Katoenveem. Unfortunately, most of its exterior was painted white at some point in time, but on the back side the brown surface colour is still clearly evident. Besides its surface treatment, the pumping station is also equipped with a detailed cornice, but unlike the detailed windows on the main building, the windows of the pumping station have no details at all.

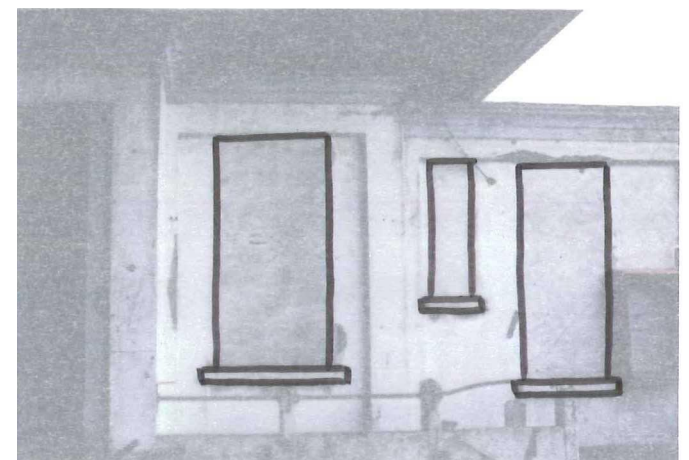
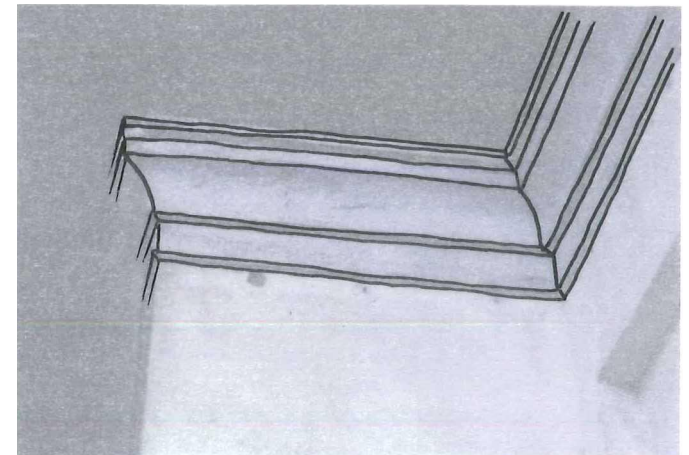
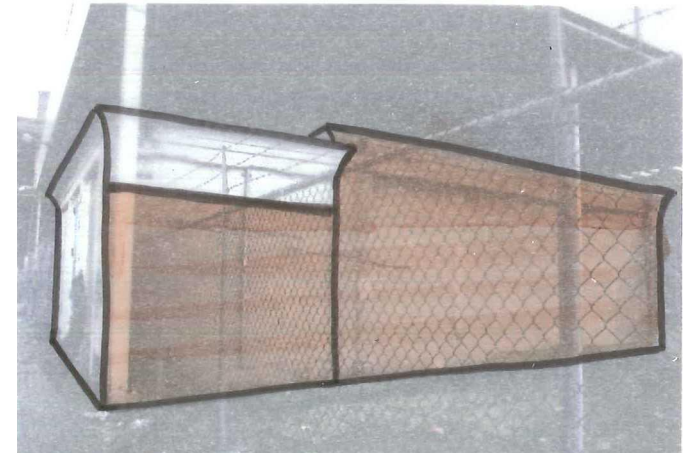

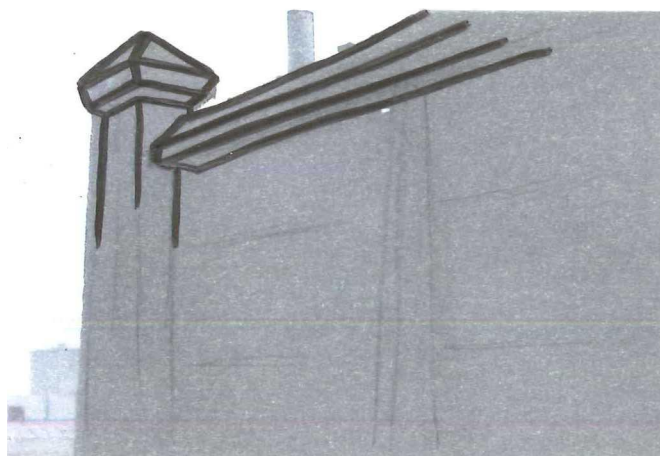
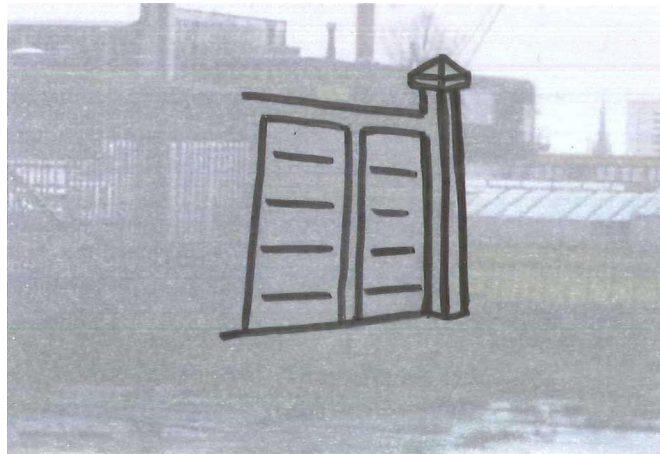
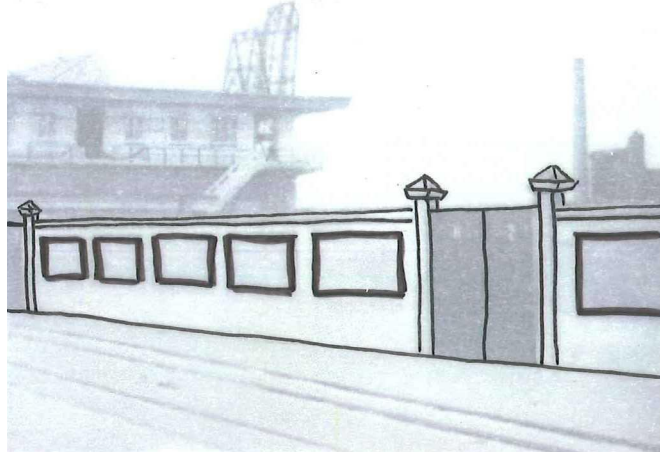

Details terrain

Observing old photographs of the rest of the complex, it becomes clear that the terrain of the Katoenvveen used to be a lot larger than it is today. The terrain stretched from the end of the pier and extended past the pumping station. (see image below) The terrain used to be enclosed with a concrete wall. Unfortunately most of the wall has been torn down during the years, apart from a small piece located next to the Keilehaven at the back of the original terrain. Comparing this piece of wall to the wall in the old photograph, it is clear that it has the same details, concluding that it is a piece of the original terrain wall.

A striking difference between the piece of the wall at the back of the property and the wall on the photograph at the front of the property is the amount of detail that is added. It is clear from the photograph that the wall near the entrance of the property has been treated with detail and presumably also a surface treatment, while the wall in the back has been left as exposed concrete. The terrain wall shows the same principle as the main building's exterior vs. its interior detailing. Architect J.J. Kanters clearly choose to detail the representative side of the property while leaving the back side untreated.

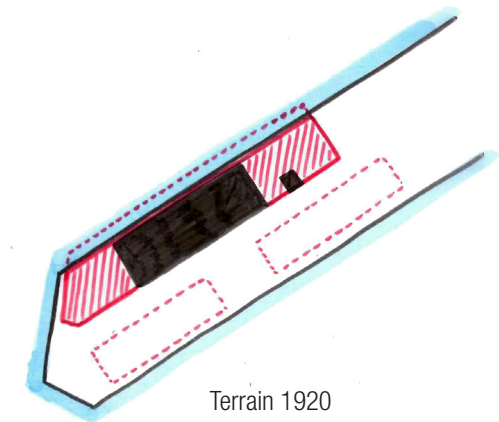

5. Reasons for aesthetic Katoenveem

Influences

Knowing that the exterior of the Katoenveem has been treated with a surface finish, the question that still arises is why architect J.J. Kanters decided to use a surface finish on the exterior of the Katoenveem.

First of all, one reason could be the influences which affected J.J. Kanters in his early life, during his studies and at the beginning of his career. Following his father's footsteps as an architect, J.J. Kanters had a connection to architecture from early on in his life. In 1889 his father began a long lasting relationship with the Blaauwhoedenveem, designing and constructing their warehouses. His most important work are the warehouses 'Westelijk Handelsterrein' commissioned by the Blaauwhoedenveem in 1894. We can assume that this relationship also influenced and stimulated J.J. Kanters' future industrial works, as he was probably inspired by his father's work. Besides this relationship, it is also assumed that J.J. Kanters was influenced by the union "Bouwkunst & Vriendschap". At age 20, he became a member of the union which focussed on newly built buildings. We can assume that the union influenced J.J. Kanters' choice of innovative materials and construction techniques, being inspired by the exhibitions and excursions which the union organized. One of the members of this union was architect J.P. Stok, who is assumed to have employed J.J. Kanters after his studies. At the office of J.P. Stok, Kanters practiced his technical and structural skills. One of J.P. Stok's most famous works is the former train station situated at Hofplein and attached to the Hofplein railway viaduct. Unfortunately the station building was destroyed in WWII, but a large part of the railway viaduct still exists which shows the same surface finish used on the Katoenveem. It is possible that J.J. Kanters was influenced by the technique used on the railway viaduct which lead him to explore the techniques further on his own buildings such as St. Job and the Katoenveem. Therefore one reason why the Katoenveem is treated with an artificial sandstone render is because it was a technique which he was already familiar with.

Secondly, another strong influence could be the strong opinion of the society about the colour of exposed concrete and the importance of the Katoenveem and the new cotton trade. The Katoenveem was build right after WWI. According to van Dam in his article 'The Cotton warehouse of "Katoenveem"' found in the Pioneer in 1919, he describes that the country had to find new ways to find welfare and to prepare themselves for the new conditions in which Europe would be placed after the termination of the terrible war. One way to do so was to rebuild the cotton trade. 30 years prior the cotton trade was of great importance to the the port, but had collapsed due to the German competition. Due to the war, the opportunity arose to rebuild the cotton trade and bring it into Rotterdam. As a result a number of different storehouse companies decided to join partnership to start the brand new cotton trade in Rotterdam. On November 20th 1915, the Katoenveem Joint Stock Company was established. A partnership between six different storehouse companies; Blaauwhoedenveem, Handelsveem, Hollandsveem, Leydsche Veem, Nederlandsche Veem, and Pakhuismeesteren. The Blaauwhoedenveem held the most shares out of all six different storehouse companies



From left to right: T.L. Kanters, J.J. Kanters. Groenendijk, P., & Citroen, H. (2008)



T.L. Kanters and J.J. Kanters in back row. Groenendijk, P., & Citroen, H. (2008)



with 10 out of the 25 shares. Joining together would mean that the companies could split the high insurance costs. To be able to start a trade, a specially developed warehouse needed to be built, and thus the Katoenveem was constructed. The initial capital of the Katoenveem was estimated at fl. 800,000, but due to material costs and requirements such as the purchase of a sprinkler system (with water tower), the total amount increased to fl.950,000. Even though the estimated capital kept increasing, the joint stock company kept paying up during the time of economic depression. (Stenvert, 2005) They believed the Katoenveem would be the 'key' to a good cotton trade and the solution to bring new welfare to the city. Believing in this trade would mean the Katoenveem had to reflect on this welfare and show it through the appearance of its exterior. An exposed concrete surface would contradict to this appearance and therefore a surface finish and details were applied to the representative parts of the building and property including the exterior façades as well as the terrain walls at the front.

Last of all, the surface finish could also be applied for a technical reason. Rendering the exterior surface of a building would improve its water-tightness. This could have been done to prevent moisture from penetrating into the building. Cotton has a strong hygroscopic behaviour (tending to absorb water from the air) and must therefore be protected from the sea, rain and condensation water and high levels of humidity to avoid decay, discolouration, mold, mildew stains and rot. Even at a relative humidity of 95%, cotton may increase its water content to 25 - 27% without feeling wet.(www.tis-gdv.de) Therefore it was important that the interior of the Katoenveem would remain cool and dry. Applying a render on the exterior would keep the humidity outside and the cotton bales dry.

Conclusion

Observing the appearance of the Katoenveem and comparing it to its original function we can clearly see a big difference between its functional interior vs. its aesthetic exterior. It is clear that architect Jan Jeronimus Kanters treated the exterior of the building to make it more appealing to the public. The damages clearly show the layers of cement which have been applied to disguise what you will find on the interior of the building.

The most striking aspect of the Katoenveem are the details that the architect added in the facade and the representative parts of the complex. For example the details around the windows and along the cornice of both the main building as well as the pumping station to suggest natural stone aspects, but most importantly the highly decorative water tower which stood firmly as the focal point of the entire building. It is odd to see that an industrial building, located at the end of a pier in a newly developed harbour, nowhere near any neighbourhoods, has so much detail and colour added to its exterior while the interior surely suggests that no such detail was needed to allow the building to function.

Knowing that the exterior of the Katoenveem has been treated with a surface finish, there are three possible reasons why J.J. Kanters decided to use a surface finish on the exterior of the Katoenveem. First of all the prior influences of the architect. Having used the same techniques on his earlier work, one reason could have been because he was already familiar with the technique. Secondly the strong influence of the society about the colour of exposed concrete and the importance of the Katoenveem and the new cotton trade. The appearance of the Katoenveem could have been used to reflect the importance of the new trade. An exposed concrete building would not have had the same effect as exposed concrete buildings were considered unimportant by society. This would also be the reason why all the representative parts of the building and property were also aesthetically treated, including the terrain wall, pumping station and the water tower. Lastly the surface finish could have been applied as a technical reason to make the building watertight and assure a dry interior climate.



The interior of the Katoenveem filled with cotton bales, photographer unknown.

Age Value Assessment

Age Value

view
section

Original from completion in 1920.

view
section

Unoriginal, added throughout the years.

Everything left white is unknown.



South-west facade



North-east facade

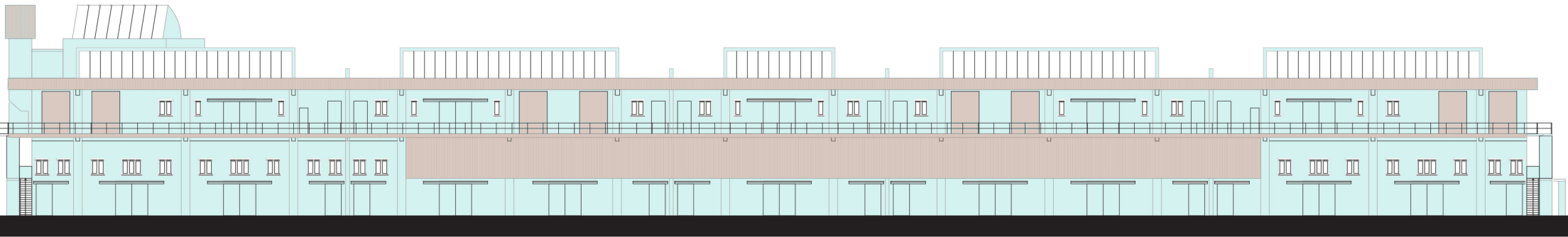

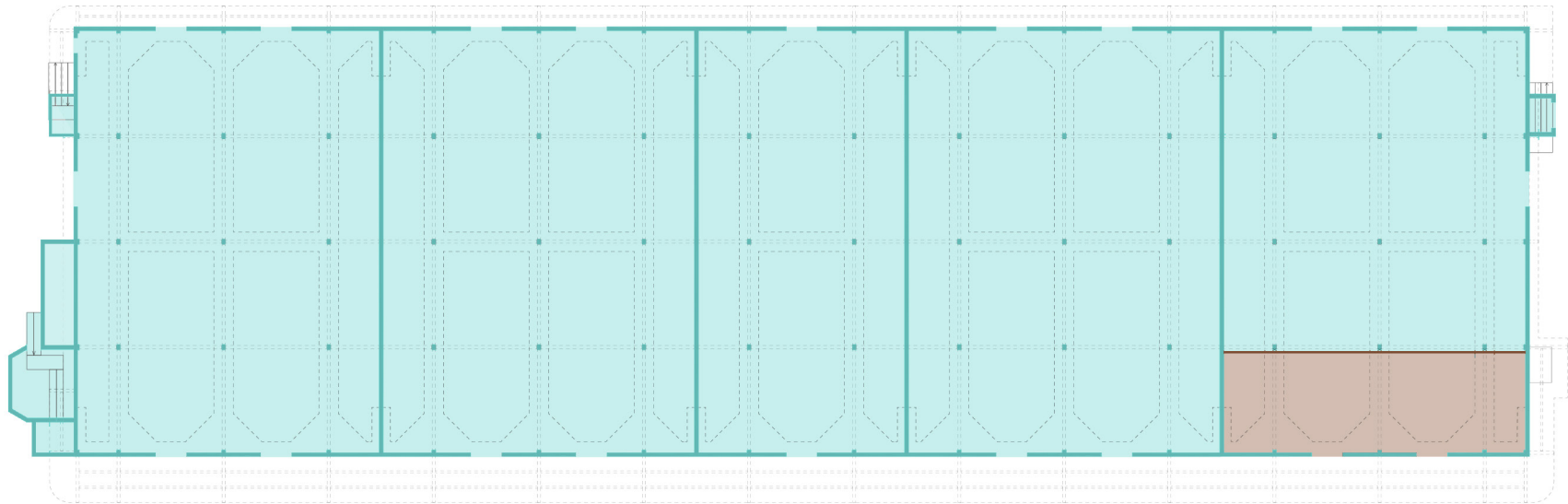

Ground floor



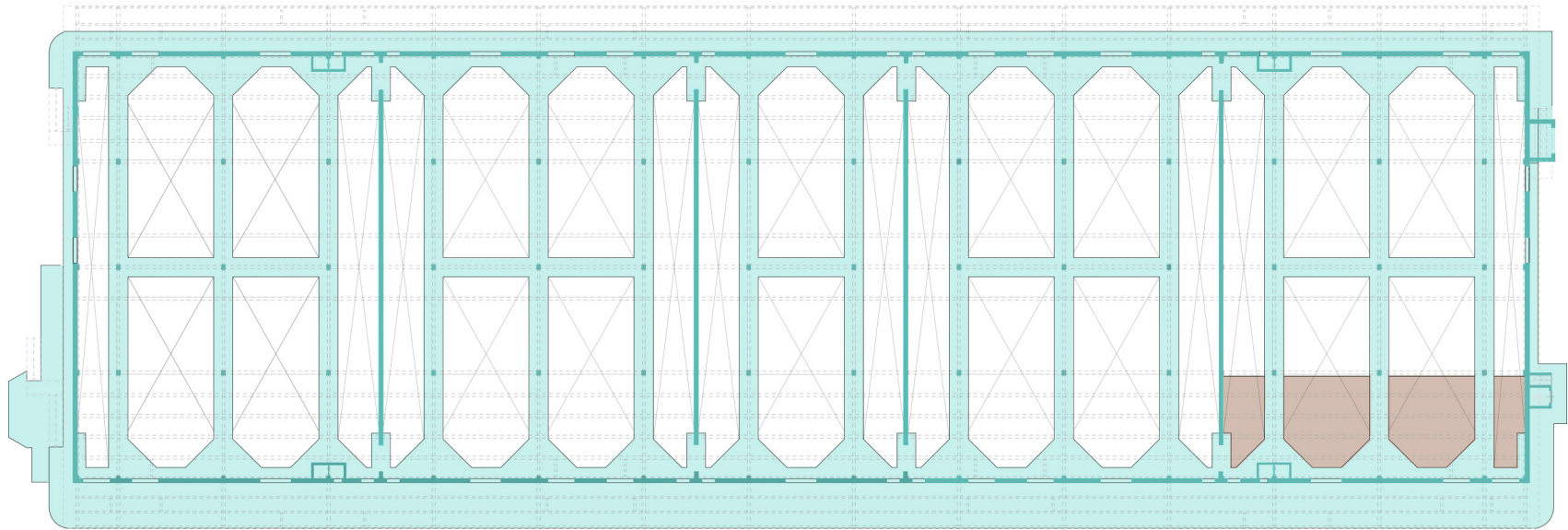

First floor

Heritage Value Assessment

Heritage Value

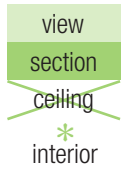

Limited heritage value:

These elements have limited architecture historical value, they were added to the building at a later date, do not add more architectural or functional value to the building and can therefore be removed.

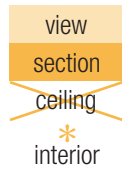

Great heritage value:

These element have great architecture and historical value, they include original elements or finishes which have been adapted or replaced according to the original design. They also include elements and finishes which are still original, but need to be altered or replaced because they are to badly damaged. Strong reasoning is needed to remove these elements.

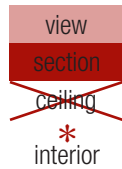

High heritage value:

These elements have essential architectural and historical value, they are distinctive and original and are not to be changed or removed.

Terrain

When the terrain was built, a quay wall was designed along the Keilehaven. This quay wall stretches along the entire original terrain of the Katoenveem. From the bend in the harbour till the end of the property.



Cranes were used on the side of the Keilehaven to lift goods from the ship onto shore. The cranes were demolished in 1966, but the concrete piers still remain. It is important that the bases remain and are used for a new function.



There is a little bit of original pavement left at the quay side.

The entire terrain was enclosed with a concrete wall. This is the only piece that remains from the original wall.

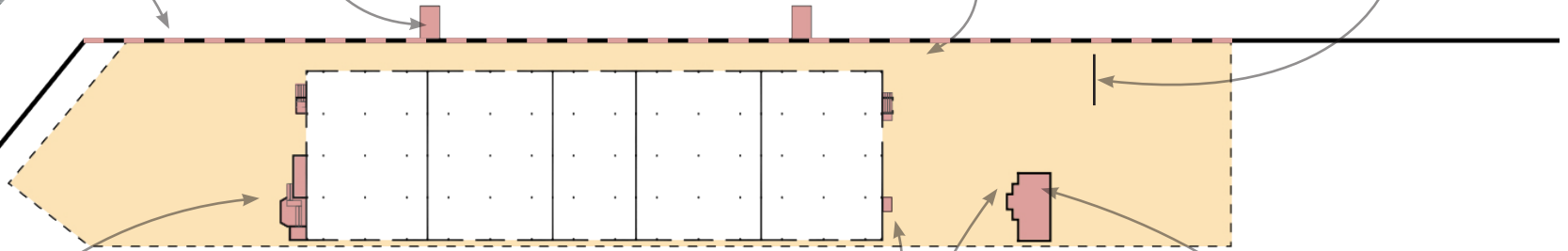

All the extra functions needed in the warehouse, such as a sampling room, offices and toilets, were added to the building as separate volumes. This was done so that the internal processes inside the warehouse could be as efficient as possible and are a result of form follows function. Therefore the added volumes are important and should remain in place.



Next to the pumping station there is also some original pavement left.



The pumping station is part of the original organization of the site and was of high importance for the sprinkler system together with the water tower. It is important that this building does not get demolished but needs to be incorporated in the design of the new function of the Katoenveem.





The windows added during the renovation in 1986 are boarded up with steel material at an unknown date. Both the steel material as well as the windows are of no heritage value as they are not original.



The windows on the ground floor on the west facade are filled in with cement, concrete or brick at an unknown date. The detail and shape of the windows still represent the original windows and therefore get a great heritage value.

The cladding applied in 1987 on the exterior of the lift shaft has no heritage value and can be removed. Removing the cladding should reveal the original concrete exterior of the Katoenveem.

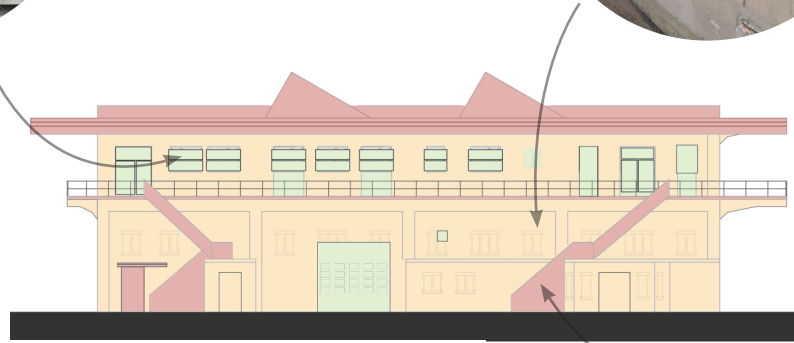

The stairs towards the balconies are of high heritage value. They are the only original vertical connection (apart from the elevator).

The appearance of the building's facade is of great heritage value. This doesn't mean that the exterior is not allowed to be touched as long as the essence of the concrete is preserved. Damages on the outside exterior are in conflict with the original appearance and the use of the building.

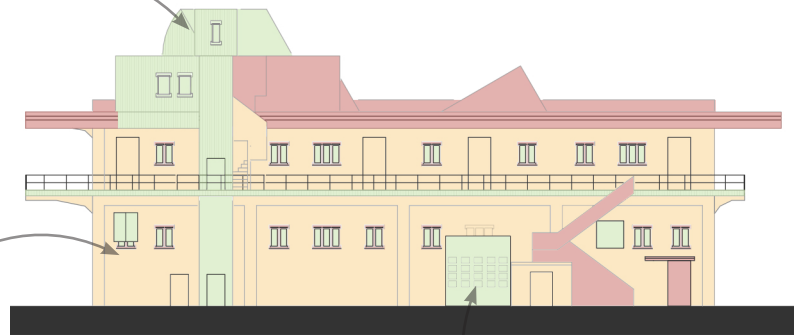

The east facade has been altered many times throughout its use. The original offices and the offices built in 1990 have been removed and multiple passages have been made in this facade.





The fire walls are of essential heritage value. They refer back to the function of the Katoenveem and are of big significance to the story of the building. There have already been connections made in the fire walls, this is allowed as long as the five compartments remain individual.

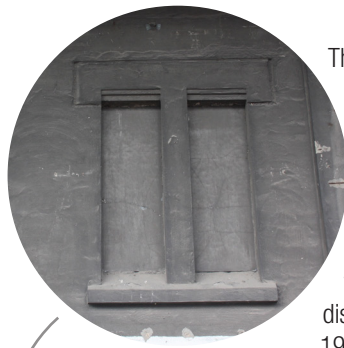

The details around the windows and the cornice are of high heritage value as they refer to the natural stone details of the building and the exposed concrete discussion during the 1920's.



The skylights are of high value. They are the main source of light and refer back to the function of the Katoenveem.

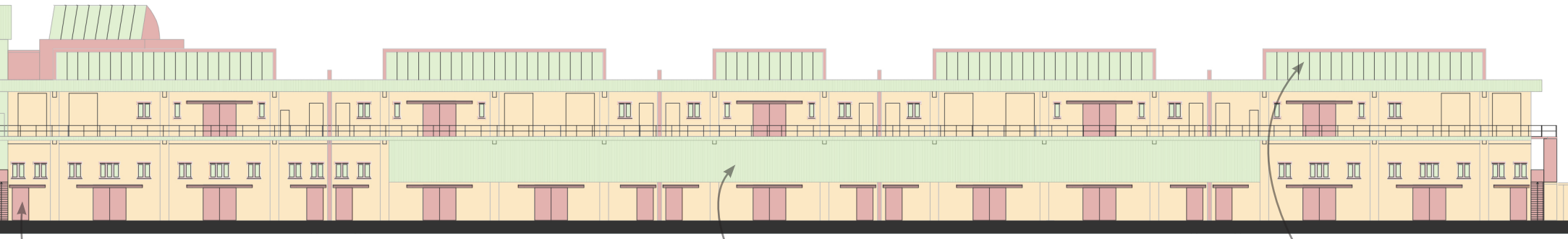
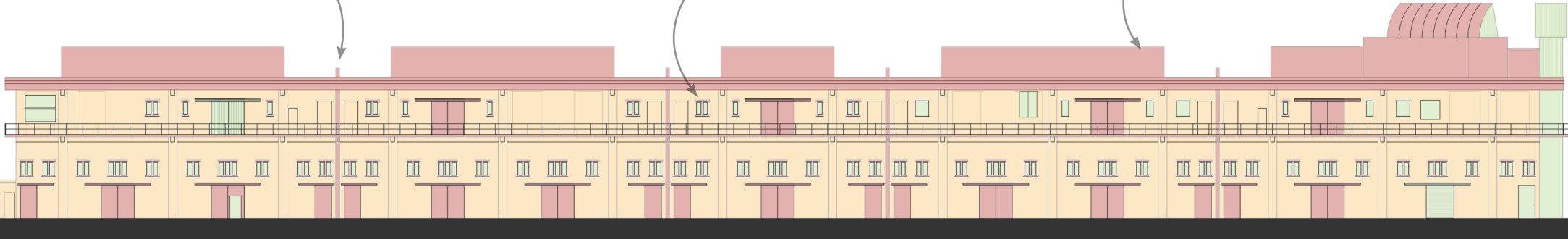

Most of the original doors are still remaining and should stay in place or be reused. They get a high heritage value.

The cladding applied in 1987 on the exterior of the north facade has no heritage value and can be removed. Removing the cladding should reveal the original concrete exterior of the Katoenveem.



The glass of the windows is in very poor state. Numerous windows have been boarded up and some window glass has been painted over. Even Though some of the glass is still original, it is not of value anymore.





The interior of the Katoenveem has a rough exposed concrete surface compared to the exterior. Its important to keep this contrast as it is part of the exposed concrete discussion during the 1920's.



The paint added onto the walls in a later stadium of the building has no value and can be removed.

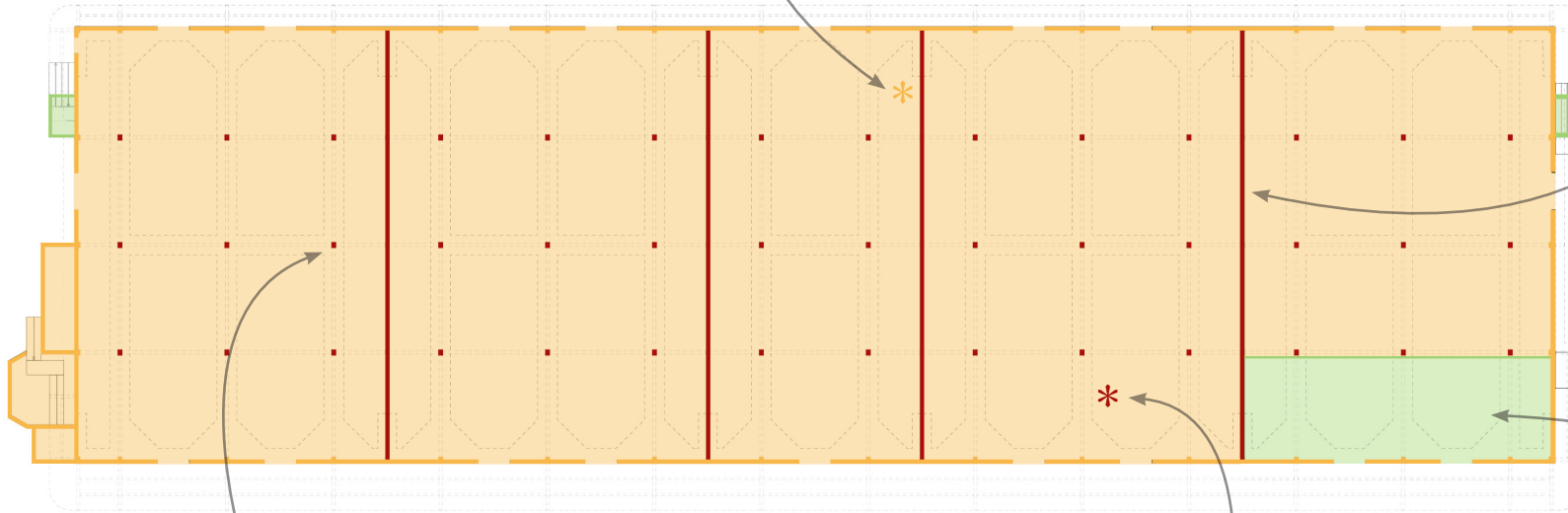

The structure has a high heritage value. It is an early example of a monolith concrete structure and remains in good condition on the interior of the building.



The details in the floor are of high value as they refer back to the main function of the Katoenveem, the storage of cotton.



The added office in the 1990's have no value and can be removed.



The connection between the ground floor and the first floor refers back to the optimization of the cotton transshipment. It is therefore of importance that this connection will still be evident at some parts of the building when it gets transformed.



The ceiling of the Katoenveem still includes most of the original transit system. It is important to keep the system in the building as it is part of the entire construction and tailor made building. It can either be reused or used somewhere else.

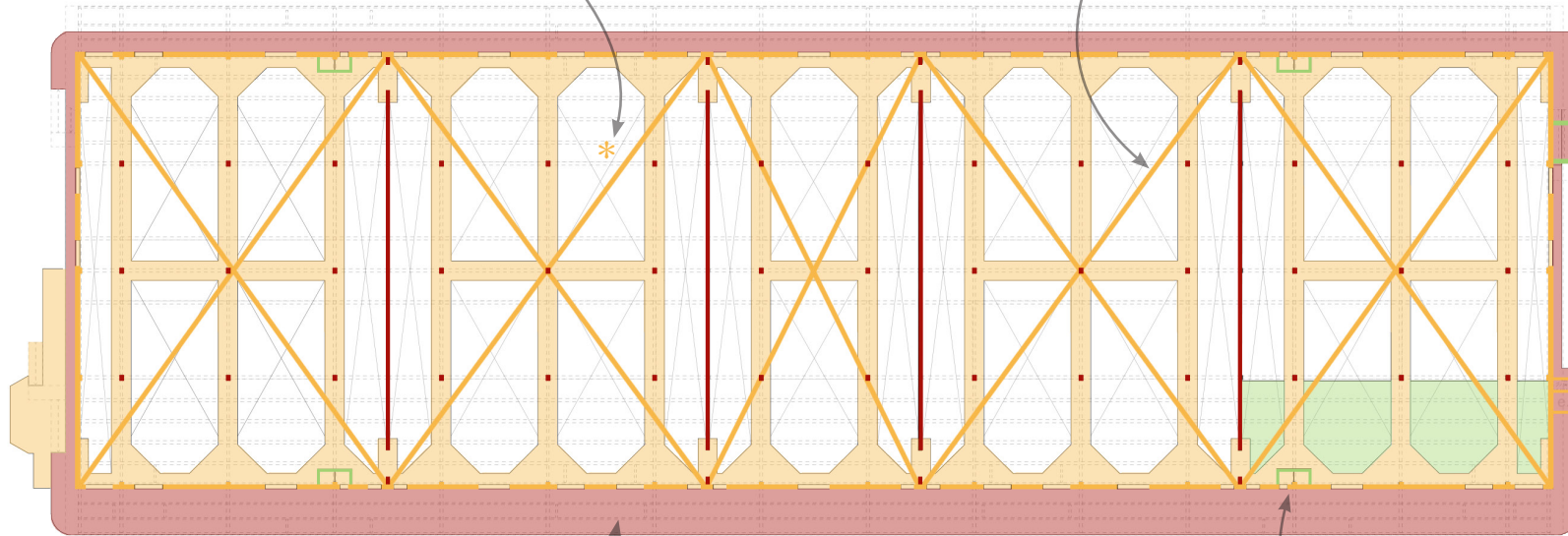

The pumping station was also treated with a surface treatment, but was painted at an unknown date in time. It is important that the pumping station is treated the same way as the façades of the main building.

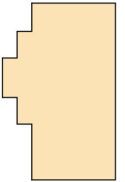

The Balconies have a high significance value due to their important transfer function when the Katoenveem was in use. Unfortunately the balconies are not safe due the poor condition of the concrete and therefore need to be restored.

The workers toilets on the first floor (accessible from the balcony) are of no use anymore. The toilet is already missing.



Value Assessment

Value Table

	<i>Artistic</i>	<i>Historical</i>	<i>Use</i>	<i>Newness</i>	<i>Conflict</i>	<i>Commemorative</i>	<i>Dilemma</i>
<i>Site</i>		The relationship with the old infrastructure (train-tracks).	The relationship with the two warehouses and the continuous transit system.	The unique/innovative system between the ships, buildings and train transport.	The missing parts such as the cranes, water-tower, bridges and old sheds. Because its a matter of sight.	Water-tower, roof and sample room as a landmark in the context.	Whether to rebuild the missing parts.
<i>Skin</i>	Details added in the skin cement around the windows and in the water-tower.	Emphasizing the value of the cotton trade.	All the openings in the facade, roof and balconies to serve the function of the building. Skin is repetitive.	Used surface finish to hide the exposed concrete.	Deterioration/interventions made to the skin. Contrast between inside and outside details.		Restore/bring back the glamour of the building or demolish/cover the facade.
<i>Structure</i>		Original structure is still functioning.	Entire structure is adjusted to the transit system to be able to transport and hold the cotton bales. Structure is repetitive.	One of the first monolith concrete structures.			Is the structure strong enough to support a new function?
<i>Spatial plan</i>		The strict division of the five fire compartments.	Strict division between storage, workers and transit system. The use of the inside and outside web of walkways.		Strict division of the five fire compartments, limiting the horizontal connection.		What to do with the fire compartments and the web of inside and outside walkways.
<i>Services</i>		Water and transit system are still partially remaining in the building. They are out of function.	Requirements for the storage of cotton.	Transit system was an innovative design made especially for the building. The water system was also a new design.		Suggestion to the innovative cotton trade in 1920.	How to integrate it into the new design.
<i>Equipment</i>	Original lighting and outside doors.	The transit system equipment and original lighting which is still hanging from the roof.	The equipment for the transit system was used to lift the bales through the voids from the first floor to the ground floor and the other way around.	Transit system was an innovative design made especially for the building. The lighting was electrical.			How to integrate it into the new design.
<i>Story</i>		The importance of the cotton trade for the city of Rotterdam.	International connection with the ships arriving from America and the train system to sent the cotton of into the rest of the country.	Introduction of a new trade in the western parts of the country.	There is no more international connection and the role of the building has been changed.	Social value for the local people.	How to give the Katoenveem an important role in the context.

	<i>Artistic</i>	<i>Historical</i>	<i>Use</i>	<i>Newness</i>	<i>Conflict</i>	<i>Commemorative</i>	<i>Dilemma</i>
<i>Site</i>							
<i>Skin</i>							
<i>Structure</i>							
<i>Spatial plan</i>							
<i>Services</i>							
<i>Equipment</i>							
<i>Story</i>							

Starting Points

Design

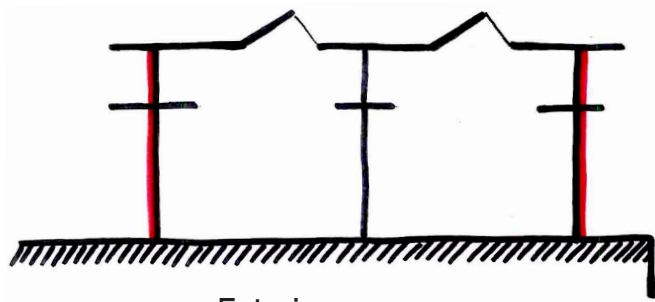

Exterior appearance

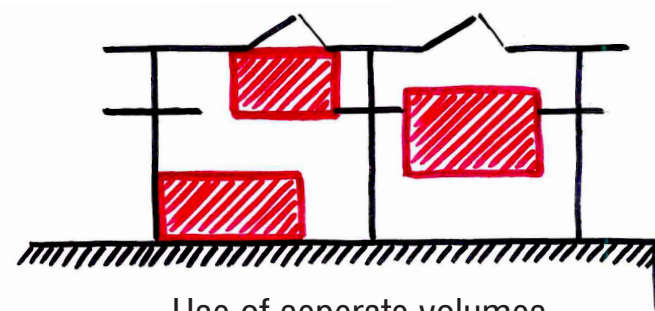

Use of separate volumes

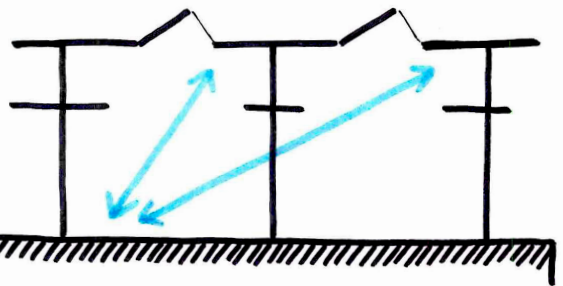

Connection between ground floor and 1st floor

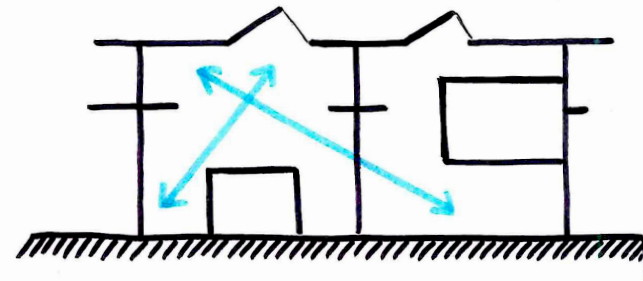

Maintain the connection

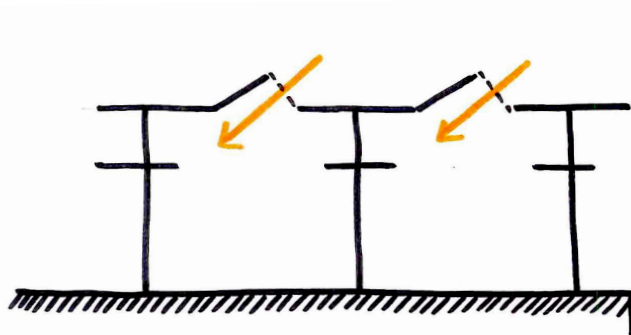

Light from above

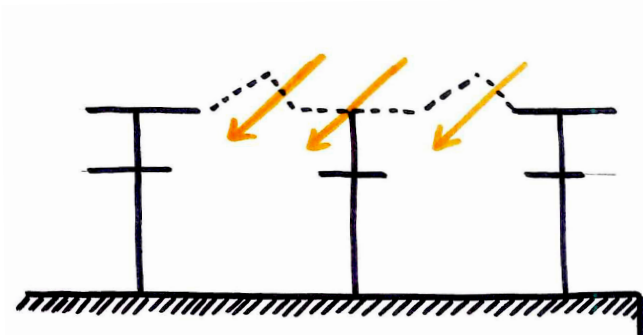

Create an atrium

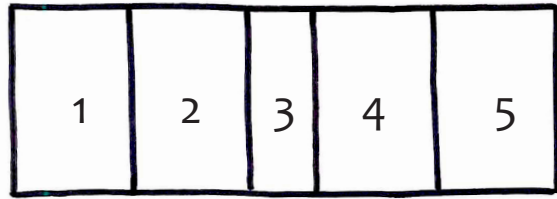

Compartment structure

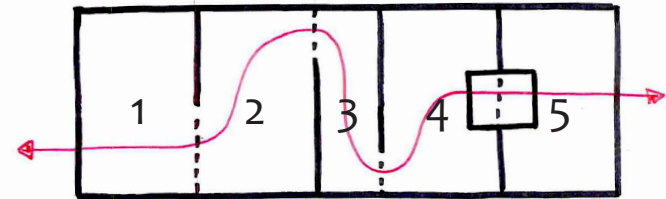

Create connection while maintaining the compartment structure

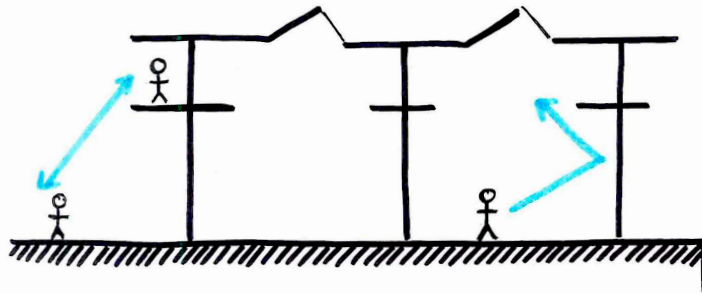

Introvert interior vs. Extrovert balconies

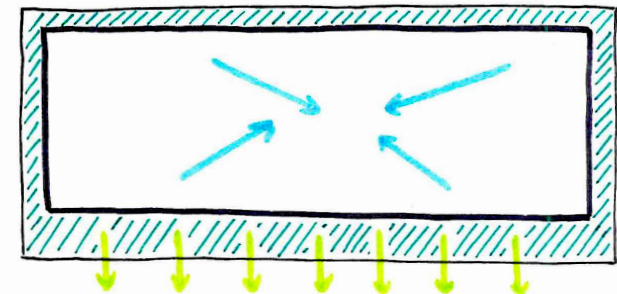

Interior interaction vs. Exterior balcony interaction

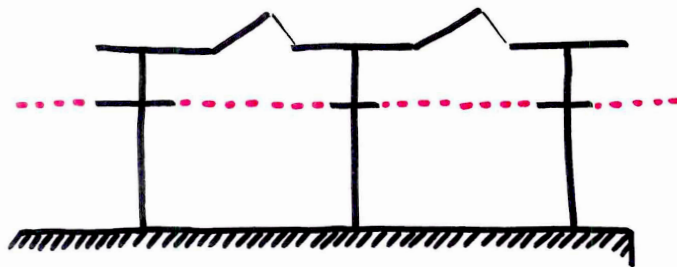

Division between the floors

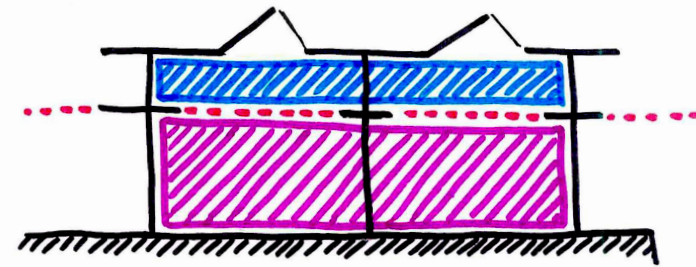

Divide with different functions

Bibliography

Literature

Dam, H.H. van, 'The Cotton warehouse of "Katoenveem"', in: The Pioneer for the shipping industry and trade of the Netherlands and her colonies, 3 (1919), march, p. 65-70

Gemeente Rotterdam, (2010) PlanMER Stadshavens, Deelstudie Landschap en Cultuurhistorie.

Gratama, J. (1912). Gewapend beton en bouwkunst. Bouwkundig Weekblad, 32 (27)

Heinemann, H. A., & Van Hees, R. P. J. (2013). Historic Concrete: From Concrete Repair to Concrete Conservation.

Lang, J. T. (1987). Creating architectural theory : The role of the behavioral sciences in environmental design. New York: Van Nostrand Reinhold Co.

Mason, R. (2002). Assessing Values in Conservation Planning: Methodological Issues and Choices, Assessing the Values of Cultural Heritage Research Report, The Getty Conservation Institute, Los Angeles.

Moussavi, F., & Kubo, M. (2006). The function of ornament. Barcelona: Actar.

Roth, L. M. (2007). Understanding architecture: Its elements, history, and meaning. New York: Icon Editions.

Stenvert, R. (2005). Bouwhistorische verkenning Katoenveem. Rotterdam.

Winter, P. d., & Jong, J. d. (1982). Havenarchitectuur: Een inventarisatie van industriële gebouwen in het Rotterdamse havengebied. Rotterdam: Rotterdamse Kunststichting.

Articles

“Ontstaan en ontwikkeling der Rotterdamsche veembedrijven.”. “Rotterdamsch nieuwsblad”. Rotterdam, 17-06-1926. Consulted from Delpher on 29-09-2016.

“Ontstaan en ontwikkeling der Rotterdamsche veembedrijven.”. “Rotterdamsch nieuwsblad”. Rotterdam, 02-07-1926. Consulted from Delpher on 29-09-2016.

“Ontstaan en ontwikkeling der Rotterdamsche veembedrijven.”. “Rotterdamsch nieuwsblad”. Rotterdam, 08-07-1926. Consulted from Delpher on 29-09-2016.

“Ontstaan en ontwikkeling der Rotterdamsche veembedrijven.”. “Rotterdamsch nieuwsblad”. Rotterdam, 29-07-1926. Consulted from Delpher on 29-09-2016.

Websites

http://www.tis-gdv.de/tis_e/ware/fasern/baumwoll/baumwoll.htm (excessed on 10/12/2016)

<http://retours.eu/nl/08-decoraties-hofpleinstation-rotterdam/#> (excessed on 21/12/2016)

Archives

Stadsarchief Rotterdam

Historisch Centrum Overijssel

The Influence of Sociocultural Values on Heritage Conservation.

**AR3A160 Lecture Series Research Methods
Position Paper**

Dec 15 2016

Charlotte de Boon / 4005430

Heritage & Architecture
MSc3 'Rotterdam Harbour Heritage'
TU Delft

Abstract

In today's world, conservation is not just about improving the technical aspects of a historic building. To properly conserve a historic building we need to understand its heritage value through its sociocultural values. This way we can preserve what we value most and prepare the building to function in the years to come. This paper will explain the importance of sociocultural values by explaining what is heritage, how we define sociocultural value and how we can apply these values when it comes to conserving a historic building.

Keywords

Heritage, culture, value, sociocultural value, future, technical

*"Heritage conservation is best understood as a sociocultural activity; not simply a technical practice; it encompasses many activities preceding and following any act of material intervention."*¹ (Mason, 2002)

With this statement Randall Mason perfectly describes the act of conservation of a historic building. Nowadays, a lot of vacant historic buildings are being conserved by either being transformed or restored. When considering to conserve a historic building, alterations to the building are unavoidable. These can range from simply restoring to fully transforming the building and giving it a new function. However, the act of conserving a historic building, as Randall Mason describes, is not just technically improving the state of the building. It is also about understanding its sociocultural values which arise from the 'activities' preceding and following any intervention made to a building.

"Sociocultural values are at the traditional core of conservation - values attached to an object, building, or place because it holds meaning for people or social groups due to its age, beauty, artistry, or association with a significant person or event or (otherwise) contributes to processes of cultural affiliation." (Mason, 2002) Sociocultural value is a combination of the values associated with society and the reasons for conserving certain aspects of the building. They are the values which have preserved the building through the years and they will help conserve the building into the future. The sociocultural value can be defined by several types.

First of all the building's historical value. As the name already suggests when dealing with a historic building, you immediately have to consider its history and historical values. As Randall Mason describes *"Historical values are at the root of the very notion of heritage. The capacity of a site to convey, embody, or stimulate a relation or reaction to the past is part of the fundamental nature and meaning of heritage objects."* (Mason, 2002) Historical values can be defined by the material's age, its association with people or events, its rarity/uniqueness, as well as technical qualities or archival/documentary potential. An important historical value people might forget is the educational/academic value, information which is provided from the past to gain knowledge for the future. We can for example gather a lot of extra information from a historic building which was built using a unique construction method which is no longer used today. Conducting historical research can help determine the historic relevance of the building, which is significant for defining its heritage value. However we should not mistake history for heritage as *"Heritage is not history: it is not what happened in the past but what has survived from the past."* (Marsden, 1992)

Secondly the cultural/symbolic value of the building. Randall Mason explains that *"History and heritage are core elements of all cultures - the ideas, materials, and habits passed through time - so cultural values are, like historical value, a part of the very notion of heritage."* Therefore *"there is no heritage without cultural value."* (Mason, 2002) A historic building is the pure evidence of cultural influences from its past as well as from its present. Buildings are meant to last at least a lifetime and each of them reflects on the cultural changes within society. *"Cultural values are used to build cultural affiliation in the present and can be historical, political, ethnic, or related to other means of living together (for instance, work- or craft-related)."* (Mason, 2002)

The third type are the work- or craft-related values which represent the methods used to design and construct the building. Even though their significance is often lost among the 'static' historical or aesthetic values, they are crucial educational/academic values, which are of high significance for the future of the building. Knowing how a building was or was meant to be constructed is important to successfully conserve a historic building.

The fourth type is the social value which relates to the 'place attachment' aspects of heritage value. *"Place attachment refers to the social cohesion, community identity, or other feelings of affiliation that social groups derive from the specific heritage and environment characteristics of their 'home' territory."* (Mason, 2002) It refers to a feeling of attachment to a place, object or building which is hard to grasp. This value is hard to define, but one of the most important ones as it ensures 'our heritage' *"our heritage is based on aspects of our past that we want to keep"*. (Marsden, 1992) A good example where social value played a large role in the conservation of a block of buildings is the Jeruzalem Frankendael neighbourhood in Amsterdam. It was realized in 1952 and was the first neighbourhood constructed with an open cluster structure placed around courtyards. The houses were constructed out of prefabricated concrete following the Dotremont-Ten Bosch building system. The only project in the Netherlands where this system was used. In 2002 the housing association decided to pull down the building blocks due to their poor technical quality. However, because of the social value of the place, inhabitants started to protest against the future demolition plans. After a full investigation it was concluded that the building blocks could be saved by refurbishing them. Dwellings could be expanded by joining them either horizontally and/or vertically together. However, the residents did not feel the need for refurbishing as they were happy with the low rent and the unique location. Drawing the conclusion that the sociocultural value played a stronger role in the conservation of the Jeruzalem Frankendael neighbourhood than the technical value. After the involvement of the inhabitants, motivated by the social value, many possible solutions seemed feasible to sustain the neighbourhood. Instead of pulling it down as was initially planned it resulted into six building blocks being listed as a national monument in 2010. (Zijlstra, 2011)

A fifth, important but intangible value of sociocultural value is that of spirituality/religion. *"These spiritual values can emanate from the beliefs and teachings of organized religion, but they can also encompass secular experiences of wonder, awe, and so on, which can be provoked by visiting heritage places."* (Mason, 2002) Unfortunately, due to secularization, many churches in the Netherlands are losing their religious function. As a result, church councils are forced to sell their church to either the municipality, a foundation or a private party. In the Netherlands, 1340 churches have become obsolete since 1975. Roughly 1000 of them have been transformed to serve a new function. (Rijksdienst voor het Cultureel Erfgoed, 2011) Transforming a historic building is also an act of conservation. An example of such conservation of a Dutch church is the Dominican Church in Maastricht. After being empty for a number of years, the Dominican Church was transformed into a bookstore in 2006. Although the church lost its religious function, it didn't lose its religious value. Churches are known for their large spatial interiors.

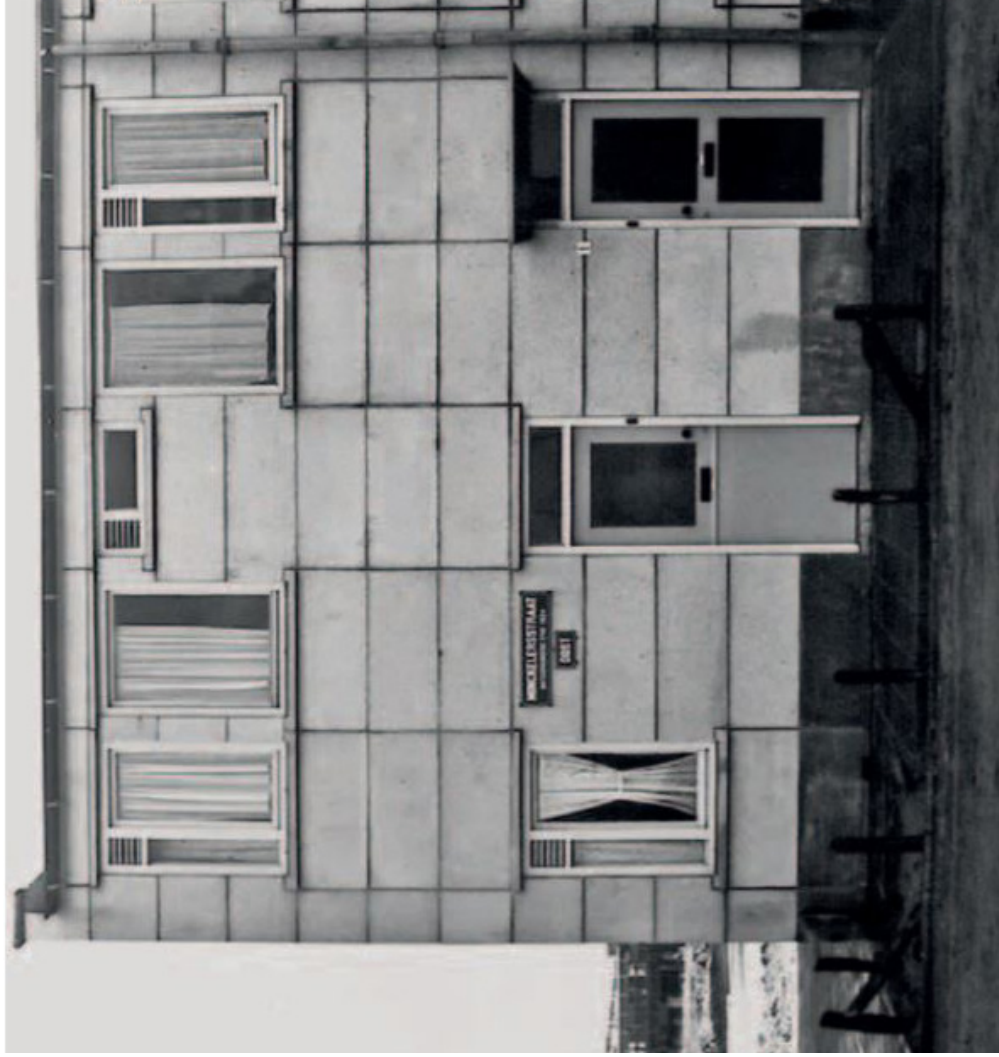

Original facade of the dwellings in 1953. (stadsarchief Amsterdam)



1950



1951



2002



2010

Four images of the transformation of one of the corner dwellings attached to a small local store.

Photo's:
 1950 (stadsarchief Amsterdam)
 1951 (stadsarchief Amsterdam)
 2002 (Hielkje Zijlstra)
 2010 (Hielkje Zijlstra)



Interior of the Dominican
Church after transformation.
Photo taken by Roos Aldershof
Copyright © 2015 Merk-X



Interior of the Dominican
Church after transformation.
Photo taken by Roos Aldershof
Copyright © 2015 Merk-X

transforming a church to suit a new function, one way to take its religious value into account is by creating a reference to its former function by making use of its spatial interior. *"A good design focusses on the spatial organization of the original church's length, width and height to come forth to its full right as much as possible."* (Rijksdienst voor het Cultureel Erfgoed, 2011) In the Dominican Church, the spatial organization of the church was respected by placing smaller, separate units for specific functions within the larger space of the church. This limited the impact of the smaller units on the spatial experience of the interior of the old church. The carefully designed freestanding installation does not distract from the spatial splendor of the interior by keeping its religious value and referring to its former religious function.

Last of all the aesthetic value of the building refers to the visual qualities of heritage. *"Aesthetic value is a strong contributor to a sense of well-being and is perhaps the most personal and individualistic of the sociocultural value types."* (Mason, 2002) According to Jon Lang in his book 'Creating Architectural Theory' written in 1987, he describes that the science of aesthetics is concerned with two things: *"(1) identifying and understanding the factors that contribute to the perception of an object or a process as a beautiful or, at least, a pleasurable experience, and (2) understanding the nature of the human ability to create and to enjoy creating displays that are aesthetically pleasing."* (Lang, 1987) Lang also describes beauty as something that has to be pleasing and creating a pleasurable experience to whomever observes it. But creating such experience means understanding what leads to such an enjoyable experience. This therefore makes the aesthetic value of a building difficult to determine because beauty is in the eye of the beholder.

Graduating at the chair of Heritage & Architecture I have been analyzing the heritage value of an old, concrete warehouse building in Rotterdam, the Katoenveem. This building is a good example of a construction where the sociocultural values are of strong influence to its technical conservation practice. As its name already suggests in Dutch, the Katoenveem was a specially designed warehouse built for one specific function, being the storage of cotton. Designed in 1920 by architect Jan Jeronimus Kanter, it was a revolutionary building completely designed to optimize the transshipment of the cotton. At the same time it assured that the cotton stored in the storehouse wouldn't lose its value. To accomplish this, the building was constructed completely out of concrete and divided into five different fire compartments to keep the cotton safe from unexpected fires.

When determining the heritage value, the first thing you notice is the state of the concrete on the exterior surface of the building. Due to concrete erosion and carbonation, large pieces of concrete have fallen off the building. This to an extent that it is no longer safe to walk up close to the building. For safety precautions the municipality has put up netting to prevent pieces of concrete from falling down. Also at first glance the exterior of the building doesn't appear to be aesthetically exciting. Therefore the first assessment of the value of its exterior is low. When considering to conserve this building, alterations to the exterior of the building will have to be made to fulfill the safety regulations to make the building useful again. Although on first glance the exterior doesn't seem very important, after further research into its sociocultural values as mentioned above, it becomes clear that the exterior of the Katoenveem has a lot more value than initially thought. When conducting historical research it becomes clear that the Katoenveem was realized during the time of discussion about the aesthetics of exposed concrete architecture. This discussion influenced the aesthetics of the exterior of the Katoenveem.

In the late 19th century, the use of concrete in architecture was mainly for structural elements such as columns and beams. The concrete itself was usually covered either by plastering or cladding with traditional materials such as brick or natural stone. (Heinemann, 2013) The

texture and the unavoidable blemishes as a result of the formworks construction methods, were not acceptable and the grey colour was considered dull and lifeless. (Heinemann, 2013) Exposed concrete was normally only found on facades with low aesthetic requirements such as industrial buildings. From the 20th century onwards, the use of concrete increased and a growing interest to find an appropriate aesthetic appearance for exposed concrete is noticeable. But the main problem was still its appearance. As a result concrete surface finishes were being developed to make the exposed concrete more appealing. (Heinemann, 2013)

Considering the age and function of the Katoenveem, it would be expected that the Katoenveem had not been treated with a surface finish. Instead, the exterior was treated with an artificial sandstone render which gives it a complete different sociocultural value. The exterior of the Katoenveem was part of the cultural discussion within society and a reaction to the discussion going on during that time period. Architect J.J. Kanters also took advantage of the chosen innovative surface finish. It was an opportunity to add detail to the facade by framing the windows with a groove pressed into the cement creating the appearance of a natural stone lintel. Considering this aesthetic value when exploring the exterior of the Katoenveem even further, it is striking how much detail has actually gone into this industrial building, giving the Katoenveem a high aesthetic value.

Taking all these values into consideration, the conservation of the exterior of the Katoenveem takes a different turn. When at first glance one might automatically say that conserving its exterior is a matter of technical interventions, then one has not considered the sociocultural values. This does not mean that technical improvements are not necessary when conserving a building. Taking the Katoenveem as an example, technical improvements will have to be made to make the building functional again. These technical improvements will be influenced by the sociocultural values given to the aesthetic exterior of the building. In looking at the Dominican Church in Maastricht, to be able to conserve the building, it had to be transformed to accommodate a new function. This demanded technical adjustments being made to its interior. But the size, place and form of these adjustments were influenced by the religious value of the Church. In the case of the conservation of the Jeruzalem Frankendaal neighbourhood technical adjustments were drastically needed to meet the comfort needs of today. These were realized by placing internal thermal insulation behind the prefab facade elements, keeping the original architectural design intact. (Zijstra, 2011) Therefore it is to say that these sociocultural values have great influence on the conservation methods as they determine its heritage value which is the guideline for taking a building into the future. *“The term heritage, a borrowing from legal terminology, may be described as embracing that which can be passed from one generation to the next and following generations, and to which descendants of the original owner(s) have rights deemed worthy of respect”* (Pearce, 2000) Therefore concluding that *“Heritage conservation is best understood as a sociocultural activity, not simply a technical practice.”* (Mason, 2002)

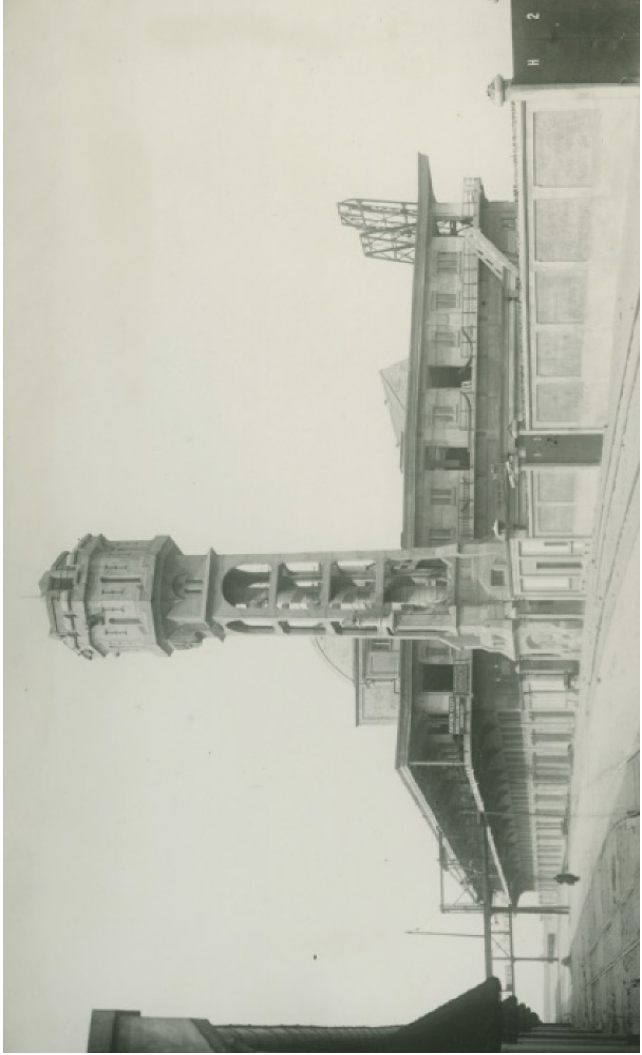

The Katoenveem on the Kellestraat, Fototechnische Dienst Rotterdam. (Gemeentewerken, Openbare Werken), 1919, Rotterdam Stadsarchief.



Damage on the exterior of the Katoenveem including the netting put up by the municipality. Own image 2016.



Exterior of the Katoenveem with the lintel detail around the windows. Own image 2016.

Literature

Heinemann, H. A., & Van Hees, R. P. J. (2013). *Historic Concrete: From Concrete Repair to Concrete Conservation*. Delft: Delft Digital Press.

Lang, J. T. (1987). *Creating architectural theory: The role of the behavioral sciences in environmental design*. New York: Van Nostrand Reinhold Co..

Marsden, S. (1992). Is heritage history? History and the built environment. *Community History*, p. 6-9.

Mason, R. (2002). *Assessing Values in Conservation Planning: Methodological Issues and Choices, Assessing the Values of Cultural Heritage Research Report*. Los Angeles: The Getty Conservation Institute.

Pearce, S.M. (2000). *The Making of Cultural Heritage, Values and Heritage Conservation Research Report*. Los Angeles: The Getty Conservation Institute.

Rijksdienst voor het Cultureel Erfgoed (2011). *Een toekomst voor kerken: Handreiking voor het herbestemmen van vrijkomende kerkgebouwen*. Eindhoven: Lecturis.

Zijlstra, H. (2011). *Jeruzalem Frankendaal Amsterdam temporary duplex can stay forever, International Conference on Durability of Building and Component*. Porto.

