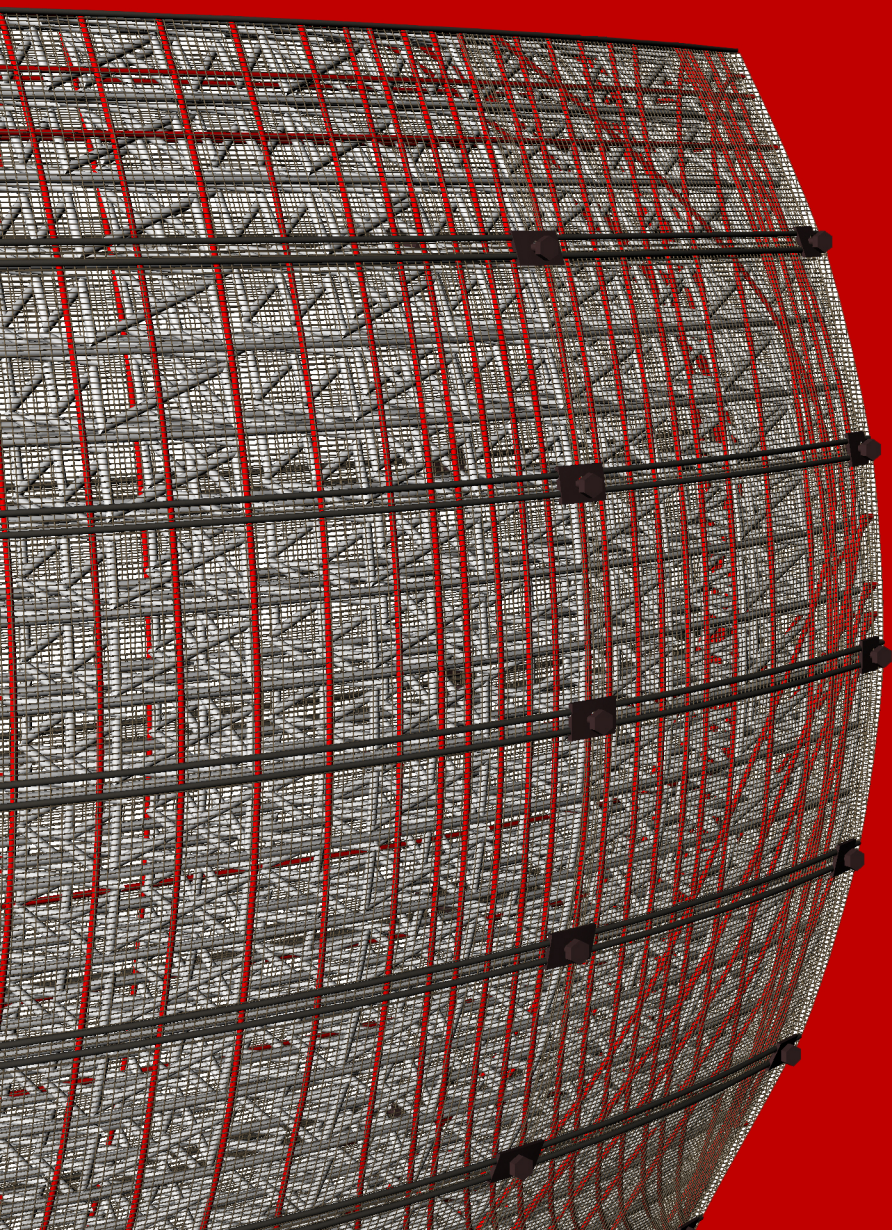


# DIGITAL MANUFACTURING OF REINFORCEMENT SYSTEM IN A FREEFORM CONCRETE STRUCTURE







# DIGITAL MANUFACTURING OF REINFORCEMENT SYSTEM IN A FREEFORM CONCRETE STRUCTURE

---

## PERSONAL INFORMATION

**Name:** Mohammad Ali Bijani  
**Student number:** 1393391  
**Telephone:** +31 650875248  
**E-mail address:** Ali.Bijani@Gmail.com

## STUDIO

**Studio:** Structural Design, Building Technology  
**Mentors:** Ir. Arie Bergsma  
Ir. Joris Smits  
Ir. Paul de Ruiter

## TITLE OF THE GRADUATION

Digital manufacturing of reinforcement system in a freeform  
concrete structure

## ABSTRACT

This research paper is a TU Delft Master's thesis for graduation track in the field of Building Technology. Its main theme, digital manufacturing of reinforced concrete structures, has already been studied/researched by many other enthusiasts; but they adopted approaches mainly based on the digital production of formworks or 3D printing of concrete. None or very few researchers have tried tackling this topic by only investigating the reinforcement production methods. Reinforcement is an essential part of any concrete structure and neglecting its role in developing techniques of digital manufacturing concrete structure makes the technique unreliable. Therefore this report approached this topic according to the suitable production techniques for reinforcement structures of freeform concrete structures. Various techniques and concepts in production of reinforcement structures have been designed and one chosen. This chosen concept got developed into its last minute details as well as its assemblage process got demonstrated on a freeform wall structure.

All the stages are also fully explained providing a source of inspiration for anyone interested in the topic to employ the presented research in creation of other possible systems.

Those research related to production technique which is done by the researcher of this report, can also be employed in other fields such as lattice mesh structure production or 3D printing of carbon fibers.

---

# CONTENTS

---

<b>1</b>	<b>Introduction.....</b>	<b>13</b>
1.1	Problem Statement .....	13
1.2	Objective .....	14
1.3	Research Question.....	14
	Main research questions .....	14
	Sub research questions .....	14
	Evaluative .....	14
	Informative .....	14
1.4	Approach and methodology .....	15
<b>2</b>	<b>Preliminary literature study .....</b>	<b>19</b>
2.1	Introduction .....	19
2.2	Additive manufacturing .....	21
	2.2.1 AM capabilities .....	21
2.3	Challenges in buildings .....	23
	2.3.1 Sagrada Familia Church .....	25
	Adaptation of new technologies .....	26
	Constructional challenges in Sagrada project .....	28
	2.3.2 Chosen structural problem .....	28
	2.3.3 Freeform structures .....	28
	challenges in freeform concrete structure .....	29
2.4	Digital manufacturing and concrete structures.....	31
<b>3</b>	<b>Literature study .....</b>	<b>35</b>
3.1	Digital Manufacturing .....	35
	3.1.1 Digital fabrication .....	36
	Formative .....	36
	Cutting .....	37
	Subtractive.....	37
	Additive .....	37



## Table of content

---

3.1.2	Techniques .....	39
	Fused Deposition Modeling (FDM) .....	40
	Multi-Jet Modeling (MJM) and Poly-Jet Modeling (PJM) .....	41
	Stereo lithography (SLA) .....	42
	Selective Laser Sintering (SLS) .....	43
	Selective Laser Melting (SLM) .....	43
	Selective Masking Sintering (SMS) .....	44
	Laminated Object Manufacturing (LOM) .....	45
	Electron Beam Melting (EBM) .....	46
<b>4</b>	<b>Design research .....</b>	<b>49</b>
4.1	Assembly process technique .....	49
4.1.1	Concepts .....	50
A.	Formwork .....	50
B.	Embedded formwork .....	51
C.	Reinforcement as formwork.....	52
D.	Embedded formwork, integrated with reinforcement.....	53
4.1.2	Evaluation .....	54
4.2	Reinforcement production concept.....	57
4.2.1	Concepts .....	57
A.	Lattice structure mesh .....	57
B.	Metal welding and mimicking tensile trajectory lines.....	59
C.	Woven fiber filament on pin points .....	61
D.	fiber placement with epoxy on rotating mold .....	63
E.	Fiber placement with epoxy on fixed mold .....	65
F.	Fiber knitting technique.....	67
4.2.2	Evaluation and conclusion .....	68
4.3	Material selection for reinforcement.....	69
4.3.1	Materials suitable for reinforcements concepts.....	71
4.3.2	Fiber Material.....	74
	Compatibility based on referencing .....	74

---

Compatibility based on “CES EduPack” software.....	75
Fiber materials compatible with concrete .....	76
4.3.3 Thermoplastic material .....	79
Compatibility based on “CES EduPack” software.....	79
Thermoplastic materials compatible with concrete .....	79
4.3.4 Conclusion.....	82
4.4 Modified reinforcement concepts .....	83
4.4.1 concepts .....	85
1. Lattice structure mesh .....	85
2. Metal Welding .....	91
3. Fiber based reinforcement .....	94
4. Fiber placement on lattices mesh structure .....	96
4.5 Evaluation and conclusion .....	97
<b>5 Design.....</b>	<b>101</b>

---

5.1 Design description .....	101
5.1.1 Predicting probable problems and its consequences on the design .....	102
5.1.2 Defining focus points .....	103
5.1.3 Defining geometry.....	103
5.2 Part 1. Mesh structure core (Element A).....	105
5.2.1 Defining the initial mesh design .....	107
Mesh system.....	107
Mesh pattern .....	109
5.2.2 Modifying mesh based on production and geometrical limitation.....	111
Downward printing .....	111
Transforming the designed mesh to a continuous curve .....	112
Geometrical detailing.....	114
5.2.3 Carbon fiber integration .....	116
Purposed fiber integration system .....	116
predicted criteria .....	117
5.2.4 Dimensioning the mesh components.....	118

---

## Table of content

---

mesh grid size .....	118
Diameter of extruded lines .....	120
5.2.5 Final mesh design and evaluation .....	121
5.3 Part 2. Outer fibers (Element B) .....	123
5.3.1 Finite Element Method FEM analysis and stress trajectory lines .....	123
5.3.2 Defining path of fibers.....	125
Prediction from deformation and bending direction .....	125
Defining fibers path based on FEM analysis .....	126
5.4 Part 3. Fiber placement on mesh structure .....	129
5.4.1 Outer fiber manufacturing setup .....	131
Rotating table .....	131
Robotic Arm .....	131
5.5 Part 4. Concrete infusion and formwork replacement strategy .....	133
5.5.1 Systems .....	133
Embedded formwork .....	133
Mesh sheets as formwork .....	135
5.5.2 Evaluation .....	136
5.6 Part 5. Integration with conventional structures .....	137
5.6.1 Concepts .....	137
Indirect connection .....	137
Direct contention.....	139
<b>6 Calculation .....</b>	<b>143</b>
6.1 Mesh core structure.....	143
6.1.1 Load cases .....	143
Attached components.....	144
6.1.2 Defining geometrical character .....	145
6.1.3 Loading scenarios.....	146
6.1.4 Calculations .....	147
Model 1 – 0.5 cm diameter .....	149
Model 2 – 1 cm diameter .....	149



---

Model 3 – 1.5 cm diameter .....	149
6.1.5 Result .....	150
6.2 Internal stresses on mesh core structure during concrete infusion.....	151
6.2.1 Defining geometry and load cases .....	151
Design elements .....	151
Construction process.....	152
6.2.2 Calculation.....	154
Part 1 Full height infusion.....	155
Part 2 maximum tolerable height .....	157
6.3 Conclusion .....	158
<b>7 Final design production and assembly .....</b>	<b>161</b>
7.1 Production factory .....	162
7.1.1 Step 1 – Mesh core .....	162
7.1.2 Step 2 – Placing connection sleeves .....	163
7.1.3 Step 3 – Placing reinforcing fibers.....	164
Automated procedure.....	164
Semi-automated mode .....	166
7.1.4 Step 4 – Fine mesh formwork installation preparation .....	168
7.2 Construction site .....	170
7.2.1 Step 1 – positioning of curved wall reinforcement structure .....	170
7.2.2 Step 2 and 3 – Placing fine mesh formwork sheets .....	173
7.2.3 Step 4 – Surface finishing .....	175
<b>8 Evaluation and Conclusion.....</b>	<b>177</b>
8.1 evaluation.....	178
8.1.1 Calculation related.....	178
8.1.2 Design related .....	178
8.1.3 Prototyping.....	179
8.2 Conclusion .....	180
8.3 Future scope .....	182

---

## Table of content

---

<b>9</b>	<b>Prototype.....</b>	<b>185</b>
9.1	Lattice structure printing.....	185
9.1.1	Planning the method.....	185
9.1.2	Experiments .....	186
9.2	Carbon fiber printing.....	187
9.2.1	Planning the method.....	187
	Cyclops hotend.....	188
	Diamond Hotend .....	189
	Standard hotend .....	190
	Evaluation.....	190
9.2.2	Experiments .....	190
	Expreiment1 .....	190
<b>10</b>	<b>References.....</b>	<b>193</b>
<b>A.</b>	<b>Appendix.....</b>	<b>196</b>
A.1.	Mesh Generator .....	197
A.2.	G-code generator.....	203
A.3.	Rebar connection .....	207
A.3.1.	Rebar lapping .....	207
A.3.2.	Threaded Coupler.....	207
	Standard coupler .....	207
	Position Coupler .....	207
A.3.3.	Screw lock System .....	208
A.3.4.	Grout Sleeve .....	208
A.3.5.	Hydraulic grip coupler .....	209
A.3.6.	Cad Weld Coupler .....	209
A.3.7.	Monkey bar coupler .....	210
A.4.	Case studies .....	211
A.4.1.	Taichung metropolitan opera house .....	212
A.4.2.	Mercedes Benz museum .....	215
A.4.3.	Mumuth University library stair.....	216

---

A.4.4. Meiso No Mori – Municipal Funeral Hall .....	217
A.4.5. Arnhem station –transfer hall .....	219
A.5. Grid pattern.....	221
A.5.1. Pattern 1 .....	222
A.5.2. Pattern 2 – Body Centered Cubic .....	223
A.5.3. Pattern 3 – Face Center Cubic.....	224
A.5.4. Pattern 4 – Dode element .....	225
A.5.5. Pattern 5 – Diamond crystal.....	226
A.5.6. Pattern 6 – Octec truss.....	227
A.5.7. Pattern 8 – Octahedral .....	228
A.5.8. Pattern 9.....	229
A.5.9. Pattern 10.....	230
A.6. Appendix reference .....	231





# 1 • Introduction

## 1 INTRODUCTION

---

### 1.1 PROBLEM STATEMENT

---

Freedom of imagination is an architect's dream. In the eyes of an architect, a building is not always a pure functional object. Similar to a sculpture, a building can also be perceived as a piece of art. Designers try to achieve aesthetically pleasing buildings by various ways in order to transform their vision into reality. Designers try to achieve aesthetic qualities by various ways. Designing fluid form structures is one of the ways to achieve this dream. However, dreams are not always achievable. The architect initial idea generally goes through different phases and each phase has its respective obstacles. Nowadays, with the help of computer software's, architects have greater freedom to design what's in their mind. On the other hand, the same cannot be said for manufacturing as the current technology available does not offer the same level of freedom. Digitally designed projects still need to be constructed in traditional methods.

Concrete is one of the most common materials in the building industry and its initial fluid phase makes it suitable for freeform objects. Nevertheless, since the invention of concrete was discovered, its fundamental construction principles have not changed massively. Concrete can be fashioned into any shape but this requires special equipment. Formwork is essential equipment used in concrete construction that controls the final shape of the object. Creation of these freeform items in complex projects require a lot of effort. Additionally, these items can only be used once. In standard concrete structures, around 50% of the budget is invested on these items (Robert, 2007).

It's also a known fact that in big loadbearing structures, basic concrete is not sufficient. Concrete requires reinforcement due it's limitations in handling tensile forces.

In simple buildings that have straight walls, the challenge can be solved by placing several reinforcement bars. However, in the case where a building has non-linear forms, reinforcement bars can also be distressed and therefore may not be enough. Consequently, the



complexity of these types of items force designers to change their materialization.

## 1.2 OBJECTIVE

---

Freeform concrete structures are one of the challenges in building industry. This is mainly because conventional methods are developed for simple and lineal objects. However, these structures are getting constructed by modifying and adjusting those techniques. The main purpose of this research is to develop a suitable technique for these types of objects.

The other objective of this research is to shift manufacturing techniques to a more digitalized approach. Currently, most stages in the design phase are done digitally. Programs such as 3D modeling, BIM and parametric design have revolutionized the design process and made life so much easier for architects. However, manufacturing techniques are still use more traditional methods.

### List of objectives

- Develop a technology suitable for freeform concrete structures
- Adapting digital manufacturing techniques to the construction process
- Fill the research gap in digitally fabricated reinforcement bars

## 1.3 RESEARCH QUESTION

---

### MAIN RESEARCH QUESTIONS

- How can digital fabrication be used to create a customizable reinforcement element in freeform concrete?

### SUB RESEARCH QUESTIONS

#### EVALUATIVE

- Can reinforcement structure eliminate the need for conventional concrete formwork?
- Can the developed reinforcement technique makes construction of complex projects more efficient?

#### INFORMATIVE

- What are the requirements for reinforcement structures?
- What are the existing reinforcement techniques?

- What are the conventional methods for creating freeform concrete?

## 1.4 APPROACH AND METHODOLOGY

---

This graduation has six stages (See Figure 1).

1. Preliminary study
2. Literature review
3. Case study
4. Design and concept development
5. Test and evaluation
6. Finalizing

In the *Preliminary study*, a brief research was done on digital manufacturing and concrete background information. With the help of information acquired, the focus point and objectives of this research were set. It has also helped to create a framework to research on literature and case studies.

In *the Literature Review*, all the necessary information for developing a new reinforcement technique should be collected. This is done by theoretic studies and research. The first section will cover the following points:

- Properties of concrete
- Requirements and regulations for reinforcement structure
- Alternative material for reinforcements
- Production process for rebar and formworks

In the second literature section, the information regarding the digital fabrication is observed:

- Available technique
- Pros and cons and limitations
- Possible printable materials with high tensile strength

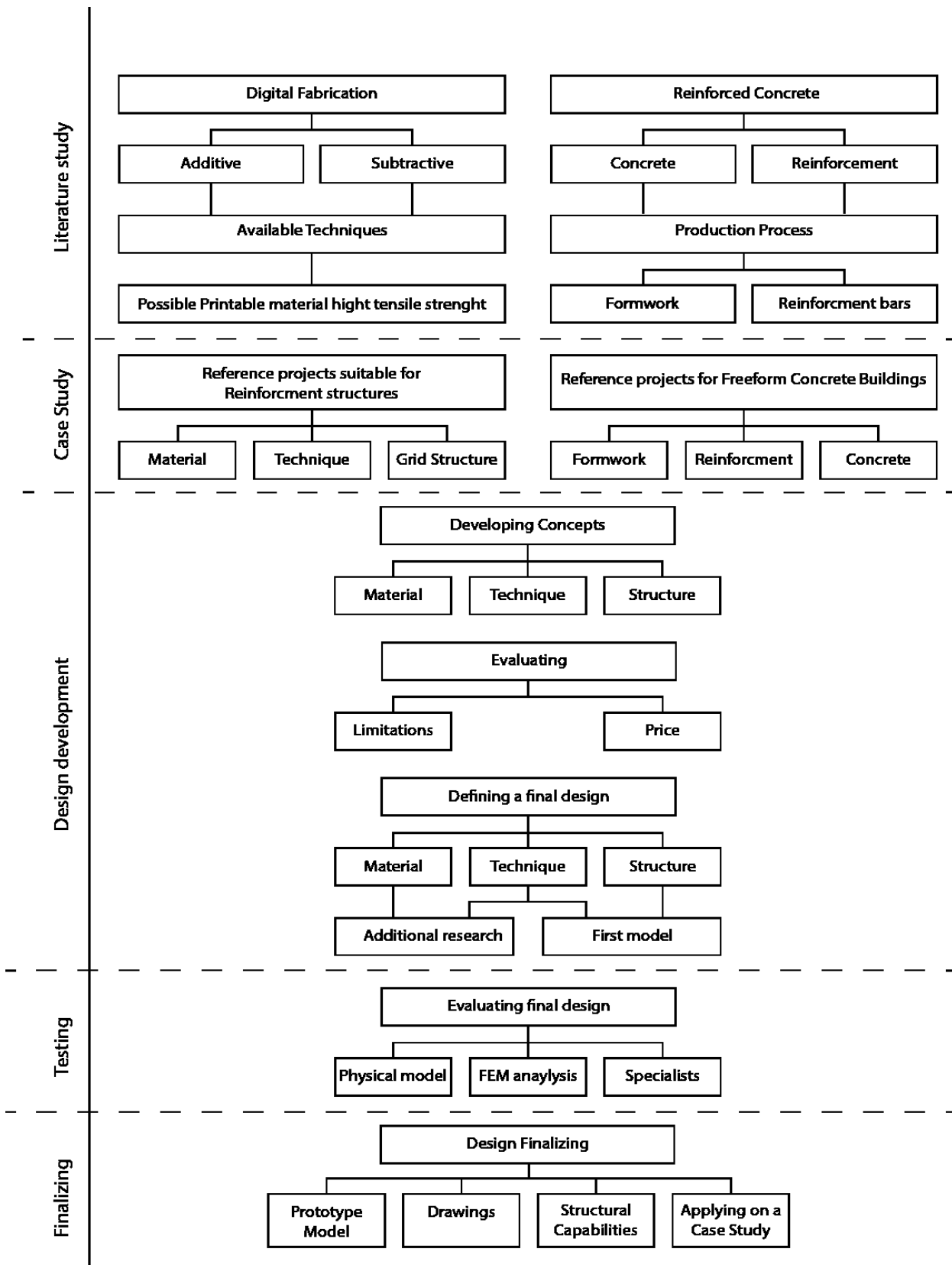
The acquired knowledge in this second stage is very important. Nevertheless, it is important to identify how these techniques are used to handle the problems of the research question. For this purpose, a list of *case studies* needs to be defined:

- A suitable digital-manufactured project for reinforcement structure.
- Freeform concrete building

With the help of these case studies, a better insight on solutions and latest developments in the building industry can be obtained. With the combination of literature and case study information, one is ready to start with the designing process. In the *Design Development* stage, various ideas should be developed. These ideas are evaluated and tested later. These steps give the reader feedback for further development of new ideas and also help creating boundaries for the final design.

After design development stage, a final concept should be chosen. Based on the available techniques, an initial model will be created. This model can further be used for testing and analyzing purposes. For verification and testing, FEM analyses software investigate the developed ideas. These steps can be repeated several times and the collected feedback is used to create the final design.

FIGURE 1 Graduation plan



# 2 • Preliminary literature study

## 2 PRELIMINARY LITERATURE STUDY

---

### 2.1 INTRODUCTION

---

Additive Manufacturing (AM) is a trending topic. If one follows the latest developments in the building industry, one can see that there is an evidence that alludes to a potential to create a new era in architecture and construction industry.

Regardless of its current developments, AM applications in the building sector are rarely seen as opposed to other industries, where it is seen more commonly. Designers who manufacture products such as furniture and wearable's are adopting this technique in a better way. They use it as an instrument to create a unique product and offer their client a possibility of customization.



**FIGURE 2** 3D printed concrete house

(Yingchuang, n.d.)

There have been a few attempts to construct AM buildings. Most of them were experimental and did not really change the prospect of this technology. In China for example, a series of 3D printed concrete houses were built. These buildings are of simple geometry and most structural parts are printed. In their second attempt, a company called 'WinSun', tried to build a two-storey villa. This building also had very simple geometry and was cladded with very traditional materials.

**FIGURE 3** 3D printed concrete villa

(Imaginechina, n.d.)

In these projects, Chinese engineers tried to prove that 3D printed buildings are possible. Additive manufactured concrete has structural capabilities and can be used to reduce material waste and construction time. However, regardless of their achievements, they were faced with a great deal of negative criticism due to its standard shape and conventional cladding. This project developed a technique to construct concrete structures that could be easily done by conventional methods. In other words, this solution did not solve any building challenges.

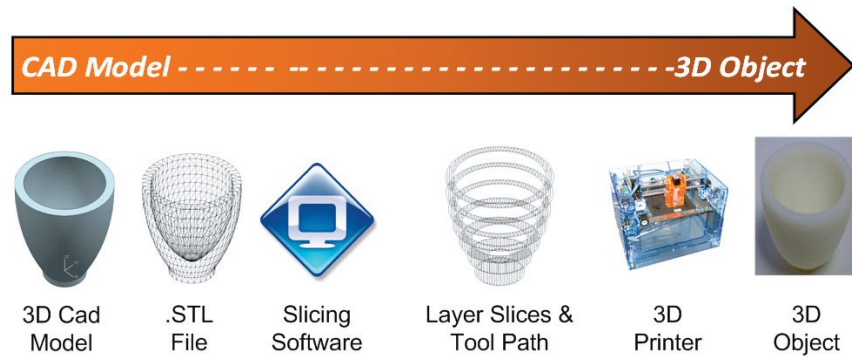
In light of the Chinese 3D printed houses, the question that should be raised is the following:

*What is the potential of additive manufacturing in building industry and should it only be used to reduce construction time and building waste?*

Whilst, these aspects such as building waste and time reduction may be appealing, they can also be achieved by further development of the conventional methods— especially, when a building has a simple geometry and need to be mass-produced. Therefore, it's more convenient to use traditional techniques to construct such structures. Which highlights the fundamental issue of AM's application.

## 2.2 ADDITIVE MANUFACTURING

*“Additive Manufacturing is defined by a range of technologies that are capable of translating virtual solid model data into physical models in a quick and easy process.”(Edgar & Tint, 2015, p. V)*



**FIGURE 4** Common AM process  
(Campbell, Williams, Ivanova, & Garrett, 2011, p. 3)

In order, to find a suitable use for AM in architecture, one should have an understanding of how it works and what are its capabilities. Most of AM methods transfer the model into series of cross sections with a defined thickness. These cross sections then are fed into a machine. Each machine has its own way of creating those layers and stacking them on top of each other. Each machine has its own characteristics but most of them share the same principles. In the chapter 3.1, AM techniques will be explored more detail.

### 2.2.1 AM CAPABILITIES

When an object is built using conventional methods, the shape complexity is big issue. This is because, when the shape complexity increases, the tools that are required for its creation also changed. On the other hand, using AM, there is less constrains for the geometrical form of an object. With AM, complex shapes are handled in the same manner as simple standard shapes which allows for greater efficiency in the process. This technique can create a complex object in one single attempt. This eliminates the need for unnecessary junction points and simplifies the assembly process. In this way, AM has the capability of offering more freedom in freeform objects.



Another advantage of using AM in the manufacturing process is that it's a fully computerized process which eliminates the need for high skilled labor. In turn, this allows for one to lower the production costs and create products with highly accurate dimensions. However, it is important to remember that there is a difference between accuracy and detailed quality. There are various techniques in AM and each respective technique of them has a different quality level. The quality can be seen as a resolution and it is the layer thickness that defines it.

Also nowadays most designs are fully developed in a computer environment. 3D modeling programs give designers freedom to design whatever they desire but when it comes to production, it becomes another challenging task. Using conventional techniques, the production process is manual and hence is time highly consuming to the extent, that that it can take more time than the actual designing process itself. This can cause a big gap between the designing and production process. Therefore, computerization of manufacturing can also help to bridge this gap.

AM processes are also environmental friendly. Objects are created by adding material layer by layer and the material is only used for the creation of the product itself. Therefore, it can be concluded that there is barely any waste and thus this process is very sustainable.

---

**TABLE 1** List of am capabilities

---

- Reduction on constrains for complex forms
  - Complexity has no extra cost
  - Simplifying the assembly process
  - Reducing the need for high skilled labors
  - Accuracy
  - Bridging the gap between design and production
  - Reduction of building waste
-

## 2.3 CHALLENGES IN BUILDINGS

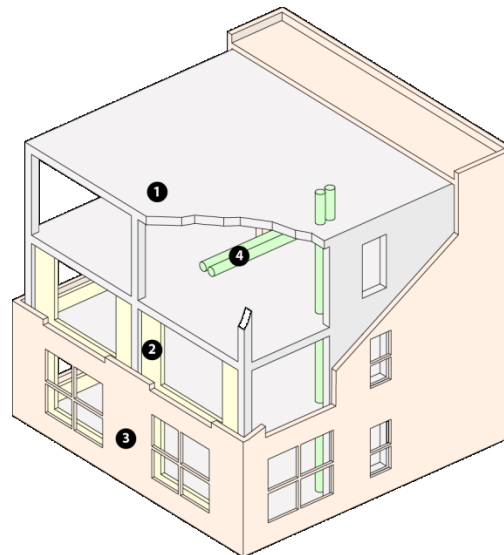
---

As mentioned in before it's important to look at the current problems in building industry. A building is a complex object consisting of different parts which respectively face various issues. These problems can be divided into two groups– material and immaterial. The focus of this research will be on construction and therefore the first group is important in this paper.

As the initial architectural design phase comes to the end, a range of consultants and engineers need to start their work. The prime focus of their considerations revolves around the following questions:

- How should that design be constructed?
- Is it feasible?
- What should be modified in the final version?

In this period, it is possible that new challenges may appear and eventually change the initial design



---

**FIGURE 5** Building components

---

To understand these problems, one must look at the structure of the building in more depth. Figure 5 shows a simplified version of a general building's structure. The structure can be categorized into four layers:

1. Load bearing (I.e. columns)
2. Non-load bearing (I.e. interior walls)
3. Cladding (I.e. façade roof exterior)
4. Installation (I.e. ventilation ducts)

Each of these components have their own requirements and based on them, they can be assessed. Cladding and load bearing structures tend to meet more challenges and have more complicated requirements to fulfill.

Cladding layers needs to provide an envelope for building's that have the ability to resist various weather conditions. It also has a decorative character that fulfil architectural aesthetic desires. Most of these components only need to handle their own weight and transfer the additional forces to load baring structures. By eliminating high forces, these structures can have more freedom in their geometrical shape and can become lighter.

Load bearing layers are the core of any building. They fulfil structural requirements and handle various forces. Any failure attributed to this layer can have catastrophic consequences. In standard buildings, achieving Structural demands are not very difficult. However, as the complexity of a building's geometry or height increases then new challenges can appear. However, it may be worthy to note that challenges and problem are not always something negative as they can lead to the invention of new solutions.



Fig. 134



Fig. 135

**FIGURE 6** Reinforced Concrete – Joseph Monier System (Engineers Outlook, 2011)

For example, in the 19<sup>th</sup> century, concrete was a common material in a building's construction. This material was cheap, could take any shape and had great compressive strength. However it was not capable of handling tensile forces that well. To overcome this, engineers used to increase the cross sectional area.

Joseph Monier, a French gardener, also dealt with the same problem. His concrete slabs could not handle tensile forces and used to develop cracks or break completely. In this situation, Monier did not want to sacrifice his design by making those slabs thicker and decided to search for a new solution. He found out that by adding a steel wire to wet concrete, this problem could be solved (Peck, 2006, p. 9). This solution marked the invention of the reinforced concrete.

The load-bearing structures tend to have more constraints and when they are merged with cladding layer, their requirements play a dominant role. Most of the time, inventions and technical developments occur when designers are faced with challenges as the existing solutions are not able to fully solve a problem or meet the desired outcome. Therefore, one can safely say that the opportunity for inventions can be borne out of the gaps that the current building industry faces.

For finding challenges in the building industry, a problematic building projects will be examined for further analysis i.e. Arnhem station from UN-studio or Sagrada Familia church Gaudi. These projects have many similarities. Both of them were initially designed to be constructed out of concrete and due to the complexity in their structural geometry their construction processes faced a lot of challenges.

### **2.3.1 SAGRADA FAMILIA CHURCH**

Sagrada Familia church is a well-known building– its construction phase was started at 1882 (Sagrada Familia, n.d). The cladding and load-bearing layers are merged together. The overall shape of the building is based on Gaudi's chain model. This model was developed to optimize the structure in a way to limit the tensile forces and thus achieve a more slender structure. Nevertheless, tensile force can never be fully eliminated and therefore reinforcements are necessary. The structure is also fully decorated with gothic and Gaudi's decorative ornaments. Those decorative ornaments are full of double curved surfaces with sharp edges. As a result, this causes the geometrical shape of the building to be even more complex.



**FIGURE 7** Left: Gaudi chain model  
Right: Sagrada church

(Niedlich, 2009)  
(Sixtysixp, 2014)

Centuries ago, stone carvers used to handle such forms. However, with the passage of time, the building industry went through a lot of changes. Nowadays, buildings are designed in a way that minimizes the need for labor intensive jobs. Consequently, this has caused a depression in the need for occupations that involve stone carving.

Nowadays, stone carvers generally work in art related industries and are considered as highly specialized and expensive labor.

These type of changes coupled with the complex interweaving geometry caused an increase in construction costs let alone time. Nevertheless, in this particular project, time and money happen to be less on issue and hence the building and design is still under construction. In recent years, Sagrada Church designers have decided to use various digital manufacturing and design techniques to speed up their design and construction process.

#### **ADAPTATION OF NEW TECHNOLOGIES**

Parametric design and 3D modelling software's were one of new technologies that were adopted in this project. This building consists of different components and each of them requires various tests and analysis. Consequently, those parts need to be modified several times. Traditionally after each modification, the components needed to be redrawn or remodeled which was an extremely

time consuming process. However, by the use of parametric designing software's, they managed to modify their designs in a much quicker fashion (Burry, Burry, & Faulí, 2001).

Newly invented 3D printers were one of the other new inventions that helped the Sagrada Church design process. During this project, building scaled models and prototypes were essential as specialist's needed them for various particular purposes. Creating such models with Sagrada geometric complexity and without 3dprinters, can be very challenging and expensive. In recent years, most design documents are converted to digital files and so 3D printing has become a very relevant solution. With this technology, they could create scaled models with high precision with the click of a button (Burry et al., 2001).

For the construction of the final parts- few digital manufacturing techniques were also added. Subtractive milling was used for creating formwork for concrete objects with doubled curved surfaces (Figure 8). The other notable one technique was semi-automated wire stone cutting.



---

**FIGURE 8** Wooden formwork for Sagrada church  
(Espel, Gómez-Serrano, Grima, Burry, & Aguado, 2009, p. 108)

---

Unfortunately, unlike the design process (that was influenced by new technologies) digital manufacturing did not add much value for construction. Additive manufacturing was only used for scaled models and prototypes and did not actually help in the construction process. According to Manuel Mallo head of stonemason team, AM techniques were not chosen because of the lack of knowledge and the need for further research (Burry et al., 2001).



### CONSTRUCTIONAL CHALLENGES IN SAGRADA PROJECT

Having reviewed a brief analysis of the Sagrada church, we can now identify the main structural construction challenges associated with this project. One of the most important points to note is the creation of segments that have complex geometrical and high-level detailed surfaces. These objects require complex formworks that are expensive. Also, as these formworks cannot be re-used, they increase the material waste in this project.

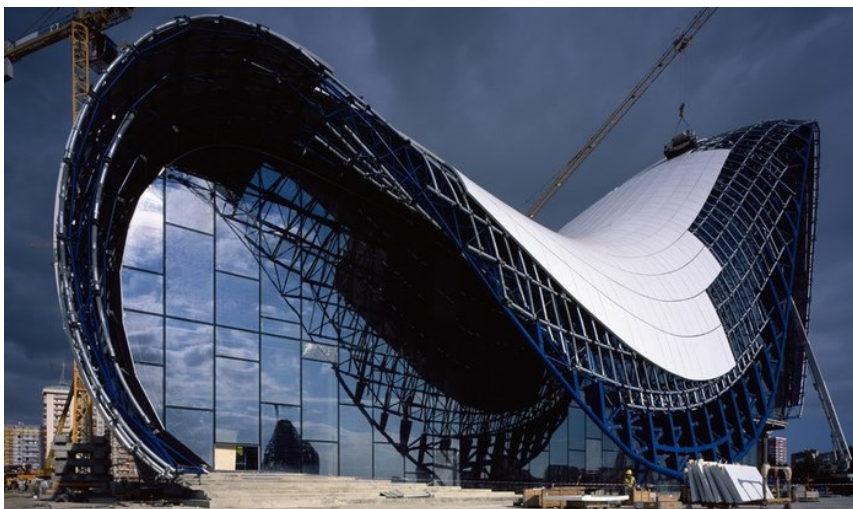
Lastly, another challenge worthy of mentioning is one that has a more structural nature. As it was mentioned, load-bearing structures are constructed out of reinforced concrete. So, this means the interweaving columns need interweaving reinforcement bars and that can be problematic.

#### 2.3.2 CHOSEN STRUCTURAL PROBLEM

The previous sections, have given us a closer look at constructional challenges in the Sagrada Church. This has allowed us to substantiate that freeform geometries can potentially create challenges in the construction process. In light of this, this paper will direct its attention on the research of freeform structural elements.

#### 2.3.3 FREEFORM STRUCTURES

Freeform structures are mainly constructed out of concrete or steel profiles. For this reason, the construction techniques depend on the material chosen.



**FIGURE 9** Heydar Gliyev Center- Steel space frame and cladding layer  
(Binet, 2011)

When steel is chosen as building material, the constructed object will be hollow and is divided amongst the load-bearing and cladding (surface) layers. In most cases, load-bearing layers are a space frame or series of cross sections (ship technology) that are cladded with non-steel materials. The purpose of cladding layers is to provide a surface on top of the structural layer in order to fill the gaps and portrait the exterior form of the designed object (See Figure 9).



**FIGURE 10** Claudio Hebberecht - freeform concrete dome

(Guerola Llorens, 2015)

In Concrete freeform object, the construction approach is different. The constructed object is a solid element and there is no need for an additional cladding layer. Concrete is a material that can take any form which makes it very interesting for freeform structures. Nevertheless, constructing freeform concrete object can be very challenging.

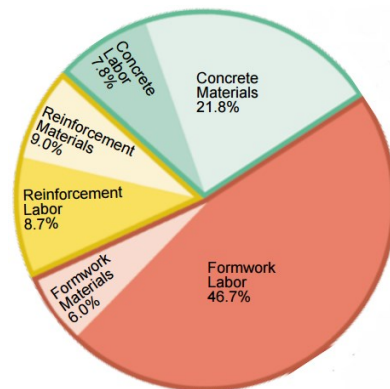
Both, steel and concrete, are suitable materials for the construction of freeform objects. It's the designers who choose one of these materials based on their preference but concrete tend to be the most preferred material.

#### **CHALLENGES IN FREEFORM CONCRETE STRUCTURE**

Concrete can be molded into any shape but for that it requires specialized equipment. Formwork is essential equipment in the construction of concrete and dictates the final shape of the object. Creation of formworks for freeform structure, require a lot of effort



and investment. Additionally these items are not reusable and end up as a building waste. In fact, in standard concrete structures, around 50% of budget is invested on these items (Robert, 2007).



**FIGURE 11** The cost of reinforced concrete in a standard structure

(Robert, 2007)

It's a well-known fact, that in big load-bearing structures, basic concrete is not sufficient. As mentioned before, concrete has a weakness in handling tensile forces and requires reinforcement. In a simple building with straight walls this is not a problem and it can be solved by placing several reinforcement bars. However, when a building has non-linear forms, reinforcement bars are also affected. Sometimes the complexity of these types of items can even force designers to change their materialization.

## 2.4 DIGITAL MANUFACTURING AND CONCRETE STRUCTURES

Until now, the focus of this research has been on finding challenges within the building construction process. With the help of the Sagrada Church case study, it was concluded that freeform load-bearing structures are difficult to construct. Also, in chapter 2.3.3, it became clear that reinforced concrete was the wisest choice in terms of the chosen material. Now that a building component is chosen, we can move on to research on the application of digital manufacturing.



What are the existing digital fabrication techniques that can handle this problem? Reinforced concrete can be divided in two elements

- Basic concrete
- Reinforcement elements

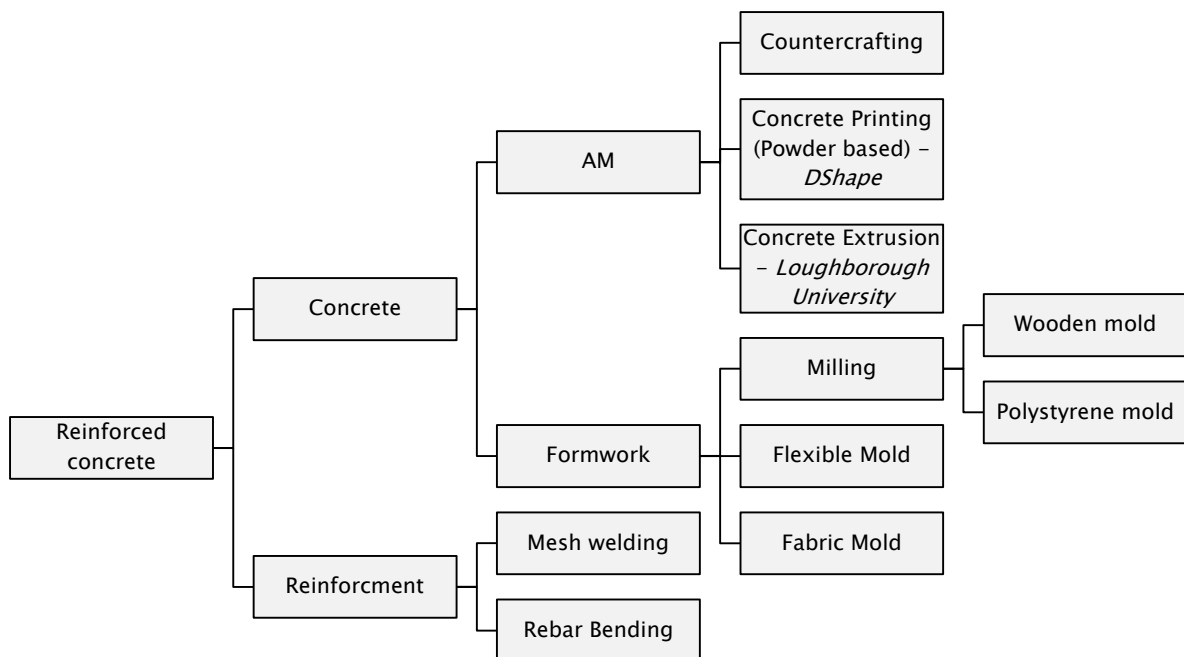


FIGURE 12 Digital manufacturing techniques for reinforced concrete

In Figure 12, the digital manufacturing techniques for reinforced concrete are presented. The focus of these techniques is mainly on concrete production and very small attention is given to reinforcements. This is mainly due to the fact that they are trying to eliminate the need of reinforcement bars by using reinforcing fibers in

the concrete. However, this solution can work in small-scale structures where tensile forces are not very high. Most of the digital fabricated objects are lineal walls, façade panels or envelop structures. These types of components usually do not need to carry any additional weight and stress levels are at the lowest.

It is fair to say that there is a lack of research on digital fabrication of reinforcement elements. Re-enforcement is necessary where the creations of load-bearing concrete structures are concerned. Therefore, in contextual frame of freeform concrete- this research will focus on solving the reinforcement problem with the help of digital manufacturing.



# 3 • Literature study

## 3 LITERATURE STUDY

---

### 3.1 DIGITAL MANUFACTURING

---

The dawn of the Information Age, also known as the Digital Age, has transformed nearly all aspects of today's industrial and technological fields. Building technology and construction has not been able to avoid this transformation. The enumerable advantages of the emerging technologies as a result of the digital revolution has challenged how we conceptualize, design, manufacture and construct buildings. This chapter provides a brief introduction into the realm of digital design and fabrication within the building industry.

The vast potential of Computer-Aided Design (CAD) and Computer-Aided Manufacturing (CAM) have long been employed by the automotive, aerospace and shipbuilding industries to open up new possibilities and achieve feats that once were believed to be unattainable (Kolarevic, 2001). In the past few years, these techniques have also started to leave their marks on building design and construction and have enabled architects to construct amazing structures whose complex forms were previously deemed prohibitively expensive to design, produce and assemble using more traditional techniques.

Advantages of CAD and CAM in the field of building industry include:

- Visualization of 3D models enables all stakeholders such as clients, designers and engineers, to experience the building early in the design process.
- Clash detection resolves design issues before the building is constructed, thus, minimizing the risk of costly design revisions during the actual construction phase.
- Information is managed and shared efficiently between the project design team, contractors and future users, reducing time, cost and risk at all stages of the building's life.
- Efficient and elegant structural forms are created by combining advanced engineering analysis tools with 3D CAD and para-

metric design methods. This strong combination leads to inspiring buildings with minimized material and energy consumption.

- Mass Customization provides the ability to mass-produce irregular building components with the same facility as standardized parts introduced the notion of mass-customization into building design and production.

### 3.1.1 DIGITAL FABRICATION

The complex spatial geometries that can be designed using CAD tools, gives rise to the issue of constructability. Fortunately, with parallel advances in CAM, their construction is perfectly attainable by means of Computer Numerically Controlled (CNC) fabrication processes. These processes are often categorized into formative, cutting, subtractive and additive techniques. This section aims to briefly describe some of these processes while focusing primarily on additive manufacturing.

#### FORMATIVE

A formative fabrication process contorts a single piece of material into the desired shape, usually by the application of mechanical forces, restricting forms, heat or steam (Kolarevic, 2001). Formative process, as used by injection molding and investment casting, is without a doubt one of the most important fabrication process for modern manufacturing. Although many aspects of injection molding and casting are automated, the process still requires a special tool (mold) to be created for each shape. This defeats the basic philosophy of automated fabrication and the “file-to-factory” concept, which requires the ability to make arbitrary shapes without special tooling. Some research into fully automating the formative process has led to techniques that can approximate double-curved, compound surfaces using arrays of height-adjustable, numerically-controlled pins, which could be used for the production of molded glass and plastic sheets and for curved stamped metal (Kolarevic, 2001).

### **CUTTING**

CNC cutting is a 2D fabrication process which has been the work-horse of most industries since its inception. This technique involves two-axis motion of the tool head with respect to the material, usually in sheet form, and is accomplished by causing a displacement of the bed, the head or both. The tool is tasked with removing the material along the path using mechanical (routing bits), abrasive (water-jet) or thermal (laser, plasma arc and electric arc) processes. Automated 2D cutting processes have greatly reduced the cost of manufacturing and have allowed many industries to benefit from mass customization. However, this technique is only limited to producing 2D sheets and as such are not suitable for manufacturing complex three-dimensional products without required additional manual assembly.

### **SUBTRACTIVE**

As indicated by the name, subtractive fabrication involves the removal of a specified volume from solid materials, commonly referred to as the stock, by means of CNC milling. Although, very similar in concept to 2D cutting, in subtractive fabrication, the head can be positioned in 3D space using complex multi-axis (sometimes as many as 6 axes) motion platforms thus enabling the production of nearly any geometry. This decades old technology has been recently applied in innovative ways in building industry, to produce the molds for the off-site and on-site casting of concrete elements with double-curved geometry (Kolarevic, 2001).

### **ADDITIVE**

Opposite to the subtractive process, additive fabrication, commonly referred to as layered manufacturing or 3D printing, involves the incremental creation of the final solid by selectively adding material to specified locations, in most cases layer upon layer. This technique has monopolized the news for its vast potential in nearly every market, including automotive, aerospace, medical/dental and robotics. The reason behind the huge interest into 3D printing is because of the numerous advantages that additive manufacturing offers. These advantages are as follows;



- Additive manufacturing is capable of producing extremely complex geometries that is simply impossible or too costly using other fabrication methods. In fact the more complex (meaning more voids) the part, the faster and cheaper it is to produce through additive manufacturing.
- Mass customization is inherent to the additive fabrication process. Every part can be different without affecting production cost as economics of scale become irrelevant.
- Faster lead times compared to traditional manufacturing techniques allows the engineers to test new prototypes in a matter of hours instead of weeks or months.
- Since material is added to specified areas, waste material is completely eliminated.

Of course not every aspect of additive fabrication is superior to other manufacturing techniques. Below is a list of the disadvantages of that would hinder its use for certain applications.

- Additive manufacturing is often regarded as having slow build rates. Even though there have been a lot of progress within this area, it still falls behind many other manufacturing processes and is thus not economically viable for mass production.
- Higher production costs often occur when using additive fabrication, which is primarily caused by slower build times, higher machine costs and higher material costs.
- Extensive knowledge of material design and the specific machine is required to make quality parts.
- Due to the layered nature of the build process, the surface finish and dimensional accuracy is inferior to other manufacturing techniques. To alleviate these problems, post-processing is required.
- Due to the machine sizes currently on the market, large parts are impossible or too costly to produce.
- The layered fabrication process, result in an an-isotropic part with inferior mechanical properties.

### 3.1.2 TECHNIQUES

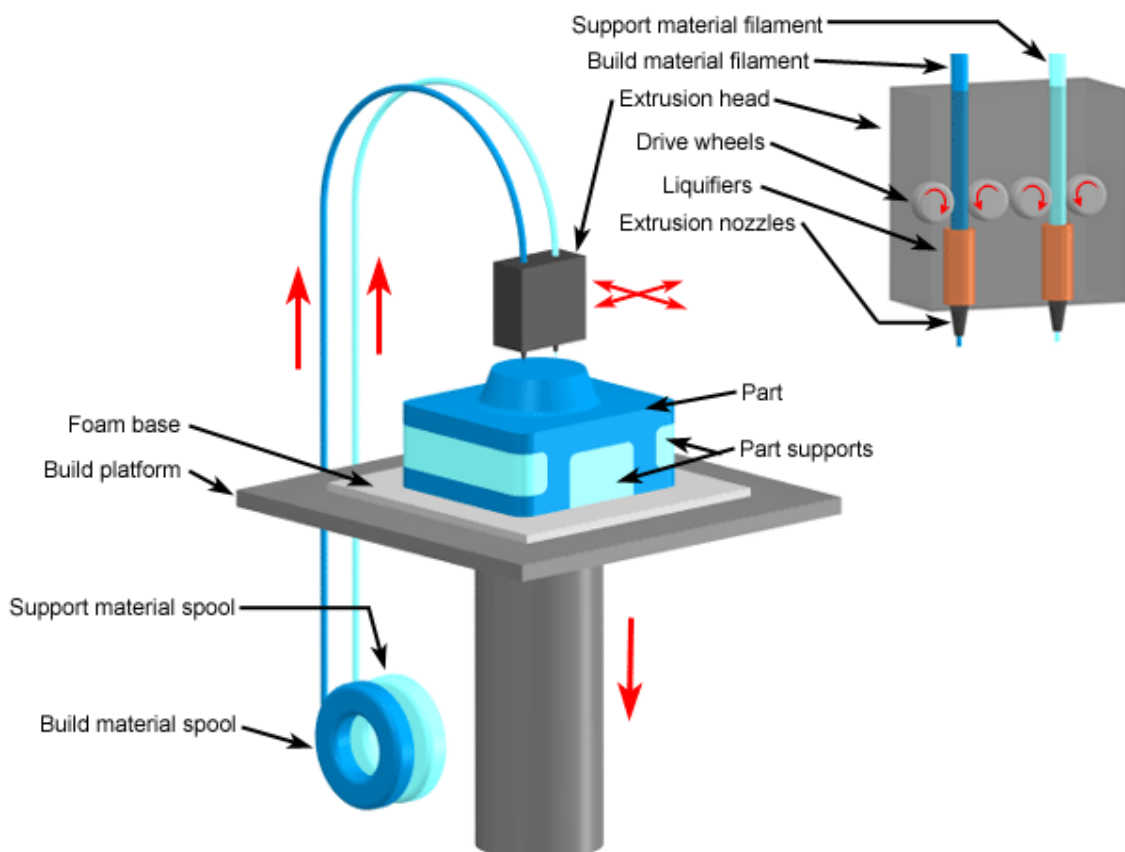
There are many different techniques employed within the field of additive manufacturing which can be categorized based on various aspects. For instance, some processes fuse the material particles, while others use some kind of binder to adhere the particles of the material together. In this work, the various additive manufacturing techniques are classified based on the mechanism of the machines, since we believe that this classification results in groupings that possess similar characteristics.

Two main categories arise from our choice of classification. Machines that move the head of the printer using multi axis motion systems to deposit the material or binder to the specified locations, and machines that selectively process a pool of material/binder using optical means.

### FUSED DEPOSITION MODELING (FDM)

FDM is an additive manufacturing technique that heats a filament (usually a thermoplastic) to its melting point and extrudes it through a nozzle to form the layers of the solid object. A multi-axes motion system guides the head (and thus the nozzle) to deposit the material in the desired location. Support material is often required for this technique to prevent issues regarding overhangs and stabilizing lightly support sections. The support material (usually water soluble) is often extruded using a secondary nozzle and its removal requires additional post-processing efforts. Due to thermal gradients, material shrinkage is often a problem that affects dimensional accuracy and requires extensive knowledge of the material and precise setup of the machine. However, due to its simplicity, this technique has become the most popular additive manufacturing process for academic institutions and home builders which has resulted in large advances within the field in the past few years alone (Miller, Vandome, & McBrewster, 2010).

**FIGURE 13** Fused deposition modeling (FDM) (CustomPartNet, n.d.-a)

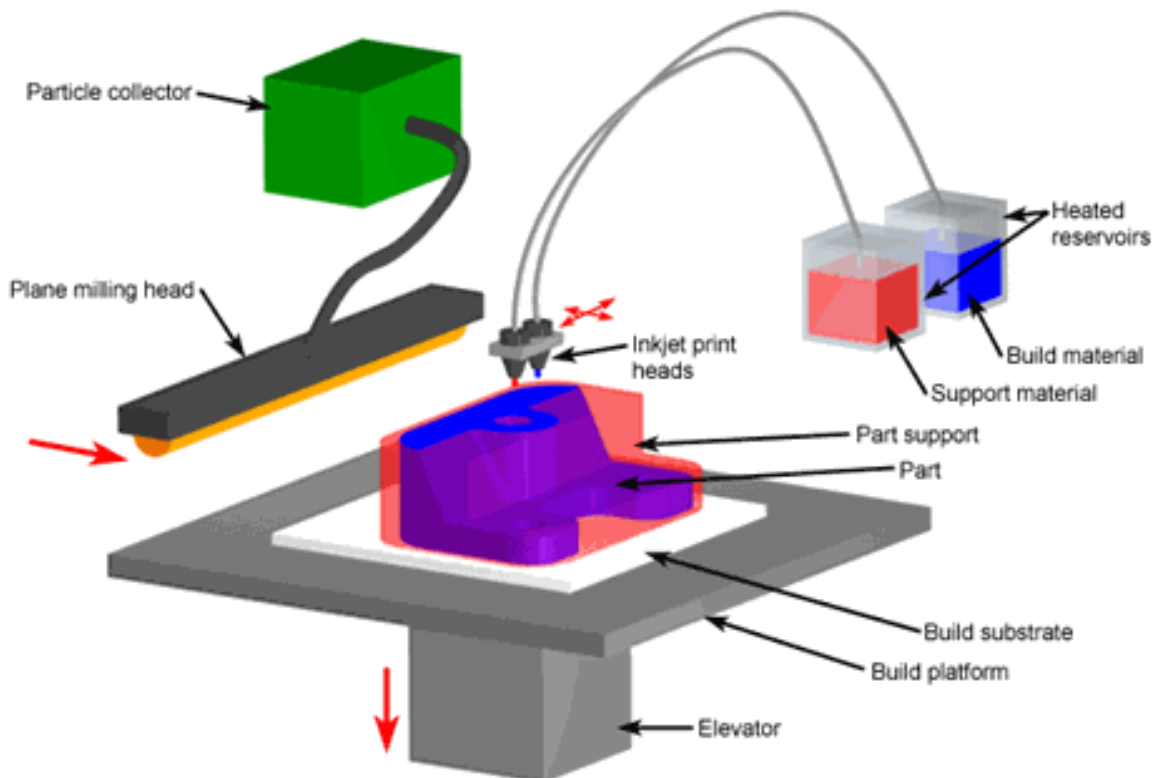


**MULTI-JET MODELING (MJM) AND POLY-JET MODELING (PJM)**

Both MJM and PJM techniques work similarly to inkjet printing, but instead of jetting drops of ink onto paper, these printers deposit layers of curable liquid photo-polymer onto a build platform which are exposed to UV light. Similar to FDM, the nozzles are mounted on a multi-axes motion system that travels across the build platform. The primary difference between MJM and PJM is the type of support material they use and thus consequently, the amount of post-processing they require. These additive manufacturing are capable of producing good surface finish because of high resolution and small layer thickness.

**FIGURE 14** Poly-jet modeling (PJM)

(CustomPartNet, n.d-b)



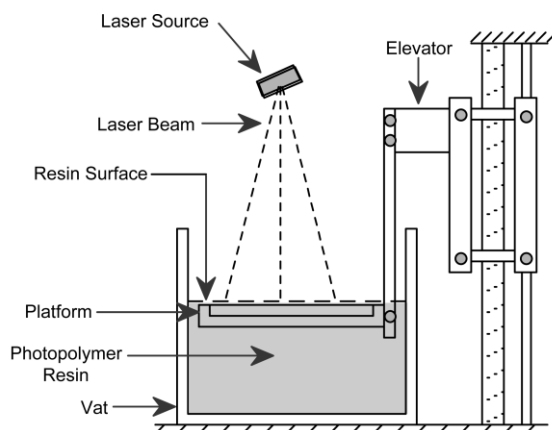
### STEREO LITHOGRAPHY (SLA)

In stereo lithography, polymerization of a UV curable resin is used to build up the final object layer by layer. The UV light source is often in the form of a focused UV laser beam which is directed by means of galvanometers (2D scanning mirrors) which traces the current slice onto a pool of resin. Newer technologies such as Digital Micro-Mirrors (DMD) allows an entire slice to be cured instantaneously and has greatly reduced the build time of 3D printed objects. Either technology provides a faster alternative to the previous additive manufacturing processes since mechanical movement is restricted to low inertia mirrors instead of high mass print heads.

Two approaches are commonly used for stacking the layers on top of each other, the top down and bottom up. In the top down approach, the entire build volume is filled with resin. As the UV source cures the resin from the top, the build platform is lowered into the vat to allow the next layers to be cured. In the bottom up approach, the UV light is shown through a transparent bottom window. The build platform is then raised out of the vat after the current layer has solidified. Additional resin is added as the build process continues. Each of these approaches have their own advantages and disadvantages with regards to material wastage, print quality and speed. It is important to note that, depending on the complexity of the part, support material may be required which have to be manually removed. Further post-processing requirements include, cleaning the uncured resin using solvents and hardening the final part in UV chambers or outside.

**FIGURE 15** Stereo lithography (SLA)

(Youde-Prototype, n.d)



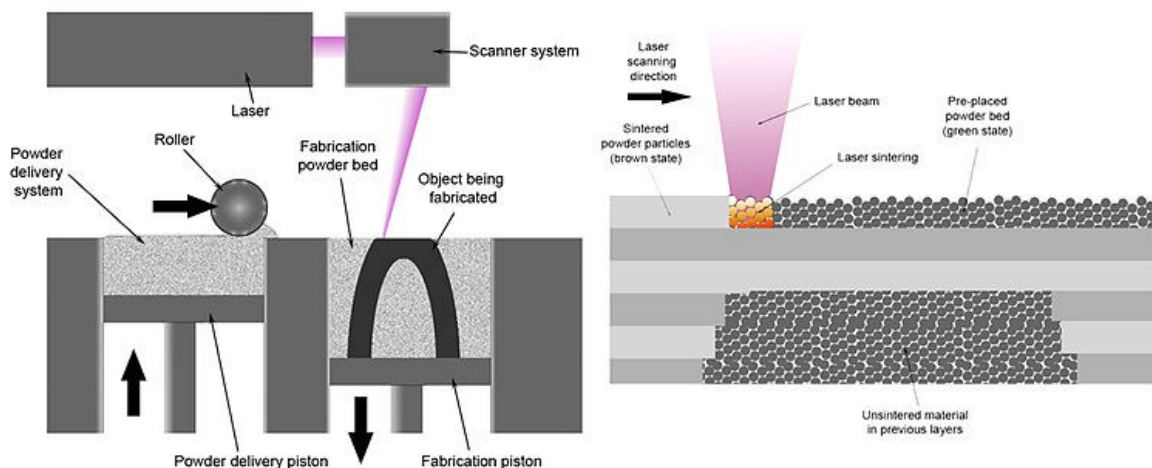
### SELECTIVE LASER SINTERING (SLS)

This additive manufacturing technique is very similar to SLA, however the build material is in the form of powder instead of liquid resin. Commonly used materials include metals, ceramics and polymers. Instead of curing the material, a focused high power laser is used to bond the powder particles together by the process of sintering (solidification without melting). After solidifying a layer, the build platform is lowered and a new layer of powder is deposited into the build vat and the process repeats (Gibson, Rosen, & Stucker, 2010). To lower the required power and improve dimensional accuracy, the build vat is often heated to a temperature just below the sintering temperature of the material. Due to the higher stability of the powder, support material is not required which greatly reduces the post-processing costs. However, to achieve better mechanical properties, the printed parts are often baked inside.

### SELECTIVE LASER MELTING (SLM)

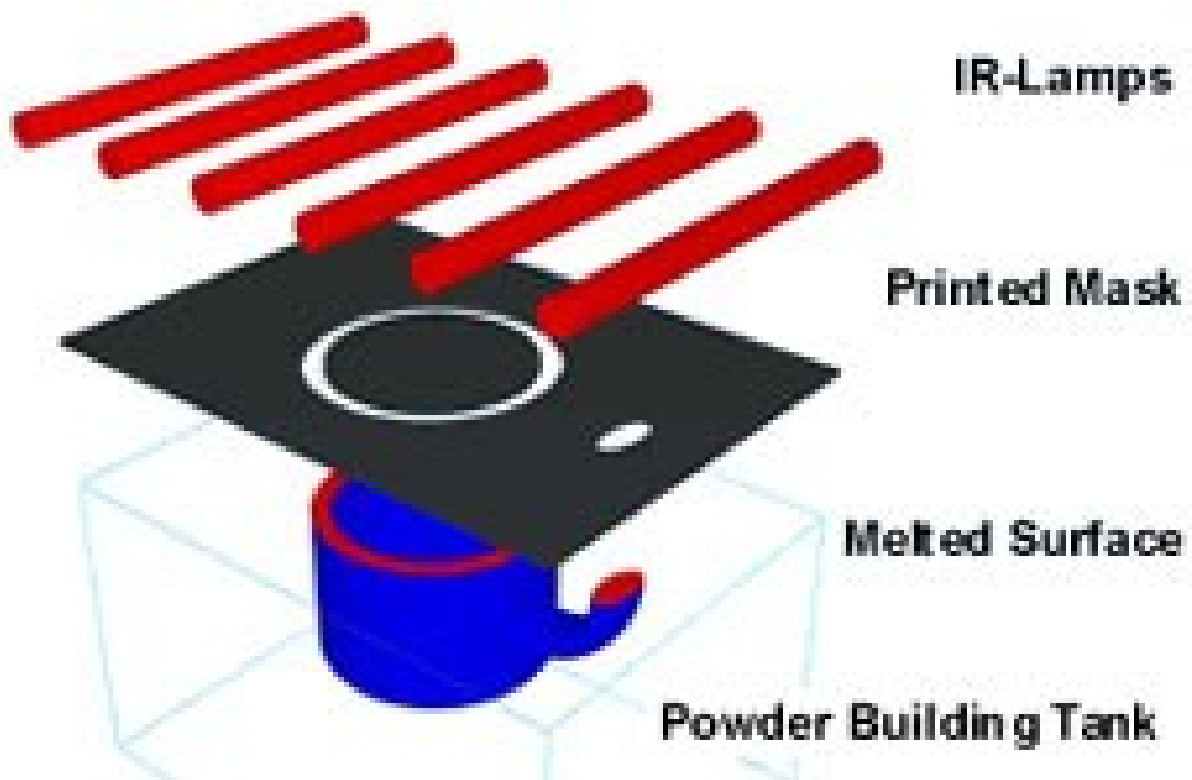
Directly related to the SLS process, Selective Laser Melting (also known as liquid phase sintering) can produce the final production quality part by melting the metal powder particles together (Gibson et al., 2010).

**FIGURE 16** Selective laser sintering (SLS) (Materialgeeza, n.d)



**SELECTIVE MASKING SINTERING (SMS)**

As previously mentioned, by allowing an entire layer to be cured at once, the DMD technology greatly decreased the build time of the SLA process. In a similar way, Selective Masking Sintering allows an entire layer of material to be sintered without the need for scanning a laser beam. This process involves printing a reflective negative into a sheet of infrared transparent material and placing it on top of the build vat. The regions that are exposed to thermal radiation solidify leaving the masked regions unprocessed. This technique can greatly reduce production time, however due to the high cost of producing the masks, only becomes economically viable through economics of scale.

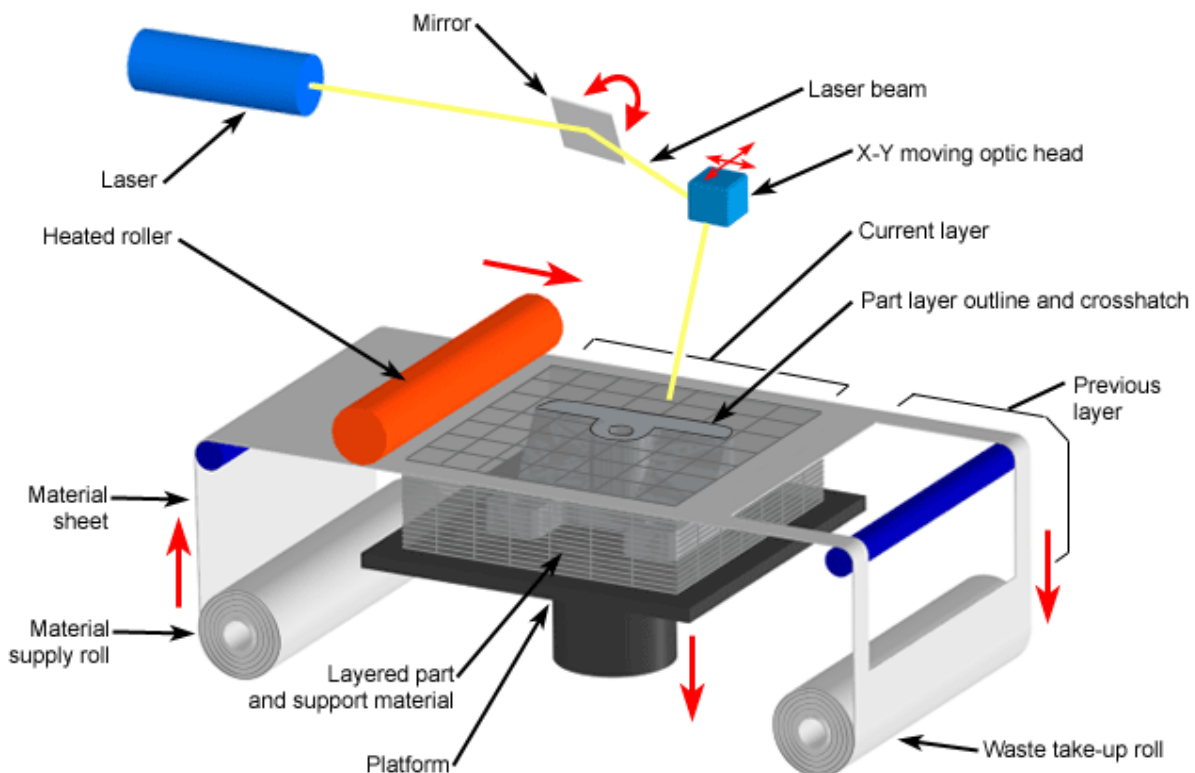
**FIGURE 17** Selective masking sintering (SMS)

### LAMINATED OBJECT MANUFACTURING (LOM)

This additive manufacturing technique is based on the idea of creating 3D object by stacking solid thin sheets on top of each other. The materials that can be processed using this technology vary wildly but include card boards, metals and plastics. The adhesion between the layers is achieved by means of various techniques such as chemical bonding and ultrasonic diffusion and depends on the materials involved. The process starts by unrolling a sheet of material into the build platform. A laser beam then traces and cuts the sheet material accordingly. After adhesion of the sheet onto the object, the process repeats. Unlike other additive manufacturing techniques, material wastage is substantial in the LOM process.

FIGURE 18 Laminated object manufacturing (LOM)

(CustomPartNet, n.d-c)



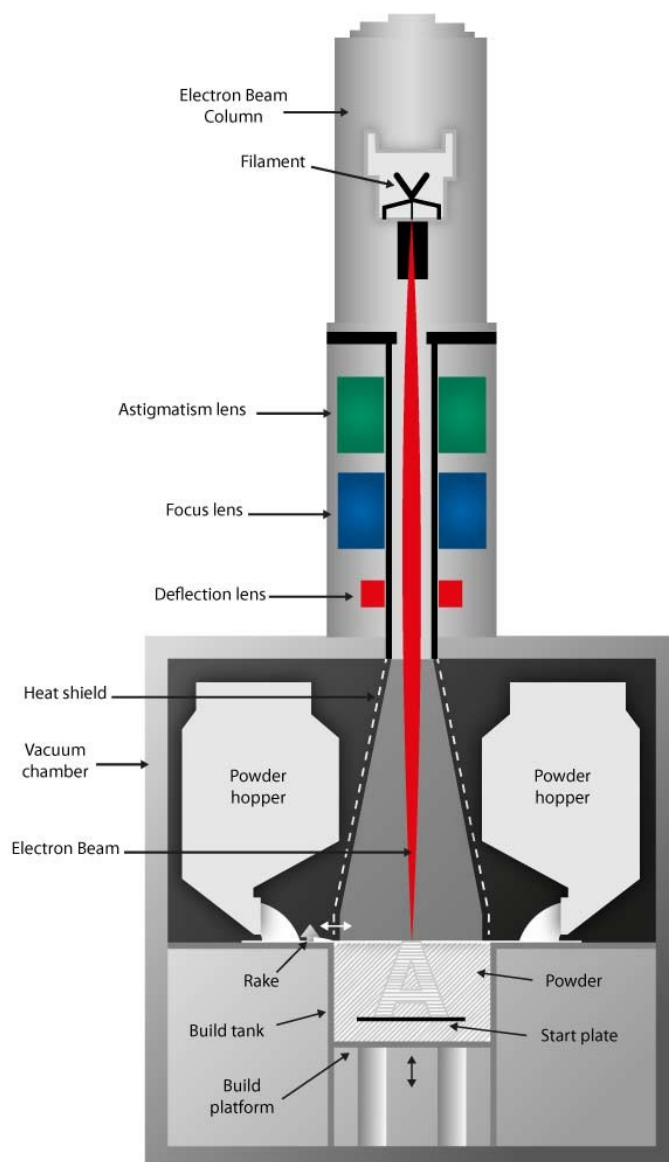


### ELECTRON BEAM MELTING (EBM)

In a process similar to SLM, EBM uses a focused electron beam as the thermal source to directly melt and fuse metal powder particles together to create a 3D object (Gibson et al., 2010). Since an electron gun is employed, the process must be performed in a vacuum which increases operating cost and complexity but allows reactive metals (such as titanium) to be used. Due to a phenomenon called charge build up, only conductive materials can be processed using EBM which limits its use to metals. Since, an electron beam is scanned on to the build platform electrostatically, very fast scan rates and thus reduced build times can be achieved.

**FIGURE 19** Electron beam melting (EBM)

(Arcam, n.d)





# 4 • Design research

## 4 DESIGN RESEARCH

---

Design is not a linear process, therefore it is essential to outline the process which leads to the final design. This research project aims to develop a suitable technique for creating reinforcement in freeform concrete structures. The outcome therefore is not a fixed design. In this chapter the process through which the final design and solution is formed is explained.

### 4.1 ASSEMBLY PROCESS TECHNIQUE

---

This section will focus on general overview of how a freeform concrete structures can be assembled. In this overview the following topics will be covered:

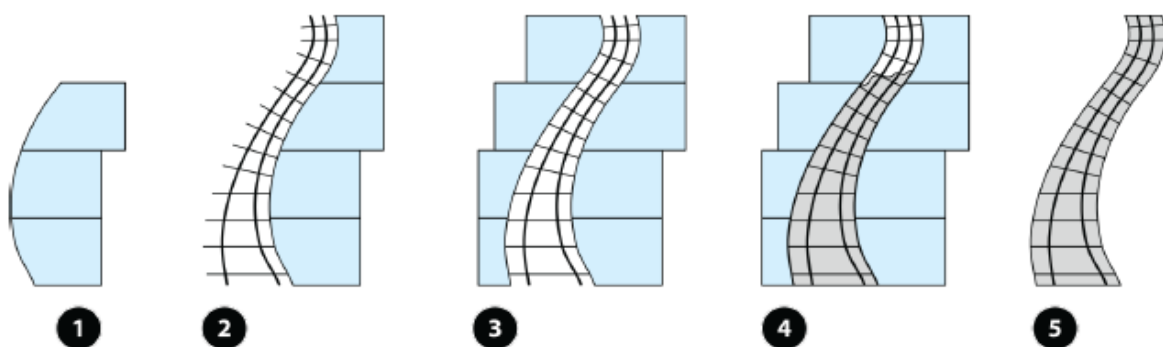
1. Formwork system
2. Assembly order
3. Required instruments during assembly
4. Building waste production
5. Overview of task that be done by people during construction

### 4.1.1 CONCEPTS

#### A. FORMWORK

- External formworks usage, which are not part of the final object
- Elements are usually created from milling foam blocks
- A Wooden grid is covered by a series of wooden panels, which are not suitable for high curvatures.
- Placement of the reinforcements after one side of formwork is created.
- An additional layer of spacer is needed for an offset from the outer layer in case of metal reinforcements
- Second layer of formwork might be needed depending on the curvature and the applied concrete's type
- Removal of the formwork after the concrete is cured. As the research focuses on freeform object, the formwork serves no additional purpose even if it is reusable
- Formwork creates a building waste or it needs to be recycled or down cycled.

FIGURE 20

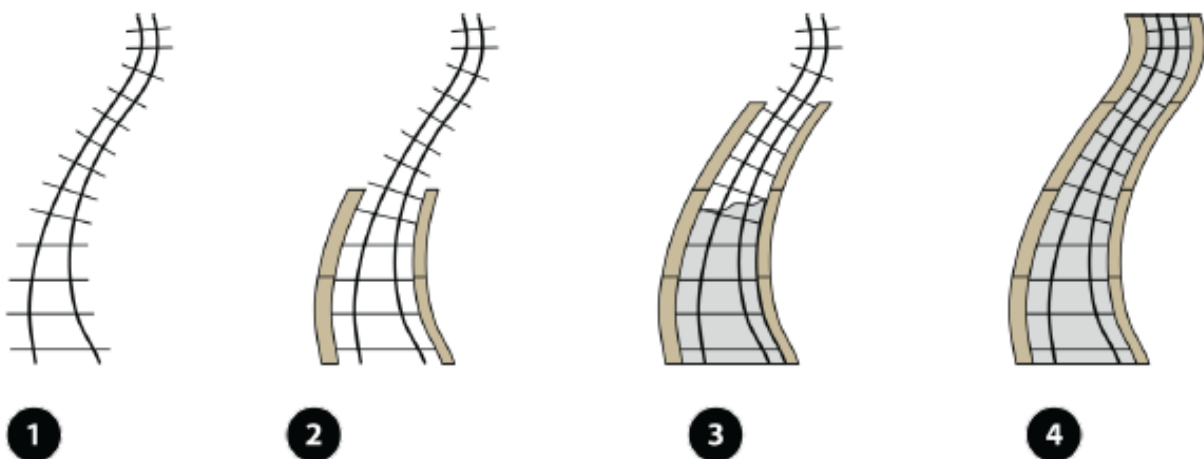


### B. EMBEDDED FORMWORK

In most buildings, the structural elements of the building are covered by an additional cladding layer. This variation is inspired by the fact that the cladding layers is given an additional purpose to the formwork.

- A series of panelized formwork which can be created from various materials (i.e. concrete, stone, aluminum, insulation material ...) are stacked on top of one another.
  - An additional support structure is probably needed to assemble the panelized formwork.
  - These panels have to be stacked precisely on one another to avoid gaps. The structure must be liquid tight.
- Reinforcement can be placed before or during the assembly of the panelized formworks
- After reinforcements and panelized formworks are assembled, the concrete can be poured in its place.
- When the concrete is cured, the panelized formworks become part of the structure.
- The only parts that must be removed are the supporting structures. These elements have a scaffold structure and can be easily reused in different projects. Therefore this method has no waste material.

FIGURE 21

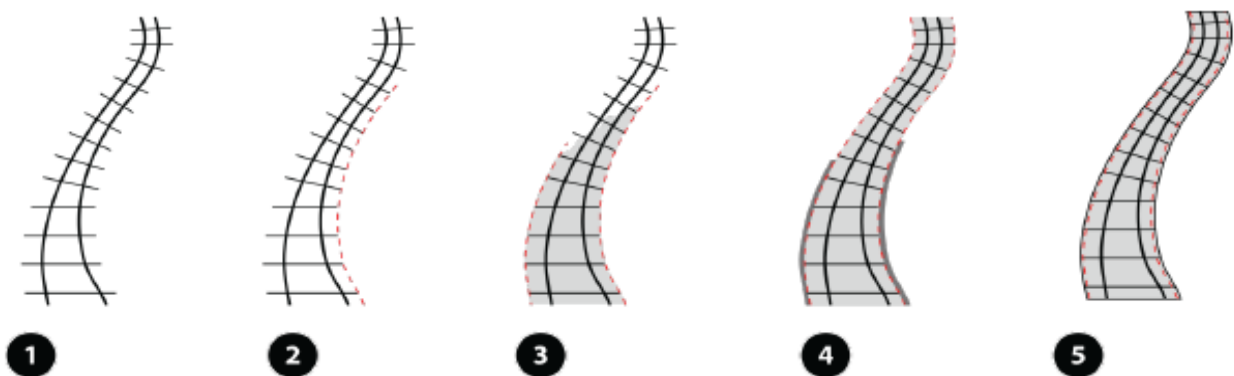


### C. REINFORCEMENT AS FORMWORK

In this method the formwork is removed. By adding a flexible 2D mesh sheet on the reinforcement structure, this structure can provide formwork functionality. The method is suitable for spray concrete or shotcrete.

- The reinforcement mesh will get erected, so depending on its geometry, a supporting structure might be necessary.
- For the purpose of applying concrete, a series of dense mesh sheets are attached to one side of the structure.
  - Something similar to chicken wire but with smaller gaps or fiber glass sheets that are flexible.
- After the placement of the mesh sheets, the concrete can be sprayed on the reinforcement structure.
- Because this method does not result in a smooth surface finish, a post-processing step is required. A cement layer has to be applied to the surface of the geometry.
- If an additional cladding layer is in the design, then post-processing step is not necessary.

**FIGURE 22**

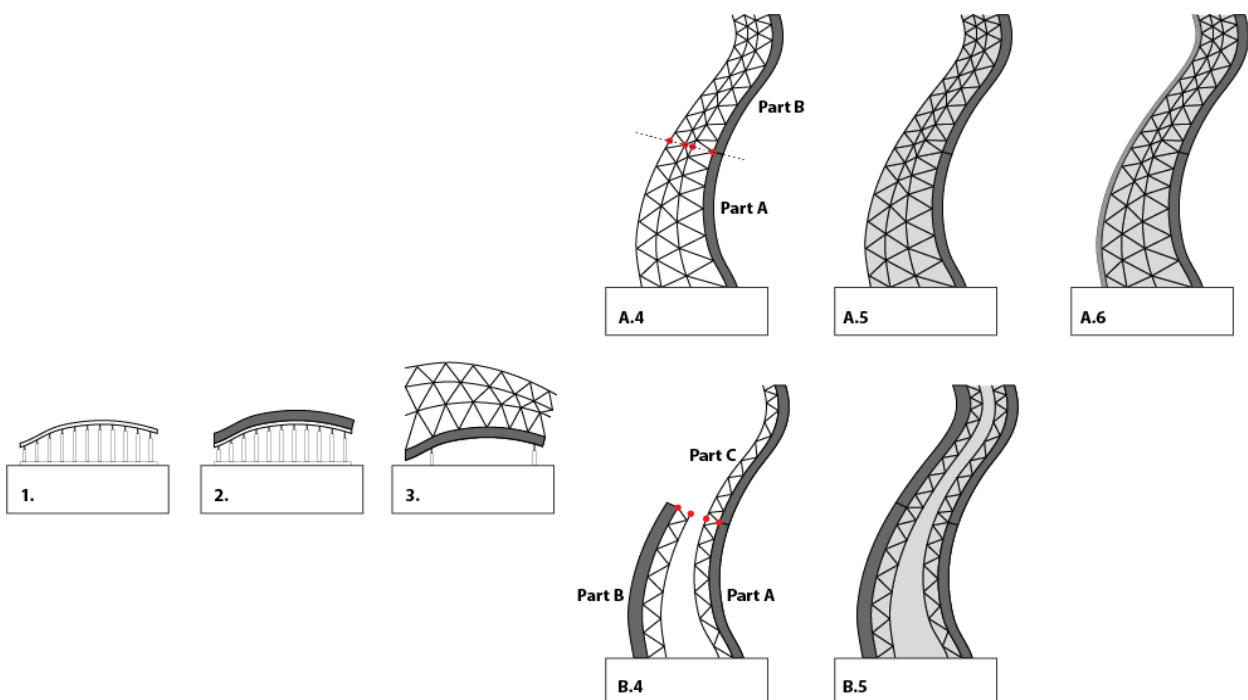


**D. EMBEDDED FORMWORK, INTEGRATED WITH REINFORCEMENT**

This concept is somewhat similar to concept B, in both concepts the formwork will become part of the final structure. However, in this version reinforcement is embedded in the formwork. The idea is to attach a segment of reinforcement to the cladding layer that has also the functionality of the formwork. During the assembly period, workers will get a series of panels. They need to stack them on top of one another and connect the reinforcement parts together.

- A series of panels will be created to serve the purpose of a formwork.
- A flexible technique such as mold or additive manufacturing is rather desired to limit the building waste.
- A reinforcement segment above each panel will be created and attached.
- Panelized segments containing formworks and reinforcements will be stacked up.
- An additional support structure will probably be needed to assemble the panelized formwork.
- The panels have to be stacked up in a way to avoid gaps. The structure needs to be liquid tight.

**FIGURE 23**





- Proper connection of the reinforcement ends of each panel is crucial for gaining the ability of carrying tensile forces.
- After the panel assembly, the concrete can be poured in its place.
- When the concrete is cured, the panelized formworks become part of the structure.
- The only necessary parts for removal are the supporting structures. They have scaffold structures and can easily be reused in different projects. Therefore this method results in no building waste.

#### 4.1.2 EVALUATION

In the previous section several designs were proposed which carried generic characters therefore there was no focus on materialization or rebar construction. The goal was to propose a general idea on how a freeform-reinforced concrete structure can be assembled.

Thus the next section deals with a closer and more detailed solution of those generic ideas. The designs need to get assessed and evaluated beforehand by the criterion compiled in Table 2 .

**TABLE 2** Criteria for assessing the generic design

Criteria
Minimum waste
Less component
Imitating junction parts
Possibility of avoiding conventional formwork
Innovation

**TABLE 3** Evaluation

<b>Waste (during construction process)</b>	
<b>A</b>	Formwork (Depending on the material, can be recycled or down cycled )
<b>B</b>	None
<b>C</b>	None
<b>D</b>	None
<b>Component</b>	
<b>A</b>	Rebar Formwork May need supporting structure for form work
<b>B</b>	Rebar Panels Supporting structure for panels
<b>C</b>	Rebar Supporting structure for the rebars Exterior mesh
<b>D</b>	Panels with integrated rebars Supporting structure
<b>Junctions</b>	
<b>A</b>	Connection between rebars and foundation Connection between rebars and their components Connection between formworks
<b>B</b>	Connection between rebars and foundation Connection between rebars and their components Connection between panels
<b>C</b>	Connection between rebars and foundation Connection between the mesh and rebars
<b>D</b>	Connection between rebars and foundation Connection between panels Connection between panels and rebars

Regarding to goals that were mentioned above, *concept A* is the least suitable concept. First of all formwork will eventually create building waste. Since formworks of freeform structures are greatly customized, there will be no possibility of reuse. Beside the sustainability aspects, creation of these types of formwork requires a high level of effort and expenses. Therefore, suggesting to use that energy on other parts of the structure will not be an irrational idea. In *concept B* this idea was implemented, the cladding layer will overtake the function of the formwork. Instead of spending effort and building budget for creating formworks, a multi-functional cladding layer will be designed that can minimize the building waste.

The idea of eliminating, the necessity of formwork is also visible in *concept C*. In this system reinforcement is a self-standing structure that does not need to be placed on a formwork. By attaching flexible fine sheet elements to the structure, the need for use of complex formwork can be avoided. But the created concrete element will most likely have a rough surface and surface polishing will be required.

*Concept D* can be seen as a combination of the previous systems that also avoids the necessity of formwork. In this system, reinforcement is embedded in the cladding layer and by stacking them on top of each other a formwork space is created for concrete. However this system also has its own problems. For formwork or embedded cladding panels, connections between elements are not very important. But for reinforcement structure, the connections between its elements are very crucial. Therefore in *concept D* extra attention should be given to junction points between panels. This can lead to a very difficult assembly process.

Out of all the mentioned concepts, *Concept B* and *C* did better according to the given criterion, but at this stage it is too early to select a final system. The obtained information in this section can be used to evaluate and analyze, the reinforcement structure system in the coming sections.

## **4.2 REINFORCEMENT PRODUCTION CONCEPT**

As stated before, the objective of this project is the creation of reinforcement technique for freeform concrete. In this section, several generic concept designs that are based on different manufacturing techniques will be presented. These concepts will then be analyzed and evaluated. The outcome might not be a single concept but rather a mixture of them.

### **4.2.1 CONCEPTS**

#### **A. LATTICE STRUCTURE MESH**

In this method, fused deposit modeling (FDM) manufacturing method will be used. FDM is the technique used in most of the standard 3D printers. Models are created by 3D printers by slicing it in a series of horizontal layers.

For the purpose of creating a mesh structure, the 3Dprinting process needs to be adjusted. Instead of extruding horizontal lines, it should be able to create vertical and diagonal lines i.e., element that stand freely on air with minimum support.

This production technique can at least be done in two ways. Firstly, by adding the extruder head to a robotic arm that has a 5 axis for rotation and has the maximum freedom. Secondly, a standard 3D printer can be used. In this way, the extruder head movement will be limited to 3 axis. However, since 3D printers are more common than robots, its tool expenses will be lowered.

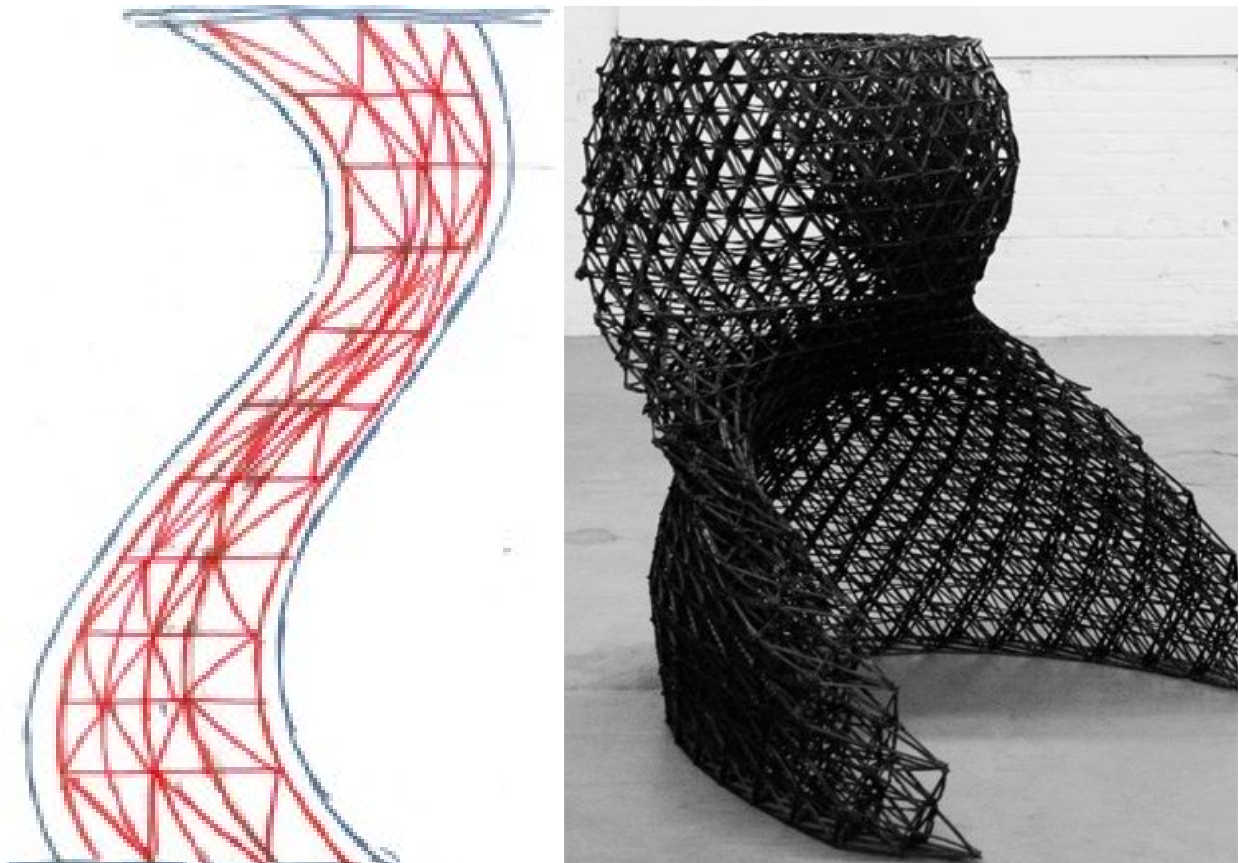
This technique is already been tested by a company called, 'Branch Technology'. Therefore, it is proof that this concept can be realized.

**TABLE 4** Specification

<b>Material</b>	Thermoplastic material mixed with fibers
<b>Technique</b>	FDM
<b>structure</b>	Lattice
<b>Optimization</b>	Possibility of adjusting cell size according to stress level. Duplicating the lines with high stress level.
<b>Formwork integration possibility</b>	Yes The mesh structure have the outline of the final structure and therefore formwork can be integrated in it.
<b>Waste</b>	Non

**FIGURE 24** Lattice mesh structure

(Branch Technology, 2016)



### **B. METAL WELDING AND MIMICKING TENSILE TRAJECTORY LINES**

In this method, the goal is to create a reinforcement structure based on tensile trajectory lines of a structural analysis. Therefore, the reinforcement pattern can be optimized fully.

The idea is to use a technique that is able to create geometry that cured in a very short period of time or instantly. The inspiration for this method came from the metal welding technique. This technique is currently under development. A leading company in this field, 'MX3D', has already created several objects using this method. Lately, they are in process of creating a metal bridge with it.

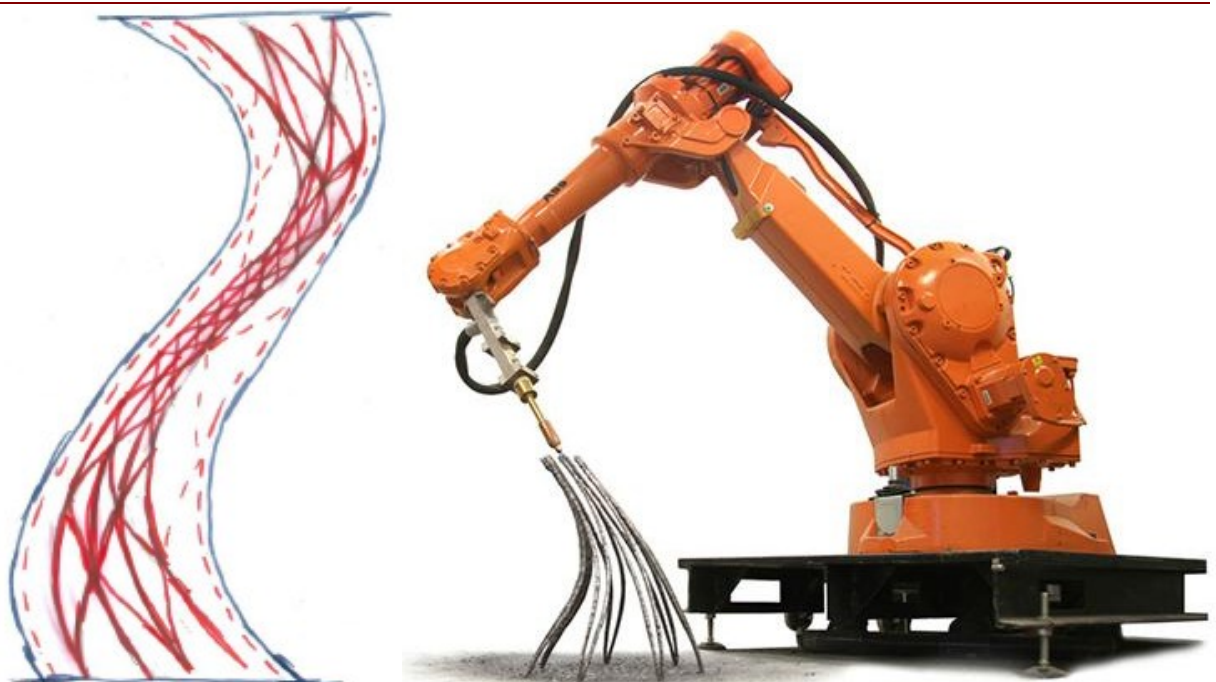
The main disadvantage of this method is mostly its time consumption. As the name says, they create their objects by welding on top of the previous welded point. Each welding session will create a point with thickness of less than one centimeter.

**TABLE 5** Specification

<b>Material</b>	Steel, Thermoset Plastic
<b>Technique</b>	Robotic welding, anti-gravity printing
<b>structure</b>	Mimicking stress trajectory lines.
<b>Optimization</b>	The created line can be adjusted easily according the stress trajectory lines.
<b>Formwork integration possibility</b>	Yes/No The stress trajectory lines does not represent the outlines of the final structure. For integration of formwork additional geometry need to be added to the reinforcement structure.
<b>Waste</b>	Non

**FIGURE 25** Metal welding

(Bishop, 2014)



### C. WOVEN FIBER FILAMENT ON PIN POINTS

“*Filament wound pillar*” was a project by a TU delft graduate student, P Mostert. This structure regardless of its lightweight character) is capable of handling pedestrian bridge loads. The used material for this pillar is continuous glass fibers which are weaved around series of pins on the top and bottom cross sections.

This system has a potential to also be used as a concrete reinforcement system. It's a known fact, that Fiber reinforced concrete is already an established technique. But due to use of chopped fiber, the full strength of this material is not in use. This system will give an opportunity to use continuous form of fiber for reinforcement of concrete. The main issue with this system is its shape limitation. The reinforcement geometry should have a cylindrical form.



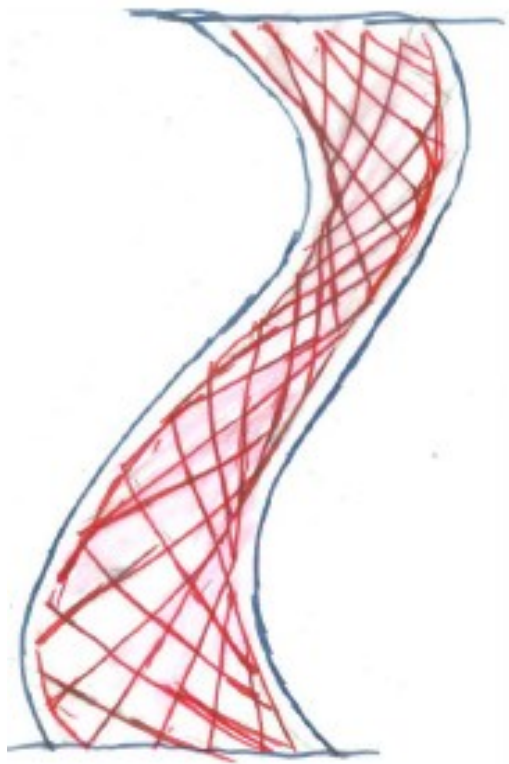
**TABLE 6** Specification

<b>Material</b>	Ceramic and glass fibers + Epoxy
<b>Technique</b>	Weaving cross pin points
<b>structure</b>	Hallow tube structure
<b>Optimization</b>	Duplicating lines where stress level are high. Decreasing grid size.
<b>Formwork integration possibility</b>	Yes The reinforcement geometry is located on the surface of the final structure.
<b>Waste</b>	Cross sections elements

**FIGURE 26**

Left: Woven filament pillar

(Mostert, 2015)



#### **D. FIBER PLACEMENT WITH EPOXY ON ROTATING MOLD**

In this concept, the geometry (as its title represents) is continuous fibers that are placed on a rotating mold. The generated geometry consists of continuous geodesic lines that are warped around a mold. Before the placement of fiber they should be mixed with epoxy. Epoxy will create a chemical bound between the fibers and give them their final strength. The geodesic character of the lines and friction between fiber and mold, will assure a stable position for these elements.

The generated structure using this method will be a hollow solid structure. This type reinforcement will only be available on outside surface of the concrete element and cannot reach the inner point of structure. Also, due to the dependency of the system on geodesic lines, fibers cannot always follow the desired position. Therefore, the reinforcement optimization can only be achieved by increasing line density in certain locations. In a building's waste perspective, the created rotating mold will not be part of the final product and therefore it will be the building's waste.

Due to the ability of creating continuous and intersecting lines, and relative freedom for their orientation– the reinforcement structure will be able to handle stress forces in most directions

**TABLE 7** Specification

<b>Material</b>	Ceramic and glass fibers + Epoxy
<b>Technique</b>	Weaving on a rotating mold
<b>structure</b>	Hallow solid structure consisting of geodesic lines
<b>Optimization</b>	Increasing line density where stress levels are higher
<b>Formwork integration possibility</b>	Yes The reinforcement structure is placed on the surface of the final structure
<b>Waste</b>	Inner mold

**FIGURE 27** Carbon fiber placement on rotating mold

(Donders, 2010)



#### **E. FIBER PLACEMENT WITH EPOXY ON FIXED MOLD**

In this concept— instead of a rotating mold, a fixed mold is implanted. With the assistance of a fiber placer head, fiber strips will be placed on their location. An additional cooling element on the head will help fibers and epoxy to bond in faster phase together and stick better to the mold surface. The Mold surface will eventually determine the geometry of reinforcement structure. This surface can create any form with complex curvature as long as they do not have undercuts.

The use of a fixed mold will have its respective pros and cons. The main issue is its geometrical limitation. When fixed mold is used, the generated reinforcement structure will have an open surface character and therefore creation of a 3D object will not be possible. But this system also has its own strong points. Unlike the rotating mold, the generated structures in this system should consist out of geodesic lines. This will give total freedom for placing fibers with any given location and orientation on the surface of the mold. Therefore, there will be more freedom for reinforcement structure optimization.

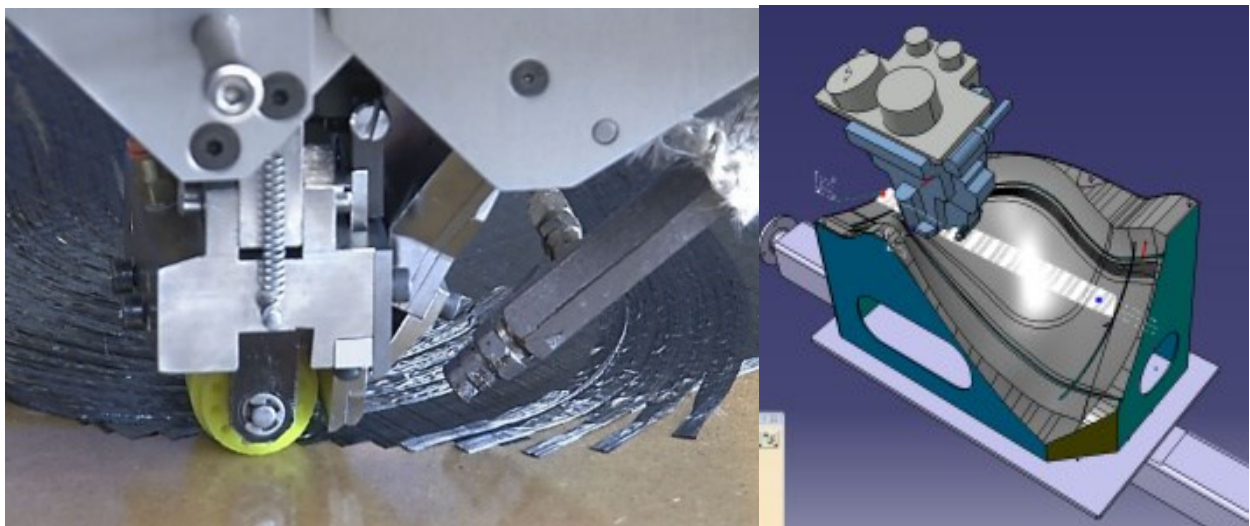
**TABLE 8** Specification

<b>Material</b>	Ceramic and glass fibers + Epoxy
<b>Technique</b>	Fiber placing on a mold
<b>structure</b>	Freeform plane
<b>Optimization</b>	Increasing line density where stress levels are higher. Placing lines according to trajectory lines.
<b>Formwork integration possibility</b>	Yes The reinforcement structure is placed on the surface of the final structure
<b>Waste</b>	Mold

**FIGURE 28**

Left: Fiber placement  
Right: CatFiber for CATIA

(NLR, 2009)  
(Coriolis-Software, n.d)



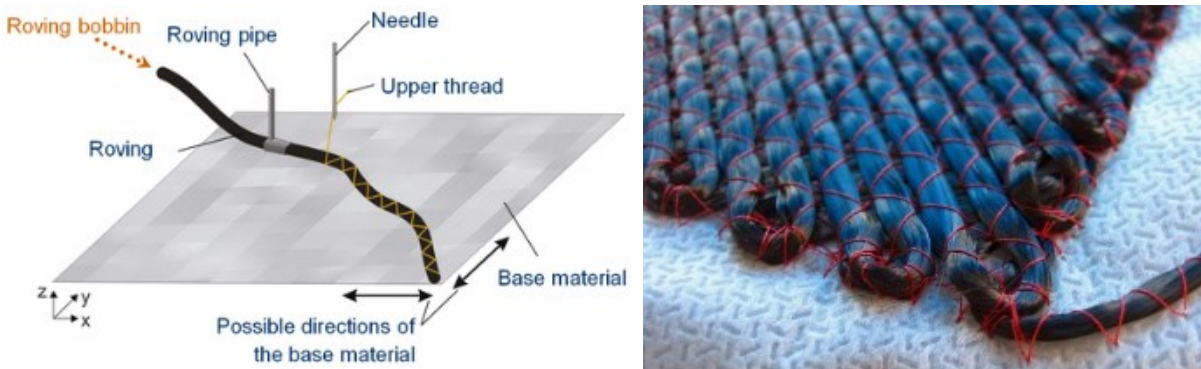
**F. FIBER KNITTING TECHNIQUE**

This concept is a bit similar to a fiber placement technique. This system uses dry fiber instead of wet ones. Dry fibers are placed using a knitting system on a sheet surfaces. Those stitches will fix the fibers in their place and avoid the need for epoxy in the placement stage. After the fibers are placed in their position, the generated sheet surface will be laid on a mold and get combined with epoxy liquid (Gardiner, 2013).

The use of the stitching technique in placing fibers will increase the speed of this stage and make this concept more time efficient. Additionally, in the same way, the stitching system will provide freedom to place fibers in any given direction. For creating a concrete structure using this system, mold is still necessary and therefore, the production process will create a building. There is also a possibility for combining this system with textile mold which avoids the need for a mold.

**FIGURE 29** Fiber knitting technique

(Gardiner, 2013)



**TABLE 9** Specification

<b>Material</b>	Ceramic and glass fibers + Epoxy
<b>Technique</b>	Knitting or gluing it to a plane
<b>structure</b>	Freeform plane
<b>Optimization</b>	Increasing line density where stress levels are higher. Placing lines according to trajectory lines.
<b>Waste</b>	Mold



### 4.2.2 EVALUATION AND CONCLUSION

In the previous section, each presented idea was briefly analyzed based on the possibility of removing formwork, reinforcement optimization and building waste. **Concept C**, “metal welding”, is probably the most suitable option for integration with conventional reinforcement systems. In this system, the generated structure can be created out of metal. Therefore, it allows easier connection to other steel conventional reinforcement systems. Additionally, during the manufacturing process no waste will be created. In comparison with other technique, this system have the best capability for 3d optimization of reinforcement structures. The main problem with this system is its time consumption and the high energy demand.

Furthermore, **Concept A** “lattice structure mesh”, has potential for creating a formwork and will not generate building waste. But regardless of having good capabilities– this system does not have the best potential for reinforcement optimization.

On the other hand, **system E and F**, have the best capability for reinforcement optimization. Nevertheless, in the production process of both of them– creation of building waste is unavoidable. Additionally, in later phases of assembly, a formwork will likely be needed.

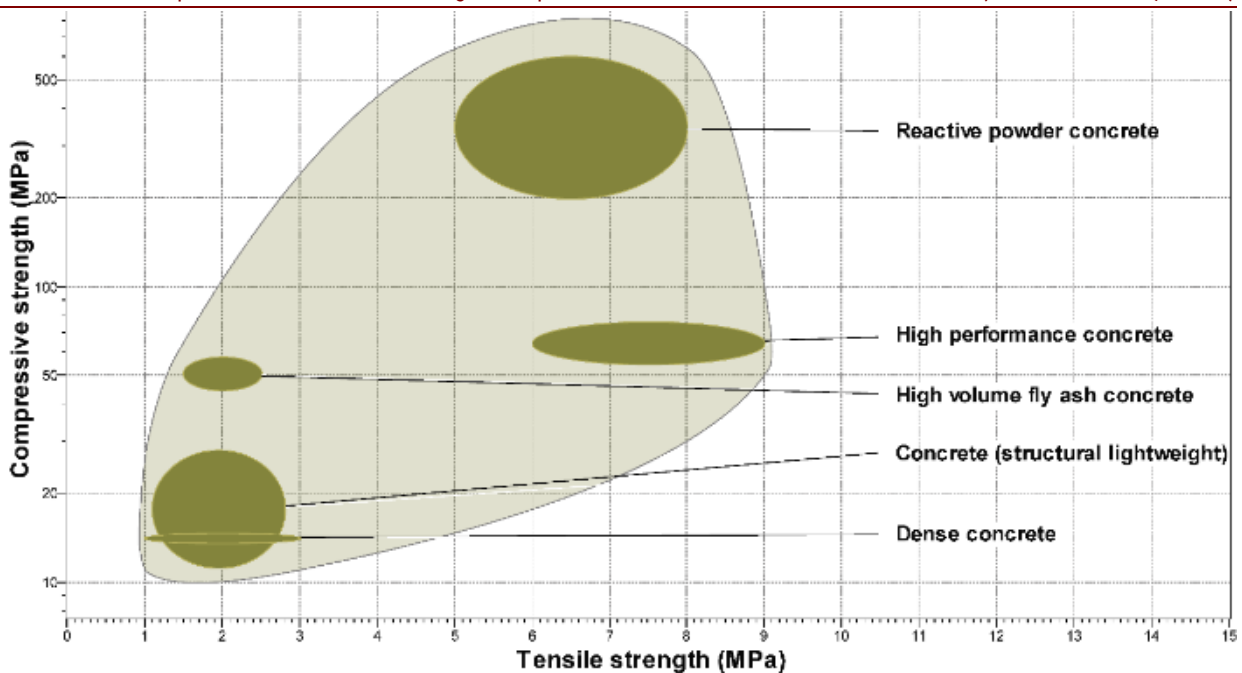
Unfortunately, none of these concepts can present a system that will fulfill all the mentioned criteria's. Each of them is good in certain fields. As a result, deciding between one of them at this stage is not possible. The final design will probably be a hybrid type of system and use combined elements of each system. Furthermore, material research will be also necessary for further developing these systems.

### 4.3 MATERIAL SELECTION FOR REINFORCEMENT

In section 4.1 and 4.2, assembly and reinforcement manufacturing was conceptually studied. In both of these sections, very little attention was given to materialization which eventually should be one of the most important aspects. Not all materials are suitable for reinforcements. They should have certain mechanical properties and should be able to be mixed with concrete.

Concrete is a material with high compressive strength, but it has shortcomings in its tensile power. This material depending on its matrix and production process has compressive strength of 11 to 600 MPa. However, its tensile strength is 1 to 9 MPa which is almost 10 to 100 times lower than its compressive capabilities ("CES EduPack ", 2016) (See Figure 30). For that reason, a concrete object needs a reinforcement structure to compensate for its shortcoming in tensile strength. This reinforcement structure should be made out of a material that have at least a higher tensile strength than concrete (9MPa).

**FIGURE 30** Compressive and Tensile strength compression of concrete ("CES EduPack ", 2016)



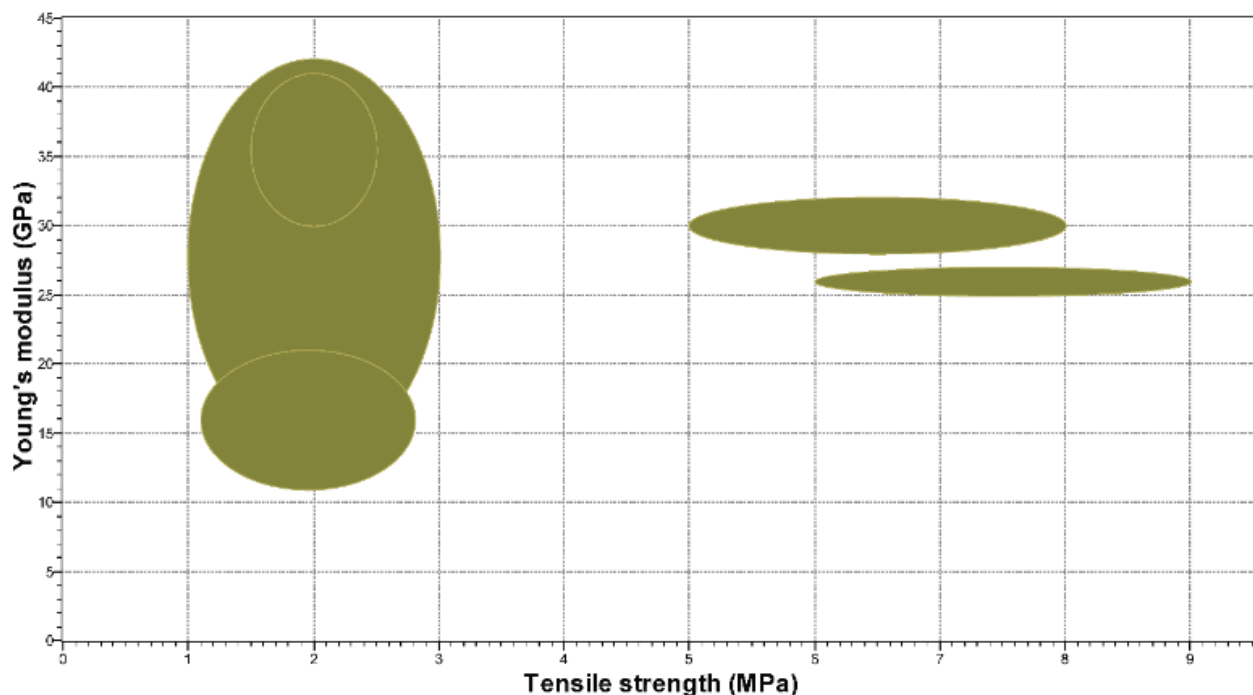


The other important mechanical properties of material, is its young modulus, "E". Regardless of the tensile strength, the young modulus will determine how much a concrete structure will bend and deform. This value defines the elongation of a material due to external forces. The young modulus of the reinforcement material should always be bigger than concrete 11 to 40 GPa ("CES EduPack ", 2016) (see Figure 31).

Based on those properties of concrete, it can be concluded that the reinforcement material should have a young modulus above 40 GPa and a tensile strength above 9 MPa. Although, choosing a material based on the minimum values are not wise decision; the outcome will eventually be a concrete structure that is mainly filled with the additional reinforcement structure. Reinforcement is an additional element and should not be the dominant material.

**FIGURE 31** Young Modulus and tensile strength of concrete

("CES EduPack ", 2016)

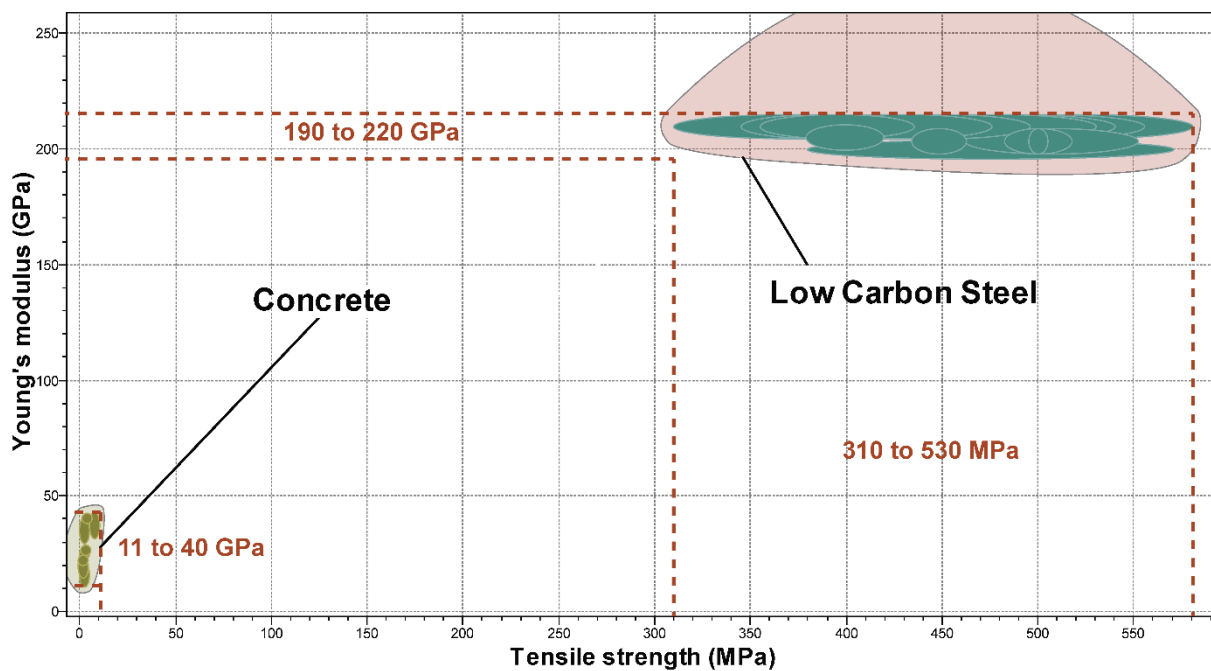


The best way to define these properties are by referring to conventional steel rebars. The most common material for rebar's, are mainly the low carbon steels which have a young modulus of 190 to 220 GPa and a tensile strengths of 310 to 530 MPa ("CES EduPack ", 2016). By using a material according to these specifications, ration of reinforcement to concrete will be similar to the conventional rebar.

**TABLE 10** Suggested specification for reinforcement material

<b>Young Modulus</b>	200 GPa
<b>Tensile strength</b>	500 MPa

**FIGURE 32** Concrete and low carbon steel properties ("CES EduPack ", 2016)



### 4.3.1 MATERIALS SUITABLE FOR REINFORCEMENTS CONCEPTS

For reinforcement there are various materials available but not all of them are suitable for the designed concepts in section 4.2.

For concept "A", *lattice structure mesh*", a thermoplastic material is needed. These material can be mixed with additional fibers for strength improvement purposes. Concept "B", *Metal welding*", as its name presents, uses the welding technique. Almost all metals

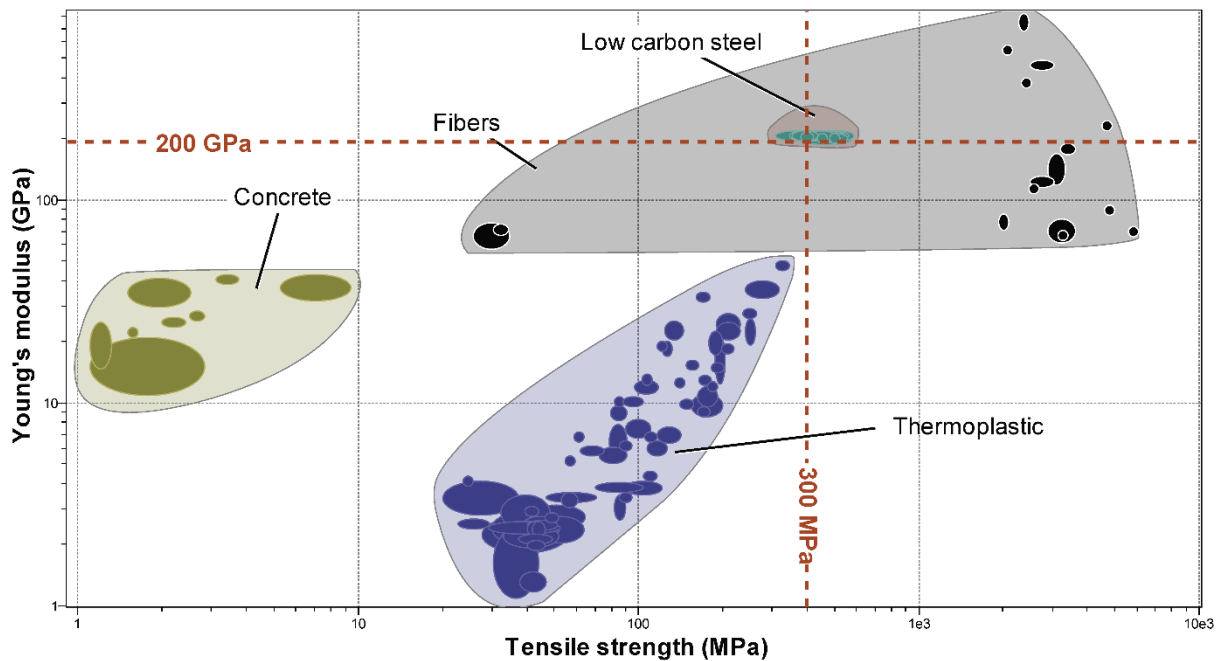
can be welded together. For welding metallic elements, welding material should be the same as the base element. As previously mentioned, low carbon steels are the common choice for the conventional rebars. For that reason, these type of materials are suitable for concept *B*. In other concepts *C*, *D*, *E* and *F*, regardless of their differences, a continuous fiber is the only suitable material.

**TABLE 11** Types of materials for concepts in section 4.2

Concepts	Types of materials
A	Thermoplastic filament material It can also be mixed with fiber for strength improvement
B	Steel
C, D, E and F	Continuous fibers

**FIGURE 33** Young modulus and tensile strength of concept material

("CES EduPack ", 2016)



**TABLE 12** Mechanical properties of materials for concepts in section 4.2

	Materials	Young Modulus	Tensile strength
A	Thermoplastic	1 to 50 GPa	20 to 340 MPa
B	Low carbon Steel	196 to 215 GPa	310 to 580 MPa
C, D, E, F	Continuous fibers	58 to 830 GPa	25 to 5800 MPa

As Figure 32 shows, it's clear that thermoplastic materials are not suitable for reinforcement. Both their young modulus and tensile strength are below the suggested value in Table 10. The strongest thermoplastic material, "PEKK (40% carbon fiber)", has a young

modulus of 50 GPa and a tensile strength of 580 MPa– which is relatively higher than the standard PEEK. This is mainly due to the chopped carbon fiber mixture. In a way, these types of thermo–plastic materials mixed with fibers work with the same principle as reinforced concrete. Keep in mind, these steel fibers that reinforce concrete SFRC are not as strong as reinforced concrete. The usage of chopped material in a reinforcement matrix will decrease the effectiveness of the reinforcement material. Strong thermoplastics, like “PEKK (40% carbon fiber)”, are not the first preference for the purpose of reinforcement. Nevertheless, those not mean that it cannot be used for the same purpose. If such materials are used, then the reinforcement elements ratio in concrete will be higher than conventional reinforcement system.

The other materials in these reinforcement concepts are steel and fibers. In terms of suitability of steel alloys, there is no question as they have been routinely used in standard conventional reinforcements. Fibers in that perspective are less conventional materials but according to Figure 33, most of those materials have a higher tensile strength than steel and a portion of them also have a higher young modulus. What’s more, Fiber reinforced concrete (FRC) is an established concrete type. In FRC, chopped fibers are being used instead of continuous fiber and those fibers are mainly glass or carbon fibers.

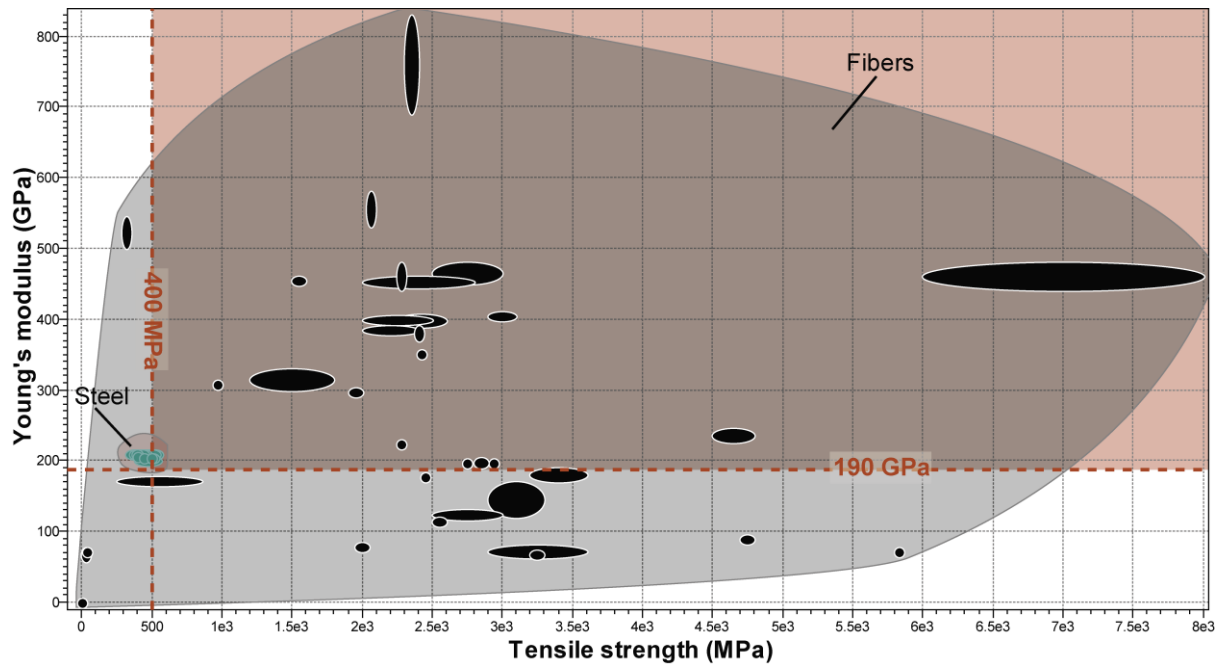
In short, this section can be summarized in advice strategies in Table 13.

**TABLE 13** Material advice for designed concepts in section 4.2

		Advice	Remarks
A	<b>Thermoplastic</b>	No	Thermoplastic materials are not suitable for reinforcement. If the FDM system want to be used, a better matrix system for fiber reinforced plastic need to be designed
B	<b>Low carbon Steel</b>	Yes	No further research is needed
C,D, E,F	<b>Continuous fibers</b>	Yes	Not all fibers are suitable and have similar strength. Their properties should be further investigated.

### 4.3.2 FIBER MATERIAL

In the previous chapter, it was advised that fibers are suitable materials but need further study. As Figure 34 shows, there are various fibers with different properties. However, the question remains as to which one of them should be used in fiber concepts?



**FIGURE 34** Fiber materials ("CES EduPack ", 2016)

In order to make the decision making phase easier a couple of criteria's need to be formed. Firstly, young modulus should be higher than 190 GPa and tensile strength should be above 190–200 MPa. These types of properties can easily be validated by a software, 'CES EduPack'. The other criteria can be the material durability and how does it react with concrete. Since the author of this paper has not sufficiently got a background in chemical studies, this matter should be solved in other ways. Firstly, reference cases will be used as validation points. Secondly, with the assistance of the 'CES EduPack' software and its durability database, the suitability of different fibers will be validated.

#### COMPATIBILITY BASED ON REFERENCING

Fiber reinforced concrete FRC (chopped fiber) is a well-established system, which uses different fibers in the concrete mix. In these type of systems, fibers such as Glass, Carbon and Aramid are being used (J. L. Clarke, 2003, p. 26 to 28). By referring to the RFC system, the assumption can be made that the fibers that are used

in this method are compatible with concrete. Nevertheless, it should be taken into account that most of the approved fibers are not used in their standard format and they went through a treatment process to make them alkaline resistant.

#### COMPATIBILITY BASED ON “CES EDUPACK” SOFTWARE

The other way to validate compatibility of these fibers is by analyzing their durability based on the ‘CES EduPack’ database. Reinforcement materials are mainly exposed to concrete and in some cases to water.

**TABLE 14** pH values for concrete-related materials

(Grubb, Limaye, & Kakade, 2007, p. 79)

Category	pH
<i>Fresh cement</i>	>12.5
<i>Low alkali cement</i>	12.7 to 13.1
<i>High alkali cement</i>	13.5 to 13.9
<i>High alumina cement</i>	11.4 to 12.5
<i>Mixing water for concrete</i>	6 to 9
<i>Sea water</i>	7.5 to 8.4
<i>Hardened cement paste with ingress of sea water</i>	12.0
<i>Class F fly ash</i>	>13.2
<i>pH of silica fume concrete</i>	>12.5

A cured concrete object has a pH level of 12 to 13 and most of its components also have a relatively high pH level (See Table 14) (Portland Cement Association, 2002, p. 3). This high pH level indicates that concrete have a very strong alkali character and therefore the chosen fibers should be able to resist alkali. Beside durability against alkali, fibers should be able to maintain their integrity against water which is a crucial element in concrete.

**TABLE 15** CES durability + Mechanical criteria's

criteria	Rating
Water (fresh)	Excellent
Water (salt)	Excellent
Weak alkali	Excellent
Strong alkali	Excellent or Acceptable
Young modulus	>190 GPa
Tensile Strength	>400 MPa

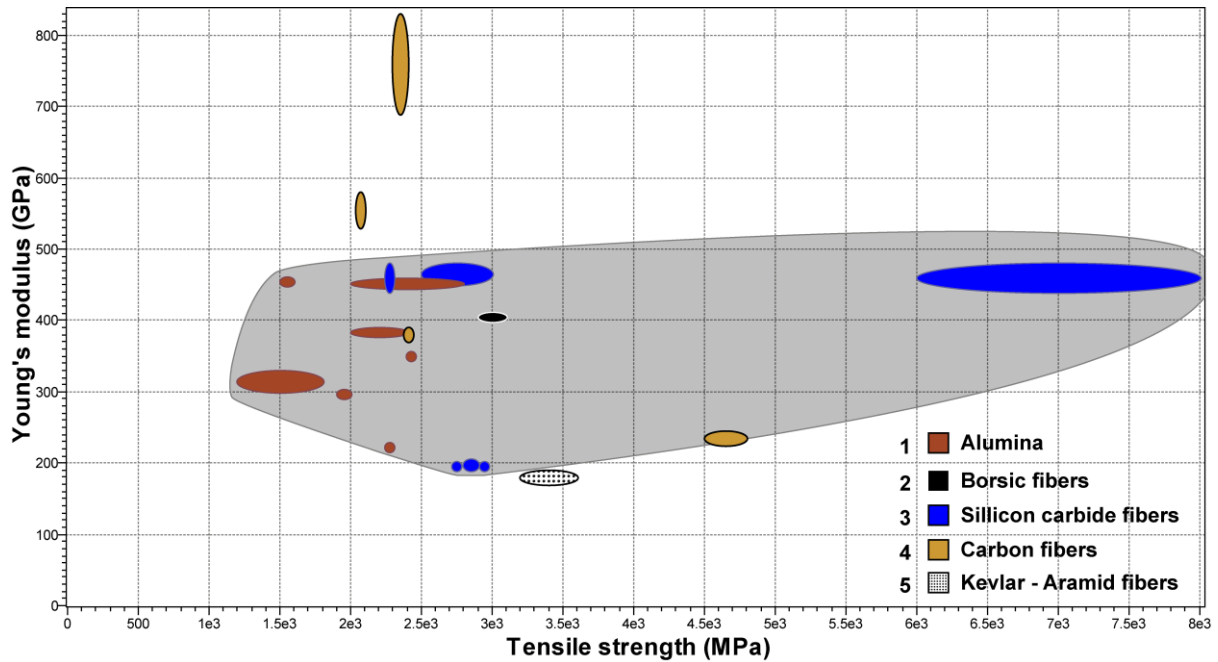


FIGURE 35 Fiber material compatible with concrete

("CES EduPack ", 2016)

**FIBER MATERIALS COMPATIBLE WITH CONCRETE**

Based on the topics mentioned in this section, a list of durability and mechanical criteria's can be made and are presented in Table 15. According to these criteria's, a list of suitable fiber are generated that are presented in Table 16 and Figure 35. According to 'CES database', carbon and aramid fibers, do not have excellent compatibility with concrete but in FRC concrete these fibers are commonly used. That means that those fibers undergo a coating treatment or other special types of carbon and aramid fibers are available that are not listed in the CES database. Consequently, these two types of materials were added to list of compatible materials.

TABLE 16 Fiber material compatible with concrete

1	Alumina
2	Borsic fibers
3	Silicon carbide fiber
4*	Carbon Fibers
5*	Kevlar – Armaid Fibers

All the materials in Figure 35 are suitable for reinforcement and compatible with concrete. Therefore, different aspects should be taken into consideration for material selection. It can be suggested

that in the first attempt, one can choose a material with the highest young modulus or tensile strength.

A reinforced concrete with a high young modulus fiber will have lower deformation rate. In parts of the structure where reinforcements are located, it's acceptable to have tensile stresses that are higher than the concrete's limits. This means a few micro cracks could appear on those locations and consequently, those parts of concrete will lose their capability to handle forces. Thus, forces will get transferred to the reinforcement fibers. If same amount of fibers, with lower young modulus and but a higher tensile strength are used then the structure might not fail. Then again, the concrete deformation will be higher and therefore more cracks will appear on the structure. To limit this deformation, a higher density will eventually be needed. Since, most fibers have a relatively high tensile strength and these materials are currently a bit expensive, choosing a fiber with higher young modulus will decrease the required volume of the material.

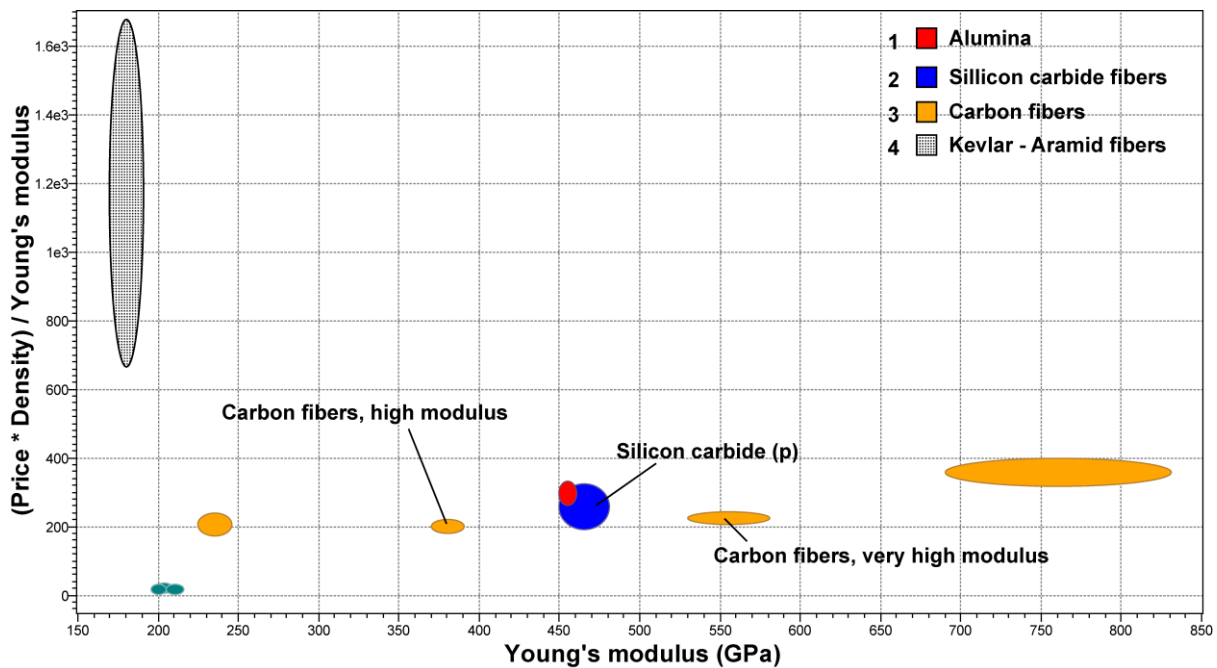


FIGURE 36 Selected fibers: Young modulus VS Indication ratio reinforcement cost ("CES EduPack ", 2016)

In Figure 36, compatible materials from Table 16 are plotted in "Price \* Density/Young modulus" and young modulus diagram. The "price \*Density / Young Modulus"<sup>1</sup> criteria will give an indication of the eventual cost of needed material for reinforcement. Price wise all the fibers are way more expensive than steel reinforcement. The



cost for reinforcement with cheapest fibers will be around 10 to 20 times higher than the conventional systems<sup>2</sup>. Nevertheless the fact that this system will be used for complex geometry and those designed concepts have more capabilities for reinforcement optimization should be kept in mind. All the same, demands for material such as carbon fibers are increasing and so, due to mass production, prices will eventually fall down (Shama Rao, Simha, Rao, & Ravi Kumar, 2014, p. 2). Additionally, BMW has also invested 102\$ million on carbon fiber research projects and indicated that its price will be lowered by 90% (Beck, 2014). For this project, the goal is to investigate for creation of new reinforcement techniques and those designed concepts will eventually be used in the future where material cost will decrease due technological developments.

1. In CES application price is given per kilogram, multiplying it by density will create a price unit per volume  $m^3$ . Since Young modulus is inversely proportional to volume, dividing  $Price \cdot Density$  by Young modulus will give an indication of the eventual cost of material regarding to how much stress it can handle.

2. This is the estimate cost for volume of material required for reinforcement according to young modulus value and not price per kilo or volume.

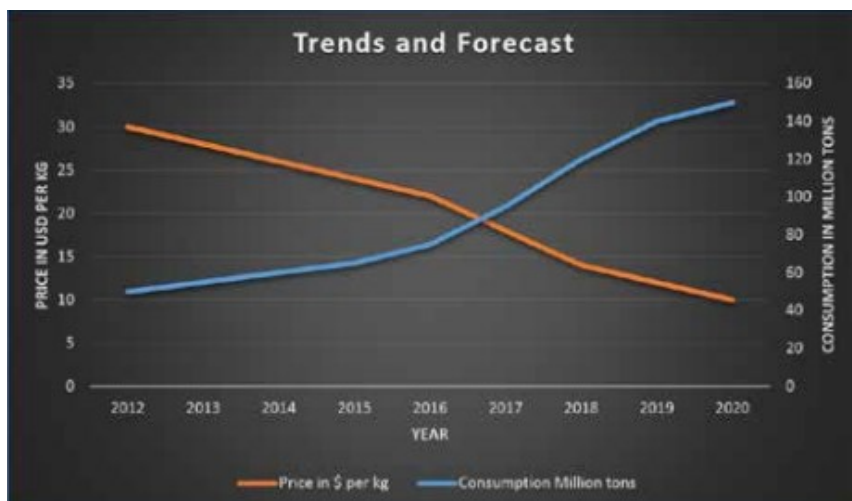


FIGURE 37 Forecast of carbon fiber (Beck, 2014)

Taking into consideration all mentioned criteria in section 4.3.2, Silicon Carbide (p) and Carbon Fiber have a very high modulus and are the most suitable materials for fiber placing concepts (designed concepts C, D, E and F in section 4.2). Reinforcement with silicon carbide will cost 10 times more and with carbon fiber will cost 12 times more.

TABLE 17 Specification of chosen fiber material and low carbon steel

	Young modulus GPa	Tensile strength MPa	Price €/m <sup>3</sup> 10 <sup>3</sup>	Price * Density/ Young Modulus
<i>Low carbon steel</i>	450–480	380–580	4–5	19–25
<i>Silicon carbide (p)</i>	450–480	2500–3000	90–151	194–325
<i>Carbon fiber Very high modulus</i>	530–580	2060–2070	118–133	209–243
<i>Carbon fiber high modulus</i>	370–390	2400–2410	70–84	184–222

### 4.3.3 THERMOPLASTIC MATERIAL

As mentioned in section 4.3.1, thermoplastic materials are not suitable for reinforcements. This is mainly due to their limitation in young modulus and tensile strength. The strongest thermoplastic material is a reinforced PEEK with 40% carbon fibers. In this material, chopped fibers are used and therefore the effectiveness of carbon fiber –which has a very high strength– is not fully utilized. One of the ways that thermoplastic material can benefit more from carbon fibers is by adding continuous fibers instead of the chopped ones. This strength difference can also be seen in reinforced steel and steel fiber reinforced concrete. Both of these concrete types are used in steel as a reinforcement material – one in a chopped format and other in a continuous format. The concrete with continuous steel rebar's have a higher strength.

#### COMPATIBILITY BASED ON “CES EDUPACK” SOFTWARE

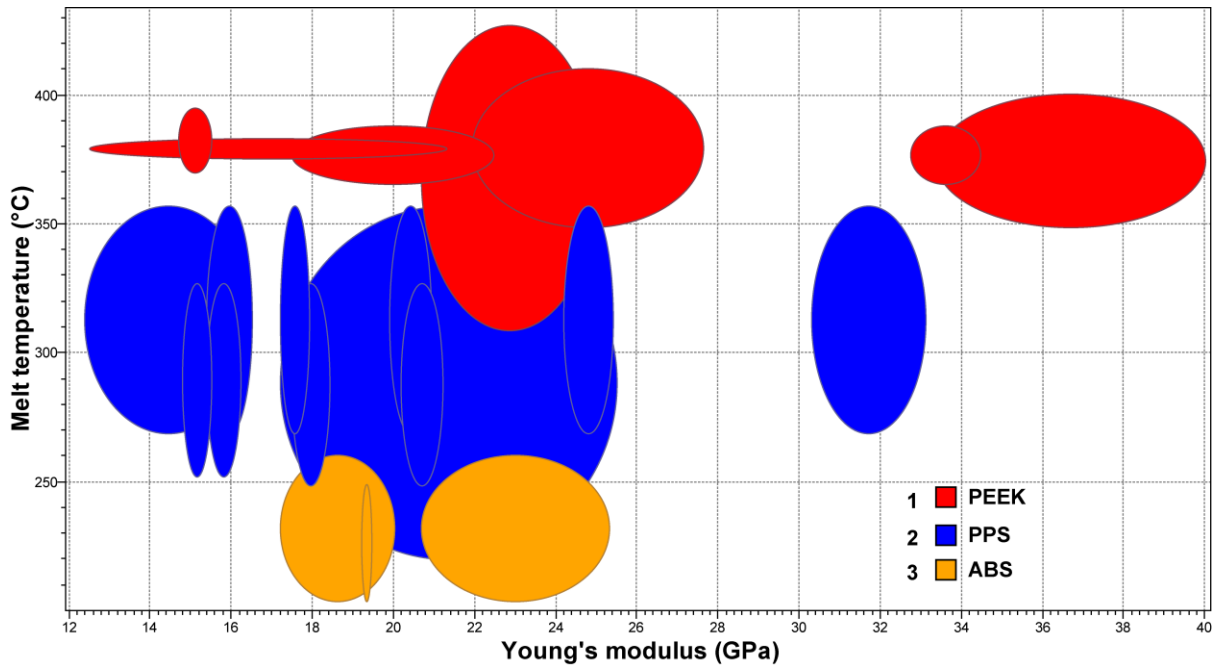
In this section, compatibility of thermoplastic material with concrete will be validated. As mentioned before, concrete has a pH level of 12.5 approximately and is considered as high alkaline material. Therefore, the chosen thermoplastic material should be able to resist against strong alkaline. Additionally, since water is crucial part of concrete– the chosen material should also have good resistance against water.

**TABLE 18** CES criteria's for thermoplastic materials

criteria	Rating
Water (fresh)	Excellent
Water (salt)	Excellent
Weak alkali	Excellent or Acceptable
Strong alkali	Excellent
Young modulus	>15 GPa

#### THERMOPLASTIC MATERIALS COMPATIBLE WITH CONCRETE

Based on the aspects mentioned in the previous sections, a list of durability criteria's is generated which is presented in Table 18. Successively, according to that list, a series of suitable materials are selected.



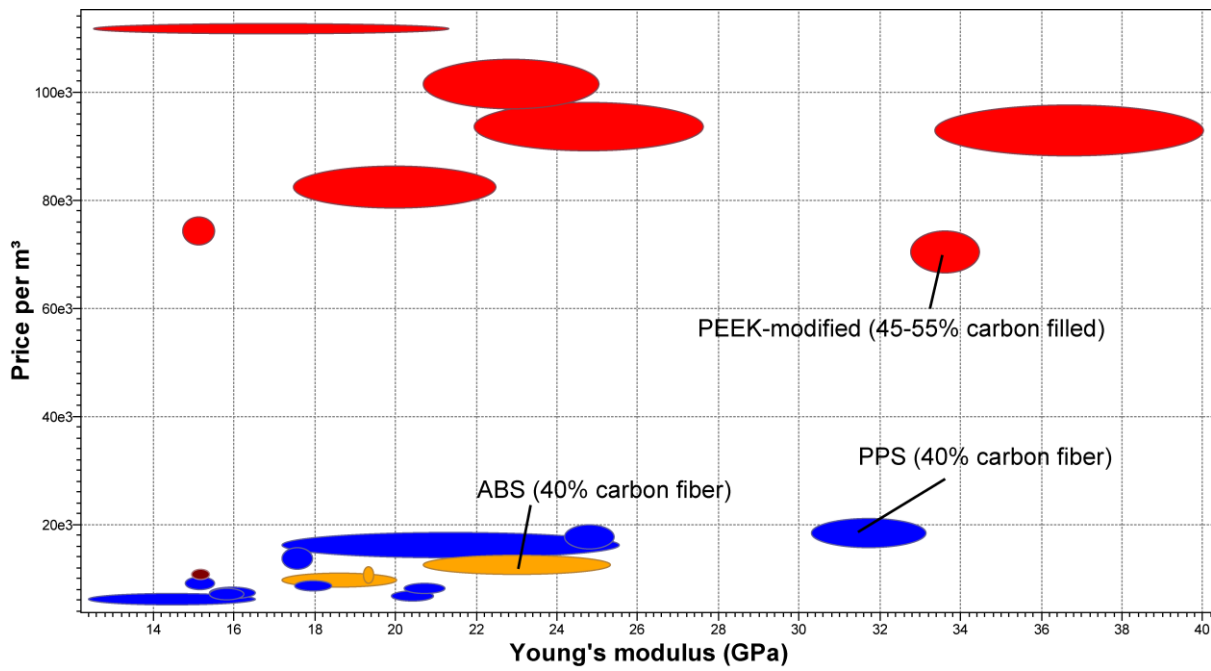
**FIGURE 38** Thermoplastic materials compatible with concrete

("CES EduPack ", 2016)

In *Figure 38*, the compatible thermoplastic materials are plotted on a melting point and Young modulus diagram. This diagram shows three categories of thermoplastic materials that are listed in Table 19. From this list, a suggestion should be made for suitable material for *concept A*, from *section 4.2* (concepts for reinforcements). As mentioned in *section 4.2*, FDM or 3D printers are the recommended system for lattice structure concepts. The suitability of thermoplastic materials with this system are bound by their melting points. Most of the standard 3D printers (FDM) heater elements can reach a maximum temperature of 280°C. These type of machines are not able to support materials such as PEEK, which have a melting point of 380°C. Working with high melting point materials will demand more advanced technology and is not suitable for prototyping. Additionally, reaching these levels of temperature, require high amount of power and will eventually increase the embodied energy of the final product.

**TABLE 19** Thermoplastic materials compatible with concrete

1	PEEK	Polyetheretherketone
2	PPS	Polyphenylene Sulfide
3	ABS	Acrylonitrile Butadiene Styrene



**FIGURE 39** Price per volume of Thermoplastic materials ("CES EduPack ", 2016)

In Table 20, one material from each thermoplastic category is chosen that has relatively high young modulus and low price per volume. Regardless of the high melting temperature of the chosen PEEK, its price per volume is also higher than the other materials. The two other materials, PPS and ABS, have a relatively lower price per volume (one third). PPS has a higher young modulus but its melting temperature is 269–357 °C, which some standard 3D printers might be able to print. On the other hand, ABS has a melting temperature of 204–260°C which most of printers can handle without any difficulties but its young modulus is relatively low. Both of these materials, as mentioned before, have a low young modulus and their strength issue should be resolved by adding continuous fibers so that their current young modulus is not that important. Therefore, without a doubt, *ABS (40% carbon fiber)* will be a definitive choice for prototyping. Furthermore, for the final product where there is more freedom in tool investment, PPS can be substituted.

**TABLE 20** Specification of chosen Thermoplastic materials

Materials	Young Modulus GPa	Melt Temperature °C	Price €/m³ 10 <sup>3</sup>
PEEK-modified (45–55% carbon filled)	33–34	366–388	66–74
PPS (40% carbon fiber)	30–33	269 – 357	16–21
ABS (40% carbon fiber)	21–25	204–260	11–14

#### 4.3.4 CONCLUSION

The goal of this chapter was to evaluate and analyze the designed reinforcement concepts in chapter 4.2. First the concepts were categorized based on their required materials. Then based on the material properties advice, was given for each category.

*Concepts A*, 'lattice structure mesh', which is a thermoplastic based design, is not suitable for reinforcements since the young modulus of these materials are low. To further develop this concept, thermoplastic reinforcement system should be redefined and the chopped fibers should be replaced continuous fibers. With this type of change, this concept might have some potential. Furthermore, the best concrete compatible thermoplastics materials were PPC and ABS as they are a better option for prototyping.

The other category was the metal based welding system (*concept B*). Since steel rebars are commonly used as reinforcements for concrete– no further analysis was needed and this material could definitely be validated for this purpose.

The last category was fiber based reinforcement concepts. In comparison with steel, they generally have a better young modulus and tensile strength. For this reason, they are a suitable reinforcement material. However, with these fibers the main issue was their chemical compatibility with concrete– which is a strong alkali material. After filtering material based on chemical criteria's– three suitable materials based on their price per volume and young modulus suggested Silicon carbide (p), Carbon fiber Very high modulus and Carbon fiber high modulus

With these materials and the gained knowledge, these concepts can be further developed in the coming chapters.

#### **4.4 MODIFIED REINFORCEMENT CONCEPTS**

---

In this section, the designed systems for concrete reinforcement in section 4.2 that had some shortcomings, will be modified and further developed. The most important step for good development, is to acknowledge the existing strengths and weaknesses of those designs. These assessments have already been done using several different criteria, such as reinforcement optimization, possibility of avoiding formwork, structural strength, material compatibility and etc. The outcome is presented in Table 21 and gives an overall perspective of different aspects of those designs.

As it was mentioned before, each of these concepts has potential in certain aspects, but they also have some shortcomings. Based on the previous conclusions and advises, some of these designs will be further modified and merged together to form a better design. At the end of this section, one of the new developed and modified designs will be selected and further developed for creation of a prototype.

TABLE 21 Overview and specification of graduated design concepts

Lattice structure		
<b>Geometry</b>	<i>3D Freeform object</i>	The reinforcement geometry is constructed from series of cells that create a lattice structure. By adjusting these cells, overall shape of the geometry can be modified to form any shape. The accuracy of the geometry depends directly on the dimensions of the cells.
<b>Formwork integration</b>	<i>+ Yes</i>	Yes – Since the reinforcement geometry has a similar shape to the final concrete object, this structure can eliminate the need of formworks. The uniform dense mesh structure of this geometry, makes it suitable to be used for shotcrete.
<b>Reinforcement optimization</b>	<i>-</i>	Reinforcement optimization is limited in this system. Structural strength of the geometry, can be increased by decreasing the dimension of the cells and increasing the thickness of the elements. Since local adjustment of cells will have a direct influence on the overall shape, local optimization will not be possible.
<b>Building waste</b>	<i>+ No</i>	No building waste is created during the production process
<b>Material Category</b>		Thermoplastic
<b>Structural strength</b>	<i>- No</i>	Thermoplastic materials have a low young modulus and tensile strength.
<b>Compatibility with concrete</b>	<i>+ Yes</i>	Only ABS, PPS and PEEK are compatible with concrete. Other thermoplastic materials cannot be used with concrete.
<b>Advise</b>		Thermoplastic materials have a low Young Modulus and Tensile Strength. If this concept is to be further developed, the thermoplastic material should be reinforced with continues fibers.
Metal welding		
<b>Geometry</b>	<i>3D Freeform object</i>	The welding techniques provide the possibility to create any freeform line structures, with minimum supports. But in this concept the created lines follow the path of the trajectory lines to create the reinforcement geometry.
<b>Formwork integration</b>	<i>- No</i>	No – the created reinforcement geometry does not represent the outline of the final concrete object. For that purpose additional elements need to be added to the geometry which will increase the cost and the production time.
<b>Reinforcement optimization</b>	<i>+++</i>	This system has the best optimization possibilities. Since the reinforcement geometry follows the stress trajectory lines, its elements are in the most optimized position.
<b>Building waste</b>	<i>+ NO</i>	No building waste is created during the production process
<b>Material Category</b>		Metal
<b>Structural strength</b>	<i>+ Yes</i>	Steel is the most conventional material for concrete reinforcement
<b>Compatibility with concrete</b>	<i>+ Yes</i>	Yes (steel reinforced concrete)
<b>Advise</b>		The main disadvantage of this design is the time and energy consumption of the manufacturing process. If these problems can be resolved, this system might have a good potential.
Fiber material concepts		
<b>Geometry</b>	<i>Freeform plane</i>	The created reinforcement geometry will follow the tensile trajectory lines on the surface of the final concrete object. The outcome will be a freeform plane that consists of fiber lines.
<b>Formwork integration</b>	<i>Yes/No</i>	The created geometry has plane shape which does not have a uniform line density on the surface. Therefore without modification it's not suitable for this purpose.
<b>Reinforcement optimization</b>	<i>++</i>	The created geometry is based on stress trajectory lines. It offers a good surface optimization for reinforcement geometry.
<b>Building waste</b>	<i>- Yes</i>	Creating these types of structures requires a mold therefore manufacturing process will result in building waste.
<b>Material Category</b>		Fibers
<b>Structural strength</b>	<i>++ Yes</i>	Fibers are one of the lightest and strongest materials.
<b>Compatibility with concrete</b>	<i>+ Yes</i>	Silicon carbide and carbon fiber
<b>Advise</b>		If the need for mold in the production process can be avoided, this technique would have more potential.

### 4.4.1 CONCEPTS

#### 1. LATTICE STRUCTURE MESH

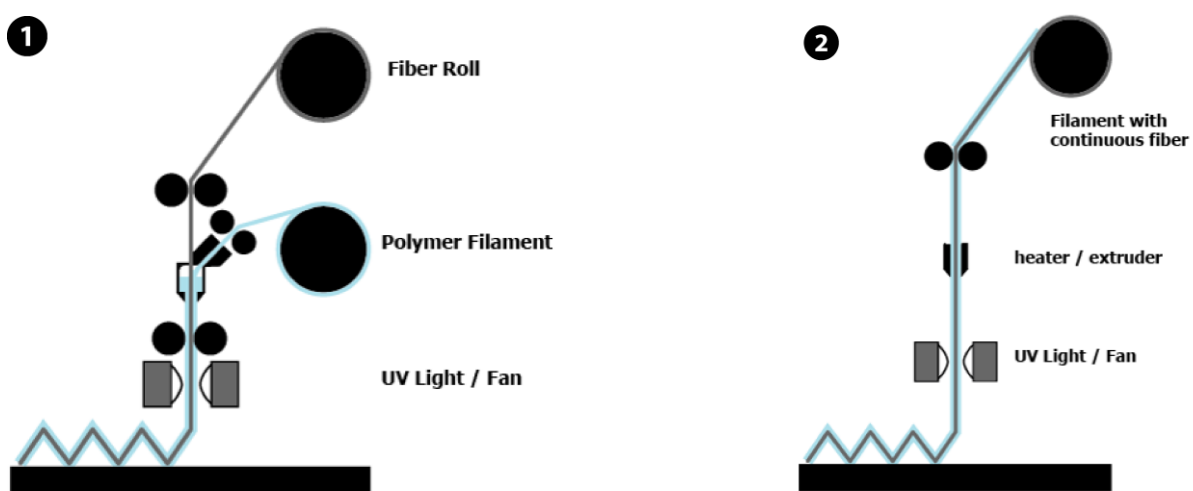
In this section the “lattice structure mesh design” which is a thermoplastic based design, will be modified and redesigned. This concept is based on a well-established fused deposit molding FDM technology which is commonly used in standard 3D printers. For that reason, the required technology for this design is easily accessible and that gives it a good potential for future applications.

#### *MECHANICAL IMPROVEMENT OF THERMOPLASTIC*

As it was mentioned, thermoplastics do not have sufficient strength and their Young Modulus and tensile strength values are low. Therefore for further development, it is necessary to improve the structural strength of these materials. One way to achieve this, is by adding fiber as reinforcement. Currently a form of this system exists in the market, where chopped carbon fiber particles are infused in the thermoplastic filament. Unfortunately, adding chopped fibers are not effective enough. The suggested idea of the author is, to add continuous fibers instead of chopped particles to the thermoplastic filaments. This can be done in two ways (see Figure 40);

1. Adding continuous fibers during the production process of filaments (filament embedded with continuous fiber in its core)
2. Adding continuous fibers during the printing process

**FIGURE 40** Printing with continuous filament





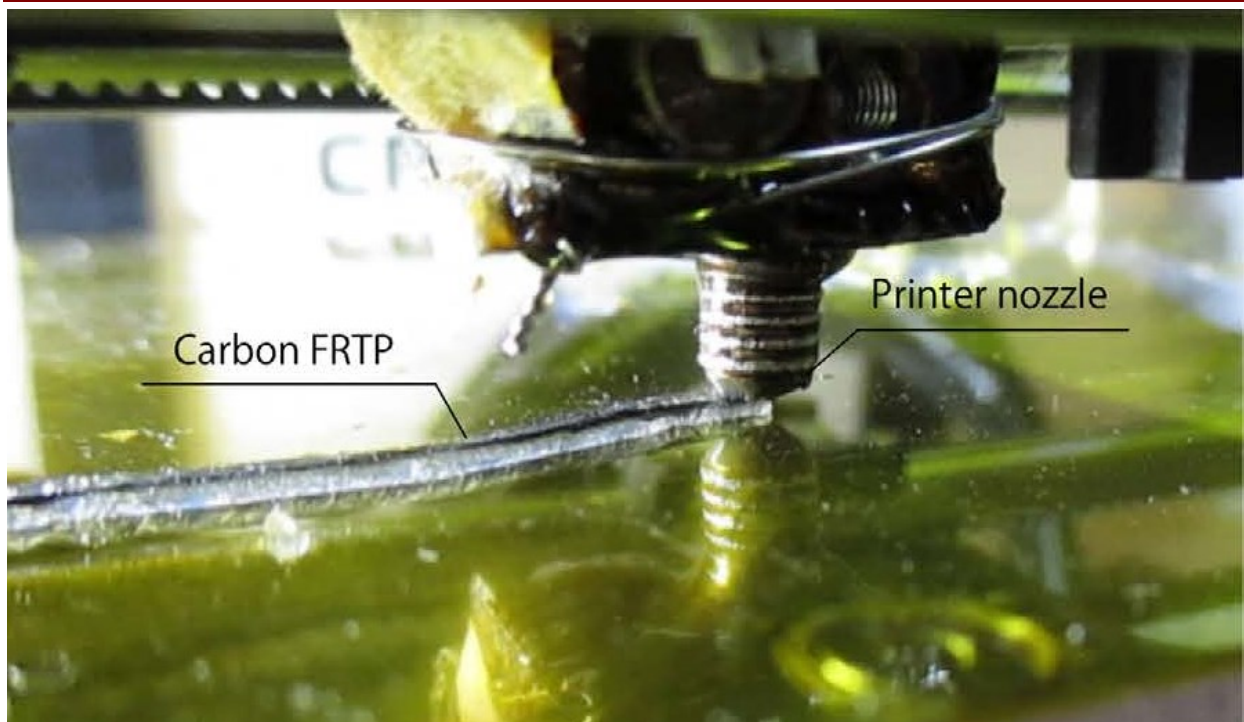
### 1. Mixing fibers and filament during the printing process

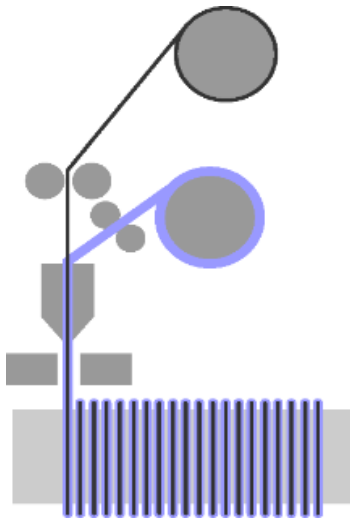
In Figure 40 (diagram 1), the principle idea of merging thermo-plastic and continuous fiber is illustrated. In this system, filament and fiber are two separate materials which are merged during the printing process. This system has only been implemented by a few researchers and is in an experimental stage. As Figure 41 shows, currently this system only generates lines in a flat surface. The traction force between the extruded filament and the underlying surface, is the pulling force that makes the fiber move (Li, Li, & Liu, 2016, p. 219). Therefore printing vertical lines might not be possible without further modifications. The primary goal of these researchers was to create a solid model based on a layer slicing system. Therefore according to their objectives, they have fulfilled their requirements.

For lattice structure concept, the system is not based on a layer slicing system and the object needs to be created out of a series of vertical lines. Therefore this technique should be further modified to serve this purpose. This type of modification is mainly possible by lab work and creation of prototypes. For that reason these steps are outlined in the prototyping section.

**FIGURE 41** printing with continuous fiber

(Matsuzaki et al., 2016, p. 2)





**FIGURE 42**  
Carbon fiber filament extruder

### 2. Integrated filament with fiber

In Figure 43, the standard mechanism for a filament extruder is illustrated. In this system with the help of a screw and a heater, plastic pellets get extruded in a filament form. Unfortunately adding continuous fibers with this system will not be feasible. Because as soon as the fibers are inserted, they will wrap around the screw and the entire system will jam. Additionally it's also not possible to guide the fibers through the system.

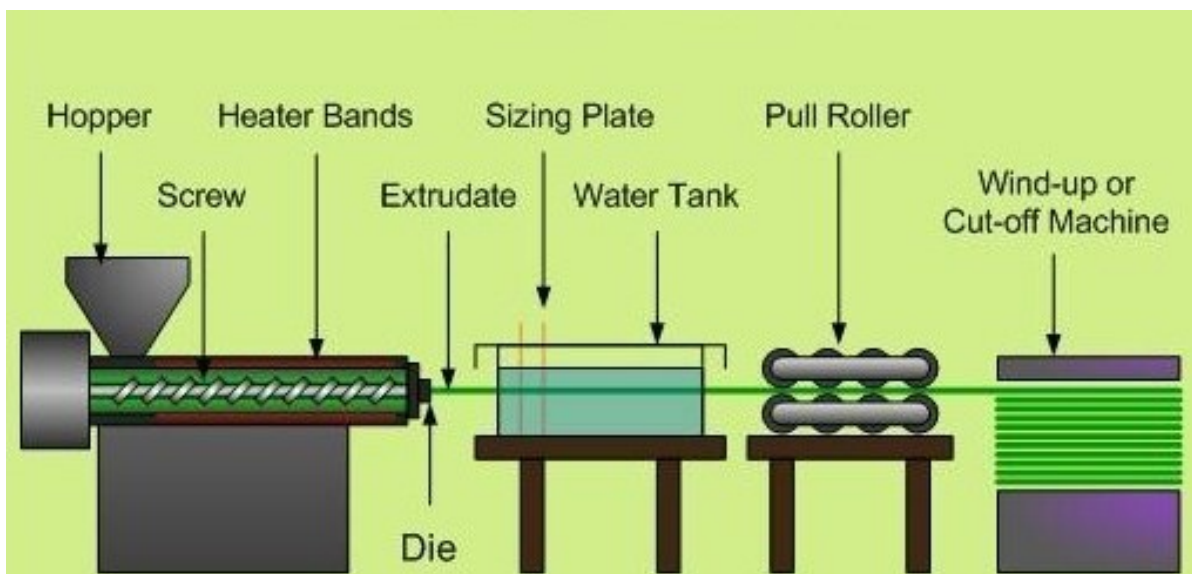
The other method is somewhat similar to the previous section, extruding a filament and mixing it with a continuous fiber through a specialized printer head (See Figure 42). The advantage of using a carbon fiber integrated filament is that, the final printing system will be simpler and avoids the required tweaking of the specialized printing head in order to achieve satisfactory results.

### Evaluation

In both of these methods, the strength of the material depends mostly on its reinforcement fibers. Therefore for reinforcement calculation purposes, the strength of the fiber should be measured. The function of the thermoplastic material is mostly to hold the fiber in its position. It also increases the cross section area of the lines and improve their buckling strength.

**FIGURE 43** Filament extrusion process simplified

(3dprintingforbeginners, 2014)

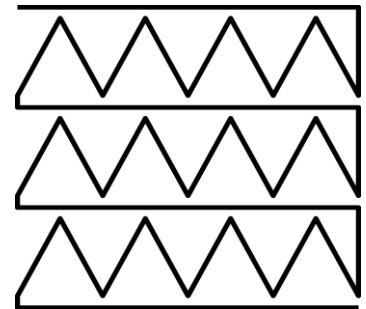


**GEOMETRICAL STRENGTH OF THE MESH**

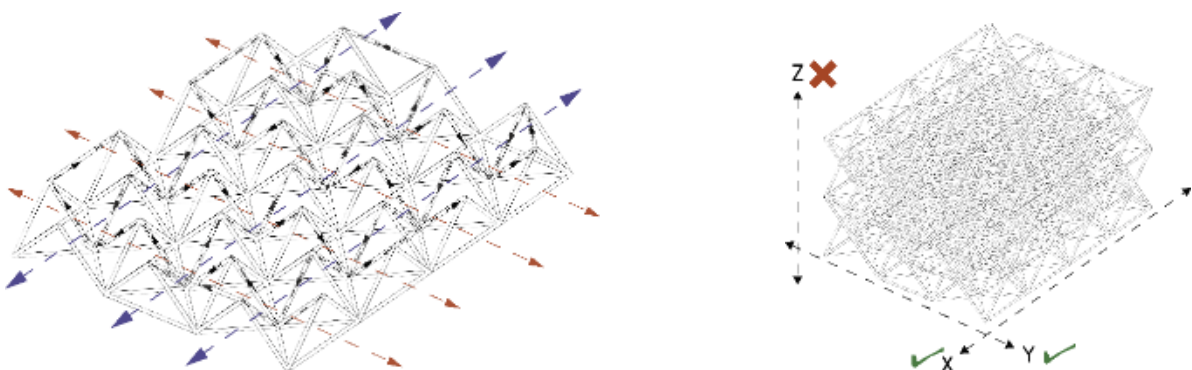
Regardless of the material strength, the geometrical structure and the way the mesh is printed has a great influence on the overall strength of the designed reinforcement structure. The lattice mesh structure should not be seen as a solid element but rather as a series of lines, which have the same thickness and diameter. By chopping these lines in segments, their strength will depend on the bonding strength between each segment and also the continuity of their fibers will be effected. The bonding strength between the extruded lines depends on the time between when the two segments were printed. If both segments are printed directly on top of each other, they form a good bond since both of them are still in glass phase. But when there is a large time gap, the underlying segment will fully solidify and cannot form a good bond with the newly printed segment. Regardless, due to the lack of a continuous fiber, the bond between segmented lines is similar to a chopped rope that is badly knotted together. Therefore it is important to create the mesh from a continuous line and avoid segmenting it as much as it's possible.

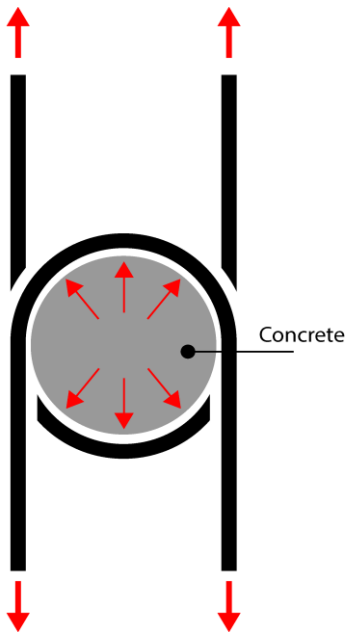
In Figure 45 a simple continuous line is illustrated. But the illustrated shape does not have the same strength in the vertical and horizontal directions. The shape is one continuous line, but only in the horizontal axis a continuous straight line through entire shape is present. If the object experiences a vertical pulling force, the structural integrity of the object becomes solely dependent on the bonding strength between the adjacent segments. Therefore the generated structure has a high strength only in the horizontal direction.

**FIGURE 45**  
Mesh vertical elevation



**FIGURE 44** Mesh axonometry: Strength analyse



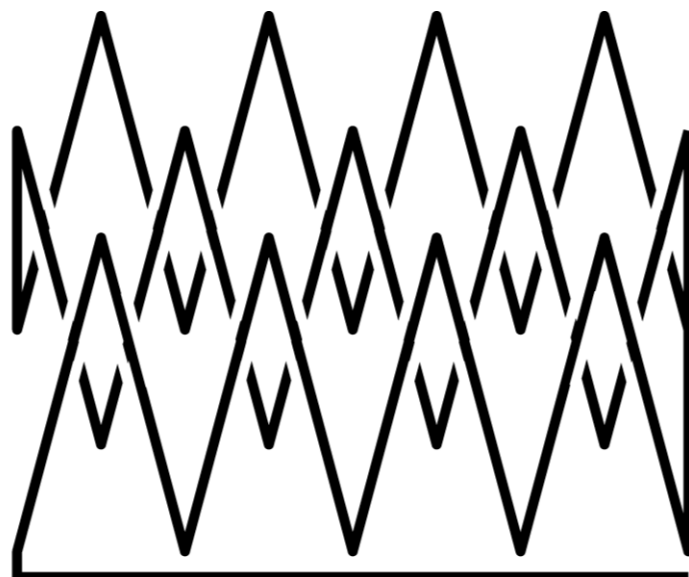


**FIGURE 46**  
Overlapping idea

A way to resolve this problem is by creating overlapping sections in the line. Since concrete is poured into the mesh, the gap between those overlapping elements will be filled. Figure 46 shows how this system works. The concrete in the overlapping gap area, will create an interlocking system that prevents the free movement of the lines across each other. In other words, the concrete will transfer the forces from one part of the line to the other part of the line.

In Figure 47, the idea of a continuous line on a 2D surface is presented. The first thing that can be noticed, is the complexity of it. Designing such a geometry in a 3D space where lines are crossing each other in different planes, will be very challenging. Beside its geometrical complexity, it would also be a challenge for the machine that will print this structure. There is a big chance that a printer head with even 6 axes of movement, will collide with its printed element during the printing process. Therefore it can be concluded that the overlapping system cannot be used as a solution.

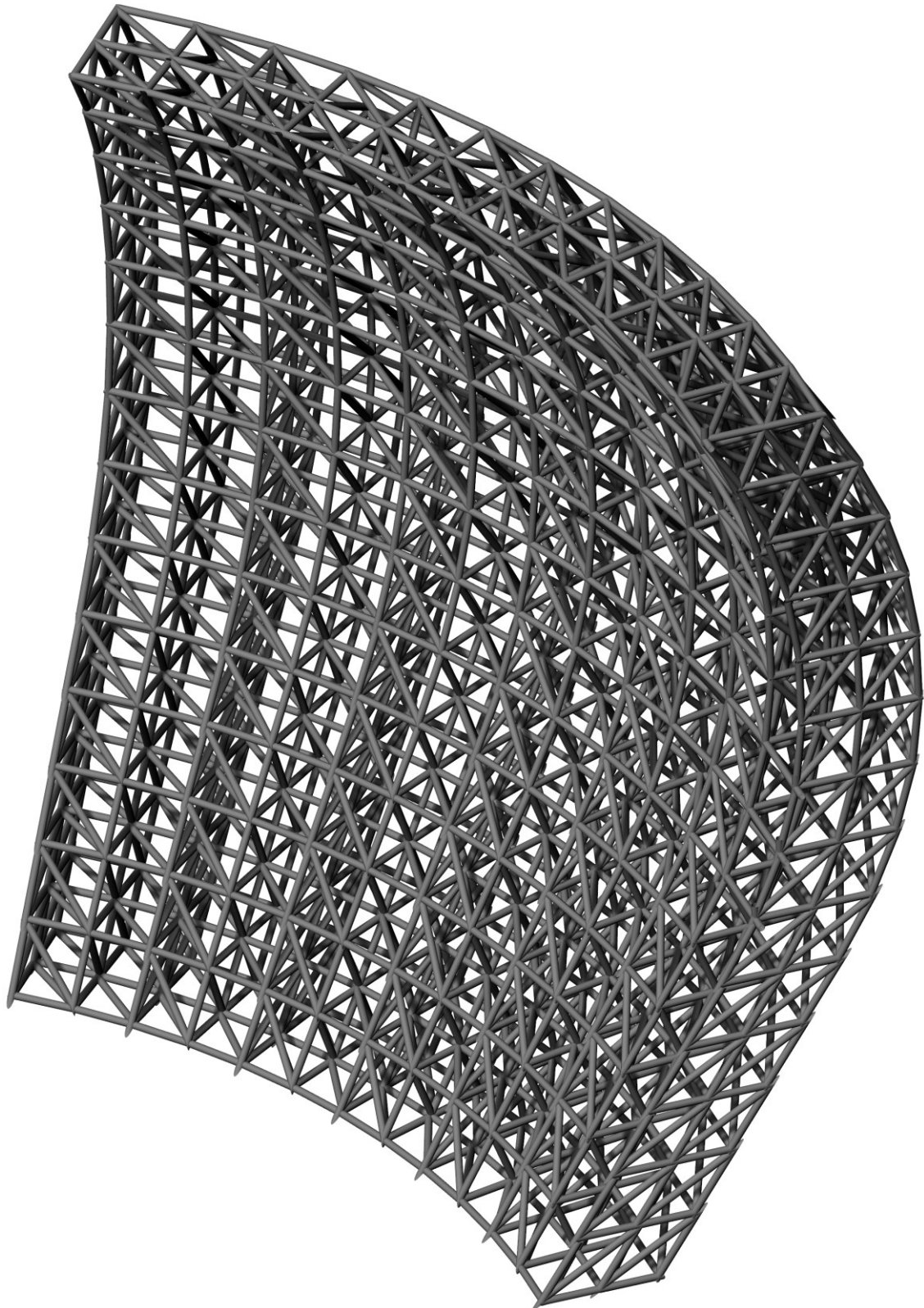
**FIGURE 47** Overlapping mesh





**FIGURE 48** Lattice mesh structure

---



## 2. METAL WELDING

In this section the “metal welding” concept, which was mentioned in section 4.2 will be modified. In section 4.2 and 4.3, the feasibility of this concept was studied. That design was then evaluated based on criteria’s such as time consumption, formwork integration, structural strength and its compatibility with concrete. Since steel is a standard material for concrete reinforcement, there is no doubt about its strength and compatibility. The issues in this concept are mainly production and design related.

### ISSUES

In the steel welding process, the metal needs to reach temperatures of around 1300° C which consumes a great amount of energy. In metal welding concept in section 4.2, the entire reinforcement structure is created out of welding points. Beside the energy consumption, welding takes a long time. In every welding arc only a few millimeters of steel are added. Therefore creating a full-scale structure using this technique can be very time consuming.

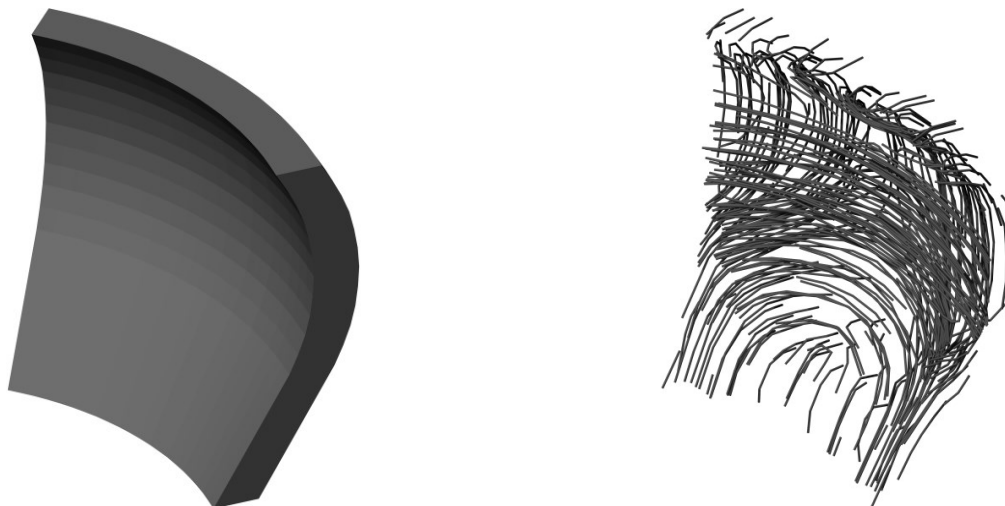
This concept has also design related problems. The reinforcement structure is created based on stress trajectory lines, which will not give the outline of the finale concrete structure. For that reason integrating formwork will not be possible with the current metal welding design. For employing this design these types of issues need to be resolved.

---

**FIGURE 49**

LEFT: concrete object,  
RIGHT: reinforcement structure (section 4.2 design)

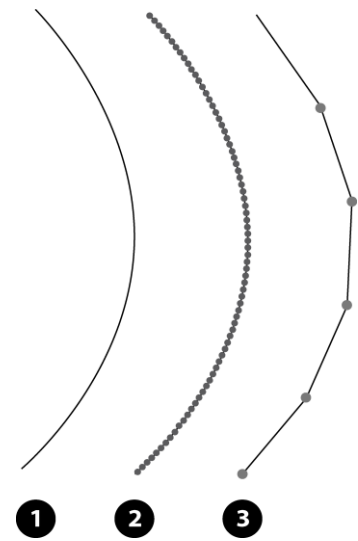
---



**TIME CONSUMPTION**

In Figure 50, three curved lines are illustrated. The first one is a smooth curve that needs to be part of the reinforcement structure. The second one represents the first curve that is produced using the original metal welding concept. The whole curve consists out of a series of welded points. But in the third one, there are only a few welding points. The original curve (first one) is transformed to a segmented polyline where welding only happens at the intersection points.

In this system (third polyline), line segments are chopped rebars and the grey dots are where the rebars are welded together. To create a reinforcement structure using this system, having only a welding robot will not be sufficient and other machines will be needed. Beside the welding robot, a rebar cutting table and a rebar placement robots will also be necessary. This system will need more tools and its design process will be a bit more challenging but in return, there will be a great reduction in time and energy consumption.

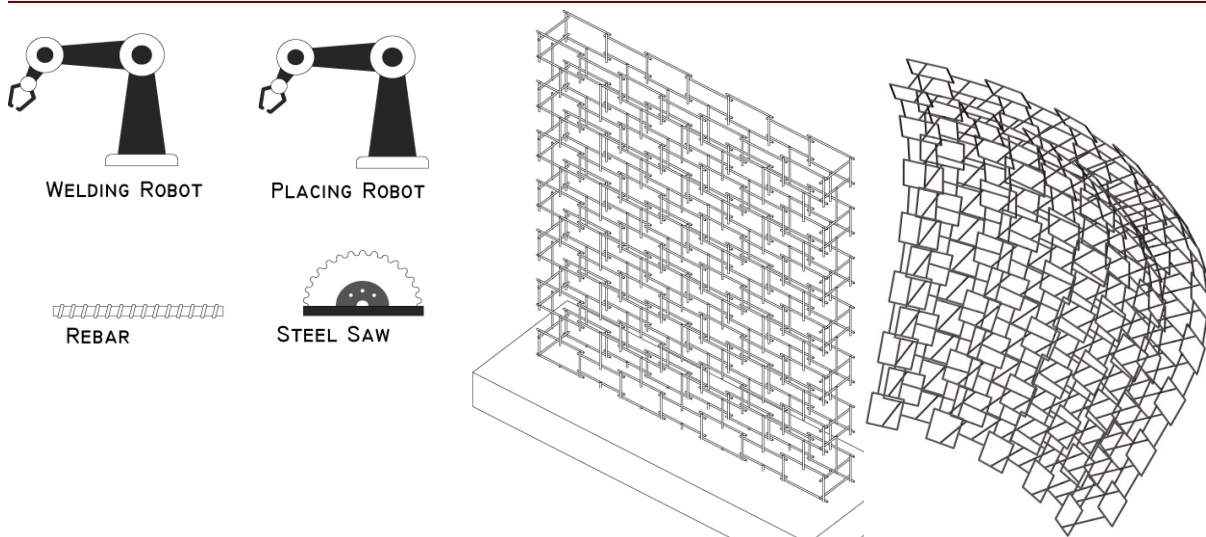


**FIGURE 50**  
Line segmentation of  
reinforcement structure

**FORMWORK INTEGRATION**

In Figure 51, the metal welding concept is transformed into something a bit similar to “lattice mesh structure” concept from section 4.2. By doing so, the transformed concept will have the same benefit of formwork integration as the mesh concept. In this design, the rebar welding system from the previous section will be used and therefore production time issue will be somewhat mitigated.

**FIGURE 51** Steel mesh structure and needed tools





*NEW HYBRID MODIFIED DESIGN*

In Figure 52 a hybrid form the original design and the newly developed design is illustrated. The new steel mesh design has a good capability for formwork integration but similar to the lattice mesh design, it does not have a lot of potential for reinforcement optimization. On the other hand the original metal welding concept had ideal prospects for this type of optimization. If the trajectory stress lines are converted to line segments, this new hybrid design will also handle the time and energy consumption issues in a decent manner.

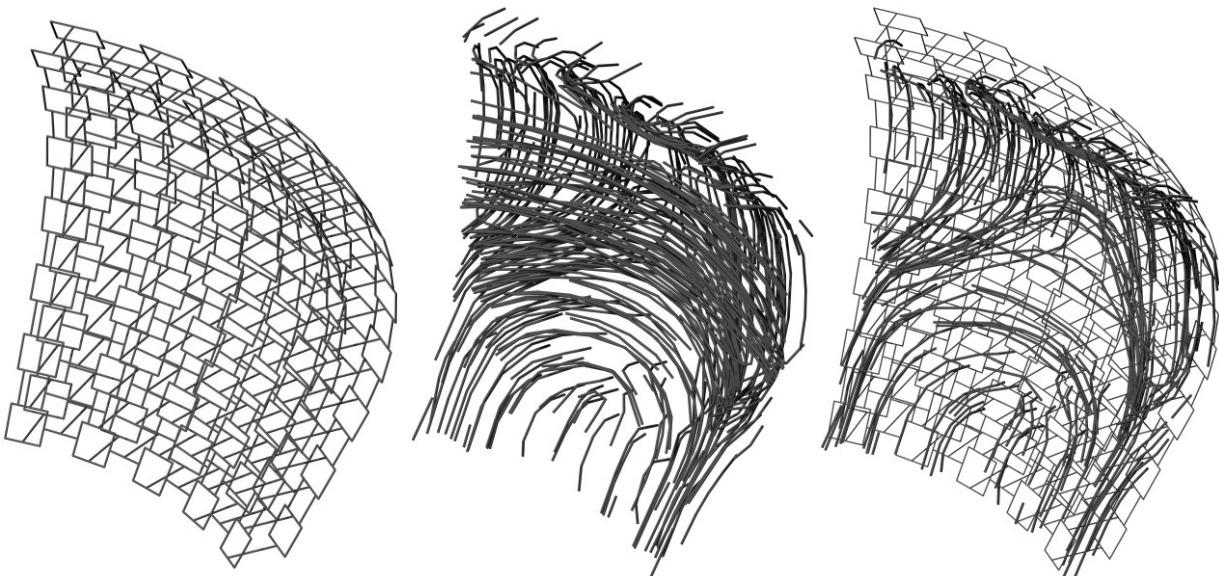
This hybrid design is only a concept and needs to be further developed in the following areas:

1. Optimum mesh pattern
2. Integration of mesh and tensile stress trajectory lines
3. Rebar placement which is suitable for welding machines.
4. Order of chopped rebar placement

---

**FIGURE 52** New hybrid metal welding reinforcement design

---

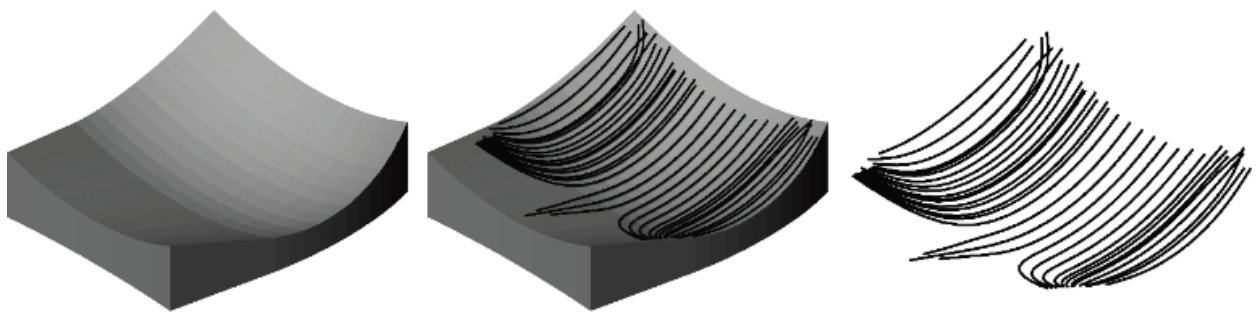




### 3. FIBER BASED REINFORCEMENT

In section 4.2, different systems for using fiber as reinforcement were presented. Most of these systems had one thing in common, they needed some sort of mold. The main problem with using a mold is the fact that it creates an additional expense for the project and increases building waste. Beside cost- and building waste issues, the generated reinforcement structure using this technique will not be able to stand on its own. Additionally integrating a formwork with this type of system is not really feasible.

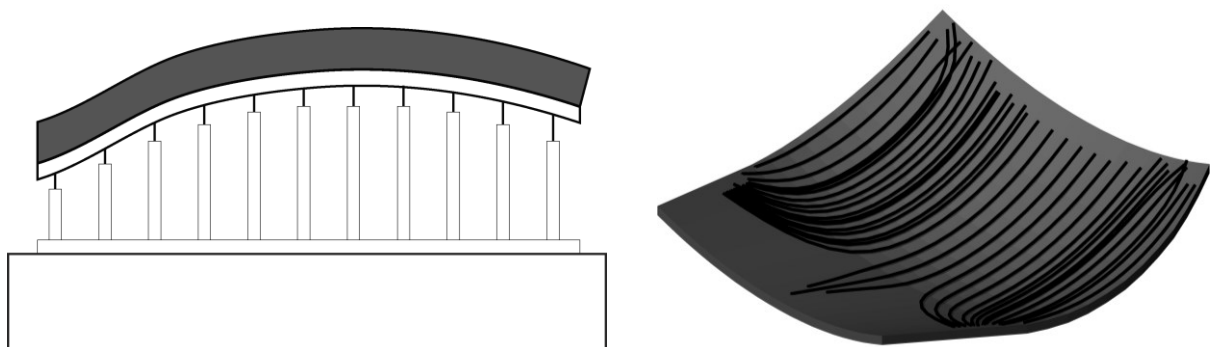
**FIGURE 53** Original fiber placing system



#### *EMBEDDED FORMWORK WITH FIBER REINFORCEMENT*

A way to solve these problems, is to refer to “*Embedded formwork, integrated with reinforcement*” concept in section 0. In that concept, an embedded formwork is integrated into the reinforcement structure (see Figure 54). The embedded formwork that has an exterior cladding, can also be created with a flexible mold (a reusable molding system). Therefore there will be no need for additional mold for fiber placement process and consequently no additional building waste will be created.

**FIGURE 54** Reinforcement integration with an embedded formwork

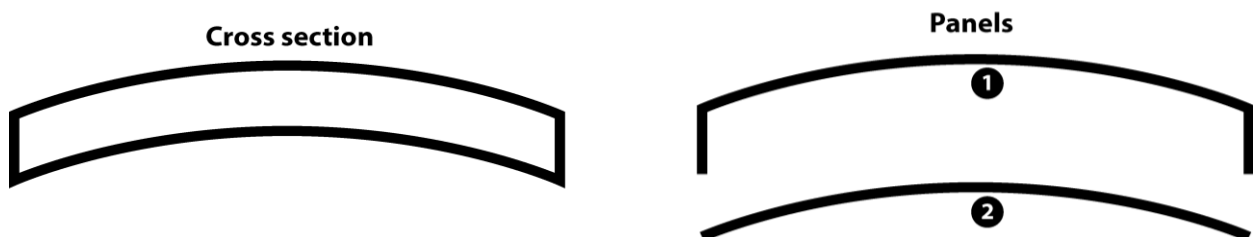


The main problem with this system, is its panel's scale. The flexible mold has to be around 1.5 by 1.5 meters in dimension. Therefore for creating a standard building component, penalization will be needed and the reinforcement structure needs to be divided in to different segments. Even if the structure is under 1.5 by 1.5 dimension, penalization is necessary. For creating an object with the simplest cross-section, at least two panels will be needed to create a semi closed surface (See Figure 55).

---

**FIGURE 55** Simple cross-section

---



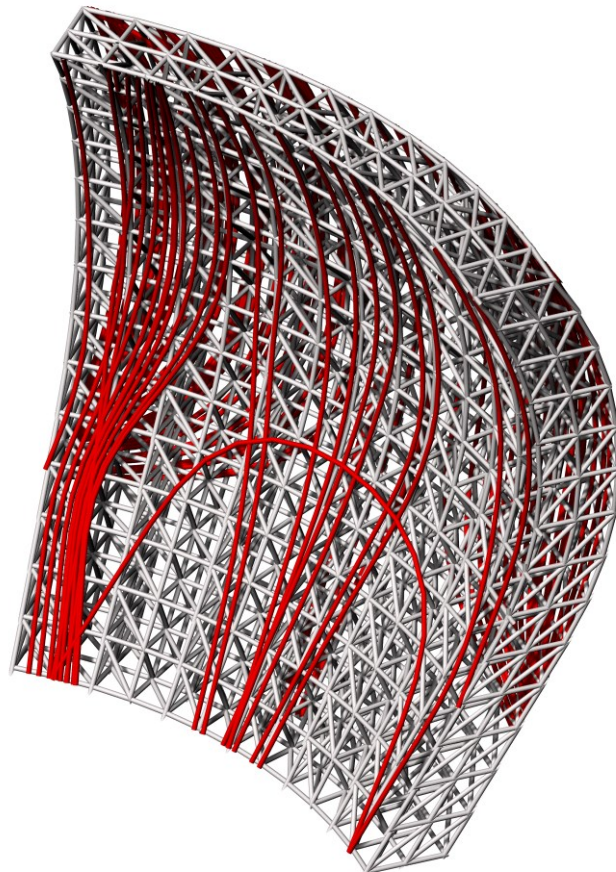
#### 4. FIBER PLACEMENT ON LATTICES MESH STRUCTURE

This design is a combination of “*lattice mesh structure*” and “*fiber based reinforcement*”, which were mentioned in this chapter (Concept 1 and 3 in chapter 4.2). The main problem with the mesh structure, was its an-isotropic structural strength. The created mesh does not have an equal tensile strength in all directions and this problem was not solvable by geometrical modification of the mesh.

In the new proposed concept, for solving this problem, continuous fibers are placed on the outer surface of the mesh (see Figure 56). These fibers are placed in a direction where the mesh structure is weak and incapable of handling tensile forces. The fiber placing technique for this design is similar to “*concept F*” in section 4.2. At the intersection points between the fibers and the mesh structure, they are knitted or glued together.

In Figure 56, this system is illustrated for a simple freeform concrete structural object. The weak axis of the mesh structure is in

**FIGURE 56 FIBER PLACED ON LATTICE STRUCTURE**



the vertical direction which is reinforced by the external fibers. In these fibers beside their vertical orientation they also follow the same path of tensile stress trajectory lines. Therefore this system also offers a reinforcement system that can be optimized.

#### **4.5 EVALUATION AND CONCLUSION**

---

In chapter 4, the author tried to investigate and design new systems and concepts for concrete reinforcement. This investigation was structured based on different stages.

In the initial stage, different possible ways for assembly and production of concrete structure, regarding the formwork and reinforcement structure were studied. In the second stage, conceptual ideas for reinforcement structure based on available digital manufacturing techniques were developed. These ideas which were more defined by their manufacturing system, got tested for their suitability and compatibility to be used as a concrete reinforcement. In the final stage, with the knowledge from the previous sections, the reinforcement concepts were modified, redesigned and combined to create a better system.

This chapter has created, two good solutions for concrete reinforcement; (see Figure 57)

1. Hybrid steel welded mesh system
2. Lattice mesh structure combined with the fiber placing technique

Both of these system have their own potentials and deserve a chance to be further developed. However due to time limitation only one of these concepts is further developed by the author. The selected concept is the second system "lattice structure mesh" because it has more potential for new innovations.

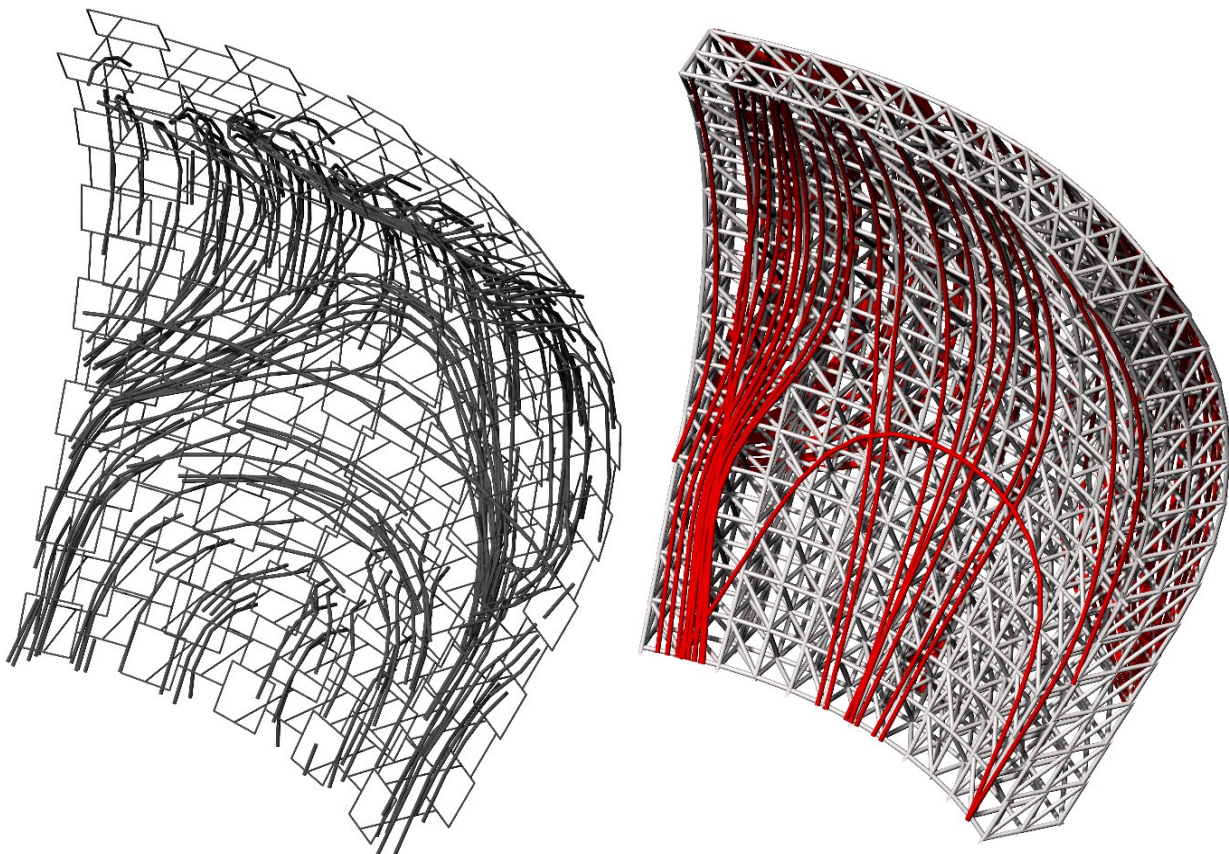
The purpose of showing all of these stages in detail were to make the reader aware of the process that this research paper has taken. In this process, different concepts and systems were developed. Due to time constrains only one of these designs can be further developed, presenting the other ideas will give them an oppor-

tunity to be developed by other researchers. After all the main purpose of this paper was to stimulate more research in the field of digital manufacturing of concrete reinforcement.

**FIGURE 57**

Left: System 1 – Hybrid steel welded mesh

Right: System 2 – Lattice mesh structure combined with fiber placing





# 5 • Design



## 5 DESIGN

### 5.1 DESIGN DESCRIPTION

In the previous sections it was decided, to continue this research with further development of the new modified lattice mesh concept. This concept consist from combination of two different elements (See Table 22);

**Element A** – Fiber reinforced thermoplastic lattice mesh structure

**Element B** – Continuous fiber which is placed on the outer surface of the mesh structure with a quick fixing mechanism (i.e. knitting)

**TABLE 22** Description of fundamental elements of design

<b>Element A – Fiber reinforced thermoplastic lattice mesh core</b>	
<b>Geometrical character</b>	3D freeform mesh; <i>Self-standing structure</i>
<b>Material</b>	Reinforced Thermoplastic; <i>PPC or ABS</i>
<b>Supplementary material</b>	Continuous fiber; <i>Carbon fiber Very high modulus</i>
<b>Manufacturing technique</b>	FDM; <i>standard 3D printer setup or a robotic arm</i>
<b>Reinforcement</b>	Complementary reinforcement system in horizontal plane
<b>Element B – Continuous fiber placement</b>	
<b>Geometrical character</b>	2D surface freeform mesh; <i>Need support to be hold in place</i>
<b>Supplementary geometry</b>	Mold; <i>Element A lattice mesh</i>
<b>Material</b>	Continuous Fiber; <i>Carbon fiber Very high modulus or</i>
<b>Manufacturing technique</b>	Fiber placement; <i>Robotic arm (knitting technology)</i>
<b>Reinforcement</b>	Main element for reinforcement that can be optimized

As it was mentioned several time the main goal of this research paper, was to design an innovative system for digital manufacturing of reinforcement elements in a freeform load-bearing concrete structure. This structure should additionally have the capability of being optimized. In this concept, both elements have the capability of being used as reinforcements, but only the continuous fiber on the outer surface (**Element B**) have a good capability for reinforcement optimization and therefore this element will be mainly used for reinforcement purposes.



### 5.1.1 PREDICTING PROBABLE PROBLEMS AND ITS CONSEQUENCES ON THE DESIGN

With the mesh structure element **(A)** of this design, there is an uncertainty that can only be resolved by many experiments and trial and error. As it was mentioned before, it is necessary to upgrade the structural strength of the thermoplastic filaments. The proposed idea was to add a continuous fiber as reinforcements, which can upgrade this material tensile strength (See chapter 4.4, Page 87).

The idea of mixing continuous fibers with filament is something new, which has only been studied by few researchers. They had only tested this system for 3D printing a solid object that consists of horizontal lines. For that reason there is no assurance that this system can be used for printing a mesh structure that consists of vertical and diagonal lines. This assurance can only be given by testing this system during the prototyping process. Since the continuous fibers on the outer surface **(Element B)** are mainly handling reinforcements, a failure in integration of fibers with thermoplastic will not have a great impact.

If fibers cannot be integrated in the mesh, then the thickness and path of the fibers on the outer surface need to get modified. Furthermore, this mesh has other crucial functionalities in this design. It functions as an embedded mold for fiber placement stage **(Element B)** that also holds them in their place during the assembly stage. Additionally, having this mesh structure also gives the design the capability to avoid using traditional formwork.

### 5.1.2 DEFINING FOCUS POINTS

Till now, this project was focusing more on refining and designing different concepts for a reinforcement system. Now that a concept is chosen, the focus will shift from a conceptual to a more detailed level. To start this stage, parts that needs to be developed, will be defined and categorized. In Figure 58, an overall scheme of the final reinforcement design is illustrated. The points that are tagged in this diagram, are the parts that need to be further developed. In Table 23 these point with a short explanation is listed;

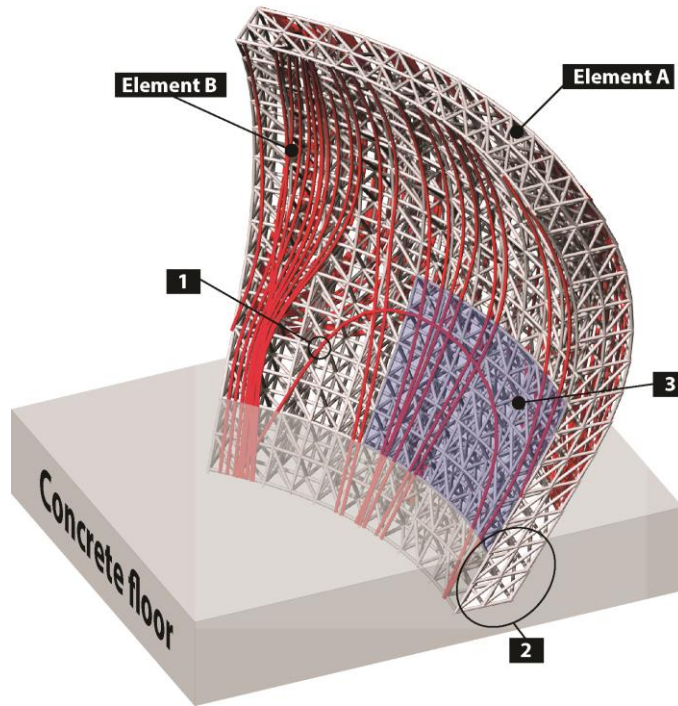
**TABLE 23** Focus points of the design

<b>Part 1. Element A – mesh structure</b>
Design of the geometrical shape of the mesh
Giving thickness to mesh lines and its consequences
<b>Part 2. Element B – outer fibers</b>
Path of the fibers
<b>Part 3. Connection of fibers (element B) and mesh (element A)</b>
Connection of the outer fibers (reinforcing elements) with the mesh structure
<b>Part 4. Formwork layer</b>
What system will be used for formwork?
<b>Part 5. Connection of the designed reinforcement (element B) with conventional system</b>
Connection of the new reinforcement system to standard reinforced concrete

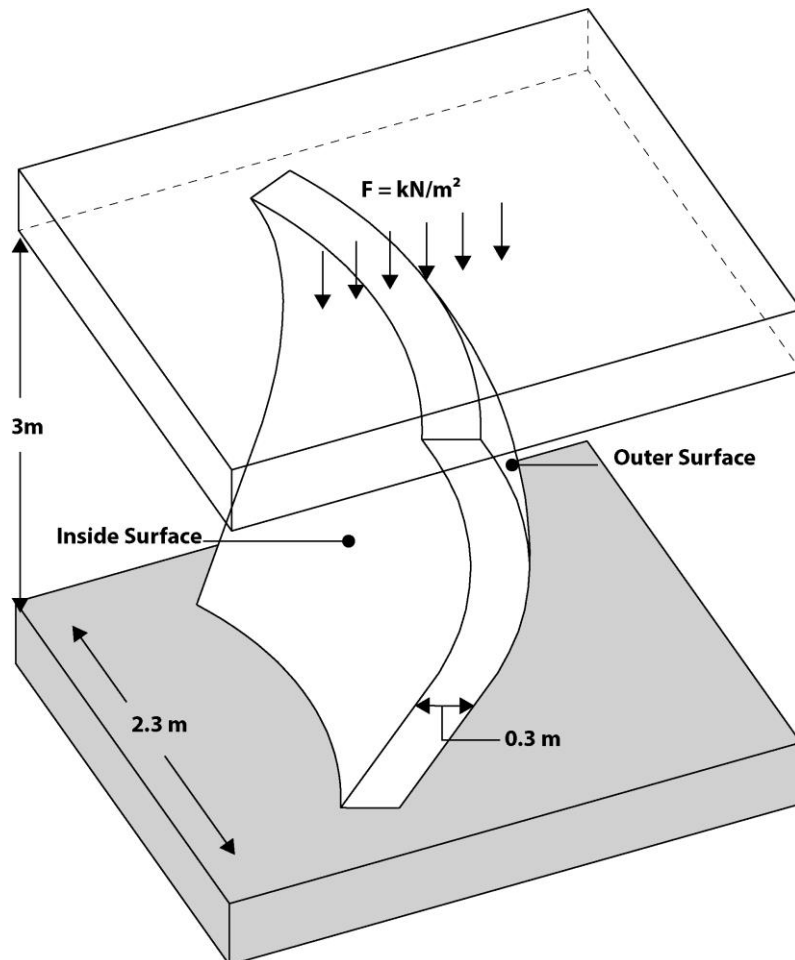
### 5.1.3 DEFINING GEOMETRY

Last thing but not least, its import to define a geometry. A geometry that the developed reinforcement system can be applied on. This system is intended for the reinforcement structure of complex, double curved freeform concrete object that conventional reinforcement system are not really suitable for them. In Figure 59, the shape and the context of this geometry is illustrated. This concrete structure is around 3 meter high, 2.3 meter wide and have a thickness of 0.3 meter. It is also anchored from top and bottom to a floor structure and is carrying the load of the top floor.

**FIGURE 58** Focus points



**FIGURE 59** The concrete load-bearing structure



## 5.2 PART 1. MESH STRUCTURE CORE (ELEMENT A)

In chapter 5.1.1, it was predicted that printing the mesh structure with continuous fiber might not be possible with the existing technology. But that does not mean, integrating carbon fiber in the mesh is totally impossible. It will eventually be possible with invention of a new system that might not fit in the time frame of this project. Regardless of the fiber integration and its reinforcement abilities, the mesh structure is a multifunctional element that create the core of this concept.

From the studies and analysis in previous chapters certain characters and specifications of this element were defined. A summary of the previous research is listed in Table 24.

**TABLE 24** Summary of mesh structure information from previous chapters

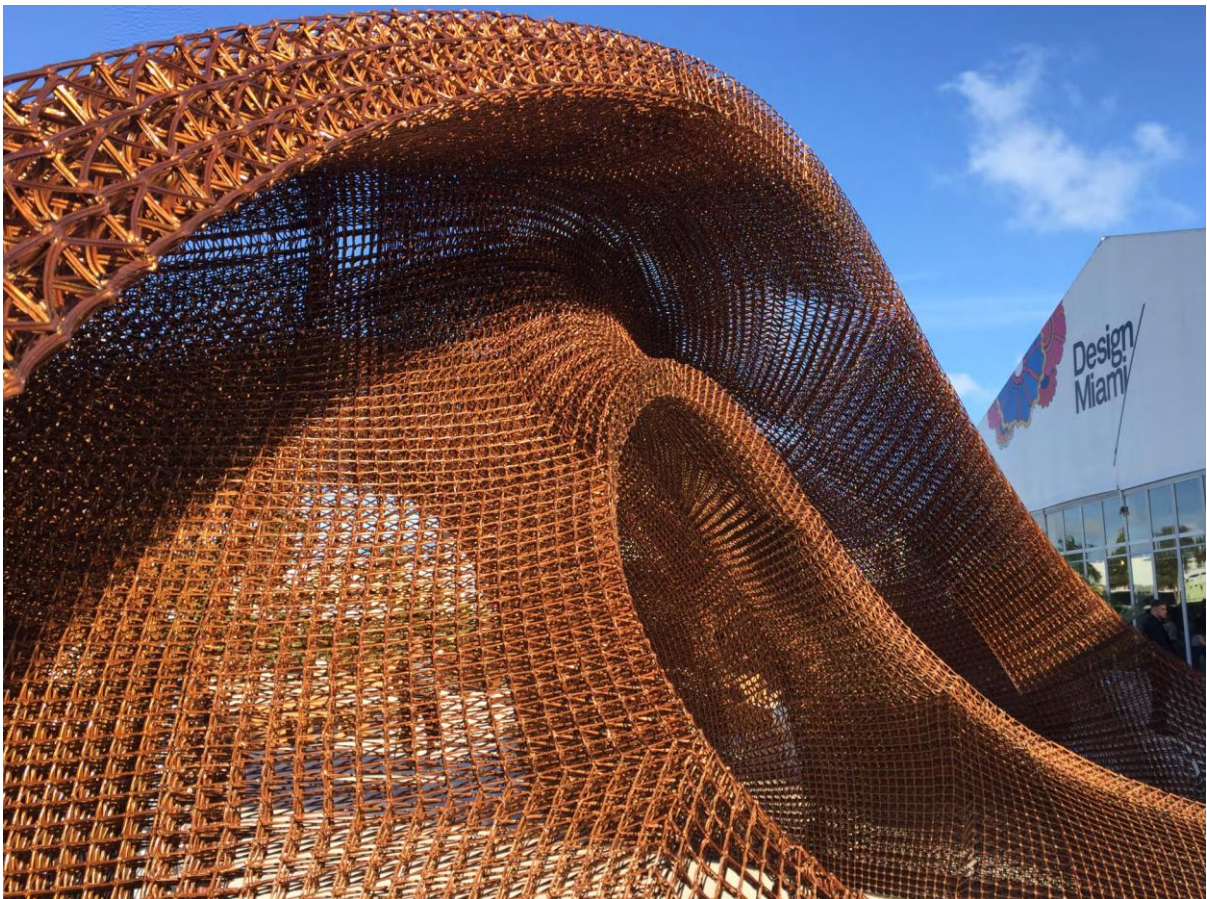
<b>Material</b>	Reinforced Thermoplastic; <i>PPC or ABS</i>
<b>Manufacturing technique</b>	FDM; <i>standard 3D printer setup or a robotic arm</i>

According to case study of Branch Technology, it's possible to create a mesh structure by using a line based FDM technology. This company use a FDM technology adopted on a robotic arm to create their structures. In their approach, their structure is created from a non-continuous lines and till now, it's not been integrated in concrete. The main difference in this project approach, is the continuity of lines and its integration with concrete. For integration purposes, a material is chosen that is compatible with high alkali material such as concrete. And for continuity the mesh is designed in a way that it can be created form one continuous line.

Now that a fixed boundary frame is defined for the mesh structure, focus should be shifted to more manufacturing and detailing process.

**FIGURE 60** Branch Technology pavilion for Miami design week

(C. Clarke, 2017)



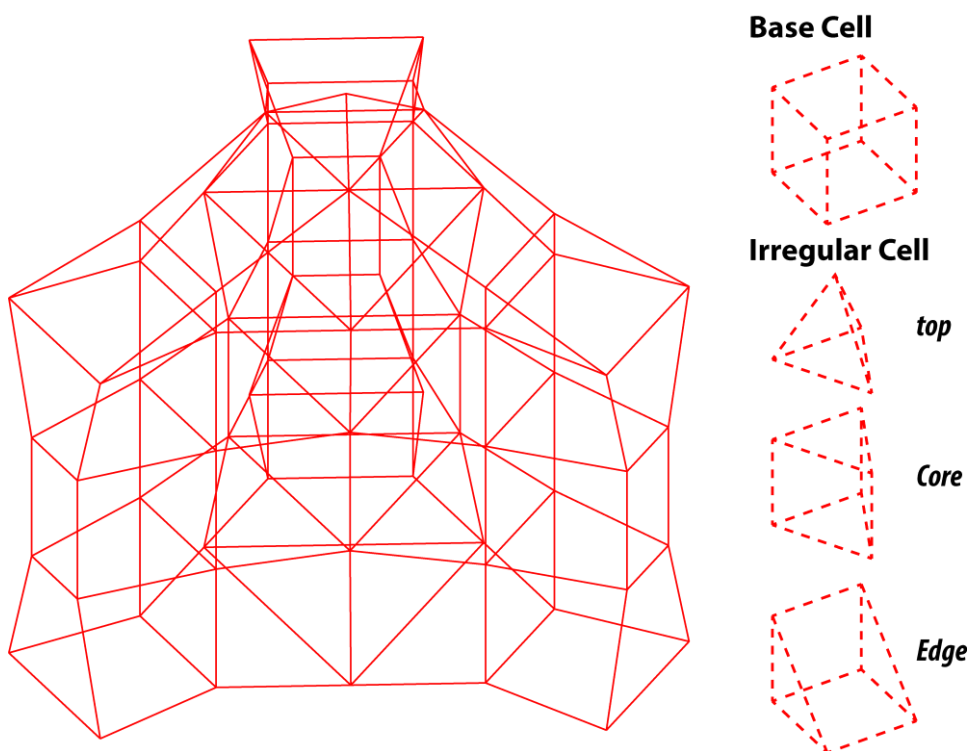


### 5.2.1 DEFINING THE INITIAL MESH DESIGN

#### MESH SYSTEM

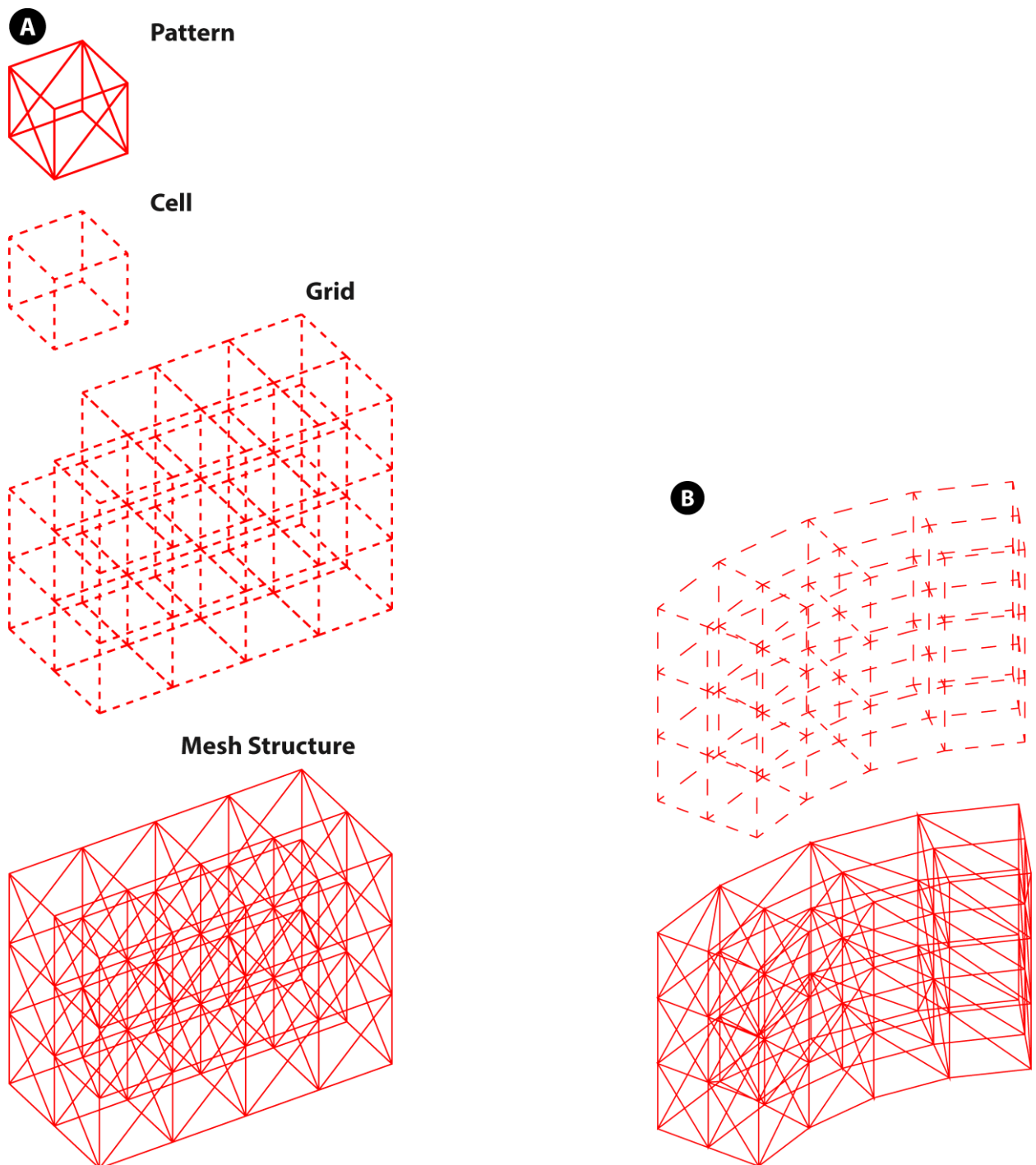
In this section, the focus will be on the design aspect of the mesh structure. How should such a structure look like? This structure does not have a solid or a plane structure, but it's more a lattice kind of a structure, something similar to a space frame. In these type of object a given line structure pattern is created in a cell which is repeated in a defined grid. Figure 62 shows how this system work for a simple geometry. But this system is not limited only to simple geometries. As long as the form can be transformed into a grid, this system can be applied to it; those cells need to get scaled and deformed to fit on the given grid. But when a shape complexity increases, single cell grid structure will not always be sufficient. For these type of shapes a grid with multiple cell types is necessary that have a unique pattern for each cell type. A simplified example of these types of grids, is illustrated in Figure 61 that have 4 types of cells. These additional cell are used only for the sharp edges and in the regions where different parts of grid are connected together. In those parts, the standard cells cannot be fitted into the grid.

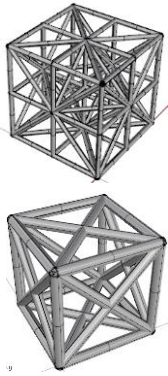
**FIGURE 61** Multi cells grid



The intent of these examples, are to show that any shape with different types of geometry can be design using a mesh structure system. Of course the given example are very basic but that is mainly for illustration and concept clarity purposes.

**FIGURE 62** Single cell grid





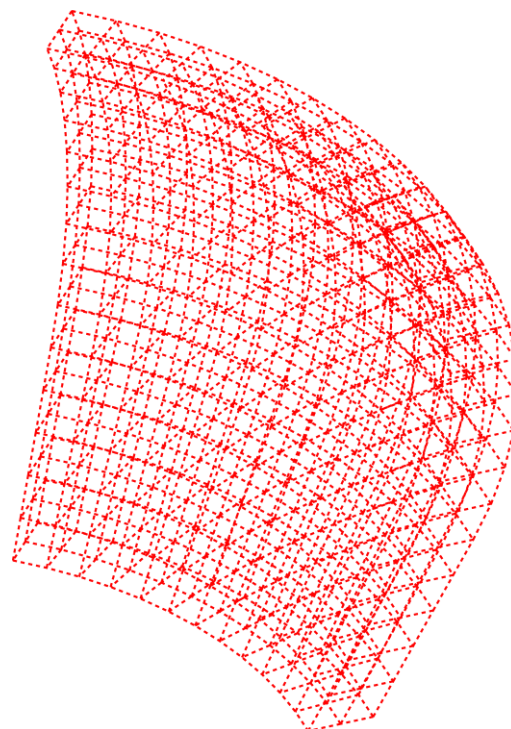
**FIGURE 63**  
 Pattern 1 and 3 from  
 Appendix **Error! Reference**

**MESH PATTERN**

In Appendix Error! Reference source not found., several pattern were designed and tested based on their structural strength and stress distribution. The first and third pattern, seemed to be more capable in most of aspects (See Figure 63). But these assessments are not necessary fully accurate. First of all depending on their pattern, number of elements that were used for support, differed in each variation. Since the manufacturing process of these element were not developed, the way and the order that these elements are stacked on each other were not defined. These type of aspect will also have a crucial impact on the way which forces get distributed element junction points. And last but not least, not all these types of pattern can be printed in one continuous line.

The first step for designing any mesh, is to define its grid (See Figure 64). Since the chosen freeform geometry does not have a very complex shape, a standard single based grid will be sufficient. That means, only one pattern for the generated cells have to be designed. Since the outer fibers are mainly handling reinforcement purposes of this structure and they are designed in a way to be optimized, structural optimization of these mesh structure is not really essential. Therefore, due to the mentioned reason and lack

**FIGURE 64** Mesh grid for the designed structure

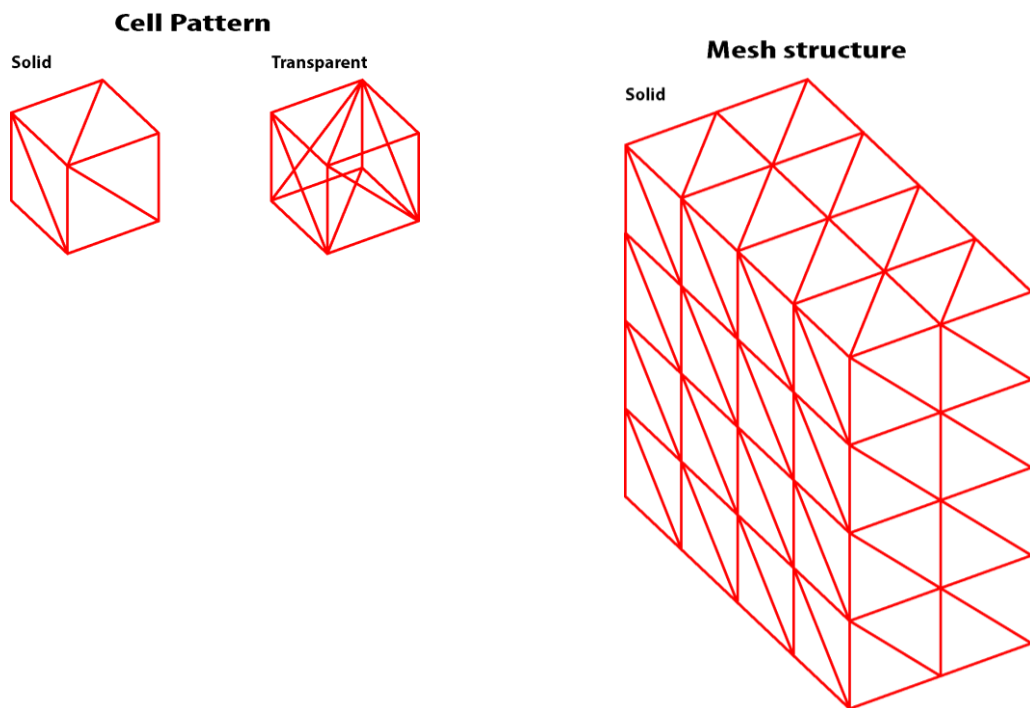


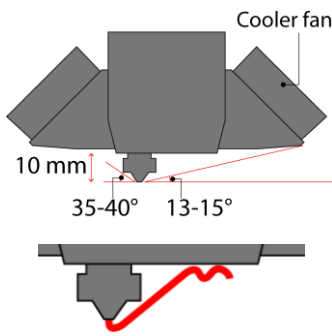


of available time for this project, structural efficiency of these element were not further studied. That designed pattern for this structure is something similar to the chosen pattern from Appendix Error! Reference source not found. (See Figure 65).

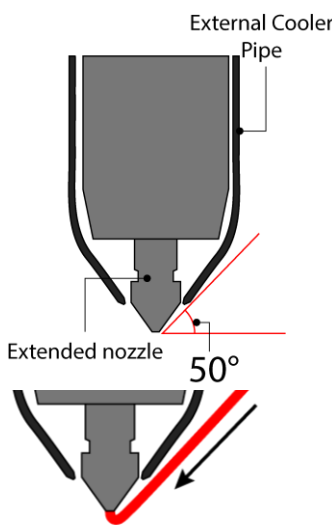
The next step for this mesh is to check its feasibility to be printed with a continuous line by a FDM system. FDM system can be mainly used in two ways; A 3d printer setup with 3 axis movement or a robotic arm with 6 axis for movement. Since this project have preference for simple and more accessible technologies, a 3D printed setting will be used form the FDM system. Additionally a mesh that is designed based on 3 axis 3D printer, can also be produced by a robotic arm.

**FIGURE 65** Pattern for the design structure

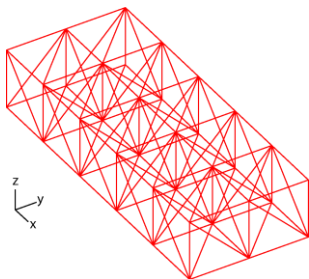




**FIGURE 66**  
Ultimaker 2 printer head



**FIGURE 67**  
Modified printer head



**FIGURE 68**  
Designed mesh pattern

### 5.2.2 MODIFYING MESH BASED ON PRODUCTION AND GEOMETRICAL LIMITATION

Using a 3D printer for creating sliced objects is a very simple task but when a mesh structure wants to be produced by it, it's not that simple anymore.

#### DOWNWARD PRINTING

Downward extruding can be one of the limitation which is caused by 3d printer. For example a simple vertical line can be printed from bottom to top. But when the same line wants to be printed from top to bottom, due to collision of the extruded element with the printer head, it will be impossible. Consequently it can be concluded that downward printing of vertical lines is a limitation. Nevertheless printing diagonal lines in downward direct can be possible in some cases. The boundary angle for downward printing of diagonals lines, depends directly on the printer head setup.

In Figure 66 the printer head of Ultimaker printer is illustrated. As this diagram shows, the nozzle edge is approximately 40° degree. Therefore this nozzle should be able to print a diagonal line with an angle of 40° degree. Since the distance between the nozzle and its top parts is around 1 cm, in downward printing no diagonal lines above this dimension can be printed.

This problem can partially be solved by simple and affordable tweaks. In Figure 67, the previous printer head is adjusted and few of its parts are replaced by a new ones;

1. Extended nozzle with sharper edge
2. Piped cooling system

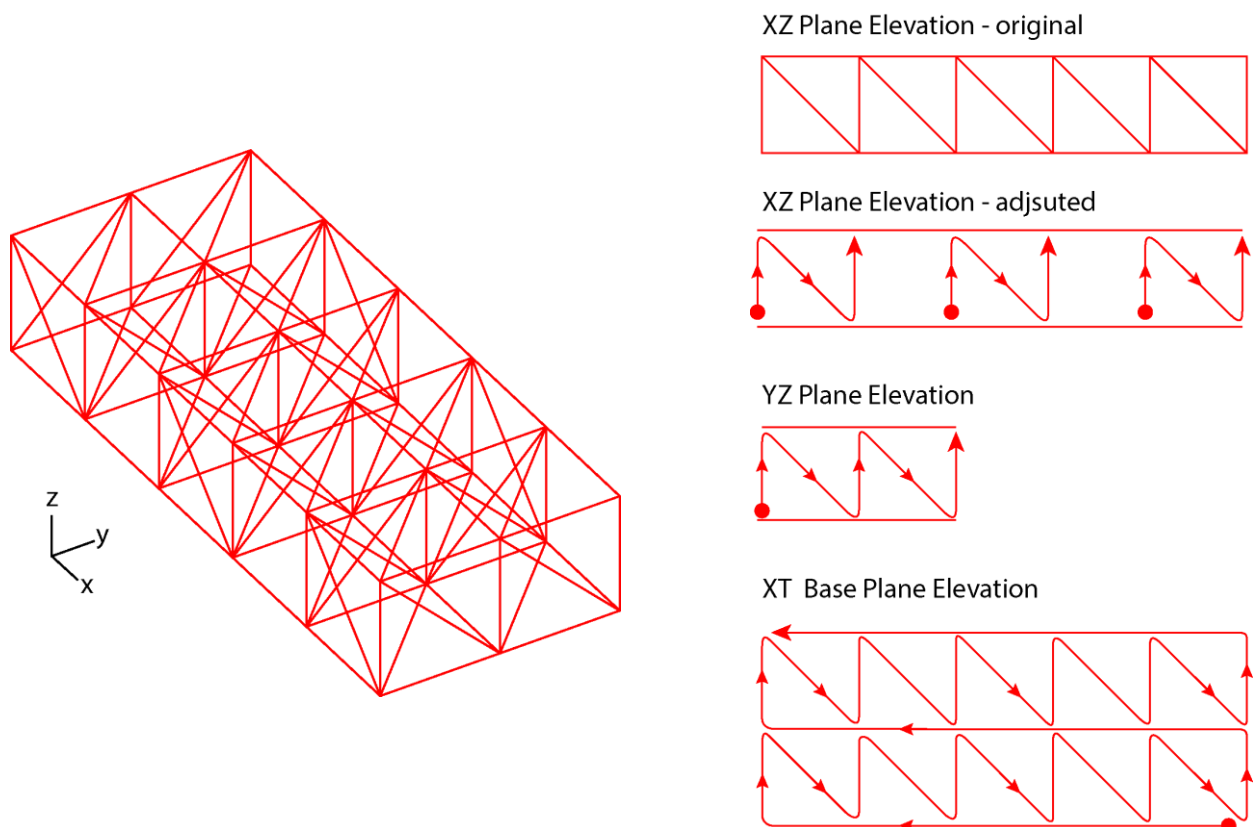
After these type of adjustment, a 3D printer can be capable of printing a downward diagonal line with an angle of 50° degree. For a FDM system with a standard 3D printer setup, this 50° degree angle is a limit. But this limitation is not valid for a 6 axis robotic arm. If a designer wants to create a mesh with lots of sharp diagonal lines, it's advisable to switch to a robotic arm FDM system.

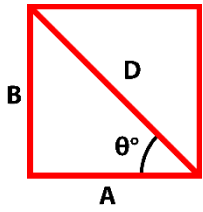
**TRANSFORMING THE DESIGNED MESH TO A CONTINUOUS CURVE**

Now that the mesh pattern is defined, this structure should be converted into a single continuous line. This continuity is important for integration of carbon fibers in ABS extruded lines.

To achieve this continuity, few changes were necessary. In the original design, this mesh was based on one cell typology with a single repetitive pattern. But in the adjusted design, that mesh was generated by 4 different types of pattern (See Figure 71). To get a better overview of continuity of this mesh, Figure 69 shows how the extruding path and direction for each elevations.

**FIGURE 69** Continuous line created mesh - elevations





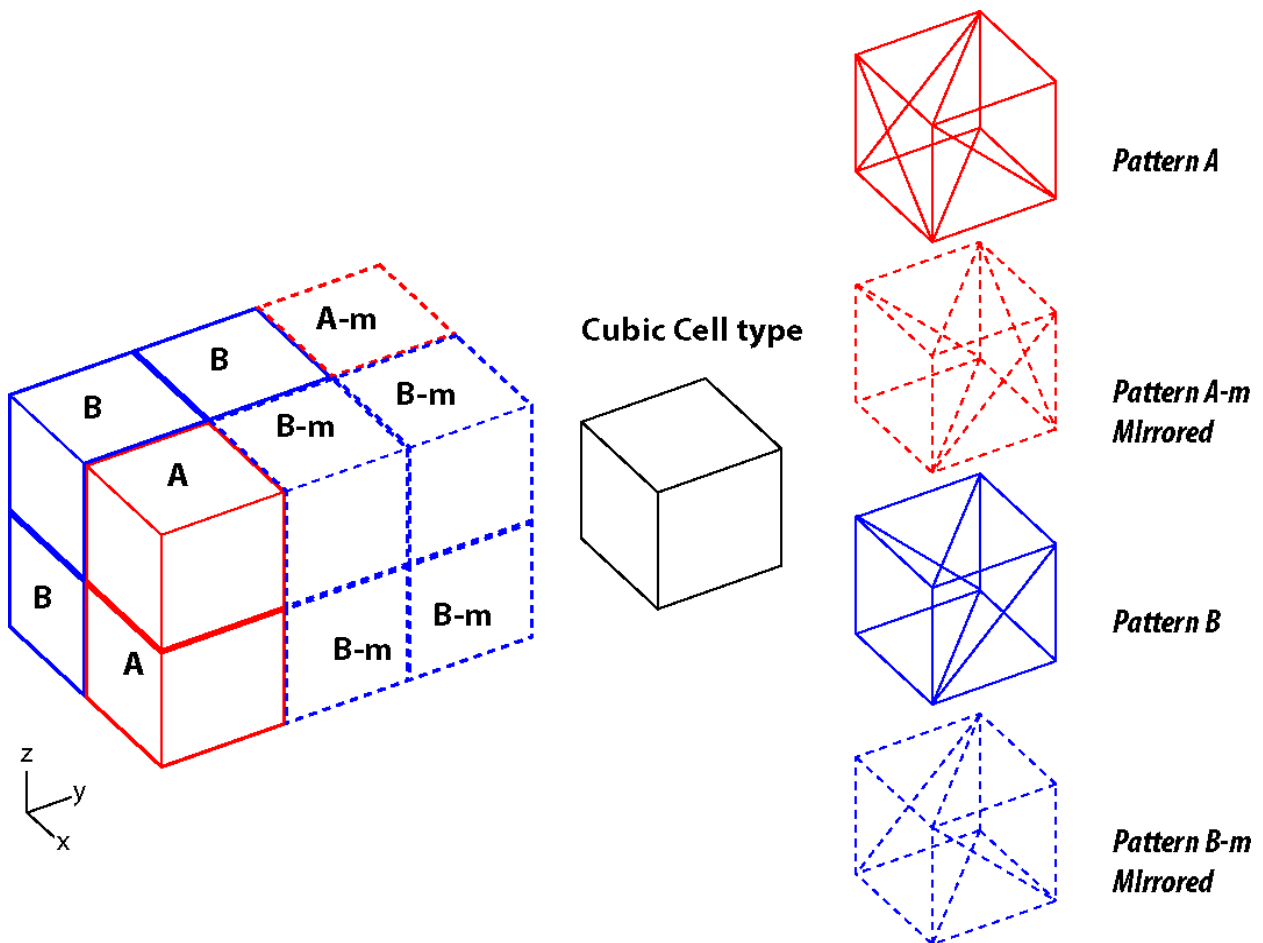
**FIGURE 70**  
Cell aspect ratio and diagonal line angel

With this system, any given shape that can be transformed into a cubic grid, can be generated in mesh structure. Nevertheless there are few rules that should be followed in the mesh generation;

1. The number of cells in X direction should be an even number and be bigger or equal to 2.  
 $nr\ X\ cells_{i \geq 1} = 2 \times i$
2. The only downward extruded elements in this structure, are the diagonal lines (D) in the pattern. The angle  $\theta^\circ$  should be than  $50^\circ$  which mean the aspect ratio of cells (B/A) should approximately be smaller than one (Refer to Figure 70).

$$B/A \leq 1$$

**FIGURE 71** Mesh cell patterns



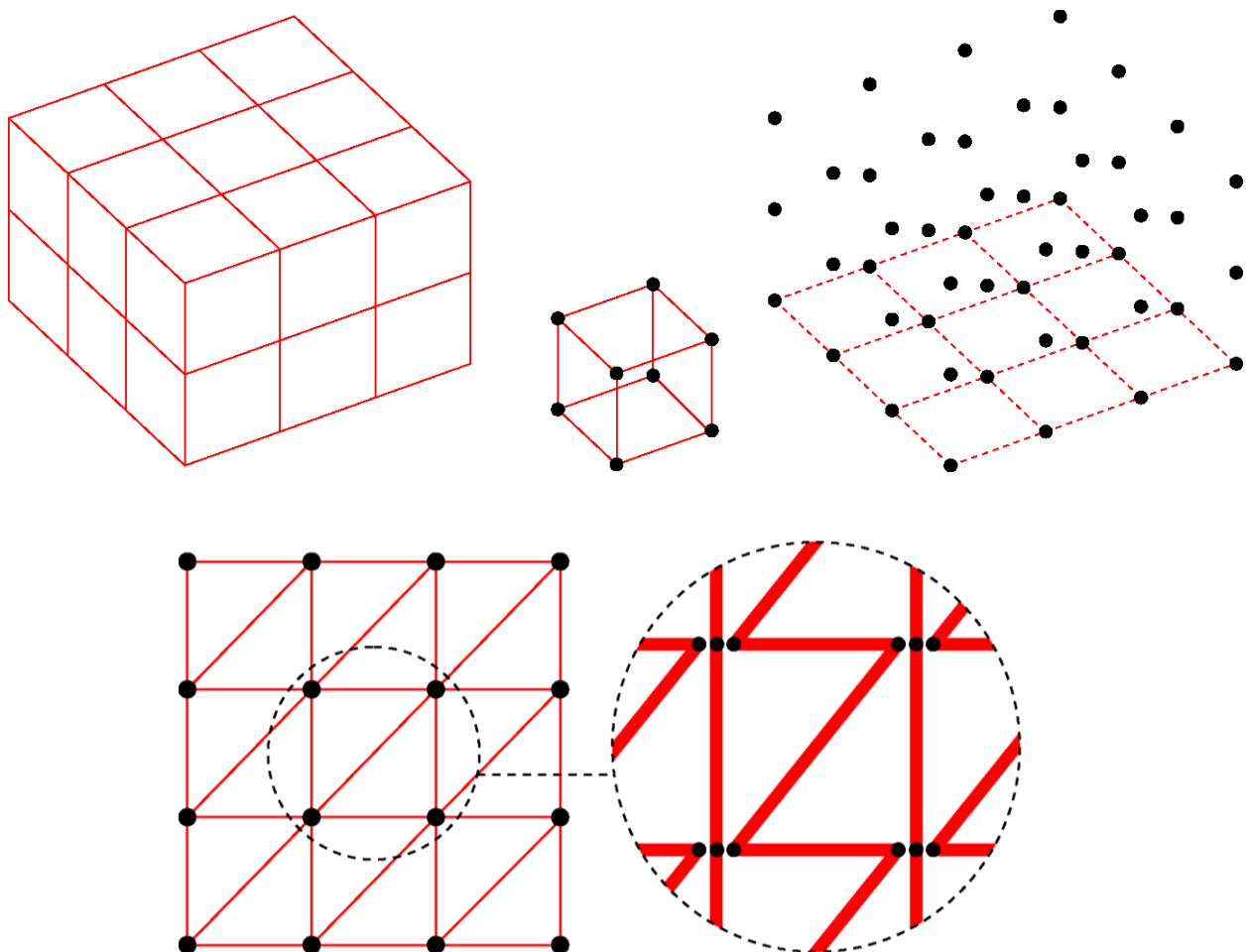
### GEOMETRICAL DETAILING

When this type structures want to be manufactured, every little details will make a difference. To design such a mesh in a computer program, the generated grid should be transformed to a point cloud. Then the desired patterns will be generated by connecting those points with lines. Since the computer generated lines does not have a thickness, intersection details can easily be neglected and get executed in a wrong manner.

#### *COLLISION AND LINE THICKNESS*

Figure 72 shows the process of, how a layer of the grid get transformed to a mesh layer. As these diagrams show, connecting the lines only through the grid generated points are not sufficient and for each line segment these point should slightly get adjusted. These type of adjustments are an offset based on line thickness that will eventually avoid the collision of the extruded segments.

**FIGURE 72** Mesh to point cloud and intersection detail



*OVERLAPPING SUPPORT*

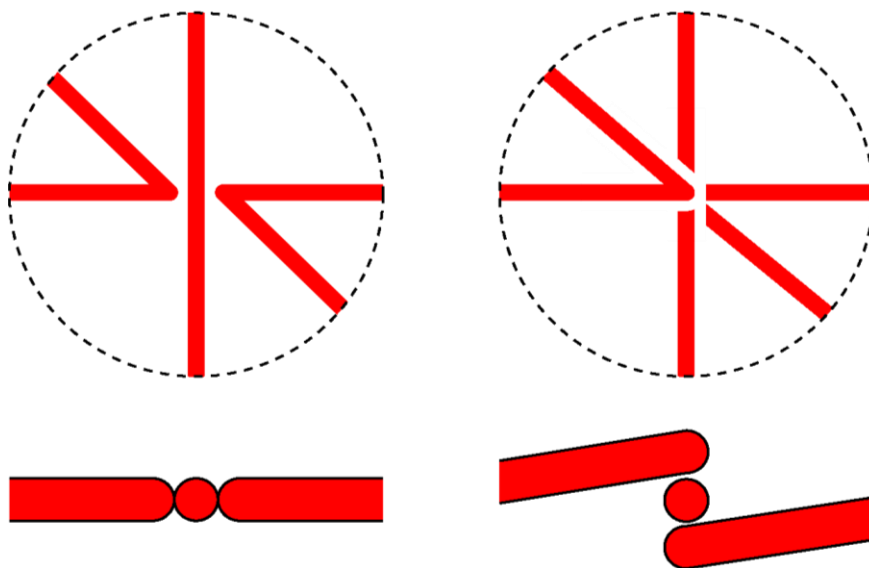
In this design, the FDM system is extruding and generating lines on air; something similar to a cantilevering beam. In theory those lines do not need additional support as long as they are connected to ground. But in reality, additional supports are necessary in every interstation where line segments get connected together.

Line segments that are printed in vertical planes, the current mesh composition provide them with supports and no further modification is necessary for that purpose. But for horizontal line segments, there is no support in the current design and a modification is necessary. This type of supports can be provided by an overlapping mechanism (See Figure 73).

---

**FIGURE 73** Overlapping support system

---



### 5.2.3 CARBON FIBER INTEGRATION

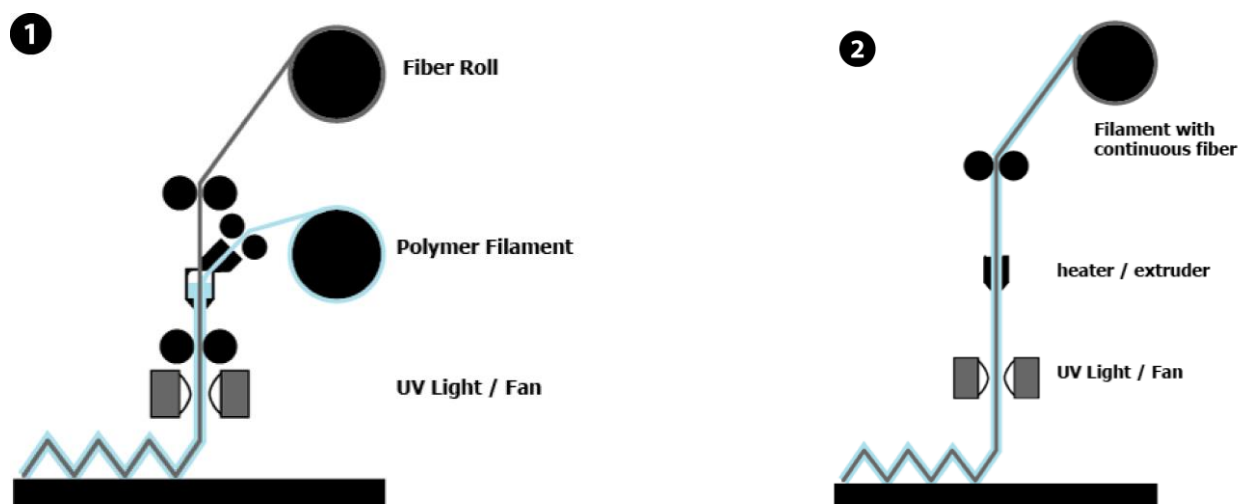
As it was mentioned in chapter 5.1.1, integrating fiber with thermoplastic material for printing mesh structure have never been tested before. The reliability of this system can only be validated by prototyping and in some cases by developing new printing system. For that reason this topic will be discussed more in the prototyping chapter.

#### PURPOSED FIBER INTEGRATION SYSTEM

In this research paper two system have been designed for fiber integration;

1. The continuous fiber will get mixed with filament while the FDM machine is extruding the geometry.
2. In this system, integration will be done in advance. A continuous fiber embedded filament, will get manufactured in a factory enjoyment. Then that filament will be used in a FDM system, to extrude structure with a continuous fibers.

**FIGURE 74** Purposed fiber integration system



**PREDICTED CRITERIA**

When continuous fibers get added to mesh structure, it can create new set of restrictions. The generate criteria can also be influenced by the chosen fiber integration system (the ones that were mentioned above). Therefore these criteria should be rephrased after the prototyping stage. However some criteria can be well predicted in the design stage.

**INSTANT COOLING**

When a line element get extruded from a FDM system, its temperature is somewhere near its melting point. Without cooling it might take around a minute to get fully solidified. Since in the mesh structure the extruded parts are semi floating on the air, they will get slightly deformed due to their own weight. For that reason there is a very high chance for continuous fibers to get displaced out of those elements. Therefore an instant cooling after extrusion is necessary. Also those elements should get extrude in a speed that an instant solidification is possible.

**ROUNDED EDGES**

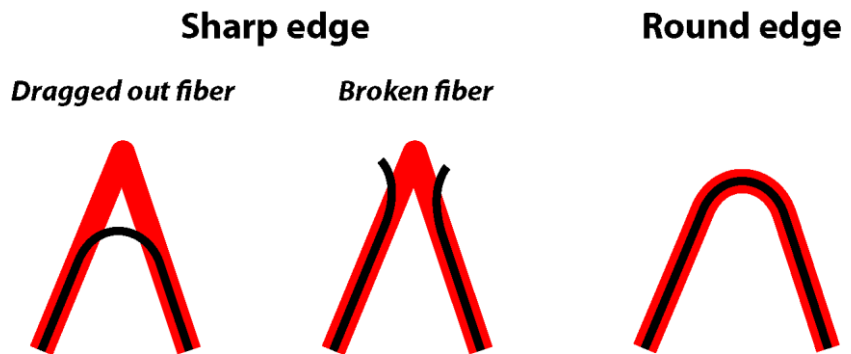
For a standard thermoplastic extruded element, sharp edges are not a problem. However since carbon fibers are brittle, sharp edges should be avoided. Additionally in a sharp corner, fibers can easily be dragged out of the extruded segments.

To avoid these types of issues, sharp edges should be avoided in the mesh structure. If these edges cannot be avoided, then they should be turned into a round edge (See Figure 75)

---

**FIGURE 75** Edge related issues

---





#### 5.2.4 DIMENSIONING THE MESH COMPONENTS

The last step to get any design ready for production, is dimensioning and calculation. As this project focuses more on developing a new technique, exact calculation is not necessary for this stage. This system is not developed to be used only for a specific object, but rather it is a system that should be capable of being adopted for any freeform structure. Additionally the author of the research project is a building technology master student that does not have the civil engineering background.

Regardless of the mentioned points above, defining criterion for structural calculation and dimensioning are well needed. These criterion should be part of the offered system, to guide the structural engineer in the detailing and finalization stage.

There are two main elements, that need to be defined for making the mesh ready for production;

1. Grid size (Average height, width and length of the cells in the grid)
2. Diameter of extruded lines

#### MESH GRID SIZE

Grid dimensions, are one of the most influential details for this system. But these values are also effected by other various elements such as; type of concrete, mesh tolerance and accuracy, nozzle diameter, preference for speed or material usage.

#### CONCRETE PENETRATION AND AIR POCKETS

For this reinforcement system, a spray type of concrete (Shotcrete) is intended to be used. A study should be done for the minimum cell size, which this material can penetrate. The concert flow will be impeded if the mesh size is too small thus causing air pockets to remain in the structure.

#### MESH TOLERANCE RATIO

Mesh tolerance ratio is an aesthetic value that should be defined by future designers. A mesh with bigger cell dimensions, will have bigger difference with its original designed form. Therefore based on designers' decisions, a tolerance level for that difference should be fixed; a maximum cell dimension.

*DEFINING THE MESH GRID SIZE*

For defining mesh grid size, factors such as production time and material usage can also be taken into account. When the grid size get bigger, the created mesh will have less internal supports. Consequently due to bigger internal spans, its cross-section need to increase too which led to a higher material usage. In other hand regardless of material volume, the mesh length will decrease. Therefore the structure can get printed in a shorter time period.

To find a perfect dimension for a grid, a multi input structural optimization system might be necessary. An optimization system, with the following factors:

1. Cross-section area for the lines (nozzle diameter)
2. Grid size in XYZ direction
3. Buckling of mesh segments
4. Internal stresses
5. Time versus material usage

These thing can of course be done, but it require a longer period to develop an algorithm script for mesh structural optimization. Since developing such programs are not the main subjective of this research, these type of task will be added to future scope of this project.

Creation of a dimension range for grid size, is well possible solution. By using the minimum value for concrete penetration and maximum value for mesh tolerance, this range can be determined. Also by referring to “Branch Technology” generated mesh structures, an estimate size for these value can be created (Around 10 to 20 cm no exact details are published till now).

---

**FIGURE 76**  
branch technology Mesh  
(Krassenstein, 2015)

---



**DIAMETER OF EXTRUDED LINES**

After the mesh grid size is determined, the extrusion diameter or in other word line thickness should get calculated.

The first step for any structural calculation, is the determination of load cases. Since the concrete material in should handle the compressive forces and the outer fibers are for reinforcements, this mesh structure does not need to carry any load in the final concrete structure. Nevertheless during the construction phase, this mesh element should be able to handle its own weight and some additional forces.

**TABLE 25** Load cases for mesh structure

Load cases	
<i>L.C 1</i>	Its own dead weight
<i>L.C 2</i>	Outer continuous fibers (Element A)
<i>L.C 3</i>	Additional connectional components
<i>L.C 4</i>	System that is attached to it for embedded formwork
<i>L.C 5</i>	Weight of concrete during solidification stage ( <i>If this load is too big, it can be assumed that concrete gone be added to the structure in two phases. Then that load can be divided by two</i> )
<i>L.C 6</i>	Bending and torsional forces during transportation stage ( <i>high deformation is tolerable as long as it does not give a permanent damage to this structure</i> )
Load case combinations	
<i>L.C 1 + 2 + 3 + 4 + 5</i>	During construction period
<i>L.C 1 + 2 + 3 + 4 + 6</i>	During transportation to construction site

To determine line thickness of the designed mesh structure, a structural calculation should be done based on the load cases in Table 25. The outcome of this calculation will be a value for diameter of the most stressed part in mesh. Since the whole mesh structure is manufactured by one fixed nozzle and it consist out of a single continuous line, creating lines with different diameter is not feasible. For material efficiency, few strategies can be fallowed;

1. Printing multiple time over the path of high stressed segment (overlapping)
2. Decreasing mesh dimensions in higher stressed areas.
  - o This adjustment will change an entire horizontal layer and cannot be applied in singular cell unit or a vertical layer of cells. Additionally the bigger cell dimension should be a

product of smaller cell dimension [Bigger Cell Size / Smaller Cell Size = Even Real Number]

Whit these type of strategies a smaller nozzle can be used and less material will be used.

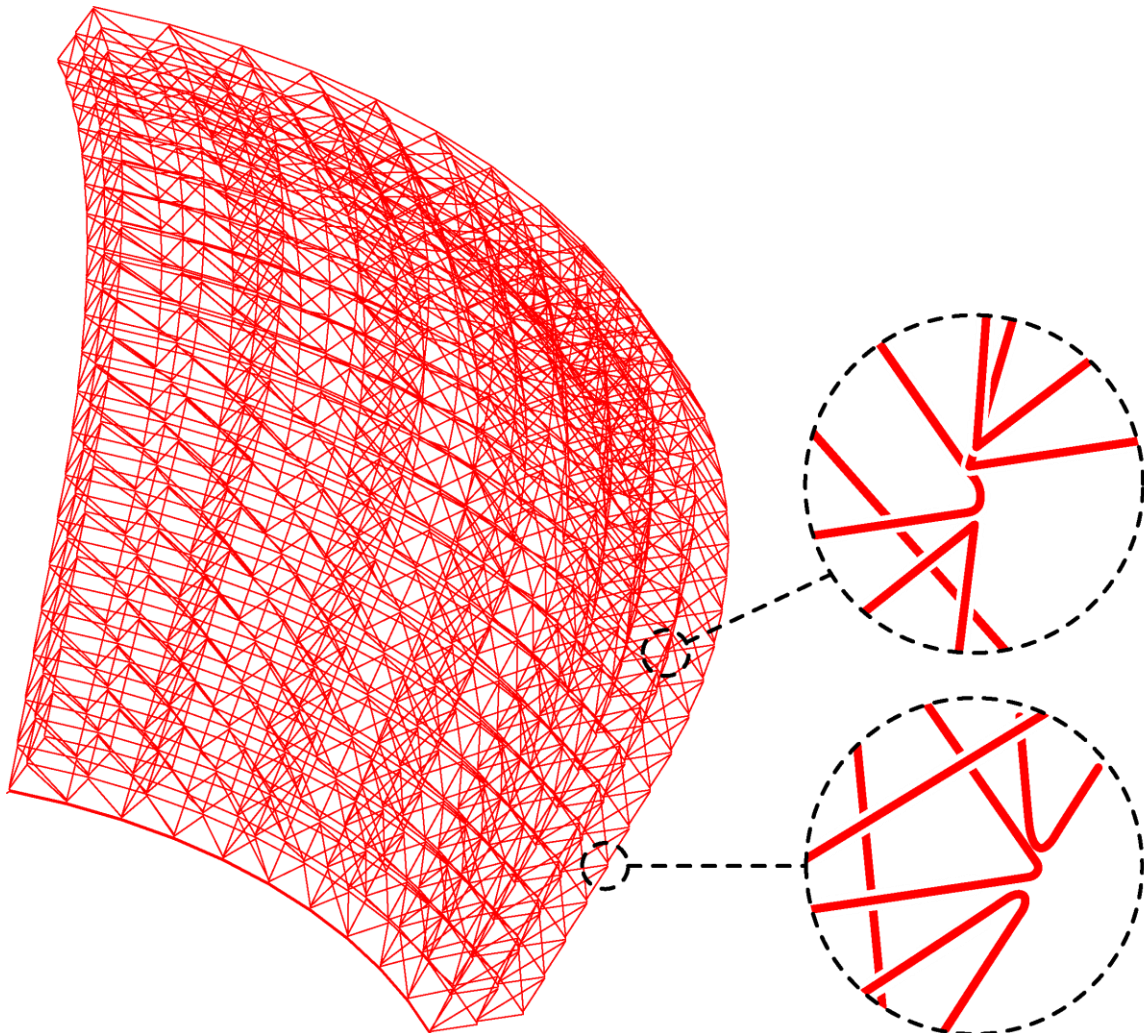
In this approach the line diameter was defined in the last stage, which should not cause any problems in the theoretical world. But in reality that might cause a problem. Especially when this system want to be used by small company or research institutes. These type of groups have mainly limited resources and they want to do as much as with their tools. For that reason changing line thickness is not always possible, and therefore this process should be done other way around; Line thickness is fixed, but mesh density should be adjusted.

#### **5.2.5 FINAL MESH DESIGN AND EVALUATION**

In Figure 77, the final mesh structure for the designed concrete structure is illustrated. This structure is designed, based on the mentioned criteria and requirements from the previous sections in chapter 5.2. The only parts that need to be calculated in this structure, is its line and fiber thickness. In Table 26, a brief evaluation of the designed mesh structure is presented and Figure 77 shows that structure.

**TABLE 26** Evaluating the designed mesh structure based on the determined criteria

	Check list	Model	Criteria
Average Cell Size X	Yes	160 mm	100 to 200 mm
Average Cell Size Y	Yes	150 mm	100 to 200 mm
Average Cell Size Z	Yes	130 mm	100 to 200 mm
Vertical diagonal lines angle	Yes	43°	<50°
Internal supports	Yes	--	Overlapping
Avoiding collision	Yes	Mesh generator script is adjustable with line thickness	
Extrusion diameter	No	This part need to be defined in next stage by a structural calculation and prototyping	
Fiber thickness	No	Carbon fiber integration requires developing a new technique and determination of its thickness cannot be done at this stage	
Rounded edges	No	Since the possibility of carbon integration is not yet determined, this design adjustment is postponed to prototyping stage	

**FIGURE 77** Final designed mesh

### 5.3 PART 2. OUTER FIBERS (ELEMENT B)

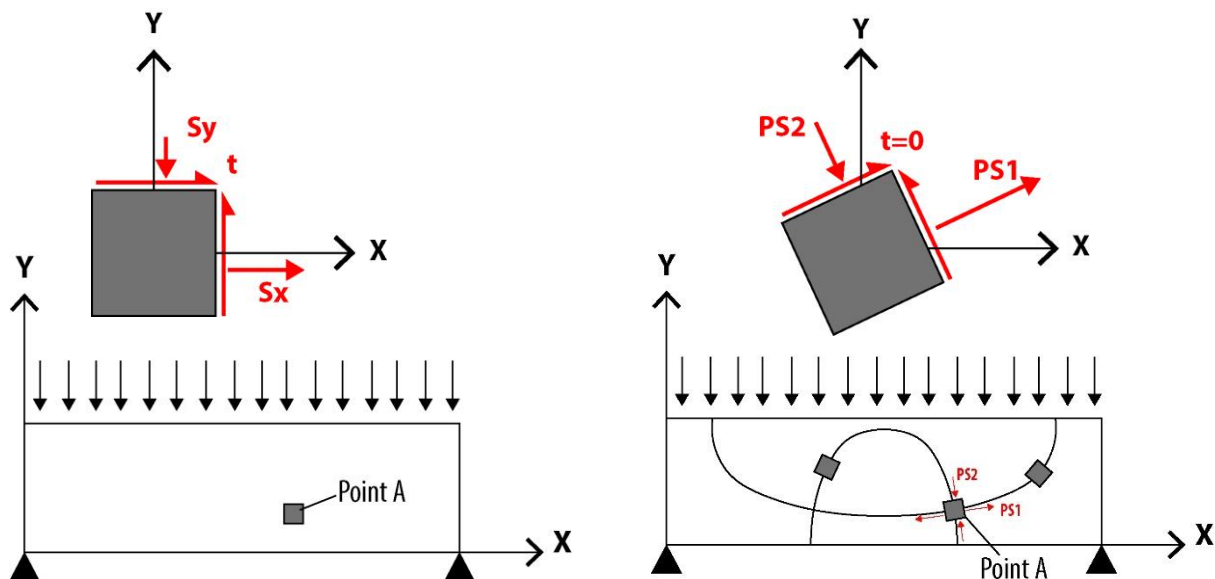
Element B which consist out of a series of continuous fibers on the outer surface of the structure, are the most important part of this design. These fibers are responsible for handling and excess tensile stresses in the concrete object. Additionally they should be used in an optimized manner and be placed in a path where tensile reinforcement is needed. To define the optimum path, tensile stresses in the concrete object need to be analyzed.

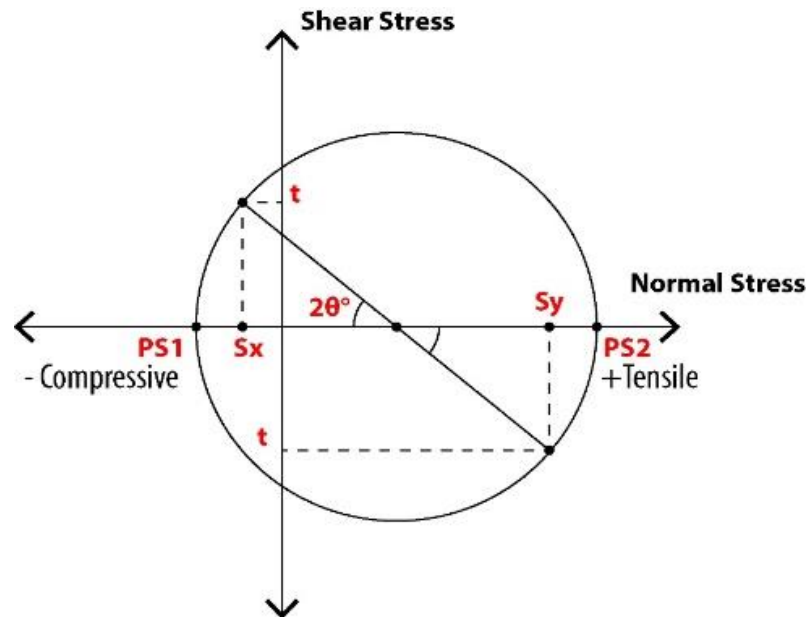
#### 5.3.1 FINITE ELEMENT METHOD FEM ANALYSIS AND STRESS TRAJECTORY LINES

Stress is a local vector measurement of forces in a particle on an object. This value will change depending on position and orientation of the particle on an object. In Figure 78, a simple normal stress example is illustrated. Point A is a fixed point on the beam, but its normal stress value differs in the X ( $S_x$ ) and Y ( $S_y$ ) axis. The particle A is under tensile stress in X direction and compressive stress in Y direction. Therefore its normal stresses, has a range of value. The maximum and the minimum normal stress in a fixed particle are referred as principal stress (**PS1 PS2**). These principal stresses are equal to upper and lower limits of the normal stress range of values in a point.

Based on principal stresses and their orientations a stress trajectory line can be plotted, curve that its tangent is similar to principal stress direction. These type of trajectory curves can be used to find

**FIGURE 78** Normal stresses diagram and principal stress trajectories



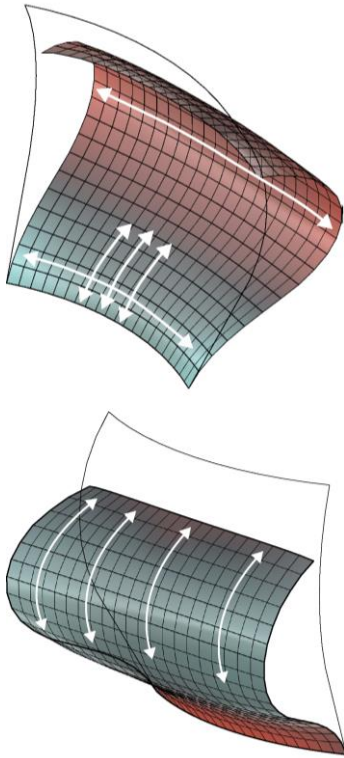


**FIGURE 79** Circle of Mohr and principal stresses

an optimum path for reinforcements. In most cases, one trajectory line represent maximum tension and the other present max compression, but this is not always true. When an object is bended in both directions, it can be under tensile stress in both directions and therefore both principal stresses will have positive value (tension). One of them will be maximum tension and the other one will be minimum tension. For that reason it's important to check the stress values of both trajectory curves.

These type of calculation are very complex and in most cases they are done in FEM software. To be able to use these software, one should always have a good understanding of the FEM concept. For that reason and the better understanding of the coming chapters, this subject and its terminology was briefly covered in this section.





**FIGURE 80**  
Deformation and principal stresses

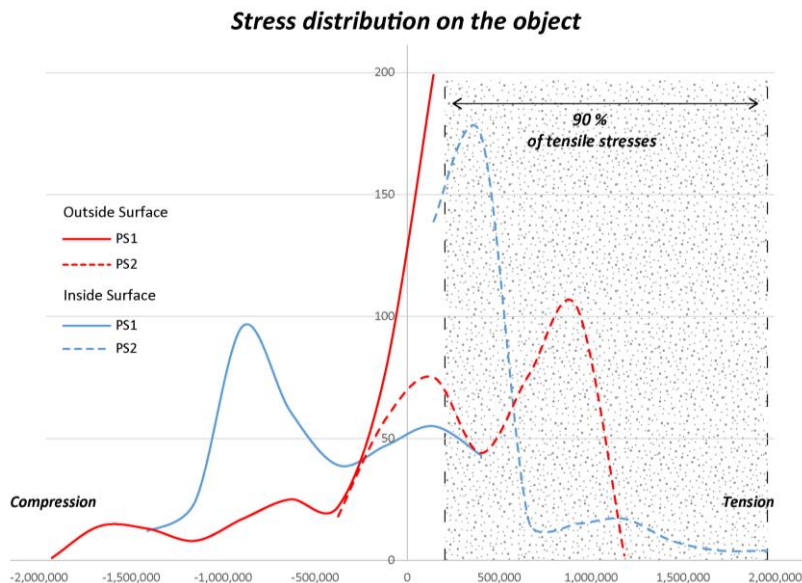
### 5.3.2 DEFINING PATH OF FIBERS

The first step for defining an optimum path for reinforcement, is to define type of forces that are applied on an object. The main load that is applied on this structure is the dead and live weight of the top floor. This force can be categorized as a vertical load type. The second force type that this structure should be able to handle is torsional force. This torsional force can be created by unequal distribution of dead weight or any horizontal force that is transfer to this object by the top floor. Regardless of their magnitude all these force will create a same trajectory curve which the reinforcement should be adjusted to it. Therefore in this stage magnitude of these stresses will not be defined.

### PREDICTION FROM DEFORMATION AND BENDING DIRECTION

In Figure 80, deformation and principal stresses of the chosen object under vertical load are illustrated (Blue stand for tensile and red stand for compressive stresses). This diagram helps to visualize how the object is bending and in which direction tensile stresses are acting. It's clear that the inner and outer surfaces do not have similar stress distribution. In the outer surface, tensile stresses are at the top region but in the inner surface, the bottom region is mainly under tension. This will give a global indication where the reinforcement elements and in what orientation should they be located.

**FIGURE 81** Stress distribution on the concrete structure



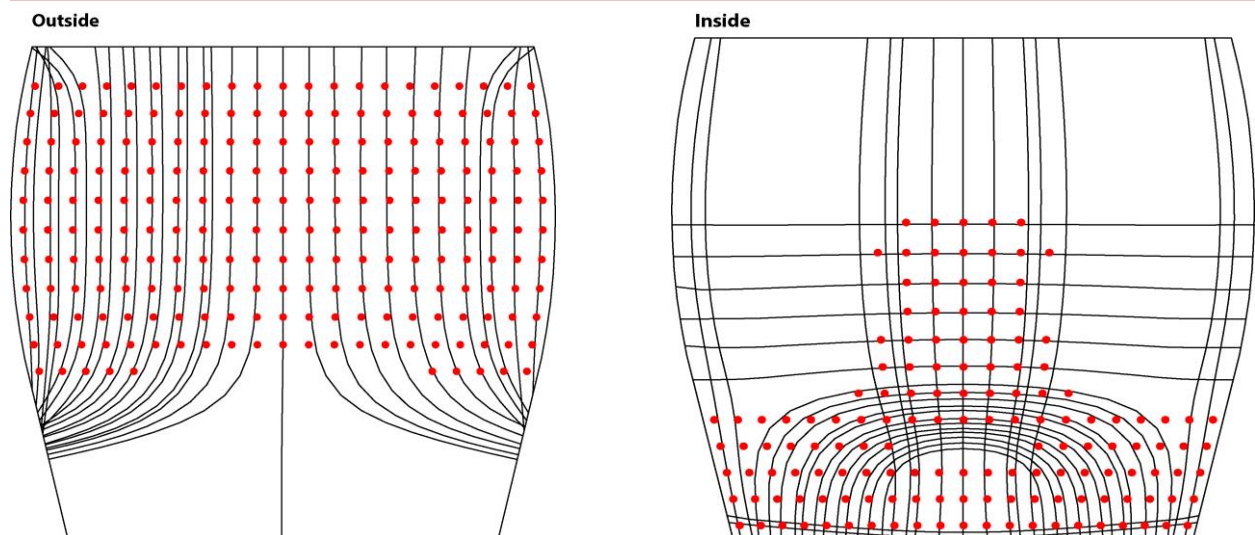


### DEFINING FIBERS PATH BASED ON FEM ANALYSIS

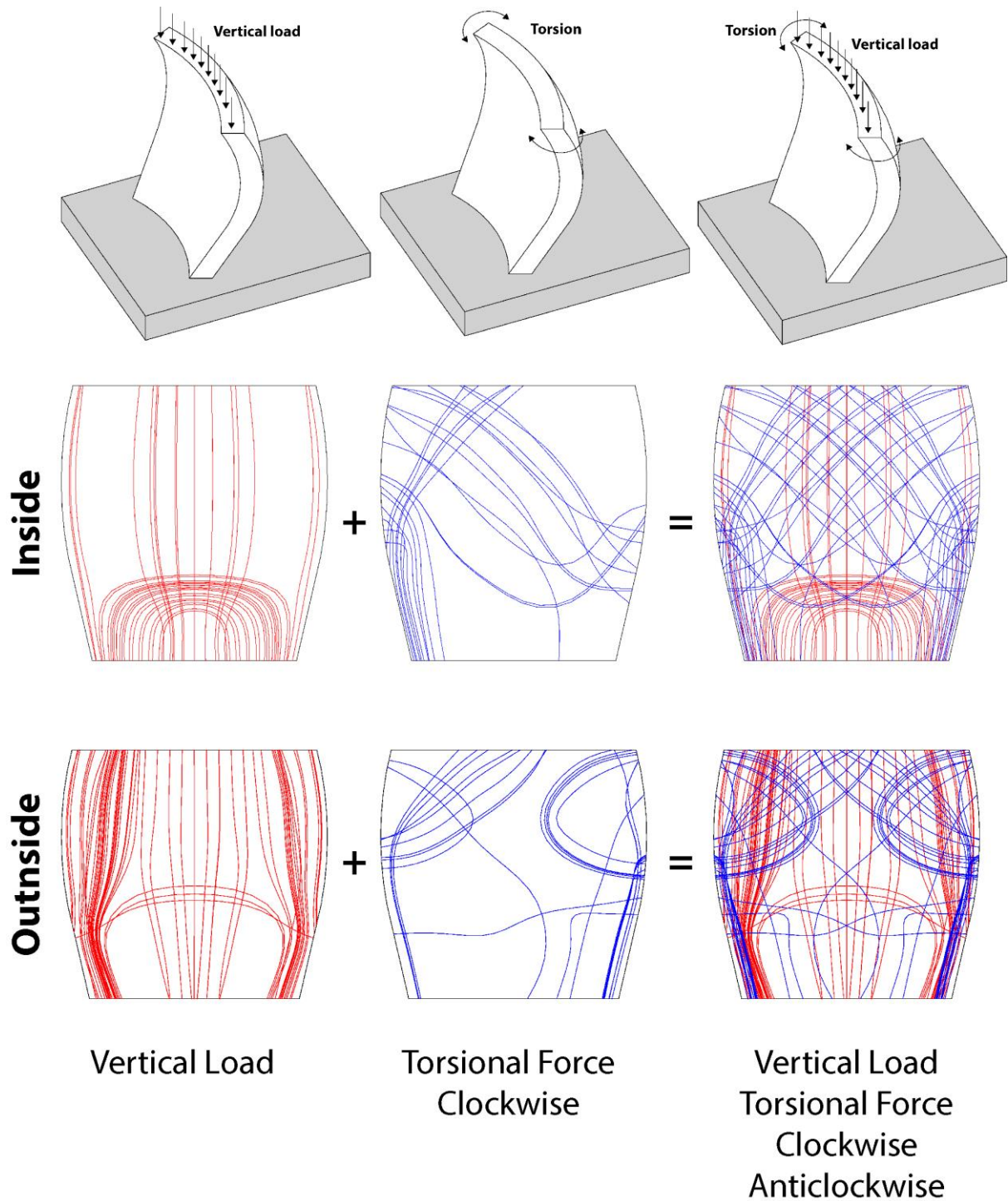
In Figure 81, a stress distribution diagram of the concrete structure is plotted. The maximum tensile and compressive stresses in this structure are almost equal. As it was mentioned in previous chapters, concrete compressive strength is around 10 times higher than its tensile strength. If it's assumed that the maximum compressive stress in this structure is equal to the compressive strength of concrete, then any point above 10% of maximum tensile stress ( $-10\%$  x max compressive principal stress) should be reinforced. In Figure 82 those points and their principal trajectory curves are plotted. As it was predicted for the inner surface, some points are under tensile stress in both directions. For that reason a grid structure curves are present at the inner surface.

The generated trajectory curves in this section, will eventually define the path of the reinforcement fibers. Since these curves were generated by only applying the vertical forces, other curves for torsional forces should also be added to the system. In Figure 83 these steps for torsional forces are repeated. This diagram presents the optimum path of fibers for both forces combined.

**FIGURE 82** Trajectory lines created from high tensile stress point



**FIGURE 83** Fiber path created from combination of different load cases





### 5.4 PART 3. FIBER PLACEMENT ON MESH STRUCTURE

In chapter 5.3 , the geometrical aspects of fibers were investigated. On that chapter, it was discussed how should the fibers be arranged and their path be optimized. In this part, the production process and production technique of these outer fibers will be discussed and designed.



Now that the path and form of those continuous fibers are defined, their production method should be designed. As it was mentioned in section 0 in chapter 0 (Pg. 95), a hybrid knitting system will be used for the fiber placement. In this system instead of using an external mold, the mesh structure (Element A) will be used a mold and the fibers will be placed and fixed on it.

In Figure 84 details for fiber placement are illustrated. As this diagram shows, fibers path and the mesh structure have more than hundreds of intersections. Any of these intersections can be used as a fixing point for the fiber tows, but logically not all of those points are needed. After a set of intersection points are selected, the designed fibers curve path will be transformed to a polyline path. For fixing those fibers to mesh, two design have been developed, which of course need to be modified during the prototyping phase;

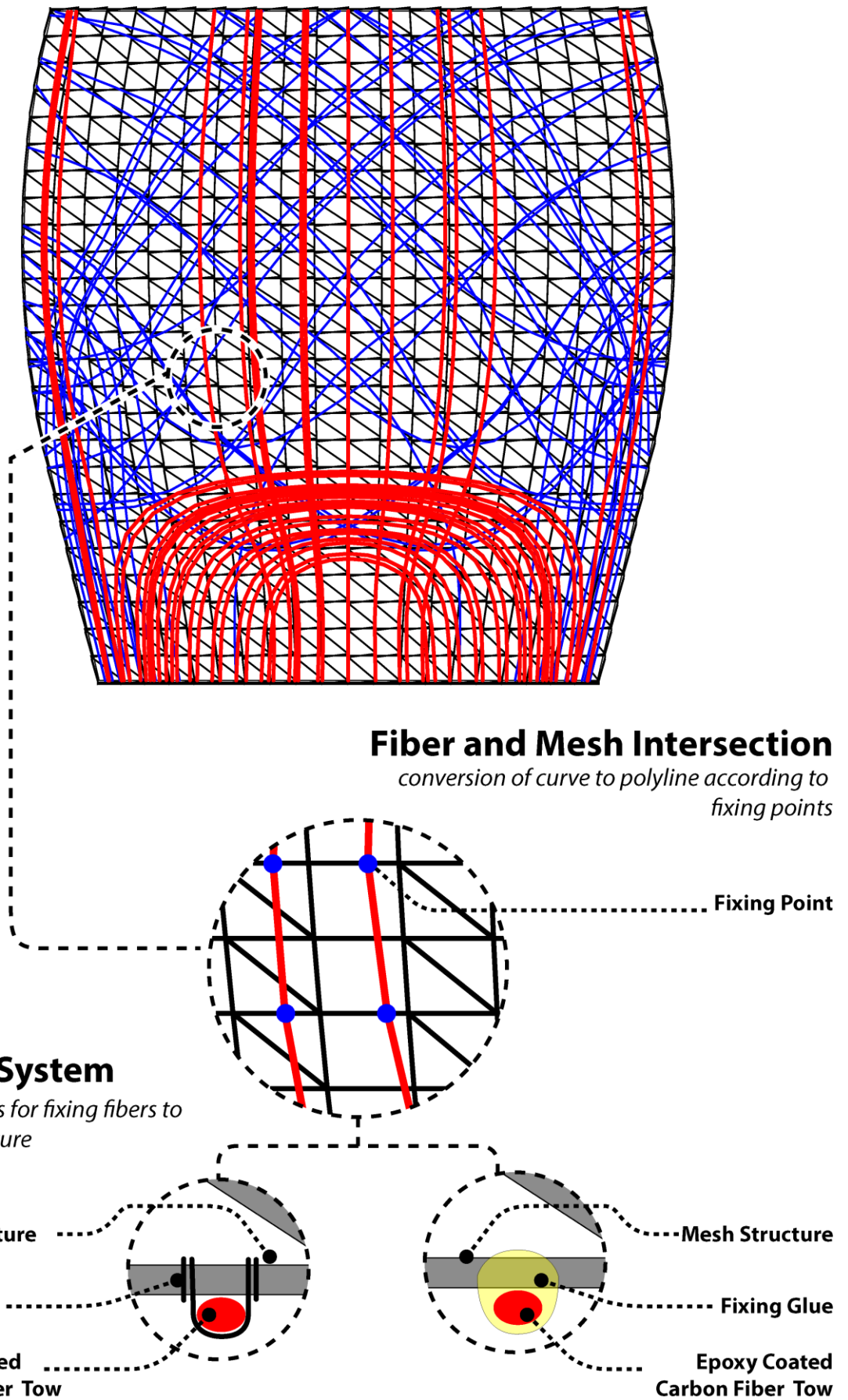
1. Fixing with knot
2. Fixing with glue

For both of these systems there is a big space for further research. In the table below possible research topics and themes are listed.

**TABLE 27** Future research themes

Fixing with glue
What type of glue gun should be used?
Can additional ABS (thermoplastic filament) extrusion be used as glue?
Forcing fibers in by heating it in cross sections
What type of mechanism should be used to accelerate the solidification of the glue
Fixing with knot
What type of knot is the most efficient in terms of automatization
What are the compact systems for mechanical knitting
What type of material should it be used for the knots

FIGURE 84 Fiber placement details





### 5.4.1 OUTER FIBER MANUFACTURING SETUP

Since time is limited in this project, without further research the gluing system will be selected for this design. In this system ABS which is the material for mesh structure will be used instead of glue. For manufacturing process of the outer fibers at least two machines are needed;

1. Robotic arm
2. Rotating table

#### ROTATING TABLE

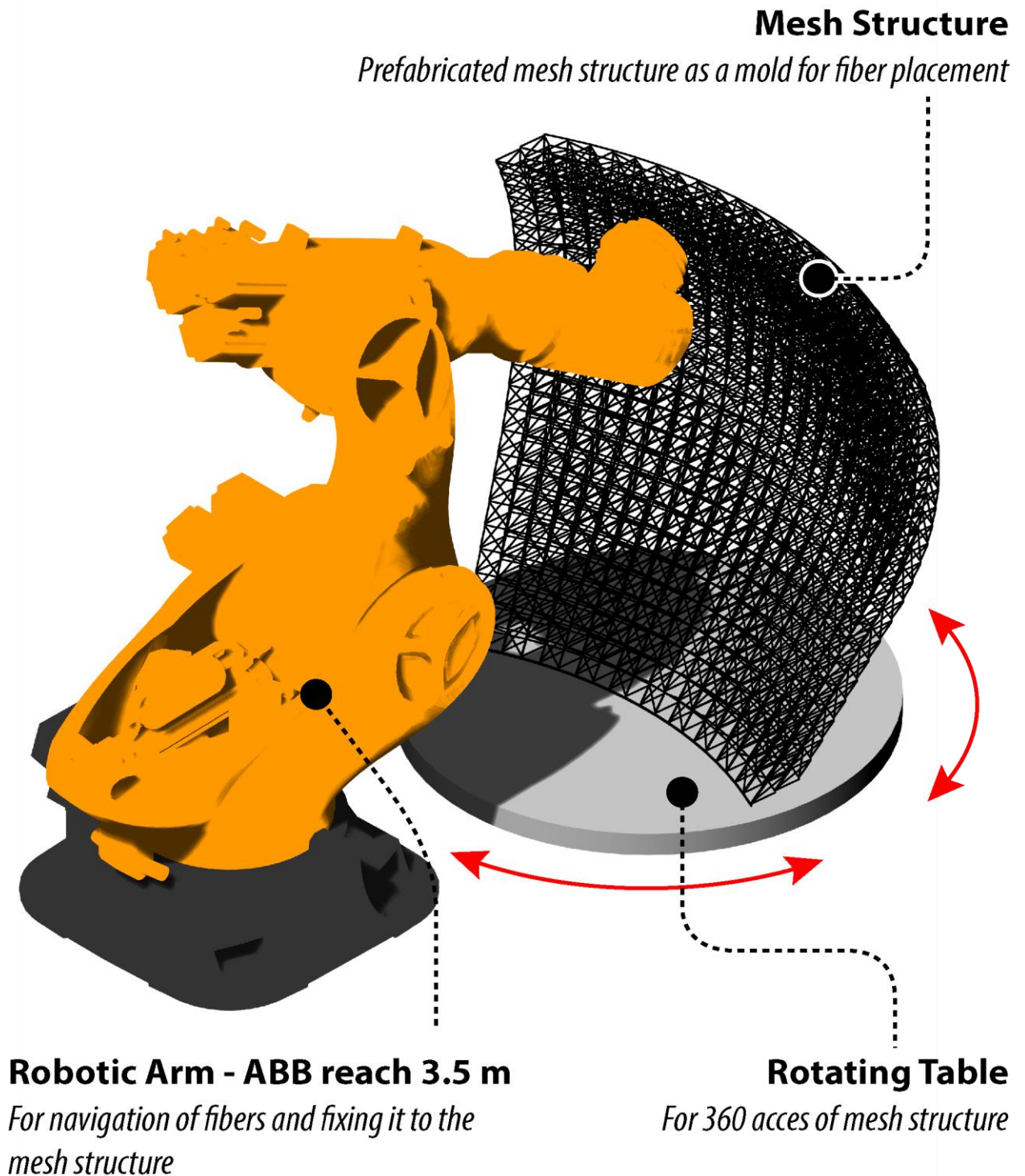
This table is used to rotate the mesh structure for giving the robotic arm an access to both side. The movement of this table is synchronized with the robot and both of these machine will be controlled by a single script.

#### ROBOTIC ARM

This machine is used for navigating and placing the carbon fiber tows in their position. The movement of that robot will be according to the path that was generated for the outer fibers in chapter 5.3. The tools that are required for fiber placement will be mounted on the head of this robot;

1. Fiber fixer
2. Fiber navigator; Extrusion of fibers will be done by the dragging force between the navigator and fixed points
3. Epoxy tank; Fibers get soaked in epoxy before being placed. This process might also be done after all the fibers are placed in their position

**FIGURE 85** Fiber placement setup



## 5.5 PART 4. CONCRETE INFUSION AND FORMWORK REPLACEMENT STRATEGY

As it was mentioned before, one of the reason for mesh structure was to avoid necessity of conventional formwork. The principle idea is to inject concrete in the mesh structure. Since mesh structure does not have dense outer layer, an additional system need to be developed for concrete injection procedure. In chapter 4.1.1 “Assembly process concepts” few ideas where suggested that could be applied for this design;

1. Embedded formwork (Concept B)
2. Dense mesh as embedded formwork (Concept C)

### 5.5.1 SYSTEMS EMBEDDED FORMWORK

This principle was based on the idea that cladding layer (façade exterior element) will get used as a formwork and it be permanently placed in the concrete structure. For that reason the materialization of this element should be determined by designer choice and then be tested for applicability by the project developer. For this research project it will be assumed that the outer layer of this designed structure should have a concrete exterior.

For creating a curved concrete panel, the most common method is a CNC milled wooden formwork. Since in this approach an additional formwork is needed, this method will have no added value for this design. For production of these curved concrete panels, a system should be used that does not create additional building waste and its mold or formwork can be reused.

**FIGURE 86** Flexible mold

(Schipper, 2015)





**FLEXIBLE MOLD**

One of the systems that fit these descriptions, is flexible mold that is developed as a TU Delft project by R. Shipper (Schipper, 2015).

This system can also be used in different ways:

1. Conventional (pouring concrete)
2. Concrete printing on that system

*Conventional system*

In conventional system the produced panel will have a smooth outer surface. But in this system adding extra details in geometry is not possible (interlocking detail). Also surface with high curvature and sharp edges will not be possible.

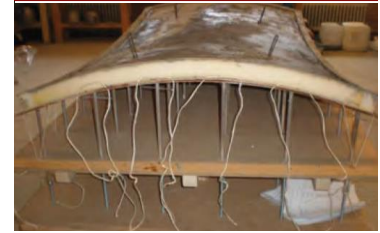
*Concrete printing on flexible mold*

This system can be categorized as a hybrid flexible mold and concrete printing system, where issues such as support structures are solved in an efficient and sustainable manner. Beside its capabilities for creation of pattern on the generated panels, this system can be useful for adding extra technical details too. This detailing capability will be useful for creation connectional and interlocking components.

**ASSEMBLY**

For all the embedded formworks, their assembly process is very similar. The mesh structure will provide a permanent integrated falsework for these panels. At back of each panel, an anchor element is embedded that will connect them to mesh structure. When the first layer of panels are assembled and the in-between gaps are sealed with kit, the concrete can be injected in the mesh structure. This step should be repeated till the whole structure is covered with concrete (See Figure 90 for details)

**FIGURE 87**  
Flexible Mold  
(Schipper, 2015, p. 151)



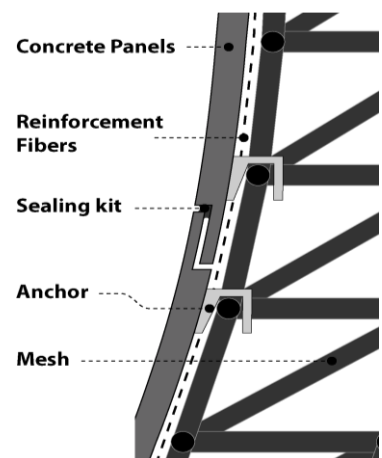
**FIGURE 88**  
Printing on flexible mold  
(Borg Costanzi, 2016, p. 89)



**FIGURE 89**  
3D printed Panel by  
Loughborough University  
(Kucharek, 2015)



**FIGURE 90**  
Assembly of panels on mesh  
structure



**MESH SHEETS AS FORMWORK**

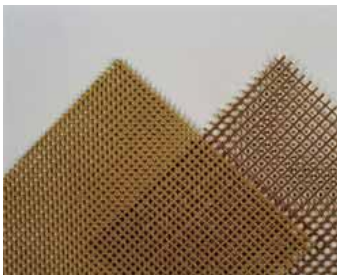
Dense mesh sheet as formwork is a system that was briefly mentioned in chapter 4.1 in section Reinforcement as formwork. This method is inspired by one the case studies “Taichung opera house” in appendix A.4.1. In this system, the reinforcement structure will be covered by a dense mesh sheet and then concrete will be injected in it. It also can be used in similar manner as an open mold concrete production system (Concrete floor have formworks only in underneath them).

In Figure 93, pictures of the construction process of “Taichung Metropolitan Opera House” are presented. Since the construction process of mesh sheet formwork system is similar to Opera House, they reliability of this technique can be validated. The materiality of these mesh sheet formworks is a topic that also need further investigation. By referring to the opera house project, this assumption can be made that fine steel mesh are suitable with concrete. For that reason and lack of time for further investigation, this material will be selected for this system. Materials such as Kevlar or fiber glass that react better with concrete and do not corrode, can also offer a good alternative.

**FIGURE 91** Fine Steel mesh

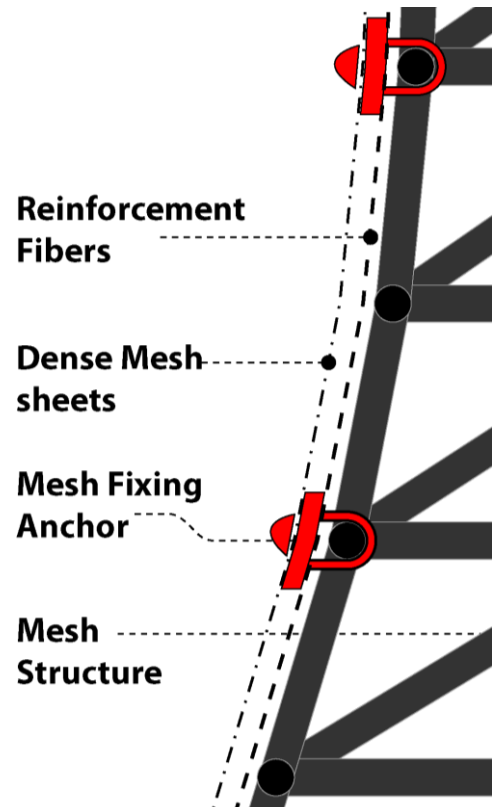
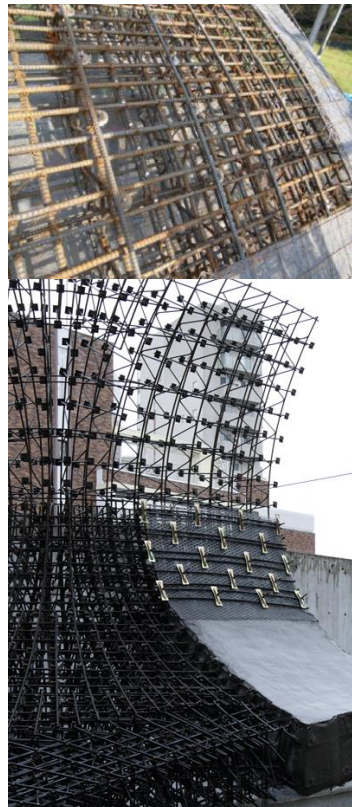


**FIGURE 92** Kevlar mesh



**FIGURE 93**  
Construction process of  
Taichung Metropolitan Opera  
House  
(Tamashige, 2014)

**FIGURE 94**  
Assembly of mesh sheets on the  
mesh structure



### 5.5.2 EVALUATION

Both of these developed system have their own, pros and cons. Depending on the clients, project context and requirements, one of these system might be more suitable. Therefore it's important to be aware of the consequences for each system.

In the embedded formwork system, the surface quality will be better and the assembly process will need less manual labor. But in other hand, manufacturing such elements will create an additional cost. For creating interlocking details for sealing purposes, it's better to use those flexible mold in combination with 3D concrete which will affect the surface quality (sausage pattern – visibility of the printed layers). Of course this effect might be desired by some designers but wither way the clients should be aware of this effect. The other problem with this method, is an increase in forces that the mesh structure should handle. Since weight of these panels should be carried with the mesh structure in the assembly stage, mesh structure should be manufacture with higher strength.

The second system was the mesh sheet formwork that was similar to one of the reference buildings in case study chapter. The main problem in here, is that it requires lots of manual labor. Beside the assembly process, smoothing and finishing process is also necessary. Since the surface quality of this system will be bumpy, it can be predicted that a concrete finishing layer will be desired. But the main advantage of this system, is its low cost and its weight contribution. In comparison to panelized formwork, this system will have less weigh. More important than that, this system will cost a fraction of budget that is needed for those embedded formwork.

For exact cost of each system it's better to get an advice of a professional contractor.

## 5.6 PART 5. INTEGRATION WITH CONVENTIONAL STRUCTURES

---

As it was mentioned before, this reinforcement system is developed for freeform concrete structures that the conventional methods are not suitable for them. But even in the most complex buildings, not all the structural elements are freeform and complex. In most cases it's a combination of complex double curved and simple elements such as standard flat floors. For those simple elements, use of the conventional system will of course be the most convenient choice. Therefore the designed system for those complex parts, should be able to integrate with standard reinforced concrete elements.

The concrete bound between different parts of a building is not a complex task, but integration of different reinforcement system can be challenging. The standard steel reinforcement mesh and the new carbon fibers reinforcement structure should be able to transfer their tensile forces. If these connections details are neglected or not well designed, the concrete structure can fail at those locations.

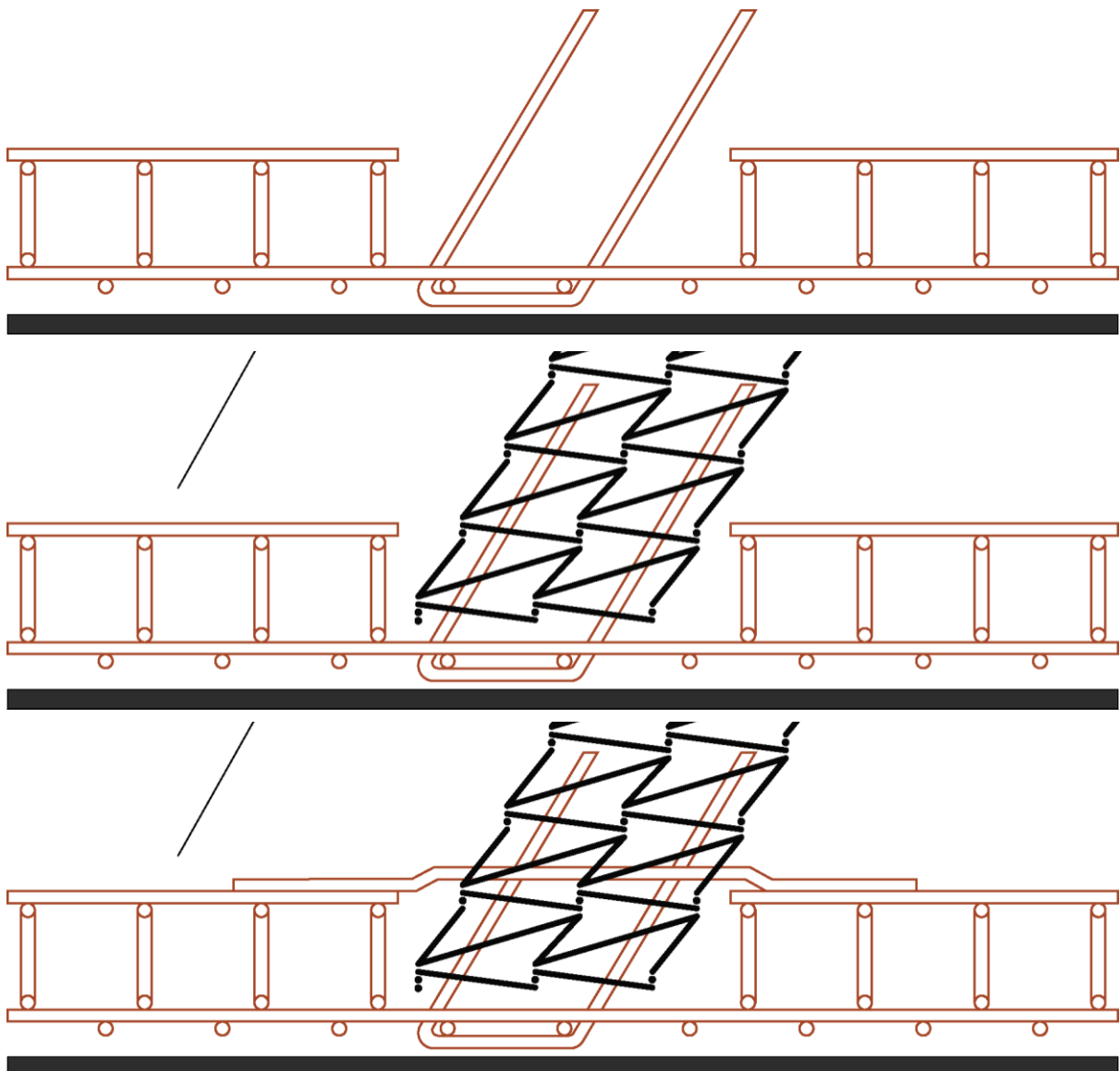
The solutions that are given in this project are more based on structural concepts but they need to be validated and calculated by a civil engineer person.

### 5.6.1 CONCEPTS

#### INDIRECT CONNECTION

As its names present, in this system no direct connection is created between the freeform and the floor structure. These two structures are connected to each other by an interlocking mechanism where forces get transferred through the concrete. It is similar to the way that overlapping rebars are working. This system might not be suitable for junctions where stress and moment levels are high. In Figure 95 this type of connection is illustrated in different assembly stages.

**FIGURE 95** Indirect reinforcement connection



### DIRECT CONTENTION

In this method a direct connects between both reinforcement system will be designed. Since different materials are used in both systems, standard connections that were studied in appendix A.3 “*Rebar connections*” are not applicable. A connection system can be defined in two way;

1. Chemical bound
2. Geometrical bounds

In steel the most common way for a chemical bounded connections is a welding system (See Appendix A.3.6 “*Cad Weld Coupler*”). But since carbon fibers are used in the freeform structure this technique cannot be applied. The other solution is to find an Epoxy that can bound carbon fiber with steel rebars. The main problem with epoxy is that they need to be applied in a control environment to create a strong bound, additionally this system will be work and time intensive.

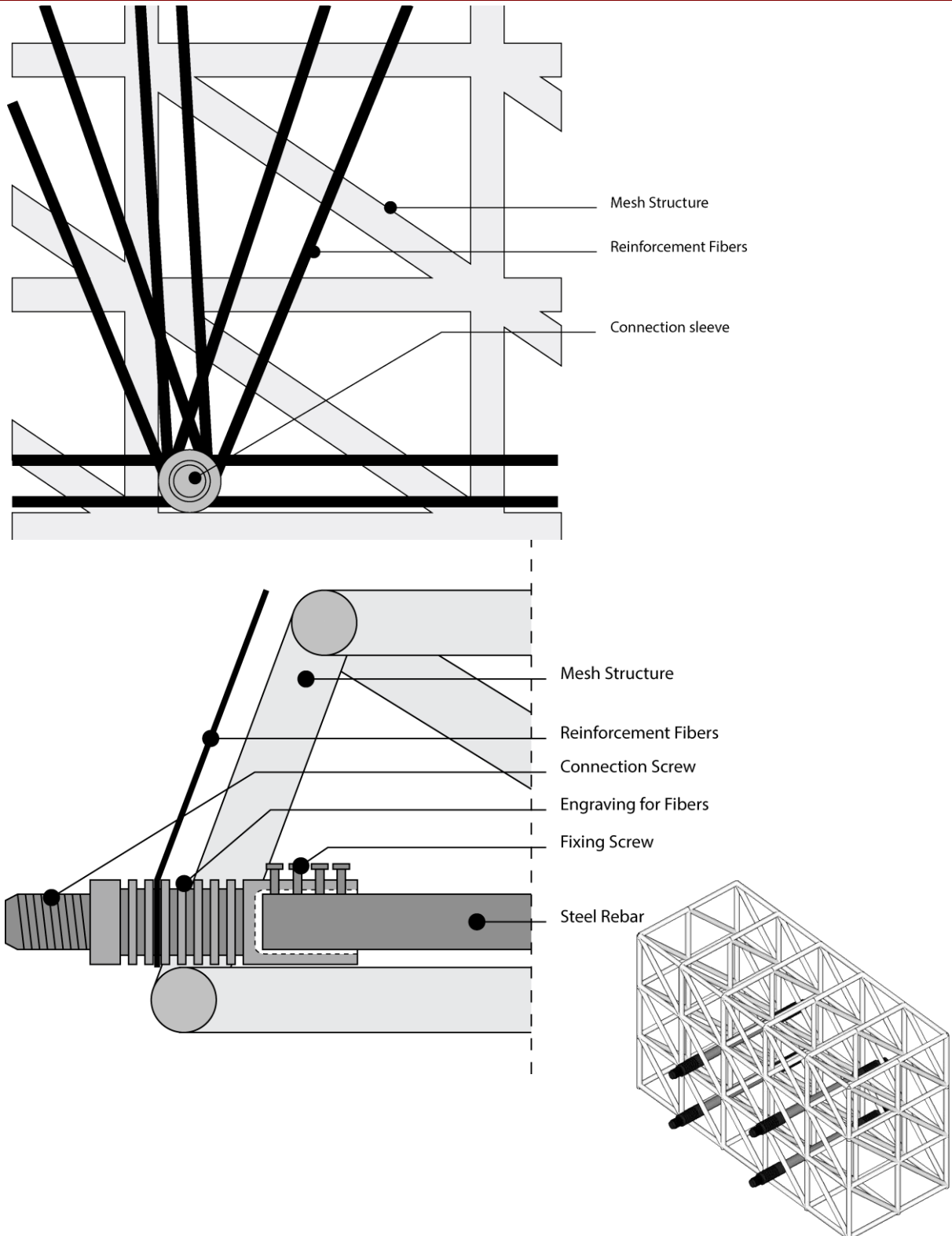
The other option will be a geometrical bound. In appendix A.3, several different system based on geometrical bound systems for rebar connection, are presented. These systems create connecting rebars by screwing or interlocking mechanism, but unfortunately they are not suitable for carbon fibers.

The best solution is to create a component that can be connected to both systems. Due to the fiber reinforcement geometrical complexity, adding a standardized connectional component after its production, wouldn't be a simple task. Therefore it's advisable to embed the connectional component in fiber reinforcement structure during its production.

Based on these principles, a connectional component for the fiber reinforcement system is designed. These elements will initially be fixed to the mesh structure and be used as pin elements. During the fiber placement stage, the path of those fibers will be modified according to positions of those pins. By wrapping fibers around those pins, a geometrical bound between fiber and those connectional components will be generated. Since these components are made out of steel, their rebar junctions can be designed according to one of the rebars sleeves systems in Appendix Error! Reference

source not found.. In Figure 96, the designed connection component is illustrated

**FIGURE 96** Direct connection designed component and its schematic detailed drawings







# 6 • Calculation

## 6 CALCULATION

The focus of this research is mainly to develop conceptual designs and principal systems. Therefore exact measurements and calculations are not the main goal of this paper. The first method to validate the designed ideas, is by referring to existing case studies and reference projects which is done in chapter 5. The second method for design validation will be to do a rough calculation that will be covered in this chapter.

### 6.1 MESH CORE STRUCTURE

In this section, the designed mesh will be analyzed and the diameter of its segments will be calculated.

**TABLE 28** Properties and regulations  
(“CES EduPack”, 2016; Nederlandse norm, 2001)

Geometrical properties	
Average X cell dimension	160 mm, nr cell 14
Average Y cell dimension	150 mm, nr cell 2
Average Z cell dimension	130 mm, nr cell 24
Mechanical properties	
Material	ABS
Young Modulus	2.9 GPa
Shear Modulus	1.03 GPa
Density	1080 Kg/m <sup>3</sup>
Yield Strength	35 MPA
Compressive strength	50 MPA
Governmental regulation	
Maximum deflection	10 mm

#### 6.1.1 LOAD CASES

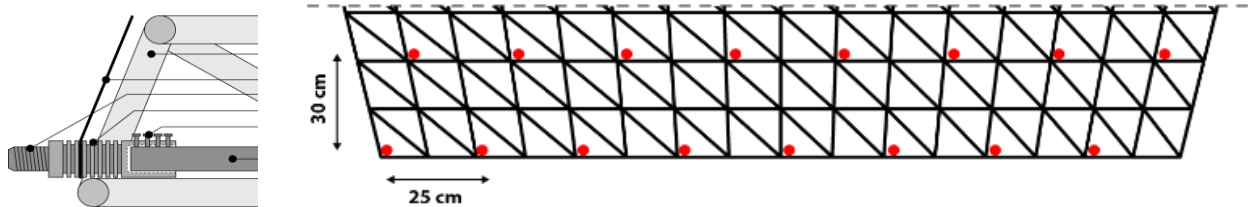
The mesh structure is not a fully load bearing structure. It only needs to carry defined loads during the construction phase. These loads are its own deadweight and the weight of elements that are attached to it. Since the attached fiber reinforcement layer and the rebar connectional components are not fully defined, an estimate for their weight will be used.

##### Load cases:

- Its own weight (deadweight)
- Carbon fibers attach to it
- Rebar connection components

**ATTACHED COMPONENTS****REBAR CONNECTIONAL COMPONENT**

In the diagram below, the connection components and their positions in the mesh are illustrated. The thickness of these components will be determined by the diameter of the rebars that will get connected to it



**FIGURE 97** Rebar connectional component

According to *European Committee for Standardization EN 10080*, nominal diameter size of rebars varies from 6 to 50 mm (European standards, 2005, p. 19). By referring to these numbers, the estimated maximum thickness of these connectional components can be defined. For the calculation purposes, a thickness of 40 mm will be chosen for this component and based on that its weight will be calculated.

**Length:** 400 mm (thickness of wall + both end extensions)

**Diameter:** 40 mm (estimation based on EN 10080)

**Density per length:** 9.86 kg/m

**Number of components:** 16 (based on design decision)

**Weight per component:**  $9.86 \times 0.3 = 3.94$  kg

**Total weight:**  $3.94 \times 16 \approx 63$  kg

**FIBER REINFORCEMENT LAYER**

Since this project focuses more on the design aspect, it was decided not to go into complex calculations. Therefore defining exact thickness of fibers are not really possible. For purpose of mesh calculation, it will assumed that the placed fibers on the given path have a diameter of 2 cm (This is a high assumption. If that amount of material is needed, intensity of the generated path will increase to achieve a similar strength with a lower diameter). By referring to this number, an estimate of fiber layer weight can be created.

**Length:**  $200 + 80 = 280$  m

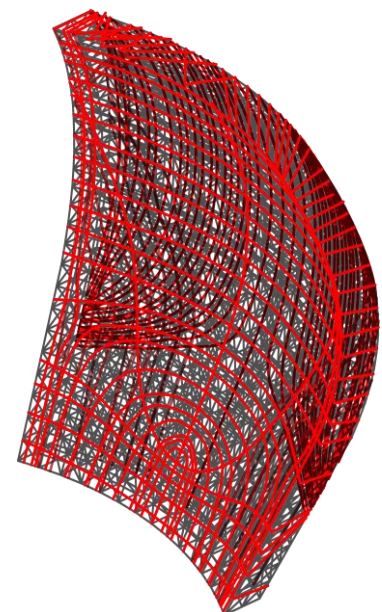
**Diameter:** 2cm

**Cross section area:**  $0.00031 \text{ m}^2$

**Density:**  $2000 \text{ kg/m}^3$

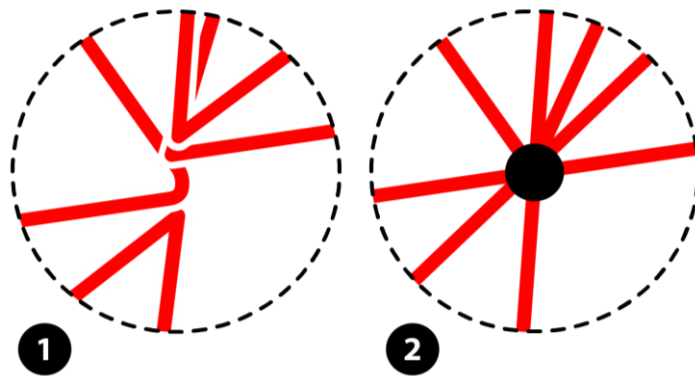
**Total weight:**  $280 \times 0.00031 \times 2000 = 176$  kg

**FIGURE 98**  
Fiber reinforcement layer



### 6.1.2 DEFINING GEOMETRICAL CHARACTER

The related structural calculation for this mesh will be done by computer calculation. In this section a program called “*Karamba*” will be used. The first step, is to simplify the model to a geometry that can be handled by the program. The simplest way to construct this geometry, is to model it as a space frame. Dividing the mesh structure into a series of straight lines that are connected at their intersection points.



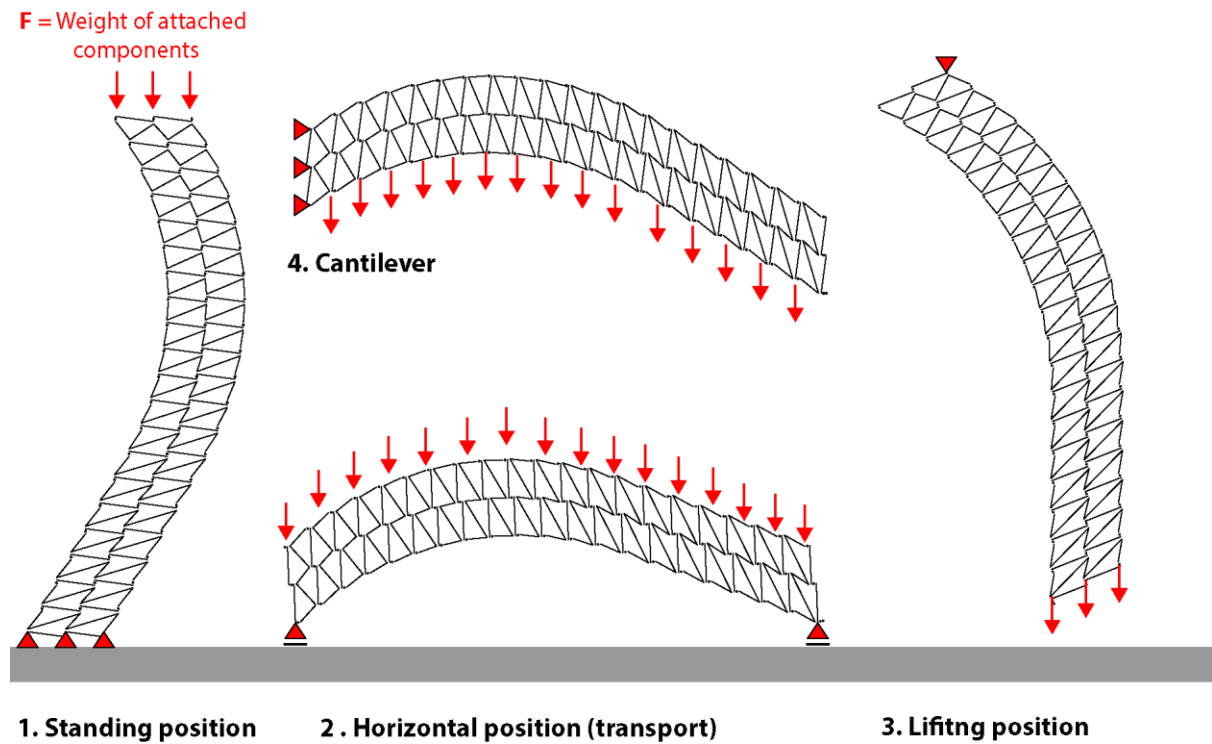
**FIGURE 99** Simplifying internal connection points

In the diagram above, the conversion of these intersection points are illustrated. It will be assumed that they all meet at one point and form a fixed connection. However boundary conditions for these types of connections depend on various aspects. It’s not a fully fixed or fully hinged connection. Unlike space frames they are not connected together by a node component. Their connections are generated by overlapping and bounding of molten thermo-plastic material that varies depending on its printing time. However they are more similar to fixed connections, and for that reason this type of connection will be used for calculation.

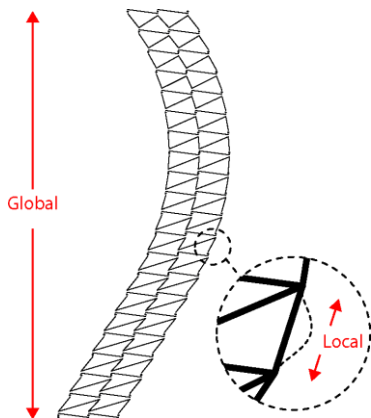
### 6.1.3 LOADING SCENARIOS

Since this object is a prefabricated element, it should be transported to the construction site. During this process the object will be placed in various positions. Therefore the structural integrity of this object should be calculated in different scenarios. List of these scenarios are illustrated in the diagram below.

**FIGURE 100** Loading scenarios



**FIGURE 101**  
Global and local buckling



### 6.1.4 CALCULATIONS

In this section the generated model will be tested in a computer model by “Karamba” plugin in Grasshopper software. The mentioned criteria in Table 28 will be used to validate the model.

Criteria	Limits
Deflection	15 mm
Buckling load factor (BLF)	Higher than 1 or -1
Tensile stress	35 MPA
Compressive stress	50 MPA

Unfortunately the Karamba plugin only calculates the global buckling factor. Therefore for local elements, an external script is necessary.

#### Buckling (Euler) critical load equation

$$P_{cr} = \frac{\pi^2 EI}{(KL)^2}$$

$P_{cr}$  = Critical load [N]  
 $E$  = Young Modulus [N/m]  
 $I$  = Moment of inertia [ $m^4$ ]  
 $K$  = Column effective length factor  
 $L$  = Length [m]  
 $KL$  = Effective length [m]

**FIGURE 102** Effective length factor (AISC, 2005)

Buckled shape of column shown by dashed line						
Theoretical K value	0.5	0.7	1.0	1.0	2.0	2.0
Recommended design value K	0.65	0.80	1.2	1.0	2.10	2.0

**Buckling load factor (BLF) equation**

$$BLF = F / P_{cr}$$

$F$  = Normal Force [N] (Compressive force is taken as positive)

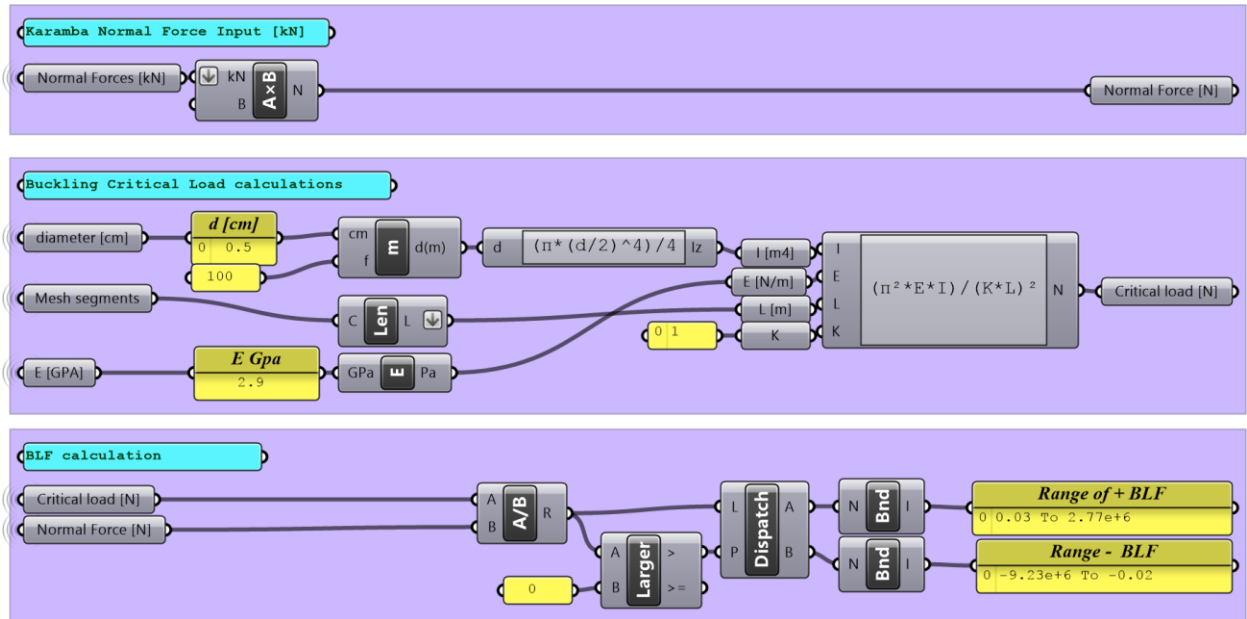
$P_{cr}$  = Critical load

$-1 < BLF < 1$  No buckling

$1 < BLF$  Buckling will occur

$-1 > BLF$  Buckling will occur if normal force is reversed

**Local BLF Grasshopper script**



This script will be used to check the BLF in the internal segment in the mesh.

**MODEL 1 – 0.5 CM DIAMETER**

*SCENARIO 1. STANDING POSITION*

**TABLE 29** Result for standing position scenario 1

Criteria	Values	Limits
Deflection	1 m	15 mm
BLF Global	0.48	BLF > 1
Lowest BLF Local	0.05	BLF > 1
Max Tensile stress	25400 MPA	35 MPA
Max Compressive stress	25400 MPA	50 MPA

**MODEL 2 – 1 CM DIAMETER**

**TABLE 30** Result for standing position scenario 1

Criteria	Values	Limits
Deflection	10 mm	15 mm
BLF Global	6.4	BLF > 1
Lowest BLF Local	0.79	BLF > 1
Max Tensile stress	5.04 MPA	35 MPA
Max Compressive stress	6.97 MPA	50 MPA

**MODEL 3 – 1.5 CM DIAMETER**

*SCENARIO 1. STANDING POSITION*

**TABLE 31** Result for standing position scenario 1

Criteria	Values	Limits
Deflection	10 mm	15 mm
BLF Global	23.28	BLF > 1
Lowest BLF Local	3.34	BLF > 1
Max Tensile stress	2.99 MPA	35 MPA
Max Compressive stress	4.14 MPA	50 MPA

*SCENARIO 2. HORIZONTAL POSITION*

**TABLE 32** Result for horizontal position scenario 2

Criteria	Values	Limits
BLF Global	8.89	BLF > 1 or BLF < 0
Lowest BLF Local	1.52	BLF > 1
Max Tensile stress	3.78 MPA	35 MPA
Max Compressive stress	9.61 MPA	50 MPA
* Since the object will not be used in this position, the deflection in this scenario is not important		



*SCENARIO 3. HANGING***TABLE 33** Result for hanging position scenario 3

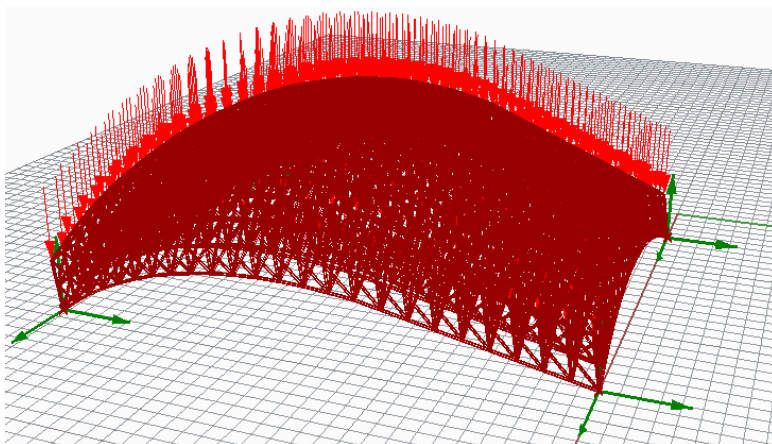
Criteria	Values	Limits
BLF Global	25.62	BLF > 1 or BLF < 0
Lowest BLF Local	2.49	BLF > 1
Max Tensile stress	14.3 MPA	35 MPA
Max Compressive stress	9.61 MPA	50 MPA

*SCENARIO 4, CANTILEVER***TABLE 34** Result for cantilever position scenario 4

Criteria	Values	Limits
BLF Global	5.38	BLF > 1 or BLF < 0
Lowest BLF Local	1.76	BLF > 1
Max Tensile stress	11.5 MPA	35 MPA
Max Compressive stress	12 MPA	50 MPA

**6.1.5 RESULT**

As it was mentioned in Table 28, the mesh used for the structural calculation has an average cell size of 16 by 15 by 13 cm (x, y, z). In these calculations, the mesh was tested as a separate element that have a series of elements attached to it. This approach was taken because in the final concrete element, the mesh will not carry structural loads of the concrete structure. With these setups, according to Karamba calculations and the created script for local BLF by author, the minimum diameter of mesh segments will be 1.5 cm.



## 6.2 INTERNAL STRESSES ON MESH CORE STRUCTURE DURING CONCRETE INFUSION

As it was mentioned before, the mesh element in this design is also used as a supporting structure for the formwork system. During the concrete infusion process, the formwork will be under hydrostatic pressure. This pressure will only last during the liquid phase of concrete.

The hydrostatic pressure that is asserted on the formwork systems, will create horizontal forces in the mesh structure. In this section, the mesh structure will be analyzed based on these types of forces that are not permanent but should be taken into considerations.

### 6.2.1 DEFINING GEOMETRY AND LOAD CASES

To calculate the amplitude of horizontal forces in the mesh structure, a few elements in the design and construction process need to be defined first. These elements are listed in Table 35.

**TABLE 35** Elements that need to be defined

Design element
1. Type of formwork system (Mesh or embedded formwork)
2. Formwork system Connection points (How many connection points are there and where are their positions)
Construction process
3. Concrete infusion method

#### DESIGN ELEMENTS

##### 1. Formwork type

In section 5.5.1, two different systems were offered to integrate formwork in the mesh structure (fine mesh and embedded formwork). For final design it was decided to go further with the “*fine mesh formwork system*”. Since the fine mesh formwork is a light system, no additional load will be added to the calculation.

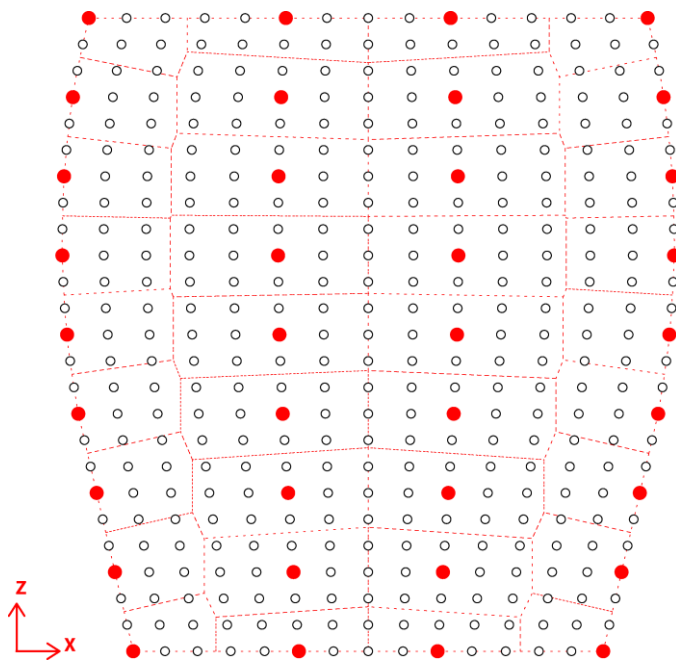
##### 2. Connection points

In this paper connection points are referred to positions where the fine mesh formwork layers are connected to the mesh structure. These connection points can be positioned on the mesh grid but not all the grid points have to be used as connections. The number

of these connections has a direct influence on amplitude of horizontal forces. However these connection points need to be fixed by human labor and can be time consuming. Therefore having a high number of connection points is not really desirable.

For calculation purposes, it was decided to use connection points in positions that are illustrated in Figure 103 (X direction 1 in 5, z direction 1 in 3 cells).

**FIGURE 103** Connection points



## CONSTRUCTION PROCESS

### 3. Concrete infusion method

The main element that generates horizontal forces in the mesh, is the hydrostatic pressure of the concrete. When concrete is infused in the mesh formwork it has a liquid state and therefore it will create a hydrostatic pressure. The hydrostatic pressure value can be defined by the equation below.

#### Hydrostatic pressure equation

$$P = \rho \cdot g \cdot h$$

$P$  = Hydrostatic pressure [N/m<sup>2</sup>]

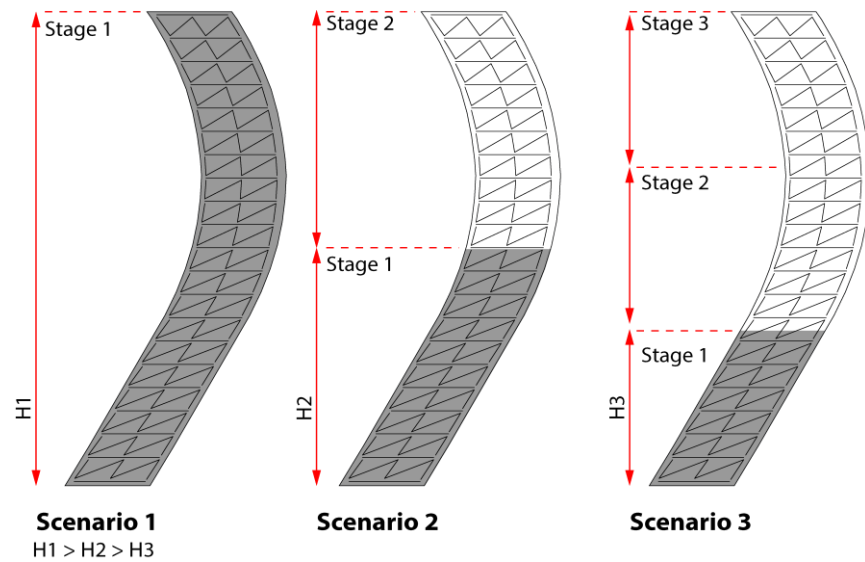
$\rho$  = Density [kg/m<sup>3</sup>]

$g$  = Gravity [m/s<sup>2</sup>]

$h$  = Height [m]

Since material density and gravitational force are constant values, height will be the only variable. To decrease the hydrostatic pressure load, concrete should be infused in different stages. In this way effective height can be adjusted (see Figure 104).

**FIGURE 104** Concrete infusion scenarios



**TABLE 36**

Geometrical and mechanical properties used for hydrostatic calculation

Geometrical properties	
Average X cell dimension	160 mm, nr cell 14
Average Y cell dimension	150 mm, nr cell 2
Average Z cell dimension	130 mm, nr cell 24
Mesh diameter thickness	1.5 cm
Mechanical properties	
Material	ABS
Young Modulus	2.9 GPa
Shear Modulus	1.03 GPa
Density	1080 Kg/m <sup>3</sup>
Yield Strength	35 MPA
Compressive strength	50 MPA

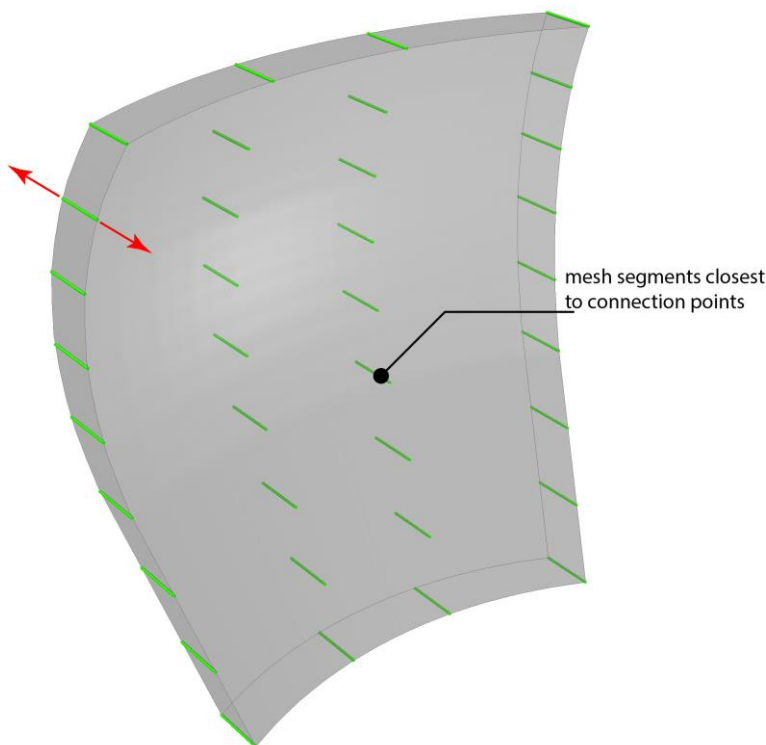
### 6.2.2 CALCULATION

In section 6.1 the structural integrity of the mesh was analyzed based on its own load and its attachments weight. It was concluded that the thickness of the mesh should be at least 1.5 cm. Based on the defined 1.5 cm thickness, the mesh will be tested against the hydrostatic pressures.

In the first part, the concrete infusion will be modeled as scenario 1 in Figure 104 and a sufficient thickness for the mesh diameter will be determined. In the second part the maximum tolerable concrete infusion height for the mesh with a thickness of 1.5 cm will be calculated.

In Figure 105 a simplified version of the mesh model that will be used for calculation purposes is illustrated. In this model, segments of the mesh that are close to connection points are presented. The green color represents the segments that are under tolerable stress and the red color is indication of high stress.

**FIGURE 105** Model for hydrostatic calculation

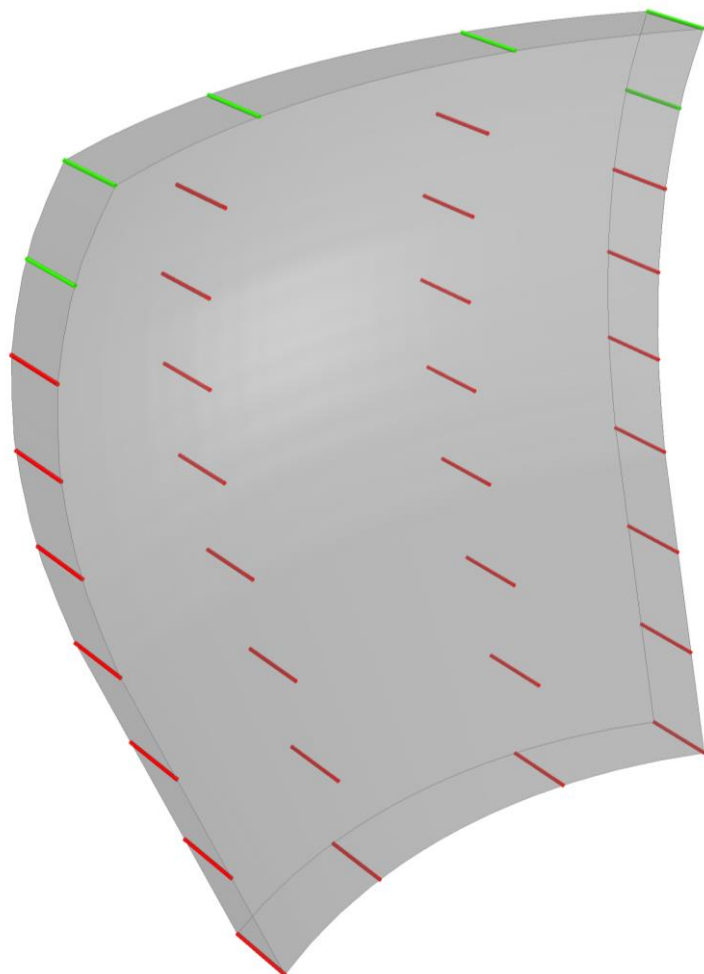


**PART 1 FULL HEIGHT INFUSION****MODEL 1 THICKNESS 1.5 CM**

In the first model, the mesh was tested with a thickness of 1.5 cm. According to the results from Karamba calculation, concrete cannot be infused in a mesh structure with a thickness of 1.5 cm. The highest stress value in the mesh is 305 MPa which is almost 10 times higher than ABS tensile strength. Therefore it can be concluded that, in one session concrete infusion is not possible with a mesh core with thickness of 1.5 cm.

**TABLE 37** Numerical result - Stage 1 model 1(1.5 cm)

<i>diameter</i>	15 mm
<i>Cross-section area</i>	176 mm <sup>2</sup>
<i>Concrete infusion height</i>	3 m
<i>Max tensile stress</i>	305 MPa
Elongation	

**FIGURE 106** Result model - Stage 1 model 1(1.5 cm)

**MODEL 2 THICKNESS 5 CM**

In this model the mesh thickness was adjusted to support concrete infusion in one session. According to the collected results from the generated grasshopper script by author and without changing number of connections, thickness of mesh should be at least 5 cm. This increase in thickness will increase the material usage for mesh core by 11 times.

**Thickness 1.5 cm**

$$\text{Cross section Area} = \left(\frac{15}{2}\right)^2 \times \pi = 177 \text{ mm}^2$$

**Thickness 5 cm**

$$\text{Cross section Area} = \left(\frac{50}{2}\right)^2 \times \pi = 1963 \text{ mm}^2$$

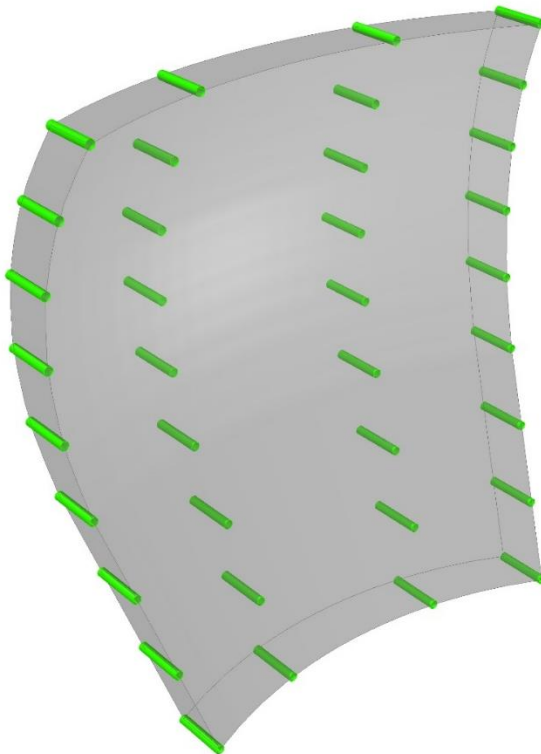
**Cross section increase ratio**

$$\text{Ratio} = 1963 / 177 = 11.1$$

**TABLE 38** Numerical result - Stage 1 model 2 (4.5 cm)

<i>diameter</i>	50 mm
<i>Cross-section area</i>	1898 mm <sup>2</sup>
<i>Concrete infusion height</i>	3 m
<i>Max tensile stress</i>	34 MPa

**FIGURE 107** Result model - Stage 1 model 2 (4.5 cm)



**PART 2 MAXIMUM TOLERABLE HEIGHT**

*MODEL 3 THICKNESS 1.5CM*

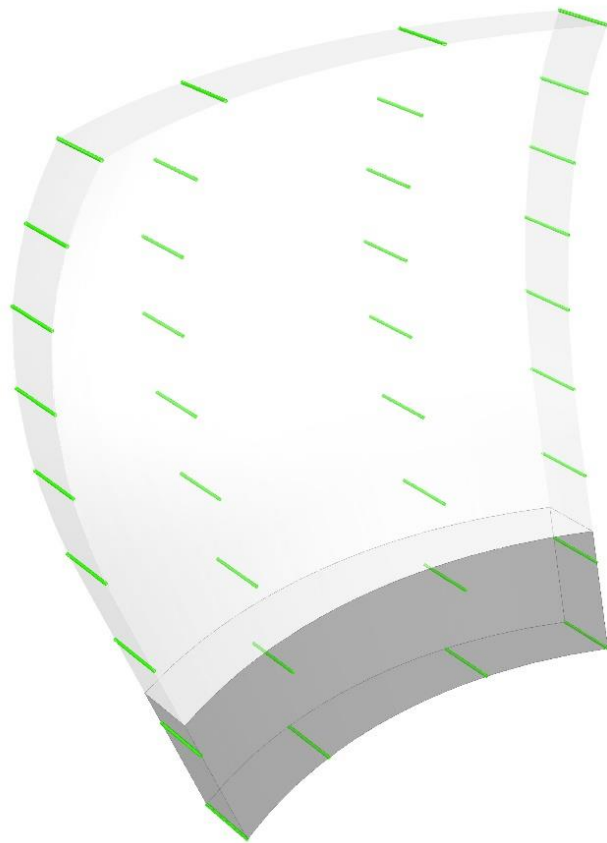
To maintain the 1.5cm thickness in the mesh structure, concrete needs to be infused in different sessions. In this part the height of concrete infusion and number of sessions will be determined.

According to the collected results, the designed mesh (1.5cm) can handle concrete hydrostatic pressures up to 0.5 meter height. In each session, 0.5 meter of concrete should be added to the mesh core. Therefore the concrete infusions should be done in 6 separate sessions.

**TABLE 39** Numerical result - Stage 2 model 3 (1.5 cm)

<i>Diameter</i>	15 mm
<i>Cross-section area</i>	176 mm <sup>2</sup>
<i>Concrete infusion height</i>	0.5 m
<i>Max tensile stress</i>	35 MPa

**FIGURE 108** Result model - Stage 2 model 3 (1.5 cm)





## 6.3 CONCLUSION

In this chapter, structural integrity of the mesh core structure was analyzed based on its own weight, load due attached components and the internal stresses due to concrete infusion. Based on the obtained results from calculations in section 6.1 and 6.2, the ABS printed mesh core structure with a grid dimension as mentioned in *Table 40* should have a minimum thickness of 1.5cm.

However with this thickness, concrete cannot be added to the mesh core structure in one go. This process should be done in several sessions and for each session the maximum height of concrete should not be above 0.5 meter.

Depending on the type of concrete and its curing time, the interval between each session can vary. It is well advised to use a concrete with epoxy mixture that are commonly used in 3D concrete printing systems. This type of concrete can cure in a very short period, and give the capability to 3d concrete printing system to print concrete layers instantly on top of each other.

**TABLE 40** Mesh core structure grid properties

Geometrical properties	
Average X cell dimension	160 mm, nr cell 14
Average Y cell dimension	150 mm, nr cell 2
Average Z cell dimension	130 mm, nr cell 24

Calculations related to reinforcing carbon fibers on the outer layer are intentionally avoided. For design purposes, a 3 cm space is provided for the reinforcement layer. In case 3 cm thick carbon fibers are not sufficient, the current reinforcing path can be duplicated to provide the needed strength.



# **7 • Final design production and assembly**

## 7 FINAL DESIGN PRODUCTION AND ASSEMBLY

---

In this chapter, the production and assembly process of the concrete structure using the developed reinforcement production technique will be covered. In Figure 109, the final concrete wall structure is presented. To create this wall structure several items should be manufactured and assembled together. The production and assembly process of the required components will be done in two phases;

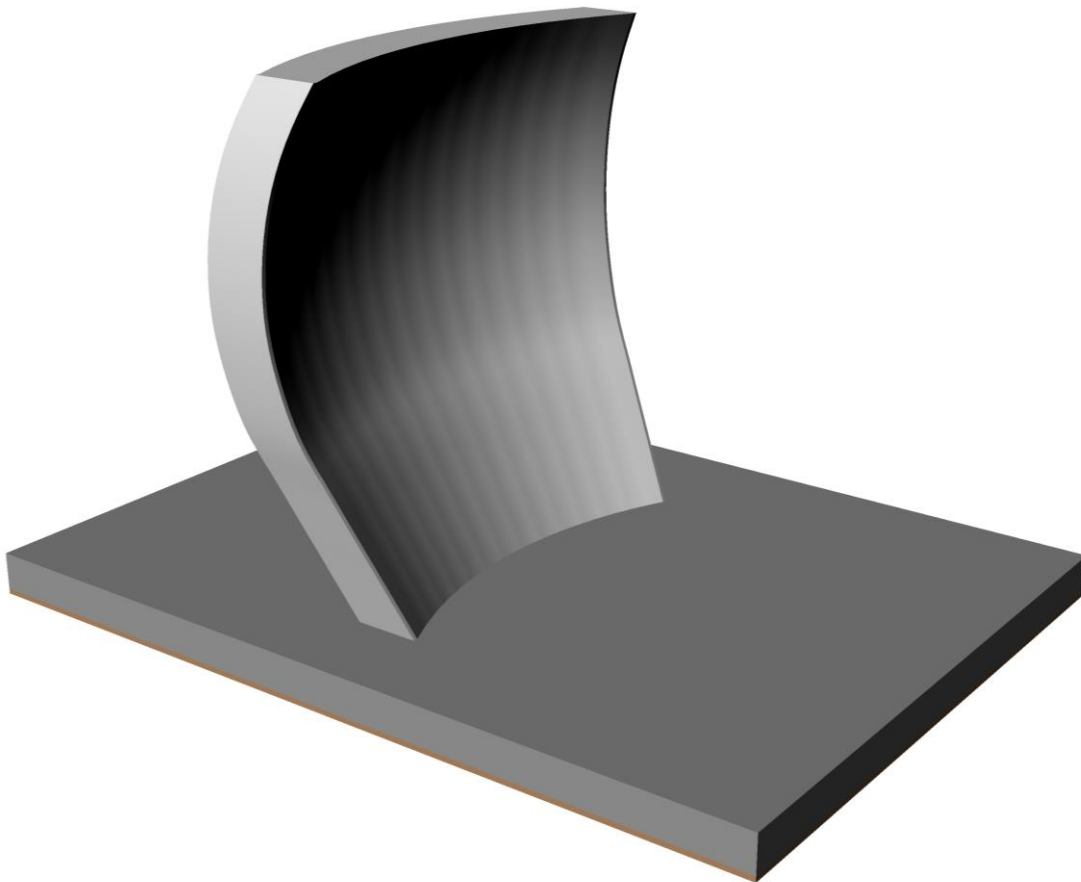
1. Production factory
2. Building site

The goal is to produce and assemble most of the elements in the controlled environment of a production factory. This strategy will give a higher production precision and decreases the demand for manual labor in the building site.

---

**FIGURE 109** Freeform concrete wall structure

---



## 7.1 PRODUCTION FACTORY

### 7.1.1 STEP 1 – MESH CORE

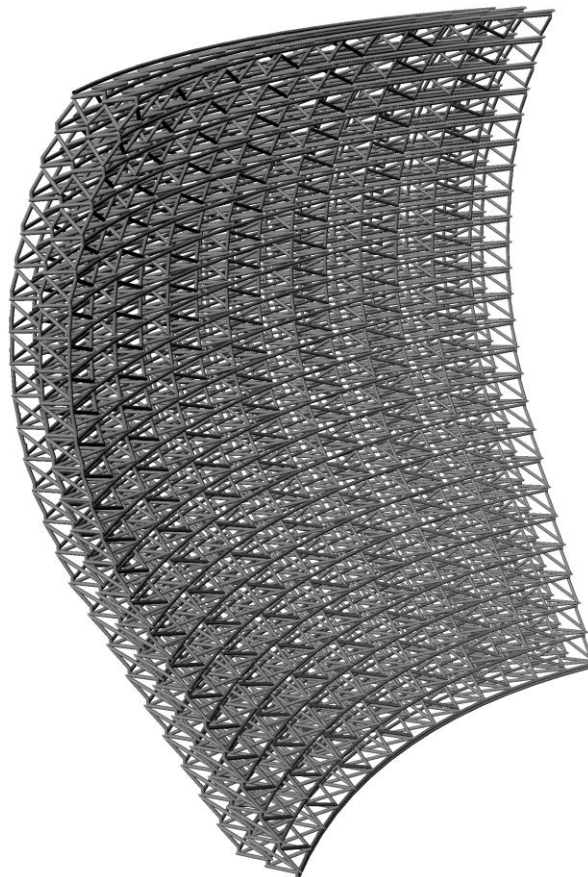
As it was mentioned in chapter 5.2, the mesh core structure will be produced using scaled 3D printer or a robotic arm equipped with FDM head (fused deposit molding). According to calculations in chapter 6, the mesh should have a thickness of 1.5 cm. Therefore, a custom made 1.5 cm nozzle is required. Additionally it is also essential that the FDM system have a cooling system.

This process will take place in a factory environment.

**TABLE 41** Summary of mesh core structure information from previous chapters

<b>Material</b>	Reinforced Thermoplastic; <i>PPC or ABS (reinforced with chopped carbon fibers)</i>
<b>Manufacturing technique</b>	FDM; <i>standard 3D printer setup or a robotic arm</i>
<b>Extrusion diameter</b>	1.5 cm

**FIGURE 110** The generated mesh core structure in a factory setup

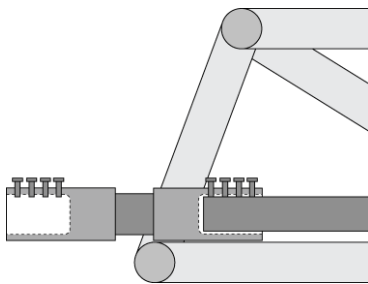


### 7.1.2 STEP 2 – PLACING CONNECTION SLEEVES

After the mesh core structure is created, the reinforcement fibers need to be placed on top of it. This can be done in two ways, fully automated or a semi-automated procedure.

Before starting the fiber placement procedure, type of connection between floor and wall reinforcement structure should be defined (see chapter 5.6).

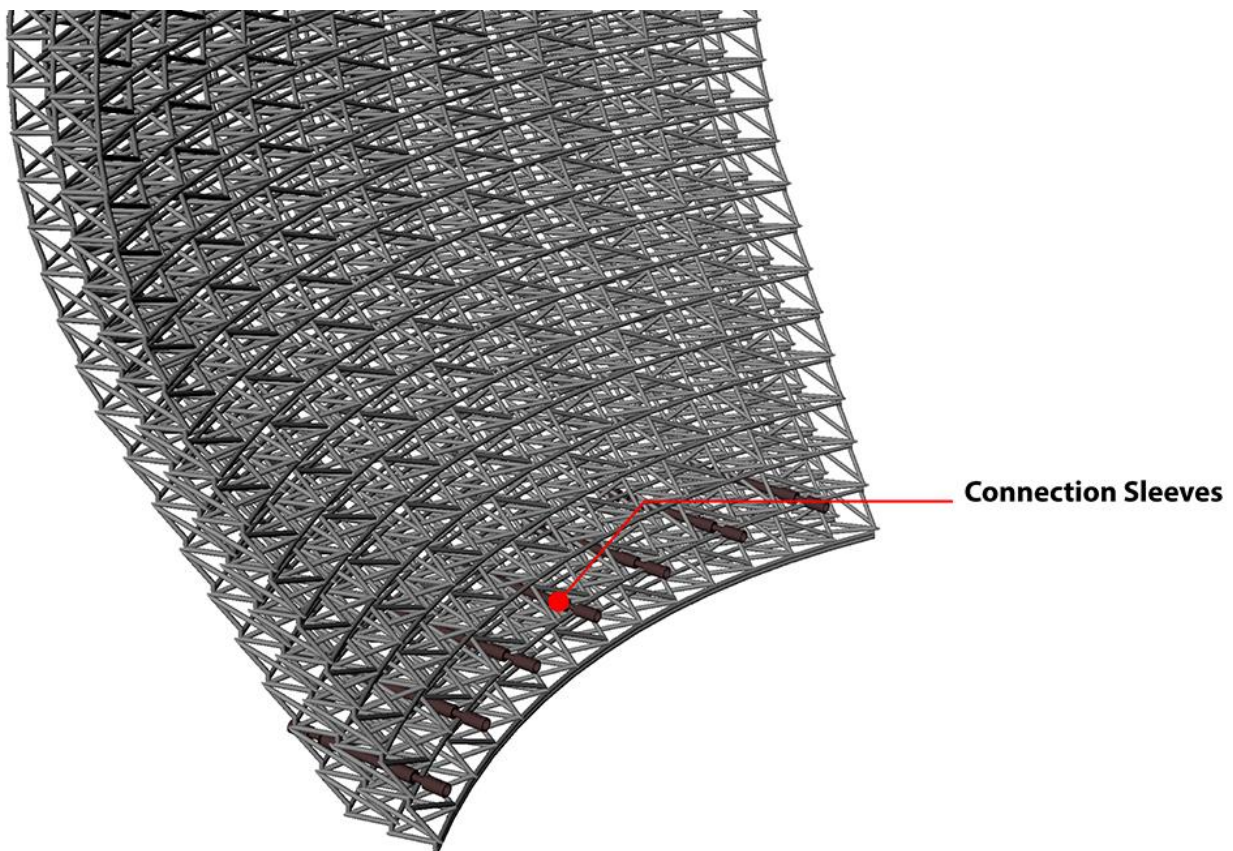
**FIGURE 111**  
Connection Sleeves



In the case of direct connection method, those designed connection sleeve component should be placed on the mesh core. This part will be done manually, but the placement of fixing of those elements should be done precisely. These items will be used on fiber placement procedure as a pin, which fibers will be warped around.

In case of an indirect connection this step can be skipped.

**FIGURE 112** Connection sleeves mesh core structure





### 7.1.3 STEP 3 – PLACING REINFORCING FIBERS

For fiber placement procedure there will be two potential approaches;

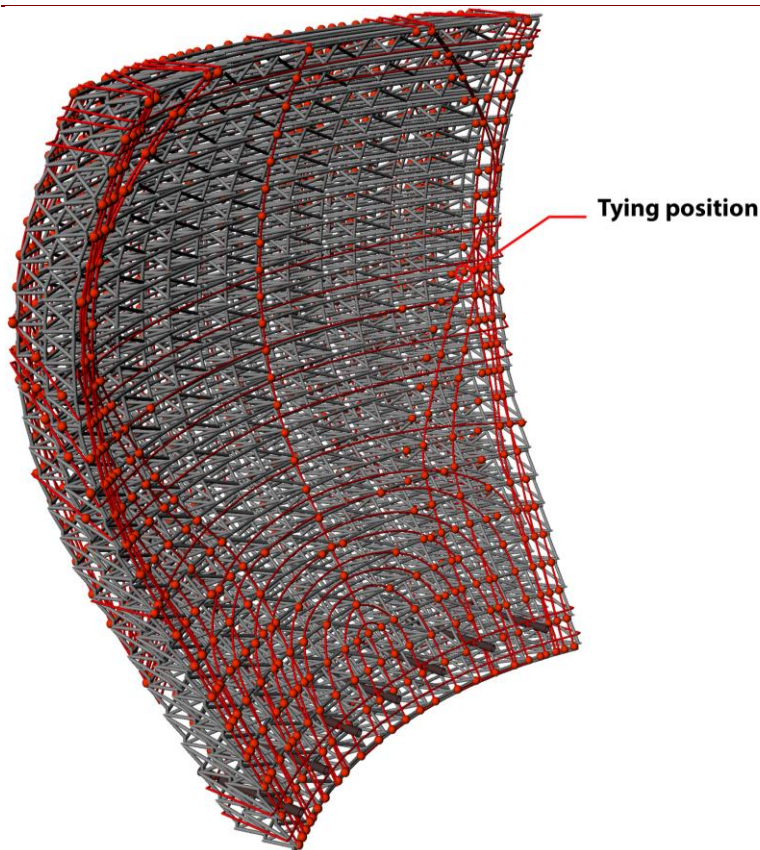
1. automated procedure
2. semi-automated procedure

#### AUTOMATED PROCEDURE

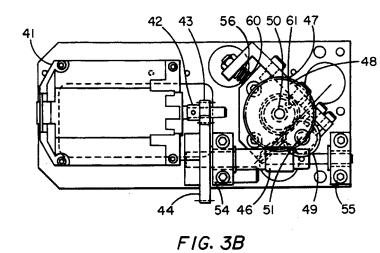
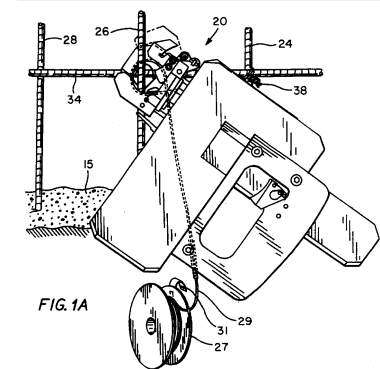
As it was mentioned in *chapter 5.4* in a fully automated approach, a continuous tow of fibers will be wrapped around the mesh core and fixed in their place by a tying mechanism. In Figure 113 a rebar tying machine is illustrated. In the automated approach, such a tool will be attached to the robotic arm which ties the fiber tow to the mesh core structure.

The setup for this procedure will be similar to the diagram illustrated in Figure 116. An automated rotating table and a robotic arm will be needed. In Figure 114 the outcome of the stage 3 in the fully automated way is illustrated. It will be a mesh core that is wrapped with a continuous tow of carbon fiber.

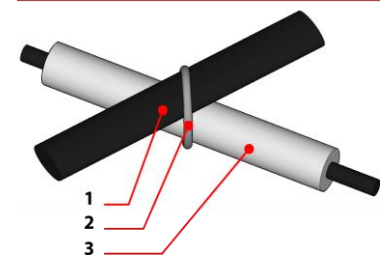
**FIGURE 114** Mesh core structure warped with carbon fiber tow. The orange spheres are indicator for the tying positions.



**FIGURE 113**  
Tying Machine Patent  
(Forrester, Kauth, & Krasovic,  
1995)

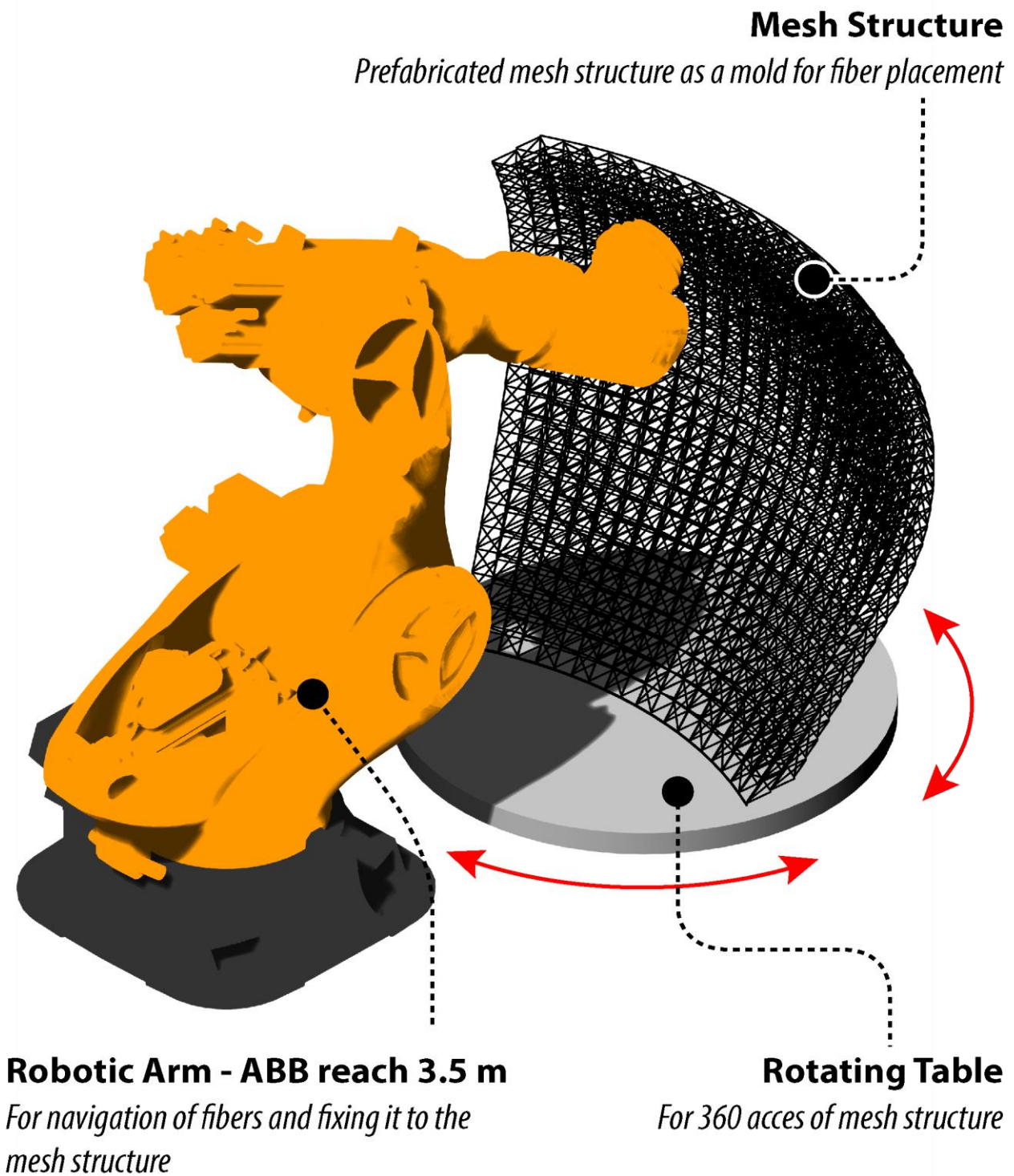


**FIGURE 115**  
Connection between mesh and  
fiber tow



1. Carbonfiber tow reinforcement path
2. Steel wire tie
3. Core Mesh Structure (ABS)

**FIGURE 116** Fiber placement setup





**SEMI-AUTOMATED MODE**

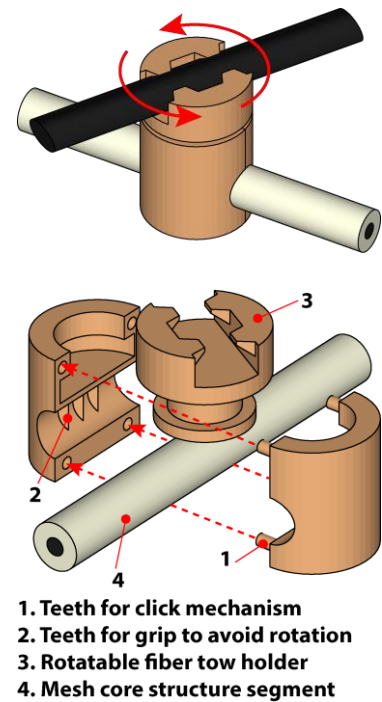
In the semi-automated procedure this stage will be done in two phases.

**PHASE 1 – ATTACHING FIBER NAVIGATORS**

In the first phase, a series of fiber navigator components will be attached to the mesh core structure. This process should preferably be done by a robotic arm. Figure 117 illustrates the assembly process of this component. These three parts will be clicked in each other by the robotic arm or a press machine. The inner teeth (2) will create a grip and make this component fixed to the mesh core structure.

Since the reinforcing carbon fibers and the mesh core structure are not always intersecting each other in the same angle, the top part of this component is designed in a way to have rotation freedom. In this manner a similar design can be used for all of the intersection points.

**FIGURE 117**  
Fiber navigator component



**FIGURE 118** Phase 1 - Attaching fiber navigator on Mesh core structure

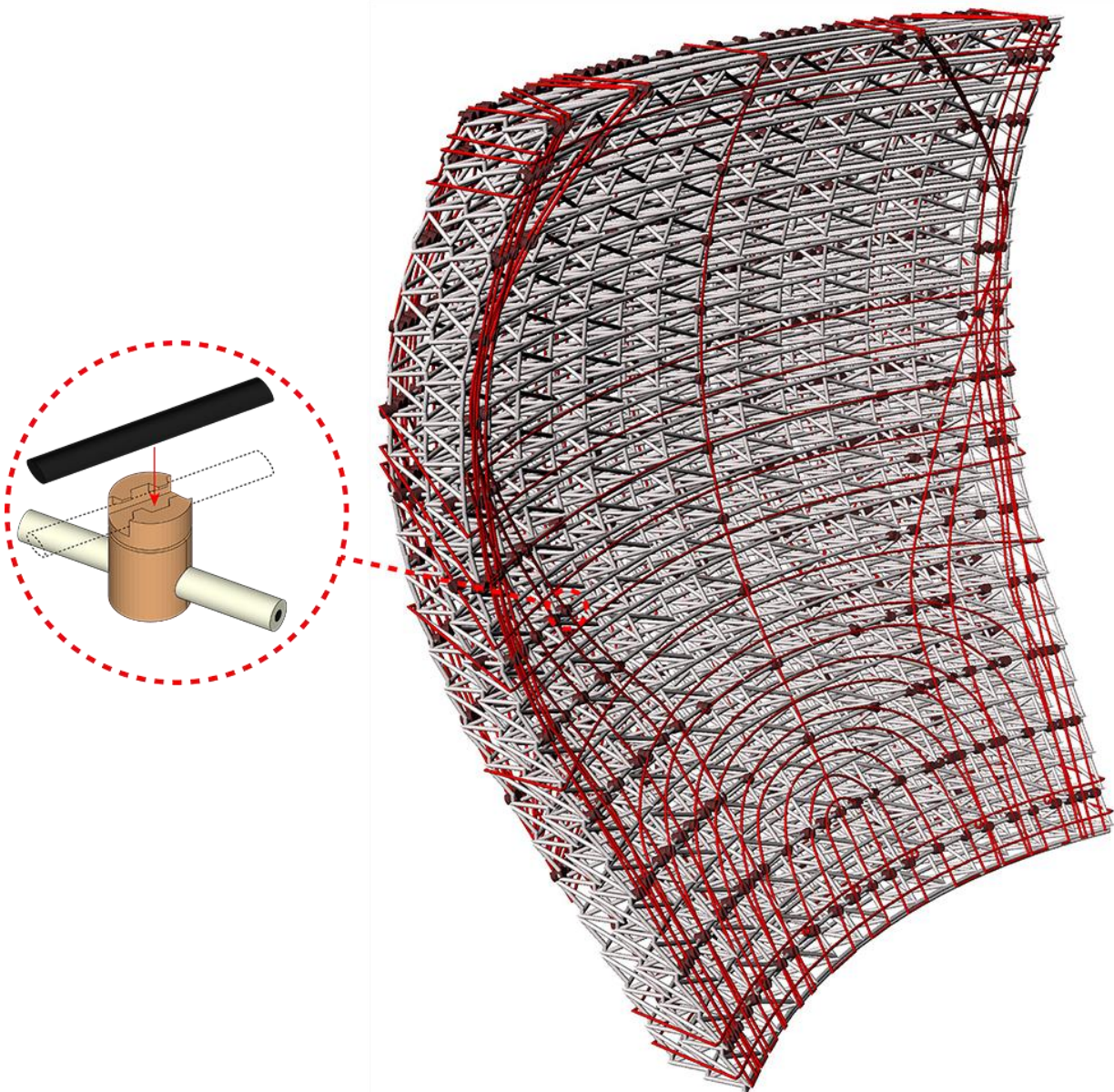


*PHASE 2 – PLACING CARBON FIBERS*

After the fiber navigator components are attached to the mesh core structure, the reinforcement fiber tow should be placed in these components. In Figure 119 this procedure and the outcome of this stage are illustrated.

It should be noted that in both automated and semi-automated methods, a carbon fiber that is dipped in epoxy should be used. Adding epoxy can be done right before placing these fibers on the mesh structure.

**FIGURE 119** Fiber placed manually on semi-automated approach





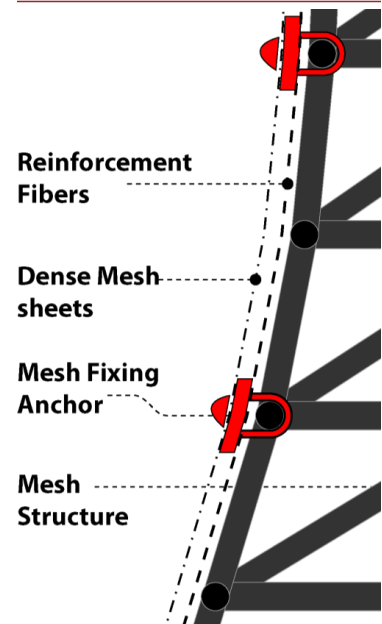
### 7.1.4 STEP 4 – FINE MESH FORMWORK INSTALLATION PREPARATION

As it was mentioned in chapter 5.5, two different strategies for formwork were presented; “Embedded formwork” and “Fine mesh sheet formwork”. If the fine mesh formwork system is to be used for concrete infusion, the following procedure should be followed.

For showing an overview of how the fine mesh formwork is assembled, refer to Figure 121. To anchor the fine mesh formwork on the mesh core structure, several components are necessary. In the original design these formwork sheets were attached directly to the mesh core structure. But during the design process for assembly, it was concluded to replace the previous system with a connection rod (element 3 in Figure 121). These connection rods will act as anchoring points for the formwork assembly process.

The formwork assembly and concrete infusion will be done at the construction site but these connection rods should be placed on the mesh core structure at the factory environment.

**FIGURE 120**  
Previous formwork anchoring system from chapter 5.5



**FIGURE 121** Fine mesh formwork assembly

1. Mesh Core Structure
2. Fine mesh formwork sheet
3. Connection rod
4. Reinforcing rod
5. Screw
6. Cap

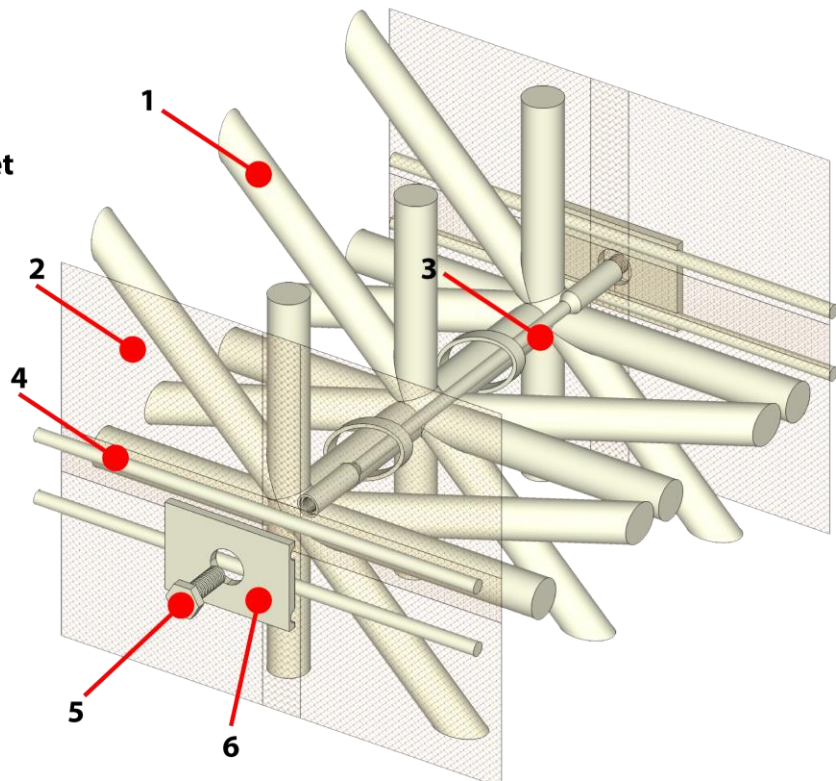


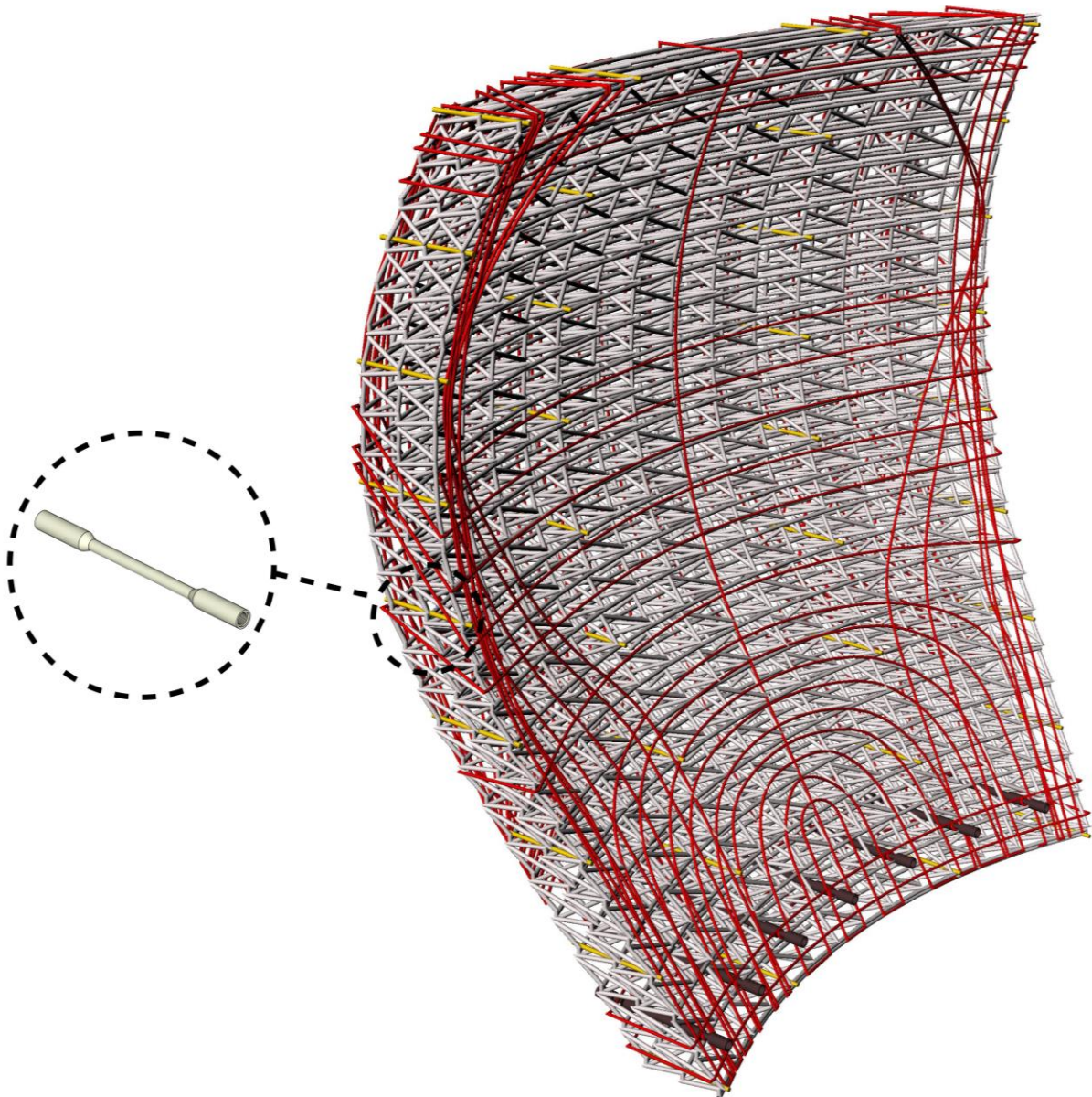
Figure 122 shows where these connection rods are placed (yellow items on the diagram). Position of these elements were defined in the calculation chapter. However in that chapter the internal stresses due to hydrostatic pressure were calculated based on ABS material. Since these connection rods are made out of steel which has superior mechanical properties than ABS, no additional calculation will be necessary.

By placing these elements on the mesh core structure the production process in the factory environment will be done. The manufactured product will be transported to a construction site as a pre-fabricated element..

---

**FIGURE 122** Addition of connection rod to mesh core structure

---



## 7.2 CONSTRUCTION SITE

The designed reinforcement technique in this report was developed in a way to limit the manual work at the construction site. The construction workers will get a prefabricated element which most of its components have already been assembled in a factory. However certain tasks should still be done at the construction site. These tasks are as following:

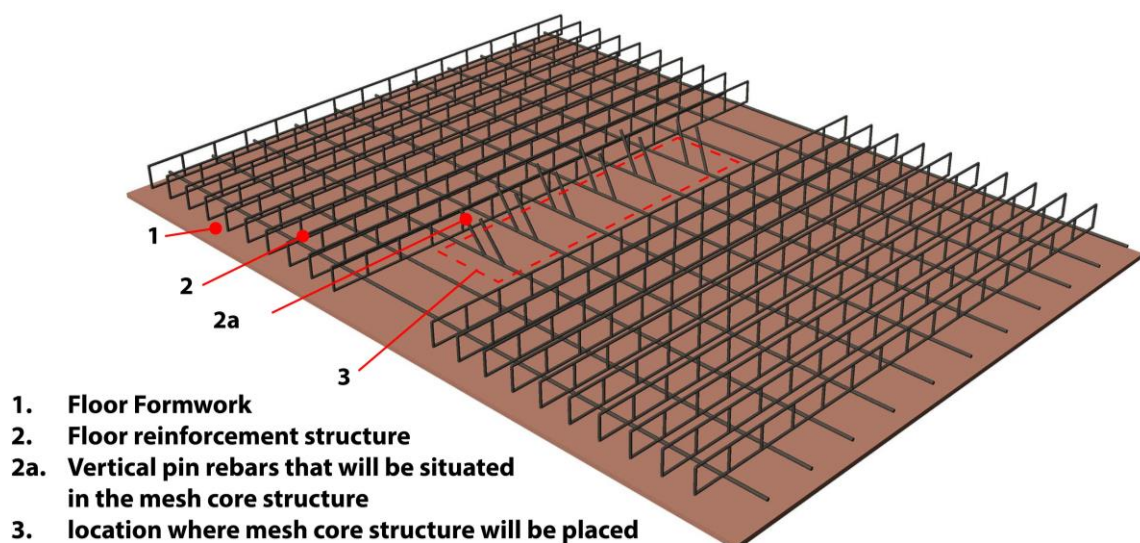
1. Placing the prefabricated reinforcement element at its position and connecting the freeform wall reinforcement structure to floor reinforcement rebars.
2. Attaching the fine mesh formwork sheets to the structure.
3. Concrete infusion.
4. Applying finishing layers.

### 7.2.1 STEP 1 – POSITIONING OF CURVED WALL REINFORCEMENT STRUCTURE

Before positioning the reinforcement structure at its place, certain elements of the underlying floor structure should be assembled. As it was already mentioned a few times in this report, the designed reinforcement technique is developed only for freeform structure. Therefore linear elements such as floors and roof structures should be constructed with the conventional methods.

The first step for onsite assembly will start with placing the first layer of the required floor rebar (Conventional reinforcement method). A semi empty space in rebar structure should be provided for the mesh core structure.

**FIGURE 123** Step 1 placement of floor reinforcement



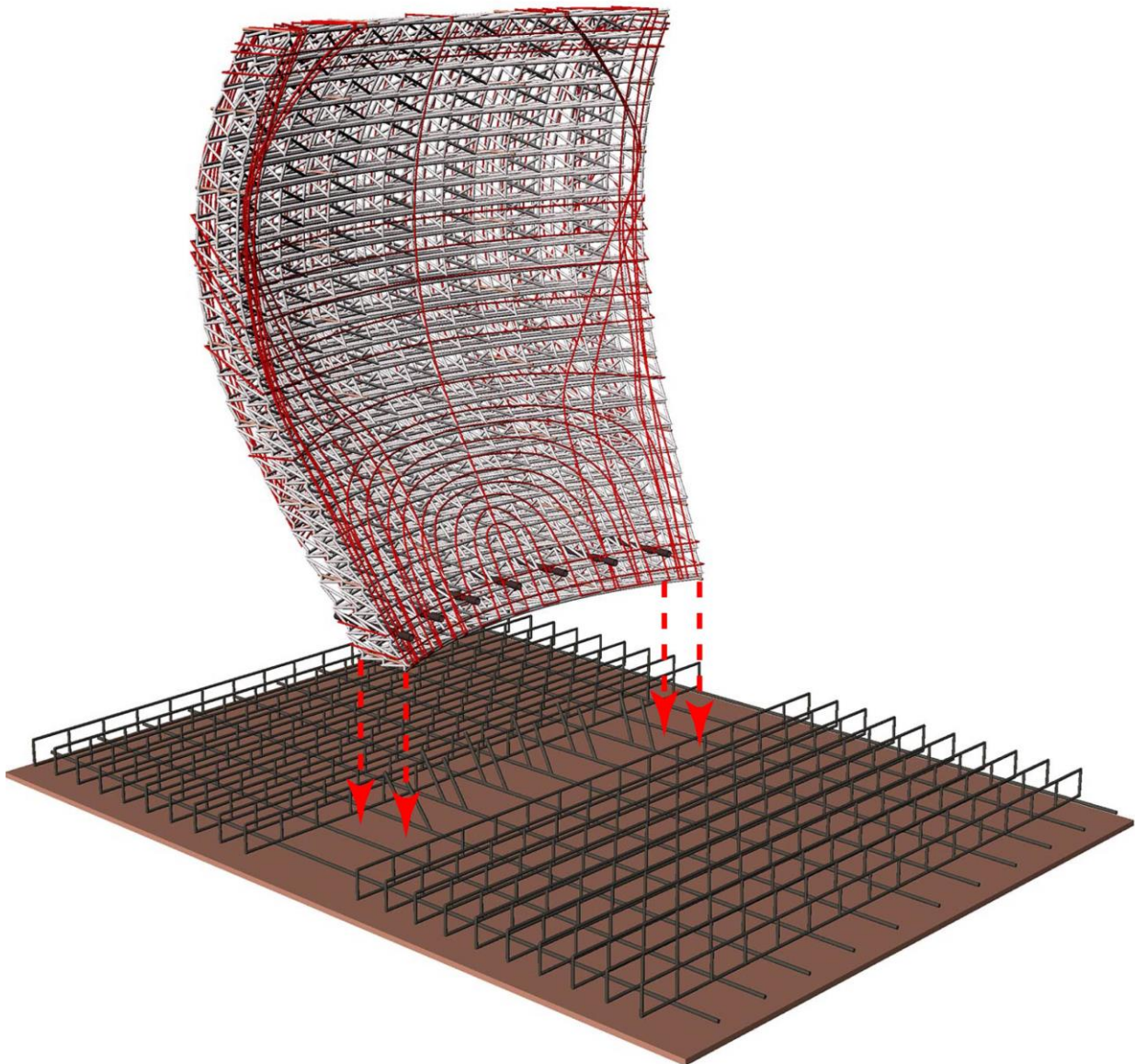


After the floor reinforcement rebars are laid down, the mesh core structure should be inserted in its position (see Figure 124). Then the top layer of floor reinforcement's rebars should be placed and attached to the connection sleeves embedded in the wall mesh core reinforcement structure. After this step, the concrete will be injected into the floor reinforcement structure (See Figure 125).

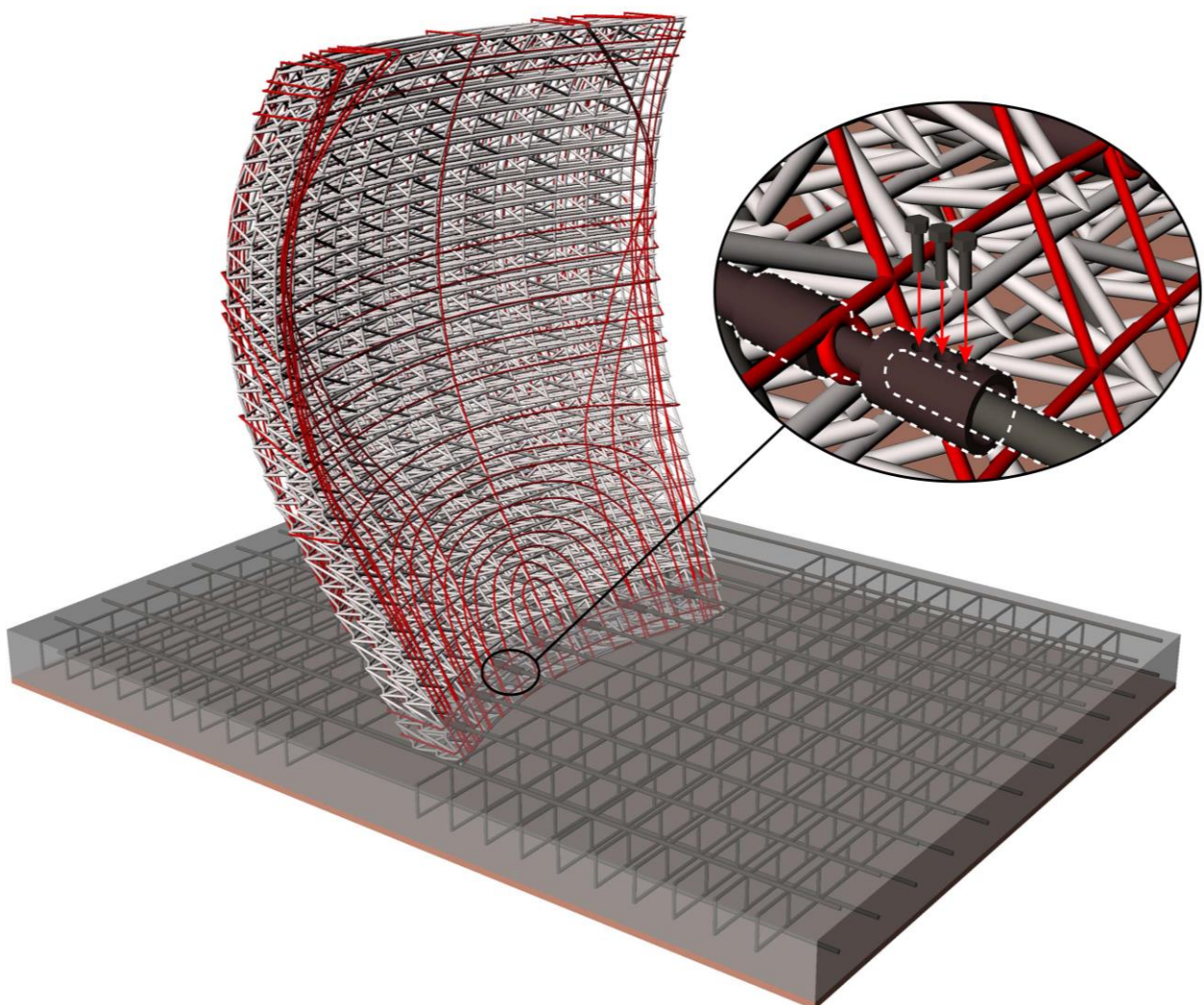
---

**FIGURE 124** Placement of Mesh core structure on underlying floor reinforcement structure

---



**FIGURE 125** Connecting reinforcement structures and injecting concrete for floor

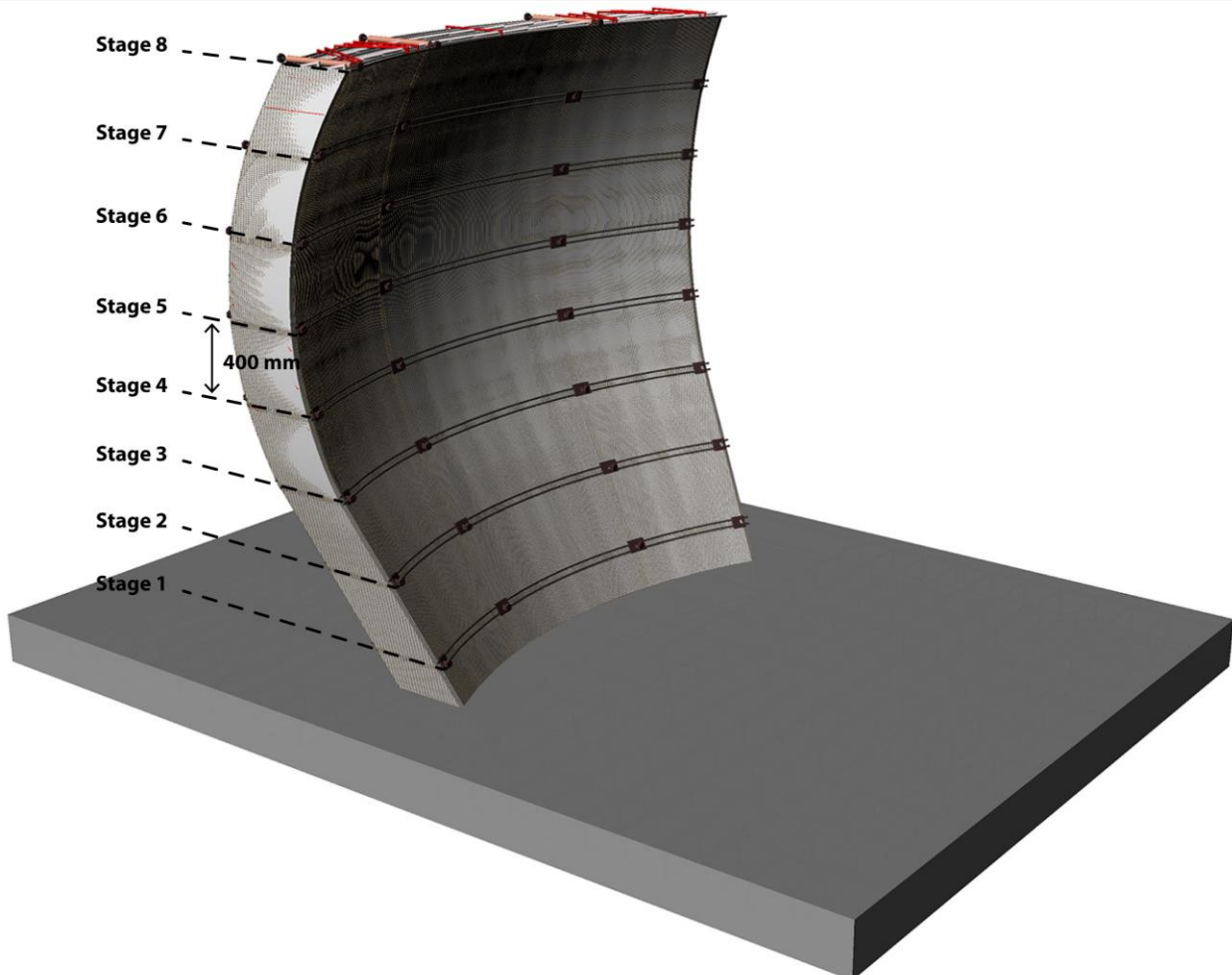


### 7.2.2 STEP 2 AND 3 – PLACING FINE MESH FORMWORK SHEETS

When the concrete on the floor structure is cured, it will be time to assemble the fine mesh formwork system.

As it was mentioned in the *calculation* chapter (Ch.6.2), concrete cannot be added to the structure in one session. Therefore the process of adding concrete should be done in separate session and in each session the height of concrete should not surpass 0.5m. In this process, infusion of concrete will be divided in 8 stages. In each stage 400 mm of concrete will be added to the mesh core structure (See Figure 126). The interval between each session depends on the curing time of concrete. If the used concrete is similar to the 3D printing concrete, no delay is needed between each session.

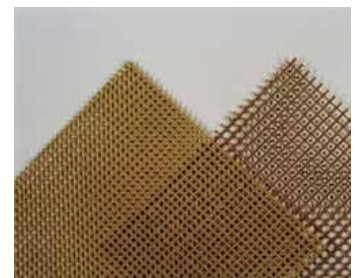
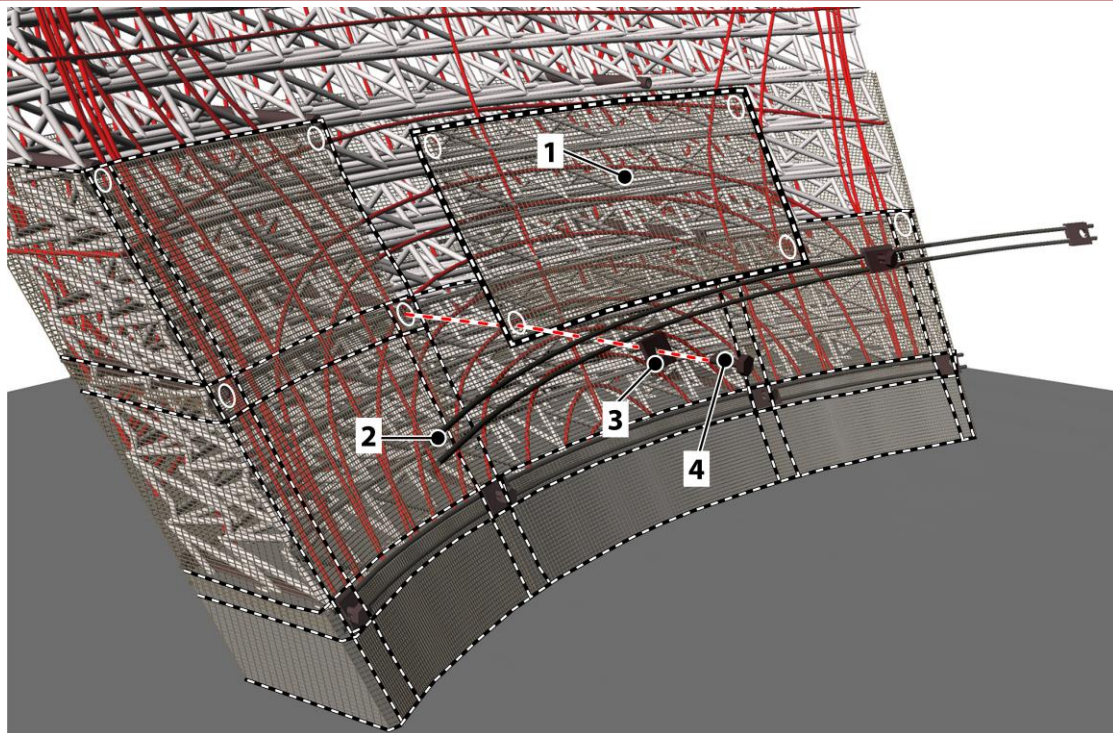
FIGURE 126 Concrete infusion secessions





In Figure 129 the assembly process of the fine mesh formwork is illustrated. As it was mentioned in section 7.1.4, the connection rod components had already been placed in the prefabricated mesh core structure. The first step for onsite assembly of formwork, is the placement of fine steel mesh sheets on the mesh core structure. This process should also be done in separate stages according to concrete infusion sessions. When the mesh sheets are placed at their positions, a thin bendable steel rod (element 2) will be placed on top of them and a cap (element 3) will hold it in its place. This cap is connected by a screw (element 4) to the connection rod component. After the mesh sheets are fixed to their position, concrete is added to the mesh core structure. This step will be repeated till the whole structure is filled with concrete.

*Steel rod act as a temporary reinforcement for edges of the mesh sheets. These elements are optional and can be replaced by other systems. For example adding an embedded layer of chicken wires to fine steel mesh will upgrade the stiffness of the whole sheet*

**FIGURE 127** Fine Steel mesh**FIGURE 128** Kevlar mesh**FIGURE 129** Assembly of fine mesh formwork

1. Fine Mesh Sheet
2. Flexible steel rod for extra rigidity for edges (Optional)
3. Cap for holding Fine mesh sheet and steel rods
4. Screw

### 7.2.3 STEP 4 – SURFACE FINISHING

When the whole structure is filled with concrete, temporary elements such as steel rods and caps should be removed. To be able to remove these elements, the attached screws should be removed from the connection rod component. Since these screws are locked in concrete, removing by rotation will not be feasible. Therefore a special screw or bolt with a breakable head should be used.

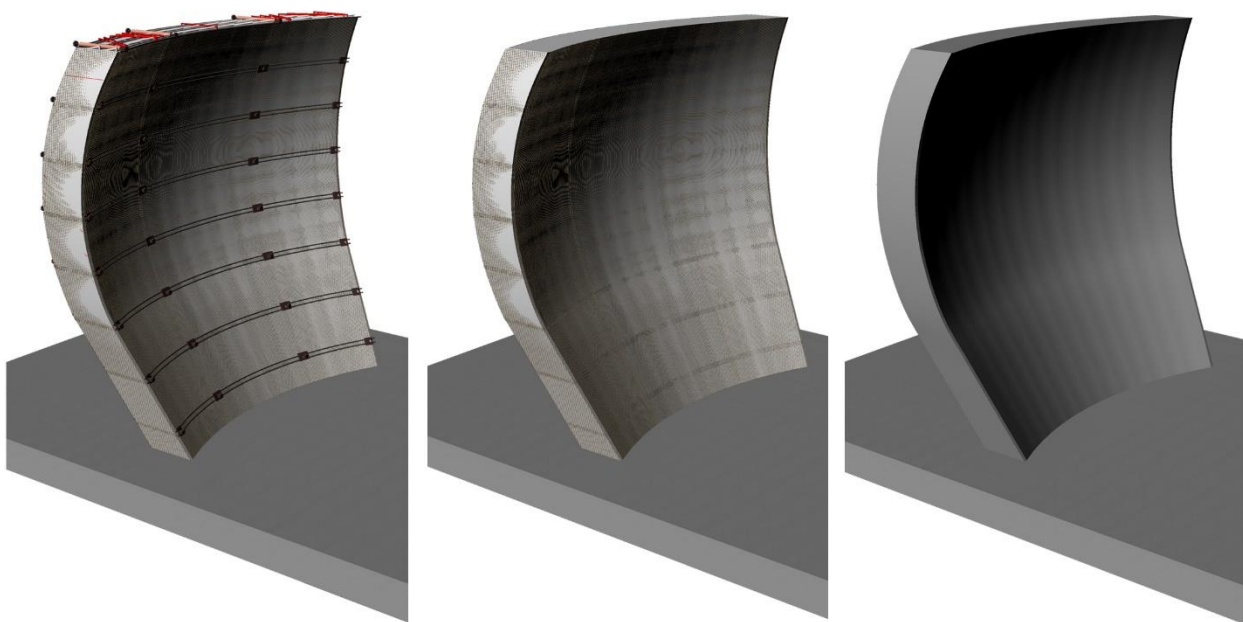
After removing the steel rods and caps, a finishing layer will be required. For this step a cement layer will be added to cover the bumps and steel mesh sheets.

After this step the curved wall is fully assembled and is ready to be used.

---

**FIGURE 130** Applying the finishing layer

---



**1.**  
Filling the whole structure with concrete in separate sessions

**2.**  
Removing steel rods and caps

**3.**  
Applying cement finishing layer to cover fine mesh sheets and a smooth exterior

# 8 • Evaluation and Conclusion

## 8 EVALUATION AND CONCLUSION

---

The goal of this research project, was to fill the knowledge and research gap in the digital manufacturing of concrete. Through the initial research, it was concluded that most scholars and students focus mainly in concrete printing or formwork production and very little attention is given to investigating new techniques for manufacturing of reinforcement elements. Therefore it was decided to focus on this field and fill the research gap in this field.

The conventional reinforcement system are a reliable system for most of the concrete structures. However in freeform concrete structures, application of this conventional reinforcement system will be a challenging task. For that reason, it was decided to focus on developing reinforcement techniques that are suitable for complex freeform structures.

To develop such a technique, this project could take two different path. These paths are as following;

1. **Design approach:** Select a single concept, material, a fixed geometry, and develop it till the last detail that where feasible for the author. In this approach a single system would have been developed that might only be suitable for the chosen structure.
2. **Research approach:** Try to research each step and come up with different solutions and technique. Develop alternative concepts and compare them together. In this approach having a fully detailed final design will not be possible. But its outcome will be series of different concept and techniques that are suitable for most of freeform concrete structures. Additionally since in this approach different systems are intended to be developed, it will better fill the research gap.

For this project the second research approach was chosen. For that reason it was decided to focus more on developing various techniques and not to do detailed reinforcement calculations. The detailed reinforcement calculations will only determine the thickness of the reinforcement material and will not have big influence on the overall idea.

## 8.1 EVALUATION

---

### 8.1.1 CALCULATION RELATED

Since the author does not have a civil engineering background, doing advanced structural calculation for every single concept in short period of master thesis was not feasible for him. However the essence of this project wasn't defined by the exact numbers and dimension, the goal was to develop a general system that can be applied for most of freeform concrete structures. This research paper can be categorized more as a research by design project rather than technical research project.

For the final design, the dimension and thickness of Mesh core structure was defined based on hand and computer calculations. Only the dimension of the outer reinforcing carbon fiber were not based on exact calculation. Regardless of lack of detailed technical calculations for this part, each step was based on structural principles. In some cases reference project was used to define a global dimensions and a set of criteria were presented for future structural calculation.

The exact calculation needed for reinforcement layer will only determine the amount carbon fiber material that will be used and will not change the reinforcing concept essence.

### 8.1.2 DESIGN RELATED

Regarding to design aspect, this project started with really conceptual level and got evolved to more realistic system.

In this thesis, each chapter got started with creation of new or modification of existing concepts. Then it was followed by research and analyses phase and got finalized by evaluation and recommendation part. In the recommendation part, one or multiple ideas were suggested that got graduated to next chapter. This process got repeated several time till this chapter.

In chapter 5 a single concept got selected and its details got investigated and developed till a level that was feasible. Most of the elements that got used in the final design are fully designed and are backed up by intensive research. The only parts that need more

investigation and possibly a modification, are the connection elements between embedded formwork (fine mesh formwork sheet) and the thermoplastic mesh structure. The current designs for those part are functional, but there were no other alternative solution developed. This can be seen as a design aspect that can be improved and further studied in future studies.

### **8.1.3 PROTOTYPING**

Last but not least is the prototyping stage. The progress in this part, is till this stage very limited. This is mainly due to lack of access to advance machines such as robotic arms. Additionally manufacturing such a design, requires developing new tools and technology. For example integration of continuous carbon fibers in a 3D printed mesh structure have never be done in this way before. To develop such system a new technique need to be developed which in its self, can be seen as another research project.

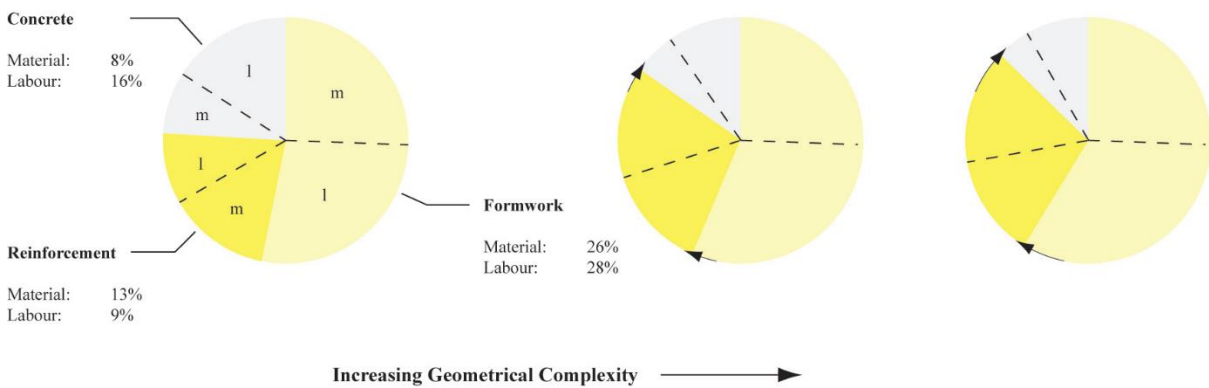
Beside carbon fiber integration, manufacturing other parts of this structure is practical. Each of its components have already been manufacture by a different research institute. It only matter of getting access to similar machine and combining and modifying different technique to get this design manufactured. Nevertheless some of this system elements, has been produced in a smaller case with the limited available resources. This process is explained briefly in the prototyping chapter.

## 8.2 CONCLUSION

One might say, that this design might not be able to compete economically with the other low cost reinforcement system. This is till certain extend true, but it should be taken into consideration that this system is not developed for simple structures.

In some building due to lack of a prober system for manufacturing reinforcement, the project developer will decide to switch from reinforced concrete to other materials (i.e. Arnhem station). Additionally when the geometric complexity of an object increases, the production cost for manufacturing its formwork and reinforcement will also increase dramatically (See Figure 131)

**FIGURE 131** Influence of geometrical complexity and reinforcement and formwork price ratio (Robert, 2007)



In a complex geometry, production of formworks and reinforcements are the most expensive part of a design. The reinforcement system that was developed in this report will combine the function of these two elements into a single product that can be used for both purposes. Therefore in future when this system is fully developed and is more accessible, it can eventually reduce the production costs of freeform concrete structure.

One of the reasons that this system is expensive at the moment is because of the needed machines and materials. Carbon fiber is currently an expensive material and for that reason one might say that this system is not practical. However the demands for this product is increasing and therefore more companies are investing on its production techniques. It should be noted that the high price



of carbon fibers are not due to the cost of its raw material but rather its production process is expensive. For that reason by technological advancement in its production techniques, the cost of this material can decrease by a notable amount.

For the machining related cost, it's also the same story. Cost of robotic arms and advance FDM system will eventually drops. If we want to refer to recent history, Couple of years ago owning a desktop 3D printer, computer or even a mobile was a luxury, but nowadays owning some of these items are considered the basic living necessity. The point is that the cost of electronics and technical machines will always drops and that is an established fact. As a designer or developer we should always think one step ahead from our current time. We should always think about adaptation of newest technological advancement in our design and try to find their added values. Either ways developing of a fully functional system always take a long time. Therefore it's better to start with that process sooner, and by the time that the product is ready of market some of its cost related issues will be solved.

So even if this new developed reinforcement system might not be that cost efficient at this moment, the development of a fully functional and tested product will takes years. By that time lots of these cost issue will be solved.

This is project is a small step to shape the manufacturing process of the future building.

### 8.3 FUTURE SCOPE

---

The intension of this research project was to fill the freeform reinforcement research gap. In the most of research projects, the goal are not only to create products or techniques but rather to offer a new future perspective in their field.

In this project beside the final design, several other concepts have also been developed. Additionally each design decision was described in details. The project was written intentional in this manner to offer a full insight to readers. The readers can also chose one of the many ideas available in this project and further develop them.

Regarding to the final design developed in this report, the next stage will be to collaborate with other expert to create a structure based on this system. For that purpose exact calculation and physical structural simulation will be necessary. Additionally a detailed investigation for available resources and tools should also be done. For some part of this design, certain tools and instruments might need to be designed. After the production and feedback collected from of a fully functional prototype, the designed system can get optimized and be ready to be used in building industry.



# 9 • Prototype

## 9 PROTOTYPE

---

This is an unfinished chapter. Due to technological limitation, the prototyping phase did not get finalized

Designing concepts in paper are always the initial step but it is very important also to manage to create a prototype out of it. In a paper design and calculation, most of the challenges do not look that hard to solve. They can be drawn and based on assumption it can be concluded that they are achievable.

But when that same idea want to get executed, it not that straight forward anymore. In this stage it's very common to face other challenges. To solve these problems, sometimes the concept should be adjusted or be re-designed. Resources and investment can have a very crucial role in this phase. Mathematically and design wise it is most likely possible to create a cable shuttle bridge from earth to moon but in reality it will be way more sophisticated. Of course this was an exaggerated example but the point was to show how important logistic, available technology and resources can be for a project.

In this project the budget and resources are limited and it is supported by personal funds. Therefore the approach should be executed by available resources in university. This will be a challenge but in other hand the outcome can be a low tech and less expensive solution.

### 9.1 LATTICE STRUCTURE PRINTING

---

In previous section it was mentioned that creating a prototype is an essential part of the design. One of the main parts of this prototype is its lattice structure. In this section creation process of this part will be covered.

#### 9.1.1 PLANNING THE METHOD

One of the basic technique to create any complex geometry is of course 3D printing. In conventional way the given model will be sliced and series of horizontal layers will be created. This system is designed initially for creating solid object. Also this type of slicing have influence on mechanical properties of that object and

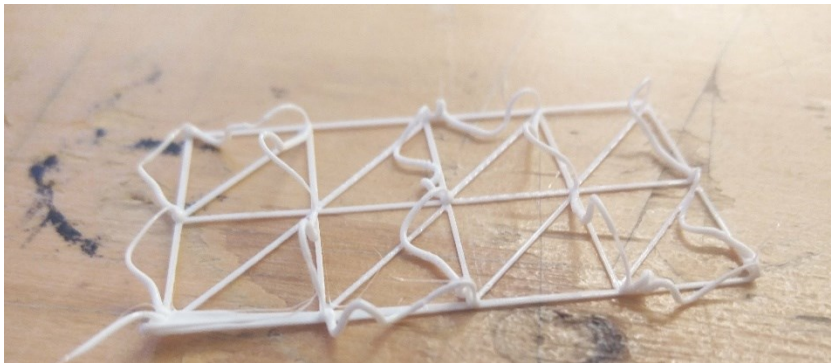
therefore for an element with structural purpose, the orientation and angle of lines and layers should be analyzed.

In this prototype, the lattice structure does not have a solid form. It is created from a series of continuous lines. Therefore the conventional system of using 3D printers is not suitable.

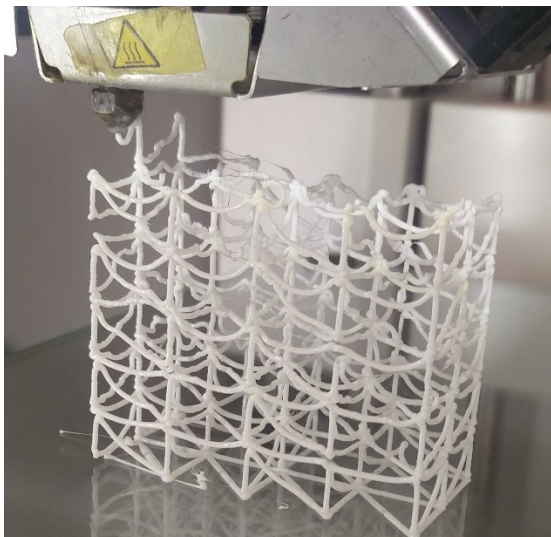
For creating this structure the most suitable technique is FDM.

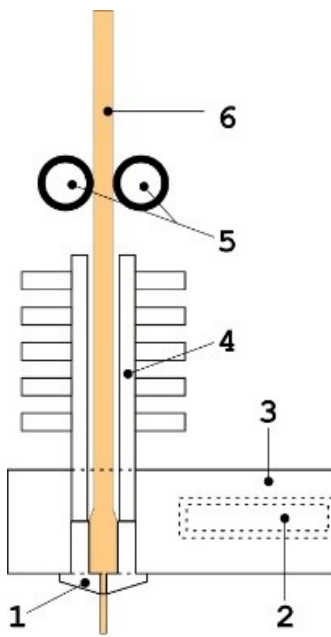
### 9.1.2 EXPERIMENTS

#### Experiment 1



#### Experiment 2





**FIGURE 132**  
Setup of a standard 3D  
printer head

## 9.2 CARBON FIBER PRINTING

As it was mentioned in previous chapter, part of reinforcement structure consists out of a 3d printed lattice structure mesh. The mesh should be created from a continuous line. The core of this line consists of carbon fibers which gives the structure its strength. Carbon fiber should take the tensile forces and therefore the structure tensile strength will be crucial. Nevertheless when the mesh need to be erected it also should be able to carry its own weight before the concrete is added to it.

For that purpose a resin or a thermoplastic material such as PLA should be added. Resin will bound all fibers together and create an entity out of them. The problem is resin is the long curing time period which makes the printing really slow if not impossible. Adding a thermoplastic is also another solution. The plastic will increase the line cross section area and therefore it will be able to handle its own weight.

In this section printing continuous fiber mixed through thermal plastic with available resources will be investigated. That means standard 3D printers will be used and some of their components will be adjusted to make this task possible.

### 9.2.1 PLANNING THE METHOD

In previous chapters different type of additive manufacturing techniques was explained. For this prototype FDM system will be used which is also referred as 3D printer. In this section, the research will be dealing with the way unconventional material can be printed with this system. Before explaining different design concepts, it's important to understand how a printer head set is constructed. The illustration in Figure 132 shows a standard printer head set. This set consists of the following components;

1. **Nozzle:** An element that forms the material extrusion. Most of the times its interchangeable but in some cases its integrated in heater block.
2. **Heater element:** An element that is responsible for heat creation.



3. **Heater block:** An element that is responsible for diffusing and transferring the generated heat from heater element to nozzle.
4. **Heat spoiler:** An element that stops the heat transfer to rest of the filament.
5. **Extruder:** This consist out of a step motor and a roller that feeds filament to heater block.
6. **Filament:** Filament is a rod form of thermoplastic plastic that is fed to 3d printers. The common size in standard printers are 1.75, 2.85 and 3 mm.

For this research the task is to print this structure with mixing of two material together. The available printers in TU Delft University have approximately the capacity of printing an object with maximum dimensions of W20xL20xH30 cm. Therefore the prototype should be scaled accordingly.

Most of the available 3D printers are only capable of printing only with one material and a few printer of them have capability of printing with two materials. The problem with those multi filament printer are they have two separate nozzle and therefore they are not capable of mixing materials together.

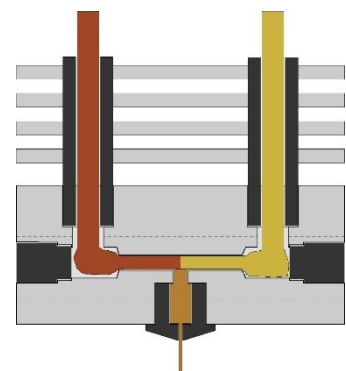
For solving this problem a new extruder head need to be find or modified. The head should have more than one input and a single output. For this function there is only two types of head currently available for desktop 3D printers; Diamond and Cyclops hotend.

#### CYCLOPS HOTEND

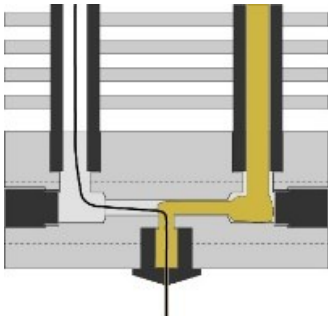
This hotend is have two filament input available and one output for nozzle. The nozzle in this element can be changed and therefore it's possible to add a custom variant to it.

The hotend is intended to be fed with two thermoplastic filament such as PLA or ABS. A horizontal shaft will connect both filament inputs to the output where nozzle is located. Since molten plastic can easily move in a bounding frame, the horizontal shaft will face no difficulties.

#### Cyclops with no physical modification



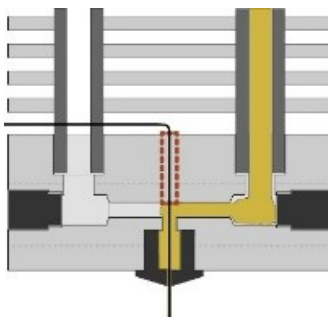
**FIGURE 133**  
Standard setup for Cyclops head



**FIGURE 134**  
Cyclops Setup for carbon fibers

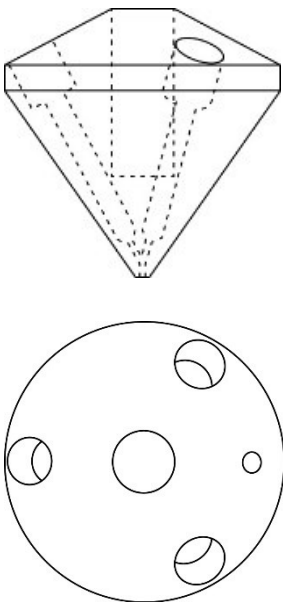
For this project the chosen filament need to be mixed with a continuous carbon fiber. The extruder head is designed to mix molten material together. Placing any given thermoplastic filament will not cause any challenge but inserting carbon fiber in the Cyclops can be well challenging. In this approach carbon fiber need to be mixed with plastic without getting molten. Therefore the fibers should manually be oriented through the sharp edges of extruder shafts. This task can cause difficulties and it should be further investigated.

### Cyclops with physical modification



**FIGURE 135**  
Modified Cyclops setup for carbon fiber

If the previous approach cannot be feasible, Cyclops head need to get modified. In new proposal a hole will be drilled straight above the extruder head. By adding this new hole placing fiber through shaft will get simplified. But this modification might cause an issue. Because that hole is really close to output, the plastic material might also travel in wrong direction and get extruded from the wrong exist. This problem might get resolved if the hole is drilled with slight an angle and if the hole is smaller than 1.5 mm (the mid-section of shaft have a diameter of 1.5mm).



**FIGURE 136**  
Diamond hotend

### DIAMOND HOTEND

Diamond Hotend is also another product that might offer a solution to this problem. This product is very similar to Cyclops hotend but it offer three inputs. The shafts inside this block is well different. Those shafts are diagonally oriented and get connected to each other at where nozzle output is located. This characteristic is the main advantage of this system, the problem of placing fibers though complex shafts of Cyclops head can be solved with this design.

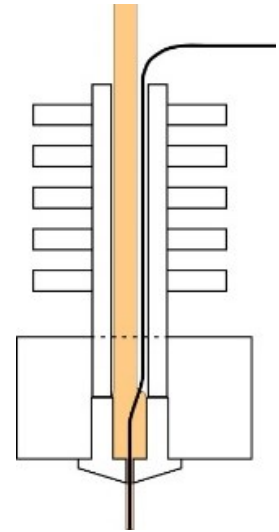
But using this product has also its own limitation. First of all, the hotend and nozzle head are a single element. That means the nozzle is not changeable. Secondly this element is only offered with 0.4 mm nozzle hole which is not really sufficient for adding fibers to plastic.

This system is not suitable for creating this prototype. But if there is a sufficient investment, this designed can be used to create a

custom designed extruder. A Diamond Head with slightly a bigger dimensions and possibility for interchangeable nozzle head.

### STANDARD HOTEND

The illustrated hotend in the Figure 137, is one of the most common hotend used in general purpose 3D printers. Of course there are different variation of it but all of them share the same design concept. These types of hotend's have one filaments input and one nozzle output which in most cases are interchangeable. Filament input component mostly have a sleeve or shaft type of geometry. This shaft is always slightly larger than filament itself and therefore a thin fine carbon fiber can also be place in the same input. So in this approach that is what exactly will happen. First the carbon fiber will be placed through hotend and nozzle and then the filament will be placed in its location.



**FIGURE 137**

### EVALUATION

In the previous sections, different concept was proposed for how carbon fiber can be mixed with thermoplastic material. They were based on the available and affordable 3D printer's components. The standard hotend solution seems to be the most affordable solution. As it names say, these type of hotend's are common and can be find in available resources. Therefore this system will be implanted for the first approach of creating the prototype.

## 9.2.2 EXPERIMENTS

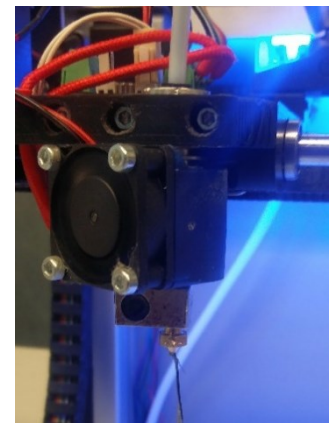
### EXPREIMENT 1

The set up for the this experiment is as following;

- Leapfrog 3d Printer
- Standard Hotend
- 0.8mm nozzle
- 1.75 mm PLA filament
- Continuous fiber  $\pm 0.5$ mm

In this experiment a standard setup with no modification was used. Fiber was placed though the filament tube and it was passed through hotend block and a 0.8 mm nozzle.

The outcome of this result was not as it was intended. The goal was to get fiber and PLA extruded in the same pace but that was

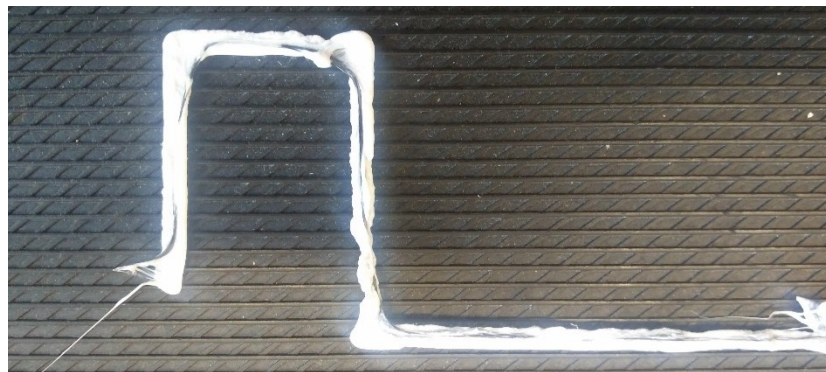


**FIGURE 138** - experiment 1 head setup, Source (author)

not achieved. This is mainly due to the fact that only feeding rate of one material is controllable (the system is designed base one material input). The hypothesis was that the extruded PLA (controlled) would drag the fiber along and a uniform extrusion could be achieved.

The second possible problem was the nozzle diameter. Because of its small diameter the nozzle hole got almost full with the fibers. Therefore the flow of PLA did not happened smoothly and non-uniform line got extruded.(Ssmesh, n.d)

### Experiment 2



The set up for the this experiment is as fallowing;

- Leapfrog 3d Printer
- Standard Hotend
- 1.5 mm nozzle (custom made)
- 1.75 mm PLA filament
- Continuous fiber  $\pm 0.5\text{mm}$

The setup for this experiment was partially identical to the previous one and only the nozzle got swapped. As it was mentioned, one of the possible issues was the small diameter of the nozzle. The biggest available standard nozzle in the testing lab had a 0.8 mm diameter. Therefore a custom modified nozzle had to be made with a diameter of 1.5mm.

# 10 • References

## 10 REFERENCES

---

- 3dprintingforbeginners. (2014). Filament extrusion process simplified. Retrieved from <http://3dprintingforbeginners.com/how-to-make-diy-filament-for-your-3d-printer/>
- AISC. (2005). *Steel construction manual*. [Chicago, Ill.]: American Institute of Steel Construction.
- Arcam. (n.d). EBM Hardware. Retrieved from <http://www.arcam.com/technology/electron-beam-melting/hardware/>
- Beck, M. (2014). Carbon Fiber Prices Could Drop by As Much As 90 Percent. Retrieved from <http://compositesmanufacturingmagazine.com/2014/10/carbon-fiber-prices-drop-much-90-percent/>
- Binet, H. (2011). construction of Heydar Aliyev Center. Retrieved from <http://www.gizmag.com/zaha-hadid-heydar-aliyev-center-baku-azerbaijan/32783/>
- Bishop, R. (2014). MX3D–Metal, A Multiple Axis Tool That 3D Prints Using Metal. Retrieved from <https://laughingsquid.com/mx3d-metal-a-multiple-axis-tool-that-3d-prints-using-metal/>
- Borg Costanzi, C. (2016). *3d Printing Concrete onto Flexible Surfaces*. (Building Technology Master thesis), TU Delft. Retrieved from <https://repository.tudelft.nl/islandora/object/uuid:84d36c2e-8969-4432-b1a5-c9c02e6304f6?collection=education>
- Branch Technology. (2016). 3D Printer’s Twist May Shape Homebuilding. Retrieved from <https://www.asme.org/engineering-topics/articles/manufacturing-design/3d-printer%E2%80%99s-twist-may-shape-homebuilding>
- Burry, M., Burry, J., & Faulí, J. (2001). *Sagrada Família Rosassa: Global computeraided dialogue between designer and craftsman (overcoming differences in age, time and distance)*. Paper presented at the Reinventing the Discourse–How Digital Tools Help Bridge and Transform Research, Education and Practice in Architecture–Twenty First Conference of the Association for Computer Aided Design In Architecture (ACADIA), New York.
- Campbell, T., Williams, C., Ivanova, O., & Garrett, B. (2011). Could 3D printing change the world. *Technologies, Potential, and Implications of Additive Manufacturing, Atlantic Council, Washington, DC*.
- . CES EduPack (Version 16.1.22). (2016). Cambridge: Granta Design.
- Clarke, C. (2017). Branch Technology unveils SHoP Architects’ 3D printed pavilion at Design Miami. Retrieved from <https://3dprintingindustry.com/news/branch-technology-unveils-shop-architects-3d-printed-pavilion-design-miami-103486/>
- Clarke, J. L. (2003). Alternative Reinforcement for Concrete. In S. C. Ban & J. Newman (Eds.), *Advanced Concrete Technology: Concrete Properties* (Vol. 3, pp. 26/23–26/21). Oxford: Elsevier.
- Coriolis–Software. (n.d). CATFiber for CATIA. Retrieved from <http://www.coriolis-software.com/products-software/catfiber-for-catia.html>
- CustomPartNet. (n.d–a). Fused Deposition Modeling (FDM). Retrieved from <http://www.custompartnet.com/wu/fused-deposition-modeling>
- CustomPartNet. (n.d–b). Inkjet Printing. Retrieved from <http://www.custompartnet.com/wu/ink-jet-printing>
- CustomPartNet. (n.d–c). Laminated Object Manufacturing (LOM). Retrieved from <http://www.custompartnet.com/wu/laminated-object-manufacturing>

- 
- Donders, P. (2010). C-Bench. Retrieved from <https://blog.carbonfibergear.com/the-making-of-peter-donders-carbon-fiber-bench/>
- Edgar, J., & Tint, S. (2015). *Additive Manufacturing Technologies: 3D Printing, Rapid Prototyping, and Direct Digital Manufacturing* (Vol. 59).
- Engineers Outlook. (2011). History of Reinforced Concrete and Structural Design. Retrieved from <https://engineersoutlook.wordpress.com/2011/10/11/structural-concrete-design/>
- Espel, R., Gómez-Serrano, J., Grima, R., Burry, M. C., & Aguado, A. (2009). Evolution of the formwork used in the temple of the Sagrada Família. *International Journal of Architectural Heritage*, 3(2), 93–109.
- European standards. (2005). Steel for the reinforcement of concrete – Weldable reinforcing steel – General (Vol. EN 10080, pp. 74). Brussels: European Committee for Standardization.
- Forrester, D. W., Kauth, T. J., & Krasovic, G. J. (1995). United States Patent No. US5431196 A. U.S. Patent and Trademark Office.
- Gardiner, G. (2013). Tailored Fiber Placement: Besting metal in volume production. *High-performance Composites*, 21(2), 54–61.
- Gibson, I., Rosen, D. W., & Stucker, B. (2010). *Additive manufacturing technologies* (Vol. 238): Springer.
- Grubb, J. A., Limaye, H. S., & Kakade, A. M. (2007). Testing pH of concrete. *Concrete international*, 29(04), 78–83.
- Guerola Llorens, I. (2015). claudio hebberecht. Retrieved from <http://www.designboom.com/architecture/deep-cavern-studio-habitat-of-the-artist-claudio-hebberecht-01-05-2015/>
- Imaginechina. (n.d.). 3D printed concrete villa. Retrieved from <http://www.theguardian.com/cities/2015/feb/26/3d-printed-cities-future-housing-architecture>
- Kolarevic, B. (2001). Designing and manufacturing architecture in the digital age. *Architectural information management*, 2001117–2001123.
- Krassenstein, E. (2015). Branch Technology 3D Prints Building Walls With World's Largest Freeform 3D Printer. Retrieved from <https://3dprint.com/85215/branch-3d-printed-walls/>
- Kucharek, J.-C. (2015). 3D-printed concrete components. Retrieved from RIBA Journal website: <https://www.ribaj.com/products/3d-printing>
- Li, N., Li, Y., & Liu, S. (2016). Rapid prototyping of continuous carbon fiber reinforced polylactic acid composites by 3D printing. *Journal of Materials Processing Technology*, 238, 218–225.
- Materialgeeza. (n.d.). SLS system schematic. Retrieved from [https://en.wikipedia.org/wiki/Selective\\_laser\\_sintering](https://en.wikipedia.org/wiki/Selective_laser_sintering)
- Matsuzaki, R., Ueda, M., Namiki, M., Jeong, T.-K., Asahara, H., Horiguchi, K., . . . Hirano, Y. (2016). Three-dimensional printing of continuous-fiber composites by in-nozzle impregnation. *Scientific reports*, 6.
- Miller, F. P., Vandome, A. F., & McBrewster, J. (2010). *Fused Deposition Modeling*. VDM Publishing.
- Mostert, P. N. (2015). *A filament wound pillar for a pedestrian bridge*.
-



- Nederlandse norm. (2001). Technische grondslagen voor bouwconstructies – TGB 1990 – Belastingen en vervormingen (Vol. NEN 6702, pp. 159). Delft: Nederlands Normalisatie-instituut,.
- Niedlich, S. (2009). Sagrada Familia: Rope Model. Retrieved from <http://www.flickr.com/photos/42311564@N00/3567463569>
- NLR. (2009). Fibre placement of a fibre steered composite lug. *Innovative fiber alignment*. Retrieved from <http://annualreport.nlr.nl/2009/en/industry/innovative-fiber-alignment/>
- Peck, M. (2006). The evolution of reinforced concrete. In M. Peck (Ed.), *Concrete: design, construction, examples*. Berlin: Birkhäuser.
- Portland Cement Association. (2002). Concrete information: Types and causes of concrete deterioration. *PCA R&D Serial*(2617).
- Robert, H. (2007). Think formwork–reduce cost. *Structure magazine*, April, 14–16.
- Sagrada Familia. (n.d). History of the temple. Retrieved from <http://www.sagradafamilia.org/en/history-of-the-temple/>
- Schipper, H. (2015). *Double-curved precast concrete elements: Research into technical viability of the flexible mould method*. TU Delft, Delft University of Technology.
- Shama Rao, N., Simha, T., Rao, K., & Ravi Kumar, G. (2014). Carbon composites are becoming competitive and cost effective. *White paper from www. infosys. com*.
- Sixtysixp. (2014). Sagrada familia. Retrieved from <https://www.flickr.com/photos/sixtysixp/13756327715/>
- Ssmesh. (n.d). Stainless Steel Woven Wire Mesh. Retrieved from <http://www.ssmesh.org/stainless-steel-wire-mesh/stainless-steel-woven-wire-mesh.html/>
- Tamashige, S. (2014). Toyo Ito literally connects architecture to the people. Retrieved from The Japan times website: <http://www.japantimes.co.jp/culture/2014/11/27/arts/toyo-ito-literally-connects-architecture-people/#.WSKRsmh97IU>
- Yingchuang. (n.d.). 3D printed concrete house. Retrieved from <http://www.yhbm.com/uploadfile/2015/0114/20150114044105663.jpg>
- Youde-Prototype. (n.d). SLA working principle. Retrieved from [http://www.youde-prototype.com/text\\_lists\\_567.html](http://www.youde-prototype.com/text_lists_567.html)

# A • Appendix

## A. APPENDIX

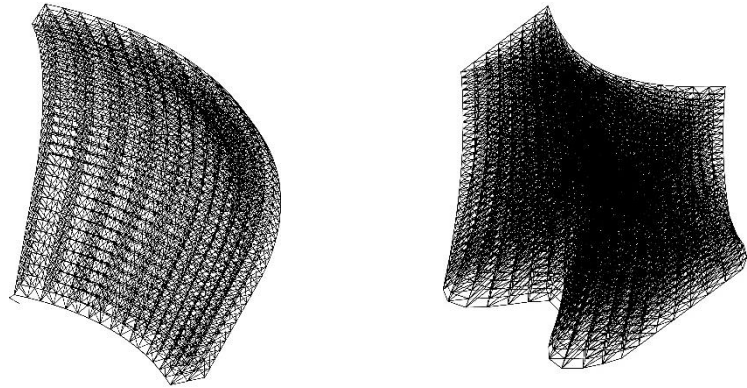
---

### A.1. MESH GENERATOR

---



<https://goo.gl/Gn15Zw>

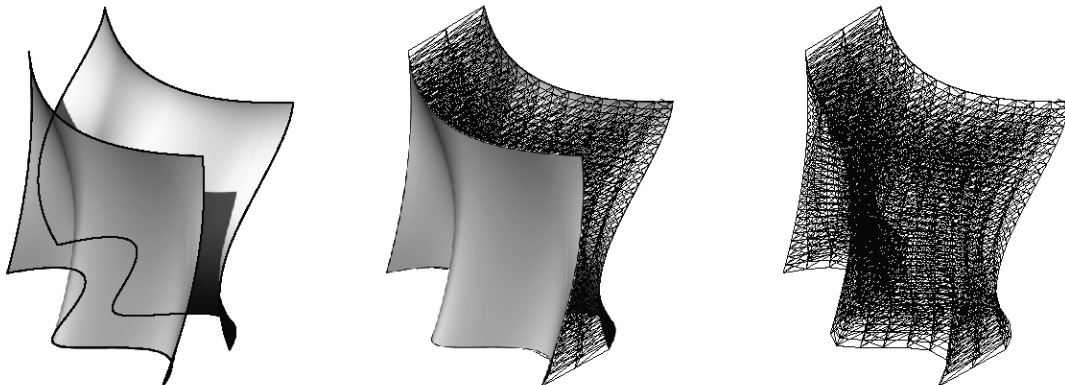


This script is used to generate the lattice mesh structure for this research project. By scanning the QR code or pressing the link above, digital files of this script can be downloaded.

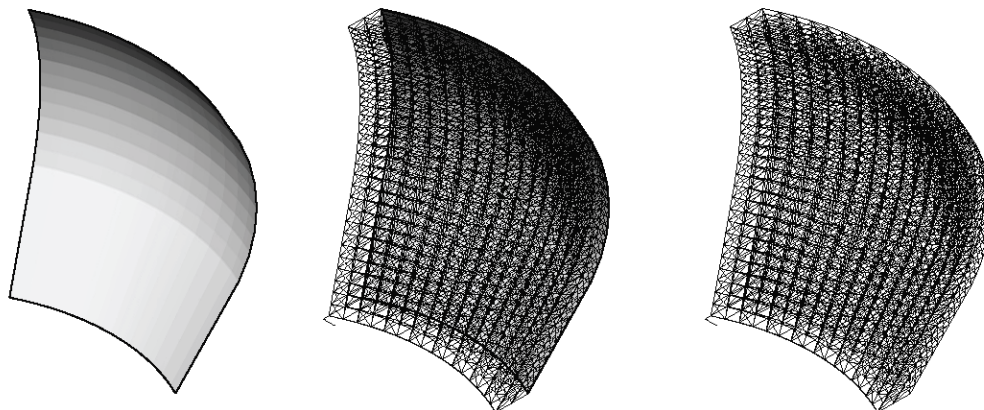
---

**FIGURE A. 1**

**Two Surface**



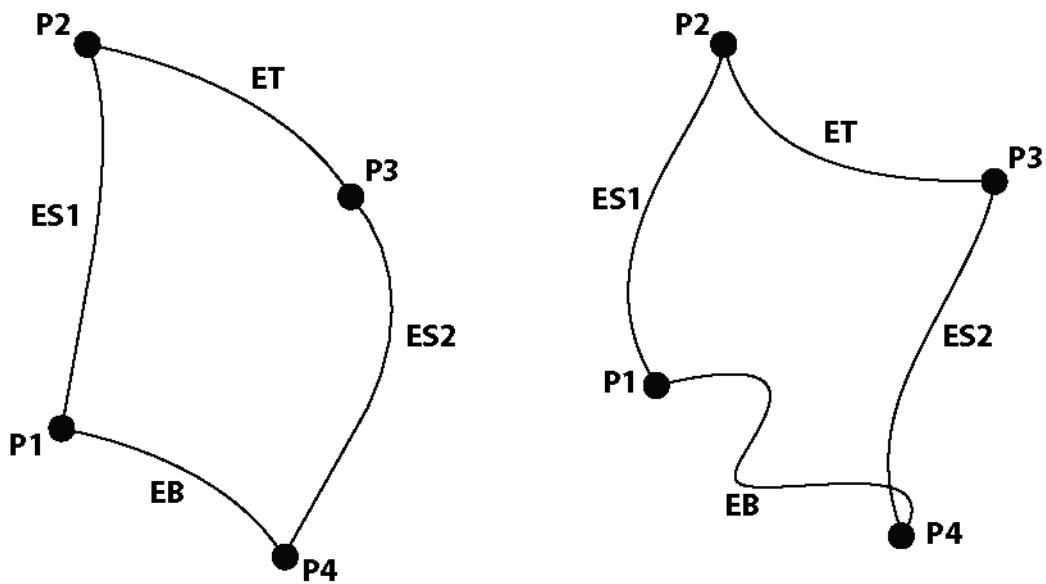
**One Surface + Thickness**



The mesh structure is a freeform wall that can have a various depth. To construct this mesh, one or two surfaces are needed. For a wall with a uniform thickness, single surface with a fixed

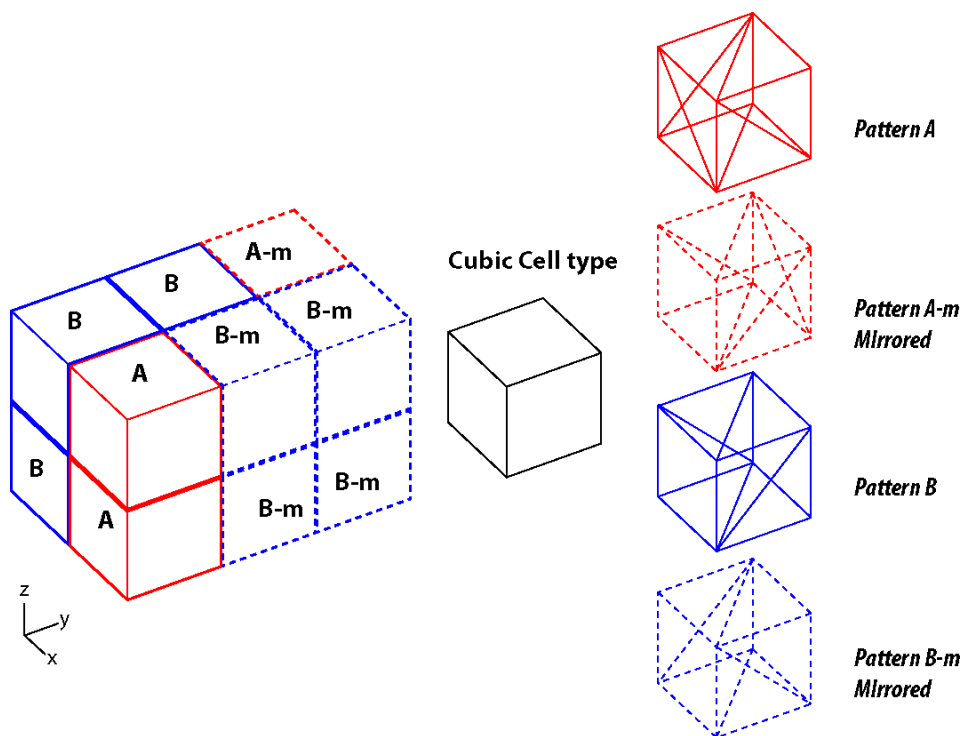
thickness will be sufficient. For a wall with non-uniform thickness 2 surfaces will be necessary; inside and outside surface (see Figure A. 1)

**FIGURE A. 2** Free-from 2D Rectangular plane



These surfaces can be categorized as a freeform 2d rectangular plane. As Figure A. 2 shows, a rectangular plane has four edges and four corners. But for this script the bottom (EB) and top (ET) should be parallel to XY plane.

**FIGURE A. 3**



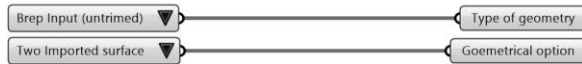
# Control center

## Inputed geometry

This script works with rectangular mesh or brep planar surface (untrimmed)  
 The top and bottom edge of the mesh, should always be horizontal (XY plane). If not this script will not work

this script support to type of geometry: Mesh and Brep.  
 Make sure the geometry type is selected properly

\* The imported mesh should be parallel to XZ Plane  
 Two option for geometrical Input  
 A) Two Mesh:  
 \* There are two geometrical input available. One for the inner surface and the second one for other surface. In this method different thickness can be achieved in the structure  
 B) One Mesh:  
 In this method only one mesh is used. thickness is created by a numerical input. For this method only insert your geometry to "1.Mesh inside" input

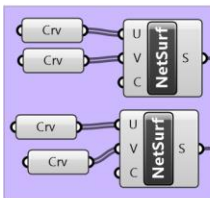


## Input Mesh

- 1. Mesh inside
- 2. Mesh outside

## Input Brep

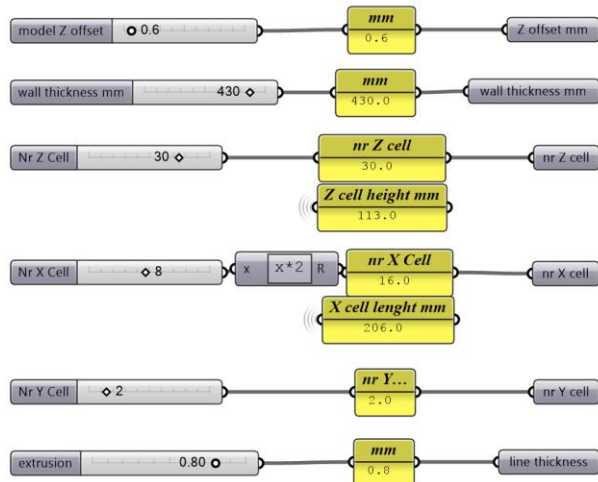
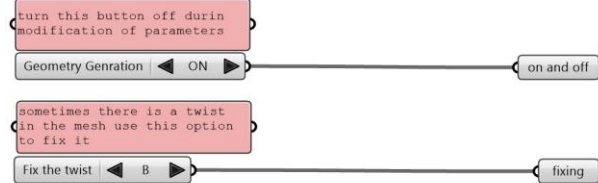
- 1. Brep inside
- 2. Brep outside

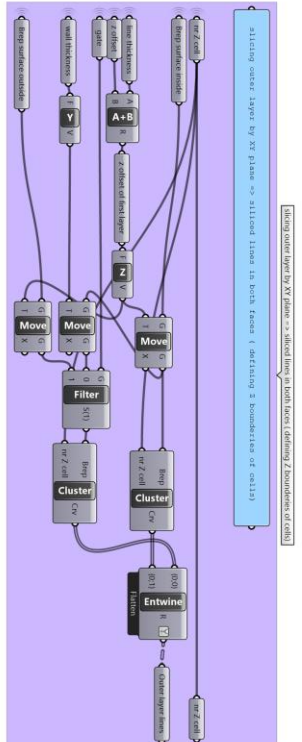
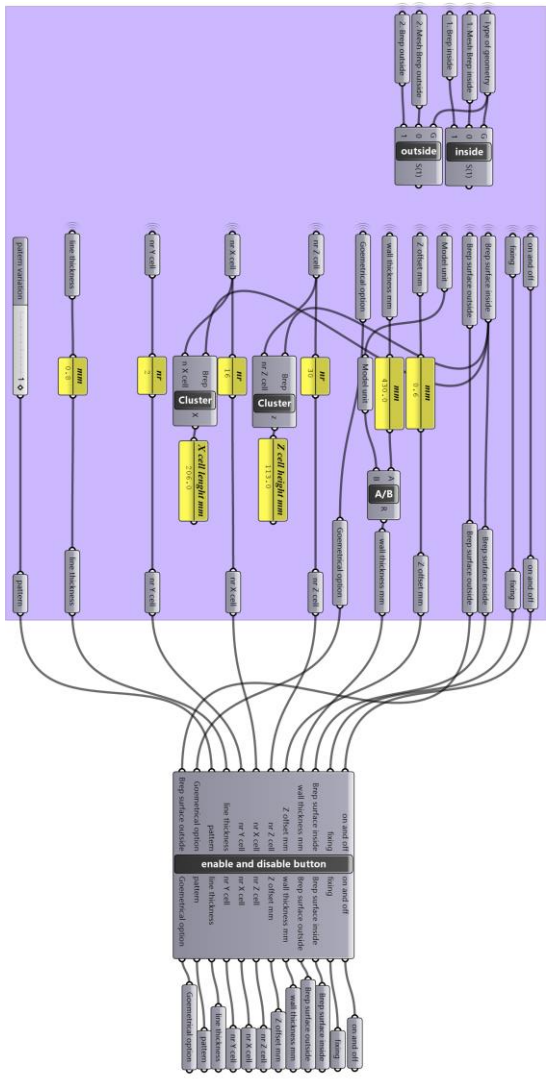


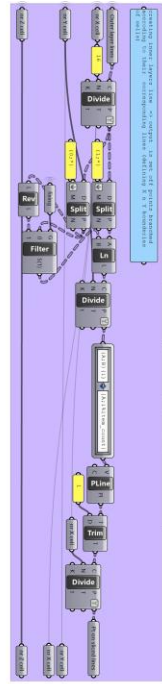
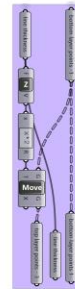
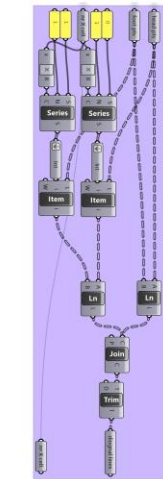
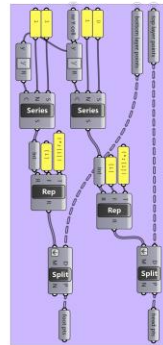
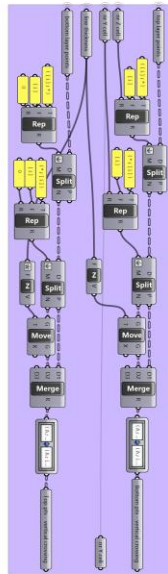
## Unit of Modle In Rhino



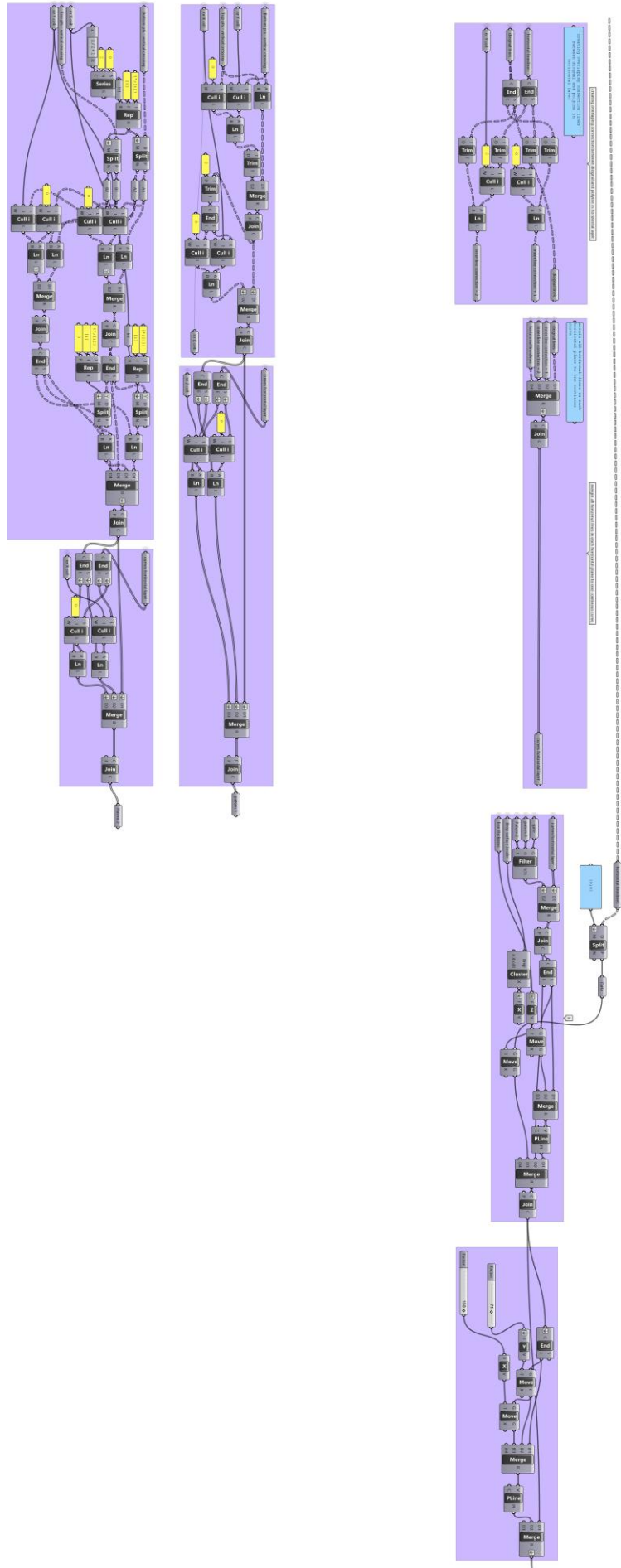
## Numerical Control of lattice mesh







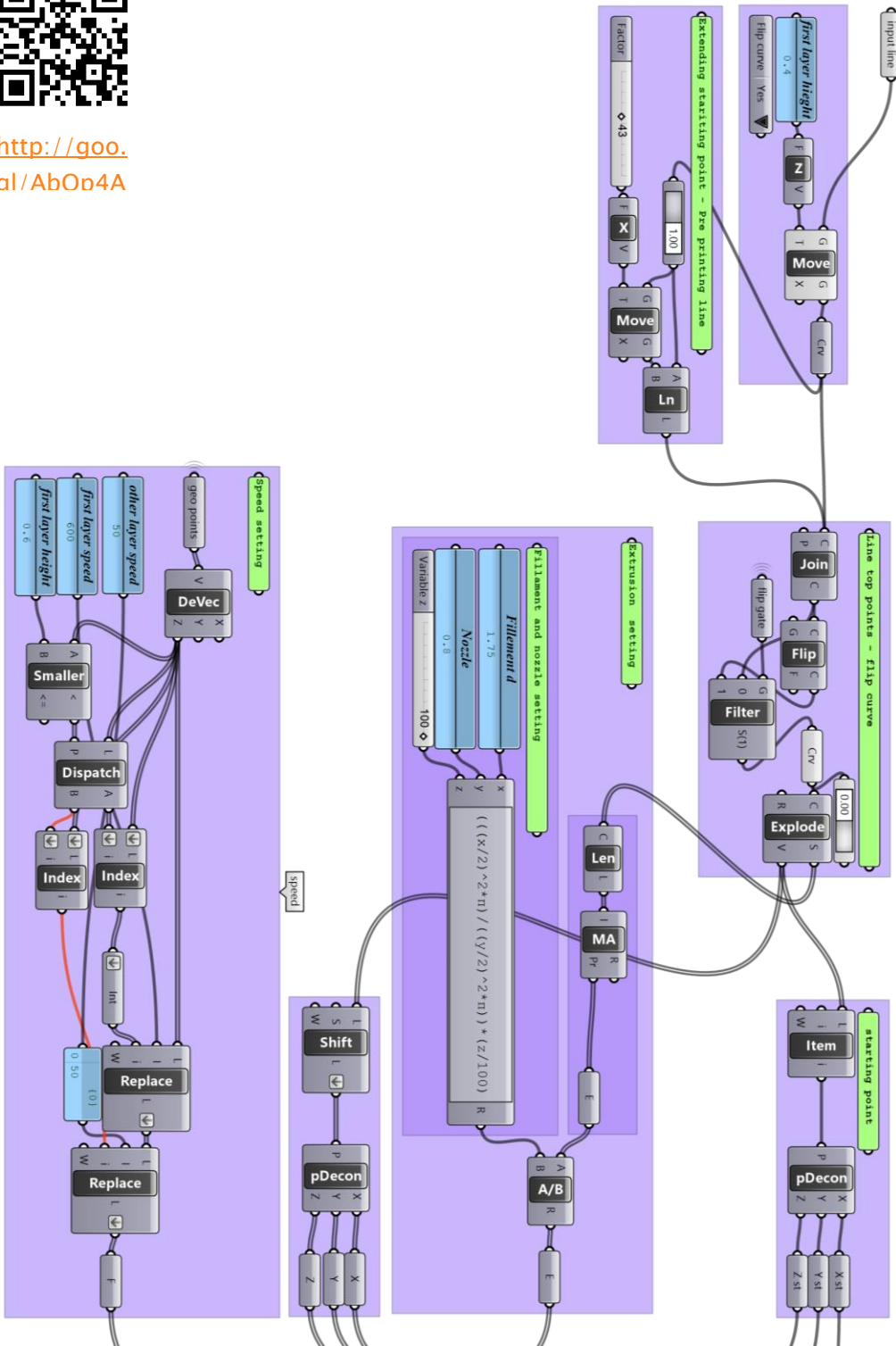


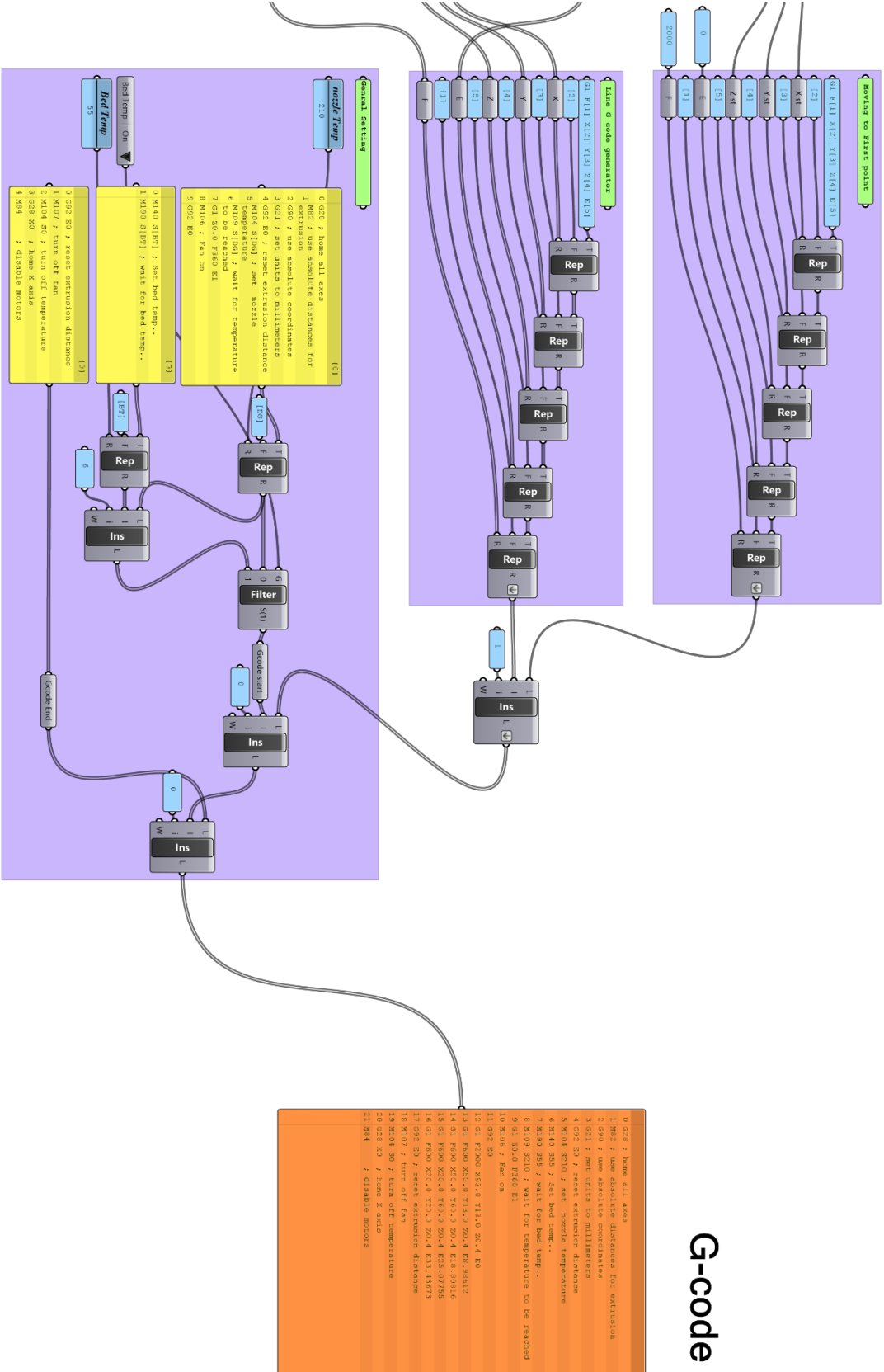


A.2. G-CODE GENERATOR



<http://go.al/AbOp4A>



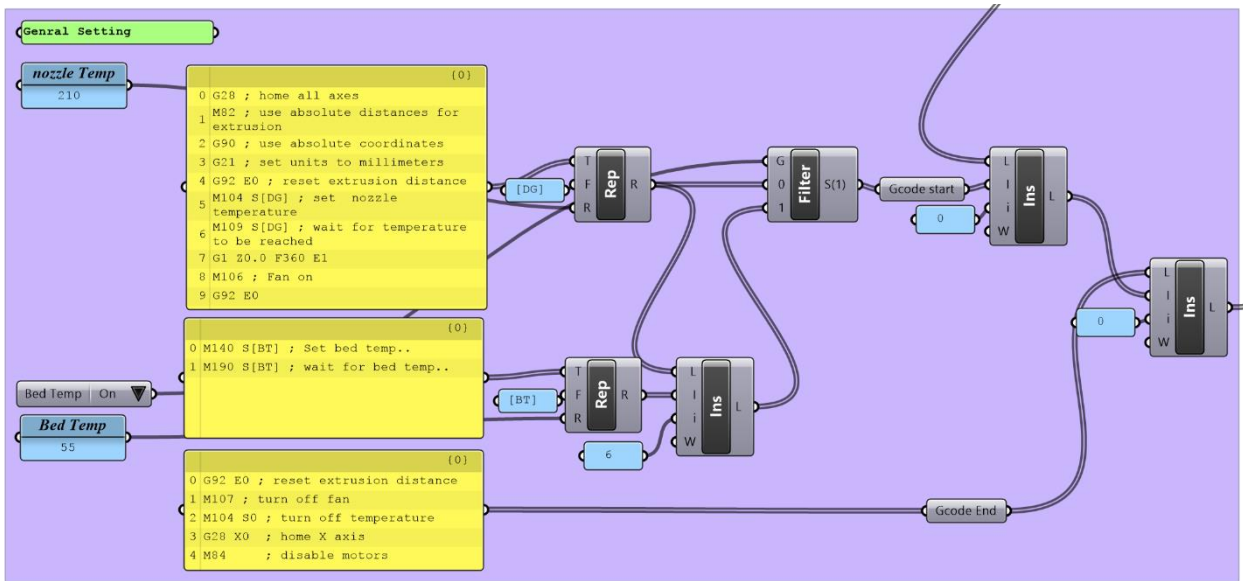


# G-code

```

0 G28 ; home all axes
1 M82 ; use absolute distances for extrusion
2 G90 ; use absolute coordinates
3 G21 ; set units to millimeters
4 G92 E0 ; reset extrusion distance
5 M104 S210 ; set nozzle temperature
6 M104 S85 ; set bed temp..
7 M109 S210 ; wait for bed temp..
8 M109 S210 ; wait for temperature to be reached
9 G1 Z0.0 F360 E1
10 M106 ; fan on
11 G92 E0
12 G1 Z200.0 Y13.0 X13.0 F50.4 E0
13 G1 X0.0 Y0.0 Z0.0 E0.06812
14 G1 X0.0 Y0.0 Z0.0 E0.00016
15 G1 X0.0 Y0.0 Z0.0 E0.00016
16 G1 X0.0 Y0.0 Z0.0 E0.00016
17 G92 E0 ; reset extrusion distance
18 M107 ; turn off fan
19 M104 S0 ; turn off temperature
20 G28 X0 ; home X axis
21 M84 ; disable motors
    
```

## Appendix A.2 • G-code generator





## A.3. REBAR CONNECTION

---

### A.3.1. REBAR LAPPING

---

This system is one of the simplest ways for connecting rebars to each other. In this method rebars are overlapped on top of each other. The overlapping distance should be around 50 times the thickness of rebar.

This method has various disadvantages; weak connection, extra use of material,

---

**FIGURE A. 4** Rebar lapping

(CRSI, n.d)



### A.3.2. THREADED COUPLER

---

In coupler a screw mechanism is used. It consists of two parts; male and female. The female part is the coupler itself and is a connecting element. The male part is rebar. Rebar's used in this system need to be modified. On their top end a screw pattern needs to be engraved on them.

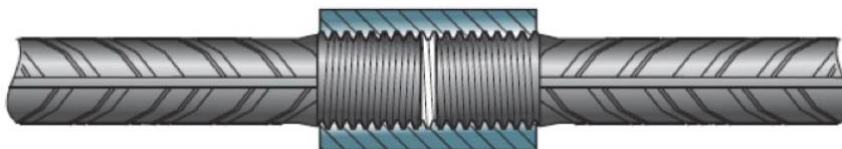
#### STANDARD COUPLER

As its name stands for, standard couplers are the basic version. In this version at least one of the rebar should be able to rotate. It's only suitable when the connecting rebar is not part of a reinforcement mesh and has

---

**FIGURE A. 5** Standard coupler

(Incon, n.d)



#### POSITION COUPLER

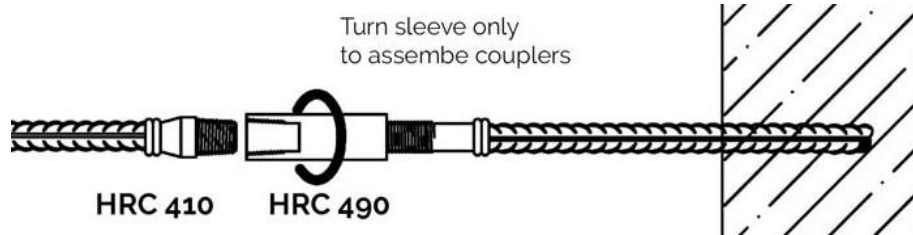
A position coupler is relatively longer than its standard version, but it offers more freedom. With this system, rebar does not need to have a rotational freedom.

In most cases, a position coupler is attached to one of the rebar. The second rebar only needs to be aligned in the right position. The connection will happen by rotating the position coupler and therefore the necessity of rotating the second rebar is eliminated.

---

**FIGURE A. 6** Position coupler

(H.R.C, n.d)



---

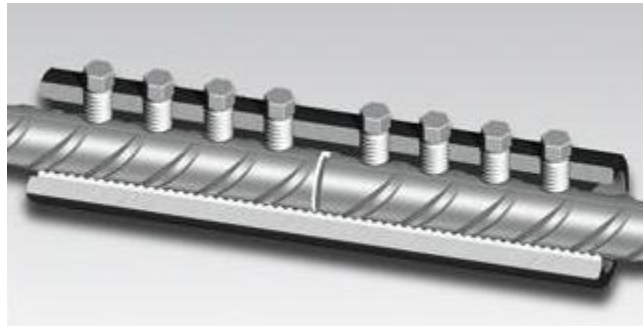
### A.3.3. SCREW LOCK SYSTEM

In this system bars end do not need to be modified and standard rebar's can be used in combination with this system. During the assembly, the bars get shifted into the sleeve and then a series of screws fixed them into their position.

---

**FIGURE A. 7** Screw lock system

(Ancon, n.d)



---

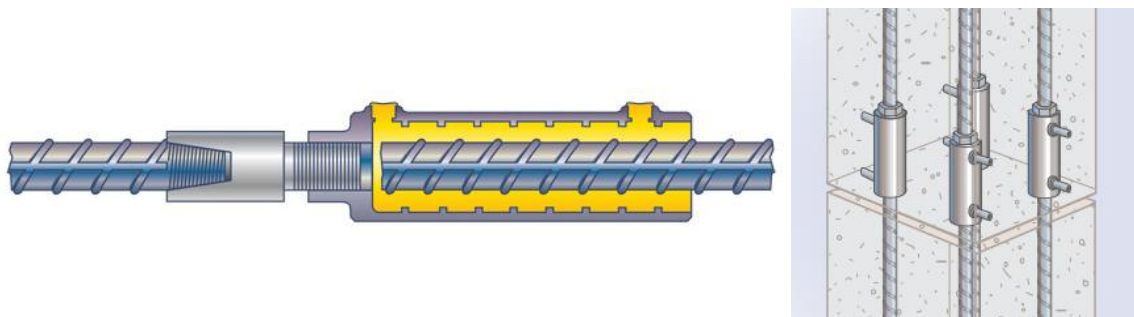
### A.3.4. GROUT SLEEVE

Grout is a fluid concrete that is used for different purposes to connect elements together. In this system threading is not necessary but in some cases one side of sleeve is threaded. For connecting rebar's screwing is not necessary. The second rebar will shift in the sleeve and then grout is injected into it. After the grout is dried, it will form a rigid connection between those two elements. Because the grout is restrained by sleeve, deformation is not possible and therefore failure is prevented.

---

**FIGURE A. 8** Grout sleeve

(Lenton, n.d)



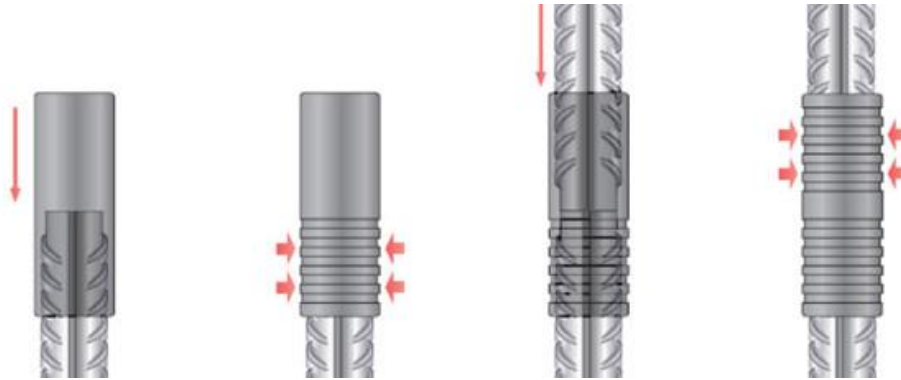


### A.3.5. HYDRAULIC GRIP COUPLER

In the Grip coupler system, the simplest form of sleeve is used and none of the rebar's need to get modified. Here both rebar are placed inside the sleeve and then with the help of a hydraulic press a grip is created between rebar's and sleeve.

FIGURE A. 9 Hydraulic grip coupler

(Halfen Moment, n.d, pp. 16–17)

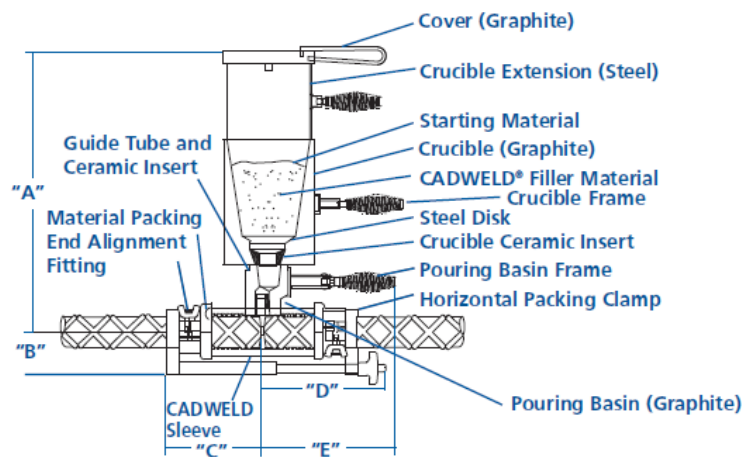


### A.3.6. CAD WELD COUPLER

Similarly to previous examples, in this system rebars do not need any modification. The sleeve is used to align rebars in their position and then a crucible is placed on top of the sleeve. With the help of gunpowder, steel powder will get molten and weld rebars together.

FIGURE A. 10 Cadweld coupler

(ERICO, 2009, p. 8)



---

### A.3.7. MONKEY BAR COUPLER

---

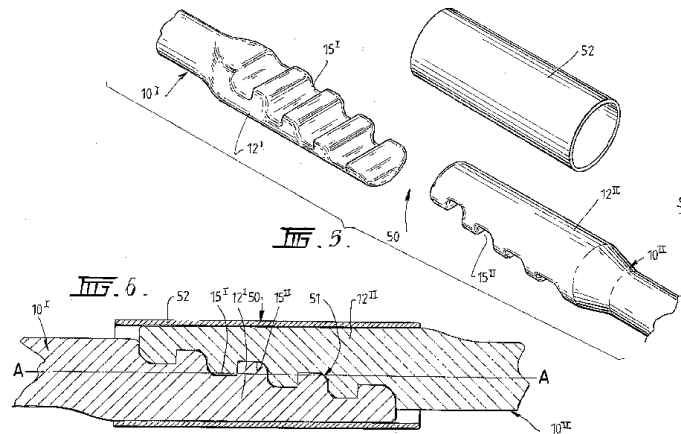
Monkey bar coupler is one the latest innovation in rebar connection. This technology is patented in 2015 and is not very common because of that reason. The rebars in this system need modification but their assembly is straight forward. No additional component or instrument is needed and on a sleeve need to shift into its position.

---

**FIGURE A. 11** Monkey bar coupler

(Comerford, 2015; Monkey Couplers n.d)

---



**A.4. CASE STUDIES**

---

---

#### A.4.1. TAICHUNG METROPOLITAN OPERA HOUSE

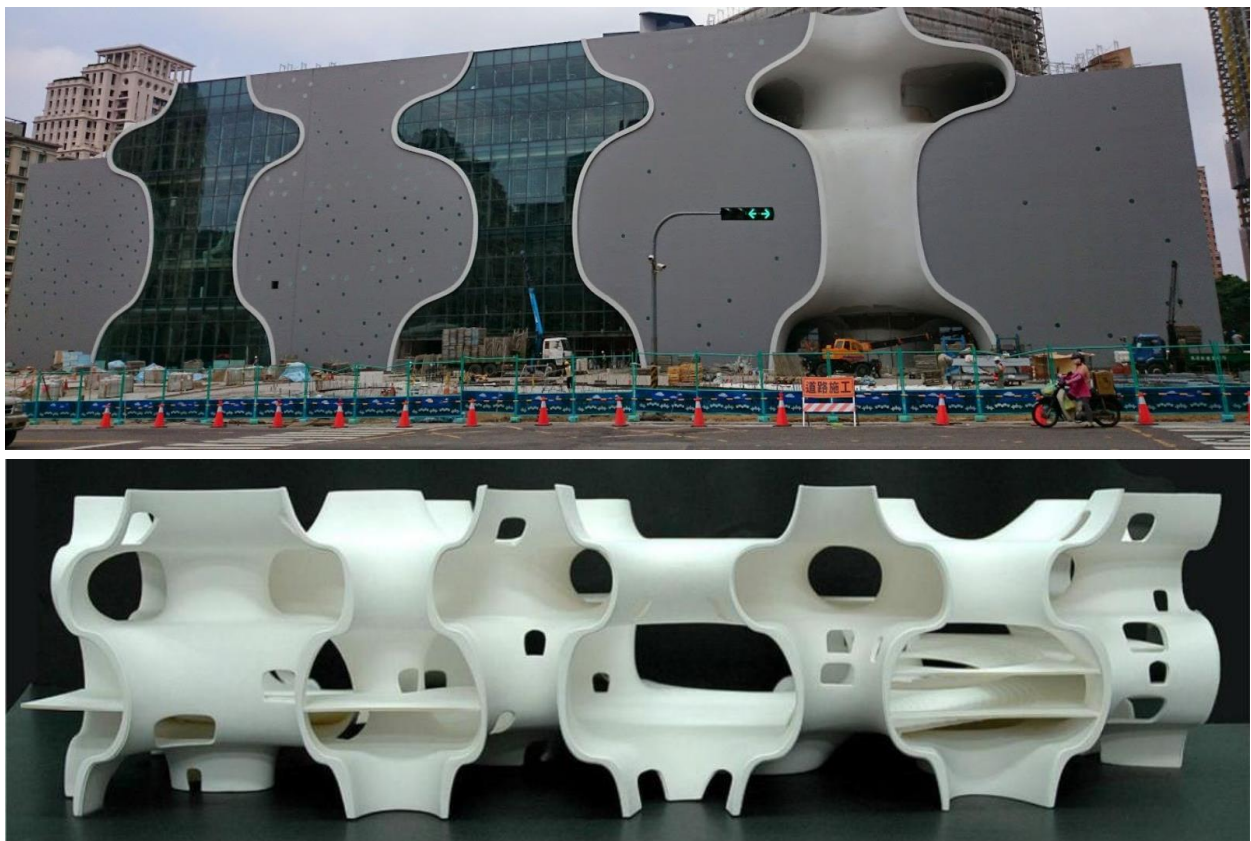
---

Shot-Crete was placed over a temporary steel framework, assembled and fixed with metal mesh, expanding between the framework providing shot Crete a surface to adhere and serving as a back stopper for concrete. The walls started at 8 inches thick and tapering up to 14 inches at the bottom, and a final mortar layer is applied as a final coating to produce a smooth finished surface. This system was selected over double curved framework that could result on a higher price construction activity and will push back the construction termination date (Rinaldi, 2014).

---

**FIGURE A. 12** Taichung Metropolitan Opera House

(Rinaldi, 2014)



---

**FIGURE A. 13** Freeform reinforcement manufacturing for Opera House

(Zhe, 2013)





**Note: Reinforcement bars**

Reinforcements are divided to two section

1 Section

These bars are bended manually and then a series of crossing bar are welded to it

2 mesh reinforcement

Alter the section bars are ready. Mesh bar are place on top of it and the n welded

- The construction doesn't need any wooden formworks
- A secondary mesh with very small perforation is place under and on top of the reinforcement bars and shotcrete is sprayed in it
- Surface smoothing id on by hand since formworks are not used
- Cement finishing layer is added as the last step

**FIGURE A. 14 OPERA HOUSE CONSTRUCTION (RINALDI, 2014; ZHE, 2013)**



**FIGURE A. 15 1:1 SCALE MODEL FOR CONCRETE INFUSION (WITHWORKS, 2014)**





A.4.2. MERCEDES BENZ MUSEUM

FIGURE A. 16 MERCEDES-BENZ MUSEUM BUILDING (MCMANUS, 2014; PERI, 2006)

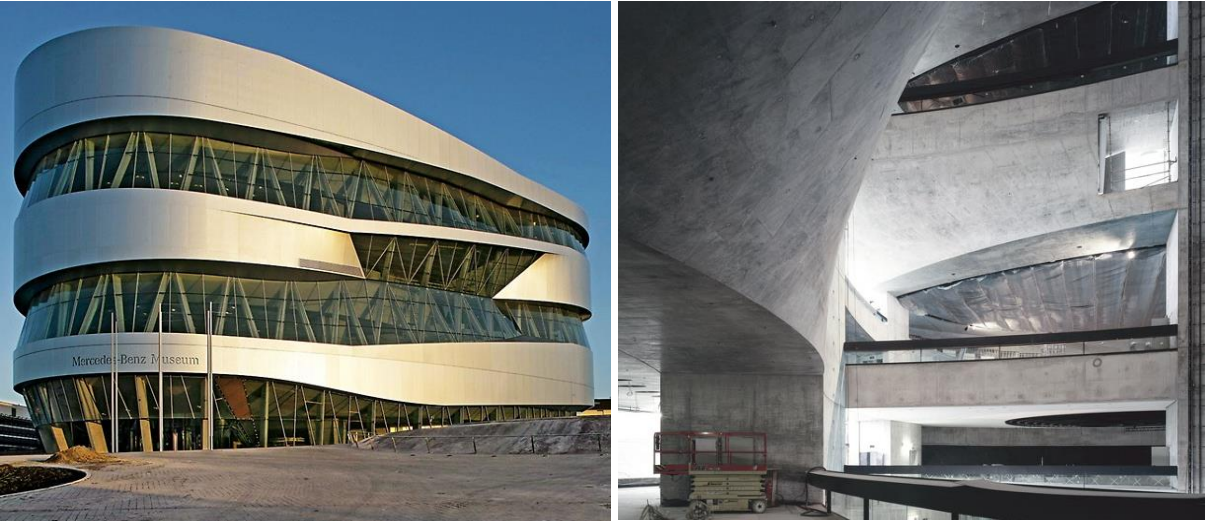


FIGURE A. 17 MERCEDES-BENZ MUSEUM BUILDING CONSTRUCTION (PERI, 2006)





---

### A.4.3. MUMMOUTH UNIVERSITY LIBRARY STAIR

---

FIGURE A. 18 MONMOUTH UNIVERSITY LIBRARY STAIR (CONVEX, 2008)

---

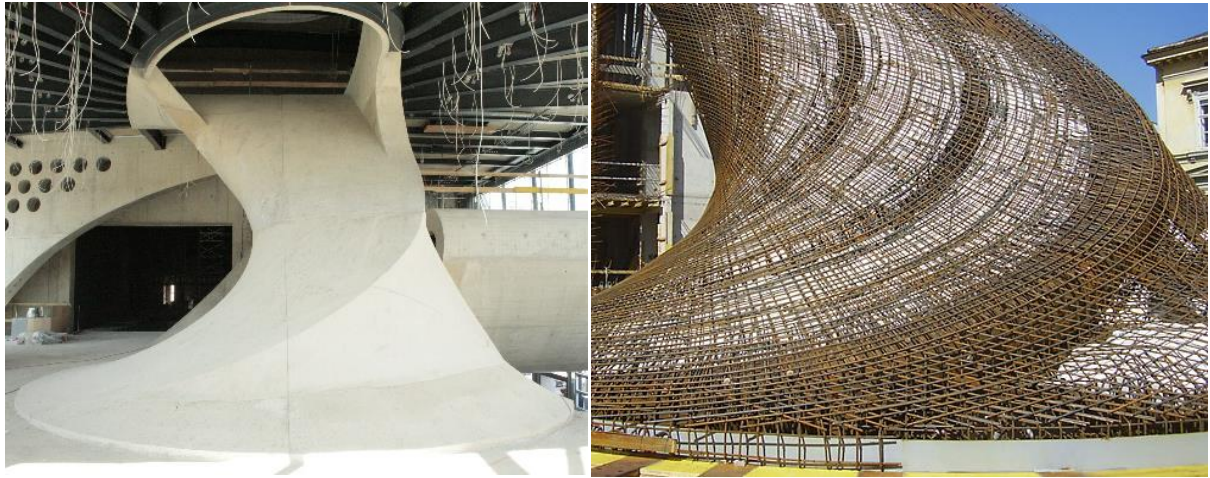


FIGURE A. 19 STAIR STEEL STRUCTURE (CONVEX, 2008)

---



**A.4.4. MEISO NO MORI – MUNICIPAL FUNERAL HALL**

---

Architect: Toyo Ito and associates  
Structure Engineer : Mutsuro Sasaki  
Location: Kagamigahara Gifu, Japan  
Project year : 2006

The form of the roof was determined precisely, using 3700 check points on the grid. It was constructed by continually cross checking the position of all points, one by one, with laser level finder, to ensure a consistent depth for 200 mm thickness of concrete, which a tolerance of only 10mm. The process was crucial for both the design and the structure. The roof was completed in five separate pours, using quick-setting mixture to eliminate the possibility of the concrete sliding off the curving section. Once hardened, all joints marks were removed with grinding machines and the entire surface trowelled with mortar to create a single surface. A flexible water proofing urethane layer was added later to compensate for any slight movement in the concrete surface (Long, 2015).

---

**FIGURE A. 20 MUNICIPAL FUNERAL HALL BUILDING (LONG, 2015)**

---





---

**FIGURE A. 21 MUNICIPAL FUNERAL HALL - REINFORCEMENT (LONG, 2015)**

---



**A.4.5. ARNHEM STATION –TRANSFER HALL**

---

**FIGURE A. 22 ARNHEM STATION HALL (DESIGNALMIC, N.D.)**

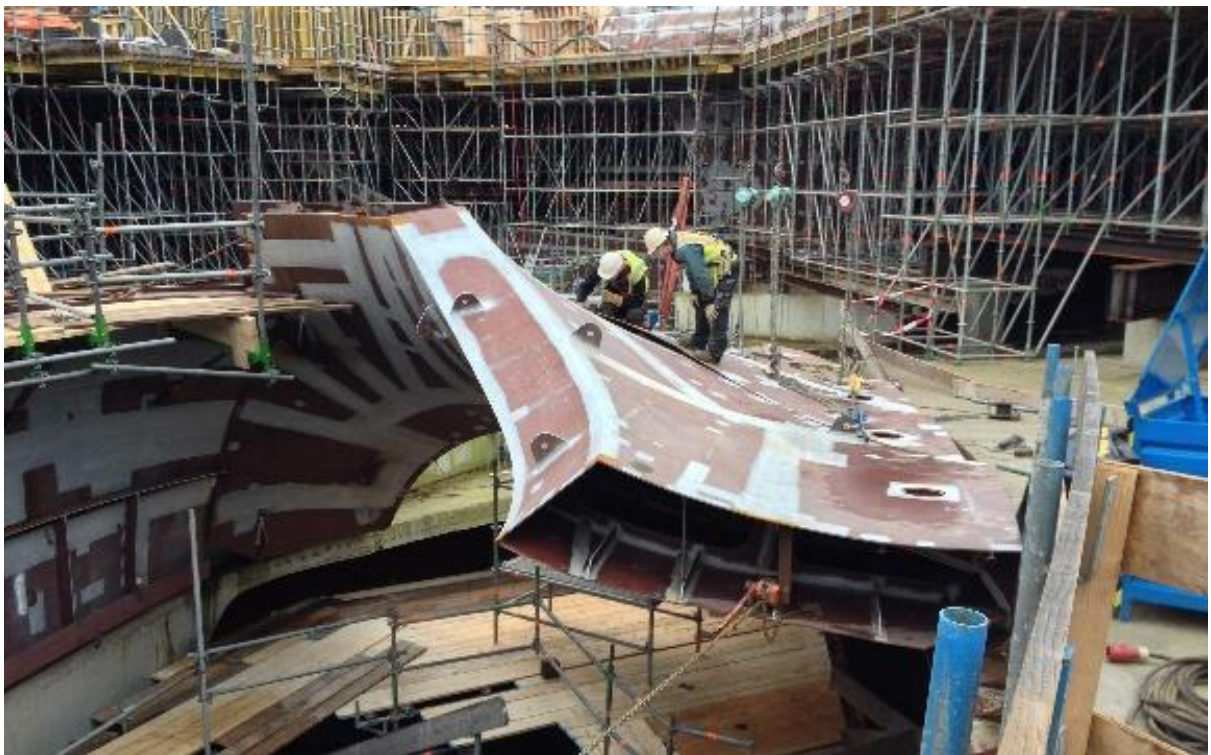
---



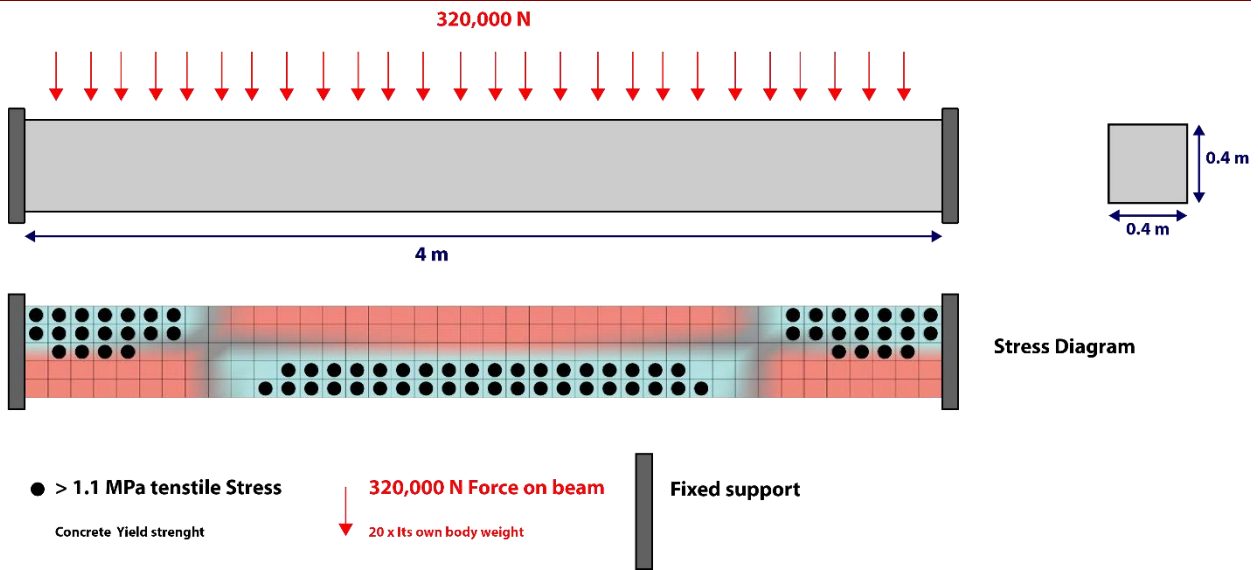
**FIGURE A. 23 ARNHEM STATION – STEEL STRUCTURAL COMPONENTS (DESIGNALMIC, N.D.)**

---



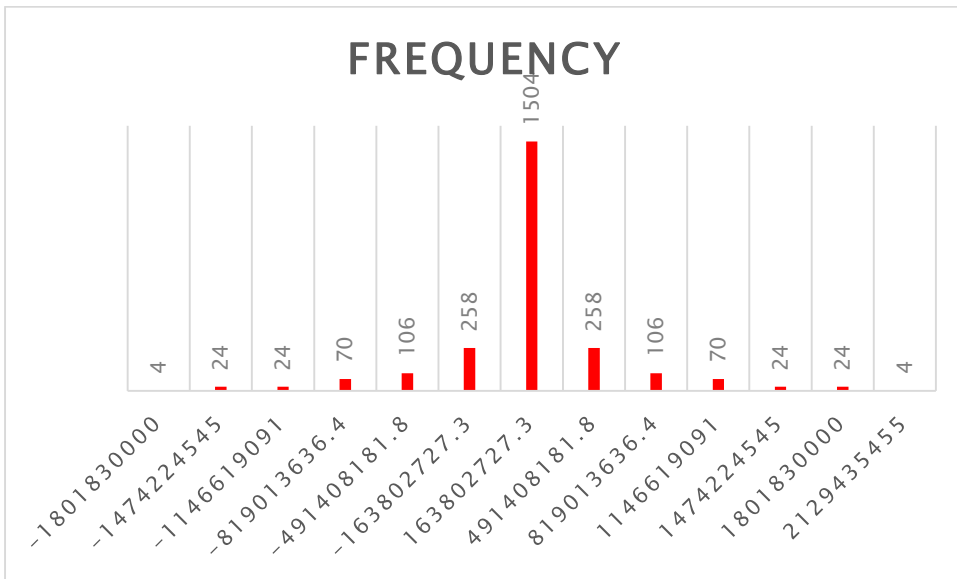
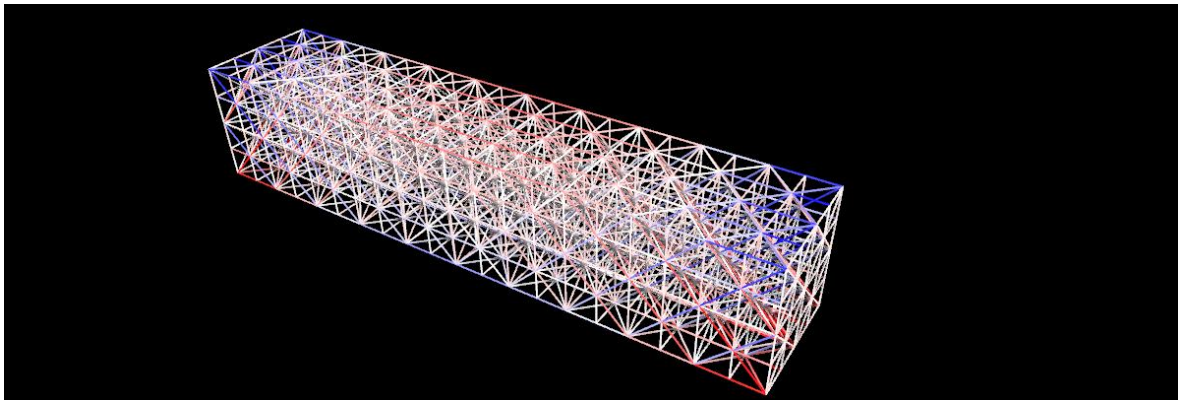
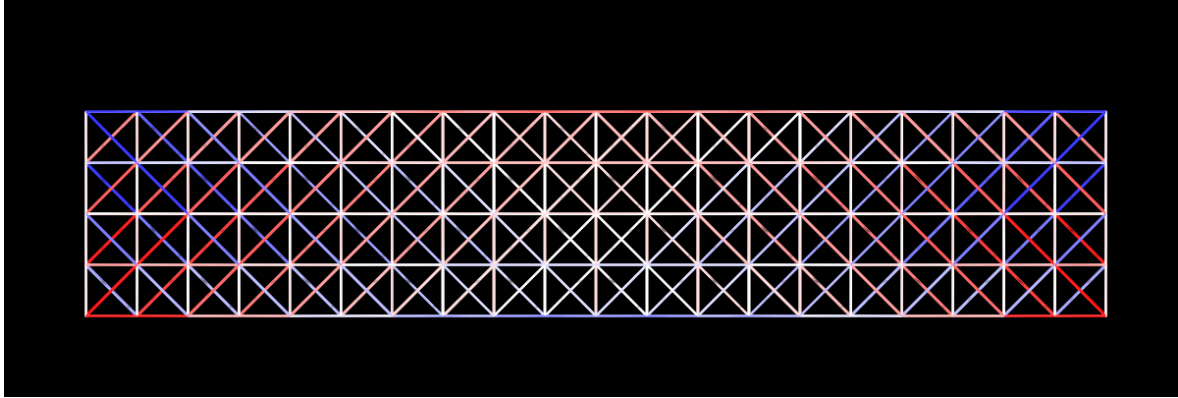
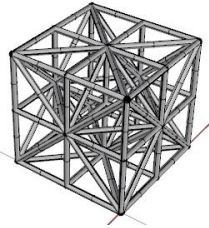


## A.5. GRID PATTERN



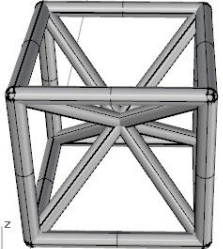
	% stiff-ness of material used	Area		Volume		length		nr. ele-ment	nr. of element al-most 0 stress		nr. of element 80% ±stress		radius	
		m2	m3	m	m	n	n		%	n	n	m	cm	
grid 1	13.50%	3	0.0029	2	1.7326	4	589.31	2476	1504	60.7%	56	2.26%	0.031	3.059
grid 2	11.48%	6	0.0035	5	2.4757	5	711.41	2620	1394	53.2%	20	0.76%	0.033	3.328
grid 3	12.26%	1	0.0023	4	2.0944	6	910.62	3612	1988	55.0%	20	0.55%	0.027	2.706
grid 4	6.68%	5	0.0033	6	2.9087	7	886.81	10240	7000	68.4%	24	0.23%	0.032	3.231
grid 5	15.15%	8	0.0058	1	1.4262	1	247.60	1857	1036	55.8%	12	0.65%	0.043	4.282
grid 6	13.55%	4	0.0031	8	3.7112	8	1185.68	6112	2916	47.7%	24	0.39%	0.032	3.156
grid 8	4.35%	9	0.0205	9	7.4254	2	362.04	2560	2104	82.2%	8	0.31%	0.081	8.080
grid 9	31.07%	7	0.0047	3	2.0618	3	443.40	1280	232	18.1%	16	1.25%	0.038	3.847
grid 10	12.19%	2	0.0024	7	3.4643	9	1474.17	8320	3942	47.4%	10	0.12%	0.027	2.735

### A.5.1. PATTERN 1



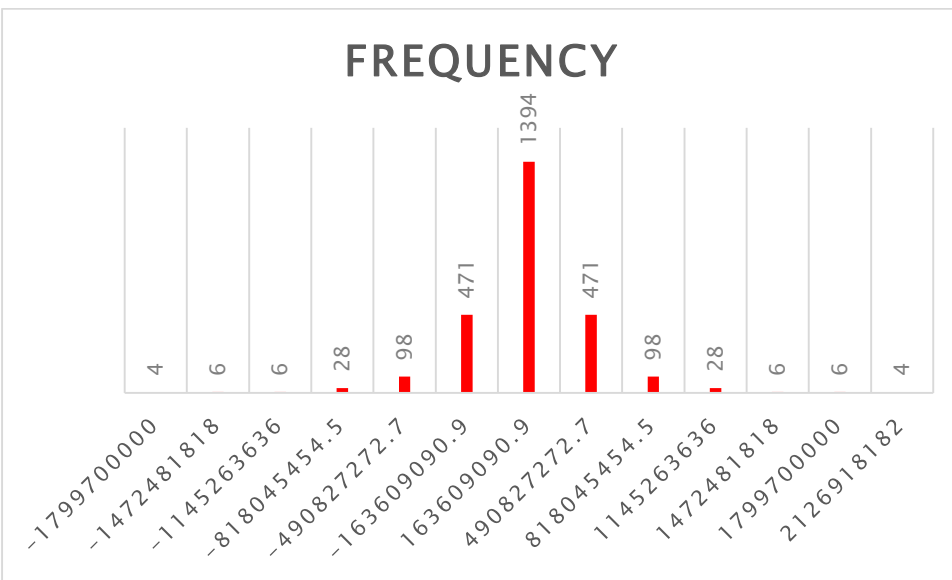
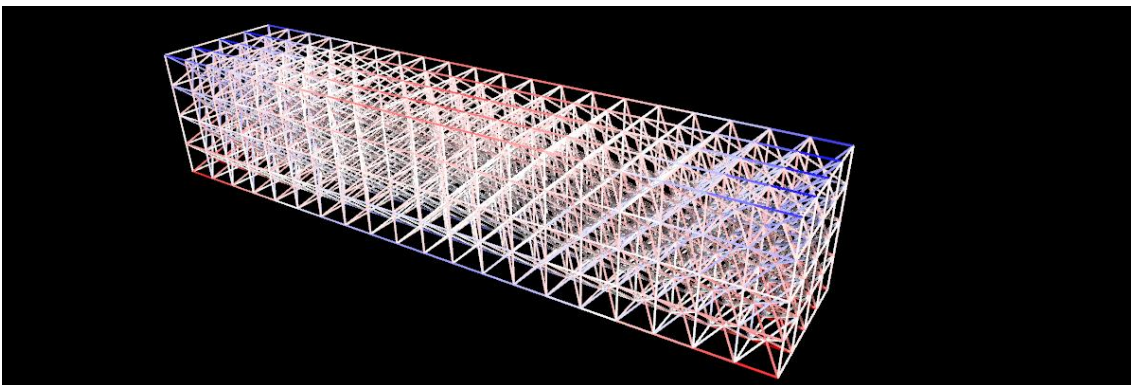
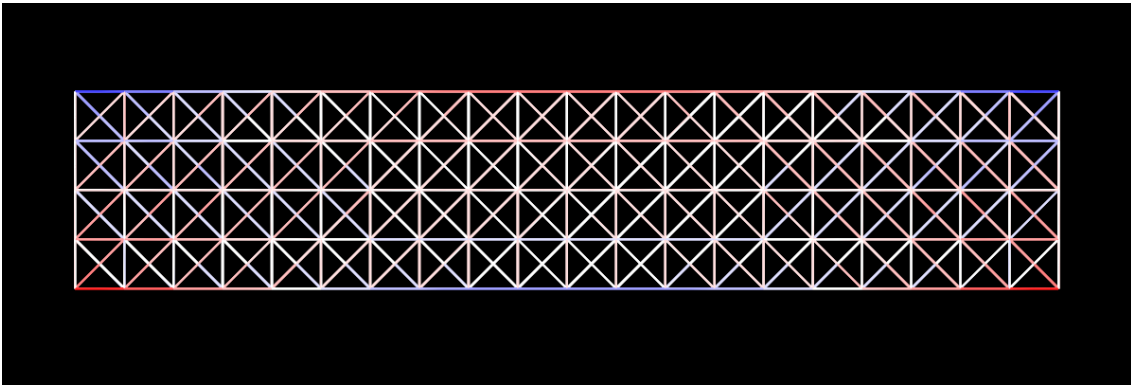


A.5.2. PATTERN 2 – BODY CENTERED CUBIC

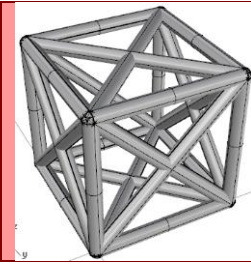


Body Centered Cubic Structure

Metals with mentioned structure:  
*V, Cr, Fe, Nb, and Mo*

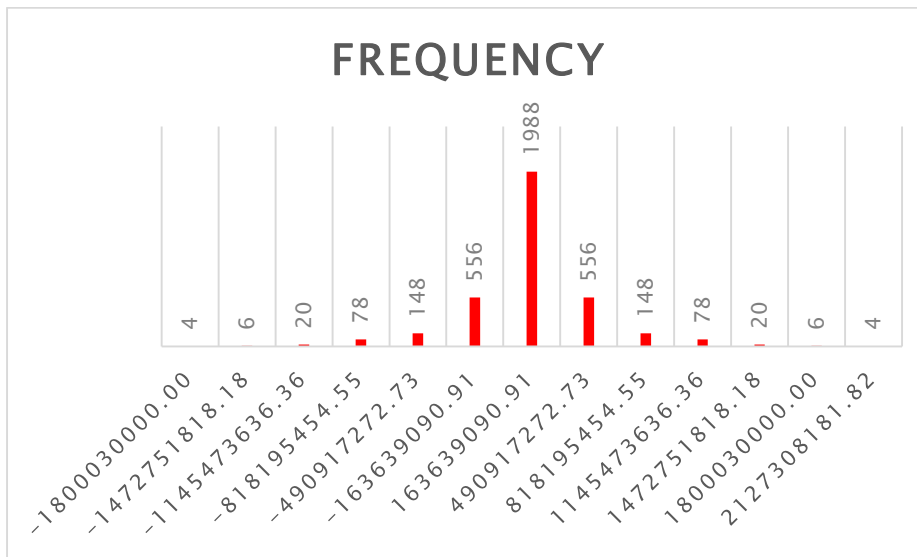
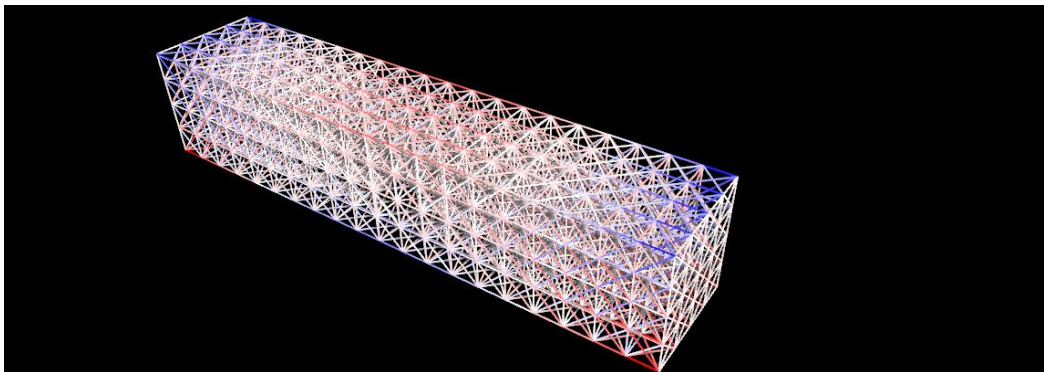
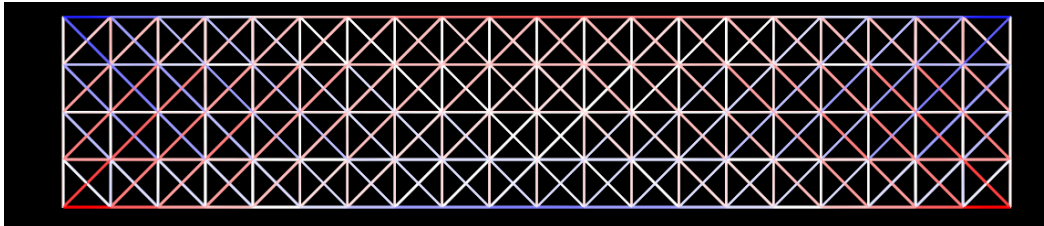


### A.5.3. PATTERN 3 – FACE CENTER CUBIC

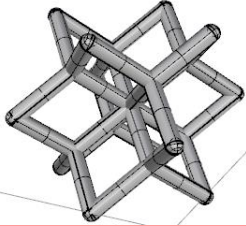


Face Center Cubic Structure (fcc)

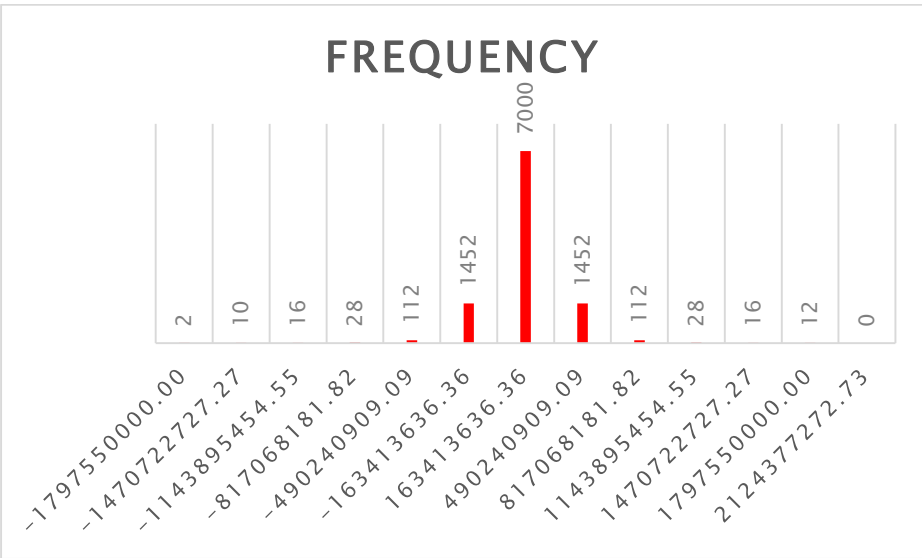
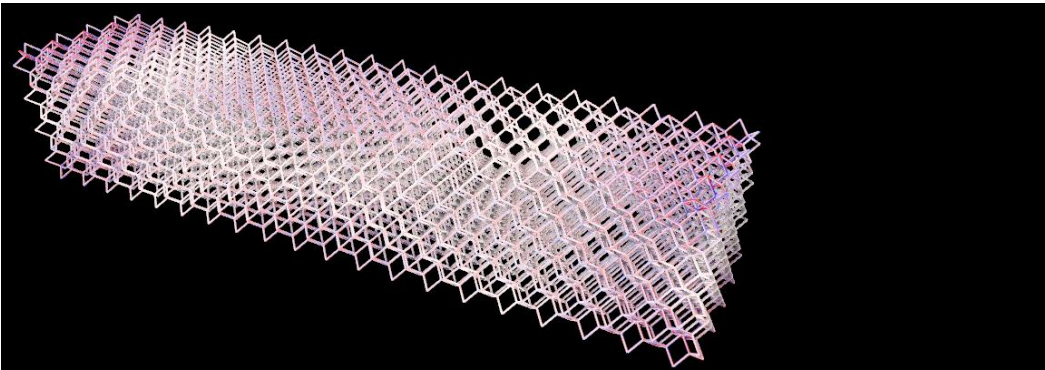
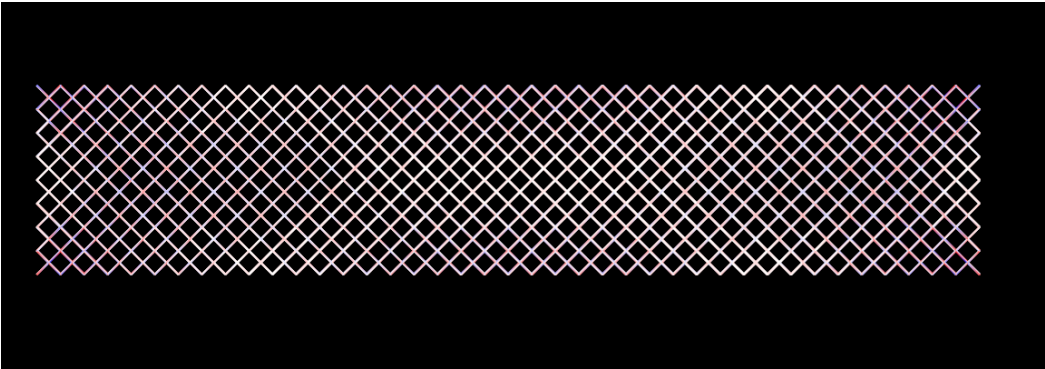
Metals with mentioned structure:  
*Al, Ni, Cu, Pd, Ag, Pt, and Au*



A.5.4. PATTERN 4 – DODE ELEMENT



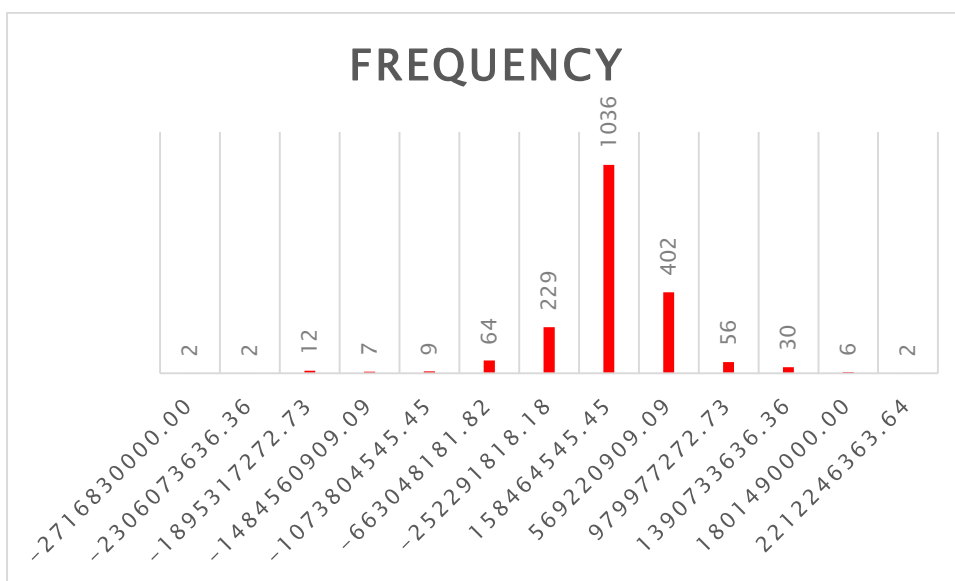
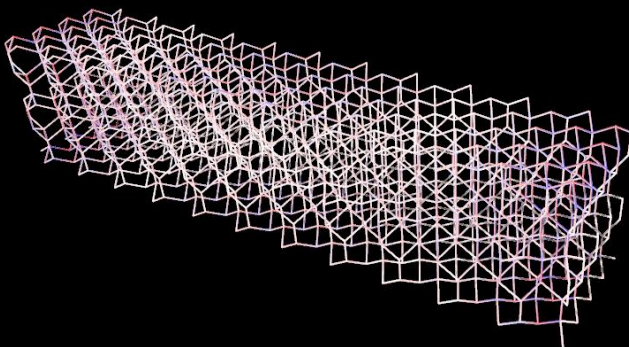
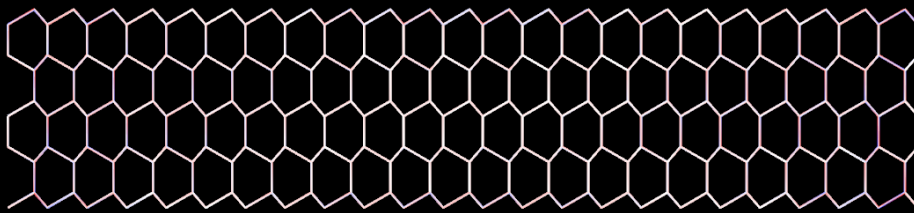
Used for bone structures



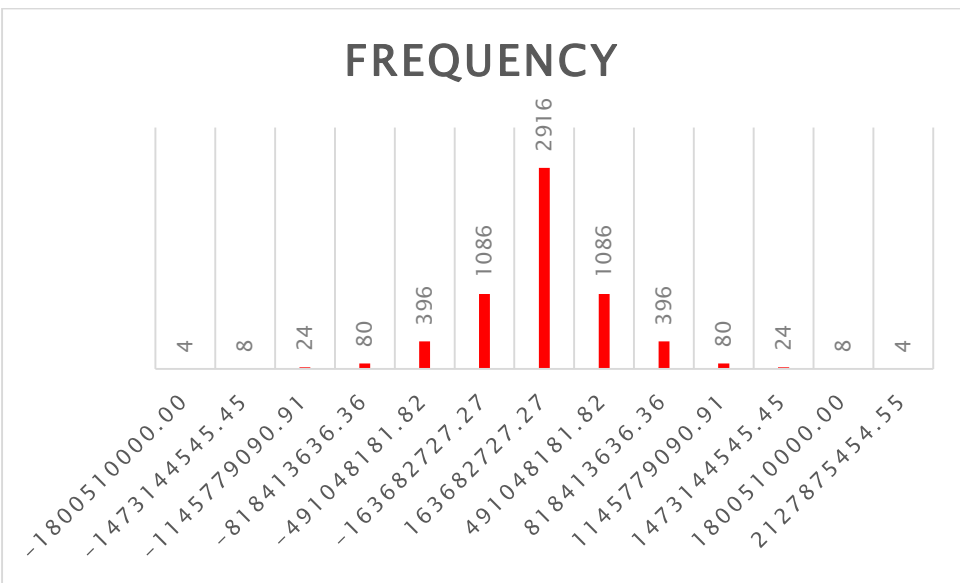
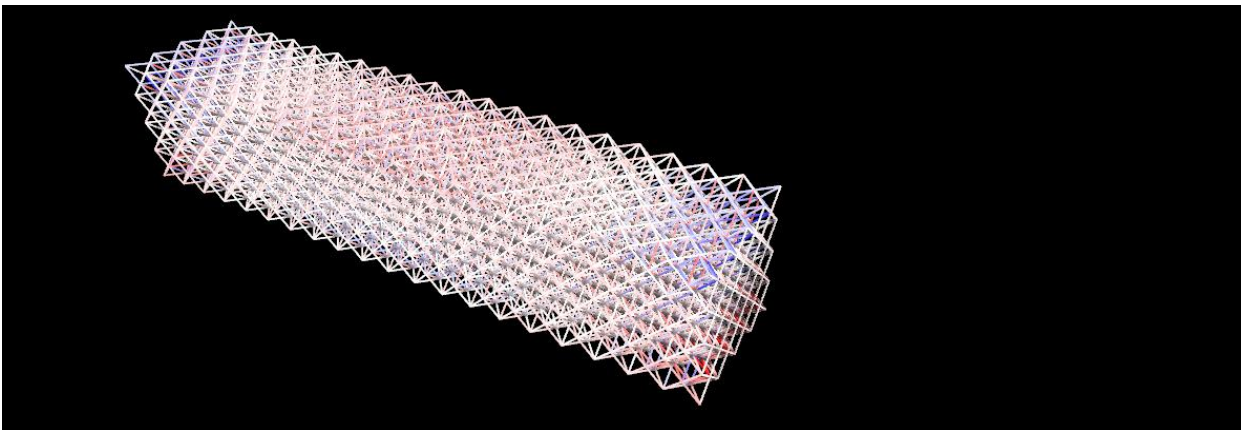
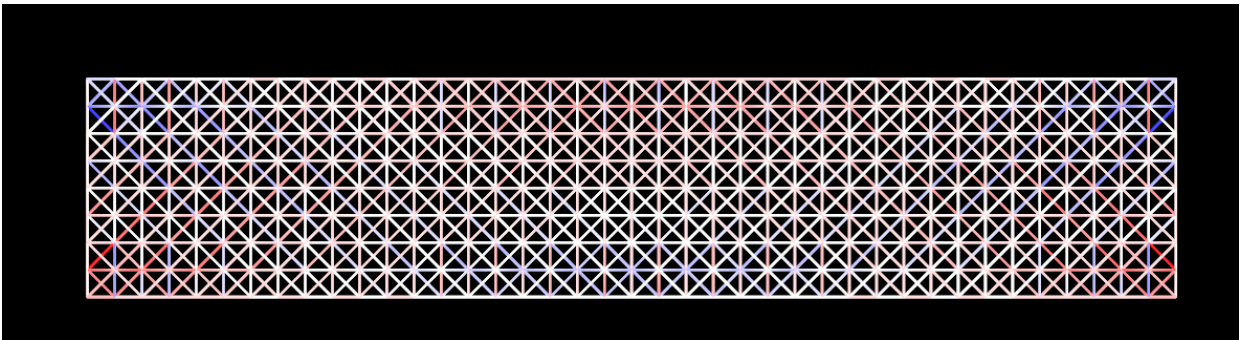
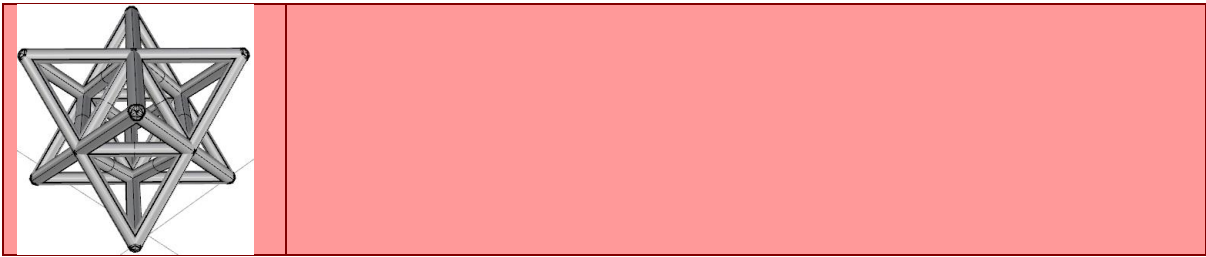
## A.5.5. PATTERN 5 – DIAMOND CRYSTAL



Diamond crystal structure

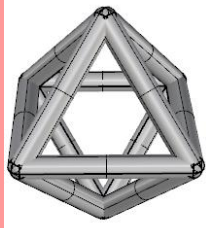


A.5.6. PATTERN 6 – OCTEC TRUSS

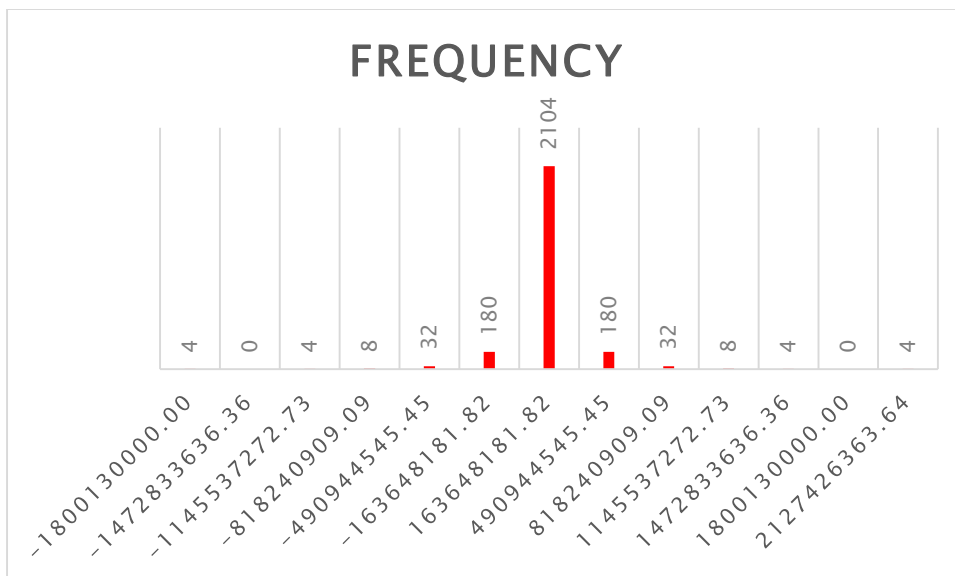
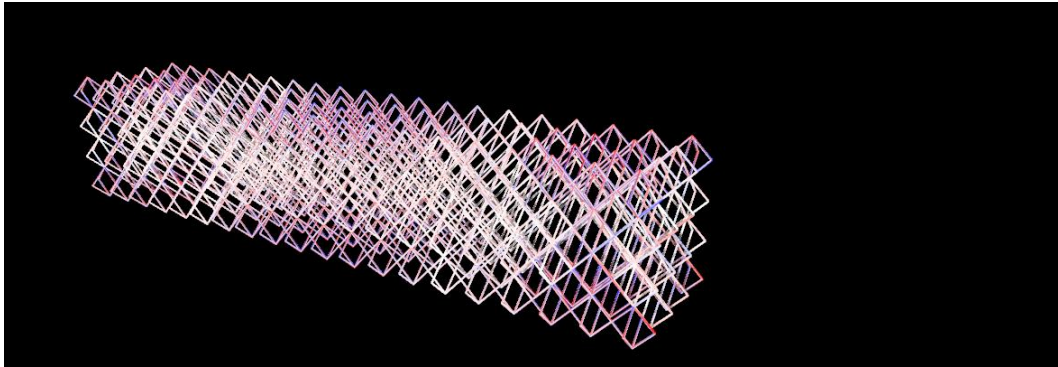
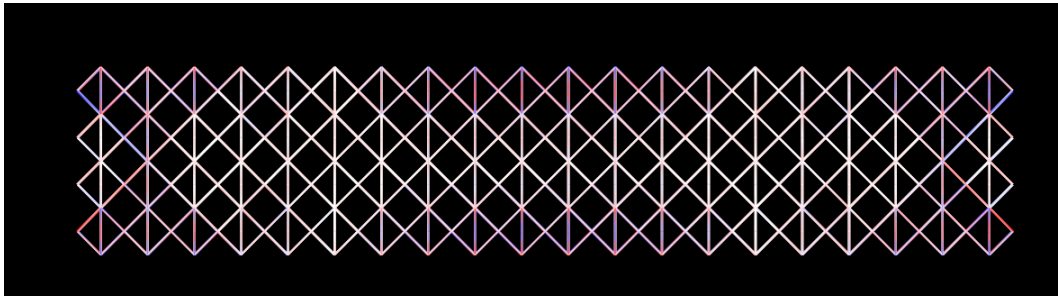




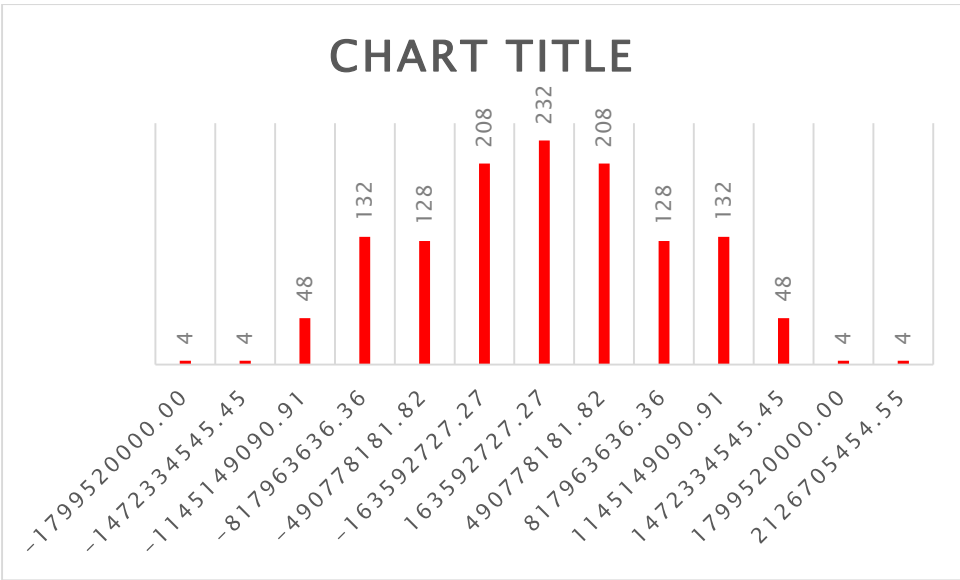
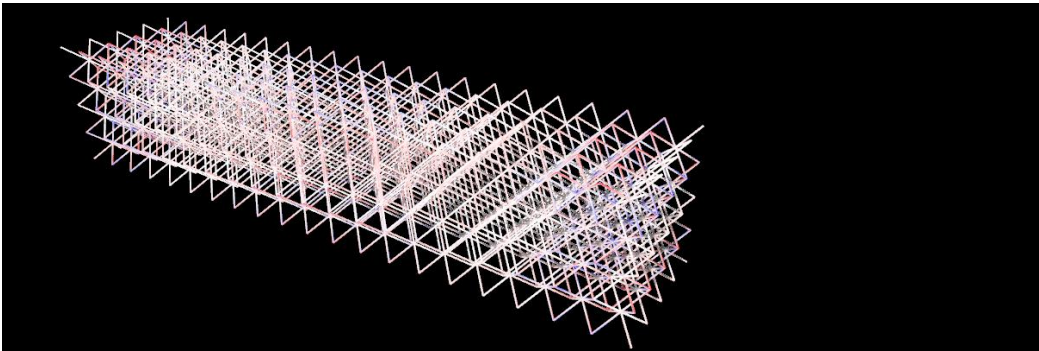
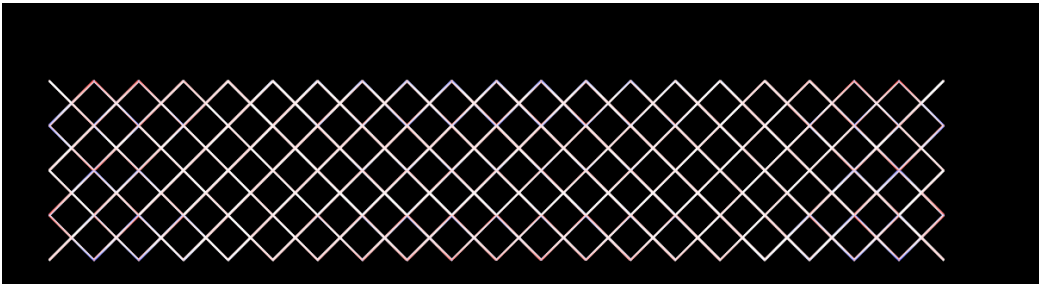
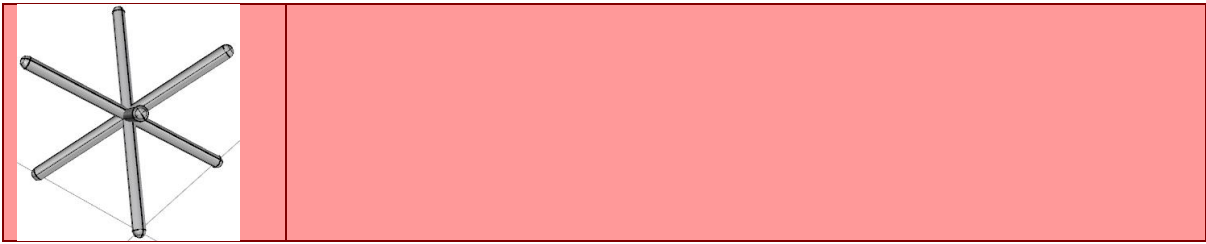
## A.5.7. PATTERN 8 – OCTAHEDRAL



NaCl crystal structure

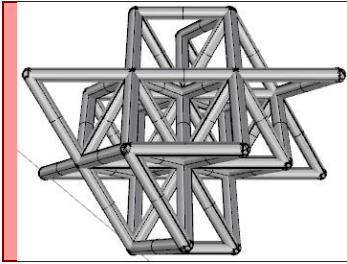


A.5.8. PATTERN 9

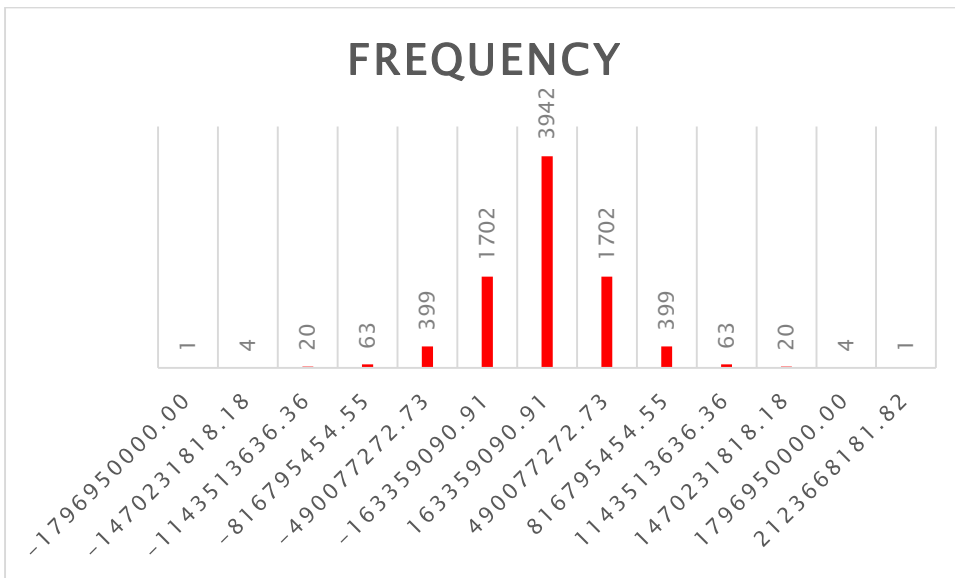
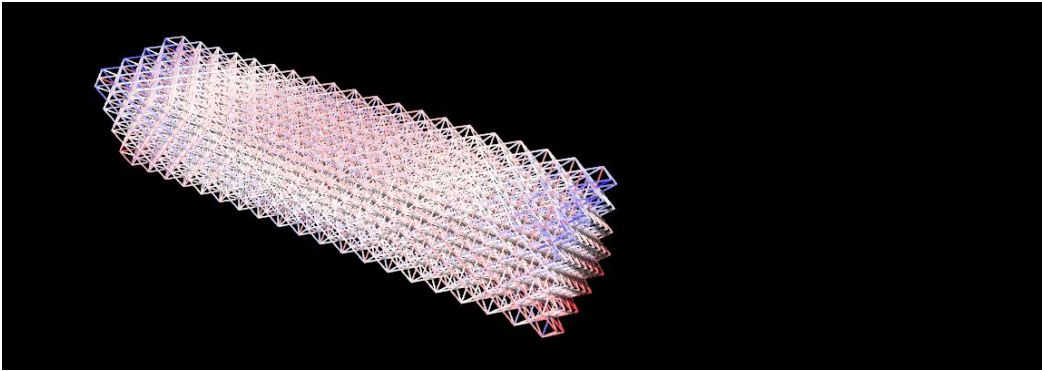
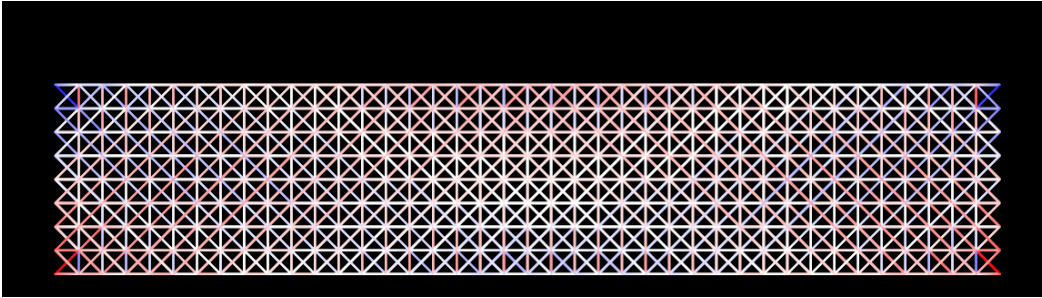




## A.5.9. PATTERN 10



Branch Technology structure



## A.6. APPENDIX REFERENCE

---

- Ancon. (n.d). MBT Rebar Coupler. Retrieved from <https://www.ancon.co.uk/products/reinforcing-bar-couplers/mbt-couplers>
- Comerford, E. (2015). Australia Patent No. AU2009311264.
- Convex. (2008). Mumuth Graz. Retrieved from <http://www.convex.at/projekte/mumuth-graz/?lang=en>
- CRSI. (n.d). Splicing Bar. Retrieved from <http://www.crsi.org/index.cfm/steel/splices>
- Designalmic. (n.d.). Arnhem station – Transfer hall
- ERICO. (2009). CADWELD® Rebar Metal Filled Mechanical Splices. In Electrical grounding bonding and connectivity products (Ed.): ERICO International Corporation.
- H.R.C. (n.d). Position Couplers. Retrieved from <https://www.hrc-europe.com/applications/joints-block-outs/>
- Halfen Moment. (n.d). mechanical rebar splicing systems. *Moment Coupler Solution*. Retrieved from [http://www.teyseerbm.com/sites/default/files/Coupler\\_0.pdf](http://www.teyseerbm.com/sites/default/files/Coupler_0.pdf)
- Incon. (n.d). Standard Coupler. Retrieved from <http://incon.ca/our-products/threaded-coupler/>
- Lenton. (n.d). Grout Sleeve Retrieved from <https://www.erico.com/part.asp?part=LK8>
- Long, V. H. (2015). Forest of meditation. Retrieved from <https://delinevietnam.wordpress.com/2015/06/22/forest-of-meditation/>
- McManus, D. (2014). Mercedes-Benz Museum Stuttgart. Retrieved from <https://www.e-architect.co.uk/stuttgart/mercedes-museum-stuttgart>
- Monkey Couplers (n.d). The Coupler. Retrieved from <http://monkeybarcouplers.com/>
- Peri. (2006). Mercedes-Benz Museum. Retrieved from <https://www.peri.com/de/projekte/kulturbau/mercedes-benz-museum.html>
- Rinaldi, M. (2014). Taichung Metropolitan Opera House. Retrieved from <http://aasarchitecture.com/2014/08/taichung-metropolitan-opera-house-toyo-ito.html>
- withworks. (2014). 비정형 건축 이야기 1\_비주얼 목업의 중요성(상). Retrieved from <http://withworks.blogspot.nl/2014/05/1.html>
- Zhe, W. (2013). 抽絲剝繭看見自己. Retrieved from <https://solomo.xinmedia.com/archi/album/detail/51855/0>



