

## Technical booklet

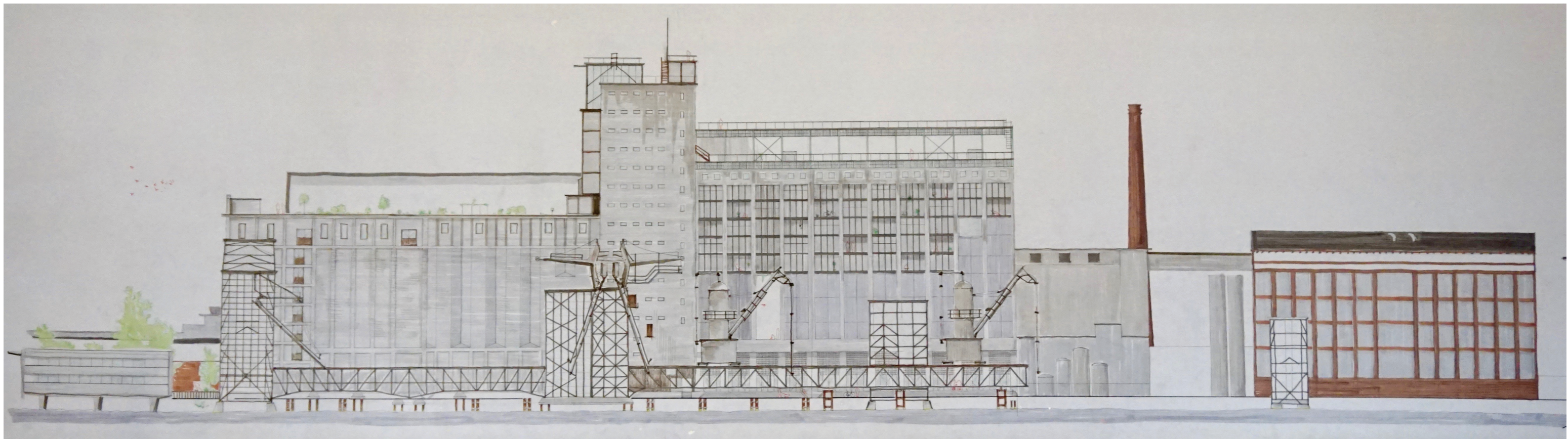

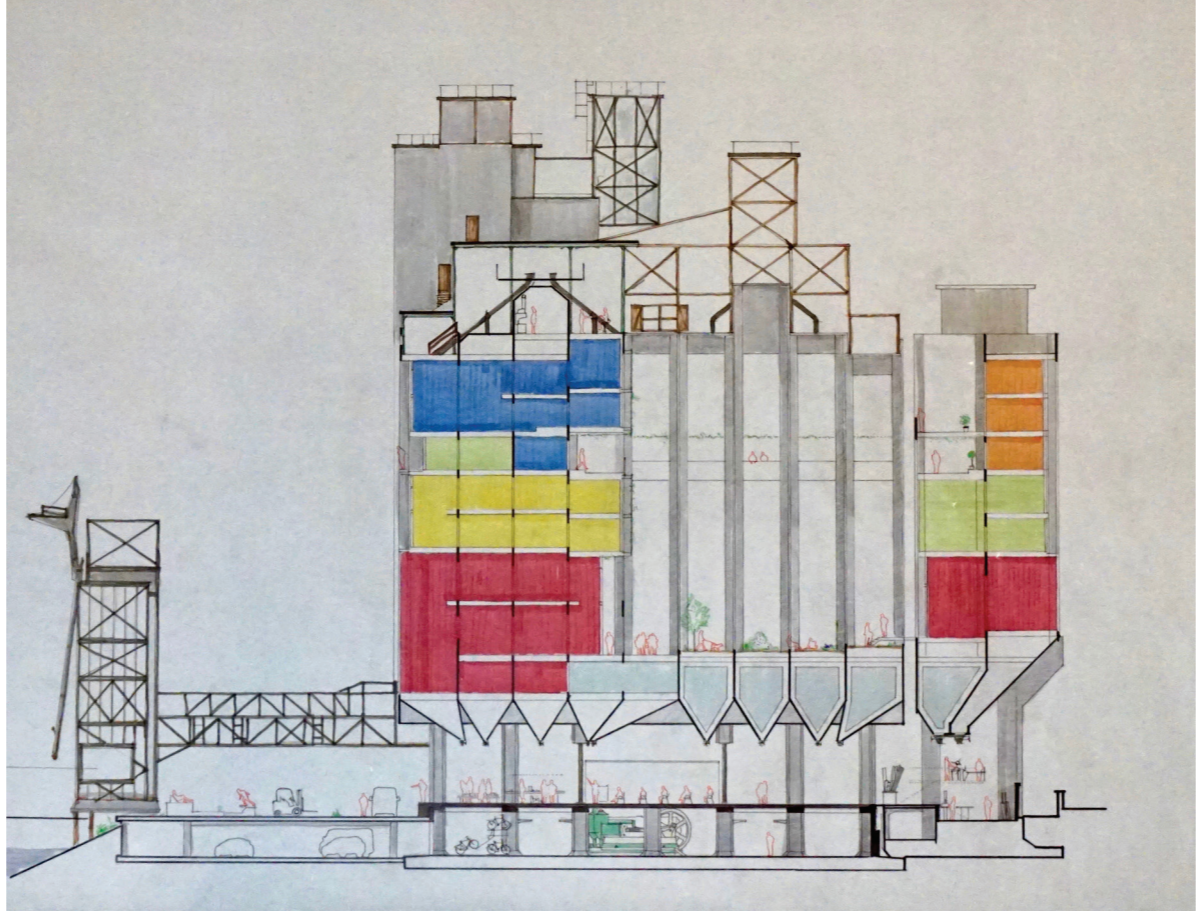

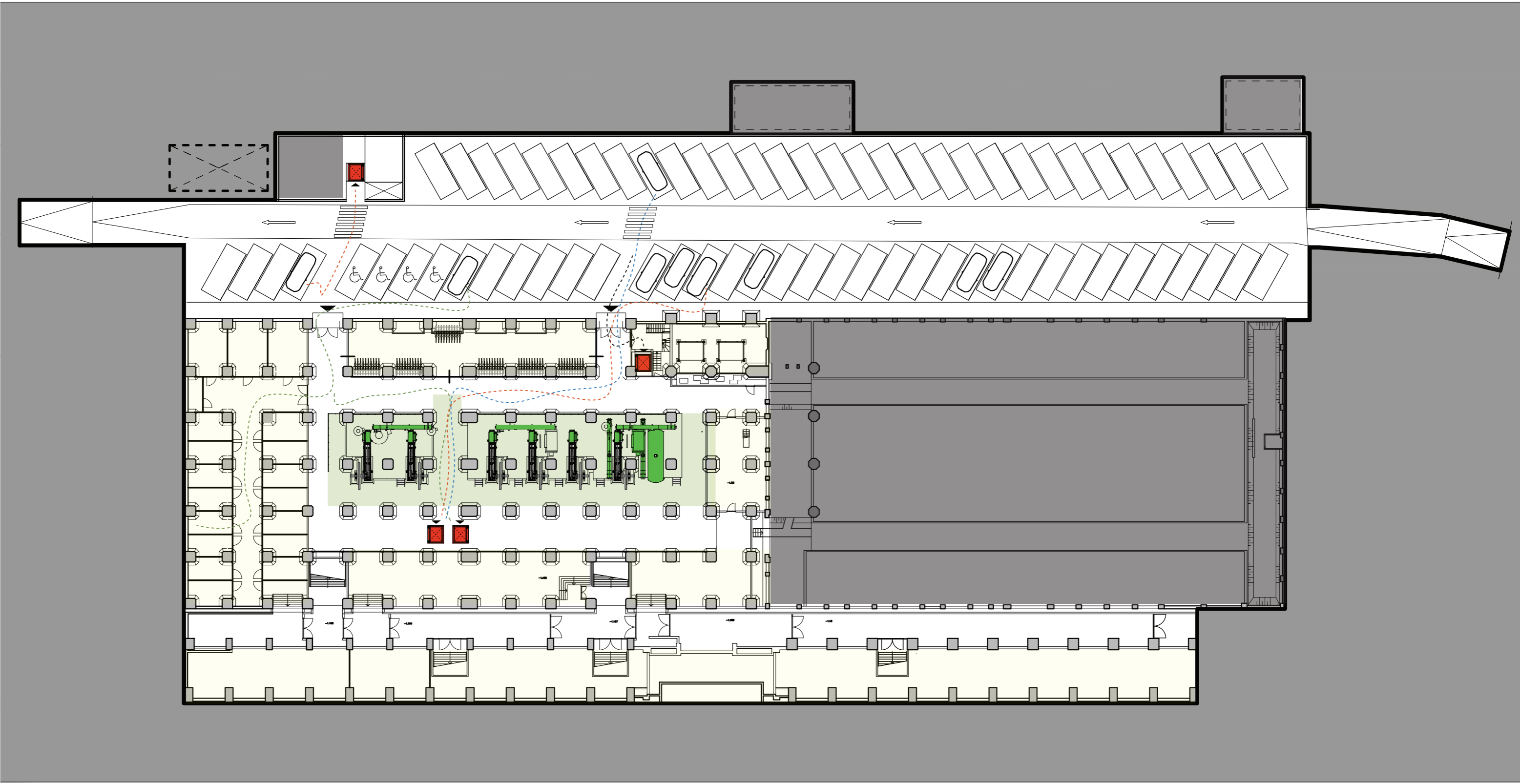

- Visitors
- Employees
- Residents
- Suppliers

0 1m 5m 10m 20m 30m 50m

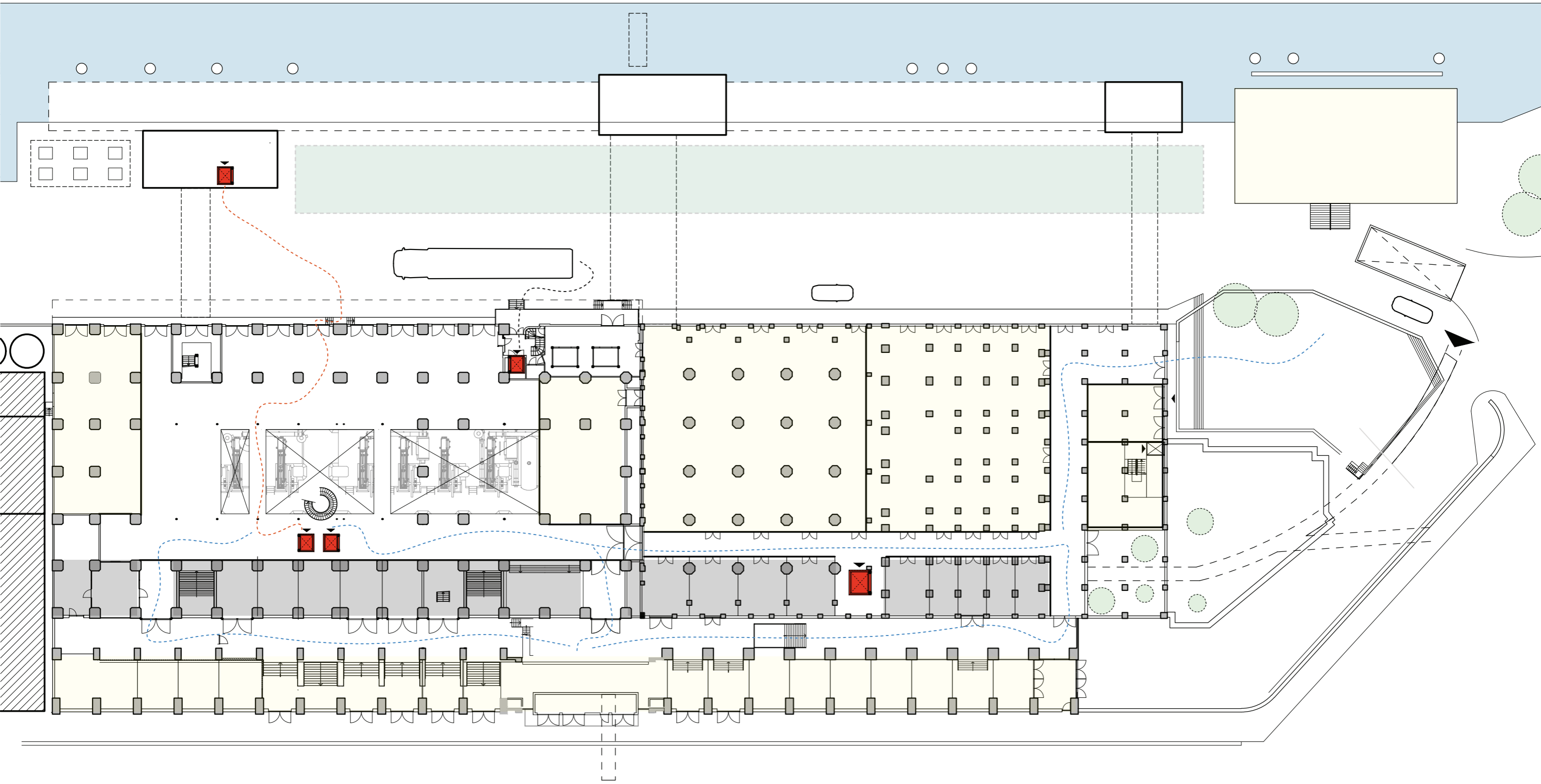

- Visitors
- Employees
- Residents
- Suppliers



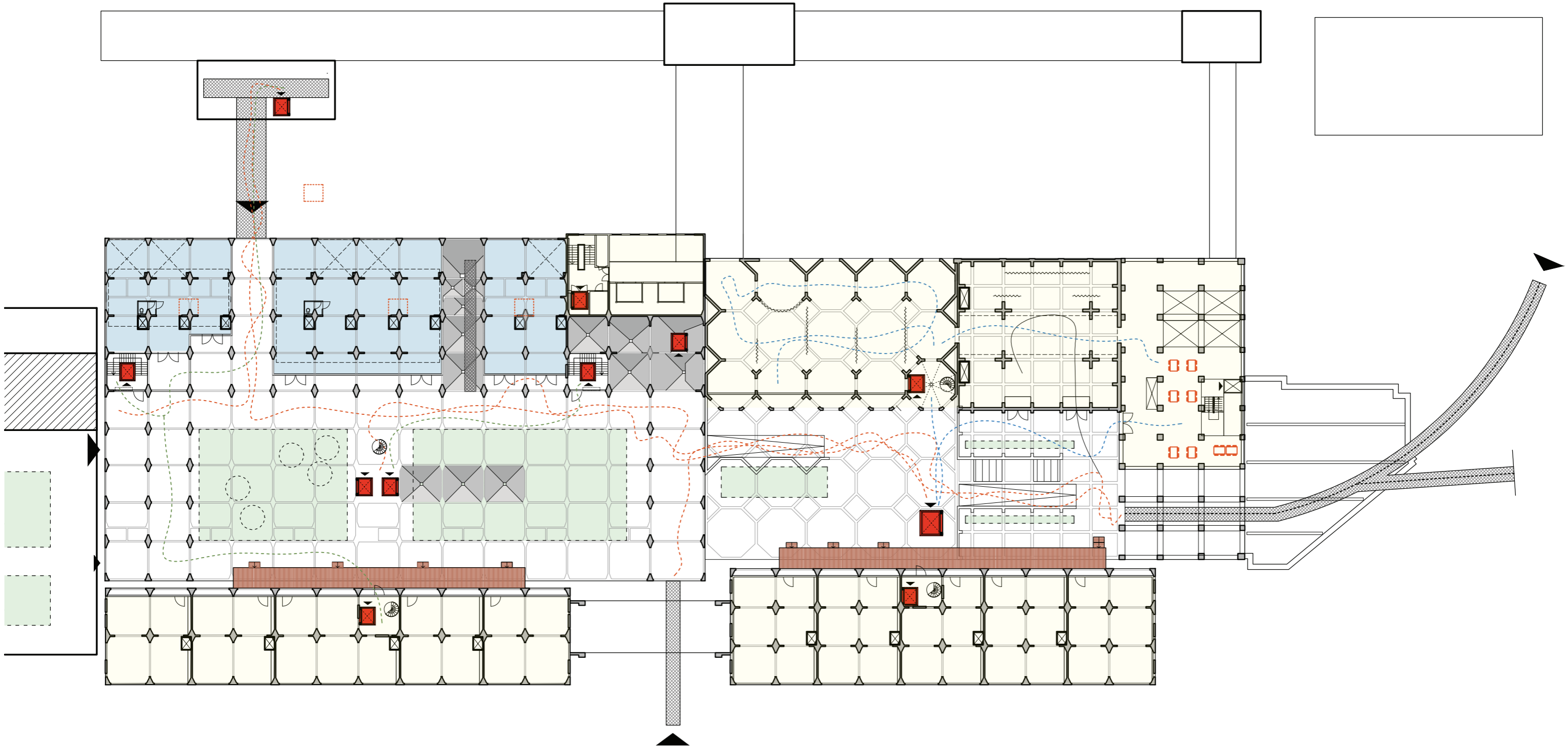

- Visitors
- Employees
- Residents
- Suppliers

0 1m 5m 10m 20m 30m 50m

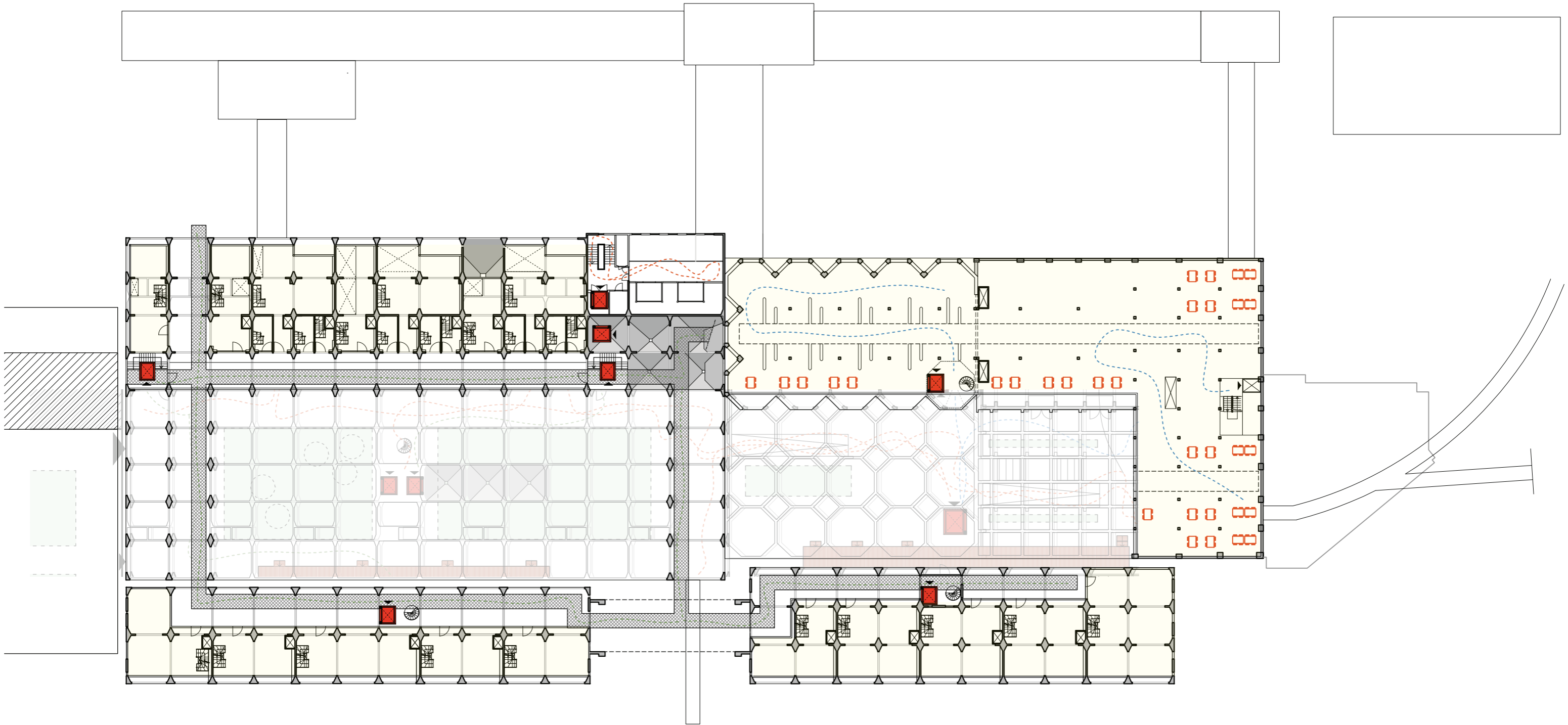

- Visitors
- Employees
- Residents
- Suppliers

0 1m 5m 10m 20m 30m 50m

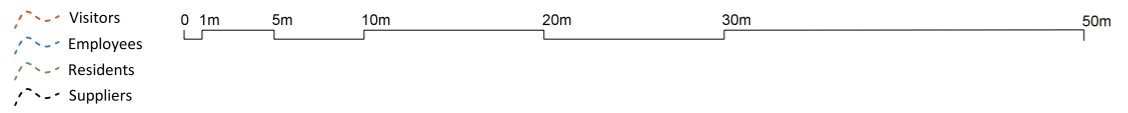
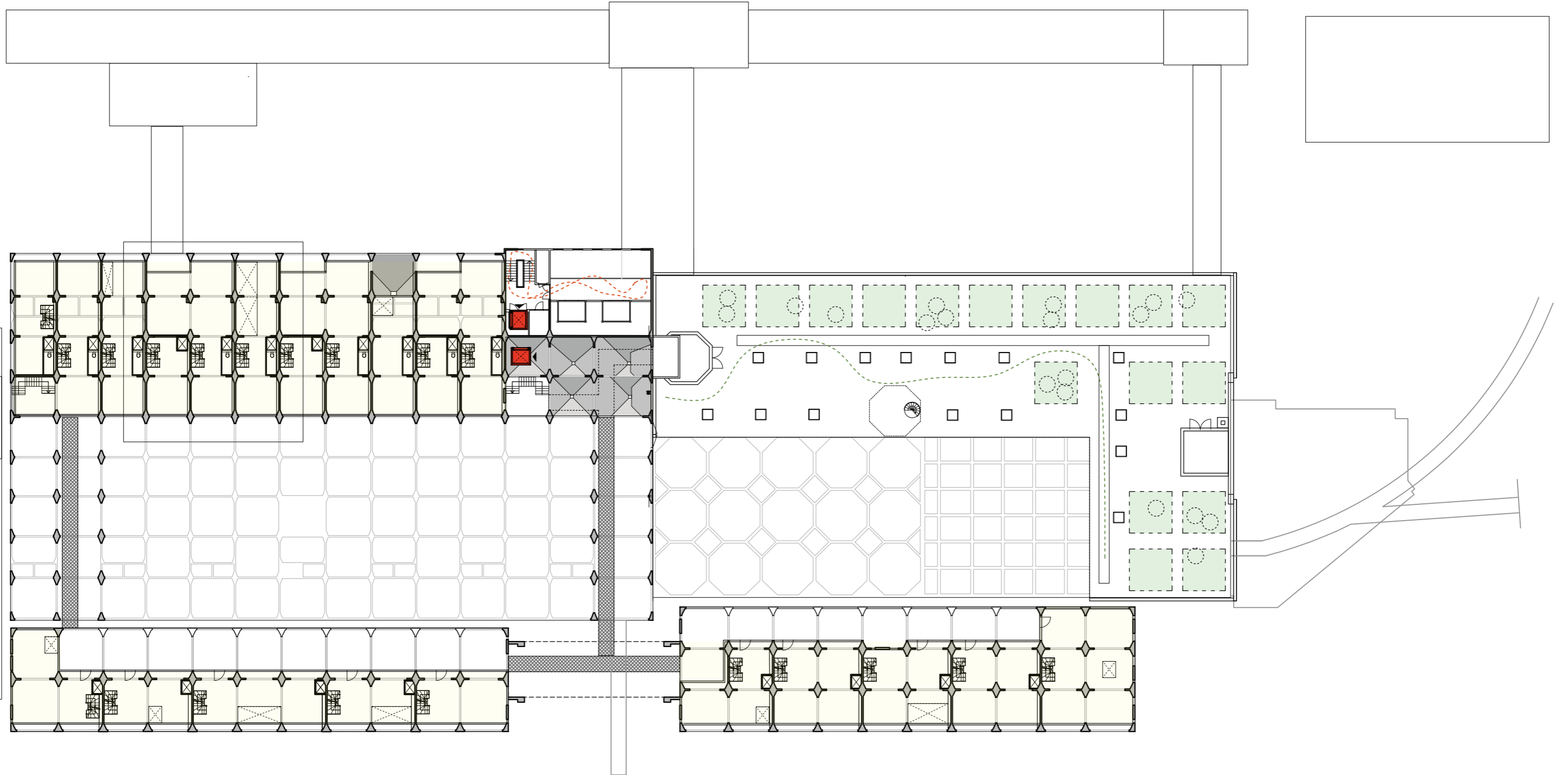



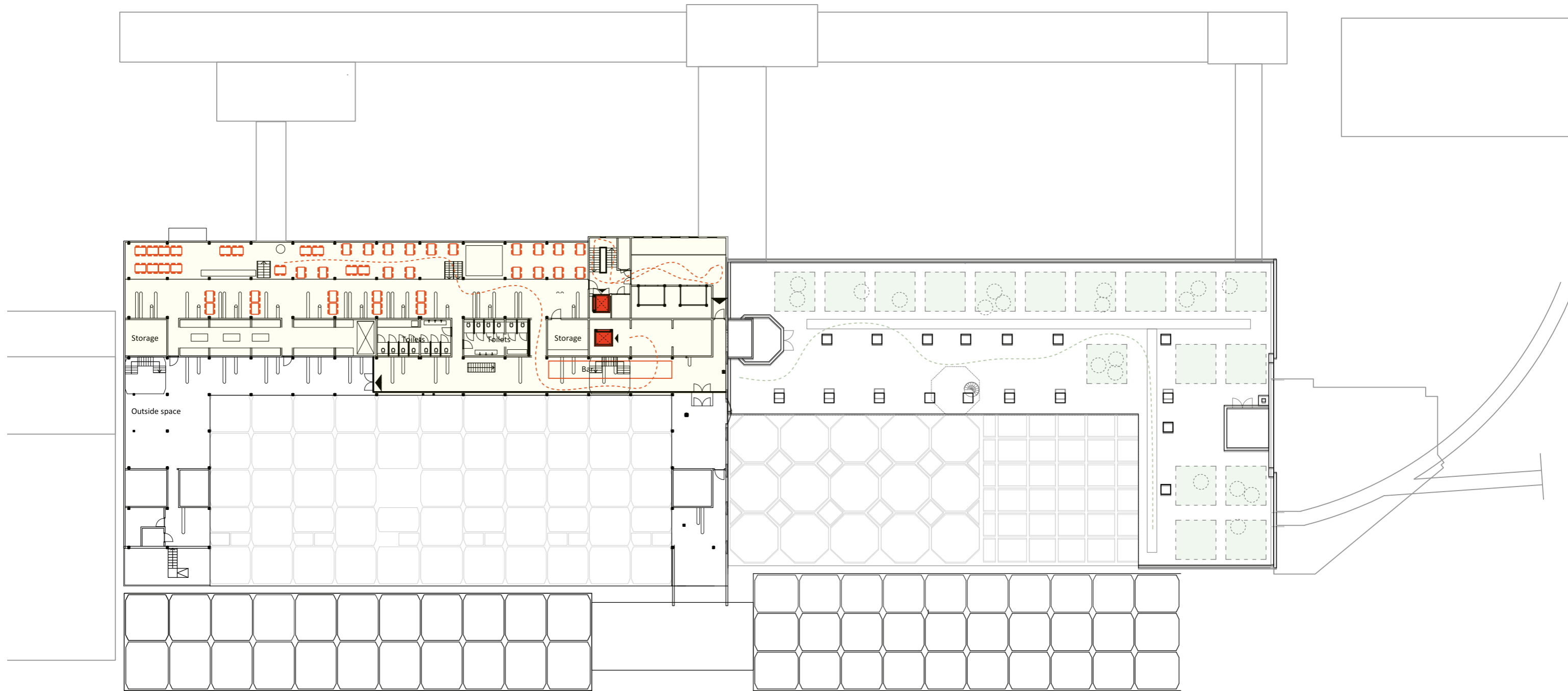

- Visitors
- Employees
- Residents
- Suppliers

0 1m 5m 10m 20m 30m 50m

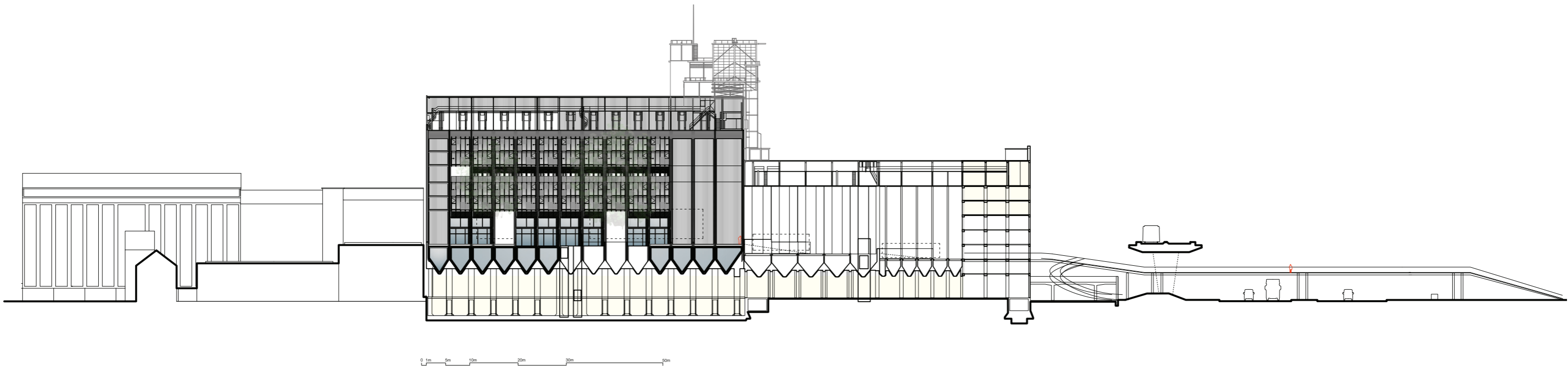

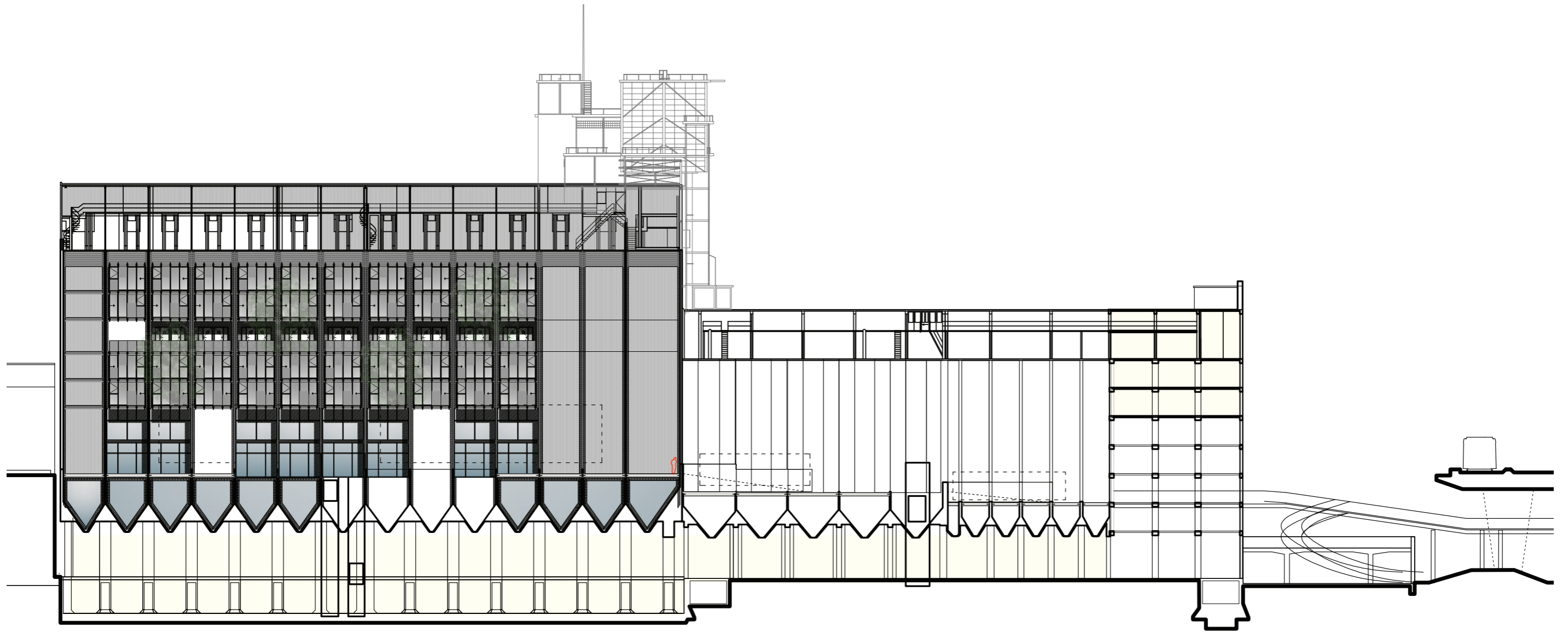

0 1m 5m 10m 20m 30m 50m

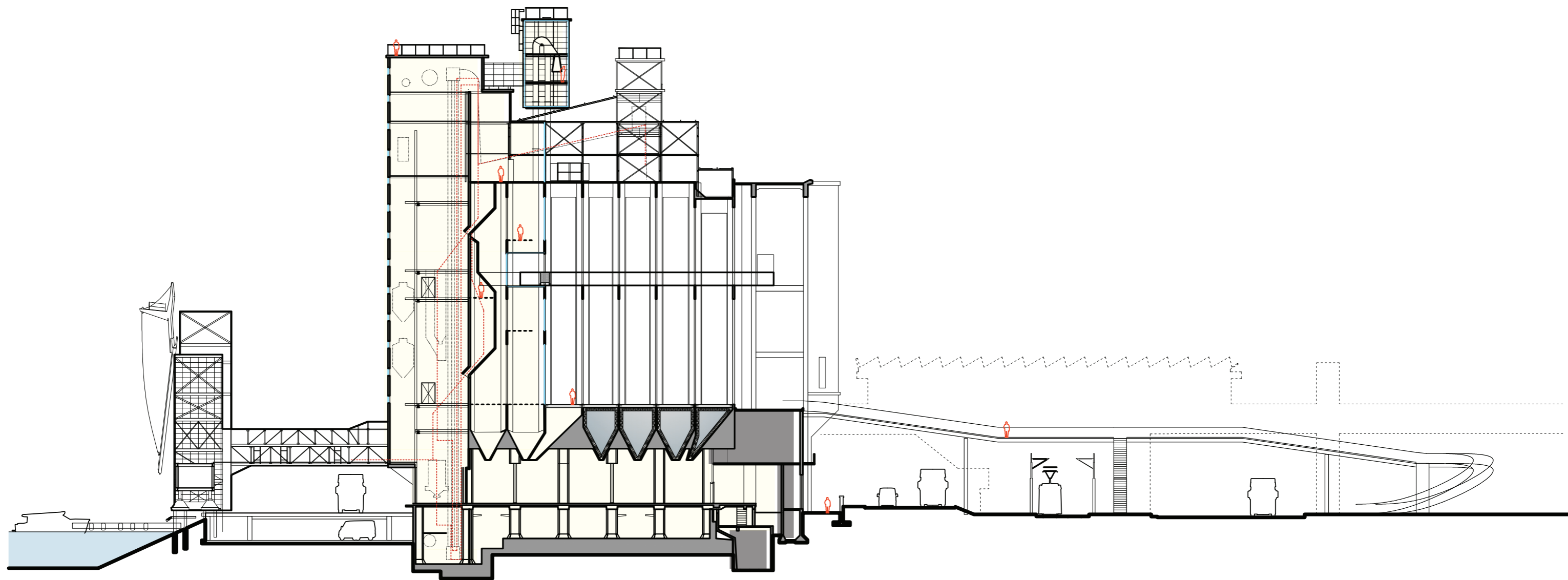
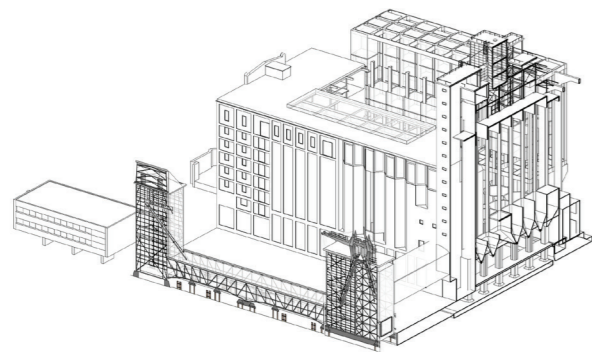

0 1m 5m 10m 20m 30m 50m

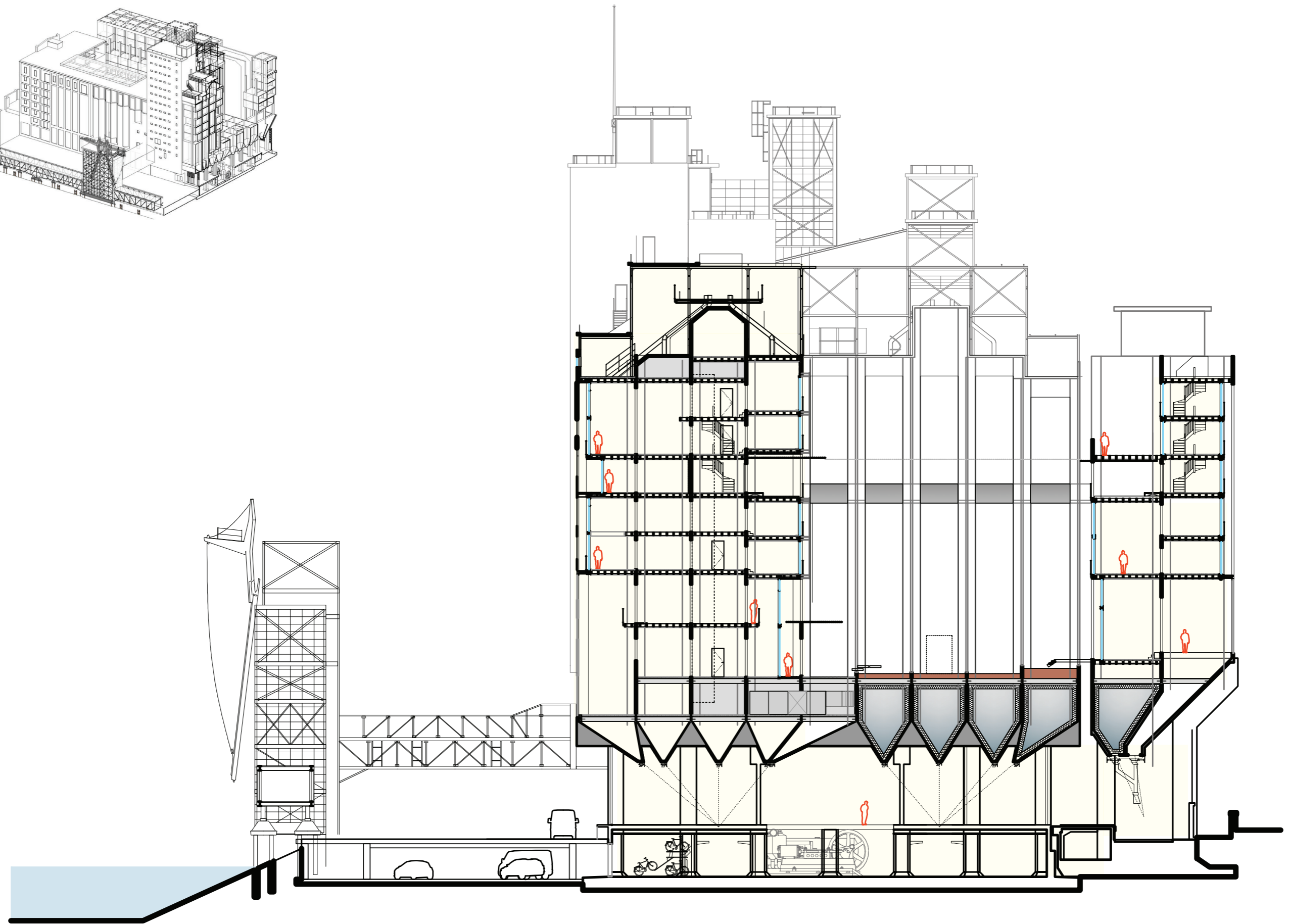
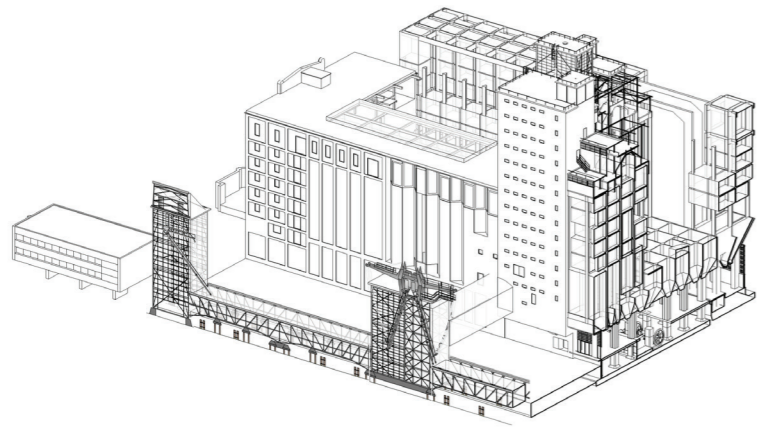

0 1m 5m 10m 20m 30m 50m

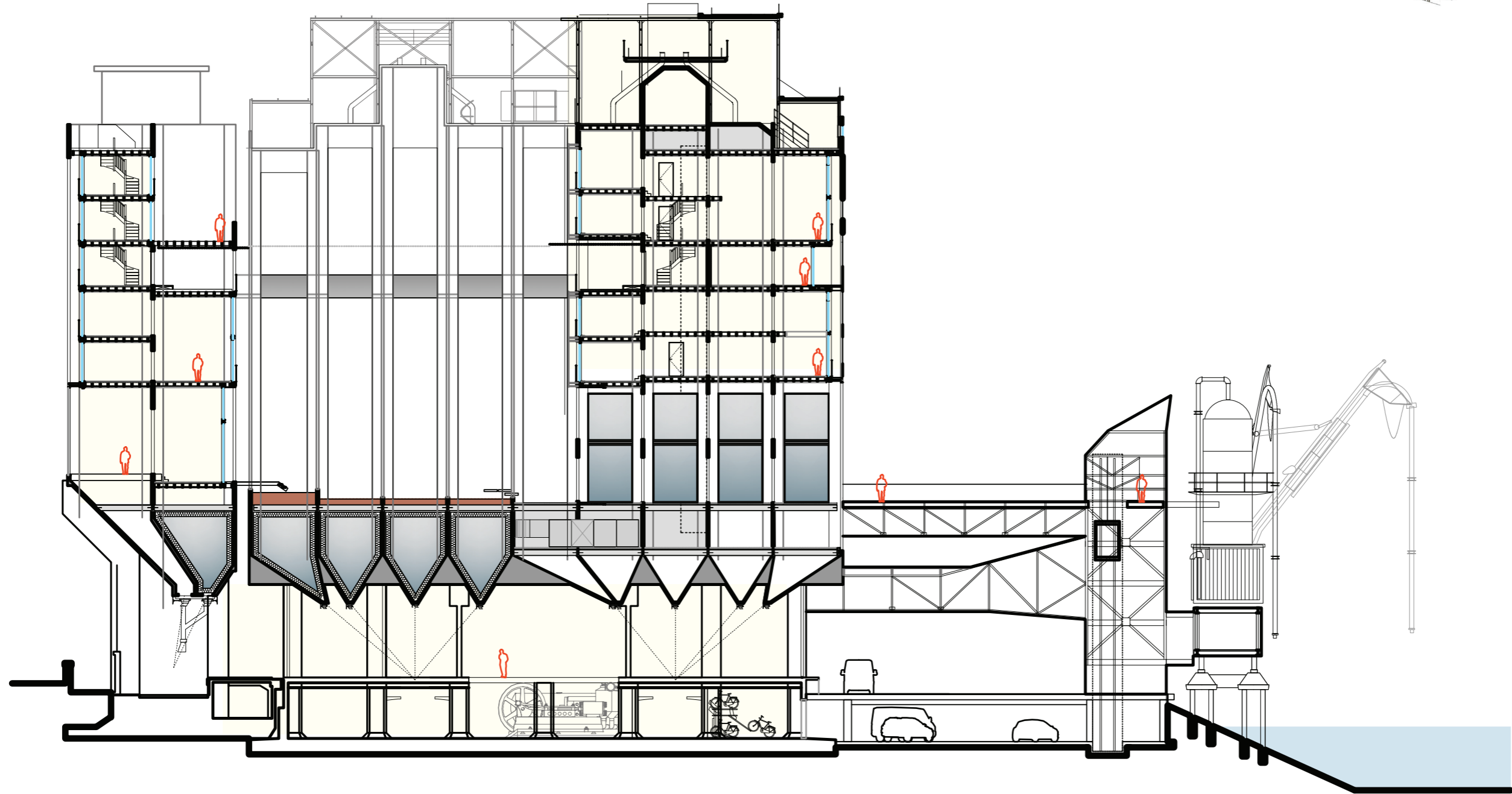
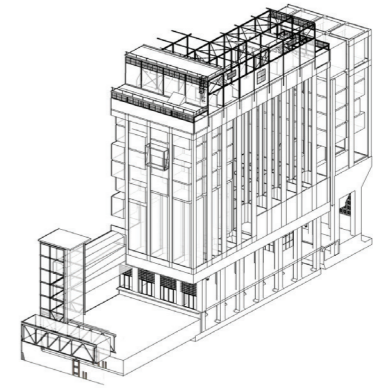

0 1m 5m 10m 20m 30m 50m

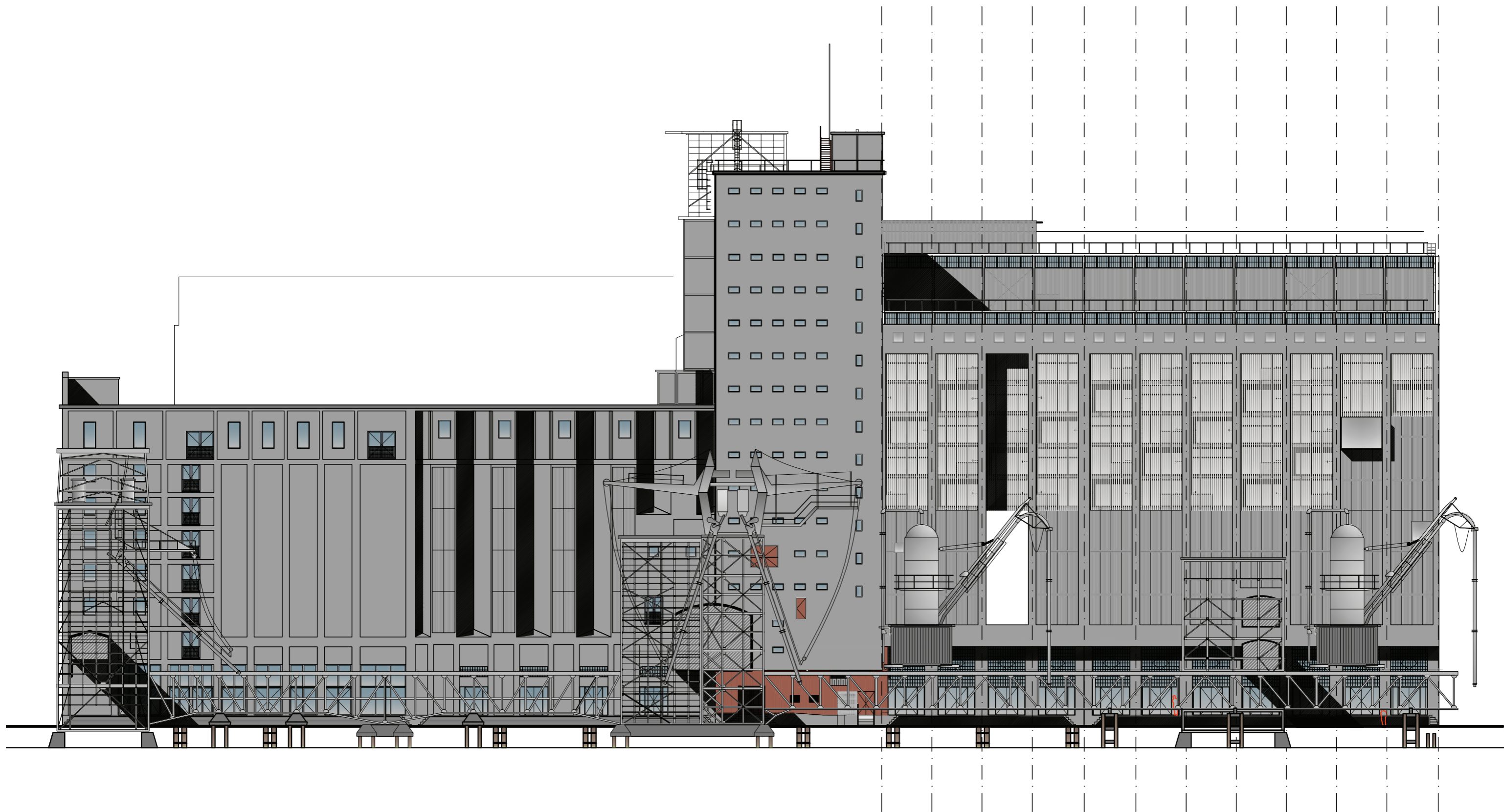

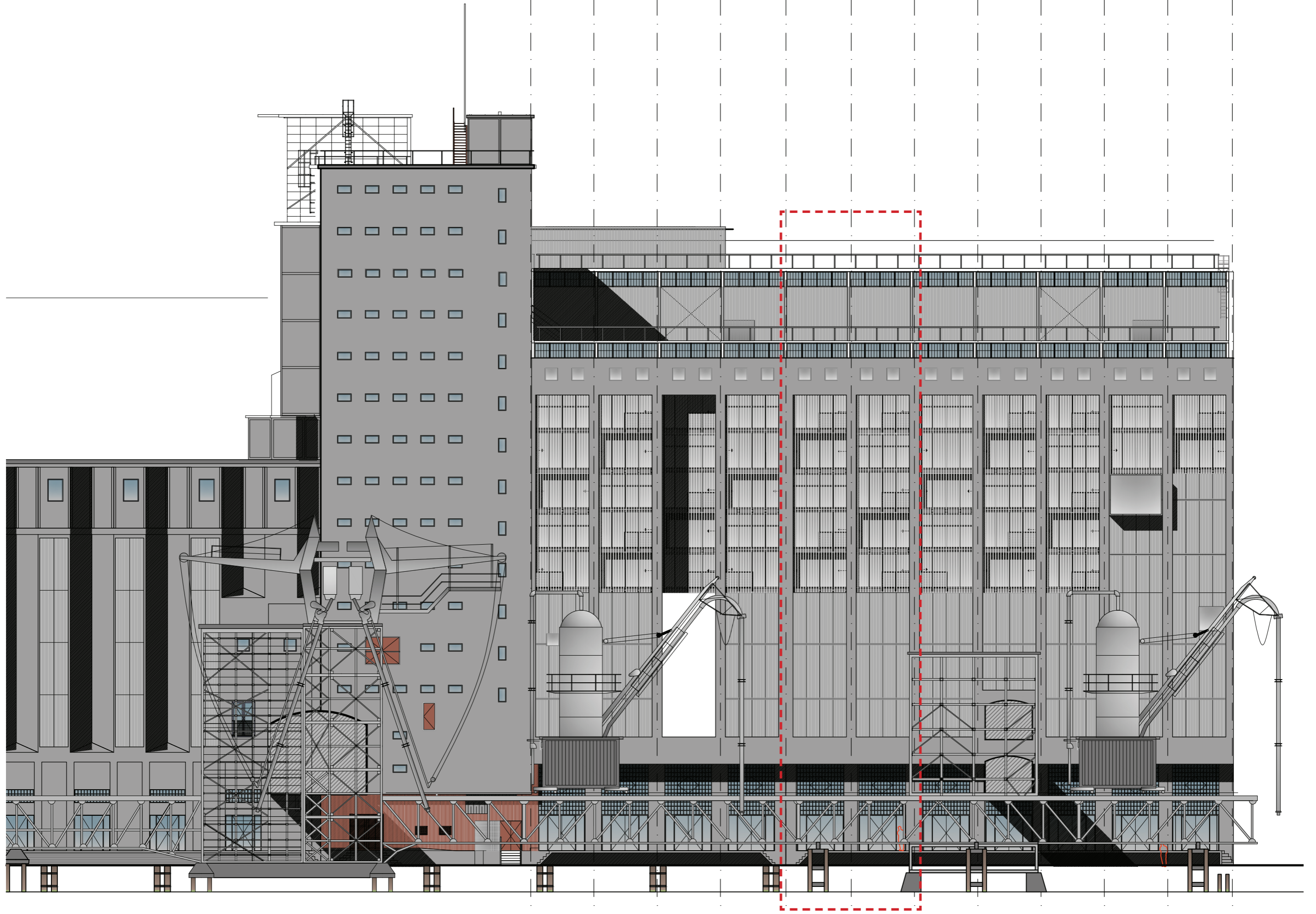



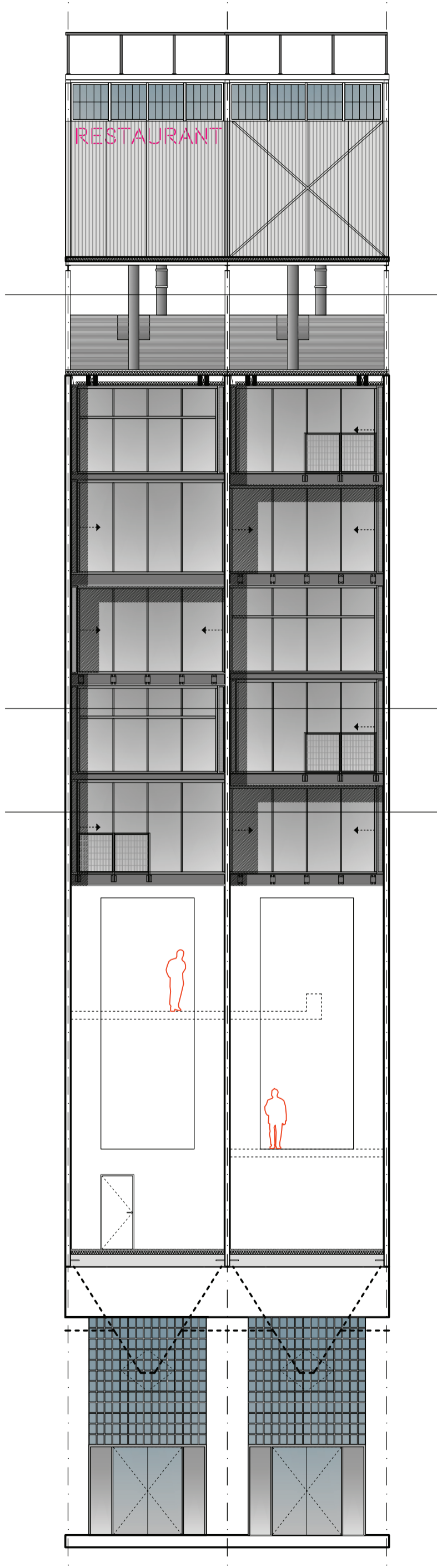

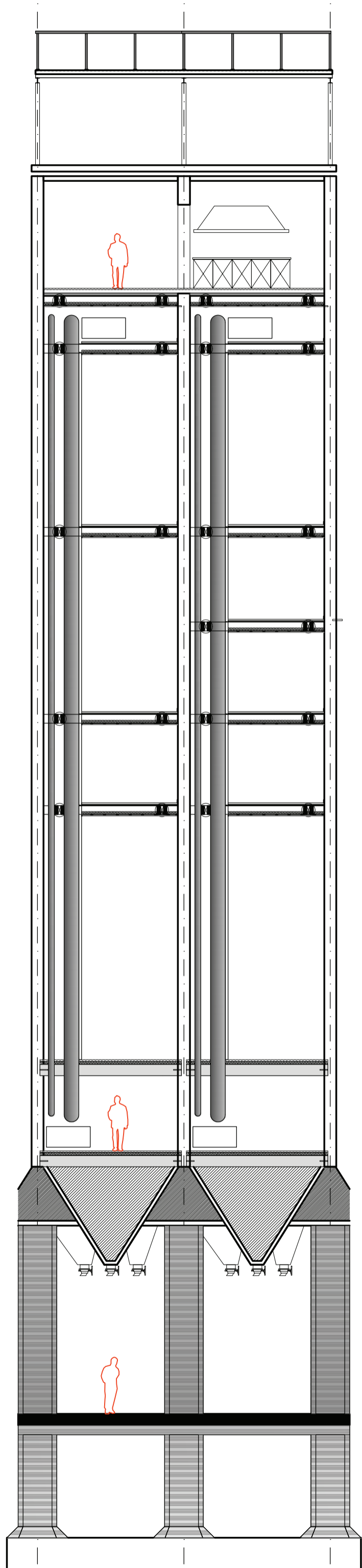
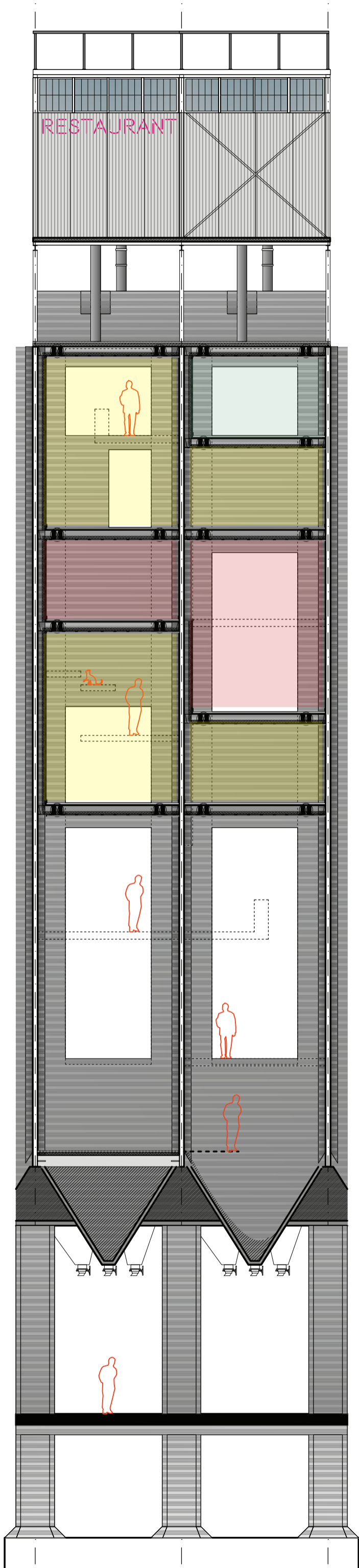

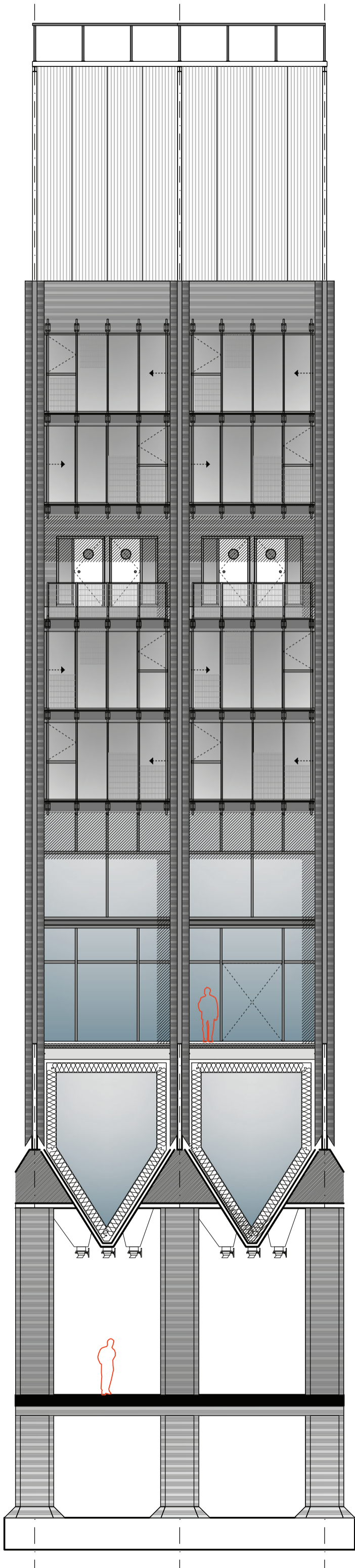

Bar/Restaurant

Apartments

Gallery



Apartments

Silopark



Ground floor

Basement



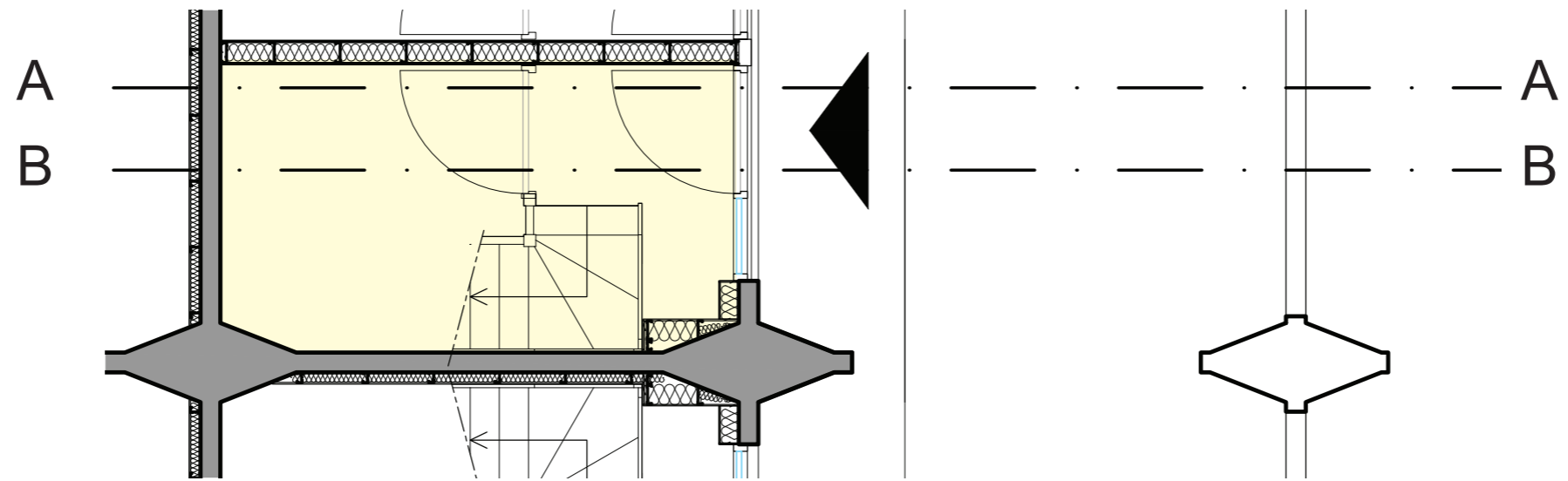
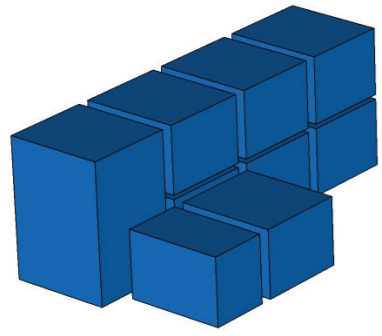

Entrance

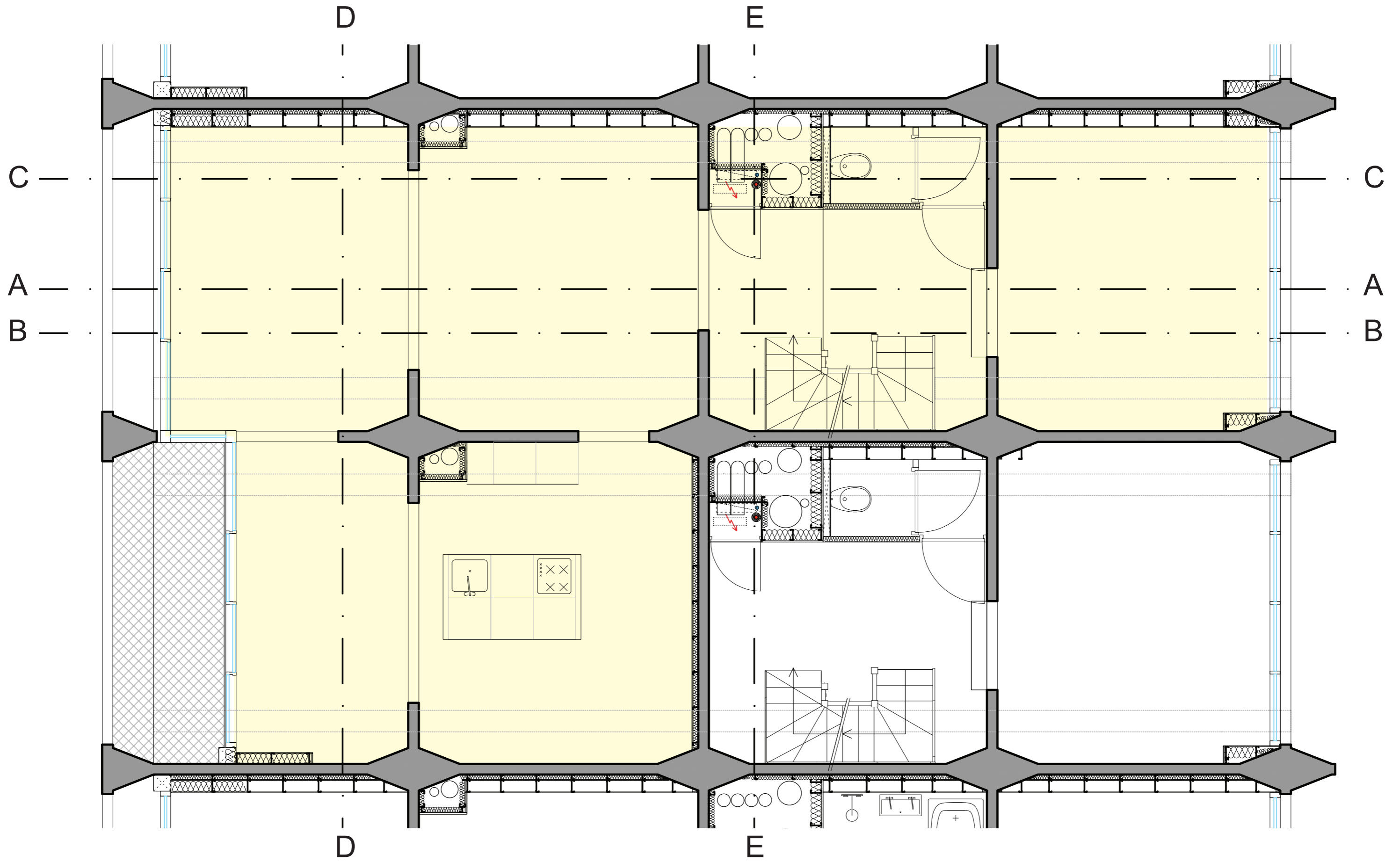

First floor

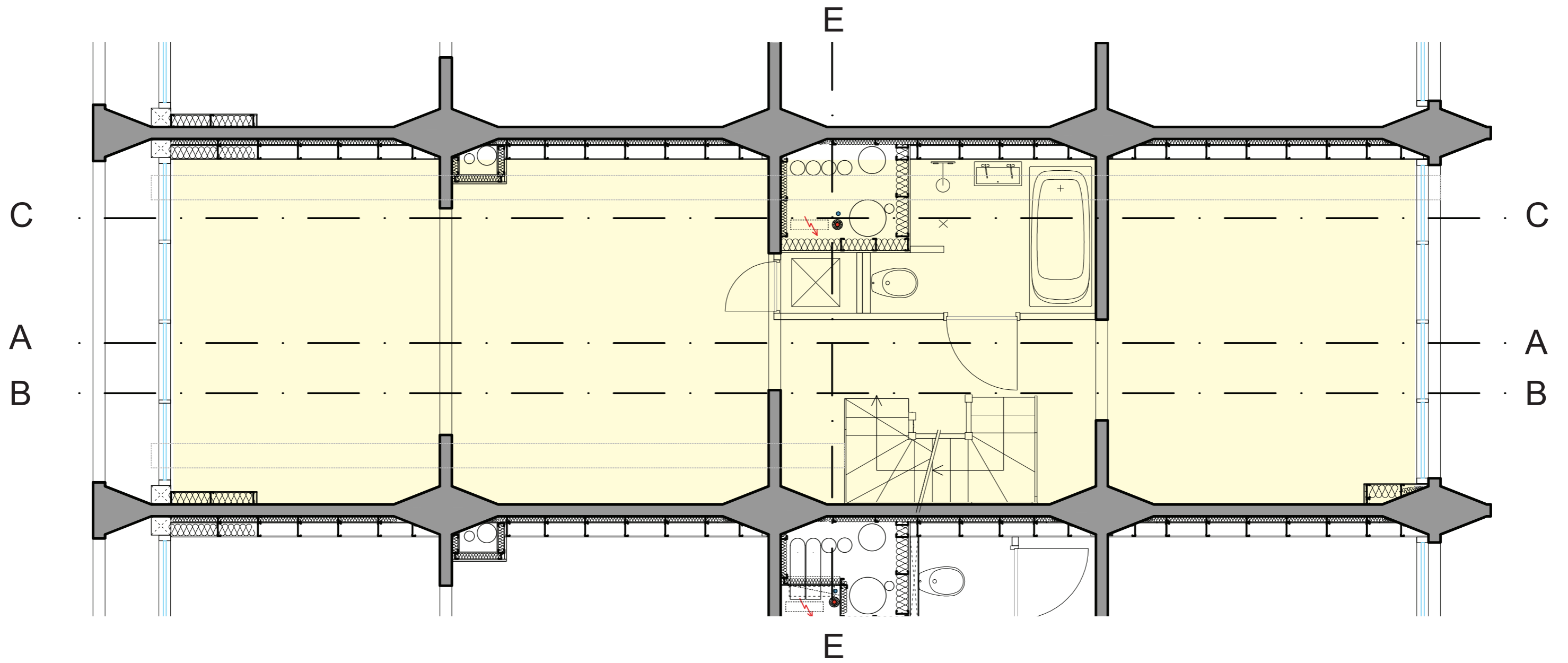

Second floor

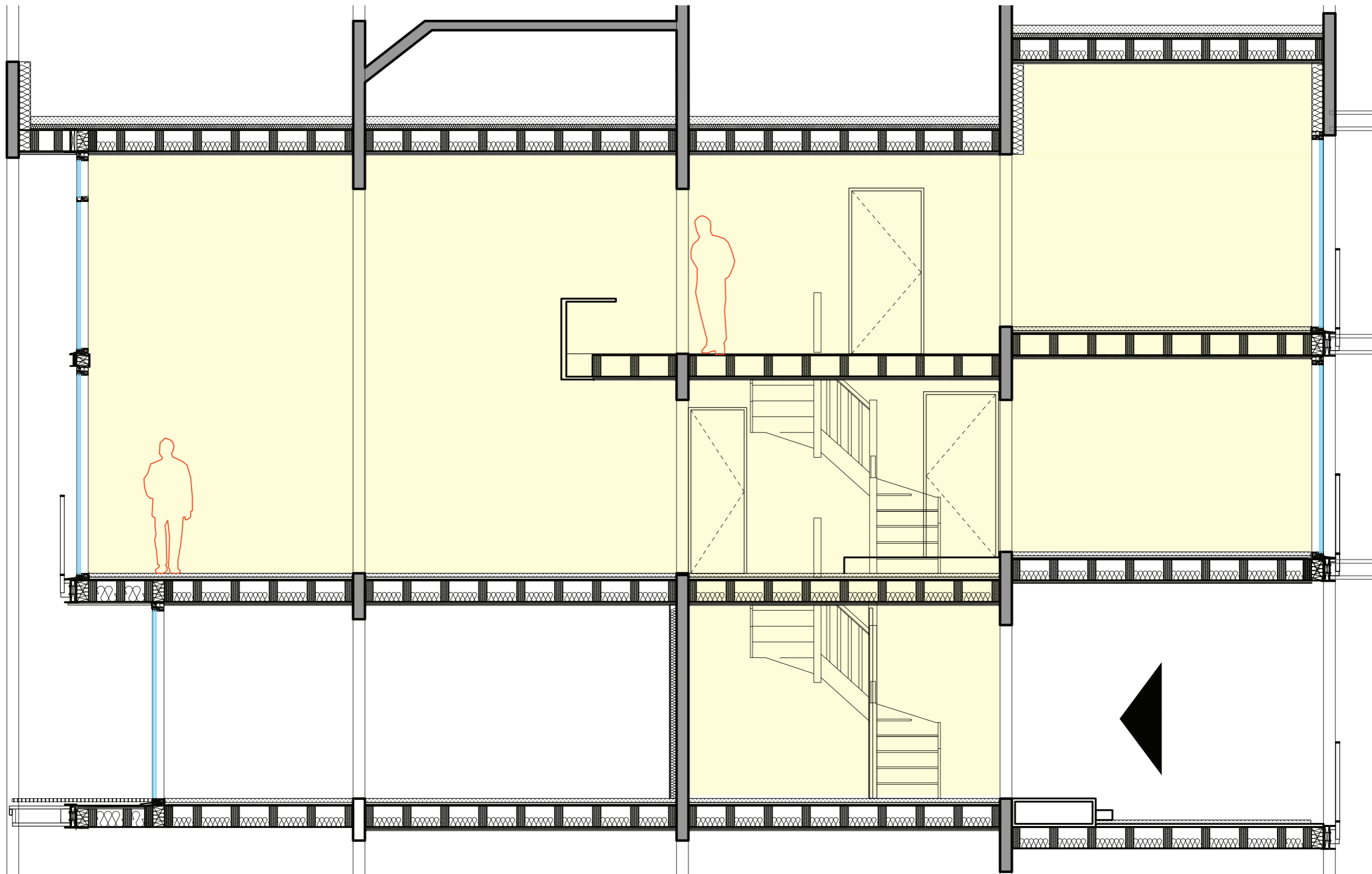

Section AA



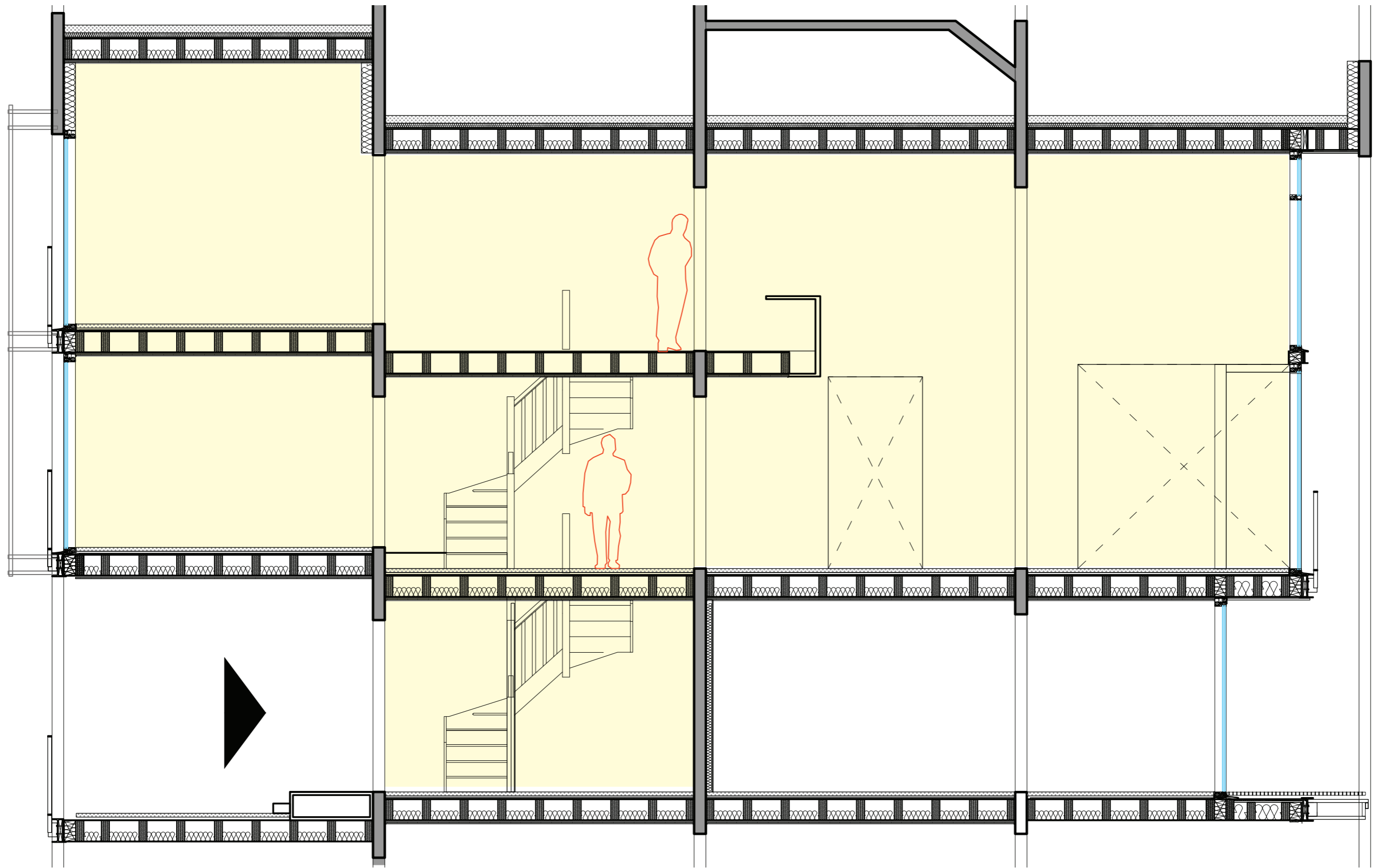

Section BB

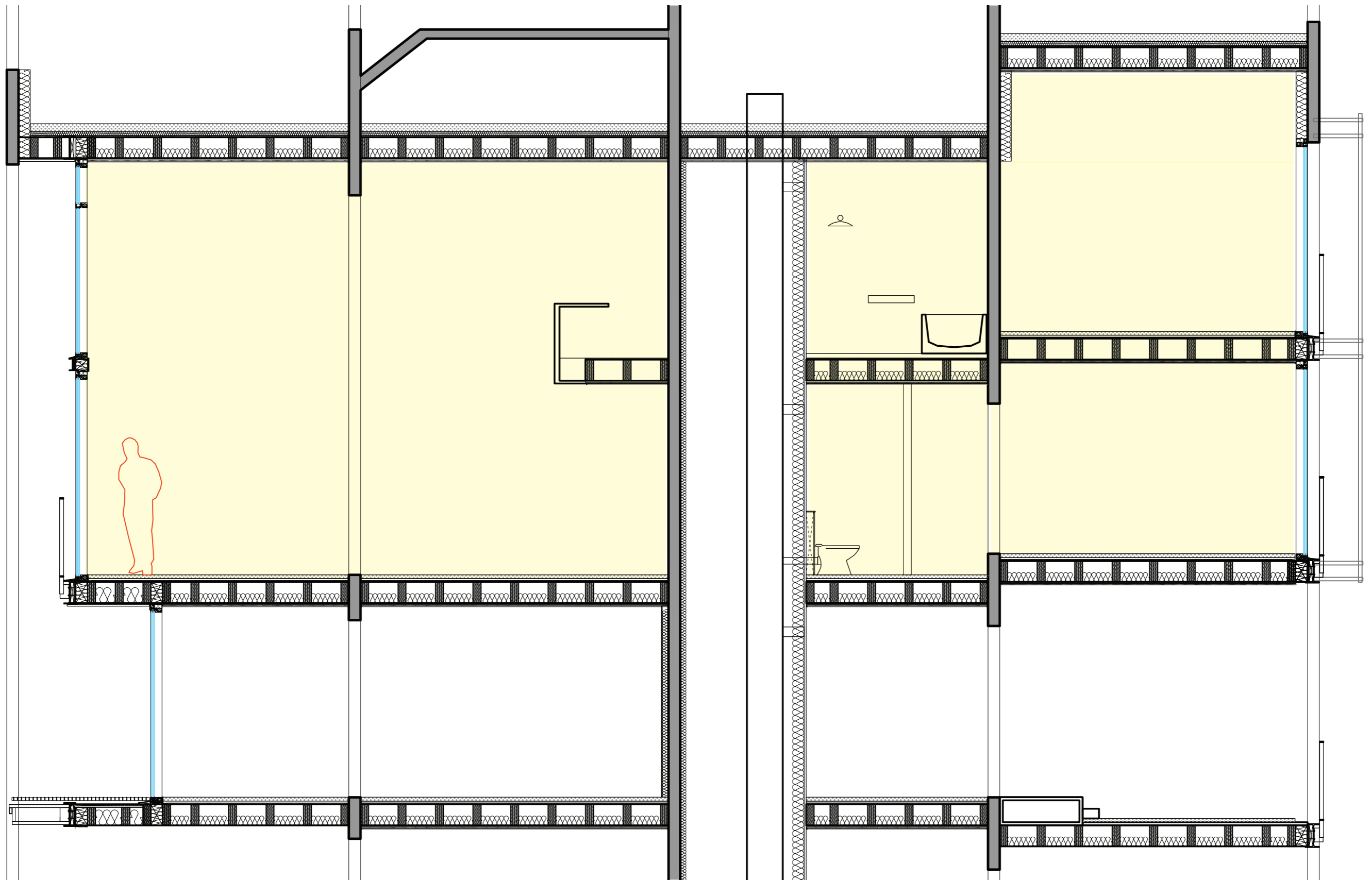

Section CC

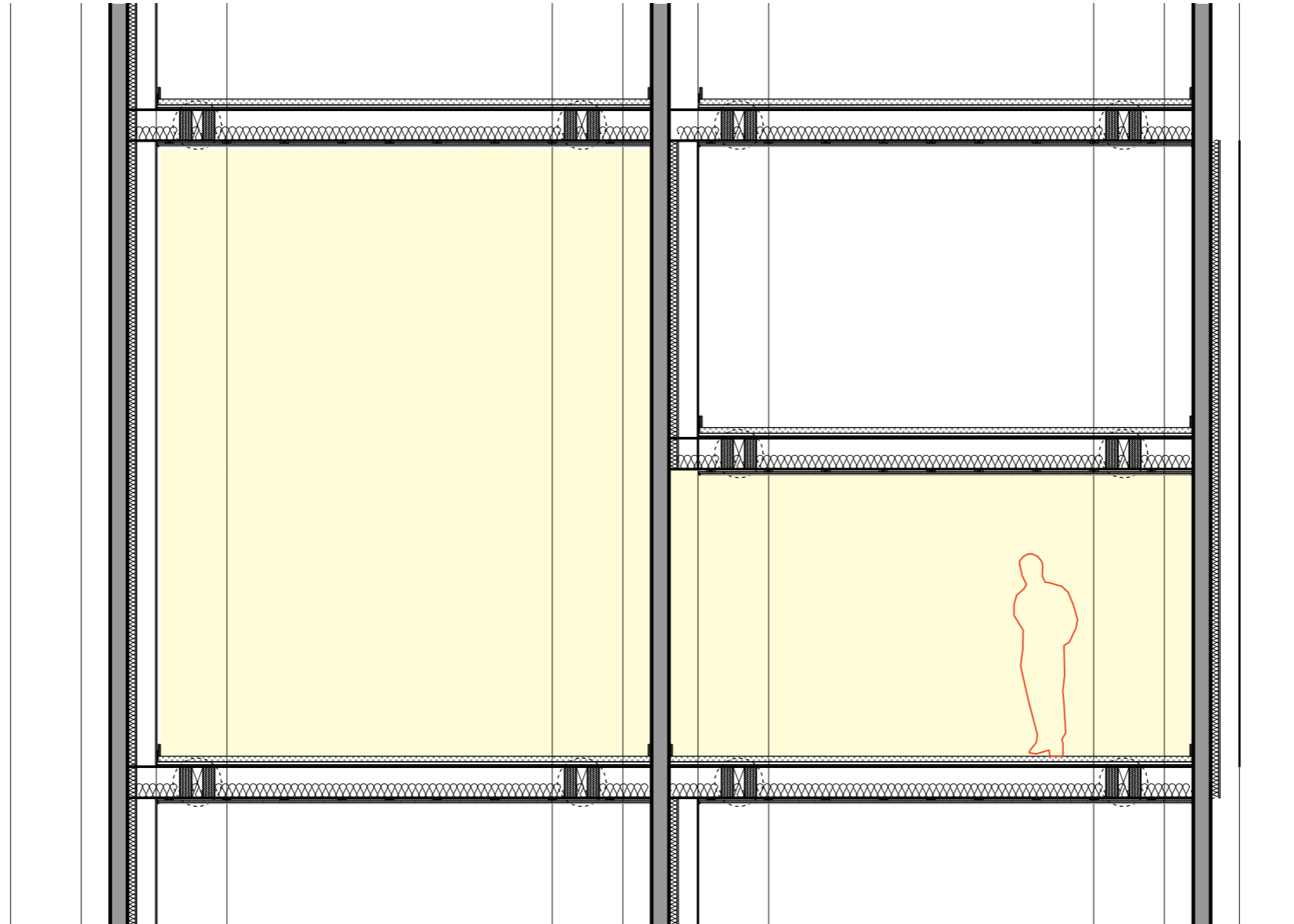

Section DD

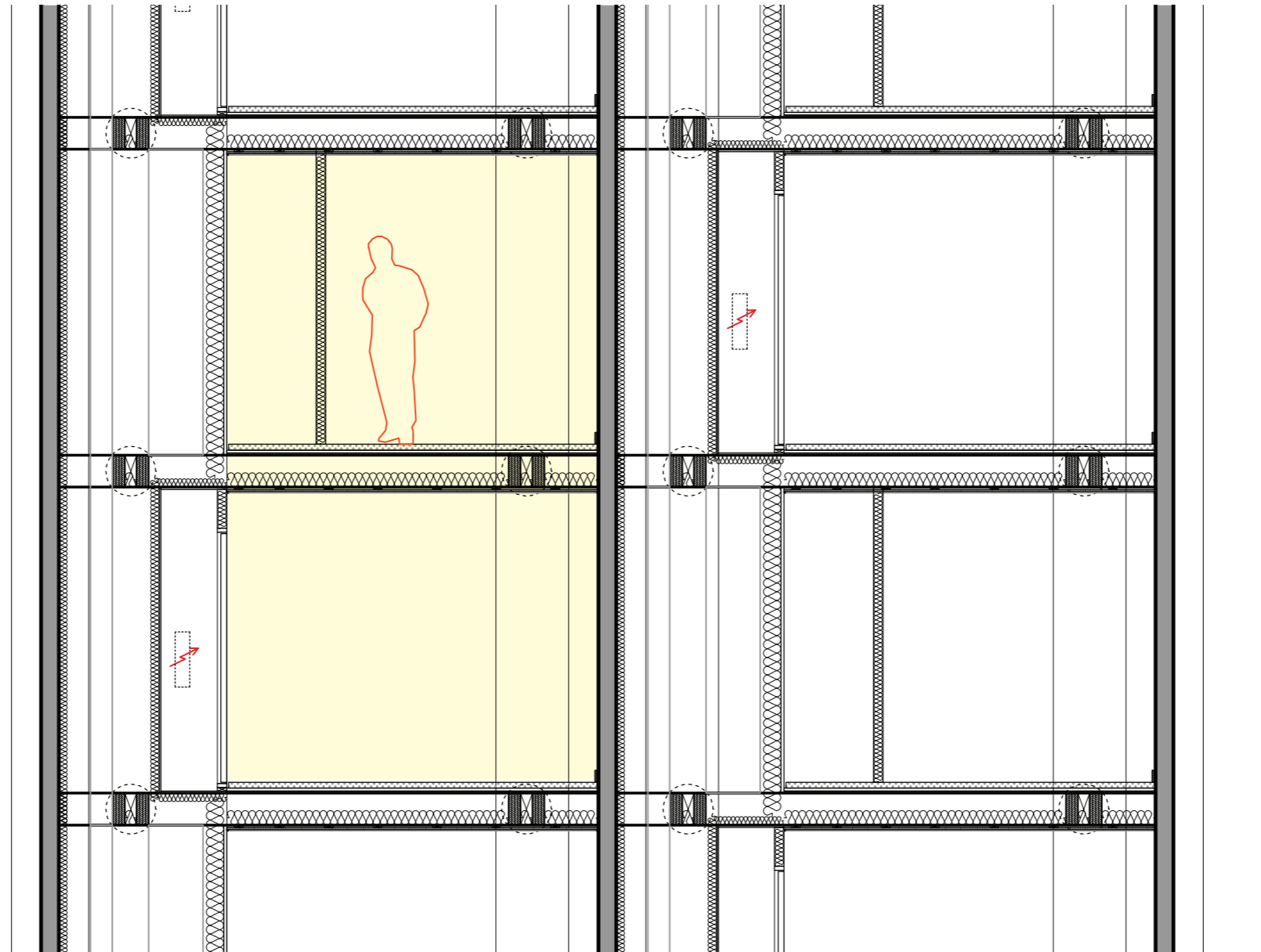

Section EE

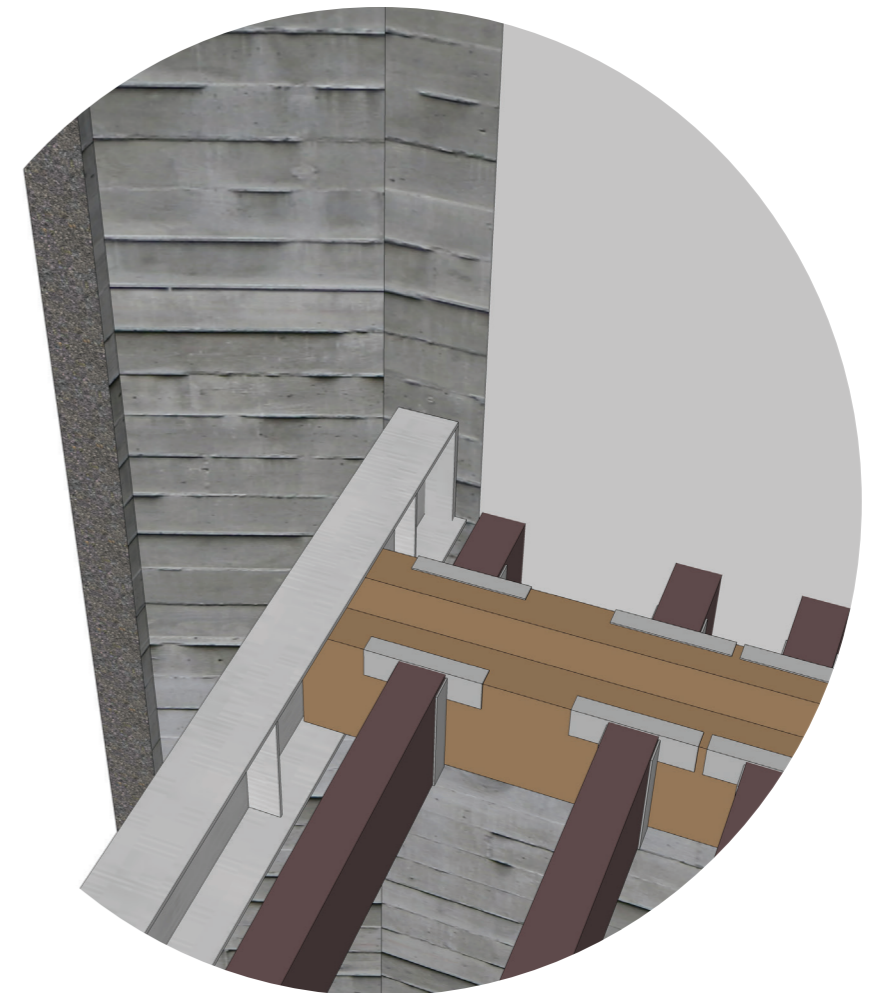
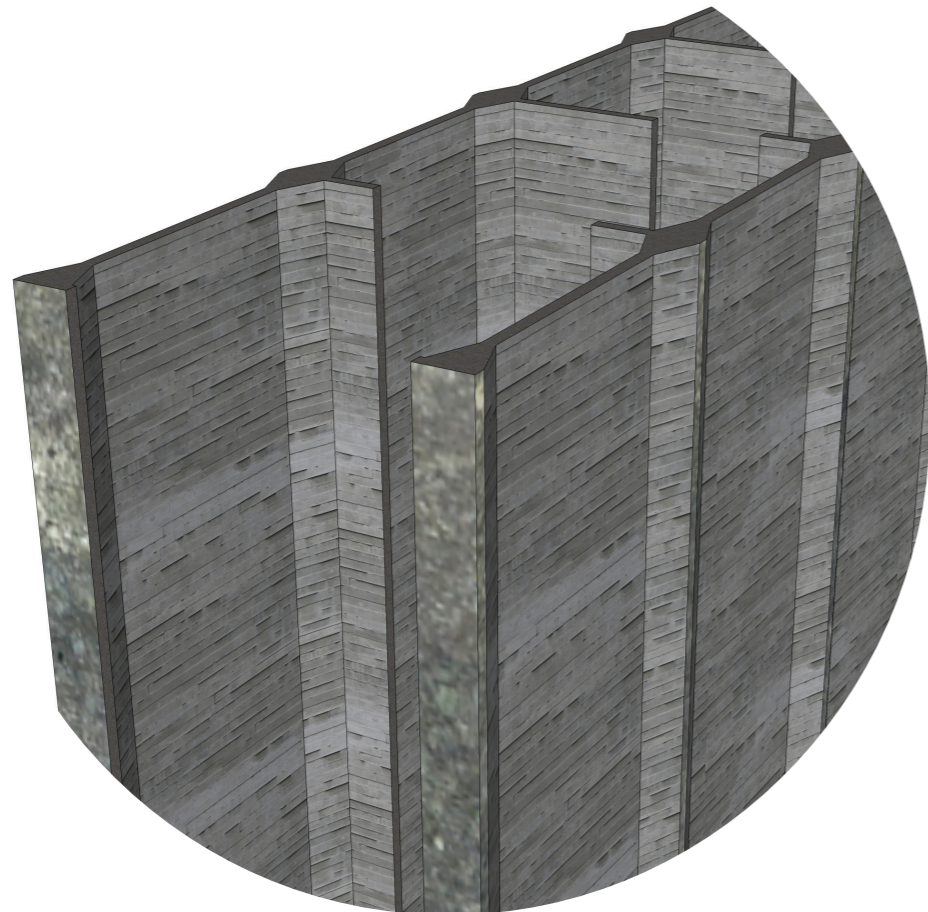
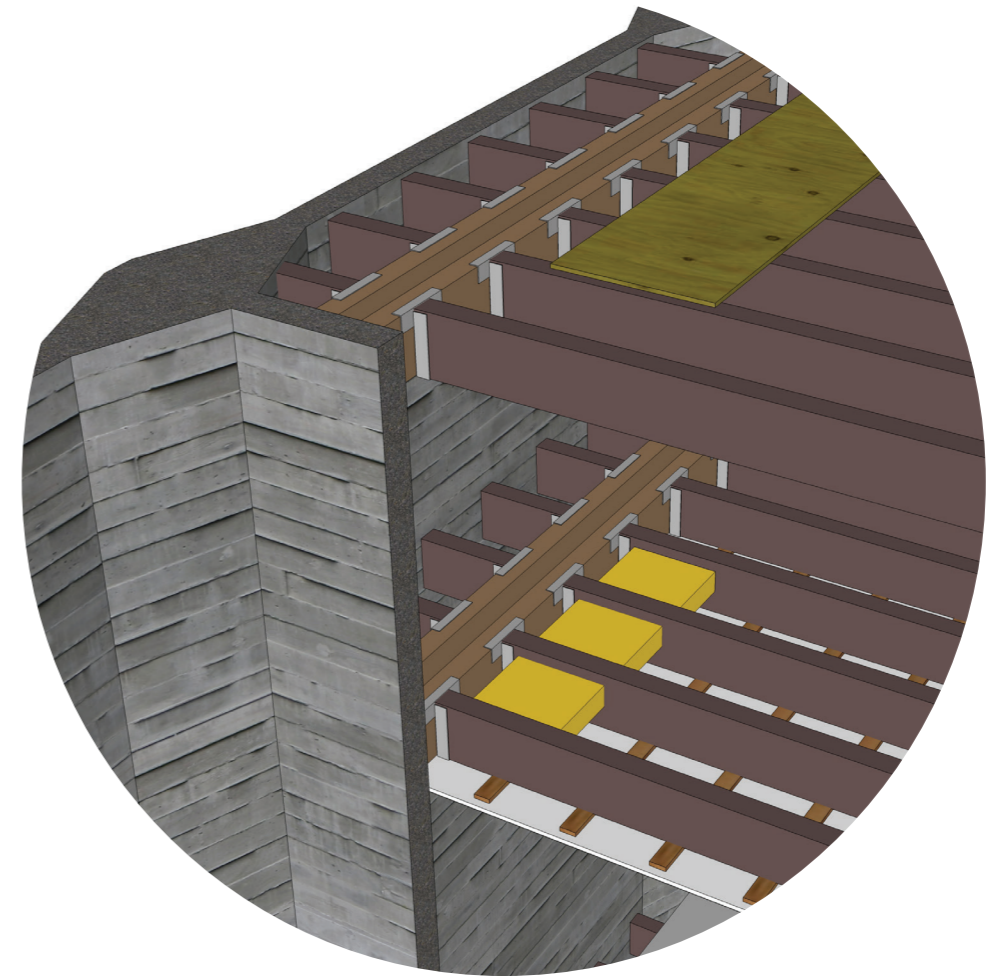
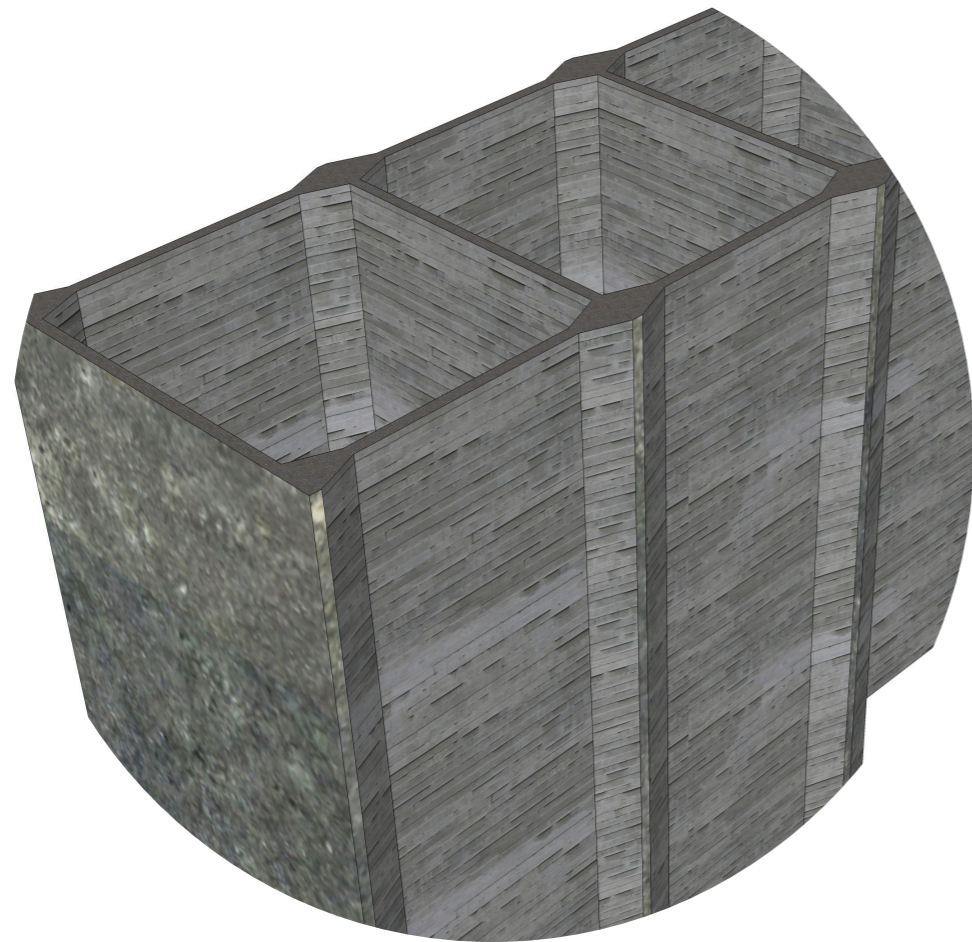

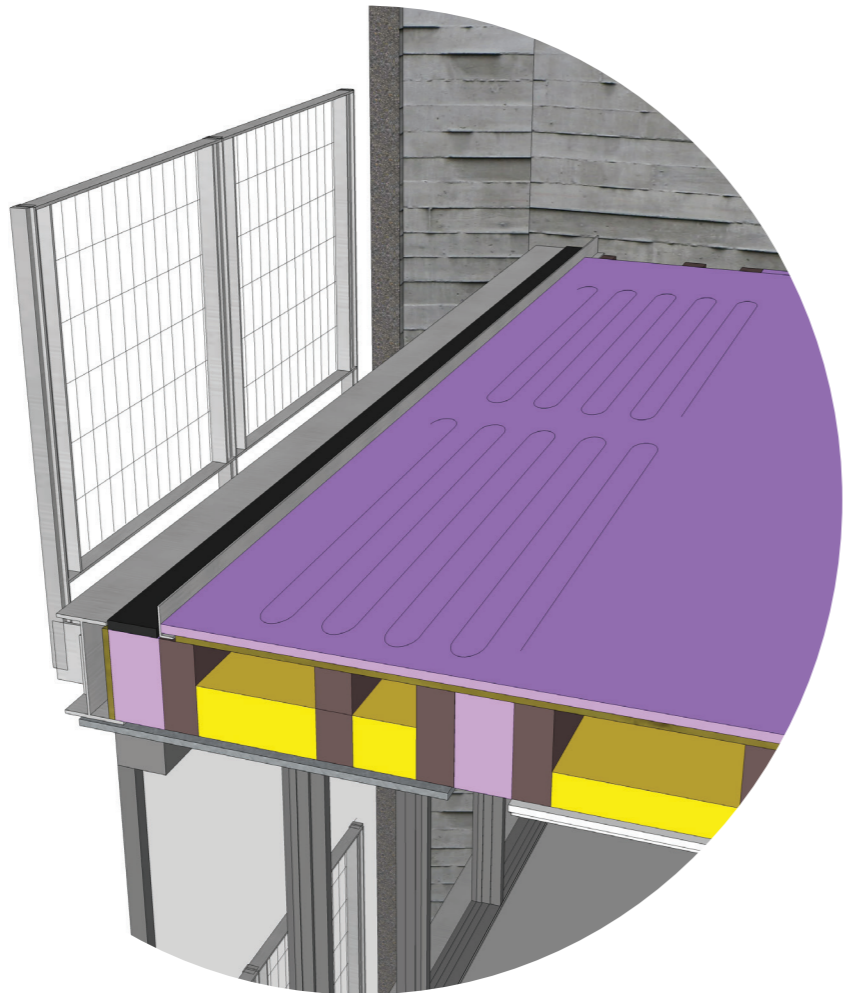
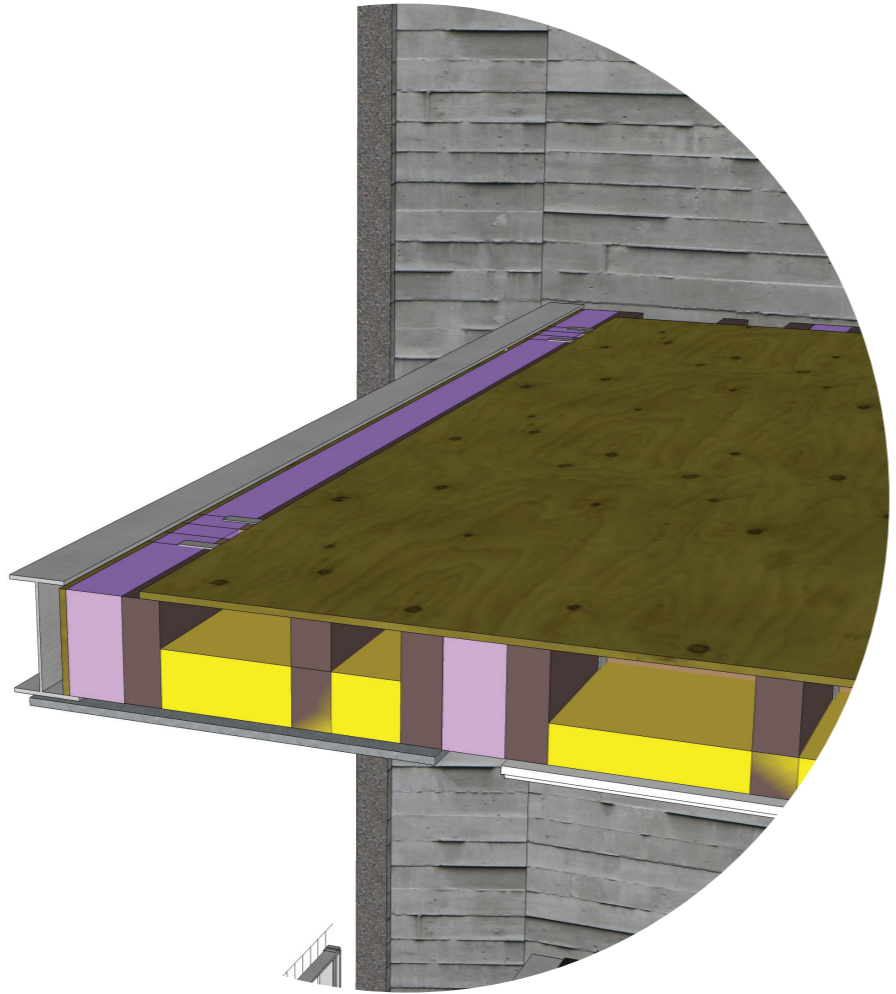

Materials

1. Original concrete construction
2. Insulation
3. Aluminium windowframe
4. Floor heating
5. I-beem IPE300 (steel)
6. Wooden beam 280x100mm
7. Terrazzo floor 50mm
8. Plasterboard
9. Slatted floor
10. Steel plate
11. Compriband (sealing)
12. Balustrade (Steel) wired
13. Spacer (wood)
14. Steel grill
15. Sliding doors
16. I-beem IPE160 (steel)

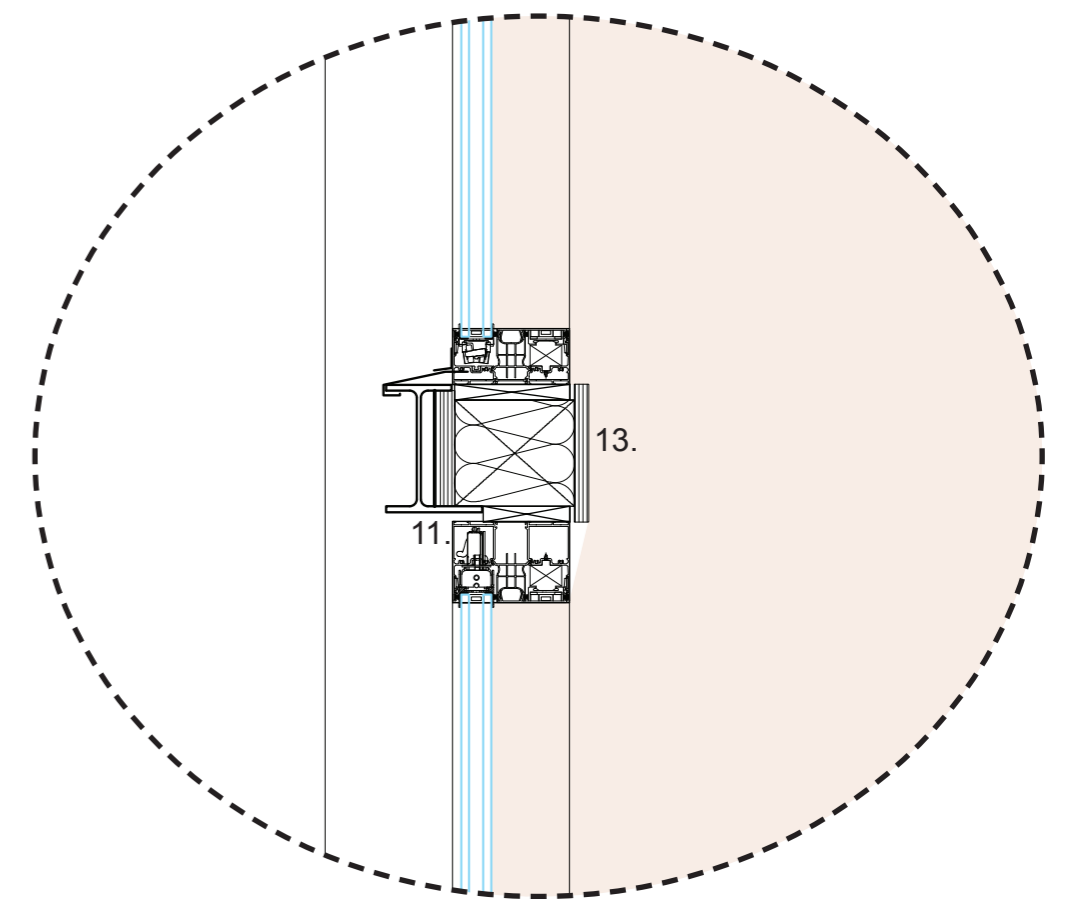
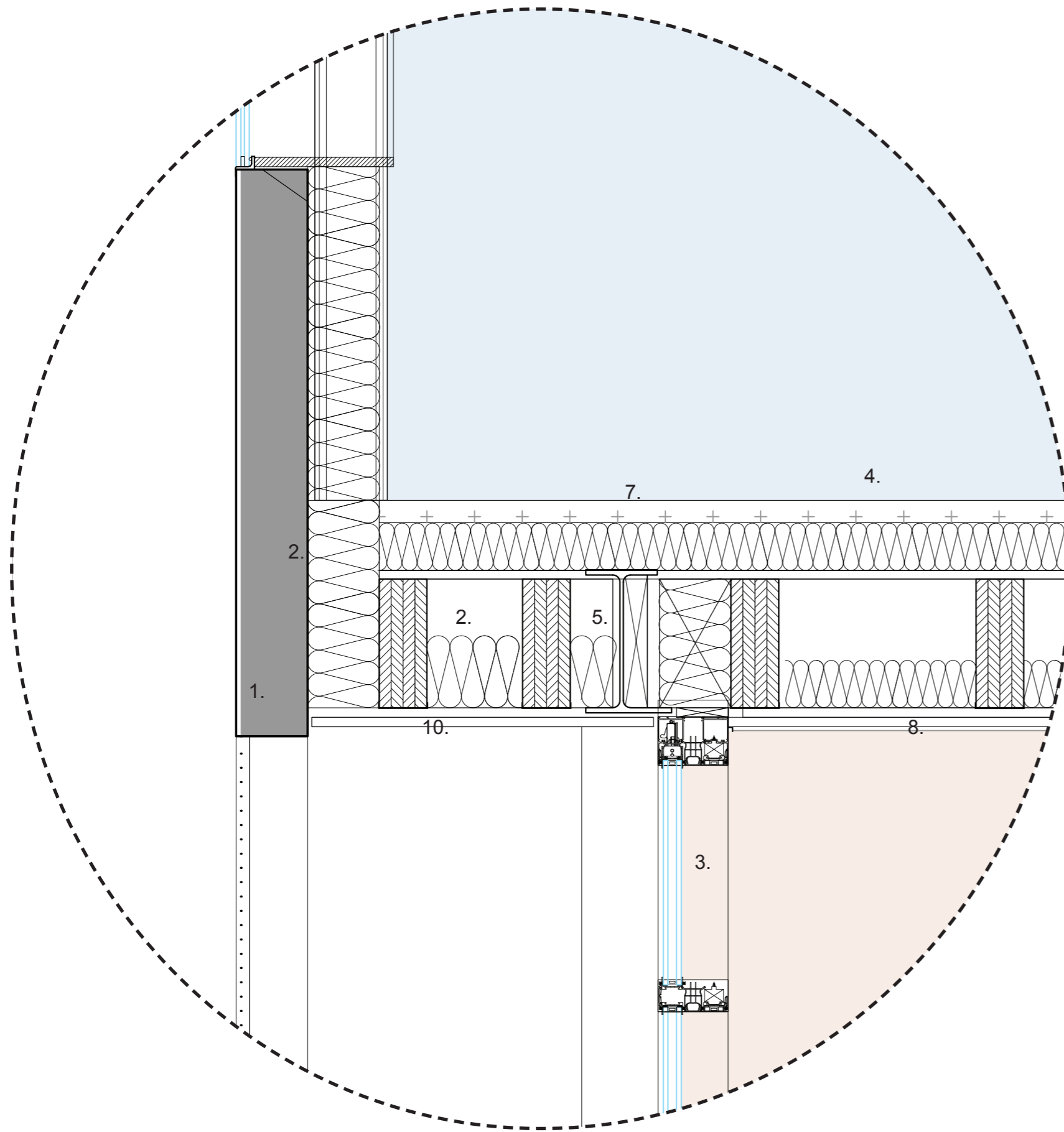

- Materials
1. Original concrete construction
  2. Insulation
  3. Aluminium windowframe
  4. Floor heating
  5. I-beem IPE300 (steel)
  6. Wooden beam 280x100mm
  7. Terrazzo floor 50mm
  8. Plasterboard
  9. Slatted floor
  10. Steel plate
  11. Compriband (sealing)
  12. Balustrade (Steel) wired
  13. Spacer (wood)
  14. Steel grill
  15. Sliding doors

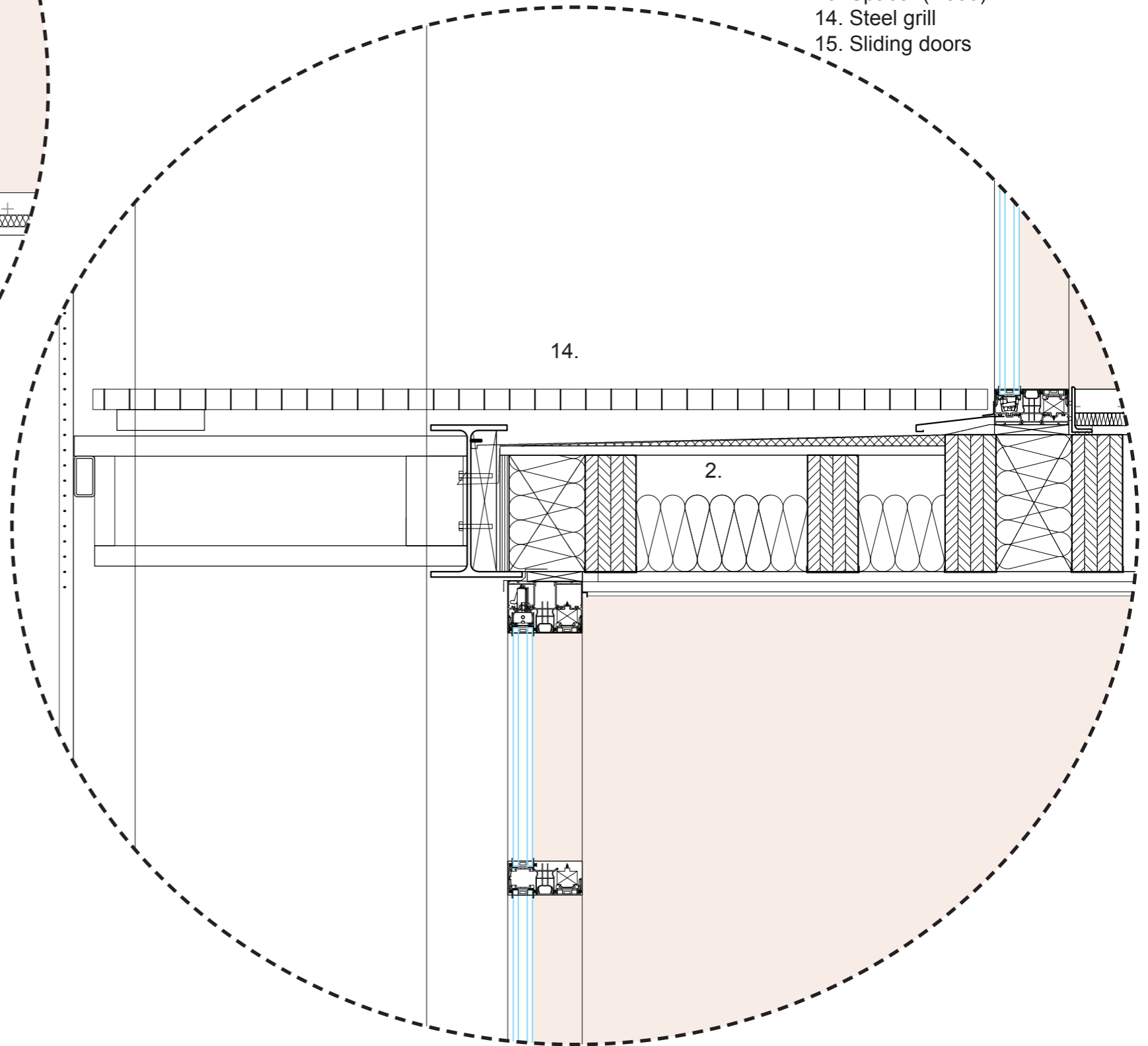
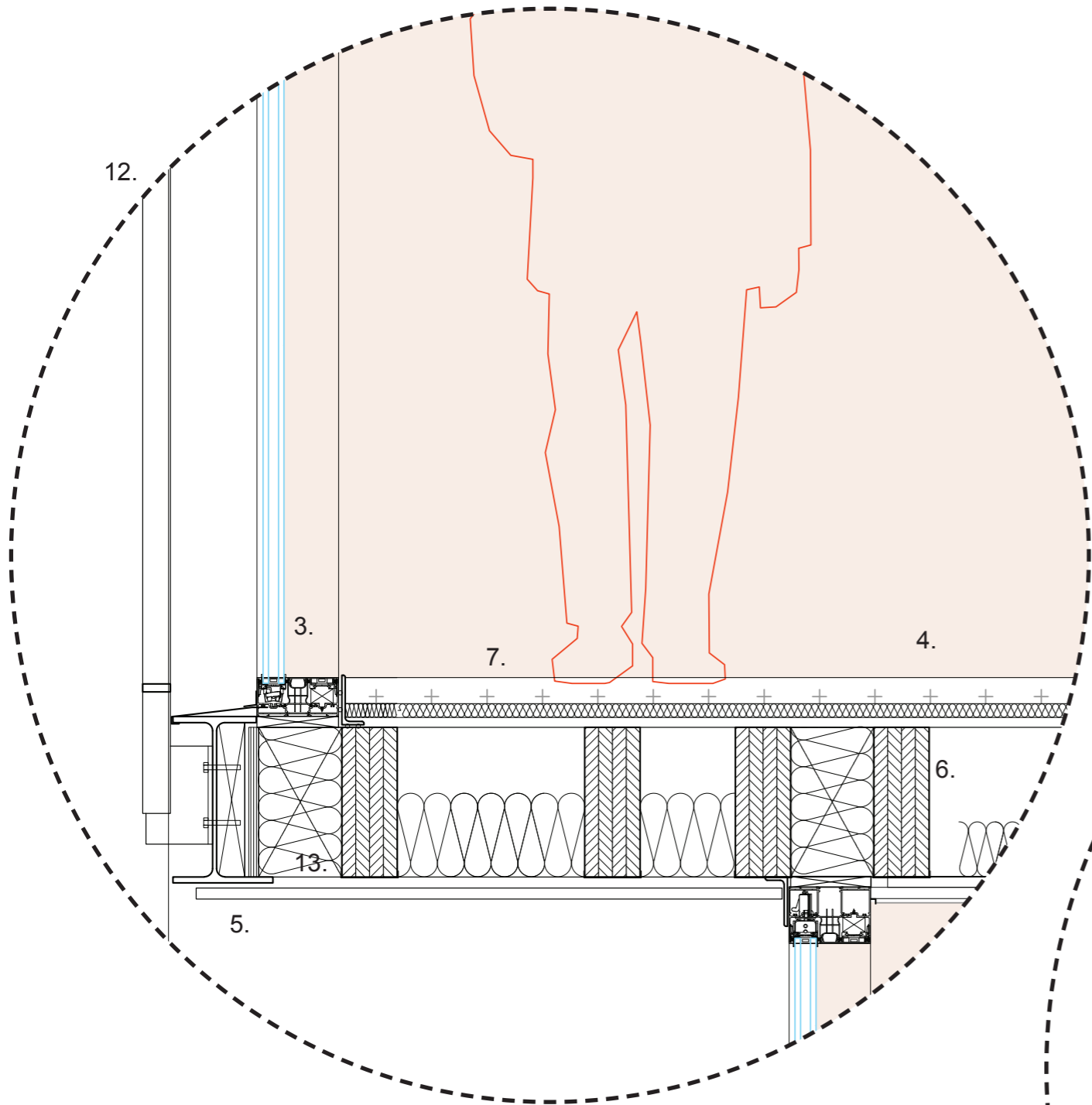



- Materials
1. Original concrete construction
  2. Insulation
  3. Aluminium windowframe
  4. Floor heating
  5. I-beem IPE300 (steel)
  6. Wooden beam 280x100mm
  7. Terrazzo floor 50mm
  8. Plasterboard
  9. Slatted floor
  10. Steel plate
  11. Compriband (sealing)
  12. Balustrade (Steel) wired
  13. Spacer (wood)
  14. Steel grill
  15. Sliding doors

