

**Surfactant Screening for Foam EOR  
Correlation between Bulk and Core-Flood Experiments**

Jones, Sian; van der Bent, V; Farajzadeh, Rouhi; Rossen, Bill; Vincent-Bonnieu, Sebastien

**DOI**

[10.1016/j.colsurfa.2016.03.072](https://doi.org/10.1016/j.colsurfa.2016.03.072)

**Publication date**

2016

**Document Version**

Accepted author manuscript

**Published in**

Colloids and Surfaces A: Physicochemical and Engineering Aspects

**Citation (APA)**

Jones, S., van der Bent, V., Farajzadeh, R., Rossen, B., & Vincent-Bonnieu, S. (2016). Surfactant Screening for Foam EOR: Correlation between Bulk and Core-Flood Experiments. *Colloids and Surfaces A: Physicochemical and Engineering Aspects*, 500, 166–176. <https://doi.org/10.1016/j.colsurfa.2016.03.072>

**Important note**

To cite this publication, please use the final published version (if applicable).  
Please check the document version above.

**Copyright**

Other than for strictly personal use, it is not permitted to download, forward or distribute the text or part of it, without the consent of the author(s) and/or copyright holder(s), unless the work is under an open content license such as Creative Commons.

**Takedown policy**

Please contact us and provide details if you believe this document breaches copyrights.  
We will remove access to the work immediately and investigate your claim.

## Surfactant screening for foam EOR: correlation between bulk and core flood experiments

S.A. Jones<sup>a</sup>, V. van der Bent<sup>a</sup>, W.R. Rossen<sup>a</sup> and S. Vincent-Bonnieu<sup>a,b</sup>

<sup>a</sup> TU Delft, The Netherlands

<sup>b</sup> Shell Global Solutions International, Rijswijk, The Netherlands

Key words: Foam EOR, core floods, foam quality scans, surfactant screening, foam stability

### Abstract

Aqueous foams play an important role in many industrial processes, from ore separation by froth flotation to enhanced oil recovery (EOR). In the latter case, the foam is used as a means of increasing the sweep efficiency through the oil bearing rock – the complex, structure dependent, flow behaviour of the foam [Jones et al., 2013] means that it has improved penetration of lower permeability regions than would be obtained with a Newtonian fluid. An understanding of how foam behaves when flowing through a rock is therefore of great importance when selecting suitable surfactants for EOR processes.

Previous tests have suggested that there is no reliable correlation between bulk foam behavior and foam behavior in a rock core, especially in the presence of oil [Dalland et al., 1994; Mannhardt et al., 2000]. We present a comparative study of bulk stability tests and core floods with foam, both with and without oil. Core-flood tests were conducted in rock cores with a diameter of 1 cm and length of 17cm, significantly smaller than typical cores [Jones et al, 2015]. Apparent viscosity / injected gas fraction response curves were obtained, both with and without oil in the system.

This current work found that there is a positive correlation between bulk foam stability and core flood performance in the absence of oil. Bulk foam experiments can therefore be a useful screening tool to get a good indication of the surfactant performance in the core flood. However, there was no correlation found between bulk foam stability and the performance in the core for the experiments performed in the presence of oil.

### Introduction

Aqueous foams play an important role in many industrial processes, from ore separation by froth flotation to enhanced oil recovery (EOR). In the latter case, the foam is used as a means of increasing the sweep efficiency through the oil bearing rock. When gas is used as a means of enhancing oil recovery the gas tends to rise to the top of the reservoir, or finger through the oil, because of its lower density and viscosity, and to prematurely reach the producers through high-permeability channels. This results in inefficient and costly utilization of the gas. Injection of gas in the form of “foam” reduces the gas mobility and gravity override which improves the sweep efficiency of the reservoir.

It is crucial to select the right surfactant, as it stabilizes the foam. The surfactant selection is specific to the application; it depends of the rock chemistry, water salinity, reservoir temperature and the oil type. The general consensus is that the most representative test of the foam behavior, especially in presence of oil, is the coreflood experiment at the reservoir conditions. However coreflood tests are time-demanding and expensive so that only a limited number of surfactants can be tested. Bulk foam tests

are faster and/or cheaper because it measures the stability of the foam with the porous media [Chabert 2012, <http://dx.doi.org/10.2118/154147-MS>]. However previous works suggest that there is no reliable correlation between the bulk foam or micromodel behavior and the foam behavior in a rock (Mannhardt et al. 2000; Vikingstad and Aarra, 2009; Farajzadeh et al., 2012; Andrianov et al., 2012; Simjoo et al., 2013).

Core flood studies have been carried out using many different types of cores (Kristiansen and Holt, 1992; Mannhardt et al. 2000; Kavscek and Bertin, 2003; Zitha et al. 2006; Nguyen et al., 2009; Farajzadeh et al., 2009, 2010), sand packs (Khatib et al. 1988; Osterloh and Jante, 1992; Apaydin and Kavscek, 2001; Ma et al. 2013) and bead packs (Khatib et al. 1988; Falls et al. 1989; Aronson et al. 1994). These tests have been very useful in providing information on a wide range of aspects of foam behavior, from the effect of surfactant type and concentration, to the interaction of the foam with oil, to foam flow properties such as apparent viscosity and mobility control. The information from these core flood tests can also be fed back into the foam models (Ma et al., 2013; Boeije and Rossen, 2013; Ma et al. 2014). The cores used in these tests typically, but not always (Moradi-Araghi et al, 1997; Nguyen et al., 2009; Farajzadeh et al., 2009), have diameters of at least 3.5 cm, with lengths of 30 cm and above, and these larger pore volume systems have the advantage that any small heterogeneities in the rock have no significant effect on the foam behavior.

However, larger-scale cores can sometimes take days to achieve steady state flow (Persoff et al., 1991; Simjoo et al., 2013). If we wish to screen a large number of surfactants, to test which is the optimal for a specific reservoir rock or for a particular oil composition, then we would like to work with a system that reaches steady state rapidly.

In the current series of tests, foam flood experiments were performed using a small core-flood system (SCFS), where the rock core is pen-sized, with a diameter of 1 cm and length of 17 cm. This small core allows for short-duration foam flow tests, as compared to longer-core experiments, with a steady state typically being achieved in two to three hours. The small pore volume of the core also means that the volume of surfactant required to do a full foam quality scan is small. The SCFS therefore has the advantage of being economical in both time and resources, making it an ideal tool for the rapid screening of surfactants in porous media for specific applications.

## **Experimental Method**

### **Core Flood Tests**

The cores used for these tests were 1 cm in diameter, 17 cm long samples of Bentheimer sandstone (permeability,  $k$ , = 0.989D; porosity,  $\phi$  = 0.23). The core holder was an aluminum tube with internal diameter, ID, = 1.1 cm and wall thickness of 0.95 cm. The rock sample was coated in a thin layer of epoxy resin (effective core diameter after coating = 0.94 cm) before being placed in the core holder. Instead of applying a confining pressure to the core, epoxy resin was then injected through a side entrance point to seal the core in position and to prevent any of the test fluids from bypassing along the side of the core. Multiple cores were available for these tests, meaning that new cores could be used for each surfactant mixture and especially for tests where oil was introduced to the core.

Because of the very small pore volume of the core ( $2.71 \text{ cm}^3$ ) the volume of the experimental set-up (pipes, connectors etc) was kept as small as possible, in order to keep system errors to a minimum. The full experimental set-up is shown in Figure 1. The system was connected together using 0.08 mm ID PTFE or PEEK tubing, with 3.2 mm junctions and valves.

The surfactant solution and nitrogen were co-injected from the bottom of the core at a constant total flow rate of 0.1 ml/min (equivalent to a superficial velocity of  $2.4 \times 10^{-5} \text{ m/s}$  or 6.75 ft/day) to generate the foam. The surfactant solution was injected using a double-piston displacement pump. The nitrogen gas was supplied from a cylinder, at a pressure of 60 bar, to the mass flow controller.

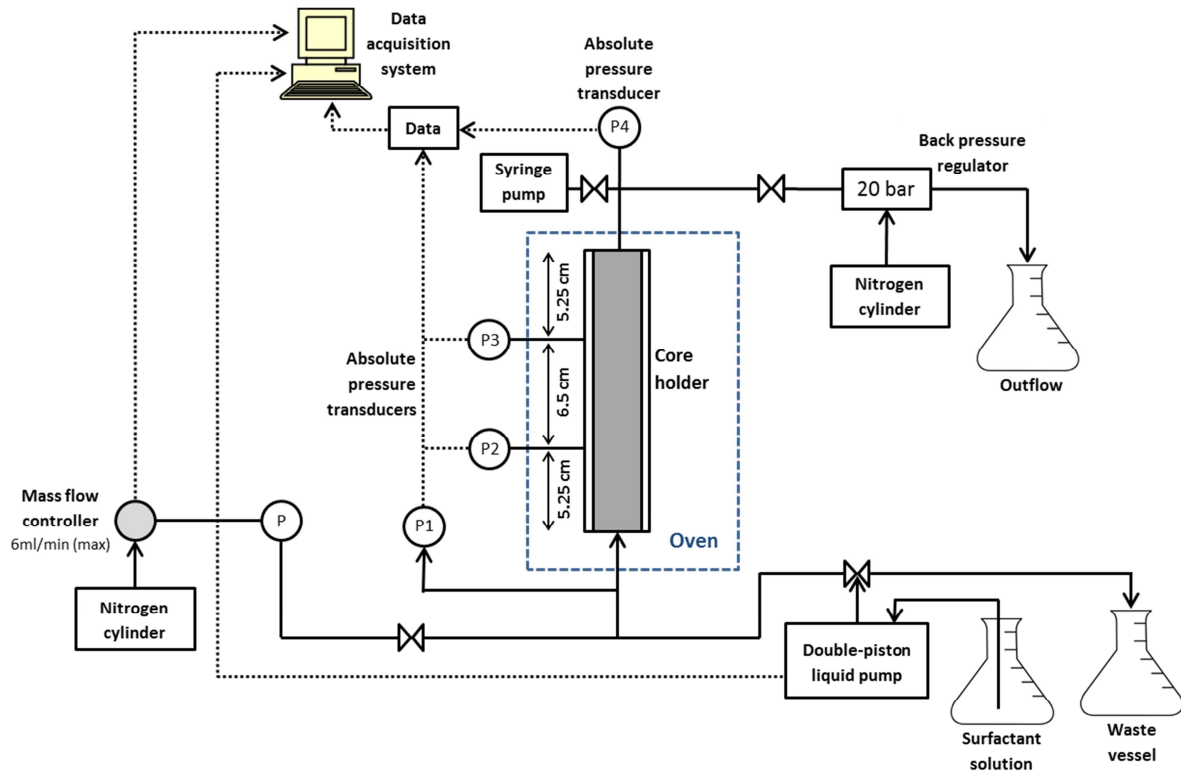

**Figure 1:** Schematic diagram of the experimental set-up.

Pressure measurements were made using four absolute pressure transducers –  $P1$  was tapped into the input line at the bottom of the core,  $P2$  and  $P3$  were connected to two taps in the core (Figure 1), and  $P4$  was located at the outlet of the core, before the back pressure regulator. During each core flood test the injected foam quality,  $f_g$ , was varied and the resultant pressure drop over the core, either the total pressure drop ( $P1 - P4$ ) or the drop over the central section of the core ( $P2 - P3$ ), was measured. All the experiments were carried out with a back-pressure of 20 bar. The back-pressure regulator used was a locally modified dome-loaded back pressure regulator with a dead volume of approximately 1 ml.

A test screening of four commercially available surfactants (Table 1) was made, in an oil-free core, at 55°C. Five different solutions (detailed in Table 2) were made with the four surfactants. Three solutions contained a single surfactant and two solutions contained a mix of two different surfactants. All the solutions contained 0.5 wt% of total active surfactant, well above the cmc for all the surfactants used, along with 3 wt% sodium chloride in demineralized water.

A test screening of the five solutions was also made in a core containing residual oil saturation. For these tests, the oil used was Isopar H (ExxonMobil Chemical), a C11-C12 paraffin oil with a density of 732.9 kg/m<sup>3</sup> and surface tension of 18.64 mN/m at 55°C (van der Bent, 2014). The oil was stained with Sudan Red (Sigma Aldrich) to make it easily observable. Due to the fact that it was the foam response to oil, rather than oil production, that was being tested, the foam floods were carried out with water-flood residual oil saturation initially within the core. To achieve this residual oil saturation, oil was first injected at the top of the core, using a syringe pump (Figure 1), until the pressure drop over the core was constant. Brine was then injected (8 PV) at the base of the core, followed by 10 PV of surfactant solution, to produce oil from the core until a residual oil saturation remained and to ensure that surfactant absorption in the core did not affect the results.

**Table 1** : Details of the surfactants used in the core flood tests

<b>Product Name</b>	<b>Surfactant Type</b>
Bio-Terge AS-40	Sodium c14-16 olefin sulfonate (AOS)
Enordet AO71	Alcohol alkoxy sulfate (AAS)
Enordet O332	Internal olefin sulfonate (IOS)
Petrostep CG-50	Cocamidopropyl betaine (Betaine)

**Table 2** : The composition of the five different surfactant solutions used in the core flood tests, with their associated surface tension and IFT with IsoparH at 55.

	<b>Surfactant</b>	<b>Co-Surfactant</b>	<b>Surface Tension of Solution at 55°C (mN/m)</b>	<b>Interfacial Tension with IsoparH at 55°C (mN/m)</b>
<b>Solution 1</b>	IOS 0.5wt%		<b>22.8</b>	<b>0.31</b>
<b>Solution 2</b>	AAS 0.5wt%		<b>25.0</b>	<b>0.61</b>
<b>Solution 3</b>	AOS 0.5wt%		<b>21.5</b>	<b>1.18</b>
<b>Solution 4</b>	AOS 0.25wt%	IOS 0.25wt%	<b>22.0</b>	<b>0.47</b>
<b>Solution 5</b>	AOS 0.25 wt%	Betaine 0.25wt%	<b>23.9</b>	<b>1.27</b>

### **Bulk Foam Tests**

The bulk foam tests were all carried out using the commercially available FoamScan apparatus (Figure 2). The test section is a 3cm diameter cylindrical glass tube of length 40cm. A fixed amount of surfactant solution is placed in this glass tube, then nitrogen is sparged through the glass frit at the bottom of the tube. The foam volume is monitored optically, using a CCD camera, during both the generation and, once the foaming is stopped, the decay of the foam. In the current experiment, the glass tube was double layered and connected to an external water bath. This enabled hot water to circulate between the walls of the tubes, allowing the temperature inside the tube to be accurately controlled. The top of the tube was covered with a cap to prevent evaporation from the foam.

Tests were carried out at 55°C and atmospheric pressure. A fixed amount of surfactant solution (50ml) was preheated to 55°C before being placed in the glass tube of the FoamScan apparatus. Nitrogen was then injected, with a flow rate of 50ml/min, until the desired volume of foam (100ml) was produced. The time taken to reach 100ml was measured as it gives an indication of the foamability, ie the ease with which foam is produced, of the solution. The nitrogen injection was then stopped, and the foam volume was recorded as the foam decayed. Of particular interest is the half-life

of the foam, the time taken for the foam volume to fall to half of the initial value (ie from 100ml to 50ml).

For tests involving oil, 2.5ml of Isopar H was preheated to 55°C before being added on top of the 50ml of surfactant solution. The sparging was started immediately after the addition of the oil, to prevent the surfactant from equilibrating with the oil.

All experiments, both in the presence and absence of oils, were performed a minimum of two times..

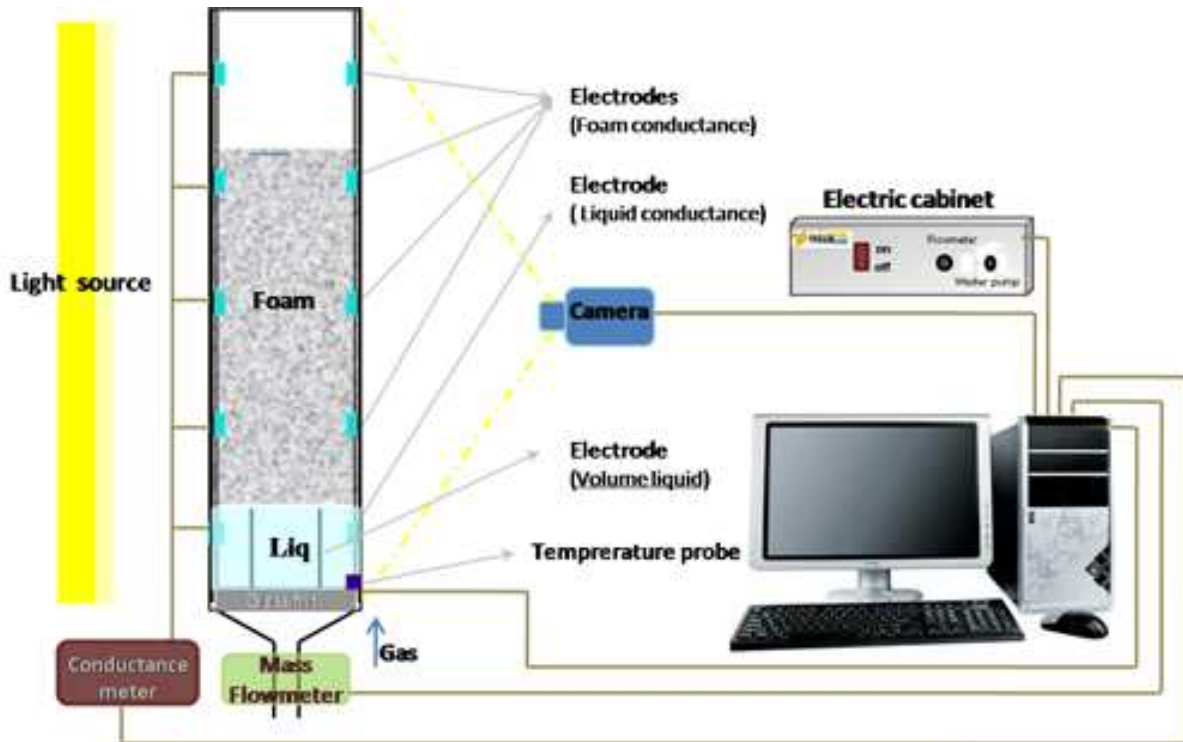

**Figure 2:** Schematic diagram of the FoamScan (Teclis) apparatus (<http://www.teclis-instruments.com/index.php/en/gallery/products/foam-analyzer/foamscan>)

## Results and Discussion – Test Screening in Oil-Free Core

Considering the steady-state pressure drop across the core for each foam quality the apparent viscosity,  $\mu_{app}$ , of the foam can be calculated using:

$$\mu_{app} = \frac{k \nabla P}{(u_l + u_g)}$$

where  $k$  is the permeability,  $u_l$  and  $u_g$  are the liquid and gas superficial velocities respectively, and, in this case,  $\nabla P$  is the pressure gradient across the whole core (calculated from  $P_4$  and  $P_1$ , see Figure 1). We acknowledge that using the pressure drop over the whole core ignores the issues of both the entrance effect (Ettinger and Radke, 1992) and the capillary end effect (Apaydin and Kovscek, 2001). The entrance effect especially, that describes the behavior near the inlet of the core where the injected surfactant solution and gas form a steady-state foam (Ettinger and Radke, 1992), can potentially extend a significant distance along the core, and its length could also change with injected foam quality. If this occurs it could significantly affect the inferred foam mobility and the effect of quality on foam mobility. However, as we are comparing like with like at each foam quality, and because the SCFS is intended as a surfactant screening tool for identifying the most promising surfactants prior to larger scale testing, any errors introduced were considered within acceptable limits.

Plotting  $\mu_{app}$  as a function of the foam quality, curves were obtained for the five surfactant mixtures tested (Figure 3). The largest apparent viscosity for each surfactant solution occurs at a critical foam quality,  $f_g^*$ , for that solution (Alvarez et al. 2001; Boeije and Rossen, 2013; Ma et al. 2014). The curve to the left of  $f_g^*$  describes the low foam quality regime where the flow is influenced by bubble trapping and release, and the apparent viscosity is mainly dependent on the gas flow rate (with shear thinning behavior expected). At foam qualities higher than  $f_g^*$  we observe the high-quality regime, where the foam behavior is dominated by coalescence, and the apparent viscosity is mainly dependent on the liquid superficial velocity, usually dropping sharply as foam quality increases (Osterloh and Jante, 1992; Alvarez et al. 2001).

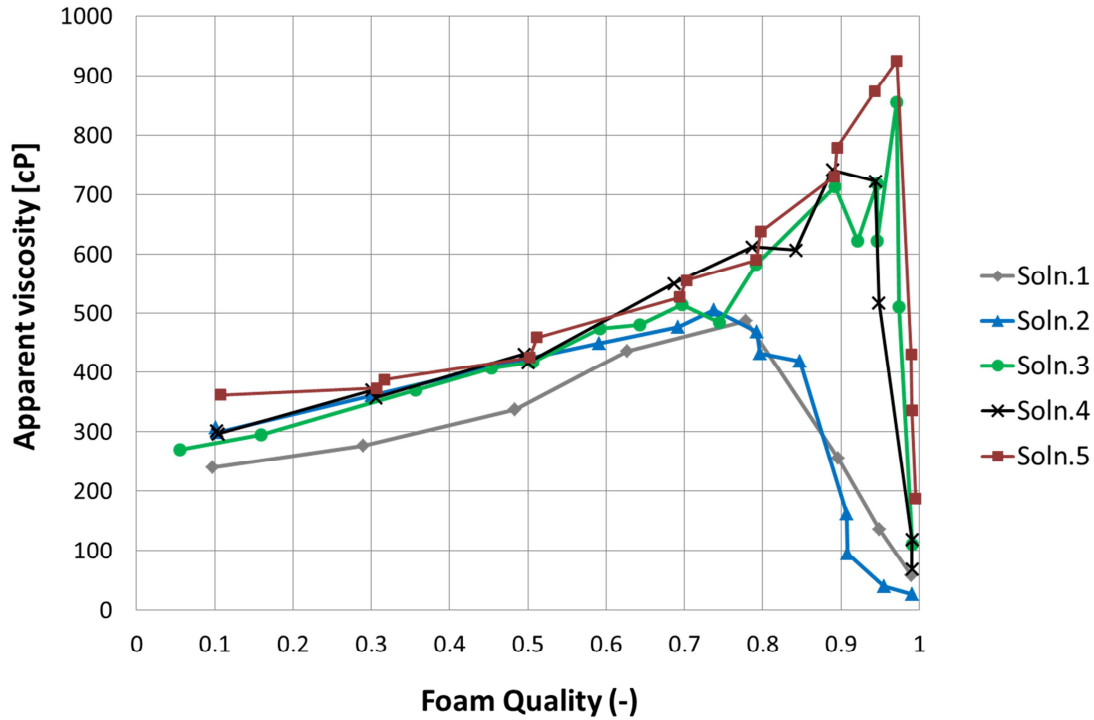

**Figure 3:** Foam-quality scans for the five surfactant solutions in the oil-free core. The temperature was 55 °C and the superficial velocity was  $2.4 \times 10^{-5}$  m/s for all the tests. The lines joining the points are simply connecting lines to aid the eye in distinguishing between the different data sets.

For each surfactant, the values of  $f_g^*$ , maximum apparent viscosity and the associated maximum pressure gradient ( $\nabla P_{max}$ ) can then be determined from the curves. These measured values are given in Table 3. These quantities are important descriptors of foam stability and can also be used to determine some of the foam parameters for the foam models (Boeije and Rossen, 2013; Ma et al. 2014).

In the low quality regime there is no significant difference in apparent viscosity between the surfactant solutions, up to a foam quality of 0.74, which is the value of  $f_g^*$  for Solution 2. This observation is in agreement with the description of the low-quality regime as being predominantly defined by bubble trapping and release (Alvarez et al. 2001). It would be expected that the surface tension of each solution also has an effect, through the capillary resistance to flow of gas in the core, but in this case the variation in the surface tensions for the five solutions tested is minimal (Table 2).

At the higher foam qualities the curves begin to diverge. Once a solution reaches its  $f_g^*$  it enters into the high-foam quality regime where the apparent viscosity starts falling. In this regime, as the foam becomes drier, the behavior is determined by foam stability and the capillary pressure. Both foam stability and capillary pressure, and hence the values of  $f_g^*$  and maximum  $\mu_{app}$  (Table 3), are strongly dependent on the surfactant solution being used. The foams with the highest values of  $f_g^*$  have the highest values of maximum  $\mu_{app}$ .

**Table 3:** Maximum apparent viscosity, with associated maximum pressure gradient and critical foam quality, for each of the surfactant solutions used.

Solution No.	$f_g^*$ [-]	Max $\mu_{app}$ [cP]	$\nabla P_{max}$ [Pa/m]
1	0.78	487	$52.4 \times 10^5$
2	0.74	504	$57.4 \times 10^5$
3	0.97	855	$89.7 \times 10^5$
4	0.91	741	$79.8 \times 10^5$
5	0.97	925	$96.5 \times 10^5$

### Results and Discussion – Test Screening in Core Containing Residual Oil

There is, unfortunately, no exact information on the residual oil saturation present in the cores during these tests, or whether the oil saturation changed during the course of the test. One of the drawbacks of the SCFS core is that, because of the very small pore volume ( $2.71 \text{ cm}^3$ ), it is very difficult to determine the exact quantity of oil in the core. In the current experiments the high apparent viscosities combine with low interfacial tensions (Table 2) to give capillary numbers ( $N_{Ca}$ ) in the range 0.02 – 0.18. These capillary numbers are very high compared to those obtained during a typical water or surfactant flood. It is therefore highly likely that any residual oil saturation in the core was very low (Lake, 1989), as most of the oil would have been displaced during the foam flood.

This is backed up by the pressure traces obtained during the first foam flood tests with an initial residual oil saturation, when water-flood residual oil was initially present in the core (Figure 4). There is clearly a displacement of a fraction of the oil before we obtain the fullest strength foam, and we require an injection of over 40 PV of foam to reach steady state flow. These tests indicate that the initial water-flood residual oil saturation was not fatal to foam; otherwise the foam could not have built the pressure gradient and the values of capillary number that would mobilize the residual oil with this immiscible gas (Simjoo and Zitha, 2013). Following these initial tests, where oil was produced from the core, any further foam flood tests reached steady state rapidly, indicating that no further (significant) oil displacement was necessary to reach steady-state flow behavior. These ongoing tests could therefore be considered as taking place at foam residual oil saturation, which is much lower than water-flood residual oil saturation.

The foam-quality scan curves, for two of the surfactant solutions tested at foam residual oil saturation, are presented in Figure 5 with the oil-free data included for comparison. For Solution 1, the foam residual oil saturation appears to have little or no effect on the steady-state foam behaviour, with no significant change observed in the values of  $f_g^*$  or maximum  $\mu_{app}$ . This either indicates a surfactant with resilient foam behavior in the presence of oil, or that the foam residual oil concentration in this case is extremely low. For solution 5, the foam residual oil has no effect in the low-quality regime, only influencing the behavior in the high-quality regime and causing a reduction in  $f_g^*$  and maximum  $\mu_{app}$  achieved. In this regime the foam is much drier and therefore much more susceptible to any destabilizing effect of the oil. The coalescence normally observed in the high-quality regime is therefore triggered at lower foam qualities.



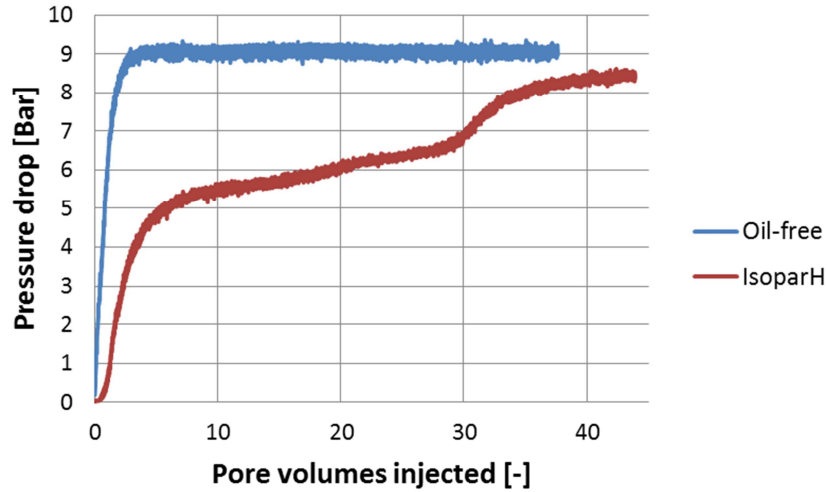

**Figure 4:** Pressure traces for two foam floods at a foam quality of 0.5, in both an oil-free core and in a core initially contaminated with Isopar H at water-flood residual saturation.

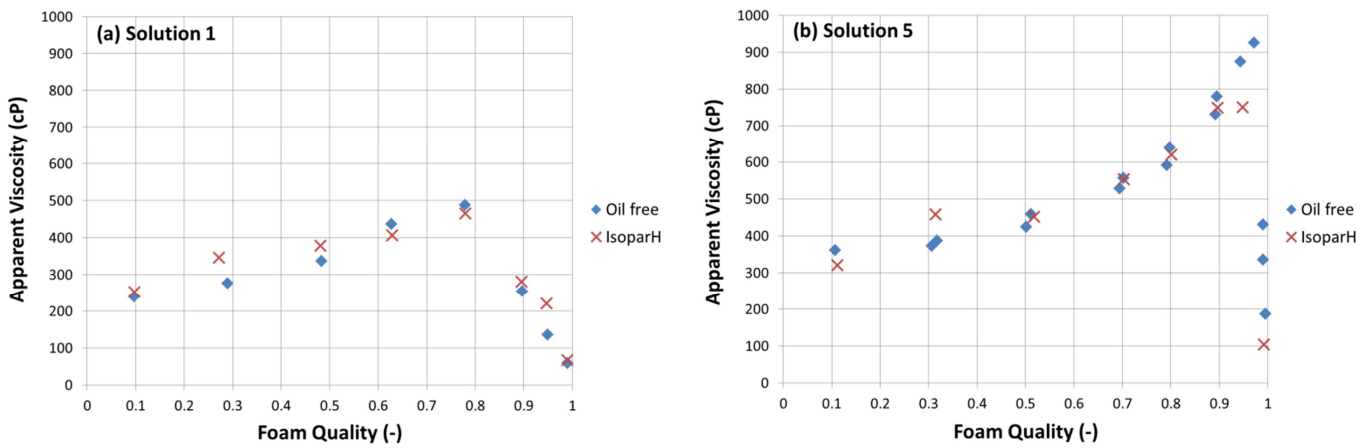

**Figure 5:** Foam quality scans for (a) Solution 1 and (b) Solution 5, showing the behavior both in the oil-free cores and in the cores contaminated with IsoparH at residual oil saturation. The temperature was 55 °C and the superficial velocity was  $2.4 \times 10^{-5}$  m/s for all the tests.

The values of the maximum apparent viscosity, critical liquid fraction and maximum pressure gradient obtained for all the solutions, in the presence of oil, are presented in Table 4. In general, as discussed previously in relation to Solutions 1 and 5, the presence of oil in the core had very little effect on the foam in the low quality regime, and only showed a destabilizing effect in the high quality regime of where reduction in  $f_g^*$  and the maximum value of  $\mu_{app}$ .

However, some of the solutions, most notably solution 2, showed values of apparent viscosity that were higher with oil than without oil in the low quality regime (Table 4). Previously, cases have been reported where the addition of oil has resulted in a more stable foam. However this effect was observed in bulk foam experiments (Koczo et al., 1992; Vikingstad et al., 2005) where oil accumulated in the plateau borders, reducing the drainage of the foam. For the single foam films in porous media, this effect is probably unimportant, and the mechanism for the observed increase in apparent viscosity is currently unknown.

**Table 4:** Maximum apparent viscosity, with associated maximum pressure gradient and critical foam quality, for each of the surfactant solutions used in the presence of oil. Values with no oil in the core are included for comparison.

Solution No.	Max $\mu_{app}$ [cP]	Max $\mu_{app}$ [cP]	$f_g^*$ [-]	$f_g^*$ [-]	$\nabla P_{max}$ [Pa/m]	$\nabla P_{max}$ [Pa/m]
	No oil	With oil	No oil	With oil	No oil	With oil
1	487	<b>486</b>	0.78	<b>0.78</b>	$52.5 \times 10^5$	<b><math>50.6 \times 10^5</math></b>
2	504	<b>606</b>	0.74	<b>0.68</b>	$57.5 \times 10^5$	<b><math>62.4 \times 10^5</math></b>
3	854	<b>908</b>	0.97	<b>0.94</b>	$89.7 \times 10^5$	<b><math>95.3 \times 10^5</math></b>
4	741	<b>742</b>	0.91	<b>0.89</b>	$79.8 \times 10^5$	<b><math>78.2 \times 10^5</math></b>
5	925	<b>749</b>	0.97	<b>0.95</b>	$96.5 \times 10^5$	<b><math>86.5 \times 10^5</math></b>

## Results and Discussion – Bulk Foam Tests

### Foamability

The foamability of each solution was evaluated by measuring the sparging time needed to create 100 ml foam. The sparging times of the surfactant solutions, both with and without oil, are shown in Table 5.

For the tests without oil there is no significant difference in the times to reach 100ml volume of foam. When oil is added to the system, all the foams show an increase in time taken to achieve 100ml of foam. For solution 3, the destabilizing effect of the oil is minimal with approximately a 6% increase in the foaming time. Solution 1 however, shows a significant (31%) increase in foaming time in the presence of oil, indicating that in this case the oil is causing significant destabilisation of the foam films.

**Table 5:** Average time ( $n=2$ ) required to generate 100 ml foam, with and without oil.

Solution No	Average foaming time without oil [s]	Average foaming time with oil [s]
1	<b>107</b>	<b>140</b>
2	<b>108</b>	<b>118</b>
3	<b>106</b>	<b>112</b>
4	<b>103</b>	<b>112</b>
5	<b>108</b>	<b>122</b>

### Bulk Foam Stability

The stability of the foam generated with the five different surfactant solutions is evaluated. Figure 6 shows the half-life of the bulk foam experiments, both in the absence and presence of oil, with a longer half-life indicating a more stable foam. The conditions in which the foam is generated are equal for all the experiments, therefore the variations in half-life can be attributed solely to the surfactant. In the absence of oil, solution 3 produced the most stable foam and solution 1 produced the least stable foam. The error bars show the standard deviation in the half-lives measured.

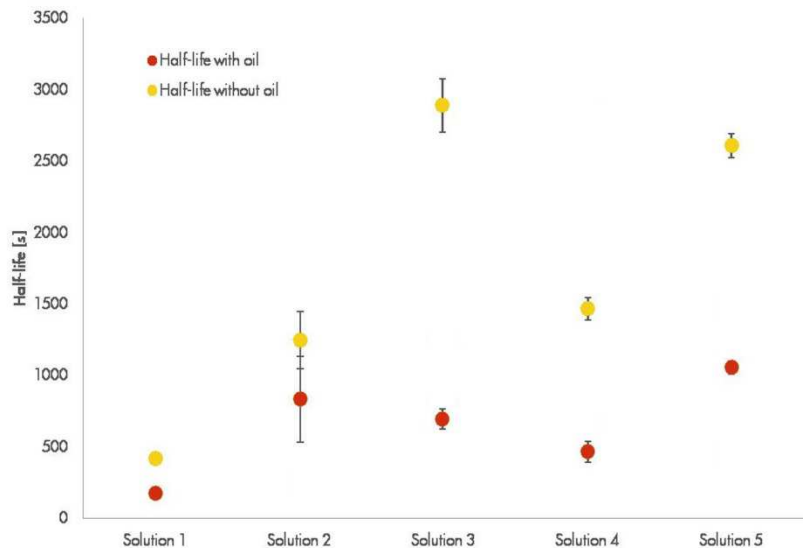

**Figure 6:** The average ( $n=2$ ) half-life of the five different solutions in the absence and the presence of oil.

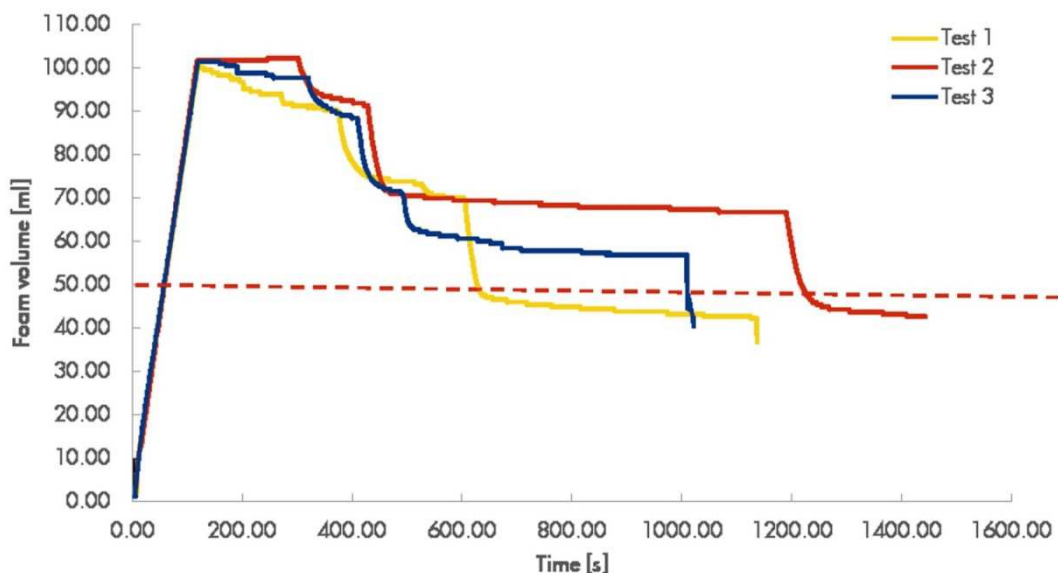
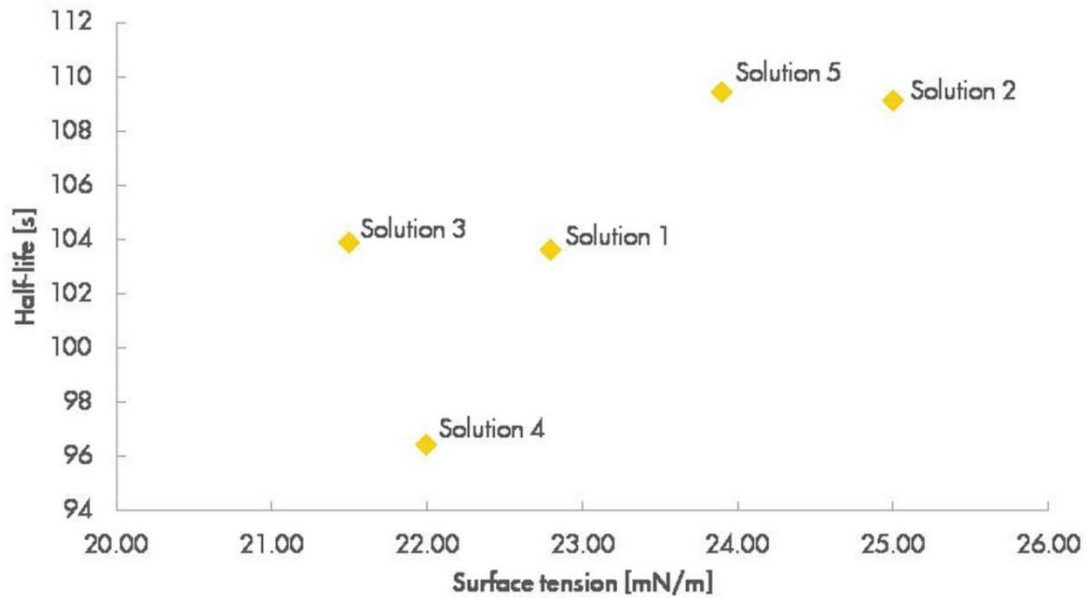

**Figure 7:** The foam volume plotted over time for three bulk foam experiments, for solution 2 in the presence of oil.

The extent to which the oil decreases the foam stability depends on the surfactant used (Figure 6). Solution 3 performs best without oil, but when oil is introduced there is a huge reduction in stability. In comparison, solution 2 does not perform very well in the absence of oil, but the stability is only slightly reduced in the presence of oil. Solution 5 produced the most stable foam in the presence of oil. The range of the error bars is small for most of the surfactants. However, there is a large variation in the half-life of solution 2 in the presence of oil. This variation can be attributed to the way the foam collapsed. For this surfactant, the oil caused irregular large foam collapse events (Figure 7) where the volume dropped stepwise rather than with the usual smooth, gradual decrease. These large collapse events occur at random intervals, and this results in scatter in the values of half-life of the foam. As can be seen in Figure 7, for the three test runs carried out the randomness in the timing of the large foam collapse events and their size, means that there is a huge variation in the times at which the foam volume crosses the 50 ml line.

## Effect of Surface Tension

The bulk behaviour of the foams were considered in terms of the surface tension of the surfactant solution in the absence of oil (Figure 8), and in terms of the interfacial tension when oil was present in the system (Figure 9). When there was no oil in the system, no correlation was found between foam stability and surface tension (Figure 8).



**Figure 8:** The half-life of the foam in the absence of oil plotted as a function of the associated surface tension for all the solutions tested.

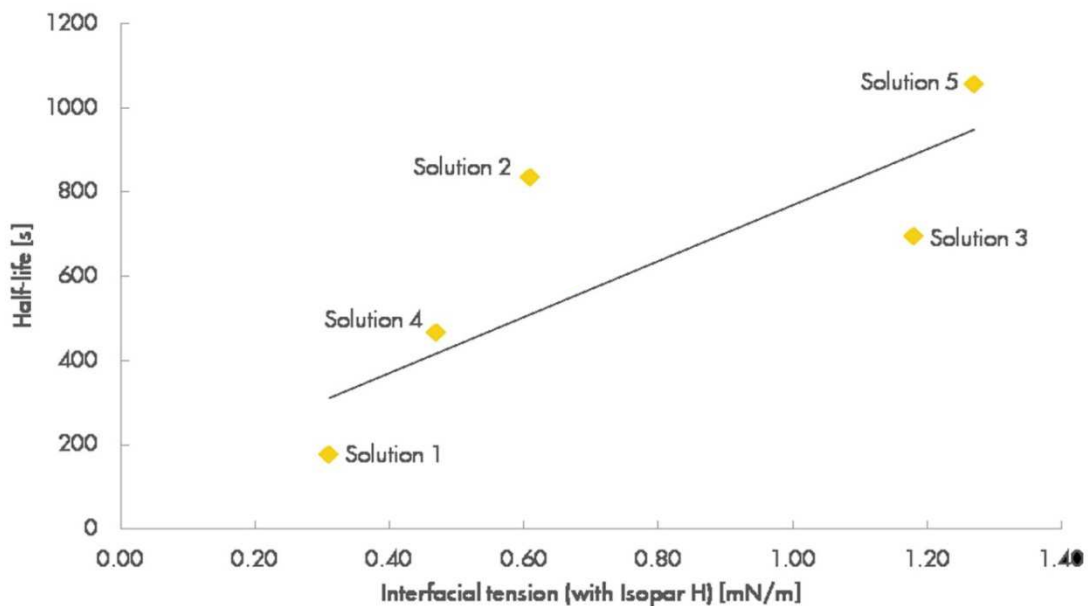

**Figure 9:** A plot of the foam half-life as a function of the interfacial tension between each surfactant solution and Isopar H.

For the tests in the presence of oils, there was a clear link between the interfacial tension and the foam stability (Figure 9), with a higher interfacial tension resulting in a foam that decays slower. It is suggested that this effect could be due to the foaming technique used in the oil tests. Before the foaming started the oil was floating as a layer on top of the surfactant solution. When the foaming

started, the first foam films generated contained a lot of oil, which was then transported upwards by the subsequent bubbles. The amount of oil transported upwards with the first foam bubbles depends on the interfacial tension of the oil with the surfactant solution. A lower interfacial tension therefore results in more oil in the foam, accelerating the foam decay and resulting in a shorter half life.

## Results and Discussion – Comparison of the Core-Flood and Bulk Foam Tests

### Core-Flood and Bulk Foam Without Oil

One of the goals of this study was to determine whether the behaviour of the bulk foam can be used to predict how a surfactant solution will perform during a core flood. There are significant physical differences between foams in porous media and bulk foams. A bulk foam decays due to gravity drainage, coalescence and coarsening, with the latter two mechanisms causing an increase in the average bubble size.

When the foam is in a porous media however, the polyhedral structure encountered in dry bulk foam no longer exists, and the gas is dispersed within a continuous liquid phase with gas flow paths, in which lamellae separate the gas phase. In porous media gravity drainage is not important. At the short length scales within the core, the hydro static pressure differences due to gravity are small and the capillary forces dominate. The two mechanisms that cause foam coalescence in porous media are capillary-suction and gas diffusion (Chambers and Radke, 1991). Capillary suction is the main cause of lamellae rupture (Kovscek and Radke, 1993).

Another difference between the bulk foam and the core flood tests was that for the bulk foam the stability was measured after the foam was generated, whereas the measurements in the core were performed while there was a constant generation of foam films.

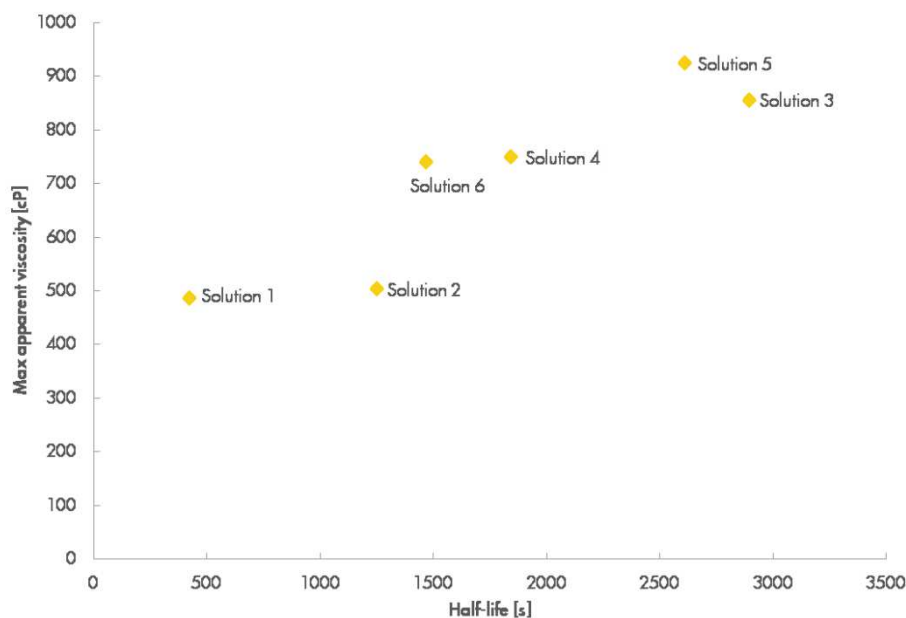

**Figure 10:** The maximum apparent viscosity of the foam in the core flood tests plotted as a function of the half-life of the foam in the absence of oil, for all the solutions tested.

Despite the many structural and procedural differences a plot of the apparent viscosity in the core as a function of the half-life of the bulk foam shows a clear relation between the two (Figure 10). Surfactant solutions that generate more stable bulk foam therefore create a foam with a higher

apparent viscosity in porous media. Khristov et al. (1983) found that bulk foam has a stability that depends on a limiting capillary pressure. Bulk foam on the other hand breaks at much lower capillary pressures than single films. Khristov et al. (1983) attributed this to the films in the bulk foams, that have larger radii than the single films, and the "collective effects," where disturbances from the rupture of one film cause its neighbours to break as well. Foam apparent viscosity in porous media is also depending of the limiting capillary pressure [Farajzadeh 2015 Energy & Fuels 04/2015; 29(5). DOI:10.1021/acs.energyfuels.5b00248]. The limiting capillary pressure could explain the relation between bulk foam stability and the maximal apparent viscosity of foam in porous media.

There are difficulties when considering the limiting capillary pressure in bulk foam, as it occurs at a critical liquid fraction, and is therefore gravity drainage related<sup>11</sup>. Consequently, bulk foam stability can only give a proper indication about performance in the core, when the parameters, that influence the drainage rate are similar. The difference in bubble size (smaller bubbles drain slower) and viscosity should therefore be reasonable small. For all the solutions the foam was generated with the Foamscan apparatus at an equal gas flow rate, therefore the difference in bubble size was relatively small (Table 6). The measured viscosities of the used solutions (Table 6) do not deviate much from each other.

**Table 6:** *The viscosities of the bulk liquid, measured at 55 °C*

Solution No.	$\mu_{\text{bulk}}$ [mPa.s]	Average bubble radius [mm]
1	0.5976	0.170
2	0.5788	0.191
3	0.5428	0.174
4	0.6640	0.199
5	0.6664	0.184

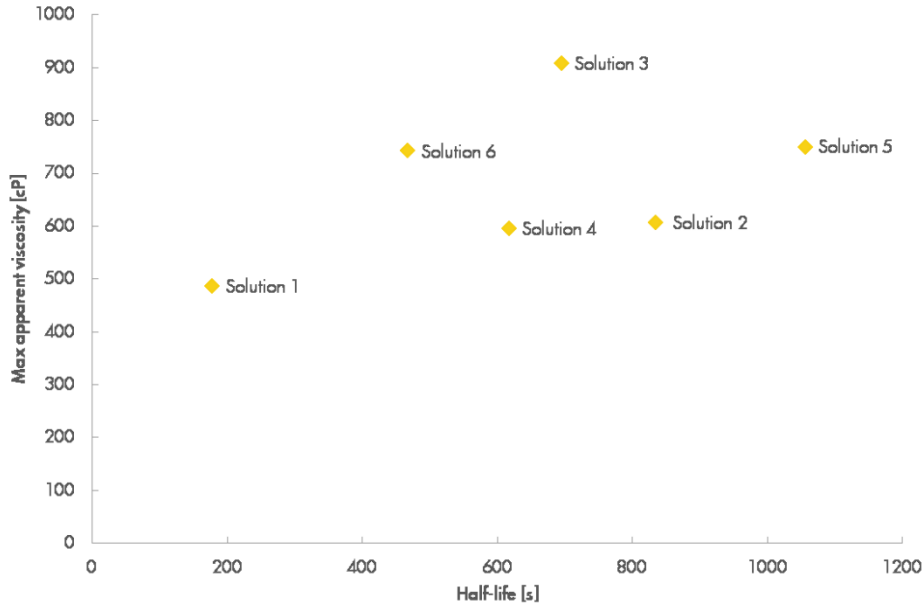

**Figure 11:** The maximum apparent viscosity of the foam in the core flood tests plotted as a function of the half-life of the foam in the presence of oil, for all the solutions tested.

### Core-Flood and Bulk Foam Without Oil

The measured maximum apparent viscosity and the half-life in the presence of oil do not correlate (Figure 11). However, it should be noted that for the experiments with oil, the oil is produced out of the core before the maximum apparent viscosity was reached.

### Conclusions

The small core-flood set-up (SCFS) has been used to carry out a test screening of five different surfactant solutions, and could be used to rapidly characterize a series of surfactants for their foam strength, resistance to oil, and behaviour as a function of foam quality. It therefore has the potential to be a powerful surfactant screening tool, with the advantage over a large-sized core that less time and material is required for each core flood experiment. The core is also easy to handle and adapt, making it a very flexible tool for foam testing.

In the core-flood tests in the presence of oil, it was found that the initial water-flood residual oil saturation affected the foam, but did not kill it completely, with high enough values of capillary number being generated to mobilize a large fraction of the residual oil. The resultant foam residual oil saturation had very little effect on further foam tests, and did not prevent the creation of strong foam. Late in the experiment this reflects the very low oil saturations in the core resulting from the high values of capillary number. For most of the solutions tested, the foam-residual oil saturation, obtained during the first foam flood, had little effect in the low-foam quality regime, and only showed a destabilizing effect in the high quality regime, reducing  $f_g^*$  and the maximum value of  $\mu_{app}$ .

### Acknowledgements

We acknowledge financial support from Shell Global Solution International and technical support from Michiel Slob. We thank Dr. Koenraad Elewaut and Dr. Ramez Nasralla for their careful review of the manuscript.

## References

- Alvarez, J. M., Rivas, H. J. and Rossen, W. R. [2001] Unified model for steady-state foam behavior at high and low foam qualities. *SPE Journal*, **6** (3), 325-333
- Andrianov, A., Farajzadeh, R., Mahamoodi Nick, M., Talanana, M. and Zitha, P.L.J. [2012] Immiscible foam for enhancing oil recovery: Bulk and porous media experiments. *Ind. Eng. Chem. Res.* **51** (5), 2214–2226
- Apaydin, O. G. and Kovscek, A. R. [2001] Surfactant concentration and end effects on foam flow in porous media. *Transport in Porous Media*, **43**, 511–536
- Aronson, A.S., Bergeron, V., Fagan, M.E. and Radke, C.J. [1994] The influence of disjoining pressure on foam stability and flow in porous media. *Colloids and Surfaces A: Physicochemical and Engineering Aspects*, **83**, 109-120
- Boeije, C.S. and Rossen, W.R. [2013] Fitting foam simulation model parameters to data. Paper presented at the *IOR 2013–17th European symposium on improved oil recovery*, St. Petersburg
- Dalland, M., Hanssen, J.E. and Kristiansen, T.S. [1994] Oil interaction with foams under static and flowing conditions in porous media. *Colloids Surfaces A: Physicochem. Eng. Aspects*, **82**, 129-140
- Ettinger, R. A., and Radke, C. J. [1992] Influence of texture on steady foam flow in Berea sandstone. *SPE Reservoir Engineering*, **7**, 83-90
- Falls, A.H., Musters, J.J. and Ratulowski, J. [1989] The apparent viscosity of foams in homogeneous bead packs. *SPE Reservoir Engineering*, **4**, 155-164
- Farajzadeh, R., Andrianov, A., Bruining, J. and Zitha, P.L.J. [2009] Comparative study of CO<sub>2</sub> and N<sub>2</sub> foams in porous media at low and high pressure–temperatures. *Industrial & Engineering Chemistry Research*, **48** (9). 4542-4552
- Farajzadeh, R., Andrianov, A. and Zitha, P.L.J. [2010] Investigation of immiscible and miscible foam for enhancing oil recovery. *Industrial & Engineering Chemistry Research*, **49** (4), 1910-1919
- Farajzadeh, R., Andrianov A., Krastev R., Hirasaki, G. and Rossen, W.R. [2012] Foam–oil interaction in porous media: Implications for foam-assisted enhanced oil recovery. *Advances in Colloid and Interface Science*, **183–184**, 1–13
- Jones, S.A., van der Bent, V., Farajzadeh, R., Rossen, W.R. and Vincent-Bonnieu, S. [2015] Small Core Flood Experiments for Foam EOR - Screening Surfactant Applications. Paper presented at the *IOR 2015 - 18th European Symposium on Improved Oil Recovery*, Dresden
- Kapetas, L., Vincent-Bonnieu, S., Danelis, S., Rossen, W.R., Farajzadeh, R., Eftekhari, A.A., Mohd Shafian, S. R. and Kamarul Bahrim, R. Z. [2014] Effect of temperature on foam flow in porous media. *SPE 172820-MS* (in preparation)
- Khatib Z.I., Hirasaki G.J. and Falls A.H. [1988] Effects of capillary pressure on coalescence and phase mobilities in foams flowing through porous media. *SPE Reservoir Engineering*, **3**, 919-926



- Koczo, K., Lobo, L.A. and Wasan, D.T. [1992] Effect of oil on foam stability: Aqueous foams stabilized by emulsions. *Journal of Colloid and Interface Science*, **150**, 492-506
- Kovscek, A. R. and Bertin, H. J. [2003] Foam mobility in heterogeneous porous media. *Transport in Porous Media*, **52**, 37–49
- Kristiansen, T.S. and Holt, T. [1992] Properties of flowing foam in porous media containing oil. *SPE/DOE 24182*, 279-287
- Lake, L.W. [1989] *Enhanced Oil Recovery*. Wiley, New York.
- Ma, K., Lopez-Salinas, J. L., Puerto, M. C., Miller, C. A., Biswal, S. L. and Hirasaki, G. J. [2013] Estimation of parameters for the simulation of foam flow through porous media. Part 1 : The dry-out effect. *Energy & Fuels*, **27**, 2363-2375
- Ma, K., Farajzadeh, R., Lopez-Salinas, J. L., Miller, C. A., Biswal, S. L. and Hirasaki, G. J. [2014] Non-uniqueness, numerical artifacts, and parameter sensitivity in simulating steady-state and transient foam flow through porous media. *Transport in Porous Media*, **102**(3), 325–348
- Mannhardt, K., Novosad, J.J. and Schramm, L.L. [2000] Comparative evaluation of foam stability to oil. *SPE Reservoir Eval. & Eng.*, **3** (1), 23-34
- Moradi-Araghi, A., Johnston, E.L., Zornes, D.R. and Harpole, K.J. [1997] Laboratory evaluation of surfactants for CO<sub>2</sub>-foam applications at the South Cowden Unit. *SPE-37218-MS*, 81-90
- Nguyen, Q.P., Rossen, W.R., Zitha, P.L.J. and Currie, P.K. [2009] Determination of gas trapping with foam using X-ray computed tomography and effluent analysis. *SPE Journal*, **14**, 222-236
- Osterloh, W.T. and Jante, M.J. [1992] Effects of gas and liquid velocity on steady-state foam flow at high temperature. *SPE/DOE 24179*, 237-248
- Persoff, P., Radke, C.J., Pruess, K., Benson, S.M. and Witherspoon, P.A. [1991] A laboratory investigation of foam flow in sandstone at elevated pressure. *SPE Reservoir Engineering*, **6**, 365-372
- Simjoo, M. and Zitha, P.L.J. [2013] Effects of oil on foam generation and propagation in porous media. *SPE-165271-MS*
- Simjoo, M.; Rezaei, T., Andrianov, A. and Zitha, P.L.J. [2013] Foam stability in the presence of oil: Effect of surfactant concentration and oil type. *Colloids and Surfaces A: Physicochemical and Engineering Aspects*, **438**, 148–158
- van der Bent, V. [2014] Comparative study of foam stability in bulk and porous media. *Master's thesis*, TU Delft, Delft, The Netherlands
- Vikingstad, A. K. and Aarra, M. G. [2009] Comparing the static and dynamic foam properties of a fluorinated and an alpha olefin sulfonate surfactant. *Journal of Petroleum Science and Engineering*, **65**, 105–111
- Vikingstad, A. K., Skauge, A., Hiland, H. and Aarra, M. [2005] Foam-oil interactions analyzed by static foam tests. *Colloids and Surfaces A: Physicochemical and Engineering Aspects*, **260**, 189-198

Zitha, P.L.J., Nguyen, Q.P., Currie, P.K and Buijse, M.A. [2006] Coupling of foam drainage and viscous fingering in porous media revealed by X-ray computed tomography. *Transport in Porous Media*, **64**, 301-313

K. T. Chambers and C. J. Radke. In *Interfacial Phenomena in Petroleum Recovery*. 1991.

A.R. Kavscek and C.J. Radke. *Fundamentals of foam transport in porous media*. 1993.

Khr.I. Khristov, D.R. Exerowa, and P.M. Krugljakov. Influence of the type of foam films and the type of surfactant on foam stability. *Colloid and Polymer Science*, 261(3):265-270, 1983.

Olivier Pitois. *Foam Engineering: Fundamentals and Applications*, chapter Foam Ripening, pages 59-73. John Wiley & Sons, Ltd, 2012.