

INDUSTRY

WINTERSWIJK

Analysis Report
Heritage & Architecture

Lidy Meijers
Hielkje Zijlstra
Frank Koopmans
Marie-Thérèse van Thoor
Charlotte van Emstede

Joost Josse 4811666
Chen Zhu 4791908
Juliëtte Zegers 4281683

"DEPOL"
1913



ANALYSIS INDUSTRY

PREFACE

This analysis booklet is made during the graduation studio AR3AH110 in the academic year of 2019-2020. This studio is part of the Heritage & Architecture Master track of the Technical University of Delft.

The graduation studio will contribute to the KaDEr reserach project of the Province of Gelderland, which addresses the preservation of built monumental heritage and searches for an innovative policy for the future. The aim of the analysis is to gain insight into one of the projects within the KaDEr research. The scope of this book ranges from architectural and technical aspects to cultural value aspects with focus on a building complex and some individual structures within this complex.

This booklet is made by:

Joost Joosse 4811666

Chen Zhu 4791908

Juliëtte Zegers 4281683

Tutors:

Lidy Meijers - Architecture

Hielkje Zijlstra - Architecture

Frank Koopmans - Technology

Marie-Thérèse van Thoor - Cultural Value

Charlotte van Emstede - Cultural Value

Date: 04-11-2019



TABLE OF CONTENTS

THE STORY

ANALYSIS

I General Information	34	VI Space Plan	138
Introduction	35	Production process	140
Geography of Winterswijk	36	Production process per factory	142
Agricultural Winterswijk	38	Floorplan and layout	155
Industrialisation	40	Conclusions	156
Textile factories East-Netherlands	41	VII Services	158
Textile industry and Winterswijk	43	Chimneys	160
The industrial site	44	Weaving machines	161
Five industrial typologies	45	Services	162
Conclusions	46	Conclusions	164
II Surroundings	48	VIII Stuff	166
Chronomapping of Winterswijk	50	Stuff	168
Infrastructure of Winterswijk	52	Stuff and flexibility	170
Green around Winterswijk	53	Conclusions	172
Urban section	54	IX Spirit of Place	174
Green and water	56	Mindmapping the area	176
Functions	57	Spirit of A, B, C, D, E	178
Conclusions	58	X Building technology	184
III Site	60	Building A	186
Chronomapping	62	Building B	194
Infrastructure	80	Building C	200
Built surface	81	Building D	208
Accessibility	82	Building E	216
Wayfinding	84	Conclusions	222
Street profiles	86	XI Cultural value	224
Green and water	88	Understanding the values	226
Conclusions	90	The ensemble	228
IV Skin	92	Building A, B, C, D, E	234
Composition and roofscapes	94	XII Conclusions	254
Materials and colours	96	Overall conclusion	256
Experience	98	Obligations	258
Façades A, B, C, D, E	111	Opportunities	260
Daylight	116	Dilemmas	262
Integrated lighting	118	XIII Bibliography	264
Conclusions	120		
V Structure	122		
Typologies	124		
Structure A, B, C, D, E	126		
Conclusions	136		

THE STORY

"Fusie zou produktiespreiding en specialisatie mogelijk maken. We hebben echter één fout gemaakt en dat was dat we geen consequenties getrokken hebben in de directiesfeer. De drie directeuren van Willink kwamen ons team versterken. Toen ging het scheef."

"Fusion would contribute to an enlarging productionline and specialisation. Although, we made one mistake, we did not set goals for the management. The three directors Willink came to support our team. Then, it went wrong."

Henk Blijdenstein, director Blijdenstein & Co

Winterswijk is a village located in the eastern part of The Netherlands, in the province of Gelderland. The village has a rich history in the textile branche. Throughout time the function of Winterswijk changed from agricultural to textile industrial. The quote already points out economic happenings and interests within this sector. This narrative of the evolvement of the industrial ensemble will be presented and discussed more specific in this chapter. To get a grip on the crucial factors within the development of the industrial ensemble, the following research question is the guideline throughout the story.

“What is the relation between developments in the textile industry and the ensemble of the industrial buildings in Winterswijk?”

To structure the statements and findings within the story the main research question is categorized into three questions:

What was there ?

What is there now?

What will be there in the future?

This narrative is based on a thorough and detailed analysis.



<< Quote Willink, 2006
>> Figure 4 The Netherlands and Winterswijk. (Own drawing based on Google Maps, 2019)

THE STORY

Within the story, the ensemble of buildings is divided according to the current situation. The whole ensemble nowadays consists of four sub-ensembles.

- 1 Gaudium
- 2 Hazewind
- 3 Morsepoort
- 4 Janfleur

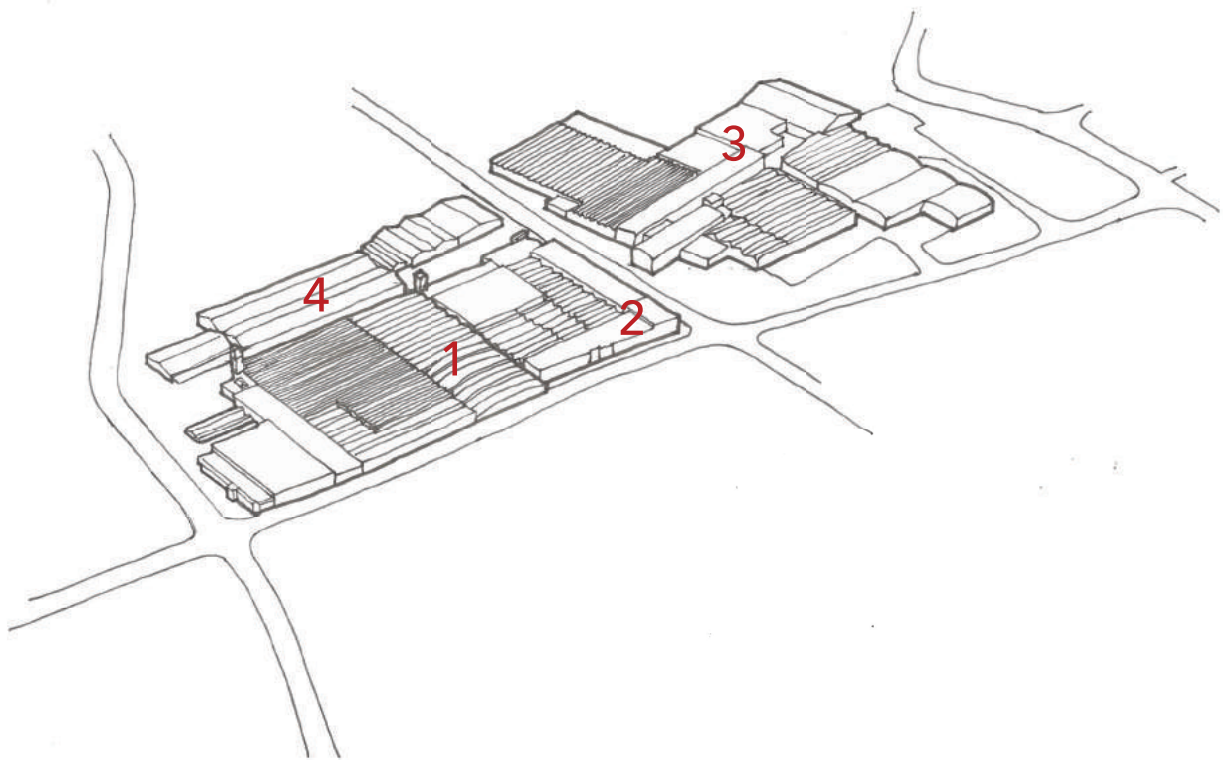
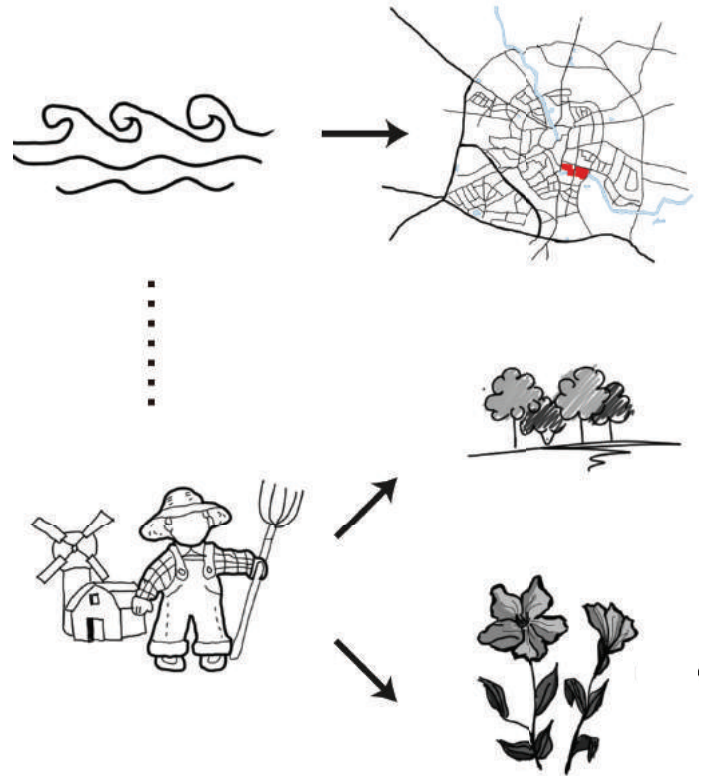

Figure 5 The project site (Own image, 2019)

WHAT WAS THERE?

In the beginning, the agricultural purpose defined Winterswijk as a village. It formed the first settlements around the Whemerbeek. Nature did not just take the dominance in the composition of Winterswijk. In fact, the ruling 'Scholte' farmers structured and defined the surrounding landscape and gave importance to the appearance of it.

Nevertheless, the farming did not earn enough money for the inhabitants. This was the reason why one needed a second labour to maintain the family. The weaving was introduced, using flax as raw material which grew on the agricultural landscapes. It was a home initiated activity taking place at home, next to the daily activities.



THE STORY

With the introduction of the steam engine during the industrial revolution, the Whemerbeek played a crucial role for the appearance and origination of the new factories. The water was needed for the production of steam, the driven factor in the industrial process. At the town edges of Winterswijk, alongside the creek, weaving factories emerged. Each factory has their own story of evolving. In the end, due to historic happenings, most of the factories closed. Except for the project site, the industrial ensemble. Consequently, Winterswijk expanded towards the North-West. As a result the industrial ensemble marks a transition from the center of the village towards the hinterland.

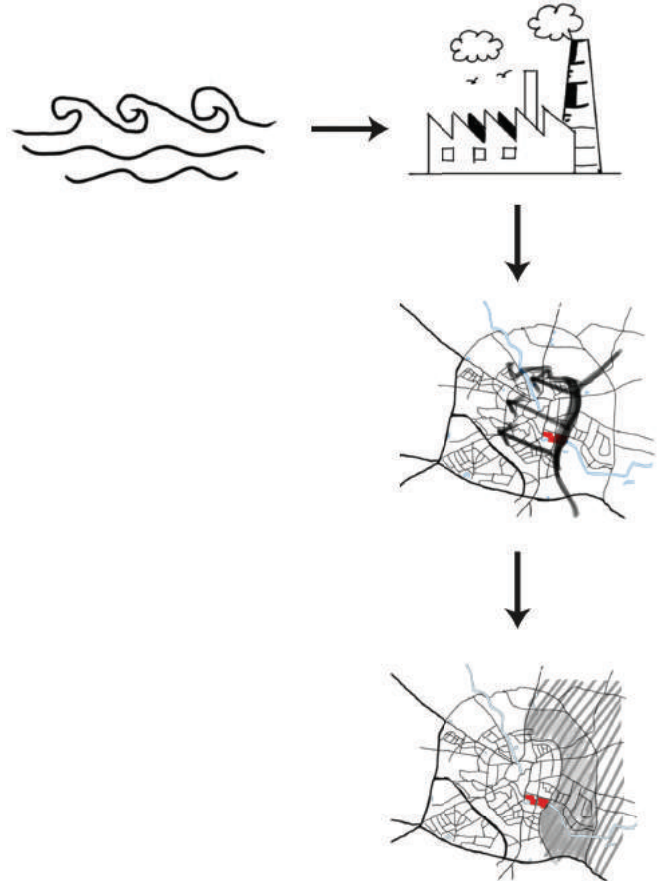

The first factories at the project site evolved in a period of 100 years until the current situation. The leading line in the expanding urban fabric was the development of the production process in the textile branch. Also technical developments influenced the buildings of the ensemble. For instance once electricity was introduced, the creek lost its importance which gave the opportunity to built on top of it and expand in a different direction.

The shift in the owner and function of an ensemble continuously led to a new expansion. The designing party which was involved was crucial in the architectural appearance of the addition, hence a big variety of typologies occurs. Every addition answers the need of each time it was built in. In the end this combination of influencing factors led to the chaotic composition as it is nowadays.

The composition was crucial for the infrastructure as well, which generally followed the façades. An exception is the Laan van Hilbelink. Alongside this road the buildings followed the streetpattern resulting in a long urban façade with a slight curve.

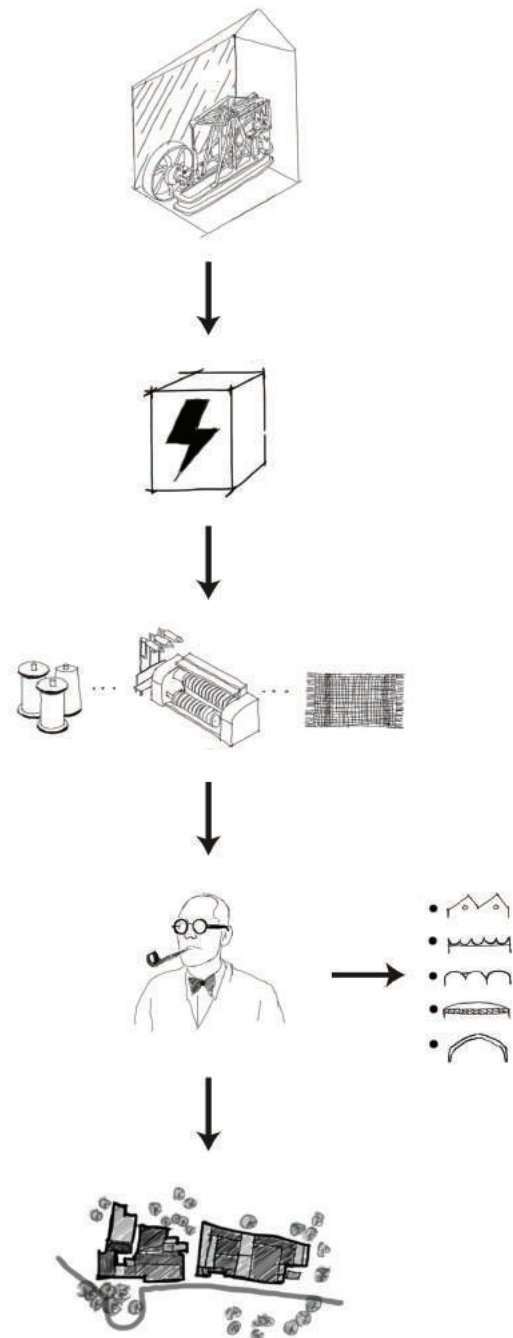

THE STORY



THE STORY

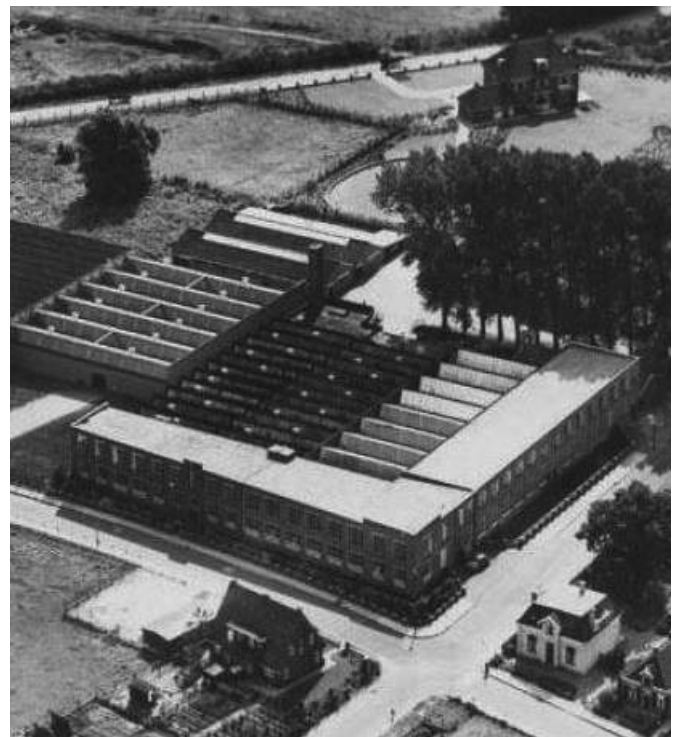
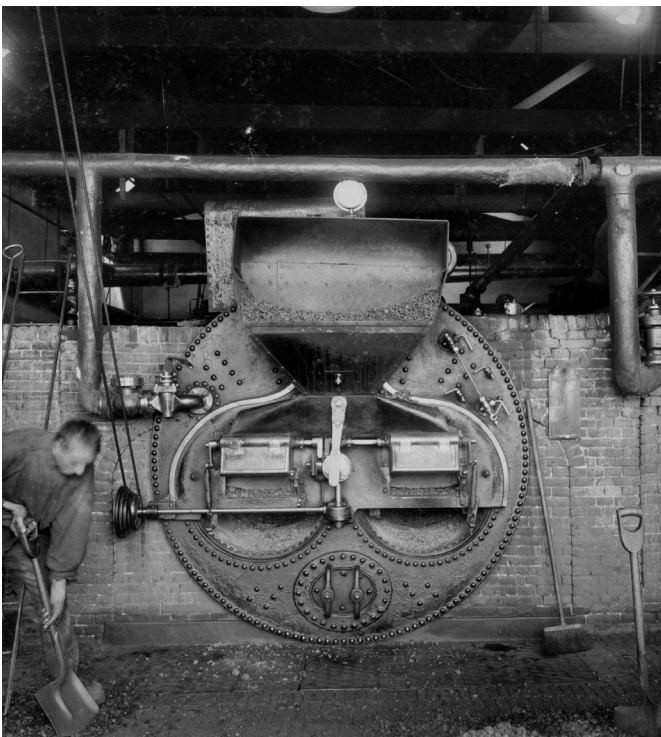
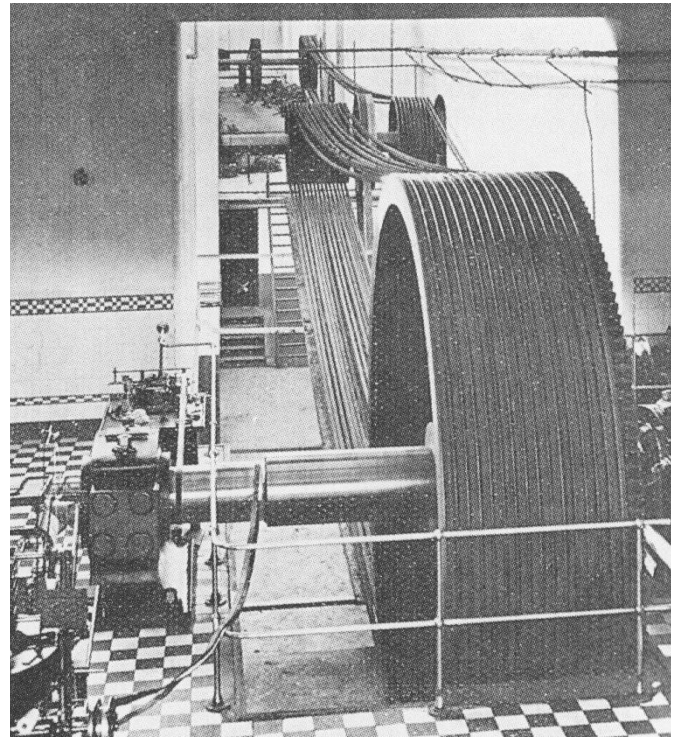

THE STORY

WHAT IS THERE?

The history of the industrial textile ensemble left its traces over time, of which some of them are still present nowadays. The phenomenon of the transition for instance. The industrial area is remarkable since it is situated close to the village centre and on most sides surrounded by a residential area. Furthermore, the change of identity and function of the surrounding leads to an abrupt transition between one another. Within this transition of spaces the infrastructure is present and plays an important role for the accessibility of the site and the village center.

On the edges of the site a lot of open, undefined space is situated. This is the result of development starting from a core and evolving towards the edges of the building ensemble. The difference is also noticeable when one reaches the core, where the green disappears and a stoney appearance is dominant.

The ensemble in its present shape defines the characteristics of the space. Following the route towards and through the site, different entrances are scattered around and the space fluctuates between convergence and divergence. The composition with its roadblocks result in disorientation. This is enhanced by the fact that there are almost no landmarks present.

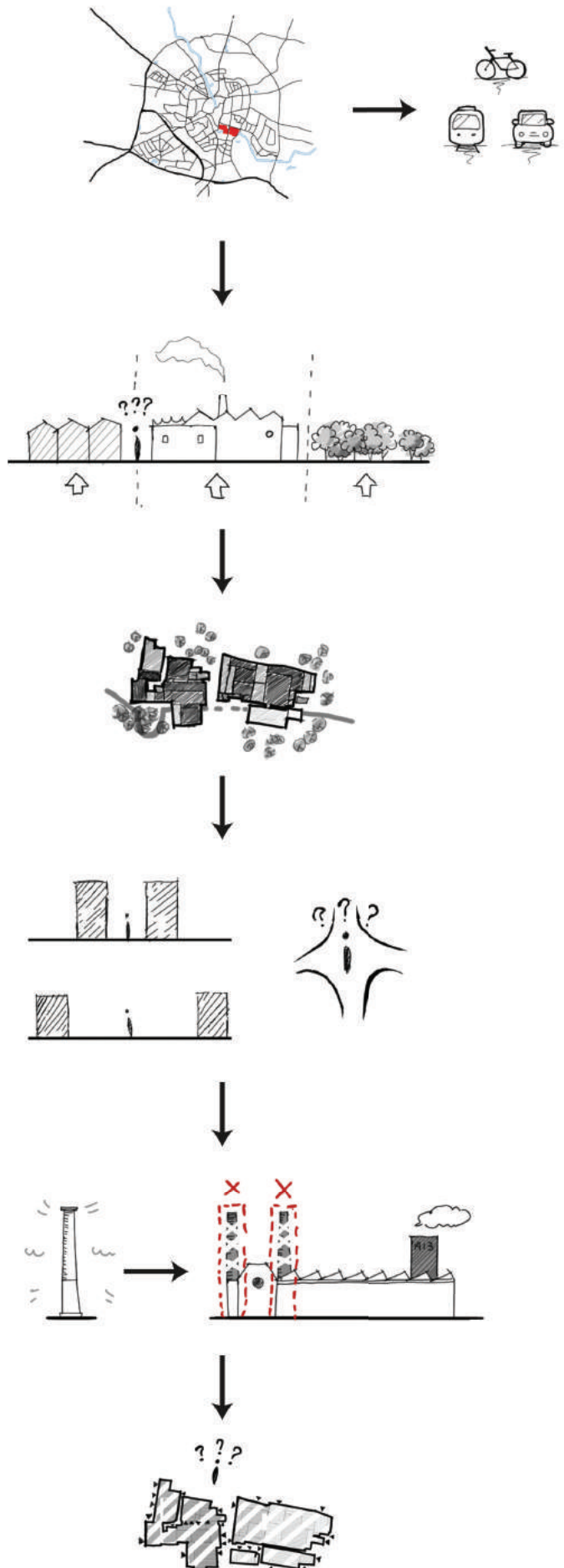

The architectural appearance is defined by the diverse roofscapes combined with closed façades made of brick. This results in a coherence with a colour appearance of red, brown and orange. As for the interior, it is characterized by white plaster or light finishings. Originally the most of the floorplans were lightened by natural daylight coming from rooflights. However, over time a lot of these were covered and replaced by artificial lights.

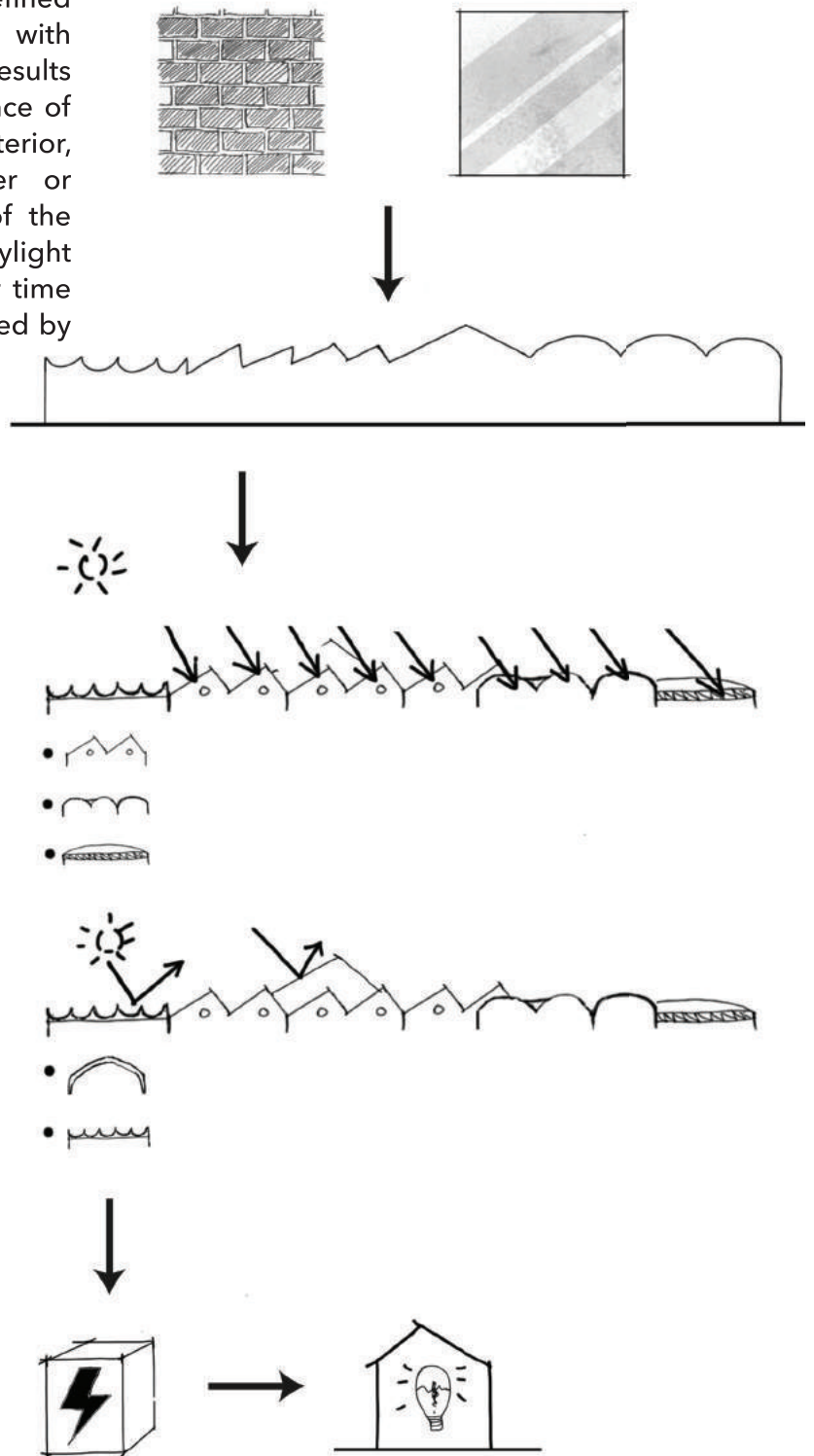

THE STORY

Of the whole ensemble Gaudium is the only part where the original intentions of the buildings are still present. Although, these textile activities logically developed and nowadays differ from ancient production techniques. On the contrary with the rest of the whole ensemble, where different functions are situated. What the buildings with new functions have in common is that they are often used on a different moment than Gaudium, scattered throughout the week. This causes the area to have few visitors and therefore it feels empty.

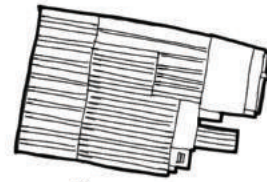

Gaudium

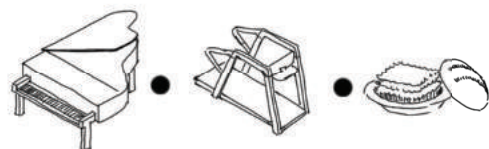
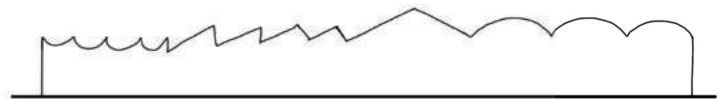
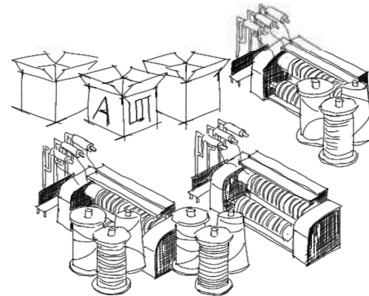

The functions of the industrial buildings required certain machinery and processes throughout time. These needed a suitable building with big spans. Besides, the buildings are structured by a straight and strict grid. Together with the repetitive structure, an open floorplan was created.

The organically development of the site is also to be seen on the smaller scale, where buildings sometimes share a façade or (loadbearing) wall.

Lastly, technical developments influenced the way the structures were designed. This in the end also influenced the architectural appearance.

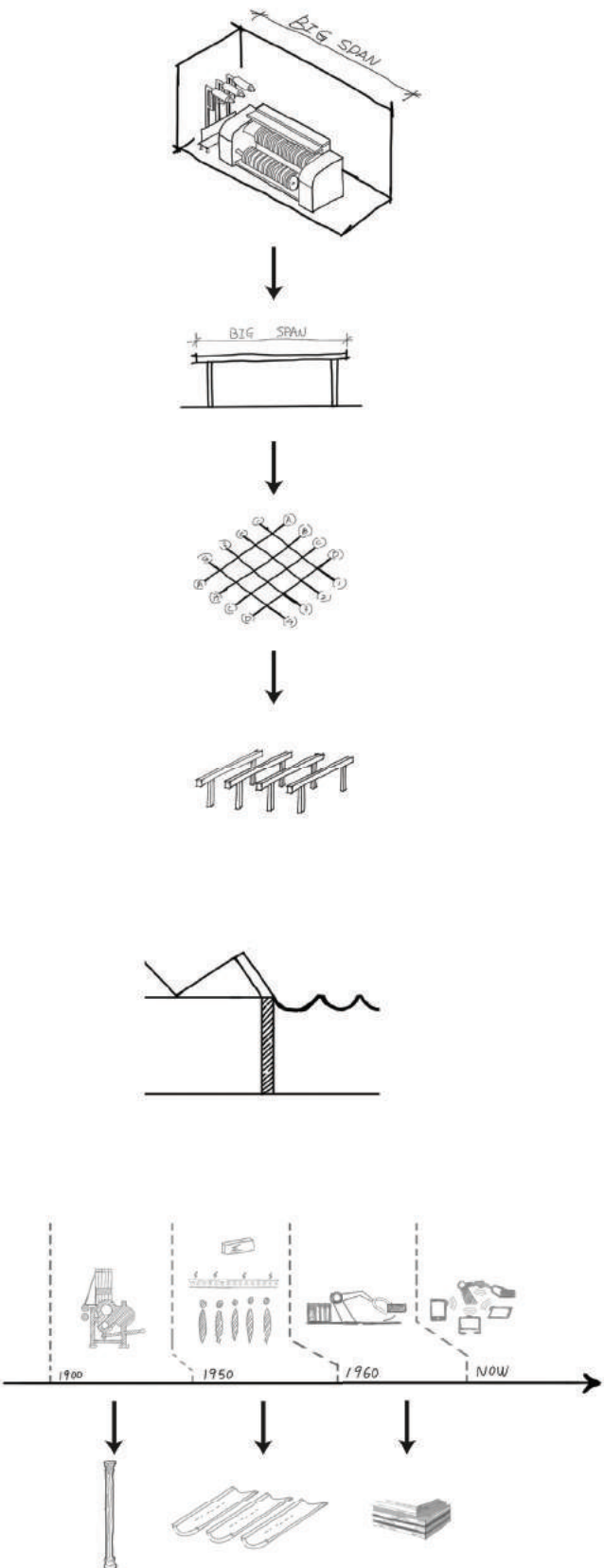

THE STORY



THE STORY

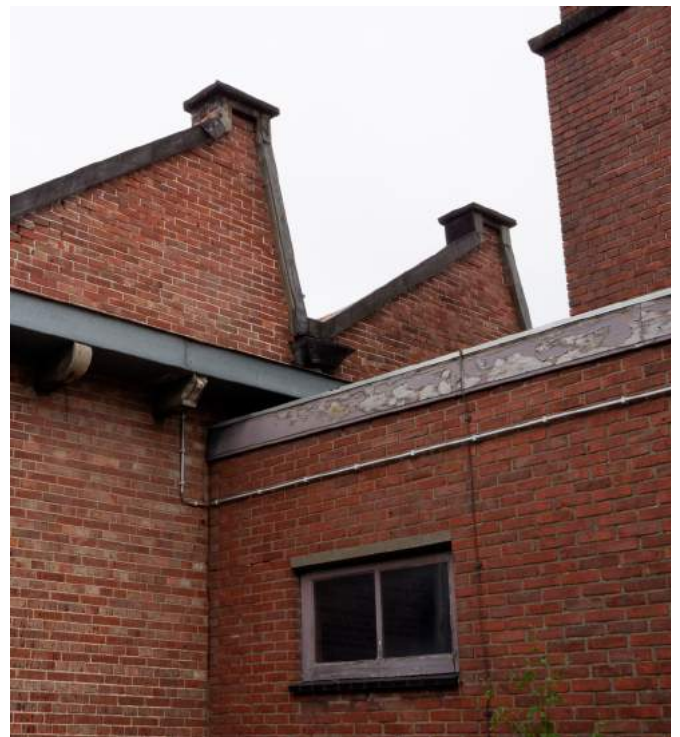

THE STORY

CULTURAL VALUE

The ensemble is the legacy of the textile industry in Winterswijk, which for over a 100 years had a major importance for the village and its inhabitants on economic and social level. Together with other traces of the industry, for instance old gates, workers houses and villas of former factory owners, the ensemble memorizes the base of what Winterswijk is nowadays. For this reason the site and its buildings are of high value for the village and their people. The results of the valuation of the ensemble can be related to

the time that the interventions took place. The latest additions, from approximately 1975 onwards, are generally valued lower in comparison with the first buildings. This has to do with the lack of detailing, use of materials and because they form a block and cover historic features. The valuation of the whole ensemble is illustrated below. The next page shows the valuation for the Gaudium. The diagrams and values explained there are applicable for Morsepoort and Hazewind as well.

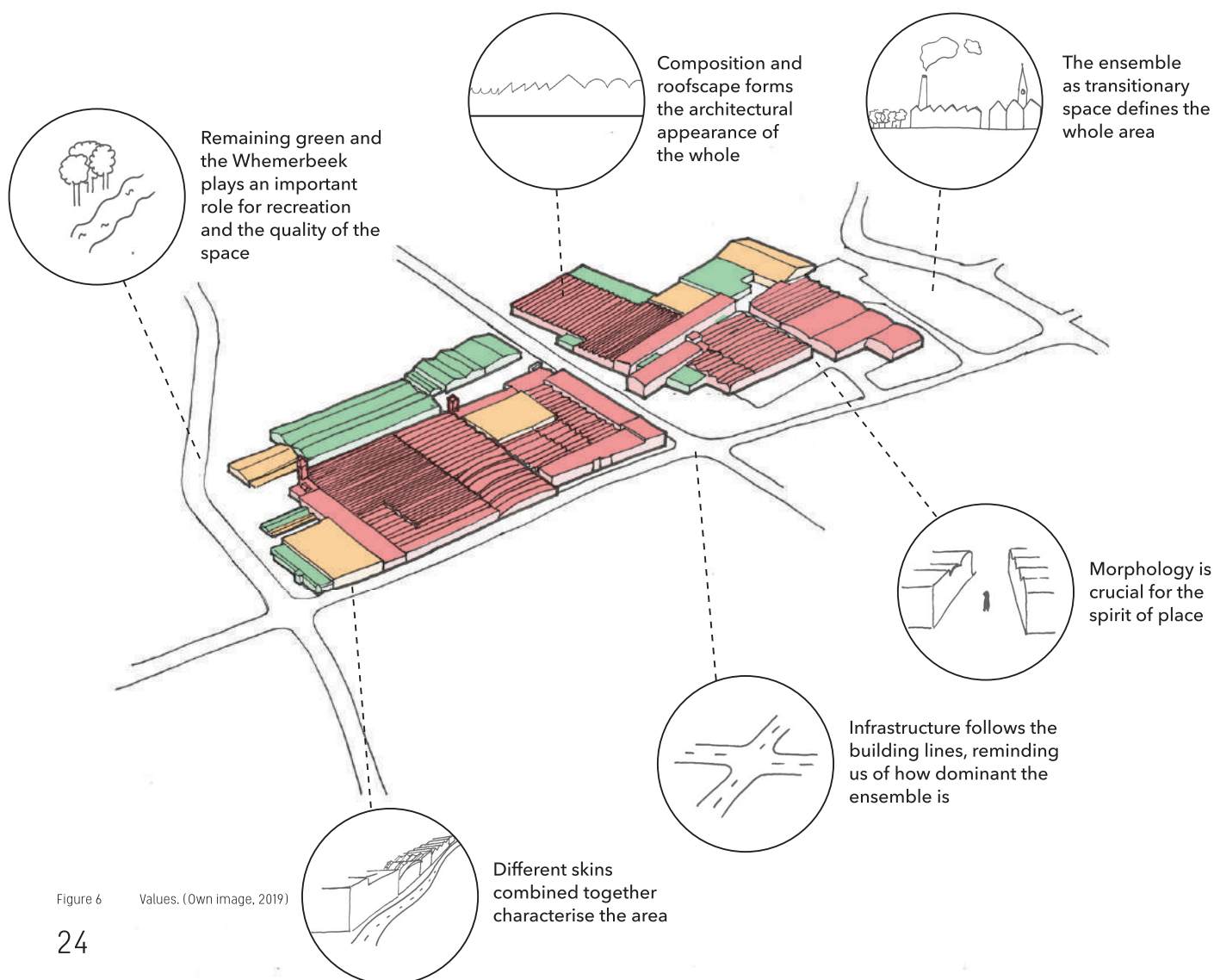

Figure 6 Values. (Own image, 2019)

THE STORY

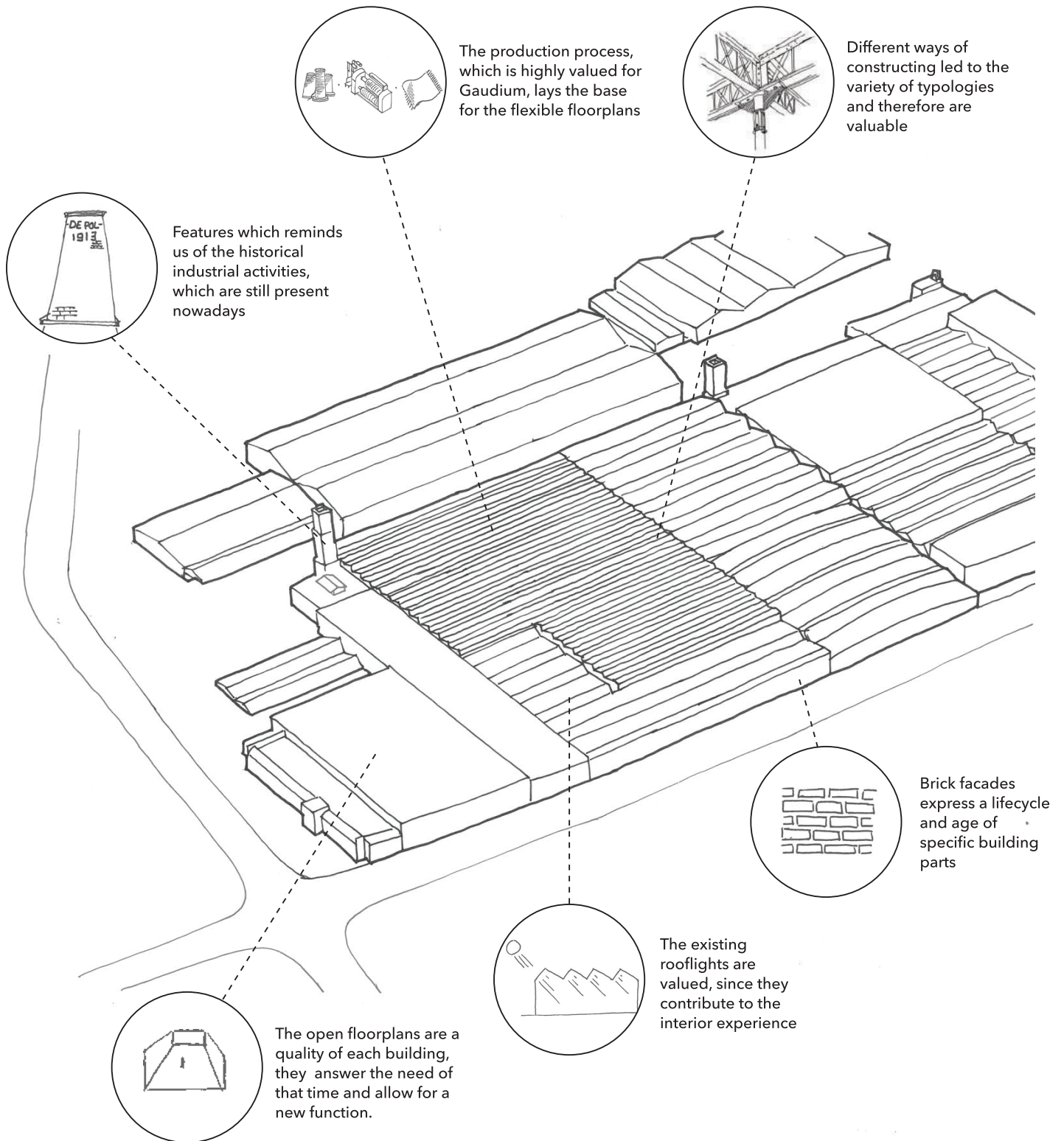

Figure 7 Values. (Own image, 2019)

THE STORY

CONCLUSIONS

Heritage is shaped by events from the past and to intervene within it will require a sensitive approach. To form a base for this approach the events and its value for the structure nowadays have been researched in this project. The question which formed the base of our research was the following:

What is the relation between developments in the textile industry and the ensemble of the industrial buildings in Winterswijk?

To conclude, throughout history once there was a shift in production line, which was the beginning of a chain reaction, a new addition was made. The reason for this shift in production line was either a new owner or a technical development in the textile branche. Consequently, functionality and the interpretation of the involved designing party have been the main pillar of the organically development of the whole. The architectural appearance of the ensemble with all its typologies is the end of the chain reaction.

Because of its history and current situation, the site and its buildings are seen as an ensemble which is highly valuated. The five typologies as a case study show that it is difficult to value the individual buildings seperately from the ensemble and the latter will therefore always be the dominant factor within designing.

WHAT WILL BE THERE IN THE FUTURE?

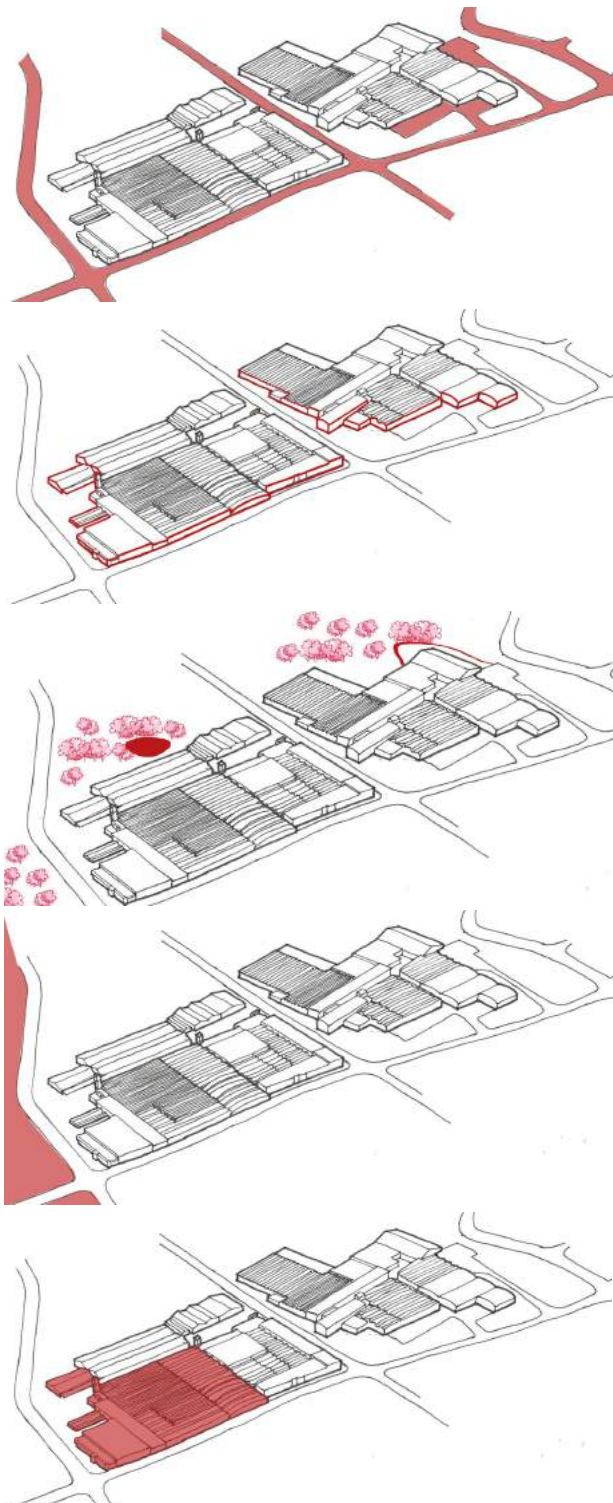

Figure 8 Obligations diagrams (Own image, 2019)

OBLIGATIONS

Infrastructure

The existing infrastructure traces back to historic events connected to the textile industry. Therefore, the urban historical layout should be highly respected.

Composition

The composition of the whole ensemble and the roofscape, which consists of different heights and shapes is characteristic for the place.

Green and water

Existing green and water structures should be kept especially the creek, which played an important roll in the history of Winterswijk and the site.

Hinterland

The connection towards the agricultural landscape of Winterswijk should be kept and possibly enhanced.

Gaudium

Of the whole ensemble Gaudium is the only part where the original intentions of the buildings still take place. Therefore, it is a remarkable feature within the ensemble which is an important aspect to keep in mind.

THE STORY

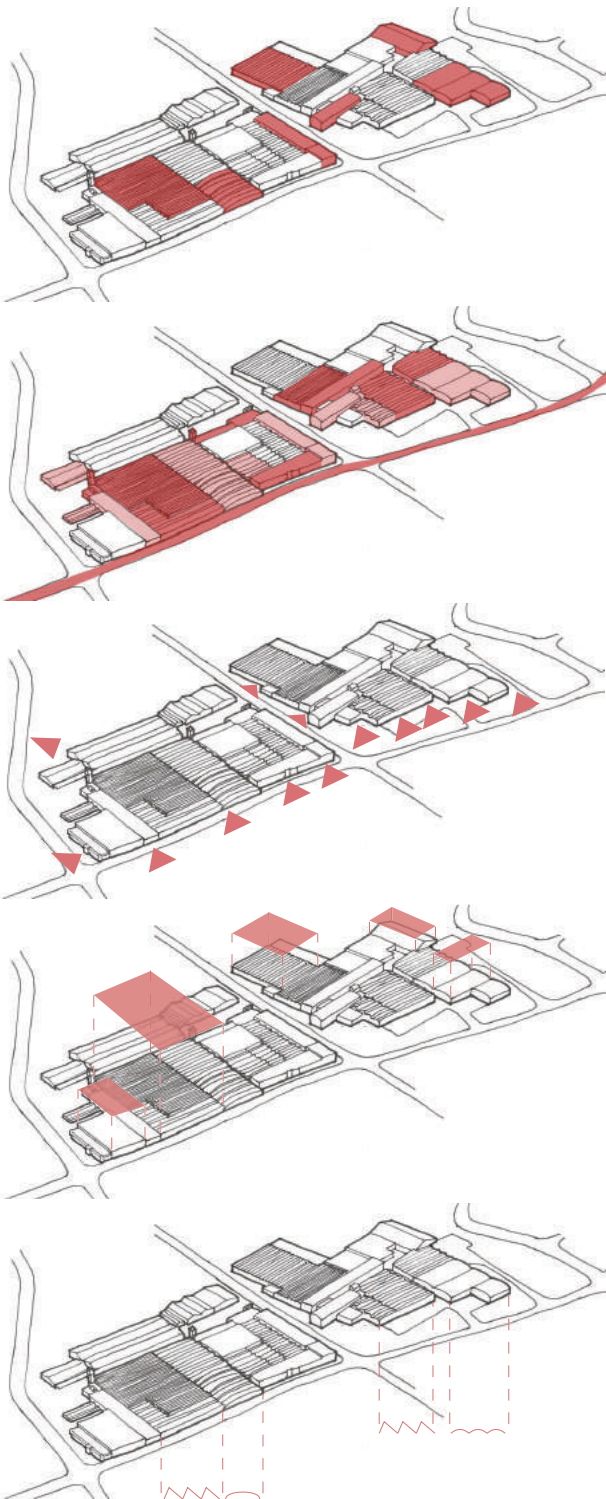

Typologies

The variety in typologies shows the development of the area throughout time

Spirit of place

The characteristics of the textile industry in the past and present are important to keep in mind while designing. Especially, the items pointed out in the research which show the traces of history are items to be kept.

Accessibility

In order for the area to function in the future, the existing accessibility of the site is important

Open floorplan

To make best use out of the originally designed big spans of each building, it is highly recommended to restore the old layout without newly added partition walls.

Structure

The structure is crucial for the architectural appearance of each building in the ensemble. These should be touched as less as possible in order to keep the current expression.

Figure 9 Obligations diagrams (Own image, 2019)

OPPORTUNITIES

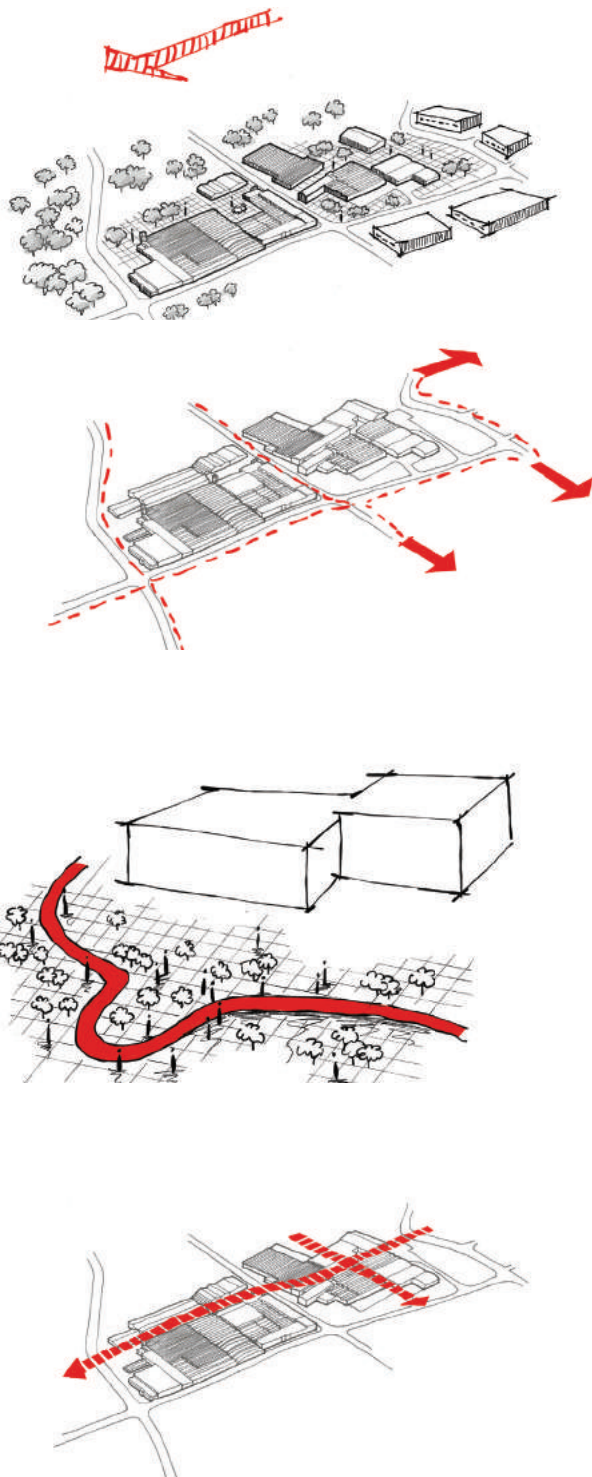

Transitional space

Because the site functions as a transitional zone between the village and the hinterland, the design could incorporate both to create a pleasant place.

Connections

The close position of the site towards the centre of the village makes way for a connection between the area and the vivid centre of Winterswijk.

Whemerbeek

The creek is currently covered, whilst it used to hold great significance for the village. An opportunity would be to expose the creek for it to a more natural environment.

Infrastructure and viewlines

The original passages and infrastructure could be restored, creating viewlines based on the old urban layout.

Figure 10 Opportunities diagrams (Own image, 2019)

THE STORY

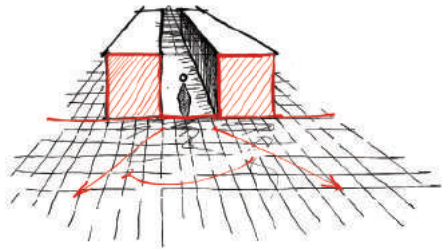

Sequences

The current sequence of public space is everchanging and provides for surprises along the way. A future design could make use of this and enhance it even more.

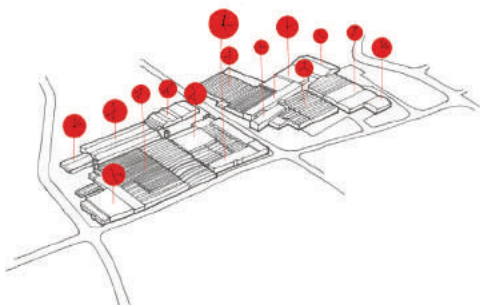

Mixed-use

One of the characteristics of the area is the fact that it has a lot of users, although it still appears as if it is not in use. The possibility is to redevelop the mixed character and to invite more users for the ensemble, equally spread throughout the week to create a living environment

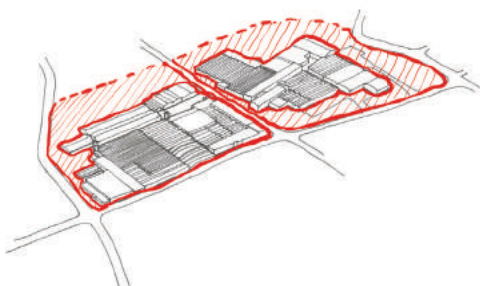

Spatial conditions

On the edge of the area, a lot of open and undefined space is noticed. These spaces give away for interventions which extend the current building plots.

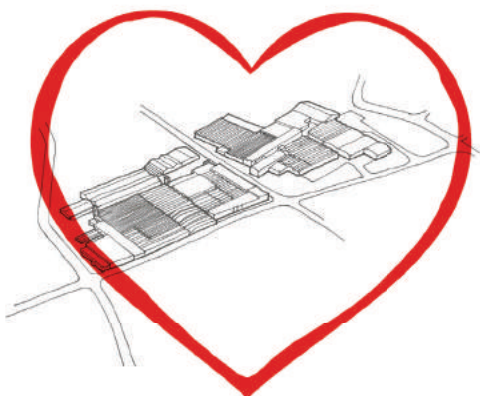

Traces from the past

Since the area is so important for Winterswijk and its inhabitants, it is an opportunity to enhance this even more and to emphasize the traces of the past.

Figure 11 Obligations diagrams (Own image, 2019)

DILEMMAS



Restore infrastructure

Restoring the passages and infrastructure to the original situation could influence the ensemble as a whole and therefore should be carefully considered.

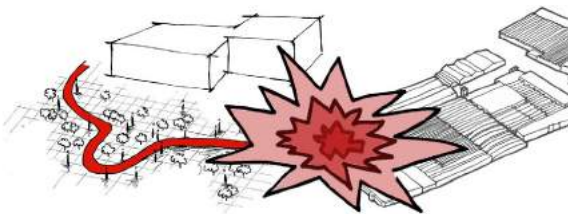

Restore nature

Restoring the creek to the original situation could touch the ensemble as a whole and therefore should be carefully considered.

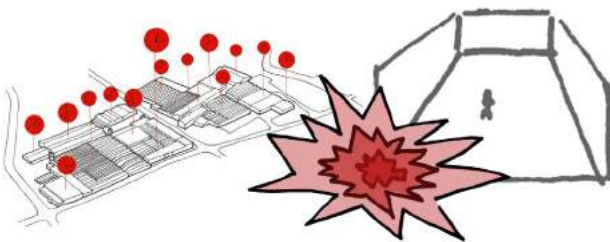

Open floorplan

An open floorplan is highly valued, since it was the original intention of the buildings. Making it a mixed-use environment could clash with this idea since it has to be functional for all users.

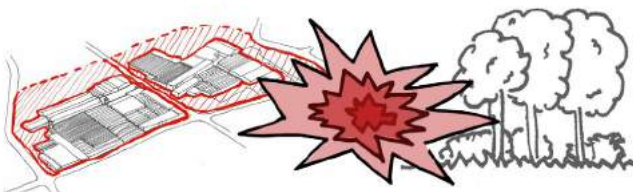

Undefined space

The undefined space around the site gives room for possible new additions, but the green surrounding the area should be taken into account since it also holds value.

Figure 12 Dilemmas diagrams (Own image, 2019)

ANALYSIS



I GENERAL INFORMATION

INTRODUCTION

Winterswijk is a village with almost 24.000 inhabitants located in the eastern part of The Netherlands, in the province of Gelderland. It's close relation to Germany is very characteristic of the place.

The village knows a rich history which is for a great part based on labour and economics. First the farmers determined the way of living in the village and the surrounding areas, afterwards the textile industry was very important for the existence of Winterswijk.

This analysis addresses the legacy of the textile industry in Winterswijk: the ensemble of textile factories. As a case study five typologies are researched.

The analysis of these buildings is done through the topics of architecture, building technology and cultural values. These topics can be recognised by the text on top of each page: Architectural Analysis (AA), Technical Analysis (TA), Cultural Value (CV).



Research question: - What is the relation between developments in the textile industry and the ensemble of the industrial buildings in Winterswijk?

Background

- How did historic events determine the characteristics of Winterswijk as it is now?
- What effect did the Industrial Revolution have on the village and its textile industry?

Architectural + Cultural Analysis

- How did the ensemble of factories come to existence and what events were crucial?
- What role does the ensemble play in the urban fabric and what is the current situation?
- What are the architectural characteristics of the building ensemble (and five typologies)?

Technical Analysis

- What kind of structures and materials are applied to the building ensemble (and five typologies) within the ensemble and why do they differ?

Cultural Value

- What are the values of different elements or aspects of the ensemble of textile factories

<< Figure 13 Aerial view of Winterswijk. (KLM, 1930)

>> Figure 14 The Netherlands and Winterswijk. (Own drawing based on Google Maps, 2019)

GEOGRAPHY OF WINTERSWIJK

The area of Winterswijk and its surroundings is characterized by layers of centuries old soil which stay very close to the surface. This unique situation is caused by locally moving pieces of the earth shell, pushing and pulling land up and down (W. Peletier & H.G. Kolstee, 1986). The complex soil structure of the area contains much clay and therefore natural

water drainage is very difficult. To control the water, people from Winterswijk and surrounding areas have been digging ditches and canals for ages. Formerly, a river branched towards the Slinge (nowadays Whemerbeek) which became Winterswijk's main waterbody. Although, the creek was very important for the village, sometimes it flooded bringing

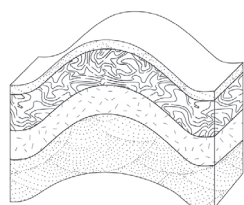
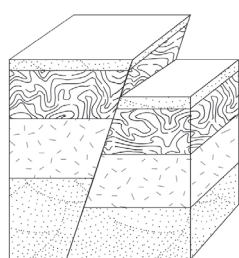
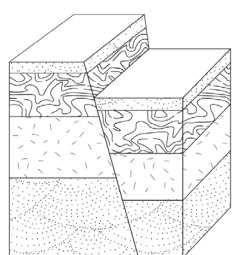

- Quarter
- Pliocene
- Oligocene
- Upper-Chalk
Cenomane
- Under-Chalk
Albien
- Jura - Dogger
- Jura - Lias
- Trias Muschelchalk
- Trias Bunter
- Fault line
- Winterswijk



Figure 15 Soil cracks and movement. (Own image based on J. Neefjes & N. Willemsse, 2009)
 Figure 16 Soil mosaics of Winterswijk and surroundings. (Own image based on W. Peletier & H.G. Kolstee, 1986)

danger to inhabitants until 1400. Then a new waterway was dug to put less pressure on the Whemerbeek. But problems weren't over just yet, because the water in the South still touched the water of the Whemerbeek frequently until the 20th Century, again causing problems with water overflows (J. Neefjes & N. Willemsse, 2009). The river was

also important for the initiation of the village. On approximately the same position as the Jacobskerk is situated now, a church was built around 1100. After the church, some buildings arose next to the Slinge (Whemerbeek) hence they formed a core. It shows first signs of a real settlement around year 1200. (C.J. Frank & M. Lemmens, 2016)

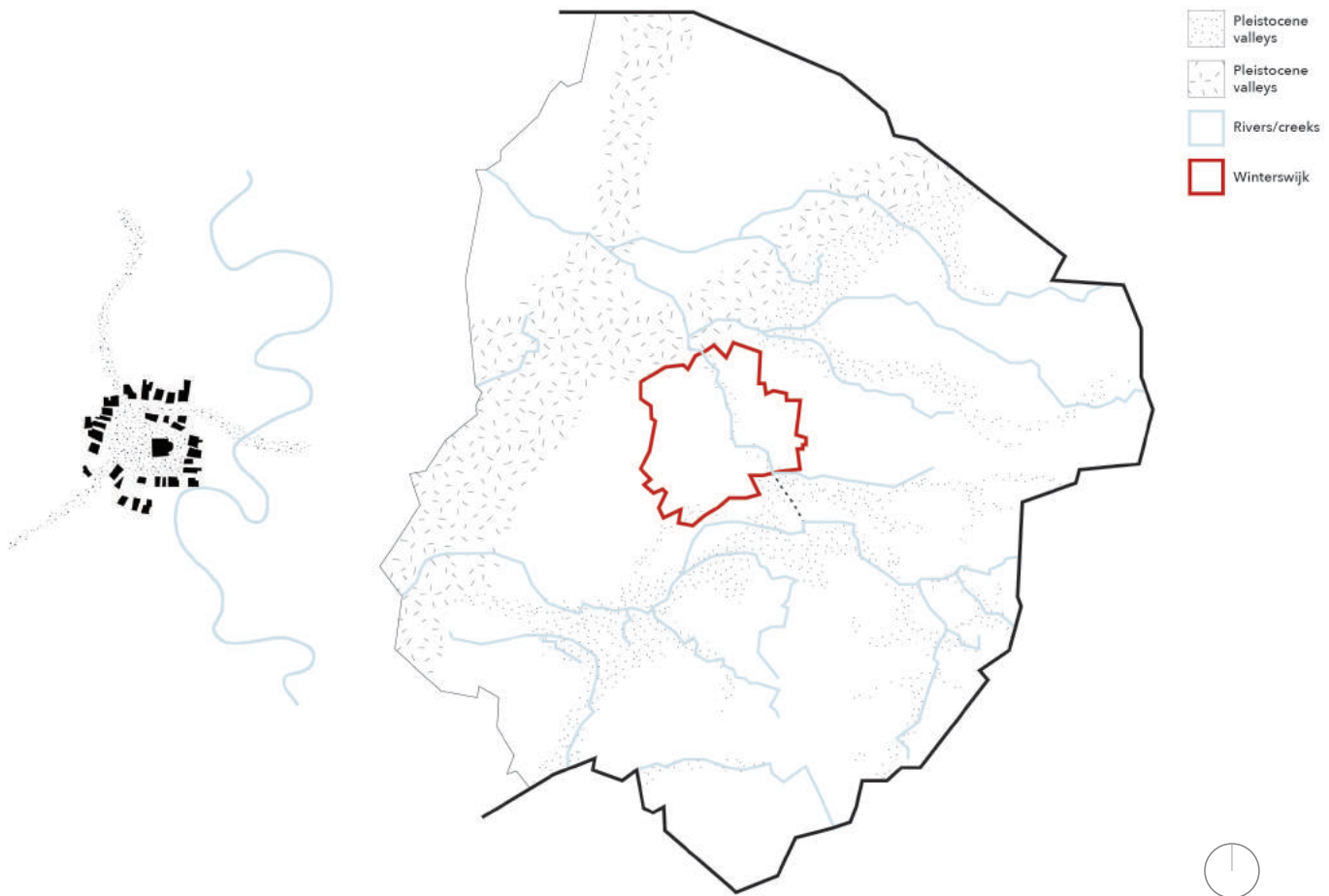

Figure 17 Settlement of Winterswijk around 1200. (Own image based on J. Neefjes & N. Willemsse, 2009)

Figure 18 Watersystem of Winterswijk and surroundings. (Own image based on J. Neefjes & N. Willemsse, 2009)

AGRICULTURAL WINTERSWIJK

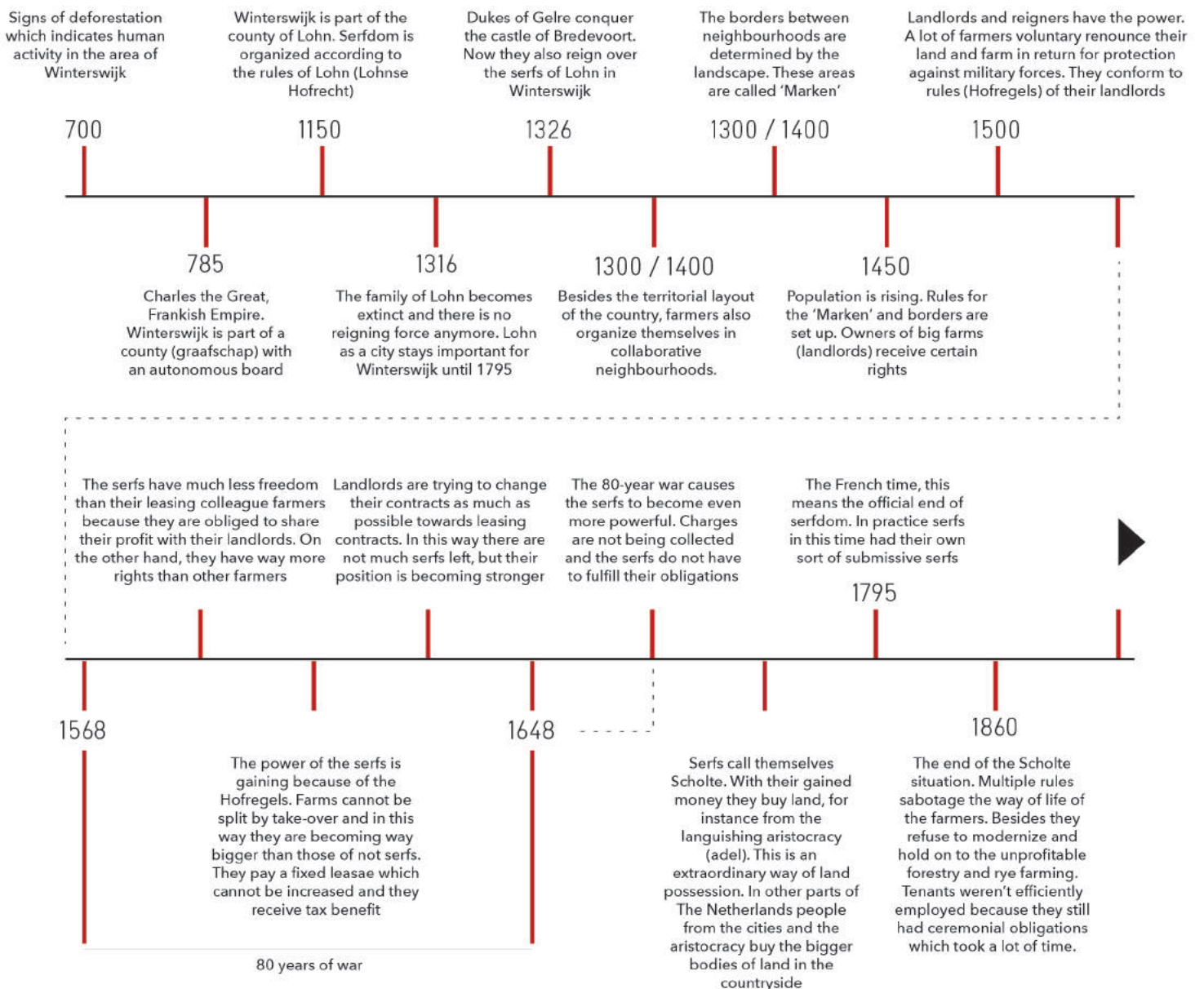

Figure 19 Timeline agricultural history of Winterswijk. (Own image based on J. Neefjes & N. Willemse, 2009)

The history explained on the left has great influence on contemporary Winterswijk.

The landscape is unique because it was created and manipulated by the Scholte farmers. They were traditional people who had the opinion that agricultural production should go hand in hand with esthetics, timber production and hunt. (J. Neefjes & N. Willemse, 2009)

Characteristics of a Scholte landscape (D. Bouten & M. Koman, 2012):

- Widespread forests
- Meandering creeks
- Green estates
- Property vegetation
- Tree lanes
- Scattered farms
- Lease farms
- Timber walls

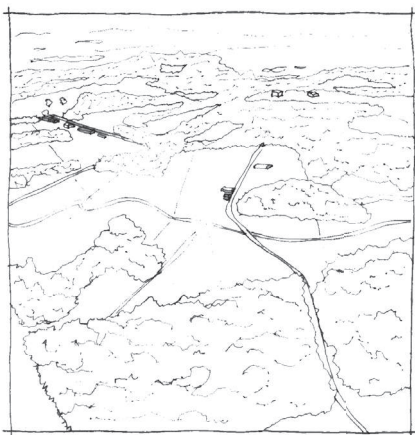
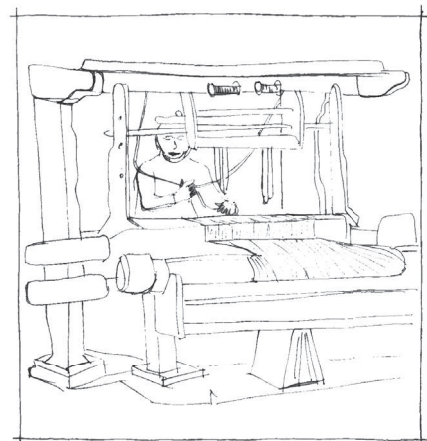

Figure 20 Scholte landscape. (Own image based on W. Peletier & J. Ardesch, 1992)

Figure 21 Textile weaving in Winterswijk. (Own image based on Canon van Nederland, n.d.)

Winterswijk's agricultural background was the base for its textile industry. Already from the 16th Century on, farmers grew flax, which is the main product used for linen weaving. The farmers and their families started weaving at home. It was until 1700 when merchants arose who were not producing fabrics anymore, but selling them. The linen industry went down around 1800 when cotton became more popular. Prices of linen increased, while prices of cotton were quite low. In 1816, Winterswijk counted cotton factories, linen weaving mills and bleacheries with approximately 180 employees.

The industry became bigger with the industrial revolution and the introduction of steam engines. (The Netherlands Institute for Industrial Heritage, 1994)



INDUSTRIALISATION OF TEXTILE INDUSTRY IN WINTERSWIJK

From the beginning on, way before the year 1900, England was taking a lead position in mechanisation and industrialisation. This is strongly linked to textiles, generally cotton. Technical developments like the 'flying shuttle', 'spinning jenny' and the 'mule' are all symbols of this, as well as the steam machine of James Watt. With the introduction of the steam machine, around 1800 big factories emerged and a lot of labour was created. Labourers moved from home business to work in factories. The Brits tried to keep their machines to themselves and had strong control on their borders to prevent people from smuggling machines and knowledge to other countries (Lintsen, 2009). Because of this, the steam machine was rarely introduced in The Netherlands until 1850. In 1830 the first steam driven spinning machine was introduced in the eastern part of the country (Blanken & Lintsen, 1981)

For weaving, the process went even slower because the machines were expensive and still a relatively large amount of labour was needed to control them. In 1861 pioneer Hendrik Willink from Winterswijk made a brave move to build a weaving factory with steam driven weaving stools (a lot of spinning and weaving factories in East-Netherlands already got bankrupt due to overambitious

leadership and fires). After 12 years the first small factory of Dericks, after Poppers, was established and 25 years until three even more viable business emerged: it still was a slow process. In the meantime, the labour shifted from home towards the factories: in 1867, 190 men, 100 women and 70 children worked there.

The textile industry kept on growing afterwards and also survived the war, but Winterswijk's big share in this industry came to an ending. In the 60's and 70's rivalry from the East became too big and factories had to close their doors: a lot of people lost their jobs, of which a lot of people from Winterswijk itself. In the end, only one weaving factory in Winterswijk has survived, but only with the help of the municipality. They bought the former Batavieren campus which includes 'De Pol' in order for Gaudium to move there and fix their business and finances. Smart management and a new way of business saved the last textile factory of Winterswijk. Instead of mass production weaving, they decided to focus on specialized carpet weaving (Willink, 2006). Because of this decision, nowadays they still exist. Weaving factory 'De Tuunte' closed in 2000, but is active now as a fashion brand and still has its storage next to Gaudium.

TEXTILE FACTORIES IN EAST-NETHERLANDS

The introduction of the steam machine in the textile industry and its specific technical demands resulted in a new type of building: textile factories. The Dutch looked at England for examples of this type of building, since it was a new architecture.

1830-1860

As explained earlier, the first big factories were spinning factories. These were relatively big, high buildings with a kettlehouse and a chimney according to the English model.

A factory for weaving purposes needed a different approach. Mechanical looms (powerlooms) weigh way more than spinning machines. They also cause a lot of resonance on the structure of the building. Because of this, a multi-storey factory for weaving would be way too expensive. A new type of building was adopted from England: the saw-tooth roof factory. This type of building with cast iron columns had rooflights facing the north for perfect light distribution into the hall. The south facing parts were covered (Tuinstra, 2006).

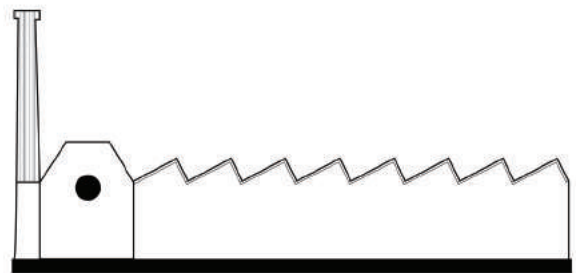
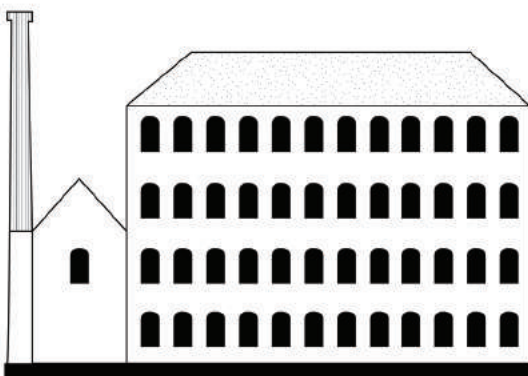

Figure 22 English model spinning factory. (Own image based on Tuinstra, 2006)
Figure 23 English model saw-tooth roof factory. (Own image, 2019)

TEXTILE FACTORIES IN EAST-NETHERLANDS

1860–1880

The Fairbairntype factory. Instead of timber beams, cast iron was used for construction. Factories were better protected against fire.



1880–1910

The Lancashiretype factory.

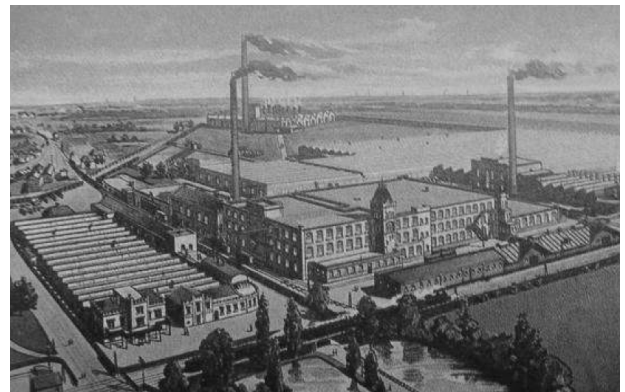

1880–1910

The Lancashiretype factory. This one in Oosterhout was the last building of this type. It still had cast iron columns and steel beams.



1910–1950

Concrete as a building material was introduced. A column-beam structure provided for big openings and a lot of glass.



Figure 24 Fairbairntype. Gelderman, Stork en Eekhout in Oldenzaal. (Tuinstra, 2006)
 Figure 25 Lancashiretype. (Tuinstra, 2006)
 Figure 26 A.G. Beltman, spinning factory Oosterveld. (Tuinstra, 2006)
 Figure 27 A.G. Beltman, spinning factory Almelo. (Tuinstra, 2006)

TEXTILE INDUSTRY AND WINTERSWIJK

When the textile industry flourished (1885-1914), a lot of factories were built. The appearance of the buildings changed, where they first were designed as purely functional, sober structures. More money was available, but also status was important. Factory directors were part of the elite and had to carry this out. They commissioned architects for monumental, decorated buildings.

An important factory architect was Gerrit Beltman, operating in Twente. He started as carpenter but soon became contractor and architect. For a while he was the fixed architect for the pretentious factory of Van Heek, but was then overruled by a cheaper English architect. His son, Arend Beltman studied architecture in Berlin and was specialized in concrete structures. With this he had an advantage on the English architects, and soon Beltman was responsible for almost all factories in Twente and surroundings. Their firm still exists Netherlands (Tuinstra, 2006).

The textile industry left its traces in Winterswijk. Jan Willink himself stood at the base of railway company NWS in 1878 which transported coal from the Ruhr area in Germany through Winterswijk towards The Netherlands. From this the traintracks kept on multiplying establishing connections to Enschede, Emmen, Groningen and Delfzijl. It didn't last that long until the company was taken over by the NS. Commuters were also transported, but didn't make much of a profit. Combined with the fact that coal became unpopular due to the introduction of natural gas and the shift in use from the Winterswijk line towards the Arnhem line, the tracks became scarcely used (Aschman, n.d.). Because of the amount of people and also the wealth connected to the textile industry, a lot of schools, worker associations, sportsclubs and music societies were established. A lot of buildings connected to these activities are still visible in village Winterswijk (SPGS, n.d.).



Figure 28 Willink's Tricot factory. (Archieven.nl, n.d.)
 Figure 29 Former traintracks and station Winterswijk. (Aschman, n.d.)
 Figure 30 Old Ambachtsschool. (Gemeente Winterswijk, 2011)
 Figure 31 Workerhousing. (Google maps, 2019)
 Figure 32 Building of music society Winterswijk in 1922. (Excelsior, n.d.)

THE INDUSTRIAL SITE

The project site consists of multiple buildings and throughout the report this ensemble will be researched. To also get a grip on some

individual buildings, five typologies are selected for research as well.

- A. *Saw-tooth*
- B. *Three curves*
- C. *Pannekoek*
- D. *Waves*
- E. *Pitch*

- 1. *Gaudium*
- 2. *Hazewind*
- 3. *Morsepoort*
- 4. *Janfleur*

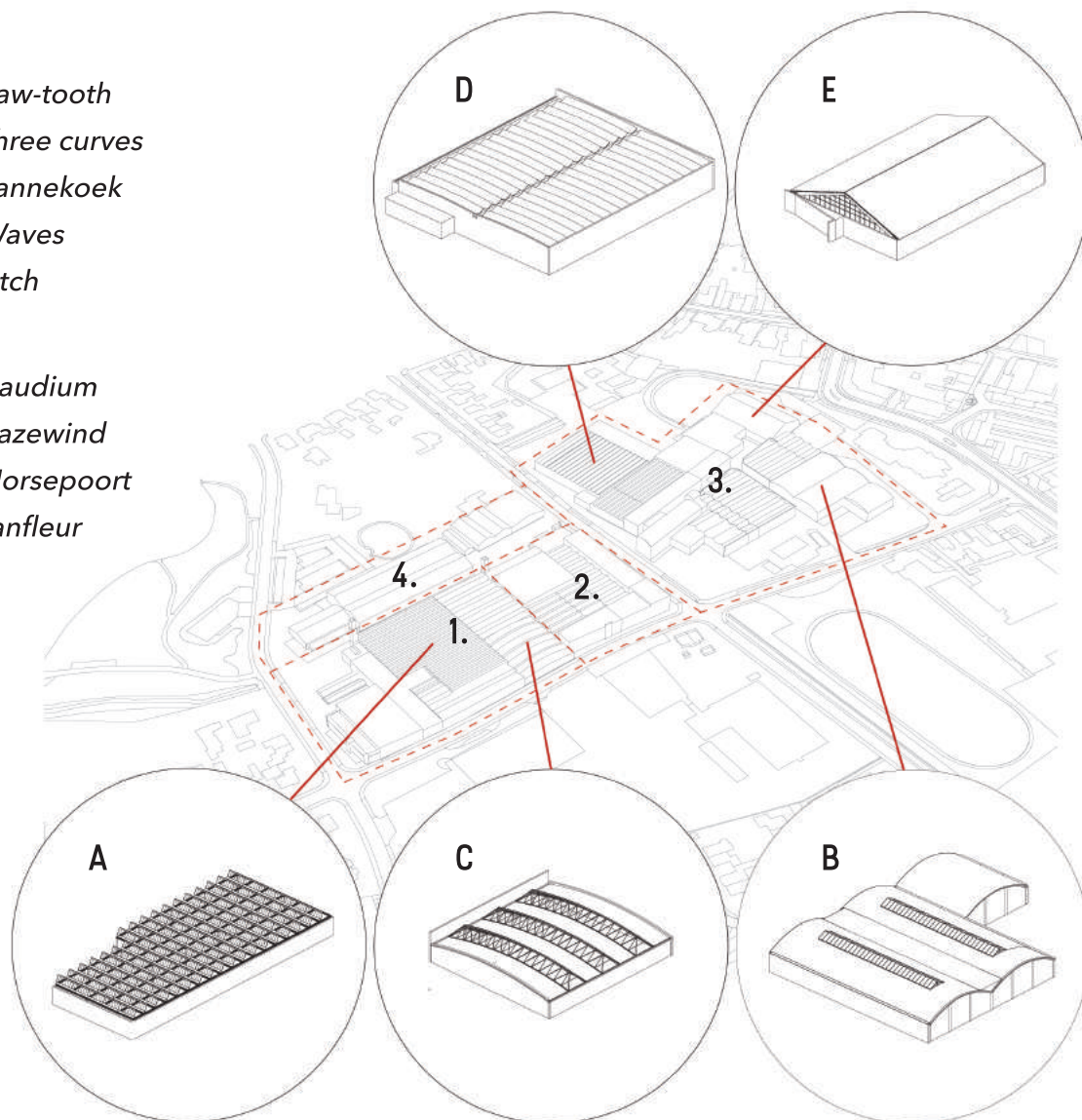

Figure 33 The project site. (Own image, 2019)

FIVE INDUSTRIAL TYPOLOGIES

- A**  *Gerrit Beltman - 1938*
One of the oldest parts of the still existing factory of Gaudium with the oldest saw-tooth roof construction of the area. It is situated in the core of the factory. This part of Gaudium is researched because it is in the interest of the students for redesigning.
- B**  *Arend Beltman - 1955*
This structure is located on the edge of the site close to the village centre and therefore has an interesting location. The building is researched because it is in the interest of the students for redesigning.
- C**  *Jan-Cornelis Pannekoek - 1957*
A building part of Gaudium which is known for its 'special' roof. Since it is a unique typology within the ensemble and it is in the interest of the students for redesigning, this building was chosen.
- D**  *Van Lingen - 1960*
Another typology which is rare within the ensemble is this building. It is interesting because of its location on the edge of the site and its position on top of the creek. The building is researched because it is in the interest of the students for redesigning.
- E**  *Sassen - 1963*
The newest building of the five typologies is situated next to the creek and close to the village centre. The building is researched because it is in the interest of the students for redesigning.

Figure 34 Five selected typologies. (Photos by Joost Jooisse, Chen Zhu and Juliëtte Zegers, 2019)

CONCLUSIONS

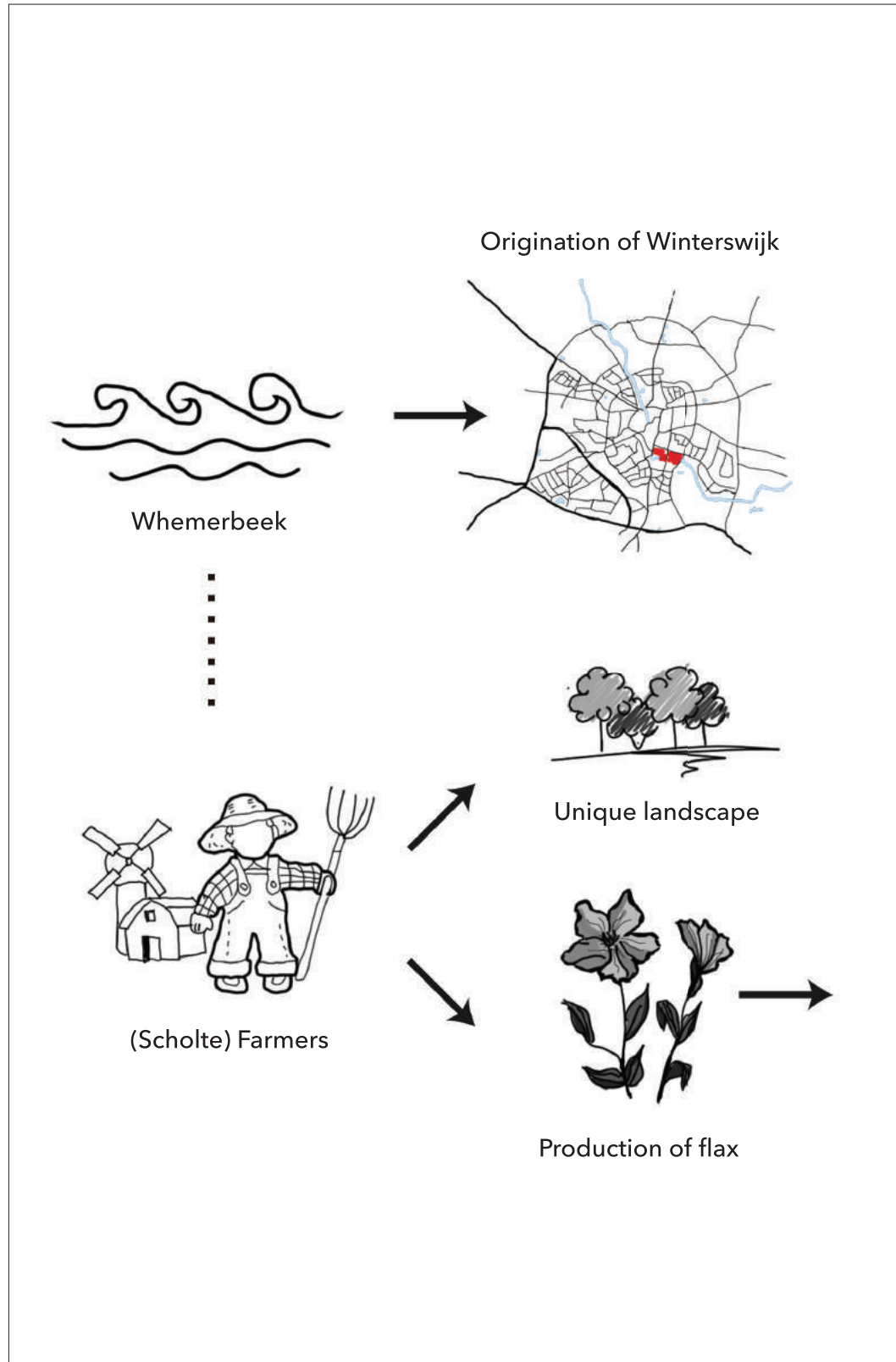
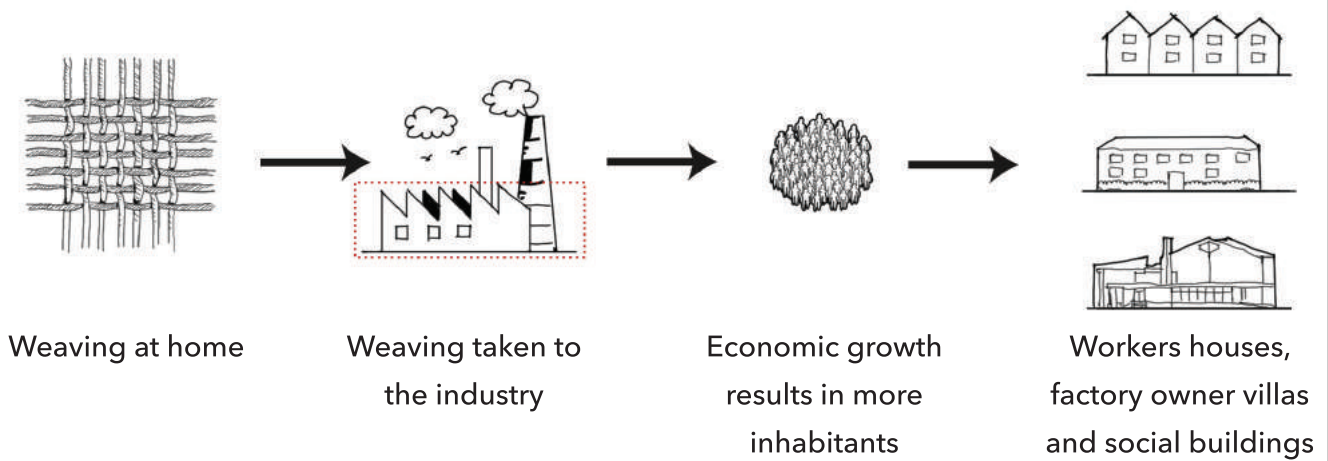

Figure 35 Conclusions. (Own image, 2019)





II SURROUNDINGS ANALYSIS

The project site evolved over time and cannot be seen without context. For that reason, it is important to understand the conditions of the surroundings of the site. Starting from a bigger scale considering the village of Winterswijk working towards a smaller scale on the direct surroundings of the site, the preconditions of the surroundings are researched. The outcome of this research shows the position of the site in the urban landscape and its most important features, to keep in mind whilst designing future plans.

CHRONOMAPPING OF WINTERSWIJK

On the maps until 1895, a strong ribbon development of the city centre is noticeable. In 1895, the first factories develop in the South East of the village where the project site is. Until 1930, the village is expanding. This was also due to the fact that the textile industry

grew rapidly. In 1955, three big industrial areas have risen, all on the edge of the village. From 1975 on, the industrial area in the West of the village disappears. The assumption is that it was due to the fact that the factories closed because of competition from the East

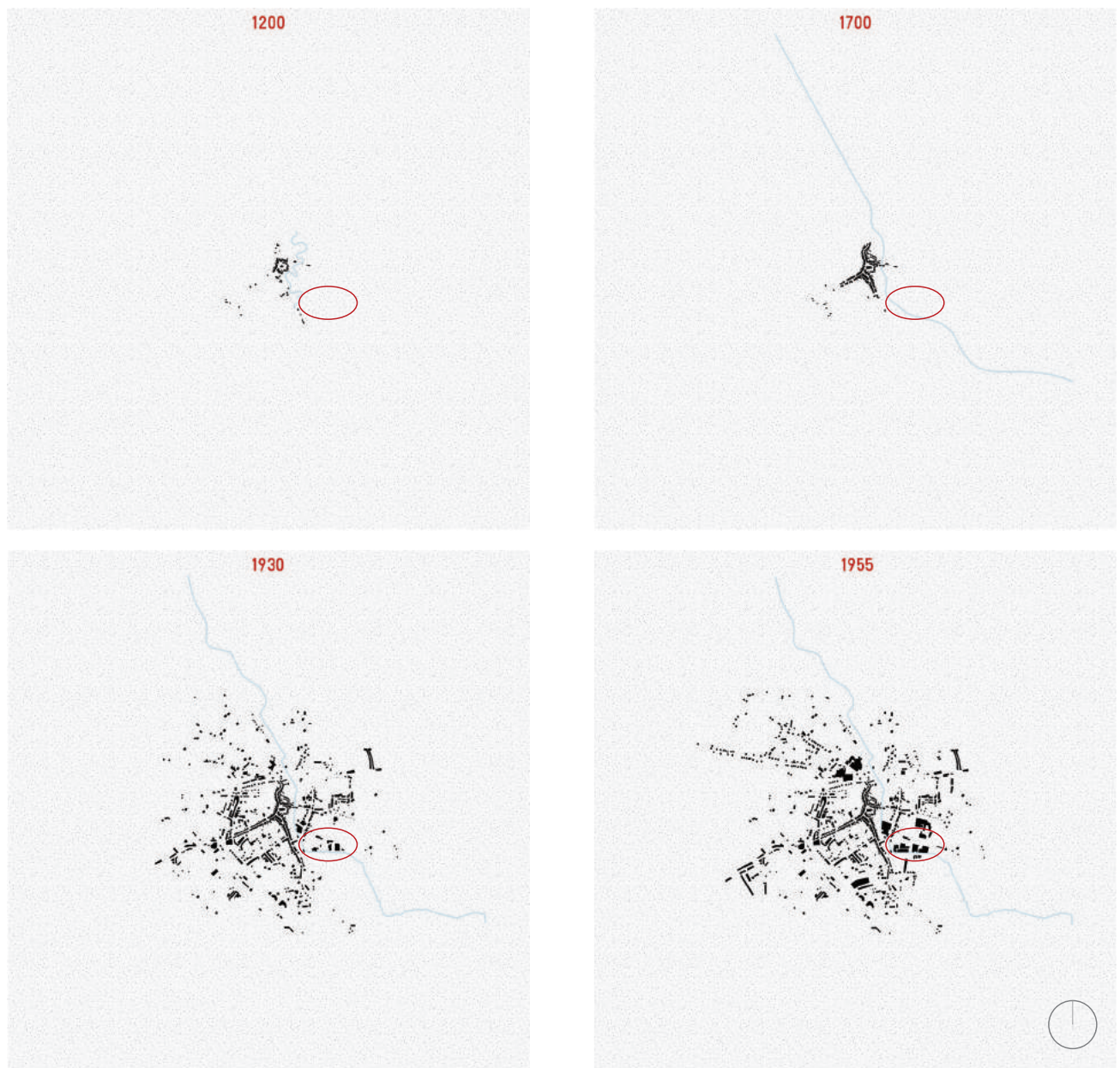
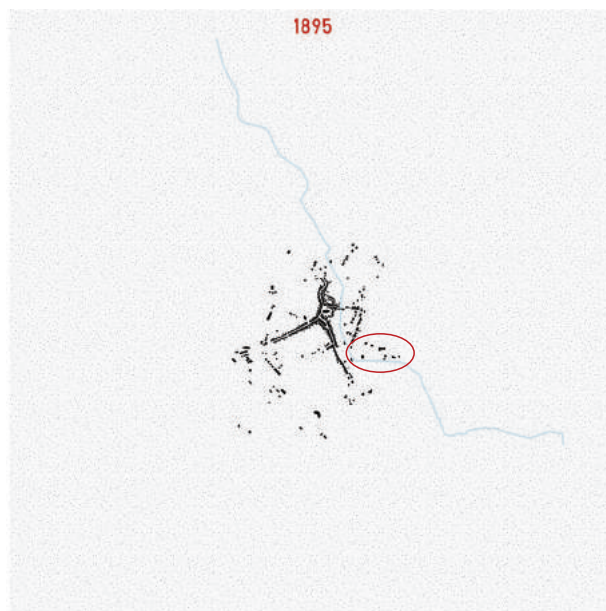
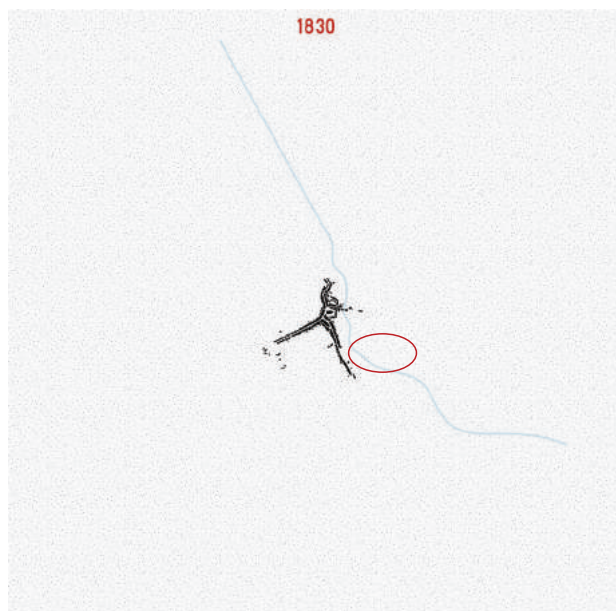

Figure 37 Chronomapping of Winterswijk. (Own images based on Hisgis 2019, Kaartenkamer TU Delft 2019, Nationaal archief n.d., Neefjes & Willemse 2009, RAAP n.d., Rijksarchief Gelderland n.d., Topografisch bureau n.d., Topotijdreis n.d.)

and therefore production decreased. Willink's Tricot factory for example, has closed its doors in 1978 (SPGS, n.d.). The industrial areas make room for new expansions of the village, mainly to the West. Somehow the East stays underdeveloped and the project

site stays at the edge of the village. Despite further developments, the site still holds a connection towards the hinterland in 2018. Also from this map, a big industrial area is visible in the South of the village. It explains the deflation of business from the centre.



INFRASTRUCTURE OF WINTERSWIJK

Winterswijk itself is easy to reach by car, train and bike. It is completely surrounded by provincial roads with branches inwards, even almost touching the centre of the village. The train station is located close to the centre creating a connection for public transport.

Winterswijk is situated very close to Germany. To cross the border it takes:

- 12 minutes by car
- 30 minutes by bike
- 1 hour and 45 minutes walking



Figure 38 Accessibility and infrastructure. (Own image based on Kaartenkamer TU Delft, 2019)

GREEN AROUND WINTERSWIJK

As explained before, Winterswijk has a rich history on soil, use of land and the 'Scholten' farmers. The surroundings of Winterswijk still link to this unique history and great nature can be found around the village. The map shows large structures of green around the area of

Winterswijk. One of these green areas is reaching to the industrial area. From the map it can be concluded that the area has a key location towards the nature.

Besides, as pointed out in the North, the surroundings hold big recreational areas.



Figure 39 Green and recreational areas. (Own image based on Kaartenkamer TU Delft, 2019)

URBAN SECTION

The urban section shows us some characteristics of Winterswijk. In the first place the transition from one area to the other. Starting from the green surroundings and moving through the city centre towards the other side of town, ending in the green surroundings again: Winterswijk is almost an island in its green surroundings. The section shows the variety of functions in the village where also German tourists like to take advantage from.

Bigger buildings emerged alongside the edge of the village where the city centre is quite horizontally structured with no big tall buildings, except for the three towers: the 'Raadhuis', 'Jacobuskerk' and 'Jacobskerk' (only one church is shown). The music school 'Boogie Woogie' is situated very close to the industrial area, just like the city centre itself, all in walkable distance from each other. Again we see the unique position of the industrial area towards the hinterland.

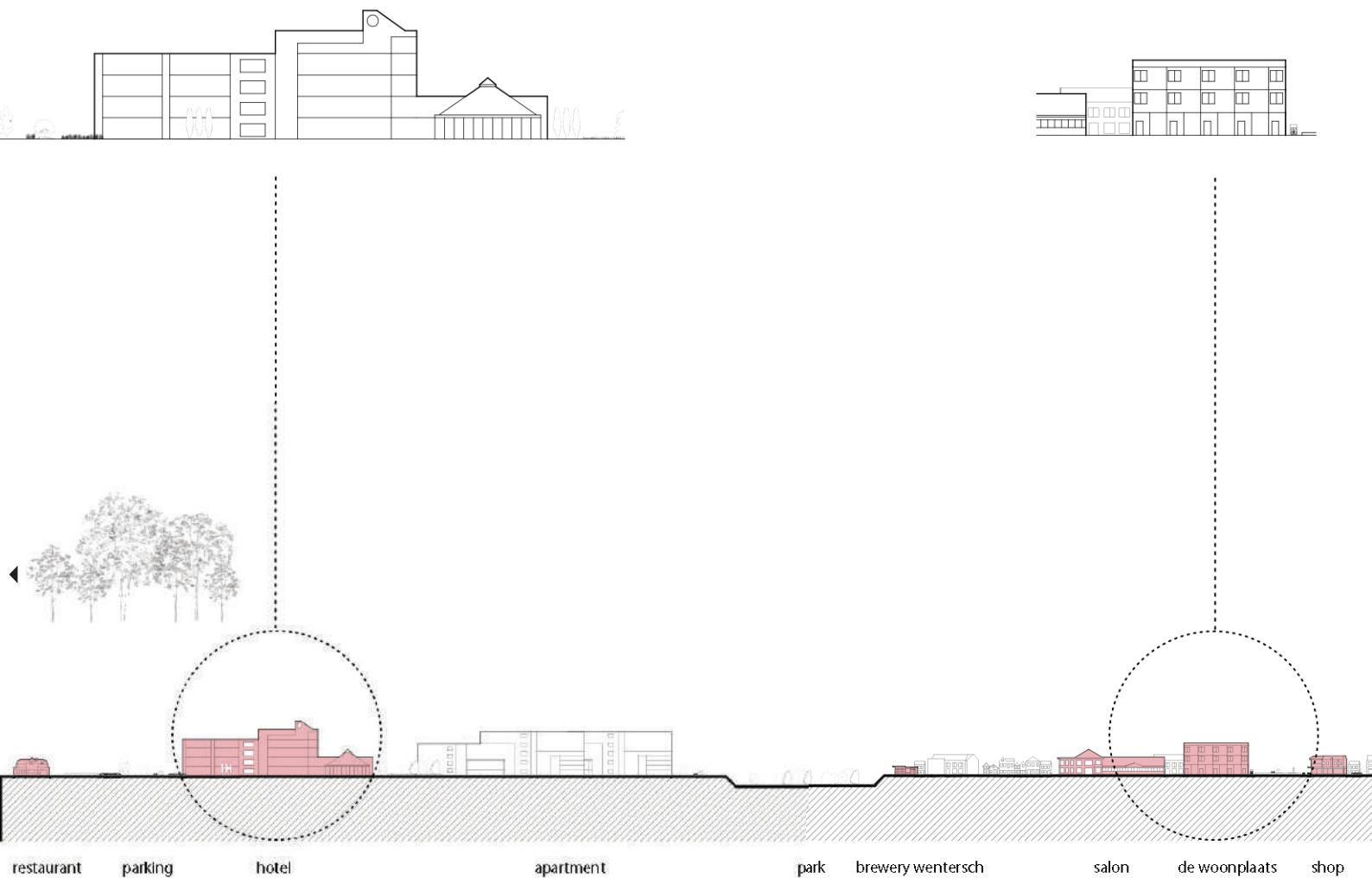
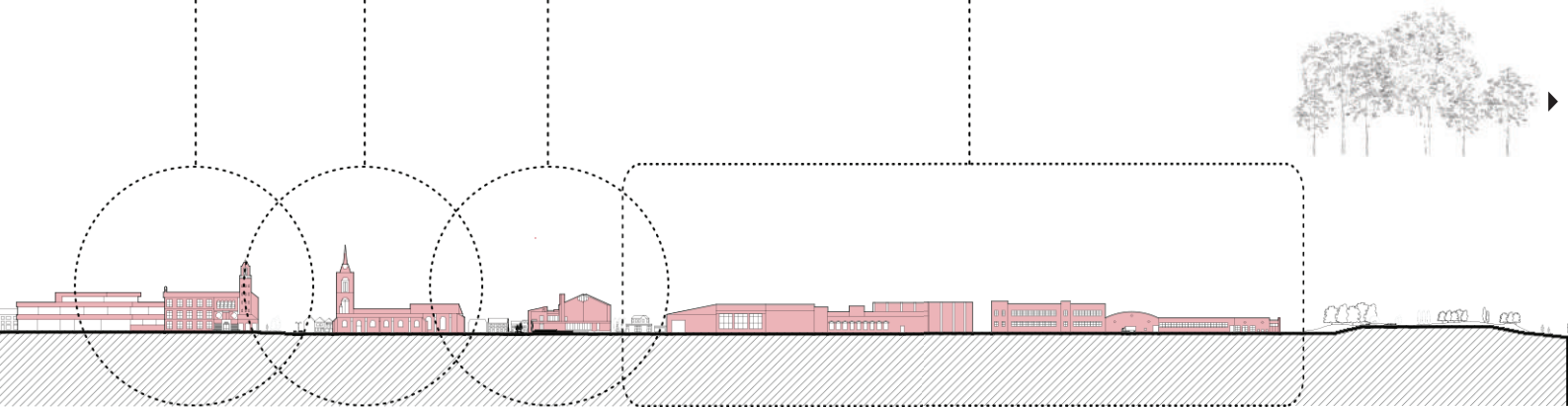
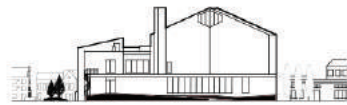
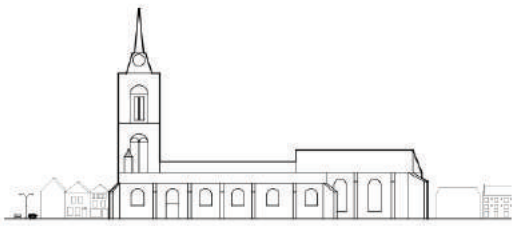

Figure 40 Urban section of Winterswijk. (Own image based on Google, 2019)



rabobank raadhuis main church boogie woogie textile factory area skateboard park

GREEN AND WATER

Zooming more into the surroundings of the site, bodies of water and green are also visible. Especially the Whemerbeek stands out, crossing the site, where it is covered and not visible, and running towards the green area South-East of the site.

As for green, the area is surrounded by open grass areas. Some of these areas also contain qualitative green, like trees and other greenery.



Figure 41 Green and water structures of the surroundings. (Own image based on EduGIS, 2019, Global Surface Water, 2019 & Google, 201941)

FUNCTIONS

The industrial area holds a unique spot in the urban fabric of the village, also because of its function and the contrast with its surrounding functions. The abrupt change from the residential area towards the industrial causes an undefined border between the two. The image also shows the popular shopping area

which more or less ends at the border of the industrial area. Some public functions are situated close to the shopping street and the industrial area. Remarkable is the amount of parking space next to the site. The municipality of Winterswijk values free parking space and would like to keep as much of it as possible.



Figure 42 Functions of the surroundings. (Own image based on EduGIS, 2019 & Google, 2019)

CONCLUSIONS

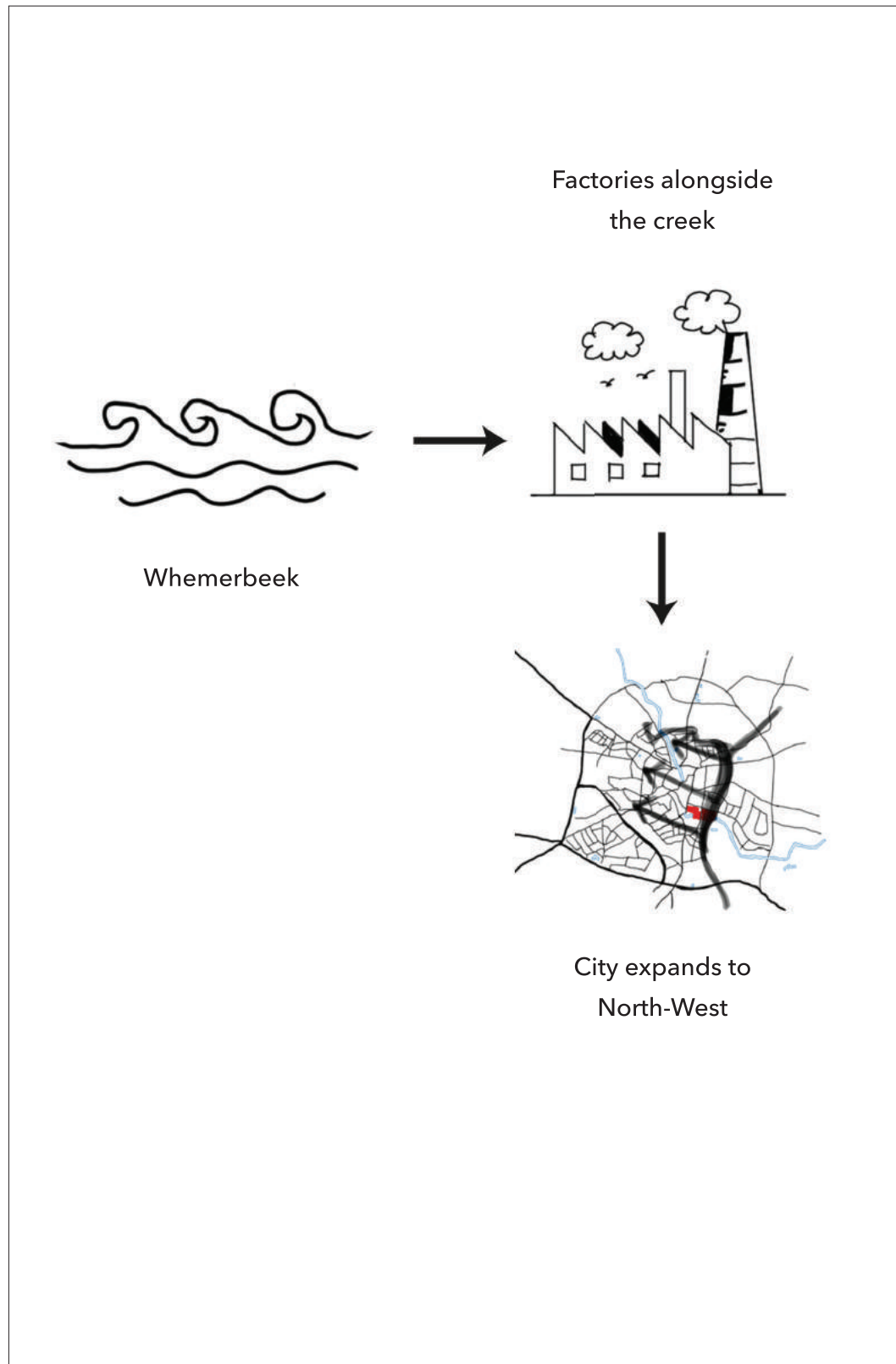
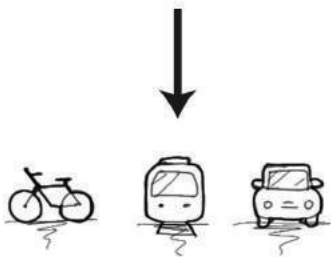
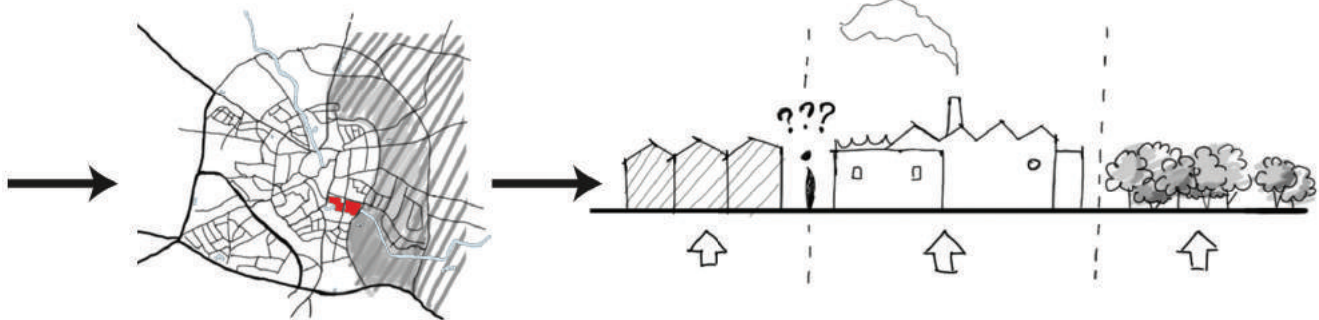

Figure 43 Conclusions. (Own image, 2019)

Green landscape
on East side of the
village

Due to the urban
development, abrupt
transitions occur



Winterswijk and
the site are well
accessible



III SITE ANALYSIS

This chapter is focussed on the project site itself. Since the site and its buildings are heritage, its past should be researched elaborately. The events, connected to the textile industry, that shaped the site are crucial for the appearance of the site nowadays and will also be leading in the further process of shaping the site. After stating the conditions of the past, the current situation is researched to define the elements which are of significance for the site as it appears nowadays. These elements can be tools to use for the design.

CHRONOMAPPING

To get a grip on the historical development of the site, the economic happenings and changes of the textile industry in Winterswijk are explained first.

Although there were weaving and spun activities for ages in Winterswijk, it did not fully utilize the benefits of this skill. This had to do with the inhibitory effect of the gild in Winterswijk. A gild is an medieval association of merchants and craftsmen, in this case focused on the weave and spin craft. This gild disappeared during the 18th century.

The foundation of the Dutch Trading Society (NHM) financed the 'Twentse' and 'Achterhoekse' textile industry, due to profits of trading between The Netherlands and India. In Winterswijk the weavers Tenkink, Winnink and Meijerink received orders of the NHM since 1837. Before that these small textile firms were not important fabricators and did not had a factory. Only the orders and administration of Meijerink is well kept. Jan Willem Meijerink, who descended from a member of the gild, founded his company in a house dated from 1835. This company consisted of approximately ten weavers and was situated at the 'Lappenbrink'. Tenkink had a bigger company and also a larger capital in comparison with Meijerink. According to 'Heren van de Stoom', Tenkink, Meijerink and Willink also had other trading disciplines besides the textile trading. Most of these generation weaving firms stagnated around 1860 due to a crisis. However, Hendrik Willink and his brother Jan Willink survived this period of stagnation.

Throughout the history of Winterswijk, there has never been any spinning or bleachery firm. These crafts were at that time very expensive to execute and needed a lot of knowledge. Most of the firms in Winterswijk bought their yarns elsewhere and bleached their products in Goor or Eibergen. This is probably the

reason why, in comparison with the rest of Twente, the 'Winterswijkse' textile industry powered by steam engines had a slow start.

① In 1861 the first factory emerged in Winterswijk commissioned by the brothers Willink. It was called H. Willink & Co located at the Zonnebrink street. H. Willink & Co fused in 1964 with the company Blijdenstein. The family Blijdenstein was founded during the end of the 19th century in Enschede. Blijdenstein-Willink was situated alongside the Groenloseweg, nearby the Tricotfactory. The remainings of this factory were demolished in 2003.

② In 1865 the second factory emerged in Winterswijk which was commissioned by J. Willink at the Groenloseweg, outside of town. It took 12 years before the next textile factory settled in Winterswijk which was founded by Dericks. Jan Willink's merged with Willem Paschen in 1869 and continued as J. Willink and Paschen (D'n Zwartstoom). In the meanwhile these hand craft textile firms changed into a steam driven industrial company. The 'Zwartstoom', focused on fur weaving and painting. In 1902 this factory and firm was called N.V. De Batavier.

③ The nephew of Jan Willink, Geert Jan Willink, founded the Tricot factory situated on the Wilhelminastraat. This firm was founded in 1888. (Willink, 2006)

④ In 1919 the company De Tuunte was founded by Huijskes from Groenlo. It was the youngest textile factory of Winterswijk. The former factory was situated at the Europalaan. Nowadays it still has a storage hall alongside the Laan van Hilbelink.

The other textile related factories are situated within the site of this analysis, marked in red. The development throughout history of this district will be explained more detailed making use of the chronomap on the following pages.



Figure 45 Factories in Winterswijk. (Own image based on Willink, 2006)



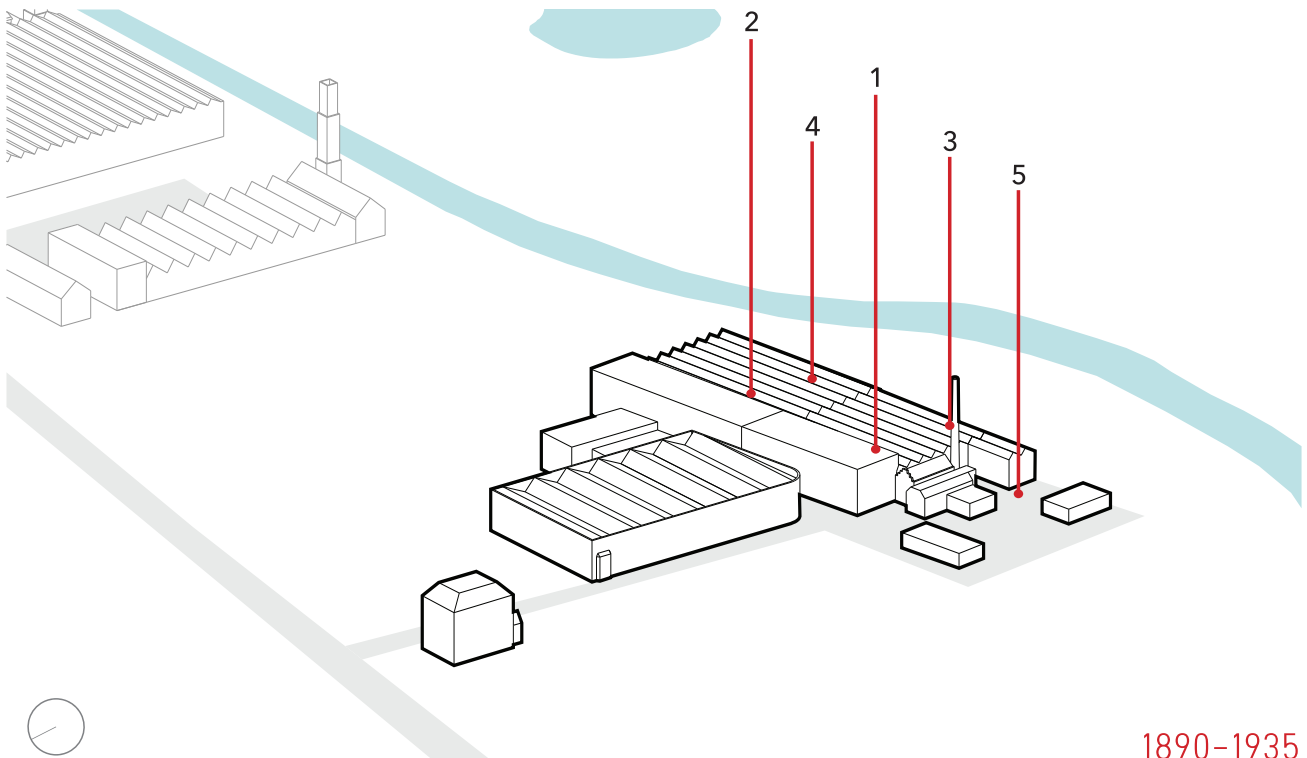

1890-1935

Figure 46 Morsepoort / Meijerink 1890-1935. (Own drawing, 2019)

According to the feasibility study of Nibag, Meijerink & Co was the first textile company which settled in what is called nowadays the 'Morsepoort' in the year 1891.

1 The first industrial building was built and occupied by family Meijerink since 1891. Ancestors of the family had their weaving workspace within their homes, situated in the center of Winterswijk. The old core, dated from 1891, is still present today. Although the gabled roof was replaced by a new floorlevel. (Nibag, 2015)

2 This core extended towards the Morsestraat in 1911, which was two levels high (Beltman, 1911) (Nibag, 2015).

3 A saw-tooth roof addition was made to this rectangular shaped volume towards the South in 1913 (Beltman, 1913) (Nibag, 2015).

4 A similar extension was made in 1916 towards the Morsestraat (Beltman, 1916) (Nibag, 2015).

5 Between 1921 and 1927 the boiler house was made. The buildings which surround the boiler house functioned as small storages, which created an inner courtyard for the workers of Meijerink & Co. The illustration below shows the building ensemble probably during 1930-1935, because the Morsestraat is visible. The Morsestraat was paved between 1935-1936 (Beltman, 1921) (Beltman, 1927).



Figure 47 Meijerink & Co between 1920-1935. (Unknown)

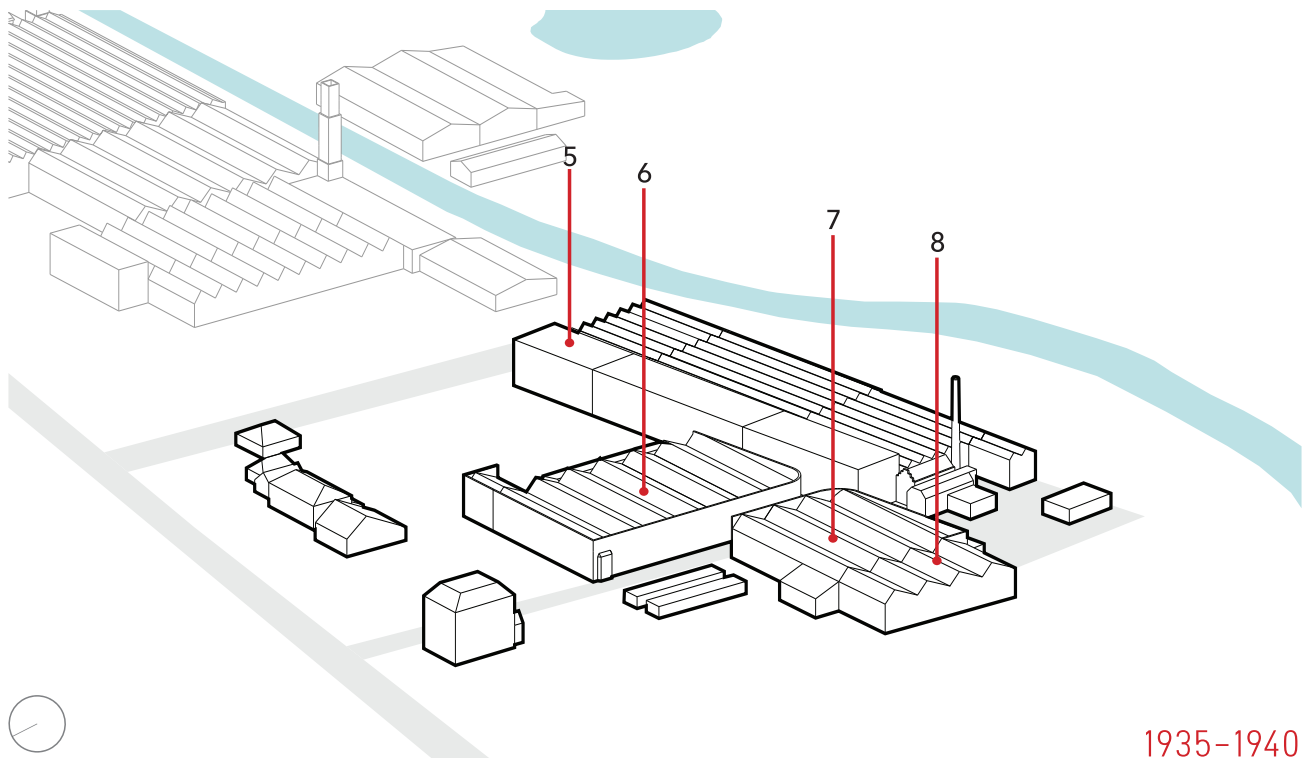

1935-1940

Figure 48 Morsepoort / Meijerink 1935-1940. (Own drawing, 2019)

Facing the Laan van Hillebink, several houses appeared from 1935 onwards. The exact date of the appearance of these dwellings is missing. Assumed is that these were occupied by family Meijerink and other important figures or workers of the textile company.

5 A final extension of the old core was made including the saw-tooth roof typology at the back in 1935 (Beltman, 1935).

6 According to the available drawings, this building functioned as a packing hall. The exact construction date is missing. Although, some drawings from 1937 show that there were already a few adjustments to the layout of the floorplan. Thus assumed is that the

building already was part of the Meijerink industrial ensemble before the timeframe shown above (Beltman, 1937).

7 This building was constructed before World War II in 1941. Similarly as 'building 6' it functioned as a packing hall (Beltman, 1941).

8 The drawings of this extending part of the packing hall is missing. However, by making use of plot drawings of other building parts, one could see that this extension was made between 1935-1939.

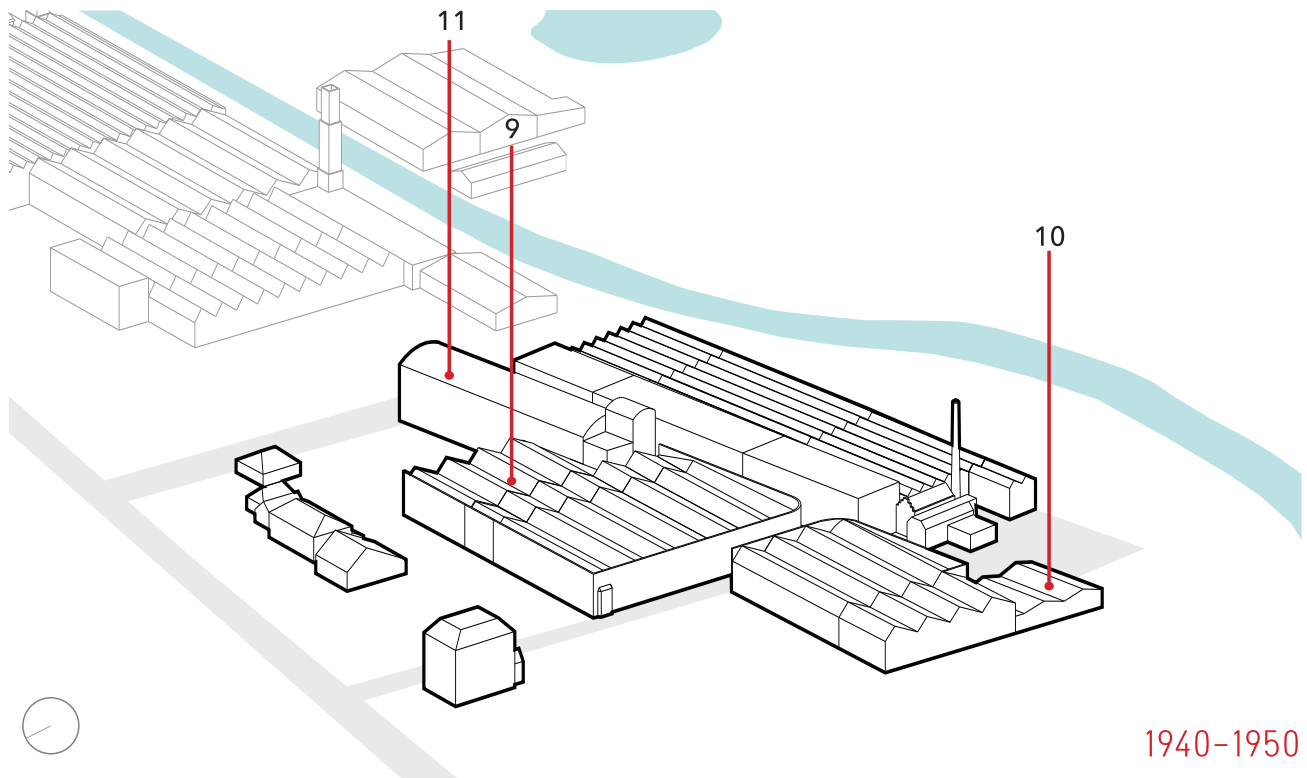

1940-1950

Figure 49 Morsepoort / Meijerink 1940-1950. (Own drawing, 2019)

The illustration above shows the timeframe between 1940 and 1950. The decision is made to show especially this sequence of timeframes, because in really short periods a lot changed to the building ensemble.

9 The renewed office and floorplan was already expanded in 1940 towards the old core. Probably there was still not enough space. Another extension with the same saw-tooth roof construction was built 8 years later towards the Morsestraat (Beltman, 1940) (Beltman, 1948).

10 At the back of the extended office there stood a warehouse. Because of the new addition, the warehouse was demolished in

1940 and built up again at another place in 1948 (Unknown, 1948).

11 The original idea behind this building was just a small addition filling of one level high. However, this plan probably contained not enough space. Therefore, a new design was made by Beltman a few months later. Which consisted of two levels and filled up the whole plot towards the Morsestraat. In this building composition the yarns were spun. It is remarkable that Beltman for the first time chooses for a different building typology for this major addition (Beltman, 1949).

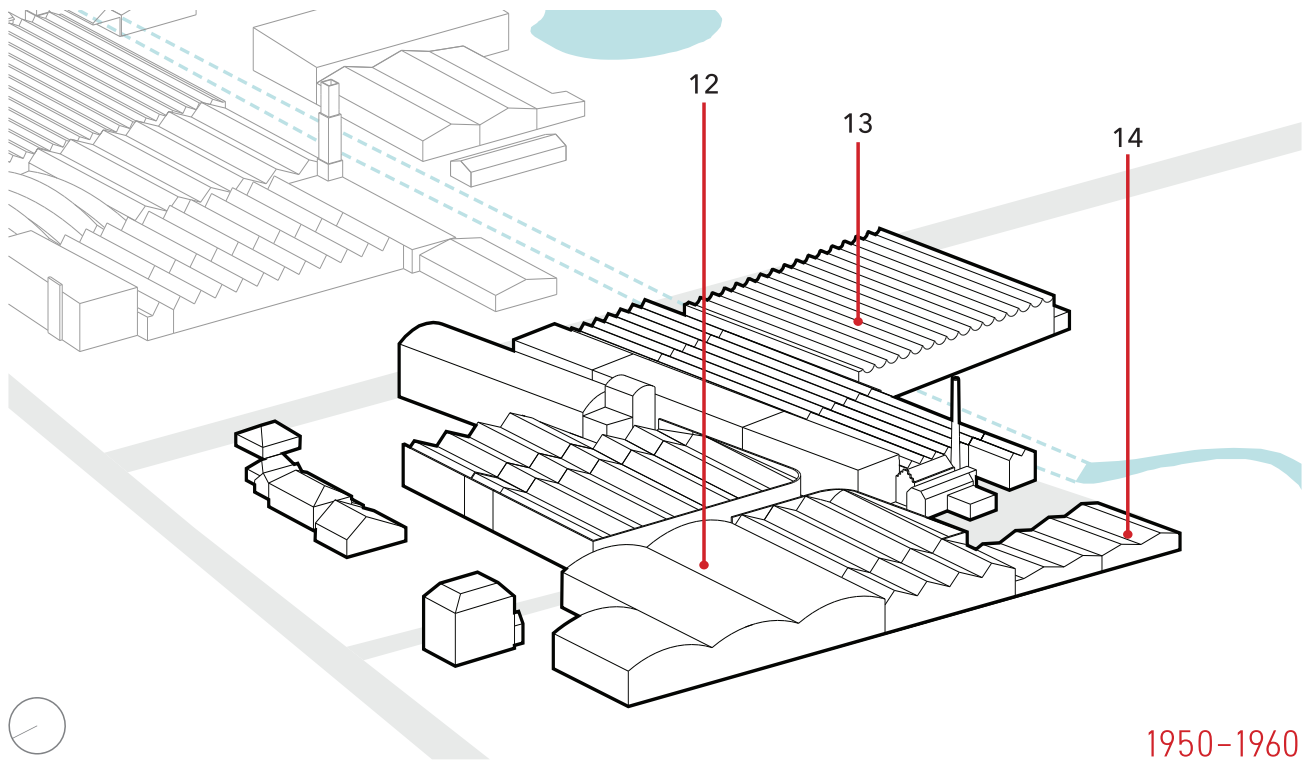

1950-1960

Figure 50 Morsepoort / Meijerink 1950-1960. (Own drawing, 2019)

From the 50's onwards, there still wasn't enough space for the textile industrial activities, which had consequences for the Whemerbeek. The Morsestraat was extended. As well as several industrial buildings which were constructed on top of the creek. One would think that these extensions were a result of prosperity. However, Meijerink & Co got bankrupt and closed in 1963. Textile company Nijverdal-Ten Cate N.V. took over the industrial complex (Peletier, 2000).

12 After World War II the industry not only expanded towards the creek, but it took fully advantage of the whole plot. This extension was just as 'building 11' a new typology introduced in the ensemble. It was the first building which was added after the construction of 'building 11'. The similarity between them is the curved roof shape. This addition was again designed by Beltman in 1955. Obviously the production changed as well. This addition functioned as a preparation room for the weaving (Beltman, 1955).

13 This piece was built in 1960 and intended for weaving. It has a remarkable concrete structure, contrasting a lot with the other typologies of the ensemble (Bouwkundig Ingenieurs-en Adviesbureau Sassen, 1960).

14 The picture on the left (1952), shows the situation from above. As visible, the storage hall which was replaced in 1948 was already enlarged in about 4 years time (Erfgoedcentrum Achterhoek Liemers, 2019).

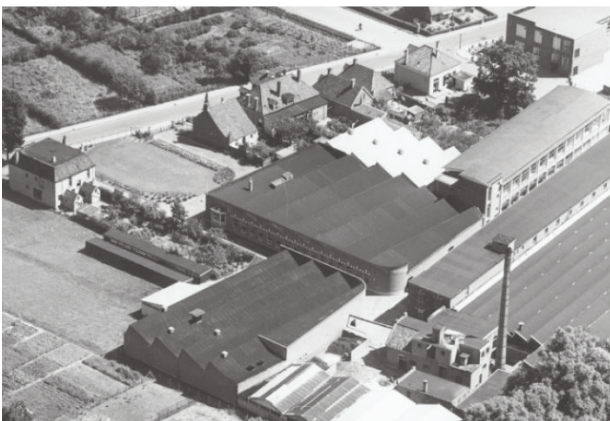

Figure 51 Meijerink & Co in 1952. (Erfgoedcentrum Achterhoek Liemers, 2019)

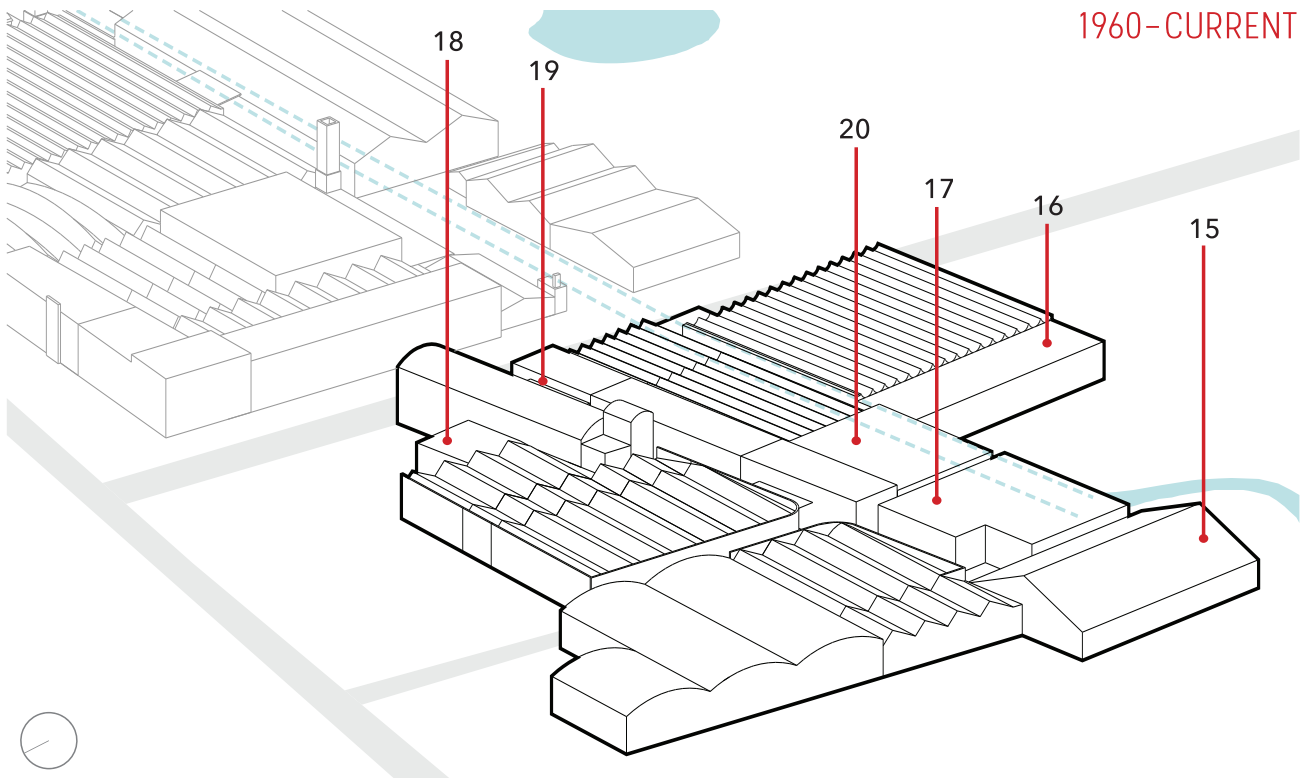

Figure 52 Morsepoort / Meijerink 1960-current. (Own drawing, 2019)

From the 60's onwards a lot interventions were made which influenced the historic urban layout designed by Beltman. All of these interventions were commissioned by Ten Cate. One could say that the complete plot is fully used for industrial purposes. Except for the location were previously the houses were standing alongside the Laan van Hillebink. It is not known when these houses were demolished. Although it left a huge open space which is used as a parking lot.

15 The coherent layout of the same building typologies was lost when a new one was introduced. In 1963 a storage hall for yarns with a wooden structure was built (Bouwkundig Ingenieurs- en Adviesbureau Sassen, 1962).

16 Another storage hall was built at the back of the 'building 13' in 1985. This functional shaped building contained also a canteen and bathrooms (Bouwureau Nijverdal, 1985).

17 In 1988 the former boiler houses were demolished and replaced by a new building. Assumed is that it had to do with a change in production line. Because the primary activities within this building was painting of yarns (Rayonarchitect, 1988).

18 A loading dock/garage was added to the building complex in 1992 (Bouwureau Nijverdal, 1992).

19 With this addition the connection between the Morsestraat towards the industrial area, which was Beltman's intention, was gone. Assumed is that this interruption was made between 1988 and 2000.

20 In 2001 the saw-tooth roof construction at the of the old core, dated from 1913, was replaced by a new building. This design was requested by Huijskes Vastgoed BV. In 1997 the textile activities came to an end. From this period onward the complex was probably owned and rented out by the real estate firm (Reukers Bouw BV, 2001) (Nibag, 2015).

1910–1930

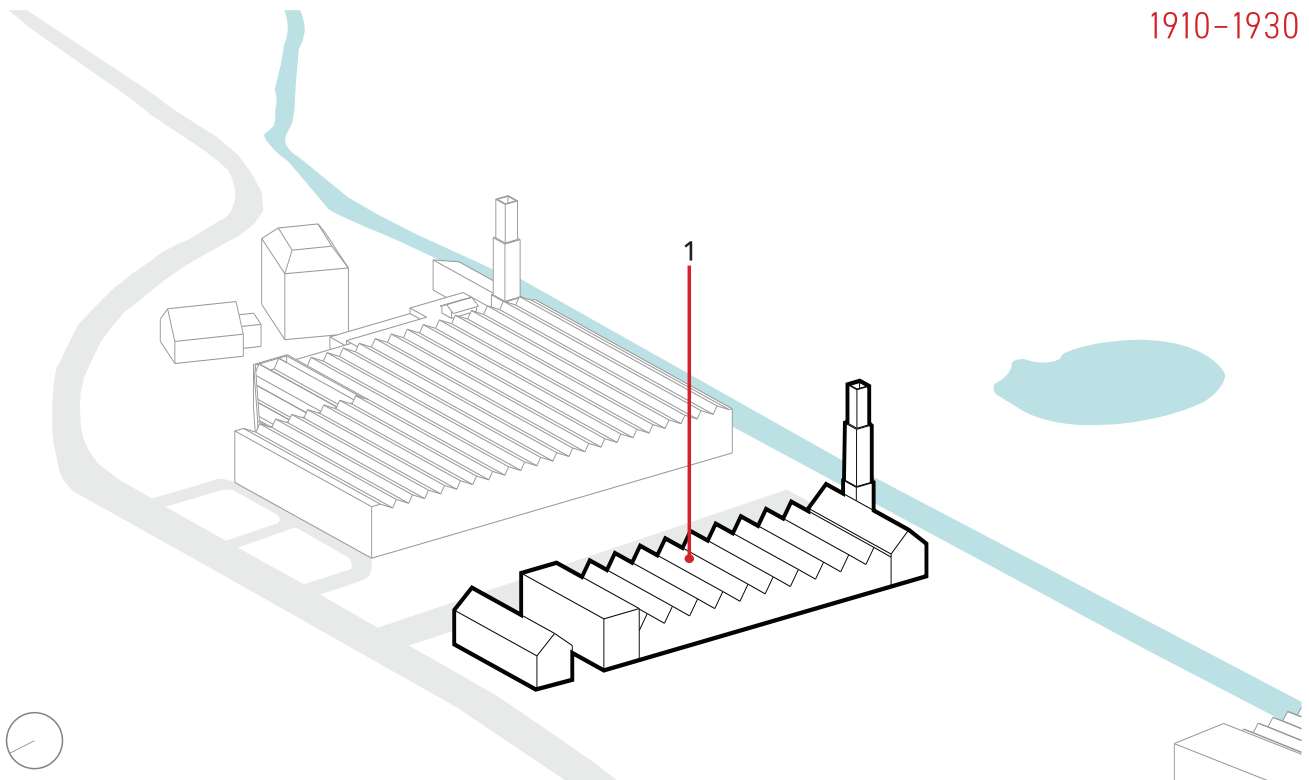

Figure 53 Poppers / Weidemann / Hazewind 1910–1930. (Own drawing, 2019)

The Jewish family Poppers already had a weaving company around 1864 within 'Het Weurden', an area in the center. Around 1890 this family took over a small weaving factory at the Hilbelinkspad. This building ensemble, which is shown in the illustration above, was occupied by family Dericks. From that period onwards the company Weverij M.M. Poppers was founded (Nibag, 2015).

1 Parts of this building ensemble are still present nowadays. Although, it is difficult to say which exact building parts. The original drawings are missing as well as drawings of new extensions of later periods.



Figure 54 De Pol and M.M. Poppers in 1924. (Erfgoedcentrum Achterhoek Liemers, 2019)

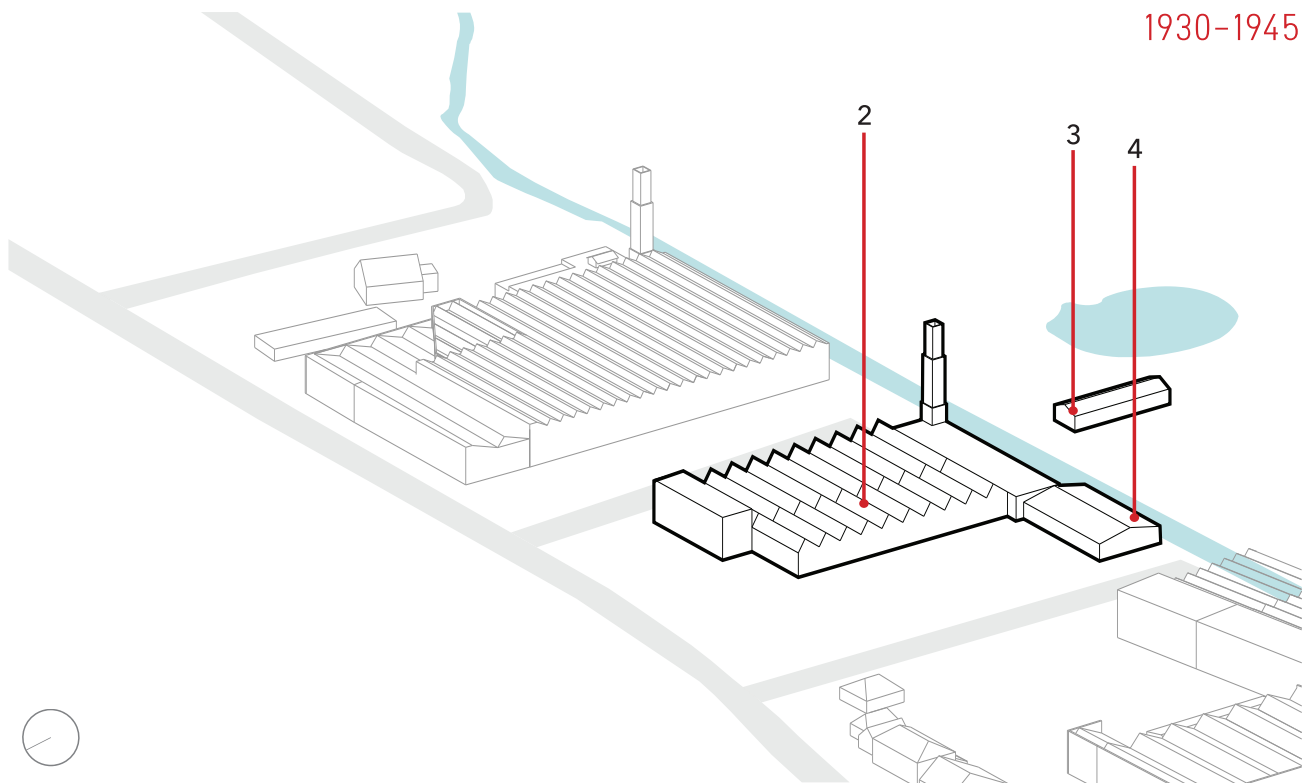

1930-1945

Figure 55 Poppers / Weidemann / Hazewind 1930-1945. (Own drawing, 2019)

During the start of the World War II Poppers had to deal with deportation threats. Therefore the company asked W.H. Weidemann director of Meijerink & Co to take over half of the production. Consequently, the firm was renamed 'Weidemann & Confectie' (Nibag, 2015).

2 The production hall expanded in 1943.

3 Moreover, a storage barn was replaced to the other side of the beek. This barn dates from 1943 and was later taken over by Janfleur (Lammers, 1943).

4 Remarkable is that the drawings of those little barns and storages are still present in the archive of the municipality of Winterswijk. Similarly for this hall, which was rebuilt at the location pointed out in 1944 (Lammers, 1944).

1945-1950

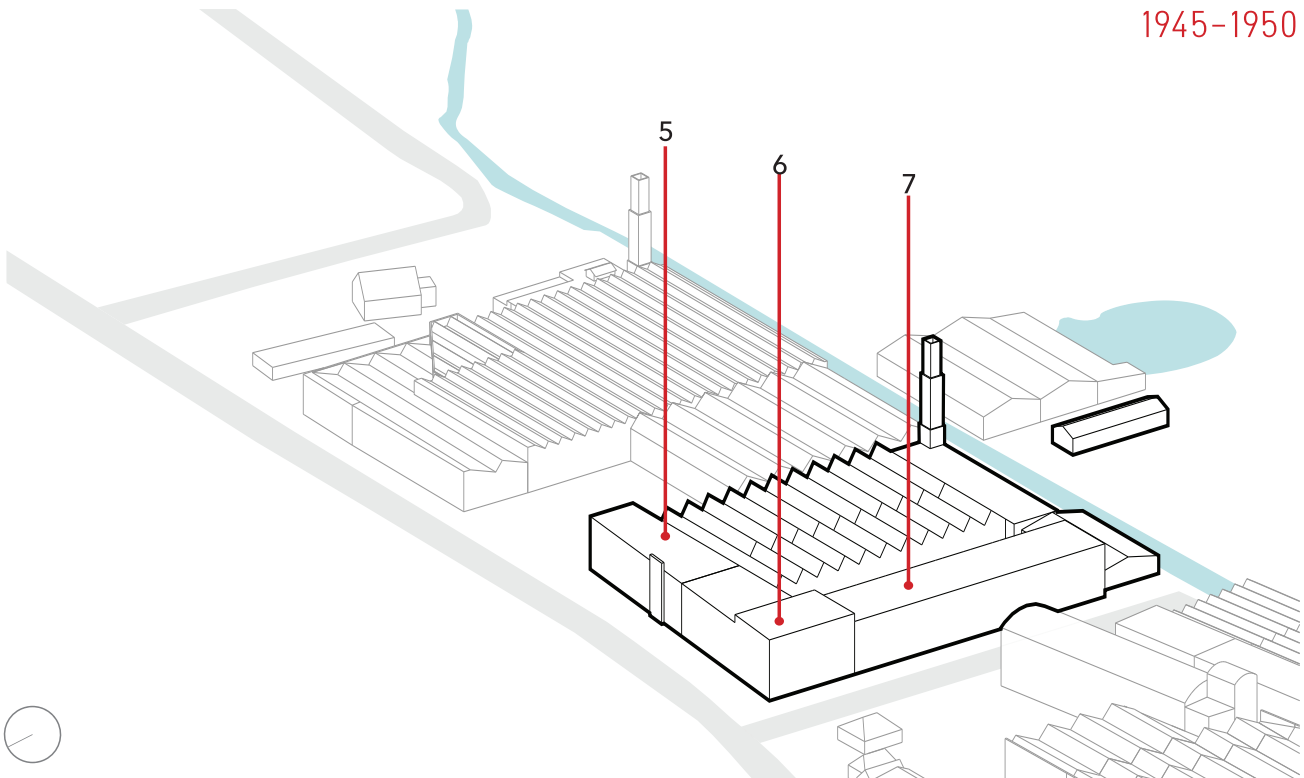

Figure 56 Poppers / Weidemann / Hazewind 1945-1950. (Own drawing, 2019)

A couple of years later around 1948, the company M.M. Poppers was bought out and was renamed in 1950, Weverij 'De Hazewind'. It was named after the badge which stands for the municipality of Winterswijk. During this period of new owners, the building ensemble changed as well (Nibag, 2015).

5 In front of the former entrance of the production halls a new building typology appeared. In 1944 an office was added consisting of two levels. Confection was on the second floor (Schaaf, 1944).

6 At the corner of the Morsestraat and Laan van Hilbelink, a connection was made with 'building 5'. Within this building an ironing room was situated at groundfloor and the confection room was enlarged at the second floor (Schaaf, 1948).

7 Another two years later the composition was 'finished' by adding a similar building alongside the Morsestraat. This building was constructed in 1950 (Schaaf, 1950).



Figure 57 De Pol and Weverij De Hazewind in 1950. (Erfgoedcentrum Achterhoek Liemers, 2019)

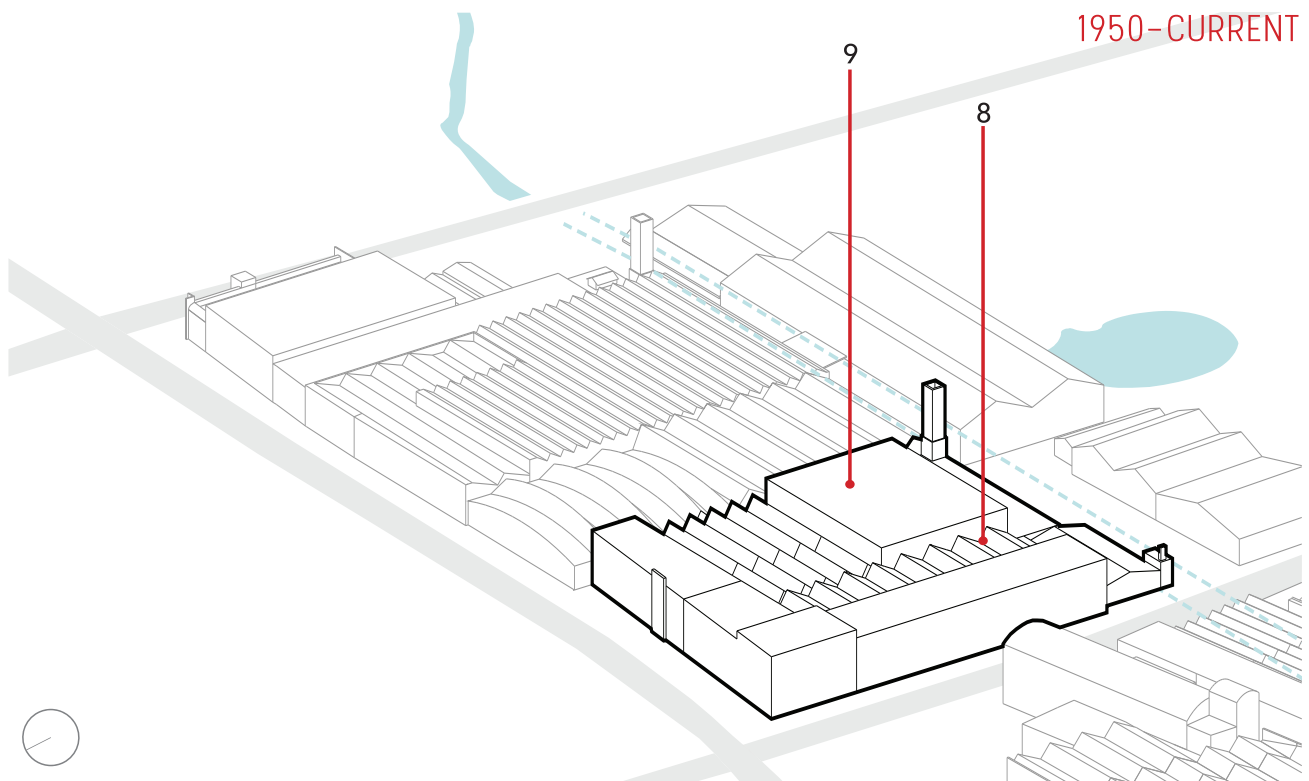

Figure 58 Poppers / Weidemann / Hazewind 1950-current. (Own drawing, 2019)

From the 1950's onwards the building ensemble only underwent some replacements and conservations, on the contrary with the surrounding infrastructure. For instance the Whemerbeek, for what the underground concrete structure was introduced with the purpose of building on top of it. However, in terms of the economics, there were some changes around 1973. During this period Hazewind Kleding Industrie N.V. stagnated and was taken over by Weidemann. In the upcoming years Weidemann had a prosperous period because of the concept Greyhound Fashion, which came to an end around 1990 (Nibag, 2015).

8 Behind the latest addition along the Morsestraat, a new industrial hall was placed consisting of a saw-tooth roof construction in the year 1951 (Nibag, 2015).

9 Behind the remainings of 'building 1', the oldest part, a new hall was made in 1961. Because of this the last pre-war building was gone. The oldest remainings are situated alongside the Whemerbeek (Konings, 1961) (Nibag, 2015).

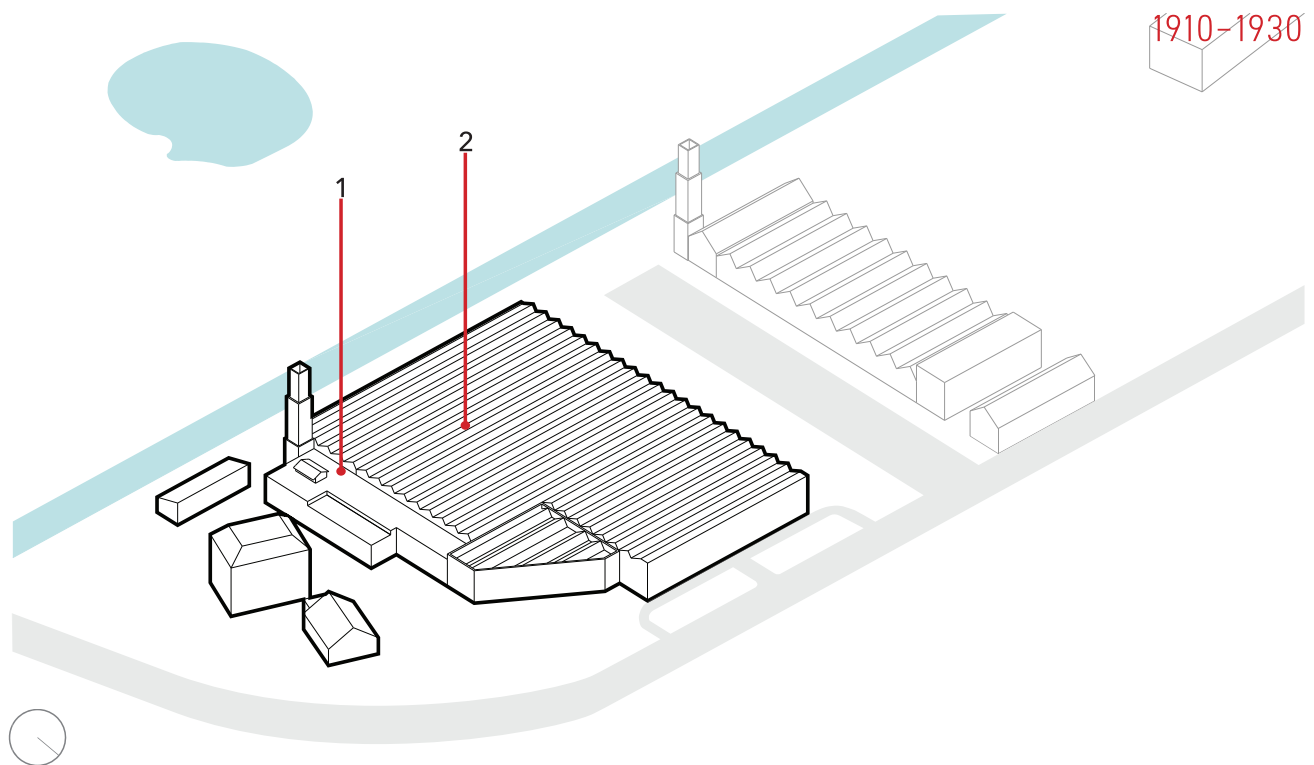

Figure 59 De Pol/Gaudium 1910-1930. (Own drawing, 2019)

The textilefactory 'De Pol' originally was a secondary part of 'De Batavier', which was owned by Jan Willink. The factory was built around 1902. During 1913 the whole plot was already full of industrial buildings. Several shedroof extensions were made towards the plot of Poppers.

1 Nowadays the complete old core, which dates from 1913 is still present. During this period the main entrance was situated alongside the Hilbelinkspad (nowadays Laan van Hilbelink). Hilbelinkspad curved around the plot of De Pol. Eelinkstraat didn't exist yet. Due to a lack of sources, one cannot tell if the

two houses had any link with the industrial activities at the site. This also applies for the triangle shaped extension on the left site of the old core. In a historical drawing of M.J. van Dugteren is visible that it had an entrance, assumed is that it was in relation with the boiler house (van Dugteren, 1928).

2 The boiler house also dates from approximately 1913 and is partly present nowadays. For every industrial company the boiler houses were situated alongside the creek, the Whemerbeek. For the reason that the creek provided the industrial activities for cooling water (Nibag, 2015).



Figure 60 Drawing De Pol 1928. (van Dugteren, 1928)

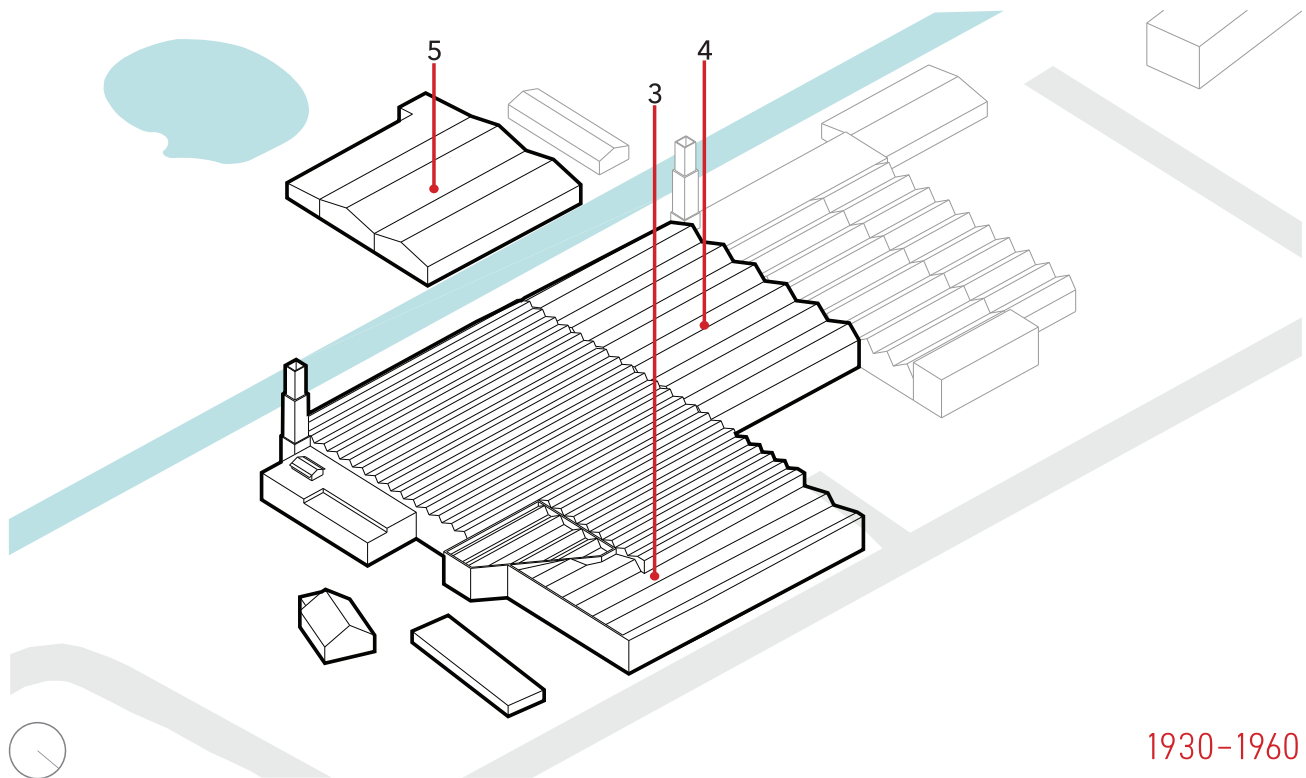

1930-1960

Figure 61 De Pol/Gaudium 1930-1960. (Own drawing, 2019)

According to historic cartographic information, the former Hilbelinkspad was paved around 1936. Moreover, it changed from a curved route along De Pol into a straight line. The Morsestraat was made between 1936 and 1948.

3 The first addition is pointed out. The extension was finished around 1938. It is possible that additions during these times had to do with a major fire at the Zonnebrink factory in 1938. When the Zonnebrink was rebuilt, the production processes were transferred towards De Pol. From that period onwards the complex continued as Gaudium (Beltman, 1947) (Nibag, 2015).

4 This was the second addition of the old core. This extension was made in 1948, also after a fire accident in 1947. The added working space also included additional functions such as a warehouse and dressing rooms for women and men. (Nibag, 2015)

5 According to historic pictures this large ensemble of barns was there before 1948. However, the information is lacking to trace back by who the building was occupied. Assumed is that it was a part of De Pol, because it follows the urban lines of the building across the creek (Erfgoedcentrum Achterhoek Liemers, 2019).

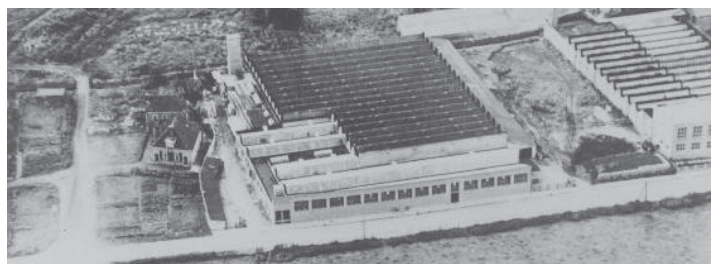
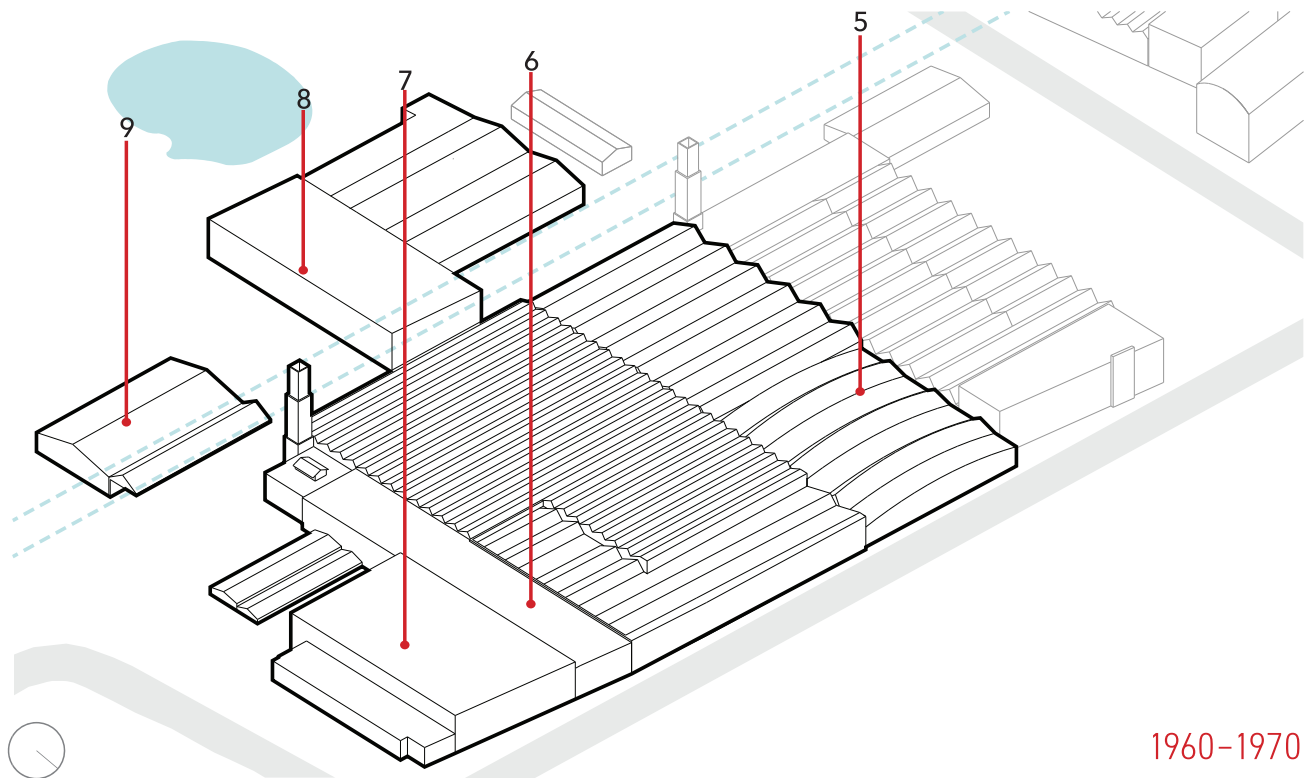

Figure 62 De Pol 1948. (Erfgoedcentrum Achterhoek Liemers, 2019)



1960-1970

Figure 63 De Pol/Gaudium 1960-1970. (Own drawing, 2019)

Around the 60's the Eelinkstraat was added to the urban fabric of this industrial area. Moreover, the Morsestraat was extended and connected with the residential area. This was one of the reasons for creating an underground structure in order to let the water flow and create extra space for expansion. The underground structure was made around 1959.

5 From the 60's onwards there were a lot of extensions in the whole industrial area. The most remarkable added building typology is the so called 'Pannekoek' hall designed by ir. J.C. Pannekoek. This new space was added in 1958 and was used for the weaving process (J.C. Pannekoek, 1958) (Nibag, 2015).

6 In 1957 some additional functions of the factory needed more space and thus expanded towards the Eelinkstraat. Spaces such as a storage, wardrobe, dressing rooms were part of this building part (Unknown, 1957) (Nibag, 2015).

7 Alongside the Laan van Hilbelink a new hall was added in 1960. Because of this addition, designed by architectural office Beltman from Enschede, the sequence of brick industrial facades was stretched out alongside the Laan van Hilbelink. This building contained storage and a rinsing space. Moreover, the former canteen and dressing rooms situated in 'building 6' was replaced towards the front of the building (Beltman, 1960) (Nibag, 2015).

8 Due to a lack of information, the exact date of this addition is not known. Although, by studying the available drawings, assumed is that this hall was added around 1965. It functioned as a carpet hall as part of De Pol (WAM bouwonderneming, 1980) (Nibag, 2015).

9 Several warehouses around the plot were added. The one pointed out functioned as a storage for transport vehicles (WAM bouwonderneming, 1969) (Nibag, 2015).

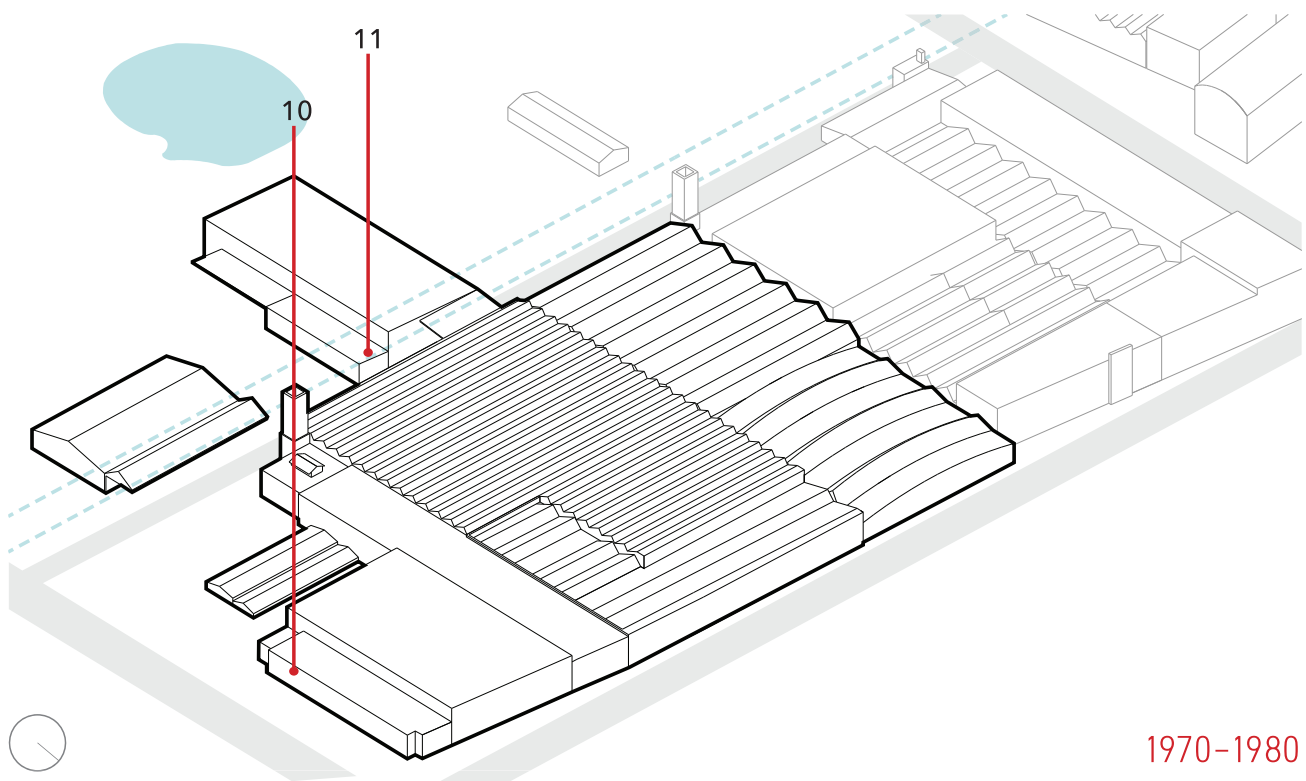

1970-1980

Figure 64 De Pol/Gaudium 1970-1980. (Own drawing, 2019)

Although the textile company ‘De Batavier’ closed around 1980, the production line of Gaudium remained intact.

10 Again the cantine and dressing rooms needed more space and thus the former building expanded towards the Eelinkstraat. Moreover, the current wardrobe transformed to office space (WAM bouwonderneming, 1980) (Nibag, 2015).

11 Around the 80’s a powerplant was added with additional transformer room against the former carpet hall. Probably building ensemble number 11, provided the electricity for the Gaudium (WAM bouwonderneming, 1980) (Nibag, 2015).



Figure 65 Picture former carpet hall De Pol 1999. (Huitink, 1999)

Figure 66 Pictures 1980 transformation to office space. (Not known, 1980)

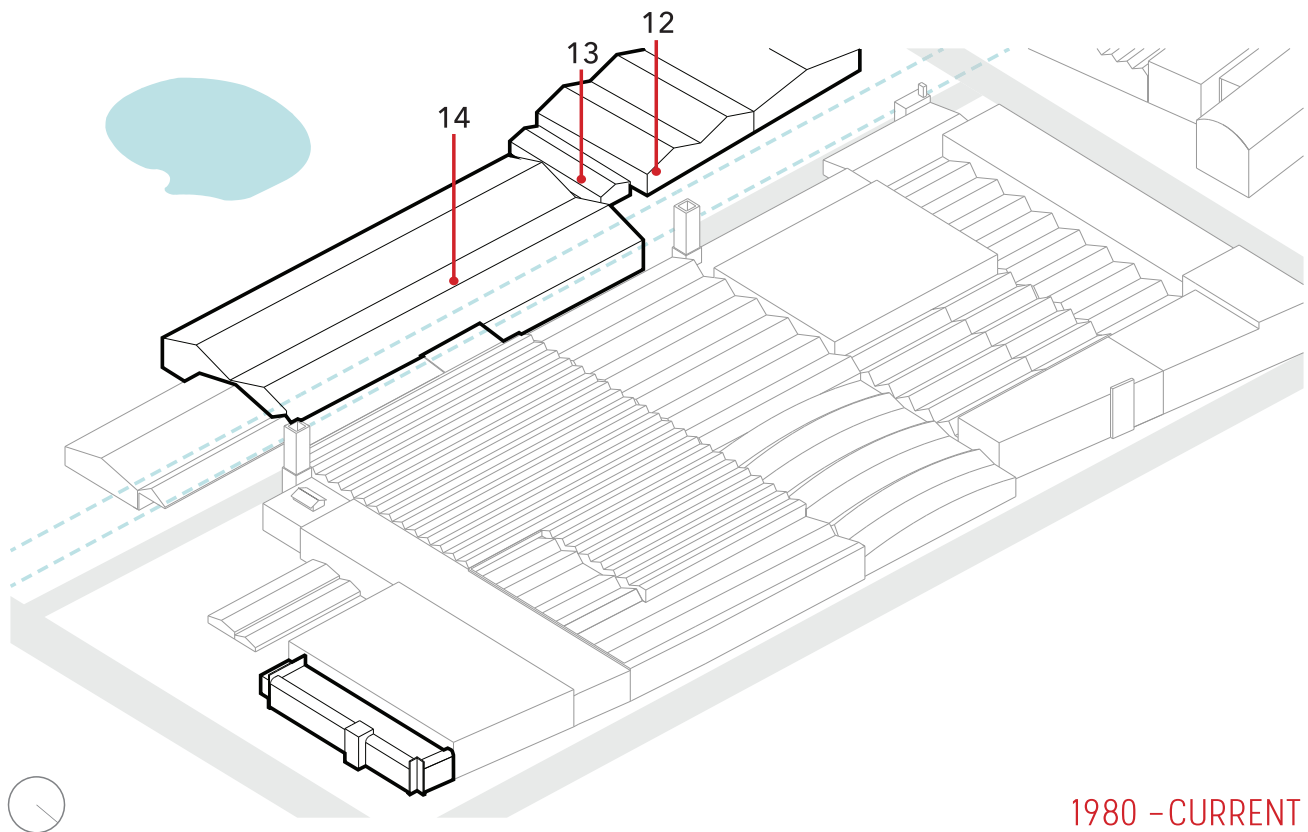

1980 - CURRENT

Figure 67 Janfleur & De Pol/Gaudium 1980 - current situation. (Own drawing, 2019)

From the 80's onwards the only building of the Gaudium that transformed was the office in 2006. As a consequence the main entrance of the whole textile complex of Gaudium was more focused towards the Eelinkstraat. The floorplan layout of the office space changed. Moreover, the façades were renewed with a more modern look.

12 In the meanwhile the flower company Janfleur developed. One of the founders of this company was A. Janssen, who traded in flowers already from the 1960's. Janssen lived at the Morsestraat and had a small storage hall along this street. According to a set of drawings this hall was constructed around the year 1974. The two additional storages at the back of this building were built in 1992 (Weidemann, 1974) (Huitink, 1992) (Nibag 2015) (100% Winterswijk, 2019).

13 The relative small warehouse originally was a storage barn of M.M. Poppers since 1943. Nowadays it is part of the complex of Janfleur. It is not known from which period it was occupied by Janfleur (Nibag, 2015).

14 In the following years around 2000, the former carpet hall and powerplant of Gaudium was demolished because Janfleur invested in a major expansion. Because of this brand new warehouse the entrance replaced from the Morsestraat towards the Eelinkstraat alongside the entrance of Gaudium. Therefore, a parkinglot was added for visitors to improve the accesability (Huitink, 2000) (Nibag, 2015).

CURRENT SITUATION

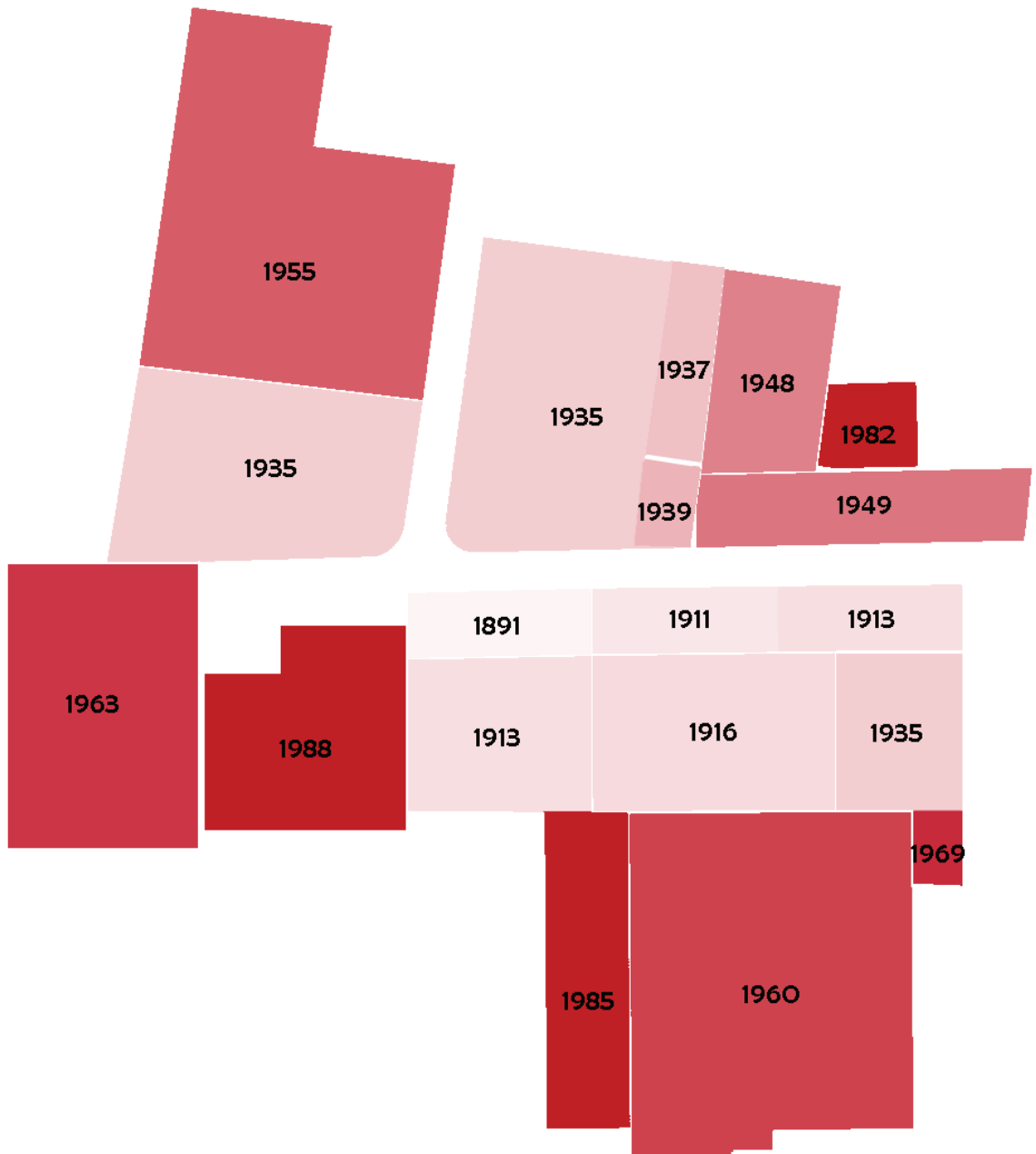
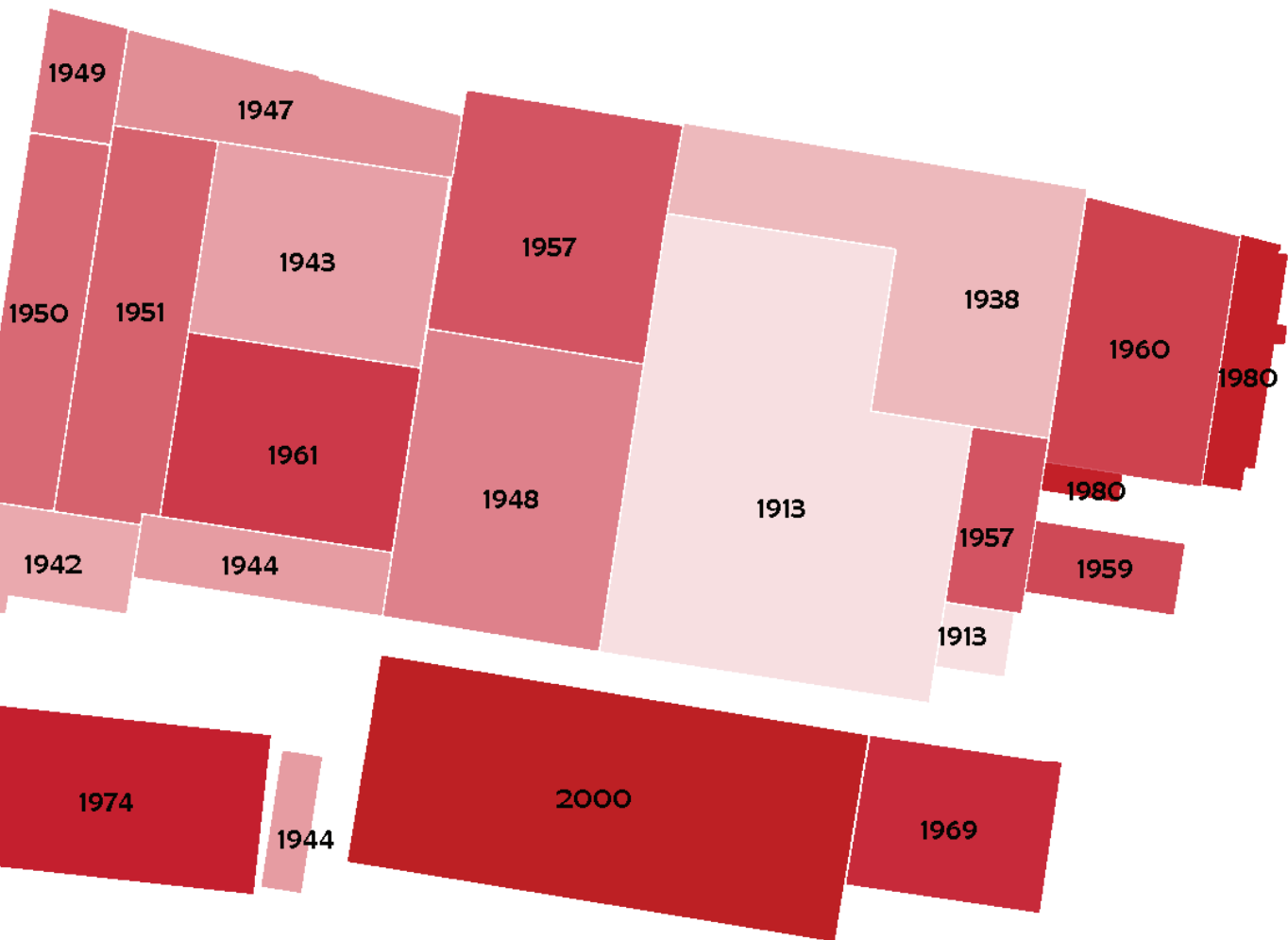

Figure 68 Years of construction. (Own image, 2019)



INFRASTRUCTURE

According historic cartographic information, the Hilbelinkspad, nowadays Laan van Hilbelink, was an unpaved road which started from the Zonnebrink and continued to towards the east. Until 1936 it had a curved shape which followed the urban lines of the industrial buildings. (Not known, 1911) (Nibag, 2015)

The part of Hilbelinkspad in front of this turn alongside De Pol was paved in 1936. Between 1936 and 1955 the path was straightened and extended towards the South East. From that period onwards the Hilbelinkspad was renamed as the Laan van Hilbelink. (Not

known, 1936) (Nibag, 2015). The Morsestraat was introduced between 1936 and 1948. This street in between the Hazewind and Morsepoort was extended in the upcoming years between 1948 and 1955. Remarkable is that the Morsestraat ends at the crossing of Karel Doormanstraat, where the house of the former mayor of Winterswijk is located. (Eibergen, 1955) (Nibag, 2015)

The Eelinkstraat emerged as well as the Morsestraat between 1936 and 1955. The Whemerbeek which crossed the whole area was covered with extending factory halls in 1960-1961 (Eibergen, 1975) (Nibag, 2015).

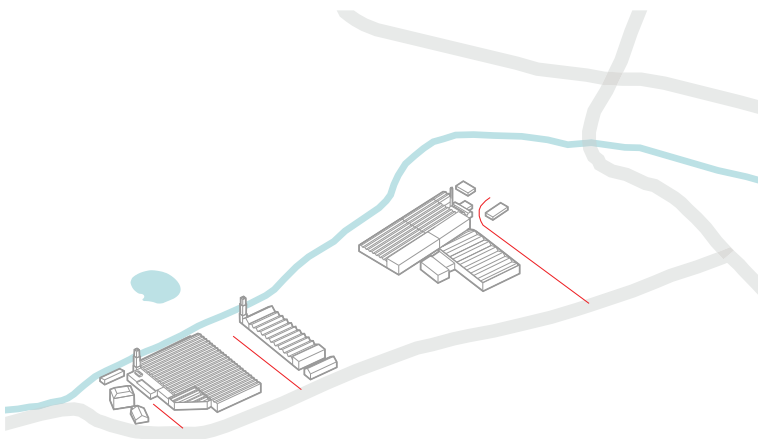

Figure 69 Infrastructure 1911. (Not known, 1911)

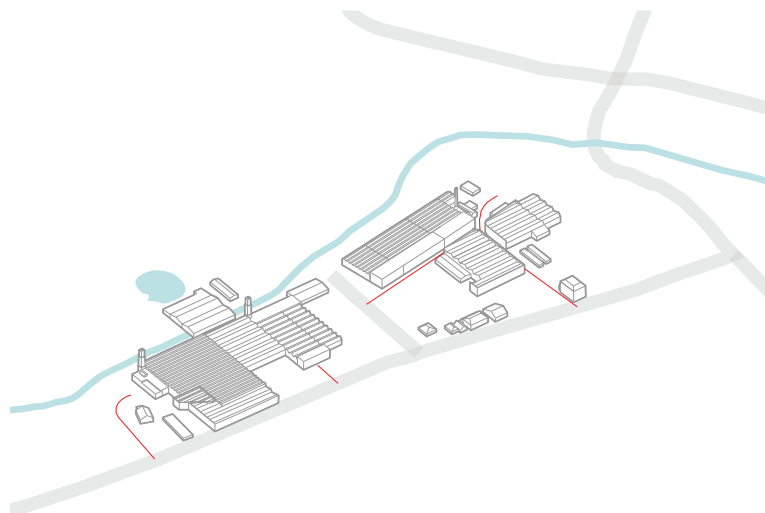

Figure 70 Infrastructure 1936. (Not known, 1936)

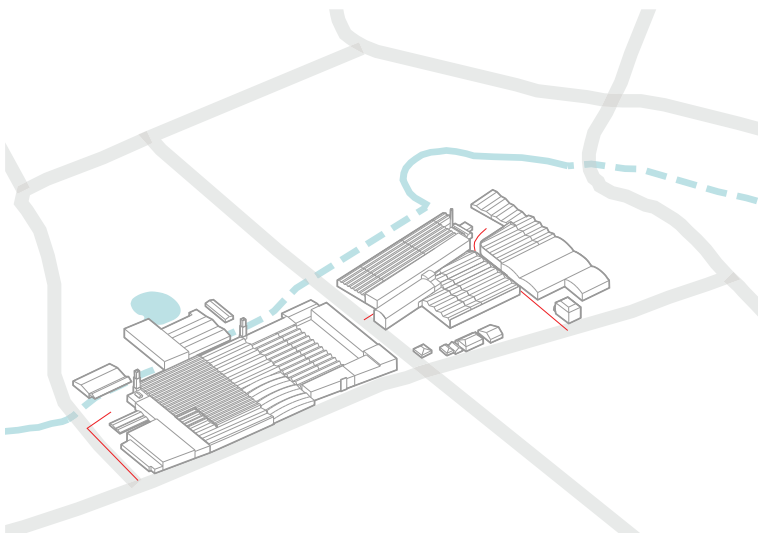

Figure 71 Infrastructure 1955. (Eibergen, 1955)

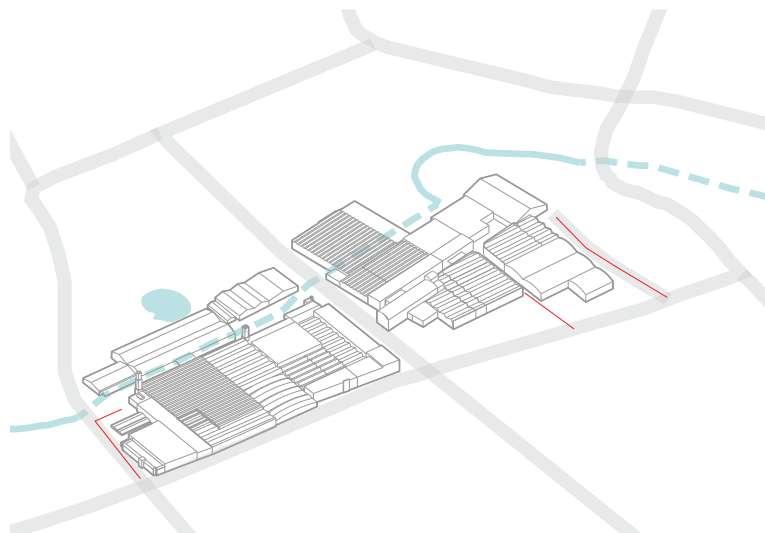

Figure 72 Infrastructure 1975. (Eibergen, 1975)

BUILT SURFACE

On the map, built plots are highlighted. It shows a large area of buildings and quite some density on the plot of the site. From this map the conclusion can be drawn, that there are almost no public connections throughout the area.

Also the site consists of one very dense core with the buildings organically grown from it. The outside edges of the plot have no clear definition. There is also no transition from the road to the 'interior' of the factories.



Figure 73 Built surface. (Own images based on Google, 2019)

ACCESSABILITY

The site is well accessible from multiple sides, especially from the South-East. There are some accessibility problems in the West, where only one road connects to the site.

In the close surroundings of the site, some historical landmarks which relate to the textile industry are still visible. Old gates, factory owner villas and worker houses are shown.



Figure 74 Accessibility and landmarks. (Own image based on Google Maps, 2019)

The different entrances towards the area are not well defined. There is no clear sign of entering the site, nor items that mark it.

From all directions the whole looks rather scattered and undefined.

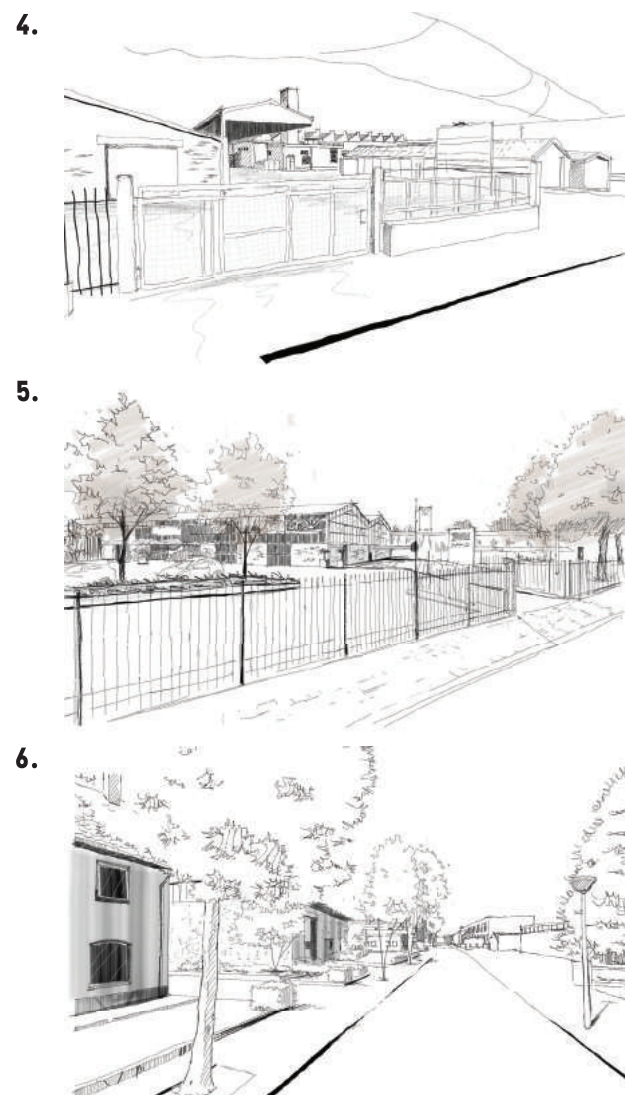
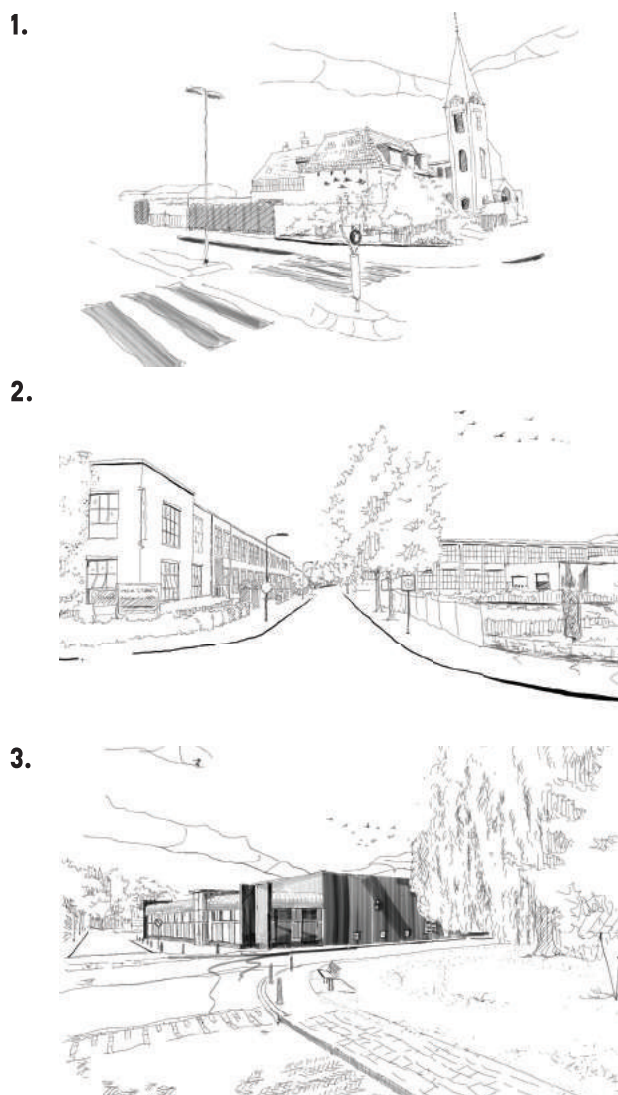

Figure 75 Entrances. (Own images based on Google Maps, 2019)

WAYFINDING

Walking through the area, orientation is a very difficult aspect. There are quite some spots where the route gets blocked by a building or structure. Also there is no high element which

helps for orientation. Back in the days, the chimneys could help with this, but now the whole ensemble is rather flat.

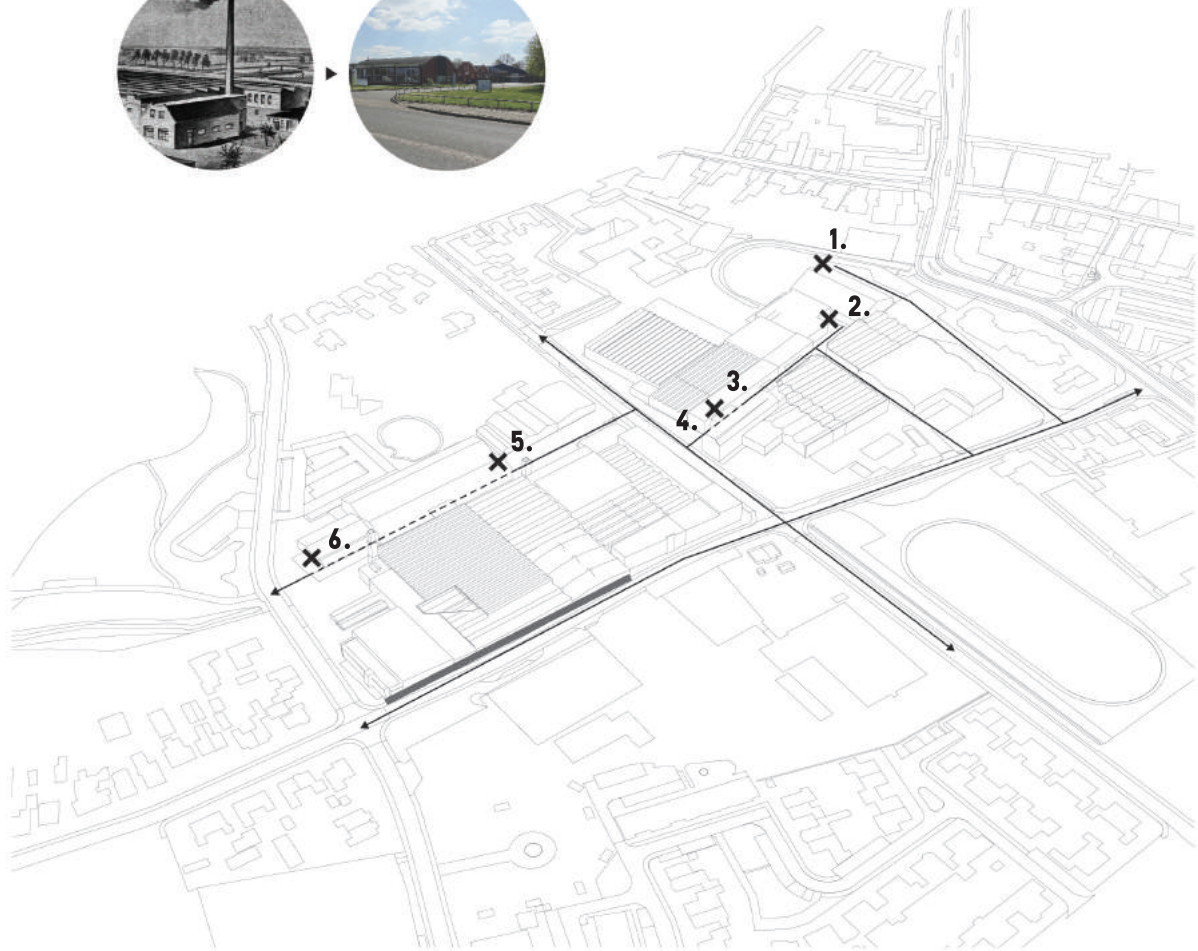
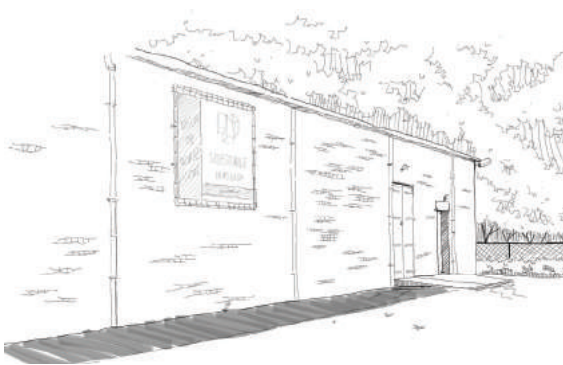

Figure 76 Wayfinding. (Own image based on Google Maps, 2019)

Where roads and lanes used to be quite clear, nowadays these infrastructures are not that visible anymore. Reason for this are the multiple structures that have been built right

on top of them. This blocks important sight lines throughout the area and makes orientation rather confusing.

1.



2.



3.



4.



5.



6.



Figure 77 Wayfinding. (Own images based on Google Maps, 2019)

STREET PROFILES

As explained before, the area emerged sort of organically. All the individual pieces of factory (halls) shape an ensemble. The ensemble

and its different buildings is highly noticed when walking around the area: it is a continuously change of size of public space.

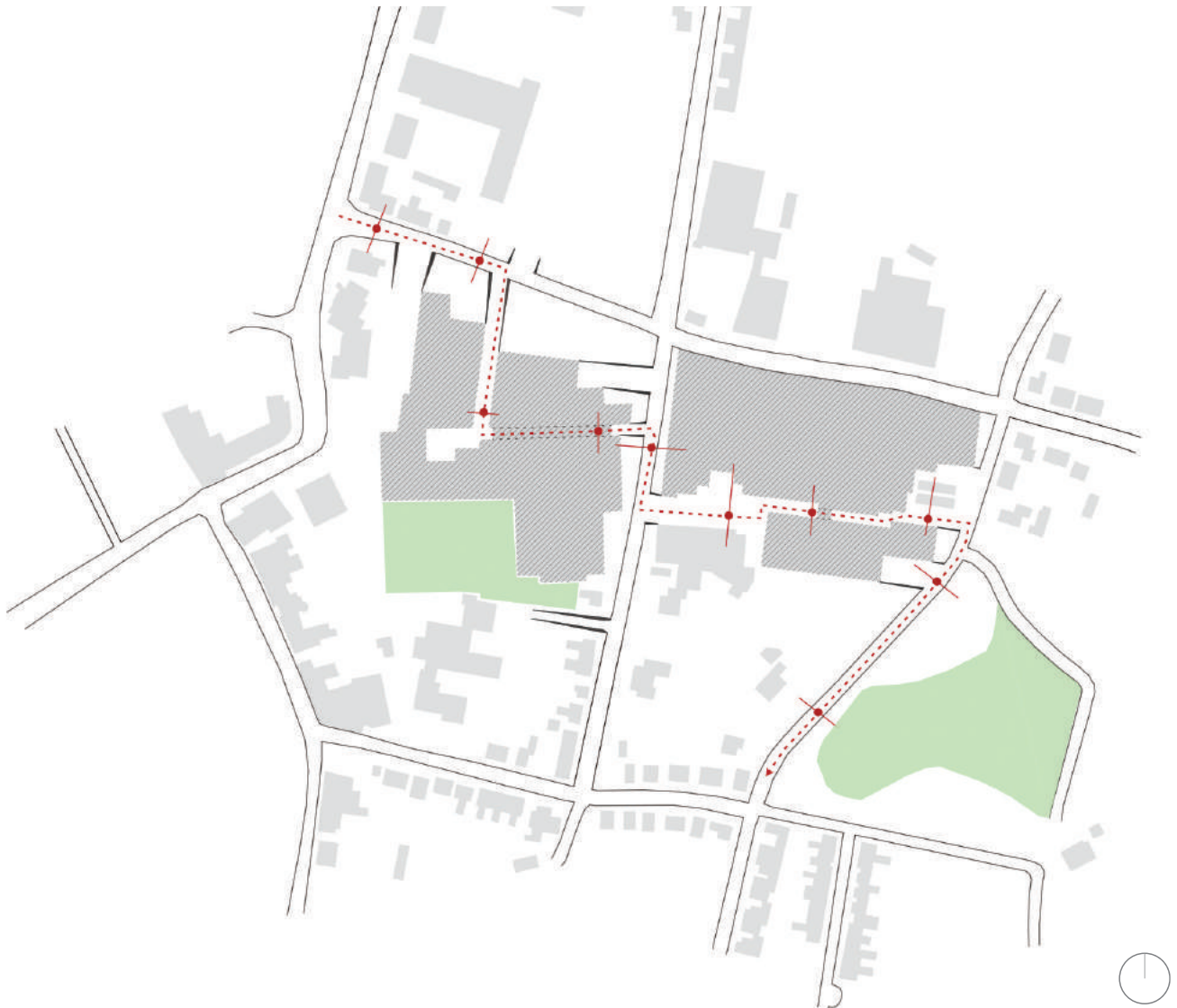

Figure 78 Street profile sections. (Own image based on ArcGIS, 2019 & Google, 2019)

This sequence of public space is explained by the drawings.

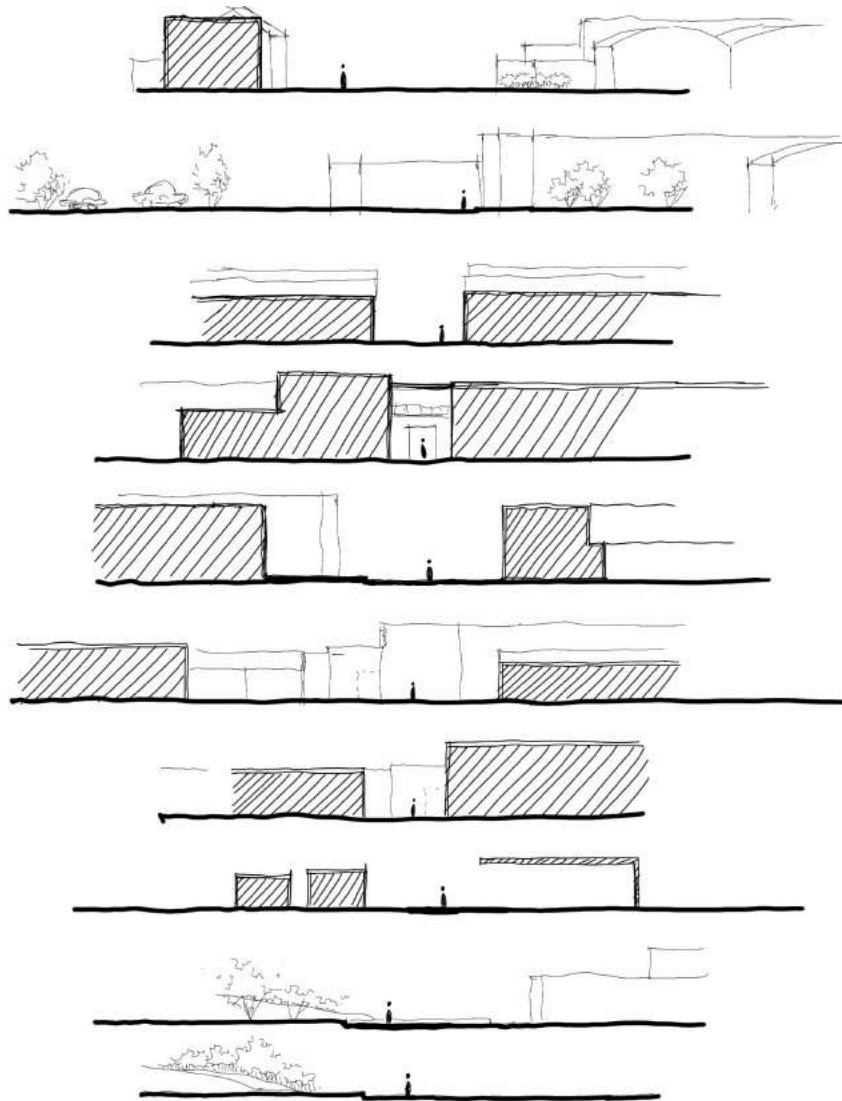

Figure 79 Street profile sections. (Own image based on ArcGIS, 2019 & Google, 2019)

GREEN AND WATER

The area holds no listed trees, although some are worth mentioning because they somehow influence the appearance of the area. On the right these trees are pictured. Remarkable is that they are scattered around the area and seem to not be planned deliberately. Also almost all trees are of a different kind, which

also indicated that they were probably not part of a structured landscape design. The trees could be taken in to account with designing the area.

On the bottom the creek 'Whemerbeek' is pictured as the situation is now.

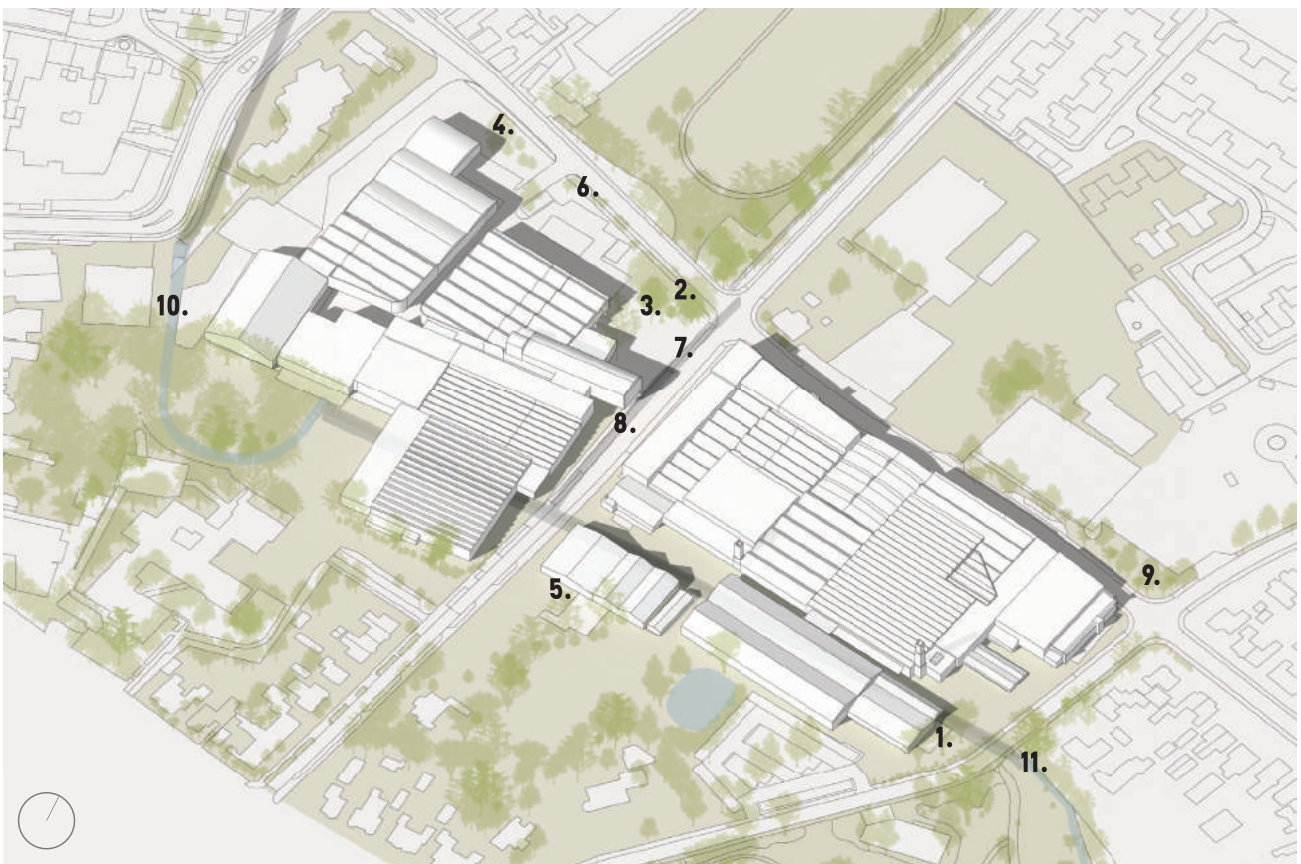

Figure 80 Green and water. (Own image based on EduGIS, 2019 & Google, 2019)



Sycamore tree



Elm tree



Oak tree



Horse chestnut tree

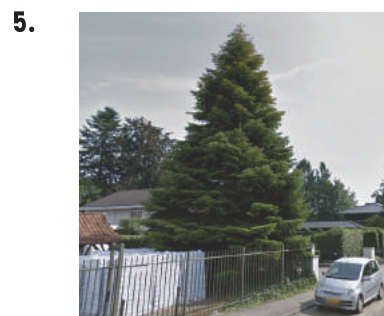

Black spruce



Type unknown



Maple tree



Maple tree



Willow



Whemerbeek, West



Whemerbeek, East

Figure 81 Pictures of green and trees. (Google Maps, 2019)
 Figure 82 Water and textile industry. (Google Maps, 2019)

CONCLUSIONS

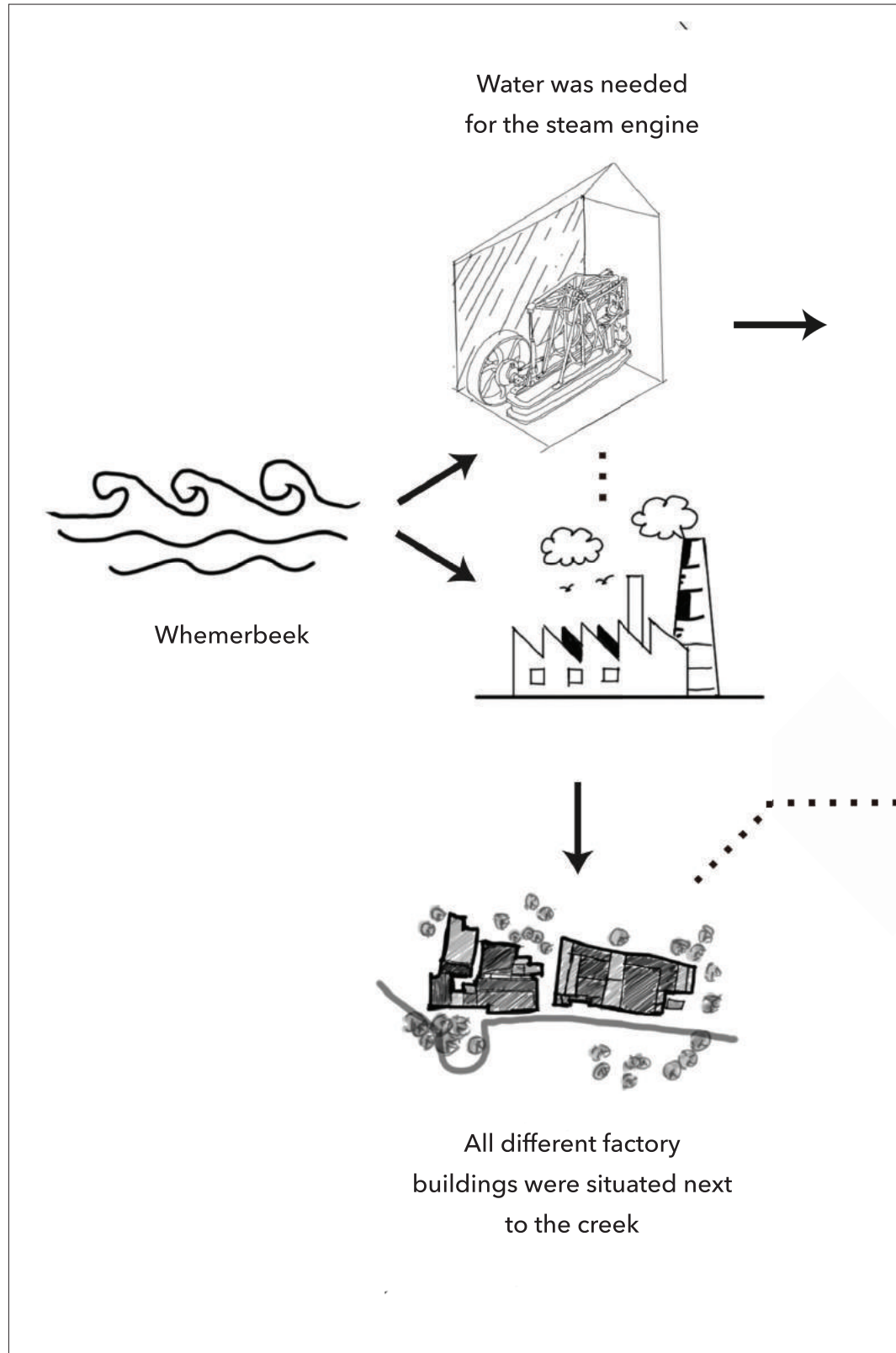
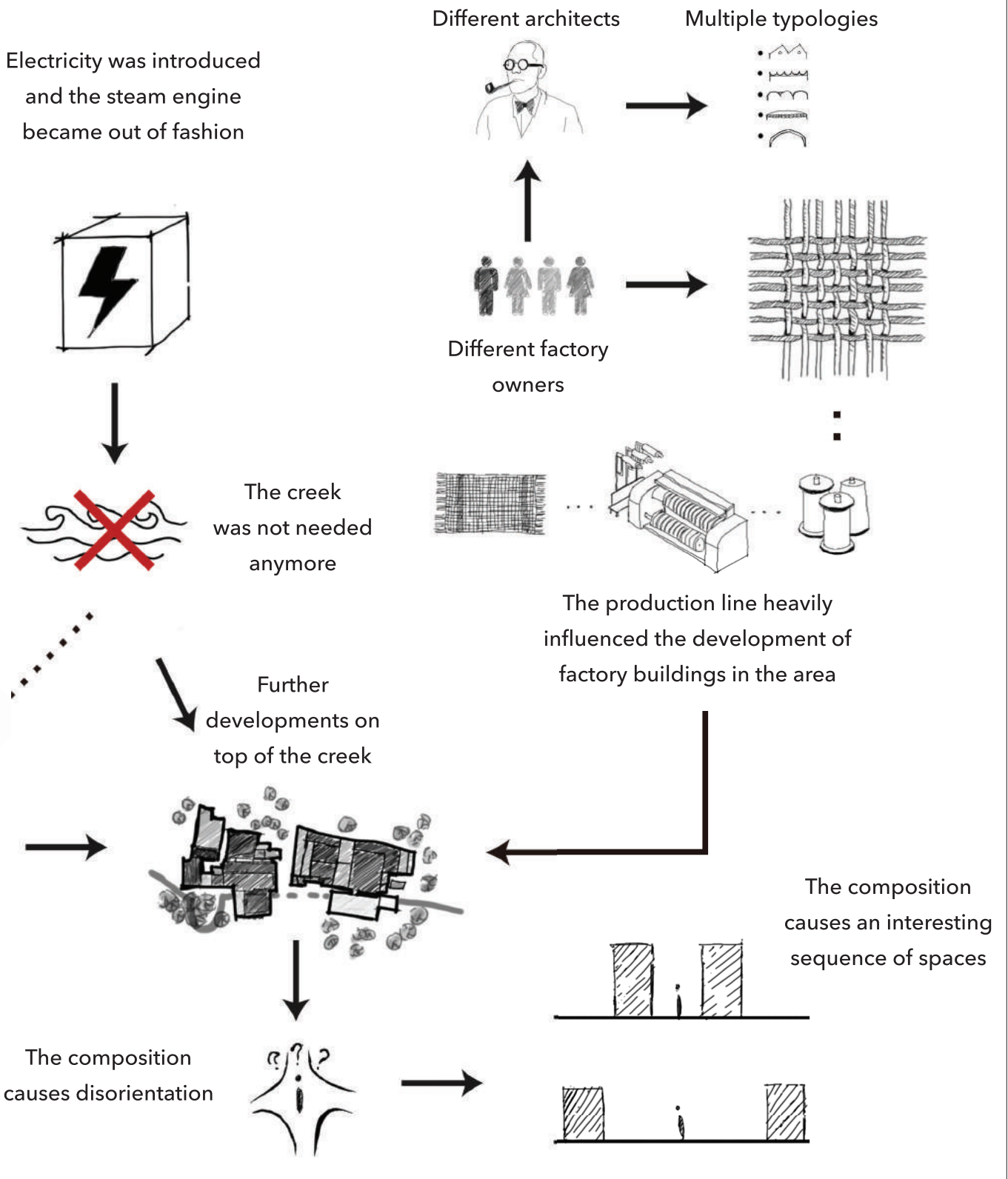

Figure 83 Conclusions. (Own image, 2019)





IV SKIN ANALYSIS

The skin is an important feature of a building. As for industrial buildings, the skin fulfills a very specific role. In this chapter the relation between the buildings and their skin is researched, first on the level of the building ensemble and afterwards zooming in to the five defined typologies. Materials and architectural elements are researched.

Although, it is not only the appearance which is an important aspect of the project. The skin is also part of how one experiences a (public) space or a building. For that reason the topic of experience will not only include materials, surfaces and finishes, but also a sense of feelings and thoughts derived from field work.

In that way is shown that the skin is important for the essence of the whole project sites and the individual buildings.

COMPOSITION AND ROOFSCAPES

These drawings show the changing, somewhat chaotic elevations of the building ensemble. Also the changing roofscape is visible. This is the result of the development of the area.

which happened over a great span of time as explained in the part about chronomapping. The whole together is the symbol of the textile industry and therefore highly valued.

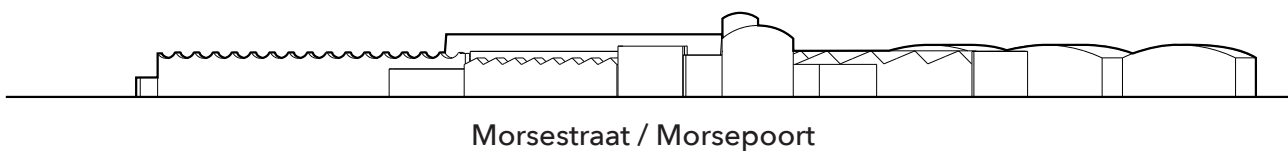
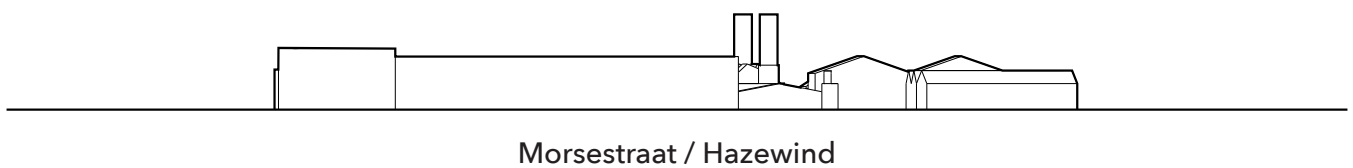
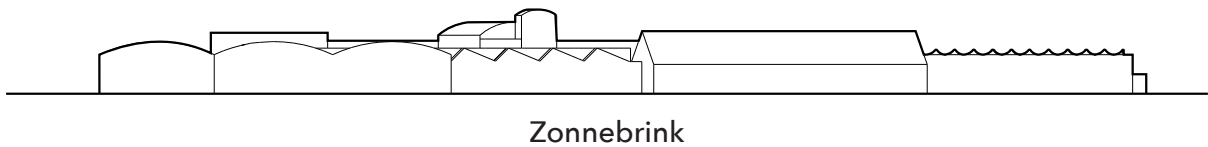
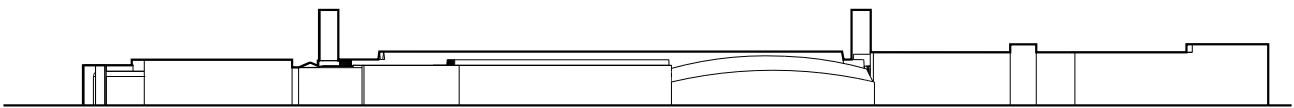
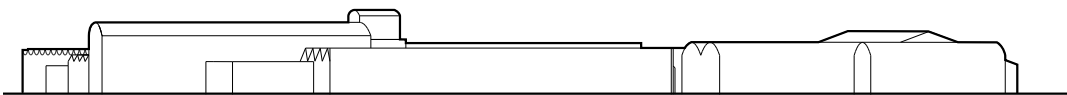

Figure 85 Façades and roofs. (Own images, 2019)



Laan van Hilbelink / Gaudium / Hazewind



Laan van Hilbelink / Morsepoort

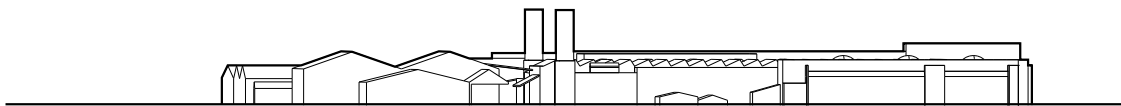

Eelinkstraat / Gaudium

MATERIALS AND COLOURS ENSEMBLE

Pictures from the multiple façades of the ensemble show a wide range of materials. The most dominant material which is used is brick: all original façades are made out of

brick. All the materials belong to a similar colour palette. Interior finishes are characterised by light colours which bring a bright atmosphere.



Figure 86 Façade colours. (Photos by various students, 2019)



Figure 87 Interior colours. (Photos by various students, 2019)

EXPERIENCE



Figure 88 The church. (Own image based on Google Maps, 2019)

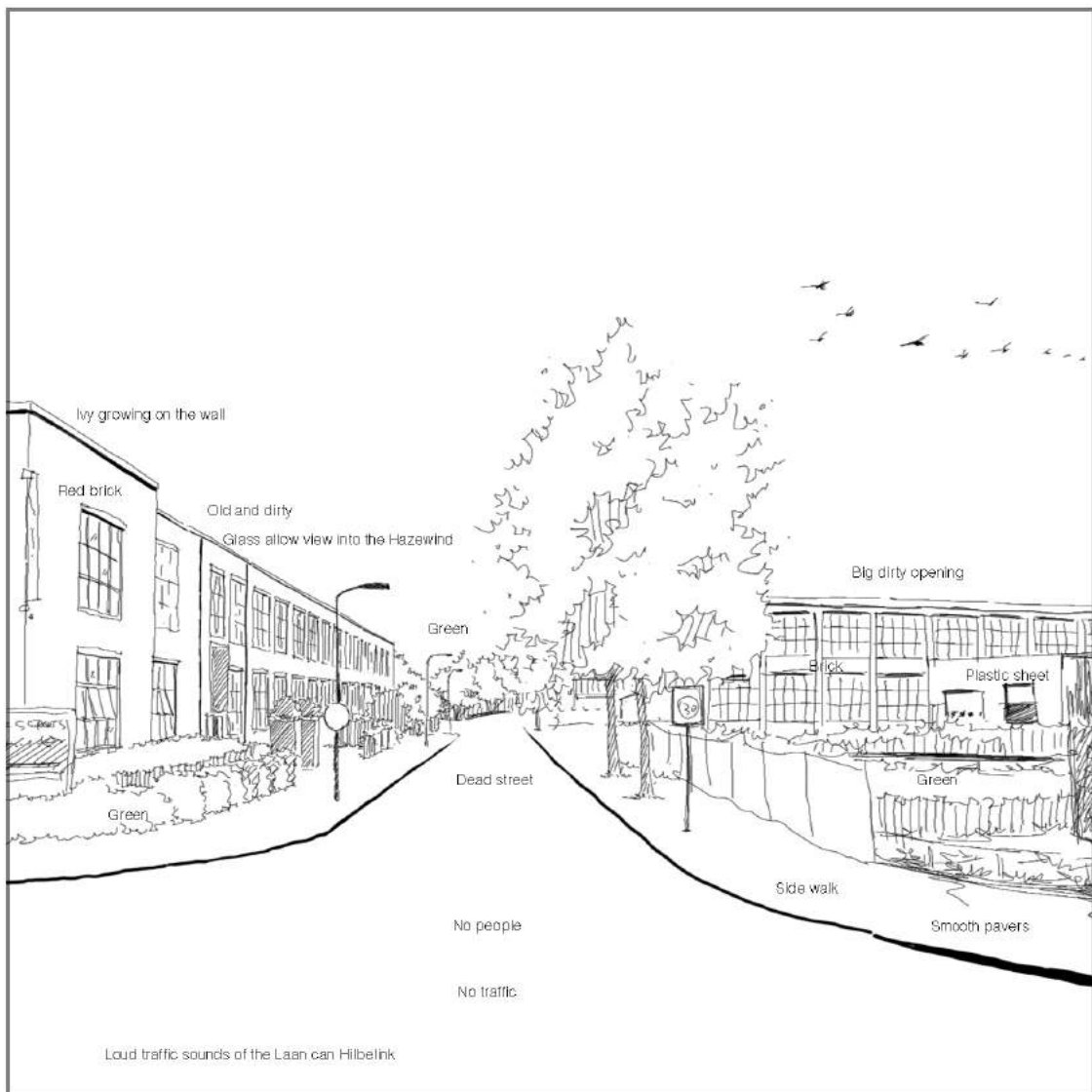

Figure 89 Hazewind. (Own image based on Google Maps, 2019)

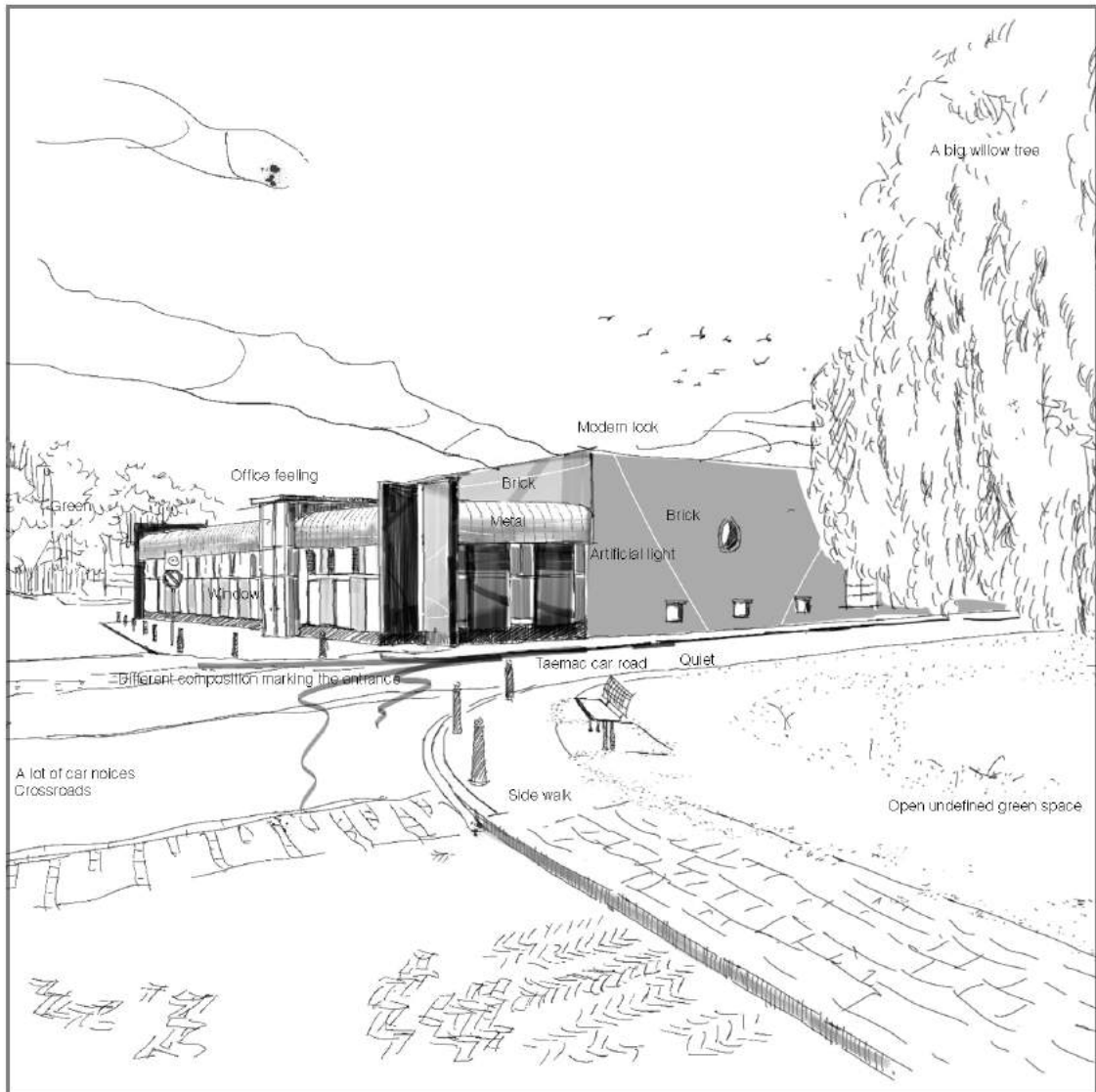

Figure 90 Gaudium. (Own image based on Google Maps, 2019)



Figure 91 Gaudium. (Own image based on Google Maps, 2019)



Figure 92 Industrial hall (Own image based on Google Maps, 2019)



Figure 93 Entering the site. (Own image based on Google Maps, 2019)

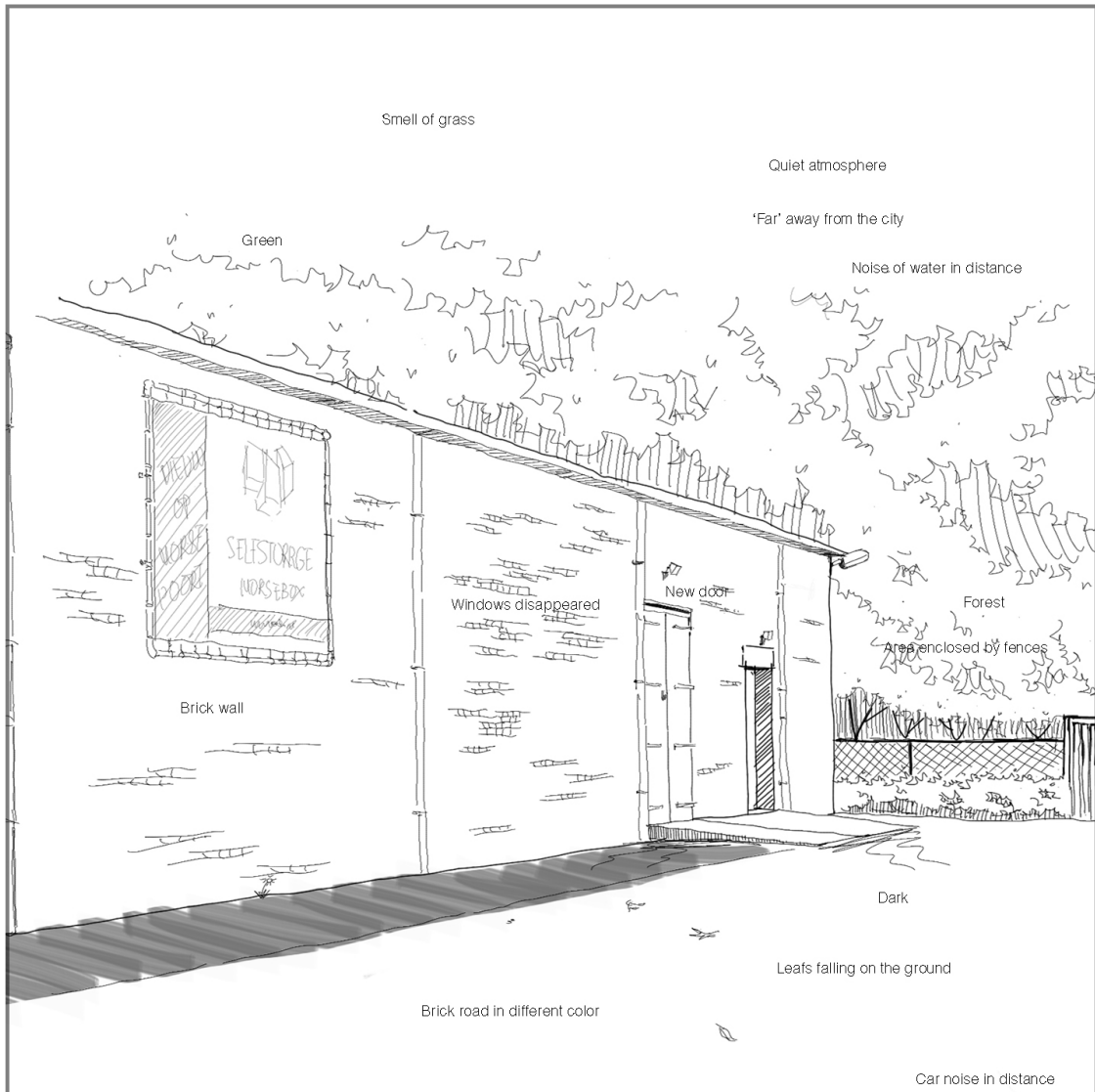

Figure 94 Pitched roof. (Own image based on Google Maps, 2019)

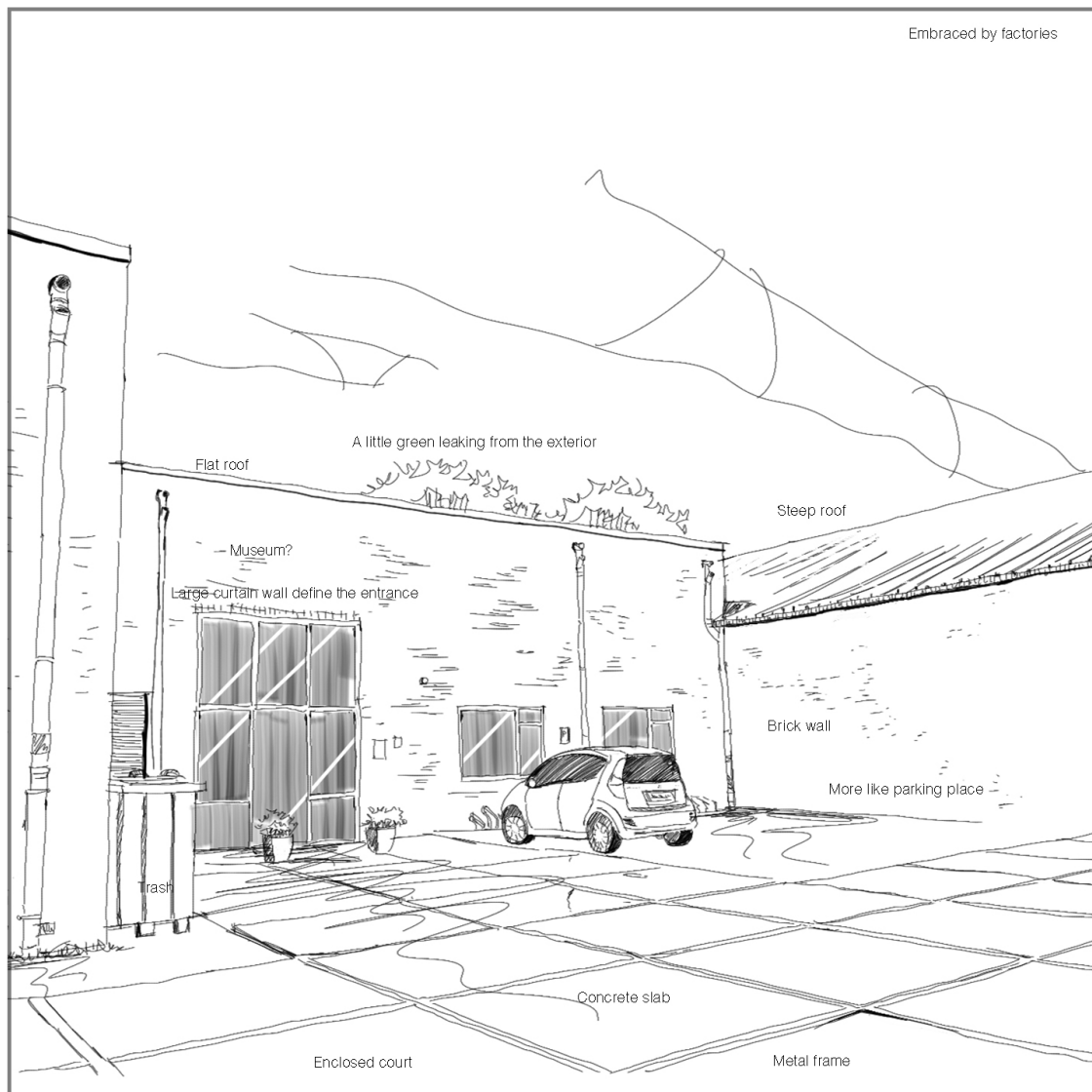

Figure 95 The museum. (Own image based on Google Maps, 2019)

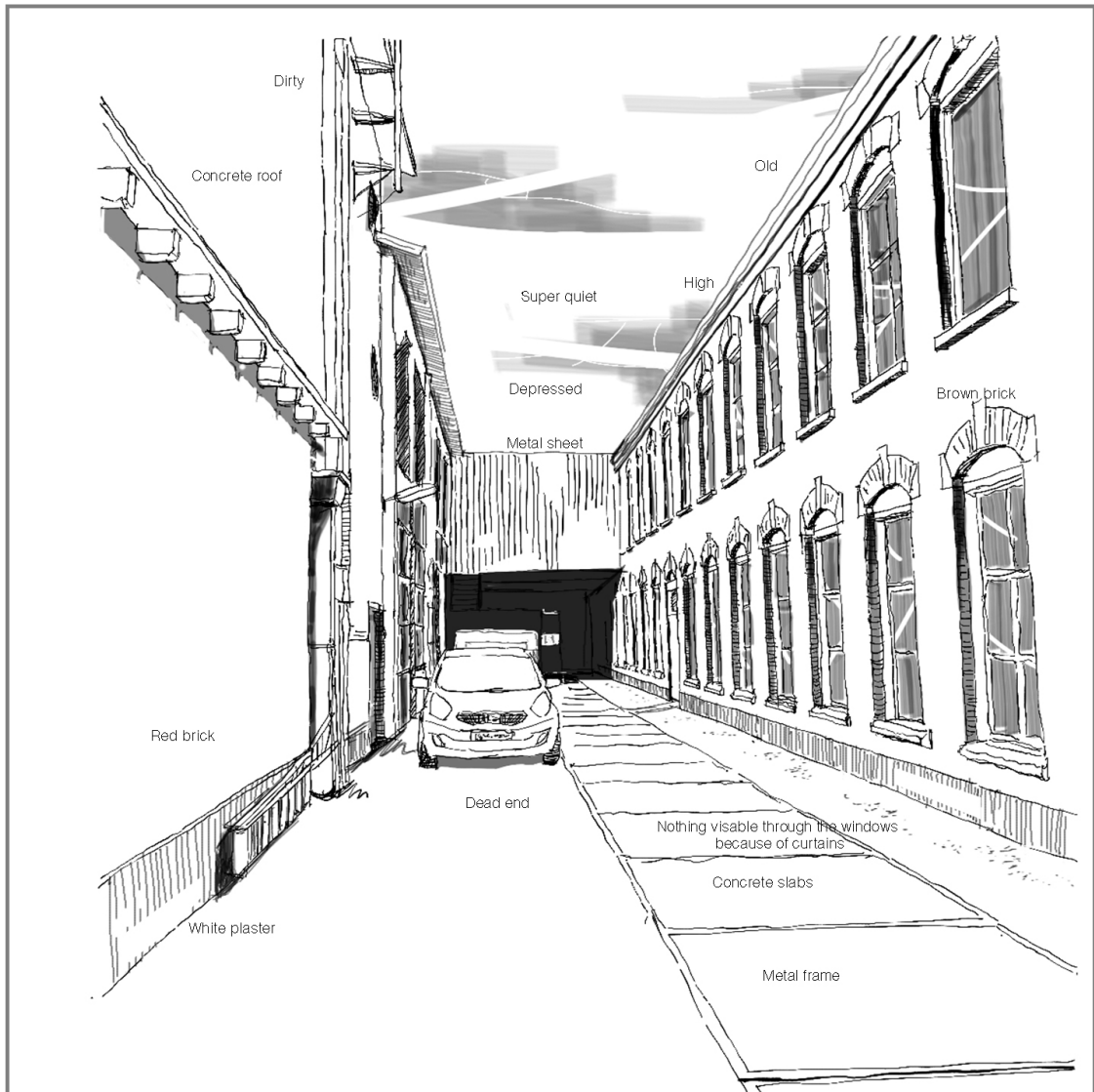

Figure 96 The old inner core (Own image based on Google Maps, 2019)

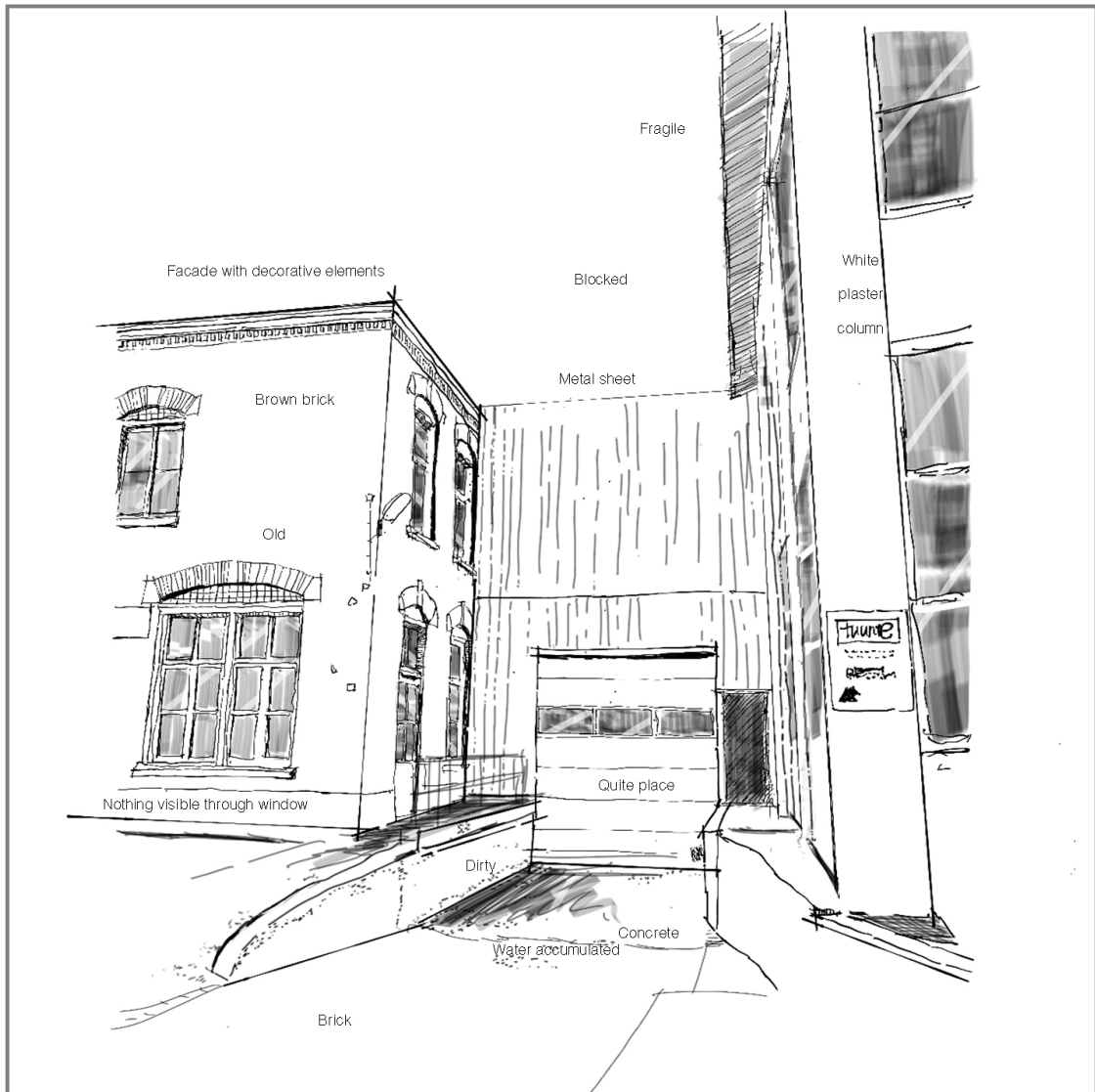

Figure 97 De Tuunte. (Own image based on Google Maps, 2019)

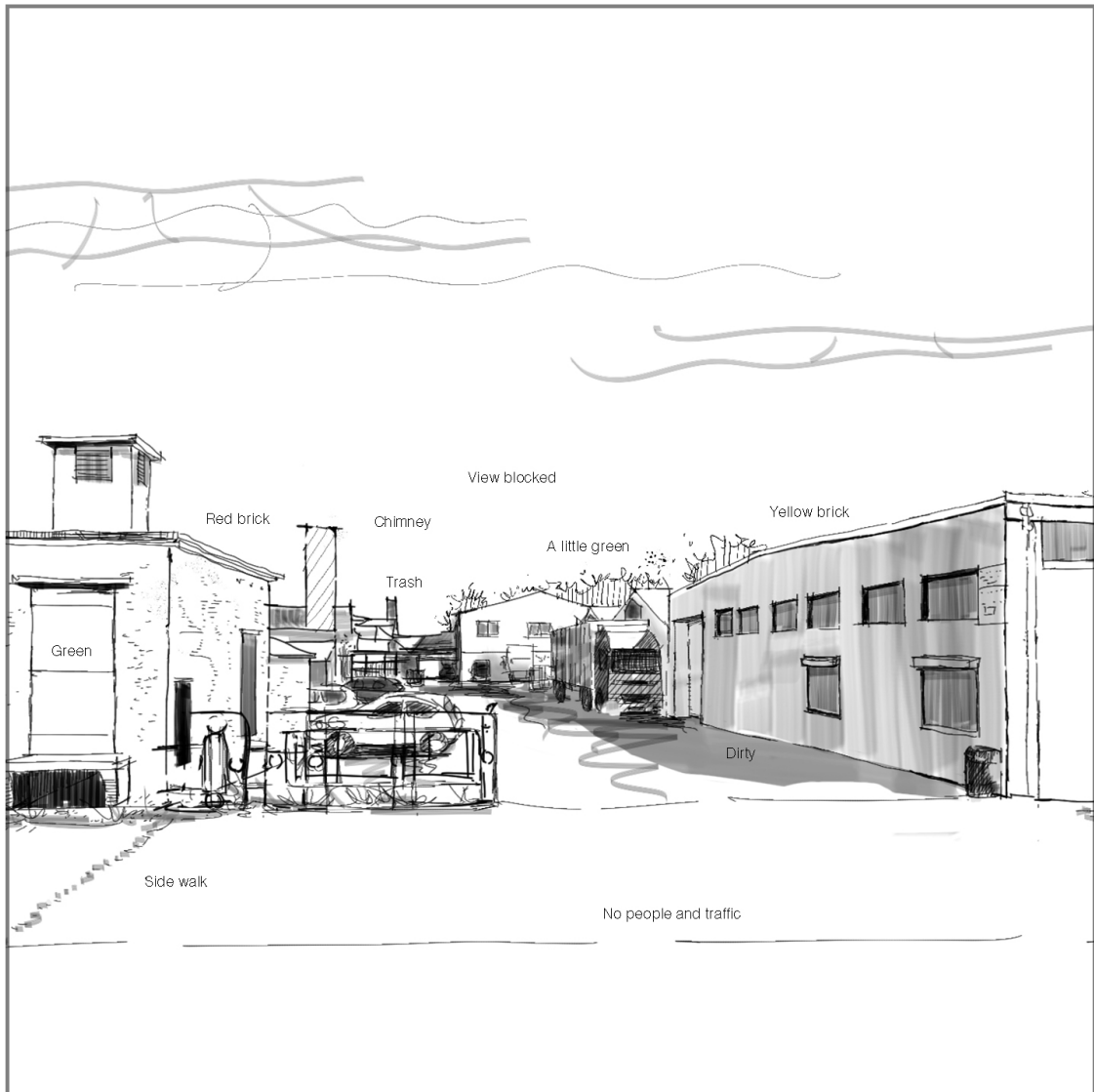

Figure 98 Janfleur (Own image based on Google Maps, 2019)

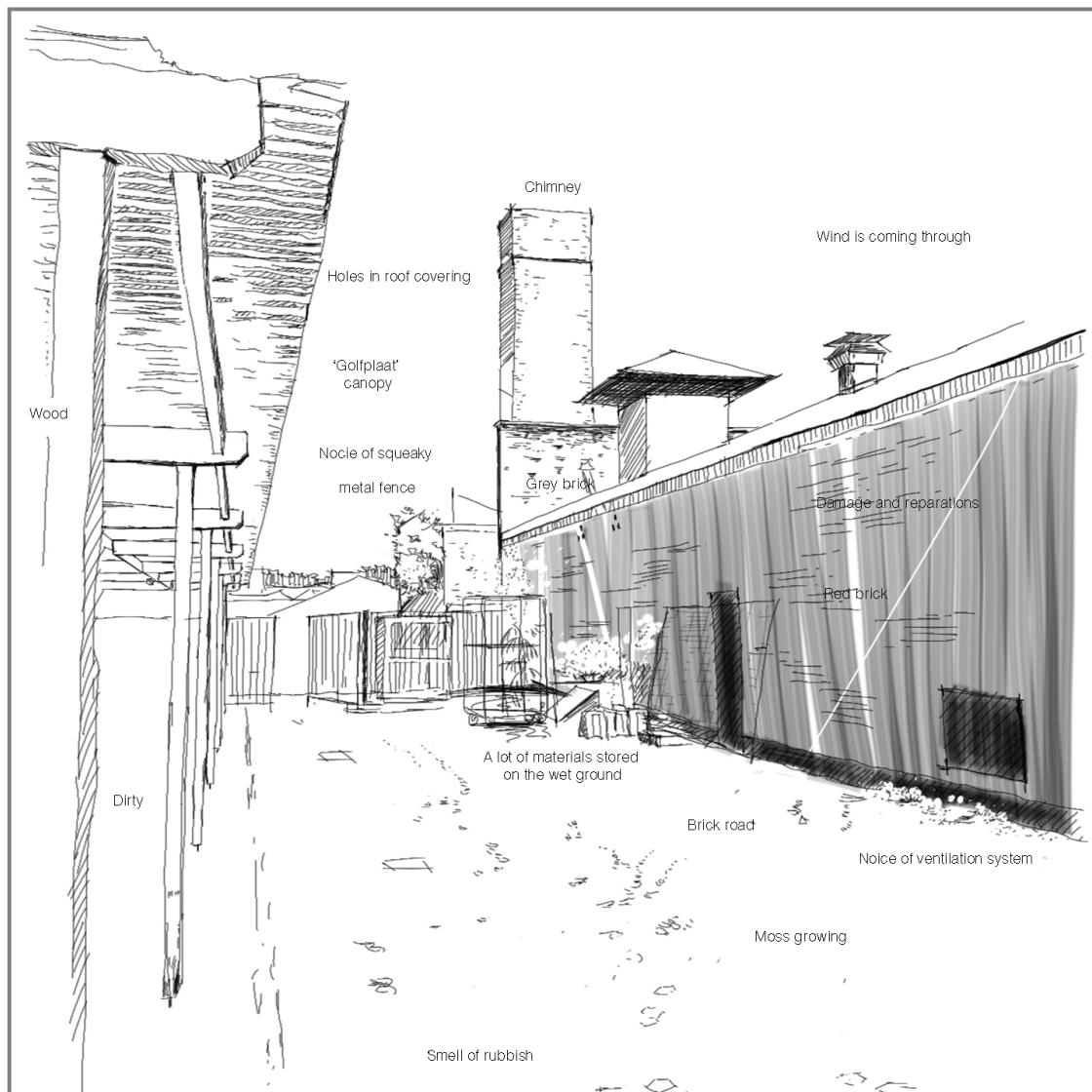

Figure 99 Alley between Janfleur and Gaudium. (Own image based on Google Maps, 2019)

FIVE INDUSTRIAL TYPOLOGIES



Figure 100 Five typologies and their locations. (Photos by Joost Joose, Chen Zhu and Jùliette Zegers, 2019)

BUILDING A, FAÇADE

This façade of the saw-tooth roof structure shows clear marks of aging. Sometimes old brickwork has been replaced by new to fix it.

Almost no openings are visible in the façade, since daylight comes from the characteristic rooflights.

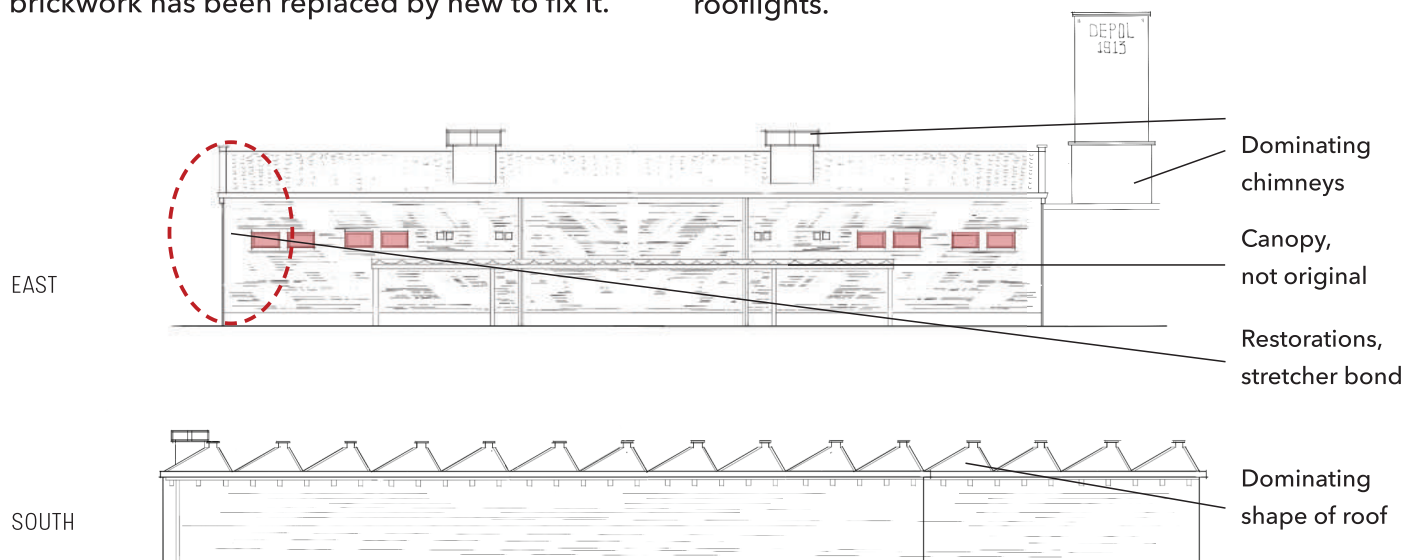

Figure 101 Façades. (Own images based on Beltman, 1913)
 Figure 102 Materials. (Photos by Dinand Kruize, 2019)

BUILDING B, FAÇADE

This façade has been changed over time, although the original façade is still there. Some installations were placed which had big ducts sticking through the façade. These

ducts nowadays are not there anymore, but they still leave their traces. Their position is still visible from the different brickwork in the façade. None of the curtain walls are original.

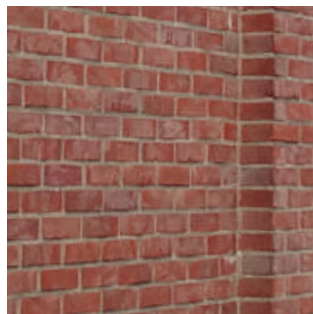
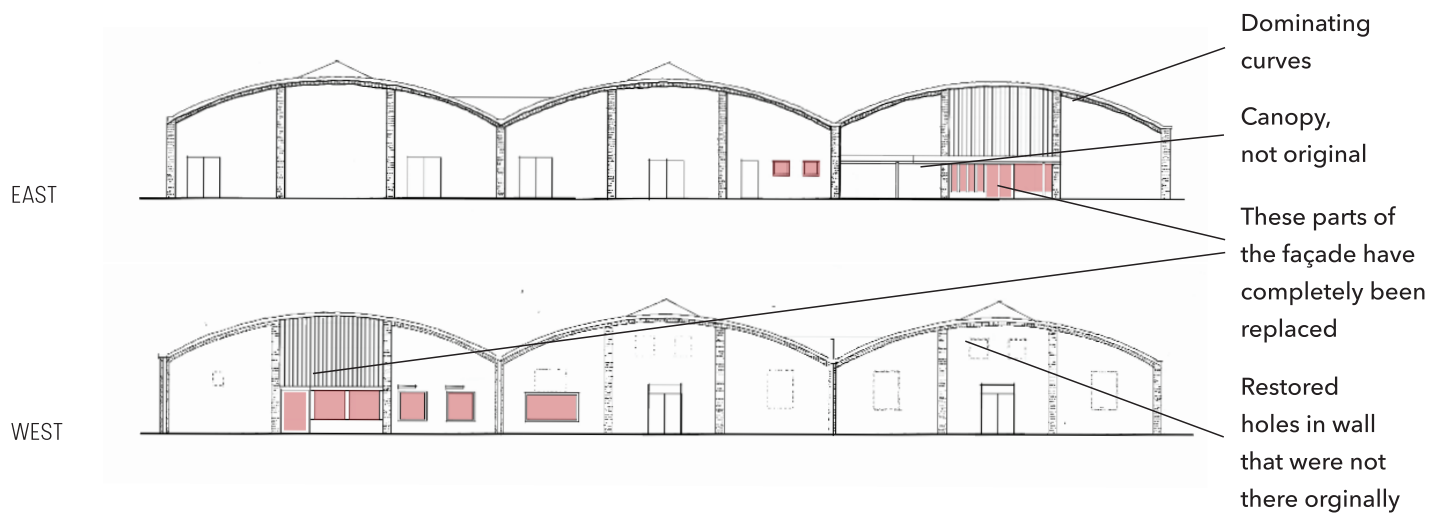

Figure 103 Façades (Own images based on Bouwk. Ing. Bureau Beltman, 1955)
 Figure 104 Materials (Photos by Joost Joosse, 2019)

BUILDING C, FAÇADE

This façade is also not in its original condition. The current holes (which have no glass in it whatsoever), were originally not there. The big door on the left was designed in the

middle. This one could also have been moved, although there are no clear traces of this. The façade shows no openings. The only incoming daylight comes from the rooflights.

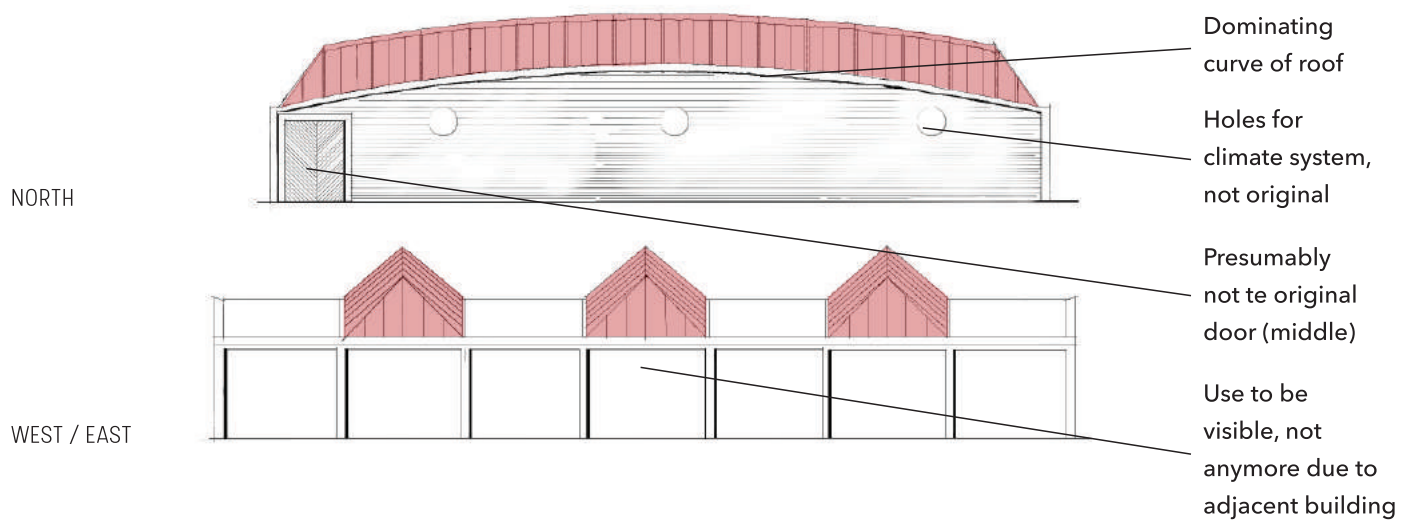

Figure 105 Façades (Own images based on Pannekoek, 1957)
 Figure 106 Materials (Photos by Joost Joosse, 2019)

BUILDING D, FAÇADE

This façade knows some interventions, whereas the big garage doors are of a later date than the building itself. The Morsepoort addition on the right doesn't belong to the

building and disturbs its continuous façade. The glass part on top of the small part of the building is not original. It is almost the only part which has openings.

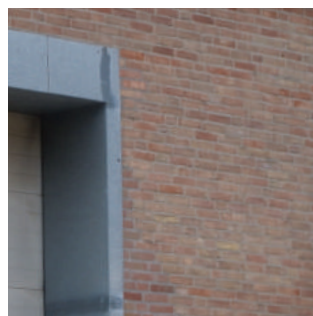
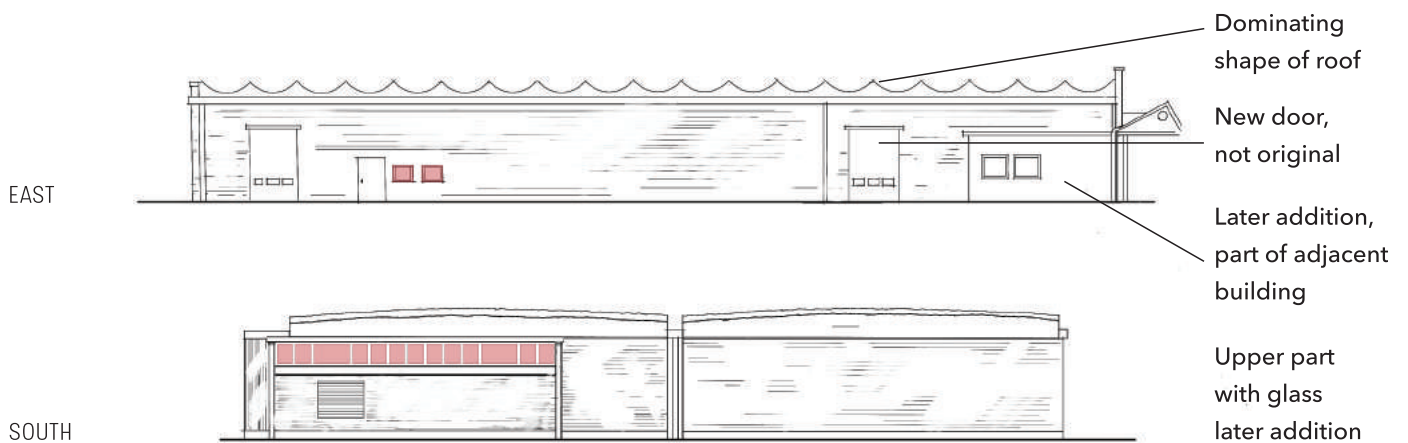

Figure 107 Façades. (Own image based on Bouwkundig Ingenieurs en Adviesbureau Sassen, 1960)
 Figure 108 Materials. (Photos by Dinand Kruize, 2019)

BUILDING E, FAÇADE

The façade of this building presumably is not original, since old drawings and pictures

show differently. The façade has no window openings at all.

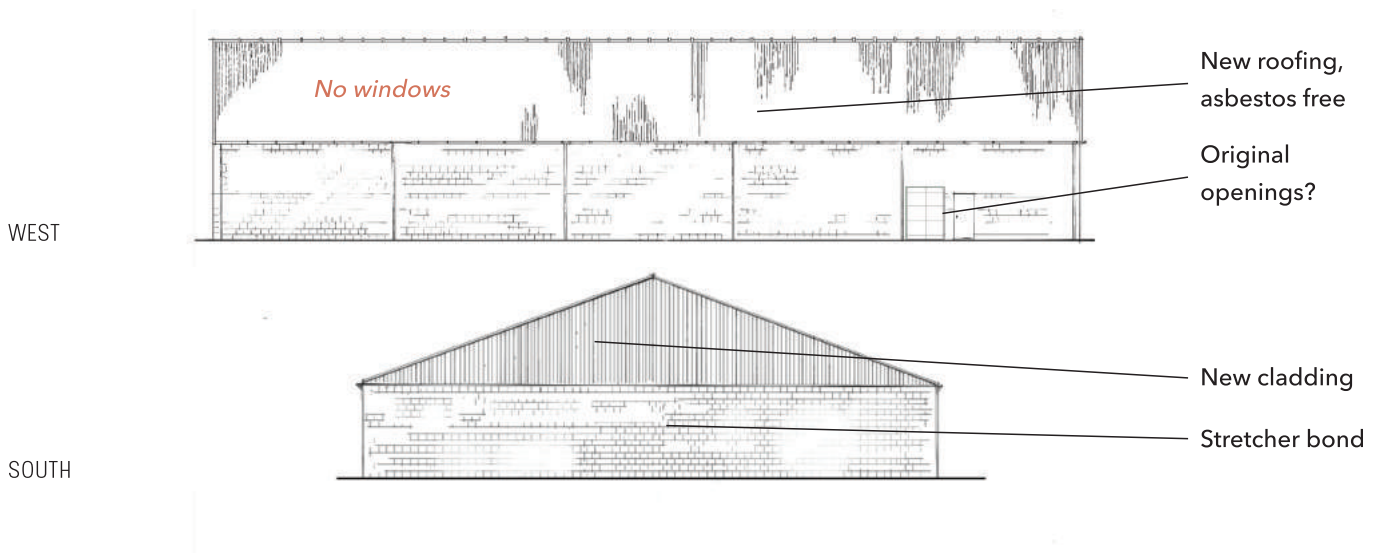

Figure 109 Façades. (Own image based on Bouwkundig Ingenieurs-en Adviesbureau Sassen, 1960)
 Figure 110 Materials. (Photos by Chen Zhu, 2019)

DAYLIGHT

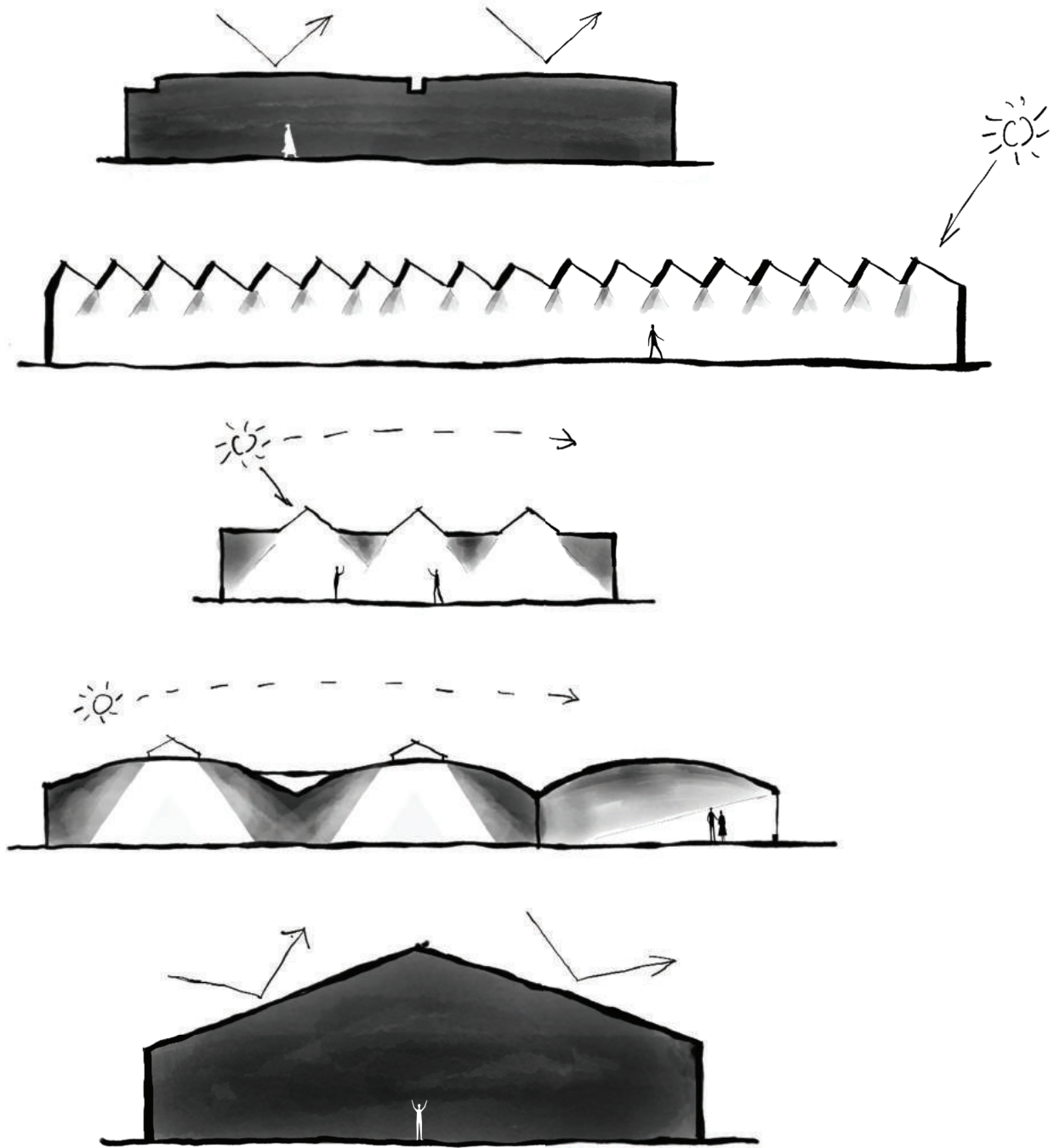
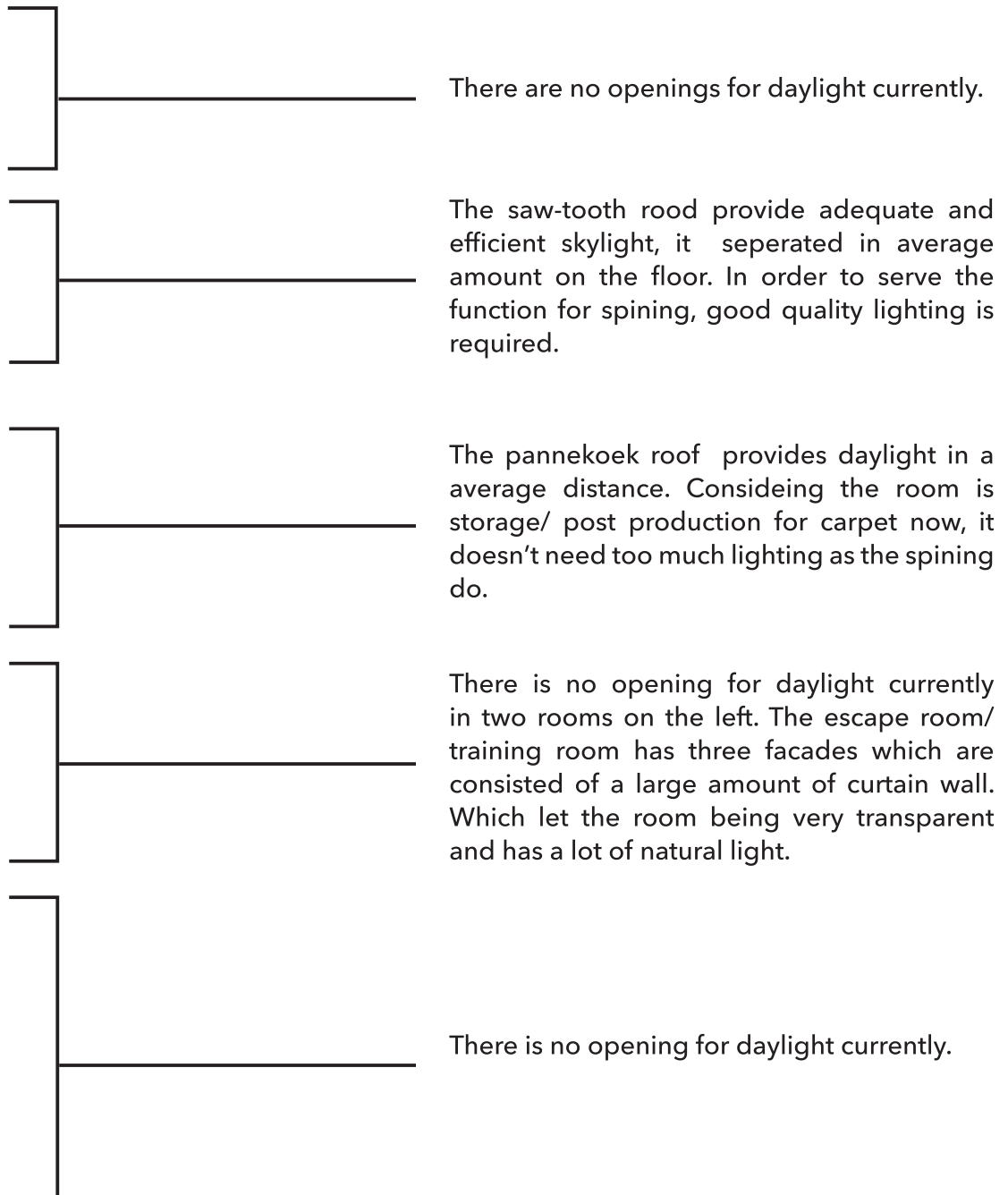

Figure 111 Daylight. (Own image based on fieldwork, 2019)



INTEGRATED LIGHTING

It is being very obvious that a lot of factories in this area doesn't have efficient or enough lighting. A lot of rooms are dark and empty, which in the architectural aspect creates certain atmosphere.

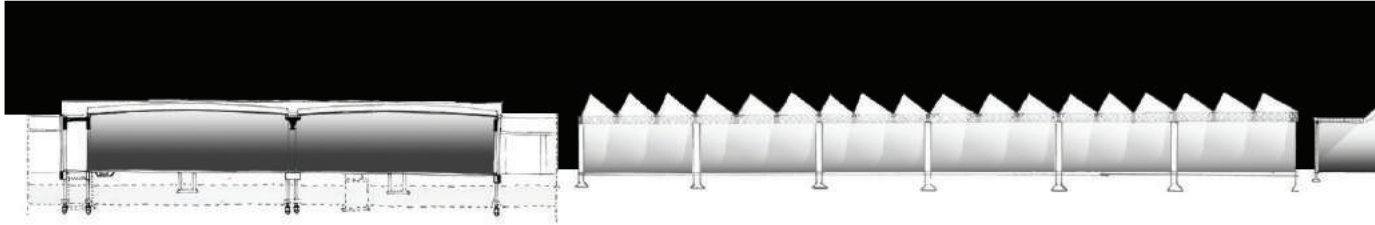
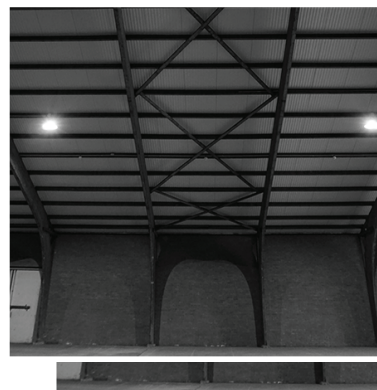
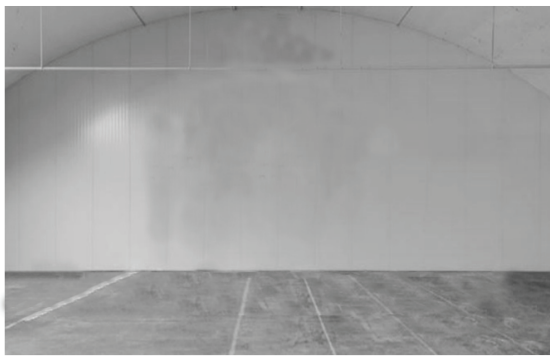

Figure 112 Integrated lighting. (Own image based on fieldwork, 2019)



CONCLUSIONS

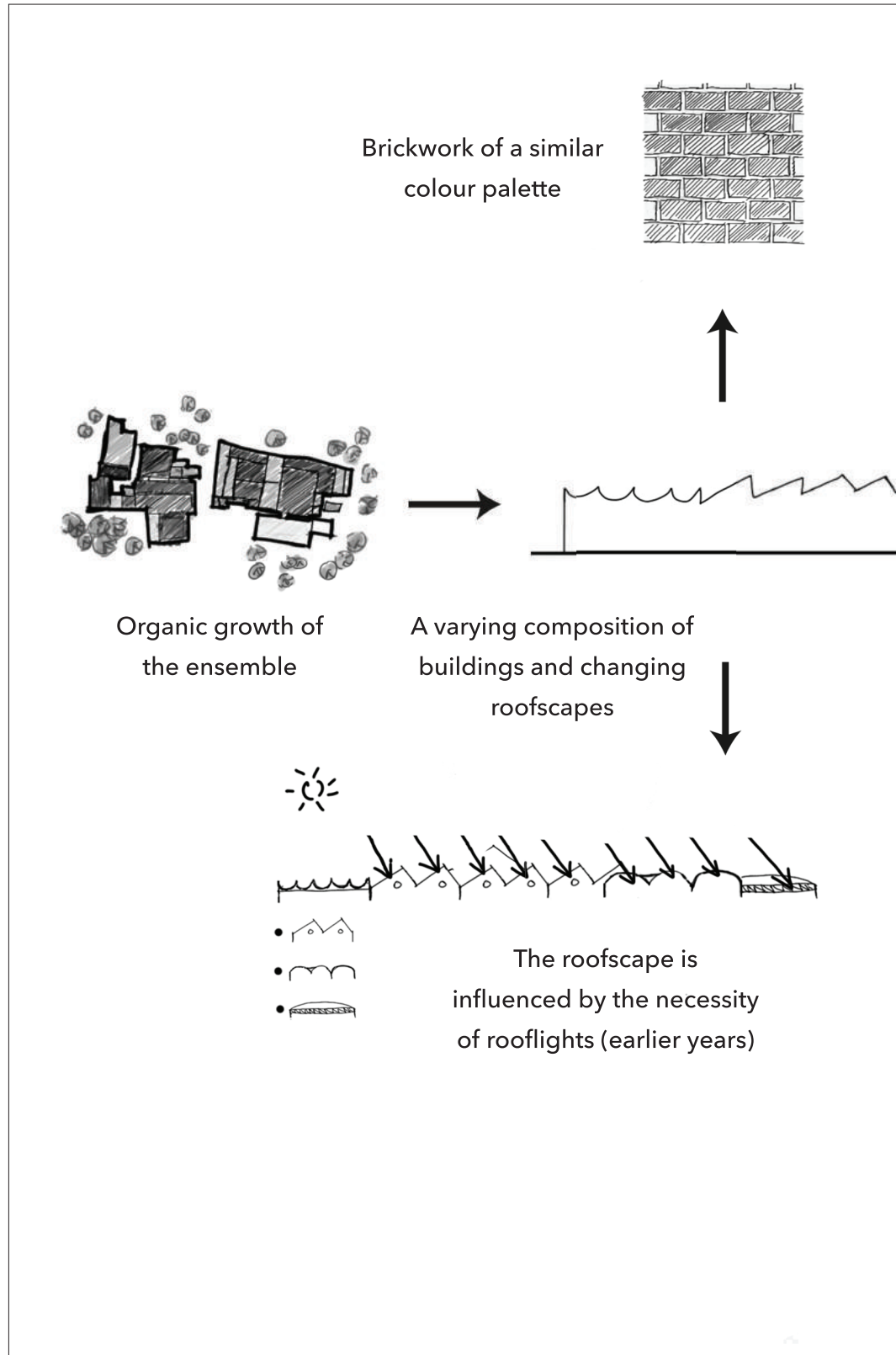
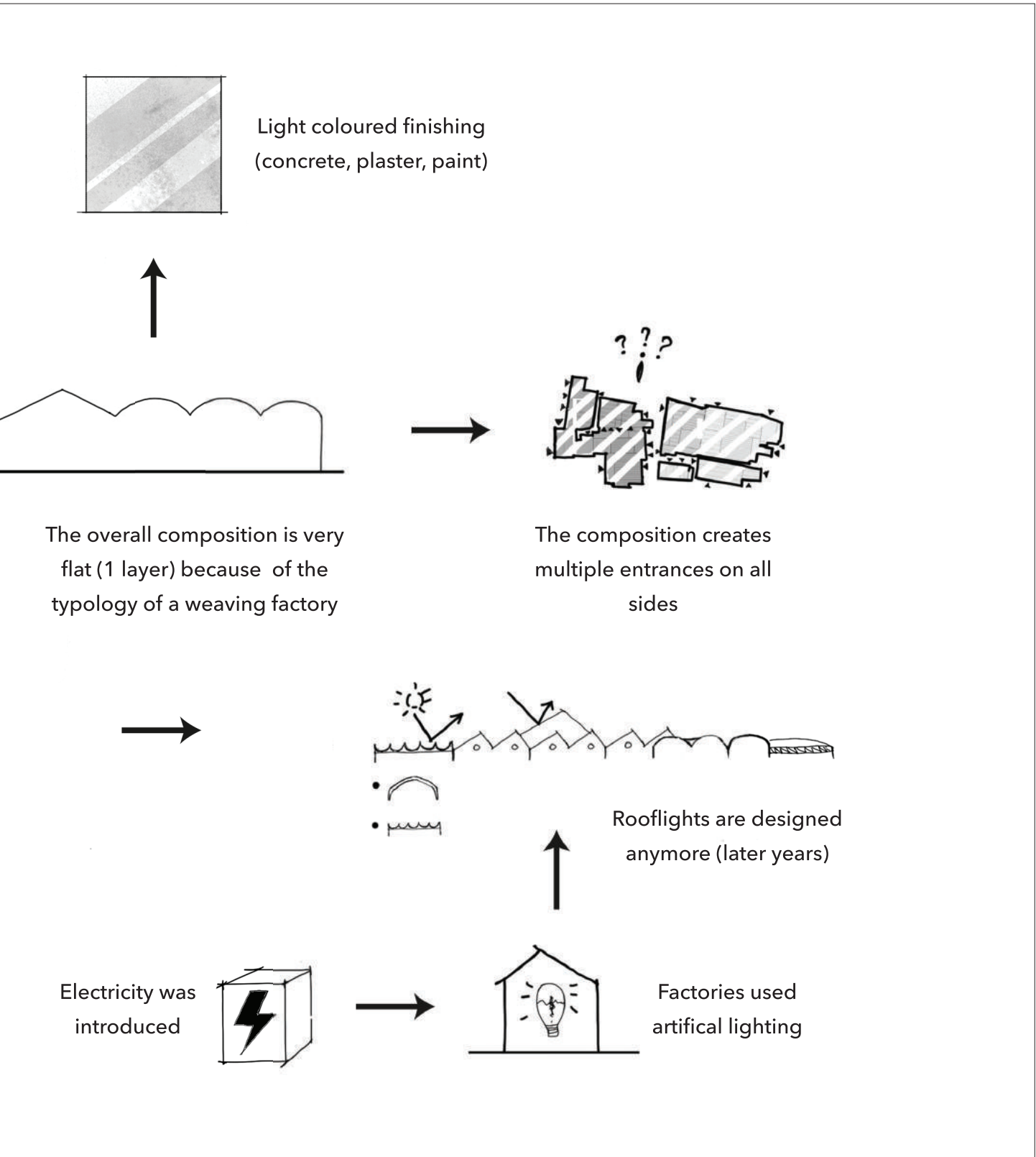

Figure 113 Conclusions. (Own image, 2019)





V STRUCTURE ANALYSIS

Just as important as the skin, the structure also plays a specific role for industrial buildings. Generally speaking these buildings emerge because they need to be functional: they serve a very defined goal. In this chapter the relation between this goal and the architectural appearance is researched. For further developments it is also important to understand why certain buildings were designed by certain architects. For this reason the five typologies are also put in an historical context.

TYOLOGIES, SPECIALITIES AND CHARACTERISTICS

In order to make a design which incorporates the chosen factory halls, it is important to understand why they in the first place were

built as they are. Why to choose for a certain architect or structure?



As explained before, Beltman's engineering office was a very important one for factories in the east part of The Netherlands. It is for that reason not surprising that a lot of buildings on the project site are built by this office. Also the fact that the company did not go bankrupt and still exists, makes up for the fact that a lot of different parts of the industrial complex are constructed by the office.



Jan Cornelis Pannekoek was an engineer from The Hague, who has built multiple industrial buildings, mainly for textile companies, in The Netherlands and Germany. He developed his own type of factory hall, based on the concept of trusses. It allowed for a very cheap and fast to built structure. The structures could reach a span of 55 without columns, which logically is very attractive for factory buildings. Choosing this architect could have been based on Pannekoek's experience with industrial buildings and the fact that he also operated in Germany and for that reason wasn't bound to the west part of the The Netherlands.



The hyperbolic paraboloid concrete shell structure is one that was used around the 60's and developed by the Germans. Due to WWII, concrete was cheaper than steel and wood, hence it was a popular material. Also labour was cheap in those days, resulting in craftsmanship which allowed for making the extremely thin double curved shells. Prefabricated elements were economically attractive and functioned as loadbearing structure and finishing at the same time: perfect for an industrial building. Presumably the choice for this type of structure was based on Winterswijk's relationship with Germany. The structure is rare since it was only used until 1975.

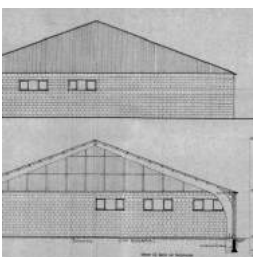

At first sight, the cross laminated timber beam structures might not appear to be special, since nowadays a lot of CLT beams are used for structures. Although looking at the time in which the buildings were established, it is kind of special. In 1955 and 1963 these structures were not so common yet. Still the choice for this structure seems to be logical, since the beam producer 'Nemaho' was situated in Doetinchem, very close to Winterswijk. 'Nemaho' was the first company in The Netherlands to produce this type of beams.

- Image 115 A. Beltman (Watertorens, n.d.)
 Image 116 A 'Pannekoek roof' (Heemkundekring, 2007)
 Image 117 Hyperbolic paraboloid precast concrete shells (Koncz, 1967)
 Image 118 Industrial hall (Ergoedcentrum Achterhoek Liemers, 2019)

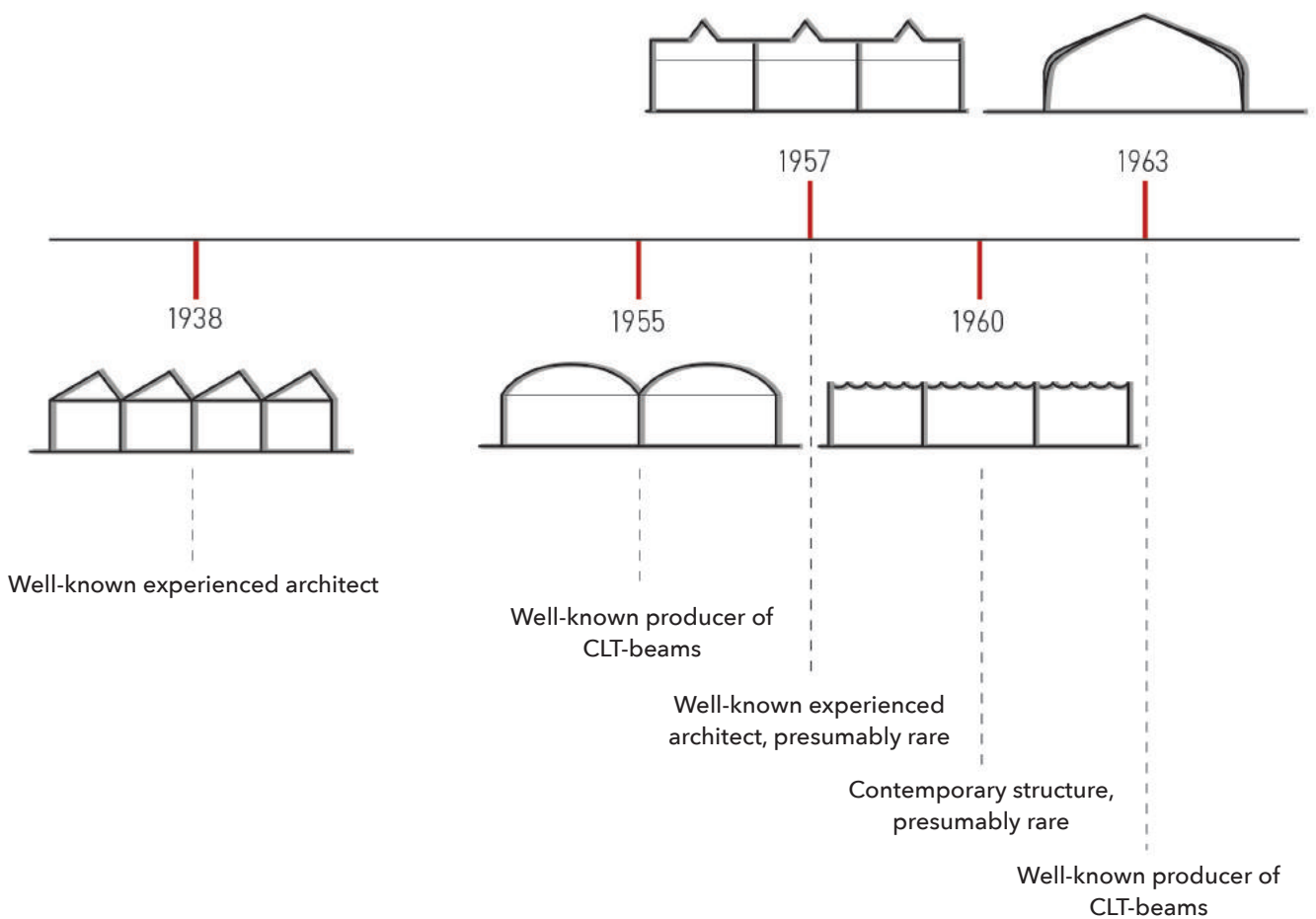

All structures have in common that they have a repetitive, straightforward (some exceptions) grid. It could also be possible to enlarge the structures (in one direction) or to take away some repetitive parts without harming the whole structure. The repetitive character is important for the look of these buildings.

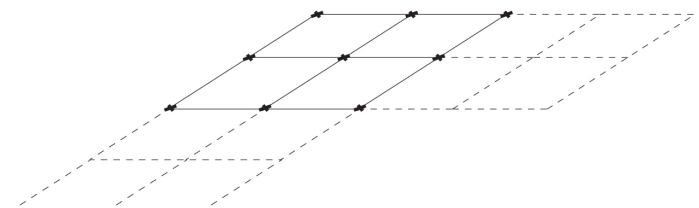

Figure 119 Typologies in history (Own image, 2019)
 Figure 120 Layout factories (Own image, 2019)

A

For building B, functionality was leading for the architectural appearance. The shape of the roof is based on getting as much as daylight as possible into the building, without causing glare for the factory workers. The resulting

saw-tooth structure creates its own architectural atmosphere. The cast iron columns and steel trusses are repetitive and shows the essence of industry: functional and robust.

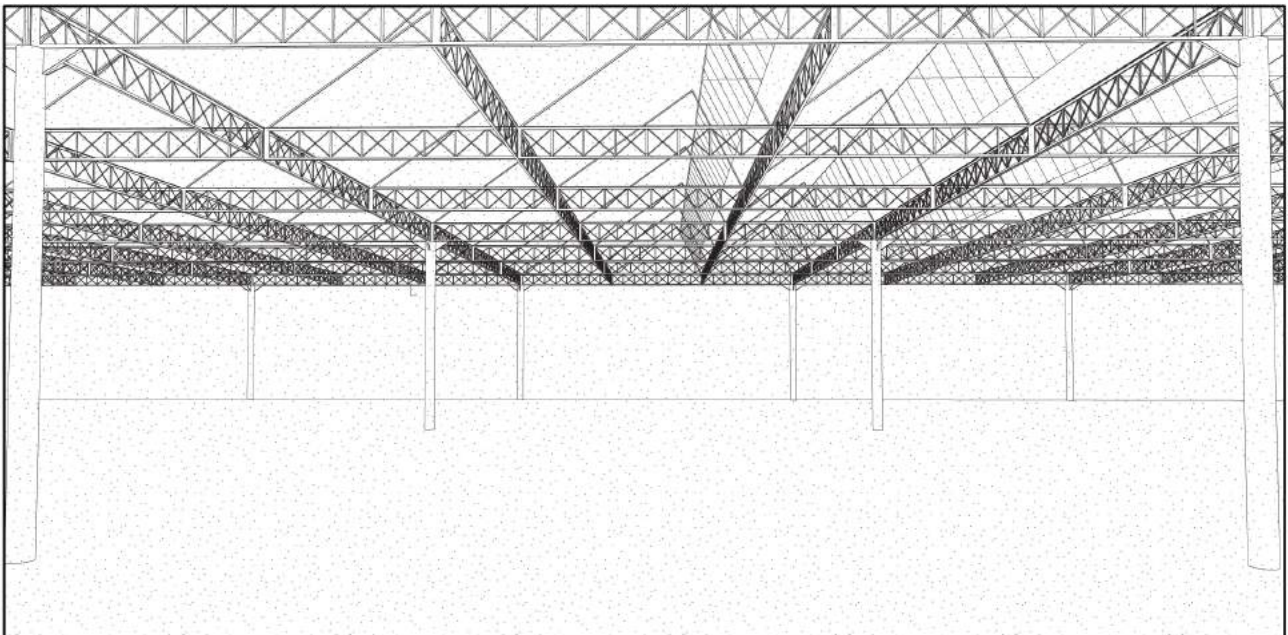

Figure 121 Building A. (Own image, 2019)

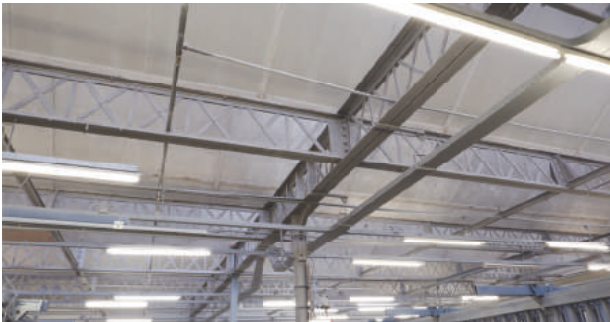

Figure 122 Building A. (Photos by Samantha Elschoot, Chen Zhu, Dinand Kruize & Juliëtte Zegers, 2019)

B

For building B the structure is very much expressed. The big I-beam truss is introduced to have as less columns as possible and creates a big span. The tension bars in between the CLT beams are inevitable and create the

structure's architectural look. Nowadays the interior is painted white, diverting from the original timer coloured CLT beams.

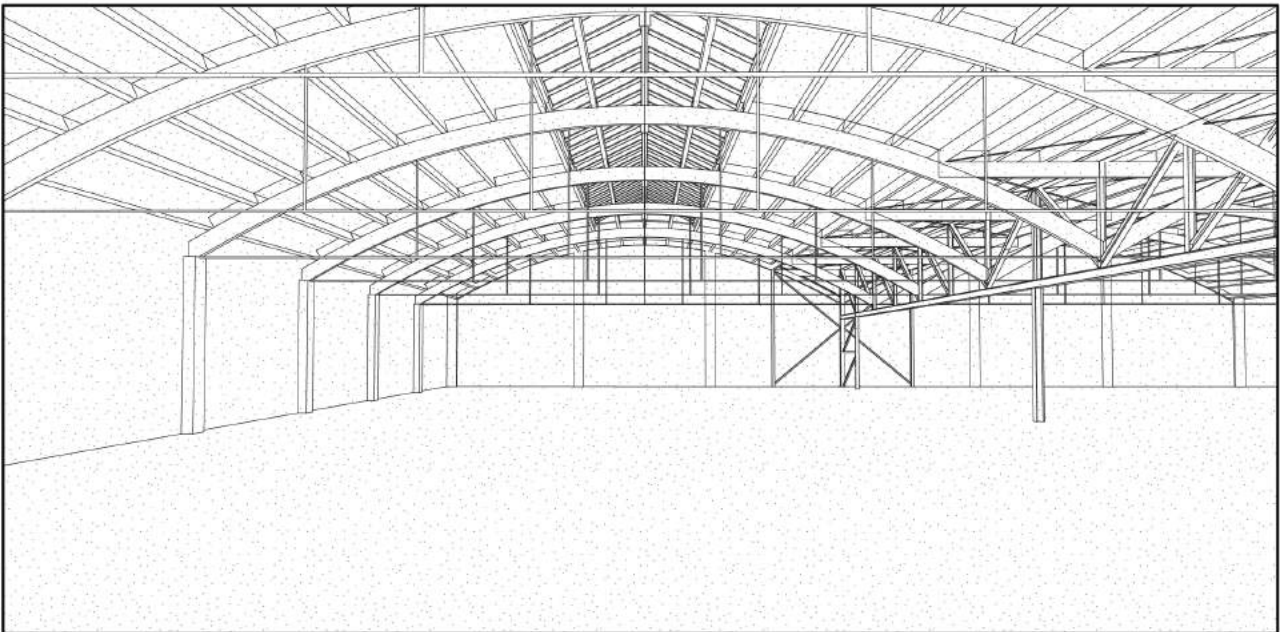

Figure 123 Building B. (Own image, 2019)

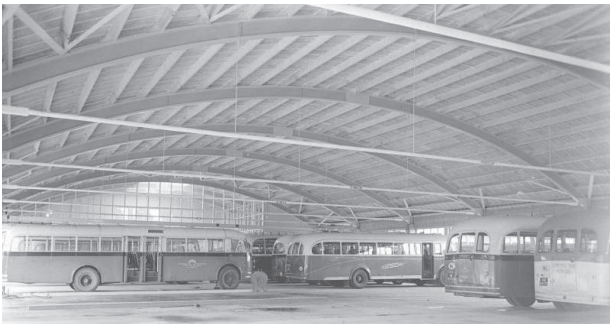

Figure 124 Building B (Photos by Samantha, Elschot, Chen Zhu, Dinand Kruize & Juliëtte Zegers, 2019)

C

For building C, the original structure is not dominating the architecture at all. Originally, this was the case when the steel trusses would still be visible and the low weaving machines would allow for the visitor of the building

to have a widespread look over the floor. Nowadays high shelves are placed in the room, which cuts the space in two and the experience is nothing what it used to be.

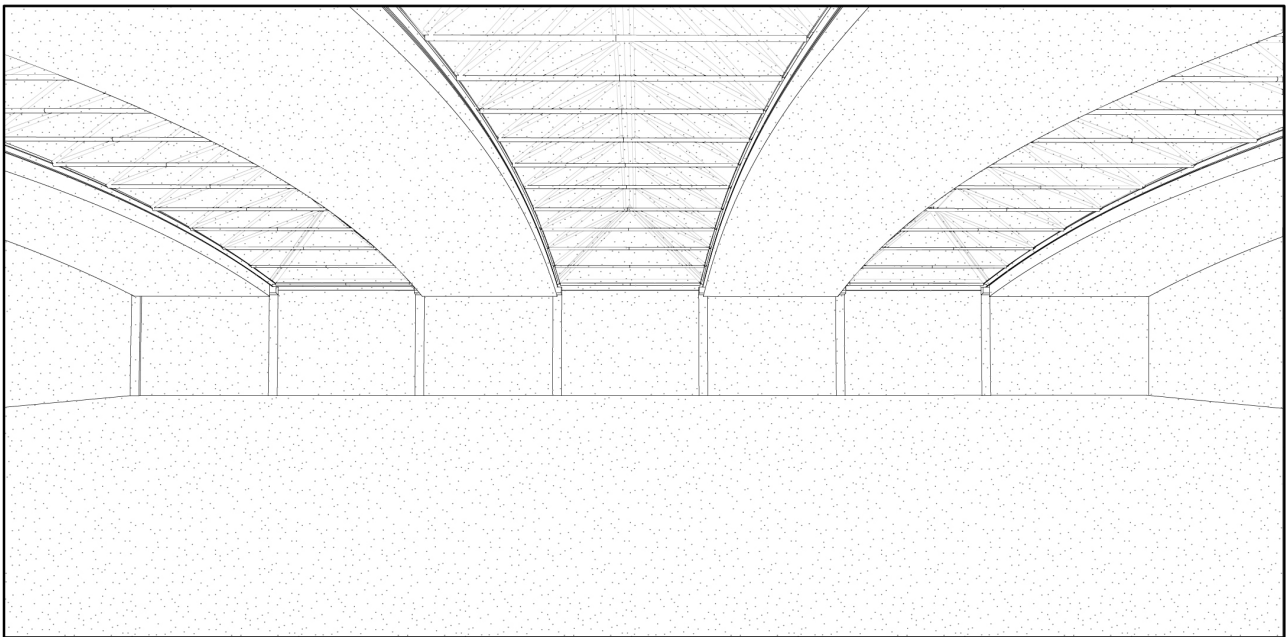

Figure 125 Building C. (Own image, 2019)

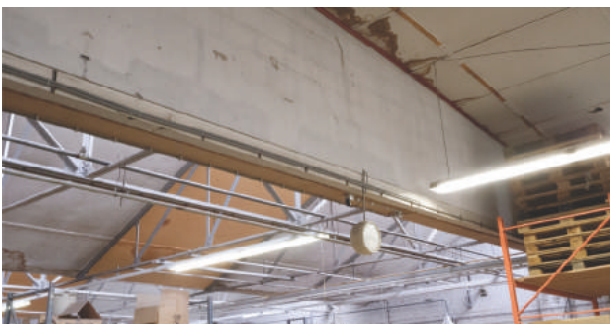

Figure 126 Building C (Photos by Samantha Elschot, Chen Zhu, Dinand Kruize & Juliëtte Zegers, 2019)

D

For building D, the structure is very much determining the interior space. Columns and roof structure are visible: the structure is the architecture. The big spans are noticeable, allowing for a very light feeling, even though

there is no natural light. Also the ceiling, which at the same time is the roof, catches the eye with the smooth curved surfaces. Its repetitiveness also brings unity for the whole building.

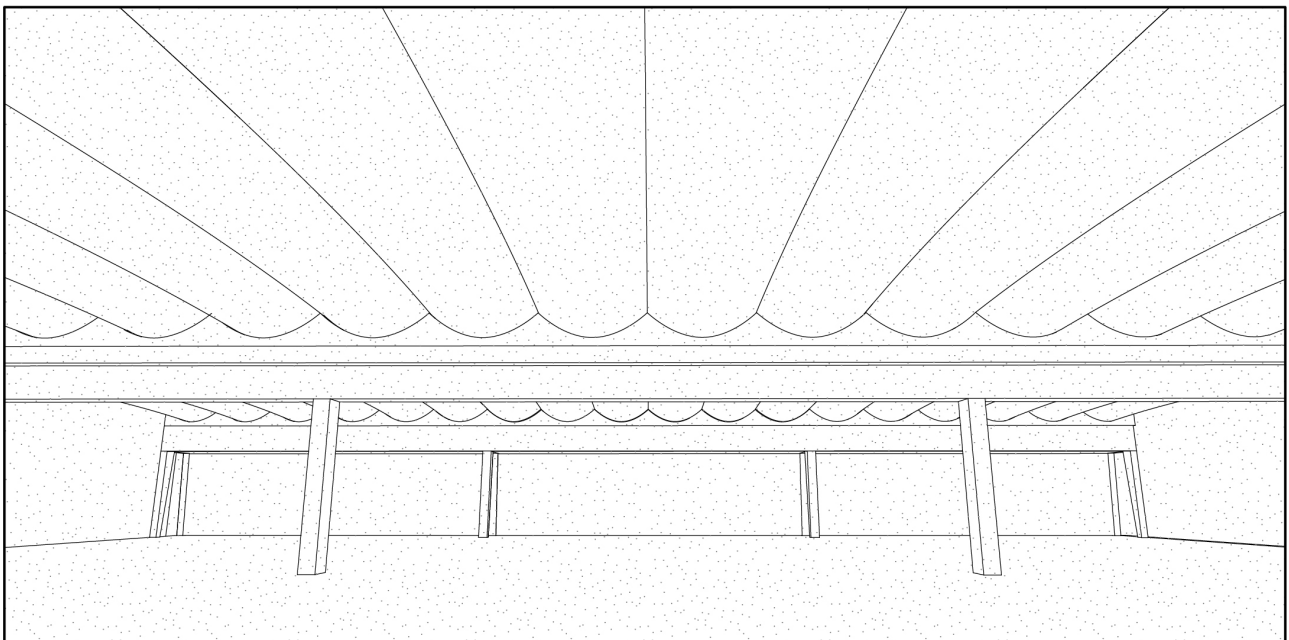

Figure 127 Building D. (Own image, 2019)



Figure 128 Building D. (Photos by Samantha Elschoot, Che Zhu, Dinand Kruize & Juliëtte Zegers, 2019)

E

For building E, the structure very much defines the architectural appearance. A minimal of materials is used and the CLT beams very much stand out. The repetitiveness of the items is noticeable.

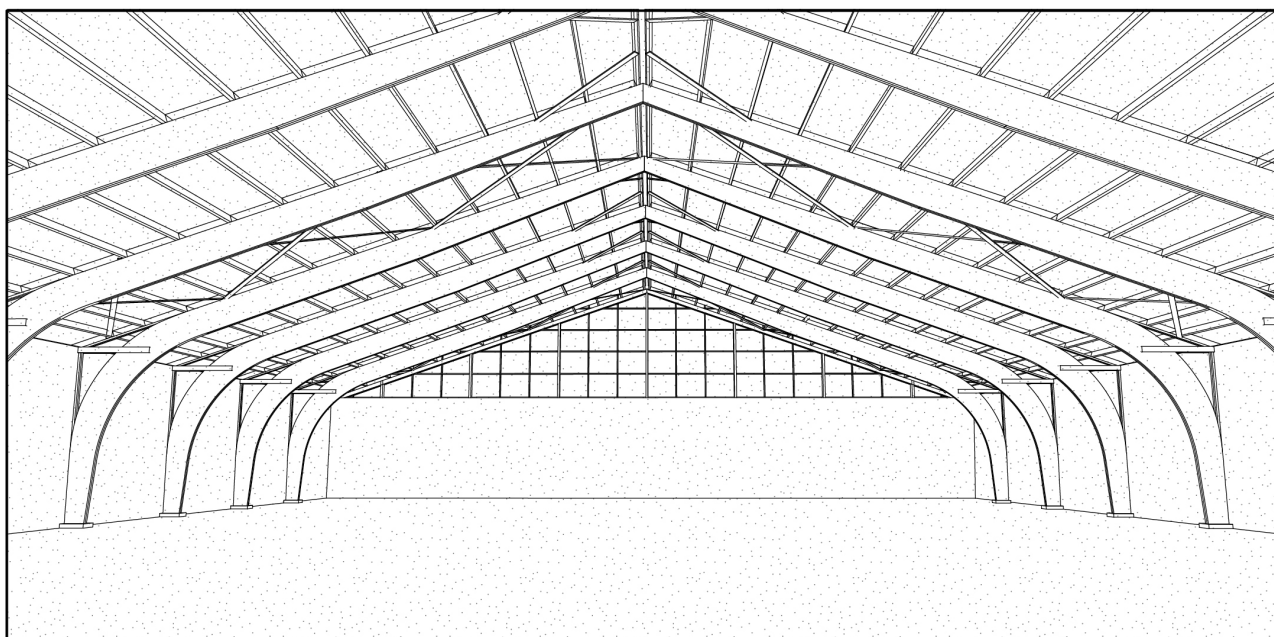
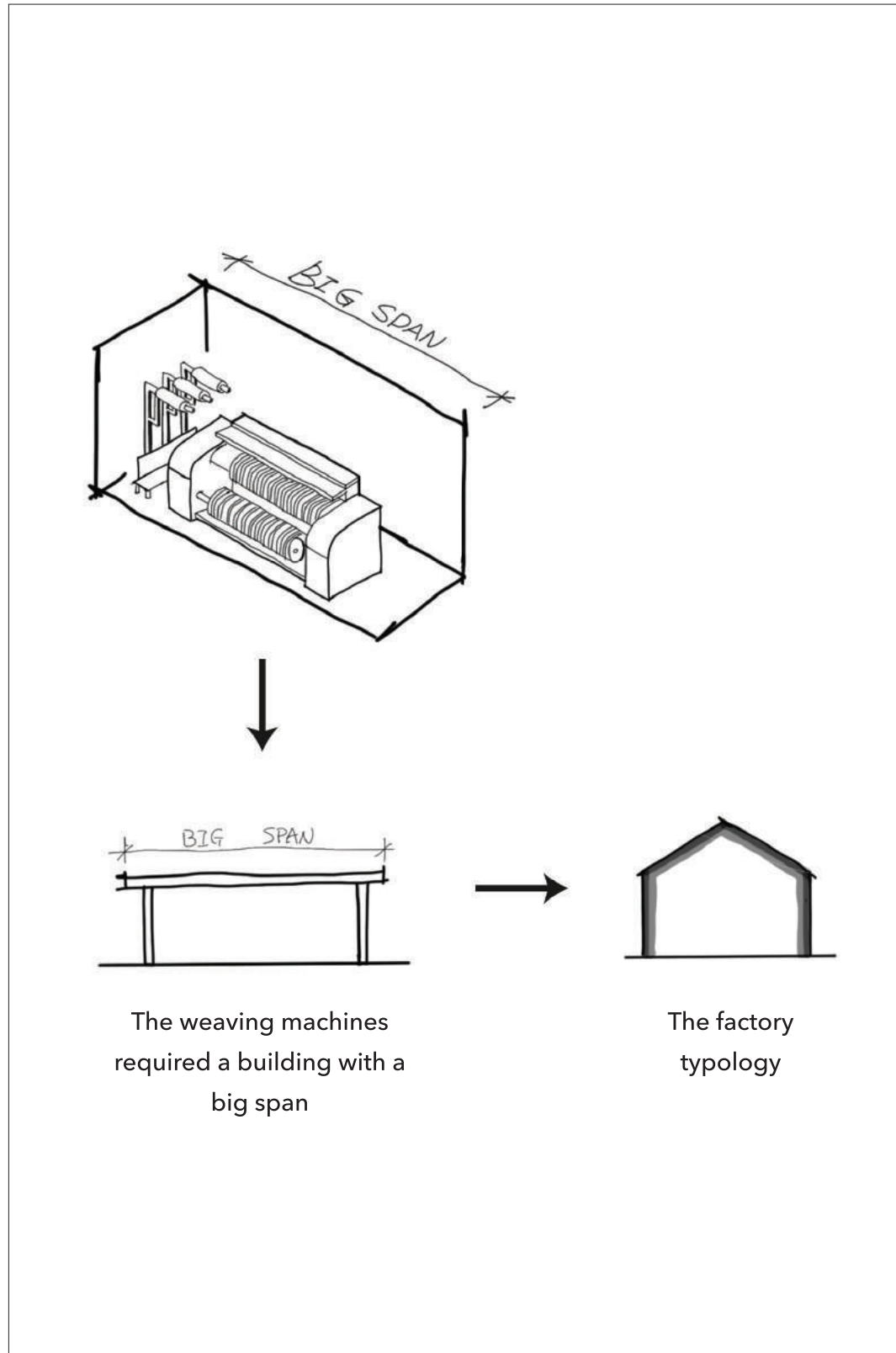

Figure 129 Building E. (Own image, 2019)



Figure 130 Building E. (Photos by Samantha Elschot, Che Zhu, Dinand Kruize & Juliëtte Zegers, 2019)

CONCLUSIONS



The weaving machines
required a building with a
big span

The factory
typology

Figure 131 Conclusions. (Own image, 2019)

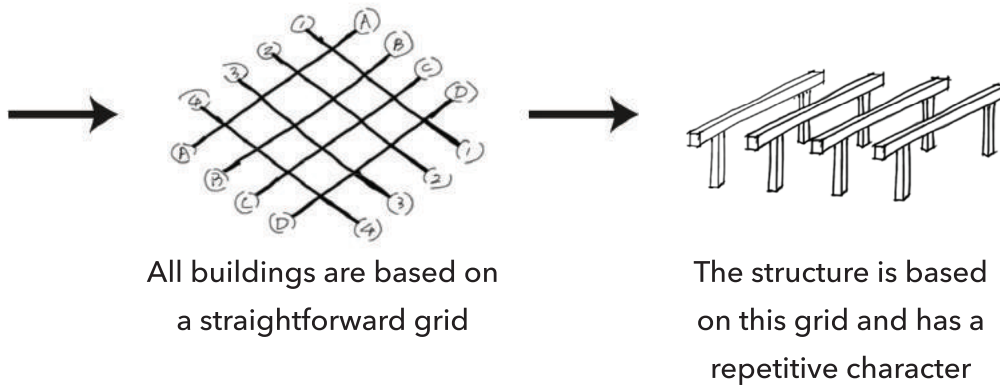

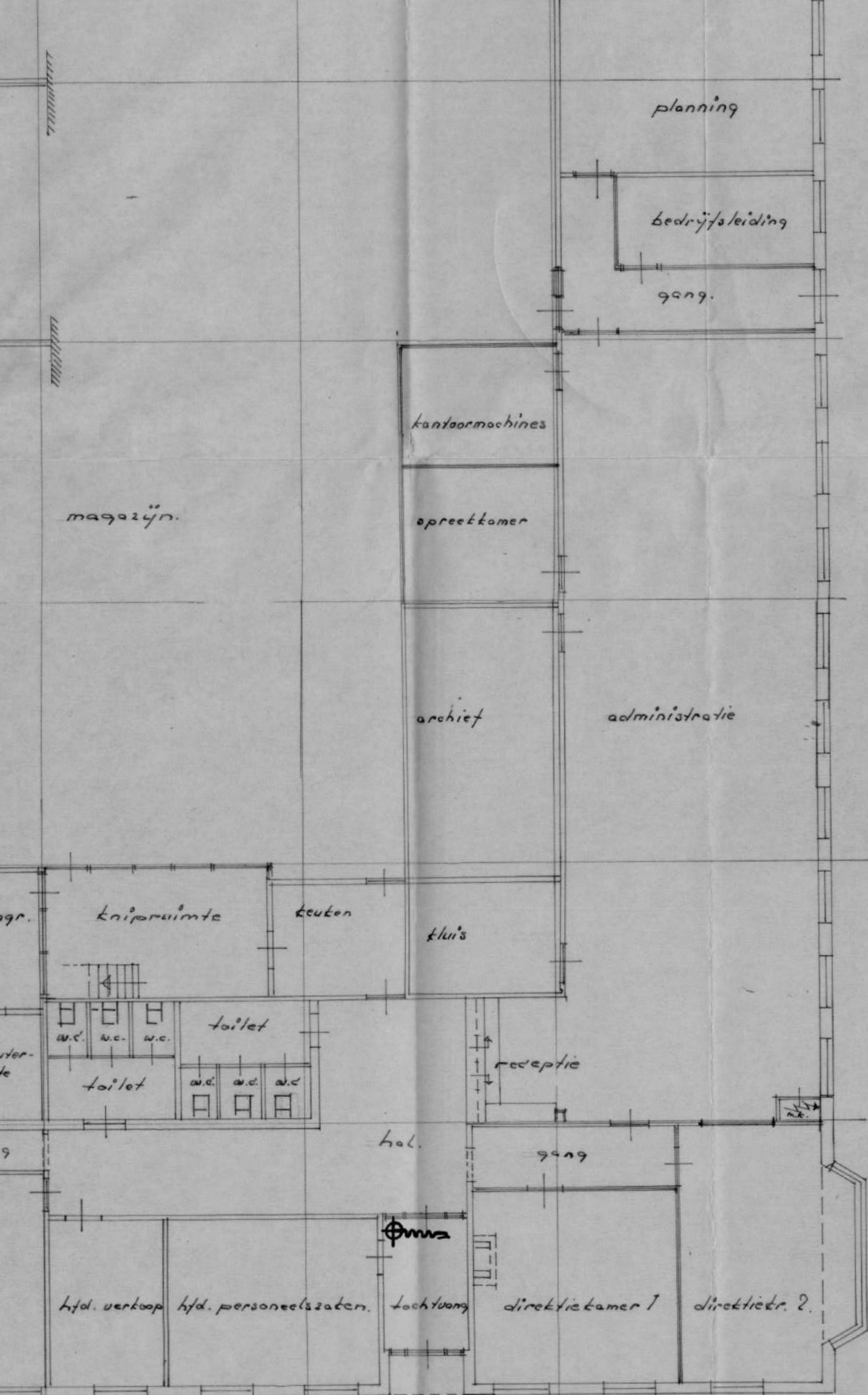

VI SPACE PLAN ANALYSIS

Very close connected to the structure is the topic of space plan. What conditions define the space plan of buildings from an industrial site and what was the influence of the process of textile industry in specific?

Afterwards the current situation and its conditions have been researched. Changes throughout time and its effect on the current situation could be key points in further design of the area.

PRODUCTION PROCESS

The production line is an industrial arrangement in which a product being manufactured is passed through a linear sequence of mechanical or manual operations. This chapter is focused on this sequence. At first, the raw materials and the general production process are discussed. Thereafter, the production process over time is illustrated for each industrial ensemble by making use of the chronomap information and original floorplan drawings.

As stated before, the presence of the textile factories is a consequence of the cultivation of flax. Originally, flax was the basis for the Western textile products. Because of the presence of flax the farmers were besides farming also active in weaving and spinning, whereby linen functioned as the raw material for this production process. From the 18th Century onwards the need for linen products decreased. This had to do with the introduction of cotton, which was cheaper in comparison with linen. The weaving parties in cotton became more and more dependent on the buyers. They were responsible for the looms and workspace. During the industrialisation and the introduction of the steam engine, a major change occurred in the production of textile products. From this period onwards, textile products were made in bigger quantities. Due to technical developments around the 1850's, new factories emerged in Winterswijk, all of them functioning as weaving factories driven by the steam engine. From the 1930's onwards the mechanisation took its place within the textile production process. Moreover, raw materials such as cotton and wool were more often replaced by rayon (artificial silk). (Weevers, 1994)

Water was a very important ingredient for the textile industry, thus the project's location is a very logical one to settle. All industrial areas were situated alongside the Whemerbeek. In the first place water was needed to keep the steam engines running, since the working of it is based on heating water in order to create steam and with that power. It could also be used to cool the cylinders of the steam machine (Wikikids, 2019). But it wasn't only the machines that made use of the water. After the weaving, the fabric almost being finished, it still needed a treatment in order to make it sustainable. For example, one of these steps is to bleach it with hot water. In this way water was an irreplaceable factor (Familie, 2019).

Nowadays the water is not visible anymore, despite the fact of it being so important for the development of the industrial area.

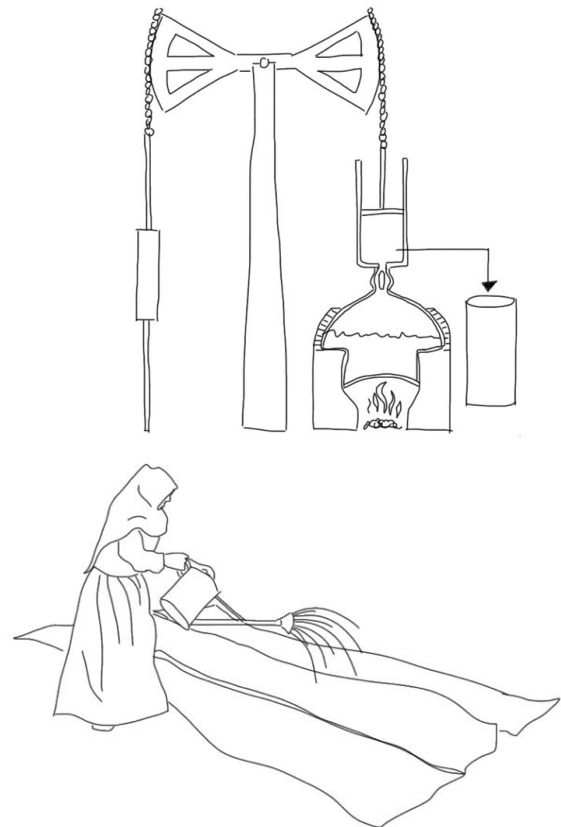

Figure 133 Steam engine (Own image based on Wikikids, 2019)
 Figure 134 Bleaching of linen (Own image based on Van vlas tot linnen, n.d.)

Boiler house

The heart of the factory is the boiler house. Within this building the steam engine and the power station for producing electricity were situated. The textile companies produced the electricity themselves. However, the electricity was not the driving factor for the machinery in the factories. The machines were powered directly by the steam engine with the help of drive shafts, flywheels, drive belts.



Wet department

Consequently, the textile product went to the one of the 'wet' departments. In this whole section the products were washed, painted or bleached.



Yarn storage

Because there were no spinning activities within the factories, all of the companies were dependent on the import of yarns. These yarns, mostly cotton and woolen, were saved in a storage called 'garenloods'.



Kalanderij

In this department the product was 'kalanderd', a process whereby the product was ironed. The aim of this operation was to make the fabric shiny and smooth.



Confection room

The improved knit was then transported to the confection department. The activities within this room was to construct the final product, bringing together the different knits.



Spool department

From the storage the yarns were transported towards the spool room or building. These yarns were delivered on specific collets, 'spinhulzen'. These collets were too small in length in order for the knit machines. Therefore the wool or cotton was firstly spooled on larger bobbins.



Press shop

For further finishes there was a press shop included in the factory. Consisting of a hydraulic press machine and a crochet machine. In this room, for instance, the buttons were added.



Knit department

Afterward, the yarns were delivered in the knitting room. In this room the weaving process took place using machines.



Package hall

The products were packaged and ready made to deliver.



Secondary spaces

This includes all the rooms which do not have a direct link with the textile productions. For instance, a storage hall.



Ruwerij

In case the products were intended for underwear, the cloths were transported to the 'ruwerij'. The ruwerij is a department where the textile fabric was made more rough, by removing in a mechanical way the fiber ends of the cloths.



Office space

The whole production process was navigated and guided from by the managing board and other office employees, which assumedly had their own private space. (Weevers, 1994)



MEIJERINK & CO

1890-1935

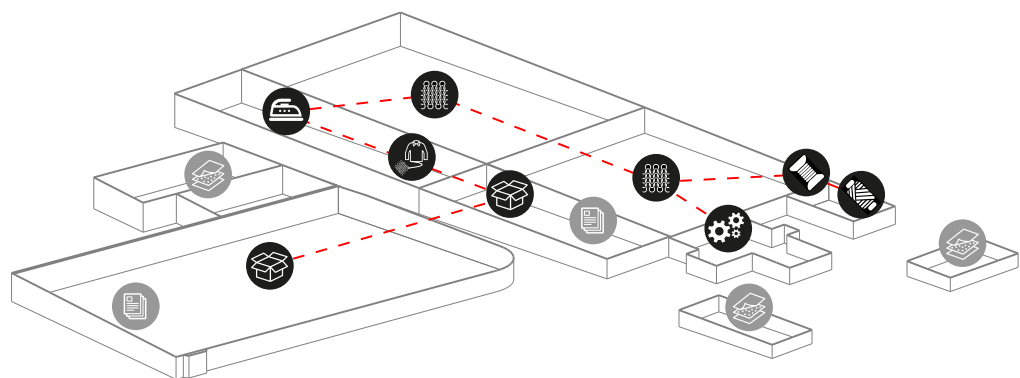

It is not known whether there was a spool department and a yarn storage, although it is assumed that one of these was situated nearby the weaving halls. A continuous production was necessary to manage the need for textile products. A striking feature of this production line between 1890-1935 is that, the main package hall is not directly

connected on the production area. Besides that, the offices were situated nearby these package halls. The halls scattered around the industrial plot are probably some kind of storage or employees rooms. (Beltman, 1911) (Beltman, 1913) (Beltman, 1916) (Beltman, 1921) (Beltman, 1927)

Figure 135 Production process Meijerink & Co 1890-1935 (Own drawing, 2019)

1935-1940

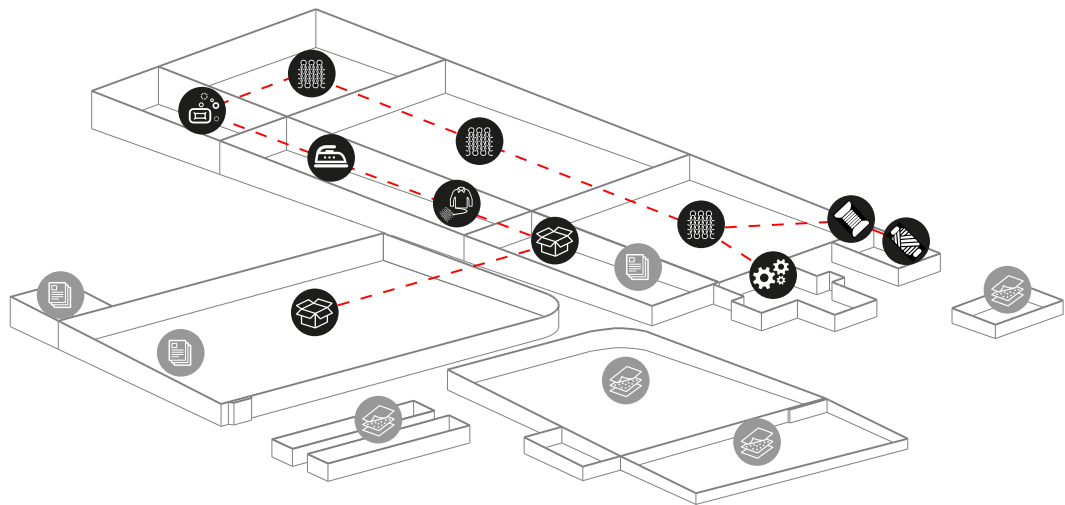

Remarkable for the Meijerink & Co company was that in contrary with the other textile factories of the ensemble, they had a confection room and a painting department. During this short duration of 5 years, especially storage halls were added. What exactly is stored within these halls is not clear. Besides that, it seems like that during this

period the office started to focus towards the Laan van Hilbelink, away from the weaving activities. Perhaps the more management and trading related business was dealt within these new added offices. Also for the fact that the package halls were closely situated to the offices. (Beltman, 1935) (Beltman, 1937) (Beltman, 1941)

1940-1950

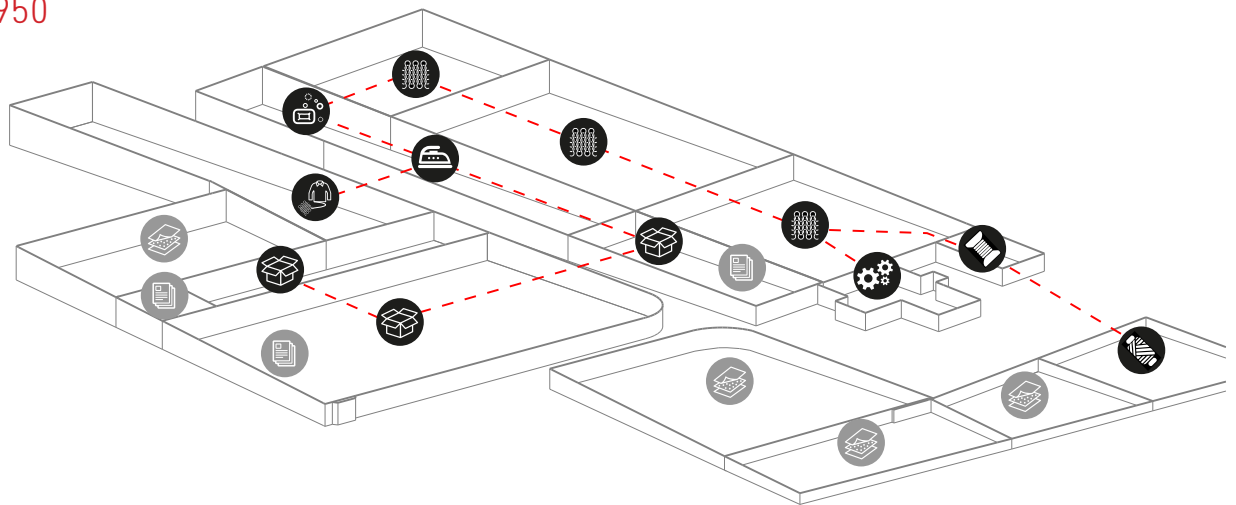

The confection of the products was plausible a great success. A complete confection building was added to the composition, which enlarged the production line. This confection building consisted of two floors. On the first floor the confection itself took place. On the ground floor the preparations beforehand the confection took place, such as 'scheren' and 'sterken' of the wires. Unfortunately it is not known if the addition next to the office had a direct link with the confection building. Assumed is that it was a storage hall, were all

of the needed tools for the confection were stored. Another assumption which is made, is that the yarn storage moved towards the new extensions alongside the Zonnebrink street. This could be plausible because of the expanding production and thus larger storage was needed for the yarns as well. The spaces next to this hall were used for the storage of wooden boxes. (Beltman, 1940) (Beltman, 1948) (Not known, 1948) (Beltman, 1949)

Figure 137 Production process Meijerink & Co 1940-1950. (Own drawing, 2019)

TEN CATE

1950-1960

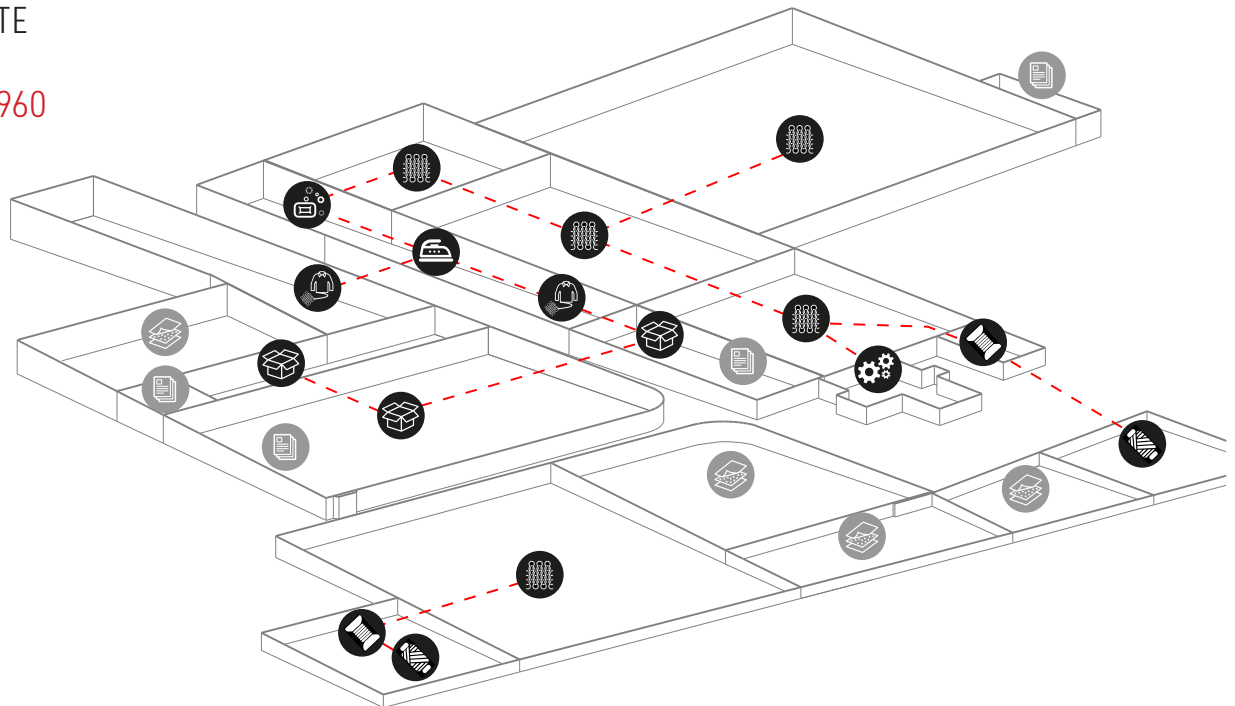

In these ten years again the production process expanded, especially the weaving activities were enlarged. Two new weaving buildings were added. The one alongside the Morsestraat is closely situated to the old core and the activities within. Therefore, assumed is that somehow the production line continued in this new weaving building. On the contrary with the new weaving building alongside the Laan van Hilbelink. It seems like other weaving activities were situated within this building. Also because it had its own

preparation department, which was not the case for the addition at the Morsestraat. For both buildings the machines were not driven anymore by the boiler house. The creek was covered, and thus electricity which was produced elsewhere was the driven factor for the machines. This was a major change for the whole production process. Because of this, it is not known if the traditional production line, dated from 1911 was still running. (Beltman, 1955) (Bouwkundig Ingenieurs- en Adviesbureau Sassen, 1960)

1960-1997

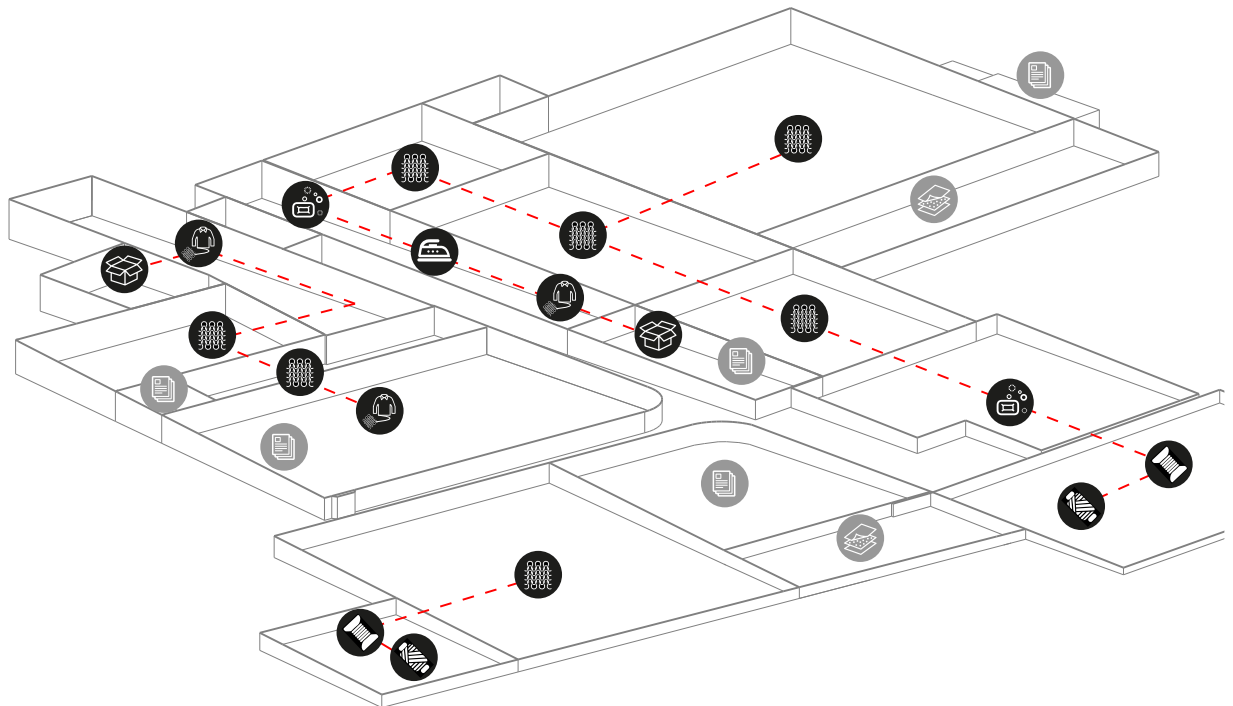

From the 1960's onwards a lot of happenings were crucial for the use of the different buildings. In 1963 another textile production firm took over the whole, Ten Cate. Logically, they had their own way in producing their products. A few changes within the buildings are registered in drawings. However, not everything is traceable from the available information.

In this timeframe the boilerhouse was replaced by a new confection building, next to a new yarn storage. Moreover, the former packing halls were also replaced by a confection department and a weaving department. Because of these changes, assumed is that Ten Cate had several production lines for their textile fabrics. This results in the scheme

above, which shows three different production lines.

Unfortunately, it is hard to tell if the original and oldest production line of Meijerink & Co was used in the same order for Ten Cate. Still, it is assumed that they did use the same order. Otherwise, the requests of change would be registered by the municipality of Winterswijk.

Besides Ten Cate, another textile company de Tuunte took also place in several buildings. However, it is not clear which kind of productivities they did and in which building. (Bouwkundig Ingenieurs- en Adviesbureau Sassen, 1962) (Bouwbureau Nijverdal, 1985) (Rayonarchitect, 1988) (Bouwbureau Nijverdal, 1992) (Reukers Bouw BV, 2001)

Figure 139 Production process Ten Cate 1960-1997. (Own drawing, 2019)

HAZEWIND

1910-1930

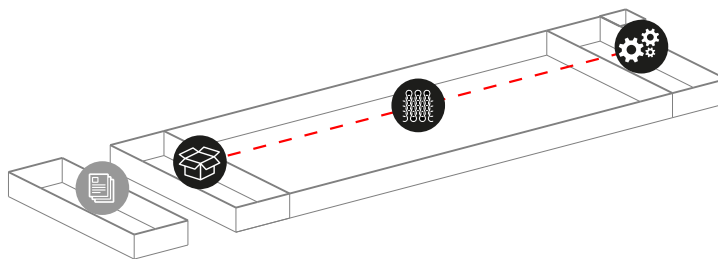

Until 1941 the factory was owned by M.M. Poppers. During this period a production line of white cloth was managed. Moreover, Poppers was also known for its trading in yarns since 1864. However, it is not known if this factory also stored and made yarns for

own production and for trading purposes. (Weevers, 1994)

As already stated in the chapter of chronomapping, a lot of drawings are missing. In fact, the available drawings also do not show functions of the floorplan.

1930-1945

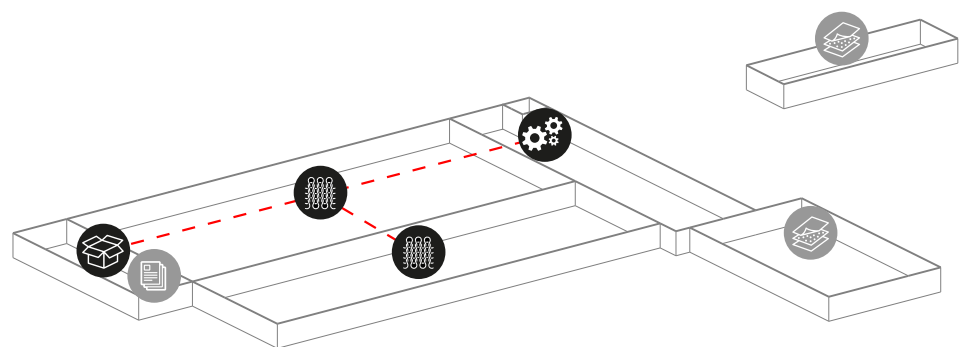

In the period of the second World War the production line was taken over by W.H. Weidemann, director of Meijerink & Co. The weaving department extended towards the

Morsestraat. Besides that, there was need for more storage space. (Lammers, 1943) (Lammers, 1944)

1945-1950

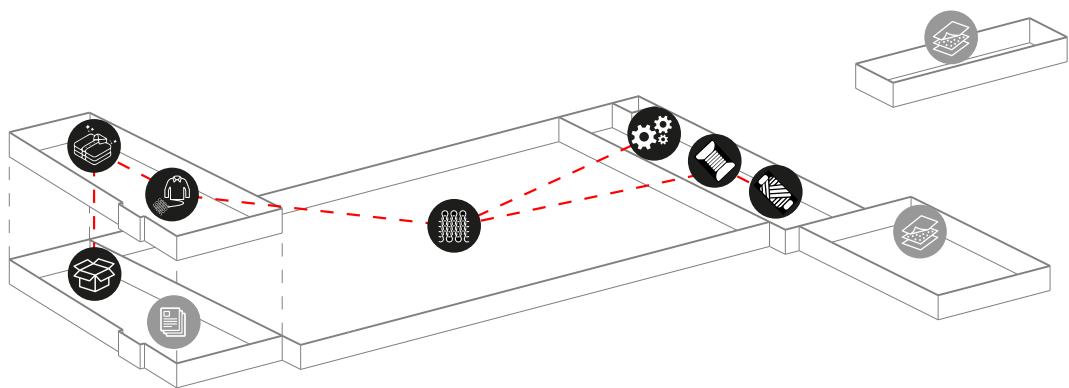

Under management of Weidemann, the textile firm was renamed. From this period onwards the company was named 'Weidemann & Confectie'. Logically this had to do with a new addition, the confection room. Moreover,

a new office was introduced at ground floor. Besides the confection department on the 1st floor, a press shop was situated for finishing the products. (Schaaf, 1944)

Figure 142 Production process Poppers / Weidemann / Hazewind 1930-1945. (Own drawing, 2019)

1950-...

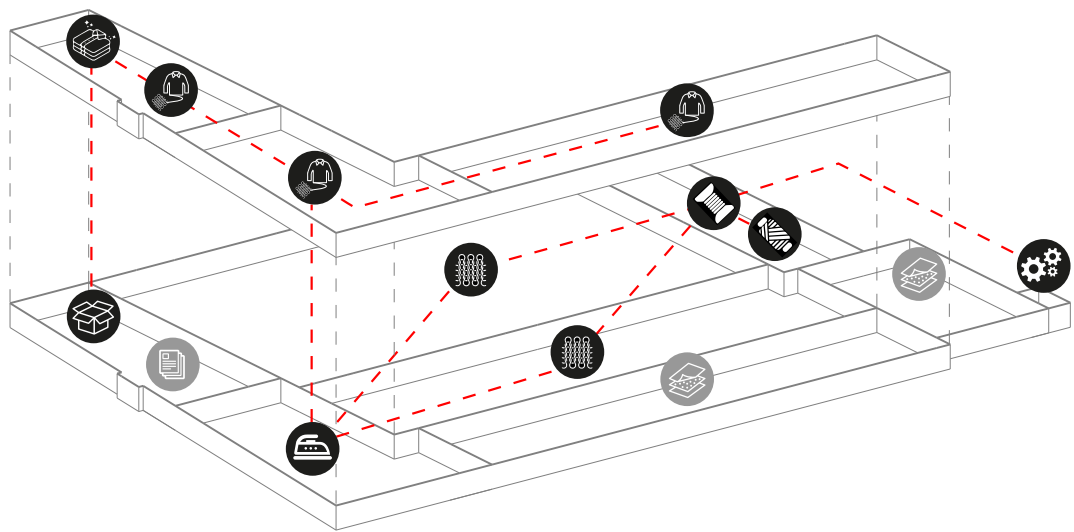

Around 1948 again new owners entered the building composition. The new firm was named 'Weverij de Hazewind'. In terms of the production line, the first floor with the confection activities enlarged. Moreover, an 'Kalanderij' was added. Because of improving

technologies, the steam engine lost its purpose. The whole technical department was now used for storage. A powerplant was added to the composition alongside the Morsestraat. (Schaaf, 1944) (Schaaf, 1948) (Schaaf, 1950) (Konings, 1961)

Figure 143 Production process Poppers / Weidemann / Hazewind 1950-1990. (Own drawing, 2019)

DE POL

1910–1930

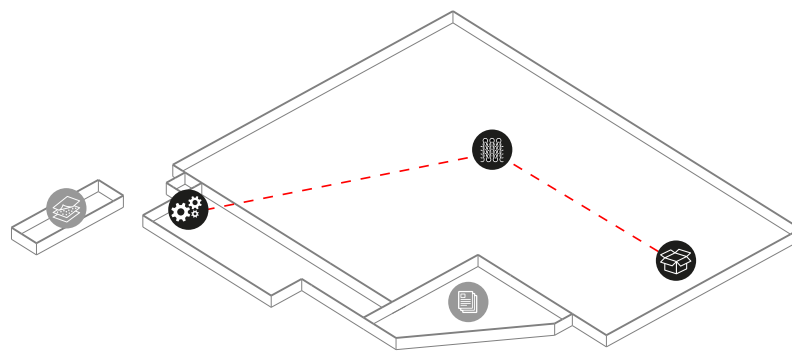

De Pol originally was a secondary industrial part of De Batavier. De Batavier, well known as the 'Zwartstoom' black steam in English. Zwartstoom produced their own yarns. Therefore, it is more likely that De Pol stored

their yarns at the department of the Batavier. This means that only the weaving process took place within this building ensemble. (van Dugteren, 1928)

1930-1960

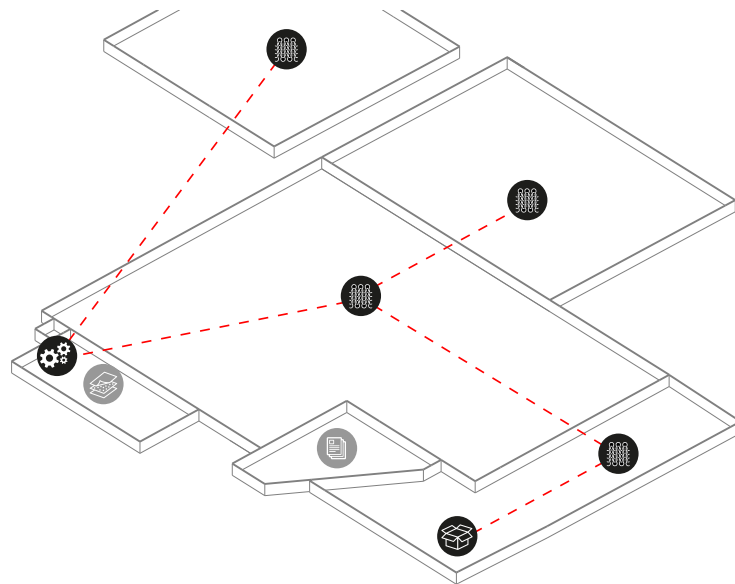

De Pol enlarged their industrial property. Within this time-frame a new weaving department was added. The building across the Whemerbeek was focussed on the weaving of wool. Unfortunately it is not known what the exact weaving activities were within the old core of De Pol. De Batavier was

known besides for its weaving, also for the painting of their products. Also in this case it is plausible that the painting of products still happened at the Zonnebrink, since there is no proof of a painting department in the Pol factory. (Beltman, 1947)

Figure 145 De Pol/Gaudium 1930-1960. (Own drawing, 2019)

1960-1980

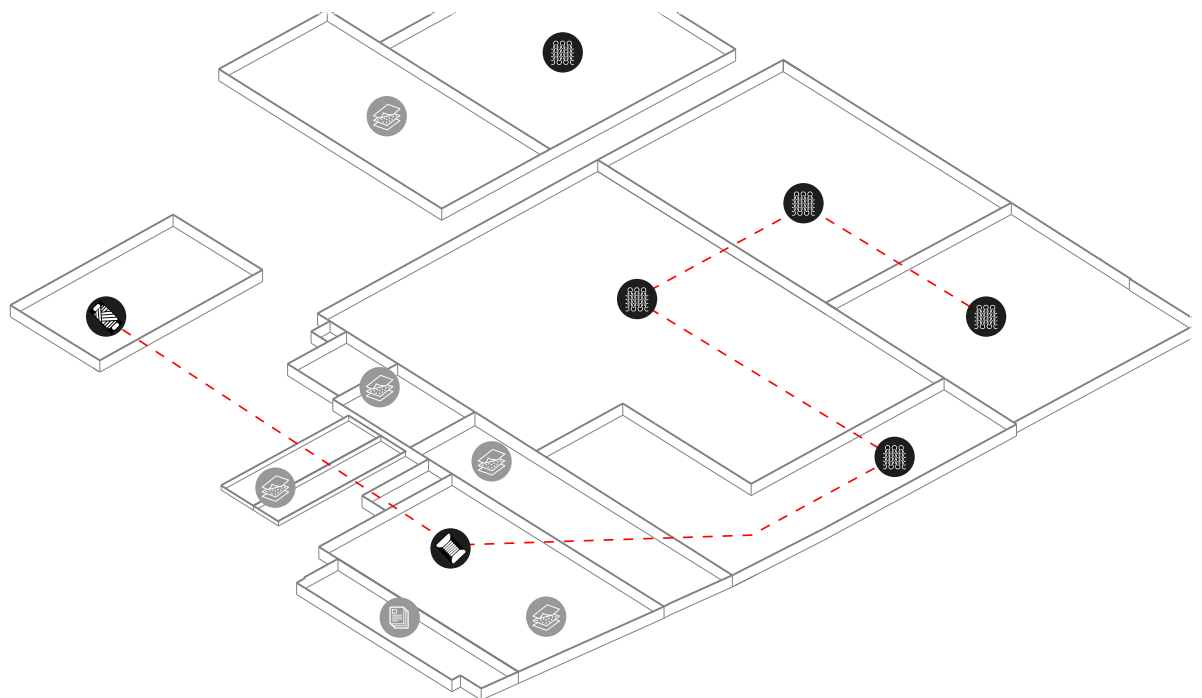

In comparison with the other two textile ensembles, De Pol is most complicated in terms of illustrating the production lines. Due to a lack of sources and incomplete drawings it is hard to state what happened in what building. Moreover, the extensions which were made from the 1980's onwards can give an misleading image of the production line. Since the 1980's Gaudium managed

these buildings, with a production line which probably differs from the production line of the Pol. The current production line of the Gaudium will be discussed in the upcoming chapter. (J.C. Pannekoek, 1958) (Not known, 1957) (Beltman, 1960) (WAM bouwonderneming, 1980) (WAM bouwonderneming, 1969)

1980 – CURRENT

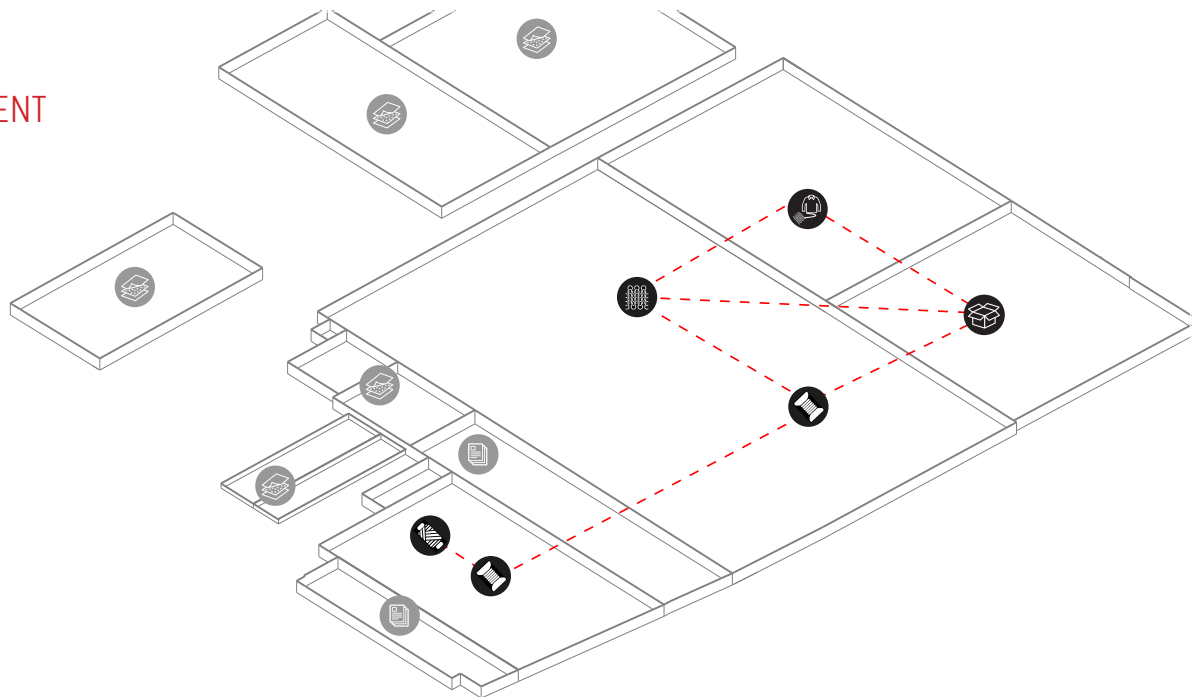

Gaudium bv. is a textile producer of gurtains and furniture fabrics. According to the Gaudium, the products are durable and consist of fire retardant tissues. The branches were Gaudium is focussed on are private living, hospitality, theatre, office/public places, healthcare, transport and outdoor. The illustration above show the production process as it is nowadays in Gaudium. The same icons are used as for the other production lines. Although, the used techniques differ in comparison with the historic production process within the textile branche.

The company states that the yarns are a crucial factor in the production lines. Therefore, Gaudium also edits the yarns themselves. The diversity of the yarns is the basis of their variety of products. The yarn storage is the beginning of the production line, situated in-between the office and the technical department. Thereafter, the 'scheerderij' is situated.

With the use of the imported yarns new 'kettingbomen' are made. In the next department these 'kettingbomen' are weaved into the final product. Gaudium has different product facilities and production lines in the weaving department. A big variety of weaving machines is used such as the 'Dobby' and the 'Jacquard'. Each machine has their own weaving technique and specifications, according to the need of the customer. In terms of the used techniques, the length and width dimensions of the products are decisive for the weaving technique.

Besides the weaving department, a carpet department is also situated within the Gaudium. In this building the 'karpetten' are manufactured by hand.

The Pannekoek building is used as expedition hall, the storage for the final products. (Oonk, 2019) (Gaudium, 2019)

Figure 147 Gaudium 1980-current. (Own drawing, 2019)

FLOORPLAN LAYOUT

For both three building complexes of the Morsepoort, Hazewind and Gaudium a lot of space is in use. The Morsepoort as well as Hazewind both rent out fairly plenty of space. In the plans below and on the next page is visible which rooms or buildings are in use and which are still empty. In case of the Hazewind it is hard to tell if the halls in the heart of the ensemble are fully in use or empty, due to a lack of information. The 'empty' spaces are marked in red. It appears as if it is going well with the use of the buildings. Nevertheless, this image misleads the reality. Because, functions are situated within these buildings which are not used frequently. Within the Morsepoort for instance a storage function and a lot of workshop related functions are situated. These function can be seen as 'part-time'

happenings. Which means that throughout the day, especially during the weekend, there is a lack of liveability, movement and social control. (Morsepoort bedrijventrum, 2019)

On the contrary, looking at Gaudium the major difference between Gaudium and the rest of the buildign complexes is that it still a running business. Here there is activity during 40 hours of the week. This on the other hand also means that it is quite a dead area during the weekends.



Figure 148 Floorplan layout Hazewind and Gaudium. (Own drawing, 2019)

CONCLUSIONS

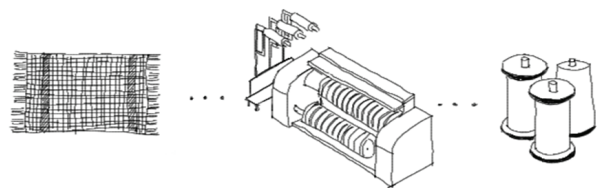

The production process
highly influence the
spaceplan of the factories

Figure 149 Conclusions. (Own image, 2019)

Gaudium is still in use. The old floorplan with big spans is still visible

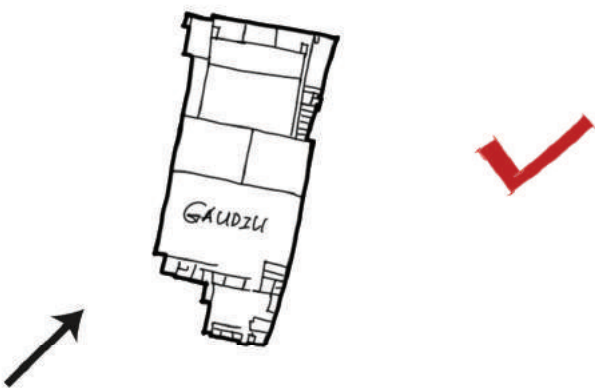

workdays

Different users of the area on different times during the week cause inactivity in the area

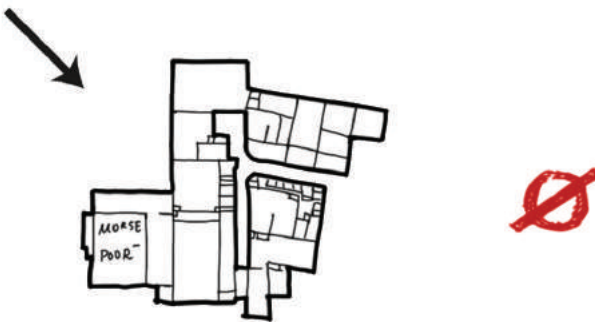

weekends

The Morsepoort is not in use anymore. The original floorplans are changed according to the new needs (smaller spaces)

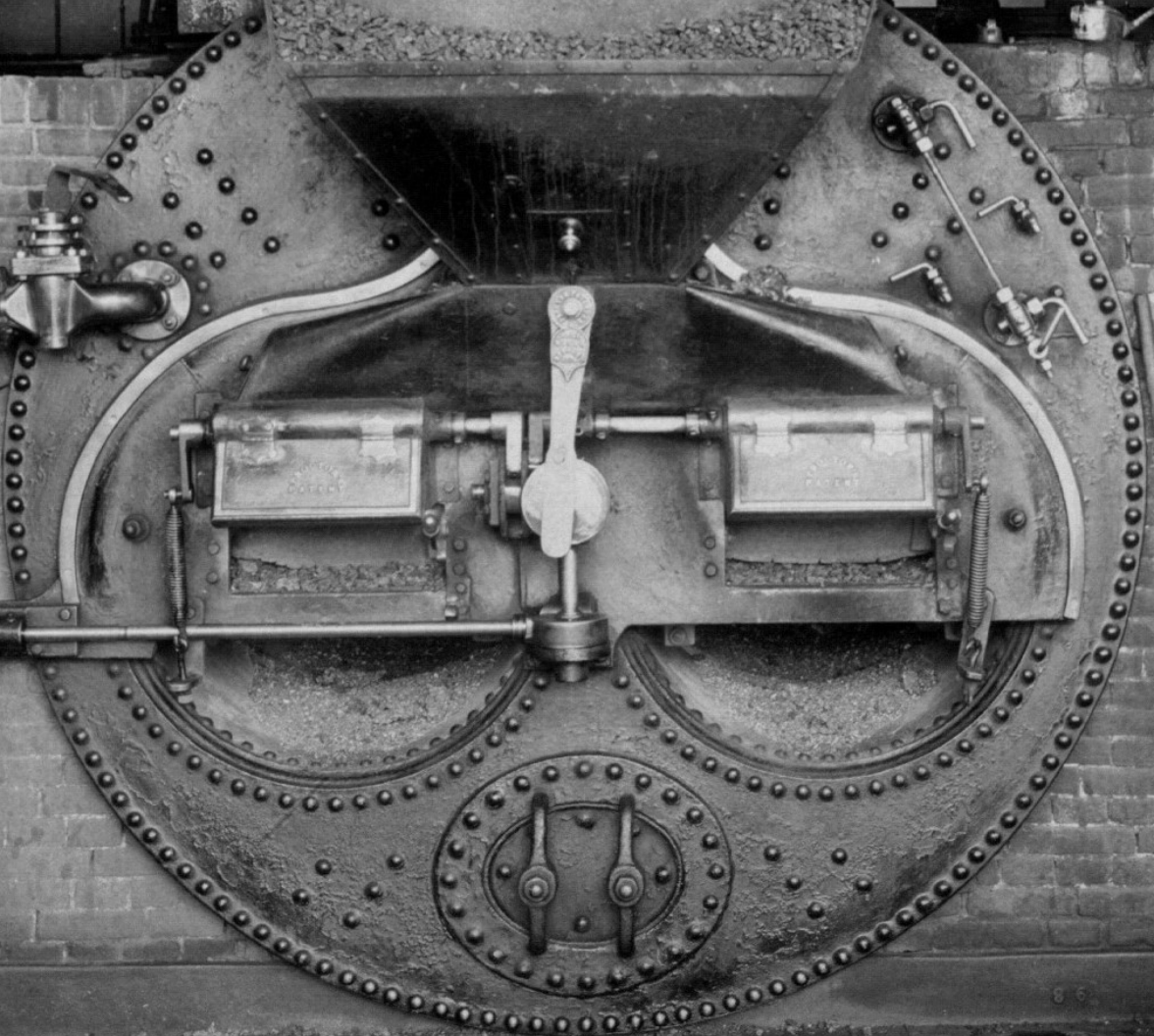
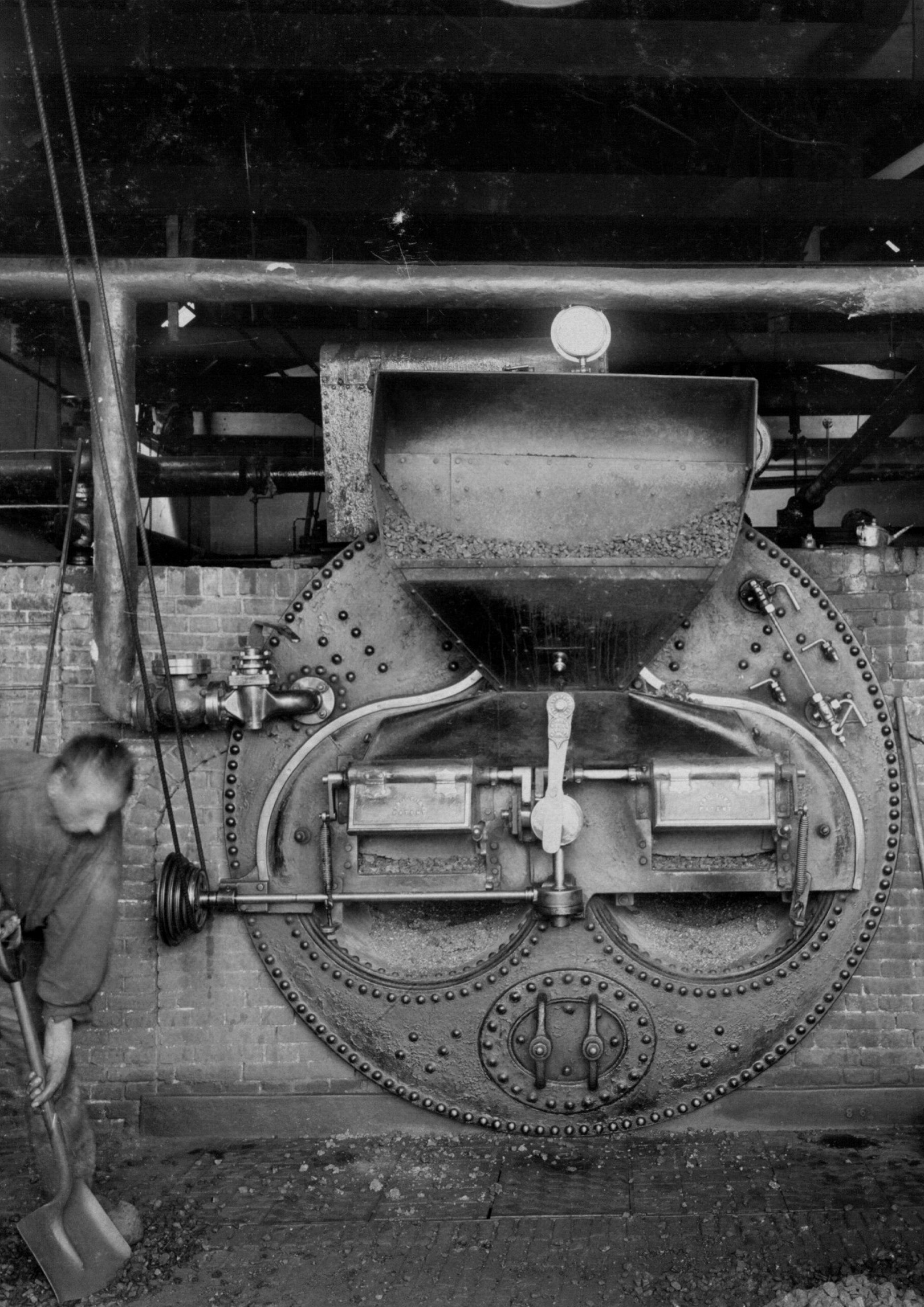

VII SERVICES ANALYSIS

An industrial site and its buildings inevitably need a lot of services to function as they should. In this chapter specific services for the textile industry are researched and mapped. As technology continuously evolves over time, these services also have changed consequently. It therefore is important to understand what were crucial types of services and technologies in the past and how they shaped the site and its architecture. An overview on the current situation is needed to get a grip on the technical features of today.

CHIMNEYS

For years, the look of Winterswijk was determined by the tall chimneys towering over the lower, horizontal structures. Only nowadays they disappeared. With the introduction of electrical driven machines and the downfall of the steam engine, boiler

houses lost their function. Since these structures and its accompanying chimneys were not used anymore and the area continuously expanded, the structures were demolished to make place for new structures with other functions: a legacy piece got lost.



Figure 151 Chimneys in Winterswijk. (SERC, 2015 & Beeldbank, 2019 & Photo by Dinand Kruize, 2019)

WEAVING MACHINES

Traces of old weaving techniques are still visible in the factory halls. For example the columns of the saw-tooth structure played a significant role within the process of the steam driven machines. From the main machine room, moving cables run through

holes in the walls towards the halls where they are connected to axles. These axles were connected to the columns: the prefabricated holes are still visible. The moving axles actuated the individual weaving machines.

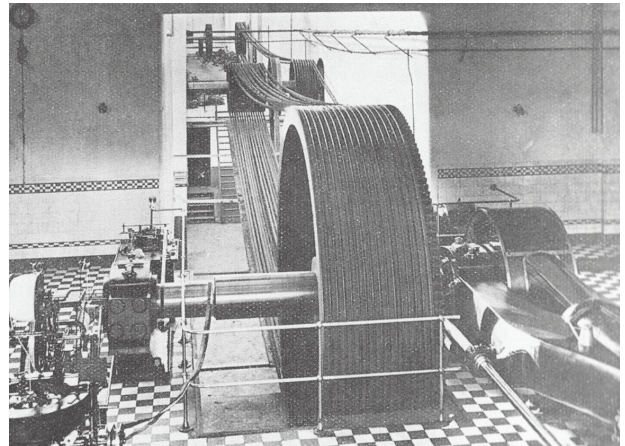
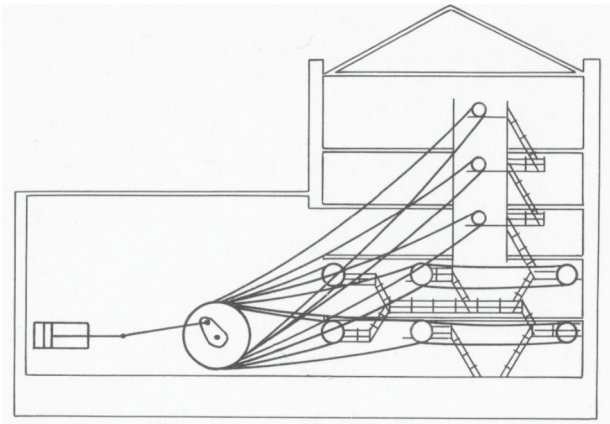

Figure 152 Scheme of steam driven engine and factory (Canon van techniek in Twente, n.d.)
 Figure 153 Steam engine cables (Canon van techniek in Twente, n.d.)
 Figure 154 Power looms (Science Source, n.d.)
 Figure 155 Connection holes in structure of saw-tooth roofs. (Juliëtte Zegers, 2019)

SERVICES

As for services, a great difference can be noticed when comparing the buildings of Gaudium and the other buildings. Logically, the first utilises a lot of them to keep the production process going. The assumption was that the buildings of for example the

Morsepoort would also still contain some services, but this was incorrect. It seems to be that these services are that much connected to the production process and events that they were taken out when this was not the case anymore. Some services are pictured.



Figure 156 Services. (Photos by various students, 2019)

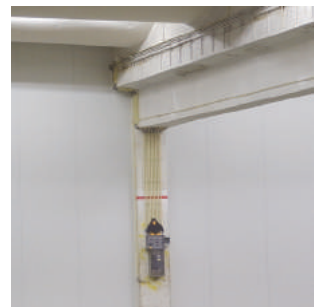

CONCLUSIONS

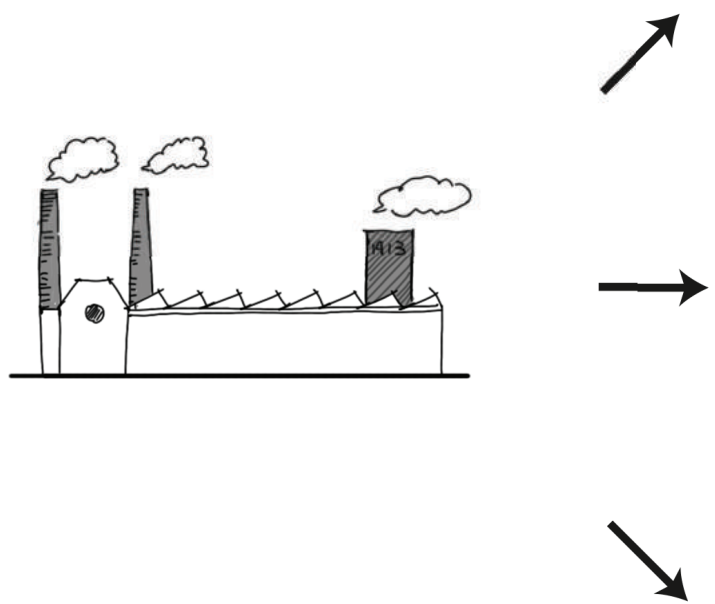
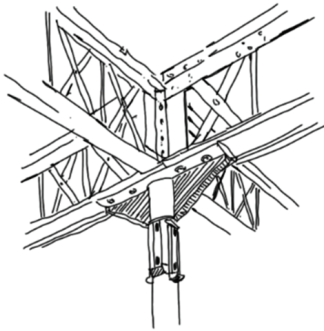
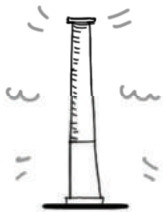

Figure 157 Conclusions. (Own image, 2019)



Old traces of the steam engine driven weaving machines are still visible



The image of the factories used to be determined by the high chimneys

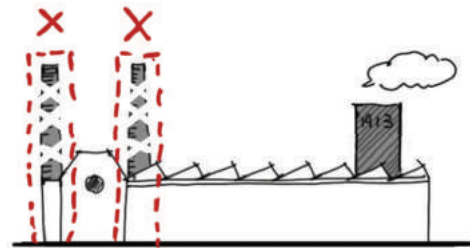

Once the steam engine was not in use anymore, the chimneys disappeared changing the architectural appearance of the whole

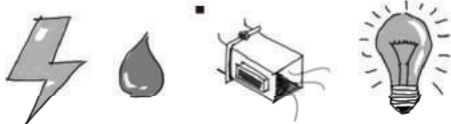
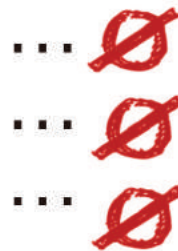
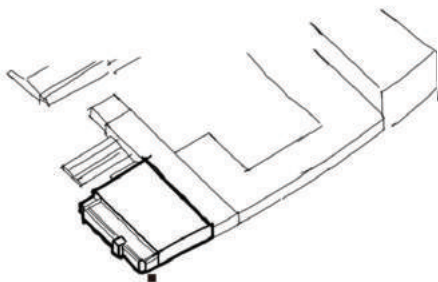
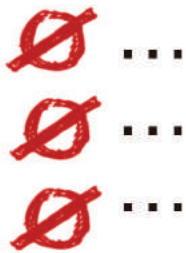

Only the one factory which is still in use holds a lot of services. The empty buildings of other former factories show almost now traces of old services



VIII STUFF ANALYSIS

As stated before, a functional building cannot operate without services. The same counts for the topic of stuff, where the stuff inside the building determines what is happening there. It is important to know what items were there in the past to understand what there is now, and to then further think of what could be there in the future. In this chapter also the link between Skin, Structure and Stuff is researched.

STUFF

Below a selection of the items which are present in the multiple factory buildings.



Figure 159 Stuff. (Photos by various students, 2019)

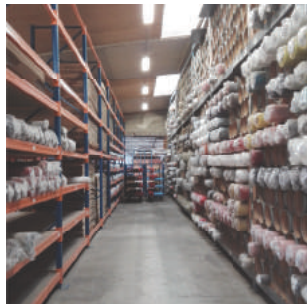
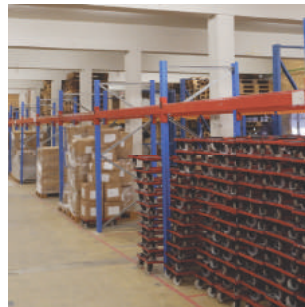

STUFF AND FLEXIBILITY

Since all the buildings used to be active factories, stuff used to be very much related to the production processes inside them. This is still visible at Gaudium. As for the other buildings, a change in stuff is noticeable. Since spans are big and openings in the

façade (doors etc.) are usually quite large, the size of items can vary and the buildings can be used for multiple different new functions. For that reason stuff is a quite flexible notion. Current stuff in the buildings is marked red and stuff that used to be there is black.

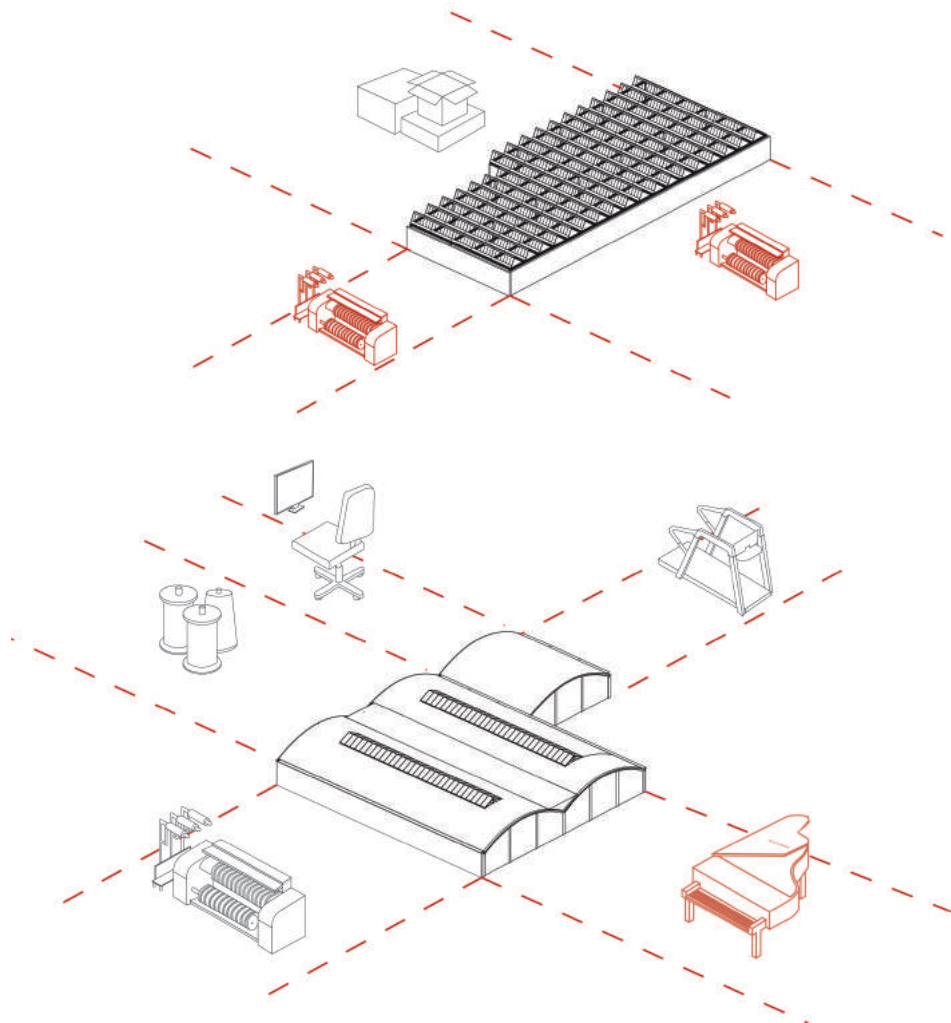
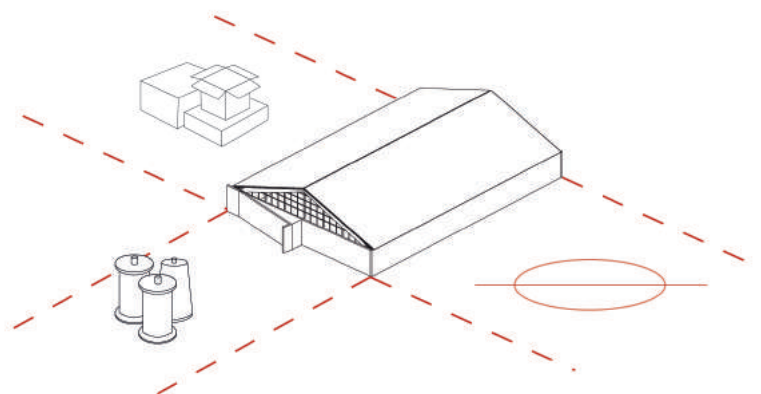
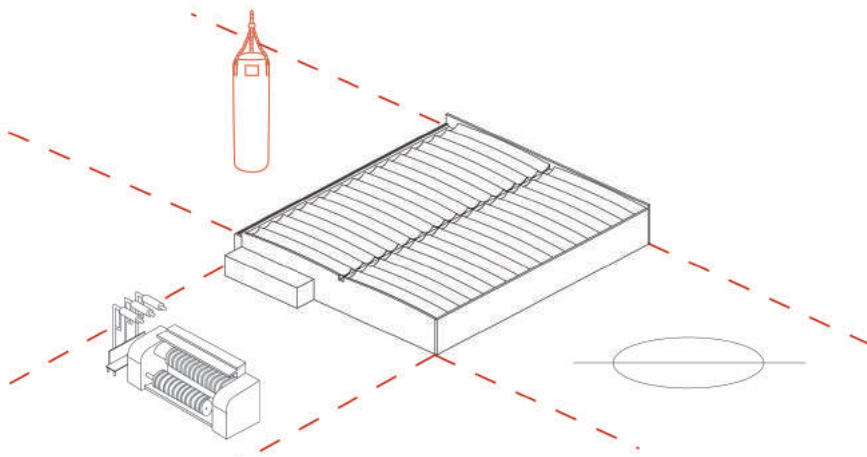
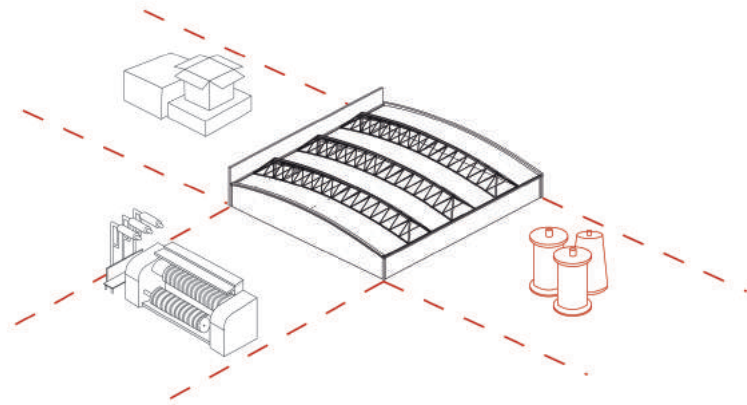
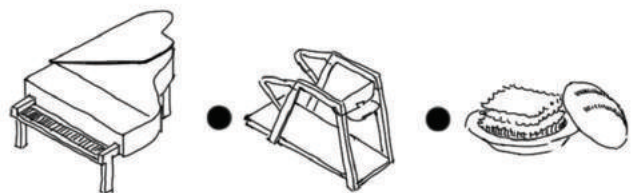
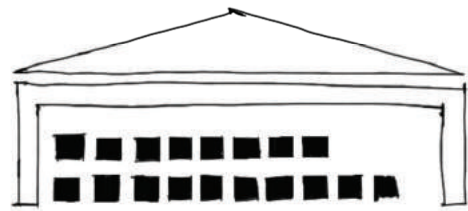

Figure 160 Stuff and flexibility (Own image, 2019)



CONCLUSIONS

Stuff has no direct connection to the building anymore. Big spans mean a lot of flexibility



'New' stuff

Figure 161 Conclusions. (Own image, 2019)

'Old' stuff

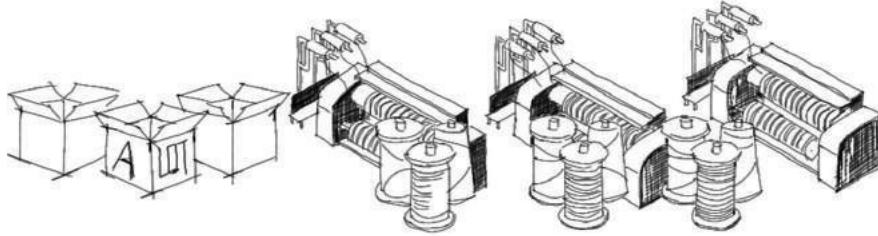

OR

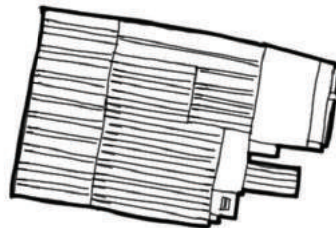

Gaudium



de werfplaats

IX SPIRIT OF PLACE ANALYSIS

Every space or place has its own characteristics which call for a specific feel of it: spirit of place. For this chapter the essence of the place and its buildings are questioned. First the whole site and its ensemble are pictured, before looking at the individual typologies and their interiors. The main spirit of the place is researched because it can be a significant factor in redesigning.

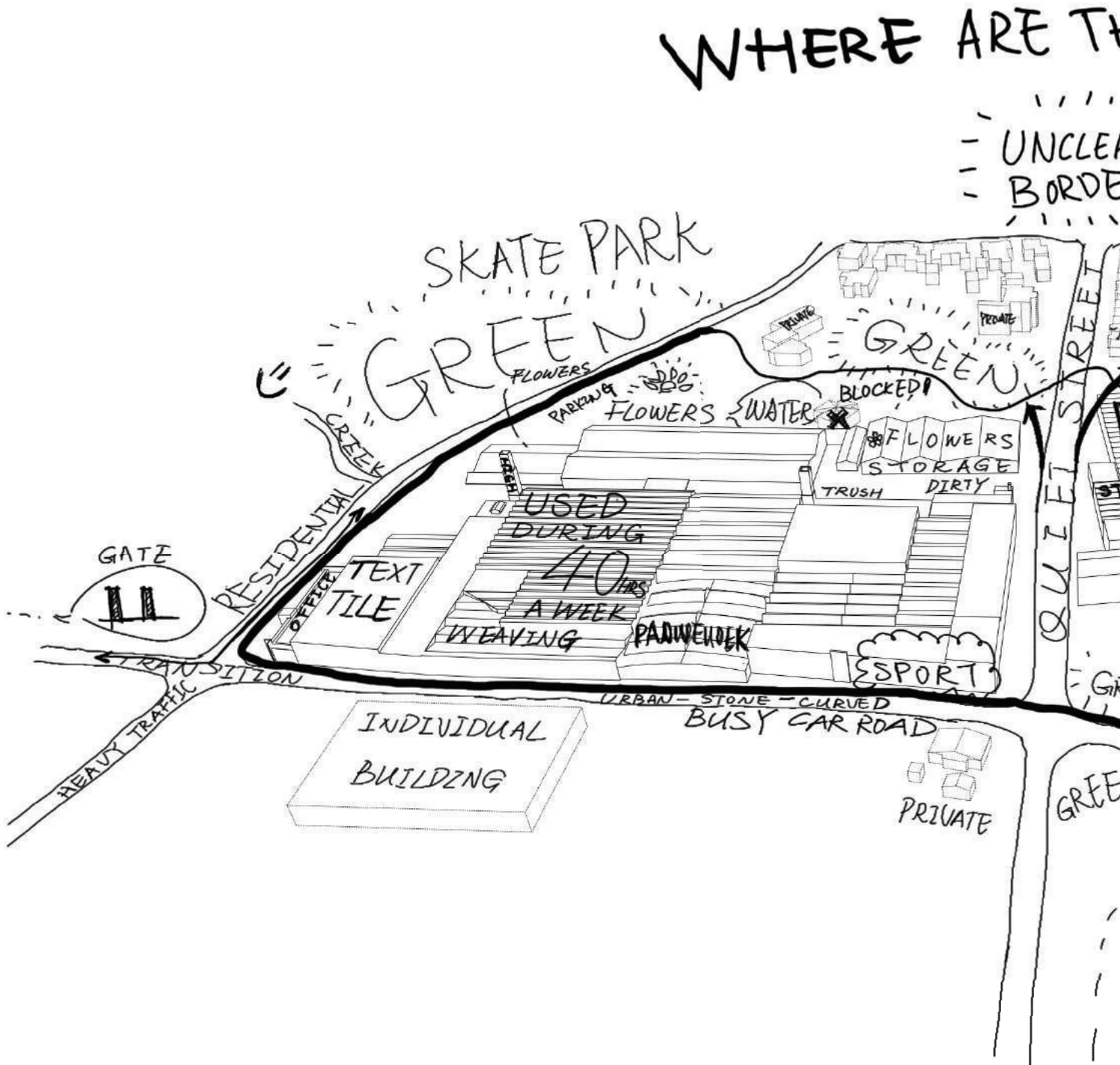

Figure 163 Spirit of Place. (Own image, 2019)

THE PEOPLE?



SPIRIT OF PLACE

All five typologies have their own interior atmosphere and characteristics that create this atmosphere. The following pages will illustrate the ambiance in a collage.

BUILDING A

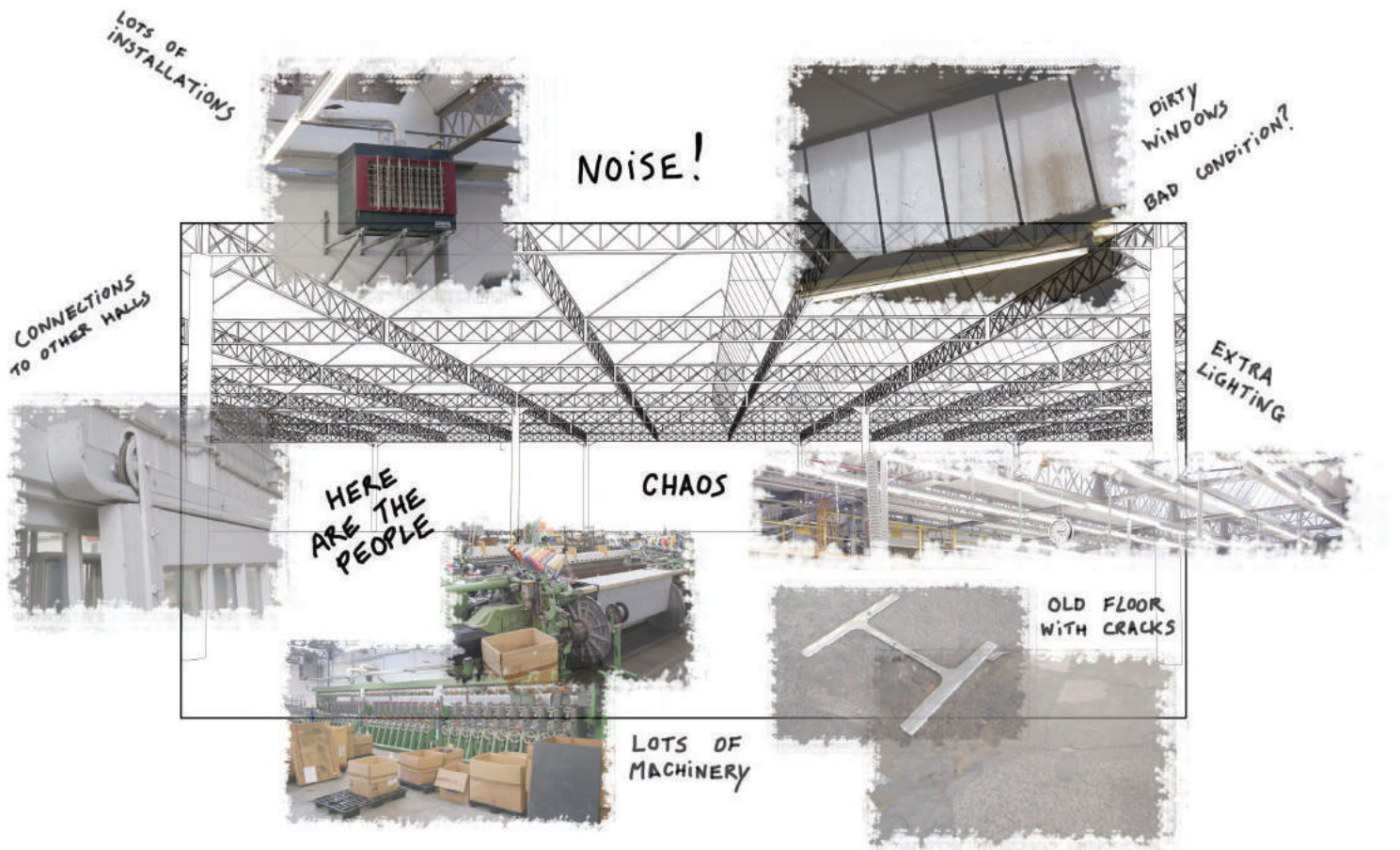

Figure 164 Spirit of building A (Own image based on photos by Dinand Kruize, 2019)

BUILDING B

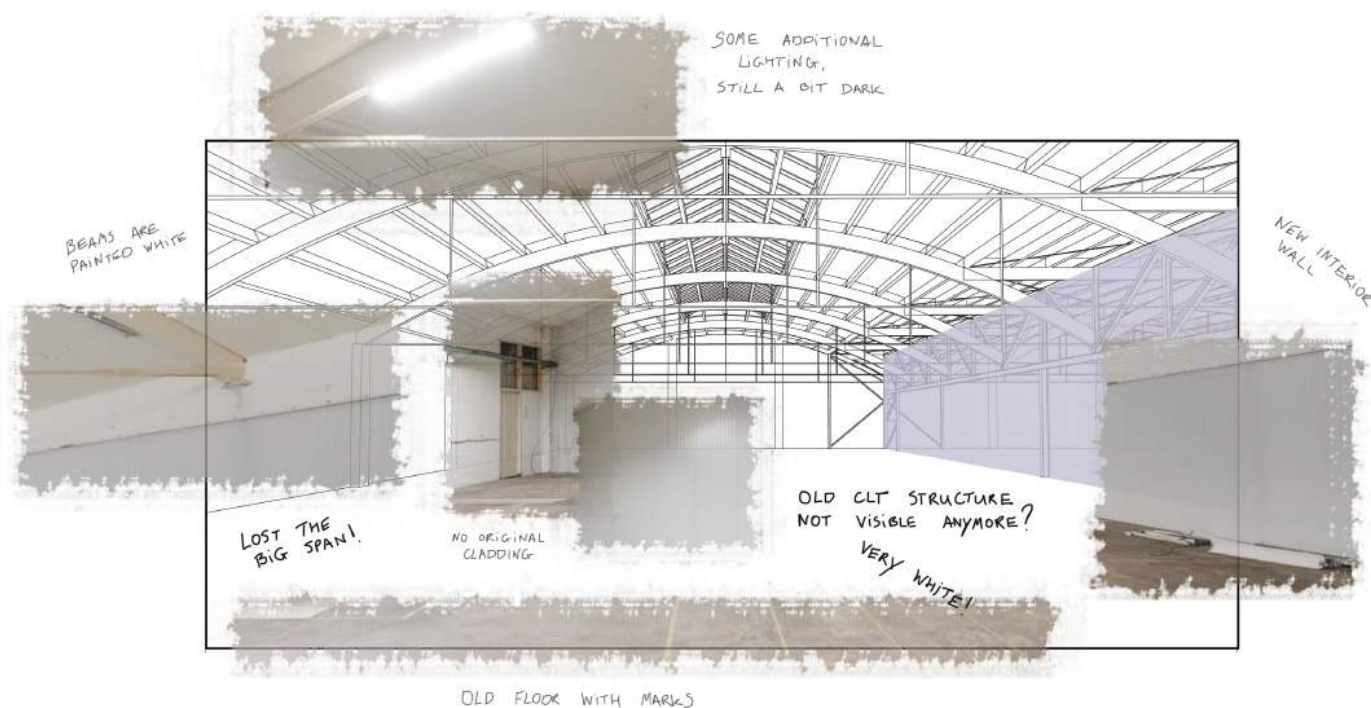

Figure 165 Spirit of building B (Own image based on Morsepoort, n.d.)

BUILDING C



Figure 166 Spirit of building C (Own image based on photos by Chen Zhu, 2019)

BUILDING D

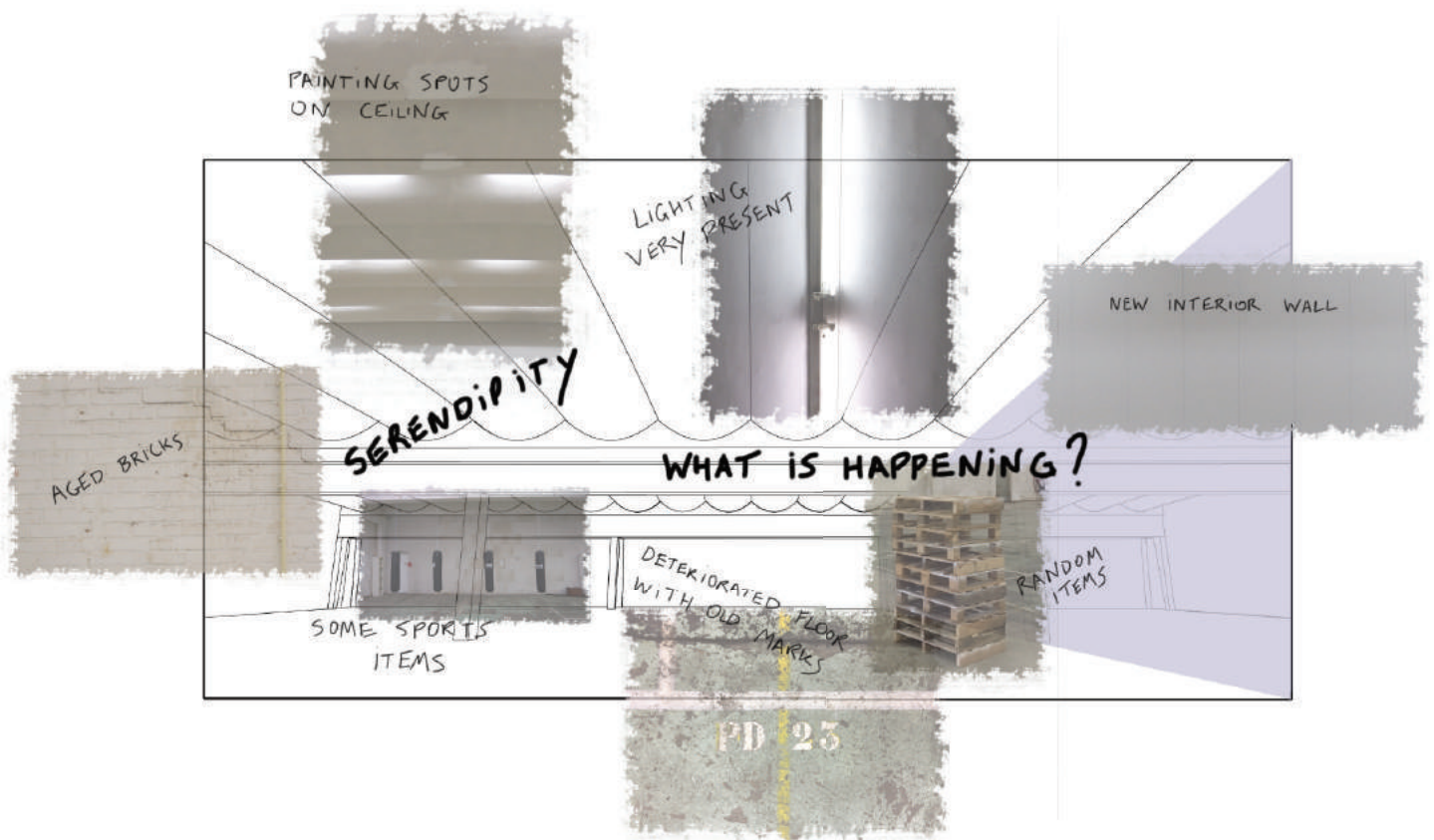

Figure 167 Spirit of building D (Own image based on photos by Ariane Zwinkels, Chen Zhu and Dinand Kruize, 2019)

BUILDING E

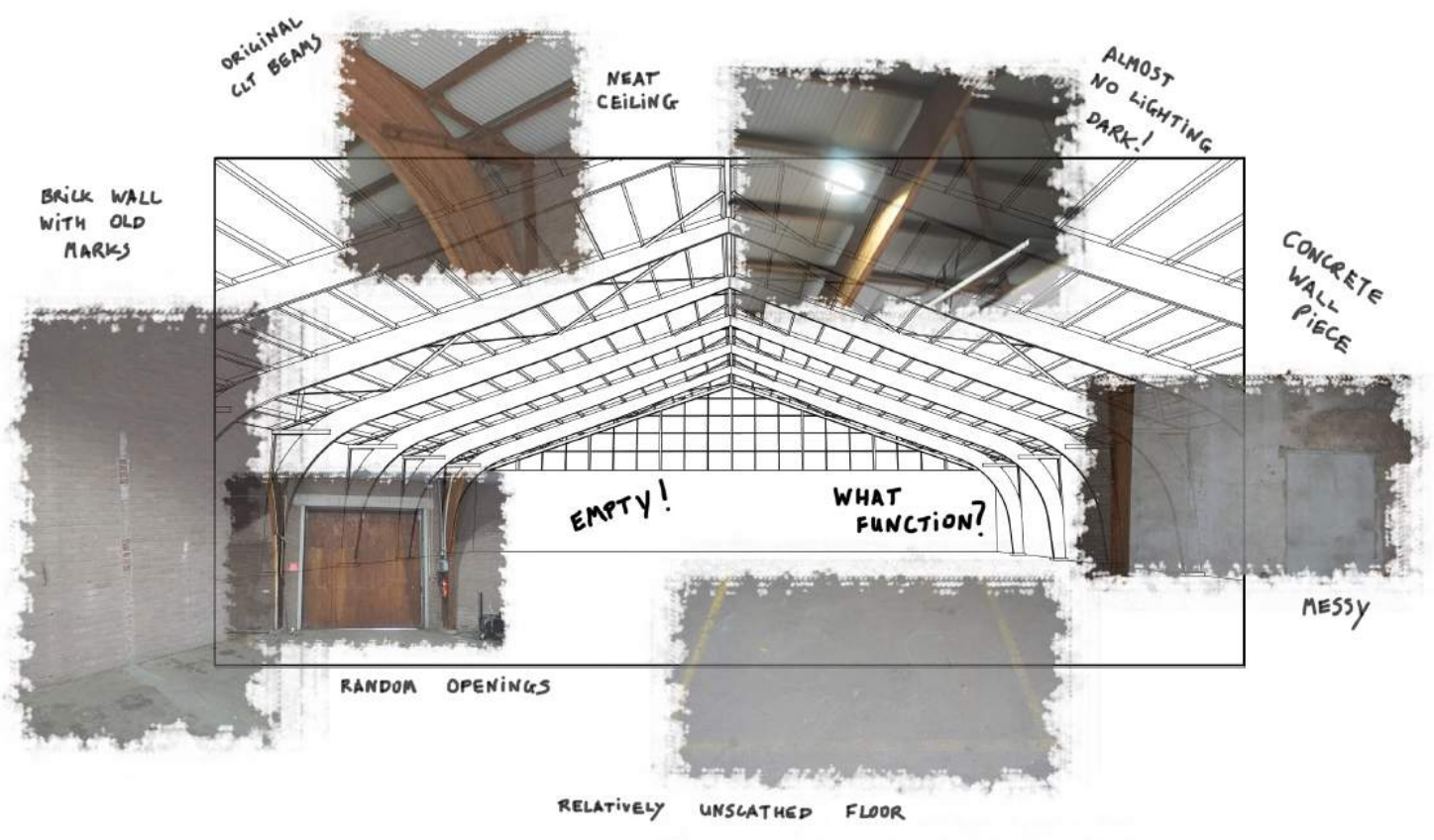

Figure 168 Spirit of building E (Own image based on photos by Dinand Kruize, 2019)



X BUILDING TECHNOLOGY ANALYSIS

As stated before, the structures of the buildings hold a specific significance for industrial buildings. In order to intervene in these structures and their own characteristics, there has to be an understanding of how these structures were actually built. Focussing on the five typologies first the most characterizing aspects of each building are defined. In a close up the structure then is exposed and stability elements are marked. Afterward, sections and façade fragments give an even more detailed look.

Changes in the existing structure will directly influence it and should be taken into considering sensitively.

BUILDING A

This building, designed by Beltman, represents a factory typology which is widely used for weaving factories, as explained

before. The characteristic saw-tooth roof allows big spans and difused daylight coming in from the North.

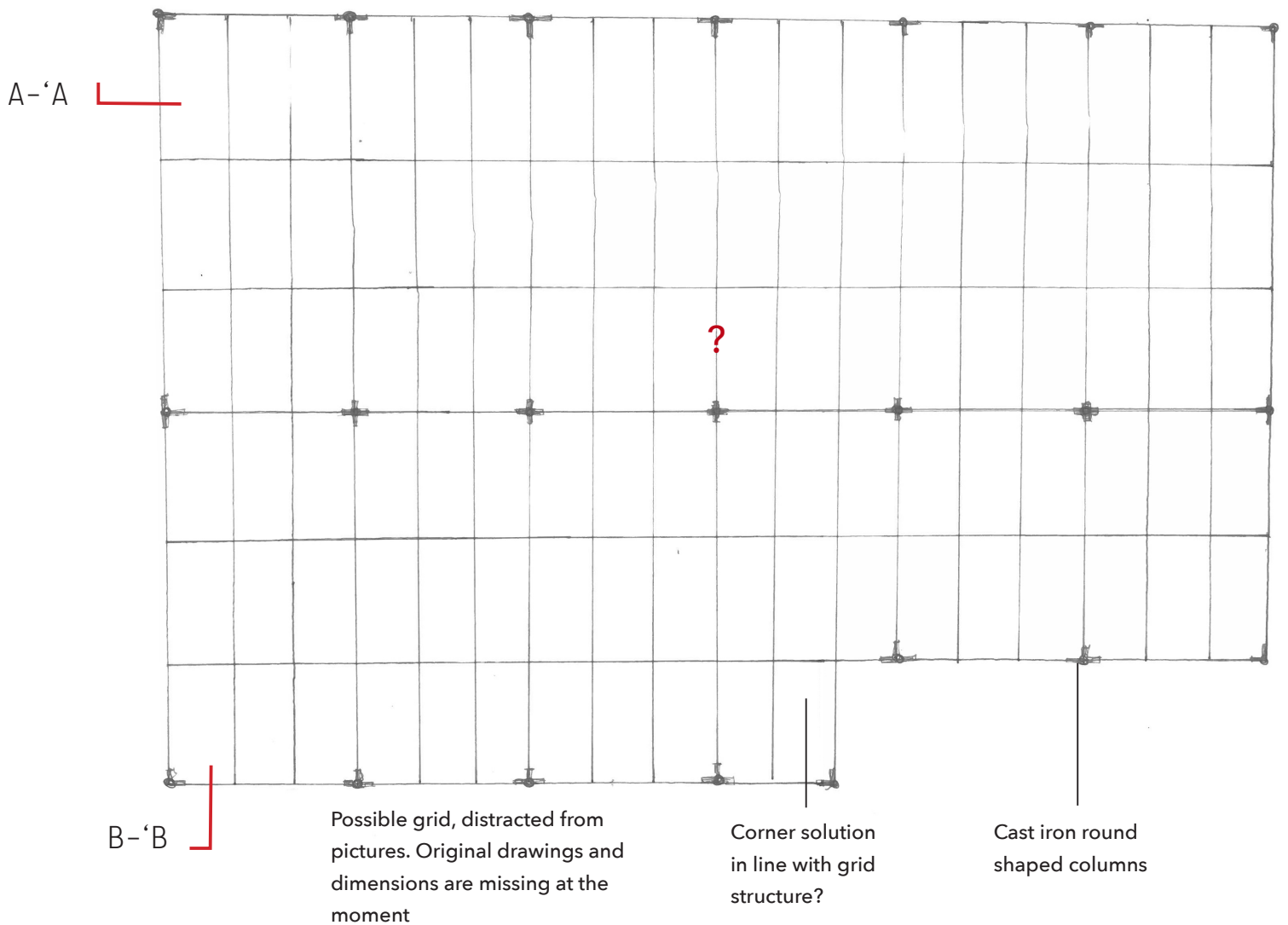
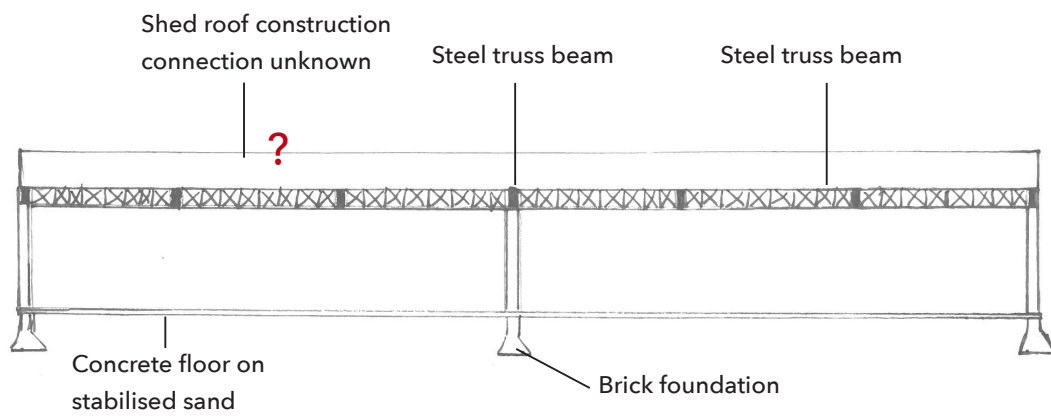

Figure 170 Structural plan/diagram (Own images based on Bouwkundig Ingenieurs Bureau Beltman, 1938)

A-'A



B-'B

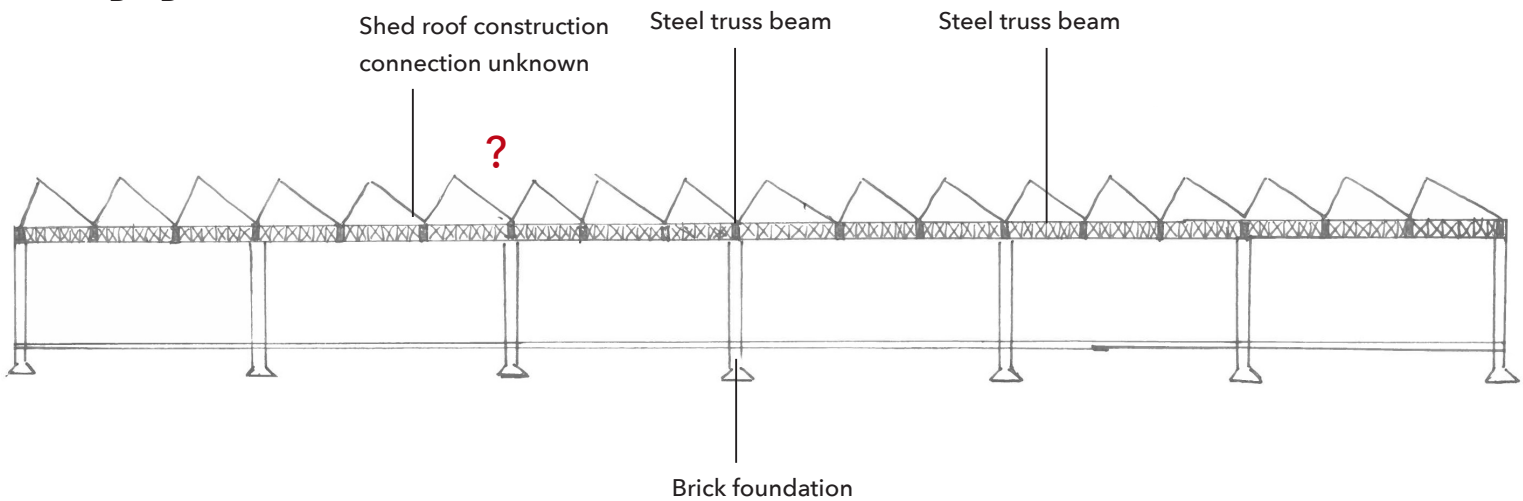
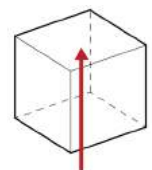
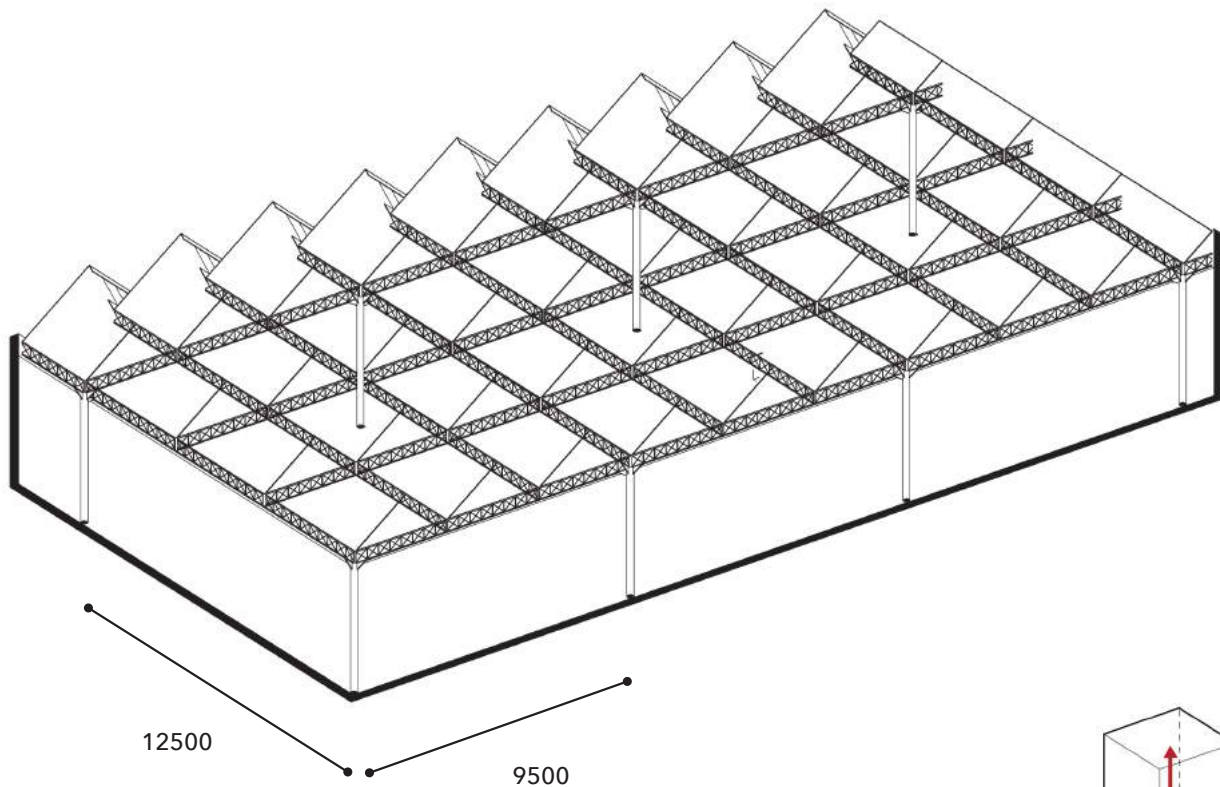

Figure 171 Structural section/diagram (Own images based on Bouwkundig Ingenieurs Bureau Beltman, 1938)

AXONOMETRIC VIEW

Building year and architect: 1938, Beltman
 Structure type: Steel/glass roof, steel trusses, cast iron columns
 Connections: welded and dry with rivets, girders on columns
 Span: 9500 mm x 12500 mm
 Stability: Steel trusses with fixed connection to columns
 Roof type: Saw-tooth
 Roof material: Steel



Worm's-eye view

Figure 172 Truss connection (Photo by Dinand Kruize, 2019)
 Figure 173 Structural axonometric view (Own image based on Bouwkundig Ingenieurs Bureau Beltman, 1938)

STABILITY

Stability for this structure is quite straightforward, because beam-column connections are stiff. This is even more

enhanced by the triangular girders which are visible in the picture on the left.

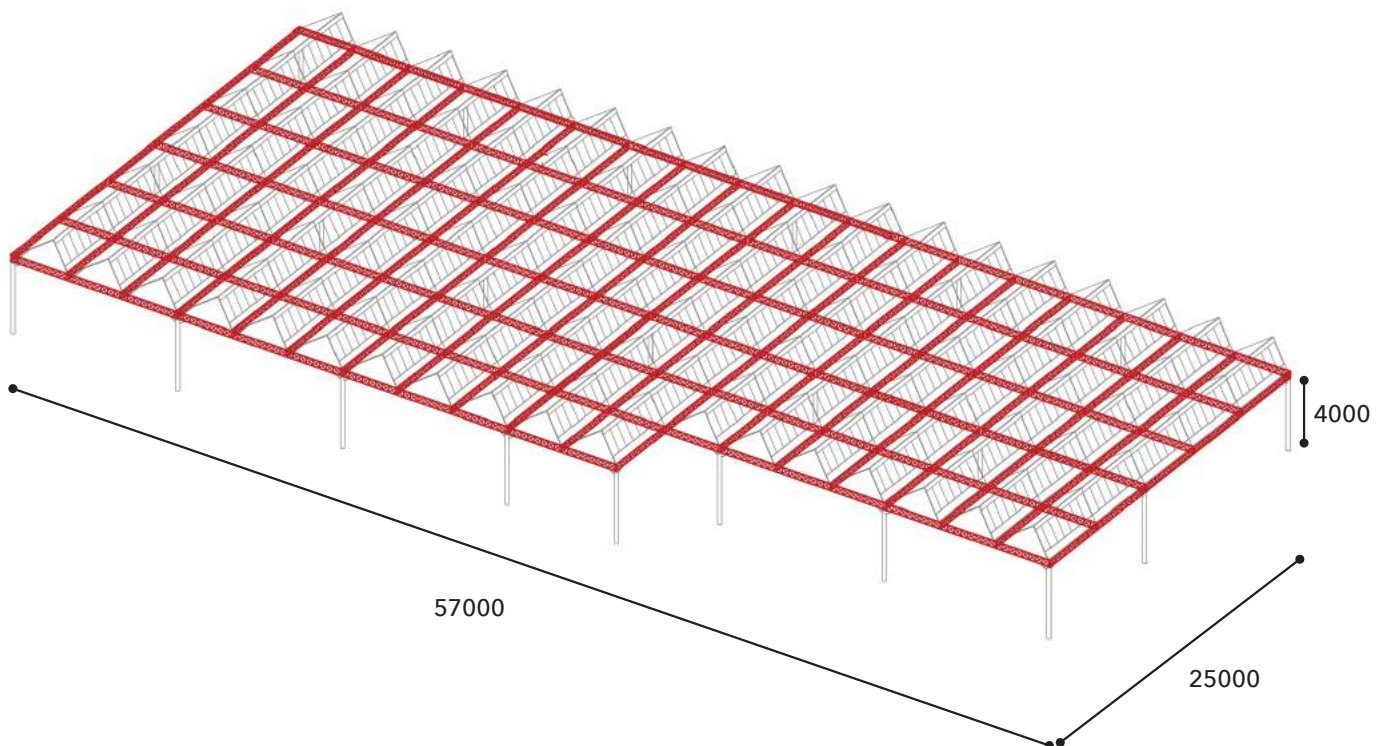

Figure 174 Stability (Own image based on Bouwkundig Ingenieurs Bureau Beltman, 1938)

SAW-TOOTH ROOF CONSTRUCTIONS

Around 1840 the first constructions of cast iron were built in the Netherlands. In comparison with our surrounding neighbours, Great-Britain or Germany, this was a late development within the Netherlands. Cast-iron was used for especially structural elements such as, columns, consoles, 'korbeelstukken' and beams. More often these structural elements were made in England, therefore they were seen as an English design as well. The first building in the Netherlands with a full steel construction was the Palace of Volksvlijt. Cast iron is able to handle pressure forces, although it is less resistant with tensile forces and thus bending moments of the structure. Around 1850 the I-shaped steel profiles were introduced by rolling. As a result

of this the cast iron elements slowly became repressed. Generally, a cast iron beam is not prismatic, meaning that the sections of this element differs in size. The height is larger in the middle of the beam, in comparison with the imposition. Throughout The Netherlands cast iron structures were not commonly used, except for the textile industry in the surrounding of Twente. Besides these beams also columns and the foot and head of the columns made of cast iron were more frequently used within this branche.

In terms of the roof construction a typology which represents the textile industry is the sawtooth roof. The first ones were built around 1850.

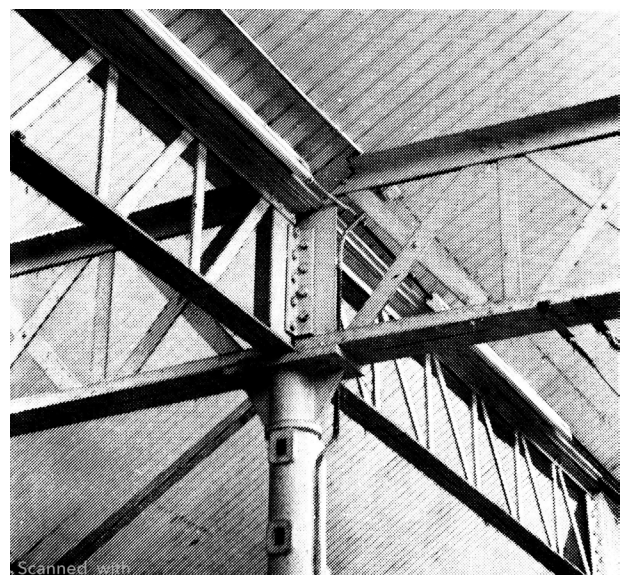
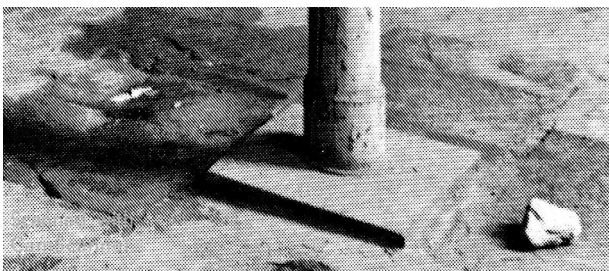
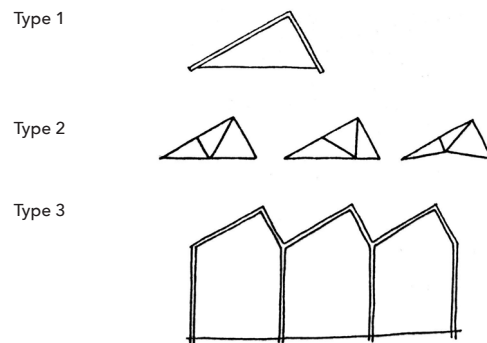

Figure 175 Palace of Volksvlijt, 1864. (Broekema, 2016)

Figure 176 Cast iron column with foot, textile factory Van Heek & Co. 1894. (Oosterhoff, Arends, van Eldik, & Nieuwmeijer, 1988)

Figure 177 Cast iron column with head and beam connection, textile factory Roombeek. 1920. (Oosterhoff, Arends, van Eldik, & Nieuwmeijer, 1988)



There are four types of this saw-tooth construction:

1. On all of the intersections of the axes columns are present. The saw-tooth trusses rest on these columns.
2. The columns in the middle in the longitudinal direction are not present. The saw-tooth elements are constructed in the transverse direction, which can be trusses or beams.
3. The columns in the middle of the transverse direction of the sawtooth constructions are missing. The sawtooth elementen are constructed in the longitudinal direction by most of the time beams or trusses.
4. This is a combination of type 2 and 3, whereby all columns of the two axes in the middle are not present. In terms of the sawtooth elements, in both directions a supporting element is introduced.

For the oldest textile buildings within the ensemble of Winterswijk, type combinations of type 2 and 4 are mostly used. In terms of the triangle, the spant, there are three ways of constructing:

1. Triangular truss (Old core of Gaudium)
2. 'Vakwerkspant'
3. 'Kniespant'

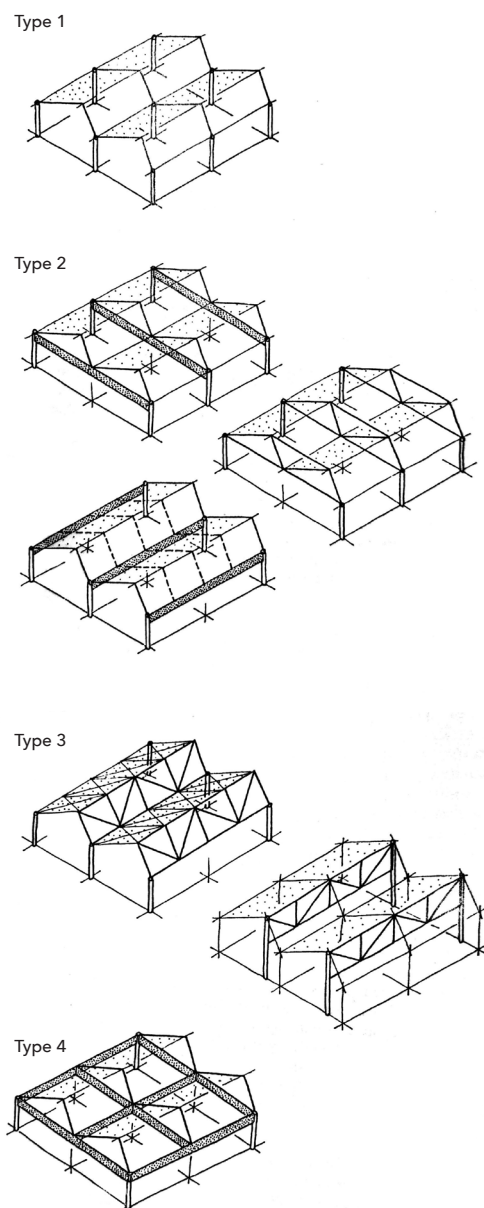
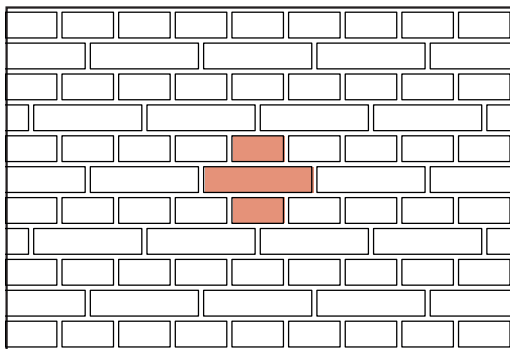

Figure 178 Spant constructions (Oosterhoff, Arends, van Eldik, & Nieuwmeijer, 1988)
Figure 179 Saw-tooth roof constructions (Oosterhoff, Arends, van Eldik, & Nieuwmeijer, 1988)

FAÇADE FRAGMENT

The section shows the steel truss which doesn't end with a column, but is partly supported by the brick wall. This exterior masonry of the cavity wall has a cross bond.



Fragment East

Figure 180 Brick pattern and position section (Own images based on Bouwkundig Ingenieurs Bureau Beltman, 1938)
 Figure 181 Façade (Photo by Dinand Kruijze, 2019)

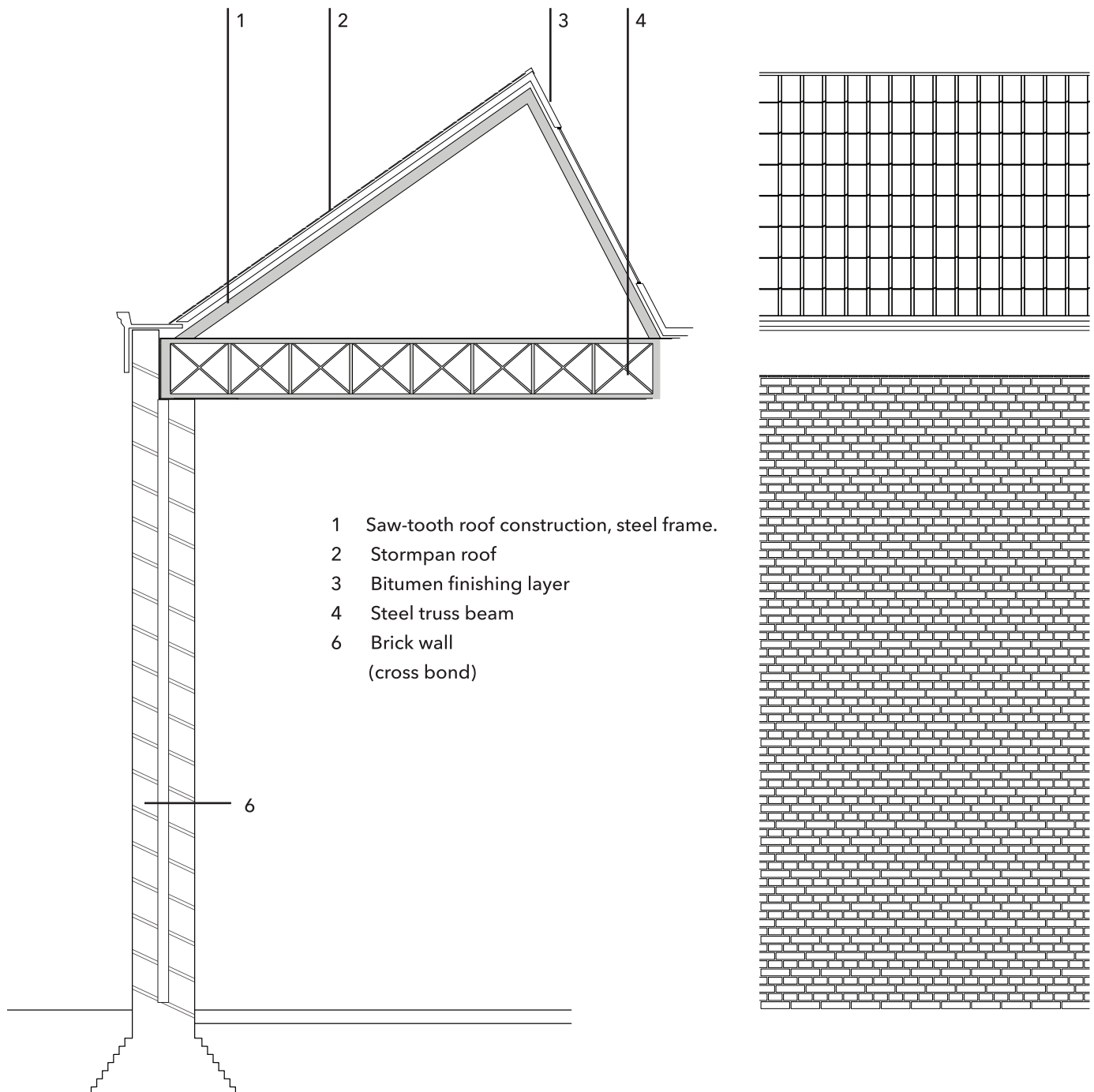

Figure 182 Section and façade fragment (Own images based on Bouwkundig Ingenieurs Bureau Beltman, 1938)

BUILDING B

Another structure designed by the office of Beltman is this building. It is characterised by the 'Nemaho' CLT beams and the single column which is supporting the space

frame which partly supports the beams. The rooflights used to be an important feature of the space. Unfortunately nowadays they are not present anymore.

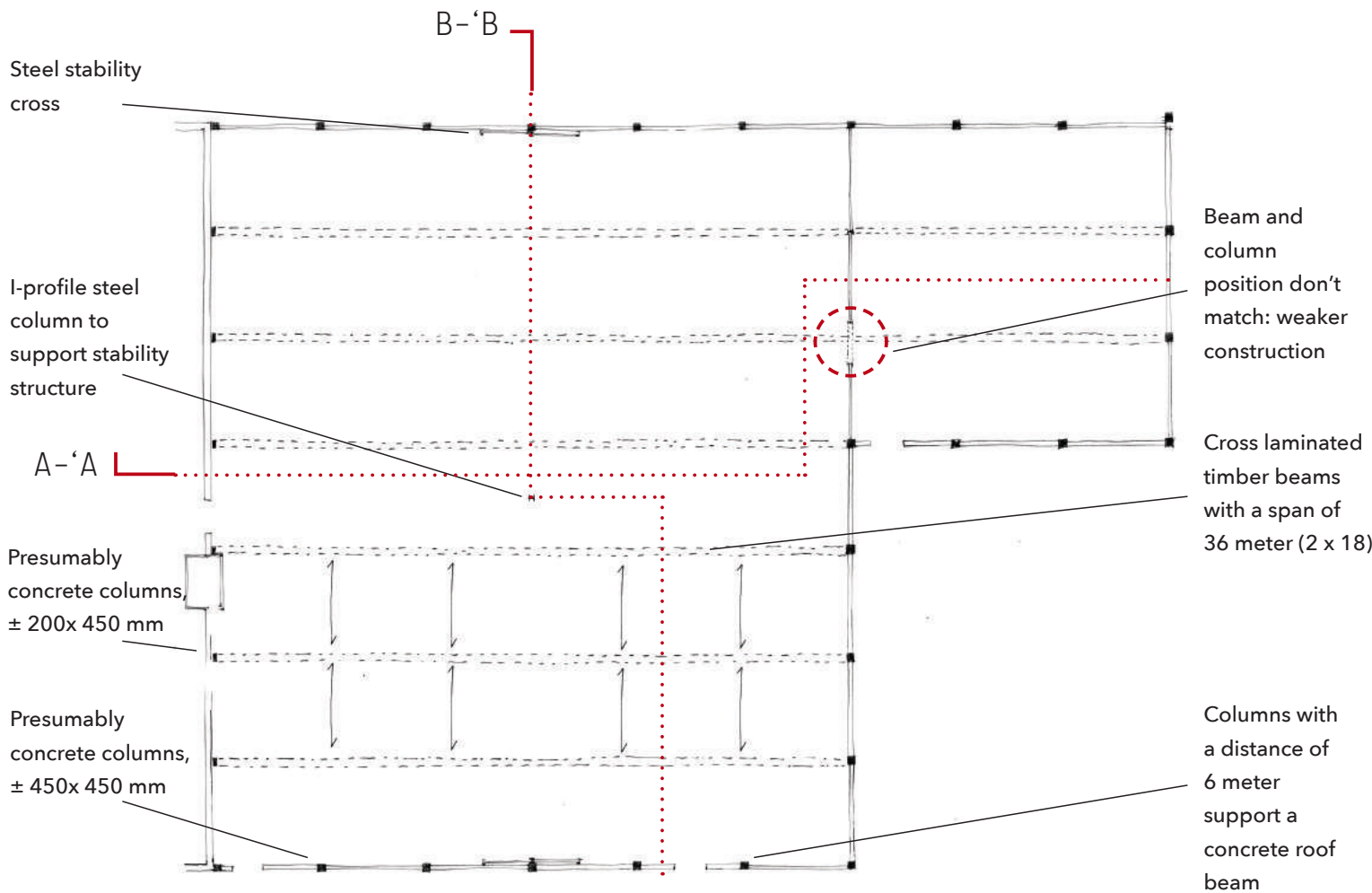
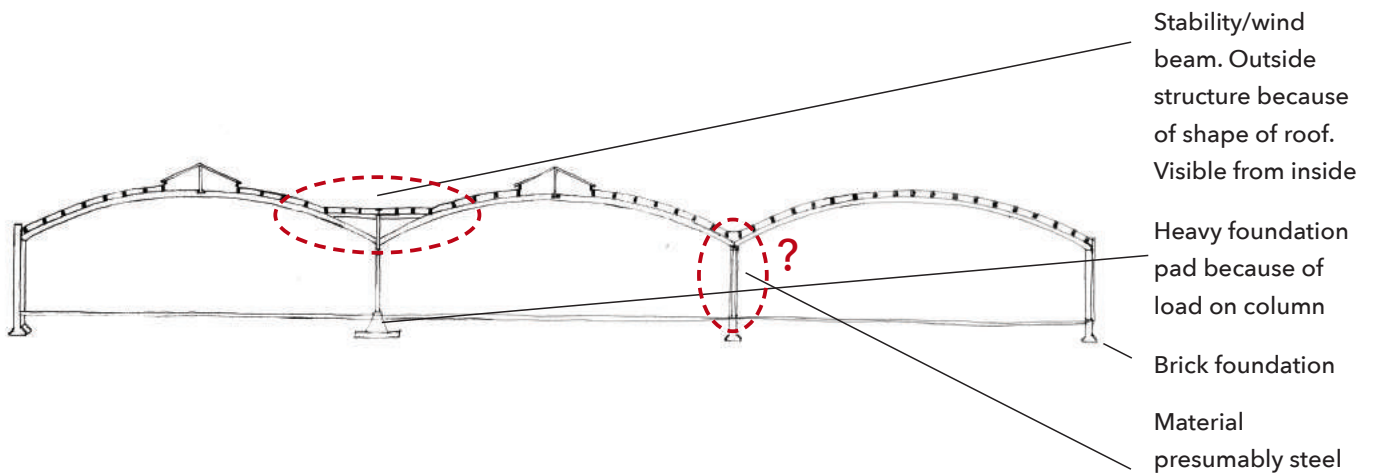

Figure 183 Structural plan/diagram (Own image based on Bouwkundig Ingenieurs Bureau Beltman, 1955 & N.V. Verbeco Ede, 1955)

A-'A



B-'B

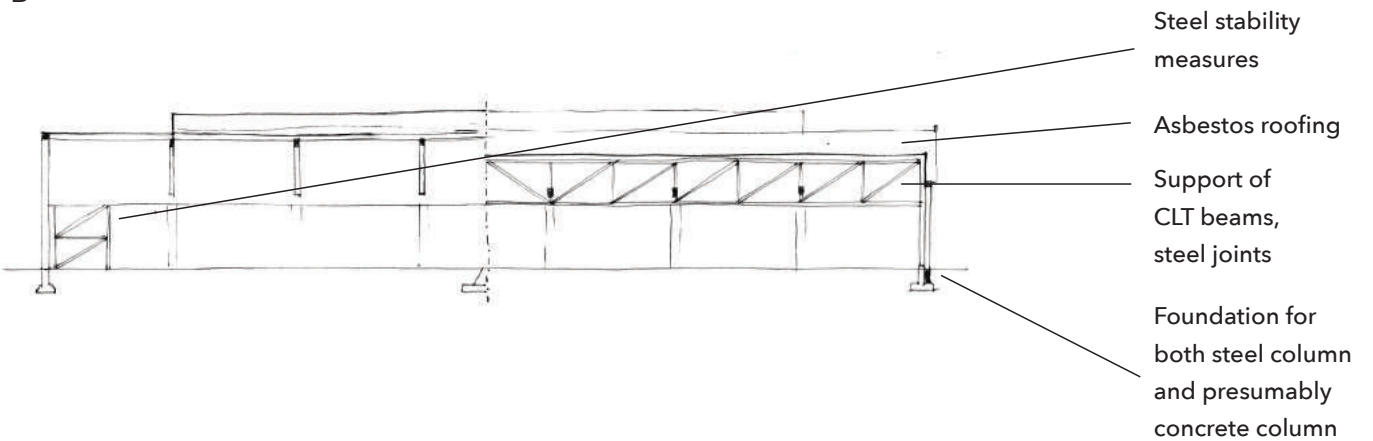

Figure 184 Structural section/diagram (Own images based on Bouwkundig Ingenieurs Bureau Beltman, 1955 & N.V. Verbeco Ede, 1955)

AXONOMETRIC VIEW

Building year and architect: 1955, Meijerink / Nemaho
 Structure type: primary prefabricated CLT-beams (tension bars) with secondary timber purlins, concrete and steel columns
 Connections: bolted and welded
 Span: 6000 mm x 17775 mm
 Stability: stability crosses and steel truss
 Roof type: Arched with pulling bars
 Roof material: CLT and timber

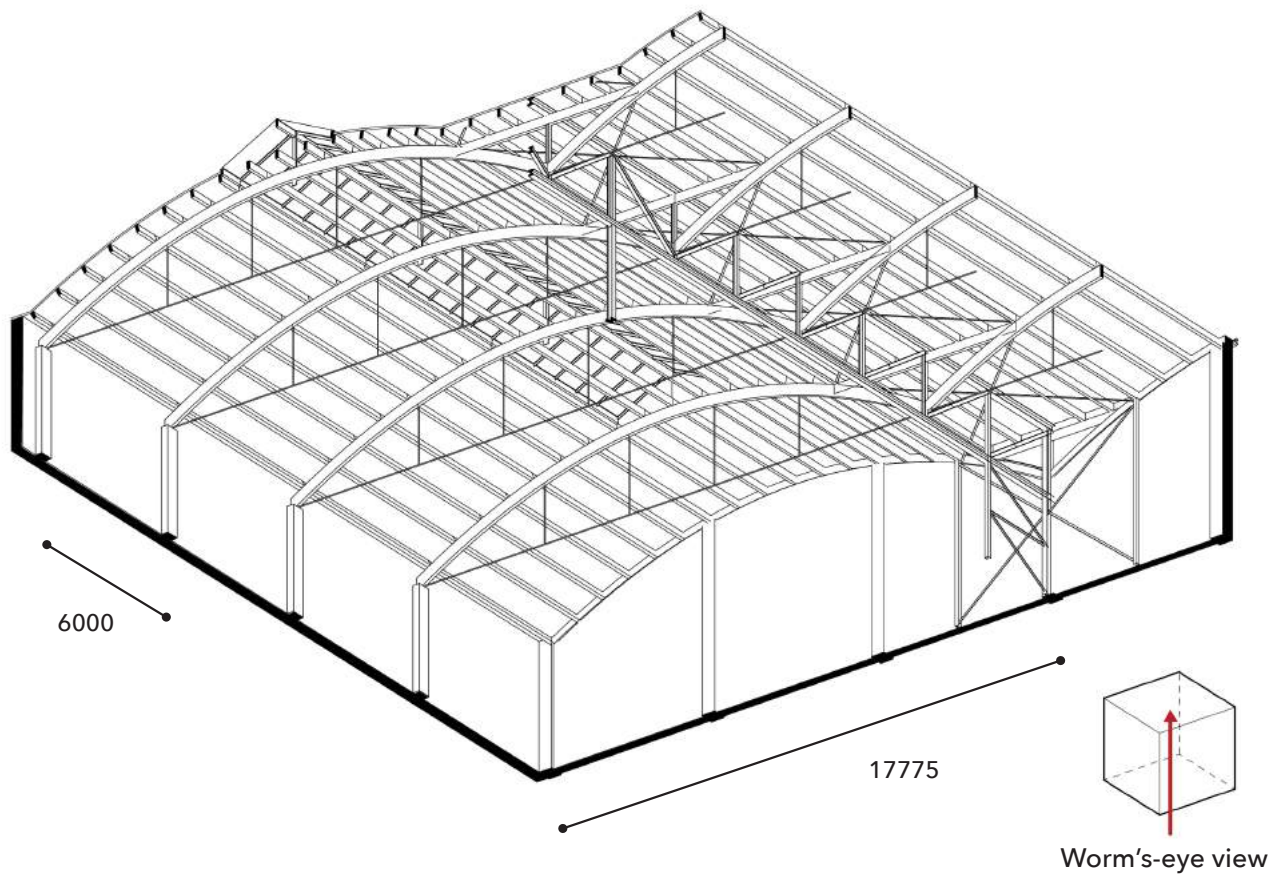

Figure 185 Example of Nemaho CLT beams. (Willemskwartier Nijmegen, 2017)
 Figure 186 Structural axonometric view (Own image based on Bouwkundig Ingenieurs Bureau Beltman, 1955 & N.V. Verbeco Ede, 1955)

STABILITY

The stability in this building is established by a 'wind beam' and the steel truss and elements connected to it. The brick walls of the façade

are positioned in between the columns, hence they also fulfill a role for the stability of the building.

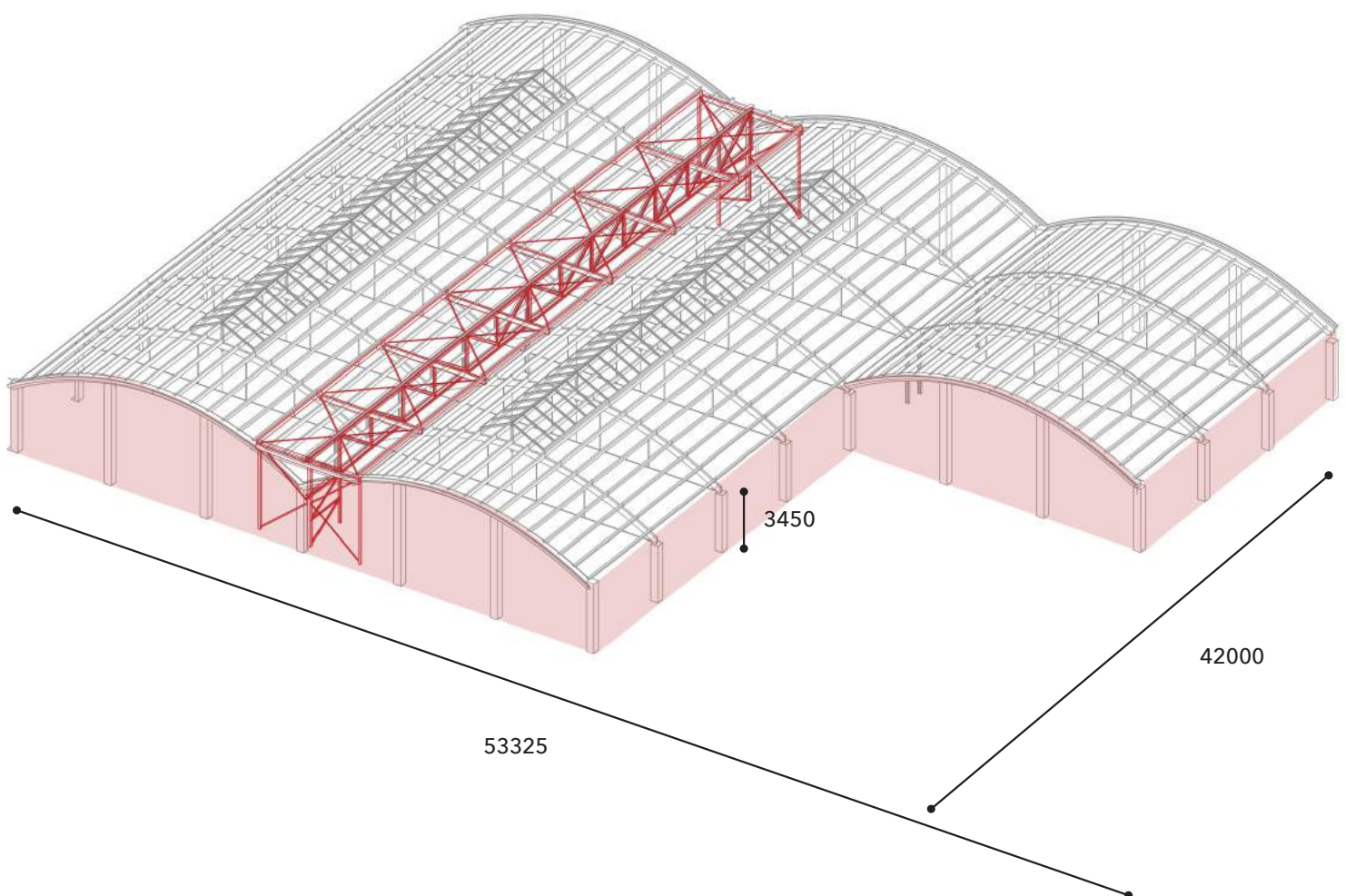
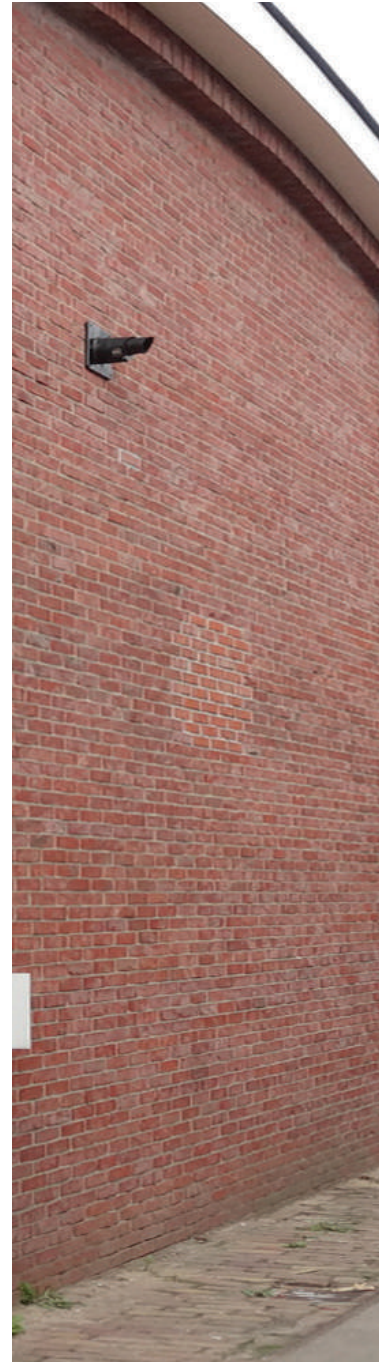
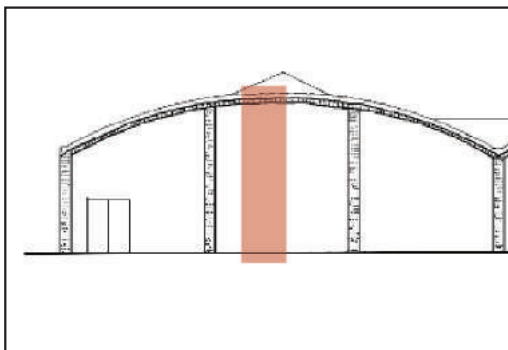
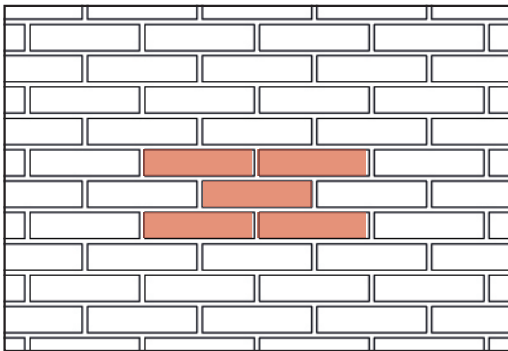

Figure 187 Stability (Own image based on Bouwkundig Ingenieurs Bureau Beltman, 1955 & N.V. Verbeco Ede, 1955)

FAÇADE FRAGMENT

The section shows the purlins which end at the concrete endbeam of the façade. This beam is supported by concrete columns, which are visible in the façade. The cavity walls are placed in between the columns. In the back the steel stability measurements and part of the steel truss is visible. The brick pattern of the façade is stretchers bond.



Fragment West

Figure 188 Brick pattern and position section (Own images based on Bouwkundig Ingenieurs Bureau Beltman, 1955 & N.V. Verbeco Ede, 1955)
 Figure 189 Façade (Photo by Joost Joosse, 2019)

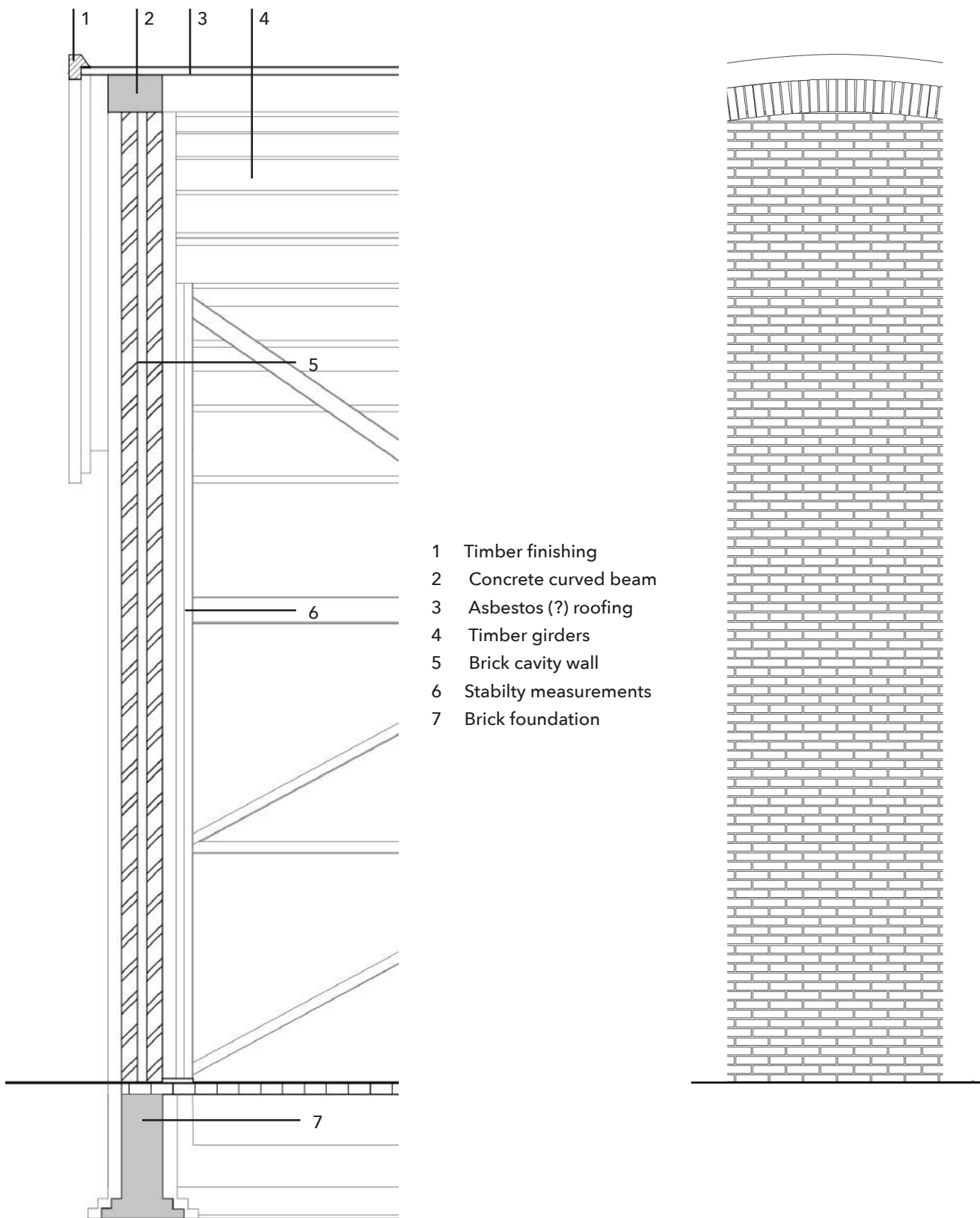

Figure 190 Section and façade fragment (Own images based on Bouwkundig Ingenieurs Bureau Beltman, 1955 & N.V. Verbeco Ede, 1955)

BUILDING C

The 'Pannekoek' structure had patent from it's architect and was remarkable because of it's big spans and light weight.

Besides structure, the steel trusses also provided for daylight from the roof. Nowadays these rooflights are covered.

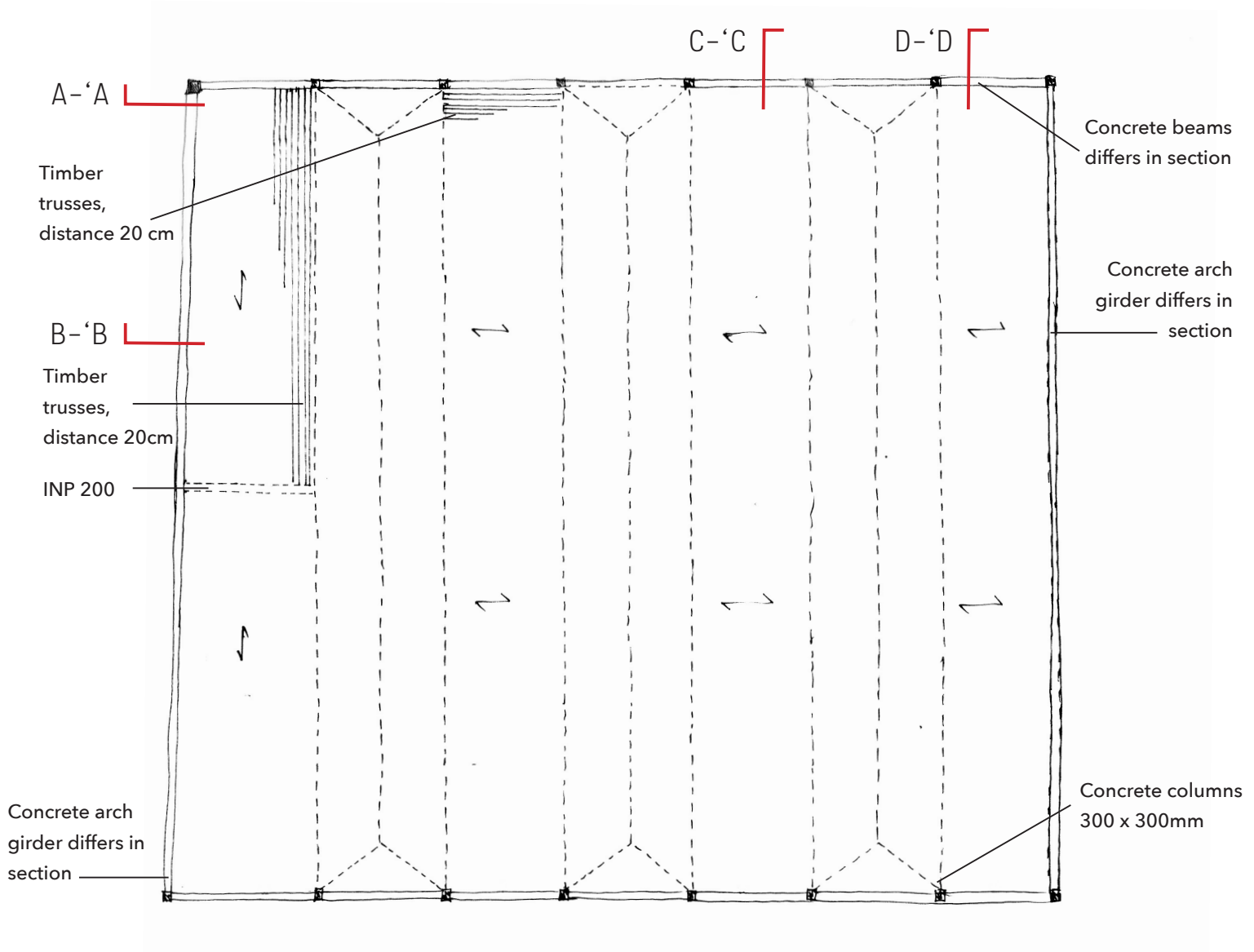

Figure 191 Structural plan/diagram (Own image based on J.C. Pannekoek, 1956/1957)

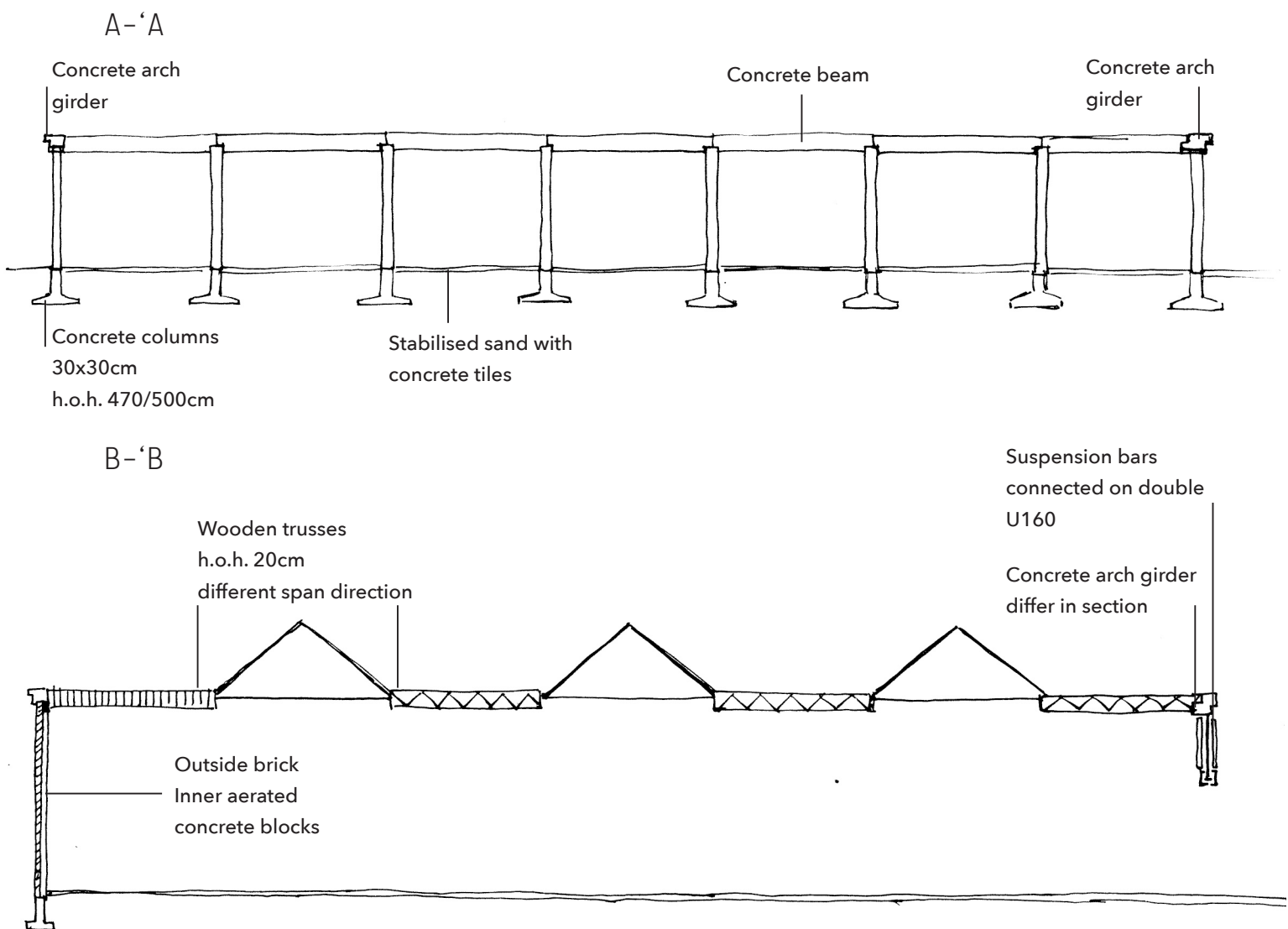
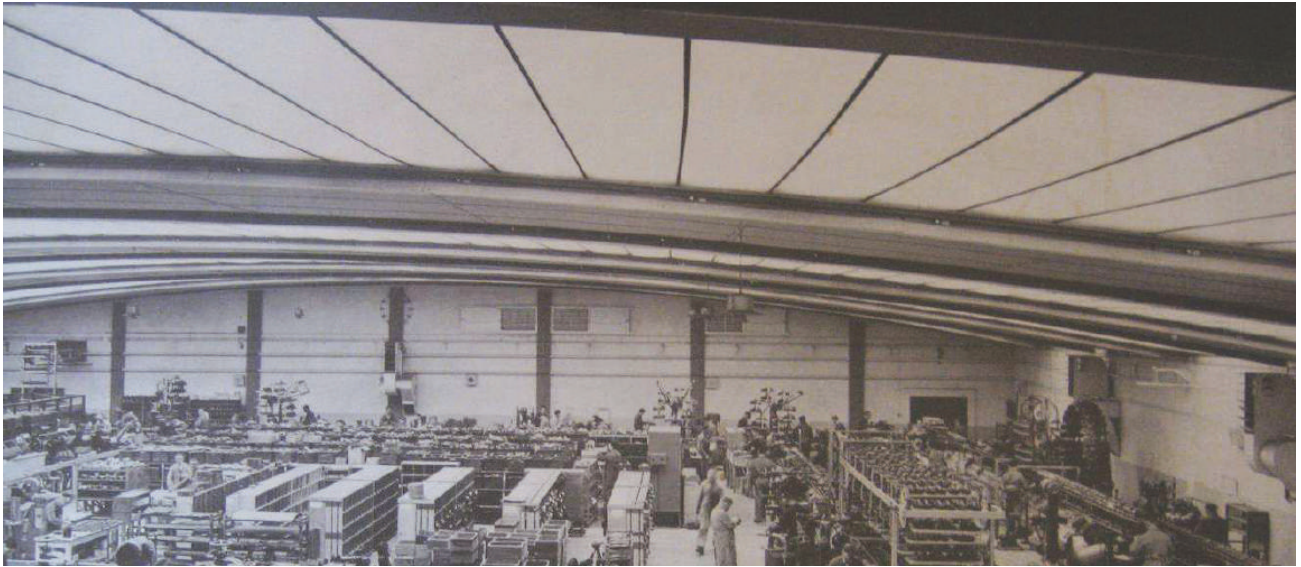
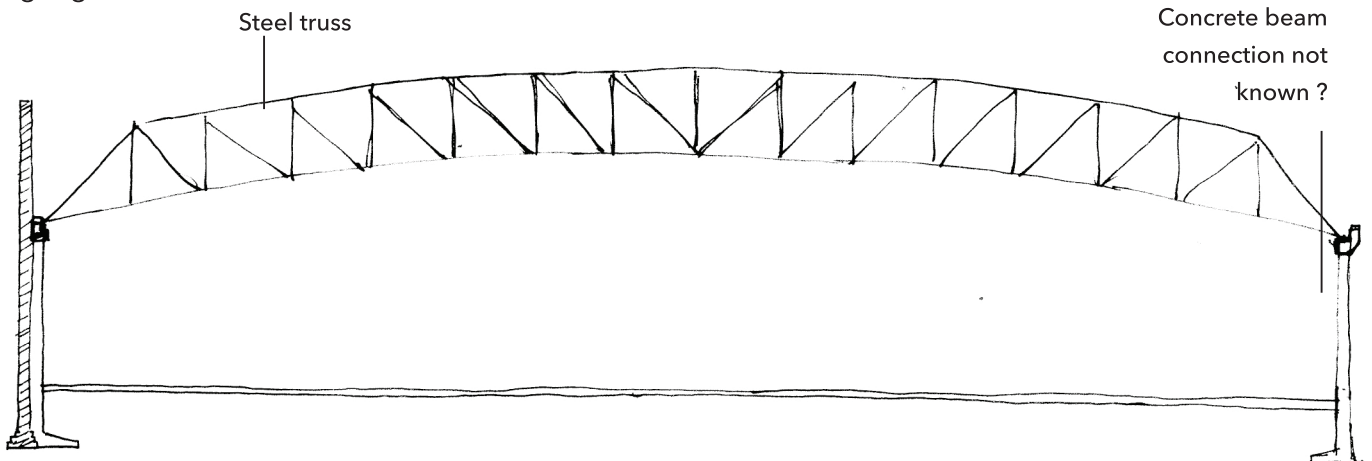

Figure 192 Structural section/diagram (Own image based on J.C. Pannekoek, 1956/1957)



C-'C



D-'D

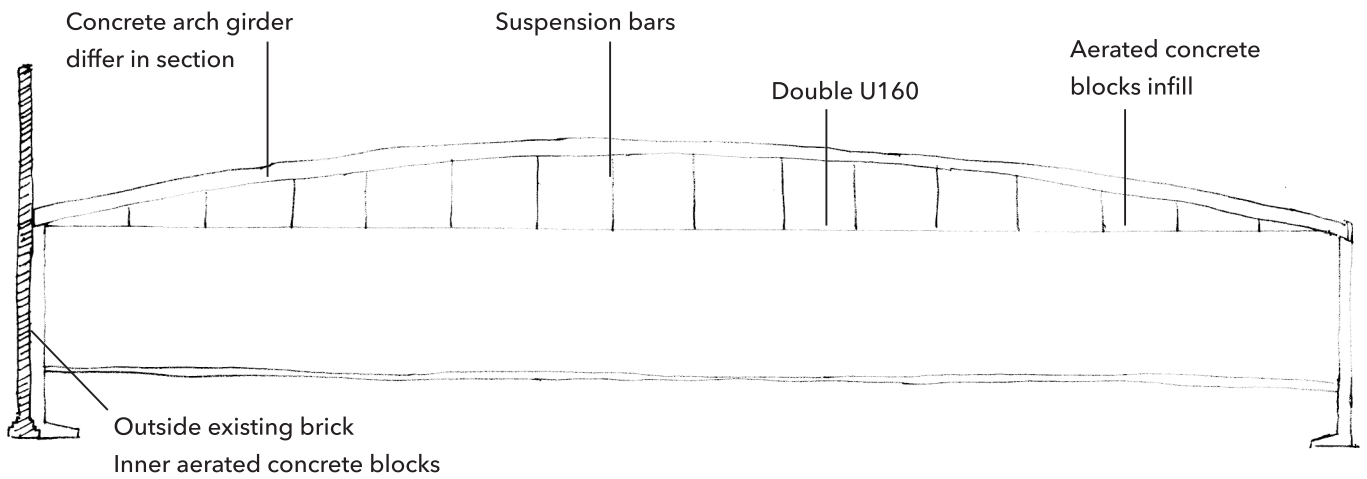
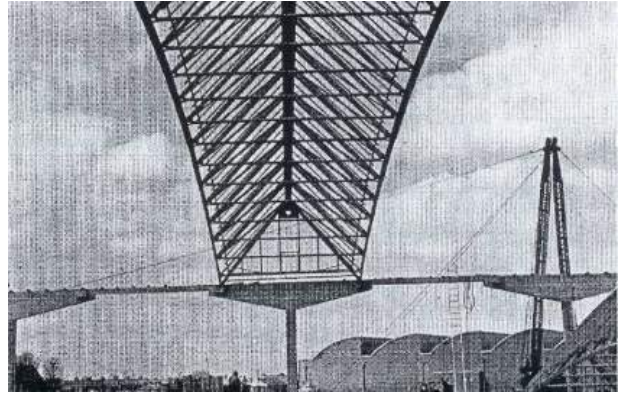

Figure 193 Structure of the 'Pannekoek' roof (Heemkundekring, 2007)
Figure 194 Structural section/diagram (Own image based on J.C. Pannekoek, 1956/1957)

'PANNEKOEK' ROOF

In 1955 J.C. Pannekoek patented his structural design, which is named after him, "Pannekoek-roof". Before J.C. Pannekoek came up with this modern structure in 1955, he worked for Rijkswaterstaat as structural engineer. Constructing bridges and other related structures taught him how to deal with spans and such issues.

The main characteristics of the "Pannekoek-roof" design is the column free floorplan, large spans and low construction costs. The core of the structure are the three-dimensional shaped steel trusses, which also provide the daylight for the whole building. These steel trusses rest on top of a concrete structure, consisting of column and beams. Moreover, the steel trusses are the heaviest part of the whole roof. Besides these elements the roof consists of wooden trusses. The whole roof construction weighs 15 kg per m².



Fragment North-Facade (front)

The entering daylight is filtered with some sort of cellophane pillows. Moreover, the walls consist of aerated concrete, which insulates together with the roof the whole and provides, according to the design descriptions, a consistent temperature throughout the whole building. (Oerlemans, 2007)

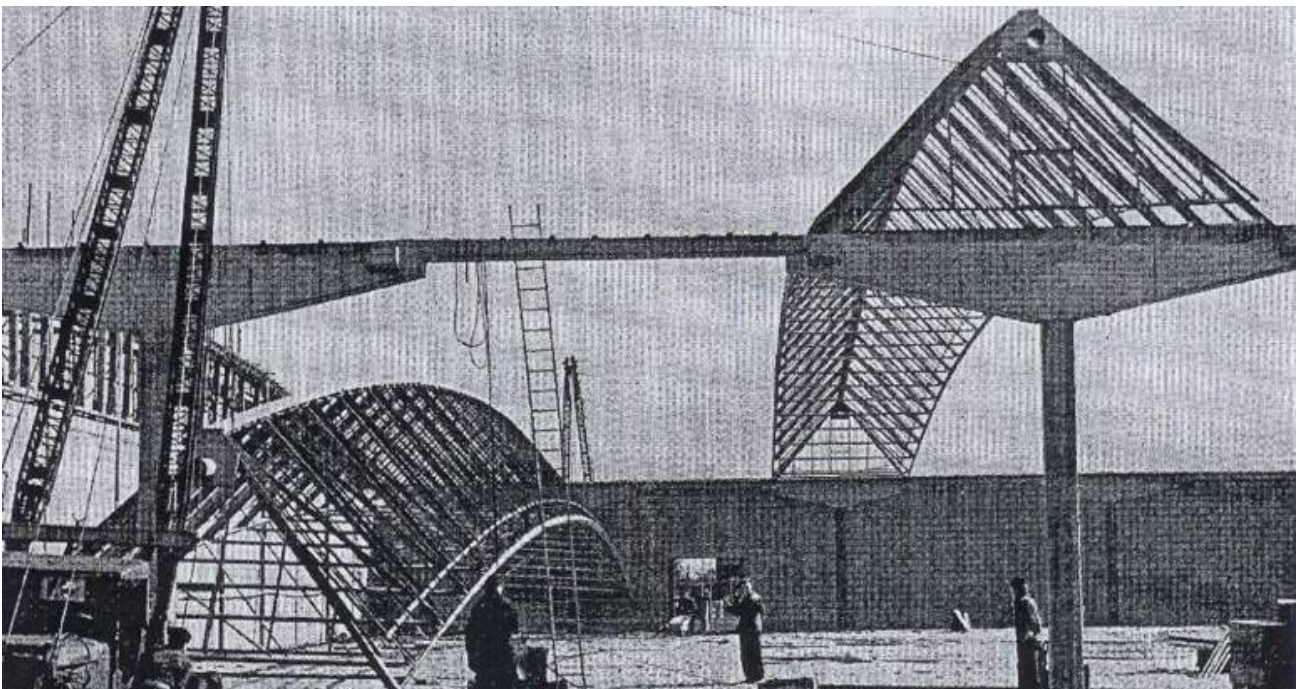

Figure 195 Structure of the 'Pannekoek' roof (Heemkundekring, 2007)

AXONOMETRIC VIEW

Building year and architect: 1957, Pannekoek
 Structure type: steel primary trusses and timber secondary trusses, concrete columns
 Connections: welded and steel plates
 Span: steel trusses 32000 mm, timber trusses 5000 mm
 Stability: stiff slabs and fixed joints
 Roof type: 'Pannekoek' (patented)
 Roof material: Steel and timber

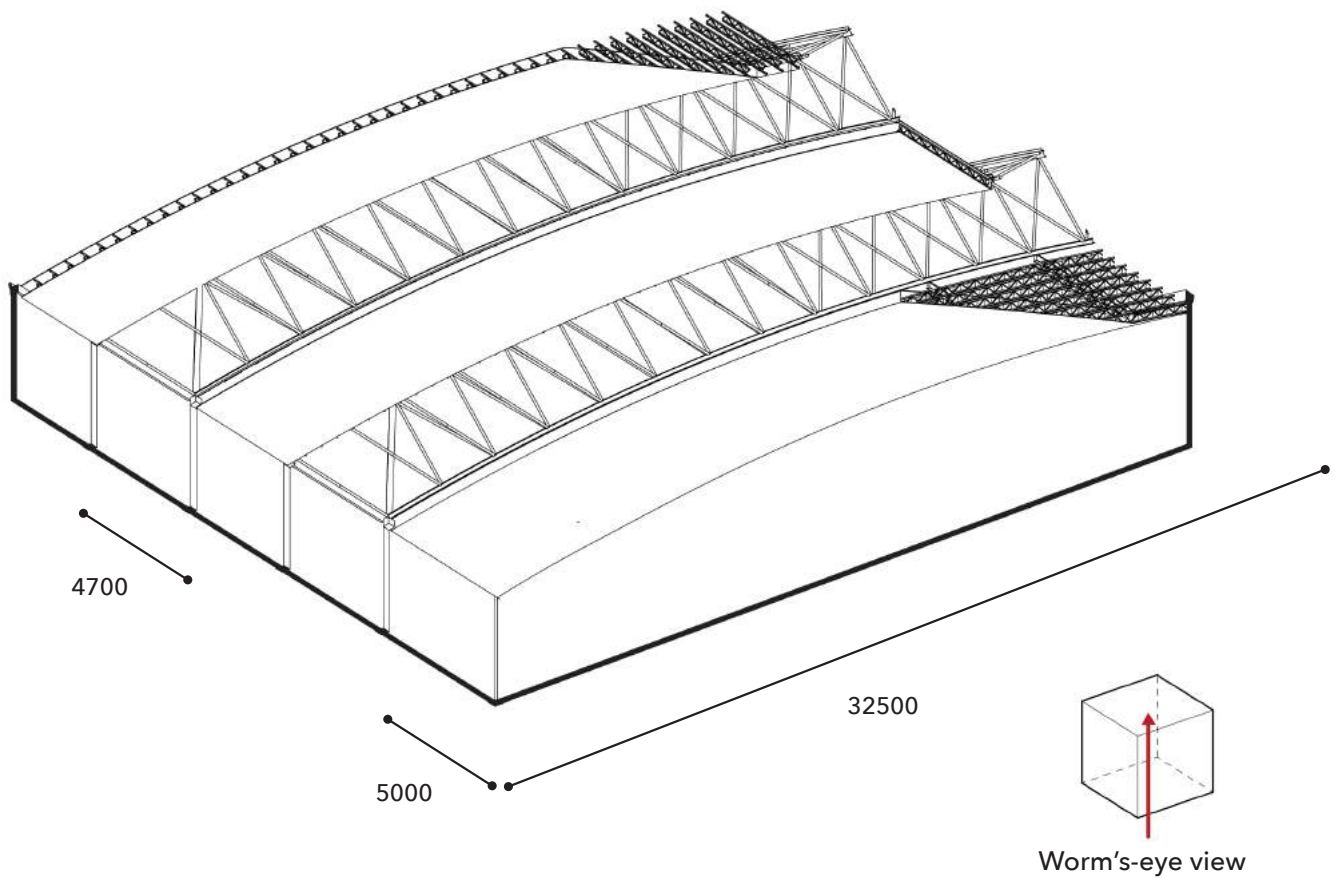

Figure 196 Ceiling (Photo by Joost Joosse, 2019)
 Figure 197 Structural axonometric view (Own image based on J.C. Pannekoek, 1956/1957)

STABILITY

As for stability, the roof works as a big slab through the stiff connections. Forces are directed downwards by the beams to the

columns (stiff connections) and in the other direction onto the concrete girder and brick wall.

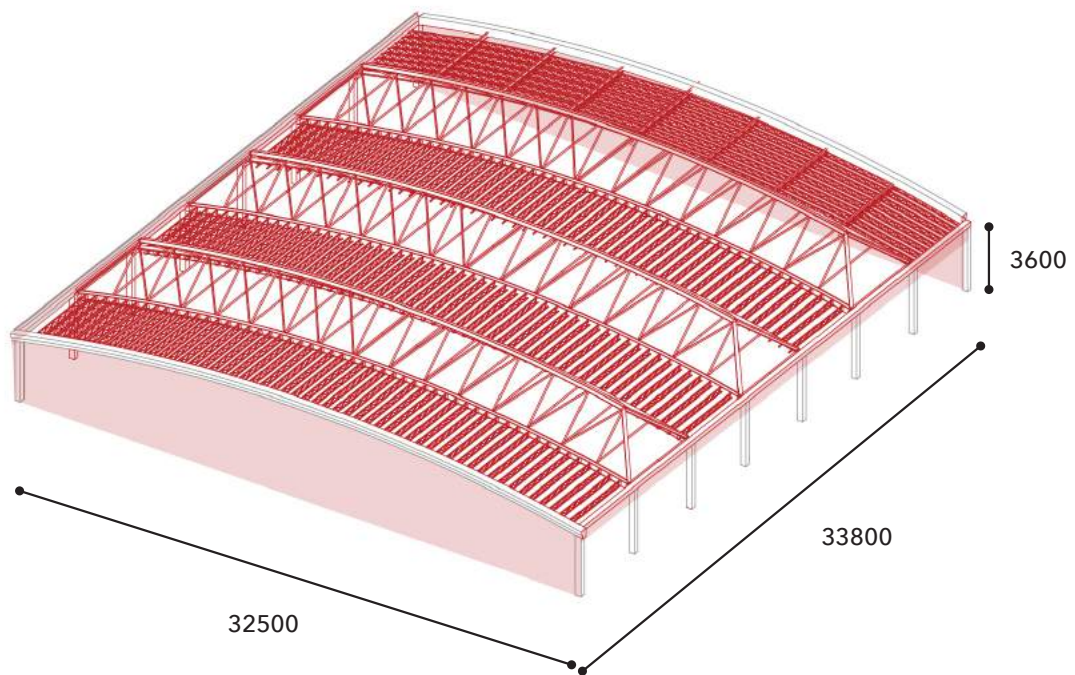
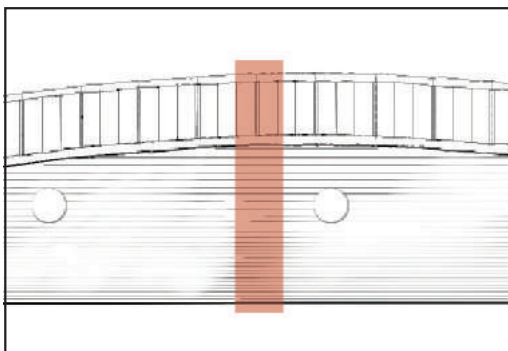
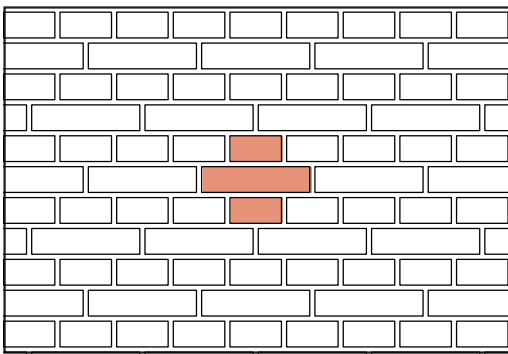

Figure 198 Stability (Own image based on J.C. Pannekoek, 1956/1957)

FAÇADE FRAGMENT

The section shows the timber trusses in the exception part of the building, they are connected to steel I-beams. The exterior masonry has a cross bond.



Fragment North

Figure 199 Brick pattern and position section (Own image based on J.C. Pannekoek, 1956/1957)
 Figure 200 Façade (Google Maps, 2019)

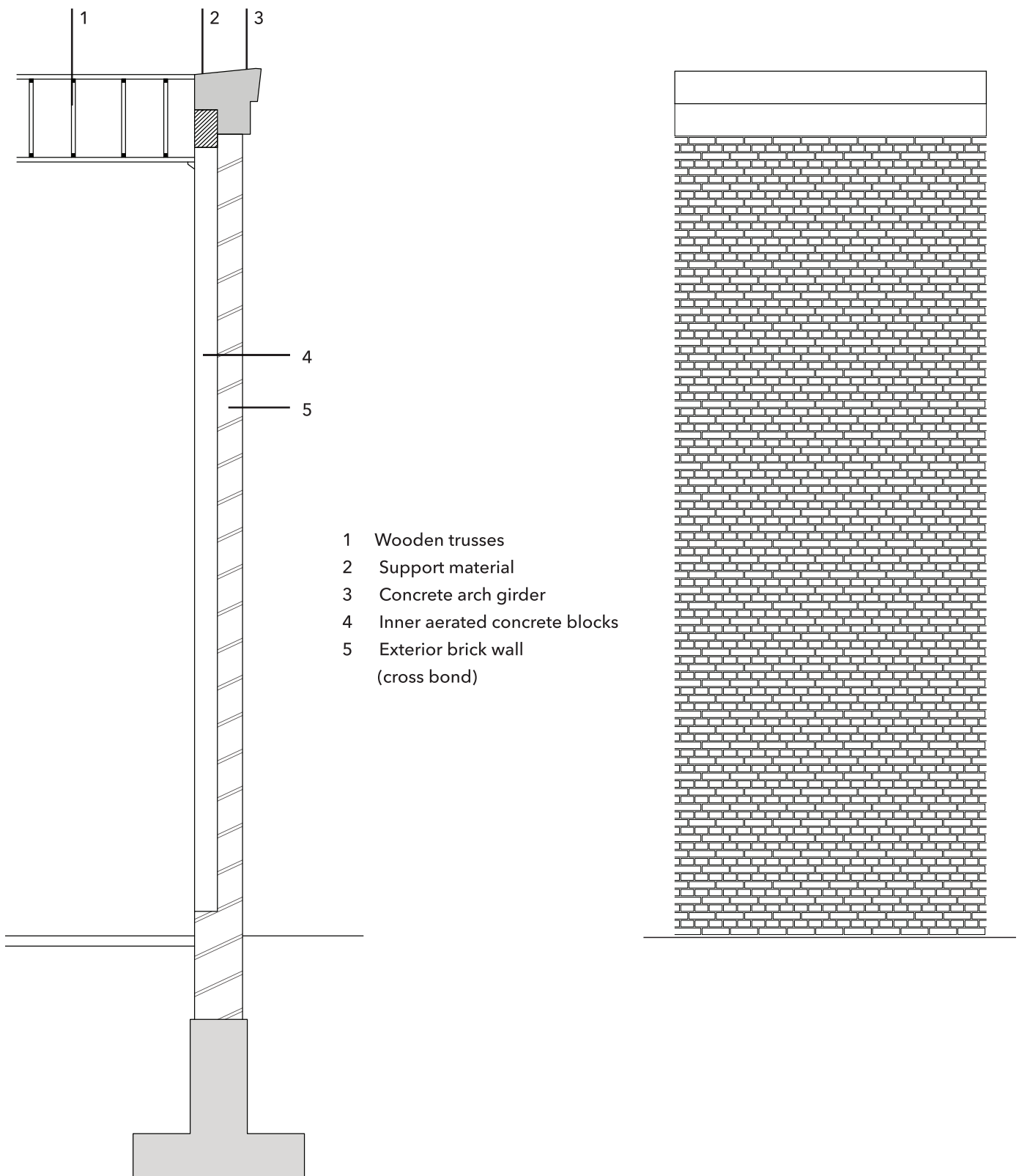

Figure 201 Section and façade fragment (Own image based on J.C. Pannekoek, 1956/1957)

BUILDING D

The general scheme of this building is a concrete column beam structure. The spans of 19 m can be achieved by the special

Hyperbolic-Paraboloid (HP) shells. The prestressed beams of the main structure span 15,5 meter.

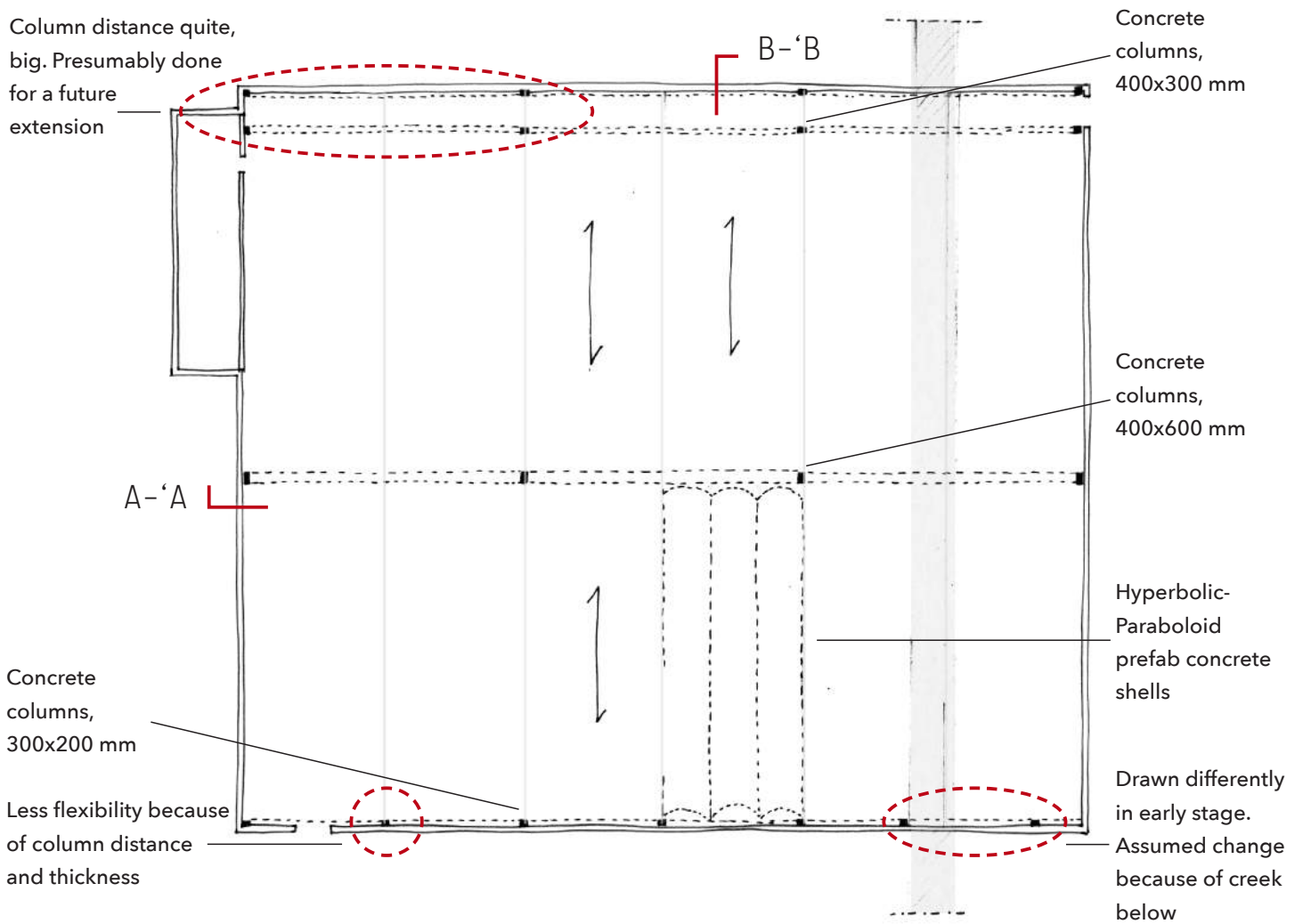
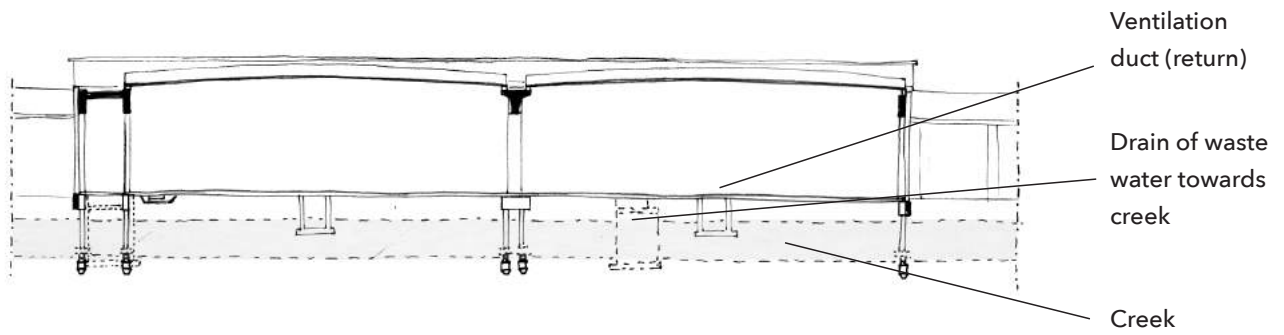

Figure 202 Structural plan/diagram (Own images based on Architectenbureau van Linge, 1960)

A-'A



B-'B

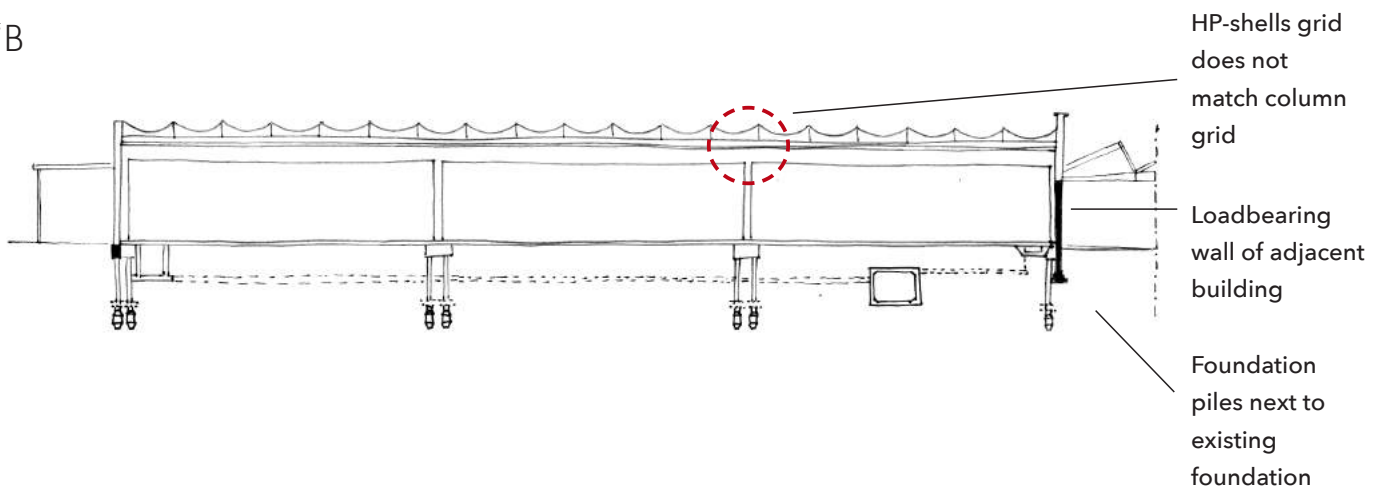

Figure 203 Structural section/diagram (Own images based on Architectenbureau van Linge, 1960)

HYPERBOLIC PARABOLOID SHELL ROOF

Concrete shells are a product that have been introduced in the beginning of the 20th century. Since then step were made in the development of the reinforcement of concrete and the acceptance of concrete as a finishing material. Large concrete plates and shells were economically beneficial, because they functioned as the loadbearing and space enclosing component at the same time. They also reduced the number of components in the building process.

After the WWII organic forms became popular again, with a lot of experimentation in the 50's and 60's. As explained before, labour was cheap and therefore this experimenting with

complex and very thin reinforced concrete shells was possible. After 1975 it disappeared as a construction type. In the few decades the type of construction has been applied, concrete shells were used for a lot of different functions, from factories to train stations and even theatres and churches. extraordinary and futuristic, this can be seen in the works of Félix Candela and in some projects of Oscar Niemeyer. There were and are some examples of concrete shells built in the Netherlands; the former Rotterdam station and platform roofs by Sybold van Ravesteyn in 1957, the main building of the ANWB in Wassenaar, built in 1959 and ofcourse the weaving building on the site of the Morsepoot. (I.T., 1968)



Figure 204 ANWB office Wassenaar (ANWB, 2019)

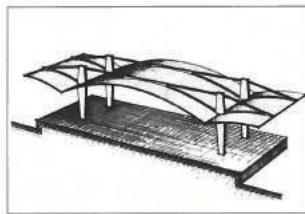
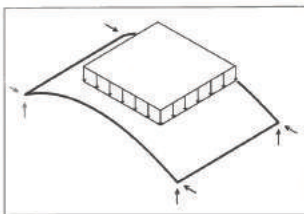
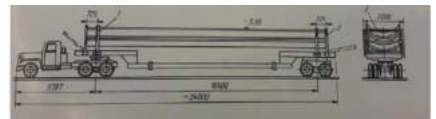
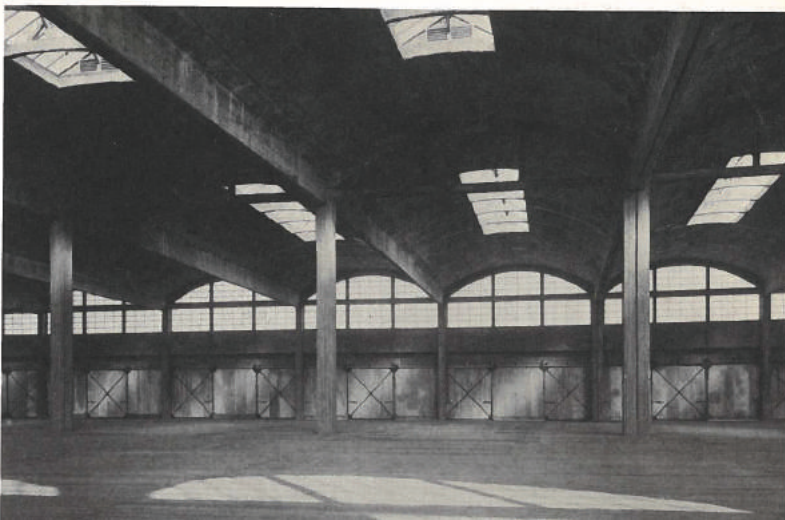
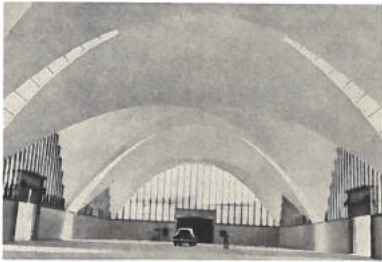
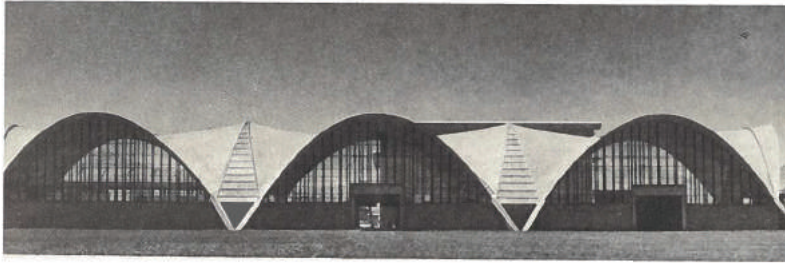

Schalen sind räumliche Flächen-tragwerke aus dünnen, gekrümmten Flächen. Sie tragen die Flächenlasten primär durch Membrankräfte, das heißt durch Zug-, Druck- und Schubkräfte ab.

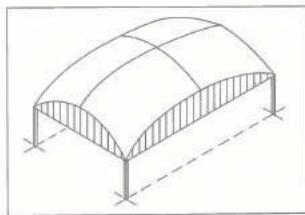

Einfach gekrümmte Schale aus Stahlbeton

Doppelt positiv gekrümmte Schale aus Stahlbeton



Figure 205 HP structures (Ackermann, 1985)
 Figure 206 HP structures (Neufert, 1973)
 Figure 207 Schemes of HP structures (Ackermann, 1985)
 Figure 208 Manufacturing, transporting and placing HP shells (Koncz, 1967)

AXONOMETRIC VIEW

Building year and architect: 1960, van Linge
 Structure type: concrete columns and concrete roof
 Connections: pre-fab
 Span: 15550 mm x 19400 mm
 Stability: stiff slabs and fixed joints
 Roof type: double curved concrete roof slabs (HP shells)
 Roof material: concrete

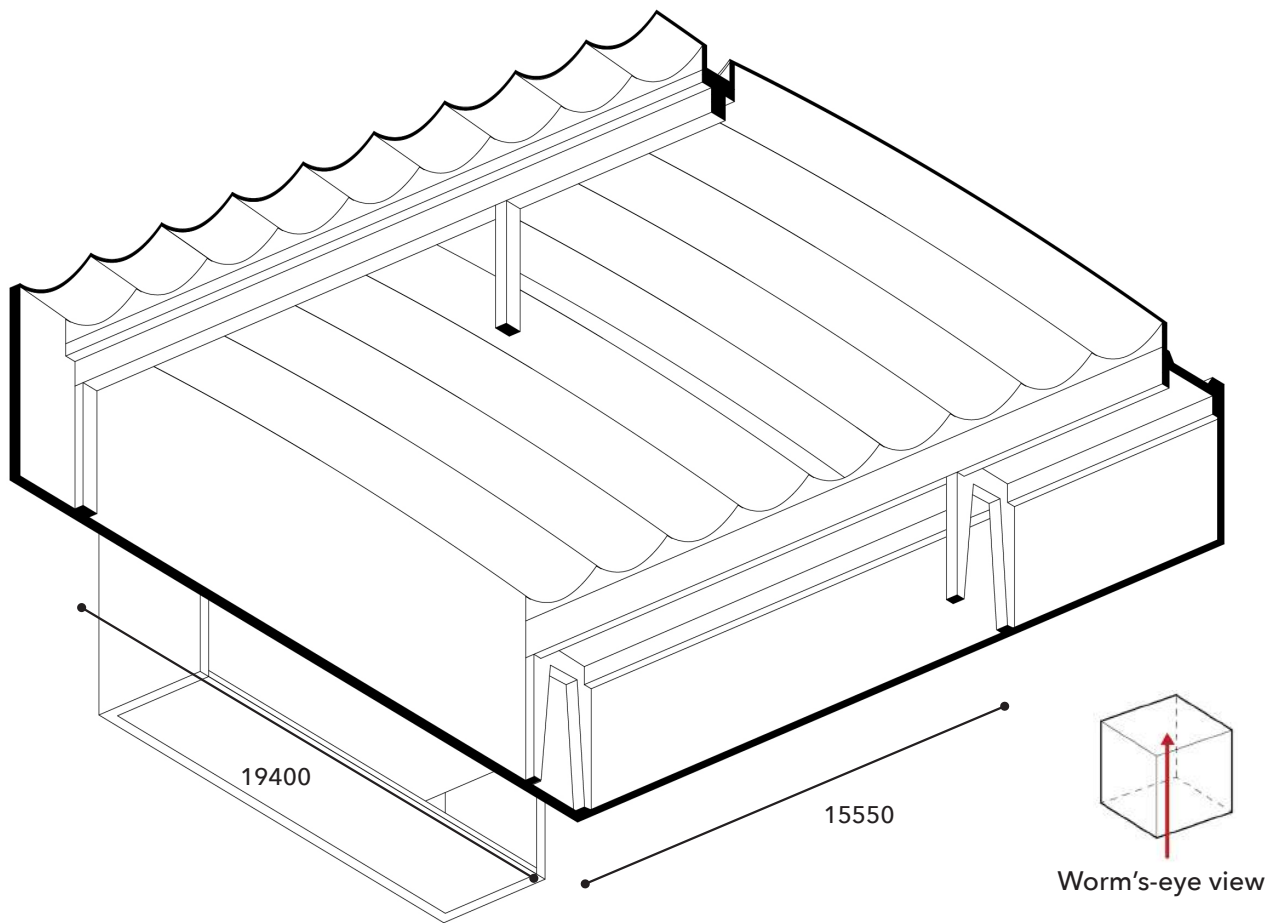

Figure 209 Structural axonometric view (Own images based on Architectenbureau van Linge, 1960)
 Figure 210 Roof structure visible (Photo by Dinand Kruize, 2019)

STABILITY

The stability of this structure is established by the stiff concrete shells in one direction which transport the load onto the concrete portals.

In the other direction the load is transported through the concrete beam-column combination with stiff connections.

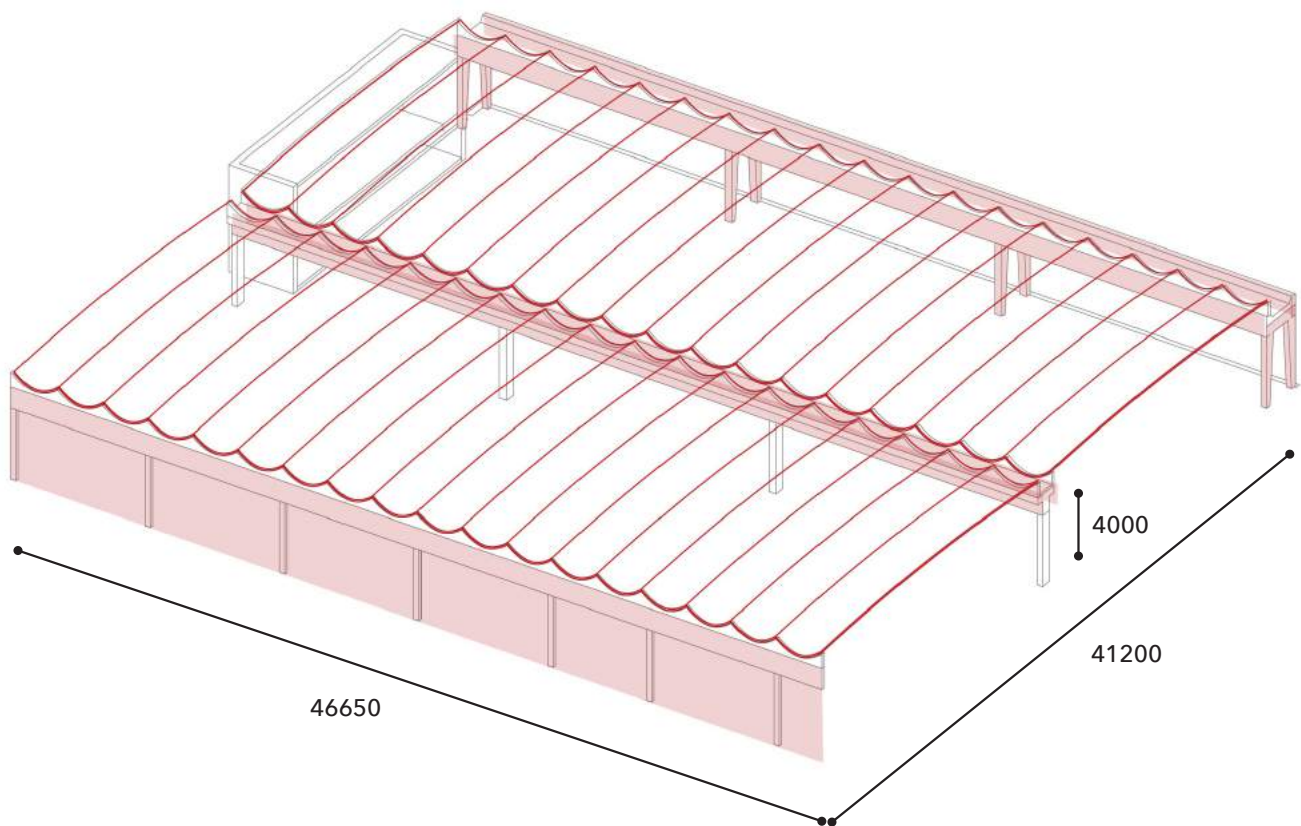
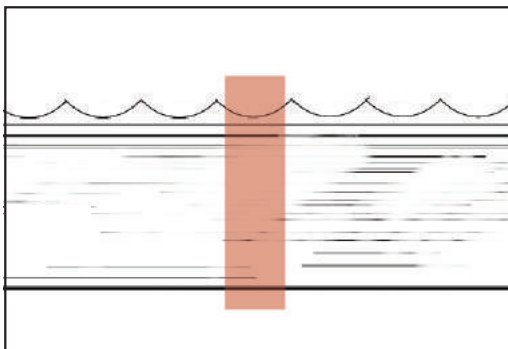
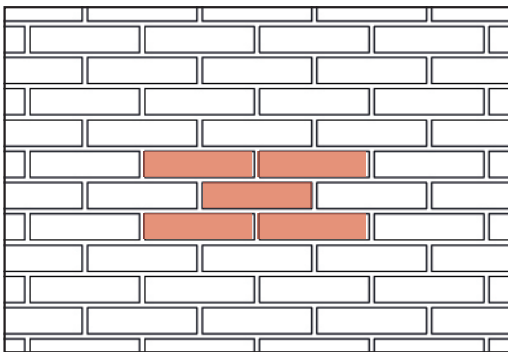

Figure 211 Stability (Own image based on Architectenbureau van Linge, 1960)

FAÇADE FRAGMENT

The section shows the roof slab which is supported by portals.



Fragment East

Figure 212 Brick pattern and position section (Own image based on Architectenbureau van Linge, 1960)
 Figure 213 Façade (Photo by Juliëtte Zegers, 2019)

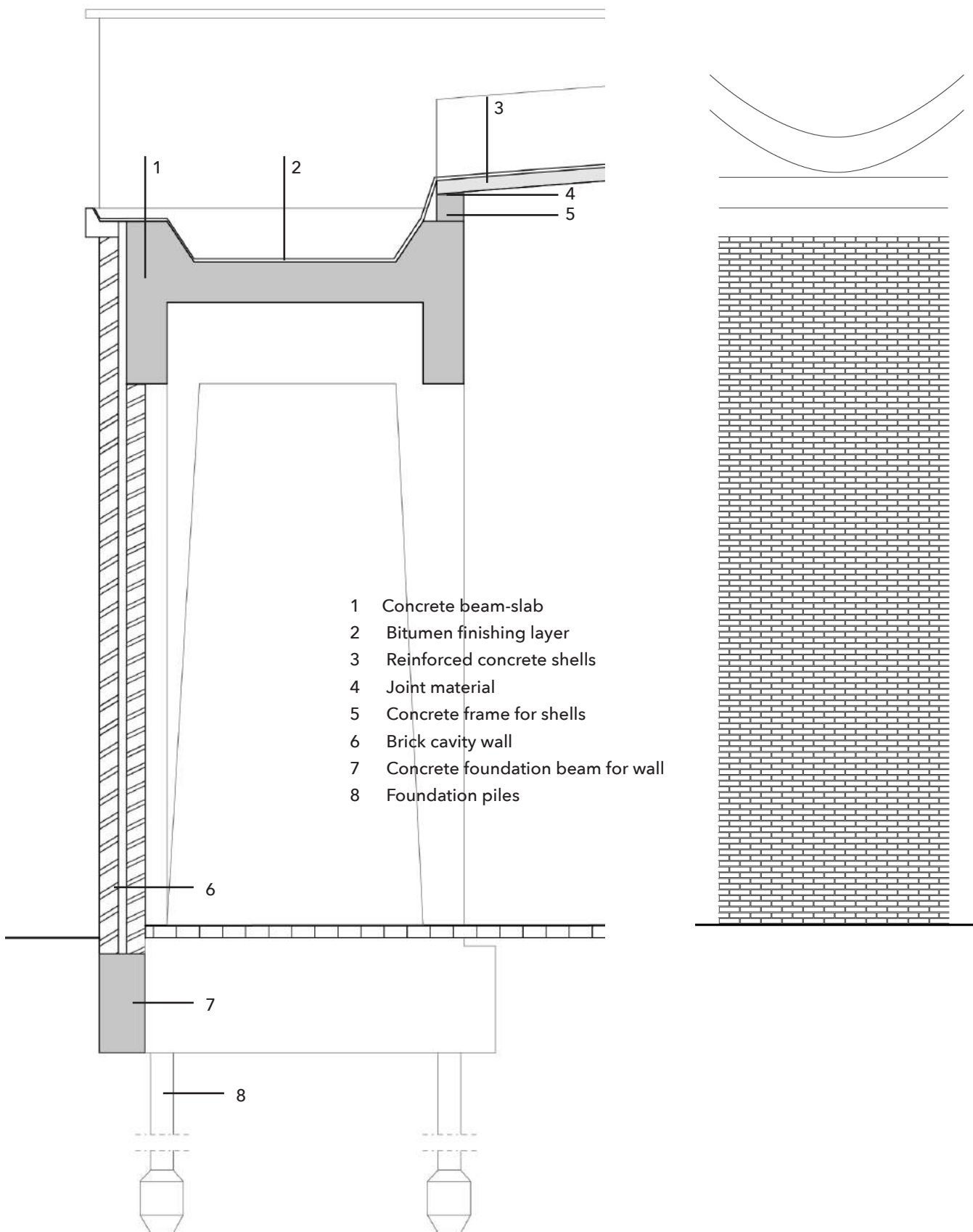

Figure 214 Section and façade fragment (Own images based on Architectenbureau van Linge, 1960)

BUILDING E

This building is generally based on a timber beam structure. There are no columns in the middle of the hall. To sufficiently support the beams and achieve pure space, it is using

a tension bar under the ground. The span of the beams is 28.51m (West-East) and 4.63m (South-North).

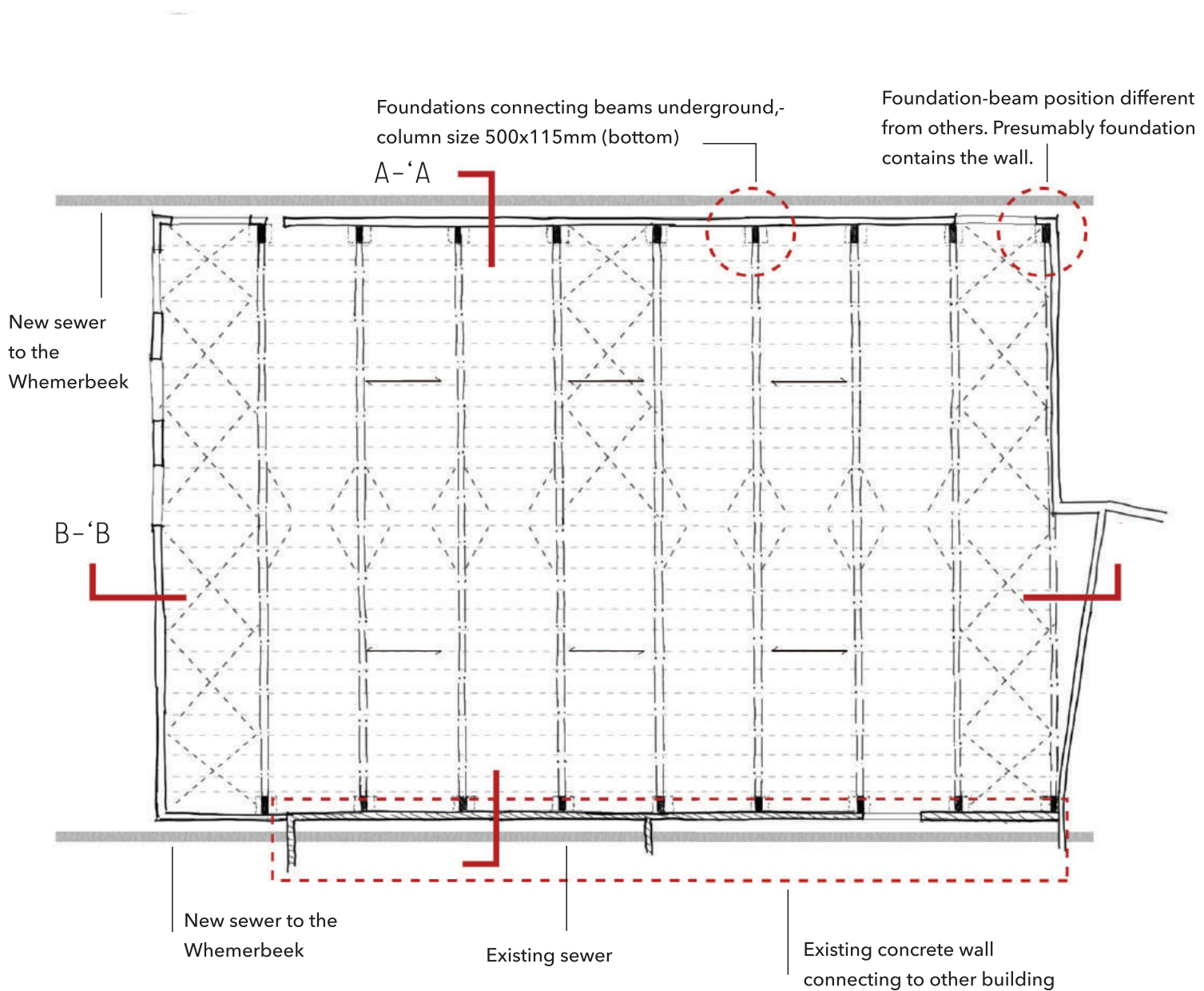

Figure 215 Structural plan/diagram (Own images based on Bouwkundig Ingenieurs en Adviesbureau Sassen, 1960)

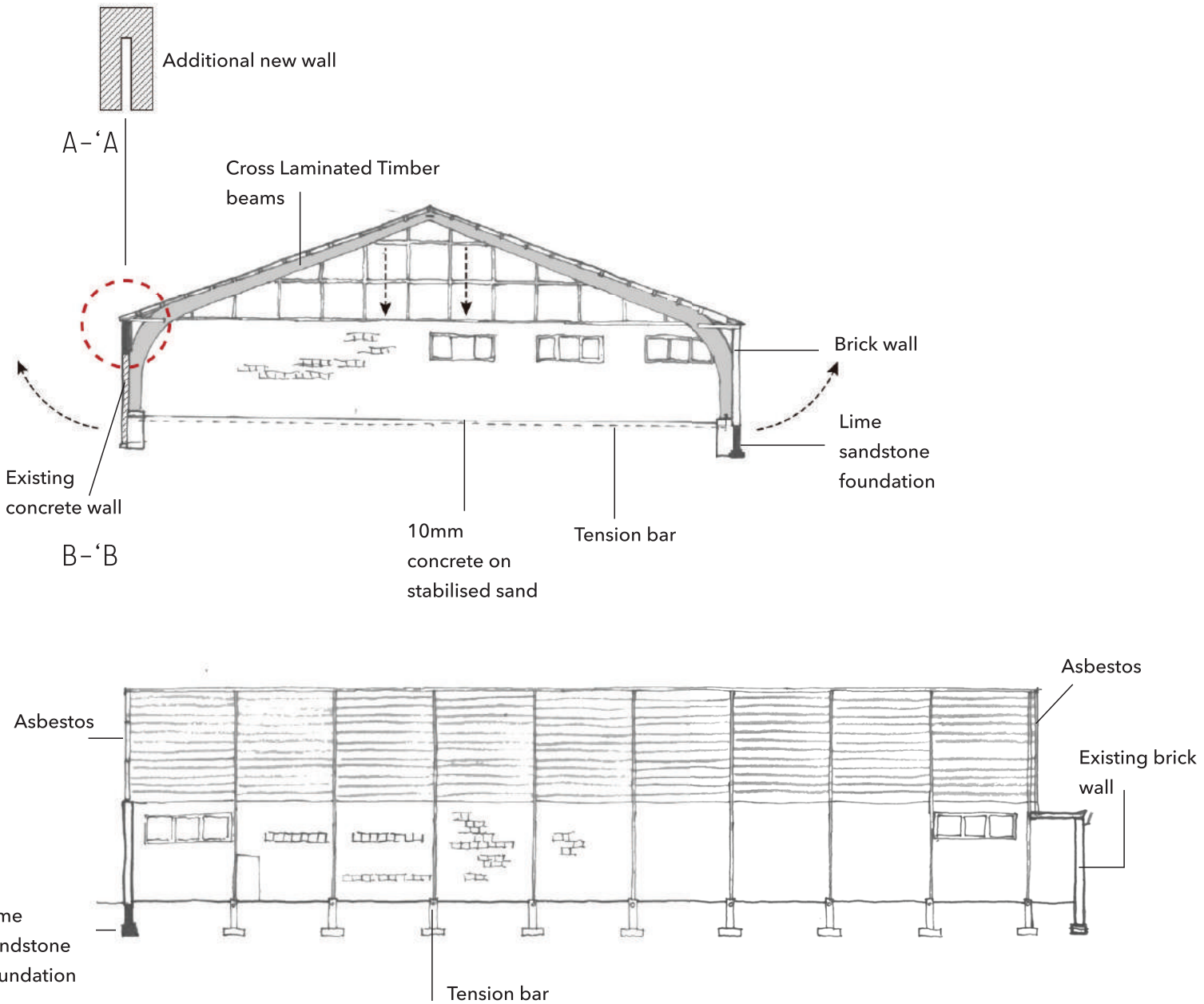

Figure 216 Structural section/diagram (Own images based on Bouwkundig Ingenieurs en Adviesbureau Sassen, 1960)

AXONOMETRIC VIEW

Building year and architect: 1963, Sassen / Nemaho
 Structure type: primary prefabricated CLT-beams (tension bars below the ground) with secondary timber purlins
 Connections: Bolted
 Span: 28510 mm x 4630 mm
 Stability: timber crosses and brick walls
 Roof type: Pitched barn roof
 Roof material: CLT and timber

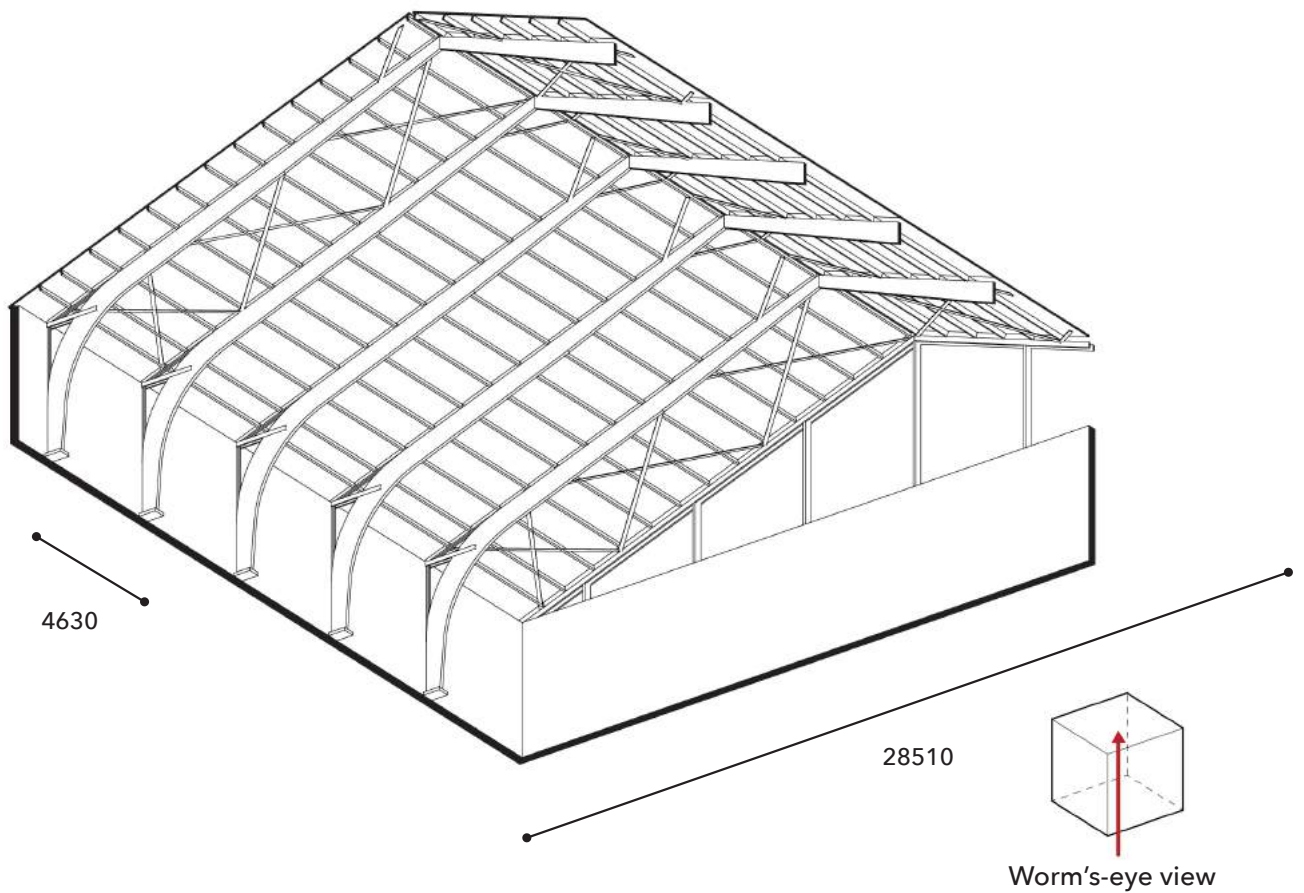

Figure 217 Structural axonometric view (Own image based on Bouwkundig Ingenieurs en Adviesbureau Sassen, 1960)
 Figure 218 CLT beams visible (Photo by Chen Zhu, 2019)

STABILITY

Stability is achieved through diagonal timber purlin connections which transport the load onto the beams. The beams are attached to

the brick façade with special anchors, thus they have a role within the stability.

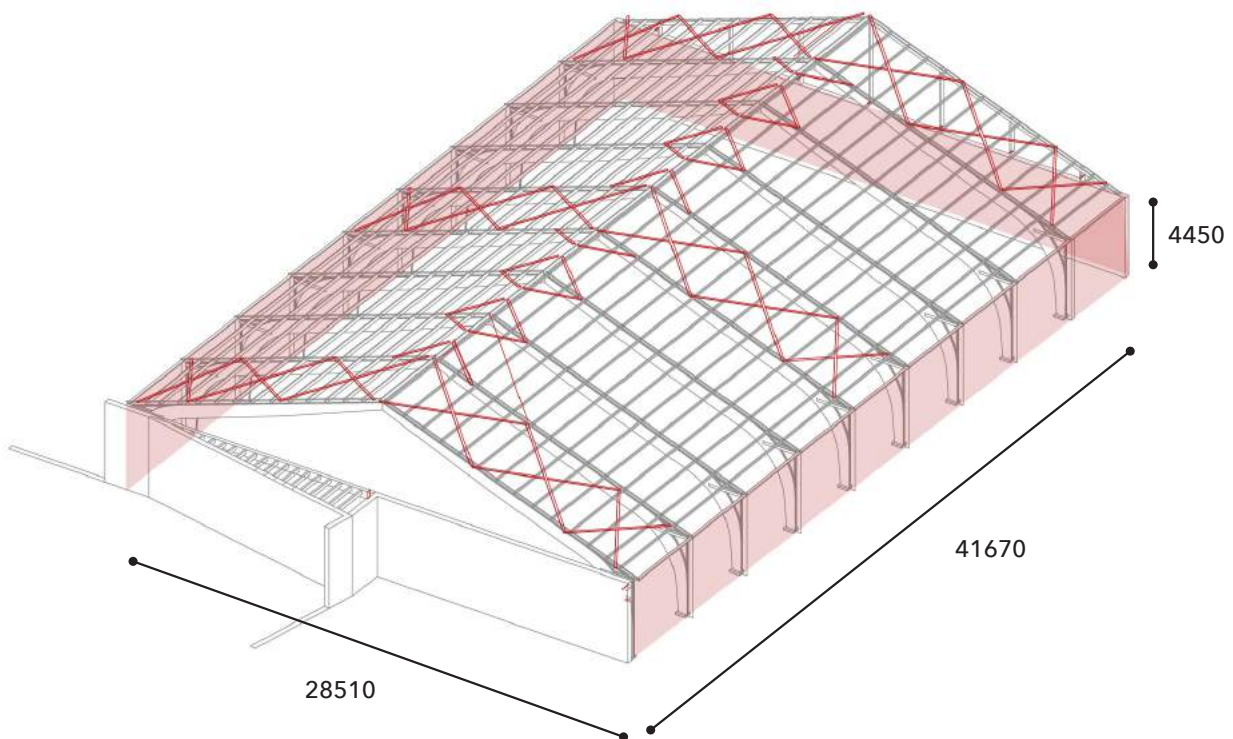
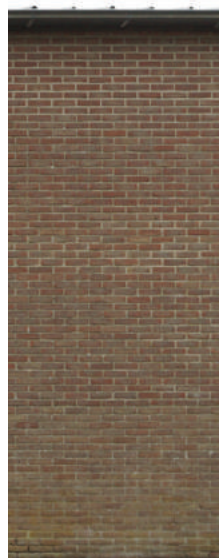
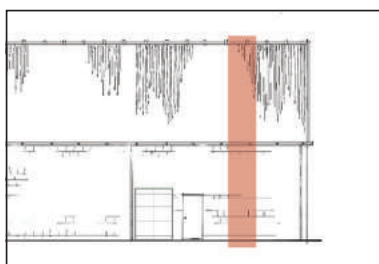
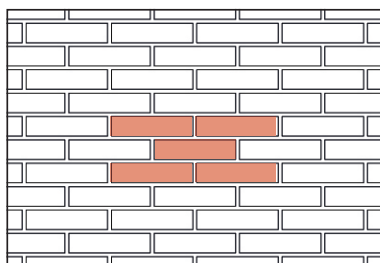

Figure 219 Stability (Own image based on Bouwkundig Ingenieurs en Adviesbureau Sassen, 1960)

FAÇADE FRAGMENT

The section shows the connection of the beam onto the floor and the attachment of the beam on the brick wall. This wall has a stretchers bond.



West

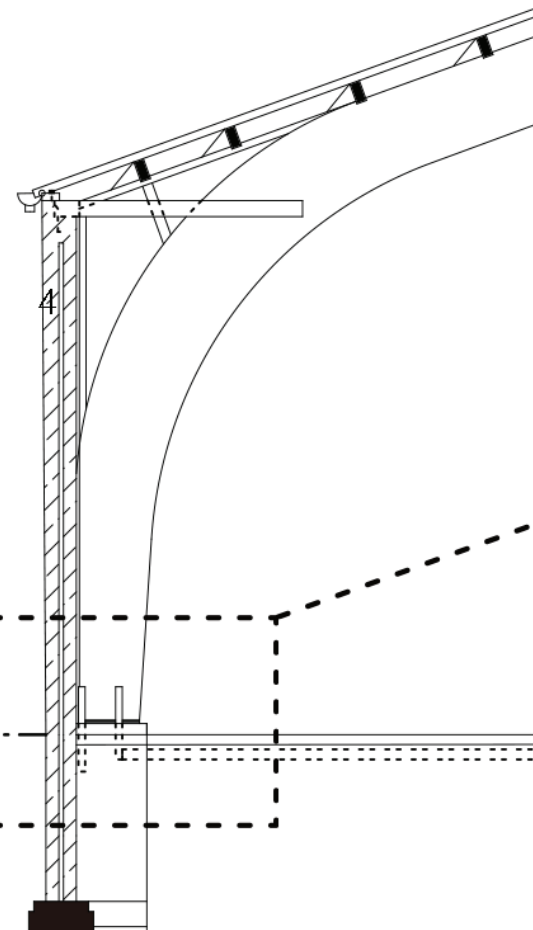
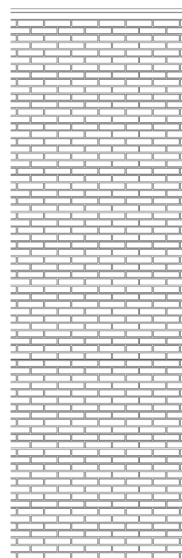
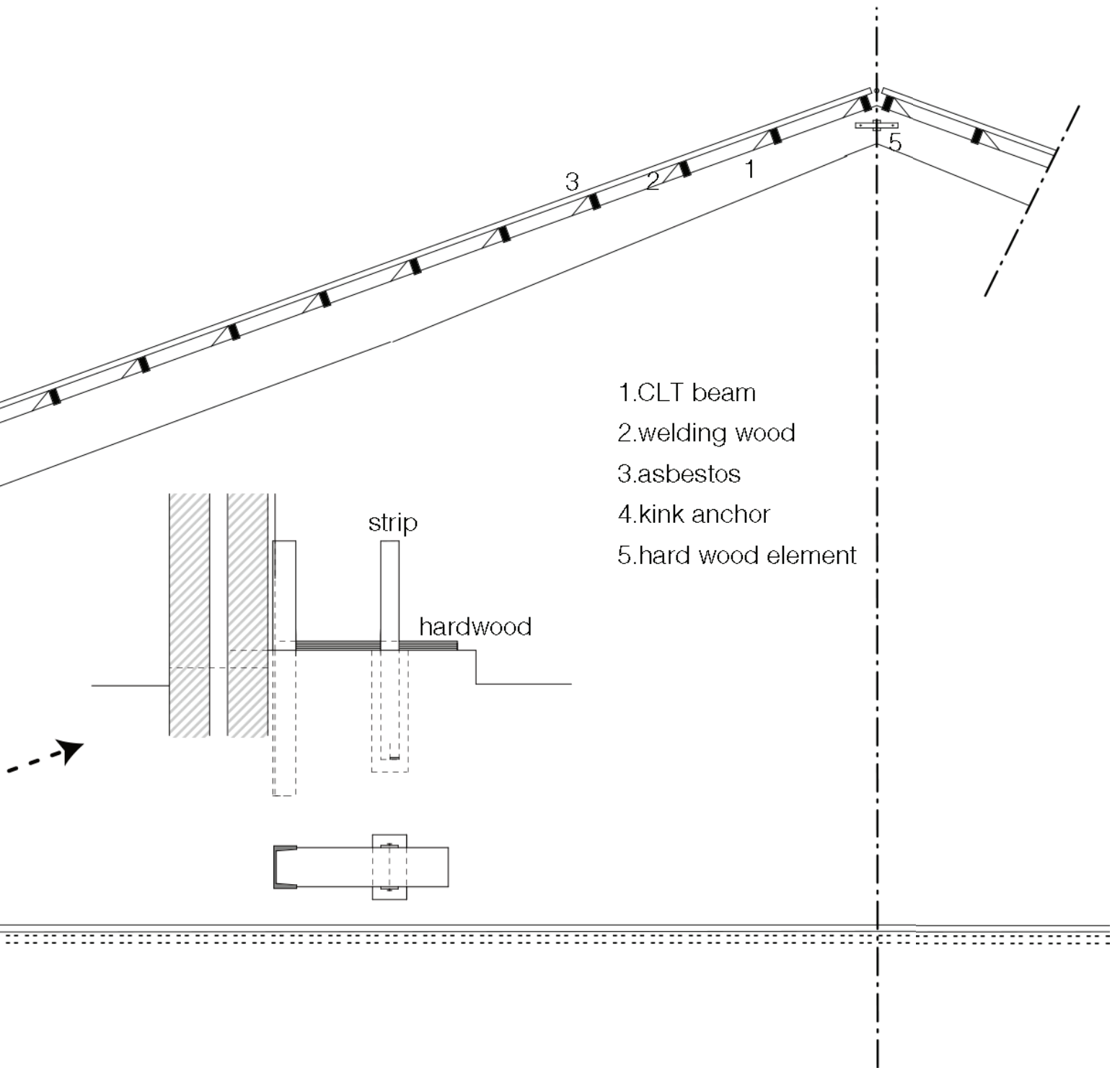
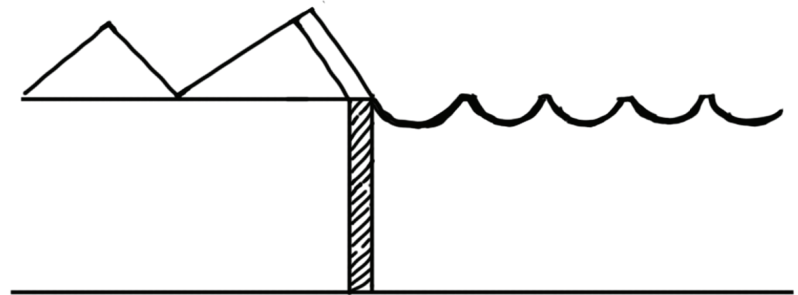

Figure 220 Brick pattern and position section (Own images based on Bouwkundig Ingenieurs en Adviesbureau Sassen, 1960)
 Figure 221 Façade (Photo by Chen Zhu, 2019)



CONCLUSIONS



Shared (loadbearing) walls are
the result of an organically grown
ensemble



Figure 222 Conclusions. (Own image, 2019)

Technology had great influence on the structures, their materials and their appearances

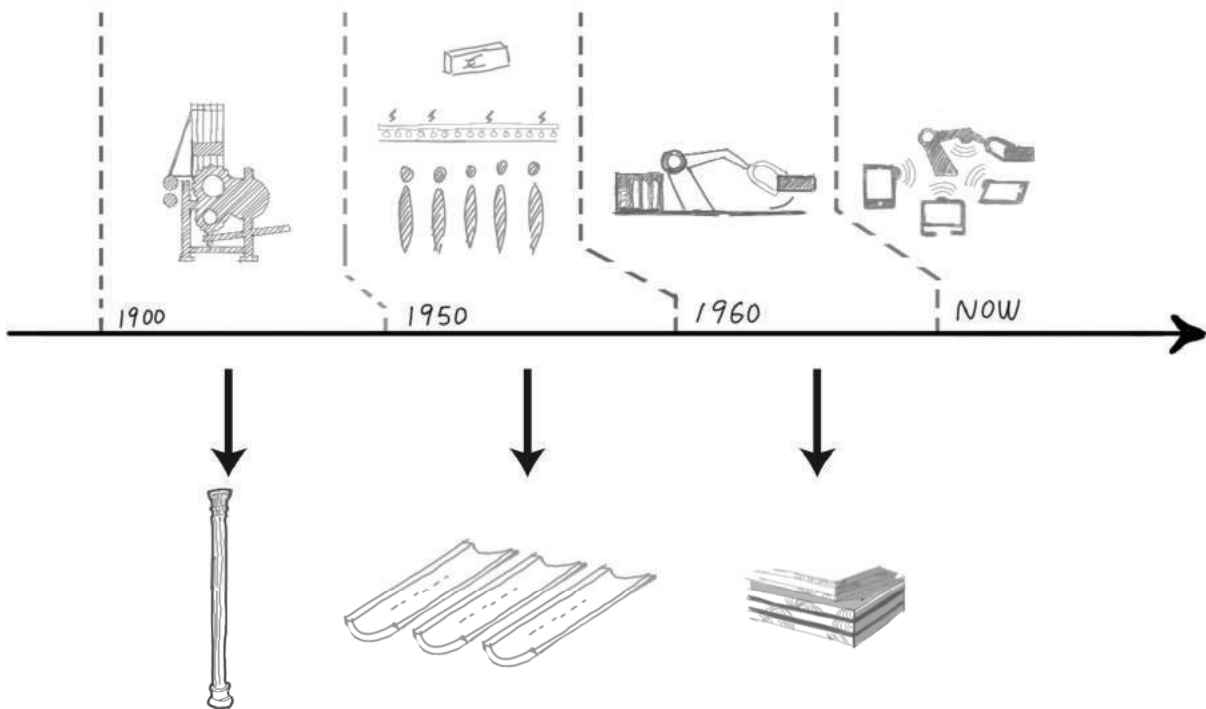

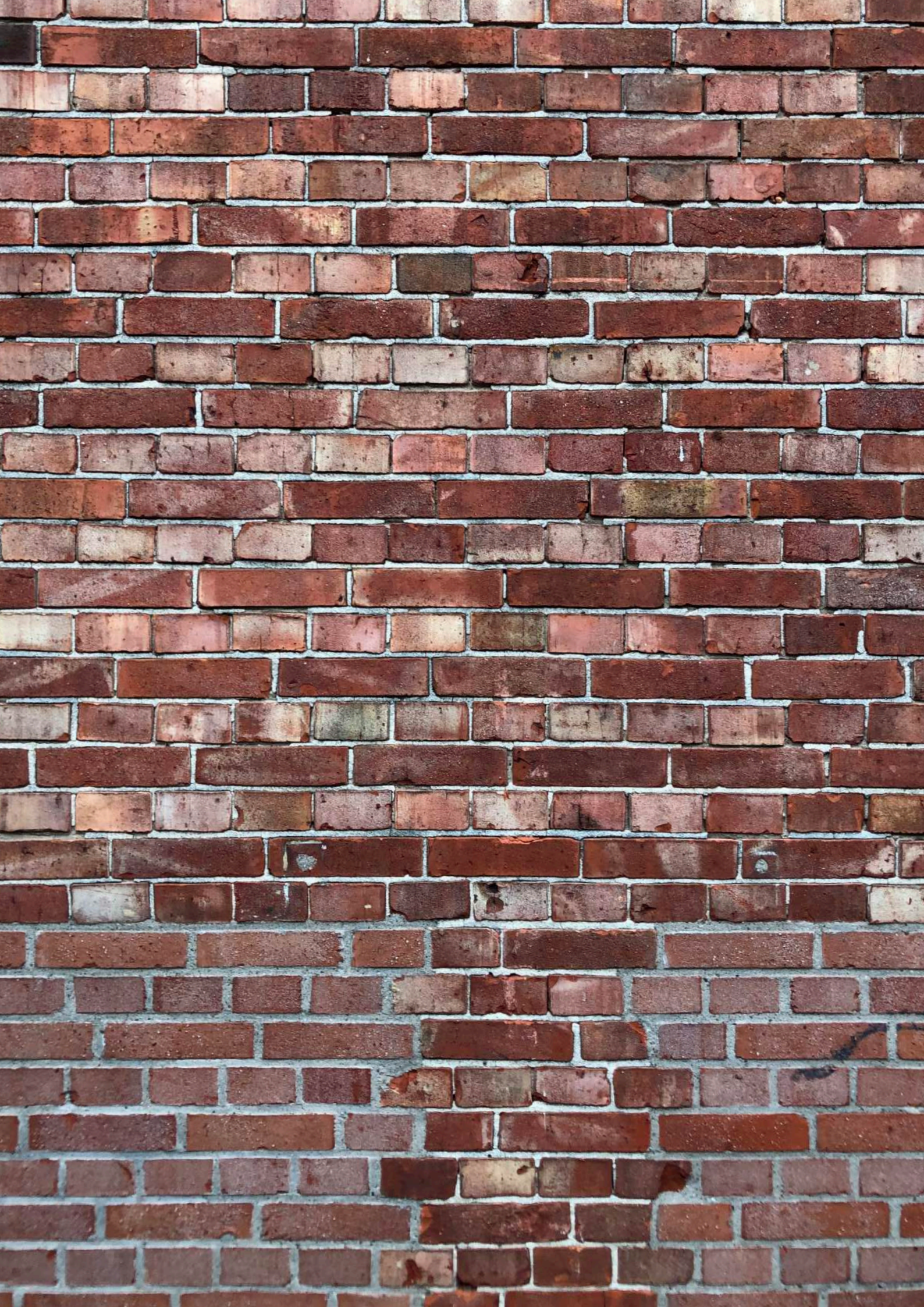

XI CULTURAL VALUE MATRIX

The urban fabric of the whole industrial building ensemble tells stories about the past and represents partly the community of Winterswijk. Hence, they are carriers of cultural values. Defining which components hold these cultural values and under what circumstances, is a challenging process because the values are not always quantitative and tangible. Moreover, each individual can associate values in different ways, which makes it difficult to manage. Valuating the industrial area is a crucial process beforehand the designing process. It forms a basis for argumentation.

In order to understand what components are valuable, the tool "Cultural Value Matrix" is used (Kuipers & De Jonge, 2017). This tool combines two theories concerning Heritage & Architecture: Riegl's theory on cultural values (Riegl, 1903) and Brand's theory on the layers of a building (Brand, 1994). The values and layers chosen for the matrix is a result of analysis and own interpretation of these theories.

UNDERSTANDING THE VALUES

The cultural values of Riegl are shown on the horizontal axis. The building layers of Brand are shown on the vertical axis. On the values axis another subject is added, which is "other relevant values". In our believes some characteristics of the industrial area do not correspond with Riegl's series of values.

Alongside the axis of Brand's S's the layers "Surroundings" and "Spirit of the place" are added. The "Surroundings" is added since it is important that the site of the industrial area and its building are seen in a larger urban context. The addition of "Spirit of place" is in our opinion important to express our own visions, ideas and feelings derived from the way we experienced the project site. Besides these additions, the order of the six S's is changed in the matrix as well. It makes more sense to describe the building from the larger urban scale to the smaller scale and from the outside towards the inside. As if one would enter Winterswijk and walk to the site where he or she enters the building ensemble and experience the whole. Therefore such layers as the "Skin" and "Structure" are swapped.

After filling in the matrix, a colour code is used in order to indicate the hierarchy of the values (red = high, yellow = positive and green = indifferent value). The next page gives an indication of the value matrix.

The following pages explain the value matrix focussed on the whole urban fabric and the value matrixes specifically focussed on the five typologies. For the value matrixes, all of Riegl's implemented categories are divided. Each page shows on one hand Riegl's category and on the other the applicable building layers of Brand. The values and their hierarchies are explained with help of own illustrations and pictures.

To help orientation, each value matrix is linked to the diagram of the ensemble or certain building as below:

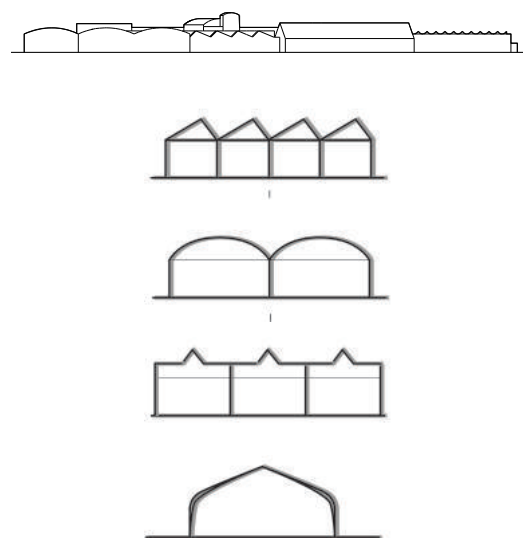

Figure 224 Typology diagrams (Own images)

Age Value

Something that is old and still there, which either shows decay or has traces of use or patina. In other words, age value is the visual evidence of a building's lifecycle.

Historical Value

Something that shows the craftsmanship (of an era) and tells the story of the development of the city, the structure and so on. Moreover, it represents something of architectural, urban or construction history.

Commemorative Value

Something that is intended to keep the past alive for present and future generations. This value as seen in the matrix is not filled in.

Use Value

Something that is still in function and maintained and fulfills the current demands for its function.

Newness Value

The newness of an artifact is, according to Riegl, not valued on the basis of its style, which could be imitated, but rather on its flawless wholeness. Age-value, on the contrary, would be seen in the lack of this wholeness.

Art Value

Art value ceases being a commemorative value and, strictly speaking, should not be included in the notion of a monument.

Other Relevant Values

This category includes values which are not relatable to Riegl's theory. This column is more focussed on activities and happenings within the ensemble and their social impact. (Jokilehto, 1986)

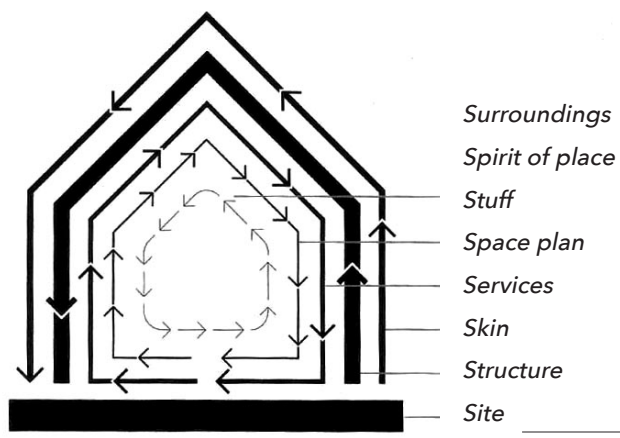
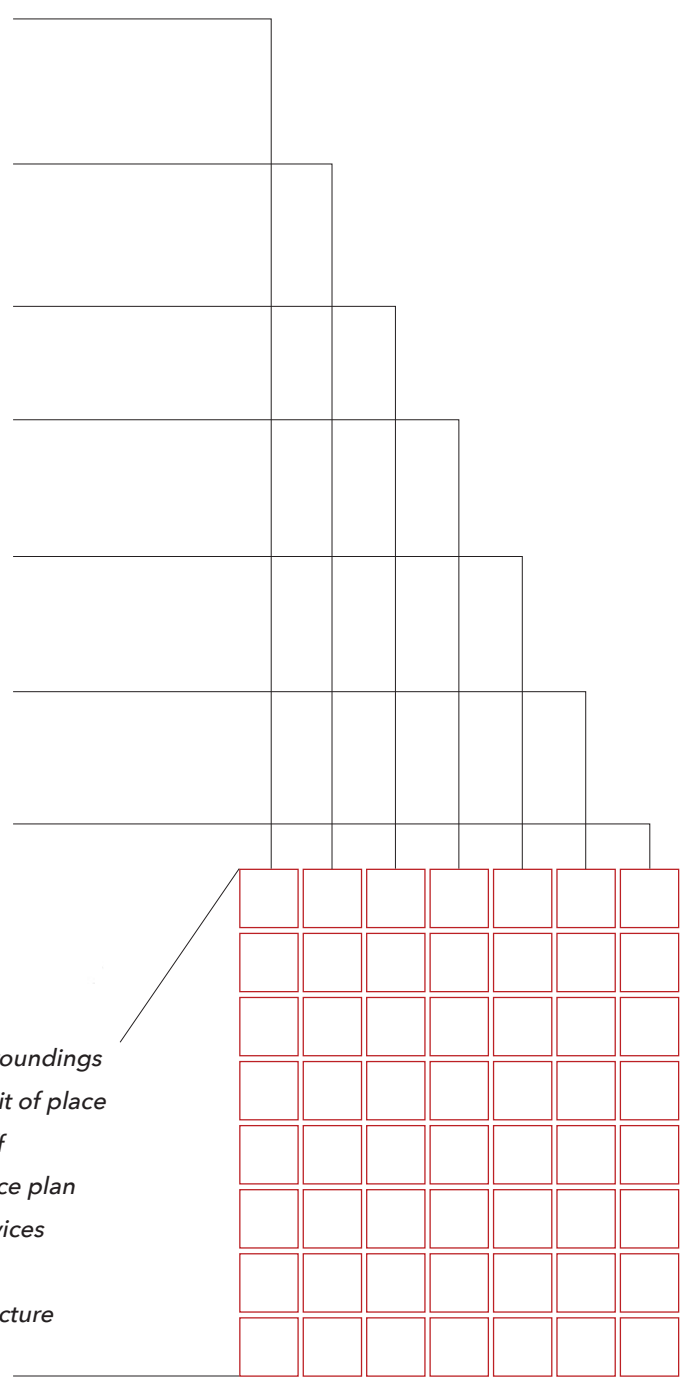
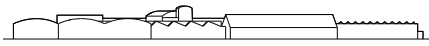

Figure 225 Layers for value. (Riegl, 1903)

VALUE MATRIX: THE ENSEMBLE



	Age	Historical	Commemorative	Use	Newness	Art	Other Relevant
Surroundings		Red		Red			Red
Site	Green	Orange		Orange			
Skin	Red	Orange					
Structure		Red					
Space plan		Orange		Green			
Services		Red					
Stuff							Red
Spirit of the place	Red	Red					Orange

There are no artistic and commemorative values within the building composition. As explained, in our beliefs the functionality was leading within the design.

One of the main characteristics of the building ensemble is the big variety in typologies which is basically the opposite of the 'flawless' of the wholeness. Therefore this column remains blank.

The intention of the whole ensemble is rather functional, on the contrary of for instance monuments and statues. Therefore the 'intentional commemorative' is not applicable for this ensemble. Moreover, there was not any historic happening including important figures or events, which made the building ensemble admirable nowadays. Therefore there are no non-intentional valuable elements as well.

Figure 226 Value matrix (Own image, 2019)

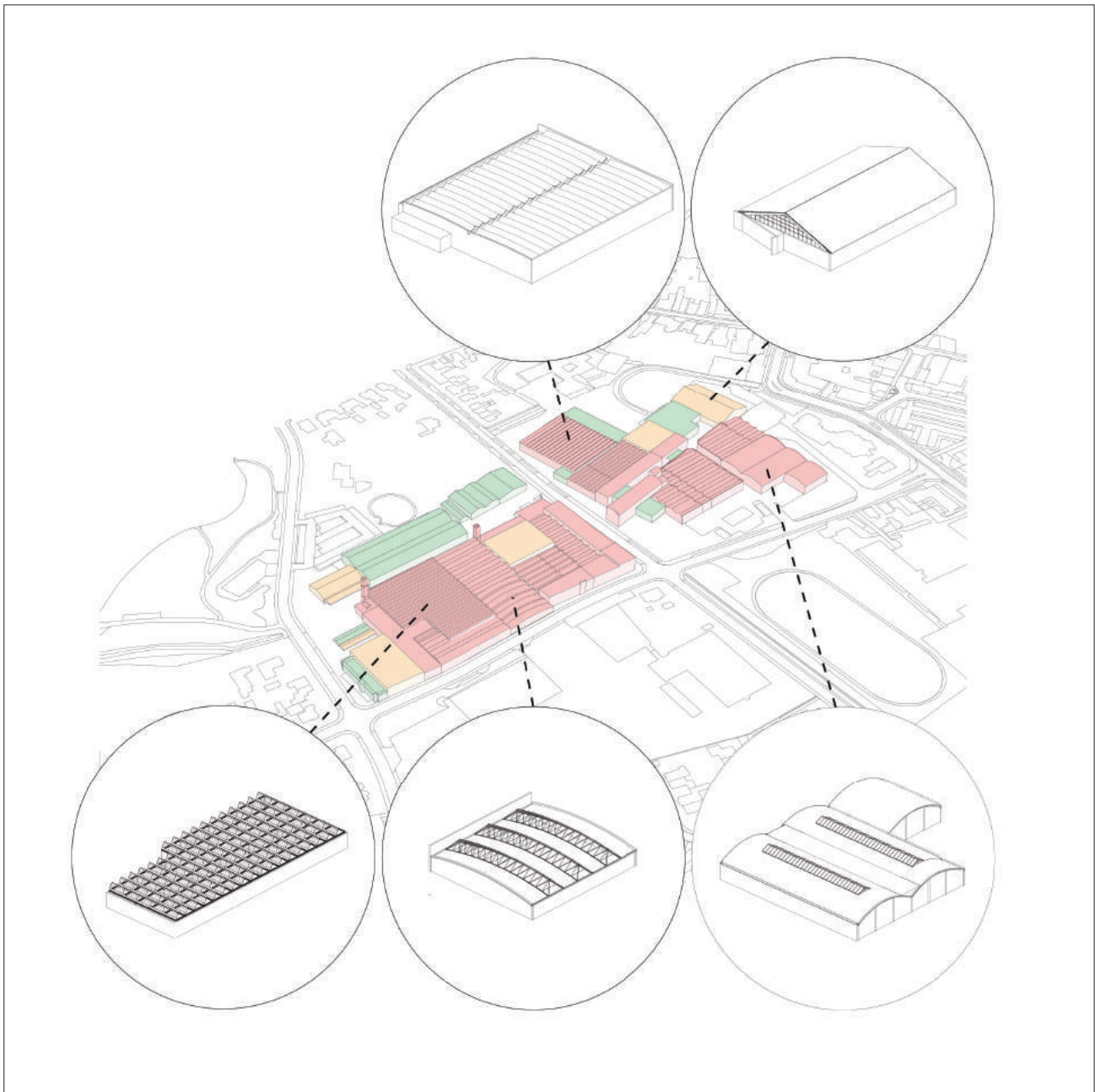
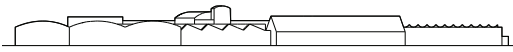

Figure 227 Valuing of the ensemble (Own image, 2019)



AGE VALUE



Gates

Close to the site of Gaudium the former entrance gates are still present as a memorial of past days.

● high ○ positive ○ indifferent

SITE

SKIN



Facades

A picture is shown of the Laan van Hilbelink. It shows a composition of different skins combined together. Although, it consists of the same materiality, the facades combined showing differences because of the age.

● high ○ positive ○ indifferent

SPIRIT OF THE PLACE



Transition

The aging of different elements within the ensemble are crucial in experiencing the transition between the industrial and the city centre. Because of this one can clearly notice when entering and leaving the industrial area.

● high ○ positive ○ indifferent

HISTORICAL VALUE

SURROUNDINGS



Whemerbeek

Throughout history the Whemerbeek played a crucial role for the textile factories. Afterwards the creek lost its importance and the expanding building ensemble covered almost the whole creek. The remainings still reminds of the original track.

● high ○ positive ○ indifferent

SITE

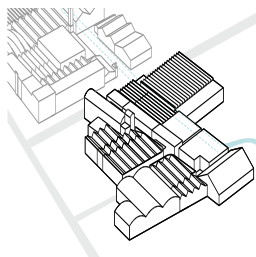

Building ensemble

The ensemble as a whole tells us the story of how each textile factory expanded and how every plot is completely changed in comparison with the beginning. The illustration shows the ensemble of the Morsepoort.

○ high ● positive ○ indifferent



Infrastructure

The infrastructure followed the building lines of extensions over time. The original infrastructural ideas and connections are not completely present nowadays, although there are still some traces present which reminds of the textile urban fabric.

○ high ● positive ○ indifferent

Figure 228 Images by Joost Joesse, 2019

SKIN



Composition and roofscapes

The organically expanded buildings of which each answered the need of extra space and the change in production lines, have their own roofscapes. Thus these roofscapes and building heights are seen as valuable.

high positive indifferent

Façade

The organically development of the ensemble created multiple typologies which is to be seen in the façade.

high positive indifferent

STRUCTURE



Technical developments

The construction techniques developed throughout history as well, which resulted in new possibilities for factories. This is clearly visible in the ensemble and therefore valued.

high positive indifferent

SPACE PLAN



Production process

The open and flexible floorplans gives an indication of the activities within the buildings. The picture an possible situation of what the spatial layout of these floorplans could be.

high positive indifferent

SERVICES



Chimneys

These features are some of the few remainings of the period when the productions were driven by steam engines. They give an impression of this historical fact. Moreover, the chimneys also function as points of reference within the area.

high positive indifferent



Columns

Other historical features which refer to the textile productions around 1910-1930, are the columns with attachment holes which were needed for the steam driven machines. Within the Gaudium these features are still visible.

high positive indifferent

Figure 229 Images by Joost Joosse, 2019

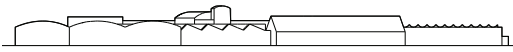

SPIRIT OF THE PLACE



Spatial experience

When walking through the building compositions, one can really notice the sequence of changing public space from an open towards more compressed walking routes. This is a result of how the building composition evolved over time.

● high ● positive ● indifferent



Transition

Besides the age, the historical background of the building ensembles plays also a crucial role in the transition which is created. By recognising industrial typologies, one can notice when leaving or entering this district of Winterswijk.

● high ● positive ● indifferent



Interconnected spaces

The interconnected spaces are a result of all of the extensions which are connected with one another. The experience of this connection feels sometimes disorientating and also tells the history how everything is connected over time.

○ high ● positive ● indifferent



Daylight

Each building within the ensemble has its own composition when it comes to daylight openings. This has to do with the typology, characteristics and timeframe. When artificial light was introduced, natural daylight was less needed.

○ high ● positive ● indifferent

USE VALUE

SURROUNDINGS



Recreation

Surrounding the industrial area there is a lot of recreational green. For instance the skatingpark across the Gaudium complex. This park also included a walking route through the surrounding nature.

● high ● positive ● indifferent

SITE



Mixed users and functions

The only remaining textile productions are taking place in the Gaudium. The rest of the buildings are occupied or used with different purposes. Such as, sports, physiotherapy, restaurant, meal delivery, storage, artistic and music related.

○ high ● positive ● indifferent

Figure 230 Images by Joost Joesse, 2019

SPACE PLAN

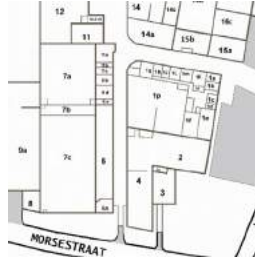

Sequence of spaces

Because of every extension, new entrances and passages were created within the space plans. In the end this resulted in a specific sequence through each building ensemble.

high positive indifferent



Flexible layout

The fact that the whole area is used by a mixed variety of occupiers is partly a result of the big spans of the structure and thus the flexible layout of each floorplan. In terms of the use of these industrial buildings it is a favourable condition.

high positive indifferent

OTHER VALUES

SURROUNDINGS



Urban fabric

The fact that the whole industrial area is so closely situated towards the city center is something admirable, since this is a rare phenomenon in comparison with other Dutch villages.

high positive indifferent

STUFF



Textile production

Nowadays, Gaudium still produces textile products. This is highly valued, because it is one of the last companies in the whole country which produces these products. Also valued is the fact that the site is still used for production of textiles.

high positive indifferent

SPIRIT OF PLACE



Craft

When visiting Gaudium one can sense the producing of textiles. These activities form the experience of the whole building ensemble of Gaudium. It is a completely different experience in comparison with the Morsepoort.

high positive indifferent

VALUES BUILDING A

The following pages explain the Value Matrix focussed on the old core of Gaudium. The values and their hierarchies are explained accompanied by own illustrations and pictures.



	Age	Historical	Commemorative	Use	Newness	Art	Other Relevant
Surroundings							
Site							
Skin							
Structure							
Space plan							
Services							
Stuff							
Spirit of the place							

Figure 232 Value matrix of building A. (Own image, 2019)

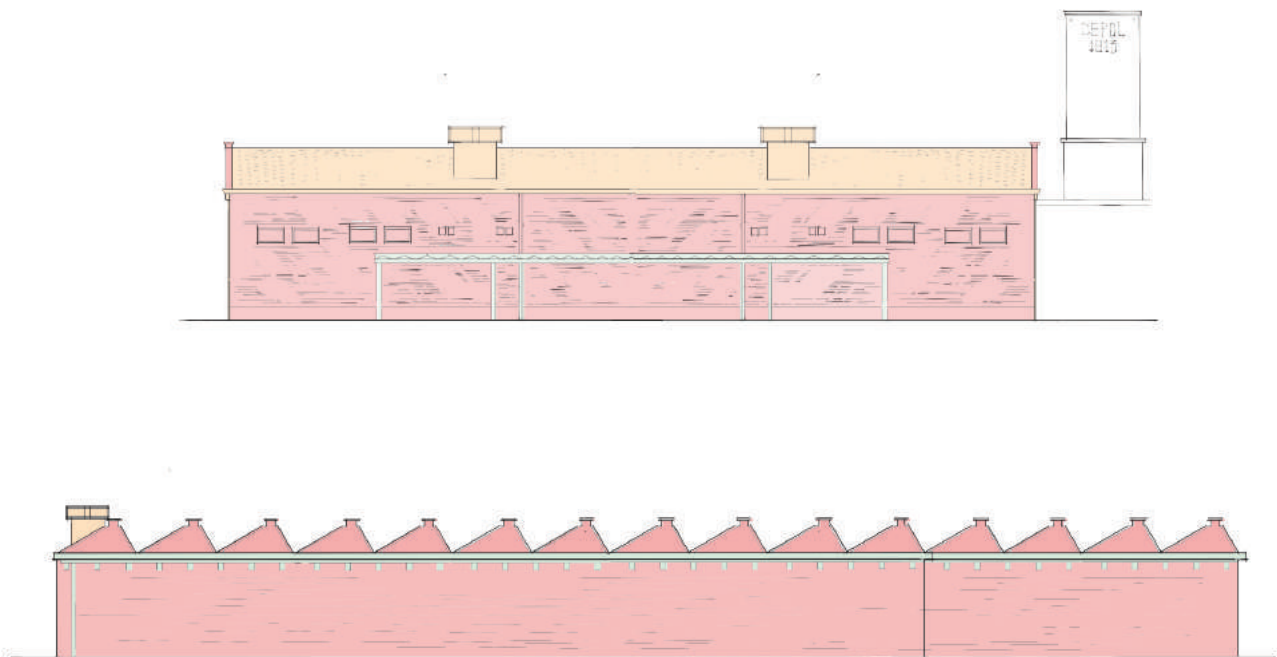

Figure 233 Values of building A. (Own image, 2019)



AGE VALUE

SKIN



Façades

The brick façades have a high value. It is a feature which describes this factory because of its age and visible lifecycle on the surfaces. Moreover, the complete original wall is not present anymore which also shows the stains of time.

● high ○ positive ● indifferent

HISTORICAL VALUE

SITE



Old core

Because this building is the old core of the Pol factory, it is highly valued.

● high ○ positive ○ indifferent

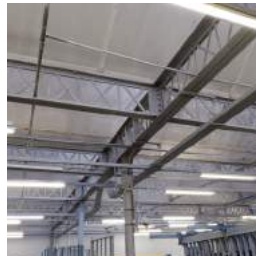

Saw-tooth roof

The sawtooth construction is highly valued, since it is a typology of its time.

● high ○ positive ○ indifferent



Floorplan

Layout derived from historic functional needs.

○ high ● positive ○ indifferent

SPACE PLAN

Figure 234 Images by Joost Joosse, 2019

USE
VALUE

STRUCTURE



Height

The saw-tooth roof structure was a construction commonly used for weaving factories which didn't need a large height for the weaving process. The structure was formed according to the needs of the production and therefore highly valued.

high positive indifferent



Daylight

The original structure provided all the light needed to light up the inner space. Unfortunately, because of the building conditions these roof lights are partly covered. The remainings of these roof lights are valued.

high positive indifferent

SPACE PLAN

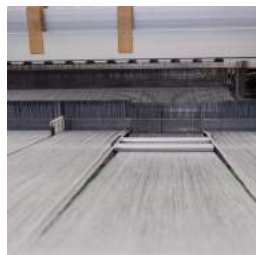

Floorplan

The spatial layout is still flexible in use and suitable for the functions of the Gaudium.

high positive indifferent

SPIRIT OF PLACE



Weaving

One can sense the textile activities within this building part. The weaving and its accompanying sounds define this space, giving an impression of the activities going on. This is highly valued because the weaving has been there since 1913.

high positive indifferent

VALUES OF BUILDING B

The following pages explain the Value Matrix focussed on the building with the curved CLT beams. The values and their hierarchies are explained accompanied by own illustrations and pictures.

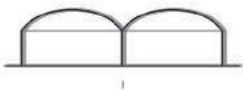

	Age	Historical	Commemorative	Use	Newness	Art	Other Relevant
Surroundings							
Site							
Skin							
Structure							
Space plan							
Services							
Stuff							
Spirit of the place							

Figure 236 Value matrix of building B. (Own image, 2019)

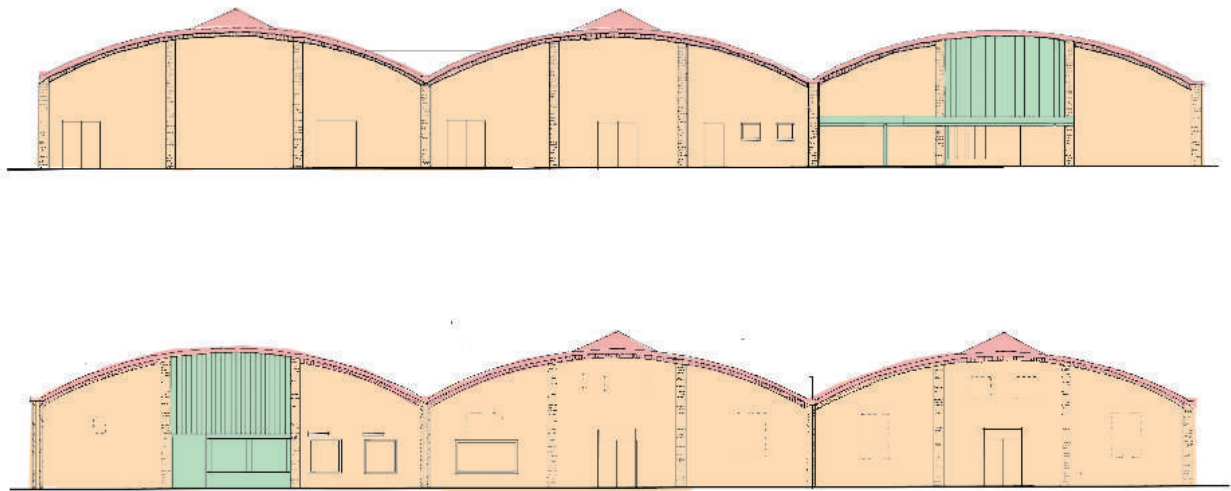
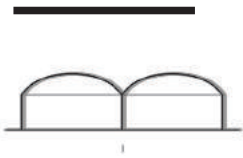

Figure 237 Values of building B. (Own image, 2019)



AGE
VALUE

SKIN



Façades

The bricks on the façade look weathered and dated, and marks of different changes are visible. Because this is typical for the site and its buildings, it is valued.

high positive indifferent

STRUCTURE



Structure

The 'Nemaho' beams were one of the first CLT beams in The Netherlands and came from a firm close to Winterswijk, thus they are valued positive.

high positive indifferent

HISTORICAL
VALUE

SKIN



Doors

Items like these doors in the façade show how the building used to function.

high positive indifferent

Figure 238 Images by Juliëtte Zegers, 2019

USE
VALUE

STRUCTURE



Height

Because of the height created by the structure, large objects can take place within the building.

high positive indifferent

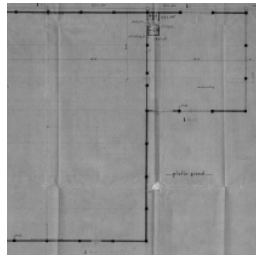

Flexibility

Due to the big spans and just one single column in the middle of the plan, the building can be used for different purposes and infills. Especially the two big halls are suitable.

high positive indifferent

OTHER
VALUES

STRUCTURE



Repetition

The structure and its repetition is visible in the façade. Also the curves of the three halls together form a great ensemble and are therefore valued.

high positive indifferent

VALUES OF BUILDING C

The following pages explain the Value Matrix focussed on the building of J.C. Pannekoek. The values and their hierarchies are explained accompanied by own illustrations and pictures.

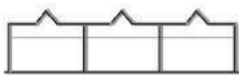

	Age	Historical	Commemorative	Use	Newness	Art	Other Relevant
Surroundings							
Site							
Skin							
Structure							
Space plan							
Services							
Stuff							
Spirit of the place							

Figure 240 Value matrix of building C. (Own image, 2019)

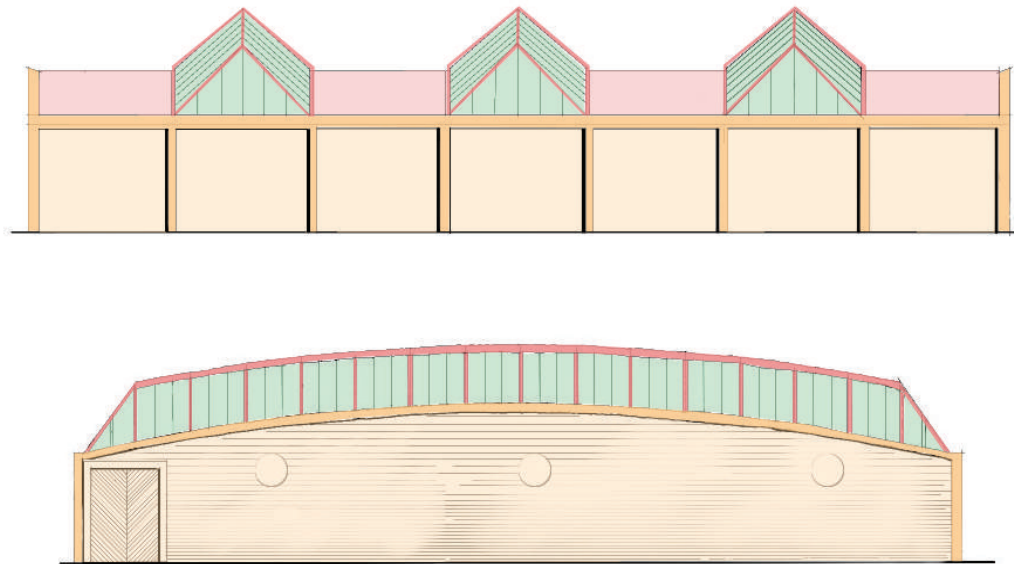

Figure 241 Values of building C. (Own image, 2019)



AGE VALUE

SKIN



Façades

The brick façades are seen as a positive value. It is a feature which describes this factory, especially because of its age and visible lifecycle on the surface.

high positive indifferent

HISTORICAL VALUE

SITE



Facades

The brick façades are seen as an indifferent value. It is a feature which describes this factory, especially because of its age and visible lifecycle on the surface. Although, it is not the most iconic or important characteristic.

high positive indifferent

STRUCTURE



Steel trusses

This structure consists of several elements, amongst which three steel trusses. They support the roof structure and provide the income of natural daylight. From an historic perspective, this is a remarkable and rare structure.

high positive indifferent



Concrete arch girder

Another high valued structural element are the concrete arch girder at the front- and back facade. These beams have the same span as the steel trusses which carry the roof. Because of this span and it is a high valued element.

high positive indifferent

SPACE PLAN



Floorplan

Layout derived from historic functional needs.

high positive indifferent

Figure 242 Images by Joost Joosse, 2019

USE
VALUE

STRUCTURE



Height

Because of the height created by the structure, large objects can take place within the building.

high positive indifferent

SPACE PLAN



Daylight

The original structure provided all the light needed to light up the inner space. Unfortunately, because of the building conditions these roof lights are partly covered. The remainings of these roof lights are valued.

high positive indifferent



Floorplan

The spatial layout is still flexible in use and suitable for the functions of the Gaudium.

high positive indifferent

SPIRIT OF PLACE



Storage

One can sense the functionality of this building, since the space can fully be used for Gaudium's purposes. On one hand the floor is used for storage and on the other hand for finishing of textile products. Original structure is not visible.

high positive indifferent

VALUES OF BUILDING D

The following pages explain the Value Matrix focussed on the building with the concrete HP shells. The values and their hierarchies are explained accompanied by own illustrations and pictures.

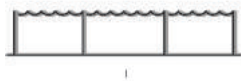

	Age	Historical	Commemorative	Use	Newness	Art	Other Relevant
Surroundings							
Site							
Skin							
Structure							
Space plan							
Services							
Stuff							
Spirit of the place							

Figure 244 Value matrix of building D. (Own image, 2019)

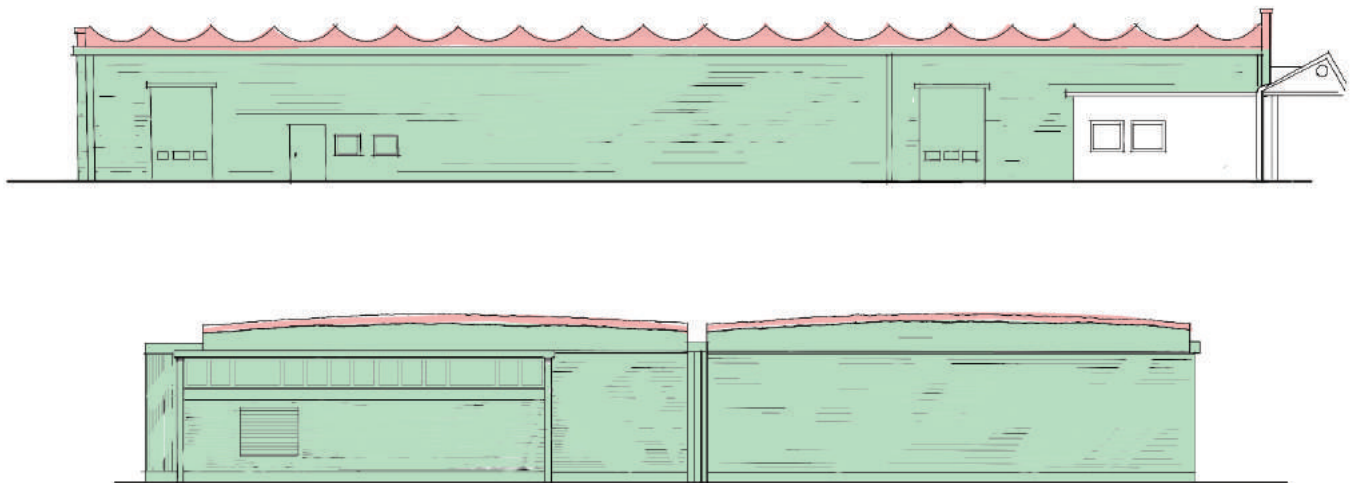
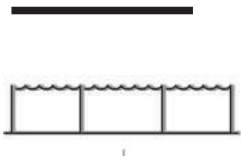

Figure 245 Values of building D (Own image, 2019)



AGE VALUE

SKIN



Facades

From the façade, the conclusion can be drawn that this structure has been here for years and the stains of time are visible. Although there is no speciality or rareness and it is valued indifferent.

high positive indifferent

SPIRIT OF PLACE



Floor

The concrete floor shows signs of usage and oldness and old factory marks are still visible. This seemingly small fact very much brings the industrial flavour to the building.

high positive indifferent

HISTORICAL VALUE

SURROUNDINGS



Whemerbeek

The direct surroundings of the plot contains the underground pipe of the Whemerbeek, which as explained is of crucial worth because of its historical significance.

high positive indifferent

SITE

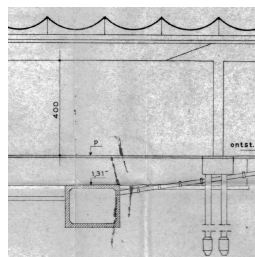

Whemerbeek

This particular building is built on top of the Whemerbeek, thus it brings a special feature to the building.

high positive indifferent

Figure 246 Images by Juliëtte Zegers, 2019





STRUCTURE		<p>Hyperbolic Paraboloid shell roof This structure tells the story of the time in which it was built and shows why it was built that way. It also shows how fast things change over time due to economy and building techniques and how a structure then can become rare.</p> <p><input checked="" type="radio"/> high <input type="radio"/> positive <input type="radio"/> indifferent</p>
USE VALUE STRUCTURE		<p>Height Because of the height created by the structure, large objects can take place within the building.</p> <p><input checked="" type="radio"/> high <input type="radio"/> positive <input type="radio"/> indifferent</p>
SPACE PLAN		<p>Flexibility Due to the big spans and just two columns in the middle of the plan, the building can be used for different purposes and infills.</p> <p><input type="radio"/> high <input checked="" type="radio"/> positive <input type="radio"/> indifferent</p>
OTHER VALUES STRUCTURE		<p>Roof and ceiling The ceiling still is in a good state and stills shows the exact shape it always has had. The whole of the slabs together can be highly valued.</p> <p><input type="radio"/> high <input checked="" type="radio"/> positive <input type="radio"/> indifferent</p>

Figure 247 Images by Juliëtte Zegers, 2019

VALUES OF BUILDING E

The following pages explain the Value Matrix focussed on the building with the pitched roof and CLT beams. The values and their hierarchies are explained accompanied by own illustrations and pictures.

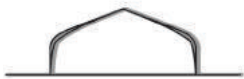

	Age	Historical	Commemorative	Use	Newness	Art	Other Relevant
Surroundings		Orange		Orange			
Site							
Skin	Green						
Structure		Orange		Red			Orange
Space plan				Orange			
Services							
Stuff							
Spirit of the place							

Figure 248 Value matrix of building E. (Own image, 2019)

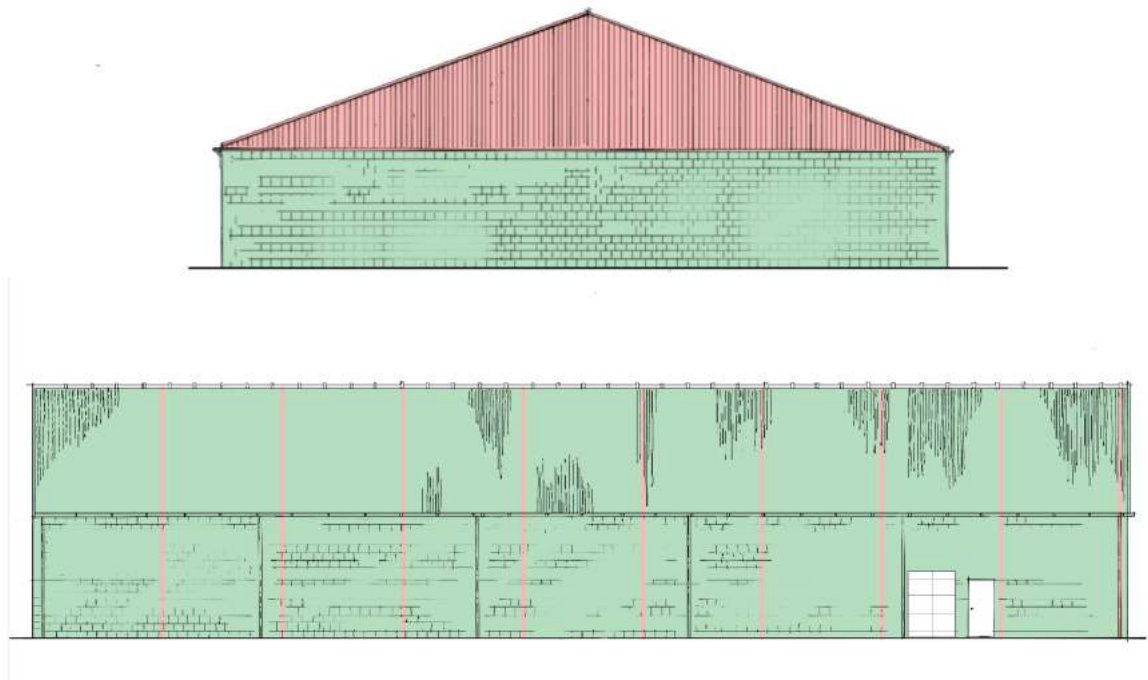

Figure 249 Values of building E. (Own image, 2019)



AGE VALUE

SKIN



History

From the look of the skin its age can easily be derived. At some points the walls have damages and aging marks. Important to note that these walls are presumably not the original ones.

high positive indifferent

HISTORICAL VALUE

SURROUNDINGS



Whemerbeek

This building happened to be built right next to the Whemerbeek, which has historical significance.

high positive indifferent

STRUCTURE



Beams

Due to the rarity of the beams in the time they were built and the fact that they are the legacy of 'Nemaho', the structure can be valued in a historical sense.

high positive indifferent

USE VALUE

SURROUNDINGS



Greenery

The building is situated next to a body of green with trees and the Whemerbeek. The green functions as a fence between the noisy road and the building.

high positive indifferent

Figure 250 Images by Chen Zhu, 2019

SPACE PLAN

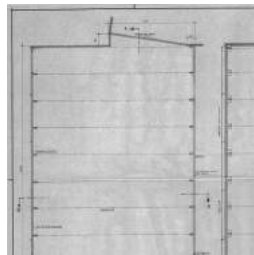

Flexibility

The big spans and trekstang underground made clear space, the building can be used for different purposes and infills. And the walls are not used for load-bearing which could be get out easily.

high positive indifferent

STRUCTURE



Beams

The exposed beams from the inside are repetitive and show a clear rhythm.

high positive indifferent

OTHER VALUES

STRUCTURE

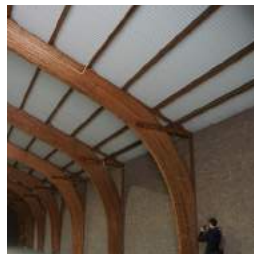

Purity

A tension bar underneath the floor is used to ensure the strength of the beams. To put the bars under the ground is a well thought choice and makes way for free space in the structure itself.

high positive indifferent



XII CONCLUSIONS

The goal of this research was to look into the industrial site and its buildings based on the following research question:

- What is the relation between developments in the textile industry and the ensemble of the industrial buildings in Winterswijk?

This chapter will elaborate on the findings in the whole booklet and combines them into an overall concluding scheme. This scheme together with the valued aspects of the chapter before are combined into three main pillars for design: Obligations, Opportunities and Dilemmas.

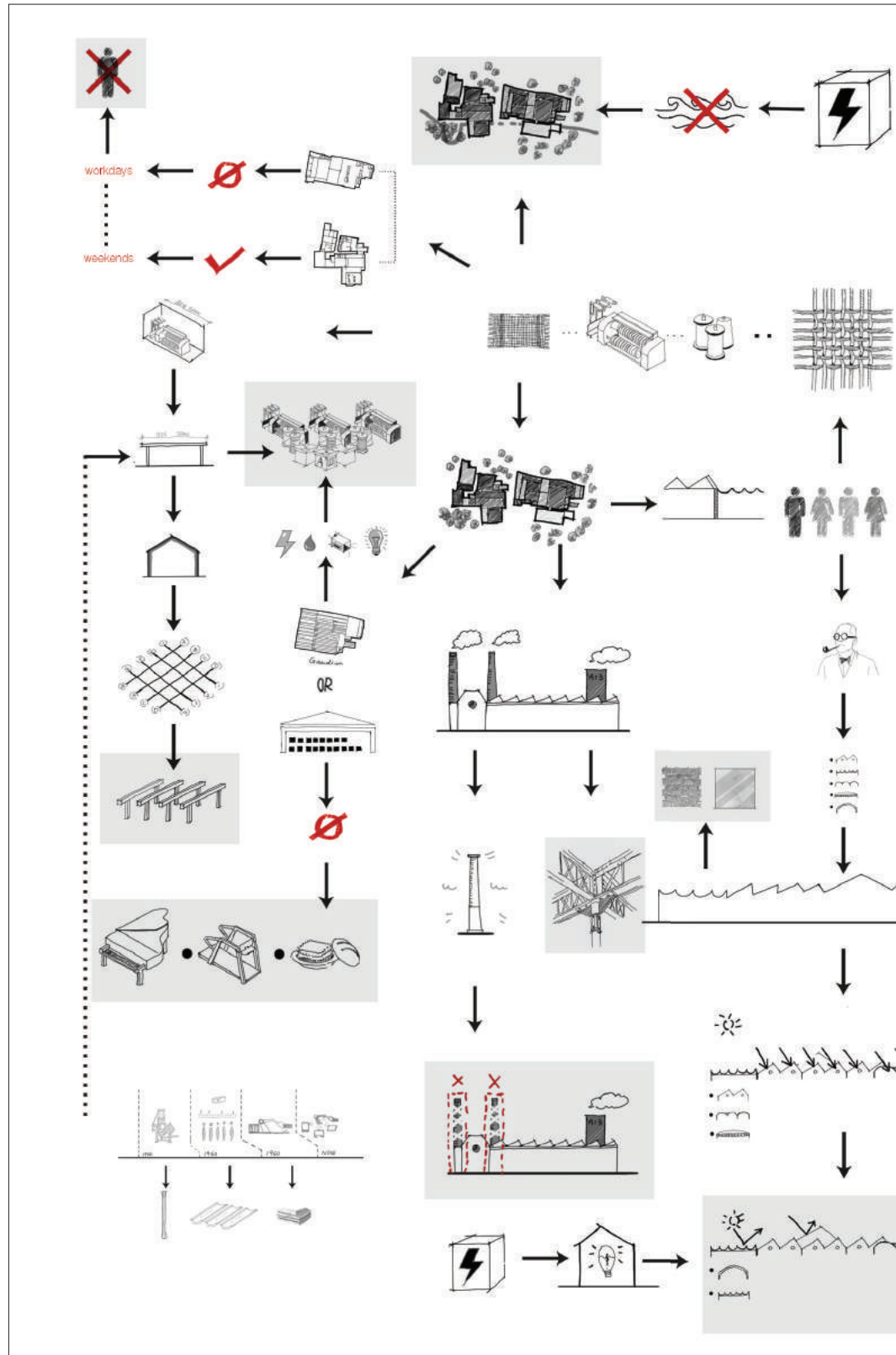
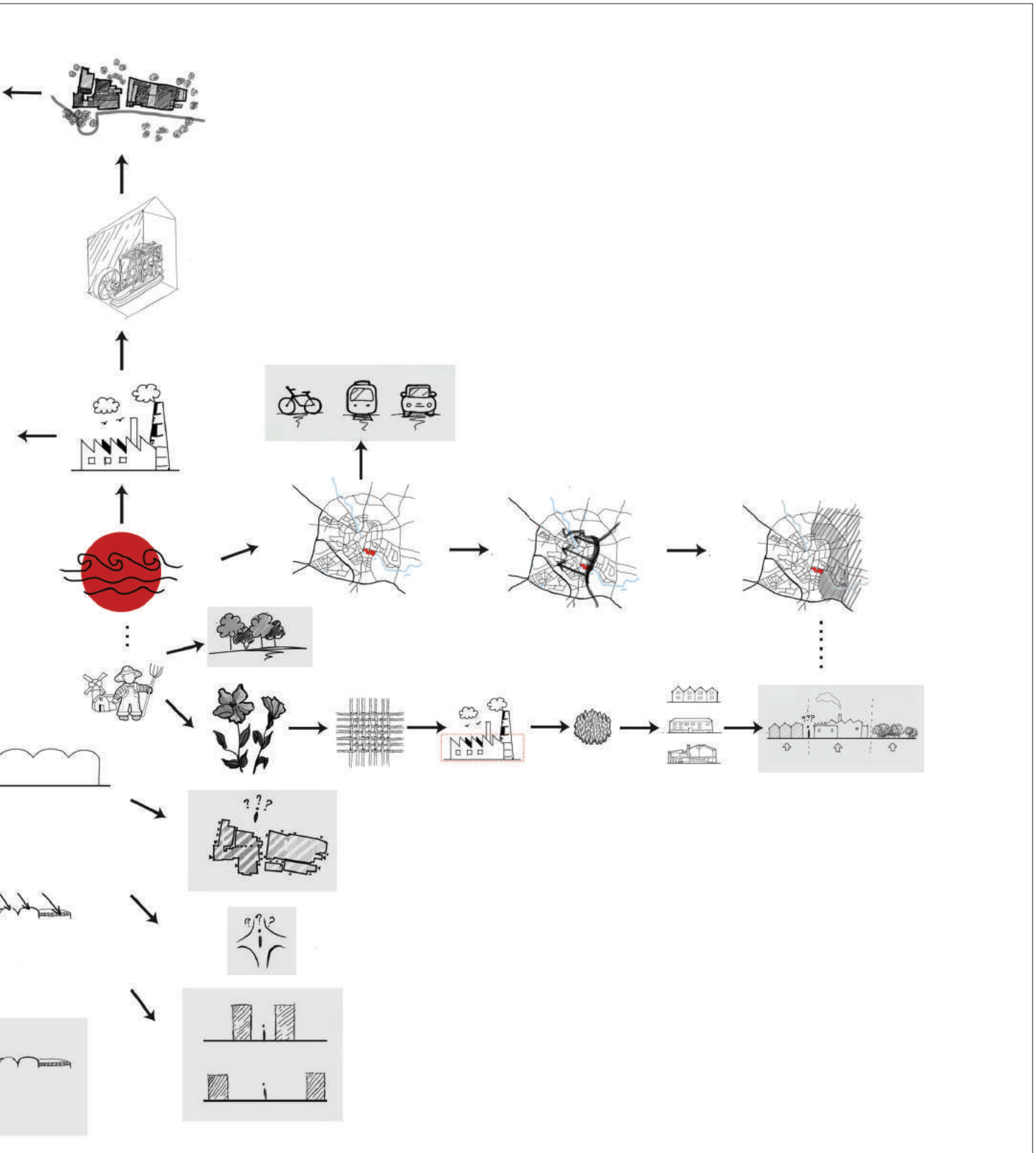

Figure 253 General conclusions. (Own image, 2019)



OBLIGATIONS – INDUSTRIAL AREA

Infrastructure

- The existing infrastructure traces back to historic events connected to the textile industry. Therefore the urban historical layout should be highly respected.

Composition

- The composition of the whole ensemble and the roofscape, which consists of different heights and shapes is characteristic for the place.

Green and water

- Existing green and water structures should be kept. Especially the creek which played an important roll in the history of Winterswijk and the site.

Hinterland

- The connection towards the hinterland of Winterswijk should be kept and possibly enhanced.

Gaudium

- Gaudium as a current operating company, with its own production process and need of space and buildings is an important aspect to keep in mind.

Typologies

- The variety in typologies shows the development of the area throughout time.

Spirit of place

- The characteristics of the textile industry in the past (and present) are important to keep in mind while designing. Especially the items pointed out in the research which show the traces of history are items to be kept.

Accessability

- In order for the area to function in the future, the existing accessability of the site is important.

Open floorplan

- To make best use out of the originally designed big spans of each building, it is highly recommended to restore the old layout without newly added partition walls.

Structure

- With structure leading for the architectural appearance, these should be touched as less as possible in order for it to keep its expression.

OBLIGATIONS – INDIVIDUAL BUILDINGS

A:

- Also in the future and during the building process, this building should be able to function as a production company
- The repetitive elements of the saw-tooth roof should be kept as much as possible
- The chimneys are important elements of the set of buildings A belongs to

B:

- The architectural appearance of the CLT-beams should be respected

C:

- The roof structure is rare and should therefore be kept

D:

- The architectural appearance of the HP-shells should be respected
- The structural layout and the flexibility it brings characterises the building

E:

- The architectural appearance of the CLT-beams should be respected

OPPORTUNITIES – INDUSTRIAL AREA

Transitory space

- Because the site functions as a transitory space between the village and the hinterland, the design could incorporate both to create a pleasant space

Connections

- The close position of the site towards the centre of the village makes way for a connection between the area and the vivid centre of Winterswijk.

Whemerbeek

- The creek is currently covered, whilst it used to hold great significance for the village. An opportunity would be to expose the creek for it to contribute to a more natural environment.

Infrastructure and viewlines

- The original passages and infrastructure could be restored, creating viewlines based on the old urban layout.

Sequences

- The current sequence of public space is everchanging and provides for surprises along the way. A future design could make use of this and enhance it even more.

Mixed-use

- One of the characteristics of the area is the fact that it has a lot of users, although it is still quite a dead area. The possibility is to redevelop the mixed character and to invite more users to use the area, equally spread throughout the week to create a living environment.

Spatial conditions

- On the edge of the area, a lot of open and undefined space is noticed. These spaces give way for interventions which extend the current building plots.

Traces from the past

- Since the area is so important for Winterswijk and its people, it is an opportunity to enhance this even more and to emphasize the traces of the past.

OPPORTUNITIES – INDIVIDUAL BUILDINGS

A:

- The creek which runs next to the building could be a feature to use
- The working environment and a public function could be combined
- Gaudium could be the pride of Winterswijk, heritage of the textile industry
- A connection with the hinterland could be established through the buildings

B:

- Through the position of the building, the plot could function as a public and active connection towards the city centre
- Because of the big spans of the building, a flexible infill is possible

C:

- Restoring the original structure could be an opportunity to create a very rare and appealing interior industrial space

D:

- The creek which runs through the building could be a feature to use
- Through the position of the building, the plot could function as a gate towards the site
- Because of the big spans of the building, a flexible infill is possible
- The green adjacent to the plot could be incorporated in the project

E:

- The creek which runs next to the building could be a feature to use
- The green adjacent to the plot could be incorporated in the project
- Because of the big spans of the building, a flexible infill is possible

DILEMMAS – INDUSTRIAL AREA

- Restoring the passages and infrastructure to the original situation could touch the ensemble as a whole and therefore should be carefully considered
- Restoring the creek to the original situation could touch the ensemble as a whole and therefore should be carefully considered
- An open floorplan is highly valued, since it was the original intention of the buildings. Making it a mixed-use environment could clash with this idea since it has to be functional for all users.
- The undefined space surrounding the site gives room for possible new additions, but the green surrounding the area should be taken into account since it also holds value.

DILEMMAS – INDIVIDUAL BUILDINGS

- A major clash between values of the whole ensemble and values of individual buildings could occur when one touches a valued element of the building which has influence on the ensemble as a whole.

A:

- Exposing the creek could have an effect on the façades and loadbearing structures of Gaudium

B:

- The values of this building do not directly cause clashes, but some design dilemmas will occur later in the process.

C:

- The values of this building do not directly cause clashes, but some design dilemmas will occur later in the process.

D:

- The floor of the building is valued positive, whereas the creek is valued high. Exposing the creek would cause a dilemma between the two features.

E:

- The values of this building do not directly cause clashes, but some design dilemmas will occur later in the process.

VERGROOTING FABRIEKSGEBOUW

VOOR DE FIRMA J.H. MEIJERINK EN ZONEN.

TE WINTERSWIJK.

VOORGEVEL EN DOORSNEDE A-B.

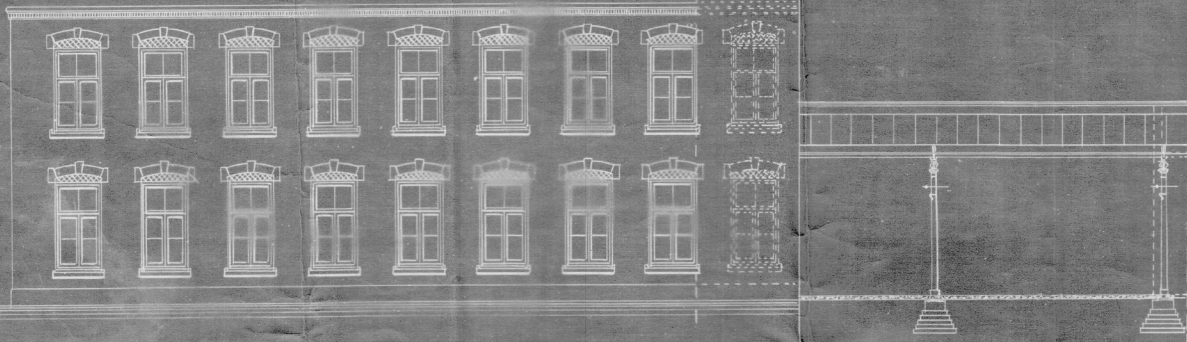

PLATTEGROND.

VERKLARING

- = NIEUW METSELWERK.
- ▨ = BESTAAND METSELWERK.
- ▤ = MITTE BREKEN METSELWERK.

PLATTEGROND VERBOUWING KANTOOR.

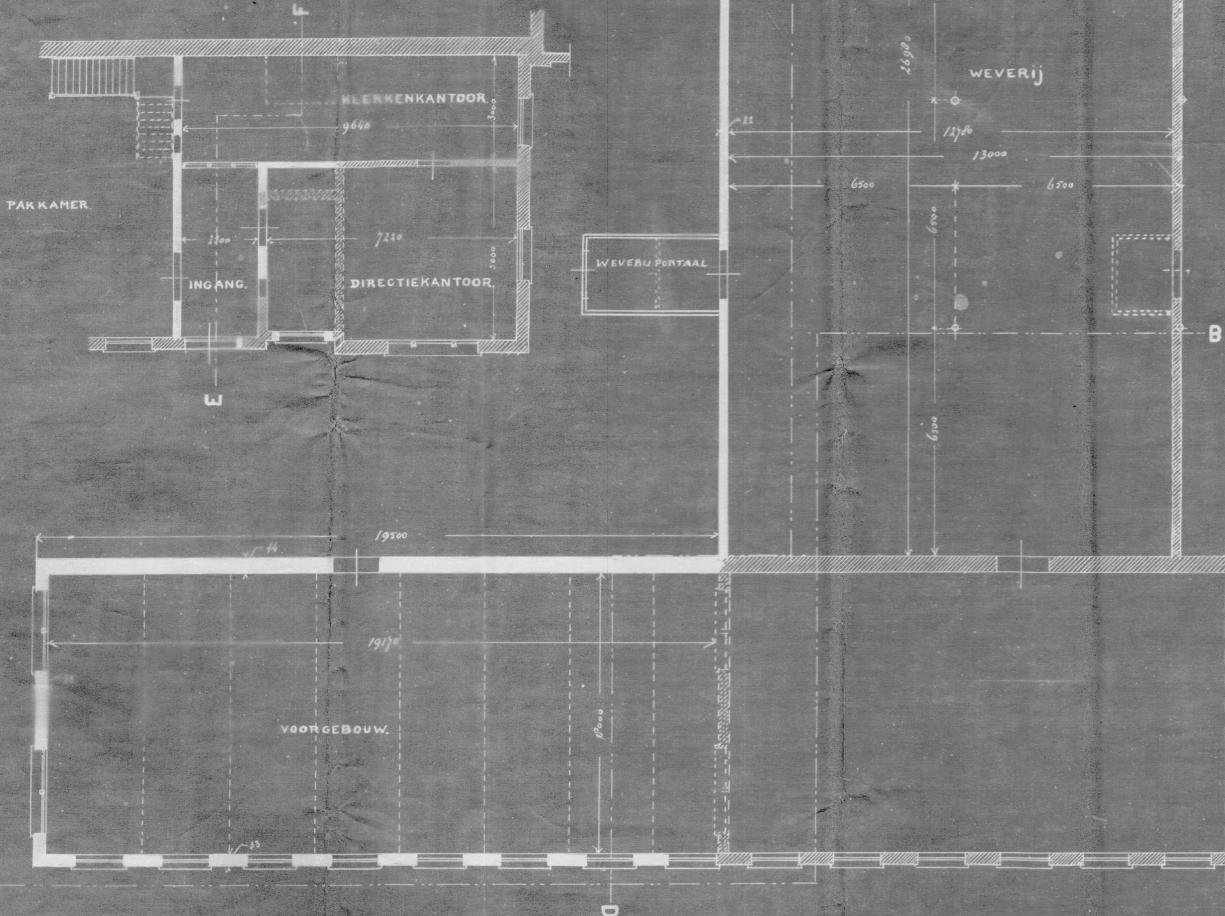

PLAN N^o 1025.

TEEKENING N^o 1.

SCHAAL 1:A.100.

XIII BIBLIOGRAPHY

- Achterhoek (2015). *Kerncijfers toerisme achterhoek*. Retrieved from https://www.gelderland.nl/bestanden/Documenten/Gelderland/06Werk-en-ondernemen/160829_Kerncijfers_Toerisme_Achterhoek_2015.pdf
- Ackermann, K. (1984). *Industriebau*. Stuttgart: Deutsche Verlags-Anstalt GmbH
- Alle Cijfers (2019). Informatie gemeente Winterswijk. Retrieved from <https://allecijfers.nl/gemeente/winterswijk/>
- Alle Cijfers (2019). Overzicht Nederland. Retrieved from <https://allecijfers.nl/nederland/>
- ANWB. (2019). ANWB-hoofdkantoor. Retrieved from: <https://www.anwb.nl/contact-en-service/contact/route-anwb-hoofdkantoor>
- ArcGIS. (2019). 3D Gebouwhoogte NL. Retrieved from <https://www.arcgis.com/home/webscene/viewer.html?webscene=5ff81227743a463981240bd22f9399cc>
- Archieven.nl (n.d.). 0602 Koninklijke Tricotfabriek G.J. Willink NV te Winterswijk, 1877-1996. Retrieved from <https://www.archieven.nl/nl/zoeken?miview=inv2&mivast=0&mizig=210&miadt=26&micode=0602&milang=nl>
- Architectenbureau Van Linge (1960). Nieuwbouw weverij. -1.733.21, 8810-11a. Erfgoedcentrum Achterhoek Liemers, Doetinchem
- Architectenbureau Van Linge (1960). Nieuwbouw weverij. -1.733.21, 8810-12. Erfgoedcentrum Achterhoek Liemers, Doetinchem
- Architectenbureau Van Linge (1960). Nieuwbouw weverij. -1.733.21, 8810-12a. Erfgoedcentrum Achterhoek Liemers, Doetinchem
- Architectenbureau Van Linge (1960). Nieuwbouw weverij. -1.733.21, 8810-13. Erfgoedcentrum Achterhoek Liemers, Doetinchem
- Architectenbureau Van Linge (1960). Nieuwbouw weverij. -1.733.21, 8810-14. Erfgoedcentrum Achterhoek Liemers, Doetinchem
- Architektenbureau G. Grevink. (1987). Verbouw bedrijfspand. -1.733.21, 11728 (1). Erfgoedcentrum Achterhoek Liemers, Doetinchem.
- Aschman, K. (n.d.). Toekomst voor station Winterswijk. Retrieved from <https://www.spoorbeeld.nl/inspiratie/toekomst-voor-station-winterswijk>
- Beeldbank (1950). Dienst Gemeentewerken, bouw opslagloods
- Beltman, A. (1913). Vergroting fabrieksgebouw. -1.733.21, 8158 (1) - 1. Erfgoedcentrum Achterhoek Liemers, Doetinchem
- Beltman architecten (n.d.). Onze historie. Retrieved from <https://www.beltmanarchitecten.nl/onze-historie/>
- Blanken, I. & Lintsen, H.W. (1981). *Mechanische kracht in de industrialisatie van Nederland (1850-1950)*. Retrieved from <https://pure.tue.nl/ws/files/4386889/351528.pdf>
- Bouten D. & Koman, M. (2012). *Cultuurhistorie in Winterswijk*.
- Bouwkundig Ingenieurs Bureau Beltman. (1911). Vergroting voorgebouw. -1.733.21, 8158 (1)-5. Erfgoedcentrum Achterhoek Liemers, Doetinchem.
- Bouwkundig Ingenieurs Bureau Beltman. (1913). Vergroting fabrieksgebouwen. -1.733.21, 8158 (1)-5. Erfgoedcentrum Achterhoek Liemers, Doetinchem.
- Bouwkundig Ingenieurs Bureau Beltman. (1916). Vergroting fabrieksgebouwen. 1.733.21, 8158 (2)-5. Erfgoedcentrum Achterhoek Liemers, Doetinchem.

- Bouwkundig Ingenieurs Bureau Beltman. (1921). Vergroting fabrieksgebouwen. 1.733.21, 8158 (3)-5. Erfgoedcentrum Achterhoek Liemers, Doetinchem.
- Bouwkundig Ingenieurs Bureau Beltman. (1940). Vergroting fabrieksgebouw. -1.733.21, 8158 (3)-5. Erfgoedcentrum Achterhoek Liemers, Doetinchem.
- Bouwkundig Ingenieurs Bureau Beltman. (1937). Vergroting kantoorgebouw. -1.733.21, 8158 (3)-5. Erfgoedcentrum Achterhoek Liemers, Doetinchem.
- Bouwkundig Ingenieurs Bureau Beltman. (1938). Vergroting fabrieksgebouw. -1.733.21, 8158 (3)-5. Erfgoedcentrum Achterhoek Liemers, Doetinchem.
- Bouwkundig Ingenieurs Bureau Beltman. (1942). Vergroting fabrieksgebouwen. -1.733.21, 8158 (4)-5.. Erfgoedcentrum Achterhoek Liemers, Doetinchem.
- Bouwkundig Ingenieurs Bureau Beltman (1955). Voorbereidingen weverij. -1.733.21, 8158 (4). Erfgoedcentrum Achterhoek Liemers, Doetinchem
- Bouwkundig Ingenieurs Bureau Beltman. (1949). Vergroting fabrieksgebouw. -1.733.21, 8158 (4)-5. Erfgoedcentrum Achterhoek Liemers, Doetinchem.
- Bouwkundig Ingenieurs Bureau Beltman. (1947). Plan tot Verbouwing Fabrieksgebouw "De Pol". -1.733.21, 8158 (5)-5. Erfgoedcentrum Achterhoek Liemers, Doetinchem.
- Bouwkundig Ingenieurs Bureau Beltman. (1960). Plantekening uitbreiding "De Pol". -1.733.21, 8158 (5)-5. Erfgoedcentrum Achterhoek Liemers, Doetinchem.
- Bouwkundig Ingenieurs Bureau Beltman. (1955). Voorbereiding en Weverij. (1907-1970) SARA 1511 8158, 5-5. Erfgoedcentrum Achterhoek Liemers, Doetinchem.
- Bouwkundig Ingenieurs en Adviesbureau Sassen (1960). Garenloods. -1.733.21, 8158 (5). Erfgoedcentrum Achterhoek Liemers, Doetinchem
- Bouwkundig Ingenieurs en Adviesbureau Sassen (1962). Garenloods. -1.733.21, 8158 (5). Erfgoedcentrum Achterhoek Liemers, Doetinchem
- Bouwonderneming, B.W. (1969). plan tot het aanbouwen van een Luifel aan een opslagloods op de "Pol". -1.733.21, 6667. Erfgoedcentrum Achterhoek Liemers, Doetinchem.
- Bouwonderneming, B.W. (1980). Plan tot het bouwen van een hoogspanningsruimte + opslagruimte aan de Eelinkstraat. -1.733.21, 14834. Erfgoedcentrum Achterhoek Liemers, Doetinchem.
- Bouwonderneming, B. W. (1980). Plan tot het verbouwen van de garderobe, Gaudium. (1980) -1.733.21, 14834. Erfgoedcentrum Achterhoek Liemers, Doetinchem.
- Brand, S. (1994). *How buildings learn: What happens after they are built*. London: Penguin Books
- Broekema, P. (2016). Nieuwe verklaring voor brand die Paleis voor Volksvlijt in de as legde. Retrieved from NOS nieuws: <https://nos.nl/artikel/2121750-nieuwe-verklaring-voor-brand-die-paleis-voor-volksvlijt-in-de-as-legde.html>
- BV, R.B. (2001). Verbouwing bedrijfshal, Ten Cate. (2001). -1.733.21, 28656. Erfgoedcentrum Achterhoek Liemers, Doetinchem.
- Canon van Nederland (n.d.). Handweverijen. Retrieved from <https://www.entoen.nu/nl/overijssel/twente/oldenzaal/handweverijen>

- Canon van techniek in Twente (n.d.). Tijd, tempo en toezicht. Retrieved from <http://canonvantechniekintwente.nl/tijd-tempo-en-toezicht/>
- CBS (2018). Landelijke Monitor Leegstand. Retrieved from <https://www.cbs.nl/nl-nl/maatwerk/2018/45/landelijke-monitor-leegstand-2017-2018>
- Capis, A. F. (1974). Bouwplan machinehal voor exploitatie. -1.733.21, 8810. Erfgoedcentrum Achterhoek Liemers, Doetinchem.
- De Gelderlander (2017). Werkloosheid Winterswijk daalt. Retrieved from <https://www.gelderlander.nl/achterhoek/werkloosheid-winterswijk-daalt-naar-3-6-procent~af9169e8/>
- EduGIS (2019). Winterswijk. Retrieved from <http://kaart.edugis.nl/>
- Eibergen, G. (1955). Title not readable. -1.733.21, 8810. Erfgoedcentrum Achterhoek Liemers, Doetinchem.
- Eibergen, G. (1975). Title not readable. -1.733.21, 8810. Erfgoedcentrum Achterhoek Liemers, Doetinchem.
- Erfgoedcentrum Achterhoek Liemers. (2019). Beeld & Geluid. Received from Erfgoedcentrum Achterhoek Liemers: <https://www.ecal.nu/beeld-en-geluid-keuze>
- Excelsior (n.d.) Geschiedenis en heden. Retrieved from <https://www.excelsior-winterswijk.nl/geschiedenis-en-heden/>
- Frank, C.J. & Lemmens, M. (2016). *Cultuurhistorische analyse Winterswijk*
- Gaudium. (2019). Over ons. Retrieved from Gaudium creative weavers: <https://gaudiumbv.eu/?lang=nl>
- Gemeente Winterswijk (2011). *Inventarisatie cultuurhistorie*
- Global surface water (2019). Winterswijk. Retrieved from <https://global-surface-water.appspot.com/map>
- Google (2019). Kortestraat 12 Winterswijk. Retrieved from <https://www.google.com/maps/@51.9645528,6.7214784,17z>
- Google (2019). Winterswijk. Retrieved from <https://www.google.nl/maps/@51.9710582,6.6838036,13z>
- Google (2019). Winterswijk. Retrieved from https://www.google.com/maps/@51.9697499,6.7257984,3a,60y,201.64h,88.01t/data=!3m6!1e1!3m4!1sZE_RjwfuqFC-4r_XGVlY5g!2e0!7i13312!8i6656
- Google (2019). Winterswijk. Retrieved from <https://www.google.com/maps/@51.9695149,6.727108,3a,75y,125.66h,92.45t/data=!3m6!1e1!3m4!1s4qQk6fLt0vjkR9C00A-aA!2e0!7i13312!8i6656>
- Google (2019). Winterswijk. Retrieved from <https://www.google.com/maps/@51.9692814,6.7288103,3a,75y,231.57h,87.82t/data=!3m6!1e1!3m4!1sUPi6ucBh1KSUf81fH4cEqw!2e0!7i13312!8i6656>
- Google (2019). Winterswijk. Retrieved from https://www.google.com/maps/@51.9692404,6.7289113,3a,75y,245.34h,85.85t/data=!3m6!1e1!3m4!1sZAYD_mVa3f7IK27ExeWQXw!2e0!7i13312!8i6656
- Google (2019). Winterswijk. Retrieved from <https://www.google.com/maps/@51.9700394,6.7247355,3a,75y,200.34h,99.97t/data=!3m6!1e1!3m4!1s1qBU8K5FjZSF2ti0hPwy-g!2e0!7i13312!8i6656>
- Google (2019). Winterswijk. Retrieved from <https://www.google.com/maps/@51.9702197,6.7237448,3a,75y,160.35h,79.23t/data=!3m6!1e1!3m4!1sBrtpaeVzUHmKHR6Bske8jQ!2e0!7i13312!8i6656>
- Heemkundekring (2007). *Cultuurhistorische verkenning De Hoogt te Dongen*. Retrieved from https://www.planviewer.nl/imro/files/NL.IMRO.0766.BP2014000025-VG01/b_NL.IMRO.0766.BP2014000025-VG01_tb3.pdf
- Hisgis (2019). Winterswijk. Retrieved from <http://hisgisfa.l/?db=zzvs&layer=050Gelderland1832%20Gelderland1832%20percelen&style=0&style=0&x0=149166.40413&x1=149234.422694&y0=487370.999695&y1=487302.981131>

- Huitink, A. (2000). Nieuwbouw van een bloemenhandel aan de Eelinkstraat, Janfleur. -1.733.21, 22284. Erfgoedcentrum Achterhoek Liemers, Doetinchem.
- Huitink, A. (1992). Verbouwing + verplaatsing koelcel, Arie Janssen. (1999-2000). -1.733.21, 22248. Erfgoedcentrum Achterhoek Liemers, Doetinchem.
- Huitink, A. (1999). Wooldseweg 44, Gaudium. (1999-2000). -1.733.21, 22248. Erfgoedcentrum Achterhoek Liemers, Doetinchem.
- Jokilehto, J. (1986). *A History of Architectural Conservation*. York: University of York.
- Kaartenkamer TU Delft (2019). Topografische kaart Winterswijk
- Koncz, I.T. (1968). *Manual of Precast Concrete Construction*. Gütersloh, Germany: Bauverlag.
- Konings, G. (1961). Vernieuwing dak weverij Hazewind. (1950-1970). -1.733.21, 8810. Erfgoedcentrum Achterhoek Liemers, Doetinchem.
- KLM (1930). Luchtfoto Winterswijk. Retrieved from <https://www.geheugenvannederland.nl/nl/geheugen/view?identificer=SPOOR01%3AKB-TOTAAL-8648>
- Kuipers, M. & De Jonge, W (2017). *Designing from Heritage: Strategies for Conservation and Conversion*. Delft University of Technology
- Lammers, A. (1943). Verplaatsen Schuur, Weverij M.M. Poppers. (1950-1970) 8810 Erfgoedcentrum Achterhoek Liemers, Doetinchem.
- Lammers, A. (1944). Verplaatsen Schuur. (1950-1970) 8810 Erfgoedcentrum Achterhoek Liemers, Doetinchem.
- Lintsen, H.W. (2009). *Geschiedenis van de techniek in Nederland*. De wording van een moderne samenleving 1800-1890
- Molenaar, M. (2018). Op pad in de Achterhoek: Winterswijk en omgeving. Retrieved from <https://www.marcellamolenaar.nl/op-pad-in-de-achterhoek-winterswijk-en-omgeving/>
- Nationaal archief (n.d.). Topografische kaart van Winterswijk en omgeving. Retrieved from https://www.nationaalarchief.nl/onderzoeken/kaartencollectie/detail?limitstart=0&q_searchfield=Winterswijk
- Neefjes, J. & Willemse, N. (2009). *Cultuurhistorische Atlas Winterswijk*. Utrecht: True Colours Nederland B.V.
- Neufert, E. (1973). *Industriebauten*. Hannover: Th. Schäfer GmbH
- Nibag. (2015). *Haalbaarheidsstudie herontwikkeling Bedrijvenpark de Morse, Laan van Hilbelink*. Winterswijk: Nibag.
- Nijverdald, B. (1982). Plan tot het bouwen van een ladingplaats, Ten Cate. (1982) 15691 Erfgoedcentrum Achterhoek Liemers, Doetinchem.
- Nijverdald, B. (1985). Uitbreiding opslag weverij ,Ten Cate. (1985). -1.733.21, 15691. Erfgoedcentrum Achterhoek Liemers, Doetinchem.
- N.V. Verbeco Ede (1955). Werktekening met opleg-details. -1.733.21, 8158 (4). Erfgoedcentrum Achterhoek Liemers, Doetinchem
- Oonk, B. (2019). Productieproces. (Questioned by J. Joosse)
- Oosterhoff, J., Arends, G., van Eldik, G., & Nieuwmeijer, G. (1988). *Bouwtechniek in Nederland*. Delft: Delftse Universitaire Pers.
- Pannekoek, J.C. (1956). Uitbreiding weverij. -1.733.21, 6667 - 1. Erfgoedcentrum Achterhoek Liemers, Doetinchem
- Pannekoek, J.C. (1957). Uitbreiding weverij. -1.733.21, 6667 - 2. Erfgoedcentrum Achterhoek Liemers, Doetinchem
- Pannekoek, J.C. (1957). Uitbreiding weverij. -1.733.21, 6667 - 3. Erfgoedcentrum Achterhoek Liemers, Doetinchem

- Pannekoek, J.C.(1957). Uitbreiding weverij. -1.733.21, 6667 - 4. Erfgoedcentrum Achterhoek Liemers, Doetinchem
- Pannekoek, J.C. (1956). Uitbreiding Weverij, De Batavier. 28 (1907-1970) -1.733.21, 8158(3)-5. Erfgoedcentrum Achterhoek Liemers, Doetinchem.
- Peletier, W. & Kolstee, H.G. (1986). *Winterswijk, Geologie*. Hoogwoud
- Peletier, W. & Ardesch, J. (1992). *Geschiedenis van de Winterswijkse steengroeve*. Stichting Freriks Winterswijk
- Peletier, W. (2000). *Winterswijk een eeuw verandering - deel 2b*. Winterswijk: Vereniging Het Museum Winterswijk.
- RAAP (n.d.). Kaartmateriaal en foto's
- Rayonarchitect. (1988). Uitbreiden Pand, Ten Cate. (1988) . -1.733.21, 15691. Erfgoedcentrum Achterhoek Liemers, Doetinchem.
- Retours. (2016). Sybold van Ravesteyn. Retrieved <https://retours.eu/nl/38-architect-sybold-van-ravesteyn/>
- Riegl, A. (1903). *The Modern Cult of Monuments: Its Character and Its Origin*. London: MIT Press
- Rijksarchief Gelderland (n.d.). Kadastrale minuut uit 1828
- Schaaf, J. (1944). Uitbreiding fabriek, M.M. Poppers. (1944) -1.733.21, 6667. Erfgoedcentrum Achterhoek Liemers, Doetinchem.
- Schaaf, J. (1948). Uitbreiding fabriek, M.M. Poppers. (1948) -1.733.21, 6667. Erfgoedcentrum Achterhoek Liemers, Doetinchem.
- Schaaf, J. (2005). Uitbreiding fabriek, M.M. Poppers. (2003-2004) -1.733.21, 31193. Erfgoedcentrum Achterhoek Liemers, Doetinchem.
- SPGS (n.d.). Tricotfabriek Willink. Retrieved from <https://spgs.nl/industrieel-erfgoed/winterswijk-tricotfabriek-willink>
- Strava (2019). Winterswijk. Retrieved from <https://www.strava.com/heatmap#15.87/6.72686/51.97396/hot/all>.
- The Netherlands Institute for Industrial Heritage (1994). Buitenbedrijf Winterswijk
- Topografisch Bureau (n.d.). Winterswijk 1865 op schaal 1:25.000
- Topotijdreis (n.d.). Winterswijk
- Tuinstra, M. (2006). *Functioneel en manifest, de architectuur van de textiel fabrieken in Twente 1850-1925*. Retrieved from <https://cultureelerfgoedenschede.nl/wordpressnew/wp-content/uploads/2017/05/Scriptie-.pdf>
- Unknown. (1956). Plan tot verbouwing fabrieksgebouw "De Pol". (1956) -1.733.21, 8810. Erfgoedcentrum Achterhoek Liemers, Doetinchem.
- Van Dugteren, M. (n.d.). De Pol. Collectie Oud-Winterswijk, Winterswijk.
- Watertorens (n.d.) A. Beltman. Retrieved from http://watertorens.eu/torens/_Architecten/Beltman_A/fotoos.html
- Weevers, C. (1994). *Buiten Bedrijf. Projectbureau Industrieel Erfgoed*. Retrieved from https://www.industrieel-erfgoed.nl/sites/default/files/bijlagen/bestanden/buiten_bedrijf_deel_1_winterswijk_n.v._tricotfabriek_g.j._willink_-_winterswijk.pdf
- Wikikids (2019). Stoommachine. Retrieved from <https://wikikids.nl/Stoommachine>
- Willemskwartier Nijmegen (2017). Sloop de Génestetlaan. Retrieved from <http://www.willemskwartiernijmegen.nl/drupal/content/sloop-de-genestetlaan>
- Willink, B. (2006). *Heren van de stoom*. Zutphen: WalburgPers.
- 100% Winterswijk. (2019). Janfleur Bloemenhandel. Retrieved from <https://www.100procentwinterswijk.nl/locaties/2263501299/janfleur-bloemenhandel>

