

Green Bulk Terminals
a Strategic Level Approach to Solid Biomass Terminal Design

Dafnomilis, Ioannis

DOI

[10.4233/uuid:1fa73d67-e69c-4a2b-89a3-b56cac13c7e7](https://doi.org/10.4233/uuid:1fa73d67-e69c-4a2b-89a3-b56cac13c7e7)

Publication date

2019

Document Version

Final published version

Citation (APA)

Dafnomilis, I. (2019). *Green Bulk Terminals: a Strategic Level Approach to Solid Biomass Terminal Design*. [Dissertation (TU Delft), Delft University of Technology]. TRAIL Research School. <https://doi.org/10.4233/uuid:1fa73d67-e69c-4a2b-89a3-b56cac13c7e7>

Important note

To cite this publication, please use the final published version (if applicable). Please check the document version above.

Copyright

Other than for strictly personal use, it is not permitted to download, forward or distribute the text or part of it, without the consent of the author(s) and/or copyright holder(s), unless the work is under an open content license such as Creative Commons.

Takedown policy

Please contact us and provide details if you believe this document breaches copyrights. We will remove access to the work immediately and investigate your claim.

Green Bulk Terminals – a Strategic Level Approach to Solid Biomass Terminal Design

Ioannis Dafnomilis

Delft University of Technology

This research has been funded by the Ministry of Economic Affairs and Climate Policy (Ministerie van Economische Zaken en Klimaat; EZK) through the ‘Subsidieregeling Energie en Innovatie Biobased Economy: Kostprijsreductie Elektriciteit- en Warmteproductie.’

Green Bulk Terminals – a Strategic Level Approach to Solid Biomass Terminal Design

Proefschrift

ter verkrijging van de graad van doctor
aan de Technische Universiteit Delft,
op gezag van de Rector Magnificus Prof. dr. ir. T.H.J.J. van der Hagen,
voorzitter van het College voor Promoties,
in het openbaar te verdedigen op woensdag 23 januari 2019 om 10.00 uur

door

Ioannis DAFNOMILIS

Master of Science in Sustainable Energy Technology,
Delft University of Technology, the Netherlands,
born in Thessaloniki, Greece

Dit proefschrift is goedgekeurd door de:
promotoren: Prof. dr. ir. G. Lodewijks, Dr. ir. D.L. Schott and Prof. dr. M. Junginger

Samenstelling van de promotiecommissie:

Rector Magnificus	voorzitter
Prof. dr. ir. G. Lodewijks	University of New South Wales, promotor
Dr. ir. D.L. Schott	Technische Universiteit Delft, promotor
Prof. dr. M. Junginger	Utrecht University, promotor

Onafhankelijke leden:

Prof. dr. ir. Andrea Ramirez Ramirez	Technische Universiteit Delft
Prof. dr. Tapio Ranta	Lappeenranta University of Technology
Prof. dr. ir. Pantelis N. Botsaris	Democritus University of Thrace
Prof. dr. ir. Lóránt A. Tavasszy	Technische Universiteit Delft

TRAIL Thesis Series no. T2019/2, the Netherlands Research School

TRAIL
P.O. Box 5017
2600 GA Delft
The Netherlands
E-mail: info@rsTRAIL.nl

ISBN: 978-90-5584-245-2

Copyright © 2018 by Ioannis DAFNOMILIS

All rights reserved. No part of the material protected by this copyright notice may be reproduced or utilized in any form or by any means, electronic or mechanical, including photocopying, recording or by any information storage and retrieval system, without written permission from the author.

Printed in the Netherlands

*Dedicated to
my mother*

Preface

Reaching the end of my 4-year long journey, there is no shortage of people I would like to thank. Everyone I had interactions with during these past years helped in a shape or form to support me and gave me supplies to successfully complete this adventure.

Firstly, I would like to thank my promotors, Gabriel Lodewijks, Dingena Schott and Martin Junginger. Gabriel, thank you for trusting in my work. Your expert comments and input always pushed me in the right direction. Even though we met sparingly the past 2 years, I could always count on your support. Martin, thank you for always being there, to answer questions, provide an outside point of view and your endless knowledge on every type of biomass aspect. I was always looking forward to coming to Utrecht and spending time discussing with you. Last but not least, my greatest thanks to Dingena for being my daily supervisor/co-promotor and later full-fledged promotor. You have been an amazing coach in every point of my work and I owe a huge part of my success to you. Thank you for the coffees, jokes and the random conversations when stuck in traffic.

I want to acknowledge the significant contribution of some of my colleagues, namely Ric Hoefnagels, Lotte Visser and Mark Duinkerken. Ric, thank you for going through with the endless feedback I requested during my first 2 years, your enthusiasm and knowledge were greatly appreciated. Lotte, thank you for the discussions and the laughs. The US trip will always be a fantastic memory. Mark, without you a huge part of this research would not be like it is. Thank you for the brainstorming, support and crucial advice during the latest part of my work.

I am thankful to all the committee members, namely Prof. dr. ir. Pantelis Botsaris, Prof. dr. Tapio Ranta, Prof. dr. ir. Andrea Ramirez Ramirez and Prof. dr. ir. Lóránt Tavasszy, for their constructive feedback.

The industrial partners involved in this project were also invaluable, in providing feedback and input during our meetings. Special thanks to Michel Corbeau from Nemag B.V., Bert Pothoven, Jaap Ruijgrok and Chris Geijs from ESI Eurosilos B.V., and the Ministry of Economic Affairs and Climate Policy of the Netherlands for funding this research.

A big thank you, in no particular order, to all the colleagues in the research group who made my work and time enjoyable: Xiao, Wenbin, Jie, Huy, Fan, Ali, Ali, Hamid, Javad, Rudy, Bilge, Breno, Johan, Stef, Linying, Marc, Wenjing, Qinqin, Maria, Guangming, Patty, Anouk, Pauline, Monique and Dineke. A big thanks to my office mate for almost 4 years, Xiao Lin for all the fun talks on endless subjects, from Chinese science fiction to Greek linguistics.

To all the new and close friends that I have made since I arrived in the Netherlands, thank you! Thank you Aris for your calmness and endurance, the holidays and beers. Stef, thank you for your kind and helpful nature, I always know I can count on you. Dimitri, thank you for the laughs, the discussions and the cooking, you were a great inspiration. Alessandro, Giulia and Elly, I am truly happy I got to meet you guys. I consider you a part of my closest people and that for me means a lot. Martino, thank you for your attitude in life and your geekiness that complimented mine. Arash, Ali and Shima, you are some of the kindest and giving people I have met and I hope we will remain friends for many, many years to come.

Gabriele and Fabio, thank you for the many nights cooking and drinking together. Ezgi, thank you for the willingness to play board games, even if it rarely materialized. Thank you Floor for your can-do attitude. Thank you Maria, Cansin and Tilbe for always providing a different note in the day.

To the friends I made when I first arrived in the Netherlands, Metin, Srikanth, Tanel and Caesar, thank you. Metin, I am proud to call you my friend and for you to be my paranymph. Srikanth, your intelligence and compassion are an inspiration to me. Tanel, thank you for the great times we had together, I hope we repeat them many times in the future. Caesar, thank you for the positive attitude you always carried with you, and for being an amazing host during our visit in Indonesia.

To all my friends from my childhood back home, thank you for being there and supporting me, each in your own unique way, even if you didn't know exactly what I was doing. Alex, Kosta, Kyriako, Vlasi, Giorgo, Dimitri, you are my family. TSG!

Thanassi, thank you for understanding me and relating to me while going through the same journey. We have been friends for almost 3 decades, and many more to come.

Argyro, thank you for being such an amazing sister. I know we fought a lot growing up, but that's what big brothers are for. Thank you for 'holding the fort' back home. I love you and I know I can always count on you and you can do the same with me.

Πατέρα, τι να πω που να μπορεί να εκφράσει την ευγνωμοσύνη και την αγάπη μου. Η ανιδιοτέλεια σου, η βοήθειά σου όποτε την έχω χρειαστεί και η στάση σου απέναντι σε οτιδήποτε σημαντικό με έχουν σχηματίσει και σημαδέψει. Σε ευχαριστώ για όλα και σε αγαπώ.

Μαμά, ήσουν, είσαι και θα είσαι ότι επιδιώκω να γίνω. Μου λείπεις.

Ermi, thank you for being a furry ball of love and making me more active than I ever thought I would be.

Faidra, trying to put my gratitude in words is almost impossible. Thank you for your patience and understanding when I was down, your kindness and your support. Your intelligence, attitude and character are a shining beacon for me. You make me want to be better in every step of the way. I love you. Γι'αυτό έγινε ο κόσμος.

Ioannis Dafnomilis

Delft, December 2018

Contents

PREFACE	VII
CONTENTS	IX
LIST OF FIGURES	XI
LIST OF TABLES	XII
CHAPTER 1. INTRODUCTION	1
1.1	BACKGROUND	2
1.2	PROBLEM STATEMENT	3
1.3	RESEARCH OBJECTIVE AND MAIN RESEARCH QUESTIONS.....	5
1.4	THESIS OUTLINE	6
CHAPTER 2. BIOMASS DEMAND, SUPPLY AND IMPORT SCENARIOS TO 2030	11
2.1	INTRODUCTION	12
2.1.1	<i>Background</i>	12
2.1.2	<i>Problem definition and objectives</i>	13
2.1.3	<i>Scope of work</i>	14
2.2	CURRENT STATUS OF BIOENERGY	15
2.2.1	<i>Projections to 2030</i>	15
2.2.2	<i>Projections of renewable energy deployment at the European level</i>	16
2.2.3	<i>Policy review and sustainability criteria</i>	16
2.2.4	<i>Input from stakeholders</i>	17
2.3	BIOMASS IN NORTHWEST EUROPE – STATE OF PLAY AND RESPECTIVE POLICIES	17
2.3.1	<i>Bioenergy breakdown per country and sector</i>	17
2.3.2	<i>Renewable energy policies and biomass sustainability criteria</i>	20
2.4	RESULTS – FUTURE OUTLOOK IN THE REGION	23
2.4.1	<i>Northwest Europe</i>	23
2.4.2	<i>Germany</i>	25
2.4.3	<i>Denmark</i>	27
2.4.4	<i>Belgium</i>	30
2.4.5	<i>United Kingdom</i>	32
2.4.6	<i>The Netherlands</i>	34
2.4.7	<i>Biomass import trends</i>	37
2.5	DISCUSSION	39
2.6	CONCLUSIONS	40
CHAPTER 3. SOLID BIOMASS HANDLING IN IMPORT TERMINALS	49
3.1	WOOD PELLET TRADE AND PORT TERMINALS	50
3.2	RESEARCH APPROACH	52
3.2.1	<i>Technical characteristics of wood pellets and interaction with equipment</i>	53
3.2.2	<i>Wood pellet port equipment and procedures</i>	54
3.3	RESULTS	60
3.3.1	<i>European Bulk Services (EBS) B.V.</i>	60
3.3.2	<i>Zeehavenbedrijf Dordrecht (ZHD) B.V.</i>	63
3.3.3	<i>Rotterdam Bulk Terminal (RBT) B.V.</i>	66
3.4	DISCUSSION	68
3.5	CONCLUSIONS	70
CHAPTER 4. OPTIMAL EQUIPMENT DEPLOYMENT FOR BIOMASS TERMINAL OPERATIONS	77
4.1	INTRODUCTION	78
4.1.1	<i>Literature review</i>	78
4.1.2	<i>Objective and contribution</i>	80

4.2	BIOMASS BULK TERMINAL DESIGN	81
4.3	MATHEMATICAL MODEL.....	85
4.3.1	<i>Notations</i>	85
4.3.2	<i>Objective function formulation and constraints</i>	87
4.3.3	<i>Relevant data</i>	89
4.4	COMPUTATIONAL RESULTS.....	90
4.5	CONCLUSIONS AND FURTHER WORK	100
CHAPTER 5. MULTI-PERIOD BIOMASS TERMINAL PLANNING.....		107
5.1	INTRODUCTION	108
5.1.1	<i>Literature review</i>	108
5.1.2	<i>Objective and contribution</i>	109
5.2	MODEL STRUCTURE.....	110
5.2.1	<i>Notations</i>	111
5.2.2	<i>Objective function formulation and constraints</i>	112
5.2.3	<i>Complete model</i>	114
5.2.4	<i>Assumptions and input data</i>	114
5.3	COMPUTATIONAL RESULTS.....	115
5.3.1	<i>Base case</i>	116
5.3.2	<i>Impact of equipment depreciation rate on investment strategy</i>	117
5.3.3	<i>Operational and storage costs</i>	119
5.3.4	<i>Equipment selection and utilization</i>	120
5.4	CONCLUSIONS AND FURTHER WORK	124
CHAPTER 6. CONCLUSIONS		135
6.1	MAIN CONCLUSIONS	136
6.2	RECOMMENDATIONS FOR FURTHER WORK.....	139
GLOSSARY		141
SAMENVATTING		143
SUMMARY		147
CURRICULUM VITAE		151
TRAIL THESIS SERIES PUBLICATIONS.....		153

List of Figures

Figure 1.1: EU-28 gross final energy consumption [1]	2
Figure 1.2: Global wood pellet trade flows [1].....	3
Figure 1.3: Thesis structure	7
Figure 2.1: Current share of RES in final energy consumption vs 2020 targets [1][19][29]	17
Figure 2.2: Northwest EU final biomass consumption by end use sector.....	24
Figure 2.3: Northwest EU primary biomass demand by end use sector	25
Figure 2.4: Final biomass consumption by end use sector (DE).....	26
Figure 2.5: Primary biomass demand and supply (DE)	27
Figure 2.6: Renewable energy development (DK) [32].....	28
Figure 2.7: Final biomass consumption by end use sector (DK)	29
Figure 2.8: Primary biomass demand and supply (DK).....	30
Figure 2.9: Final biomass consumption by end use sector (BE).....	31
Figure 2.10: Primary biomass demand and supply (BE)	32
Figure 2.11: Final biomass consumption by end use sector (UK)	33
Figure 2.12: Primary biomass demand and supply (UK).....	34
Figure 2.13: Final biomass consumption by end use sector (NL).....	34
Figure 2.14: Final energy demand from solid biomass (NL) [64]	36
Figure 2.15: Primary biomass demand and supply (NL)	37
Figure 2.16: Projected biomass imports for Northwest Europe	38
Figure 3.1: Example of a solid bulk material handling chain [57,58].....	55
Figure 3.2: Generic closed clam-shell grab design (Image courtesy of Nemag B.V.).....	56
Figure 3.3: Pouch conveyor (Image courtesy of ContiTech AG)	57
Figure 3.4: Pipe conveyor (Image courtesy of Bridgestone Corporation)	57
Figure 3.5: Walking floor reclaimer (Image courtesy of Stobart Group Limited)	59
Figure 3.6: Sliding frame reclaimer (Image courtesy of Spirac Engineering AB).....	59
Figure 3.7: Overview of wood pellet handling equipment	60
Figure 3.8: St Laurens haven terminal aerial view (Image courtesy of EBS B.V.)	61
Figure 3.9: EBS pellet handling chain	61
Figure 3.10: Closed clam-shell grab used in EBS terminal (Image courtesy of EBS B.V.)	62
Figure 3.11: ZHD pellet handling chain	64
Figure 3.12: Direct transshipment of wood pellets (Image courtesy of ZHD B.V.)	65
Figure 3.13: Direct transshipment operation (Image courtesy of RBT B.V.)	66
Figure 3.14: RBT pellet handling chain.....	66
Figure 3.15: Rotterdam Bulk Terminal aerial view (Image courtesy of RBT B.V.).....	67
Figure 4.1: Illustration of the proposed solid biomass bulk handling chain [69,70].....	82
Figure 4.2: Example of solid biomass handling equipment [3]	83
Figure 4.3: Cost per ton of throughput for terminals of 1-15 Mt of throughput	91

Figure 4.4: Total annual costs (1, 5 & 10 Mt throughput terminals)	96
Figure 4.5: Total cost breakdown (1, 5 & 10 Mt throughput terminals).....	96
Figure 4.6: Non-peak vs peak capacity design (3.5 Mt throughput terminal)	97
Figure 4.7: Non-peak vs peak capacity cost breakdown (3.5 Mt throughput terminal).....	98
Figure 4.8: Operational hours vs Cumulative cost decrease (1, 5 & 10 Mt throughput terminals).....	99
Figure 4.9: Costs per ton of throughput calculation progress	100
Figure 5.1: Biomass throughput scenarios.....	115
Figure 5.2: Total terminal costs, base case	117
Figure 5.3: Terminal costs, scenarios A to D, depreciation rate=30%	118
Figure 5.4: Terminal costs, scenario A, depreciation rates 10 to 40%.....	119
Figure 5.5: Terminal investment strategy, scenario A (Low), base case	122
Figure 5.6: Terminal investment strategy, scenario A (Low), depreciation rate=30%	123
Figure 5.7: Utilization of loading equipment, scenario A (Low), depreciation rate=30%	124

List of Tables

Table 2.1: Final energy consumption, overall RES and biomass in 2014 [1][19][29].....	18
Table 2.2: Renewable energy policy overview per MS [39]	20
Table 2.3: Future biofuel scenarios (DK) [54].....	28
Table 2.4: Bioenergy demand and respective imports required [PJ]	46
Table 2.5: Biomass imports in NW EU [Mt].....	46
Table 3.1: Physical properties of wood pellets compared to bituminous coal [38,39]	53
Table 3.2: Overview of wood pellet terminals in the Port of Rotterdam [70,71]	60
Table 4.1: Equipment database	84
Table 4.2: Vessel size and service time based on terminal throughput [11,13,71]	89
Table 4.3: Equipment selection for two consecutive terminal sizes	92
Table 4.4: Optimal equipment allocation and utilization for a terminal with a throughput of 1, 5 & 10 Mt	94
Table 4.5: Model calibration (total annual costs of a 3.5 Mt terminal).....	99
Table 5.1: Terminal costs, scenarios A to D, base case	116
Table 5.2: Terminal costs, scenarios A to D, depreciation rate 10 to 30%	117
Table 5.3: Operational and storage costs, scenarios A to D, base case.....	120
Table 5.4: Equipment database	131
Table 5.5: Availability, performance and quality of equipment according to their age.....	132
Table 5.6: Equipment lifetime and depreciation factor for the realistic approach	133

Chapter 1. Introduction

1.1 Background

Biomass used for energy purposes is already a substantial contributor to all the energy production sectors of the European Union (EU). Figure 1.1 shows that in 2015, bioenergy consumed in the EU amounted to 61% of the total renewable energy consumption or 4416 PJ, and 10% of the gross final energy consumption. Bioenergy had the greatest contribution in the heating sector (88% of total renewable heating), but with significant shares in electricity production and transport fuels as well [1]. Although the bioenergy share in the total renewable energy consumption is expected to decrease by 2020 to a total of 57% [2], due to the development of other renewable sources such as wind and photovoltaics (PV), the actual amount of biomass for heating, electricity and transport is expected to increase to 5860 PJ [3].

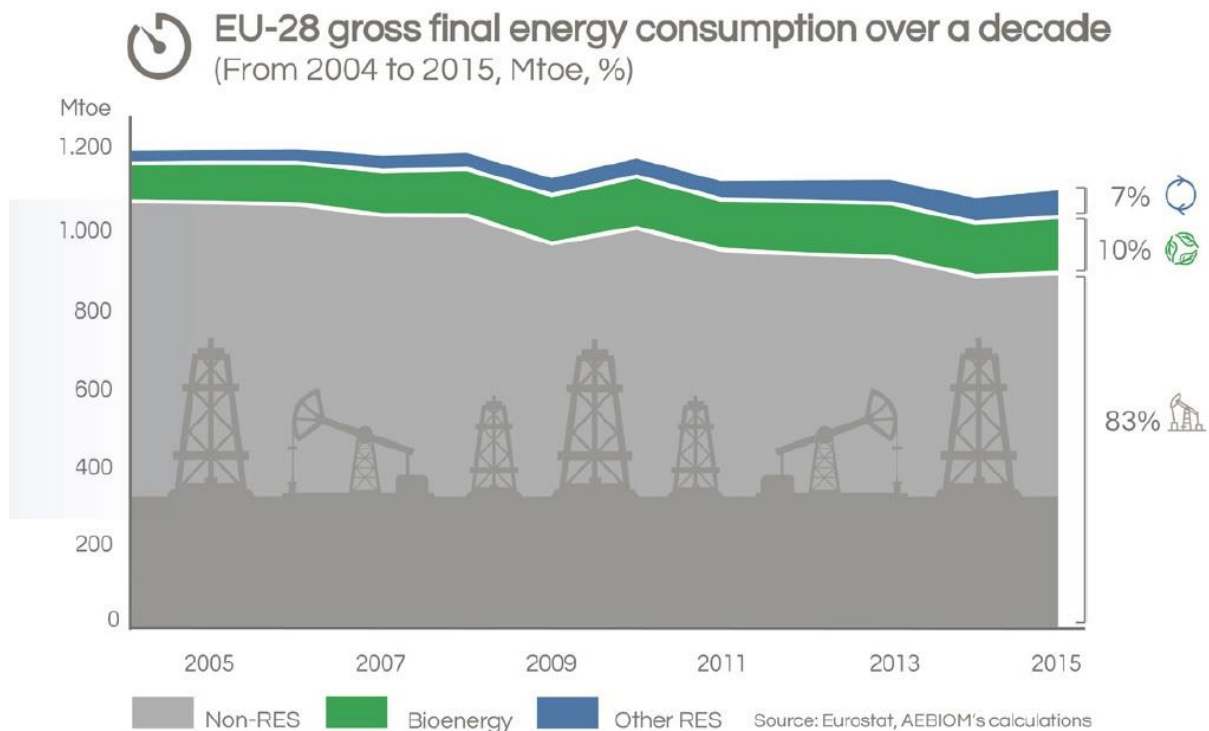

Figure 1.1: EU-28 gross final energy consumption [1]

The largest part of EU biomass supply is and will be based on domestic sources. Currently, only 4% of the total biomass used for energy purposes is imported [4]. However by 2030, this amount could increase significantly, taking into account potential supply gaps, especially in the industrial sector (electricity production, scheduled closing down of coal power plants). Inequalities in forested areas, waste biomass streams, differences in the amounts of supply and demand for bioenergy from one member state (MS) to another, open up opportunities for bioenergy trade.

In the case of surplus of supply, EU-28 members such as the Baltic countries or Portugal may export bioenergy products to other countries, e.g. the Netherlands or Belgium, where bioenergy demand cannot be fulfilled from local resources [5,6]. Most of the biomass trade within the EU relates to wood logs used as fuel wood, waste wood streams from construction or agriculture and low-level processed biomass like wood chips. In an attempt to facilitate electricity and heat production, however, the industry has turned to wood pellets in recent years. Coal power plants can use their existing infrastructure (with some modifications) to store and pulverize wood pellets, due to their similar physical characteristics. Wood pellets are also superior for heat

production compared to wood chips or fuel wood due to their uniform production characteristics and higher energy density. Their increased energy density makes them much more cost efficient to transport over long distance shipping routes and use in co-firing and heat production. This, combined with the lack of adequate production capacity in the EU, has led to a necessity of wood pellet imports from countries such as the US and Canada. In 2016, 35% (8 Mt) of the wood pellets consumed by the EU-28 members was imported, mainly via North America, as is shown in Figure 1.2.

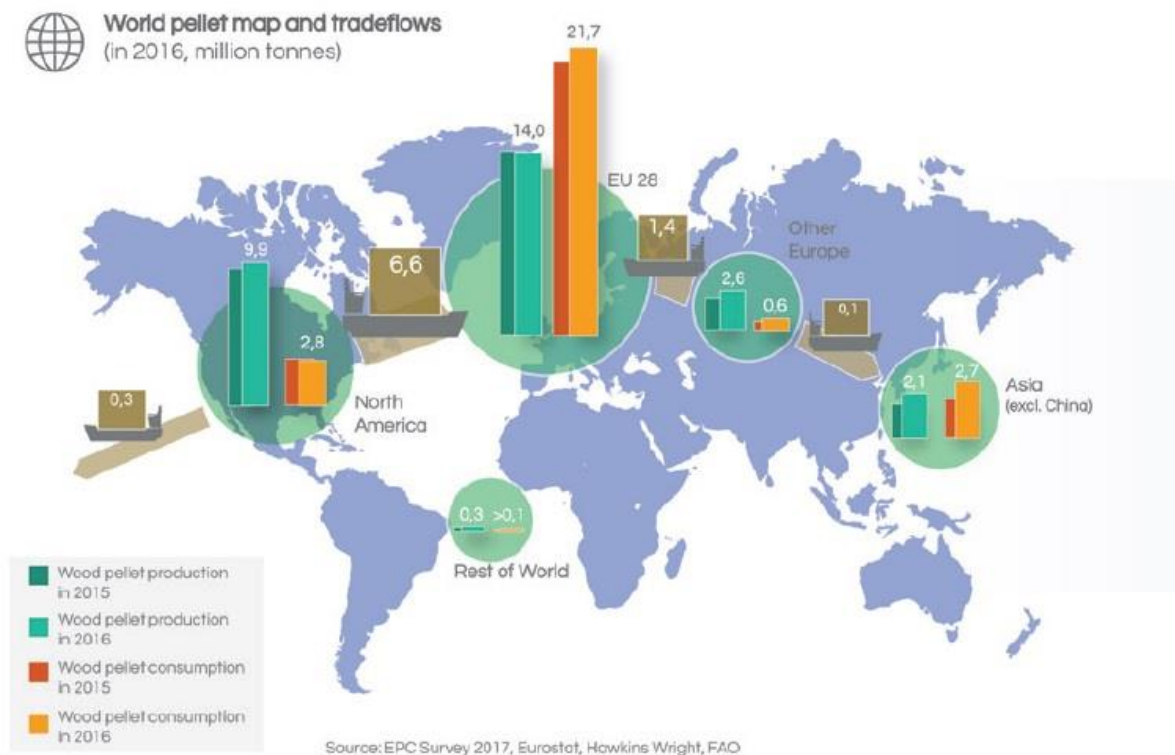

Figure 1.2: Global wood pellet trade flows [1]

Wood pellet imports in the Northwestern Europe in particular are expected to grow in specific sectors, such as co-firing in coal power plants and residential heating in the short-term future, and in the form of high quality industrial heat in the long-term future [7,8]. The use of wood pellets in coal-fired power plants in the Netherlands will be ramped up to approximately 25 PJ of final energy (60 PJ primary energy) by 2020 [8]. This corresponds to approximately 3.5 Mt of imports, since the country has been relying on them in order to reach the renewable energy target for electricity production, and is expected to rely on them for the future as well [6,7]. Concurrently, Belgium consumed more than 1.5 Mt of wood pellets in 2015, almost exclusively imported, and the same was true for Denmark and its 2.6 Mt of wood pellet consumption in 2015 [9]. In total, the 3 countries are expected to consume more than 11 Mt by 2025 [10]. Accordingly, the bulk port terminals in the Amsterdam-Rotterdam-Antwerp (ARA) region will have to accommodate the increased imports of wood pellets intended for the Northwestern EU region.

1.2 Problem statement

Solid biomass -and by extension wood pellets- is regarded as a bulk material, as it is mostly transported in large quantities. However, compared to traditional dry bulk materials, such as coal, grain and iron ore, biomass has other unique demands for handling, transport and storage,

due to its different physical and biological properties, such as bulk density, durability, angle of repose, moisture content and chemical activity [11]. Use of unsuitable equipment or careless treatment can damage the product and constitute major health and safety hazards. Dust formation and dust explosions, self-heating and ignition, gas formation and oxygen depletion while in storage and biological hazards, are all issues that need to be dealt with when handling biomass [12]. Nevertheless, material specific equipment and terminal setups are only utilized to a limited extent at the moment. Since the volumes currently being moved are low, they do not necessitate investments in specialized infrastructure. Port terminals tend to use sub-par, unsuitable equipment risking damage to the product, unsafe conditions and incurring much higher costs per ton of product handled. Such has not been the case so far in wood pellet exporting ports in North America, as well as receiving ports in the UK, which has been the biggest pellet importer worldwide for the past several years. Dedicated export and imports terminals are used for the handling and storage of solid biomass, with specialized equipment and safety measures in place along the whole handling chain, from production plant to sea vessel to end user. In order to optimize the handling procedures in the continental EU region as well, the equipment and techniques at the respective import terminals might need to adjust to cope with biomass' specific properties. In several cases, brand new facilities need to be constructed.

Taking into account the aforementioned developments in biomass trade and imports, port terminals will have to reexamine their facilities and possibly redesign them. This retrofitting of preexisting facilities could lead to numerous small sized mix-purpose bulk terminals. The multiple bulk terminals currently operational in dry bulk ports will also take the role of receiving the incoming biomass. Alternatively, the industry could drift towards creating a small core of biomass dedicated terminals in the region. For instance, Du Mez states that the Port of Rotterdam aims to handle 8-10 Mt of biomass by 2020, and as such assume a hub role for biomass imports to the whole of Northwestern Europe (personal communication, May 11, 2017). This could have a range of implications for the receiving bulk terminals; existing infrastructure might have to be adjusted in the short term, while larger scale and elaborate infrastructure will probably be required in the long term future. Extended periods of development will be needed for most of these actions. Even minor changes in a port terminals' design and operations require considerable investments in numerous elements of its setup. It is therefore crucial to have a comprehensive understanding of solid biomass terminal equipment setup and operations before any substantial commitments in relation to strategic investment decisions are made.

Research performed on solid biomass handling so far has focused mainly on specific aspects of the handling and storage infrastructure. Rossner has researched the carbon monoxide (CO) monitoring of small scale wood pellet storage for residential or small building use [13], and Proskurina looked into the bulk handling of wood pellets in export and import ports, for which she states that specialized equipment is required [14]. The mechanical degradation of wood pellets during indoor and outdoor storage was examined by Graham [15], albeit on a small scale. Graham also performed research on the mechanical properties of wood pellets in a laboratory environment [16]. Research on real life operation of biomass room heating appliances was conducted by Wohler, but it was focused on user behavior and type of fuel [17]. Thompson also investigated the suitability of wood pellets for domestic heating applications and provided several recommendations [18]. The most comprehensive and recent account of biomass handling and storage comes from Bradley and Carbo, offering advice on selecting equipment when dealing with biomass, considerations when setting up a project, and future trends [19,20]. However, the conclusions were either based on too small a scale of a few dozen or hundred

tons, or they come in the form of general rules of thumb for design and use of equipment and methods, which cannot be applied to a dedicated large scale port terminal as is.

Until now, most research in the field of terminal design had a goal of providing information, improving or optimizing a terminal's setup. However, the focus has been asymmetrically put on vessel arrival and their subsequent service time optimization, i.e. stochastic, discrete event approaches, or a fairly linear and straightforward equipment needs approach. Equipment allocation and utilization in these approaches have a second role, even though they can be equally (or more) important costs of a terminal. Most importantly, scientific research into the techno-economic optimal design of bulk terminals is limited. A comprehensive design method that still serves as an important guideline on terminal design was introduced by the United Nations Conference on Trade and Development in 1985 and again in 1991, focusing on the physical characteristics, management and operation of bulk terminals [21,22]. Memos provided planning parameters and other bases for estimating vessel queuing times, vessel service time and estimation of storage area needed (among many other options) for dry bulk cargo terminals [23]. Wu [24,25] researched dedicated biomass terminals analysing the effect of time dependent processes and provided a database of suitable equipment for biomass terminal operations. Discrete-event simulation for designing and improving the operations of dry bulk terminals was used by Ottjes et al. [26]. Lodewijks discussed the application of discrete event simulation as a tool to determine the best operational control of the terminal and the required number of equipment and their capacity for dry bulk in general [27].

Given the fact that solid biomass imports are expected to significantly increase in the medium- to long-term future, it is crucial to investigate how the corresponding infrastructure can be developed in the most (economically) efficient way. On top of that, taking into account the current lack of scientific expertise in comprehensive biomass terminal design, there is an urgent need to research in detail the techno-economic optimal design of solid biomass terminals. The establishment of such a comprehensive approach will assist related stakeholders such as terminal operators, port authorities and government agents in decision making, relating to biomass terminal design and investment strategies. In the context of this thesis, the expression 'terminal design' signifies the equipment and infrastructure selection and utilization necessary to perform the handling and storage functions effectively. The term 'investment strategies' includes the equipment and infrastructure procurement, utilization and salvage policies in order to minimize the total costs of the terminal.

1.3 Research objective and main research questions

This thesis aims to analyze and improve the development potential of the solid biomass infrastructure in the port of Rotterdam as a focal point, and in port terminals in general. The key research objective is formulated as follows:

- How can a solid biomass terminal's design and investment strategy be optimized with respect to its required investment and operational costs?

In order to achieve the aforementioned research objective, several sub-questions need to be investigated:

1. Can future biomass imports in Northwest Europe be quantified? What do the potential bandwidths of imports look like?

2. What is the state-of-the-art in wood pellet handling in import terminals? Given the incoming wood pellet volume increase, what are potential bottlenecks that can be encountered in existing biomass terminals? How can they be overcome?
3. How can the equipment selection and operations of a dedicated biomass terminal be optimized with respect to investment and operational costs? What is the relation between a biomass terminal size and its total annual logistics? Which are the most important operational parameters that affect said costs?
4. How can we most effectively make strategic level decisions relating to biomass terminal infrastructure development? What will a multi-period investment planning model look like? What are the most important functions and parameters to take into account when developing such a multi-period modelling approach?

1.4 Thesis outline

The answers to the research questions posed in the previous sections are provided in the following 4 chapters of this thesis, and are organized as follows:

- In chapter 2, biomass trade developments, and specifically import, are researched and quantified, formulated into future scenarios. Biomass trade is generally regarded a volatile and uncertain sector. It is highly influenced by respective policies, global trade developments, governmental support in the form of subsidies, and face steep competition from concurrent renewable sources. These potential volumes of biomass is what drives import terminal investments and determines their logistics. As such, a reliable assessment of the future ranges of biomass trade is imperative.
- Biomass handling in import terminals is examined in depth in chapter 3. All the possible steps in a terminal handling chain that need to be retrofitted or designed differently to efficiently cope with the material will be pin-pointed. The current setup and equipment in bulk terminals, geared mainly towards material like coal or iron ore with different properties than wood pellets, can deal with low volumes of pellet throughput. If the expected increases in wood pellet imports materialize, import terminals may have to invest in adjusting their approach. This can be done either by retrofitting existing facilities, or creating new ones altogether. The focus of (re)designing solid biomass import terminals should be primarily located in the transportation aspect (capability of high volumetric capacity transport) and storage (adequate storage capacity with acceptable safety systems in place).
- Consequently, the optimal equipment selection and operational logistics for dedicated biomass terminals are researched in chapter 4. The knowledge gained from work performed in the previous 2 chapters is implemented here. As a result, a static, mixed-integer linear programming model was developed, providing detailed equipment configuration solutions for a wide range of biomass throughput scenarios. It is also the first terminal model to take shared equipment (equipment used in more than one operational step) into account. The modelling improves on previous terminal design approaches by providing an in-depth database of dedicated biomass equipment that can be used at each terminal operation step. The configuration of the equipment is presented to a detailed level within the terminals bounds, and, most importantly, the utilization of this equipment is linked directly to the material throughput, as is the case in reality.

- Chapter 5 presents a multi-period investment planning model. The aim is to determine an equipment investment and salvage policy for dedicated biomass terminals in order to minimize total costs over a multiple year period. Time dependent parameters such as the biomass throughput over a future time period, developed into discrete scenarios based on the research performed in chapter 4, or the decrease of performance of equipment according to their age are taken into account in this model development. The results can support strategic level decision planning when applied to existing bulk terminals, which may need to retrofit equipment or parts of their handling chain, but are mostly geared towards assisting in strategic level planning – investing in new terminal setups, infrastructure and equipment decisions.
- This work ends with conclusion and recommendations for further research in chapter 6.

The outline of this thesis and the interconnections between the chapters are illustrated in Figure 1.3.

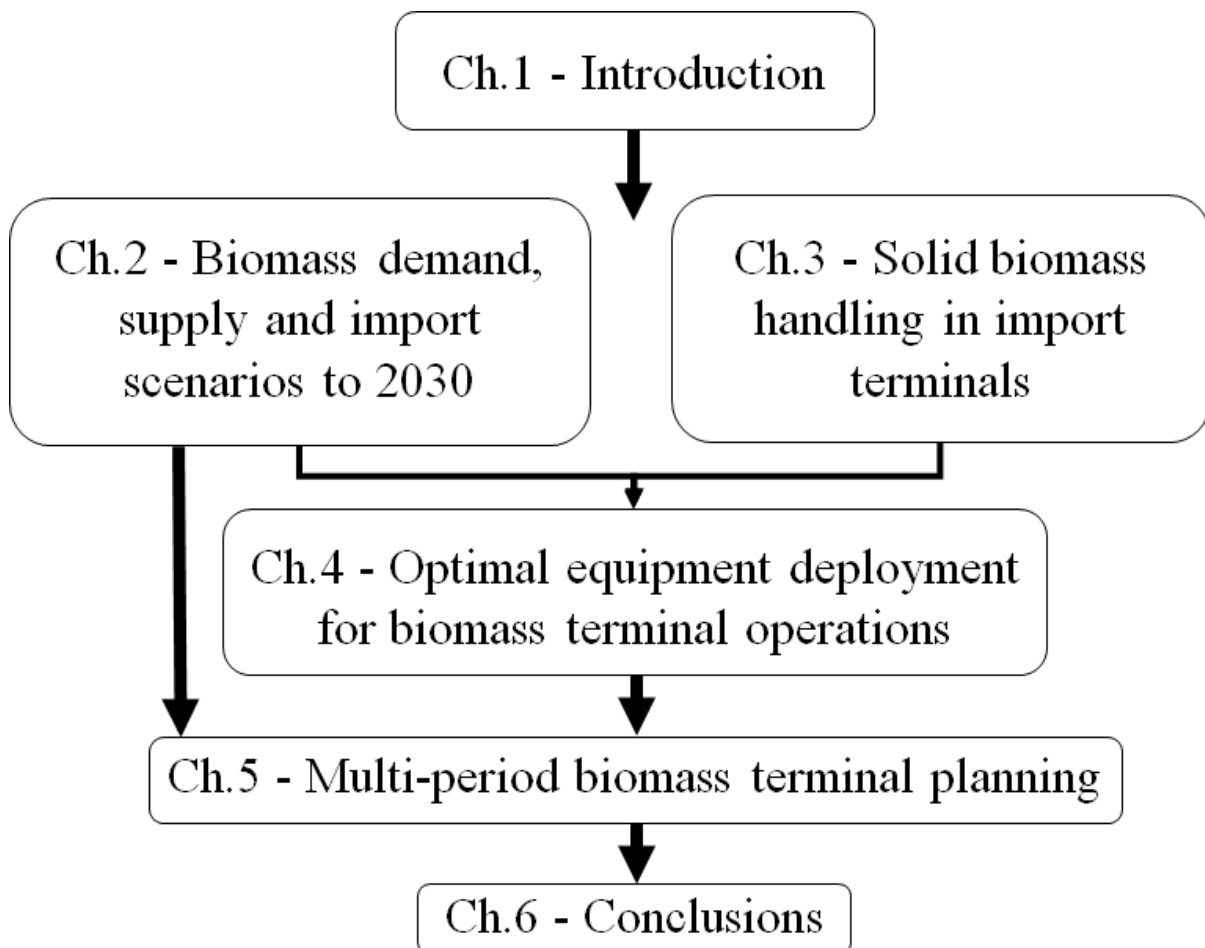

Figure 1.3: Thesis structure

References

- [1] European Biomass Association. AEBIOM Statistical Report - Key Findings. 2017.
- [2] Proskurina S, Sikkema R, Heinimö J, Vakkilainen E. Five years left – How are the EU member states contributing to the 20% target for EU’s renewable energy consumption; the role of woody biomass. *Biomass and Bioenergy* 2016;95:64–77. doi:10.1016/j.biombioe.2016.09.016.
- [3] European Biomass Association. AEBIOM Statistical Report - Key Findings. 2016.
- [4] Mai-Moulin T, Visser L, Junginger M. Assessment of sustainable biomass export potentials from international sourcing countries. Int Work “Towards a Eur Trade Strateg Sustain Solid Biomass Imports to EU” 2016.
- [5] Devriendt N, Guisson R. IEA Bioenergy – Task40: Sustainable International Bioenergy Trade Securing Supply and Demand Country Report Belgium / Flanders. 2015.
- [6] Goh CS, Junginger M, Winkel J, Kwant K. IEA Bioenergy – Task40: Sustainable Biomass and Bioenergy in the Netherlands: Factsheet Based on the 2013 Report. 2015.
- [7] Dafnomilis I, Wachyar YP, Schott DL, Junginger M, Hoefnagels R. Bioenergy development in the Netherlands. 2015. doi:2015.TEL.8045.
- [8] Social and Economic Council of the Netherlands. Energy Agreement for Sustainable Growth. 2013.
- [9] Thrän D. Global Wood Pellet Industry and Trade Study 2017. 2017.
- [10] Strauss W. Industrial Wood Pellet Fuel in Pulverized Coal Power Plants. BioCleantech Forum, Ottawa, Canada: 2016.
- [11] Hancock VE, Dafnomilis I, Schott DL, Lodewijks G. Torrefied Biomass and its Handling Aspects – A State-of-the-art Review. Bulk Mater. Storage, Handl. Transp., Darwin, Australia: 2016.
- [12] Dafnomilis I, Lanphen L, Schott DL, Lodewijks G. Biomass handling equipment overview. Mater. Handl. Constr. Logist., Vienna, Austria: 2015, p. 66–70.
- [13] Rossner A, Jordan CE, Wake C, Soto-Garcia L. Monitoring of CO in Residences with Bulk Wood Pellet Storage in the Northeast. *J Air Waste Manage Assoc* 2017;2247. doi:10.1080/10962247.2017.1321054.
- [14] Proskurina S, Rimppi H, Heinimö J, Hansson J, Orlov A, Raghu K, et al. Logistical, economic, environmental and regulatory conditions for future wood pellet transportation by sea to Europe: The case of Northwest Russian seaports. *Renew Sustain Energy Rev* 2016;56:38–50. doi:10.1016/j.rser.2015.11.030.
- [15] Graham S, Eastwick C, Snape C, Quick W. Mechanical degradation of biomass wood pellets during long term stockpile storage. *Fuel Process Technol* 2017;160:143–51. doi:10.1016/j.fuproc.2017.02.017.
- [16] Graham S, Ogunfayo I, Hall MR, Snape C, Quick W, Weatherstone S, et al. Changes in mechanical properties of wood pellets during artificial degradation in a laboratory environment. *Fuel Process Technol* 2016;148. doi:10.1016/j.fuproc.2016.03.020.
- [17] Wöhler M, Andersen JS, Becker G, Persson H, Reichert G, Schön C, et al. Investigation of real life operation of biomass room heating appliances - Results of a European survey. *Appl Energy* 2016;169:240–9. doi:10.1016/j.apenergy.2016.01.119.

- [18] Thomson H, Liddell C. The suitability of wood pellet heating for domestic households: A review of literature. *Renew Sustain Energy Rev* 2015;42. doi:10.1016/j.rser.2014.11.009.
- [19] Bradley MSA. Biomass fuel transport and handling. *Fuel Flex. Energy Gener. Solid, Liq. Gaseous Fuels*, Elsevier Ltd; 2016. doi:http://dx.doi.org/10.1016/B978-1-78242-378-2.00004-3.
- [20] Carbo MC, Abelha PMR, Cieplik MK, Mourao C, Kiel JHA. Fuel pre-processing, pre-treatment and storage for co-firing of biomass and coal. *Fuel Flex. Energy Gener. Solid, Liq. Gaseous Fuels*, Elsevier Ltd; 2016. doi:10.1016/B978-1-78242-378-2.00005-5.
- [21] United Nations Conference on Trade and Development (UNCTAD). *Development and improvement of ports - Development of bulk terminals*. 1985.
- [22] United Nations Conference on Trade and Development (UNCTAD). *Handbook on the management and operation of dry ports*. 1991.
- [23] Memos CD. *Port Planning. Port Eng. planning, Constr. maintenance, Secur.*, New Jersey: John Wiley & Sons; 2004.
- [24] Wu M-R, Schott DL, Lodewijks G. *Design of a large-scale biomass bulk terminal aided by a simulation model*. Bulk Solids Eur., Glasgow, Scotland: Vogel Business Media; 2010.
- [25] Wu M. *A Large-scale Biomass Bulk Terminal*. PhD Dissertation. Delft University of Technology, 2012. doi:doi:10.4233/uuid:cfb51421-504d-46df-8309-e10ac65dbbc3.
- [26] Ottjes JA, Lodewijks G, Schott DL. Bulk terminal modelling and simulation. *Int. Ind. Simul. Conf.*, Delft, The Netherlands: 2007.
- [27] Lodewijks G, Schott DL, Ottjes JA. *Modern Dry Bulk Terminal Design*. *Bulk Solids Handl* 2007:364–76.

Chapter 2. Biomass demand, supply and import scenarios to 2030¹

¹ Published as: Dafnomilis I, Hoefnagels R, Pratama YW, Schott DL, Lodewijks G, Junginger M. Review of solid and liquid biofuel demand and supply in Northwest Europe towards 2030 – A comparison of national and regional projections. *Renewable and Sustainable Energy Reviews*, 2017;78. doi:10.1016/j.rser.2017.04.108

2.1 Introduction

The introduction chapter briefly debated the importance of understanding the current and future state of solid biomass trade and imports in the Northwest European Union (EU) region. The goal of this chapter is to present a comprehensive, aggregate view into bioenergy supply, demand and trade in Northwest Europe to 2030, by quantifying biomass trade developments and formulating them into future scenarios. Initially, policies followed by the European Member States (MSs) that affect the use and trade of bioenergy are investigated and discussed. The contribution of biomass to all the energy sectors of the Northwest EU countries is presented in detail. Consequently, the significance of biomass imports in the region is also examined. Finally, a multitude of data sources are used to supplement previous existing model projections that assess bioenergy deployment in the EU.

2.1.1 Background

In a pathway towards sustainable energy supply with deep reductions in greenhouse gas (GHG) emissions and decreased dependency on fossil fuels, biomass used for energy purposes (bioenergy) is expected to play a substantial role by all Member States (MS). In 2013, bioenergy consumed in European Union (EU) amounted to 64% of the total renewable energy consumption; mainly in the heating sector, but with significant contributions to electricity production and transport fuels [1]. Although this share is expected to decrease by 2020, due to the development of other renewable sources such as wind and photovoltaics (PV), the actual amount of biomass for heating, electricity and transport is expected to rise by up to 1400 PJ (from 5360 PJ in 2013 to 6760 PJ in 2030) [2].

Mandates and support policies to increase the share of renewable energy to 20% in 2020 as agreed on by EU MS in the Renewable Energy Directive (RED) 2009/28/EC have been the main driver of the increased supply of renewable energy including bioenergy in the EU. Between 2000 and 2013, bioenergy supply more than doubled. According to EU MS, renewable energy production from biomass should increase by 33% in 2020 compared to 2013 as reported in the National Renewable Action plans (NREAPs) [3].

Under the 2030 climate & energy framework, the EU has agreed to achieve 40% reduction in GHG emissions (compared to 1990), 27% energy consumption from renewable sources, and at least 27% increase in energy efficiency by 2030. A major challenge for the 2030 horizon is how this 27% share will be distributed through the EU, considering there are still no binding national targets. MS action plans will need to be drawn up, allowing for different national capacities for RE production, while expanding upon the already achieved targets of 2020 [4].

The publication of the ILUC directive (Directive EU 2015/1513), amends the Fuel Quality Directive (2009/30/EC) and RED by imposing a cap on food based biofuels. Similar to the RED, at least 10% of energy consumption in transport should come from renewable energy sources, with a maximum of 7% biofuels made from food crops. The imposed cap on food based transport biofuels might further shift biomass demand towards non-food lignocellulosic sources.

With the growing demand for biomass in the last decade, international trade of liquid biofuels and solid biomass has grown substantially, particularly in the EU. Extra-EU imports of biodiesel were practically zero before 2005 but peaked in 2012 at 118 PJ (19% of transport biofuel consumption in the EU in 2012) and declined to 34 PJ in 2014.

The largest part of EU biomass supply is and will be based on domestic sources; currently, 4% of the total biomass used for energy purposes is imported. However by 2020, and especially by 2030, this amount could increase by a significant amount, taking into account potential supply

gaps, especially in the industrial sector (electricity production, closing down of coal power plants) [5]. Inequalities in forested area, waste biomass streams, differences in the amounts of supply and demand for bioenergy from one MS to another, open up opportunities for bioenergy trade. In the case of surplus of supply, countries may export bioenergy products to other countries, where bioenergy demand cannot be fulfilled from local resources (the Netherlands, Belgium).

Production costs of bioenergy feedstock (e.g. wood pellets) are also an important factor driving bioenergy trade. These costs can be lower if raw materials are pre-treated, in the form of wood pellets, torrefied wood pellets, intermediate or final form of biofuels in the case of liquid biomass. The higher costs for producing bioenergy feedstock within the EU (labor cost, supply of raw materials), make the option of importing bioenergy feedstock from countries where raw materials are abundant and production costs are lower, a more reasonable option [6]. This situation supports the growth of global bioenergy trade since availability of raw materials and low production cost are usually found in countries outside EU (United States, Canada, Brazil, and Indonesia) that can cater to several diverse end markets of biomass.

Especially in the US, which is by far the biggest exporter of wood pellets to the EU, independence of mills from the sawmill industry has allowed a focus on the export of pellets. Raw material is more readily available as a result of the lower demand from a declining paper and pulp industry and increasing forest productivity. Factors such as a large availability of feedstock at competitive prices, as well as sustainable forest management, straightforward logistics, and cheap transport has attracted investment in the southeast USA from pellet producers from all over the world. A large percentage of the additional capacity installed in the US since 2010 is aimed at producing industrial grade pellets for export to the EU [7][8][9][10].

Biomass use is expected to grow in specific sectors, such as co-firing in coal power plants in the short-term future, possible high quality industrial heat in the long-term future and residential heating. The resource for the two first aforementioned sectors is wood pellets, while residential is traditionally achieved through the use of wood logs. However, use of higher quality wood pellets for heating has been getting traction the last several years. Moreover, in light of the conservation or unavailability of domestic resources, imports of solid biomass may increase across the EU region [11][12][13].

2.1.2 Problem definition and objectives

Despite the importance of biomass in the renewable energy landscape in the medium to long term future (2020 to 2030), there is a great deal of uncertainty on how the development of bioenergy will be like. While scenarios show a growth in bioenergy if renewable energy and climate policy targets are pursued [2][12], subsequent policy progress and political conviction seem to be lacking in respect to bioenergy support.

Bioenergy development projections, while attempting to take policy progress into account, do not always directly reflect the effects of policy measures, as it can usually be difficult to predict behavior (including the behavior of markets). As an example, the latest National Energy Outlook of the Netherlands under the ‘existing policy’ scenario refers to specific measures that are as binding as possible, such as the European Emissions Trading System (ETS) and subsidies for renewable energy. The ‘intended policy’ scenario is based on existing policy plus published intended measures that, as of May 1st 2015, were not yet officially implemented but were specific enough to incorporate in the calculations [14]. Latest developments show that the utility companies in the country have submitted four applications for co-firing under the spring SDE+ auction [15].

The bioenergy situation in Northwest Europe is generally characterized by highly erratic short term developments, diverse sustainability criteria between MS, complex logistics and hesitation for long term investment in dedicated infrastructure. Current economic growth, demographic development and technology costs are not always in line with these projections [14]. There is a knowledge gap concerning biomass's future presence in the sectors of electricity, heating and transport, as well as the supply potentials of EU – which region will need to import biomass, to what amounts and what will be the source region.

This chapter's objective is to quantify the uncertainties of the future status of bioenergy supply in NW Europe. An effort is made to provide, in as much detail as possible, developments in the bioenergy field on a regional level initially and on a MS level additionally. The main path to achieve that is to accurately supplement previous regional (EU level) model projections related to the bioenergy future with up-to-date national (MS level) plans for the short to long term energy sector evolution.

All of the above mentioned uncertainties are formulated into 'bandwidths' of expectations, relating to indicators such as final and primary energy demand and, more importantly, future supply, as imports of feedstock will heavily influence sector growth and international trade of biofuels, especially in the MS that have small potential of domestic supply. The results of this chapter can be used to visualize the needs for future infrastructure development, as well as logistics and policy support in the bioenergy sector.

In order to achieve this objective the following steps need to be undertaken:

- 1) Review of current status of bioenergy by end use sector
- 2) Review of national and regional projections of renewable energy deployment
- 3) Industry, market announcements, expert interviews, existing and future policies and sustainability criteria relevant to bioenergy in NW Europe, stakeholder participation in workshops
- 4) Comparison of projections of solid and liquid biomass demand and supply in Northwest Europe
- 5) Quantification of future bandwidths of biomass imports

2.1.3 Scope of work

The focus is largely set on lignocellulosic biomass, as heat and electricity needs consist by far the biggest percentage of biomass use. According to Sikkema and Fiorese [16], EU has become the largest importer of woody biomass for energy purposes in the form of wood pellets. Import of woody biomass, especially for electricity generation, will likely continue beyond 2020. In 2035, the author remarks that the import of biomass may reach up to 16 Mt of wood pellets (from 6 Mt in 2015), in order to fulfill the demand in the electricity sector alone.

Liquid biofuel prospects are also explored, as the use of second generation (advanced) biofuels is expected to grow beyond 2020 in order to prevent conflict between energy supply and food security issues [17].

Production of biochemicals, plastics and novel biomaterials through biomass were excluded from this research. According to expert opinions and industry representatives as well as macro-economic outlooks of sustainable energy and biorenewable innovations the use of biomass for energy purposes (heat, electricity and transport fuels) is still expected to be dominant over biobased materials up to 2030. Moreover, in case the market for bio based materials arises, production is more likely to take place outside the EU, close to the feedstock source regions [18].

Five MS from the NW EU region are looked at into detail, based on the biomass status in each respective country. The UK, the Netherlands, Denmark, Belgium and Germany (along with Sweden and Italy) are the largest consumers of solid biomass for energy purposes. The importance of solid, liquid or gaseous biofuels varies between countries, mainly due to typical concepts and capacities of production and utilization plants, and support schemes [6]. The Netherlands, Belgium and Denmark are characterized by limited forested areas and land that is better used for other purposes. Germany, while a net exporter of solid and liquid biomass, imports feedstock for the production of biofuels from across the globe, mainly Argentina and Indonesia [19]. The UK is by far the largest importer of solid biomass in the form of wood pellets in the EU, reaching up to 7.3Mt in 2015 [15]. At the same time, all five MS have highly ambitious targets for the future, especially considering industrial uses of biomass, which may play the most significant role for these technologies in low-carbon energy systems [12][20][21]. With the available internal production peaking in most EU countries, it follows that these states will also be among the biggest biomass importing EU members by 2030 and will play a major role in intra- and extra-EU biomass trade [22].

2.2 Current status of bioenergy

The current role of solid and liquid biofuels in NW Europe is investigated through data collection from statistical offices, government organizations and literature review. As a starting point, Eurostat statistical data is used, complemented with statistical data from national organizations such as Statistics Netherlands (CBS), Department of Energy and Climate Change (DECC) etc. However, a detailed breakdown in type of feedstock or source of the biomass is not available from these data sources. The main reason is that biomass uses (e.g. wood chips, wood pellets, vegetable oil, and agriculture residues) are complexly intertwined with non-energy sectors and that stocks of renewable products for non-energy purposes are not part of energy balances. Furthermore, lack of detailed resource monitoring, unregistered uses (e.g. household consumption) and cascaded uses, i.e. process of biomass into a final product which is used at least one more time for materials or energy [23],[24], make it difficult to monitor and analyse biomass use for energy. In particular direct and indirect trade of biomass used for energy purposes is weakly covered in statistics for similar reasons [25]. In addition, significant differences have been observed while comparing import and export quantities in the same or different statistical data sources [26].

A major source of information, was the IEA Bioenergy Task 40 national reports. Task 40 is an international working group under the IEA Bioenergy Implementing Agreement, aiming to support the development of a sustainable, international, bioenergy market by providing high quality information and analyses, as well as overviews of bioenergy developments. Data from government agencies and organizations were used as well to complement information not currently present in the Task 40 national reports.

In order to get a more detailed overview on a national level it is necessary to supplement the official statistics from Eurostat and the other available national data with anecdotal information and reports.

2.2.1 Projections to 2030

The publication of the national renewable action plans in 2011 and progress reports that are published biannually provide quantified insight in how EU MS expect to meet the 2020 national binding renewable energy targets as agreed on in the RED. Regarding the 2030 goals mentioned in section 2.1.1, while the EC has published several reports, they focus more on establishing a policy framework for the renewable energy progress rather than quantifying specific targets.

Industry and market announcements concerning future demand and imports of biomass were also taken into account. Presentations in conferences, workshops and personal interviews with representatives from the energy sectors assure that both empirical and research data are incorporated to ensure a more thorough outcome on bioenergy development.

Results of studies that take a national perspective on renewable energy deployment are compared to scenarios of renewable energy deployment at the EU level. To this purpose, projections of RES deployment of the DiaCore project are considered [12].

2.2.2 Projections of renewable energy deployment at the European level

The review of national data is compared and combined with results from the Intelligent Energy project DiaCore which aims to facilitate and coordinate an efficient and sustainable deployment of renewable energy, including biomass, to 2020 and 2030. The DiaCore results were developed using the energy system model Green-X². Green-X is a partial equilibrium model of the European energy sector developed by the Energy Economics Group of Vienna University of Technology and has been widely used within the European Commission for facilitating renewable energy strategies.

Two main scenarios of policy support from the DiaCore study were selected:

- The Baseline (BAU) scenario assumes a continuation of current support policies for renewable energy to 2020. Beyond 2020, a carbon price will remain, but support for renewable energy is assumed to be phased out.
- The QUO-27 scenario assumes that the target of at least 20% renewable energy share in gross final energy consumption and 10% in transport by 2020. Furthermore, at least 27% renewable energy is assumed to be achieved by 2030 without country specific targets. National policies to meet 2020 targets are assumed to be replaced with more integrated policies with EU-wide quotas (QUO) to meet the renewable energy target of 27% by 2030. The efficiency target (27% increase in energy efficiency compared to 2007) and GHG target (40% reduction compared with 1990) are not taken into account.

A more detailed description of these scenarios is provided in Resch et al. [27][28]. A detailed assessment of bioenergy in these scenarios is provided in Hoefnagels et al. [12].

2.2.3 Policy review and sustainability criteria

Policies related to renewable energy generation in each respective country were also reviewed. The objective was to investigate to which level governmental policy support is substantial when considering energy production from biomass, and to what extent these policies affect (or may affect in the future) bioenergy development.

Policies in all three sectors were reviewed (Table 2.2). Policies in the heat and electricity sector focus mainly in feed-in tariffs, tax exemptions and investment support across all countries. The transport sector is mainly governed by a blending quota obligation. However, according to personal interviews and discussions of the author with stakeholders in the industry, it is the lack of long-term stability and guarantee of support that creates such uncertainty in the biomass market, as well as hesitation for long-term investments of any kind. The results are presented in section 2.3.2.

² A detailed description of the Green-X model is available online: www.green-x.at

2.2.4 Input from stakeholders

Discussions were held with experienced and active stakeholders in the (bio)energy industry in the Netherlands, via interviews and focus group discussions. The purpose of these activities was to obtain information from an industrial perspective and to gain insight in possible situations regarding the bioenergy deployment beyond 2020. The Copernicus Institute of Sustainable Development from Utrecht University organized a workshop that aimed to identify, qualify, and quantify the demand for energy, traditional and new material purposes to 2030. Representatives from the power, transport fuels, chemicals and domestic and international imports (US) forestry sectors presented their views on the bio based economy and gave their respective opinions in the shaping of these scenarios.

The author also had personal contact with experts from the other MS under examination in this chapter: professors from universities focused on bioenergy research, government officials from respective Ministries of Energy and/or Environment and researchers from institutes or organizations dealing with biomass development. A list of the interviewees can be found in Appendix B – Personal communication.

2.3 Bioenergy in Northwest Europe – state of play and respective policies

The current share of renewable energy sources to the final energy consumption of each country is shown in Figure 2.1. By examining the respective stipulated targets for 2020, it can be seen that Germany and Denmark are well on their way to meet their renewable targets while Belgium, the UK and the Netherlands are lagging behind.

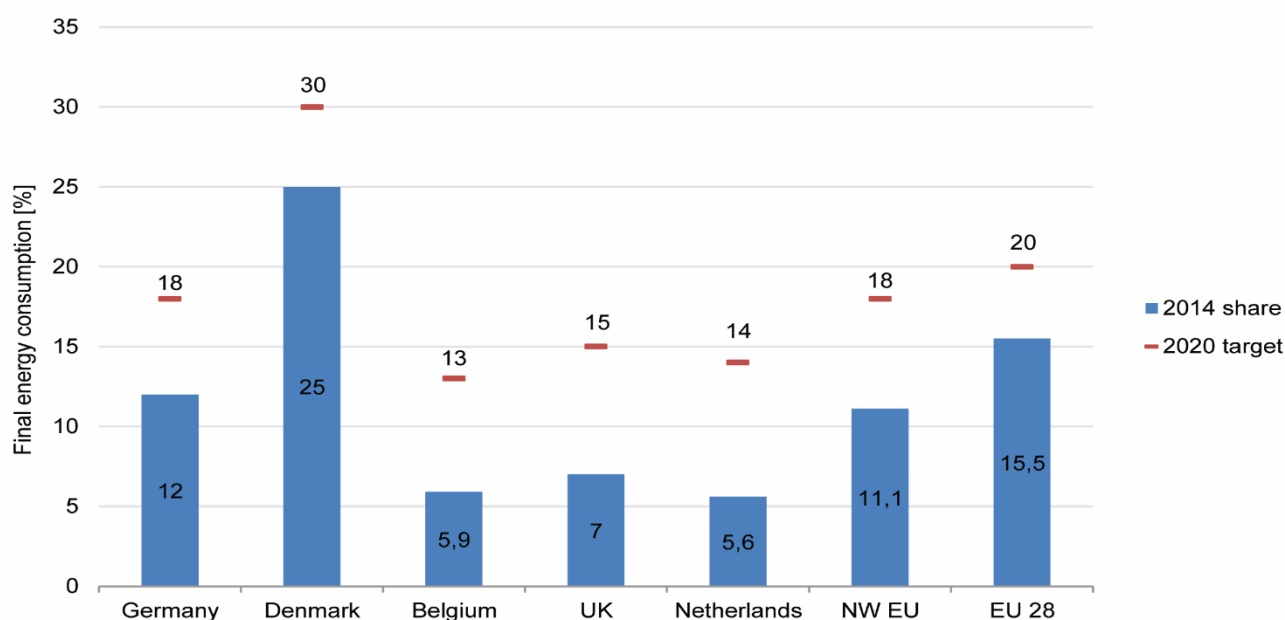

Figure 2.1: Current share of RES in final energy consumption vs 2020 targets [1][19][29]

2.3.1 Bioenergy breakdown per country and sector

A more detailed, per sector view of the renewable energy state of play takes place in this section. In Table 2.1, the share of renewable energy sources in the sectors of electricity, heat

and transport is presented. In the electricity and heat sectors, variations are significant between countries. The share of biomass in the renewable electricity production varies from 20% in the UK to 50% in the Netherlands. Biomass is by far the greatest contributor in the renewable heat sector with more than 75% share in the whole region. In the transport sector, percentages of biofuel hover around the 5% mark (in total final consumption) for all investigated countries.

Table 2.1: Final energy consumption, overall RES and biomass in 2014 [1][19][29]

	Biomass-electricity		Biomass-heat		Biomass-transport		Biomass/Total final energy	Biomass/RES
	% RE-e	PJ	% RE-h	PJ	% RE-t	PJ	%	%
Germany	31	169	87.4	425	88.6	112	7.8	61
Denmark	27	12.5	98	43.5	100*	10	8.7	65.6
Belgium	35	10.5	77	20.5	100*	9	2.7	61
UK	20	47	94	107	100*	52	3.4	51.3
Netherlands	50	18.5	86	46.5	100*	15	4.6	75.4
NW EU	32.6	258	88.5	642.5	97.7	198	5.5	62.9
EU28	17.7	565	89	3282	100*	548	9.5	61.3

*Not including renewable electricity in transport

The distinct bioenergy sectors in the individual countries are presented in detail in the following section.

Germany: Electricity from biomass (all types of feedstock) accounts for 31% of the total renewable electricity generation in the country [30]. The national Task 40 report states that 'the majority of bio-electricity comes from biogas plants, mostly small-scale installations on farms, larger plants for bio-waste digestion and in larger landfill and sewage gas plants. The main biomass resources used are animal manure and renewable raw materials as maize silage'. Solid bioenergy is the second main biomass source for electricity generation in Germany through more than 640 CHP plants. Bioenergy provides the largest renewable heat contribution, as is the case in all MS under examination (Table 2.1). The largest share comes from solid biomass, followed by heat from biogas (mainly through cogeneration) [30]. Solid biomass for domestic heating is wood-based and predominantly applied in small- to medium-scale systems in private households. Major fuels for the decentralized heat supply in buildings are primarily wood logs, followed by a small share of pellets, chips and briquettes [31]. The current share of biofuels is 5.5% based on energy content, with the major contributors being biodiesel and bioethanol [30].

Denmark: The consumption of biomass has increased significantly the last years and in 2014 it contributed to 15% of the electricity generation from RE in Denmark. A total of 39 CHP plants used biomass as fuel in 2014 corresponding to a total consumption of approx. 2.7 Mt biomass [32].

Biomass is used in stand-alone heating applications as well. The use of biomass in the industry sector was mainly for heating purpose in farms and minor industries, while wood pellets are used in private and district heating boilers [30],[33]. Concerning biofuels, at present, there is small scale production of biodiesel from animal waste and an ethanol pilot plant. Other than that, the entirety of the biofuels needs is imported, consisting of biodiesel and bioethanol [32].

Belgium (Flanders): The share of solid biomass in the total net green power production in 2013 was 35% [34][35]. Gross green power production from biogas had a share of 9.6% in the total Flemish gross renewable power production in 2013 as well.

77% of the total green heat production in 2013 is produced by installations using solid biomass. The main heat production is from wood combustion systems (stoves, open fires) in households (73% of the total heat production by solid biomass). Industry is contributing at a 12.6% share. Only a few installations are using other biomass streams for heat production (sludge, olive pits/pulp and coffee waste) [34][35]. All liquid biofuels consumed in the transport sector in 2013 consist of biodiesel (81%) and bio-gasoline (19%) [34][35].

UK: In 2014, electricity generation from bioenergy reached 20% of the total renewable electricity generation. Bioenergy in the above context consisted of landfill and sewage gas, energy from waste, plant and animal biomass, anaerobic digestion and co-firing with fossil fuel. The majority of the bioenergy generation came from plant biomass, which includes enhanced co-firing (>85% biomass) [36].

Renewable sources accounted for 4.9% of total heat consumption during 2014. The main form of renewable heat production in the UK is direct combustion of various forms of biomass (94% of the total). Domestic wood is the main contributor to renewable heat production – around 57% of the total renewable heat. Nondomestic use of wood and wood waste, and plant biomass are the following largest contributors, around 17% and 14% respectively [37]. In 2014 biodiesel represented 60.2% of biofuel consumption and bioethanol the remaining 39.8% for a cumulative of 3.9% of total road fuel consumption [36].

The Netherlands: Data for 2014 show a slight decline in production, mainly stemming from the previous subsidy scheme coming to an end causing the power plants to fall back on co-firing. However, latest RES applications under the 2016 spring SDE+ auction reached more than double the €4bn budget – with 4 co-firing applications, and another auction following in autumn 2016 [15].

Biomass had a much greater participation in the production of renewable heat than electricity, with 86% of the total renewable heat production. Municipal waste (24%) and industrial biomass boilers (15%) were the leading sources, while a big percentage of biomass heat came from small residential or farm installations [38]. Consumption of biofuels consisted solely of biogasoline (35%) and biodiesel (65%) [38].

2.3.2 Renewable energy policies and biomass sustainability criteria

A summary of policies supporting bioenergy (and RE in general) production can be found in Table 2.2 below.

Table 2.2: Renewable energy policy overview per MS [39]

	Germany	Denmark	Belgium	UK	Netherlands
Electricity	<p>Renewable Energy Sources Act (EEG): feed-in tariffs for renewable electricity</p> <p>Market Premium: Premium tariff I</p> <p>Investment loans for private individuals and domestic and foreign companies</p>	<p>Feed-in premium tariffs for renewable power; support for bioelectricity production is given for lifetime</p> <p>No energy or CO₂-tax on biomass</p>	<p>Quota system: Green power certificates</p> <p>Investment support</p>	<p>Renewables Obligation (RO): quota system, obligation on electricity suppliers for renewable supply</p> <p>Contracts for Difference (CfD): contract between the generator and government - increases investor certainty</p> <p>Tax exemption mechanisms</p>	<p>Tax regulation mechanisms I (reduction of environmental protection tax)</p> <p>SDE+ scheme: a feed-in premium, depending on the technology, the amount of energy produced and phase of application</p>
Heat	<p>New buildings:</p> <p>Renewable Heat Act - requirement for owners to get a certain share of their heat from renewable energy</p> <p>Existing buildings:</p> <p>Market Incentive Program (MAP) - investment grants and low-interest loans and repayment subsidies</p>	<p>Tax exemption on heat production under certain conditions</p> <p>Grants for research / development in bioenergy</p>	<p>Quota system: CHP certificates</p> <p>Investment subsidies for industry and households</p>	<p>Renewable Heat Incentive (RHI): tariffs for use of renewable heat in buildings</p> <p>Green Deal: investment loans, incentive scheme for energy-efficiency improvements in buildings</p>	<p>SDE+: feed-in premium, supports installations for the production of renewable heat via biomass</p> <p>Tax regulation mechanisms: enables entrepreneurs based in the Netherlands to write off investments in renewable energy plants against tax</p>
Transport	<p>Biofuel quota-> GHG emissions reduction quota: imported or produced fuels need to include a defined percentage of biofuels. From 2015, a greenhouse gas reduction quota is introduced.</p> <p>Tax regulation mechanism (reduced tax rate for biofuels)</p>	<p>Blending obligation of 5.75% biofuels for transportation fuels (on energy content)</p> <p>CO₂ and energy tax exemption</p>	<p>Quota obligation</p> <p>Tax regulation mechanisms</p>	<p>Renewable Transport Fuel Obligation (RTFO): biofuel quota, legal requirement on transport fuel suppliers to ensure that 4.75% v/v of their overall sales are from a renewable source</p>	<p>Biofuel quota: imported or produced fuels need to include a defined percentage of biofuels</p> <p>Tax regulation mechanism II (MIA/VAMIL scheme): opportunity for private companies to deduct an extra amount of the investment cost from the taxable profit</p>

Schemes for RES are a key mechanism to help achieve the renewables goal, but also attract high levels of interest in relation to the differences between EU MS and the overall costs to consumers. Their objective is to promote and support large scale take-up and deployment of renewable energy generation and energy efficiency amongst consumers. The above policies and support schemes are the major drivers for bioenergy development in Northwest Europe.

The policies presented in Table 2.2 are in support of renewable development in general. However, as the European Biomass Association (AEBIOM) states, 'sufficient financial incentives cannot guarantee the success of a support scheme. They must be combined with attractive framework requirements, for instance regarding spatial planning, grid connection, and other barriers in order to unfold their full potential' [39]. In reality, policies specifically relating to bioenergy may be less or more favorable, depending on the specific MS. Moreover, these policies are often driven by oil prices. When oil prices increase, more policies are enacted to support the use of renewable energy. When oil prices drop, these projects are put on hold. Therefore, higher fossil fuel prices reduce the cost of renewable energy policies and consumer energy bills [40].

Regarding electricity production from biomass, both the costs and the support level may vary significantly for the different types of biomass resources. However, there are considerable differences in generation costs, partly due to the fact that the support systems of countries with comparatively low minimum generation costs allow the application of cost-efficient co-firing. Moreover, it should be added that the generation costs in the biomass sector are heavily dependent on plant size.

Currently, less than half of the MS deployed more biomass electricity than what they planned and this situation is not changing in the medium term. At EU level a considerable underperformance is expected by the year 2020 compared to the NREAP targets. The deployment is slowed down especially by non-cost barriers, which are not immediately solved in the short term [39]. Van Stralen et al. [20] researched the importance of biomass in the EU's 2020 energy mix for electricity, heat, and transport and concluded that the NREAP targets are ambitious and questioned whether they can be reached, especially under strict sustainability criteria. However, later research by Lamers et al. [41] indicates that 'while stricter criteria will increase the overall supply (and thus policy) costs, the EU will still be able to supply sufficient solid biomass to meet its targets in the electricity and heating sector plus second generation transport fuel. The key question will be how cost-effective the 2020 targets can be achieved and how policy makers will incentivize the mobilization of biomass'.

In Germany, for example, the newly reduced feed-in tariffs and the "cap" on eligible new capacity led to a massive decrease in new plants in 2014 – the German Biogas Association calculates that less than 50 MW_{el} of newly-built plants came online, and has a pessimistic view on future electricity produced from biomass. The German Bioenergy Association expects that 'no new plants for solid biomass will be built. Overall, it is expected that some of the existing companies will go bankrupt in the near future due to lack of markets' [30]. In the Netherlands, support is provided through the SDE+ scheme until 2023, and there is an established cap on promoting the use of biomass by coal-fired power stations that will not exceed the level of 25 PJ [42], linked to the shut-down of five coal-based power plants built in the 1980s. The further scope for expanding the share of (liquid and solid) biofuels will however depend on the final outcome of the EU agreement on sustainability criteria for biomass [43]. Up until April 2017, the cap on co-firing was assumed to remain in place beyond 2023 as well. In Belgium, the generous green certificates systems, together with a drop in deployment costs in other renewable sources, led to overcompensation, excess demand for installations and increased

distribution tariffs for electricity. Consequently, the support levels were reduced several times at regional and federal levels between 2012-14 [44].

In contrast, in Denmark, while the level of support has changed many times, support for bioelectricity producers applies for the lifetime of the production unit, along with exemption from taxes. As a result, there is a high level of certainty about future support at the time of investment. [32][45].

The International Energy Agency states however, that, 'due to economic downturn in many countries, electricity demand has grown less in recent years than projected when the NREAPs were first developed. So while it currently appears that the European Union as a whole – and several countries in particular – may undershoot their NREAP trajectories in terms of TWh generated, in fact, the contribution as a share of electricity demand and final energy demand may still be on track' [21].

The biomass heating sector shows a comparatively smaller gap than the biomass electricity one. Centralized (district heating, large biomass plants) and decentralized (heat plants which use pellets, wood chips, or log wood as fuel and are not connected to a heat grid) heat production from biomass seems to have adequate or even higher than necessary support levels across the MS through tax exemptions and/or investment subsidies among other schemes. Based on the attractive compensation levels - both for centralized and decentralized biomass heating - the deployment of biomass heat at EU level is higher than expectations based on the NREAPs and is not expected to change in the medium term.

Until 2020, it can be expected that the targets will be achieved on an EU level, by a slight margin. Large members states though, like France and the UK are expected to fail in delivering the planned deployment which will have a major impact on overall target achievement at an EU level since significant gaps arising in few large MS can hardly be compensated by surpluses in comparatively small countries [39]. Fewer MS can maintain their progress achieved by 2014 and several MS are at risk of achieving their indicative 2020 targets for biomass heat production, also with new policies implemented in the coming years. Most noteworthy, the United Kingdom risks losing its frontrunner position and falling behind other MSs.

Policy regarding biofuel stimulation can be described as quite "effective", as there are strong drivers to deploy biofuels. As described in [39], mandates are not just a cost-neutral instrument for the government, but also an efficient driver for the advancement of biofuels usage. In case of a mandate, there can be a buy-out price, or there is no escape option (penalty).

However, a high buy out price it is not a guarantee that targets are met. Belgium and Germany have reasonable high buy out prices set, but did not manage to reach their 2012 target. Similar to other sectors and technologies, it can be expected that the situation will become worse until 2020. There are only few planned measures described in the MS' progress reports that may positively impact the deployment of biofuels in the transport sector. According to scenarios assessed, only five countries are expected to end up with a higher deployment of biofuels in 2020 than their planned one. Denmark is the only one of the MS examined in this chapter that is expected to do so. The strongest deficits can be expected for the United Kingdom and Germany – all facing projected deficits larger than or of about 40%. The Netherlands and Belgium are expected to have a deficit between 15-25%.

It is clear that although each MS has a clear ambition of tackling the 2020 targets, there is still progress to be made. Harmonization and optimization of policies and regulations help in this respect, and more gains can be made by using the joint projects of the RED, tools not yet used by most MS, but with longer term potential [46].

In addition to policy indecisiveness and lack of long term support, sustainability criteria also add to the layer of complexity and uncertainty that bioenergy development faces. For the largest importers of solid biomass for heat and power production in the EU (the UK, Belgium, Denmark and the Netherlands), sustainability of biomass supply is imperative. Therefore, each MS has developed its own governance frameworks such as legislation or voluntary agreements with the industry to safeguard sustainable production of solid biomass. This had led to varying sustainability requirements between these countries, which may potentially cause market barriers and impede international trade. European suppliers and generators of wood pellets and wood chips have been calling for a consistent, harmonized set of sustainability criteria at the EU level to avoid trade barriers [47][48]. Lack of EU level sustainability criteria for solid biomass leads to concerns about the overall benefits of the RES target in some countries [46].

According to Scarlat [49]: 'EU-wide harmonized sustainability criteria are necessary to provide reliable evidence to the general public on the sustainable use of biomass in order to increase public acceptance. Sustainability criteria should cover all types of biomass, with the same criteria for different uses of biomass (food, feed, bio-based products, bioenergy and biofuels) to avoid leakage, cover the entire supply chain and include various aspects such as GHG emissions or resource efficiency'. The Roundtable on Sustainable Biomaterials (RSB) made some significant steps in this direction and expanded its scope in 2013 to cover bioenergy and bio-based products [50].

2.4 Results – Future outlook in the region

In this section, future developments of bioenergy in the selected countries are examined. The final bioenergy consumption of each MS is presented, as reported by each respective country. The subsequent primary energy demand is calculated, based on the Energy Efficiency Indicators of the International Energy Agency (IEA) [51]. Feedstock sources, both domestic and imports are then determined, taking into account information of types of biomass needed per sector, domestic supply potential and future energy sector needs and import trends.

The results are then set side by side with existing model projections that have been performed on an EU level concerning biomass consumption, demand and supply, to obtain a comprehensive report of bioenergy development in the region [12].

The uncertainty of bioenergy development, especially after 2020 is showcased in the limited information available for each sector, spread among different types of reports from different organizations. Most notable effort on that front is the Task 40 reports undertaken by the IEA Bioenergy organization. In this chapter, a complete overview of the following periods of bioenergy deployment is given: (1) short-term bioenergy development aimed at policies and trends in order to comply with RED 2009/28/EC and FQD 2009/30/EC; and (2) long-term bioenergy development beyond 2020, more uncertain due to lack of clear (bioenergy) policies.

While each EU member has committed to achieving the RED and FQD targets, the path to that end varies significantly between them. The state of technology in each sector, pre-existing industrial installations, (un)availability of domestic biomass supply, sustainability criteria and political as well as economical aspirations are just several of the factors influencing the development of bioenergy.

2.4.1 Northwest Europe

Biomass consumption and demand

An overview of the bioenergy development in terms of final energy consumption for the whole Northwestern Europe can be seen in Figure 2.2.

While a sizeable increase from the current level of bioenergy production in 2013 can be observed by 2020, the national reports project a decline in production by 2030. The most important factor are respective governmental policies and the respective energy systems changes in the two biggest MS under examination, Germany and the UK. A detailed explanation is provided in each MS' respective section (2.4.2 for Germany, 2.4.5 for the UK).

The model outcomes do not exactly reflect these future expectations. Their results closely follow the national outlooks for the short-term horizon of 2020. As expected the BAU scenario is follows the national projections closer, since it assumes a continuation of current renewable policies. However, the results diverge when assessing the long-term future of bioenergy. The biomass development scenarios based on the national reports incorporated up-to-date renewable energy policies, recent energy sector development and outlooks from 2014 and 2015. They are developed by each MS individually, focusing on its energy sector and market and they naturally mimic the national policies and follow the political 'spirit' of each respective MS.

The DiaCore work operates on an EU level, analyzing the impact of the global biomass markets on the EU RES supply until 2030. DiaCore scenarios are partly based on projections of final energy demand, conventional (fossil) generation mix and related primary fossil energy demand and CO₂ emissions taken from the PRIMES Reference scenario (2012) [52]. Their main goal is 'splitting' available biomass streams (domestic supply or imports) among all EU MS in an effort to reach the 2020 and 2030 targets.

The different scope and the uncertainty of the field itself, lead to greater deviations in the scenarios for the 2030 horizon.

A similar overview can be given for the primary energy demand in Figure 2.3.

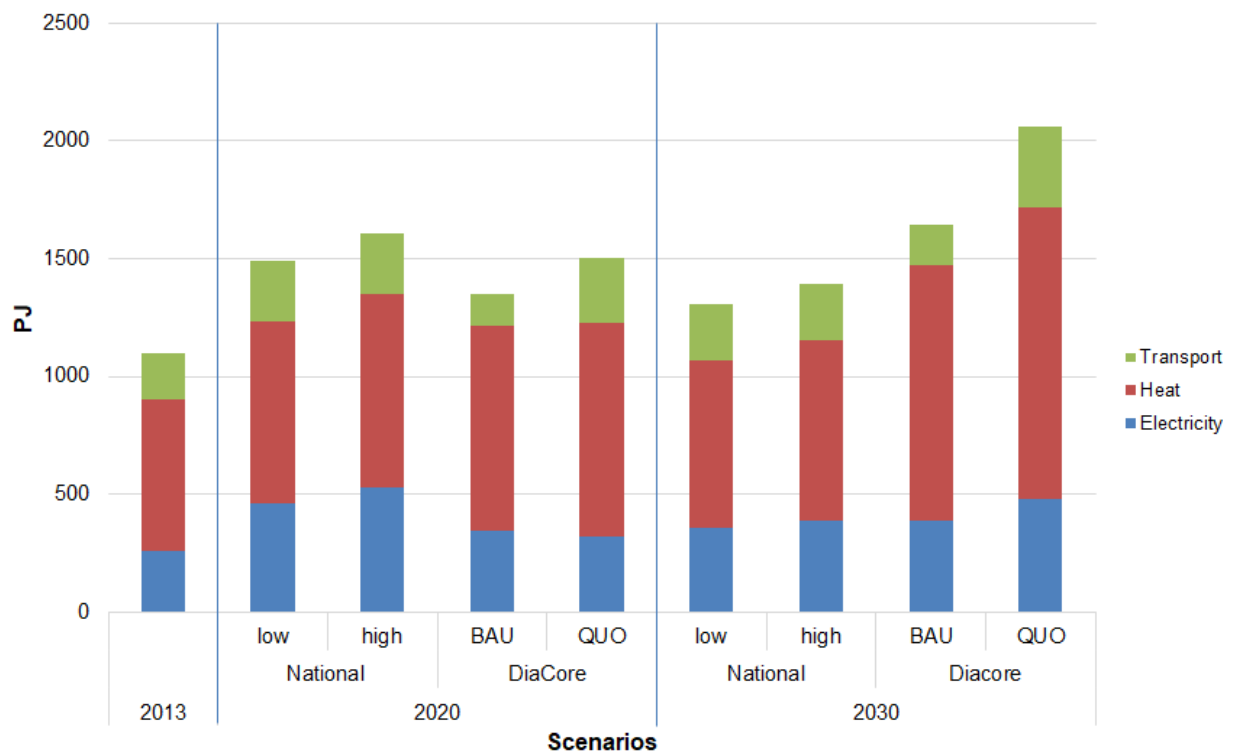

Figure 2.2: Northwest EU final biomass consumption by end use sector

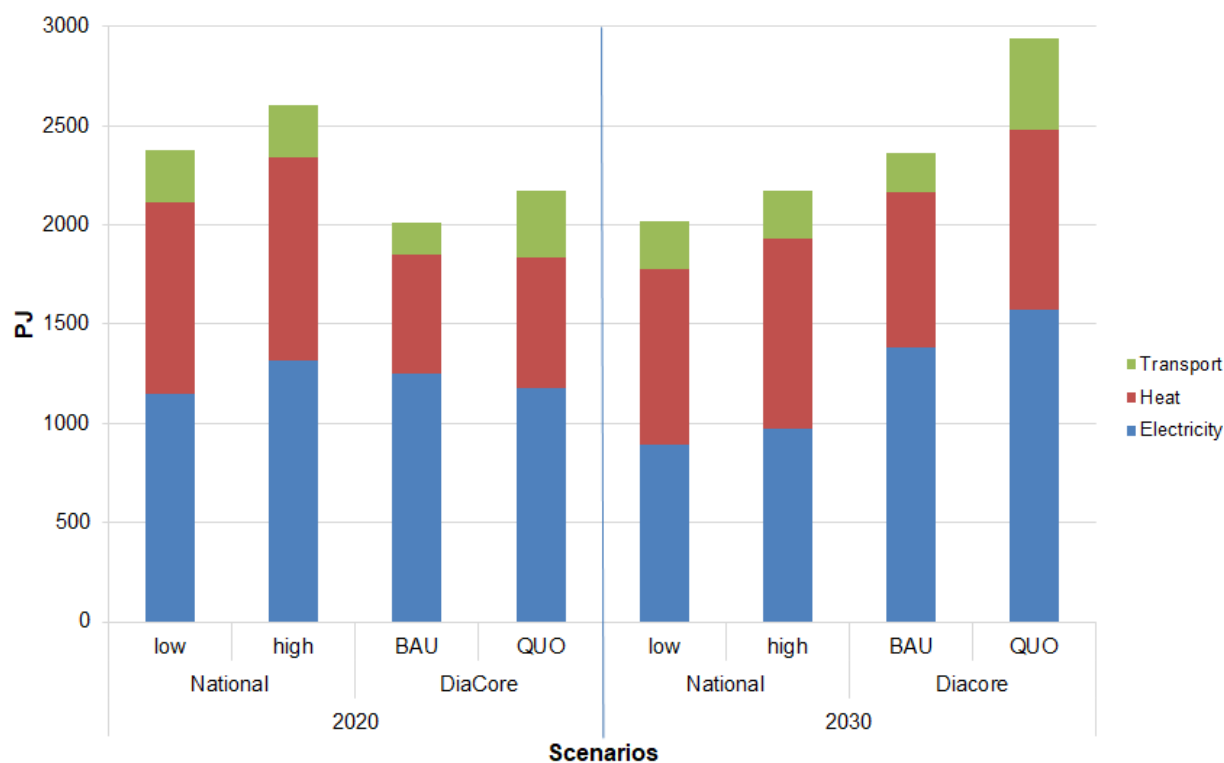

Figure 2.3: Northwest EU primary biomass demand by end use sector

2.4.2 Germany

Final consumption

Total final biomass consumption in all forms is projected to peak in 2020, but will decline significantly by 2030 according to the country's national report (Figure 2.4) [30]. Primary reason behind this drop in biomass consumption is the desire of the German government against further growth, but restructure towards more efficient use of residues and wastes, and less land-intensive production [30]. In contrast, the DiaCore energy model projects a sizeable increase in the use of biomass in all sectors.

Preliminary analysis of the current policy scheme (EEG 2.0) effects on new net electricity generation indicate that between 2020 and 2030 the overall capacity will shrink due to retirement rates of existing plants being higher than the rate of newly added capacity [52]. The cumulated installed bioelectricity capacity under the EEG 2.0 scenario would reach a maximum of 236 PJ (8.2 GW_{el}) by the end of 2015, and would then be reduced to 230 PJ (8 GW_{el}) by 2020, and to 144 PJ (5 GW_{el}) by 2030, i.e. it would reach the level of 2010.

In the heat sector, the development of lower oil (and natural gas) prices until 2020 implies that less biomass will be used unless more favourable incentives will be available. Nitsch [53] shows that instead of a 15% renewable heat share by 2020 (and 25% by 2030), the current policies would result in only 11% (2020) (11.5% in 2030) shares respectively. Bioenergy is expected to remain on the 2015 level until 2020, and then be reduced to a lower level than in 2010 [30].

The current share of biofuels is not expected to increase much until 2020. Uncertainties concerning both the future EU regulation on biofuels (“cap” on 1st generation biofuels, minimum quota for 2nd generation biofuels) and post-2020 energy and climate policy of the EU reinforce that projection. Moreover, German renewable transport policies currently favour electric cars running on renewable electricity over biofuels [19]. The transport sector will most probably be characterized by low fossil fuel prices and missing targets for advanced biofuels,

which, coupled with the uncertainty on post- 2020 regulations - may lead to a similar outcome as in the other sectors: overall levelling-off, and even net reductions by 2030 [30].

So far, all financial incentives offered by the government in Germany are for R&D activities. There are no definite policies or regulations addressing biorefineries or the bioeconomy. There is, however, a growing debate about incentives for bio-based materials, and “advanced” biomass conversion systems such as biorefineries [30].

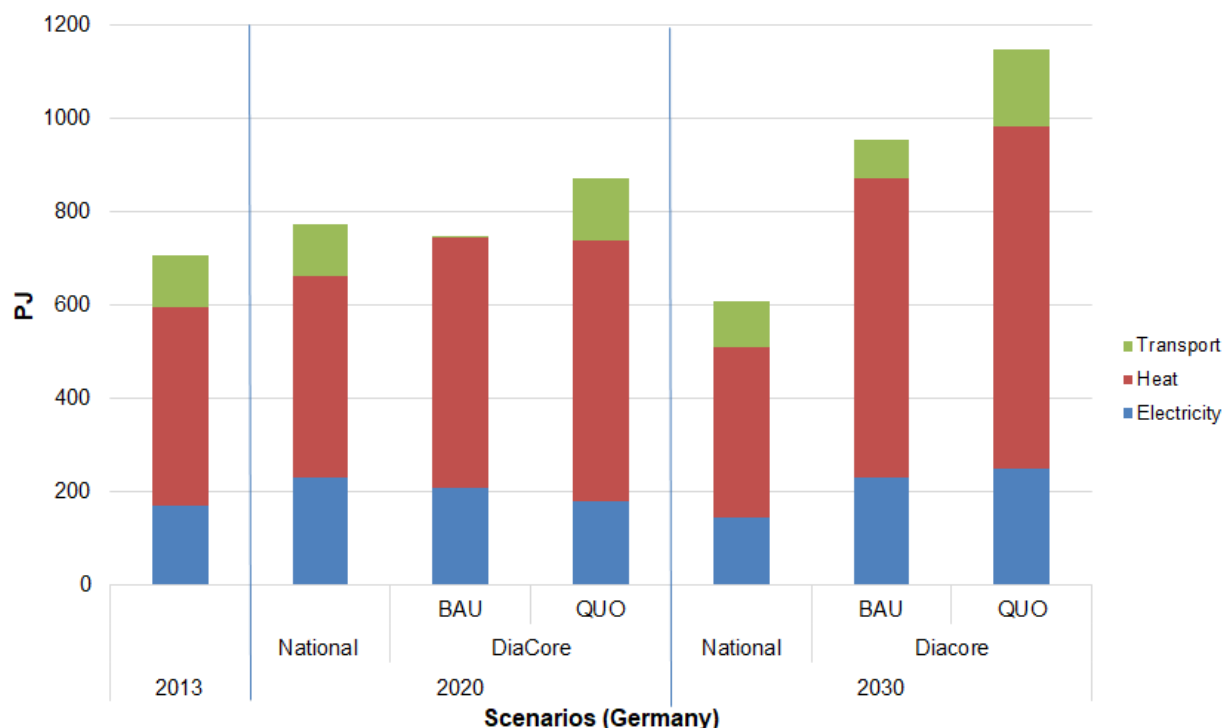

Figure 2.4: Final biomass consumption by end use sector (DE)

Primary demand and biomass supply

Primary demand and related biomass imports are shown in Figure 2.5. Primary biomass demand follows the consumption projections; however expected imports vary significantly between the energy models projections and the national outlook.

Germany has been increasingly relying on domestic supply for the majority of the electricity and heat production from biomass. A certain amount of wood pellets and waste wood is expected to be imported, but there will only be a small participation of solid biomass in the electricity sector and domestic supply in the heating sector. This further illustrates the desire of the German government to restructure towards more efficient use of residues and wastes and reduce the imports between 2020 and 2030.

Liquid biofuel imports are expected to remain constant.

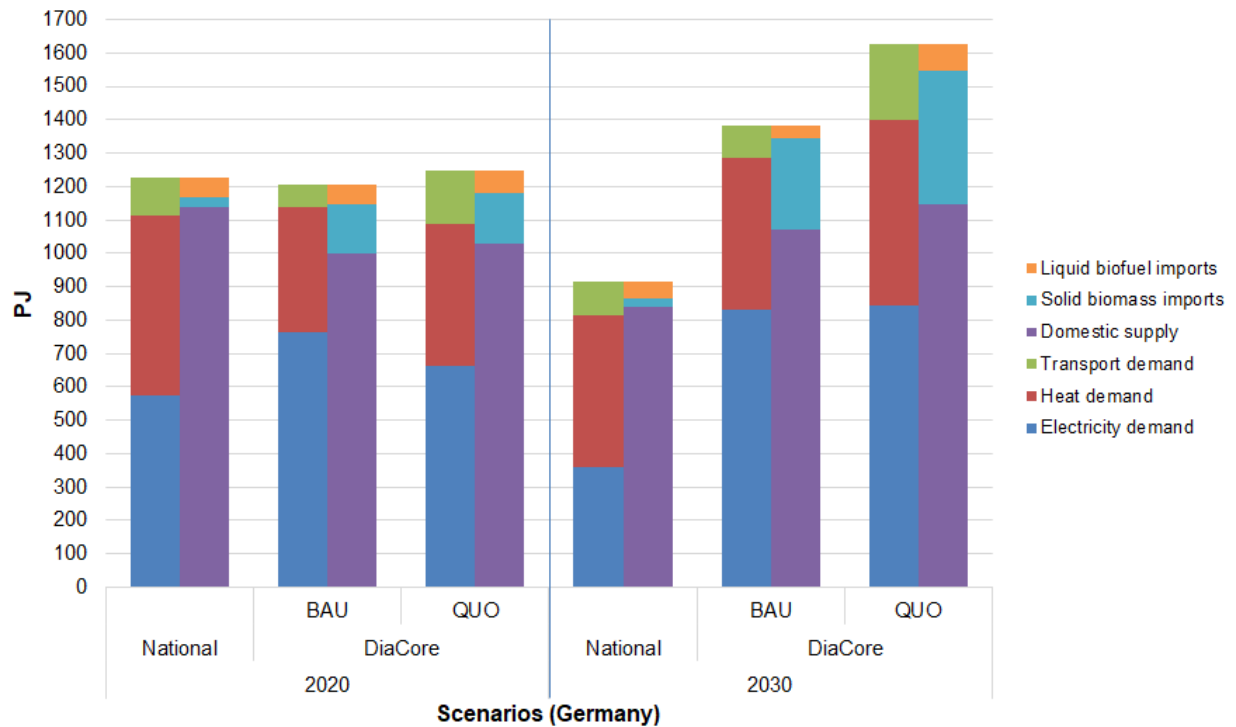

Figure 2.5: Primary biomass demand and supply (DE)

2.4.3 Denmark

Final consumption

The Danish Energy Agency (DEA) has defined different scenarios for 'a fossil free energy supply by 2050 and with fossil free production of heat and electricity by 2035'. The share of renewable energy in Denmark is expected to amount to approximately 35% by 2020, and thereby exceed the targeted obligation of 30%. More than half of this renewable energy will be produced from biomass. The use of all types of biomass is expected to steadily increase until 2030 comparatively to 2014 levels, supported by a no energy or CO₂ tax policy and financial support through feed-in tariffs (see section 2.3.2).

Key driver in this increase is the use of solid biomass in the electricity and district heating system, mainly through a growth in the use of woody biomass. Consumption of biomass increases in central power stations as well, which are, or will be converted to 100% biomass or a combination of coal and biomass. Overall it is estimated that the central power consumption of solid biomass for electricity production grows from about 23 PJ in 2012 to about 41 PJ in 2020 (Figure 2.6).

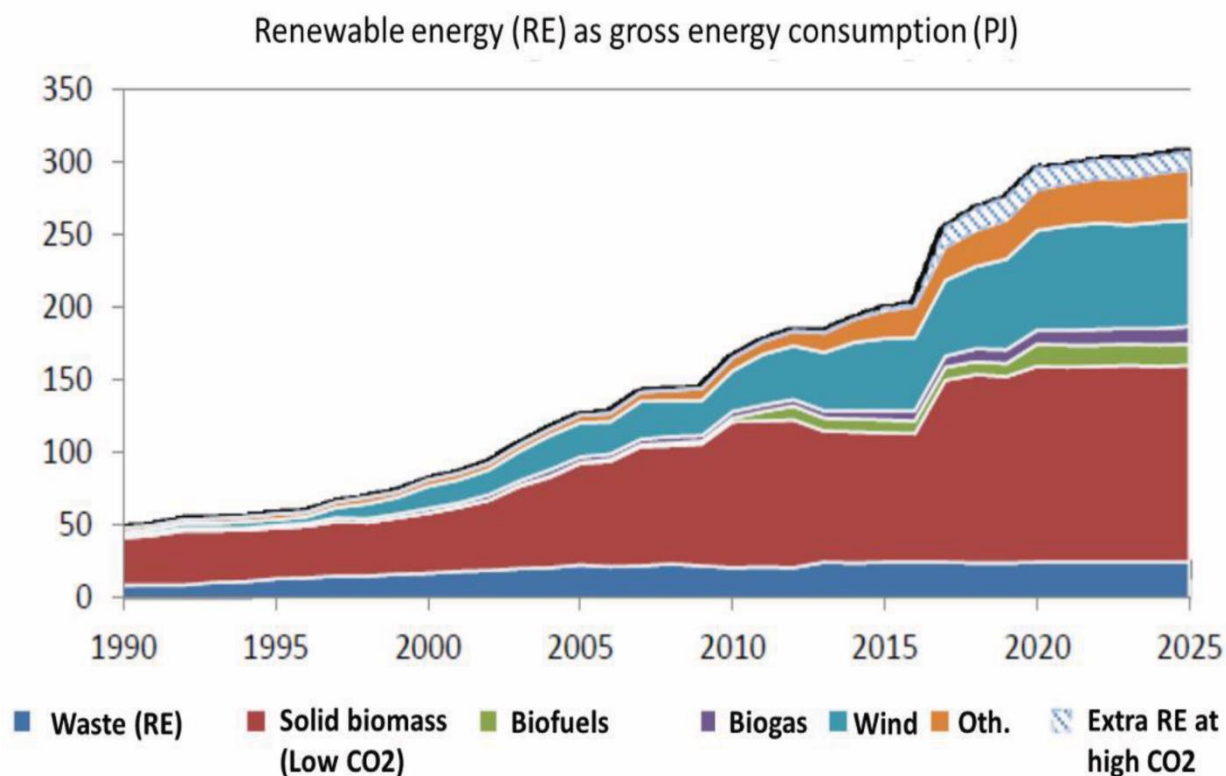

Figure 2.6: Renewable energy development (DK) [32]

As mentioned above, biomass consumption exhibits a significant increase in the district heating sector by 2020 as well. Households are estimated to have an almost unchanged consumption of wood in 2020 for heating purposes.

From a report by the Danish Centre for Environment and Energy (DCE), there are two scenarios for biofuel demand, in road transport, up to 2020 and 2030 [54]. Scenario 1, which follows the major European biofuels policy and scenario 2, which is aimed at more aggressive policy to achieve bioenergy deployment (Table 2.3).

Table 2.3: Future biofuel scenarios (DK) [54]

Demand [PJ]	Scenario 1		Scenario 2	
	2020	2030	2020	2030
Biodiesel	14.9	17.7	22.3	44.2
Ethanol 1 st generation	2.5	2	2.75	2.9
Ethanol 2 nd generation	3	3.8	5.6	11.7

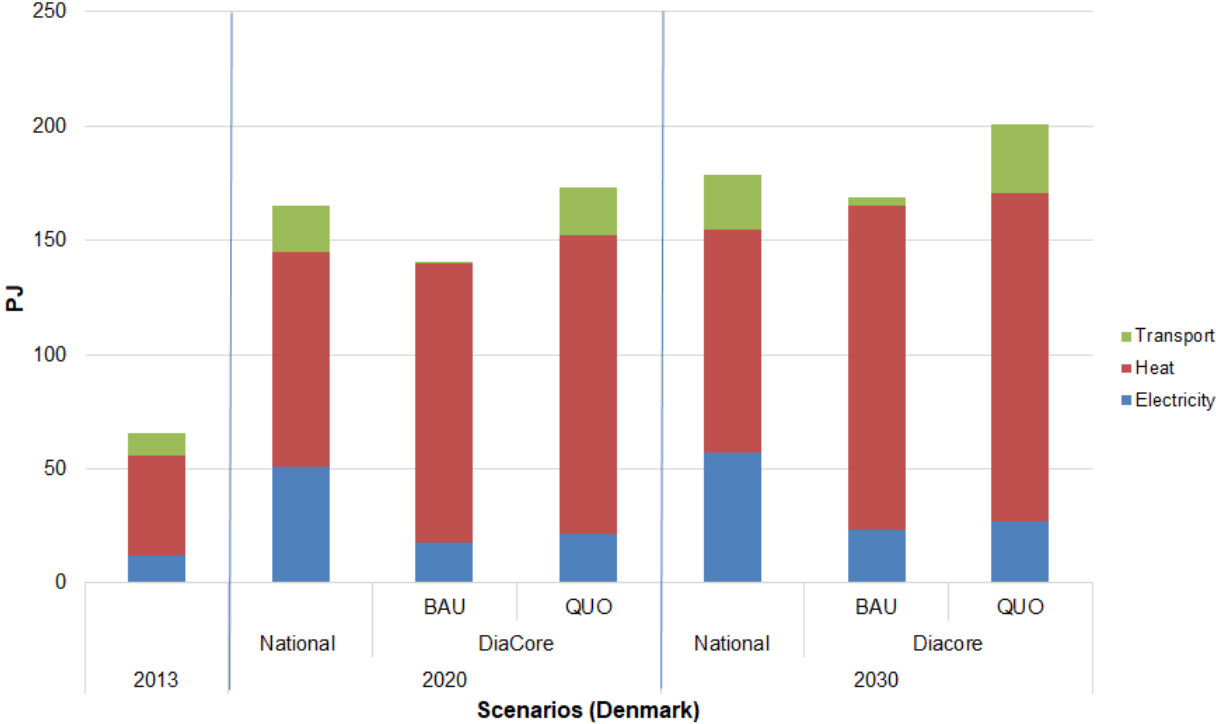

Figure 2.7: Final biomass consumption by end use sector (DK)

Primary demand and biomass supply

In Denmark, biomass is imported in considerable amounts, compared to the Danish production and consumption of biomass. In 2013, 34% of the biomass utilised for energy was imported in the country. Import of wood pellets are dominant, mainly for replacing coal in large scale CHP plants [32]. As mentioned in section 2.3.1, liquid biofuels are almost exclusively imported as well.

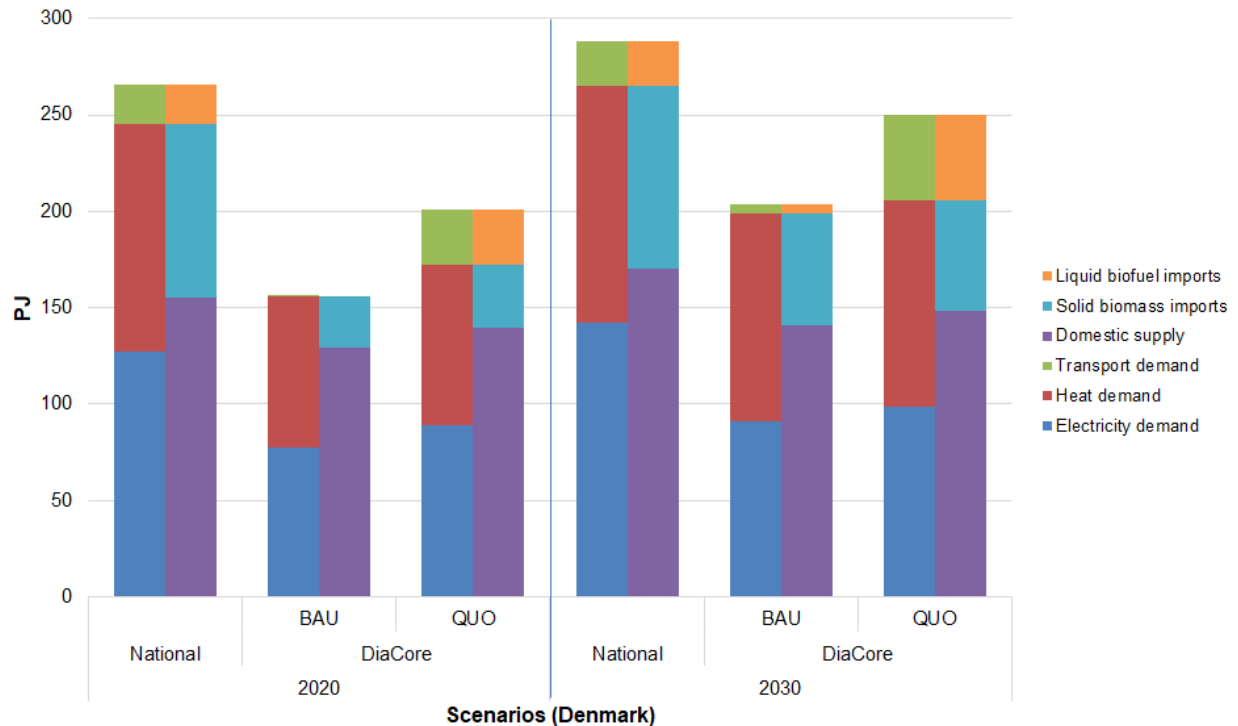

Figure 2.8: Primary biomass demand and supply (DK)

2.4.4 Belgium

Final consumption

Electricity production from biomass and waste in Belgium is expected to increase by 2030. The contribution of biomass increases in absolute terms, though its share in electricity production from renewable sources decreases, mainly due to an increase in wind power and PV contribution [55].

Conversion of biomass and waste to distributed heat in the industrial sector increases slightly from 7% to 10% in 2020 and remains the same up until 2030. Residential heating remains at the same levels throughout the time period to 2030, partly due to increased energy efficiency measures in the sector [56].

Biofuel consumption between 2010 and 2020 doubles (from 4% to 8% of total transport energy needs), exclusively due to bioethanol and biodiesel demand [56].

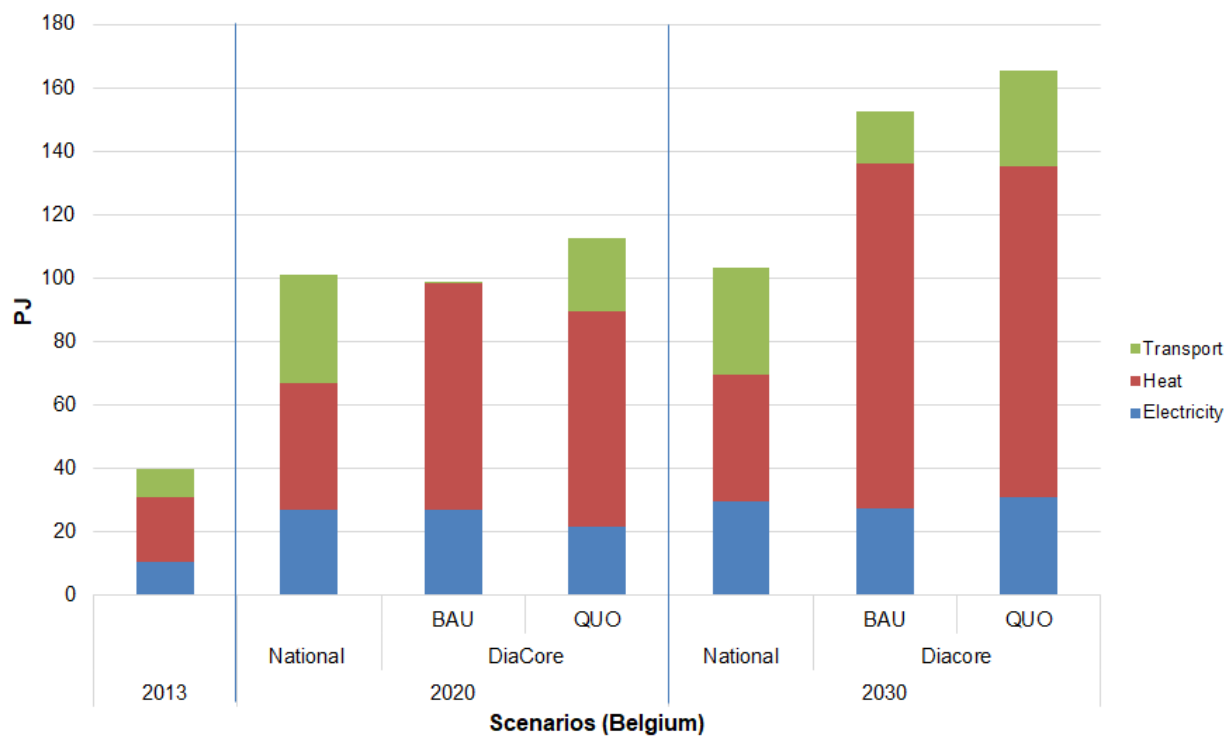

Figure 2.9: Final biomass consumption by end use sector (BE)

Primary demand and biomass supply

Belgium has limited domestic biomass potential; as such, biomass imports play a major role in reaching the national targets. Wood is the main imported biomass source from inside and outside the EU, while agricultural crops are also imported from the EU. The main biomass feedstock for energy that is traded are wood pellets.

31% of the biomass used in 2013 is estimated to have been imported: 19% outside Europe and 12% from other European countries [34]. Belgium will be importing almost a third of the country's solid biomass needs in the form of wood pellets (and to a lesser extent wood logs) in the future, mainly for use in electricity production; only 20% of the total Belgian pellet consumption was produced locally [34]. Liquid biofuels, as in the case of Denmark, are almost exclusively imported.

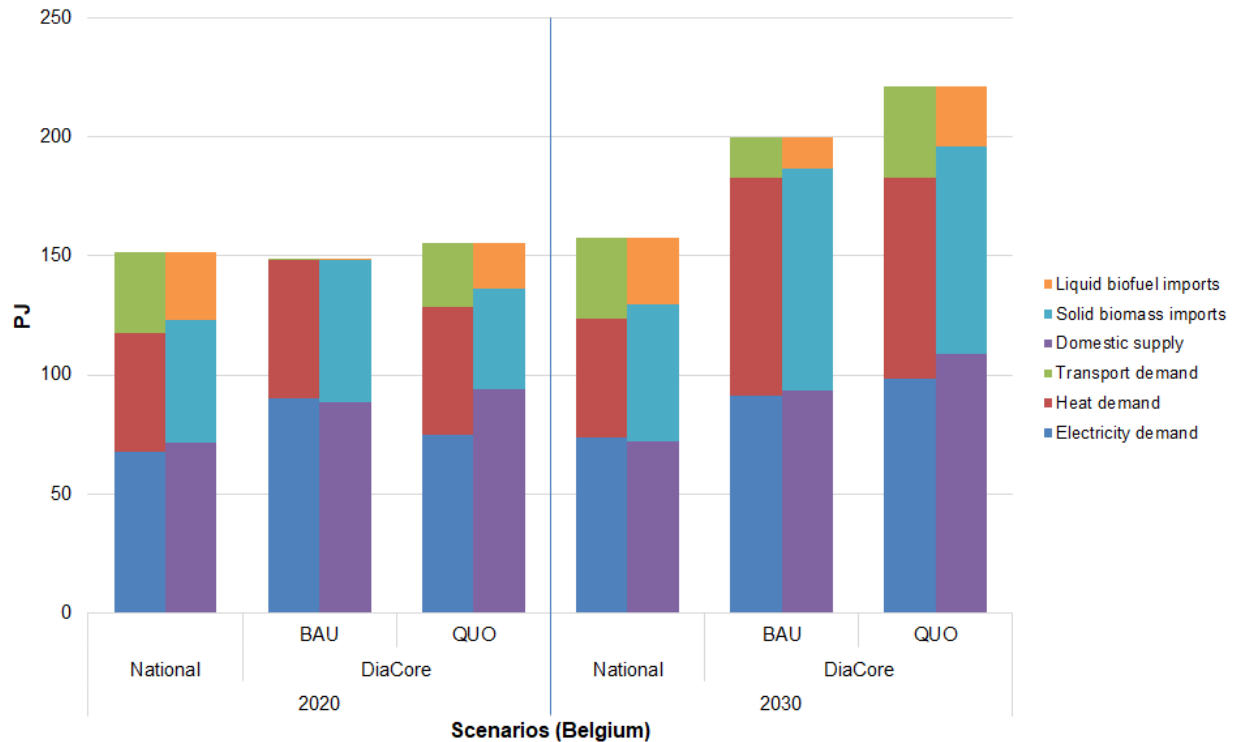

Figure 2.10: Primary biomass demand and supply (BE)

2.4.5 United Kingdom

Final consumption

The United Kingdom's Department of Energy and Climate Change (DECC) submitted 2 different scenarios for the bioenergy future in the UK, ranging between 350-466 PJ in 2020 and 288-327 PJ in 2030 [57]. The absolute amounts of bioenergy in all forms are reduced by 2030, due to the competitive development of other forms of renewable energy and alternative uses of biomass.

It is estimated that between 10 and 18 Mt/y of solid biomass will be required for electricity generation in the UK in 2020; this biomass will be used in power stations which have converted from being coal-fired to biomass-fired, as well as in new, dedicated biomass plants (including CHP plants) [57].

Bioelectricity slightly decreases in 2030, mainly due to landfill gas resource availability decline and the rising share of other forms of renewable electricity such as wind and tidal energy [58].

In earlier reports, the UK government's goal was to achieve 205 PJ of heat production from biomass by 2020 [59]. According to more recent publications, the projected delivered heat from biomass in the UK in 2020 ranges between 155-205 PJ, requiring approximately 4.3 to 8.3 Mt/y of solid biomass for heat by 2020 [57].

Key transitions to 2030 are the use of boilers, domestic or not, and industrial heat. Use of biomass in domestic boilers increases slightly, but the share of boilers in non-domestic buildings and in the process industry greatly decreases, due to more widespread use of heat pumps, the phasing out of boilers at the end of their life, and bioresource diversion to alternative uses. Use of biomass in heat production ranges between 100-137 PJ [58].

In a research commissioned by British Petroleum regarding the role of biofuels up to and beyond 2020, scenarios were developed to represent a range of possible biofuels futures.

According to the ‘middle’ scenario, demand for biofuels will be around 80 PJ in 2020 and will drop down to 66 PJ in 2030, as the overall gasoline consumption drops, a result of improvements in vehicle fuel efficiency [60]. More recent reports project a wider range (43-118 PJ) of biofuel demand for 2020 [57].

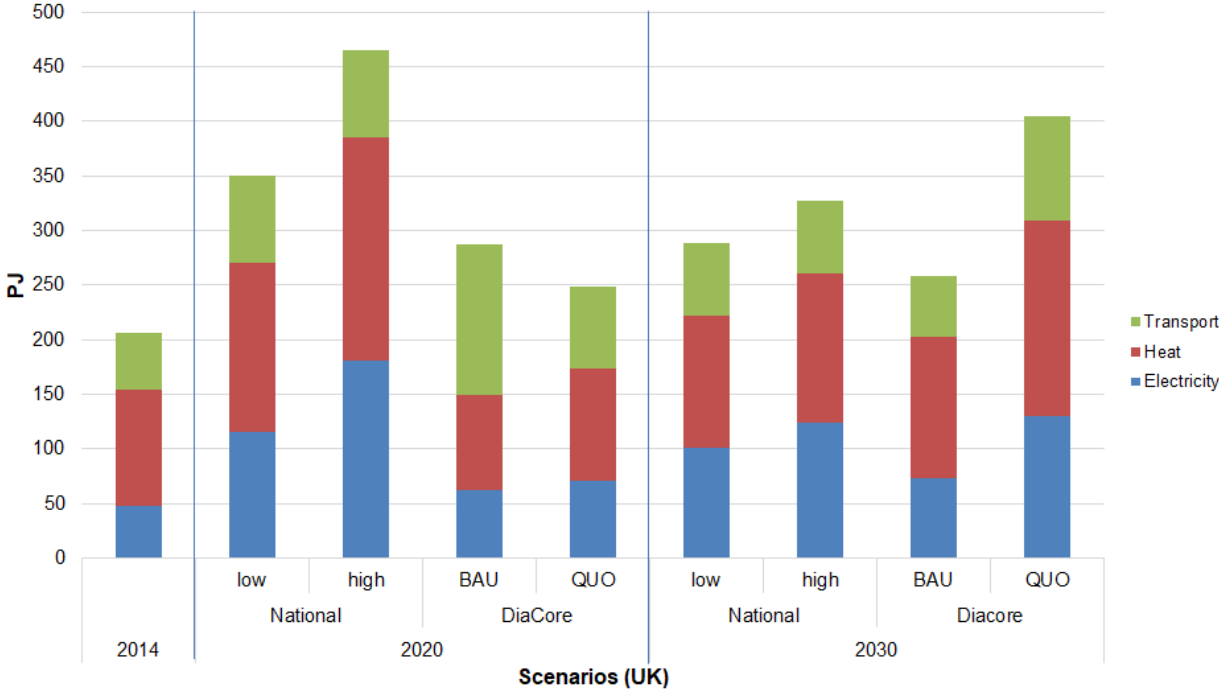

Figure 2.11: Final biomass consumption by end use sector (UK)

Primary demand and biomass supply

Figure 2.12 showcases the importance of the UK's biomass landscape in the EU's biomass imports. In 2011, 41% of the solid biomass used for electricity generation in the UK were in the form of imported wood pellets (mainly from North America). This percentage is projected to increase to 48% by 2020 (31% respectively for heat production) and remain relatively stable until 2030. This makes the UK the main importer of solid biomass in the region by far, and a key country in shaping the development of bioenergy in the region.

Reports from 2016 proclaim that almost 71% of the liquid biofuels used in the country were imported [61]. For the purposes of this chapter, this amount was assumed to remain the same until 2030.

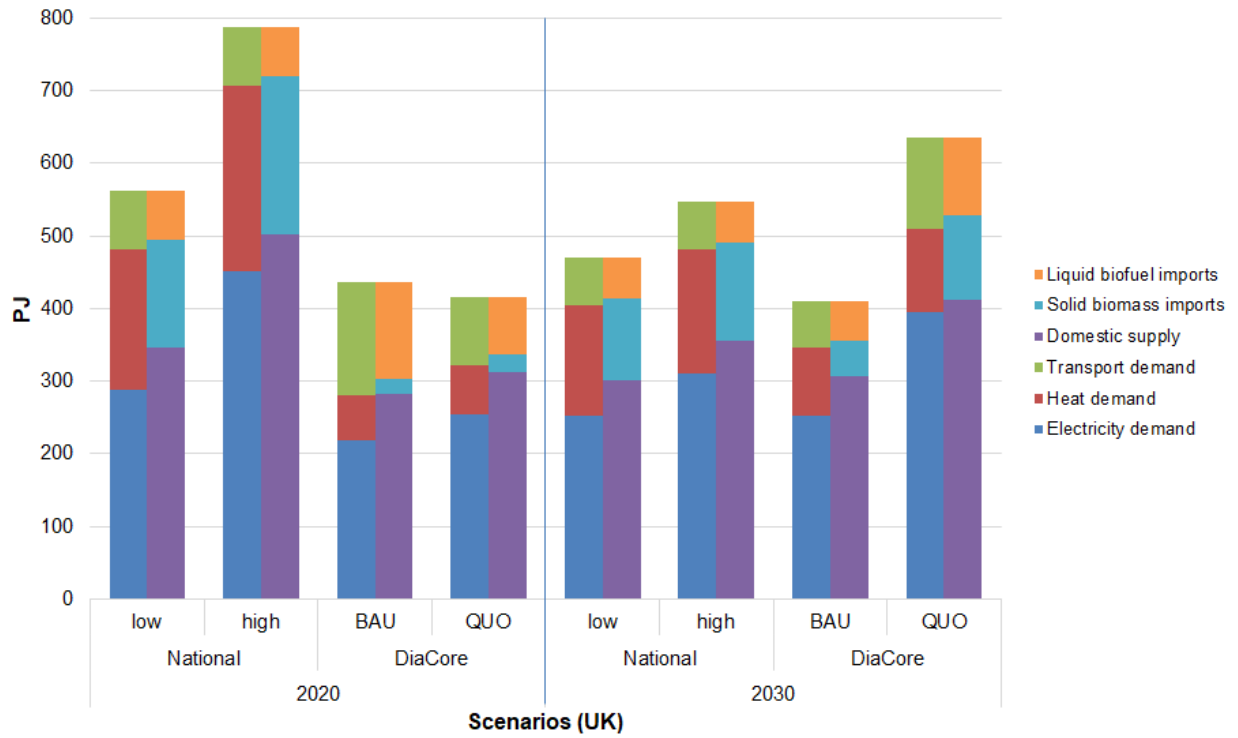

Figure 2.12: Primary biomass demand and supply (UK)

2.4.6 The Netherlands

Final consumption

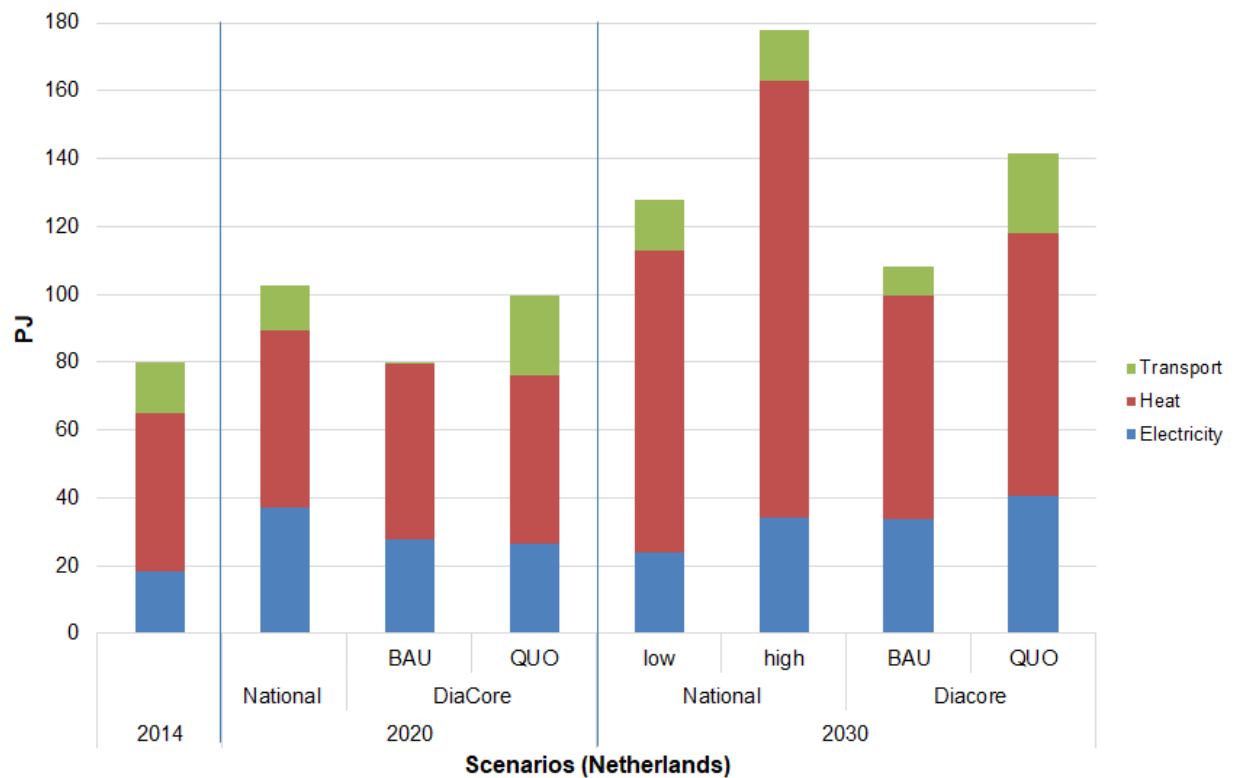

Figure 2.13: Final biomass consumption by end use sector (NL)

Final energy consumption from biomass increases by 2020, supported through the co-firing of solid biomass in coal power plants and small to medium scale heating. Despite a projected reduction of co-firing amounts, bioenergy consumption in 2030 is expected to increase in the heating sector, where industrial heat could pick up a sizeable share. Liquid biofuel consumption is expected to remain relatively stable from 2020 to 2030.

The deployment of bioenergy in the Netherlands to 2020 will most likely be in line with the energy agreement, including a 25 PJ cap on co-firing and the decommissioning of coal power plants that were built in the 1980s. There is much more uncertainty for the 2030 horizon: the energy agreement concerning the co-firing capacity in power plants is assumed to remain the same, but the actual amount of final consumption of biomass for co-firing is reduced due to a lower utilization of the power plants and the increasingly larger share of wind and PV power production. Combined demand for biomass electricity and heat ranges from 138-168 PJ for 2030 [14][62].

As mentioned in section 2.3.2, four applications for co-firing have been submitted already, reaffirming the move towards meeting the Energy Agreements' targets [46].

Heat from biomass might still grow in order to meet the gap in meeting the renewable energy target, though this is unlikely for the 2020 horizon. Biomass use is not expected to be a major contributor to heating for residential and services sector in the Netherlands, however industrial heat production from wood pellets, in light of the SDE+ subsidy scheme and the Energy Agreement support, will become competitive by 2030. Waste incineration and small-scale energy production from biomass will grow, as will biogas production through gasification of waste, manure and slurry streams [14]. Final energy demand from solid biomass sources can be seen in Figure 2.14.

The demand of biofuels will largely depend on policies, such as blending obligations, double counting and technological development. According to projections by different sources taking into account competing technologies and increased efficiency in fossil fuel use biofuel demand in the Netherlands can range from 15 to 40 PJ in 2030 [14][63].

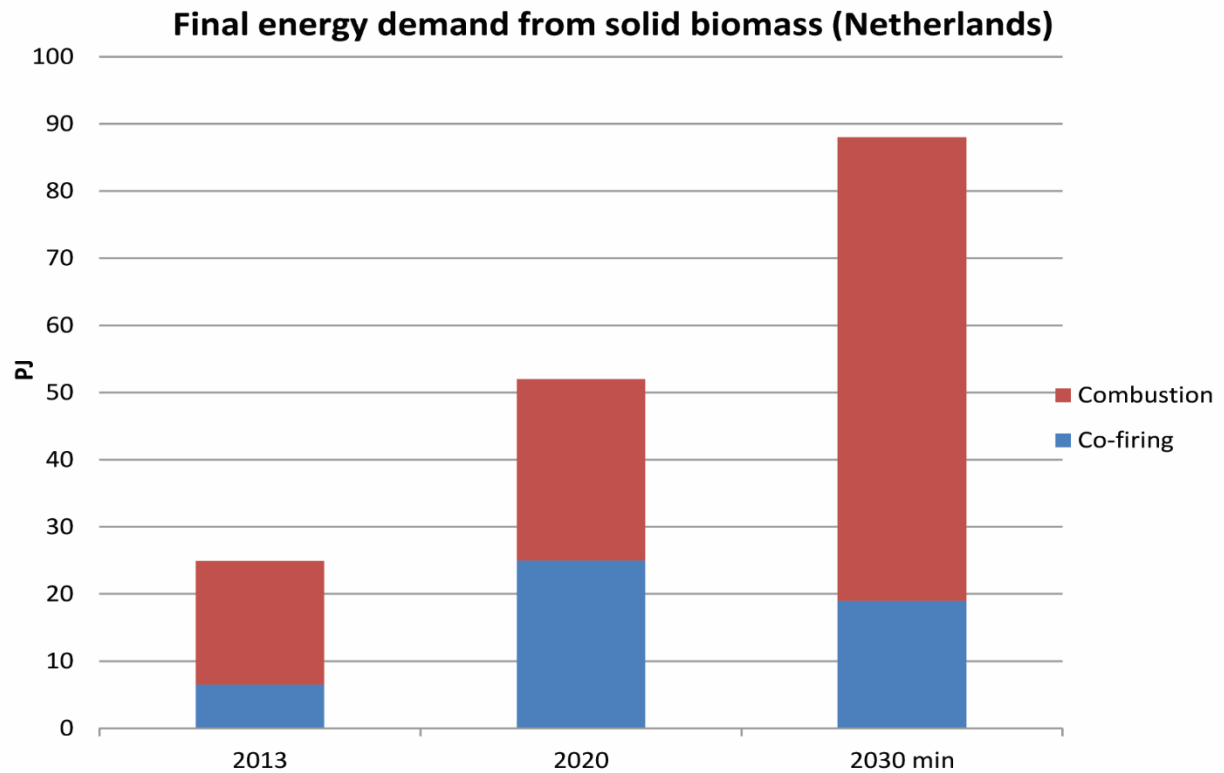

Figure 2.14: Final energy demand from solid biomass (NL) [64]

Primary demand and biomass supply

Despite the increase in use in the heating sector, the actual imports of biomass are projected to decrease (low scenario) or remain even from 2020 to 2030. While co-firing will be supported by imported wood pellets, large part of the heat share is covered by domestic sources. Industrial heat may require higher quality feedstock that can offset the decrease in the electricity sector in the high scenario.

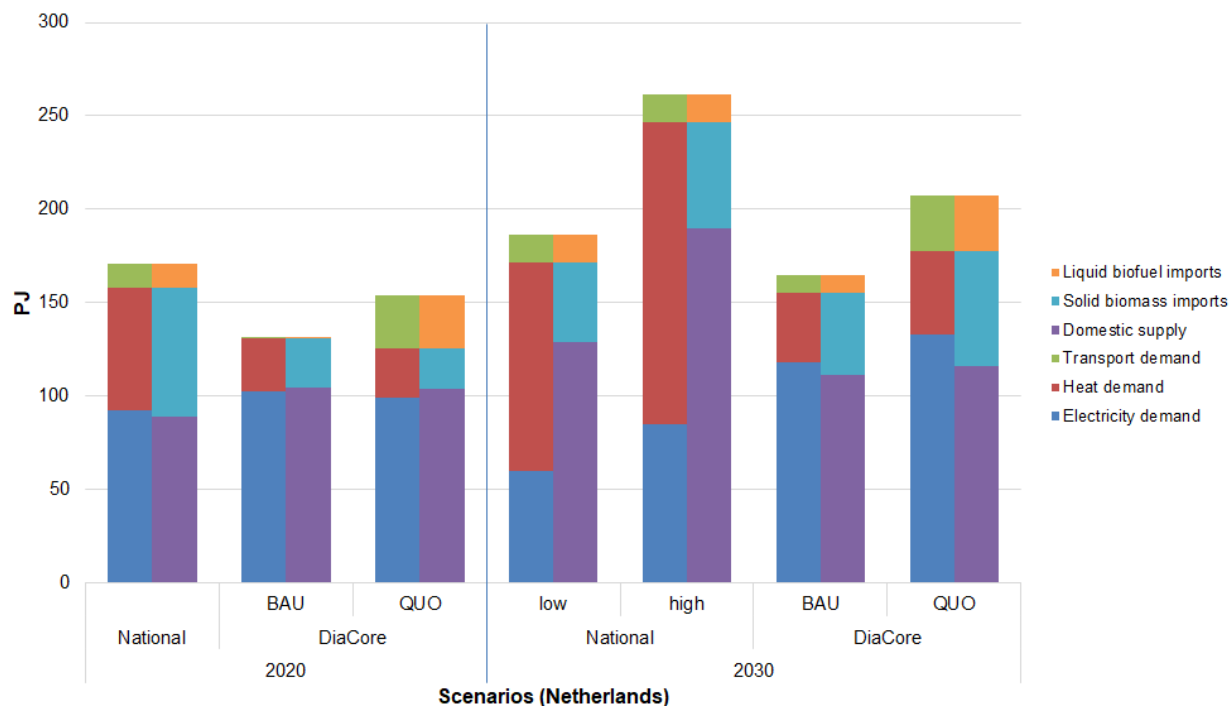

Figure 2.15: Primary biomass demand and supply (NL)

2.4.7 Biomass import trends

Based on the information presented in the previous sections, an overview of the future bioenergy status in Northwest Europe can be visualized. When we juxtapose the results from the regional models with the national projections, we can see that in most cases the final bioenergy demand deviates within reasonable limits (5-15%) for the 2020 horizon. Required imports however are either overestimated (Germany, the Netherlands) or underestimated (Denmark, UK). Bigger divergences between sources are observed on the 2030 horizon, highlighting the uncertainty of biomass development on a national level on the one hand, and the inability to include future policy of the previous projections on the other.

Although most of the biomass will be supplied from domestic resources, especially in the cases of Germany and the UK, an increase in imports is also expected (Table 2.4). Import amounts are based on current and future trends, technological developments and sector needs.

Solid biomass is imported in the selected countries for use in the electricity and heat sector. It is assumed that the feedstock is first processed into pellets, the main traded commodity of solid biomass, at the source region. Industry indicates that the majority of the biomass feedstock used for electricity or heat generation in Denmark, Belgium, the UK and the Netherlands will be imported mainly from North (or South) America, Russia and the Baltic region. Notable exception is Germany, where waste wood (from construction and demolition activities, municipal solid waste etc.) is imported mainly from the Netherlands (>50% of total imports) or other neighboring countries for use in electricity and heat production [30].

Liquid biomass is imported in the already processed form of biodiesel or bioethanol mainly from Brazil, the US, and Southeast Asian countries. Liquid biofuels are predominantly used in the transport sector, blended with fossil fuels.

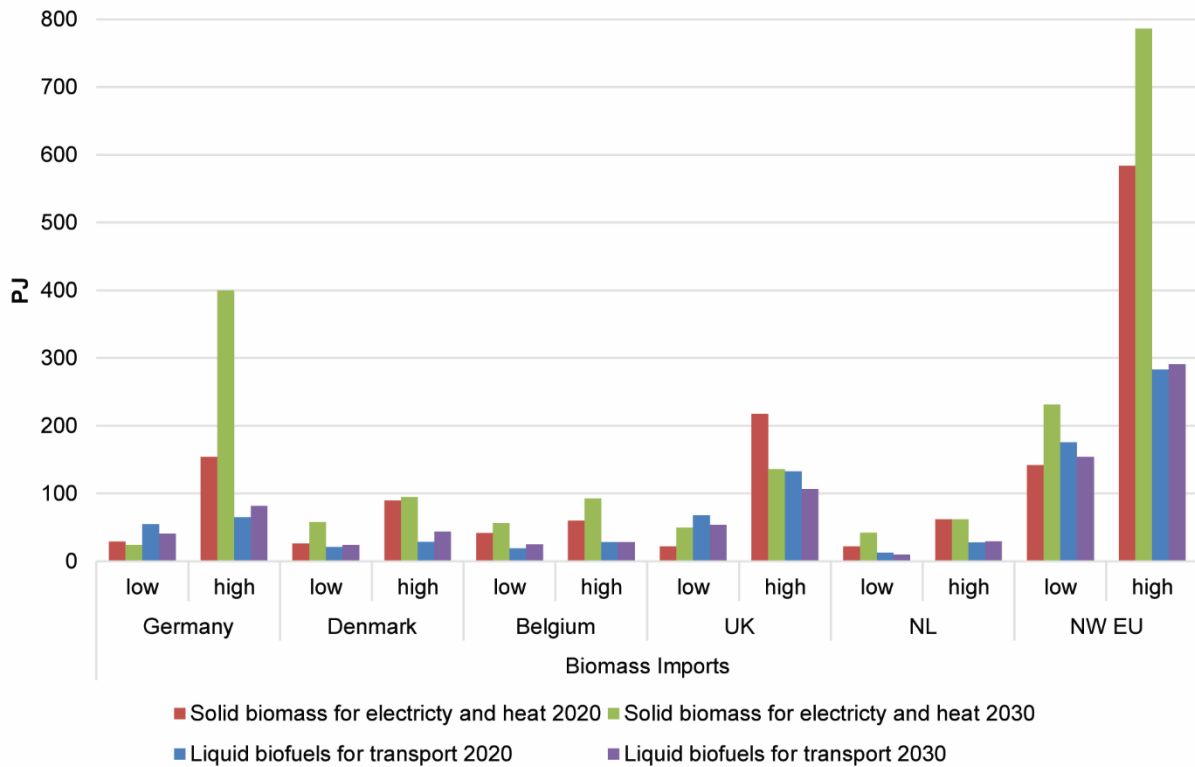

Figure 2.16: Projected biomass imports for Northwest Europe

Solid biomass use for electricity and heating purposes is expected to increase by 35-49% to 1213-1348 PJ by 2020 (from 900 PJ in 2014) and reach 1068-1717 PJ by 2030. Imported biomass may consist 8-25% of the above in 2020, and 13-32% in 2030, taking into account the least to most optimistic projections (see also Table 2.5).

Taking into account only national report data, bioenergy consumption will decrease to some extent by 2030 (1068-1157 PJ), mainly due to the decreased participation of bioenergy in the German energy system offsetting the slight increases in the rest of the region. (Table 2.4)

Consumption of biofuels is also projected to rise to 243-348 PJ in 2020 (a 21.5-74% increase from 2014) and slightly more (231-464 PJ) by 2030. Imports of biofuels are expected to range between 62-70% of the primary demand up to 2030.

Once again, national reports show more moderate projections, with a sizeable increase to 260 PJ by 2020, but a leveling off of consumption by 2030 (239 PJ) due to decreased use in Germany and the UK.

In general, despite the net trade of biomass more than doubling compared to the current levels, overall solid biomass imports, while quite high, are not as impressive as expected a few years ago. Whereas imports in the smaller MS under investigation (Denmark, Belgium and the Netherlands) will increase, the total imports might even decrease due to reorganizations of the renewable energy field, more efficient use of existing resources, or competition from other forms of renewable energy – as explained in each countries respective section, 2.4.2 to 2.4.6.

Liquid biofuels are expected to be predominantly imported in their final form for all MS under consideration (the UK is the lowest among them with projected imports around 85% of the primary demand), except Germany, whose projected domestic production lowers the total percentage of imports, as presented above.

2.5 Discussion

A multitude of data sources (see section 2.1.2) were used to supplement previous existing model projections that assess bioenergy deployment in the EU. While energy models taken into consideration approximate the final consumption in the region quite accurately, there are some divergences between them and the national projections. Future development in particular is shaped by an ever-shifting policy landscape and political decisions that may (or not) change in rapid succession. The models cannot completely incorporate these parameters into its function. Careful analysis is needed of up-to-date governmental decisions in order to successfully supplement previous bioenergy projections.

The most up-to-date relevant data were taken into account up until April 2017. However, there are also parallel developments that may influence them significantly, but that did not have a quantifiable effect in published media until this point. As an example, the UK government's announcement that 'the support rate under the Renewables Obligation (RO) for future biomass co-firing and conversion projects should no longer be covered by the government's grandfathering policy' could pose a hindrance to the development of a biobased economy in the respective countries.

The recent Brexit decision may have even greater ramifications on the bioenergy future of the UK and the EU as a whole. On the short term, the post-referendum empowerment of the dollar against the sterling has left Europe supplying most of the UK's marginal and spot demand for wood pellets in recent months as the cost competitive advantage of European pellet suppliers relative to the North Americans has increased [65][66]. On the long term, statements coming from the U.K. government have confirmed that the commitment to increasing renewable energy generation remains [67]. Contracts between the UK government and UK utilities for closing down (or retrofitting) the country's coal power plants by 2023 are still in place. Brexit, in whatever form, is unlikely to change the UK's climate change goals; these are established at a national level under the Climate Change Act 2008. But, there will nevertheless be important issues to settle. For example, at an international level the UK's emissions reduction commitment would need to be disentangled from the EU target under the United Nations Framework Convention on Climate Change (UNFCCC) and the recent Paris agreement. Regarding renewable and low carbon energy policy, following Brexit, the UK would be released from its renewable energy targets under the EU Renewable Energy Directive and from EU state aid restrictions, potentially giving the government more freedom both in the design and phasing out of renewable energy support regimes. However, given that the UK would still be bound by national and international decarbonization obligations, it is anticipated that renewable and low carbon energy development would continue to form part of UK Government climate change policy [68].

In the Netherlands, the SDE+ scheme supports above all cost-efficient technologies, but it cannot immediately cater for all innovative and costly technologies by 2020. The existing subsidy or support schemes are the main means of achieving the renewable energy targets in the MSs. However, they alone might not be enough [43]. In addition several key non-economic barriers have to be addressed: the time needed to bring new installations to operational levels, the protection of the environment (permitting procedures) and public acceptance by the concerned public [69]. As renewables deployment advances, policies have to adapt over time, moving from clear targets and regulations to adapting market design and ensuring public acceptance.

Also on EU-level, the forthcoming updated directive on the promotion of the use of energy from renewable sources is currently causing uncertainty. For example, if and how first- and second generation biofuels will receive policy support, and whether solid biomass for heat and

electricity production will have to adhere to EU-wide mandatory or voluntary sustainability criteria will largely determine future biomass trade flows towards the EU as well.

The above examples and developments only further serves to showcase the uncertainty and volatility of the sector. Developments in policy are rapid and may be significant enough to warrant an overhaul of existing or ongoing work in the field, in order to have a current, detailed picture of the biomass state in the EU at all times. The effectiveness and efficiency of almost all the RED provisions can be enhanced by putting a stable post-2020 policy in place that includes a continuation of these measures as well as a clear governance system. This conclusion holds for all provisions. Moiseyev et al. [70] studied the impact of subsidies on the production of wood-based electricity and heat under different levels of carbon emission prices. Even a modest subsidy of 30 €/MWh for electricity generation used in just a few EU member countries leads to a substantial increase in the use of industrial wood use for energy, even under a modest carbon price. A stable longer term outlook will increase investor certainty as well as the incentive for stakeholders and government authorities to put in the required effort. The initial effort and cost of setting up the procedures and processes is then offset by much more long term and overall higher benefits [52].

Being open economies, the MSs of NW EU benefit from trade, but at the same time, they are impacted by global energy market trends as well as by the energy policy choices of their neighbors. There is a certain risk of increased market distortion from nationally focused subsidies of renewables and capacity mechanisms in neighboring MSs. Global price differences in gas, coal and raw materials between the MSs and their major trading partners can have a significant impact on the competitiveness of the bioenergy industry [43][69].

2.6 Conclusions

In the previous sections, the uncertainties of future bioenergy development in NW Europe were quantified and reported. The variability of bioenergy development is made evident by the sizable gap of the projection bandwidths after the 2020 horizon. Depending on whether the projections are derived from national reports or regional models, whether future policy developments were taken into account, the ranges of biomass consumption are multiple times apart by 2020 already, and the gap increases by 1.4 times more by 2030.

Total imports (solid and liquid biomass) for the NW EU region, taking into account the lowest and highest scenarios, range between 318-875 PJ by 2020 and 386-1076 PJ by 2030 (Figure 2.16). A more moderate view, taking into account mostly the national outlook for each respective country suggests imports of 389-528 PJ for 2020 and 331-369 PJ for 2030.

Imports of solid biomass could reach up to 276-458 PJ by 2020, supported by the need for preprocessed biomass in the form of wood pellets in the electricity and heat sector which cannot be produced domestically in the reviewed countries (except Germany which has a positive wood pellet trade balance). Biomass imports will increase, due to more power plants turning into co-firing or dedicated biomass use, [14][32][34], concerns regarding domestic land use and food production [19] or a combination of the above. Assuming an energy content of 17.6 GJ/ton for processed wood pellets and 14 GJ/ton for wood logs and waste wood (in the case of Germany) the required import amounts for the whole region leads to 8.5-35 Mt of solid biomass in 2020. Imports may fluctuate between 13.5-49 Mt in 2030. Detailed numbers are provided in Table 2.5,

Appendix A of this chapter.

The summation of the national projections lead to 22-30 Mt (390-530 PJ) of solid biomass imports by 2020, and a decrease (321-370 PJ) by 2030, following the decreasing trend in biomass consumption for electricity and heat, leading to 19-21 Mt of imports.

Biofuel imports could reach up to 283 PJ by 2020 and will likely plateau around this level (291 PJ) until 2030, mainly due to low fossil fuel prices and increases in vehicle efficiency [30][57], but also depending on the future EU policy towards 1st and 2nd generation biofuels. Taking into account the energy content of biodiesel and bioethanol and assuming that the percentages of each biofuel will remain more or less steady, imports can reach 6 Mt in 2020 (7 million liters) and 4.6 Mt in 2030 (6.4 million liters).

On the whole, a modest growth is expected in biomass trade volumes. As explained in section 2.4.7, due to numerous inter-connected and complicated factors, even while the trade numbers double, the overall imports are expected to fluctuate in a lower spectrum than previously assumed.

Implications of the above could mean little to massive infrastructure development by 2030, mainly by developing new biobased industries, opening up new markets for bio-based products and creating new business and innovation opportunities in all European regions, in areas such as agriculture, forestry and industry [71]. Depending on the expected throughput to NW EU, supply, handling and storage chains will need to be adapted as well in order to cope with the physical and biological properties of the respective feedstock. Ranging from modification of the equipment in import terminals up to the need for constructing new, dedicated facilities (biomass terminals or biorefineries) to efficiently process the volume of imports.

References

- [1] European Biomass Association (AEBIOM). AEBIOM Statistical Report - European Bioenergy Outlook. 2015.
- [2] Matthews R, Mortimer N, Lesschen JP, Lindroos TJ, Sokka L, Morris A, et al. Carbon impacts of biomass consumed in the EU: quantitative assessment. 2015.
- [3] Beurskens LWM, Hekkenberg M. Renewable Energy Projections as Published in the National Renewable Energy Action Plans of the European Member States Covering all 27 EU Member States. 2011.
- [4] European Commission. Renewable Energy Package: New Renewable Energy Directive and Bioenergy Sustainability Policy for 2030. 2016.
- [5] Mai-Moulin T, Visser L, Junginger M. Assessment of sustainable biomass export potentials from international sourcing countries. Int Work “Towards a Eur Trade Strateg Sustain Solid Biomass Imports to EU” 2016.
- [6] Junginger M, Faaij A, Goh CS. International Bioenergy Trade- History, status & outlook on securing sustainable bioenergy supply, demand and markets. Springer; 2014.
- [7] Sheng Goh C, Junginger M, Marchl D, Thran D, Hennig C. Wood pellet market and trade: a global perspective. *Biofuels, Bioprod Biorefining* 2012;6:246–56.
- [8] Heinimo J, Lamers P, Ranta T. International trade of energy biomass - an overview of the past developments in direct and indirect trade flows. 21st Eur. Biomass Conf., 2013.
- [9] Abt KL, Abt RC, Galik CS, Skog KE. Effect of Policies on Pellet Production and Forests in the U.S. South - Update of the 2010 RPA Assessment. 2014.
- [10] Fingerman K, Iriarte L, Fritsche UR, Nabuurs G-J, Elbersen B, Staritsky I, et al. Biomass Use and Potential for export to the European Union from 2015 to 2030. United States Southeast – Case Study. 2016.
- [11] Ehrig R, Behrendt F. Co-firing of imported wood pellets - An option to efficiently save CO₂ emissions in Europe? *Energy Policy* 2013;59:283–300.
- [12] Hoefnagels R, Junginger M, Resch G. DiaCore - Coordination of biomass resource availability import strategies and demand. Utrecht (NL), Vienna (AT): 2015.
- [13] Fritsche UR, Iriarte L. Biomass Policies Task 2 . 4 : Sustainable Imports. 2016.
- [14] ECN Policy Studies. National Energy Outlook 2015. Netherlands. 2015.
- [15] Blaire L. Global wood pellet market update. 7th Int. Bioenergy Conf. Exhib., Prince George, BC: 2016.
- [16] Sikkema R, Fiorese G. Use of Forest Based Biomass for Bioenergy in EU-28, 2014.
- [17] Popp J, Lakner Z, Harangi-rákos M, Fári M. The effect of bioenergy expansion : Food , energy , and environment. *Renew Sustain Energy Rev* 2014;32:559–78.
- [18] Aeschelmann F, Carus M. Bio-based Building Blocks and Polymers in the World - Capacities, Production and Applications: Status Quo and Trends towards 2020. 2015.
- [19] Thrän D, Arendt O, Ponitka J, Braun J, Millinger M, Wolf V, et al. Summary of Milestones 2030: Elements and Milestones for the Development of a Stable and Sustainable Bioenergy Strategy. 2015.
- [20] van Stralen J, Uslu A, Dalla Longa F, Panoutsou C. The role of biomass in heat, electricity, and transport markets in the EU27 under different scenarios. *Biofuels*,

- Bioprod Biorefining 2012;6:246–56.
- [21] International Energy Agency (IEA). Energy Policies of IEA Countries: European Union 2014 Review. 2014.
- [22] Dell J. Biomass Market – Global Overview Market Update and Future Trends. 2015.
- [23] Mantau U. Wood flow analysis : Quantification of resource potentials , cascades and carbon effects. Biomass and Bioenergy 2014;79:28–38.
- [24] Olsson O, Bruce L, Hektor B, Roos A, Guisson R, Lamers P, et al. Cascading of woody biomass: definitions, policies and effects on international trade. 2016.
- [25] Eurostat. Renewable Energy Statistics 2016. http://ec.europa.eu/eurostat/statistics-explained/index.php/Renewable_energy_statistics (accessed February 20, 2016).
- [26] Lamers P, Junginger M, Hamelinck C, Faaij A. Developments in international solid biofuel trade - An analysis of volumes, policies, and market factors. Renew Sustain Energy Rev 2012;16:3176–99. doi:10.1016/j.rser.2012.02.027.
- [27] Resch G, Busch S. DiaCore - Interim Report on: Prospects for RES in Europe up to 2030. 2014.
- [28] Resch G, Ortner A, Welisch M, Busch S, Liebmann L, Totsching G. Policy Dialogue on the assessment and convergence of RES Policy in EU Member States. 2016.
- [29] Netherlands Enterprise Agency. Sustainable Biomass and Bioenergy in the Netherlands: Factsheet Based on the 2013 Report. 2014.
- [30] Thrän D, Hennig C, Rensberg N, Denysenko V, Fritsche UR, Eppler U. IEA Bioenergy Task 40 : Country Report Germany 2014. Leipzig: 2015.
- [31] Rheinisch-Westfälisches Institut Wirtschaftsforschung. Erhebung des Energieverbrauchs der privaten Haushalte für die Jahre 2009-2010. 2013.
- [32] Stelte W, Hinge J, Dahl J. IEA Bioenergy Task 40: Country report 2014 for Denmark. 2015.
- [33] Gregg JS, Bolwig S, Soler O, Vejlgaard L, Gundersen SH, Grohnheit PE. Experiences with biomass in Denmark. 2014.
- [34] Devriendt N, Guisson R. IEA Bioenergy Task 40: Country report Belgium/Flanders. 2015.
- [35] Energy outlook for Belgium towards 2050 (October 2014 edition) - Statistical annex. 2014.
- [36] Hemingway J, Waters L. Energy Trends section 6: Renewables. Department of Energy and Climate Change (DECC). UK. 2015.
- [37] Hemingway J, Waters L. Energy Trends: June 2015, special feature articles - Renewable energy in 2014. Department of Energy and Climate Change (DECC). UK. 2015.
- [38] Statistics Netherlands (CBS). Renewable energy; final use and avoided use of fossil energy 2016. <http://statline.cbs.nl/StatWeb/publication/?DM=SLEN&PA=83109ENG> (accessed May 30, 2016).
- [39] European Biomass Association (AEBIOM). AEBIOM Statistical Report -Bioenergy 2015 Support Schemes. 2015.
- [40] Izadian A, Girrens N, Khayyer P. Renewable energy policies: A brief review of the latest U.S. and E.U. policies. IEEE Ind Electron Mag 2013;7:21–34.

- [41] Lamers P, Hoefnagels R, Junginger M, Hamelinck C, Faaij A. Global solid biomass trade for energy by 2020: An assessment of potential import streams and supply costs to North-West Europe under different sustainability constraints. *GCB Bioenergy* 2014:618–34.
- [42] Hamelinck C, Koper M. Renewable energy progress and biofuels sustainability. Ecofys BV by order of the European Commission (EC). 2014.
- [43] International Energy Agency (IEA). Energy policies of IEA countries: The Netherlands 2014 Review. 2014.
- [44] International Energy Agency (IEA). Energy policies of IEA countries: Belgium 2016 Review. 2016.
- [45] International Energy Agency (IEA). Energy Policies of IEA Countries: Denmark 2011 Review. 2012.
- [46] Social and Economic Council of the Netherlands. Energy Agreement for Sustainable Growth. 2013.
- [47] Sina S, Grinsven A Van, Hers S, Prahl A. Mid-term evaluation of the Renewable Energy Directive: A study in the context of the REFIT programme. 2015.
- [48] Mai-Moulin T, Junginger M. Towards a Harmonisation of National Sustainability Requirements for Solid Biomass. Copernicus Institute, Utrecht University. 2016.
- [49] Scarlat N, Dallemand JF, Monforti-Ferrario F, Nita V. The role of biomass and bioenergy in a future bioeconomy: Policies and facts. *Environ Dev* 2015;15:3–34.
- [50] Roundtable on Sustainable Biomaterials (RSB) 2016. <http://rsb.org/> (accessed November 20, 2016).
- [51] International Energy Agency (IEA). Energy Efficiency Indicators : Fundamentals on Statistics. 2014.
- [52] European Commission (EC). EU Energy, Transport and GHG Emissions: Trends to 2050 - Reference Scenarios 2013. Brussels: 2013.
- [53] Nitsch J. GROKO – II: Szenarien der deutschen Energieversorgung auf der Basis des EEG-Gesetzentwurfs - insbesondere Auswirkungen auf den Wärmesektor. 2014.
- [54] Frederiksen P. Scenarios for biofuels in the road transport sector - environmental and welfare economic consequences. 2013.
- [55] Devogelaer D, Gusbin D. 2030 Climate and Energy Framework for Belgium - Impact assessment of a selection of policy scenarios up to 2050. 2015.
- [56] Devogelaer D, Gusbin D. Het Belgische energiesysteem in 2050: Waar naartoe? Federal Planning Bureau Belgium. 2014.
- [57] Stephenson A, MacKay D. Life Cycle Impacts of Biomass Electricity in 2020. Department of Energy and Climate Change (DECC). UK. 2014.
- [58] Greenleaf J, Alberici S. Assessment of the appropriate uses of bioenergy feedstocks in the UK energy market. Redpoint Energy and Ecofys BV on behalf of the UK Department of Energy and Climate Change (DECC) and the Committee on Climate Change. UK. 2012.
- [59] Rosillo F, Galligani S. IEA Bioenergy Task 40 : Country Report for United Kingdom 2011. Centre for Environmental Policy (CEP), Imperial College London. 2011.
- [60] Element Energy. The Role of Biofuels Beyond 2020. Commissioned by British

- Petroleum (BP). UK. 2013.
- [61] Department of Transport. Renewable Transport Fuel Obligation statistics: period 8 2015/16, report 3. 2016.
- [62] Commissie Duurzaamheidsvraagstukken Biomassa (CDB). Biomassa Vraag en Aanbod in Nederland in 2030. 2014.
- [63] Cuelenaere R, Koornneef G, Smokers R, Van Essen H, Van Grinsven A, Hoen M 'T, et al. Scenarios for energy carriers in the transport sector. 2014.
- [64] Dafnomilis I, Wachyar YP, Schott DL, Junginger M, Hoefnagels R. Bioenergy development in the Netherlands. 2015. doi:2015.TEL.8045.
- [65] Fall L. Brexit and the UK biomass burn 2016. <http://blog.argusmedia.com/brexit-and-the-uk-biomass-burn/> (accessed November 20, 2016).
- [66] Bingham J. Brexit - implications for biomass 2016. <http://www.hawkinswright.com/news-and-events/blog/post/hawkins-wright-blog/2016/07/04/brexit---implications-for-biomass> (accessed November 20, 2016).
- [67] Saint A. Brexit and Biomass 2016. <http://biomassmagazine.com/articles/13486/brexit-and-biomass> (accessed November 20, 2016).
- [68] Norton Rose Fulbright. Impact of Brexit on the energy sector 2016. <http://www.nortonrosefulbright.com/knowledge/publications/136979/impact-of-brexit-on-the-energy-sector> (accessed November 20, 2016).
- [69] International Energy Agency (IEA). Key World Energy Statistics. 2016.
- [70] Moiseyev A, Solberg B, Kallio AMI. The impact of subsidies and carbon pricing on the wood biomass use for energy in the EU. *Energy* 2014;76:161–7.
- [71] Scarlat N, Dallemand J-F, Monforti-Ferrario F, Banja M, Motola V. Renewable energy policy framework and bioenergy contribution in the European Union – An overview from National Renewable Energy Action Plans and Progress Reports. *Renew Sustain Energy Rev* 2015;51:969–85.

Appendix A – Tables

Table 2.4: Bioenergy demand and respective imports required [PJ]

		Germany	Denmark	Belgium	UK	Netherlands	NW EU
Final consumption							
<i>Electricity and heat</i>	2020	661-744	140-152	67-99	149-386	76-90	1212-1348
	2030	508-984	155-171	70-136	202-309	99-163	1068-1717
<i>Transport</i>	2020	112-132	21	23-34	75-138	13-24	243-348
	2030	83-165	24-30	16-34	55-95	9-24	187-348
Primary demand							
<i>Electricity and heat</i>	2020	1088-1138	156-245	118-148	280-482	126-158	1837-2341
	2030	815-1401	199-265	124-183	347-509	155-246	1780-2477
<i>Transport</i>	2020	112-159	21-29	27-34	80-157	13-28	252-406
	2030	99-227	24-44	34-38	64-126	10-30	231-464
Biomass supply							
<i>Domestic</i>	2020	994-1084	129-163	66-97	312-490	89-117	1629-1883
	2030	791-1177	144-189	66-119	292-478	115-190	1448-2097
<i>Imports solid bioenergy</i>	2020	30-154	27-90	42-60	22-218	22-69	142-591
	2030	24-400	58-95	57-93	50-136	42-62	232-786
<i>Imports liquid bioenergy</i>	2020	55-65	21-29	19-28	68-133	13-28	176-284
	2030	41-82	24-44	25-28	54-107	10-30	154-290
Total imports	2020	85-219	47-119	61-88	90-351	35-98	318-875
	2030	65-481	82-139	82-121	104-243	52-91	386-1076

Table 2.5: Biomass imports in NW EU [Mt]

Sector	Biomass imports					
	Germany	Denmark	Belgium	UK	Netherlands	NW EU
Electricity & heat						
2020	2-10.5	1.5-5.1	2.4-3.4	1.3-12.4	1.3-3.5	8.4-35
2030	1.6-27.5	3.3-5.4	3.2-5.3	2.8-7.7	2.4-3.5	13.4-49
Transport						
2020						
<i>Mt</i>	1.7-2	0.7-0.9	0.6-0.8	2.4-4.6	0.4-0.9	5.7-9.3
<i>ML</i>	2-2.3	0.8-1	0.6-1	2.8-5.6	0.5-1	6.7-11
2030						
<i>Mt</i>	1.3-2.5	0.7-1.4	0.7-0.8	2-3.7	0.3-0.9	5-9.4
<i>ML</i>	1.5-2.9	0.9-1.6	0.8-1	2.3-4.5	0.4-1.1	5.8-11

Appendix B – Personal communication

The list of the contacts providing information mentioned in section 2.2.4 includes:

- Peter - Paul Schouwenberg, Head Environment - Stakeholder Management - New Energy, RWE Essent
- Mark Bouwmeester, Developer - Renewable Energy and Process Technology, RWE Essent
- Benjamin Tromp, Controller Asset Management, Alliander
- Hugo du Mez, Advisor Business Intelligence - Dry Bulk, Port of Rotterdam Authority
- Jeroen Daey Ouwens, Business Developer, ENGIE Energie Nederland N.V.
- Richard Peberdy, Vice President - Sustainability, Drax Biomass
- Wolfgang Stelte, Project Manager, Danish Technological Institute - Center for Biomass and Biorefinery
- Anders Evald, Chief Consultant, HOFOR A/S
- Christiane Hennig, Senior Research Associate - Sustainable energy supply, German Biomass Research Centre
- Guisson Ruben, Project Manager - Biobased Economy, VITO
- Tom Pauwels, Project Manager, POM Oost-Vlaanderen
- Rocio Diaz-Chavez, Research Fellow, Centre for Environmental Policy, Imperial College London
- André de Haan, Corporate Scientist - Process Technology, Corbion Purac
- Rob Groeliker, Technical Director, Biopetrol Industries
- Robert C. Abt, Professor of Natural Resource Economics and Management, North Carolina State University
- Jan Oldenburger, Senior Consultant - Forest Products and Statistics, Probos Foundation

Chapter 3. Solid biomass handling in import terminals³

In the previous chapter, a multitude of data sources were used to supplement previous existing model projections that assess bioenergy development in the EU. Altogether, a reasonable growth is expected in biomass trade volumes. Due to numerous complicated factors, even in cases where the trade numbers double, the overall imports are expected to fluctuate in a lower spectrum than previously assumed. Implications of the above could range from little to massive expected infrastructure development by 2030. Also depending on the expected imports to Northwest Europe, handling and storage chains might need to be adapted in order to cope with the physical and biological properties of biomass. This adaptation could range from modification of the equipment in import terminals, up to the need for constructing new, dedicated facilities (biomass terminals or biorefineries) to efficiently process the volume of imports.

Concerning these adaptations to equipment, it has to be considered that biomass is a much more reactive and potentially hazardous material than coal or grain. Thus, it needs specific equipment, safety systems and personnel training in order to handle it safely and efficiently. Despite some availability of data concerning the safe handling and storage of biomass, there is a lack of insight into the equipment and operations of actual biomass handling facilities. A detailed literature research was performed initially, in order to ascertain relevant biomass material properties that affect its behavior. Subsequently, visits in biomass facilities in the Netherlands and in-depth interviews with representatives were conducted and served as a means of gaining an overview of actual industrial conditions in import terminals. This chapter provides an assessment of the current biomass import terminals, in terms of equipment and techniques selection and terminal setup. Section 3.1 showcases how decisive material

³ Published as: I. Dafnomilis, G. Lodewijks, M. Junginger, D.L. Schott, Evaluation of wood pellet handling in import terminals, *Biomass and Bioenergy*. 117 (2018). doi:10.1016/j.biombioe.2018.07.006.

properties are for the choice of equipment when dealing with biomass. Sections 3.2 and 3.3 provide a detailed account of current industry practices and equipment used for the handling and storage of biomass materials. The results in section 3.4 show that part of the terminals' existing infrastructure could be adopted for biomass in the short term future, with a relatively low cost. In general however, larger scale biomass throughputs will require an elaborate and expensive monitoring and safety infrastructure, besides fully covered handling and storage.

3.1 Wood pellet trade and port terminals

Biomass used for energy purposes (bioenergy) is expected to increase in final energy consumption in all the European Union Member States (MS). In 2014, bioenergy consumed in European Union (EU) amounted to 61% of the total renewable energy consumption or 4416 PJ, and 10% of the gross final energy consumption. Use of biomass was concentrated mainly in the heating sector (88% of total renewable heating), but with significant contributions to electricity production and transport fuels [1]. Although this share is expected to decrease by 2020 to a total of 57% [2], due to the development of other renewable sources such as wind and photovoltaics (PV), the actual amount of biomass for heating, electricity and transport is expected to rise to 5860 PJ [1].

The largest part of EU biomass supply is and will be based on domestic sources; currently, 4% of the total biomass used for energy purposes is imported. However by 2030, this amount could substantially increase, taking into account potential supply gaps, especially in the industrial sector (electricity production, closing down of coal power plants) [3,4].

Specifically, wood pellet use in the EU is expected to grow in sectors such as co-firing in coal power plants and residential heating in the short-term future, and possibly in the form of high quality industrial heat in the long-term future [4]. The majority of the wood pellets consumed will be imported, as many of the EU members lack the industrial tradition of wood processing on the one hand, and import of wood pellets from overseas seems to be more economically efficient than road transportation, even from neighboring countries [5]. In the Netherlands, the use of wood pellets in coal-fired power plants will be ramped up to approximately 25 PJ by 2020 [6]. This corresponds to approximately 3.5 Mt of imports, since the country has been relying on them in order to reach the renewable energy target for electricity production [7], and is expected to rely on them for the foreseeable future. Concurrently, Belgium consumed more than 1.5 Mt of wood pellets in 2015, almost exclusively imported. Similarly, Denmark consumed 2.6 Mt of imported wood pellets in 2015 [8]. In total, the 3 countries are expected to consume more than 11 Mt by 2025 [9]. Accordingly, the bulk port terminals in the Amsterdam-Rotterdam-Antwerp (ARA) region will have to accommodate the increased flows of wood pellets.

At the same time, Japan and South Korea are set to become two of the largest wood pellet consumers in the world. Japan is looking to shift from a dependency on fossil fuels to renewable energy sources, and aims for biomass to comprise 20% of its renewables generation by 2030 [10]. The Japanese government recently approved regulations that allow major utility companies to benefit from the national feed-in-tariff. Wood pellet imports to Japan reflecting this policy change are expected to start in 2018 [8]. Canada is currently Japan's biggest source of wood pellets, supplying approximately 63% of Japan's imports in 2015 [11]. Similarly, South Korea aims to increase its wood pellet use through the Renewable Portfolio Standard (RPS) [12]. Having Vietnam as a primary supplier of biomass, South Korea could reach more than 8 Mt of wood pellet demand by 2025 [9]. Combined, these two countries could require more than 17 Mt of wood pellets by 2025, most of which will need to be covered by imports [11,13]. Overall, Asia is expected to provide one of the largest future growth opportunities in the medium- to long-term, leading to similar challenges for port facilities as in the EU.

Wood pellets are regarded as a bulk material, as they are mostly transported in large quantities. However, compared to traditional dry bulk materials, such as coal, grain and iron ore, wood pellets have other unique demands for handling, transport and storage, regarding for example prevention of degradation and moisture uptake [14]. Use of unsuitable equipment or careless treatment can damage the product or constitute major health and safety hazards. This constitutes the main issue with wood pellet terminal facilities: in order to optimize the handling procedures, the equipment and techniques at the respective terminals need to cope with the materials' specific properties. This is only realized to a limited extent at the moment; since the volumes currently being moved in the EU are low, they do not necessitate investments in specialized infrastructure.

The notable exception to this is the UK, where utility company Drax consumed 50% of the 2016 global industrial pellet demand of 13.6 Mt [15]. Drax is serviced by four ports, where dedicated biomass equipment and infrastructure is used to handle the incoming wood pellets, mainly from the Southeast US [16,17]. However, this required years of development of an expansive, specialized freight and logistics infrastructure dedicated to the import, storage and delivery of wood pellets (such as their high volume rail wagons [18]), and more than 284 million euros of investments (250 million pounds⁴) [19]. Drax and the UK situation in relation to wood pellets represent an extreme end of the spectrum of pellet imports and it is not representative of the EU or Asian import terminal situation. While some terminals may come close to that range, especially if they function as a hub import terminal like stated in the following paragraph, achieving the scale of Drax's facilities is not going to manifest for the short to medium term future. However, the lessons to be learned by the UK's experience when handling wood pellets can support import terminals around the world in decision making regarding biomass infrastructure setup and investments.

As an example, du Mez [20] states that the Port of Rotterdam aims to handle 8-10 Mt of wood pellets by 2020, and as such assume a hub role for biomass imports to the whole of Northwestern Europe [21]. This could have a range of implications for the receiving bulk terminals; existing infrastructure might have to be adjusted in the short term, while larger scale and elaborate infrastructure will be required in the long term future. Extended periods of development will be needed for most of these actions. Generally, even minor changes in a port terminals' design and operations require considerable investments in numerous elements of its setup. It is therefore crucial to have a comprehensive understanding of wood pellet terminal equipment setup and operations before any substantial commitments are made.

Despite numerous technical reports offering detailed advice on handling and storage of solid biomass in general [22–24], there is little information to be found in scientific literature considering a state-of-the-art approach in a real-world industrial setting. Several researchers have investigated different aspects of the subject: Rossner et al. [25] have researched the CO monitoring of small scale wood pellet storage for residential or small building use, and Proskurina et al. [26] looked into the bulk handling of wood pellets in export and import ports, for which the authors state that specialized equipment is required. The mechanical degradation of wood pellets during indoor and outdoor storage was examined by Graham et al. [27], albeit on a small scale. Graham et al. [28] also performed research on the mechanical properties of wood pellets in a laboratory environment. The most comprehensive and recent account of wood pellet handling and storage comes from Bradley and Carbo et al. [29,30], offering advice on selecting equipment when dealing with pellets, considerations when setting up a project, and future trends. Ilic et al. [31] provide the most recent and complete aggregation of key design parameters for solid biofuels in general, as well as suggestions on how to approach biomass

⁴ Based on the exchange rate of 1 GBP = 1.13497 EUR on December 5th 2017

handling systems design. Thus, research so far has examined different aspects of the wood pellet handling and storage infrastructure. However, the conclusions are either based on too small a scale, or they come in the form of general rules of thumb for design and use of equipment and methods. As such, most of the up-to-date scientific literature lacks a perspective of actual large scale, bulk pellet handling. Consequently, informed decisions regarding import terminal developments might be lacking. An in-depth analysis and assessment of receiving terminals has not been performed so far in scientific literature.

The main objective of this chapter is to assess the state-of-the-art in wood pellet handling in import terminals. After a comprehensive understanding of the current status in the particular research field is gained, the goal of providing advice on import terminal design changes is also explored. Potential future bottlenecks that might hinder wood pellet handling in import terminals are identified and suggestions to overcome these hurdles are provided.

3.2 Research approach

As a first step, an extensive literature review in wood pellet handling and storage issues was conducted. The aim was to comprehend the state-of-the-art and the limitations of the subject. Initially, the technical characteristics of wood pellets and how they relate to their handling aspects were researched. The most common issues that arise when handling or storing pellets are also examined and presented in section 3.2.1. Consequently, dedicated equipment or measures to most effectively handle wood pellets in different handling chain steps are discussed in section 3.2.2.

In continuity, due to the access the author possessed to the biggest and most experienced bulk terminal operators in the Port of Rotterdam, as well as other industrial stakeholders related to wood pellet transport and use, the actual industrial condition of wood pellet handling in import terminals was examined. To do so, the author participated in key planning meetings and conducted interviews with relevant to the subject employees of the wood pellet industry in the Netherlands. This provided a unique opportunity to gain a detailed account of first hand industrial conditions of wood pellet handling. Specifically, stevedoring companies and terminal operators that handle, among other products, pellets in the Port of Rotterdam, advisors on dry bulk cargo from the Port of Rotterdam Authority, equipment manufacturing and storage infrastructure companies were interviewed. The interviewees occupy several different positions within their respective companies and were contacted with the scope-limited agenda of providing information strictly related to wood pellet handling, based on their expertise and experience. Apart from these interviews, personal visits to the facilities were performed by the author, techniques and equipment of the industrial entities engaged in pellet handling and storage were investigated and are presented in this article. The results of this part of the research are presented in section 3.3.

The Port of Rotterdam is the busiest port in Europe and the 6th busiest in the world. The basic principles of wood pellet transportation in the Port of Rotterdam are representative of mix-product bulk ports worldwide and are applicable to other dry bulk ports [21,26,32–37]. The range and typology of facilities and equipment mirrors most of the small- to medium-sized bulk terminals. Through years of experience the terminal operators have settled in the few terminal setups that favor the handling of the most commonly traded materials, which include all types of hinterland transportation modalities - truck, rail and barge inland transportation. As such, the information gained can be used as a focal point to extract useful conclusions from, concerning wood pellet port terminal operations in general. The bulk terminals examined for the purposes of this chapter are not dedicated pellet terminals, since the incoming throughputs do not yet justify such investments. They are all mix-product bulk cargo terminals, i.e. they handle coal, iron ore, gypsum, grain and other bulk materials. While some equipment in place

is suitable for pellet handling as well, terminals have already had to adjust some of their infrastructure and techniques. A significant increase of throughput of a new material, such as wood pellets, that requires different equipment and techniques than the ones used so far, will also require similar future applications between all pellet bulk terminals. Detailed information regarding the examined terminals at the Port of Rotterdam can be found in section 3.3.

3.2.1 Technical characteristics of wood pellets and interaction with equipment

Wu et al. and Towler et al. [38,39], studied various decisive physical material properties of wood pellets in comparison to coal, as well as the characteristics of the material's interaction with mechanical equipment, presented in Table 3.1.

Table 3.1: Physical properties of wood pellets compared to bituminous coal [38,39]

Material	Bituminous coal	Wood pellets
Size [mm]	-	6, 8, 12 (Ø)
Particle density [$\text{kg}\cdot\text{m}^{-3}$]	1200 - 1800	1200 - 1900
Bulk density [$\text{kg}\cdot\text{m}^{-3}$]	720 - 880	500 - 650
Net calorific value [$\text{GJ}\cdot\text{t}^{-1}$]	27	16 - 18
Moisture content [%]	< 20	8 - 11
Internal friction angle [°]	50	33 - 43
Effective internal friction angle [°]	55	39 - 45
Angle of repose [°]	35-45	37 - 41
Breakage	N/A	Easy to break

The similarity between most of the physical properties of coal and wood pellets means that the fundamental design of equipment and infrastructure between the two bulk material could remain the same. However, the equipment in charge of handling wood pellets needs to be able to handle a wider range of flow properties due to the range of the physical properties values [39]. The relatively high bulk density and calorific value make wood pellets one of the most preferable solid biofuels, yet handling and storing wood pellets requires multiple units of equipment with larger volumetric capacities compared to coal [40]. Hancock et al. [13] state that the design of equipment for bulk material handling operations must be closely linked to the specific physical, mechanical and material interacting properties of the material.

Having knowledge of what kind of forces have an impact on feedstock degradation can aid in choosing or designing equipment and methods in order to reduce those effects, or adjust existing facilities in order to better facilitate pellet handling. However, quality certifications and standards on wood pellets is very fragmented, with many different national wood pellet-related standards in circulation [41]. Duca et al. [42] presented wood pellet standards used in Europe in the period 2006–2012. Currently, the International Organization for Standardisation (ISO) is preparing almost 60 standards for all types of solid biofuels, including wood pellets, wood chips, wood briquettes as well as other types of thermally treated and densified biomass fuels. Nevertheless, current solid biomass experimental testing per ISO standards can be inconclusive as to whether it actually simulates real industrial scale handling conditions [43,44]. Schott and Mahajan [45,46], have performed Discrete Element Method (DEM) simulations of wood pellet behavior and have concluded that the current tumbling can testing cannot be considered as representative for realistic handling conditions for filling and discharging silos [45], or moving the material through transfer chutes [46]. Whittaker and Shield [47] also states that there is no standard protocol for drop tests for pellets, even though

pellets are handled and dropped at least between eight to ten times between production and unloading at the final destination.

The main issue when handling wood pellets is the degradation and breakage of the material. Mechanical forces during transshipment, conveying and loading or unloading of vessels can cause particle degradation of the pellets, leading to fines and dust generation [22,48]. Wood pellet fines are specified as particles generated during wood pellet production, handling and storage that are smaller than the specified size of 3.15 mm, but not small enough to be classified as dust particles (100 μ m) [49]. These dry pellet particles have a low density and high drag coefficient and can easily become airborne. Airborne particles can pose a significant health risk to personnel that come in contact with them, causing irritation of the lungs, nasal and respiratory system, allergic reactions and severe illnesses when exposed for a prolonged period of time [22].

Dust explosions are the second major risk linked to wood pellet handling. Dust particles of combustible materials mixed with air will burn with an intensity and speed increased with decreasing particle size [23]. Ignition of pellet dust can occur due to electrostatic discharges, high friction temperatures or hot surfaces at any point in the handling chain. The required ignition energy can be very small and, after ignition, the combustion rate of a dust cloud is usually extremely fast, resulting in a dust explosion and possible fatal damage [23,50]. Dust explosions can propagate at a quick pace in completely enclosed spaces [51].

Other problems when dealing with large quantities of wood pellets can be self-heating and ignition, oxygen depletion, off-gas formation and biological hazards, which is directly related to the length of storage periods [24,52]. According to Röder et al. [53], wood pellet emissions during storage are also essential in properly accounting for the greenhouse gas emissions of the whole wood pellet supply chain. As can be deduced, all of the above do not only constitute a potential personnel threat, but also a significant professional and financial threat to the facilities that handle and store pellets; storage fires are quite common, even in regulated facilities, due to the unpredictability and parameters that affect the material self-ignition [22,54].

3.2.2 Wood pellet port equipment and procedures

The inherent problems with wood pellets, as well as the problems that arise during handling and storage, can be minimized with improvements to equipment design. Using specialized equipment or techniques specifically suited for the product, additionally to common handling methods and equipment, is a solution. This section presents a summary of ways to prevent problems and risks, as they appear in relevant technical reports or biomass related studies. Apart from general advice, the pellet handling procedures are subdivided into four distinct functions of solid bulk handling: transshipment (loading is considered as transshipment), transportation, storage and transfer (Figure 3.1). Specific advice for each handling function can be found in the respective subsections.

Dust formation and dust explosions can be prevented either through reduction of the physical damage inflicted on the pellets during handling, or via dust containment and prevention of explosions. Handling and transport of wood pellets should be as gentle as possible, as the degree of degradation of pellets increases with the number of handling steps. Conveying distances and speeds should be kept to a minimum, and transfer points and large drops should be avoided as they increase the fine content. Getting the pellet trajectories right at transfer points, i.e. minimizing impact points and impact force, also helps to reduce the dust emissions. Handling and storage under enclosed buildings and conveyors is also suggested in order to avoid intake of moisture [55].

Stelte, Khan and the Nordic Innovation Centre [22,23,54] offer a detailed account on key features to deal with when handling wood pellets. In general the following should be observed: avoid unnecessary dust formation, secure sufficient ventilation, remove potential ignition sources and keep the premises clean.

Obernberger and Thek [56] offer general recommendations in order to avoid self-heating and ignition of pellet feedstocks. The distribution temperature within the stored material is the most important measure to take. If high temperatures (>323 K) are detected, appropriate measures need to be taken. These usually include removing part of the material from the heap, spreading out the material over a larger area or recirculating it in the chain to facilitate cooling [23].

In order to address oxygen depletion, off-gas formation and biological hazards, emphasis should primarily be given to equipping enclosed storage areas with CO and CO₂ detectors, removing air pollution through ventilation, exhaust ventilation, curtains, walls, fine water sprays, closed sections and remote control. The gas composition must be analysed before the personnel enters the facility [48].

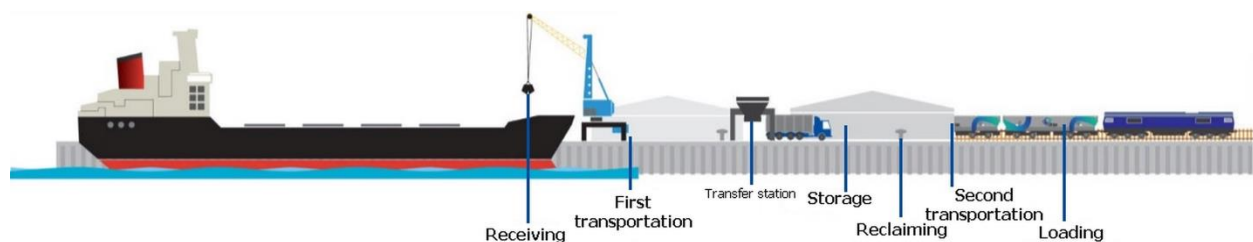

Figure 3.1: Example of a solid bulk material handling chain [57,58]

Transshipment

The first step when handling the wood pellets at a port terminal is to transship the material from the incoming vessel, which can be a ship, barge, truck or train. This can be done via multiple options: grabs, vertical conveyors, pneumatic systems, bucket elevators or self-unloaders.

When using a grab to unload the pellets, the focal point is the reduction of pellet degradation. According to Corbeau [59] from the grab manufacturing company Nemag, by experience, the closed clam-shell grab design (Figure 3.2) reduces dust emission and breakage by 50% when used instead of pneumatic, continuous ship unloading (CSU) systems. The shells of the grabs themselves can have an open, semi-closed or completely enclosed upper part and are able to operate in every kind of opening direction.



Figure 3.2: Generic closed clam-shell grab design (Image courtesy of Nemag B.V.)

CSU systems are pneumatic transshipment systems which are mainly used for ship unloading. Janzé [60] states that pneumatic ship unloaders need to be avoided where possible, because they cause relatively large particle degradation due to high velocity impacts during operation. However, pneumatic systems are sometimes preferable as they can reach a high throughput with their flexible design.

Truck and rail unloading can be done in several ways; the truck or wagon carrier tips its load into a reception bunker or the whole truck or wagon is tipped. Furthermore, underground hoppers that lead to conveyor belt can be used to unload the truck or rail wagons. This option however requires trucks and wagons fitted with bottom unloading systems.

Transportation and transfer

After unloading, bulk materials need to be transported to a storage area. This can be performed by conveying equipment. In this section the most commonly used options for wood pellet transfer are discussed. The transfer from one conveyor to another one can be done through transfer stations along the transportation line.

Belt conveyors are more cost effective over large distances than, for example, screw conveyors, because of their high throughput and relatively low power requirements. Belt conveyors can be totally enclosed, which improves dust control (compared to regular open conveyors). However, they can be expensive to install and intermediate discharges are problematic. When choosing a belt conveyor for wood pellets, systems that encourage impacts or rubbing, wedging or grinding actions need to be avoided, as they can cause damage to the material.

Pouch and pipe conveyors do not need a cover to protect the pellets against, for example, wind, spillage, contamination or rain, and improve dust control as can be seen in Figure 3.3 and Figure 3.4. According to Janzé [60] a pipe conveyor is an ideal transport equipment for handling pellets, because it can accommodate both vertical and horizontal curves and therefore minimize the number of transfer points. On the other hand, Wu et al. [40] state that the pipe conveyor is not applicable for a large-scale pellet bulk terminal, because it is more costly, requires extra coverage distances for opening and closing (folding) of the pipe, and in addition, a pipe conveyor cannot cope with a ship unloader that moves along the quay of the terminal. However, they can be an ideal solution for small terminal sizes or really short transportation

distances. The Ferrybridge power station in the United Kingdom for example, uses these pipe conveyors over a distance of 500 m to transport the wood pellets to a storage silo [61].



Figure 3.3: Pouch conveyor (Image courtesy of ContiTech AG)



Figure 3.4: Pipe conveyor (Image courtesy of Bridgestone Corporation)

When handling pellets, the number of transfer points must be as low as possible to minimize the impact points and by that particle degradation and dust emission. A gentle transfer design can avoid knocking dust out of the flow. Spiral or cascade loading chutes are preferred, because pellets falling from a great height in a silo will break apart. Fans can create a negative pressure that directs dust into the hopper and not in the surrounding area [58].

Storage

According to Williams et al. [62] there are 5 solid dry bulk storage types in use; silos, dome storage, flat storage, bunkers and bins. Silos, dome and flat storage are the most common types used and are covered in this section.

Covered storage is needed when dealing with wood pellets, as high moisture contents can result in material degradation. Enclosed storage also prevents dust from spreading. Furthermore the storage needs to be large enough to accommodate the peak throughput of pellets due to seasonal fluctuations of energy supply and demand [63,64].

The silos' and domes' loading- and unloading systems are very economical and efficient. They are frequently used in power plants and port terminals. The construction can be made from concrete or steel and can reach up to 100 000 m³ of available storage capacity. The expensive concrete storage systems are desirable for high throughput due to its durability, whereas steel silos are more economical though not quite as durable. The pellet silos and domes are emptied through either a tapered bottom or underground hopper system respectively (emptied by gravity) or a flat bottom emptied using a circulating auger for center feed) [65]. The maintenance and discharge time required for flat bottom storage is usually longer.

The flat storage buildings are an economical and efficient design and consists of high bunker style walls with a metal building or hoop type structure over the top of retaining walls. The volume for this large storage type can range from 15 000 – 100 000 m³. Loading and discharging of flat storage facilities can be fully automated, but usually will involve a labor intensive, thus expensive, step in the chain. Emptying is done mostly by a front loader either into a feed system for a boiler (power plant site) or onto trucks, vessels or rail cars for further transportation.

Reclaiming

After storage, the pellets need to be reclaimed for further transport to another location within the port (preferably following the 'first-in, first-out' principle), like the loadout system [60]. A requirement of the reclaiming system is that it should be adequate for enclosed storage and enclosed transport systems. Wu et al. [40] has listed several types of reclaimers that can be used for enclosed storage facilities, but these reclaiming systems are not specifically designed for wood pellets. However, there are several types of reclaimers that are designed (or adjusted) to handle the material.

The most common reclaiming system is a series of underground hoppers beneath the storage infrastructure. Most of the wood pellets (up to 80% of the capacity) are emptied via the hoppers into a conveyor belt and transported to the next stage. The remaining amount has to be manually fed into the hoppers via manual labor, usually with front loaders. This system is preferred due to low costs and simplicity of design, installation and maintenance compared to other, mechanically complex approaches.

Other reclaiming systems include equipment designed for difficult bulk solids, such as walking or vibrating floors and sliding frames (Figure 3.5 and Figure 3.6). Further advantages of these systems are that they work on the 'first-in, first-out' principle, have low power use and maintenance costs and can be placed in the economical flat storage buildings.



Figure 3.5: Walking floor reclaimer (Image courtesy of Stobart Group Limited)

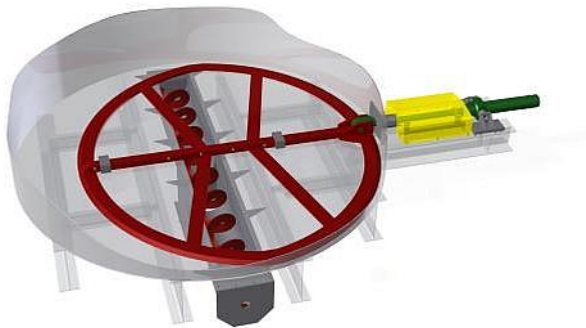

Figure 3.6: Sliding frame reclaimer (Image courtesy of Spirac Engineering AB)

An overview of the most commonly used handling equipment for wood pellets found in port terminals can be found in Figure 3.7.

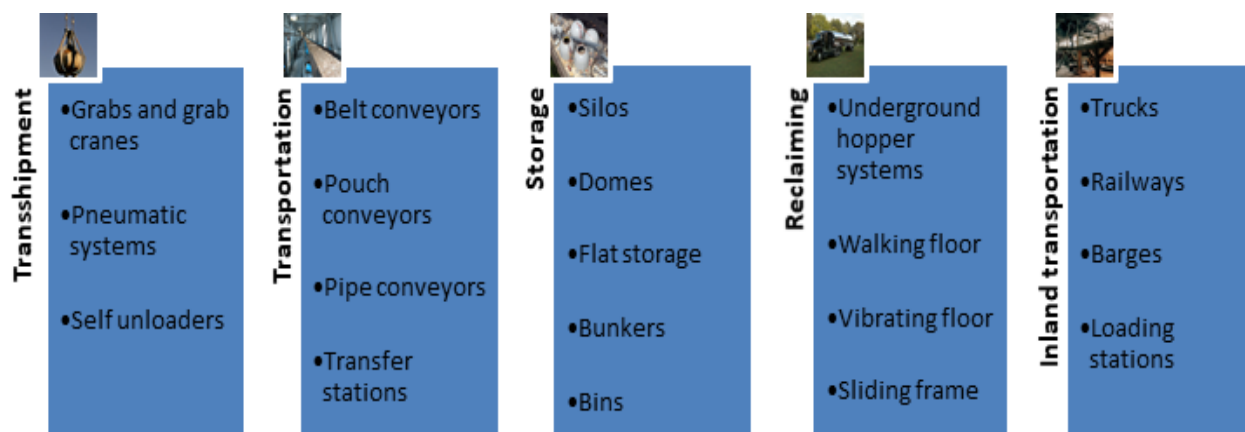

Figure 3.7: Overview of wood pellet handling equipment

3.3 Results

This section presents the way several of the biggest terminals in the Port of Rotterdam that engage in wood pellet trade handle the material. Between 2010 and 2014 the Netherlands imported approximately 1 Mt of wood pellets per annum, exclusively through the 3 port terminals examined in this section [66–68]. In 2015 and 2016 there was no sizeable imports of wood pellets in the Netherlands, due to the previous subsidy scheme running out – 75 kt in 2015 and 56 kt in 2016 respectively [69]. However, the market is expected to pick up in 2018 as plant operators managed to re-secure subsidies for co-firing of biomass. An overview of the examined terminals can be found in Table 3.2.

Table 3.2: Overview of wood pellet terminals in the Port of Rotterdam [70,71]

Terminal	European Bulk Services (EBS)	Zeehavenbedrijf Dordrecht (ZHD)	Rotterdam Bulk Terminal (RBT)
Annual throughput [Mt]	12	5	3
Wood pellet capacity [kt]	150	500	250 via storage - 700 via direct transshipment
Transshipment	Grabs and grab cranes	Grabs and grab cranes, floating cranes	Grabs and grab cranes
Transportation	Conveyor belts (when not in direct storage)	Trucks (when not in direct transshipment)	Conveyor belts
Storage	4 bunkers: total capacity 65 000 m ³ 4 silos: total capacity 80 000 m ³	2 flat warehouses: total capacity 16 000 m ³	6 silos: total capacity 72 000 m ³ 1 flat warehouse: capacity 20 000 m ³
Reclaiming	Grabs and grab cranes	Front loaders	5 underground hoppers Front loaders

3.3.1 European Bulk Services (EBS) B.V.

European Bulk Services (EBS) B.V. is a multipurpose dry bulk terminal operator consisting of two terminals in the Rotterdam port area, Europoort and St. Laurens haven. The St. Laurens haven terminal in Figure 3.8 is used mainly for minerals coal and wood pellets. In 2013 EBS handled approximately 150 000 kt of wood pellets, almost 20% of the total solid biomass imports in the Netherlands.



Figure 3.8: St Laurens haven terminal aerial view (Image courtesy of EBS B.V.)

Wood pellet handling

The wood pellets are unloaded with grabs directly from the vessel into a series of bunkers built along the quay side. There are no intermediate transfer points such as conveyor belts, hoppers or transfer towers. Direct storage means less handling steps, less impact points and friction for the wood pellets which, as mentioned in section 3.2.1, directly decreases the dust and fine production [72].

Unloading of the bunkers is also performed 100% through grabs. Grab operators have been instructed and trained to use lower speeds and gentler handling of the crane and grab when transferring the wood pellets from the vessel to the bunkers. The pellets are also dropped into the bunker from a lower point than other bulk material in order to minimize breakage. After reclaiming, pellets can be loaded in either barges or other vessels, or in trains or trucks. Loading and unloading stations for both are present in the terminal. A scheme of the EBS main pellet handling chain is seen in Figure 3.9.

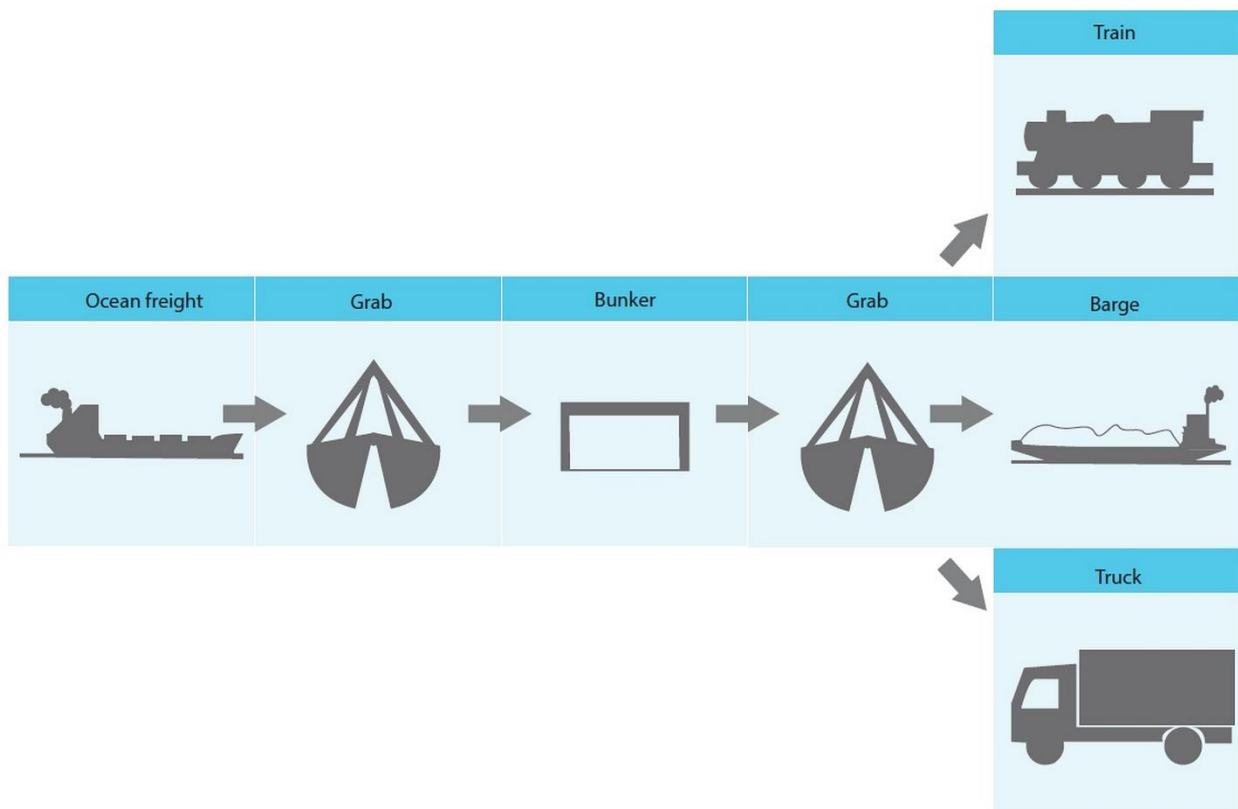

Figure 3.9: EBS pellet handling chain

The grabs themselves are closed clam-shell grab models as seen in Figure 3.2, especially suitable for handling fine and free flowing materials like wood pellets. They are equipped with high enclosed shells to minimize spillage and the influence of wind on the material. The grab shape is designed in such a way that compression of material is minimized (see Figure 3.10). As a result the pellets are damaged as little as possible during the grabbing cycle. The open upper side of the grab enables the crane operator to manually check the filling degree.

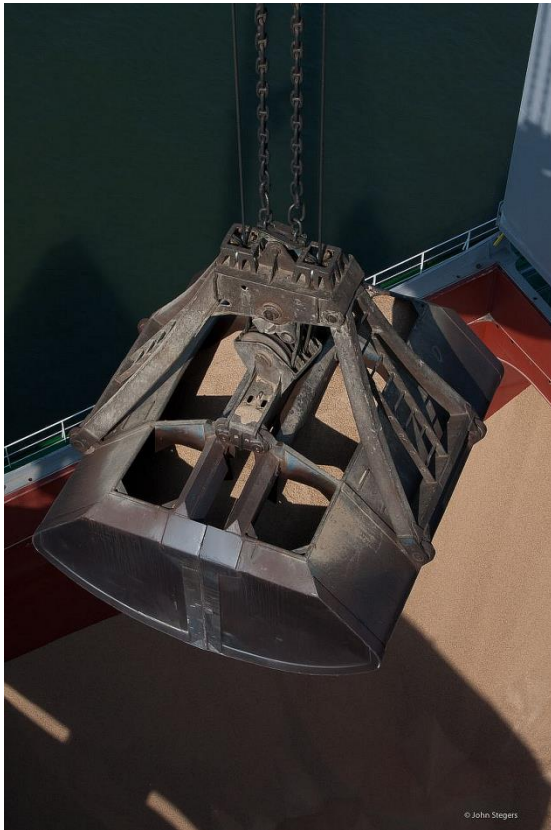

Figure 3.10: Closed clam-shell grab used in EBS terminal (Image courtesy of EBS B.V.)

If the quay bunkers get full, 4 pyramid silos (see Figure 3.8) of 20 000 m³ each are also available as storage space. In this case, a conveyor belt system is used for transportation of the pellets. Dust control systems are already in place, since the terminal is used for the handling of several fine materials, such as alumina and other minerals. However, due to the low volume of wood pellets traded so far, the silos have not yet been used for wood pellet storage.

Transshipment of wood pellets can also be performed in the St. Laurens haven terminal via floating cranes of 36 t capacity, to either lighten or completely discharge a vessel, transferring part or all the cargo in another vessel. In case of bigger vessels, board to board transshipment can also occur at the Europoort terminal using "dolphins", fixed structures that extend the berth of a terminal or provide a mooring point.

No handling of wood pellets is performed during rain to prevent the biological hazards from increased moisture content, as well as deterioration of the product.

Except the specialized grabs, no other equipment used is uniquely tailored to deal with wood pellets, mainly due to the currently small market of the product. Normal conveyor belts, trucks and trains, as well as dust containment systems used during the handling of other fine materials are used when handling pellets.

Wood pellet storage

The quay side bunkers used for the enclosed storage are simple concrete structures with no reclaiming function except using grabs. The bunker sheds can open and close automatically and be controlled by the crane operator in order to limit the exposure of wood pellets to the outside environment as much as possible.

EBS requires from the incoming vessels to monitor and report the temperature of the cargo during the journey and before arriving to the terminal. In the past there have been false or inaccurate reports and assumptions of pellet temperatures that have led to self-ignition. Any temperature above 323 K is a cause for concern. A solution EBS uses is storing the material temporarily in floating barges to minimize security risk until it has cooled down enough to allow storage in the bunkers.

The temperature in the bunkers is monitored with temperature ‘sticks’ dispersed throughout the piles. Temperature is monitored each second and the temperature gradient over time is also reported. A steep increase in temperature may lead to removing part of the material with grabs to a temporary storage in order to cool it down. Different quality and property types of pellets are not stored together. In the past, this practice led to a fire breaking out in a 30 000 m³ silo, burning for 3 weeks before destroying the silo and the material [73].

Constant gas measurements in the bunkers are also performed in order to avoid asphyxiation conditions.

Other issues

According to several terminal operators, a major problem concerning fine production is lack of prior information [72]. The terminal operator does not know and cannot control what happens to the material on the source side. Inadequate conditions and operations there can lead to a large presence of fines in the material delivered to the terminals, for which the operators are responsible. Efforts are being made by EBS to improve communication and knowledge of the source regions and operators as well.

EBS believe that in the case of wood pellets becoming more of a commodity market in Northwest Europe, much like in the UK, specialized handling and storage methods can be used. Drax's specialized rail wagons are an example [18].

3.3.2 Zeehavenbedrijf Dordrecht (ZHD) B.V.

Zeehavenbedrijf Dordrecht (ZHD) B.V. is an independent stevedoring company operating in Dordrecht, Moerdijk and with a floating terminal at Rotterdam. It regularly handled around 300 to 400 kt of wood pellets per year (peaking at 500 kt), representing more than half of the Port of Rotterdam total wood pellet imports. ZHD was the main supplier of the RWE Amercentrale and the Vattenfall power plants before the previous subsidy scheme ran out and the plants stopped co-firing wood pellets. In 2013, 50% of the wood pellet imports through ZHD went to residential clients, primarily in Germany.

Wood pellet handling

ZHD uses mainly direct transshipment from ocean-going vessels to barges (see Figure 3.12), operating with the ‘just in time’ delivery principle to their customers in order to avoid higher transportation and storage costs. Vessels served can reach up to Supermax - Handymax sizes (40 000-60 000 t). They are unloaded via cranes on the quay side or with the operators floating cranes that can reach up to 10 000 t per day of discharge capacity. The operators floating terminal allows no limitations to ship draft size and can service Capesize vessels as well, if

pellets imports increase to the point where using vessels of this size is profitable. A scheme of the ZHD main pellet handling chain is seen in Figure 3.11.

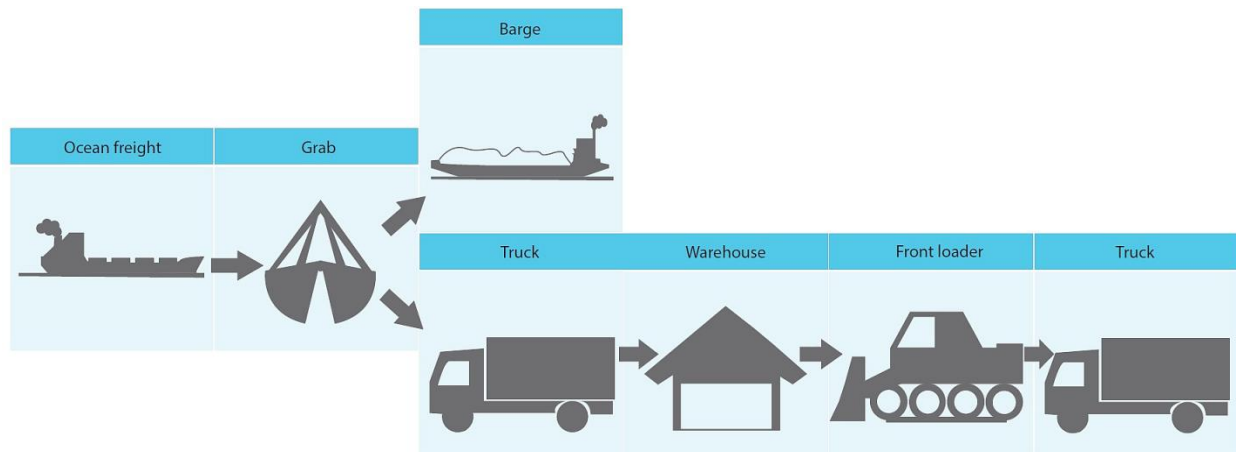

Figure 3.11: ZHD pellet handling chain

Much like EBS, unloading of vessels and loading of barges and coasters is done in a gentle way. ZHD offers a ‘soft landing’ contract clause to its clients. This ensures that handling is done in a way that prevents as much as possible damage to the product by lowering the grab more into the barge while loading, spreading the product evenly in the bottom of the barge to provide a ‘cushion’ for the next load and maintaining low speeds throughout the procedures. The constant transshipment enables cooling down of the product at the same time [74,75].

If the wood pellets need to be stored, ZHD has 2 flat warehouses available. Transport of pellets to the warehouses is performed via trucks (the grabs load the truck with pellets) and discharge via front-loaders and manual labor into trucks as well. As in EBS, handling of wood pellets is conducted weather permitting.

Since almost the entirety of handling consists of vessel-to-vessel transfer, there are no dust control systems in place.



Figure 3.12: Direct transshipment of wood pellets (Image courtesy of ZHD B.V.)

Wood pellet storage

The flat warehouses available have a height of 8.5 m and a capacity of 8 000 t each. Flat storage was selected over silos as it was deemed that silos would be too hard to deal with in case of overheating and self-ignition, taking into account that the hot spot is usually located in the bottom of the piles. Pellets can be piled up to 7.5-8 m with the use of a push board.

Before the pellets are discharged from the vessel, a ‘gas doctor’ [76] goes on board to measure the gas levels and assess any potential danger from oxygen depletion or carbon monoxide generation. The temperature in storage is constantly monitored through temperature sensors on ‘sticks’ through the storage area. If the sensors report a high temperature, a manual checking is also performed and part of the material is transported to a barge until it cools off (usually in a weeks’ time). All personnel working in the storage area is equipped with O₂ sensors. The warehouses are equipped with CO₂ sensors as well and both them and the equipment used is ATEX-proof; no spark sources are present in the vicinity and complete enclosure and overpressure in the front loaders’ cabin are maintained.

Finally, one of the warehouses is equipped with a screening device to use before the final transport step, which enables the product to arrive to the client with as less fines as possible. Similar to the handling step, dust control systems are not in place, as, from experience, they are not required at the moment.

Other issues

As was mentioned in section 3.3.1, product arriving with a large percentage of fines already present is a big problem. Fines can constitute up to 10-15% of the cargo in some extreme cases depending on the source and quality of the pellets. The inability to expect them only exacerbates the situation [74,75].

3.3.3 Rotterdam Bulk Terminal (RBT) B.V.

Rotterdam Bulk Terminal (RBT) B.V. is a multipurpose dry bulk terminal operator in the port of Rotterdam. The terminal has direct access to the sea and inland waterways and can receive up to Handysize vessels. RBT was providing the Amercentrale Unit 9 with almost 6 000 t per day of wood pellets, operating on the ‘just in time’ principle via direct transshipment (Figure 3.13). A scheme of the RBT main pellet handling chain is seen in Figure 3.14.



Figure 3.13: Direct transshipment operation (Image courtesy of RBT B.V.)

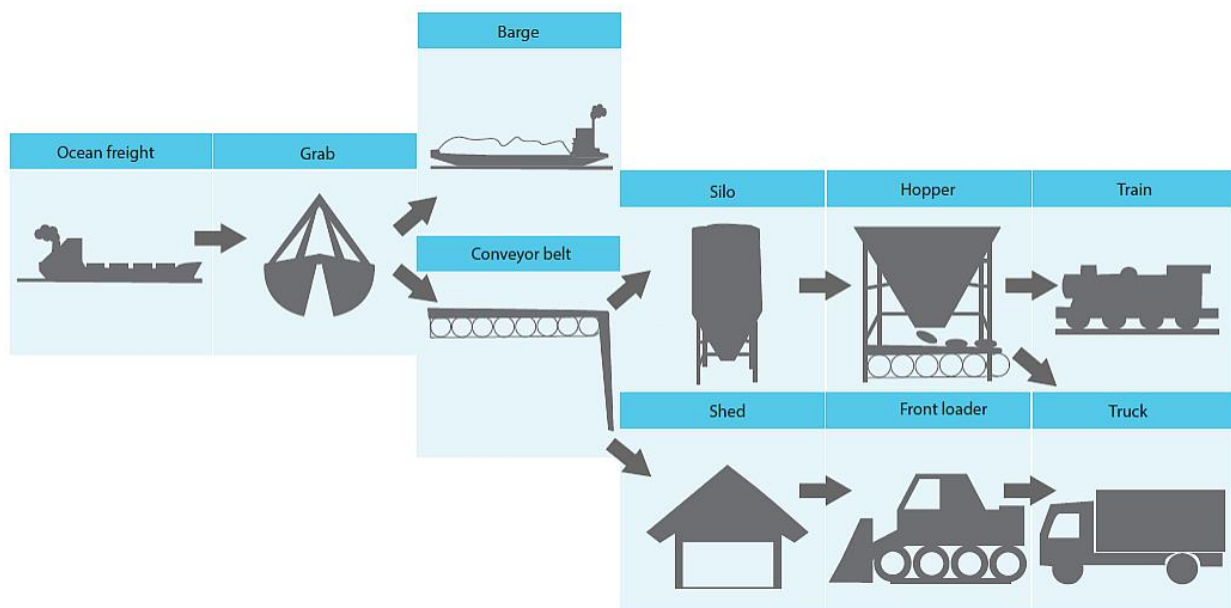

Figure 3.14: RBT pellet handling chain

Wood pellet handling

Owing to the compact structure of the terminal, 80% of all operations are executed with gantries. When it is absolutely necessary, quicker discharge is easily fixed with help of floating cranes. Wood pellets are unloaded via grabs, irrespective of the procedure being a direct transshipment or intermediate storage. Handling with the grab is done as gently as possible. In the case of intermediate storage the transportation of wood pellets is performed through a completely covered (but not 100% enclosed) 1500m conveyor belt with a maximum capacity of 18 00 t·h⁻¹ (Figure 3.15). When transporting pellets the conveyor belt speeds are lower than when other bulk material is handled.

The silos and shed are filled through direct drop of the product (20m height). Sviderski [77] reports that the first layer of the product shields the next layers from impact, restricting the fines to a percentage of approximately 4% of the total product weight, a loss acceptable by the operator. Silo discharging is performed through 5 underground hoppers which allow two thirds of the silo to be emptied through the materials own weight (gravity discharge) while the remaining one third is discharged manually. The shed is discharged 100% through manual labor with front loaders.

According to RBT's experiences, dust explosions are not a danger when ATEX certified equipment is used during the loading and discharge of the facilities. The equipment operators have also followed courses per ATEX regulations. The conveyor belts are not completely enclosed, just covered, so that a dust explosion will not propagate through the belt. During rain, there is no work performed at all and the pellets remain stored in the source vessels [77].



Figure 3.15: Rotterdam Bulk Terminal aerial view (Image courtesy of RBT B.V.)

Wood pellet storage

In direct transshipment there is no danger of self-heating and ignition of pellets, as the temperature drops to 298-303 K. Temperature in storage however is monitored constantly with temperature sensors on 'sticks'. The sticks are placed in the piles manually and transmit their readings to GPS boxes located in the facility. The readings are then forwarded to the offices of RBT in the premises. When a temperature higher than 333 K is reported, the storage area is

cooled down through mechanical ventilation. Moreover, an amount of wood pellets can be discharged, circulated around the terminal grounds in the conveyor belts, and then brought in storage again. Nitrogen flooding of the silos is also possible in a fire breaks out. According to RBTs' experience, temperature sticks in silos can be a problem when underground discharge is used, as the weight of the material tends to rip the sticks down from their holders.

Personnel that enter the enclosed storage spaces always do so in pairs and carry CO₂ sensors on them at all times to avoid suffocation or respiratory problems.

There is no screening system in place in the silos as it is a completely closed system. It is possible to have a screening system at the end of the handling chain coming from the flat storage, but this will happen only after direct request from the client who will have to bear the costs of the equipment.

3.4 Discussion

For the low amount of pellets going through the bulk terminals so far, operators report that with the described techniques presented in this chapter, the end quality and safety of the product is within acceptable limits. However, none of the terminals is a dedicated pellet import terminal. They handle pellets as another product among many which make for several sub-optimal procedures in the chain; manual discharge, no screening equipment, limited dust prevention and containment measures. Major investments in infrastructure are also hindered by the relatively low cost contribution of terminal handling costs to the overall wood pellet supply chain costs. Handling and storage in import terminal usually ranges between 2.5 to 5 €·t⁻¹, depending on factors such as relevant equipment, weather delays, or whether storage or direct transshipment is used [73,74,78]. With a (CIF ARA) spot price of approximately 135 €·t⁻¹ [79,80] and a 'delivered to end user' price than can reach up to 200 €·t⁻¹ in continental Europe [81,82], reducing the terminal handling and storage costs seems trivial from an overall perspective. However, from a terminal operator's point of view, investing in dedicated wood pellet infrastructure and equipment is a major strategic decision that can have severe implication on their long-term planning strategy. Moreover, taking into account the future increased imports, several more stakeholders will benefit from dedicated equipment and terminals and a lower delivered wood pellet price. End users such as power plants, that may need to rely less on governmental subsidies, and households or industry, in the case of pellets used for heating purposes, will support lower wood pellet prices via dedicated or properly equipped import terminals.

As imports are expected to grow, and with ports transitioning into high volume wood pellet handling facilities as well, significant changes will be necessary; direct transshipment with floating cranes might no longer be an option, as floating cranes generally have 50% of the capacity of stationary gantry cranes of the same tonnage [59]. In the case of throughput in the range of 10 Mt per year or more, unloading using exclusively high capacity gantry cranes or CSU systems will be needed, although the CSU effect on the deterioration of the product will have to be taken into account. Transportation with trucks instead of a continuous conveyor cannot be the only possible option any more due to low capacity of the trucks. Fully enclosed instead of covered conveyors will be required, with state-of-the-art dust extraction systems and explosions prevention and suppression; as the volumes will increase, so will the chances of an accidental ignition and explosion. Currently, there is absolutely no handling during rain or otherwise unfavorable weather conditions. This is manageable, as for the present low throughputs there is no congestion of wood pellet vessels in the berths of the terminals. Extra demurrage costs are manageable due to the small vessel sizes (compared to the respective costs of coal). However, if the projected increases in wood pellet trade materialize, weather related operations will also become a major factor to be taken into account. Storage options will need

to transition from numerous smaller buildings to fewer larger ones to keep costs down. At the same time, larger storage infrastructure could possibly mean longer storage times that leads to increased chances of self-heating and ignition. New storage options will need to be equipped with better temperature monitoring systems, as well as increased ventilation to keep temperatures down in the piles of material. Automated reclaiming systems might also need to be put into place, as manual labor is too time consuming and usually results in a much bigger percentage of fines in the material than e.g. a screw conveyor or sliding frame. Lastly, the personnel will need to undergo special training, just as some terminals in the Port of Rotterdam have already done, in order to familiarize themselves with the new equipment and techniques needed for safe and efficient handling of wood pellets.

Part of the terminals' existing infrastructure could be adopted for pellets in the short term future, with a relatively low cost. In general, however, larger scale throughputs require an elaborate and expensive monitoring and safety infrastructure, besides fully covered handling and storage [25]. Most biomass handling facilities do not start up and function effectively straight away – many need an extended period of development during which retrofit and lost opportunity costs are incurred, often for a year or two before they become fully operational [24]. All of the above constitute significant changes in the port terminals' design and operations and will require considerable investments in almost all aspects of a terminal's setup: infrastructure type and layout, personnel training and land availability. Research has been performed by the author on optimizing the equipment deployment and operations in a dedicated biomass terminal [83]. One particular successful example of wood pellet import terminal setup is the facilities of Drax, one of the biggest providers of UK's electricity. Drax's power station in North Yorkshire has wood pellets delivered to it from 4 different dedicated biomass terminals along the UK's East coast. The terminals use supply chain systems designed especially for this task, such as continuous ship unloading systems (a combination of suction and screw conveyor), completely covered conveyor belts, silos for storage, and has even developed specific train wagons to efficiently transport the low density wood pellets at high capacities. As explained in the introduction, whilst Drax is at the extreme upper end of the size scale, the proportions and scale are similar in many projects [24], and it can be used as a guideline to facilitate a successful wood pellet terminal setup.

Finally, equipment manufacturers are not always as well informed as the buyers (in this case the terminals) expect, when it comes to offering advice on the right 'tools for the job' [29]. Although the manufacturing companies are experts in equipment design, in certain cases they cannot be expected to know exactly how every possible material will behave and this in turn highly affects the equipment design itself – it is the buyer's responsibility to make sure suitable solutions are selected. It might be necessary at this stage to bring in more stakeholders, such as experts in material interaction to advice on the equipment design and selection process.

The author acknowledges that the human factor of this research can be viewed as a limitation. Empirical research can be viewed as inadequate when performed with no research design or the right focus. However, the strict scope of the information exchange and the personal experience of terminal operators with industrial wood pellet handling conditions after years of dealing with the product constitute valid scientific data. The importance of the information gained from the above methods becomes more important when coupled with the limited scientific background on the subject and the difficult access to actual industrial data due to several reasons – confidentiality issues, industrial reticence to data sharing etc. These techniques are widely used in several empirical research fields for the purpose of data gathering (e.g. residential or industrial sector data gathering from energy companies) with a high degree of success and credibility. A full list of interviewees can be found in the reference section of this chapter.

Potential future research relating to wood pellets could focus on various aspects. Equipment interaction could be identified with greater accuracy; the compression, shearing and impact forces inflicted on pellets during handling and storage could be examined into more depth in order to identify which part of the chain to focus on to avoid associated problems. This will promote improving the design of currently used equipment and handling chains and developing new equipment or techniques for more efficient handling and storage. Regarding transport, more information is needed for the status of the material when it arrives in the port terminals; most terminal facilities report that there is no way of gaining prior information and have no control on the steps pellets go through from production until delivery to the terminal, which might result in shipments with an unacceptable number of fines present.

Research into innovation in wood pellet handling and storage has identified recent advances in these areas. Stammes [84] has pinpointed recent advances in the fields of explosion protection, which encompasses explosion resistant design, venting, suppression and isolation equipment and methods [85,86]. A promising solution to temperature related problems can be solved by monitoring closely with disposable passive RFID tags in wireless sensor networks [87,88].

Finally, there might be merit in researching the replacement of normal wood pellets, which constitute 100% of the co-firing fuel, with steam-treated or torrefied pellets [89]. These type of pellets are generally more energy intensive and more costly than conventional pellet production methods [90,91]. Yet, they have a higher calorific value than normal wood pellets, they are more resistant to moisture and degradation and generally can make use of conventional bulk equipment with minimal to no need for retrofitting or replacing infrastructure [92], resulting in greater operational flexibility with lower investments. However, despite the co-firing industry being a front-runner of torrefaction research, there is little available data about current use of torrefied pellets in industrial applications, and limited knowledge of its implementation in industries such as the chemical and petrochemical industry, pulp and paper etc. [30]. The market of torrefied pellets is relatively on the earlier stage and its future seems unclear [90,92].

3.5 Conclusions

The main objective of this chapter was to evaluate the state-of-the-art conditions relating to wood pellet handling in import terminals in the port of Rotterdam, and assess whether the terminal design needs to be reexamined to efficiently handle the expected increase in pellet imports.

When dealing with wood pellets, special care is given in order to prevent the degradation of the material due to handling forces acting on it, minimizing dust and fine production. This is mainly performed through lowering the speed of the grab cycle, the height of the drop and training personnel specifically on how to handle the material. Some terminals have eliminated the need for conveying all together in most cases by having storage facilities located right next to the quay or by using direct transshipment. Others mainly use covered conveyor belts for transport of the wood pellets to storage facilities. The conveying distance is kept as short as possible and the belt speeds when handling pellets are lower than usual. Handling of wood pellets is not performed during rain to avoid deterioration of the quality of the product in the short term and mold growth which leads to biological hazards in the long term. In any case, containment and extraction of dust and particulates and ensuring a dry environment throughout the chain is of the highest priority.

Self-heating and ignition is considered as the major problem inherent with wood pellet handling and storage. Temperature is monitored continuously in storage and in some cases vessel holds. ATEX equipment and procedures are in place and ignition sources are avoided. When high

temperatures are reported material is removed temporarily, either to a different storage area or recirculated in order to allow it to cool down. Temperature monitoring systems are functioning continuously, especially in enclosed facilities. Gas (CO, CO₂) and oxygen measurements are also performed often and all personnel who enter enclosed facilities carry gas and oxygen sensors.

The majority of the bulk equipment and facilities designed for other bulk commodity goods is used for wood pellets as well, and can be suboptimal (e.g. hopper design in RBT). The port terminals' need to use manual labor in certain cases (front-loaders in warehouses, physical engagement in others) showcases the fact that not all equipment is fit for handling material with different properties. Still, the current setup and equipment in bulk terminals, geared mainly towards coal, iron ore and other material with different properties than wood pellets, can deal with low volumes of pellet throughput. If the expected increases in wood pellet imports materialize, most import terminals will have to invest in adjusting their approach, either by retrofitting existing facilities, or creating new ones altogether. The focus should be primarily put on two aspects: transportation of high volumetric capacity and adequate storage capacity. Both of these aspects will need to comply with the strict safety measures and regulations discussed in this chapter.

References

- [1] European Biomass Association, AEBIOM Statistical Report - Key Findings, 2016. <http://www.aebiom.org/wp-content/uploads/2016/12/AEBIOM-KEY-FINDINGS-REPORT-2016.pdf>.
- [2] S. Proskurina, R. Sikkema, J. Heinimö, E. Vakkilainen, Five years left – How are the EU member states contributing to the 20% target for EU’s renewable energy consumption; the role of woody biomass, *Biomass and Bioenergy*. 95 (2016) 64–77. doi:10.1016/j.biombioe.2016.09.016.
- [3] T. Mai-Moulin, L. Visser, M. Junginger, Assessment of sustainable biomass export potentials from international sourcing countries, *Int. Work. “Towards a Eur. Trade Strateg. Sustain. Solid Biomass Imports to EU.”* (2016).
- [4] I. Dafnomilis, R. Hoefnagels, Y.W. Pratama, D.L. Schott, G. Lodewijks, M. Junginger, Review of solid and liquid biofuel demand and supply in Northwest Europe towards 2030 – A comparison of national and regional projections, *Renew. Sustain. Energy Rev.* 78 (2017). doi:10.1016/j.rser.2017.04.108.
- [5] L. Paolotti, G. Martino, A. Marchini, R. Pascolini, A. Boggia, Economic and environmental evaluation of transporting imported pellet: A case study, *Biomass and Bioenergy*. 83 (2015) 340–353. doi:10.1016/j.biombioe.2015.09.011.
- [6] Social and Economic Council of the Netherlands, *Energy Agreement for Sustainable Growth*, 2013. <https://www.ser.nl/en/publications/publications/2013/energy-agreement-sustainable-growth.aspx>.
- [7] I. Dafnomilis, Y.P. Wachyar, D.L. Schott, M. Junginger, R. Hoefnagels, *Bioenergy development in the Netherlands*, 2015. doi:2015.TEL.8045.
- [8] D. Thrän, *Global Wood Pellet Industry and Trade Study 2017*, 2017.
- [9] W. Strauss, *Industrial Wood Pellet Fuel in Pulverized Coal Power Plants*, in: *BioCleantech Forum*, Ottawa, Canada, 2016.
- [10] L. du Plessis, *Japan’s Biomass Market Overview*, in: *JETRO London*, 2015.
- [11] J. Carter, *New Opportunities for Biomass Growth : Japan and South Korea*, (2017). <https://blog.forest2market.com/new-opportunities-for-biomass-growth-japan-and-south-korea> (accessed August 5, 2017).
- [12] International Trade Administration (ITA), *2016 Top Markets Report Renewable Fuels Country Case Study: South Korea*, 2016.
- [13] W. Strauss, *Global Industrial Wood Pellet Markets – Future Demand and Future Prices (White Paper)*, *Futur. Metrics*. (2016).
- [14] V.E. Hancock, I. Dafnomilis, D.L. Schott, G. Lodewijks, *Torrefied Biomass and its Handling Aspects – A State-of-the-art Review*, in: *Bulk Mater. Storage, Handl. Transp.*, Darwin, Australia, 2016.
- [15] W. Strauss, *Overview of Wood Pellet Co-firing*, in: *Co-Firing Work.*, 2016. <http://www.biomasscofiring.ca/images/stories/PDFs/WoodPelletCo-firingOverviewFutureMetrics.pdf>.
- [16] Drax Group PLC, *Building a 21st century port*, (2016). <https://www.drax.com/sustainability/21centuryport/> (accessed November 5, 2017).
- [17] Drax Group PLC, *About us*, (2017). <https://www.drax.com/about-us/> (accessed November 5, 2017).
- [18] *Railway Gazette*, *Drax unveils high-volume biomass wagon*, (2013). <http://www.railwaygazette.com/news/traction-rolling-stock/single-view/view/drax-unveils-high-volume-biomass-wagon.html> (accessed January 1, 2015).
- [19] Oxford Economics, *The Economic Impact of Drax Group in the UK*, 2016. www.huawei.com/ilink/uk/download/HW_441177.
- [20] H. du Mez, *Advisor Business Intelligence - Dry Bulk*, Port of Rotterdam Authority,

- (2017). Personal communication.
- [21] Port of Rotterdam Authority, European hub for biomass, 2013. <https://www.portofrotterdam.com/nl/file/843/download?token=wg3CCekF%0A>.
- [22] W. Stelte, *Guideline: Storage and Handling of Wood Pellets*, 2012.
- [23] Nordic Innovation Centre, *Guidelines for storing and handling of solid biofuels.*, 2008.
- [24] J.R. Berry, *Advances in Materials Handling Solutions for Biomass*, 2012.
- [25] A. Rossner, C.E. Jordan, C. Wake, L. Soto-Garcia, Monitoring of CO in Residences with Bulk Wood Pellet Storage in the Northeast, *J. Air Waste Manage. Assoc.* 2247 (2017). doi:10.1080/10962247.2017.1321054.
- [26] S. Proskurina, H. Rimppi, J. Heinimö, J. Hansson, A. Orlov, K. Raghu, E. Vakkilainen, Logistical, economic, environmental and regulatory conditions for future wood pellet transportation by sea to Europe: The case of Northwest Russian seaports, *Renew. Sustain. Energy Rev.* 56 (2016) 38–50. doi:10.1016/j.rser.2015.11.030.
- [27] S. Graham, C. Eastwick, C. Snape, W. Quick, Mechanical degradation of biomass wood pellets during long term stockpile storage, *Fuel Process. Technol.* 160 (2017) 143–151. doi:10.1016/j.fuproc.2017.02.017.
- [28] S. Graham, I. Ogunfayo, M.R. Hall, C. Snape, W. Quick, S. Weatherstone, C. Eastwick, Changes in mechanical properties of wood pellets during artificial degradation in a laboratory environment, *Fuel Process. Technol.* 148 (2016). doi:10.1016/j.fuproc.2016.03.020.
- [29] M.S.A. Bradley, Biomass fuel transport and handling, in: *Fuel Flex. Energy Gener. Solid, Liq. Gaseous Fuels*, Elsevier Ltd, 2016. doi:http://dx.doi.org/10.1016/B978-1-78242-378-2.00004-3.
- [30] M.C. Carbo, P.M.R. Abelha, M.K. Cieplik, C. Mourao, J.H.A. Kiel, Fuel pre-processing, pre-treatment and storage for co-firing of biomass and coal, in: *Fuel Flex. Energy Gener. Solid, Liq. Gaseous Fuels*, Elsevier Ltd, 2016. doi:10.1016/B978-1-78242-378-2.00005-5.
- [31] D. Ilic, K. Williams, R. Farnish, E. Webb, G. Liu, On the challenges facing the handling of solid biomass feedstocks, *Biofuels, Bioprod. Biorefining.* 12 (2018) 187–202. doi:10.1002/bbb.1851.
- [32] United Nations Conference on Trade and Development (UNCTAD), *Development and improvement of ports - Development of bulk terminals*, 1985.
- [33] United Nations Conference on Trade and Development (UNCTAD), *Handbook on the management and operation of dry ports*, 1991.
- [34] F.E. Agos, *Multi-purpose port terminals. Recommendations for planning and management.*, UNCTAD Monogr. Port Manag. (1991).
- [35] United Nations Conference on Trade and Development (UNCTAD), *Port Performance Indicators*, (1976). http://unctad.org/en/PublicationsLibrary/tdbc4d131sup1rev1_en.pdf.
- [36] E.G. Frankel, J. Cooper, Y.W. Chang, G. Tharakan, *Bulk Shipping and Terminal Logistics*, 1985.
- [37] D.L. Schott, G. Lodewijks, Analysis of dry bulk terminals: Chances for exploration, *Part. Part. Syst. Charact.* 24 (2007). doi:10.1002/ppsc.200601121.
- [38] M.R. Wu, D.L. Schott, G. Lodewijks, Physical properties of solid biomass, *Biomass and Bioenergy.* 35 (2011) 2093–2105. doi:10.1016/j.biombioe.2011.02.020.
- [39] G. Towler, R. Sinnott, *Specification and Design of Solids-Handling Equipment*, Elsevier Ltd, 2013. doi:10.1016/B978-0-08-096659-5.00018-3.
- [40] M. Wu, *A Large-scale Biomass Bulk Terminal*. PhD Dissertation, Delft University of Technology, 2012. doi:doi:10.4233/uuid:cfb51421-504d-46df-8309-e10ac65dbbc3.
- [41] S. Proskurina, E. Alakangas, J. Heinimö, M. Mikkilä, E. Vakkilainen, A survey analysis

- of the wood pellet industry in Finland: Future perspectives, *Energy*. 118 (2017) 692–704. doi:10.1016/j.energy.2016.10.102.
- [42] D. Duca, G. Riva, E. Foppa Pedretti, G. Toscano, Wood pellet quality with respect to en 14961-2 standard and certifications, *Fuel*. 135 (2014) 9–14. doi:10.1016/j.fuel.2014.06.042.
- [43] International Organization for Standardization (ISO), ISO 17831-1: Solid biofuels - Determination of mechanical durability of pellets and briquettes - Part 1: Pellets, 2015. <http://www.hse.gov.uk/electricity/standards.htm>.
- [44] S.H. Larsson, R. Samuelsson, Prediction of ISO 17831-1:2015 mechanical biofuel pellet durability from single pellet characterization, *Fuel Process. Technol.* 163 (2017). doi:10.1016/j.fuproc.2017.04.004.
- [45] D.L. Schott, R. Tans, I. Dafnomilis, V. Hancock, G. Lodewijks, Assessing a Durability Test for Wood Pellets by Discrete Element Simulation, *FME Trans.* (2016) 279–284. doi:10.5937/fmet1603279S.
- [46] A. Mahajan, I. Dafnomilis, V. Hancock, G. Lodewijks, D.L. Schott, Assessing the representativeness of durability tests for wood pellets by DEM Simulation – Comparing conditions in a durability, in: *Powders & Grains*, 2017: pp. 1–4.
- [47] C. Whittaker, I. Shield, Factors affecting wood, energy grass and straw pellet durability – A review, *Renew. Sustain. Energy Rev.* 71 (2017) 1–11. doi:10.1016/j.rser.2016.12.119.
- [48] I. Dafnomilis, L. Lanphen, D.L. Schott, G. Lodewijks, Biomass handling equipment overview, in: *Mater. Handl. Constr. Logist.*, Vienna, Austria, 2015: pp. 66–70.
- [49] International Organization for Standardization (ISO), ISO 17225-1: Solid biofuels - Fuel specifications and classes - Part 1: General requirements, 2014. <https://www.iso.org/obp/ui/#iso:std:iso:9241:-11:ed-2:v1:en>.
- [50] C. Huéscar Medina, H.N. Phylaktou, H. Sattar, G.E. Andrews, B.M. Gibbs, The development of an experimental method for the determination of the minimum explosible concentration of biomass powders, *Biomass and Bioenergy*. 53 (2013) 95–104. doi:10.1016/j.biombioe.2013.03.008.
- [51] J. Lottermann, The underestimated explosion hazards of solid biofuels, (2015). doi:2014.TEL.7893.
- [52] F. Yazdanpanah, S. Sokhansanj, C.J. Lim, A. Lau, X. Bi, S. Melin, Stratification of off-gases in stored wood pellets, *Biomass and Bioenergy*. 71 (2014) 1–11. doi:10.1016/j.biombioe.2014.04.019.
- [53] M. Röder, C. Whittaker, P. Thornley, How certain are greenhouse gas reductions from bioenergy? Life cycle assessment and uncertainty analysis of wood pellet-to-electricity supply chains from forest residues, *Biomass and Bioenergy*. 79 (2014) 50–63. doi:10.1016/j.biombioe.2015.03.030.
- [54] N.S. Khan, Best Practice Guide for handling of Biomass Fuels and Coal - Biomass Mixes, 2011.
- [55] C.D. Memos, Port Planning, in: *Port Eng. Planning, Constr. Maintenance, Secur.*, John Wiley & Sons, New Jersey, 2004.
- [56] I. Obernberger, G. Thek, *The pellet handbook – The production and thermal utilization of biomass pellets*, Routledge, 2010.
- [57] M. Rivers, Biomass sourcing strategies, (2013). http://www.drax.com/media/13853/2_cmd_biomass_markets_final.pdf.
- [58] L. Lanphen, Biomass handling equipment in European ports - an overview of current designs and required design improvements, 2015. doi:2014.TEL.7893.
- [59] M. Corbeau, General Manager, Nemag BV, (2017). Personal communication.
- [60] P. Janze, Biomass Handling Handling Pellets – Things to Consider, (2016) 1–8.

- <http://www.advancedbiomass.com/2010/10/handling-pellets-things-to-consider/>
(accessed June 1, 2017).
- [61] A. Mills, Ferrybridge power station, (2016). <https://portasilo.com/sectors/energy-from-waste-and-power/ferrybridge-power-station/> (accessed June 5, 2017).
- [62] G.D. Williams, Biomass Storage and Handling: Status and Industry Needs, American Society of Agricultural and Biological Engineers (ASABE) Annual International Meeting, Providence, Rhode Island, USA, 2008.
- [63] J. Ruijgrok, Managing Director, ESI Eurosilos BV, (2016). Personal communication.
- [64] C. Geijs, Project Engineer, ESI Eurosilos BV, (2016). Personal communication.
- [65] P. Basu, Biomass Handling, First Edit, Elsevier Inc., 2013. doi:10.1016/B978-0-12-396488-5.00012-5.
- [66] W. Van Der Lans, Bio-Synergy in the Port, 2016.
- [67] Port of Rotterdam Authority, Rotterdam Bio Port: Our contribution to a biobased economy, 2013.
- [68] Port of Rotterdam Authority, Jaarverslag 2014, 2014. doi:10.1007/s13398-014-0173-7.2.
- [69] Port of Rotterdam Authority, Jaarverslag 2016, 2016.
- [70] Port of Rotterdam Authority, Dry Bulk Companies, 2016.
- [71] RBT – 700 000 tonne coal transshipment capacity in the port of Rotterdam, Dry Cargo. (2012).
- [72] F. van der Stoep, Sales Manager, European Bulk Services (EBS) BV, (2015). Personal communication.
- [73] L. Ljungblom, Pellets: booming in Rotterdam, Bioenergy Int. No 9. (2004) 6–7.
- [74] L. Lokker, Commercial Director, ZHD Stevedoring, (2015). Personal communication.
- [75] D. Regoord, Sales Manager, ZHD Stevedoring, (2015). Personal communication.
- [76] British Government Health and Safety Executive, Wood pellet bio-fuel, (2012). <http://www.hse.gov.uk/confinedspace/updates/wood-pellet-fuels.htm>.
- [77] B. Sviderski, Commercial Manager, Rotterdam Bulk Terminal (RBT) BV, (2015). Personal communication.
- [78] B. Pothoven, Business Analyst and Insurance Manager, Europees Massagoed Overslag (EMO) BV, (2015). Personal communication.
- [79] Argus Media, Biomass Markets, (2016). <http://media.argusmedia.com/~media/Files/PDFs/Samples/Argus-Biomass.pdf> (accessed November 5, 2017).
- [80] W. Strauss, Global pellet market outlook in 2017, Wood Pellet Assoc. Canada. (2017). <https://www.pellet.org/wpac-news/global-pellet-market-outlook-in-2017> (accessed November 5, 2017).
- [81] FOEX Indexes Ltd, Bioenergy and Wood Indices, (2017). <http://www.foex.fi/biomass/> (accessed November 8, 2017).
- [82] L. Blair, Wood pellet market update, in: Nord. Balt. Bioenergy Conf., Hawkins Wright, Helsinki, 2017.
- [83] I. Dafnomilis, M.B. Duinkerken, M. Junginger, G. Lodewijks, D.L. Schott, Optimal equipment deployment for biomass terminal operations, Transp. Res. Part E Logist. Transp. Rev. 115 (2018). doi:10.1016/j.tre.2018.05.001.
- [84] S.A. Stammes, Innovative approaches in woody biomass handling and storage, 2017. doi:2017.TEL.8140.
- [85] A. Tascon, Design of silos for dust explosions: Determination of vent area sizes and explosion pressures, Eng. Struct. 134 (2017) 1–10. doi:10.1016/j.engstruct.2016.12.016.
- [86] Atex Explosion Hazards, Explosion Prevention in the Biomass Industry, (2017). <http://www.explosionhazards.co.uk/explosion-prevention-biomass-and-waste-industry/>

- (accessed May 24, 2017).
- [87] Phase IV Engineering, RFID Temperature Sensors, (2017). <http://www.phaseivengr.com/product-category/rfid-battery-free-passive-wireless-sensors/rfid-passive-battery-free-temperature-sensors/> (accessed May 29, 2017).
- [88] B. Kvarnström, E. Vanhatalo, Using RFID to improve traceability in process industry, *J. Manuf. Technol. Manag.* 21 (2009) 139–154. doi:10.1108/17410381011011524.
- [89] J.H. Miedema, R.M.J. Benders, H.C. Moll, F. Pierie, Renew, reduce or become more efficient? The climate contribution of biomass co-combustion in a coal-fired power plant, *Appl. Energy.* 187 (2017). doi:10.1016/j.apenergy.2016.11.033.
- [90] J. McKechnie, B. Saville, H.L. MacLean, Steam-treated wood pellets: Environmental and financial implications relative to fossil fuels and conventional pellets for electricity generation, *Appl. Energy.* 180 (2016). doi:10.1016/j.apenergy.2016.08.024.
- [91] D.A. Agar, A comparative economic analysis of torrefied pellet production based on state-of-the-art pellets, *Biomass and Bioenergy.* 97 (2017) 155–161. doi:10.1016/j.biombioe.2016.12.019.
- [92] S. Proskurina, J. Heinimö, F. Schipfer, E. Vakkilainen, Biomass for industrial applications: The role of torrefaction, *Renew. Energy.* 111 (2017). doi:10.1016/j.renene.2017.04.015.

Chapter 4. Optimal equipment deployment for biomass terminal operations⁵

Chapter 3 provided an evaluation of the current biomass import terminals, in particular in the port of Rotterdam, in terms of equipment and setup. While biomass bulk terminals may be able to cope with the low amounts of biomass being traded currently, a reexamination and possible redesign or retrofitting of biomass terminals and facilities to accommodate the expected increased biomass volumes will be required by 2030. Such significant changes in the port terminals' design and operations and require considerable investments in almost all aspects of a terminal's setup: infrastructure type and layout, personnel training and land availability.

In order to optimize the investments in a dedicated biomass terminal, a modelling approach that can perform such a task is needed. Several studies have been conducted related to improving or optimizing terminal design, but the focus was disproportionately put on vessel arrival and the subsequent service time simulation, i.e. stochastic, discrete event approaches, or a straightforward integer linear approach. In most cases, simulation of operations does not necessarily include their optimization as well. The purpose of chapter 4 is to present a novel optimization approach in the form of a mixed integer linear programming model. Section 4.1 provides the background in terminal design research needed. Section 4.2 introduces the mathematical model, along with its objective, constraints and assumptions. The results in section 4.3 provide the optimum equipment selection setup for minimizing annual terminal costs, and can indicate tipping points of technology or equipment size change as the size of the terminal increases. Furthermore, the results can be used as a guideline for assessing the most advantageous biomass terminal size, based on costs per ton of throughput for a wide range of terminal sizes.

⁵ Published as: Dafnomilis I, Duinkerken MB, Junginger M, Lodewijks G, Schott DL. Optimal equipment deployment for biomass terminal operations. *Transp Res Part E Logist Transp Rev* 2018;115. doi:10.1016/j.tre.2018.05.001.

4.1 Introduction

Biomass is considered a bulk material, such as coal or iron ore. However, unlike these products, biomass requires specific equipment and techniques used during bulk handling, transport and storage [1]. Use of unsuitable equipment can lead to deterioration of the product or lead to health and safety hazards, such as dust production and explosions, self-heating and ignition or respiratory issues [2]. The equipment at a port terminal handling biomass need to match biomass's specific properties. This includes specifically designed equipment (e.g. grabs) that minimize product deterioration; fully covered or enclosed transportation and storage facilities; spark detectors, fire detection and suppression systems and temperature monitoring through the whole handling chain. This is not entirely realized at the moment; traded volumes are low, so most terminal operators choose not to invest in specialized infrastructure [3]. This can lead to a general degradation of the product and incur significant financial losses, as well as facility and personnel hazards [3]. Increasing the service reliability, profit margins and reducing cargo damages are therefore essential to a biomass bulk terminal and are identified as some of the most important Port Performance Indicators (PPIs) [4,5].

Due to the above reasons, biomass terminal logistics are more demanding in terms of designing the terminal setup and selecting the suitable equipment to efficiently handle the product. The additional safety equipment and facilities increase the capital investments required, and, since only a handful of port terminals are dedicated biomass terminals, mostly in the US, Canada and the UK, terminal operators do not have a lot of information sources on which to base the required investment decisions. Despite the existence of dedicated biomass terminals and the expected biomass trade growth, there is currently no comprehensive method to assist terminal operators in optimizing equipment and facility selection when dealing with biomass. The scientific literature relating to equipment and facility deployment is minimal, and focuses on extremely particular cases or is applied on relatively small scale examples. The existing literature data, such as capital and operational costs of equipment and facilities are usually simplified approaches and do not reflect the actual situation within the industry. This is the scientific gap that this chapter aims to address, by providing a model that can be used in the field of biomass terminal design, taking into account dedicated and shared equipment within the same terminal. The results can assist terminal operators and port authorities with strategic level planning decisions related to biomass terminal investments.

4.1.1 Literature review

A substantial amount of research has been performed on terminal design, both for dry bulk material and container terminals. Dry bulk terminals are usually characterized by the presence and size of the terminal jetty. Dry bulk vessels can have large draughts, because of the large cargo density and thus large tonnage, and as such, it can be more economical to realize a jetty/pier instead of a quay wall [6]. Terminals located in deep waters however, such as the port of Rotterdam, can still make use of quay walls for bulk cargo handling without the need for a jetty [7]. The equipment used for each necessary function that a terminal performs, such as loading/unloading vessels, transport of material and storage is unique and more complex than the equivalent for container terminals [8]. Most importantly however, the equipment selected and installed must take into account the numerous properties of the cargo, such as density, angle of repose, dust generation, hazardous and handling properties [6,9]. The selection of equipment differs per transport direction and depends on the type and quantity of the bulk material, space and environmental conditions and the intensity of operations. Dust generating materials like cement require enclosed transport and small terminals with low capacity requirements can make use of wheel mounted mobile installations [6]. The type of storage selected is also completely dependent on the material handled, ranging from open storage, to

covered storage (warehouses and sheds, to silos and domes) [2,6]. Finally, the productivity of equipment used is measured in tons of material handled per hour of operation [10–12].

A comprehensive design method that still serves as an important guideline on bulk terminal design was introduced by the United Nations Conference on Trade and Development [11,13] in 1985 and again in 1991, focusing on the physical characteristics, management and operation of bulk terminals. At the same time, the Transportation Department of the World Bank [14] published a comprehensive report on bulk terminal development, including information on terminal logistics and mathematical models used in evaluating preliminary design options. Memos [15] provided planning parameters and other bases for estimating vessel queuing times, vessel service time and estimation of storage area needed for dry bulk cargo terminals. Discrete-event simulation for designing and improving the operations of dry bulk terminals was used by Ottjes et al. [16]. Lodewijks [17] discusses the application of discrete event simulation as a tool to determine the best operational control of the terminal and the required number of equipment and their capacity. Cimpeanu [18] introduced a discrete event simulation model as well to analyze bulk carrier unloading and material transport, storage and discharge. Taneja [19] suggested that Adaptive Port Planning methods, which value flexibility of design, are better suited in times of uncertainty than the traditional methods. Vianen [8] approached the issue suggesting an expansion of existing design methods, based on stochastic variations of the operational parameters, rather than developing a new design method. Bruglieri et al., Babu et al. and Robenek et al. [20–22], among others, have investigated yard planning problems in bulk terminals. The berth allocation problem has also been extensively examined by Ernst et al., Robenek et al., Umang et al. and Al-Hammadi [22–25].

Scientific research into specific types of equipment used in dry bulk terminals has also been performed. Schott [26] provides an overview and analysis of the terminal facilities provided for handling, storage and processing of bulk materials. General information on equipment needs of dry bulk terminals has been provided by Negenborn, Schott et al. [27]. Research on types of equipment has been performed by Strien [28], on equipment used in stacking, reclaiming or the combination of these 2 functions. Wang et al. [29] developed a model for the optimum allocation of loading and unloading equipment at a bulk terminal. The unloading capacity of a bulk cargo terminal was examined by Bugarcic et al. [30] using queuing theory. Pratap et al. [31,32] looked into crane and unloader allocation respectively in two different works. Wu [33,34] researched dedicated biomass terminals in details and provided a database of suitable equipment for biomass terminal operations. Studies on the selection of equipment through different software or modelling approaches have been performed by Temiz and Prasad [35,36] regarding equipment selection in construction sites. Velury [37] used a similar approach to the one discussed in this chapter, although the depth and detail of data used were more superficial.

Container terminal design differs from bulk terminal design in several major elements. Vertical quay walls directly connected to the land are used, instead of jetties in the case of bulk terminals [38,39]. The storage yard in container terminals is preferably as close to the berth as possible [40]. The handling of containers from and to the storage yard is performed mostly via mobile equipment such as tractor trailer units, container stackers or carriers and automated guided vehicles (AGV) [41]. The storage yard is an uncovered open area, and in the design phase, the storage capacity of empty containers as well as the container freight station needs to be taken into account. The container yard has dedicated equipment for container handling as well [42]. Finally, the productivity of the equipment used is measured in terms of moves performed per hour for the transportation equipment [12,43], or average container stacking height and density for the storage yard equipment [10,41,44].

Despite the differences in terminal design approach, the research into container terminal design focuses on similar approaches as the bulk terminal design field. Iris et al., Tao et al., and Liu et al. [45–47] investigated the berth allocation and, to a smaller extent, the quay crane and yard allocation problem in container terminals. Imai et al., Lau et al. and Liu et al. [48–50] used heuristic approaches and queuing theory to study a strategic berth scheduling problem, to integrate the scheduling of handling equipment and to model the assignment of quay cranes in a container terminal respectively. Alcade et al. [51] presented a method for determining the optimal storage space utilization in a container storage yard based on a stochastic approach. Sun et al. [52] developed a general simulation framework to facilitate the design and evaluation of mega-sized container terminals which require multiple berths and yards. Chang et al. [53] used a centralized data envelopment analysis to optimize resource allocation in a container terminal based on a single company's perspective. Similarly, Mbiydzonyuy [54] realized a linear programming model for a container terminal's equipment configuration, based on a case study of a small port in Sweden.

Apart from significant research on container and bulk terminals, the field of biomass and biofuel supply chains has also been investigated by numerous researchers. Poudel et al., Marufuzzaman, Ghaderi et al. and Quddus et al. [55–59] all examined different approaches in designing and managing biomass supply networks and transportation chains. De Jong et al., Lee et al., Yue et al. and Ahmad et al. [60–63] developed approaches for optimizing biomass to biofuel production under different conditions and scenarios. Stevens et al. [64] conceptualized port integration with biofuel supply chains on a qualitative level. Some of the only scientific literature that specifically deals with biomass terminals originates mostly from Scandinavian researchers such as Sikanen et al., Kons et al., Virkunnen et al. and Gautam [65–68]. However, the above is true only if only land terminals located next to forested source areas are examined and do not go into a detailed examination of the terminals beyond an assessment of scenarios with different biomass throughputs, truck capacities and transport distances.

4.1.2 Objective and contribution

While most of the studies presented in section 4.1.1 had a goal of providing information, improving or optimizing terminal design, the focus was asymmetrically put on the simulation field of research. Terminal simulation tries to measure the performance of the terminal under different scenarios, and does not necessarily consider achieving the optimum solution as its end goal. On the other hand, research on equipment selection usually focuses on optimizing the (un)loading operational steps only, which are deemed as the most important parts of the terminal handling chain. Total equipment allocation and utilization in these approaches have a second role, even though they can be equally (or more) important costs of a terminal. Most importantly, all the above works are lacking either in depth of data used (equipment database, parameters etc.) or in scale of application – only performed for a pre-existing site of a specific company or for a unique small scale port terminal. The precise equipment configuration, and the utilization of such equipment are some of the most critical decisions that dry bulk terminals must take, and affect almost every aspect of a terminal's operation. The goal of an efficient equipment configuration and utilization planning is twofold: firstly, to minimize the total investment costs incurred while determining a terminal's design; secondly, to minimize the operational costs while handling a product. An approach through this scope however is distinctly lacking in the present scientific literature.

To this end, a novel optimization model is developed, with the aim to determine the total equipment allocation and utilization in a solid bulk biomass terminal. The scope of the model includes the complete activities within a terminal, from the unloading of the biomass from an arriving vessel, to the loading at a vessel at the end of the handling chain. Our research goal is

to provide a model that can be used in the field of biomass terminal design, assisting terminal operators and port authorities with biomass terminal investment decisions. The results can support tactical level decision planning when applied to existing bulk terminals, which may need to retrofit equipment or parts of their handling chain, but are mostly geared towards assisting in strategic level planning – investing in new terminal setups, infrastructure and equipment decisions. For this purpose, the equipment configuration is presented on a detailed level within the terminal bounds, and, most importantly, the utilization of this equipment is taken into account and is linked directly to the material throughput, as is the case in reality. The equipment allocation and utilization are optimized in order to provide a better estimation of a dedicated biomass terminal's logistics. In summary, this chapter contributes to the above in that a holistic approach is used, unbound by pre-existing conditions, and at the same time using an extensive database with data depth that is unique for the occasion. Consequently, to the best of the author's knowledge, this chapter provides the following novel contributions:

1. A defined mathematical model for optimizing biomass terminal equipment configuration, not only for dedicated equipment, but also for equipment that is partially used and shared between different operational steps
2. An approach for minimizing total (investment and operational) costs in biomass bulk terminals from a strategic planning point of view, taking into account all the discrete operations of a terminal, as well as the respective equipment needed
3. Results that are based on real world data instead of assumptions or relevant experience only, thus providing increased credibility and validity of the outcomes of the proposed model

The author was able to collaborate with numerous industrial experts, including the biggest and most experienced solid bulk terminal operators in the port of Rotterdam, the Port of Rotterdam Authority, equipment manufacturers, power plant and energy industry stakeholders. Their input was used in ascertaining the accuracy of operational assumptions, as well as confirming the validity and usefulness of the results and their approximation of real-life terminal design.

The chapter is organized as follows. The outline and context of the terminal design and setup selected is explained in section 4.2. The mathematical model is presented in section 4.3. The computational results are presented in section 4.4, showing that our model is capable of providing significant information regarding terminal equipment configuration and utilization decisions in a reasonable amount of time. Conclusions are presented in section 4.5.

4.2 Biomass bulk terminal design

For the purposes of this chapter, the focus in terminal design is on the equipment configuration, i.e. what type of equipment to use and in what amount for each selected task. A proportionate amount of attention is given to equipment utilization, i.e. how much is the selected equipment used to perform its task. The terminal operations are assigned into 6 discrete steps: receiving and transshipment of material, first transportation, storage of material, reclaiming, second transportation and finally, loading of material onto a vessel, truck or train for further transportation outside the terminal boundaries (see Figure 4.1 for an illustration of the proposed biomass bulk handling terminal setup). The operational steps are defined based on the specific function that is performed within their bounds, as described above. In order to perform said

function, unique equipment associated with it needs to be present in each operational step, chosen based on their capacity, capital and operational costs, as well as potential synergy with equipment in adjacent operational steps.

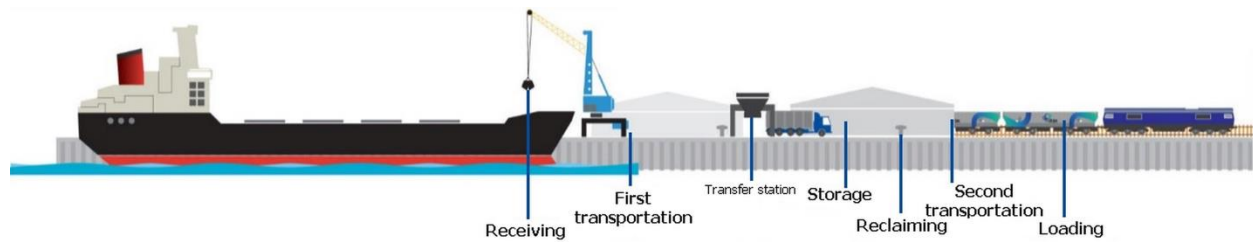

Figure 4.1: Illustration of the proposed solid biomass bulk handling chain [69,70]

A wide range of types of equipment that can be used in each discrete operational step, depending on their function, is considered. In total, 15 different types of equipment of 82 different sizes and capacities are in the database used for this chapter at the moment, with plans to be significantly expanded (see section 4.5). The most common equipment used in each specific bulk terminal function, i.e. operational step is included in this research. Grabs and grab cranes are used for the receiving step, with pneumatic unloaders as an additional option for increased capacity. Belt and pipe conveyors, as well as trucks are used for the two transportation steps. Pneumatic conveyors are present in the transportation step when a pneumatic conveyor is used as the selected receiving equipment, since they constitute a continuous closed system, expanding into both operational steps. Warehouses, domes, silos, bunkers and floating barges are the options under consideration for the storage of bulk material. Only enclosed storage options are taken into account since wood pellets require it [1–3] (Ruijgrok, Pothoven and Lokker, personal communication, May 2017). Underground hoppers are used in the reclaiming step when dealing with domes or silos, since gravity reclaiming is easier performed that way. Respectively, front loaders are used when the storage option selected is a bunker or a warehouse. Finally, loaders generally consist of a feed conveyor and a chute emptying into a vessel, or, less often, a gran and grab crane that perform the same function. Where data was available, all additional equipment or systems related to biomass bulk terminals were included in the equipment capital and operational costs. A full list of the types and sizes of equipment used can be seen in Table 4.1 at the end of this section.

The information presented in this section originated from an extensive literature review and industrial field investigation. The most detailed and relevant information came from the author's personal visits to several of the biggest and most experienced bulk (and biomass) terminals in the Port of Rotterdam in the Netherlands. This provided a unique opportunity to gain a detailed account of first hand industrial conditions of biomass handling. Personal interviews were conducted with representatives from terminal operators that handle biomass in the Port of Rotterdam, the Port of Rotterdam Authority, and other fields closely related to biomass production and handling. During these interviews and visits to the facilities, equipment of the industrial stakeholders engaged in biomass handling and storage were investigated and they are presented in this section. A general overview of the types of equipment used in each discrete operational step can be found in Figure 4.2.



Figure 4.2: Example of solid biomass handling equipment [3]

Each type of equipment in each operational step is linked to its respective capital and operational costs, relating also to its capacity and its lifetime. For example for the operational step ‘transportation’ there are 9 different belt conveyor capacities, ranging from 300 tph to 2500 tph capacity, and of different lengths, depending on their position and function in the terminal handling chain (see Table 4.1). Both the capacity and the length are important parameters of the model, as they directly affect the capital and operational costs of each equipment. In this particular case, as the capacity increases a wider belt with a more powerful drive and support structure is needed. Likewise, as length increases, additional structural elements and more powerful drives are needed.

Utilization of equipment is directly linked to and affects the operational expenses of a terminal. According to industrial experts, operational costs can actually be the biggest factor in a terminal's annual expenses, especially as the throughput and the size and capacity of the related equipment is increased; bigger and heavier equipment means larger drives, more fuel or electricity consumed while in operation and more personnel to maintain or operate them (Corbeau and Pothoven, personal communication, May 2017).

All the additional measures needed to be taken into account for dedicated biomass handling equipment, i.e. temperature sensors, dust extraction systems, fire detection and suppression systems, covered or enclosed conveyors, incur extra costs relative to simple bulk handling equipment. These costs are incorporated in the capital and operational costs of the equipment used for this chapter, after extensive literature study and close collaboration with numerous industrial experts as stated in section 4.1.2.

Table 4.1: Equipment database

Operational step	Equipment type	Capacity	Lifetime [y]
Receiving	Mobile crane 25t & grab 23m ³	500 [tph]	20
	Mobile crane 50t & grab 42m ³	880 [tph]	20
	Gantry crane 25t & grab 23m ³	1000 [tph]	40
	Gantry crane 50t & grab 42m ³	1750 [tph]	40
	Pneumatic unloader	500:500:2500 [tph]	7
Transport1	Belt conveyor	300, 600, 1000, 1200, 1500, 1800, 2000, 2200, 2500 [tph]	10
	Pipe conveyer	300, 600, 1000, 1200, 1500, 1800, 2000, 2200, 2500 [tph]	10
	Pneumatic conveyer	500:500:2500 [tph]	7
	Truck	25.5 [t]	10
Storage	Warehouse	15000 [t]	30
	Dome	15000 [t]	30
	Silo	20000, 110000 [t]	30
	Bunker	20000, 130000 [t]	30
	Floating barge	2500 [t]	15
Reclaiming	Underground hopper & belt conveyor , 200m length	300, 600, 1000, 1200, 1500, 1800, 2000, 2200, 2500 [tph]	10
	Underground hopper & pipe conveyor , 200m length	300, 600, 1000, 1200, 1500, 1800, 2000, 2200, 2500 [tph]	10
	Front loader	9 [t]	10
Transport2	Belt conveyor, 500m length	300, 600, 1000, 1200, 1500, 1800, 2000, 2200, 2500 [tph]	10
	Pipe conveyer, 500m length	300, 600, 1000, 1200, 1500, 1800, 2000, 2200, 2500 [tph]	10
	Truck	25.5 [t]	10
Loading	Loader	500:500:2500 [tph]	15

4.3 Mathematical model

The optimization approach presented in this chapter is formulated as a mixed-integer linear programming (MILP) problem that minimizes terminal infrastructure and operational costs on a normalized annual basis. Our MILP model differs from simulation based approaches in the way that it optimizes a detailed equipment configuration solution. It is also, to the best of the author's knowledge, the first terminal model to take into account shared equipment (equipment used in more than one operational step) into account, and provide information on the utilization of equipment. Costs related to utilization of equipment is normally calculated as a percentage of the equipment's capital costs. In this chapter, the actual throughput of the terminal is linked to the utilization of equipment, in order to demonstrate its importance and effect on total costs, especially at larger terminal sizes. The overall goal is to minimize the total annual costs of a biomass terminal by optimizing the amount of fully utilized and shared or partially used equipment within the terminal.

One of the most important decisions, following a functional analysis is the breakdown of terminal operations in 6 steps, as mentioned in section 4.2. However, no matter the level of detail that can be achieved with a specific terminal design approach, certain assumptions about terminal operations had to be taken. Each operational step in the terminal handling chain is assumed to be independent of the others (unless specifically stated otherwise, see constraint (4.6) in section 4.3.2), with deterministic characteristics. In reality, the assignment of such discrete steps within a terminal is not so straightforward. This is more evident when using continuous equipment such as conveyor belts, where there may be transfer stations or towers present connecting multiple equipment. In our model, the transfer stations and their associated costs are incorporated in the transportation steps of the terminal.

As input for the model, equipment and terminal data need to be specified beforehand, as well as relevant assumptions. Based on these data, the cost function is minimized respecting certain system constraints. The output of the model is the optimal terminal configuration with specific installed capacities for the chosen equipment in terms of overall costs. The optimization performed by the model is an overall terminal logistics optimization and not a step-specific one. In certain cases it might seem that the results in individual operational steps are contrary to common sense or relevant experience, but that proposed solution will be the cost optimal from a terminal perspective.

4.3.1 Notations

The following notations are used for developing the MILP model.

Indices:

I	Set of equipment types indexed by i	$i \in I$
J	Set of operational steps indexed by j	$j \in J$

System parameters:

CC_i	Capital costs of equipment i	[€]
CAP_i	Capital costs of equipment i on an annual basis	[€]

OP_i	Operational costs of equipment i	[€/ton]
C_i	Nominal capacity of equipment i	[tph]
η_i	Effective utilization of equipment i	[%]
EqC_i	Average annual capacity of equipment i	[t]
EPC_i	Peak capacity of equipment i	[t]
CRF_i	Capital recovery factor of equipment i	[-]
LT_i	Lifetime of equipment i	[y]
AT	Annual throughput of the terminal	[Mt]
TW	Time window to complete vessel unloading	[h]
OPH	Annual operational hours of the terminal	[h/y]
sf	Storage factor	[-]
VS	Vessel size	[t]
IR	Interest rate	[%]
M	Sufficiently large number to control binary variables	[-]
B_{ijkl}	Parameter to control interdependency of equipment	[-]

Decision

variables:

n_{ij}	Number of dedicated (or fully used) equipment i in step j	$n_{ij} \in \mathbb{N}^0$
m_i	Number of shared or partially used equipment i	$m_i \in \mathbb{N}^0$
x_{ij}	Utilization of equipment i in step j	$x_{ij} \in \mathbb{R}^+$

The investment in equipment is split into two parts: dedicated equipment and shared or partially used equipment. Dedicated equipment is used for a single operational step only and operated for 100% of the time. The number of dedicated equipment of type i in step j is indicated by n_{ij} . n_{ij} signifies the amount of equipment present in the terminal, as well as the utilization of the particular equipment, since it is used 100% of the time.

Partially used or shared equipment is used by one or more operational steps and are operated at a single step for less than 100% of the time. The number of partially used or shared equipment of type i is indicated by m_i . The fraction of time that the partially used or shared equipment m_i is used for step j is indicated by x_{ij} .

4.3.2 Objective function formulation and constraints

The objective function Z represents the total annual costs of a biomass terminal and depends on the design variables corresponding to the amount of fully utilized and shared or partially used equipment within the terminal. The mathematical representation of the optimization problem can therefore be formulated in the following way:

$$Z = \sum_{i \in I} \left[\sum_{j \in J} n_{ij} + m_i \right] * CAP_i + \left[\sum_{i \in I} \sum_{j \in J} \left[n_{ij} + x_{ij} \right] * OP_i \right] * AT$$

s.t.

$$\sum_{i \in I} (n_{ij} + x_{ij}) * EqC_i \geq AT \quad \forall j \in J \quad (4.1)$$

$$\sum_{i \in I} (n_{ij} + x_{ij}) * EPC_i \geq \max(VS) \quad \forall j \in J \quad (4.2)$$

$$\sum_{i \in I} (n_{ij} + x_{ij}) * EqC_i \geq sf * AT \quad \text{when } j = 3 \quad (4.1)$$

$$\sum_{i \in I} (n_{ij} + m_{ij}) * = 1 \quad \text{when } j = 2, 4 \quad (4.4)$$

$$B_{ijkl} (n_{ij} + x_{ij}) \leq B_{ijkl} * M * (n_{kl} + x_{kl}) \quad \forall i, k \in I, \forall j, l \in J \quad (4.5)$$

$$\sum_{j \in J} x_{ij} \leq m_i \quad \forall i \in I \quad (4.6)$$

$$n_{ij}, m_i \in \mathbb{N}^0 \quad \forall i \in I, j \in J \quad (4.7)$$

$$0 \leq x_{ij} \leq 1 \quad \forall i \in I, j \in J \quad (4.8)$$

Relations between parameters present in the model are as follows:

$$CAP_i = CC_i * CRF_i \quad \forall i \in I \quad (4.9)$$

$$CRF_i = \frac{IR * (1 + IR)^{LT_i}}{(1 + IR)^{LT_i} - 1} \quad \forall i \in I \quad (4.10)$$

$$EqC_i = C_i * \eta_i * OPH \quad \forall i \in I \quad (4.11)$$

$$EPC_i = TW * C_i \quad \forall i \in I \quad (4.12)$$

The objective is to minimize the annual capital and operational costs incurred by the selected equipment. As mentioned in section 4.3.1, dedicated equipment is used for a single operational step only and operated for 100% of the time. The number of dedicated equipment of type i in step j is indicated by n_{ij} . Therefore, n_{ij} contributes to both capital and operational costs in the objective function. Similarly, the number of partially used or shared equipment of type i is indicated by m_i and the fraction of time that equipment m_i is used for step j is indicated by x_{ij} . Therefore, m_i contributes to the capital costs and x_{ij} to the operational costs in the objective function respectively. For example, in the result where a silo would be used as the optimal storage

option as dedicated (fully used) equipment, $n_{silo,3} = 1 \cdot n_{silo,3}$ is used in the calculations of the capital costs since only 1 unit of infrastructure incurring full capital costs is present, but it is also used in the calculations of the operational costs with a utilization of 1, since it is used 100% of the time. If the silo was only partially used at 50% utilization, then $m_{silo} = 1$ and $x_{silo,3} = 0.5 \cdot m_{silo}$ is used in the calculations of the capital costs since 1 unit of infrastructure incurring full capital costs is present, regardless of utilization. $x_{silo,3}$ is used in the calculations of the operational costs with a utilization of 0.5 since it is only used for 50% of the time. Similarly, if a truck was used in transport steps 2 and 4 for 25% and 50% of the time respectively, then $m_{truck} = 1$ and $x_{truck,2} = 0.25$, $x_{truck,4} = 0.50$.

The capital costs are calculated by equation (4.9). CRF_i represents the capital recovery factor (the annual equivalent of the capital cost) of equipment i and is given by equation (4.10), where IR is the interest rate and LT_i is the technical and economic lifetime of equipment i . The operational costs OP_i , as indicated in section 4.3.1, are directly related to equipment i on a euro per ton basis, based on relevant literature and personal communication of the author with industrial experts [11,13,14] (Pothoven, Corbeau, Ruijgrok and Lokker, personal communication, May 2017).

The capacity of the sum of the equipment used in each operational step j on an annual basis is ensured in (4.1) to be able to handle the average annual throughput of the terminal. The average annual capacity of the selected equipment EqC_i is calculated in equation (4.11), where C_i is the nominal capacity of the selected equipment, η_i the effective utilization of the selected equipment and OPH the operational hours of the terminal on an annual basis.

Constraint (4.2) is a peak capacity constraint that ensures that the selected equipment will be able to unload the maximum size vessel VS that is serviced by the terminal, at the minimum required service time TW . The minimum required service time is dependent on the size of the vessel which is, in turn, dependent on the amount of throughput of the terminal. These inter-relations can be seen in Table 4.2. The equipment peak capacity is then given by equation (4.12). The peak capacity design is not always in effect, rather the user chooses whether he wants to focus on this approach, or a design based on the average annual capacity approach. In the latter case, constraint (4.2) is deactivated.

Storage constraint (4.3) guarantees that all the possible equipment used for storage is able to hold a percentage of the total annual throughput. The storage factor is defined as the ratio of storage capacity over the annual throughput between the required stockyard size and the terminal's annual throughput [8].

When deciding on continuous equipment, the general rule in terminal design is that there should be only one present for each discrete operational step. Unless looking into the far end of large scale terminals, single conveyor belts of varying capacity can handle the incoming material. Even when talking about redundancy of equipment in conveyor belts, it is taken into account in the form of individual components; idlers, belt fabric rolls, drive motors etc. Otherwise, logistics increase disproportionately and issues with available land, support structures etc. become overcomplicated. Constraint (4.4) signifies that whenever a continuous equipment is used in the 2 inter-terminal transportation steps, the amount is limited to a single type and capacity only.

Terminal planning may also require certain types of equipment to be interdependent, or mutually exclusive. For example, when unloading a flat warehouse, it is only possible to accomplish through front loader use. This interdependency is established by constraint (4.5). Due to the nature of the input, it has to be 100% controlled by the user via the use of the binary parameter B_{ijkl} .

Constraint (4.6) guarantees that the utilization of each shared or partially used equipment can never exceed the actual amount of used equipment. Summing the utilization over all operational steps where shared or partial equipment may be used and denoting it to be equal or less to the units of equipment ensures that.

Constraints (4.7) and (4.8) guarantee that the units of dedicated or shared equipment are positive integers only (including 0), and that the utilization of equipment is a real number between 0 and 1 respectively.

4.3.3 Relevant data

Other assumptions used to calculate the values for the model constraints appear in this section. A considerable effort has been made for the assumptions to depict as close as possible the industrial setting reality, rather than educated guesses or literature data. The overall projects industrial partners were a great asset in this endeavor, proving first hand field experience and input.

Table 4.2: Vessel size and service time based on terminal throughput [11,13,71]

Annual throughput [Mt]	Vessel type	Max vessel size [t]	Service time window [h]
$AT \leq 3.5$	Handymax / Panamax	65000	48
$3.5 \leq AT \leq 7$	Capesize A	100000	72
$7 \leq AT \leq 10$	Capesize B	140000	96
$AT \geq 10$	Capesize C	180000	144

A 1 km transportation distance is assumed between the arriving vessel and the storage facilities, as well as a 200m transportation length after reclaiming and a 500m transportation distance to the loading point, at the end of the terminal chain.

In the context of this approach, the term equipment utilization refers to the percentage of the terminal's total operating hours that an equipment is being used. That means that a result of e.g. 0.5 utilization for a 7000 operating hours per year terminal, indicates that that particular piece of equipment is functioning for 3500 hours throughout the year. The operating hours of the terminal is one of the varied parameters of the model developed in this chapter.

Dry bulk terminals usually have a storage factor of 0.1 (10%) (Pothoven and Lokker, personal communication, May 2017). However, this is the rule of thumb for terminals handling coal or iron ore, which can be stored outside in piles, for long periods of time and do not require special safety measures. In the case of biomass, there is a need for enclosed storage which significantly increases costs. Additionally, biomass requires shorter storage times in order to avoid problems like self-heating and ignition or chemical and biological deterioration, which in turns leads to lower storage needs [3] (Pothoven and Ruijgrok, personal communication, May 2017). For the aforementioned reasons a storage factor sf of 0.02 or 2% of the annual throughput of the terminal is assumed. In this way, the logistics of storage become more manageable and the storage time is kept low.

The annual operational hours of the terminal OPH are assumed to be 7000. Port terminals usually operate 24/7 year round. However, taking scheduled and unscheduled maintenance and downtime and important holidays into account gives a more realistic number of 7000 hours per year (Bouwmeester, Pothoven, Lokker and Theunissen, personal communication, May 2017).

A uniform interest rate IR of 0.06 (or 6%) is used throughout the model due to lack of more detailed data at the current stage. The effective utilization rate η_i is assumed to be 0.9 (or 90%) for all equipment types. Each specific equipment has a specific utilization rate, related to numerous factors - individual characteristics, material handled, speed of transportation etc. Moreover, the technical and economic lifetime LT_i of the equipment are assumed to be the same. Economic lifetime is the expected period of time during which a unit of equipment is useful to the average owner. The economic life of an asset could be different than its actual technical life. The values related to the lifetime of equipment are based on relevant literature and personal communication of the author with industrial experts [11,13–15] (Pothoven, Corbeau, Ruijgrok and Lokker, personal communication, May 2017).

A detailed database of the equipment types and their respective capacities used in each operational step can be found in Table 4.4. The detailed cost data for each equipment type cannot be included in this thesis as they are considered confidential information between the author and industrial partners.

4.4 Computational results

Based on the input data presented in section 4.3 the MILP model was solved using the inherent MATLAB MILP solver ('intlinprog', MATLAB R2015b, v8.6.0.267246) using a dual simplex algorithm. In terms of solve time, a single application of the problem is solved to optimality within 4.7 s on an Intel Core i5-4670 CPU @ 3.4 GHz processor, and 8 GB of RAM. The above formulation of the problem was constructed for the maximum amount of biomass equipment for which accurate reliable data were available and approximates a realistic case– 6 operational steps within a port terminal's boundaries, and 83 different types of equipment to be used for the terminal's operations. In order to analyze the complexity of the model, a randomly generated database of 10 operational steps and 1000 different types of equipment, leading to 11000 decision variables was used. The model can solve approaches of this size to optimality within approximately 17 seconds, making it appropriate for larger scale problems as well.

By applying the model to a wide range of throughputs, results for the costs per ton of throughput are obtained (Figure 4.3). Minimization of total terminal costs per ton is achieved around 5 Mt of throughput and remains relatively stable thereafter. As can be discerned from Figure 4.3, certain differences between discrete terminal sizes do not follow the economies of scale 'doctrine'. For example, Table 4.3 shows the results in costs per ton, and equipment selection between two terminals of 5 and 6 Mt respectively, for which an observable difference in costs (8%) per ton of throughput is present. The tipping points where technology and equipment selection can most evidently be observed here. The larger terminal while using the same equipment for transport and reclaiming (with a higher utilization), needs to use larger equipment and infrastructure for receiving, storage and loading, which drives up costs per ton. After that point, costs continue to decrease until the 10 Mt milestone is reached, where another major switch to larger equipment is present once more. The general trend however supports the industry's experience of aggregating

handling and storage facilities in order to take advantage of economies of scale (Corbeau, Bouwmeester and Pothoven, personal communication, May 2017).

Results like this showcase the importance of economies of scale in terminal setups and suggest that the model can be an important asset in aiding stakeholders with terminal design and investment decisions. In the context of dedicated biomass terminals design this means that equipment selection and utilization on its own becomes less significant as the size of the terminal increases. Wider implications of the results suggest that a smaller number of medium to larger size terminals are probably the best solution to increasing biomass throughputs instead of multiple smaller terminals. For the case of Northwest Europe, it seems that there is no considerable difference in terms of costs per ton on whether to situate biomass terminals in a central location, thus creating a central biomass hub for the whole region, or split them between the limited number of respective importing countries – as long as all respective terminals are above the 5-6 Mt throughput threshold in order to take advantage of economies of scale. Other important cascading factors need to be considered at the same time, such as geographical location of the terminal, further transportation connections to the hinterland, client demand and location relative to the terminals, and low port charges or environmental regulations [72]. In any case, relevant decisions are directly related to expected throughput. In the case of biomass, the high uncertainty of future developments, owing to lack of long term political commitments also affects industry investments. Dedicated (biomass) terminals require significant investments upfront. If terminal operators are unable to take advantage of economies of scale over a long period of time, there is little point in proceeding with such a task. Easier access and encouragement of investments usually leads to reduction in logistics costs and increases in port efficiency [73].

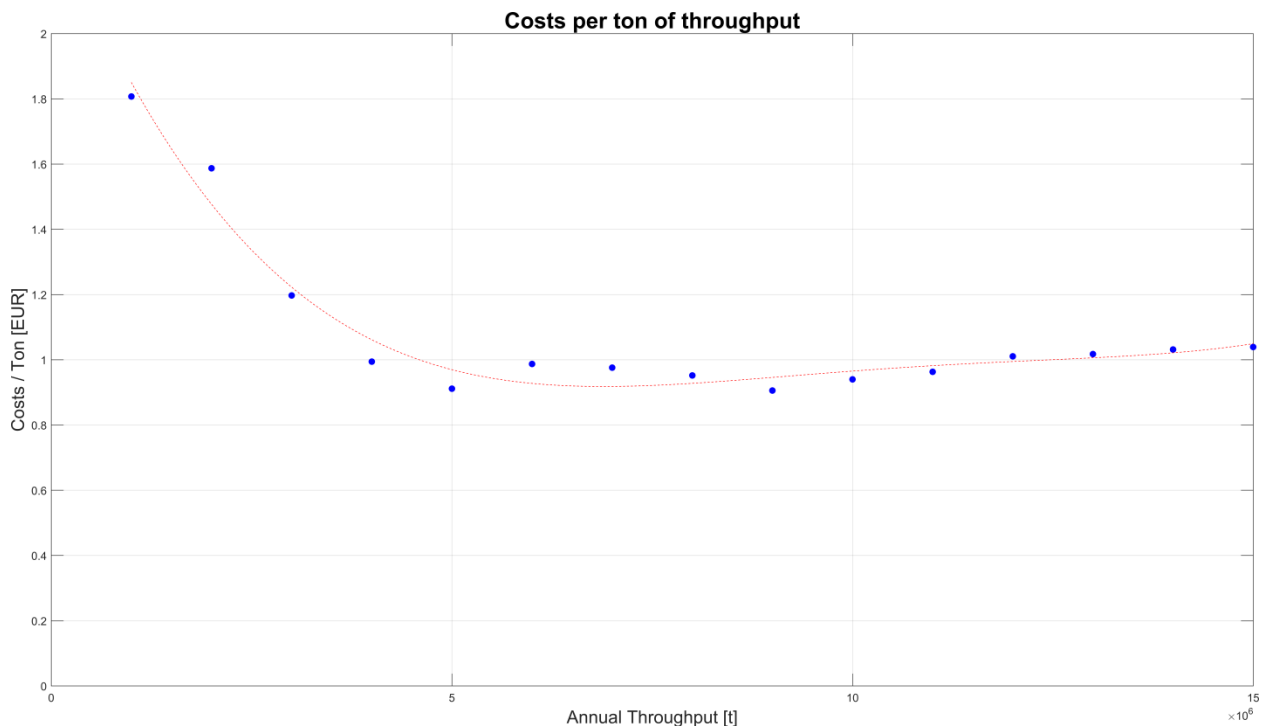

Figure 4.3: Cost per ton of throughput for terminals of 1-15 Mt of throughput

Table 4.3: Equipment selection for two consecutive terminal sizes

Annual throughput [Mt]	5		6	
Costs per ton of throughput [€/ton]	0.911		0.987	
Receiving	Mobile crane 50t & grab 42m ³ [tph]	880	Gantry crane 25t & grab 23m ³	1000 [tph]
Transport 1	Belt conveyor [tph]	1200	Belt conveyor	1200 [tph]
Storage	Silo [kt]	100	Bunker	130 [kt]
	Floating barge [t]	2250	Bunker	20 [kt]
Reclaiming	Underground hopper & belt conveyor [tph]	1200	Underground hopper & belt conveyor	1200 [tph]
Transport 2	Belt conveyor [tph]	1200	Belt conveyor	1200 [tph]
Loading	Loader [tph]	1000	Loader	1500 [tph]

Table 4.4 presents in detail the results of the optimization for the equipment selection and utilization for terminals with a throughput of 1, 5 and 10 Mt respectively. The equipment selection and utilization depicted here are the optimum result for each specific terminal in terms of average annual costs. Smaller terminals use equipment with lower capacities at a lower utilization rate, switching to heavier equipment with higher capacity that is used more as the throughput increases. In the storage step, combination of a bigger and a smaller type of storage offers the best results, enabled by the choice of small, floating barges to be used as extra storage facilities. With most types of equipment, this form of small, additional equipment types is usually unavailable. One exception is trucks, which are used as complimentary transport methods for small size terminals (approximately 500 kt per year throughput) as it makes no financial sense to invest in a heavy equipment like a conveyor belt yet. Despite their significantly higher operational costs compared to the other transportation methods, trucks also appear in larger terminals, where investing in another major transporting equipment would incur much larger investments.

Focusing on major equipment and technology tipping points, 25 ton mobile cranes are used up to a 3 Mt terminal, 50 ton mobile cranes from 3 to 5 Mt, 25 ton gantry cranes for 6 Mt terminals, and above that size, all terminals use 50 ton gantry crane with different degrees of utilization. Small terminals (1 and 2 Mt throughput) use 20 kt bunkers for storage. 100 kt silos appear at 3 Mt up to 5 Mt terminals. Bigger terminals, 6 Mt and above, switch to 130 kt bunkers and add extra storage infrastructures as their size increases – 15 Mt terminals need a 130 kt bunker and two 110 kt silos as storage capacity.

From an optimization perspective, belt conveyors are always preferable to pipe conveyors for transportation of biomass. Due to higher investment and operational costs, pipe conveyors are usually used when specific reasons arise, such as more strict environmental regulations concerning dust emissions, proximity to populated areas etc. It should be noted also, that at this point the

additional costs regarding covered belt conveyors are not taking into account miscellaneous equipment that should be used when dealing with biomass, such as temperature and spark monitoring throughout the belt, dust extraction or explosion prevention and suppression systems.

Table 4.4: Optimal equipment allocation and utilization for a terminal with a throughput of 1, 5 & 10 Mt

Annual throughput [Mt]	1		5		10	
	Equipment	Utilization	Equipment	Utilization	Equipment	Utilization
Receiving	25t mobile crane & 25m ³ grab	0.32	50t mobile crane & 42m ³ grab	0.90	50t gantry crane & 42m ³ grab	0.91
Transport1	300tph belt conveyor (1km)	0.53	1200tph belt conveyor (1km)	0.66	1800tph belt conveyor (1km)	0.88
Storage	20kt bunker	1.00	110kt silo	1.00	2 * 110kt silo	1.00
	2250t floating barge	0.89	2250t floating barge	0.44	20kt bunker	0.11
Reclaiming	300tph underground hopper & belt conveyor (200m)	0.53	1200tph underground hopper & belt conveyor (200m)	0.66	2000tph underground hopper & belt conveyor (200m)	0.79
Transport2	300tph belt conveyor (500m)	0.53	1200tph belt conveyor (500m)	0.66	1800tph belt conveyor (500m)	0.88
Loading	500tph loader	0.32	1000tph loader	0.79	2000tph loader	1.00

Figure 4.4 and Figure 4.5 offer a detailed overview of the total costs for 3 individual terminal throughputs, broken down per operational step and the individual costs as a percentage of the total. For each operational step, the annual equivalent of the capital cost of the selected equipment along with the annual operational cost can be seen. In smaller terminals, the infrastructure costs dominate the total costs in every operational area of the terminal. This is expected, as even smaller terminal equipment have significant investment costs; since the throughput is limited the operational costs incurred are kept low.

The importance of operational costs as the throughput (and therefore the size) of the terminals increases is obvious in Figure 4.4. Operational costs of equipment are directly linked to throughput and directly affect the operational expenses of a terminal. While the amounts may seem insignificant at first for smaller size terminals, as the size and throughput of a terminal increases, so will the utilization of increasingly larger types of equipment. Using bigger, heavier equipment, operating longer hours or moving more material incurs much higher costs on an annual basis than the annual equivalent of each equipment's capital cost. Operational costs can reach up to 32% of the total terminal costs and 55% of the individual costs in certain operational steps. These numbers are confirmed by industry expert group the author is collaborating with on this project (Pothoven, Lokker and Theunissen, personal communication, May 2017).

Storage costs are by far the biggest contributors to the total costs in all terminal sizes. This is because biomass as a bulk material requires enclosed storage, continuous temperature monitoring and safety equipment, which increases the storage infrastructure costs exponentially, especially the infrastructure costs. Storage costs represent already 30% of the costs in smaller terminals, increasing gradually and representing almost half the total costs at bigger size terminals (Figure 4.5). This is contrary to the expected economies of scale effect, which would suggest all costs to decrease as terminal size increases. The reality is that enclosed storage can only go up to a certain size before running into problems with available land use, need for support structures or material stress against the inner walls of the facility. A single bulk material storage facility is generally limited to a maximum size of around 130 kt (Ruijgrok and Geijs, personal communication, May 2017). This in turn leads to multiple storage facilities of the maximum available size as terminal throughput increases, causing disproportionately high storage costs for larger terminal sizes. However, as seen in Figure 4.3, the economies of scale in the other operational areas of a terminal are sufficient to bring about a leveling out of the costs per ton as terminals increase in size.

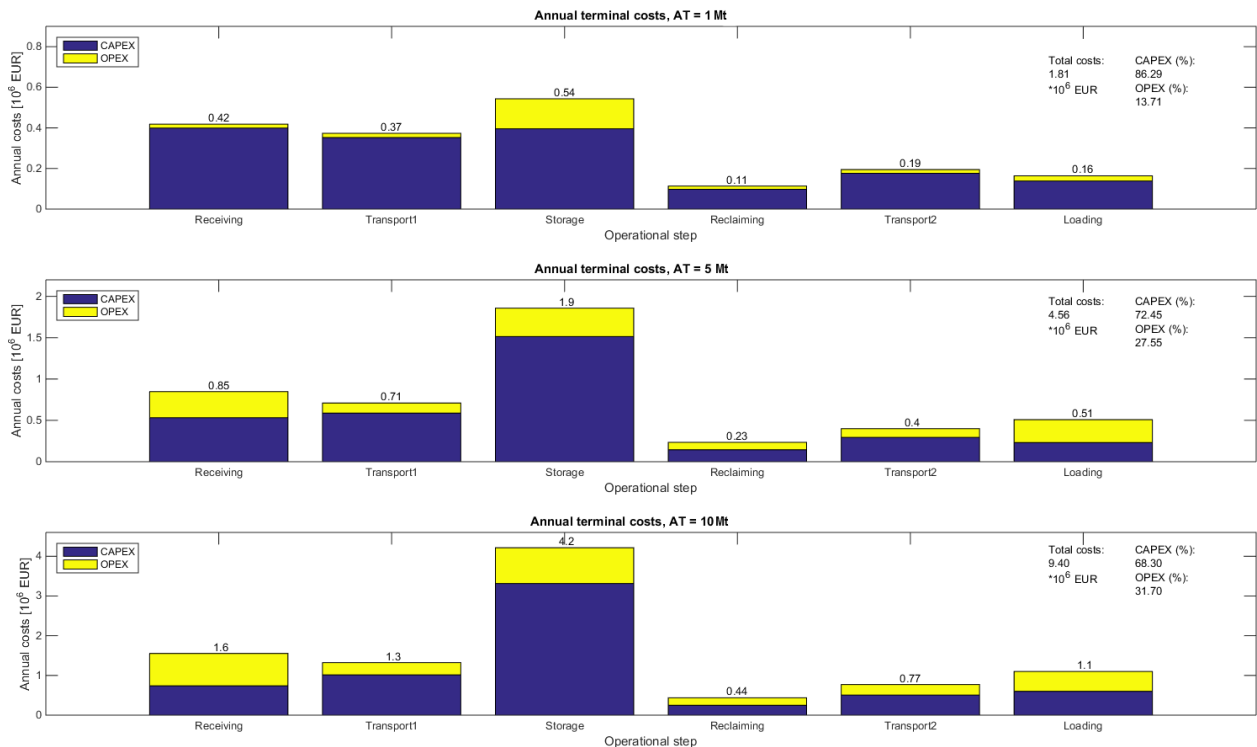

Figure 4.4: Total annual costs (1, 5 & 10 Mt throughput terminals)

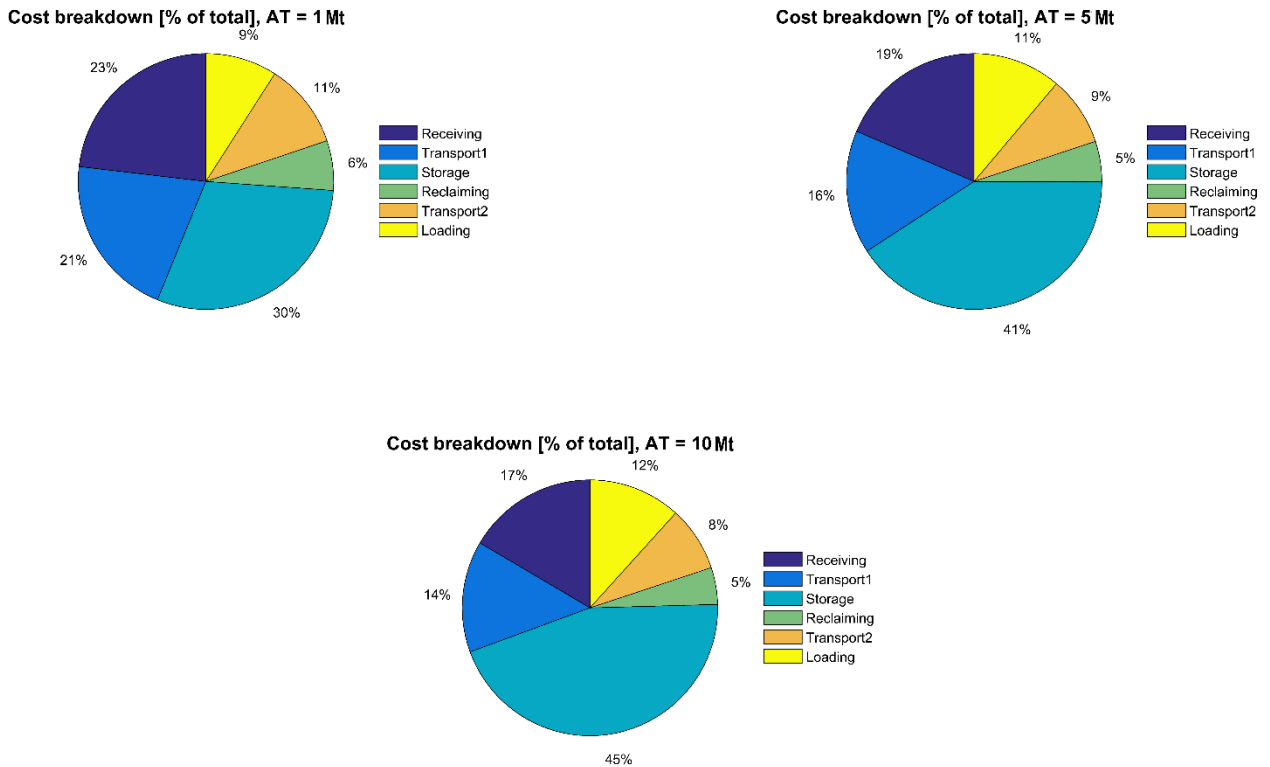

Figure 4.5: Total cost breakdown (1, 5 & 10 Mt throughput terminals)

Figure 4.6 presents the results of optimizing for a peak capacity approach (details can be found in section 4.3.2), for two specific terminals of 3.5 and 10 Mt throughput respectively. Smaller size terminals tend to be impacted a lot more in terms of size and utilization of equipment when designing for peak capacity. Bigger and heavier equipment is required to handle a specific size

of vessel in a specific allotted time, leading to a significant difference in total costs. On the other hand, moving to bigger size terminals eliminates this difference, since the selected equipment for the non-peak approach is of sufficient capacity to handle bigger size vessel during peak approaches as well. The non-peak and peak cost graphs in this case are completely identical.

Storage costs remain the same during both approaches as they are unrelated to service times of vessels, but only to total throughput of a terminal in our model. Additionally, the percentage breakdown of each operational step in both approaches for a terminal of 3.5 Mt of throughput can be seen in Figure 4.7. The 'spread' between the individual step costs is more balanced, since the equipment in all other steps except storage either switch to bigger types, or are utilized more during the peak approach. The storage costs still remaining dominant, even in peak approach though.

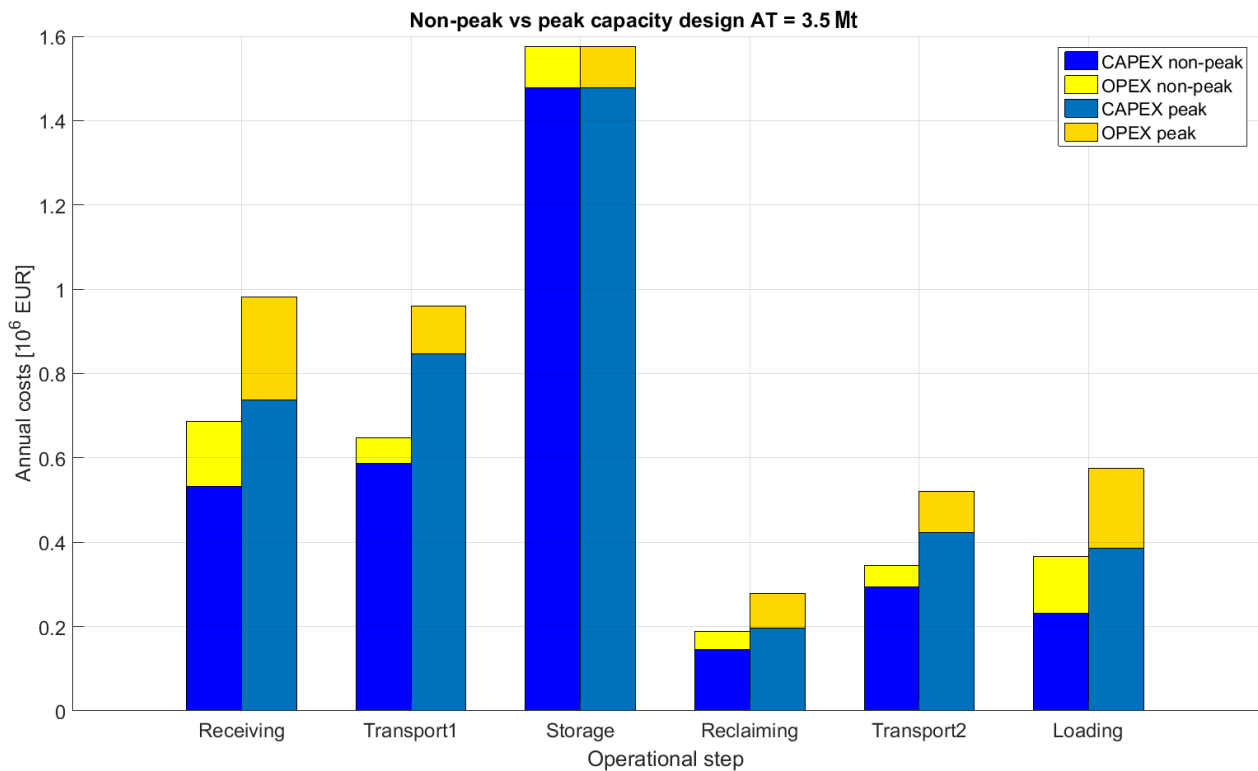

Figure 4.6: Non-peak vs peak capacity design (3.5 Mt throughput terminal)

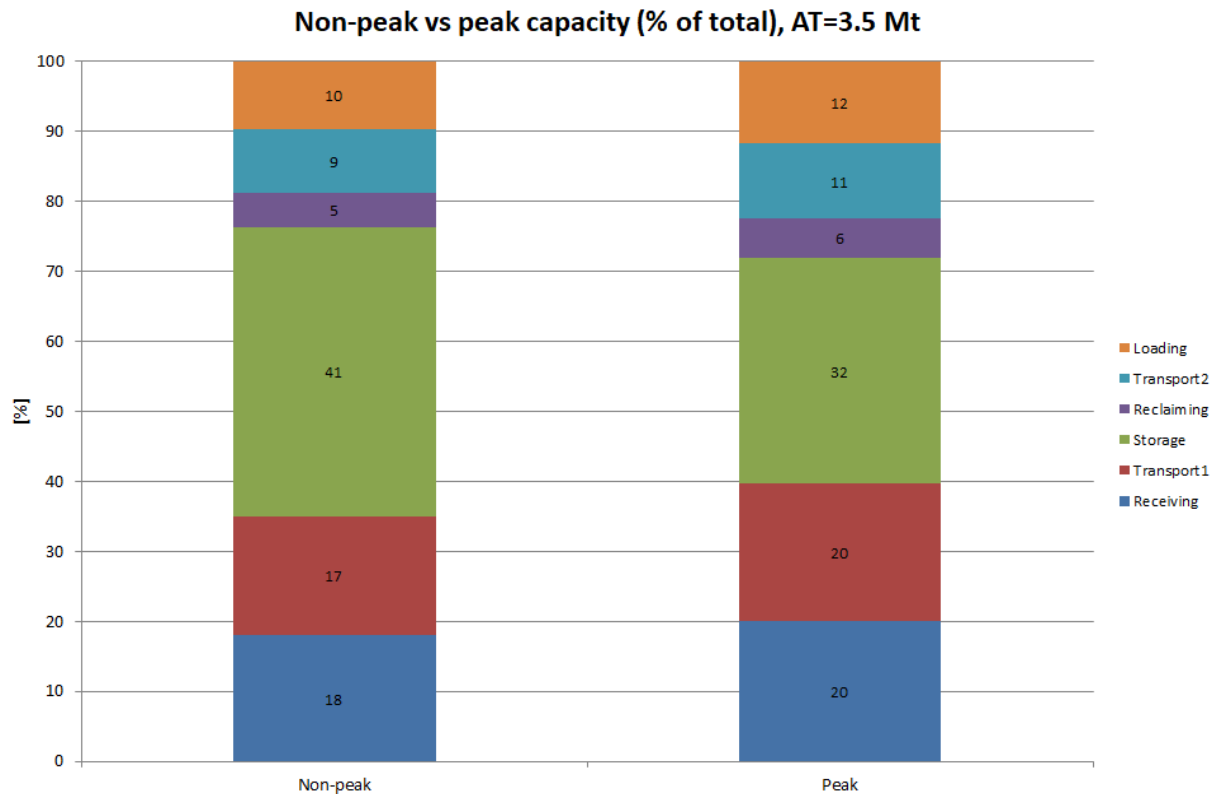

Figure 4.7: Non-peak vs peak capacity cost breakdown (3.5 Mt throughput terminal)

In Figure 4.8, the effects of the annual operational hours on the decrease of costs is depicted. For small terminals which have already invested in small equipment with low utilization, the effect of increasing the operational hours is extremely low in terms of costs decrease (less than 2% from 6000 to 8000 operational hours). The terminal is able to handle all throughput even at lower available operational hours, as the minimum required equipment is sufficient. As terminal size increases, an increase in operational hours is significantly more impactful, leading up to 13% reduction in total annual costs in some cases. As the operational hours increase, the optimum terminal setup moves to bigger heavier equipment with lower utilization. In contrast, for lower operating hours, smaller equipment is used at a near full utilization. This means that while terminals will incur higher capital expenses for the heavier equipment, they will be using it much less to handle the same throughput, as their capacity also increases. As explained before, utilization costs have a higher impact for larger size terminals than capital costs, which leads to a total decrease of costs with an increase in operational hours.

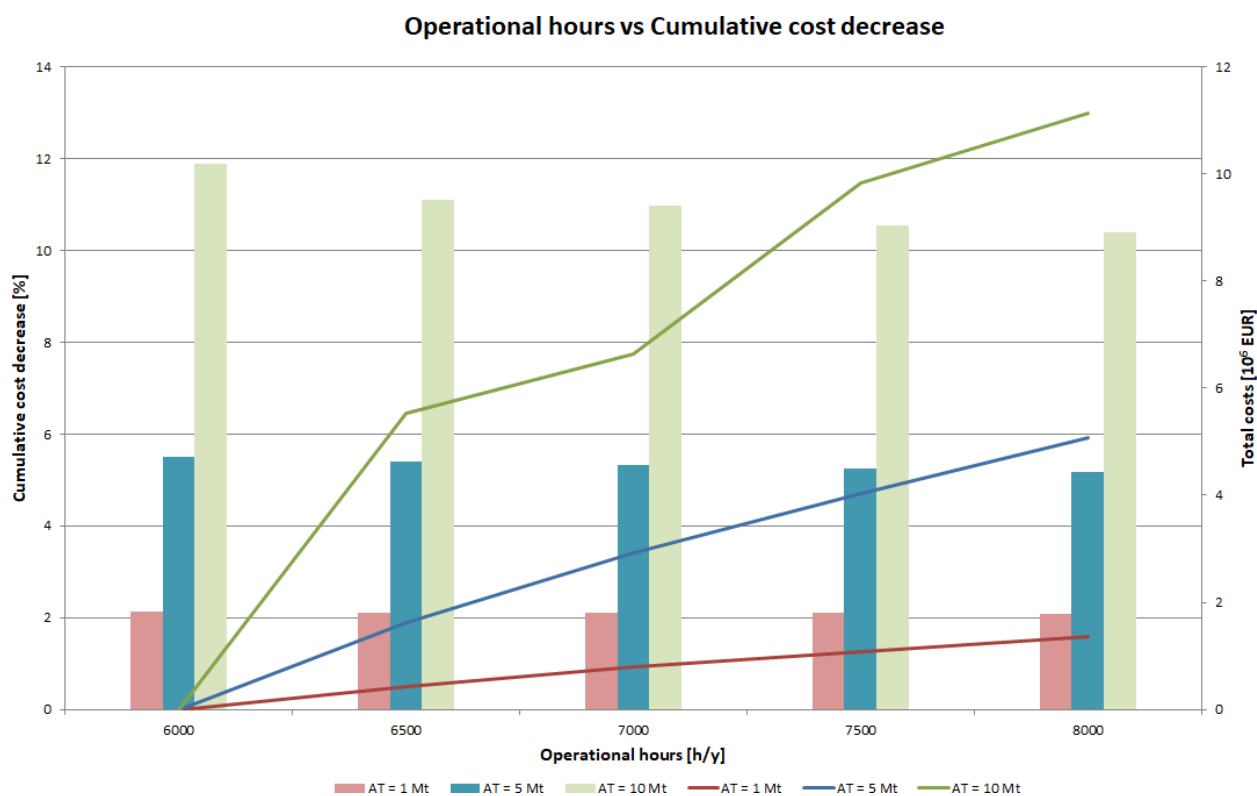

Figure 4.8: Operational hours vs Cumulative cost decrease (1, 5 & 10 Mt throughput terminals)

Table 4.5 provides an overview of the calibration process of the model. For the initial data (collected in May 2017), only values obtained from scientific literature or freely available in online or printed sources were used. As mentioned in sections 4.1.1 and 4.1.2, the scientific literature directly relating to the subject is either dated [11,13,14], or contains intentionally vague data due to confidentiality or other reasons. However, the author was able to get access to more detailed data over the course of this project (with the final data collected in October 2017). As a result, through this calibration process the deviation of the final results significantly decreased. Initially, total annual costs for a 3.5 Mt terminals amounted to 13.56 million euros, a considerable +256% difference with the final, rational value of 3.81 million euros per annum.

Table 4.5: Model calibration (total annual costs of a 3.5 Mt terminal)

	Initial results	Interim results	Interim results	Final results
Total annual costs [10⁶ €]	13.56	4.16	3.61	3.81
Deviation [%]	+256	+9.2	-5.2	0

Figure 4.9 highlights the improvements made in calculating the costs per ton of throughput for a wide range of terminal sizes. When using literature data and educated assumptions, the initial absolute values are in stark contrast with the final results. Costs per ton handled in port terminals decrease significantly as data accuracy increased; from 3.6 €/ton for a 10 Mt terminal to 0.94 €/ton. Additionally, the trends of development did not resemble the economies of scale effect that was expected until late in the data collection period. As an additional frame of reference, the wood pellet handling prices for a small terminal (500 kt) in the Port of Rotterdam in 2014 were around 3.5-4 €/ton when intermediate storage was used. Our model achieves an optimal price of 2.1 €/ton, effectively decreasing costs by 39-47%. The final results illustrate that access

to real-life detailed data relating to capital and operational costs of the equipment and infrastructure database is of paramount importance to verifying and validating such a model.

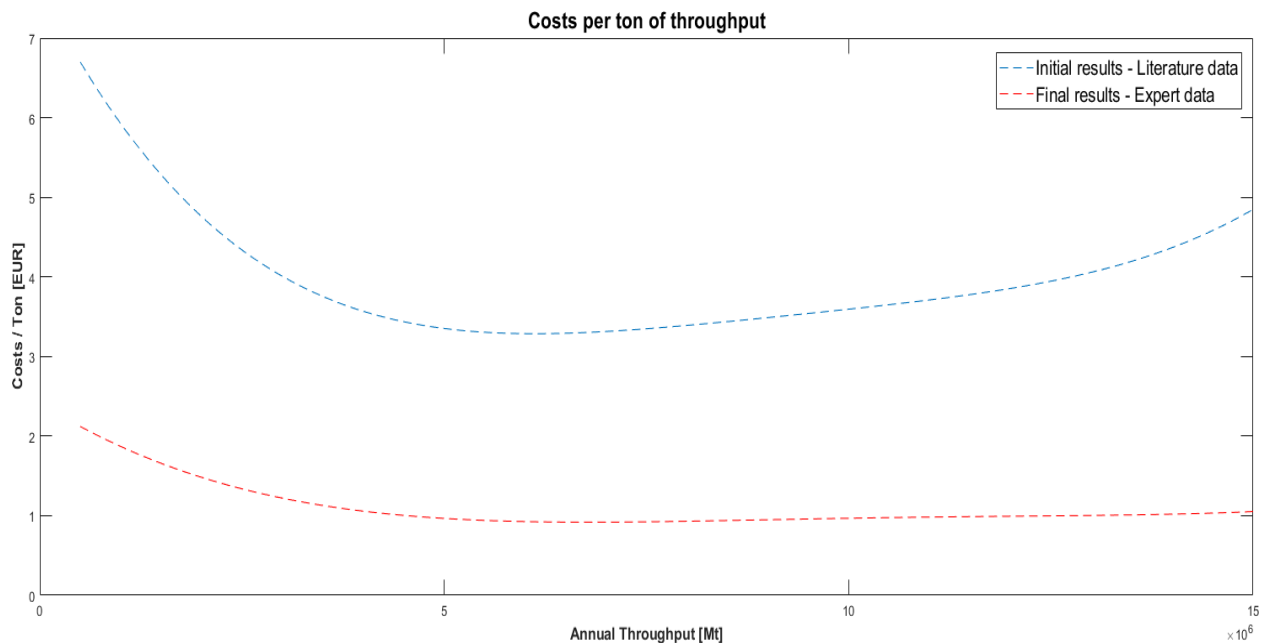

Figure 4.9: Costs per ton of throughput calculation progress

The relevance and validity of the assumptions and results presented in this chapter were discussed with a wide range of industrial experts that the author collaborated on for the purposes of the broader project this chapter is a part of. They have been verified to be as close to reality as possible at this stage. Partners include the biggest and most experienced solid bulk terminal operators in the Port of Rotterdam, the Port of Rotterdam Authority, equipment manufacturers, power plant and energy industry stakeholders. Their comments and feedback were useful in figuring out the accuracy of operational assumptions, as well as confirming the validity and usefulness of the results and their approximation of real-life terminal design.

4.5 Conclusions and further work

It has been shown that the model presented and developed in this chapter is fit for its intended purpose: identifying the optimal selection and utilization of equipment of a dedicated biomass terminal in terms of total annual costs. This work is, to the best of the author's knowledge, the first attempt to investigate terminal equipment selection and utilization to such an extensive manner and detail.

- Computational results based on real-life input data for biomass bulk terminals indicate that the optimum size of terminals in order to achieve the minimum cost per ton of throughput is achieved at 5 Mt of throughput and beyond.
- The total optimal equipment allocation and utilization is presented alongside each specific terminal size. The switch to a different type of technology or equipment is needed as throughput increases can be evidently observed.
- Partially used equipment in specific steps or shared equipment between different operational steps is also taken into account with the same level of detail as dedicated equipment.

- Most relevant work in literature focused on simulation of different scenarios rather than optimization of operations; attempts at optimization of equipment and operations logistics had been limited in scope and application.

The results also demonstrate the relevance of biomass storage needs over the total terminal logistics. Necessary enclosed storage can contribute to as much as 45% of the total terminal logistics, since enclosed facilities can only reach a certain size before requiring multiple units to accommodate the throughput. The importance of the effect of the utilization of equipment on bigger size terminals is also presented. Decoupled from a percentage of capital costs, operational costs have a significant role in terminal logistics, amounting to 32% of the total terminal costs in larger terminals and 55% of individual operational steps. The model can be used as a decision tool for practitioners and regulators in order to rationalize tactical level decision planning (when there is a chance of retrofitting or adjusting existing terminal equipment) or strategic level planning when designing a dedicated biomass port terminal. Its framework allows the model to potentially be used for optimization of a biomass terminal in terms of energy consumption or CO₂ emissions, as long as the relevant equipment operation data are known to a similar detail.

Further improvement of the model will include an expansion of the database with more equipment types per operational step. As mentioned throughout the body of the text, an effort is made to stick to data as close to real-life industrial conditions as possible, made feasible by the close cooperation with numerous industrial partners. This, however, means that in this 'quest' for detailed foundations, the usefulness of our model's output depends directly on the quality of the input. For this reason, a constant effort is made to update all relevant equipment data in order to stay relevant to current circumstances. The detailed cost components of support and safety systems – such as dust extraction, continuous temperature monitoring etc. - in certain types of equipment will also be implemented in the optimization routine.

Different approaches to biomass storage will also be investigated in further work. Instead of a fixed percentage of the annual throughput, terminal storage facilities could be designed based on: a) The demand rate and related safety stock levels. This however means knowing when and how much biomass each terminal client demands and planning accordingly. b) The bulk carrier size and arrival intervals. The bulk vessel size is based on the total throughput (see section 4.3.3), so the storage facilities could be designed to accommodate, e.g. one full maximum size vessel. This, however, means that the arrival rate must be known in detail and plan appropriately beforehand.

Redundancy of equipment is another important cost factor that has not yet been taken into account. Most terminals usually plan ahead and have extra units of equipment on stand-by, in case of failure or emergency. Of course this is most common for smaller types of equipment, like the grabs of the grab crane, or related miscellaneous components (generators, inverters, idlers for conveyor belts etc.). These do not necessarily constitute terminal 'equipment', but can however have a substantial impact on terminal logistics. At a later stage, linking the interest rates and effective utilization to each specific equipment type will improve the accuracy and realism of the results as well.

References

- [1] Hancock VE, Dafnomilis I, Schott DL, Lodewijks G. *Torrefied Biomass and its Handling Aspects – A State-of-the-art Review*. Bulk Mater. Storage, Handl. Transp., Darwin, Australia: 2016.
- [2] Dafnomilis I, Lanphen L, Schott DL, Lodewijks G. Biomass handling equipment overview. *Mater. Handl. Constr. Logist.*, Vienna, Austria: 2015, p. 66–70.
- [3] Dafnomilis I, Lodewijks G, Schott DL. Assessment of wood pellet handling in import terminals. *Biomass and Bioenergy* 2017.
- [4] Ha MH, Yang Z. Comparative analysis of port performance indicators: Independency and interdependency. *Transp Res Part A Policy Pract* 2017;103:264–78. doi:10.1016/j.tra.2017.06.013.
- [5] Talley WK, Ng MW, Marsillac E. Port service chains and port performance evaluation. *Transp Res Part E Logist Transp Rev* 2014;69:236–47. doi:10.1016/j.tre.2014.05.008.
- [6] Kox SAJ. *A Tool for Determining Marine Terminal Dimensions and Costs in a Project's Feasibility Phase*. Delft University of Technology, 2017. doi:cab027b6-fe58-4be5-a97d-21d88e7fb0ec.
- [7] Port of Rotterdam Authority. *Deep Sea Shipping* 2018. <https://www.portofrotterdam.com/en/connections-logistics/liner-services/deep-sea-shipping> (accessed January 5, 2018).
- [8] van Vianen T. *Simulation-integrated Design of Dry Bulk Terminals*. PhD Dissertation. Delft University of Technology, 2015.
- [9] Bradley MSA. *Biomass fuel transport and handling*. Fuel Flex. Energy Gener. Solid, Liq. Gaseous Fuels, Elsevier Ltd; 2016. doi:http://dx.doi.org/10.1016/B978-1-78242-378-2.00004-3.
- [10] Ligteringen H. *Ports and terminals*. Delft Academic Press (DAP) / VSSD; 2014.
- [11] United Nations Conference on Trade and Development (UNCTAD). *Development and improvement of ports - Development of bulk terminals*. 1985.
- [12] World Association for Waterborne Transport Infrastructure (PIANC). *Report no. 158: Masterplans for the development of existing ports*. 2014.
- [13] United Nations Conference on Trade and Development (UNCTAD). *Handbook on the management and operation of dry ports*. 1991.
- [14] Frankel EG, Cooper J, Chang YW, Tharakan G. *Bulk Shipping and Terminal Logistics*. 1985.
- [15] Memos CD. *Port planning*. Port Eng. planning, Constr. maintenance, Secur., New Jersey: John Wiley & Sons; 2004.
- [16] Ottjes JA, Lodewijks G, Schott DL. Bulk terminal modelling and simulation. *Int. Ind. Simul. Conf.*, Delft, The Netherlands: 2007.
- [17] Lodewijks G, Schott DL, Ottjes JA. Modern Dry Bulk Terminal Design. *Bulk Solids Handl* 2007:364–76.
- [18] Cimpeanu R, Devine MT, O'Brien C. A simulation model for the management and expansion of extended port terminal operations. *Transp Res Part E Logist Transp Rev* 2017;98:105–31. doi:10.1016/j.tre.2016.12.005.

- [19] Taneja P, Ligteringen H, Walker WE. Flexibility in port planning and design. *Eur J Transp Infrastruct Res* 2011;12.
- [20] Bruglieri M, Gerzelj E, Guenzani A, Maja R, de Alvarenga Rosa R. Solving the 3-D yard allocation problem for break bulk cargo via variable neighborhood search branching. *Electron Notes Discret Math* 2015;47:237–44. doi:10.1016/j.endm.2014.11.031.
- [21] Babu SAKI, Pratap S, Lahoti G, Fernandes KJ, Tiwari MK, Mount M, et al. Minimizing delay of ships in bulk terminals by simultaneous ship scheduling, stockyard planning and train scheduling. *Marit Econ Logist* 2015;17:464–92. doi:10.1057/mel.2014.20.
- [22] Robenek T, Umang N, Bierlaire M, Ropke S. A branch-and-price algorithm to solve the integrated berth allocation and yard assignment problem in bulk ports. *Eur J Oper Res* 2014;235:399–411. doi:10.1016/j.ejor.2013.08.015.
- [23] Ernst AT, Oguz C, Singh G, Taherkhani G. Mathematical models for the berth allocation problem in dry bulk terminals. *J Sched* 2017;20:459–73. doi:10.1007/s10951-017-0510-8.
- [24] Umang N, Bierlaire M, Vacca I. Exact and heuristic methods to solve the berth allocation problem in bulk ports. *Transp Res Part E Logist Transp Rev* 2013;54:14–31. doi:10.1016/j.tre.2013.03.003.
- [25] Al-Hammadi J, Diabat A. An integrated berth allocation and yard assignment problem for bulk ports: Formulation and case study. *RAIRO - Oper Res* 2017;51:267–84. doi:10.1051/ro/2015048.
- [26] Schott DL, Lodewijks G. Analysis of dry bulk terminals: Chances for exploration. *Part Part Syst Charact* 2007;24. doi:10.1002/ppsc.200601121.
- [27] Negenborn RR, Schott DL, Corman F. Port Equipment and Technology. *Encycl. Marit. Offshore Eng.*, 2017. doi:10.1002/9781118476406.emoe546.
- [28] Strien JN. Details of stackers, reclaimers and stackers/reclaimers for the use in terminal stockyards. 2010. doi:2010.TEL.7510.
- [29] Wang X, Wu L, Dong M. Modeling and Accomplishment of Loading-and-Unloading Equipment Optimum Allocation System at Bulk Terminal. *Int J Comput Netw Inf Secur* 2011;3.
- [30] Bugaric U, Petrovic D, Petrovic Z, Pajcin M, Markovic-Petrovic G. Determining the capacity of unloading bulk cargo terminal using queuing theory. *Stroj Vestnik/Journal Mech Eng* 2011;57. doi:10.5545/sv-jme.2009.084.
- [31] Pratap S, Nayak A, Kumar A, Cheikhrouhou N, Tiwari MK. An integrated decision support system for berth and ship unloader allocation in bulk material handling port. *Comput Ind Eng* 2017;106:386–99. doi:10.1016/j.cie.2016.12.009.
- [32] Pratap S, Manoj Kumar B, Cheikhrouhou N, Tiwari MK. The robust quay crane allocation for a discrete bulk material handling port. *IEEE Int. Conf. Ind. Eng. Eng. Manag.*, Singapore: 2016, p. 1174–8. doi:10.1109/IEEM.2015.7385833.
- [33] Wu M-R, Schott DL, Lodewijks G. Design of a large-scale biomass bulk terminal aided by a simulation model. *Bulk Solids Eur.*, Glasgow, Scotland: Vogel Business Media; 2010.
- [34] Wu M. A Large-scale Biomass Bulk Terminal. PhD Dissertation. Delft University of Technology, 2012. doi:doi:10.4233/uuid:cfb51421-504d-46df-8309-e10ac65dbbc3.

- [35] Temiz I, Calis G. Selection of Construction Equipment by using Multi-criteria Decision Making Methods. *Procedia Eng* 2017;196:286–93. doi:10.1016/j.proeng.2017.07.201.
- [36] Prasad K, Zavadskas EK, Chakraborty S. A software prototype for material handling equipment selection for construction sites. *Autom Constr* 2015;57:120–31. doi:10.1016/j.autcon.2015.06.001.
- [37] Velury J, Kennedy WJ. A systematic procedure for the selection of bulk material handling equipment. *Int J Prod Econ* 1992;27:233–40. doi:10.1016/0925-5273(92)90097-Q.
- [38] de Gijt JG. *Handbook of Quay Walls*. CRC Press; 2005. doi:10.1016/S0065-230X(09)04001-9.
- [39] de Gijt JG. *A History of Quay Walls*. PhD dissertation. Delft University of Technology, 2010.
- [40] Quist P, Wijdeven B. *Container terminals*. Ports Termin., Delft Academic Press (DAP) / VSSD; 2014, p. 276.
- [41] World Association for Waterborne Transport Infrastructure (PIANC). Report no. 135: Design principles for small and medium marine container terminals. 2014.
- [42] Mohseni NS. Developing a tool for designing a container terminal yard. Delft University of Technology, 2011. doi:020efc36-c130-4429-a1b6-7028235400ab.
- [43] Agerschou H, Dand I, Ernst T, Ghooos H, Jensen OJ, Korsgaard J, et al. *Planning and designing of ports and marine terminals*. ICE Publishing; 2004.
- [44] Bose J. *Handbook of terminal planning*. Springer; 2011.
- [45] Iris Ç, Pacino D, Ropke S, Larsen A. Integrated Berth Allocation and Quay Crane Assignment Problem: Set partitioning models and computational results. *Transp Res Part E Logist Transp Rev* 2015;81:75–97. doi:10.1016/j.tre.2015.06.008.
- [46] Tao Y, Lee CY. Joint planning of berth and yard allocation in transshipment terminals using multi-cluster stacking strategy. *Transp Res Part E Logist Transp Rev* 2015;83:34–50. doi:10.1016/j.tre.2015.08.005.
- [47] Liu M, Lee CY, Zhang Z, Chu C. Bi-objective optimization for the container terminal integrated planning. *Transp Res Part B Methodol* 2016;93:720–49. doi:10.1016/j.trb.2016.05.012.
- [48] Imai A, Yamakawa Y, Huang K. The strategic berth template problem. *Transp Res Part E Logist Transp Rev* 2014;72:77–100. doi:10.1016/j.tre.2014.09.013.
- [49] Lau HYK, Zhao Y. Integrated scheduling of handling equipment at automated container terminals. *Int J Prod Econ* 2008;112:665–82. doi:10.1016/j.ijpe.2007.05.015.
- [50] Liu D, Ge YE. Modeling assignment of quay cranes using queueing theory for minimizing CO2 emission at a container terminal. *Transp Res Part D Transp Environ* 2017:1–12. doi:10.1016/j.trd.2017.06.006.
- [51] Martin Alcalde E, Kim KH, Marchán SS. Optimal space for storage yard considering yard inventory forecasts and terminal performance. *Transp Res Part E Logist Transp Rev* 2015;82:102–28. doi:10.1016/j.tre.2015.08.003.
- [52] Sun Z, Tan KC, Lee LH, Chew EP. Design and evaluation of mega container terminal configurations: An integrated simulation framework. *Simul Trans Soc Model Simul Int* 2013;89:684–92. doi:10.1177/0037549712475097.

- [53] Chang S-M, Wang J-S, Yu M-M, Shang K-C, Lin S-H, Hsiao B. An application of centralized data envelopment analysis in resource allocation in container terminal operations. *Marit Policy Manag* 2015;42:776–88. doi:10.1080/03088839.2015.1037373.
- [54] Mbiydzennyuy G. An Optimization Model for Sea Port Equipment Configuration. Blekinge Institute of Technology, 2007. doi:MCS-2006:18.
- [55] Poudel SR, Marufuzzaman M, Bian L. A hybrid decomposition algorithm for designing a multi-modal transportation network under biomass supply uncertainty. *Transp Res Part E Logist Transp Rev* 2016;94:1–25. doi:10.1016/j.tre.2016.07.004.
- [56] Poudel SR, Marufuzzaman M, Bian L. Designing a reliable bio-fuel supply chain network considering link failure probabilities. *Comput Ind Eng* 2016;91:85–99. doi:10.1016/j.cie.2015.11.002.
- [57] Marufuzzaman M, Ekşioğlu SD. Managing congestion in supply chains via dynamic freight routing: An application in the biomass supply chain. *Transp Res Part E Logist Transp Rev* 2017;99:54–76. doi:10.1016/j.tre.2017.01.005.
- [58] Ghaderi H, Pishvae MS, Moini A. Biomass supply chain network design: An optimization-oriented review and analysis. *Ind Crops Prod* 2016;94:972–1000. doi:10.1016/j.indcrop.2016.09.027.
- [59] Quddus MA, Chowdhury S, Marufuzzaman M, Yu F, Bian L. A two-stage chance-constrained stochastic programming model for a bio-fuel supply chain network. *Int J Prod Econ* 2018;195:27–44. doi:10.1016/j.ijpe.2017.09.019.
- [60] de Jong S, Hoefnagels R, Wetterlund E, Pettersson K, Faaij A, Junginger M. Cost optimization of biofuel production – The impact of scale, integration, transport and supply chain configurations. *Appl Energy* 2017;195:1055–70. doi:10.1016/j.apenergy.2017.03.109.
- [61] Lee M, Cho S, Kim J. A comprehensive model for design and analysis of bioethanol production and supply strategies from lignocellulosic biomass. *Renew Energy* 2017;112:247–59. doi:10.1016/j.renene.2017.05.040.
- [62] Yue D, You F, Snyder SW. Biomass-to-bioenergy and biofuel supply chain optimization: Overview, key issues and challenges. *Comput Chem Eng* 2014;66:36–56. doi:10.1016/j.compchemeng.2013.11.016.
- [63] Ahmad AA, Zawawi NA, Kasim FH, Inayat A, Khasri A. Assessing the gasification performance of biomass: A review on biomass gasification process conditions, optimization and economic evaluation. *Renew Sustain Energy Rev* 2016;53:1333–47. doi:10.1016/j.rser.2015.09.030.
- [64] Stevens LCE, Vis IFA. Port supply chain integration: analyzing biofuel supply chains. *Marit Policy Manag* 2016;43:261–79. doi:10.1080/03088839.2015.1050078.
- [65] Sikanen L, Korpinen OJ, Tornberg J, Saarentaus T, Leppänen K, Jahkonen M. Energy Biomass Supply Chain Concepts Including Terminals. Natural Resources Institute Finland (Luke); 2016.
- [66] Kons K, Bergström D, Eriksson U, Athanassiadis D, Nordfjell T. Characteristics of Swedish forest biomass terminals for energy. *Int J For Eng* 2014;25:238–46. doi:10.1080/14942119.2014.980494.
- [67] Virkkunen M, Kari M, Hankalin V, Nummelin J. Solid biomass fuel terminal concepts and a cost analysis of a satellite terminal concept. VTT Technol 2015.

- doi:10.13140/RG.2.1.3865.3921.
- [68] Gautam S. A multicriteria decision making approach to locate a terminal in bioenergy supply chains. Canadian Institute of Forestry; 2016.
- [69] Rivers M. Biomass sourcing strategies 2013.
- [70] Lanphen L. Biomass handling equipment in European ports - an overview of current designs and required design improvements. 2015. doi:2014.TEL.7893.
- [71] van den Brand S. Storage sharing at import dry- bulk terminals: a case study at Gadani Energy Park. 2017. doi:803ceabb-64ff-4ee7-a521-ddafe81fb15d.
- [72] Tongzon JL. Port choice and freight forwarders. *Transp Res Part E Logist Transp Rev* 2009;45:186–95. doi:10.1016/j.tre.2008.02.004.
- [73] Chang V, Tovar B. Drivers explaining the inefficiency of Peruvian and Chilean ports terminals. *Transp Res Part E Logist Transp Rev* 2014;67:190–203. doi:10.1016/j.tre.2014.04.011.

Chapter 5. Multi-period biomass terminal planning⁶

A mixed integer linear programming model was presented in chapter 4. This approach is suitable to identify the optimal selection and utilization of equipment of a dedicated biomass terminal in terms of total annual costs. Computational results indicate the optimum size of terminals in order to achieve the minimum cost per ton of throughput, and the optimal equipment allocation and utilization is presented alongside each specific terminal size. The switch to a different type of technology or equipment is needed as a function of increasing throughput can be observed. The model can be used as a decision tool for stakeholders in order to support tactical level decision planning (when there is a chance of retrofitting or adjusting existing terminal equipment) or strategic level planning when designing a dedicated biomass port terminal.

While the MILP model developed in chapter 4 is a useful tool to provide us with the optimal equipment setup for a specific throughput, it is fairly static in nature; variations of throughput over a specified timeline cannot be handled – rather, a single, throughput specific solution can be suggested for each time unit. Designing and planning a port terminal is not a straightforward process. Most, facilities that handle biomass do not start up and operate straight away – many need an extended period of development during which retrofit and lost opportunity costs are incurred, often for a year or two before they get to full operation. This chapter presents a multi-period model, able to propose the optimal investment pathway throughout a specific development timeline, such as the ones ascertained in chapter 2. Most importantly, this model transitions from a discrete, MILP approach to multi-stage planning approach. This enables us to have an overview of the investments needed in infrastructure and the expected operational costs throughout the whole time period.

⁶Submitted for publication as: Dafnomilis I, Duinkerken MB, Junginger M, Lodewijks G, Schott DL. Multi-period biomass terminal design. *Transp Res Part E Logist Transp Rev* 2018.

5.1 Introduction

Maritime transportation of goods and products is the most crucial global economic activity, representing roughly 90% of the world's trade [1,2]. Seaborne dry cargo shipments totaled 7.23 billion tons in 2016, representing 70.3% of all seaborne trade. Dry bulk cargo specifically, meaning all the commodity cargo that is transported unpackaged in large quantities, constituted almost 68% of the total dry cargo, followed by containerized trade [3]. This systematic growth of maritime freight traffic has been fueled by absolute advantages such as geographical considerations, comparative advantages (international division of production and trade globalization), technical improvements in the maritime freight industry and economies of scale [4]. Still, maritime transportation has one of the highest entry costs of the transport sector; high terminal costs, since port infrastructures are among the most expensive to build, maintain and improve, as well as significant inventory costs. With the majority of the seaborne trade originating or targeted towards developing economies or economies in transition, minimization of the costs of the necessary infrastructure expansion becomes of increasing importance [4].

Solid biomass, and wood pellets in particular, which is what this thesis is mostly concerned about, is considered a dry bulk material, such as coal. As a renewable energy carrier biomass use in the European Union (EU) is expected to significantly grow in the co-firing and heating sectors by 2030 and be of considerable importance towards meeting the new EU renewable energy targets of 32% [5,6]. Several EU Member States (MS) such as the Netherlands, Belgium and Denmark have been relying on wood pellet imports in order to transition to renewable energy production, and are expected to rely on them for the future as well. However, unlike other dry bulk material, biomass requires specific equipment and techniques used during bulk handling, transport and storage [8]. Appropriate trade infrastructure has to be developed and built, such as storage, loading and handling capacities in the pellets production regions, as well as in commercial areas and harbors [9].

The above constraints, in combination with the high costs of port terminal logistics impose additional complexities and burdens on wood pellet terminal design. Only certain port terminals are dedicated wood pellet terminals, mostly in the US, Canada and the UK. Currently, there is no standardized procedure or strict guidelines to aid relevant stakeholders. Additionally, scientific literature relating to equipment selection and investment decisions is limited. For such an expensive and complex undertaking as port terminal development, the need for a robust planning strategy is of great importance. This chapter aims to provide a model that can be used in wood pellet terminal design, with results that can assist terminal operators and port authorities with strategic level planning decisions related to multi-period equipment selection and investments.

5.1.1 Literature review

Multi-period optimization research has been performed on numerous fields of study. Amanshoori et al. [10–12] and Almaraz et al. [13–15] developed modeling approaches for design and operation of hydrogen supply chains. Gupta [16] presented a planning model for oil and gas offshore infrastructure development. Chakraborty [17] introduced a planning methodology for optimal waste reduction and investments in pharmaceutical plants, while Balakrishnan [18] provided a review of multi-period planning in cellular manufacturing. Optimization of energy systems planning has also been extensively researched by Fazlollahi et al. [19], Mirzaesmaeeli et al. [20] and Flores et al. [21]. Pina et al. [22] developed a renewable electricity systems optimization, while Baringo et al. [23] and Giarola et al. [24] examined multi-stage wind power investments and bioethanol supply chains respectively.

Several works in port terminal design and investments have also been published. An extensive design method that functions as a guideline on bulk terminal design was introduced by the

United Nations Conference on Trade and Development in 1985 and again in 1991 [25,26], focusing on the physical characteristics, management and operation of bulk terminals. The Transportation Department of the World Bank [27] also produced a technical report on bulk terminal infrastructure. Lin et al. [28] and Cimpeanu et al. [29] developed simulation approaches for managing port investments and the expansion of terminal operations. Cheng et al. [30] researched the equilibria of port investments for a multi-port region in China. Lagoudis et al. [31] and Zheng et al. [32] proposed a decision-making process for port infrastructure investments taking into account uncertainties. A multi-period investment optimization model based on supply and demand matching was introduced by Zhao et al. [33].

Scientific research into equipment selection has also been performed. Santelices et al. [34] and Patterson et al. [35] developed integrated models for loading and hauling equipment selection in mining. Ozdemir et al. [36] evaluated assembly-line design alternatives with equipment selection. Burt et al. [37] used a similar approach to the one discussed in this chapter, for the equipment selection and salvage in mining operations. Temiz and Prasad [38,39] respectively developed software approaches for equipment selection in construction sites. Regarding the port terminal field specifically, Negenborn, et al. [40] provide general information on equipment needs of dry bulk terminals. Research on types of equipment has been performed by Strien, Bugaric and Pratap et al. [41–44]. Wu [45] researched dedicated biomass terminals in detail and provided a database of suitable equipment for biomass terminal operations.

Most of the previously conducted scientific studies provided useful insights into improving or optimizing terminal design. However the focus was asymmetrically put on simulation approaches. Generally, simulation tries to measure the performance of the researched objective under different assumptions or parameters, but does not optimize the solutions it provides. Similarly, research on equipment selection focused on optimizing the (un)loading equipment selection only. The limited multi-period investment optimization approaches that have been developed, are lacking either in the detailed examination of the subject (equipment database, parameters etc.) or in the scale of application – usually they are applied as case studies for pre-existing ports. Moreover, while salvage of equipment is commonly practiced in port terminals, it has very rarely been considered, if at all in previous scientific literature. For a complex and costly design of a port terminal, equipment salvage can be a major parameter to have into account when optimizing the infrastructure over a long term period. For wood pellet biomass bulk terminals especially, with all the added restrictions regarding efficient handling of the material and safety concerns, and by extension the higher associated logistics, the need for a robust approach that can minimize the development costs over a long-term, strategic planning is required.

5.1.2 Objective and contribution

In Chapter 4, the aim was to develop a model that was able to provide the total equipment allocation and utilization in a solid biomass bulk terminal. The scope of that work included the complete activities within a terminal, from the unloading of the biomass from an arriving vessel, to the loading at a vessel at the end of the handling chain. The results provided useful insight into the importance of several parameters of a biomass terminal design, such as utilization of equipment and storage infrastructure effect on the total costs. It was however, a static approach that could optimize a biomass terminal design for a given throughput. The model was not able to handle time-dependent parameters, such as future throughput variations or the decrease of equipment performance depending on their age and depreciation factors.

For this purpose, the work performed previously is expanded into a multi-period modeling approach. The novelty of previous work is kept intact; the equipment selection and configuration is presented on a detailed level within the terminal bounds, and the utilization of

this equipment is taken into account and is linked directly to the material throughput, as is the case in reality. At the same time an extensive database with significant data depth that is uniquely tailored for biomass terminal operations is used. However, this work transforms the previous model into a multi-stage planning approach, providing optimal design solutions for an extensive range of time periods. Multiple scenarios for biomass imports in the continental EU are generated from Chapter 2 and are used as input. The decrease in equipment performance and the depreciation of equipment is taken into account, and salvage of equipment can occur when the equipment reaches its maximum lifetime (if not sooner). The overall objective of this chapter is to present a comprehensive approach to wood pellet terminal investment strategies, by providing the optimum (i.e. lowest net present cost) solution for equipment selection, purchase and salvage, as well as equipment utilization over a long-term future period. Consequently, the research performed in this chapter provides the following novel contributions:

1. A multi-stage mathematical model for optimizing wood pellet terminal equipment selection and configuration, not only for dedicated wood pellet equipment, but also for equipment that is partially used and shared between different operational steps.
2. An approach for minimizing total (investment and operational) costs in biomass bulk terminals from a strategic planning point of view, taking into account all the discrete operations of a terminal, as well as salvage of used equipment
3. Results that are based on real world data instead of assumptions or relevant experience only, thus providing increased credibility and validity of the outcomes of the proposed model.

As mentioned in Chapter 4, the author was able to collaborate with numerous industrial experts, including the biggest and most experienced solid bulk terminal operators in the port of Rotterdam, the Port of Rotterdam, equipment manufacturers, power plant and energy industry stakeholders. Their input was used in ascertaining the accuracy of operational assumptions, as well as confirming the validity and usefulness of the results and their approximation of real-life terminal design.

This chapter is organized as follows. The mathematical model is presented in section 5.2. The computational results are presented in section 5.3, showing that our model is capable of providing significant information regarding terminal equipment configuration and utilization decisions in a reasonable amount of time. Conclusions can be found in section 5.4.

5.2 Model structure

The multi-period optimization approach presented in this work is formulated as a mixed-integer linear programming (MILP) problem that minimizes terminal equipment and infrastructure investments and operational costs over a selected time period. It is, to the best of the author's knowledge, the first multi-period terminal model to take into account equipment used in more than one operational step into account and provide information on the utilization of the selected equipment. Moreover, the salvage value of the equipment is also taken into account, relating to the equipment's age. The overall goal is to minimize the total investment costs of a biomass terminal in terms of net present costs, by optimizing the amount of fully utilized and shared or partially used equipment within the terminal.

The assumptions regarding the terminal operations parameters and the used inputs can be found in detail in section 4.3 of Chapter 4. The optimization performed by the model is a terminal cost optimization over the whole time period under examination and not a step-specific one. The optimum equipment selection and associated investment or operational costs for individual operational steps or time periods might be counter-intuitive. However, the solution provides the ideal pathway for terminal developments from a strategic point of view.

5.2.1 Notations

The following notations are used in the development of the MILP model.

Indices:

I	Set of equipment types indexed by i	$i \in I$
J	Set of operational steps indexed by j	$j \in J$
T	Set of time periods indexed by t	$t \in T$
K	Set of equipment ages indexed by k	$k \in K$

System parameters:

CC_{ij}	Capital costs of equipment i in step j	[€]
OC_{ijk}	Operational costs of equipment i of age k in step j	[€/ton]
C_{ij}	Nominal capacity of equipment i in step j	[tph]
a_{ik}	Availability of equipment i of age k	[%]
p_{ik}	Performance of equipment i of age k	[%]
q_{ik}	Quality of equipment i of age k	[%]
oee_{ik}	Overall equipment efficiency of equipment i of age k	[%]
EqC_{ijk}	Average annual capacity of equipment i of age k in step j	[t]
LT_i	Lifetime of equipment i	[y]
AT_t	Throughput of the terminal in time period t	[Mt]
OPH	Annual operational hours of the terminal	[h/y]
sf	Storage factor	[%]
dr	Discount rate	[%]
df	Depreciation rate	[%]
svf_{tk}	Salvage factor at time period t for equipment of age k	[%]

Decision

variables:

n_{ijk}	Number of equipment i in step j in time period t that is of age k	$n_{ijk} \in \mathbb{N}^0$
-----------	---	----------------------------

x_{ijtk}	Utilization of equipment i in step j in time period t that is of age k	$x_{ijtk} \in \mathbb{R}^+$
s_{ijtk}	Salvaged equipment i in step j in start of time period t that is of age k	$s_{ijtk} \in \mathbb{N}^0$

5.2.2 Objective function formulation and constraints

Objective function

In order to properly assess the investment costs, all related costs and profits (i.e. salvage values) need to be discounted to the present. Capital expenses CC_{ij} only incur when the equipment is purchased, thus for equipment of age $k = 0$. Any capital expenses incurred in a future time period t are discounted to the present via the commonly used discount factor $\frac{1}{(1+dr)^t}$, where

dr is the discount rate used in this chapter. Thus, the net present capital costs for the purchasing of each equipment i used in step j are given as:

$$NPCC_{ijt0} = CC_{ij} * \frac{1}{(1+dr)^t} \quad (5.1)$$

Similarly, the operational costs of the terminal for each time period are discounted to the present with the same discount factor as above, and have the following expression:

$$NPOC_{ijtk} = OC_{ij} * \frac{1}{(1+dr)^t} * AT_t \quad (5.2)$$

Finally, the salvage factor of each equipment type is calculated based on its depreciation rate df . It is also discounted to the present and is represented by $svf_{tk} = \frac{(1-df)^k}{(1+dr)^t}$. Consequently,

the net present salvage value of each equipment is given by:

$$NPSV_{ijtk} = CC_{ij} * svf_{tk} \quad (5.3)$$

The complete objective function Z that represents the total investment costs of a biomass terminal can therefore be formulated in the following way:

$$Z = \sum_{ij} n_{ijt0} * NPCC_{ijt0} + \sum_{ijtk} x_{ijtk} * NPOC_{ijtk} + \sum_{ijtk} s_{ijtk} * NPSV_{ijtk}$$

Constraints

Capacity constraints

All the equipment used in each operational step for a given time period, need to be able to handle the throughput of that specific time period:

$$\sum_{itk} (x_{ijtk} + EqC_{ijk}) \geq AT_t \quad \text{when } j = 1, 2, 4, 5, 6 \quad (5.4)$$

and

$$\sum_{itk} (x_{ijtk} + EqC_{ijk}) \geq sf * AT_t \quad \text{when } j = 3 \quad (5.5)$$

The equipment capacity $EqC_{ijk} = CC_{ij} * OPH * oee_{ik}$ for each type of equipment is calculated based on the nominal capacity of the equipment CC_{ij} , the operating hours of the terminal OPH and the overall equipment effectiveness $oee_{ik} = a_{ik} * p_{ik} * q_{ik}$. Details on the overall equipment effectiveness (OEE) method and the way it is handled in this chapter can be found in section 5.2.4.

Storage constraints guarantees that all the possible equipment used for storage is able to hold a percentage of the respective annual throughput. The storage factor is defined as the ratio of storage capacity over the annual throughput between the required stockyard size and the terminal's annual throughput [46].

Conservation and salvage constraints

For each time period t , the number of selected equipment must be equal to the number of selected equipment in time period $(t - 1)$, subtracting any selected equipment that are salvaged at the start of period t :

$$n_{ijt} = n_{ij,t-1,k-1} - s_{ijtk} \quad \forall i, j, t > 0, k > 0 \quad (5.6)$$

This holds true for any equipment of type i , as long as it has not reached its maximum allowable lifetime $\max(LT_i)$. Once any equipment reaches the end of its lifetime, it is forcibly salvaged at the start of the next time period:

$$n_{ij,t,k-1} = s_{ij,t+1,k} \quad \forall i, j, t \in [0, T - 1], k < \max(LT_i) \quad (5.7)$$

At the same time, in the first time period several constraints need to be ensured: a) new equipment is purchased and b) that there can be no salvage. The salvage value of just purchased equipment is set to 0:

$$n_{ij0k} = 0 \quad \forall i, j, k \quad (5.8)$$

$$s_{ij0k} = 0 \quad \forall i, j, k \quad (5.9)$$

$$s_{ijt0} = 0 \quad \forall i, j, t \quad (5.10)$$

Utilization constraints

The utilization of each shared or partially used equipment can never exceed the actual amount of owned equipment. Summing the utilization of each time step over all operational steps where shared or partial equipment may be used and denoting it to be equal or less to the units of equipment ensures that:

$$x_{ijtk} \leq n_{ijtk} \quad \forall i, j, t, k \quad (5.11)$$

Non-negativity constraints

Finally, the units of selected and salvaged equipment are positive integers only (including 0), and that the utilization of equipment is a real number between 0 and 1 respectively.

$$n_{ijtk}, s_{ijtk} \in \mathbb{N}^0 \quad \forall i, j, t, k \quad (5.12)$$

$$x_{ijtk} \in [0, 1] \quad \forall i, j, t, k \quad (5.13)$$

5.2.3 Complete model

$$\text{Minimize } Z = \sum_{ijt} n_{ijt0} * NPCC_{ijt0} + \sum_{ijtk} x_{ijtk} * NPOC_{ijtk} + \sum_{ijtk} s_{ijtk} * NPSV_{ijtk}$$

s.t.

$$\sum_{itk} (x_{ijtk} + EqC_{ijk}) \geq AT_t \quad \text{for } j = 1, 2, 4, 5, 6 \quad (5.14)$$

$$\sum_{itk} (x_{ijtk} + EqC_{ijk}) \geq sf * AT_t \quad \text{for } j = 3 \quad (5.15)$$

$$n_{ijtk} = n_{ij,t-1,k-1} - s_{ijtk} \quad \forall i, j, t > 0, k > 0 \quad (5.16)$$

$$n_{ij,t,k-1} = s_{ij,t+1,k} \quad \forall i, j, t \in [0, T-1], k < \max(LT_i) \quad (5.17)$$

$$n_{ij0k} = 0 \quad \forall i, j, k \quad (5.18)$$

$$s_{ij0k} = 0 \quad \forall i, j, k \quad (5.19)$$

$$s_{ijt0} = 0 \quad \forall i, j, t \quad (5.20)$$

$$x_{ijtk} \leq n_{ijtk} \quad \forall i, j, t, k \quad (5.21)$$

$$n_{ijtk}, s_{ijtk} \in \mathbb{N}^0 \quad \forall i, j, t, k \quad (5.22)$$

$$x_{ijtk} \in [0, 1] \quad \forall i, j, t, k \quad (5.23)$$

5.2.4 Assumptions and input data

Information on assumptions and decisions taken relating to biomass terminal design, such as the utilization of equipment definition, the annual operating hours and the storage factor, are explained in detail in [46]. A complete list of the types and sizes of equipment used can be seen in Table 5.4 at the Appendix of this chapter.

A uniform discount rate dr of 0.06 (or 6%) is used throughout the model. As a base case, an individual depreciation rate is assigned to each equipment type, in an effort to have as realistic as possible result. Depreciation rates of equipment depends directly on the equipment type and varies between low depreciation rates for heavy infrastructure such as rail mounted gantry cranes and higher depreciation for light, mobile equipment, such as trucks and front loaders. The complete list of depreciation rates can be found in Table 5.6 in the Appendix. A sensitivity analysis of the depreciation rate is also performed and the results can be found in section 5.3.2.

Overall equipment efficiency (OEE) is the metric that is used in this chapter to calculate the effect of aging on the equipment's overall performance. It is the product of 3 different factors: the availability and performance of equipment, and the quality of the end product. Availability of equipment takes into account all events that stop operations for a considerable amount of time that makes sense for the terminal operators to look into. In our model, the availability of equipment a_{ik} is assumed to be 0.9 (or 90%) throughout the whole time period since a dedicated biomass terminal is under consideration, where no other products are handled. Performance takes into account anything that causes the operation of equipment to run at less than the maximum possible speed. The initial performance p_{ik} is assumed to be 0.95. Quality is a term usually found in the manufacturing processes and takes into account manufactured parts that do not meet quality standards. In our model, the term quality is used to represent the loss of product when handled by each type of equipment, due to mechanical degradation, spillage and other

factors [49]. The initial quality q_{ik} is assumed to be 0.98, since our database contains only dedicated biomass equipment that are specifically suited to handle biomass with the best possible efficiency. The performance and quality of equipment, p_{ik} and q_{ik} are assumed to decrease as the age of the equipment increases (Table 5.5 in the Appendix).

The technical and economic lifetime LT_i of each equipment type are assumed to be the same. Economic lifetime is the expected period of time during which a unit of equipment is useful to the average owner. The economic life of an asset could be different than its actual technical life. The values related to the lifetime of equipment are based on relevant literature and personal communication of the author with industrial experts. Additionally, a linear relationship between time periods and equipment age is assumed; one time period in the model equals with one period of equipment age (in this case, one time period equals one year).

Several scenarios have been developed to be used as input and can be seen in Figure 5.1. The ranges for scenarios A and B are based on the research conducted in Chapter 2, relating to the expected biomass imports in the Northwest Europe. Additionally, 2 more scenarios are used as case studies. Scenario C is a peak scenario, where biomass imports reach a peak at some point in the time period under consideration, and gradually decline thereafter. Scenario D represents the plateauing of biomass imports after biomass reaches a level of commodity similar to that of coal or iron ore. The scenarios are based on the assumption that the port of Rotterdam will assume the role of a hub for solid biomass imports for the Netherlands and hinterlands Member States, so a volume of 20-30 Mt of solid biomass is not unrealistic for 2030 and beyond.

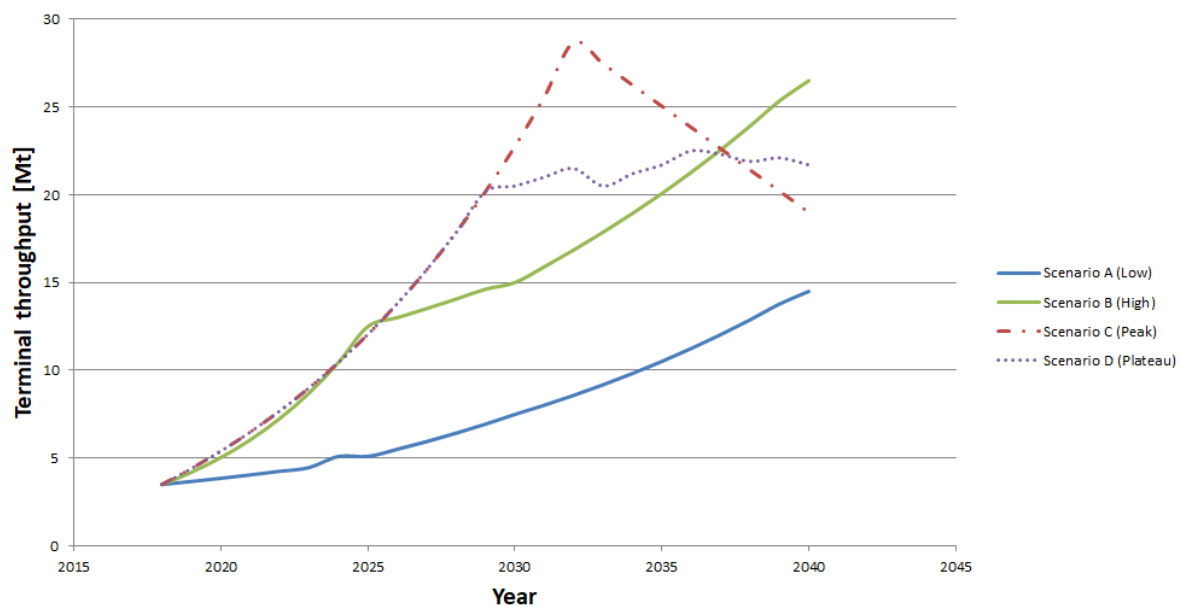

Figure 5.1: Biomass throughput scenarios

5.3 Computational results

The MILP model was programmed in *Python 3.6.0* using the LP modeler *PuLP 1.6.8* and a *Gurobi 8.0.0* solver, on an Intel Core i5-4690 CPU @ 3.5 GHz processor, and 8 GB of RAM. The complete problem contains 790326 variables and 548142 constraints. All cases were solved with an optimality gap of 0.01 (1%) with computational times that can be seen in Table 5.1 and Table 5.2. The model provides the optimal (i.e. lowest cost) long-term investment strategy for

each scenario. The end result is a timeline of equipment purchase costs and salvage profits, as well as associated operational costs across the whole time period.

5.3.1 Base case

A uniform depreciation rate for all equipment in a terminal is unlikely to occur. Thus, a ‘realistic’ base case was developed, where each equipment type is linked to a specific depreciation rate, which can be seen in Table 5.6 in the Appendix. The results can be seen in Table 5.1 and Figure 5.2 below.

In Table 5.1, the total terminal costs and their breakdown for all scenarios for the base case can be seen. The total costs per ton of solid biomass handled are also presented. Generally, a value of 0.83-0.89 €t⁻¹ is achieved for all cases, improving our optimum solution in [46] (1 €t⁻¹) by 8-16% depending on the scenario.

The detailed results present a complex solution. Most heavy port terminal equipment used for bulk handling and storage, which is the majority of equipment used in a solid biomass terminal as well, have depreciation rates below 14% (see Table 5.6). Low equipment depreciation leads to higher salvage values, which in turn leads to frequent salvage, even 1 year into the equipment’s age. A large variety of equipment (both in type and in amount) is used, for short time periods. Capital costs are high, but they are offset by the high salvage profits that can be achieved. Terminal operators need to invest regularly in medium and heavy equipment purchasing, and salvage equipment with the same frequency as well. The feasibility of such a complex strategy in real world industrial settings is discussed in section 5.3.4.

While certain light equipment such as trucks and front loaders suffer much higher depreciation, they are not affecting the end result significantly, less than 2% of the total costs in all cases. As mentioned, low depreciation rates means more potential for salvage profits, which leads to frequent salvage and a bigger variety of equipment types and capacities used for shorter time periods. A visualization of the investment strategy for the individual depreciation rate case can be seen in Figure 5.5.

Table 5.1: Terminal costs, scenarios A to D, base case

	Depreciation rate [%]	Terminal costs [10 ⁶ €]			Total costs per ton [€t ⁻¹]	Computational time [s]	
		Total	Capital	Operationa			Salvag
Scenario A	Individual	146.5	165.4	29.8	-48.7	0.83	7640
Scenario B	Individual	301.9	268.9	93.5	-60.6	0.89	48529
Scenario C	Individual	345.1	294.6	128.7	-78.2	0.88	15865
Scenario D	Individual	321.2	266.7	110.5	-56	0.88	15704

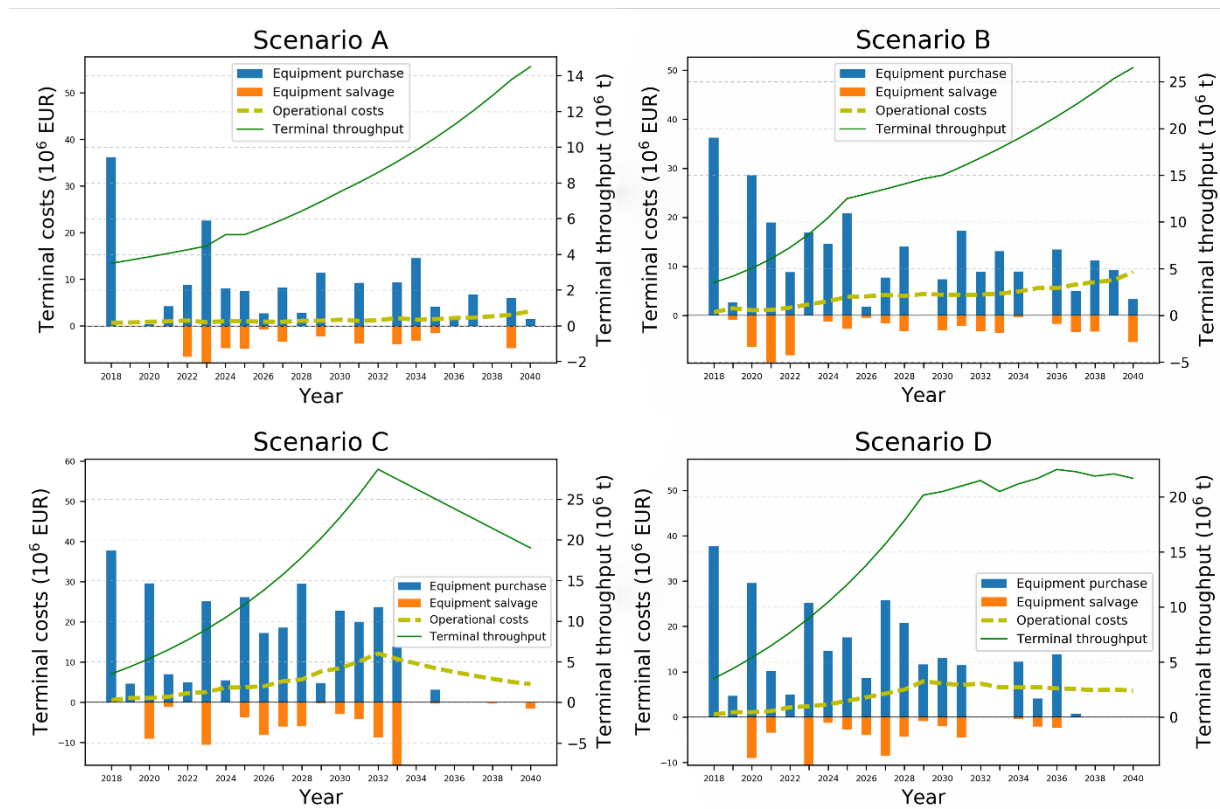

Figure 5.2: Total terminal costs, base case

5.3.2 Impact of equipment depreciation rate on investment strategy

The results of the sensitivity analysis on the depreciation rate of equipment for each scenario can be seen in Table 5.2. Even though the solutions with low depreciation rates are much more complex as will be presented in detail in this section, the final results (i.e. total terminal costs) are within a 5.5% deviation for all depreciation rates applied. As is evident in Table 5.2, capital costs between high and low depreciation rates have large variations, but they are offset by the inversely proportional salvage profits, which leads to the small deviation in the total terminal costs. Operational costs are fairly similar throughout all the cases, since the same quantity of material is handled in every case.

Table 5.2: Terminal costs, scenarios A to D, depreciation rate 10 to 30%

	Depreciation rate [%]	Terminal costs [10 ⁶ €]			Total costs per ton [€t ⁻¹]	Computational time [s]	
		Total	Capital	Operational			Salvage
Scenario A (Low)	10	144.7	151.1	31.4	-37.8	0.82	7001
	20	150.1	128	32.1	-10	0.85	839
	30	152.4	124.6	32.1	-4.3	0.86	476
Scenario B (High)	10	298.1	298.6	92.9	-93.5	0.88	41443
	20	307.9	229.2	94.4	-15.6	0.91	1685
	30	309.4	216.6	97.9	-5.1	0.92	2124
Scenario C (Peak)	10	342.6	304.5	127.2	-89.1	0.88	40953
	20	356.6	243.3	133.2	-20	0.91	2865

	30	356.9	229.7	134.6	-7.5	0.92	3330
Scenario D (Plateau)	10	317.9	285.6	108.8	-76.5	0.87	35021
	20	329.7	235.6	112.3	-18.3	0.90	2367
	30	330.2	222.4	113.2	-5.4	0.91	2088

The visualized results for a depreciation rate of equipment set at 30%, for all scenarios, can be seen in Figure 5.3. The high depreciation leads to a rapidly decreasing salvage value of equipment, with minimal profit generation when that equipment is salvaged, even early in its lifetime. The investment strategy is to invest in large capacity equipment early, and use them at a low rate of utilization that increases according to the throughput increase until the end of their lifetime before salvaging them for minor profit. New equipment is purchased only when increases in capacity deem that necessary. As expected, in higher throughput scenarios (B to D), there is much more frequent purchasing of equipment throughout the whole time period in order to cover the steeper increase in biomass throughput, than in scenario A. Certain small equipment is purchased across all scenarios for a single time period and salvaged shortly thereafter in order to fill in small gaps in capacity for that particular time period, as shown in Figure 5.6, section 5.3.4.

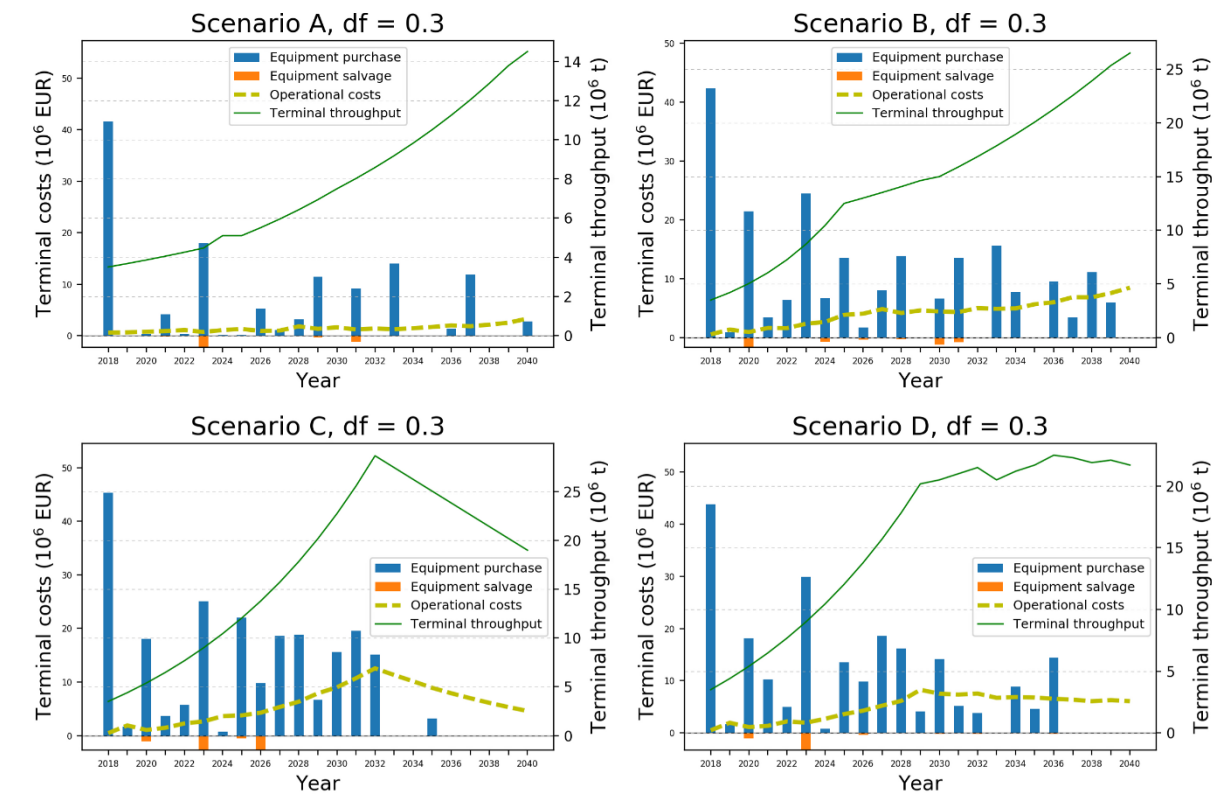

Figure 5.3: Terminal costs, scenarios A to D, depreciation rate=30%

The results for a specific scenario (scenario A) for different values of the depreciation rate can be seen in Figure 5.4. For lower depreciation rates, there is a much higher variation of equipment selection, purchase and salvage. The results of lower depreciation rates are quite similar to the realistic base case results, as in that approach the individual equipment depreciation rate was quite low on average. A larger variety of equipment (both in type and in amount) than the high depreciation case is used, but for shorter time periods. The overall total costs in this case are lower than when higher depreciation rate is assumed (see Table 5.2). The

depreciation rate also has a significant effect on the computational time of each separate run. Lower depreciation rates have a much more complex solution that significantly increases their solve time. The situation presented in Figure 5.4 for scenario A is similar when the sensitivity analysis is applied to all scenarios. While uniform depreciation rates for all of the equipment used in a port terminal is not realistic, the results show how important an effect it can have on the investment decisions of the terminal. Taking into account that in terms of total costs, the difference over the whole time period is not significant (approximately $7.6 \cdot 10^6$ € between the 10 and 40% depreciation rate), it is preferable for terminal operators to invest early in larger, heavy equipment with high depreciation rates, unless this cannot be avoided. This will prevent more frequent equipment purchasing in the long-term, and can facilitate important decisions regarding investments in terminal infrastructure.

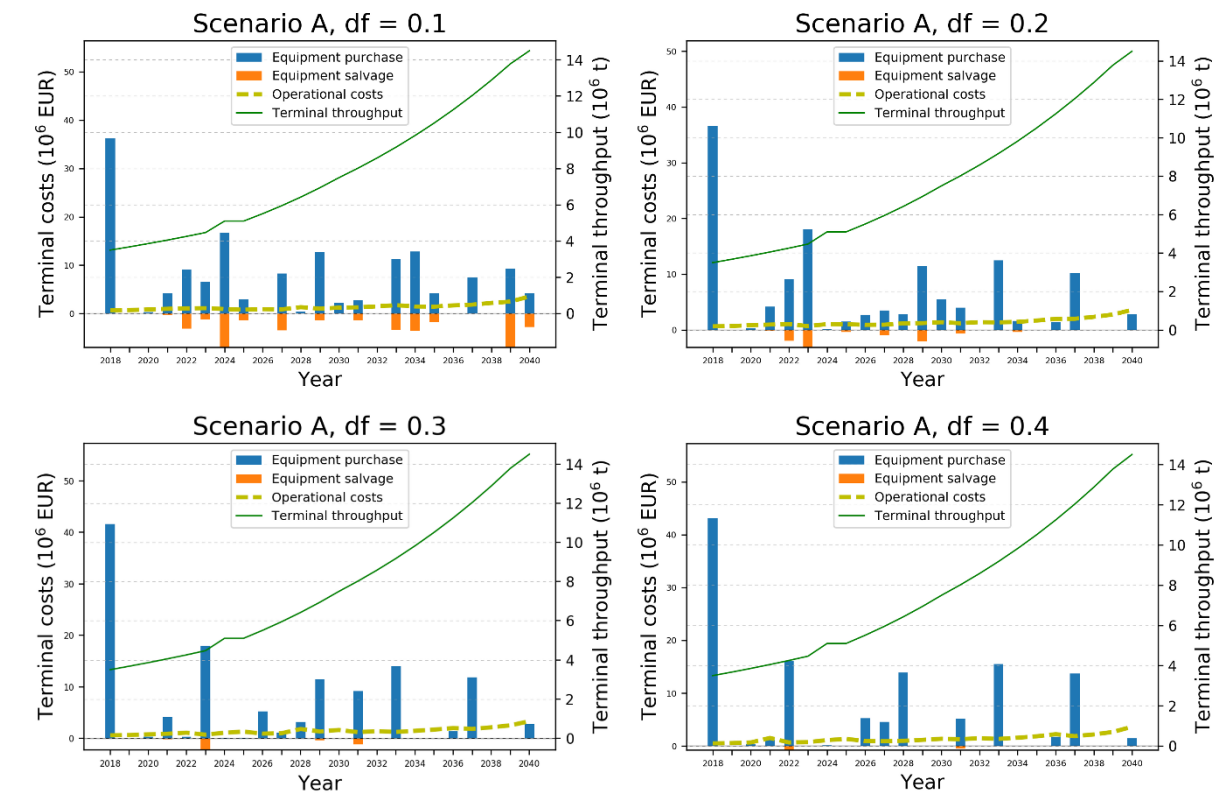

Figure 5.4: Terminal costs, scenario A, depreciation rates 10 to 40%

5.3.3 Operational and storage costs

In [46], the impact of operational costs on the total costs of a solid biomass terminal for a given throughput was explored. The importance of operational costs as the throughput of a terminal increases is demonstrated also in this chapter as seen in Table 5.3. Operational costs of equipment are directly linked to the throughput on a $\text{€} \cdot \text{ton}^{-1}$ basis. Lower overall throughputs such as in scenario A have lower operational costs (20.3 % of the total). As the size and throughput of a terminal increases in scenarios B to D, so will the utilization of increasingly larger types of equipment. Using bigger, heavier equipment that operate longer hours or moving more material incurs higher relative operational costs, ranging from 31 to 37.1% for the respective scenarios. The depreciation rate does not affect operational costs significantly, as equipment of similar capacity will still be used at the same rate of utilization despite its salvage value.

Storage costs have also been identified as the most impactful in a solid biomass terminal's costs in [46]. In particular wood pellets require enclosed storage at all times, and the storage facilities need to be outfitted with safety systems for dust prevention and dust explosions, constant temperature, oxygen and CO monitoring and fire suppression systems. All of these additional costs have been incorporated in the equipment costs that are used for this model. Total storage costs still claim the bulk of total costs with percentages ranging from 50-62.4% for the different scenarios and depreciation rates, as seen in Table 5.3, even for a low storage factor of 2% of the annual terminal's throughput [46]. As is evident from Figure 5.5 as well, the investment strategy is to invest early in the biggest capacity storage infrastructure possible and operate it throughout the time period under examination. The large, static storage infrastructure (domes, silos etc.) have long lifetimes (30 years) so there is no need to salvage them at any point during the operation of the terminal in the time range examined in this chapter. Smaller storage vessels such as floating barges are frequently purchased, operated for a short time and then salvaged in order to cover small increases in throughput. For certain time periods, smaller infrastructure (storage bunkers) are chosen to handle the increase in throughput, since there is no future information present, and the model chooses not to invest in big expensive infrastructure for this purpose.

Table 5.3: Operational and storage costs, scenarios A to D, base case

	Depreciation rate	Operational costs		Storage costs	
	[%]	[10 ⁶ EUR]	[% of total costs]	[10 ⁶ EUR]	[% of total costs]
Scenario A (Low)	Individual	29.8	20.3	91.4	62.4
Scenario B (High)	Individual	93.5	31.0	151.5	50.0
Scenario C (Peak)	Individual	128.7	37.1	172.7	50.0
Scenario D	Individual	110.5	34.5	162.0	50.4

5.3.4 Equipment selection and utilization

The modeling approach developed in this chapter provides detailed information not only on the total terminal costs over a multi-time period, but also an optimum solution for the equipment selection, purchase and utilization over the same period. The results present detailed information on what type of equipment of what capacity should be chosen for each operational step, how many years it should be used and at what utilization rate and when it should be salvaged. A comprehensive visualization of the investment strategy that our model provides is presented in Figure 5.5 and Figure 5.6. The equipment is categorized per operational step over the whole time period of 23 years under examination (2018-2040). In general, gantry cranes and conveyor belts are always chosen by the model over equipment that can perform the same function, such as pneumatic unloader or pipe conveyors. Gantry cranes and conveyor belts have slightly lower capital costs than their respective counterparts and in combination with their lower depreciation rates they are always the less costly, and at the same time most profitable when salvaged, choice. For the storage function, large infrastructure is always selected early as the main storage capacity. Storage costs are disproportionately larger than other terminal function costs which makes their frequent purchase and salvage not economically rational. They also have low depreciation rates (approximately 10%), so they are purchased early in the timeline and used for numerous years in order to be capitalized upon as much as possible. Large storage infrastructure is frequently complemented with smaller, short-lived options only when increases in throughput demand so.

The investment strategy for the base case can be seen in Figure 5.5. As mentioned in section 5.3.1, there is a much bigger variety of equipment types, and frequent salvage of heavy equipment even early in their lifetime. These are the optimum results of an optimization approach, which did not take certain parameters into account, such as the decommissioning and installation times of salvaged and newly purchased equipment respectively. Some equipment will co-exist between time periods, as a terminal needs to operate using the soon-to-be salvaged equipment while the new equipment is being installed. Additionally, from a practical point of view, though salvage for small equipment like trucks, dozers etc. is common in port terminals and practiced often, it is a huge burden, in terms of added costs and time, to purchase and salvage equipment such as gantry and mobile cranes or storage bunkers often. Terminal operators will probably opt to lease a mobile gantry crane for a year instead of purchasing it on a certain time period and salvaging it the very next. For storage infrastructure, easier to setup options will be used, such as more floating barges or light warehouse constructions, instead of short lived heavy bunkers. These options will lead to higher overall costs, but are much simpler to achieve in reality.

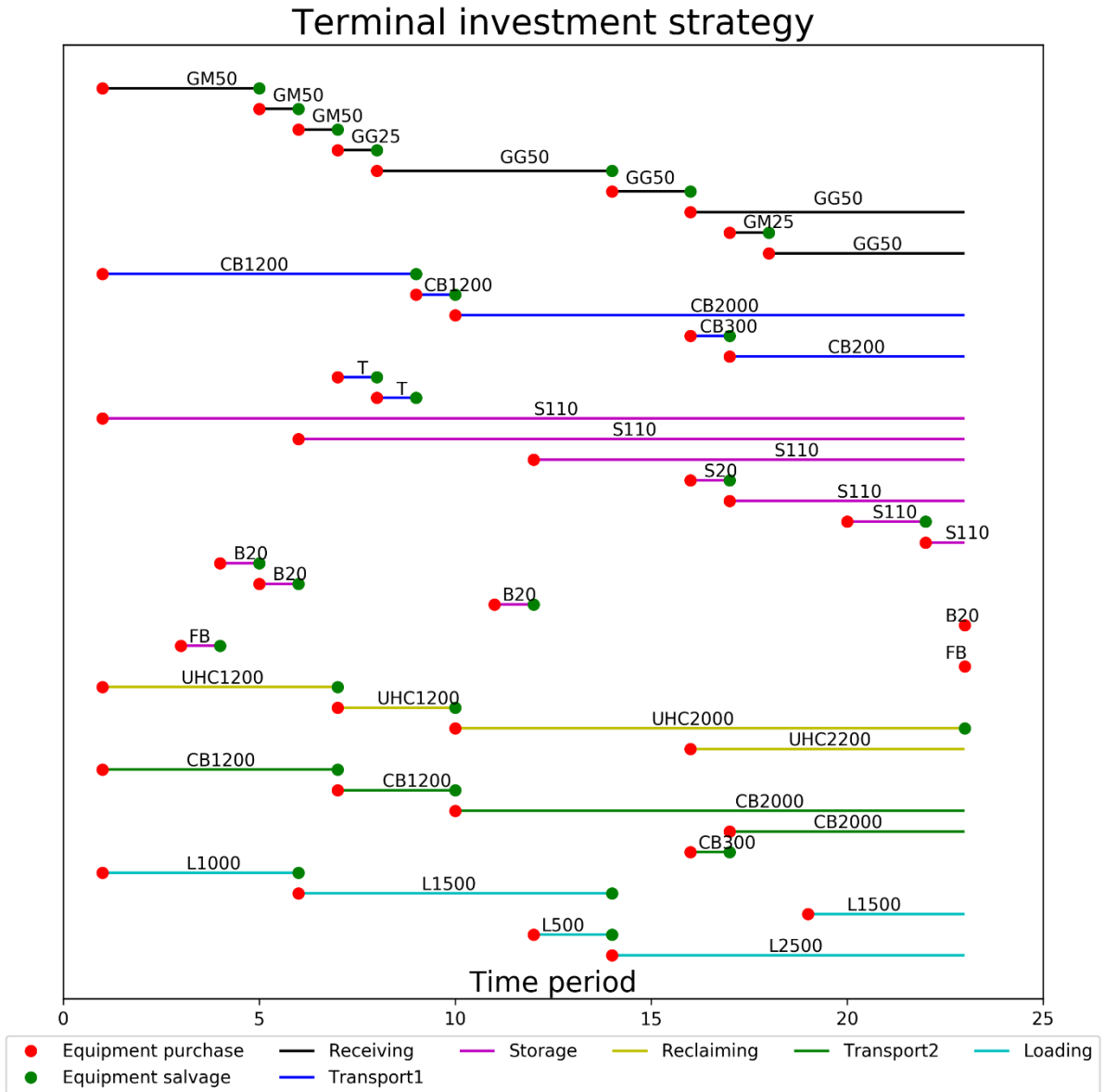

Figure 5.5: Terminal investment strategy, scenario A (Low), base case

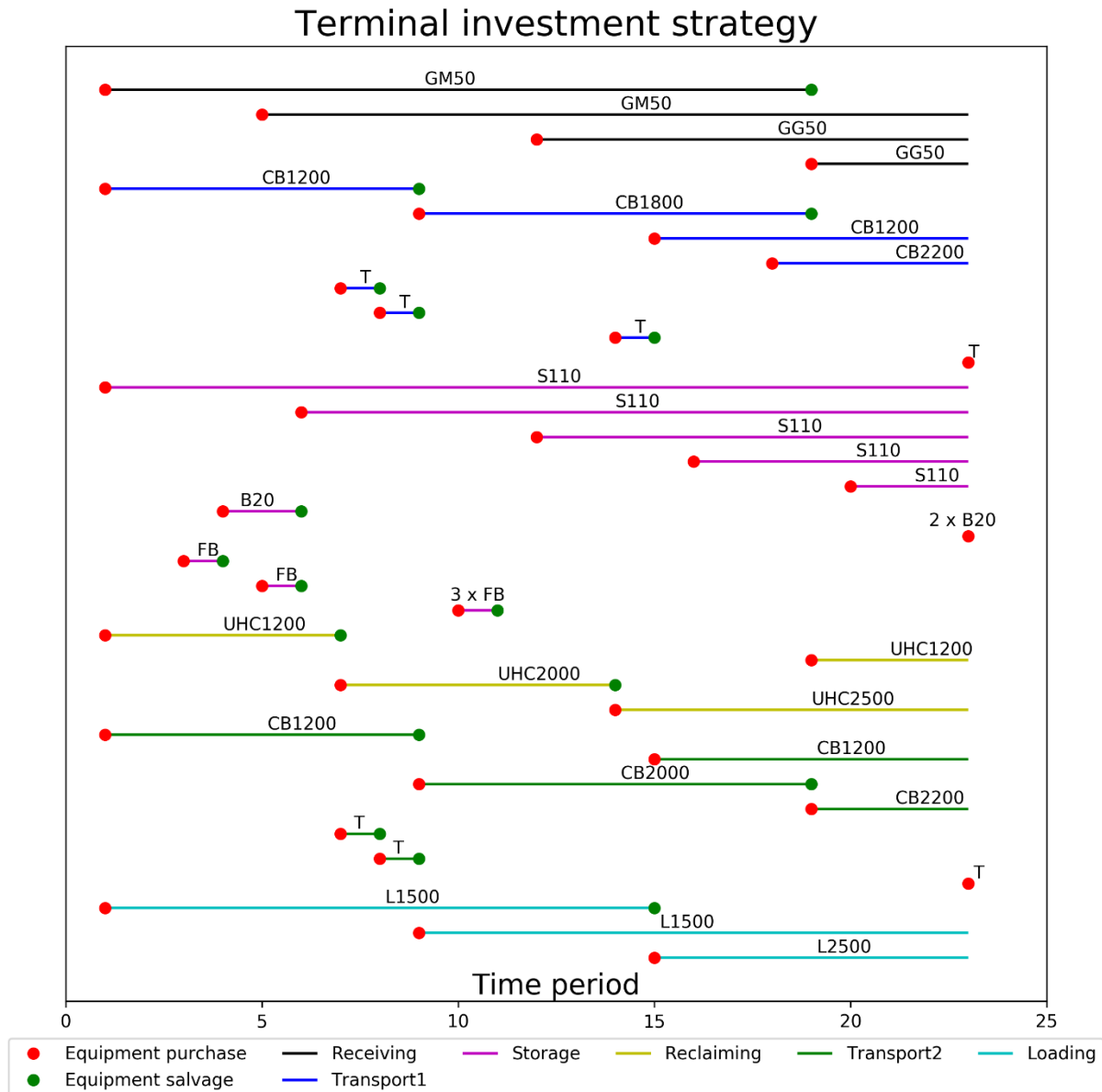

Figure 5.6: Terminal investment strategy, scenario A (Low), depreciation rate=30%⁷

The utilization of each type of equipment is calculated on an annual basis and is related to its specific nominal capacity, OEE and the operating hours of the terminal (7000 h/y). Each dedicated equipment has an associated operational costs based on a €·ton⁻¹ value, calculated based on extensive literature research and input from the industrial partners in collaboration with the author, and as such directly affects the total operational costs of the terminal. The utilization represents the actual amount of time that the equipment is used within a given year, e.g. an equipment at 50% utilization will be used for 3500 hours within the year in question. An example of the utilization spread for the last operational step of the terminal (loading of biomass in vessels for further transportation) can be seen in Figure 5.7. The increase in utilization of the loader(s) can be seen as the throughput steadily increases, from 0.42 initial utilization of a single 1500 tph loader to a combination of a 1500 and 2500 tph loaders working

⁷ GM: Mobile crane grab, GG: Gantry crane grab, CB: Conveyor belt, T: Truck, S: Silo, B: bunker, FB: Floating barge, UHC: Underground hopper % conveyor, L: Loader. The numbers represent the capacity of each equipment in tph unless only one type of equipment is in our database (see Table 5.4 in Appendix)

at full utilization in the last time period. As mentioned in section 5.3.2, the model chooses to invest early in medium to large equipment and operate them at lower utilization levels, even maintaining the equipment without operating it at all for several years, before investing in new equipment to cover the increasing capacity, in order to achieve the lowest possible overall costs.

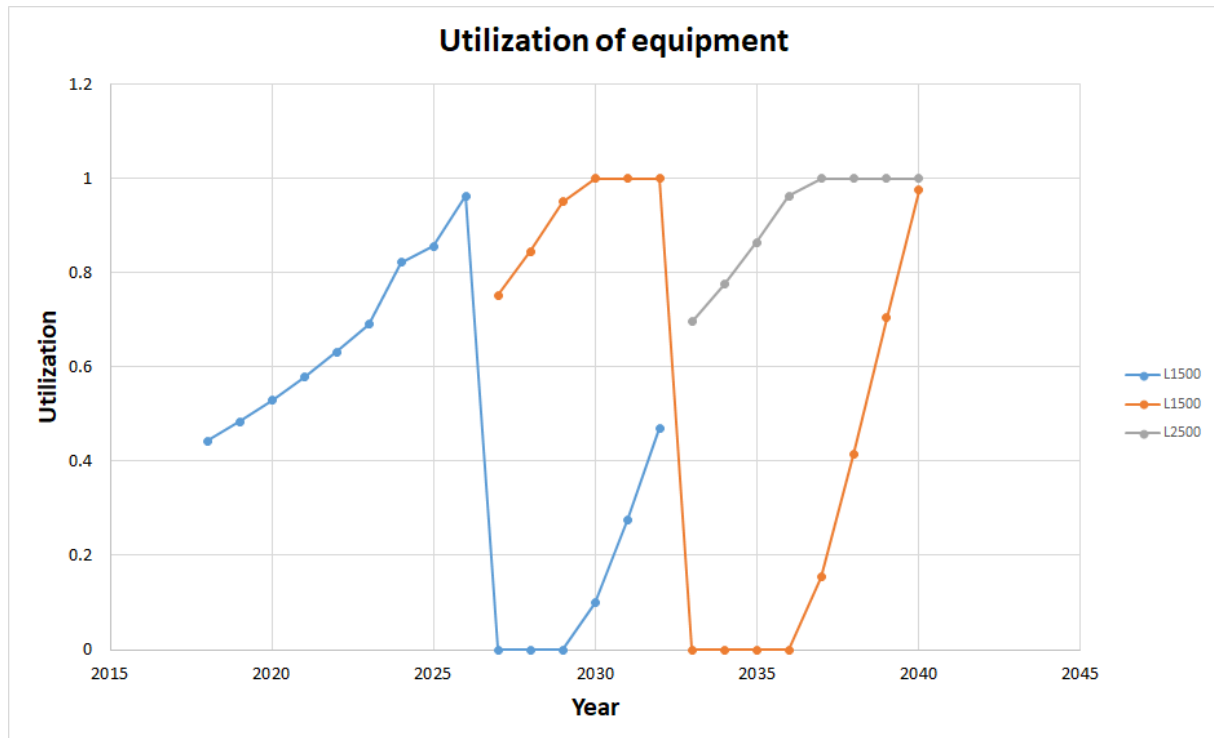

Figure 5.7: Utilization of loading equipment, scenario A (Low), depreciation rate=30%

5.4 Conclusions and further work

The multi-stage model developed is a continuation of the static modelling approach examined in Chapter 4. However, it has been expanded to cover several more aspects of major significance in biomass port terminal design and operations, among others:

1. Solid biomass import developments over an extended future time period,
2. Dedicated biomass equipment use for each of the terminals operational steps,
3. Overall equipment efficiency and utilization based on the aging of said equipment and
4. Salvage of equipment either for cost minimization or end-of-life purposes

The aim was to derive a mixed-integer linear programming model that can provide support regarding strategic decisions in biomass terminal design. Based on several throughput scenarios, the model is capable of calculating the optimum strategy for minimizing total (investment and operational) costs over a multi-time period. The final results depend on the combination of scenario and depreciation rates chosen. For the base case, total terminal costs range between $165.4 \cdot 10^6$ and $294.6 \cdot 10^6$ €, depending on the scenario under consideration. The sensitivity analysis on depreciation rates results in total terminal costs ranging between 144.7 and $152.4 \cdot 10^6$ € for scenario A. Scenarios B to D, where the throughput is significantly higher reflect that with total costs reaching $357 \cdot 10^6$ € for peak scenario C. On a per ton basis, the results presented in the previous chapter (approximately 1.1 €t^{-1}) are reduced by approximately 8-16%, depending on the case. Overall, handling costs of wood pellets range between 0.83 and 0.89 €t^{-1} . This should not be confused with market prices. Handling prices depend on the market

conditions, as do wood pellet prices - they relate to short-term future or forward contracts between suppliers and end users. Depending on market conditions and throughput over a specific period, handling prices will frequently be higher (or lower) than the average costs stated above. However, over the time horizon that is used for the strategic planning of the solid biomass terminal, far lower overall costs than the current situation in biomass bulk terminals ($3.5\text{--}4 \text{ €t}^{-1}$) can be achieved, which should ultimately also lead to lower average market prices.

The results show that in a realistic approach, where each individual equipment has a specific depreciation rate, the solution is quite complex. Equipment purchase and salvage is regular, a large variety of equipment types and capacities is used in succession or in parallel, and most equipment are generally kept only for a few years and salvaged before the end of their lifetime. Exception to this are the largest storage infrastructure where the high capital expenses and long lifetimes make frequent salvage less favorable. The sensitivity analysis performed on depreciation rates of equipment leads to a much more simple strategy for equipment with high depreciation rates: invest early in more expensive equipment that will initially be used at low capacities, and operate them throughout their lifetime. In all cases, the results show that total costs over the whole time period have a deviation of only 5.5% between them (Table 5.2).

The importance of equipment utilization and storage costs, previously examined in [46], is verified through the results in this chapter as well. Specifically storage costs is the biggest contributor by a large margin to wood pellet terminal infrastructure (>50% of the total costs in all cases), as the material requires completely enclosed storage at all times with several safety systems in place. Finally, the results also provide a visualization of the optimum investment strategy, where all the types and capacities of equipment selected, and the periods for which they should operate are presented in detail. Certain types of equipment such as gantry cranes and conveyor belts are always favored for wood pellet receiving and transport, mainly due to their lower capital costs or lower depreciation rates over other equipment that can perform the same function (Table 5.6).

The significance of the results for stakeholders in the industry and policy making will need to be assessed from a practical point of view as well before implemented: a complete strategic planning of terminal investments is provided, which means that for adequately formulated inputs (in the way of wood pellet import scenarios), all interested parties can have a detailed long-term strategy provided. At the same time, the heavy duty nature of port terminal equipment means that most of said equipment have low depreciation rates. The results suggest complex, constant decision making in order to achieve the optimum solution. Practically, some kind of compromise will need to be made, such as investing in heavy equipment that will be used for long periods, but choosing to lease or short-term rent simpler equipment rather than purchasing and salvaging belt conveyors or storage bunkers in rapid succession. This will lead to slightly higher overall costs, but will be much simpler to implement in reality.

While originally developed for wood pellet terminals, the model can be used for any type of biomass such as torrefied pellets and wood chips, that have different considerations, such as open storage or different equipment needs for certain operational steps. Similarly, it can be applied to mix-product biomass terminals or bulk terminals that serve other materials, such as coal or iron ore. Changing the focus material of the terminal will naturally lead to significantly different results; however, the model developed can be a useful instrument in comparing different terminal designs for different products. Nevertheless, the quality of input data in the form of throughput tonnage, dedicated equipment with specific capital and operational costs is a priority for meaningful results.

The multi-stage model developed in this chapter is strictly used for the equipment selection within the bounds of the terminal. For a complete picture of a terminal's development, other

civil infrastructure works such as the dredging of the ocean floor and the construction of the jetty and berths for vessel mooring, both of which represent considerable expenses should be taken into account. However, most of these costs, with the exception of the land rental from the port authority, usually burden the related governmental or port authorities, and not the terminal operators themselves.

Another useful addition would be the possibility of adjusting the model in order to analyze and process terminals where existing equipment is already present. This will enable the use of the developed model as a tool for the retrofitting and redesign of bulk-to-biomass terminals, instead of being focused only in the development of ‘green field’ dedicated terminals. Moreover, decommissioning and installation times can be also taken into account in the model in the future, making the results even more realistic.

Finally, a further improvement of the model will include a more accurate estimation of the overall equipment efficiency (OEE), or replacement by another metric that may be better suited to biomass equipment and infrastructure performance. In the current definition, performance and quality are independent of each other, which might not always be the case. Additionally, OEE has the properties of a geometric mean, and as such it punishes variability among its subcomponents [49]. Finally, a detailed analysis of the subcomponents of the equipment’s OEE is needed, as an improvement in OEE may not necessarily correlate with the terminal operators’ desires: an increase in availability by 10% at an expense of decrease in quality by 5% will result in a higher OEE but not many operators would choose this outcome.

References

- [1] International Maritime Organization (IMO), CE Delft. Update of Maritime Greenhouse Gas Emission Projections. 2017. doi:17.7I69.67.
- [2] Jeschke S. Global trends in transport routes and goods transport: influence on future international loading units. 16th ACEA Sci. Advis. Gr. Meet. Bruxelles, June 2011, 2011, p. 3–31.
- [3] Hoffmann J. Developments in International Seaborne Trade. 2017.
- [4] Rodrigue JP. The Geography of Transport Systems. 4th ed. New York: Routledge; 2017.
- [5] European Commission. Statement: Europe leads the global clean energy transition. 2018.
- [6] European Biomass Association. AEBIOM Statistical Report - Key Findings. 2017.
- [7] European Biomass Association. AEBIOM Statistical Report - Key Findings. 2016.
- [8] Hancock VE, Dafnomilis I, Schott DL, Lodewijks G. Torrefied Biomass and its Handling Aspects – A State-of-the-art Review. Bulk Mater. Storage, Handl. Transp., Darwin, Australia: 2016.
- [9] Thrän D. Global Wood Pellet Industry and Trade Study 2017. 2017.
- [10] Almansoori A, Shah N. Design and operation of a future hydrogen supply chain: Snapshot model. Chem Eng Res Des 2006;84:423–38. doi:10.1205/cherd.05193.
- [11] Almansoori A, Shah N. Design and operation of a future hydrogen supply chain: Multi-period model. Int J Hydrogen Energy 2009;34:7883–97. doi:10.1016/j.ijhydene.2009.07.109.
- [12] Almansoori A, Shah N. Design and operation of a stochastic hydrogen supply chain network under demand uncertainty. Int J Hydrogen Energy 2012;37:3965–77. doi:10.1016/j.ijhydene.2011.11.091.
- [13] De-León Almaraz S, Azzaro-Pantel C, Montastruc L, Pibouleau L, Senties OB. Assessment of mono and multi-objective optimization to design a hydrogen supply chain. Int J Hydrogen Energy 2013;38:14121–45. doi:10.1016/j.ijhydene.2013.07.059.
- [14] De-León Almaraz S, Azzaro-Pantel C, Montastruc L, Domenech S. Hydrogen supply chain optimization for deployment scenarios in the Midi-Pyrénées region, France. Int J Hydrogen Energy 2014;39:11831–45. doi:10.1016/j.ijhydene.2014.05.165.
- [15] De-León Almaraz S, Azzaro-Pantel C, Montastruc L, Boix M. Deployment of a hydrogen supply chain by multi-objective/multi-period optimisation at regional and national scales. Chem Eng Res Des 2015;104:11–31. doi:10.1016/j.cherd.2015.07.005.
- [16] Gupta V, Grossmann IE. An efficient multiperiod MINLP model for optimal planning of offshore oil and gas field infrastructure. Ind Eng Chem Res 2012;51:6823–40. doi:10.1021/ie202959w.
- [17] Chakraborty A, Malcolm A, Colberg RD, Linninger AA. Optimal waste reduction and investment planning under uncertainty. Comput Chem Eng 2004;28:1145–56. doi:10.1016/j.compchemeng.2003.09.023.

- [18] Balakrishnan J, Cheng CH. Multi-period planning and uncertainty issues in cellular manufacturing: A review and future directions. *Eur J Oper Res* 2007;177:281–309. doi:10.1016/j.ejor.2005.08.027.
- [19] Fazlollahi S, Mandel P, Becker G, Maréchal F. Methods for multi-objective investment and operating optimization of complex energy systems. *Energy* 2012;45:12–22. doi:10.1016/j.energy.2012.02.046.
- [20] Mirzaesmaeli H, Elkamel A, Douglas PL, Croiset E, Gupta M. A multi-period optimization model for energy planning with CO₂ emission consideration. *J Environ Manage* 2010;91:1063–70. doi:10.1016/j.jenvman.2009.11.009.
- [21] Flores JR, Montagna JM, Vecchiotti A. An optimization approach for long term investments planning in energy. *Appl Energy* 2014;122:162–78. doi:10.1016/j.apenergy.2014.02.002.
- [22] Pina A, Silva CA, Ferrão P. High-resolution modeling framework for planning electricity systems with high penetration of renewables. *Appl Energy* 2013;112:215–23. doi:10.1016/j.apenergy.2013.05.074.
- [23] Baringo L, Conejo AJ. Risk-constrained multi-stage wind power investment. *IEEE Trans Power Syst* 2013;28:401–11. doi:10.1109/TPWRS.2012.2205411.
- [24] Giarola S, Zamboni A, Bezzo F. Environmentally conscious capacity planning and technology selection for bioethanol supply chains. *Renew Energy* 2012;43:61–72. doi:10.1016/j.renene.2011.12.011.
- [25] United Nations Conference on Trade and Development (UNCTAD). *Development and improvement of ports - Development of bulk terminals*. 1985.
- [26] United Nations Conference on Trade and Development (UNCTAD). *Handbook on the management and operation of dry ports*. 1991.
- [27] Frankel EG, Cooper J, Chang YW, Tharakan G. *Bulk Shipping and Terminal Logistics*. 1985.
- [28] Lin J, Gao B, Zhang C. Simulation-based investment planning for Humen Port. *Simul Model Pract Theory* 2014;40:161–75. doi:10.1016/j.simpat.2013.09.009.
- [29] Cimpeanu R, Devine MT, O'Brien C. A simulation model for the management and expansion of extended port terminal operations. *Transp Res Part E Logist Transp Rev* 2017;98:105–31. doi:10.1016/j.tre.2016.12.005.
- [30] Cheng J, Yang Z. The equilibria of port investment in a multi-port region in China. *Transp Res Part E Logist Transp Rev* 2017;108:36–51. doi:10.1016/j.tre.2017.06.005.
- [31] Lagoudis IN, Rice JB, Salminen JB. Port investment strategies under uncertainty: The case of a Southeast Asian multipurpose port. *Asian J Shipp Logist* 2014;30:299–319. doi:10.1016/j.ajsl.2014.12.003.
- [32] Zheng S, Negenborn RR. Terminal investment timing decisions in a competitive setting with uncertainty using a real option approach. *Marit Policy Manag* 2017;44:392–411. doi:10.1080/03088839.2016.1274832.

- [33] Zhao G, Wang K, Yu F, Kuang H. Port Multi-Period Investment Optimization Model Based on Supply-Demand Matching. *J Syst Sci Inf* 2015;3:77–85. doi:10.1515/JSSI-2015-0077.
- [34] Santelices G, Pascual R, Lüer-Villagra A, Mac Cawley A, Galar D. Integrating mining loading and hauling equipment selection and replacement decisions using stochastic linear programming. *Int J Mining, Reclam Environ* 2017;31:52–65. doi:10.1080/17480930.2015.1115589.
- [35] Patterson SR, Kozan E, Hyland P. An integrated model of an open-pit coal mine: Improving energy efficiency decisions. *Int J Prod Res* 2016;54:4213–27. doi:10.1080/00207543.2015.1117150.
- [36] Özdemir RG, Ayağ Z. An integrated approach to evaluating assembly-line design alternatives with equipment selection. *Prod Plan Control* 2011;22:194–206. doi:10.1080/09537281003790515.
- [37] Burt CN, Caccetta L, Welgama P. *Single Location Equipment Selection* 2018;11:75–90.
- [38] Temiz I, Calis G. Selection of Construction Equipment by using Multi-criteria Decision Making Methods. *Procedia Eng* 2017;196:286–93. doi:10.1016/j.proeng.2017.07.201.
- [39] Prasad K, Zavadskas EK, Chakraborty S. A software prototype for material handling equipment selection for construction sites. *Autom Constr* 2015;57:120–31. doi:10.1016/j.autcon.2015.06.001.
- [40] Negenborn RR, Schott DL, Corman F. *Port Equipment and Technology*. *Encycl. Marit. Offshore Eng.*, 2017. doi:10.1002/9781118476406.emoe546.
- [41] Strien JN. Details of stackers, reclaimers and stackers/reclaimers for the use in terminal stockyards. 2010. doi:2010.TEL.7510.
- [42] Bugarcic U, Petrovic D, Petrovic Z, Pajcin M, Markovic-Petrovic G. Determining the capacity of unloading bulk cargo terminal using queuing theory. *Stroj Vestnik/Journal Mech Eng* 2011;57. doi:10.5545/sv-jme.2009.084.
- [43] Pratap S, Nayak A, Kumar A, Cheikhrouhou N, Tiwari MK. An integrated decision support system for berth and ship unloader allocation in bulk material handling port. *Comput Ind Eng* 2017;106:386–99. doi:10.1016/j.cie.2016.12.009.
- [44] Pratap S, Manoj Kumar B, Cheikhrouhou N, Tiwari MK. The robust quay crane allocation for a discrete bulk material handling port. *IEEE Int. Conf. Ind. Eng. Eng. Manag.*, Singapore: 2016, p. 1174–8. doi:10.1109/IEEM.2015.7385833.
- [45] Wu M. *A Large-scale Biomass Bulk Terminal*. PhD Dissertation. Delft University of Technology, 2012. doi:doi:10.4233/uuid:cfb51421-504d-46df-8309-e10ac65dbbc3.
- [46] van Vianen T. *Simulation-integrated Design of Dry Bulk Terminals*. PhD Dissertation. Delft University of Technology, 2015.
- [47] Dafnomilis I, Hoefnagels R, Pratama YW, Schott DL, Lodewijks G, Junginger M. Review of solid and liquid biofuel demand and supply in Northwest Europe towards 2030 – A comparison of national and regional projections. *Renew Sustain Energy Rev* 2017;78. doi:10.1016/j.rser.2017.04.108.

- [48] Dafnomilis I, Duinkerken MB, Junginger M, Lodewijks G, Schott DL. Optimal equipment deployment for biomass terminal operations. *Transp Res Part E Logist Transp Rev* 2017.
- [49] Overall Equipment Effectiveness: 2018:5–9. https://en.wikipedia.org/wiki/Overall_equipment_effectiveness (accessed September 5, 2018).
- [50] Australian Taxation Office. Taxation Ruling TR2018/4 2018:2018. <https://www.ato.gov.au/law/view/document?LocID=%22TXR%2FTR20184%2FNAT%2FATO%2F00001%22&PiT=99991231235958> (accessed September 23, 2018).
- [51] Ankobiah M. Valuation of port assets: Impact on the financial performance of a port and the national economy. World Maritime University, Malmo, Sweden, 2001.
- [52] Carr J. Heavy Duty Truck Used Price Depreciation Due to High Utilization 2018. <https://intel.equipmentwatch.com/heavy-duty-truck-used-price-depreciation-due-high-utilization/> (accessed September 23, 2018).

Appendix

Table 5.4: Equipment database

Operational step	Equipment type	Capacity	Lifetime [y]
Receiving	Mobile crane 25t & grab 23m ³	500 [tph]	10
	Mobile crane 50t & grab 42m ³	880 [tph]	10
	Gantry crane 25t & grab 23m ³	1000 [tph]	20
	Gantry crane 50t & grab 42m ³	1750 [tph]	20
	Pneumatic unloader	500:500:2500 [tph]	10
Transport1	Belt conveyor	300, 600, 1000, 1200, 1500, 1800, 2000, 2200, 2500 [tph]	15
	Pipe conveyor	300, 600, 1000, 1200, 1500, 1800, 2000, 2200, 2500 [tph]	15
	Pneumatic conveyor	500:500:2500 [tph]	10
	Truck	25.5 [t]	5
Storage	Warehouse	15000 [t]	20
	Dome	15000 [t]	30
	Silo	20000, 110000 [t]	30
	Bunker	20000, 130000 [t]	30
	Floating barge	2500 [t]	15
Reclaiming	Underground hopper & belt conveyor , 200m length	300, 600, 1000, 1200, 1500, 1800, 2000, 2200, 2500 [tph]	15
	Underground hopper & pipe conveyor , 200m length	300, 600, 1000, 1200, 1500, 1800, 2000, 2200, 2500 [tph]	15
	Front loader	9 [t]	9
Transport2	Belt conveyor, 500m length	300, 600, 1000, 1200, 1500, 1800, 2000, 2200, 2500 [tph]	15
	Pipe conveyor, 500m length	300, 600, 1000, 1200, 1500, 1800, 2000, 2200, 2500 [tph]	15
	Truck	25.5 [t]	5
Loading	Loader	500:500:2500 [tph]	10

Table 5.5: Availability, performance and quality of equipment according to their age

Equipment age	Availability	Performance	Quality	OEE
1	0.9	0.950	0.980	0.838
2	0.9	0.922	0.970	0.805
3	0.9	0.894	0.960	0.773
4	0.9	0.867	0.950	0.742
5	0.9	0.841	0.941	0.713
6	0.9	0.816	0.932	0.684
7	0.9	0.791	0.923	0.660
8	0.9	0.768	0.913	0.631
9	0.9	0.745	0.904	0.606
10	0.9	0.722	0.895	0.582
11	0.9	0.700	0.886	0.559
12	0.9	0.680	0.877	0.537
13	0.9	0.660	0.868	0.515
14	0.9	0.640	0.859	0.495
15	0.9	0.620	0.851	0.475
16	0.9	0.602	0.843	0.456
17	0.9	0.584	0.834	0.438
18	0.9	0.566	0.826	0.421
19	0.9	0.550	0.818	0.404
20	0.9	0.532	0.810	0.388
21	0.9	0.516	0.801	0.373
22	0.9	0.501	0.794	0.358
23	0.9	0.486	0.786	0.344

Table 5.6: Equipment lifetime and depreciation factor for the realistic approach (Based on personal communication and [50–52])

Operational step	Equipment type	Lifetime	Depreciation rate
Receiving	Mobile crane 25t & grab 23m ³	10	0.1
	Mobile crane 50t & grab 42m ³	10	0.1
	Gantry crane 25t & grab 23m ³	20	0.08
	Gantry crane 50t & grab 42m ³	20	0.08
	Pneumatic unloader	10	0.14
Transport1	Belt conveyor	15	0.14
	Pipe conveyor	15	0.14
	Pneumatic conveyor	10	0.14
	Truck	5	0.25
Storage	Warehouse	20	0.14
	Dome	30	0.1
	Silo	30	0.1
	Bunker	30	0.1
	Floating barge	15	0.14
Reclaiming	Underground hopper & belt conveyor	15	0.14
	Underground hopper & pipe conveyor	15	0.14
	Front loader	9	0.23
Transport2	Belt conveyor	15	0.14
	Pipe conveyor	15	0.14
	Truck	5	0.25
Loading	Loader	10	0.2

Chapter 6. Conclusions

6.1 Main conclusions

This PhD project developed a static and a multi-stage approach to analyze and improve the development potential of the solid biomass infrastructure in the Netherlands and potentially surrounding countries. The main question of the thesis can be found in Chapter 1 and reads:

- How can a solid biomass terminal's design and investment strategy be optimized with respect to its required investment and operational costs?

This main research question is answered by addressing the several sub-questions in the respective chapters of this thesis:

1. Can future biomass imports into Northwest Europe be quantified? What do the potential bandwidths of imports look like?

Biomass imports into Northwest Europe were quantified. Data were collected from a wide variety of sources – international organizations and statistical bodies such as the International Energy Agency and Eurostat, EU Member State reports, and regional models. The range of expected solid biomass imports varies significantly, ranging from 8.5-35 Mt of solid biomass in 2020 to 13.5-49 Mt in 2030. Solid biomass imports are supported by the need for preprocessed biomass in the form of wood pellets in the electricity and heat sector which cannot be produced domestically in most of the Northwestern EU Member States. If the more conservative individual MS projections are taken into account, solid biomass imports can reach 19 Mt by 2020, decreasing to 16 Mt by 2030, following the decreasing trend in biomass consumption for electricity and heat.

2. What is the state-of-the-art in wood pellet handling in import terminals? Given the incoming wood pellet volume increase, what are potential bottlenecks that can be encountered in existing biomass terminals? How can they be overcome?

Special care is given by terminal operators in order to prevent the degradation of wood pellets, minimizing dust and fine production. This is achieved through lowering the speed of the grab cycle, the height of the drop and training personnel specifically on how to handle the material. Some terminals have eliminated the need for conveying all together in most cases by having storage facilities located right next to the quay or by using direct transshipment. Others mainly use covered conveyor belts for transport of the wood pellets to storage facilities. The conveying distance is kept as short as possible and the belt speeds when handling pellets are lower than usual. Handling of wood pellets is not performed during rain to avoid deterioration of the quality of the product in the short term and mold growth which leads to biological hazards in the long term. Nevertheless, containment and extraction of dust and particulates and ensuring a dry environment throughout the chain is of the highest priority. Self-heating and ignition is considered as the major problem inherent with wood pellet handling and storage. Temperature is monitored continuously in storage and in some cases ship holds. ATEX equipment and procedures are in place and ignition sources are avoided. When high temperatures are reported material is removed temporarily, either to a different storage area or recirculated in order to allow it to cool down. Temperature monitoring systems are functioning continuously, especially in enclosed facilities. Gas (CO, CO₂) and oxygen measurements are also performed often and all personnel who enter enclosed facilities carry gas and oxygen sensors.

However, the research performed also uncovered that the majority of the solid bulk equipment and facilities designed for other bulk commodity goods is used for wood pellets as well, and can be suboptimal for this purpose. The terminals' need to use manual labor in certain cases (front-loaders in warehouses, or manual work in others) showcases the fact that not all equipment is fit for handling material with different properties. For the time being, the current

setup and equipment in bulk terminals, geared mainly towards coal, iron ore and other bulk material, can deal with low volumes of pellet throughput. If the expected increases in wood pellet imports materialize, most import terminals will have to invest in adjusting their approach, either by retrofitting existing facilities, or creating new ones altogether. The focus should be primarily put on two aspects: transportation of high volumetric capacity and adequate storage capacity. Both of these aspects will need to comply with the strict safety measures and regulations discussed in this dissertation.

3. How can the equipment selection and operations of a dedicated biomass terminal be optimized with respect to investment and operational costs? What is the relation between a biomass terminal size and its total annual logistics? Which are the most important operational parameters that affect said costs?

A mixed-integer linear programming model was developed with the aim to determine the total equipment allocation and utilization in a solid bulk biomass terminal in terms of total annual costs. The scope of the model includes the complete activities within a terminal, from the unloading of the biomass from an arriving vessel, to the loading at a vessel at the end of the handling chain. The computational results based on real-life input data for biomass bulk terminals indicate that the optimum size of terminals in order to achieve the minimum cost per ton of throughput is achieved at 5 Mt of throughput and beyond. The importance of biomass storage needs over the total terminal logistics is also demonstrated. Necessary enclosed storage can contribute to as much as 45% of the total terminal logistics, since enclosed facilities can only reach a certain size before requiring multiple units to accommodate the throughput. The effect of the utilization of equipment on bigger size terminals is also examined. Decoupled from a percentage of capital costs, operational costs have a significant role in terminal logistics, amounting to 32% of the total terminal costs in larger terminals and 55% of individual operational steps.

4. How can we most effectively make strategic level decisions relating to biomass terminal infrastructure development? What will a multi-period investment planning model look like? What are the most important functions and parameters to take into account when developing such a multi-period modelling approach?

The static MILP model is developed into a multi-period linear programming model, expanded to cover several more aspects of major significance in biomass port terminal design and operations, among others:

- Solid biomass import developments over an extended future time period,
- Dedicated biomass equipment use for each of the terminals operational steps,
- Overall equipment efficiency and utilization based on the aging of said equipment and
- Salvage of equipment either for cost minimization or end-of-life purposes

The aim was to derive a mixed-integer linear programming model that can provide support regarding strategic decisions in biomass terminal design. Based on several throughput scenarios, the model is capable of calculating the optimum strategy for minimizing total (investment and operational) costs over a multi-time period. The results show that in a realistic approach, where each individual equipment has a specific depreciation rate, the solution is quite complex. Equipment purchase and salvage is regular, a large variety of equipment types and capacities is used in succession or in parallel, and most equipment are generally kept only for a few years and salvaged before the end of their lifetime. Exception to this are the largest storage infrastructure where the high capital expenses and long lifetimes make frequent salvage less

favorable. The sensitivity analysis performed on depreciation rates of equipment leads to a much simpler strategy for equipment with high depreciation rates: invest early in more expensive equipment that will initially be used at low capacities, and operate them throughout their lifetime. In all cases, the results show that total costs over the whole time period have a deviation of only 6% between them (Table 5.2).

The importance of equipment utilization and storage costs, previously examined in Chapter 4, is verified through the results in this chapter as well. Specifically storage costs is the biggest contributor by a large margin to wood pellet terminal infrastructure (>45% of the total costs in all cases), as the material requires completely enclosed storage at all times with several safety systems in place. Last, the results provide a visualization of the optimum investment strategy, where all the types and capacities of equipment selected, and the periods for which they should operate are presented in detail. Certain types of equipment such as gantry cranes and conveyor belts are always favored for wood pellet receiving and transport, mainly due to their lower capital costs or lower depreciation rates over other equipment that can perform the same function (Table 5.6).

Several potential biomass import pathways were proposed based on the results of Chapter 1. In Chapter 3, extensive research in bulk terminals that handle wood pellets was performed, providing a state-of-the-art of the industry, and insight into how a dedicated biomass terminal should be set up. Based on the detailed results from Chapter 4 and Chapter 5, two distinct options emerge as far as solid biomass terminal designs are concerned:

- a) Design of solid biomass terminals for a given throughput in terms of lowest possible annualized costs.

This approach was developed and presented in Chapter 4. The terminal sizes after which economies of scale achieve the best possible costs per ton of solid biomass throughput have been identified at 5 Mt and above. Wider implications of the results suggest that a smaller number of medium to larger size terminals are probably the best solution to increasing biomass throughputs instead of multiple smaller terminals. For the case of Northwest Europe, there is no considerable difference in terms of costs per ton on whether to situate biomass terminals in a central location, thus creating a central biomass hub for the whole region, or split them between the limited number of respective importing countries – as long as all respective terminals are above the 5-6 Mt throughput threshold. Other important cascading factors need to be considered at the same time, such as geographical location of the terminal, further transportation connections to the hinterland, client demand and location relative to the terminals, and low port charges or environmental regulations. However, relevant decisions are directly related to the given throughput. In the case of biomass, the high uncertainty of future developments, owing to lack of long term political commitments also affects industry investments. Dedicated (biomass) terminals require significant investments upfront and terminal operators must be able to take advantage of economies of scale.

Based on real world data, we can already achieve 39-47% reduction in costs per ton handled for small size terminals of 500 kt annual throughput (2.1 €/ton compared to 3.5-4 €/ton of the current industry standard). After the 5 Mt milestone is crossed the cost reductions double, leading to approximately 1 €/ton for any terminal size above 5 Mt.

- b) Design of solid biomass terminals for multi-period throughputs, in terms of lowest total costs over the whole time period.

This approach was developed and presented in Chapter 5. In contrast to the static MILP model in Chapter 4, the results do not provide a ‘best size’ terminal, but rather a detailed investment strategy to invest and expand a solid biomass terminal to accommodate a time-

dependent throughput. The results are given in the form of lowest total capital and operational costs as well as salvage profits over the whole time period.

For scenario A, total terminal costs range between 122 and $165 \cdot 10^6$ €. Scenarios B to D, where the throughput is significantly higher reflect that, with total costs reaching $357 \cdot 10^6$ € for peak scenario C. On a per ton basis, the results presented in Chapter 4 are further improved by approximately 8-18%, depending on the case, for an overall handling price of wood pellets than ranges between 0.82 and $0.92 \text{ €} \cdot \text{t}^{-1}$, averaged over the whole time period into consideration.

However, the results will need to be assessed from a practical point of view as well before implemented: a complete strategic planning of terminal investments is provided, which means that for adequately formulated inputs (in the way of wood pellet import scenarios), all interested parties can have a detailed long-term strategy provided. At the same time, the heavy duty nature of port terminal equipment means that most of said equipment have low depreciation rates. The results suggest complex, constant decision making in order to achieve the optimum solution. Practically, some kind of compromise will need to be made, such as investing in heavy equipment that will be used for long periods, but choosing to lease or short-term rent simpler equipment rather than purchasing and salvaging belt conveyors or storage bunkers in rapid succession. This will lead to slightly higher overall costs, but will be much simpler to implement in reality.

Major investments in infrastructure in wood pellet terminals are generally hindered by the relatively low cost contribution of terminal handling costs to the overall wood pellet supply chain costs. Handling and storage in import terminal usually ranges between 2.5 to $5 \text{ €} \cdot \text{t}^{-1}$, depending on factors such as relevant equipment, weather delays, or whether storage or direct transshipment is used. With a (CIF ARA) spot price of approximately $135 \text{ €} \cdot \text{t}^{-1}$ and a 'delivered to end user' price than can reach up to $200 \text{ €} \cdot \text{t}^{-1}$ in continental Europe, reducing the terminal handling and storage costs seems trivial from an overall perspective. However, from a terminal operator's point of view, investing in dedicated wood pellet infrastructure and equipment is a major strategic decision that can have severe implication on their long-term planning strategy. Moreover, taking into account the future increased imports, several more stakeholders will benefit from dedicated equipment and terminals and a lower delivered wood pellet price. End users such as power plants, that may need to rely less on governmental subsidies, and households or industry, in the case of pellets used for heating purposes, will support lower wood pellet prices via dedicated or properly equipped import terminals.

Ultimately, the choice of deciding which approach to use depends on the certainty of the future of wood pellet flows to the region, and the willingness of interested parties to capitalize on them. For a scenario where the materialization of these trade flows, or at least a considerable amount of them, is concrete, a port terminal (or a set of terminals) of set size is a better option, as it takes away a lot of the constant equipment selection, retrofitting and salvage burden. For the case where great uncertainty is present, or trade flows are expected to fluctuate considerably in time, using the multi-stage modelling approach is the better choice, since it ensures that import terminal(s) will be able to better utilize their equipment and infrastructure. In both cases, as demonstrated by the results of Chapter 4 and Chapter 5, considerable cost reductions compared to the current industry standards can be achieved.

6.2 Recommendations for further work

While originally developed for wood pellet terminals, both modelling approaches (static and multi-stage) can be used for any type of biomass such as torrefied pellets and wood chips. These type of pellets are generally more energy intensive and more costly than conventional pellet

production methods. Yet, they have a higher calorific value than conventional (white) wood pellets, they are more resistant to moisture and degradation, can be stored in open areas and generally can make use of conventional bulk equipment with minimal to no need for retrofitting or replacing infrastructure, resulting in greater operational flexibility with lower investments. Similarly, it can be applied to mix-product biomass terminals or bulk terminals that serve other materials, such as coal or iron ore. In any case, the quality of input data in the form of throughput tonnage, dedicated equipment with specific capital and operational costs is a priority for meaningful results.

The models developed in Chapters 4 and 5 are strictly used for the equipment selection within the bounds of the terminal. For a complete picture of a terminal's development, other civil infrastructure works such as the dredging of the ocean floor and the construction of the jetty and berths for vessel mooring, both of which represent considerable expenses should be taken into account. However, most of these costs, with the exception of the land rental from the port authority, usually burden the related governmental or port authorities, and not the terminal operators themselves. Another useful addition would be the possibility of adjusting the model in order to analyze and process terminals where existing equipment is already present. This will enable the use of the developed model as a tool for the retrofitting and redesign of bulk-to-biomass terminals, instead of being focused only in the development of 'green field' dedicated terminals.

While an extensive research was performed in Chapter 2 regarding biomass import developments in Northwest Europe, developments relating to biomass policies are rapid and the field of research is constantly changing. In addition to the direct use in electricity and heat production, solid biomass may be a viable intermediate feedstock for the production of liquid (mainly 2nd generation) biofuels in facilities located within the EU, or as a feedstock for biorefineries, producing bioplastics and other added value products. Extensive research, technological development, investment, and upgrading biorefineries and logistic facilities have to be prioritized to support the bio-based economy in EU beyond 2020. Since 2nd generation biofuels are prioritized, production and logistic facilities can be developed in order to produce these bioenergy products. Therefore, the focus regarding bioenergy trade flows will most likely increase towards importing feedstock for the production of advanced biofuels.

Potential future research relating to wood pellets could focus on various aspects. Equipment interaction could be identified with greater accuracy; the compression, shearing and impact forces inflicted on pellets during handling and storage could be examined into more depth in order to identify which part of the chain to focus on to avoid associated problems. This will promote improving the design of currently used equipment and handling chains and developing new equipment or techniques for more efficient handling and storage. Regarding transport, more information is needed for the status of the material when it arrives in the port terminals; most terminal facilities report that there is no way of gaining prior information and have no control on the steps pellets go through from production until delivery to the terminal, which might result in shipments with an unacceptable number of fines present. Research into innovation in wood pellet handling and storage has identified recent advances in areas such as explosion protection or disposable passive RFID tags in wireless sensor networks.

Glossary

List of symbols and notations

°	degree angle
°C	degrees Celsius
€	euros
dwt	deadweight tonnage
GJ	gigajoule
h	hours
kg	kilogram
kt	kilotons
m ³	cubic metre
mm	millimetre
Mt	million tons
PJ	petajoule
s	second
t	tons
tph	tons per hour
y	year

List of abbreviations

ARA	Amsterdam-Rotterdam-Antwerp region
ATEX	Atmosphères Explosibles (Explosive Atmospheres)
BAU	Business as Usual
BE	Belgium
CIF	Cost, Insurance and Freight
CO	Carbon Monoxide
CSU	Continuous Ship Unloader
DE	Deutschland (Germany)
DEM	Discrete Element Method
DK	Denmark
EC	European Commission
EU	European Union
FQD	Fuel Quality Directive
GHG	Green House Gas

ISO	International Organization for Standardization
MILP	Mixed-integer Linear Programming
MS	Member State
NL	Netherlands
NREAP	National Renewable Action Plan
OECD	Organization for Economic Co-operation and Development
OEE	Overall Equipment Effectiveness
PPI	Port Performance Indicator
PV	Photovoltaics
QUO	Quotas
RED	Renewable Energy Directive
RFID	Radio-frequency Identification
RPS	Renewable Portfolio Standard
UK	United Kingdom
UN	United Nations
UNFCCC	United Nations Framework Convention on Climate Change

Samenvatting

Dit proefschrift gaat over het ontwerp van terminals voor vaste biomassa, vanuit strategisch perspectief. Ontwerp van een terminal wordt hier gekenmerkt als het totaal van de inrichting en aankoop, gebruik en verkoop van equipment op de terminal.

De toegangskosten van zeevervoer behoren bij de hoogste in de transportsector; de terminalkosten zijn hoog, aangezien haveninfrastructuur duur is om te bouwen, onderhouden en verbeteren, en de opslagkosten zijn aanzienlijk. Zelfs kleine veranderingen in het ontwerp en de bediening van een haventerminal vereisen aanzienlijke investeringen. Daarnaast zijn er bij het ontwerp van terminals voor vaste biomassa talloze andere overwegingen waarmee rekening moet worden gehouden, in vergelijking met andere bulkterminals: brand- en explosiegevaar voor infrastructuur en personeel, degradatie van materialen en biologische en chemische gevaren. De logistiek van biomassa-terminals is veeleisender in termen van het ontwerp van de terminalopzet en het selecteren van de geschikte apparatuur om het product efficiënt te verwerken. Het is daarom van cruciaal belang een goed begrip te hebben van de inrichting en werking van equipment voor verwerking van vaste biomassa, voordat substantiële afspraken worden aangegaan.

Dit onderzoeksproject heeft tot doel een optimalisatiemodel te ontwikkelen, dat kan worden gebruikt als hulpmiddel bij de investeringsplanning voor terminals voor vaste biomassa. Om een dergelijk model effectief te kunnen ontwikkelen, moeten eerst verschillende gebieden van verwant onderzoek worden nagegaan. Het overslagvolume aan vaste biomassa dat op de terminal wordt verwacht moet adequaat worden bepaald en de state-of-the-art van de handling van vaste biomassa in haventerminals moet worden onderzocht. Er zijn daarom twee verschillende manieren van optimalisatie ontwikkeld: een waarin een terminal van gekozen grootte met constant overslagvolume wordt bestudeerd, en een meerperiode benadering waarin rekening wordt gehouden met onzekerheden en fluctuaties in de doorvoer.

Dit onderzoek begint met het nagaan van een grote hoeveelheid gegevensbronnen, die worden gebruikt ter aanvulling van eerdere modelvoorspellingen van de ontwikkeling van bio-energie in de EU. Al met al wordt een behoorlijke groei verwacht van de handel in biomassa. Tengevolge van een heleboel, gecompliceerde factoren, zelfs in gevallen waarin het volume van de handel in biomassa verdubbelt, wordt verwacht dat het totale invoervolume minder zal variëren dan eerder werd aangenomen. De implicaties van het voorgaande kunnen variëren van een verwachte groei van de infrastructuur van 'gering' tot 'massief' tegen 2030. De resultaten van hoofdstuk 2 laten zien dat, afhankelijk van de verwachte import naar Noordwest-Europa, de handling- en opslagketens moeten worden aangepast om te kunnen omgaan met fysieke en biologische eigenschappen van biomassa. Deze aanpassing zou kunnen gaan van aanpassing van de apparatuur in importterminals tot de behoefte aan nieuwe, speciale faciliteiten (biomassa-terminals of bioraffinaderijen) om het volume van de invoer efficiënt te kunnen verwerken.

Hoofdstuk 3 geeft een evaluatie van de huidige importterminals voor biomassa, met name in de haven van Rotterdam, in termen van infrastructuur en equipment. Hoewel bulkterminals voor biomassa de tegenwoordige, lage volumes biomassa kunnen verwerken, is het nodig om vóór 2030 over te gaan tot herontwerp of aanpassing van biomassa-terminals en -faciliteiten om de verwachte grotere volumes aan biomassa op te vangen. Bestaand equipment en faciliteiten voor vaste bulk, worden ook gebruikt voor houtpellets, maar zijn daarvoor mogelijk niet optimaal. Het feit dat op terminals extra werk nodig is (frontloaders in de opslag, handwerk elders) laat zien dat niet alle apparatuur geschikt is om materiaal met verschillende eigenschappen te verwerken. Vooralsnog kan met de inrichting van en het equipment op bestaande bulkterminals - die voornamelijk zijn afgestemd op steenkool, ijzererts en ander bulkmateriaal - worden omgegaan met kleine volumes

pellets. Als de verwachte toename van de import van houtpellets plaats vindt, zullen de meeste importterminals moeten investeren in veranderingen, hetzij door bestaande faciliteiten aan te passen, hetzij door nieuwe te creëren. De focus zal in de eerste plaats moeten zijn op twee aspecten: transport van grote volumetrische capaciteit en voldoende opslagcapaciteit. Beide aspecten zullen moeten voldoen aan de strenge veiligheidsmaatregelen en -voorschriften die in dit proefschrift worden besproken.

Om de investeringen in een terminal voor biomassa te optimaliseren, wordt een daarvoor passende modelleringsaanpak gevolgd en gepresenteerd in hoofdstuk 4. Het doel van het onderzoek is om inzet en benutting van equipment op een bulkterminal voor biomassa te bepalen in termen van totale jaarlijkse kosten. De scope van het model omvat alle activiteiten op een terminal, van het lossen van de biomassa van een aankomend vaartuig tot het laden ervan in een schip aan het einde van de keten. De berekende resultaten, gebaseerd op praktijkgegevens voor biomassa bulkterminals, geven aan dat de optimale grootte van terminals, bij minimale kosten per ton doorvoer, wordt bereikt bij een doorvoer van 5 Mt en meer. Op basis van praktijkgegevens kan een vermindering van 39-47% van de kosten per afgehandelde ton worden gerealiseerd voor kleine terminals met een jaarlijkse doorvoer van 500 kt (2.1 €t^{-1} in vergelijking met $3.5\text{-}4 \text{ €t}^{-1}$ volgens de huidige industriestandaard). De kostenbesparingen verdubbelen, wat leidt tot ongeveer 1 €t^{-1} , voor elke terminalgrootte boven die grens van 5 Mt. Het belang van de opslag van biomassa en de operationele kosten van een terminal voor de totale terminallogistiek wordt ook getoond. Benodigde overdekte opslag kan tot 45% van de totale terminallogistiek bedragen, omdat overdekte faciliteiten slechts een beperkte grootte kunnen hebben, tot er meerdere units nodig zijn om de doorvoer te accommoderen. De operationele kosten spelen een belangrijke rol in de terminallogistiek; tot 32% van de totale terminalkosten bij grotere terminals en 55% van de operationele kosten.

Hoewel het MILP-model (MILP ~ Mixed Integer Linear Programming) dat in hoofdstuk 4 is ontwikkeld een handig hulpmiddel is om het optimale equipment voor een specifieke doorvoer te bepalen, is het betrekkelijk statisch van aard. Variaties van de doorvoer over een gespecificeerde periode kunnen niet worden verwerkt - in plaats daarvan kan voor elke deelperiode een enkele doorvoerspecifieke oplossing worden gevonden. Het ontwerpen en plannen van een haventerminal is geen eenvoudig proces. In hoofdstuk 5 wordt een meer-periode-model gepresenteerd, dat in staat is om een optimaal investeringsplan te bepalen voor een gegeven ontwikkelingstraject in de tijd, zoals die welke zijn besproken in hoofdstuk 2. Het belangrijkste is dat dit model overgaat van een statische MILP-benadering naar een meerfasige planningsaanpak. Dit geeft de mogelijkheid om een overzicht te krijgen van de benodigde investeringen in infrastructuur en de verwachte operationele kosten gedurende de hele periode. In tegenstelling tot het statische MILP-model in hoofdstuk 4, bieden de resultaten geen 'best size' terminal, maar eerder een gedetailleerde strategie voor investering in en uitbreiding van een biomassa-terminal om een dynamische, tijdsafhankelijke doorvoer te realiseren. De resultaten worden weergegeven in de vorm van de laagste totale kapitaal- en operationele kosten, evenals de opbrengst van de verkoop van equipment over de hele periode. De in hoofdstuk 4 gevonden resultaten voor de verwerkingskosten per ton worden verder verbeterd met ongeveer 8-16%, afhankelijk van de situatie, bij totale verwerkingskosten van de houtpellets van tussen 0.83 en 0.89 €t^{-1} , gemiddeld over de hele beschouwde periode.

Uiteindelijk moeten de resultaten worden beoordeeld vanuit een praktisch oogpunt, voordat ze worden geïmplementeerd: er wordt een volledige, strategische planning van terminalinvesteringen gegeven, wat betekent dat voor passend geformuleerde inputs (in de vorm van importscenario's voor houtpellets), alle geïnteresseerde partijen een gedetailleerde langetermijnstrategie kunnen krijgen. Tegelijkertijd geven de resultaten een complexe reeks, achtereenvolgende beslissingen aan voor het bereiken van de optimale oplossing. In de praktijk zal er een vorm van compromis moeten worden gesloten. Dit zal leiden tot iets hogere totale kosten, maar zal in de praktijk veel eenvoudiger te implementeren zijn.

Grote investeringen in infrastructuur in houtpelletterminals worden over het algemeen belemmerd door de relatief lage aandeel van de verwerkingskosten op de terminal in de totale supply chain-

kosten van pellets. Het verminderen van de handling- en opslagkosten op de terminal lijkt triviaal, gezien vanuit een algemeen perspectief. Vanuit het oogpunt van een terminaloperator is investeren in gespecialiseerde infrastructuur en apparatuur voor de behandeling van houtpellets echter een belangrijke strategische beslissing die serieuze gevolgen kan hebben voor de langetermijnstrategie. Bovendien, rekening houdend met de toekomstige toegenomen invoer, zullen verschillende andere belanghebbenden profiteren van speciale apparatuur en terminals en een lagere prijs voor houtpellets. Voor eindgebruikers zoals energiecentrales, die mogelijk minder op subsidie van de overheid kunnen rekenen, en voor huishoudens of de industrie, die de pellets voor verwarmingsdoeleinden gebruiken, zullen lagere prijzen voor houtpellets door dedicated of goed uitgeruste importterminals welkom zijn.

De keuze van de te volgen aanpak is afhankelijk van de zekerheid over de toekomstige toevoer van houtpellets naar de regio en de bereidheid van geïnteresseerde partijen om daarop in te spelen. Voor een scenario waarin de realisatie van deze stromen, of op zijn minst een aanzienlijk deel ervan, concreet is, is een haventerminal (of een verzameling terminals) van vaste grootte een betere optie, omdat deze veel van de voortdurende zorg over keuze, aankoop en aanpassing van equipment wegneemt. Als er onzekerheid is over de verwachten stromen, of als de stromen naar verwachting in de tijd veel zullen fluctueren, is de dynamische modelleringsbenadering de betere keuze, omdat deze ervoor zorgt dat importterminals hun apparatuur en infrastructuur beter kunnen benutten. In beide gevallen, zoals aangetoond door de resultaten van hoofdstuk 4 en hoofdstuk 5, kunnen aanzienlijke kostenbesparingen worden gerealiseerd ten opzichte van de huidige industriestandaard.

Summary

This thesis deals with the design of solid biomass terminals from a strategic operational point of view. The design of terminals is here characterized as the total equipment selection, purchase, utilization and salvage within the terminal bounds.

As a general rule, maritime transportation has one of the highest entry costs of the transport sector; high terminal costs, since port infrastructures are among the most expensive to build, maintain and improve, as well as significant inventory costs. Even minor changes in a port terminals' design and operations require considerable investments in numerous elements of its setup. Additionally, solid biomass terminal design has numerous more design considerations to take into account compared to regular bulk terminals – fire and explosion risk for infrastructure and personnel, material degradation, and biological and chemical hazards. Biomass terminal logistics are more demanding in terms of designing the terminal setup and selecting the suitable equipment to efficiently handle the product. It is therefore crucial to have a comprehensive understanding of solid biomass terminal equipment setup and operations before any substantial commitments are made.

This research project aims to develop an optimization model that can be used as an aid tool for the investment planning in solid biomass terminals. To be able to effectively develop such a tool, several fields of adjoining research need to be examined first. Future solid biomass throughput of a terminal needs to be adequately identified, and the state-of-the-art of solid biomass handling in port terminals needs to be researched. Consequently, two different optimization approaches are developed, taking into consideration a set size terminal of steady biomass throughput, as well as a multi-period design approach that handles uncertainty and fluctuations of throughput effectively.

Initially, this research deals with the examination of a multitude of data sources, used to supplement previous existing model projections that assess bioenergy development in the EU. Altogether, a reasonable growth is expected in biomass trade volumes. Due to numerous complicated factors, even in cases where the actual trade numbers double, the overall imports are expected to fluctuate in a lower spectrum than previously assumed. Implications of the above could range from little to massive expected infrastructure development by 2030. The results of Chapter 2 show that depending on the expected imports to Northwest Europe, handling and storage chains will need to be adapted in order to cope with the physical and biological properties of biomass. This adaptation could range from modification of the equipment in import terminals, up to the need for constructing new, dedicated facilities (biomass terminals or biorefineries) to efficiently process the volume of imports.

Chapter 3 provides an evaluation of the current biomass import terminals, in particular in the port of Rotterdam, in terms of equipment and infrastructure setup. While biomass bulk terminals might be able to cope with the low amounts of biomass being traded currently, a reexamination and possible redesign or retrofitting of biomass terminals and facilities to accommodate the expected increased biomass volumes will be required by 2030. The majority of the solid bulk equipment and facilities designed for other bulk commodity goods is used for wood pellets as well, and can be suboptimal for this purpose. The terminals' need to use manual labor in certain cases (front-loaders in warehouses, or manual work in others) showcases the fact that not all equipment is fit for handling material with different properties. For the time being, the current setup and equipment in bulk terminals, geared mainly towards coal, iron ore and other bulk

material, can deal with low volumes of pellet throughput. If the expected increases in wood pellet imports materialize, most import terminals will have to invest in adjusting their approach, either by retrofitting existing facilities, or creating new ones altogether. The focus should be primarily put on two aspects: transportation of high volumetric capacity and adequate storage capacity. Both of these aspects will need to comply with the strict safety measures and regulations discussed in this dissertation.

In order to optimize the investments in a dedicated biomass terminal, a modelling approach that can perform such a task is performed and presented in Chapter 4. The research objective was to determine the total equipment allocation and utilization in a solid bulk biomass terminal in terms of total annual costs. The scope of the model includes the complete activities within a terminal, from the unloading of the biomass from an arriving vessel, to the loading at a vessel at the end of the handling chain. The computational results based on real-life input data for biomass bulk terminals indicate that the optimum size of terminals in order to achieve the minimum cost per ton of throughput is achieved at 5 Mt of throughput and beyond. Based on real world data, we can achieve 39-47% reduction in costs per ton handled for small size terminals of 500 kt annual throughput (2.1 €t^{-1} compared to $3.5\text{-}4 \text{ €t}^{-1}$ of the current industry standard). After the 5 Mt milestone is crossed the cost reductions double, leading to approximately 1 €t^{-1} for any terminal size above that size. The importance of biomass storage needs and operational costs of a terminal over the total terminal logistics is also demonstrated. Necessary enclosed storage can contribute to as much as 45% of the total terminal logistics, since enclosed facilities can only reach a certain size before requiring multiple units to accommodate the throughput. Operational costs have a significant role in terminal logistics, amounting to 32% of the total terminal costs in larger terminals and 55% of individual operational steps.

While the MILP model developed in chapter 4 is a useful tool to provide us with the optimal equipment setup for a specific throughput, it is fairly static in nature; variations of throughput over a specified timeline cannot be handled – rather, a single, throughput specific solution can be suggested for each time unit. Designing and planning a port terminal is not a straightforward process. Chapter 5 presents a multi-period model, able to propose the optimal investment pathway throughout a specific development timeline, such as the ones ascertained in chapter 2. Most importantly, this model transitions from a discrete, MILP approach to a multi-stage planning approach. This enables us to have an overview of the investments needed in infrastructure and the expected operational costs throughout the whole time period. In contrast to the static MILP model in Chapter 4, the results do not provide a ‘best size’ terminal, but rather a detailed investment strategy to invest and expand a solid biomass terminal to accommodate a time-dependent throughput. The results are given in the form of lowest total capital and operational costs as well as salvage profits over the whole time period. On a per ton basis, the results presented in Chapter 4 are further improved by approximately 8-16%, depending on the case, for an overall handling price of wood pellets that ranges between 0.83 and 0.89 €t^{-1} , averaged over the whole time period into consideration.

Ultimately, the results will need to be assessed from a practical point of view as well before implemented: a complete strategic planning of terminal investments is provided, which means that for adequately formulated inputs (in the way of wood pellet import scenarios), all interested parties can have a detailed long-term strategy provided. At the same time, the results suggest complex, constant decision making in order to achieve the optimum solution. Practically, some kind of compromise will need to be made. This will lead to slightly higher overall costs, but will be much simpler to implement in reality.

Major investments in infrastructure in wood pellet terminals are generally hindered by the relatively low cost contribution of terminal handling costs to the overall wood pellet supply

chain costs. Reducing the terminal handling and storage costs seems trivial from an overall perspective. However, from a terminal operator's point of view, investing in dedicated wood pellet infrastructure and equipment is a major strategic decision that can have severe implication on their long-term planning strategy. Moreover, taking into account the future increased imports, several more stakeholders will benefit from dedicated equipment and terminals and a lower delivered wood pellet price. End users such as power plants, that may need to rely less on governmental subsidies, and households or industry, in the case of pellets used for heating purposes, will support lower wood pellet prices via dedicated or properly equipped import terminals.

Ultimately, the choice of deciding which approach to use depends on the certainty of the future of wood pellet flows to the region, and the willingness of interested parties to capitalize on them. For a scenario where the materialization of these trade flows, or at least a considerable amount of them, is concrete, a port terminal (or a set of terminals) of set size is a better option, as it takes away a lot of the constant equipment selection, retrofitting and salvage burden. For the case where great uncertainty is present, or trade flows are expected to fluctuate considerably in time, using the multi-period modelling approach is the better choice, since it ensures that import terminal(s) will be able to better utilize their equipment and infrastructure. In both cases, as demonstrated by the results of Chapter 4 and Chapter 5, considerable cost reductions compared to the current industry standards can be achieved.

Curriculum vitae

Ioannis Dafnomilis was born in Thessaloniki, Greece. In 2002, he enrolled in the Mechanical Engineering faculty of Aristotle University Thessaloniki, graduating in 2008 with a Bachelor's degree in Mechanical Engineering and a Master's degree in Energy and Sustainability Engineering. During his Master thesis, he developed a method to characterize and simulate heat conductivity in buildings according to their building code. During his Master's degree he worked as an intern in a mechanical engineering firm, where he performed research and simulation of heating, heating losses and air conditioning of residential and office buildings.

In August 2010, he moved to the Netherlands to pursue a second Master's degree in Sustainable Energy Technologies in Delft University of Technology. He concluded the Master's in 2012, developing a work stream for the exergy analysis of carbon capture and storage (CCS) through enhanced oil recovery (EOR). He received an award for the best Master thesis in the Energy category in the Future Ideas competition, which took into account Master theses across European universities.

During the last months of his Master and until mid-2013 he worked in the European Patent Office as an Assistant Patent Examiner. The work entailed examination and reclassification of patent applications, based on their function and mechanical design drawings, as well as creation and application of new classification schemes. He left Netherlands for Barcelona, Spain, in 2013, in order to work as a Research Engineer in the Catalonia Institute for Energy Research (IREC) for the European Commission's RenewIT project. There, he aided in developing a simulation tool to evaluate the energy performance of different technical solution integrating RES in several European climate regions, with the aim to reduce the carbon footprint of planned Data Centers in the horizon of 2030.

In June 2014, he left the Institute to pursue his PhD back in Delft University of Technology, in the section of Transport Engineering and logistics, department of Maritime and transport Technology under the supervision of Prof. G. Lodewijks, Prof. M. Junginger and Assoc. Prof. D. L. Schott. The research objective was to examine the logistics of solid biomass terminals' infrastructure development, from a strategic planning point of view. The results of his PhD research are presented in this thesis.

TRAIL Thesis Series publications

The following list contains the most recent dissertations in the TRAIL Thesis Series. For a complete overview of more than 200 titles see the TRAIL website: www.rsTRAIL.nl.

The TRAIL Thesis Series is a series of the Netherlands TRAIL Research School on transport, infrastructure and logistics.

Dafnomilis, I., Green Bulk Terminals: A strategic level approach to solid biomass terminal design, T2019/2, January 2019, TRAIL Thesis Series, the Netherlands

Feng, Fan, Information Integration and Intelligent Control of Port Logistics System, T2019/1, January 2019, TRAIL Thesis Series, the Netherlands

Beinum, A.S. van, Turbulence in Traffic at Motorway Ramps and its Impact on Traffic Operations and Safety, T2018/12, December 2018, TRAIL Thesis Series, the Netherlands

Bellsolà Olba, X., Assessment of Capacity and Risk: A Framework for Vessel Traffic in Ports, T2018/11, December 2018, TRAIL Thesis Series, the Netherlands

Knapper, A.S., The Effects of using Mobile Phones and Navigation Systems during Driving, T2018/10, December 2018, TRAIL Thesis Series, the Netherlands

Varotto, S.F., Driver Behaviour during Control Transitions between Adaptive Cruise Control and Manual Driving: empirics and models, T2018/9, December 2018, TRAIL Thesis Series, the Netherlands

Stelling-Kończak, A., Cycling Safe and Sound, T2018/8, November 2018, TRAIL Thesis Series, the Netherlands

Essen, van M.A., The Potential of Social Routing Advice, T2018/7, October 2018, TRAIL Thesis Series, the Netherlands

Su, Zhou, Maintenance Optimization for Railway Infrastructure Networks, T2018/6, September 2018, TRAIL Thesis Series, the Netherlands

Cai, J., Residual Ultimate Strength of Seamless Metallic Pipelines with Structural Damage, T2018/5, September 2018, TRAIL Thesis Series, the Netherlands

Ghaemi, N., Short-turning Trains during Full Blockages in Railway Disruption Management, T2018/4, July 2018, TRAIL Thesis Series, the Netherlands

Gun, van der J.P.T., Multimodal Transportation Simulation for Emergencies using the Link Transmission Model, T2018/3, May 2018, TRAIL Thesis Series, the Netherlands

Van Riessen, B., Optimal Transportation Plans and Portfolios for Synchronodal Container Networks, T2018/2, March 2018, TRAIL Thesis Series, the Netherlands

Saeedi, H., Network-Level Analysis of the Market and Performance of Intermodal Freight Transport, T2018/1, March 2018, TRAIL Thesis Series, the Netherlands

- Ypsilantis, P., The Design, Planning and Execution of Sustainable Intermodal Port-hinterland Transport Networks, T2017/14, December 2017, TRAIL Thesis Series, the Netherlands
- Han, Y., Fast Model Predictive Control Approaches for Road Traffic Control, T2017/13, December 2017, TRAIL Thesis Series, the Netherlands
- Wang, P., Train Trajectory Optimization Methods for Energy-Efficient Railway Operations, T2017/12, December 2017, TRAIL Thesis Series, the Netherlands
- Weg, G.S. van de, Efficient Algorithms for Network-wide Road Traffic Control, T2017/11, October 2017, TRAIL Thesis Series, the Netherlands
- He, D., Energy Saving for Belt Conveyors by Speed Control, T2017/10, July 2017, TRAIL Thesis Series, the Netherlands
- Bešinović, N., Integrated Capacity Assessment and Timetabling Models for Dense Railway Networks, T2017/9, July 2017, TRAIL Thesis Series, the Netherlands
- Chen, G., Surface Wear Reduction of Bulk Solids Handling Equipment Using Bionic Design, T2017/8, June 2017, TRAIL Thesis Series, the Netherlands
- Kurapati, S., Situation Awareness for Socio Technical Systems: A simulation gaming study in intermodal transport operations, T2017/7, June 2017, TRAIL Thesis Series, the Netherlands
- Jamshidnejad, A., Efficient Predictive Model-Based and Fuzzy Control for Green Urban Mobility, T2017/6, June 2017, TRAIL Thesis Series, the Netherlands
- Araghi, Y., Consumer Heterogeneity, Transport and the Environment, T2017/5, May 2017, TRAIL Thesis Series, the Netherlands
- Kasraian Moghaddam, D., Transport Networks, Land Use and Travel Behaviour: A long term investigation, T2017/4, May 2017, TRAIL Thesis Series, the Netherlands
- Smits, E.-S., Strategic Network Modelling for Passenger Transport Pricing, T2017/3, May 2017, TRAIL Thesis Series, the Netherlands
- Tasseron, G., Bottom-Up Information Provision in Urban Parking: An in-depth analysis of impacts on parking dynamics, T2017/2, March 2017, TRAIL Thesis Series, the Netherlands
- Halim, R.A., Strategic Modeling of Global Container Transport Networks: Exploring the future of port-hinterland and maritime container transport networks, T2017/1, March 2017, TRAIL Thesis Series, the Netherlands
- Olde Keizer, M.C.A., Condition-Based Maintenance for Complex Systems: Coordinating maintenance and logistics planning for the process industries, T2016/26, December 2016, TRAIL Thesis Series, the Netherlands