

COMPLEX PROJECTS CRISIS HUB P5.0

GERMAN RED CROSS CENTER FOR HUMANITARIAN RELIEF OPERATIONS
Helena van Swaay De Marchi
17th January 2025

CRISIS

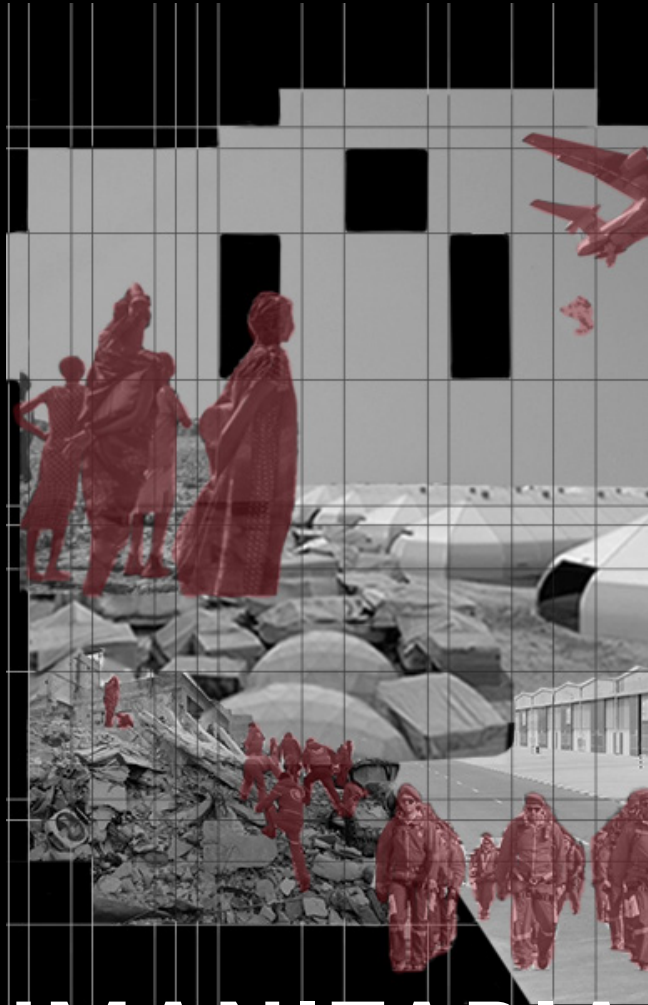

HUMANITARIAN CRISIS

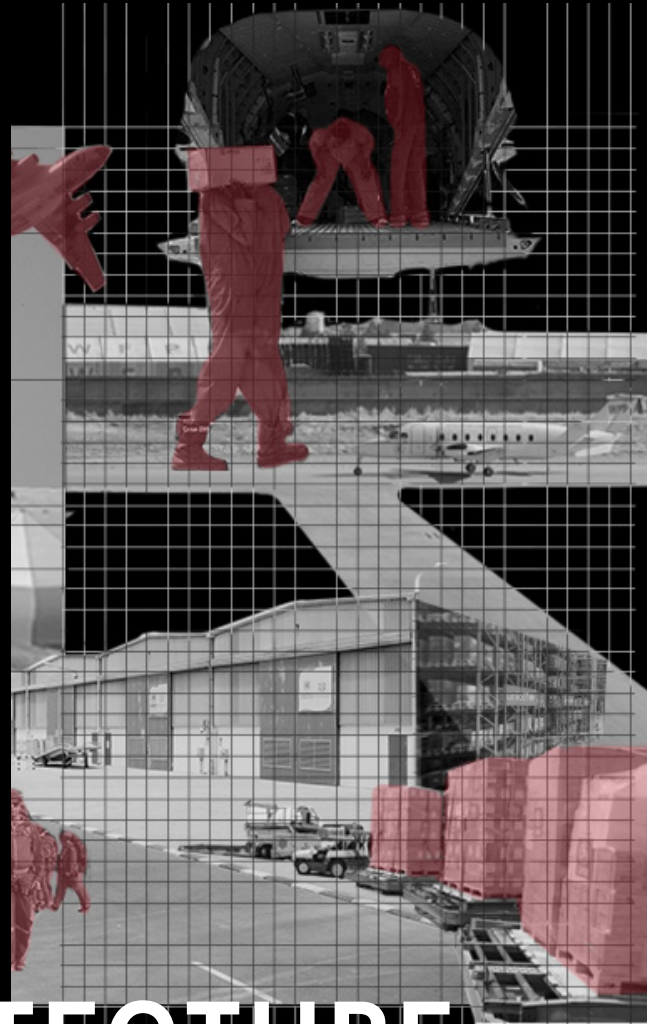

CRISIS ARCHITECTURE



“ (...) **CRISIS ARCHITECTURE** is nothing more than an attempt to identify and define **IMMEDIATE ARCHITECTURAL RESPONSES** to short-term differing socio-cultural conditions. (...)” (Driessen, 1995)

INTRODUCTION

RESEARCH

DESIGN BRIEF

CONCEPT

IMPLEMENTATION

DEVELOPMENT

CONCLUSION

GLOBAL HUMANITARIAN NEED

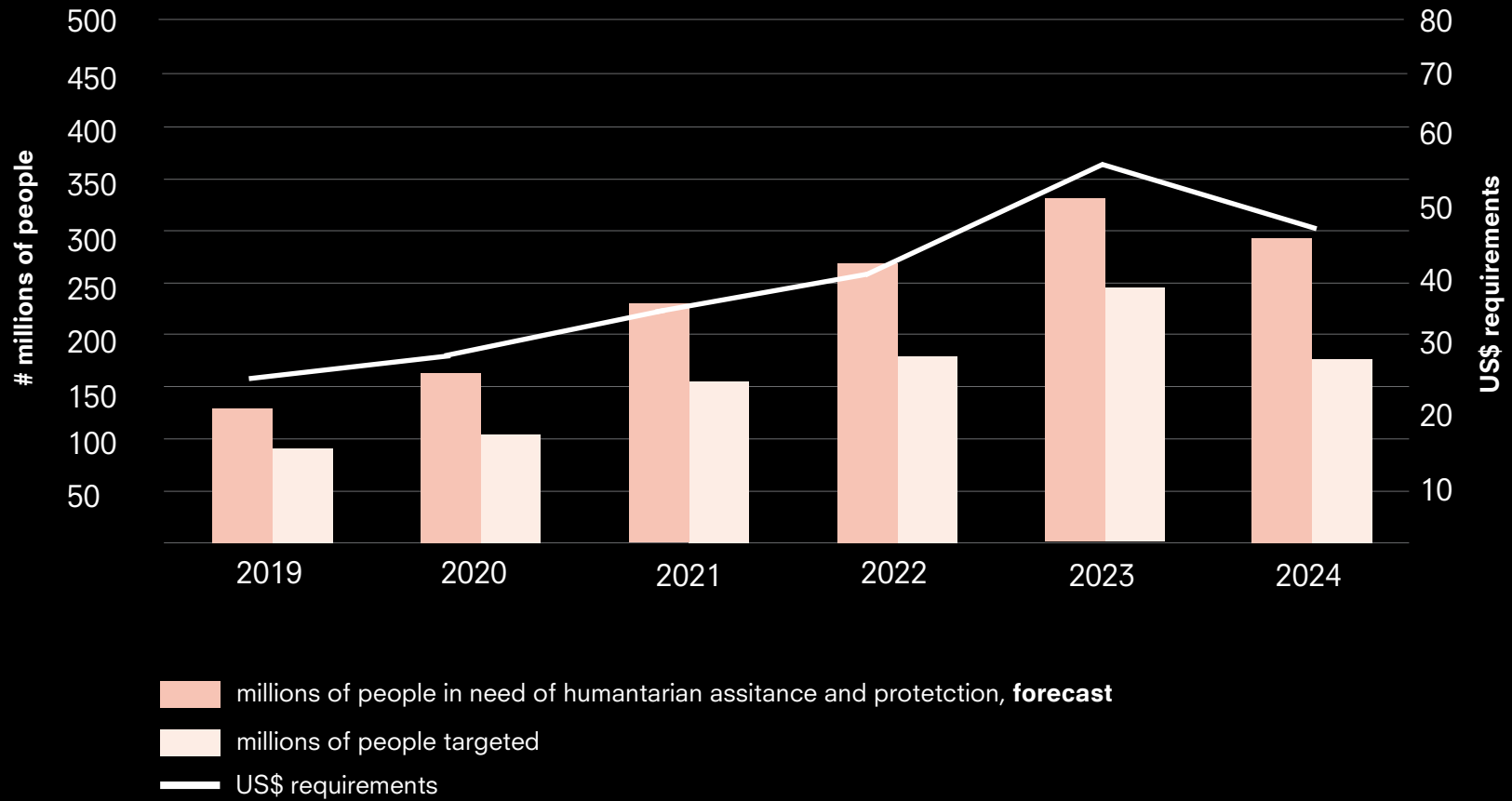

Source: UN Global Humanitarian Overview 2019 - 2024
UNHAS Annual Reports 2019, 2020, 2021, 2022
Global Humanitarian Assistance Report 2023

GLOBAL HUMANITARIAN NEED

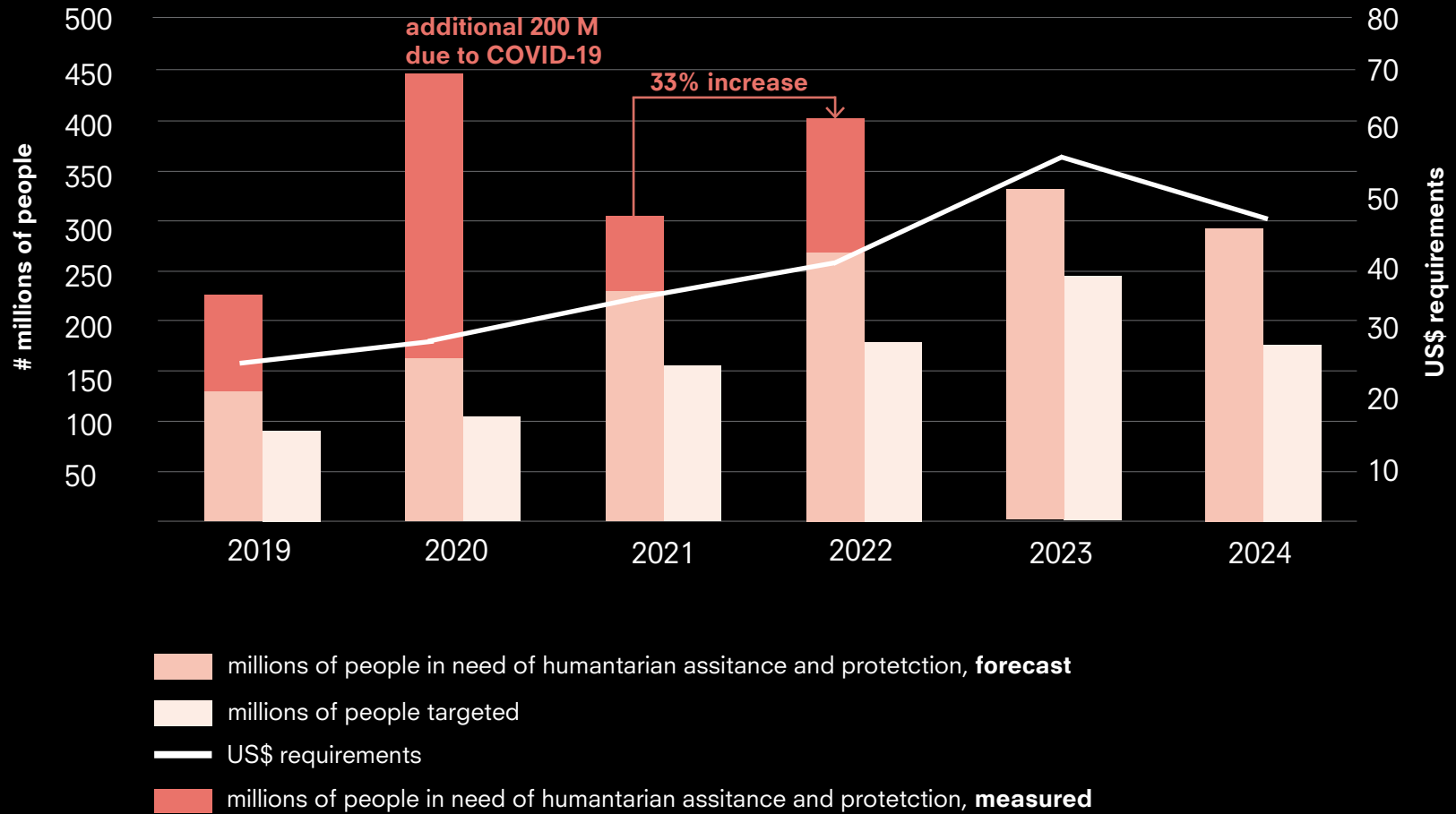

Source: UN Global Humanitarian Overview 2019 - 2024
UNHAS Annual Reports 2019, 2020, 2021, 2022
Global Humanitarian Assistance Report 2023

GLOBAL HUMANITARIAN NEED

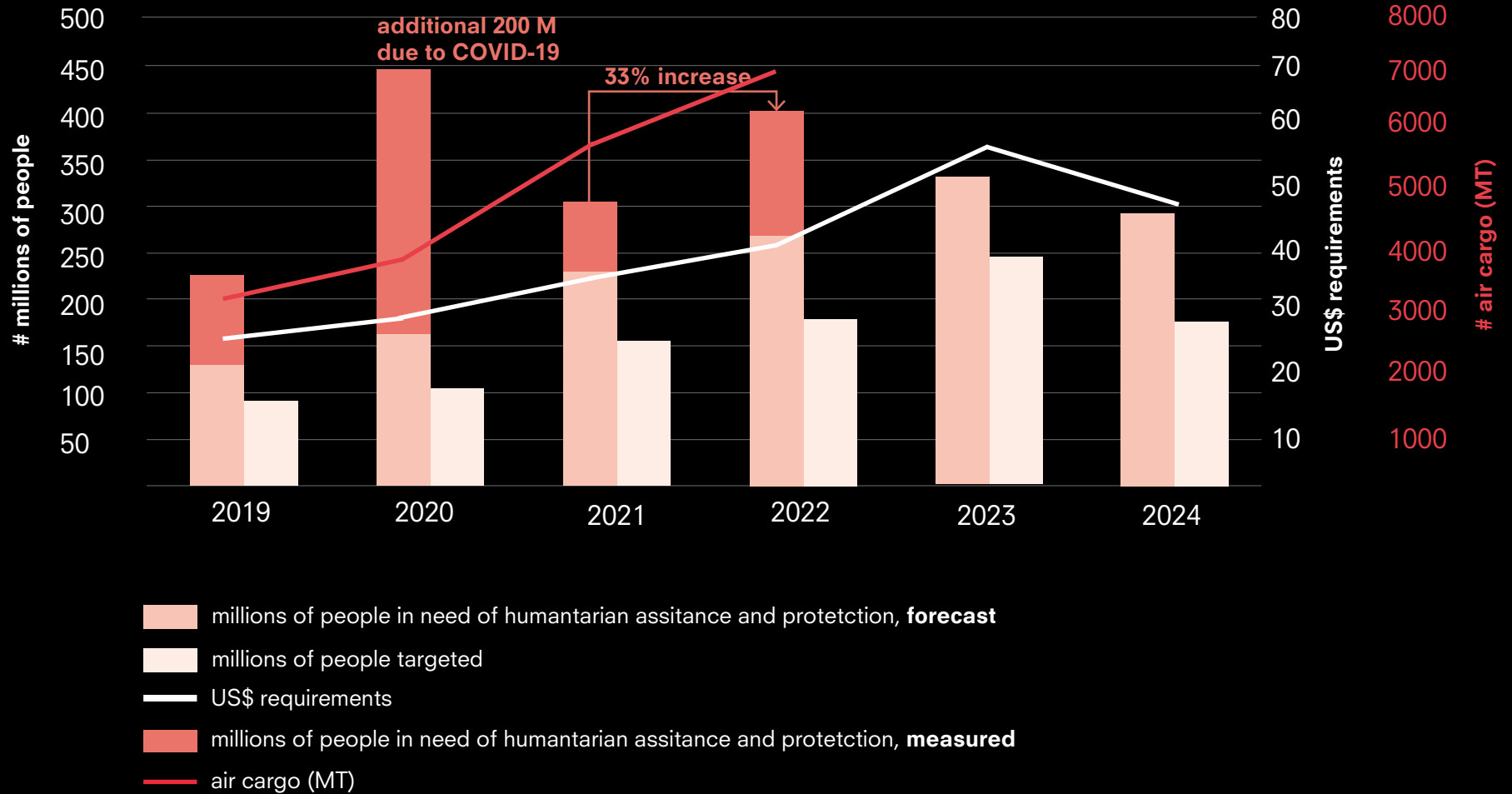

Source: UN Global Humanitarian Overview 2019 - 2024
 UNHAS Annual Reports 2019, 2020, 2021, 2022
 Global Humanitarian Assistance Report 2023

Introduction

HUMANITARIAN AIR CARGO

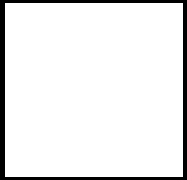

FOOD

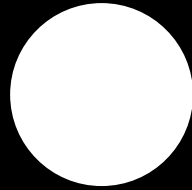

WATER

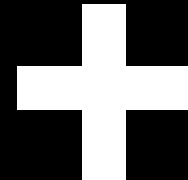

MEDICINE

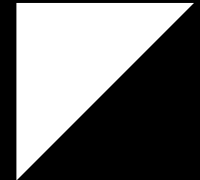

SHELTER

INCREASING DEMAND

Humanitarian action trends 2020-2030



CLIMATE CRISIS



WIDENING INEQUALITY



PANDEMICS AND DISEASE
OUTBREAKS



SLOW AND UNEVEN
ECONOMIC GROWTH



INCREASING INSTABILITY,
FRAGILITY AND CONFLICT



FRAGMENTED
AND COMPETITIVE
GEOPOLITICAL LANDSCAPE

STRATEGIC VALUE OF AIRPORTS

“Aviation plays an essential role in the movement [of goods and people] in emergency relief situations. Air services are crucial in situations where crumbling infrastructure or active conflict cuts off access to entire regions” (IATA, 2022)

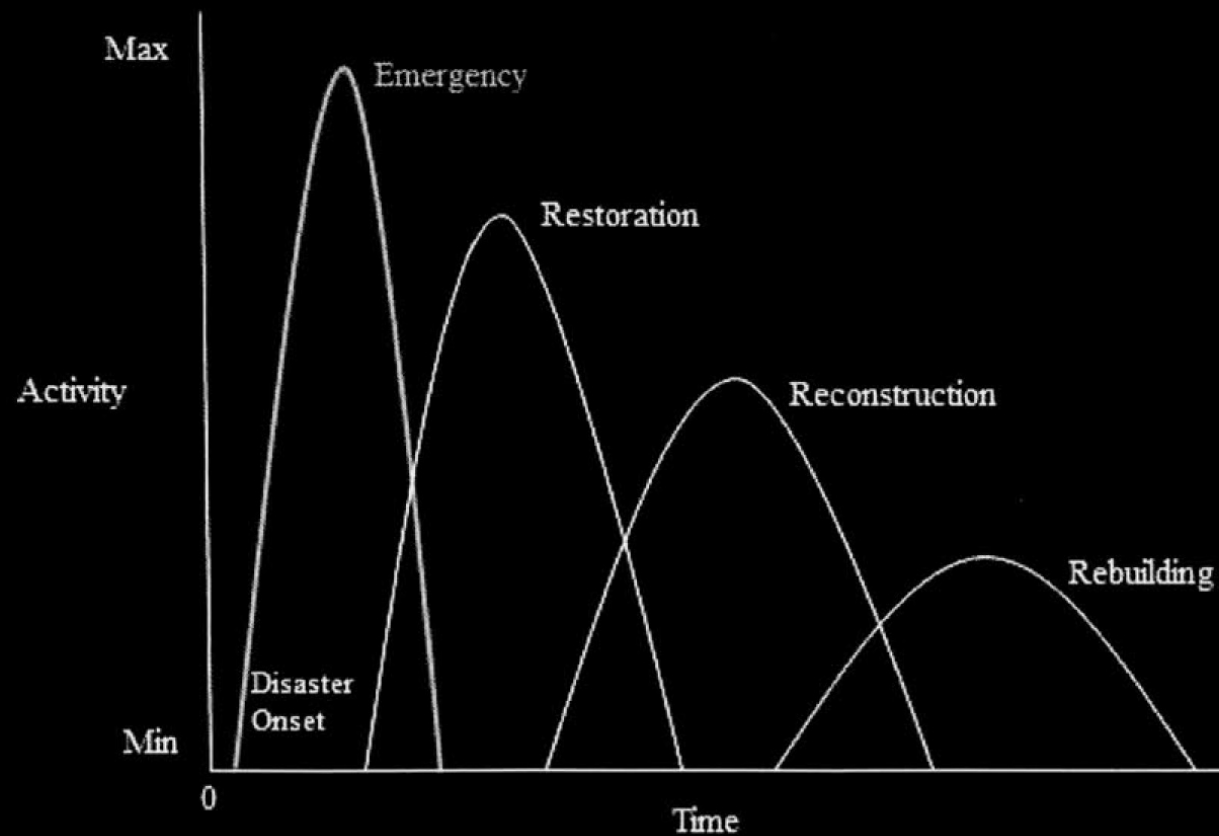

BERLIN CONTINGENCY - "BERCON", 1950s

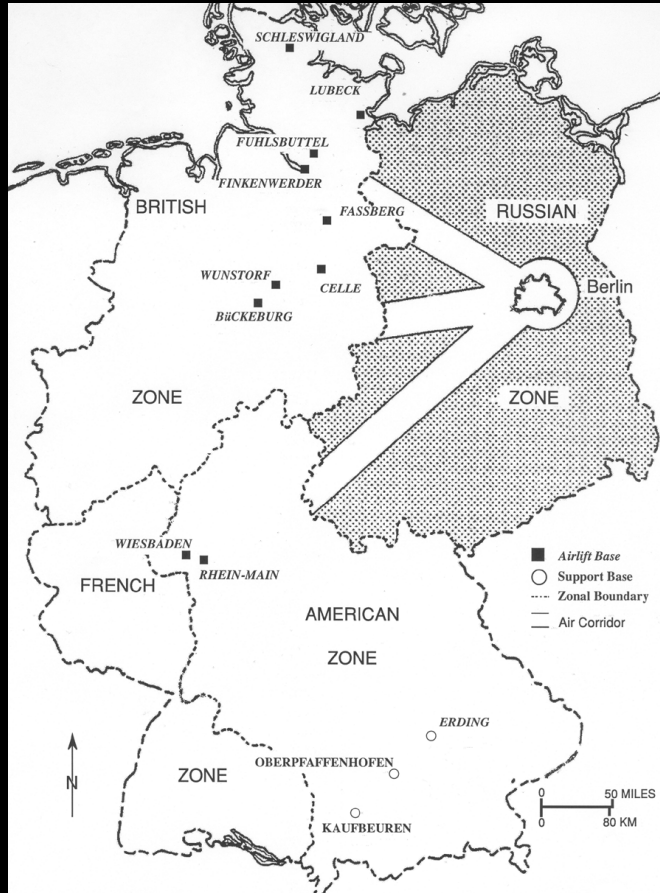

"(...) **BERCON (Berlin Contingency)** [in the 1950s] (...) called for ground and air actions along the access routes and air corridors to Berlin, plus possible demonstrative use of nuclear weapons" (Harrington, 2008)

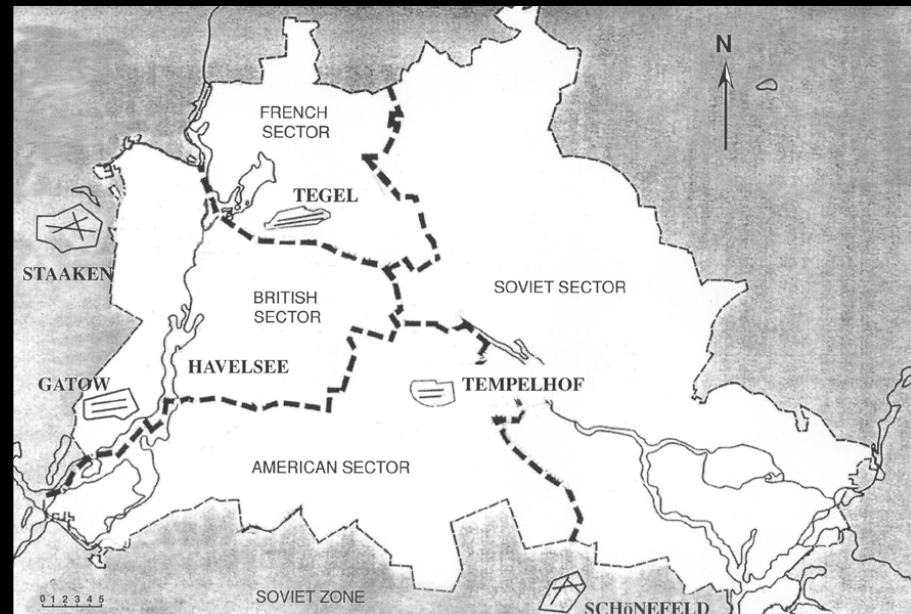

Introduction

BERLIN AIRLIFT, 1948

World's largest ever air supply



~ **275 K** flights to Berlin in one year
~ **2.5 M** tons of goods in one year

INTRODUCTION
RESEARCH
DESIGN BRIEF
CONCEPT
IMPLEMENTATION
DEVELOPMENT
CONCLUSION

Research
PROBLEM STATEMENT

Airports lack space planning to effectively deal with **crisis** situations, including the stages of **preparedness and response**

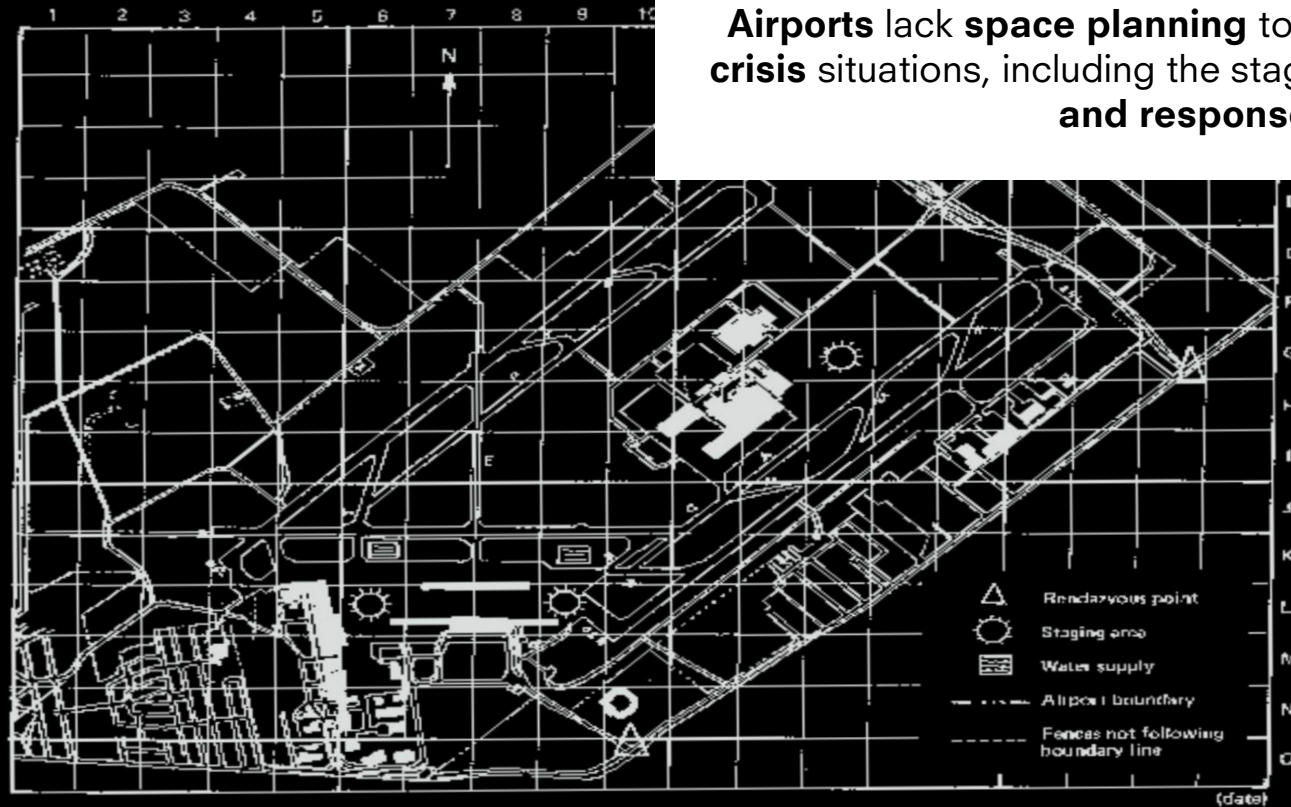

AERODROME GRID MAP - Coordinate reference system for communication during airport emergency response (ACI, 2014)

Research

CRISIS MANAGEMENT CYCLE

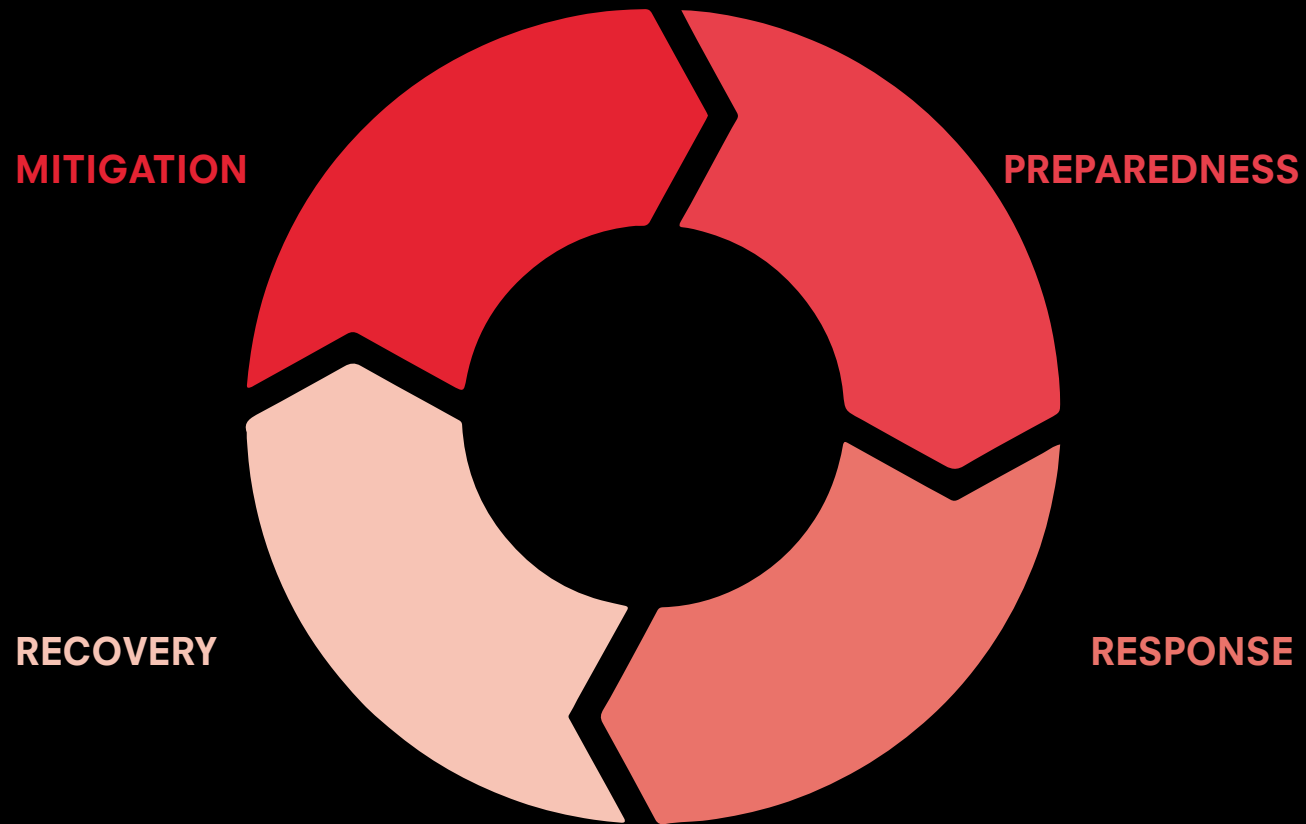

Development: before the disaster

Relief: after the disaster

CRISIS MANAGEMENT CYCLE



PREPAREDNESS

- Pre-positioned supplies
- Research and innovation
- Training

CRISIS MANAGEMENT CYCLE

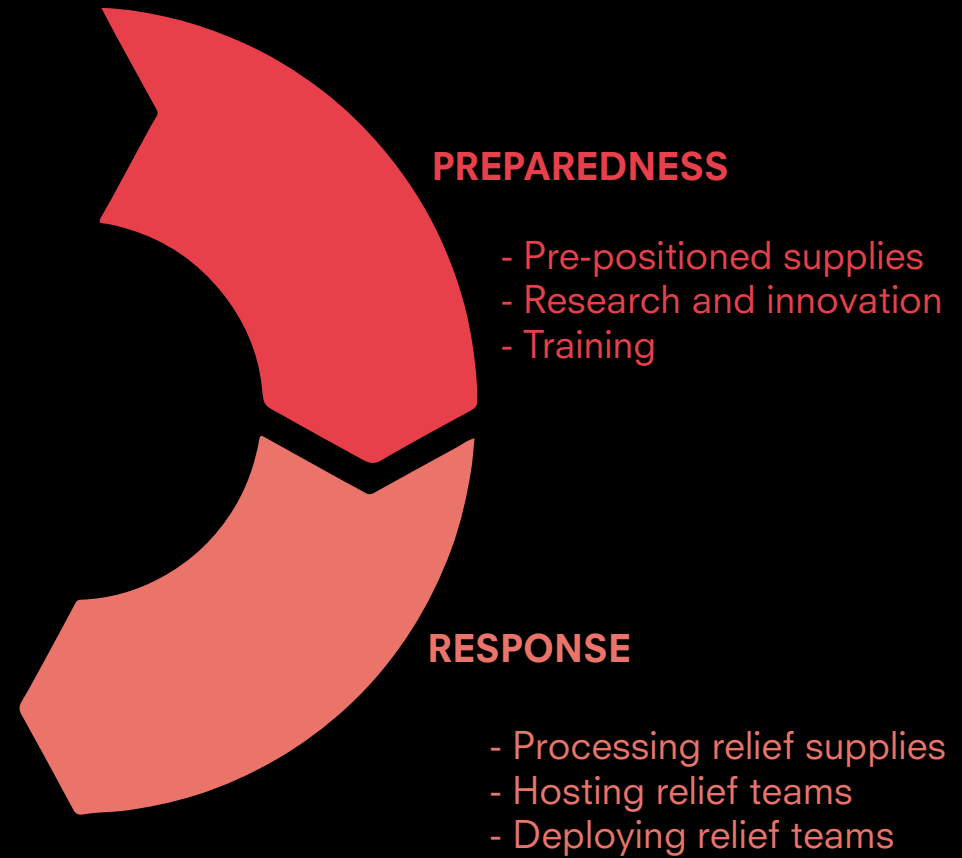

CRISIS ARCHITECTURE - THEORETICAL FRAMEWORK

ON PERSPECTIVE *from demand to supply*

ON EXPRESSION *from humanitarian spaces to military bases*

ON TEMPORALITY *from transitional to permanent*

ON ADAPTABILITY *from change of plan to change of function*

ON MATERIALITY *from residual to resilient*

ON TOOLS *from contingency planning to scenario planning*

CRISIS ARCHITECTURE - THEORETICAL FRAMEWORK

ON PERSPECTIVE *from demand to supply*

ON EXPRESSION *from humanitarian spaces to military bases*

ON TEMPORALITY *from transitional to permanent*

ON ADAPTABILITY *from change of plan to change of function*

ON MATERIALITY *from residual to resilient*

ON TOOLS *from contingency planning to scenario planning*

Research

CRISIS ARCHITECTURE ON PERSPECTIVE *from demand (disaster location, beneficiaries)...*

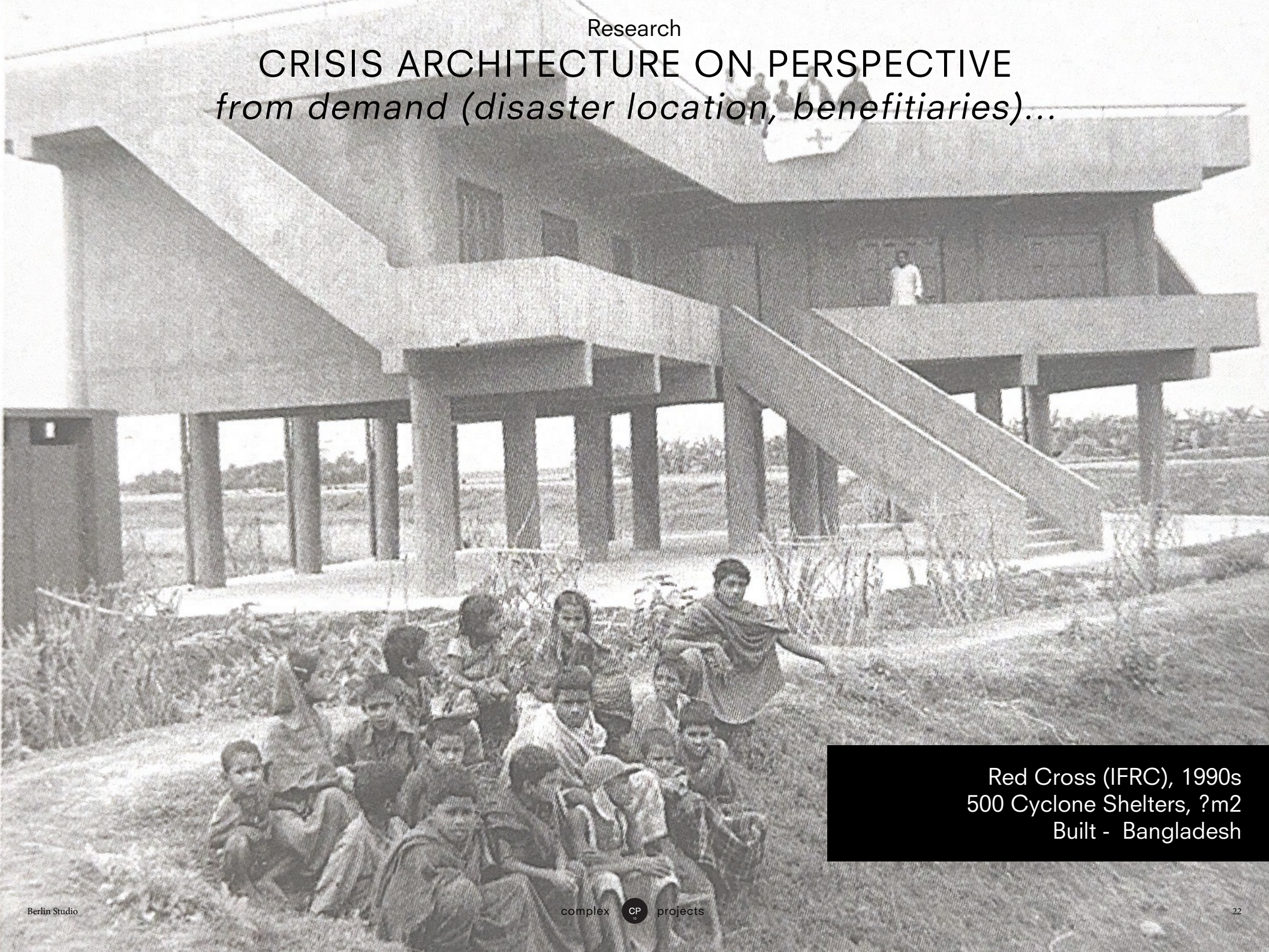

Red Cross (IFRC), 1990s
500 Cyclone Shelters, ?m2
Built - Bangladesh

Research

CRISIS ARCHITECTURE ON PERSPECTIVE *... to supply (warehouse, benefactors)*



Amazon warehouse, 2011
Photo: Ben Roberts,
Rugeley, Staffordshire, UK

CRISIS ARCHITECTURE - THEORETICAL FRAMEWORK

ON PERSPECTIVE *from demand to supply*

ON EXPRESSION *from humanitarian spaces to military bases*

ON TEMPORALITY *from transitional to permanent*

ON ADAPTABILITY *from change of plan to change of function*

ON MATERIALITY *from residual to resilient*

ON TOOLS *from contingency planning to scenario planning*

Research

CRISIS ARCHITECTURE ON EXPRESSION *from humanitarian spaces...*

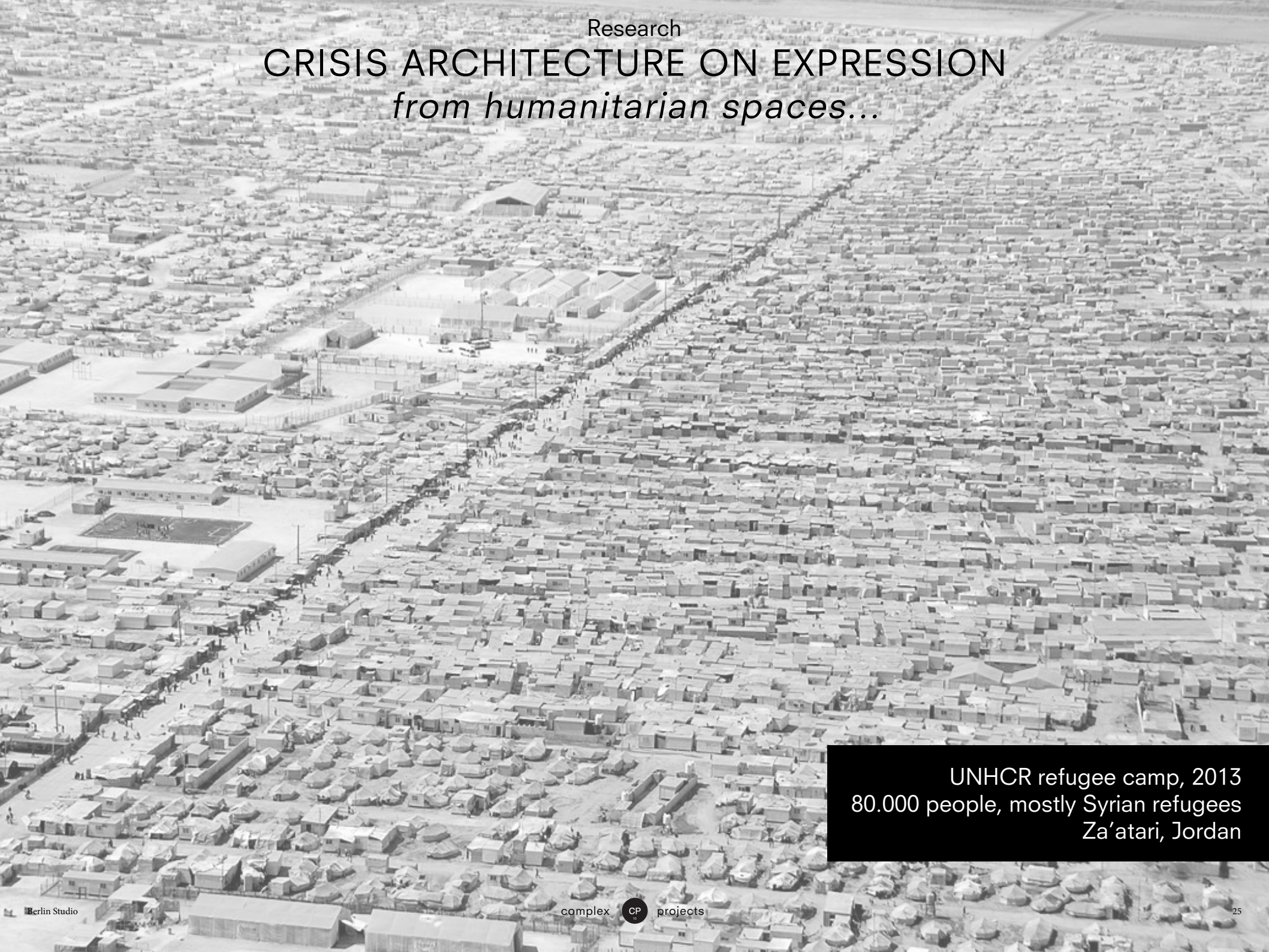

UNHCR refugee camp, 2013
80.000 people, mostly Syrian refugees
Za'atari, Jordan

Research
CRISIS ARCHITECTURE ON EXPRESSION
...to military bases

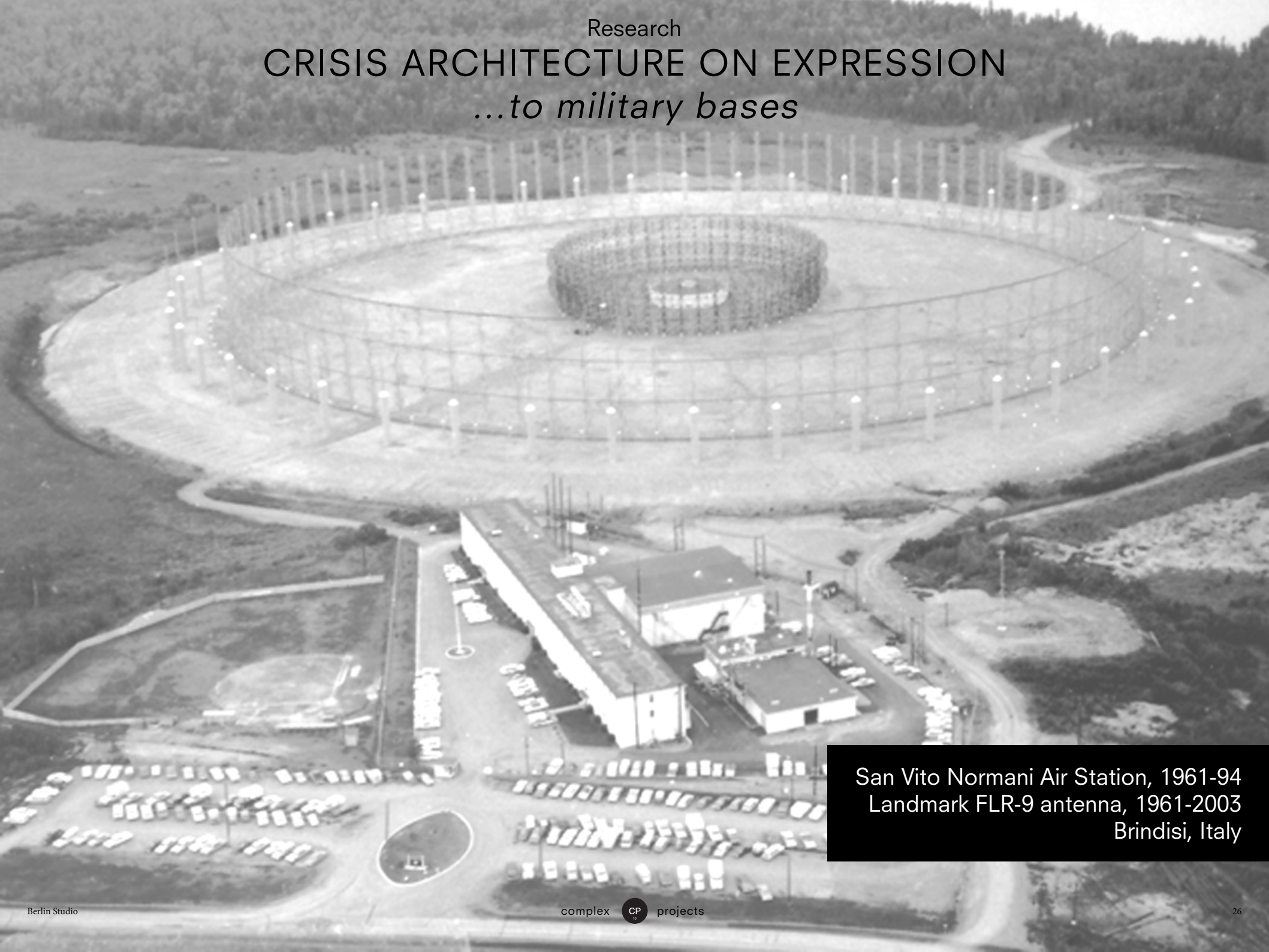

San Vito Normani Air Station, 1961-94
Landmark FLR-9 antenna, 1961-2003
Brindisi, Italy

CRISIS ARCHITECTURE - THEORETICAL FRAMEWORK

ON PERSPECTIVE *from demand to supply*

ON EXPRESSION *from humanitarian spaces to military bases*

ON TEMPORALITY *from transitional to permanent*

ON ADAPTABILITY *from change of plan to change of function*

ON MATERIALITY *from residual to resilient*

ON TOOLS *from contingency planning to scenario planning*

Research

CRISIS ARCHITECTURE ON TEMPORALITY

from transitional...



Red Cross, Medical Care Unit, 2020
COVID-19 Mobile Camp
Location unknown

Research

CRISIS ARCHITECTURE ON TEMPORALITY

...to permanent



CR Architects, Station No. 122's, 2018
Fireman pole , David Kenyon -1870s,
Plainfield, IN - USA

CRISIS ARCHITECTURE - THEORETICAL FRAMEWORK

ON PERSPECTIVE *from demand to supply*

ON EXPRESSION *from humanitarian spaces to military bases*

ON TEMPORALITY *from transitional to permanent*

ON ADAPTABILITY *from change of plan to change of function*

ON MATERIALITY *from residual to resilient*

ON TOOLS *from contingency planning to scenario planning*

CRISIS ARCHITECTURE ON CONTEXT

from change of plan...



Führerbunker, 1936-1944
Bunkers & Air raid shelters
Berlin, Germany

Research

CRISIS ARCHITECTURE ON CONTEXT *...to change of function*



DRK refugee hub at TXL airport, 2022
Capacity for 900 Ukranian refugees
Berlin, Germany

CRISIS ARCHITECTURE - THEORETICAL FRAMEWORK

ON PERSPECTIVE *from demand to supply*

ON EXPRESSION *from humanitarian spaces to military bases*

ON TEMPORALITY *from transitional to permanent*

ON ADAPTABILITY *from change of plan to change of function*

ON MATERIALITY *from residual to resilient*

ON TOOLS *from contingency planning to scenario planning*

Research

CRISIS ARCHITECTURE ON MATERIALITY

from residual...

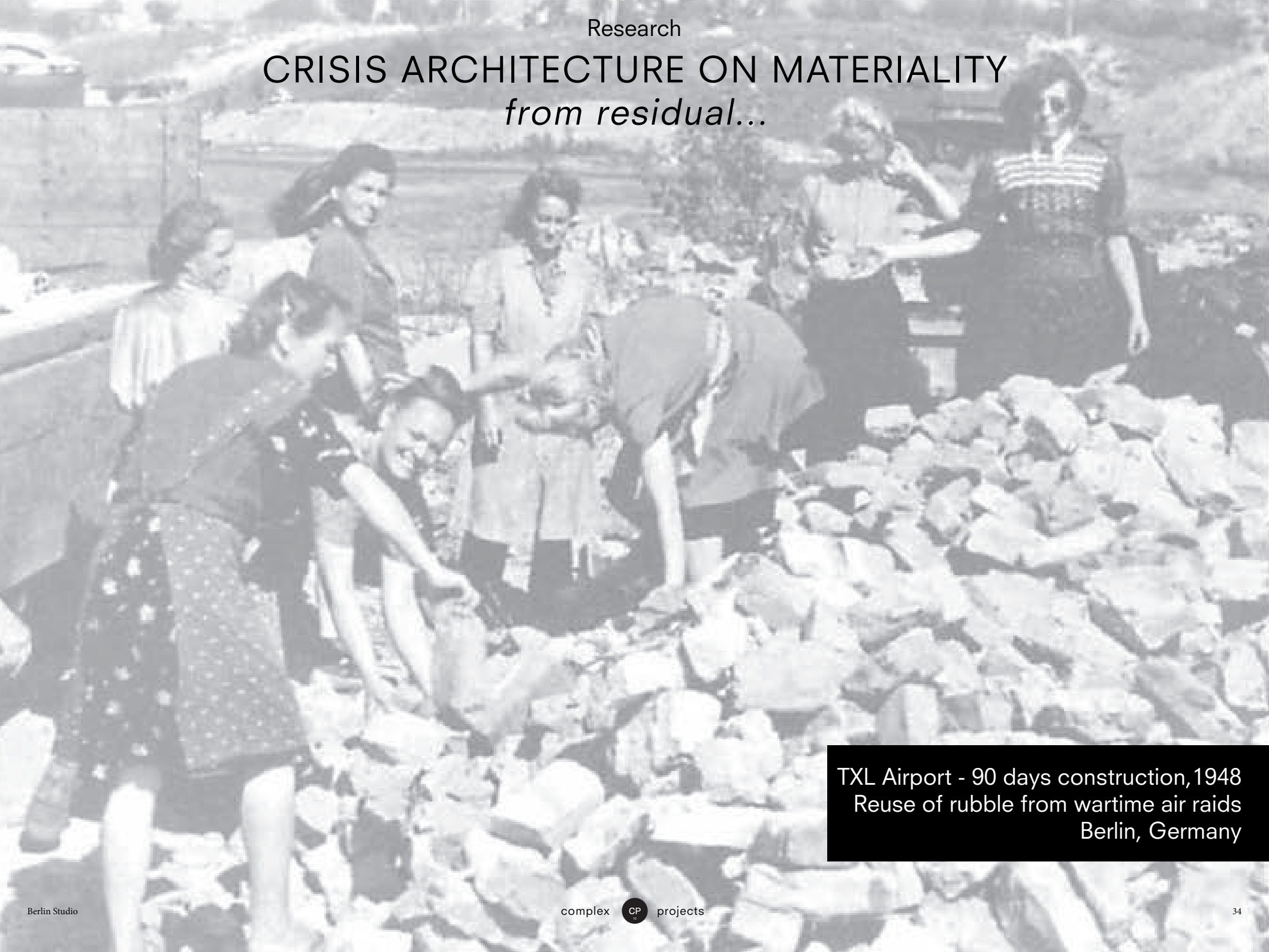

TXL Airport - 90 days construction, 1948
Reuse of rubble from wartime air raids
Berlin, Germany

Research

CRISIS ARCHITECTURE ON MATERIALITY

...to resilient



Construction of *Grenzmauer 75*.1975
Reinforced concrete & smooth piping
Berlin, Germany

CRISIS ARCHITECTURE - THEORETICAL FRAMEWORK

ON PERSPECTIVE *from demand to supply*

ON EXPRESSION *from humanitarian spaces to military bases*

ON TEMPORALITY *from transitional to permanent*

ON ADAPTABILITY *from change of plan to change of function*

ON MATERIALITY *from residual to resilient*

ON TOOLS *from contingency planning to scenario planning*

Research

CRISIS ARCHITECTURE ON TOOLS

from contingency planning...



HHP AG, Swissmill Tower, 2016
Grain tower, 118m - Food scarcity
Zurich, Switzerland

Research

CRISIS ARCHITECTURE ON TOOLS

...to scenario planning



UN Global Service Centre, 1994
First permanent UN Logistics Base
Salento Airport - Brindisi, Italy

CRISIS ARCHITECTURE - DESIGN PRINCIPLES

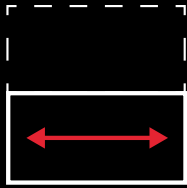

REFUGEE CAMPS
HORIZONTALITY

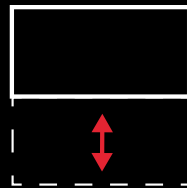

SHELTERS & BUNKERS
UNDER- OR ABOVE GROUND

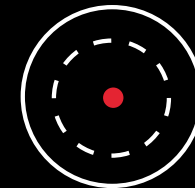

PRISON
VISIBILITY & SECURITY BARRIERS

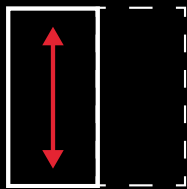

GRAIN TOWERS
VERTICALITY

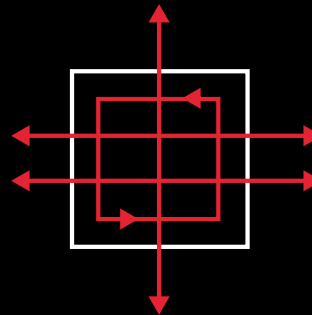

MILITARY CAMPS
REDUNDANCY IN CIRCULATION

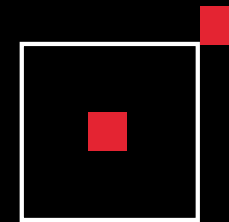

FIRE STATION
CIRCULATION LOOPHOLES

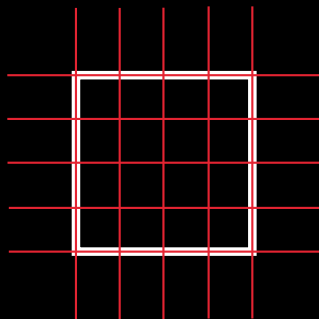

WAREHOUSE
STANDARDISATION

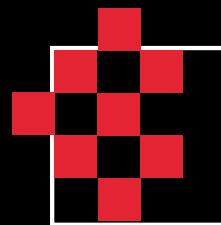

MOBILE HEALTHCARE
MODULARITY

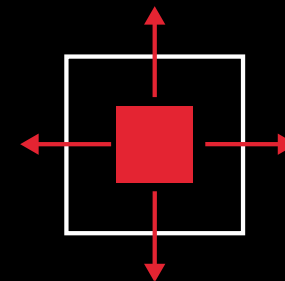

LOGISTICS BASES
SURGE CAPACITY

MAIN RESEARCH QUESTION

To what extent can the understanding of **CRISIS ARCHITECTURE** inform the design of **EFFICIENT AIRPORT BASES** for humanitarian relief operations?

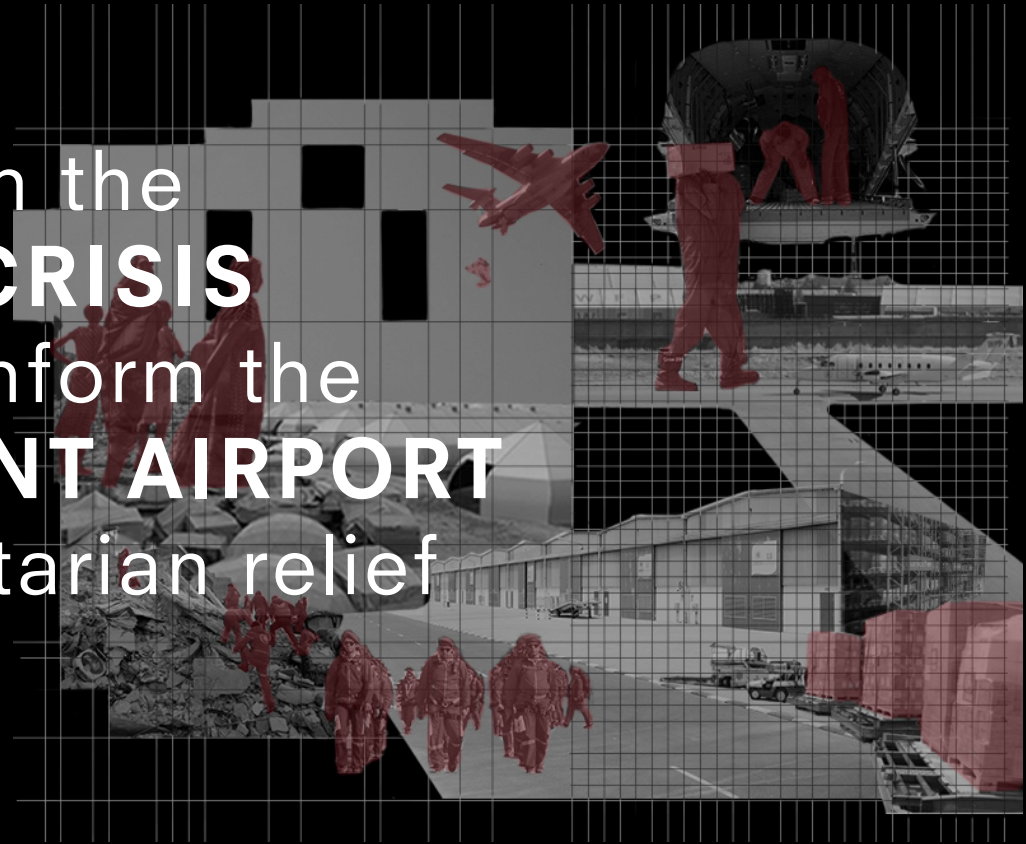

INTRODUCTION
RESEARCH
DESIGN BRIEF
CONCEPT
IMPLEMENTATION
DEVELOPMENT
CONCLUSION

DESIGN BRIEF

program

site

client

Design Brief
CASE STUDIES



PANAMA
BLB



ACCRA
KIA



BRINDISI
BDS



DUBAI
DWC



KUALA LUMPUR
SZB

UNHRD
Humanitarian
Response Depot



RÉUNION
ZAA



GENEVA
GVA



UNHRD PROGRAM BENCHMARK

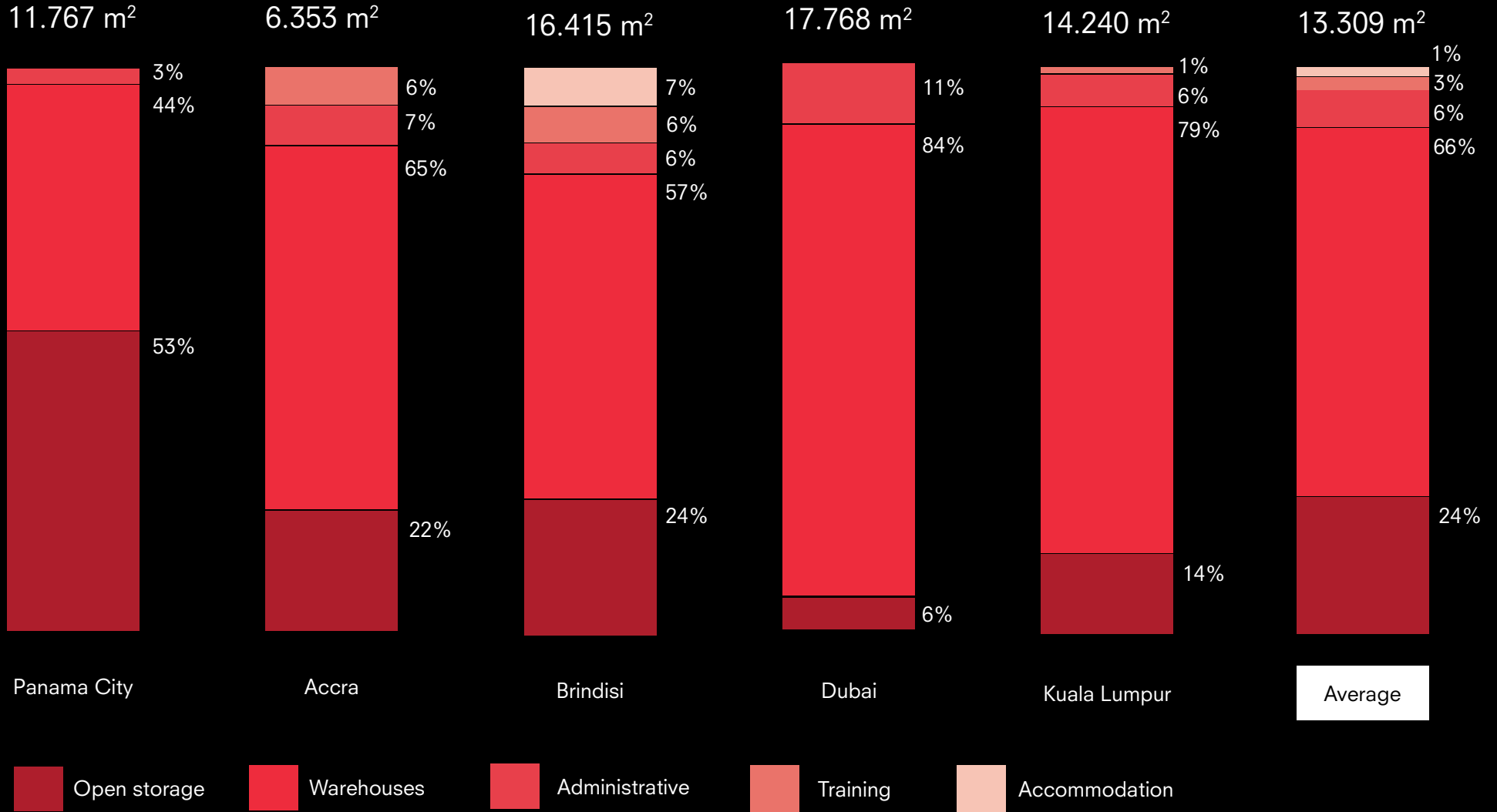

IFRC/ICRC PROGRAM BENCHMARK

4.000 m²

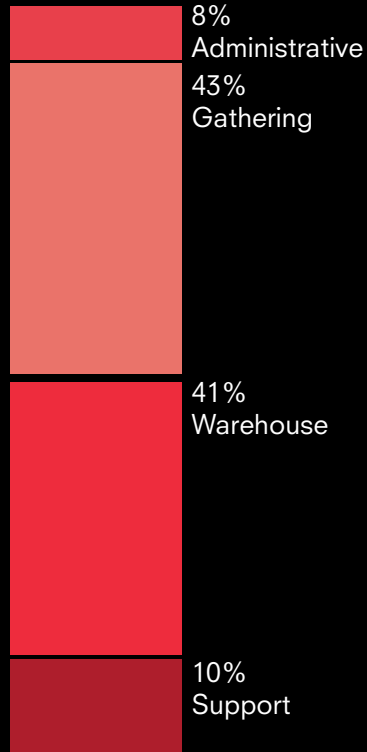

**IFRC
Réunion
Island**

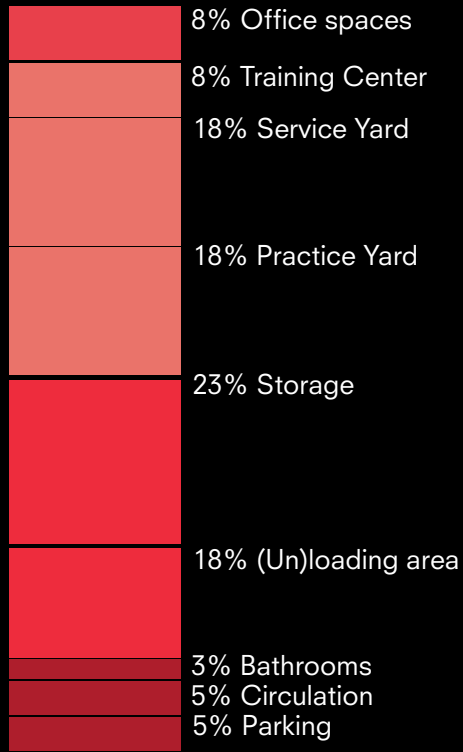

11.500 m²

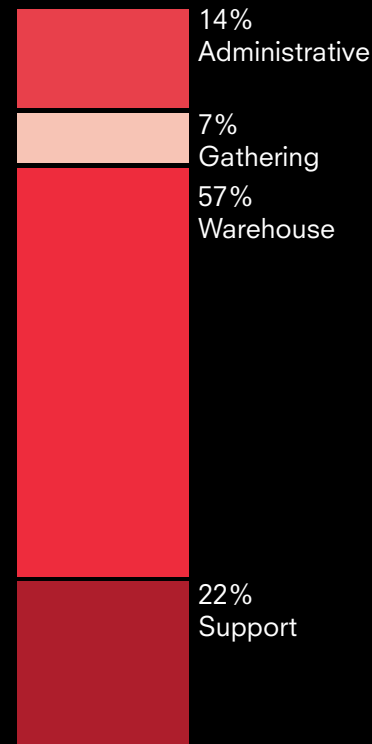

**ICRC
Geneva**

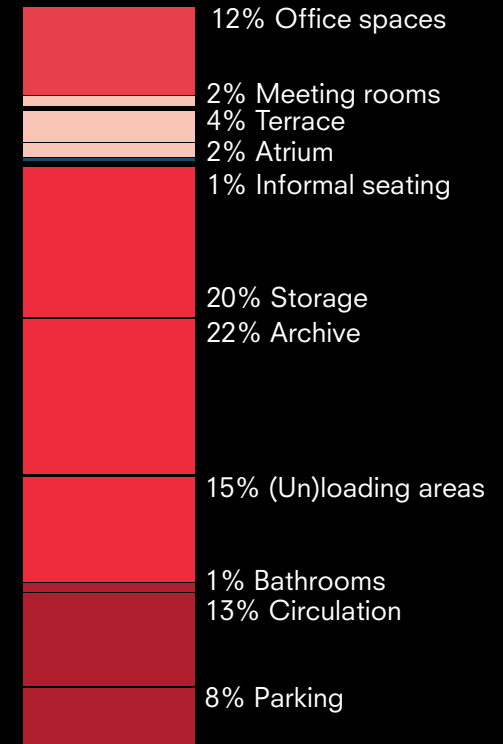

CRISIS HUB - PROGRAM BAR



KEY SPACES & CRISIS MANAGEMENT CYCLE

PREPAREDNESS



RESEARCH CENTER



VOLUNTEER CENTER



WAREHOUSE

RESPONSE



EMT BASE

DESIGN BRIEF

program

site

client

Design Brief
GROUP SITE PLAN



Design Brief

TEGEL AIRPORT - HISTORY

Construction for the Berlin Airlift, 1948



TXL Airport - 90 days construction, 1948
Reuse of rubble from wartime air raids
Berlin, Germany

TEGEL AIRPORT - HISTORY

End of commercial operations in 2020



DRK refugee hub at TXL airport, 2022
Capacity for 900 Ukrainian refugees



Design Brief

TEGEL AIRPORT - TODAY

Helicopter Flight Readiness Base, since 2018



Military apron at TXL becomes the helicopter base of the FIBschftBMVg

Design Brief

TEGEL AIRPORT - TODAY

TFK Disaster Control Base, since 2022



TFK settles at the Julius Leber Barracks.
Humanitarian relief operations in
cooperation w/ the German Red Cross

Design Brief

TEGEL - EXISTING SITUATION

Masterplan



FIBschftBMVg = Federal Ministry of Defense's Flight Readiness
 TerrFüKdoBw (TFK) = Territorial Command of the Armed Forces

EXISTING SITUATION - MILITARY APRON

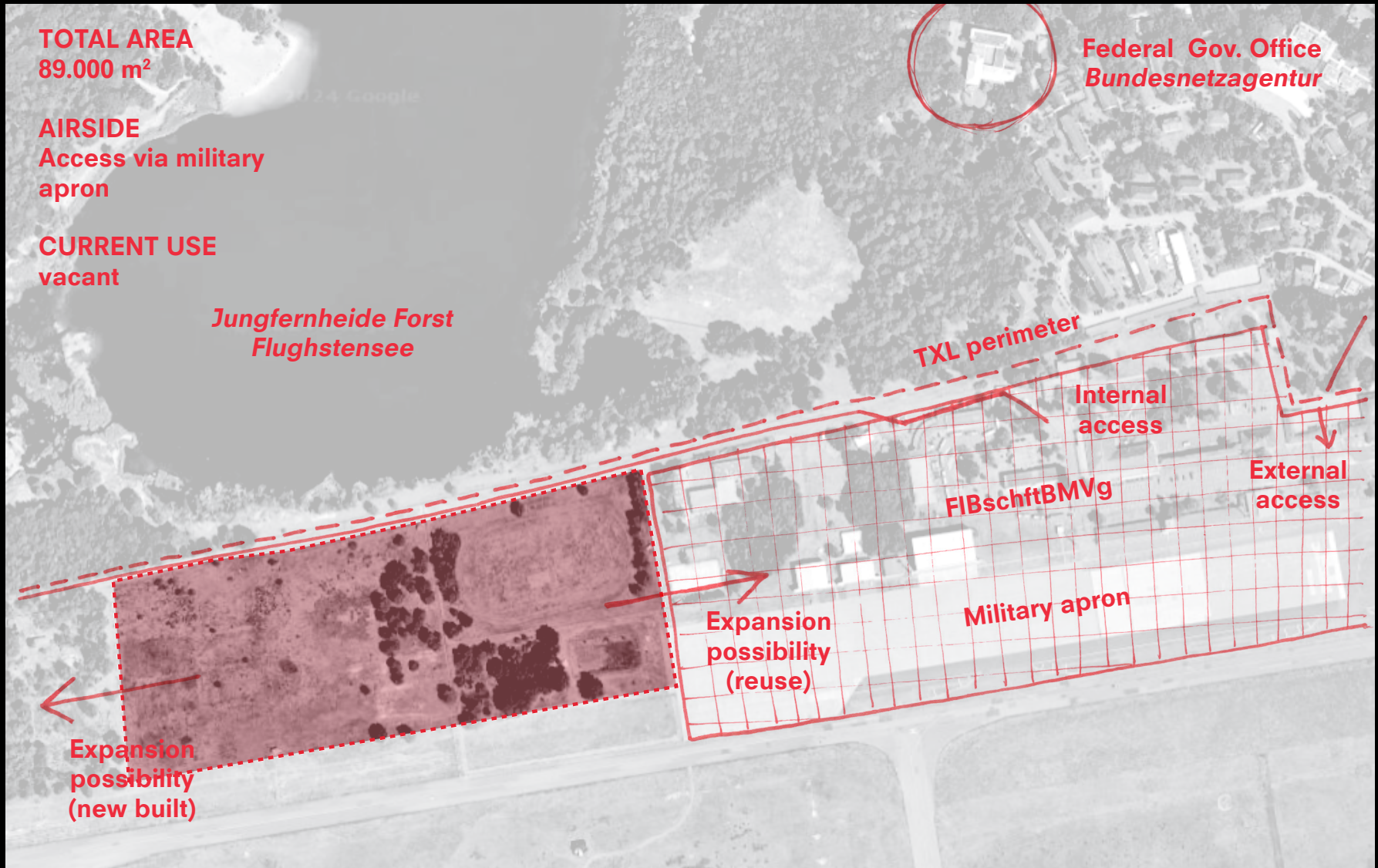

Scale 1:5000

DESIGN BRIEF

program

site

client

PROJECT PROPOSAL - CRISIS HUB



**Deutsches
Rotes
Kreuz**

RED CROSS MOVEMENT - EXISTING LOGISTICS FACILITIES



- Global Logistics Service *global coordination, management, support, and training*
- Zonal Logistics Unit (ZLU) *localized logistical support to National Societies*
- Logistics Hub *main storage points for pre-positioned stock*

BERLIN AS A HUB FOR MEDICAL RELIEF OPERATIONS

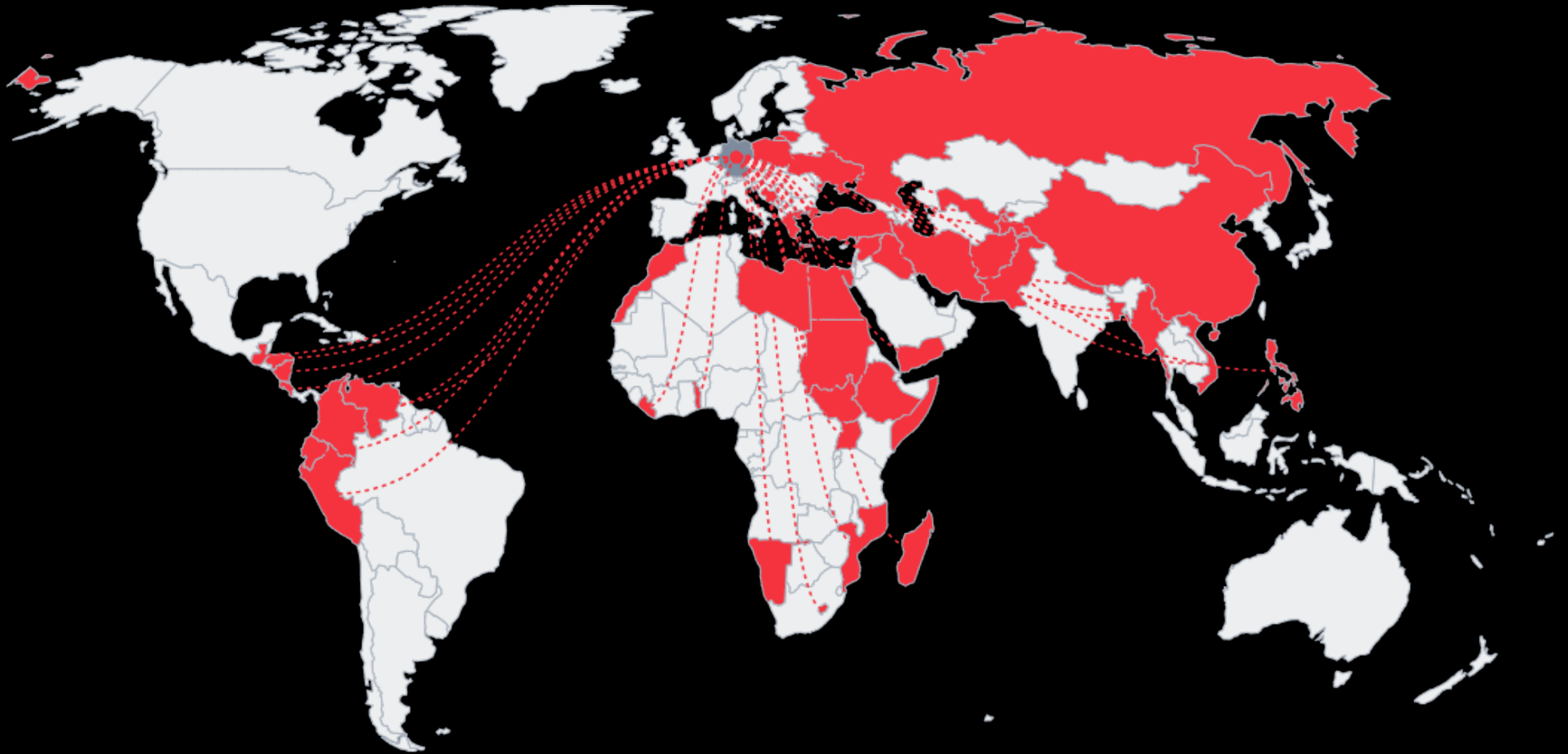

The German Red Cross has aided circa 3M people in 2022
More than half of the relief supplied was health-related

INTRODUCTION
RESEARCH
DESIGN BRIEF
CONCEPT
IMPLEMENTATION
DEVELOPMENT
CONCLUSION

CONCEPT

efficiency

contingency

standardisation

Concept
EFFICIENCY: SPLIT VOLUMES

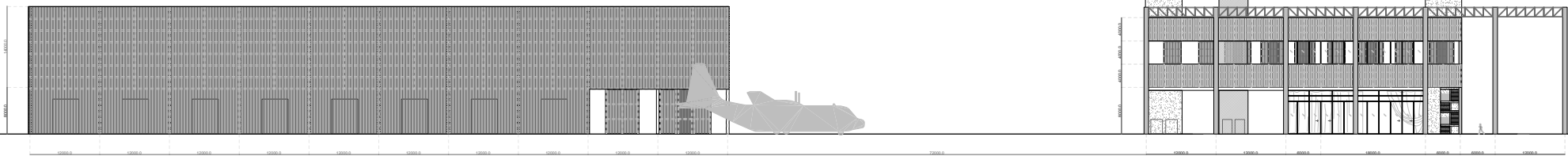

Concept
EFFICIENCY: DESIGNING WITHIN

WAREHOUSE SURGE

RESEARCH CENTER
MEDICAL TEAM BASE
VOLUNTEER CENTER SURGE

Concept
EFFICIENCY: SPLIT VOLUMES



Concept

EFFICIENCY: LOGISTICS ON THE GROUND



EFFICIENCY: LOGISTICS ON THE GROUND

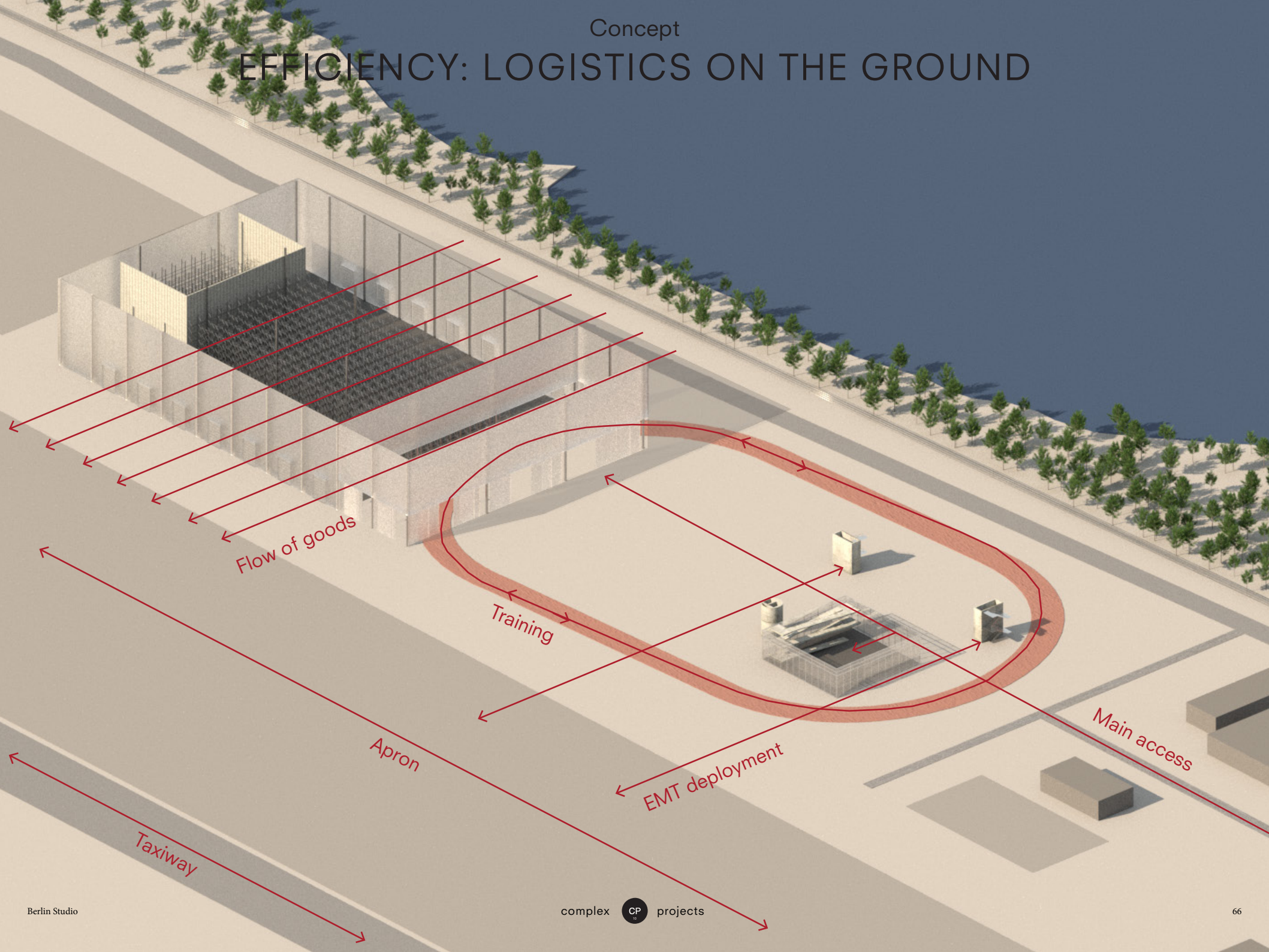

Flow of goods

Training

EMT deployment

Apron

Taxiway

Main access

Concept

EFFICIENCY: CIRCULATION

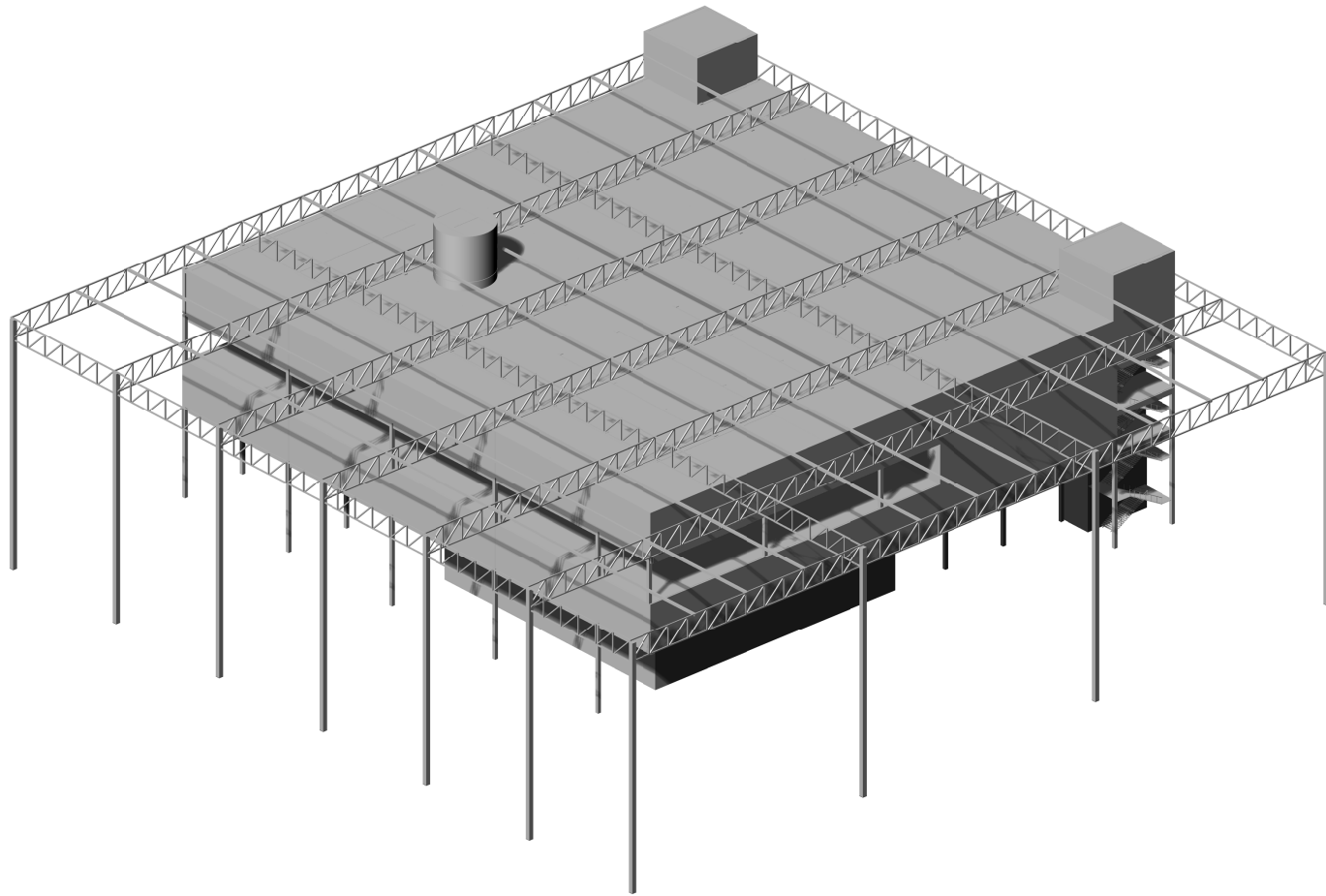

Concept
EFFICIENCY: CIRCULATION

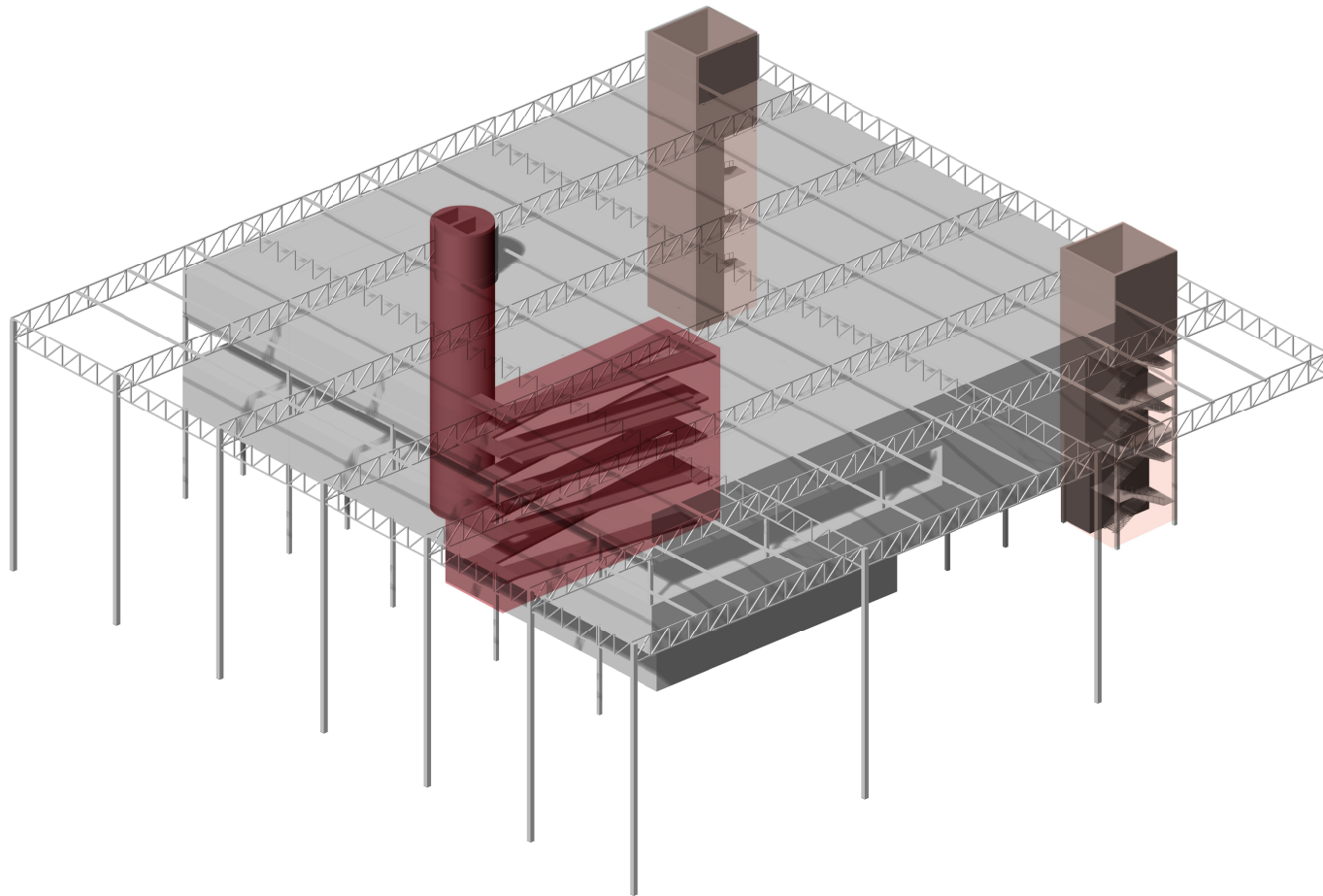

- Researchers & Volunteers (preparedness)
- Emergency Medical Team (response)

EFFICIENCY: CRISIS MANAGEMENT CYCLE

PREPAREDNESS

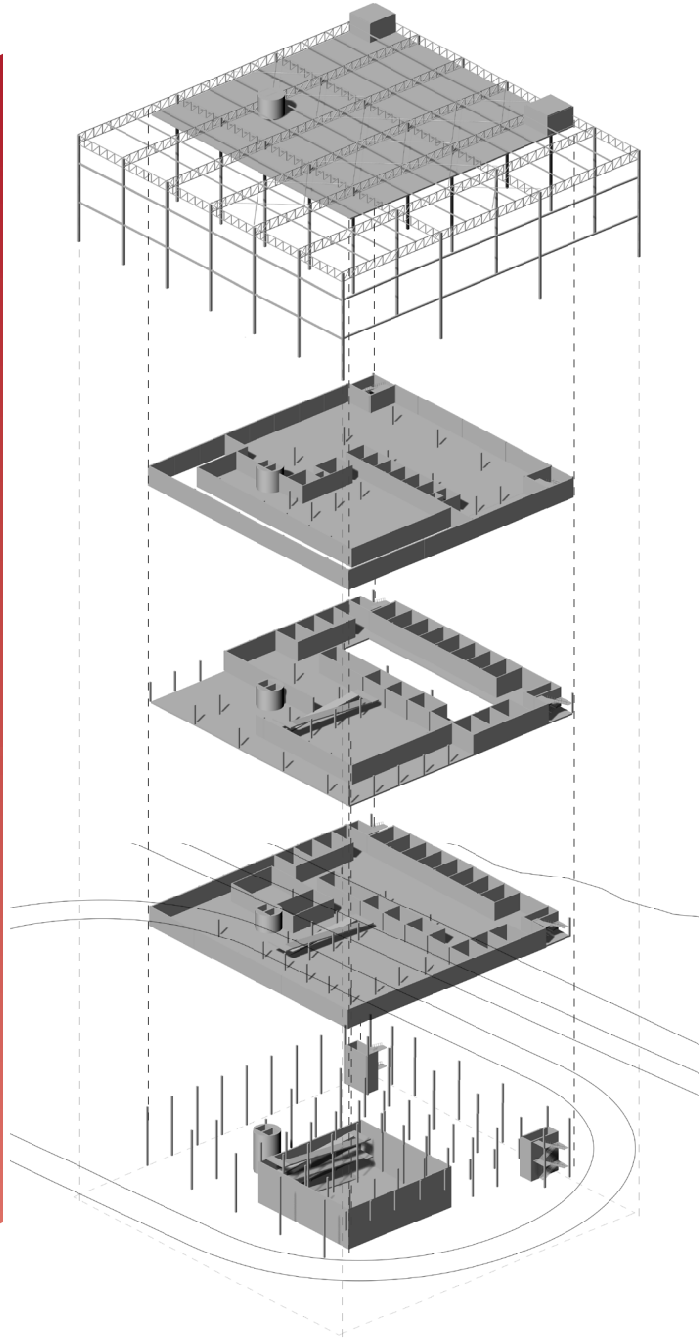

CONTINGENCY PLANNING

RESEARCH CENTER

EMERGENCY MEDICAL TEAM
VOLUNTEER CENTER

EMERGENCY MEDICAL TEAM
VOLUNTEER CENTER

SURGE CAPACITY
VOLUNTEER CENTER

RESPONSE

Concept
EFFICIENCY: PROGRAMME

RESEARCHERS

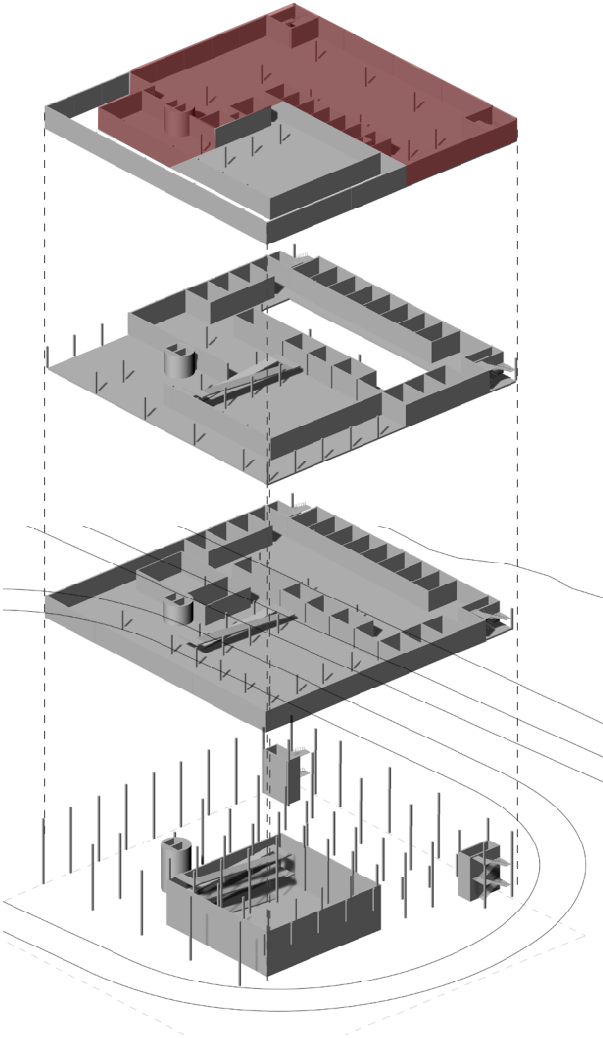

PREPAREDNESS

RESPONSE

Concept
EFFICIENCY: PROGRAMME

RESEARCHERS

VOLUNTEERS

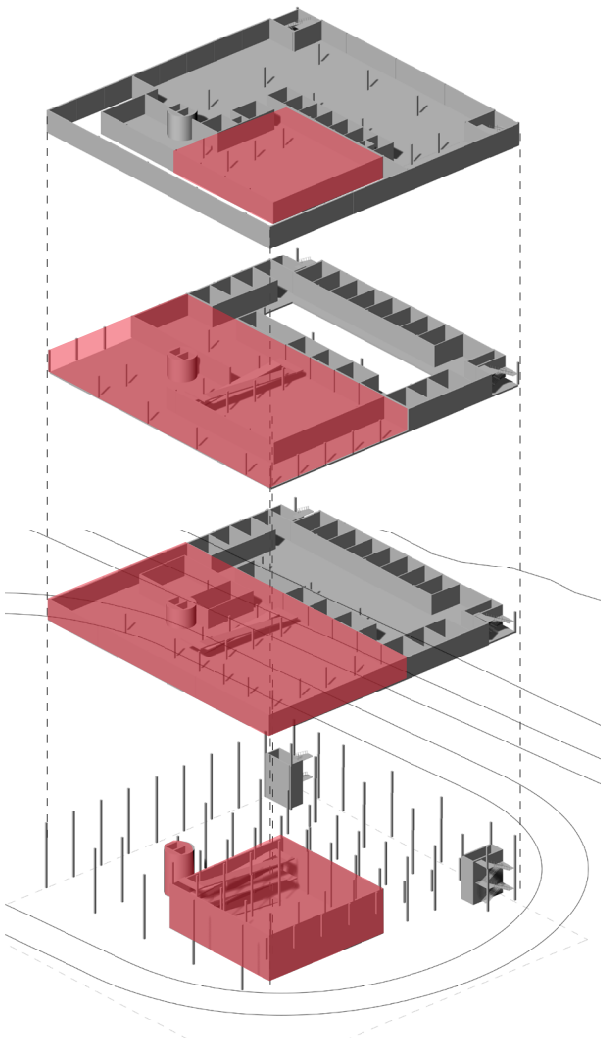
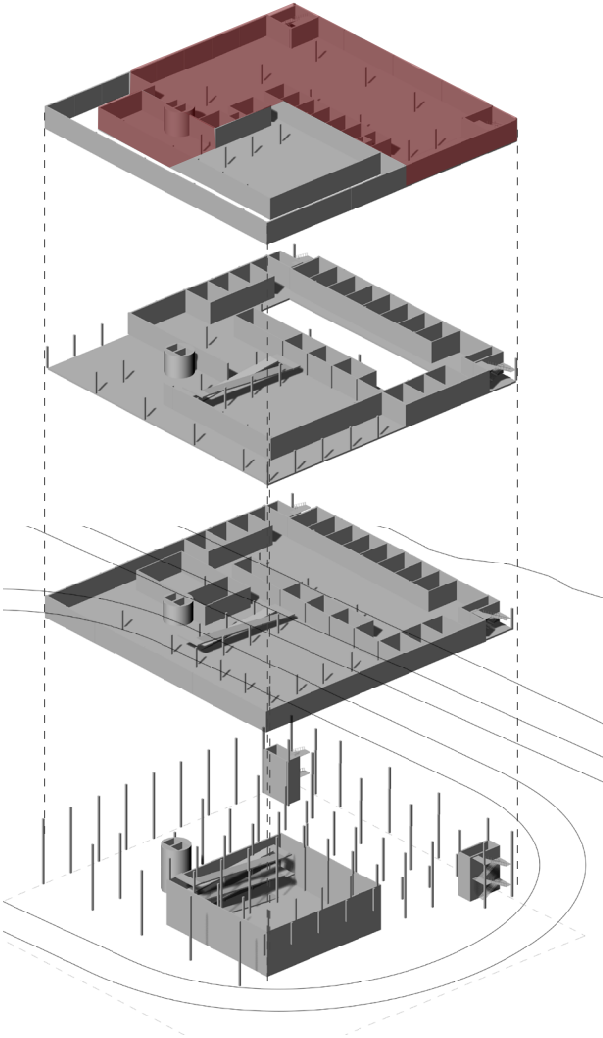

PREPAREDNESS

RESPONSE

Concept
EFFICIENCY: PROGRAMME

RESEARCHERS

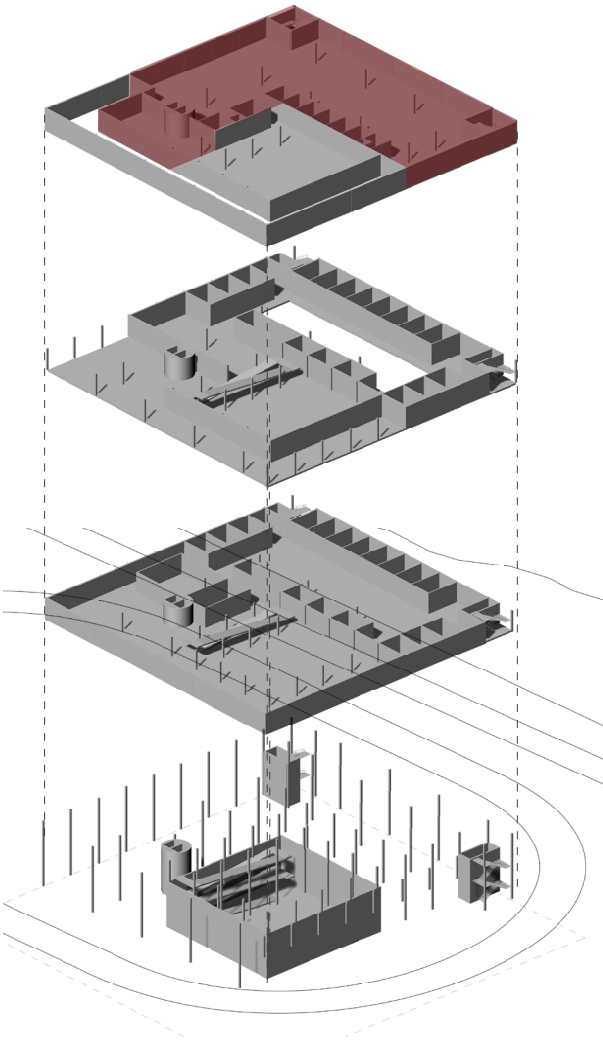

VOLUNTEERS

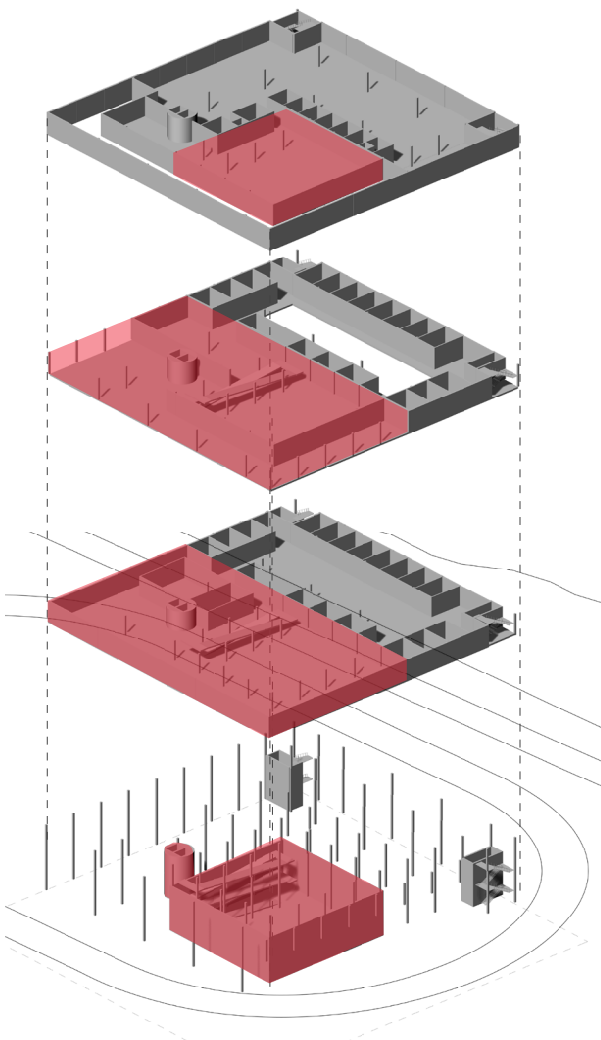

MEDICAL TEAMS

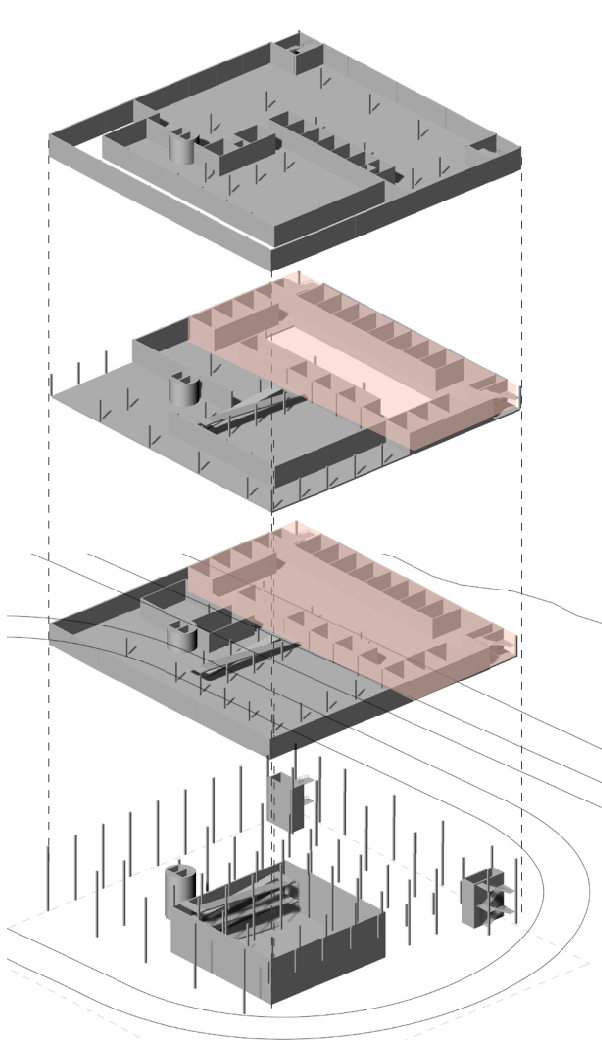

PREPAREDNESS

RESPONSE

CONCEPT

efficiency

contingency

standardisation

Concept

CONTINGENCY: DESIGNING FOR SURGE CAPACITY

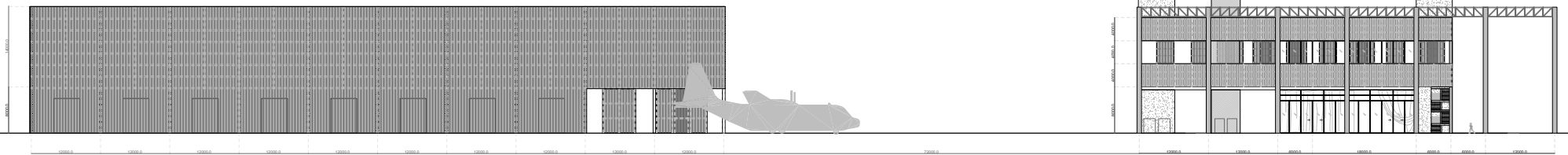

Concept

CONTINGENCY: DESIGNING THE "IN BETWEEN"

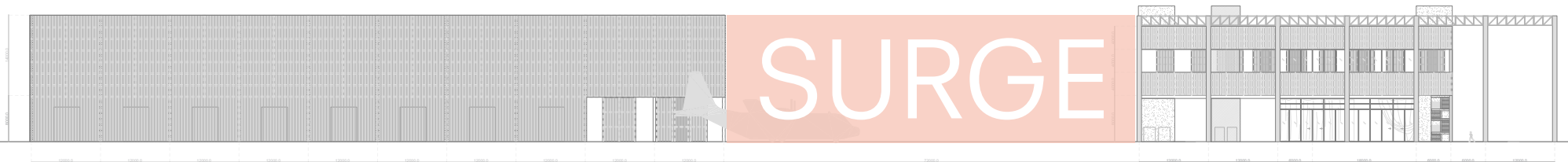

Concept

CONTINGENCY: DESIGNING FOR SURGE CAPACITY



Concept
CONTINGENCY: SCENARIO I



Concept

CONTINGENCY: SURGE SCENARIO II



STANDARD RED CROSS EMERGENCY HOSPITAL SETUP

Concept

CONTINGENCY: SURGE SCENARIO II

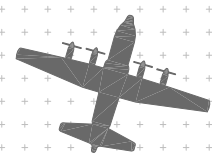
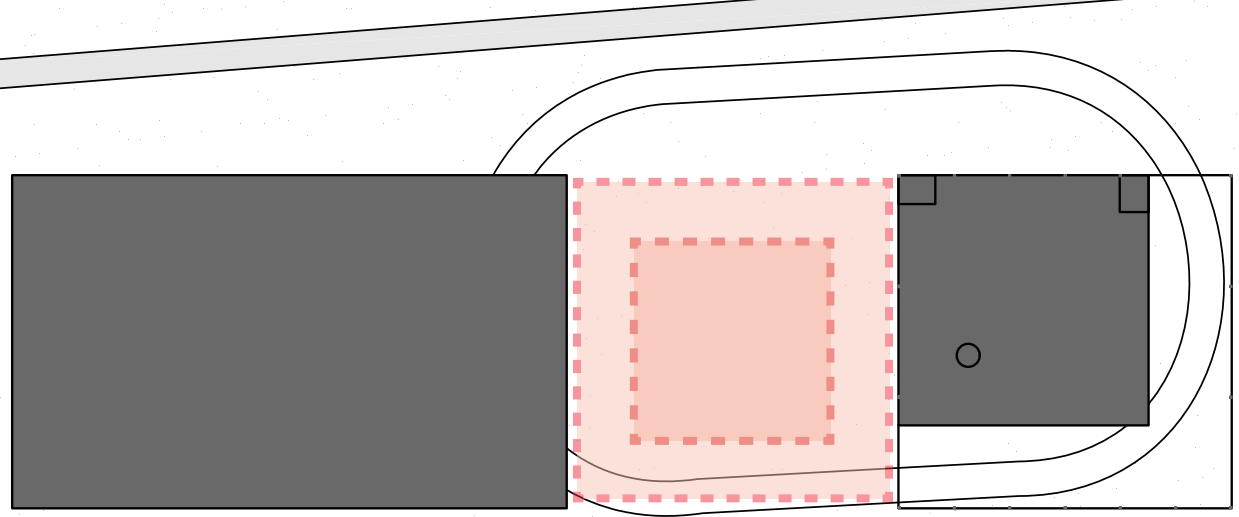

POSSIBILITY OF EXPANSION AS A PUBLIC HEALTH CRISIS HUB



Red Cross Emergency Health Clinic

Red Cross Emergency Health Hospital

Concept

CONTINGENCY: SURGE SCENARIO III

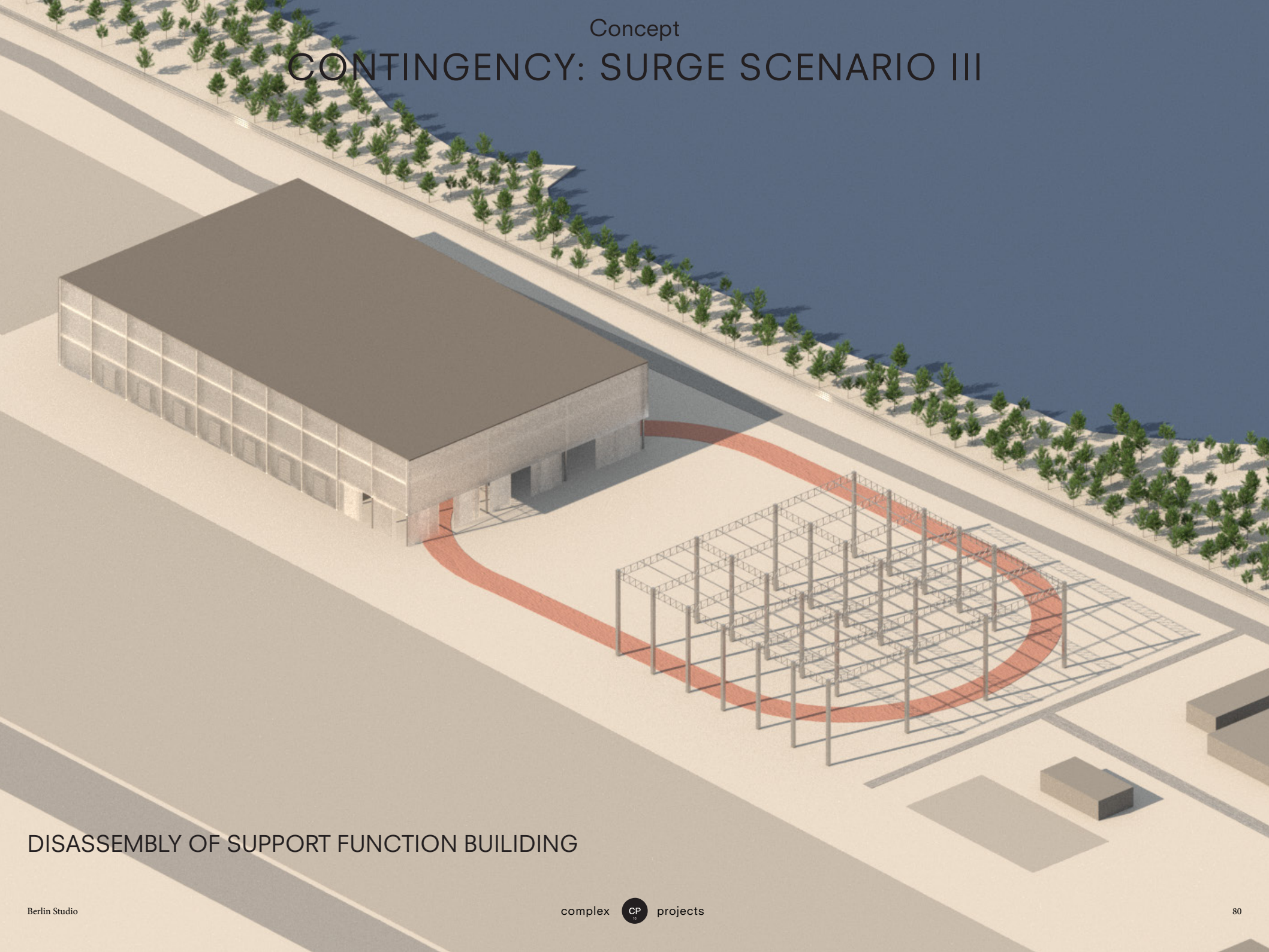

DISASSEMBLY OF SUPPORT FUNCTION BUILDING

Concept

CONTINGENCY: SURGE SCENARIO III



CONSTRUCTION OF A SECOND WAREHOUSE

CONCEPT

efficiency

contingency

standardisation

Concept
STANDARDISATION: SITE FREEDOM



Concept

STANDARDISATION: LOGISTICS' GRID

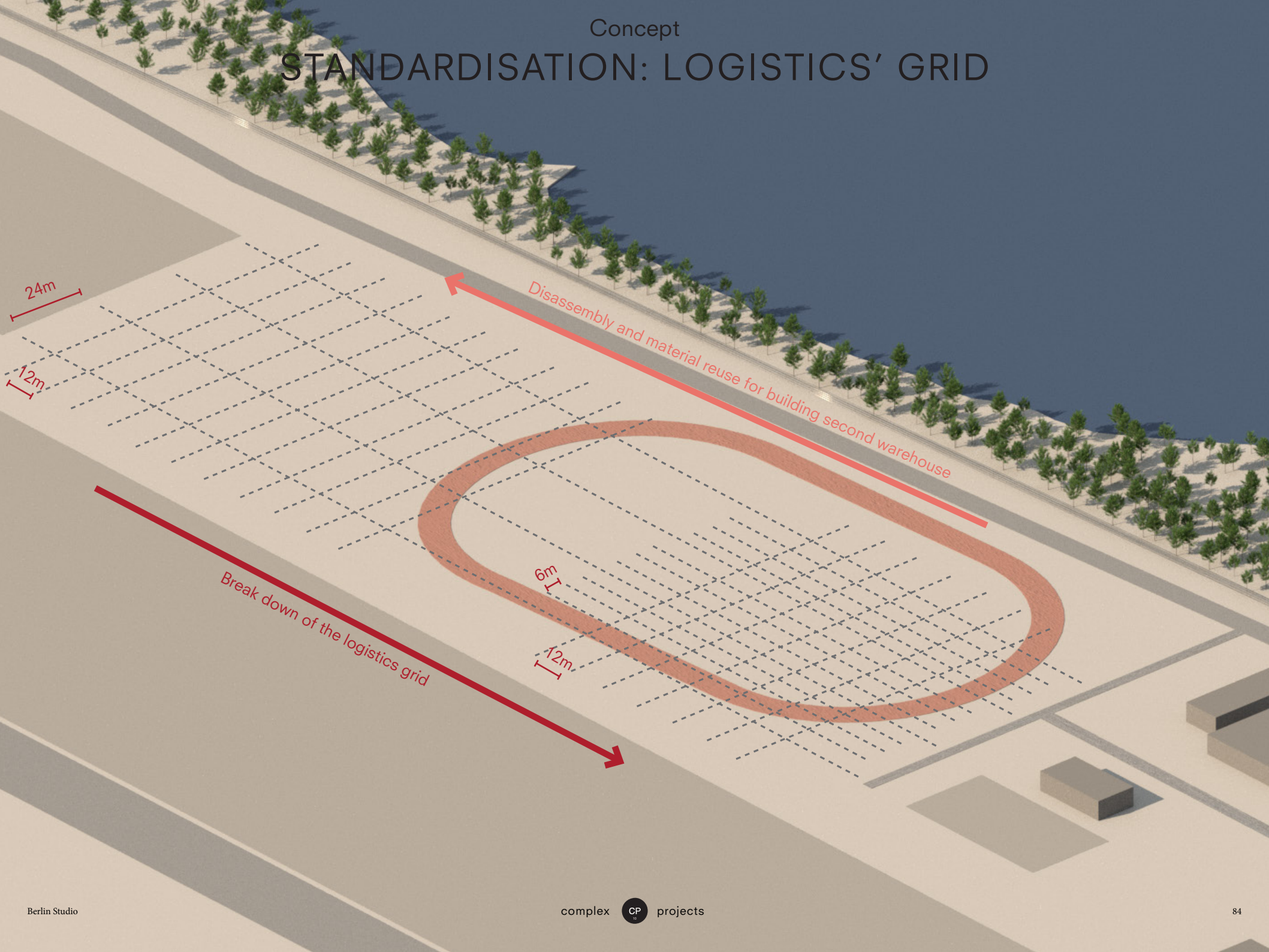

Concept

STANDARDISATION: MATERIAL REUSE



INTRODUCTION
RESEARCH
DESIGN BRIEF
CONCEPT
IMPLEMENTATION
DEVELOPMENT
CONCLUSION

Implementation
CRISIS HUB: FROM AIRSIDE



Implementation
CRISIS HUB: FROM AIRSIDE



Implementation SITE PLAN

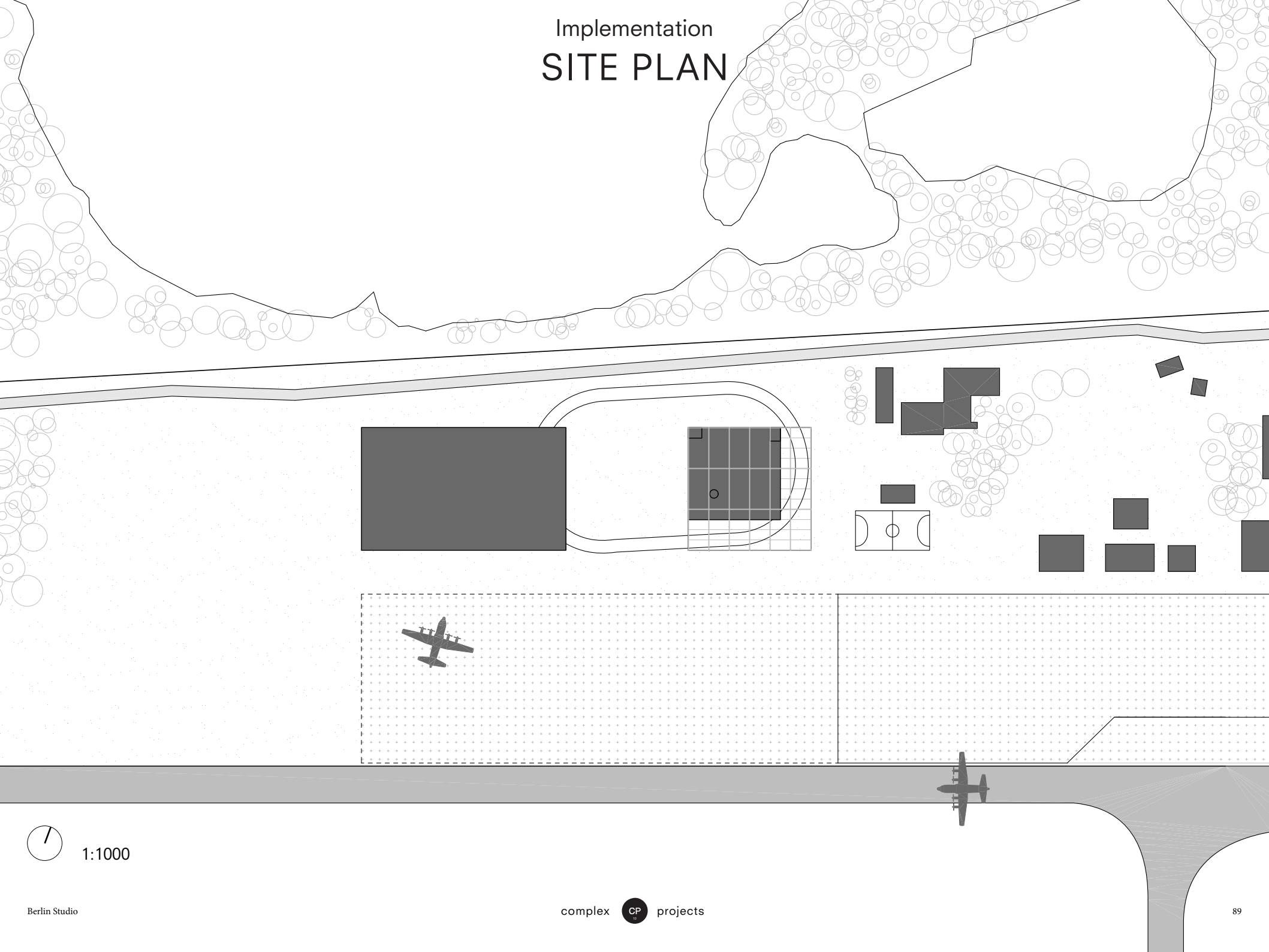

1:1000

URBAN IMPLEMENTATION

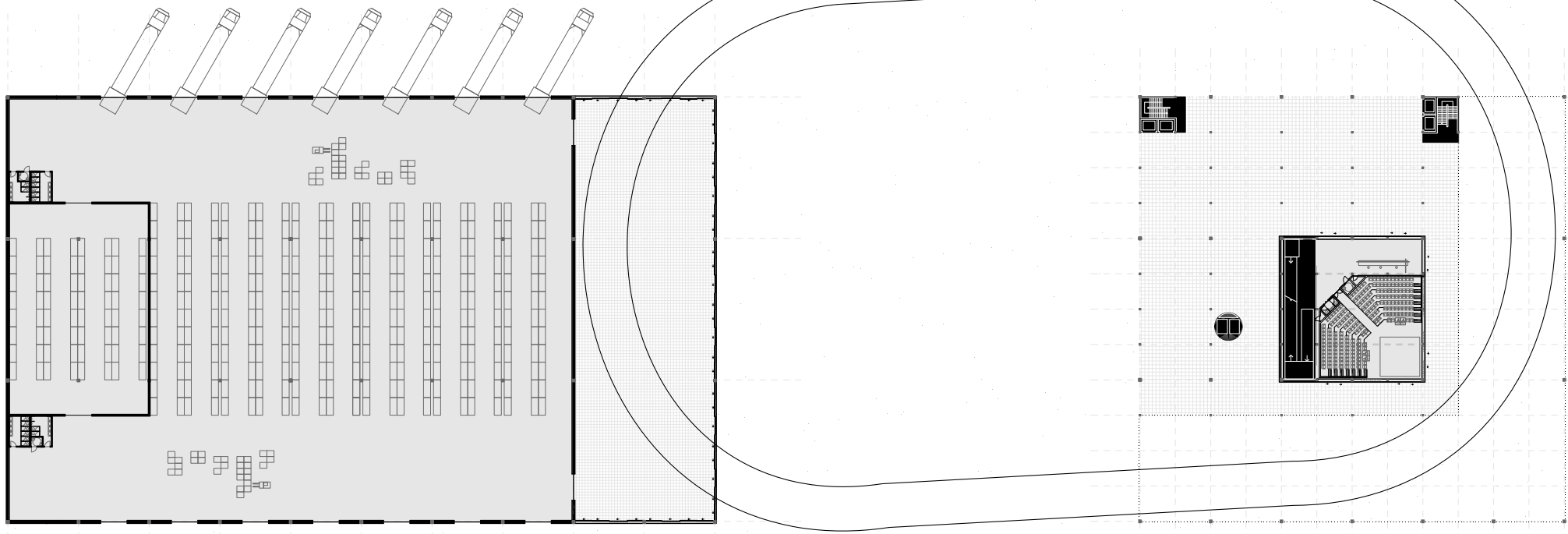

1:500

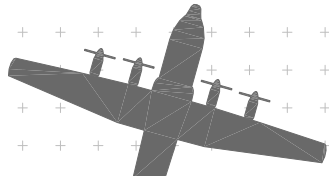

URBAN IMPLEMENTATION

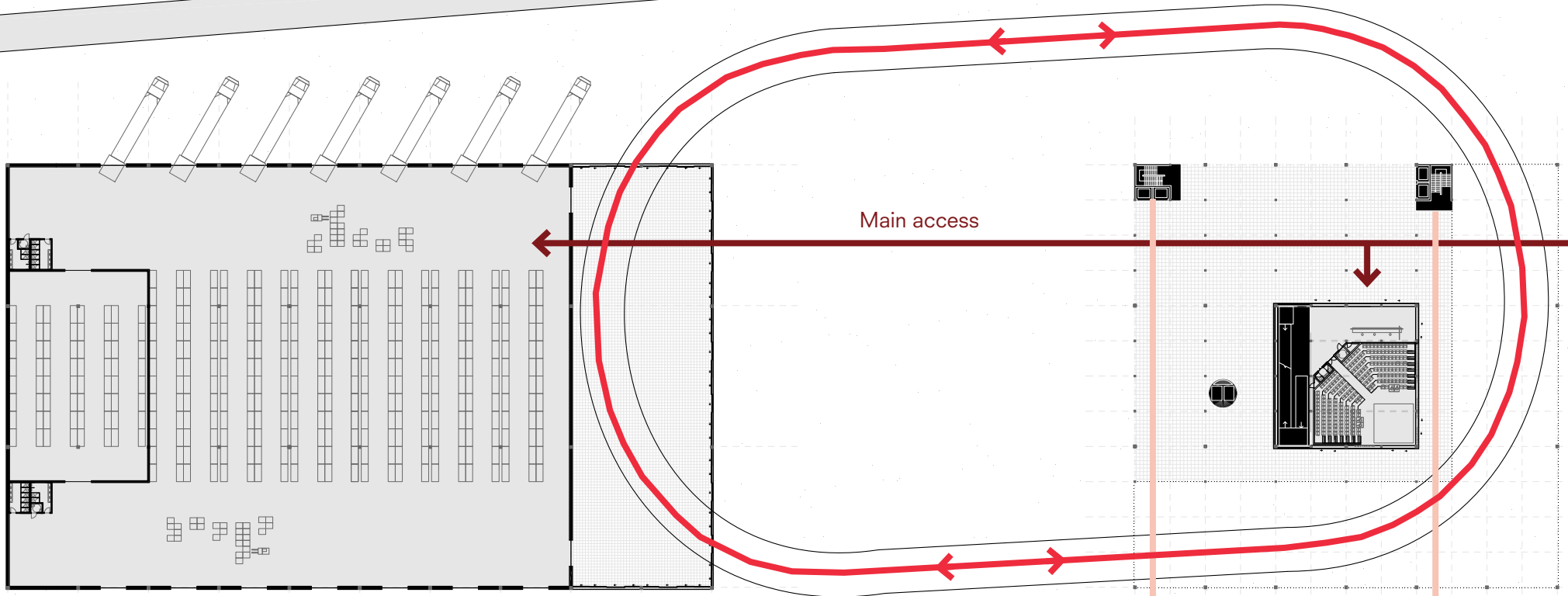

1:500

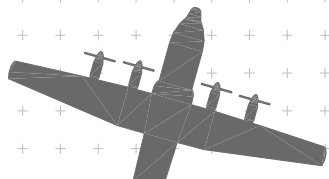

Implementation

SUPPORT FUNCTION BUILDING: MAIN ACCESS



Implementation

SUPPORT FUNCTION BUILDING: EMT DEPLOYMENT



Implementation

SUPPORT FUNCTION BUILDING: TRAINING ACTIVITIES



Implementation

00 FLOOR PLAN

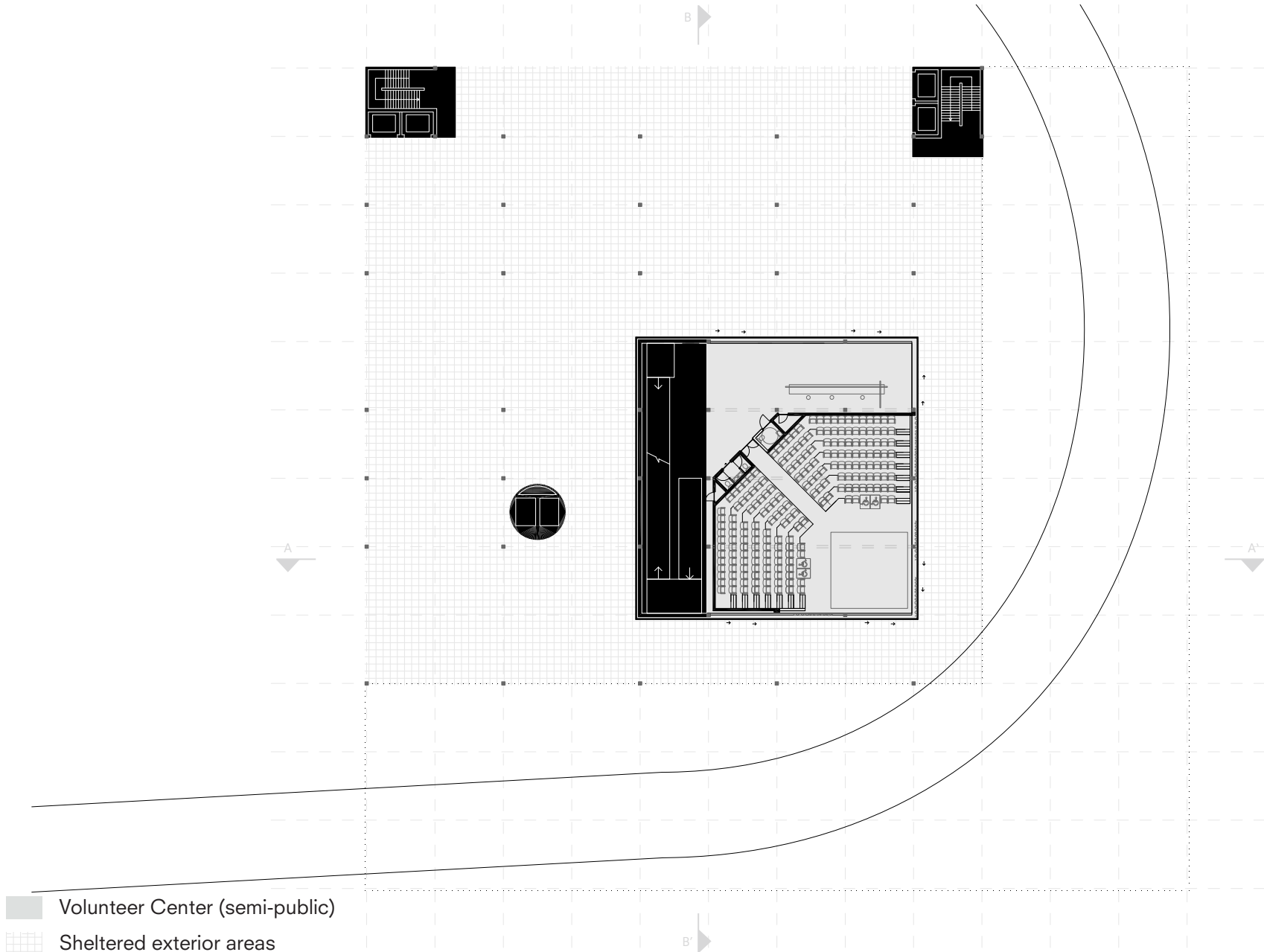

- Volunteer Center (semi-public)
- Sheltered exterior areas

1:200

Implementation
PREPAREDNESS: VOLUNTEER CENTER

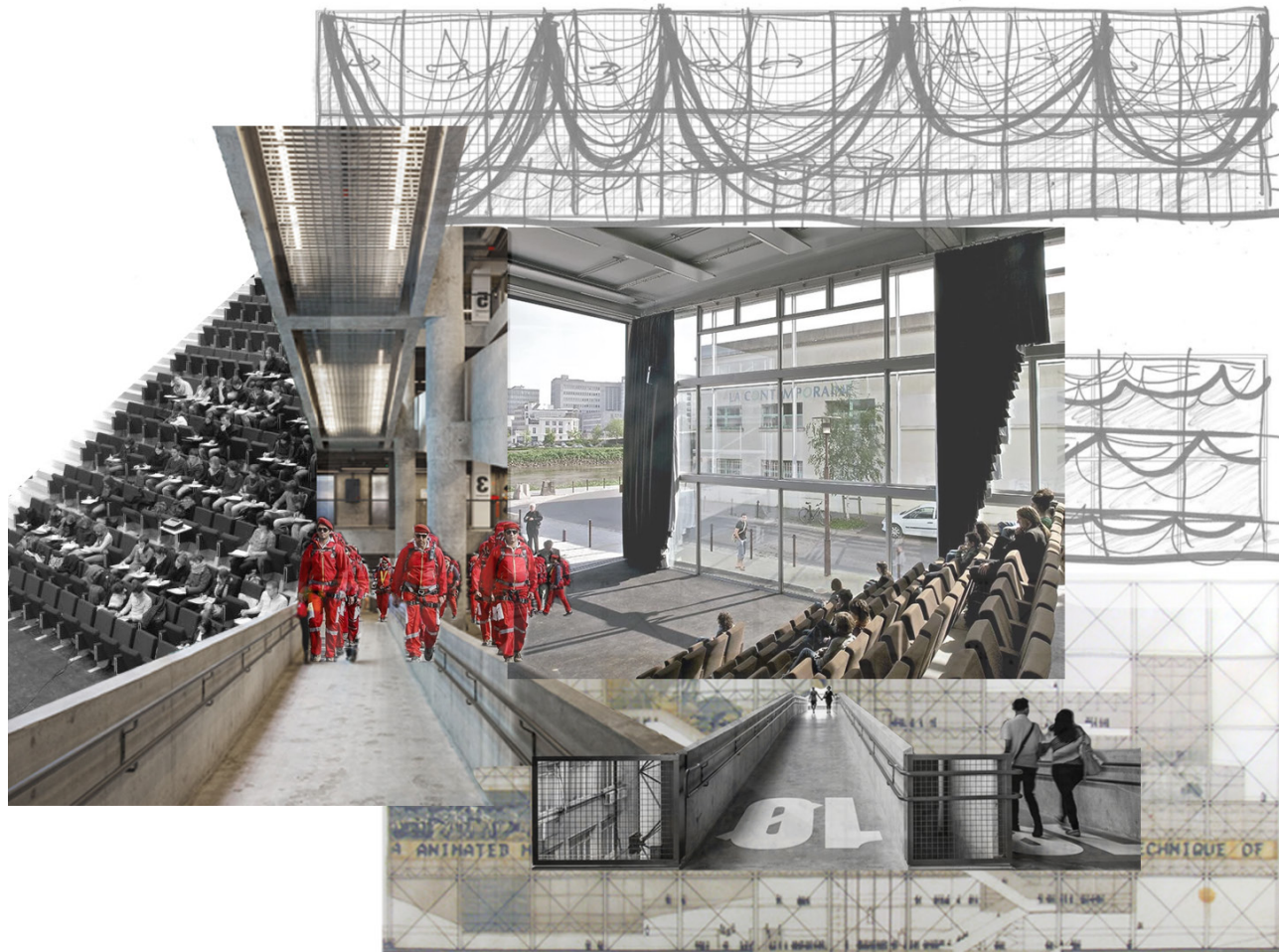

Implementation

01 FLOOR PLAN

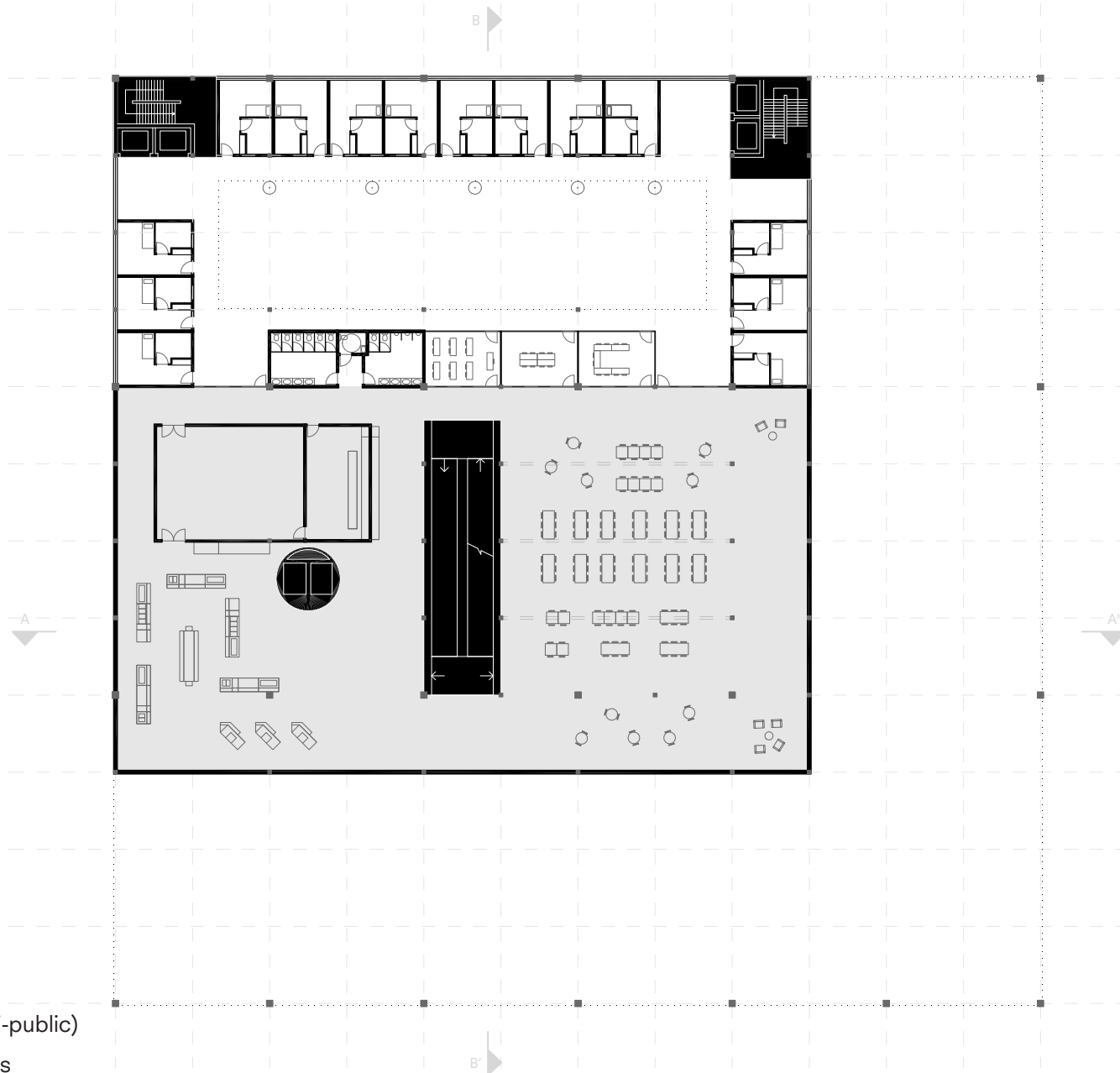

Volunteer Center (semi-public)

Sheltered exterior areas

1:200

Implementation 02 FLOOR PLAN

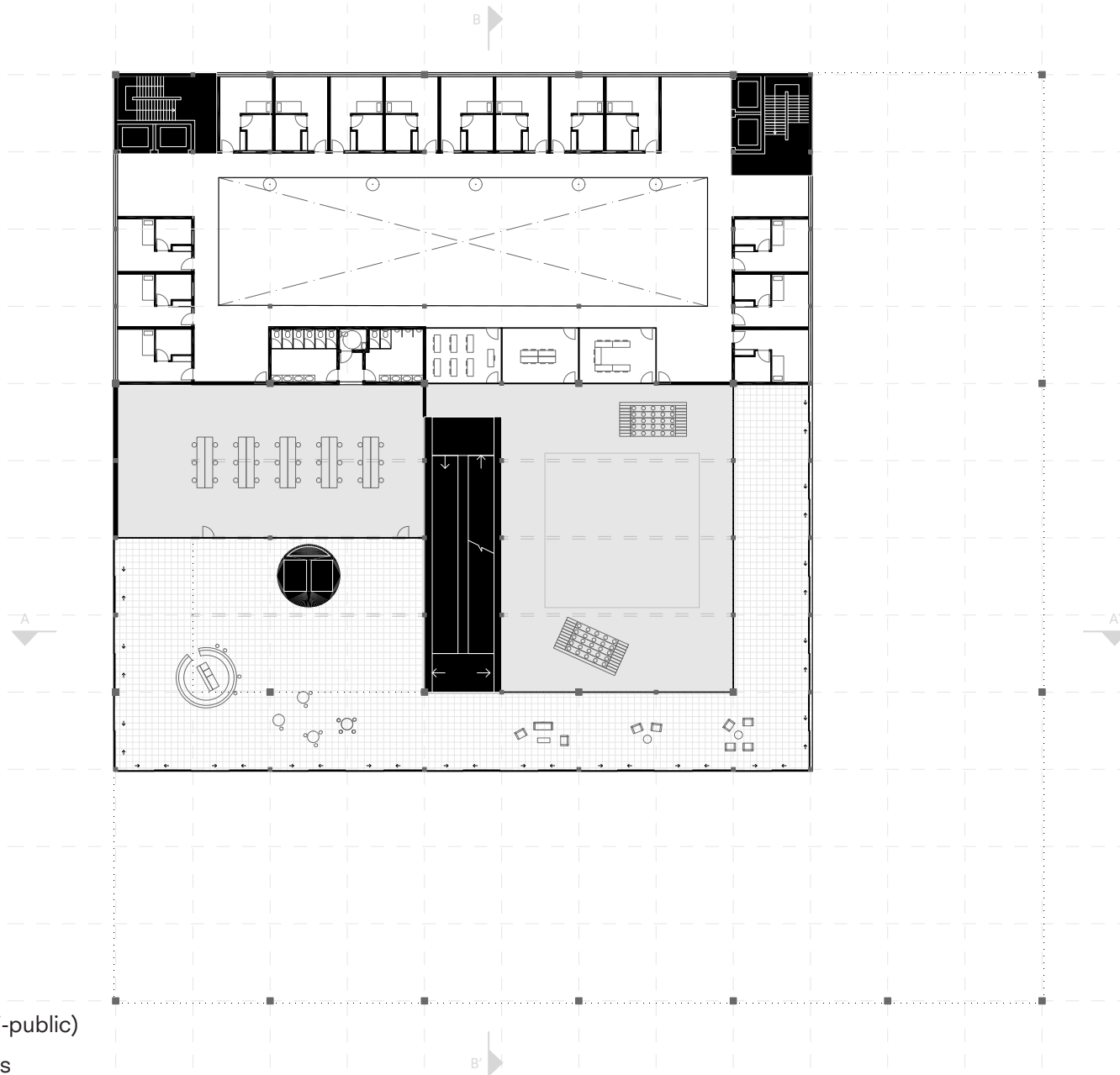

- Volunteer Center (semi-public)
- Sheltered exterior areas

1:200

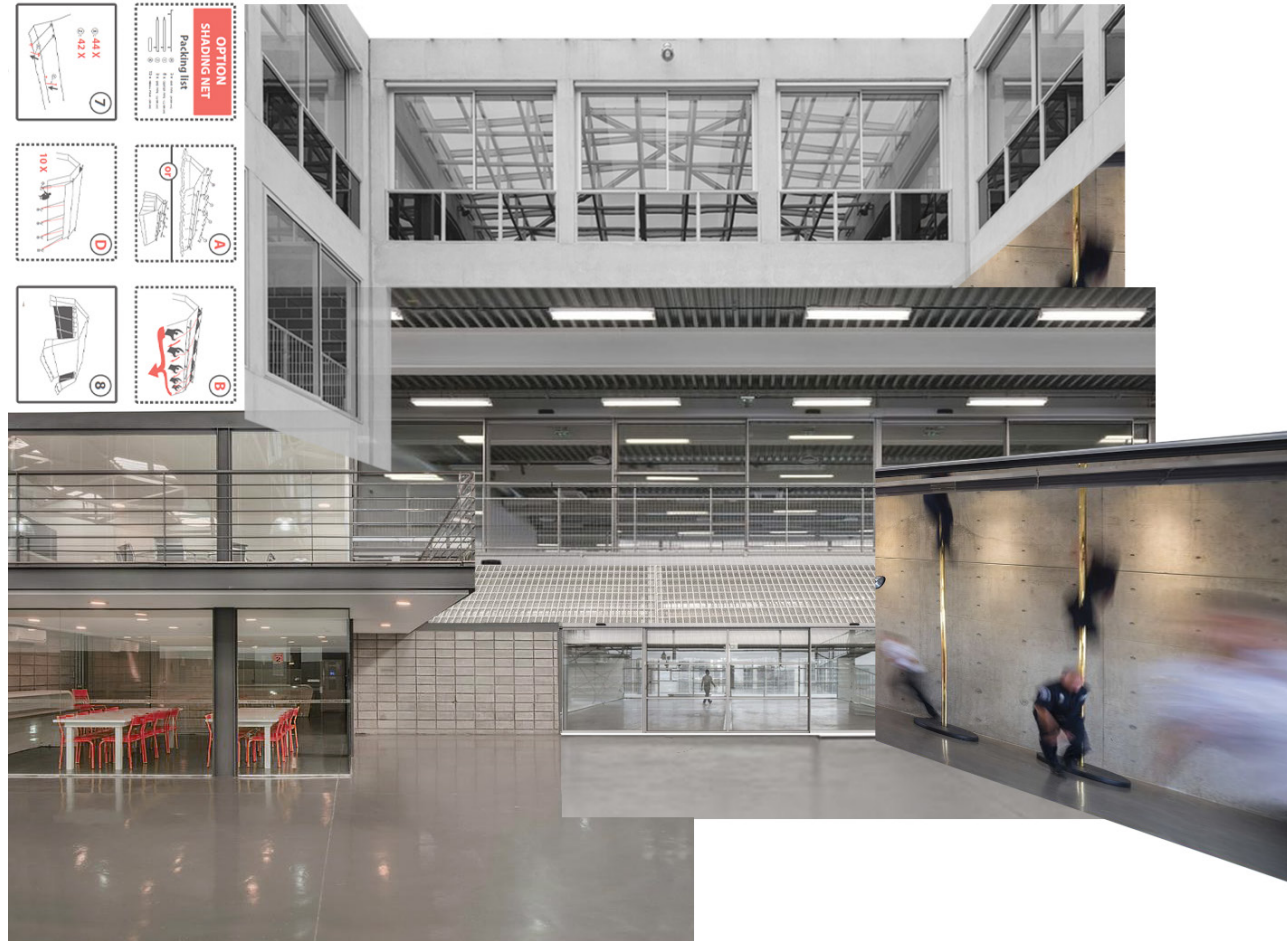

Implementation

RESPONSE: MEDICAL TEAM BASE

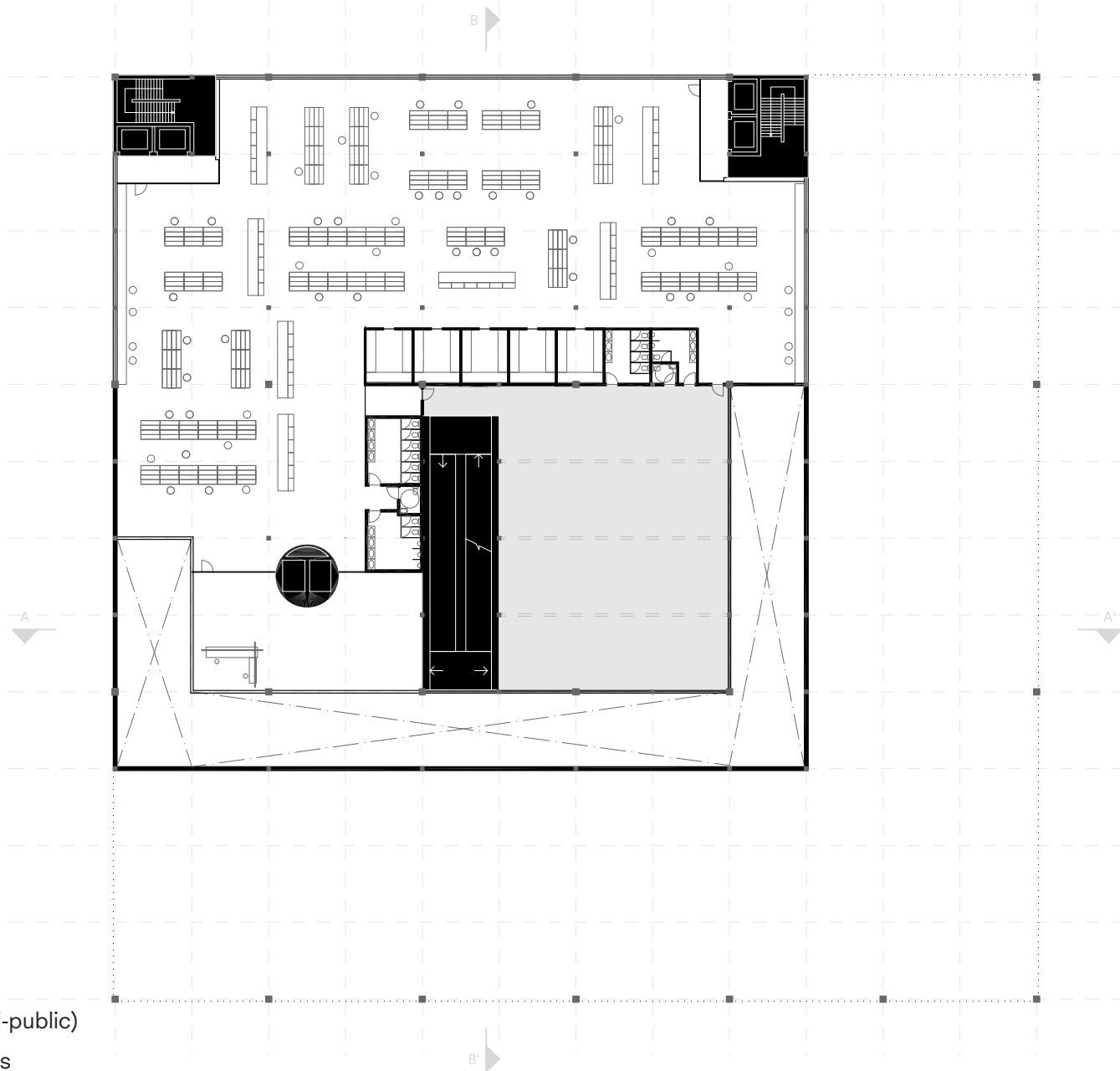

Implementation 03 FLOOR PLAN



-  Volunteer Center (semi-public)
-  Sheltered exterior areas

 1:200

Implementation
PREPAREDNESS: RESEARCH CENTER



Implementation

CROSS SECTION BB'

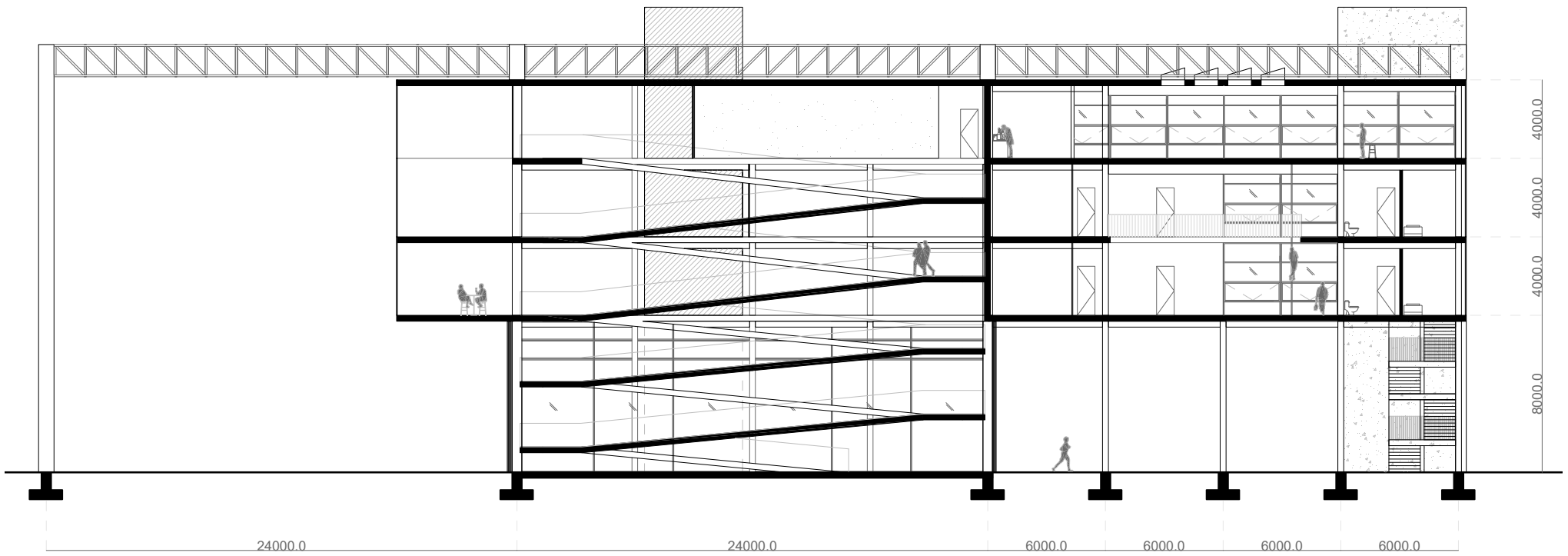

1:200

Implementation CROSS SECTION BB'

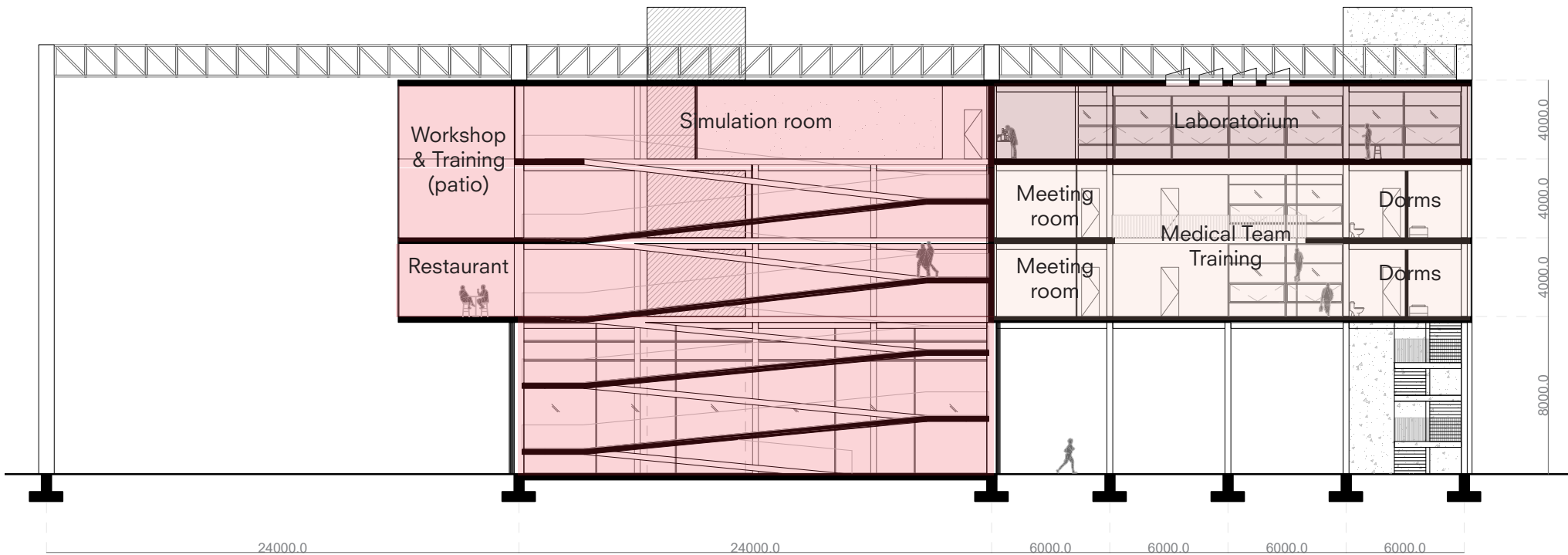

- Research Center (private)
- Volunteer Center (semi-public)
- Emergency Medical Team Base (private)

1:200

Implementation
CROSS SECTION AA'

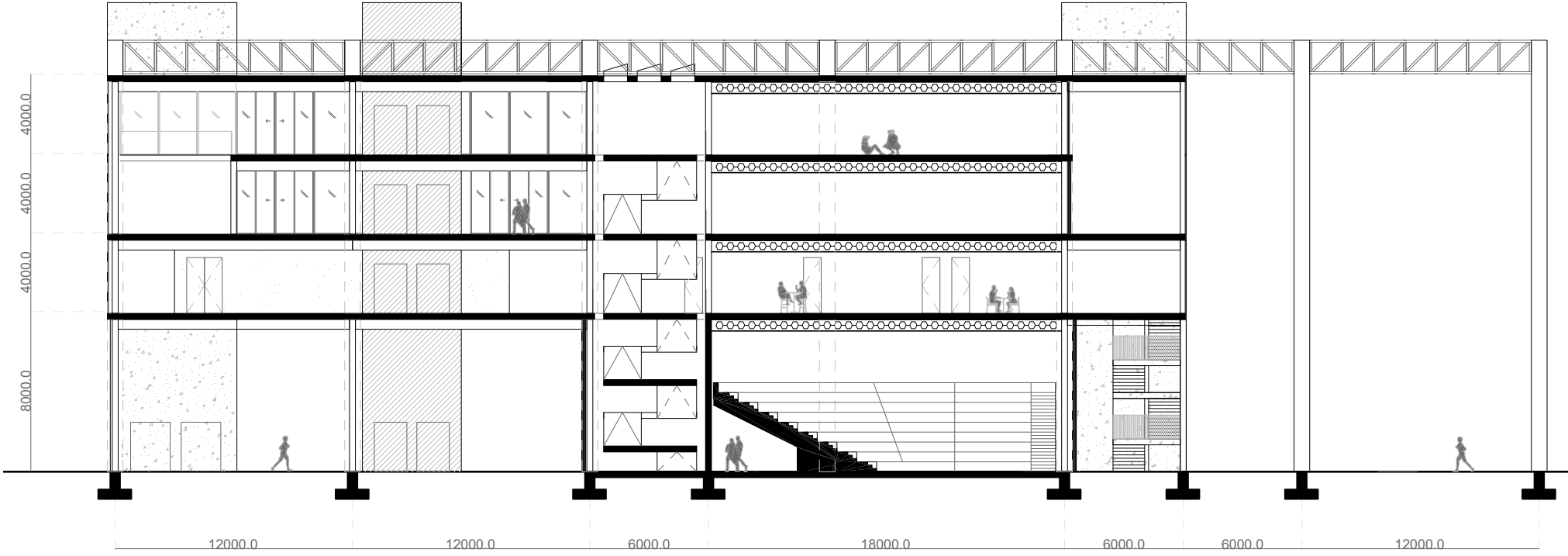

1:200

Implementation

CROSS SECTION AA'

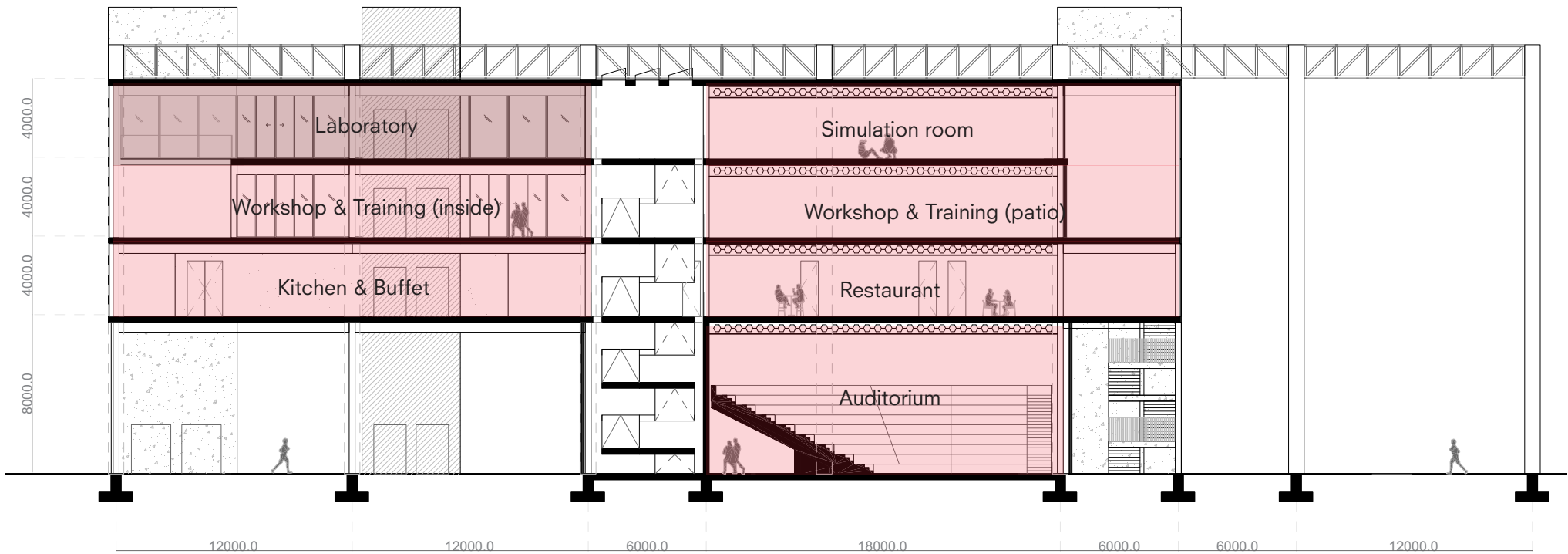

- Research Center (private)
- Volunteer Center (semi-public)

1:200

Implementation
ELEVATION EAST - MAIN ACCESS

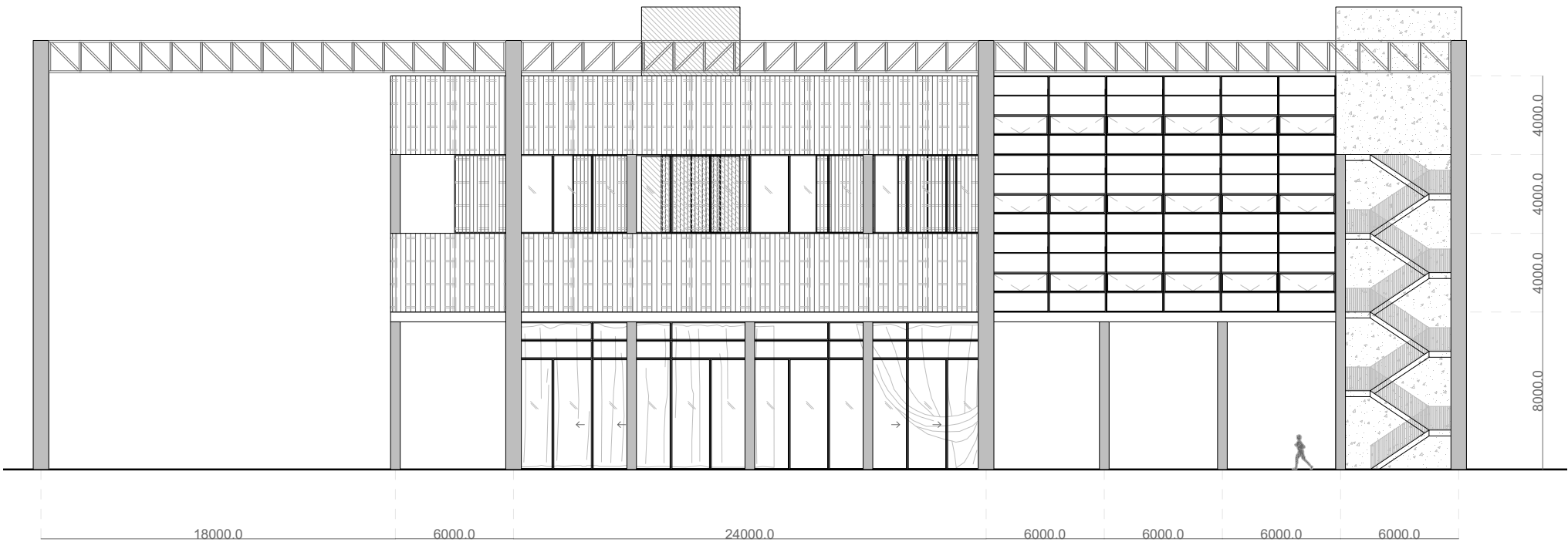

1:200

Implementation
ELEVATION WEST - FROM WAREHOUSE

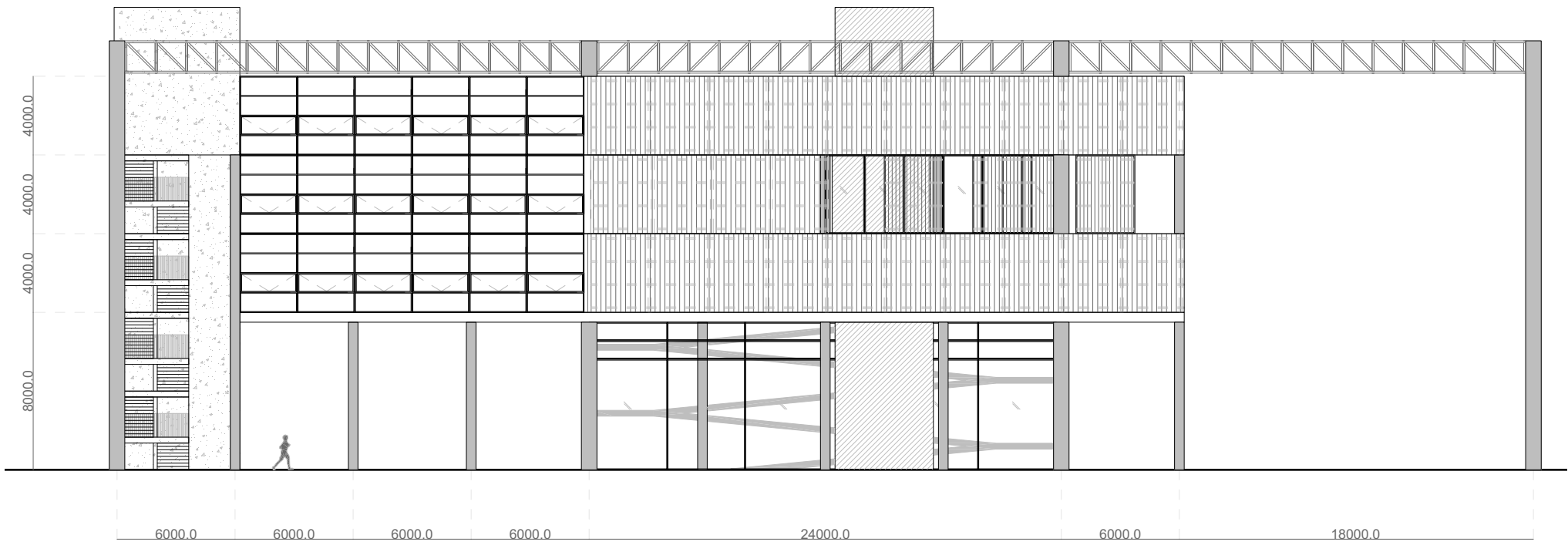

1:200

Implementation
ELEVATION NORTH - LANDSIDE

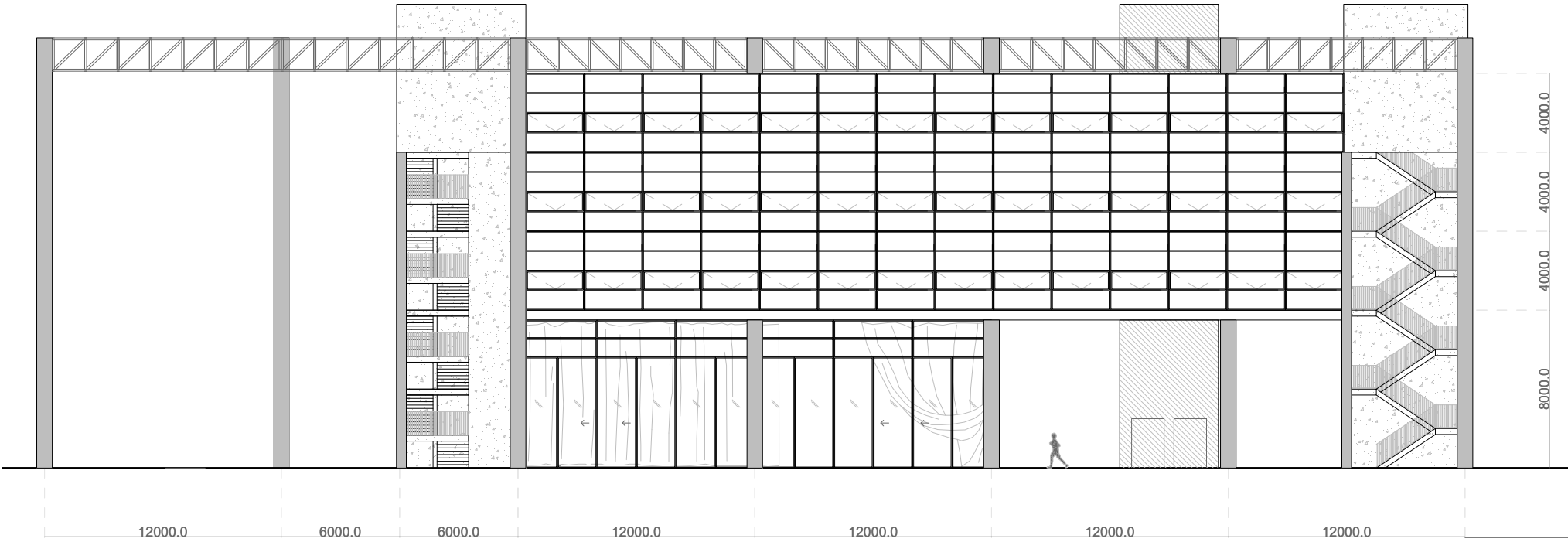

1:200

Implementation
ELEVATION SOUTH - AIRSIDE

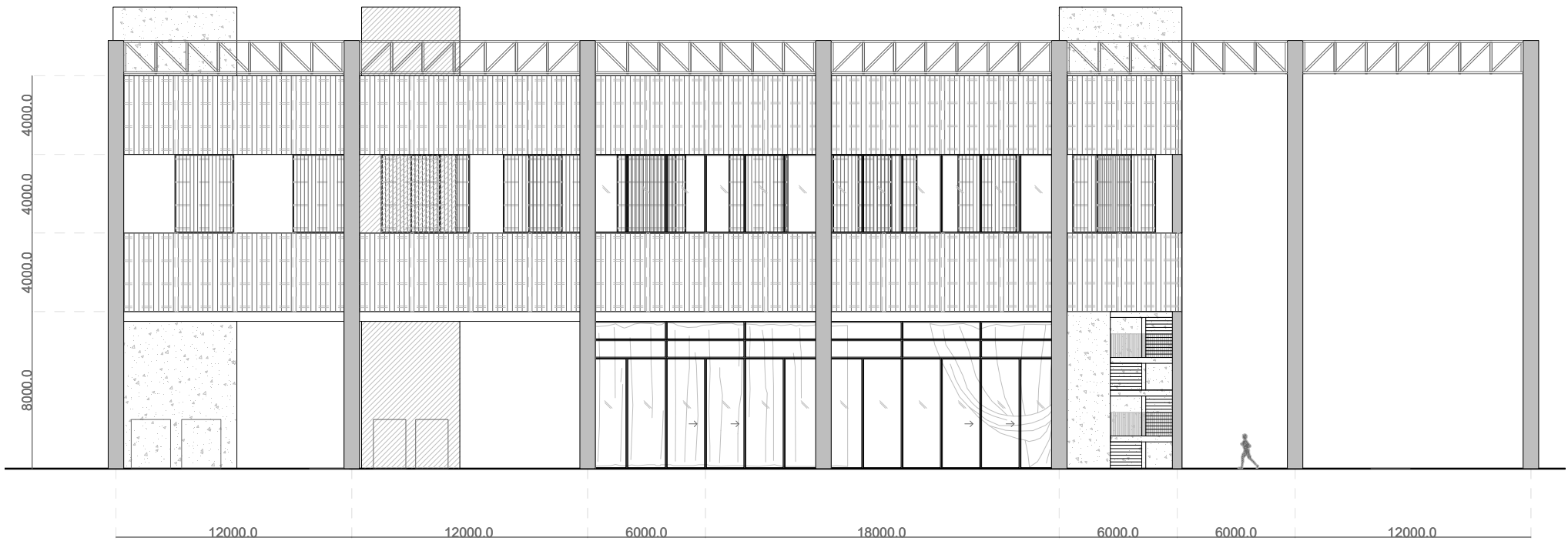

1:200

Implementation

ELEVATIONS - MASTERPLAN

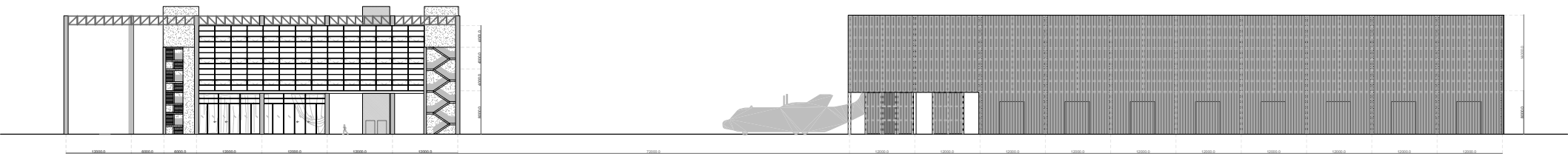

NORTH (LANDSIDE)

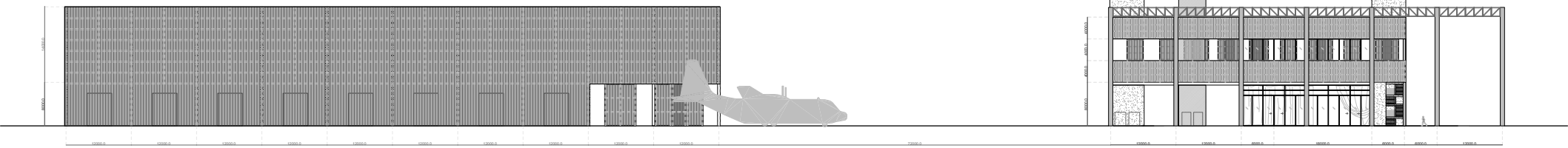

SOUTH (AIRSIDE)

INTRODUCTION
RESEARCH
DESIGN BRIEF
CONCEPT
IMPLEMENTATION
DEVELOPMENT
CONCLUSION

Development
INTERIOR FRAGMENT

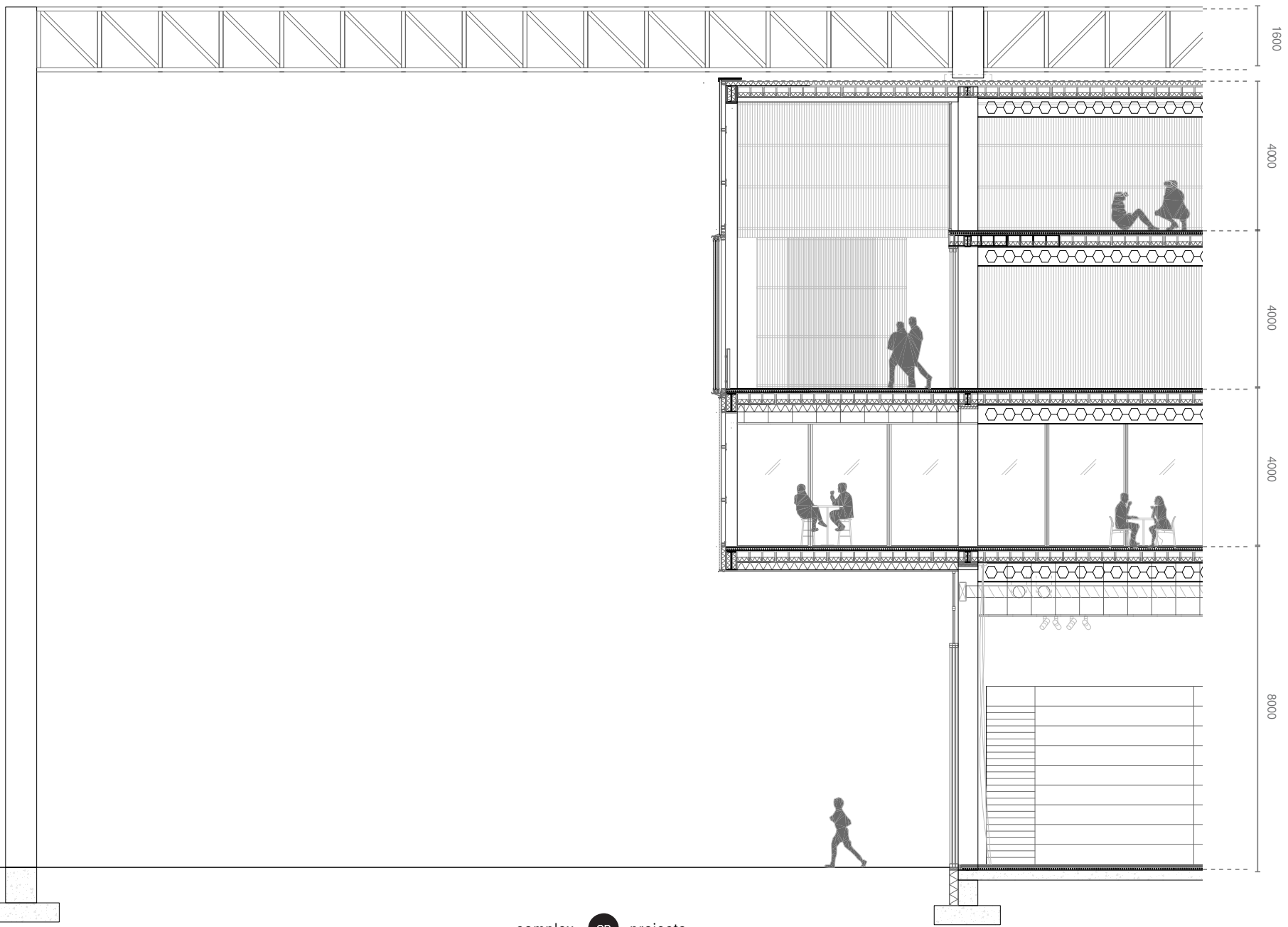

1:50

Development
FRAGMENT MODEL 1:100



Development
FRAGMENT MODEL 1:100



Development
FRAGMENT MODEL 1:100



Development
FRAGMENT MODEL 1:100



Development 00 FLOOR PLAN

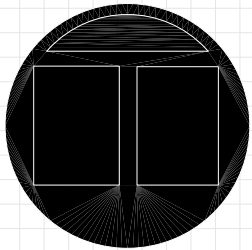
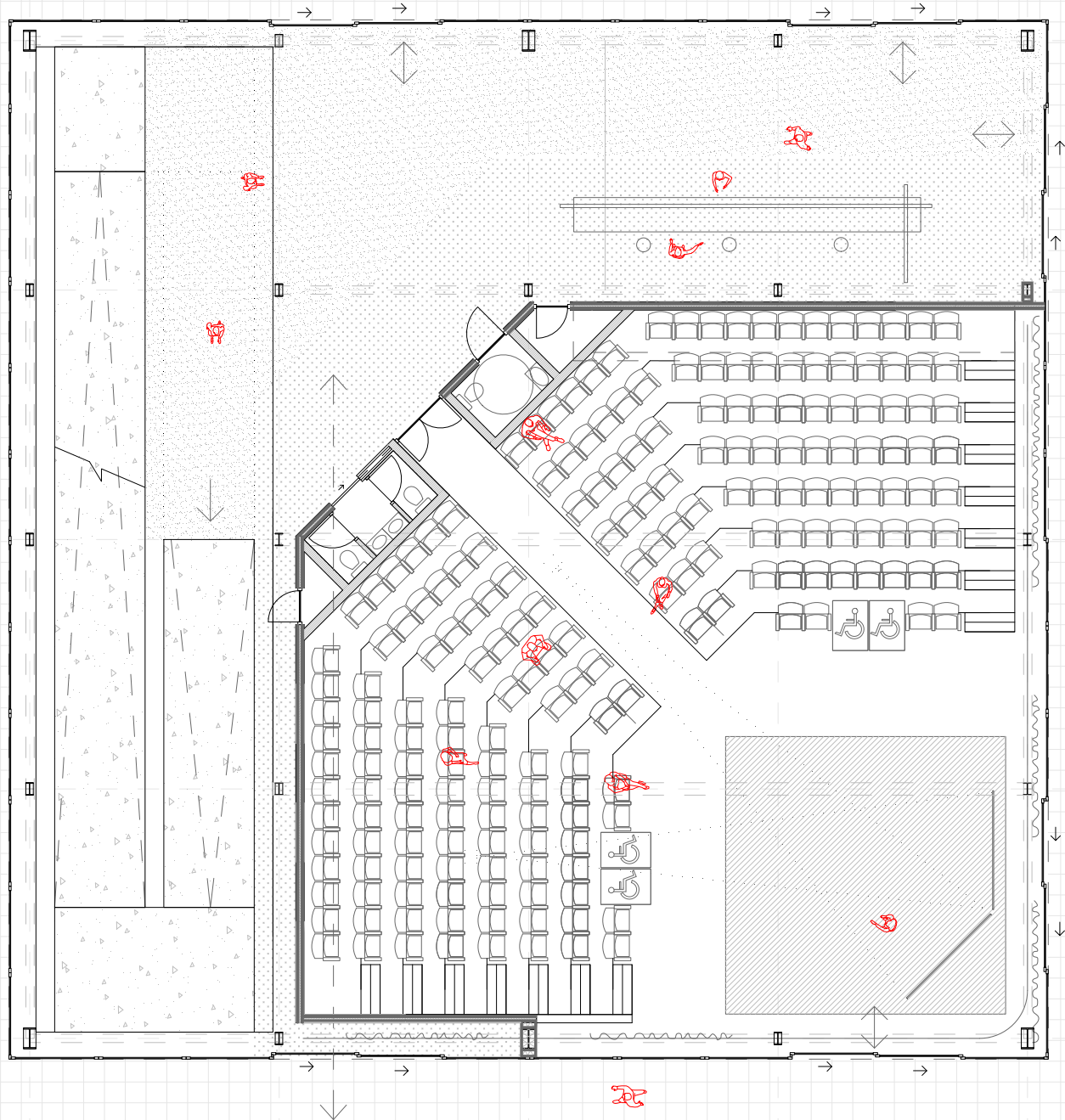

1:50

Development ENVELOPE FRAGMENT

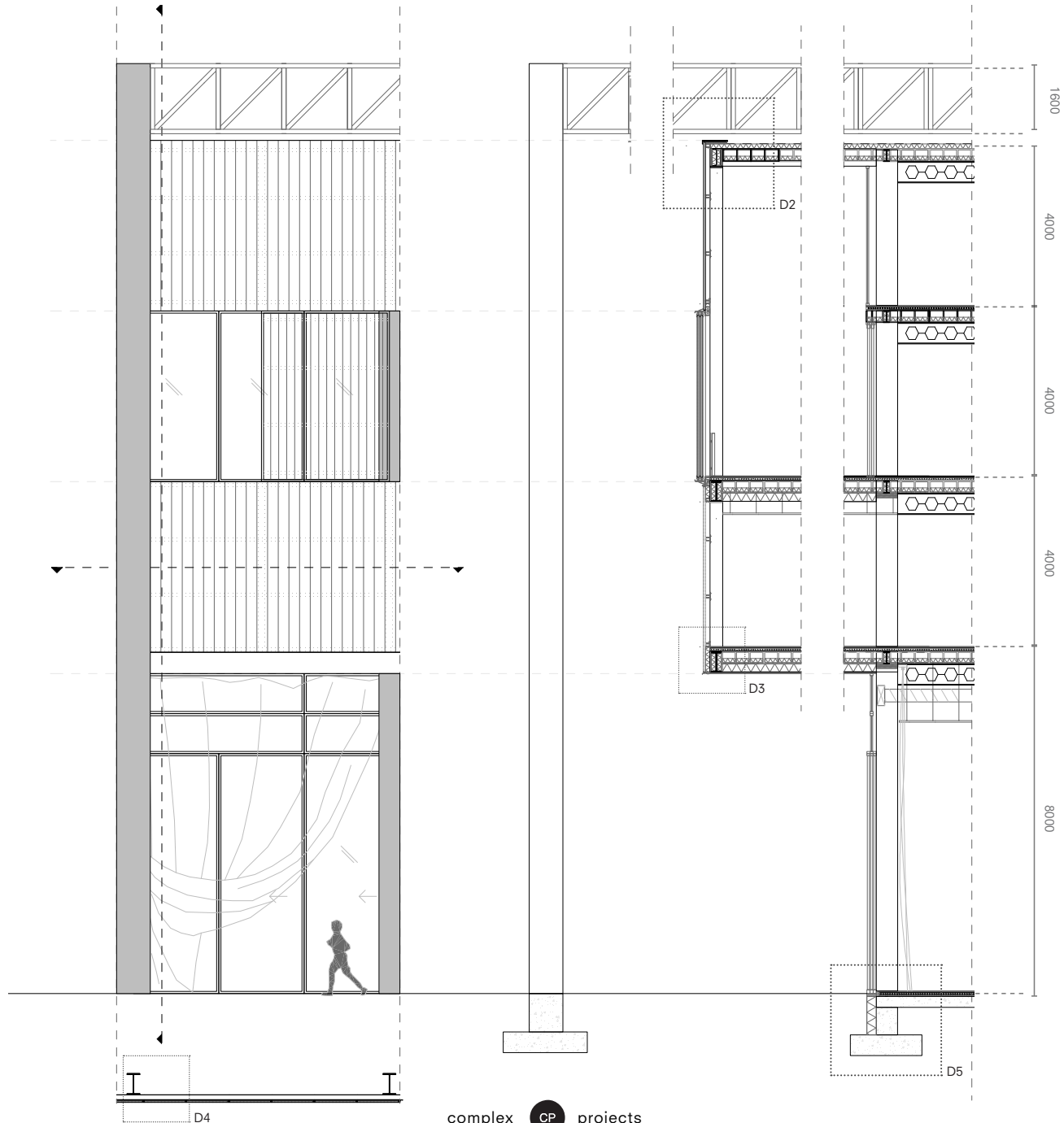

1:20

DETAIL 1 - WAREHOUSE ROOF

- 1 Bitumen finishing
300mm Kerto-ripa box (prefab LVL roof element)
100mm Mineral wool insulation
Vapor barrier foil
Mechanical ventilation exhaust pipe (Smoke and Heat Exhaust Ventilation System)
1600mm pratt truss (24m span of warehouse)

- 2 60mm polycarbonate panel (3000x1150mm)
50mm ventilation/insulation gap
60mm polycarbonate panel (3000x1150mm)
Aluminium box profile for façade attachment
Secondary support structure of the polycarbonate panels (1150mm center-to-center)
HEB 500 column
IPE 500 beam

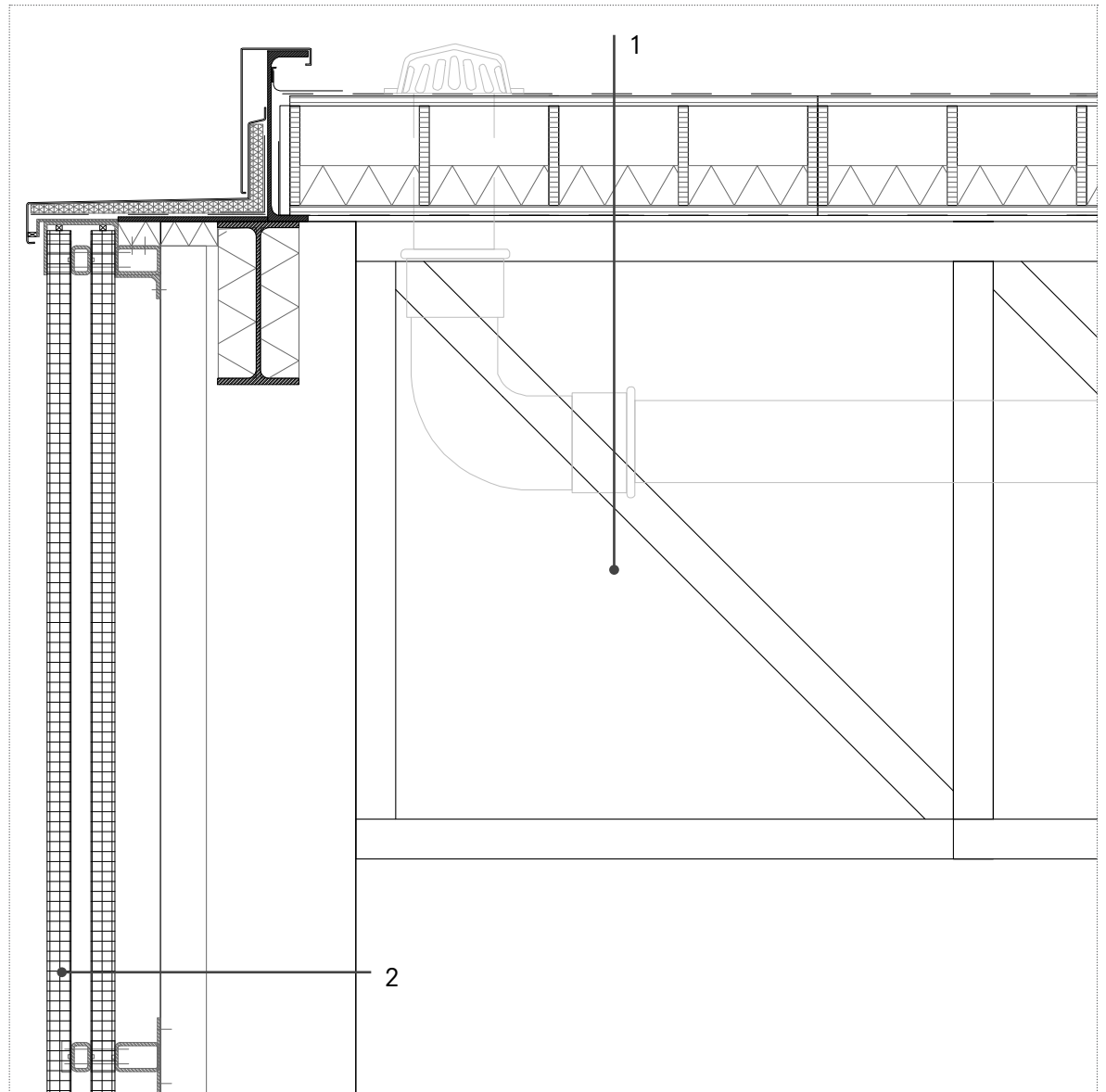
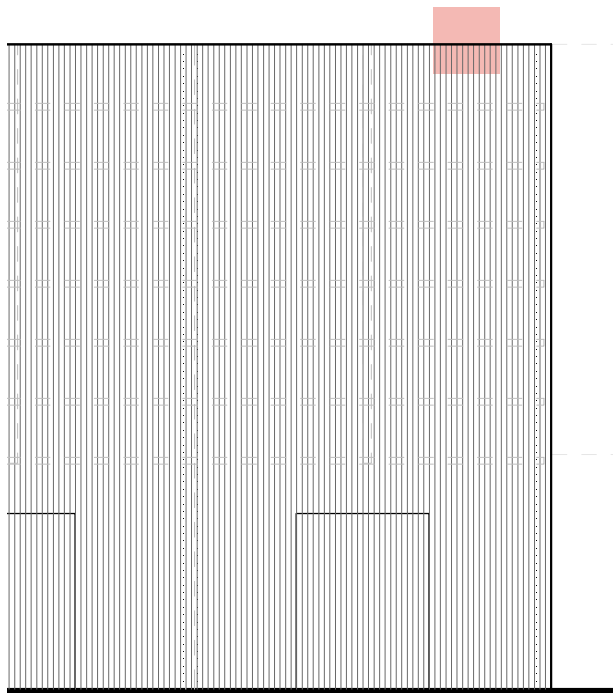

WAREHOUSE ROOF
1:5

DETAIL 2 - BUILDING ROOF

- 1 1600mm pratt truss (touchpoint element with building)
 Bitumen finishing
 110mm Mineral wool insulation
 Vapor barrier foil
 300mm Kerto-riipa box (prefab LVL slab)
 100mm Mineral wool insulation
 HEB 500 beam
 Lower ceiling

- 2 60mm polycarbonate panel (3000x1150mm)
 50mm ventilation/insulation gap
 60mm polycarbonate panel (3000x1150mm)
 Aluminium box profile for façade attachment
 HEB 500 column
 IPE 500 beam

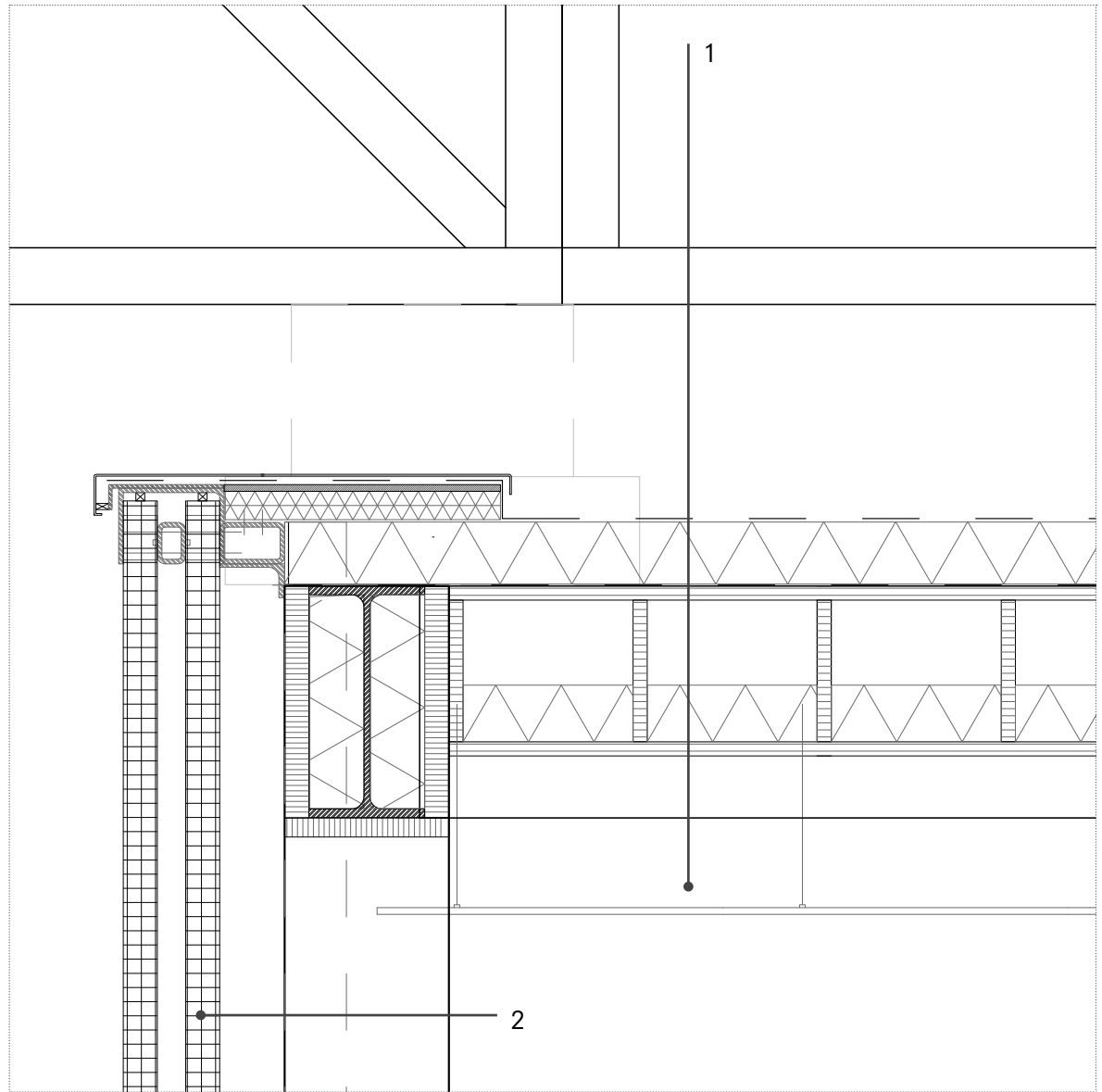
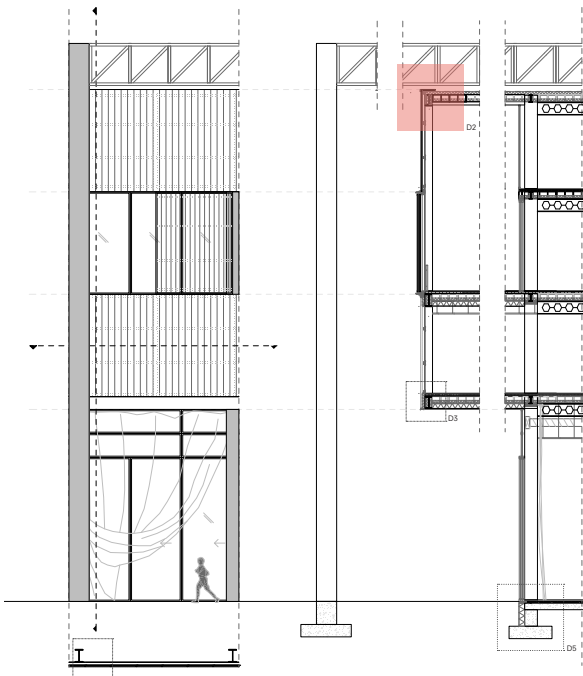

BUILDING ROOF
1:5

DETAIL 3 - CANTILEVER

- 1 30mm floor finishing
70mm floor heating
Vapor barrier foil
100mm Mineral wool insulation
300mm Kerto-riipa box ((prefab LVL slab)
190mm mineral wool insulation
Water retaining layer
15mm Exterior finishing layer
- 2 60mm polycarbonate panel (3000x1150mm)
50mm ventilation/insulation gap
60mm polycarbonate panel (3000x1150mm)
Aluminium box profile for façade attachment
HEB 500 column
IPE 500 beam
- 3 Ventilation grid

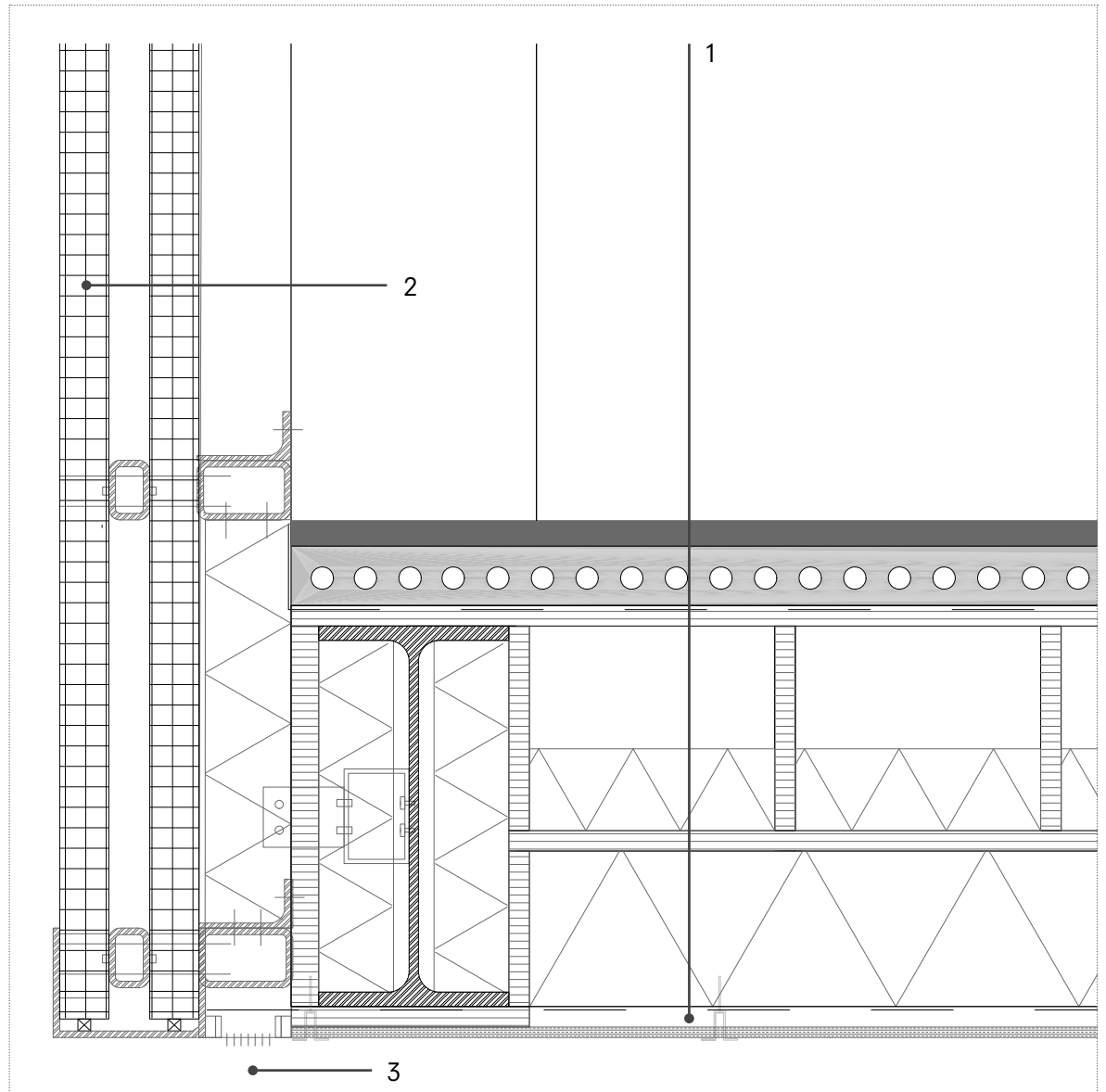
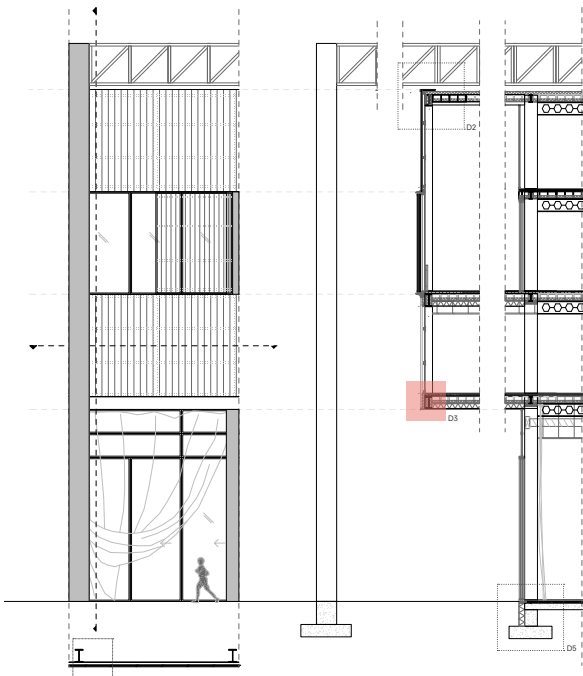

CANTILEVER
1:5

DETAIL 4 - PAD FOUNDATION

- 1 25mm Epoxi finishing (same as warehouse)
70mm Floor heating
Vapor barrier foil
20mm Insulation (fire protection rock wool)
250mm Concrete slab (in situ, same as warehouse)
220mm Gravel
- 2 Sliding glass door
HEA 500 column
- 3 500mm Pad foundation with reinforcement
200mm Mineral wool insulation
15mm Concrete plate

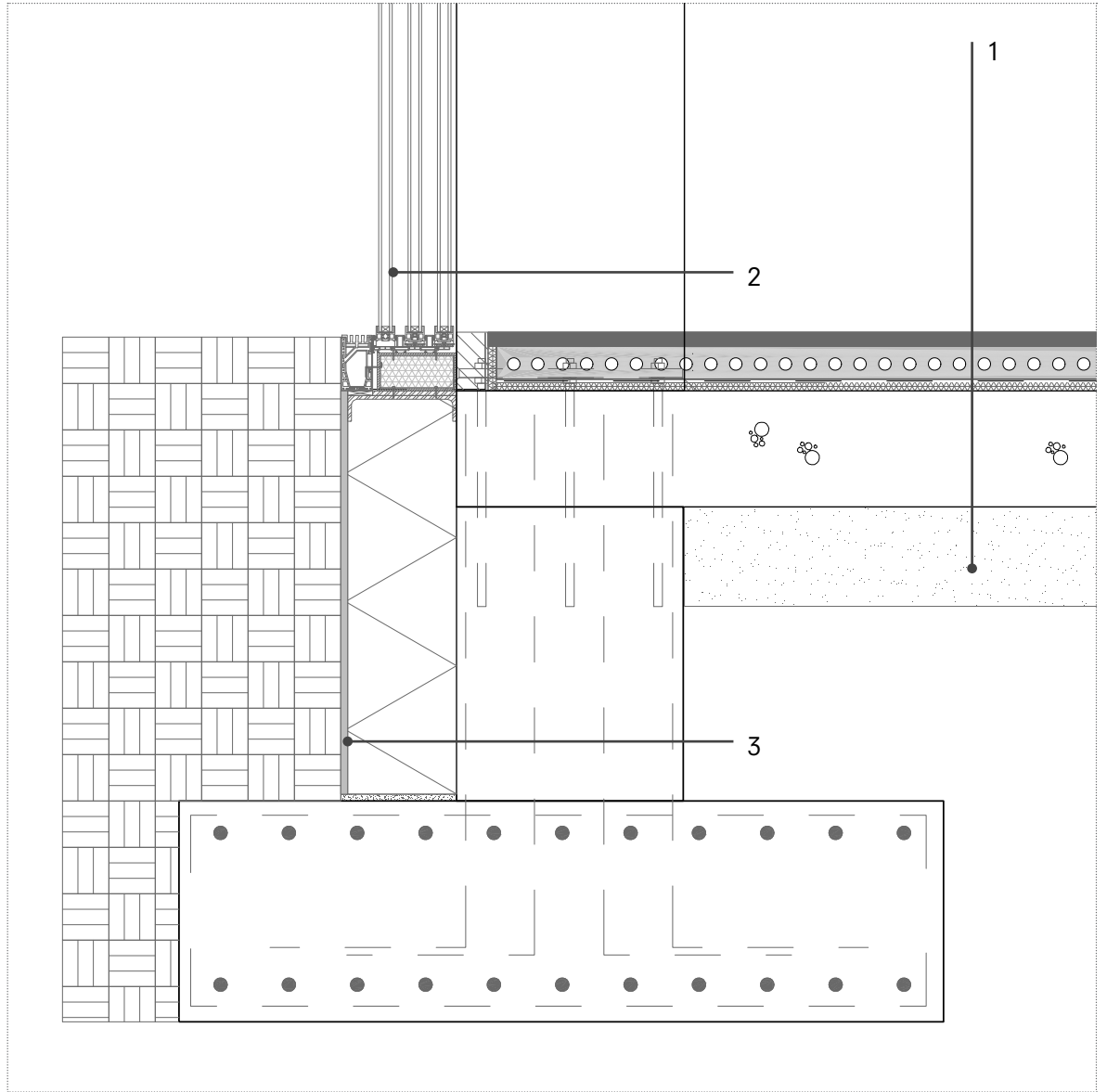
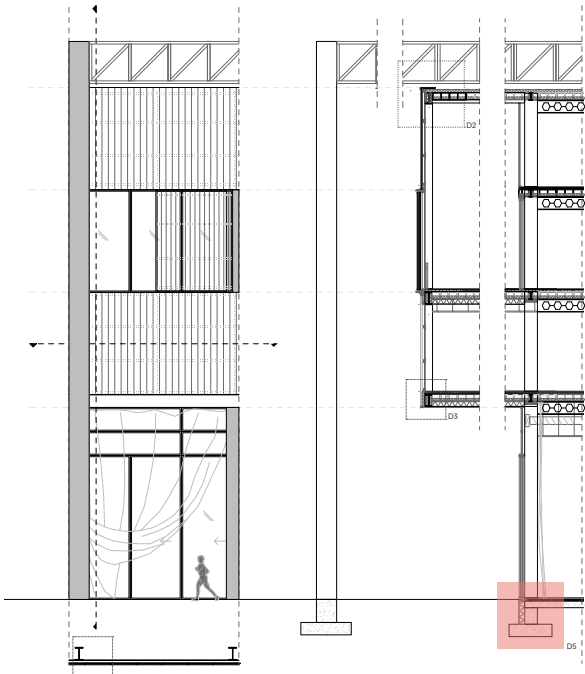

FOUNDATION
1:5

DETAIL 5 - POLYCARBONATE FAÇADE

- 1 60mm polycarbonate panel (3000x1150mm)
- 50mm ventilation/insulation gap
- 60mm polycarbonate panel (3000x1150mm)
- Smoke and Heat Exhaust Ventilation System (only for warehouse)
- Aluminium box profile for façade attachment
- HEA 500 (incl. fire coating)

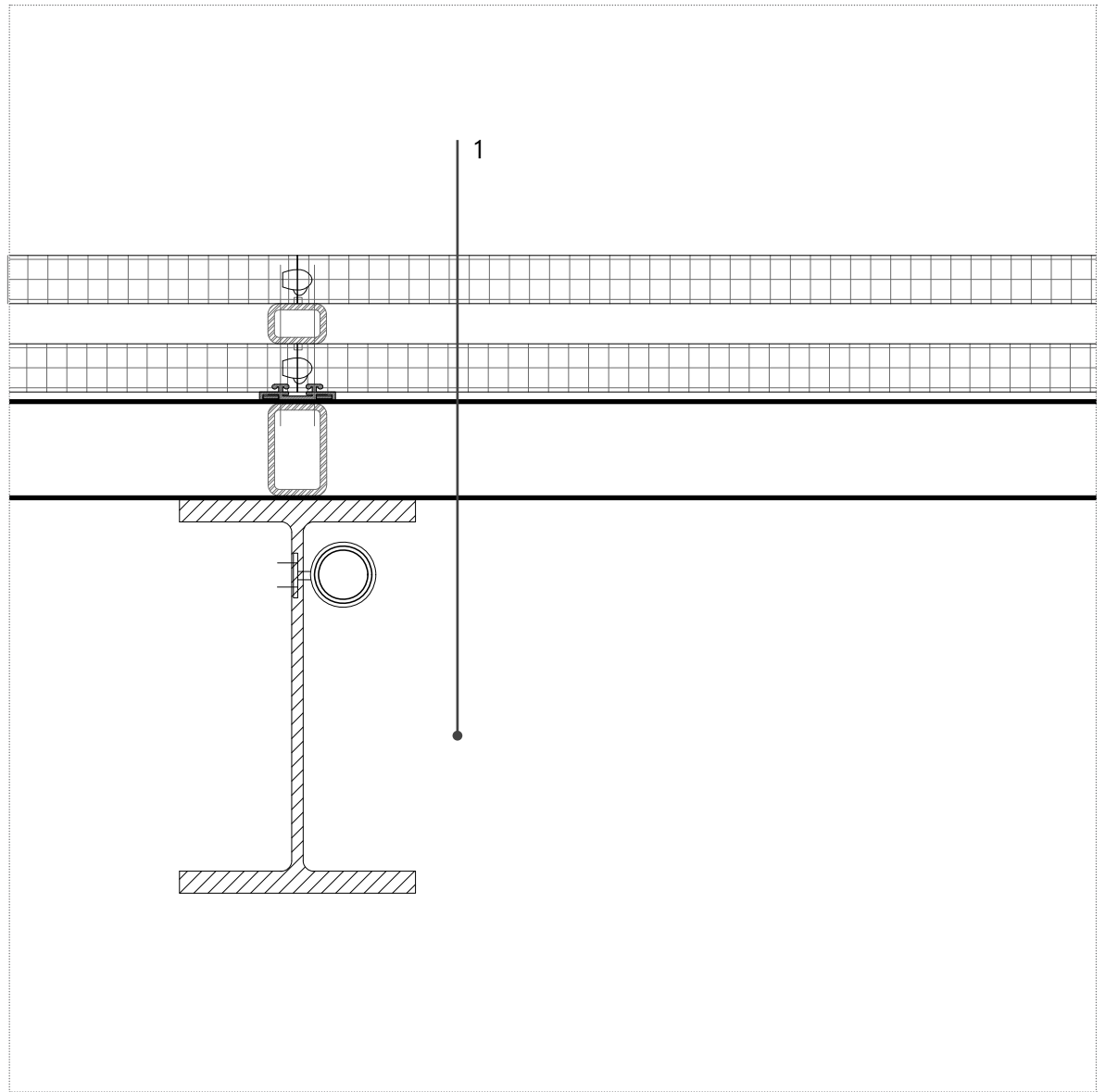
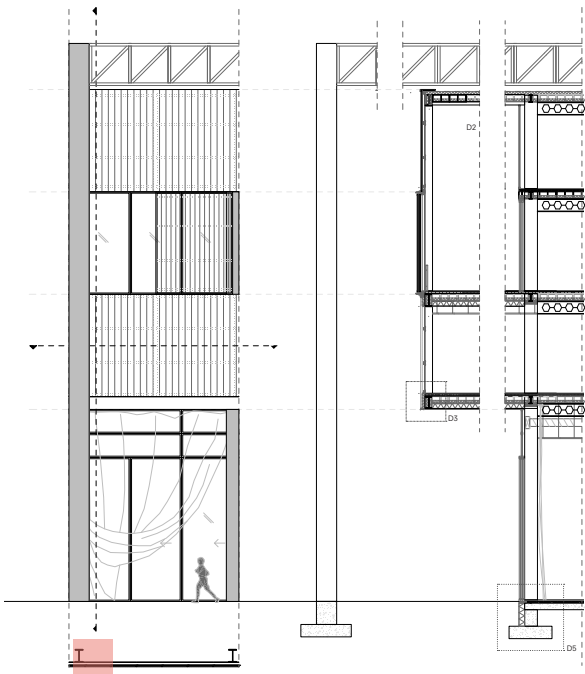

POLYCARBONATE FAÇADE
1:5

Development
CONSTRUCTION - LOGISTICS GRID

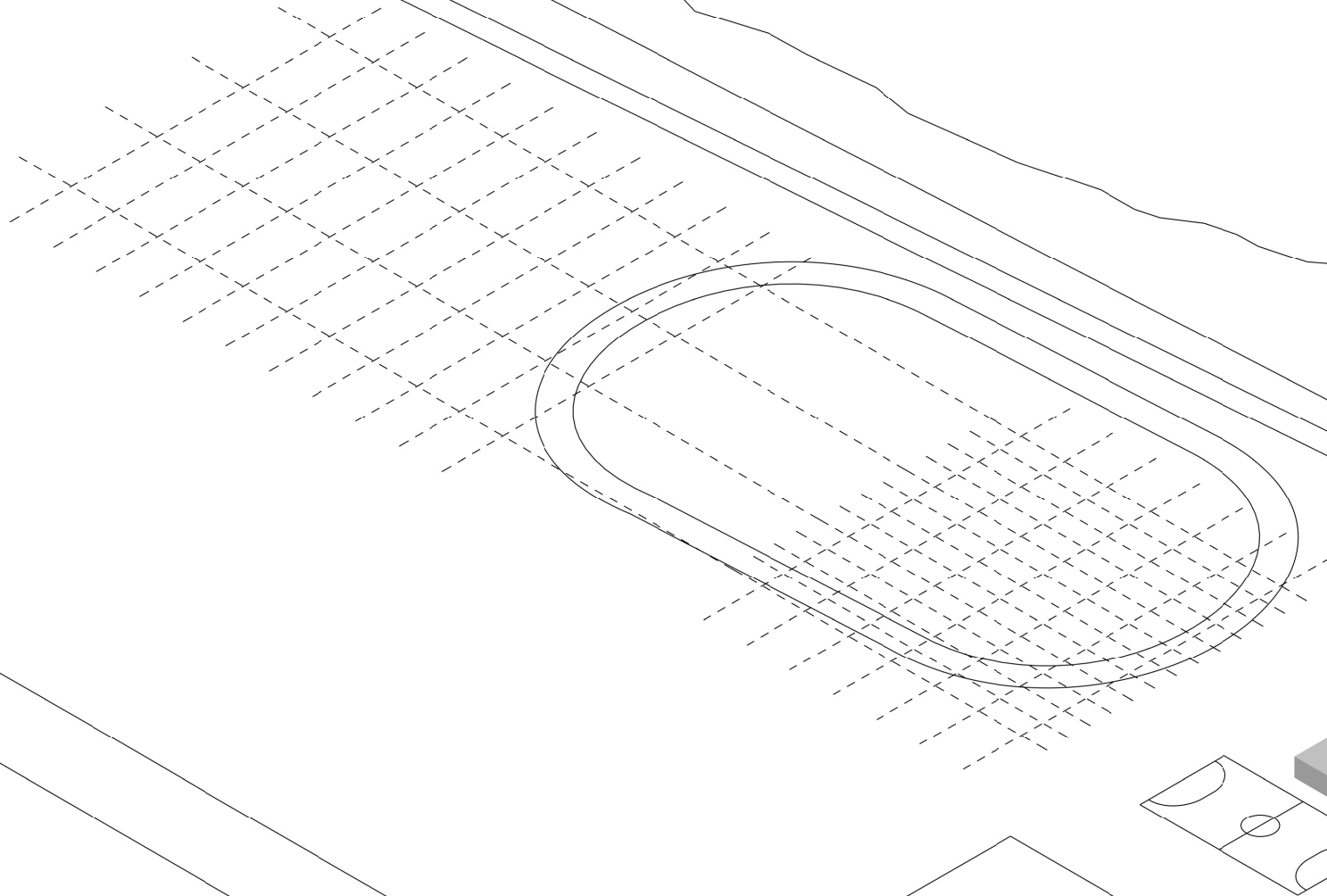

Development
CONSTRUCTION SCHEME

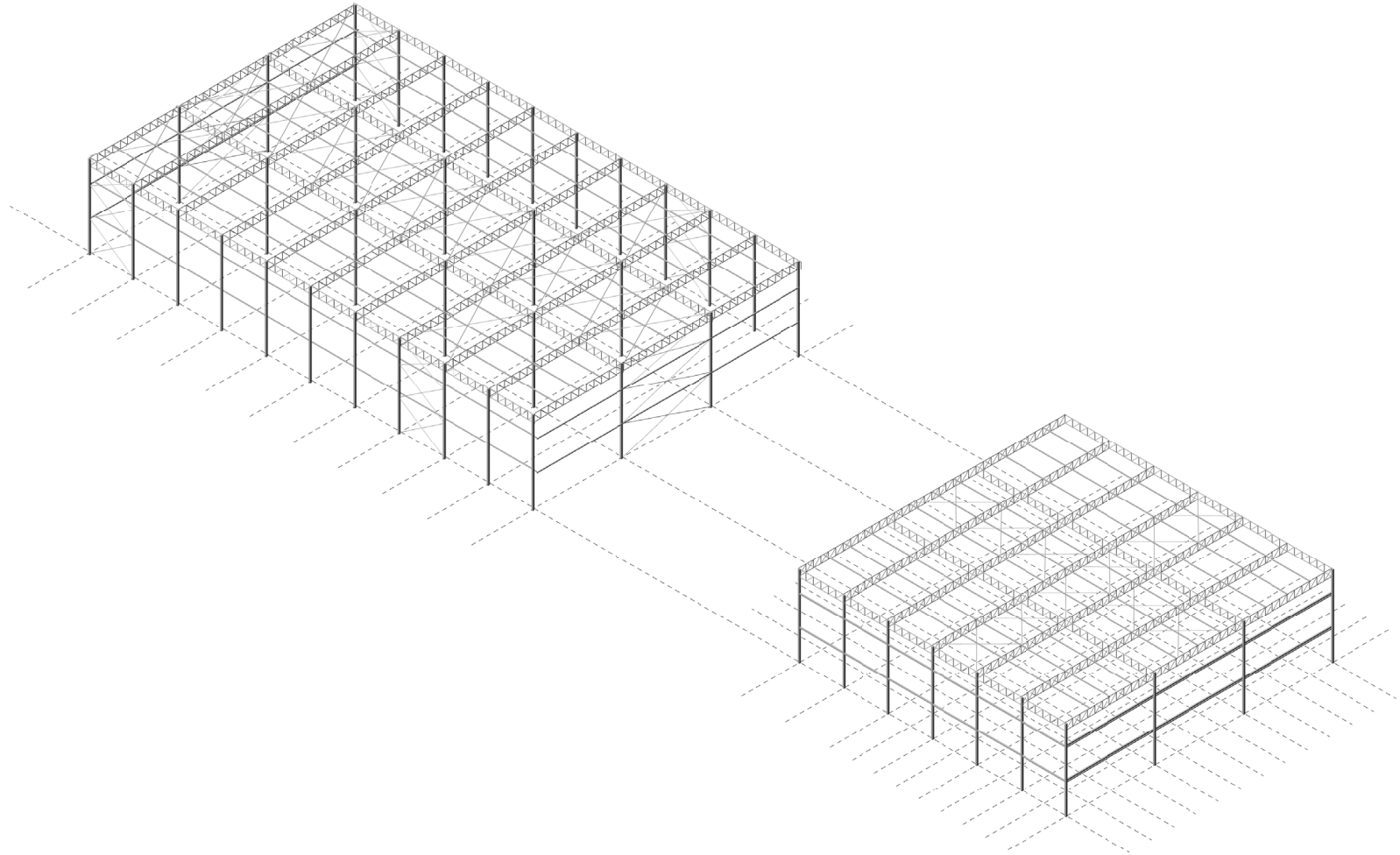

Development
CONSTRUCTION SCHEME

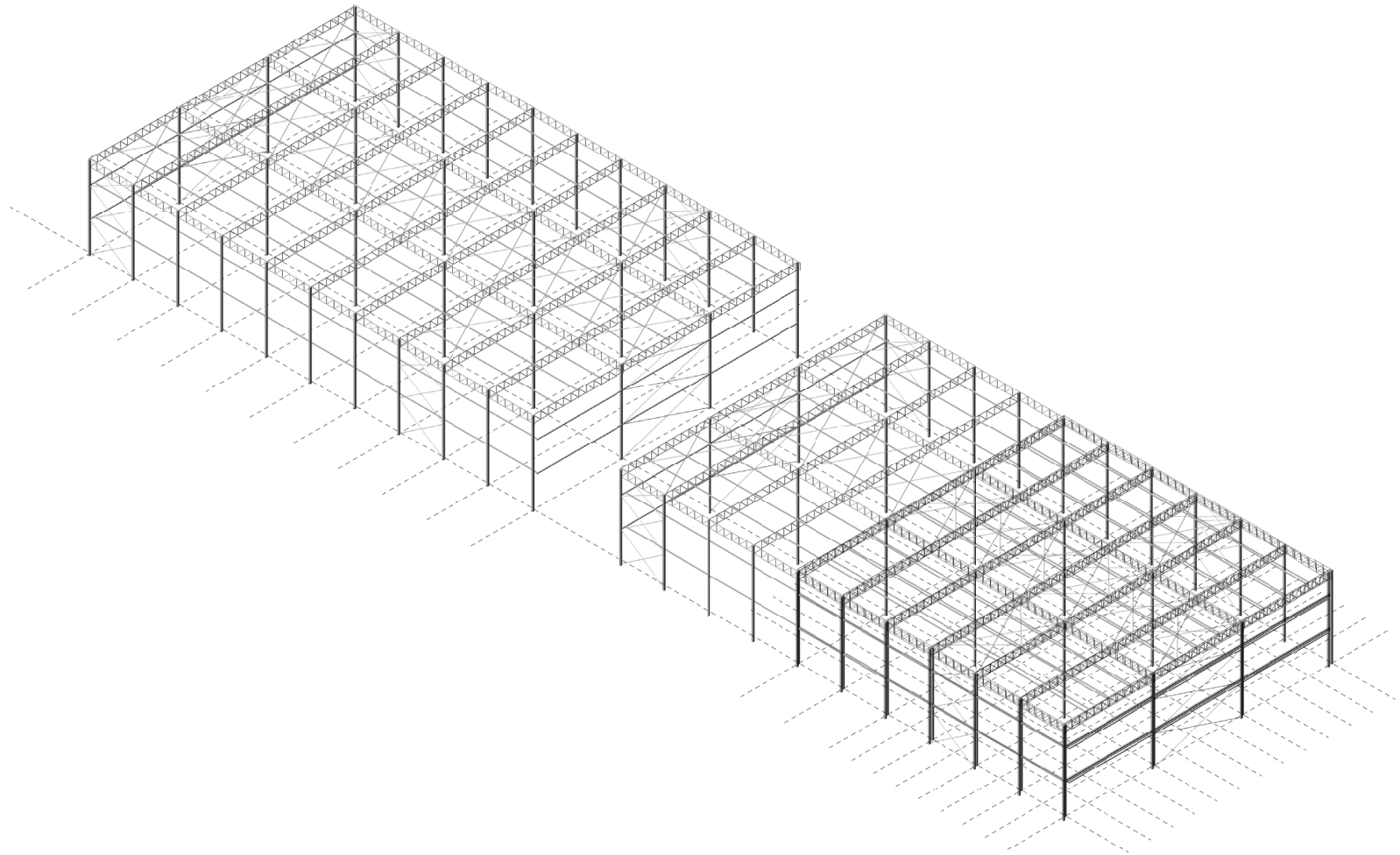

Development CONSTRUCTION SCHEME

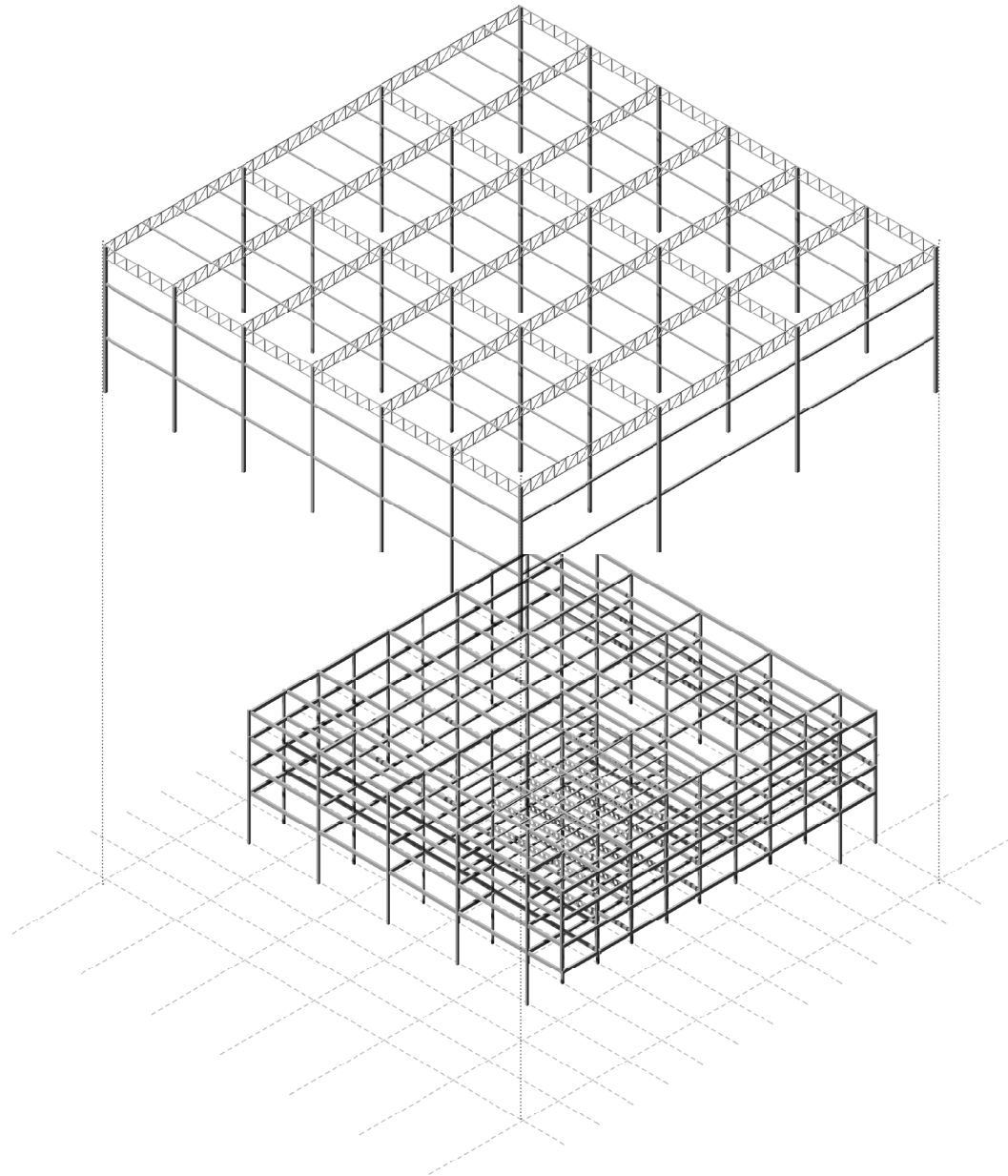

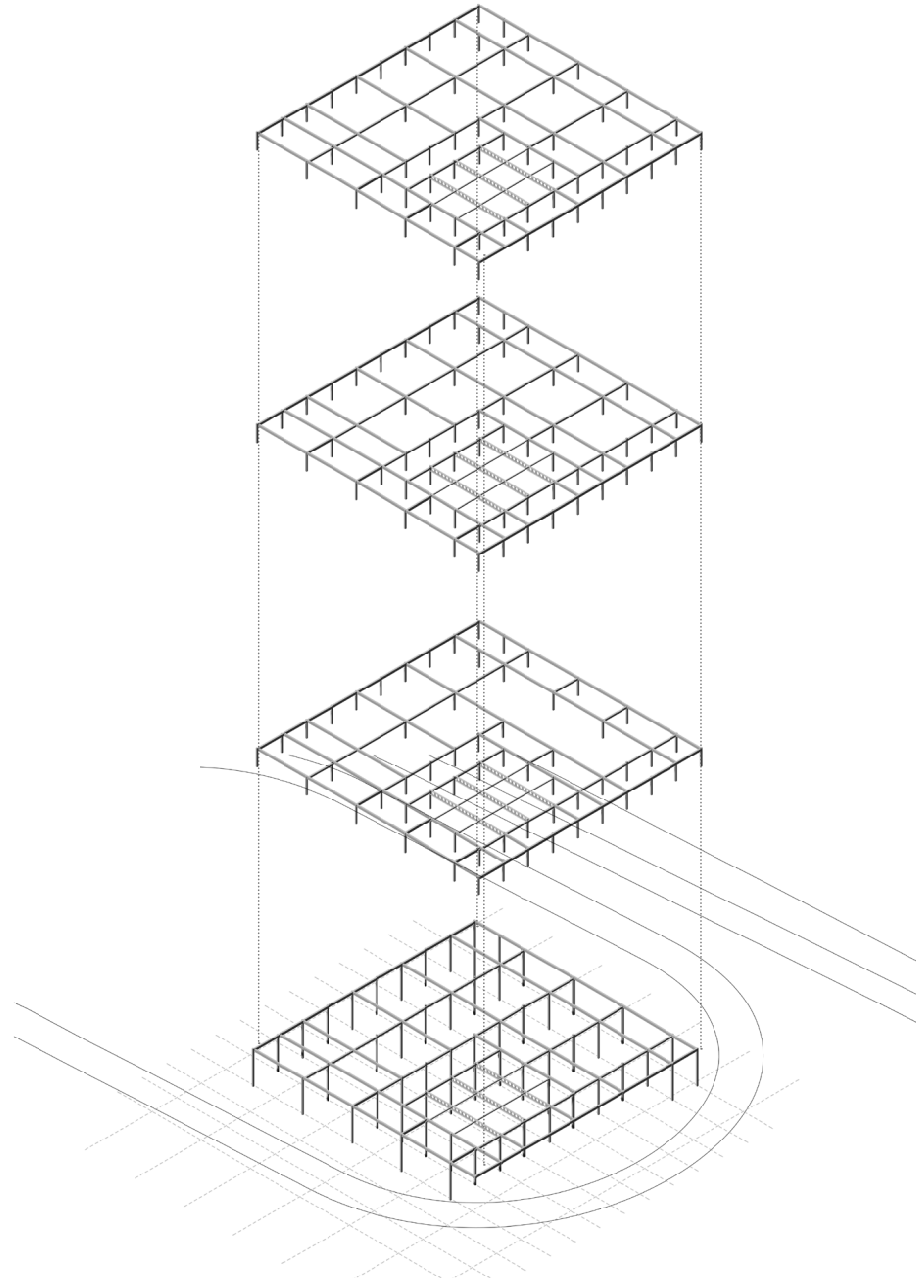

Development CONSTRUCTION SCHEME

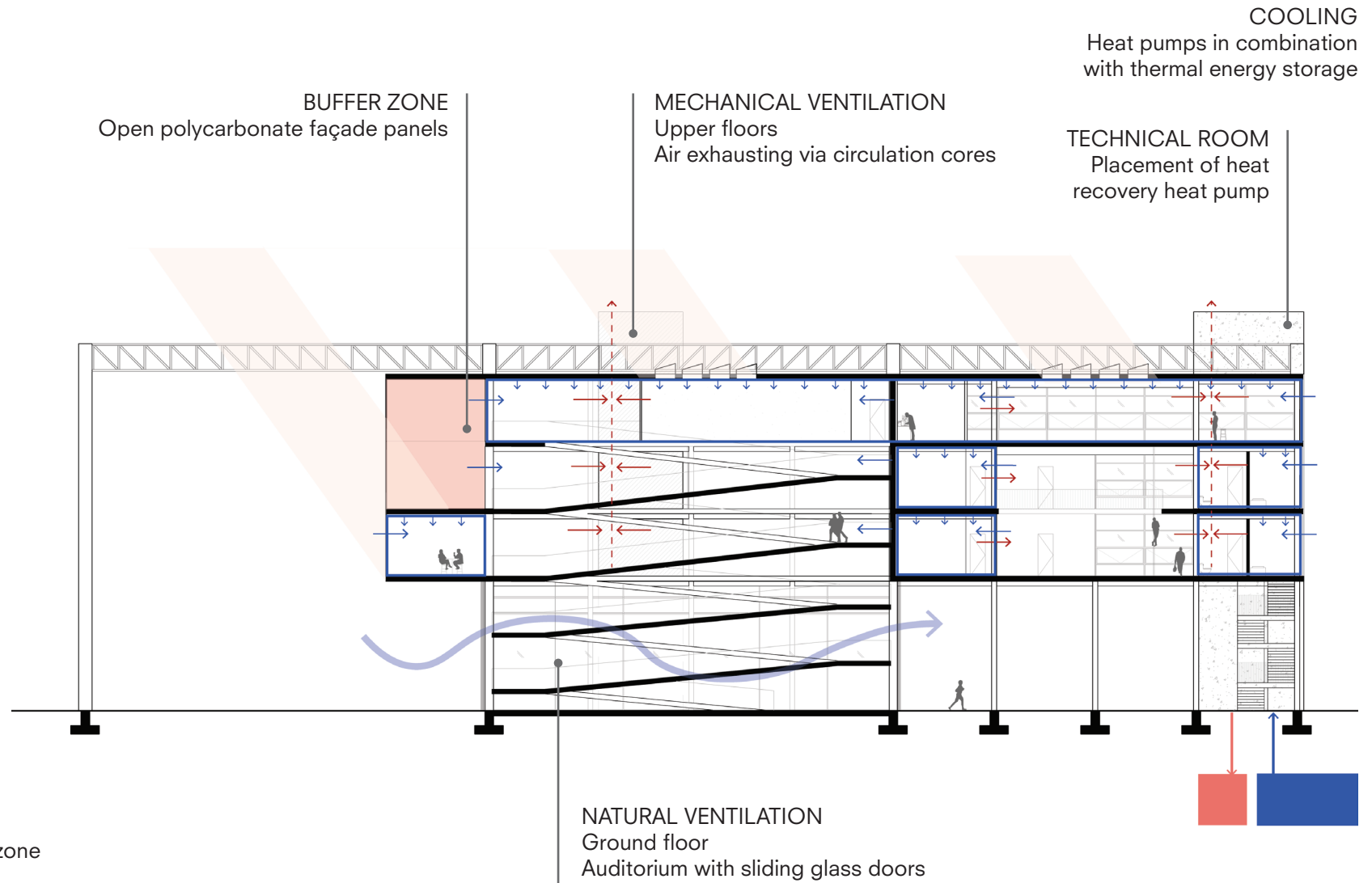

Development CLIMATE DIAGRAM - SUMMER



-  Buffer zone
-  Climated controlled (ceiling cooling)
-  Natural ventilation

Development CLIMATE DIAGRAM - WINTER

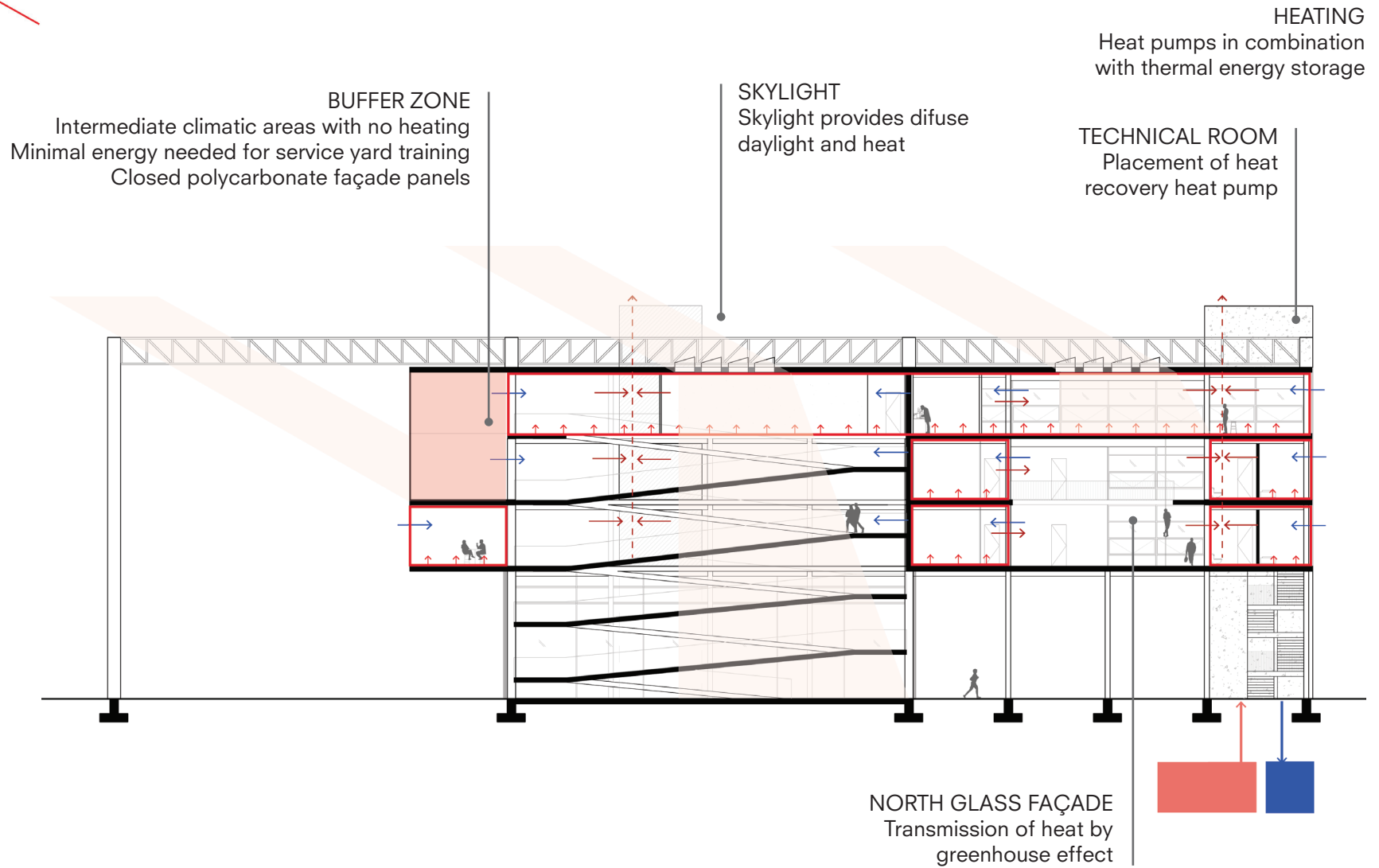

- Buffer zone
-



Development
POLYCARBONATE FAÇADE - SLIDING PANELS



Development

POLYCARBONATE FAÇADE - SLIDING PANELS



INTRODUCTION
RESEARCH
DESIGN BRIEF
CONCEPT
IMPLEMENTATION
DEVELOPMENT
CONCLUSION

Conclusion

CRISIS ARCHITECTURE

Symbolism

“The irregular features of the building conveyed the **impression of earthquake damage** and were intended to **symbolize the instability** caused by both war and disaster” (Reid & Gilbo, 1997)

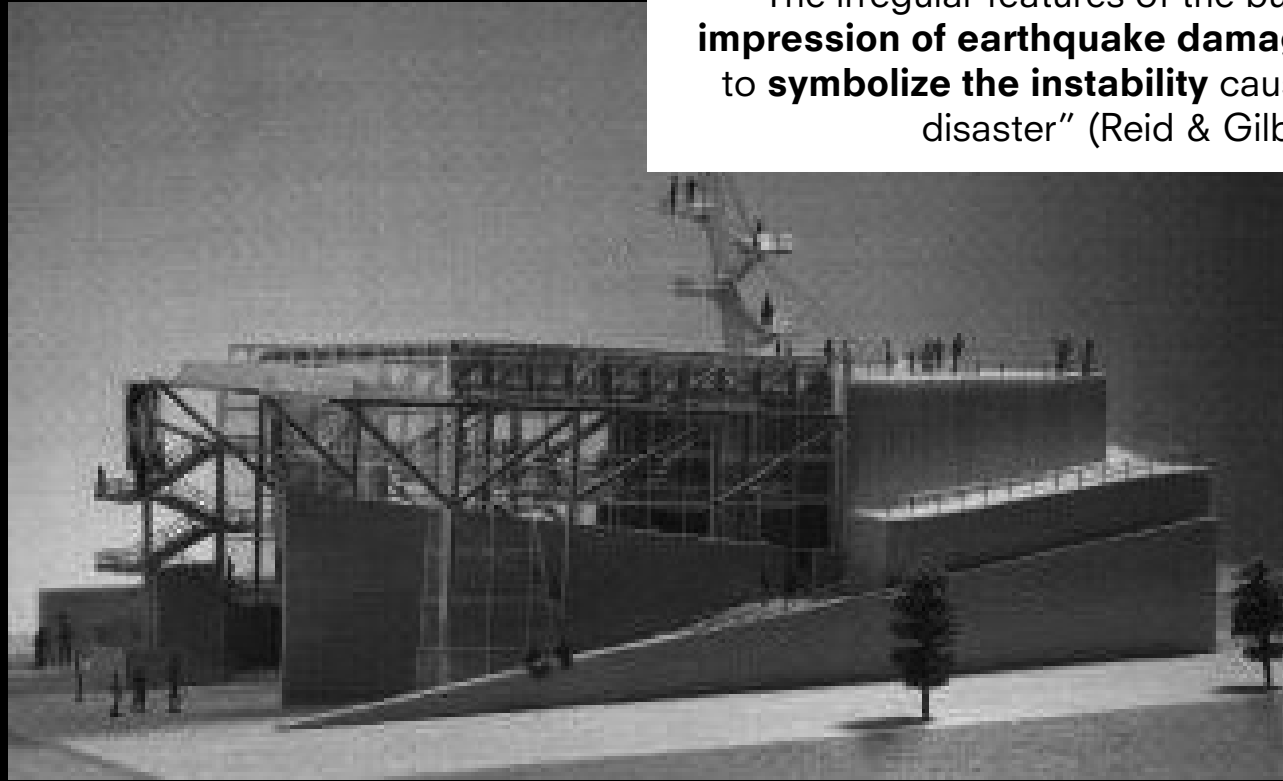

ELBA, 1992
Red Cross Pavillion, ?m2
Built - '92 Expo Seville, Spain



THANK YOU!



Q&A

Program
OVERVIEW BENCHMARK

UNHRD
Humanitarian
Response Depot



PANAMA
BLB



ACCRA
KIA



BRINDISI
BDS



RÉUNION
ZAA



DUBAI
DWC



KUALA LUMPUR
SZB



GENEVA
GVA

Program OVERVIEW BENCHMARK

UNHRD
Humanitarian
Response Depot



PANAMA
BLB



ACCRA
KIA



BRINDISI
BDS



RÉUNION
ZAA



DUBAI
DWC



KUALA LUMPUR
SZB



GENEVA
GVA

Warehouse
Temporary tents
Outside (un)loading space

Program
PANAMA - BLB

UNHRD
Humanitarian
Response Depot

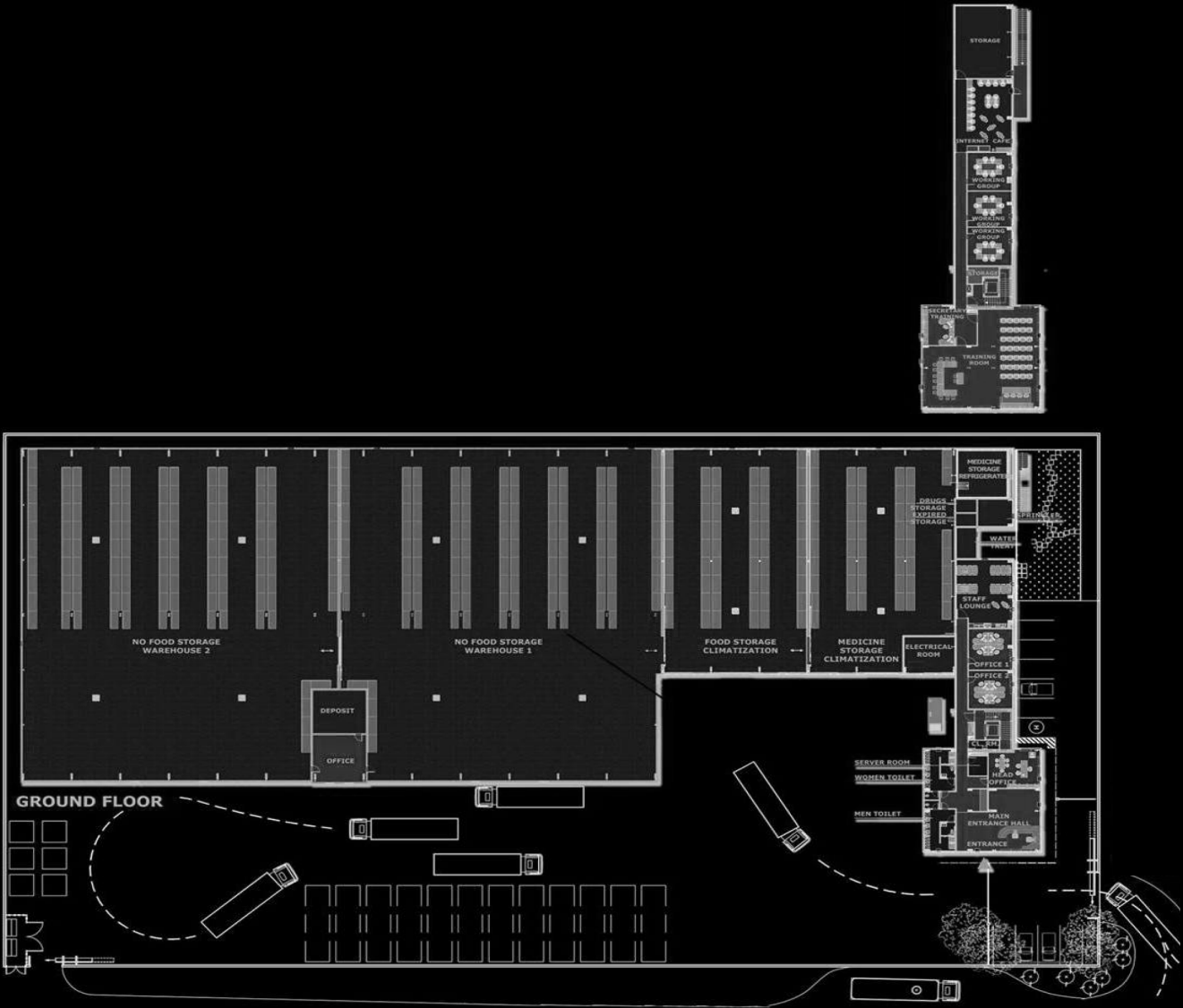

Program
ACCRA - KIA

UNHRD
Humanitarian
Response Depot



Program
KUALA LUMPUR - SZB



Program
UNHRD BENCHMARK

UNHRD
Humanitarian
Response Depot



PANAMA
BLB



ACCRA
KIA



BRINDISI
BDS



RÉUNION
ZAA



DUBAI
DWC



KUALA LUMPUR
SZB

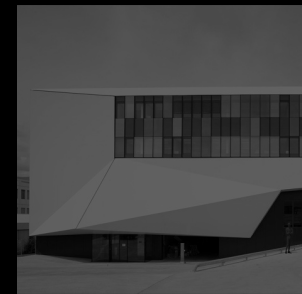

GENEVA
GVA

Program UNHRD NETWORK AND FACILITIES

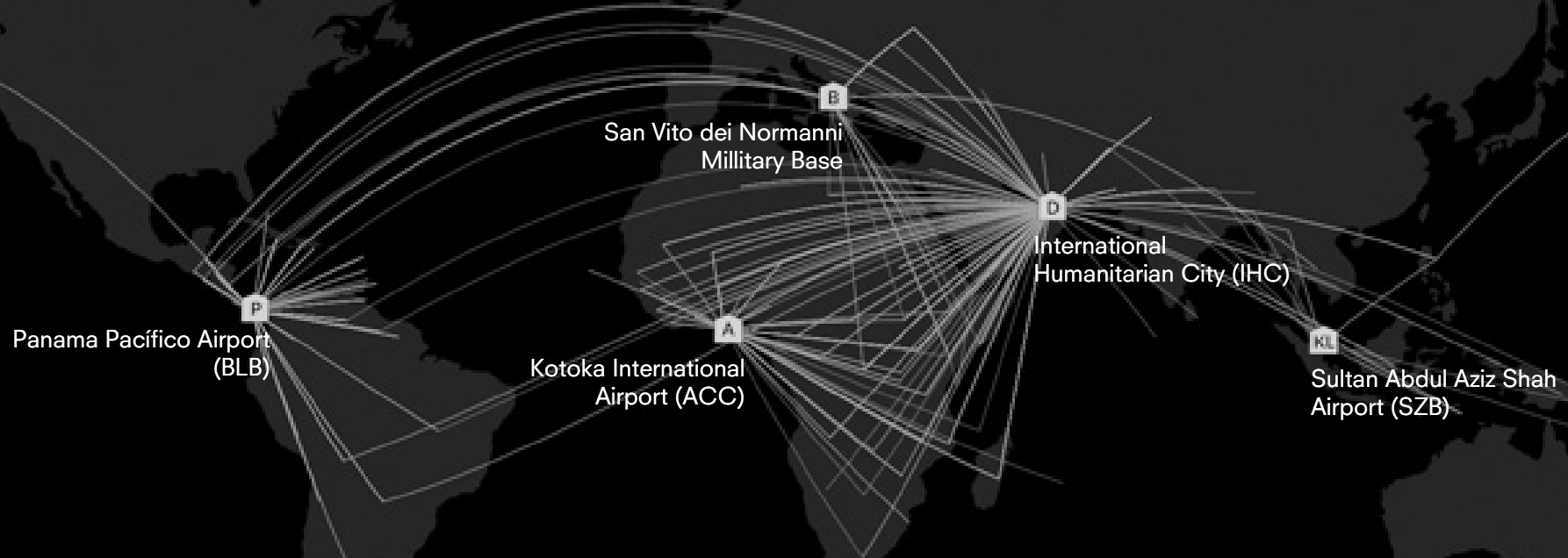

	PANAMA, 2007	ACCRA, 2007	BRINDISI, 2000	DUBAI, 2006	KUALA LUMPUR, 2012
Covered space	4.100 m ²	3.600 m ²	8.500 m ²	11.500 m ²	9.980 m ²
Temperature controlled space (18-23°C)	1.100 m ²	500 m ²	900 m ²	3.360 m ²	1.192 m ²
Office space	342 m ²	450 m ²	1.000 m ²	1.900 m ²	921 m ²
Guesthouse	-	-	45 pax	-	-
Open storage	6.200 m ²	1.400 m ²	3.900 m ²	1.000 m ²	2.000 m ²
Cold Room (below -5°C)	23,6 m ³	40 m ³	40 m ²	100 m ³	42 m ²
Freezing Room	282 m ³	-	-	-	-
Training centre	-	400 m ²	950 m ²	-	105 m ²

Program UNHRD & AIRPORTS

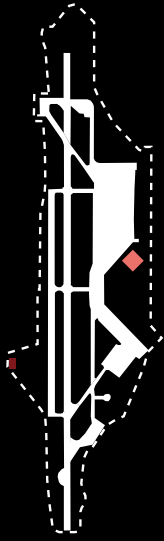

PANAMA
BLB Airport
UNHRD: 4 km

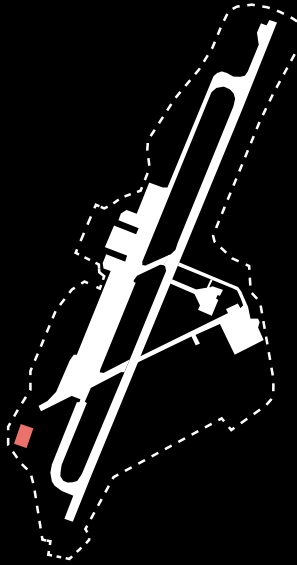

ACCRA
KIA Airport
UNHRD: 0 km

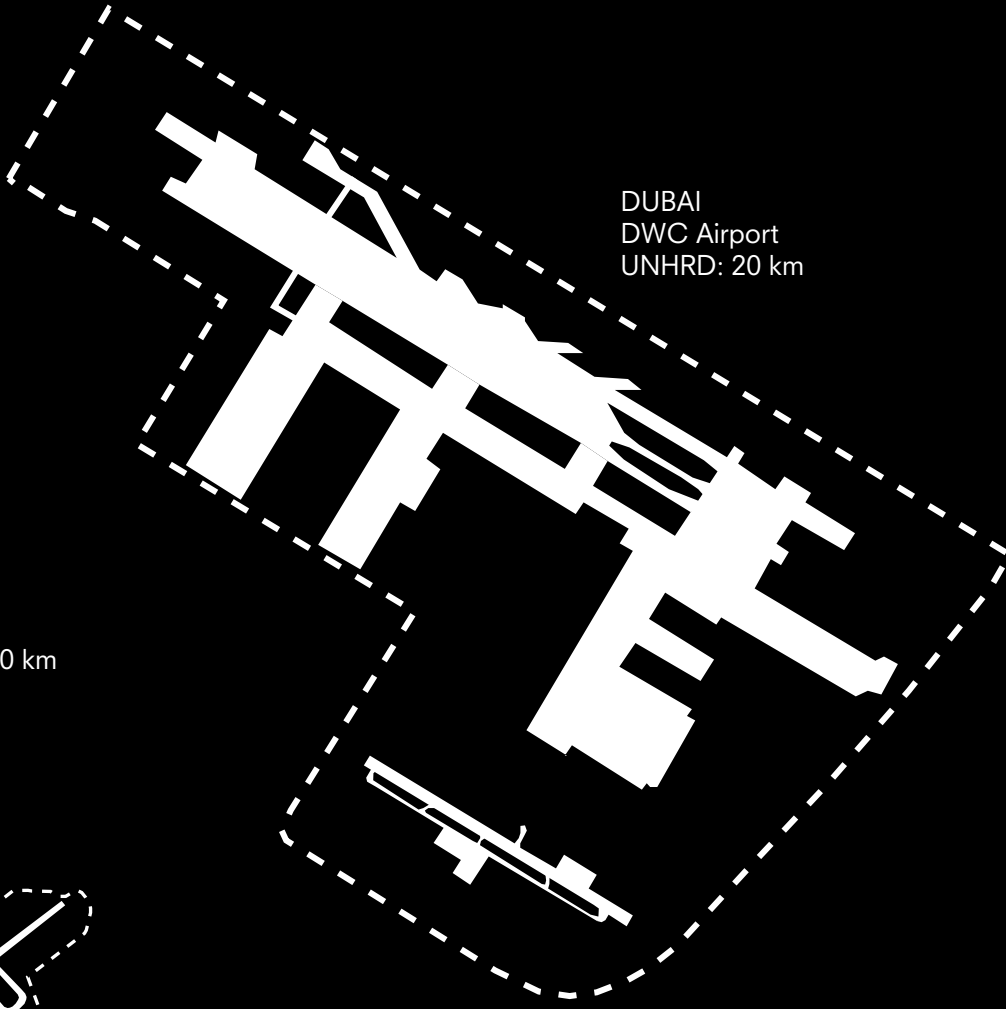

DUBAI
DWC Airport
UNHRD: 20 km

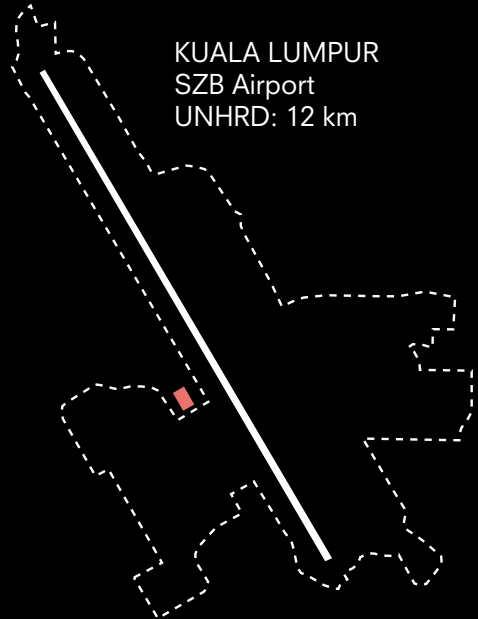

KUALA LUMPUR
SZB Airport
UNHRD: 12 km

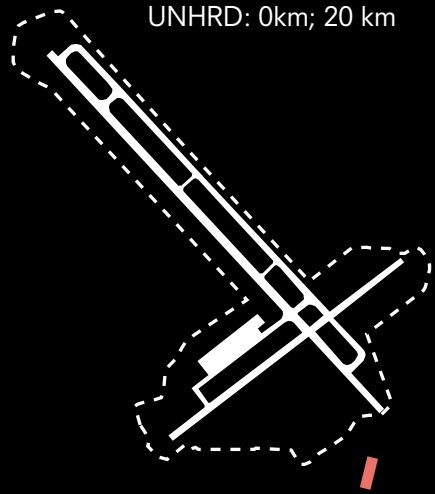

BRINDISI
BDS Airport
UNHRD: 0km; 20 km

1:50.000

UNHRD

Program
IFRC & ICRC BENCHMARK

UNHRD
Humanitarian
Response Depot



PANAMA
BLB



ACCRA
KIA



BRINDISI
BDS



RÉUNION
ZAA



DUBAI
DWC



KUALA LUMPUR
SZB



GENEVA
GVA

Client
IFRC FACILITIES
Logistics & Research

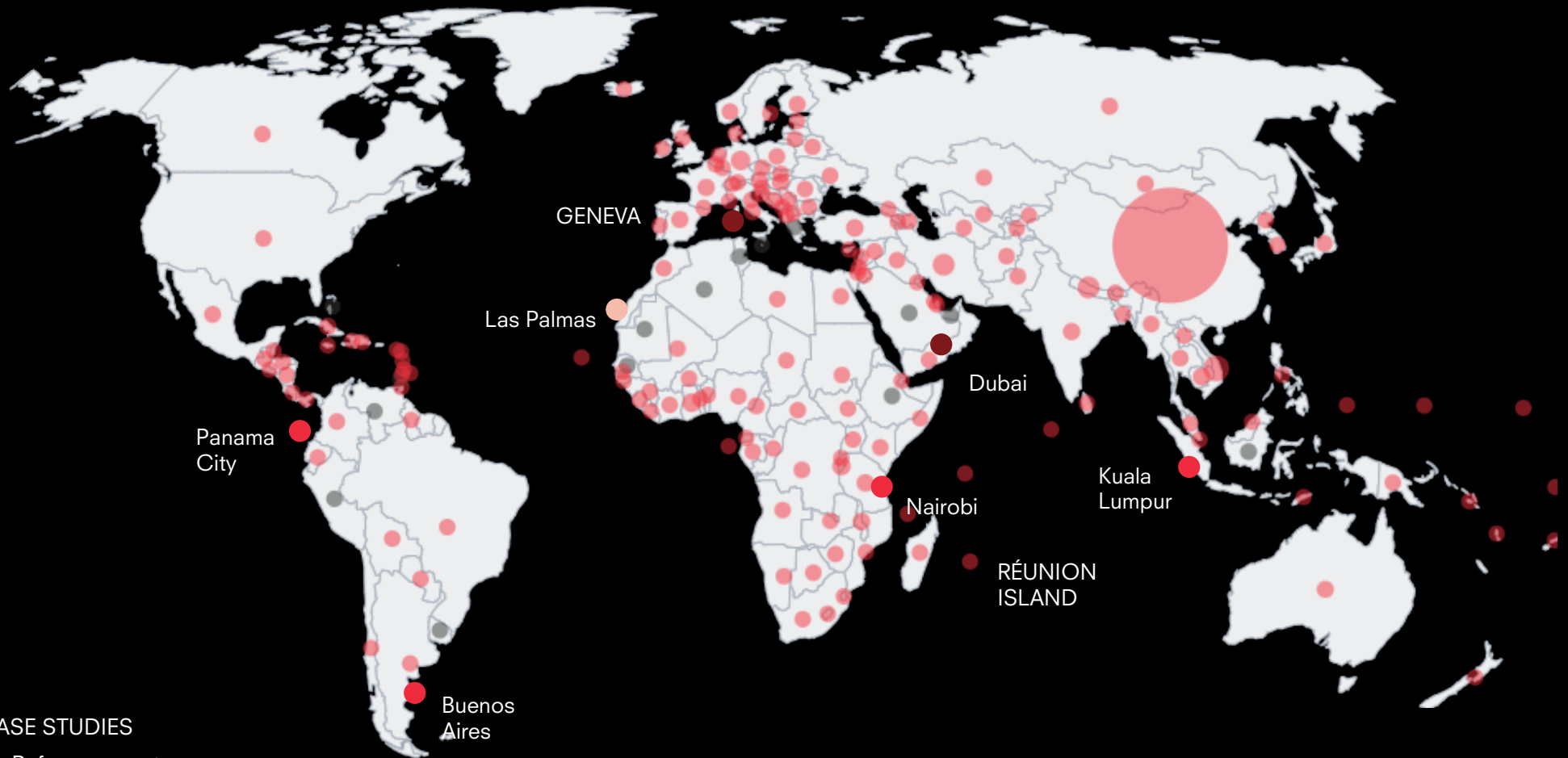

CASE STUDIES

- Reference centers
- Global Logistics Service
- Zonal Logistics Unit (ZLU)
- Logistics Hub

Program
IFRC/ICRC & AIRPORTS

GENEVA
GVA Airport
ICRC Logistics Complex: 5 km

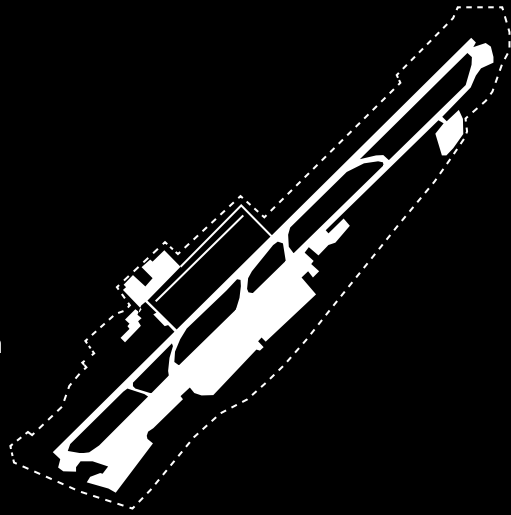

RÉUNION ISLAND
ZAA Airport
IFRC PIROI: 4 km

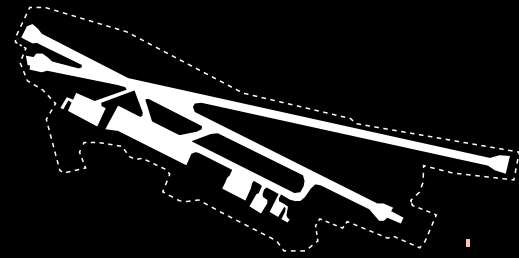

1:50.000

IFRC/ICRC Centers