

Artificial Intelligence-based short-term forecasting of vessel performance parameters

Valchev, I.; Coraddu, A.; Oneto, L.; Kalikatzarakis, M.; Tiddens, W.; Geertsma, R.D.

DOI

[10.24868/10736](https://doi.org/10.24868/10736)

Publication date

2022

Document Version

Final published version

Published in

Proceedings of the International Ship Control Systems Symposium

Citation (APA)

Valchev, I., Coraddu, A., Oneto, L., Kalikatzarakis, M., Tiddens, W., & Geertsma, R. D. (2022). Artificial Intelligence-based short-term forecasting of vessel performance parameters. *Proceedings of the International Ship Control Systems Symposium, 16*, Article 31. <https://doi.org/10.24868/10736>

Important note

To cite this publication, please use the final published version (if applicable).
Please check the document version above.

Copyright

Other than for strictly personal use, it is not permitted to download, forward or distribute the text or part of it, without the consent of the author(s) and/or copyright holder(s), unless the work is under an open content license such as Creative Commons.

Takedown policy

Please contact us and provide details if you believe this document breaches copyrights.
We will remove access to the work immediately and investigate your claim.

Artificial Intelligence-based short-term forecasting of vessel performance parameters

I Valchev, MEng, MIEEE^a, Prof. A Coraddu, PhD^{b*}, Prof. L Oneto, PhD^c, M Kalikatzarakis, MSc^d, W Tiddens, PhD^e, dr. ir. R D Geertsma, CEng, FIMarEST^f

^aDepartment of Naval Architecture, Ocean and Marine Engineering, University of Strathclyde, United Kingdom;

^bDepartment of Maritime & Transport Technology, Delft University of Technology, The Netherlands;

^cDepartment of Informatics, Bioengineering, Robotics, and Systems Engineering, University of Genoa, Italy;

^dDamen Naval, Research & Technology Support, the Netherlands;

^eDirectorate of Materiel Sustainment, Royal Netherlands Navy, the Netherlands;

^fFaculty of Military Sciences, Netherlands Defence Academy, the Netherlands

*Corresponding author. Email: a.coraddu@tudelft.nl

Synopsis

Deterministic models based on the laws of physics, as well as data-driven models, are often used to assess the current state of vessels and their systems, as well as predict their future behaviour. Predictive maintenance methodologies (i.e., Condition Based Maintenance) and advanced control strategies (i.e., Model Predictive Control) are built upon the use of such numerical tools to identify ensuing performance shifts. In fact, forecasting near-future performance can substantially contribute to enhancing operational efficiency and enabling advanced system control. Data from modern sensor technology, which has become more readily available, combined with automatic control systems capable of prescribing optimal control strategies, can improve vessel operation and reduce energy consumption. A data-driven model that relies on recent advances in Artificial Intelligence, Machine Learning, and Data Mining, leveraging historical observations is employed to forecast a vessel's onboard power generation trends as a function of the past, present, and future behaviour of a ship and its systems. To prove the framework, the proposed methodology is tested on real data collected from the Integrated Platform Management System of an Oceangoing Patrol Vessel of the Royal Netherlands Navy. The developed data-driven model is achieves high forecasting accuracy in the near-term. The authors foresee that the proposed methodology could be used as part of an electric energy control strategy, within a more integrated and intelligent mission planning framework.

Keywords: Near-Term Forecasting, Machine Learning, Electric Power Generation, Hybrid Propulsion, Data-Driven Models.

1 Introduction

In order to meet IMO goals and the Netherlands Ministry of Defense (MoD) ambitions to reduce greenhouse gas emissions and fossil fuel dependency by 70% before 2050 (International Maritime Organisation (IMO), 2018; Netherlands MoD, 2015), shipping, in general, and the Royal Netherlands Navy, specifically, urgently need to increase their energy efficiency. While advanced hybrid propulsion and hybrid power generation systems can reduce warship energy efficiency by up to 40% (Schulten et al., 2017), current ships with hybrid propulsion do not utilise their generators at their most efficient working point leading to 10% to 15% additional fuel consumption (Vasilikis et al., 2022; Vasilikis, 2020). Optimisation-based power and energy management systems can increase the efficiency of the energy system and reduce greenhouse gas emissions by optimising the allocation of load to various power sources (Xie et al., 2022; Jaurola et al., 2019). For a case study Offshore Patrol Vessel (OPV), such an

Authors' Biographies

Iliya Valchev is currently a PhD Candidate in Naval Architecture & Marine Engineering at the University of Strathclyde, Glasgow, focusing on data-driven and hybrid modelling of marine systems. He received his MEng in Naval Architecture and Marine Engineering from the same university in 2020.

Prof. Andrea Coraddu is an Assistant Professor in the Department of Maritime and Transport Technology of Delft University of Technology and a visiting Professor at the University of Strathclyde. In 2012 he was awarded a Laurea and a PhD in Naval Architecture and Marine Engineering at the University of Genoa. His primary research involves taking advantage of on-board data availability in assessing vessel performance, energy optimization, and real-time monitoring of the primary systems towards autonomous operations.

Prof. Luca Oneto was born in Rapallo, Italy in 1986. He received his MSc in Electronic Engineering at the University of Genoa, Italy in 2010 and his PhD with the thesis "Learning Based On Empirical Data" in 2014. In 2017 he obtained the Italian National Scientific Qualification for the role of Associate Professor in Computer Engineering and in 2018 the one in Computer Science. He is currently an Assistant Professor in Computer Engineering at the University of Genoa with particular interests in Statistical Learning Theory and Data Science.

Miltiadis Kalikatzarakis currently is a research engineer at Damen Naval. He received his MEng. in Naval Architecture at the National Technical University of Athens, and an MSc in Marine Technology at Delft University of Technology, in 2013 and 2017, respectively.

dr. Wieger Tiddens has extensive experience and knowledge in the implementation and development of predictive maintenance. His passion is to achieve the maintenance of tomorrow. Within the Royal Netherlands Navy's Data for Maintenance group, he works on data-driven asset management and Predictive Maintenance for the current and future fleet.

Cdr (E) Rinze Geertsma is an Assistant Professor in sustainable energy systems for ships at the Netherlands Defence Academy. He is an experienced naval engineering officer with a strong interest in applying revolutionary technology on naval vessels to improve their performance and availability, reduce their environmental footprint, and increase their autonomy while leaving key decisions to human operators and maintainers.

optimisation strategy that runs the diesel generators close to its most efficient working point in a DC distribution system with battery energy storage, can lead up to 15% fuel savings (Zahedi et al., 2014).

Advanced and optimal control strategies for the operation of various onboard systems and equipment are necessary to ensure energy efficiency (Mehrzadi et al., 2020), supplement operational planning (Vorwald et al., 2016), and enhance safety on a vessel (Duan et al., 2015). Many propulsion systems and auxiliary loads such as weapon systems for naval vessels, hotel and service loads, and dynamic positioning systems are dependent on the produced electrical supply (Skjong et al., 2016). Therefore, smooth operation of a power generation system is not only crucial for energy efficiency onboard, but also essential for safety out at sea, where an electric black-out could lead to catastrophic events.

To ensure improved energy efficiency and safety, various strategies and methods are employed to control a vessel's dynamic power systems by utilising real-time feedback and state predictions or a forecast of the system's future behaviour (Xie et al., 2022). For example, Model Predictive Control (MPC) has gained popularity due to the incorporation of a forecast of system parameters for a set time horizon within its structure, which has been shown to increase performance compared to controllers that lack advanced knowledge of changes in power load (Opila et al., 2018). In this sense, an MPC strategy relies on a forecasting method or model that can accurately identify ensuing operational shifts (Camacho and Alba, 2013; Schwenzer et al., 2021; Dahl et al., 2018). Control inputs to the system can then be optimised to ensure the power generation system's efficiency and ability to deal with fast transients, avoiding blackout scenarios. Therefore, energy and power management and electrical system safety can be improved by forecasting the future load of the power system.

Automatic monitoring systems are now standard on new-built vessels and are increasingly often retrofitted to older vessels, making high-fidelity and high-frequency data more readily available (Valchev et al., 2022). The broad range of on-board sensors on ships has allowed maritime researchers to utilise varying subsets of the available data features in developing purpose-specific Machine Learning (ML) forecasting models (Khan et al., 2005; De Masi et al., 2011; Üney et al., 2019; Abualhaol et al., 2018). The ability to forecast a key parameter or a parameter set in the short term is essential for many control strategies for marine applications. Apart from the popular Neural Network-based methods, which require extensive training and validation datasets (Coraddu et al., 2015), kernel methods (e.g. Support Vector Machines) are also often explored, for example, in applications such as vessel motion forecasting (Zhou and Shi, 2010) and vessel traffic flow forecasting (Haiyan and Youzhen, 2015; Feng et al., 2011).

Similarly, data from monitoring systems can be used for the forecast of electrical loads (Zhao et al., 2021; Kim et al., 2021; Mehrzadi et al., 2020). For shore utility grids, the load demand of industrial and residential electrical power consumers can be predicted based on historical load profiles in combination with forecasts of the dew point and temperature with a sequence-to-sequence (seq2seq) forecast framework previously applied to translation learning (Zhao et al., 2021). Kim et al. (2021) has demonstrated historical data on ship speed, relative wind, ship draught, propulsion, and auxiliary load on a predetermined route can be used to predict propulsion and auxiliary load on the same route under predetermined conditions for route planning purposes. Furthermore, Mehrzadi et al. (2020) has demonstrated the use of a novel recurrent neural network algorithm to forecast thruster power to counter environmental disturbances for dynamic positioning applications. However, the use of marine environment and ship system monitoring data to forecast electrical load in the short term during sailing with hybrid propulsion has not yet been addressed.

Therefore, in this paper, the authors aim to accurately forecast the short-term electrical load of a vessel with hybrid propulsion, with both auxiliary loads and propulsion power supplied simultaneously by the electrical power generation plant. To do this, a kernel-based ML approach, Kernel-Based Regularised Least Squares (KRLS) (Vovk, 2013), which has not previously been applied to vessel power forecasting, is used to learn a forecasting model based on high-fidelity sensor data from the automatic monitoring system of a Naval vessel. The work clearly demonstrates that the proposed methodology can predict future load changes without complex hydrodynamic physical models, even during manoeuvring.

The rest of the paper will be structured as follows: Section 2 presents the sensor data from the Holland Class OPVs that is used to train and evaluate the forecasting models. Section 3 outlines the proposed forecasting method and how it is applied in the current work. Based on the results presented in Section 4, a discussion is carried out, drawing observations on the performance and potential of the developed methods. Finally, the work is concluded in Section 5 and avenues for future research are discussed.

2 Problem and Dataset Description

The schematic representation of the hybrid propulsion and combustion power supply system is illustrated in Figure 1. The propulsion of the vessel is either from two propulsion electric motors (PEMs) for low-speed sailing or from one or two main diesel engines for sailing at cruise speed and high speed. Vasilikis et al. (2022) has demonstrated that the load of the power system for the steering, mission, and auxiliary systems is fairly consistent,

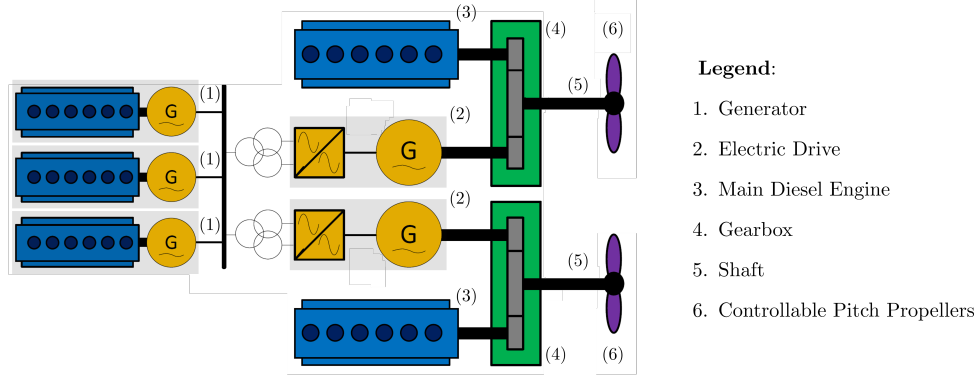

Figure 1: Schematic representation of hybrid propulsion plant with combustion power generation of the case study vessel

but that the load varies significantly when sailing in electric propulsion mode on its two PEMs. Moreover, the current power management system, in combination with operator decisions, does not ensure the diesel generators are running at its optimum operating point (Vasilikis et al., 2022). Therefore, a hybrid power generation system, with generators operating at their optimal load and batteries supplying load levelling, with an energy management system that takes into account future load forecast, can achieve an estimated 10% to 15% fuel savings.

Thus, the current work seeks to address the problem of predicting short-term trends in power generation by leveraging real operational data and state-of-the-art data-driven methods, toward maximising electric propulsion plants' efficiency and safety, whilst maximising blackout prevention, and minimising downtime. To this aim, real data describing the operational behaviour of a hybrid propulsion system has been used over periods characterized by full electric propulsion mode on its two PEMs. In detail, the Holland Class OPV sensor dataset fully encapsulates the vessel's operation, including over 70 features that describe the vessel's propulsion, steering, navigation, and energy generation systems, as well as the load characteristics including trim and draft, as described in Table 1. From the total dataset, periods during which the vessel was sailing in full electric mode were selected based on the propulsion and sailing mode parameters in the dataset. In particular, a time period of almost 40 hours, within which the OPV operates in electric propulsion mode is utilised for model training, validation, and testing. This translates to a time series of around 47000 data points with a sampling period of 3 seconds.

In the dataset covering a period of 40 hours, the ship sails using its two PEMs. Operation on the PEMs is characterised by slow speed sailing and limited maneuvering, as the main diesel engines are engaged when higher speed and instant acceleration are required. The complete dataset used for training and validation consists of sailing periods at speeds between 4 and 9 knots and shaft speed settings between 50 and 90 rpm, as shown in Figure 2. The total electrical load for propulsion, steering, mission and auxiliary systems ranges from 900 to 1200 kW. The variation in load (see Figure 2(a)) is mainly influenced by the electrical propulsion motor load. When sailing on 2 PEMs the ship typically has two generators providing the electric power to the electric grid. This leads to a load in the range from 450 to 600 kW per generator (see Figure 2(d)). The data in Table 1 will be used to predict the total auxiliary load to be shared between the two diesel generators, which could be used in similar vessels to ensure better load sharing between the generators and additional batteries installed.

A subset of the dataset of 4 hours duration has been kept aside from training and validation data to test whether the established data-driven model can be used to forecast future load. This dataset consists of a period of 4 hours of sailing at around 6 knots with a constant shaft speed setting of 65 rpm shaft speed and 1180 rpm electric motor speed. During this manoeuvre, the ship takes two turns, one turn to starboard with a 35° starboard (SB) rudder angle and one turn to port with a 35° port rudder angle. This leads to an increase in the power absorbed by the PEMs due to the extra hydrodynamic load on the propeller. Only a complex hydrodynamic model would be able predict this effect physically.

3 Proposed Approach

In the proposed context, namely the forecasting of near-term vessel electric power generation based on an input feature set describing the operation of the vessel, a general modelisation framework can be defined, characterized by an input space $\mathcal{X} \subseteq \mathbb{R}^d$, an output space $\mathcal{Y} \subseteq \mathbb{R}^d$, and an unknown relation $\mu : \mathcal{X} \rightarrow \mathcal{Y}$ to be learned (Shalev-Shwartz and Ben-David, 2014; Hamilton, 1994). Within the current work, \mathcal{X} contains the features listed in Table 1, whereas \mathcal{Y} consists of the target parameter, namely the Total Produced Auxiliary Power. In this context, the authors define the model $h : \mathcal{X} \rightarrow \mathcal{Y}$ as an approximation of μ . The aim of the current work is to develop a model h that is able to predict vessel performance parameters in the short-term.

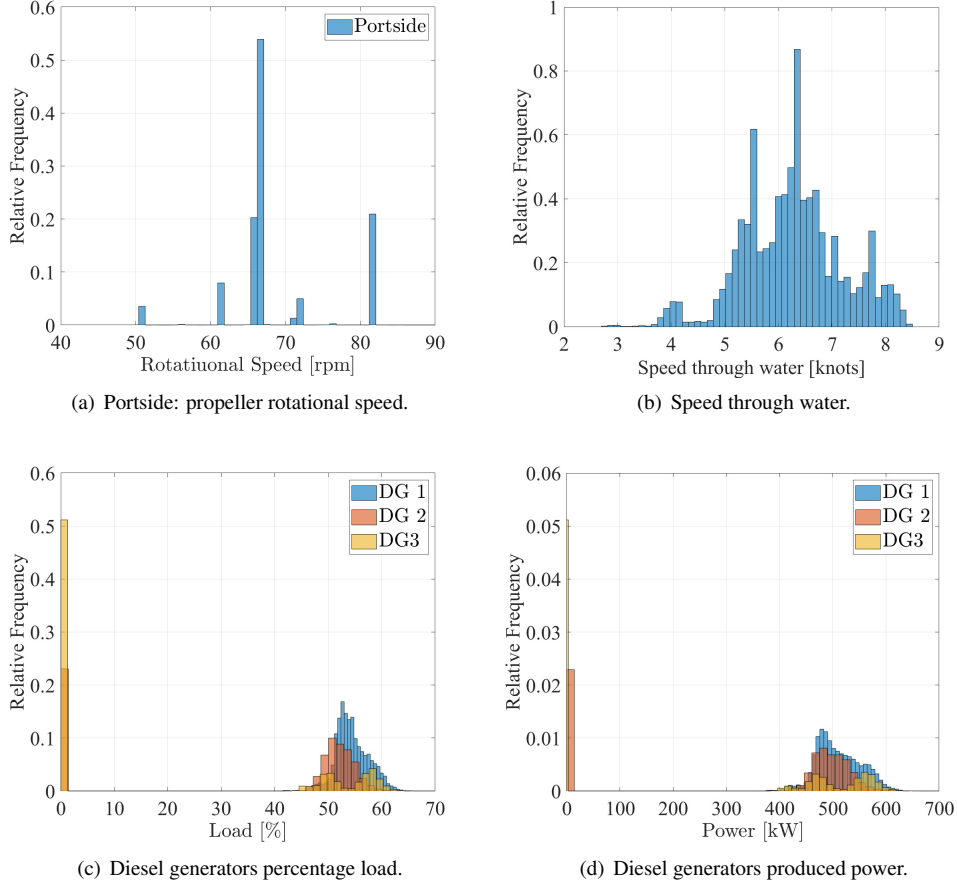

Figure 2: Subset of relevant features distribution for the considered dataset

In the case of a forecasting framework, such as the current scenario, the input space \mathcal{X} is comprised of past and current information in a defined time window $[t - \Delta^-, t]$ (i.e. historical information about the input parameters described in Table 1 spanning multiple data points up to Δ^- seconds in the past), while the output space \mathcal{Y} consists of the total electric energy production at time $t + \Delta^+$. For a better understanding, the above is graphically portrayed in Figure 3. Δ^- and Δ^+ define the characteristics of the forecasting procedure. In particular, Δ^- is a hyperparameter which controls the amount of historical information to be exploited to predict the future state of the target feature. Being a hyperparameter, there is an optimal value for Δ^- which balances between having too little historical information (i.e., Δ^- being too small) to be able to make accurate forecasts and having too much information (i.e., Δ^- being too large), which would make the model susceptible to the curse of dimensionality (Shalev-Shwartz and Ben-David, 2014; Oneto, 2020; Hamilton, 1994). On the other hand, Δ^+ is application specific, as the time horizon within which accurate predictions can be expected is not the same between different scenarios. Logically, the further into the future we try to predict, the lower the accuracy of and confidence in the results (Shalev-Shwartz and Ben-David, 2014; Oneto, 2020; Hamilton, 1994).

The approximating model h can be obtained through different types of techniques, for example, requiring some physical knowledge of the problem, as in physics-based methods, or the acquisition and utilisation of large amounts of data, as in data-driven methods. In this paper, a Machine Learning approach is adopted, as discussed in Section 1, to map the task of forecasting onboard electrical generation into a typical regression problem (Vapnik, 1998; Shawe-Taylor et al., 2004). In fact, ML techniques aim at estimating the unknown relationship μ between input and output through a learning algorithm $\mathcal{A}_{\mathcal{H}}$ which exploits historical data to learn h and where \mathcal{H} is a set of hyperparameters which characterises the generalisation performance of \mathcal{A} (Oneto, 2020). The historical data consists of a series of n examples of the input/output relation μ and are defined as $\mathcal{D}_n = \{(\mathbf{x}_1, y_1), \dots, (\mathbf{x}_n, y_n)\}$, where $\mathbf{x} \in \mathcal{X}$ and $y \in \mathcal{Y}$.

As mentioned in Section 1, in the current work an ML algorithm coming from the Kernel methods family called KRLS (Vovk, 2013) is utilised. The idea behind KRLS can be summarised as follows. During the training phase, the quality of the learned function $h(\mathbf{x})$ is measured according to a loss function $l(h(\mathbf{x}), y)$ (Rosasco et al., 2004) with empirical error

Input Variables			
Variable Name	Unit	Variable Name	Unit
Speed through water	knots	SB Prop. shaft speed	rpm
PS Prop. shaft speed	rpm	SB Prop. pitch	%
PS Prop. pitch	%	SB Prop. shaft torque	Nm
PS Prop. shaft torque	Nm	SB Rudder Angle	°
PS Rudder Angle	°	SB PEM absorbed power	kW
PS PEM absorbed power	kW	DG1 Fuel cons.	l/h
DG2 Fuel cons.	l/h	DG3 Fuel cons.	l/h
DG1 produced power	kW	DG2 produced power	kW
DG3 produced power	kW	DG1 Load	%
DG2 Load	%	DG3 Load	%
SB PEM speed	rpm	PS PEM speed	rpm
Bow thruster absorbed power	kW	Draft at bow	m
Draft at stern	m	Rate of turn	°/s
Target Variable			
Variable Name		Unit	
Total Produced Power		kW	

Table 1: Dataset Features

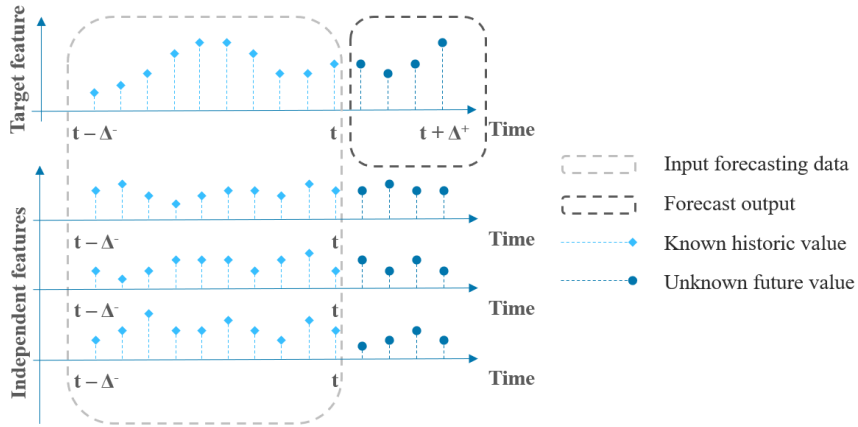

Figure 3: Data-Driven proposed framework for forecasting

$$\hat{L}_n(h) = \frac{1}{n} \sum_{i=1}^n l(h(\mathbf{x}_i), y_i). \quad (1)$$

A simple criterion for selecting the final model during the training phase could then consist in simply choosing the approximating function that minimises the empirical error $\hat{L}_n(h)$. This approach is known as empirical risk minimisation (ERM) (Vapnik, 1998). However, ERM is usually avoided in ML as it leads to severe overfitting of the model on the training dataset. In fact, in this case, the training process could choose a model, complicated enough to perfectly describe all the training samples (including the noise that afflicts them). In other words ERM implies memorisation of data rather than learning. A more effective approach is to minimise a cost function where the trade-off between accuracy on the training data and a measure of the complexity of the selected model is achieved (Tikhonov and Arsenin, 1979), implementing the Occam's razor principle

$$h^* : \min_h \hat{L}_n(h) + \lambda C(h). \quad (2)$$

In other words, the best approximating function h^* is chosen as one that is complicated enough to learn from the data without overfitting. In particular, $C(h)$ is a complexity measure: depending on the Machine Learning approach used, different measures are realised. Instead, $\lambda \in [0, \infty]$ is a hyperparameter, that must be set a-priori and is not obtained as an output of the optimisation procedure: it regulates the trade-off between the overfitting tendency, related to the minimisation of the empirical error, and the underfitting tendency, related to the minimisation of

$C(h)$. The optimal value for λ is problem-dependent, and tuning this hyperparameter is a non-trivial task, as will be discussed later in this section. In KRLS, models are defined as

$$h(\mathbf{x}) = \mathbf{w}^T \boldsymbol{\varphi}(\mathbf{x}), \quad (3)$$

where $\boldsymbol{\varphi}$ is an a-priori defined Feature Mapping (FM) (Shalev-Shwartz and Ben-David, 2014) allowing to keep the structure of $h(\mathbf{x})$ linear. The complexity of the models, in KRLS, is measured as

$$C(h) = \|\mathbf{w}\|^2, \quad (4)$$

i.e., the Euclidean norm of the set of weights describing the regressor, which is a standard complexity measure in ML (Shalev-Shwartz and Ben-David, 2014; Vovk, 2013). Regarding the loss function, the square loss is typically adopted due to its convexity, smoothness, and statistical properties (Rosasco et al., 2004)

$$\hat{L}_n(h) = \frac{1}{n} \sum_{i=1}^n l(h(\mathbf{x}_i), y_i) = \frac{1}{n} \sum_{i=1}^n [h(\mathbf{x}_i) - y_i]^2. \quad (5)$$

Consequently, Problem (2) can be reformulated as

$$\mathbf{w}^* : \min_{\mathbf{w}} \sum_{i=1}^n [\mathbf{w}^T \boldsymbol{\varphi}(\mathbf{x}_i) - y_i]^2 + \lambda \|\mathbf{w}\|^2. \quad (6)$$

By exploiting the Representer Theorem (Schölkopf et al., 2001), the solution h^* of the Problem (6) can be expressed as a linear combination of the samples projected in the space defined by $\boldsymbol{\varphi}$

$$h^*(\mathbf{x}) = \sum_{i=1}^n \alpha_i \boldsymbol{\varphi}(\mathbf{x}_i)^T \boldsymbol{\varphi}(\mathbf{x}). \quad (7)$$

It is worth highlighting that, according to the kernel trick, it is possible to reformulate $h^*(\mathbf{x})$ without explicit knowledge of $\boldsymbol{\varphi}$, and consequently avoiding the curse of dimensionality of computing $\boldsymbol{\varphi}$, using a proper kernel function $K(\mathbf{x}_i, \mathbf{x}) = \boldsymbol{\varphi}(\mathbf{x}_i)^T \boldsymbol{\varphi}(\mathbf{x})$:

$$h^*(\mathbf{x}) = \sum_{i=1}^n \alpha_i K(\mathbf{x}_i, \mathbf{x}) \quad (8)$$

Several kernel functions can be found in the literature (Cristianini et al., 2000; Schölkopf, 2001), each with a particular property that can be exploited according to the problem under examination. Usually, the Gaussian kernel is chosen

$$K(\mathbf{x}_i, \mathbf{x}) = e^{-\gamma \|\mathbf{x}_i - \mathbf{x}\|^2}, \quad (9)$$

because of the theoretical reasons described in Keerthi and Lin (2003); Oneto et al. (2015) and because of its effectiveness (Fernández-Delgado et al., 2014; Wainberg et al., 2016). γ is another hyperparameter, which regulates the non-linearity of the solution that must be tuned as will be described later. Basically, the Gaussian kernel is able to implicitly create an infinite dimensional $\boldsymbol{\varphi}$, and because of this, KRLS is able to learn any possible function (Keerthi and Lin, 2003). The KRLS problem of Eq. 6 can be reformulated by exploiting kernels as

$$\boldsymbol{\alpha}^* : \min_{\boldsymbol{\alpha}} \|\mathbf{Q}\boldsymbol{\alpha} - \mathbf{y}\|^2 + \lambda \boldsymbol{\alpha}^T \mathbf{Q}\boldsymbol{\alpha}, \quad (10)$$

where $\mathbf{y} = [y_1, \dots, y_n]^T$, $\boldsymbol{\alpha} = [\alpha_1, \dots, \alpha_n]^T$, the matrix \mathbf{Q} such that $Q_{i,j} = K(\mathbf{x}_j, \mathbf{x}_i)$, and the identity matrix $\mathbf{I} \in \mathbb{R}^{n \times n}$. By setting the gradient equal to 0 w.r.t. $\boldsymbol{\alpha}$, it is possible to state that

$$(\mathbf{Q} + \lambda \mathbf{I})\boldsymbol{\alpha}^* = \mathbf{y}, \quad (11)$$

which is a linear system for which effective solvers have been developed over the years, allowing it to cope with even very large sets of training data (Young, 2003).

One problem remains, namely, how to choose the hyperparameters of the forecasting method, namely λ , γ and Δ^- . These directly influence the model's ability to approximate μ , therefore requiring a proper Model Selection (MS) and Error Estimation (EE) procedure (Oneto, 2020) to be tuned. Resampling techniques such as k-fold Cross Validation (Kohavi et al., 1995), the nonparametric Bootstrap (Efron and Tibshirani, 1994), or Monte Carlo simulation (Metropolis and Ulam, 1949) are normally used when dealing with real-world scenarios, as these have been observed to perform well in practice (Coraddu et al., 2021). When utilising Resampling techniques, the

Total power generation forecasting				
Δ^+ [s]	Optimised Δ^- [s]	MSE [kW ²]	MAPE [%]	REP [%]
3	6	25.7 ± 3.1	0.26 ± 0.01	0.42 ± 0.04
6	9	52.0 ± 5.9	0.48 ± 0.01	0.74 ± 0.04
15	21	99.1 ± 9.3	0.64 ± 0.01	1.03 ± 0.05
30	27	167.1 ± 10.9	0.87 ± 0.02	1.35 ± 0.04
60	33	307.2 ± 20.9	1.22 ± 0.04	1.82 ± 0.06
120	39	549.1 ± 33.7	1.72 ± 0.04	2.44 ± 0.07
240	45	981.0 ± 52.9	2.22 ± 0.04	3.27 ± 0.09

Table 2: MSE, MAPE, and REP values of the proposed model when changing Δ^+ with the identified optimal Δ^- .

original dataset \mathcal{D}_n is resampled a number of times (n_r), with or without replacement, to build three independent datasets called learning, validation and test sets, respectively \mathcal{L}_1^r , \mathcal{V}_v^r , \mathcal{T}_t^r , with $r \in \{1, \dots, n_r\}$, such that

$$\mathcal{L}_1^r \cap \mathcal{V}_v^r = \emptyset, \mathcal{L}_1^r \cap \mathcal{T}_t^r = \emptyset, \mathcal{V}_v^r \cap \mathcal{T}_t^r = \emptyset \quad (12)$$

$$\mathcal{L}_1^r \cup \mathcal{V}_v^r \cup \mathcal{T}_t^r = \mathcal{D}_n \quad (13)$$

Following this, to perform the MS process and select the best set of hyperparameters $\mathcal{H} = \{\lambda, \gamma, \Delta^-\}$ from the set of all possible ones $\mathfrak{S} = \{\mathcal{H}_1, \mathcal{H}_2, \dots\}$ for the specific algorithm $\mathcal{A}_{\mathcal{H}}$, the following procedure must be applied:

$$\mathcal{H}^* : \arg \min_{\mathcal{H} \in \mathfrak{S}} \sum_{r=1}^{n_r} M(\mathcal{A}_{\mathcal{H}}(\mathcal{L}_1^r), \mathcal{V}_v^r), \quad (14)$$

where $h = \mathcal{A}_{\mathcal{H}}(\mathcal{L}_1^r)$ is a model built with the algorithm \mathcal{A} with its set of hyperparameters \mathcal{H} and with the data \mathcal{L}_1^r and where $M(\mathcal{A}_{\mathcal{H}}(\mathcal{L}_1^r), \mathcal{V}_v^r)$ is a desired metric. Since the data in \mathcal{L}_1^r is independent of the data in \mathcal{V}_v^r , \mathcal{H}^* should be a set of hyperparameters, which allows $\mathcal{A}_{\mathcal{H}}$ to achieve good performance on unseen data. Furthermore, for the EE phase, the optimal model $h_{\mathcal{A}}^* = \mathcal{A}_{\mathcal{H}^*}(\mathcal{D}_n)$ is evaluated according to:

$$M(h_{\mathcal{A}}^*) = \frac{1}{n_r} \sum_{r=1}^{n_r} M(\mathcal{A}_{\mathcal{H}^*}(\mathcal{L}_1^r \cup \mathcal{V}_v^r), \mathcal{T}_t^r) \quad (15)$$

Similarly to the process of MS, since the two datasets ($\mathcal{L}_1^r \cup \mathcal{V}_v^r$ and \mathcal{T}_t^r) are independent, $M(h_{\mathcal{A}}^*)$ estimates the true performance of the final model without bias (Oneto, 2020).

In the current work, the MS procedure is completed using Monte Carlo simulation without replacement (Metropolis and Ulam, 1949). Within this, $l = 0.7n_s$, $v = 0.15n_s$, and $t = 0.15n_s$, where n_s is the number of data points to be resampled from \mathcal{D}_n in each Monte Carlo iteration. The latter is implemented as a user input, which balances the computational requirement of the model and the accuracy & confidence of its results. For what concerns the error metric M , Mean Square Error (MSE) is used here for the reasons outlined earlier in this section. Additionally, to analyze and ensure the performance of the developed model, Mean Absolute Percentage Error (MAPE) and Relative Error Percentage (REP), as well as a range of visualization methods are also utilized.

4 Experimental Results & Discussion

The current section shows and discusses the results obtained according to the methods described in Section 3, leveraging the real-world sensor data described in Section 2. The best performing model was selected with Monte Carlo simulation from the hyperparameter grids: $\mathcal{H} = \{\lambda, \gamma, \Delta^-\}$, chosen in $\mathfrak{S} = \{10^{-5}, 10^{-4.63}, 10^{-4.26}, \dots, 10^2\} \times \{10^{-3}, 10^{-2.74}, 10^{-2.47}, \dots, 10^2\} \times \{3, 6, \dots, 63\}$. The statistical validity of the results is demonstrated with averages over 30 iterations, along with their t-student 95% confidence intervals. The MS and EE results for the future forecast power system load are presented in Table 2 over a varying time horizon, for the best historical data duration. Additionally, in Figure 4, the committed MAPE and REP of the forecasting model are presented graphically, together with the corresponding Δ^+ and optimised Δ^- .

The modelling results demonstrate accurate predictions of the total future load of the power system under changing conditions. For very short-term predictions, the model is accurate and able to follow fluctuations in the power system based on a short history of past information (6 seconds). For predictions further into the future, the accuracy reduces but remains within 2% MAPE for predictions up to 2 minutes into the future. As the forecast moves further into the future, the level of historical knowledge that is utilised by the optimum model, selected

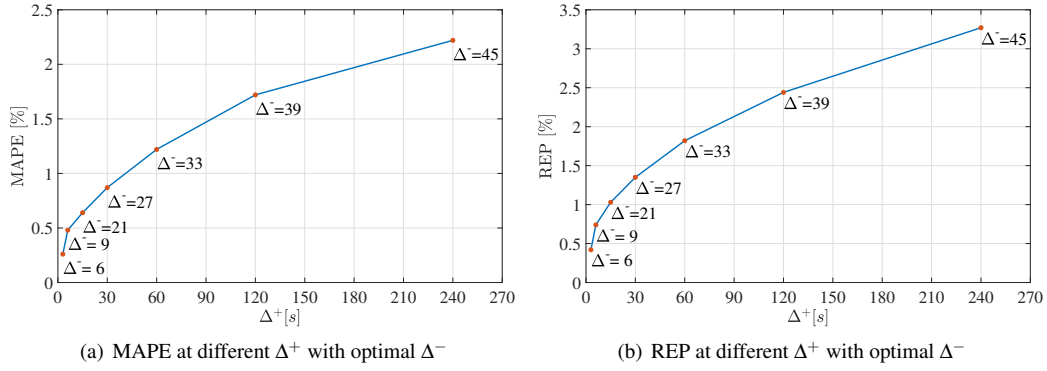

Figure 4: MAPE 4(a) and REP 4(b) behaviour as a function of Δ^+ with the identified optimal Δ^- .

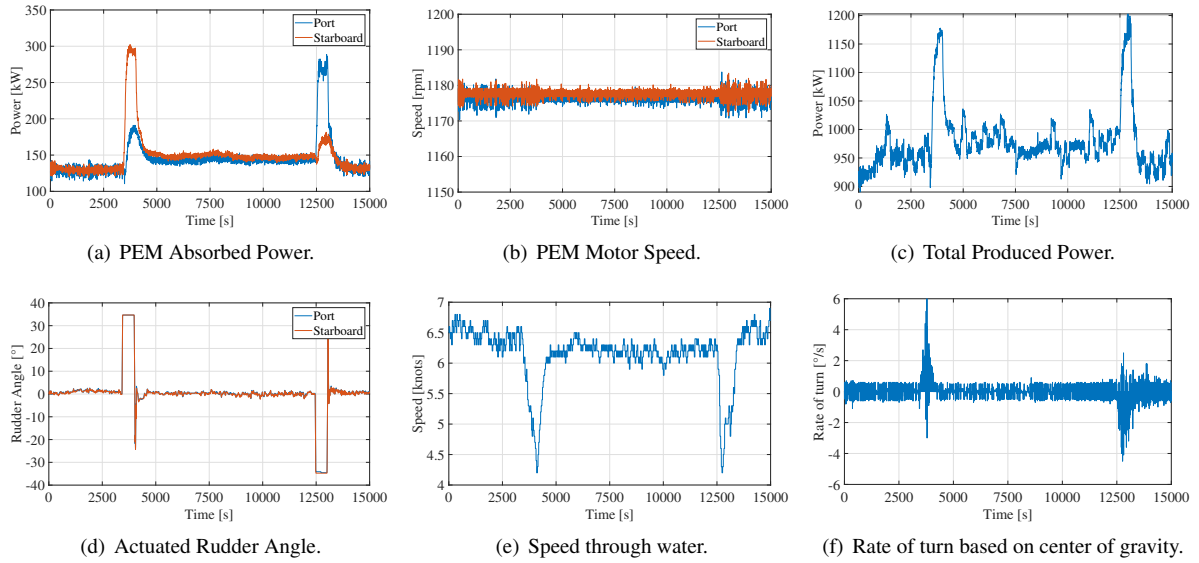

Figure 5: Time frame and representative subset of propulsive features for the test set considered in full electric operating mode.

by the methodology described in Section 3, naturally increases. In conclusion, the model performs well and its accuracy seems to suggest that it can be used for control strategies that can utilise load forecasts.

To verify and understand the high accuracy of the forecast and to evaluate the applicability of the model, the model was further tested on the unseen set of data that represents full electric operation at constant speed with rudder actuation, as described in Section 2 and shown in Figure 5. When predicting the future load of the power system 3s into the future, the prediction is accurate, the forecast follows the actual trend, but does not accurately follow the fluctuations (Figure 6). This confirms that the model can provide a forecast, but its applicability is limited, as it does not follow the smaller fluctuations exactly. When increasing the future horizon to up to 60s into the future, the forecast still follows the trend (Figures 7 and 8). However, when the power increases due to an operator-initiated event such as rudder actuation, this causes a delay of up to 60s between the start of the rudder actuation and the power increase. As the power increase during rudder actuation takes over 2 minutes to reach its maximum, the prediction horizon of 60s allows an early forecast of power increase, before the peak of the increase has been achieved. For other systems that cause a power increase, the time between a command and the actual power increase could also allow an accurate forecast. More autonomous systems, such as an autopilot, that actuate system loads based on data would potentially allow even more accurate forecasts, potentially also over longer horizons. These forecasts with different horizons could be used in power and energy management strategies that perform load levelling or energy management in systems with multiple power sources with different dynamic responses, such as combustion engines, fuel cells, batteries, and ultracapacitors.

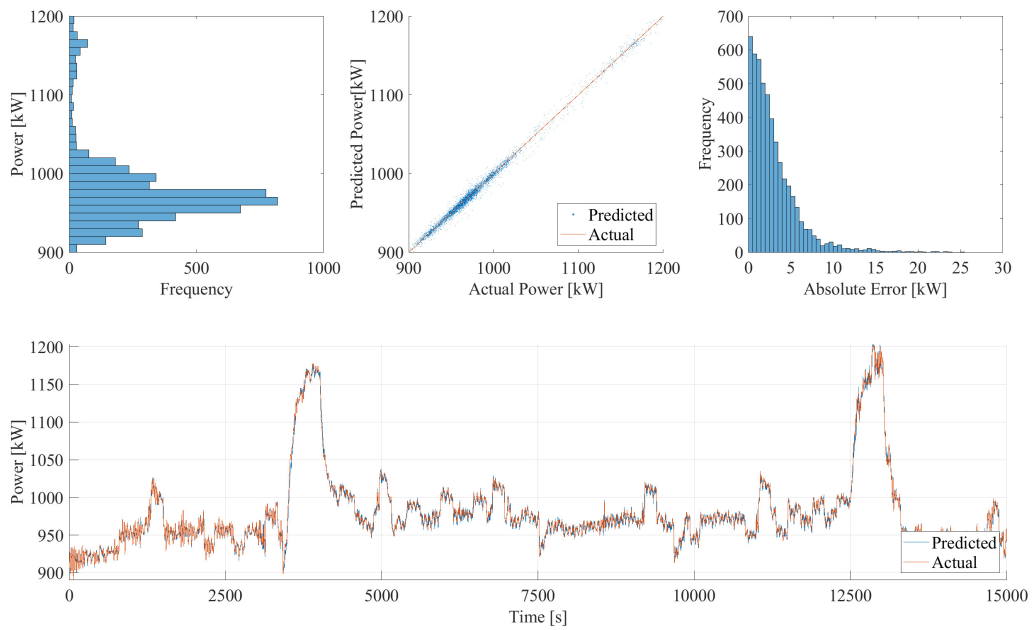

Figure 6: Real distribution - top left, scatter plot (Actual vs Predicted) - top middle, error distribution - top right, and trend in time (Actual vs Predicted) of produced power - bottom, when Δ^+ is 3s and optimal Δ^- is 6s, according to Table 2

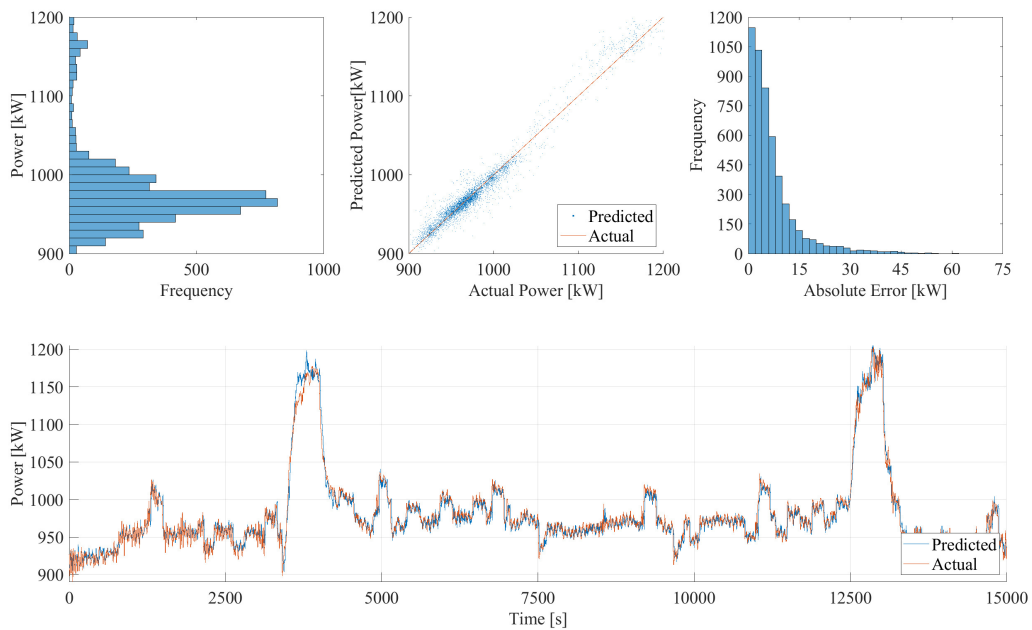

Figure 7: Real distribution - top left, scatter plot (Actual vs Predicted) - top middle, error distribution - top right, and trend in time (Actual vs Predicted) of produced power - bottom, when Δ^+ is 15s and optimal Δ^- is 21s, according to Table 2

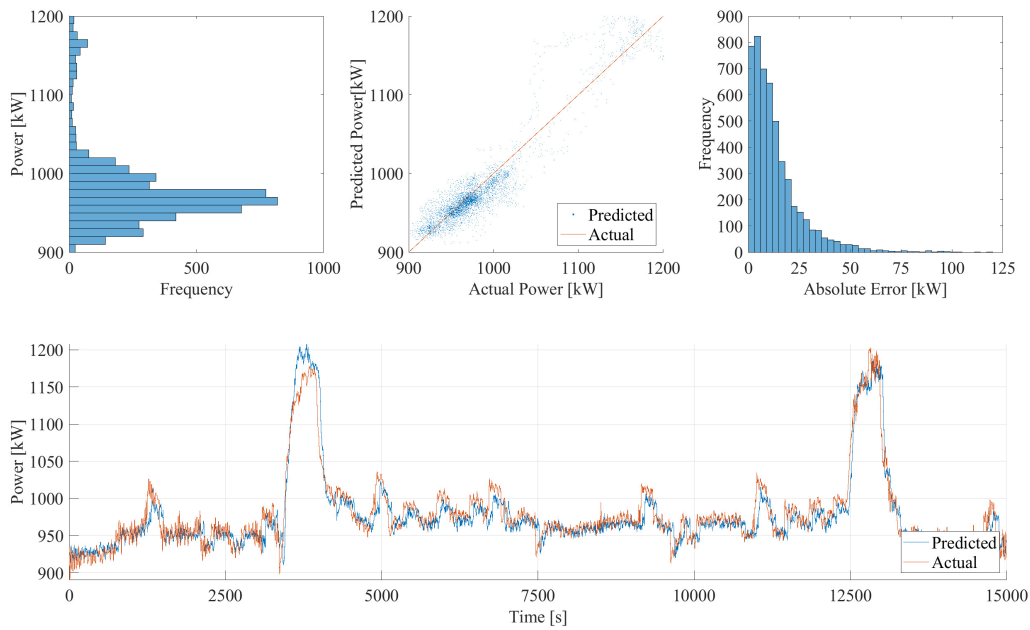

Figure 8: Real distribution - top left, scatter plot (Actual vs Predicted) - top middle, error distribution - top right, and trend in time (Actual vs Predicted) of produced power - bottom, when Δ^+ is 60s and optimal Δ^- is 33s, according to Table 2

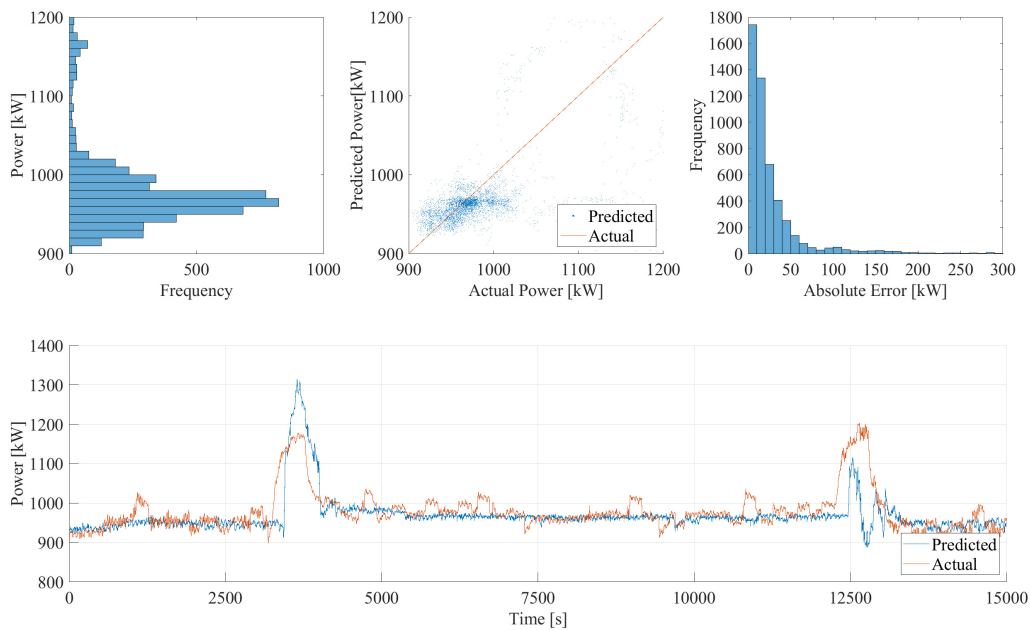

Figure 9: Real distribution - top left, scatter plot (Actual vs Predicted) - top middle, error distribution - top right, and trend in time (Actual vs Predicted) of produced power - bottom, when Δ^+ is 240s and optimal Δ^- is 45s, according to Table 2

5 Conclusion & Future work

In this paper, a short-term electric load forecasting method for ships with electric or hybrid propulsion is presented based on a novel KRLS model that uses typical data of a commercial platform management system. This model accurately predicts the future power requirement for the combination of electrical propulsion and auxiliary systems loads, 6 seconds to 4 minutes ahead in time, based on the past 9 to 45 seconds of data. For predictions up to 30 seconds into the future, the MAPE is within 1%. For predictions up to 2 minutes, the accuracy reduces to 2% MAPE, but still maintains an average prediction error within 100 kW, even during load steps of 250 kW due to heavy rudder actuation. These short-term predictions can be used for novel load sharing algorithms for future hybrid power systems, with combinations of combustion engines, fuel cells, batteries, and ultracapacitors in order to use the batteries for load levelling and the ultracapacitors for pulse loads. They can also be used in control strategies such as MPC and can allow sufficient time for automatic starting and stopping algorithms to start additional diesel generators and prevent electrical blackouts.

The current implementation does not use information about the marine environment that surrounds the vessel during operation due to insufficient sampling rate. In an ideal scenario, high granularity readings of wind, wave, and currents are expected to increase the capability and performance of the forecasting model, due to the high correlation between the environment and electrical power loads. Researchers have previously explored the use of X-band radar readings of near-term ocean behaviour in the creation of vessel motion forecasting models. Due to the connection between propulsive power and wave loads, it can be expected that for a hybrid propulsion vessel, an electric power forecasting model would also benefit from the above. Considering the current success in the development of an accurate short-term forecasting framework, the authors are interested in further developing the methodology by supplementing the model with information about the surrounding environment, depending on the availability of suitable data, as well as exploring other ML algorithms and their forecasting performance.

References

- Abualhaol, I., Falcon, R., Abielmona, R., Petriu, E., 2018. Data-driven vessel service time forecasting using long short-term memory recurrent neural networks, in: 2018 IEEE International Conference on Big Data (Big Data), IEEE. pp. 2580–2590.
- Camacho, E.F., Alba, C.B., 2013. Model predictive control. Springer science & business media.
- Coraddu, A., Oneto, L., Baldi, F., Anguita, D., 2015. Ship efficiency forecast based on sensors data collection: Improving numerical models through data analytics, in: OCEANS 2015-Genova, IEEE. pp. 1–10.
- Coraddu, A., Oneto, L., Cipollini, F., Kalikatzarakis, M., Meijn, G.J., Geertsma, R., 2021. Physical, data-driven and hybrid approaches to model engine exhaust gas temperatures in operational conditions. *Ships and Offshore Structures*, 1–22.
- Cristianini, N., Shawe-Taylor, J., et al., 2000. An introduction to support vector machines and other kernel-based learning methods. Cambridge university press.
- Dahl, A.R., Thorat, L., Skjetne, R., 2018. Model predictive control of marine vessel power system by use of structure preserving model. *IFAC-PapersOnLine* 51, 335–340.
- De Masi, G., Gaggiotti, F., Bruschi, R., Venturi, M., 2011. Ship motion prediction by radial basis neural networks, in: 2011 IEEE Workshop On Hybrid Intelligent Models And Applications, IEEE. pp. 28–32.
- Duan, W., Huang, L., Han, Y., Zhang, Y., Huang, S., 2015. A hybrid ar-emd-svr model for the short-term prediction of nonlinear and non-stationary ship motion. *Journal of Zhejiang University-SCIENCE A* 16, 562–576.
- Efron, B., Tibshirani, R.J., 1994. An introduction to the bootstrap. CRC press.
- Feng, H., Kong, F., Xiao, Y., 2011. Vessel traffic flow forecasting model study based on support vector machine, in: International Conference on Electronic Commerce, Web Application, and Communication, Springer. pp. 446–451.
- Fernández-Delgado, M., Cernadas, E., Barro, S., Amorim, D., 2014. Do we need hundreds of classifiers to solve real world classification problems? *The journal of machine learning research* 15, 3133–3181.
- Haiyan, W., Youzhen, W., 2015. Vessel traffic flow forecasting with the combined model based on support vector machine, in: 2015 International Conference on Transportation Information and Safety (ICTIS), IEEE. pp. 695–698.
- Hamilton, J.D., 1994. Time series analysis. Princeton university press.
- International Maritime Organisation (IMO), 2018. Initial strategy on greenhouse gas emissions reduction for ships, in: IMO MEPC 72.
- Jaurola, M., Hedin, A., Tikkanen, S., Huhtala, K., 2019. Optimising design and power management in energy-efficient marine vessel powersystems: a literature review. *Journal of Marine Engineering & Technology* 18:2, 92–101. doi:10.1080/20464177.2018.1505584.
- Keerthi, S.S., Lin, C.J., 2003. Asymptotic behaviors of support vector machines with gaussian kernel. *Neural computation* 15, 1667–1689.

- Khan, A., Bil, C., Marion, K.E., 2005. Ship motion prediction for launch and recovery of air vehicles, in: Proceedings of OCEANS 2005 MTS/IEEE, IEEE. pp. 2795–2801.
- Kim, J.Y., Lee, J.H., Oh, J.H., Oh, J.S., 2021. A comparative study on energy consumption forecast methods for electric propulsion ship. *Journal of Marine Science and Engineering* 10, 32.
- Kohavi, R., et al., 1995. A study of cross-validation and bootstrap for accuracy estimation and model selection, in: *Ijcai*, Montreal, Canada. pp. 1137–1145.
- Mehrzadi, M., Terriche, Y., Su, C., Xie, P., Bazmohammadi, N., Costa, M.N., Liao, C., Vasquez, J.C., Guerrero, J.M., 2020. A deep learning method for short-term dynamic positioning load forecasting in maritime microgrids. *Applied Sciences* 10, 4889.
- Metropolis, N., Ulam, S., 1949. The monte carlo method. *Journal of the American statistical association* 44, 335–341.
- Netherlands MoD, 2015. Operational Energy Strategy. Technical Report. URL: <https://zoek.officielebekendmakingen.nl/blg-683462.pdf>.
- Oneto, L., 2020. Model selection and error estimation in a nutshell. Springer.
- Oneto, L., Ghio, A., Ridella, S., Anguita, D., 2015. Support vector machines and strictly positive definite kernel: The regularization hyperparameter is more important than the kernel hyperparameters, in: 2015 International Joint Conference on Neural Networks (IJCNN), IEEE. pp. 1–4.
- Opila, D.F., Stevens, J.D., Cramer, A.M., 2018. The role of future information in control system design for shipboard power systems, in: Proceedings of the International Ship Control Systems Symposium (iSCSS).
- Rosasco, L., De Vito, E., Caponnetto, A., Piana, M., Verri, A., 2004. Are loss functions all the same? *Neural computation* 16, 1063–1076.
- Schölkopf, B., 2001. The kernel trick for distances. *Advances in neural information processing systems* 13.
- Schölkopf, B., Herbrich, R., Smola, A.J., 2001. A generalized representer theorem, in: International conference on computational learning theory, Springer. pp. 416–426.
- Schulten, P.J.M., Geertsma, R.D., Visser, K., 2017. Energy as a weapon, part 2, in: Proceedings of the Engine As A Weapon VII conference, Bristol, UK.
- Schwenzer, M., Ay, M., Bergs, T., Abel, D., 2021. Review on model predictive control: An engineering perspective. *The International Journal of Advanced Manufacturing Technology* 117, 1327–1349.
- Shalev-Shwartz, S., Ben-David, S., 2014. Understanding machine learning: From theory to algorithms. Cambridge university press.
- Shawe-Taylor, J., Cristianini, N., et al., 2004. Kernel methods for pattern analysis. Cambridge university press.
- Skjong, E., Volden, R., Rødskar, E., Molinas, M., Johansen, T.A., Cunningham, J., 2016. Past, present, and future challenges of the marine vessel's electrical power system. *IEEE Transactions on Transportation Electrification* 2, 522–537.
- Tikhonov, A.N., Arsenin, V.Y., 1979. Methods of solution of ill-posed problems. Nauka, Moscow.
- Üney, M., Milleflori, L.M., Braca, P., 2019. Data driven vessel trajectory forecasting using stochastic generative models, in: ICASSP 2019-2019 IEEE International Conference on Acoustics, Speech and Signal Processing (ICASSP), IEEE. pp. 8459–8463.
- Valchev, I., Coraddu, A., Kalikatzarakis, M., Geertsma, R., Oneto, L., 2022. Numerical methods for monitoring and evaluating the biofouling state and effects on vessels' hull and propeller performance: A review. *Ocean Engineering* 251, 110883.
- Vapnik, V.N., 1998. Statistical Learning Theory. Wiley-Interscience.
- Vasilikis, N.I., 2020. Operational data-driven energy efficiency and effectiveness assessment of a hybrid propulsion equipped naval vessel, in: Proceedings of the 15th International Naval Engineering Conference and Exhibition (INEC).
- Vasilikis, N.I., Geertsma, R.D., Visser, K., 2022. Operational data-driven energy performance assessment of ships: the case study of a naval vessel with hybrid propulsion. *Journal of Marine Engineering and Technology* doi:10.1080/20464177.2022.2058690.
- Vorwald, J., Schwartz, A., Kent, C., 2016. Near term ship motion forecasting from prior motion, in: Fluids Engineering Division Summer Meeting, American Society of Mechanical Engineers.
- Vovk, V., 2013. Kernel ridge regression, in: Empirical inference. Springer, pp. 105–116.
- Wainberg, M., Alipanahi, B., Frey, B.J., 2016. Are random forests truly the best classifiers? *The Journal of Machine Learning Research* 17, 3837–3841.
- Xie, P., Guerrero, J.M., Tan, S., Bazmohammadi, N., Vasquez, J.C., Merhzadi, M., AL-Turki, Y., 2022. Optimization-based power and energy management system in shipboard microgrid: a review. *IEEE systems journal* 16(1), 578–590.
- Young, D.M., 2003. Iterative solution of large linear systems. Dover Publications.
- Zahedi, B., Norum, L.E., Ludvigsen, K.B., 2014. Optimized efficiency of all-electric ships by dc hybrid power

- systems. *Journal of power sources* 255, 341–354.
- Zhao, D., Ge, Q., Tian, Y., Cui, J., Xie, B., Hong, T., 2021. Short-term load demand forecasting through rich features based on recurrent neural networks. *IET Generation, Transmission, & Distribution* 15.
- Zhou, B., Shi, A., 2010. Lssvm and hybrid particle swarm optimization for ship motion prediction, in: 2010 International Conference on Intelligent Control and Information Processing, IEEE. pp. 183–186.