



Google



Google



Google



Google



Google



Google



Google



Google



Google













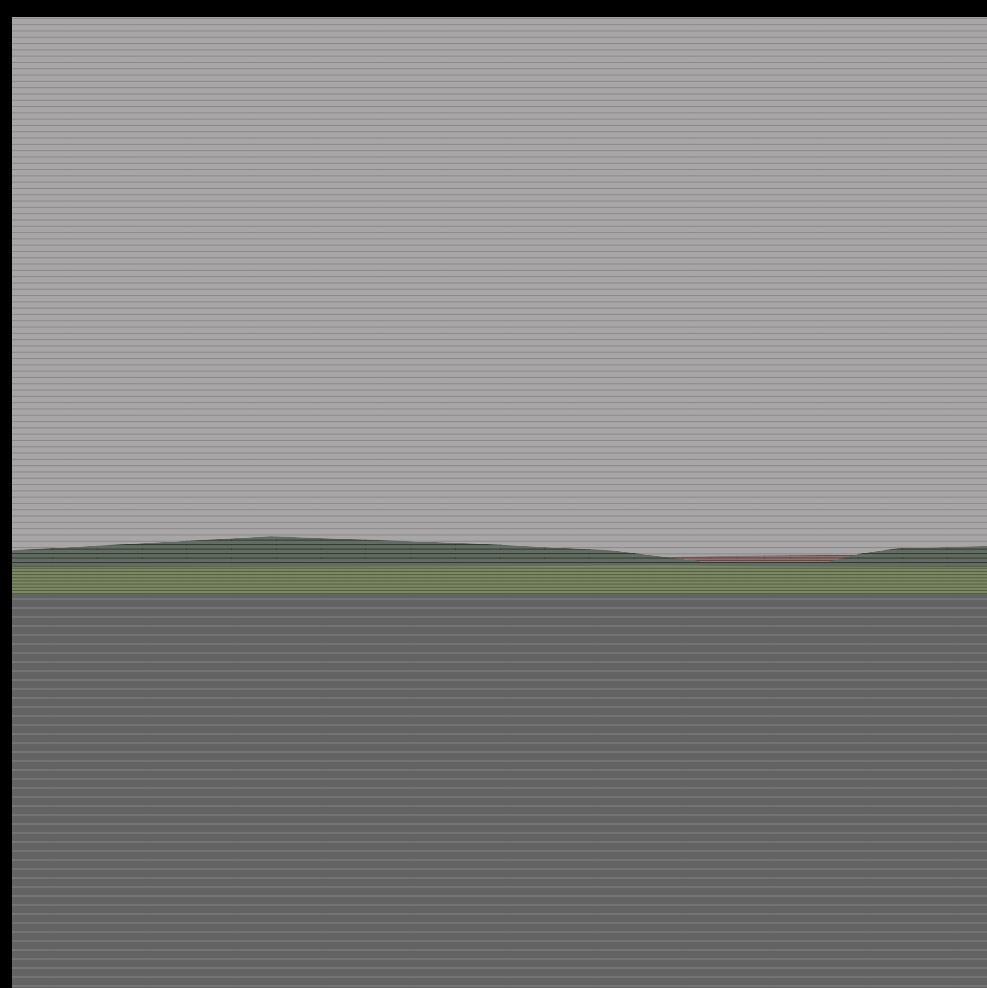
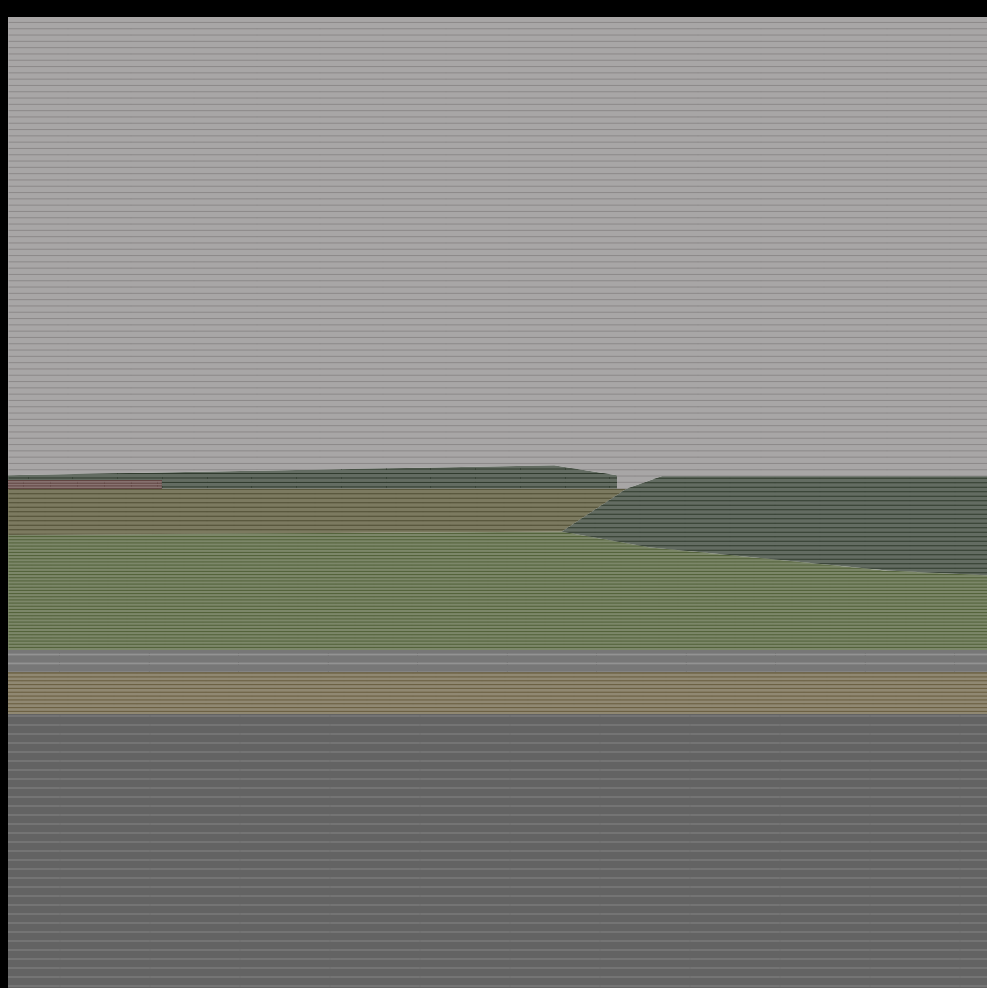
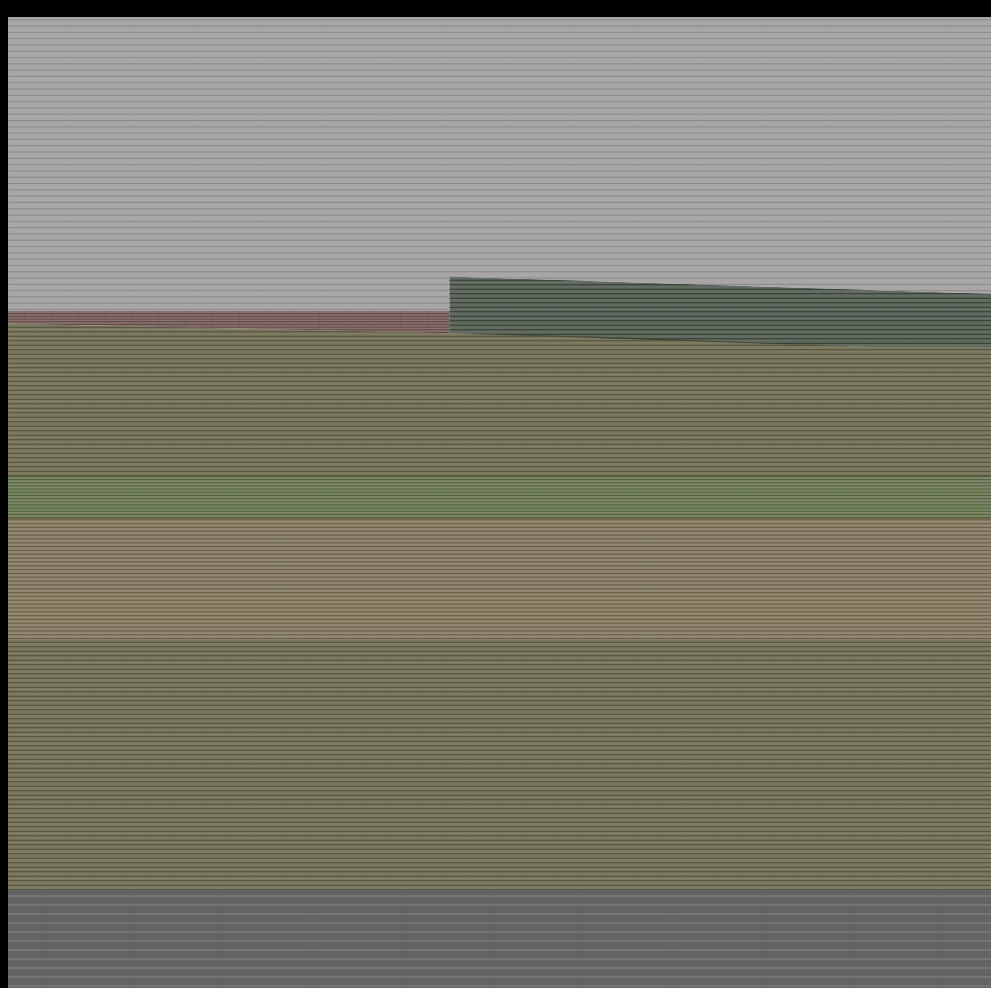
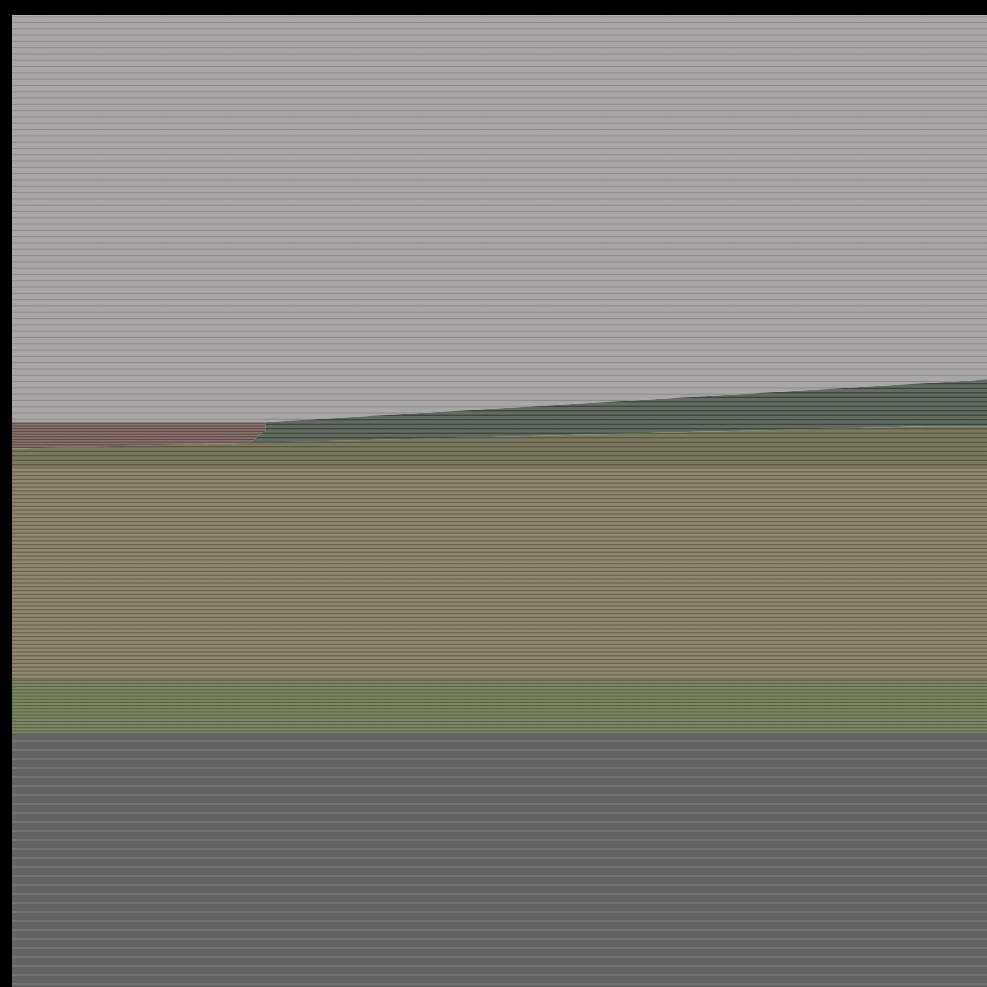
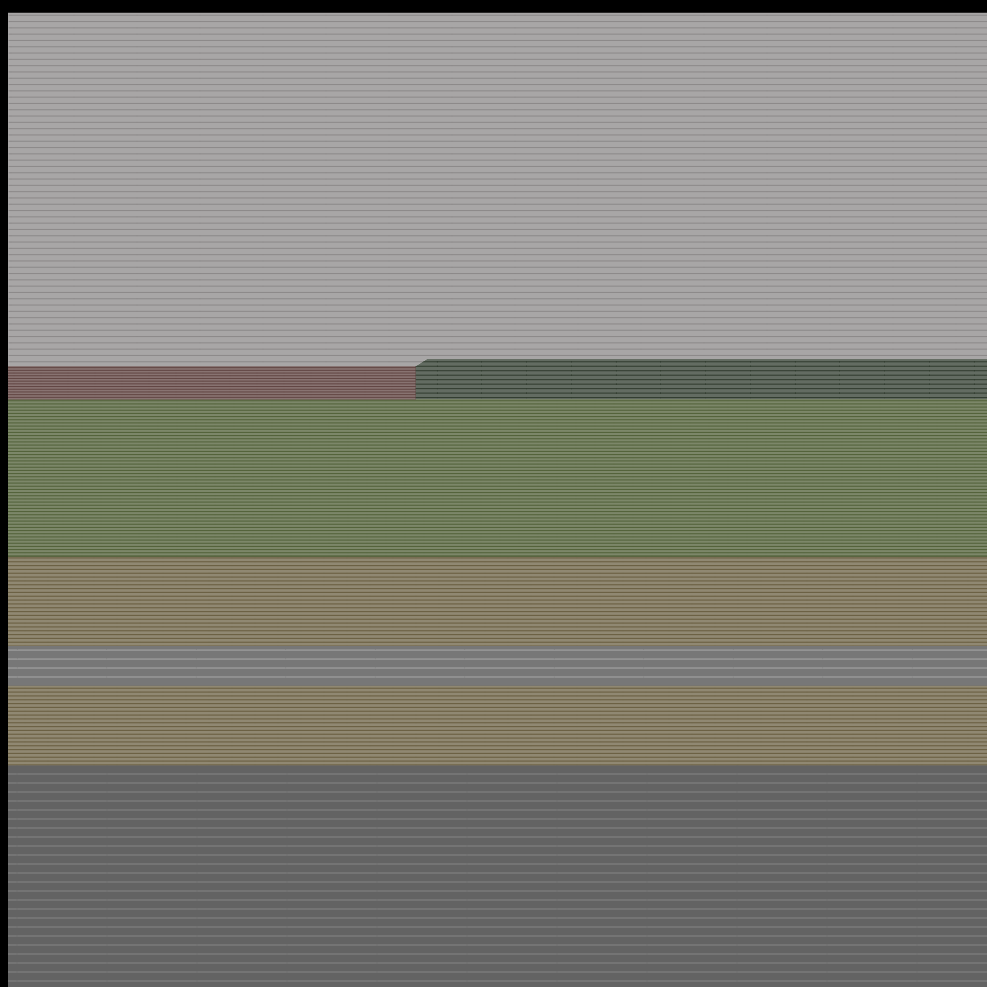
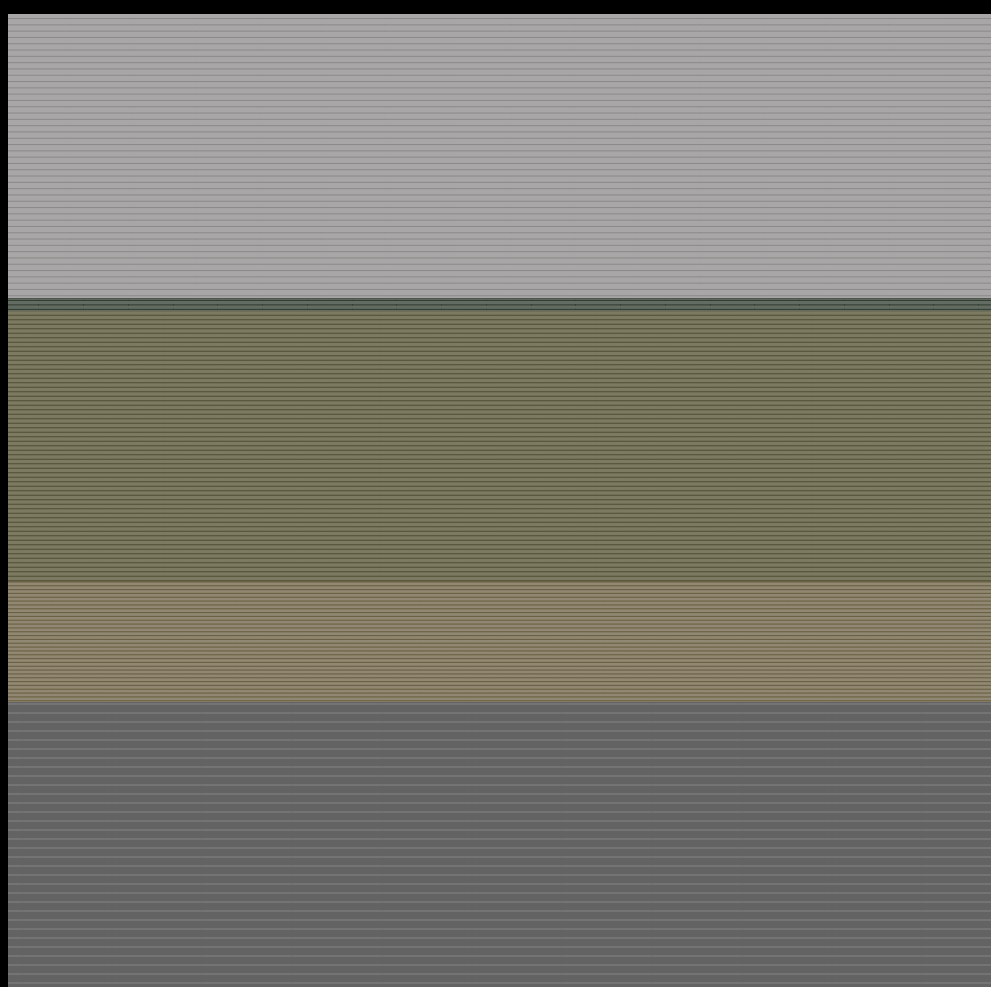
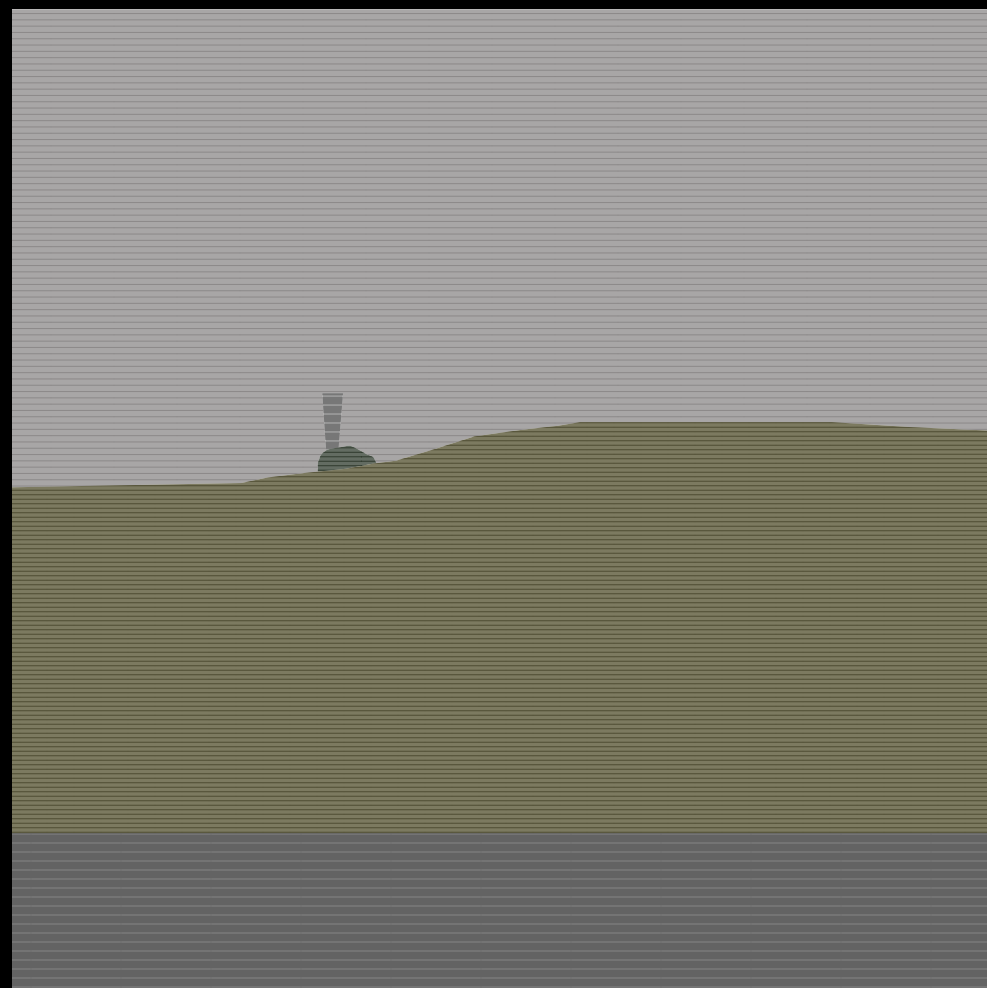
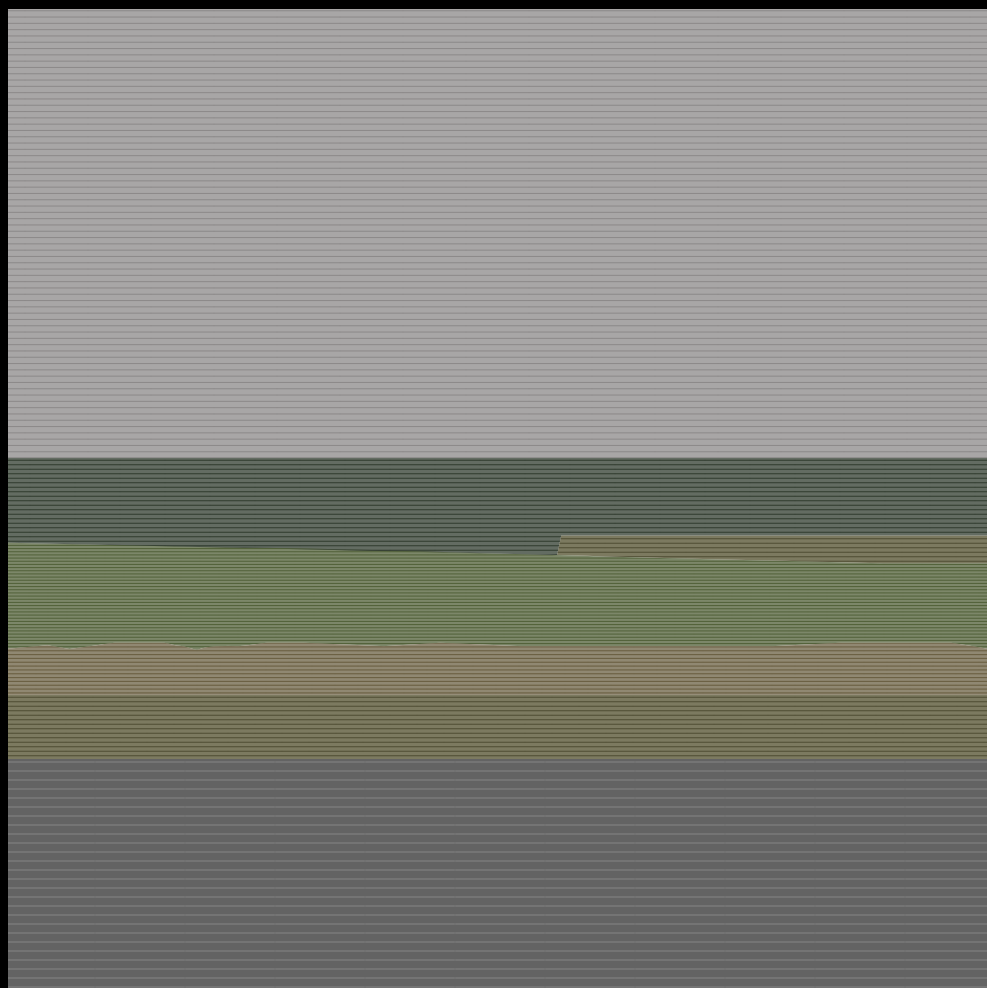
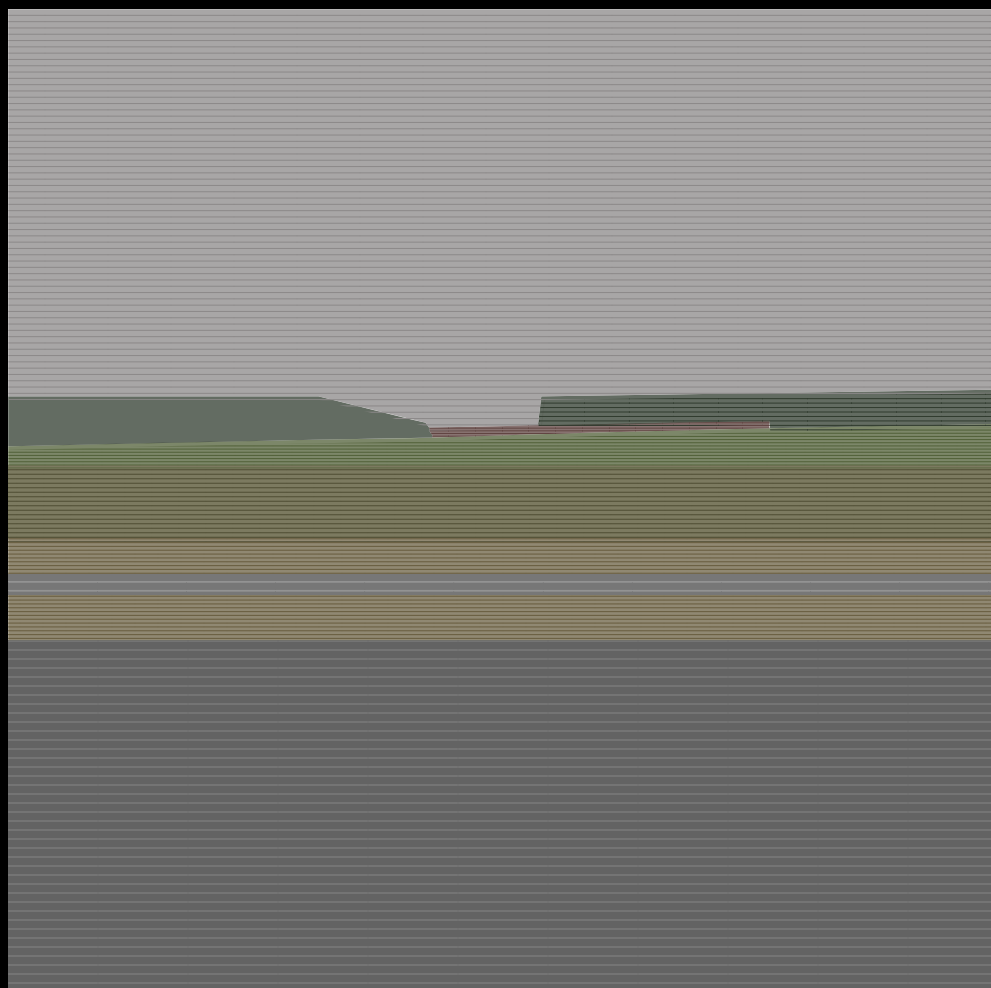

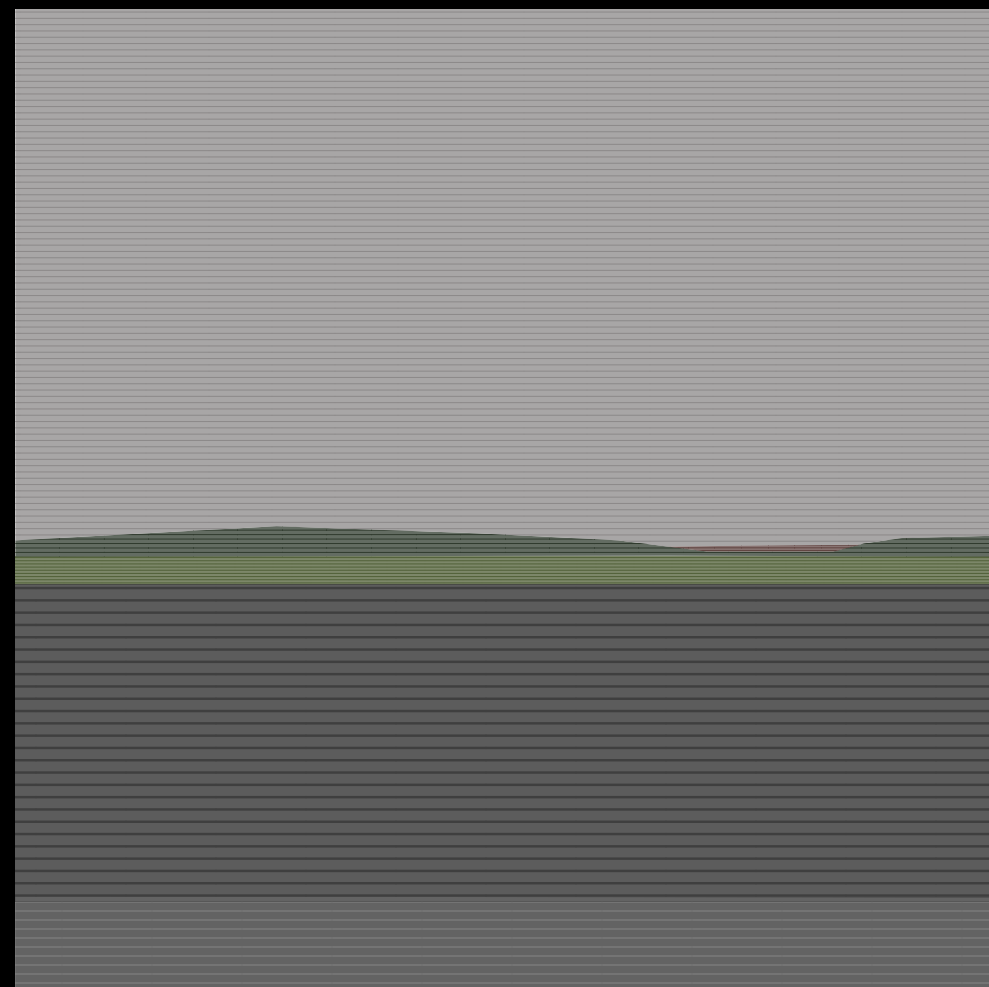
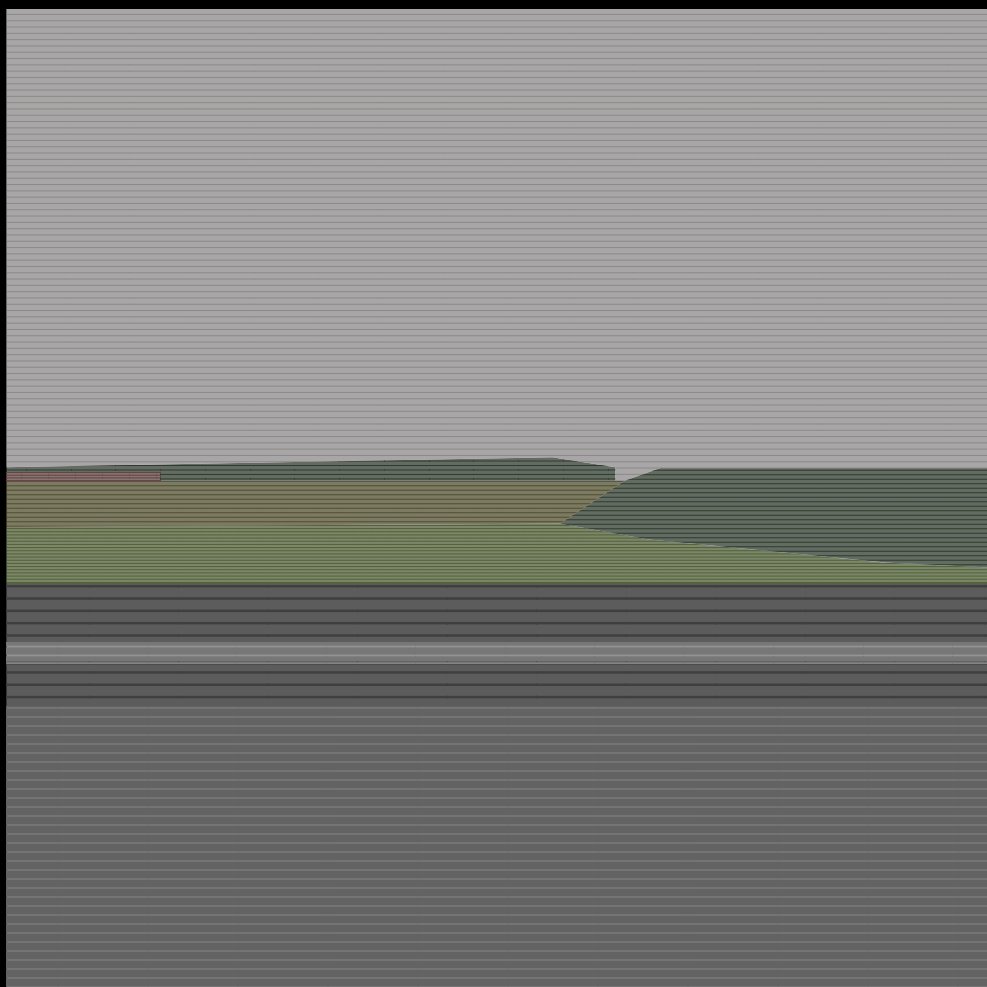
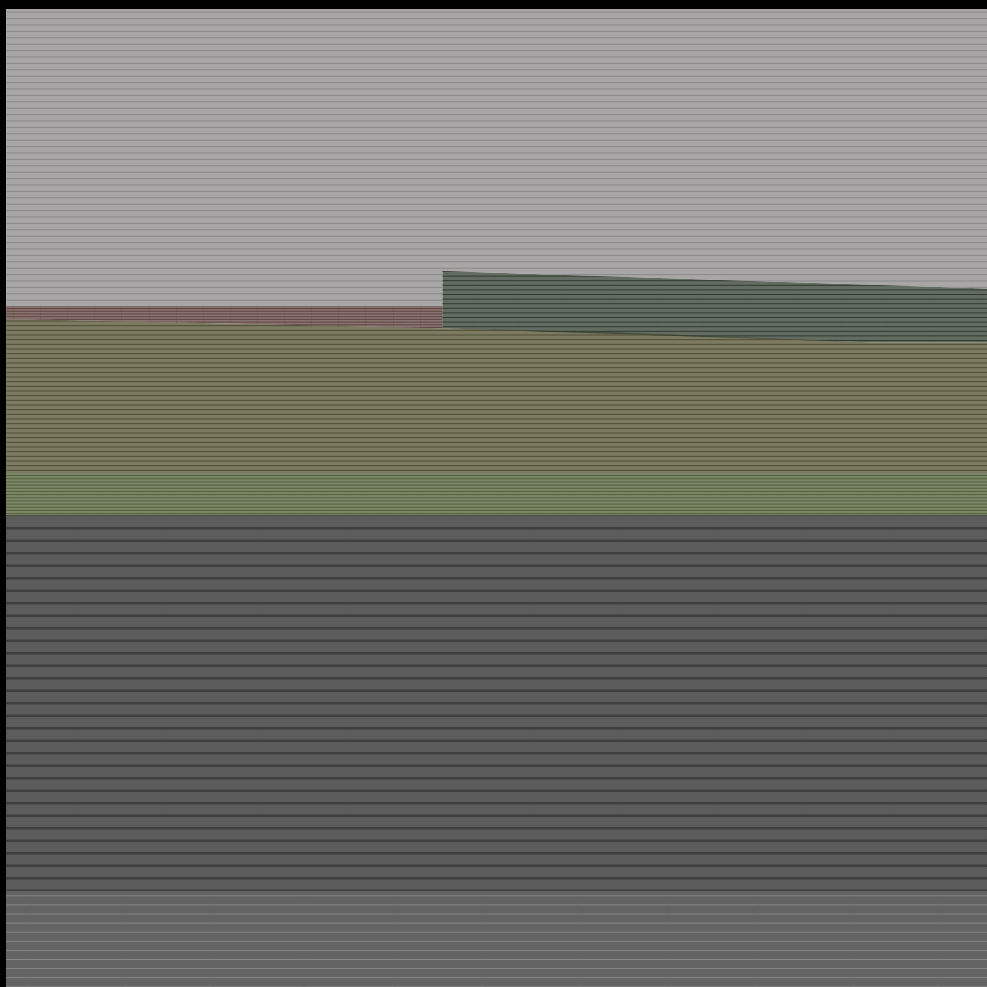
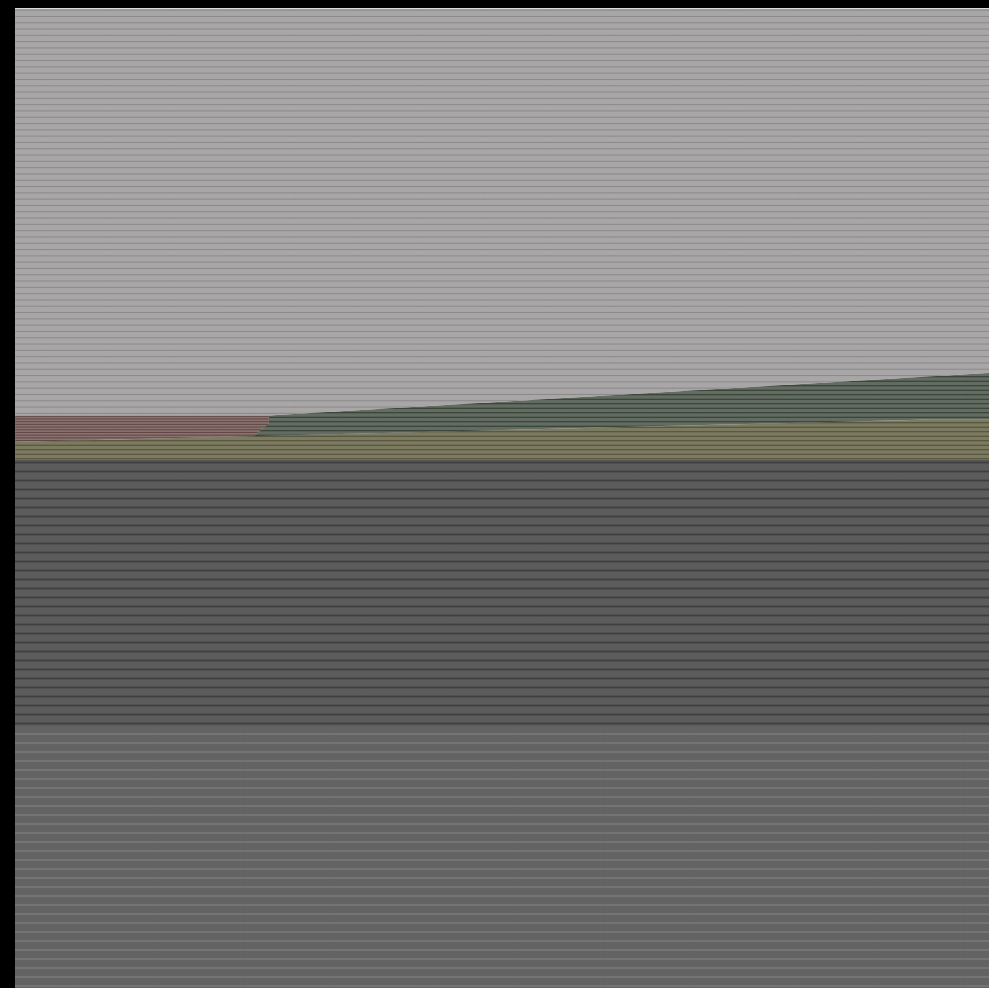
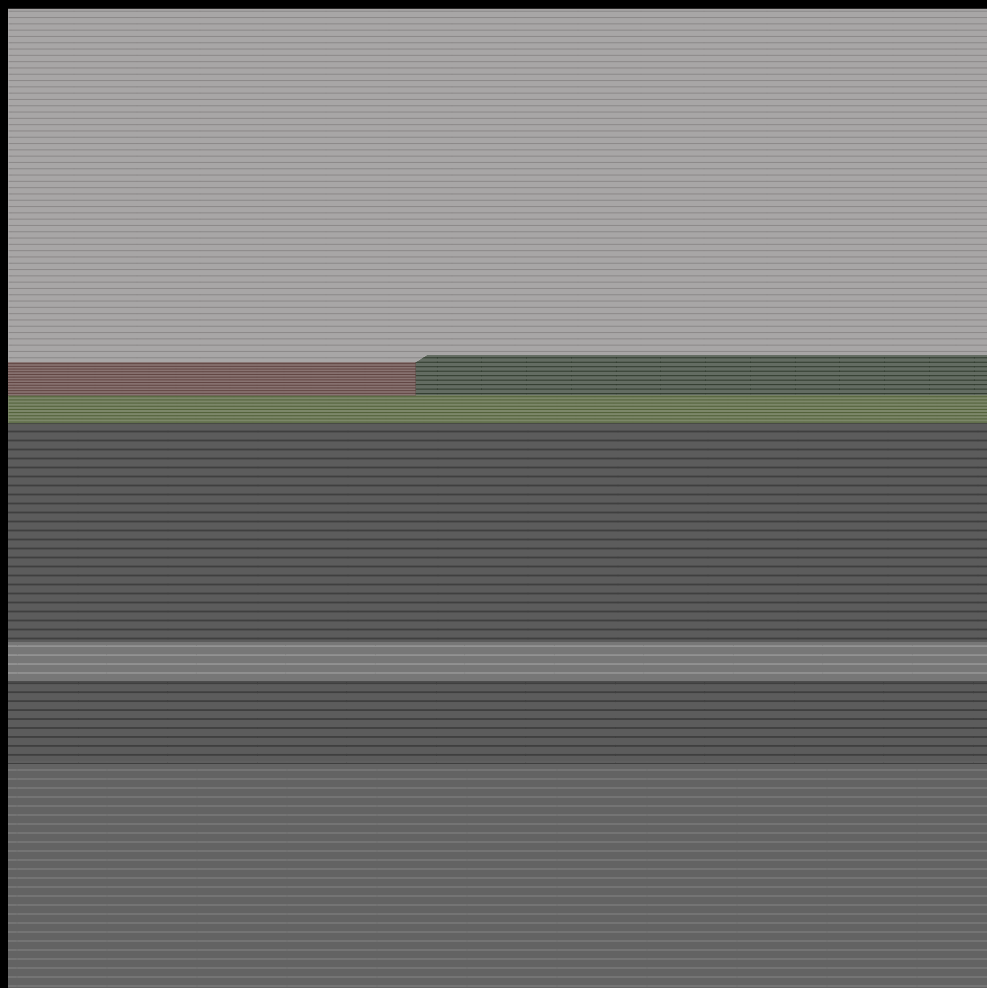
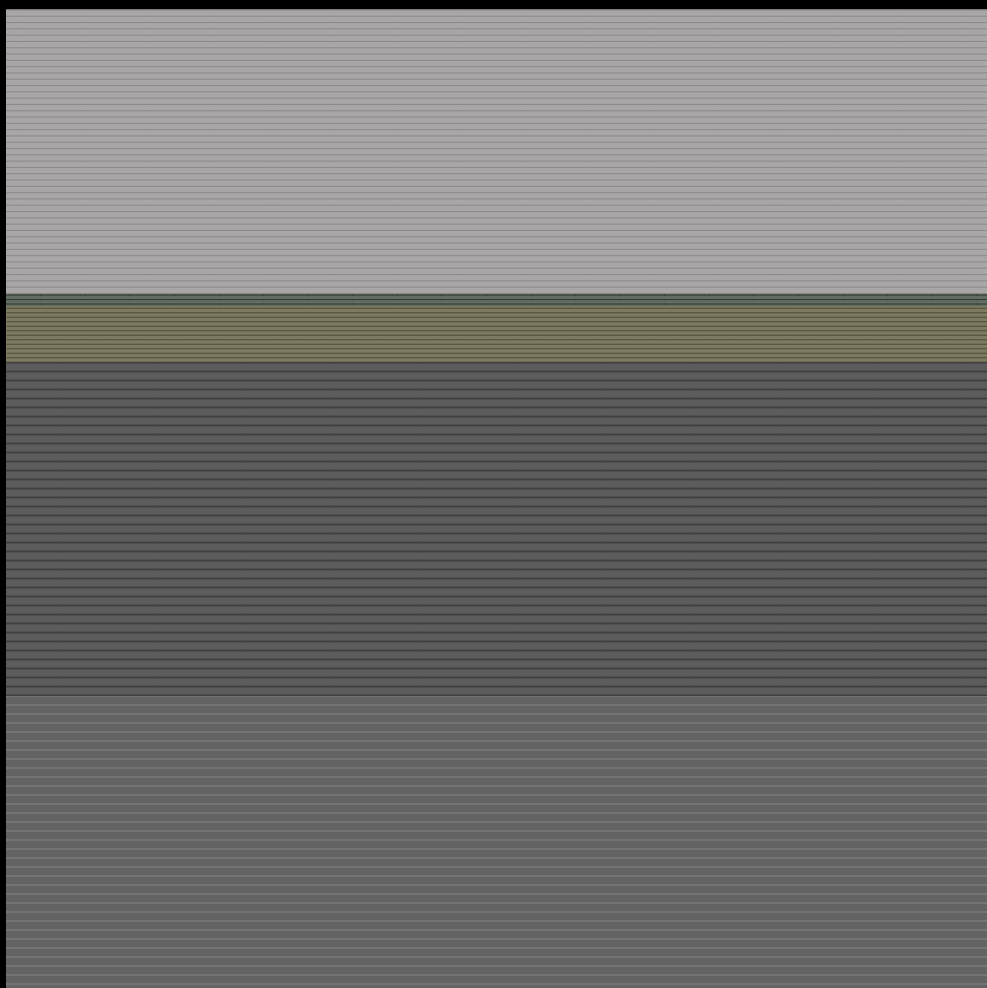
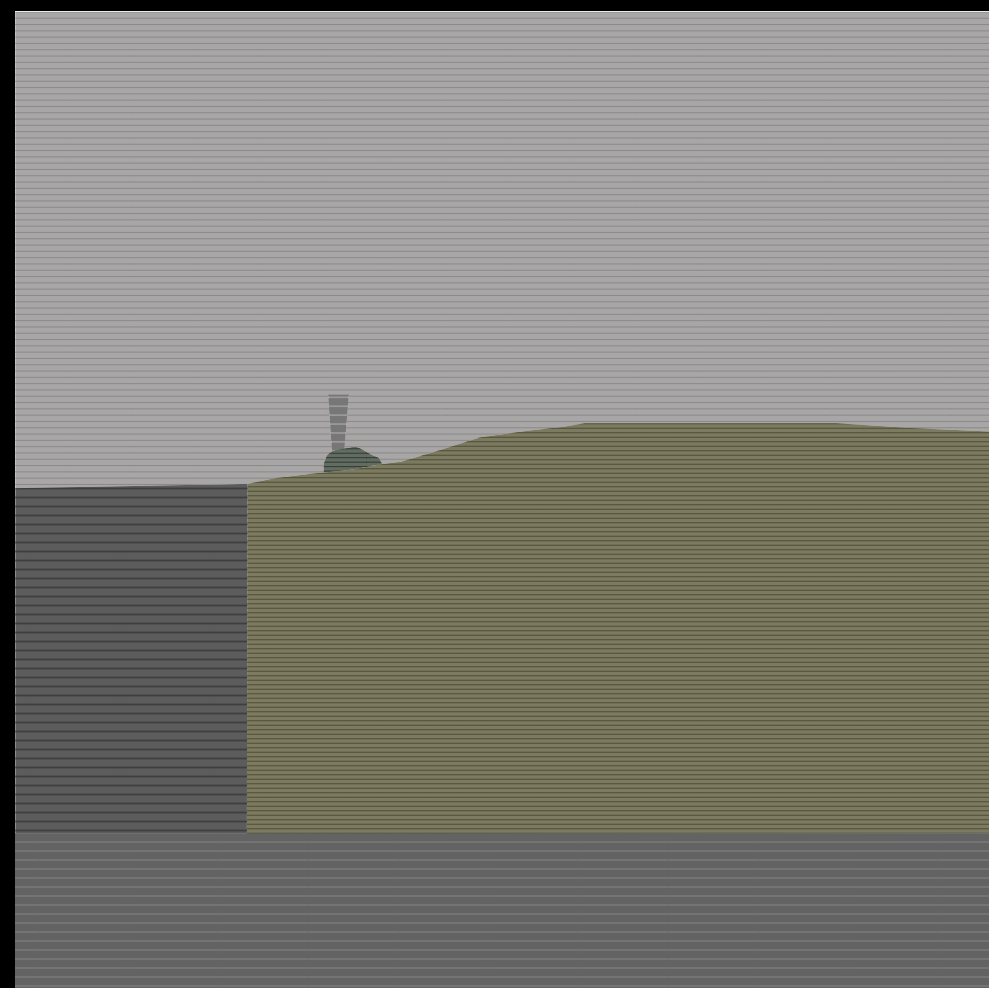
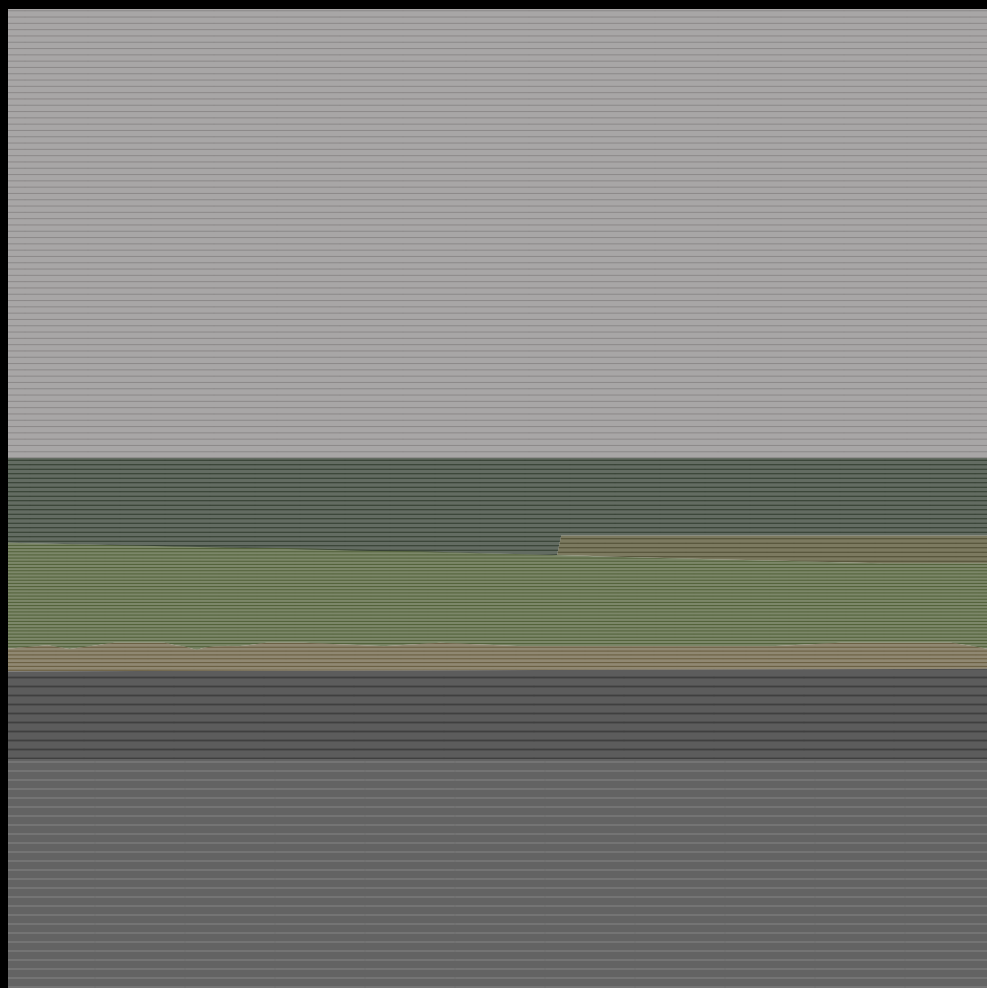
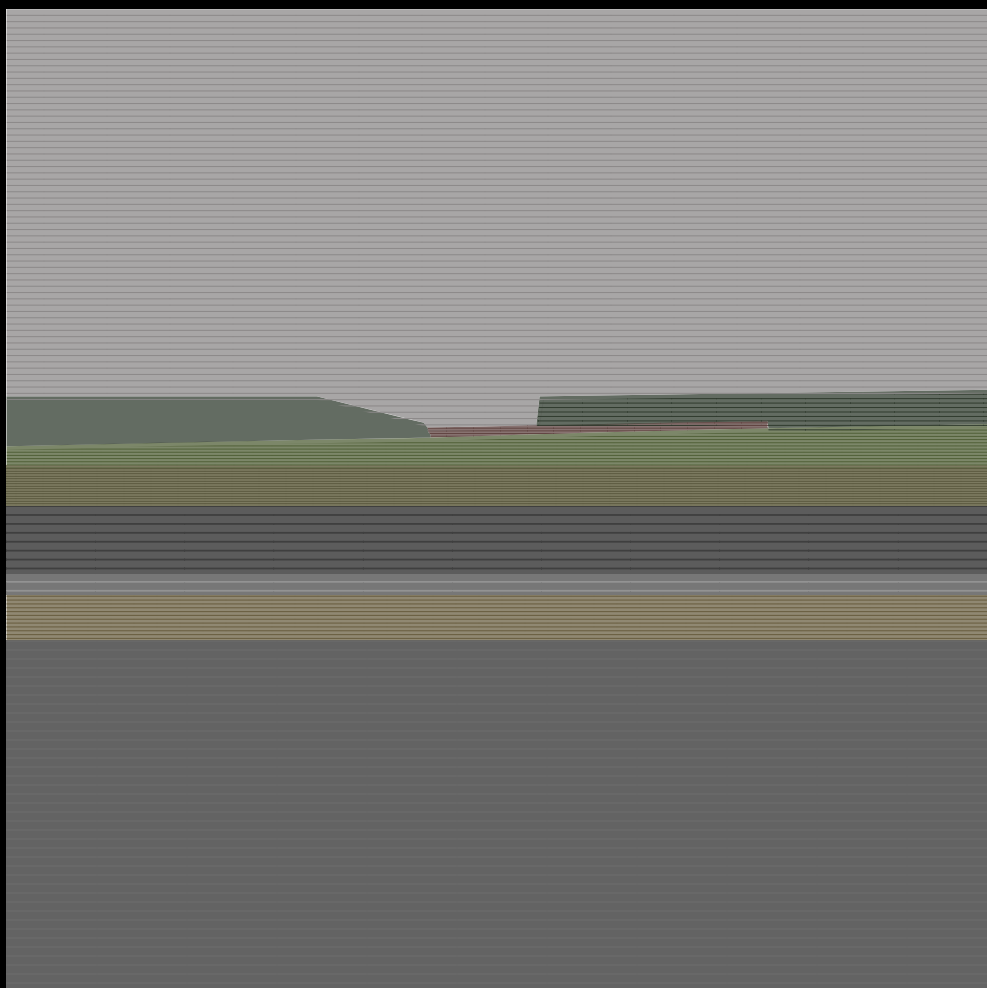

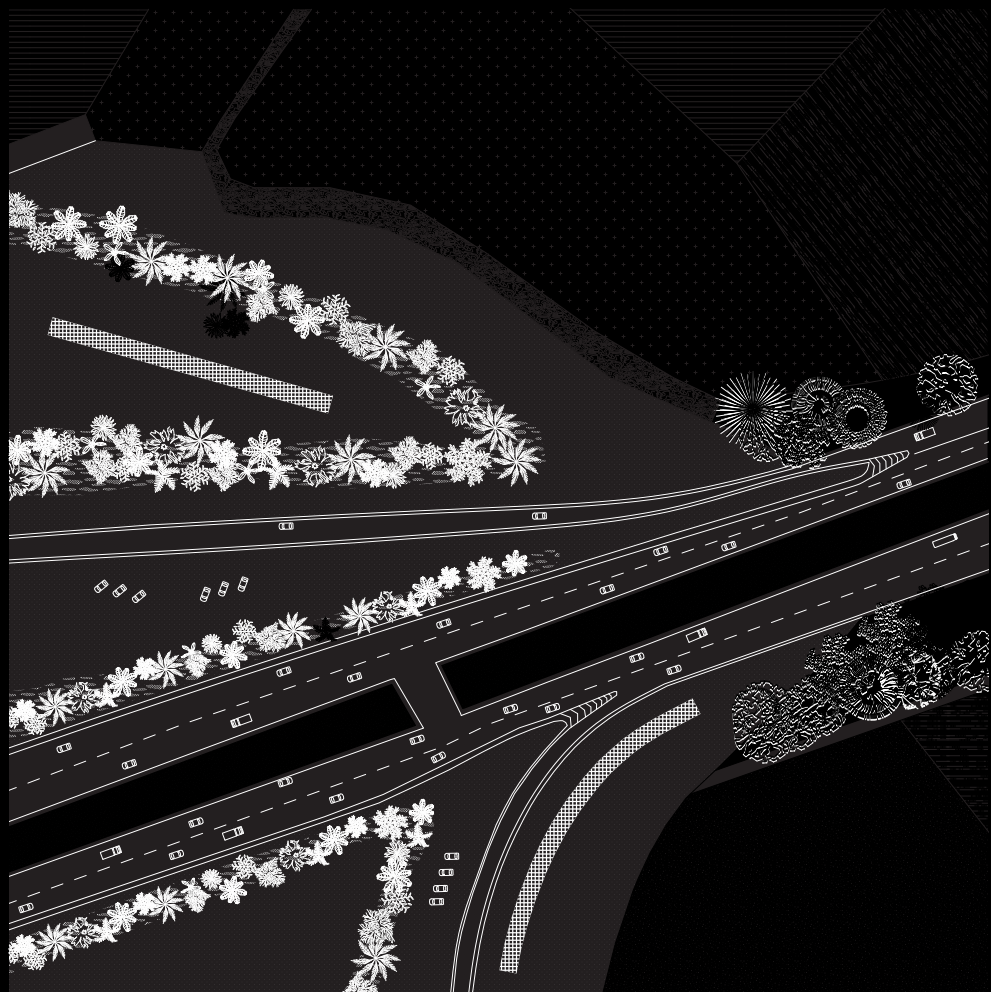
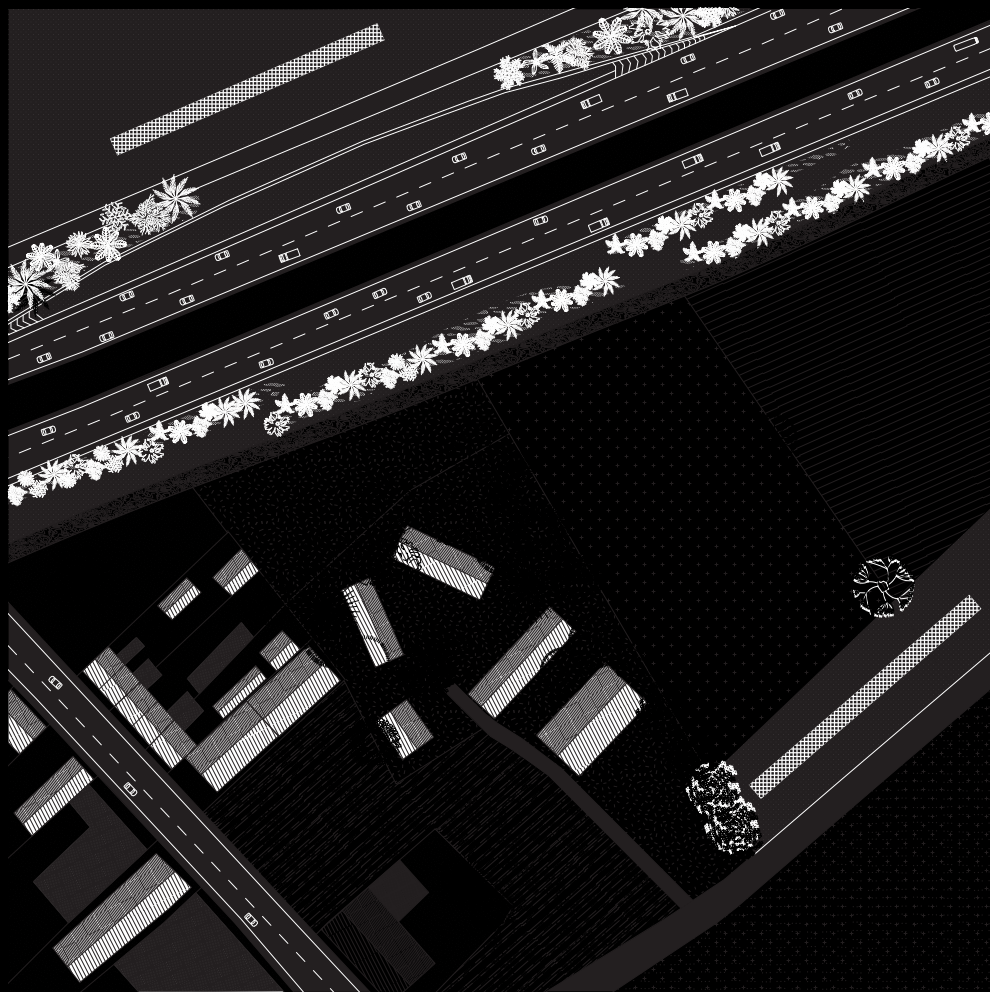
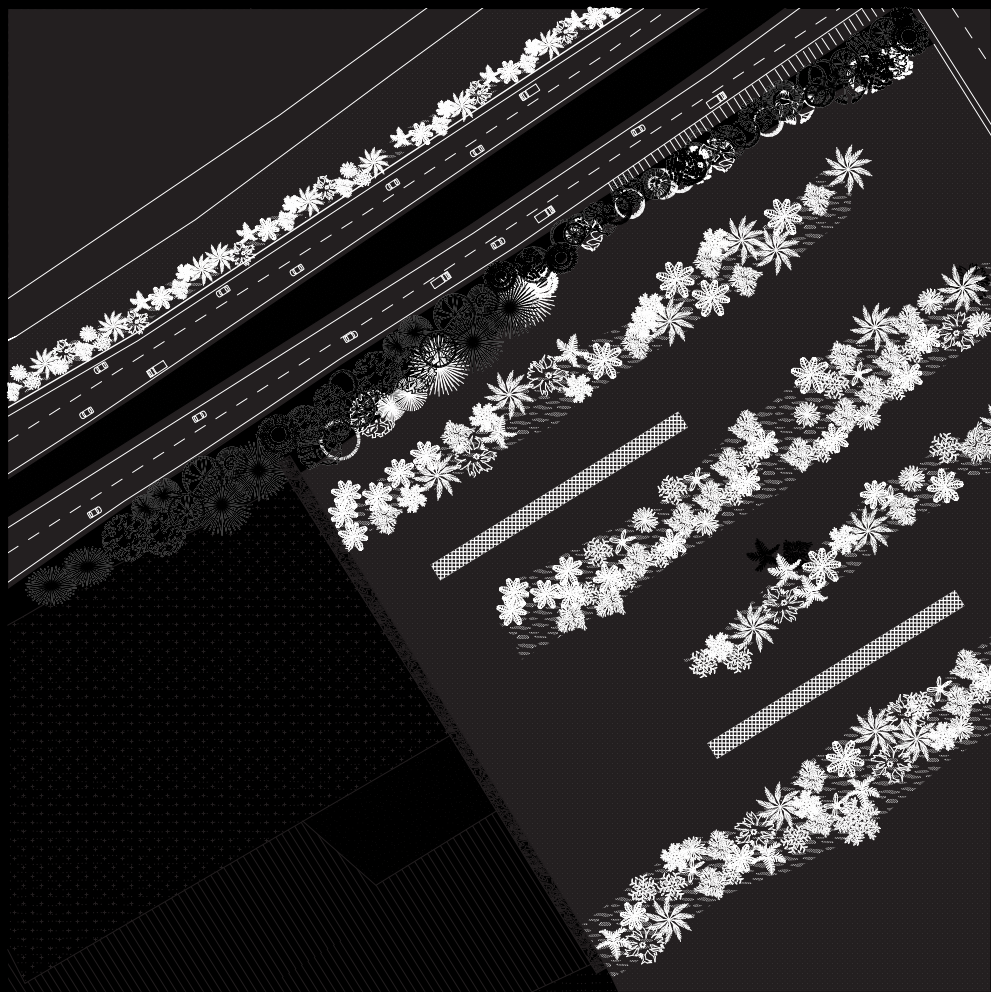
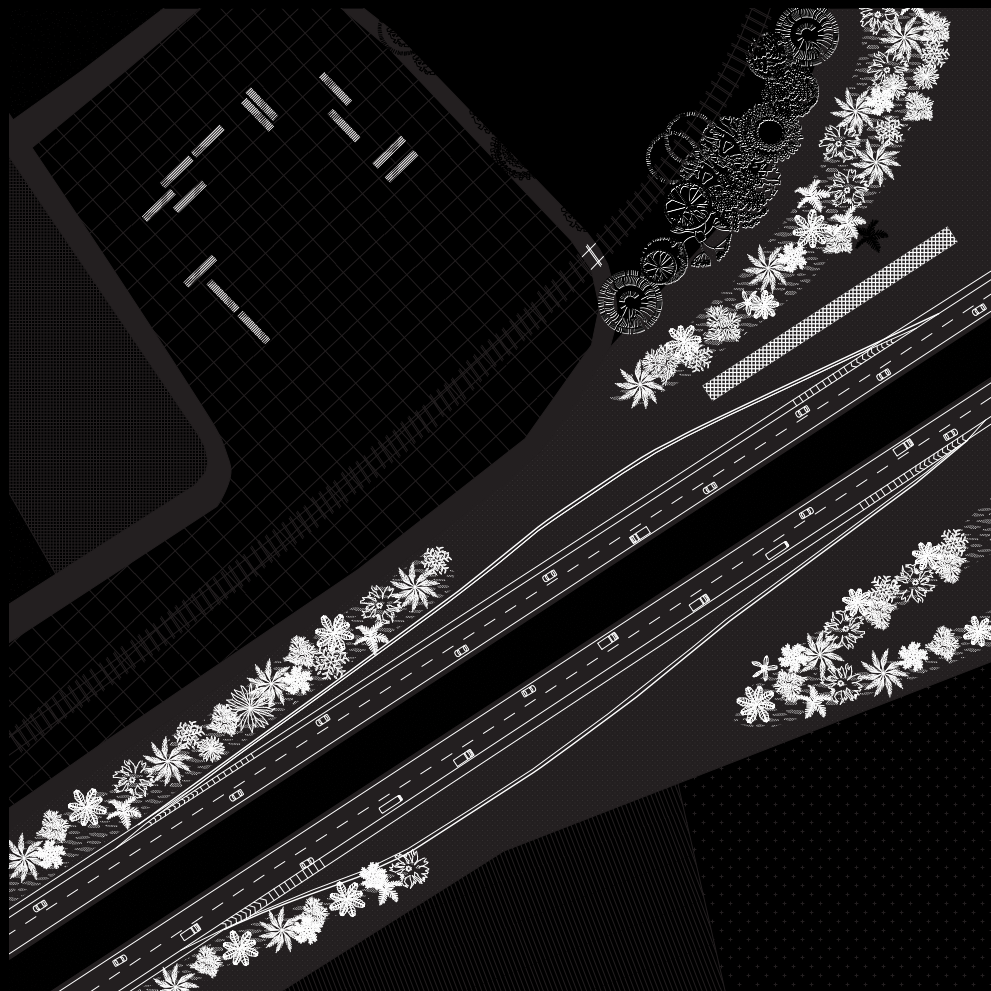
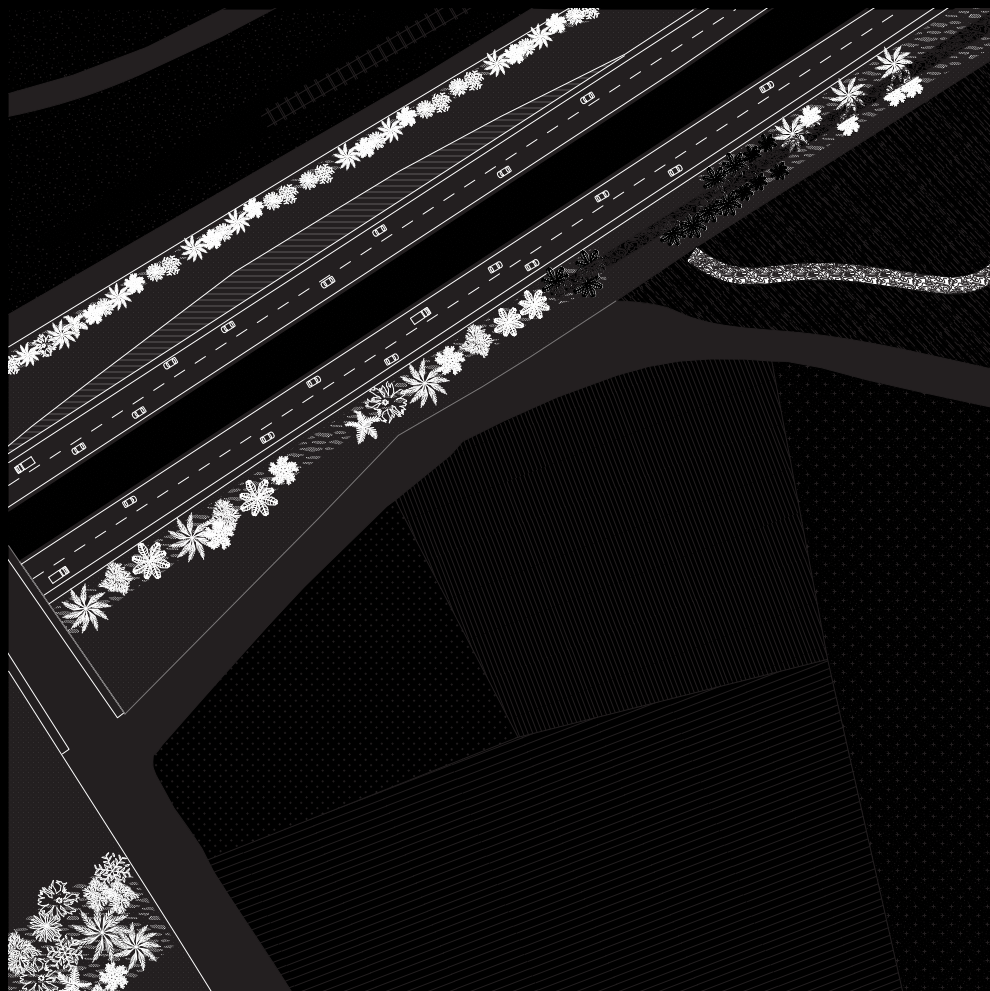
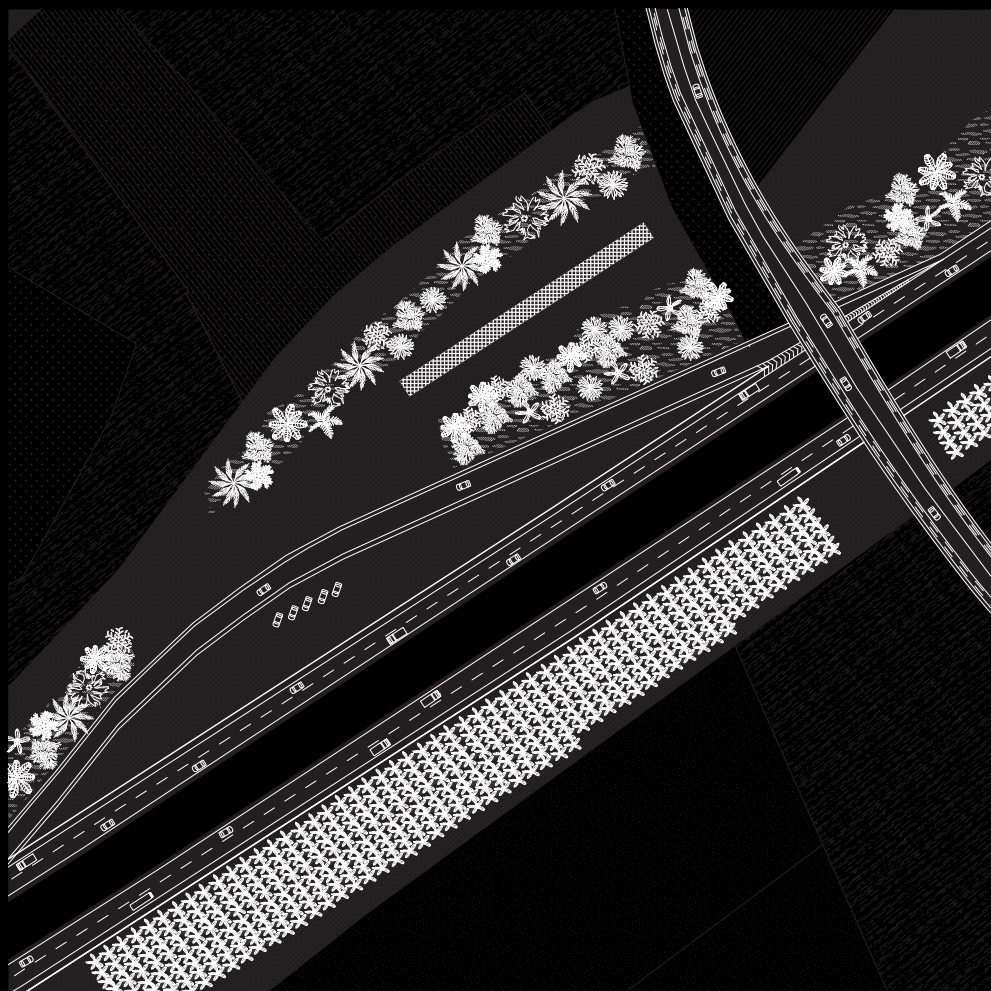
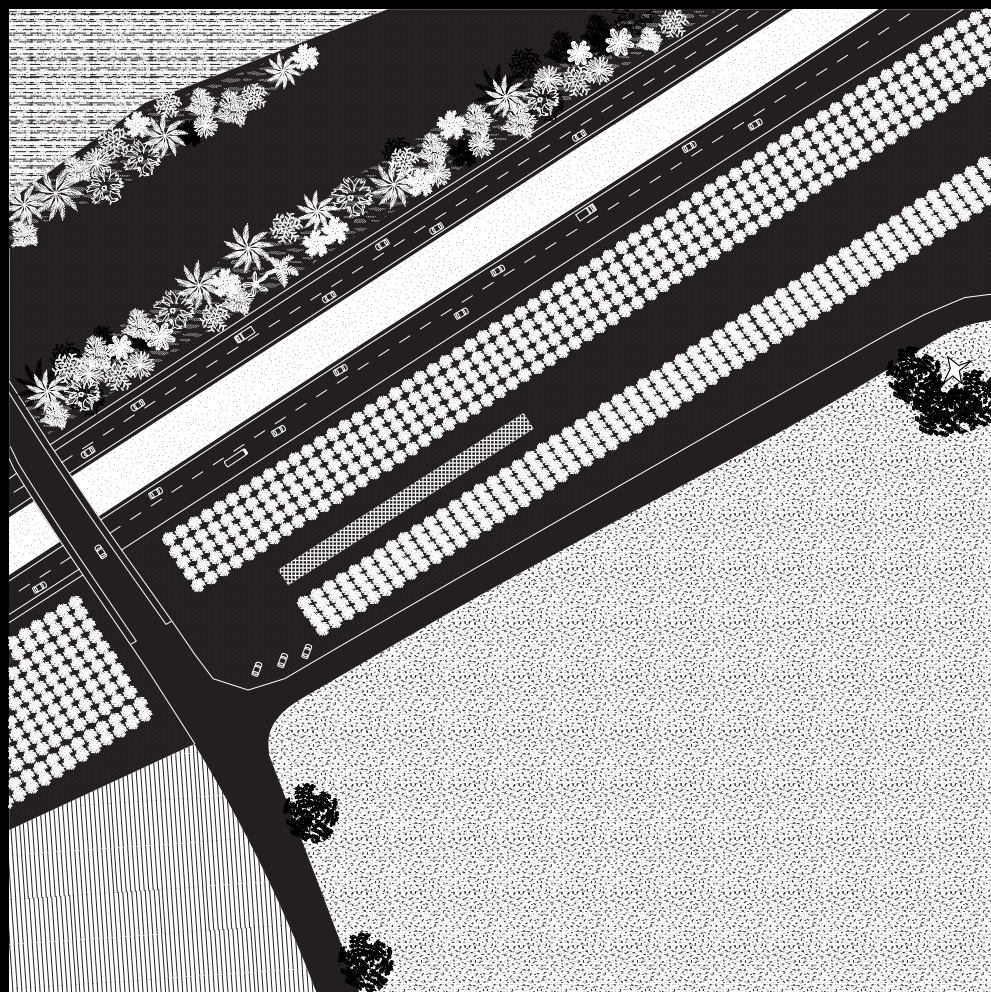
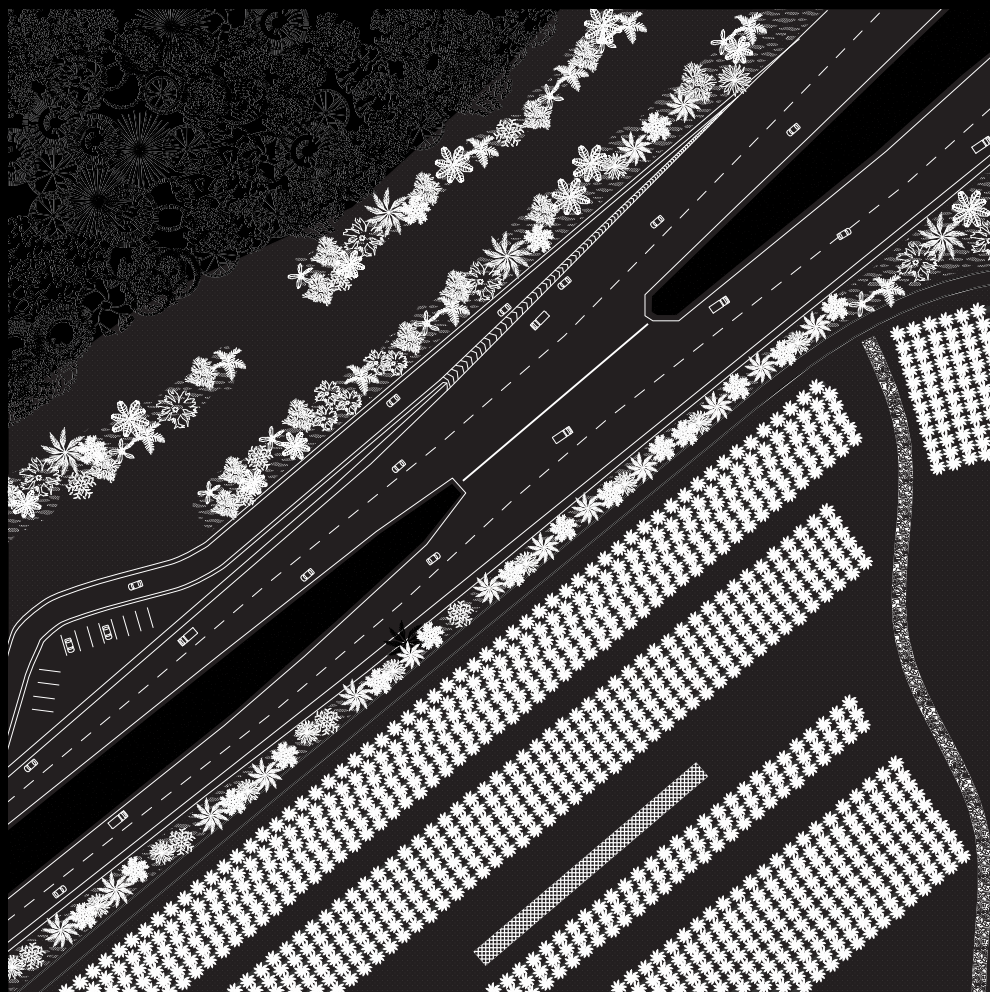
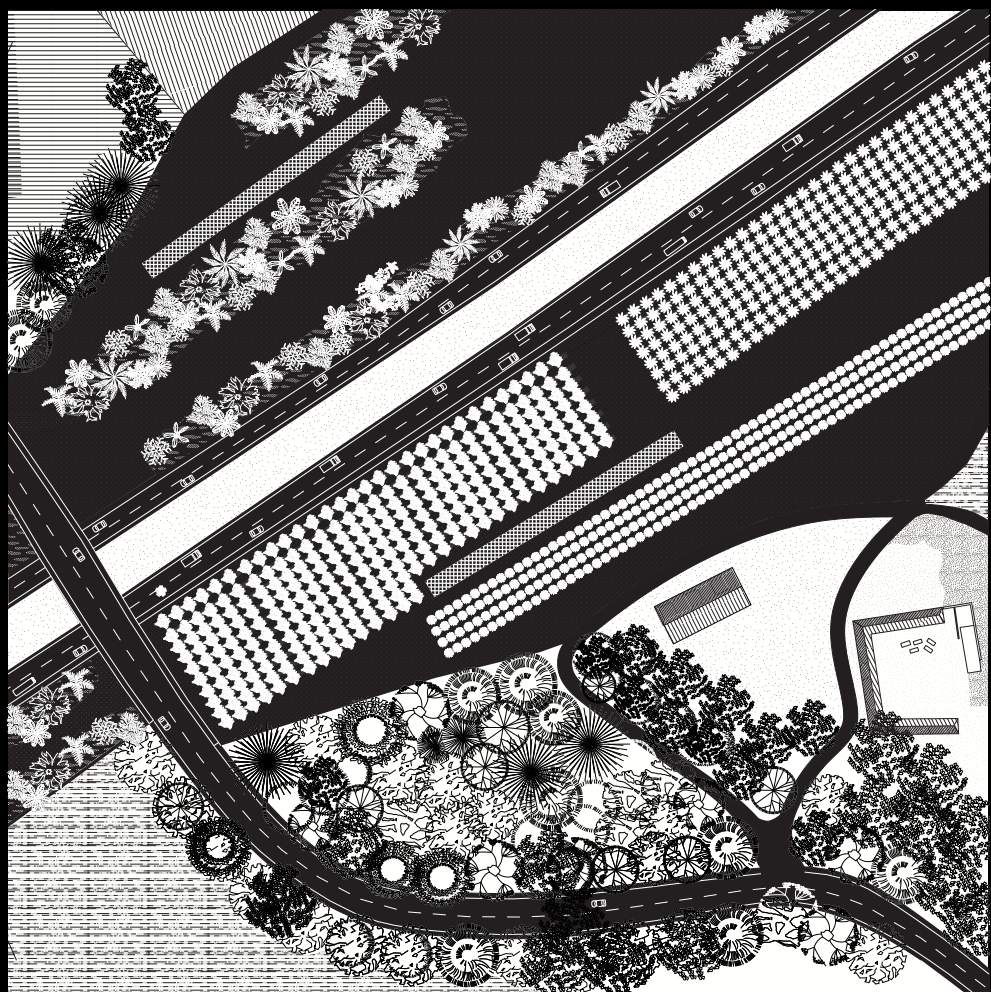

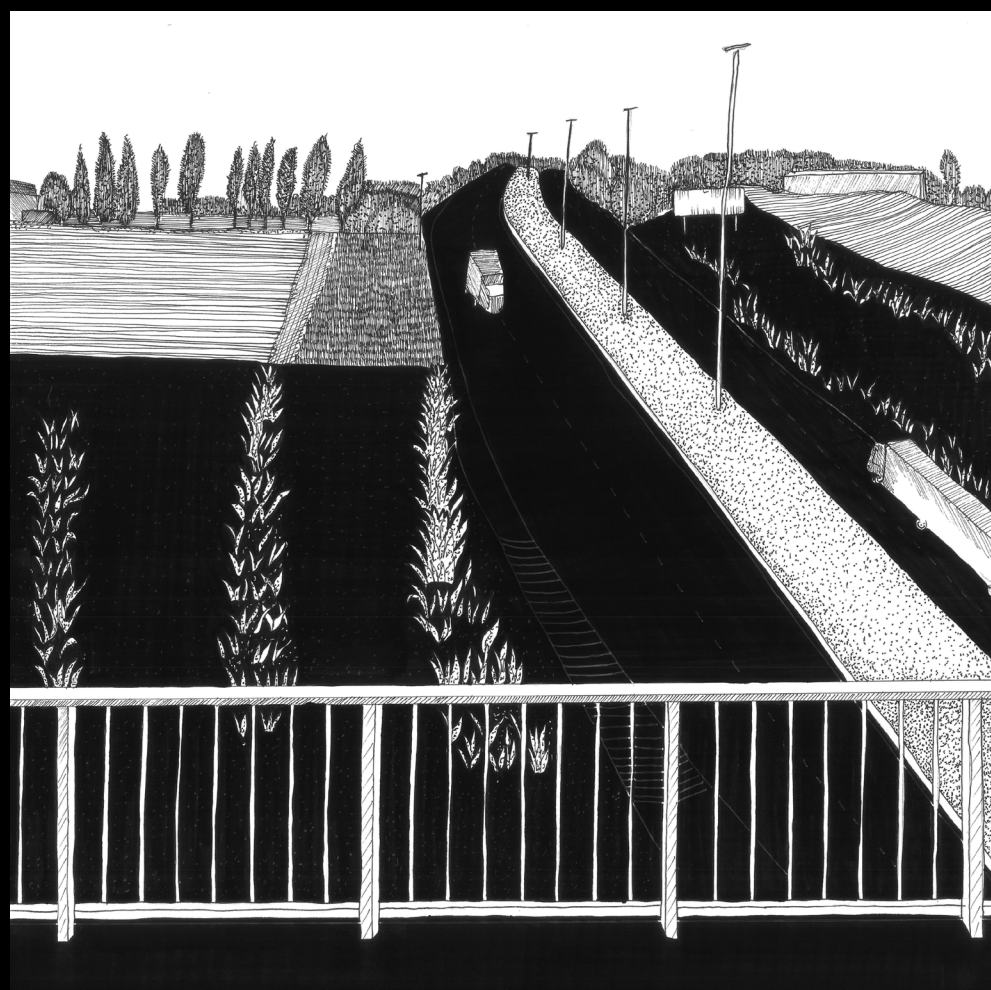
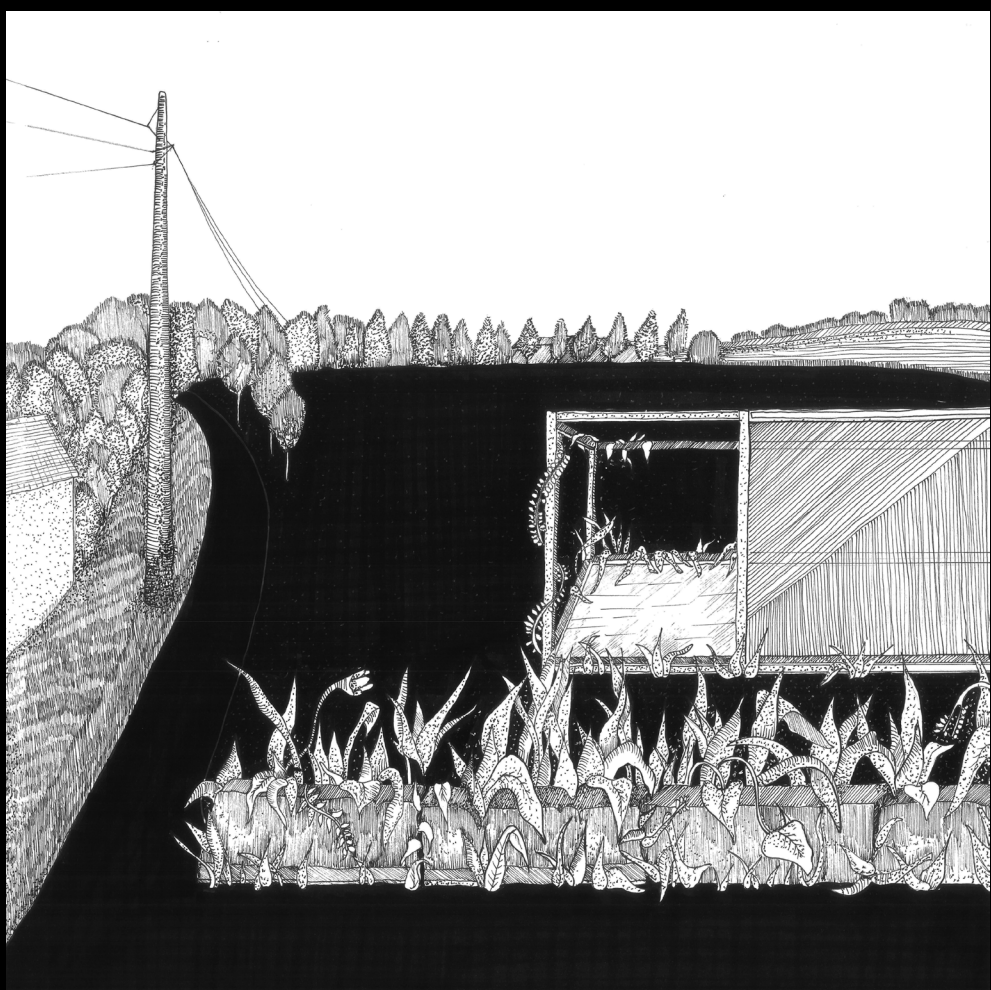
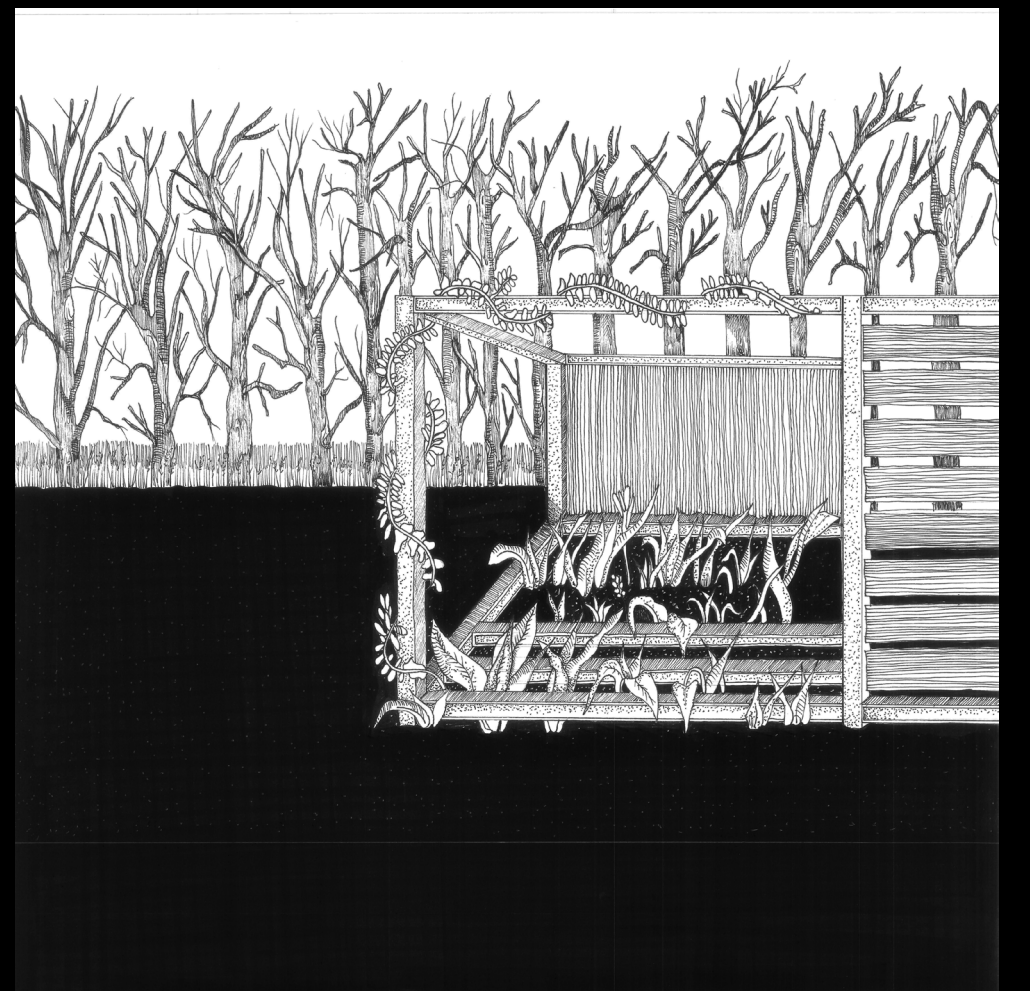
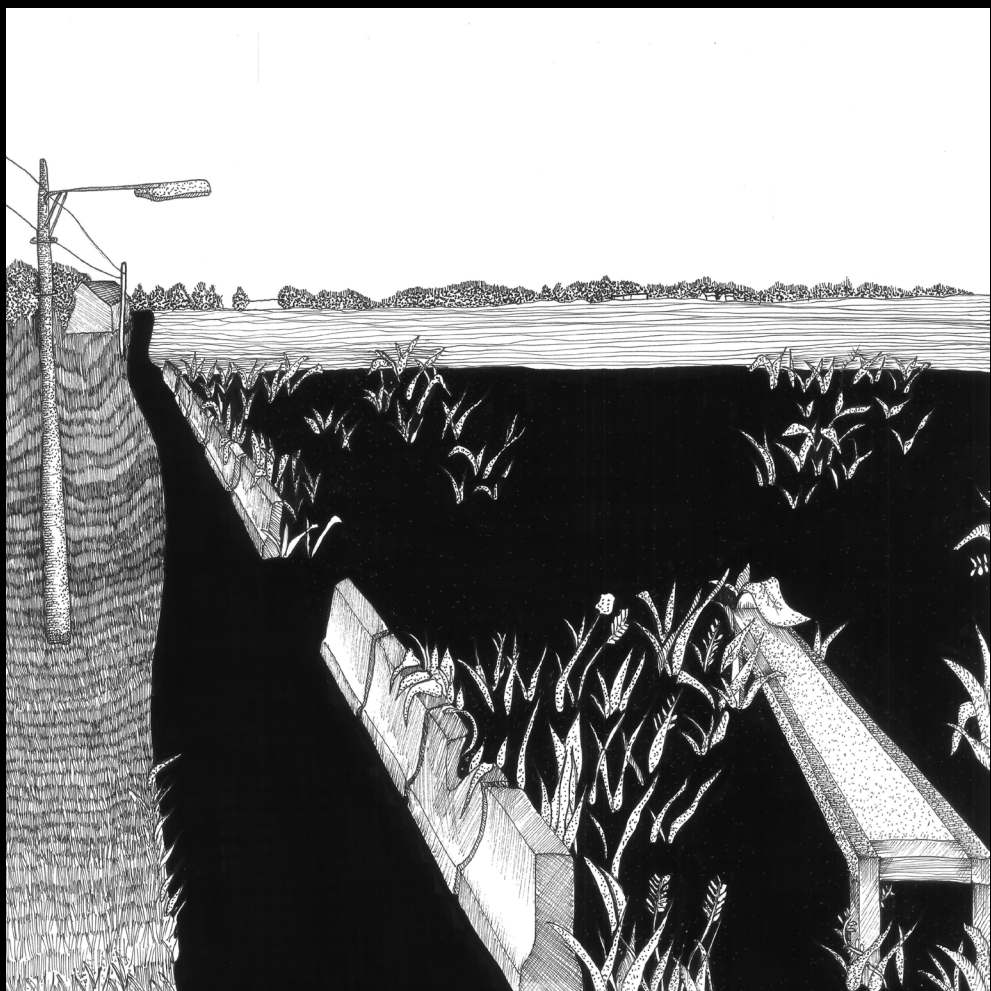
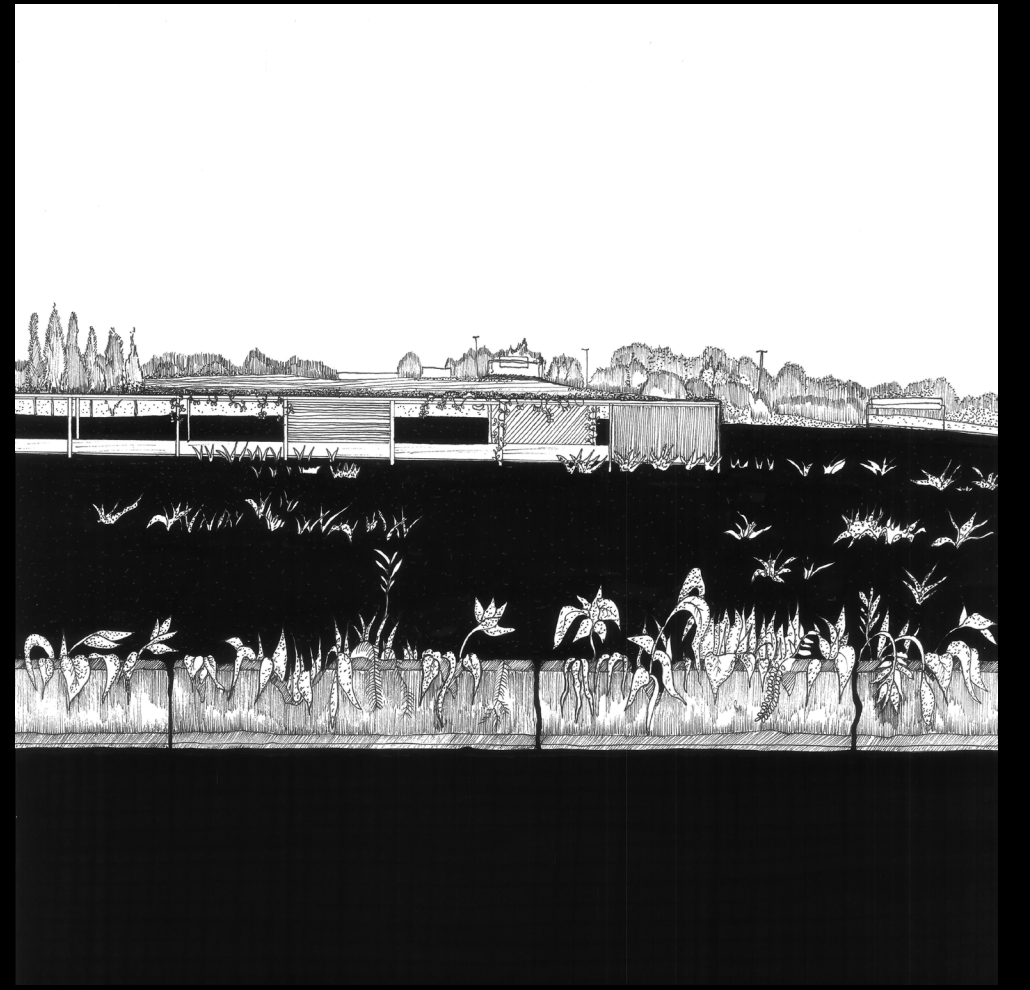
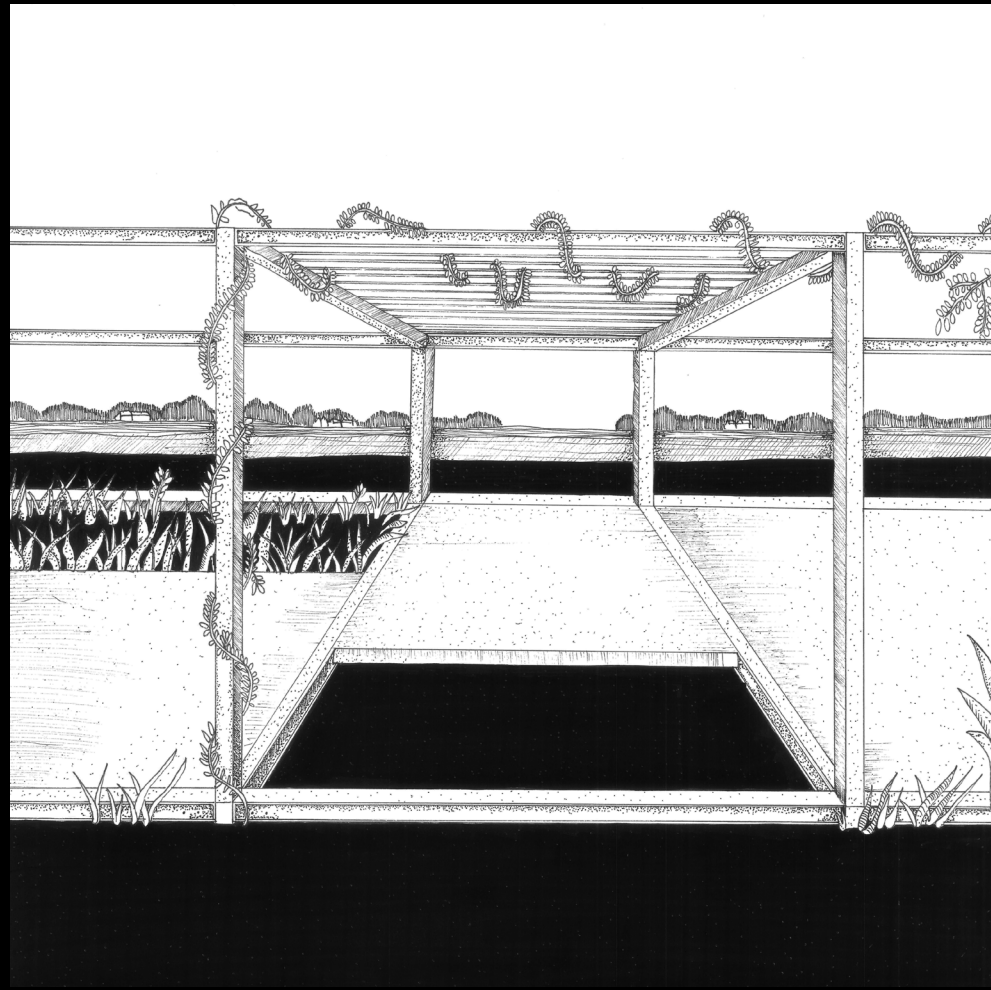
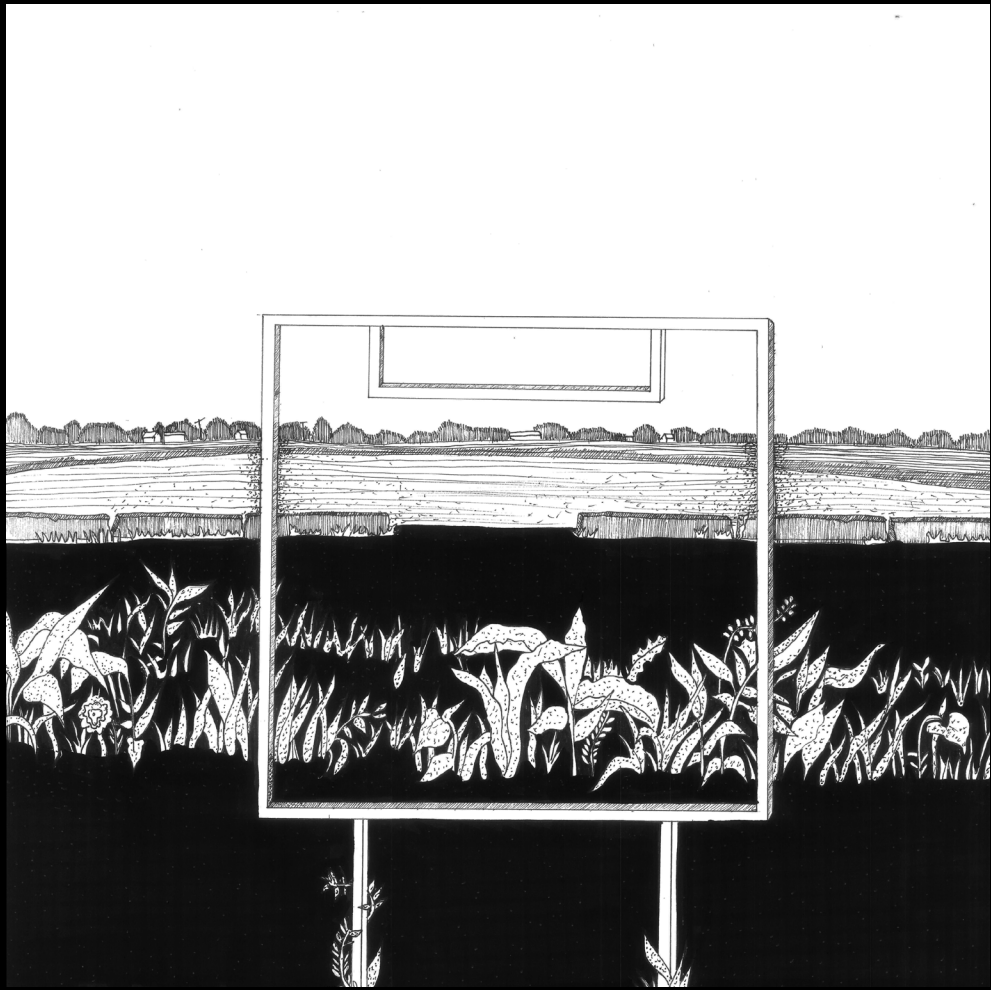

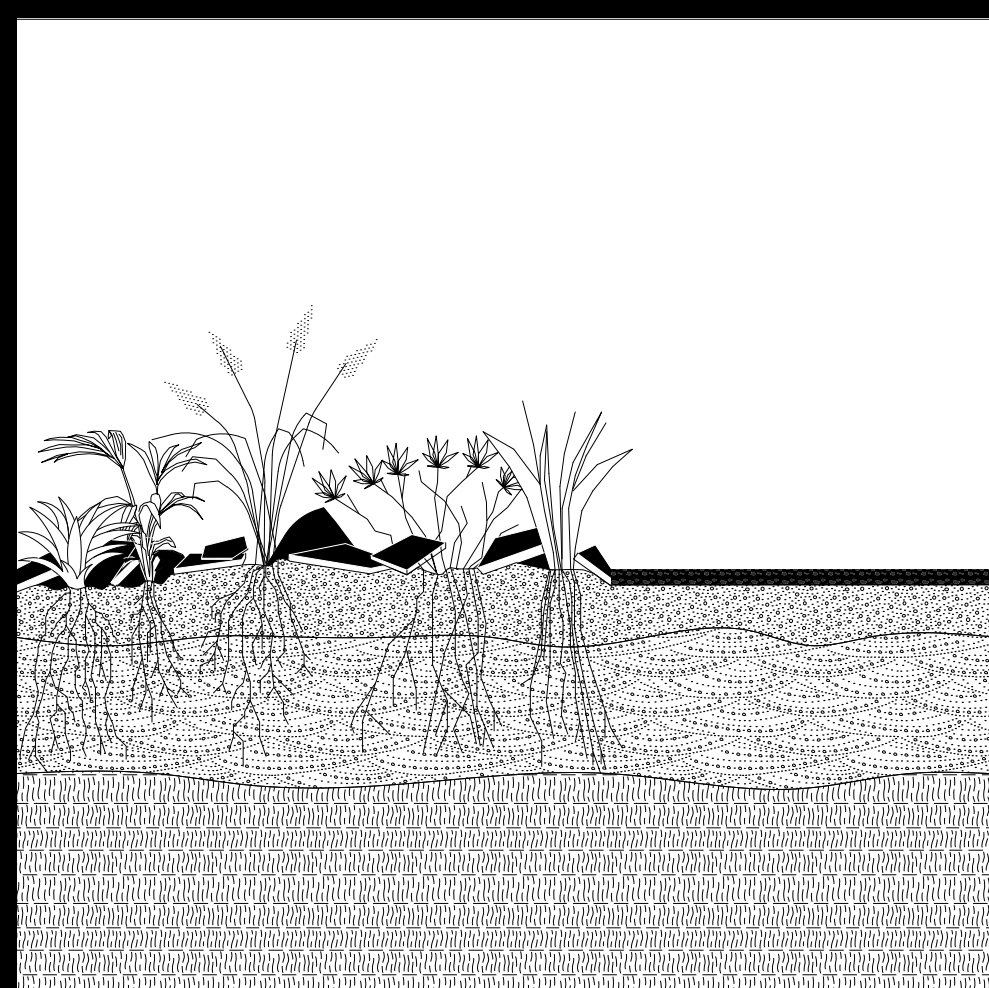
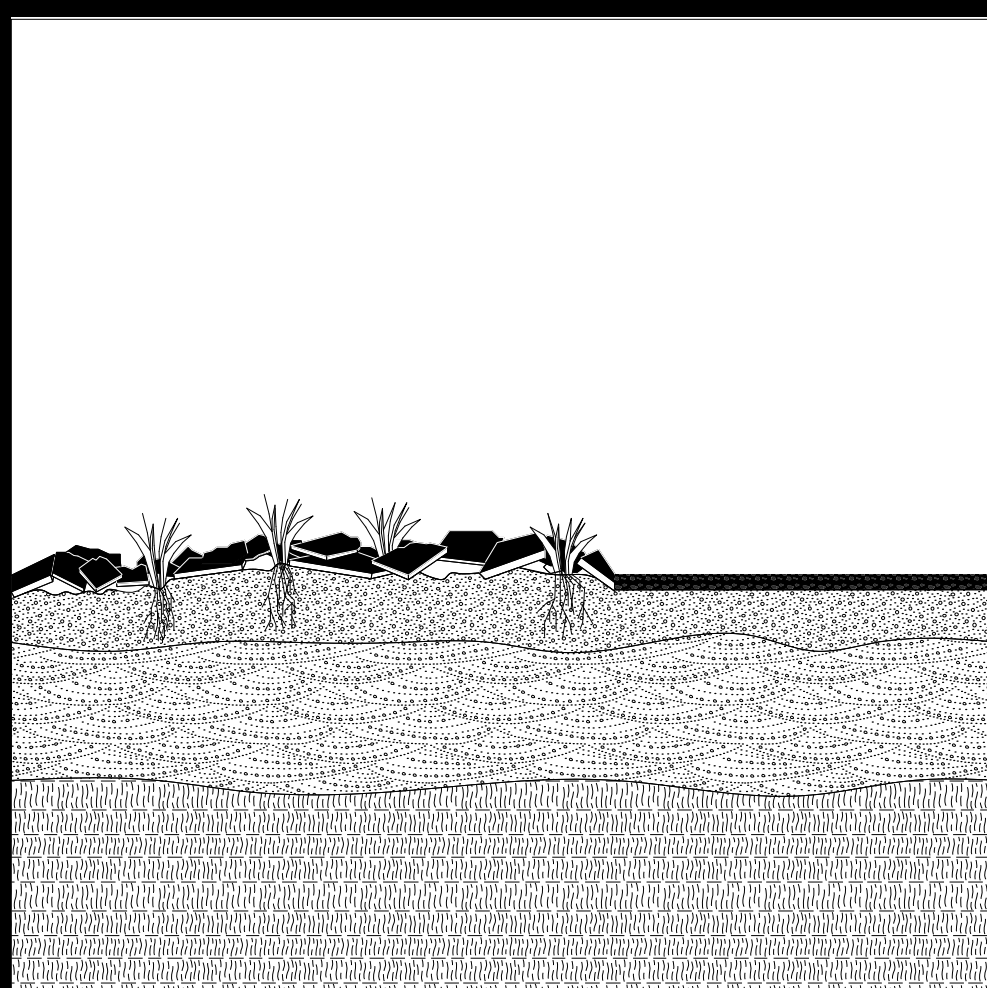
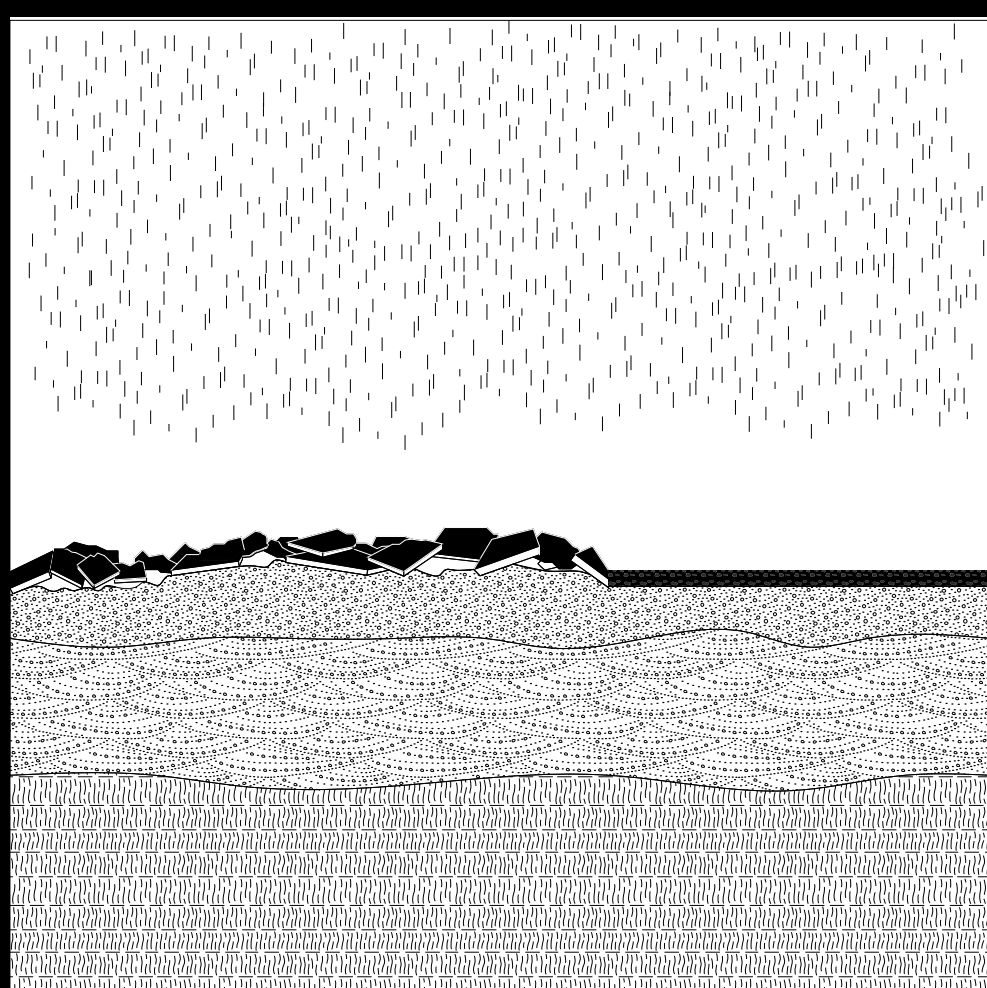
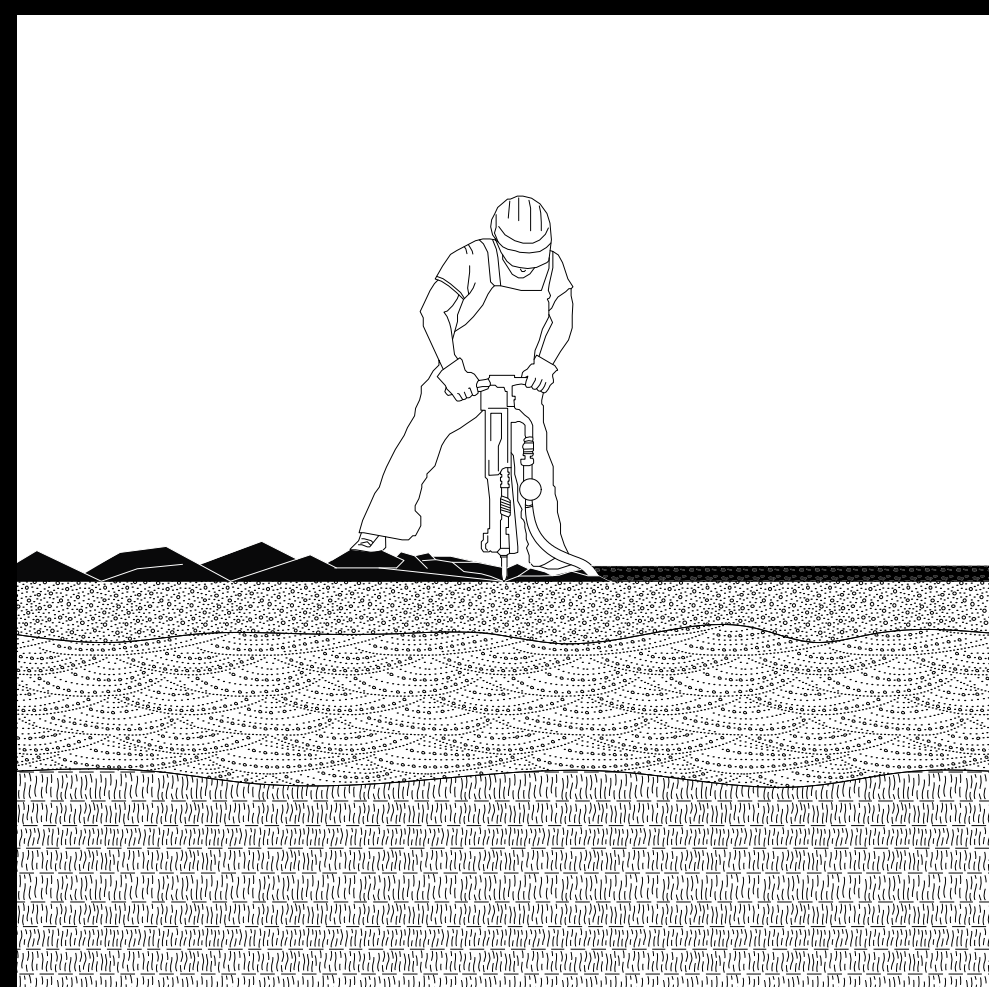
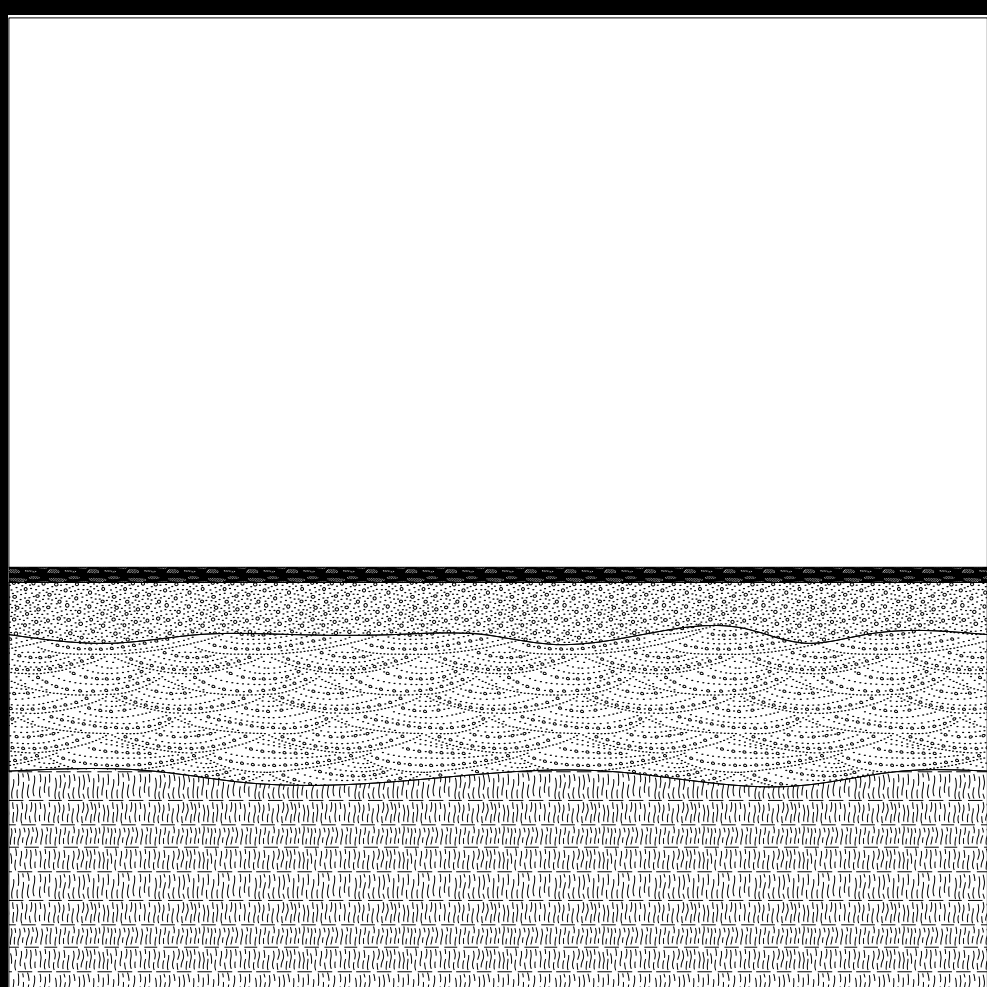
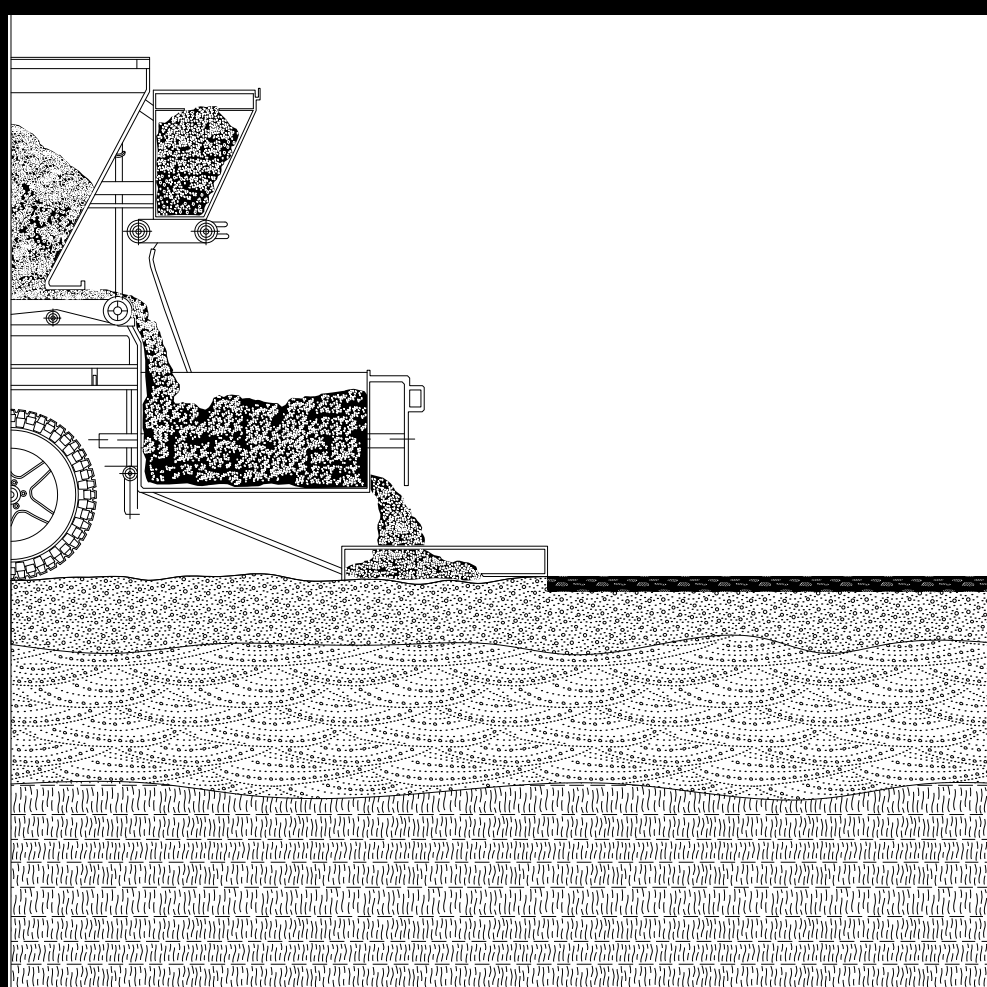
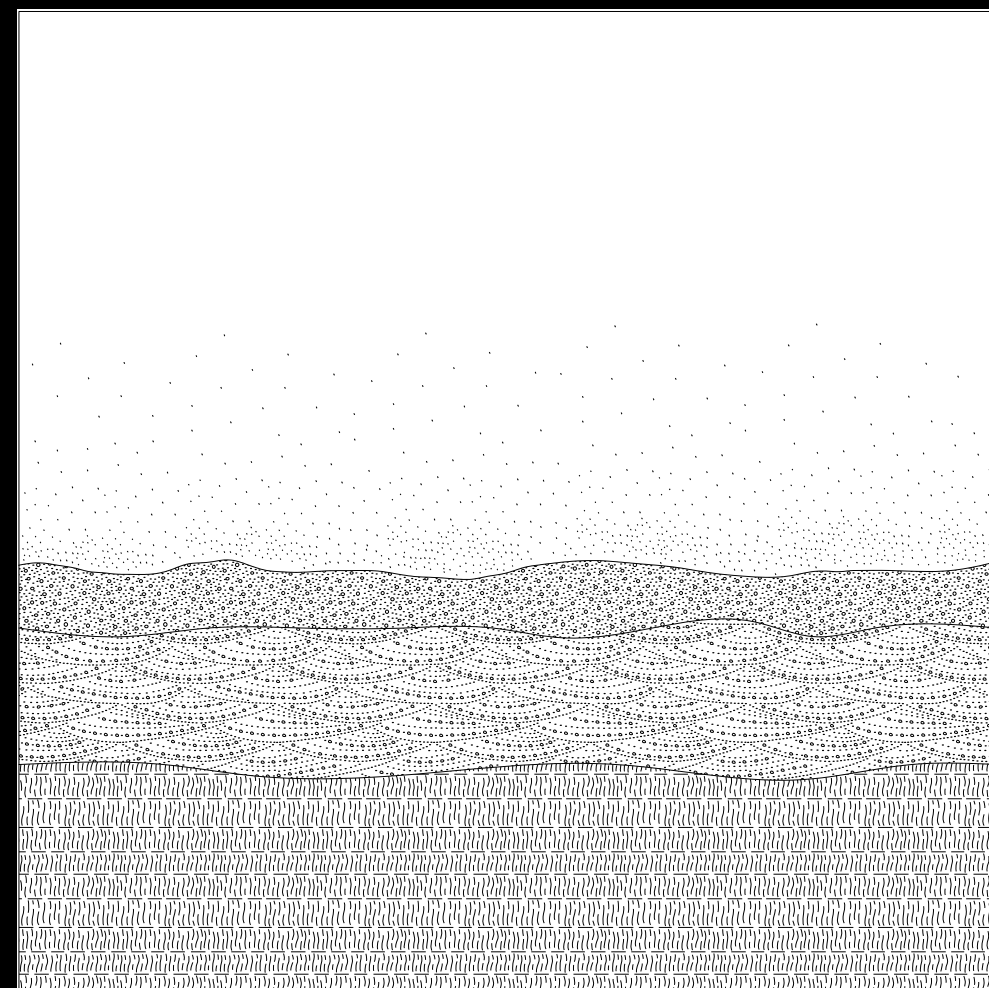
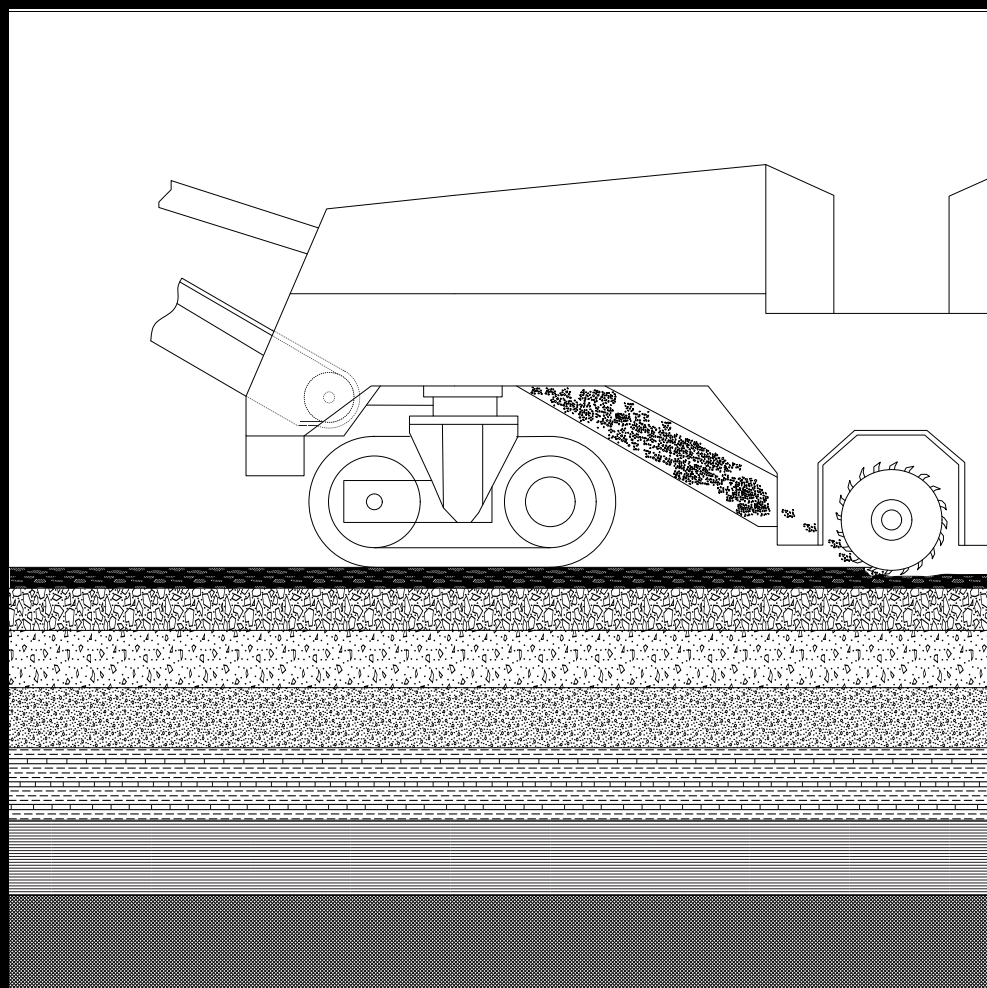
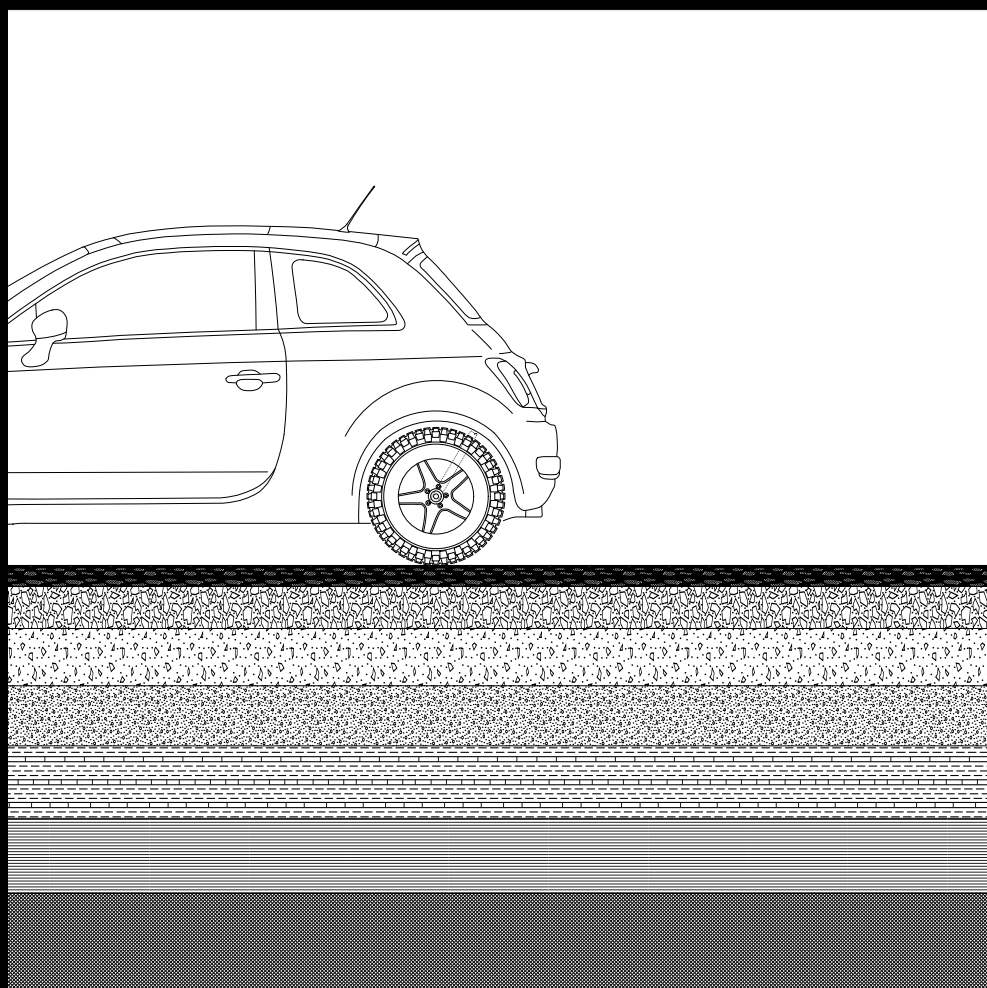

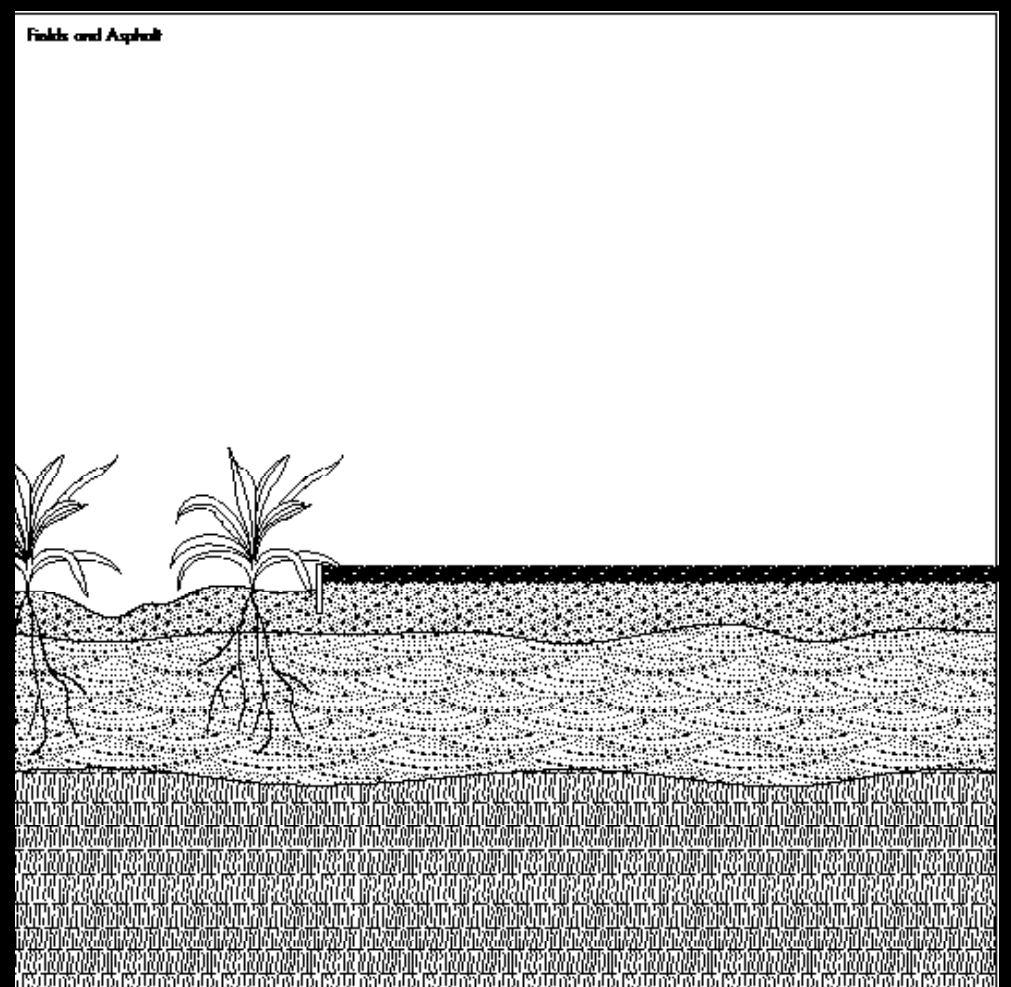
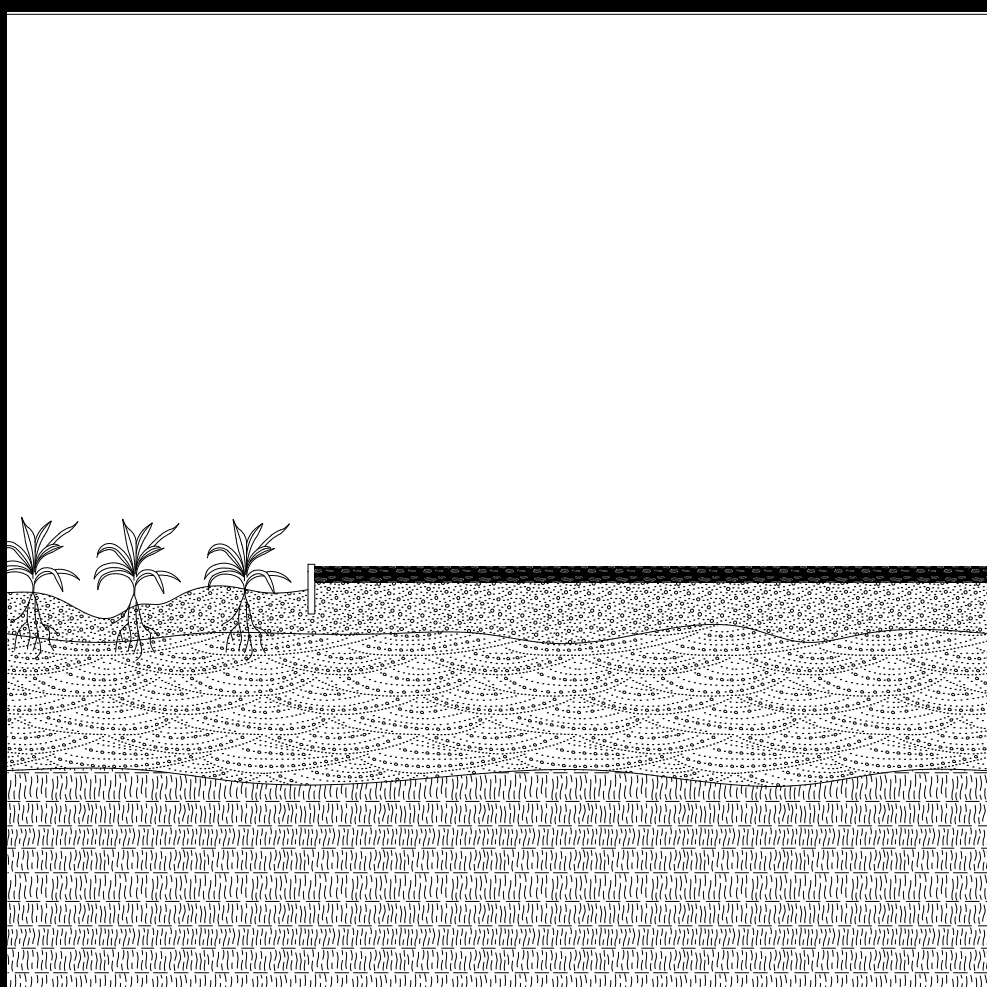
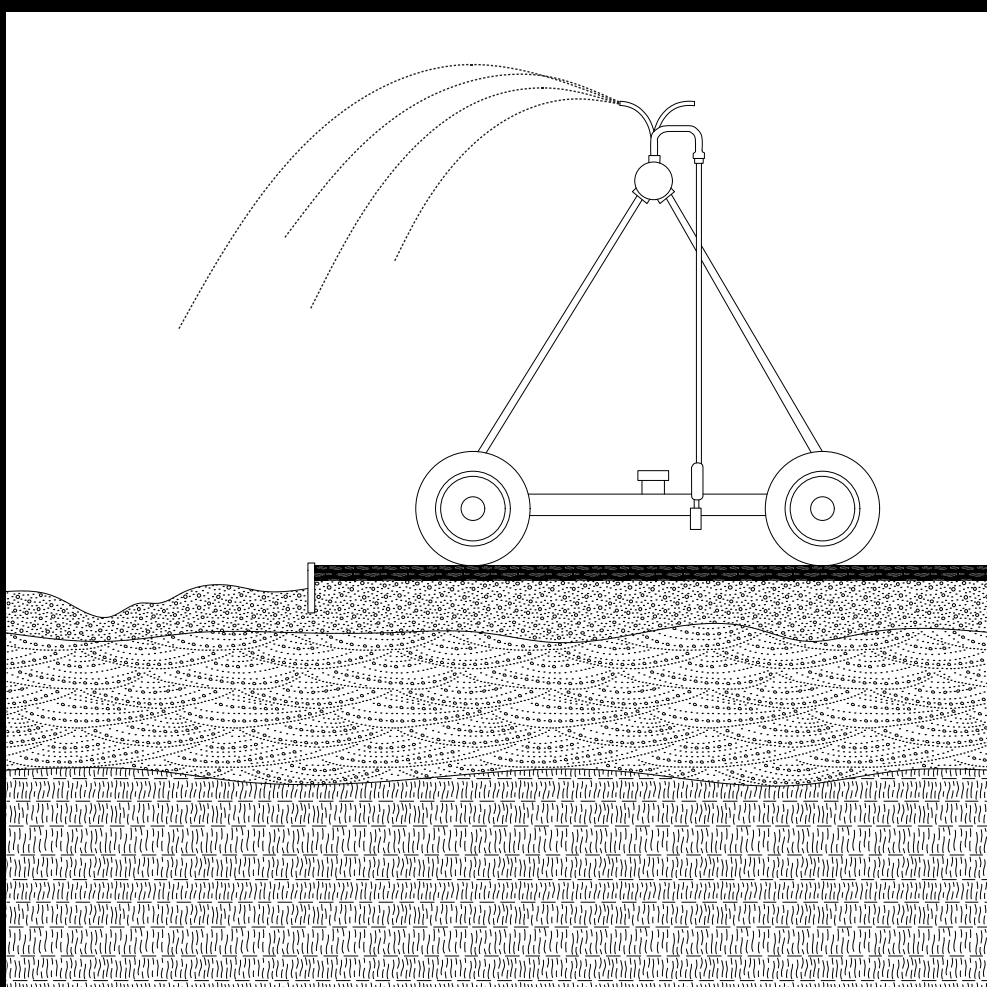
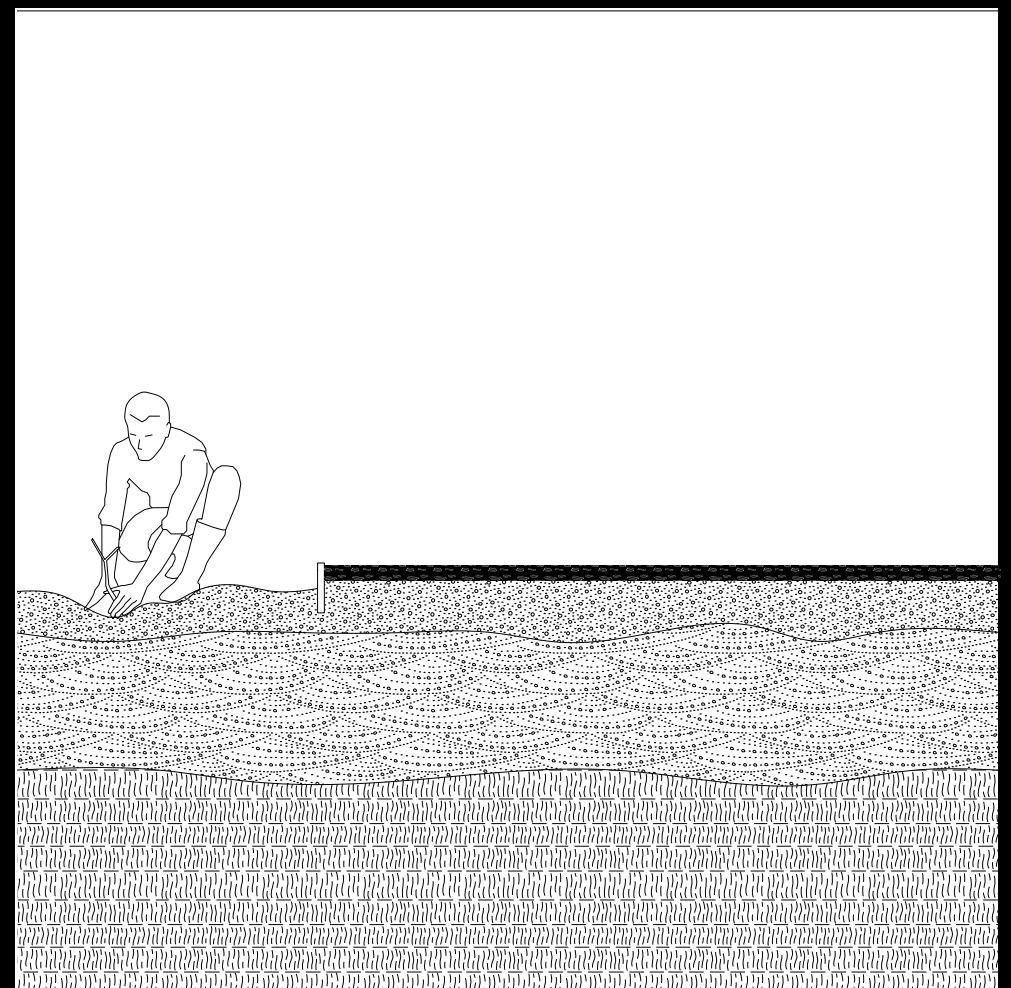
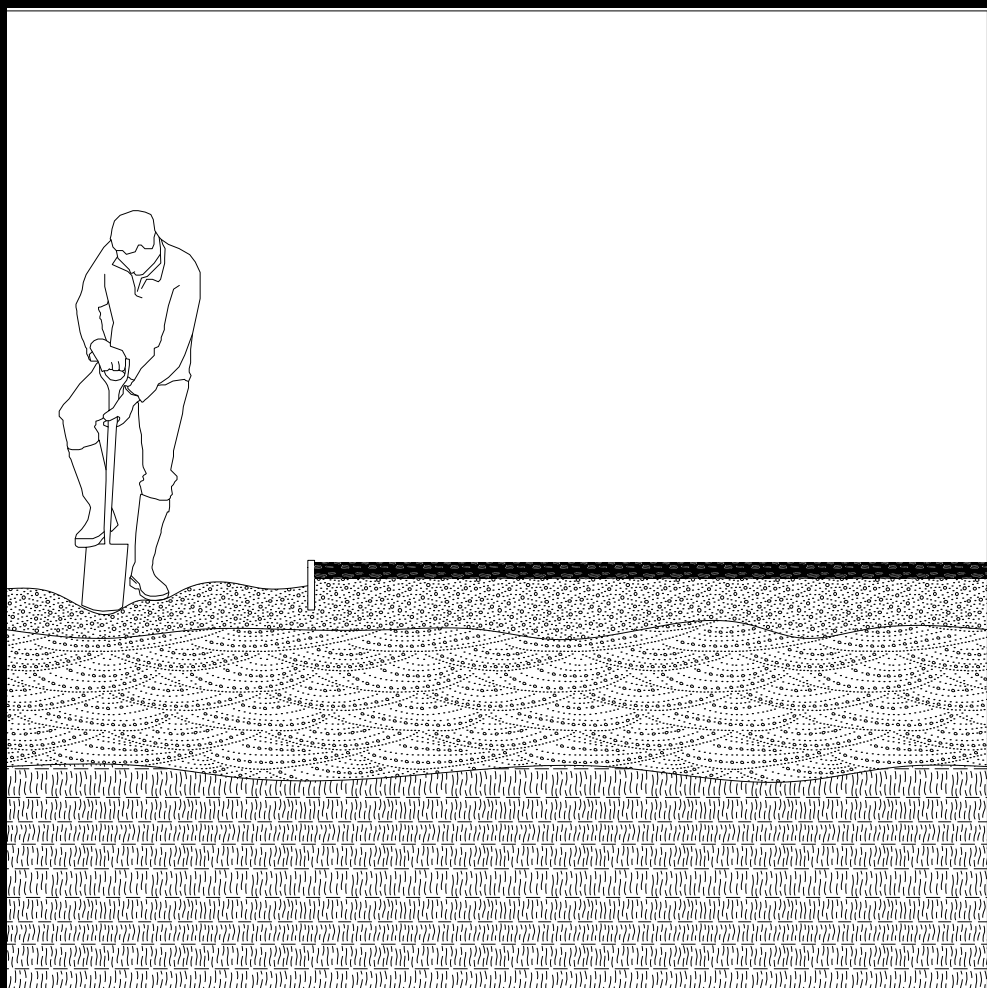
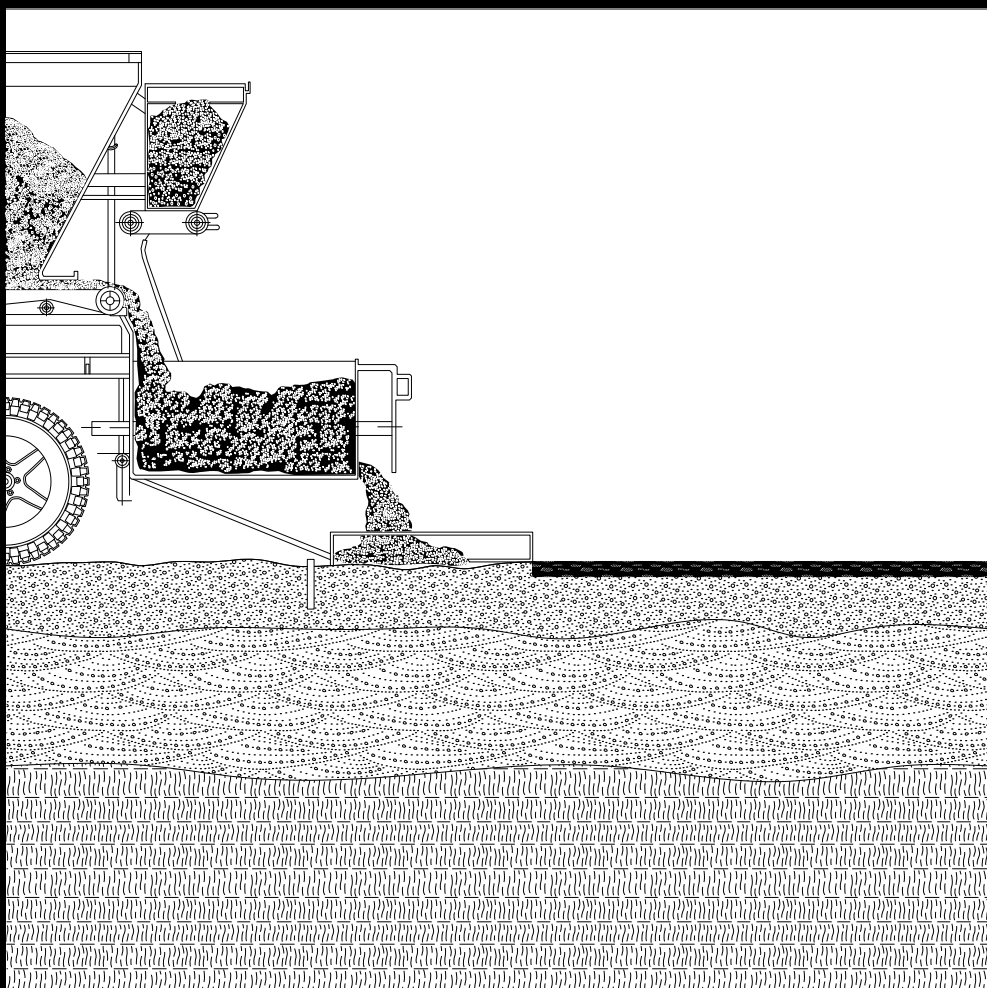
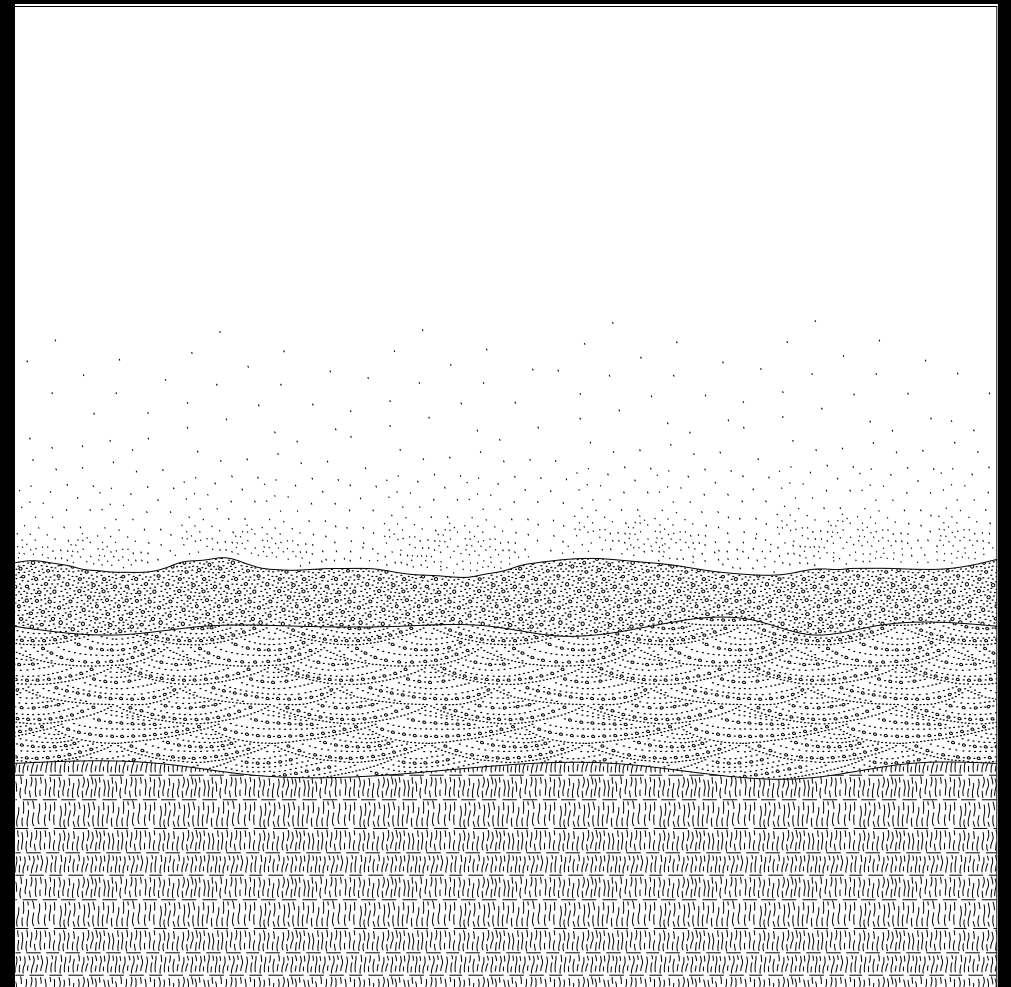
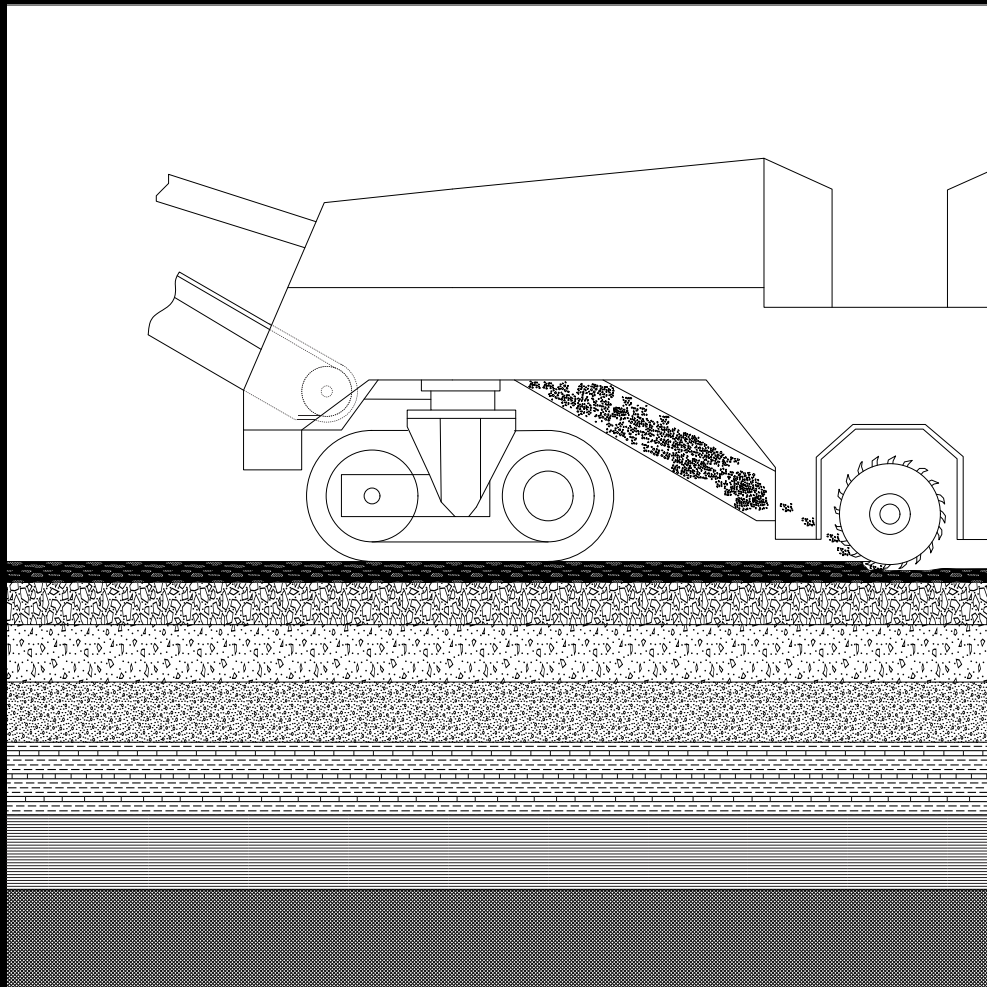
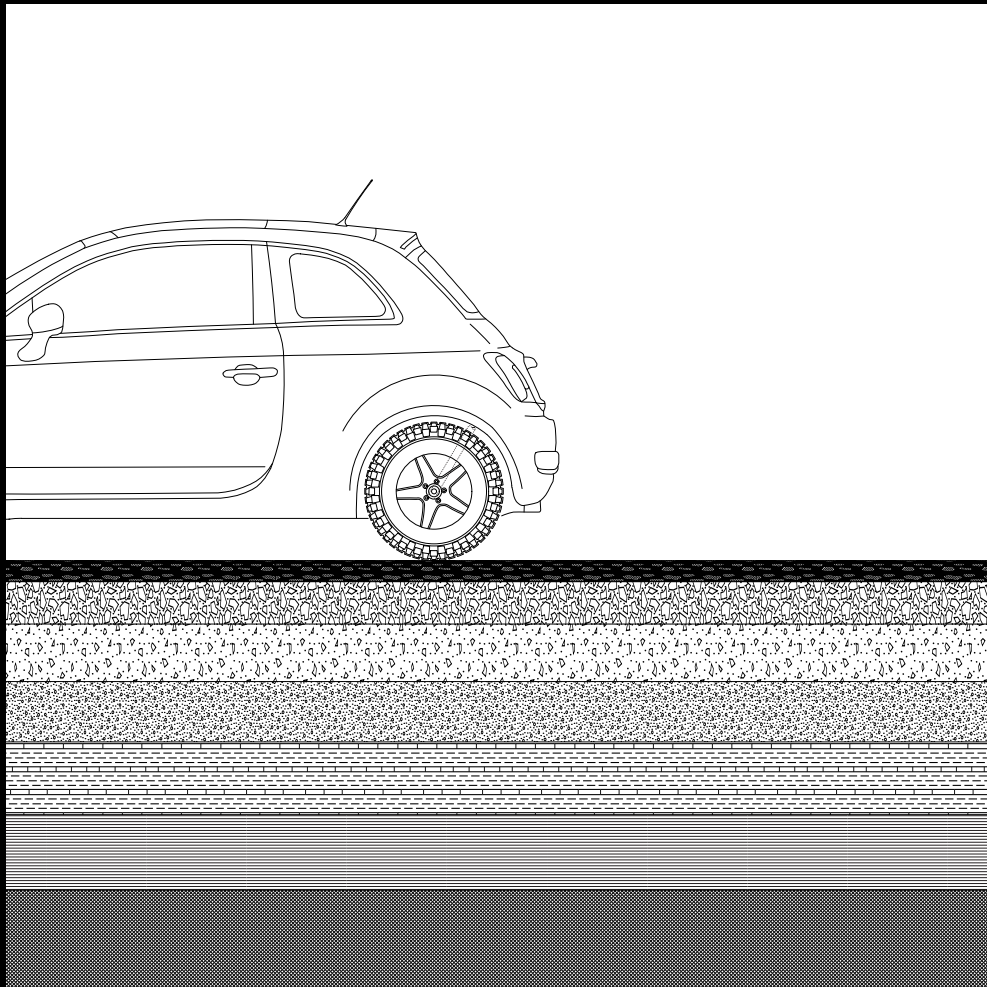

Felds und Asphalt

