

**Linear fractional order controllers  
A survey in the frequency domain**

Dastjerdi, Ali Ahmadi; Vinagre, Blas M.; Chen, Yang Quan; Hossein Nia Kani, Hassan

**DOI**

[10.1016/j.arcontrol.2019.03.008](https://doi.org/10.1016/j.arcontrol.2019.03.008)

**Publication date**

2019

**Document Version**

Accepted author manuscript

**Published in**

Annual Reviews in Control

**Citation (APA)**

Dastjerdi, A. A., Vinagre, B. M., Chen, Y. Q., & Hossein Nia Kani, H. (2019). Linear fractional order controllers: A survey in the frequency domain. *Annual Reviews in Control*, 47, 51-70.  
<https://doi.org/10.1016/j.arcontrol.2019.03.008>

**Important note**

To cite this publication, please use the final published version (if applicable).  
Please check the document version above.

**Copyright**

Other than for strictly personal use, it is not permitted to download, forward or distribute the text or part of it, without the consent of the author(s) and/or copyright holder(s), unless the work is under an open content license such as Creative Commons.

**Takedown policy**

Please contact us and provide details if you believe this document breaches copyrights.  
We will remove access to the work immediately and investigate your claim.

# Linear Fractional Order controllers; A Survey in the Frequency Domain

Ali Ahmadi Dastjerdi<sup>a</sup>, Blas M Vinagre<sup>b</sup>, YangQuan Chen<sup>c</sup>, S. Hassan  
HosseinNia<sup>a,\*</sup>

<sup>a</sup>*Department of Precision Micro System Engineering, Delft University of Technology, The Netherlands*

<sup>b</sup>*Department of Electrical, Electronics and Automation Engineering, University of Extremadura, Spain*

<sup>c</sup>*Mechatronics, Embedded Systems and Automation (MESA) Lab, University California Merced, USA*

---

## Abstract

Today, there is a great tendency toward using fractional calculus to solve engineering problems. The control is one of the fields in which fractional calculus has attracted a lot of attention. On the one hand, fractional order dynamic models simulate characteristics of real dynamic systems better than integer order models. On the other hand, Fractional Order (FO) controllers outperform Integer Order (IO) controllers in many cases. FO-controllers have been studied in both time and frequency domain. The latter one is the fundamental tool for industry to design FO-controllers. The scope of this paper is to review research which has been carried out on FO-controllers in the frequency domain. In this review paper, the concept of fractional calculus and their applications in the control problems are introduced. In addition, basic definitions of the fractional order differentiation and integration are presented. Then, four common types of FO-controllers are briefly presented and after that their representative tuning methods are introduced. Furthermore, some useful continuous and discrete approximation methods of FO-controllers and their digital and analogue implementation methods are elaborated. Then, some Matlab toolboxes which

---

\*Corresponding author

*Email addresses:* A.AhmadiDastjerdi@tudelft.nl (Ali Ahmadi Dastjerdi),  
bvinagre@unex.es (Blas M Vinagre), ychen53@ucmerced.edu (YangQuan Chen),  
S.H.HosseinNiaKani@tudelft.nl (S. Hassan HosseinNia)

*Preprint submitted to Journal of L<sup>A</sup>T<sub>E</sub>X Templates*

*June 26, 2019*

facilitate utilizing FO calculus in the control field are presented. Finally, advantages and disadvantages of using FO calculus in the control area are discussed. To wrap up, this paper helps beginners to get started rapidly and learn how to select, tune, approximate, discretize, and implement FO-controllers in the frequency domain.

*Keywords:* Fractional order PID, Fractional order lead/lag compensators, CRONE generations, Tuning methods for fractional order controllers, frequency domain analysis, Fractional calculus, Toolboxes for fractional order controllers

---

## 1. Introduction

Fractional Order (FO) calculus has attracted attention from academic and industrial associations because its applications have been increased in many aspects of science and engineering [1, 2, 3, 4]. The control field is no exception and utilizing of FO-calculus has been raised in the modelling and controlling of dynamic systems. Basically, in control applications, there are four combinations for closed-loop systems: Integer Order (IO) plants with IO controllers, IO plants with FO controllers, FO plants with FO controllers and FO plants with IO controllers [5, 6].

Using FO-calculus in the modelling of system dynamics is increased since many phenomena such as the voltage-current relation of a semi-infinite lossy transmission line, the diffusion of heat through a semi-infinite solid, viscoelasticity, damping and chaos, fractals etc. inherently show fractional order behaviour [5, 7, 8, 9]. Particularly, when the dynamic of a system has a distributed parameter nature, the best solution for modelling is using FO-calculus [5, 6]. Moreover, it has been reported that FO-calculus models the behaviour of biomimetic systems the best [6]. Furthermore, in the electrical engineering field, there are some electrical devices which show intermediate properties between resistances and capacitances. These devices are known as "fractance" and are modelled by means of FO-calculus [10]. Hence, FO-models can help engineers to simulate

the dynamic behaviour of many systems more precisely than IO-ones.

FO-calculus has high potential to improve performances of controllers since designers have more flexibility in selecting power of FO-controllers in comparison with IO-controllers [11, 12, 13, 14, 15]. Moreover, since FO-calculus can provide a proper trade-off between the first and second order integrator or differentiator part of controllers, linear FO-controllers particularly the FO-PID types become very popular among control engineers. In this manner, researchers have tried to develop FO-linear controllers in both time [1, 16, 17, 18, 19, 20, 21, 22] and frequency domain [8, 2, 23, 24, 25, 10, 26]. In the time domain, most of research is based on optimization methods and in the frequency domain, the most widely-used methods are  $H_\infty$  norm, loop-shaping, iso-damping, etc.

Despite all the comments, IO-controllers are predominately used in the control field [27]. Apart from the water-bed effect from which all linear controllers are suffered [28], there are other significant barriers which confine development of FO-controllers. First, direct analytical methods for solving fractional order differential and integral equations are very complicated [5]. Secondly, the implementation of FO-controllers is more difficult than IO ones owing to certain reasons which are elaborated in the next sections. Finally, the existing tuning methods are sophisticated and proper for specialists and most of them are applicable for process control problems (first order plant with low bandwidth requirement).

During these years, several investigations have been done about reviewing FO-controllers [29, 5, 6, 30]. *Chen et al.* introduced and compared four common types of FO-controllers [5]. Also, investigation [5] presents several realization methods for FO-controllers. Moreover, they talked about potential advantages of FO-controllers and their application in [6]. In [29], aspects of linear and non-linear Fractional Order Proportional Integral and Derivatives (FO-PID) controllers such as tuning, history, and toolboxes are discussed in both time and frequency domains. These review paper give general insight about the FO-controllers; however, some of them are very specific which do not cover all aspects about these controllers, or some of them are very abroad that cannot give

enough information about each concept. Thus, this article focuses on the linear FO-controllers in the frequency domain. This paper gives enough information efficiently and comprehensively about linear FO-controllers in the frequency domain by which beginners can understand FO-calculus, select a proper type for their application, tune and implement these controllers.

This review paper is organized so that, the basic definitions of the fractional order derivative and integral are presented in the first section. Then, common types of FO-controllers which are introduced in the literature are commented in Section 3 and their representative tuning methods are delineated in Section 4. Section 5 is devoted to the realization of FO-controllers in which approximation methods in the S, Z and  $\delta$  domain, and analogue and digital implementation methods are presented. Then, some useful toolboxes are introduced which facilitate design, approximation and realization of FO-controllers in the frequency domain in Section 6. Finally, the advantages and disadvantages of FO-controllers are discussed in Section 7 and some conclusions and remarks are given in Section 8.

## 2. Definitions of fractional order derivative and integral

Although fractional order calculus which means the generalization of the integration and differentiation operator to a fractional order operator is a 300-years-old topic [31], it has only gained attention in the last two decades to facilitate modelling and control problems. There are various definitions like Riemann, Letnikov, Liouville, Caputo for fractional order derivative and integral [28, 5, 32, 33, 34]. Based on the Cauchy's formula, Riemann defined the general fractional order integral as below for a general complex order  $\nu$  [28, 33, 35, 36]:

$$I_{t_o}^\nu f(t) \triangleq \frac{1}{\Gamma(\nu)} \int_{t_o}^t \frac{f(\tau)}{(t-\tau)^{1-\nu}} d\tau \quad \begin{cases} t > t_o \\ t_o \in R \\ \nu \in C \end{cases} \quad (1)$$

In which  $\Gamma(\nu)$  is Gamma function:

$$\Gamma(\nu) = \int_0^{\infty} e^{-x} x^{\nu-1} dx \quad (2)$$

When  $\nu$  is a real fractional order, (1) can be re-written as [28, 33, 35, 36]:

$$I_{t_0}^{\nu} f(t) \triangleq \int_{t_0}^t \frac{f(\tau)(t-\tau)^{\nu-1}}{\Gamma(\nu)} d\tau = \int_{t_0}^t g_{\nu}(t-\tau) f(\tau) d\tau = g * f \quad (3)$$

where:

$$g_{\nu}(t-\tau) = \frac{(t-\tau)^{\nu-1}}{\Gamma(\nu)} \quad (4)$$

Now, the Laplace transform of the fractional order integral can be interpolated from the convolution (3) [28]:

$$\mathcal{L}\{I_{t_0}^{\nu} f(t)\} = \mathcal{L}\left\{\frac{(t)^{\nu-1} u(t)}{\Gamma(\nu)}\right\} \mathcal{L}\{f(t)\} = \frac{1}{s^{\nu}} F(s) \quad (5)$$

Liouville simply calculated fractional order derivative. In his method, the exponential presentation function  $f(t) = \sum_{n=0}^{\infty} c_n e^{a_n t}$  is used for this purpose. In this respect, the fractional order derivative is obtained as [33, 35]:

$$D^{\nu} f(t) = \sum_{n=0}^{\infty} c_n a_n^{\nu} e^{a_n t} \quad (6)$$

The Riemann-Liouville's definition of the general fractional order derivative is as below [5, 28, 33, 35, 36]:

$$D_{t_0}^{\nu} f(t) \triangleq \frac{1}{\Gamma(n-\nu)} \frac{d^n}{dt^n} \left( \int_{t_0}^t \frac{f(\tau)}{(t-\tau)^{1+\nu-n}} d\tau \right), \quad n = [\text{integer real part of } \nu] + 1 \quad (7)$$

The second popular definition of fractional order derivative is given by Caputo [33, 35, 36]:

$$D_{t_0}^{\nu} f(t) = \frac{1}{\Gamma(\nu-n)} \int_{t_0}^t \frac{f^{(n)}(\tau) d\tau}{(t-\tau)^{\nu+1-n}} \quad (n-1 \leq \nu < n) \quad (8)$$

This definition is improved as [37]:

$$\mathcal{D}_{t_0}^{\nu} = \frac{M(\nu)}{1-\nu} \int_{t_0}^t \dot{f}(\tau) e^{-\frac{\nu(1-\tau)}{1-\nu}} d\tau \quad (9)$$

where  $M(\nu)$  is a normalized function so that  $M(0) = M(1) = 1$ . Another general definition of the fractional order derivative is given by Grünwald-Letnikov

[5, 28, 33, 35, 36, 29]:

$$D^\nu f(t) = \lim_{h \rightarrow 0} \frac{\sum_{k=1}^{\infty} (-1)^k \binom{\nu}{k} f(t - kh)}{h^\nu}, \quad \binom{\nu}{k} = \frac{\Gamma(\nu + 1)}{k! \Gamma(\nu - k + 1)} \quad (10)$$

Eventually, the Laplace transform of a real fractional order derivative can be achieved by using the Riemann-Liouville's and Caputo's definition ((7) and (8)) [5, 28]:

$$\mathcal{L}\{D_0^\nu f(t)\} = sF(s) - \sum_{k=0}^{n-1} s^k D_0^{\nu-k-1} f(t)|_{t=0} \quad (n-1 < \nu \leq n) \quad (11)$$

$$\mathcal{L}\{D_{t_0}^\nu f(t)\} = sF(s) - \sum_{k=0}^{n-1} s^{\nu-k-1} D_{t_0}^k f(t)|_{t=0} \quad (n-1 < \nu \leq n) \quad (12)$$

By considering definitions of the fractional order derivative and integral which are described above, the continuous integro-differential operator for a general complex value of  $\nu$  is introduced as [5]:

$$D_{t_0}^\nu = \begin{cases} \frac{d^\nu}{dt^\nu} & \mathcal{R}e(\nu) > 0 \\ 1 & \mathcal{R}e(\nu) = 0 \\ \int_{t_0}^t (d\tau)^{-\nu} & \mathcal{R}e(\nu) < 0 \end{cases} \quad (13)$$

The two main properties of the continuous integro-differential operator are listed as [5, 28]:

1. This is a linear operator:

$$D_{t_0}^\nu (af(t) + bg(t)) = aD_{t_0}^\nu f(t) + bD_{t_0}^\nu g(t)$$

2. It follows the additive index law:

$$D_{t_0}^\nu D_{t_0}^\alpha f(t) = D_{t_0}^\alpha D_{t_0}^\nu f(t) = D_{t_0}^{\alpha+\nu} f(t)$$

Note, in the next sections, the frequency analyses of the FO-controllers will be presented. Initial condition is not considered in the following equations since the frequency analysis is performed in the steady state.

### 3. Common types of linear fractional order controllers

In this section, four common types of linear FO-controllers which are represented in the literature are described shortly. In what follows, Tilted Integral Derivative (TID) controllers, CRONE controllers, FO lead/lag compensators and Fractional Order Proportional and Derivative (FO-PID) controllers shall be introduced.

Note, from practical viewpoint, controllers must have a proper transfer function to be realizable. Controllers which are not proper in the following sections should be made proper by adding an extra low pass filter.

#### 3.1. TID controller

By substituting the proportional component in the PID controller with the fractional order integrator ( $s^{-\frac{1}{n}}, n \in N$ ), the TID controller was introduced [38]. The configuration of TID controllers is shown in figure 1. Figure 2 compares the frequency response of TID and PID controllers such that both controllers provide the same phase margin and gain values at high frequencies. As was shown, the TID controller has better performance in rejecting disturbances than the PID controller since it has higher gain before the cross-over frequency (i.e  $\omega_{i-TID} \leq \omega \leq \omega_d$ ). A method for tuning of TID controller parameters will be elaborated in Section 4.1.

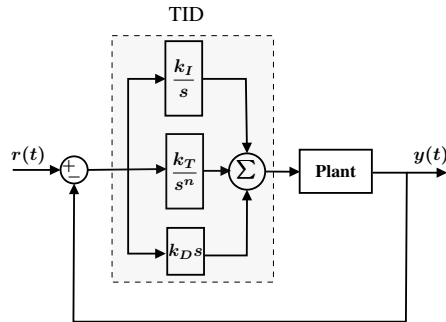

Figure 1: Block diagram of TID controller



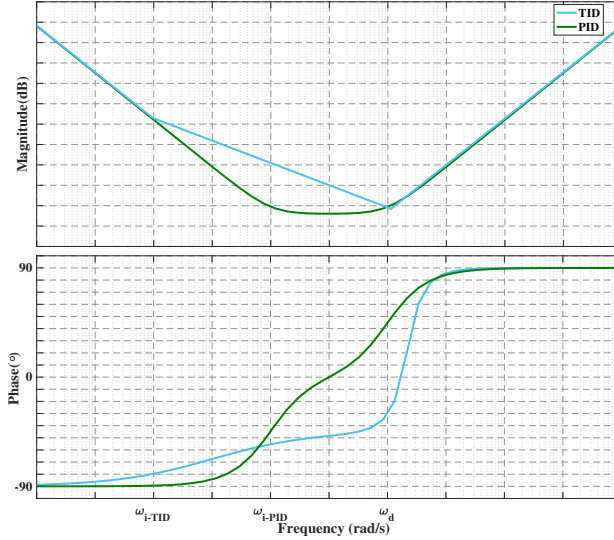

Figure 2: Bode diagram of TID controller

### 3.2. CRONE controllers

CRONE (French abbreviation for Commande Robuste d'Ordre Non Entier, which means non-integer robust control) controllers have been established by Oustaloup since the 1980s in tracking fractal robustness [28]. Three CRONE generations were proposed in the frequency domain in which the open-loop transfer function has fractional order integrators and differentiators. These three generations are used for controlling robustly against plant uncertainties. The first generation of CRONE has the simplest configuration among CRONE generations and can be considered as a simple FO-PID controller. As it is shown in figure 3, the open-loop transfer function of the second generation is shaped following the Bode's ideal cut-off frequency characteristic.

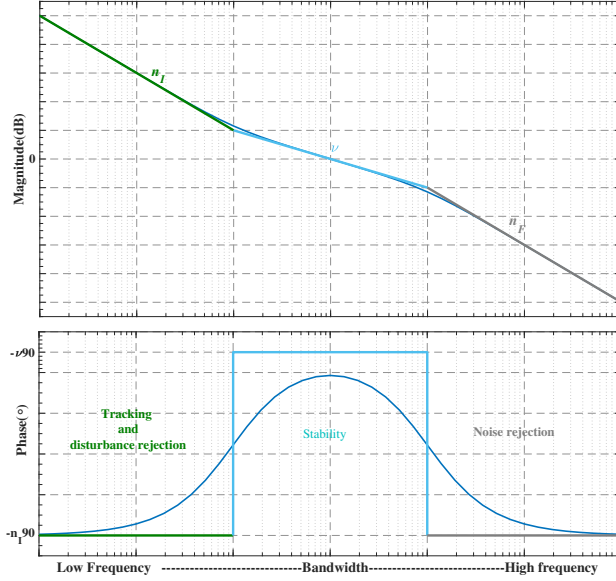

Figure 3: Open-loop transfer function in the second generation of CRONE while  $n_F = n_I$

The third generation of CRONE widens the application of the second generation of CRONE so that it is applicable to plants which have general uncertainties than just gain-like perturbations. The configurations and tuning methods of CRONE generations will be delineated in Section 4.2.

### 3.3. lead/lag compensators

The generalization of classical lead/lag compensators to FO lead/lag compensators has been studied in some investigations [28, 6, 5]. Fractional order lead/lag compensators are obtained by:

$$C(s) = k_p \left( \frac{1 + \frac{s}{\omega_L}}{1 + \frac{s}{\omega_h}} \right)^\mu, \quad \omega_L < \omega_h, \quad \begin{cases} \text{Lead} & \mu \in (0, +\infty) \\ \text{Lag} & \mu \in (-\infty, 0) \end{cases} \quad (14)$$

Sometimes, fractional order lead/lag compensators are also defined as [39, 2]:

$$C(s) = k_p x^\mu \left( \frac{1 + \Delta s}{1 + \Delta x s} \right)^\mu, \quad 0 < x < 1, \quad \begin{cases} \text{Lead} & \mu > 0 \\ \text{Lag} & \mu < 0 \end{cases} \quad (15)$$

Another configuration of these compensators is as [40]:

$$C(s) = k_p \left( \frac{1 + x\Delta s^\mu}{1 + \Delta s^\mu} \right), \quad 0 < \mu < 2, \quad \begin{cases} \text{Lead} & x > 1 \\ \text{Lag} & 0 < x < 1 \end{cases} \quad (16)$$

where  $\Delta$  is a tuning knob which determines corner frequencies of these compensators. It must be recalled that it is not possible to consider  $\mu \geq 2$  because the transfer function of the controller is not bounded-input bounded-output (BIBO) stable [41]. The bode plot of a lead compensator is shown in figure 4.

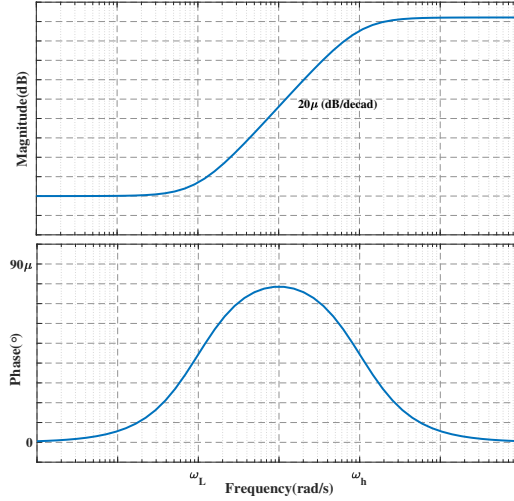

Figure 4: Bode diagram of FO-lead compensator

In the lead compensators, the more distance between  $\omega_L$  and  $\omega_h$ , the more robustness and stability (phase margin) for the controller. Also, the phase margin can be increased by increasing  $\mu$  and the maximum achievable phase by FO lead compensators is  $\mu 90^\circ$ . However, increasing  $\mu$  or the distance between the corner frequencies ( $\omega_L$  and  $\omega_h$ ) leads to have high magnitudes in high frequencies. Consequently, the controller has the less noise rejection characteristic which may cause practical complications. So, similar to integer lead/lag compensators, the stability and robustness have conflict with the precision in this type of FO-controllers. In Section 4.3, tuning methods of these controllers will be discussed.

### 3.4. Fractional order $PI^\lambda D^\mu$ controllers

Podlubny was the first to use the FO-PID name for a kind of FO controllers in 1994 [42]. FO-PID controllers are the general form of the conventional integer order PID controllers. The parallel or ideal form of this controller is:

$$C(s) = k_p + \frac{k_i}{s^\lambda} + k_d s^\mu \quad \lambda, \mu \in R \quad (17)$$

. Figure 5 shows the various types of controller (17) versus  $\lambda$  and  $\mu$ . It can be stated that all families of (PID) controller can be derived from (17) as follows:

1. P controllers can be obtained when  $\lambda = \mu = 0$ .

$$C(s) = k_p \quad (18)$$

2. IO-PI controllers can be obtained when  $\mu = 0, \lambda = n \in N$

$$C(s) = k_p \left(1 + \frac{k_i}{s^n}\right) \quad (19)$$

3. FO-PI controllers can be obtained when  $\mu = 0, \lambda \notin N$

$$C(s) = k_p \left(1 + \frac{k_i}{s^\lambda}\right) \quad (20)$$

4. IO-PD controllers can be obtained when  $\lambda = 0, \mu = m \in N$

$$C(s) = k_p (1 + k_d s^m) \quad (21)$$

5. FO-PD controllers can be obtained when  $\lambda = 0, \mu \notin N$

$$C(s) = k_p (1 + k_d s^\mu) \quad (22)$$

6. IO-PID controllers can be obtained when  $(\lambda = n, \mu = m) \in N$

$$C(s) = k_p + \frac{k_i}{s^n} + k_d s^m \quad (23)$$

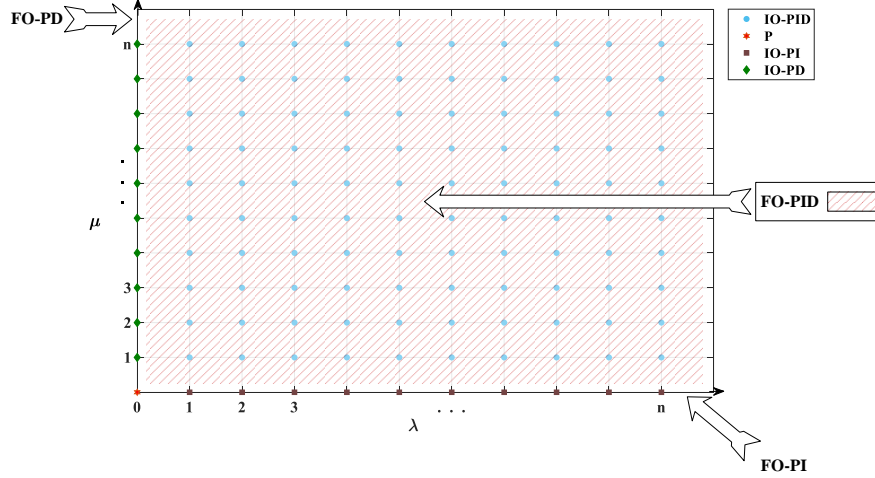

Figure 5: Various types of PID controllers

There are some drawbacks of parallel FO-PID controllers. First, if  $\lambda \in (0, 1)$  in the integration part of this controller, the settling time is very high. So, sometimes  $\frac{1}{s^\lambda}$  is replaced with  $\frac{1}{s} s^{1-\lambda}$  to decrease the settling time value [28, 43, 2]. Also, it is necessary to tame the derivative part of the parallel FO-PID controller for avoiding saturation phenomenon and having the better noise rejection feature. Hence, (17) becomes:

$$C(s) = k_p + \frac{k_i}{s^\lambda} + \frac{k_d s^\mu}{1 + \tau_f s^\gamma} \quad \gamma \geq \mu \quad (24)$$

If  $\mu \neq \gamma$  a memory with a high capacity is required for implementing the discrete time or continuous-time approximation of this controller. So, it is better to consider  $(\gamma - \mu = n, \quad n \geq 0)$  [28]. By increasing  $n$ , the phase margin decreases and the system has the better noise rejection feature and vice versa. In most cases,  $n$  is equal to zero. The most widely-used parallel FO-PID controller is:

$$C(s) = k_p + \frac{k_i}{s^\lambda} + \frac{k_d s^\mu}{1 + \tau_f s^\mu} \quad (25)$$

Moreover, for the ease of practical implementation, FO-PID controllers can be represented in the series form (which is very similar to the first generation of

CRONE):

$$C(s) = k_p \left(1 + \frac{k_i}{s^\lambda}\right) \left(\frac{1 + \frac{s}{\omega_l}}{1 + \frac{s}{\omega_h}}\right)^\mu \quad (26)$$

Bode plot of FO-PID controllers is shown in figure 6. As was shown, the maximum phase which is achievable by these controllers is about  $90\mu$  degree.

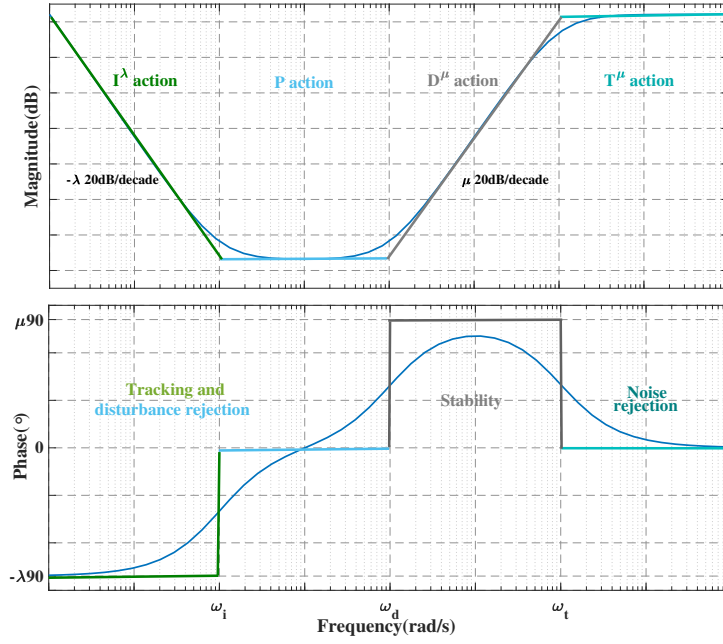

Figure 6: Bode plot of FO-PID controllers

In [44, 45], the FO-[PD] and and FO-[PI] controller is defined as (27) and (28), respectively.

$$C(s) = k_p(1 + k_d s)^\mu \quad (27)$$

$$C(s) = k_p \left(1 + \frac{k_i}{s}\right)^\lambda \quad (28)$$

The comparison between FO-PD (22) and FO-[PD] controller is performed in figure 7. It was observed that the FO-[PD] controller has less overshoot for a step response than FO-PD controller for FO-systems [44] while the FO-PI and FO-[PI] do not have significant differences in the performance for the fractional order process systems[45].

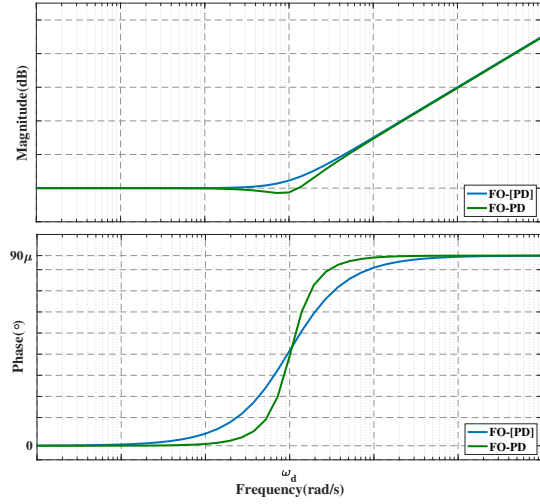

Figure 7: Bode plot of FO-PD and FO-[PD] controllers

Another type of FO-controllers which is presented in the literature is  $D^{1-\lambda}I^\lambda$  [43, 46, 47]:

$$C(s) = \frac{k_i + k_d s}{s^\lambda} \quad (29)$$

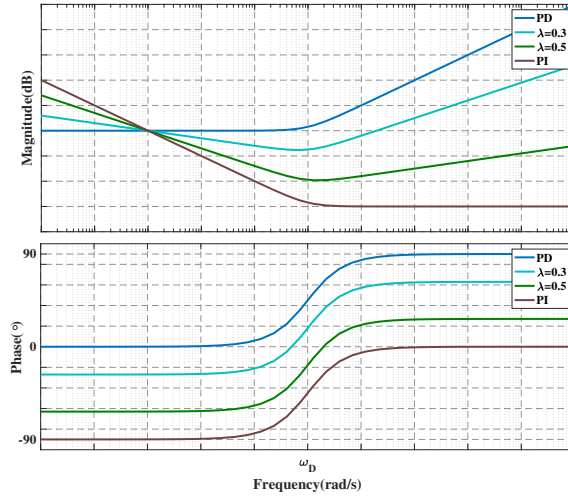

Figure 8: Bode plot of  $D^{1-\lambda}I^\lambda$  controller for various values of  $\lambda$

The bode plots of controller (29) for several values of  $\lambda$  are drawn in figure 8.

It is obvious that when  $\lambda = 0$ , this is an IO-PD controller and when  $\lambda = 1$  this is an IO-PI controller. So, the  $D^{1-\lambda}I^\lambda$  controller is a trade-off between IO-PD and IO-PI controllers. When  $\lambda$  increases, the gain at low frequencies increases while the phase at cross-over frequency decreases. Having higher gains at low frequencies (increasing integral action of the controller) leads to improving the tracking performance of this controller. Consequently, stability decreases and precision improves for this controller by increasing  $\lambda$  and vice versa. Therefore, it can be said that this controller is a trade-off between stability and precision.

#### 4. Tuning methods of FO-controllers

In this section, representative tuning methods for FO-controllers which are developed in the frequency domain are discussed. Similar to Section 3, tuning methods are fallen down into four categories including tuning methods for TID controllers, tuning methods for CRONE generations, tuning methods for FO lead/lag compensators, and tuning methods for  $PI^\lambda D^\mu$  controllers. Let's describe some general equations and constraints which are used in a lot of literature in order to tune FO-controllers [28, 48, 8, 39, 49, 50, 17, 51]. These constraints are:

1. The phase margin definition:

$$\text{Arg}[G(j\omega_c)C(j\omega_c)] = -\pi + \varphi_m \quad (30)$$

where  $G(j\omega)$  and  $C(j\omega)$  are the plant and control transfer functions respectively.

2. The cross-over frequency definition:

$$|G(j\omega_c)C(j\omega_c)| = 1 \quad (31)$$

3. The flatness of the phase curve of the open-loop transfer function near the cross-over frequency which leads to the robustness of the system against gain variations in a specific range (iso-damping):

$$\left. \frac{d(\text{Arg}[G(j\omega)C(j\omega)])}{d\omega} \right|_{\omega=\omega_c} = 0 \quad (32)$$



4. The gain margin definition:

$$\begin{aligned} \text{Arg}(G(\omega_{cp})C(\omega_{cp})) &= -\pi \Rightarrow \\ |G(\omega_{cp})C(\omega_{cp})| &= \frac{1}{M_g} \end{aligned} \quad (33)$$

5. The complementary sensitivity constraints [28]:

$$\inf |T(j\omega) = \frac{CG}{1 + CG}| \geq T_l(\omega) \quad (34)$$

$$M_r = \sup |T(j\omega)| \leq T_u(\omega) \quad (35)$$

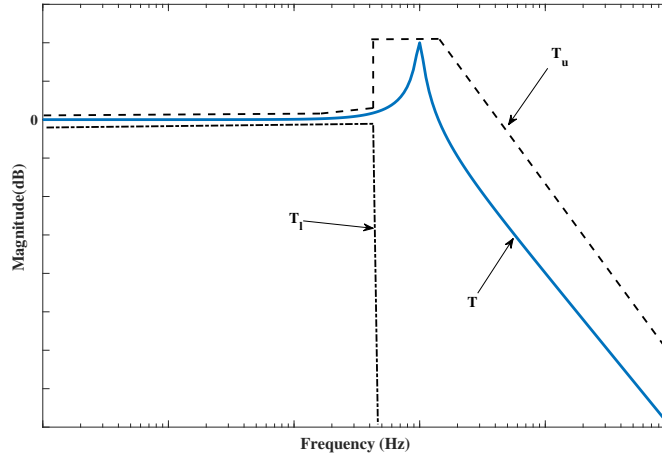

Figure 9: Frequency domain constraints on complementary sensitivity function

As it was shown in figure 9,  $T_l$  and  $T_u$  are two frequency constraint functions so that low frequency characteristics of bound  $T_l$  and  $T_u$  are used to avoid slow response of the system to a step variation of reference signals or disturbances. Middle frequency behaviours of  $T_l$  and  $T_u$  confine the highest value of the settling time (enhance the speed of the system) and high values of the resonant peak. Sometimes, high frequency properties of  $T_u$  increases the noise rejection feature of the system.

6. The modulus margin constraint (the sensitivity function constraint):

$$M_s = \sup |S(j\omega) = \frac{1}{1 + CG}| \leq S_u(\omega) \quad (36)$$

where the  $S(j\omega)$  is the sensitivity transfer function and  $S_u$  is a desired bound. This constraint can be used for improving the disturbance rejection characteristic of the system. The lower values of the modules margin, the more robustness of the system against disturbances.

7. The control sensitivity constraint:

$$\sup |CS(j\omega)| \leq CS_u(\omega) \quad (37)$$

where  $CS_u$  is a desired bound. This constraint limits the control effort in respect of noises and disturbances, so this increases the energy efficiency of the controller.

8. The process sensitivity constraint:

$$\sup |GS(j\omega)| \leq GS_u(\omega) \quad (38)$$

where  $GS_u$  is a desired bound. This constraint improves disturbance rejection of the plant, so it leads to enhancing the precision of the system.

#### 4.1. Tuning methods for TID controller

As discussed in section 3.1, TID controller has the simplest configuration among FO-controllers. It is noteworthy to recall that auto-tuning methods for PID controllers are applicable for TID controllers since they are very similar to PID controllers. Apart from this fact, there is one explicit tuning method in the frequency domain for this type of FO-controllers [38]. As it was shown in figure 1, three parameters  $k_I$ ,  $k_T$  and  $k_D$  must be tuned for these controllers. In this respect, these three simple steps must be followed:

1. Assume  $k_I = k_D = 0$  and set  $k_T$  in order to satisfy constraint (31)
2.  $k_I = \frac{k_T}{4} \left(\frac{\omega_c}{2\pi}\right)^{1-\frac{1}{n}}$
3. At the end, considering the phase margin  $5^\circ$  above the desired phase margin,  $k_D$  is obtained using (30)

#### 4.2. Tuning Methods for CRONE generations

As was described in section 3.2, three generations of CRONE controllers exist and each generation has its tuning method and can be used in a special condition. The first generation of CRONE is used to robustly control a plant with an uncertain gain but constant phase around the cross-over frequency. In other words, if the cross-over frequency ( $\omega_c$ ) of a controlled system changes due to gain variation of the plant in a frequency range  $[\omega_A, \omega_B]$ , its phase stays unchanged within this frequency range. The configuration of the first generation of CRONE controller is [28, 48]:

$$C_{R_1}(s) = k \left(1 + \frac{\omega_I}{s}\right)^{n_I} \left(\frac{1 + \frac{s}{\omega_L}}{1 + \frac{s}{\omega_h}}\right)^n \left(\frac{1}{1 + \frac{s}{\omega_f}}\right)^{n_F}, \quad (39)$$

$$n_I, n_f \in N, n \in R, \omega_I < \omega_L < \omega_A < \omega_B < \omega_h < \omega_f$$

It is suggested that  $\omega_L$  and  $\omega_h$  must be set so that they ensure a constant phase for the open loop response within the range of  $[\omega_A, \omega_B]$  (for more details, see [28]). Parameters  $n$  and  $k$  are obtained by using constraints (30) and (31) [28]:

$$n = \frac{-\pi + \varphi_m - \arg(G(j\omega_c)) + n_F \arctan\left(\frac{\omega_c}{\omega_f}\right) + n_I \left(\frac{\pi}{2} - \arctan\left(\frac{\omega_c}{\omega_I}\right)\right)}{\arctan\left(\frac{\omega_c}{\omega_L}\right) - \arctan\left(\frac{\omega_c}{\omega_h}\right)} \quad (40)$$

$$k = \frac{\left(1 + \frac{\omega_c^2}{\omega_f^2}\right)^{0.5n_F}}{|G(j\omega_c)| \left(\frac{\omega_h}{\omega_L}\right)^{0.5n} \left(1 + \frac{\omega_I^2}{\omega_c^2}\right)^{0.5n_I}} \quad (41)$$

When, in a frequency range  $[\omega_A, \omega_B]$ , there is perturbation in the gain behaviour of a plant, and its phase is function of the frequency and is not constant, the second generation of CRONE must be used to make the system robust against uncertainties. The configuration of the second generation of CRONE controller is [28, 52, 53, 48]:

$$C_{R_2}(s) = k G^{-1}(s) \left(1 + \frac{\omega_I}{s}\right)^{n_I} \left(\frac{1 + \frac{s}{\omega_h}}{1 + \frac{s}{\omega_L}}\right)^\nu \left(\frac{1}{1 + \frac{s}{\omega_f}}\right)^{n_F}, \quad (42)$$

$$n_I, n_f \in N, \nu \in R, \omega_I < \omega_L < \omega_A < \omega_B < \omega_h < \omega_f$$

Similar to the first generation of CRONE,  $\nu$  and  $k$  are obtained using (30) and (31):

$$\nu = \frac{-\pi + \varphi_m + n_F \arctan\left(\frac{\omega_c}{\omega_f}\right) + n_I\left(\frac{\pi}{2} - \arctan\left(\frac{\omega_c}{\omega_I}\right)\right)}{\arctan\left(\frac{\omega_c}{\omega_h}\right) - \arctan\left(\frac{\omega_c}{\omega_L}\right)} \quad (43)$$

$$k = \frac{\left(1 + \frac{\omega_c^2}{\omega_f^2}\right)^{0.5n_F}}{\left(\frac{\omega_L}{\omega_h}\right)^{0.5\nu} \left(1 + \frac{\omega_I^2}{\omega_c^2}\right)^{0.5n_I}} \quad (44)$$

Parameters  $n_I$  and  $n_F$  must be set so that  $n_I \geq n_{pl}$  and  $n_F \geq n_{ph}$  if the order of plant at low frequencies ( $\omega < \omega_I$ ) and high frequencies ( $\omega > \omega_f$ ) is  $n_{pl}$  and  $n_{ph}$ , respectively (for more details see [28]).

Although the second generation of CRONE controller extends the frequency range for choosing the cross-over frequency, in some cases such as existing delay on the system, this configuration is not able to ensure robustness of a system. Hence, the third generation of CRONE is utilized when uncertainties of a plant are more general than just gain-like perturbations. In the basic idea of the third generation of CRONE, the open-loop transfer function (45) has a complex integration order ( $\nu = a + ib$ ) which leads to have a general template in the Nichols chart [28, 48].

$$\beta = k \left( \cosh\left(b\frac{\pi}{2}\right) \left(\frac{\omega_c}{s}\right)^a \left( \mathcal{R}e_{/i} \left( \left(\frac{\omega_c}{s}\right)^{ib} \right) \right)^{-\text{sign}(b)} \right) \quad (45)$$

Tuning of the third generation of CRONE controller is the most complicated among all CRONE generations (for more information see [28]). A designer can set the number of tuning parameters by considering more general templates based on how a plant is sophisticated.

$$\beta_T = \prod_{j=1}^N \beta_j \Rightarrow C_{R_3}(s) = G^{-1} \beta_T \quad (46)$$

When the number of tuning parameters are determined, a designer must select a proper cost function and solve an optimization problem under some constraints which definitely include constraints (30) and (31). CRONE recommends four

optimization problems for tuning the third generation of CRONE controller [28, 54].

1. Considering  $J = \sup |T(j\omega)| - M_r$  as the cost function in which  $M_r$  is the desired resonant peak. Minimization must be done under constraint (34) to (38).
2. Considering  $J = \frac{20}{2\pi} \log(\int_{\omega^{min}}^{\omega^{max}} \max |e(j\omega)|^2 d\omega)$  as the cost function in which  $e(t) = y_{ref}(t) - y(t)$ . Minimization must be done under the constraints (37).
3. Considering  $J = \max \sup \left| \frac{G(j\omega)S(j\omega)}{j\omega} \right|_{dB}$ . Minimization must be done under the constraints (35) to (37).
4. Considering  $J = \max \sup \left| \frac{S(j\omega)}{j\omega} \right|_{dB}$ . Minimization must be done under the constraints (35) to (37).

CRONE generations have been successfully applied to some practical systems [55]. The second generation was implemented mechanically to a suspension system of a vehicle [25]. The third generation was applied to a resonant plant (flexible transmission) [24], a four mass-spring system with low damping [56], and a nonlinear hydraulic actuator [23]. To sum up, it appears that the CRONE generations are very useful for designing a robust controller against plant uncertainties.

#### 4.3. Tuning methods for fractional order lead/lag compensators

In this part, tuning methods which are applicable for tuning FO-lead lag compensators are presented. Monje et al. obtained a method for auto-tuning of these compensators (controller (15)) [39]. The magnitude of  $|G(j\omega_c)|$  and  $\arg(G(j\omega_c))$  are found by using the relay test (see [39] for more information). For this purpose, the constraints (30), (31), and the definition of the static error constant:

$$k_{ss} = \lim_{s \rightarrow 0} s^n C(s)G(s), \quad (47)$$

where  $n$  is type of the plant are used for tuning of an FO-lead/lag compensator. There are four unknown parameters  $(x, \mu, \Delta, k_p)$  with three equations, so an

optimization problem has to be solved. The objective function has chosen to minimize the  $\mu$  since the less value of  $\mu$ , the less value of  $x$  which results in more robust compensator. Following the trial and error approach is taken to solve this optimization problem:

1. Consider a minimum value for  $\mu$  (for instance,  $\mu = 0.05$ )
2. Calculate the  $x$ ,  $\Delta$ , and  $k_p$
3. If  $x$  is positive, the compensator is tuned. Otherwise, the  $\mu$  is increased with a fixed value and repeat steps (2)-(3)

In a similar way, [Tavazoei and Tavakoli-Kakhki](#) obtained a general method for tuning controller (16). In this way, the constraints (30), (31) and the definition of the static error constant (47), and the maximum value of the controller output (to avoid saturation) are considered for tuning of its four parameters [40].

#### 4.4. Tuning methods for $PI^\lambda D^\mu$

As discussed before, the most popular type of FO-controller is the FO-PID controller. In this section, tuning methods for these controllers in the frequency domain are reviewed.

Several researchers proposed tuning methods using optimization techniques. [Zhao et al.](#) tuned FO-PID controller (controller (17)) for on type of FO-plants ( $G(s) = \frac{1}{a_1 s^\alpha + a_2 s^\beta + a_3}$ ) [8]. For a given phase and gain margin, (30), (31), and (33) are accounted for tuning. This leads to four equations with seven unknown parameters ( $\omega_c, \omega_{cp}, k_p, k_i, k_d, \mu, \lambda$ ) :

- (i)  $f(\omega_c, \omega_{cp}, \mu, \lambda, \varphi_m, M_g) = 0$
- (ii)  $k_p = g(\omega_c, \omega_{cp}, \mu, \lambda, \varphi_m, M_g)$
- (iii)  $k_i = y(\omega_c, \omega_{cp}, \mu, \lambda, \varphi_m, M_g)$
- (iv)  $k_d = z(\omega_c, \omega_{cp}, \mu, \lambda, \varphi_m, M_g)$

This problem is solved through an optimization method in which four parameters ( $\omega_c, \omega_{cp}, \mu, \lambda$ ) form a desired cost function  $J = \mathcal{L}(\omega_c, \omega_{cp}, \mu, \lambda)$  based on the required performance (robustness, stability, etc). The optimization problem is

solved under constraint (i). After finding these four parameters through a suitable optimization algorithm, parameters  $(k_p, k_i, k_d)$  are obtained using equations (ii)-(iv). This method is flexible and users are able to add their requirements as an objective function in the optimization part. They also concluded that FO-PID controller has better performance than IO-one for FO-plants.

In addition, [Zhong and Li](#) proposed a tuning method for FO-PID controllers for a specific type of FO-plants ( $G(s) = \frac{1}{a_1 s^{\alpha_1} + a_2 s^{\alpha_2} + a_3 s^{\alpha_3} + a_4}$ ,  $a_i > 0$ ) [57]. In this method, constraints (30), (31), and (32) are used for tuning, so there are seven unknown parameters  $(\omega_c, \varphi_m, k_p, k_d, k_i, \mu, \lambda)$  and three equations. Then, the feasible region for unknown parameters based on the stability analyses is found. Next, one of the suggested cost functions including (IAE= $J = \int_0^{\infty} |e(t)|dt$ ), (34), and (36) is used for optimization under constraints (30), (31), and (32). A fixed-step search method is utilized for solving. If the obtained controller satisfies the desired performances, the tuning is finished; otherwise, two narrow intervals for  $\mu$  and  $\lambda$  are taken so that previous obtained optimal  $\lambda$  and  $\mu$  are placed in the middle of intervals. After that, the step-size is reset to a smaller value the procedure is repeated, and the controller is finally tuned. The tuned controller is robust against gain variations and shows iso-damping behaviour.

[Valério and da Costa](#) obtained a tuning method similar the Ziegler-Nichols method for FO-PID controllers (controller (17)) [49]. It is assumed that each plant frequency response can be approximated by an S-shaped response ( $G(s) = \frac{e^{-Ls}}{1 + Ts}$ ). Then, to solve the problem, (30) is supposed as the minimization cost function and (31), (32), (35), and (36) are counted for constraints. For many different  $L$  and  $T$ , the Nelder-Mead's simple optimization method is applied to solve this optimization problem for a specific requirement and then the least-square method is used to find a relation between  $L$ ,  $T$  and tuning parameters for the given specifications. For any requirement, this procedure can be done to find a relation between dynamic parameters of the system and tuning knobs. They reported that the FO-PID which is tuned by this method is more robust than IO-PID (controller (23)) which is tuned by the Ziegler-Nichols method.

Similarly, [Saidi et al.](#) proposed a tuning method for FO-PID controllers for any general plants [58]. In the proposed approach, (30), (31), (32), (35), and (36) are considered for tuning. Also, they assumed flatness of the phase in a desired band  $[\omega_l, \omega_h]$  and then considered  $N$  frequencies belong to this band. They changed constraints (30) and (32) to (48) (phase margin constraint) and (49) (iso-damping), respectively.

$$\sum_{i=1}^N (\arg[C(j\omega_i)G(\omega_i)] + \pi - \varphi_m)^2 = 0, \quad \forall \omega_i \in [\omega_l, \omega_h] \quad (48)$$

$$\sum_{i=1}^N \left( \frac{d \arg[C(j\omega)G(j\omega)]}{d\omega} \Big|_{\omega=\omega_i} \right)^2 = 0, \quad \forall \omega_i \in [\omega_l, \omega_h] \quad (49)$$

Then, they supposed (31) as the minimization cost function under constraints (30), (32), (35), and (36) to tune the controller. Both methods have robustness against gain variations.

[Chen et al.](#) generalized Modulus margin constrained Integral Gain Optimization (MIGO) based controller tuning method for FO-PI controllers (20) and called it F-MIGO method [59]. In this respect, they faced with an optimization problem which is:

- $R = \frac{M_s + M_r - 1}{2M_s(M_r^2 - 1)}$ .  $M_r$  and  $M_s$  are respectively the resonant peak (35) and the modules margin (36)
- $f(k_p, k_i, \omega, \lambda) = |1 + C(j\omega)G(j\omega)|^2$
- Constraints:  $f(k_p, k_i, \omega, \lambda) \geq R^2$
- Objective function:  $\max\{k_i\}$

This optimization problem is solved for a fixed value of  $\lambda$  through this mathematical method:

$$f(k_p, k_i, \omega, \lambda) = R^2, \quad \frac{\partial f}{\partial \omega} = 0, \quad \frac{\partial f}{\partial k_p} = 0, \quad \frac{d^2 f}{d\omega^2} > 0 \quad (50)$$

Then, this procedure is performed for a range of  $\lambda$  and best  $\lambda$  is selected to minimize (ISE =  $\int_0^\infty e^2(t)dt$ ) for a step response. This method is applied to a first



order system plus time delay ( $G(s) = \frac{ke^{-Ls}}{1+Ts}$ ) and relations between controller parameters and process parameters ( $L$  and  $T$ ) are obtained. This method is compared with IO-PI controllers (controller (19)) tuned by the Ziegler-Nichols, modified Ziegler-Nichols and AMIGO [60] for six different plants. It is concluded that if the relative dead time ( $\frac{L}{L+T}$ ) is very small, the FO-PI controllers are better than IO-PI controllers, for systems with a balanced lag and delay values ( $L \approx T$ ), there is no difference between IO-PI and FO-PI controllers and for a systems with high relative dead time, FO-PI controller responses are faster with higher values of the overshoot than IO-PI controller responses.

Vu and Lee developed this tuning method and introduced a new tuning guideline [61]. In this approach, the open-loop transfer function is considered as  $(\frac{s}{\omega_c})^\gamma$ , and then,  $\lambda$  is selected based on the previous method. Next,  $k_p$ ,  $\gamma$ , and  $\omega_c$  are tuned based on one of the suggested optimization criteria under constraint (34). In the end,  $k_i$  is found through  $CG(j\omega) = (\frac{j\omega}{\omega_c})^\gamma$ .

Padula and Visioli found tuning methods for integral ( $G(s) = \frac{k}{s}e^{-Ls}$ ), stable ( $G(s) = \frac{k}{Ts+1}e^{-Ls}$ ), and unstable ( $G(s) = \frac{k}{Ts-1}e^{-Ls}$ ) process plants [50, 17]. Three types of controllers including the tamed series FO-PID (similar to the controller (26)), the tamed series IO-PID controller (controller (26) with  $\lambda = \mu = 1$  and  $\omega_h = 10\omega_l$ ) and the ideal or parallel tamed FO-PID (controller (25) with a low-pass filter) are tuned for this purpose. For tuning integral and stable plant, IAE and (36) are respectively selected as the cost function and constraint for an optimization problem. For tuning the unstable plant, the cost function remains the same but the constraint is substituted with checking stability. In this respect, the stability condition of the closed-loop transfer function is checked at the first step for each trial. If the trial makes the system unstable, the objective function will get a high value, so it is discarded automatically. This tuning method is performed for a step disturbance and reference signal response separately and relations between controller parameters,  $L$  and  $T$  are found for each controller in each scenario (disturbance rejection or reference tracking). They recognized that FO calculus has significant effects on differentiator part of

FO-PID and does not provide any advantages for integral part since the integral order became one in all optimization solution. In addition, FO-PID controllers outperforms IO-PID controllers in three considered systems.

Monje et al. proposed a method for tuning FO-PI controllers (controller (20)) robustly against plant uncertainties and changing the time delay for the second order plus time delay process systems ( $G(s) = \frac{ke^{-Ls}}{(T_1s + 1)(T_2s + 1)}$ ) [43]. In the robust design against the time delay variation ( $L$ ), (31) is assumed as the cost function and (30) and (32) are considered as constraints. In the robust design against the variation of time constants ( $T_1$  or  $T_2$ ), the cost function remains the same as time delay variation and constraints are replaced with (30) and (33). The nonlinear optimization method (FMINCON in MATLAB) is used for solving these optimization problems. As it was discussed before,  $\frac{1}{s^\lambda}$  was replaced with  $\frac{1}{s}s^{1-\lambda}$  in their controller to improve the settling time. In a similar way, they tuned FO-PID controller (controller (17)) for the first order systems plus time delay ( $G(s) = \frac{ke^{-Ls}}{1 + Ts}$ ). In this respect, they use the same cost function under constraints (30), (32), (35), and (36) [2].

Moreover, similar to their method for FO-lead/lag compensator [39], they proposed an auto-tuning method for series FO-PID controller (controller (26)) [2]. The magnitudes of  $|G(j\omega_c)|$  and  $\text{Arg}(G(j\omega_c))$  are found by using the relay test and FO-PID is reshaped as an FO-PI controller (controller (20)) multiplied to an FO-lead compensator (controller (15)). First, the FO-PI part is designed so that it makes the slope of the phase of the open loop-transfer function to zero while  $k_i = \frac{1}{\omega_c}$  (in order to minimize the value of  $\lambda$ ). Next, the FO-lead compensator is tuned for the plant multiplied FO-PI part using method described in [39] (elaborated in Section 4.3).

In addition, De Keyser et al. developed an auto-tuning for FO-PD (22) and FO-PI (20) controllers [62]. In this method,  $\left. \frac{d(\text{Arg}[G(j\omega)])}{d\omega} \right|_{\omega=\omega_c}$ ,  $\text{Arg}[G(j\omega_c)]$ , and  $|G(j\omega_c)|$  are found through a novel experiment for an unknown plant, and then, the controller is tuned using constraints (30), (31), and (32) (for more details see [62]). Also, these auto-tuning methods are robust against gain variations of

the plant.

Some people try to tune FO controllers utilizing loop-shaping tools. [Krijnen et al.](#) combined the loop-shaping with optimization methods for tuning a series FO-PID controllers (51) for a precision positioning system (a mass-spring damper system) to maximize crossover frequency (bandwidth frequency) [26]. Controller (51) is a FO-PID controller which is multiplied by a FO-low pass filter as:

$$C(s) = k_p \left(1 + \frac{\omega_i}{s}\right) \left(\frac{1 + \frac{s}{\omega_z}}{1 + \frac{s}{\omega_p}}\right)^\mu LP_{(n,r)}(s)$$

$$LP_{(n,r)}(s) = \begin{cases} n = 1 & \frac{1}{1 + \frac{s}{\omega_{lp}}} \\ n = 2 & \left(\frac{1}{1 + (\frac{s}{\omega_{lp}})^r}\right) \left(\frac{1}{1 + \frac{s}{\omega_{lp}}}\right) \\ n = 3 & \left(\frac{1}{1 + (\frac{s}{\omega_{lp}})^r + (\frac{s}{\omega_{lp}})^{2r}}\right) \left(\frac{1}{1 + \frac{s}{\omega_{lp}}}\right) \end{cases} \quad (51)$$

In their method, tuning parameters  $x = [k_p, \omega_i, \omega_z, \omega_p, \omega_{lp}, n, r, \mu]$  are found through an optimization procedure in which  $\min\{\frac{\omega_{c,bm}}{\omega_c(x)}\}$  ( $\omega_{c,bm}$  is the target bandwidth) is considered as a cost function under constraints (30), (31), and (33). The tuned FO-PID controller is compared with an IO-PID controller (controller (26) with  $\lambda = \mu = 1$ ) which is tuned by an empirical method [63] and it is revealed that the FO-PID controller increases the achievable bandwidth frequency in comparison with IO-PID controller.

[Dastjerdi et al.](#) proposed an industrially applicable tuning method using the loop-shaping method for controller (51) without FO-low pass filter ( $LP_{(n,r)}$ ) [64]. In that method, knowing the value of the phase and gain margin, the controller is tuned using some curves which are obtained based on the loop-shaping approach (for more details see [64]). The advantage of this method is that it does not need to solve complicated equations, so it is very convenient for industrial applications. Moreover, this method is less sensitive to gain variations of the plant.

Moreover, another tuning method based on the combination of Internal Model Control (IMC), loop-shaping, and second generation of CRONE is proposed in [65]. This method is very simple and straightforward and FO-PID controllers are tuned for all process plants based on the phase margin, cross-over frequency, and type of the plant. In addition, [Cervera et al.](#) considered combination of FO lead compensator (controller (15)), FO-PI (controller (20)), and an IO low-pass filter and tuned it upon constraints (30), (31), (35), and (36) using loop-shaping tools [66].

Some researchers introduced tuning methods based on solving these non-linear equations ((30) to (38)) by utilizing mathematical methods such as the graphical method, the Newton-Raphson numerical iterative algorithm and so on. [Feliu-Batlle et al.](#) carried out research to tune controller  $D^{1-\lambda}I^\lambda$  (controller (29)) for the second order plus time delay process systems ( $G(s) = \frac{ke^{-Ls}}{(T_1s+1)(T_2s+1)}$ ) [46]. It is noteworthy to say that the controller is multiplied by  $(1 + \frac{\alpha}{s})$  where  $\alpha$  is very small and set by the trial and error method in order to decrease the settling time value. The constraints (30), (31) and (33) were solved using the Newton-Raphson numerical iterative algorithm. They assert that  $D^{1-\lambda}I^\lambda$  controllers are more robust and stable than IO-PID controllers (23) against changes in  $T_1$ . Moreover, [Chen et al.](#) used an accurate approximation method to directly solve constraints (30), (31), and (32) to tune FO-PI controllers (controller (20)) robust against gain variations for any general plant [67].

[Luo and Chen](#) tuned three controllers including IO-PID (23), FO-PD (controller (22),  $\mu \in (0, 2)$ ), and FO-[PD] (controller (27),  $\mu \in (0, 2)$ ) controllers for fractional order plants ( $G(s) = \frac{1}{s(Ts^\alpha + 1)}$ ) [44]. The constraints (30), (31) and (32) are solved using the graphical method for designing a robust controller against gain variations. It is concluded that IO-PID controllers are not proper for some cases because they cause systems to become unstable and also FO-[PD] controllers are more robust and have better performances than FO-PD ones. Moreover, they used this approach for tuning FO-PI and FO-[PI] for the

similar type of fractional order plants [45]. They concluded that there are no differences between FO-PI (20) and FO-[PI] (28) controllers for this type of plant [45]. Similarly, Luo et al. followed this method to tune the FO-PD controller for a servo hard disk drive [68]. This method is also used to tune FO-PI controllers (20) for the first order plants [69].

## 5. Realization of fractional order controllers

Control engineers are faced with a big difficulty which is the realization of FO-controllers when they want to utilize this type of controllers. Implementation of FO-controllers will be done in two steps. First, the irrational function  $s^\nu$  must be approximated with a rational function. There are some methods for obtaining the rational approximation functions of  $s^\nu$  in the  $S$ ,  $Z$  and  $\delta$  domain. In other words, there are continuous approximation functions ( $S$  domain) and discrete approximation functions ( $Z$  and  $\delta$  domain). Second, the rational transfer functions can be implemented by analogue circuits (for continues transfer functions) or by special digital devices such as PLC, PIC, FPGA and so forth (for discrete approximation functions).

### 5.1. Continuous approximation methods ( $S$ domain)

One of the important problems in implementing of fractional order controllers can be addressed as finding a way for the rational approximation of the irrational transfer function  $s^\nu$ . There are several mathematical methods for the rational approximation of  $s^\nu$ . In the control theory, the Continuous Fractional Expansion (CFE) method, which is a well-known method for function evaluation, is a proper way among many other mathematical methods. In this way, any irrational function  $G(s)$  can be expressed as [70, 71]:

$$G(s) \approx a_0(s) + \frac{b_1(s)}{a_1(s) + \frac{b_2(s)}{a_2(s) + \frac{b_3(s)}{a_3(s) + \dots}}} \quad (52)$$

This technique yields to approximate the irrational function  $G(s)$  by a rational function which is achieved by dividing two polynomial functions of the variable  $s$ :

$$G(s) \approx \frac{P_n(s)}{Q_m(s)} = \frac{p_0 + p_1s + \dots + p_ns^n}{q_0 + q_1s + \dots + q_ms^m} \quad (53)$$

which is passed through these points  $(s_1, G(s_1)), \dots, (s_{1+a}, G(s_{1+a}))$  where  $a = m + n + 1$ .

A method upon the CFE technique is suggested by Matsuda in selected logarithmically spaced points  $(s_k, k = 0, 1, 2, \dots)$ . His approximation method is [70, 71]:

$$H(s) \approx a_0 + \frac{s - s_0}{a_1 + \frac{s - s_1}{a_2 + \frac{s - s_2}{a_3 + \dots}}} \quad (54)$$

where:

- $V_0(s) = H(s), \quad V_{i+1}(s) = \frac{s - s_i}{V_i(s) - a_i}, \quad a_i = V_i(s_i)$

The most widely applicable method for the approximation of  $s^\nu$  in a limited frequency range is the Oustaloup's method [72, 70, 73, 71, 28]:

$$s^\nu \approx C_o \prod_{k=-N}^{k=N} \frac{(1 + \frac{s}{\omega_k})}{(1 + \frac{\omega_k}{s})} \quad (55)$$

where:

- $C_o = (\sqrt{\frac{\omega_h}{\omega_b}})^\nu, \quad \omega_k = \omega_b (\frac{\omega_h}{\omega_b})^{\frac{k+N+\frac{1-\nu}{2}}{2N+1}}, \quad \omega_k = \omega_b (\frac{\omega_h}{\omega_b})^{\frac{k+N+\frac{1+\nu}{2}}{2N+1}}, \quad \omega_h > \omega_b$

- $\omega_h$  and  $\omega_b$  are frequency bands on which  $s^\nu$  is acted.

Quality of the Oustaloup's method near frequency bands may not be satisfactory when  $\omega_h$  is very high and  $\omega_b$  is very low. So, an extension of this method is proposed to overcome this problem by combining the Taylor's series and Oustaloup's method [72]:

$$s^\nu \approx C_o \left( \frac{ds^2 + b\omega_h s}{d(1-\nu)s^2 + b\omega_h s + d\nu} \right) \prod_{k=-N}^{k=N} \frac{s + \omega_k}{s + \omega_k} \quad (56)$$

in which:

- $C_o = \left(\frac{d\omega_b}{b}\right)^\nu \prod_{k=-N}^{k=N} \frac{\omega_k}{\omega'k}$

The suggested values for  $b$  and  $d$  are respectively 10 and 9 [72].

Similar to the Oustaloup's method, Chareff proposed an approximation for functions in the form of  $G(s) = \frac{1}{\left(1 + \frac{s}{P_T}\right)^\nu}$  as [71]:

$$\frac{1}{\left(1 + \frac{s}{P_T}\right)^\nu} \approx \frac{\prod_{i=1}^{N-1} \left(1 + \frac{s}{z_i}\right)}{\prod_{i=1}^N \left(1 + \frac{s}{p_i}\right)} \quad (57)$$

where:

- $a = 10^{\frac{y}{10(1-\nu)}}$ ,  $b = 10^{\frac{y}{10\nu}}$
- $p_0 = P_T\sqrt{b}$ ,  $p_i = p_0(ab)^i$ ,  $z_i = ap_0(ab)^i$
- $N = \left\lceil \frac{\log\left(\frac{\omega_{max}}{p_0}\right)}{\log(ab)} \right\rceil + 1$  in which  $\omega_{max}$  is the desired bandwidth

These coefficients are computed so that deviation from the original magnitude response in the frequency domain becomes less than  $y$ (dB). Yüce et al. introduced an approximation method based on Laplace transform of FO integrator (4) by utilizing the least square fitting tool of Matlab. In this way [74]:

$$\mathcal{L}^{-1}\left\{\frac{1}{s^{\nu+1}}\right\} = \frac{t^\nu}{\nu\Gamma(\nu)} = \mathcal{F}(t) \quad (58)$$

It is assumed that function  $\mathcal{Y}$  (59) is fitted properly to the function  $\mathcal{F}$  and then  $m_i$  and  $n_i$  parameters are achieved by using the least square fitting tool in Matlab.

$$\mathcal{F}(t) \approx \mathcal{Y}(t) = m_1e^{-n_1t} + m_2e^{-n_2t} + m_3e^{-n_3t} + m_4e^{-n_4t} + m_5e^{-n_5t} + c \quad (59)$$

Then, the inverse Laplace transform is applied to (59) and the approximation function is obtained as:

$$\mathcal{L}\{\mathcal{Y}\} = \frac{m_1}{s+n_1} + \frac{m_2}{s+n_2} + \frac{m_3}{s+n_3} + \frac{m_4}{s+n_4} + \frac{m_5}{s+n_5} + \frac{c}{s} \approx \frac{1}{s^{\nu+1}} \quad (60)$$

Upon the Newton's iterative method for solving nonlinear equations, Carlson introduced an approximation method for FO transfer functions. In this respect

[75, 73, 76]:

$$(G(s))^\nu \approx H_n(s) = H_{n-1}(s) \frac{(a-1)(H_{n-1}(s))^a + (a+1)G(s)}{(a+1)(H_{n-1}(s))^a + (a-1)G(s)} \quad (61)$$

where:

- $a = \frac{1}{\nu}$ ,  $H_0(s) = 1$

It is obvious that this method is restricted to that  $a$  must be an integer number. So, some researchers tried to overcome this limitation. [Shrivastava and Varshney](#) considered that the Carlson's method is applicable for  $\nu = 0.1, 0.2$ , and  $0.5$ . Then, they built other  $\nu$  values in the range of  $[0.1, 0.9]$  by combination of these three values (for example,  $0.3 = 0.1 + 0.2$  or  $0.8 = 0.3 + 0.5$ ) and obtained a table for approximation of  $(s^\nu, \nu \in [0.1, 0.9])$  [75]. Moreover, [Tepljakov et al.](#) modified the Carlson's method in order to approximate  $s^\nu$  in a frequency range. They declared that the behaviour of the  $s^\nu$  in a frequency band is similar to an FO lead/lag compensator (15). If the  $\nu^{-1}$  is not an integer number, it will be decomposed by a special algorithm (for more information see [76]) as:

$$\nu = \sum_{i=1}^{i=k} \frac{1}{m_i} \quad (62)$$

Then, the approximation function in the frequency band is obtained as:

$$(G(s))^\nu \approx \prod_{i=1}^{i=k} \left( \frac{1 + \Delta s}{1 + x\Delta s} \right)^{\frac{1}{m_i}} \approx \prod_{i=1}^{i=k} H_n \left( \frac{1}{m_i} \right) \quad (63)$$

where  $\frac{1}{m_i}$  is calculated through (61) while  $a = m_i$ .

In addition, [Aware et al.](#) introduced a new method for approximation of  $s^\nu$  in the frequency band of  $(\omega_L, \omega_H)$  [77]. They obtained this method by optimizing the number of poles and zeros to maintain the phase value of  $s^\nu$  within the  $\epsilon^\circ$  tolerance of its actual value as follows:

$$s^\nu \approx \frac{(s - z_1)(s - z_2) \dots (s - z_n)}{(s - p_1)(s - p_2) \dots (s - p_n)}, \quad (64)$$

in which:



- $p_1 = 10^{2\nu + \log(\omega_L) + 1}$ ,  $p_n = 10^{\log(p_{n-1}) + 2 - \mu}$ ,  $z_1 = 10\omega_L$ ,
- $z_n = 10^{\log(z_{n-1}) + 2 - \mu}$ ,  $\mu = 0.64\epsilon$ ,  $n = \min(n)_{p_n > \omega_H}$ .

Lino and Maione obtained an approximation method for FO lead/lag compensator (15) which is [78]:

$$C(s) = k_p x^\mu \left( \frac{1 + \Delta s}{1 + \Delta x s} \right)^\nu \approx \frac{\sum_{k=0}^N B_{N-k} s^k}{\sum_{k=0}^N A_{N-k} s^k}, \quad \nu > 0, \quad \begin{cases} \text{Lead} & 0 < x < 1 \\ \text{Lag} & 1 < x \end{cases} \quad (65)$$

where:

- $A_{N-k} = \sum_{i=1}^N a_{N-i} L_{ki}^C$ ,  $B_{N-k} = \sum_{i=1}^N b_{N-i} L_{ki}^C$ ,  $L_{ki}^C = T^k \sum_{j=j_1}^{j_2} \binom{i}{j} \binom{N-i}{k-j} x^{k-j}$
- $j_1 = \max\{0, k + i - N\}$ ,  $j_2 = \min\{i, k\}$
- $a_i = \binom{N}{i} (N-i+1+\nu)_{(i)} (N-\nu)_{(N-i)^*}$ ,  $b_i = \binom{N}{i} (i+1+\nu)_{(N-i)} (N-\nu)_{(i)^*}$
- $(\nu + i + 1)_{(N-i)} = (\nu + i + 1)(\nu + i + 2) \dots (\nu + N)$
- $(N - \nu)_{(i)^*} = (N - \nu)(N - \nu - 1) \dots (N - \nu - i + 1)$
- $(\nu + N + 1)_{(0)} = (\nu - N)_{(0)} = (N - \nu)_{(0)^*} = 1$

As it asserts that the  $s^\nu$  in a frequency band can be considered as an FO lead/lag compensator [76], this method can be applied to approximate  $s^\nu$  in a frequency range.

### 5.2. Discrete approximation methods (Z domain)

In this age, using digital logic in some applications such as controller implementation has been increased because of development of digital computers. FO-controllers are not exceptional and there are many investigations for digital implementation of these controllers. Tenreiro Machado was one of the pioneer researchers who proposed an algorithm for the digital implementation of FO-controllers [79]. The first step in digital implementation is the discretization of the FO-transfer function. For this purpose, there are several methods which are categorized into two main groups: direct discretization and indirect discretization methods [80].

Table 1:  $\beta$  and  $\gamma$  tuning parameters

Methods	Forward Euler	Tustin	Al-Alaoui	Backward Euler	Implicit Adams
$\beta$	1				
$\gamma$	0	0.5	$\frac{7}{8}$	1	1.5

### 5.2.1. Direct discretization methods

In these methods, two steps must be taken for obtaining a discrete function of fractional order differentiators. At first, it is important to select a proper generating function. Generating functions express the discretization of fractional order differentiators ( $s = \omega(z^{-1})$ ) and usually have the below general configuration [81]:

$$\omega(z^{-1}) = \frac{1 - z^{-1}}{\beta T(\gamma + (1 - \gamma)z^{-1})} \quad (66)$$

In which  $\beta$ ,  $\gamma$ , and  $T$  are respectively the gain tuning parameter, phase tuning parameter, and sample period. The most commonly used generating functions are most usable for the discretization are listed in table 2. Most of these generating functions can be obtained using (66) by considering gain and phase tuning parameters listed in table 1.

Table 2: Discrete Time Conversion Rules

Methods	$s \rightarrow z$ Conversion	Taylor series [7]
Backward-Difference (Euler) [80, 7, 5, 71]	$s^\nu \approx \left[\frac{1 - z^{-1}}{T}\right]^\nu$	$\left(\frac{1}{T}\right)^\nu [1 - \nu z^{-1} + \frac{\nu(\nu-1)}{2!} z^{-2} + \dots]$
Trapezoidal (Tustin) [80, 7, 5, 71]	$s^\nu \approx \left[\frac{2(1 - z^{-1})}{T(1 + z^{-1})}\right]^\nu$	$\left(\frac{2}{T}\right)^\nu [1 - 2\nu z^{-1} + 2\nu^2 z^{-2} + \dots]$
Al-Alaoui [80, 5]	$s^\nu \approx \left[\frac{8(1 - z^{-1})}{7T(1 + \frac{z^{-1}}{7})}\right]^\nu$	-
Simpson [7]	$s^\nu \approx \left[\frac{3(1 - z^{-1})(1 + z^{-1})}{T(1 + 4z^{-1} + z^{-2})}\right]^\nu$	$\left(\frac{3}{T}\right)^\nu [1 - 4\nu z^{-1} + 2\nu(4\nu + 3)z^{-2} + \dots]$

Obviously, the generating functions which are listed in table 2 are irrational. So, in the second step, it is necessary to approximate these irrational formulas with finite order rational formulas. To obtain this goal, two most applicable mathematics methods (Power Series Expansion (PSE) and CFE) are utilized in direct discretization methods in many studies. In other words, it can be said

that:

$$D^{\pm\nu}(z) \approx CFE\{\omega(z^{-1})^\nu\} \quad \text{or} \quad D^{\pm\nu}(z) \approx PSE\{\omega(z^{-1})^\nu\} \quad (67)$$

As it was shown in table 2, Machado et al. proposed some discrete approximation functions by applying the Taylor series, which is one of the mostly used PSE methods, to several generating functions [7].

One of the well-known approximation function is obtained based on the PSE method by utilizing the Euler generating function and the Grünwald-Letnikov definition (10). In this respect, the discrete approximation of the FO integro-differential operator is gotten by using the short memory principle [80, 5, 71]:

$$(s)^{\pm\nu} = T^{\mp\nu} z^{-[\frac{L}{T}]} \sum_{j=0}^{[\frac{L}{T}]} c_j^\nu z^{[\frac{L}{T}]-j} \quad (68)$$

in which:

- L is the memory length,  $c_j^\nu = (1 - \frac{(1+\nu)}{j})c_{j-1}^\nu$ ,  $c_0^\nu = 1$

In order to improve the accuracy of the discrete approximation functions in high frequencies, Chen et al. introduced a new generating function by combining the Tustin and Simpson generating functions. Their new generating function is [80]:

$$s^\nu \approx k_0 \left( \frac{1 - z^{-2}}{1 + r_2 z^{-1}} \right)^\nu \quad (69)$$

where:

- $k_0 = \frac{6r_2}{T(3-a)}$ ,  $r_2 = \frac{3+a-2\sqrt{3a}}{3-a}$   $a \in [0, 1]$  is a weighting factor or a tuning knob

Then, this generating function is expanded rationally by the implementation of the CFE method using MATLAB Symbolic Toolbox [80].

Chen et al. proposed a discrete approximation method upon the Muir-recursion formula, which is applicable in the geophysical data processing, in order to express the Tustin generating function rationally [5] and claimed that their method is as accurate as the Taylor series expansion method. In this method:

$$s^\nu \approx \left( \frac{2}{T} \right)^\nu \left( \frac{1 - z^{-1}}{1 + z^{-1}} \right)^\nu = \left( \frac{2}{T} \right)^\nu \lim_{n \rightarrow \infty} \frac{A_n(z^{-1}, \nu)}{A_n(z^{-1}, -\nu)} \quad (70)$$

In which:

- $A_0(z^{-1}, \nu) = 1$ ,  $A_n(z^{-1}, \nu) = (1 - c_n z^n) A_{n-1}(z^{-1}, \nu)$ ,  $c_n = \begin{cases} \frac{\nu}{n} & n : \text{is odd} \\ 0 & n : \text{is even} \end{cases}$

Similar to (65), a closed-form formula is obtained for discrete approximation of FO lead/lag compensators [78] as:

$$C(s) = k_p x^\mu \left( \frac{1 + \Delta s}{1 + \Delta x s} \right)^\nu \approx \frac{\sum_{h=0}^N D_{N-h} z^h}{\sum_{h=0}^N C_{N-h} z^h}, \quad \nu > 0, \quad \begin{cases} \text{Lead} & 0 < x < 1 \\ \text{Lag} & 1 < x \end{cases} \quad (71)$$

with:

- $C_{N-h} = \sum_{k=0}^N A_{N-k} L_{hk}^D$ ,  $D_{N-h} = \sum_{k=0}^N B_{N-k} L_{hk}^D$ ,  $j_2 = \min\{h, k\}$
- $L_{hk}^D = \left(\frac{2}{T}\right)^k \sum_{j=j_1}^{j_2} (-1)^{k-j} \binom{k}{j} \binom{N-k}{h-j} x^{k-j}$ ,  $j_1 = \max\{0, k + h - N\}$
- $A_{N-k}$  and  $B_{N-k}$  are described in (65)

### 5.2.2. Indirect discretization methods

There are two stages in indirect discretization methods. At the first stage, the irrational transfer function  $s^\nu$  is approximated by a rational transfer function by using methods which are described in Section 5.1. Then, by replacing  $s$  in the approximation function with generating functions which are represented in table (2) ( $s \rightarrow \omega(z^{-1})$ ), the discrete approximation function is obtained. In other words,

$$s^\nu \approx \frac{P_n(s)}{Q_m(s)} \xrightarrow{s=\omega(z^{-1})} s^\nu \approx G(z). \quad (72)$$

For instance, Folea et al. approximated  $s^\nu$  with Oustaloup's method (55) firstly. Then, to obtain the discrete approximate transfer function, they replaced  $s$  with

$$s = \frac{(1 + \alpha)(z - 1)}{T(z + \alpha)}, \quad (73)$$

where  $T$  is sampling period and  $\alpha \in [0, 1]$  is a weighting factor [82, 83]. This method is generalized for any non-rational continuous-time transfer function

by passing following steps or a general [84]. After replacing  $s$  with (73), the frequency response is obtained replacing  $z = e^{j\omega t}$  where  $\omega$  is a vector of equally-spaced frequencies. Then, the impulse response of the discrete-time fractional order system is obtained using the inverse Fast Fourier Transform (FFT) to the previous calculated frequency response. The approximated transfer function is achieved from the impulse response using some techniques such as Steiglitz-McBride in the form of

$$G(z^{-1}) = \frac{a_0 + a_1 z^{-1} + \dots + a_n z^{-N}}{b_0 + b_1 z^{-1} + \dots + b_n z^{-n}}, \quad n \text{ is the order of approximation.} \quad (74)$$

### 5.3. $\delta$ domain approximation methods

Although the digital implementation is widely used in this era because of the development of digital computers, there is a big concern in discrete approximation methods. As it is known, stable poles and minimum-phase zeros in the  $s$ -plane are lain inside the unit circle in the  $z$ -plane when the bilinear transformed is utilized. So, the high resolution presentation of compensators with long words are essential for ensuring stability. But, it is impossible to get infinite accuracy in designing values of coefficients in a software and hardware implementation because a finite number of bits are available [78]. Furthermore, when the sampling rate is increased, zeros and poles of discrete approximation functions get close to each other and concentrate at the point  $(1,0)$ . Hence, discrete approximation functions are very sensitive to small variations of coefficients in high sampling rates and even may lose their stability in some cases [85, 78]. To overcome these dilemmas, the  $\delta$  operator can be a proper solution because it allows a gradual transformation from the discrete to continues time domain. For this purpose, the continues transfer function is converted to the  $\delta$  domain through the below equation [85, 78]:

$$s = \frac{1}{T} \ln(\delta T + 1) \approx \frac{\delta}{0.5\delta T + 1} \quad (75)$$

where  $T$  is the sampling period. Similar to indirect discretization methods, it is possible to approximate irrational transfer functions with presented methods

in Section 5.1 and then use the preceding equation to obtain  $\delta$  domain approximation functions.

Moreover, some researchers introduced some direct methods to obtain rational  $\delta$  domain transfer functions. Similar to (71) and (65), a closed-form formula is obtained for the approximation of FO lead/lag compensators  $\delta$  domain as [78]:

$$C(s) = k_p x^\nu \left( \frac{1 + \Delta s}{1 + \Delta x s} \right)^\nu \approx \frac{\sum_{h=0}^N F_{N-h} \delta^h}{\sum_{h=0}^N E_{N-h} \delta^h}, \quad \nu > 0, \quad \begin{cases} \text{Lead} & 0 < x < 1 \\ \text{Lag} & 1 < x \end{cases} \quad (76)$$

with:

- $E_{N-j} = \sum_{k=0}^j \binom{N-k}{j-k} (0.5T)^{j-k} A_{N-k}$ ,  $F_{N-j} = \sum_{k=0}^j \binom{N-k}{j-k} (0.5T)^{j-k} B_{N-k}$
- $A_{N-k}$  and  $B_{N-k}$  are described in (65)

As it has been explained, all methods (65), (71), and (76) can be used for  $s^\nu$  which acts on a frequency band. In addition, [Maione](#) introduced a formula to approximate  $s^\nu$  in  $\delta$  domain as [85]:

$$s^\nu \approx G_\delta^{(N)} = \frac{\sum_{k=0}^N c_k \delta^{N-k}}{\sum_{k=0}^N d_k \delta^{N-k}} \quad (77)$$

In which:

- $c_{(N-j)}(\nu) = \sum_{r=0}^j p_{(N-r)}(\nu) (0.5T)^{j-r} \binom{N-r}{j-r}$
- $d_{(N-j)}(\nu) = \sum_{r=0}^j q_{(N-r)}(\nu) (0.5T)^{j-r} \binom{N-r}{j-r}$
- $p_j(\nu) = q_{(N-j)}(\nu) = (-1)^j \binom{N}{j} (\nu + j + 1)_{(N-j)} (\nu - N)_{(j)}$
- $(\nu + j + 1)_{(N-j)} = (\nu + j + 1)(\nu + j + 2) \dots (\nu + N)$
- $(\nu - N)_{(j)} = (\nu - N)(\nu - N - 1) \dots (\nu - N + j - 1)$
- $(\nu - N)_{(0)} = 1$ ,  $N$  is the order of approximation

It must be noted that for the implementation of the  $\delta$  transfer functions, the following equation is used [85].

$$\delta^{-1} = \frac{Tz^{-1}}{1 - z^{-1}} \quad (78)$$

#### 5.4. Digital implementation

The first step in the digital implementation is getting the finite difference equation which is achieved by the discrete approximation methods elaborated in Sections 5.2 and 5.3. Then, all discrete approximation of FO transfer functions can be implemented directly to any microprocessor based devices like as PLC, PIC, PCL I/O card, FPGA, FPAA, switched capacitors, etc [86, 87]. Figure 10 shows the implementation of the canonical form (74) of discrete approximation of FO transfer functions. To implement this form, two codes are needed: initialization and loop code (see the pseudo-code in [5, 88]).

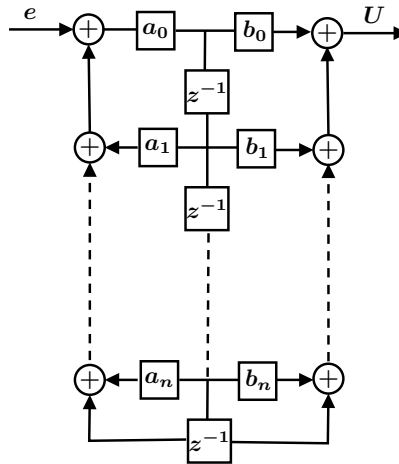

Figure 10: Block diagram of the canonical representation

#### 5.5. Analogue implementation

Although digital controllers are used widely nowadays because of the revolution of cost-effective digital computers, they have some limitations in some aspects. The first problem comes from the nature of the discretization. This is related to the sampling period which must be significantly more than the time

of computation length. Also, a memory with high capacity is needed for high order discrete approximations. Digital controllers are not as fast as analogue controllers. As a result, although several digital controllers have been recently used to control relatively high modes of systems, they are not proper for very fast processes such as vibration control [70]. As some limitations are mentioned, analogue realization is the only solution in some cases. Although there are several ways for analogue realization such as hydraulics, mechanical, electronics etc, this section focuses on electronics implementation.

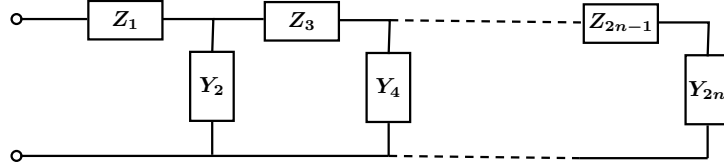

Figure 11: Finite ladder circuit

A circuit which represents fractional order behaviour is termed a "fractance". Basically, there are three fractance devices: domino ladder network, tree structure of electrical elements and transmission line circuit [5]. It asserts that ladder lattice networks can approximate FO transfer functions more accurate than the lumped networks [89]. Consider the finite ladder circuit which is depicted in figure 11, in which  $Z_{2k-1}(s)$ ,  $Y_{2k}(s)$ ,  $k = 1, \dots, n$  are the impedance of circuit elements. The equivalent impedance of the whole circuit  $Z(s)$  is obtained by [70]

$$Z(s) = Z_1(s) + \frac{1}{Y_2(s) + \frac{1}{Z_3(s) + \frac{1}{Y_4(s) + \frac{1}{\ddots + \frac{1}{Y_{2n-2}(s) + \frac{1}{Z_{2n-1}(s) + \frac{1}{Y_{2n}(s)}}}}}}}, \quad (79)$$

so, first, continuous approximation function of FO-controllers must be expressed



in the form of (79). Then,  $Z_{2k-1}(s)$  and  $Y_{2k}(s)$ ,  $k = 1, \dots, n$  will give the type of necessary electrical elements using the first Cauer's canonic LC circuit [90] (for more information, see examples in [70]). If  $b_i < 0$ , then the circuit is depicted in figure 12 is considered [70]. The entire circuit has equivalent impedance of  $-Z$  in which  $Z$  can be a resistor, capacitor or coil.

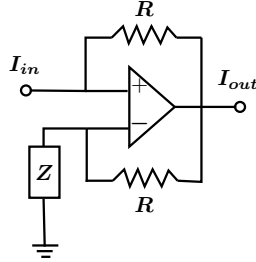

Figure 12: Negative-impedance converter

There are also some methods for the direct implementation of fractional order derivatives  $s^\nu$  which lead to increase the accuracy of the realization of FO controllers. In these methods, there is no need for approximation of FO transfer functions. Bohannan found some electrical elements, named as "fractor", exhibit fractance attributes [91]. It is revealed that Lithium Hydrazinium Sulfate ( $LiN_2H_5SO_4$ ) behaves in a wide range of temperatures and frequencies like an electrical element with the impedance of [91]:

$$Z_F = \frac{k}{s^{0.5}} \quad (80)$$

Figure 13 shows a circuit which implements the half order integrator by using a fractor made from ( $LiN_2H_5SO_4$ ) material [91]. It is hoped that many investigations will be done in the future in materials to build fractors with a wide range of exponents. Then, it facilitates introducing fractional order control elements to engineering applications without using approximation methods.

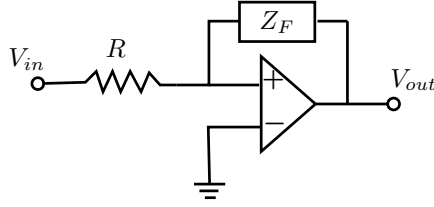

Figure 13: Schematic of a simple circuit of half order integrator

Another way for direct realization of fractional order controllers is using new electrical element whose name is "Memristor" [92]. Memristor is an electrical element which exhibits a fractional order behaviour with the impedance of [92]:

$$Z_{MS} = K s^\nu \quad (\nu, K) \in R \quad (81)$$

Two configurations which are shown in figure 14a and 14b are considered for the analogue implementation of fractional order controllers. The equivalent impedance of the entire circuit figures 14a and 14b are respectively  $Z(s) = -\frac{M}{K}s^{-\nu}$  and  $Z(s) = -\frac{K}{M}s^\nu$ , ( $\nu \in R$ ) in which  $M$  called memristance with the physical unit of Ohm [92]. Although this method is promising, further research has to be conducted to prove this method can implement the FO transfer functions.

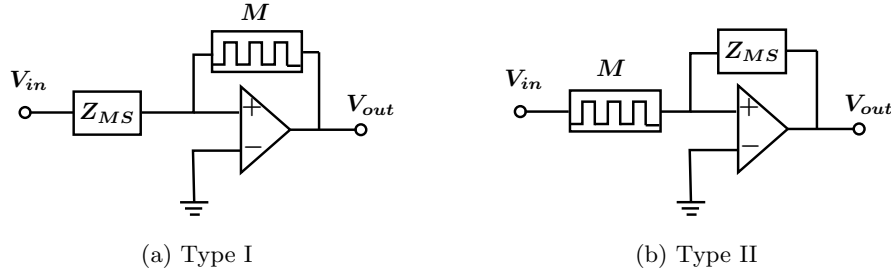

Figure 14: Analogue fractional-order operators

In addition, [Aware et al.](#) developed an analogue implementation technique based on their approximation method (64) [77]. In this technique, first,  $s^\nu$  is approximated using (64), and then, each set of zero and pole ( $z_i, p_i$ ) is implemented as shown in figure 15. In figure 15, firstly, any available capacitor ( $C_i$ )

is selected. Then,

$$\begin{cases} R_i = \frac{1}{p_i C_i}, R'_i = \frac{1}{z_i - p_i} & \nu < 0 \\ R_i = \frac{1}{z_i C_i}, R'_i = \frac{1}{p_i - z_i} & \nu > 0 \end{cases} \quad (82)$$

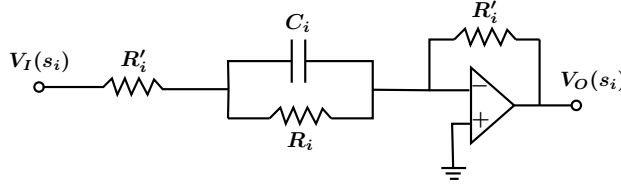

Figure 15: Schematic of implementing each set of zero-pole pair of  $s^\nu$

## 6. Several useful codes for fractional order controllers

Now, it is noteworthy to introduce some Matlab codes which simplify using FO calculus in control field. One of these toolboxes is CRONE CSD toolbox which is designed for tuning all generations of CRONE controllers [28]. The online version of this toolbox is available through this [link](#).

Valério and Sa da Costa introduced a general and user friendly toolbox which is termed Ninteger [73]. It has three identification methods. Also, it has many approximation methods which have been described in this article. Moreover, it is proper for tuning all generations of CRONE and FO-PID controllers (controller (17)) in both time and frequency domain.

One of the useful open source software for tuning FO-PID controllers (controller (17)), FO-lead/lag compensators and all IO-filters in both time and frequency domain is FLOreS which is designed at the mechatronic system design group of TU Delft University by S.H. HosseinNia et al [93]. Also, it has several approximation methods like Ninteger software and is available through the [link](#). Furthermore, there are some simple codes for the frequency domain analysis of fractional order functions in [5]. Lachhab et al. designed a FO toolbox which automatically tune an FO-PID controller based on given specifications and dynamics of the plant. Moreover, this software includes some approximation methods

[94]. [Tepljakov et al.](#) developed a very general toolbox whose name is FOMCON [95] which has several options including both time and frequency analysis, fractional order controllers in the state-space, CRONE controllers, approximation methods, optimization criteria for tuning FO-controllers, and identification with FO-models. In addition, it has some FO-blocks which can be added in Simulink library of Matlab. It can be downloaded through this [link](#).

[Dingy](#) wrote a book about FO controllers and also designed a toolbox which contains every method which is described in his book [96]. This toolbox which is termed FOTF includes several approximation methods, functions for analyzing FO controllers in both time and frequency domain, Simulink blocks for FO functions, and tuning methods for FO controllers. This toolbox is available through the [link](#).

## 7. Discussion

In this section, the advantages and disadvantages of using FO calculus in the control area are commented based on the literature reviewed in this article. Many researchers believe that FO controllers outperform IO ones [10, 49, 43, 97, 98, 99, 100, 101, 102]. In the case of linear controllers, on the one hand, it can be asserted that FO-PID controllers give more flexibility to designers to select the tuning parameters due to two important factors. First, the orders of integration and differentiator of the controller are not restricted to integer numbers. Second, the stability region of tuning knobs ( $k_p$ ,  $k_i$ , and  $k_d$  in controller (17)) which guarantees the stability of the whole system for a specific phase margin value is bigger than one for IO-PID controllers as proposed by [Hamamci](#) in [103]. On the other hand, the tuning knobs of FO-PID controllers are more than classical IO ones, so, designers can consider more efficient constraints for tuning FO-PID compared to classical IO ones. In comparison with high order IO-PID controllers, since FO-PID controllers are approximated with several zeros-and poles, their performances are similar with high order IO-PID. But the tuning of FO-PID is easier because two extra orders must be tuned in FO-PID instead of

determining places of several zeros-poles in high order IO-PID controllers.

Among several constraints, iso-damping behaviour (constraint (32)) has attracted a lot of attention from researchers in tuning FO controllers. It is reported that FO-PID controllers are more robust against plant uncertainties than IO-PID ones [10, 49, 43, 104]. It is asserted that the third generation of CRONE is one of the most appropriate solutions when uncertainties of a plant are more general than just gain-like perturbations [24, 56, 23]. Hence, from robustness viewpoint, FO controllers are more effective in comparison with IO ones.

Furthermore, some researchers believe that it is possible to consider the energy efficiency constraint for tuning FO-PID controllers [105, 106, 107]. As a result, from the energy perspective, FO-PID can outperform classical IO-PID controllers; for instance, using FO-PID decreases averagely 20% power consumption of a DC motor [105]. Another example, it is showed that using FO-PID controllers for a magnetic levitation system leads to a better fuel efficiency in comparison with classical IO-PID controllers [106].

In addition, FO controllers can properly compensate disturbances due to undesired nonlinearities such as dead zone, backlash, hysteresis, and static distortion in the systems which results in increasing the precision of the systems [108, 109, 110]. Moreover, some research manifests that using FO transfer functions for describing the dynamic characteristics of some special plant is more precise than IO ones [5, 7, 8, 6, 111]. Also, it is concluded that FO controllers are more proper than IO controllers for FO plants [10, 103]. Therefore, for some special plants, it is necessary to use FO calculus in both modelling and control.

It can be concluded that FO controllers have better performance than IO ones and improve significantly the performance of systems. However, there are two big barriers which confine the adoption of FO controllers in the industry. Firstly, tuning of the FO controllers is more complex than IO ones. This problem is solved to some extent by present tuning methods and toolboxes which are elaborated in Sections 4 and 6, respectively. Even though, based on the knowledge of the author, there are few reports about tuning of FO controllers for motion systems (high cross-over frequency is required). Secondly, realiza-

tion of FO controllers need devices with high memory capacity because FO controllers are approximated with high order transfer functions. Since there is no direct method for realization of FO controllers, approximation methods must be used for this purpose. In order to increase accuracy of the approximation methods, the order of estimated functions must be increased which leads to a high order controller. Although some researchers are trying to solve this problem, their methods need further efforts to be complete [91, 92]. It is hoped that researchers can propose a direct method for realization of FO controllers using some special materials such as Memristor and ( $LiN_2H_5SO_4$ ).

To wrap up, FO calculus advances the control area in many aspects. It can be claimed that FO calculus facilitates modelling of complicated dynamic systems such as distributed parameter systems, biomimetics materials, smart materials, etc. [98, 6, 99, 112]. Moreover, it improves performance of both linear and nonlinear controllers particularly from the robustness viewpoint. In addition, it is claimed that FO calculus has potential to shape the phase and gain of the frequency response independently and achieve the Bode ideal transfer function [6]. However, nobody attempted to solve this significant problem. All in all, it is predicted that overcoming mentioned barriers leads to substitution of IO-PID controllers with FO ones in the near future.

## 8. Conclusion

FO controllers have attracted much attention from academia and industrial associations. In this article, linear FO controllers are reviewed with the focus on the frequency domain. In this respect, FO calculus including basic definitions of FO derivative and integrator were introduced. Next, four well-known linear FO controllers which are TID controller, CRONE generations, FO lead/lag compensators, and FO-PID controllers were commented and after that, their representative tuning methods were elaborated. Although many simple tuning methods for FO controllers were reported, most of them are useful for process control problems (low bandwidth and high time delay systems) and motion

control problems (high bandwidth systems) have not been considered much in the literature yet. Then, continuous and discrete approximation methods of FO controllers and their analogue and digital implementation were explained. Approximation methods lead to high order functions which makes the implementation of FO controllers to be more difficult than IO ones. Although much of recent research resolved this problem to some extent, further investigations are required. Then, some useful codes which facilitate using FO calculus in the control field were presented. Finally, It is anticipated that IO-PID controllers are replaced with FO ones in the near future by finding a direct method for implementation of FO controllers. All in all, this review paper helps beginners to get started rapidly and learn how to select, tune, approximate, and implement FO-controllers.

### **Acknowledgement**

This study is partly based upon works from COST action CA15225, a network supported by COST (European Cooperation in Science and Technology).

### **References**

- [1] F. Padula, A. Visioli, and M. Pagnoni, "On the anti-windup schemes for fractional-order pid controllers," in *Emerging Technologies & Factory Automation (ETFA), 2012 IEEE 17th Conference on*. IEEE, 2012, pp. 1–4.
- [2] C. A. Monje, B. M. Vinagre, V. Feliu, and Y. Chen, "Tuning and auto-tuning of fractional order controllers for industry applications," *Control engineering practice*, vol. 16, no. 7, pp. 798–812, 2008.
- [3] K. Rajagopal, A. Karthikeyan, and P. Duraisamy, "Hyperchaotic chameleon: fractional order fpga implementation," *Complexity*, vol. 2017, 2017.

- [4] L. Liu, H. Xing, X. Cao, Z. Fu, and S. Song, “Guaranteed cost finite-time control of discrete-time positive impulsive switched systems,” *Complexity*, vol. 2018, 2018.
- [5] Y. Chen, I. Petras, and D. Xue, “Fractional order control-a tutorial,” in *American Control Conference, 2009. ACC’09*. IEEE, 2009, pp. 1397–1411.
- [6] Y. Chen, “Ubiquitous fractional order controls?” *IFAC Proceedings Volumes*, vol. 39, no. 11, pp. 481–492, 2006.
- [7] J. T. Machado *et al.*, “Discrete-time fractional-order controllers,” *Fractional Calculus and Applied Analysis*, vol. 4, no. 1, pp. 47–66, 2001.
- [8] C. Zhao, D. Xue, and Y. Chen, “A fractional order PID tuning algorithm for a class of fractional order plants,” in *Mechatronics and automation, 2005 IEEE international conference*, vol. 1. IEEE, 2005, pp. 216–221.
- [9] Y. Zhao, Y. Li, F. Zhou, Z. Zhou, and Y. Chen, “An iterative learning approach to identify fractional order kibam model,” *IEEE/CAA Journal of Automatica Sinica*, vol. 4, no. 2, pp. 322–331, 2017.
- [10] Y. Luo, Y. Chen, and Y. Pi, “Experimental study of fractional order proportional derivative controller synthesis for fractional order systems,” *Mechatronics*, vol. 21, no. 1, pp. 204–214, 2011.
- [11] S. H. HosseinNia, I. Tejado, D. Torres, B. M. Vinagre, and V. Feliu, “A general form for reset control including fractional order dynamics,” *IFAC Proceedings Volumes*, vol. 47, no. 3, pp. 2028–2033, 2014.
- [12] I. Tejado, S. Hosseinnia, and B. Vinagre, “Adaptive gain-order fractional control for network-based applications,” *Fractional Calculus and Applied Analysis*, vol. 17, no. 2, pp. 462–482, 2014.
- [13] S. H. HosseinNia, I. Tejado, B. M. Vinagre, and Y. Chen, “Iterative learning and fractional reset control,” in *ASME 2015 International Design En-*



- gineering Technical Conferences and Computers and Information in Engineering Conference.* American Society of Mechanical Engineers, 2015, pp. V009T07A041–V009T07A041.
- [14] S. H. HosseinNia, I. Tejado, and B. M. Vinagre, “A method for the design of robust controllers ensuring the quadratic stability for switching systems,” *Journal of Vibration and Control*, vol. 20, no. 7, pp. 1085–1098, 2014.
- [15] S. M. RakhtAla, M. Yasoubi, and H. HosseinNia, “Design of second order sliding mode and sliding mode algorithms: a practical insight to dc-dc buck converter,” *IEEE/CAA Journal of Automatica Sinica*, vol. 4, no. 3, pp. 483–497, 2017.
- [16] S. Khubalkar, A. Chopade, A. Junghare, M. Aware, and S. Das, “Design and realization of stand-alone digital fractional order pid controller for buck converter fed dc motor,” *Circuits, Systems, and Signal Processing*, vol. 35, no. 6, pp. 2189–2211, 2016.
- [17] F. Padula and A. Visioli, “Tuning rules for optimal pid and fractional-order pid controllers,” *Journal of process control*, vol. 21, no. 1, pp. 69–81, 2011.
- [18] S. Das, I. Pan, and S. Das, “Multi-objective lqr with optimum weight selection to design fopid controllers for delayed fractional order processes,” *ISA transactions*, vol. 58, pp. 35–49, 2015.
- [19] C. Wang, H. Li, and Y. Chen, “ $H_\infty$  output feedback control of linear time-invariant fractional-order systems over finite frequency range,” *IEEE/CAA Journal of Automatica Sinica*, vol. 3, no. 3, pp. 304–310, 2016.
- [20] H. Chen and Y. Chen, “Fractional-order generalized principle of self-support (fogpss) in control system design,” *IEEE/CAA Journal of Automatica Sinica*, vol. 3, no. 4, pp. 430–441, 2016.

- [21] M. Zarghami, S. H. Hosseinnia, and M. Babazadeh, “Optimal control of egr system in gasoline engine based on gaussian process,” *IFAC-PapersOnLine*, vol. 50, no. 1, pp. 3750–3755, 2017.
- [22] S. H. HosseinNia, “Robust model predictive control using iterative learning,” in *Control Conference (ECC), 2015 European*. IEEE, 2015, pp. 3514–3519.
- [23] V. Pommier, J. Sabatier, P. Lanusse, and A. Oustaloup, “Crone control of a nonlinear hydraulic actuator,” *Control Engineering Practice*, vol. 10, no. 4, pp. 391–402, 2002.
- [24] A. Oustaloup, B. Mathieu, and P. Lanusse, “The crone control of resonant plants: application to a flexible transmission,” *European Journal of control*, vol. 1, no. 2, pp. 113–121, 1995.
- [25] A. Oustaloup, X. Moreau, and M. Nouillant, “The crone suspension,” *Control Engineering Practice*, vol. 4, no. 8, pp. 1101–1108, 1996.
- [26] M. E. Krijnen, R. A. van Ostayen, and H. HosseinNia, “The application of fractional order control for an air-based contactless actuation system,” *ISA transactions*, 2017.
- [27] A. O’Dwyer, *Handbook of PI and PID controller tuning rules*. World Scientific, 2009.
- [28] J. Sabatier, P. Lanusse, P. Melchior, and A. Oustaloup, *Fractional order differentiation and robust control design*. Springer, 2015, vol. 77.
- [29] P. Shah and S. Agashe, “Review of fractional pid controller,” *Mechatronics*, vol. 38, pp. 29–41, 2016.
- [30] A. Tepļjakov, B. B. Alagoz, C. Yeroglu, E. Gonzalez, S. H. HosseinNia, and E. Petlenkov, “Fopid controllers and their industrial applications: A survey of recent results,” *IFAC-PapersOnLine*, vol. 51, no. 4, pp. 25–30, 2018.

- [31] B. Vinagre, I. Petráš, I. Podlubny, and Y. Chen, “Using fractional order adjustment rules and fractional order reference models in model-reference adaptive control,” *Nonlinear Dynamics*, vol. 29, no. 1-4, pp. 269–279, 2002.
- [32] J. Sabatier, O. P. Agrawal, and J. T. Machado, *Advances in fractional calculus*. Springer, 2007, vol. 4, no. 9.
- [33] M. Dalir and M. Bashour, “Applications of fractional calculus,” *Applied Mathematical Sciences*, vol. 4, no. 21, pp. 1021–1032, 2010.
- [34] R. E. Gutiérrez, J. M. Rosário, and J. Tenreiro Machado, “Fractional order calculus: basic concepts and engineering applications,” *Mathematical Problems in Engineering*, vol. 2010, 2010.
- [35] C. Li and W. Deng, “Remarks on fractional derivatives,” *Applied Mathematics and Computation*, vol. 187, no. 2, pp. 777–784, 2007.
- [36] B. Ross, “The development of fractional calculus 1695–1900,” *Historia Mathematica*, vol. 4, no. 1, pp. 75–89, 1977.
- [37] M. Caputo and M. Fabrizio, “A new definition of fractional derivative without singular kernel,” *Progr. Fract. Differ. Appl*, vol. 1, no. 2, pp. 1–13, 2015.
- [38] B. J. Lurie, “Three-parameter tunable tilt-integral-derivative (tid) controller,” 1994.
- [39] C. A. Monje, B. M. Vinagre, A. J. Calderon, V. Feliu, and Y. Chen, “Auto-tuning of fractional lead-lag compensators,” *IFAC Proceedings Volumes*, vol. 38, no. 1, pp. 319–324, 2005.
- [40] M. S. Tavazoei and M. Tavakoli-Kakhki, “Compensation by fractional-order phase-lead/lag compensators,” *IET Control Theory & Applications*, vol. 8, no. 5, pp. 319–329, 2014.

- [41] M. Aoun, R. Malti, F. Levron, and A. Oustaloup, “Synthesis of fractional laguerre basis for system approximation,” *Automatica*, vol. 43, no. 9, pp. 1640–1648, 2007.
- [42] I. Podlubny, “Fractional-order systems and fractional-order controllers,” *Institute of Experimental Physics, Slovak Academy of Sciences, Kosice*, vol. 12, no. 3, pp. 1–18, 1994.
- [43] C. A. Monje, A. J. Calderon, B. M. Vinagre, Y. Chen, and V. Feliu, “On fractional  $PI^\lambda$  controllers: some tuning rules for robustness to plant uncertainties,” *Nonlinear Dynamics*, vol. 38, no. 1, pp. 369–381, 2004.
- [44] Y. Luo and Y. Chen, “Fractional order [proportional derivative] controller for a class of fractional order systems,” *Automatica*, vol. 45, no. 10, pp. 2446–2450, 2009.
- [45] H. Malek, Y. Luo, and Y. Chen, “Identification and tuning fractional order proportional integral controllers for time delayed systems with a fractional pole,” *Mechatronics*, vol. 23, no. 7, pp. 746–754, 2013.
- [46] V. Feliu-Batlle, R. R. Perez, and L. S. Rodriguez, “Fractional robust control of main irrigation canals with variable dynamic parameters,” *Control Engineering Practice*, vol. 15, no. 6, pp. 673–686, 2007.
- [47] S. Folea, C. I. Muresan, R. De Keyser, and C. M. Ionescu, “Theoretical analysis and experimental validation of a simplified fractional order controller for a magnetic levitation system,” *IEEE transactions on control systems technology*, vol. 24, no. 2, pp. 756–763, 2016.
- [48] A. Oustaloup and P. Melchior, “The great principles of the crone control,” in *Systems, Man and Cybernetics, 1993. 'Systems Engineering in the Service of Humans', Conference Proceedings., International Conference on*, vol. 2. IEEE, 1993, pp. 118–129.

- [49] D. Valério and J. S. da Costa, “Tuning of fractional PID controllers with ziegler–nichols-type rules,” *Signal Processing*, vol. 86, no. 10, pp. 2771–2784, 2006.
- [50] F. Padula and A. Visioli, “Optimal tuning rules for proportional-integral-derivative and fractional-order proportional-integral-derivative controllers for integral and unstable processes,” *IET Control Theory & Applications*, vol. 6, no. 6, pp. 776–786, 2012.
- [51] F. Merrikh-Bayat, N. Mirebrahimi, and M. R. Khalili, “Discrete-time fractional-order pid controller: Definition, tuning, digital realization and some applications,” *International Journal of Control, Automation and Systems*, vol. 13, no. 1, pp. 81–90, 2015.
- [52] J. Cervera and A. Baños, “Automatic loop shaping in qft by using crone structures,” *IFAC Proceedings Volumes*, vol. 39, no. 11, pp. 207–212, 2006.
- [53] J. Sabatier, A. Oustaloup, A. G. Iturricha, and P. Lanusse, “Crone control: principles and extension to time-variant plants with asymptotically constant coefficients,” *Nonlinear Dynamics*, vol. 29, no. 1-4, pp. 363–385, 2002.
- [54] P. Lanusse, M. Lopes, J. Sabatier, and B. Feytout, “New optimization criteria for the simplification of the design of third generation crone controllers,” *IFAC Proceedings Volumes*, vol. 46, no. 1, pp. 355–360, 2013.
- [55] A. Oustaloup, J. Sabatier, P. Lanusse, R. Malti, P. Melchior, X. Moreau, and M. Moze, “An overview of the crone approach in system analysis, modeling and identification, observation and control,” *IFAC Proceedings Volumes*, vol. 41, no. 2, pp. 14 254–14 265, 2008.
- [56] J. Sabatier, S. Poullain, P. Latteux, J. L. Thomas, and A. Oustaloup, “Robust speed control of a low damped electromechanical system based on crone control: application to a four mass experimental test bench,” *Nonlinear Dynamics*, vol. 38, no. 1-4, pp. 383–400, 2004.

- [57] J. Zhong and L. Li, “Tuning fractional-order  $PI^{\lambda}D^{\mu}$  controllers for a solid-core magnetic bearing system,” *IEEE transactions on control systems technology*, vol. 23, no. 4, pp. 1648–1656, 2015.
- [58] B. Saidi, M. Amairi, S. Najar, and M. Aoun, “Bode shaping-based design methods of a fractional order pid controller for uncertain systems,” *Nonlinear Dynamics*, vol. 80, no. 4, pp. 1817–1838, 2015.
- [59] Y. Chen, T. Bhaskaran, and D. Xue, “Practical tuning rule development for fractional order proportional and integral controllers,” *Journal of Computational and Nonlinear Dynamics*, vol. 3, no. 2, p. 021403, 2008.
- [60] T. Hägglund and K. J. Åström, “Revisiting the ziegler-nichols tuning rules for pi control,” *Asian Journal of Control*, vol. 4, no. 4, pp. 364–380, 2002.
- [61] T. N. L. Vu and M. Lee, “Analytical design of fractional-order proportional-integral controllers for time-delay processes,” *ISA transactions*, vol. 52, no. 5, pp. 583–591, 2013.
- [62] R. De Keyser, C. I. Muresan, and C. M. Ionescu, “A novel auto-tuning method for fractional order pi/pd controllers,” *ISA transactions*, vol. 62, pp. 268–275, 2016.
- [63] R. M. Schmidt, G. Schitter, and A. Rankers, *The Design of High Performance Mechatronics-: High-Tech Functionality by Multidisciplinary System Integration*. IOS Press, 2014.
- [64] A. A. Dastjerdi, N. Saikumar, and S. H. HosseinNia, “Tuning guidelines for fractional order pid controllers: Rules of thumb,” *Mechatronics*, vol. 56, pp. 26–36, 2018.
- [65] B. Maâmar and M. Rachid, “Imc-pid-fractional-order-filter controllers design for integer order systems,” *ISA transactions*, vol. 53, no. 5, pp. 1620–1628, 2014.

- [66] J. Cervera, A. Banios, C. A. Monje, and B. M. Vinagre, "Tuning of fractional PID controllers by using qft," in *IEEE Industrial Electronics, IECON 2006-32nd Annual Conference on*. IEEE, 2006, pp. 5402–5407.
- [67] Y. Chen, H. Dou, B. M. Vinagre, and C. A. Monje, "A robust tuning method for fractional order pi controllers," *IFAC Proceedings Volumes*, vol. 39, no. 11, pp. 22–27, 2006.
- [68] Y. Luo, T. Zhang, B. Lee, C. Kang, and Y. Chen, "Fractional-order proportional derivative controller synthesis and implementation for hard-disk-drive servo system," *IEEE Transactions on Control Systems Technology*, vol. 22, no. 1, pp. 281–289, 2014.
- [69] C. I. Muresan, S. Folea, G. Mois, and E. H. Dulf, "Development and implementation of an fpga based fractional order controller for a dc motor," *Mechatronics*, vol. 23, no. 7, pp. 798–804, 2013.
- [70] I. Podlubny, I. Petraš, B. M. Vinagre, P. O’leary, and L. Dorčák, "Analogue realizations of fractional-order controllers," *Nonlinear dynamics*, vol. 29, no. 1, pp. 281–296, 2002.
- [71] B. Vinagre, I. Podlubny, A. Hernandez, and V. Feliu, "Some approximations of fractional order operators used in control theory and applications," *Fractional calculus and applied analysis*, vol. 3, no. 3, pp. 231–248, 2000.
- [72] D. Xue, C. Zhao, and Y. Chen, "A modified approximation method of fractional order system," in *Mechatronics and Automation, Proceedings of the 2006 IEEE International Conference on*. IEEE, 2006, pp. 1043–1048.
- [73] D. Valério and J. Sa da Costa, "Ninteger: A non-integer control toolbox for matlab," *Proceedings of the Fractional Differentiation and its Applications, Bordeaux*, 2004.

- [74] A. Yüce, F. N. Deniz, and N. Tan, “A new integer order approximation table for fractional order derivative operators,” *IFAC-PapersOnLine*, vol. 50, no. 1, pp. 9736–9741, 2017.
- [75] N. Shrivastava and P. Varshney, “Rational approximation of fractional order systems using carlson method,” in *Soft Computing Techniques and Implementations (ICSCIT), 2015 International Conference on.* IEEE, 2015, pp. 76–80.
- [76] A. Tepļjakov, E. Petlenkov, and J. Belikov, “Application of newton’s method to analog and digital realization of fractional-order controllers,” *International Journal of Microelectronics and Computer Science*, vol. 2, no. 2, pp. 45–52, 2012.
- [77] M. V. Aware, A. S. Junghare, S. W. Khubalkar, A. Dhabale, S. Das, and R. Dive, “Design of new practical phase shaping circuit using optimal pole–zero interlacing algorithm for fractional order pid controller,” *Analog Integrated Circuits and Signal Processing*, vol. 91, no. 1, pp. 131–145, 2017.
- [78] P. Lino and G. Maione, “Realization of new robust digital fractional-order compensators,” *IFAC-PapersOnLine*, vol. 50, no. 1, pp. 8580–8585, 2017.
- [79] J. Tenreiro Machado, “Theory of fractional integrals and derivatives, application to motion control,” *International Conference on Recent Advances in Mechatronics, 1995*, 1995.
- [80] Y. Chen, B. M. Vinagre, and I. Podlubny, “Continued fraction expansion approaches to discretizing fractional order derivatives—an expository review,” *Nonlinear Dynamics*, vol. 38, no. 1, pp. 155–170, 2004.
- [81] R. S. Barbosa, J. T. Machado, and M. F. Silva, “Time domain design of fractional differintegrators using least-squares,” *Signal Processing*, vol. 86, no. 10, pp. 2567–2581, 2006.
- [82] S. Folea, R. De Keyser, I. R. Birs, C. I. Muresan, and C.-M. Ionescu, “Discrete-time implementation and experimental validation of a fractional



- order pd controller for vibration suppression in airplane wings,” *Acta Polytechnica Hungarica*, vol. 14, no. 1, pp. 191–206, 2017.
- [83] R. De Keyser and C. I. Muresan, “Analysis of a new continuous-to-discrete-time operator for the approximation of fractional order systems,” in *Systems, Man, and Cybernetics (SMC), 2016 IEEE International Conference on*. IEEE, 2016, pp. 003 211–003 216.
- [84] R. De Keyser, C. I. Muresan, and C. M. Ionescu, “An efficient algorithm for low-order direct discrete-time implementation of fractional order transfer functions,” *ISA transactions*, vol. 74, pp. 229–238, 2018.
- [85] G. Maione, “High-speed digital realizations of fractional operators in the delta domain,” *IEEE Transactions on Automatic Control*, vol. 56, no. 3, pp. 697–702, 2011.
- [86] I. Petráš, L. Dorcák, I. Podlubny, J. Terpák, and P. O’Leary, “Implementation of fractional-order controllers on plc b&r 2005,” in *Proceedings of the ICCO*, 2005, pp. 24–27.
- [87] I. Petráš, “Tuning and implementation methods for fractional-order controllers,” *Fractional Calculus and Applied Analysis*, vol. 15, no. 2, pp. 282–303, 2012.
- [88] R. Caponetto, *Fractional order systems: modeling and control applications*. World Scientific, 2010, vol. 72.
- [89] S. Roy, “On the realization of a constant-argument immittance or fractional operator,” *IEEE Transactions on Circuit Theory*, vol. 14, no. 3, pp. 264–274, 1967.
- [90] J. Kvasil and J. Čajka, “An introduction to synthesis of linear circuits,” *SNTL/ALFA, Prague*, 1981.
- [91] G. W. Bohannon, “Analog realization of a fractional control element-revisited,” in *Proc. of the 41st IEEE int. conf. on decision and control, tutorial workshop*, vol. 2, 2002, pp. 203–208.

- [92] C. Coopmans, I. Petrás, and Y. Chen, “Analogue fractional-order generalized memristive devices,” in *Proc. of the ASME 2009 International Design Engineering Technical Conferences & Computers and Information in Engineering Conference*, 2009.
- [93] L. van Duist, G. van der Gugten, D. Toten, N. Saikumar, and S. Hossein Nia Kani, “Flores-fractional order loop shaping matlab toolbox,” in *3rd IFAC Conference on Advances in Proportional-Integral-Derivative Control*, vol. 51, no. 4. IFAC-Elsevier, 2018.
- [94] N. Lachhab, F. Svaricek, F. Wobbe, and H. Rabba, “Fractional order PID controller (FOPID)-toolbox,” in *Control Conference (ECC), 2013 European*. IEEE, 2013, pp. 3694–3699.
- [95] A. Tepljakov, E. Petlenkov, and J. Belikov, “Fomcon: Fractional-order modeling and control toolbox for matlab,” in *Mixed Design of Integrated Circuits and Systems (MIXDES), 2011 Proceedings of the 18th International Conference*. IEEE, 2011, pp. 684–689.
- [96] X. Dingy, *Fractional-order Control Systems - Fundamentals and Numerical Implementations*. Berlin: de Gruyter Press, 2017.
- [97] J. Liu, T. Zhao, and Y. Chen, “Maximum power point tracking with fractional order high pass filter for proton exchange membrane fuel cell,” *IEEE/CAA Journal of Automatica Sinica*, vol. 4, no. 1, pp. 70–79, 2017.
- [98] F. Ge, Y. Chen, and C. Kou, “Cyber-physical systems as general distributed parameter systems: three types of fractional order models and emerging research opportunities,” *IEEE/CAA Journal of Automatica Sinica*, vol. 2, no. 4, pp. 353–357, 2015.
- [99] K. Cao, Y. Chen, and D. Stuart, “A fractional micro-macro model for crowds of pedestrians based on fractional mean field games,” *IEEE/CAA Journal of Automatica sinica*, vol. 3, no. 3, pp. 261–270, 2016.

- [100] S. H. Hosseinnia, I. Tejado, V. Milanés, J. Villagrà, and B. M. Vinagre, “Experimental application of hybrid fractional-order adaptive cruise control at low speed,” *IEEE transactions on control systems technology*, vol. 22, no. 6, pp. 2329–2336, 2014.
- [101] L. Marinangeli, F. Alijani, and S. H. HosseinNia, “Fractional-order positive position feedback compensator for active vibration control of a smart composite plate,” *Journal of Sound and Vibration*, vol. 412, pp. 1–16, 2018.
- [102] M. Zarghami, M. Babazadeh, and S. H. Hosseinnia, “Performance enhancement of spark ignition engines by using fractional order controller,” in *Control Conference (ECC), 2016 European*. IEEE, 2016, pp. 1248–1252.
- [103] S. E. Hamamci, “An algorithm for stabilization of fractional-order time delay systems using fractional-order PID controllers,” *IEEE Transactions on Automatic Control*, vol. 52, no. 10, pp. 1964–1969, 2007.
- [104] M. E. Meral and D. Çelik, “A comprehensive survey on control strategies of distributed generation power systems under normal and abnormal conditions,” *Annual Reviews in Control*, 2018.
- [105] S. Das, M. Aware, A. Junghare, and S. Khubalkar, “Energy/fuel efficient and enhanced robust systems demonstrated with developed fractional order pid controller,” *Innov Ener Res*, vol. 7, no. 182, pp. 2576–1463, 2018.
- [106] A. S. Chopade, S. W. Khubalkar, A. Junghare, M. Aware, and S. Das, “Design and implementation of digital fractional order pid controller using optimal pole-zero approximation method for magnetic levitation system,” *IEEE/CAA Journal of Automatica Sinica*, vol. 5, no. 5, pp. 977–989, 2018.
- [107] S. Khubalkar, A. Junghare, M. Aware, and S. Das, “Modeling and control of a permanent-magnet brushless dc motor drive using a fractional order

- proportional-integral-derivative controller,” *Turkish Journal of Electrical Engineering & Computer Sciences*, vol. 25, no. 5, pp. 4223–4241, 2017.
- [108] C. Ma and Y. Hori, “The application backlash of fractional order control to vibration suppression,” in *American Control Conference, 2004. Proceedings of the 2004*, vol. 3. IEEE, 2004, pp. 2901–2906.
- [109] S. H. HosseinNia, R. L. Magin, and B. M. Vinagre, “Chaos in fractional and integer order nsg systems,” *Signal Processing*, vol. 107, pp. 302–311, 2015.
- [110] P. P. Singh and B. K. Roy, “Comparative performances of synchronisation between different classes of chaotic systems using three control techniques,” *Annual Reviews in Control*, vol. 45, pp. 152–165, 2018.
- [111] I. Tejado, S. H. HosseinNia, D. Torres, B. M. Vinagre, Á. López-Bernal, F. J. Villalobos, L. Testi, and I. Podlubny, “Fractional models for measuring sap velocities in trees,” in *Fractional Differentiation and Its Applications (ICFDA), 2014 International Conference on*. IEEE, 2014, pp. 1–6.
- [112] J. Huang, Y. Chen, H. Li, and X. Shi, “Fractional order modeling of human operator behavior with second order controlled plant and experiment research,” *IEEE/CAA Journal of Automatica Sinica*, vol. 3, no. 3, pp. 271–280, 2016.