

Study on Soft Start-Up and Shut-Down Methods for Wireless Power Transfer Systems for the Charging of Electric Vehicles

Riekerk, Calvin; Grazian, Francesca; Soeiro, Thiago Batista; Dong, Jianning ; Bauer, Pavol

DOI

[10.1109/WoW51332.2021.9462867](https://doi.org/10.1109/WoW51332.2021.9462867)

Publication date

2021

Document Version

Final published version

Published in

2021 IEEE PELS Workshop on Emerging Technologies

Citation (APA)

Riekerk, C., Grazian, F., Soeiro, T. B., Dong, J., & Bauer, P. (2021). Study on Soft Start-Up and Shut-Down Methods for Wireless Power Transfer Systems for the Charging of Electric Vehicles. In *2021 IEEE PELS Workshop on Emerging Technologies: Wireless Power Transfer (WoW)* Article 9462867 IEEE. <https://doi.org/10.1109/WoW51332.2021.9462867>

Important note

To cite this publication, please use the final published version (if applicable). Please check the document version above.

Copyright

Other than for strictly personal use, it is not permitted to download, forward or distribute the text or part of it, without the consent of the author(s) and/or copyright holder(s), unless the work is under an open content license such as Creative Commons.

Takedown policy

Please contact us and provide details if you believe this document breaches copyrights. We will remove access to the work immediately and investigate your claim.

Green Open Access added to TU Delft Institutional Repository

'You share, we take care!' - Taverne project

<https://www.openaccess.nl/en/you-share-we-take-care>

Otherwise as indicated in the copyright section: the publisher is the copyright holder of this work and the author uses the Dutch legislation to make this work public.

Study on Soft Start-Up and Shut-Down Methods for Wireless Power Transfer Systems for the Charging of Electric Vehicles

Calvin Riekerk, Francesca Grazian, Thiago Batista Soeiro, Jianning Dong and Pavol Bauer

DC System Energy conversion and Storage (DCE&S)

Delft University of Technology

Delft, The Netherlands

Email: (C.Riekerk, F.Grazian, T.BatistaSoeiro, J.Dong-4, P.Bauer)@tudelft.nl

Abstract—The increase in popularity of electric vehicles (EVs) and the pursuit of user convenience makes wireless power transfer (WPT) an attractive technology for the charging of batteries. The usage of WPT in e-transportation is not straightforward because the current standardization limits the allowed operating frequency range and magnitude of the irradiated magnetic field. Although, to safeguard the zero voltage switching (ZVS) of the intrinsic inverter switches, their operating frequency needs to be slightly adapted at all time such that the circuit functions in the equivalent inductive region of the passive network. Besides the semiconductors' soft switching, another control objective is limiting the inverter current to restrain the irradiated magnetic field. The start-up of the WPT system can be particularly challenging because uncertainties on the loading condition and coils' misalignment can complicate these control objectives. This paper benchmarks three start-up modulation strategies for the H-bridge inverter which aim to reduce the amplitude of the transient currents and to ensure ZVS operation for the S-S compensation and double-sided LCC compensation. In addition two soft shut-down strategies are compared for the S-S compensation. The results show that the symmetrical phase-shift (SPS) control with self-oscillating feedback control, also known as Dual Control gives the best performance for S-S compensation at start-up and shut-down. The combination of frequency and SPS control starting below resonance gives the best results for the soft start-up of the double-sided LCC compensation.

Keywords—Electric vehicle (EV), inductive power transfer (IPT), start-up transient, wireless power transfer (WPT).

I. INTRODUCTION

The charging of electric vehicles (EVs) via wireless power transfer (WPT) systems has gained popularity mainly because of the users' convenience. The implementation of WPT for EV charging is regulated by international standards. For example, the operating frequency range of the fundamental transferred magnetic field must be within 79-90 kHz [1]–[3]. The consequence of this is that the commonly used H-bridge inverter at the transmitter side must operate within the same frequency range. This means that a relative high frequency is used for the inverter in which the soft switching of the semiconductors needs to be provided such that lower energy losses and reduced electromagnetic interference (EMI) [4],

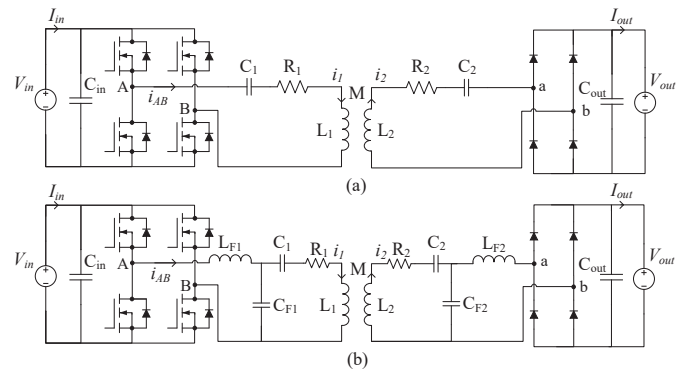

Fig. 1. Typical WPT EV battery charger based on the resonant converter with (a) S-S compensation and (b) LCC-LCC compensation.

[5] are ensured. This means that a fast control loop strategy is necessary.

Besides the nominal charging operation, it is fundamental to guarantee a safe start-up of the WPT circuit because there could circulate a high current through the inverter. This is specifically relevant in the application of dynamic charging because the EV needs to start-up and shut-down every time when it reaches or leaves a charging pad. The high circulating current in the inverter might damage the MOSFETs and could trip an over-current protection. Herein, the main challenge is to safeguard the MOSFETs soft switching while ensuring that the circuit operation is within the rated voltage and current of the WPT system. Note that the start-up dynamics can be harmful to the circuit in any resonant converters with compensation networks, including the series-series (S-S) and double-sided LCC (LCC-LCC) compensation [6], [7] shown in Fig. 1. However, it is possible to contain the voltage and current transients in any resonant converters by operating the circuit in an inductive region. For example, it is possible to reduce the settling time and the current amplitude flowing through the inverter by starting up the circuit at a switching frequency above the natural frequency of the compensation network [8]–[10].

Alternatively, as performed in [11], the soft start-up control can be done with the help of an additional DC-DC converter.

Therein, a buck converter is operated with one-cycle control incorporating a proportional differential logic which results in a low overshoot and a short settling time. A simpler solution to reduce the output voltage of the inverter is to control the H-bridge inverter with phase-shift or unipolar modulation with a controllable low equivalent duty cycle. This has been investigated by [12] for a resonant converter employing a S-S compensation network. Although, the question is if soft switching is sustained over the whole start-up process.

This paper benchmarks three different soft start-up methods for a S-S and a LCC-LCC compensated WPT system specified according to Table I. In addition two soft shut-down methods are compared for S-S compensation. First, the implementation logic behind the three methods for each compensation is explained in detail in Section II. Next, an analysis is given in Section III that shows how to identify the inductive region for each studied compensation network. Afterward, simulations are performed in Section IV to verify the functionality of the studied soft start-up methods for both S-S and LCC-LCC compensated WPT systems. Furthermore, two soft shut-down methods are also compared for the S-S compensated WPT system.

II. SOFT START-UP AND SHUT-DOWN METHODS

In dynamic WPT systems the power electronics converter will start-up and shutdown according to the maximum misalignment allowed, which in practical systems can make the coupling coefficient (k) of a double-sided rectangular IPT coil to be around one third of the nominal value found at perfect alignment condition. For the dynamic analysis of current/voltage transients in the compensation network it is reasonable to consider that the circuit will startup or shutdown with the lowest allowed magnetic coupling coefficient (k_{min}). Additionally, a constant coupling coefficient of $k=0.05$ is assumed for the first or final 3 ms of operation during the start-up and shutdown process respectively due to Magneto-Quasi-Static (MQS) limits [13]. Typically the time constant MQS is much smaller than the travel time of the EV which means that the dynamic effects can be neglected even in the case that the EV is driving at a speed of 100 km/h.

Three soft start-up control methods are considered for the S-S compensated WPT system, of which all act solely on the H-bridge inverter at the transmitter side. The first method performs the symmetrical phase-shift control (SPS) by using a duty cycle that will limit the nominal current under the maximum nominal current when perfectly aligned. This is done while operating the inverter at an operating frequency above resonance, e.g. 86 kHz to reduce the effect of hard switching and keep it close to the natural frequency. The second method consists of controlling the H-bridge inverter in the inductive region by controlling solely the switching frequency of the H-bridge inverter, while the duty cycle is kept at its highest value with a symmetric bipolar modulation, e.g. $D=0.5$. Note that the first and second studied methods initiate the system in an equivalent open-loop control before the commonly employed self-oscillating feedback control (cf.

[14]) is released. The third method makes use of a feedback control loop for the switching frequency since the beginning of the start-up process, i.e. after the first half-cycle of the resonating series current, in which the frequency is controlled (or adjusted automatically) by identifying the zero-crossing of the measured current at the transmitter coil side. This is advantageous because lower reactive power circulation can be achieved while safeguarding the ZVS turn-on of the H-bridge inverter. This method also implements a SPS control as shown in [15]–[17] to limit the rise of the resonant current, however herein the equivalent duty cycle is controlled in open-loop at a value that will limit the transient current under the rated maximum current when perfectly aligned. This method is also known as Dual Control.

When considering the LCC-LCC compensation, the SPS control varies first the duty cycle from 0.05 to 0.5 starting at 90 kHz. Then it changes the frequency from 90 kHz to 85 kHz. This is displayed in Fig. 2. Frequency control changes the frequency from 79 kHz to 85 kHz. However, it is challenging to implement self-oscillating feedback in the LCC-LCC compensation as it consists of multiple resonant components. This makes the identification of the resonance cumbersome as opposed to the application to the S-S compensated WPT system. Instead, herein the SPS control will operate at a frequency in the inductive region at the start. This could potentially improve the soft switching capabilities [18].

The soft shut-down methods will use the SPS control and self-oscillating methods as described earlier, but in this case, the SPS control will decrease the duty cycle of the output voltage of the H-bridge inverter from 0.5 to 0.05.

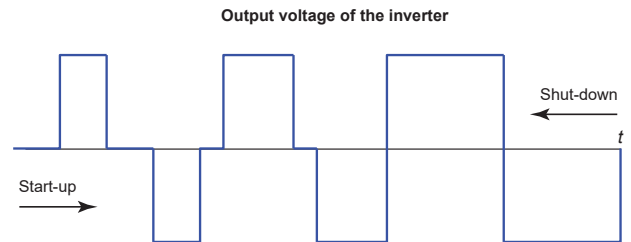

Fig. 2. One of the proposed concepts for the start-up of WPT: SPS control that varies the equivalent duty ratio from 0.05 to 0.5.

Table I. Values of the 7.7 kW S-S and LCC-LCC compensations.

	S-S	LCC-LCC
L_1	63.35 [μ H]	63.35 [μ H]
L_2	43.53 [μ H]	43.53 [μ H]
C_1	55.6 [nF]	88.07 [nF]
C_2	80.8 [nF]	120.7 [nF]
L_{f1}	N/A	23.54 [μ H]
L_{f2}	N/A	14.49 [μ H]
C_{f1}	N/A	148.93 [nF]
C_{f2}	N/A	242.02 [nF]
R_1	0.187 [Ω]	0.187 [Ω]
R_2	0.062 [Ω]	0.062 [Ω]
V_{bat}	400 [V]	400 [V]
k	0.05	0.05
Nominal peak current aligned	130 [A]	28 [A]

III. ANALYSIS OF THE S-S AND LCC-LCC COMPENSATION

In order to achieve ZVS turn on of the H-bridge semiconductors, it is beneficial to operate the system in the inductive region. The inductive region is the frequency where the phase of the input impedance of the IPT system is positive. The input impedance of the S-S compensation is calculated by (1) and for the LCC-LCC compensation by (2). However, the output power of the WPT system is 3.5 kW instead of 7.7 kW because of the reduced coupling coefficient the power should be limited to stay within the rated current.

$$Z_{in-S-S} = j\omega L_1 + \frac{1}{j\omega C_1} + \frac{\omega^2 M^2}{j\omega L_2 + \frac{1}{j\omega C_2} + R_{ac}} \quad (1)$$

$$Z_{in-LCC} = j\omega L_{f1} + \frac{Z_{Cf1}(Z_r + j\omega L_1 + j\omega C_1)}{Z_{Cf1} + Z_r + j\omega L_1 + j\omega C_1} \quad (2)$$

$$Z_r = \frac{\omega^2 M^2}{j\omega L_2 + \frac{1}{j\omega C_2} + \frac{Z_{Cf2}(R_{ac} + j\omega L_{f2})}{R_{ac} + j\omega L_{f2} + \frac{1}{j\omega C_{f2}}} \quad (3)$$

$$R_{ac} = \frac{8}{\pi^2} \frac{V_{bat}^2}{P_{out}} \quad (4)$$

The phase angle of the input impedance's are plotted in Fig. 3. This shows that the inductive region for the S-S compensated system is above the resonance frequency. On the other hand, for the LCC-LCC compensation, this is below the resonance frequency as the phase angle should be positive to be in the inductive region.

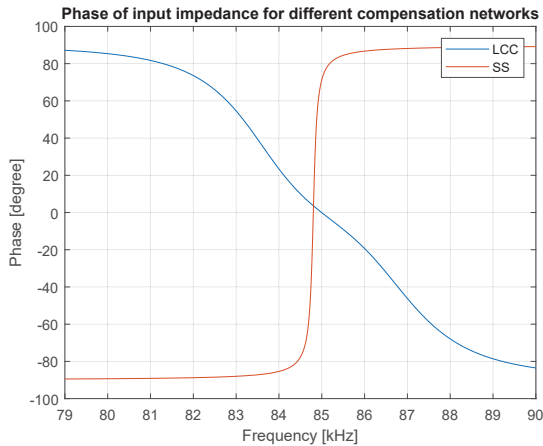

Fig. 3. Phase angle of Z_{in} of the S-S and LCC-LCC compensations.

IV. CIRCUIT SIMULATIONS

A. Soft start-up S-S compensation

Circuit simulations of the start-up transient are done on a 7.7 kW WPT system for the S-S compensation network with the specifications in Table I. Fig. 4 shows the output voltage and current of the inverter when the soft start-up is not used. It is observed that, for the S-S compensation the peak current reaches approximately 394.4 A when the soft start-up is not used which is about 264 A higher than the nominal current

peak when the coils are perfectly aligned. The peak currents at start-up could eventually result in an overvoltage over the resonant capacitors. This means that more capacitors should be placed in series to protect the resonant capacitors. This would increase the cost and size of the WPT system.

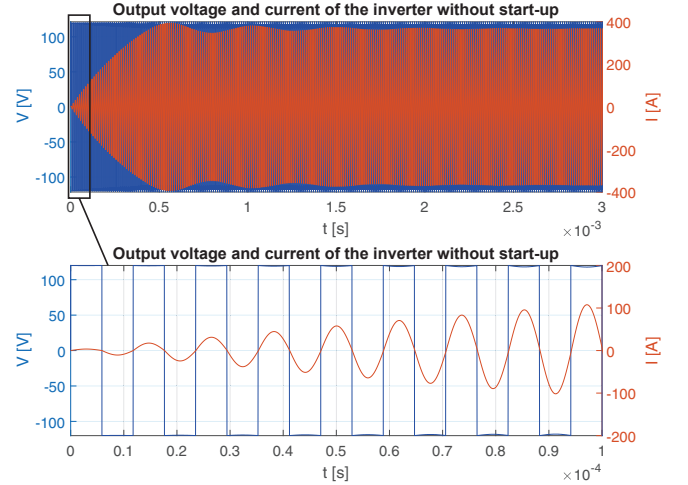

Fig. 4. The output voltage and current of the inverter without soft start-up for S-S compensation, frequency = 85 kHz.

The first soft start-up strategy for the S-S compensated WPT system makes use of SPS control. It is found that the optimum power transfer is reached when the duty cycle is 0.32, so the system starts at 0.32 duty cycle with an operating frequency of 86 kHz. This is done to start in the inductive region which will help to avoid hard switching. Moreover the value is slightly higher than the resonance, so the self-oscillation can find the desired operating frequency faster. Fig. 5 shows the simulation results where it is observed that there is a small current overshoot around 0.4 ms. Not to mention, there is hard switching at the start.

The second soft start-up strategy for the S-S compensated WPT system uses frequency control. The optimum starting frequency is found to be 86.25 kHz. Fig. 6 shows the simulation results. It is shown that there is also current overshoot at 0.4 ms, but soft switching is achieved. However, the turn-off losses would be high due to the inductive behavior.

The third soft start-up with Dual Control is presented in Fig. 7. A duty cycle of 0.135 would provide a nominal current that would stay under the nominal current when perfectly aligned. This method also shows no overshoot in the current during the start-up transient. Furthermore, it is able to maintain soft switching over the whole process. The results are summarized in Table II. The current overshoot compares the nominal peak current when the coils are perfectly aligned and the peak current of the three soft start-up methods. The Dual Control gives the best result from the benchmarked strategies. It is able to stay under the nominal peak current when the coils are aligned and provide soft switching over the whole process. This would be useful for Si MOSFETs in the H-bridge inverter as they are cheaper than SiC MOSFETs.

Table II. Comparison: soft-start methods for the S-S compensation.

	Current overshoot [A]	Soft switching
No soft start-up	264.4	Yes
SPS control	68.7	Yes, but not at start-up
Frequency control	76.9	Yes, but high losses at turn-off
Dual Control	0	Yes

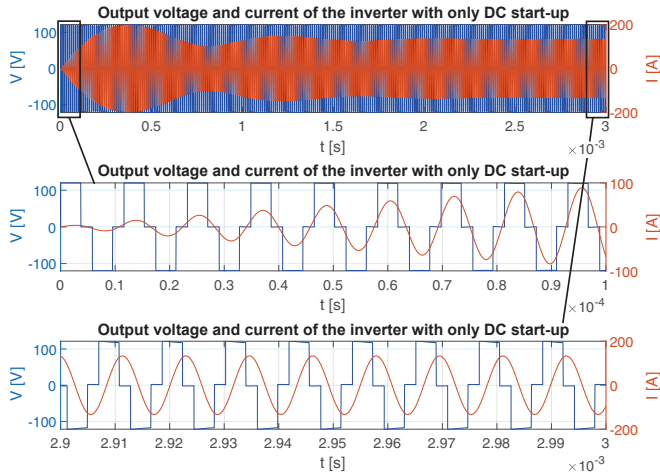

Fig. 5. The output voltage and current of the inverter with SPS control for S-S compensation, frequency = 86 kHz, duty cycle = 0.32.

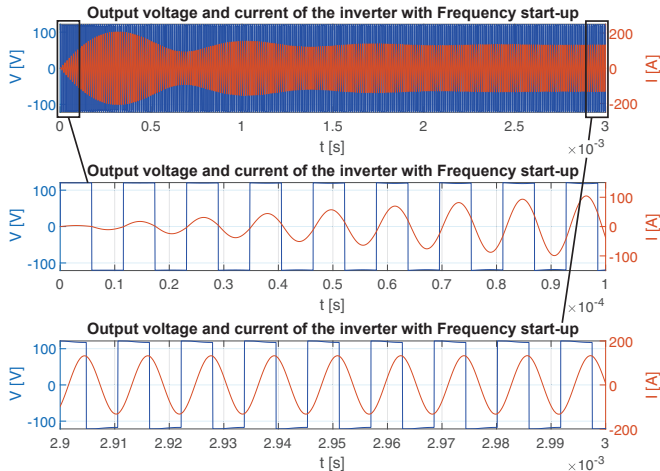

Fig. 6. The output voltage and current of the inverter with only frequency control for S-S compensation, frequency = 86.25 kHz, duty cycle = 0.5.

B. Soft start-up LCC-LCC compensation

Likewise, simulations are done for the start-up transient for the LCC-LCC compensation. The start-up transient without soft start-up is shown in Fig. 8. The peak current at the start is 112.8 A which is more than 80 A higher than the steady-state current at perfect alignment. This will result in an overvoltage over the resonant capacitors similar to the S-S compensation. However, in this case, the peak current is even more severe, so soft start-up would be mandatory.

The phase-shift control above resonance is used in Fig. 9. This method would offer a much lower peak current at the start-up transient compared with the case without soft start-up, but soft switching is lost during the start-up process. This shows that it is important to start in the inductive region to

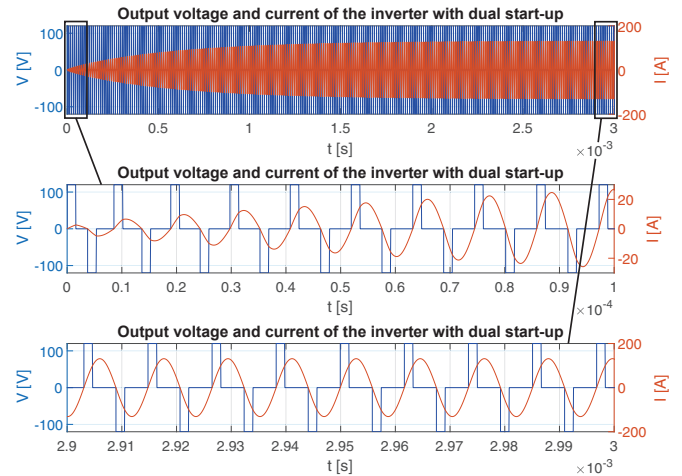

Fig. 7. The output voltage and current of the inverter with Dual Control for S-S compensation, duty cycle = 0.135.

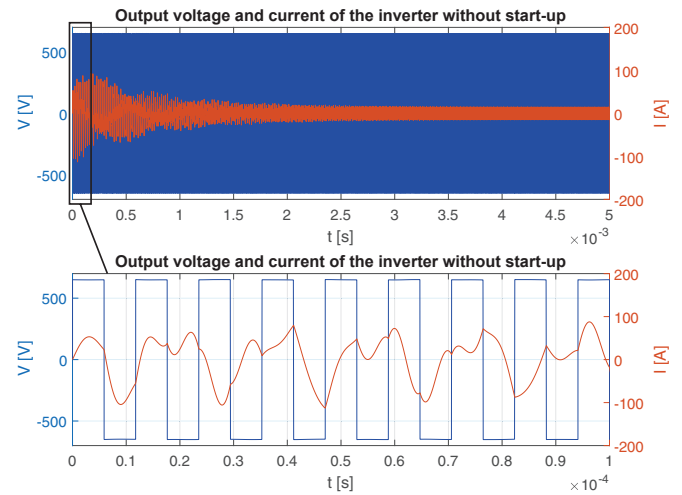

Fig. 8. The output voltage and current of the inverter without soft start-up for LCC-LCC compensation, frequency = 85 kHz.

secure soft switching as presented in Section III.

Frequency control is used in Fig. 10 in an attempt to maintain soft switching. The converter would then operate in the inductive region. Nevertheless, soft switching would be lost at the start-up transient and the overshoot would still remain.

Phase-shift control starting at 79 kHz is used in Fig. 11. Despite the short loss of soft switching at the start-up transient as seen in Fig. 11(b), it is able to maintain soft switching during the whole phase-shift process while reducing overshoot at the start. However, the losses of these few instances could be minimized with the use of SiC MOSFETs due to the low switching losses. Nevertheless, this demonstrates the importance of starting in the inductive region which in this case is below the resonance frequency.

The results are summarized in Table III. The combination of phase-shift and frequency control when started at 79 kHz would give the best result from the benchmarked strategies. Even though, the current overshoot is slightly higher than starting at 90 kHz, it is able to provide soft switching over most of start-up process. The system should be able to handle

Table III. Comparison: soft-start methods for the LCC-LCC compensation.

	Current overshoot [A]	Soft switching
No soft start-up	84.8	No
SPS control	0	No
Frequency control	92.9	Yes, but not at start-up
SPS and frequency control	11.8	Yes, but not at start-up

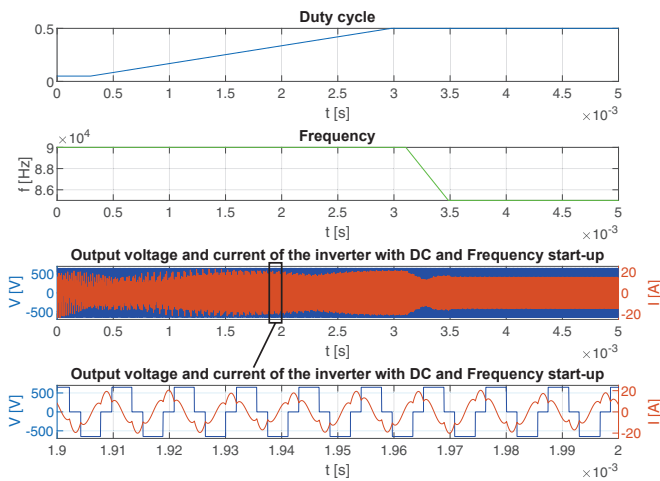

Fig. 9. The output voltage and current of the inverter with SPS control for LCC-LCC compensation, frequency = 85-90 kHz.

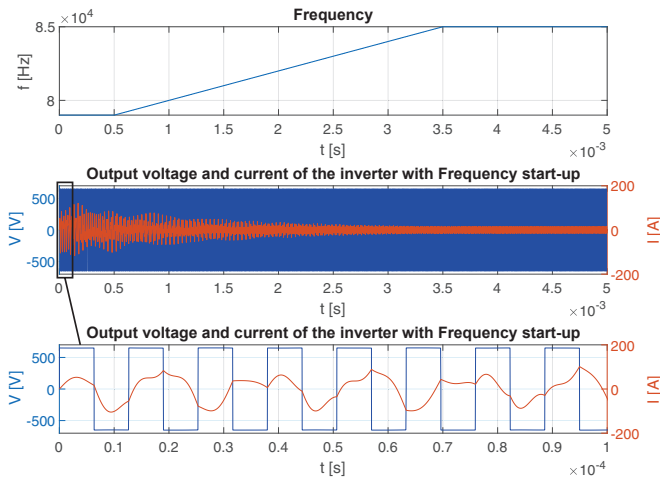

Fig. 10. The output voltage and current of the inverter with frequency control for LCC-LCC compensation, duty cycle = 0.5.

current overshoot for a short time.

C. Soft shut-down S-S compensation

Misalignment will occur when the EV would leave the charging station. This will cause the coupling coefficient to reduce. In the case of S-S compensation, this would result in a rapid increase in the current as shown in Fig. 12, but for the LCC-LCC compensation, it would reduce the current. This is the same case as for the start-up transients. This is the reason why it is necessary to use a soft shut-down strategy for the S-S compensation.

The first soft shut-down strategy uses only SPS control and is displayed in Fig. 13. It is able to stop the current from increasing, but hard switching will be introduced.

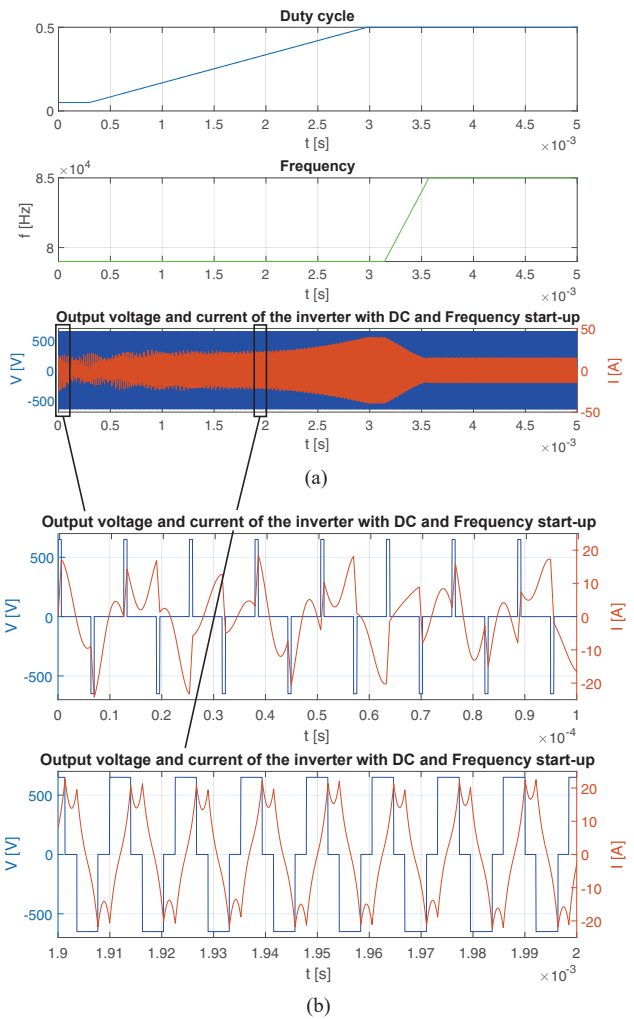

Fig. 11. The output voltage and current of the inverter with SPS control and frequency control for LCC-LCC compensation (a) full version and (b) zoomed-in version, frequency = 79-85 kHz.

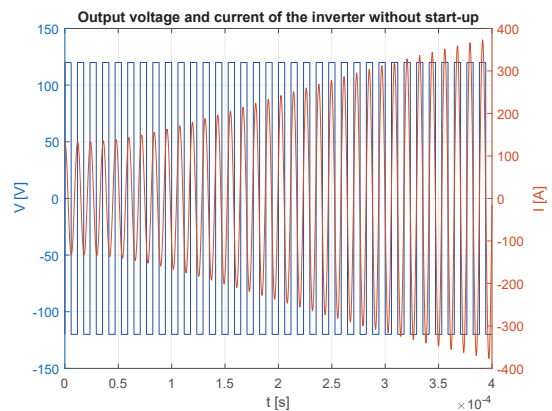

Fig. 12. The output voltage and current of the inverter without soft shut-down for S-S, frequency = 85 kHz.

The second soft shut-down strategy uses Dual Control. This method is able to maintain soft switching, but the current overshoot would be 42 A in comparison with the nominal peak current at perfect alignment. Nevertheless, it would be the preferred strategy because of the soft switching. Similar to

the start-up, the MOSFETs should be able to handle a small current overshoot for a short time.

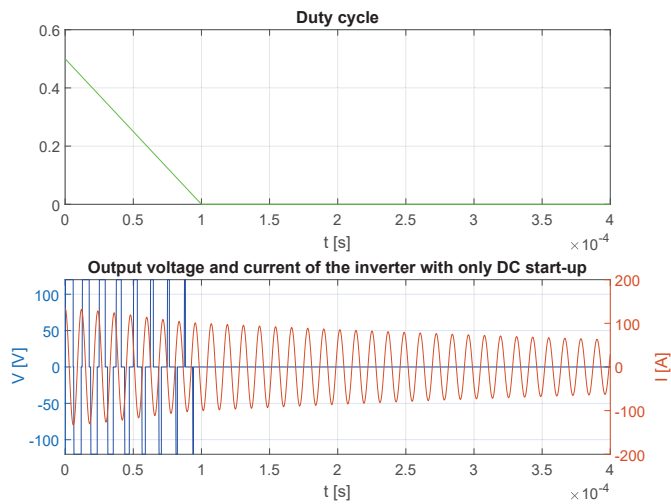

Fig. 13. The output voltage and current of the inverter with only SPS control for S-S compensation, frequency = 85 kHz.

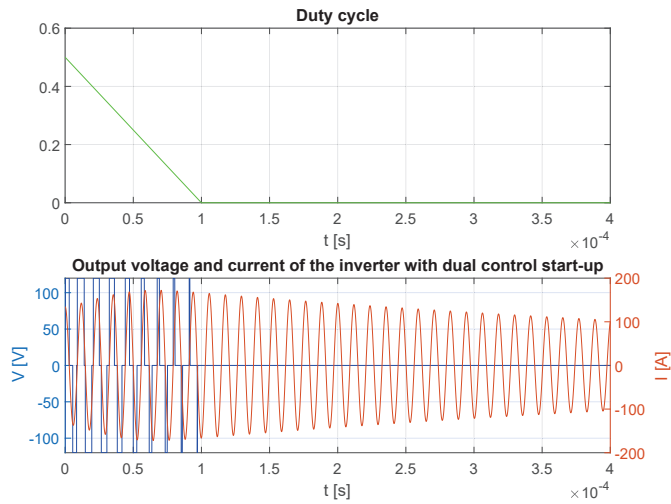

Fig. 14. The output voltage and current of the inverter with SPS control and self-oscillating feedback control for S-S compensation, frequency = 85 kHz.

V. CONCLUSION

This paper benchmarks three soft start-up methods for the S-S compensation network which use SPS control, frequency control and Dual Control. The S-S compensation is found to perform at its best when the Dual Control is used at the start-up and shut-down. This method provides soft switching while retaining a low current overshoot. For the LCC-LCC compensation, it is concluded that the combination of frequency and SPS control starting at 79 kHz gives the best performance. Even though this method would still have some instances of hard switching at the start, it is still able to provide soft switching for the rest of the process while keeping a low overshoot. Furthermore, the importance of starting in the inductive region to safeguard soft switching has been addressed. However, more research is needed to

preserve soft switching during the start-up transient for the LCC-LCC compensation.

REFERENCES

- [1] ISO/PAS19363:2017, "Electrically propelled road vehicles - magnetic field wireless power transfer - Safety and interoperability requirements," ISO, Standard, Jan. 2017.
- [2] J2954RP, "Wireless power transfer for Light-Duty Plug-In/ Electric Vehicles and Alignment Methodology," SAE International, Standard, Apr. 2019.
- [3] F. Grazian, W. Shi, J. Dong, P. van Duijsen, T. B. Soeiro, and P. Bauer, "Survey on standards and regulations for wireless charging of electric vehicles," in *2019 AEIT International Conference of Electrical and Electronic Technologies for Automotive (AEIT AUTOMOTIVE)*, 2019, pp. 1–5.
- [4] F. Grazian, P. van Duijsen, T. B. Soeiro, and P. Bauer, "Advantages and tuning of zero voltage switching in a wireless power transfer system," in *2019 IEEE PELS Workshop on Emerging Technologies: Wireless Power Transfer (WoW)*, June 2019, pp. 367–372.
- [5] W. Shi, F. Grazian, J. Dong, T. B. Soeiro, and P. Bauer, "Analysis of magnetic field emissions in inductive power transfer ev chargers following reference designs in sae j2954/2019," in *2020 IEEE International Symposium on Circuits and Systems (ISCAS)*, 2020, pp. 1–5.
- [6] W. Li, H. Zhao, S. Li, J. Deng, T. Kan, and C. C. Mi, "Integrated LCC compensation topology for wireless charger in electric and plug-in electric vehicles," *IEEE Transactions on Industrial Electronics*, vol. 62, no. 7, pp. 4215–4225, July 2015.
- [7] F. Grazian, W. Shi, T. B. Soeiro, J. Dong, P. van Duijsen, and P. Bauer, "Compensation network for a 7.7 kw wireless charging system that uses standardized coils," in *2020 IEEE International Symposium on Circuits and Systems (ISCAS)*, 2020, pp. 1–5.
- [8] A. Nabih, M. Ahmed, Q. Li, and F. C. Lee, "Transient control and soft start-up for 1 mhz llc converter with wide input voltage range using simplified optimal trajectory control," *IEEE Journal of Emerging and Selected Topics in Power Electronics*, pp. 1–1, 2020.
- [9] C. Fei, F. C. Lee, and Q. Li, "Digital implementation of soft start-up and short-circuit protection for high-frequency llc converters with optimal trajectory control (etc)," *IEEE Transactions on Power Electronics*, vol. 32, no. 10, pp. 8008–8017, 2017.
- [10] R. Zheng, B. Liu, and S. Duan, "Analysis and parameter optimization of start-up process for llc resonant converter," *IEEE Transactions on Power Electronics*, vol. 30, no. 12, pp. 7113–7122, 2015.
- [11] W. Shi, J. Deng, Z. Wang, and X. Cheng, "The start-up dynamic analysis and one cycle control-pd control combined strategy for primary-side controlled wireless power transfer system," *IEEE Access*, vol. 6, pp. 14 439–14 450, 2018.
- [12] K. Hata, T. Imura, H. Fujimoto, and Y. Hori, "Soft-start control method for in-motion charging of electric vehicles based on transient analysis of wireless power transfer system," in *2018 IEEE Energy Conversion Congress and Exposition (ECCE)*, 2018, pp. 2009–2015.
- [13] K. Stoyka, G. Di Capua, G. Di Mambro, N. Femia, F. Freschi, A. Maffucci, and S. Ventre, "Behavioral models for the analysis of dynamic wireless charging systems for electrical vehicles," in *2020 IEEE International Symposium on Circuits and Systems (ISCAS)*, 2020, pp. 1–5.
- [14] H. Pinheiro, P. Jain, and G. Joos, "Self-sustained oscillating resonant converters operating above the resonant frequency," *IEEE Transactions on Power Electronics*, vol. 14, no. 5, pp. 803–815, 1999.
- [15] T. B. Soeiro, J. Mühlethaler, J. Linnér, P. Ranstad, and J. W. Kolar, "Automated design of a high-power high-frequency llc resonant converter for electrostatic precipitators," *IEEE Transactions on Industrial Electronics*, vol. 60, no. 11, pp. 4805–4819, 2013.
- [16] R. Bosshard, U. Badstübner, J. W. Kolar, and I. Stevanović, "Comparative evaluation of control methods for inductive power transfer," in *2012 International Conference on Renewable Energy Research and Applications (ICRERA)*, Nov 2012, pp. 1–6.
- [17] A. Namadmalan, "Self-oscillating pulsewidth modulation for inductive power transfer systems," *IEEE Journal of Emerging and Selected Topics in Power Electronics*, vol. 8, no. 2, pp. 1813–1820, 2020.
- [18] H. Hu, T. Cai, S. Duan, X. Zhang, J. Niu, and H. Feng, "An optimal variable frequency phase shift control strategy for zvs operation within wide power range in ipt systems," *IEEE Transactions on Power Electronics*, vol. 35, no. 5, pp. 5517–5530, 2020.