



Floating Community

Designing a floating module for a
resilient community in Manila, Phillipines

Megatrends

The increasing frequency of climatic disasters, especially **water related**, coupled with the megatrend of **urbanization**, leads to a sense of urgency to offer long-term resilient solutions in the urban context.

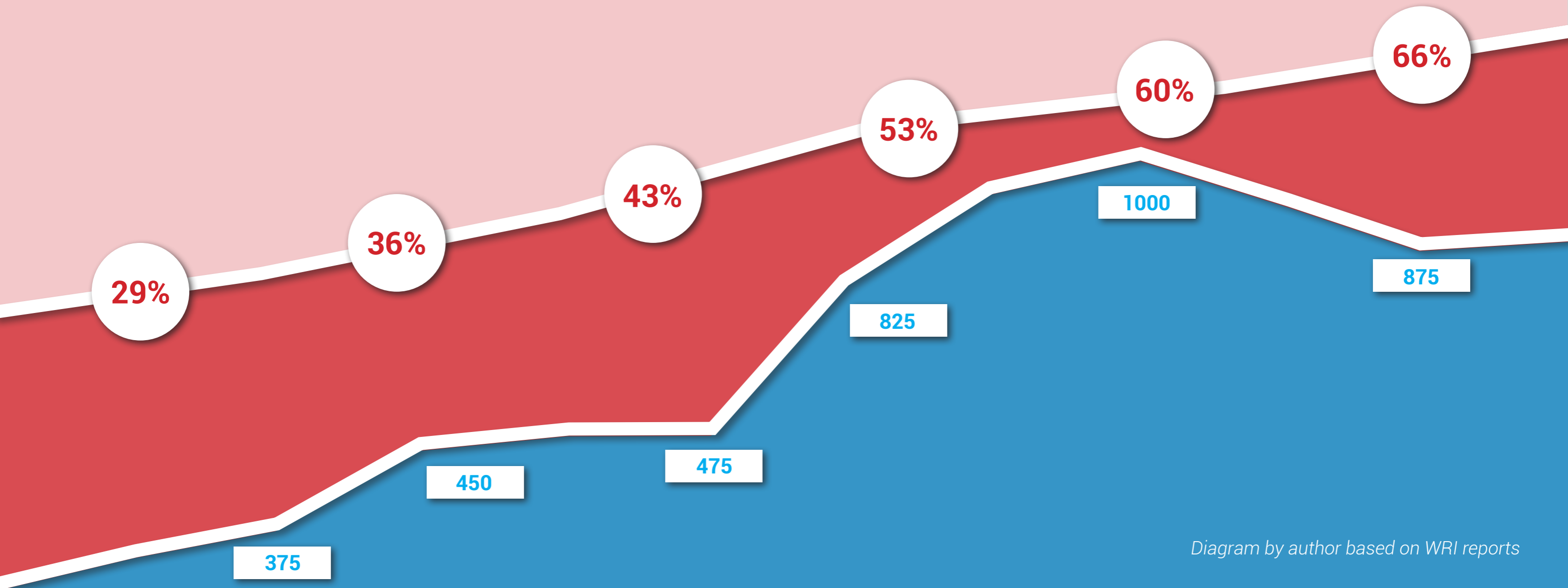

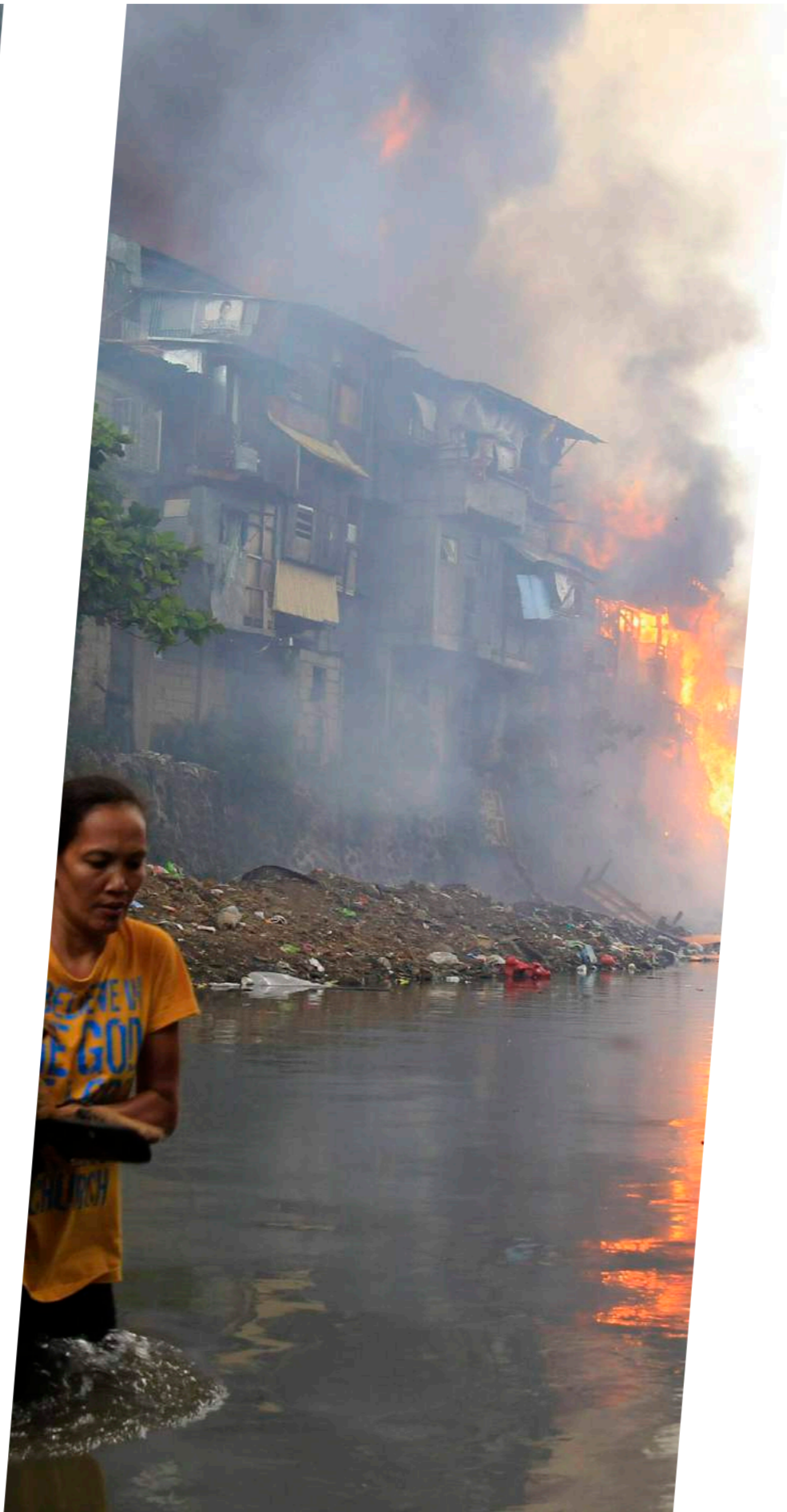

Cycle of Vulnerability

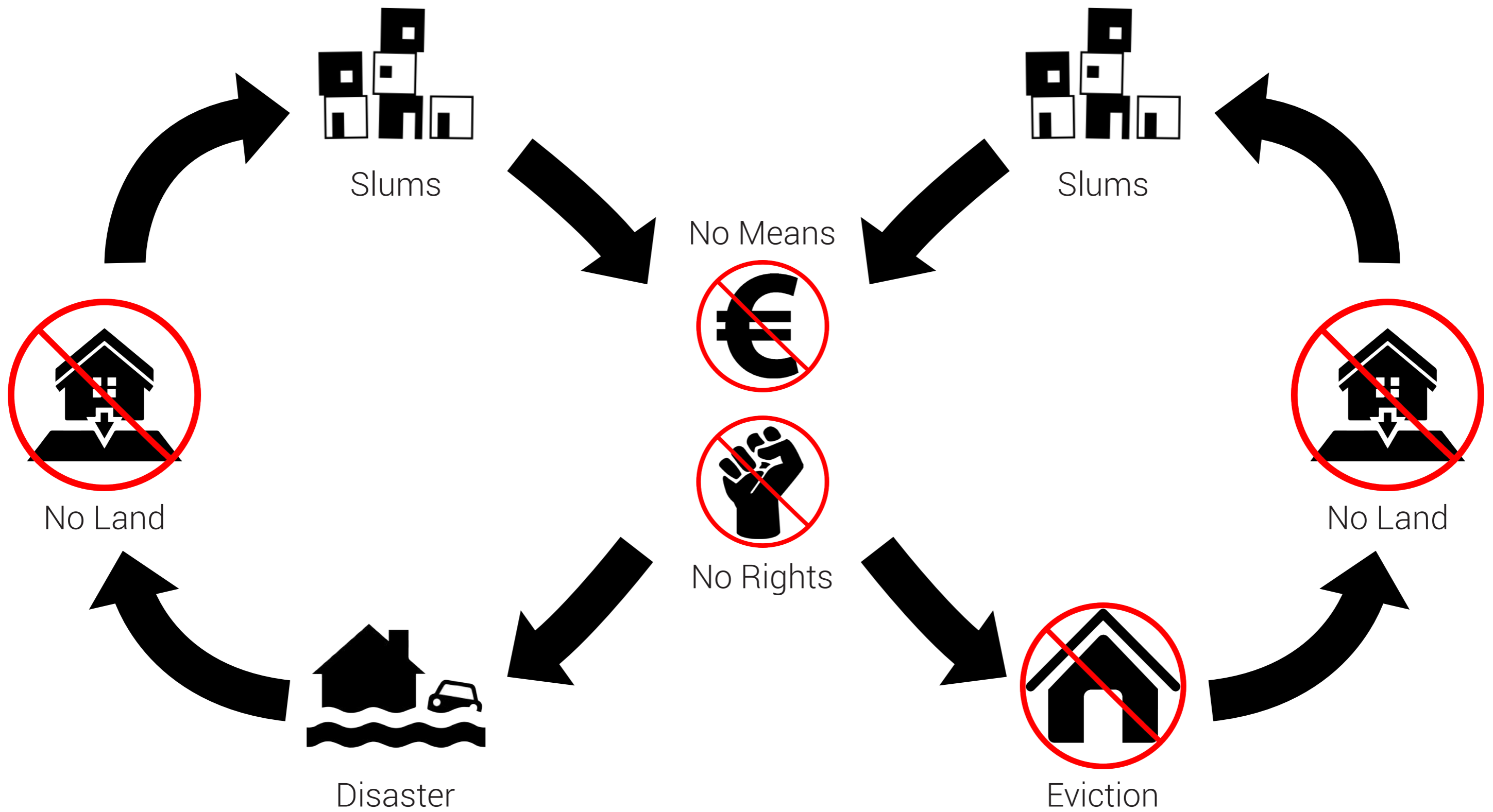

To address the problem, the areas which are at **most risk** and which are the most populated should be examined.

Out of the top 10 countries on the WRI (World Risk Index), **HALF** are in the Southeast Asia region.

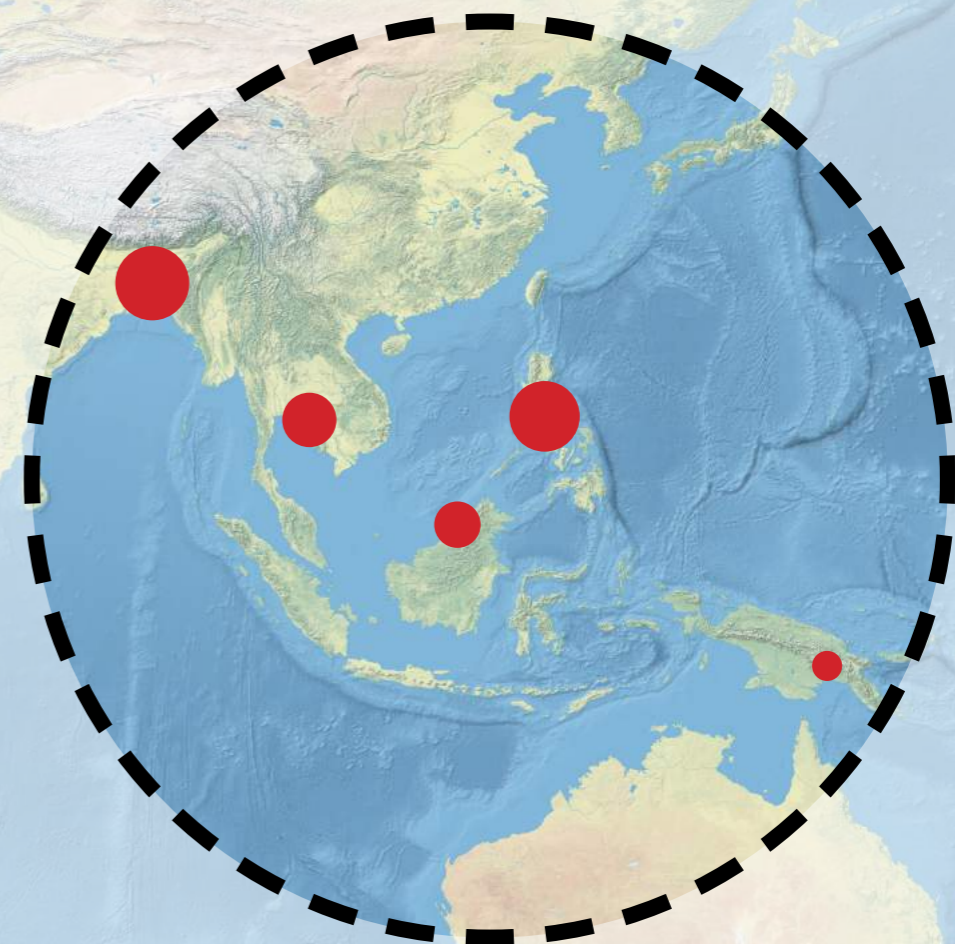

" In Asia, for example, more than 18 percent of the urban population lives in the Low Elevation Coastal Zone... "

" ...around 3 million people in Manila live in areas threatened by flooding.... "



World Risk Index (WRI) top 10:

Country:	% risk:
Vanuatu	36.28
Tonga	29.33
Philippines	26.70
Guatemala	19.88
Bangladesh	19.17
Solomon Islands	19.14
Brunei Darussalam	17.00
Costa Rica	17.00
Cambodia	16.58
Papua New Guinea	16.43

“ [...] urbanization pressure leads to urban growth rates that exceed the capacity of government authorities to adequately develop and operate urban infrastructure e.g. for healthcare, flood protection, storm evacuation... ”

Research process

How can sustainable interventions in **dense coastal vulnerable communities** help improve urban and environmental **resilience**?

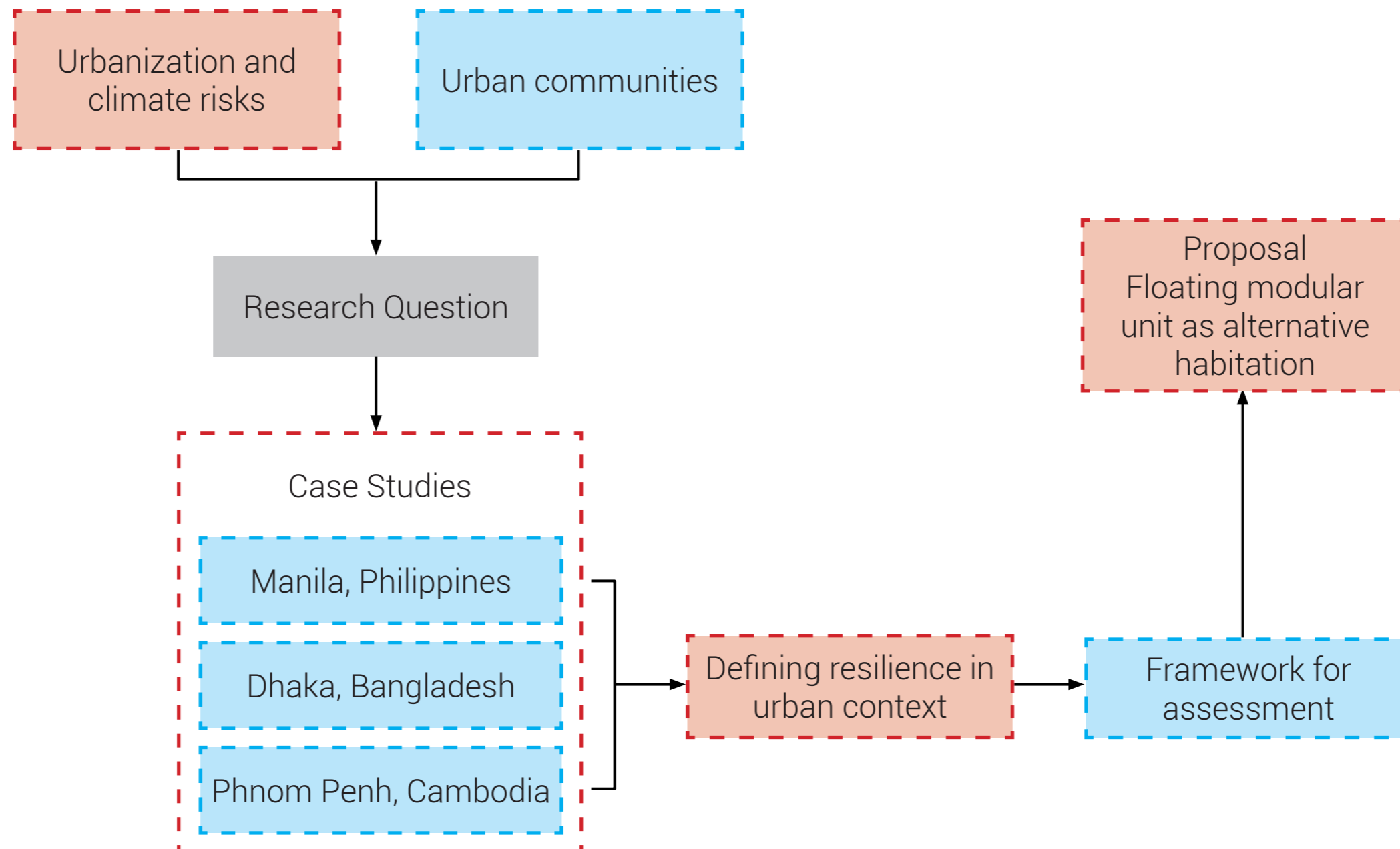

Informal housing inhabitants

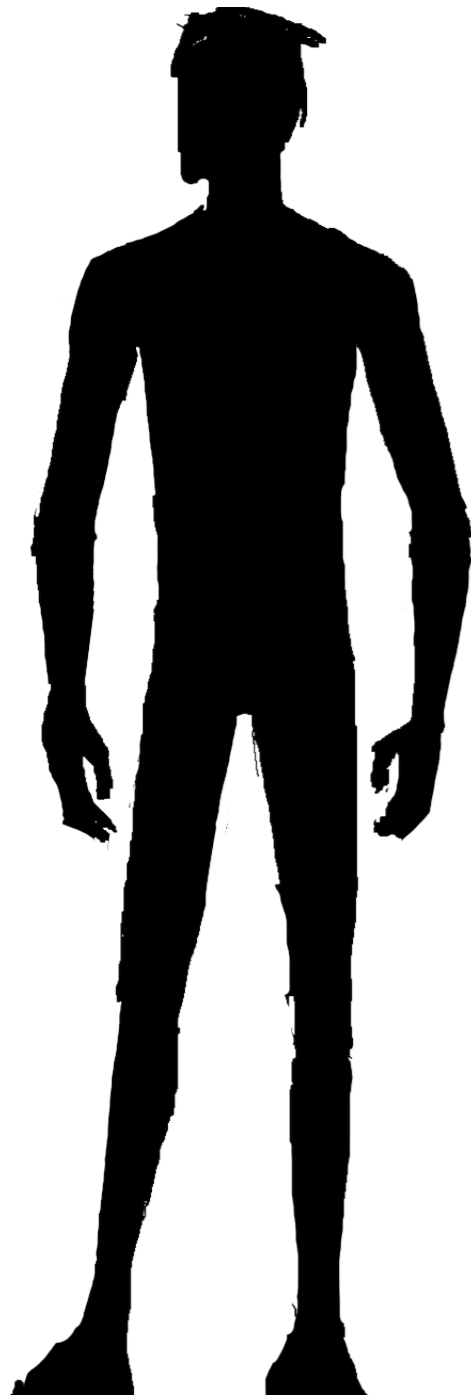

Age: 28

Previous Occupation: Rice farmer

Current occupation: Rubbish collector

Highest education: none

Family size: 6

Housing location: Canal slum

House size: 22 m²

Shared with: 6

Running water: no

Toilet: no

Stove: no

Flooring: yes

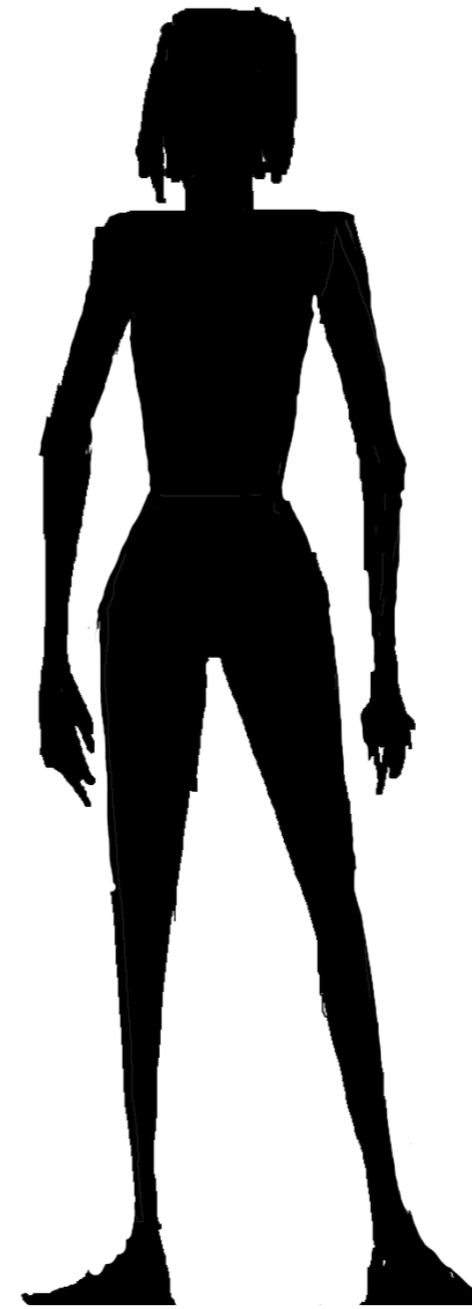

Age: 23

Previous Occupation: Midwife

Current occupation: Food vendor

Highest education: secondary

Family size: 5

Housing location: Coast slum

House size: 14 m²

Shared with: 5

Running water: yes

Toilet: yes

Stove: no

Flooring: yes

Adaptive design for urban risk

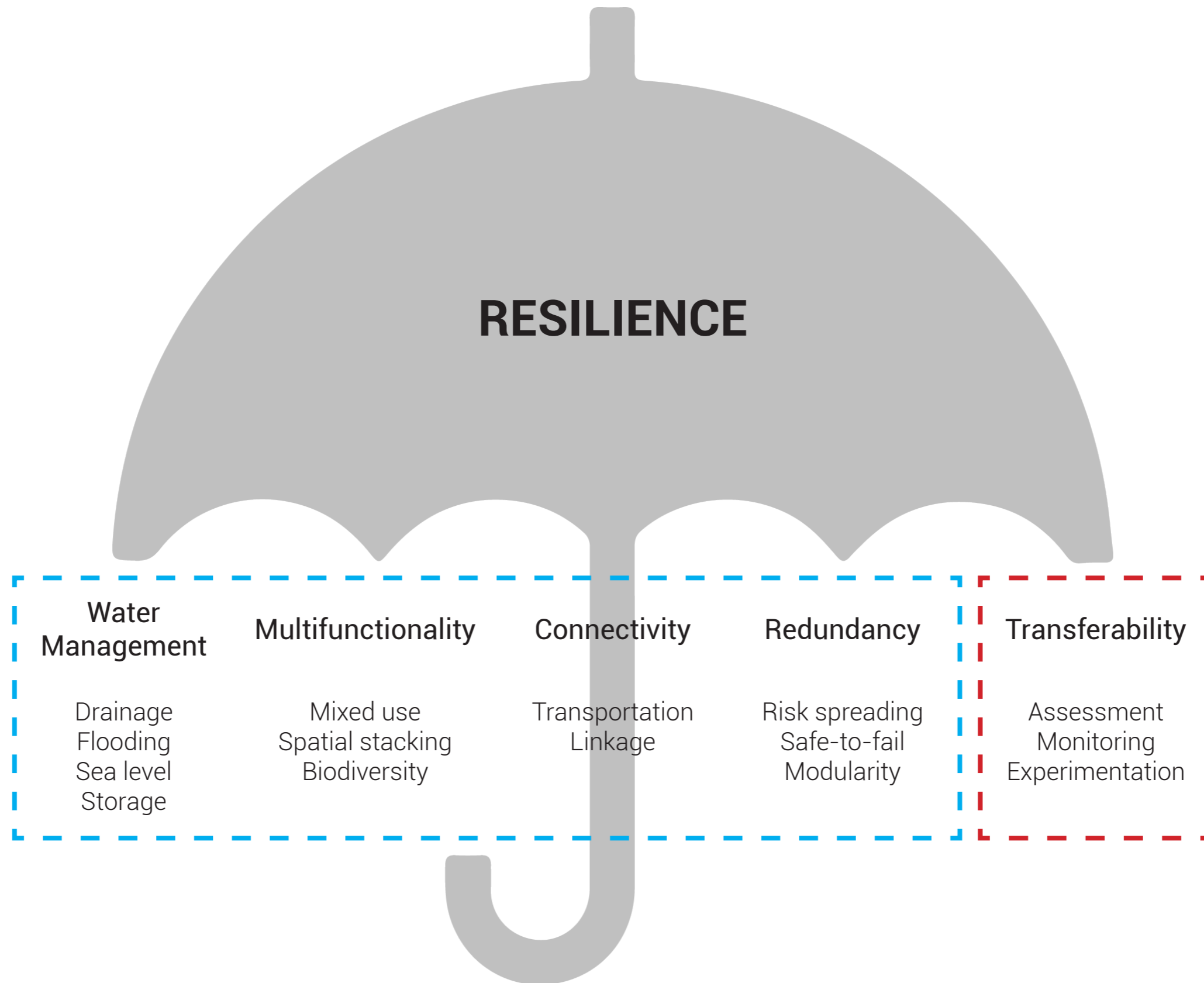

Assessment of Resilience

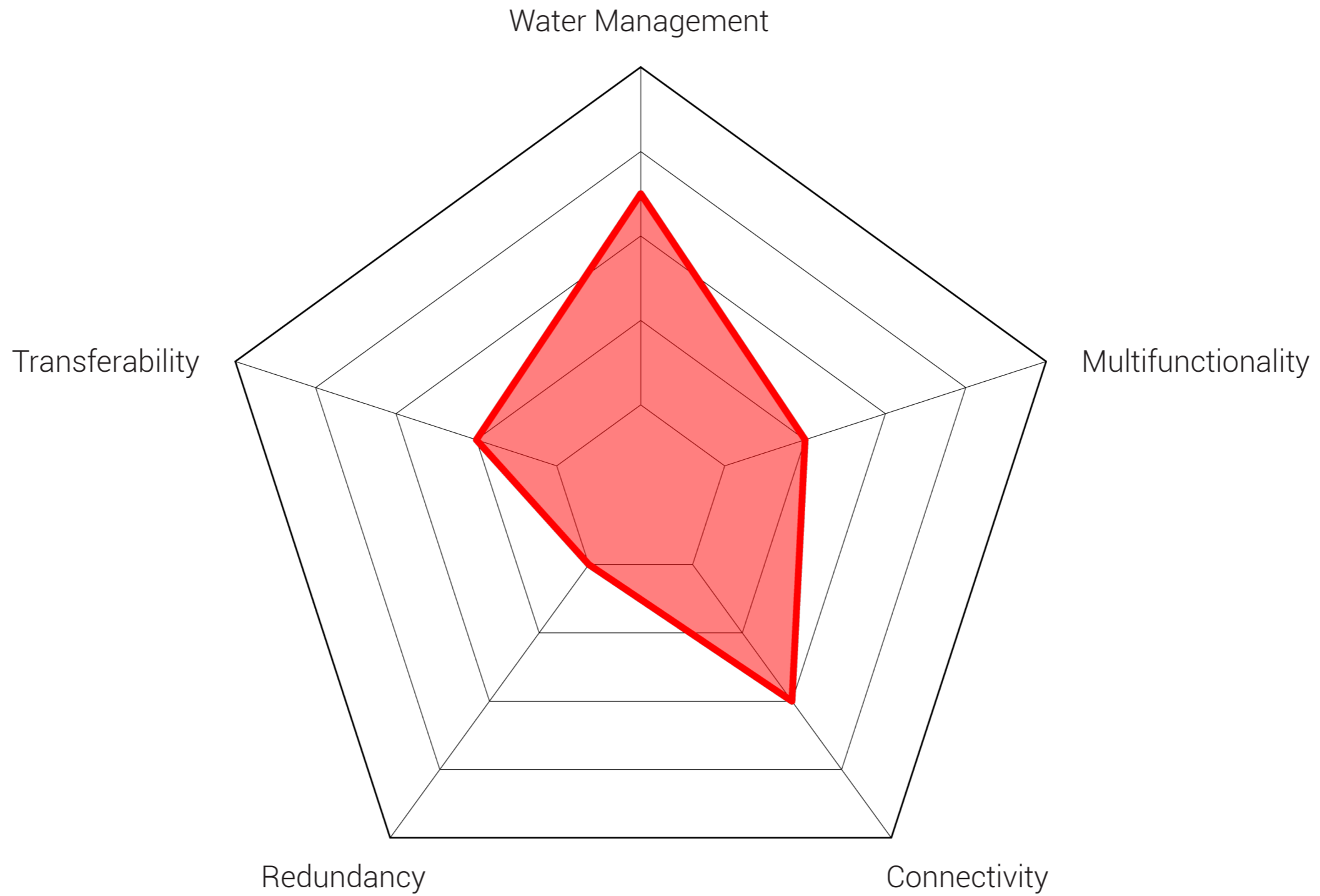

Phnom Penh, Cambodia

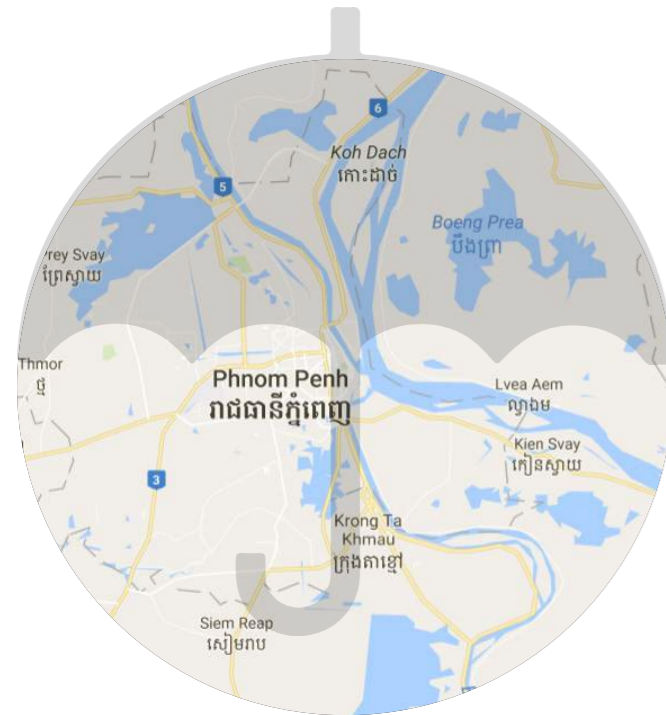

ACTIONS

- No effective action has been implemented or properly organized to deal with flood-risk and climate change in the Phnom Penh urban context.
- Ineffective or partially successful drainage improvement projects by Japan International Cooperation Agency (JICA) since the early 2000's totalling € 300 million.
- Habitat For Humanity (HFH) conducted 600 house improvements since 2004.

Manila, Philippines



ACTIONS

- 2011 declogging of 39,436 linear meters of waterways to improve flood drainage.
- Relocation project for informal settlers for a 5-year plan costing € 1 billion. About 10% were relocated.
- Long term (until 2035) master plan of dams and river improvements at cost of € 6.5 Billion.

Dhaka, Bangladesh

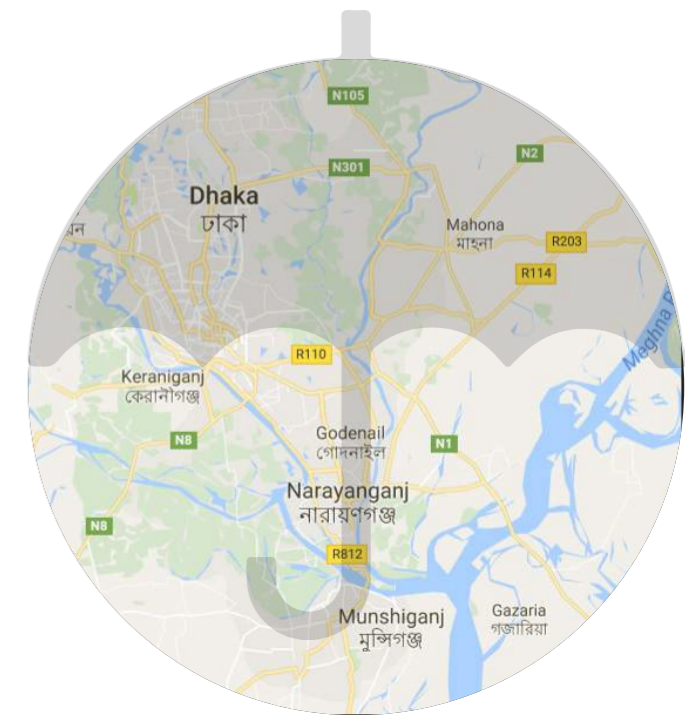

ACTIONS

- Failed "Action Plan" of 1990 to embank rivers in Bangladesh. Cost is € 140 Billion.
- United Nations Development Programme's Early Recovery Facility (ERF) innovation of dismantable housing units from wood and metal sheets for relocation during disaster and flooding. 200 units so far.
- ERF and UNDP program to raise housing above flood levels. 2,250 houses raised so far.

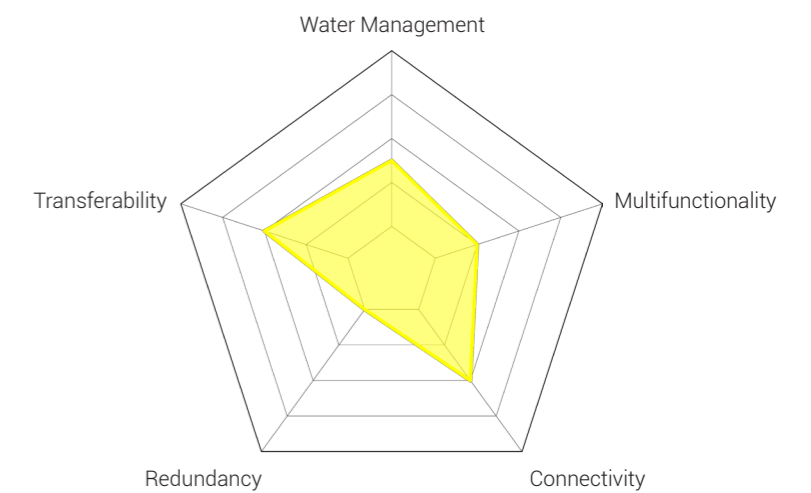
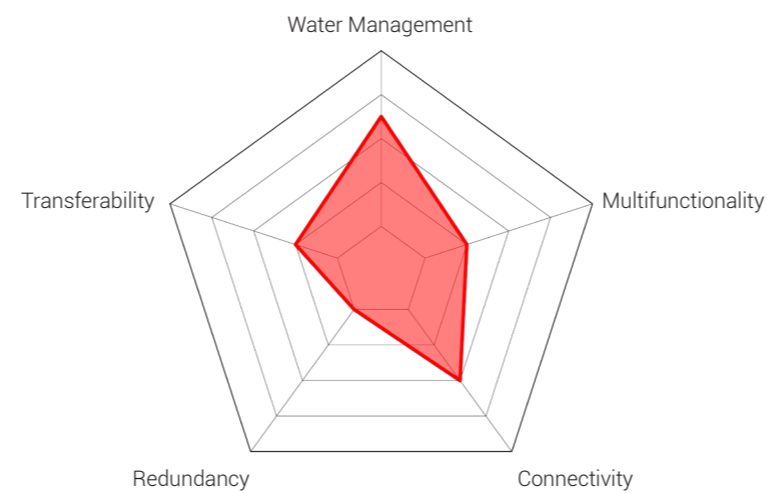
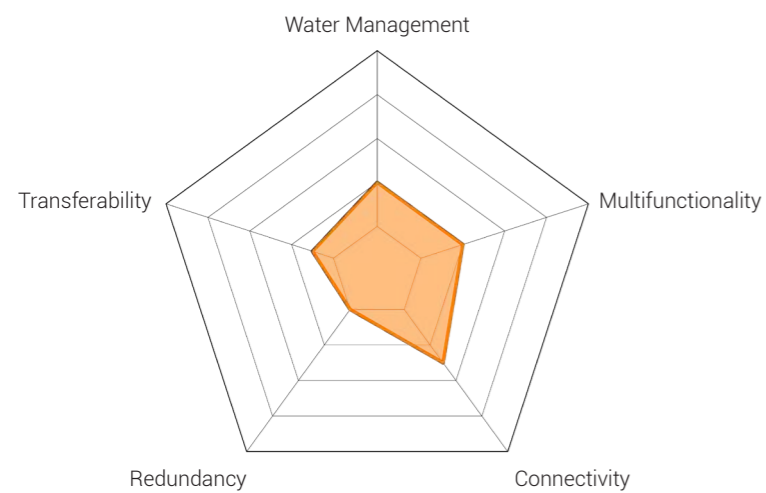

“Urban Land that does not Flood”



NOT utopic

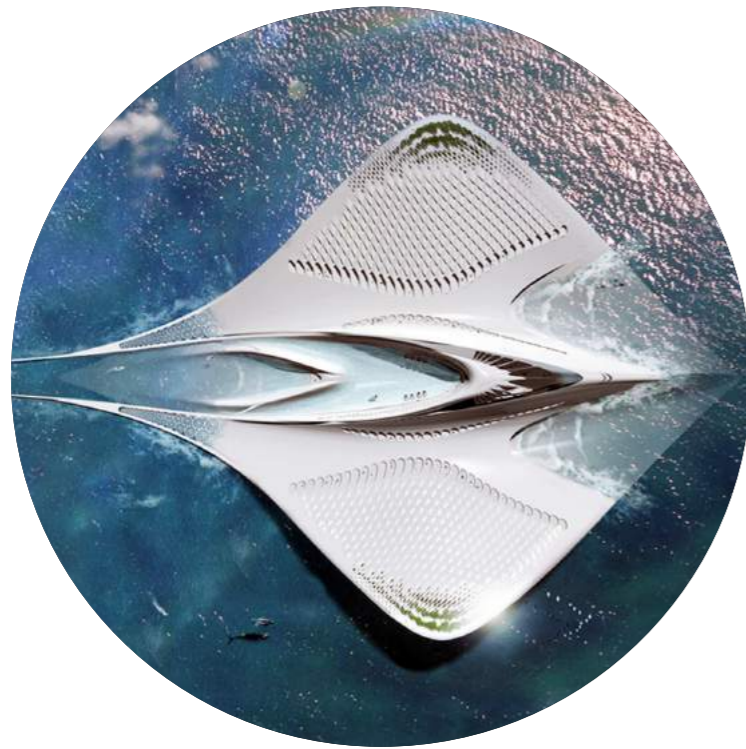

NOT isolated



NOT enormous



NOT expensive

Evolutionary Adaptivity

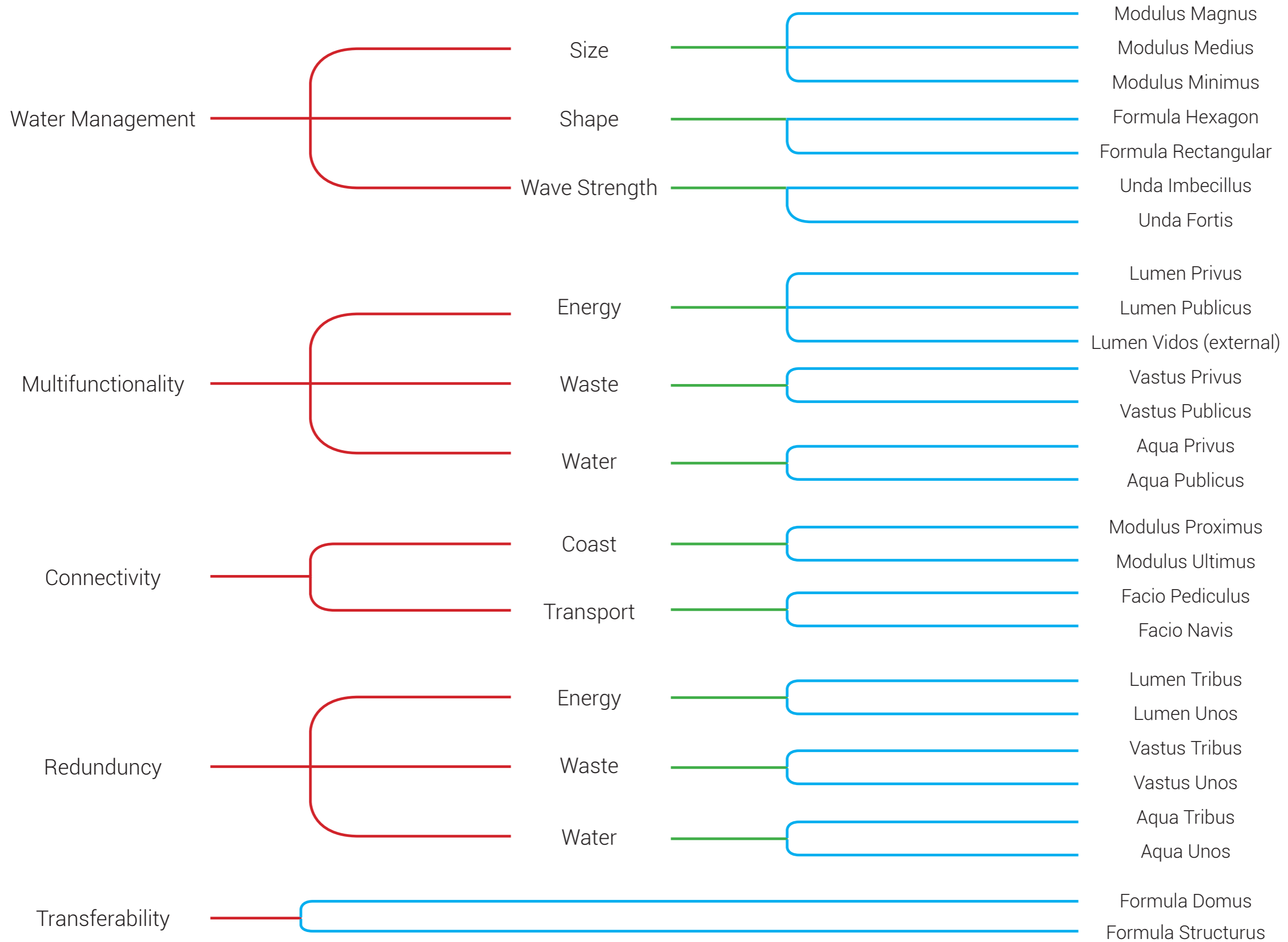

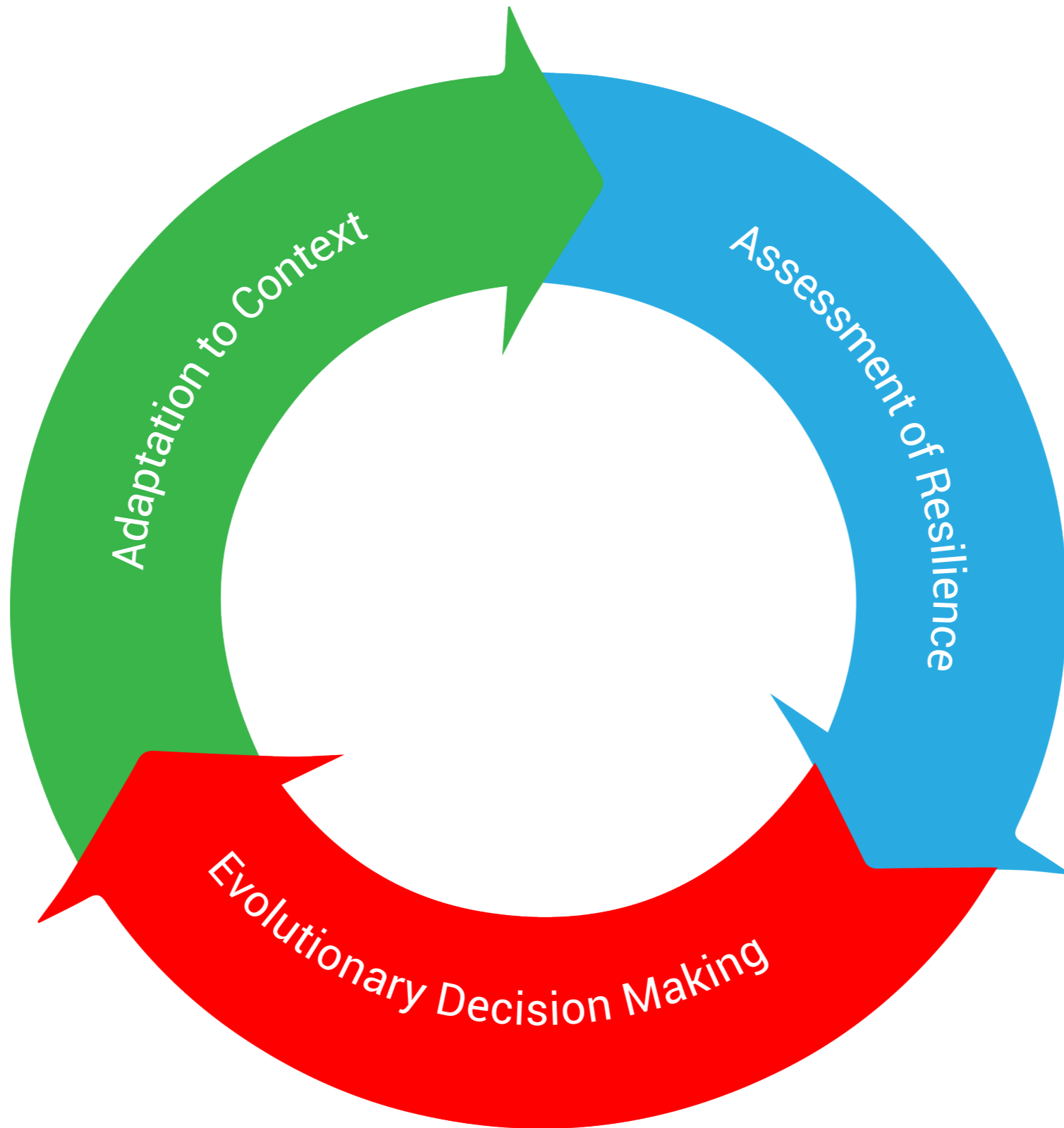

Site Selection



Manila, Philippines

One of the **major metropolis** in Southeast Asia, Manila has a water network which includes both **coast and river**, which offers opportunities to analyze and address the needs of vulnerable urban populations from multiple aspects and can inform future contexts.



Manila, Philippines



Avg. elevation - 16m

Metropolitan population
12,877,253

Density
42,000 / km² (1st)

**Poor population
4 million**



Tropical region

High humidity

24 - 32 °C

Comfort temperature
10% too hot
3% too cold



July - October

5-10 storms / year

30% of rainfall

**Typhoon Haiyan
November 2013
6,300 dead
2 Billion USD**

Approach to existing urban fabric

Rural populations **in need** of land arrive to the city in search of new economic opportunities.

They would benefit from a location only in the **proximity** of the existing city center.

Therefore the module is not created as a separate entity but **new land in connection to the existing fabric.**



Manila

Slum



Port



Ship path

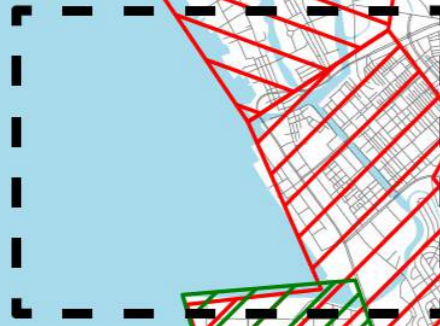

7.5 m

5 m

0

3 km

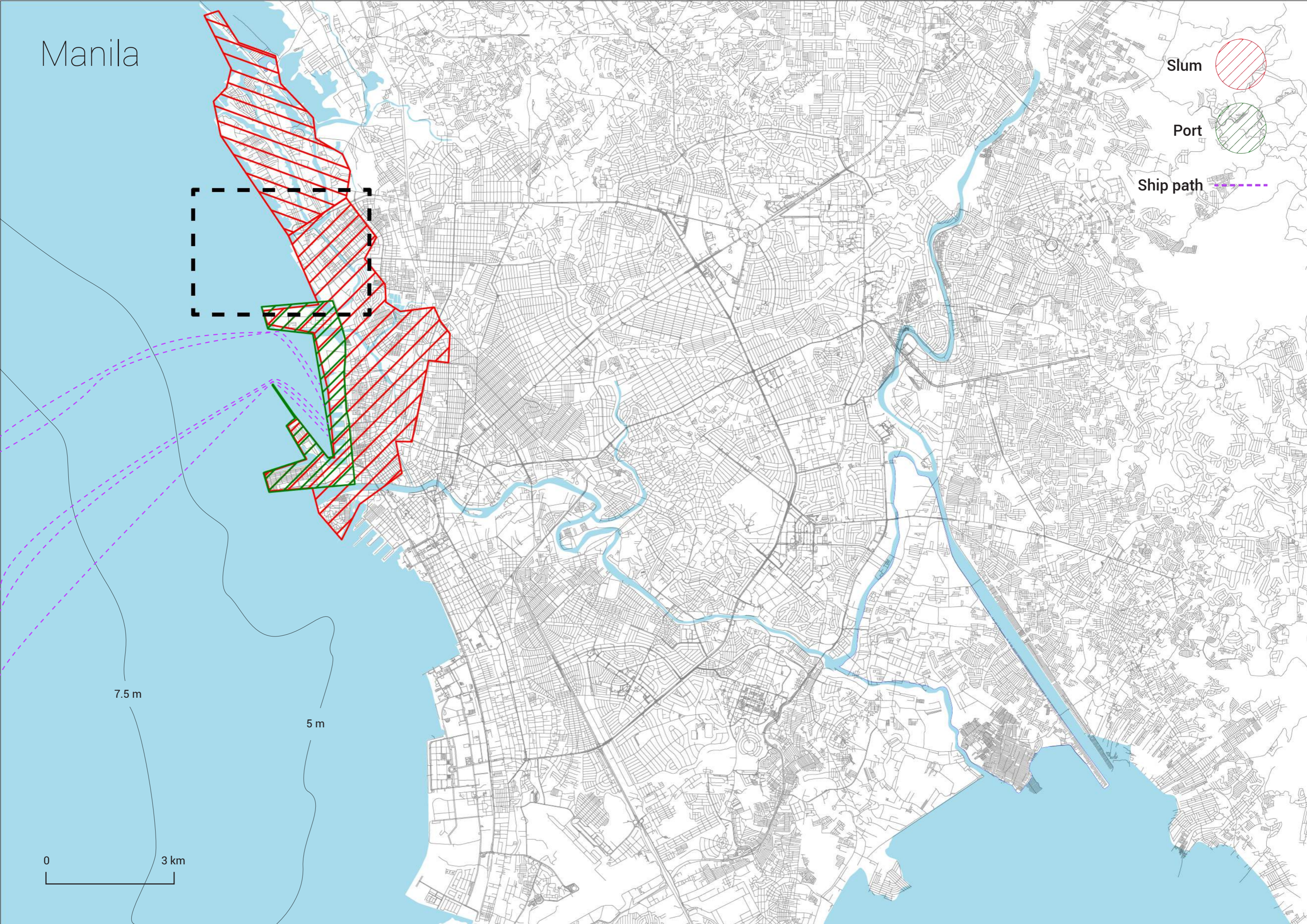

Navotas Slum

3000 Inhabitant Development

Floating Wave Breaker

Bus Terminal

Navotas Fish Port Complex

0 500m

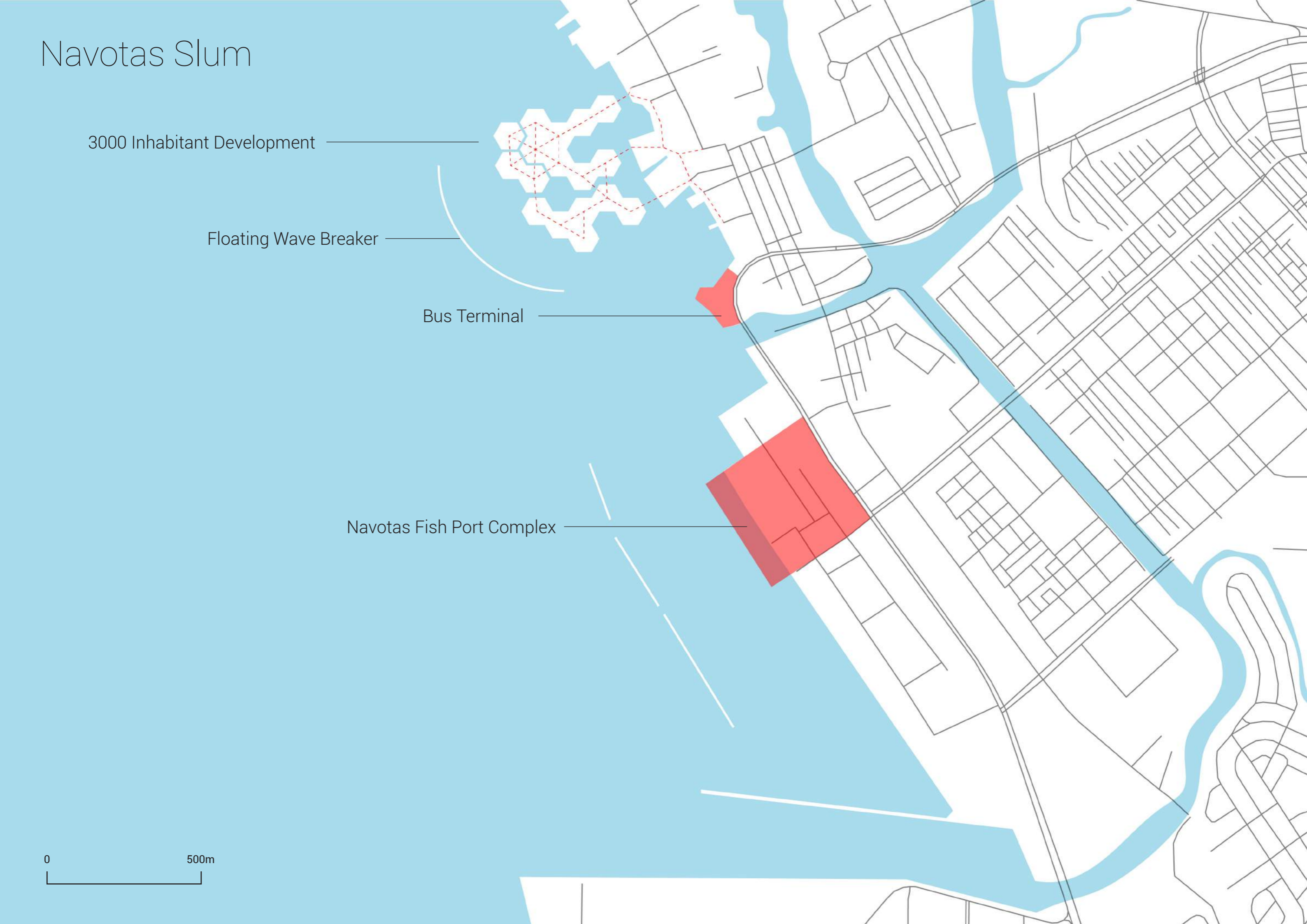

Elements of the Design

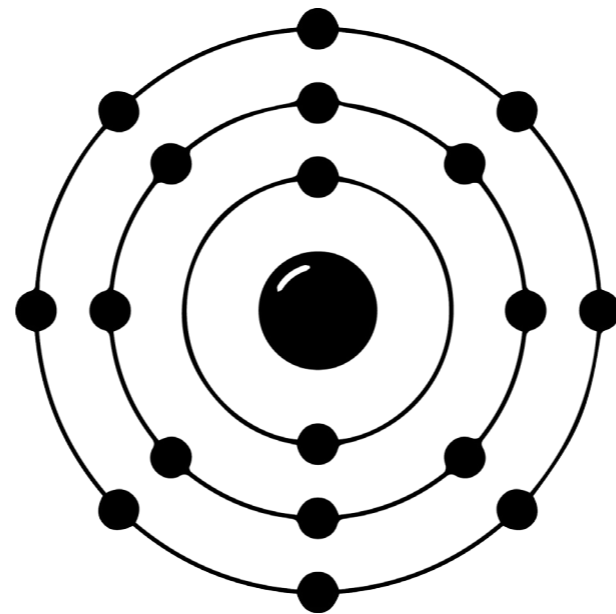

Elements of Value

City scale

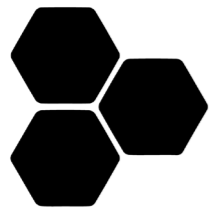

Modularity

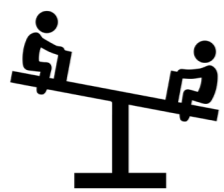

Stability



Storm Break

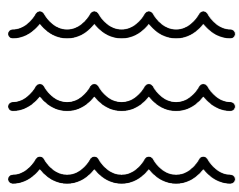

Wave Height

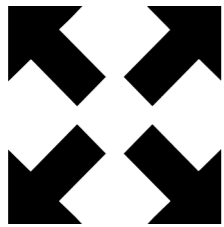

Module Size



Tsunami



Weight



Cost



Energy



Monsoon



of People



Transport



Education



Health



Energy



Monsoon



of People



Food



Materials



Demographics

Family scale



Climate



Food



Materials



Demographics

Module scale

How will it float?

If the structure is **more than twice the wavelength** in extent, its response will tend to zero.

- *Seasteading engineering report (2011)*

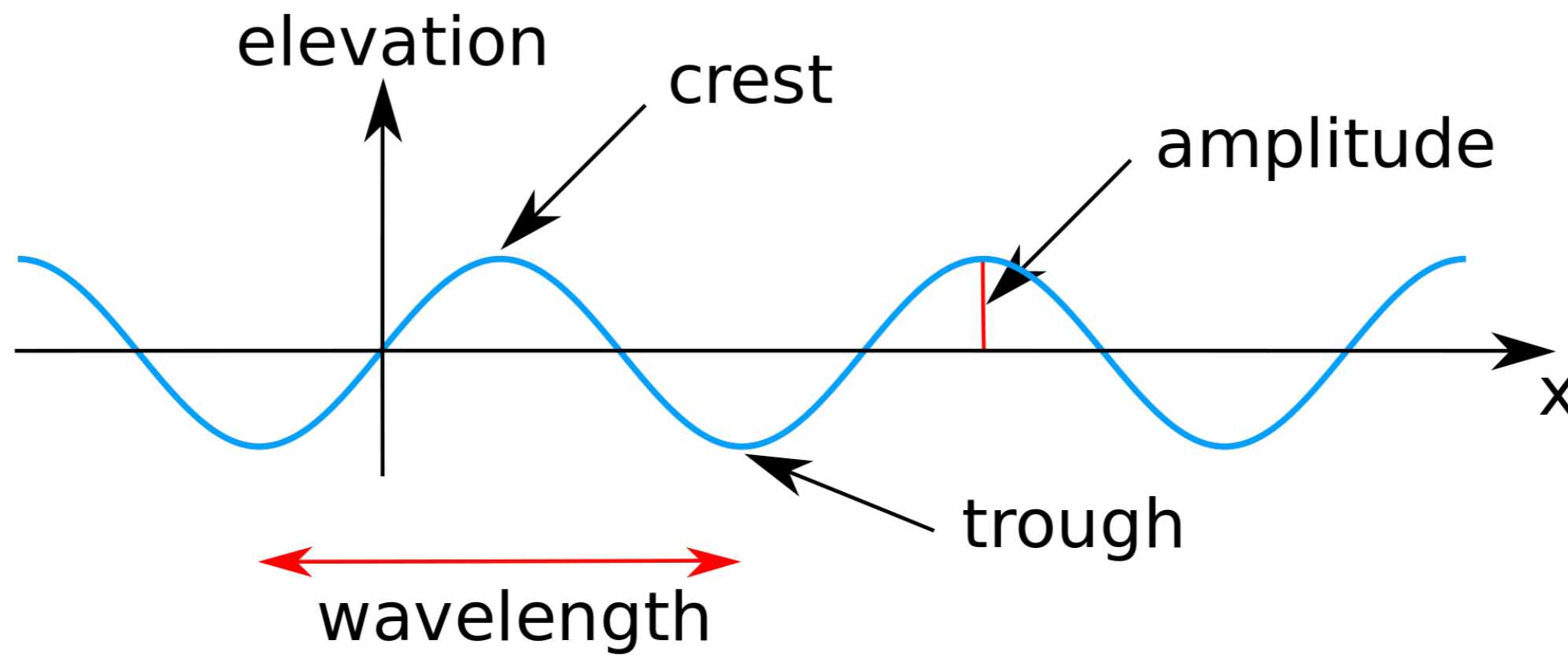

A platform with very high width to depth ratio will have a very large **metacentric height**, adding to its stability.

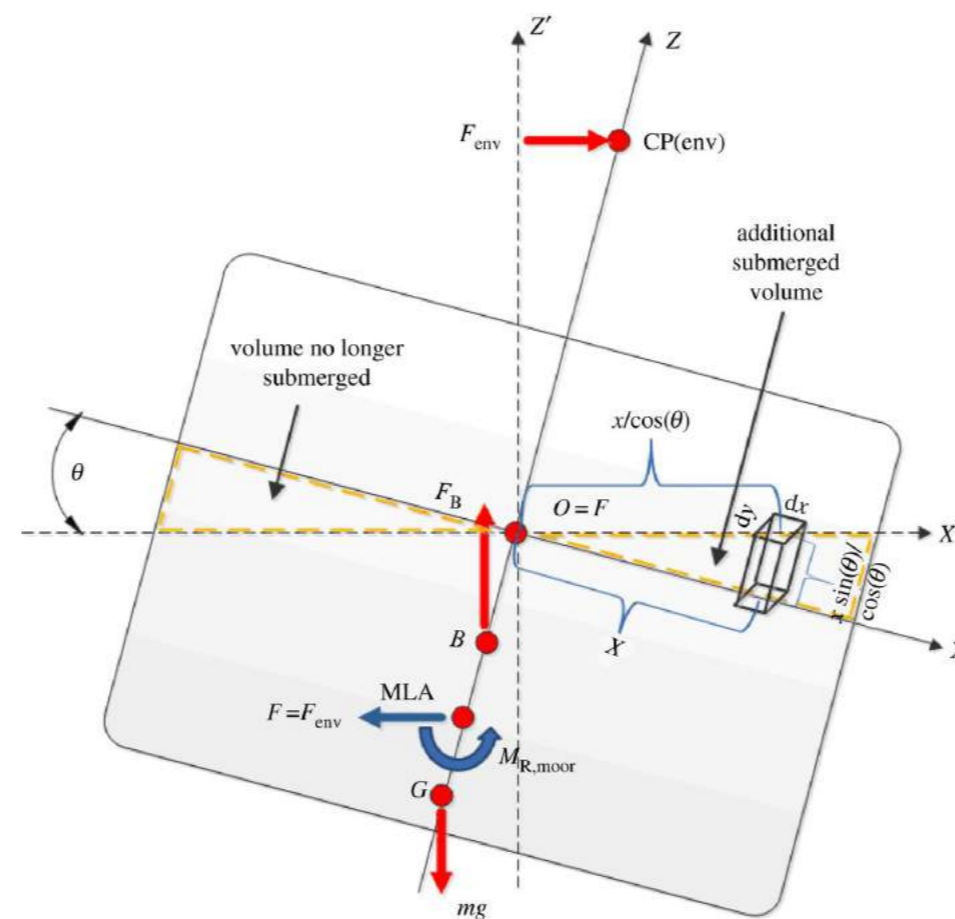

Modularity = Value

Multifunctionality

Risk-spreading

Efficiency

Functional stacking

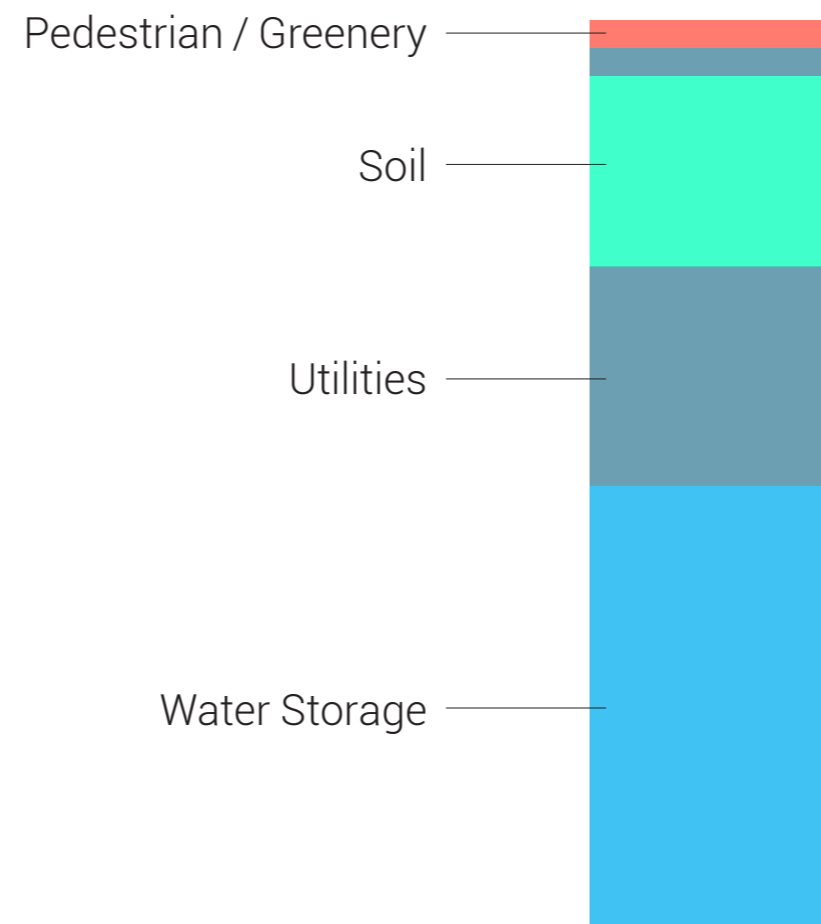

Decentralization of utilities



Centralized

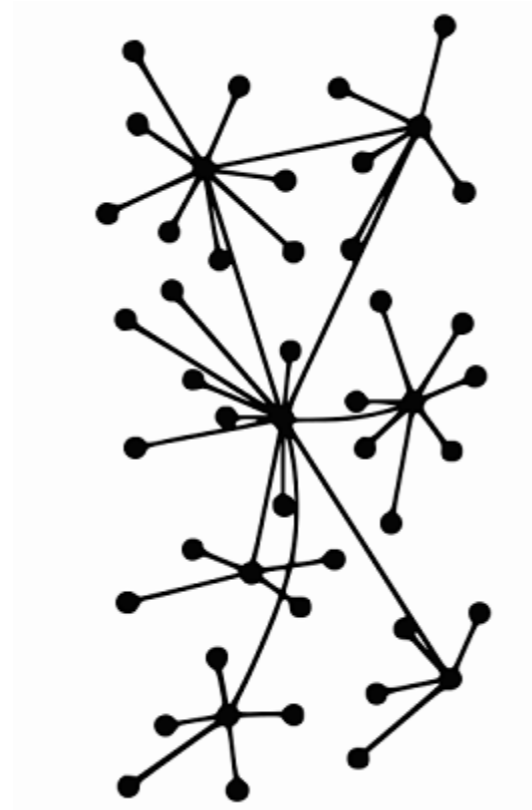

Decentralized

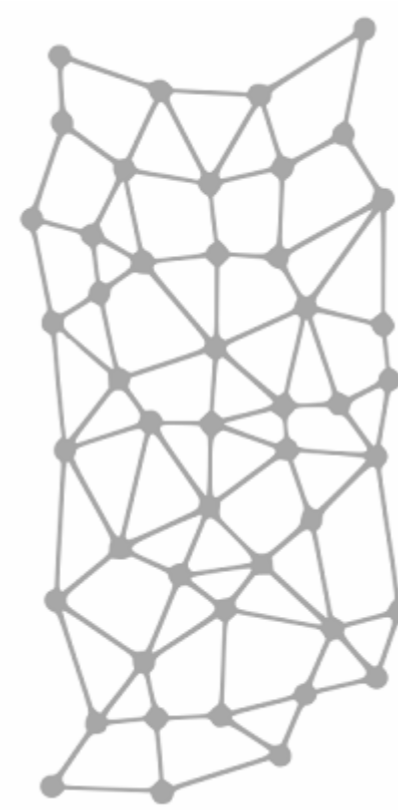

Distributed

Volume to Surface ratio



Storage capacity
Material efficiency
Bouyancy

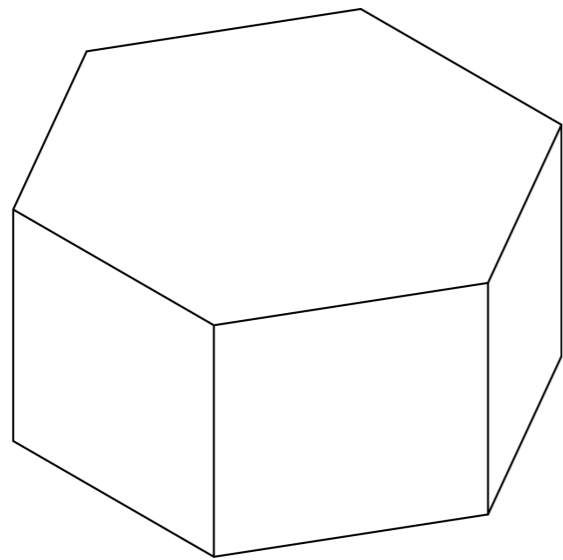

1.166

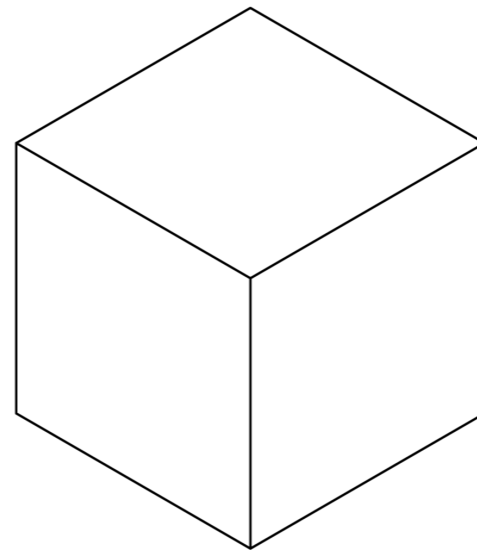

0.833

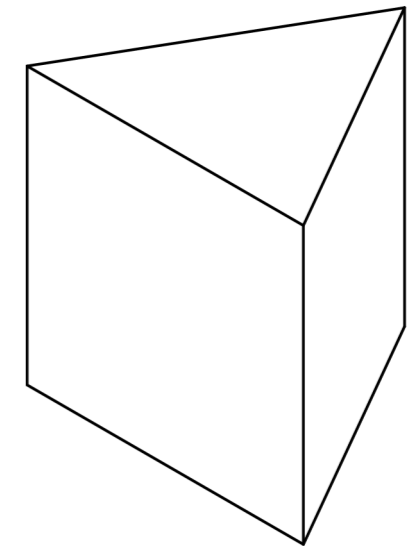

0.56

Community

Barangay

Administrative urban unit
> 2000 people

Human social unit

Dunbar's number
~150 people

Density of Manila City

300 people / ~7000 m²

Area of stable module

6500 m²

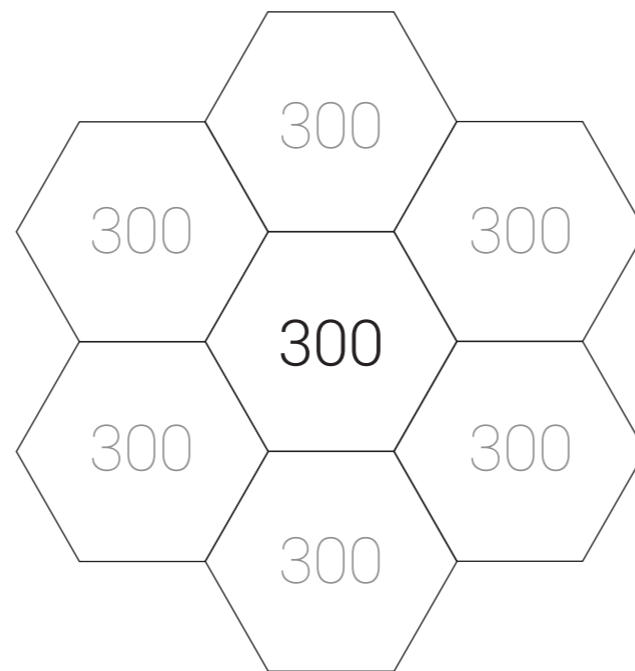

General types of Modules

Large public space

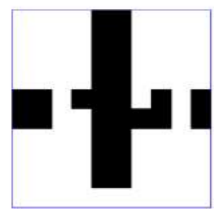
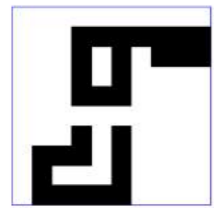
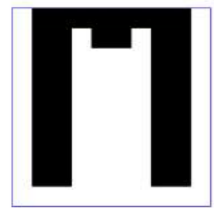
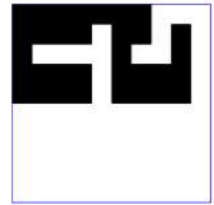

Medium spaces

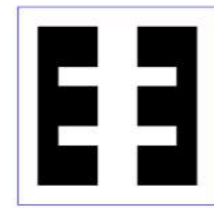
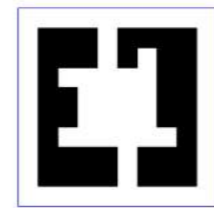
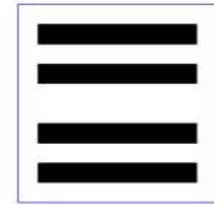
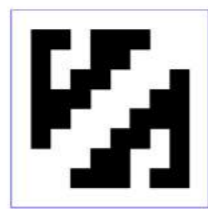
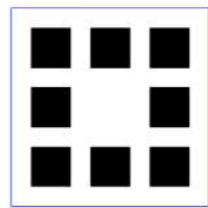
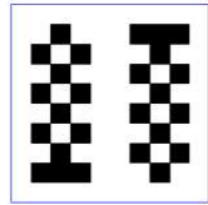

Small spaces

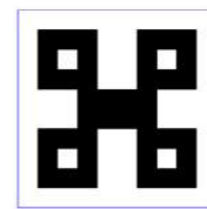
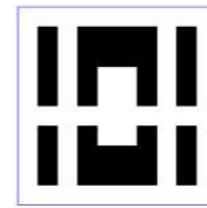
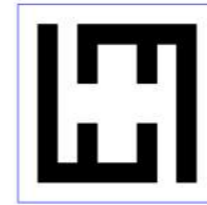

Dense housing

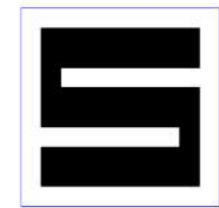
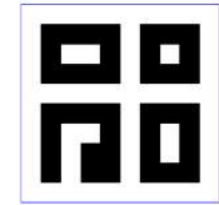
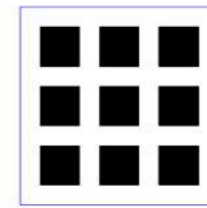
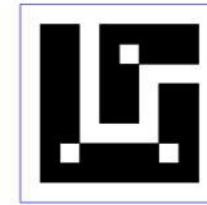

General types of Modules

Large public space

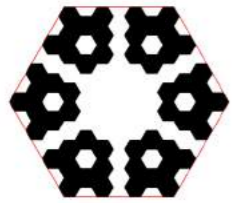
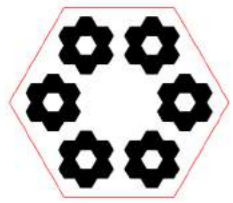
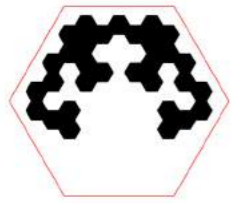
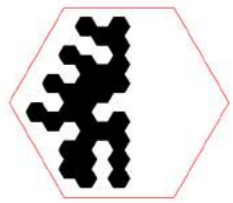

Medium spaces

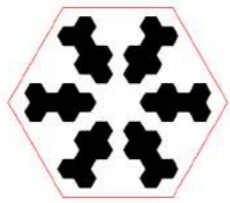
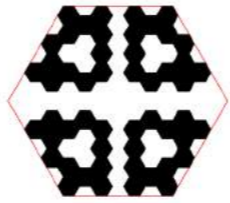
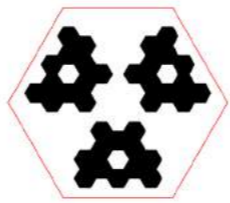
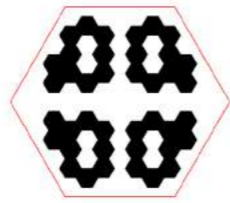
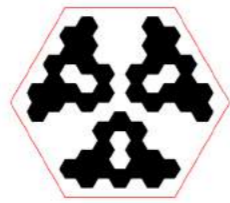
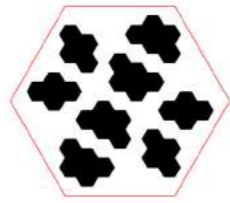
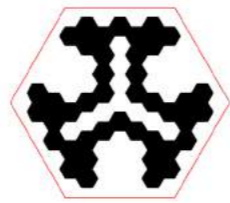

Small spaces

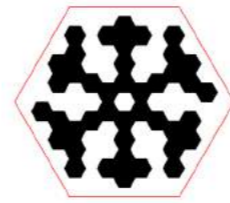
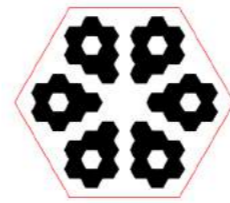
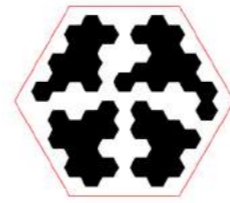
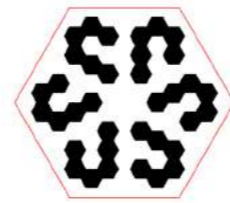

Dense housing

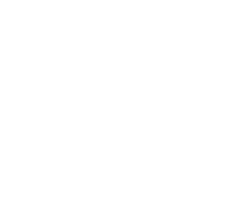
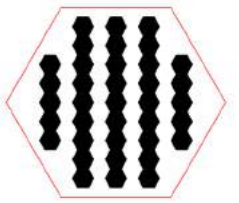
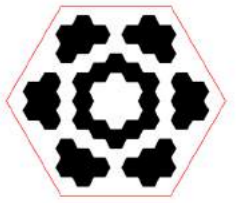
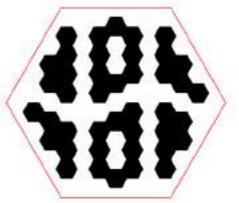
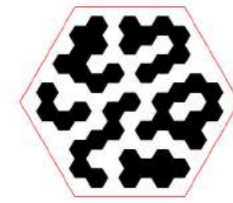
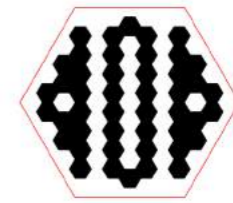
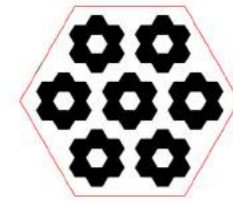
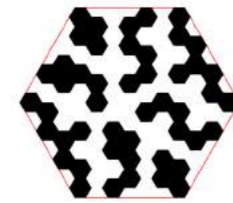

Requirements for selection

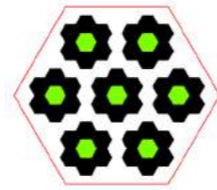

Number of Units



Courtyard Access

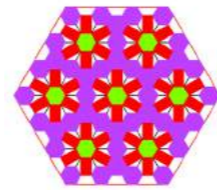

Public Space

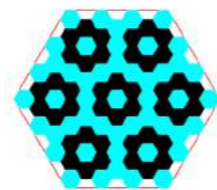

Water Collection

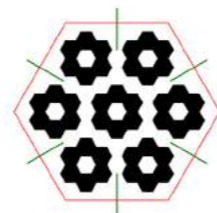

Accessibility

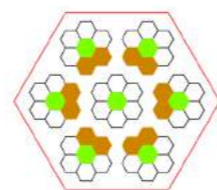

Quality of Views

Adaptation of Manila

	Number of Units	Courtyard Access	Public Space	Water Collection	Accessibility	Quality of Views	Score	Weight
Number of Units	1	1	1	1	1	1	5	3
Courtyard Access	0	1	1	1	1	1	4	3
Public Space	0	0	1	0	0	1	1	1
Water Collection	0	0	1	1	1	1	3	2
Accessibility	0	0	1	0	1	1	2	2
Quality of Views	0	0	0	0	0	1	0	1

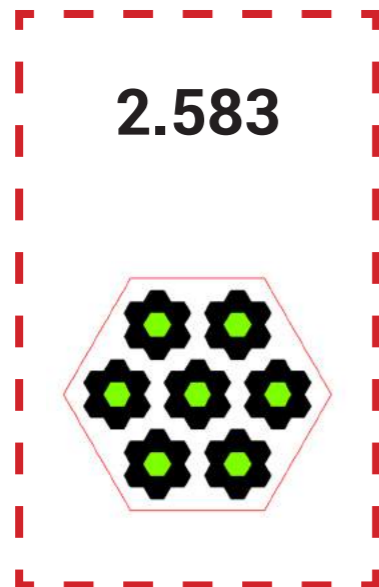

2.25

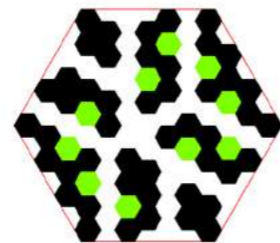

1.917

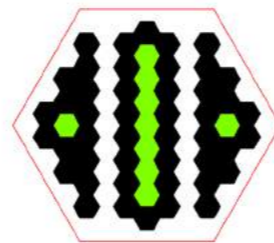

1.667

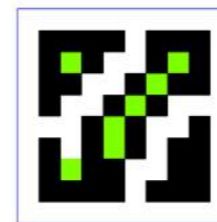

1.667

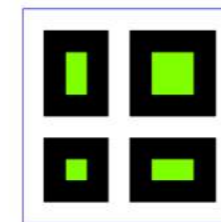

2.25

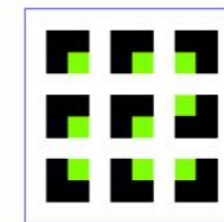

Evolutionary Variations

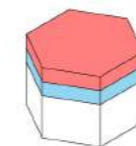
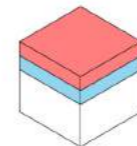
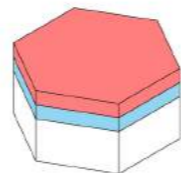
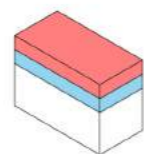
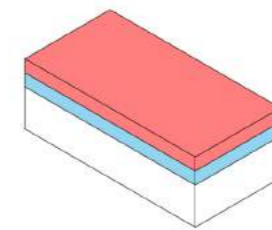
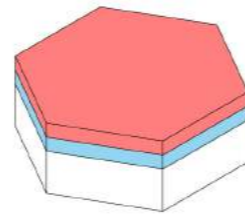
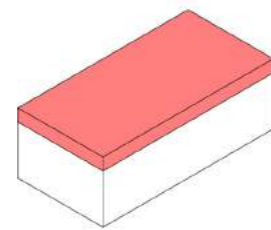
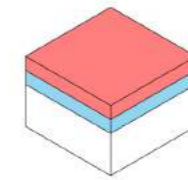
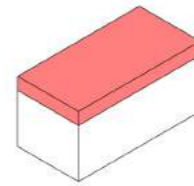
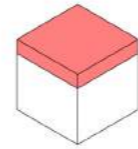
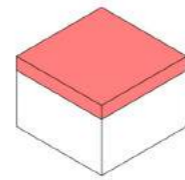
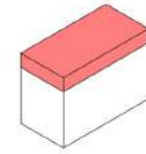
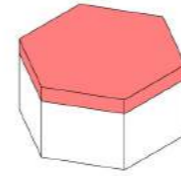
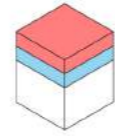
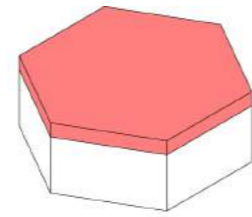

Adaptation of Manila

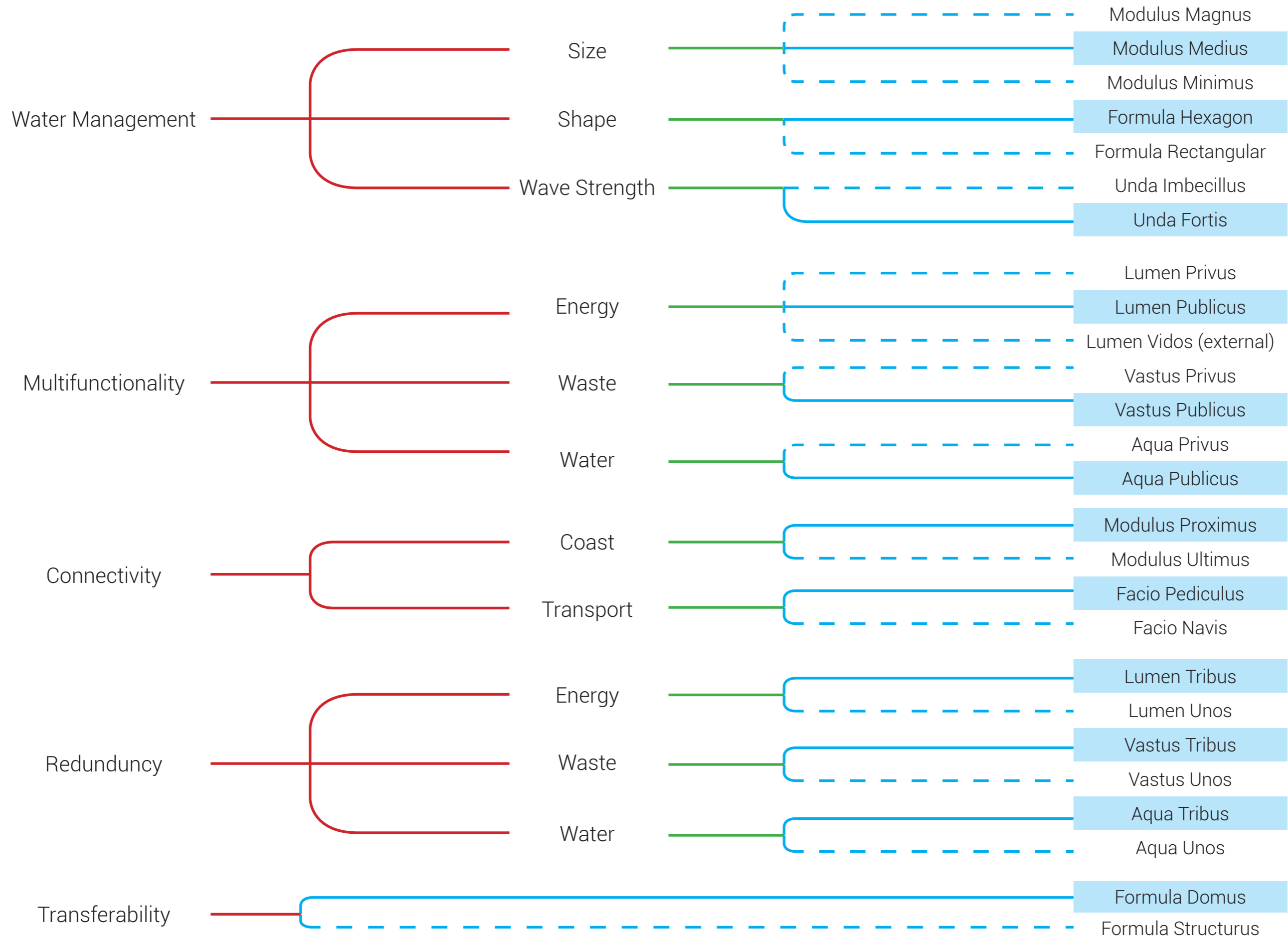

Size of prototype community

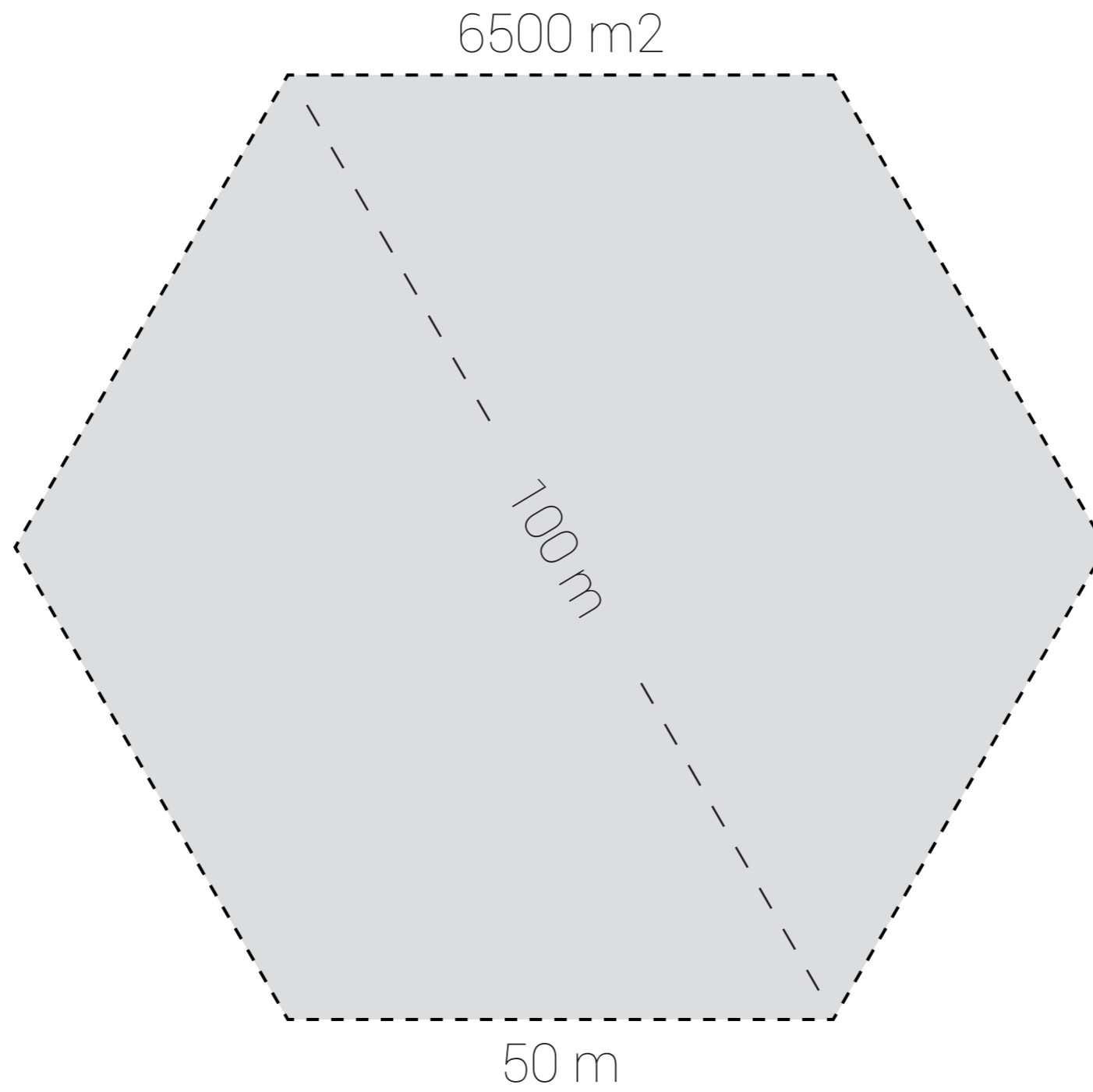

Infrastructure

Distribution of urban services

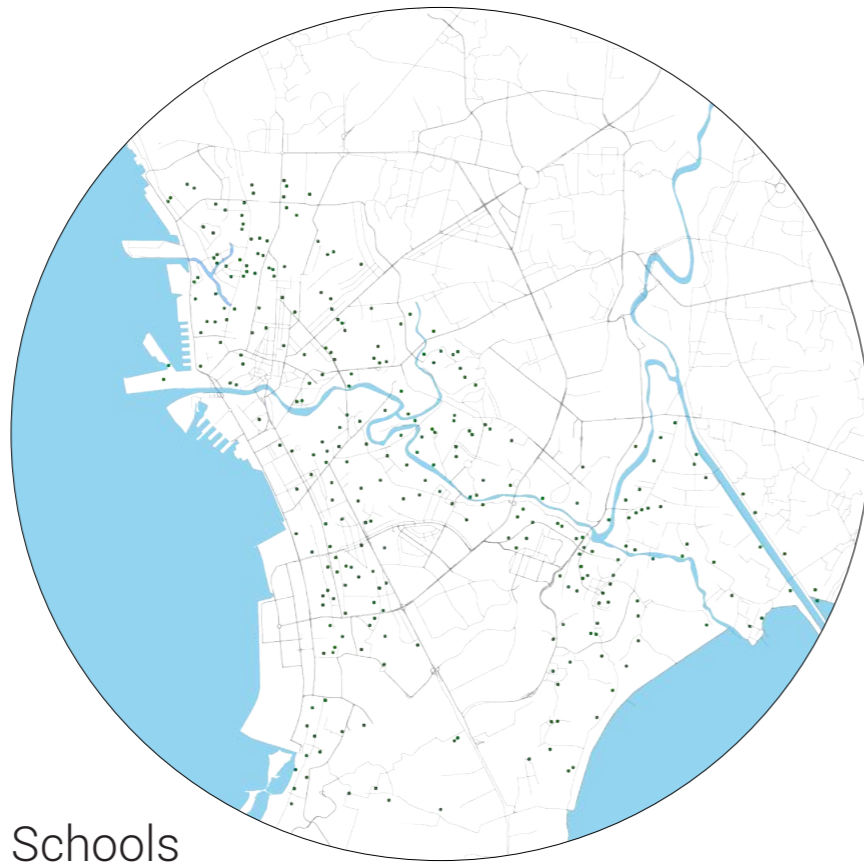

Schools

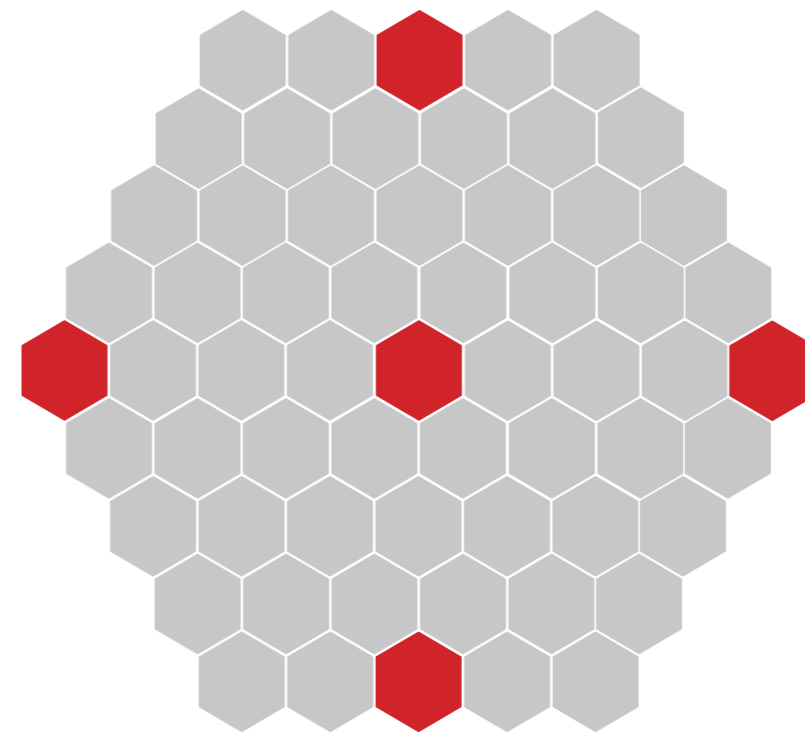

Hospitals

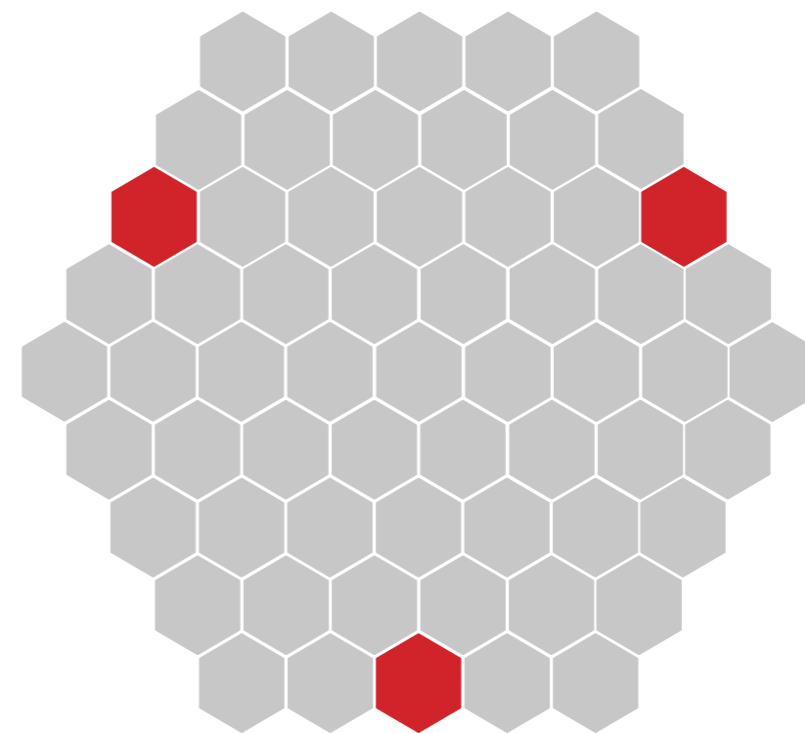

Employment radius

The average distance from **slum to work** is 2.5 km.

The intervention in Manila should therefore be kept at a close distance to shore, **adapting** to the local patterns.



Public buildings

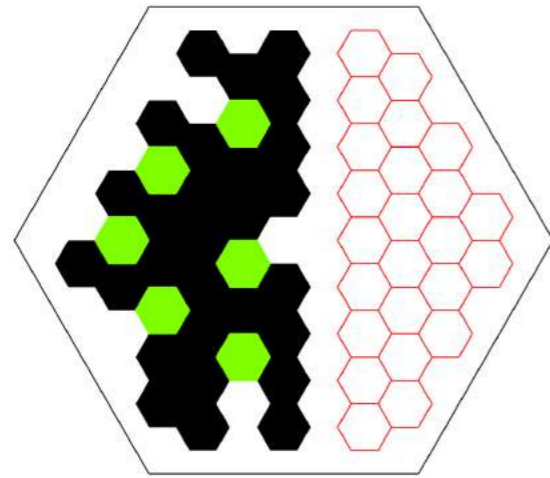

Area

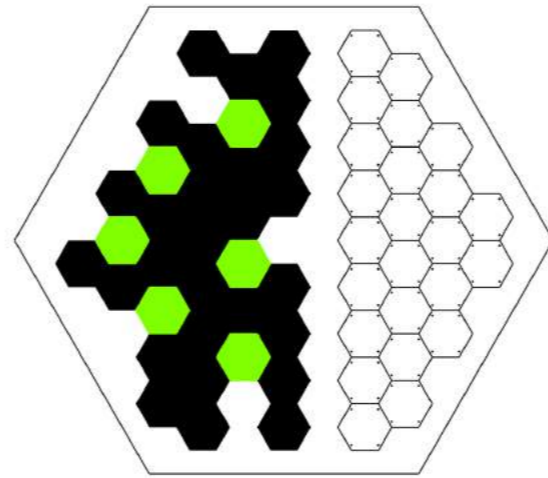

Columns

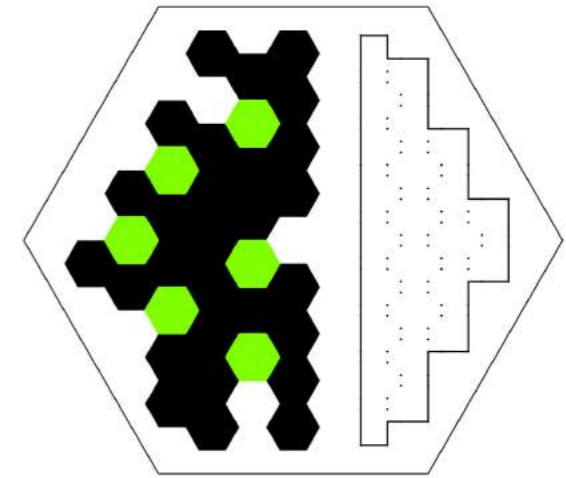

Footprint

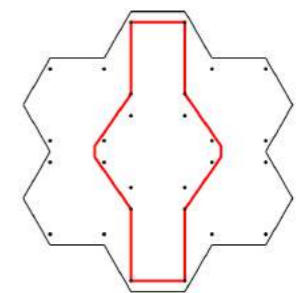
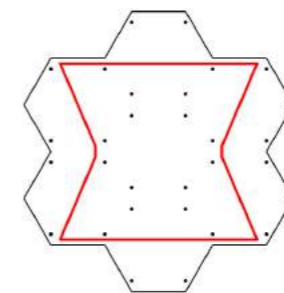
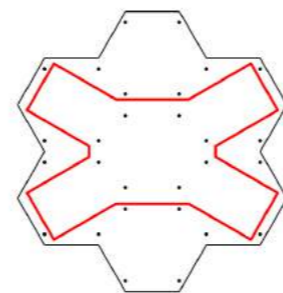
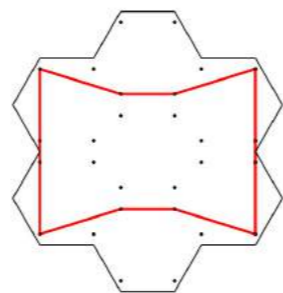
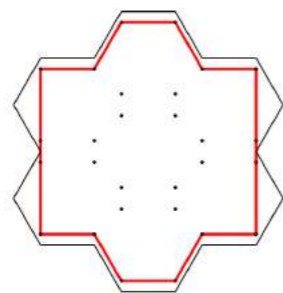
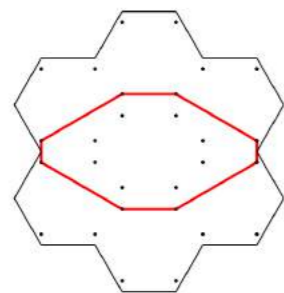
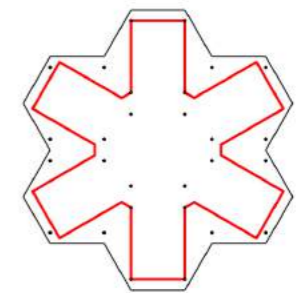
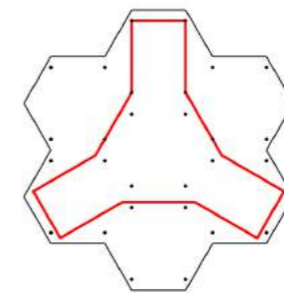
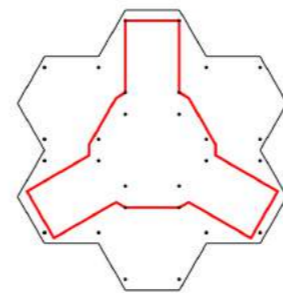
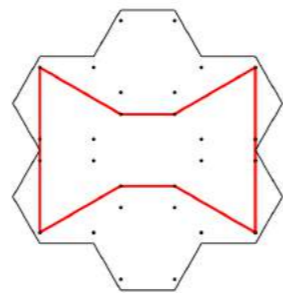
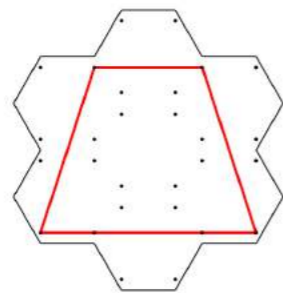
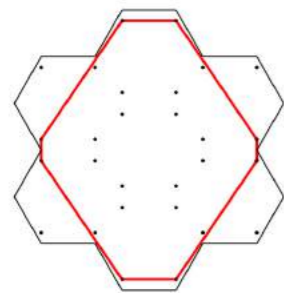
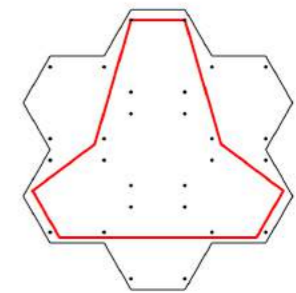
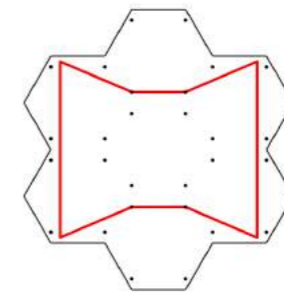
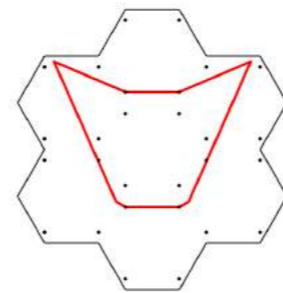
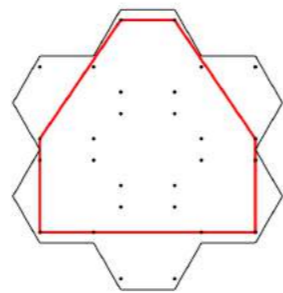
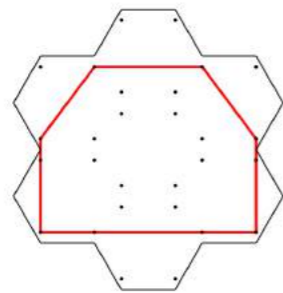
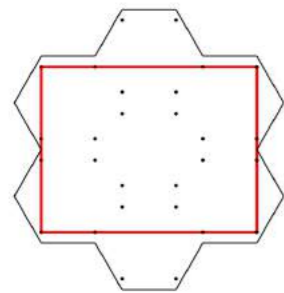

Power to the people

Manila - W / m² / Day

~1800

Solar Panel Tilt (Avg.)

20 degrees from Horizontal

Typical Solar Panel

1.64 m² - 17% efficiency

Output / Day

~1 Kwh

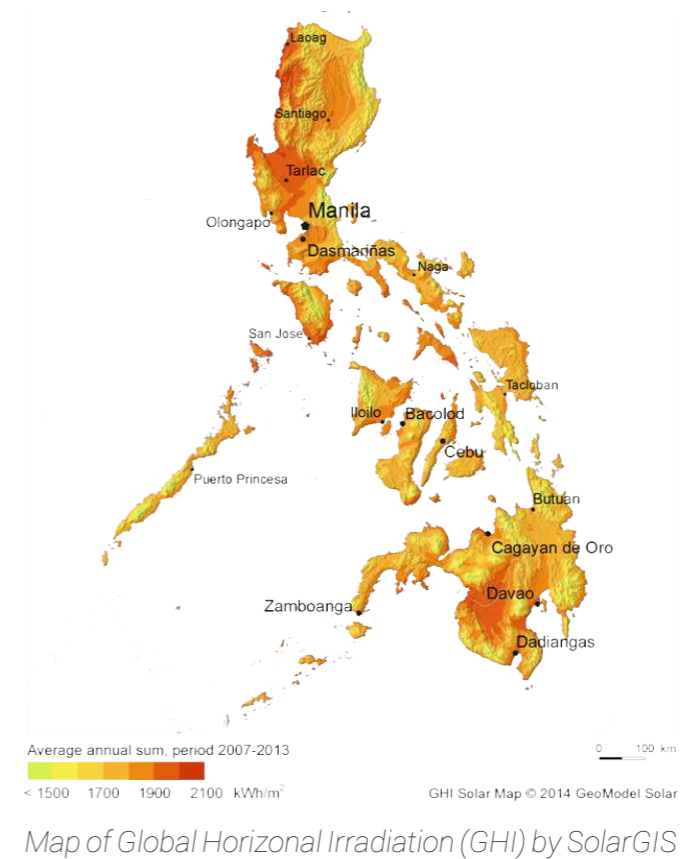

	w/hour MIN	w/hour MAX	Hours / day	Kwh/day MIN	Kwh/day MAX
Ventilation Fan	10	25	6	0.06	0.15
Lightbulb	25	100	6	0.15	0.6
TV	80	400	6	0.48	2.4
Refrigerator	100	400	24	2.4	9.6
Electric Stove	1000	1500	1	1	1.5
Total				4.09	14.25

Power to the people

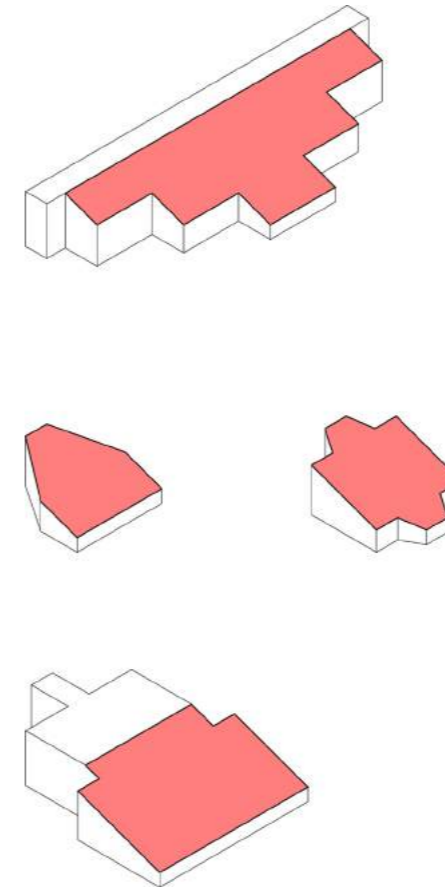
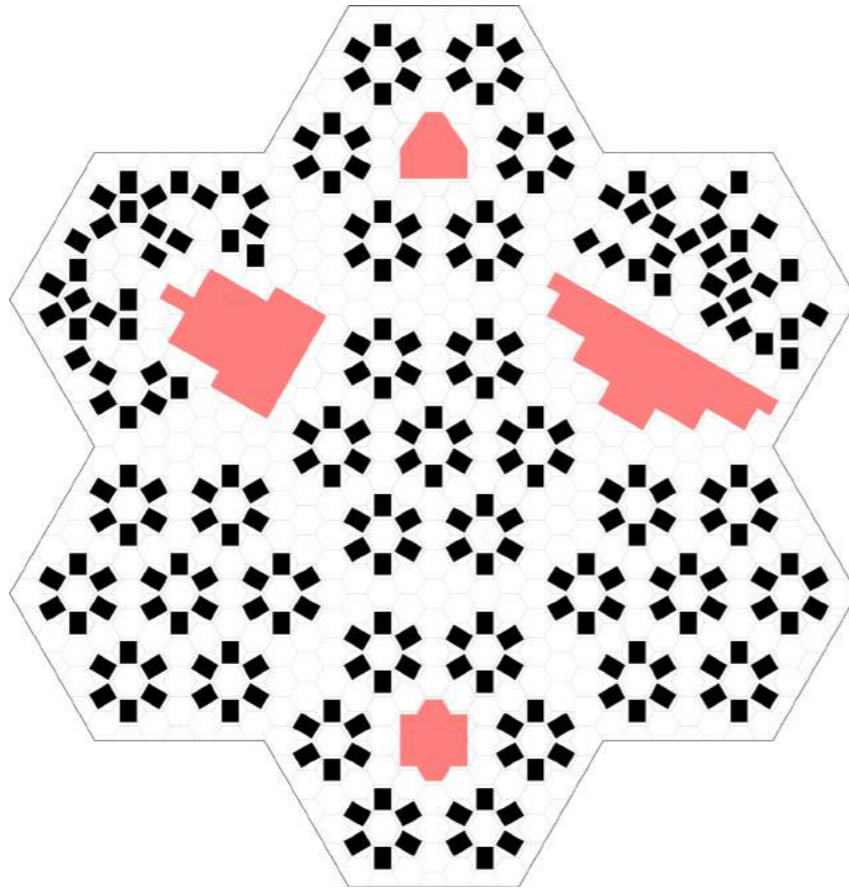

Roof area : 2508 m²

Families : 257

Solar panels : 1529

Kwh / Family : 5.95



Water from the sky

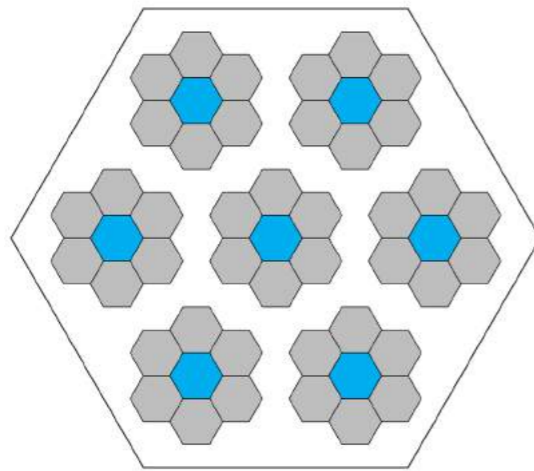

Storage
325m³ / Pod

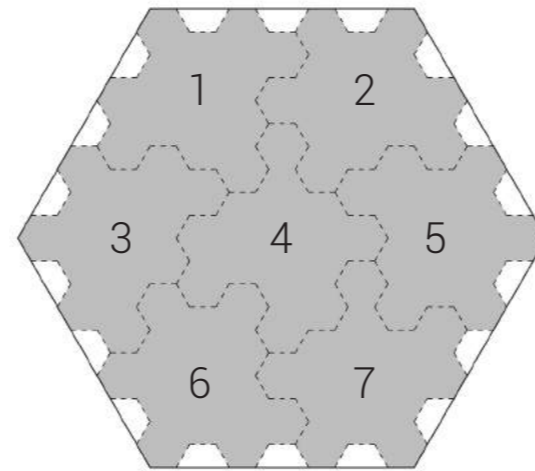

Sectors

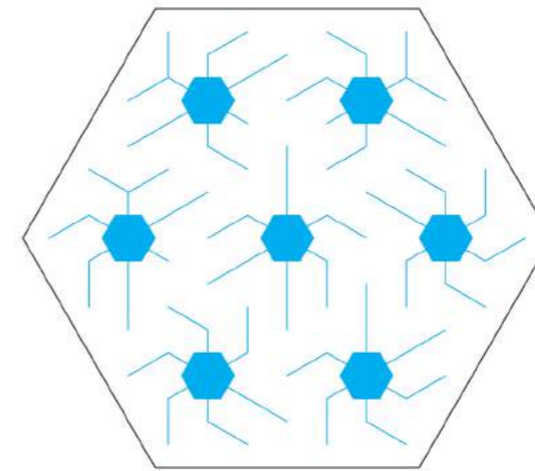

Pipes

Liter storage over time

	July	August	September	October	June
1 Pod	23010	30810	26065	11830			18655
2 Pod	28020	71640	105770	111430			51930

Constructed wetland

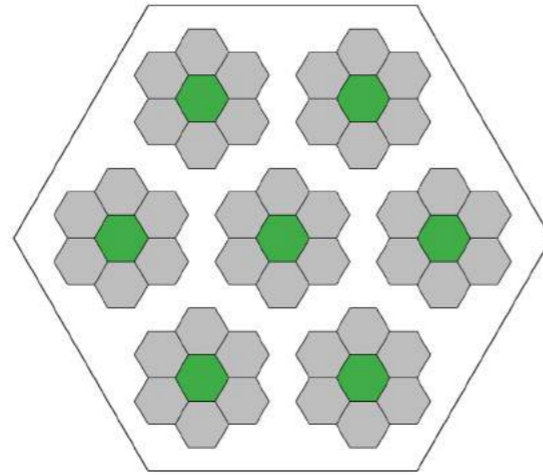

Common Gardens

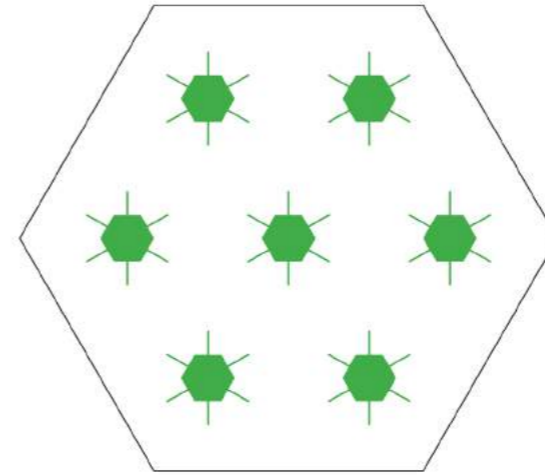

Pipes

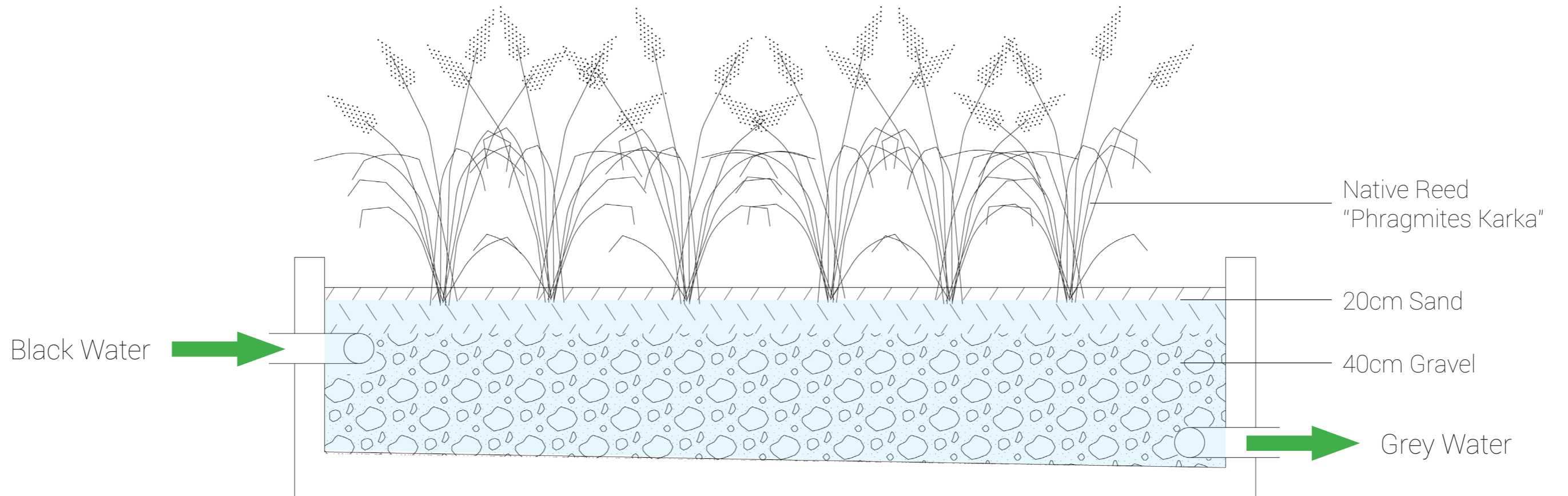

Water and Waste flows

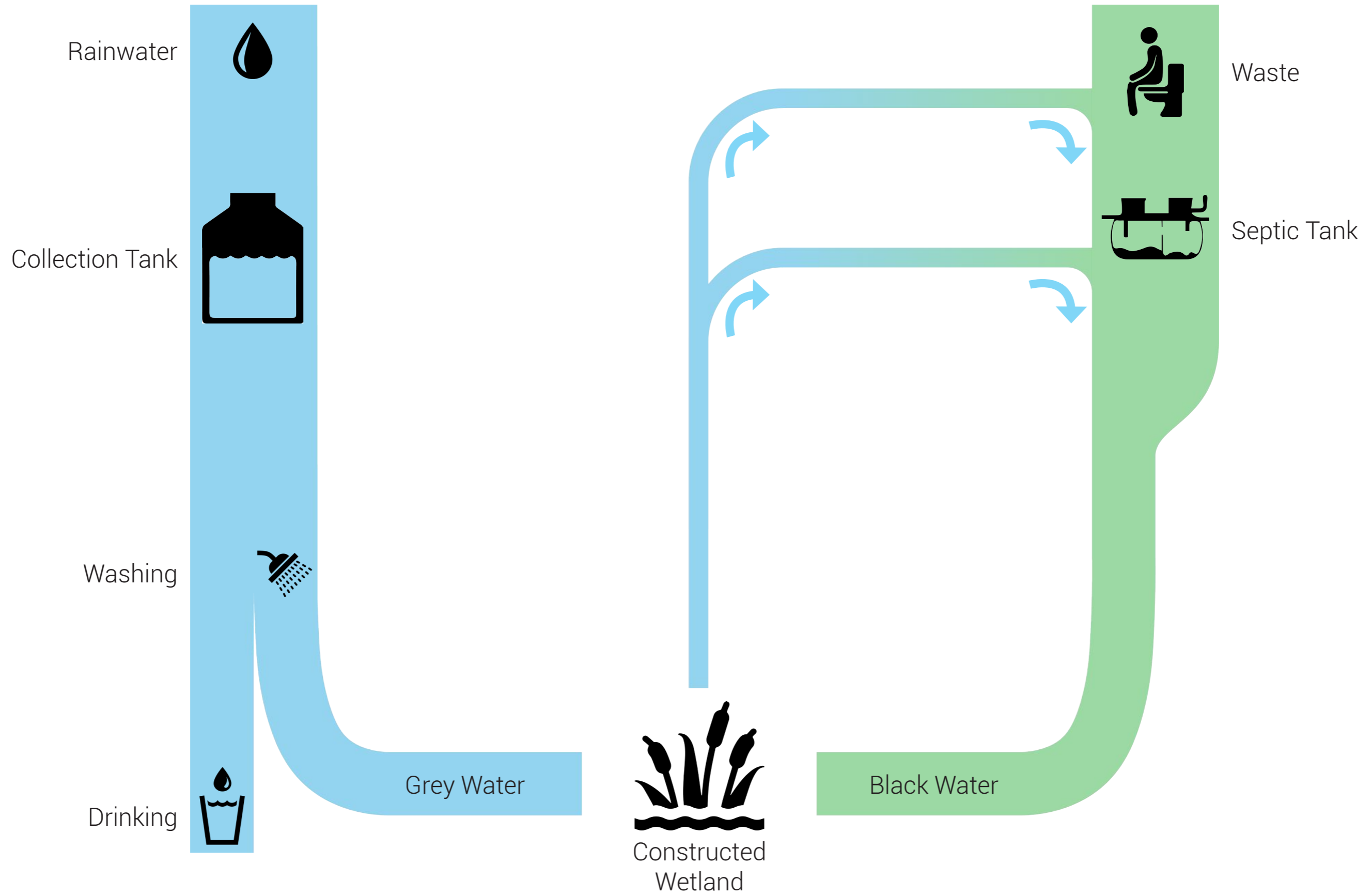

How to make a "module"?

Employment

Local materials

Circular usage

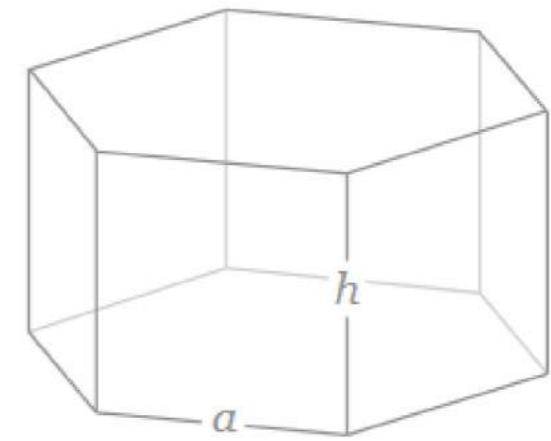

Choosing a material for modular pod

	HDPE (plastic)	Concrete	Wood	Steel
Weight	●	●	●	●
Durability	●	●	●	●
Sustainability	●	●	●	●
Strength	●	●	●	●
Cost	●	●	●	●

● Good

● OK

● Bad

Pods and Caps

Street Pod

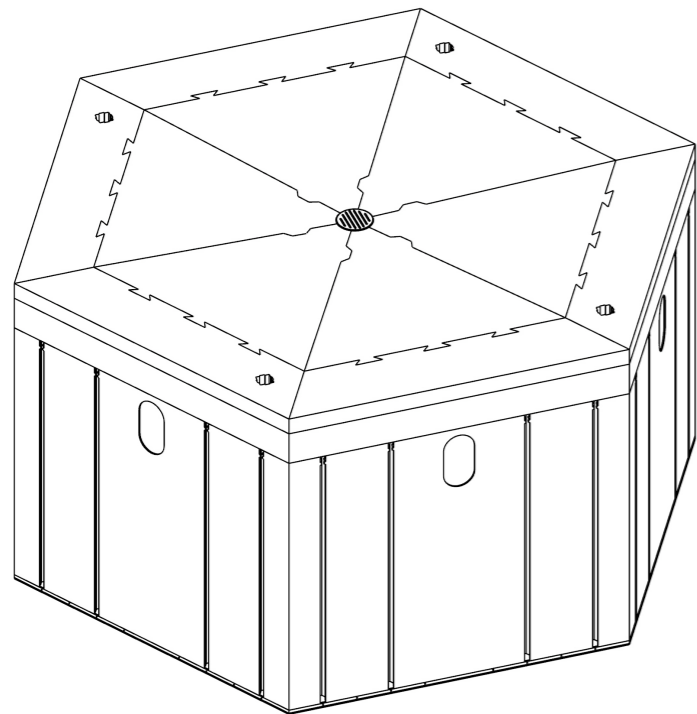

1% slope IN

Bouyancy chamber

Wetland Pod

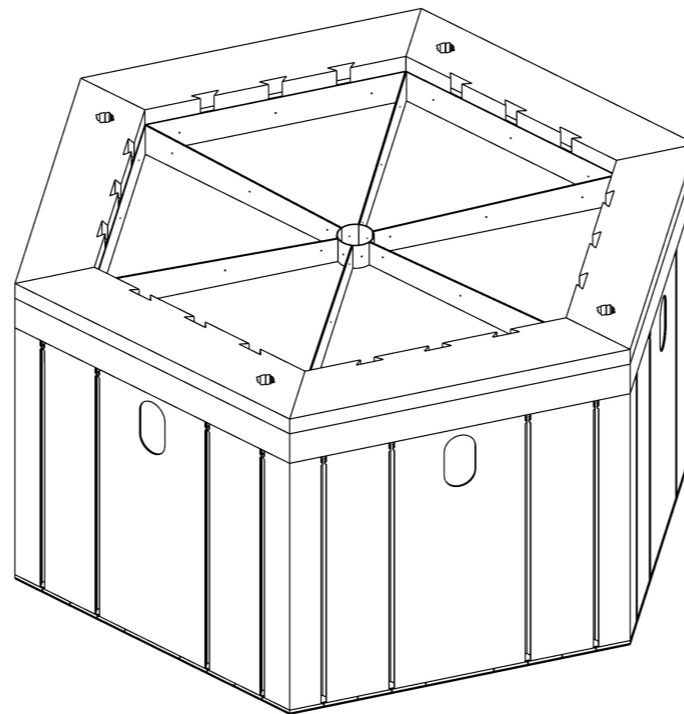

Wetland soil

Rainwater tank

Septic tank

Family Pod

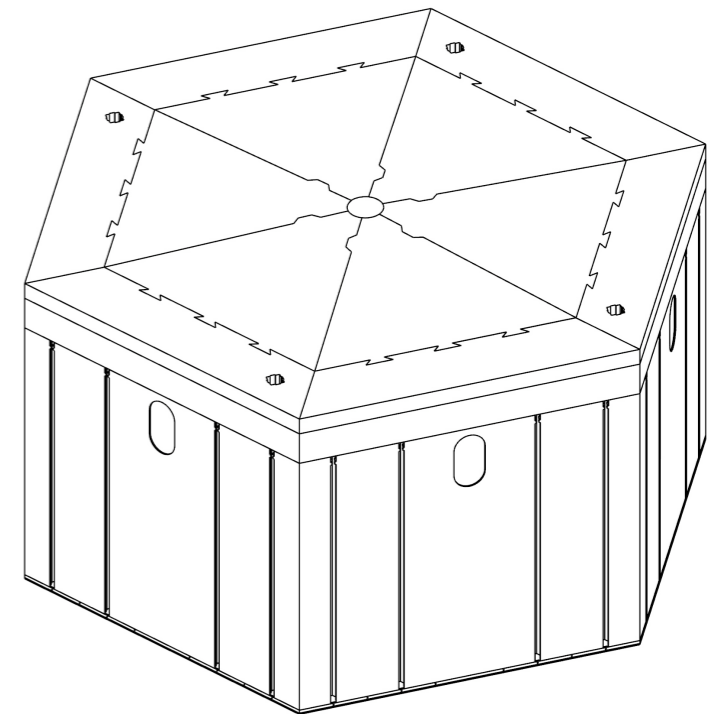

1% slope OUT

Bouyancy chamber

Multiple uses

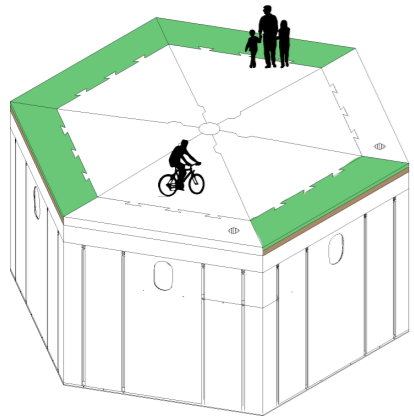

Low green

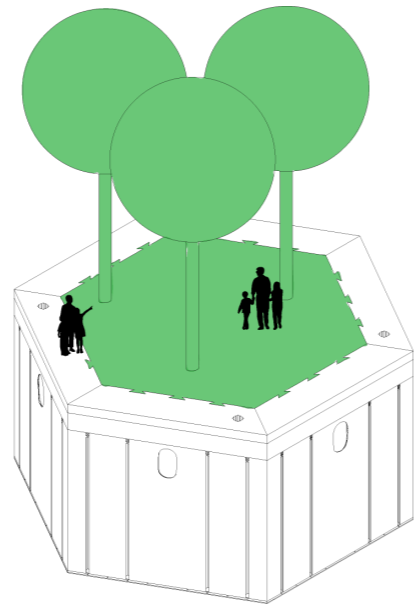

Trees

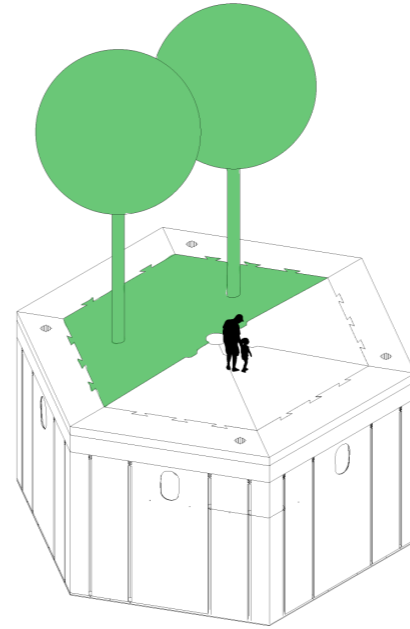

Trees + Street

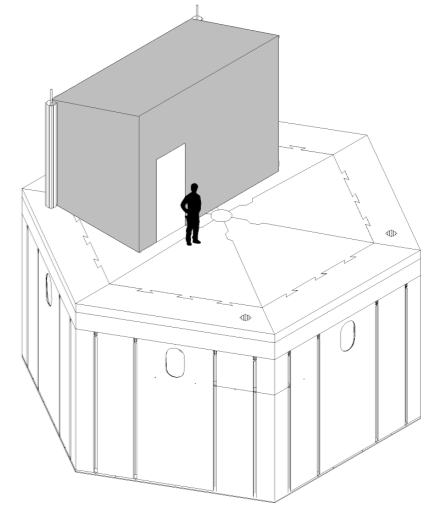

Public bathroom

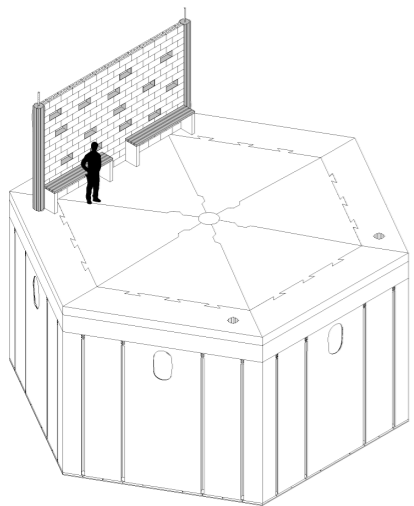

Socializing

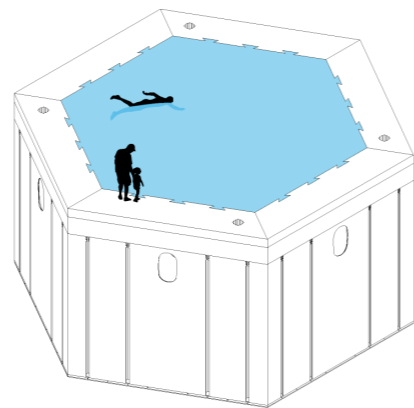

Water feature

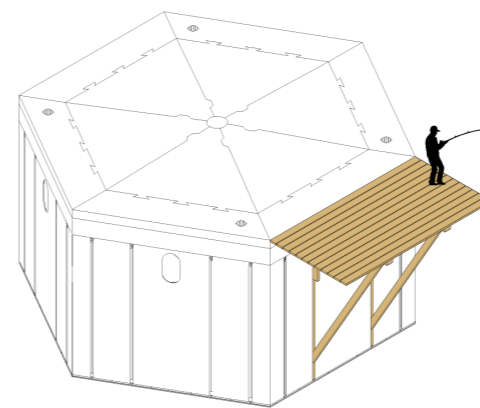

Small deck

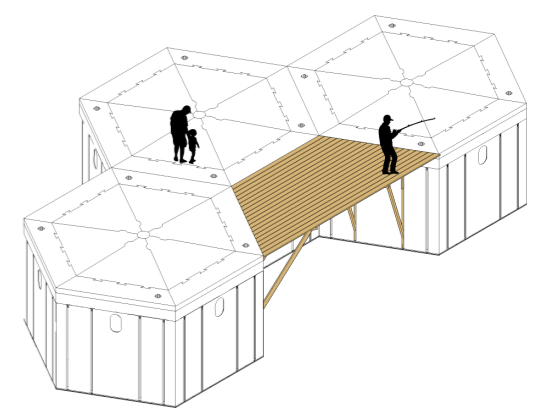

Large deck

Bouyancy chamber - Pod

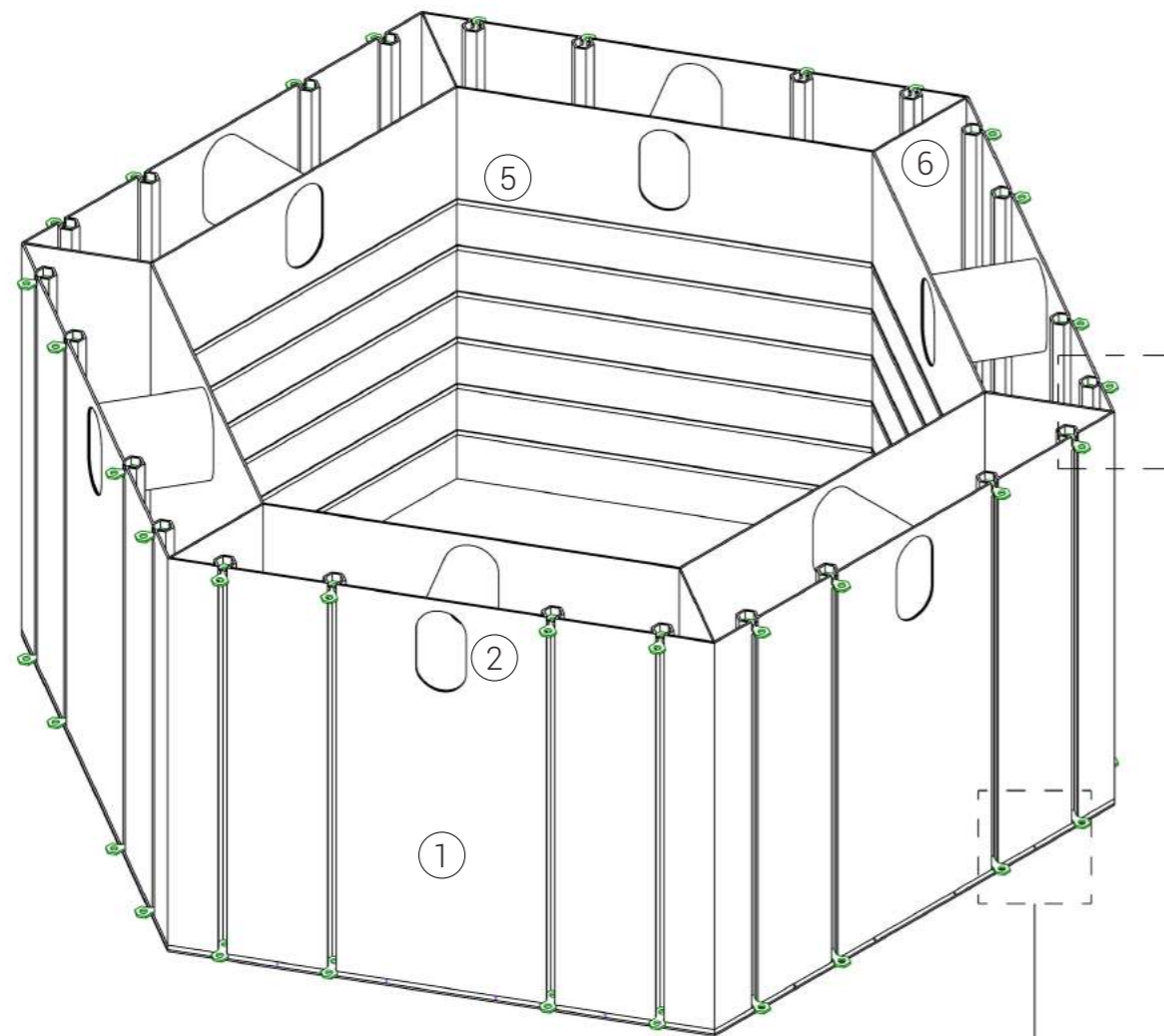

Corner joint

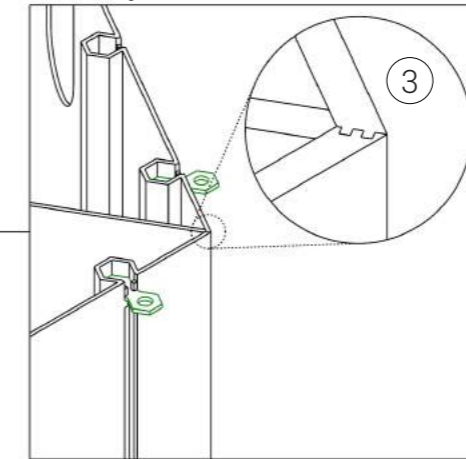

Interlocking mechanism between pods

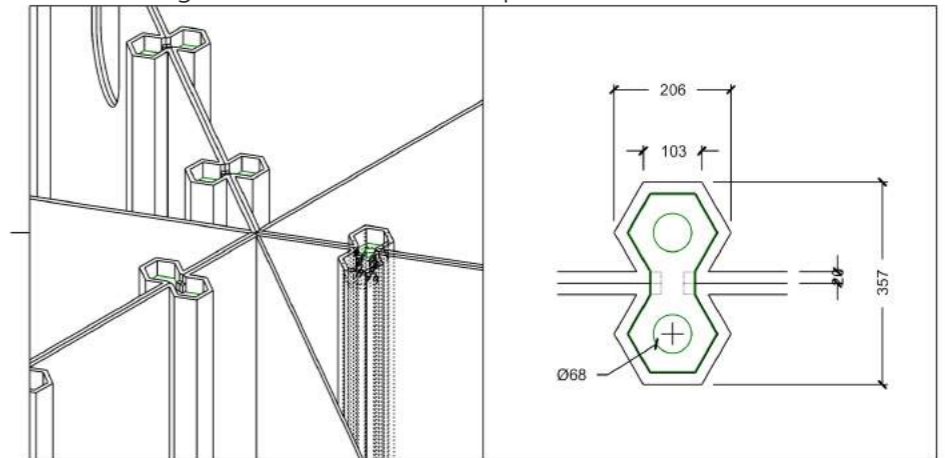

Connecting HDPE bolts

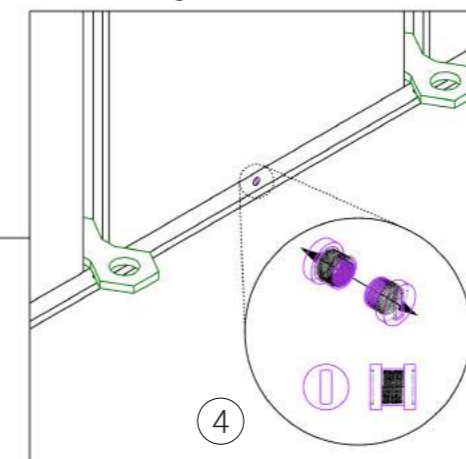

- ① 2cm HDPE panel
- ② Water and waste service tunnel
- ③ Zigzag connection between panels
- ④ HDPE 2cm bolts
- ⑤ 2cm inner HDPE panel with reinforcing ribs
- ⑥ 2cm corner HDPE panel for rigidity - 1m cavity chamber

Pod layers

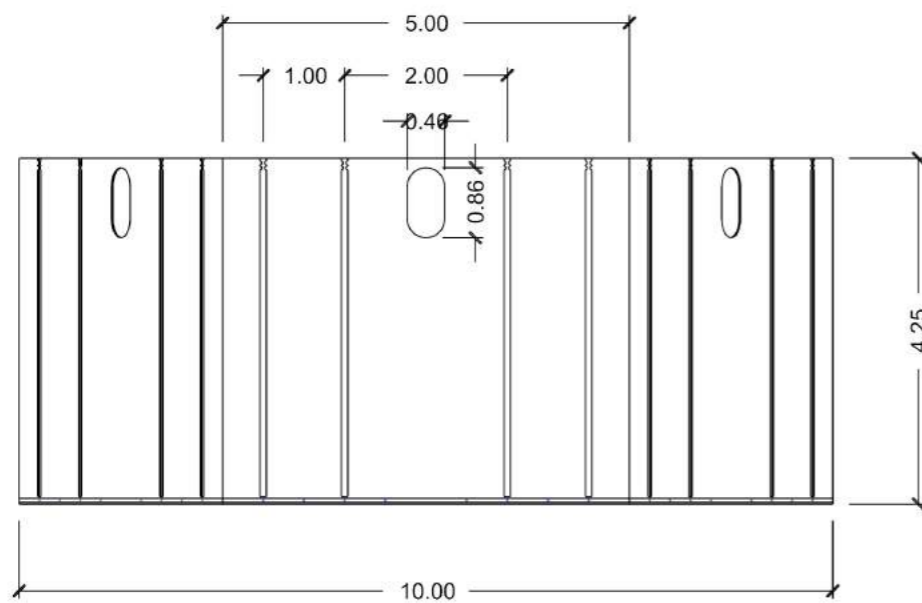
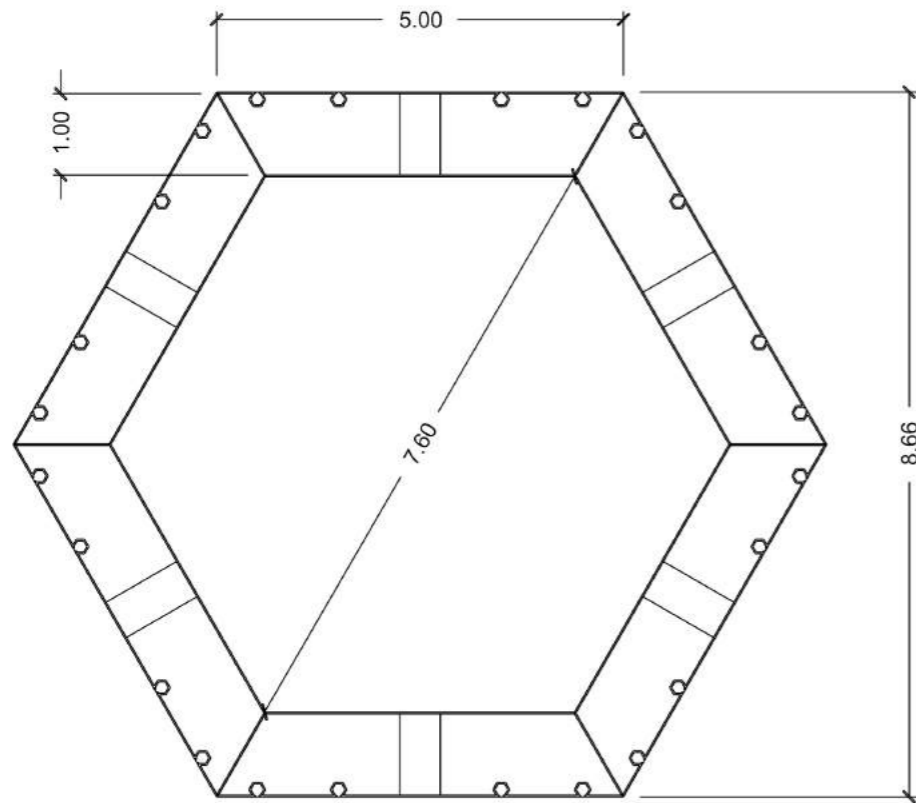

25cm thick reinforced concrete cap modules

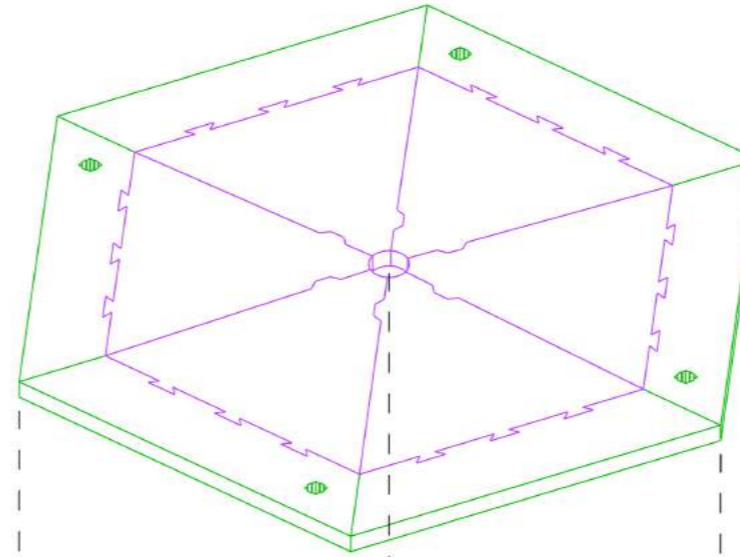

50cm thick 2cm HDPE service modules

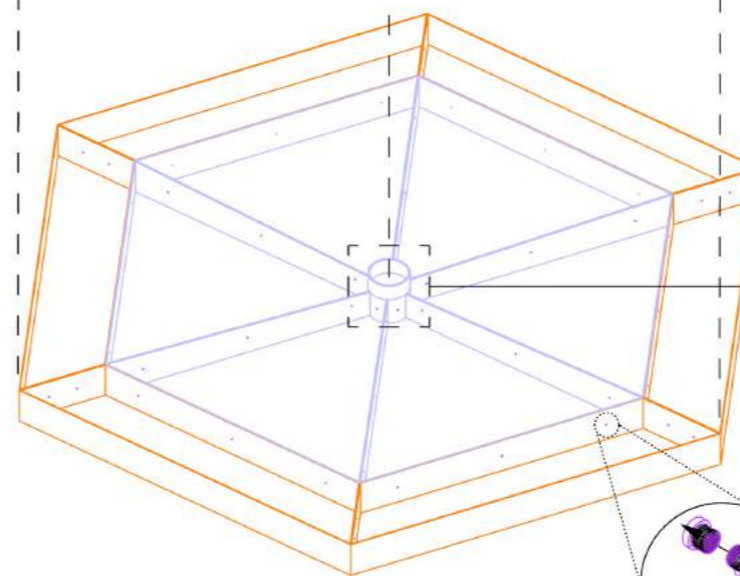

Center HDPE holding ring (optional)

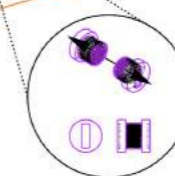
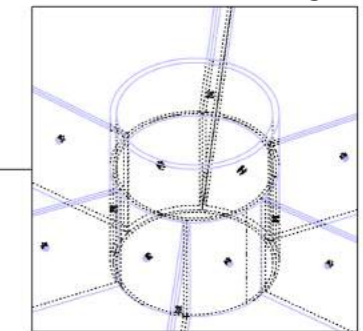

Assembly package

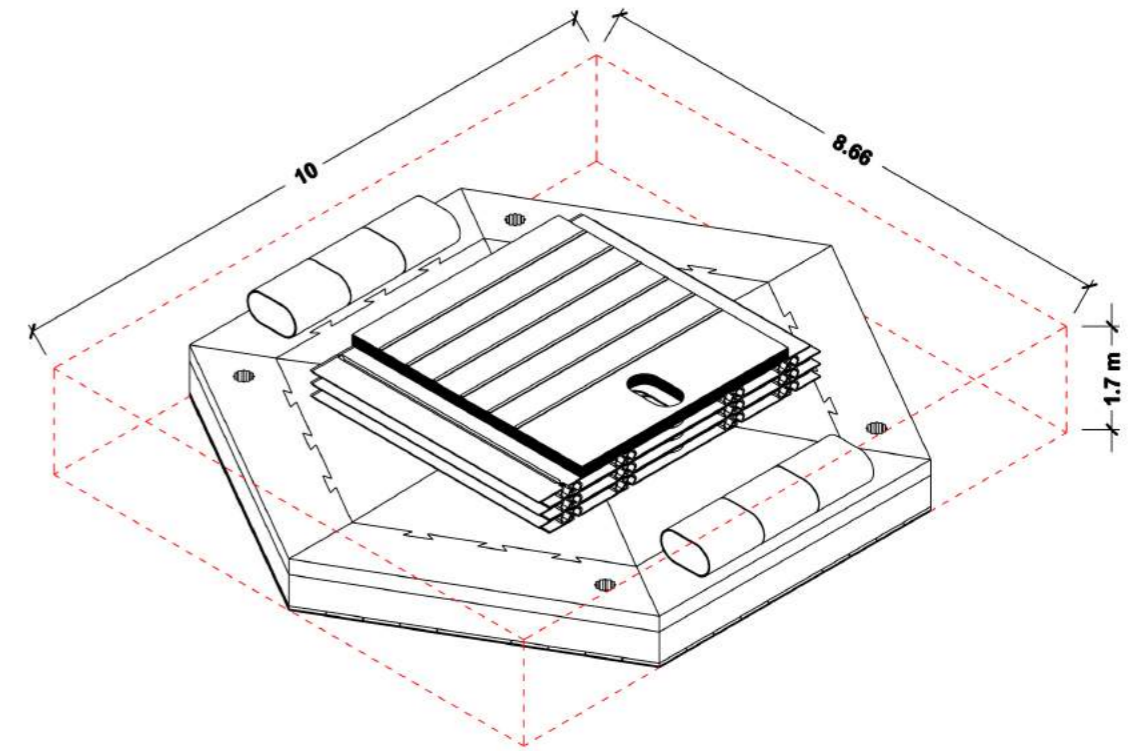
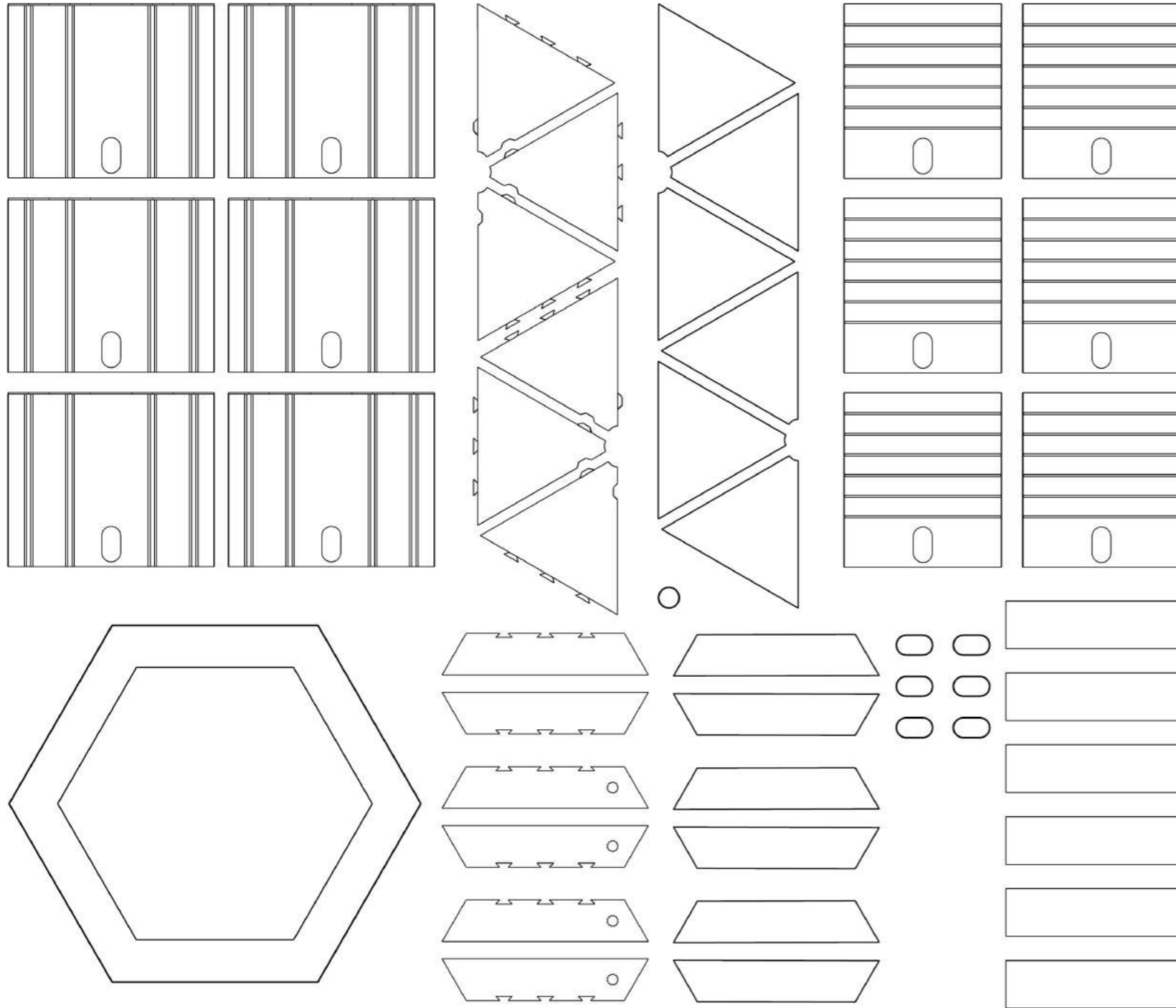

Street Pod

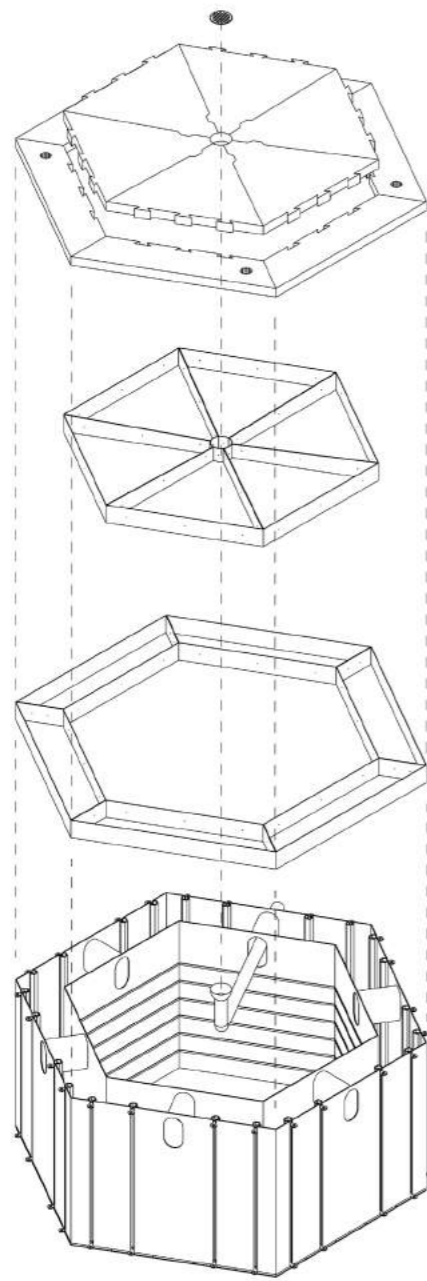

Wetland Pod

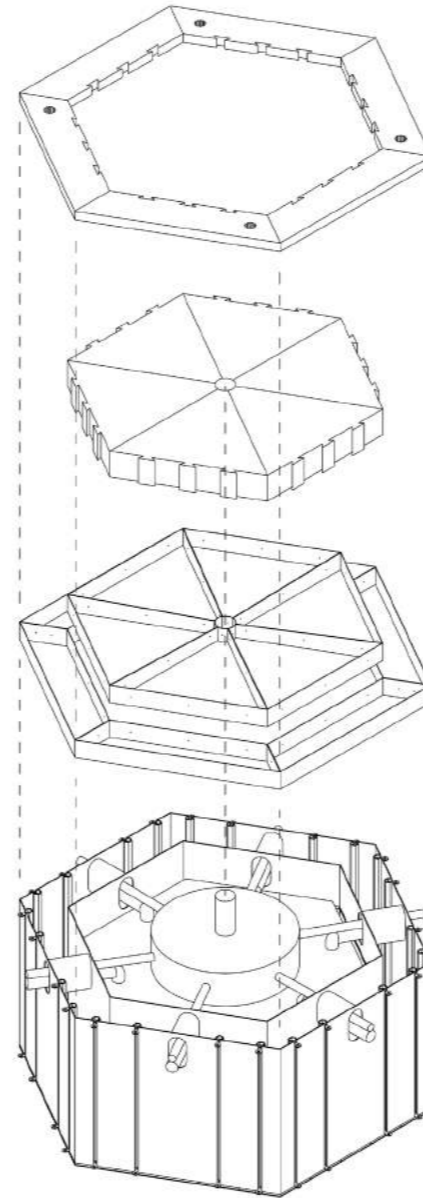

Family Pod

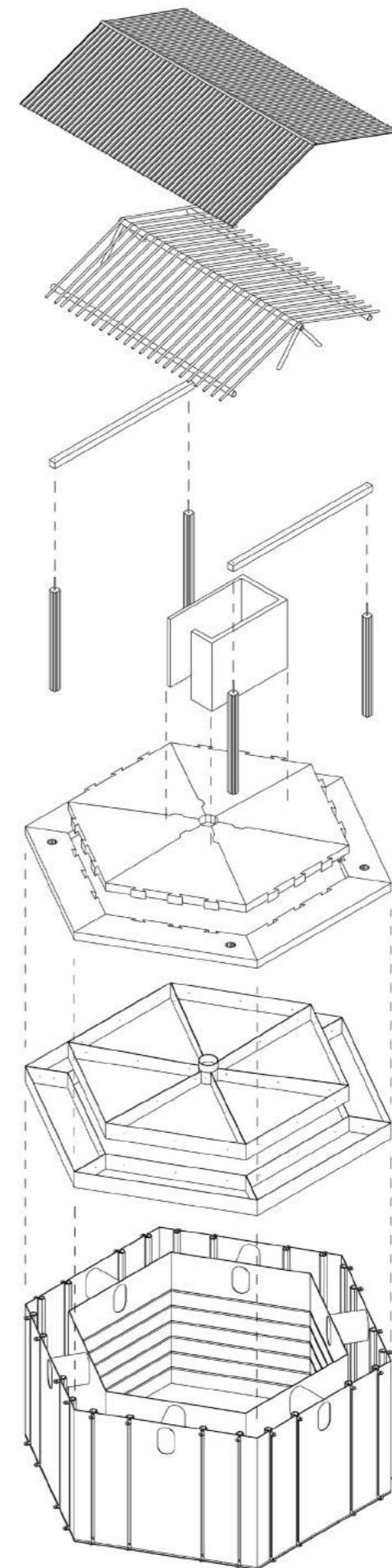

Housing for the Urban Poor





Vernacular huts / Vernacular slums

Coco Lumber



Wood Scraps



Nipa Hut



Slum

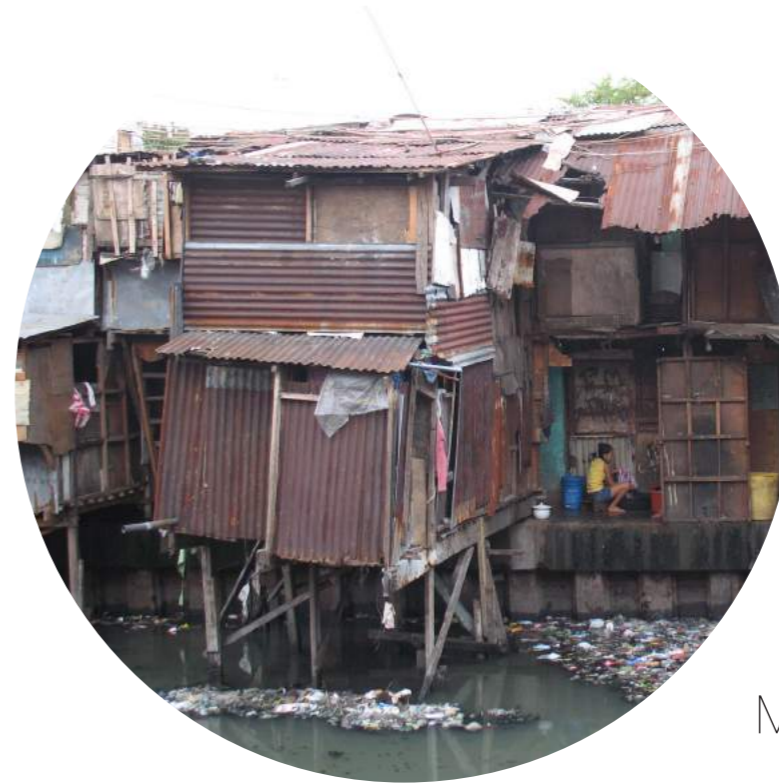

Bamboo



Plastics



Nipa Palm



Metal Sheet



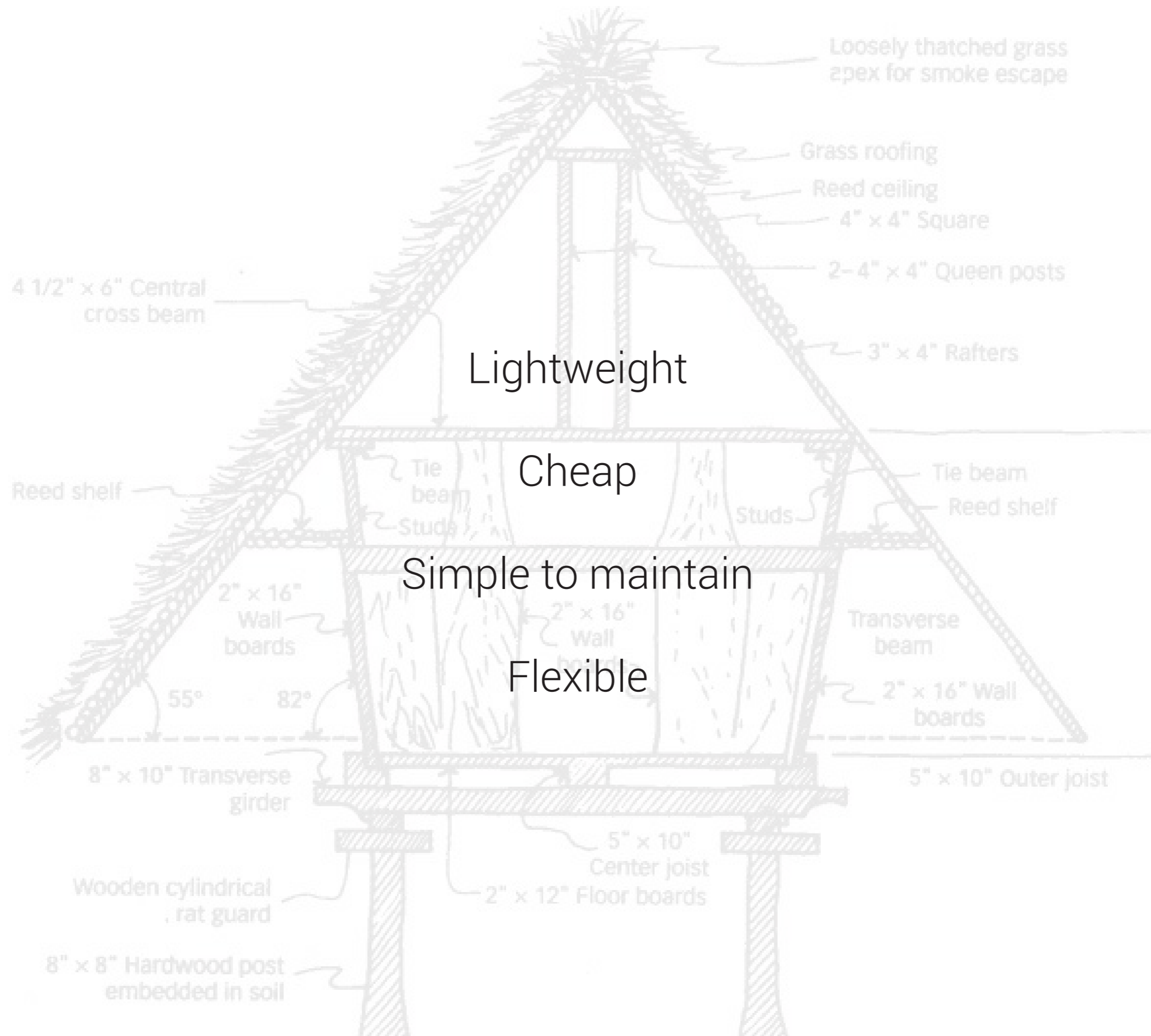



35 m2 core

Kitchen



Shower



Solar Heating



Toilet



STRUCTURE

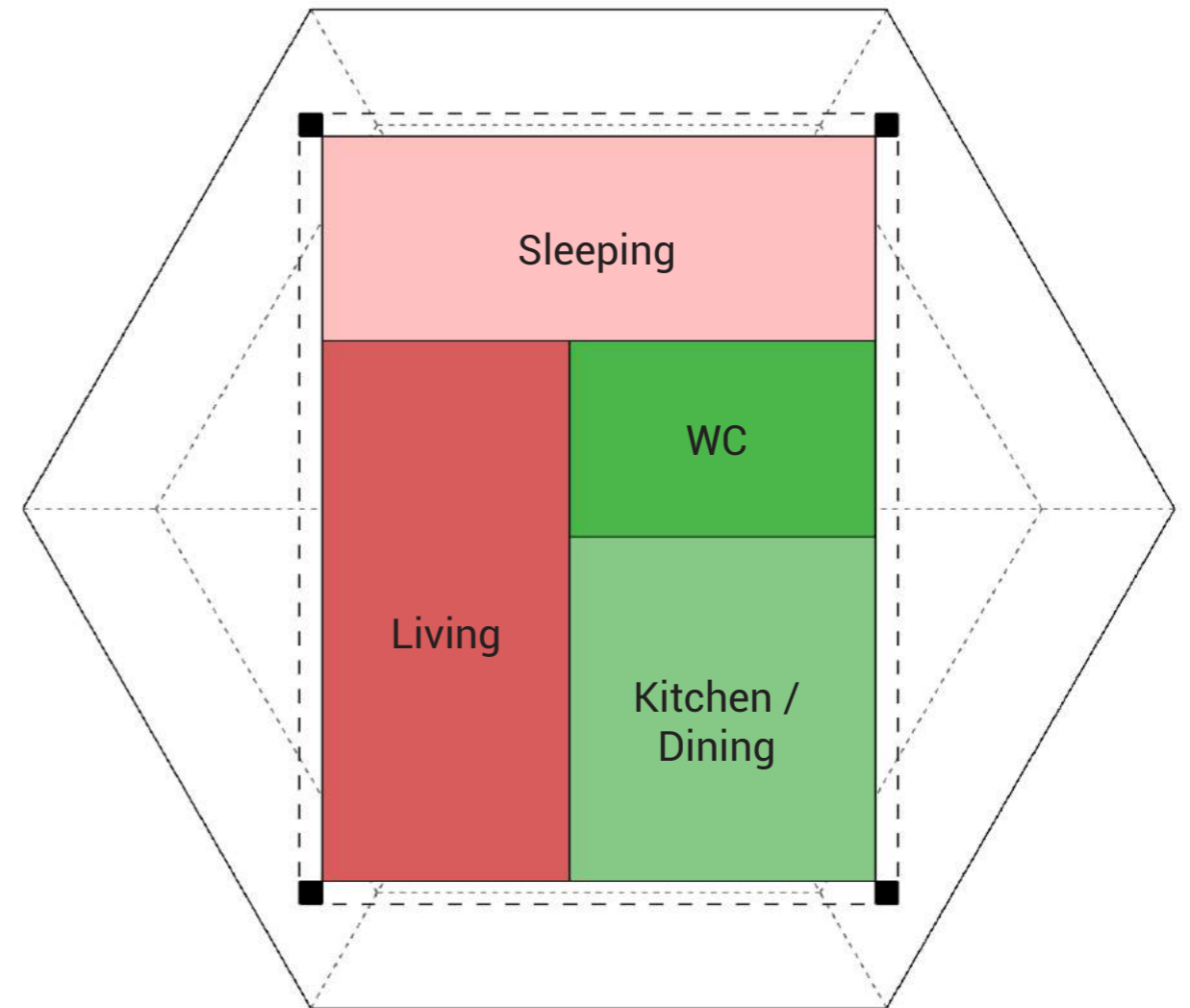
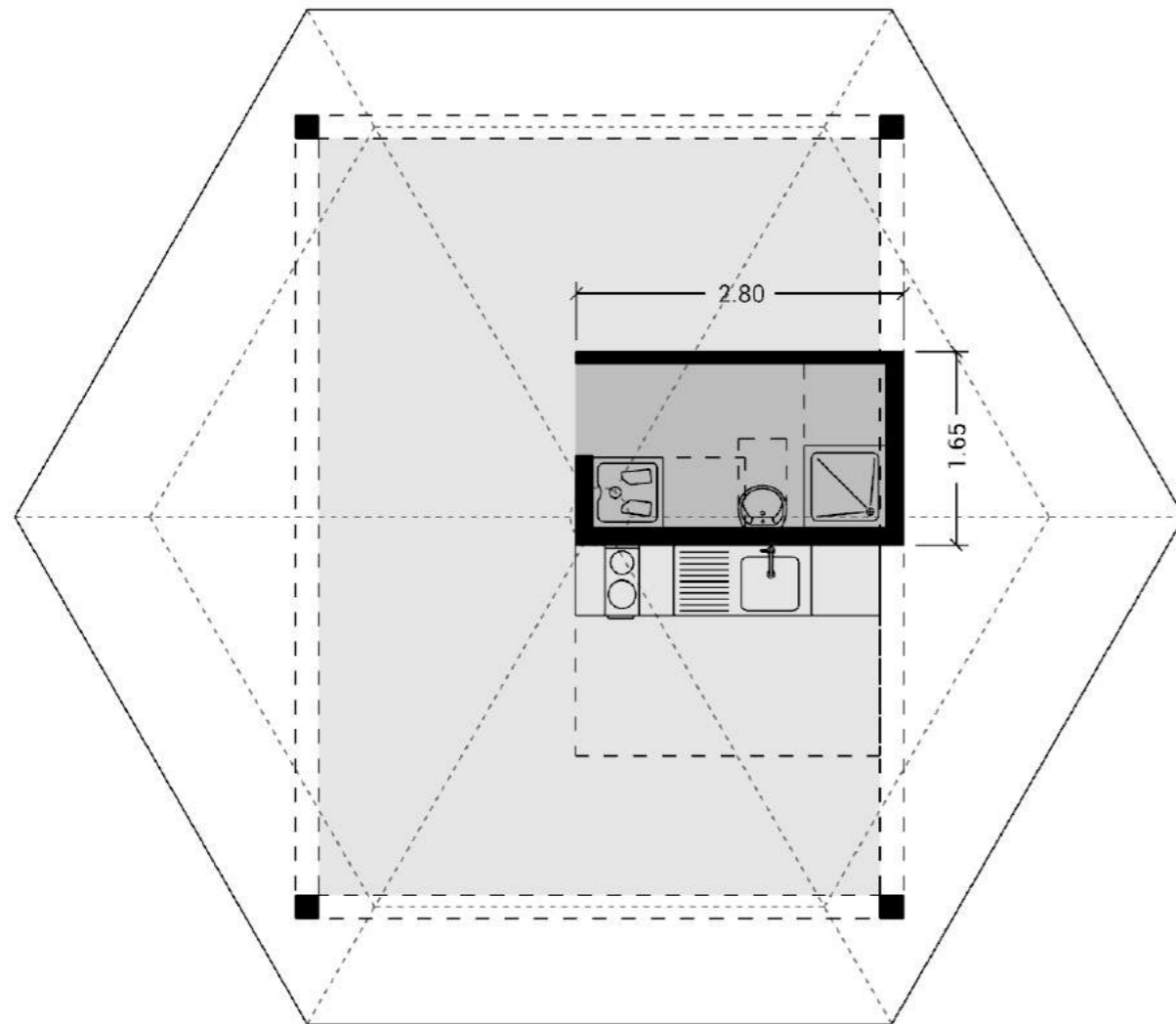

35 m² / floor

5-7 people

Prefab elements

Local materials

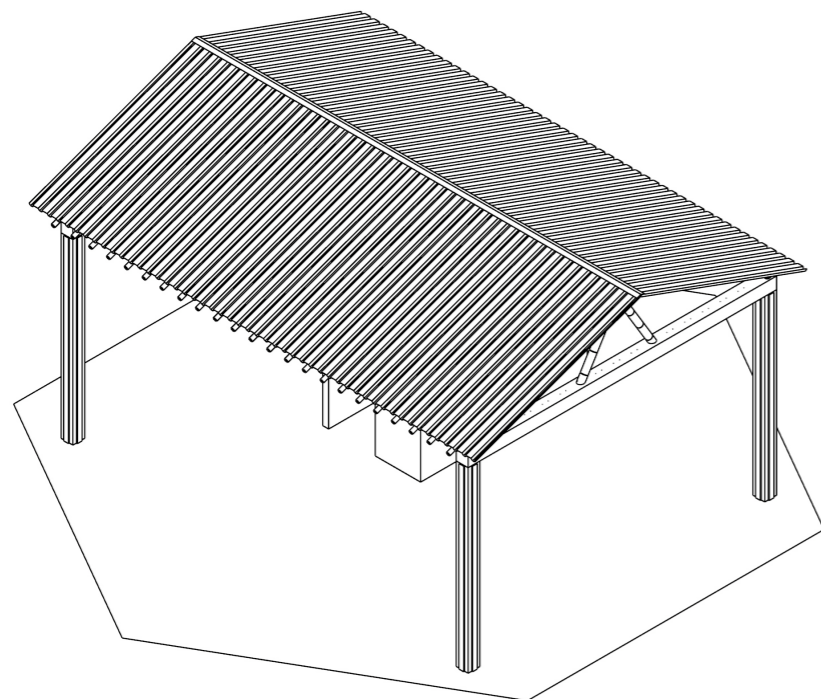
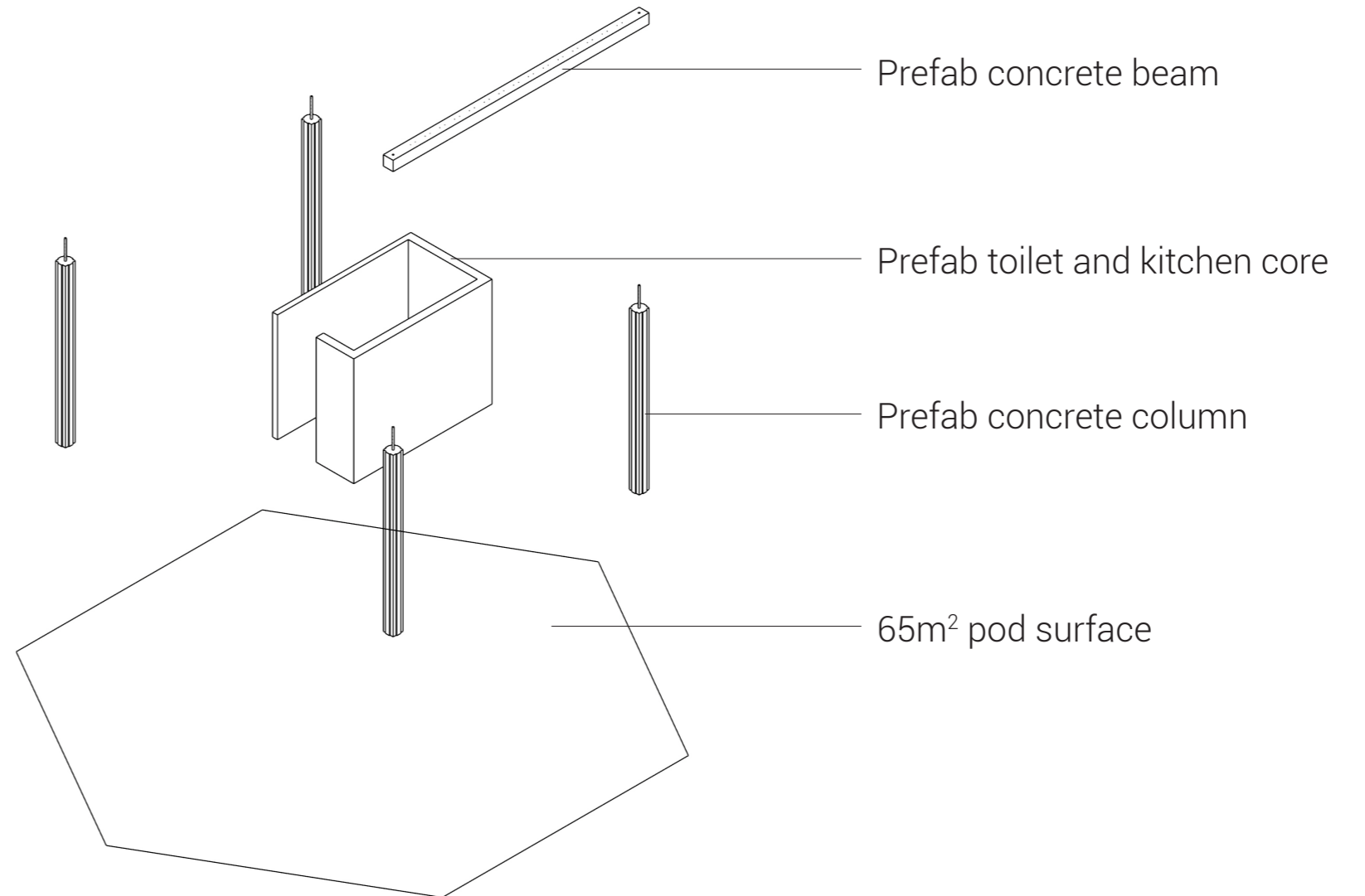
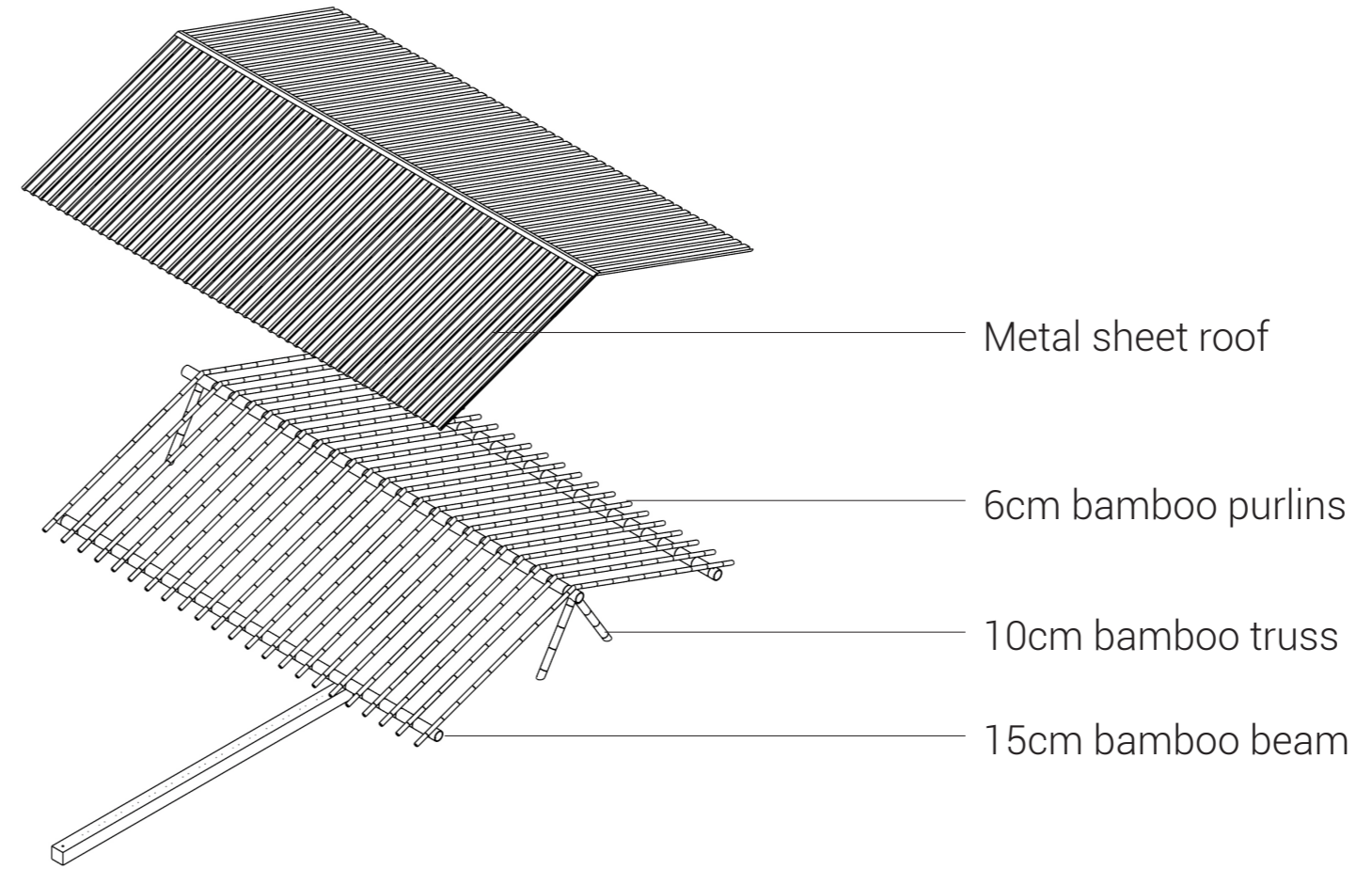

Prefab Columns & Bamboo Roof

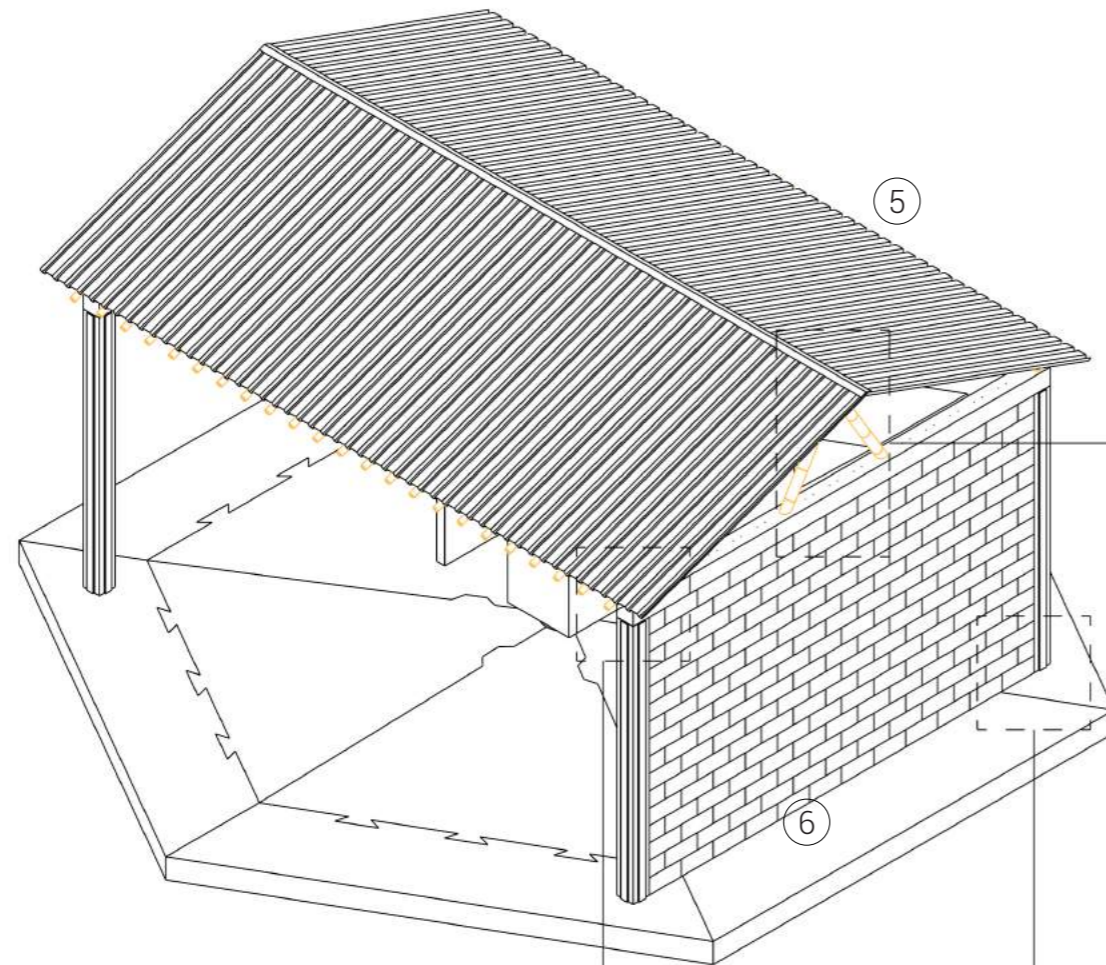

Bamboo truss and purlins

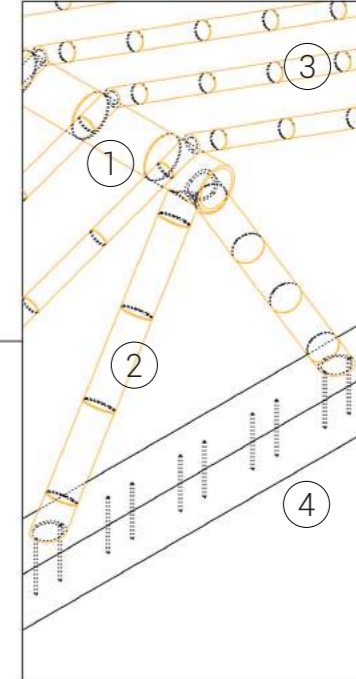

Column section and hollow concrete brick

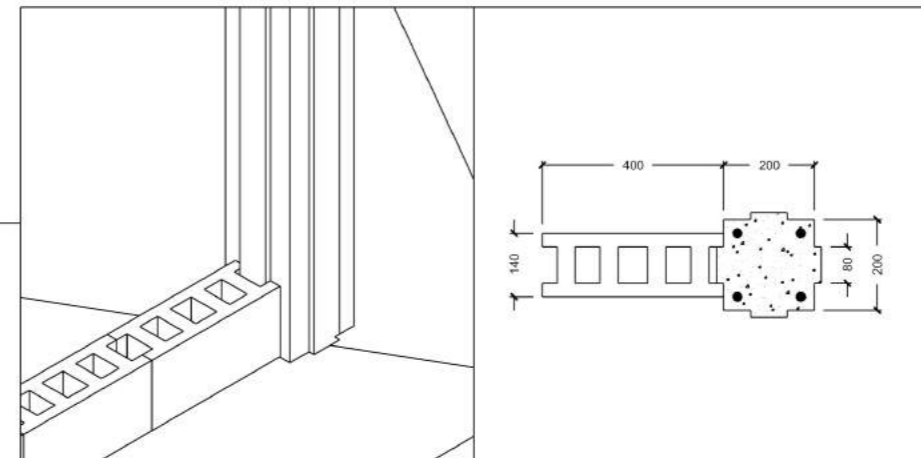

Column steel pin and roof connection

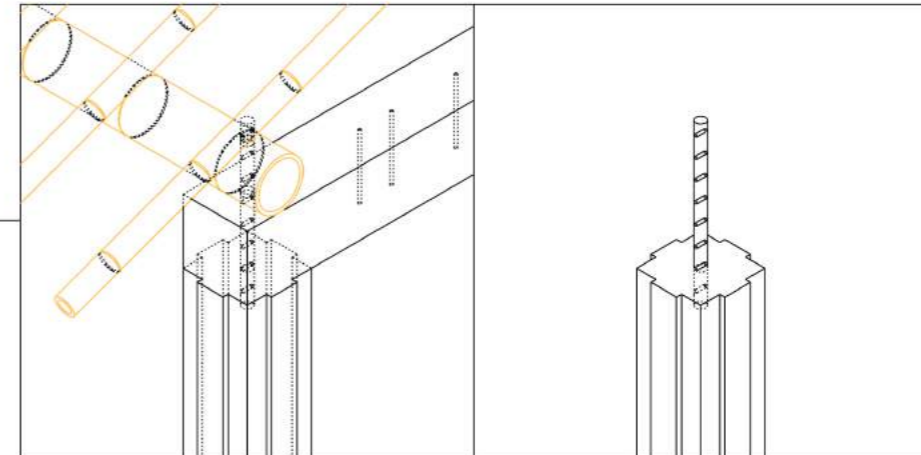

- ① 15cm bamboo beam
- ② 10cm bamboo beam
- ③ 6cm bamboo purlin
- ④ 20x20cm reinforced concrete beam
- ⑤ 20 degree angle corrugated steel roof
- ⑥ Potential DIY hollow brick wall

Column to Cap connection

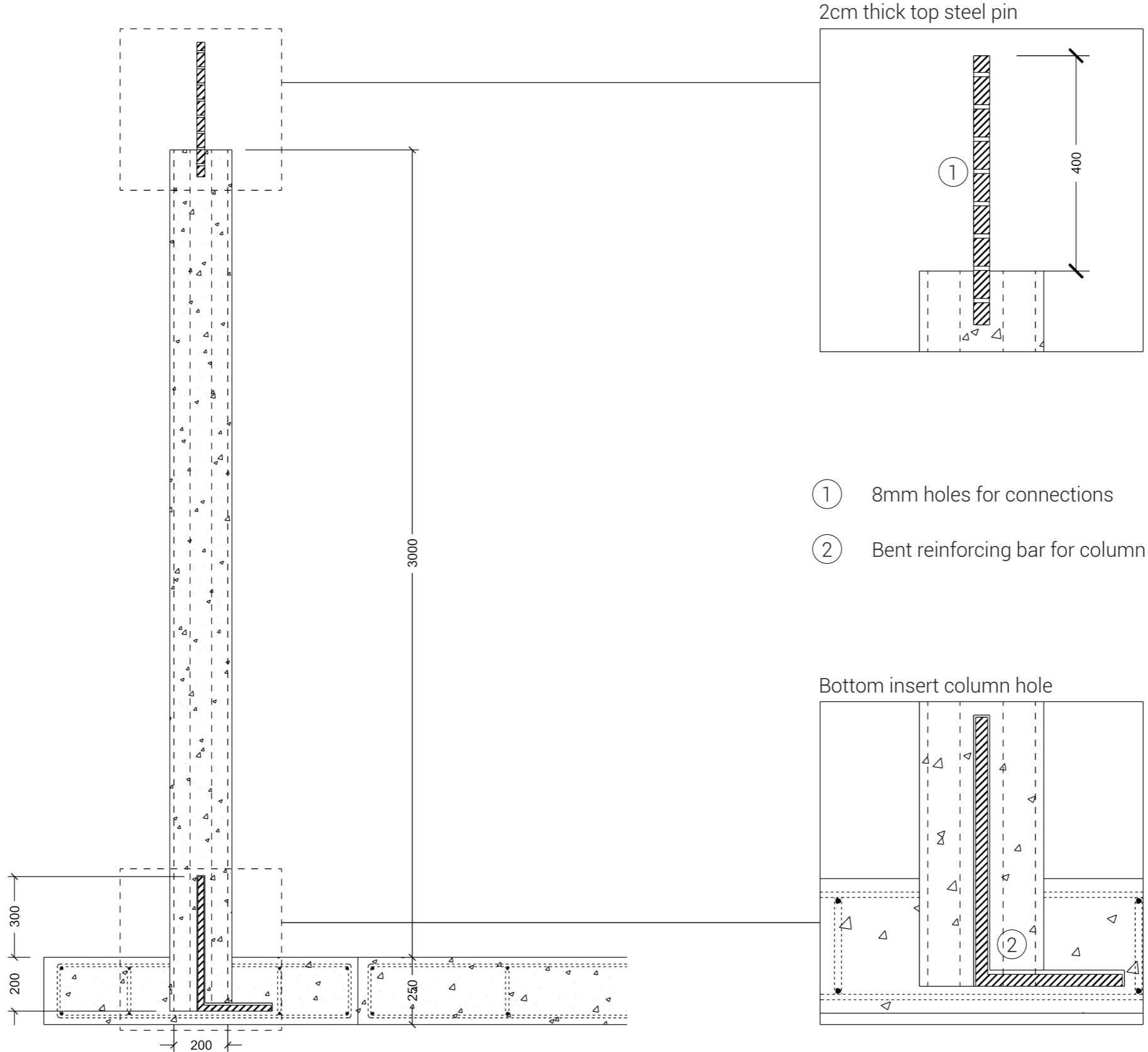

2cm thick top steel pin

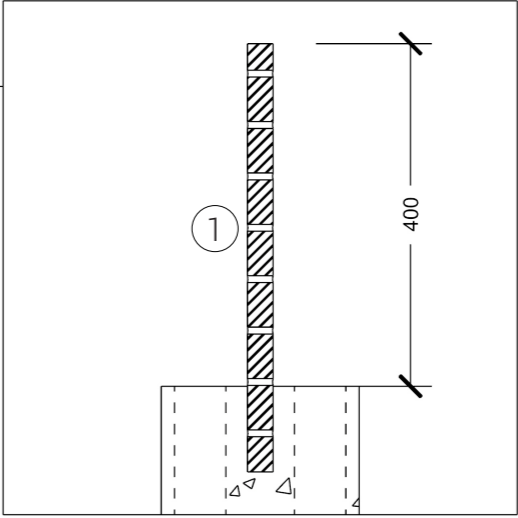

- ① 8mm holes for connections
- ② Bent reinforcing bar for column

Bottom insert column hole

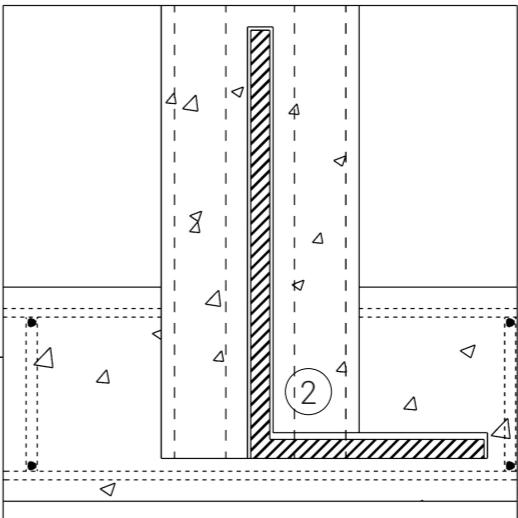

Basic plan

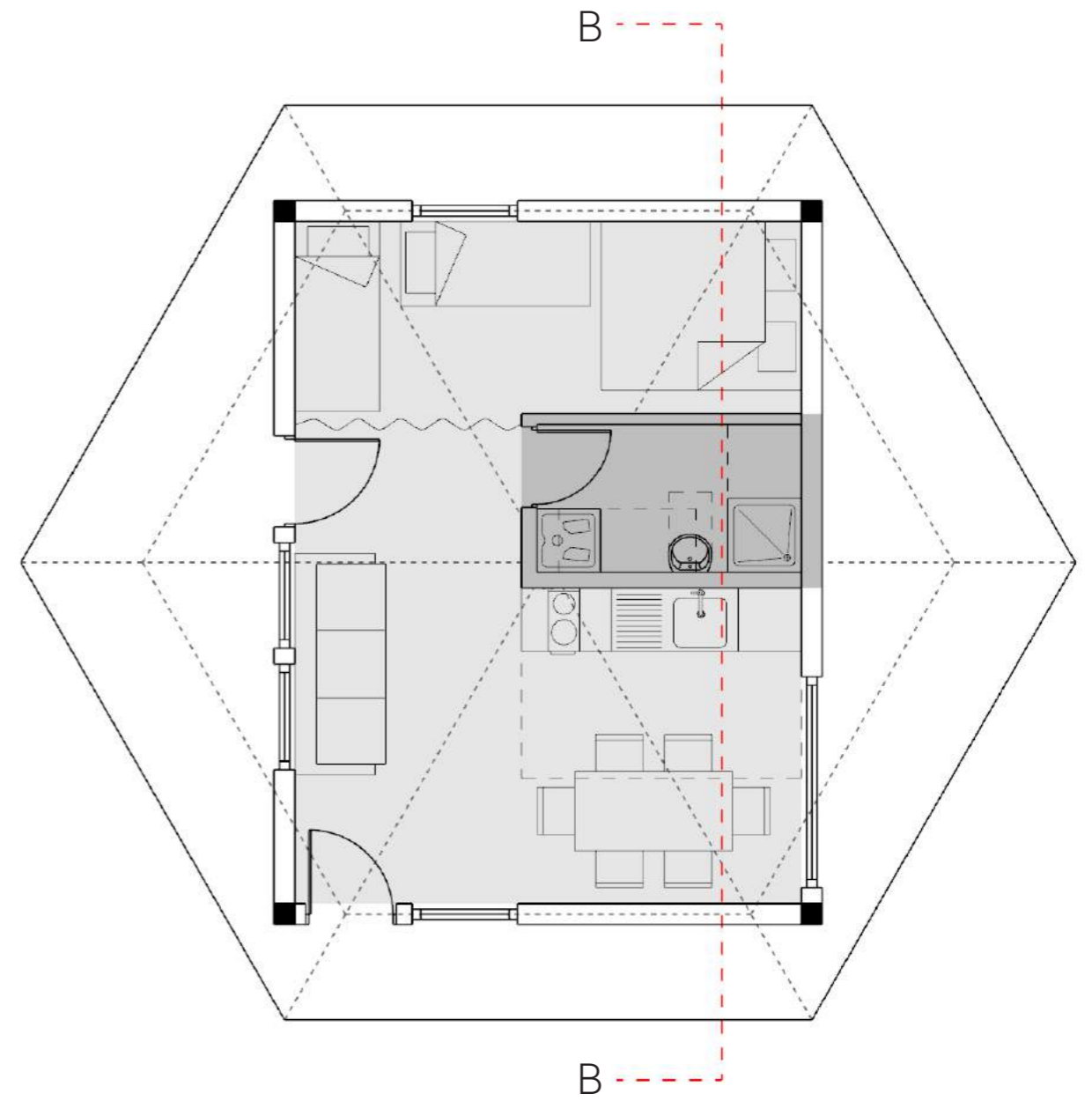
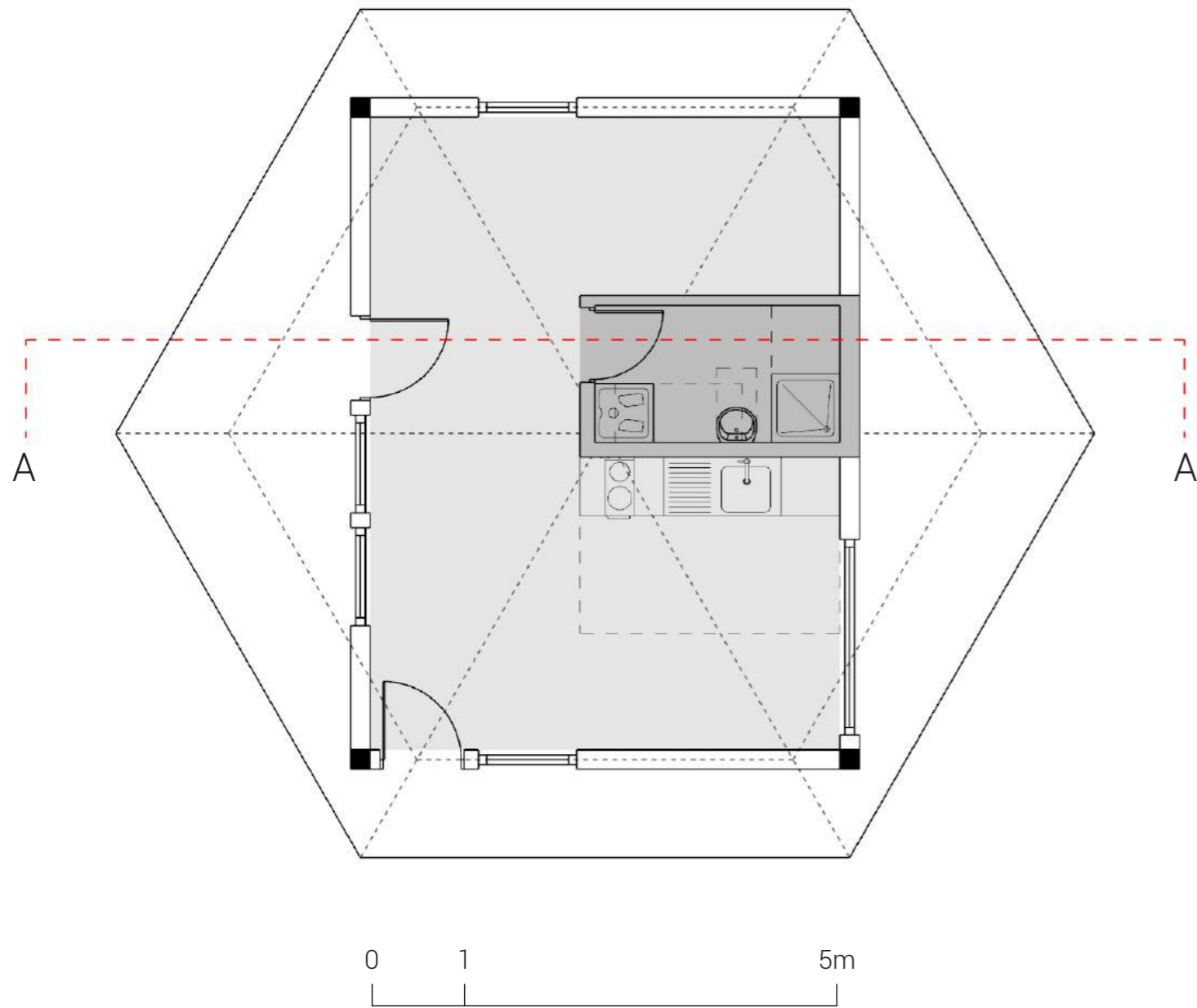

Plan variations

Front shop

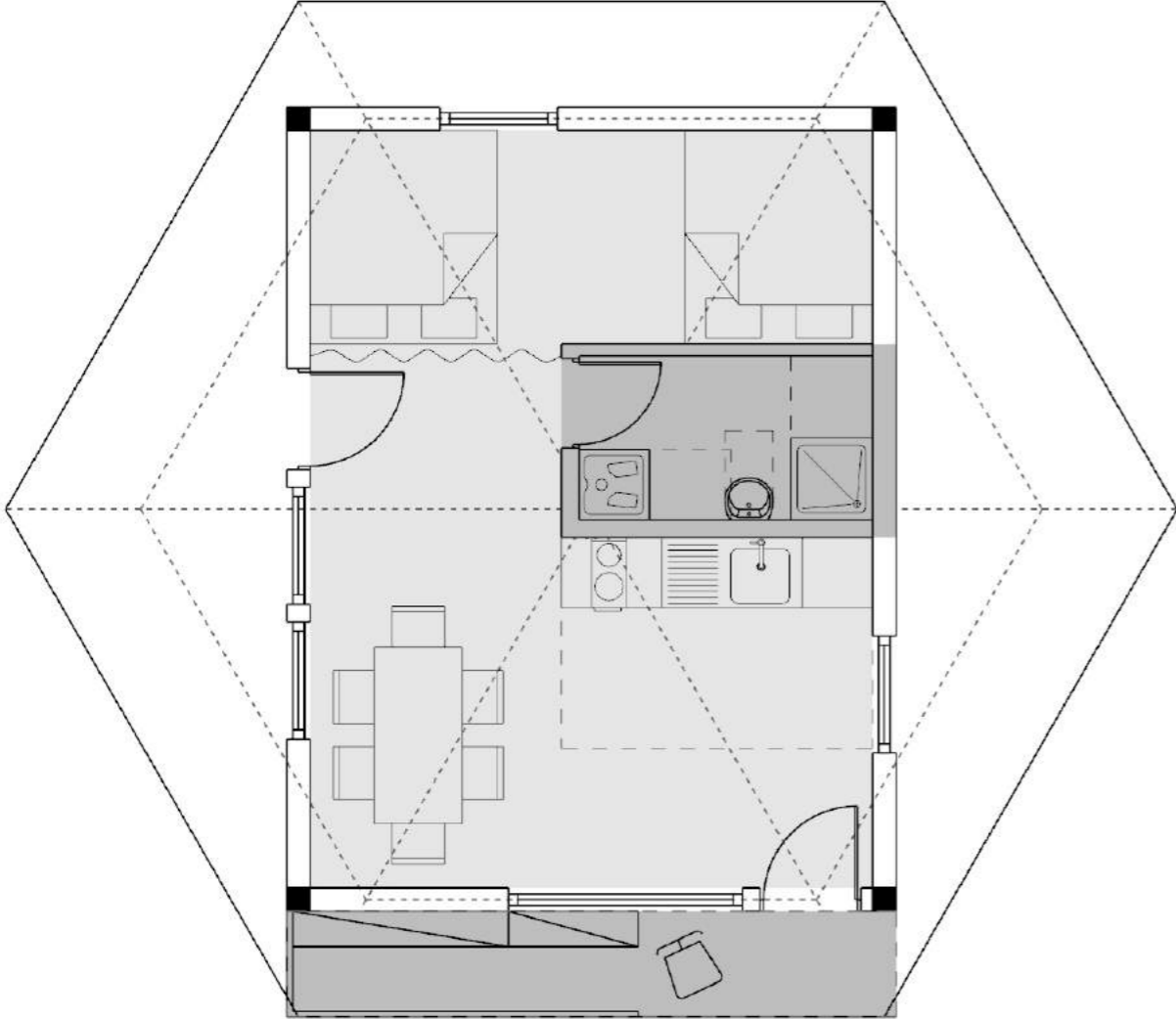

0 1 5m

Back garden

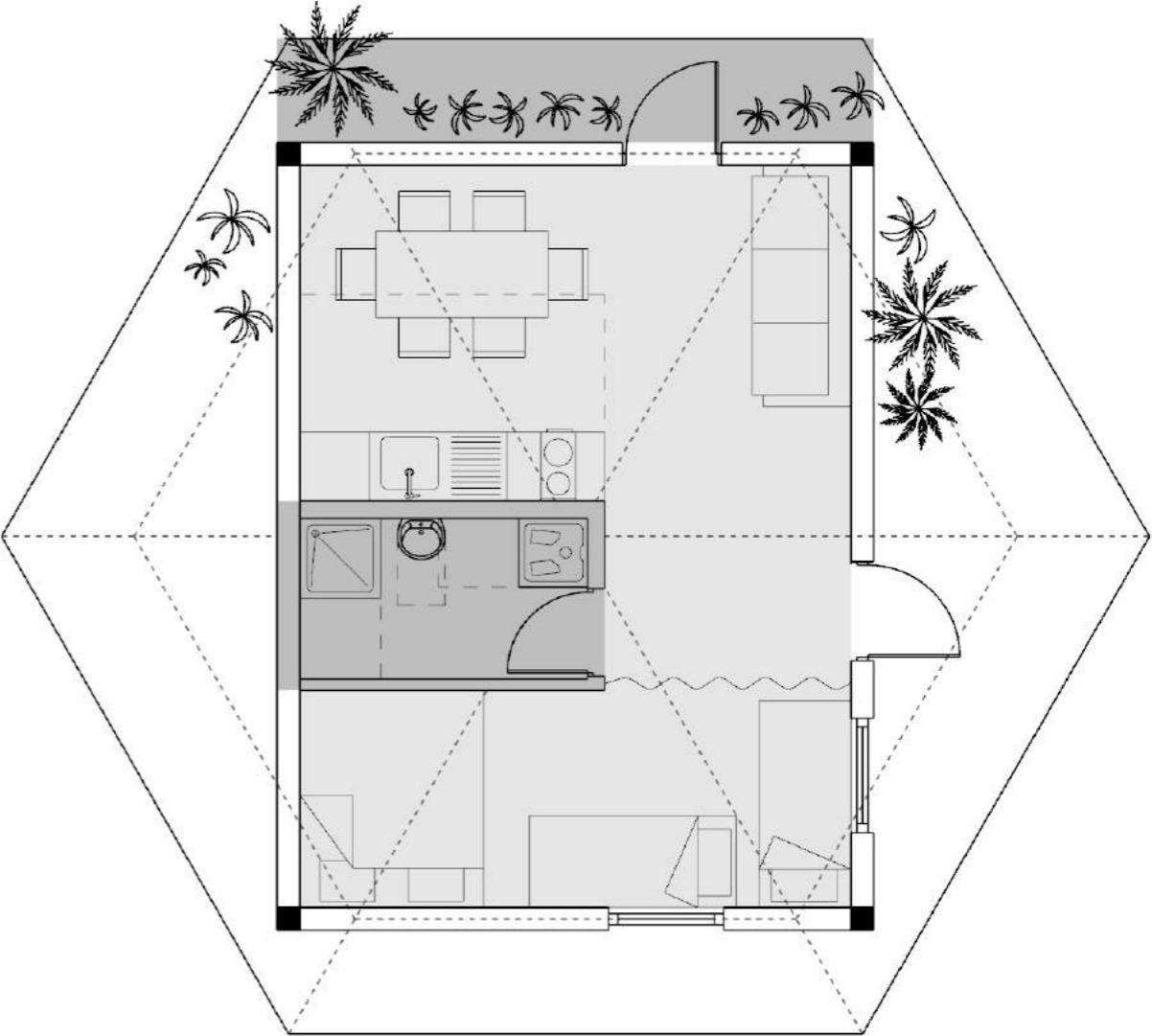

Construction

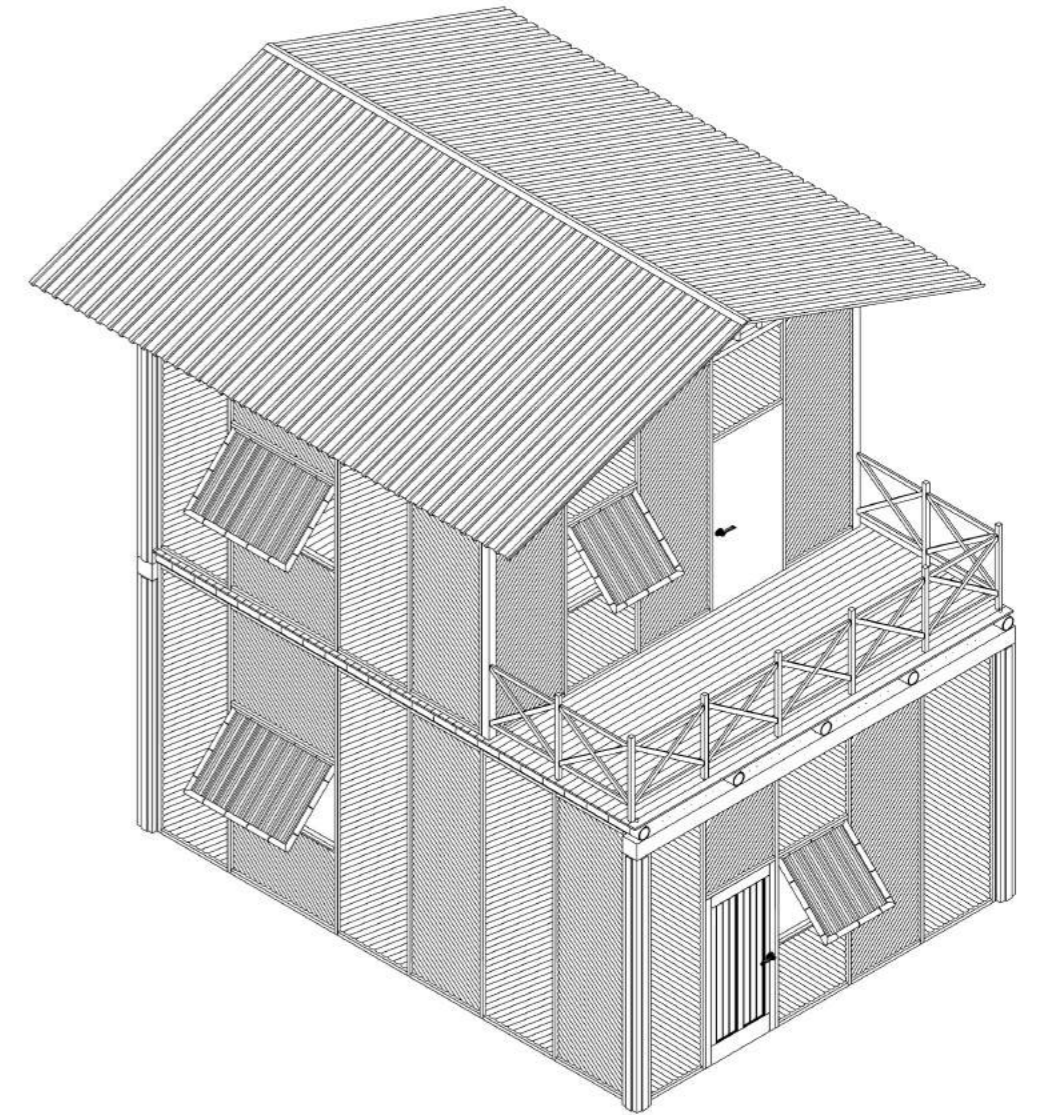
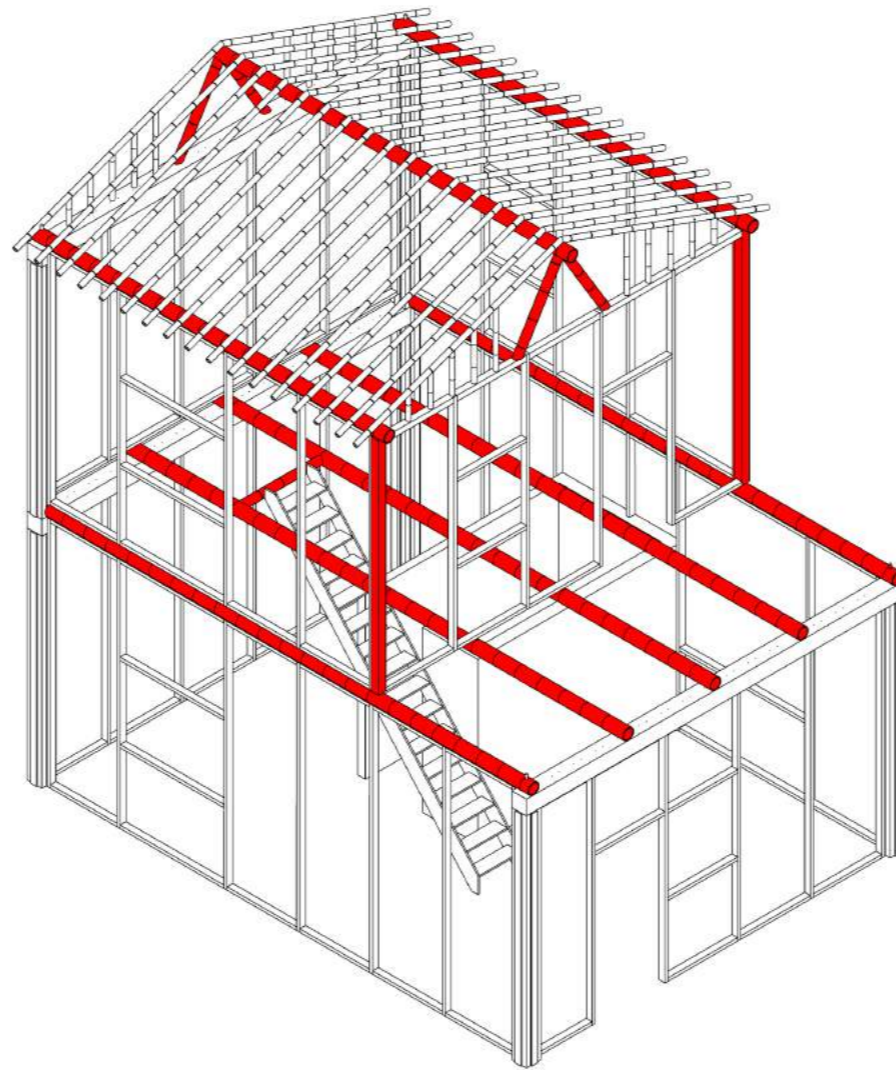
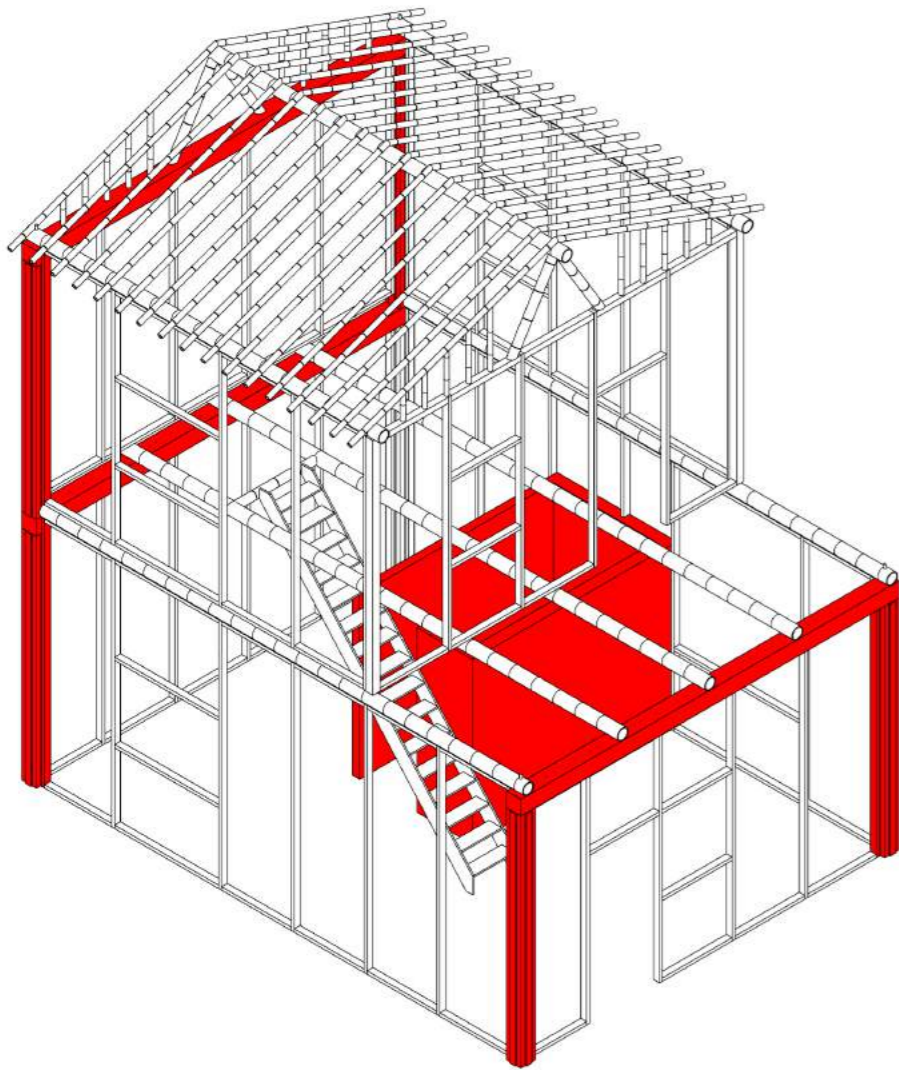

Climate section

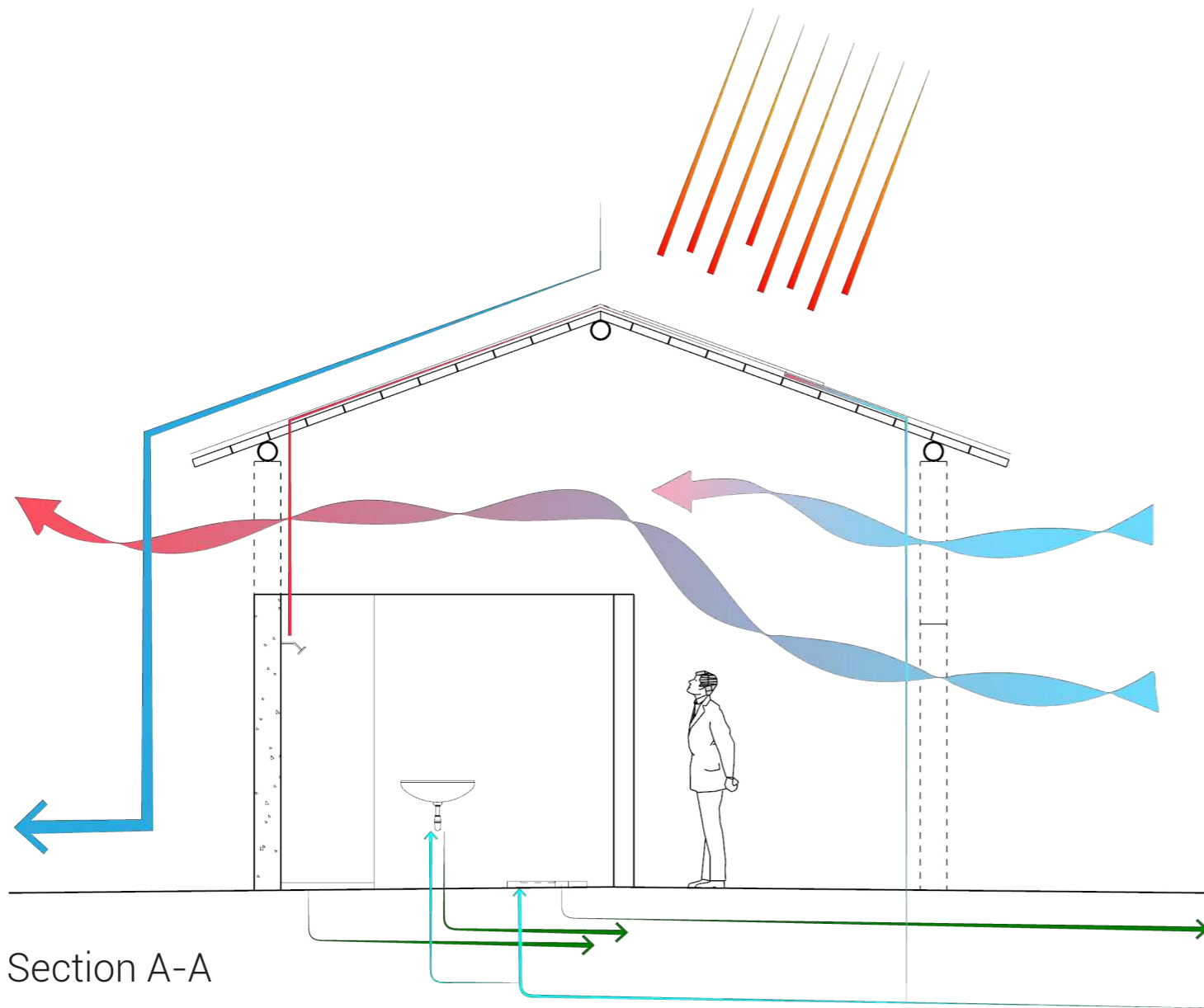

Section A-A

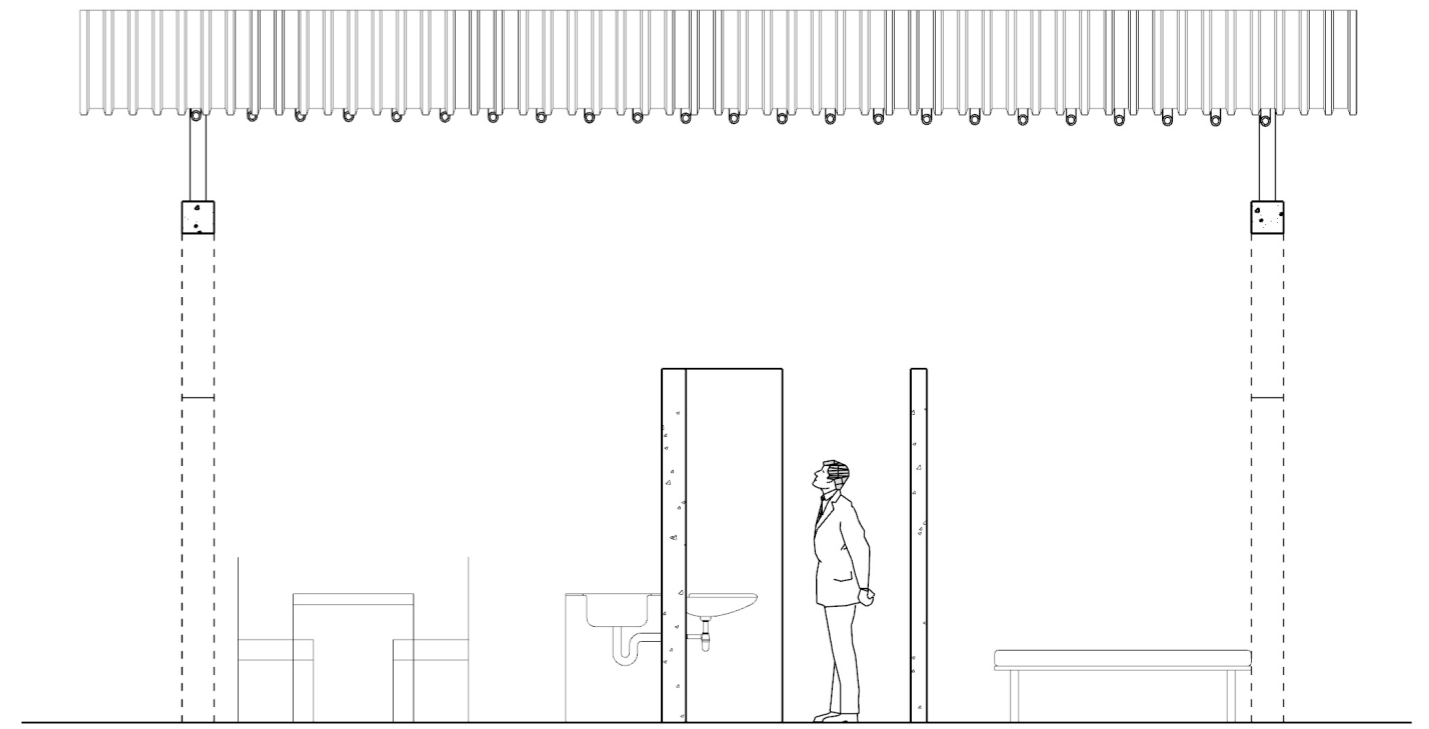

Section B-B



INFILL

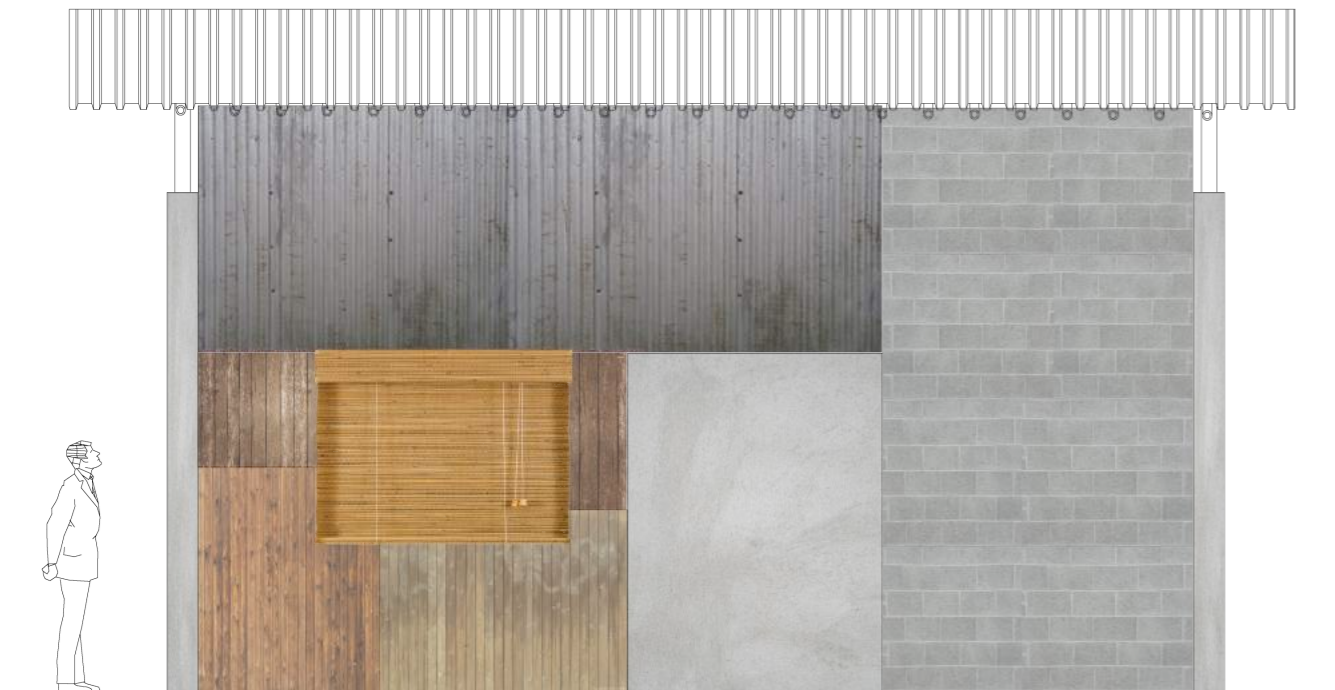
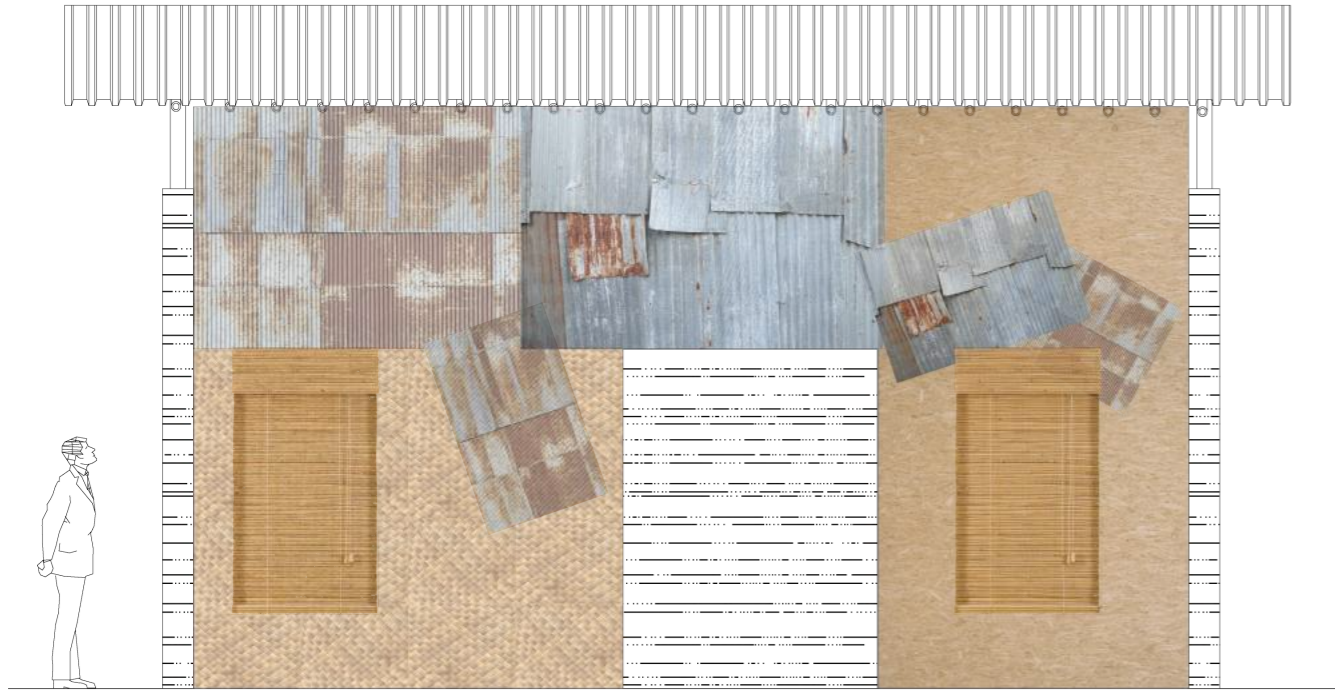

DIY extension

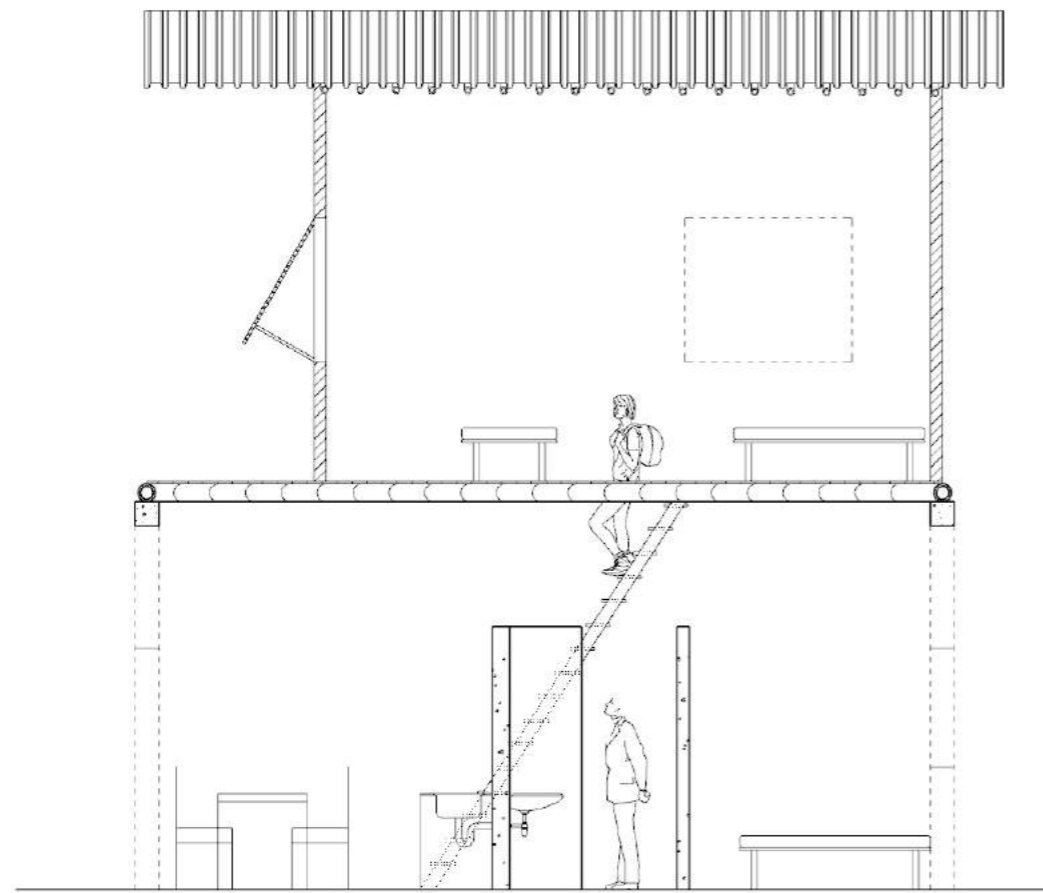

Section C-C

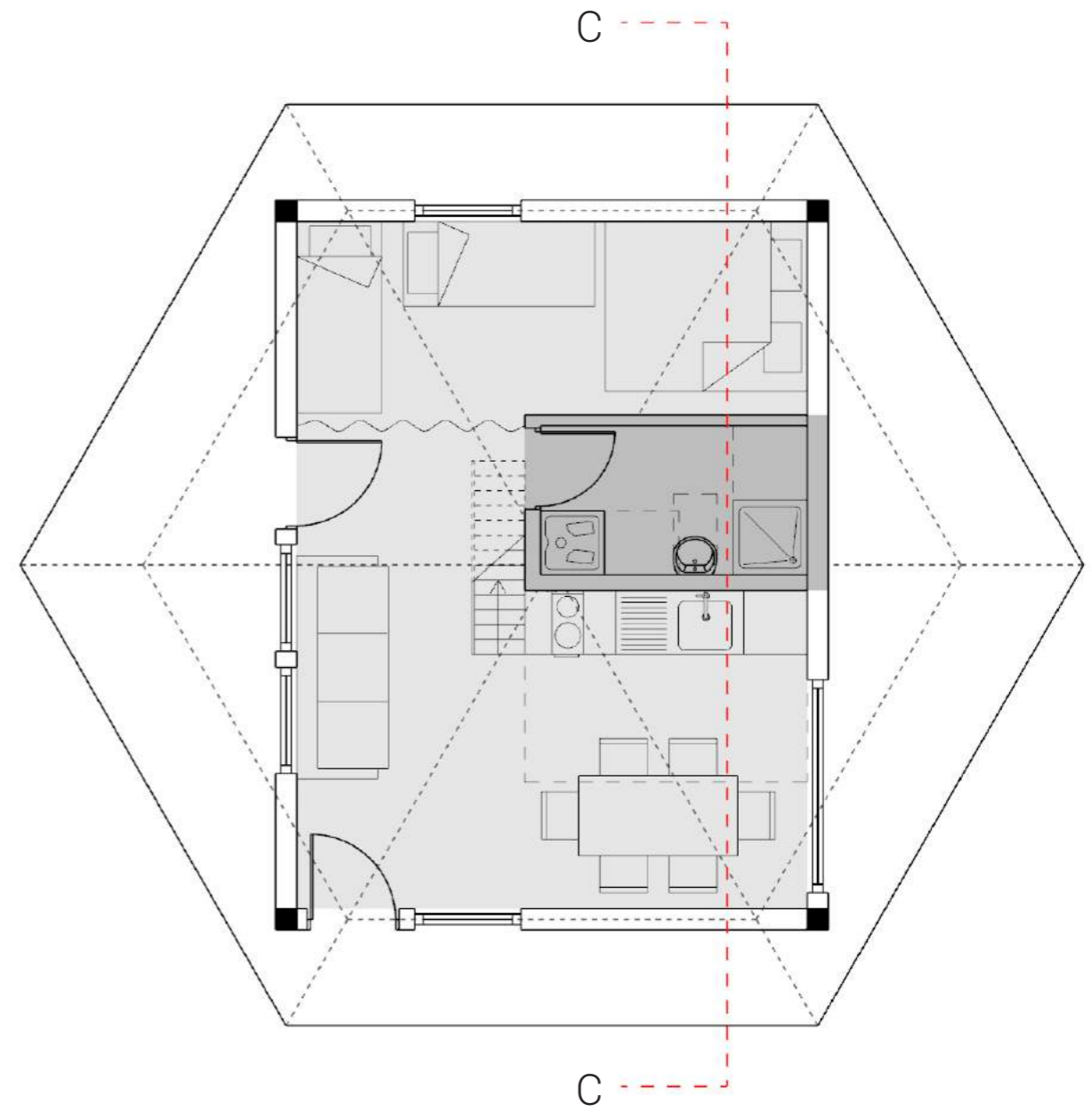

Appropriation and Improvement







Exploring other house typologies

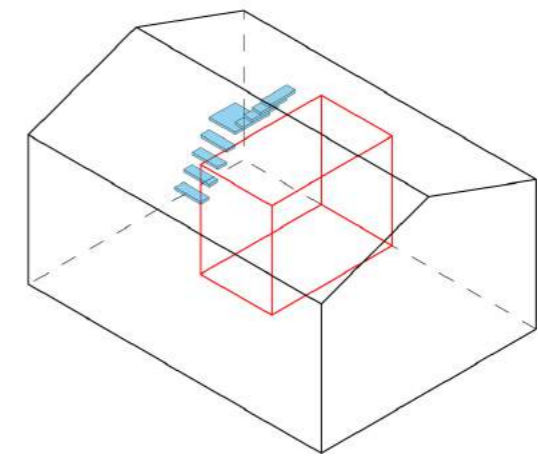
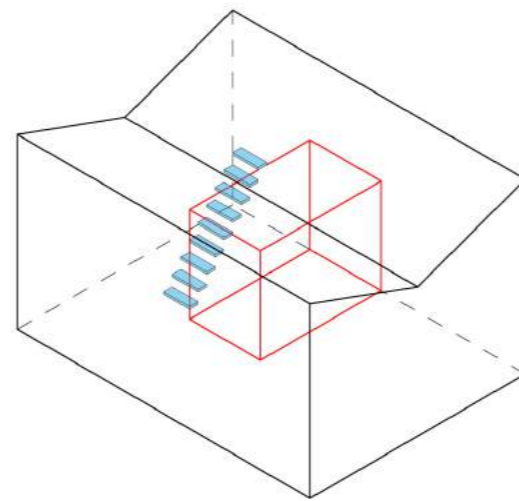
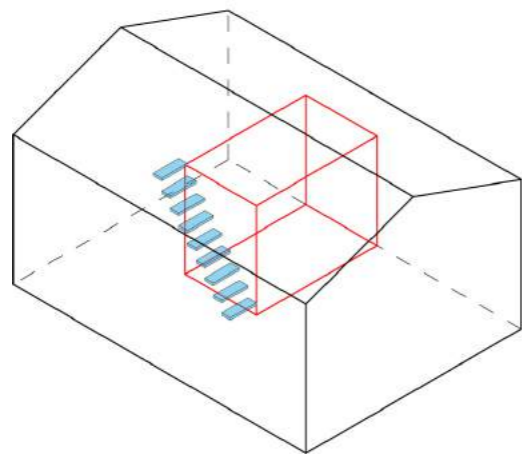
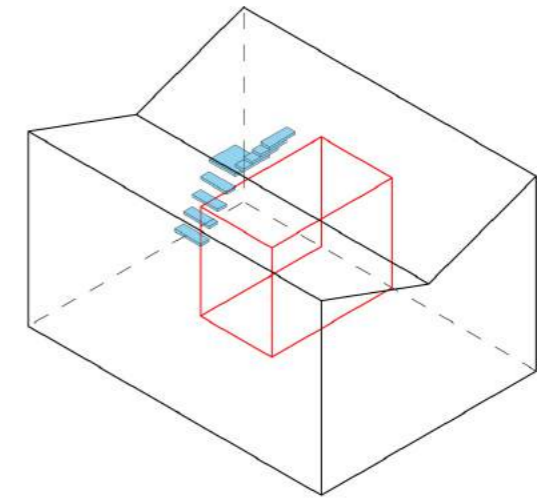
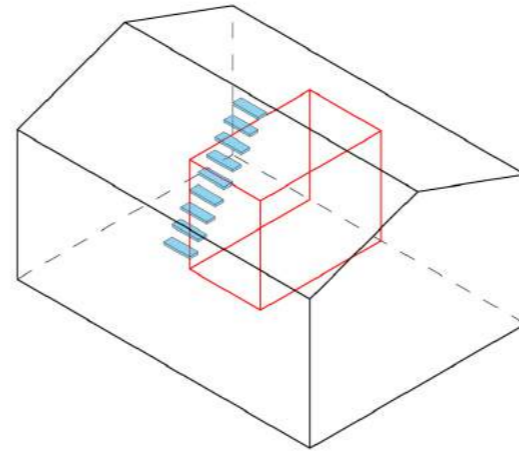
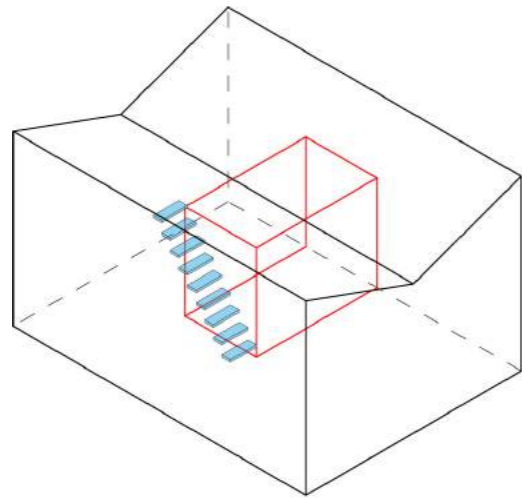

Hexagonal options

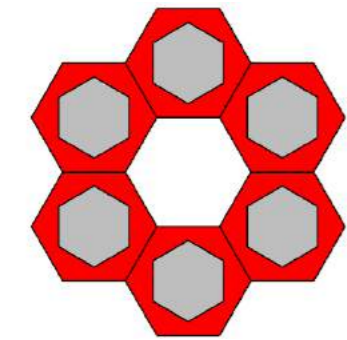
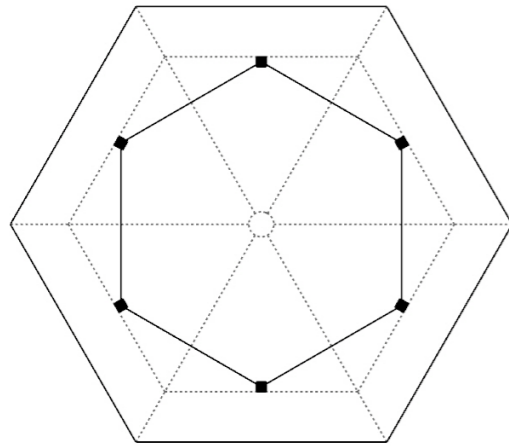

27 m²
2m between houses

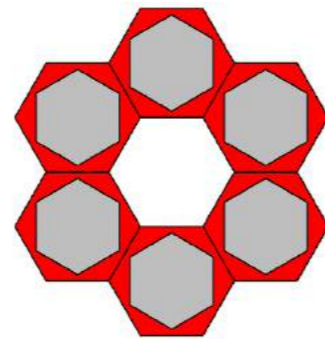
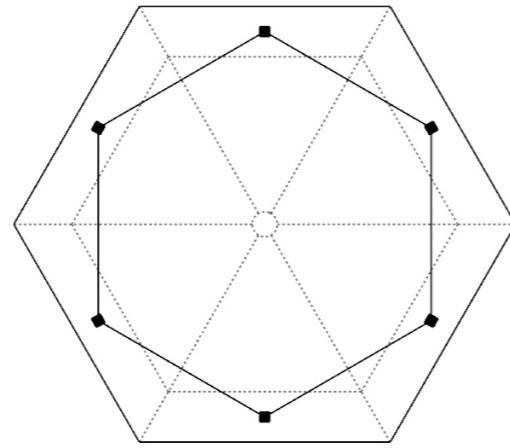

38 m²
0.8m between houses

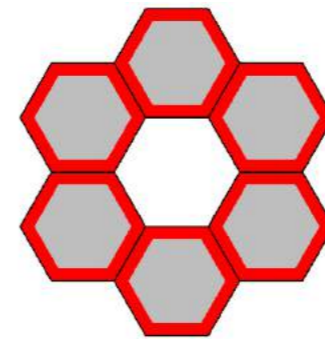
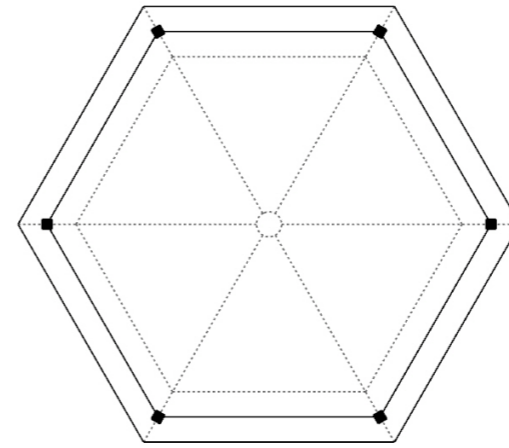

38 m²
1.7m between houses

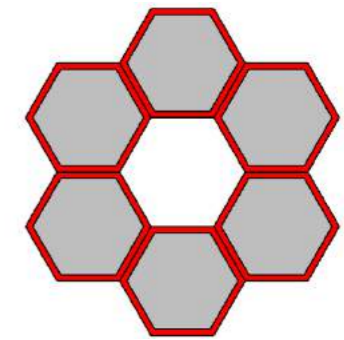
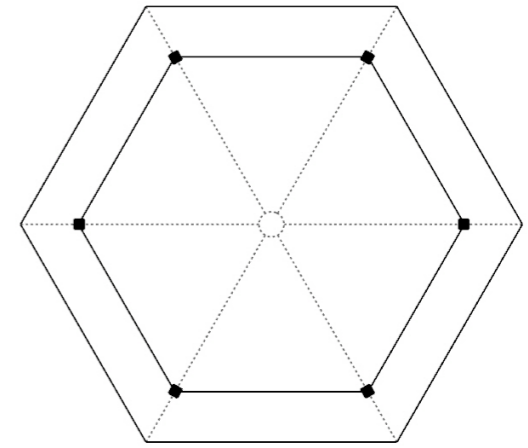

38 m²
0.7m between houses

Hexagonal floorplan

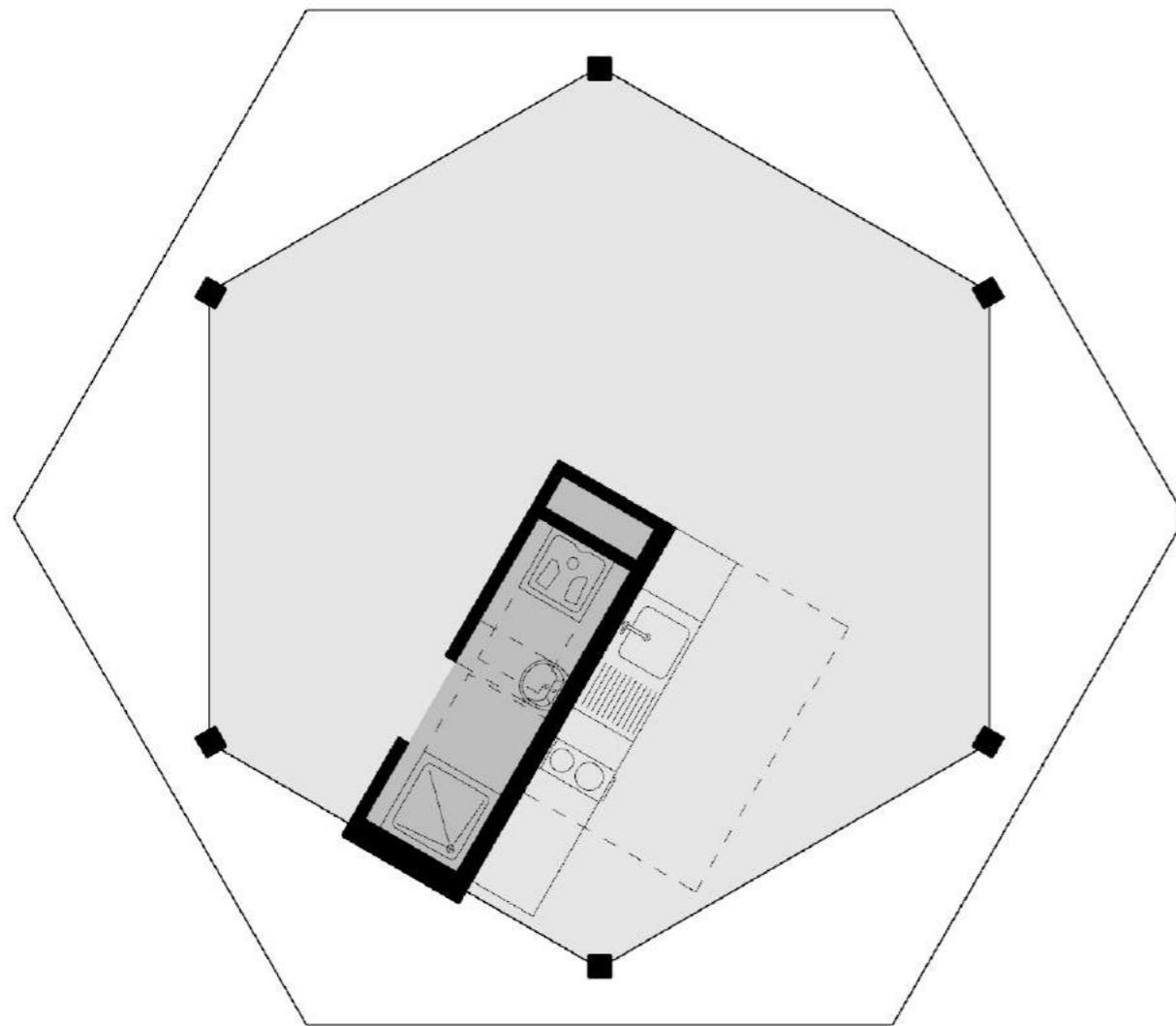

0 1 5m

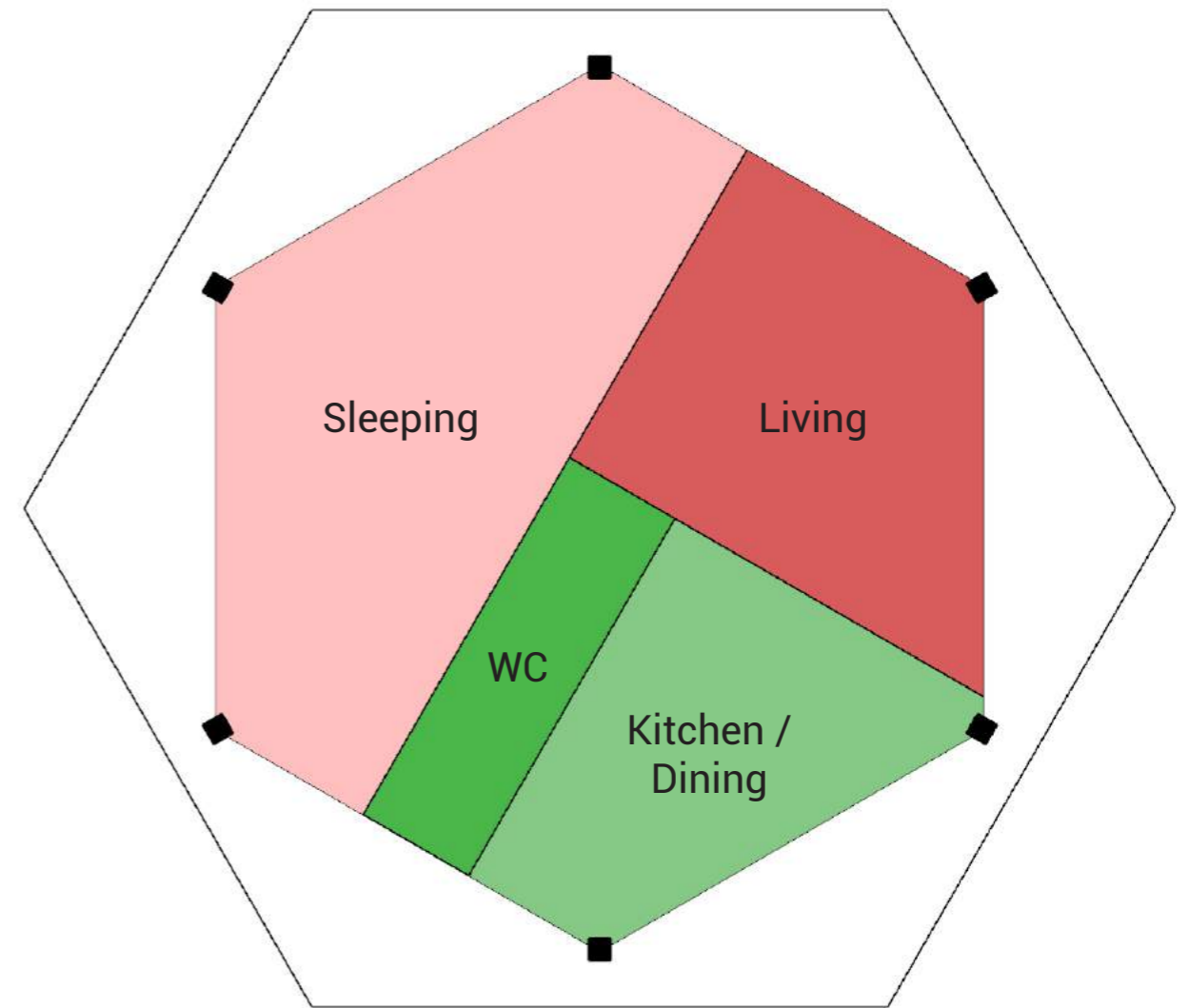

Hexagonal volume

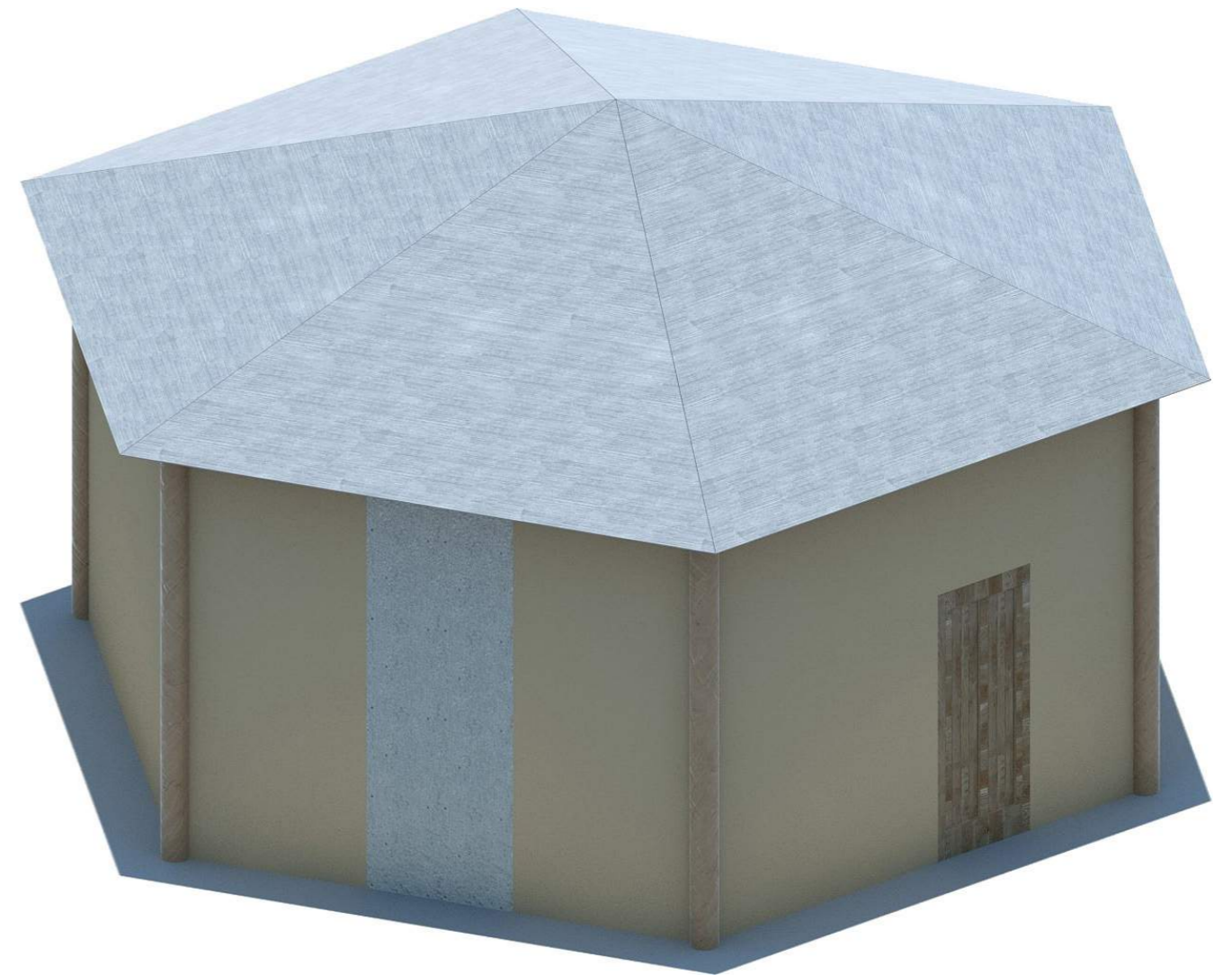
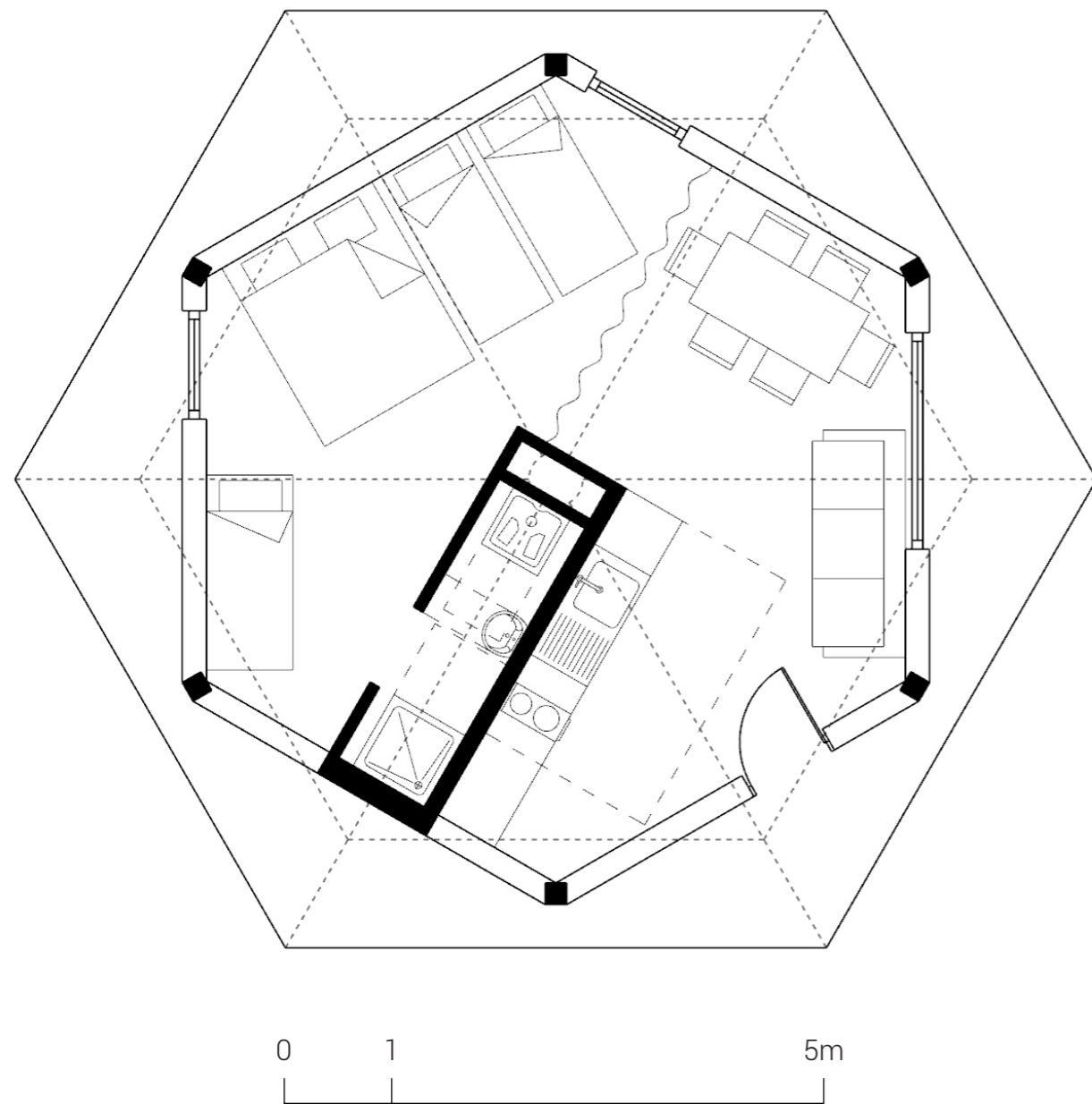

Comparison of hexagonal and rectangular houses

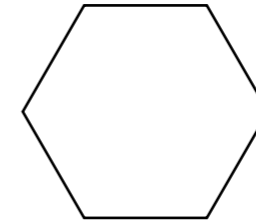
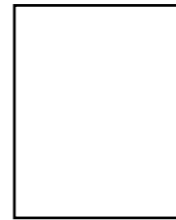

Floorarea	●	●
Structural complexity	●	●
Maintenance	●	●
Durability	●	●
Flexibility	●	●
Accessibility	●	●
Cost	●	●
Material use	●	●
Waterproofing	●	●

Collective informal

House extensions

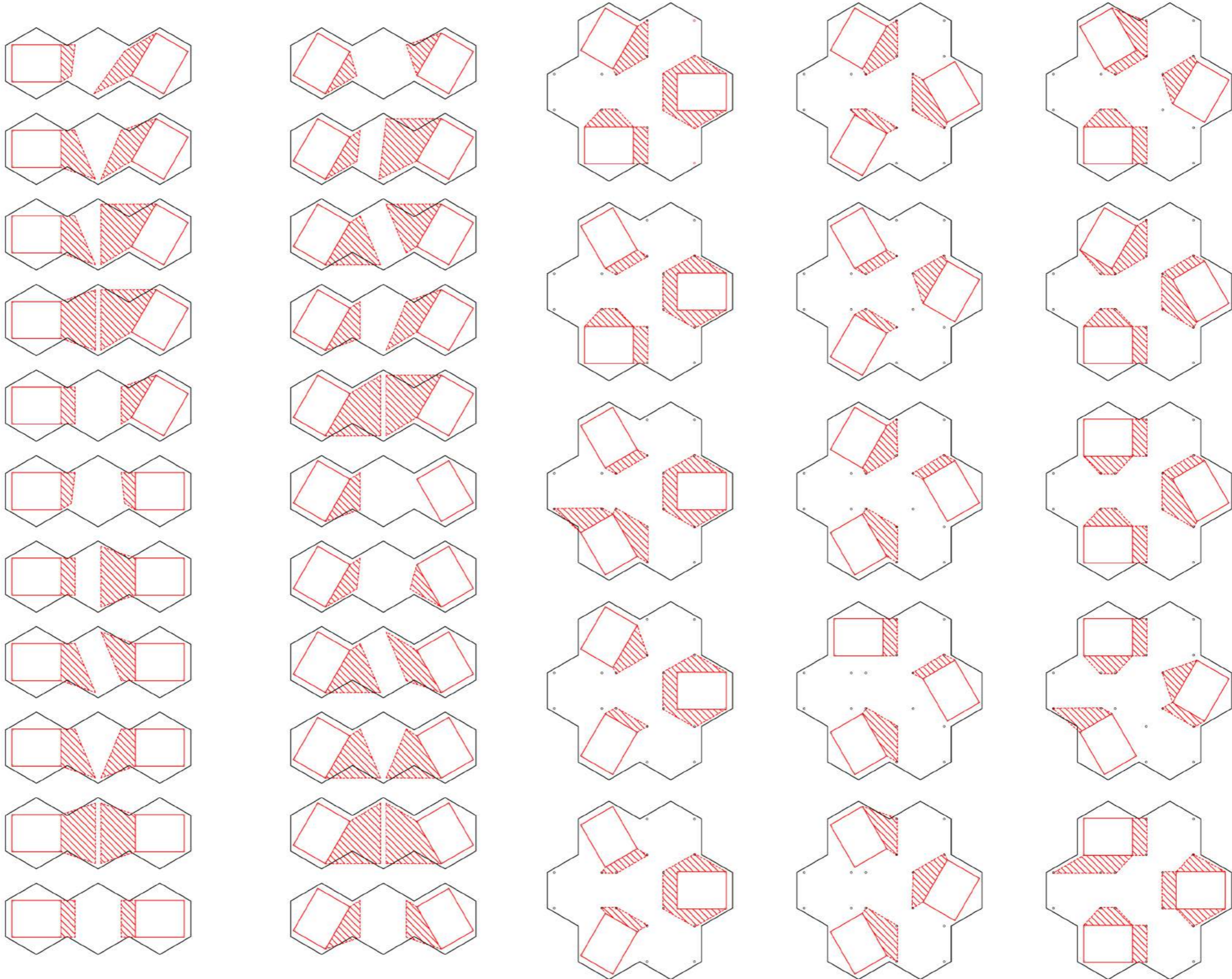

Collective extensions

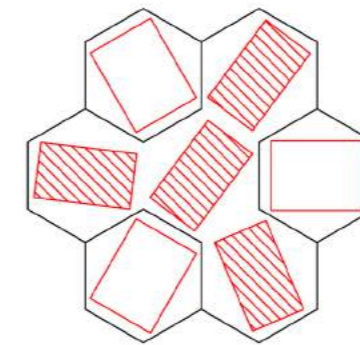
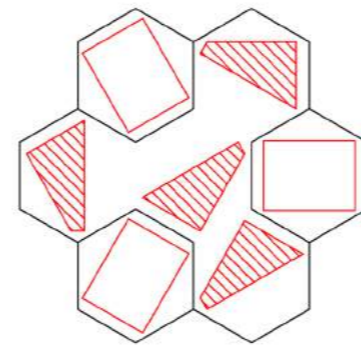
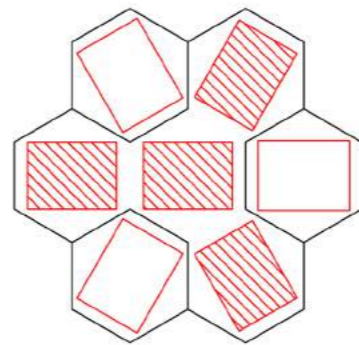
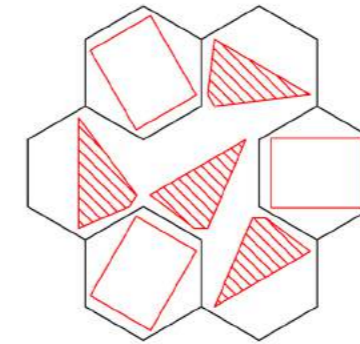
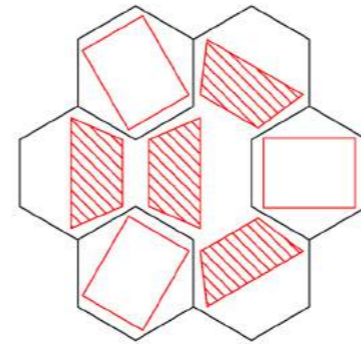
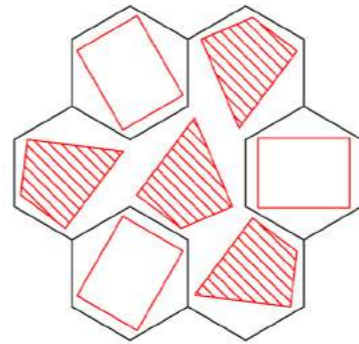
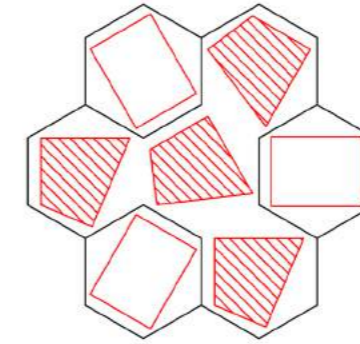
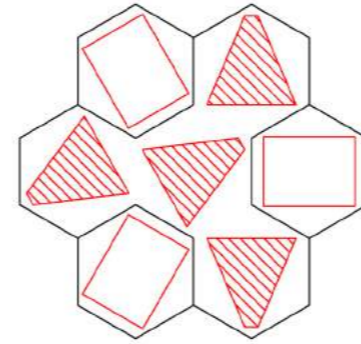
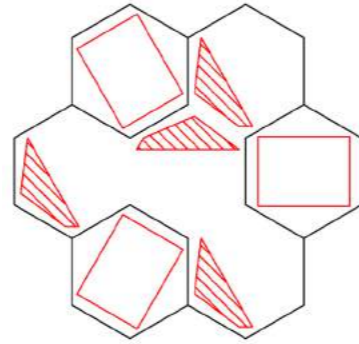

Street life

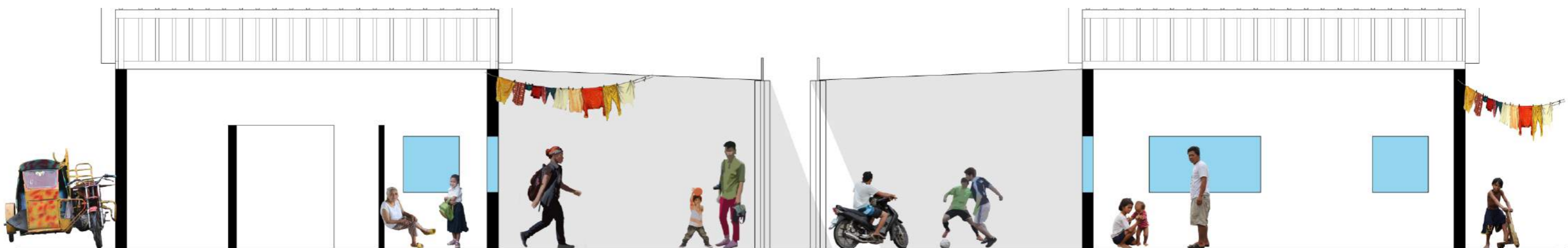
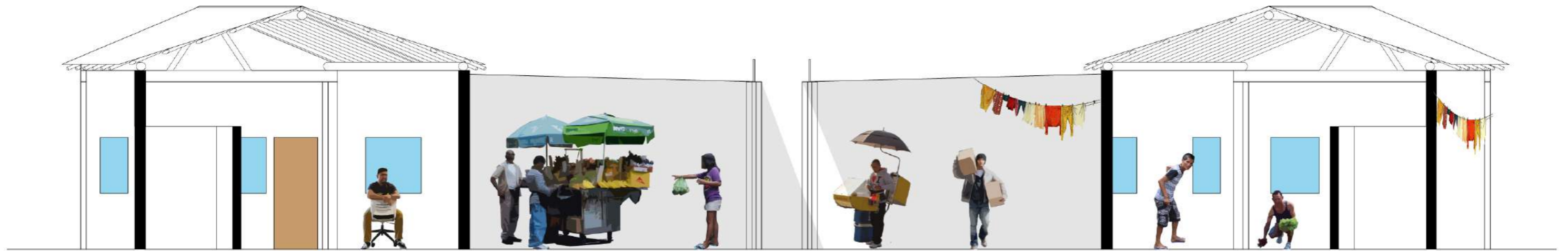



Housing in Time

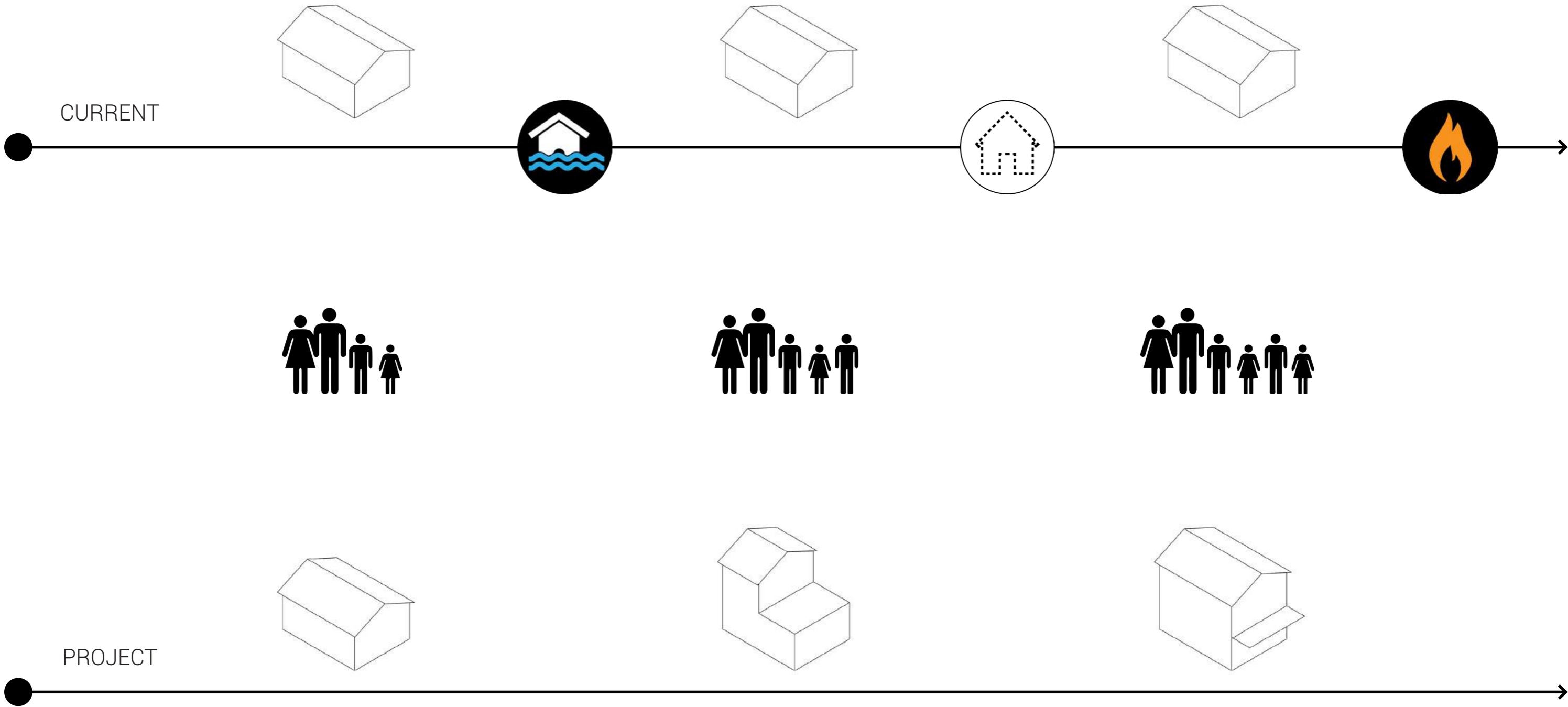

Components in Time

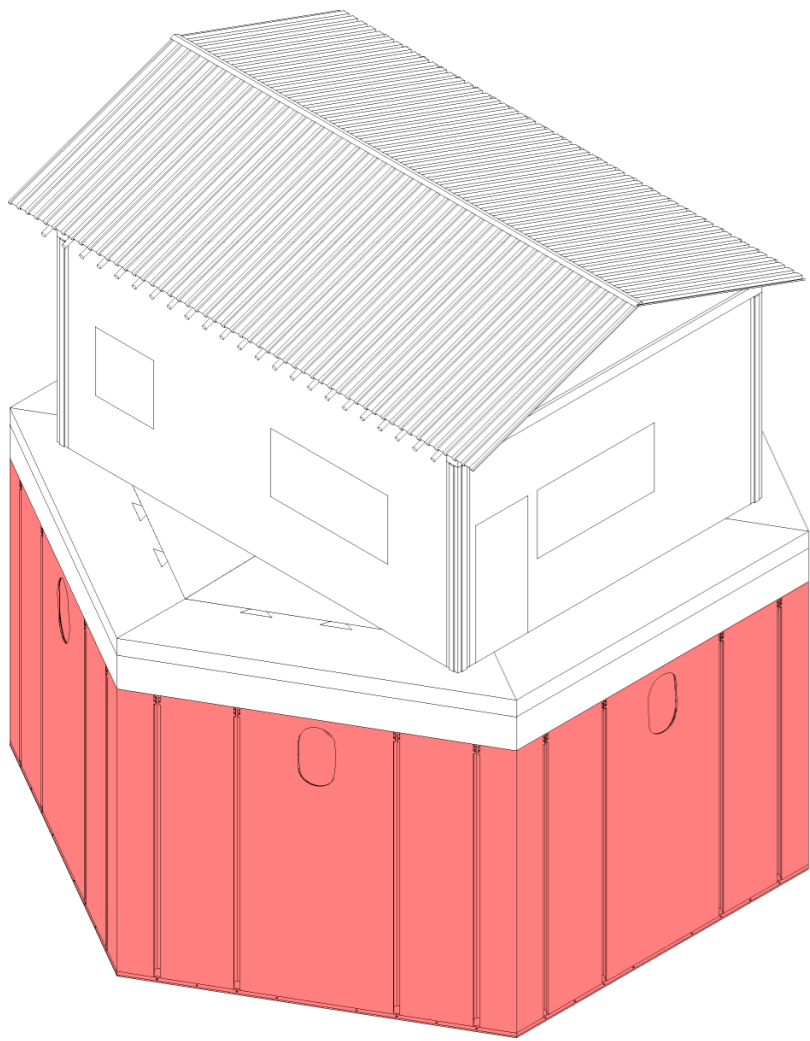

Base pod

30 years

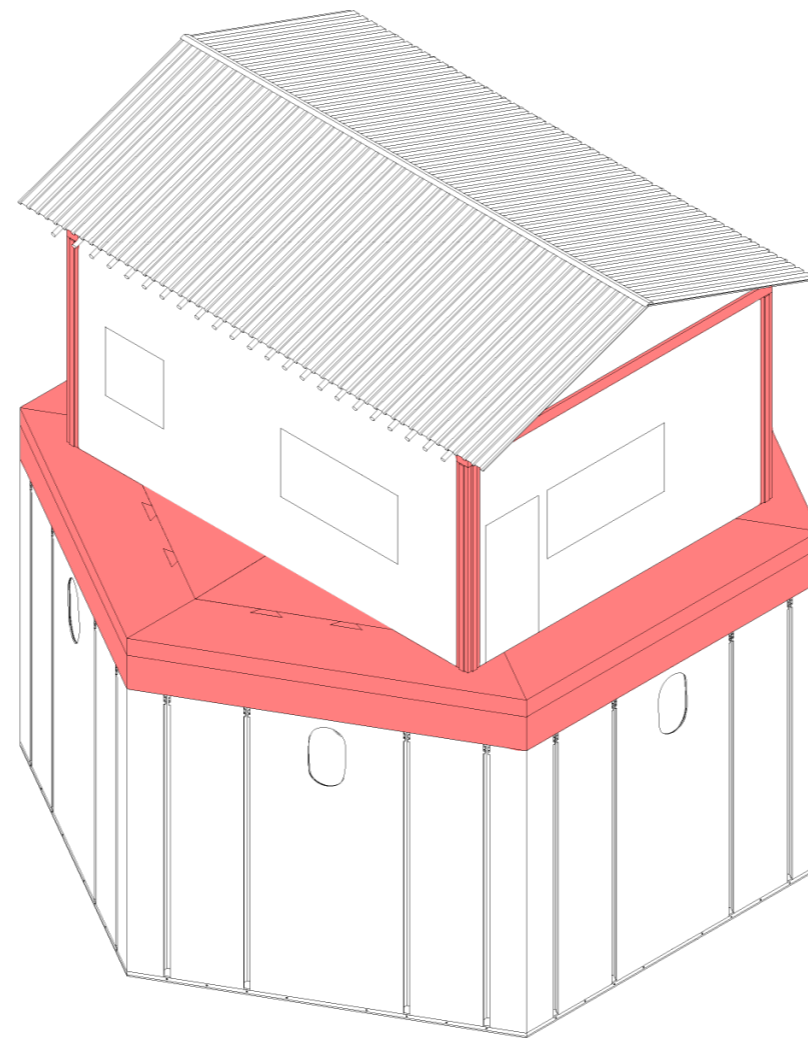

Modular elements

10 years

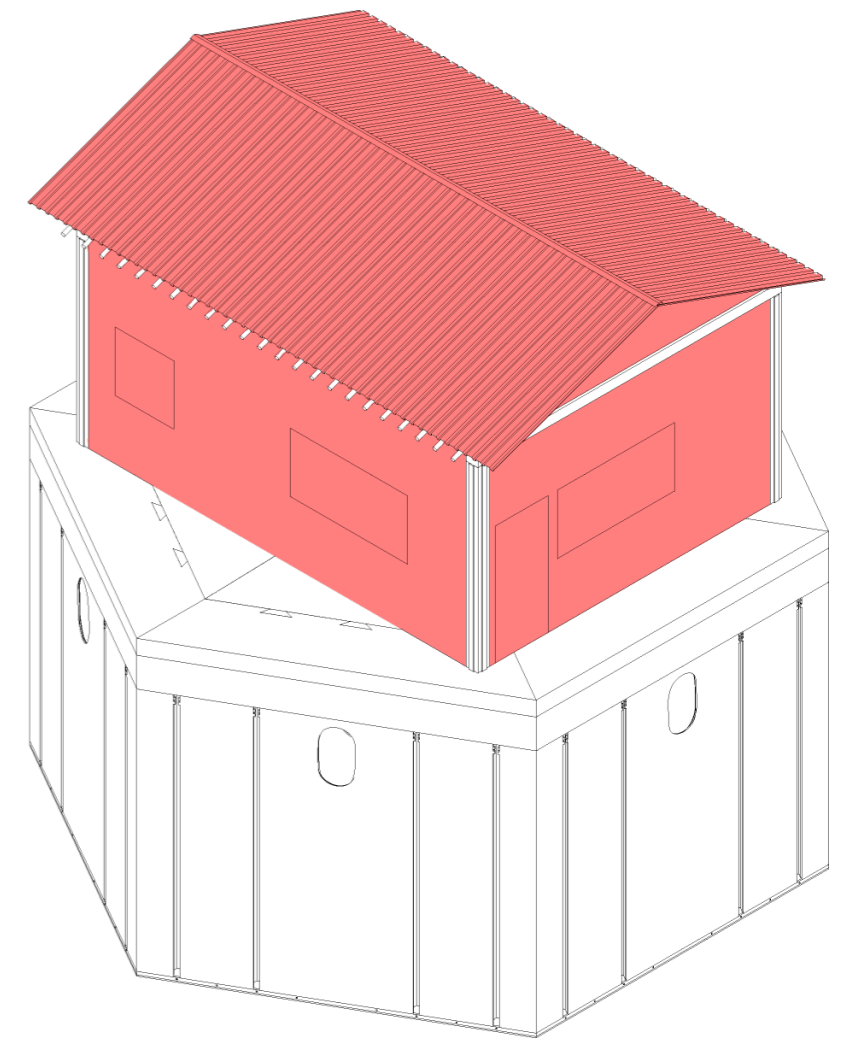

Daily life

3 years

Life on the water

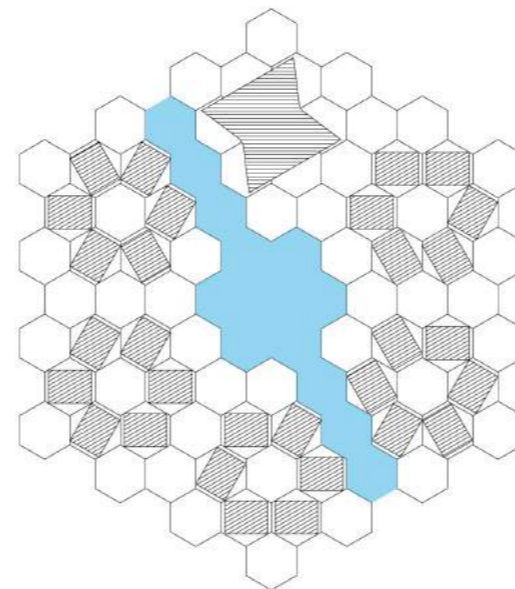
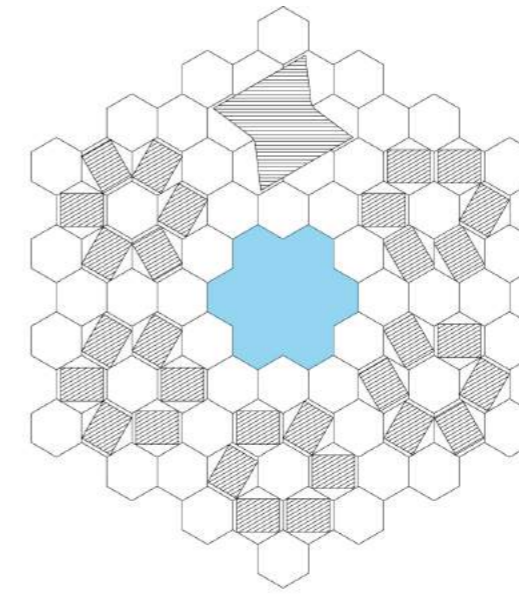
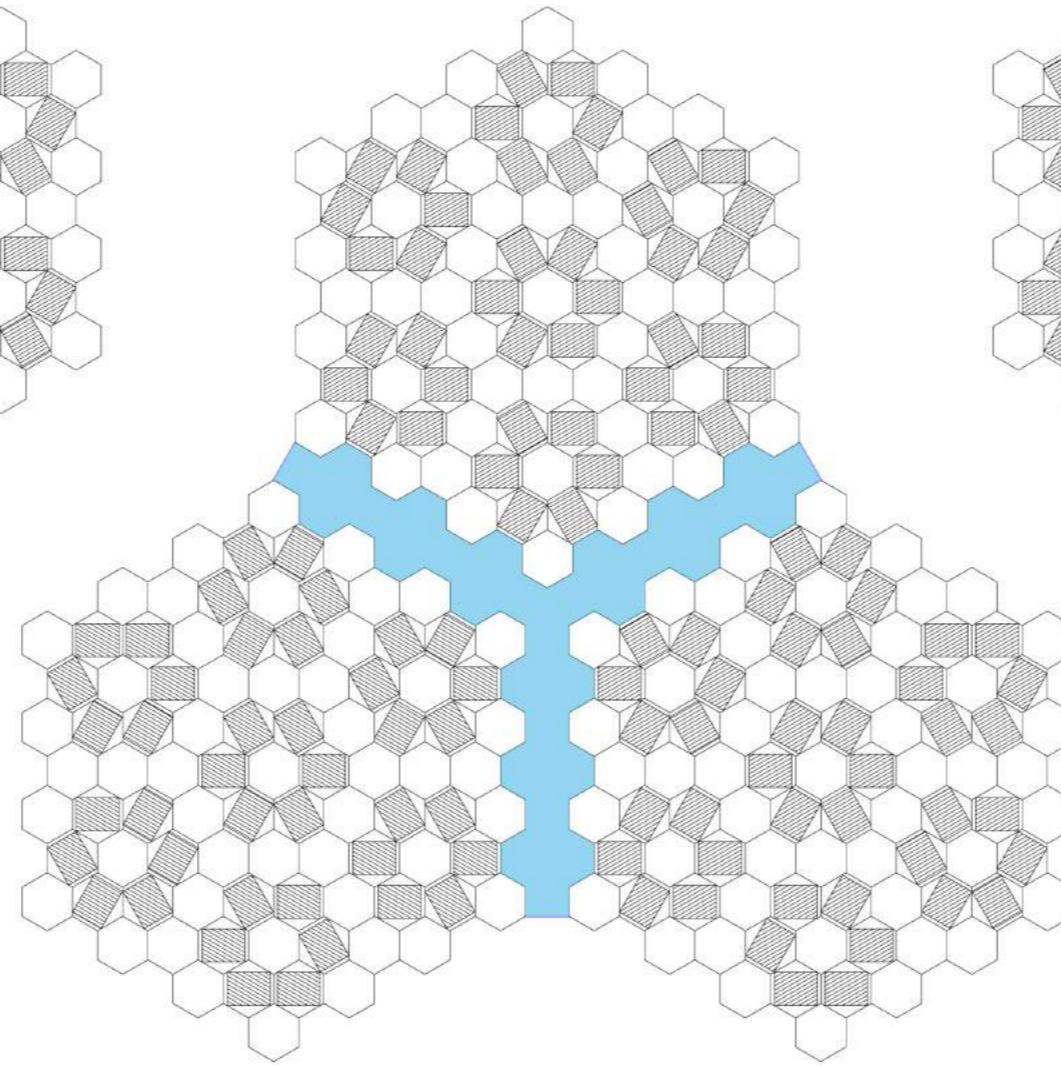
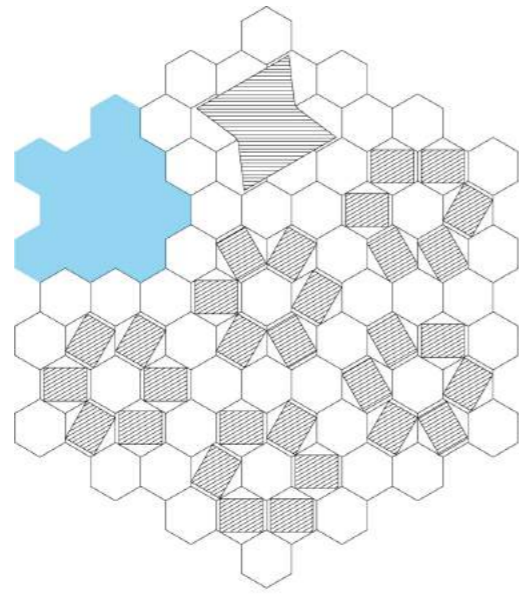

Relation with water

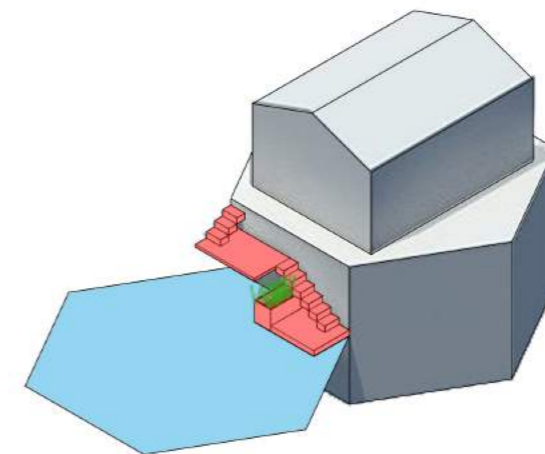
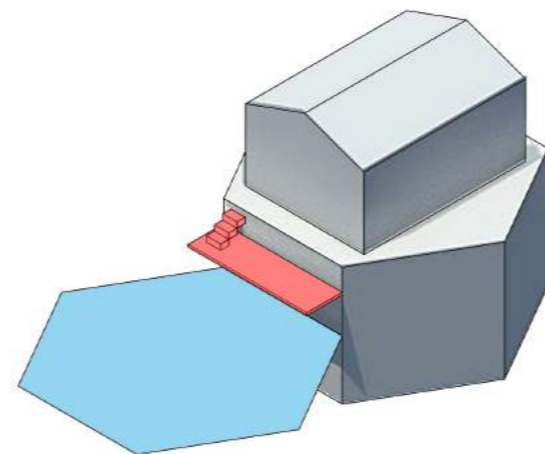
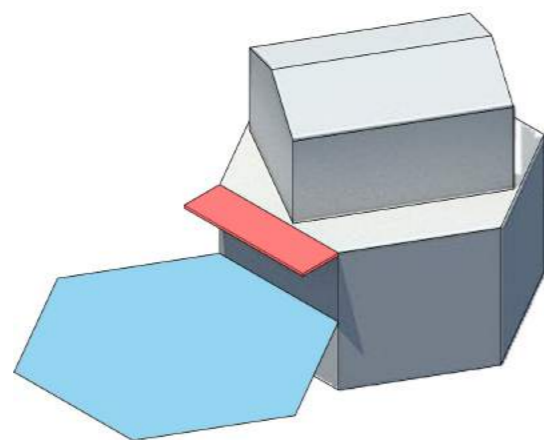
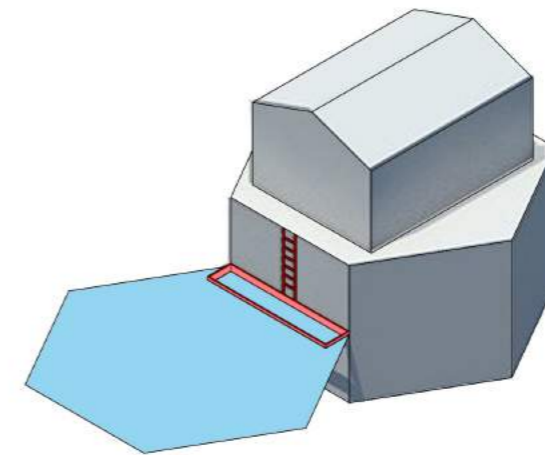
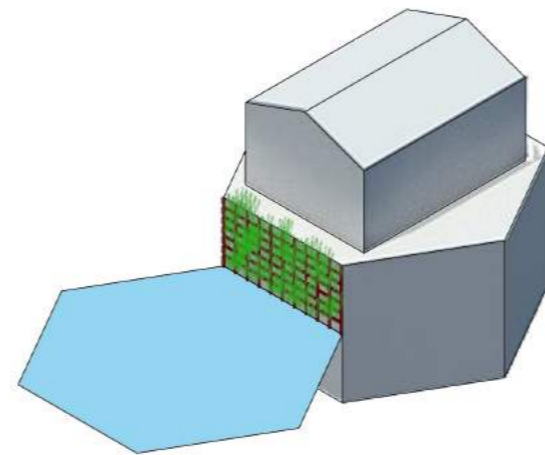
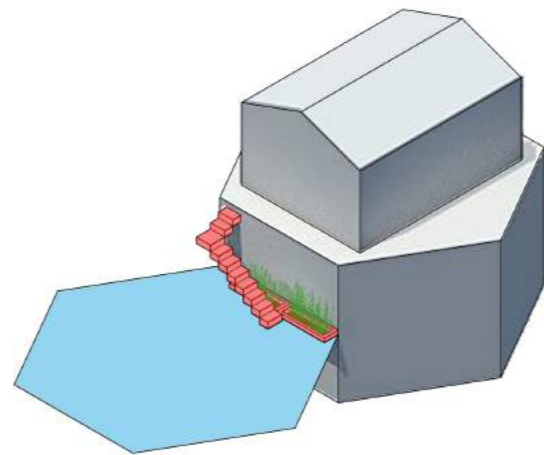
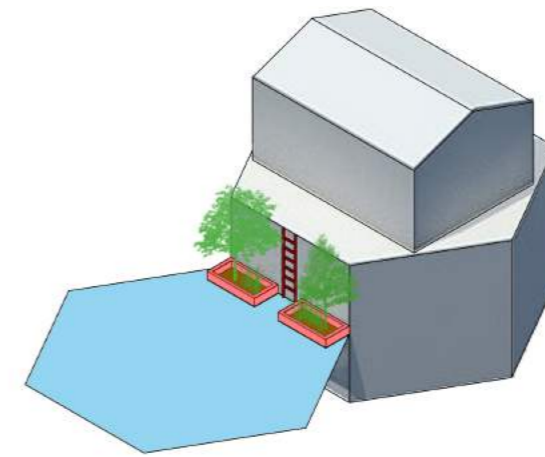
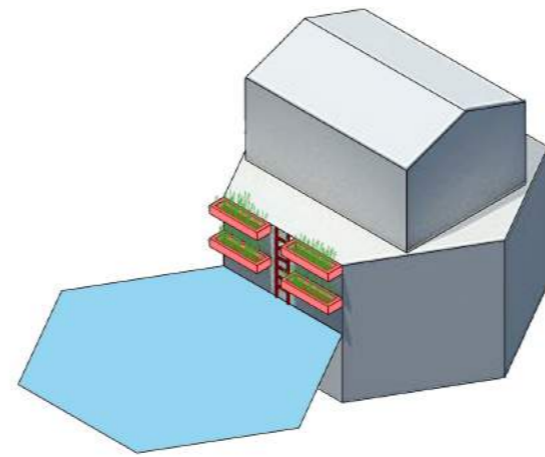
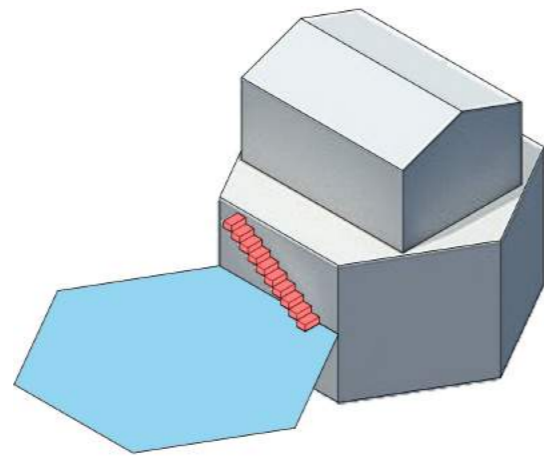

Biodiversity

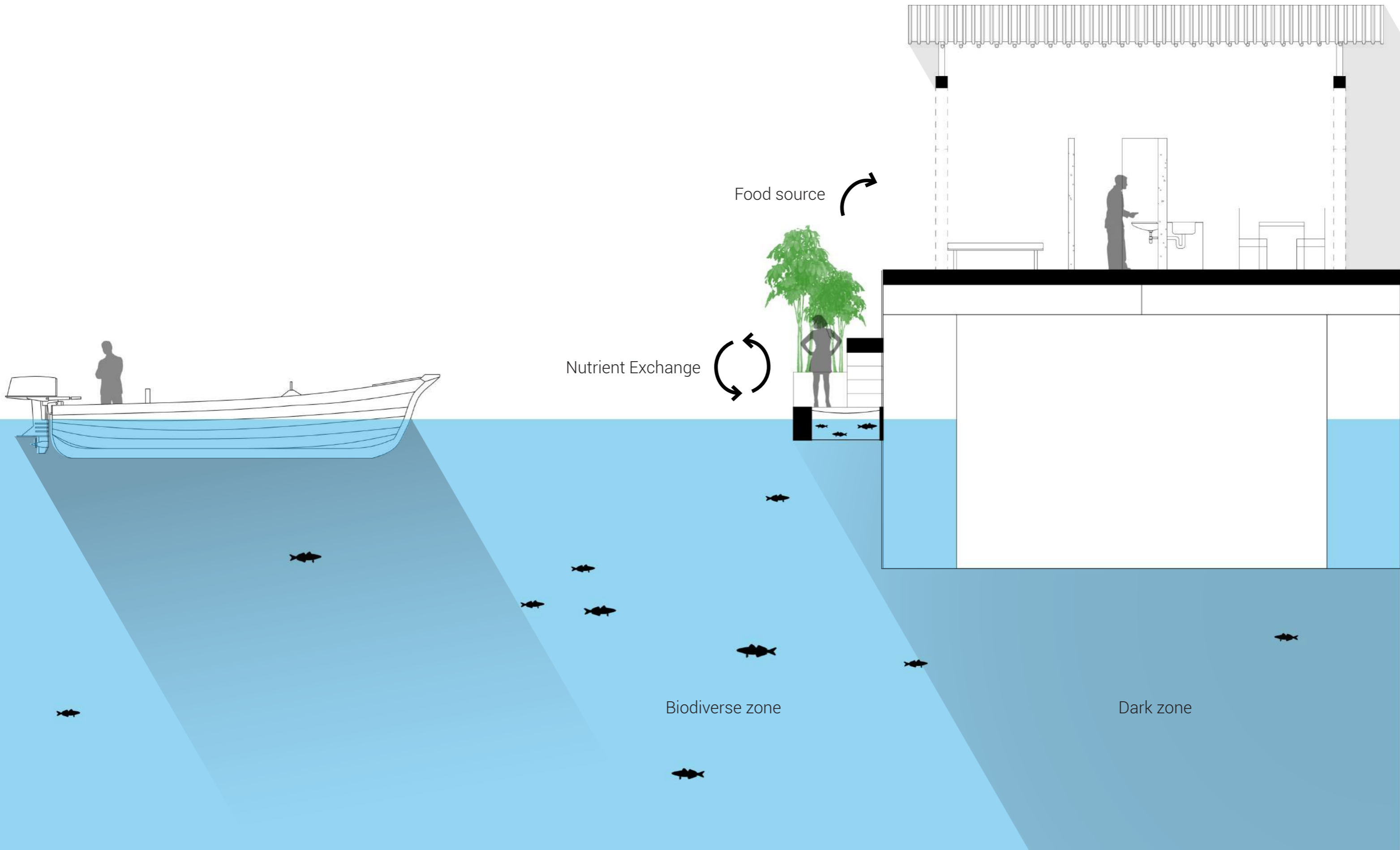

Private

Semi-private

Public

Semi-public

A Couple with 4 children
Home shop

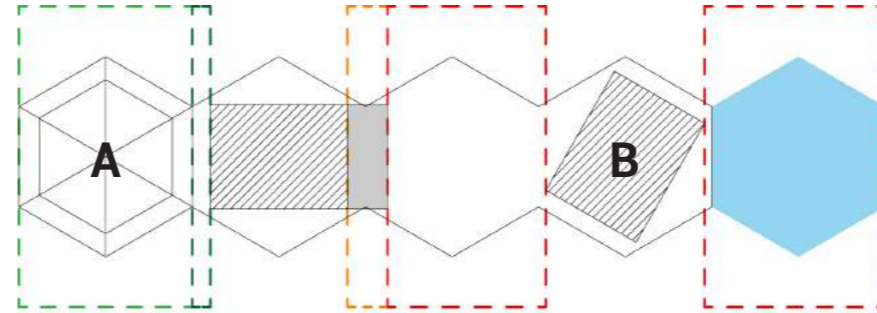

B 3 generation home
Fishermen

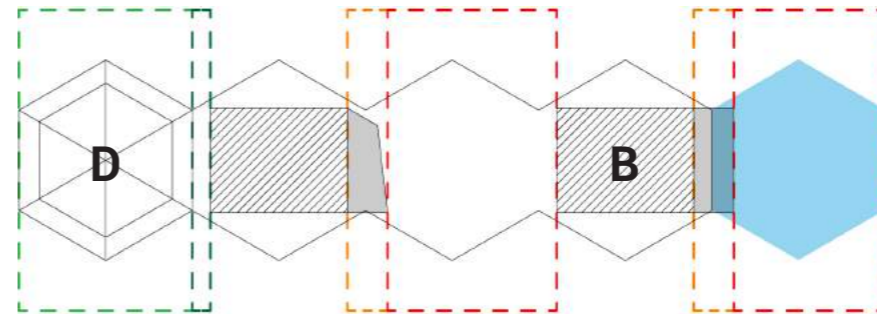

C Young couple with relatives
Street vendors

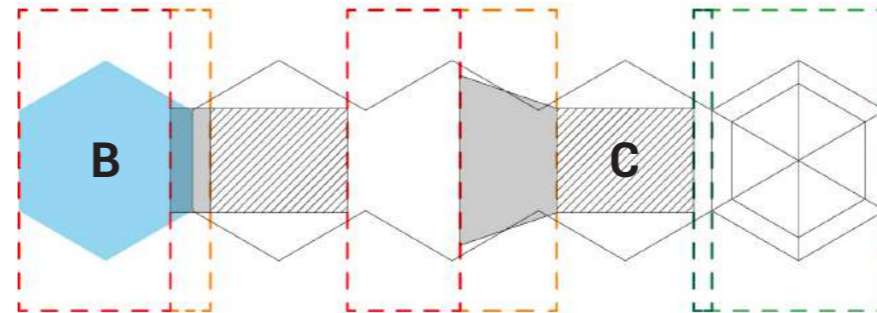

D Young couple with children
Scavenging trash

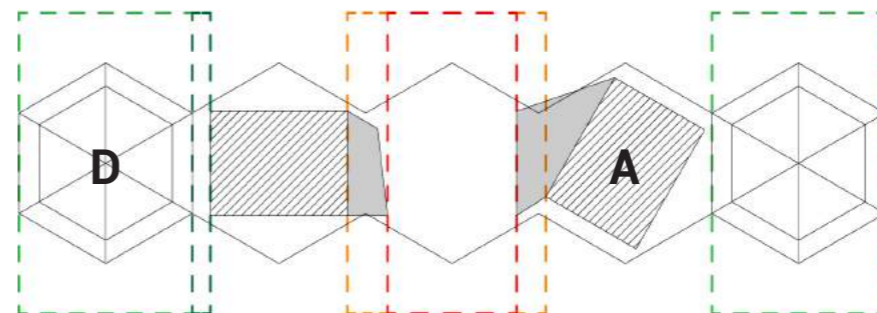

E Young couple with children
Construction worker

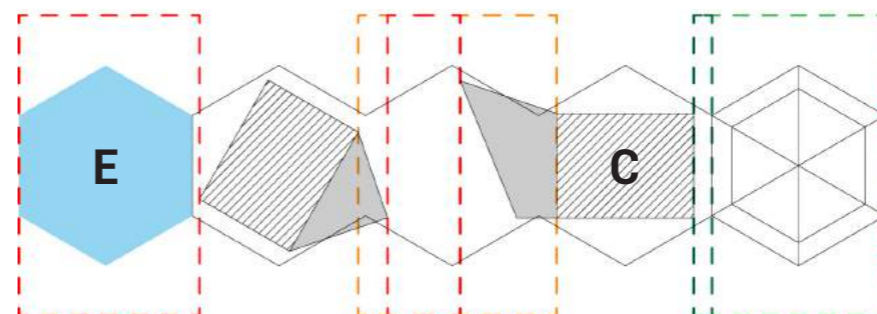



Types of movement

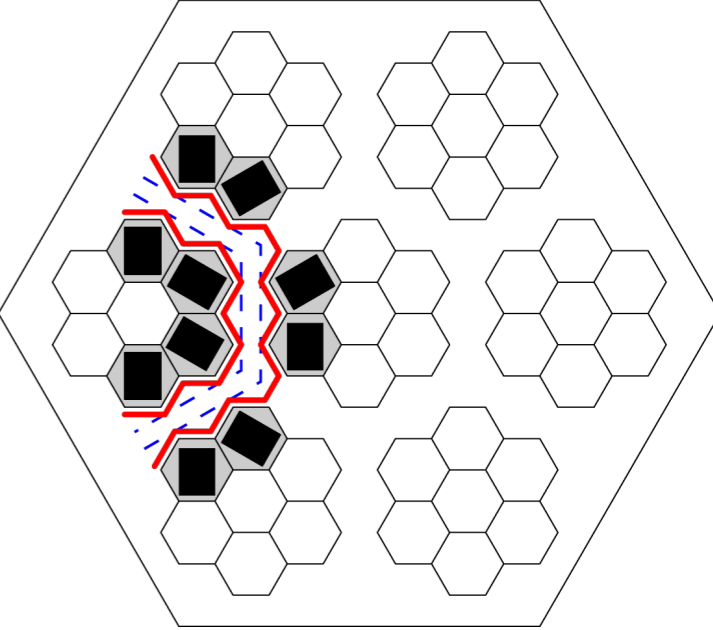
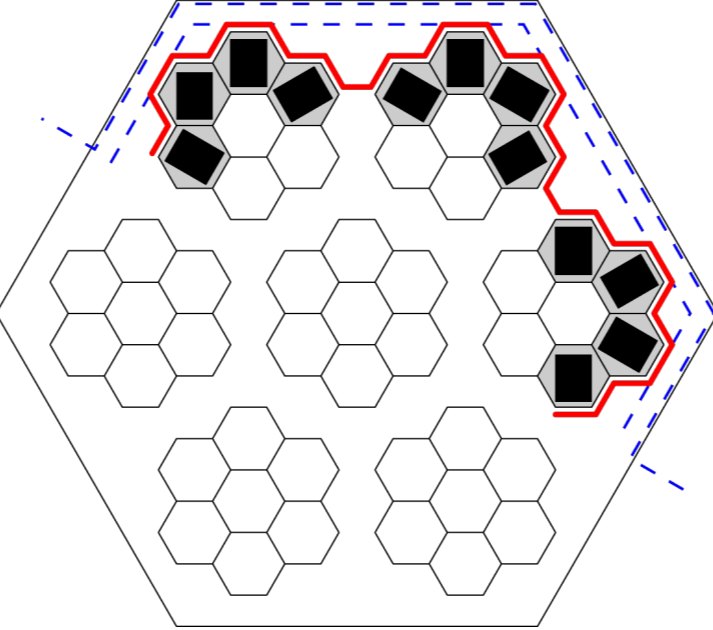
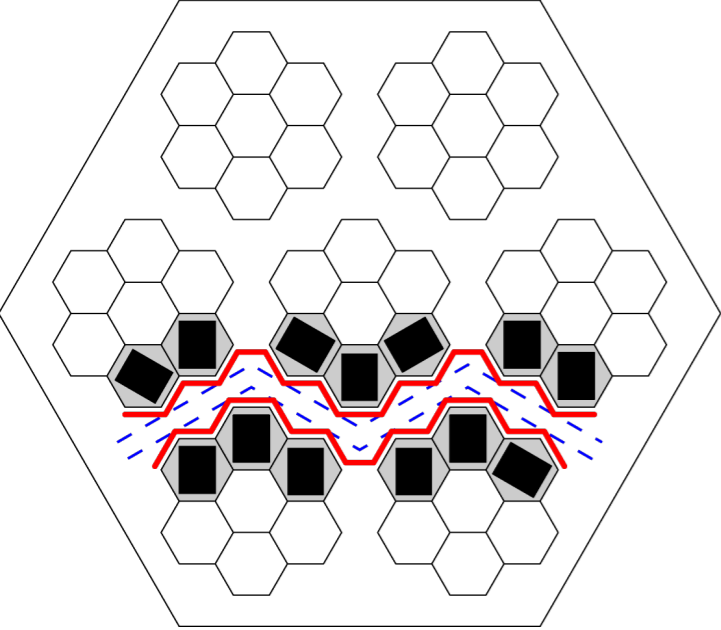
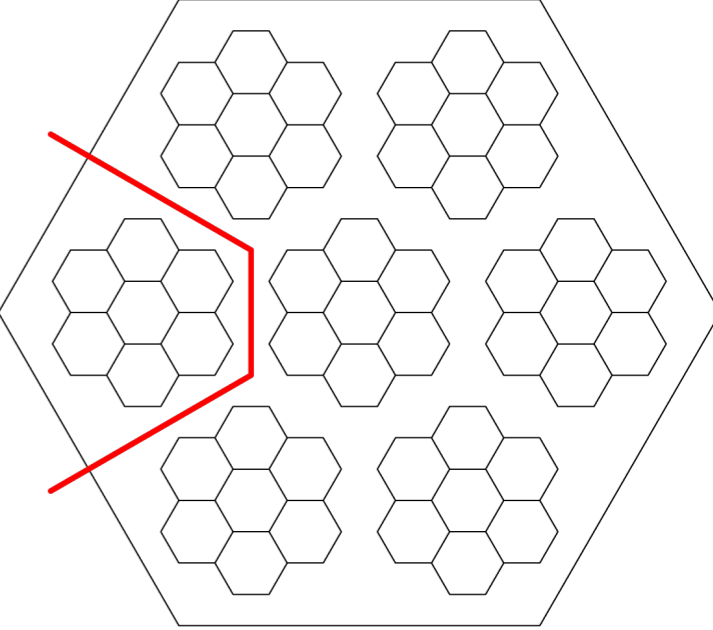
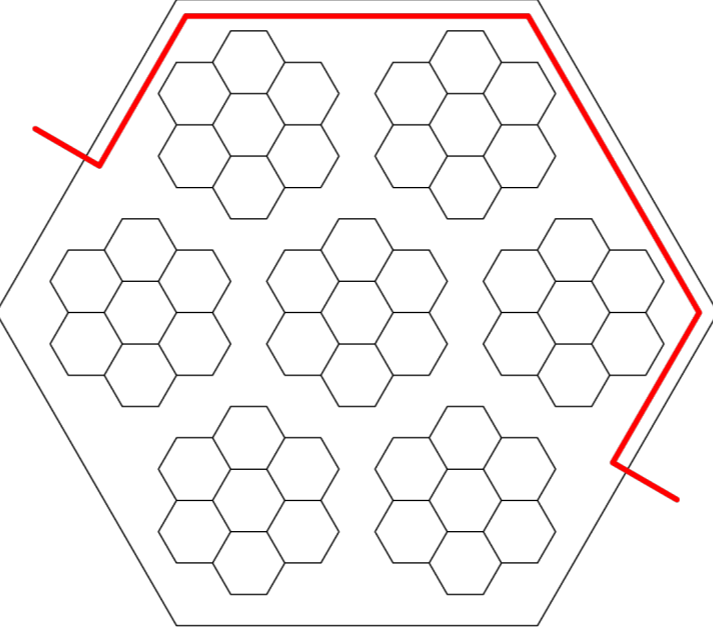
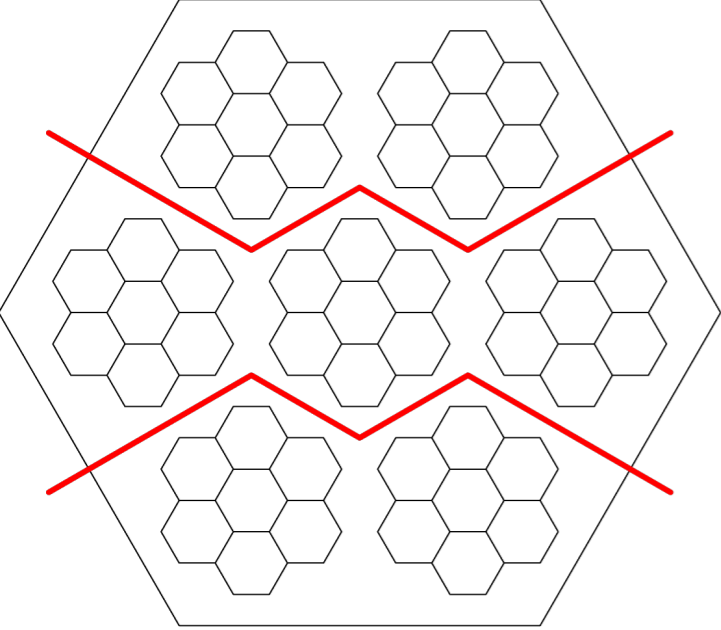

Transportation types

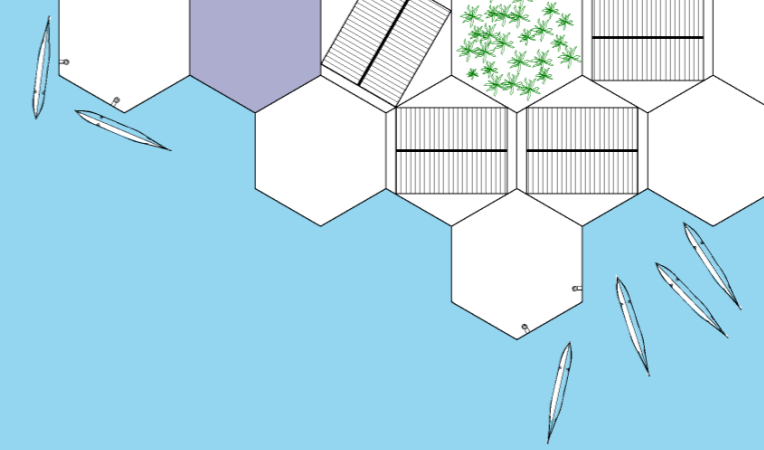
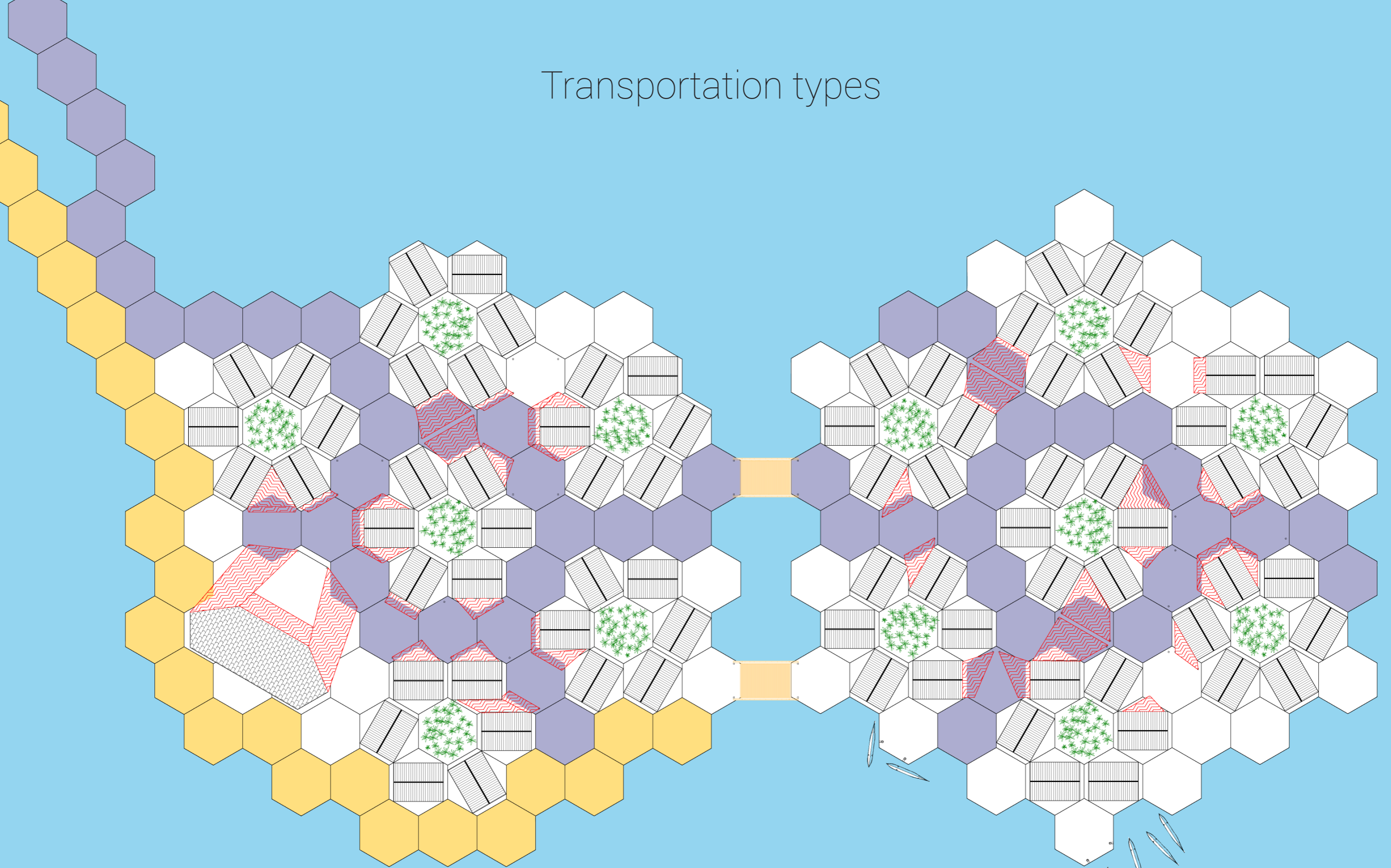

Street hierarchy

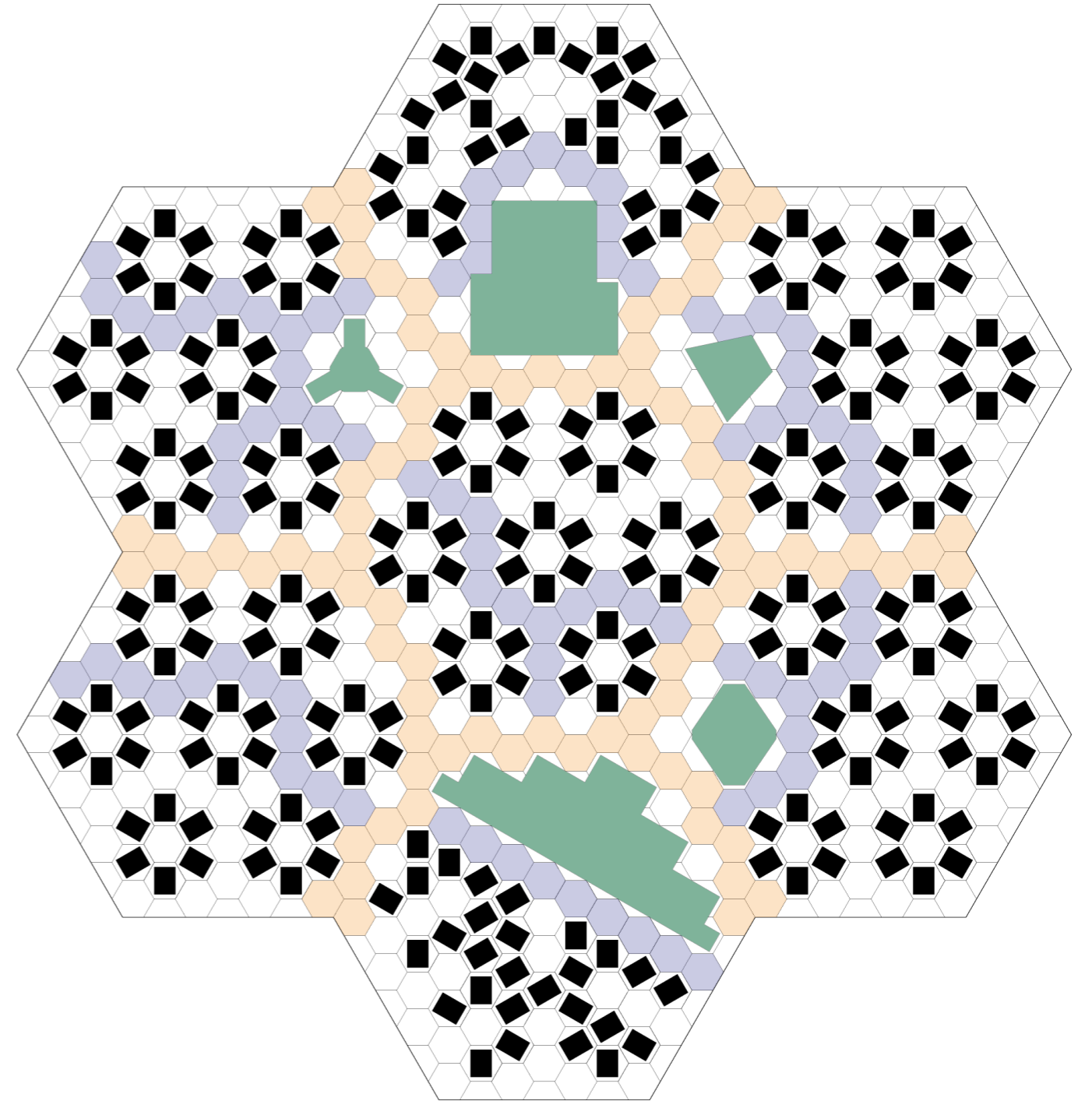
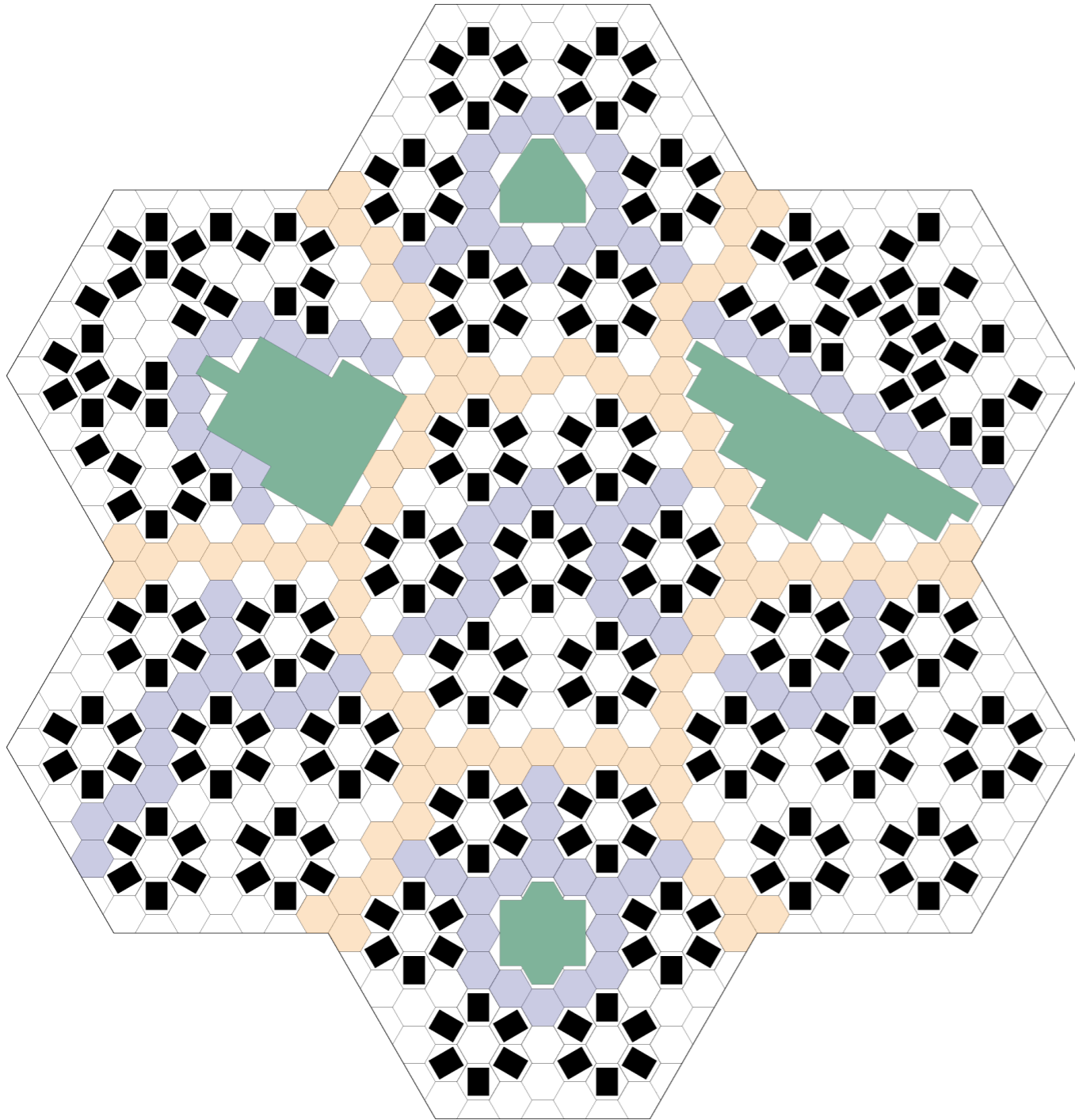

Urban section

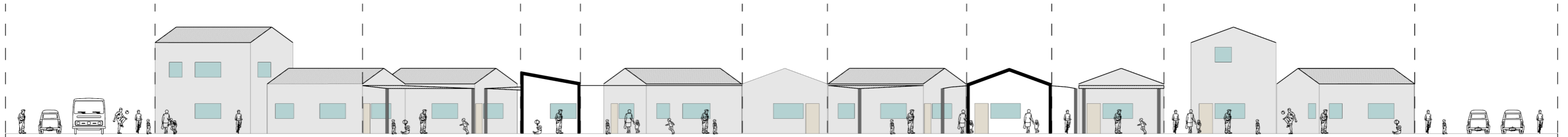
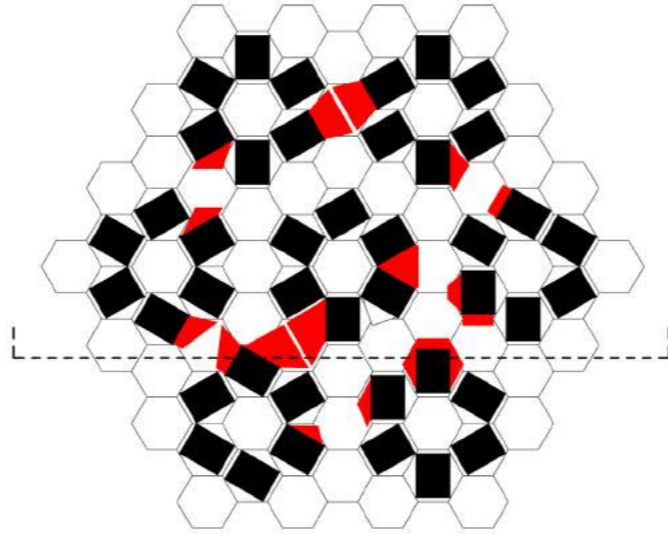

**Perimeter
Street**

House / Street

Canopy

House

Canopy

House

Canopy

House

Canopy

House / Street

**Perimeter
Street**

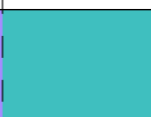
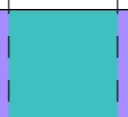
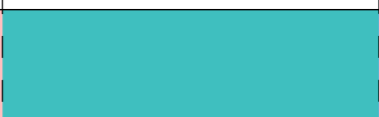

0 20 m

Urban Scenarios

Scenario 1 - Housing

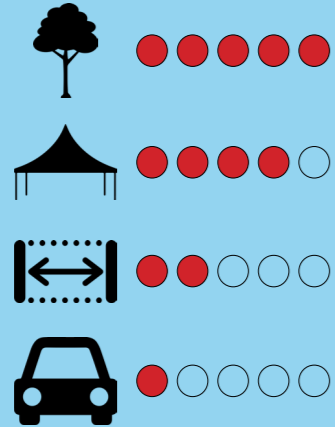

Scenario 2 - Industry & Commerce

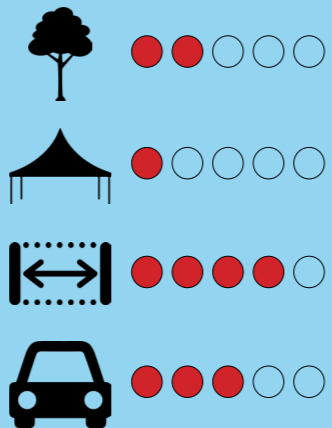

Scenario 3 - Housing & Commerce

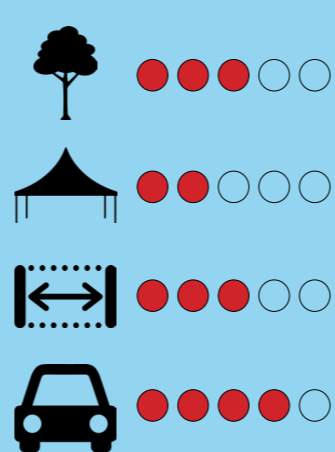

Placement of the development in **proximity** to current habitation and economic activities creates an **extension of the city fabric**.

● Slums ● Housing







0 10 50 m

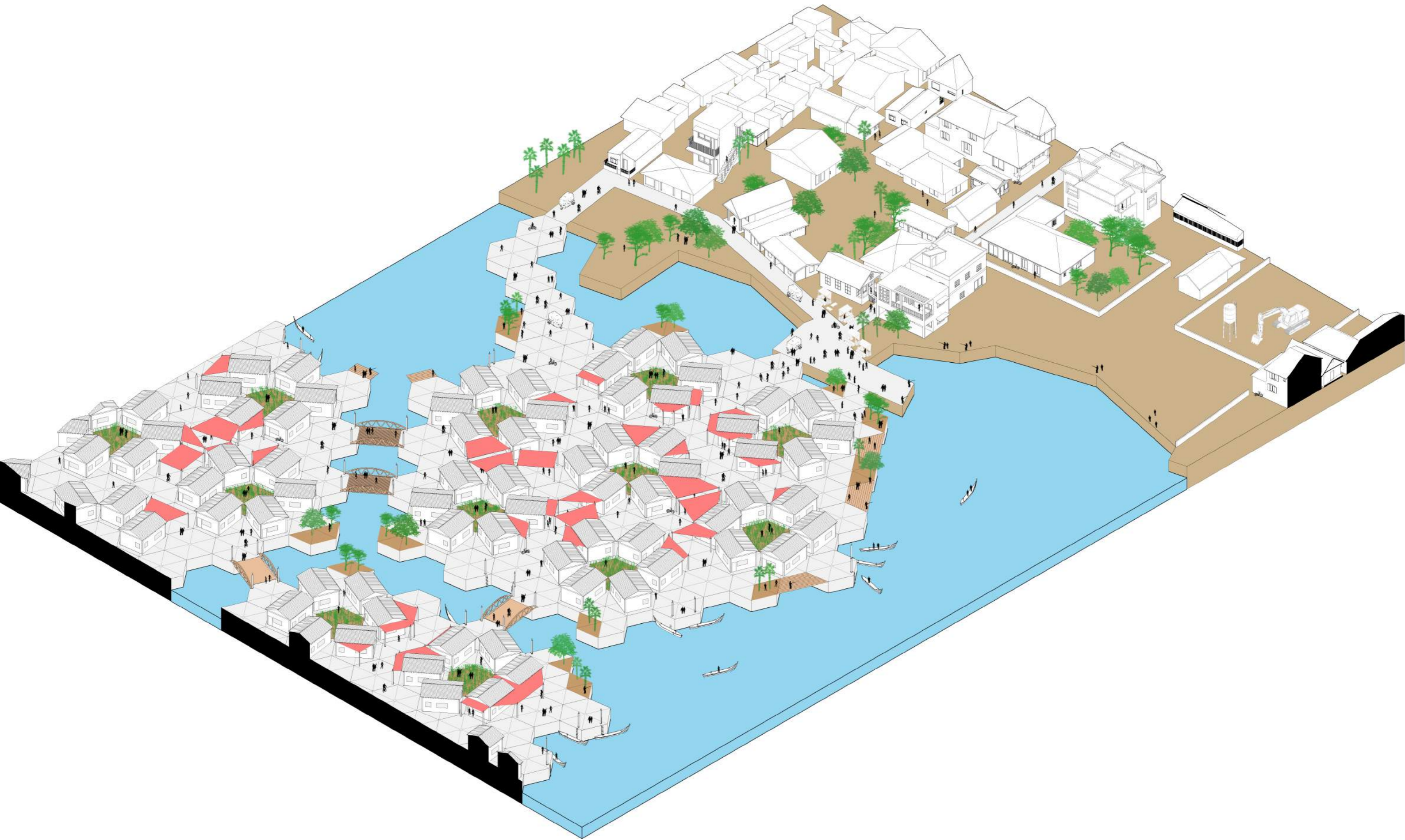



0 10 50 m

A horizontal scale bar with a vertical tick at 0, a vertical tick at 10, and a vertical tick at 50. The text "0", "10", and "50 m" is placed above the bar.

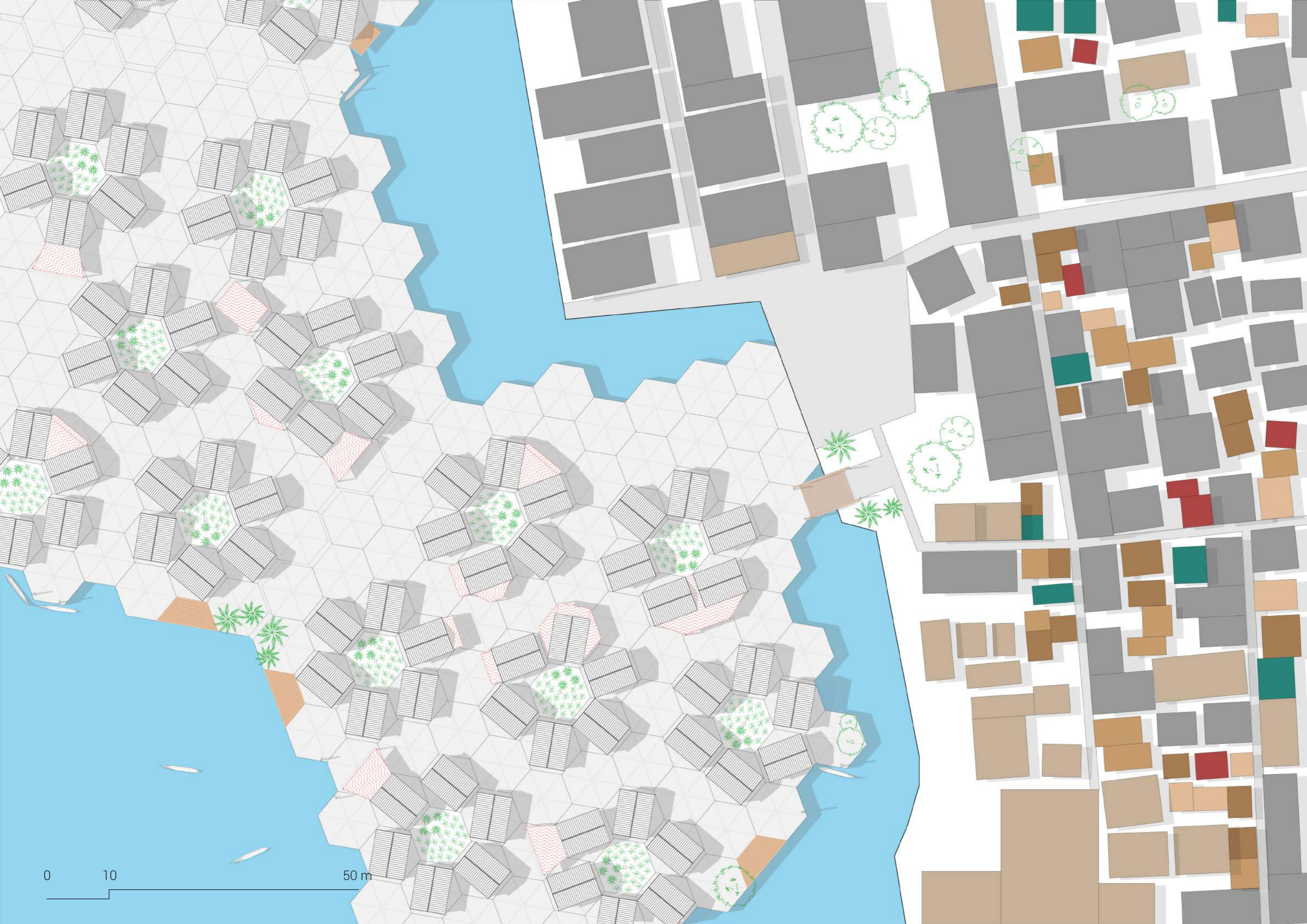

0 10 50 m

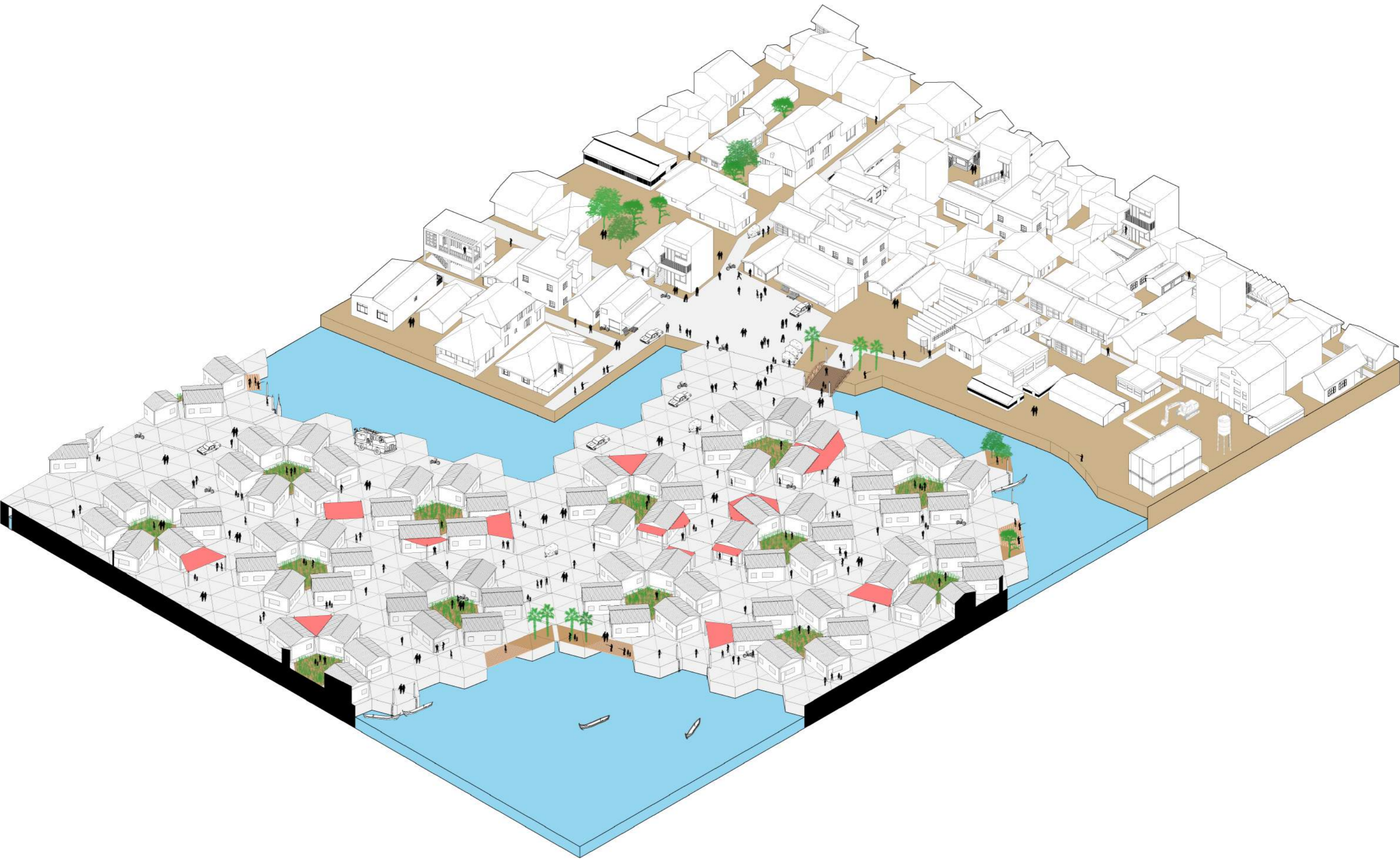





0 10

50 m

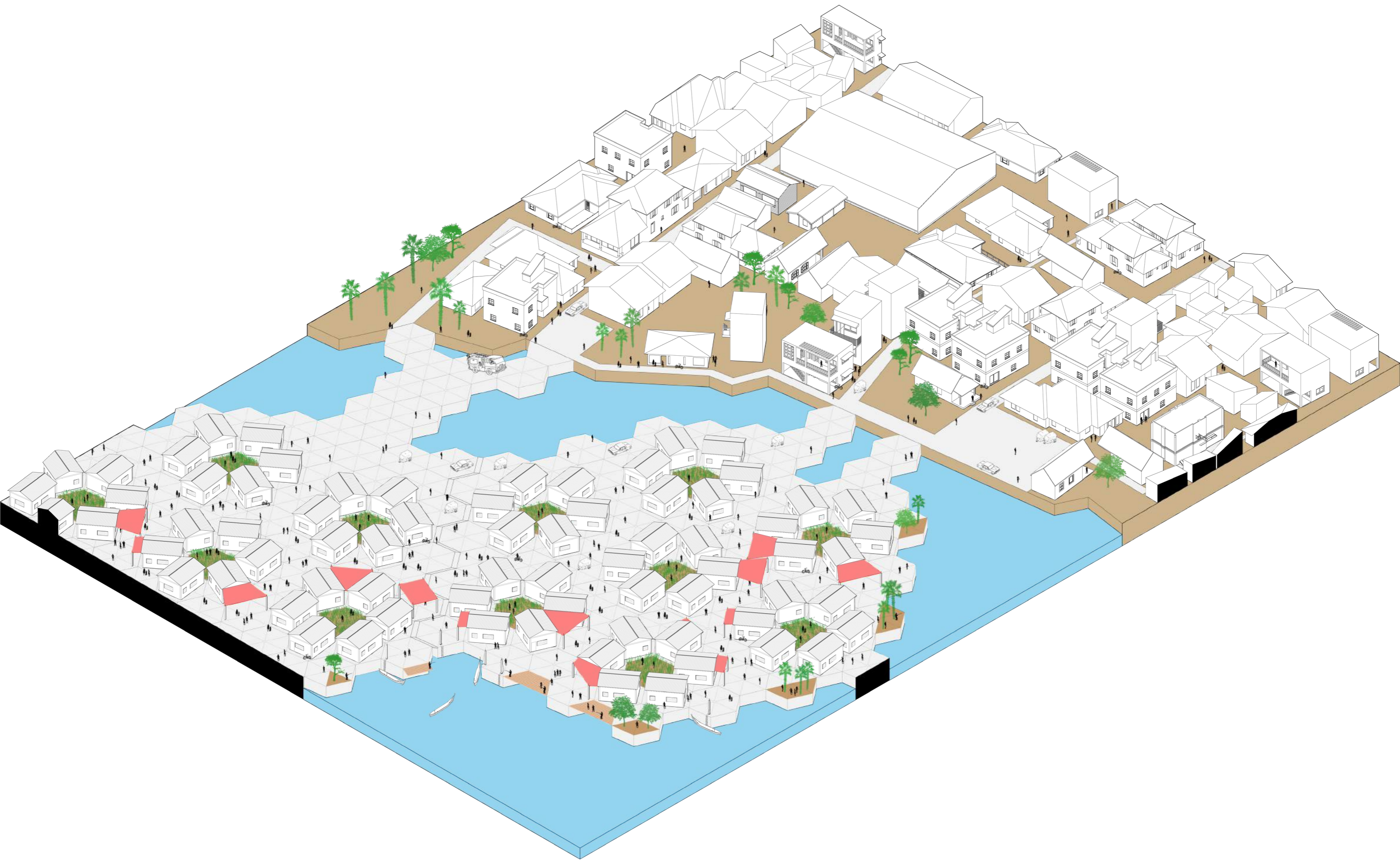

- Coastal improvements
- Mixed transport
- Pedestrian only
- Housing cluster
- Boat docking



Urban Scenario Year 3

10 communities
1000 pods

400 housing units
3000 inhabitants

65,000 m²

3 wavebreakers
45 IMTA units

0 100m



Wave Breaker

A **floating wave breaker** which integrates **nutrient remediation** with **economic opportunity** could prove resilient on many scales.

Integrated multi-trophic aquaculture [IMTA]

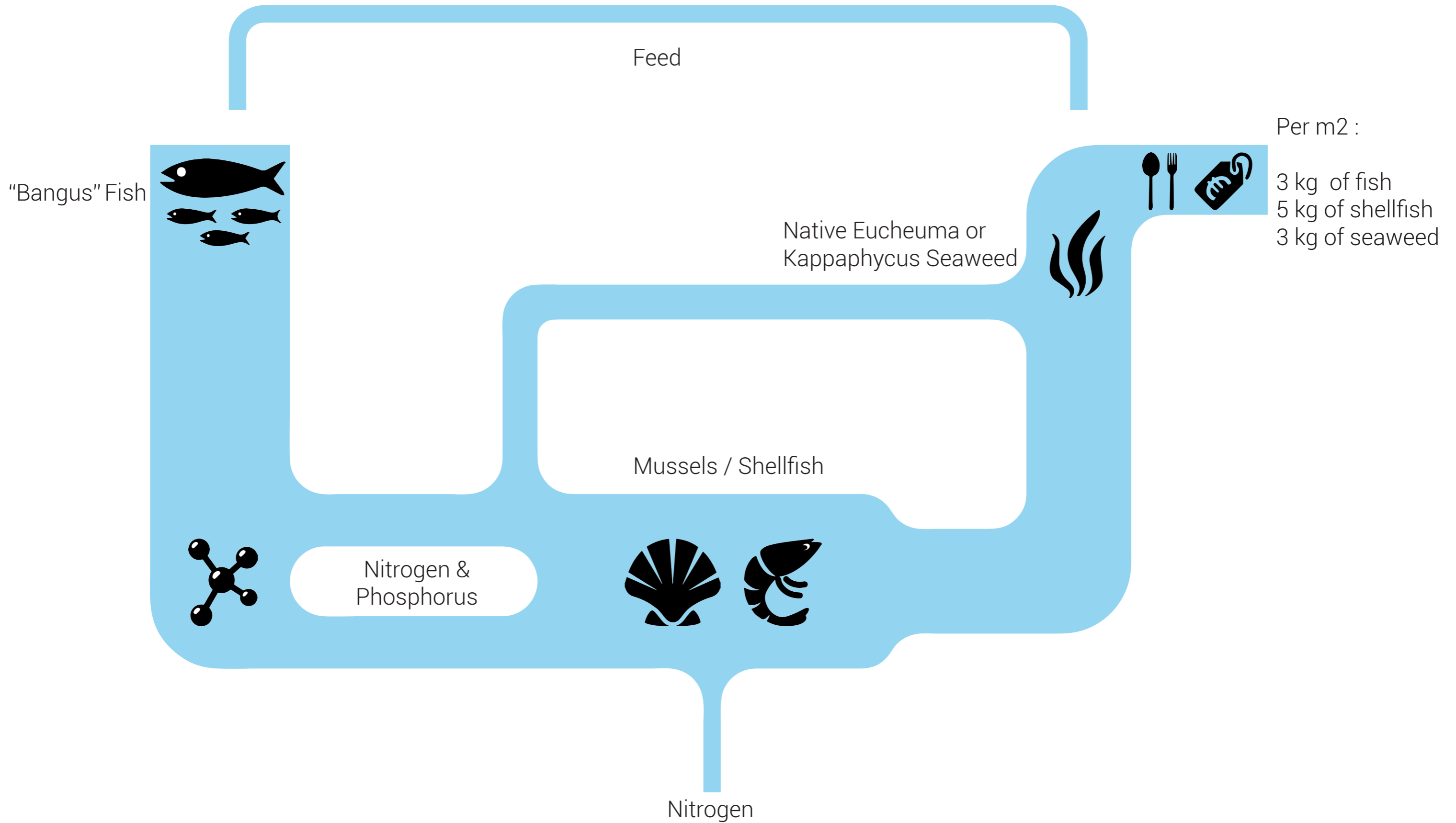



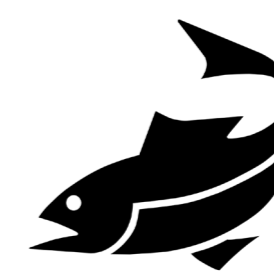
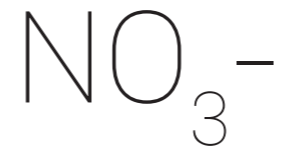
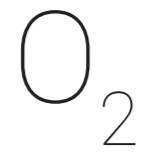

Working at sea

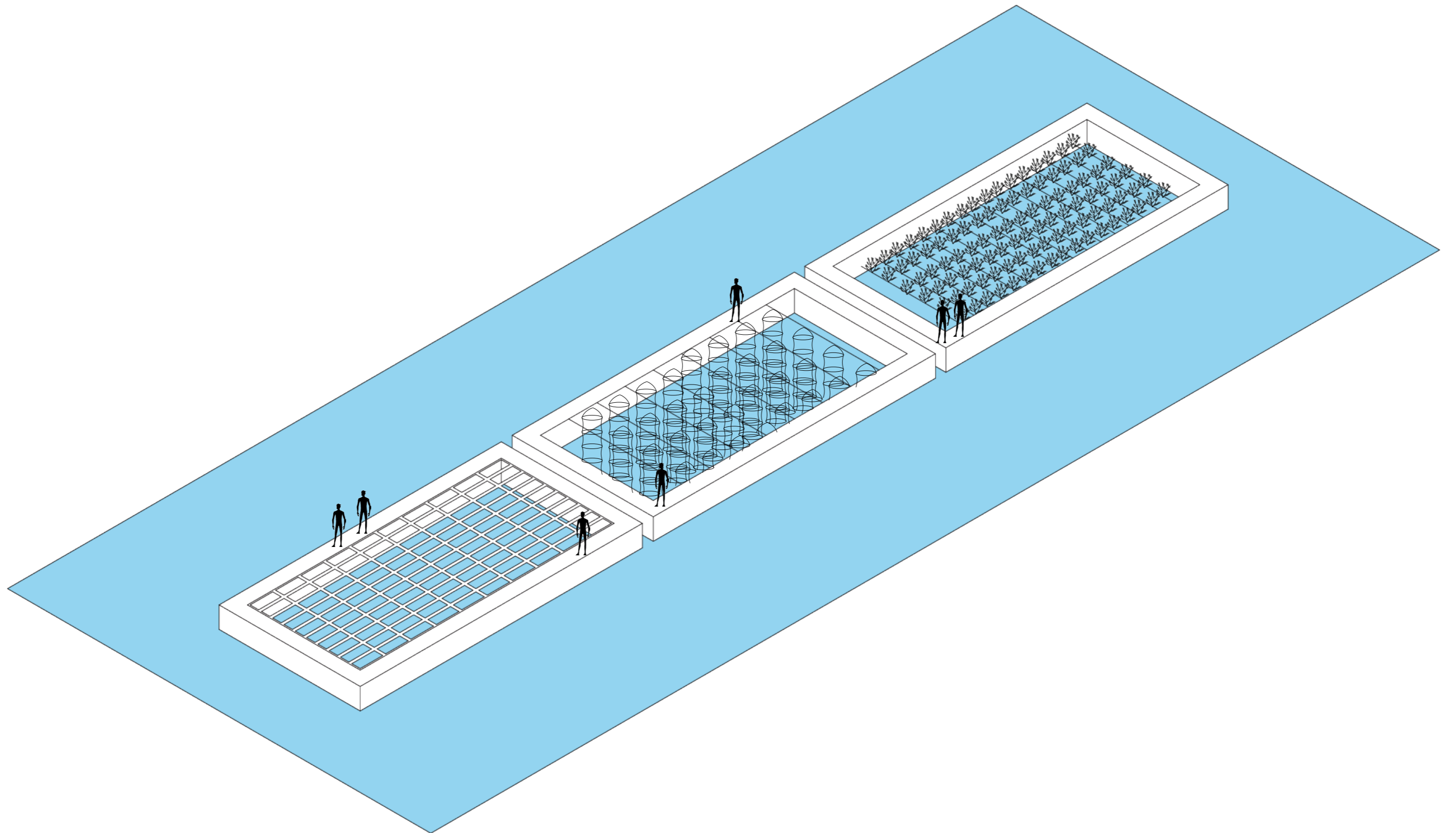

IMTA

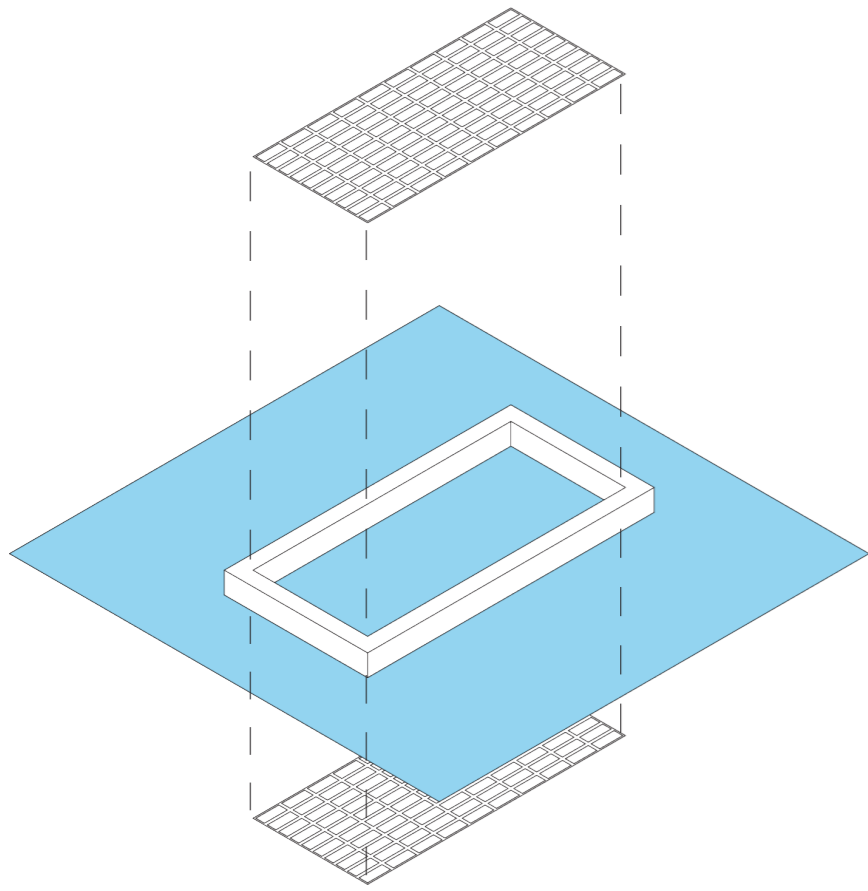

Milkfish Cages

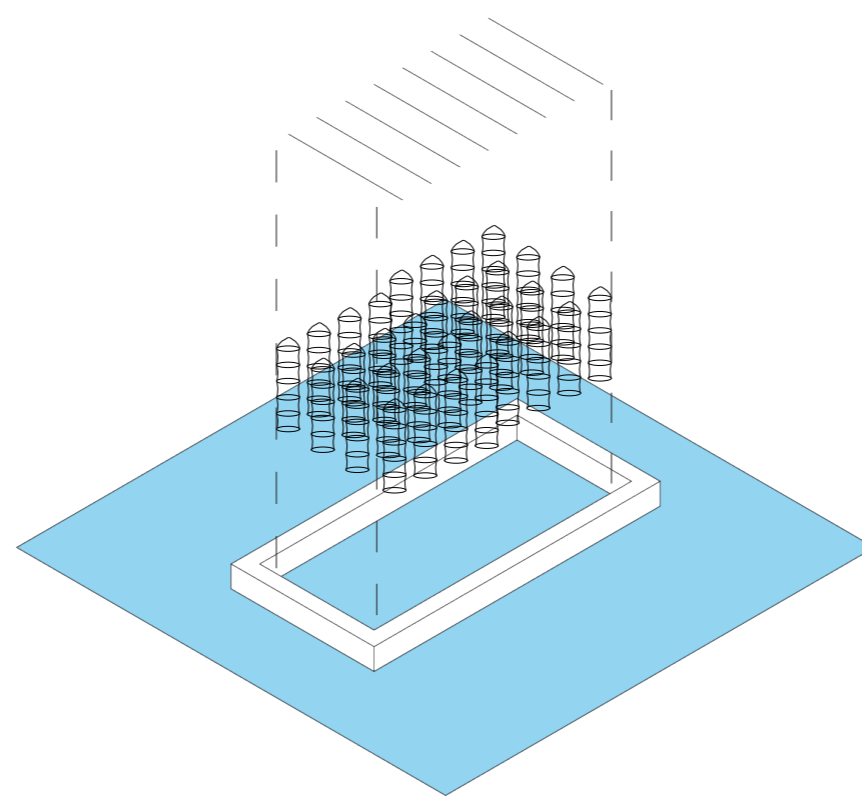

Shellfish Nets

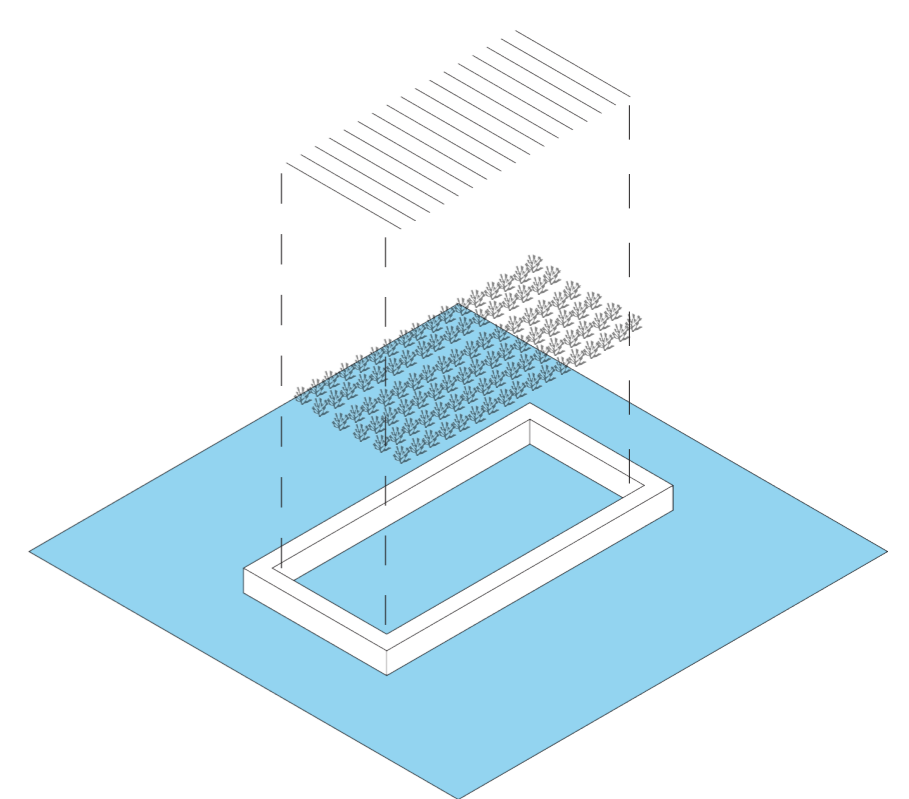

Seaweed Lines

Large scale defensive strategy

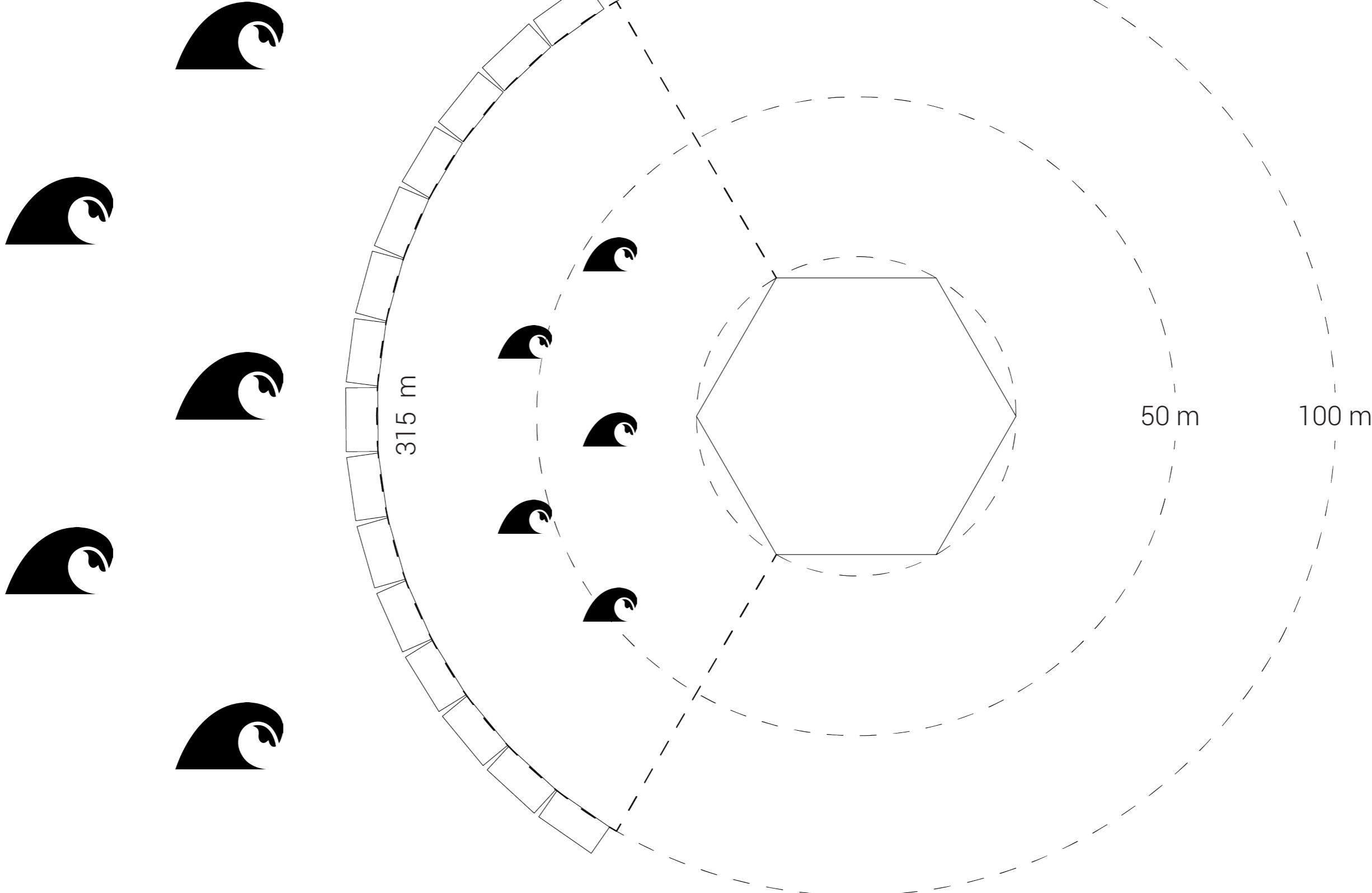

IMTA unit section

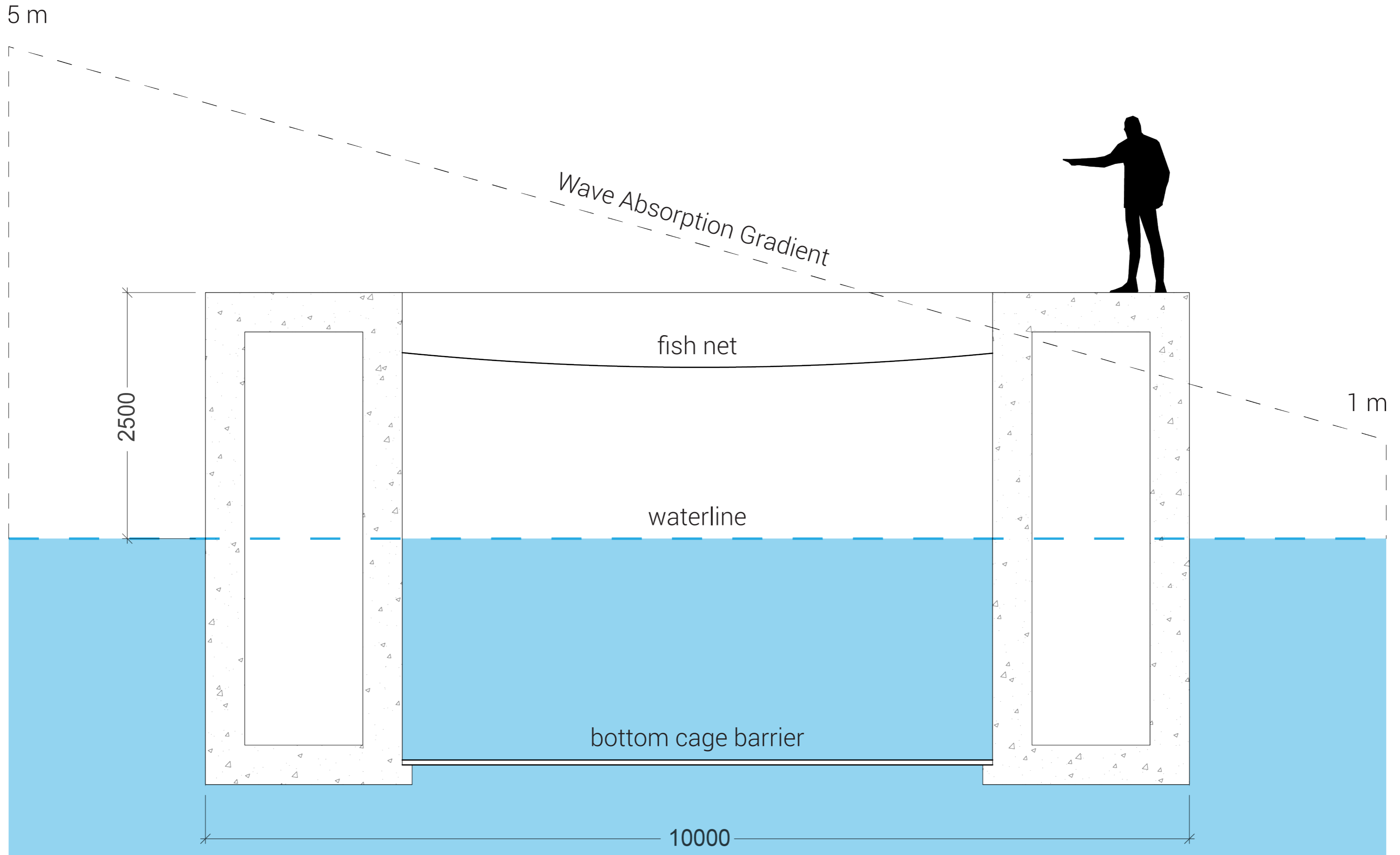

Connecting modules

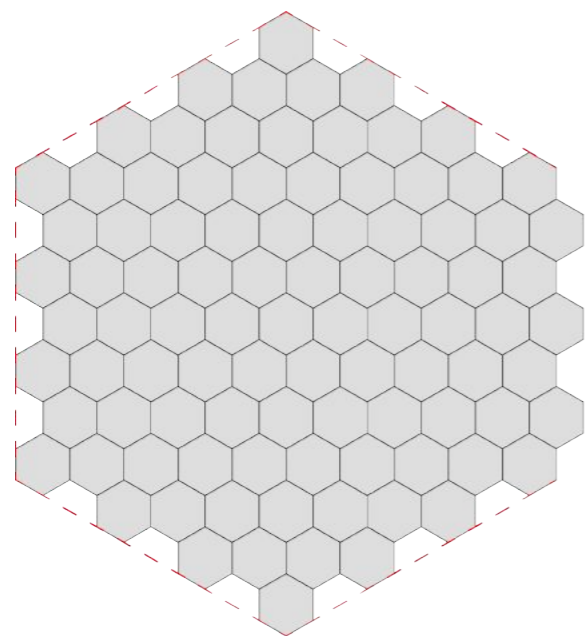

A

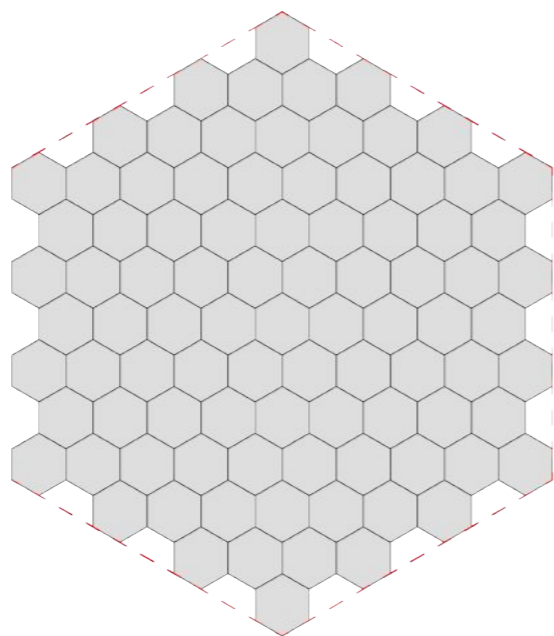

B

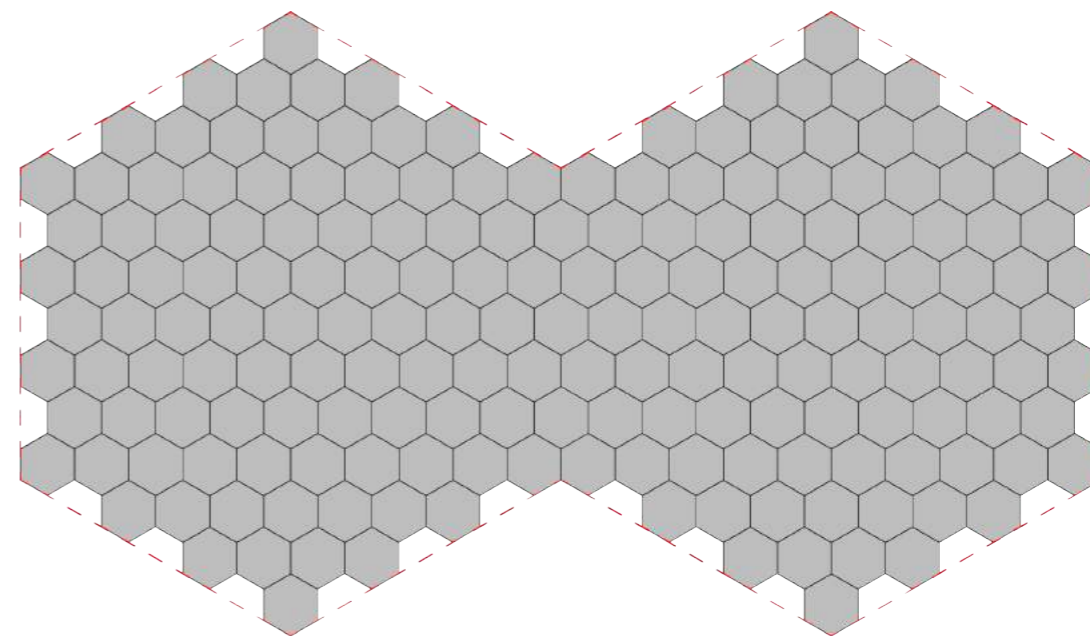

A-B

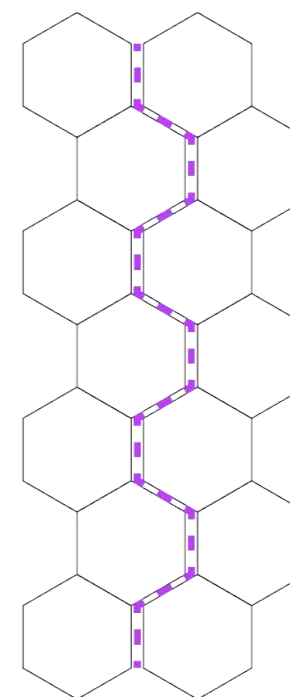
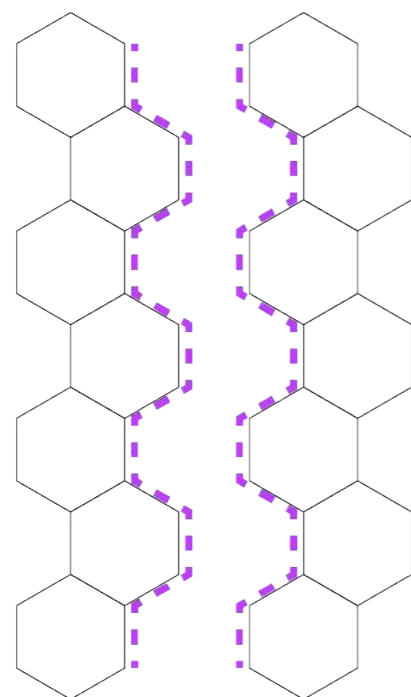

Connecting modules

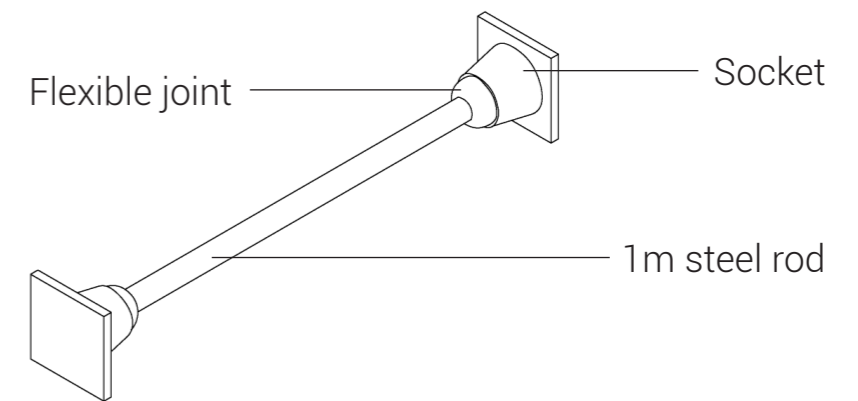
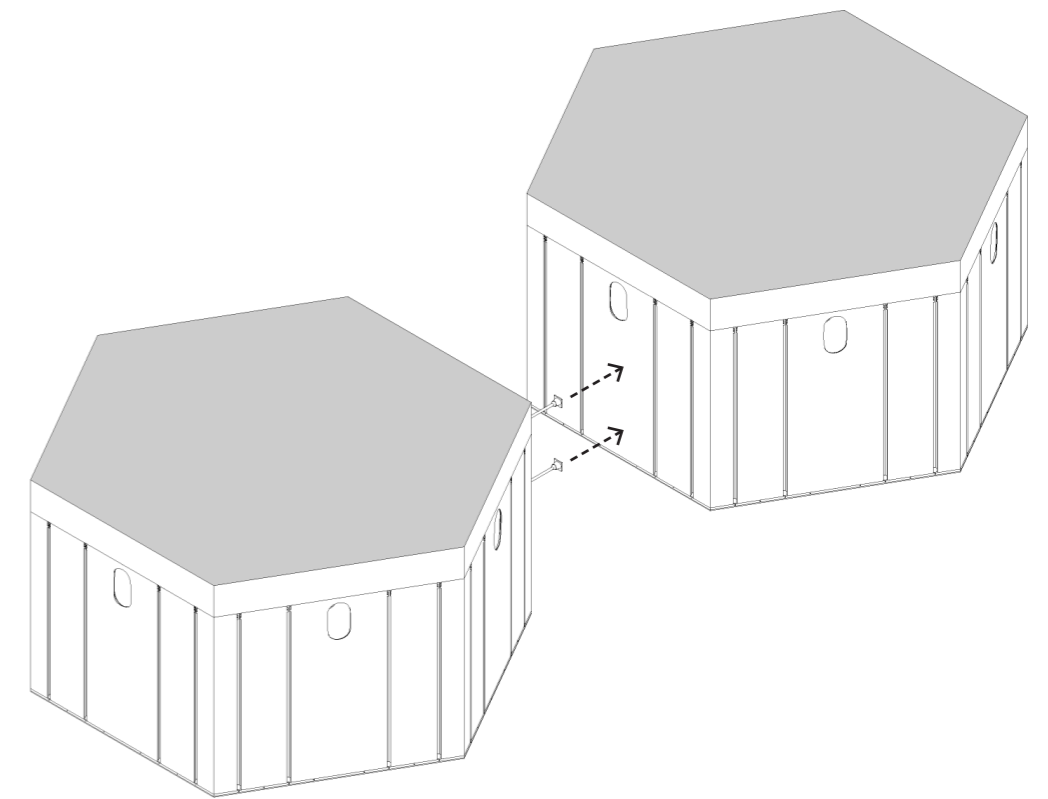
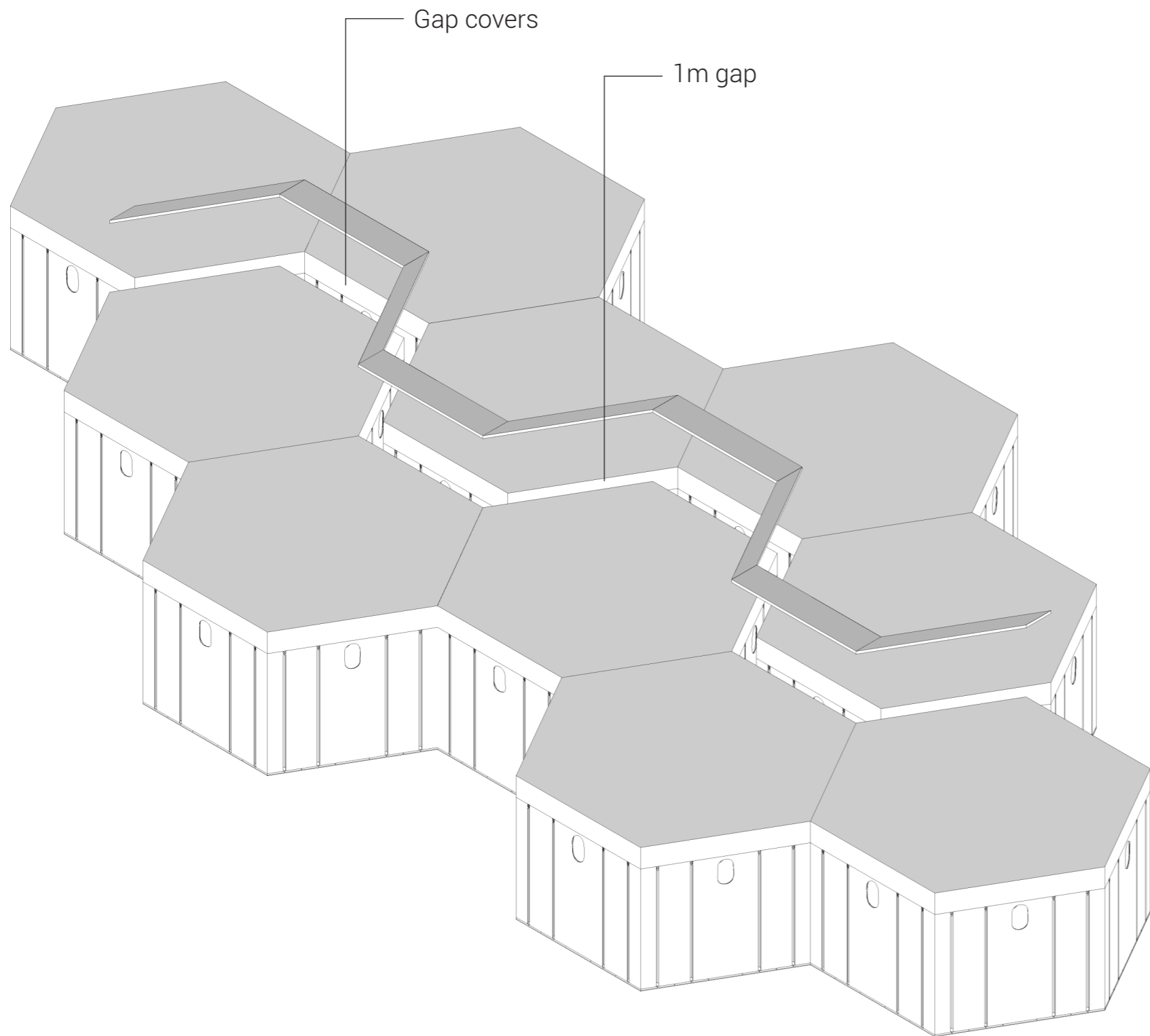

Seabed anchoring - suction caissons

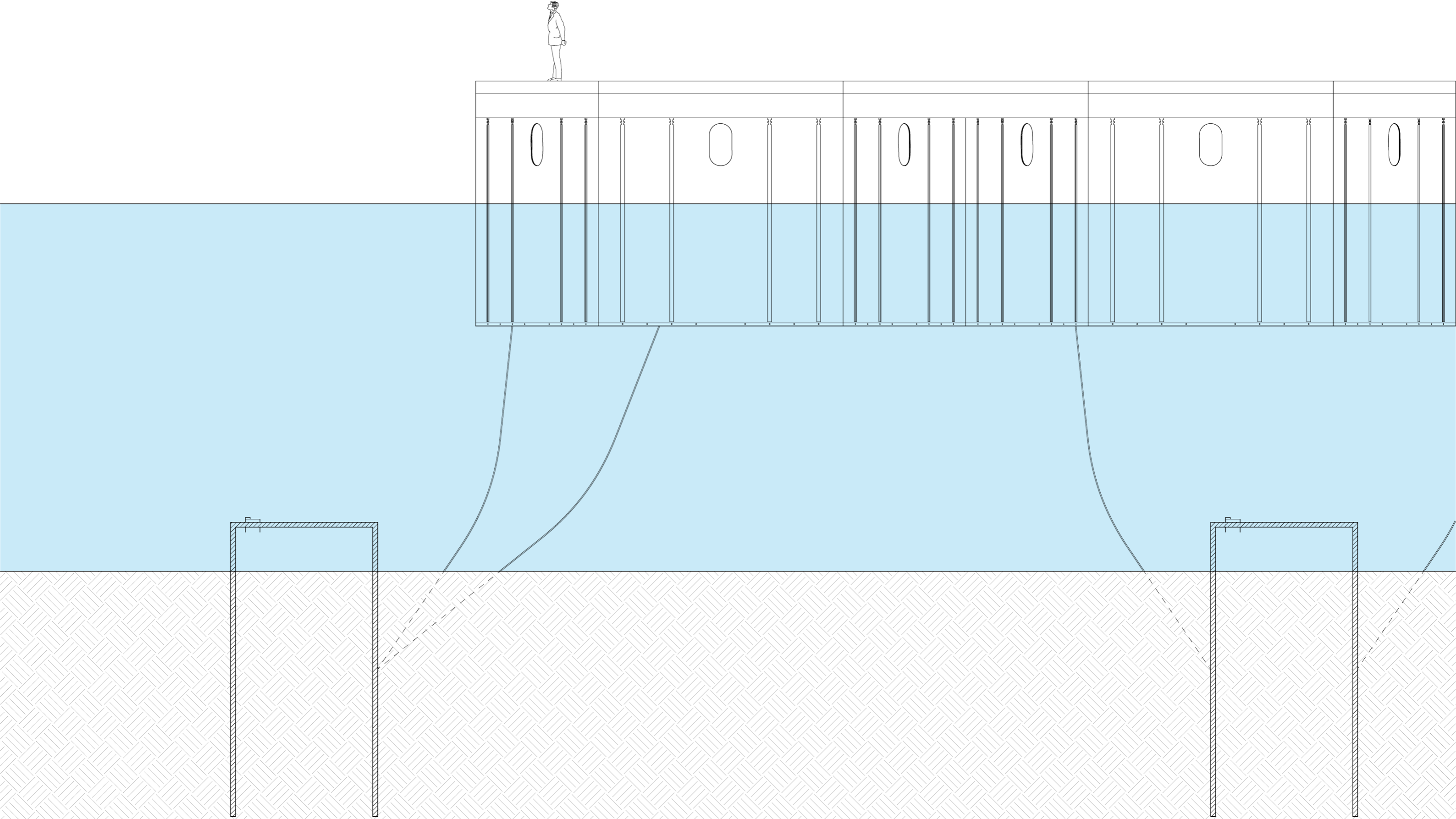

Development Sequence

1st Pod

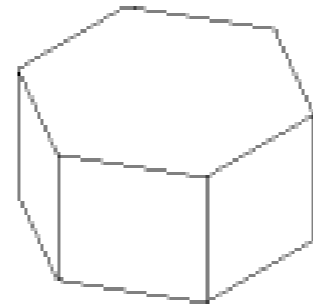

Development Sequence

Attached Pods

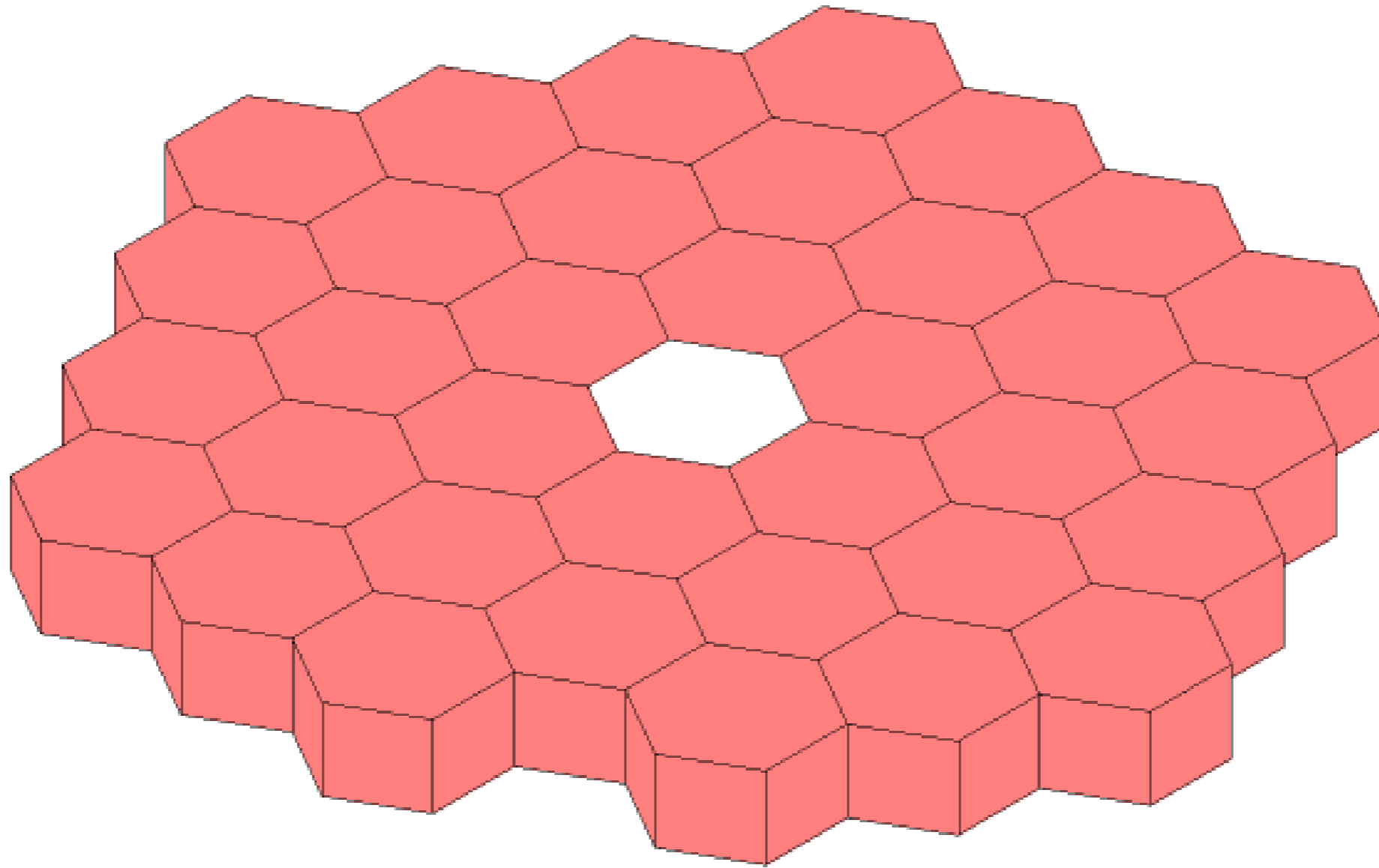

Development
Sequence

Complete
Assembly

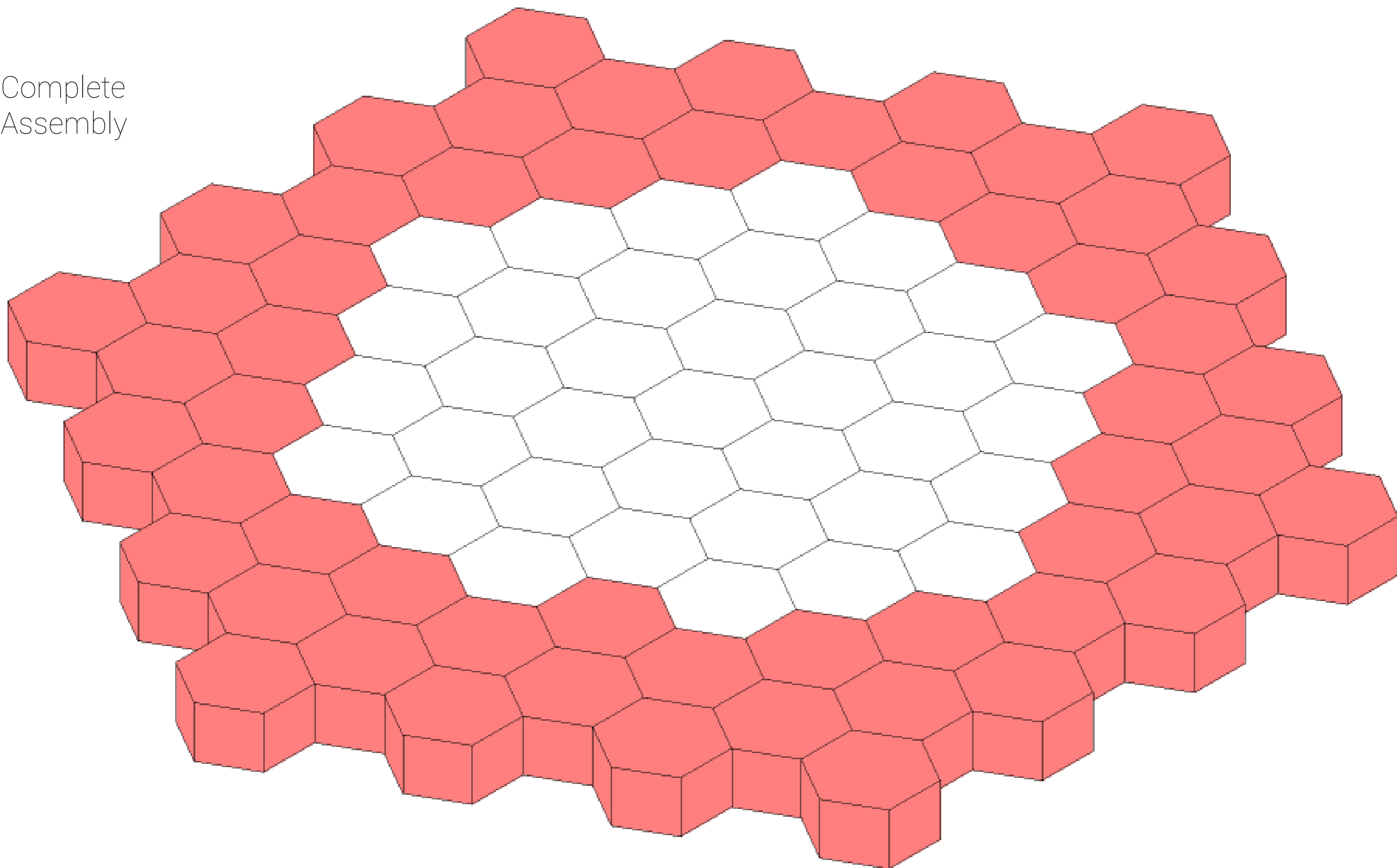

Development
Sequence

Structure

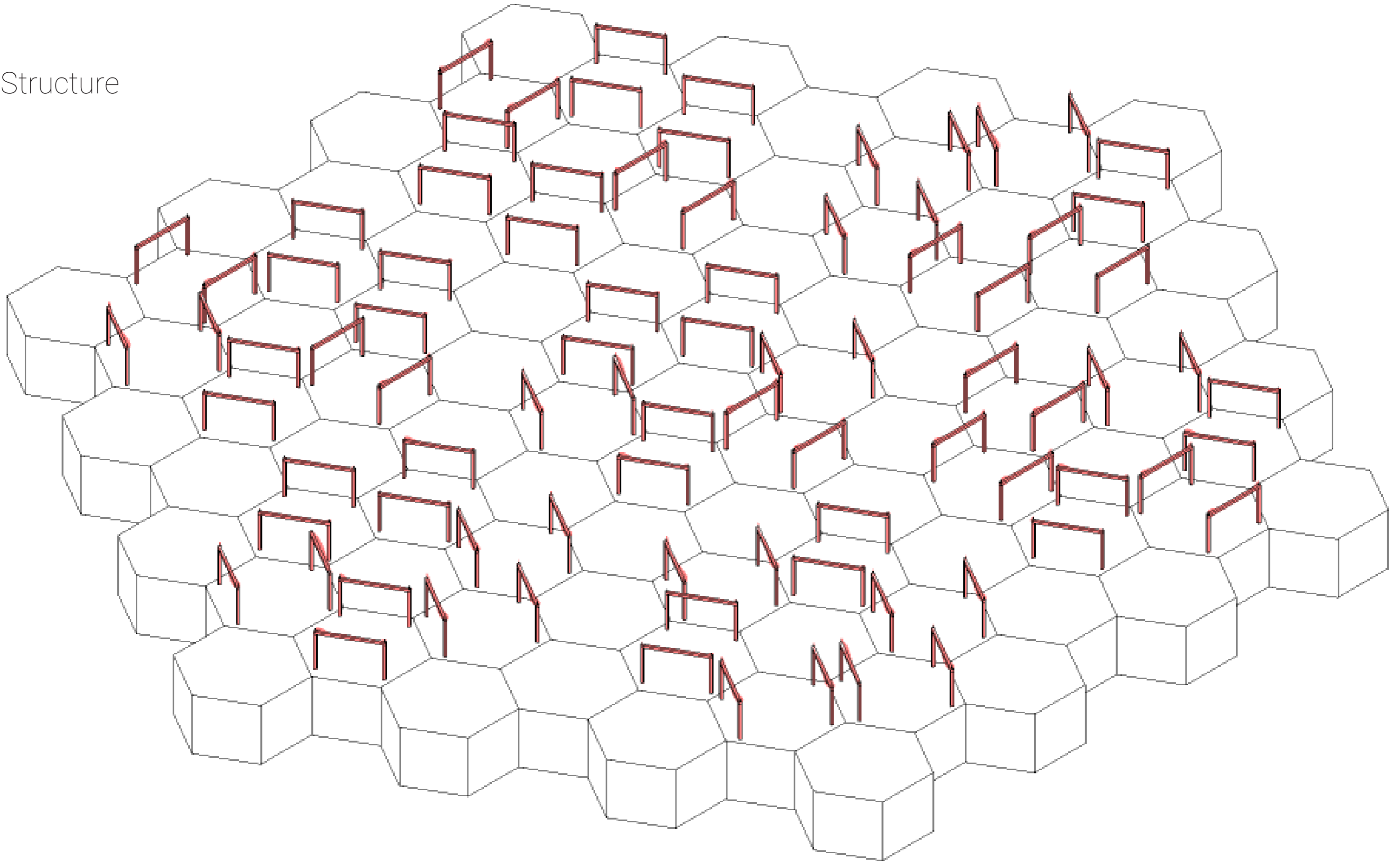

Development Sequence

Utility Core

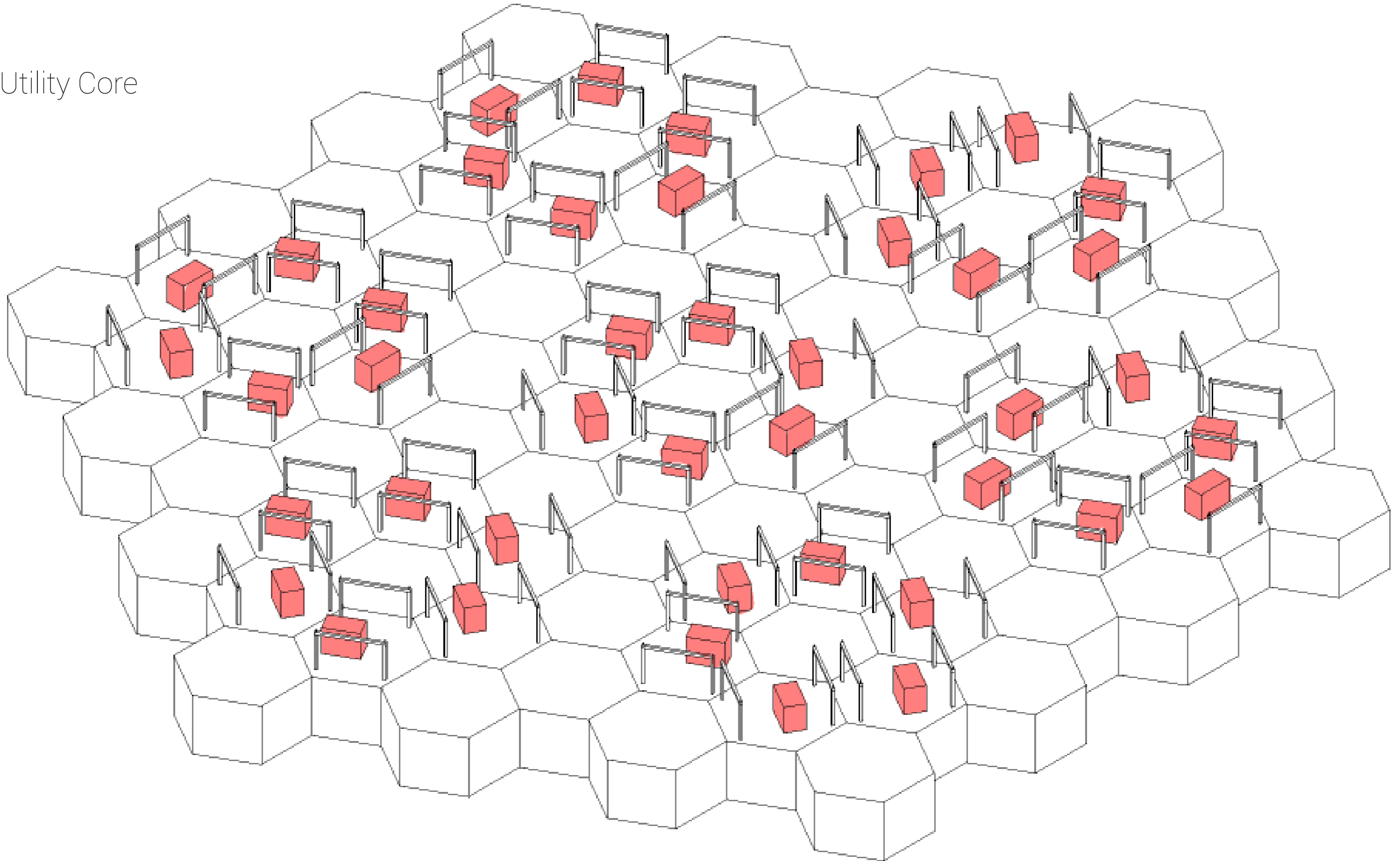

Development Sequence

Roof

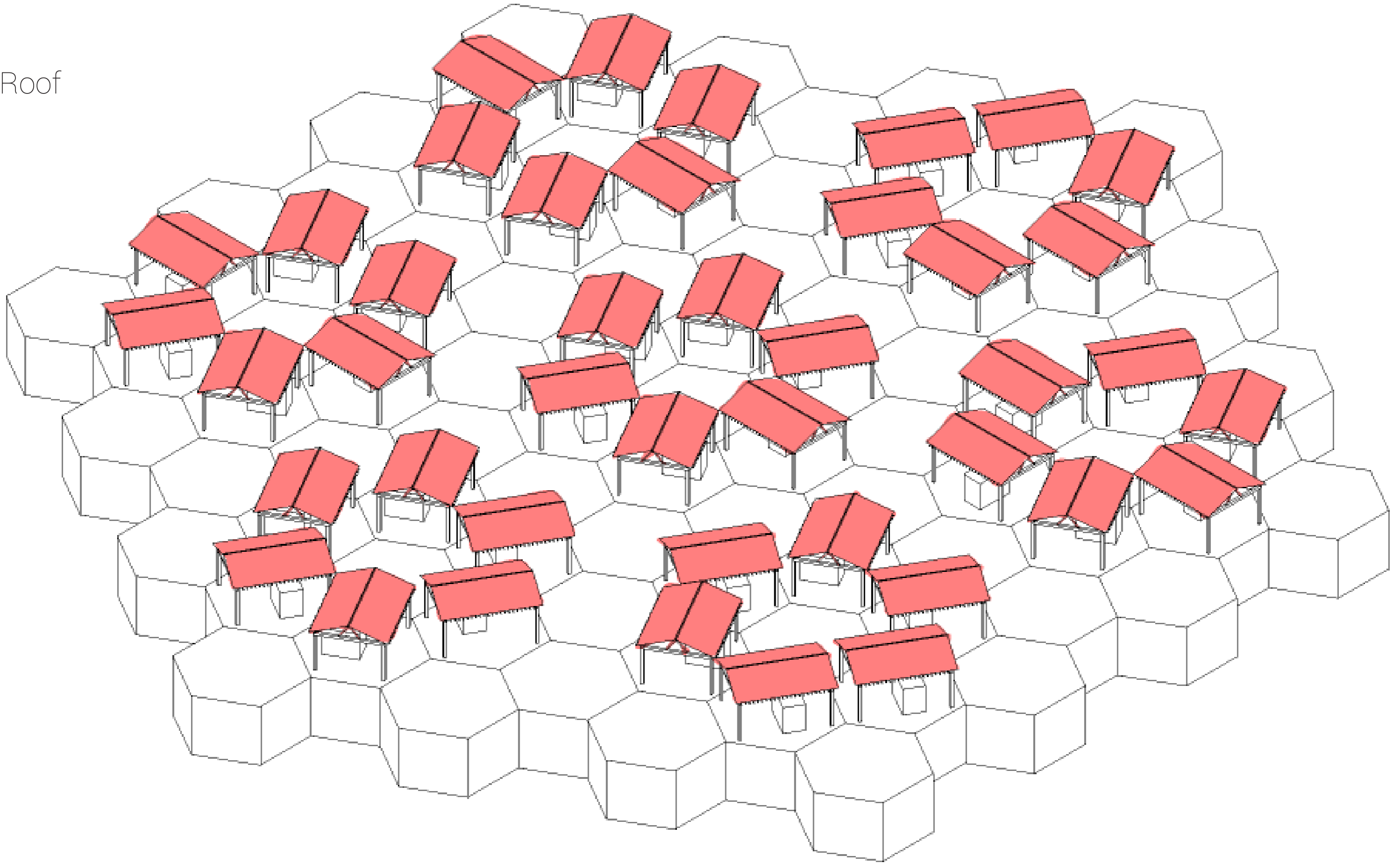

Development Sequence

Infill

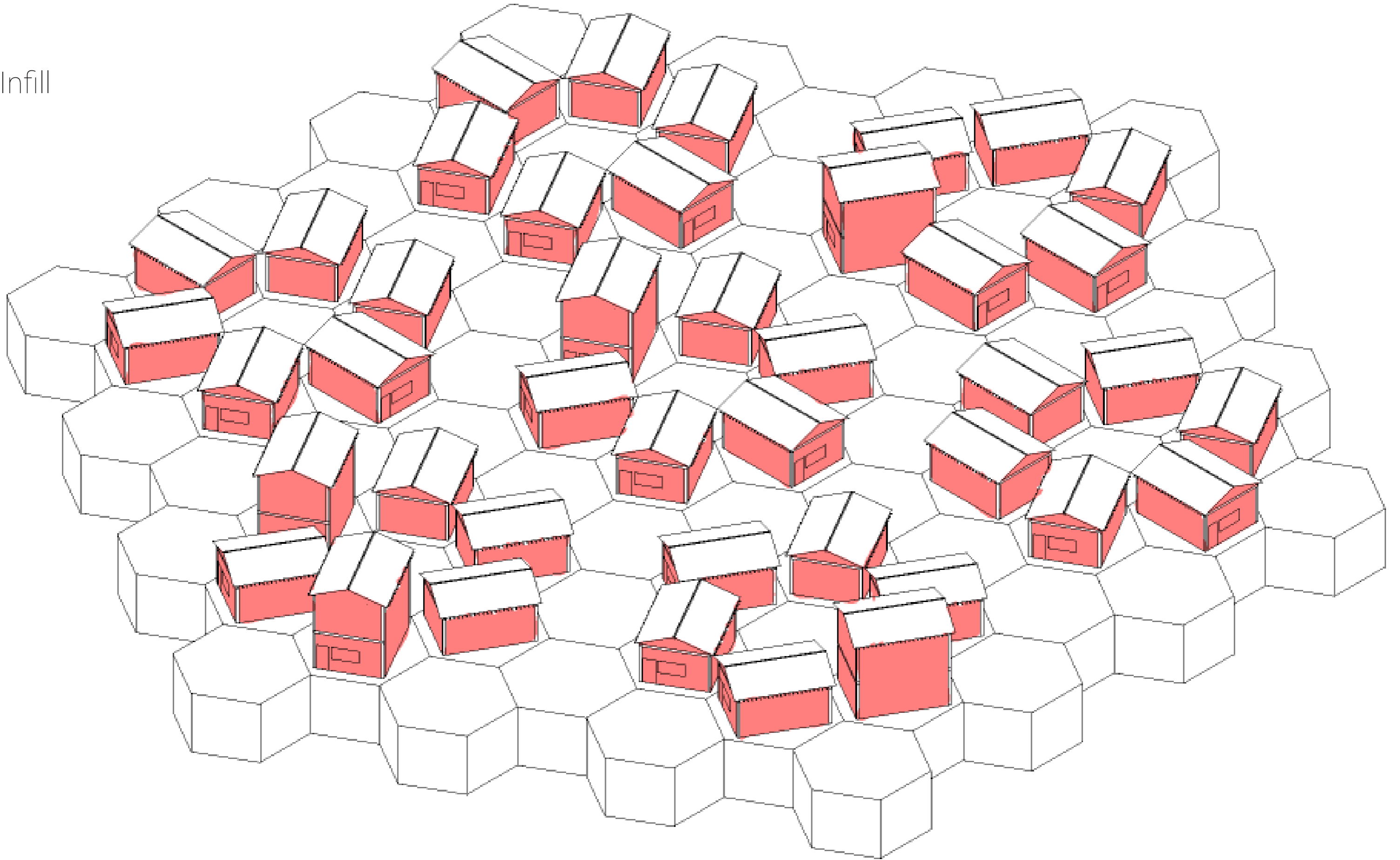

Development Sequence

Canopies

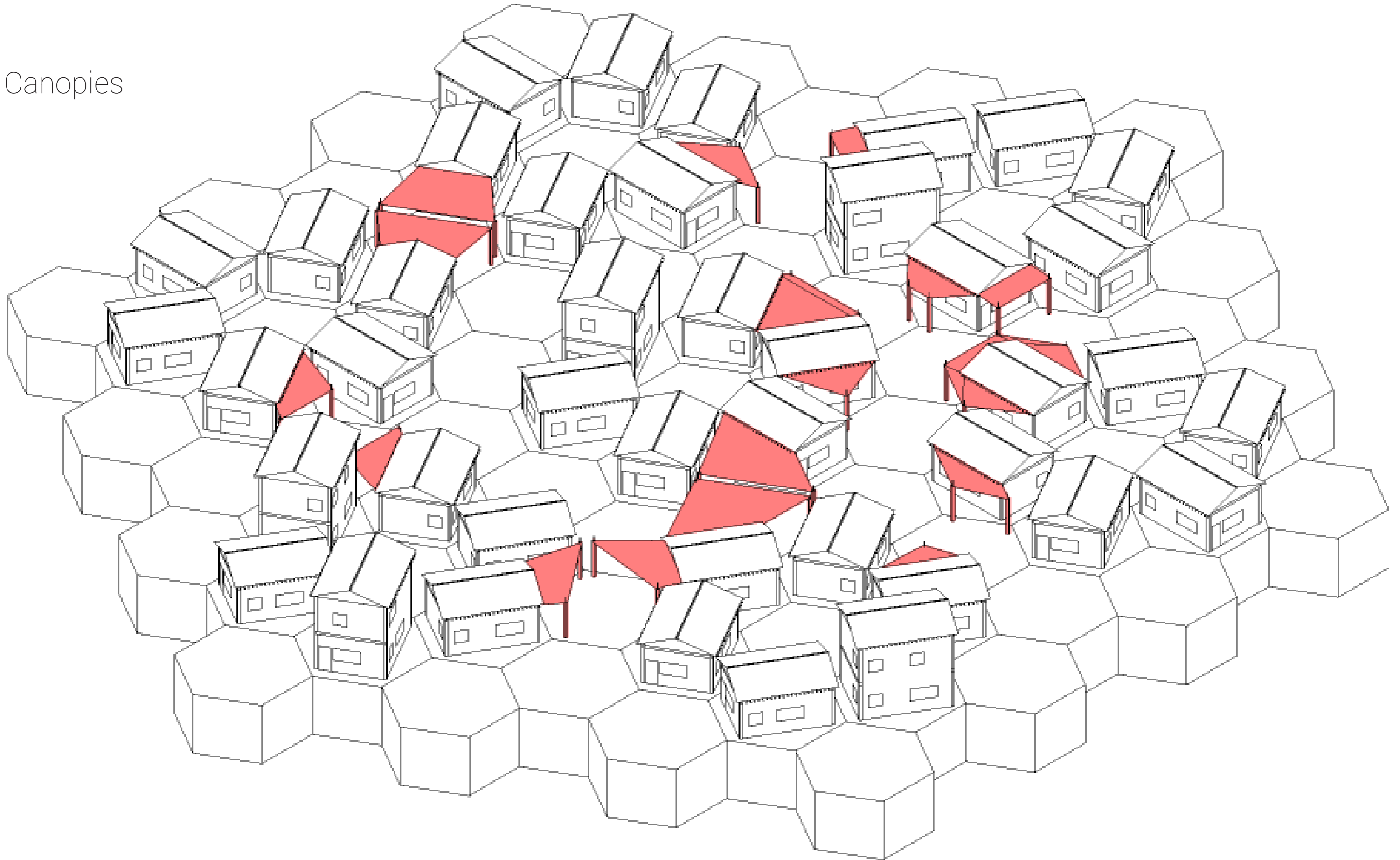





APPENDIX

Utility schematic for House and Courtyard

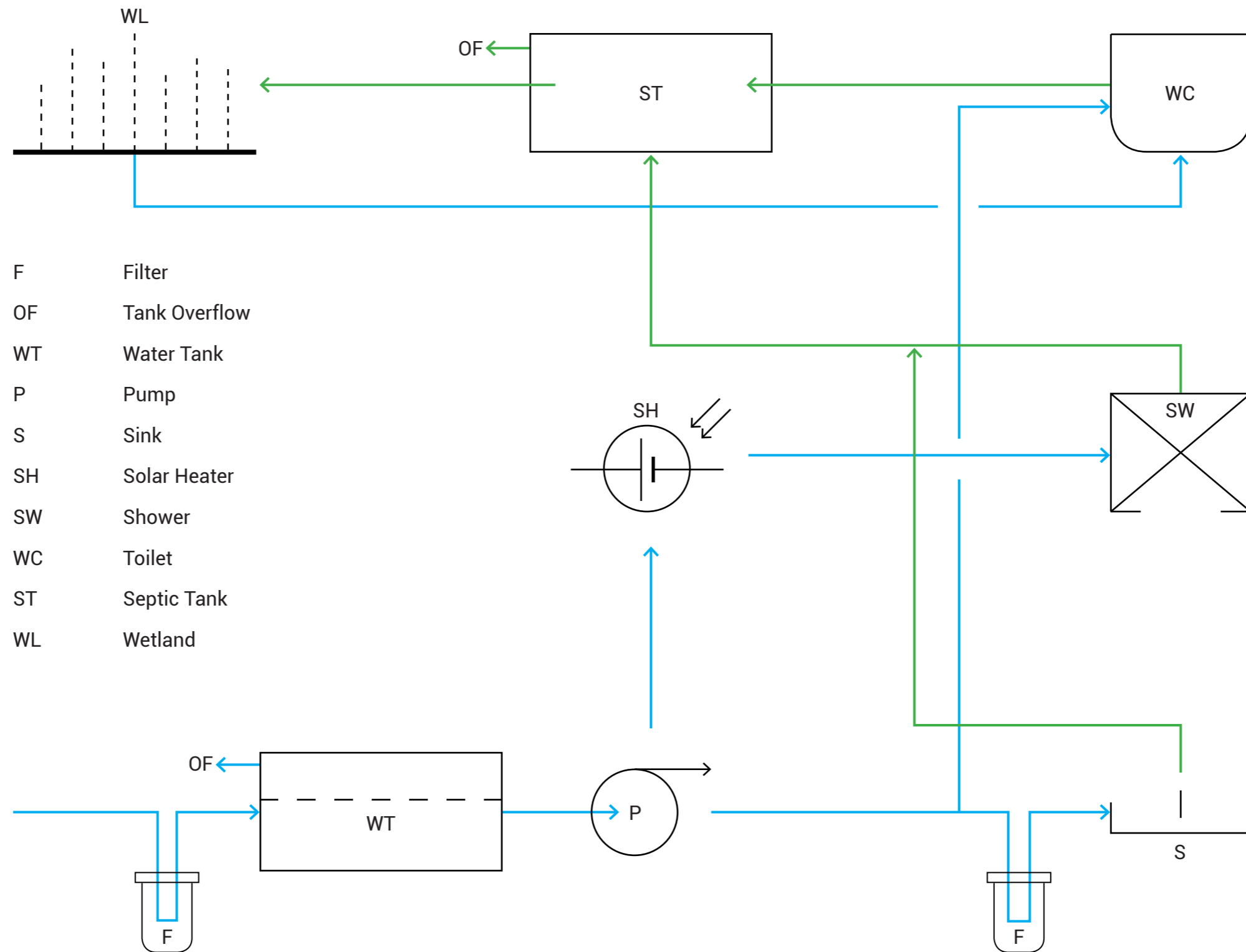

Safety measures

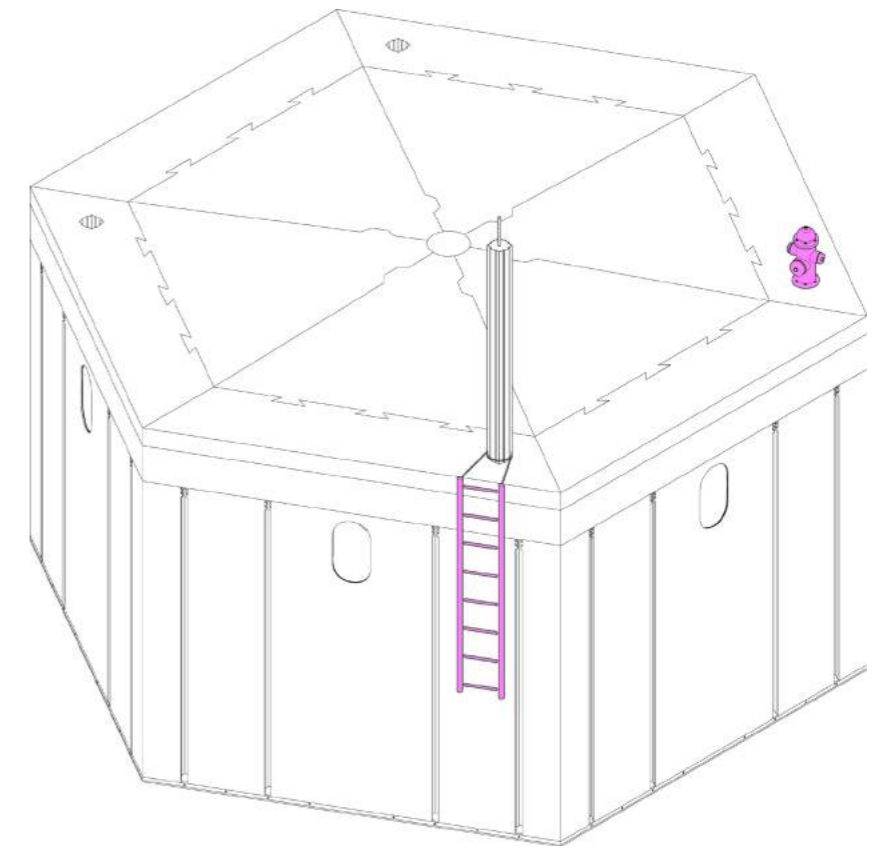
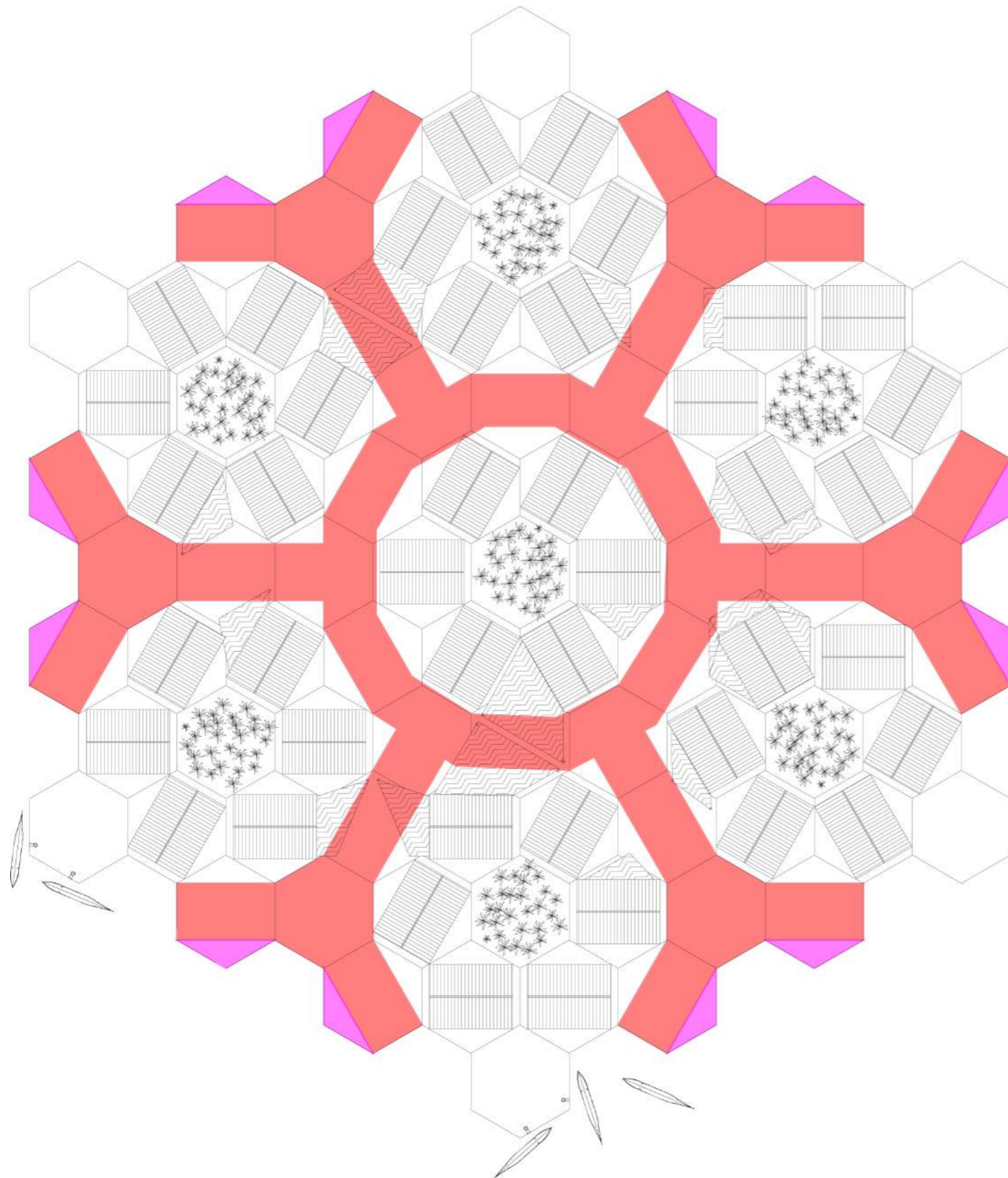

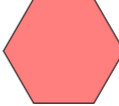
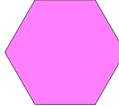
-  Evacuation path [max 50 m]
-  Hydrant and Ladder locations

Pod weight calculations

Material	m ³	m ³ * (Kg/m ³)	Kg / 325 m ³	% submerged
HDPE plastic	6.5	6240	19.20	1.92
Concrete	17	40800	125.54	12.55
Seawater	111	111000	341.54	34.15
Bamboo	0.25	125	0.38	0.04
Other	x	~5000	15.38	1.54
		163165		50