

Effective continuous-flow supply chains using centralized model predictive control

Hipolito, Tomas; Nabais, Joao Lemos; Botto, Miguel Ayala; Negenborn, Rudy R.

DOI

[10.1016/j.ifacol.2020.12.2808](https://doi.org/10.1016/j.ifacol.2020.12.2808)

Publication date

2020

Document Version

Final published version

Published in

IFAC-PapersOnline

Citation (APA)

Hipolito, T., Nabais, J. L., Botto, M. A., & Negenborn, R. R. (2020). Effective continuous-flow supply chains using centralized model predictive control. *IFAC-PapersOnline*, 53(2), 10855-10860. <https://doi.org/10.1016/j.ifacol.2020.12.2808>

Important note

To cite this publication, please use the final published version (if applicable). Please check the document version above.

Copyright

Other than for strictly personal use, it is not permitted to download, forward or distribute the text or part of it, without the consent of the author(s) and/or copyright holder(s), unless the work is under an open content license such as Creative Commons.

Takedown policy

Please contact us and provide details if you believe this document breaches copyrights. We will remove access to the work immediately and investigate your claim.

Effective Continuous-flow Supply Chains Using Centralized Model Predictive Control

Tomás Hipólito* João Lemos Nabais*** Miguel Ayala Botto*
Rudy R. Negenborn***

* *IDMEC, Instituto Superior Técnico, Universidade de Lisboa, Lisboa, Portugal, (e-mail: tomas.hipolito@tecnico.ulisboa.pt)*

** *Centro de Investigação em Ciências Empresariais, Instituto Politécnico de Setúbal (CICE-IPS), Setúbal, Portugal*

*** *Department of Maritime and Transport Technology, Delft University of Technology, The Netherlands*

Abstract: This paper proposes three different formulations of a centralized Model Predictive Control framework to manage the logistics of continuous-flow Supply Chains subject to fluctuating demand. The Supply Chain is modeled as a dynamical system composed of several players handling commodities from the production phase to the retail phase. Additionally, commodities are categorized according to their characteristics. An external control agent continuously gathers information regarding Supply Chain operation. Using that information, the control agent monitors the inventory of the retailer and assigns the commodity quantity to replenish it, adopting a Model Predictive Control algorithm. Three different formulations of the Model Predictive Control algorithm are designed based on the inventory of the retailer: i) constant inventory, ii) dynamical heuristic inventory, and iii) dynamical control inventory. These formulations are simulated for a Supply Chain operating under a “just-in-time” management policy.

Copyright © 2020 The Authors. This is an open access article under the CC BY-NC-ND license (<http://creativecommons.org/licenses/by-nc-nd/4.0>)

Keywords: Modeling of Manufacturing Operations; Logistics in Manufacturing; Model Predictive Control; Continuous-flow Supply Chains; Commodity Categorization

1. INTRODUCTION

Continuous-flow Supply Chains refer to Supply Chains satisfying a regular customer demand with some fluctuations. Their top priority consists of operating on the lowest possible costs by maximizing the utilization rate of their storage and handling resources. For that reason, retail facilities intend to store the exact amount of inventory required to meet the expected customer demand.

Continuous-flow Supply Chains require strong cooperation between the multiple players involved in the operation to perform effectively. These Supply Chains guarantee high customer service levels, however they behave poorly when dealing with irregular demand patterns. They usually operate under a “just-in-time” management policy, where commodities are delivered on-demand at the retail facilities to satisfy immediate customer demand, without intermediate inventory. This policy is commonly adopted by necessity goods industries such as paper and low-cost fashion industries. It can also be applied to perishable

goods industries with short shelf-lives, such as vegetables and dairy products.

The dimensionality and complexity of Supply Chains make it difficult to design universal and concrete solutions to manage them. For that reason, splitting the Supply Chain in stages based on operational processes, and focusing on specific network configurations has allowed researchers to formulate and solve these problems using mainly ad-hoc techniques (Amorim et al. 2013). Operations Research (OR) field has been developing simple and efficient heuristics, and mathematical programming formulations to deal with these problems (Li and Marlin 2009). However, by not considering the effect of interdependent operational processes and the distinct goals of the players involved, these approaches lack a broad view of the entire operation of Supply Chains (Min and Zhou 2002). On the other hand, Control Theory (CT) field has also been addressing Supply Chain Management problems. Despite facing difficulties dealing with modeling and dimensionality, optimal control techniques are able to describe clearly the main dynamics and drivers of Supply Chains, while controlling their operation through feedback and predictive techniques (Mestan et al. 2006). Combining both OR and CT concepts, to overcome the difficulties faced when using both theories separately, seems to be an interesting path to explore (Ivanov et al. 2011).

* This research work is financially supported by FCT, through IDMEC, under LAETA, project UIDB/50022/2020 and through MIT Portugal, grant reference PD/BD/150253/2019, and by NWO (Netherlands Organisation for Scientific Research), project “Complexity Methods for Predictive Synchromodality” (project 439.16.120)

The present paper focuses on increasing the performance of a continuous-flow Supply Chain handling multiple commodities simultaneously, by modifying the formulation of a centralized Model Predictive Control framework, responsible for the flow assignment of the Supply Chain. It builds on the previous work presented in Hipólito et al. (2017). Hence, the Supply Chain model tracks the commodity flow and storage along the entire chain, integrating the roles of the distinct players. The customer demand is modeled as a disturbance acting on the inventory of the retailer. On top of that, a centralized Model Predictive Control algorithm manages the commodity flow assignment of the entire Supply Chain, aiming to control effectively the level of the inventory of the retailer. The cost function of the optimization problem is a linear function consisting in the weighted sum of the commodity quantity stored at the nodes of the Supply Chain model. In order to maintain the linearity, the optimization of the performance is achieved through the manipulation of the Model Predictive Control algorithm formulation. Three formulations were designed based on the inventory of the retailer: i) constant inventory, consisting in maintaining a fixed stock level at the retailer; ii) dynamical heuristic inventory, consisting in adjusting the weights of the cost function at each iteration according to the current level of the inventory of the retailer; and iii) dynamical control inventory, consisting in splitting the inventory of the retailer into smaller inventories and assigning them different weights. The performance of these three formulations is then simulated assuming a Supply Chain operating under a “just-in-time” management policy.

To sum up, the main contributions of this paper are: i) combining CT and OR concepts to improve the performance of a centralized Model Predictive framework; and ii) designing a demand-driven approach, where satisfying customer demand is the main driver of the Supply Chain Management. This paper is organized as follows. In Section 2, the conceptual approach and the Supply Chain model are described. Subsequently, the centralized Model Predictive Control framework and its three distinct formulations are presented in Section 3. Thereafter, the performance of the three formulations is evaluated for a Supply Chain operating under a “just-in-time” management policy, through numerical simulation, in Section 4. Lastly, in Section 5, conclusions and future research extensions are highlighted.

2. MODELLING

2.1 Conceptual approach

In this paper, the Supply Chain is modeled as a network of players interacting between themselves to produce and move commodities from the production stage to the retail stage, described in detail in Hipólito et al. (2017). Therefore, the model of the Supply Chain is based on the following concepts:

- end-to-end flow approach - it tracks the commodity flow from the production stage to the retail stage. Commodities are produced at the manufacturer and then moved to the retailer, passing through intermediary stages. At the retailer, commodities are consumed.

- flow categorization - it categorizes commodities into different classes according their *nature* - raw materials or perishable goods -, their *type* - type 1 or 2 - and, in case of perishable goods, according their *time until expiration*. Raw materials are commodities that can be used to produce perishable goods or consumed directly at the retailer. On the other hand, perishable goods need to be produced from raw materials and have a limited lifetime. Besides, raw materials and perishable goods are categorized according their type, e.g., raw material 1 and raw material 2. Lastly, the Supply Chain model also categorizes perishable goods according to their time until expiration, creating flow classes for every possible age class of a perishable good with a specific lifetime.

2.2 Model of the supply chain

From a flow perspective, Supply Chain exhibits two main events:

- storage - related to the ability of Supply Chain players to handle commodities at well-defined facilities. These facilities are modeled as center nodes (see Figure 1(a));
- flow - related to the production and transport of commodities. Flow events are modeled using connections, which are composed of a succession of flow nodes, representing the steps of the flow event connecting two center nodes (see Figure 1(b)). Connections follow a pull-push flow principle, pulling commodities from the upstream center node and pushing these to the downstream center node. The proposed model features two distinct types of connections:
 - production connections - this type of connections are composed of two links and one flow node. They model the process of transforming raw materials into perishable goods;
 - transportation connections - this type of connections are composed of three links and two flow nodes, that might represent cross-docking locations. They model the movement of commodities between center nodes. The commodity quantity remains constant along the transportation connection, noting that, in case of perishable goods, their time until expiration reduces.

Using the basic components presented in Figure 1, it is possible to build the entire model of a continuous-flow Supply Chain. Figure 2 schematically represents the model of a Supply Chain, composed of a manufacturer, a distributor and a retailer, two production connections and two transportation connections. Furthermore, the Supply Chain design addresses separately the connections and center nodes, using the following heuristic: i) connections related to production lines are addressed first; ii) connections related to transport are addressed second; and, lastly, iii) center nodes are addressed. All nodes and flows are numbered sequentially from upstream to downstream.

2.3 Mathematical Representation

The model of the continuous-flow Supply Chain can be represented using a state-space representation as:

$$\mathbf{x}(k+1) = \mathbf{A}\mathbf{x}(k) + \mathbf{B}_u\mathbf{u}(k) + \mathbf{B}_d\mathbf{d}(k) \quad (1)$$

$$\mathbf{y}(k) = \mathbf{x}(k), \quad (2)$$

where \mathbf{A} , \mathbf{B}_u and \mathbf{B}_d , are the time-invariant state-space matrices. The state of the system $\mathbf{x}(k)$ represents the commodity quantity of each flow class stored at each node.

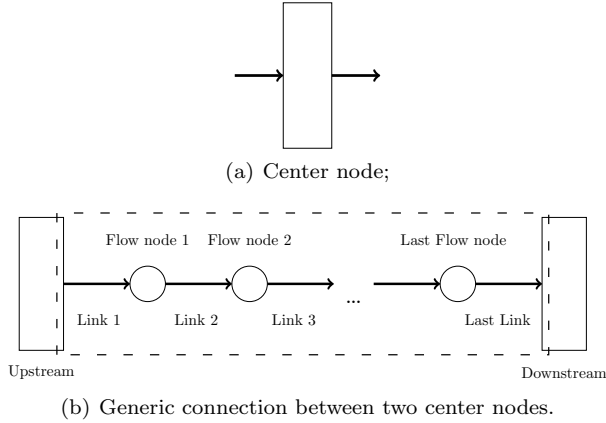

Fig. 1. Basic components of the proposed Supply Chain model.

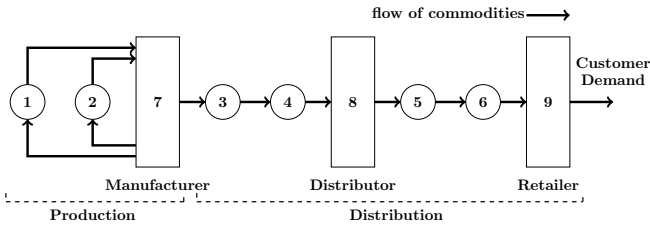

Fig. 2. Schematic representation of the model of the continuous-flow Supply Chain.

The control action $\mathbf{u}(k)$ corresponds to the commodity quantity of each flow class assigned to be moved between nodes. The disturbance $\mathbf{d}(k)$ acts on the downstream node of the Supply Chain and represents the commodity quantity demanded by the market. The Supply Chain state at the next time instant, $\mathbf{x}(k+1)$, is calculated using (1) and it is a function of the current Supply Chain state, $\mathbf{x}(k)$, the control action, $\mathbf{u}(k)$, and the disturbance, $\mathbf{d}(k)$. Besides, the Supply Chain is considered fully observable, so the output of the model is the state of the system, $\mathbf{y}(k) = \mathbf{x}(k)$.

3. CENTRALIZED MODEL PREDICTIVE CONTROL

3.1 Theoretical principle

The present paper assumes the existence of a control agent, external to the Supply Chain, communicating directly with all players involved and gathering real-time information regarding the operation of all nodes. This information consists of the commodity quantity of each flow class, the expected maximum storage capacity, the expected transportation capacity available and the predictions on the customer demand intensity. The control agent compiles this data and runs a centralized Model Predictive Control algorithm to optimize the flow assignment to implement in the system, in order to maximize the performance of

the Supply Chain. Then, the flow assignment decisions are communicated to the players responsible for the operation of the nodes. Figure 3 illustrates the block diagram of the Model Predictive Control framework, where $\tilde{\mathbf{d}}_k$ is the sequence vector composed of the demand vectors, for each time sample, over the prediction horizon N_p ,

$$\tilde{\mathbf{d}}_k = [\mathbf{d}^T(k), \dots, \mathbf{d}^T(k+N_p-1)]^T \quad (3)$$

$\tilde{\mathbf{x}}_{\max,k}$ and $\tilde{\mathbf{u}}_{\max,k}$ are the sequence vectors composed of maximum storage capacity and maximum transportation capacity vectors, respectively, for each time instant, over the prediction horizon N_p .

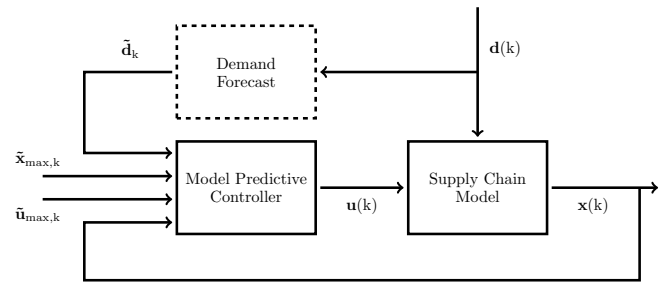

Fig. 3. Block diagram of the model predictive control framework.

The demand forecast module generates the sequence of predicted customer demand. Hence, demand predictions are assumed to be known a priori.

From a control perspective, at each time sample, the control agent gathers information concerning the updated state of the system and predictions on the storage capacity, transportation capacity and demand profile over a defined prediction horizon, N_p . Then, it formulates an optimization problem considering a cost function based on a desired performance measure and the constraints inherent to the operation of the Supply Chain. The output of the optimization problem is the sequence of future control actions that optimizes the Supply Chain over the prediction horizon N_p . The first predicted control action is implemented in the Supply Chain model and the state of the system is updated. At the next time sample, the process is repeated considering the updated state of the system and new predictions (Maciejowski 2002).

3.2 Cost Function

The cost function depends on the current state of the system, and the control actions and predicted demand, over the prediction horizon N_p . The cost function adopted is a linear function which associates weights $\mathbf{q}_i(k)$, $i = 1, \dots, 9$, to the system nodes, over the N_p , intending to minimize the cost of holding inventory. The cost function of the model predictive control algorithm is described by:

$$J(\tilde{\mathbf{x}}_k) = \sum_{l=0}^{N_p-1} \mathbf{q}(k+l) \mathbf{x}(k+1+l), \quad (4)$$

where $\tilde{\mathbf{x}}_k$ is the vector composed of the state-space vectors, for each time sample, over the N_p ,

$$\tilde{\mathbf{x}}_k = [\mathbf{x}^T(k+1), \dots, \mathbf{x}^T(k+N_p)]^T. \quad (5)$$

It is possible to increase the performance of the Supply Chain by manipulating the formulation of the optimization problem. The present paper presents three distinct formulations of the centralized Model Predictive Control algorithm based on the inventory of the retailer.

3.3 Formulation 1 - constant inventory

This formulation consists of maintaining a fixed level of the inventory of the retailer. Hence, the weights associated to the retailer are independent of its inventory level (see Figure 4). The control agent continuously monitors the inventory of the retailer and replenishes it whenever the demand consumes it.



Fig. 4. Weights of the cost function are independent of the level of inventory of the retailer - formulation 1.

Thus, the optimization problem to perform the Logistics Management of the Supply Chain is formulated as follows:

$$\min_{\tilde{\mathbf{u}}_k} J(\tilde{\mathbf{x}}_k) \quad (6)$$

$$\text{s.t. } \mathbf{x}(k+1+l) = \mathbf{A}\mathbf{x}(k+l) + \mathbf{B}_u\mathbf{u}(k+l) + \mathbf{B}_d\mathbf{d}(k+l), \quad l = 0, \dots, N_p - 1, \quad (7)$$

$$\mathbf{x}(k+1+l) \geq \mathbf{0}, \quad (8)$$

$$\mathbf{u}(k+l) \geq \mathbf{0}, \quad (9)$$

$$\mathbf{P}_{xx}\mathbf{x}(k+1+l) \leq \mathbf{x}_{\max}, \quad (10)$$

$$\mathbf{P}_{uu}\mathbf{u}(k+l) \leq \mathbf{u}_{\max}, \quad (11)$$

$$\mathbf{x}(k+l) \geq \mathbf{P}_{xu}\mathbf{u}(k+l), \quad (12)$$

where $\tilde{\mathbf{u}}_k$ is the vector composed of the control actions vectors, for each time sample, over the prediction horizon N_p ,

$$\tilde{\mathbf{u}}_k = [\mathbf{u}^T(k), \dots, \mathbf{u}^T(k + N_p - 1)]^T \quad (13)$$

\mathbf{x}_{\max} is the maximum storage capacity per node, \mathbf{u}_{\max} corresponds to the available transportation capacity, \mathbf{P}_{xu} is the projection from the control action set \mathcal{U} into the state-space set \mathcal{X} , \mathbf{P}_{xx} is the projection matrix from the state-space set \mathcal{X} into the maximum storage capacity set \mathcal{X}_{\max} and \mathbf{P}_{uu} is the projection matrix from the control action set \mathcal{U} into the available transportation capacity set \mathcal{U}_{\max} . Constraints (8)–(12) are necessary to obtain feasible and meaningful control actions:

- non-negativity of states and control actions: negative storage at the nodes and negative flows of commodities are not physically possible. The non-negativity of states and control actions is imposed by constraints (8)–(9);

- maximum storage capacity: each Supply Chain node has to respect its storage capacity limits. This feature is captured in constraint (10);
- maximum control actions: the maximum transportation capacity to move commodities between nodes is represented by constraint (11);
- flow conservation: not all control actions that satisfy constraints (9) and (11) are feasible. The flow of commodities to be moved from a node must never exceed the amount of commodities stored in that node. Constraint (12) imposes this restriction.

3.4 Formulation 2 - dynamical heuristic inventory

Formulation 2 introduces a dynamical inventory of the retailer, $J(\mathbf{x}_g)$, described in Figure 5, where the weights associated to the node of the retailer vary according to its inventory level (see Figure 6). Although, $J(\mathbf{x}_g)$ is a non-linear function, it can be divided into three linear sub-functions represented in Figure 7, where LL and HL stand for low and high inventory limits, respectively. At each time sample, based on the current inventory of the retailer, one of the sub-functions is selected to be the cost function $J(\tilde{\mathbf{x}}_k)$ of the optimization problem. Thus, mathematically, the formulation 2 is identical to formulation 1.

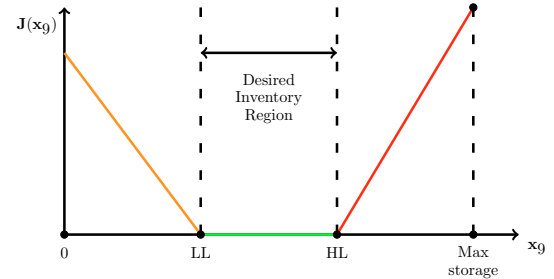

Fig. 5. Dynamical inventory of the retailer - formulations 2 and 3.

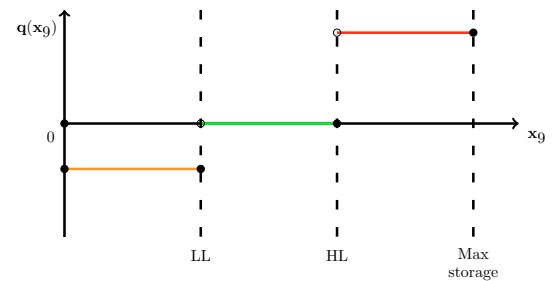

Fig. 6. Weights of the cost function vary according to the level of inventory of the retailer - formulation 2.

3.5 Formulation 3 - dynamical control inventory

Formulation 3 also implements a dynamical inventory of the retailer, $J(\mathbf{x}_g)$, described in Figure 5. However, this formulation splits the inventory of the retailer, \mathbf{x}_g , into three new states, \mathbf{x}_{gL} , \mathbf{x}_{gM} and \mathbf{x}_{gH} (see Figure 8). The three inventories will be sequentially filled, starting by \mathbf{x}_{gL} , followed by \mathbf{x}_{gM} and \mathbf{x}_{gH} .

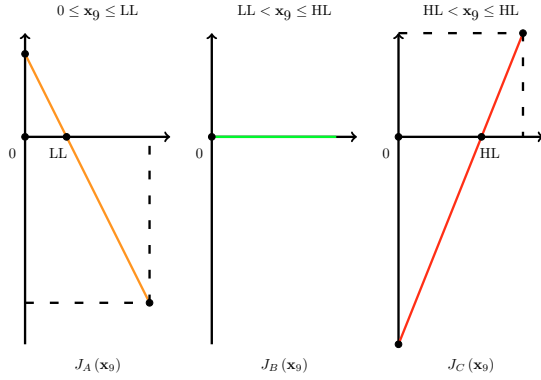

Fig. 7. Linear sub-functions of the decomposed objective function - formulation 2.

New constraints need to be added to the optimization problem to describe the new dynamics of the retailer:

$$\mathbf{x}_{9L}(k+1+l) \leq \mathbf{LL}, \quad l = 0, \dots, N_p - 1, \quad (14)$$

$$\mathbf{x}_{9M}(k+1+l) \leq \mathbf{HL} - \mathbf{LL}, \quad (15)$$

$$\mathbf{x}_{9H}(k+1+l) \leq \mathbf{x}_{9\max} - \mathbf{HL}, \quad (16)$$

$$\mathbf{x}_9 = \mathbf{x}_{9L} + \mathbf{x}_{9M} + \mathbf{x}_{9H} \quad (17)$$

Thus, the new optimization problem assumes the following formulation:

$$\min_{\tilde{\mathbf{u}}_k} J(\tilde{\mathbf{x}}_k) \quad (18)$$

$$\text{s.t. } \mathbf{x}(k+1+l) = \mathbf{A}\mathbf{x}(k+l) + \mathbf{B}\mathbf{u}(k+l) + \mathbf{B}_d\mathbf{d}(k+l), \quad l = 0, \dots, N_p - 1, \quad (19)$$

$$\mathbf{x}(k+1+l) \geq \mathbf{0}, \quad (20)$$

$$\mathbf{u}(k+l) \geq \mathbf{0}, \quad (21)$$

$$\mathbf{P}_{xx}\mathbf{x}(k+1+l) \leq \mathbf{x}_{\max}, \quad (22)$$

$$\mathbf{P}_{uu}\mathbf{u}(k+l) \leq \mathbf{u}_{\max}, \quad (23)$$

$$\mathbf{x}(k+l) \geq \mathbf{P}_{xu}\mathbf{u}(k+l), \quad (24)$$

$$\mathbf{x}_{9L}(k+1+l) \leq \mathbf{LL}, \quad (25)$$

$$\mathbf{x}_{9M}(k+1+l) \leq \mathbf{HL} - \mathbf{LL}, \quad (26)$$

$$\mathbf{x}_{9H}(k+1+l) \leq \mathbf{x}_{\max} - \mathbf{HL}, \quad (27)$$

$$\mathbf{x}_9 = \mathbf{x}_{9L} + \mathbf{x}_{9M} + \mathbf{x}_{9H} \quad (28)$$

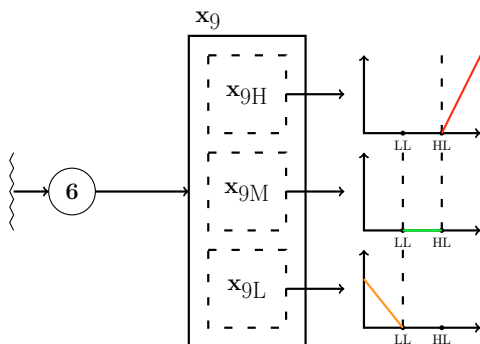

Fig. 8. Splitting the inventory of the retailer into three states, each one accounting for a specific inventory region with specific weights - formulation 3.

4. NUMERICAL EXPERIMENTS

In this section, the centralized Model Predictive Control formulations are used to perform the Logistics Management of a Supply Chain handling two raw materials and two perishable goods. A “just-in-time” management policy is applied, meaning that after production, goods are delivered as soon as possible at the retailer, minimizing inventory at the distributor.

4.1 Scenario Description

The sampling time considered in the simulation is one day. Four different commodities are supplied to the market: two raw materials, M_1 and M_2 , and two perishable goods, G_1 and G_2 , manufactured from the raw materials, with a lifetime of 12 and 14 days, respectively. The commodity quantity is measured in units. The raw materials are, initially, available at the manufacturer. They are consumed to produce the perishable goods in separate production lines at the manufacturer, according to a specific ratio (see Table 1).

Table 1. Ratio of production.

	raw materials		Max due time
	M_1	M_2	
perishable goods	G_1	1	12
	G_2	2	14

Once produced and made available at the manufacturer, the perishable goods need to be delivered at the retailer before expiring. Raw materials are also delivered at the retailer and sold directly to the customers. The supply chain storage capacity limits and handling resource availability are discriminated per commodity at each node and connection (Table 2 and Table 3).

Table 2. Maximum storage capacity.

		total	commodities			
			M_1	M_2	G_1	G_2
Capacity	Manufacturer	3000	1500	1400	50	50
	Distributor	100	25	25	25	25
	Retailer	40	10	10	10	10

4.2 Scenario Configuration

Customer selling starts 20 days after the beginning of the simulation. Initially, there is only inventory of raw materials at the manufacturer, in a sufficiently large amount to fulfil the demand at the retailer over the entire simulation period. This means that all perishable goods must be produced. The market demand scenario was designed using gamma distributions (considering the describing parameters values: $k = 2$ and $\theta = 1$) (Burgin 1975) to generate the demand profiles of the four different commodities. The customer demand profiles are assumed to be deterministic. Furthermore, it is assumed that the predictions of the demand match the demand. The inventory lower limit (LL) at the retailer is 3 units for all commodities and the upper limit (UL) is 6 units for all commodities.

Table 3. Maximum flow capacity of connections.

		total	commodities				
			M_1	M_2	G_1	G_2	
flow nodes	node 1	3	0	0	3	0	
	node 2	4	0	0	0	4	
	node 3	20	5	6	4	5	
	node 4	20	5	6	4	5	
	node 5	20	5	6	4	5	
	node 6	20	5	6	4	5	
connections	connection 1	1 st flow	3	0	0	3	0
		2 nd flow	3	0	0	3	0
	connection 2	1 st flow	4	0	0	0	4
		2 nd flow	4	0	0	0	4
	connection 3	1 st flow	20	5	6	4	5
		2 nd flow	20	5	6	4	5
		3 rd flow	20	5	6	4	5
	connection 4	1 st flow	20	5	6	4	5
		2 nd flow	20	5	6	4	5
		3 rd flow	20	5	6	4	5

4.3 Numerical Results

The Supply Chain operation is evaluated using the total amount of commodity movements performed as the performance measure. Considering $N_p = 12$, the performance of the three distinct formulations is analyzed. All three formulations satisfied the customer demand. However, the operational behavior and performance of the Supply Chain were distinct. Figure 9 shows that, although the formulations present different usage of the inventory of the distributor, the average inventory level at the distributor is similar for all.

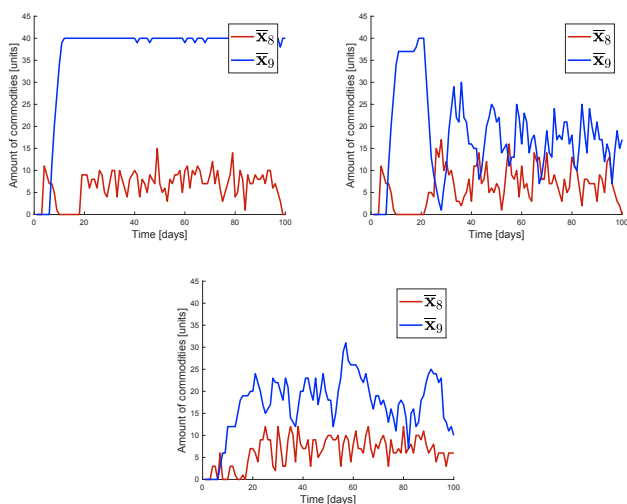

Fig. 9. Storage evolution at the distributor, \bar{x}_8 , and the retailer, \bar{x}_9 , for the three distinct formulations, considering $N_p = 12$: formulation 1 (upper left), formulation 2 (upper right), formulation 3 (lower center).

Concerning the inventory of the retailer, formulation 1 behaves poorly, holding excessive inventory, while formulation 2 presents an oscillating and intense inventory usage compared to the inventory usage of formulation 3. Furthermore, Table 4 presents the values of the total amount

of commodity movements for the three formulations and confirms formulation 3 as the most effective.

Table 4. Performance analysis for the three distinct formulations considering $N_p = 12$.

Prediction Horizon	Total amount of commodity movements		
	Formulation 1	Formulation 2	Formulation 3
$N_p = 12$	3918	3841	3831

5. CONCLUSIONS AND FUTURE WORK

In this paper, a centralized Model Predictive Control framework is proposed to address the Logistics Management of continuous-flow Supply Chains. Three different Model Predictive Control algorithm formulations are designed to improve the effectiveness of the Supply Chain, operating under a “just-in-time” management policy. The proposed framework is modular and scalable. Therefore, future work consists of upgrading this framework by: i) modeling Supply Chain processes in more detail; ii) considering uncertainty in demand predictions and Supply Chain processes; and iii) applying distributed Model Predictive Control.

REFERENCES

- Amorim, P., Meyr, H., Almeder, C., and Almada-Lobo, B. (2013). Managing perishability in production-distribution planning: A discussion and review. *Flexible Services and Manufacturing Journal*, 25, 389–413.
- Burgin, T.A. (1975). The gamma distribution and inventory control. *Operational Research Quarterly*, 26, 507–525.
- Hipólito, T., Nabais, J., Carmona-Benítez, R., Botto, M.A., and Negenborn, R.R. (2017). MPC approach for synchronized supply chains of perishable goods. In *Proceedings of 7th International Conference on Industrial Engineering and Systems Management (IESM 2017)*, 574–579. Saarbrücken, Germany.
- Ivanov, D., Sokolov, B., and Kaeschel, J. (2011). Integrated supply chain planning based on a combined application of operations research and optimal control. *Central European Journal of Operations Research (CEJOR)*, 19, 299–317.
- Li, X. and Marlin, T.E. (2009). Robust supply chain performance via model predictive control. *Computers Chemical Engineering*, 33, 2134–2143.
- Maciejowski, J. (2002). *Predictive Control with Constraints*. Prentice Hall. UK.
- Mestan, E., Türkay, M., and Arkun, Y. (2006). Optimization of operations in supply chain systems using hybrid systems approach and model predictive control. *Industrial & Engineering Chemistry Research*, 45, 6493–6503.
- Min, H. and Zhou, G. (2002). Supply chain: Past, present and future. *Computers & Industrial Engineering*, 43, 231–249.