

**Environmental design guidelines for circular building components based on LCA and MFA
Lessons from the circular kitchen and renovation façade**

van Stijn, A.; Eberhardt, L. C.M.; Wouterszoon Jansen, B.; Meijer, A.

DOI

[10.1016/j.jclepro.2022.131375](https://doi.org/10.1016/j.jclepro.2022.131375)

Publication date

2022

Document Version

Final published version

Published in

Journal of Cleaner Production

Citation (APA)

van Stijn, A., Eberhardt, L. C. M., Wouterszoon Jansen, B., & Meijer, A. (2022). Environmental design guidelines for circular building components based on LCA and MFA: Lessons from the circular kitchen and renovation façade. *Journal of Cleaner Production*, 357, Article 131375. <https://doi.org/10.1016/j.jclepro.2022.131375>

Important note

To cite this publication, please use the final published version (if applicable).
Please check the document version above.

Copyright

Other than for strictly personal use, it is not permitted to download, forward or distribute the text or part of it, without the consent of the author(s) and/or copyright holder(s), unless the work is under an open content license such as Creative Commons.

Takedown policy

Please contact us and provide details if you believe this document breaches copyrights.
We will remove access to the work immediately and investigate your claim.



Environmental design guidelines for circular building components based on LCA and MFA: Lessons from the circular kitchen and renovation façade

A. van Stijn^{a,b,*}, L.C.M. Eberhardt^c, B. Wouterszoon Jansen^{a,b}, A. Meijer^d

^a Department of Management in the Built Environment, Faculty of Architecture and the Built Environment, Delft University of Technology, Delft, the Netherlands

^b Amsterdam Institute for Advanced Metropolitan Solutions (AMS), Amsterdam, the Netherlands

^c Department of the Built Environment (BUILD), Section for Sustainability of Buildings, Aalborg University, Copenhagen, Denmark

^d Department of Architectural Engineering and Technology, Faculty of Architecture and the Built Environment, Delft University of Technology, Delft, the Netherlands

ARTICLE INFO

Handling Editor: Yang Liu

Keywords:

Circular economy

(CE)

Life cycle assessment

(LCA)

Material flow analysis

(MFA)

Design guidelines

Building components

Multi-cycle

ABSTRACT

The transition towards a Circular Economy (CE) in the built environment is vital to reduce environmental impacts, resource consumption and waste generation. The built environment can be made circular by replacing building components with more circular ones. There are many circular design options for building components and knowledge about which options perform better – from an environmental perspective – is limited. Existing guidelines focussed on single components, single circular design options, applied different assessment methods and provide conflicting guidelines. Therefore, in this article, we develop environmental design guidelines by comparing multiple circular design options for two building components: a kitchen (short service life) and renovation façade (medium service life). First, we synthesize design variants based on distinct circular pathways, such as renewable-, non-virgin material use, and modularity for reuse. Second, we compare their environmental performance to a ‘business-as-usual’ variant through Material Flow Analysis (MFA) and a multi-cycle Life Cycle Assessment (LCA) including extensive sensitivity analysis on circular parameters. Analysing the 78 LCAs and MFAs, we derive 8 lessons learned on the environmental design of circular building components. We compare our findings to existing guidelines, including those for circular building structures (long service life). Amongst other lessons, we found components with a short service life benefit more from prioritizing circular design options to slow and close future cycles, whilst components with a longer service life benefit more from reducing resources and slowing loops on site. However, applying circular design options does not always result in a better environmental performance. Tipping-points were identified based on the number of use cycles, lifespans and the assessment methods applied.

1. Introduction

The building sector is said to consume 40% of resources globally, produces 40% of global waste and 33% of all human-induced emissions (Ness and Xing, 2017). Therefore, the building industry plays a crucial role in society’s pursuit to become more sustainable. Transitioning to a Circular Economy (CE) could support minimizing pollution, emissions and waste in the built environment.

The CE model builds on previously developed schools of thought and there is no commonly accepted understanding of the concept (Kirchherr et al., 2017). We understand CE as “a regenerative system in which resource input and waste, emission, and energy leakage are minimised by narrowing, slowing and closing material and energy loops” (adapted

from Geissdoerfer et al. (2017 p. 759)). Narrowing loops is to reduce resource use or achieve resource efficiency. Slowing loops is to lengthen the use of a building, component, part or material. Closing loops is to (re)cycle materials from end-of-life back to production (Bocken et al., 2016). Value Retention Processes (VRPs) – such as reuse, repair, refurbish, recycle and recover – operationalize narrowing, slowing and closing cycles (Reike et al., 2018; Wouterszoon Jansen et al., 2020).

The built environment can gradually be made circular by replacing building components with (more) circular building components during new construction, maintenance and renovation. Integral changes in the design, supply chain and business model are needed to make building components more circular, involving many design parameters. For each parameter, numerous circular design options can be identified (van Stijn and Gruis, 2020). Consequently, designers can develop different design

* Corresponding author. Department of Management in the Built Environment, Faculty of Architecture and the Built Environment, Delft University of Technology, Delft, the Netherlands.

E-mail address: a.vanstijn@tudelft.nl (A. van Stijn).

<https://doi.org/10.1016/j.jclepro.2022.131375>

Received 28 September 2021; Received in revised form 9 February 2022; Accepted 13 March 2022

Available online 1 April 2022

0959-6526/© 2022 The Authors. Published by Elsevier Ltd. This is an open access article under the CC BY license (<http://creativecommons.org/licenses/by/4.0/>).

Nomenclature		
CE	Circular Economy	Reclaim!
VRP	Value Retention Process	LIFE+
MFA	Material Flow Analysis	P2P
LCA	Life Cycle Assessment	P&P
SL	Service Life	C-n
BAU	Business-As-Usual	C+n
CE-LCA model	Circular Economy Life Cycle Assessment model	L n
CE LD approach	Circular Economy Linearly Degressive allocation approach	Lf n
FU	Functional Unit	Lt n
Rc	(thermal) Resistance construction	GWP
RSP	Reference Study Period	EoL
ESL	Estimated Service Life	t
CE-LCI	Circular Economy Life Cycle Inventory	
CE-LCIA	Circular Economy Life Cycle Impact Assessment	
BIO	Biological design variants applying bio-based and biodegradable materials	

variants for circular building components, taking different pathways towards a circular built environment. For example, a façade which applies reclaimed materials, a modular façade which will be updated and reused, or a bio-based and biodegradable façade are all more circular in their own respect. This raises the questions: which circular design option (s) will result in the least amount of resource use, environmental impacts and waste generation? And, how can we make such a decision? Designers, policy makers, and other decision-makers could benefit from this knowledge when designing circular building components. In this article, we aim to answer the aforementioned questions and develop environmental design guidelines for circular building components.

2. Background on environmental design guidelines for circular building components

Literature already provides numerous circular design aids, such as methods, tools and frameworks. We distinguish between generative and evaluative aids (Bocken et al., 2014; de Koeijer et al., 2017). The former includes (e.g.) rules of thumb, checklists, guidelines and archetypes. They support integration of circular options during design synthesis. The latter help evaluate ‘the circularity’ of a generated design. Without claiming to be comprehensive, in this section we discuss existing generative and evaluative design aids for circular building components.

van Stijn and Gruis (2020) reviewed 36 generative design aids and developed a tool to support synthesis of circular building components. They concluded that generative aids provide circular design options, but do not indicate which option(s) lead to the most circular components. Similarly, Bocken et al. (2016) discussed that merely narrowing loops could result in an environmental performance comparable to applying their circular design strategies to slow and close resource cycles. Cambier et al. (2020) found that general circular design guidelines are available but *specific* design guidelines for circular building components are lacking.

Corona et al. (2019), Elia et al. (2017), Pomponi and Moncaster (2017), and Sassanelli et al. (2019) extensively discuss evaluative methods, tools and frameworks for circularity. Material Flow Analysis (MFA) and Life Cycle Assessment (LCA) are often identified as suitable methods to evaluate environmental performance of designs in a CE. In MFA, mass balances of a defined system are calculated over time (Corona et al., 2019). MFA can be used to analyse the quality of resource import and export flows (e.g., virgin, renewable, recycled) and resource consumption (Elia et al., 2017; Pomponi and Moncaster, 2017). LCA can be used to analyse environmental impacts over a building components’

life cycle in a CE context (Pomponi and Moncaster, 2017; Scheepens et al., 2016). Using LCA and MFA when designing could significantly reduce resource use, impacts, and waste generation. However, evaluations with LCA and MFA are often considered time consuming, laborious and expensive by practice (Cambier et al., 2020; De Wolf et al., 2017).

Environmental design guidelines based on LCA and MFA results could help bring LCA and MFA knowledge into practice. Table 1 summarizes precedent studies that compared the environmental performance of circular design options in building components through LCA and/or MFA. De Wolf (2017) and Eberhardt et al. (2021) focus on a building structure, a component with a long Service Life (SL). Buyle et al. (2019), Geldermans et al. (2019) and van Stijn et al. (2020) study either partitioning walls or kitchens: components with a short SL. Vandenbroucke et al. (2015) and Cruz Rios et al. (2019) studied components with a medium SL such as a roof, floor, exterior wall and façade components. However, Buyle et al. (2019), Cruz Rios et al. (2019) and Vandenbroucke et al. (2015) compared ‘only’ Business-As-Usual (BAU) variants to one circular design option. So, their results do not compare different circular design options to each other. Furthermore, applied methods and assessment scope differed between studies hindering comparability. Indeed, Table 1 shows authors come to different conclusions on which circular design options perform best. Even Eberhardt et al. (2021) and van Stijn et al. (2020) who compared multiple circular design options and applied the same methods, still come to different conclusions. Eberhardt et al. (2021) and Buyle et al. (2019) suggested that guidelines could differ between components which might depend on their SL. This raises the question which circular design option(s) result in the best environmental performance for which building component?

3. Goal and method

We developed environmental design guidelines based on MFA and LCA comparing multiple circular design options for two building components: a kitchen and renovation façade. Kitchens are building components with a short SL and high replacement frequency. Hoxha and Jusselme (2017) show domestic furniture and appliances can contribute up to 35% of the building’s environmental impacts. We built on the initial circular kitchen study of van Stijn et al. (2020). A renovation façade is a relevant example of a component with a medium SL. It improves the operational energy efficiency and provides an aesthetic upgrade. Such façades can decrease operational carbon emissions but add significantly to embodied impacts (Ibn-Mohammed et al., 2013).

Table 1
Precedent studies comparing environmental performance of circular design options in building components.

Author	Building component	Circular design options compared	Method	Design option(s) with best environmental performance
Byule et al. (2019)	Interior partitioning wall	4 BAU designs and 3 demountable and reusable designs	Consequential LCA	<ul style="list-style-type: none"> Demountable and reusable designs with higher initial impact but low lifecycle impact; Design with no possibilities for direct reuse but low initial impact.
Cruz Rios et al. (2019)	External framed wall	1 single-use wood-framed wall and 1 reusable steel-framed wall	Hybrid and process-based LCA	<ul style="list-style-type: none"> If reused 2 times, a reuse rate of >70%, and short transport distance then reusable steel-framed wall; If wood-framed wall is reused, then wood-framed wall has highest environmental benefits.
De Wolf (2017)	Building structure	BAU design and material efficient design with low carbon materials	LCA (embodied carbon only)	<ul style="list-style-type: none"> Choosing low carbon materials and optimising the structural efficiency to reduce the material quantity in the building structure.
Geldermans et al. (2019)	Interior partitioning wall	Adaptable design (modular; demountable); biobased and non-virgin materials.	Circ-flex design guidelines and Activity-based Spatial MFA	<ul style="list-style-type: none"> Combining design for adaptation with bio-based and reversible fibre composite materials.
Eberhardt et al. (2021)	Building structure	1 BAU design, 1 material efficient design; 1 biobased design, 1 demountable and reusable design and 1 on-site adaptable design	CE-LCA (includes all cycles); MFA	<ul style="list-style-type: none"> Combining resource efficiency, long use on-site through adaptability, low-impact renewable materials and (only then) facilitating future use cycles (off-site) for parts and materials.
van Stijn et al. (2020)	Kitchen	1 BAU design, 1 biobased design, 1 design with reclaimed materials, 1 optimized design and 1 adaptable design	CE-LCA (includes all cycles); MFA	<ul style="list-style-type: none"> Modular design which facilitates partial replacements of parts to prolong use of the entire kitchen and introduces more use-cycles in parts and materials.
Vandenbroucke et al. (2015)	Ground level floor; Flat roof; External wall; Internal Partitioning wall	Per component: 1 BAU design for new built; 1 BAU design for renovation; 1 demountable and adaptable design for renovation	LCA following building standard	<ul style="list-style-type: none"> Demountable design for all building components is only useful if the adjustments are done frequently; Tipping point depends on how much extra material is needed to achieve demountability.

An iterative, stepwise approach was used (Fig. 1). In step 1, we synthesized circular design variants for the kitchen and renovation façade. In step 2, we compared their environmental performance to a BAU variant through MFA and LCA. In step 3, we analysed the results to derive environmental design guidelines. In step 4, we evaluated these in expert sessions. The evaluations were used to iteratively improve the design variants, assessments and environmental design guidelines, until the evaluation yielded no new remarks. In sections 3.1-3.4, we elaborate on the methods applied per step. Sections 4-6 present the final iteration of steps 1-3, respectively. In section 7, we compare the guidelines to existing guidelines, including those for circular building structures of Eberhardt et al. (2021); we discuss our findings and draw conclusions.

3.1. Synthesis circular design variants kitchen and renovation façade

The design variants were developed in co-creation with Delft University of Technology, AMS-institute, Dutch housing associations, and

industry partners. The variants were developed by applying the generative tool for circular building components of van Stijn and Gruis (2020): the researchers synthesized design variants through systematically ‘mixing and matching’ circular design options for each design parameter. Although more variants are imaginable, these variants were considered plausible in the near future, and representative for different CE pathways. The designs were developed to the level of proof-of-concept and consist of a technical, industrial and business model.

3.2. Comparison environmental performance through LCA and MFA

The equations and parameters for the LCA and MFA are included in Appendix A.

3.2.1. Life Cycle Assessment

We employed the ‘Circular Economy LCA model for circular building

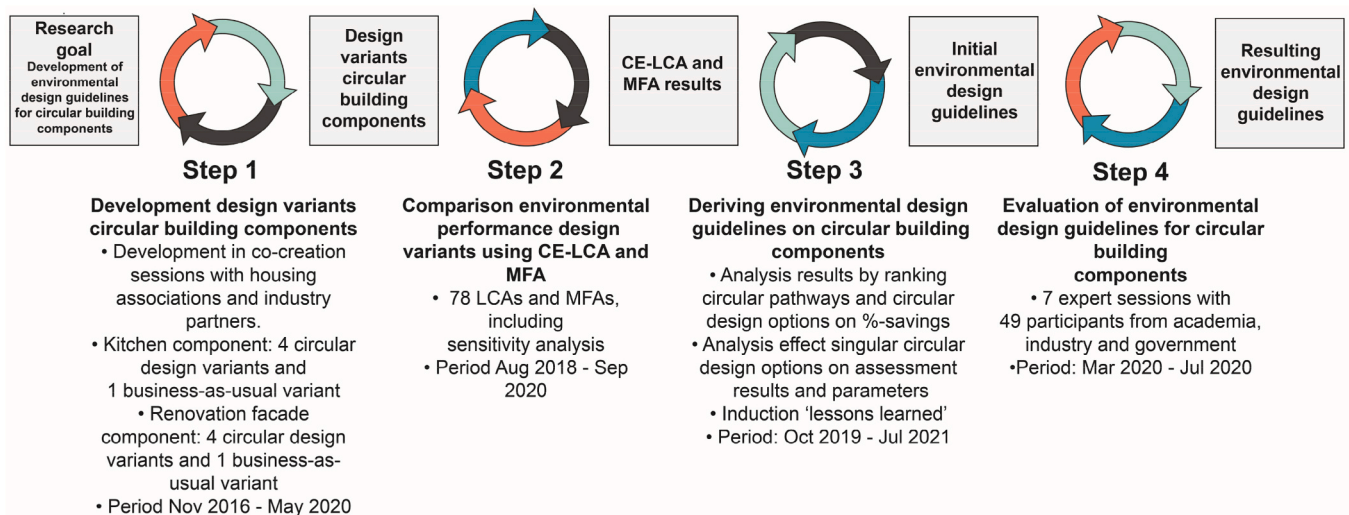

Fig. 1. Approach to develop environmental design guidelines.

components' (van Stijn et al., 2021). This model builds on existing LCA standards applied in the building sector: EN 15804 (2012) and EN 15978 (2011). In the standard LCAs, environmental impacts are assessed over a single use cycle of a building (component), captured in 'life cycle modules A-C'. Module D reports potential burdens and benefits of only one subsequent reuse, recycling or recovery cycle. Such LCAs do not fully capture the burdens and benefits of a CE (see Allacker et al. (2017); De Wolf et al. (2020); Eberhardt et al. (2020); van Stijn et al. (2021)). In CE-LCA, building components are considered as a composite of parts and materials with different and multiple use cycles; the system boundary is extended to include all cycles. For example, if reclaimed material is used in the component, initial production and use of the virgin material is included within the system boundary; if parts will be reused twice, both reuse cycles are included. Impacts were divided between use cycles using the Circular Economy Linearly Degressive (CE LD) allocation approach of Eberhardt et al. (2020). CE LD is suitable when the use and value of materials is not the same in each cycle (van Stijn et al., 2021) – which was the case in this study. The largest share of impacts from initial production and construction is allocated to the first use cycle and the share of impacts allocated to following cycles decreases linearly. For disposal most impacts are allocated to the last cycle. Impacts of VRPs are distributed equally between all use cycles.

For the kitchen, a lower cabinet was considered representative for the whole kitchen. For the façade, a section of façade for a terraced dwelling was considered representative. The functional unit (FU) for the kitchen was 'the use of a specific configuration of a lower kitchen cabinet in a circular system for the period of 80 years'. For the façade the FU was 'the use of a specific renovation façade for the reference façade section, with an approximate R_c value 5.0, in a circular system over a period of 90 years'. Note that the word 'specific' in the FU indicates that we distinguished if the building component, part or material is in its first, second, etc. use cycle rather than assuming an average. Following van Stijn et al. (2021, p. 4), the Reference Study Periods (RSPs) of 80 and 90 years were based on the longest Estimated Service Life (ESL) of parts of the kitchen and façade variants. These RSPs resulted in the fairest comparison between design variants. As we do not directly compare the environmental performance of kitchen to façade variants the RSP could differ for both.

The design variants remain theoretical concepts. When developing the CE-Life Cycle Inventory (CE-LCI), estimations were made on transport distances, production, VRPs and disposal processes, number of use cycles, and ESLs. The ESLs were determined by considering the interplay of functional, economic and technical lifespans on component, part and material level. Assumptions were based on how circular design options might perform compared to the BAU variant and on experience of involved practice partners. The CE-LCIs were modelled in openLCA version 1.9.0 software; the background system was modelled with the Ecoinvent 3.4 APOS database (Wernet et al., 2016), using system processes to get aggregated results. The CE Life Cycle Impact Assessment (CE-LCIA) was calculated using characterization factors from the Centre for Environmental Studies (CML)-IA baseline (Guinée et al., 2001). CML includes 11 environmental, resource-depletion and toxicology midpoint

impact categories and is commonly used in the building sector. There are two main approaches for accounting biogenic carbon: the '-1/+1' and '0/0' approach. See also Andersen et al. (2021) and Hoxha et al. (2020). In CE-LCA, carbon impacts from production and disposal are divided linearly between all use cycles. The -1/+1 approach would favour the first use cycles unfairly, so we applied the 0/0 approach. We refer to Appendix B for all CE-LCIs and CE-LCIA parameters.

Including multiple cycles into the assessment scope increases uncertainty of the results. Therefore, we conducted a scenario-based sensitivity analysis by varying the number of use cycles and lifespans of (parts of) the building components (see Table 2). By varying the lifespan and number of cycles, we actually combined circular design options associated with different pathways (e.g., a design combining bio-based materials with one re-use cycle). For a detailed description of all sensitivity scenarios, see appendix C.

3.2.2. Material Flow Analysis

In the MFA we calculated the direct material import and export of each design variant over the RSP in kilogram using the inventory developed for the CE-LCA. For the material import, we distinguished virgin or non-virgin flows, and renewable or non-renewable flows. For the export, we distinguished reused, remanufactured, recycled, biodegraded or incinerated for energy recovery, and discarded flows. By subtracting reused, remanufactured and recycled flows from the total import, we calculated the material consumption. As MFA is based on the law of matter conservation, no flows from prior or subsequent use cycles were allocated to the assessed building component.

3.3. Environmental design guidelines development

The environmental performance of design variants differed from one environmental impact-, or material flow category to another. Furthermore, between design variants many parameters differed simultaneously, such as lifespan, materialisation, number of use cycles. This inhibited selection of the best performing circular design option(s). Therefore, in step 3, we analysed the results to determine which circular design option(s) resulted in the best environmental performance and induce design guidelines (see Fig. 2).

Multiple procedures can be used to support decision-making. These vary in how the CE-LCA and MFA are valued to each other as well as the relative importance of different environmental impact categories. Each procedure has (dis)advantages. We ranked the variants based on percentual savings to the BAU baseline using multiple procedures in parallel. In the CE-LCA, (i) applying no weighting factors, we calculated the average percentual reduction of the 11 midpoints. (ii) We applied the 'single' issue approach. As Global Warming Potential (GWP) is often a focal point in industry and governmental policy, we singled out the percentual savings based on GWP. (iii) We calculated the percentual savings based on the prevention-based, single indicator: 'shadow costs' (Stichting Bouwkwaliiteit, 2019). Shadow costs are commonly applied in the Dutch building context. For the MFA, we considered the unweighted

Table 2
Scenarios of the sensitivity analysis.

Type of sensitivity scenario	Abbreviation	Explanation	Kitchen design variants				Façade design variants					
			BAU ^a	BIO ^a	Reclaim! ^a	LIFE+ ^a	P&P ^a	BAU ^a	BIO ^a	Reclaim! ^a	P2P ^a	P&P ^a
Number of use cycles	C-n	Removing future cycles									x	x
	C+n	Adding future reuse cycles	x	x	x	x	x	x	x	x	x	x
Lifespans of (parts of) the building components	L n	Increasing/decreasing technical and functional lifespan of all parts in parallel	x	x	x	x	x	x	x	x	x	x
	Lf n	Increasing/decreasing functional lifespan of parts of the building component				x	x					x

^a These abbreviations refer to the names of the kitchen and façade design variants and will be further explained in section 4.

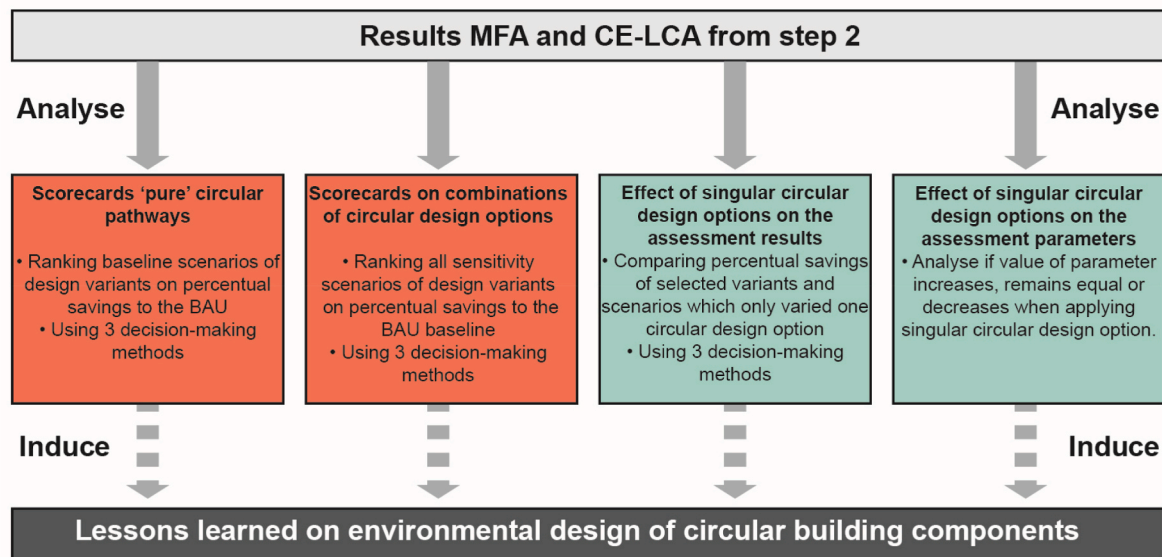

Fig. 2. 4 Analyses to induce lessons learned.

average of the percentual reduction on 5 categories: (1) the total material import and (2) material consumption and the percentage of (3) virgin, (4) non-renewable-, and (5) (bio)degraded, recovered, or discarded flows. We counted the CE-LCA and MFA equally. By ranking the savings of circular variants baseline scenarios to the BAU baseline, we developed a scorecard for the 'pure' circular pathways. By ranking the savings of all assessed scenarios to the BAU baseline, we developed a scorecard for combinations of circular design options.

The effect of 'singular' circular design options was investigated in depth. We analysed the effect of (1) applying non-virgin materials, (2) applying renewable materials, (3) increasing the functional- and technical lifespan in parallel, (4) increasing the functional lifespan, (5) adding future use cycles. We analysed their savings by comparing the results of selected variants and scenarios which only varied this one circular design option. Additionally, we analysed how these options affected the parameters in the CE-LCA and MFA equations.

From these 4 analyses, we induced lessons-learned on the environmental design of circular building components.

3.4. Evaluation of the environmental design guidelines

The environmental design guidelines were evaluated in 7 semi-structured expert sessions, with 49 experts and practitioners from academia, industry and government in the field of LCA, CE design and circular built environment. The researchers presented the methods, results and conclusions. The participants were asked the following questions: do you think the environmental design guidelines are valid or not; how would you improve them? The answers and discussion were documented in minutes and analysed using an emergent coding technique (Dahlsrud, 2008; Kirchherr et al., 2017). See Appendix D for the results.

4. Design variants for the kitchen and renovation façade

Figs. 3 and 4 visualise the technical models for the kitchen and façade design variants.

The kitchens in Dutch social housing are sober and appliances are typically not provided. So, the design focussed on the cabinetry. Similar countertop options were available for each variant. Therefore, they were left outside of the design scope. The BAU kitchen represents the current practice: a melamine-coated chipboard kitchen with a 20-years ESL. In the Biological (BIO) kitchen, bio-based and biodegradable materials are

applied; after 10 years, the cabinet is industrially composted. The Reclaim! kitchen is similar to the BAU kitchen but applies directly reused materials; it has a reduced ESL of 10 years. The LIFE+ kitchen optimizes the BAU kitchen by changing materials to optimize lifespans of parts. The construction is designed for long life (40 years) by substituting the chipboard with plywood. Fronts are designed for a shorter use (10 years) by applying low-impact, biological materials. The Plug-and-Play (P&P) kitchen applies a combination of circular design options to slow and close future cycles. Through a modular design, kitchen parts can be replaced at different rates so the whole kitchen can be kept for 80 years. The cabinets consist of a construction frame with an 80-year lifespan, drawers, shelves with a 40-year lifespan, and fronts with a use cycle of 20 years. The design facilitates repair and future adjustments. Additionally, parts and materials have reuse, remanufacturing, recycling and/or recovery cycles. The kitchen is constructed with long-life material (plywood), to facilitate longer and multiple use-cycles.

The BAU façade is an integrated and lightweight solution in which EPS and mineral brick strips are glued onto the existing façade. It is typically placed for an exploitation period of 30 years. After use, the materials are incinerated or landfilled. In the Biological (BIO) façade, bio-based and biodegradable materials are applied; after 30 years, the façade is industrially composted. The Reclaim! façade applies non-virgin materials. Demountable connectors are used. After 30 years, the façade can be disassembled and materials reused, recycled and/or recovered. The Product2Product (P2P) façade applies long-life materials in standardized sizes. De-, and remountable connectors facilitate multiple reuse cycles after 30 years. The Plug-and-Play (P&P) façade combines circular design options to slow and close future cycles. The façade is modular. Standard-sized façade panels are attached to insulation modules with click-on connectors. This design allows repair and adjustment of the façade and reuse(s) of parts after 30 years. At End of Life (EoL) of the modules, materials are recycled and/or recovered. An elaborate description of the design variants, flowcharts, and (re)placement charts have been included in Appendix E.

5. MFA and CE-LCA results

The CE-LCIA and MFA results are provided in Table 3. Fig. 5a and b provide a temporal perspective, showing the GWP over the RSP. Note, tipping points might differ for other impact categories.

Both the BIO and Reclaim! kitchens have a higher material import

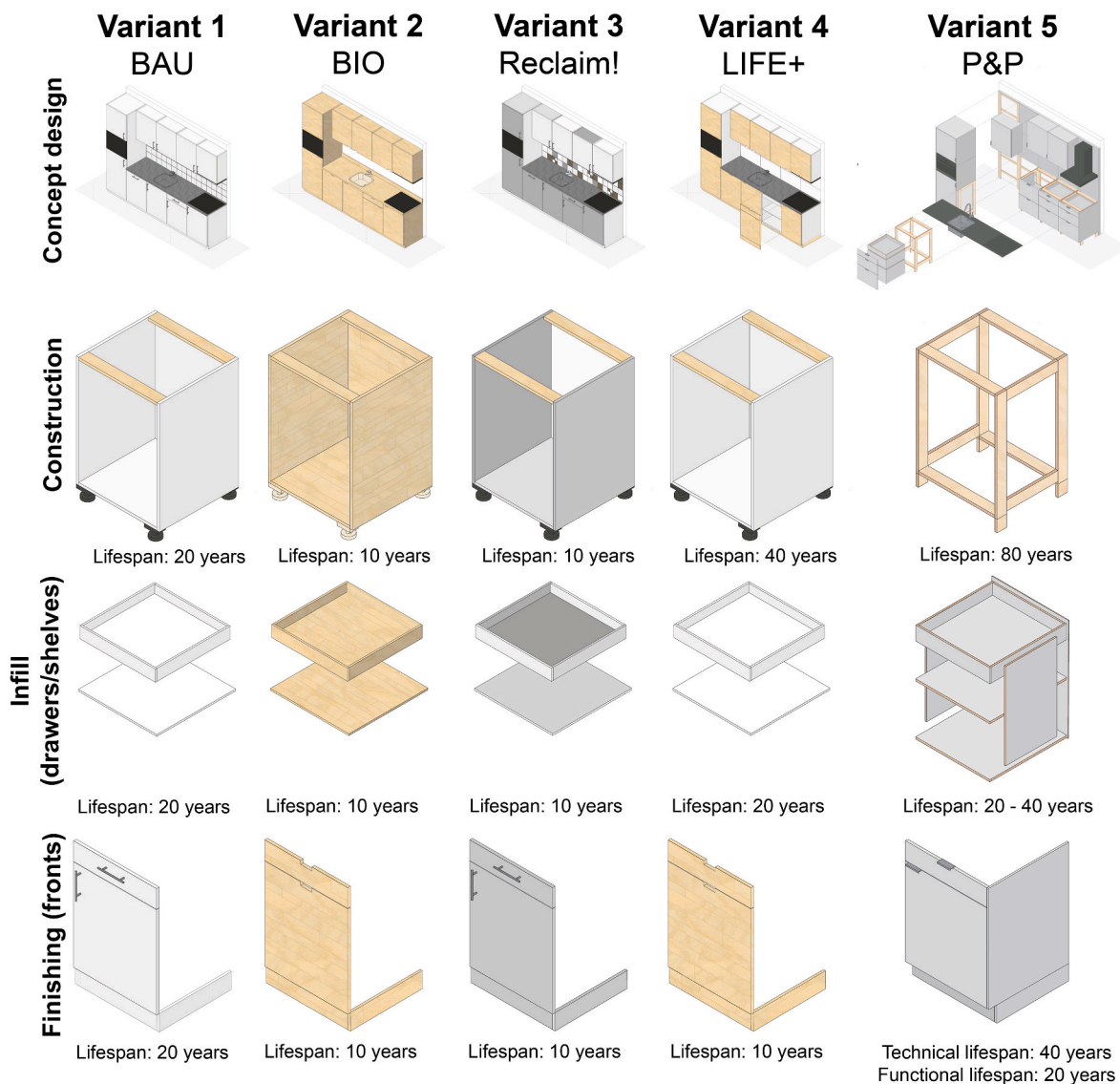

Fig. 3. Technical model of the kitchen design variants showing materialisation and lifespans.

and consumption than the BAU. Although the mass of a single placement is similar to a BAU, the reduced ESL of both variants result in more placements over time. In the Reclaim! variant, virgin material flows are reduced by 100%; In the BIO kitchen, non-renewable flows are reduced 100%. Both variants also have lower environmental impacts for one placement. Yet, they realise a lower impact on only 6 of the 11 impact categories over the RSP due to the higher replacement rate.

The LIFE+ kitchen has a slightly lower material import (13%) and material consumption (13%) than the BAU, due to the longer lifespan of the construction. The P&P reduces material import by 24% due to the longer lifespan of the construction, drawers and shelves. The P&P also reduces material consumption by 93%, as materials still have a cycle(s) after use in the kitchen. Both LIFE+ and P&P kitchens reduce impacts in all categories compared to the BAU: for the LIFE+ between 8% and 38%, and for the P&P, between 37% and 57%. The reduction stems from partial replacements. When only parts of the kitchen are replaced (e.g., at $t = 10$, $t = 20$), the impact is significantly less than during full replacements (e.g., at $t = 0$). For the LIFE+ kitchen, reductions also stem from using less impactful material for the fronts. For the P&P kitchen, substituting the particle board with plywood does not reduce impacts much. However, the multiple use cycles of parts and materials result in a lower share of impacts allocated to the P&P kitchen.

The BAU façade contains plastics, cement and brick. In all other façades, metals and renewable materials are applied causing a shift of burdens to other impact categories. All circular façades increase material import compared to the material-efficient BAU. In the BIO façade, more renewable insulation material was needed to reach a comparable insulation value. All circular variants have additional structural materials. In the Reclaim!, P2P and P&P façades, additional metal connectors were needed to allow dis- and reassembly.

In the BIO façade, non-renewable flows were reduced by nearly 100% compared to the BAU. Impacts are lower on 8 out of 11 categories, ranging between -600% and 79% . Notably, burdens were shifted towards eutrophication, abiotic depletion and terrestrial ecotoxicity categories: categories related to growth of renewable materials. The Reclaim! façade reduced virgin material flows 100%. Although material import was more than doubled, a large part is wood. Wood has a relatively low-impact and was modelled with 5 use cycles. So, a low share of impacts is allocated to the façade. As such, the Reclaim! variant reduces impacts on 9 categories.

The P2P and P&P façades reduced 4 and increased 7 impact categories: burdens are shifted to abiotic depletion and toxicity impact categories caused by the metals. The multiple use cycles of parts and materials result in a lower share of impacts allocated to these façades.

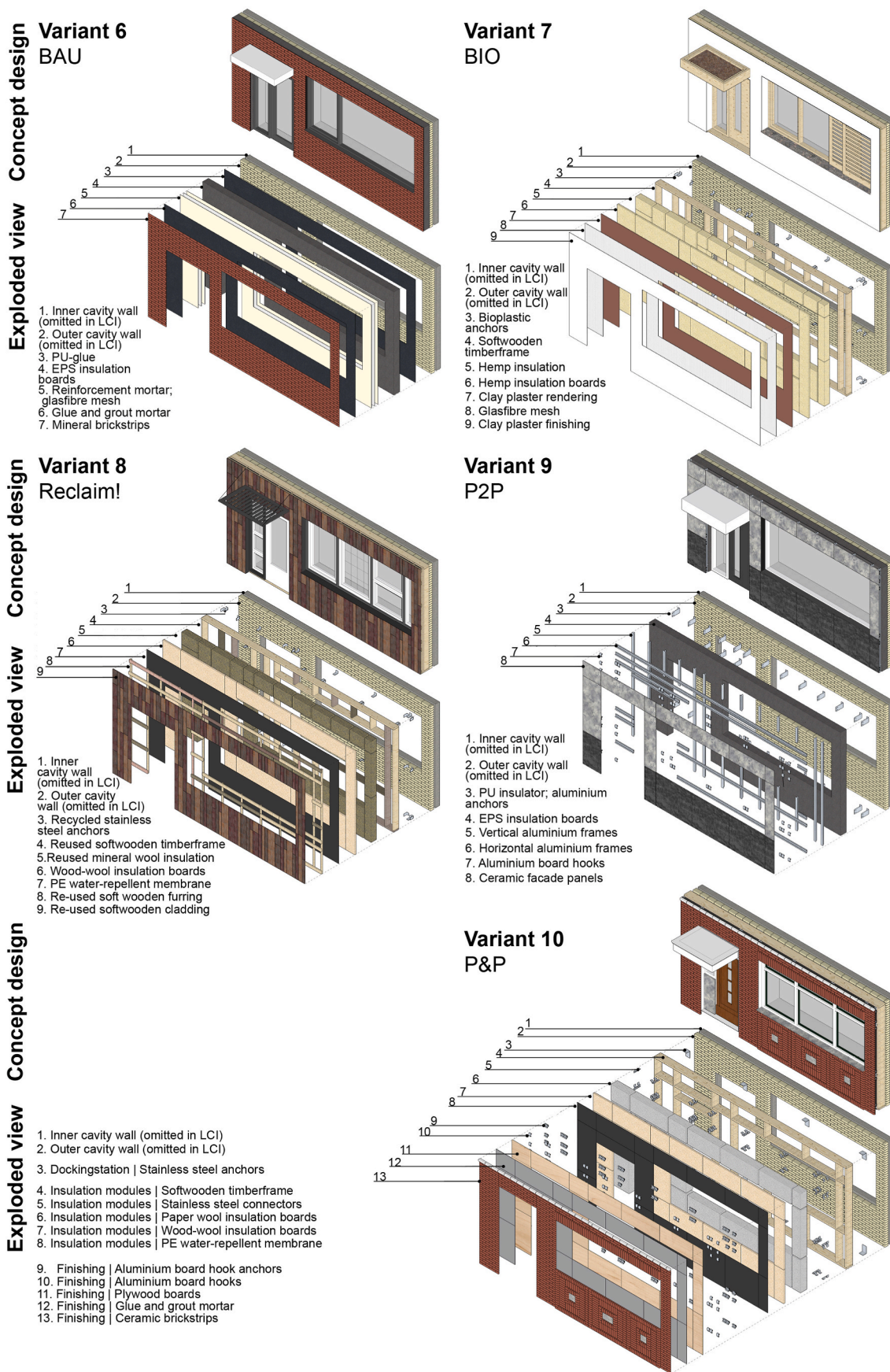

Fig. 4. Technical model of the façade design variants showing materialisation.

Table 3
Environmental impacts and material flows over the RSP per kitchen and façade variant.

Impact category	Unit	Design variants kitchen					Design variants facade					
		BAU	BIO	Reclaim!	Life +	P&P	BAU	BIO	Reclaim!	P2P	P&P	
MFA	Import Total	kg	132	210	264	115	101	801	1488	1857	987	1731
	Import Virgin	kg	92	210	0	103	63	801	1488	4	329	518
	Import Non-virgin	kg	40	0	264	11	38	0	0	1853	658	1213
	Import Renewable	kg	92	210	184	85	76	0	1483	1752	0	1035
	Import Non-renewable	kg	40	0	80	30	25	801	4	105	987	696
	Export Re-used	kg	0	0	0	0	28	0	0	856	899	1416
	Export Remanufactured	kg	0	0	0	0	34	0	0	0	0	0
	Export Recycled	kg	9	0	18	8	30	350	0	610	87	206
	Export Recovered/biodegraded	kg	123	210	246	107	8	138	1488	391	0	109
	Export Discarded	kg	0	0	0	0	0	313	0	0	0	0
	Material consumption	kg	123	210	246	107	8	451	1488	391	0	109
CE-LCA	Global warming potential	kg CO ₂ eq	1.48E+02	1.20E+02	1.50E+02	1.08E+02	6.40E+01	9.78E+02	3.17E+02	3.36E+02	5.33E+02	3.78E+02
	Ozone layer depletion potential	kg CFC ₋₁₁ eq	1.32E-05	1.83E-05	1.12E-05	1.02E-05	6.92E-06	3.25E-05	2.81E-05	3.60E-05	3.38E-05	4.74E-05
	Photochemical ozone creation potential	kg C ₂ H ₄ eq	5.10E-02	4.05E-02	4.71E-02	4.06E-02	2.54E-02	1.95E-01	1.65E-01	1.55E-01	1.38E-01	1.39E-01
	Acidification potential	kg SO ₂ eq	5.99E-01	7.02E-01	5.34E-01	4.66E-01	2.99E-01	2.81E+00	2.20E+00	2.13E+00	2.31E+00	1.64E+00
	Eutrophication potential	kg PO ₄ ³⁻ eq	2.22E-01	2.45E-01	1.98E-01	1.77E-01	1.05E-01	5.96E-01	3.23E+00	5.70E-01	7.35E-01	7.43E-01
	Abiotic depletion potential for elements	kg Sb eq	1.55E-03	1.71E-03	1.24E-03	9.62E-04	9.77E-04	1.15E-03	8.02E-03	9.11E-04	2.86E-02	5.93E-03
	Abiotic depletion potential for fossil fuels	MJ	1.81E+03	1.73E+03	1.56E+03	1.27E+03	7.88E+02	1.36E+04	2.87E+03	3.83E+03	6.27E+03	4.11E+03
	Fresh water aquatic ecotoxicity potential	kg 1,4-DB eq.	8.30E+01	3.59E+01	9.37E+01	5.87E+01	3.73E+01	2.95E+02	1.16E+02	1.68E+02	6.49E+03	1.83E+03
	Human toxicity potential	kg 1,4-DB eq.	1.82E+02	5.41E+01	2.37E+02	1.51E+02	9.11E+01	2.85E+02	1.25E+02	2.25E+02	4.88E+02	5.79E+02
	Marine aquatic ecotoxicity potential	kg 1,4-DB eq.	1.70E+05	1.05E+05	1.71E+05	1.17E+05	7.62E+04	1.27E+06	3.01E+05	6.45E+05	2.74E+06	1.37E+06
	Terrestrial ecotoxicity potential	kg 1,4-DB eq.	4.93E-01	6.64E-01	4.94E-01	4.52E-01	2.81E-01	5.87E-01	1.39E+00	9.95E-01	1.35E+00	1.79E+00

Note: The colour shows a gradient between the worst (dark grey) and best (white) value. The best value is the lowest value in all categories, except for the renewable-, and non-virgin import, and the reused-, remanufactured-, and recycled material export.

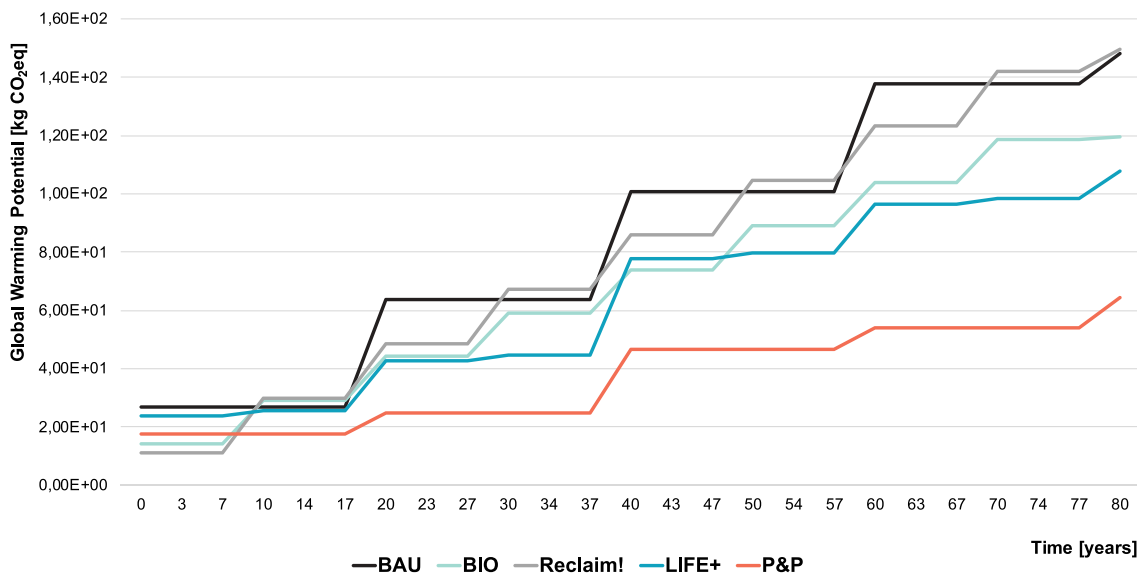

Fig. 5a. GWP per kitchen variant over the RSP.

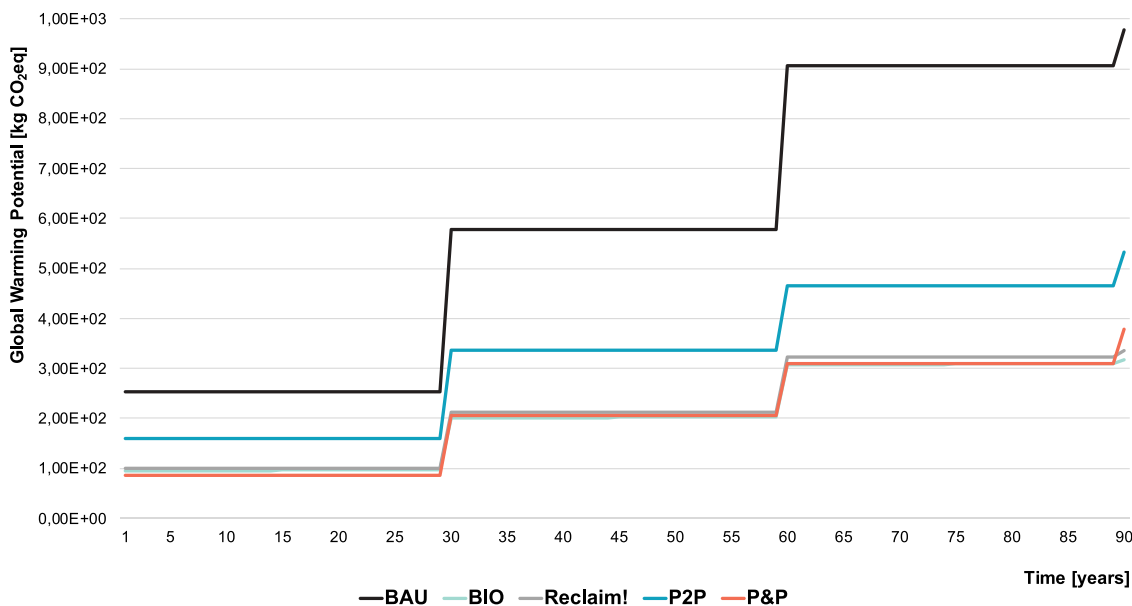

Fig. 5b. GWP per façade variant over the RSP.

Fig. 5b illustrates the benefit of placing second-, and third-hand parts during replacements ($t = 30$ and $t = 60$): lower shares of impact are allocated to the façade than during the placement of virgin parts at $t = 0$. However, these gains only (partially) make up for the high production impacts and higher material mass. Due to the multiple reuse cycles of parts and materials, the P2P and P&P reduce material consumption by 100% and 76%, respectively.

5.1. Results of the sensitivity analysis

To support comparison of scenarios, we included charts visualising the MFA and GWP over the RSP in Appendices F-I. The results for all impact categories and material flows are provided in Appendix J, Appendix K contains additional analysis on the contribution of materials and processes.

When adding 1 or 2 reuse cycles (scenarios C+1 and C+2), impacts decrease for all kitchen and façade variants. Savings are highest for

variants which apply virgin materials and do not yet have future cycles (i.e., BAU, BIO and LIFE+). For example, adding one cycle to the BAU, BIO and LIFE+ kitchens, reduces impacts between 18% and 34% compared to their baseline scenarios and between 27% and 50% when adding 2 reuses. Adding a reuse cycle to non-virgin material does not decrease the fraction of impacts allocated to the building component as much as for virgin materials. For the Reclaim! kitchen, impacts are only reduced between 1% and 10% when adding one reuse. For the Reclaim! façade this is between 7% and 16%. In the P2P and P&P variants, the scenarios in which cycles are removed (C-1, C-2, and C-3) show that not all future cycles reduce impacts. In C-1, impactful recycling processes no longer take place. Although a higher share of impacts is allocated to the component, this is offset by reducing (heavy) impacts from these cycles. In the P&P C-1 scenarios, impacts are reduced between -4% and 73% for the kitchen and between -1% and -9% for the façade. In scenarios C-2 for the façade and C-3 for the kitchen impacts increase because reuse cycles are no longer realised. In the MFA, when adding cycles, all

materials become reused flows. Subsequently, material consumption is lowered to 0. Likewise, subtracting cycles leads to a significant increase in material consumption.

The sensitivity is highest when varying the technical and functional lifespan in parallel: there is a proportional relationship between the environmental impacts, mass of flows and the technical-functional lifespan. In their baseline, the BIO and Reclaim! kitchen have shorter ESLs than the BAU, whereas the LIFE+ and P&P kitchen have longer ESLs. Compared on a ± 20 -year ESL, BIO and Reclaim! have half the impacts, material import and consumption compared to their baseline. The BIO now reduces impacts between 31% and 85% compared to the BAU and the Reclaim! between 35% and 60%, whilst having a similar material import and consumption. In the LIFE+ and P&P kitchens, a 20-year technical lifespan increases material import, consumption and impacts compared to their baseline. The LIFE+, now only has a -1% and 41% impact reduction compared to the BAU; for the P&P this is between -38% and 10%. Note that a key circular design option of the LIFE+ and P&P – facilitating partial replacements to keep the whole kitchen in use longer – is nullified in this scenario. Furthermore, in the P&P kitchen, finishing parts are still exchanged every 10 years preventing full comparability.

Varying only the functional lifespan of parts of the LIFE+ kitchen and P&P kitchen and façade results in less impact deviation from their baseline. When reducing the functional lifespan, more finishing parts are placed throughout the RSP. However, in the LIFE+ kitchen, these parts are made of low-impact renewable materials, keeping impacts low. In the P&P kitchen and façade, although more finishing parts are placed, they are also reused more often as the technical lifespan remains the same. So, a lower amount of impact is allocated to the components.

5.2. Interpretations of the results

From results of the kitchen baseline scenarios, we found that the P&P kitchen has the lowest environmental impacts, material import and consumption over time. However, in the sensitivity analyses we found clear tipping points. Any savings are dependent on realizing the longer technical lifespans of parts and future cycles, in particular the low-impact reuse cycles. Furthermore, were the BIO and Reclaim! kitchen to have a longer lifespan and/or reuse cycle(s), these variants could reduce impacts, material import and/or consumption equally or more than the P&P. But these kitchens are currently not designed for long use and multiple cycles. Their designs would need adaptations, effectively merging different circular design options.

The baseline scenario for the façade does not indicate a variant which consistently reduces impacts and material flows on all categories. The Reclaim! façade has the most stable reductions. From the sensitivity analysis we found that if this variant were combined with longer lifespans and/or reuse cycle(s), further savings could be achieved on impact. However, in all these scenarios the material import still increases compared to the BAU. Realizing reuse cycle(s) or longer lifespans in the BAU variant could result in equal or higher impact reductions than the Reclaim! façade. However, the BAU would then likely need redesign. In the other façades, changes in materials cause shifts in burdens which inhibit the evaluation of these variants.

The results of these assessments are interpretable in multiple ways depending on where priorities are placed and what approach is used to make decisions, inhibiting selection of the best performing circular design option(s).

6. Resulting environmental design guidelines for circular building components

In this section, we present the analysis of the assessment results and induced lessons-learned.

6.1. Scorecards for circular pathways and combinations of circular design options

In [Appendix L](#), we show the percentual savings of the design variants for all scenarios compared to the BAU baseline, and their rankings following the ranking methods described in section 3.3. [Table 4a–b](#) shows the resulting scorecards for pure circular pathways (baseline scenarios); [Table 5a–b](#) presents the scorecard for combinations of circular design options (all analysed scenarios).

For the kitchens, different ranking methods lead to a similar ranking. For the façade, rankings deviate significantly. The ranking from the single-issue method differs most from the other two methods. The P2P and P&P have negative savings based on the shadow-costs and the average of all impact categories. However, they do reduce GWP causing the shift in rankings.

In [Table 4a–b](#), the BAU kitchen scores significantly lower than the BAU façade. The BAU façade is more material efficient compared to the circular façades. However, all circular façades reduce the GWP impacts, so the BAU ranks lower using the GWP-based method. For the kitchens, the LIFE+ and P&P variants based on optimising or prolonging lifespan of parts of the kitchen and adding future cycles rank highest. Similarly, the P&P façade ranks high, whilst the P2P ranks lowest. In the P2P, benefits of multiple reuse cycles do not compensate the high production impacts and mass. The Reclaim! kitchen scores low due to the reduced ESL, whilst for the façade it scores highest. The ESL of the Reclaim! façade is shorter than the technical lifespan of the non-virgin materials. So, initial impact savings accumulate with each new placement. The BIO kitchen suffers from its reduced ESL but still provides some impact savings compared to the BAU, resulting in a third place. Even though the BIO façade reduces the shadow costs most (57%) compared to the BAU, due to the shifts in burdens and its high material import and consumption, the BIO façade is placed below the BAU.

By ranking all sensitivity scenarios, we found that ‘pure’ circular pathways do not rank highest on environmental performance. Both in the kitchen and façade, the highest-ranking scenarios are combinations of circular pathways. Variants rank high which combine circular materials, longer lifespans, and/or reuse cycles. This combination reduces environmental impacts and virgin and/or non-renewable import during initial placement (narrowing loops); it reduces impacts, material import and consumption over time (slowing and closing loops). However, these higher scoring variants are likely either unfeasible or require some redesign.

6.2. Analysis effect of circular design options on assessment results and parameters

The analysis of the effect of singular circular design options on the assessment results is included in [Appendix M](#); the analysis of their effect on assessment parameters is provided in [Appendix N](#).

Increasing the ESL (technical-functional in parallel) results in consistent savings on all impact categories and mass of flows. It only decreases one parameter: the ‘rate’ in which materials are replaced and impacts occur. All other circular design options influenced two or more parameters with trade-offs between them. How parameters were affected differed between the kitchen and façade variants, making savings inconsistent. Applying non-virgin material reduces the impacts allocated to the building component. For non-virgin and bio-based, biodegradable materials, the effect on impact/kg, technical lifespans or required mass varied. Adding a direct reuse cycle resulted in consistent impact savings because the added impacts from reuse were outweighed by the lower share of impacts allocated to the component. However, adding higher-impact recycling cycles, could result in less or no savings. It depends if the lower allocation share outweighs the increased impacts of the recycling cycles.

We conclude that most of the circular design options do not lead to a better environmental performance ‘by default’. It depends on how they

Table 4a
Scorecard circular pathways for the circular kitchen.

Rank all impact categ.; MFA	Rank GWP; MFA	Rank Shadow costs; MFA	Variant	Applied circular design options		
				Technical model	Industrial model	Business model
1	1	1	P&P	Adjustable modular design, optimising lifespans, durable materials, multiple cycles (re-use, reman., recycling, recovery)	Maintenance, updates and re-use by manufacturer, reman. recycl. and recov. in collaboration with third parties	Lease, or sale with take- or buy-back, maintenance and update services
2	2	2	LIFE+	Optimising lifespans (40-20-10-20 years), long-life materials, bio-based, biodegradable materials	Open-loop recycling, recovery, industrial composting by third parties	Sale
4	3	3	BIO	Bio-based, biodegradable materials, short lifespan (10 years)	Industrial composting by third parties	Sale
3	4	4	BAU	Linear design	Open-loop recycling and recovery by third parties	Sale
5	5	5	Reclaim!	Non-virgin materials, short lifespan (10 years)	Open-loop recycling and recovery by third parties	Sale

Table 4b
Scorecard circular pathways for the circular renovation façade.

Rank all impact categ.; MFA	Rank GWP; MFA	Rank Shadow costs; MFA	Variant	Applied circular design options		
				Technical model	Industrial model	Business model
1	3	1	Reclaim!	Non-virgin materials, easy to disassemble	Open-loop (local) re-use, recycling and recovery by third parties	Sale and re-sale
3	1	2	P&P	Adjustable, modular design, standard sizes, easy to dis-and re-assemble, optimising lifespans, durable materials, multiple cycles (re-use, recycling, recovery)	Maintenance, updates, re-use by provider. Recycling and recovery in collaboration with third parties	Lease, or sale with take- or buy-back, mainten. and update services
2	5	3	BAU	Linear design	Open-loop recycling and recovery by third parties	Sale
4	4	4	BIO	Bio-based, biodegradable materials	Industrial composting by third parties	Sale
5	2	5	P2P	Easy to dis-, and re-assemble, durable materials, standard sized parts, re-use of parts	Re-use by provider or client, recycling and recovery by third parties	Lease, sale-with takeback, or sale and re-sale

are applied and in which context.

6.3. Lessons learned on the environmental design of circular building components

From the analyses above, we induce 8 lessons-learned on the environmental design of circular building components. An overview has been included in Appendix O.

(Lesson 1) We found that environmental performance improves most by combining circular design options to narrow, slow and close cycles. (Lesson 2) For the kitchen, we found that facilitating partial replacements to increase the overall lifespan of the component, introducing multiple use cycles of parts and materials and applying bio-based or non-virgin materials results in the lowest material use, impacts and waste. For the façade the emphasis seems to slightly shift: the ‘best’ performing façade combines non-virgin materials with long lifespans and/or multiple reuse cycles on site. Material investments to make the facade modular for facilitating repair, adjustments and reuse of parts were ‘larger’ than in the kitchen and took longer to pay back. We stress that multiple trade-offs and changes in assumptions can cause tipping points.

First, the environmental performance of components is dependent on the ability to design, determine, guarantee and realise multiple cycles. (Lesson 3) When designing circular components all future cycles need to be considered, understanding the building component as a composite of parts and materials (Lesson 4). Additionally, circularity should not only be facilitated in the technical model, but future cycles also need to be organised and incentivised in the supply chain and business models. (Lesson 5) As such, circular building components should be designed ‘integrally’ and in cocreation with all supply chain partners. (Lesson 6) If

it seems unlikely that future cycles can be organized or incentivised, it could be more beneficial to develop a circular component which is efficient, lightweight and kept in use as long as possible; low impact, non-virgin, and/or bio-based materials could be applied which are biodegradable or recyclable in an open-loop supply chain.

Circular design options have trade-offs. Their environmental performance depends on how they are applied and in which context. Facilitating repair, adjustments and reuse cycles through modularity, easy de- and remountable joints and applying materials with a longer technical lifespan can both improve environmental performance (the P&P kitchen) or reduce it (P2P façade). A balance should be found between the higher impact of the material/kg for long-life materials, the additional mass needed to make a modular design and the savings due to the longer lifespan and/or increased number of use cycles. Applying renewable or non-virgin material means carefully balancing the environmental impacts per kg, material required initially and replacement rate. (Lesson 7) In other words, all design parameters need to be considered in parallel.

Finally, we found that for relatively light-weight components (such as the kitchen and façade) most of the impact is related to the material production and remanufacturing, recycling or waste treatment processes. (Lesson 8) Increased transport to realise VRPs has less impact than replacement with a new building component. Although minimizing and optimising transport remains preferable, all VRPs need not occur locally.

7. Discussion and conclusion

The built environment can gradually be made circular by replacing building components with more circular ones. There are many possible

Table 5a
Scorecard of circular design options for the circular kitchen.

Rank all impact categories; MFA	Rank GWP; MFA	Rank Shadow costs; MFA			Applied circular design options		
			Variant	Scenario	Technical model	Industrial model	Business model
1	1	1	Reclaim!	L80	Non-virgin materials, very long lifespan (80 years)	Open-loop recycling and recovery by third parties	Sale
2	2	2	BIO	L80	Bio-based, biodegradable materials, very long lifespan (80 years)	Industrial composting by third party	Sale
3	3	3	P&P	Lt = 80-80-80-80, Lf = 80-80-40-80	Adjustable, modular design, standard sizes, easy to dis-and re-assemble, durable materials, multiple cycles (re-use, reman., recycling, recov.), very long lifespan (80 years)	Maintenance, updates, re-use by manufacturer. Remanufacturing, recycling and recovery in collaboration with third parties	Lease, or sale with take- or buy-back, mainten. and update services
6	7	4	BIO	L40	Bio-based, biodegradable materials, long lifespan (40 years)	Industrial composting by third party	Sale
5	4	5	P&P	C+2	Adjustable, modular design, standard sizes, easy to dis-and re-assemble, optimising lifespans, durable materials, multiple cycles (re-use, reman., recycling, recov.), 2 additional re-use cycle	Maintenance, updates, re-use by manufacturer. Remanufacturing, recycling and recovery in collaboration with third parties	Lease, or sale with take- or buy-back, mainten. and update services
4	6	6	Reclaim!	L40	Non-virgin materials, long lifespan (40 years)	Open-loop recycling and recovery by third parties	Sale
7	5	7	P&P	C+1	Adjustable, modular design, standard sizes, easy to dis-and re-assemble, optimising lifespans, durable materials, multiple cycles (re-use, reman., recycling, recov.), 1 additional re-use cycle	Maintenance, updates, re-use by manufacturer. Remanufacturing, recycling and recovery in collaboration with third parties	Lease, or sale with take- or buy-back, mainten. and update services
14	12	8	BIO	C+2	Bio-based, biodegradable materials, short lifespan (10 years), 2 re-use cycles	Local re-use. Industrial composting by third party	Sale
8	9	9	BAU	L80	Linear design, very long lifespan (80 years)	Open-loop recycling and recovery by third parties	Sale
9	8	10	P&P	Lt = 80-40-40-40, Lf = 80-40-40-40	Adjustable, modular design, standard sizes, easy to dis-and re-assemble, optimising lifespans, durable materials, multiple cycles (re-use, reman., recycling, recov.), long function. lifespan finishing (40 years)	Maintenance, updates, re-use by manufacturer. Remanufacturing, recycling and recovery in collaboration with third parties	Lease, or sale with take- or buy-back, mainten. and update services
10	11	11	LIFE+	L = 80-80-80-80	Long-life materials, bio-based, biodegradable materials, very long functional-technical lifespan (80 years)	Open-loop recycling, recovery, and industrial composting by third parties	Sale
18	16	12	BIO	C+1	Bio-based, biodegradable materials, short lifespan (10 years), 1 re-use cycle	Local re-use. Industrial composting by third party	Sale
11	10	13	P&P	Baseline	Adjustable, modular design, standard sizes, easy to dis-and re-assemble, optimising lifespans, durable materials, multiple cycles (re-use, reman., recycling, recovery)	Maintenance, updates, re-use by manufacturer. Remanufacturing, recycling and recovery in collaboration with third parties	Lease, or sale with take- or buy-back, mainten. and update services
12	14	14	P&P	C-1	Adjustable, modular design, standard sizes, easy to dis-and re-assemble, optimising lifespans, durable materials, 1 cycle not realised (re-use, reman., open-loop recycling and recovery)	Maintenance, updates, re-use by manufacturer. Remanufacturing, recycling and recovery in collaboration with third parties	Lease, or sale with take- or buy-back, mainten. and update services
13	13	15	LIFE+	C+2	Optimising lifespans, long-life materials, bio-based, biodegradable materials, 2 re-use cycles	Local re-use, open-loop recycling, recovery, and industrial composting by third parties	Sale
22	20	16	BIO	L20	Bio-based, biodegradable materials, medium lifespan (20 years)	Industrial composting by third party	Sale
15	15	17	LIFE+	C+1	Optimising lifespans, long-life materials, bio-based, biodegradable materials, 1 re-use cycle	Local re-use, open-loop recycling, recovery, and industrial composting by third parties	Sale
17	19	18	LIFE+	L = 80-40-20-40	Optimising lifespans, long-life materials, bio-based, biodegradable materials, long functional-technical lifespan (80-40-20-40 years)	Open-loop recycling, recovery, and industrial composting by third parties	Sale
19	18	19	P&P	Lt = 80-40-40-40, Lf = 80-40-7-40	Adjustable, modular design, standard sizes, easy to dis-and re-assemble, optimising lifespans, durable materials, multiple cycles (re-use, reman., recycling, recov.), very short function. lifespan finishing (7 years)	Maintenance, updates, re-use by manufacturer. Remanufacturing, recycling and recovery in collaboration with third parties	Lease, or sale with take- or buy-back, mainten. and update services
16	17	20	BAU	C+2	Linear design, 2 re-use cycles	Local re-use, open-loop recycling and recovery by third parties	Sale
20	21	21	P&P	C-2	Adjustable, modular design, standard sizes, easy to dis-and re-assemble, optimising lifespans, durable materials, 2	Maintenance, updates, re-use by manufacturer. Open-loop recycling	Lease, or sale with take- or buy-back,

(continued on next page)

Table 5a (continued)

Rank all impact categories; MFA	Rank GWP; MFA	Rank Shadow costs; MFA	Applied circular design options				
			Variant	Scenario	Technical model	Industrial model	Business model
23	23	22	BAU	L40	cycles not realised (re-use, open-loop recycling and recovery) Linear design, long lifespan (40 years)	and recovery in collaboration with third parties Open-loop recycling and recovery by third parties	mainten. and update services Sale
24	22	23	BAU	C+1	Linear design, 1 re-use cycle	Local re-use, open-loop recycling and recovery by third parties	Sale
21	24	24	Reclaim!	L20	Non-virgin materials, medium lifespan (20 years)	Open-loop recycling and recovery by third parties	Sale
25	25	25	Reclaim!	C+2	Non-virgin materials, short lifespan (10 years), 2 re-use cycles	Local re-use, open-loop recycling and recovery by third parties	Sale
27	30	26	P&P	C-3	Adjustable, modular design, standard sizes, easy to dis-and re-assemble, optimising lifespans, durable materials, 3 cycles not realised (only open-loop recycling and recovery)	Maintenance, updates, by manufacturer. Open-loop recycling and recovery in collaboration with third parties	Lease, or sale with take- or buy-back, mainten. and update services
29	27	27	P&P	Lt = 40-20-20-20, Lf = 40-20-10-20	Adjustable, modular design, standard sizes, easy to dis-and re-assemble, optimising lifespans, durable materials, multiple cycles (re-use, reman., recycling, recov.), medium lifespan (40-20-20-20 years)	Maintenance, updates, re-use by manufacturer. Remanufacturing, recycling and recovery in collaboration with third parties	Lease, or sale with take- or buy-back, mainten. and update services
26	26	28	Reclaim!	C+1	Non-virgin materials, short lifespan (10 years), 1 re-use cycle	Local re-use, open-loop recycling and recovery by third parties	Sale
28	28	29	LIFE+	Lf = 40-20-20-20	Optimising lifespans, long-life materials, bio-based, biodegradable materials, medium functional lifespan finishing (20 years)	Open-loop recycling, recovery, and industrial composting by third parties	Sale
31	29	30	P&P	Lt = 20-20-20-20, Lf = 20-20-10-20	Adjustable, modular design, standard sizes, easy to dis-and re-assemble, durable materials, multiple cycles (re-use, reman., recycling, recov.), medium lifespan (20 years)	Maintenance, updates, re-use by manufacturer. Remanufacturing, recycling and recovery in collaboration with third parties	Lease, or sale with take- or buy-back, mainten. and update services
30	31	31	LIFE+	Baseline	Optimising lifespans (40-20-10-20 years), long-life materials, bio-based, biodegr. materials	Open-loop recycling, recovery, and industrial composting by third parties	Sale
34	33	32	BIO	Baseline	Bio-based, biodegradable materials, short lifespan (10 years)	Industrial composting by third party	Sale
32	32	33	LIFE+	Lf = 40-20-7-20	Optimising lifespans, long-life materials, bio-based, biodegradable materials, very short functional lifespan finishing (7 years)	Open-loop recycling, recovery, and industrial composting by third parties	Sale
33	34	34	BAU	Baseline	Linear design	Open-loop recycling and recovery by third party	Sale
35	35	35	Reclaim!	Baseline	Non-virgin materials, short lifespan (10 years)	Open-loop recycling and recovery by third parties	Sale
37	37	36	BIO	L7	Bio-based, biodegradable materials, very short lifespan (7 years)	Industrial composting by third party	Sale
36	36	37	LIFE+	L = 20-10-7-10	Optimising lifespans, long-life materials, bio-based, biodegradable materials, short lifespan (20-10-7-10 years)	Open-loop recycling, recovery, and industrial composting by third parties	Sale
38	38	38	Reclaim!	L7	Non-virgin materials, very short lifespan (7 years)	Open-loop recycling and recovery by third parties	Sale
40	39	39	P&P	Lt = 7-7-7-7, Lf = 7-7-3,5-7	Adjustable, modular design, standard sizes, easy to dis-and re-assemble, durable materials, multiple cycles (re-use, reman., recycling, recov.), very short lifespan (7 years)	Maintenance, updates, re-use by manufacturer. Remanufacturing, recycling and recovery in collaboration with third parties	Lease, or sale with take- or buy-back, mainten. and update services
39	40	40	LIFE+	L = 7-7-7-7	Long-life materials, bio-based, biodegradable materials, very short functional-technical lifespan (7 years)	Open-loop recycling, recovery, and industrial composting by third parties	Sale
41	41	41	BAU	L7	Linear design, very short lifespan (7 years)	Open-loop recycling and recovery by third parties	Sale

design alternatives for circular building components. Industry could benefit from knowledge on what the most circular design options are from an environmental performance perspective. Environmental design guidelines based on LCA and MFA could help bring this knowledge into practice. Existing guidelines are conflicting: some focus on singular circular design options and different assessment methods are applied. Guidelines also differ for different building component which might depend on their Service Life (SL). Therefore, we developed

environmental design guidelines by comparing 4 circular design options and a business-as-usual design for two building components: a kitchen (short SL) and renovation façade (medium SL). We compared their environmental performance through Material Flow Analysis (MFA) and Circular Economy Life Cycle Assessment (CE-LCA) including extensive sensitivity analysis. We derived 8 lessons learned from 78 CE-LCAs and MFAs. One of the key lessons found for both components is that the environmental performance improves most by combining circular

Table 5b
Scorecard of circular design options for the circular renovation façade.

Rank all impact categories; MFA	Rank GWP; MFA	Rank Shadow costs; MFA			Applied circular design options		
			Variant	Scenario	Technical model	Industrial model	Business model
1	1	1	Reclaim	L90	Non-virgin materials, easy to disassemble, very long lifespan (90 years)	Open-loop (local) re-use, recycling and recovery by third parties	Sale and re-sale
10	7	2	BIO	C+2	Bio-based, biodegradable materials, 2 re-use cycles	Local re-use, industrial composting by third party	Sale
5	2	3	P&P	L90	Adjustable, modular design, standard sizes, easy to dis-and re-assemble, optimising lifespans, durable materials, multiple cycles (re-use, recycling, recovery), very long lifespan (90 years)	Maintenance, updates, re-use by provider. Recycling and recovery in collaboration with third parties	Lease, or sale with take- or buy-back, mainten. and update services
3	6	4	Reclaim	L45	Non-virgin materials, easy to disassemble, long lifespan (45 years)	Open-loop (local) re-use, recycling and recovery by third parties	Sale and re-sale
14	10	5	BIO	C+1	Bio-based, biodegradable materials, 1 re-use cycle	Local re-use, industrial composting by third party	Sale
4	4	6	Reclaim	C+2	Non-virgin materials, easy to disassemble, 2 re-use cycles	Open-loop (local) re-use, recycling and recovery by third parties	Sale and re-sale
7	9	7	Reclaim	C+1	Non-virgin materials, easy to disassemble, 1 re-use cycle	Open-loop (local) re-use, recycling and recovery by third parties	Sale and re-sale
2	15	8	BAU	L90	Linear design, lightweight, very long lifespan (90 years)	Open-loop recycling and recovery by third party	Sale
6	24	9	BAU	C+2	Linear design, lightweight, 2 re-use cycles	Local re-use, open-loop recycling and recovery by third party	Sale
13	21	10	BIO	L90	Bio-based, biodegradable materials, very long lifespan (90 years)	Industrial composting by third party	Sale
12	5	11	P&P	Lf90	Adjustable, modular design, standard sizes, easy to dis-and re-assemble, optimising lifespans, durable materials, multiple cycles (re-use, recycling, recovery), very long functional lifespan insulation modules and finishing panels (90 years)	Maintenance, updates, re-use by provider. Recycling and recovery in collaboration with third parties	Lease, or sale with take- or buy-back, mainten. and update services
20	3	12	P2P	L90	Easy to dis-, and re-assemble, durable materials, standard sized parts, re-use of parts, very long lifespan (90 years)	Re-use by provider or client, recycling and recovery by third parties	Lease, sale-with takeback, or sale and re-sale
11	20	13	Reclaim	Baseline	Non-virgin materials, easy to disassemble	Open-loop (local) re-use, recycling and recovery by third parties	Sale and re-sale
8	25	14	BAU	C+1	Linear design, lightweight, 1 re-use cycle	Local re-use, open-loop recycling and recovery by third party	Sale
9	26	15	BAU	L45	Linear design, lightweight, long lifespan (45 years)	Open-loop recycling and recovery by third party	Sale
15	8	16	P&P	L45	Adjustable, modular design, standard sizes, easy to dis-and re-assemble, optimising lifespans, durable materials, multiple cycles (re-use, recycling, recovery), long lifespan (45 years)	Maintenance, updates, re-use by provider. Recycling and recovery in collaboration with third parties	Lease, or sale with take- or buy-back, mainten. and update services
17	12	17	P&P	Lf45	Adjustable, modular design, standard sizes, easy to dis-and re-assemble, optimising lifespans, durable materials, multiple cycles (re-use, recycling, recovery), long functional lifespan insulation modules and finishing panels (45 years)	Maintenance, updates, re-use by provider. Recycling and recovery in collaboration with third parties	Lease, or sale with take- or buy-back, mainten. and update services
21	29	18	BIO	L45	Bio-based, biodegradable materials, long lifespan (45 years)	Industrial composting by third party	Sale
18	13	19	P&P	C+2	Adjustable, modular design, standard sizes, easy to dis-and re-assemble, optimising lifespans, durable materials, multiple cycles (re-use, recycling, recovery), 2 additional re-use cycles	Maintenance, updates, re-use by provider. Recycling and recovery in collaboration with third parties	Lease, or sale with take- or buy-back, mainten. and update services
19	14	20	P&P	C+1	Adjustable, modular design, standard sizes, easy to dis-and re-assemble, optimising lifespans, durable materials, multiple cycles (re-use, recycling, recovery), 1 additional re-use cycle	Maintenance, updates, re-use by provider. Recycling and recovery in collaboration with third parties	Lease, or sale with take- or buy-back, mainten. and update services
22	18	21	P&P	Baseline	Adjustable, modular design, standard sizes, easy to dis-and re-assemble, optimising	Maintenance, updates, re-use by provider. Recycling and	Lease, or sale with take- or buy-back,

(continued on next page)

Table 5b (continued)

Rank all impact categories; MFA	Rank GWP; MFA	Rank Shadow costs; MFA	Variant	Scenario	Applied circular design options		
					Technical model	Industrial model	Business model
16	34	22	BAU	Baseline	lifespans, durable materials, multiple cycles (re-use, recycling, recovery) Linear design, lightweight	recovery in collaboration with third parties Open-loop recycling and recovery by third party	mainten. and update services Sale
24	23	23	P&P	C-1	Adjustable, modular design, standard sizes, easy to dis-and re-assemble, optimising lifespans, durable materials, multiple cycles (re-use, recycling, recovery), 1 cycle not realised	Maintenance, updates, re-use by provider. Recycling and recovery in collaboration with third parties	Lease, or sale with take- or buy-back, mainten. and update services
26	33	24	BIO	Baseline	Bio-based, biodegradable materials	Industrial composting by third party	Sale
29	11	25	P2P	L45	Easy to dis-, and re-assemble, durable materials, standard sized parts, re-use of parts, long lifespan (45 years)	Re-use by provider or client, recycling and recovery by third parties	Lease, sale-with takeback, or sale and re-sale
25	35	26	Reclaim	L15	Non-virgin materials, easy to disassemble, short lifespan (15 years)	Open-loop (local) re-use, recycling and recovery by third parties	Sale and re-sale
27	27	27	P&P	C-2	Adjustable, modular design, standard sizes, easy to dis-and re-assemble, optimising lifespans, durable materials, multiple cycles (re-use, recycling, recovery), 2 cycles not realised	Maintenance, updates, re-use by provider. Recycling and recovery in collaboration with third parties	Lease, or sale with take- or buy-back, mainten. and update services
30	16	28	P2P	C+2	Easy to dis-, and re-assemble, durable materials, standard sized parts, re-use of parts, 2 additional re-use cycles	Re-use by provider or client, recycling and recovery by third parties	Lease, sale-with takeback, or sale and re-sale
23	36	29	BAU	L15	Linear design, lightweight, short lifespan (15 years)	Open-loop recycling and recovery by third party	Sale
28	30	30	P&P	Lf15	Adjustable, modular design, standard sizes, easy to dis-and re-assemble, optimising lifespans, durable materials, multiple cycles (re-use, recycling, recovery), short functional lifespan insulation modules and finishing panels (15 years)	Maintenance, updates, re-use by provider. Recycling and recovery in collaboration with third parties	Lease, or sale with take- or buy-back, mainten. and update services
32	17	31	P2P	C+1	Easy to dis-, and re-assemble, durable materials, standard sized parts, re-use of parts, 1 additional re-use cycle	Re-use by provider or client, recycling and recovery by third parties	Lease, sale-with takeback, or sale and re-sale
33	19	32	P2P	Baseline	Easy to dis-, and re-assemble, durable materials, standard sized parts, re-use of parts	Re-use by provider or client, recycling and recovery by third parties	Lease, sale-with takeback, or sale and re-sale
35	22	33	P2P	C-1	Easy to dis-, and re-assemble, durable materials, standard sized parts, re-use of parts, 1 cycle not realised	Re-use by provider or client, recycling and recovery by third parties	Lease, sale-with takeback, or sale and re-sale
34	37	34	BIO	L15	Bio-based, biodegradable materials, short lifespan (15 years)	Industrial composting by third party	Sale
36	28	35	P2P	C-2	Easy to dis-, and re-assemble, durable materials, standard sized parts, re-use of parts, 2 cycles not realised	Re-use by provider or client, recycling and recovery by third parties	Lease, sale-with takeback, or sale and re-sale
31	32	36	P&P	L15	Adjustable, modular design, standard sizes, easy to dis-and re-assemble, optimising lifespans, durable materials, multiple cycles (re-use, recycling, recovery), short lifespan (15 years)	Maintenance, updates, re-use by provider. Recycling and recovery in collaboration with third parties	Lease, or sale with take- or buy-back, mainten. and update services
37	31	37	P2P	L15	Easy to dis-, and re-assemble, durable materials, standard sized parts, re-use of parts, short lifespan (15 years)	Re-use by provider or client, recycling and recovery by third parties	Lease, sale-with takeback, or sale and re-sale

design options to narrow, slow and close cycles. Cruz Rio et al. (2019), De Wolf (2017), Geldermans et al. (2019) and Eberhardt et al. (2021) – who also compared multiple circular design options – support our finding: their best performing variants apply combinations of circular design options. Furthermore, we conclude that different building components could benefit from different combinations of circular design options: components with a shorter SL seem to benefit from prioritizing circular design options to slow and close future cycles; components with a medium SL benefit more from prioritizing reducing resource use now and slowing loops in the future. This guideline is in line with those of Eberhardt et al. (2021). Their guidelines emphasize – even stronger – reducing production impacts now and prolonging use on site for components with a long lifespan. Likewise, Buyle et al. (2019) and Vandebroucke et al. (2015) found facilitating future adjustments or reuse was only beneficial for components or part with a short SL.

We do not claim that our guidelines are entirely novel: the circular design options have been proposed before and parts of our guidelines overlap with existing guidelines. Our contribution lies in having compared the environmental performance of multiple circular design options for different building components. As such we provide a preliminary answer to the knowledge gaps posed in Bocken et al. (2016) and Cambier et al. (2020): what specific circular design option(s) would result in the most environmental savings, specifically for different circular building components? Applying our guidelines can support designers, policy makers and other decision makers to develop more circular building components in research and practice. Furthermore, our step-by-step approach could support others in comparing environmental performance of different circular design variants and decision-making. However, completing this study revealed additional questions. We stress that our guidelines should be understood as ‘preliminary’ for the

following five reasons.

First, even though our guidelines align with existing design guidelines, we still urge utmost care with generalising them. Our guidelines are based on assessments. We identified multiple trade-offs and tipping points depending on how circular design options were applied and what assumptions were made. Circular design options can increase and decrease environmental performance of a building component (see also Buyle et al. (2019) and Vandembroucke et al. (2015)). Moreover, this study and the precedent studies took place in the context of the Netherlands, Belgium, Denmark and the USA. So, the guidelines might not be valid for all components, for always, everywhere. Experience in circular design could be beneficial to estimate in which design context assumptions align or differ with those underlying our guidelines. Application of our guidelines should be validated case-per-case through additional environmental performance assessments. Also, additional assessments on other circular components, in other contexts and varying individual circular design parameters could further validate and specify our guidelines.

Second, determining what is 'most' circular depends on how we define and measure circularity. How the LCA and MFA were executed influenced our findings. Eberhardt et al. (2020) already showed the effects of using different LCA allocation approaches; the CE-LCA model could benefit from further development (van Stijn et al., 2021). The single-cycle MFA does not match the CE-LCA system boundary. Future research could explore how to embed flows of multiple cycles within the system boundary. Moreover, we focused on the environmental performance based on resource use, impacts and waste. Circular assessment could also include economic, value, and/or social performance assessments. Already, each design variant provides different burdens and benefits on different assessment criteria. Future research on circularity metrics should be equally concerned with prioritization: (e.g.) environmental performance versus economic, environmental impact reduction versus increasing quality of resource flows, reducing GWP versus ecotoxicity. Priorities might be context specific: circular for whom? Also, they have a temporal perspective. Some circular design options provide more savings over time but what if benefits only arrive in the future? Decisions could be based on average savings or disqualifying criteria could be set. We showed that different decision-making approaches result in different rankings of circular design options. Other assessment methods and decision-making approaches could lead to different guidelines.

Third, our guidelines could be unfeasible in practice. Experts indicated these could increase cost and might not comply with legislation. Testing the presented guidelines in practice cases could validate their feasibility. Also, the construction industry is characterised by its fragmented supply chain where partners temporarily collaborate in a project setting. Our findings suggest that we need to design for and realise multiple future cycles. The experts questioned if such multiple-cycle

scope is feasible in current practice. This would require developing different ways of collaborating. Alternatively, it implies that in today's practice the transition to the 'most' circular built environment is not (yet) feasible.

Fourth, we question whether we can yet speak of a 'best' performing variant. Despite significant savings, all variants result in resource use, impacts and waste. Applying circular design options might limit resource use, impacts and waste generation but does not nullify them. Subsequently, we should speak of 'more' rather than 'most' circular. Additional sufficiency-oriented strategies might be needed to reduce consumption of building components altogether.

Fifth, to support uptake of these guidelines in practice further development can focus on improving their usability by adding more concrete examples and clarification, providing guidelines on individual design parameters and by developing a synthesis tool. The above-mentioned opportunities to further develop the environmental design guidelines remain open for further discussion and inquiries. Our study can therefore be seen as an introduction on the environmental design of circular building components rather than a final answer. Nevertheless, the presented guidelines, supported by extensive LCAs and MFAs, make an important contribution to supporting industry in developing more circular building components.

CRediT authorship contribution statement

A. van Stijn: Funding acquisition, Conceptualization, Methodology, Validation, Investigation, Writing – original draft, Visualization. **L.C.M. Eberhardt:** Conceptualization, Validation, Investigation, Writing – review & editing. **B.Wouterszoon Jansen:** Conceptualization, Visualization, Writing – review & editing. **A. Meijer:** Writing – review & editing, Supervision.

Declaration of competing interest

The authors declare that they have no known competing financial interests or personal relationships that could have appeared to influence the work reported in this paper.

Acknowledgements

This research has been carried out in collaboration with researchers from Aalborg University and Delft University of Technology. The research was part of the research projects "REHAB" (carried out by the Delft University of Technology) and "Circular Kitchen (CIK)" (carried out by Delft University of Technology and Chalmers University of Technology). As such, this research has received funding from the Delft University of Technology, Amsterdam Institute for Advanced Metropolitan Solutions, EIT Climate-KIC and the REHAB project partners.

Appendix J and P. Supplementary data

Supplementary data to this article can be found online at <https://doi.org/10.1016/j.jclepro.2022.131375>.

Appendix A. CE-LCIA and MFA equations and parameters

In this appendix we clarify the used equations in the CE-LCIA and MFA and define all parameters.

Nomenclature appendix A

CE-LCA Circular Economy Life Cycle Assessment

RSP Reference Study Period

$I_{life\ cycle\ stage}$ Impact of a life cycle stage in the material's lifecycle which is allocated to the assessed building component during the RSP

$R_{life\ cycle\ stage}$ Rate in which a life cycle stage occurs in the RSP and following chain of cycles of the material

$P_{life\ cycle\ stage}$ Probability of a life cycle stage occurring

$Af_{life\ cycle\ stage}$	Allocation Fraction of a lifecycle stage: fraction of impact of a life cycle stage which is allocated to the material in the use cycle of the assessed building component
$AI_{life\ cycle\ stage}$	Absolute Impacts (i.e., before allocation) from completing a life cycle stage once
CE LD	Circular Economy Linearly Degressive
N_{cycles}	Number of use cycles within a material's lifecycle
F	Factor determining how much more initial production and construction impacts are allocated to the first cycle versus the last cycle, and vice versa for disposal impacts
C_{number}	Cycle number in which the material is when applied in the assessed building component
AI_x	Absolute Impact of material, transport, process or energy used to complete a lifecycle stage
Qty	Quantity
$\frac{AI_x}{unit}$	Absolute Impact of material, transport, process or energy per unit
$M_{mat., x}$	Mass of the material per placement in [kg]
M_{import}	total Mass of all material applied in the assessed building component during the RSP
$M_{import, mat., x}$	Mass of material x applied in the assessed building component during the RSP
$R_{mat., x}$	Rate in which material x is placed in the building component during the RSP
$M_{flow\ x\ mat., x}$	Mass of import or export flows of material x with 'quality x'
$r_{flow\ x\ mat., x}$	Ratio describing the percentage of material x that has quality x
$r_{virgin, mat., x}$	Ratio describing the percentage of material x that is virgin material
$r_{non-virgin, mat., x}$	Ratio describing the percentage of material x that is non-virgin material
$M_{consumption, mat., x}$	Mass of material x which is consumed during its use cycle in the assessed building component during the RSP
$M_{reuse, mat., x}$	Mass of material x which is reused after its use cycle in the assessed building component during the RSP
$M_{reman., mat., x}$	Mass of material x which is remanufactured after its use cycle in the assessed building component during the RSP
$M_{recyc, mat., x}$	Mass of material x which is recycled after its use cycle in the assessed building component during the RSP

A.A1 CE-LCIA equations

To assess the life cycle impacts of the circular building components, we followed the CE-LCA model presented in van Stijn et al. (2021). In this model, the impacts of the building component are calculated in a series of sums. The impact of the building component is calculated by adding the impact of all parts. Likewise, the impact of a part is a sum of the impact of all its materials. Materials are not only distinguished based on type (e.g., stainless steel, aluminum or spruce) but also if they have different lifespans and use cycles in the material's total lifecycle. The impact of the material is a sum of the impact of all the materials lifecycle stages which are allocated to the assessed building component over the RSP.

To calculate the impact of each life cycle stage in the material's lifecycle which is allocated to the assessed building component during the RSP, we use equation A.A1 (adapted from van Stijn et al. (2021):

$$I_{lifecycle\ stage} = R_{life\ cycle\ stage} \cdot P_{life\ cycle\ stage} \cdot Af_{life\ cycle\ stage} \cdot AI_{life\ cycle\ stage} \quad (A.A1)$$

in which $R_{life\ cycle\ stage}$ is the rate – the number of times – in which a life cycle stage occurs in the RSP and following chain of cycles of the material. For example, a virgin stainless-steel connector is replaced 2 times during the RSP; after use as a connector, the stainless steel has 10 recycling cycles. In this example, the rate of the recycling lifecycle stage equals 20.

$P_{life\ cycle\ stage}$ represents the probability of a life cycle stage to occur. For example, repair of parts might only occur in a certain percentage of the building components. Due to the selected goal and scope of the kitchen and façade assessments, the value of P was set at 1: all lifecycle stages were assumed to occur.

The allocation fraction ($Af_{life\ cycle\ stage}$) is the fraction of impact of a life cycle stage which is allocated to the material in the use cycle of the assessed building component. The Af can be determined using different allocation approaches including an equal distribution approach or the Circular Economy Linearly Degressive (CE LD) approach of Eberhardt et al. (2020) (see also van Stijn et al. (2021)). In both approaches the share of impact of a material's lifecycle stage which is allocated to the use cycle when the material is applied in the assessed building component is influenced by the total number of use cycles (N_{cycles}) within this material's lifecycle. In the previous example, the stainless steel had a total number of 11 use cycles. The more use cycles, the less impact is allocated to individual cycles. In the assessments of the façades and kitchens, we applied the CE LD approach. In this approach the impact share is further influenced by factor F . F determines how much more initial production and construction impacts are allocated to the first cycle versus the last cycle, and vice versa for disposal impacts. In our assessment this factor is a fixed value (50). Additionally, in CE LD the value for Af is influenced by the cycle number (C_{number}) in which the material is when applied in the assessed building component. In the example of the virgin stainless-steel connector, the material is in its first use cycle, If the stainless-steel connector would be of recycled material, it might be in a second-, third use cycle, or more. Using CE-LD, a material in its first use cycle gets more initial production and construction impacts than in its second cycle (vice versa for disposal impacts).

$AI_{life\ cycle\ stage}$ represents the absolute environmental impacts (i.e., before allocation) from completing a life cycle stage once. This is a sum of absolute impacts of the material, transport, process and energy in this life cycle stage as described in equation A.A2:

$$AI_{lifecycle\ stage} = AI_{materials} + AI_{transport} + AI_{process} + AI_{energy} \quad (A.A2)$$

In which the absolute impact of material, transport, process and energy can be calculated using equation A.A3:

$$AI_x = Qty \cdot \frac{AI_x}{unit} \quad (A.A3)$$

in which the absolute impact of a materials, transport, processes or energy (AI_x) can be calculated by multiplying the quantity (Qty) with the absolute impact per unit ($\frac{AI_x}{unit}$). For example, to calculate the production impacts of the stainless-steel connector, the mass ($M_{mat., x}$) of the required stainless steel would be multiplied with the production impacts of stainless steel per kg.

A.A2 MFA equations

The total mass of all material applied in the assessed building component during the RSP is the material import ($M\text{ Import}$), which is calculated by adding the material import for each separate material applied in the building component during the RSP. To determine the material import for each individual material, we use equation A.A4:

$$M\text{Import}_{mat.,x} = R_{mat.,x} \cdot M_{mat.,x} \quad (\text{A.A4})$$

in which ($R_{mat.,x}$) is the rate – the number of times – in which that material is placed in the building component during the RSP. $M_{mat.,x}$ is the mass of the material per placement in [kg].

Following the law of matter conservation, the $M\text{ Import}$ equals the export mass for that material. $M\text{ flow } x_{mat.,x}$ describes the mass of import or export flows of a material with a certain ‘quality’. For example, an import flow can be virgin, non-virgin, renewable, or non-renewable; an export flow can be reusable, remanufacturable, recyclable, biodegradable, recoverable or discarded. To calculate $M\text{ flow } x_{mat.,x}$, equation (A.A5) is used:

$$M\text{ flow } x_{mat.,x} = M\text{ import}_{mat.,x} \cdot r\text{ flow } x_{mat.,x} \quad (\text{A.A5})$$

where the $M\text{ Import}$ of a material is multiplied by a ratio describing the percentage of the material flow that has the to-be-analysed quality ($r\text{ flow } x_{mat.,x}$). For example, the ratio might describe how much of the stainless steel applied in a connector of the building component is virgin ($r\text{ virgin}$) or non-virgin ($r\text{ non-virgin}$). Finally, the material consumption is then calculated using equation A.A6.

$$M\text{ consumption}_{mat.,x} = M\text{ import}_{mat.,x} - M\text{ reuse}_{mat.,x} - M\text{ reman.}_{mat.,x} - M\text{ recyc.}_{mat.,x} \quad (\text{A.A6})$$

where the reused export flows of a material ($M\text{ reuse}_{mat.,x}$), the remanufactured export flows ($M\text{ reman}_{mat.,x}$) and the recycled export flows ($M\text{ recyc.}_{mat.,x}$) are subtracted from the $M\text{ Import}$ of a material.

Appendix B. Detailed Life Cycle Inventory and Life Cycle Impact Assessment parameters

For the complete Circular Economy Life Cycle Inventory and overview of applied values for each Circular Economy Life Cycle Impact Assessment parameter – of all assessed kitchen and façade variants, for all scenarios – we refer to the provided excel files (APPENDIX B-1 and B-2).

Appendix C. Clarification sensitivity scenarios CE-LCA and MFA

We tested the sensitivity of two key circular economy parameters: (1) the number of cycles and (2) the lifespan of (parts of) the building component. The sensitivity analysis was based on ‘what-if’ scenarios. An overview of the sensitivity scenarios for the kitchen variants has been included in Table A.C1 and for the façade in Table A.C2. For a detailed description of the kitchen and façade design variants, we refer to appendix E.

The number of cycles for each material influences the percentual division of export flows in the MFA and how much environmental impact is allocated to the assessed building component in the CE-LCA; if assumptions are too optimistic, flows might be dispersed to non-existing reused flows and impacts might be spread over non-existent cycles. Hence, we investigated the effects of adding and subtracting cycles. When adding cycles, we assumed local, direct reuse: no extra transportation or processes were added to the model. For variants with uncertain reuse, remanufacturing and recycling cycles in their baseline scenario, we also tested the effects if these cycles would not be realised. When subtracting cycles, we subtracted from more uncertain to more certain cycles. In the design variants of the façade and kitchen, we found the uncertainty is largest for cycles far in the future and open cycles (i.e., when the producing partners are not in control or involved in the VRPs). When subtracting cycles, we upheld the final cycle. This is usually either recycling, recovery and disposal). We then subtracted from the outer cycles, inwards. For example, for the shelves in the kitchen P&P variant, we always maintained final recovery (incineration); in scenario ‘minus 1 cycle’, we removed recycling (i.e., chipping of the wood for OSB production); in scenario ‘minus 2 cycles’, we also removed the remanufacturing cycle (i.e., recoating of shelves); in scenario ‘minus 3 cycles’, we also removed the direct reuse cycle. This C-3 scenario can be considered a linear scenario.

The second sensitivity analysis focussed on lifespan – and so, the rate of (re)placements. How often production, use, VRPs and disposal cycles take place is influenced by assumptions on the functional, technical and economic lifespans of the material, part and building component level. The functional lifespan is influenced by changing regulations and user needs, including function or appearance of the component (Geraedts et al., 2009; Méquignon and Ait Haddou, 2014). The technical lifespan can be defined as “the maximum period during which it can physically [perform]” (Cooper, 1994, p. 5). The economic lifespan is the period in which the benefits outweigh the costs (Geraedts et al., 2009). We tested the effect of varying different types of lifespans for the building component as a whole and for specific subcomponents, parts and materials. First, for all kitchen and façade variants, we varied the technical and functional lifespan of the building component, parts and materials in parallel. This is closest to a ‘traditional replacement rate’ or ‘service life’ sensitivity analysis. For example, for the BIO kitchen, the technical and function lifespan was set at 10 years in the baseline scenario. What would happen if the whole kitchen is replaced every 7 years (i.e., average tenancy period); what if it has a similar lifespan as the BAU kitchen (i.e., 20 years); what if it lasts double or even four times as long (i.e., 40 or 80 years, respectively)? Second, for the LIFE+ and P&P kitchen variants, the finishing parts can be updated separately in order to increase the lifespan of the whole kitchen. Likewise, in the P&P façade, the insulation modules and façade finishing can be adjusted easily. But, allowing for such adjustments might result in a higher replacement rate of these parts. Therefore, we tested the effect of varying the functional lifespan of these parts, whilst maintaining their technical lifespan. For example, if the functional lifespan of the fronts in the P&P kitchen decreases, more fronts are produced; fronts are reused more often.

Table A.C1
Detailed description scenarios sensitivity analysis kitchen design variants

Design variant	Scenario	Type of sensitivity scenario	What if question for scenario	Replacement [years]	Number of future cycles removed	Number of additional direct, local re-use cycles entire kitchen	What processes/parameters are varied
BAU	Baseline			20	0	0	
	C+1	<i>Ncycles</i>	What if the entire BAU kitchen would be re-used once locally?	20	0	1	Decrease allocation fractions for all materials*
	C+2	<i>Ncycles</i>	What if the entire BAU kitchen would be re-used twice locally?	20	0	2	Decrease allocation fractions for all materials*
	L7	<i>Ltechnical - Lfunctional</i>	What if the BAU kitchen would already be replaced after ±7 years?	7	0	0	Increase replacement rate for all materials*
	L40	<i>Ltechnical - Lfunctional</i>	What if the BAU kitchen would only be replaced after 40 years?	40	0	0	Decrease replacement rate for all materials*
	L80	<i>Ltechnical - Lfunctional</i>	What if the BAU kitchen would only be replaced after 80 years?	80	0	0	Decrease replacement rate for all materials*
BIO	Baseline			10	0	0	
	C+1	<i>Ncycles</i>	What if the entire BIO kitchen would be re-used once locally?	10	0	1	Decrease allocation fractions for all materials*
	C+2	<i>Ncycles</i>	What if the entire BIO kitchen would be re-used twice locally?	10	0	2	Decrease allocation fractions for all materials*
	L7	<i>Ltechnical - Lfunctional</i>	What if the BIO kitchen would already be replaced after ±7 years?	7	0	0	Increase replacement rate for all materials*
	L20	<i>Ltechnical - Lfunctional</i>	What if the BIO kitchen would last as long as the BAU kitchen?	20	0	0	Decrease replacement rate for all materials*
	L40	<i>Ltechnical - Lfunctional</i>	What if the BIO kitchen would only be replaced after 40 years?	40	0	0	Decrease replacement rate for all materials*
Reclaim!	Baseline			10	0	0	
	C+1	<i>Ncycles</i>	What if the entire Reclaim! kitchen would be re-used once locally?	10	0	1	Decrease allocation fractions for all materials*
	C+2	<i>Ncycles</i>	What if the entire Reclaim! kitchen would be re-used twice locally?	10	0	2	Decrease allocation fractions for all materials*
	L7	<i>Ltechnical - Lfunctional</i>	What if the Reclaim! kitchen would already be replaced after ±7 years?	7	0	0	Increase replacement rate for all materials*
	L20	<i>Ltechnical - Lfunctional</i>	What if the Reclaim! kitchen would last as long as the BAU kitchen?	20	0	0	Decrease replacement rate for all materials*
	L40	<i>Ltechnical - Lfunctional</i>	What if the Reclaim! kitchen	40	0	0	

(continued on next page)

Table A.C1 (continued)

Design variant	Scenario	Type of sensitivity scenario	What if question for scenario	Replacement [years]				Number of future cycles removed	Number of additional direct, local re-use cycles entire kitchen	What processes/ parameters are varied
	L80	<i>Ltechnical - Lfunctional</i>	would only be replaced after 40 years? What if the Reclaim! kitchen would only be replaced after 80 years?	80				0	0	Decrease replacement rate for all materials* Decrease replacement rate for all materials*
				Construction panel, feet, structural lath	Infill panels, back-panel, connectors	Fronts	connectors			
LIFE +	Baseline C+1	<i>Ncycles</i>	What if the entire LIFE + kitchen would be re-used once locally?	40	20	10	20	0	0	
	C+2	<i>Ncycles</i>	What if the entire LIFE + kitchen would be re-used twice locally?	40	20	10	20	0	1	Decrease allocation fractions for all materials* Decrease allocation fractions for all materials*
	Lf = 40-20-7-20	<i>Lfunctional (finishing parts)</i>	What if the fronts of the LIFE + kitchen would already be (ex) changed after 7 years?	40	20	7	20	0	0	Increase replacement rate for front materials*
	Lf = 40-20-20-20	<i>Lfunctional (finishing parts)</i>	What if the fronts of the LIFE + kitchen would only be (ex) changed after 20 years?	40	20	20	20	0	0	Decrease replacement rate for front materials*
	L = 7-7-7-7	<i>Ltechnical - Lfunctional</i>	What if the LIFE + kitchen would already be replaced after ±7 years?	7	7	7	7	0	0	Increase replacement rate for all materials*
	L = 20-10-7-10	<i>Ltechnical - Lfunctional</i>	What if the LIFE + kitchen last half as long and the fronts ±7 years?	20	10	7	10	0	0	Increase replacement rate for all materials*
	L = 80-40-20-40	<i>Ltechnical - Lfunctional</i>	What if the LIFE + kitchen lasts double as long?	80	40	20	40	0	0	Decrease replacement rate for all materials*
	L = 80-80-80-80	<i>Ltechnical - Lfunctional</i>	What if the LIFE + kitchen would only be replaced after 80 years?	80	80	80	80	0	0	Decrease replacement rate for all materials*
P&P	Baseline C-3	<i>Ncycles</i>	What if all of the outer (uncertain) future cycles of materials would not come to pass?	Construction 80	Infill 40	Finishing 20	Connectors 40	0 3	0 0	
	C-2	<i>Ncycles</i>	What if the two most-outer (uncertain) future cycle of materials would not come to pass?	80	40	20	40	2	0	Increase allocation fractions for materials of which future cycles are removed*; remove processes of removed outer cycles* Increase allocation fractions for materials of which future cycles are removed*; remove processes of removed outer cycles*

(continued on next page)

Table A.C1 (continued)

Design variant	Scenario	Type of sensitivity scenario	What if question for scenario	Replacement [years]				Number of future cycles removed	Number of additional direct, local re-use cycles entire kitchen	What processes/ parameters are varied
	C-1	<i>Ncycles</i>	What if the most-outer (uncertain) future cycle of materials would not come to pass?	80	40	20	40	1	0	Increase allocation fractions for materials of which future cycles are removed*; remove processes of removed outer cycles*
	C+1	<i>Ncycles</i>	What if the entire P&P kitchen has one local re-use cycle additional to the baseline scenario?	80	40	20	40	0	1	Decrease allocation fractions for all materials*
	C+2	<i>Ncycles</i>	What if the entire P&P kitchen has two local re-use cycles additional to the baseline scenario?	80	40	20	40	0	2	Decrease allocation fractions for all materials*
	Lf = 80-40-7-40, Lt = 80-40-40-40	<i>Lfunctional (finishing parts)</i>	What if the finishing parts of the kitchen would be already (ex) changed after ±7 years whilst their technical lifespan remains the same?	80	40	7	40	0	+3 (finishing parts)	Increase replacement rate for all finishing materials*; decrease allocation fractions for all finishing materials (as the number of re-use cycles of the finishing parts increases)*
	Lf = 80-40-40-40, Lt = 80-40-40-40	<i>Lfunctional (finishing parts)</i>	What if the finishing parts of the kitchen would only be (ex) changed after 40 years whilst their technical lifespan remains the same?	80	40	40	40	-2 (finishing parts)		Decrease replacement rate for all finishing materials*; Increase allocation fractions for all finishing materials (as the number of re-use cycles of the finishing parts decreases)*
	Lt = 7-7-7-7, Lf = 7-7-3,5-7	<i>Ltechnical - Lfunctional</i>	What if the entire kitchen lasts only ±7 years and the finishing parts are refurbished after ±3,5 years?	7	7	3.5	7	0	0	Increase replacement rate for all parts of the kitchen*
	Lt = 20-20-20-20, Lf = 20-20-10-20	<i>Ltechnical - Lfunctional</i>	What if the P&P kitchen lasts as long as the BAU kitchen (with one refurbishment of the finishing parts at 10 years)?	20	20	10	20	0	0	Increase replacement rate for all parts of the kitchen*
	Lt = 40-20-20-20, Lf = 40-20-10-20	<i>Ltechnical - Lfunctional</i>	What if the P&P kitchen lasts half as long and the finishing parts are (ex)changed twice as fast as the P&P baseline scenario?	40	20	10	20	0	0	Increase replacement rate for all parts of the kitchen*
	Lt = 80-80-80-80,	<i>Ltechnical - Lfunctional</i>	What if the entire kitchen lasts 80 years and the	80	80	40	80	0	0	Decrease replacement rates for infill, finishing

(continued on next page)

Table A.C1 (continued)

Design variant	Scenario	Type of sensitivity scenario	What if question for scenario	Replacement [years]	Number of future cycles removed	Number of additional direct, local re-use cycles entire kitchen	What processes/ parameters are varied
	Lf = 80-80-40-80		finishing parts are refurbished after 40 years?				and connector parts of the kitchen*

* For the value of each varied parameter, we refer to the detailed overview of all CE-LCIA parameter in [Appendix B](#).

Table A.C2

Detailed description scenarios sensitivity analysis façade design variants

Design variant	Scenario	Type of sensitivity scenario	What if question for scenario	Replacement [years]		Number of future cycles removed	Number of additional direct, local re-use cycles entire kitchen	What processes/ parameters are varied
BAU	Baseline			30		0	0	
	C+1	<i>Ncycles</i>	What if the entire BAU façade would be re-used once locally?	30		0	1	Decrease allocation fractions for all materials*
	C+2	<i>Ncycles</i>	What if the entire BAU façade would be re-used twice locally?	30		0	2	Decrease allocation fractions for all materials*
	L15	<i>Ltechnical - Lfunctional</i>	What if the BAU façade would already be replaced after 15 years?	15		0	0	Increase replacement rate for all materials*
	L45	<i>Ltechnical - Lfunctional</i>	What if the BAU façade would only be replaced after 45 years?	45		0	0	Decrease replacement rate for all materials*
	L90	<i>Ltechnical - Lfunctional</i>	What if the BAU façade would only be replaced after 90 years?	90		0	0	Decrease replacement rate for all materials*
BIO	Baseline			30	Clay plaster	0	0	
	C+1	<i>Ncycles</i>	What if the entire BIO façade would be re-used once locally?	30	15	0	1	Decrease allocation fractions for all materials*
	C+2	<i>Ncycles</i>	What if the entire BIO façade would be re-used twice locally?	30	15	0	2	Decrease allocation fractions for all materials*
	L15	<i>Ltechnical - Lfunctional</i>	What if the BIO façade would already be replaced after 15 years?	15	15	0	0	Increase replacement rate for all other materials*
	L45	<i>Ltechnical - Lfunctional</i>	What if the BIO façade would only be replaced after 45 years?	45	15	0	0	Decrease replacement rate for all other materials*
	L90	<i>Ltechnical - Lfunctional</i>	What if the BIO façade would only be replaced after 90 years?	90	15	0	0	Decrease replacement rate for all other materials*
Reclaim!	Baseline			30		0	0	
	C+1	<i>Ncycles</i>	What if the entire Reclaim! façade would be re-used once locally?	30		0	1	Decrease allocation fractions for all materials*

(continued on next page)

Table A.C2 (continued)

Design variant	Scenario	Type of sensitivity scenario	What if question for scenario	Replacement [years]			Number of future cycles removed	Number of additional direct, local re-use cycles entire kitchen	What processes/ parameters are varied
	C+2	<i>Ncycles</i>	What if the entire Reclaim! façade would be re-used twice locally?	30			0	2	Decrease allocation fractions for all materials*
	L15	<i>Ltechnical - Lfunctional</i>	What if the Reclaim! façade would already be replaced after 15 years?	15			0	0	Increase replacement rate for all materials*
	L45	<i>Ltechnical - Lfunctional</i>	What if the Reclaim! façade would only be replaced after 45 years?	45			0	0	Decrease replacement rate for all materials*
	L90	<i>Ltechnical - Lfunctional</i>	What if the Reclaim! façade would only be replaced after 90 years?	90			0	0	Decrease replacement rate for all materials*
				PU insulator, Aluminium frames and connectors, EPS boards	Ceremic tiles	stainless steel bolts/ screws			
P2P	Baseline			30	30	30	0	0	
	C-2	<i>Ncycles</i>	What if the two most-outer (uncertain) future cycle of materials would not come to pass?	30	30	30	2	0	Increase allocation fractions for materials of which future cycles are removed*; remove processes of removed cycles*
	C-1	<i>Ncycles</i>	What if the most-outer (uncertain) future cycle of materials would not come to pass?	30	30	30	1	0	Increase allocation fractions for materials of which future cycles are removed*; remove processes of removed cycles*
	C+1	<i>Ncycles</i>	What if the entire P2P façade would be re-used once locally?	30	30	30	0	1	Decrease allocation fractions for all materials*
	C+2	<i>Ncycles</i>	What if the entire P2P façade would be re-used twice locally?	30	30	30	0	2	Decrease allocation fractions for all materials*
	L15	<i>Ltechnical - Lfunctional</i>	What if the P2P façade would be used and last half as long?	15	15	15	0	0	Increase replacement rate for all materials*
	L45	<i>Ltechnical - Lfunctional</i>	What if the P2P façade would be used and last 1,5 times as long?	45	45	45	0	0	Decrease replacement rate for all materials*
	L90	<i>Ltechnical - Lfunctional</i>	What if the P2P façade would be used and last 3 times as long?	90	90	90	0	0	Decrease replacement rate for all materials*
P&P	Baseline			Docking-station 90	Insulation modules 30	Facade finishing 30	0	0	
	C-2	<i>Ncycles</i>	What if the two most-outer (uncertain) future cycle of materials would not come to pass?	90	30	30	2	0	Increase allocation fractions for materials of which future cycles are removed*; remove processes of removed cycles*
	C-1	<i>Ncycles</i>		90	30	30	1	0	

(continued on next page)

Table A.C2 (continued)

Design variant	Scenario	Type of sensitivity scenario	What if question for scenario	Replacement [years]			Number of future cycles removed	Number of additional direct, local re-use cycles entire kitchen	What processes/ parameters are varied
			What if the most-outer (uncertain) future cycle of materials would not come to pass?						Increase allocation fractions for materials of which future cycles are removed*; remove processes of removed cycles*
	C+1	<i>Ncycles</i>	What if the entire P&P façade would be re-used once locally?	90	30	30	0	1	Decrease allocation fractions for all materials*
	C+2	<i>Ncycles</i>	What if the entire P&P façade would be re-used twice locally?	90	30	30	0	2	Decrease allocation fractions for all materials*
	L15	<i>Ltechnical - Lfunctional</i>	What if the P&P façade modules and finishing would be used and last half as long?	90	15	15	0	0	Increase replacement rate for all materials*
	L45	<i>Ltechnical - Lfunctional</i>	What if the P&P façade modules and finishing would be used and last 1,5 times as long?	90	45	45	0	0	Decrease replacement rate for all materials*
	L90	<i>Ltechnical - Lfunctional</i>	What if the P&P façade modules and finishing would be used and last 3 times as long?	90	90	90	0	0	Decrease replacement rate for all materials*
	Lf = 15	<i>Lfunctional</i>	What if the P&P modules and finishing would be used half as long?	45	15	15	0	+3 (modules) +6 (finishing)	Increase replacement rate for all modules and finishing materials*; decrease allocation fractions for all modules and finishing materials (as the number of re-use cycles increases)*
	Lf = 45	<i>Lfunctional</i>	What if the P&P modules and finishing would be used 1,5 times as long?	90	45	45	-1 (modules) -2 (finishing)	0	Decrease replacement rate for all modules and finishing materials*; Increase allocation fractions for all modules and finishing materials (as the number of re-use cycles decreases)*
	Lf = 90	<i>Lfunctional</i>	What if the P&P modules and finishing would be used 3 times as long?	90	90	90	-2 (modules) -3 (finishing)	0	Decrease replacement rate for all modules and finishing materials*; Increase allocation fractions for all modules and finishing materials (as the number of re-use cycles decreases)*

* For the value of each varied parameter, we refer to the detailed overview of all CE-LCIA parameter in [Appendix B](#).

Appendix D. Results from the expert sessions

The results of the expert sessions are summarized in [Table A.D1](#). Participants suggested the guidelines were clear, providing useful information to designers of circular building components, and vital to support the transition to a circular built environment. Participants explicitly mentioned the guidelines align with their existing assumptions on environmental performance in circular building components. However, participants also questioned aspects of individual guidelines. These comments were related to validity, uncertainty, usability, relevancy and implementability; they have been used to refine the guidelines. The participants raised their concern on the inclusion of multiple future cycles in the LCA: this increases the

uncertainty of assumptions and, subsequently, the accuracy of the results underlying the environmental design guidelines. It was argued that the validity of the guidelines is largely dependent if industry can determine, document and realise future cycles. Furthermore, participants suggested that determining future cycles is beyond their practice and the scope in building projects.

The participants provided opportunities for improvement of the presented guidelines: these concerned opportunities for clarification, increasing the validity, transparency, ease of use and implementability. Participants posed that transparency in the applied CE-LCA and MFA methods, results and limitations of the study is crucial for validity of the guidelines. Also, experts suggested rigorous sensitivity analysis of circular design parameters to improve the certainty of the guidelines – which has been included within the scope of the study. The participants advised to improve the usability of the guidelines by making them less abstract, and include more concrete examples. They also stressed that guidelines should not be merely induced from the LCA, but directly, quantitatively derived. Their suggestions have resulted in the deeper analysis (and development of the scorecards).

The majority of the improvements suggested during the expert sessions have been – iteratively – implemented (see the third column in [Table A.D1](#)). Remaining recommendations for further development were included in the discussion and conclusion section.

Table A.D1
Results expert session

	Category	Remarks	Implementation remarks	
Guidelines are valid	Validity	The guidelines align with existing assumptions and/or circular design strategies The guidelines are based on relevant CE design variants The design guidelines are clear The guidelines are based on, and distinguish between components with different lifespans		
	Urgency	The guidelines are vital to transition to a CE in the built environment		
	Relevancy	The guidelines stimulate more circular thinking The design guidelines are useful for practitioners The guidelines show the complexity of true circularity in the built environment		
Guidelines are not valid	Validity	The guidelines can vary depending on the applied LCA, MFA, decision-making methods The design variants are not fully comparable as they have different functionalities, clouding the LCA and MFA results Some of the guidelines are not valid in all cases, contradict previous knowledge or expectations	Influence of applied assessment method was emphasized in discussion and conclusion; suggested as future direction of research Need for assessing the functional value performance included in discussion and conclusion Tipping-points based on changing design assumptions was emphasized in guidelines; need for more assessments included in discussion and conclusion	
	Uncertainty	Some variants and guidelines propose opposite or unlikely combinations of design principles (e.g., modular and material efficiency, long lifespan and re-used materials) The results of the guidelines are highly dependant on uncertain future cycles The circularity of the guidelines depends if future cycles can be determined, documented and realised by industry in the long term	Guidelines were reformulated to emphasize priorities. Unlikely combinations of circular design options were pointed out in the interpretation of the results Importance of testing sensitivity of uncertain future cycles was emphasized in method section Importance of ability to determine, guarantee and realise cycles was included in the guidelines	
	Usability	The guidelines remain too abstract and general	More concrete examples could improve usability; direction for future research included in discussion and conclusion	
	Relevancy	The guidelines are complex Guidelines are not sufficient to make truly circular designs, circular assessment (and developing EPD's) of developed designs is necessary The guidelines do not provide novel information (are reduced to high level of abstraction where they merely confirm previous guidelines)	Guidelines were reformulated; a list is provided in the Appendix Discussion on value of design aids for synthesis, evaluation and LCA- and MFA-based guidelines included in introduction Guidelines built upon existing knowledge. Contribution more precisely indicated in discussion and conclusion	
	Implementability	Industry focusses on current cycles; it does not consider or organise multiple cycles as suggested in the guidelines During design, industry focusses on 'best value' for low initial costs in decision making; including environmental design guidelines will be challenging Current regulations prevent following guidelines (e.g., legislation on non-virgin materials) Difficult to use materials from innovative suppliers: they might not be able to prove they conform to the guidelines (i.e., too expensive) The guidelines ask for many simultaneous changes by industry: priorities need to be identified In practice it is very complex to 'determine' many of the circular design parameters (e.g., leading lifespan) mentioned in the guidelines	Questionable feasibility of guidelines noted in discussion and conclusion Questionable feasibility of guidelines noted in discussion and conclusion Questionable feasibility of guidelines noted in discussion and conclusion Questionable feasibility of guidelines noted in discussion and conclusion Need to prioritize in decision-making included in discussion and conclusion Questionable feasibility of guidelines noted in discussion and conclusion	
	Improvements	Clarification	Clarify what the guidelines provide 'advice on' Provide a clear explanation with each guideline Clarify, simplify and distinguish the terminology in the design guidelines (e.g., lean, open-loop, reloop, bio-based and biodegradable, leading lifespan)	Mentioned the types of components for which guidelines apply (i.e., short vs. medium lifespan) A list with short explanations is provided in the Appendix Terminology simplified and explained in description of design variants

(continued on next page)

Table A.D1 (continued)

Category	Remarks	Implementation remarks
Increasing validity guidelines	Quantify the design guidelines (e.g., scorecard of each design principles)	Quantitative analysis of CE-LCA and MFA results used to develop scorecards
	Curtail the scope of variations between the design variants to improve the clarity of results (and usefulness of the guidelines)	Need for more assessments testing (individual) assumptions included as direction for future research in discussion and conclusion
	Consider chances of cycles according to design variant (e.g., when glue is applied there is 0% chance of re-use)	A probability parameter was included in the assessment method.
Transparency	Perform additional sensitivity analysis (e.g., future cycles, transport, materials)	Sensitivity analysis was conducted, focusing on assumptions on cycles and lifespans; need for more assessments testing assumptions included in discussion and conclusion
	Test the guidelines with stakeholders to improve validity and/or implementability	Direction for future research noted in discussion and conclusion
	Present the LCA and MFA data in parallel with the design guidelines	The data of the CE-LCA and MFA was presented separately from the design guidelines
Ease of use	Describe the applied assessment methods and the method to derive the design guidelines from the LCA and MFA	Procedure for developing guidelines described in method section
	Visualise the LCA and MFA results more transparent (e.g., visualise impacts per time, impacts per cycle)	Additional visualisations plotting impacts allocated over RSP provided in the article
	Provide non-abstract guidelines (e.g., practical advice, concrete rules of thumb, dos and don'ts, visualise the building component)	Direction for future research noted in discussion and conclusion
Implementability	Provide concrete examples for guidelines	Analysis on contributions included in Appendix
	Provide insight in relative contributions of building components to the building over time to determine priorities	Direction for future research noted in discussion and conclusion
	Adapt the guidelines into a synthesis tool	Direction for future research noted in discussion and conclusion
	Include guidelines based on single design parameters (e.g., choices of materials)	Direction for future research noted in discussion and conclusion
	Provide instructions to designers on how and when to use the design guidelines (and/or additional assessment methods) during the design process	Discussion on use of design aids for synthesis, evaluation and LCA- and MFA-based guidelines included in introduction
	Relate the guidelines to other sustainability guidelines (e.g., operational energy efficiency)	Noted, not included in scope of paper
	Reduce the amount of guidelines to core principles; provide extra background document for further information	Core findings included in abstract and highlights
	Include guidelines into legislation to incentivise their uptake	Noted, not included in scope of paper

Appendix E. Detailed description, flowcharts and (re)placement charts of the kitchen and renovation façade variants

A.E1 Business-as-usual and circular kitchen variants

The business-as-usual (BAU) kitchen represents the current practice: the cabinets are made with melamine-coated chipboard. Static joints are glued and connectors are used for movable joints (i.e., hinges and drawer sliders). The entire kitchen is replaced, on average, every 20 years. The manufacturer sells the BAU kitchen to housing associations; as the initial cost price is low, kitchens are seldom repaired, refurbished, or reused. At the End-of-Life (EoL), a contractor demolishes the kitchen and separates waste flows. The chipboard is (usually) incinerated for energy recovery at a municipal incineration plant.

The 'Biological (BIO) kitchen' follows the biological cycle of the circular economy: the cabinets are made, entirely, with panels from renewable and biodegradable materials. Examples of such materials are boards from (untreated) wood, agaric waste, or mycelium. We applied laminated timber boards bound with a biological resin. Panels are joint with connectors made from bio-based, biodegradable plastics. The manufacturer sells the BIO kitchen to housing associations. As bio-materials are untreated, we assume a shorter lifespan of 10 years; at EoL, the kitchens are composted at an industrial compost plant.

In the 'Reclaim! kitchen', virgin materials are substituted with non-virgin alternatives. Examples are materials with recycled content (e.g., recycled cellulose boards, recycled plastics) or materials which are directly reused. For this variant, we assumed a similar technical, industrial and business model as the BAU kitchen, only applying directly reused material. As the material is directly reused, we assume the Reclaim! kitchens have a lifespan of 10 years.

The LIFE+ kitchen optimizes the BAU kitchen through modest adaptations in the technical, industrial and business model. A combination of circular design options is applied. The technical lifespan of parts is optimized based on functional lifespan: the construction of the kitchen cabinet could be used longer than the current 20 years. Hence, it is designed for long-life by substituting the chipboard with plywood. On the other hand, the finishing parts (e.g., fronts) are designed for a shorter functional lifespan by applying low-impact, biological materials. The industrial model and business model is not altered compared to the BAU. The reduced sales of the construction parts – due to the longer lifespan – is offset by offering update services for the finishing.

The Plug-and-Play (P&P) kitchen applies a combination of circular design options focusing on slowing and closing resource loops. The P&P kitchen is a modular design; parts are separated based on their functional and technical lifespan. The P&P kitchen consists of a docking station to which kitchen modules can be attached allowing for future changes in lay-out. The construction of the modules is a long-life frame. Infill (e.g., drawers, shelves) with a medium lifespan and the finishing (e.g., fronts) with a short use-cycle are attached to the construction with click-on connections. This design, allows for adjustments in the function and appearance of the cabinet. The kitchen is constructed with (durable) plywood, prolonging the technical lifespan so multiple use-cycles of parts are possible. The kitchen manufacturer sells the docking station and kitchen modules directly to the housing associations with a take-back guarantee and maintenance subscription. Extra kitchen modules and finishing-updates are offered to users. Financial arrangements – such as lease and sale-with-deposit – motivate returning the product at End of Use (EoU). This business model offers a clear

incentive for the manufacturer to realise a kitchen which is easy to repair, reuse, refurbish and recycle. Products are returned to a local ‘return-street’, where they are sorted to be traded, resold, lightly refurbished or sent back to the kitchen manufacturer. Products that are sent back to the national ‘return-factory’ are sorted to be refurbished (i.e., infill and finishing parts are re-coated and reused), cascaded or recycled (e.g., the plywood is used for particle-board production). See Figures A.E1a-e for the flowcharts of all kitchen design variants and Figure A.E2 for a chart showing the lifespan of kitchen parts and their replacement rate in the RSP.

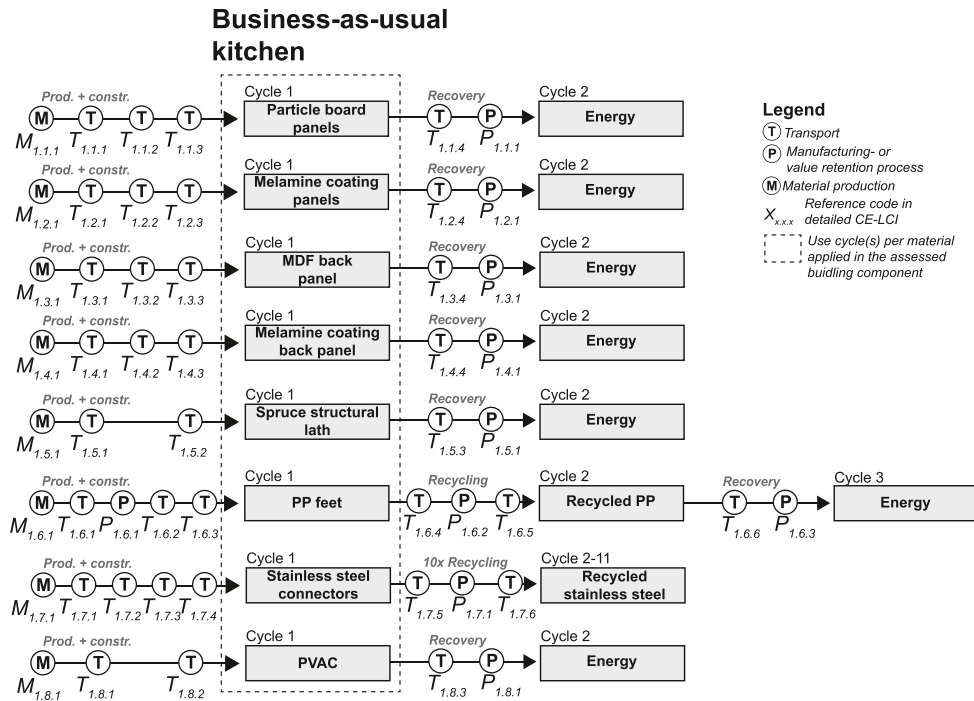

Figure A.E1a. Flowchart of the BAU kitchen design variant

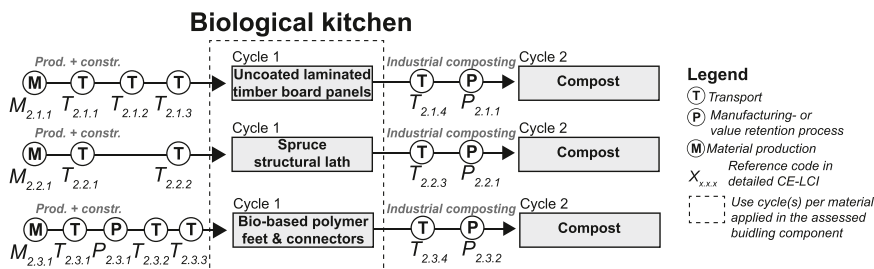

Figure A.E1b. Flowchart of the BIO kitchen design variant

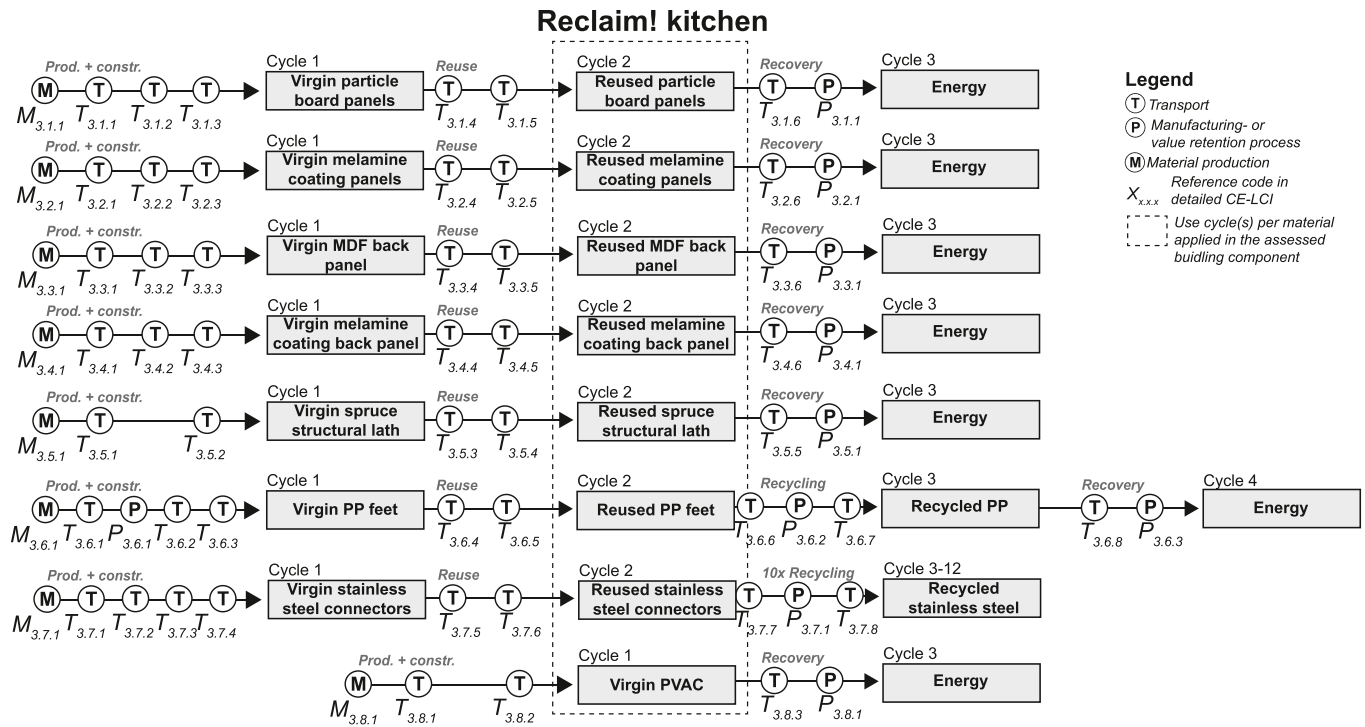

Figure A.E1c. Flowchart of the Reclaim! kitchen design variant

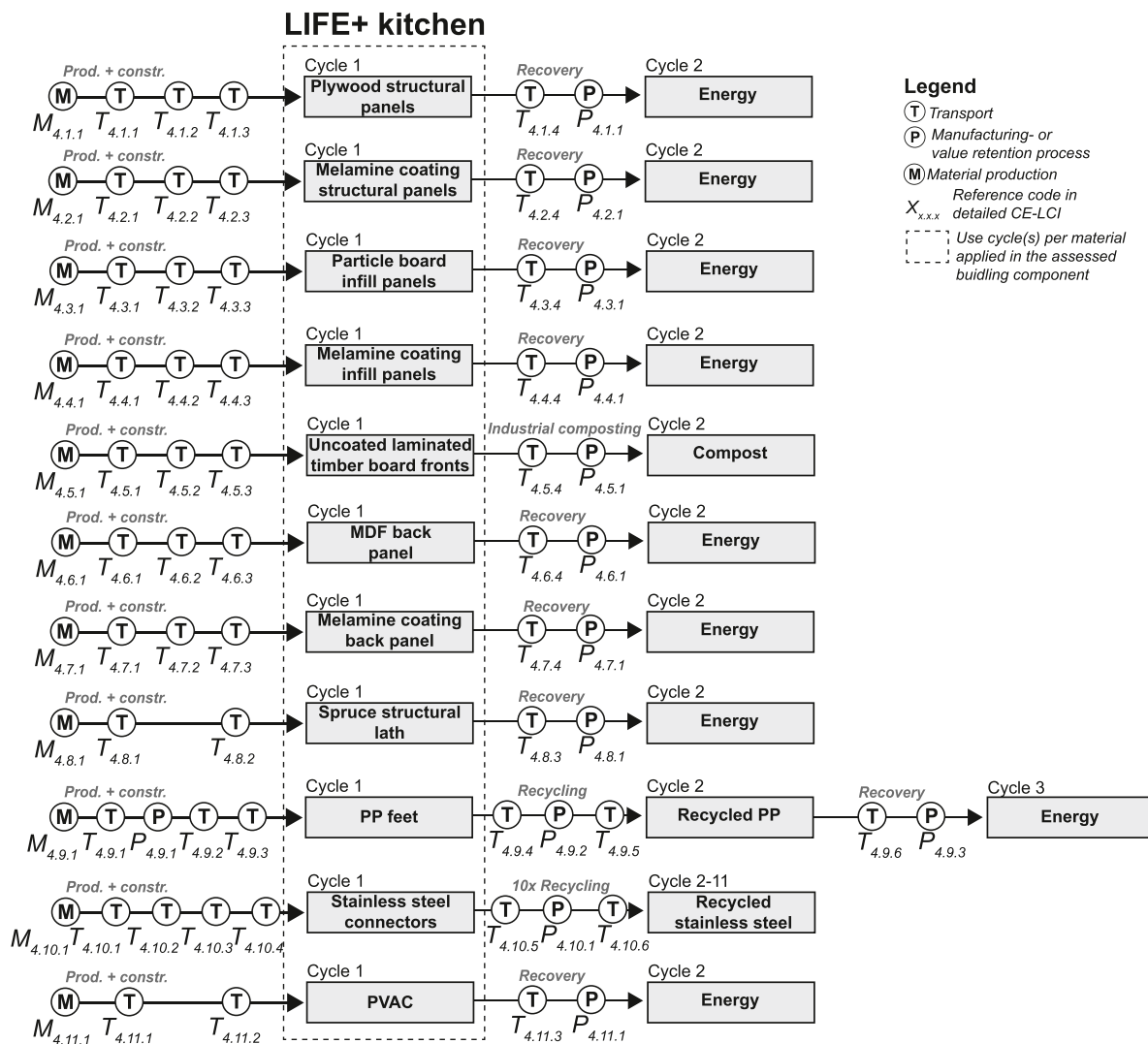

Figure A.E1d. Flowchart of the LIFE + kitchen design variant

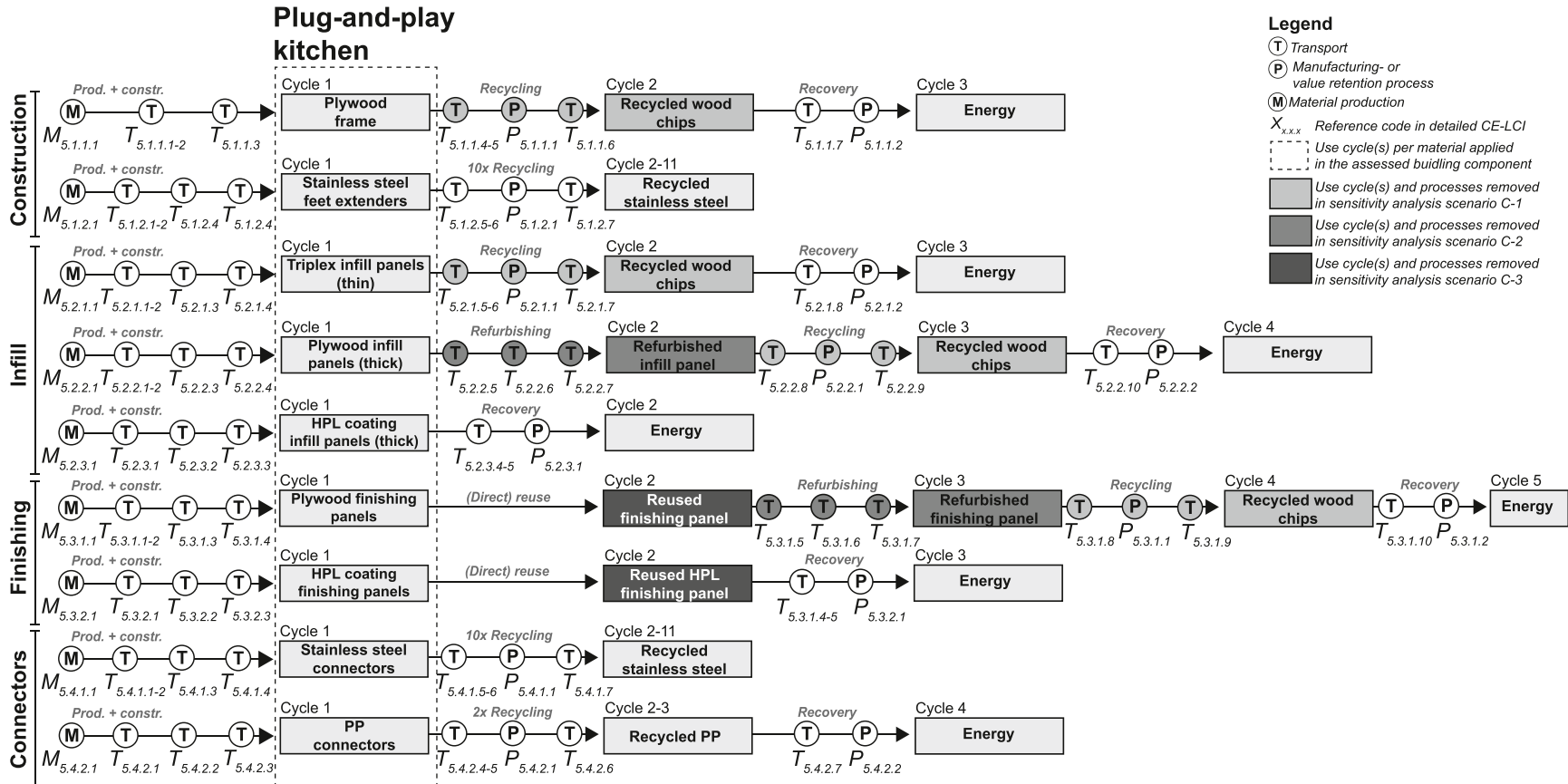

Figure A.E1e. Flowchart of the Plug-and-play kitchen design variant

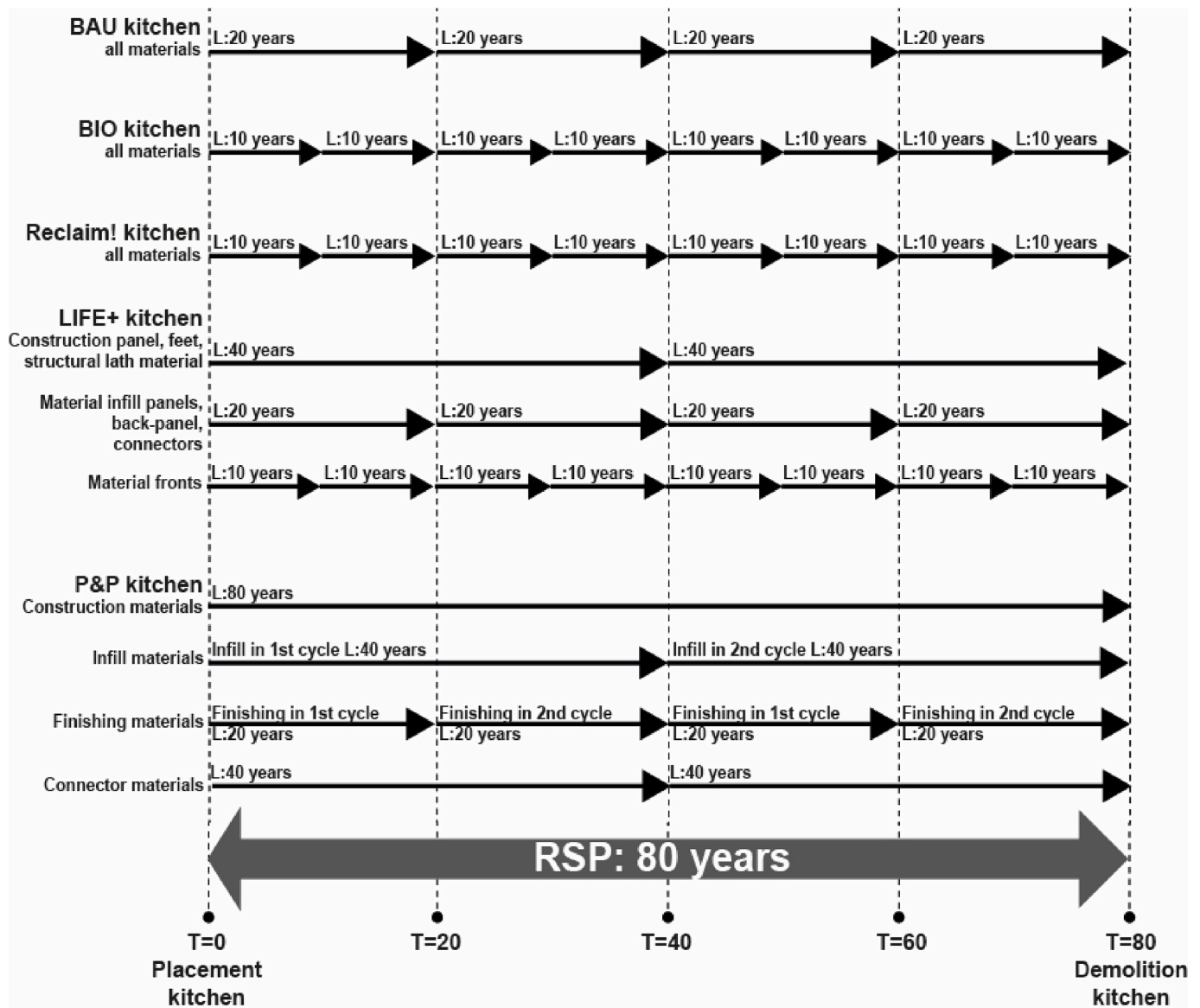

Figure A.E2. Lifespan of kitchen parts per design variant and their (re)placements during the RSP

A.E2 Business-as-usual and circular renovation façade variants

The circular renovation façade is an exterior insulation solution. An insulation layer and new façade finishing are applied on top of the existing façade. This intervention is typically applied in (Net) Zero Energy housing renovations; it improves the energy efficiency of the building during use phase and, simultaneously, provides an aesthetic upgrade. Such renovation façades are typically placed for an exploitation period of around 30 years. For each of the variants, in-situ application or off-site prefabrication is imaginable.

The ‘Business-As Usual (BAU) façade’ represents an exterior insulation solution commonly applied in practice. The BAU solution is a ‘lean’ solution, which is integrated and light-weight. It consists of EPS foam which is glued to the façade with a PU-adhesive; a glue and grout mortar and glass-fibre mesh is applied on top of the EPS, followed by thin-layered mineral brick-strips. The BAU façade is sold to the housing association. We assumed a relatively short lifespan of the glue (± 30 years); the integrated system is tailor-sized to the specific project. It has limited potential for repair, future adjustments in lay-out and finishing, or reuse on other façades. Therefore, we assumed that EoU will equal EoL, setting the lifespan of the façade at 30 years. At EoL, the materials of the façade are separated – as much as possible – into separate waste flows and incinerated or land-filled.

The ‘Bio-façade’ (BIO) applies bio-based and biodegradable materials; it consists of a timber frame, attached to the existing façade with anchors. The timber frame is filled with hemp insulation. A hemp-insulation board is applied on the exterior side of the timber frame and finished with clay plaster. All connectors are made from bio-based, and biodegradable plastics. For the bio-materials we assume a relatively short technical lifespan. The clay-plaster is re-applied every 15 years; we assume that EoU of the façade will equal EoL at 30 years. At EoL, the materials are industrially composted.

The ‘Reclaim! façade’ applies non-virgin materials, either directly reused or recycled materials. It consists of a reused wooden timber frame attached to the existing façade with stainless steel anchors. The timeframe is filled with recycled mineral wool insulation. Hard-pressed, wood-wool boards – manufactured with secondary wood – are applied on the exterior side of the timber frame. The finishing consists of reused wood cladding attached to reused wooden furring strips. The joints (i.e., screws and anchors) are made of recycled stainless steel; they allow the timber frame to be

disassembled at EoL. EoL is assumed to be at 30 years at which the façade is disassembled and materials are either directly reused (e.g., the timber frame), recycled (e.g., mineral wool insulation), or incinerated (e.g., the wooden furring strips).

The ‘Product2Product (P2P) façade’ is based on direct reuse of building products: it consists of building products with a long technical lifespan (>90 years), applying standardized sizes and connectors which allow for easy dis-, and re-assembly. The P2P is constructed with EPS foam boards clamped behind an aluminium framework; on the framework, ceramic façade panels are clicked-on. We assume a business model in which the façade is sold to the building owner. At EoU (30 years), the façade can be dissembled, resold (e.g., on a building material platform), and re-assembled on another façade.

The ‘Plug-and-play (P&P) façade’ applies a combination of circular design options to slow and close the loops. The P&P façade is modular, separating parts based on their functional and technical lifespan. The façade has a long-life docking station consisting of wall anchors to which insulation modules are attached. The insulation modules consist of an adjustable timber frame which facilitates future changes in lay-out and reuse on another façade. The timber frame is filled with recycled cellulose insulation. A recycled, wood-wool board covers the exterior side of the timber frame. For the finishing of the façade, a wide variety of standard-sized panels can be easily (de-, and re-) attached using aluminium board anchors; here, we assumed high-quality ceramic brick-strip panels. The P&P façade is either leased, sold with (prepaid) buy-back guarantee, or take-back guarantee. If sold, accompanying maintenance subscription and update services are offered. This business model provides an incentive for the provider (i.e., manufacturer and contractor) to realise a façade which is easy to repair, update, reuse or recycle. At EoU (30 years), we assume the insulation modules can be adjusted and/or reused on the same or another façade twice, whilst the façade panels have four reuse cycles. At EoL, the docking station, insulation module and finishing panels are disassembled and their materials are either recycled, down-cycled or incinerated.

For each variant, in-situ construction or off-site prefabrication are imaginable. For example, the BAU façades could be prefabricated in an off-site factory, transported as façade panels to the site and installed on the existing façade with a construction crane. Alternatively, the materials could be transported to the site and manually glued on the existing façade. Both methods result in different designs and manufacturing, transport and installation processes. As these different scenarios are possible for all façade variants, we aligned our assumptions between variants. We assumed the materials have a standard transport to the site (i.e., based on kg*km) and excluded prefabrication and installation processes. See Figures A.E3a-e for the flowcharts of all façade variants and Figure A.E4 for a chart showing the lifespan of façade parts and their replacement rate in the RSP.

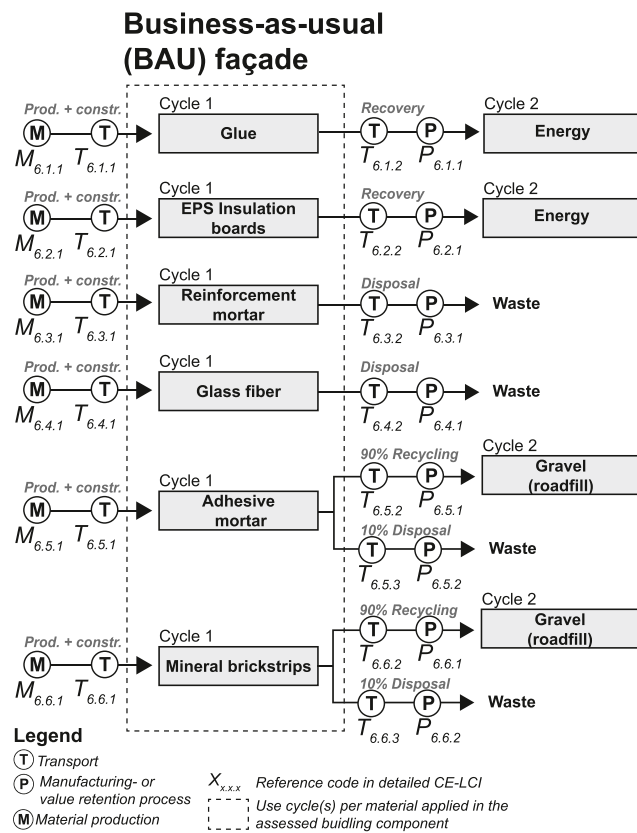

Figure A.E3a. Flowchart of the Business-as-Usual (BAU) façade design variant

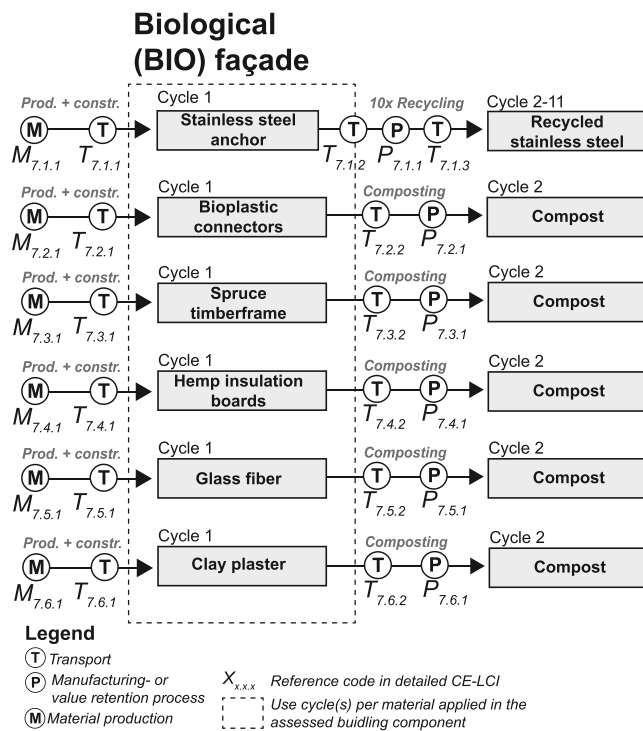

Figure A.E3b. Flowchart of the Biological (BIO) façade design variant

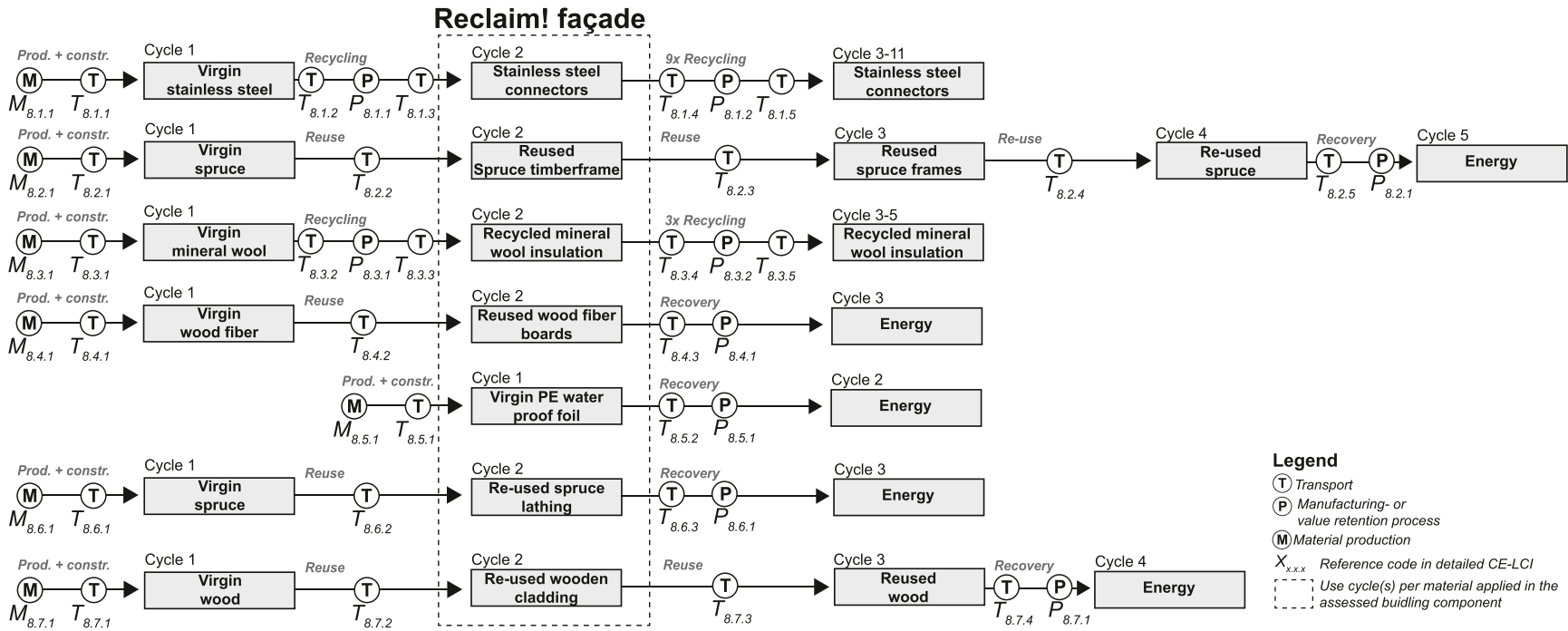

Figure A.E3c. Flowchart of the Reclaim! façade design variant

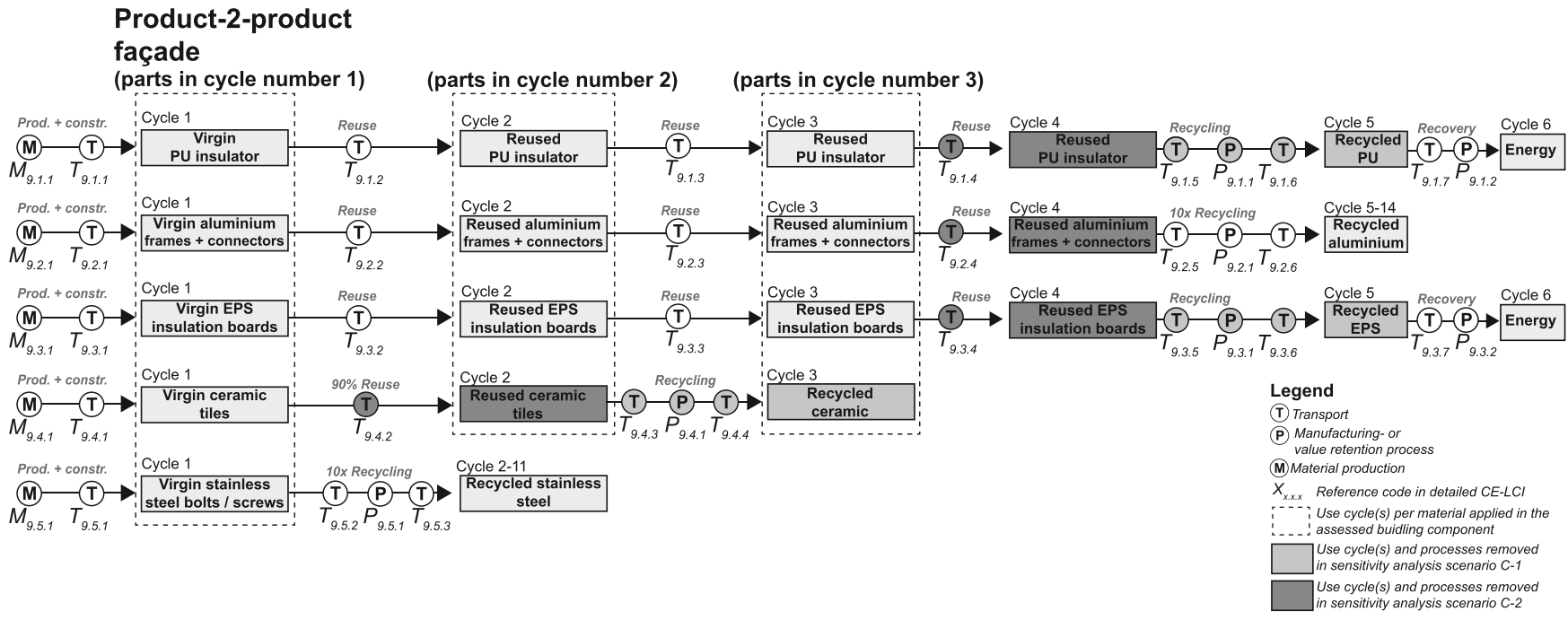

Figure A.E3d. Flowchart of the Product-2-product (P2P) façade design variant

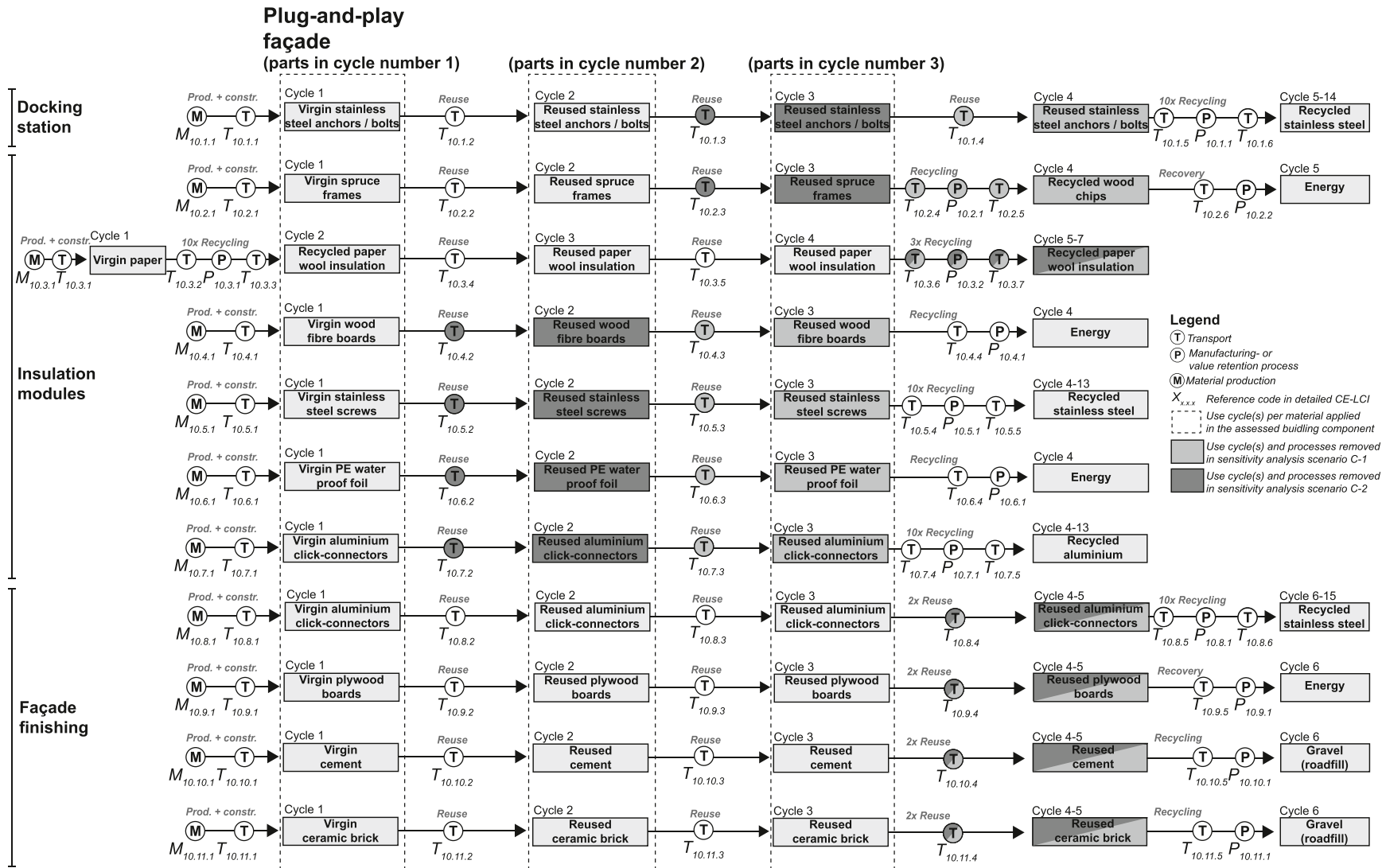

Figure A.E3e. Flowchart of the Plug-and-play (P&P) façade design variant

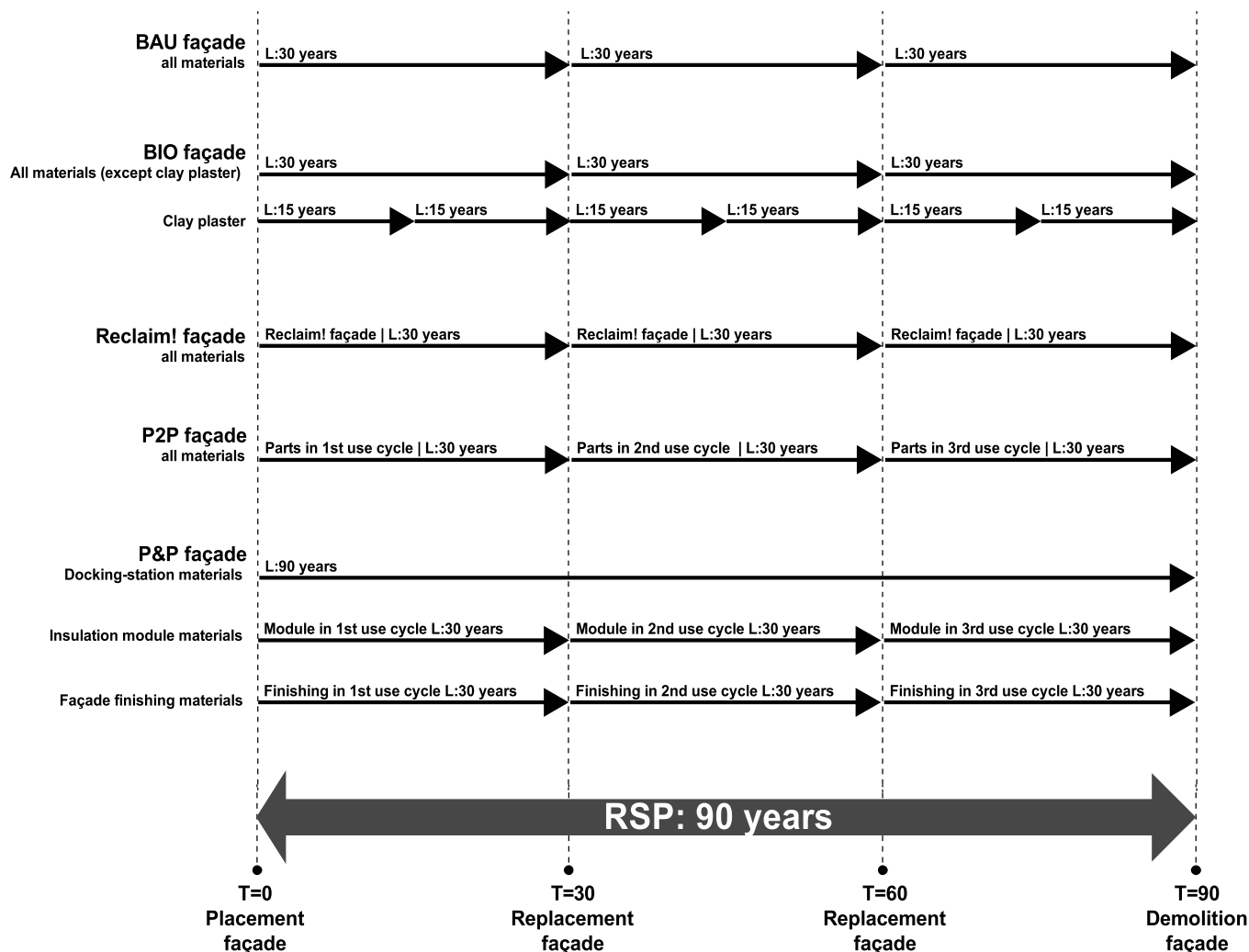

Figure A.E4. Lifespan of façade parts per design variant and their (re)placements during the RSP

Appendix F. Sensitivity analysis results on number of cycles for the kitchen variants: allocated GWP over time and MFA

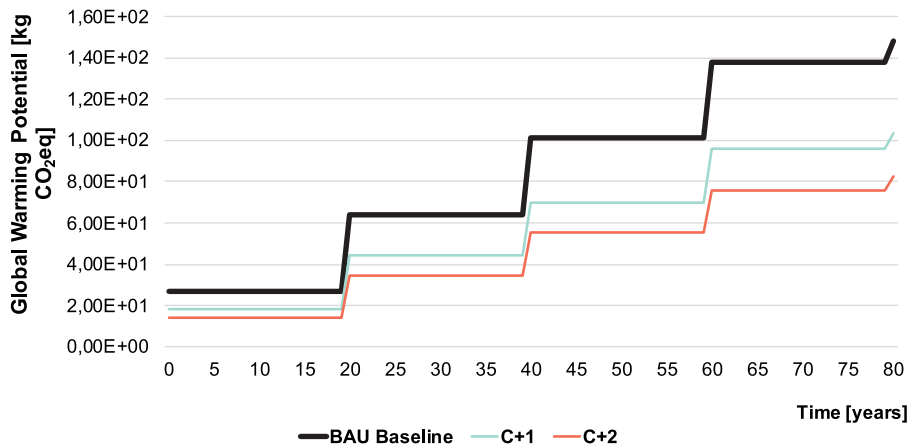

Figure A.F1a. LCA Sensitivity analysis on the number of cycles for the BAU kitchen (GWP over 80 years)

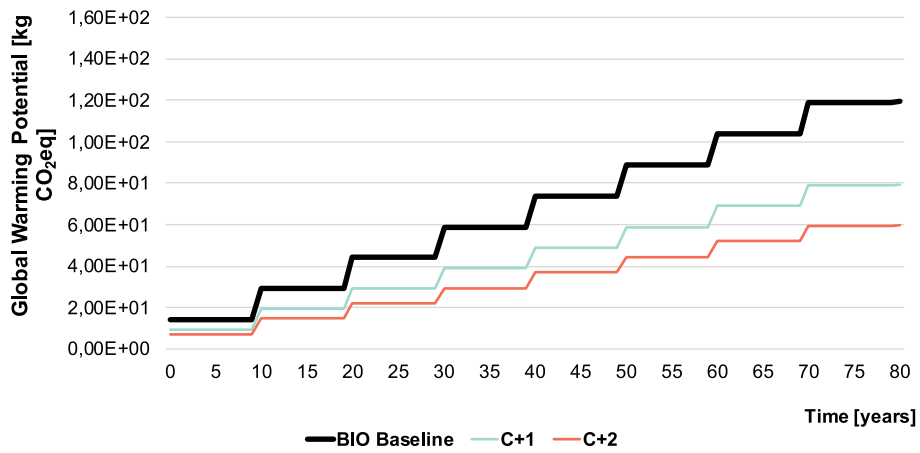

Figure A.F1b. LCA Sensitivity analysis on the number of cycles for the Bio kitchen (GWP over 80 years)

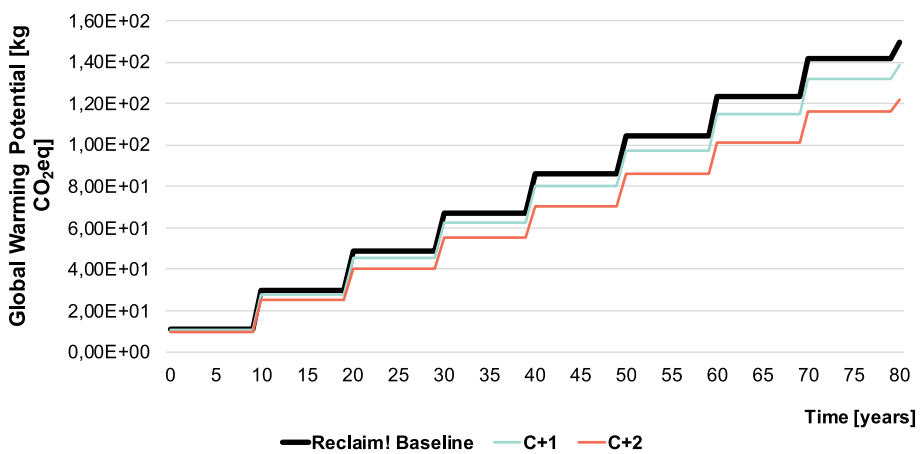

Figure A.F1c. LCA Sensitivity analysis on the number of cycles for the Reclaim! kitchen (GWP over 80 years)

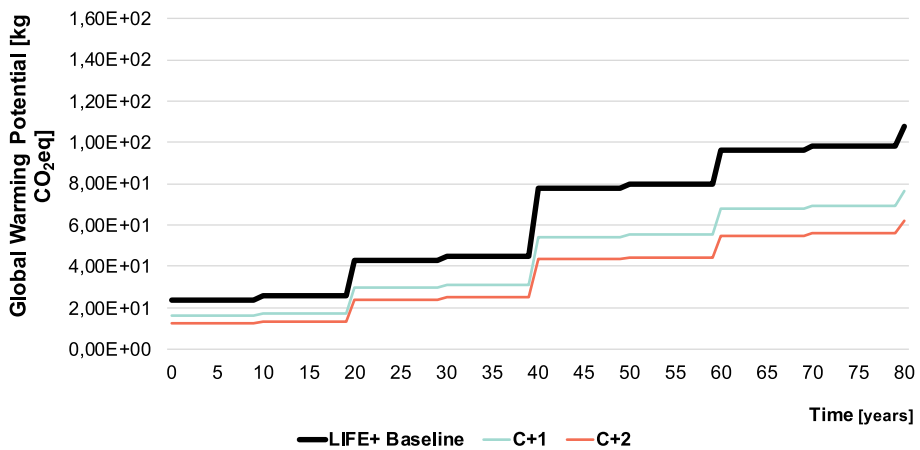

Figure A.F1d. LCA Sensitivity analysis on the number of cycles for the BAU kitchen (GWP over 80 years)

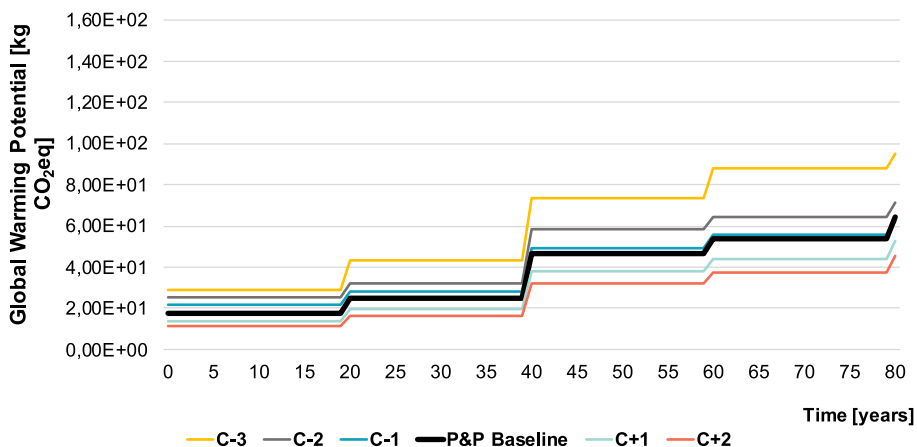

Figure A.F1e. LCA Sensitivity analysis on the number of cycles for the P&P kitchen (GWP over 80 years)

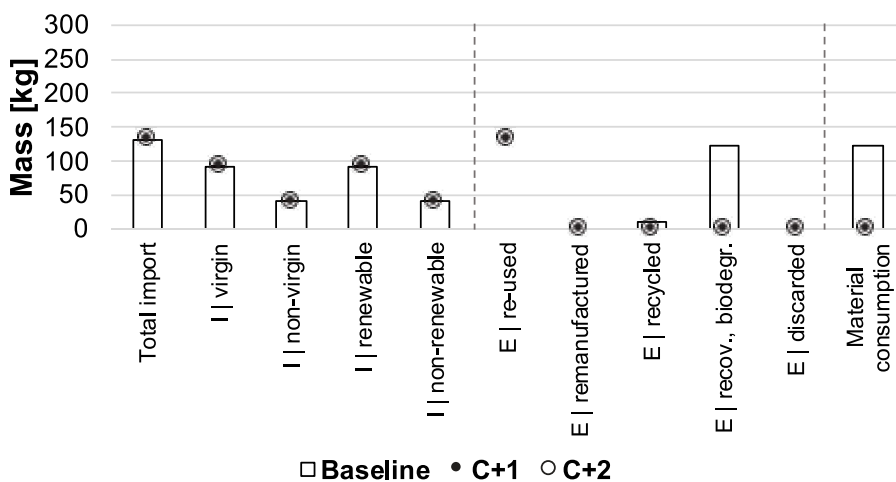

Figure A.F2a. MFA Sensitivity analysis on the number of cycles for the BAU kitchen (material flows over 80 years)

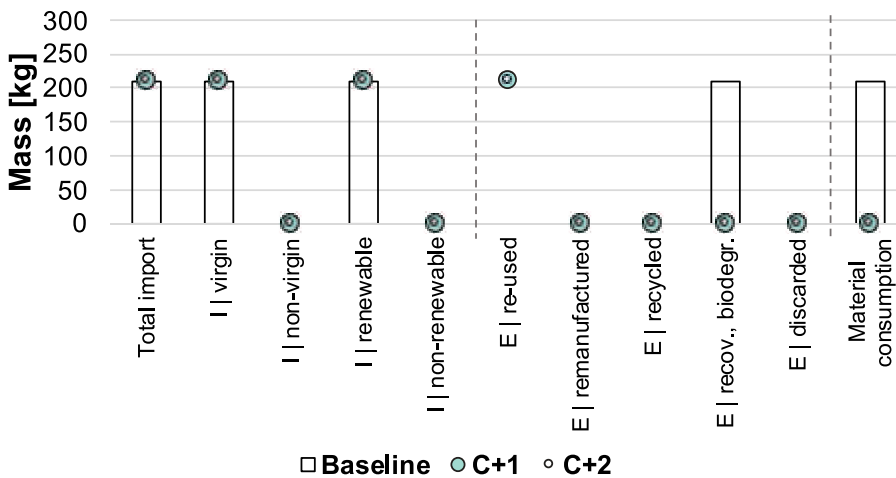

Figure A.F2b. MFA Sensitivity analysis on the number of cycles for the BIO kitchen (material flows over 80 years)

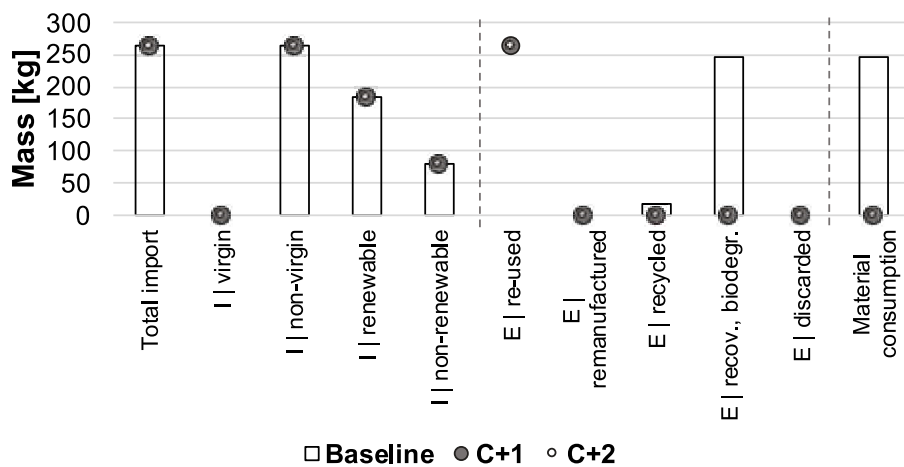

Figure A.F2c. MFA Sensitivity analysis on the number of cycles for the Reclaim! kitchen (material flows over 80 years)

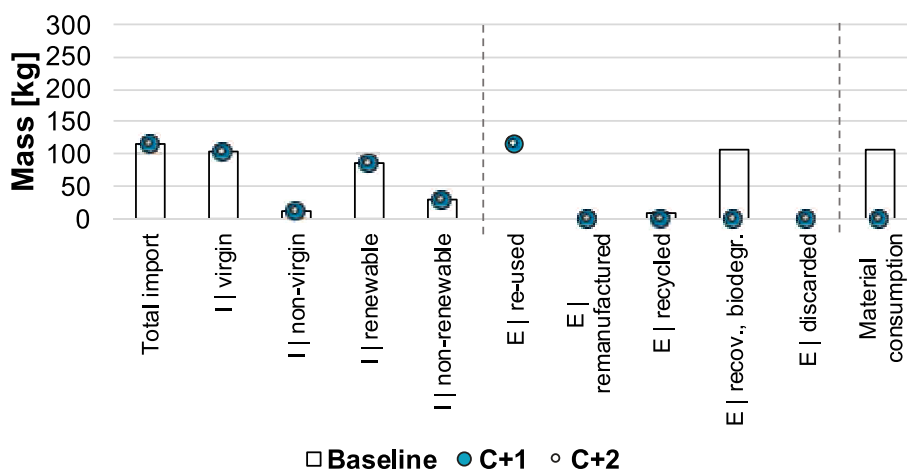

Figure A.F2d. MFA Sensitivity analysis on the number of cycles for the LIFE + kitchen (material flows over 80 years)

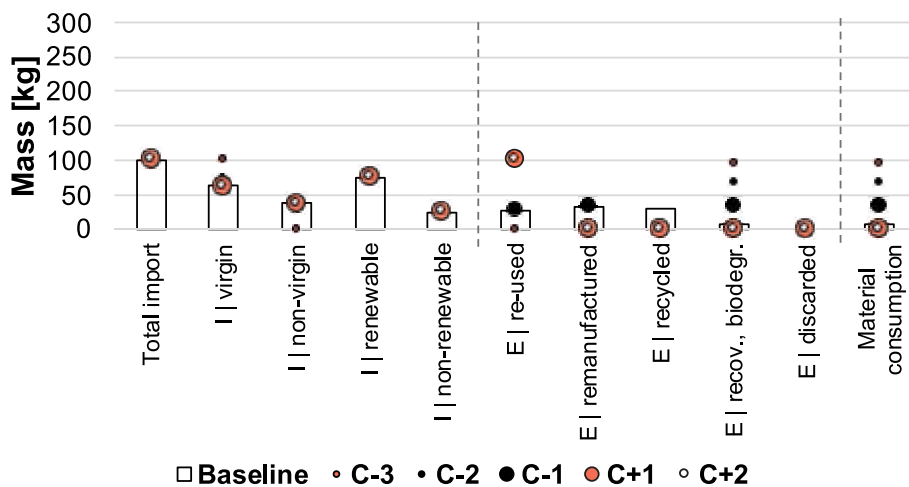

Figure A.F2e. MFA Sensitivity analysis on the number of cycles for the P&P kitchen (material flows over 80 years)

Appendix G. Sensitivity analysis results on number of cycles for the façade variants: allocated GWP over time and MFA

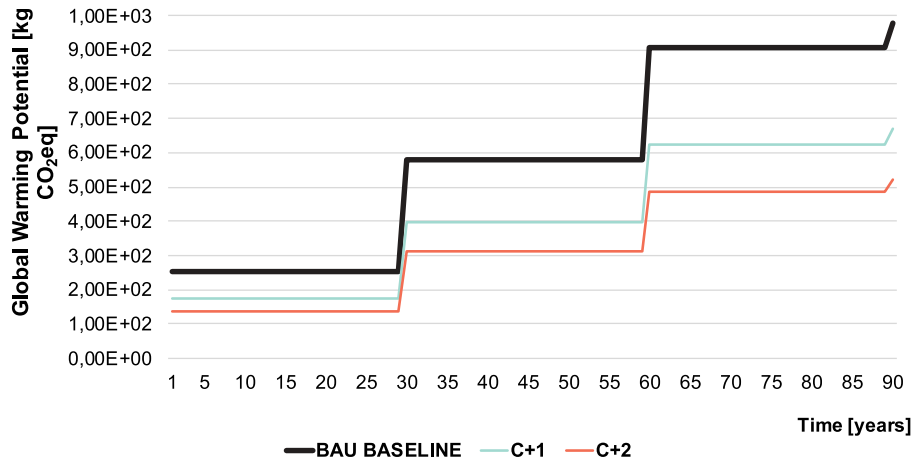

Figure A.G1a. LCA Sensitivity analysis on the number of cycles for the BAU façade (GWP over 90 years)

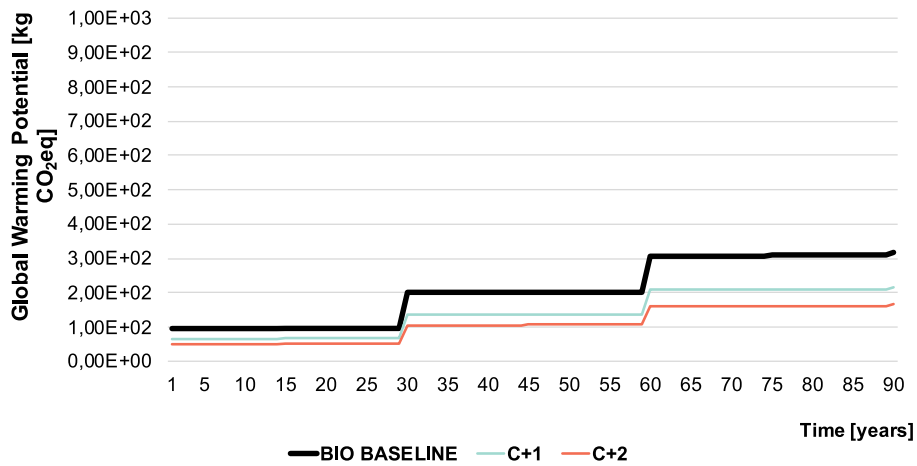

Figure A.G1b. LCA Sensitivity analysis on the number of cycles for the BIO façade (GWP over 90 years)

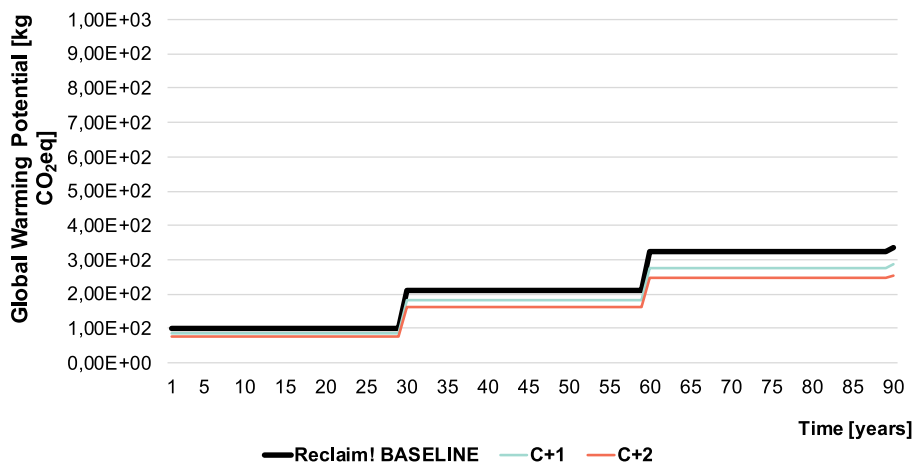

Figure A.G1c. LCA Sensitivity analysis on the number of cycles for the Reclaim! Façade (GWP over 90 years)

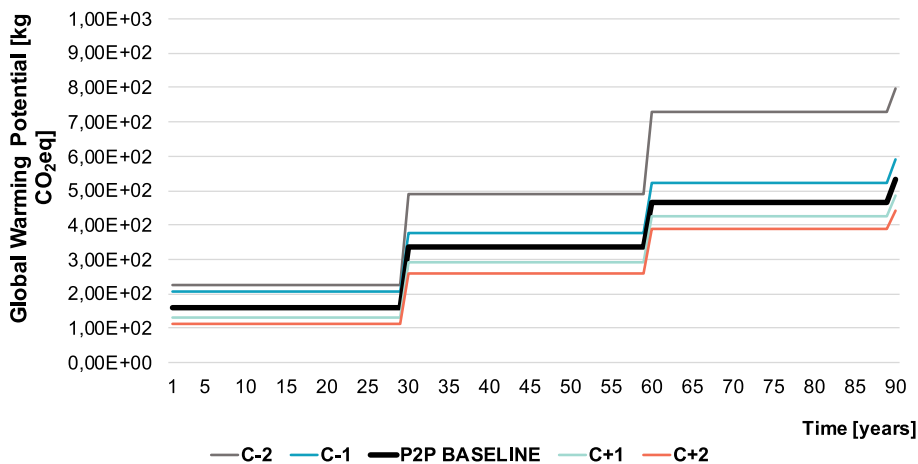

Figure A.G1d. LCA Sensitivity analysis on the number of cycles for the P2P façade (GWP over 90 years)

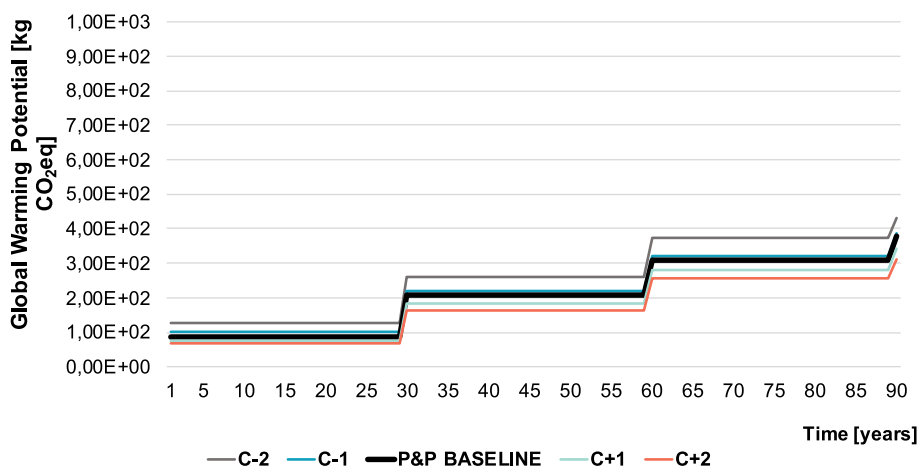

Figure A.G1e. LCA Sensitivity analysis on the number of cycles for the P&P façade (GWP over 90 years)

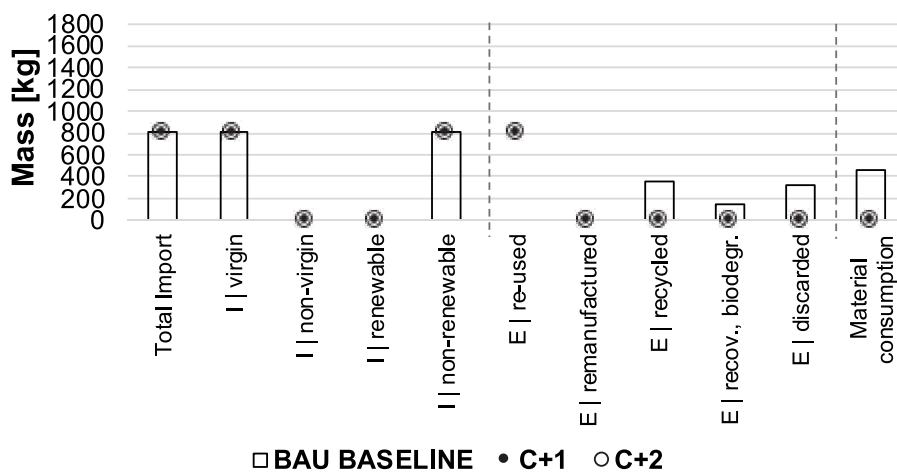

Figure A.G2a. MFA Sensitivity analysis on the number of cycles for the BAU façade (material flows over 90 years)

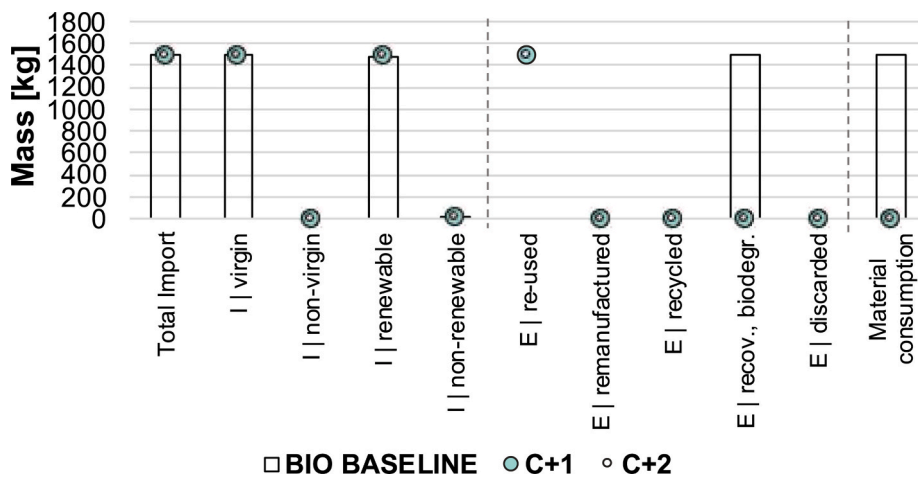

Figure A.G2b. MFA Sensitivity analysis on the number of cycles for the BIO façade (material flows over 90 years)

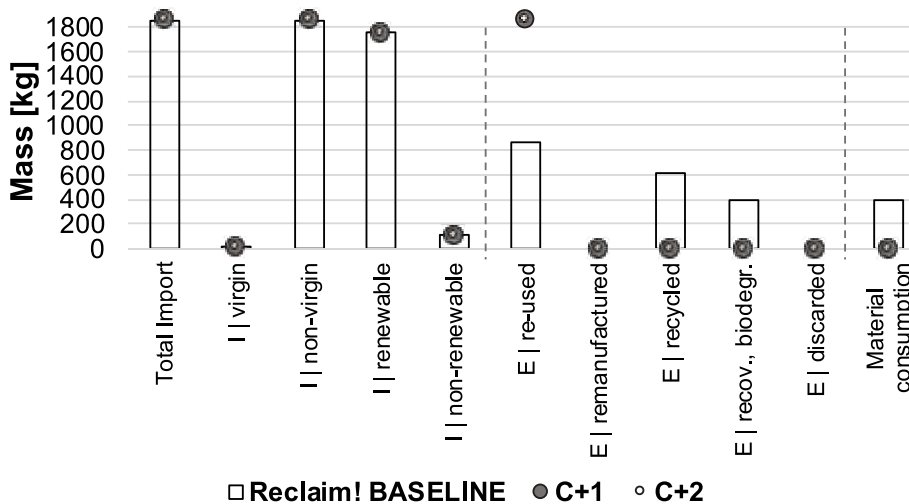

Figure A.G2c. MFA Sensitivity analysis on the number of cycles for the Reclaim! façade (material flows over 90 years)

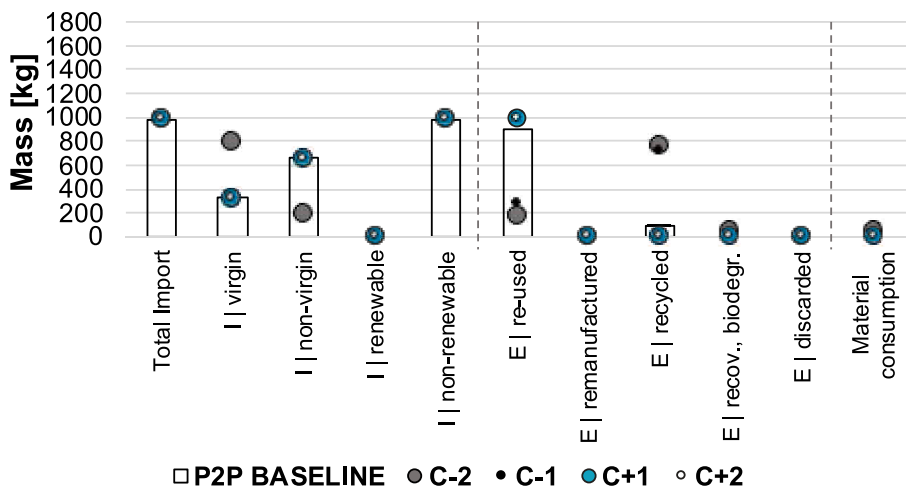

Figure A.G2d. MFA Sensitivity analysis on the number of cycles for the P2P façade (material flows over 90 years)

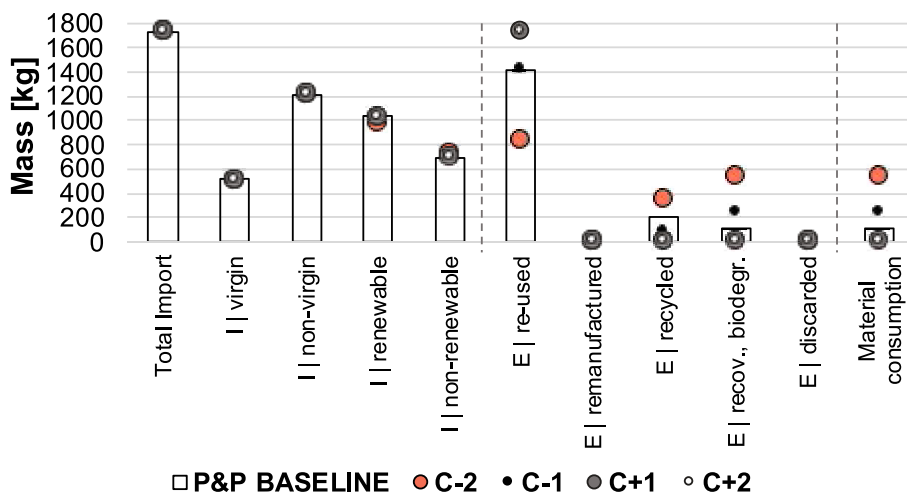

Figure A.G2e. MFA Sensitivity analysis on the number of cycles for the P&P façade (material flows over 90 years)

Appendix H. Sensitivity analysis results on lifespans for the kitchen variants: allocated GWP over time and MFA

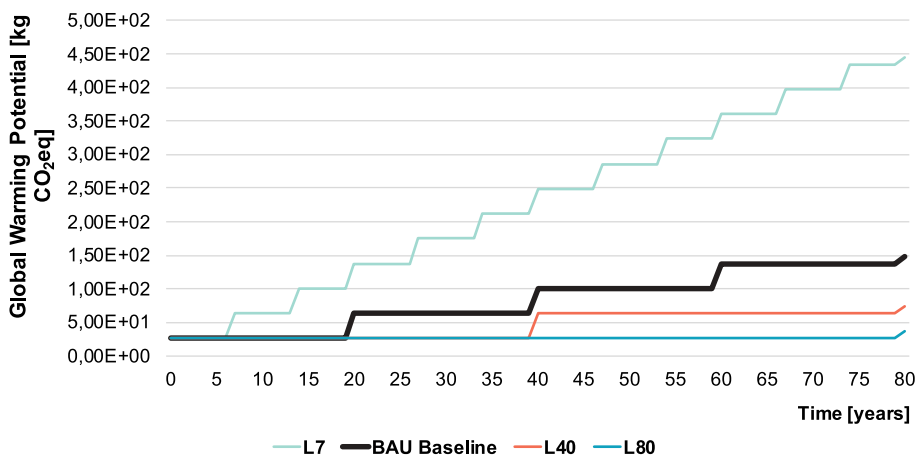

Figure A.H1a. LCA Sensitivity analysis on the $L_{technical}$ and $L_{functional}$ for the BAU kitchen (GWP allocated over 80 years)

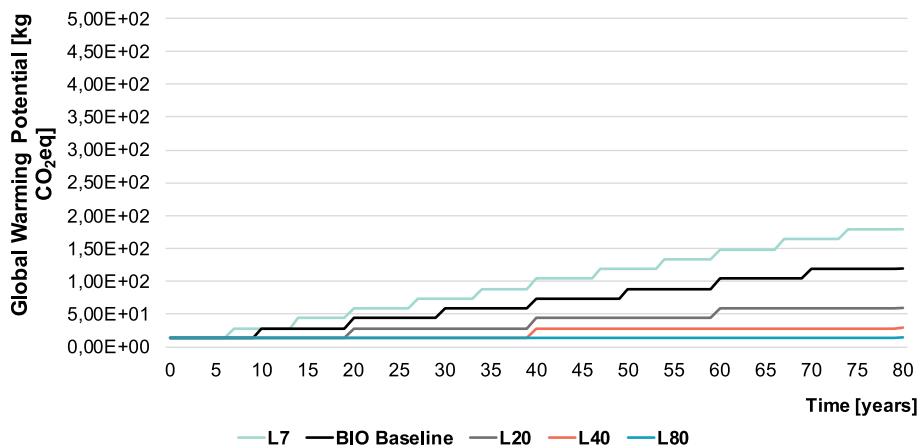

Figure A.H1b. LCA Sensitivity analysis on the $L_{technical}$ and $L_{functional}$ for the BIO kitchen (GWP allocated over 80 years)

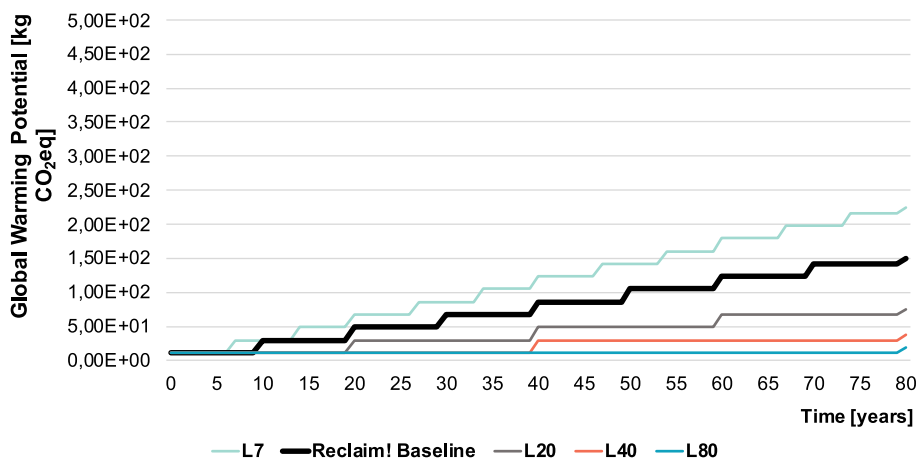

Figure A.H1c. LCA Sensitivity analysis on the $L_{technical}$ and $L_{functional}$ for the Reclaim! kitchen (GWP allocated over 80 years)

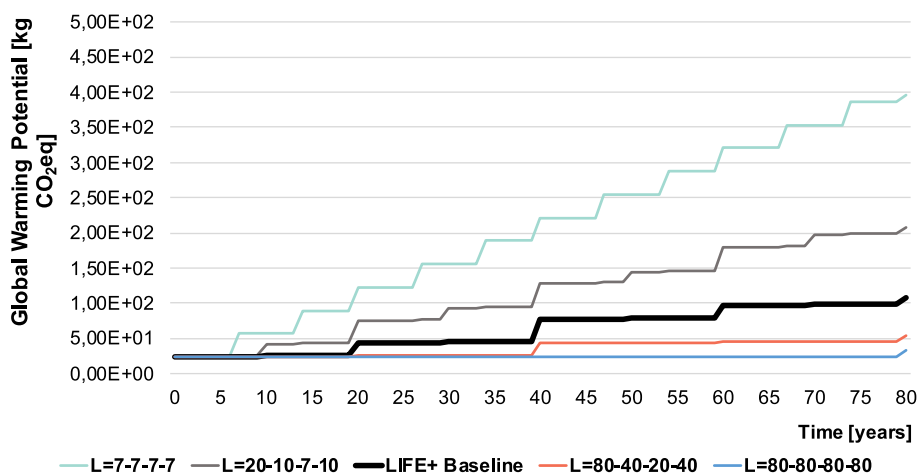

Figure A.H1d. LCA Sensitivity analysis on the $L_{technical}$ and $L_{functional}$ for the LIFE + kitchen (GWP allocated over 80 years)

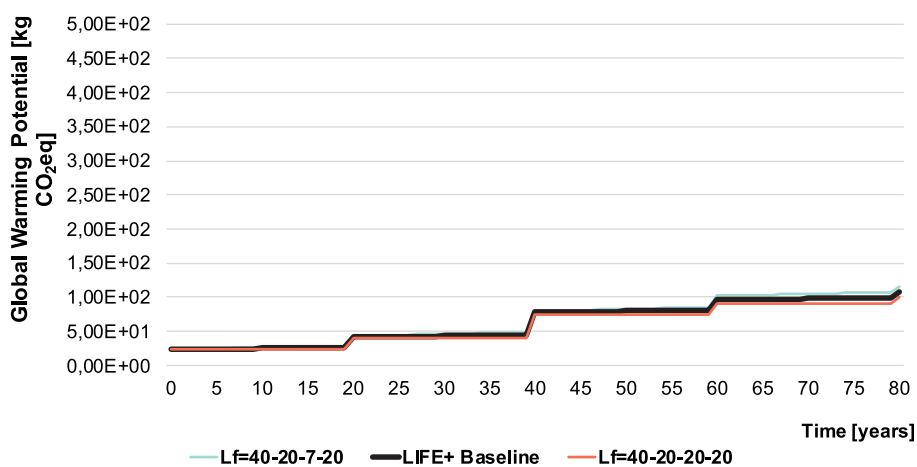

Figure A.H1e. LCA Sensitivity analysis on the $L_{functional}$ for the LIFE + kitchen (GWP allocated over 80 years)

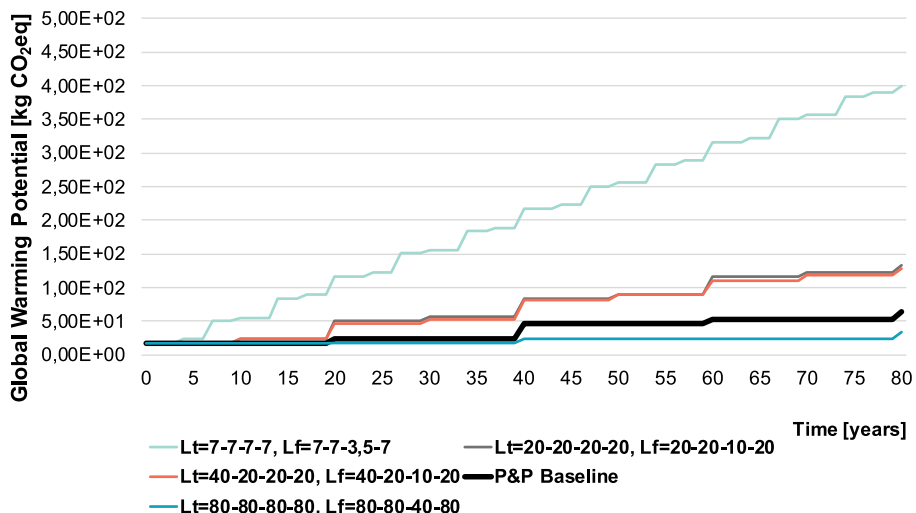

Figure A.H1f. LCA Sensitivity analysis on the $L_{technical}$ and $L_{functional}$ for the P&P kitchen (GWP allocated over 80 years)

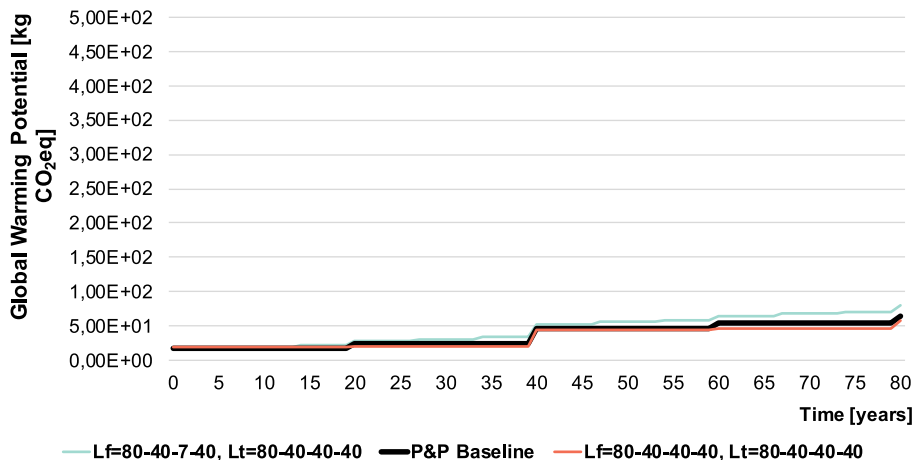

Figure A.H1g. LCA Sensitivity analysis on the $L_{functional}$ for the P&P kitchen (GWP allocated over 80 years)

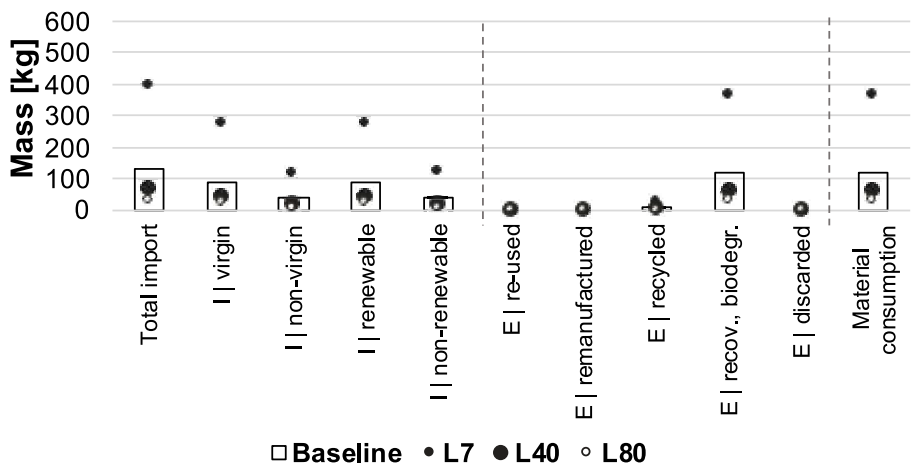

Figure A.H2a. MFA Sensitivity analysis on the $L_{technical}$ and $L_{functional}$ for the BAU kitchen (material flows over 80 years)

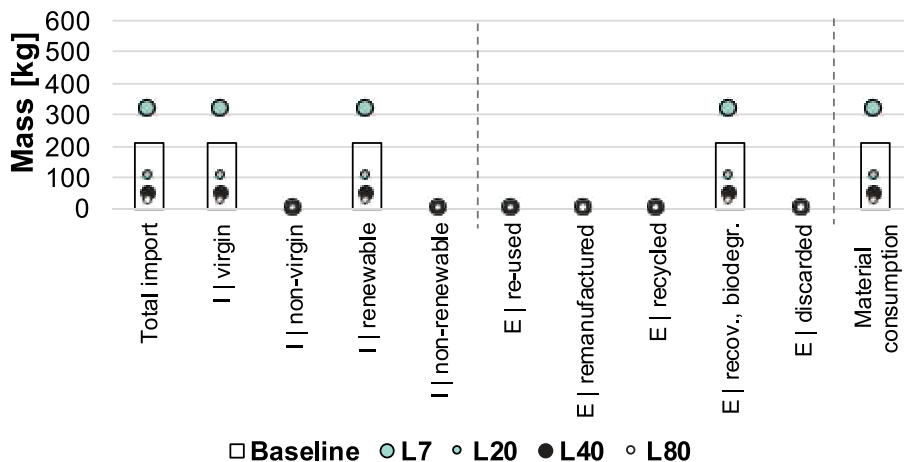

Figure A.H2b. MFA Sensitivity analysis on the $L_{technical}$ and $L_{functional}$ for the BIO kitchen (material flows over 80 years)

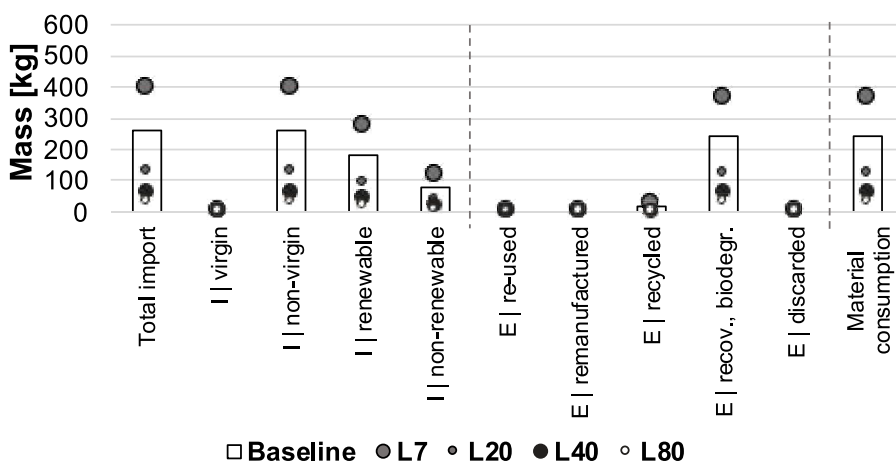

Figure A.H2c. MFA Sensitivity analysis on the $L_{technical}$ and $L_{functional}$ for the Reclaim! kitchen (material flows over 80 years)

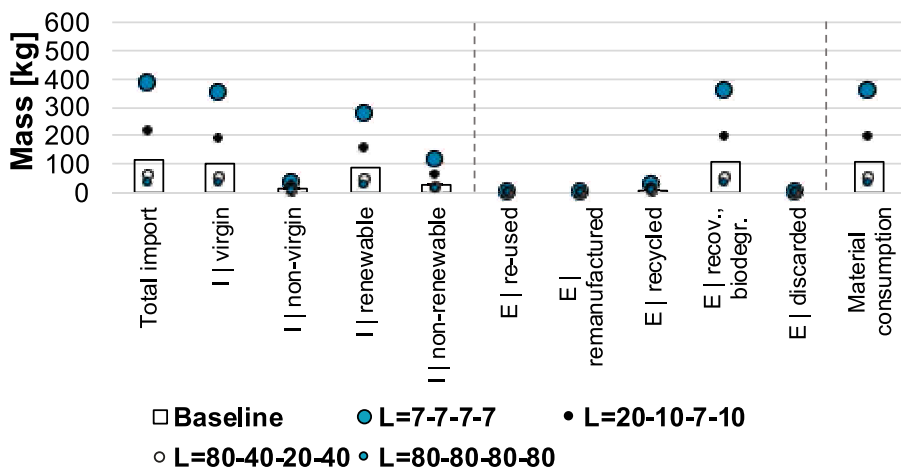

Figure A.H2d. MFA Sensitivity analysis on the $L_{technical}$ and $L_{functional}$ for the LIFE + kitchen (material flows over 80 years)

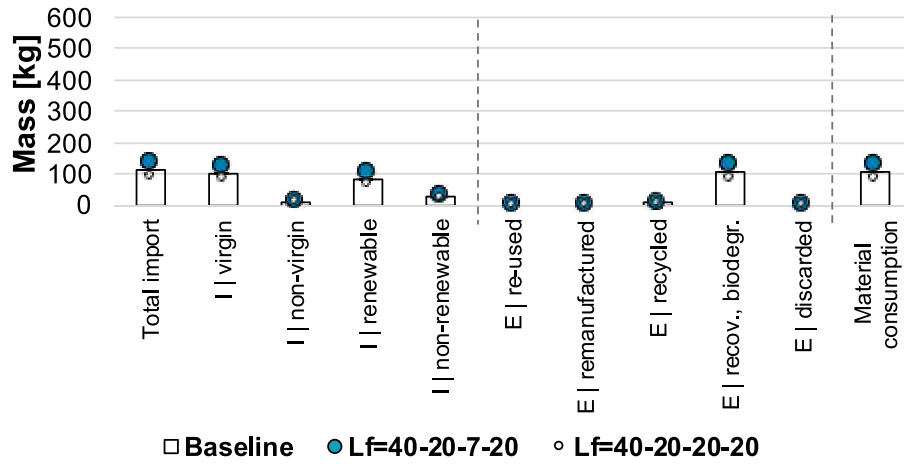

Figure A.H2e. MFA Sensitivity analysis on the $L_{functional}$ for the LIFE + kitchen (material flows over 80 years)

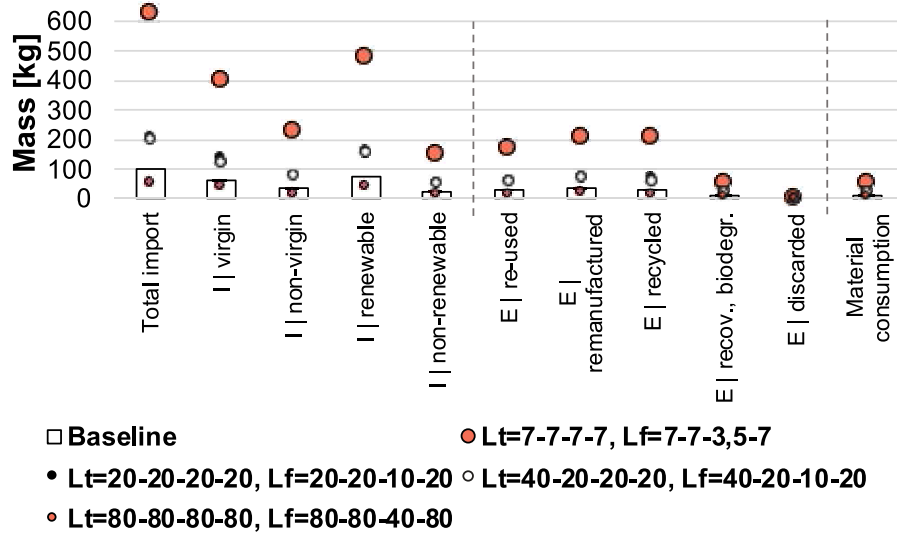

Figure A.H2f. MFA Sensitivity analysis on the $L_{technical}$ and $L_{functional}$ for the P&P kitchen (material flows over 80 years)

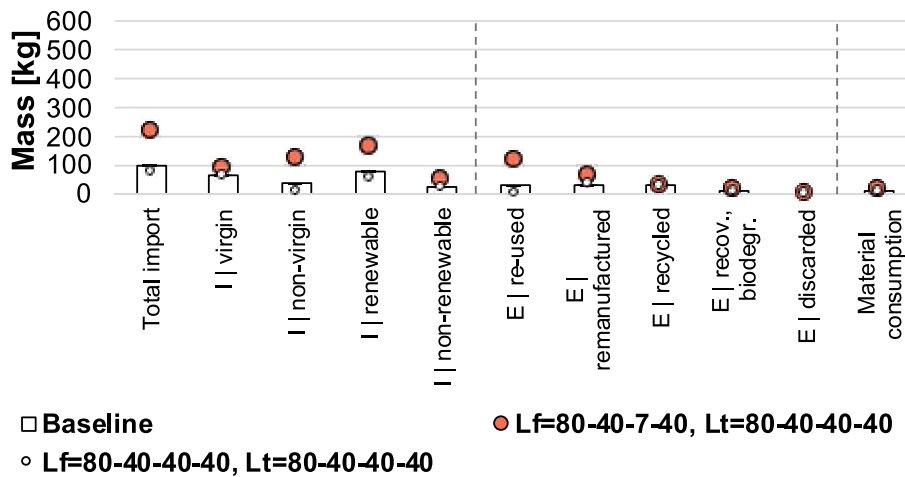

Figure A.H2g. MFA Sensitivity analysis on the $L_{functional}$ for the P&P kitchen (material flows over 80 years)

Appendix I. Sensitivity analysis results on lifespans for the façade variants: allocated GWP over time and MFA

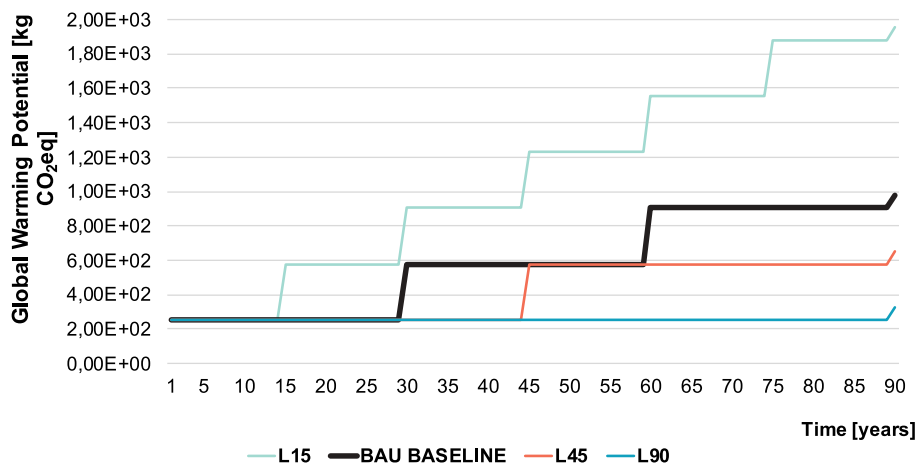

Figure A.IIa. LCA Sensitivity analysis on the L_{technical} and L_{functional} for the BAU façade (GWP allocated over 90 years)

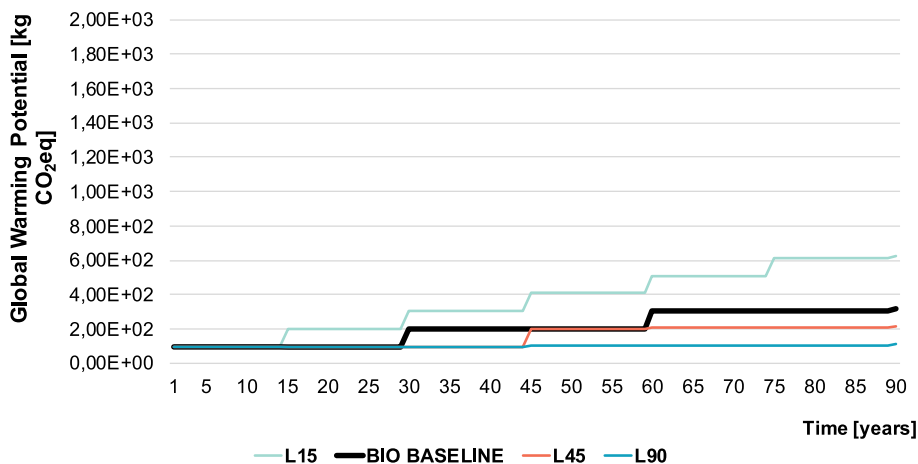

Figure A.IIb. LCA Sensitivity analysis on the L_{technical} and L_{functional} for the BIO façade (GWP allocated over 90 years)

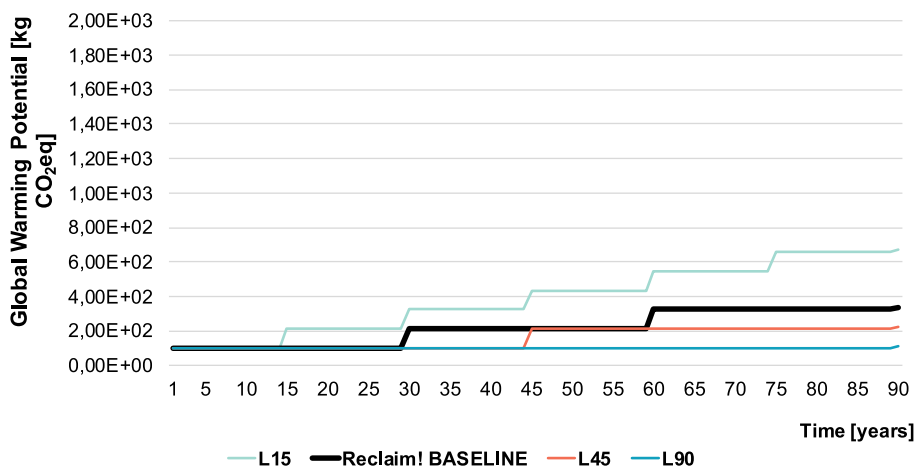

Figure A.IIc. LCA Sensitivity analysis on the L_{technical} and L_{functional} for the Reclaim! façade (GWP allocated over 90 years)

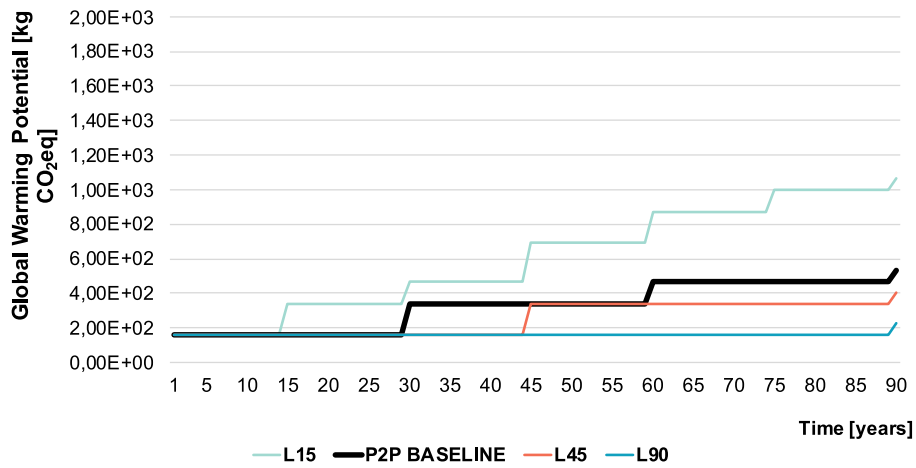

Figure A.II.d. LCA Sensitivity analysis on the $L_{technical}$ and $L_{functional}$ for the P2P façade (GWP allocated over 90 years)

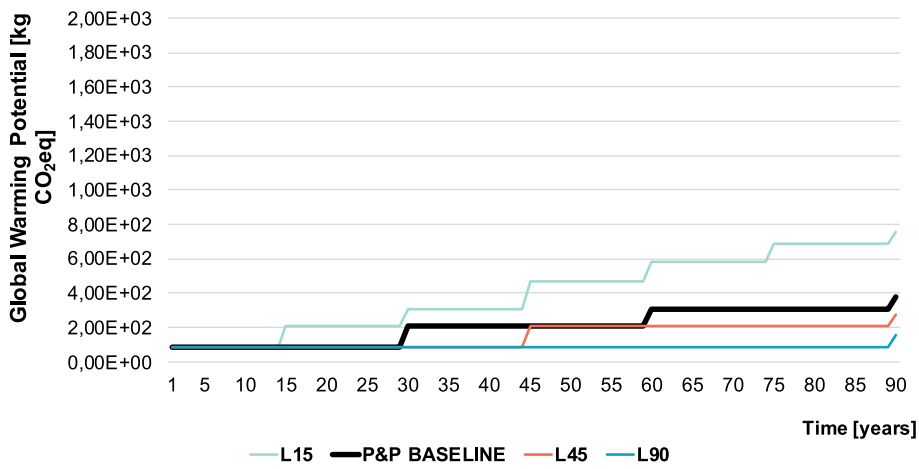

Figure A.II.e. LCA Sensitivity analysis on the $L_{technical}$ and $L_{functional}$ for the P&P façade (GWP allocated over 90 years)

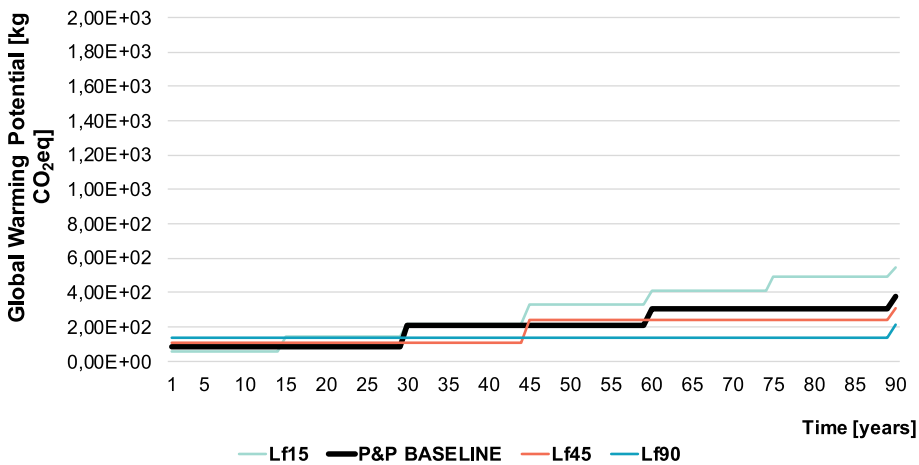

Figure A.II.f. LCA Sensitivity analysis on the $L_{functional}$ for the P&P façade (GWP allocated over 90 years)

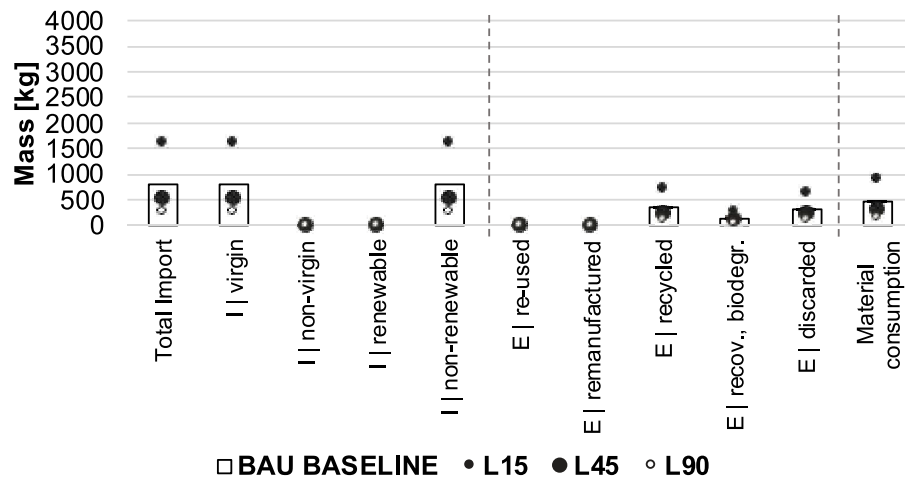

Figure A.I2a. MFA Sensitivity analysis on the $L_{technical}$ and $L_{functional}$ for the BAU façade (material flows over 90 years)

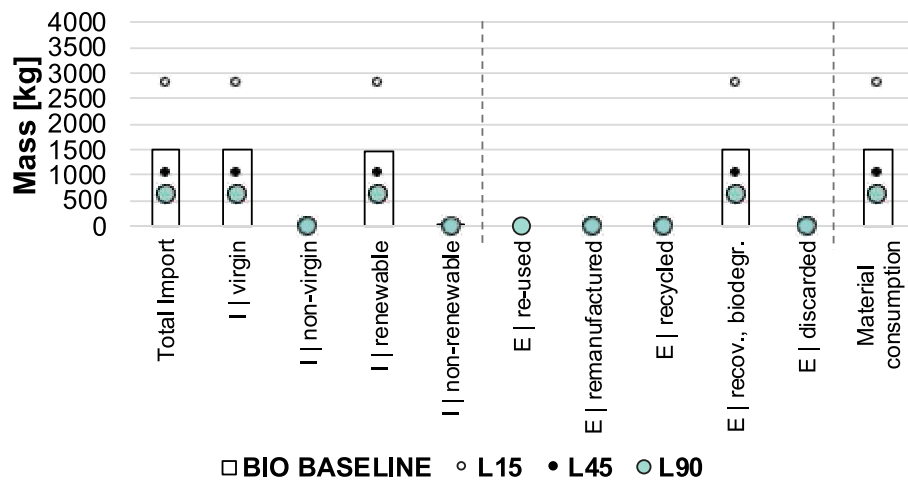

Figure A.I2b. MFA Sensitivity analysis on the $L_{technical}$ and $L_{functional}$ for the BIO façade (material flows over 90 years)

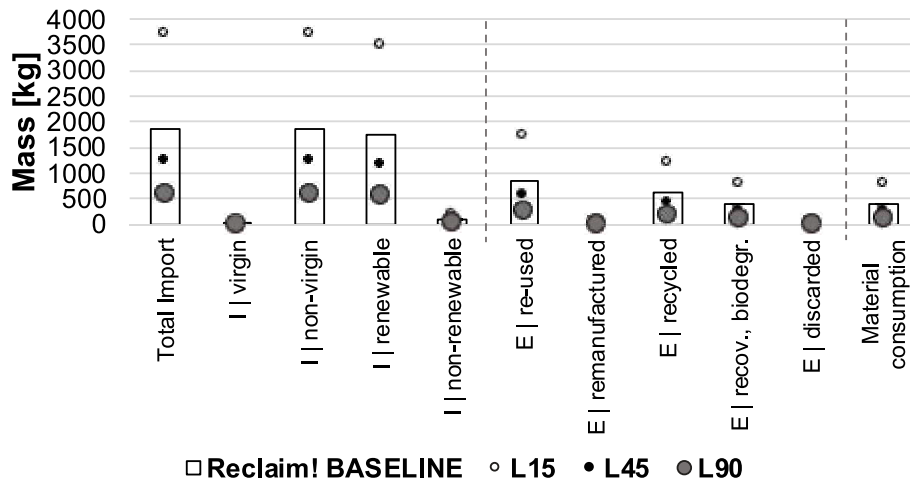

Figure A.I2c. MFA Sensitivity analysis on the $L_{technical}$ and $L_{functional}$ for the Reclaim! façade (material flows over 90 years)

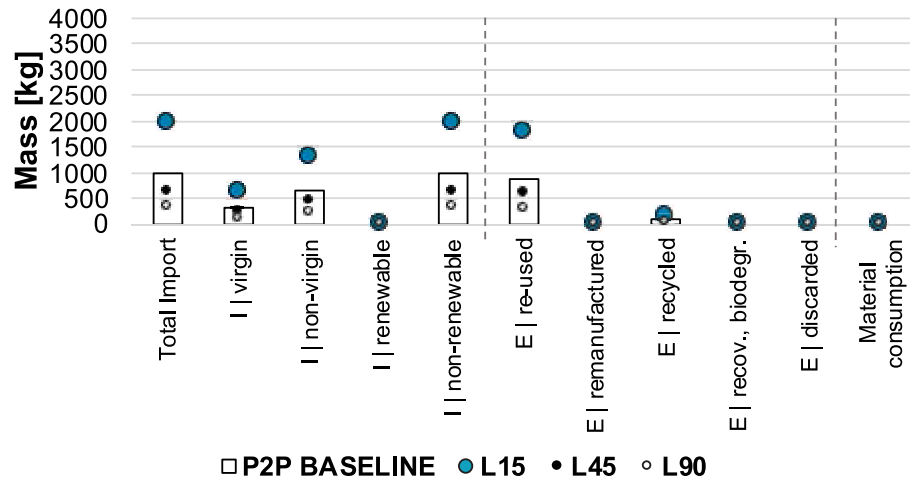

Figure A.I2d. MFA Sensitivity analysis on the $L_{technical}$ and $L_{functional}$ for the P2P façade (material flows over 90 years)

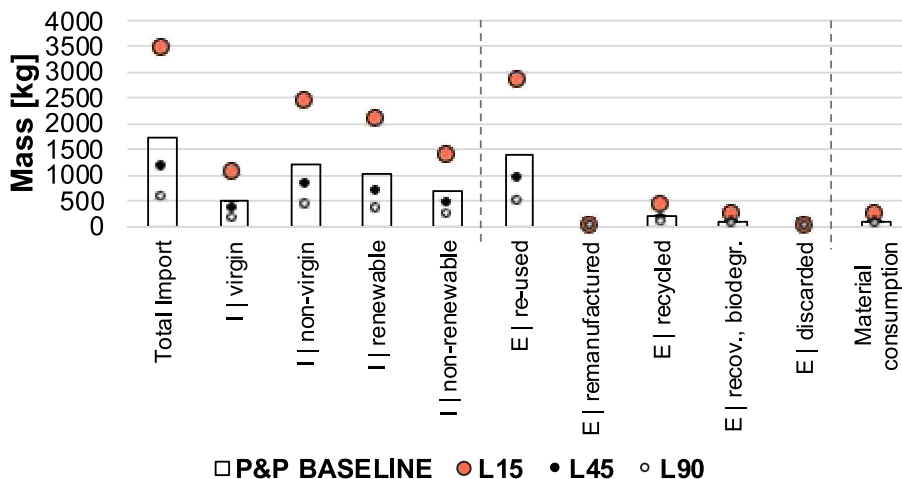

Figure A.I2e. MFA Sensitivity analysis on the $L_{technical}$ and $L_{functional}$ for the P&P façade (material flows over 90 years)

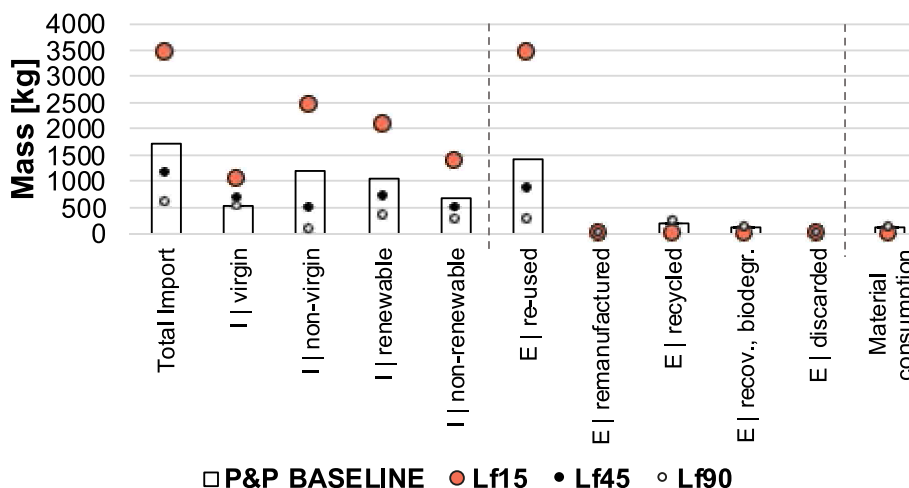

Figure A.I2f. MFA Sensitivity analysis on the $L_{functional}$ for the P&P façade (material flows over 90 years)

Appendix K. Additional analysis of contribution of materials and processes to CE-LCIA and MFA results

Which materials or processes contribute most to the results varies per material flow category. Looking at the material import in the kitchens over the RSP, the majority share originates from the wood-based materials used in the panels, fronts, infill and/or finishing parts: in the baseline scenarios, this is 76% for the BAU, Reclaim! and P&P, 81% for the LIFE+ and 95% for the BIO kitchen. The share is larger for variants with no, or little coating materials. For the BAU, P2P and P&P façades, the finishing contributes significantly to the total material import over the RSP: in the baseline scenarios, the share of cement, mortar and brick-strips is 82% in the BAU; for the ceramic tiles in the P2P, this is 71%; for the P&P, the plywood boards, cement and brick-strips make up 44%. In the BIO, Reclaim! and P&P façade baselines, wood-based materials make up 36%, 61% and 41%, respectively. For the BIO façade baseline, the share of hemp-based materials in the total import is 28% and 31% for clay.

Which materials or processes contribute most to the environmental impacts varies per impact category. In most instances the majority of impacts originates from materials with high shares in the import. However, several materials and processes made disproportional contributions. In the P&P kitchen, the recycling process 'chipping for OSB production' results in a high share of impacts, especially in the abiotic depletion for elements category. Considering the limited mass of the stainless steel, aluminium and coatings (i.e., melamine), we found that these materials contribute disproportionately to the total impacts, especially for the toxicity categories. In both the kitchen and façades, most of the impact originates from material production VRP, or disposal processes; transport played a limited role.

Appendix L. Ranking of design variants based on the percentual savings in the CE-LCA and MFA to the BAU (baseline scenario)

Appendix M. Analysis percentual savings circular design options in assessment results

Table A.M1

Analysis percentual savings applied circular design options in assessment results

		Adding 1 re-use cycle for virgin material			Adding 2 re-use cycles for virgin material			Adding 1 re-use cycle for non-virgin material			Adding 2 re-use cycles for non-virgin material			Substituting with bio-based material			Substituting with non-virgin material			Increasing Lt-Lf in parallel (i.e., 2x)			Incr. Lf (i.e., 2x)		
		[% reduction]			[% reduction]			[% reduction]			[% reduction]			[% reduction]			[% reduction]			[% reduction]					
		Min.	Aver.	Max.	Min.	Aver.	Max.	Min.	Aver.	Max.	Min.	Aver.	Max.	Min.	Aver.	Max.	Min.	Aver.	Max.	Min.	Aver.	Max.	Min.	Aver.	Max.
MFA	Total import	0%	0%	0%	0%	0%	0%	0%	0%	0%	0%	0%	0%	0%	0%	0%	0%	0%	0%	0%	0%	0%	0%	0%	0%
	% Virgin	0%	0%	0%	0%	0%	0%	0%	0%	0%	0%	0%	0%	0%	0%	0%	0%	0%	0%	0%	0%	0%	0%	0%	0%
	% Non-renewable	0%	0%	0%	0%	0%	0%	0%	0%	0%	0%	0%	0%	0%	0%	0%	0%	0%	0%	0%	0%	0%	0%	0%	0%
	% Biodegr., recov., disc.	100%	100%	100%	100%	100%	100%	100%	100%	100%	100%	100%	100%	100%	100%	100%	100%	100%	100%	100%	100%	100%	100%	100%	100%
	Material consumption	100%	100%	100%	100%	100%	100%	100%	100%	100%	100%	100%	100%	100%	100%	100%	100%	100%	100%	100%	100%	100%	100%	100%	100%
LCA	Aver. all imp. categories	28%	31%	34%	41%	45%	50%	4%	8%	12%	14%	18%	22%	-72%	-9%	54%	22%	37%	51%	44%	48%	50%	20%	26%	31%
	GWP	29%	31%	34%	42%	46%	50%	7%	11%	14%	19%	21%	24%	60%	64%	68%	50%	58%	66%	43%	48%	50%	22%	26%	31%
	Shadow costs	24%	30%	34%	36%	44%	50%	7%	8%	10%	16%	18%	20%	57%	64%	71%	45%	46%	47%	30%	48%	50%	17%	47%	77%
	number of underlying comparisons	5			5			2			2			2			2			10			2		
	Underlying comparisons	(1,2,3) CIK - BAU-BIO-LIFE + - C+1 to baseline			(1,2,3) CIK - BAU-BIO-LIFE + - C+2 to baseline			(1) CIK - Reclaim! - C+1 to baseline			(1) CIK - Reclaim! - C+2 to baseline			(1) CIK-BIO - L20 to BAU - baseline			(1) CIK- Reclaim! - L20 to BAU - baseline (2)			(1) CIK - BAU - L40 to baseline; (2,3) CIK - BIO & Reclaim! - L20 to baseline; (4) CIK - LIFE + - L80-40-20-40 to baseline; (5) CIK - P&P - Baseline to L40-20-10-20; (6,7,8,9,10) Fac. - BAU-BIO-Reclaim!-P2P-P&P - L90 to L45			(1) CIK - P&P - Lf = 80-40-40 to Lf = 80-40-20-40; (2) Fac. P&P Lf90 to Lf45		

Appendix N. Effect of circular design options on the CE-LCIA and MFA parameters

In this appendix, we analyse how different circular design options influenced each parameter in the kitchen and façade assessments. We analysed the effect of 5 circular design options: (1) applying bio-based and biodegradable materials, (2) applying non-virgin materials, (3) realizing multiple use cycles of parts and materials after use in the building component, (4) prolonging the technical and functional lifespan of the building component, its parts and materials in parallel and (5) increasing the functional lifespan of parts. We refer to [Appendix A](#) for an explanation of all the CE-LCIA and MFA equations and parameters.

Our analysis of the effect of the applied circular design options on the MFA and CE-LCA parameters in the kitchen and façades assessments is summarized in [table A.N1](#).

Table A.N1
Effect circular design options on MFA and CE-LCIA parameters.

Circular design option	Influenced parameters	Case	Effect circular design option on parameter in kitchen and façade assessments
Applying bio-based, biodegradable materials	$\frac{AI_x}{unit}$	BIO kitchen	↓ Lower impact/unit compared to non-renewable materials (e.g., uncoated laminated timber boards)
		BIO façade	↑↓ Shift of burdens between impact categories.
	$M_{mat., x}$	BIO kitchen	– Mass of renewable materials per kitchen remained comparable to the non-renewable material in BAU.
		BIO façade	↑ More renewable materials were required compared to non-renewable materials to fulfil the same function (e.g., insulation and structural materials).
	$r^{renew. mat., x}$	BIO kitchen and façade	↑ Percentage of renewable materials increased.
	$r^{biodegr. mat., x}$	BIO kitchen and façade	↑ Percentage of biodegraded materials increased.
	R	BIO kitchen	↑ Doubling of replacement rate due to lower assumed technical lifespan renewable material
		BIO façade	– Similar replacement rate façade (30 years) compared to façade of non-renewable material.
Applying non-virgin, materials	$\frac{AI_x}{unit}$	Reclaim! façade	↓ Alternative non-virgin material is applied with lower impact/unit compared to virgin materials (e.g., recycled paper wool insulation)
		Reclaim! kitchen	↓ Material in second use cycle has a lower share of impacts allocated to the use cycle of the building component.
	Af	Reclaim! kitchen	↑ Reuse processes for the non-virgin materials result in additional transport related impacts.
	AI	Reclaim! façade	↑ Reuse and/or recycling processes for the non-virgin materials result in additional transport and process related impacts.
	$M_{mat., x}$	Reclaim! kitchen	– Mass of non-virgin materials per kitchen remained comparable to the mass of virgin material in BAU.
		Reclaim! façade	↑ More non-virgin materials were needed than virgin materials to fulfil the same function (e.g., for non-virgin insulation a reduced insulation value needs to be used in calculations; more material is required to have the same insulation value).
	$r^{non-virgin. mat., x}$	Reclaim! kitchen and façade	↑ Percentage of non-virgin materials increased.
		Reclaim! kitchen	↑ Doubling of replacement kitchen rate due to lower assumed technical lifespan non-virgin material
R	Reclaim! façade	– Similar replacement rate façade (30 years) compared to façade of virgin material.	
	All kitchens and façades	↓ A higher technical and functional lifespan of a component, parts and materials reduced the number of replacements of materials over the RSP.	
Increasing technical and function lifespan in parallel	R	LIFE+ kitchen, P&P kitchen and façade	↓ A higher functional lifespan reduced the number of material replacements over the RSP (e.g., finishing parts).
		P&P kitchen and façade	↑ A higher functional lifespan reduced the number of reuse cycles which reduced the total number of cycles; this increased the share of impacts allocated to the use cycle of the kitchen or façade (e.g., finishing parts).
Increasing number of cycles in material life cycle	Af	All kitchen and façade variants	↓ More use cycles reduce the share of impacts allocated to the use cycle of the building component.
	AI	All kitchen and façade variants	– Low impact, direct reuse cycles result in low (or no) additional transport- and process-related impacts.
	AI	Reclaim!, P2P, P&P façade and P&P kitchen,	↑ High-impact recycling cycles result in high additional transport- and process-related impacts.
	$r^{reuse_{mat., x}}$	All kitchen and façade variants	↑ For reuse cycles, the percentage of reused material flows increases 100%.

Appendix O. List of lessons learned on environmental design of circular building components

Table A.O1

List of lessons learned on environmental design of circular building components

1. **Consider not only the present placement and maintenance, but consider all future cycles.**
During design, do not only consider the initial placement of the building component in the project. Also consider (re)placements in the future and consider what happens after the component, parts and materials leave the building.
2. **Considering building components as a composite of sub-components, parts and materials with different and multiple use cycles.**
Determine the expected lifespan, usecycle(s), and value retention processes (VRPs) for each material and part applied in the building component.
3. **Combine circular design options to facilitate multiple Value Retention Processes as opposed to focusing on a single one.**
Environmental performance often improves most by combining circular design options to narrow, slow and close cycles simultaneously, instead of focusing on one.
4. **(Re)design the technical, industrial and business model integrally and in co-creation with involved stakeholders.**
The environmental performance of components is dependent on the ability to design, determine, guarantee and realise multiple cycles.
5. **Consider all circular design parameters in interrelation with each other.**
Trade-offs and changes in assumptions can cause tipping points. Applying circular design options could also result in higher impacts and resource use. For example, merely substituting linear materials with more circular materials (e.g., biological, low-impact, reused or recycled) does not necessarily result in a more circular building component.
6. **Prioritize impacts from material production and recycling processes over transport.**
Most of the impacts are linked to material production and recycling: increasing transport to realise VRPs is preferable over placing a new building component. Unless the component is bulky or heavy, then, transport should be kept to a minimum.
7. **Components with a shorter service life benefit from prioritizing combinations of circular design options to slow and close future cycles, and components with a longer service life from reducing resources now and slowing loops on site.**
 - **For a circular building component with a short service life (e.g., circular kitchen) the better environmentally performing design could apply the following circular design options:**
 - o *The component is designed (as efficient as possible) modular, facilitating partial replacement such as technical repairs and functional and aesthetic updates whilst keeping the whole of the component in use longer;*
 - o *The component applies materials with long technical lifespans;*
 - o *Multiple cycles are facilitated, organised and incentivised after EoU to prolong the period of use (e.g., repair, reuse, and refurbishment), and after EoL to close the loop (e.g., biodegrading, recycling);*
 - o *Non-virgin materials, and/or bio-based, biodegradable materials are applied if they show a favourable balance between impacts/kg, technical lifespan, quantity needed compared to virgin, non-renewable materials.*
 - **For a circular building component with a middle service life (e.g., circular façade) the better environmentally performing design could apply the following circular design options:**
 - o *Non-virgin materials, and/or bio-based, biodegradable materials are applied which show a favourable balance between impacts/kg, technical lifespan, quantity needed compared to virgin, non-renewable materials.*
 - o *The component applies materials with long technical lifespans;*
 - o *If it can be done efficiently, the component is designed modular, facilitating partial replacement such as technical repairs and functional and aesthetic updates whilst keeping the whole of the component in use longer;*
 - o *Multiple cycles are facilitated organised and incentivised after EoU to prolong the period of use (e.g., repair, reuse, and refurbishment), and after EoL to close the loop (e.g., biodegrading, recycling);*
8. **If future cycles cannot be organised in the supply chain and incentivised in the business model, then the best environmentally performing design for a circular building component with a short or middle-long service life (e.g., circular façade and kitchen) applies the following circular design options:**
 - o *The component is an efficient, lightweight solution;*
 - o *The component is kept in use as long as possible;*
 - o *Non-virgin materials, and/or bio-based, biodegradable materials are applied if they show a favourable balance between impacts/kg, technical lifespan, quantity needed compared to virgin, non-renewable materials;*
 - o *The component applies materials which are open-loop biodegradable or recyclable.*

References

- Allacker, K., Mathieux, F., Pennington, D., Pant, R., 2017. The search for an appropriate end-of-life formula for the purpose of the European Commission Environmental Footprint initiative. *Int. J. Life Cycle Assess.* 22, 1441–1458. <https://doi.org/10.1007/s11367-016-1244-0>.
- Andersen, C.E., Rasmussen, F.N., Habert, G., Birgisdóttir, H., 2021. Embodied GHG emissions of wooden buildings—challenges of biogenic carbon accounting in current LCA methods. *Front. Built Environ.* 7, 120. <https://doi.org/10.3389/fbuil.2021.729096>.
- Bocken, N.M.P., de Pauw, I., Bakker, C., van der Grinten, B., 2016. Product design and business model strategies for a circular economy. *J. Ind. Prod. Eng.* 33, 308–320. <https://doi.org/10.1080/21681015.2016.1172124>.
- Bocken, N.M.P., Farracho, M., Bosworth, R., Kemp, R., 2014. The front-end of eco-innovation for eco-innovative small and medium sized companies. *J. Eng. Technol. Manag.* 31, 43–57. <https://doi.org/10.1016/j.jengtecman.2013.10.004>.
- Buyle, M., Galle, W., Debacker, W., Audenaert, A., 2019. Sustainability assessment of circular building alternatives: consequential LCA and LCC for internal wall assemblies as a case study in a Belgian context. *J. Clean. Prod.* 218, 141–156. <https://doi.org/10.1016/j.jclepro.2019.01.306>.
- Cambier, C., Galle, W., De Temmerman, N., 2020. Research and development directions for design support tools for circular building. *Buildings* 10, 1–20. <https://doi.org/10.3390/buildings10080142>.
- Cooper, T., 1994. Beyond recycling: the longer life option. *New Econ. Found.* 1–22.
- Corona, B., Shen, L., Reike, D., Rosales Carreón, J., Worrell, E., 2019. Towards sustainable development through the circular economy—a review and critical assessment on current circularity metrics. *Resour. Conserv. Recycl.* 151, 1–15. <https://doi.org/10.1016/j.resconrec.2019.104498>.
- Cruz Rios, F., Grau, D., Chong, W.K., 2019. Reusing exterior wall framing systems: a cradle-to-cradle comparative life cycle assessment. *Waste Manag.* 94, 120–135. <https://doi.org/10.1016/j.wasman.2019.05.040>.
- Dahlsrud, A., 2008. How corporate social responsibility is defined: an analysis of 37 definitions. *Corp. Soc. Responsib. Environ. Manag.* 15, 1–13. <https://doi.org/10.1002/csr.132>.
- de Koeijer, B., Wever, R., Henseler, J., 2017. Realizing product-packaging combinations in circular systems: shaping the research agenda. *Packag. Technol. Sci.* 30, 443–460.
- De Wolf, C., 2017. Low Carbon Pathways for Structural Design: Embodied Life Cycle Impacts of Building Structures (Doctoral Dissertation). Massachusetts Institute of Technology, Cambridge, MA, USA.
- De Wolf, C., Hoxha, E., Fivet, C., 2020. Comparison of environmental assessment methods when reusing building components: a case study. *Sustain. Cities Soc.* 61, 1–11. <https://doi.org/10.1016/j.scs.2020.102322>.
- De Wolf, C., Pomponi, F., Moncaster, A., 2017. Measuring embodied carbon dioxide equivalent of buildings: a review and critique of current industry practice. *Energy Build.* 140, 68–80. <https://doi.org/10.1016/j.enbuild.2017.01.075>.
- Eberhardt, L.C.M., van Stijn, A., Kristensen Stranddorf, L., Birkved, M., Birgisdóttir, H., 2021. Environmental design guidelines for circular building components: the case of the circular building structure. *Sustainability* 13, 5621. <https://doi.org/10.3390/su13105621>.
- Eberhardt, L.C.M., van Stijn, A., Nygaard Rasmussen, F., Birkved, M., Birgisdóttir, H., 2020. Development of a life cycle assessment allocation approach for circular

- economy in the built environment. *Sustainability* 12, 9579. <https://doi.org/10.3390/su12229579>.
- Elia, V., Gnoni, M.G., Tornese, F., 2017. Measuring circular economy strategies through index methods: a critical analysis. *J. Clean. Prod.* 142, 2741–2751. <https://doi.org/10.1016/j.jclepro.2016.10.196>.
- EN 15804, 2012. Sustainability of Construction Works - Environmental Product Declarations - Core Rules for the Product Category of Construction Products. European Committee for Standardization (CEN), Brussels.
- En 15978, 2011. Sustainability of Construction Works – Assessment of Environmental Performance of Buildings – Calculation Method. European Committee for Standardization (CEN), Brussels.
- Geissdoerfer, M., Savaget, P., Bocken, N.M.P., Hultink, E.J., 2017. The circular economy – a new sustainability paradigm? *J. Clean. Prod.* 143, 757–768. <https://doi.org/10.1016/j.jclepro.2016.12.048>.
- Geldermans, B., Tenpierik, M., Luscuere, P., 2019. Circular and flexible indoor partitioning-a design conceptualization of innovative materials and value chains. *Buildings* 9. <https://doi.org/10.3390/buildings9090194>.
- Geraedts, R.P., Vande Putte, H.J.M., Vercouteren, J., Binnekamp, R., 2009. *Tijd*. In: Wamelink, J.W.F., Geraedts, R.P., Hobma, F.A.M., Lousberg, L.H.M.J., De Jong, P. (Eds.), *Inleiding Bouwmanagement*. VSSD, pp. 273–303.
- Guinée, J.B., Gorrée, M., Heijungs, R., Huppes, G., Kleijn, R., de Koning, A., Wegener Sleeswijk, A., Suh, S., Udo de Haes, A.H., de Bruijn, H., van Duin, R., Huijbregts, M. A.J., 2001. *Handbook on Life Cycle Assessment: an Operational Guide to the ISO Standards*. Kluwer Academic Publishers, Dordrecht.
- Hoxha, E., Jusselme, T., 2017. On the necessity of improving the environmental impacts of furniture and appliances in net-zero energy buildings. *Sci. Total Environ.* 596–597, 405–416. <https://doi.org/10.1016/j.scitotenv.2017.03.107>.
- Hoxha, E., Passer, A., Saade, M.R.M., Trigaux, D., Shuttleworth, A., Pittau, F., Allacker, K., Habert, G., 2020. Biogenic carbon in buildings: a critical overview of LCA methods. *Build. Cities* 1, 504–524. <https://doi.org/10.5334/bc.46>.
- Ibn-Mohammed, T., Greenough, R., Taylor, S., Ozawa-Meida, L., Acquaye, A., 2013. Operational vs. embodied emissions in buildings - a review of current trends. *Energy Build.* 66, 232–245. <https://doi.org/10.1016/j.enbuild.2013.07.026>.
- Kirchherr, J., Reike, D., Hekkert, M., 2017. Conceptualizing the circular economy: an analysis of 114 definitions. *Resour. Conserv. Recycl.* 127, 221–232. <https://doi.org/10.1016/j.resconrec.2017.09.005>.
- Méquignon, M., Ait Haddou, H., 2014. The construction industry and lifespan. In: *Lifetime Environmental Impact of Buildings*. SpringerBriefs in Applied Sciences and Technology. Springer, Cham, pp. 3–23. https://doi.org/10.1007/978-3-319-06641-7_1.
- Ness, D.A., Xing, K., 2017. Toward a resource-efficient built environment: a literature review and conceptual model. *J. Ind. Ecol.* 21, 572–592. <https://doi.org/10.1111/jiec.12586>.
- Pomponi, F., Moncaster, A., 2017. Circular economy for the built environment: a research framework. *J. Clean. Prod.* 143, 710–718. <https://doi.org/10.1016/j.jclepro.2016.12.055>.
- Reike, D., Vermeulen, W.J.V., Witjes, S., 2018. The circular economy: new or refurbished as CE 3.0? – exploring controversies in the conceptualization of the circular economy through a focus on history and resource value retention options. *Resour. Conserv. Recycl.* 135, 246–264. <https://doi.org/10.1016/j.resconrec.2017.08.027>.
- Sassanelli, C., Rosa, P., Rocca, R., Terzi, S., 2019. Circular economy performance assessment methods: a systematic literature review. *J. Clean. Prod.* 229, 440–453. <https://doi.org/10.1016/j.jclepro.2019.05.019>.
- Scheepens, A.E., Vogtländer, J.G., Brezet, J.C., 2016. Two life cycle assessment (LCA) based methods to analyse and design complex (regional) circular economy systems. Case: making water tourism more sustainable. *J. Clean. Prod.* 114, 257–268. <https://doi.org/10.1016/j.jclepro.2015.05.075>.
- Stichting Bouwkwaliiteit, 2019. *Bepalingsmethode milieuprestatie gebouwen en GWW-werken*. Stichting Bouwkwaliiteit, Rijswijk.
- van Stijn, A., Eberhardt, L.C.M., Wouterszoon Jansen, B., Meijer, A., 2021. A circular economy life cycle assessment (CE-LCA) model for building components. *Resour. Conserv. Recycl.* 174, 1–34. <https://doi.org/10.1016/j.resconrec.2021.105683>.
- van Stijn, A., Eberhardt, L.C.M., Wouterszoon Jansen, B., Meijer, A., 2020. Design guidelines for circular building components based on LCA and MFA: the case of the Circular Kitchen. *IOP Conf. Ser. Earth Environ. Sci.* 588, 1–8. <https://doi.org/10.1088/1755-1315/588/4/042045>.
- van Stijn, A., Gruis, V., 2020. Towards a circular built environment: an integral design tool for circular building components. *Smart Sustain. Built Environ.* 9, 635–653. <https://doi.org/10.1108/SASBE-05-2019-0063>.
- Vandenbroucke, M., Galle, W., De Temmerman, N., Debacker, W., Paduart, A., 2015. Using life cycle assessment to inform decision-making for sustainable buildings. *Buildings* 5, 536–559. <https://doi.org/10.3390/buildings5020536>.
- Wernet, G., Bauer, C., Steubing, B., Reinhard, J., Moreno-Ruiz, E., Weidema, B., 2016. The ecoinvent database version 3 (part I): overview and methodology. *Int. J. Life Cycle Assess.* 21, 1218–1230. <https://doi.org/10.1007/s11367-016-1087-8>.
- Wouterszoon Jansen, B., van Stijn, A., Gruis, V., van Bortel, G., 2020. A circular economy life cycle costing model (CE-LCC) for building components. *Resour. Conserv. Recycl.* 161, 104857. <https://doi.org/10.1016/j.resconrec.2020.104857>.