

Ground Improvement Techniques for Constructing Infrastructural Embankments on Soft Soils in the Netherlands

Part 1 - General Study on Ground Improvement Techniques

Part 2 - Experimental Study on the Innovative Concept of Mini Drains

H. Wildeboer



Ground Improvement Techniques for Constructing Infrastructural Embankments on Soft Soils in the Netherlands

PART 1 - GENERAL STUDY ON GROUND IMPROVEMENT TECHNIQUES
PART 2 - EXPERIMENTAL STUDY ON THE INNOVATIVE CONCEPT OF MINI DRAINS

by

H. Wildeboer

in partial fulfillment of the requirements for the degree of

Master of Science
in Civil Engineering

at the Delft University of Technology,
to be defended publicly on Thursday October 26, 2017 at 03:00 PM.

Thesis committee:	Dr. ir. W. Broere,	TU Delft Geo-Engineering
	Prof. dr. C. Jommi,	TU Delft Geo-Engineering
	Ir. K. J. Reinders,	TU Delft Hydraulic-Engineering
	Ir. J. Dijkstra,	Cofra B.V.

This thesis is confidential and cannot be made public until October, 2019.

PREFACE

This report is the product which finalises my master study Civil Engineering at the Delft University of Technology. This thesis concerns the subject ground improvement techniques for constructing infrastructural embankments on soft soils. An interesting topic with worldwide relevance and numerous links to geotechnical engineering.

First of all I would like to thank my graduation committee for their time, and input during my thesis project. Wout Broere and Cristina Jommi for their scientific view and contributions, and Kristina Reinders for her personal touch, ideas and reviewing work. Furthermore, I would like to thank Cofra B.V. for the pleasant time and their encouraging attitude to innovations. In particular I would like to thank Jeroen Dijkstra and René Bodamer for their help, input, motivational words, and numerous interesting discussions during the thesis project.

Last but not least, I would like to thank my parents, brother and sister, girlfriend, and friends for their support during my study. Enjoy reading.

*H. Wildeboer
Delft, October 2017*

ABSTRACT

Worldwide numerous ground improvement techniques (GIT) are available to improve soil conditions and maintain functional requirements of the infrastructure by limiting residual and differential settlements. This research focusses on innovations and optimisations regarding GIT for constructing infrastructural embankments on soft soils in the Netherlands.

A preliminary study on GIT was performed to refine the research scope and observe potential optimisations and innovations, whereas an assessment compared GIT based on future potential, economy, implementation and performance. Three GIT proved to be most promising: (i) lightweight mixed soil, (ii) anchor drains, and (iii) mini drains. With mini drains multiple permeable elements with reduced discharge capacity are installed simultaneously in a small spacing. This innovative concept was selected because it captures important optimisation possibilities regarding consolidation with prefabricated vertical drains (PVD): cost reduction by decreasing the drain size or quality, and acceleration of consolidation by applying an extreme small drain spacing. The remainder of this research studied well-resistance and smear effects using literature, analytical formulations, the finite element software Plaxis, and small-scale consolidation and discharge capacity experiments.

The consolidation process is not affected by well-resistance as long as the drain capacity exceeds the required capacity for consolidation. With a linear elastic (LE) method was verified that the required capacity increases with horizontal permeability and layer thickness. Compared to non-linear soil models, the LE method provided a conservative estimation for the required capacity. The drain capacity exceeded the required capacity with a factor 230 to 3, and 300 to 15 for a varying layer thickness (5 to 30 m) and horizontal permeability ($1E-10$ to $1E-9$ m/s) respectively. A safety margin is required because the drain capacity decreases in time, whereas the required capacity is independent of time. The required safety margin is unknown because laboratory and field conditions differ significantly. Despite the previous, cost optimisation is possible by reducing the drain size or quality because the drain over-capacity is substantial for most considered cases. A full-scale experiment is recommended to determine the reduction of drain capacity in time. The performance of three mini drain types were compared with experiments: (i) mini Mebradrain (MMD), (ii) wool drain (WD), and (iii) wool drain with a filter sleeve (WDF). The observed consolidation rates were lower than predicted for all consolidation tests. The delay was attributed to a filter cake which developed on the drain-soil interface. The MMD performed as good as the WDF during consolidation, whereas the WD and WDF performed significantly less during the discharge capacity tests. The previous implies that the WDF capacity was sufficient and that over-capacity was available in the MMD. Additional small-scale experiments are recommended to study consolidation with just (in)sufficient drain capacities.

The rate of consolidation is delayed through remoulding of the soil structure during the drain installation procedure. Minimisation of this so-called smear effect and acceleration of consolidation is possible by reducing the installation speed and mandrel size. According to literature, a drain spacing below 0.50 m is not beneficial for the consolidation time because the reduction in radial drainage path is dominated by the effect of interacting smear zones. An explanation for this statement was not provided by literature because the reduction in permeability is only assigned to remoulding of the anisotropic soil structure. This simplification is valid for large spacing, but seems incorrect for small spacing because it neglects the change in void ratio through the added drain volume. The experiments on overlapping smear zones could not confirm nor reject the previous hypothesis because the results were biased through unexpected preferential flow. It is recommended to perform a field test to study the relation between drain spacing and overlapping smear zones.

Although a comparison between mini drains and currently existing PVD is not included, this research on the concept of mini drains triggers development of PVD because the most important fields of optimisation and uncertainties are considered. Cost optimisation is possible by reducing the drain capacity, whereas more research is required on the reduction in drain capacity in time, and the effect of overlapping smear zones.

DEFINITIONS AND SYMBOLS

A_w, A_{uc}	Cross-sectional surface area drain, Cross-sectional surface area unit cell	m^2
C'_{ref}	Cohesion at reference stress level	kN/m^2
C_c, C_α, C_r	Compression index for primary deformations, Compression index for secondary deformations, Re-compression index for unloading and reloading	–
c_h, c_v	Horizontal coefficient of consolidation, Vertical coefficient of consolidation	m^2/s
$C_k, C_{ks}, C_{kd}, C_{kf}$	Relation between hydraulic conductivity and deformation: Soil, Drain, Filter cake	–
D_s, D	Drain spacing, Drain spacing adjusted for installation pattern	m
e, e_0, de	Void ratio: Initial void ratio, Change in void ratio	–
E_{oed}	Oedometer stiffness	m^2/kN
FOS	Safety factor for minimum required drain discharge capacity	–
z, H, H_0	Depth coordinate, Layer thickness, Initial layer thickness	m
i	Vertical hydraulic gradient in drain	–
k, k_h, k_v, k_s, k_w	Hydraulic conductivity, horizontal hydraulic conductivity, vertical hydraulic conductivity, hydraulic conductivity in the smear zone, hydraulic conductivity in the drain	m/s
l	Length of drain	m
m_v	Volumetric compressibility	m^2/kN
n	Extent ratio unit cell (r_e/r_w)	–
OCR	Over consolidation ratio: σ'_p/σ'_{ov}	–
Q	Rate of water flow	m^3/s
Q_v	Amount dissipated water volume	m^3
$q_w, q_{w0}, q_{w.req}$	Discharge capacity, initial discharge capacity, required discharge capacity	m^3/s
r, r_e, r_s, r_w, r_m	Radial coordinate, unit cell radius, constant smear zone radius, drain radius, mandrel radius	m
s, s_x	Extent ratio for constant, and overlapping smear zone (r_s/r_w)	–
S, S_{final}	Settlement, final settlement after consolidation	m
t, t_0, t_{90}	Time, Initial time, Time at $U = 0, 9$	s
T_h	Dimensionless time factor	–
U	Average degree of consolidation	–
u, u_0	Excess pore water pressure, Initial excess pore water pressure	kN/m^2
w, PL, LL, PI	Water content, Water content at Plastic limit, Water content at Liquid limit, Plasticity index	%
ϕ', ψ'	Friction angle, Dilatancy angle	$^\circ$
ν'	Poissons ratio	–
$\gamma_w, \gamma_{sat}, \gamma_{dry}$	Unit weight: Water, Soil below phreatic level, Soil above phreatic level	kN/m^3
κ, κ_x	Hydraulic conductivity ratio for constant, and overlapping smear zone (k_h/k_s)	–
λ^*, κ^*	Modified compression index, Modified swelling index	–
μ_x	Reduction factor for consolidation $\mu_x = \mu_{spacing} + \mu_{well} + \mu_{smear} + \mu_{filter}$	–
$\mu_{spacing}$	Reduction factor for consolidation - Drain spacing	–
μ_{well}	Reduction factor for consolidation - Well-resistance	–
μ_{smear}	Reduction factor for consolidation - Smear zone ($\mu_0, \mu_1, \mu_2, \mu_3$)	–
μ_{filter}	Reduction factor for consolidation - Filter cake	–
$\mu_0, \mu_1, \mu_2, \mu_3$	Reduction factor consolidation for smear - No smear zone, Constant smear zone, Linear smear zone, Linear overlapping smear zone	–
$\sigma'_v, \sigma'_{0v}, \sigma'_p$	Vertical effective stress, Initial vertical effective stress, Pre-consolidation stress	kN/m^2

CONTENTS

Preface	iii
Abstract	v
Definitions and Symbols	vii
1 Introduction	1
1.1 Research Questions and Methodology	3
1.2 Part I - General Study on Ground Improvement Techniques	4
1.3 Part II - Experimental Study on the Concept of Mini Drains	4
I General Study on Ground Improvement Techniques	5
2 Ground Improvement Techniques	7
2.1 Type A - Without Admixtures in Non-Cohesive Soils	7
2.2 Type B - Without Admixture in Cohesive Soils.	8
2.3 Type C - With Admixtures or Inclusions	12
2.4 Type D - With Grouting Type Admixtures	15
2.5 Type E - Earth Reinforcement	17
2.6 Conclusion	17
3 Assessment	19
3.1 Group 1 - Load Reduction using Lightweight Construction Materials	22
3.2 Group 2 - Acceleration of Consolidation using Preloading and Enhanced Drainage	23
3.3 Group 3 - Load Redistribution using Columnar Inclusions	24
3.4 Group 4 - Soil Modification using Mixing Methods	25
3.5 Conclusion	26
II Experimental Study on the Concepts of Mini Drains	29
4 Consolidation with Mini Drains	31
4.1 Basic Analytical Solution for Consolidation	31
4.2 Smear Effect and Drain Installation	33
4.3 Well-Resistance and Drain Capacity.	35
4.4 Compressibility of Remoulded Soils.	37
5 Research Methodology	41
5.1 Preparation Experiments	43
5.2 Experiments Without Drains	44
5.3 Experiments on Well-Resistance and Drain Capacity	45
5.4 Experiments on the Smear Effect	46
5.5 Analytical Solutions	47
5.6 Finite Element Method Plaxis	50
6 Results and discussion	53
6.1 Experiments Without Drains	54
6.2 Discharge Capacity and Well-Resistance	55
6.3 Experiments with Mini Drains on Well-Resistance	61
6.4 Smear Effect and Experiments	66
7 Conclusion	69
8 Recommendations	71
Bibliography	73

III Appendices	77
A Ground improvement techniques	79
B Assessment on ground improvement techniques	83
B.1 Assessment student	84
B.2 Assessment internal professionals	85
B.3 Assessment external professionals	87
C Oedometer test results	89
C.1 General overview results	90
C.2 Results Oedometer A	93
C.3 Results Oedometer B	95
C.4 Results Oedometer C	97
D Experimental testing results	101
D.1 Vertical consolidation without drains	102
D.2 Consolidation using a mini Mebradrain.	105
D.3 Consolidation using a wool drain	108
D.4 Consolidation using a wool drain encased with a filter	111
D.5 Consolidation using three mini Mebradrains	114
D.6 Consolidation using three wool drains with filter	117
D.7 Consolidation using a mini Mebradrain with preconsolidation	120
D.8 Consolidation using a mini Mebradrain and fake drains with preconsolidation	123
D.9 Consolidation using three mini Mebradrains with preconsolidation	126
E Plaxis models	129
E.1 Experiments - Soft soil	130
E.2 Default case for discharge capacity - Linear elastic	131
E.3 Default case for discharge capacity - Soft soil	132

1

INTRODUCTION

Approximately 17,000,000 people live in the Netherlands at an surface area of only $41,543 \text{ km}^2$. All these people use a dense infrastructural network to move themselves or transport products from one place to another. High quality highways, regional roads, and train tracks are needed for transportation of goods, user safety and friendliness. The Dutch infrastructure is therefore maintained and extended each year in order to meet quality demands of the society. One of the most important aspects which affects the long-term performance is the subsoil on which the infrastructure is build.

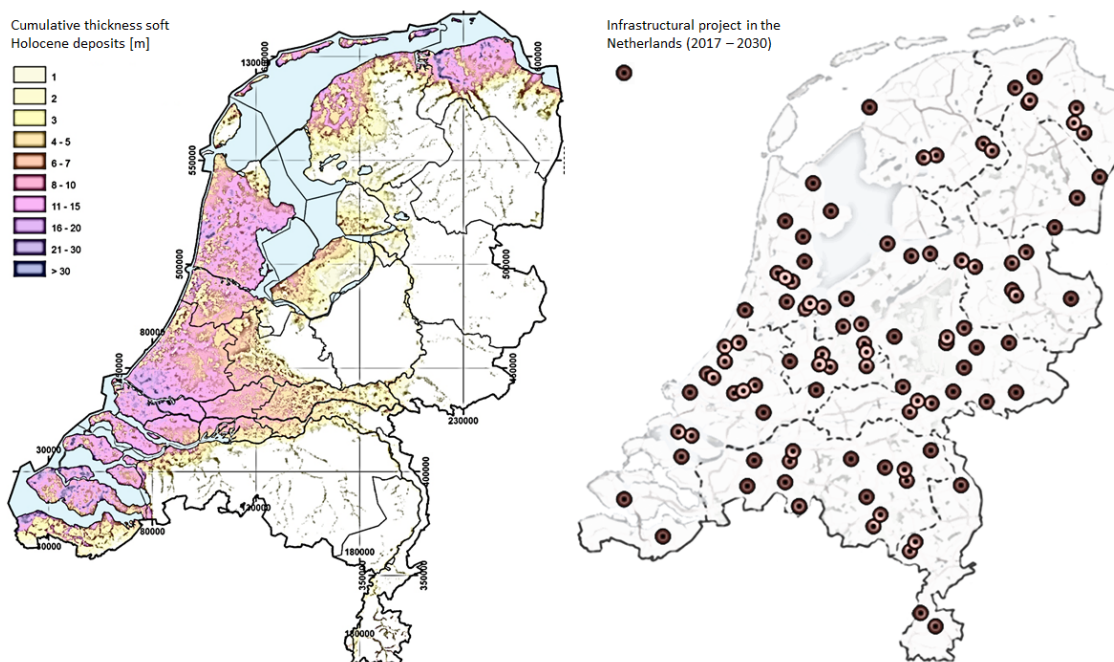

Figure 1.1: Relevance for ground improvement techniques in the Netherlands: (left) cumulative thickness of soft Holocene deposits, (right) planned infrastructural projects for 2017 - 2030.

In the Netherlands the superficial soil layers were formed in the Holocene (11,700 - present) and the Pleistocene (2,588,000 - 11,700 years ago) epoch [1, 2]. The Pleistocene was characterised by alternating cold and moderate warm periods in which alluvial (course to fine granular materials and clay), marine (fine sediments like silt and clay), and glacial deposits (moraines, boulder clay, and the so-called 'Potclay') were deposited in the Netherlands. A significant portion of the Pleistocene depositions are over-consolidated due to former glaciers (north) and low ground water tables (south), and therefore relative incompressible. The Holocene was characterised by higher temperatures, a rising sea level and groundwater table in which 'De Formatie

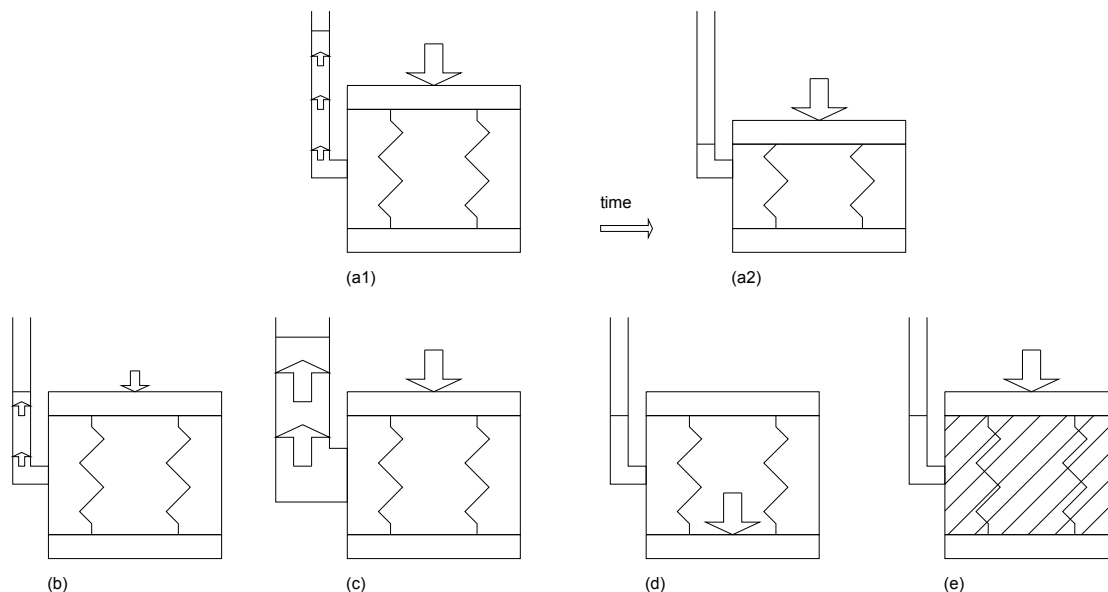

Figure 1.2: Problem definition and ground improvement principles regarding the construction of embankments on soft soils: (a1) low rate of consolidation, (a2) large final deformations, (b) load reduction using lightweight construction materials, (c) acceleration of consolidation using preloading and enhanced drainage, (d) load redistribution using columnar inclusions, (e) soil modification using mixing techniques.

van Nieuwkoop' (Peat), 'De Formatie van Naalwijk' (marine deposition: silt, clay, and dunes), and 'De Formatie van Echteld' (alluvial deposition: coarse to fine granular materials and clay) were formed. Most of the Holocene depositions are not suitable as a foundation layer for infrastructural embankments because these soils are characterised by low shear strength at low confining pressure, low hydraulic conductivity, and high primary and secondary compressibility [3]. Ground improvement techniques are needed to maintain functional requirements of the infrastructure by limiting residual and differential settlements of embankments founded on soft soils. Figure 1.1 shows the relevance of ground improvement techniques by indicating the cumulative thickness of the soft Holocene depositions and the planned infrastructural projects (2017 - 2030) in the Netherlands. Numerous projects are planned in areas at which ground improvement techniques are needed to improve the characteristics of the soil. Four ground improvement principles are available for constructing embankments on soft soils and which are elaborated in figure 1.2.

- Load reduction using lightweight construction materials
- Acceleration of consolidation using preloading and enhanced drainage
- Load redistribution using columnar inclusions
- Soil modification using mixing methods

The first ground improvement principle minimises or prevents additional loading of underlying soft soil, by (partially) replacing soil with lightweight construction materials. This load compensation principle is especially effective for constructing low embankments founded on highly compressible soils. Lightweight materials are also applicable in situations where construction time is limited, where adjacent structures cannot be affected by settlements induced by typical embankment loads, and as backfill behind retaining structure to reduce horizontal earth pressures. Lightweight construction materials are especially applied at small scale, and often in combination with other solutions because material cost are high [4]. In the second ground improvement principle the consolidation process itself is used to improve strength and stiffness properties of soft soils. The time-demanding consolidation process is accelerated with preloading and prefabricated vertical drains. The drains enhance dissipation of excess pore water pressure generated during preloading, because the drainage path is reduced and the direction of water flow is changed from vertical to mainly horizontal. These effects are beneficial because consolidation time and drainage path length have a quadratic rela-

tion, and horizontal permeability is greater compared to vertical permeability due to depositional anisotropy. Prefabricated vertical drains combined with preloading are widely applied when construction time is available, and creep deformations are limited and stay within the project requirements [3]. With the third ground improvement principle columnar inclusions combined with a reinforced embankment, also known as a piled embankment, are applied to reduce loads on soft layers by redistributing them to deeper bearing strata. The embankment is reinforced at its base with horizontal layers of Geogrid alternated with granular material to redistribute loads towards the rigid inclusions based on the soil arching principle. A piled embankment is expensive, but is, especially for high embankments, often also the only remaining solution in the Netherlands when primary and secondary deformations are excessive. With the last ground improvement principle soil properties are modified by mixing the soil with binders like cement, lime, or others to stabilize a soil mass. With soil stabilisation construction time is limited, and residual and differential settlements are reduced, because both soil stiffness and strength are improved quickly. The mixing techniques are not commonly applied in the Netherlands but are very popular in Scandinavia.

Worldwide numerous ground improvement techniques are available to improve soil conditions for constructing infrastructural embankments on soft soils. Most of these ground improvement techniques were developed long ago, but innovations and optimisations are still taking place nowadays because both clients and contractors benefit from developments which lower costs, reduce construction time, and improve quality of the ground improvement. This introduces the topic of this master thesis because there could be room for innovation and optimisation within the world of ground improvement techniques.

1.1 RESEARCH QUESTIONS AND METHODOLOGY

In the introduction was show that there are four ground improvement principles available for constructing infrastructural embankment of soft soils. These principles are represented by numerous techniques with potential for innovation and optimisation. The following main research question was formulated to aid the study on innovative ground improvement techniques:

Main research question:

Are there new / innovative ground improvement techniques for constructing high infrastructural embankments on soft soils which could compete with the current Dutch market?

To answer the main research questions, the master thesis was subdivided in a general study on ground improvement techniques for constructing infrastructural embankments on soft soils and an elaboration on a specific ground improvement technique (mini drains) for constructing infrastructural embankments on soft soils.

Research question part I:

What ground improvement techniques are available for constructing high infrastructural embankments on soft soil, and for which promising technique could additional research result in an opportunity for implementing the technique in the Netherlands?

Research question part II:

How is the consolidation process affected when multiple vertical permeable elements (mini drains) are installed simultaneously in a small spacing, and can this new type of drain compete with the conventional prefabricated vertical drains?

1.2 PART I - GENERAL STUDY ON GROUND IMPROVEMENT TECHNIQUES

The general study on ground improvement techniques was performed to get familiar with ground improvement techniques and observe potential innovations and optimisations. Available and innovative ground improvement techniques were reviewed and compared with traditional solutions based on literature and assessed based on future potential, economy, performance and implementation. The general study selected one of the most promising techniques for which an additional research could lead to innovation or further optimisation.

Sub-questions part I:

1. *What is the principle of the ground improvement technique, and which uncertainties regarding design, installation and performance are involved?*
2. *What are the engineering, material and installation costs of the ground improvement techniques?*
3. *What are the benefits of the implementation procedure when construction time, ground stability, EMVI score, and environmental alteration are considered?*
4. *What are the performance benefits when residual settlements, differential settlements, material degradation, and the ecological footprint are considered?*

1.3 PART II - EXPERIMENTAL STUDY ON THE CONCEPT OF MINI DRAINS

The experimental study on the concept of mini drains was performed to obtain insight in the innovative concept of mini drains. With mini drains multiple permeable elements are installed simultaneously in a small spacing to enhance fast dissipation of excess pore water pressure. Three hypotheses regarding the traditional solution with prefabricated vertical drains formed the basis for the research on mini drains: (i) cost optimisation is possible by reducing the drain discharge capacity (well-resistance), (ii) acceleration of consolidation is possible by minimising soil disturbance during drain the installation procedure (smear effect), and (iii) acceleration of consolidation is possible by reducing the drain spacing and including the effect of overlapping smear zones (smear effect).

To answer the following sub-research questions the effect of well-resistance and overlapping smear zones was studied based on literature, analytical formulations, Plaxis, and small scale consolidation and discharge capacity experiments.

Sub-questions part II:

1. *What is the impact of the mini drain properties on the consolidation process?*
2. *What is the influence of soil disturbance in the (overlapping) smear zones on the consolidation process?*
3. *How do mini drains perform compared to conventional prefabricated vertical drains?*

I

GENERAL STUDY ON GROUND IMPROVEMENT TECHNIQUES

2

GROUND IMPROVEMENT TECHNIQUES

Worldwide many different ground improvement techniques (GIT) are available to improve soil conditions for construction works. The standardized classification framework, proposed by Chu (2009) and adopted by the Technical Committee 211 (TC211) [5], was used for the literature study on ground improvement techniques (GIT), see appendix A. The most important GIT for soft soils and some innovative ideas were discussed and clarified in the following sections. Ground improvement techniques with potential were selected and categorized according to figure 1.2 for the applicability assessment.

- Type A – Ground Improvement without admixtures in non-cohesive soils or fill materials
- Type B – Ground Improvement without admixtures in cohesive soils
- Type C – Ground Improvement with admixtures or inclusions
- Type D – Ground Improvement with grouting type admixtures
- Type E – Earth reinforcement

2.1 TYPE A - WITHOUT ADMIXTURES IN NON-COHESIVE SOILS

Ground improvement techniques applicable in non-cohesive soils without admixtures are (A1) Dynamic compaction, (A2) Vibro compaction, (A3) Explosive compaction, (A4) Electric pulse compaction, and (A5) surface compaction. These techniques decrease potential liquefaction, and increase stiffness and bearing capacity of non-cohesive soils by rearranging soil particles into a denser state.

Dynamic compaction (DC), invented by Louis Menard in the late 1960's, densifies the subgrade by dropping a heavy weight (15 – 40 *t*) from air (10 – 30 *m*) onto the ground. The impact creates stress waves that densify granular soil up to a depth of 10 *m*. High energy DC is performed to densify soils at greater depths than 10 *m* using more energy through heavier drop weights, and higher dropping heights. The technique is particular effective in loose sand and gravel but is not applicable in cohesive soils. With vibro compaction (VC) non-cohesive soil is densified by inserting a horizontally vibrating probe into the ground. Through the vibrations excess pore water pressures (EPWP) are generated and the effective inter particles stresses are reduced temporally which causes densification. Vibro compaction is applicable onshore and offshore for granular materials with fine contents below 10-15 %, until depths of more than 60 *m* [6, 7]. The upper 2-3 *m* with VC and DC are not densified because overburden pressure is needed for the rearrangement of particles and lacking in these upper zones. Granular soils near the ground surface are compacted with roller compaction (static load, 1-2 *m*), polygonal drum (vibratory load, 3-4 *m*), high energy impact compaction (impact load, 3-4 *m*). The depth of influence of these surface compaction methods is limited because the applied energy is low and applied at ground surface. A variant between DC and surface compaction is rapid impact compaction (RIC). This technique, also known as Cofra dynamic compaction (CDC), uses a hydraulically accelerated weight (9 – 16 *t*) to induce shear and compression waves approximately 40 times a minute. Using CDC non-cohesive soils are compacted up to a depth of 6 to 7 *m* when the fine content is not exceeding 10-15 %. Densification in non-saturated soil is obtained because shear resistances between soil particles are exceeded, whereas in

the saturated zone effective stresses are reduced because the pore water pressure increases during passage of the compression wave. During the passage of the shear wave, the EPWP is not completely dissipated which assists on the actual densification [8]. The more unconventional techniques of explosive compaction and electric pulse compaction are not commonly applied but are based on similar principles, namely densification of granular materials using energy waves. With explosive compaction shock waves and vibrations are generated by blasting of explosives. Disadvantages of explosive compaction are that the technique is mainly based on experience rather than theory, and the technique is not applicable in urbanized areas. However, the method is inexpensive, and effective for mitigating liquefaction of hydraulically placed sands [3]. Electric pulse compaction densifies the soil using the shock waves and energy generated by electric pulses at different depths. The effectiveness of this last technique is yet unproven [5].

These techniques are not applicable in soft cohesive soils, and therefore outside the scope of this research. However, a brief discussion was included for completeness and because some concepts were used within other GIT which are applicable in soft soils.

2.2 TYPE B - WITHOUT ADMIXTURE IN COHESIVE SOILS

Ground improvement techniques in cohesive soil without admixtures are subdivided in seven categories, namely (B1) Replacement and Displacement, (B2) Preloading using fill, (B3) Preloading using vacuum, (B4) Dynamic drainage consolidation, (B5) Electro-osmotic consolidation, (B6) Thermal stabilization, and (B7) Hydro-blasting compaction.

REPLACEMENT WITH LIGHTWEIGHT CONSTRUCTION MATERIALS

The simplest methods within category B is the replacement method where bad soil is excavated and replaced with suitable construction materials like sand or rock aggregates. In situations where soft soils are removed completely, replacement is a successful solution because post-construction deformations of treated granular soils are negligible. Where thick soft soil layers are encountered only partial replacement is feasible. In these situations lightweight materials like expanded polystyrene (EPS) ($15 - 40 \text{ kg/m}^3$) or pumice (800 kg/m^3) are often applied to minimise or prevent additional loading of underlying soft strata. This load reduction principle is especially effective for constructing low embankments founded on highly compressible soils like peat. Lightweight materials are also applied in situations where construction time is limited, where adjacent structures cannot be affected by settlements induced by typical embankment loads, and as backfill material behind retaining structures to reduce horizontal earth pressure [4]. The ecological footprints of conventional lightweight construction materials is significant because EPS is non-natural (recycled) material and pumice is imported from elsewhere.

An interesting development in Asia concerning lightweight construction materials is the lightweight mixed soil (LWMS) which consist of dredged material, foaming agent, water and a curing agent. Hou (2015) described a mixture using EPS particles, and several other authors described usage of foamed air bubbles [10–13]. In an extensive case study was described that LWMS was successfully applied as back-fill material behind a retaining structure with a total volume of 20,000 m³. Large particles and organic content were removed, water and a curing agent were added and mixed into a homogeneous slurry before pre-foamed air bubbles were included. Hereafter, the lightweight mixture was poured in layers of 0.60 m and sealed using vinyl to prevent evaporation of water from the mixture. The limited layer thickness allowed for quality control and was needed to reduce segregation and collapse of air cells. After five days curing another layer of LWMS was poured. Density of LWMS varied between 830 kg/m^3 and 1200 kg/m^3 for air-dried and water-soaked specimen. Permeability was recorded to be $4.86\text{E-}6 \text{ cm/s}$, and the unconfined compression strength after one month was 500 kN/m^2 and slightly higher after five months. Strength depended significantly on the location of sampling which means that homogeneity of LWMS was not guaranteed [12]. A different type of LWMS which overcomes the problem of strength and density heterogeneity is the so-called Air-Trapped soil (ATS). A cement hardening agent, a foaming agent, and sand are mixed in a factory. Because pre-selected sand is used rather than in situ soil, uniformity of ATS is higher compared to LWMS because airbubble formation depends on soil type [13].

In the Netherlands lightweight viscous mixtures are especially applied as backfill materials behind retaining structures, and in specific situations like old sewerage or basements. Interestingly enough, none of the

suppliers considered mixing their product with waste or dredged materials like was done in Asia. Therefore, LWMS is an interesting topic for additional research because there is no experience and knowledge on LWMS in the Netherlands, and it could potentially compete with the standard lightweight construction materials. In the applicability assessment group 1, load reduction using lightweight construction materials, EPS, Pumice and LWMS were compared based on future potential, economy, implementation and performance.

PRELOADING USING FILL AND PREFABRICATED VERTICAL DRAINS

Preloading using surcharge and prefabricated vertical drains (PVD) is well-known, and widely applied to accelerate consolidation of soft soils. The drains enhance dissipation of EPWP generated during preloading, because (i) the drainage path is reduced and (ii) the direction of water flow is changed from vertical to mainly horizontal. These effects are beneficial because consolidation time and drainage path length have a quadratic relation, and horizontal permeability is greater compared to vertical permeability due to depositional anisotropy [3].

An major limitation regarding the preloading method, especially in organic soils, are the secondary deformations, because loads are permanently increased. In situations where secondary deformations are excessive, a solution with lightweight construction materials or a piled embankment is often the only remaining option. Another important limitation regarding the preloading method is construction time. Although consolidation is extremely accelerated with respect to original situation, the preloading method is still time consuming, because the surcharge height is bound to practical limits. Large amounts of surcharge material are needed, transported and placed in different stages to limit EPWP and prevent slope instability. Another crucial reason which tempers the consolidation rate is related to disturbance of the soil structure during installation of a PVD with a steel mandrel (120 x 60 mm). A remoulded zone around the mandrel, also known as the smear zone, is created in which soil permeability is reduced and the stress-strain behaviour is changed significantly. Despite many research projects no real consensus exists on the extent, amount, and spatial distribution of remoulding around the drain. However, it is widely accepted that smear effect increases with mandrel size and installation speed, and has a detrimental effect on the consolidation rate [14–18]. In current practice a minimum spacing of 0.85 m is used, whereas research observed a minimum spacing of approximately 0.50 m, i.e. 7 to 10 times the equivalent mandrel radius, below which the consolidation rate did not increase [19]. With a theory on linear overlapping smear zones a conceptual explanation was provided for this observation [20]. Indraratna and Walker (2007) assumed that further acceleration of consolidation is not possible because the altered hydraulic permeability will dominate the benefit of a reduced spacing. It was however also recognized that it is not fully understood how the consolidation rate is affected when spacings are applied far beyond the threshold spacings. It sounds reasonable that the consolidation rate increases when spacings are applied far beyond the current threshold spacings. The discharge capacity of PVDs is very important for the rate of consolidation because it is determinative for the ease of EPWP dissipation. It is widely accepted that the discharge capacity reduces with confining pressure and decreases in time due to clogging and PVD deformations [21–24]. Nowadays, PVD are well developed and have extremely high discharge capacities to minimise long-term well-resistance in deformed and un-deformed orientation. For example, PVD installed in a triangular grid with a spacing of 1.0 m allow, based on a discharge capacity of 100 ml/s, for settlements up to 2.75 m/day. Unfortunately, observed consolidation rates are much lower which means that the current PVD are cost ineffective because the discharge capacities are over dimensioned.

The observations regarding (i) slope stability problems with preloading, (ii) the smear zone – mandrel size relation, (iii) hypothesis on the potential benefit of extreme PVDs spacings, and (iv) the mismatch between discharge capacity and consolidation rate are important, because improvement of a well-developed concept seems possible. Based on the previous observations three innovative concepts were considered and elaborated below.

The first considered innovative concept were the anchor drains. This concept originated from the observation regarding the slope stability problem. The effectiveness of surcharge fill is maximum just after placement, therefore consolidation time is reduced significantly with higher preloading rates. However, a time consuming staged construction for the embankment is needed to limit EPWP development and thereby prevent slope stability problems. A loading rate of 0.5 m/week is often used as a first approximation for loading schedule, which means that already 8 weeks are needed to construct a preloading embankment of 4.0 m. The potential benefit of the anchor drains is that a high tensile strength prefabricated vertical anchor drain al-

low for faster application of surcharge loading. Resistance against slope failure is higher because the anchor drains are intersecting with failure planes. Alternatives for anchor drains are horizontal geogrids placed on ground surface or stone columns. However, neither of them combines enhanced draining and quick installation advantages. It is currently unknown what the impact of a grid of high tensile strength anchor drains is on slope stability. The anchor drain is comparable to soil nailing but additional research is definitely needed because it combines different concepts. The second considered innovative concept were the radial drains. This concept originated from the observations regarding the minimum spacing, and the impact of smear on the rate of consolidation. As stated before, a disturbed zone with lower permeability is generated during the drain installation procedure with steel mandrel. The radial drain consist of a main drain with numerous radial draining branches. These branches penetrate the soil in radial direction during a pull-back operation. The potential benefit of these branches is that they could drain outside the main smear zone and enhance dissipation of EPWP. The individual smear zones of these draining branches are less decisive because the dimensions of the radial penetrating mandrels are smaller. Despite these promising concepts, the installation procedure, the production process, and the calculation method of radial drains are unknown which means that additional research is required. The third and last considered innovative concept was the Mini drains. This concept originated from the observations regarding the minimum spacing, the impact of smear on the rate of consolidation, and the mismatch between drainage capacity and the consolidation rate. The idea of Mini drains is that multiple permeable elements are installed simultaneously in a small spacing to enhance fast dissipation of EPWP. The three observations allow for optimisation because the intended installation procedure and the drain characteristics are different compared to the current PVDs. It is unknown how Mini drains affect the consolidation process and additional research is needed.

Although PVDs are well-developed and widely applied worldwide and within the Netherlands, optimisation based on the principles of anchor drains, radial drains, and mini drains variants seems possible. In the applicability assessment group 2, acceleration of consolidation using preloading and enhanced drainage, the three innovative concepts were compared to the conventional PVDs based on future potential, economics, implementation and performance.

PRELOADING USING VACUUM

Vacuum consolidation was first introduced in Sweden by Kjellman (1952), nowadays it has proven its value and is applied worldwide [16]. In traditional consolidation procedures an increase in effective stress is obtained by dissipating excess pore water using surcharge loading. In vacuum consolidation an increase in effective stress is obtained by reducing pore water pressure using vacuum pumps. Many authors state that vacuum pressures of 80 kN/m^2 or even above can be maintained for long periods [25, 26], however the average vacuum pressure is lower than the observed pressure at the vacuum pump. The effectiveness of vacuum consolidation depends on the groundwater level and can be only 50% to 40% instead of the often quoted 80% which means that it equivalent to a surcharge load of approximately 40 to 50 kN/m^2 . An interesting improvement is to increase the average vacuum effectiveness by applying vacuum at multiple depth. However, the equivalent loading will always be lower than the physical limit of 100 kN/m^2 .

A major advantages of vacuum loading is that a reduced staged construction is needed because no EPWP is generated which affects slope stability [27]. Actually, overall ground stability increases because pore water pressures decreases, therefore vacuum loading is not only applicable as surcharge but also as stabilization method. The effective stress path for vacuum consolidation is close to isotropic consolidation for a soil element at ground surface, and converges to 1D consolidation with increasing depth [28]. Many authors state that inward soil movement due to isotropic consolidation is one of the drawbacks of vacuum consolidation because adjacent structures are potentially affected. However, the inward movement is easily compensated by combining vacuum consolidation with surcharge fill which means that vacuum preloading is a suitable mitigation measure for excessive outward soil displacement [29]. Another misconception is that vacuum consolidation can only be applied until a depth of 10 m, several case studies showed that vacuum preloading is effective until a depth of 20 m or deeper [30].

Different techniques are available to apply vacuum pressure, namely the membrane method, the IFCO method, and the BeauDrain-(S) method. In the membrane method vacuum pressure is applied at ground surface underneath an airtight membrane, usually made of PVC, entrenched below the groundwater water level. A drawback is that local air leakage affects the vacuum pressure for the whole area. In the second method

horizontal drains are installed at the bottom of sand trenches. In each trench a venturi pump is lowered to subtract soil water and apply vacuum pressure of 70 kN/m^2 maximum. Advantages are that vacuum pressure is applied at large surfaces areas, trenches work independently, and sand trenches aid bearing capacity. Disadvantages are that soil spoil is enormous, installation depth is limited to 7 m , and no air tight sealing is used at ground surface to prevent air leakage. In the Beaudrain-(S) method vacuum pressure is applied in specially developed vertical drains. For the Beaudrain method an airtight system is obtained by applying vacuum in a shallow trench below the groundwater table which is sealed using impermeable material like clay. For smaller projects the Beaudrain-S is more suitable. In this variant an airtight system is obtained using a thylene hose. Again, the connection is located underneath the water table in the soft soil preventing air leakage. At ground surface the Beaudrain-S drains are coupled with horizontal hoses and connected to vacuum pumps. Advantages of this system are that no soil is excavated and large working depths are possible.

An innovative vacuum preloading method was described by Cai, et al. (2015) where vacuum pressure was combined with a pressurized system. Vertical drains were installed in a pentagon grid, and afterwards pressurization tubes were installed in pentagon centre. In the presented case study a vacuum pressure of 80 kN/m^2 was applied and settlements were recorded. When average settlement rate was less than 2 mm/day for 10 consecutive days, pressurized air (20 kN/m^2) was injected into the ground for 15 days to enhance consolidation. Accelerated settlement rates were observed and assigned to the pressurization system for two reasons: pore water pressure was pushed towards PVDs by pressurized air bubbles, and permeability in the smear zone was increased due to rearrangement of soil particles. Interestingly enough, nothing was stated about vacuum loss during injection of pressurized air. Actually, it seems to be more effective to inject a stiff permanent low viscous liquid like is done with compaction grouting. In general the principle of a pressurization system, either pressurized air or an alternative liquid, is an expensive and comprehensive method to accelerate consolidation.

No vacuum preloading methods were included in the applicability assessment because optimisation of the conventional methods is bounded to a physical limit of 100 kN/m^2 , and the considered innovative method is expensive and comprehensive.

DYNAMIC DRAINAGE CONSOLIDATION

Dynamic consolidation with enhanced drainage, or dynamic drainage consolidation (DDC), combines the benefits of DC and PVDs. As stated before, DC is applicable in non-cohesive soils with less than 10-15 % fines. In soils with higher fine contents, DC destroys the soil macro-structure because the EPWP generated through dynamic loading cannot dissipate fast enough. To overcome this problem PVDs are installed to enhance dissipation of EPWP and accelerate the consolidation process [31–33].

Narendranathan and Lee (2015) reported a case studies where DDC was applied to improve soft soils. A compressible soft clayey silt with a varying thickness of $2\text{-}3 \text{ m}$ was loaded with a hydraulic fill of $5\text{-}8 \text{ m}$. Dynamic drainage compaction, 20 passes with HIEDYC Tria (3-sided surface compactor) at top of surcharge, was applied to accelerate consolidation of the soft layer and the hydraulic fill. The solution was successful because surcharge was reduced from 3.0 m to 1.5 m and PVDs spacing was adjusted to 1.2 m instead of 1.0 m with respect to traditional solution with PVD only [6].

Dynamic drainage consolidation is an innovative method to accelerate consolidation in soft soils which was not applied the Netherlands. Especially in silts and soft mud DDC had proven itself by accelerating consolidation [34]. Potential benefits are that less surcharge is needed, or that fill material with higher fine contents are applicable. However, no clear framework is available in which situations, and under which conditions DDC is an effective GIT. Therefore, DDC is an interesting field for additional research because better understanding of the limits regarding the affected depth, soil types and different types of dynamic loading is needed. Dynamic drainage consolidation was included in group 2, acceleration of consolidation using preloading and enhanced drainage, of the applicability assessment.

ELECTRO OSMOSIS CONSOLIDATION

Electro kinetic consolidation is a technique in which water is subtracted from a wet soil mass by applying a direct electrical current. The electrical current is created by applying electrical potential difference across the

soil using a grid of electrodes installed in the ground. The most important phenomena regarding electrokinetic is called electro osmosis [35], therefore electro kinetic consolidation is also known as electro osmosis consolidation (EOC). With electro osmosis anions are attracted towards the anode, whereas cations (with their water of hydration) are attracted towards the cathode due to the applied electrical current. By applying drainage at the cathode, the water content is reduced, shear strength is increased and compressibility is reduced. Soil hardening, cementation and an increase in Attenberg limits due to heat generation and electrical chemical reactions are less important effects of electro osmosis [36].

An advantage of EOC over conventional preloading methods is that the electro osmotic permeability, (k_e) (cm^2/sv) is relatively independent from pore size making it applicable in soils with low hydraulic conductivities. Other advantages of EOC are that shear strength increases faster compared to the conventional preloading method [37]. However, modelling and predicting the effectiveness of EOC is very complicated because of many coupled processes, chemical reactions, and time dependent aspects are related to EOC. The effectiveness of the applied electrical current is decreasing in time because water content reduces, pH increases, corrosion of anode increases, and gas generation increases the electro kinetic resistance of the soil. These problems are partially mitigated by increasing voltage in time, using coated electrically vertical drains, and by switching the applied electrical current.

Despite these potential mitigation measures, the energy consumption with EOC is expansive, and strict safety regulations regarding electrocution are needed [38]. Electro osmotic consolidation was not included the applicability assessment, because it is expensive, complex, and good alternatives like vacuum preloading and the conventional preloading with PVD are available.

THERMAL STABILIZATION USING HEATING AND FREEZING

Heating causes permanent changes in soil properties and is applicable for consolidation of soft soils. The pre-consolidation pressure for normally consolidated clays is for example increased after a heating-cooling cycle [5]. These changes are attributed to physical-chemical forces between clay particles which alter due to temperature differences. Additionally, consolidation is accelerated because viscosity of warm water is higher causing an increased hydraulic conductivity [39]. Thermal stabilisation was not included in the applicability assessment, because good alternatives are available to accelerate consolidation.

Ground freezing is a useful method for temporary support in underground excavations because strength and stiffness of frozen ground are very high. The improved soil properties are especially beneficial in situations where temporal support is needed to facilitate stable excavations or prevent excessive deformations of adjacent structures [3]. The most applied freezing method is circulating either brine ($-20^\circ C$) or liquid nitrogen ($-200^\circ C$) through a system of steel pipes in the ground. The freezing method is applicable in all soil types when enough soil water is available. In fine grained soils frost heave and thawing settlements need to be considered because water expands with 10 % in frozen state. Besides that, freezing of soil is troublesome when groundwater flow is encountered, because it hinders the freezing process [5]. The freezing method was not further considered and outside the scope of this research because it is only applied to improve soil conditions temporarily.

HYDRO-BLASTING COMPACTION

Hydro-blasting compaction is a ground improvement technique which is effective for treating collapsible soils like loess. In the first step of the procedure the soil is wetted to induce collapse, and afterwards blasting of explosives are applied for further densification. This technique was excluded from further review because its particular field of application.

2.3 TYPE C - WITH ADMIXTURES OR INCLUSIONS

Ground improvement methods with admixtures or inclusions are categorized in eight groups namely (C1) vibro replacement or stone columns, (C2) dynamic replacement, (C3) sand compaction piles, (4) geotextile encased columns, (C5) rigid inclusions, (C6) piled embankments, and (C7) microbial methods. The most important is the piled embankment because the other categories, excluding microbial methods, are often used as columnar elements within concept of a piled embankment. The microbial methods were excluded for this research although they were identified in literature as a promising technique with large potentials [5].

Columnar inclusions are applied to reduce differential settlements by stabilizing soil masses with rigid or semi-rigid columns. These inclusions have similarities with pile foundations but the underlying principle is different: columnar inclusions are applied to reduce global differential settlements by reducing loads (60–90 %) on soft soils, instead of transmitting all the loads directly to deeper strata as is the case for pile foundations. With columnar inclusions soft layers do support the remainder of the loads, whereas these layers are bypassed or used for skin friction within pile foundations. Another aspect which differs between a pile foundation and a ground improvement with columnar inclusion is the needed number of elements in a system. Where a single pile would be effective for transferring loads, multiple columnar inclusions are needed to stabilize a soil mass. There are two distinguishable principles within the application of columnar inclusions, namely end-bearing and floating columns. The floating columns are installed until a depth at which the relative increase in vertical effective stress is too small (15 %) to induce large vertical settlements. Therefore, column lengths are reduced, but residual settlements are higher due to deformations in the soil mass below the column tips [40]. The end-bearing granular columns are installed the bearing layer is reached, a very common procedure for deep foundations and piled embankments in the Netherlands. Residual settlements for the end-bearing principle are small, but column length are higher.

In many situations in the Netherlands a reinforced embankment, which consist of horizontal layers of Geogrid alternated with granular material, is constructed on top of end-bearing columnar inclusions. This load transferring platform is crucial for the effectiveness of the columnar inclusions because loads are redistributed towards the columnar inclusion based on the principle of soil arching. For this reason loads on the soft soil, and therefore residual settlements of the structure are reduced significantly compared to the initial situation. The combination between columnar inclusions and a reinforced embankment is also known as a piled embankment and are often applied in situations where primary and secondary settlements are excessive for the preloading method, or in situations where construction time is limited. Different types of columnar elements for a piled embankment were considered in this section: granular columns without encasement (C1, C2, and C3), geotextile encased columns (C4), and finally the rigid inclusions (C5).

GRANULAR COLUMNS WITHOUT ENCASEMENT

The first three categories of ground improvements with admixtures or inclusions were grouped as granular columns without encasement. Within this group the ground improvement principle is similar, but the installation procedures and the column dimensions are different.

The general objectives of granular columns are to increase shear resistance, stiffness, and permeability of non-cohesive and cohesive soil masses [41]. Shear resistance, and therefore also bearing capacity, increases because shear strength at low effective stresses of granular additives is higher compared to the in-situ soft soil. Residual and differential settlements are reduced because stiffness of the overall soil mass is higher and distributed more equally in space. Additionally, loads on the original soil are reduced because loads are redistributed towards the granular columns based on the principle of soil arching. The overall permeability of the soil mass is higher because hydraulic conductivity of granular additives is larger which implies the consolidation of soft soils is accelerated and the liquefaction susceptibility of non-cohesive soils in seismic areas is reduced.

Lateral confinement of surrounding soil is important for granular columns, because these columns must undergo lateral deformation to mobilize interaction with the surrounding soil. When confining pressures are not large enough excessive bulging of the pile diameter leads to failure. Bulging is especially an important failure mechanism when soft soils ($S_u < 15$ kPa) are encountered in the upper 1/3 of the pile, but it can also become problematic for deep thick soft soil deposits outside this range [42].

Many different variants are available for the installation of granular columns without encasement, but the most important are vibro replacement, dynamic replacement, and the sand compaction method. With vibro replacement a hole is created using a horizontally vibrating probe. Afterwards granular materials are added and compacted using the same vibrating probe with the wet top feet method, or the dry bottom feed method. The diameter of granular columns created with vibro replacement varies from 0.3–0.5 m. A similar technique to vibro replacement is the rammed aggregate pier in which a borehole is created using an auger instead of a horizontally vibrating probe. The borehole is refilled with granular materials and compacted using a special

tamper which forces aggregates to displace in radial direction up to a diameter of 0.6 – 0.9 *m*. With dynamic replacement aggregates are rammed into the soil by dropping a heavy weight, similar to dynamic compaction, onto the surface. The created crater is refilled with granular materials and the compaction procedure is repeated until the intended column length is reached. Columns created using dynamic replacement are 2.5 to 5.0 *m*, and therefore larger compared to column created with vibro replacement. Different to other techniques, sand compaction piles are installed with a temporal steel casing which is vibrated or rammed into the ground. After the installation of the steel casing, granular material is added and compacted using vibrations, and static or dynamic loads. In the meanwhile, the steel casing is gradually lifted leaving a granular column with a diameter of 0.4 – 0.7 *m* behind in the soil.

Granular columns are worldwide widely applied to increase bearing capacity, reduce settlements and mitigate liquefaction susceptibility of soil masses. However, granular columns are not very common in the Netherlands as GIT in infrastructural because good alternative columnar inclusions are available. Besides that, research innovation or improvement of granular columns is limited [5]. The granular columns were included in group 3 (load redistribution using columnar inclusions) of the applicability, and compared with GECs and rigid inclusions.

GEOTEXTILE ENCASED COLUMNS

A variant of the conventional granular columns are the geotextile encased columns (GEC), which are granular columns confined by a seamless geosynthetic encasement. Similar to granular columns GEC are applied to increase shear strength, stiffness and permeability of soil masses. The main advantages of GEC over conventional granular columns is the potential application in very soft soils. Where granular columns fail in soft soils ($S_u < 15$ kPa) due to excessive bulging, GEC are stable because the supporting effect of the encasement [43, 44]. Several case studies were reported in which GEC were successfully applied in peat or sludge layers with undrained shear strengths lower than 5 kPa [45]. Cost regarding the geotextile encasement and installation procedure are considered as the biggest disadvantages of GEC compared to granular columns.

Two installation methods are available for installing GEC, namely the excavation methods and the vibro displacement method [46]. In the first method an open steel pipe is driven into the ground and soil is removed afterwards. With the second method, a steel pipe with two bottom flaps is vibrated downwards displacing the soil. After installation and excavation of the steel pipe the geosynthetic sock is lowered and filled with granular material. During retrieval of the steel pipe and in the final loading situation the geotextile encasement displaces in lateral direction until equilibrium. The amount of radial displacement depends on vertical loading, horizontal confining earth pressures, the granular fill and the ring stiffness. This interaction is crucial for the performance of the system and is regulated with a suitable tensile ring modulus which ranges from 2000 to 4000 *kN/m*. Large lateral displacements results in large vertical displacements, but when lateral displacements are too small the needed interaction with surrounding soil disappears. Since the first project with GECs in Germany in 1995, several successful project were completed in different countries including the Netherlands. At Westrick an embankment for the Dutch high-speed railroad link was constructed using GEC in 2002. The GEC, with a diameter of 0.8 *m*, were installed in a former industrial waste fill with a layer thickness of 4–6 *m*. Another project where GEC were used in the Netherlands are the so-called Bastion embankments near Houten. These encased columns were used to limit residual settlements and accelerate consolidation caused by these 6.0 *m* height embankments [47].

Despite some GEC projects in the Netherlands, the technique is commonly not applied nowadays because material and installation costs, and good alternatives are available. However, the performance is good and the possible applications are numerous, meaning that GEC are an interesting GIT which could compete with the commonly applied rigid inclusion. Geotextile encased columns were therefore included in group 3, load redistribution using columnar inclusions, of the applicability assessment.

RIGID INCLUSIONS

Numerous types of rigid inclusions are available: (i) drilled displaced columns, (ii) multiple stepped piles, (iii) grouted granular columns, (iv) vibro-concrete columns, (v) cast-in-situ large diameter concrete pile (PCC), (vi) Y or X shaped piles, and many more. Granular columns and GECs are similar to rigid inclusions but there are important differences because the materials of granular columns and GEC are disintegrated, and column

stability of rigid inclusions is assumed to be achieved without any lateral confinement.

Drilled displaced columns, also known as controlled modulus columns or controlled stiffness columns, are installed using a special designed auger which displaces soil in radial direction. During extraction of the auger, low pressure grout is added and a vertical column (250 – 450 mm) is formed. Strength and stiffness of the column is controlled by changing the properties of the grout mixture. The multiple stepped grout column, especially applied within rail road construction works, is formed using a special developed opening tool which enlarges a borehole to form a pile with a varying (stepped) diameters up to 400 and 600 mm. The main advantage is that the column capacity is increased without much larger installation cost, a drawback is that a stable and unsupported borehole is needed. Grouted granular columns are created by injecting grout (bottom upward) into a granular column using a pre-installed grouting tube. Strength, stiffness and the interface friction of the granular column increase significantly with grout injection. Disadvantages are installation costs, difficult quality control, and loss of drainage capacity because the grouted columns are impermeable. A variant of the grouted granular column is the vibro-concrete column which is formed in a similar way as stone columns are created with the bottom-feed dry method. This method has especially advantages in situation where conventional stone columns are not applicable, like soft ground conditions or sensitive soils. An interesting new type of rigid inclusion, developed in China, is the large diameter (1.0–1.5 m) hollow concrete pile. With this method a double-walled steel pipe is installed in the ground by means of vibrations. After installation concrete is poured in the annulus and compacted using vibrations caused by retrieval of the steel pipe. This ring-shaped column is more cost-effective and quality control is better possible, but specialized installation tools are needed. The last considered type of rigid inclusion are the Y or X shaped piles. The underlying idea of these irregular column is that the circumference, and therefore the skin friction, remains unchanged, while the amount of needed concrete is smaller. A disadvantage is that specialized installation tools are needed, but an advantage of this type of columns is cost-saving without reducing bearing capacity.

Rigid inclusions are effective GIT to reduce differential and residual settlements. However, cost related to installation are higher compared to preloading methods, and specialized installation equipment is needed. Innovation or optimisation of rigid inclusions within this study is limited because they are closely related to the installation procedures. The rigid inclusions were included in group 3, load redistribution using columnar inclusions, of the applicability, and compared with granular columns and GEC.

2.4 TYPE D - WITH GROUTING TYPE ADMIXTURES

Ground improvement techniques with grouting type of admixtures are subdivided in six categories, namely (D1) particulate grouting, (D2) chemical grouting, (D3) mixing methods, (D4) jet grouting, (D5) compaction grouting, and (D6) compensation grouting. Especially deep mixing methods, and jet grouting are applicable within the construction of embankments on soft soils. Therefore, only a brief discussion was given on particulate grouting, chemical grouting, compaction grouting, and compensation grouting, whereas a more elaborated description given on deep mixing methods and jet grouting.

For grouting methods without ground displacement penetrability and viscosity of the grouting mixture are crucial. Penetrability of grouts depends on its viscosity, and the mixture particulate size with respect to pore sizes of the soil mass. For penetration grouting, intrusion of the grout mixture into the soil matrix is needed, whereas penetration must be prohibited for soil displacing grouting methods. With penetration grouting, grout under low pressure is injected in soil and rock to increase strength or reduce permeability by intruding cavities, fissures or pores in the subsurface. The difference between particulate grouting (suspensions with regular and ultrafine cement) and chemical grouting is penetrability. A chemical grout penetrates fine soil because it is a solution with chemicals without solid particles. Therefore, penetrability of a chemical grout does not depend on the mixture particle size, but on the mixture viscosity with respect of the pore sizes of the soil mass.

Grouting methods with ground displacement are divided into compaction grouting and hydraulic fracturing. With compaction grouting a very stiff grout is injected under high pressure which does not penetrate soil and remains in a homogeneous mass. Traditionally compaction grouting is applied to densify loose sand, but nowadays it is also used for compensation grouting. Compensation grouting compensates soil movement caused by adjacent or underground excavation works to limit structural damage. Consequently, this technique is often applied together with the observational method in which movements in soil and struc-

tures are continuously monitored. Besides compaction grouting, hydraulic fracturing is another possibility for compensating soil movement. With hydraulic fracturing a grout with low viscosity is injected into the ground under high pressure. The grout fractures the soil and penetrates into the created fissures, this will eventually lead to soil displacement and soil improvement.

JET GROUTING

With Jet grouting, high speed jets erode soil and inject grout to form vertical grout columns. The original system, developed in Japan in the 1970s [48], uses a single jet stream of pressurized grout to erode soil and create a grouted column with diameters varying from 0.5-1.0 *m*. Nowadays, more advanced jet grouting systems are available to obtain better quality and larger column diameters. With the double tube systems more soil is eroded because compressed air and grout are jetted simultaneously through separate nozzles. In a triple tube system, soil is first eroded with nozzles injecting pressurized air and water, and afterwards grout is injected with a third nozzle and mixed with the soil to form the column. The grouted columns with the latter technique are of higher quality because a more uniform mixture is obtained through the preliminary erosion with the air and water nozzles [49].

Typical application of Jet grouting are strengthening of soil for underground excavations, groundwater control, and temporal or permanent soil stabilisation [50], in which the latter is most interesting for this research. Although jet grouted piles are definitely qualified as rigid inclusions, benefits of jet grouting with respect to other systems were only significant in difficult situations where other techniques are not applicable. For this reason jet grouting was not included in the applicability assessment because cheaper alternatives columnar inclusions are available to support large infrastructural embankments.

MIXING METHODS

Soil mixing methods are ground improvement methods in which soil is mixed using a binders like cement, lime, or others with a specialized mixing tool. The fields of application of soil mixing methods are numerous, but most important for this research is soil stabilisation. Using soil stabilisation infrastructural embankments are constructed on soft soils without large residual and differential settlements. Mixing methods are potentially applicable in all soil types and fills without large obstructions. High productivity is possible for large-scale projects, and installation causes no vibrations and limited noise hindrance. Despite minimal changes in horizontal and vertical effective stresses, applicability of mixing methods close to structures is limited. An important drawback of mixing methods is that uniformity and quality are inherent to the local soil profile and project location because mixing is executed in-situ. Often, laboratory mixing, quality control during installation, and quality checks after finalization are needed to guarantee success.

For the implementation of deep mixing two general methods are available, namely dry-mixing and wet-mixing. With wet-mixing methods soil is mixed with a slurry type of admixture, and with dry-mixing methods only a dry binder is mixed with the soil. The used binders for dry-mixing are mainly cement and lime, but also other products like fly-ashes and gypsum are also applied. For dry-mixing methods cohesive soils with high water contents are most suitable because water is needed for hydration of the binder. For soils with water contents below 20% wet-mixing methods are applied instead of the dry-mixing methods. Homogeneity is better and compressive strength is often higher for wet-mixing methods because mixing effectiveness is larger compared to dry-mixing. Especially in stratified soil profiles strength of stabilized soil can vary with depth for mixing methods where vertical soil movement and mixing is limited. A major advantage of dry-mixing over wet-mixing is the amount of soil spoil. Whereas spoil is limited for dry-mixing, spoil is potentially excessive for wet-mixing methods due to usage of viscous mixtures. With mixing methods different configurations like columns, panels, continuous barriers, and even mass stabilisation are possible to stabilize the soil. Besides that, numerous mixing tools and mixture variants are available for soil stabilisation. Therefore only three promising methods are selected, because it is impossible to treat all variations: Cutter soil mixing (CSM), trench mixing, and mass stabilization.

The first selected mixing method for stabilisation is CSM, a wet-mixing method. Cutter soil mixing panels are comparable to diaphragm walls, however there is an important difference. With diaphragm walls soil is excavated and replaced with a cement slurry, and during excavation bentonite is used for stability. With CSM soil is not excavated but mixed with a self-hardening slurry. The panel size of CSM depends on the used equipment but the width varies from 2.4 – 2.8 *m*, panel thickness ranges from 0.55–1.2 *m*, and installation

depths up to 25 *m* are possible. Currently the CSM technique is especially applied for temporal retaining structure for building pits, and not as soil improvement method for the construction of embankments on soft soils. However, Varaksin (2016) reported a promising case study in which a grid of CSM panels were installed as load bearing elements instead of a pile group underneath a building. The second selected mixing method is trench mixing. Before trenching a binder, either dry or wet, is placed in a shallow trench along the designated location of the ground improvement. During trenching, the binder is vertically blended with soil using a specially developed trenching machine. A continuous mixed wall is created with a width equal to 0.4 *m* and a maximum installation depth of 10.0 *m*. Due to an ongoing installation process, trench mixing is especially effective to stabilise large areas and create impermeable barriers. This ongoing installation properties is appealing for fast stabilisation of infrastructural routes where the thickness of the soft soil deposit is limited. The last technique selected is mass stabilisation which was developed in Scandinavia to stabilize peat and soft soil susceptible to large consolidation and creep deformations, but the technique is also used for fast stabilisation of dredged fills nowadays. With mass stabilisation ground is completely remoulded, and dry-mixed with a cement or lime binder up to a depth of 7.0 *m*. The stabilized superficial slab acts as subgrade for infrastructure, but is also used as working platform to allow for heavy constructing equipment. Although mass stabilisation is applied worldwide, it is not that well-known in the Netherlands making it an interesting research topic.

Cutter soil mixing, trench mixing and mass stabilisation were selected for group 4, soil modification using mixing techniques, of the applicability assessment because the mixing techniques are not commonly applied in the Netherlands despite their applications worldwide.

2.5 TYPE E - EARTH REINFORCEMENT

Ground improvement techniques in which the earth is reinforced are subdivided in three categories, namely (E1) Geosynthetic or mechanically stabilized earth, (E2) ground anchors or soil nails, and (E3) the biological methods using vegetation. The latter falls outside the scope of this research but is applicable to stabilize soil and slopes using the roots of vegetation. The first two methods fall also outside the scope of this research but their concepts are important for the innovative anchor drains elaborated in a previous section. With soil nailing an unstable soil slab is nailed to stronger geological depositions with steel rods, often to increase the stability of a slope nearby infrastructure in hilly terrains. A recent development in the Netherlands is that soil nailing is applied to increase the stability of dikes, i.e. similar to the concept of anchor drains. The concept of Geosynthetic stabilized earth is slightly different to the concepts of anchor drains and soil nailing. The elements of the latter two (i.e. drains and steel rods) are orientated perpendicular to the ground surface, whereas the layers of Geosynthetics are often constructed parallel to the ground surface. This implies that the angle between the additives and the potential failure plane is different. In the Netherlands, a horizontal layer of geogrid is sometimes placed at ground level to increase the slope stability of a preloading embankment which is placed on top of the geogrid to accelerate the consolidation process. The soil nailing and Geosynthetic stabilized earth concepts are important competitors of the anchor drain and need to be used as reference framework.

2.6 CONCLUSION

In the previous section numerous ground improvement techniques were reviewed and discussed, and some innovative concepts were presented. The concepts of each ground improvement technique was elaborated, the advantages, disadvantages, and limitation were mentioned, and potential innovations and improvements were appointed. Based on the literature study ground improvement techniques were selected for the applicability assessment and categorized according to figure 1.2:

Group 1 - Load reduction using lightweight materials	
EPS	Reduce loads on the subsoil with Expanded Polystyrene
Pumice	Reduce loads on the subsoil with Pumice
LWMS	Reduce loads on the subsoil with a lightweight mixed soil (LWMS)

Group 2 - Acceleration of consolidation using preloading and enhanced drainage	
PVD	Accelerate the consolidation process with prefabricated vertical drains (PVD)
Anchor drains	Increase the stability of the embankment by nailing the soil with high tensile anchor drains
Radial drains	Accelerate consolidation with a radially branched drain
Mini drains	Accelerate consolidation with multiple permeable elements installed simultaneously in a small spacing
DDC	Accelerate consolidation by increasing the EPWP with dynamic loads

Group 3 - Load redistribution using columnar inclusions	
Granular columns	Redistribute loads to bearing strata with granular columns
GEC	Redistribute loads to bearing strata with geotextile encased columns (GEC)
Rigid inclusions	Redistribute loads to bearing strata with rigid inclusions

Group 4 - Soil modification using soil mixing	
Cutter soil mixing	Redistribute embankment loads to bearing strata with mixed panels
Trench mixing	Stabilize the subsoil by mixing the soil with continuous mixed walls
Mass stabilisation	Stabilize the subsoil by mixing the soil with a binder

3

ASSESSMENT

A selection of promising ground improvement techniques was made in the previous chapter based on a general literature study on available and innovative ground improvement techniques. A standardized assessment framework was developed to compare the selected techniques based on future potential, economy, implementation, and performance. The assessment was performed by the student, three internal professional, and three external professionals. The assessment results were used to select a ground improvement technique for which additional research could result in a significant gain in knowledge or improvement of the technique.

- Group 1 – Load reduction using lightweight materials
- Group 2 - Acceleration of consolidation using preloading and enhanced drainage
- Group 3 - Load redistribution using columnar inclusions
- Group 4 - Soil modification using soil mixing

The assessment methodology and the importance factors assigned to the different subcategories were elaborated below, whereas the results of the four groups of ground improvement techniques were included in separate sections hereafter. The data of the assessments was elaborated in appendix B.

METHODOLOGY

Ground improvement techniques (GIT) were assessed based on four categories: future potential, economy, implementation and performance. The latter three categories were subdivided in several subcategories to capture the most important GIT characteristics for the client and contractor. Future potential was included to establish the ideas of the assessors on the general potential of a particular GIT. Especially for the innovative GIT this was an important indicator of the engineering judgement of the assessors. The assessment (sub)categories, and the corresponding ratings (from 1 (good) to 5 (bad)) were elaborated table 3.1. The definitions were formulated such that a wide interpretation was possible to prevent a predefined outcome based on the formulation and include engineering judgement of the assessors.

The economy category was subdivided in design, installation and material costs. The design costs are related to engineering, site investigation and laboratory testing costs. The installation cost represent the labour and equipment needed for installation. Maintenance costs were excluded because they were implicitly represented by the material degradation, residual and differential settlements subcategories. The implementation category was subdivided in construction time, ground stability, EMVI score, and environmental conservation. The construction time category was a measure for the amount of time needed for the implementation of the GIT. The ground stability subcategory represented potential stability problems during implementation, whereas the EMVI score ("economisch meest voordelige inschrijving") is related to the social environmental nuisance of a particular solution. The environmental conservation subcategory indicated the amount of natural alteration of the environment caused by the implementation. The product performance category was subdivided in residual settlement, differential settlements, degradation and the ecological footprint. The

first two subcategories represented potential problems related to primary and secondary deformations which could affect the long term functional requirements of the GIT. The degradation subcategory captured the degradation susceptibility of additives which might affect the GIT performance. The ecological footprint, captured the usage of ecological friendly materials and the amount of CO_2 emissions related to the GIT.

Besides the subcategories, assessors were asked to rate the importance of the subcategories because not all are equally important. For each (main) category assessors could subdivide 1.0 point over the corresponding subcategories, i.e the most important subcategory received the largest portion and vice versa for the least important subcategory.

The results of the performed assessments (importance subcategory, subcategory ratings) were used to compare the GIT. The (average) importance factors of the subcategories were multiplied with the (average) ratings of the subcategories to obtain the weighted ratings of the subcategories.

- Importance = Average(Expert 1, Expert 2, Expert 3, Expert 4, Expert 5, Expert 6, Student)
- Subcategory = Average(Expert 1, Expert 2, Expert 3, Expert 4, Expert 5, Expert 6, Student)
- Weighted subcategory = Importance x Subcategory

The weighted subcategories were used to determine the average of the main category, i.e. the economy, implementation, and performance category.

- Economy = Average(Design cost, Installation cost, Material costs)
- Implementation = Average(construction time, ground stability, EMVI, environmental conservation)
- Performance = Average(residual settlement, differential settlements, degradation, ecological footprint)

The final result was obtained by summing the economy, implementation and performance categories. The future potential category was included in a similar way, i.e. by means of summation between the main categories.

- Result = Economy + Implementation + Performance
- Result = Economy + Implementation + Performance + Future Potential

IMPORTANCE OF ASSESSMENT CRITERIA

The average importance factors of the complete assessments, were presented in figure 3.1. The largest differences were found for the economy category, i.e the installation costs (0.44) was the most important, followed by materials costs (0.33) and design costs (0.23). For many ground improvement techniques this is valid because engineering costs are often smaller compared to installation and material costs. For the implementation category construction time (0.35) was a more important than, ground stability (0.24), EMVI score (0.22), and environmental alteration (0.19). This is especially important for ground improvement techniques in soft soils without additives where time is needed for consolidation. The latter remaining implementation subcategories were rated similar, but environmental alteration was less important compared to ground stability and environmental conservation. For the performance category the differences between the difference subcategories were rather small, i.e residual settlements (0.28) were most important followed by differential settlements (0.24), material degradation (0.24), and the ecological footprint (0.23).

Table 3.1: Assessment criteria and ratings for ground improvement techniques. General: Future potential, Economy: design cost, installation cost and material cost. Implementation: construction time, ground stability, EMVI score, environmental conservation. Performance: residual settlements, differential settlements, degradation and ecological footprint.

General	Score	1	2	3	4	5
Future potential	Future potential of ground improvement technique	High	High – Medium	Medium	Medium – Low	Low

Product economy	Score	1	2	3	4	5
Design cost	Engineering, site investigation and laboratory testing	Low	Low–Medium	Medium	Medium-high	High
Installation cost	Labour and equipment used for implementation	Low	Low–Medium	Medium	Medium-high	High
Material cost	Materials needed for ground improvement method	Low	Low–Medium	Medium	Medium-high	High

Product implementation	Score	1	2	3	4	5
Construction time	Start construction until the product is available for client	Short	Short – Medium	Medium	Medium - Long	Long
Ground stability	Ground stability during implementation	High	High – Medium	Medium	Medium - Low	Low
EMVI score	Economics and Areal nuisance	High	High – Medium	Medium	Medium - Low	Low
Environmental conservation	Alteration of environment caused by implementation	High	High – Medium	Medium	Medium - Low	Low

Product performance	Score	1	2	3	4	5
Residual settlements	Residual settlements in relation to project requirements	Low	Low–Medium	Medium	Medium-high	High
Differential settlements	Differential settlements in relation to project requirements	Low	Low–Medium	Medium	Medium-high	High
Degradation	Degradation of additives affecting long term performance	Low	Low–Medium	Medium	Medium-high	High
Ecological footprint	Ecological footprint of ground improvement technique	Low	Low–Medium	Medium	Medium-high	High

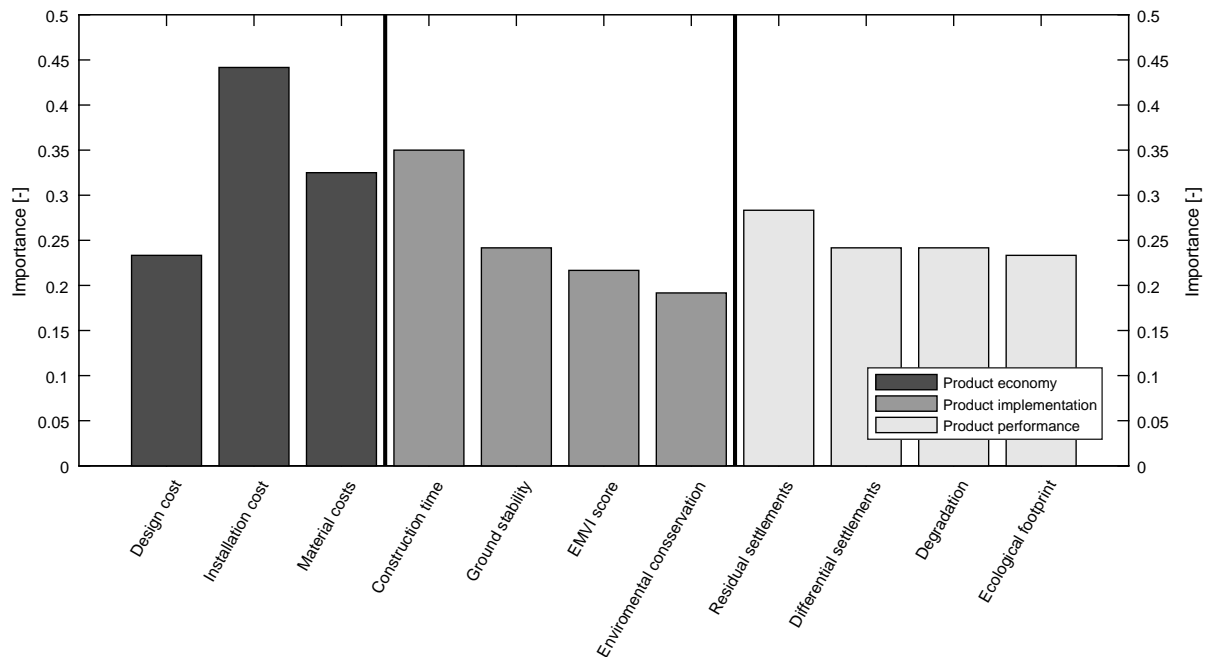

Figure 3.1: Average importance factors of the subcategories for the assessment on ground improvement techniques.

3.1 GROUP 1 - LOAD REDUCTION USING LIGHTWEIGHT CONSTRUCTION MATERIALS

The conventional lightweight materials pumice (6.9) and EPS (7.9) were rated better compared to the innovative lightweight mixed soil (8.4) when the economy, implementation and performance categories are added, see figure 3.2.

Design and installation costs for the lightweight mixed soil (LWMS) were higher because the mixture receipt is project dependent, and the installation process is more comprehensive due to additional mixing operations. Material cost of LWMS are lower according to the assessment results. This result is however up for discussion because nothing is known about the actual material costs. The construction time of LWMS is longer because an additional mixing operation needed which is not part of the installation process for pumice and EPS. For residual settlements, differential settlements, and material degradation long term mixture properties are needed and currently not available. For this reason it is reasonable that LWMS scored worse on these subcategories compared to EPS and pumice. Despite lacking information on the strength properties of the mixture it is reasonable that ground stability is affected positively because soil is unloaded and replaced by a cohesive mixture. The EMVI scores for the three ground improvement techniques were almost equal, whereas it was expected that LWMS would obtain a better EMVI score because material transportation is limited and waste materials are potentially reused. The environmental alteration is larger for LWMS because the subsoil is completely remoulded during installation, whereas it is untouched for EPS and pumice. An advantage of LWMS over EPS and pumice is the smaller ecological footprint due to the additives and transport movements correlated conventional techniques. The ecological footprint for LWMS is smaller because the mixture is mixed in place and consist only of natural environmental friendly binders.

Despite the conclusion that LWMS cannot compete with EPS and pumice it is a very interesting innovative ground improvement technique with a high future potential. When future potential is also included in the summation the LWMS (10.7) scored better compared to pumice (11.5) and EPS (12.3). The LWMS has specific benefits over the other lightweight materials, especially in terms of the ecological footprint and EMVI score, and it is likely that the results were affected by the unknowns. For this reason, additional research on mixture properties and mixing procedures is needed to determine the real potential of LWMS.

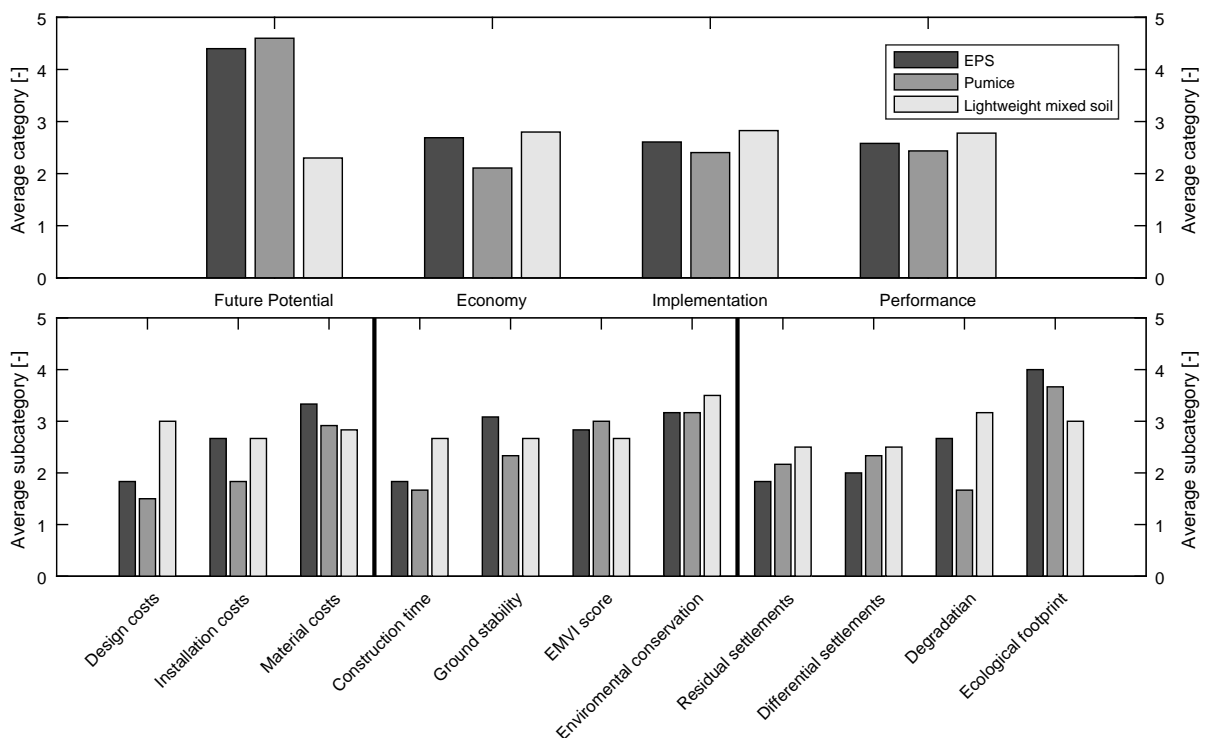

Figure 3.2: Assessment results for lightweight construction materials based on the completed assessments: (top) average ratings of main categories, (bottom) average ratings of the underlying subcategories.

3.2 GROUP 2 - ACCELERATION OF CONSOLIDATION USING PRELOADING AND ENHANCED DRAINAGE

When the economy, implementation and performance categories are considered the conventional prefabricated vertical drains (7.0) scored better compared to the innovative anchor drains (7.4), radial drain (7.9), mini drains (7.7) and dynamic drainage consolidation (8.9), see figure 3.3. The conventional prefabricated vertical drains (PVD) scored well for all economical subcategories, and scored worse on implementation and performance because construction time is long, ground stability is affected, and residual and differential settlements are large. Degradation in time is not a problem, but the ecological footprint of the plastic PVD is significant.

Despite some promising case studies presented in literature, the ratings of dynamic drainage consolidation (DDC) were bad. The results are reasonable because the project range in which DDC might be beneficial is really small, and it is not well-understood until what depth, and how much the pore water pressure in soft soils is affected during dynamic loading. The radial drains were rated rather well, but the expected benefits of the radial drains were limited and dominated by practical drawbacks related to the production process and the installation procedure. Construction time scored only slightly better compared to conventional PVD, whereas the installation and material costs of the radial drains were rated much worse. This result for radial drains was reasonable because both the drain production and the installation procedure seems troublesome. Similar to the radial drains, the mini drains scored worse on the economical categories when compared to conventional PVD. Although the installation procedure and the production of mini drains are currently not established there are large similarities with the conventional PVD: mini drains could be pushed into the ground and produced with an ongoing production process. Interestingly enough, mini drains scored better on construction time, residual and differential settlements. These results were in favour of mini drains because these subcategories are very important for consolidation problems. Mini drains score slightly worse on the degradation and ecological footprint compared to the other techniques. However, optimisation is possible because these two subcategories are correlated to the used material for mini drains. The best rated innovative ground improvement technique within this group of ground improvement principles were the anchor drains. The material and design costs were higher, whereas the installation costs were comparable to the PVD. The results agree

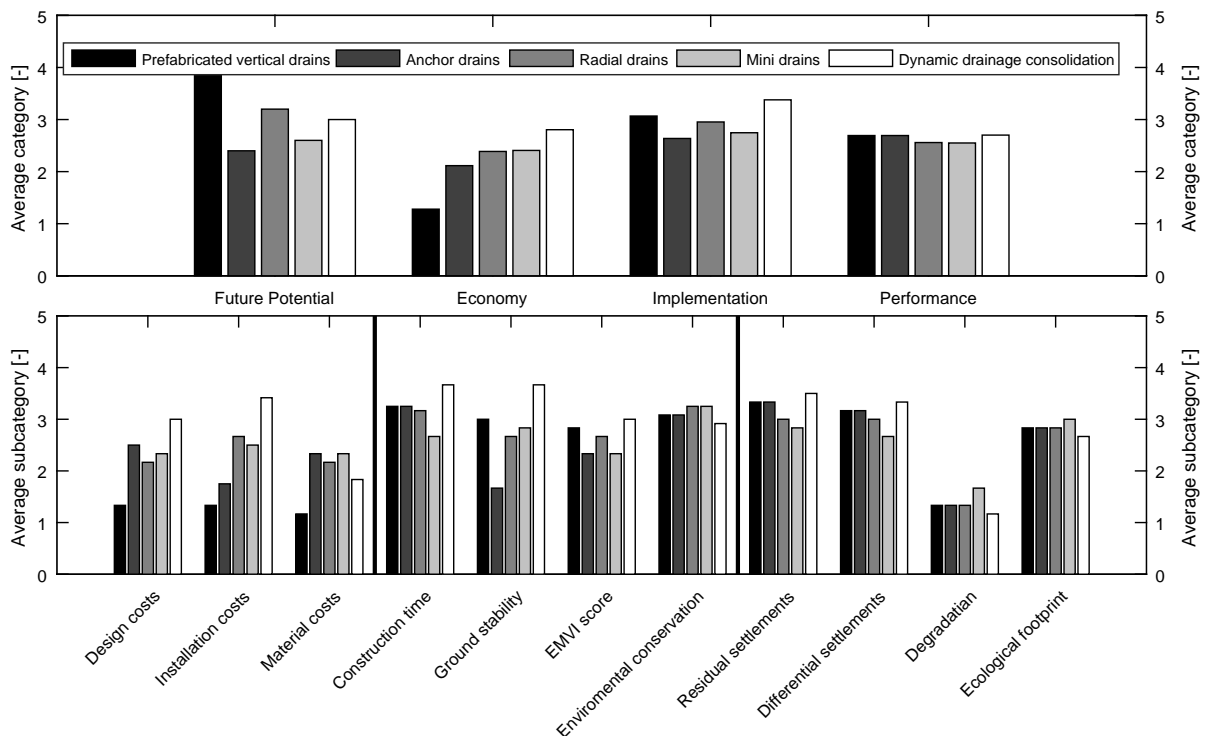

Figure 3.3: Assessment results for acceleration of consolidation using preloading and enhanced drainage based on the completed assessments: (top) average ratings of main categories, (bottom) average ratings of the underlying subcategories.

with the fact that an expensive high tensile drain is needed, and the design requires a more sophisticated stability calculation. The installation costs are similar because the installation procedure is equal to the current installation procedure for PVD. The major benefit of anchor drains over conventional PVD is the additional ground stability during preloading which opens the possibility to apply a higher preloading rate. However, assessors did not recognize that any reduction in the consolidation time despite more preloading is potentially applicable.

When the future potential is included the anchor drains (9.8) and mini drains (10.3) scored significantly better compared to PVD (11.3), the radial drains (11.2) and the DDC (11.9). This implies that the experts and the student were most convinced by the anchor and mini drains, and less convinced by the radial drainage and DDC. Based on this, and the interpretation of the subcategories was concluded that anchor drains and mini drains are the most interesting options as future research topics within this group of ground improvement techniques.

3.3 GROUP 3 - LOAD REDISTRIBUTION USING COLUMNAR INCLUSIONS

The widely applied rigid inclusions (7.2) were rated better compared the less frequently used granular columns (7.9) and geotextile encased columns (8.4), see figure 3.4. This group of ground improvement techniques scored worse on the economical categories and significantly better on the implementation and performance categories.

For the economical category rigid inclusion were in favour of the other variants based on the installation costs, because the installation process of rigid inclusions is quicker compared to granular columns and geotextile encased columns (GEC). For granular columns and GEC an additional compaction operation is needed to guarantee column quality. For the implementation category rigid inclusions scored better on installation time, whereas: ground stability, EMVI score, and environmental alteration were rated identical. Ground stability for columnar inclusions was not identified as an important problem, and environmental hindrance and alteration were rated moderate. Within the performance category there were some differences present. Residual settlements were lowest for the rigid inclusions because stiffness of rigid inclusion is higher compared to the granular columns with and without encasement. Material degradation is not possible for the

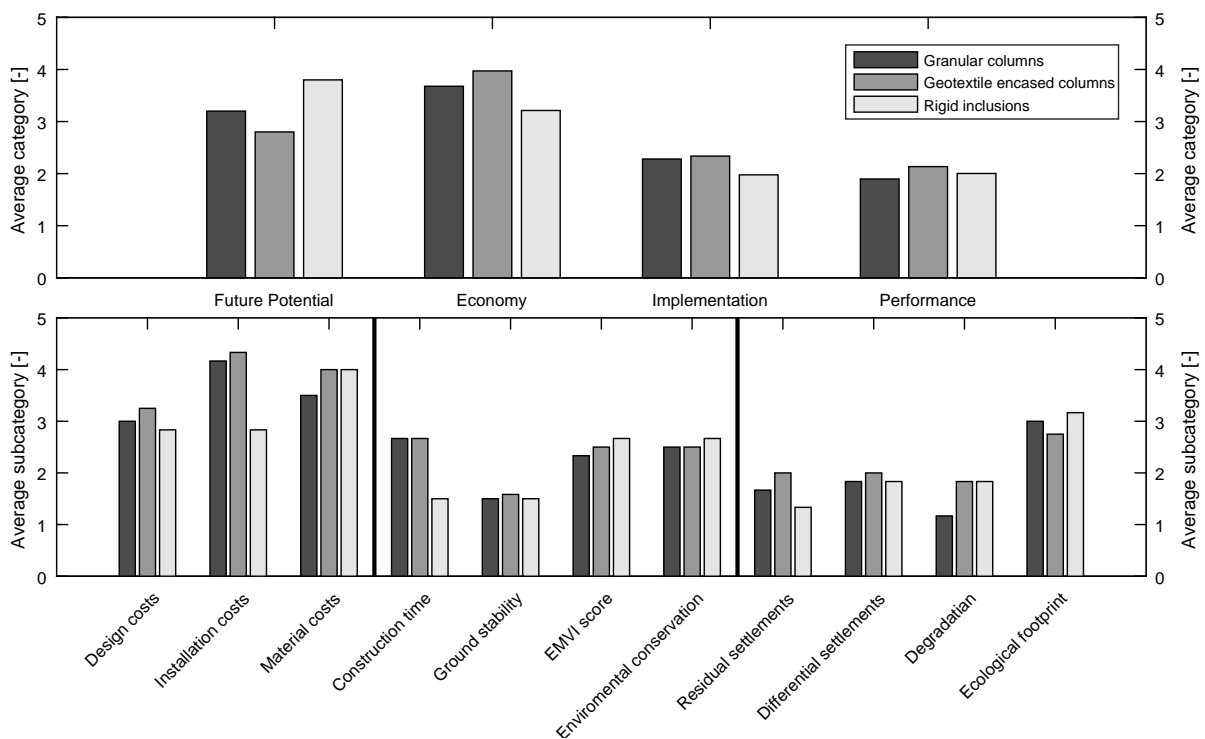

Figure 3.4: Assessment results for load redistribution using columnar inclusions based on the completed assessments: (top) average ratings of main categories, (bottom) average ratings of the underlying subcategories

pure granular columns, but can be significant for rigid inclusion and GECs. Especially in aggressive environments material degradation of concrete inclusions or the geotextile encasements affects the long term behaviour. For all three variants the ecological footprint is significant because materials like cement, plastic and non-local granulates are needed.

When future potential is included in the total average result, the rigid inclusions (11.0) still scored better compared to the granular columns (11.1) and GEC (11.2). Although the previous, the granular columns with and without encasement are beneficial in situations where also consolidation of soft soils is needed. For these situations granular column without encasement are preferred because an expensive geotextile encasement is not required to guarantee column stability in most soil profiles. An important drawback of the consolidation benefits of granular columns is that PVD are an excellent and cheap alternative to enhance dissipation of excess pore water pressure. This emphasizes that the future potential of granular column and GEC is limited and that additional research should focus on rigid inclusion. The potential optimisation of rigid inclusions are especially related to the installation procedure and the mixing properties.

3.4 GROUP 4 - SOIL MODIFICATION USING MIXING METHODS

The results, based on the economy, implementation, and performances, showed that trench mixing (9.2) was rated higher compared the cutter soil mixing (10.0) and mass stabilisation (9.7), see figure 3.5. In general and similar to the columnar inclusions, the mixing techniques scored bad on economy and better on the implementation and performance.

Based on design, installation and material costs cutter soil mixing (CSM) was clearly more expensive compared to the other mixing techniques. This difference is reasonable because CSM panels are installed individually with well-developed expensive mixing equipment which is for example, able to install temporary retaining structures of high quality. These high quality CSM panels are unnecessary expensive in situations where only bearing elements are needed. For the implementation category, the construction time for CSM panels and mixed trenches were rated similar, whereas mass stabilisation was rated slightly worse because more soil is treated. For the mixing techniques environmental alteration was significant, especially for mass stabilisation in which the soil is completely remoulded. For both residual and differential settlement mass

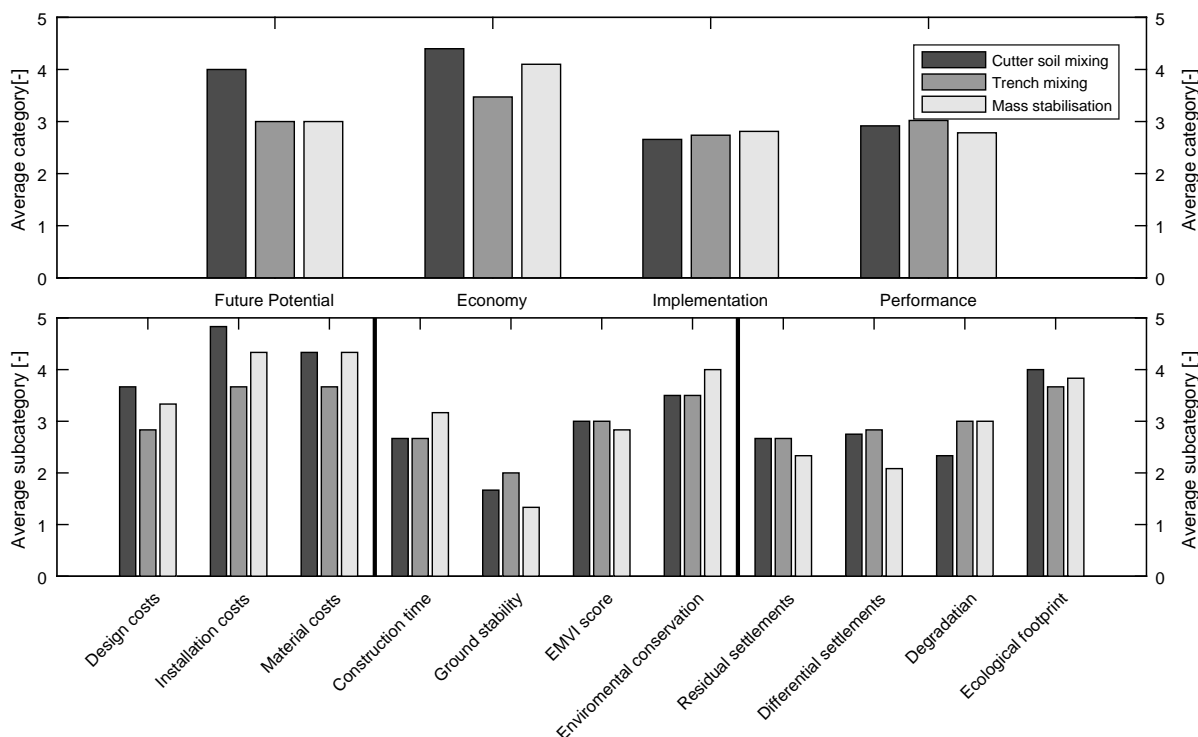

Figure 3.5: Assessment results for soil modification using mixing techniques based on the completed assessments: (top) average ratings of main categories, (bottom) average ratings of the underlying subcategories

stabilisation scored better compared CSM and trench mixing. For the differential settlement subcategory this is reasonable because a superficial rigid plate is created with mass stabilisation, whereas the soil is partially improved with trench mixing and CSM. However, residual settlements of a treated soil mass with mass stabilisation were rated higher because mixing quality is lower compared to the other techniques, and installation depth is limited. The latter property of mass stabilisation becomes important for soil profiles with thick soft deposits. For material degradation CSM was rated better because the quality of the soil cement mixture is higher and therefore less susceptible for degradation compared to trench mixing and mass stabilisation. The ecological footprint for all mixing techniques were badly rated because unnatural binders are needed for each of techniques.

The total average results, including the future potential, indicate that the potential of trench mixing (12.2) is slightly higher compared to mass stabilisation (12.7) and significantly higher than CSM (14.0). Although the installation depth is limited, trench mixing seems suitable to improve large areas of soft soil because of the ongoing mixing procedure. However, for soil profiles with a very low bearing capacity, i.e. dredged slurries, trench mixing is not applicable because bearing capacity is needed for machine stability. In these situations mass stabilisation is a great alternative because a superficial bearing layer is created within a limited amount of time. The CSM panels are expensive and more suitable as retaining structure. Additionally, columnar inclusions are a good alternative for individually CSM panels. Research on trench mixing and mass stabilisation is especially needed to obtain good quality assurance and quality control of the mixing processes.

3.5 CONCLUSION

The selected ground improvement techniques in the four ground improvement principles were compared based future potential, economy, implementation, and performance by six professionals and the student. The total results, i.e. the sum of the future potential, economy, implementation and the performance categories, were included in figure 3.6.

In group 1, load reduction using lightweight construction materials, the innovative lightweight mixed soil (LWMS) was compared with EPS and pumice. It was recognized that the LWMS concept has several important potential benefits over EPS and pumice: reduction of transport movements because LWMS is mixed

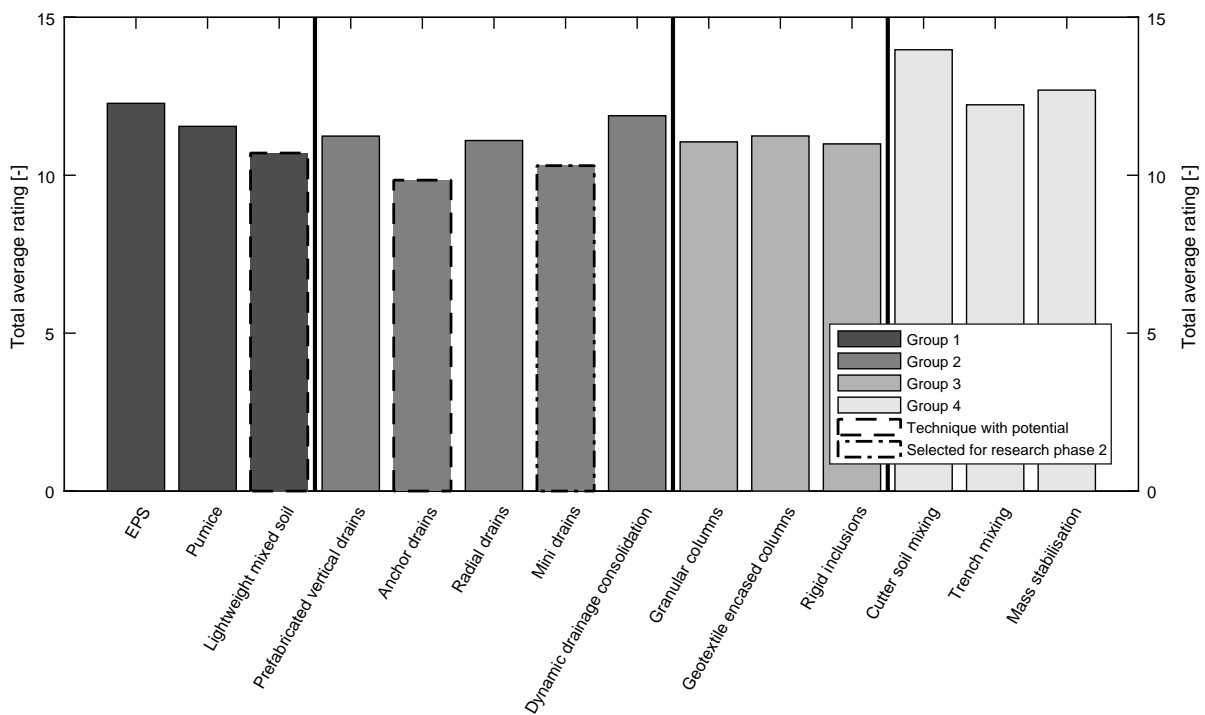

Figure 3.6: Assessment results of all groups of ground improvement techniques based on the total average rating (= future potential + economy + implementation + performance).

on-site, and possible reuse of waste materials. The LWMS (10.7) scored therefore better than EPS (12.3) and pumice (11.5). In group 2, acceleration of consolidation using preloading and enhanced drainage, prefabricated vertical drains (PVD) were compared with the innovative concepts of anchor drains, radial drains, mini drains and dynamic drainage consolidation (DDC). The anchor drains (9.8) and mini drains (10.3) were rated better compared to the other techniques: PVD (11.3), radial drains (11.2), and DDC (11.9). The anchor drains have benefits over PVD during the preloading phase because ground stability is enhanced. However, stability problems are prevented rather easily by applying a proper preloading scheme which means that the anchor drains are not a crucial improvement. The most important drawback of the current PVD is related to the long construction time needed for the consolidation process. The mini drain concept accelerates consolidation and is therefore more interesting for further research than the anchor drains. In group 3, load redistribution using columnar inclusions, granular columns, geotextile encased columns (GEC) and rigid inclusions were compared. The rigid inclusions (11.0) were rated better than granular columns (11.1) and the GEC (11.2). Unknowns or optimisation potentials of the rigid inclusions are especially related to the installation procedure, and therefore not suitable for additional research within this project. In group 4, soil modification using mixing techniques, cutter soil mixing (CSM), trench mixing and mass stabilisation were compared. The trench mixing technique (12.2) was rated better compared to CSM (14.0) and mass stabilisation (12.7). Although the experience with trench mixing is limited in the Netherlands, optimisation is again especially related to the implementation procedure. Therefore the trench mixing technique is not suitable for additional research within this project.

The most suitable ground improvement techniques for additional research within this master project were the lightweight mixed soil (10.7), anchor drains (9.8), and the mini drains (10.3). The latter was chosen in consultation with the supervisors because the rated future potential, the potential benefits and improvements, and the unknowns related to the innovative concept. The following three hypotheses formed the basis for the research on mini drains and captured the most important fields of optimisation regarding the conventional prefabricated vertical drains: (i) cost optimisation is possible by reducing the drain discharge capacity, (ii) acceleration of consolidation is possible by minimising soil disturbance during drain the installation procedure, and (iii) acceleration of consolidation is possible by reducing the drain spacing and including the effect of overlapping smear zones.

II

EXPERIMENTAL STUDY ON THE CONCEPTS OF MINI DRAINS

4

CONSOLIDATION WITH MINI DRAINS

In research phase 1 was concluded that the concept of mini drains had potential with several possible improvements with respect to the conventional prefabricated vertical drains. Research phase 2 of this master thesis project explored the concept and theory of mini drains.

With mini drains multiple permeable elements are installed simultaneously in a small spacing to enhance fast dissipation of excess pore water pressure. Three hypotheses regarding the traditional solution formed the basis for the research on mini drains. The observations/hypotheses allow for possible optimisation because the intended installation procedure and the drain characteristics of mini drains are different compared to the current prefabricated vertical drains: (i) cost optimisation is possible by reducing the drain discharge capacity, (ii) acceleration of consolidation is possible by minimising soil disturbance during drain the installation procedure, and (iii) acceleration of consolidation is possible by reducing the drain spacing and including the effect of overlapping smear zones.

In this chapter a theoretical framework on the concept of mini drains was established. The first section concerned a review on the basic analytical solution for the consolidation problem. Hereafter, the basic solution was extended to account for the the impact of soil disturbance and well-resistance on primary and secondary deformations rate.

4.1 BASIC ANALYTICAL SOLUTION FOR CONSOLIDATION

In 1948 Barron obtained an exact solution (eq. 4.1) for an axisymmetric 1D consolidation problem around a vertical drain of a unit cell under a uniform load [52]. This solution was used as a starting point for the analytical approximation for consolidation of soft soils using mini drains.

Barron obtained the solution by reducing a square or triangular grid of prefabricated vertical drains (PVD) to a unit cell, which represents the affected soil mass around a single drain (fig. 4.1). To solve the relation between dissipation of excess pore water pressure (EPWP) and deformation, i.e. a second order differential equation, Barron assumed laminar water flow (Darcy's law), a linear stress-strain relation (Hooke's law), uniform vertical deformations within the unit cell (equal strain condition), and simplified initial and boundary conditions: no EPWP at the drain boundary, no pressure gradient at the unit cell boundary, and the initial EPWP is equal to surcharge load.

$$U(t) = 1 - \exp\left(\frac{-8T_h}{\mu_x}\right) \quad (4.1)$$

$$\text{with: } T_h = \frac{C_h \cdot t}{4r_e^2}, \quad C_h = \frac{k_h}{m_v \cdot \gamma_w} \quad (4.2)$$

$$t_{90} = -\ln(0.1) \cdot \frac{\mu_x \cdot r_e^2}{2C_h} \quad (4.3)$$

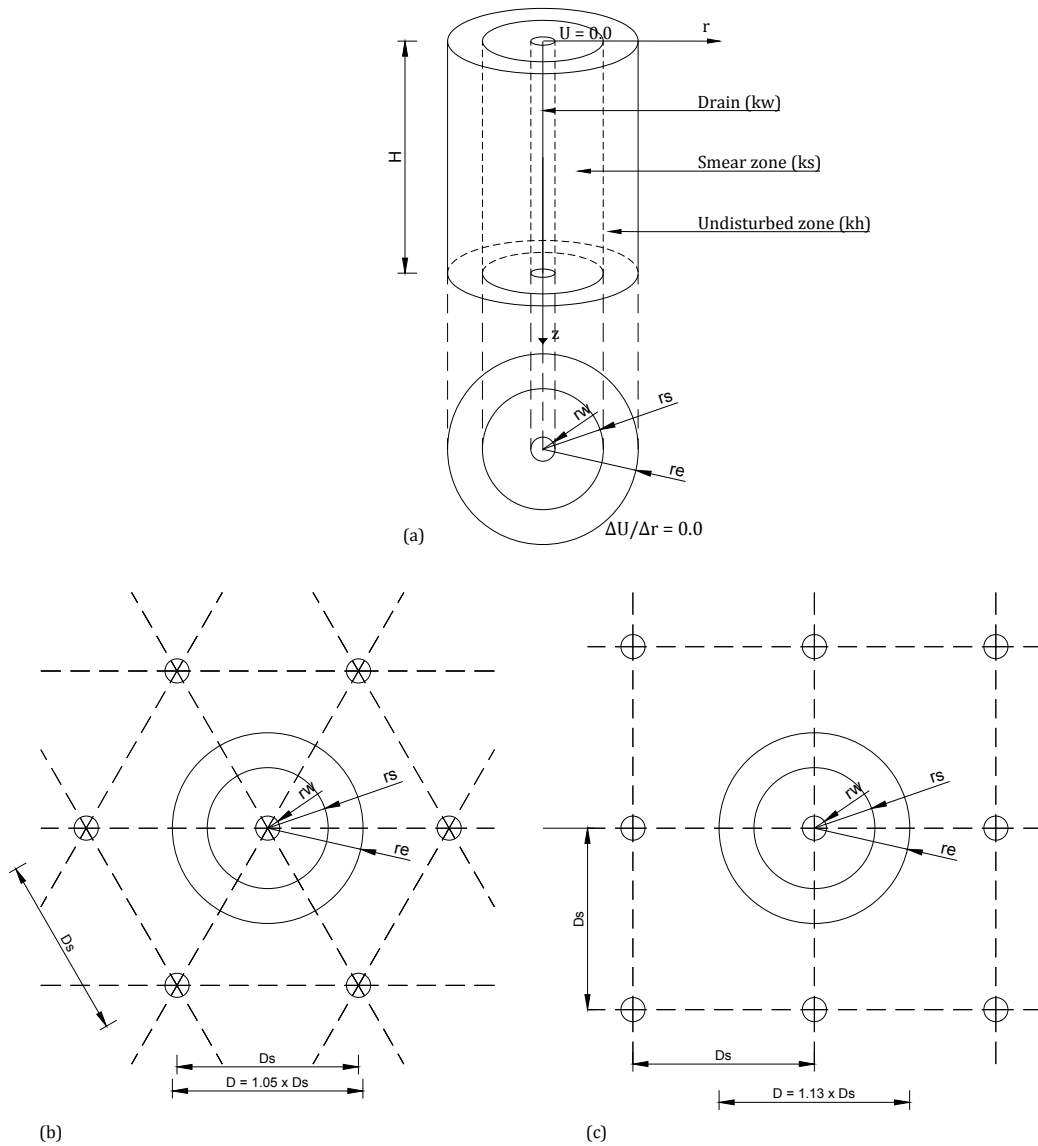

Figure 4.1: Unit cell representation of a field of a grid of prefabricated vertical drains: (a) unit cell boundary conditions with smear and undisturbed zone, (b) triangular drain grid, (c) square drain grid (u = excess pore water pressure, r = radius, r_w = equivalent radius of drain, r_s = radius of smear zone, r_e = radius of unit cell, H = layer thickness, k_w = permeability drain, k_s = permeability smear zone, k_h = horizontal permeability, D_s = c.t.c. distance drains, D = drain spacing)

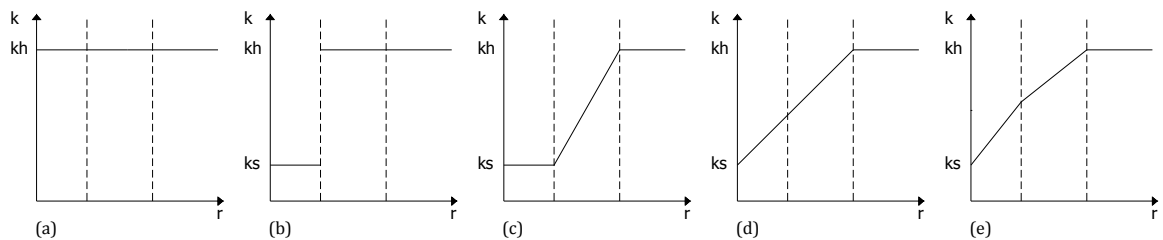

Figure 4.2: Distribution of hydraulic conductivity around a prefabricated vertical drain for different smear zone representations: (a) no smear zone (Barron 1948), (b) constant smear zone (Hansbo 1948), (c) constant smear with linear transition zone, (d) linear transition zone, (e) bi-linear transition zone [18].

The average degree of consolidation $U(t)$ is a measure for the consolidation progress, and increases in time from the start of consolidation $U(t_0) = 0.0$ towards the end of consolidation $U(t_{end}) = 1.0$. The time (t_{90}) needed for a degree of consolidation of 90 % is calculated with equation 4.3. This equation was obtained by rewriting equation 4.1 with $U(t_{90}) = 0.9$. A dimensionless time factor (T_h) is used to describe the consolidation state, and depends on time (t), the horizontal coefficient of consolidation (C_h), and the external radius of the unit cell (r_e). The horizontal coefficient of consolidation is a measure for the consolidation speed, and increases with horizontal hydraulic conductivity (k_h), and decreases with volumetric compressibility (m_v). For Barron's solution the reduction factor (μ_x) only accounts for the PVD spacing ($\mu_x = \mu_0 = \mu_{spacing}$) with the ratio between the unit cell radius (r_e) and the equivalent well or drain radius (r_w). The spacing reduction factor translates the solution for vertical consolidation towards a solution for horizontal radial consolidation of a unit cell.

Barron's basic analytical solution was extended according to equation 4.4 to account for the smear effect and well-resistance. The smear zone, the well-resistance, and the corresponding reduction factors (μ_{smear}) and (μ_{well}) were elaborated in the following sections because they are important for the mini drain concept.

$$\mu_x = \mu_{spacing} + \mu_{smear} + \mu_{well} \quad (4.4)$$

$$\mu_0 = \mu_{spacing} = \frac{n^2}{n^2 - 1} \ln(n) - \frac{3n^2 - 1}{4n^2} \quad (4.5)$$

$$with: \quad n = \frac{r_e}{r_w} \quad (4.6)$$

4.2 SMEAR EFFECT AND DRAIN INSTALLATION

Prefabricated vertical drains (PVD, 100 x 3 mm) are pushed into the ground with a steel mandrel (120 x 60 mm). The mandrel is retrieved once it reached the desired depth, and PVD with its anchor plate are left behind in the soil. The intrusion and retrieval of the mandrel are causing a change in soil compressibility and a reduction of the horizontal hydraulic conductivity. These two installation effects are known as the smear effect, and are important for consolidation. The reduction in hydraulic conductivity was discussed in this section, whereas the change in soil compressibility was discussed in the final section of this chapter.

The reduced hydraulic conductivity in the smear zone is detrimental for consolidation because the dissipation of EPWP is slowed down through the additional resistance against water flow in the remoulded zone. The horizontal hydraulic conductivity in the smear zone is reduced because the initial anisotropic permeability ($k_h > k_v$) is disturbed, and the added PVD volume impose a reduction in void ratio

Through remoulding of the soil structure, the permeability in the smear zone (k_s) converges towards a combination between the initial vertical and horizontal permeability. Often is assumed that the horizontal permeability in the smear zone equals the undisturbed vertical permeability ($k_s = k_v$). This substantiate the observation that consolidation is delayed though remoulding of the soil structure because the undisturbed horizontal permeability (k_h) is often higher than the undisturbed vertical permeability (k_v) due to geological deposition processes. The void ratio, and therefore also the permeability in the smear zone is reduced during installation through the added volume of the drain. This effect is however often disregarded because the replacement ratio, i.e. the area of the drain (A_d) over area of the unit cell (A_{uc}), is very small for the conventional drain spacings.

An additional reduction factor (μ_{smear}) was introduced by Hansbo (1981) to account for reduced permeability in the smear zone. Hansbo proposed to change k_h for a constant remoulded permeability (k_s) in the smear zone, see (b) in figure 4.2. The reduction factor μ_0 was extended according to equation 4.7, with the extent ratio ($s = r_s/r_w$), and the permeability ratio ($\kappa = k_h/k_s$).

$$\mu_1 = \mu_{spacing} + \mu_{constant-smear} = \frac{n^2}{n^2 - 1} \ln(n) - \frac{3n^2 - 1}{4n^2} - \ln(s) + \kappa \cdot \ln(s) \quad (4.7)$$

$$with: \quad n = \frac{r_e}{r_w}, \quad s = \frac{r_s}{r_m}, \quad \kappa = \frac{k_h}{k_s} \quad (4.8)$$

No real consensus exists on the extent of the remoulded zone, and the amount of disturbance in smear zone [53, 54]. The extent ratio ($s = r_s/r_m$) varied from 1-7, whereas the permeability ratio ($\kappa = k_h/k_s$) differed from 1-10. The observed variation is reasonable because soil stress, soil structure and over-consolidation ratio affect the extent and permeability ratio. These soil characteristics, and therefore also the smear effect, vary from place to place because of local heterogeneities and differences in geological history.

Despite the lack of consensus between soil characteristics and the smear effect, it is widely accepted that extent of the smear zone increases with mandrel size and installation speed [14–18]. This is important for the concept of mini drains because based on literature it is attractive to consider a more sophisticated installation procedure which is designed to minimise soil disturbance, rather than optimise the daily installation production. A smaller mandrel combined with a lower installation speed would reduce the smear effect and increase the PVD efficiency.

The constant remoulded permeability in the smear zone proposed by Hansbo (1981) is not a measure for actual permeability distribution in the disturbed zone around the drain. The actual permeability, correlated with the amount remoulding, is minimum at the drain interface and converges towards the undisturbed horizontal permeability with increasing radial distance. Researches tried to overcome this discrepancy between theory and reality by redefining the relation between the hydraulic conductivity and the distance towards the drain. Figure 4.2 showed some of the available proposed distributions of hydraulic conductivity in the smear zone [18, 55]. The constant smear zone formulation was the first and most basic formulation which included the smear effect for radial consolidation. The linear smear zone was also elaborated because it formed the basis for the theory on linear overlapping smear zones. The latter formulation is important for the concept of mini drains because smear zones of adjacent unit cells interact when the drain spacing is reduced. The remaining distributions of hydraulic conductivity were excluded from further elaboration because the mentioned distributions are sufficient to appreciate the smear effect for mini drains.

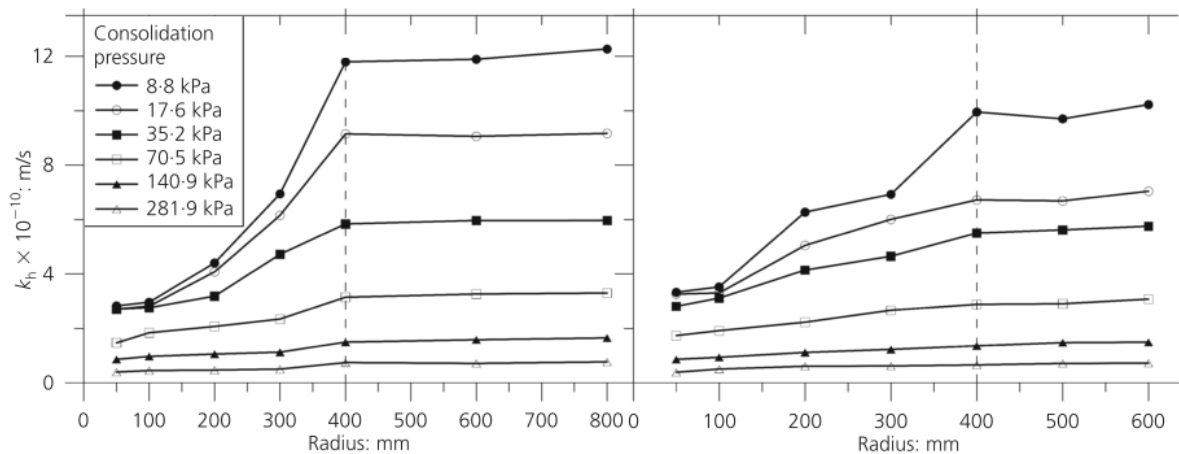

Figure 4.3: Hydraulic conductivity in the soil mass around a drain for the single-drain (left) and multiple-drain case (right) at different consolidation pressures [14].

In most formulations was assumed that the distribution of hydraulic conductivity is not affected by adjacent unit cells. This assumption is valid for large drain spacings, but is however incorrect when drains are installed at close distances. A great example of interacting smear zones was presented by Perera (2015). In this research a single-drain case (no adjacent drains), and a multiple-drain case (adjacent drains, square grid, $S = 1.20\text{ m}$) were compared to determine the effect of interacting smear zones [14]. The results, included in figure 4.3, indicated that the hydraulic conductivity was affected, especially for low consolidation pressures. Within the same research project, similar results were obtained for the reduction in void ratio in the smear zone. A limitation of the paper was that a comparison based on actually measured settlement rates was not possible because the consolidation was not finished at the time of publication. The importance of the interaction between adjacent unit cell was also observed by Saye (2001) and experienced in engineering practice. Both concluded that there exist a minimum spacing (0.50 m and 0.85 m) below which consolidation rate does not further accelerates [19].

With a theory on linear overlapping smear zones a conceptual explanation was provided for the observation regarding the experienced minimum spacing [20]. Walker and Indraratna (2007) used an equivalent linear transition zone (eq. 4.9) instead of a constant smear zone to incorporate interaction. The equivalence implied a similar rate of consolidation for both cases by setting the reduction factors μ_1 and μ_2 equal. The linear extent ratio is larger compared to the observed extend ratios elaborated in ???. This theoretical transformation to a linear extent ratio seem unrealistic but was needed to induce interaction when for conventional drain spacings (0.85 - 1.5 m).

$$\mu_2 = \mu_{spacing} + \mu_{linear-smear} = \frac{n^2}{n^2 - 1} \times \left[\begin{array}{l} \ln\left(\frac{n}{s}\right) - \frac{3}{4} + \frac{s^2}{n^2} \left(1 - \frac{s^2}{4n^2}\right) - \frac{\kappa}{B} \ln\left(\frac{\kappa}{s}\right) + \\ \frac{\kappa \cdot B}{A^2 \cdot n^2} \left(2 - \frac{B^2}{A^2 \cdot n^2}\right) \ln(\kappa) - \frac{\kappa(s-1)}{A \cdot n^2} \times \\ \left\{ 2 + \frac{1}{n^2} \left[\frac{A-B}{A} \left(\frac{1}{A} - \frac{s+1}{2}\right) - \frac{s+1}{2} - \frac{(s-1)^2}{3} \right] \right\} \end{array} \right] \quad (4.9)$$

$$with: \quad n = \frac{r_e}{r_w}, \quad s = \frac{r_s}{r_w}, \quad \kappa = \frac{k_h}{k_s}, \quad A = \frac{\kappa - 1}{s - 1}, \quad B = \frac{s - \kappa}{s - 1} \quad (4.10)$$

The reduction factors (μ_1) and (μ_2) for the constant and linear smear zones were elaborated in equation 4.7 and 4.9. These equations form the basis for equation 4.11 which describes reduction factor for overlapping smear zones. Figure 4.4 shows the three different considered situations for interacting smear zones: (i) no overlapping smear zone, (ii) partially overlapping smear zones, and (iii) fully overlapping smear zones. Without overlapping ($n \geq s$) the reduction coefficient μ_3 is equal to the reduction coefficient μ_2 , with fully overlapping smear zones ($2n - s < 1$) the reduction coefficient is equal to μ_0 multiplied with a factor representative for the altered hydraulic conductivity ($k_h \rightarrow k_s \approx k_v$). In the intermediate case with partially overlapping smear zones ($2n - s \geq 1, s > n$), the reduction coefficient (μ_3) is based on μ_2 but with adjusted input parameters for the smear zone extent ratio (s_x) and the permeability ratio (κ_x). The parameters κ_x and s_x are representative for the extent of the overlapping zone and the (constant) hydraulic conductivity in the overlapping smear zone. For the partially overlapping smear zones was assumed that hydraulic conductivity in the overlapping zone is equal to the hydraulic conductivity at the intersection. For fully overlapping smear zones the hydraulic conductivity is assumed to be constant and equal to the k_s , i.e. the vertical hydraulic conductivity (k_v).

$$\mu_3 = \mu_{spacing} + \mu_{linear-overlapping-smear} = \begin{cases} \mu_2 \cdot [n, s, \kappa] & n \geq s \\ \mu_2 \cdot [n, s_x, \kappa_x] \cdot \frac{\kappa}{\kappa_x} & 2n - s \geq 1, \quad and \ s > n \\ \mu_0 \cdot [n] \cdot \frac{\kappa}{\kappa_x} & 2n - s < 1 \end{cases} \quad (4.11)$$

$$with: \quad n = \frac{r_e}{r_w}, \quad s = \frac{r_s}{r_w}, \quad \kappa = \frac{k_h}{k_s}, \quad \kappa_x = 1 + \frac{\kappa - 1}{s - 1} (s_x - 1), \quad s_x = 2n - s \quad (4.12)$$

4.3 WELL-RESISTANCE AND DRAIN CAPACITY

The drain discharge capacity, and corresponding well-resistance are crucial properties of prefabricated vertical drains (PVD) because it can affect the dissipation of excess pore water pressure (EPWP). This section discusses the importance of discharge capacity and well-resistance for the concept of mini drains. The consolidation process with drains is deteriorated when the drain discharge capacity is not large enough to dissipate the available pore water. This means that the well-resistance limits the consolidation speed instead of the soil properties [21, 22, 56–59].

In the solution of Barron the discharge capacity (q_w) was excluded because a infinite drain permeability (k_w) was assumed [52]. According to Indraratna (2007) this simplification is valid when the long term discharge capacity exceeds $2.0E-6 \text{ m}^3/\text{s}$, whereas Holtz et al. (1988) mentioned minimum values of $5.0E-6 \text{ m}^3/\text{s}$. Below these values an additional reduction factor on the rate of consolidation is needed to account for well-resistance (μ_{well}). The reduction factor is defined in equation 4.13 and is incorporated in the formulation for consolidation with equation 4.1 and 4.4 [20, 21, 60]. The reduction factor for well-resistance depends on the drain discharge capacity (q_w), the drain length (l), and the depth (z) at which the degree of consolidation is

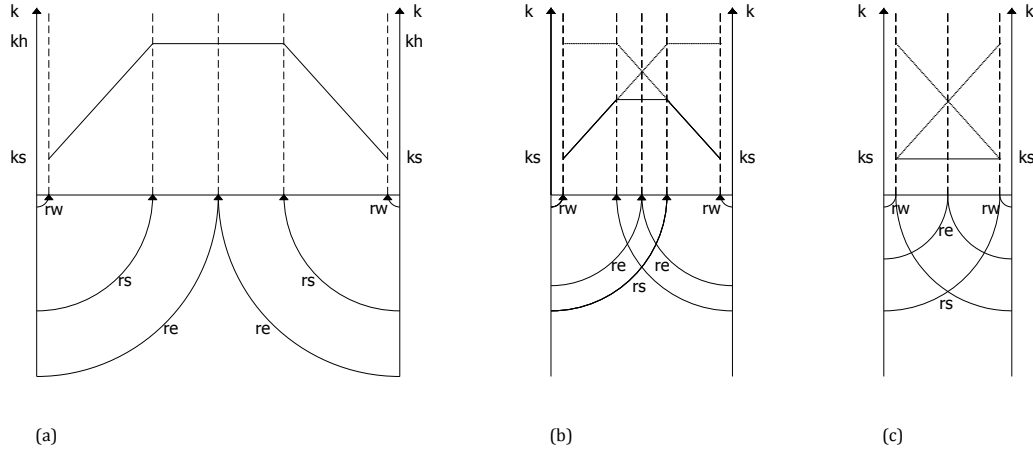

Figure 4.4: Linear overlapping smear zones and the distribution of hydraulic conductivity: (a) no overlapping smear zone, (b) partially overlapping smear zone, (c) and fully overlapping smear zones.

considered [60, 61]. The discharge capacity is defined as the rate of water flow (Q) per unit hydraulic gradient (i), which is the head difference (dh) over the flow distance (dl). An alternative formulation of the discharge capacity of a drain is given by the draining area (A) multiplied with the permeability of the drain (k_w).

$$\mu_{well} = \frac{k_h}{q_w} \cdot \pi \cdot z \cdot (2l - z) \quad (4.13)$$

$$q_w = \frac{Q}{i} = Q \cdot \frac{dl}{dh} = Ak_w \quad (4.14)$$

The drain discharge capacity is an important drain specification which is determined in the laboratory by measuring the flow through the drain (300 mm) induced by a certain hydraulic gradient. For straight drains the discharge capacity is determined at a confining pressure of 300 kN/m², a gradient of 0.1, and a test duration of 30 days, whereas the discharge capacity of a buckled drain is determined at a confining pressure of 200 kN/m² [62]. The straight and buckled discharge capacities of the MD7007 and the MD88H were elaborated in table 4.1. The results emphasize the importance of drain deformation for MD7007 because the discharge capacity is 86 % and 47 % with respect to the initial conditions. The discharge capacity of the MD88H is with 142 % and 134 % higher for the buckled configuration. This indicates that the MD88H is less susceptible for deformations compared to the MD7007, note that the difference in confining pressures (300 and 200 kN/m²) is responsible for the increase in discharge capacity for the MD88H.

Table 4.1: Discharge capacity of the MD7007 and MD88H prefabricate vertical drains in straight and buckled configuration (confining pressure = 300 and 200 kN/m², test duration = 30 days, hydraulic gradient = 0.1.) [62].

Test	Duration	Loading	Gradient	MD7007	MD88H
				m^3/s	m^3/s
Straight	30	300	0.1	32.0 E-6	35.0 E-6
Buckled, 1 sharp fold	30	200	0.1	27.4 E-6	48.0 E-6
Buckled, 3 sharp folds	30	200	0.1	14.9 E-6	63.0 E-6

Despite the standardization of testing procedure it is tricky to extrapolate the discharge capacity determined in the laboratory to a drain performance in the field for various reasons: (i) the drain length in the laboratory is limited whereas it is much longer in the field (ii) the hydraulic gradient in the field is time dependent whereas it is kept constant in the laboratory, (iii) the effective lateral stress or confining pressure is constant in the laboratory whereas it increases in time and with depth in the field, (iv) drain deformations in the soil are random and increase in time whereas the laboratory deformations are standardized and independent of time, and (v) clogging and siltation are not included in the laboratory [57, 59, 61, 63, 64].

Table 4.2: Important difference between laboratory and field conditions which affect the measured/observed drain discharge capacity

	Laboratory conditions	Field conditions
Length drain	Standardized at 300 mm	Project dependent
Hydraulic gradient	Standardized at 0.1	Decreases in time and with depth
Confining pressure	300 and 200 kN/m ²	Increases in time and with depth
Drain deformation	Straight or standard deformation	Multiple, increases in time
Infiltration of fines	Excluded in laboratory	Increases in time
Water flow	Measured quantity	Project dependent

Although extrapolation of laboratory discharge capacities is not straight-forward, it is well-understood that the drain discharge capacity during consolidation reduces in time and with depth. More important is how the actual drain discharge capacity relates itself to the required discharge capacity during consolidation. In the ideal situation the discharge capacity of the drain matches with the required discharge capacity during consolidation. The required discharge capacity for consolidation depends on the ease, the amount of water flow towards and through the drain [58, 65–67]. The methods to estimate the required discharge capacity were elaborated in the next chapter, whereas in the following subsection the results were included of a field test on the drain discharge capacity.

In Bo (2004) the discharge capacity of several drains were back-calculated for the Changi East project and elaborated in figure 4.5. In this research project the discharge capacities were back-calculated based pore water pressure and settlement measurements. An important limitation is that no description was given on the horizontal distance between the drains and the piezometers, which were used to determine the hydraulic gradient in the drain. The maximum discharge capacity was observed just after loading and varied between 13.0E-06 and 8.5E-07 m³/s. The minimum discharge capacities were approximately two orders of magnitude lower compared to the initial and maximum measure discharge capacities and varied between 6.2E-08 - 1.8E-08 m³/s. The results indicate that the maximum measured discharge capacity matches reasonable good with the straight discharge capacities determined in the laboratory. However, the results also indicate that the minimum did not match the buckled discharge capacities determined in the laboratory which implies that optimisation is possible.

Project	Square spacing (m)							
	1.5 × 1.5		1.8 × 1.8		2.0 × 2.0		2.5 × 2.5	3.0 × 3.0
	Colbond	Mebra	Colbond	Mebra	Colbond	Mebra	Colbond	Colbond
	Discharge capacity (m ³ /s)		Discharge capacity (m ³ /s)		Discharge capacity (m ³ /s)		Discharge capacity (m ³ /s)	
Phase 1B	Maximum				2.5E-06		3.2E-06	8.5E-07
	At 3 month				1.2E-06		1.5E-06	5.6E-07
	At 6 month				8.0E-07		8.9E-07	3.1E-07
	Minimum				2.5E-08		6.2E-08	2.6E-08
Phase 1C	Maximum	2.2E-06	2.2E-06	4.3E-06	3.5E-06	5.0E-06	2.9E-06	
	At 3 month	5.3E-07	4.2E-07	5.0E-07	5.7E-07	6.7E-07	6.3E-07	
	At 6 month	2.6E-07	2.2E-07	6.2E-07	2.6E-07	8.7E-07	6.6E-07	
	Minimum	1.9E-08	1.8E-08	2.0E-08	2.0E-08	3.3E-08	2.3E-08	
Area A (North)	Maximum		8.2E-06		1.3E-05			
	At 3 month		2.5E-07		7.2E-07			
	At 6 month		2.2E-07		6.7E-07			
	Minimum		2.1E-08		4.0E-08			

Figure 4.5: Back-calculated discharge capacity for various test location for the Changi East reclamation project based on pore water pressure and surface settlement measurements.

4.4 COMPRESSIBILITY OF REMOULDED SOILS

The stress-strain relation of soil is important to predict deformations in time. Equation 4.15 and 4.16 are used to describe the amount of primary deformation, and the development of secondary deformation in time [3]. The development of total settlement is given by equation 4.17, and is obtained by combining the average degree of consolidation with the formulations for primary and secondary deformations. Primary and secondary

deformations are assumed to develop right after the surcharge load is applied.

$$\Delta H = \frac{H_0}{1 + e_0} \left(C_r \cdot \log \left(\frac{\sigma'_p}{\sigma'_{ov}} \right) + C_c \cdot \log \left(\frac{\sigma'_{ov} + u_0}{\sigma'_p} \right) \right) \quad (4.15)$$

$$\Delta H(t) = \frac{H_0}{1 + e_0} \cdot C_\alpha \cdot \log \left(\frac{t}{t_0} \right) \quad (4.16)$$

$$\Delta H(t) = \frac{H_0}{1 + e_0} \left(\left(1 - \exp \left(\frac{-8T_h}{\mu_x} \right) \right) \left(C_r \cdot \log \left(\frac{\sigma'_p}{\sigma'_{ov}} \right) + C_c \cdot \log \left(\frac{\sigma'_{ov} + u_0}{\sigma'_p} \right) \right) + C_\alpha \cdot \log \left(\frac{t}{t_0} \right) \right) \quad (4.17)$$

The impact of the drain installation procedure on the stiffness of the soil is important for predicting the deformations in time, and is illustrated by comparing the stress-strain relation for of un-remoulded and completely remoulded soils. The stress-strain relation of un-remoulded overconsolidated soft soil is characterised by two distinctive stress ranges separated by the pre-consolidation. The pre-consolidation, or yield stress depends on desiccation and the geological stress history of the site (Briaud, 2013) and is 'remembered' by the soil. For surcharge loads below the pre-consolidation pressure the stress-strain behaviour is elastic and rather stiff compared to the behaviour when stresses are applied beyond the pre-consolidation or yielding stress. The soil stiffness in the elasto-plastic region, i.e. a surcharge load which exceeds the pre-consolidation pressure, is much lower and decreases with the stress level. The stress-strain relation for completely remoulded soft soils is significantly different and is not characterised in terms of the elastic and elasto-plastic regions [68, 69]. Due to remoulding the soil structure is altered, and therefore the 'remembered' pre-consolidation pressure is 'forgotten' by the soil. For this reason, the stiffness of completely remoulded soil is characterised by a stress-strain relation which is independent from the initial pre-consolidation pressure. Many authors state that soil compressibility increases with remoulding however, one can argue that this statement is only valid for stress levels below the initial yield stress. In figure 4.6 it is shown that for stress levels above the pre-consolidation pressure the soil stiffness of a remoulded soil is higher compared to the stiffness of a 'virgin' soil. This implies that the total settlement of a un-remoulded and completely remoulded soil converge as the stress level increase.

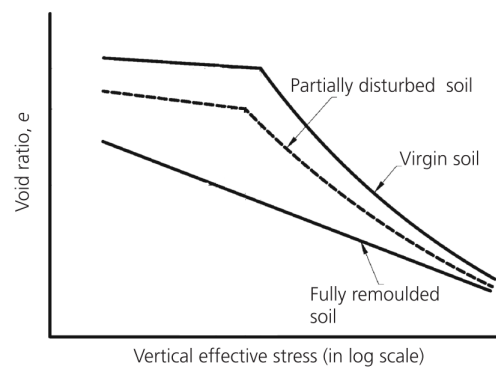

Figure 4.6: Simplified stress-strain relation for: (1) un-remoulded soil, (2) partially remoulded soil, and (3) completely remoulded soils. [69]

The un-remoulded and completely remoulded stiffness shown in figure 4.6 describes the upper and lower bounds within the stress-strain relation. The actual behaviour of soil layer disturbed by the installation of PVD is situated somewhere between the formulated limits, and depends on the soil structure and PVD spacing. For the concept of mini drains it is expected that the soil is more remoulded during installation compared to the amount of disturbance caused by the conventional installation procedure. This implies, assuming a completely remoulded soil, that the total settlement for mini drains is higher compared to the total settlement of PVDs. This difference is especially significant at stress levels near the preconsolidation pressure, and reduced as the stress level increases. This is not necessarily a disadvantage because the residual settlements, which develop after the construction is finished, are often of more importance for the functional requirements of the infrastructure. For the concept of mini drains it is expected, assuming that faster consolidation

is possible, that the contribution of primary deformations to the residual settlements are reduced because more consolidation has taken place. This implies that the increase in total settlements are not a problem as long as there is enough time to finish the consolidation process.

What could become normative for the mini drains is the contribution of secondary settlements to the residual settlements. Secondary deformations, also known as creep, are permanent deformations under the influence of constant mechanical stresses. For soils creep is related to reorientation of soil particles and this effect is especially significant in clays and peats. The reorientation of the soil structure in clay and peat is triggered by degradation of organic content. This triggering mechanism is however not affected through remoulding because degradation of organic content is an ongoing process which (partially) already has taken place. Based on this reasoning, it is not expected that the contribution of secondary deformations to the residual settlements are significantly different for mini drains compared to the conventional PVD.

5

RESEARCH METHODOLOGY

In the literature study on consolidation with mini drains was concluded that consolidation is not affected when the drain discharge capacity exceeds the required discharge capacity. Especially for the relation in time between the required capacity and the drain capacity more research is needed. Additionally, it was also concluded that the effect of overlapping smear zones dominates the reduction in drainage path for a drain spacing smaller than 0.50m. However, there are no case studies, and a limited number of papers available which discuss the particular situation of an extreme drain spacing which is needed for the concept of mini drains.

This section elaborates on the applied methodology to study the time effect, and the effect of overlapping smear zones. Eleven experimental consolidation and discharge capacity tests were performed. Additionally, several analytical methods and Plaxis models were used to study both effects.

To give a brief introduction in the experiments, the tests with drains consisted of a consolidation test to determine, followed by a discharge capacity test to determine the discharge capacity of deformed drains. Additionally, the tests on the smear effect consisted of a pre-consolidation without drain, followed by drain installation, consolidation with drains, and again a discharge capacity test. The details of the experimental testing program were elaborated on the next page, whereas the detailed testing procedures were included in the corresponding sections. Figure 5.1 gives insight in the experimental set-up used within this research.



Figure 5.1: Experimental consolidation and discharge capacity test: (left) sample tubes with loading balloon, (middle) consolidation tests without drains, (right) permeability test on a consolidated sample with a drain.

Experiments on filter efficiency				
Goal: verification of coefficient of consolidation, determination of filter efficiency of three filter types				
Procedure: Consolidation without drains.				
Report tag	Drains	Filter Type	Test motivation	Repetitions
ND1	-	Fliter: VD Typar 27	Reference test: filter efficiency known	2
ND2	-	Filter: BRWLA 050	Filter efficiency new filter	2
ND3	-	Filter: Thailand	Filter efficiency new filter	2

Experiments on well-resistance				
Goal: determination of the effect of well-resistance on the rate of consolidation for three drain types.				
Procedure: drain installation, addition of clay slurry, consolidation with drains, discharge capacity test on consolidated sample with deformed drains.				
Comments: Drains are installed before addition of the clay slurry to exclude the smear effect.				
Report tag	Drains	Drain Type	Test motivation	Repetitions
MMD	1	Mini Mebradrain	Reference test: No well-resistance	3
WD	1	Wool drain	Potential well resistance	3
WDF	1	Wool drain with filter	Potential well resistance, interpretation MMD and WD	2
3MMD	3	Mini Mebradrain	Reference test: No well-resistance reduced spacing	3
3WDF	3	Wool drain with filter	Potential well resistance, verification MMD, WD, WDF and 3MMD	3

Experiments on overlapping smear zones				
Goal: determination of the effect of overlapping smear zones on the rate of consolidation for three different drain configuration.				
Procedure: pre-consolidation, drain installation, consolidation with drains, discharge capacity test on consolidated sample with deformed drains.				
Comments: drains with high discharge capacity are used to exclude the effect of well-resistance.				
Report tag	Drains	Drain Type	Test motivation	Repetitions
PC-MMD	1	Mini Mebradrain	Reference test: Single smear zone, single discharge capacity	3
PC-MMD-3FD	1	Mini Mebradrain	Multiple overlapping smear zones, single discharge capacity	2
PC-3MMD	3	Mini Mebradrain	Multiple overlapping smear zones, multiple discharge capacity	3

5.1 PREPARATION EXPERIMENTS

This section describes the preparation of the clay slurry and the results of the executed reference tests on the clay slurry. For each experimental test approximately 3000 g of viscous clay slurry with a water content of 100 % was needed. The clay slurry was made of Vingerling K122, a river clay which is normally used by artists as exercise material but which is also applicable for small scale geotechnical experiments.

The initial water content (w) and void ratio (e) of each clay block (10 kg) was determined to calculate the amount of additional water needed for a water content of 100 %. The water content and void ratio were calculated according to equation 5.1 and 5.2 by weighting a specific volume of clay before and after drying in a oven at 105 degree C° for 24 hours. Based on the obtained information water was added and mixed with the Vingerling clay block. To ease the mixing process, the clay blocks were cut into small chumps and set aside together with the additional water for a couple of days. In the mean time evaporation of water was prevented by sealing the mixture with a plastic foil. The mixing process was executed with a drilling machine equipped with a mixing tool, and was continued until all clay chumps where gone. The water content of the clay slurry was verified afterwards using the same procedure as described earlier. In figure 5.2 the variation in water content and void ratio were elaborated. The water content of the clay blocks varied between 29 % and 33 %, whereas the water content of the clay slurry varied between 99 % and 103 %. The void ratio of the clay ranged from 0.85 to 1.06, and the void ratio of the mixture was approximately 2.7.

$$w = \frac{m_{water}}{m_{clay}} \quad (5.1)$$

$$e = \frac{V_{water} + V_{void}}{V_{clay}} \quad (5.2)$$

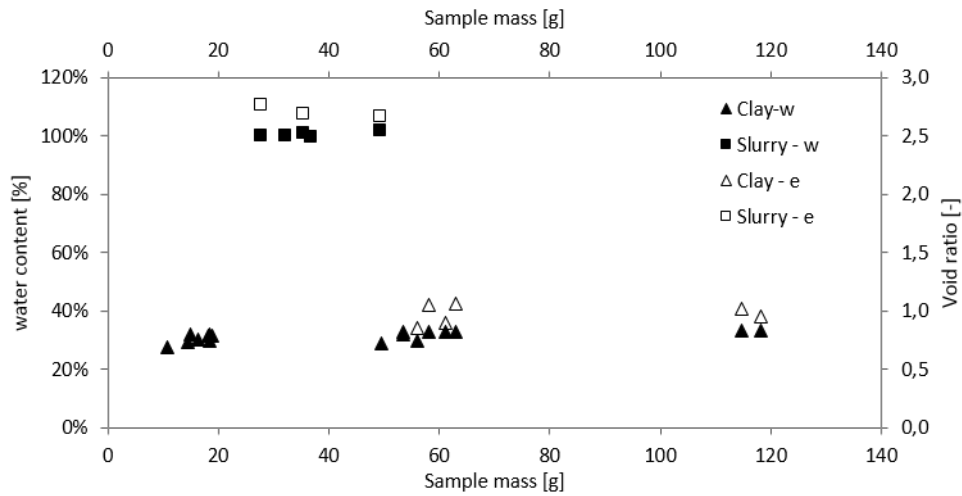

Figure 5.2: Void ratio and water content of initial Vingerling clay blocks, and mixed viscous clay slurry.

Three Oedometer test on the Vingerling clay slurry were executed to obtain the oedometer stiffness (E_{oed}), the coefficient of consolidation (c_v), the volumetric compressibility (m_v), and the compression index for primary loading (C_c), the re-compression index for reloading (C_r), and the compression index for secondary deformations (C_α). The Oedometer testing data was elaborated and analysed in C, whereas the most important results were included in table 5.1.

Table 5.1: Results Oedometer tests

E_{oed}	m_v	C_c	C_r	C_α	c_v (Taylor)	c_v (Casagrande)
kN/m^2	m^2/kN	–	–	–	m^2/s	m^2/s
133	0.0075	0.75	0.025	0.0126	5.00E-09	1.87E-08

The stress range of the oedometer test varied from 0 to 70 kN/m^2 , similar to the stress range applied in the experimental consolidation tests. The oedometer stiffness was approximately 130 kN/m^2 , and the volumetric compressibility was $0.0075 \text{ m}^2/\text{kN}$. The compression index for primary loading was determined over a stress range 0 to 95 kN/m^2 and equals 0.75. The re-compression equalled 0.025, and was determined with a unloading and reloading step of 15 kN/m^2 . The compression index for secondary deformations was 0.0126, and was determined at a vertical stress of 95 kN/m^2 which was maintained for 7 days. The coefficient of consolidation was determined for each loading step with the Taylor method (log-t method), and the Cassagrande method. The tabulated coefficients of consolidation were obtained at stress level of 70 kN/m^2 , i.e. approximately equal to the applied surcharge loading in consolidation experiments (60 kN/m^2). The Oedometer results were used as initial input for the analytical solutions and the Plaxis models.

5.2 EXPERIMENTS WITHOUT DRAINS

The first set of experiment consisted of a consolidation test without drains. The experiment was performed for two reasons: (i) to establish the relation with a standardized oedometer, and (ii) to verify the filter characteristic of three different filter sleeves. A schematic representation of the experimental consolidation test without drain was given in figure 5.3. In total six consolidation tests without drains were performed to verify the efficiency of three filter sleeves: (i) VD Typar 27, (ii) BRWLA 050, and (iii) the Thailand filter. The filter sleeve characteristics are of minor importance for the research on mini drains, but are crucial for consideration on future developments of prefabricated vertical drains.

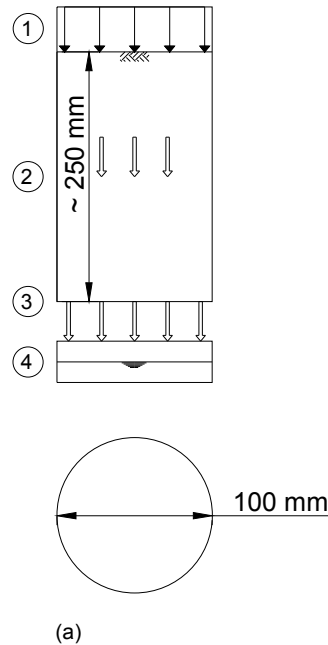

Figure 5.3: Schematic representation of consolidation test without drains (with 1 = 60 kN/m^2 surcharge pressure, 2 = sample tube with 3000 g clay slurry without drains, 3 = open drainage boundary with a variable filter type, 4 = measurement cup).

The bottom element consists of a tube with a steel grid to support the filter sleeve during the consolidation test. The filter, enclosed by two rubber rings, was placed on the steel grid to allow dissipation of water during the consolidation test. The middle element was placed on the upper rubber ring and connected to the bottom element with a screwed connection element. Afterwards, the tube was filled with 3000 g slurry to obtain a sample height of approximately 250 mm. A rigid loading plate was placed carefully on the sample to create an equal settlement condition, i.e. similar to the oedometer test. The sample tube was closed with a loading balloon and a plastic cap which was screwed to the middle element. The complete sample tube was weighted and placed in a steel framework. Underneath the sample tube a measurement cup was located to collect water during the consolidation test. To prevent evaporation of water the sample tube and the measurement cup were sealed with a plastic foil. The consolidation test was started by inflating the balloon up to a pressure of

0.6 bar, i.e. approximately equal to a surcharge load of 60 kN/m^2 . The amount water in the measurement cup was weighted continuously with a scale, and the air pressure in the balloon was monitored continuously with a manometer. Primary settlements were back-calculated based on the measured dissipated water mass, i.e. in accordance with the definition of consolidation. Secondary deformations related to creep were disregarded for two reasons: (i) the limited time-span, and (ii) the indirect determination of settlement. The total amount of dissipated water was verified with a mass balance check in which the whole sample tube was weighted before and after the consolidation test. A third data verification step was performed with a ruler by measuring the initial and consolidated sample height. The degree of consolidation, i.e. the amount of settlement with respect to the final settlement, was obtained with a prediction of the final settlement based on the compressibility parameters determined with the oedometer tests. To verify the degree of consolidation three samples were taken at different heights to determine the reduction in water content.

5.3 EXPERIMENTS ON WELL-RESISTANCE AND DRAIN CAPACITY

The second set of experiments, explained in this section, and was performed to determine the impact of reduced drain quality on the consolidation process. Three types of mini drains were used to determine the effect of drain quality: (i) a mini Mebra drain (MMD), (ii) a wool drain (WD), and (iii) a wool drain with a filter (WDF), see figure 5.4. The MMD, made of a modern MebraDrain (MD7007), was included as reference drain without well-resistance, i.e. the discharge capacity exceeds the minimum discharge capacity for consolidation. The WD is a very simplistic drain without a filter and a stiff core and was included to mimic a low quality drain with a reduced discharge capacity. The WDF is a WD encased in a VD 27 Typar filter and was included to attribute potential differences between the MMD and WD to the filter sleeve or drain core. The smear effect was excluded because a slurry lacks structure and anisotropy which could be affected during the installation process. Another precaution measure to prevent smear is that the drains were installed before the slurry was added such that the void ratio was constant and not affect by the installation procedure.

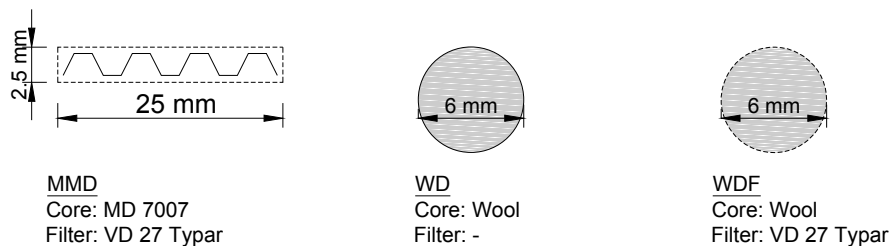

Figure 5.4: Prototypes of mini drains used within the testing series on well-resistance: (a) mini Mebradrain (MMD), (b) wool drain (WD), and (c) wool drain encased with a filter (WDF).

Two different drain configuration were used to determine the impact of a different drain spacing: (i) a sample tube with a single drain, and (ii) a sample tube with three drains, see figure 5.5. Each testing series consisted of a consolidation test with one (a) or three drains (c), and was followed by a discharge capacity test with one (b) or three (d) drains. In total five testing series, all consisting of a consolidation test and a discharge capacity test, were performed to verify the impact of the drain quality on the consolidation process.

The test procedure of the consolidation tests with drains had large similarities to the consolidation test without drains. The most important differences were that drains were used to accelerate the consolidation process and that the bottom element was designed such that water could only dissipate through the drains. The connection between the bottom plate and the drain was made with PVC tubes, tape and wood to prevent slurry leakage. The drains were installed in the sample tube before 3000 g slurry was added to exclude the smear effect and any reduction of void ration caused by the installation process.

The discharge capacity test was performed after the consolidation test on two of the three sample tubes to determine the discharge capacity of deformed drains. The sample tubes with the consolidated sample and deformed drains were placed in a steel framework. The bottom element was maintained such that only the flow though the drains was measured, whereas the top element with the loading balloon was replaced for a plastic cap with two holes, one for inflow of water and one for outflow of air. The discharge capacity was calculated by measuring the amount of water flow through the drain caused by a constant head difference of

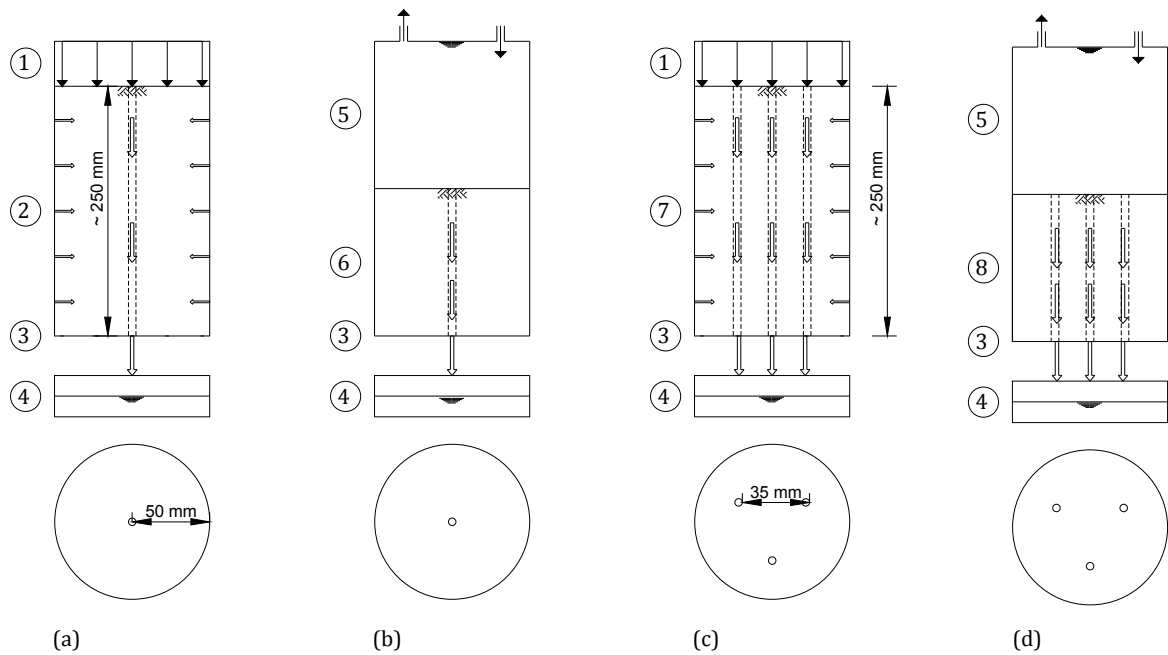

Figure 5.5: Consolidation with drains without preconsolidation: (a) consolidation test with a single drain, (b) discharge capacity test single drain, (c) consolidation test with three drains, and (d) discharge capacity test three drains (with 1 = 60 kN/m^2 , 2 = 3000 g slurry with one/three drains, 3 = drainage possible at drains, 4 = measurement cup, 5 = constant water head and air/water valve, 6 = consolidated sample with deformed drains).

approximately 2.0 m. Each discharge capacity test was repeated once to verify the results obtained the first test. After the discharge capacity tests the consolidated samples were pushed out of the tubes to examine the orientation of the deformed drains and collect samples for the determination of the water content.

5.4 EXPERIMENTS ON THE SMEAR EFFECT

The third set of experiments was performed gain insight in the effect of overlapping smear zones because it is an important unknown for the concept of mini drains. In the previous section on the well-resistance, drain were installed before the slurry was added to exclude the smear effect. In this section on the smear effect drains were installed in a preconsolidated sample to mimic the smear effect on the consolidation process, see figure 5.6 and 5.7 for the testing procedure. The effect of well-resistance was excluded for this set of experiments by using the mini Mebradrain with a sufficient high discharge capacity.

Three testing series were performed to determine the impact of overlapping smear zones on the rate of consolidation: (i) a single mini Mebradrain installed in a preconsolidated sample (PC-MMD), (ii) a single mini Mebradrain and three fake drains installed in a preconsolidated sample (PC-MMD-3FD), and (iii) three mini Mebradrains installed in a preconsolidated sample (PC-3MMD). The PC-MMD was performed as reference test to determine the effect of a single smear zone on the rate of consolidation. The PC-3MMD was performed to determine the additional reduction induced by interacting and overlapping smear zones. The PC-MMD-3FD was included to ease the comparison between the PC-MMD and PC-3MMD because the test represented an intermediate situation with overlapping smear zones but without additional drainage capacity. This means that the PC-MMD-3FD allows for direct interpretation of the effect of overlapping smear zones without accounting for the additional discharge capacity and the reduced spacing.

The testing procedure for the PC-MMD, PC-MMD-3FD, and the PC-3MMD were a combination of the tests described in the previous two sections. The preconsolidation phase was performed for approximately seven days and was similar to the consolidation test without drains. This phase was included to create a soil sample which was susceptible for remoulding during the drain installation, i.e. the development of a smear zone

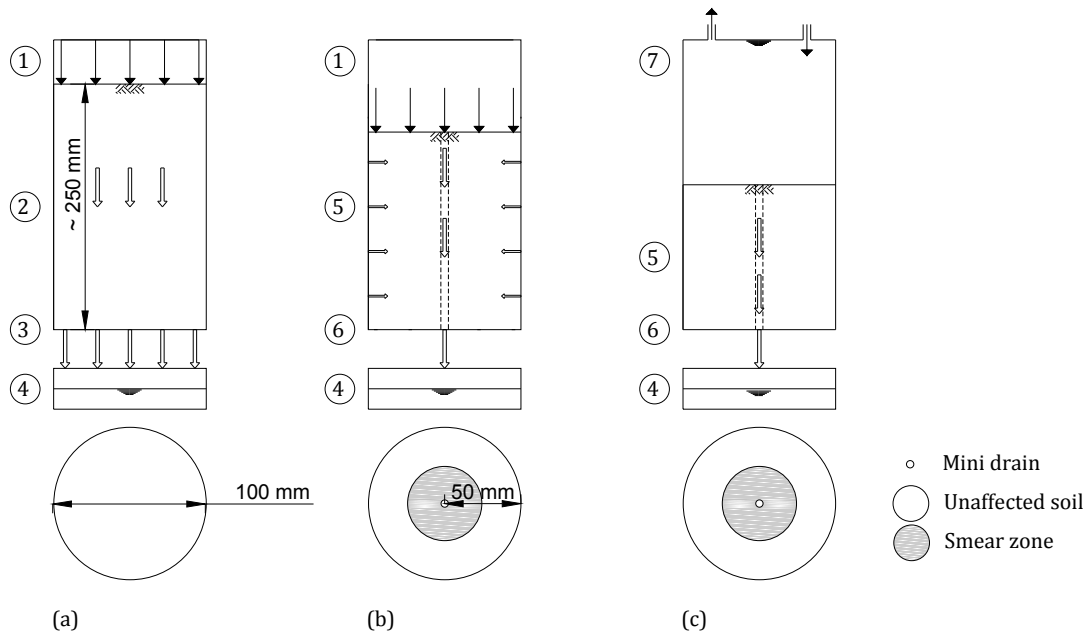

Figure 5.6: Schematic representation of the testing procedure for the experiment with a single drain with preconsolidation: (a) preconsolidation phase, (b) consolidation phase with a drain, (c) discharge capacity test (with $1 = 60\text{ kN/m}^2$ surcharge pressure, 2 = sample tube with 3000 g clay slurry without drains, 3 = open drainage boundary through a filter, 4 = measurement cup, 5 = consolidate sample with a single drain and a smear zone, 6 = drainage possible at location of drains, 7 = constant water head and air/water valve).

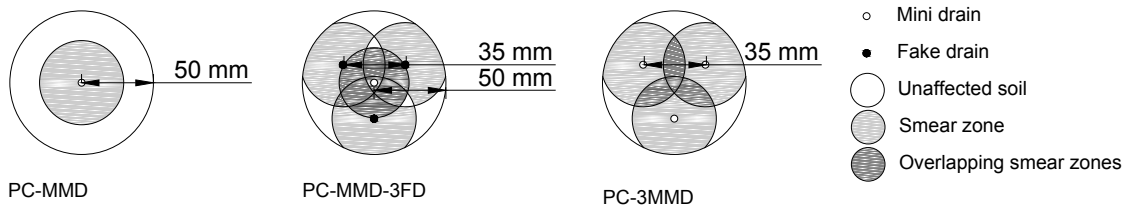

Figure 5.7: Location of the drains and fake drains, and the location of the corresponding theoretical (overlapping) smear zones for the PC-MMD, PC-MMD-3FD, and the PC-3MMD experiments.

around the drain. After seven days the top, and bottom element were removed to prepare the sample tube for the drain installation procedure. To create a slurry tight connection, the drains were connected to the bottom plate before they were installed with a PVC mandrel. Afterwards, the drains were installed by pushing the sample tube with the consolidated clay over the mandrel until the bottom plate was reached. Additional remoulding was obtained by moving sample up and down multiple times before removing the mandrel and connecting it to the bottom element with a screwed connection. Once the drain was installed and the mandrel removed, the rigid loading plate as well as top element with the loading balloon were returned in its original position. The balloon was pressurized again until 0.6 bar and the consolidation test was continued and monitored by weighting the amount of dissipated water. Similar to the previous section a discharge capacity test was performed after the consolidation test to obtain information on the discharge capacity of the deformed drains. The sample tubes were weighed between all testing phases to allow for a settlement check based on the mass balance.

5.5 ANALYTICAL SOLUTIONS

Numerous analytical solution available to determine the degree of consolidation with drains. In this section is explained how these formulation were used to analyse the results of the experiments and substantiate the concept of mini drains.

INTERPRETATION OF EXPERIMENTS WITH ANALYTICAL SOLUTIONS

The reduction factors for the spacing, well-resistance, and the smear effect were used to back calculated the well-resistance and smear effect. The reference experiments (MMD, 3MMD) without the preconsolidation phase were used to confirm the validity of the analytical solution and detect any discrepancies with the theory. The smear effect was excluded because drains were installed prior to the addition of the slurry, whereas well-resistance was excluded because discharge capacity of mini Mebradrain is sufficient. For the experiments on well-resistance and the smear effect the equations below were used to back-calculate the corresponding reduction factors.

- Reference experiments: $\mu_x = \mu_{spacing} + \mu_{smear} + \mu_{well} = known + 0.0 + 0.0$
- Experiments on well-resistance: $\mu_x = \mu_{spacing} + \mu_{smear} + \mu_{well} = known + 0.0 + unknown$
- Experiments on smear effect: $\mu_x = \mu_{spacing} + \mu_{smear} + \mu_{well} = known + unknown + 0.0$

REQUIRED DISCHARGE CAPACITY FOR CONSOLIDATION

Multiple methods are available to estimate the required discharge capacity which is needed to prevent additional consolidation time. In principle the methods are based on an estimation of the water flow through the drain, and an estimation of the hydraulic gradient in the drain. Three analytical methods and Plaxis models were compared and used to estimate the minimum required discharge capacity for consolidation by varying the parameters according to table 5.2. The Plaxis models were elaborated in the next section, whereas the analytical models were explained below.

Direct methods:

- Mesri (1991)- Empirical relation based on layer thickness and horizontal permeability.
- Bo (2004) - Based on average degree of consolidation and an assumed vertical hydraulic gradient.

Indirect methods:

- Leo (2004) - Based on excess pore water pressure distribution in the unit cell during consolidation.
- Plaxis - Linear elastic model with constant soil and drain permeability
- Plaxis - Soft soil model with deformation dependent soil permeability
- Plaxis - Soft soil model with deformation depended soil and drain permeability

Table 5.2: Default parameters for the determination of the required discharge capacity varying circumstances.

	r_e	r_w	H_0	u_0	m_v	k_h	C_h	k_w
	m	m	m	kN/m^2	m^2/kN	m/s	m^2/s	m/s
Default	0.60	0.03	10	40.0	0.001	5e-10	5E-08	0.1
Max	1.0	-	30	100	0.01	1E-9	5E-7	1.0
Min	0.1	-	5	10	0.0001	1E-10	5E-9	1E-5
Experiment	0.05	0.003	0.25	60	0.0077	1.5E-9	2E-8	2E-5

The first method is based on an empirical relation developed by Mesri (1991) and is included in equation 5.3. The method assumes that the required discharge capacity is independent of time and is only affected by the layer thickness (H_0) and the horizontal permeability (k_h) [67, 70, 71]. Lee (2010) proposed to use a factor of safety (FOS) of 5.0 to account for drain deformation and infiltration of fines. Within this research the FOS was excluded to aid the comparison with the other methods.

$$q_{w.req-Mesri(1991)} = 7.85FOSk_hH_0^2 \quad (5.3)$$

The second method based on Bo (2004) is based on the average degree of consolidation and an assumption on the vertical hydraulic gradient in the drain. The water flow in the drain in vertical direction is estimated based on the final settlement multiplied with the average degree of consolidation [63, 67, 72]. The hydraulic

gradient in the drain in vertical direction is estimated based on the applied surcharge load (u_0) and the initial layer thickness (H_0), see equation 5.4. The final settlement is obtained by multiplying the volumetric compressibility (m_v) with the layer thickness and the applied surcharge load. The water flow is obtained by dividing dissipated water volume by the required time (t_x) needed to obtain the considered average degree of consolidation (U). The required time is calculated with equation 5.5 with μ_x is the reduction factor for spacing according to equation 4.5, and C_h is horizontal coefficient of consolidation. It was decided to excluded the smear effect to obtain maximum required discharge capacity. Including the effect of smear would result in a lower required discharge capacity because the water flow towards the drain is deteriorated.

$$q_{w.req-Bo(2004)} = \frac{Q}{i} = \frac{H_0 m_v u_0 \pi r_e^2 U}{t_x} \frac{H_0 \gamma_w}{u_0} \quad (5.4)$$

$$with: \quad t_x = - \frac{Ln(U) \mu_x r_e^2}{2C_h} \quad (5.5)$$

The initial required discharge capacity is obtained by implementing a low degree of consolidation ($U < 0.05$) into the equation, i.e. a water flow rate which is representative for the initial stages of the consolidation process. An important limitation of this method is the assumption on the hydraulic gradient in the drain and the fact that drain permeability is infinitely large.

The method Leo (2004) was based on equation 5.6 which describes the excess pore water pressure (u) at a prescribed radius (r), depth (z) and time (t) [73], and was developed to excluded the assumption on the hydraulic gradient in Bo (2004) by including a finite drain permeability. The smear effect was excluded by setting the permeability in the smear zone (k_s) equal to the horizontal permeability of the soil (k_h), and by setting the extent of the smear zone (r_s) equal to the equivalent drain radius (r_w).

$$u(z, r, Th) = \sum_{ii=1}^{\infty} \frac{4u_0}{(2ii+1)\pi v_n} e^{-\frac{8Th}{v_n}} \cdot \left[\ln\left(\frac{r}{r_s}\right) - \left(\frac{r^2 - r_s^2}{2r_s^2}\right) + \frac{k_h}{k_s} \left(\frac{n^2 - s^2}{n^2}\right) \cdot \ln(s) + \frac{2k_h}{k_w w_n^2 r_w^2} \left(\frac{n^2 - s^2}{n^2}\right) \right] \cdot \sin(w_n \cdot z) \quad (5.6)$$

$$with: \quad v_n = \frac{n^2}{n^2 - s^2} \ln\left(\frac{n}{s}\right) - \frac{3}{4} + \frac{s^2}{4n^2} + \frac{k_h}{k_s} \frac{(n^2 - s^2)}{n^2} + \frac{2k_h}{w_n^2 r_w^2 k_w} \frac{n^2 - s^2}{n^2}, \quad and \quad w_n = \frac{(2ii+1)\pi}{2H_0} \quad (5.7)$$

The discharge capacity during consolidation was back-calculated based on the consolidation rate and the excess pore water pressure at the drain/soil interface with depth. The vertical hydraulic gradient in the drain at a certain moment in time ($i(t_i)$) was obtained by dividing the excess pore water pressure difference by the vertical flow path, see equation 5.9. The water flow through the drain was calculated by subtracting the multiplication of the average degree of consolidation with the final settlement at two time intervals, see equation 5.10.

$$q_w(t_i) = \frac{Q(t_i)}{i(t_i)} \quad (5.8)$$

$$i(t_i) = \frac{u(z_{max}, r_w, t_i) - u(z_{min}, r_w, t_i)}{(z_{max} - z_{min})} \quad (5.9)$$

$$Q(t_i) = \frac{U(t_{i-1})S_{final} - U(t_i)S_{final}}{t_i - t_{i-1}} \quad (5.10)$$

The minimum required discharge capacity was obtained by implementing a certain drain permeability (k_w) which is just sufficient to aid the consolidation process. This limit drain permeability was obtained by comparing the average degree of consolidation of Barron with the average degree of consolidation of Leo (2004) according to the relation below

$$0.98 > \frac{U_{Leo}(t_{90})}{U_{Barron}(t_{90})} = \frac{U_{Leo}(t_{90})}{0.9} > 0.95 \quad (5.11)$$

5.6 FINITE ELEMENT METHOD PLAXIS

The finite element program Plaxis was used to mimic the experimental tests, and verify the analytical methods on the required discharge capacity. For the experiments, the soft soil model, see figure 5.8, was selected because the clay slurry was very compressible and normally consolidated. The soft soil models uses a Mohr-Coulomb failure criterion and describes cap hardening in terms of mean effective stress (p') and the pre-consolidation pressure (p_p). The logarithmic stress-strain relation in the soft soil is described by the modified compression index (λ^*), the modified re-compression index (κ^*), the preconsolidation pressure, and the initial void ratio (e). The relation between strain and the permeability is described according to equation 5.12 with parameter C_k . This parameter was used to model the reduction of permeability of the soil, the drain and the filter cake (introduced in the next chapter).

$$\log \frac{k}{k_0} = \frac{de}{C_k} \quad (5.12)$$

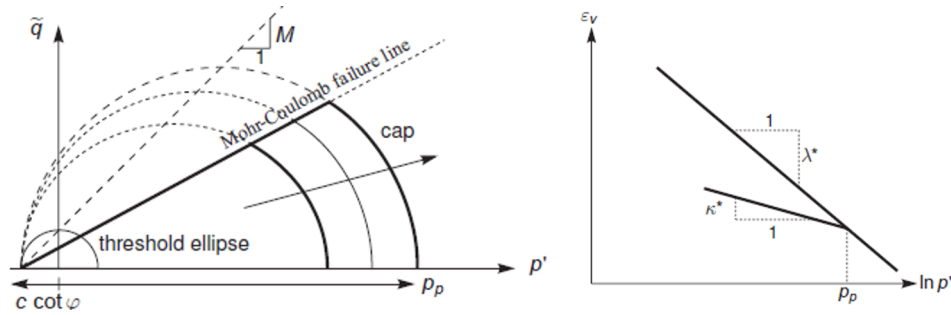

Figure 5.8: Soft soil model characteristics: (left) Failure surface and cap-hardening described in mean effect stress and deviatoric stress plane (right) Logarithmic relation between volumetric strain and mean effective stress.

MIMIC THE CONSOLIDATION EXPERIMENTS

Three different axisymmetric models were developed to mimic the experimental consolidation tests regarding the well-resistances of mini drains. The model designs and the input parameters were elaborated in appendix E.

- Consolidation test without drains
- Consolidation test with drains, reference model
- Consolidation test with drains, filter cake effect.

The first model corresponds to the consolidation test without drain (ND) and was executed to establish the soil permeability (k), the modified compression index (λ^*), and the modified swelling index (κ^*). The obtained parameters were used as input for the following models. The second model was included to determine the drain permeability (k_d) by comparing the results with the theoretical analytical solution without well-resistance, i.e. an infinite k_d . This intermediate stage was required to account for the equivalent drain radius, without the filter cake effect. The third model was included to model the observed delay caused by the filter cake effect, introduced in the results section. The filter cake effect was implemented by adjusting the C_k 's value in a zone adjacent to the drain.

REQUIRED DISCHARGE CAPACITY

In the previous section on analytical formulations three methods were elaborated to estimate the required discharge capacity for consolidation. This part explains how these analytical methods were verified with three Plaxis models. The model layout and the input parameters were included in appendix E.

Plaxis models:

- Linear elastic model with constant soil and drain permeability
- Soft soil model with deformation dependent soil permeability
- Soft soil model with deformation depended soil and drain permeability

Similar to the procedure for Leo(2004), the drain permeability is reduced step by step to determine the relation between the back-calculated discharge capacity and the consolidation time. The required discharge capacity is equal to the back-calculated discharge capacity corresponding to the drain permeability which is just sufficient. Besides the verification of the required discharge capacity, the Plaxis models were also used to study the required discharge capacity in time and obtain more insight in the relation with respect of the drain capacity.

The linear elastic model in Plaxis, i.e. without a failure criterion, was used to verify the results obtained with the linear elastic method based on Leo (2004). The soft soil model was included to verify how the required discharge capacity changes for non-linear soil behaviour, i.e. non-linear stress-strain relation and a deformation dependent permeability of the soil. The results of this analysis were used to determine whether or not more advanced models are required for determination of the required discharge capacity. In addition to the soft soil model, a soft soil model with a deformation dependent drain permeability was included to study a decrease in drain capacity. The decrease in drain permeability was implemented by correlating the drain permeability with the reduction in void ratio using the C_k parameter. For the comparisons with the other models a C_{kd} was selected which represented an average drain capacity reduction of 15%.

The soft soil model with a deformation dependent drain permeability was also used to study extreme reductions in drain capacities. This was done by reducing the C_{kd} value step by step, and relating the back-calculated discharge capacity to the consolidation time with the minimum required discharge capacity.

SMEAR EFFECT

The effect of a single smear zone on the rate of consolidation is well understood and well-captured by the available analytical solution. However, the knowledge on the effect of overlapping smear zones on the rate of consolidation is not fully understood and only included in one analytical solution. It was therefore decided to research the possibilities within Plaxis to model the effect over overlapping smear zones. Two simplified options were considered and discussed below to model the effect of overlapping smear zones. An in-depth Plaxis campaign was not possible because the research consisted of more than Plaxis only.

Considered methods:

- Predefined smear effect
- Prescribed displacement to model the smear effect

Before describing the considered methods first some general comments on modelling the smear effect in Plaxis. The smear effect represents multiple effects caused by the installation of drains: (i) a change in stress-stress behaviour through remoulding of the clay structure, (ii) alteration of the horizontal permeability towards the vertical permeability through remoulding of the clay structure, and (iii) general reduction in permeability based on the added volume of the drain. It is well-known that modelling installation effects in Plaxis is hard because these effects can often not be described with continuum mechanics, i.e. one of the underlying principles of a finite element program. Another thing which causes problems with modelling installation effects are excessive (plastic) deformations which develop during the installation of foundation piles or drains. The excessive installation deformations do not follow the constitutive stress-strain relations, and often cause problems with numerical stability. The material point method was not considered in this thesis.

The first considered option requires a predefined description of the extent and permeability ratio around the drain, i.e. the smear zone. For a single drain without adjacent drains this is possible because numerous papers are available which define distributions for the horizontal permeability around the drain. However, it is not possible to follow a similar approach for multiple drains, including overlapping smear zones, because data on the distribution of horizontal permeability is not available. This model was therefore excluded from further elaboration because the results are user dependent.

The idea of second model was to alter the consolidation process by reducing the void ratio around the drain by subjecting this zone to a prescribed displacement based on the volume of the drain. It was found that the distribution of the void ratio depends on the installation speed of the prescribed displacement. A fast implementation speed resulted in extreme void ratio reduction around the drain, whereas a slow implementation speed resulted in a more generally distribute reduction in void ratio. The previous emphasises an important limitation of the second method because the results were again dependent on the input of the user. Another limitation of the second modelling option was that the final settlement was affect by the added volume. Re-setting the displacements to overcome this problem was not possible because the reduction in void ratio was also reset to its initial value. This model was therefore excluded from further elaboration for obtaining insight in the effect of overlapping smear zones.

To conclude the previous paragraphs it was stated that it is not recommended to study the smear effect with Plaxis. Quality input and validation data are needed to exclude user dependency, include the installation effects and enable extrapolation towards more general cases. This data is often not available or expensive to obtain. An analysis on the over-all effect of overlapping smear zones based on a field study is easier and more applicable in practice.

6

RESULTS AND DISCUSSION

This chapter describes the results of the research on mini drains by discussing the consolidation experiments, the discharge capacity experiments, and the results obtained with the analytical solutions and the Plaxis models. A general overview of the performed consolidation experiments was included in 6.1. Within this chapter the average settlement in time and the results of the discharge capacity tests were used. The results of the individual test were included in Appendix D and consists of: (i) average settlement and corresponding settlement curves of the separate consolidation tests, (ii) final settlement verification check, (iii) discharge capacity tests, and (iv) the variation of water content of the consolidated sample.

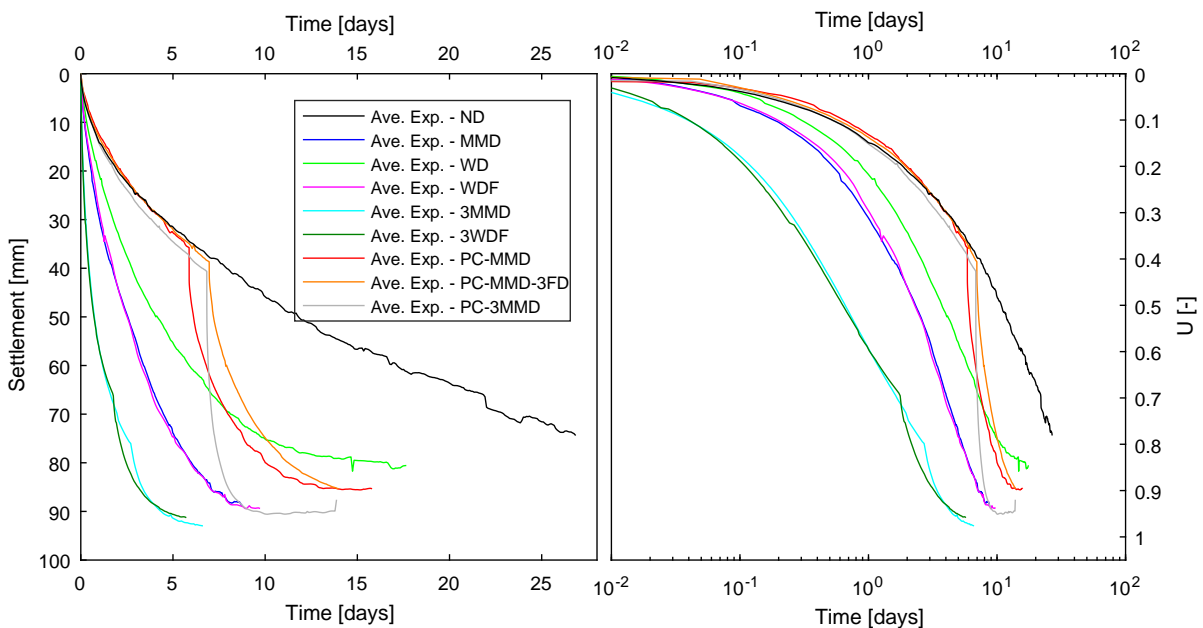

Figure 6.1: General overview of the results of the experiments: average vertical settlement in time and corresponding degree of consolidation.

The first section concerned the vertical consolidation experiment without drains (ND). The second section discussed the effect of well-resistance on consolidation based on the analytical methods and Plaxis models. The third section described the consolidation and discharge capacity experiments on the drain types (MMD, WD, WDF and 3MMD, 3WDF). The final section elaborated the result regarding the smear effect and the corresponding consolidation experiments on the (overlapping) smear zones (PC-MMD, PC-MMD-3FD, PC-3MMD).

6.1 EXPERIMENTS WITHOUT DRAINS

The results of the consolidation tests without drains (ND), the corresponding analytical approximation and the verification with Plaxis2D were described in this section. The vertical consolidation tests were performed to establish the relation with the oedometer tests and verify the filter efficiency of three filter sleeves.

The results of the consolidation experiment were elaborated in figure 6.2. The average settlement was 73 mm for ND1 after 24 days, 73 mm for ND2 after 27 days, and 70 mm for ND3 after 22 days. Test ND2-2 was excluded because measurement cup was not properly replaced afterwards. Test ND3-2 was excluded because the loading balloon was twisted during the pressurization phase such that the sample was not loaded until 60 kN/m².

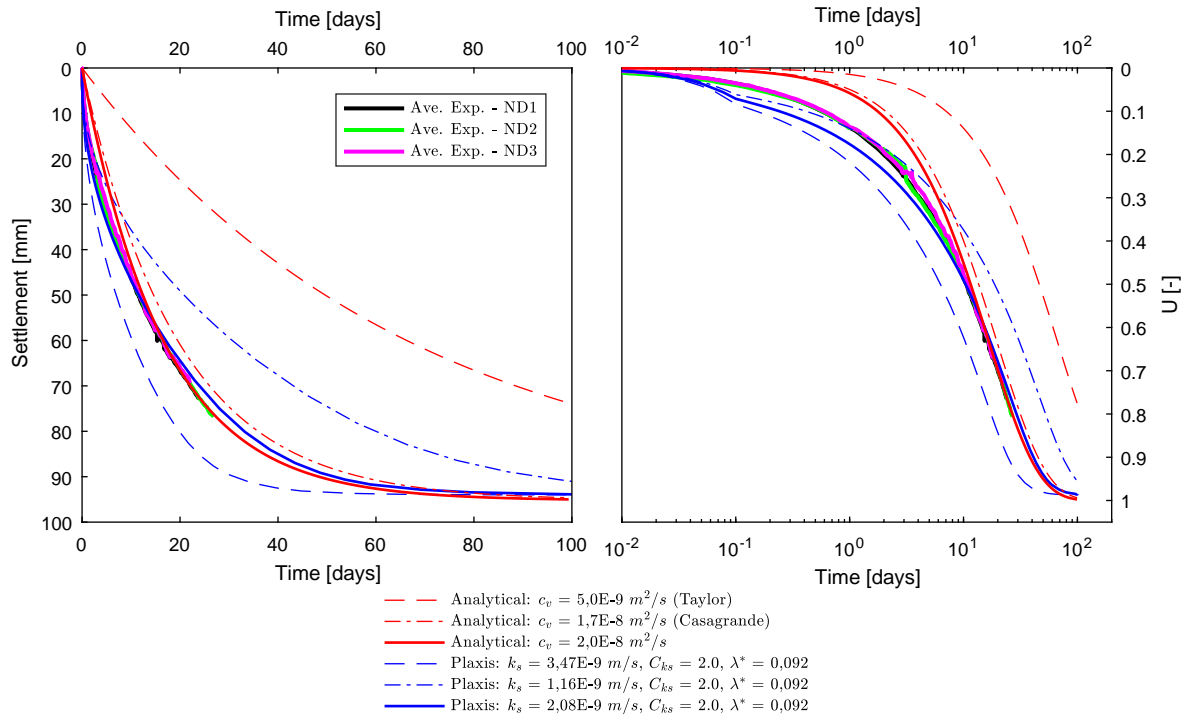

Figure 6.2: Results consolidation test without drains: (i) Measured average vertical settlement in time for the consolidation test without drains, (ii) analytical approximation of measurements, and (iii) Plaxis verification of measurements (with ND1 = VD Typar 27 filter, ND2 = BRWLA 050 filter, ND3 = Thailand filter).

Filter efficiency and filter cake:

No significant differences were observed in the rate of consolidation between the three tested filter types which means that the filter type did not affect the consolidation process. More fines were visually detected in the measurement cup of ND1 compared to the measurement cups of ND2/ND3 which implies that the initial filter efficiency of ND1 was lower. During the consolidation test a change in filter efficiency in time was observed because the expelled water during the initial stages contained more fines compared to the water in the latter consolidation stages.

This observation suggested that the filter efficiency increased in time through the development of a filter cake on the filter-soil interface. The filter cake consists of accumulated fines which were transported towards the filter due to the hydraulic gradient. The filter cake improved the filter efficiency because the layer reduces the mesh opening size and prevents additional infiltration of fines into the drainage channels. The development of a filter cake seems especially important to reduce the effect of clogging and siltation caused by local filter inhomogeneities. The filter cake effect is not solely positive because the permeability reduces due to accumulated fines. It was not possible to establish the amount of reduction caused by the reduced permeability in the filter cake because a reference test without a filter was not available.

Test observations

The drainage conditions changed during the initial stages of the consolidation experiment from a two-way

drainage system towards the intended one-way drainage system. Water dissipated both upwards and downwards during the first moments of the consolidation test because the space around the loading balloon was not saturated at the time of loading. After saturation water could only dissipate downwards through the filter which implies that the degree of consolidation based on the dissipated water mass underestimates the actual degree of consolidation. For the verification of the soil properties this observation was of less significance because the long term results were used to verify the soil properties.

The (back-calculated) settlements based on the dissipated water mass were verified with the mass balance and the ruler check. For the consolidation test without drains the ruler check indicated that the final settlements were slightly underestimated. These differences were attributed to the effect of secondary deformations, an effect which can not be back-calculated based on dissipated water mass because it is related to reorientation of clay particles and degradation of organic matter. An exact determination of the contribution of secondary deformations was therefore not possible because direct measurement of high quality were available.

Parameter validation

Figure 6.2 showed that the degree of consolidation determined based on Casagrande's coefficient of consolidation matches the data, whereas the degree of consolidation based on a coefficient of consolidation determined with Taylor's method underestimated the development of settlement in time. Taylor's coefficient of consolidation was excluded because the difference with Casagrande and the 'best fit' c_v $2.0E-8$ m^2/s are too large.

The analytical approximation with a coefficient of consolidation of $2.0E-8$ m^2/s underestimates the development of settlement during the initial stages of the consolidation, whereas it overestimates the settlement rate during the latter stages of the consolidation procedure. This difference was not solely related to the changing drainage conditions, but was also related to the definition of the coefficient of consolidation in the analytical solutions. Barron assumed a constant coefficient of consolidation during the whole consolidation process, i.e. the permeability and compressibility remain unchanged as the consolidation progresses. The consequences of this assumption were amplified in the experiments because the difference between the viscous clay slurry and the stiff consolidated material are extreme.

The Plaxis model with a permeability (k) of 0.00018 m/day , the modified compression index (λ^*) of 0.092 , and a change in permeability (C_k) of 2.0 showed great visual agreement with measured data. The difference between the analytical solution and the Plaxis model is especially significant during the initial stages of the consolidation.

6.2 DISCHARGE CAPACITY AND WELL-RESISTANCE

This sections presents the results regarding discharge capacity, well-resistance and the consolidation time for general project and soil conditions based on a theoretical approach. The soil and project parameters described in table 5.2 were used for the analysis. The default case was used for an 'in-depth' analysis on the discharge capacity, whereas the varying soil/project parameters were used to obtain insight in the required discharge capacity under varying soil/project conditions. The default case can only be used conceptually because the analysis represents a single situation.

For convenience it was decided to described the characteristic of the drain both in terms of drain discharge capacity (q_w in m^3/s) and drain permeability (k_w in m/s), see equation 6.1 in which A_w is the cross-sectional area of the drain.

$$q_w = \frac{Q}{i} = A_w k_w \quad (6.1)$$

REQUIRED DISCHARGE CAPACITY

This part includes the analysis on the default case to emphasize the relation between the required discharge capacity ($q_{w.req}$), the consolidation time (t_{90}), the back-calculated discharge capacity ($q_{w.BC}$), and the drain discharge capacity of modern prefabricated vertical drains. Besides the simple methods of Mesri (1991), Bo (2004), and Leo (2004), four Plaxis models were used to analyse the required discharge capacity during con-

solidation. The first model (*LE*) was included for verification of the analytical method based on Leo (2004), the second model (*SS*) was included to account for non-linear stress-strain behaviour and the change in soil permeability ($C_k = C_c$), the latter two models were used to account for the reduction in drain (15%) permeability in time. The results of the analysis were included in figure 6.3, whereas the corresponding observations are discussed below.

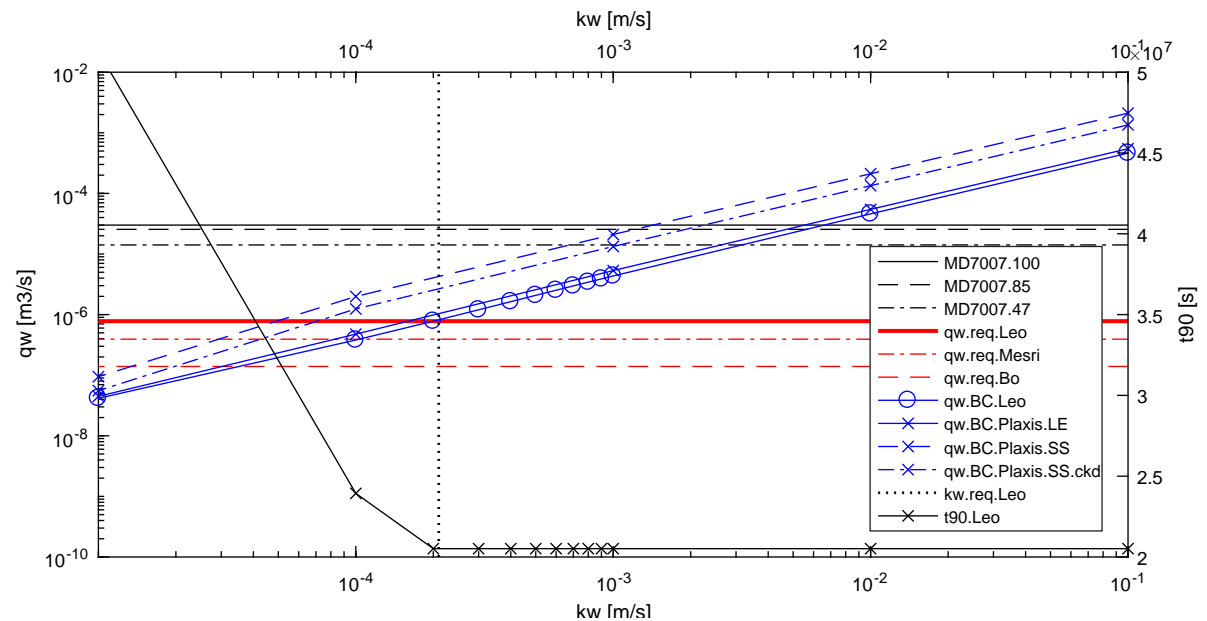

Figure 6.3: Relation between discharge capacity for the default case: required discharge capacity, consolidation time, back-calculated discharge capacity, and the drain discharge capacity of the MD7007.

Required discharge capacity:

The required discharge capacities ($q_{w.req}$) according to Bo (2004), Mesri (1991), and Leo (2004) are $1.4E-7$, $3.9E-7$, and $7.8E-7$ m^3/s , and described in figure 6.3 by three horizontal red lines. Although, the required discharge capacity is underestimated by Bo (2004) and Mesri (1991) when compared to model based on Leo (2004), it can be stated that the correspondences between the methods is reasonably well, i.e. Bo deviates a factor 5, whereas Mesri deviates only a factor 2. An important limitation of Bo (2004) and Mesri (1991) is that the methods are not directly correlated to consolidation time, i.e. an advantage of the linear elastic model based on Leo (2004).

Back-calculated discharge capacity:

The discharge capacities were back-calculated ($q_w = Q/i$) for the linear elastic model based on Leo(2004), the linear elastic model in Plaxis, the soft soil in Plaxis, and the soft soil model in Plaxis with a deformation dependent drain permeability, and represented in figure 6.3 by the blue lines. The back-calculated discharge capacities reduce linearly with a reduction in drain permeability as long as they exceed the minimum required discharge capacity. The obtained discharge capacities were higher than the required discharge capacity as long as the drain capacity was sufficient, i.e. no increase in consolidation time (t_{90}). At the moment that the drain capacity was insufficient, the back-calculated discharge capacity was lower than the required discharge capacity. This seems contradictory but is explained by the back-calculation procedure. The water flow rate is not affected as long as the drain capacity is sufficiently large (Q_{fixed}), but the vertical hydraulic gradient in the drain (i) is affected by the implemented drain permeability:

- High $k_w \rightarrow$ Low $i \rightarrow q_w = \frac{Q_{fixed}}{i_{low}} \rightarrow$ Low back-calculated q_w
- Low $k_w \rightarrow$ High $i \rightarrow q_w = \frac{Q_{fixed}}{i_{high}} \rightarrow$ High back-calculated q_w

Consolidation time:

In the literature study on consolidation with prefabricated vertical drains was observed that the consolidation

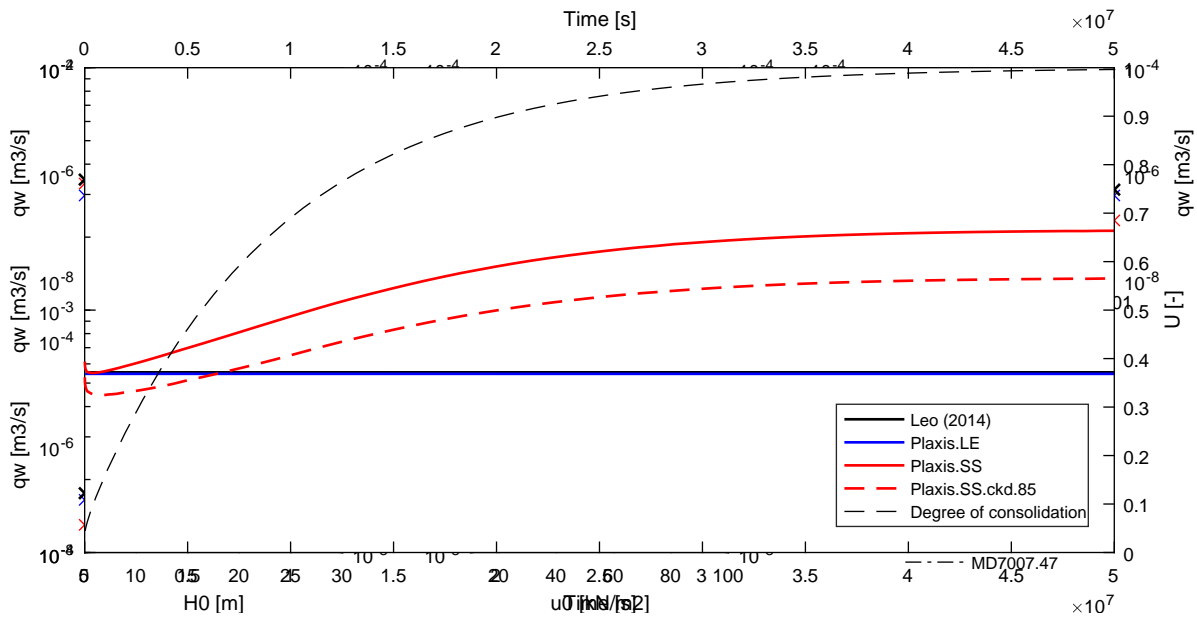

Figure 6.4: Back-calculated discharge capacity in time in relation with the degree of consolidation for: Leo (2004), linear elastic model Plaxis, soft soil model, soft soil model with deformation dependent drain permeability ($q_w = 85\%$)

time is not affected as long as the drain discharge capacity exceeds the minimum required discharge capacity for consolidation. This observation was confirmed by the analysis on the default case with the analytical model based on Leo (2004) and the three Plaxis models. It was found that t_{90} equals 230 days for sufficient drain capacity, whereas t_{90} increased significantly with 121% and 225% for the insufficient drain permeabilities of $1E-4$ and $1E-5$ m/s respectively. These results emphasized the importance of the minimum required drain discharge capacity because the increase in consolidation time is excessive and unacceptable.

Over-capacity of modern prefabricated vertical drains:

The drain over-capacity is described by the difference between the required discharge capacity and the available drain discharge capacity. The available drain discharge capacities were represented in figure 6.3 by the horizontal black lines, whereas the required discharge capacity were described by the horizontal red lines. The horizontal black lines describe the discharge capacity of an MD7007 with 100%, 85%, and 47% capacity, i.e. $3E-5$, $2.5E-5$ and $1.4E-5$ m^3/s respectively. These discharge capacities were obtained during laboratory tests on a straight drain, and a drain buckled drain in one-, and threefold. The results indicated that for the default case the drain capacity can be reduced with 98%, whereas reductions of 97% and 94% are allowed for the buckled drain capacities.

REQUIRED DISCHARGE CAPACITY IN TIME

In literature was concluded that the drain discharge capacity decreases in time through deformations (kinking/buckling), infiltration of fines (clogging/siltation), and creep in the drain material. However, none of the methods which estimate the required discharge capacity for consolidation included the effect of time. This part discusses the analysis on the relation between the required discharge capacity in time, and the drain discharge capacity in time. Similar to the previous part, the simple analytical model based on Leo (2004) was compared with the more advanced Plaxis models.

During consolidation the amount of water flow through the drain reduces in time because the rate of consolidation reduces in time. The vertical hydraulic gradient reduces in time as well because less water accumulates when the water flow rate decreases. Combining the previous observations with the definition of discharge capacity ($q_w = Q/i$) one can conclude that the required discharge capacity for consolidation is fairly independent of time because Q and i decrease similar time. This reasoning was confirmed with analysis on the back-calculated discharge capacity based on Leo (2004) and the three Plaxis models, see figure 6.4.

Linear elastic models:

The results in figure 6.4 indicate that the back-calculated discharge capacity is independent of time for the linear elastic models, i.e. Leo (2004) and the linear elastic model in Plaxis. The results are explained by the fact that the vertical hydraulic gradient (i) in the drain and the water flow rate (Q) through the drain reduce in time in the exact same manner. The ratio between i and Q is constant in time, which means that the discharge capacity is constant in time as well ($q_w = Q/i$).

Soft Soil model:

The results in figure 6.4 for the Soft soil model are slightly different compared to the results obtained for the linear elastic models. The back-calculated discharge capacity obtained with the SS increased in time and exceeds the back-calculated discharge capacity for the linear elastic methods. The relation between the hydraulic gradient and the water flow through the drain becomes constant in time as the degree of consolidation approaches unity. The increase of q_w in time was assigned to non-linear stress-strain behaviour, and the deformation dependent soil permeability which are included in the soft soil model.

Comparison between Leo (2004) and Soft Soil model:

The results based on Leo (2004) were compared to the results of the linear elastic (LE) model and the Soft Soil (SS) model in Plaxis to determine if a simple analysis based on Leo (2004) is valid. The back-calculated discharge capacities in figure 6.4 and 6.3 for the soft soil model exceed the back-calculated discharge capacities based on Leo (2004). This emphasizes that LE elastic model produce a conservative estimation for required discharge capacity for consolidation, i.e. as explained before higher back-calculated discharge capacities are correlated to more over-capacity. Based on these results was decided to use Leo (2004) for estimation of the required discharge capacity under varying soil and project conditions.

Soft Soil model with deformation dependent drain capacity:

In the previous paragraphs was concluded that the required discharge capacity for consolidation is fairly independent of time. However, in literature was concluded that the drain discharge capacity reduces in time. This implies that a safety margin is required to guarantee that the drain discharge capacity exceeds the minimum required discharge capacity during the whole consolidation process. The importance of this reduction effect is explained by comparing the back-calculated discharge capacities of the LE and SS models with back-calculated discharge capacities for the SS model with a deformation dependent drain permeability, see figure 6.4. The back-calculated discharge capacity of the latter methods is lower compared to the one related to the SS model, i.e. the amount of over-capacity with respect to the minimum required discharge capacity reduces in time.

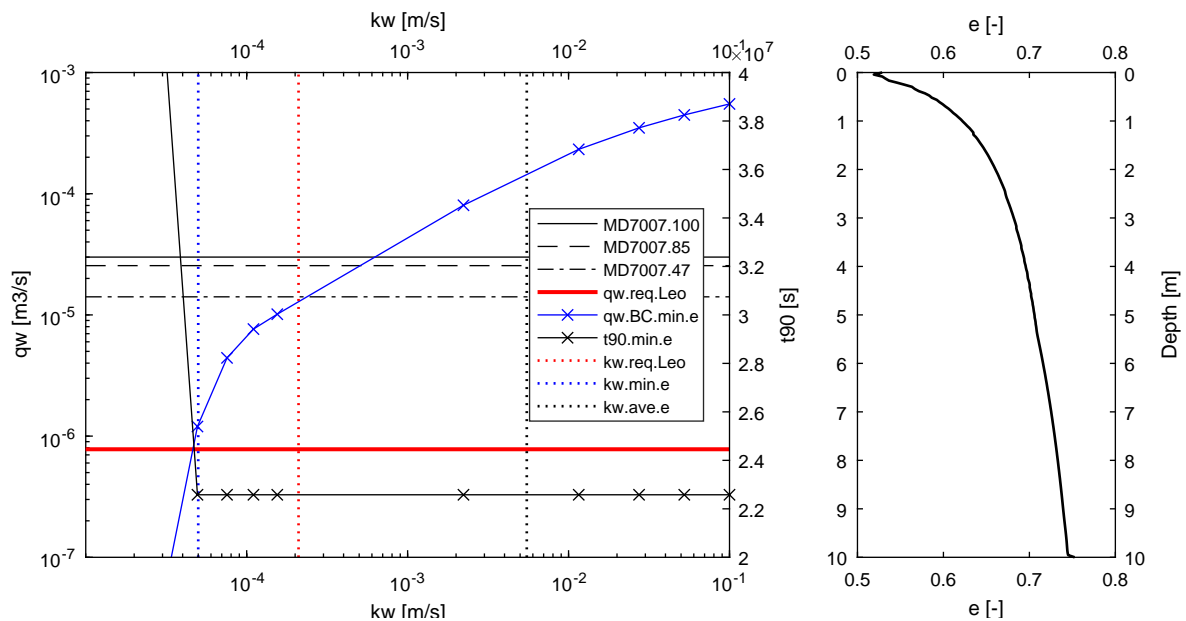

Figure 6.5: The effect of an extreme local reductions in discharge capacity: (left) relation between drain capacity, back-calculated capacity, required capacity, consolidation time and equivalent drain permeabilities, (right) void ratio profile with depth.

The reduction effect was further elaborated by assigning more higher deformation dependency to the drain permeability, see figure 6.5. The figure describes the relation between the required capacity, the back-calculated capacity corresponding to the minimum encountered drain permeability (k_h), the consolidation time, and the drain capacities of the MD7007 drain. The highest reduction in void ratio, and thus the highest reduction in discharge capacity, was encountered at the ground surface because the soft soil model uses a stress dependent stiffness. The results in 6.5 emphasize again that the consolidation time increases significantly at the moment that the back-calculated discharge capacity exceeded by the minimum required capacity.

Interesting to note is that limiting local drain permeability ($5E-5 \text{ m/s}$) is lower than the average required drain permeability ($2E-4 \text{ m/s}$). This indicates that some local reduction in the drain capacity is allowed without affecting the consolidation process. More research on local drain reductions is required and advised because this might give more insight on the required safety margin.

REQUIRED DISCHARGE CAPACITY UNDER VARYING PROJECT AND SOIL CONDITIONS

The required discharge capacity under varying conditions (drain spacing, horizontal permeability, volumetric compressibility, layer thickness, and surcharge load) were estimated based on Mesri (1991) and Bo (2004). The estimated required discharge capacities (Mesri and Bo) were verified with the method based on Leo (2004) in which the required discharge capacity was back-calculated ($q_w = Q/i$) by implementing a drain permeability (k_w) which was just sufficiently large to prevent alteration of the consolidation process.

Within each graph of figure 6.6 one soil/project parameter was varied, whereas the remaining parameters were set to its default value according to table 5.2. Important to note is that the presented results (Bo (2004), Leo (2004)) are based on a linear-elastic solution for consolidation. In the previous section section was concluded that the linear-elastic models provide conservative estimations of the required discharge capacities compared to non-linear soil behaviour.

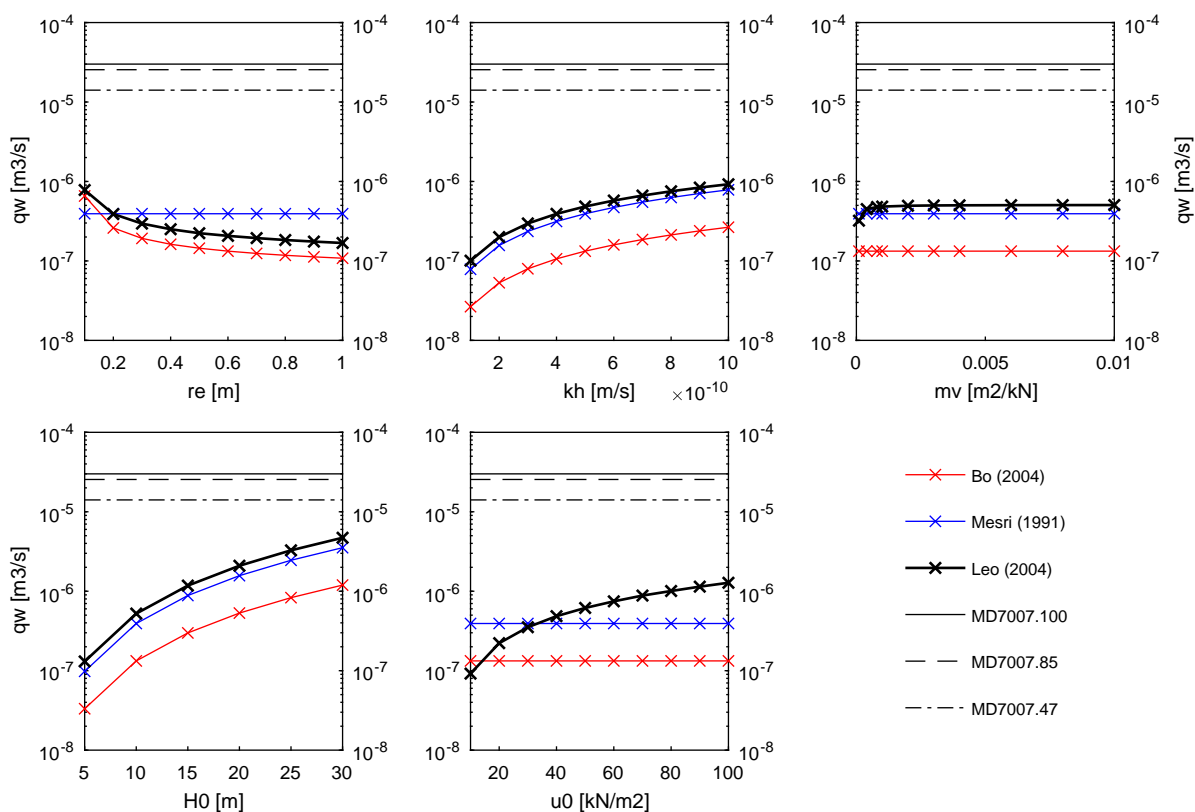

Figure 6.6: Required drain discharge capacity for consolidation under varying project and soil conditions, and the the drain discharge capacity of the MD7007 drain (100, 85, and 47%).

External radius unit cell:

The required discharge capacity is independent of the drain spacing according to Mesri (1991), whereas the required discharge capacity based on Bo (2004) and Leo (2004) increases with reducing drain spacing. The results seems to be correct because the total dissipated water volume ($\pi r_e^2 S$) and the consolidation time (t_x , equation 5.5) are increase quadratic with r_e . The observed change in required discharge capacity was attributed to the reduction factor for spacing (μ_x) which which reduces with drain spacing according to equation 4.5. This results is important for the concept of mini drains because the required drain discharge capacity for mini drains is higher compared to conventional prefabricated vertical drains.

Horizontal permeability:

All methods indicated that the required discharge capacity increases with horizontal permeability. This results are reasonable because the water flow rate through the soil towards the drain increases with horizontal permeability. Important to note is that the horizontal permeability in Mesri(1991), Bo (2004), and Leo (2004) is constant in time, whereas the in reality the soil permeability decreases during consolidation through the reduction in void ratio. Additionally, the smear effect was excluded from the elaboration obtain a conservative estimation on the required drain capacity.

Soil compressibility:

The required discharge capacity is independent of volumetric compressibility (m_v) according to the three methods. For the considered models (Bo (2004), Leo (2004)) the results are explained by the effect that the consolidation time and the total dissipated water volume increase both with volumetric compressibility. To put it differently, the water flow rate (Q) is not affect for the linear elastic models which implies the required discharge capacity is independent of volumetric compressibility. Important to note is that in reality the stress-strain relation for soil is non-linear which means that the observed relation might be different.

Layer thickness:

The required drain discharge capacity increases quadratic with layer thickness according to all considered methods. This observation seems valid because the flow rate (Q) increases, whereas the vertical hydraulic gradient (i) decrease with the layer thickness. This implies that the required discharge capacity ($q_w = Q/i$) increases quadratic with the soil layer thickness. For the concept of mini drains this is important because the installation depth is probably limited which implies that lower drain discharge capacities are applicable.

Surcharge load:

For the surcharge load (u_0) the obtained results with the direct methods (Mesri (1991), Bo (2004)) differ from the results obtained with back-calculated discharge capacity based on the analytical model of Leo (2004). According to Mesri the required discharge capacity is a function of the layer thickness and horizontal permeability, i.e. no correlation with the surcharge load. For Bo (2004) no correlation with surcharge load was found because the method is based on an analytical model with a infinite drain discharge capacity, and an assumption on the initial vertical hydraulic gradient ($i = u_0/(H_0\gamma_w)$). The effect of the surcharge load on the hydraulic gradient in Bo (2004) is equivalent but opposite to the effect of the surcharge load on the water flow rate. The analytical model of Leo (2004) differs because the model is based on a finite drain permeability which implies that the hydraulic gradient in the drain is a function of the drain permeability itself. This is the reason why the required discharge capacity according to Leo (2004) increase with surcharge load to prevent significant water pressure build up in the drain which deteriorates consolidation.

Despite the previous discussion it is important to keep in mind that the surcharge load is bounded by practical limits because of slope stability during application of the preloading. Additionally, the surcharge load in the considered methods is implied instantaneously, whereas in reality the surcharge load is applied in stages. This emphasize that the surcharge load is of minor importance for the determination of the required drain discharge capacity.

Comparison with MD7007 drain:

The horizontal black lines in figure 6.6 represent the drain discharge capacity of the MD7007 drain. The overcapacity for the various situations is equal to vertical difference between the black and coloured lines. The results for the method based on Leo (2004) were elaborated in table 6.1. Only the max/min horizontal permeability and the max/min layer thickness were considered because they are the most significant for the design considerations.

Table 6.1: Over-capacity available in the MD7007 drain based on the max/min horizontal permeability and the max/min layer thickness.

Required and drain discharge capacity				
	m^3/s		m^3/s	
Horizontal permeability	1E-10 m/s	1E-07	1E-9 m/s	9.2E-07
Layer thickness	5 m	1.3E-07	30 m	4.7E-06
MD7007	100 %	3.0E-05	47 %	1.4E-05

Overcapacity = Drain / Required				
	Undemanding cases		Demanding cases	
MD7007	100 %	47 %	100 %	47 %
Horizontal permeability	298	140	33	15
Layer thickness	229	108	6	3

From table was concluded that there is significant variation and room for optimisation. The drain over-capacity varies from 6 to almost 300 for the un-buckled MD7007 drain, whereas the drain over-capacity varies from 3 to 140 for the MD7007 drain which was buckled in threefold. Especially for less demanding project/soil conditions reduction in drain capacity is possible, either by reducing the drain size or quality. For the demanding project/soil conditions the MD7007 capacity matches reasonably well with the required capacities.

The largest uncertainty in previous analysis is related to the actual reduction in drain permeability in the field during consolidation. In the laboratory a reduction of 15% and 53% were encountered for a single/three buckled situation. However, field and laboratory conditions differ significantly which implies that extrapolation of laboratory performances towards field performance is tricky. It was therefore concluded that a full-scale experiment is required to gain more understanding in the reduction effect, and thus the ultimate drain over-capacity during consolidation.

6.3 EXPERIMENTS WITH MINI DRAINS ON WELL-RESISTANCE

The results of the experiments with mini drains were elaborated in this section. In the first part the consolidation experiments with a single drain were discussed (MMD,WD,WDF), in the second part concerned the consolidation tests with three drains (3MMD, 3WDF), whereas the finally part presented the results of the discharge capacity experiments.

CONSOLIDATION EXPERIMENTS WITH A SINGLE DRAIN

The results of the consolidation tests with a single drain without preconsolidation were included in figure 6.7. The settlement for the mini Mebradrain (MMD) and the wool drain with filter (WDF) were 89 mm after almost 9 days, whereas the settlement of the wool drain (WD) was only 80 mm after 15 days.

Wool drain experiment excluded:

The WD experiment was excluded from further research because it was impossible adjust the measurements correctly to account for the observed discrepancy in the data. The WD settlement was significantly less compared to MMD and WDF, whereas the mass balance check indicated that the final settlement was incorrect, underestimated and should approximately by 94 mm . Two possible scenarios/explanations were considered of which the first was more likely because multiple observations agreed with this scenario.

- The WD performed similar as the MMD and WDF, but water was evaporated from the measurement cup and errors were made with the ruler check.
- The WD performed less than the MMD and WDF, but errors were made with the mass balance.

The discharge capacity of the WD was higher than the minimum required discharge capacity for consolidation, i.e. it is unlikely that the WD discharge capacity was insufficient and delaying the consolidation process. The water content profiles (WD, WDF, MMD) confirmed this observation because the water content for the WD experiment varied between 0.45-0.50, whereas it varied between 0.42-0.53 and 0.47-0.57 for

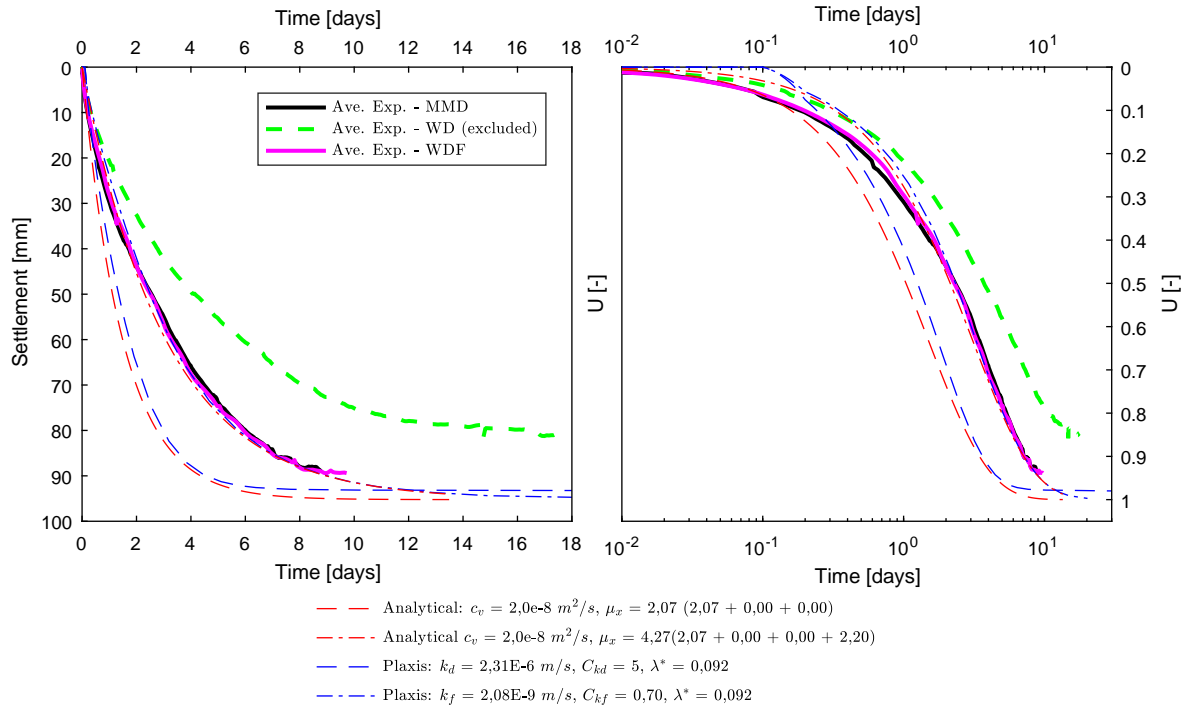

Figure 6.7: Results consolidation with a single drain: (i) measured average vertical settlement in time for the consolidation test with a single MMD/WD/WDF, (ii) analytical approximation of measurements, and (iii) Plaxis verification of measurements (with MMD = mini Mebradrain, WD = wool drain, WDF = wool drain with filter).

the MMD and WDF respectively. Additionally, the ruler check precision was lower compared to the mass balance check precision because results depended significantly on the ruler position procedure on the (inclined) loading plate. Another important observation which is in line with the first scenario is the fact that the air-conditioning in 'climate room' did not functioned properly during the WD testing period. Based on the previous was concluded that it is very likely that the WD performed as good as the MMD and WDF drain during the consolidation experiment. No time was available to repeat the experiment and confirm on the previous scenario.

Analytical solution and filter cake:

The rate of consolidation is overestimated when only the reduction factor for spacing (2.07) is included. An additional reduction factor of approximately 2.2 was needed to fit the MMD and WDF data properly. The additional reduction was not expected because no smear zone can develop ($\mu_{smear} = 0.0$) when the drains are installed prior to the clay slurry, and well-resistance was excluded ($\mu_{well} = 0.0$) for drains with sufficiently discharge capacity. A possible explanation for the observed delay is the development of a filter cake at the drain-soil interface.

- MMD and WDF: $\mu_x = \mu_{spacing} + \mu_{smear} + \mu_{well} + \mu_{filter} = 2.07 + 0.0 + 0.0 + 2.2$

The filter cake increases the filter sleeve efficiency but decreases its permeability because fines in suspension accumulate at the drain-soil interface during the initial stages of consolidation. The effect of the filter cake is more significant for consolidation with drains compared to the consolidation without drains, because the surface area of the filter sleeve is larger (80 vs 115 cm^2).

Other possible explanations for the observed delay are related to the surcharge load. The surcharge load on the sample is reduced in time because friction between the loading plate and the sample tube increases in time, and the contact area between the loading balloon and the loading plate reduces in time because of the settlement. Although, both effects are related to the dissipation of pore water it is unlikely that they are responsible for the observed additional reduction of the consolidation process because the effects were minimised with the maintenance, and a load reduction would result in a lower final settlement which was not observed.

Plaxis verification:

Based on the observation regarding the filter a Plaxis model was developed in which a filter cake was included. The drain properties ($k_d = 0.2 \text{ m/day}$, $ck_d = 5.0$) was obtained with the model without a filter cake based on comparison with the analytical solution without smear and well-resistance. The filter cake properties were obtained by fitting the Plaxis model to the MMD/WDF data by adjusting the reduction in permeability (ck_f) of the filter cake zone ($r_f = 0.003$ to 0.006 m) from 2.0 towards 0.7. It is important to note that similar fitting results are possible with a smaller or larger filter cake zone and adjusting the (ck_f) value consequently.

CONSOLIDATION EXPERIMENTS WITH THREE DRAINS

The results of the consolidation tests with three drains without preconsolidation were included in figure 6.8. The observed settlements for the three mini Mebradains (3MMD) and the three wool drain with filter (3WDF) were 93 and 91 mm after 6 days, i.e. approximately equal to the final settlement observed for the MMD and WDF tests. The reorientate procedure of the loading plate (3WDF = day 2, 3MMD = day 3) is clearly visible at day 1 and 3. This maintenance effect was exaggerated with respect to MMD/WDF because (differential) settlements developed faster with higher consolidation rates. The results indicate that it is possible to accelerate consolidation by reducing the drain spacing when the effect of smear is excluded.

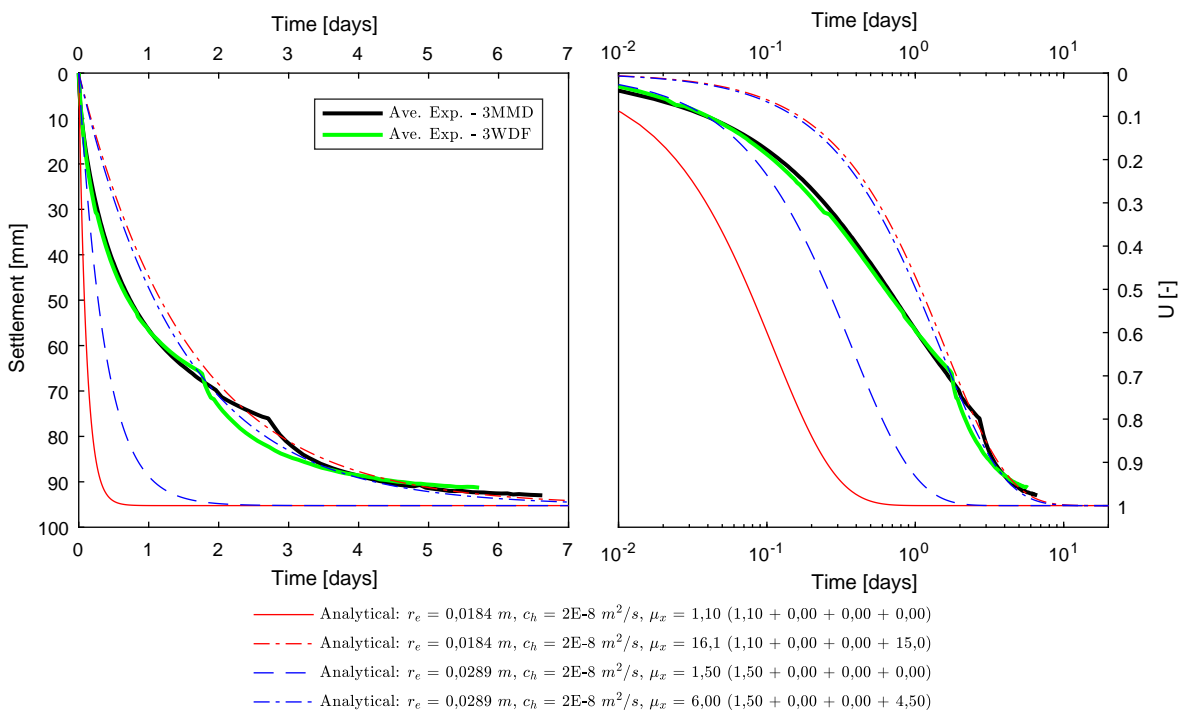

Figure 6.8: Results consolidation with a single drain: (i) Average vertical settlement in time for the consolidation test 3MMD/3WDF; (ii) analytical approximation, and (iii) Plaxis verification (with 3MMD = three mini Mebradains, 3WDF = three wool drains with filter).

Zone of influence of a single drain:

The fact that three drains were used to consolidate the slurry in the sample tube introduced a problem for the interpretation with the analytical solution. The main unknown in the translation from three drains towards an unit cell with one drain is related to the zone of influence. A direct translation based on the applied drain spacing is not possible because the sample tube does not represent a large field with numerous drains. To account for the previous effect it was decided to include both the maximum and minimum external radius. The maximum external radius ($r_e = 0.0315 \text{ m}$) was based on the assumption that 1/3 of the total area was affected by a single drain, whereas the minimum external radius ($r_e = 0.0175 \times 1.05 \text{ m}$) was related to the actual applied spacing in the test.

Analytical solution and filter cake:

The observed rate of consolidation was slower compared to the predicted rate based on the update coefficient of consolidation. Similar to the MMD/WDF results, but the additional reduction for the 3MMD and 3WDF tests was more significant, i.e. approximately 4.5 for the maximum radius and 15 for the minimum radius.

- 3MMD/3WDF minimum r_e : $\mu_x = \mu_{spacing} + \mu_{smear} + \mu_{well} + \mu_{filter} = 1.1 + 0.0 + 0.0 + 15$
- 3MMD/3WDF maximum r_e : $\mu_x = \mu_{spacing} + \mu_{smear} + \mu_{well} + \mu_{filter} = 1.5 + 0.0 + 0.0 + 4.5$

The maximum radius and the corresponding filter cake reduction factor is more representative for the experiments because the minimum disregarded the time required for consolidation of the soil outside the fictive unit cells. Based on an assumed linear relation between the filter cake reduction factor and the surface area of the filter sleeve, the reduction factor for the 3MMD/3WDF test was estimated to be 6.6 ($= \frac{2.2 \cdot 345 \text{ cm}^2}{115 \text{ cm}^2}$). This corresponded reasonably good with the statement that maximum radius is more representative. The reduction factor converges towards the estimated 6.6 under the assumption that the true external radius is slightly lower than the maximum external radius.

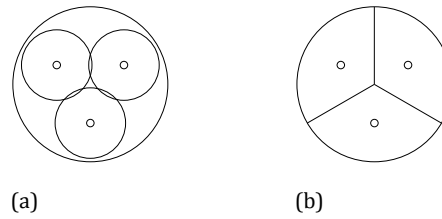

Figure 6.9: Zone of influence of a single drain in the consolidation experiments with three drains: (a) minimum zone of influence based on drain spacing, (b) maximum zone of influence based on 1/3 of the cross-sectional area.

DISCHARGE CAPACITY EXPERIMENTS

The results of all the performed discharge capacity test were included in figure 6.10. The discharge capacity for the mini Mebradrains (MMD, PC-MMD, PC-MMD-3FD, 3MMD, PC-3MMD) varied between $2\text{E}-7$ and $3\text{E}-6 \text{ m}^3/\text{s}$, whereas the discharge capacity for the wool drains with a filter sleeve (WDF, 3WDF) varied between $9\text{E}-10$ and $3\text{E}-9 \text{ m}^3/\text{s}$. The performance of the wool drains without a filter (WD) was slightly less compared to the wool drains with a filter, and ranged from $9\text{E}-10$ to $3\text{E}-9 \text{ m}^3/\text{s}$. The measured discharge capacities were higher compared to the minimum required discharge capacity for the consolidation, which were determined in the previous paragraph.

Hydraulic gradient:

The hydraulic gradient was calculated based on measured hydraulic head on top of the sample, and on the assumption that the hydraulic head at the drain opening was equal to zero. However, in a standardized ASTM test for the discharge capacity the hydraulic head is measured at both ends of the drain to obtain the hydraulic gradient. This assumption introduces some uncertainty because exact hydraulic head at the bottom of the drain is unknown. This assumption implies that the presented discharge capacities are the lower bounds, i.e. the actual discharge capacity is probably higher because the hydraulic gradient was overestimated.

Another test limitation which need discussion is the difference in hydraulic head on top of the drain between the wool drains (with/without filter) and the mini Mebradrains. For the latter drain types the a lower hydraulic head was applied because the amount of water flow though the tubes was not sufficient to obtain a hydraulic head of approximately 2 m . This difference in hydraulic head implies that the mini Mebradrains were tested under a lower hydraulic gradient compared to the wool drains. In the literature study was concluded that the discharge capacity tends to decrease with an increasing hydraulic gradient. Under the assumption that this statement is valid it can be concluded that the discharge capacity of the mebradrain is probably lower than the presented ones in figure 6.10. It is however impossible to estimate the discharge capacity of both drains at an equal hydraulic gradient because the relation between the hydraulic gradient and the water flow is not linear.

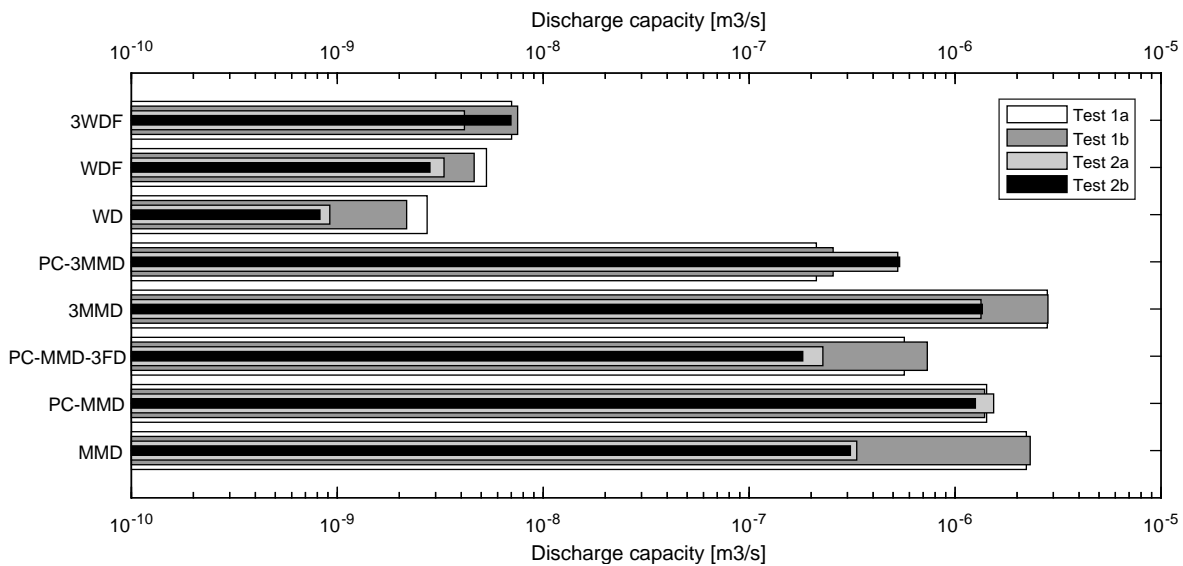

Figure 6.10: Results discharge capacity tests for all testing series (with MMD = mini Mebradrain, WD = wool drain, WDF = wool drain with filter, 3MMD = three mini Mebradrains, 3WDF = three wool drains with filter, PC-MMD = mini Mebradrain with preconsolidation phase, PC-MMD-3FD = mini Mebradrain and three fake drains with preconsolidation phase, PC-3MMD = three mini Mebradrains with preconsolidation phase).

Confining pressure and ASTM test:

The third limitation of the experimental discharge capacity test is that experiment was executed without surcharge load. This means that the effect of the confining soil pressure was not included, and that the presented discharge capacities of the drains are higher compared to the in-situ (with surcharge load) drain performance. To get some insight in the susceptibility of confining pressure on the discharge capacity a standardized ASTM test was performed and included in figure 6.11. The results of the ASTM test clearly indicate the importance of a stiff drain core on the discharge capacity under higher confining pressure. The results were obtained by applying a hydraulic gradient of 1.0 and measuring the water flow at different confining pressure. At the lowest possible surcharge pressure the difference between the wool drains (WD, WDF) and the Mebradrain is already significant, however this difference becomes even more apparent as the surcharge pressure increases. For the WD and WDF it was impossible to measure the water flow at a confining pressure of 50 kN/m^2 .

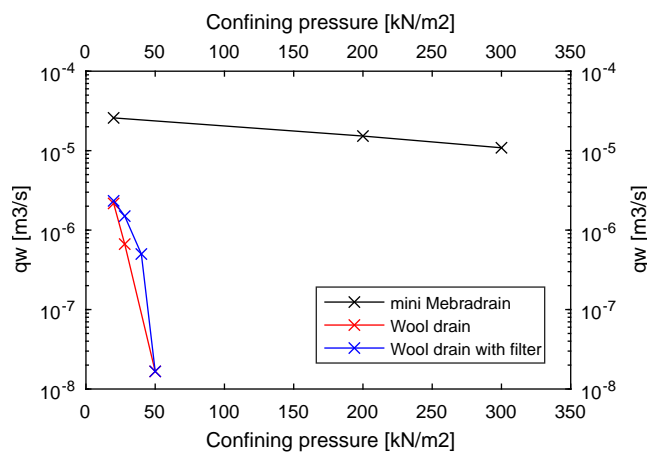

Figure 6.11: Reference test on the discharge capacity of the used mini drains based on the ASTM testing method.

The ASTM results indicate the importance of the plastic drain core. The horizontal effective stress stress, or confining stress, on the drain increase in time because excess pore water pressures dissipate. For a drain without a stiff core this introduces a problem because it affects the drain efficiency. For future developments of (mini) drains this observation is significant and should be taken into account.

6.4 SMEAR EFFECT AND EXPERIMENTS

This section discusses the results regarding the smear effect and mini drains. In the first part the analytical approximation with linear overlapping smear zones is presented and discussed, the second part explains the potential optimisation by minimising soil disturbance during installation, and the final section discusses the results of the experimental tests.

ANALYTICAL APPROXIMATION ON OVERLAPPING SMEAR ZONES

The consolidation time for different drain spacings based on the solution of overlapping smear zones was included in figure 6.12. The zones represent the non-overlapping, partially overlapping, and the fully overlapping smear zone. The blue line describes the consolidation time needed for a degree of consolidation of 90 %, whereas the red line represents the underlying reduction factor for spacing and smear.

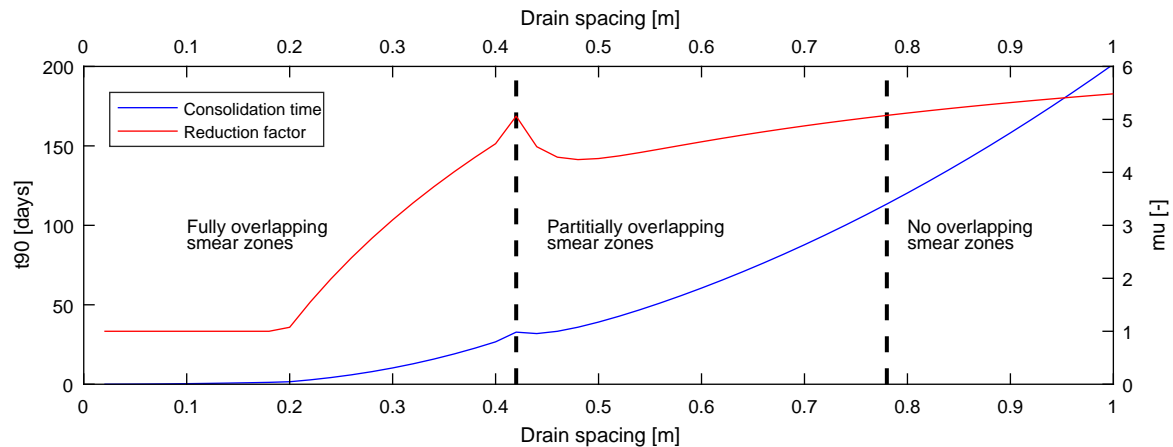

Figure 6.12: Prediction of consolidation time and reduction with the analytical solution on overlapping smear zones for various drain spacings, according to equation 4.3 and 4.11.

Walker and Indraratna (2007) stated that the theoretical minimum spacing is likely to be equal to the minimum spacing observed in practice (0.50 m). Although the graph suggest differently, further acceleration of consolidation by reducing the drain spacing is not possible for fully overlapping smear zones. A clear explanation for this statement was however not given, and not included in the formulation because the alteration of hydraulic conductivity was assumed constant ($k_s = k_v$) for the fully overlapping smear zones. This assumption is valid for a large spacing because the alteration is dominated by remoulding of the anisotropic clay structure, but seems incorrect for a small spacing because the hydraulic conductivity is not only related to the orientation of the clay particles, but also to void ratio.

Conceptually, the void ratio and thus the permeability decreases with a decreasing spacing because the replacement ratio increases in these situations, i.e. the area of the drain (A_d) over area of the unit cell (A_{uc}). Especially for an extreme small drain spacing, the added drain volume could have a significant effect on the permeability because the reduction in void ratio is relatively large. Despite the logics of the previous concept, it was not included in any analytical formulation for consolidation.

MINIMISING SOIL DISTURBANCE DURING INSTALLATION

The theoretical potential benefit of minimising soil disturbance was elaborated in figure 6.13 in which a normalized time ($t_{90} / t_{90, r.m. max}$) was plotted against the equivalent mandrel radius (r_m) and radius ratio (r_m / r_w). Independent from drain spacing, the consolidation time decreases from 100 % for the Cofra mandrel (120 x 60 mm, $r_e = 48$ mm) and Mebradrain (100 x 3 mm, $r_w = 3$ mm) towards approximately 50% for a mandrel which has the same size as the drain. Although the analysis is based on theory, the results clearly indicate the benefit of an optimised installation process. The actual optimisation varies between 100 % and 50 %. An important drawback is that the mandrel dimensions are bound to practical limits because the mandrel should be strong enough to penetrate the soil without breaking and deforming. The installation procedure of mini drains is not within the scope of this project and therefore excluded from further elaboration.

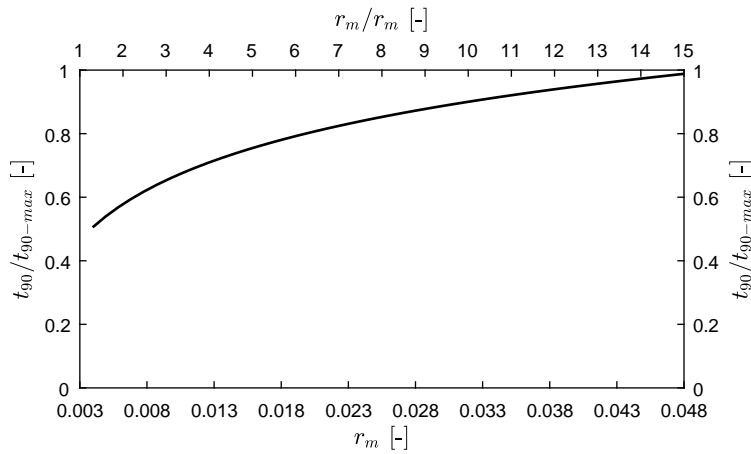

Figure 6.13: Theoretical decrease of consolidation time (t_{90}) by reducing the mandrel size (r_m) with respect to the drain size (r_w), (with $c_h = 1.0E07 \text{ m}^2/\text{s}$, $r_s/r_m = 3.0$)

CONSOLIDATION EXPERIMENTS WITH SMEAR ZONES

The results of the consolidation test with a preconsolidation phase to determine the effect of overlapping smear zones are presented in figure 6.14. The single mini Mebradrain (PC-MMD) was the reference tests, whereas the experiment with a single mini Mebradrain plus three fakes drains (PV-MMD-3FD), and the experiment with three mini Mebradrains (PC-3MMD) were used to study the effect of overlapping smear zones. The samples were consolidated for 6 to 7 days to create a sample which is susceptible for remoulding. This susceptibility was required to study the smear effect, and the overlapping smear effect.

The settlement during the pre-consolidation phases was 36, 38 and 40 mm for the PC-MMD, PC-MMD-3FD, and PC-3MMD respectively. The final settlement was 85, 85, and 90 mm for the PC-MMD, PC-MMD-3FD, and PC-3MMD respectively. The results of the preconsolidation phase confirmed the results obtained with the consolidation test without drains, whereas the results of consolidation phase were unexpected.

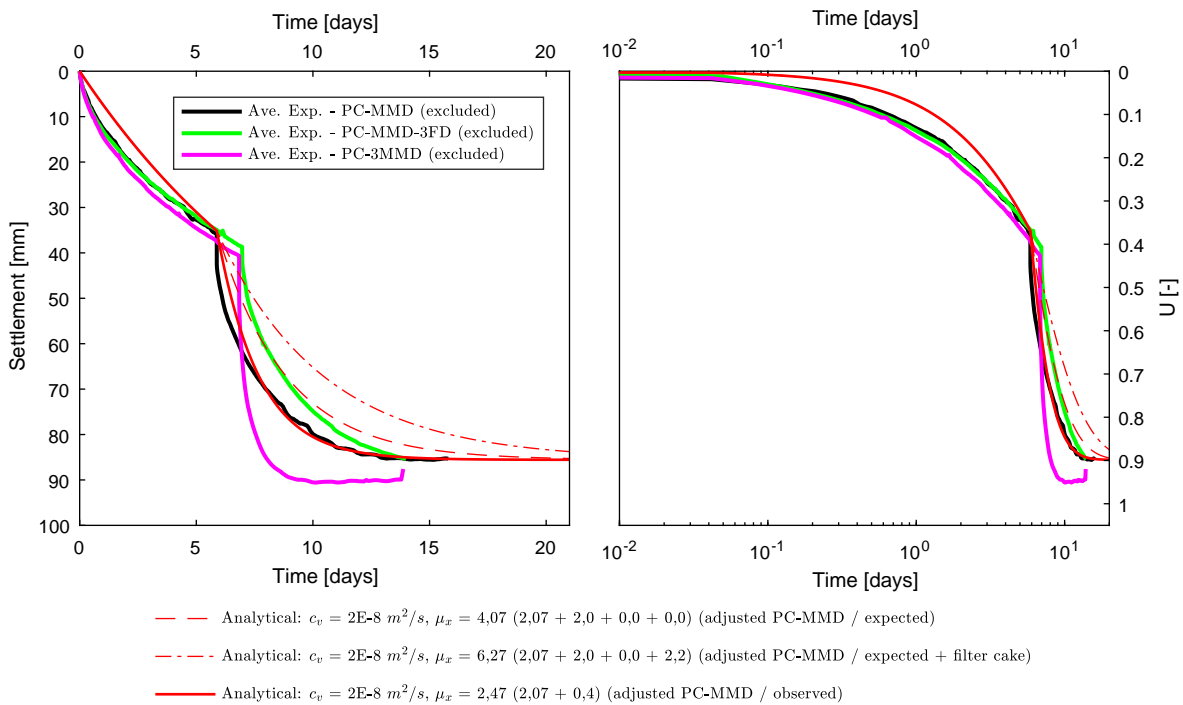

Figure 6.14: Results consolidation with drains installed in a preconsolidated sample drain: Average vertical settlement in time for the consolidation test PC-MMD/PC-MMD-3FD/PC-3MMD

The rate of consolidation for PC-MMD-3FD was higher compared to PC-MMD, whereas the opposite was expected because of the effect of overlapping smear zones. An explanation for this unexpected observation was found during the examination of the sample afterwards. Three holes were detected at the location where the fake drains were installed with a mandrel. It is likely that these holes accelerated the consolidation process because of additional drainage capacity in the sample. Although similar observations were not found for the PC-MMD and PC-3MMD test it is impossible to excluded the possibility that these tests were affected as well. For this reasons it was decided to exclude the tests on overlapping smear zones from further interpretation.

It was concluded that it is hard/impossible to research the smear effect in the laboratory because, the soil structure, the soil stress, and installation conditions are hard to mimic when the test dimensions are limited. To get more insight in the smear effect on the rate of consolidation a full scale field experiment produces more reliable results which are representative for other situation.

7

CONCLUSION

This chapter presents the most important conclusions of the research on innovative ground improvement techniques (GIT) for constructing high infrastructural embankments on soft soil. Most GIT were developed long ago, but innovations and optimisations are still taking place nowadays because both clients and contractors benefit from developments which lower costs, reduce construction time, and improve quality. The research was subdivided in two phases to answer the main research question.

Are there new / innovative ground improvement techniques for constructing high infrastructural embankments on soft soils which could compete with the current Dutch market?

A preliminary study on GIT was performed to refine the research scope by selecting one promising GIT for additional research. The preliminary study consisted of a literature study and an assessment based on future potential, economy, implementation and performance to answer the following sub-question.

What ground improvement techniques are available for constructing high infrastructural embankments on soft soil, and for which promising technique could additional research result in a significant improvement of knowledge?

The most important conclusion of the preliminary study on GIT is that the innovative concept of mini drains was selected for additional research. The sub-conclusions of the preliminary study are elaborated below.

- Four ground improvement principles for constructing infrastructural embankments on soft soil are available: load reduction using lightweight construction materials, acceleration of consolidation using preloading enhanced drainage, load redistribution using columnar inclusions, and soil modification using mixing techniques. These principles are well-represented in the Netherlands.
- Three innovative GIT with significant potential and optimisation possibilities were recognized: the lightweight mixed soil, the anchor drains, and the mini drains. The concept of mini drains was one of the most promising innovations according to the preliminary study, and was selected in consultation with Cofra.
- The concept captured important optimisation possibilities regarding consolidation with prefabricated vertical drains (PVD): cost reduction by decreasing the drain size or quality, and acceleration of consolidation by applying an extreme small drain spacing and minimising soil disturbance during drain installation.

The study on mini drains consisted of literature study, analytical solutions, Plaxis, and small-scale consolidation and discharge capacity experiments to answer the following sub-question.

How is consolidation affected when multiple vertical permeable elements with reduced discharge capacity are installed simultaneously in a small spacings?

The most important conclusion of the study on mini drains is that costs optimisation is possible by reducing the drain size or quality because the PVD over-capacity is significant for numerous project and soil conditions. Additionally, acceleration of consolidation is possible by minimising soil disturbance during installation. And finally, acceleration of consolidation seems not possible by installing drains in a spacing smaller than 0.50 *m*. The sub-conclusions regarding the study on mini drain are elaborated below.

- The rate of consolidation is not affected as long as the drain capacity exceeds the required capacity for consolidation. The drain capacity decreases in time through deformation, infiltration of fines, and creep in the drain material. With a linear elastic (LE) method was determined that the required capacity is independent of time, and increases with horizontal permeability and layer thickness. Compared to non-linear soil models, the used LE model provided a relative simple and conservative method to estimation the required capacity.
- A safety margin on the drain capacity is required because the drain capacity decreases in time, whereas the required capacity is independent of time. The required safety margin and the actual drain over-capacity are unknown because laboratory and field conditions differ significantly.
- Despite the previous, cost optimisation is possible by reducing the drain size or quality because the laboratory drain capacity exceeded the required capacity for consolidation for all considered cases. For a varying layer thickness (5 to 30 *m*) and horizontal permeability (1E-10 to 1E-9 *m/s*), the drain capacity exceeded the required capacity with a factor 230 to 3, and 300 to 15 respectively.
- The consolidation and discharge capacity experiments confirmed that consolidation is not affected as long as the drain capacity exceeds the minimum required capacity. The performance of three mini drain types were compared: (i) mini Mebradrain (MMD), (ii) wool drain (WD), and (iii) wool drain with a filter sleeve (WDF). The consolidation rates of MMD and WDF were equal during the consolidation experiment, whereas the WD/WDF discharge capacities were substantially less compared to MMD during the discharge capacity experiments.
- For all consolidation experiments, the consolidation rates were lower than predicted. The delay was attributed to a filter cake which developed on the drain-soil interface. The filter cake effect improves the filter efficiency, but deteriorates consolidation because the local permeability decreases. Before implementation in the current design practice, more research is needed. The filter cake effect was not encountered before and seems especially important for consolidation of viscous soils.
- Acceleration of consolidation is possible through minimising soil disturbance during installation by reducing the installation speed and mandrel size. The previous statement is based on an analytical approach and verification with full-scale experiments is required.
- Acceleration of consolidation is achieved by reducing the drain spacing, as the radial drainage path decreases. However, according to literature a drain spacing below 0.50 *m* does not result in additional acceleration of consolidation because the reduction in drainage path is dominated by the effect of overlapping smear zones.
- The reduction in permeability in the smear zone is predominantly assigned to remoulding of the soil structure. This simplification is valid for large spacing, but seems incorrect for small spacing because the reduction in void ratio through the added drain volume is neglected.
- The consolidation experiments with pre-consolidation and drain installation could not give more insight in the effect of interacting smear zones. The results were biased through unexpected preferential water flow along the mandrel hole remainders.

To conclude on the main research question, it was emphasized that the four ground improvement principles for constructing infrastructural embankments on soft soils are well-represented in the Netherlands. Despite the previous, this research demonstrated that opportunities arise when uncertainties and optimisation possibilities of a specific GIT are studied, even if this concerns a study on the well-developed solution for accelerating consolidation with PVD.

8

RECOMMENDATIONS

This study focussed on the ground improvement techniques for constructing infrastructural embankments on soft soils. The results of research phase 1 and 2 are promising, but many more subjects can be investigated. The recommendations for further work are presented below.

- It is recommended to perform a large scale consolidation and discharge capacity test to determine the amount of over-capacity which is present in the drain during consolidation. By monitoring the surface settlement, the dissipated water, and the excess pore water pressure around and in the drain the required discharge capacity for consolidation can be back-calculated. The available discharge capacity is determined with the discharge capacity test after finalization of the consolidation test by measuring the water flow through the drain under a representative hydraulic gradient. The required and the available discharge capacity give insight in the amount of over-capacity and required safety margin.
- Additional research on the effect of reduced drain capacity during consolidation using the finite element program Plaxis is advised. It is recommended to study the required discharge capacity for varying soil profiles. Additionally, it is suggested to extend this thesis project by studying the impact of multiple local reductions in the drain capacity.
- The effect of a insufficient drain capacity on the rate of consolidation was not observed in the experimental consolidation test because the wool drain encased in a filter performed as good as the mini Mebradrain. For better understanding of the lower bound discharge capacity, it is recommended to perform more experiments with different and smaller mini drain types.
- The effect of overlapping smear zone is not fully understood and important for the acceleration of consolidation. It is therefore recommended to perform a field test to study the effect of overlapping smear zones because the installation procedure (speed, time, mandrel size), and the in-situ soil characteristics (structure, k_h , k_v , k_s , OCR, stress conditions) are hard to mimic in the laboratory. It is advised to subdivide a project location in multiple test fields and apply a different drain spacing to each one of them. The effect of overlapping smear zones on the rate of consolidation is back-calculated with the analytical solutions by comparing the development of settlement in time of the different test fields.
- It is recommended to consider the development of a biodegradable drain: the current prefabricated vertical drains are made of (recycled) plastic and do not match with the (future) sustainability demands of the society, degradation of the drain is possible as long as the functional requirements during consolidation are fulfilled.

BIBLIOGRAPHY

- [1] H. Keijer, *1-2-3 Geology voor Ingenieurs* (Koninklijk instituut voor Ingenieurs (KIVI), 2015).
- [2] T. Wong, D. A. Batjes, and J. Jager de, *Geology of the Netherlands* (Royal Netherlands Academy of Arts and Sciences, 2007).
- [3] J. Briaud, *Geotechnical Engineering - Unsaturated and Saturated soils* (John Wiley and Sons, Inc., Hoboken, New Jersey, 2013).
- [4] A. Marradi, U. Pinori, and G. Betti, *The Use of Lightweight Materials in Road Embankment Construction*, in *Procedia - Social and Behavioral Sciences*, Vol. 53 (2012) pp. 1000–1009.
- [5] J. Chu, S. Varaksin, U. Klotz, and P. Meng, *Construction processes*, in *Proceedings of the 17th International Conference on Soil Mechanics and Geotechnical Engineering: The Academia and Practice of Geotechnical Engineering*, Vol. 4 (2009) pp. 3006–3135.
- [6] N. Narendranathan and E. C. Lee, *Dynamic Compaction and Dynamic Consolidation of Soils*, in *Ground Improvement Case Histories: Compaction, Grouting, and Geosynthetics* (2015) pp. 365–398.
- [7] E. Brûlé, Stéphane; Javelaud, *Soil dynamic response after ground improvement by heavy dynamic compaction or vibrocompaction*, in *Proceedings of the international symposium: recent research, advantages & execution aspects of ground improvement works*, Vol. 2 (Brussels, 2012) pp. 3–8.
- [8] J. Dijkstra and A. Nooy van der Kolf, *Ground improvement tank terminal Amsterdam - The Netherlands*, in *Proceedings of the international symposium: recent research, advantages & execution aspects of ground improvement works* (Brussels, 2012) pp. 11–21, Volume II.
- [9] T.-S. Hou, *Prescription Formula of Foamed Particles in Lightweight Soil*, in *Geotechnical and Geological Engineering*, Vol. 33 (2015) pp. 153–160.
- [10] Y. Watabe, H. Saegusa, H. Shinsha, and T. Tsuchida, *Ten year follow-up study of airfoam-treated lightweight soil*, in *Proceedings of the Institution of Civil Engineers: Ground Improvement*, Vol. 164 (2011) pp. 189–200.
- [11] D.-W. Park, H. V. Vo, and Y. Lim, *Applications of Air-Foamed Stabilized Soil as Potential Subgrade Material of Railway Track*, in *International Journal of Railway*, Vol. 7 (2014) pp. 91–93.
- [12] T. H. Kim, T. H. Kim, and G. C. Kang, *Performance evaluation of road embankment constructed using lightweight soils on an unimproved soft soil layer*, in *Engineering Geology*, Vol. 160 (2013) pp. 34–43.
- [13] T.-H. Kim, G.-C. Kang, and L.-K. Park, *Development and mechanical strength properties of a new lightweight soil*, in *Environmental Earth Sciences*, Vol. 72 (2014) pp. 1109–1116.
- [14] D. Perera, R. Kelly, C. Rujikiatkamjorn, and B. Indraratna, *Soil disturbance analysis due to vertical drain installation*, in *Proceedings of the ICE - Geotechnical Engineering*, Vol. 168 (2015) pp. 236–246.
- [15] C. Rujikiatkamjorn, M. Ardana, B. Indraratna, and S. Leroueil, *Conceptual model describing smear zone caused by mandrel action*, (2013) pp. 1377–1388.
- [16] A. Ghandeharioon, B. Indraratna, and C. Rujikiatkamjorn, *Laboratory and finite-element investigation of soil disturbance associated with the installation of mandrel-driven prefabricated vertical drains*, in *Journal of Geotechnical and Geoenvironmental Engineering*, ASCE, Vol. 138 (2012) pp. 295–308.
- [17] S. Hansbo, *Consolidation of Fine-grained Soils by Prefabricated Drains*, in *Proceedings of 10th International Conference on Soil Mechanics and Foundation Engineering* (1981) pp. 677–682.

- [18] M. Prezzi and D. Basu, *Analytical solutions for consolidation aided by vertical drains*, in *Geomechanics and Geoengineering: An International Journal*, Vol. 1 (2006) pp. 63–71.
- [19] S. Saye, *Assessment of Soil Disturbance by the Installation of Displacement Sand Drains and Prefabricated Vertical Drains*, in *Soil Behavior and Soft Ground Construction*, ASCE Geotechnical Special publication No. 119 (2001) pp. 325–362.
- [20] B. Indraratna and R. Walker, *Vertical drain consolidation with overlapping smear zones*, in *Géotechnique*, Vol. 57 (2007) pp. 463–467.
- [21] Y. B. Deng, K. H. Xie, M. M. Lu, H. B. Tao, and G. B. Liu, *Consolidation by prefabricated vertical drains considering the time dependent well resistance*, in *Geotextiles and Geomembranes*, Vol. 36 (2013) pp. 20–26.
- [22] T. Edil, H. Tran-Nguyen, and J. Schneider, *Effect of deformation of prefabricated vertical drains on discharge capacity*, in *Geosynthetics International*, Vol. 17 (2010) pp. 431–442.
- [23] J. C. Chai, N. Miura, and T. Nomura, *Effect of hydraulic radius on long-term drainage capacity of geosynthetic drains*, in *Geotextiles and Geomembranes*, Vol. 22 (2004) pp. 3–16.
- [24] N. Miura and J. Chai, *Discharge capacity of prefabricated vertical drains confined in clay*, in *Geosynthetics International*, Vol. 7 (2000) pp. 119–135.
- [25] Y.-Q. Cai, J. Wang, and J.-J. Ma, *Application of a New Vacuum Preloading Method for Tideland Reclamation in Wenzhou, China*, in *Ground Improvement Case Histories: Embankments with Special Reference to Consolidation and Other Physical Methods* (2015) pp. 381–397.
- [26] C. Rujikiatkamjorn and B. Indraratna, *Analytical solutions and design curves for vacuum-assisted consolidation with both vertical and horizontal drainage*, in *Canadian Geotechnical Journal*, Vol. 44 (2007) pp. 188–200.
- [27] N. Teerachakulpanich and T. Kosaka, *High Pressure for Vacuum Consolidation Method Using Air-Water Separation System*, in *Ground Improvement Case Histories: Embankments with Special Reference to Consolidation and Other Physical Methods* (2015) pp. 293–314.
- [28] B. C. O’Kelly, *Case studies of Vacuum Consolidation Ground Improvement in Peat Deposits*, in *Ground Improvement Case Histories: Embankments with Special Reference to Consolidation and Other Physical Methods* (2015) pp. 315–345.
- [29] J. Chai and J. P. Carter, *Consolidation theory for combined vacuum pressure and surcharge loading*, in *Proceedings of the 18th International Conference on Soil Mechanics and Geotechnical Engineering* (2013) pp. 2449–2452.
- [30] J. Chu and S. Yan, *Application of the Vacuum Preloading Method in Soil Improvement Projects*, in *Ground Improvement Case Histories: Embankments with Special Reference to Consolidation and Other Physical Methods* (2015) pp. 123–150.
- [31] Z. Li, M. Li, and F. Qiang, *Dynamic Response of Mud in the Field Soil*, in *4th International Conference on Recent Advances in Geotechnical Earthquake Engineering and Soil Dynamics* (2001) pp. 1–8.
- [32] G. H. Yang, R. Xue, and H. Q. Li, *Application of Dynamic Drainage Consolidation Method in Subgrade Strengthening*, in *Applied Mechanics and Materials*, Vol. 170-173 (2012) pp. 2395–2398.
- [33] L. J. Zhang, Z. M. Li, and K. T. Law, *Key Factors for the Dynamic-Static Drainage Consolidation Method*, in *Applied Mechanics and Materials*, Vol. 105-107 (2011) pp. 827–831.
- [34] R. Xue and J. Hu, *Study on the Influencing Factors under Dynamic Drainage Consolidation*, in *Applied Mechanics and Materials*, Vol. 99-100 (2011) pp. 243–249.
- [35] S. Glendinning, C. J. Jones, and J. Lamont-Black, *Ground Improvement Case Histories: Chemical, Electrokinetic, Thermal and Bioengineering Methods* (2015) pp. 403–452.

- [36] J. Yuan, *Multi-dimensional electro-osmosis consolidation of clays*, in *ISSMGE - TC 211 International Symposium on Ground Improvement* (2012).
- [37] E. C. Lee, *Ground Improvement Case Histories: Chemical, Electrokinetic, Thermal and Bioengineering Methods* (2015) pp. 487–513.
- [38] J. Yee, A. Athapaththu, and H. Lau, *Electro-osmotic Consolidation for Improvement of Geotechnical Engineering Properties of Tropical Peat*, in *Proceedings of the international symposium: recent research, advantages & execution aspects of ground improvement works* (2012) pp. 231–239.
- [39] H. M. Abuel-Naga, D. T. Bergado, S. Soralump, and P. Rujivipat, *Thermal consolidation of soft Bangkok clay*, in *Lowland Technology International*, Vol. 7 (2005) pp. 13–21.
- [40] M. Bouassida and L. Hazzar, *Performance of Soft Clays Reinforced by Floating Columns*, in *Ground Improvement Case Histories: Embankments with Special Reference to Consolidation and Other Physical Methods* (2015) pp. 433–449.
- [41] R. Alonso, José A; Jimenez, *Reliability-based design of stone columns for ground improvement considering settlement and bulging as failure modes*, in *Proceedings of the international symposium: recent research, advantages & execution aspects of ground improvement works*, Vol. 3 (2012) pp. 319–328.
- [42] G. L. S. Araujo, E. M. Palmeira, and R. Pinto, *Numerical analysis of instrumented granular columns*, in *Pan-Am CGS Geotechnical Conference* (2011).
- [43] M. J. Nasab and A. Asakereh, *A Review of Methods of Increasing the Efficiency of Stone Columns to Ground Improvement*, in *International Journal of Science and Engineering*, Vol. 4 (2015) pp. 75–78.
- [44] I. Hosseinpour, M. S. S. Almeida, and M. Riccio, *Full-scale load test and finite-element analysis of soft ground improved by geotextile-encased granular columns*, in *Geosynthetics International*, Vol. 22 (2015) pp. 428–438.
- [45] M. Raithel, V. Kuster, and A. Lindmark, *Geotextile-Encased Columns - a foundation system for earth structures, illustrated by a dyke project for a works extension in Hamburg*, (2002) pp. 1–10.
- [46] M. Raithel and A. Kirchner, *Calculation Techniques and Dimensioning of Encased Columns - Design and State of the Art*, in *Proceedings of the 4th Asian Regional Conference on Geosynthetics* (2008) pp. 718–723.
- [47] D. Alexiew and M. Raithel, *Geotextile-Encased Columns*, in *Ground Improvement Case Histories: Embankments with Special Reference to Consolidation and Other Physical Methods* (2015) pp. 451–477.
- [48] S. Coulter and C. D. Martin, *Single fluid jet-grout strength and deformation properties*, in *Tunnelling and Underground Space Technology*, Vol. 21 (2006) pp. 690–695.
- [49] S. L. Shen, Z. F. Wang, S. Horpibulsuk, and Y. H. Kim, *Jet grouting with a newly developed technology: The Twin-Jet method*, in *Engineering Geology*, Vol. 152 (2013) pp. 87–95.
- [50] D. Wen, *Use of Jet Grouting in Deep Excavations*, in *Ground Improvement Case Histories: Chemical, Electrokinetic, Thermal and Bioengineering Methods* (2015) pp. 109–122.
- [51] S. Varaksin, B. Hamidi, N. Huybrechts, and N. Dinies, *Ground Improvement vs Pile Foundations - the wrong debate*, in *ISSMGE - ETC 3 - International symposium on Design of Piles in Europe* (2016) pp. 1–48.
- [52] R. Barron, *Consolidation of fine-grained soils by drain wells*, in *Transactions of the American Society of Civil Engineers*, Vol. 113 (1948) pp. 718–742.
- [53] A. Parsa-Pajouh, B. Fatahi, and H. Khabbaz, *Experimental and Numerical Investigations to Evaluate Two-Dimensional Modeling of Vertical Drain – Assisted Preloading*, in *International Journal of Geomechanics* (2013) pp. 1–14.
- [54] J. S. Sharma and D. Xiao, *Characterization of a smear zone around vertical drains by large-scale laboratory tests*, in *Canadian Geotechnical Journal*, Vol. 37 (2000) pp. 1265–1271.

- [55] C. Rujikiatkamjorn and B. Indraratna, *Radial consolidation modelling incorporating the effect of a smear zone for a multilayer soil with downdrag caused by mandrel action*, in *Canadian Geotechnical Journal*, Vol. 47 (2010) pp. 1024–1035.
- [56] B. Indraratna, T. T. Nguyen, J. Carter, and C. Rujikiatkamjorn, *Influence of biodegradable natural fibre drains on the radial consolidation of soft soil*, in *Computers and Geotechnics*, Vol. 78 (2016) pp. 171–180.
- [57] F. H. Ali, *The flow behaviour of deformed prefabricated vertical drains*, in *Geotextiles and Geomembranes*, Vol. 10 (1991) pp. 235–248.
- [58] D. T. Bergado, R. Manivannan, and A. S. Balasubramaniam, *Proposed Criteria for Discharge Capacity of Prefabricated Vertical Drains*, in *Geotextiles and Geomembranes*, Vol. 14 (1996) pp. 481–505.
- [59] J.-C. Chai and N. Miura, *Investigation of factors affecting vertical drain behavior*, in *Journal of Geotechnical and Geoenvironmental Engineering*, Vol. 125 (1999) pp. 216–226.
- [60] Y. Hiroshi and H. Nakanodo, *Consolidation of soils by vertical wells with finite permeability*, in *Japanese society of soil mechanics and foundation engineering*, Vol. 14 (1974) pp. 35–46.
- [61] Y. M. Park and S. S. Kim, *An Evaluation on Discharge Capacity of Prefabricated Vertical Drains Using Large Scale Test Apparatus*, (2004) pp. 330–337.
- [62] J. W. Dijkstra and R. M. Bodamer, *Determination of the discharge capacity of buckled prefabricated vertical drains*, (2014).
- [63] M. Win, A. Arulrajah, S. Horpibulsuk, A. Chinkulkijniwat, and M. Leong, *Laboratory measurements of factors affecting discharge capacity of prefabricated vertical drain materials*, in *Soils and Foundations*, Vol. 56 (2016) pp. 129–137.
- [64] M. W. Islam and A. J. Khan, *Performance of a Prefabricated Vertical Jute Drain in a Remolded Soft Soil*, in *Proceedings of Bangladesh Geotechnical Conference*, January (2009) pp. 240–248.
- [65] T. Stapelfeldt, *Preloading and vertical drains*, (2006) pp. 1–27.
- [66] J. Chu, B. Indraratna, S. Yan, and C. Rujikiatkamjorn, *Overview of preloading methods for soil improvement*, in *Proceedings of the institution of Civil Engineers*, Vol. 166 (2014) pp. 1–13.
- [67] K. K. Tripathi and M. S. Nagesha, *Geotextiles and Geomembranes Discharge capacity requirement of prefabricated vertical drains*, in *Geotextiles and Geomembranes*, Vol. 28 (2010) pp. 128–132.
- [68] J. B. Burland, *On the compressibility and shear strength of natural clays*, in *Géotechnique*, Vol. 40 (1990) pp. 329–378.
- [69] B. Indraratna, R. Zhong, and C. Rujikiatkamjorn, *An Analytical Model of PVD-assisted Soft Ground Consolidation*, in *The 3rd International Conference on Transportation Geotechnics*, Vol. 143 (2016) pp. 1376–1383.
- [70] G. Mesri and D. Lo, *Field performance of prefabricated vertical drains*, in *International Conference on Geotechnical Engineering for Coastal Development*, Vol. 1 (1991) pp. 231–236.
- [71] N. K. Lee and S. G. Chung, *Reevaluation of the factors influencing the consolidation of ground by incorporating prefabricated vertical drains*, in *KSCE Journal of Civil Engineering*, Vol. 14 (2010) pp. 155–164.
- [72] M. W. Bo, *Discharge capacity of prefabricated vertical drain and their field measurements*, in *Geotextiles and Geomembranes*, Vol. 22 (2004) pp. 37–48.
- [73] C. J. Leo, *Equal Strain Consolidation by Vertical Drains*, in *Journal of Geotechnical and Geoenvironmental Engineering*, Vol. 130 (2004) pp. 316–327.

III

APPENDICES

A

GROUND IMPROVEMENT TECHNIQUES

A. Ground improvement without admixtures in non-cohesive soils or fill materials	
A1. Dynamic compaction	Densification of granular soil by dropping a heavy weight from air onto ground.
A2. Vibrocompaction	Densification of granular soil using a vibratory probe inserted into ground.
A3. Explosive compaction	Shock waves and vibrations are generated by blasting to cause granular soil ground to settle through liquefaction or compaction.
A4. Electric pulse compaction	Densification of granular soil using the shock waves and energy generated by electric pulse under ultra-high voltage.
A5. Surface compaction (including rapid impact compaction).	Compaction of fill or ground at the surface or shallow depth using a variety of compaction machines

B. Ground improvement without admixtures in cohesive soils	
B1. Replacement/displacement (including load reduction using lightweight materials)	Remove bad soil by excavation or displacement and replace it by good soil or rocks. Some lightweight materials may be used as backfill to reduce the load or earth pressure.
B2. Preloading using fill (including the use of vertical drains)	Fill is applied and removed to pre-consolidate compressible soil so that its compressibility will be much reduced when future loads are applied.
B3. Preloading using vacuum (including combined fill and vacuum)	Vacuum pressure of up to 90 kPa is used to pre-consolidate compressible soil so that its compressibility will be much reduced when future loads are applied.
B4. Dynamic consolidation with enhanced drainage (including the use of vacuum)	Similar to dynamic compaction except vertical or horizontal drains (or together with vacuum) are used to dissipate pore pressures generated in soil during compaction.
B5. Electro-osmosis or electrokinetic consolidation	DC current causes water in soil or solutions to flow from anodes to cathodes which are installed in soil.
B6. Thermal stabilization using heating or freezing	Change the physical or mechanical properties of soil permanently or temporarily by heating or freezing the soil.
B7. Hydro-blasting compaction	Collapsible soil (loess) is compacted by a combined wetting and deep explosion action along a borehole.

C. Ground improvement with admixtures or inclusions	
C1. Vibro replacement or stone columns	Hole jetted into soft, fine-grained soil and back filled with densely compacted gravel or sand to form columns.
C2. Dynamic replacement	Aggregates are driven into soil by high energy dynamic impact to form columns. The backfill can be either sand, gravel, stones or demolition debris.
C3. Sand compaction piles	Sand is fed into ground through a casing pipe and compacted by either vibration, dynamic impact, or static excitation to form columns.
C4. Geotextile encased column	Sand is fed into a closed bottom geotextile lined cylindrical hole to form a column.
C5. Rigid inclusions	Use of piles, rigid or semi-rigid bodies or columns which are either pre-made or formed in-situ to strengthen soft ground.
C6. Geosynthetic reinforced column or pile supported embankment	Use of piles, rigid or semi-rigid columns/inclusions and geosynthetic girds to enhance the stability and reduce the settlement of embankments.
C7. Microbial methods	Use of microbial materials to modify soil to increase its strength or reduce its permeability.
C8 Other methods	Unconventional methods, such as formation of sand piles using blasting and the use of bamboo, timber and other natural products.

D. Ground improvement with grouting type admixtures	
D1. Particulate grouting	Grout granular soil or cavities or fissures in soil or rock by injecting cement or other particulate grouts to either increase the strength or reduce the permeability of soil or ground.
D2. Chemical grouting	Solutions of two or more chemicals react in soil pores to form a gel or a solid precipitate to either increase the strength or reduce the permeability of soil or ground.
D3. Mixing methods (including premixing or deep mixing)	Treat the weak soil by mixing it with cement, lime, or other binders in-situ using a mixing machine or before placement
D4. Jet grouting	High speed jets at depth erode the soil and inject grout to form columns or panels
D5. Compaction grouting	Very stiff, mortar-like grout is injected into discrete soil zones and remains in a homogenous mass so as to densify loose soil or lift settled ground.
D6. Compensation grouting	Medium to high viscosity particulate suspensions is injected into the ground between a subsurface excavation and a structure in order to negate or reduce settlement of the structure due to on-going excavation.

E. Earth reinforcement	
E1. Geosynthetics or mechanically stabilized earth (MSE)	Use of the tensile strength of various steel or geosynthetic materials to enhance the shear strength of soil and stability of roads, foundations, embankments, slopes, or retaining walls.
E2. Ground anchors or soil nails	Use of the tensile strength of embedded nails or anchors to enhance the stability of slopes or retaining walls.
E3. Biological methods using vegetation	Use of the roots of vegetation for stability of slopes.

B

ASSESSMENT ON GROUND IMPROVEMENT TECHNIQUES

B.1 ASSESSMENT STUDENT

Results assessment Rik-Jan Wildeboer

		Group 1			Group 2					Group 3			Group 4		
		EPS	PU	LWMS	PVD	AD	RD	MD	DDC	GC	GEC	RI	CSM	TM	MS
	Importance	Score	Score	Score	Score	Score	Score	Score	Score	Score	Score	Score	Score	Score	Score
Potential	0	5	5	1	5	2	3	1	3	3	3	5	4	3	3
Design costs	0,25	1	1	2	1	2	2	1	3	4	5	5	4	4	4
Installation costs	0,35	2	2	3	1	1	3	2	3	5	5	4	5	4	5
Material costs	0,4	3	3	4	1	3	3	3	1	4	5	5	4	4	4
Construction time	0,5	1	1	2	5	4	4	4	5	2	2	1	2	1	2
Ground stability	0,1	3	3	3	4	3	4	4	4	2	1	1	2	2	2
EMVI Score	0,25	3	4	2	4	4	4	4	3	2	2	2	3	3	3
Environmental alteration	0,15	2	2	3	2	2	3	3	2	1	1	1	2	3	4
Residual settlements	0,3	1	2	2	5	5	4	4	5	2	2	1	2	2	3
Differential settlements	0,3	2	2	2	5	5	5	4	5	2	2	2	2	2	2
Degradation	0,2	4	1	4	1	1	1	1	1	1	2	1	2	3	3
Ecological footprint	0,2	4	3	2	2	2	2	3	2	5	4	3	3	4	4

B.2 ASSESSMENT INTERNAL PROFESSIONALS

Results assessment Jeroen Dijkstra

	Importance	Group 1			Group 2					Group 3			Group 4		
		EPS	PU	LWMS	PVD	AD	RD	MD	DDC	GC	GEC	RI	CSM	TM	MS
		Score	Score	Score	Score	Score	Score	Score	Score	Score	Score	Score	Score	Score	Score
Potential	0	5	5	3	5	4	3	2	2	3	3	5	5	3	3
Design costs	0,2	1	1	1	2	2	2	2	3	4	4	4	5	3	5
Installation costs	0,4	2	2	2	1	1	2	2	3	4	5	4	5	3	5
Material costs	0,4	3	3	3	1	3	2	2	3	3	4	4	5	3	5
Construction time	0,4	1	1	1	4	4	2	1	3	2	2	1	1	3	1
Ground stability	0,2	2	2	2	3	1	2	2	2	1	1	1	1	3	1
EMVI Score	0,3	2	1	1	3	4	3	3	3	3	3	3	2	3	2
Environmental alteration	0,1	3	3	3	3	3	3	3	3	3	3	3	3	3	3
Residual settlements	0,25	2	2	2	4	4	3	3	3	2	2	1	2	3	2
Differential settlements	0,25	2	2	2	4	4	3	3	3	2	2	1	2	3	2
Degradation	0,25	3	1	3	1	1	1	1	1	1	1	2	2	3	2
Ecological footprint	0,25	5	3	3	3	3	3	3	3	2	2	2	4	...	4

Results assessment Jan Willem Vink

	Importance	Group 1			Group 2					Group 3			Group 4		
		EPS	PU	LWMS	PVD	AD	RD	MD	DDC	GC	GEC	RI	CSM	TM	MS
		Score	Score	Score	Score	Score	Score	Score	Score	Score	Score	Score	Score	Score	Score
Potential	0	0	0	0	0	0	0	0	0	0	0	0	0	0	0
Design costs	0,25	3	2	4	2	4	2	3	4	3	3	2	3	3	3
Installation costs	0,5	4	2	2	2	3	2	3	4	4	4	3	5	4	5
Material costs	0,25	4	4	4	2	4	2	3	4	4	4	3	4	4	4
Construction time	0,2	4	2	2	2	3	2	2	4	4	4	2	3	3	4
Ground stability	0,2	5	3	3	2	1	2	2	5	1	2	2	2	2	1
EMVI Score	0,3	3	3	2	3	1	3	1	3	3	3	4	3	3	2
Environmental alteration	0,3	4	3	2	4	4	4	4	4	3	3	4	4	4	3
Residual settlements	0,25	3	3	3	2	2	2	1	4	1	2	2	4	4	2
Differential settlements	0,25	3	3	3	2	2	2	1	4	1	2	2	4	4	2
Degradation	0,2	3	2	3	3	3	3	3	2	2	3	3	2	2	3
Ecological footprint	0,3	4	2	3	4	4	4	4	4	3	3	4	4	4	2

Results assessment Andre de Lange

	Importance	Group 1			Group 2					Group 3			Group 4		
		EPS	PU	LWMS	PVD	AD	RD	MD	DDC	GC	GEC	RI	CSM	TM	MS
		Score	Score	Score	Score	Score	Score	Score	Score	Score	Score	Score	Score	Score	Score
Potential (groei)	0	5	5	3,5	5	2	4	3	3	5	3	1	5	3	4
Design costs	0,4	2	1	5	1	4	4	4	3	1	2,5	2	4	2	3
Installation costs	0,4	4,0	2	4	1	1,5	5	3	2,5	2	3	1	5	3	3
Material costs	0,2	3	2,5	4	1	1	3	2	1	2	3	4	4	3	5
Construction time	0,3	1	1	2	2,5	1,5	3	1	2	2	3	1	4	2	4
Ground stability	0,35	3,5	1	2	2	1	2	2	3	2	1,5	1	3	2	1
EMVI Score	0,2	3	3	2	2	1	2	2	3	3	3	1	4	2	2
Environmental alteration	0,15	1	2	5	3,5	3,5	3,5	3,5	3,5	2	2	2	3	3	5
Residual settlements	0,25	1	1	1	2	2	2	2	2	1	1	1	2	2	3
Differential settlements	0,3	1	1	1	3	3	3	3	2	2	1	2	2,5	3	2,5
Degradation	0,25	3	1	4	1	1	1	1	1	1	2	1	2	3	3
Ecological footprint	0,2	4	5	2	4	4	4	4	5	2	2,5	4	3	2	4

B.3 ASSESSMENT EXTERNAL PROFESSIONALS

Results assessment external professional 1

	Importance	Group 1			Group 2					Group 3			Group 4		
		EPS	PU	LWMS	PVD	AD	RD	MD	DDC	GC	GEC	RI	CSM	TM	MS
		Score	Score	Score	Score	Score	Score	Score	Score	Score	Score	Score	Score	Score	Score
Potential	0	2	3	2	1	1	3	4	2	2	2	3	4	4	3
Design costs	0,2	3	3	2	1	2	2	3	2	4	3	3	3	2	2
Installation costs	0,5	3,0	2	3	2	3	3	4	3	5	4	4	5	4	3
Material costs	0,3	4	2	2	1	2	2	3	1	5	4	4	5	4	3
Construction time	0,4	2	3	3	1	2	3	3	4	4	3	3	3	4	5
Ground stability	0,3	3	3	4	4	1	3	4	4	1	2	3	1	2	2
EMVI Score	0,15	5	4	3	4	3	3	3	3	2	3	4	2	3	4
Environmental alteration	0,15	5	4	3	5	5	5	5	1	4	4	3	5	4	4
Residual settlements	0,4	2	3	3	4	4	4	4	4	1	2	2	3	2	1
Differential settlements	0,1	2	4	3	2	2	2	2	3	1	2	3	3	2	1
Degradation	0,3	2	2	3	1	1	1	3	1	1	2	3	2	3	3
Ecological footprint	0,2	5	5	3	3	3	3	3	1	5	4	3	5	4	4

Results assessment external professional 2

	Importance	Group 1			Group 2					Group 3			Group 4		
		EPS	PU	LWMS	PVD	AD	RD	MD	DDC	GC	GEC	RI	CSM	TM	MS
		Score	Score	Score	Score	Score	Score	Score	Score	Score	Score	Score	Score	Score	Score
Potential	0
Design costs	0,33	1	2	3	3	3	3	3	4	3	4	3	3	3	3
Installation costs	0,33	2,0	2	3	3	3	3	3	4	3	3	3	4	4	3
Material costs	0,33	4	3	2	3	3	3	4	3	2	3	2	4	4	4
Construction time	0,25	2	2	3	4	4	4	3	3	4	4	3	2	2	2
Ground stability	0,25	2	1	1	2	2	2	2	4	2	2	2	1	1	1
EMVI Score	0,25	3	2	2	3	3	3	3	4	2	2	2	3	3	3
Environmental alteration	0,25	5	1	4	3	3	3	3	3	2	2	4	4	4	5
Residual settlements	0,25	2	2	2	2	2	2	2	3	2	2	2	2	2	2
Differential settlements	0,25	2	2	2	3	3	3	2	3	3	3	3	2	2	2
Degradation	0,25	3	1	2	3	3	3	3	3	1	2	1	1	1	1
Ecological footprint	0,25	5	2	3	3	3	3	3	3	2	3	2	4	4	4

Results assessment external professional 3

	Importance	Group 1			Group 2					Group 3			Group 4		
		EPS	PU	LWMS	PVD	AD	RD	MD	DDC	GC	GEC	RI	CSM	TM	MS
		Score	Score	Score	Score	Score	Score	Score	Score	Score	Score	Score	Score	Score	Score
Potential	0	5	5	2	5	3	3	3	5	3	3	5	2	2	2
Design costs	0,1	1	1	3	1	1	1	1	3	2	2	1	3	3	3
Installation costs	0,5	1,0	1	3	1	1	1	1	5	5	5	1	4	4	5
Material costs	0,4	3	3	2	1	1	1	1	1	3	4	4	4	4	5
Construction time	0,3	2	2	3	5	5	5	5	4	2	2	1	3	3	3
Ground stability	0,3	2	2	1	3	3	3	3	4	2	2	1	1	1	1
EMVI Score	0,1	2	3	4	1	1	1	1	3	1	1	2	4	4	4
Environmental alteration	0,3	4	5	5	1	1	1	1	4	2	2	3	4	4	5
Residual settlements	0,25	2	2	2	3	3	3	3	3	3	3	1	3	3	3
Differential settlements	0,25	2	2	2	3	3	3	3	3	3	3	1	3	3	3
Degradation	0,25	3	1	4	1	1	1	1	1	1	1	1	4	4	4
Ecological footprint	0,25	4	4	5	1	1	1	1	1	1	1	3	5	5	5

C

OEDOMETER TEST RESULTS

C.1 GENERAL OVERVIEW RESULTS

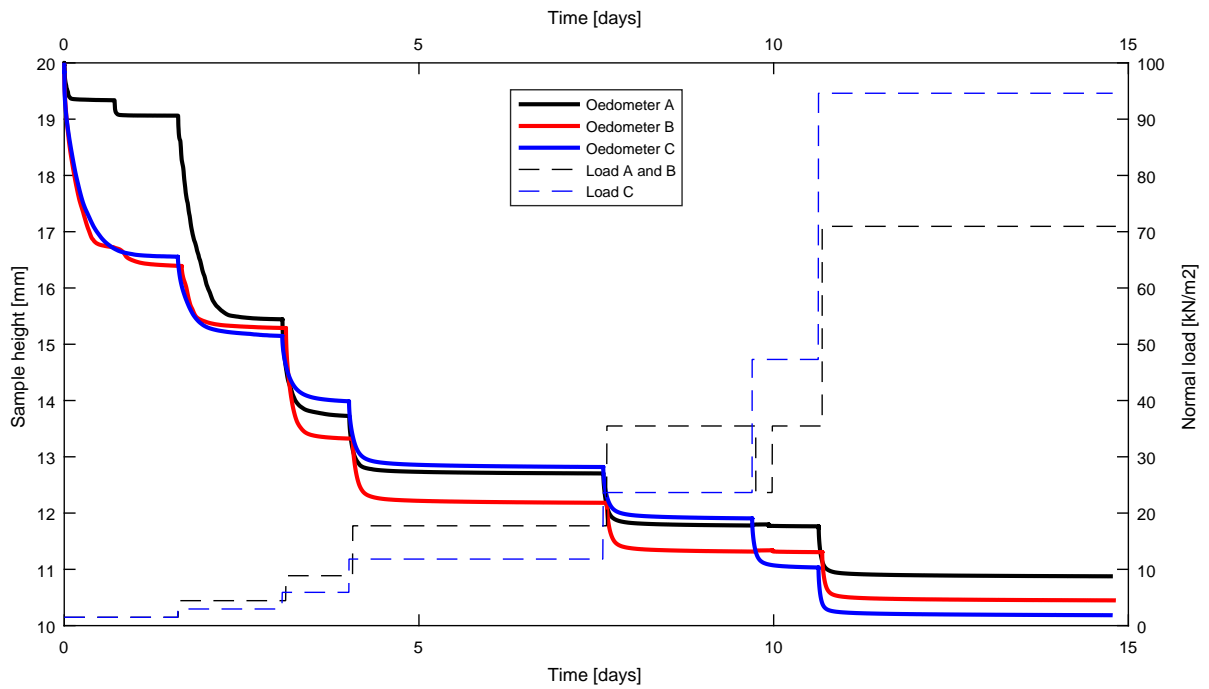

Physical properties of initial sample

Oedometer	Sample	Water	Clay	Water	Clay	Total	Air	Void ratio
[-]	[g]	[g]	[g]	[cm3]	[cm3]	[cm3]	[cm3]	[-]
A	92,1	46,05	46,05	46,13	17,62	66,37	2,61	2,77
B	94,58	47,29	47,29	47,38	18,10	66,37	0,89	2,67
C	93,97	46,985	46,985	47,07	17,98	66,37	1,32	2,69

Physical properties of consolidated sample

Oedometer	Sample	Water	Clay	Water	Clay	Total	Air	Void ratio
[-]	[g]	[g]	[g]	[cm3]	[cm3]	[cm3]	[cm3]	[-]
A	61,57	15,52	46,05	15,55	17,62	36,09	2,92	1,05
B	61,34	14,05	47,29	14,08	18,10	34,67	2,50	0,92
C	61,78	14,795	46,985	14,82	17,98	33,80	0,99	0,88

Stiffness related parameters				
Eoed	Mv	Cc	Cr	Ca
[kN/m ²]	[m ² /kN]	[-]	[-]	[-]
133,58	0,00749	0,75	0,026	0,00930

Coefficient of consolidation								
Cv-A			Cv-B			Cv-C		
Load	Taylor	Casagrande	Taylor	Casagrande	Load	Taylor	Casagrande	
[kN/m ²]	[m ² /s]	[m ² /s]	[m ² /s]	[m ² /s]	[kN/m ²]	[m ² /s]	[m ² /s]	
8,00	2,99E-09	1,38E-08	2,80E-09	2,97E-08	3,00	1,73E-09	8,31E-09	
17,00	3,76E-09	1,61E-08	3,11E-09	1,29E-08	6,00	2,63E-09	1,05E-08	
35,00	3,79E-09	1,51E-08	3,41E-09	1,39E-08	12,00	2,83E-09	1,28E-08	
70,00	5,66E-09	1,76E-08	4,45E-09	1,62E-08	24,00	3,42E-09	1,20E-08	
					48,00	3,97E-09	1,64E-08	
					95,00	5,42E-09	1,87E-08	

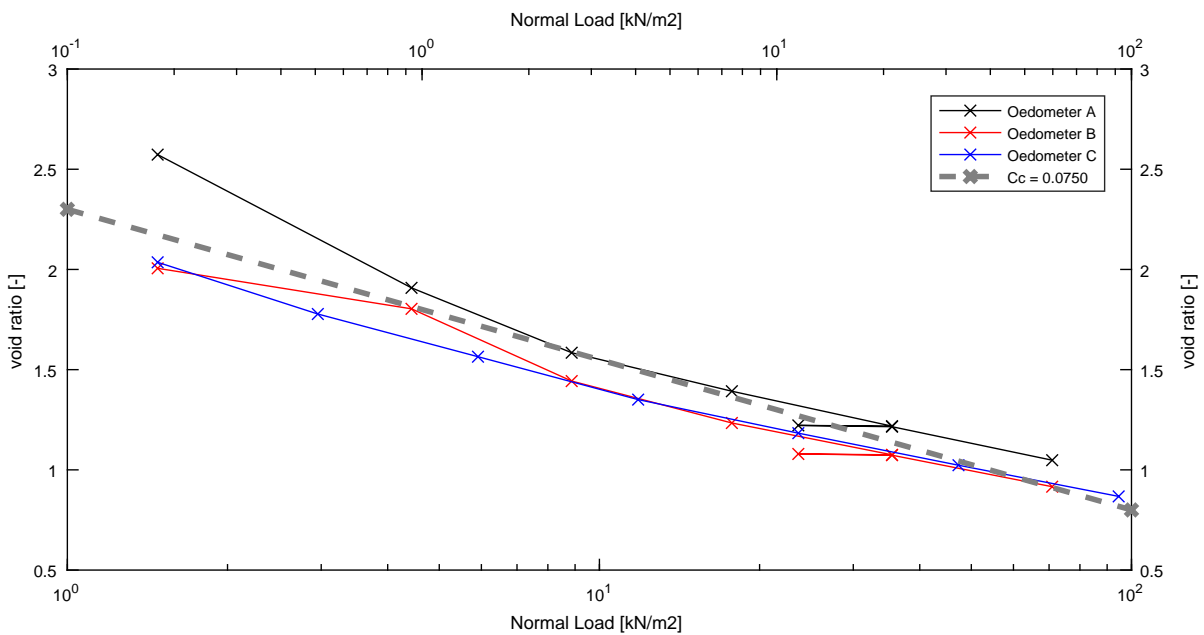
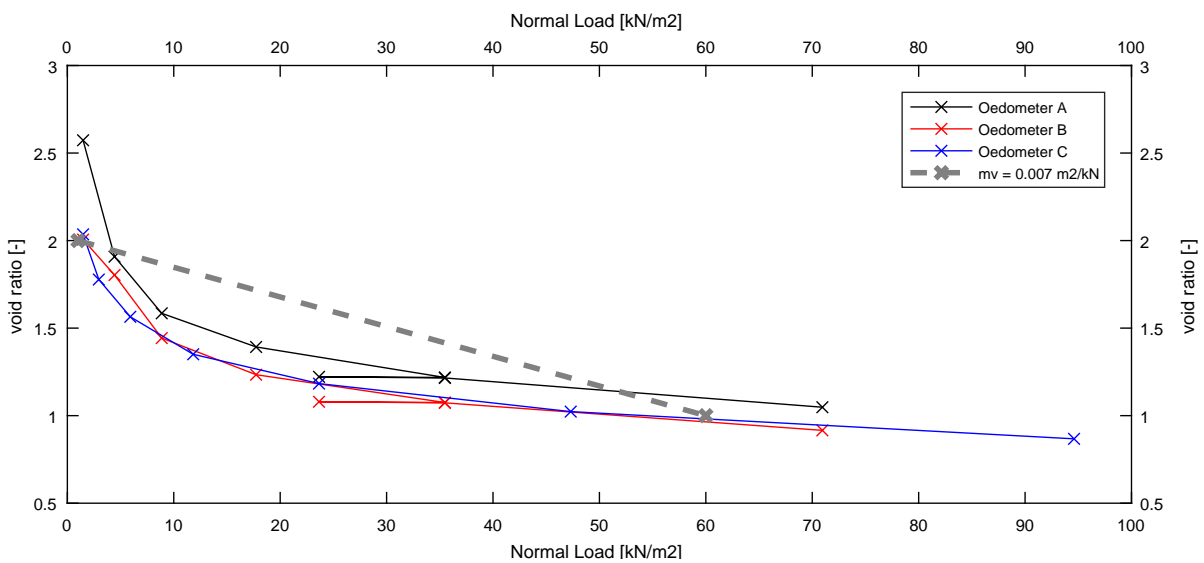

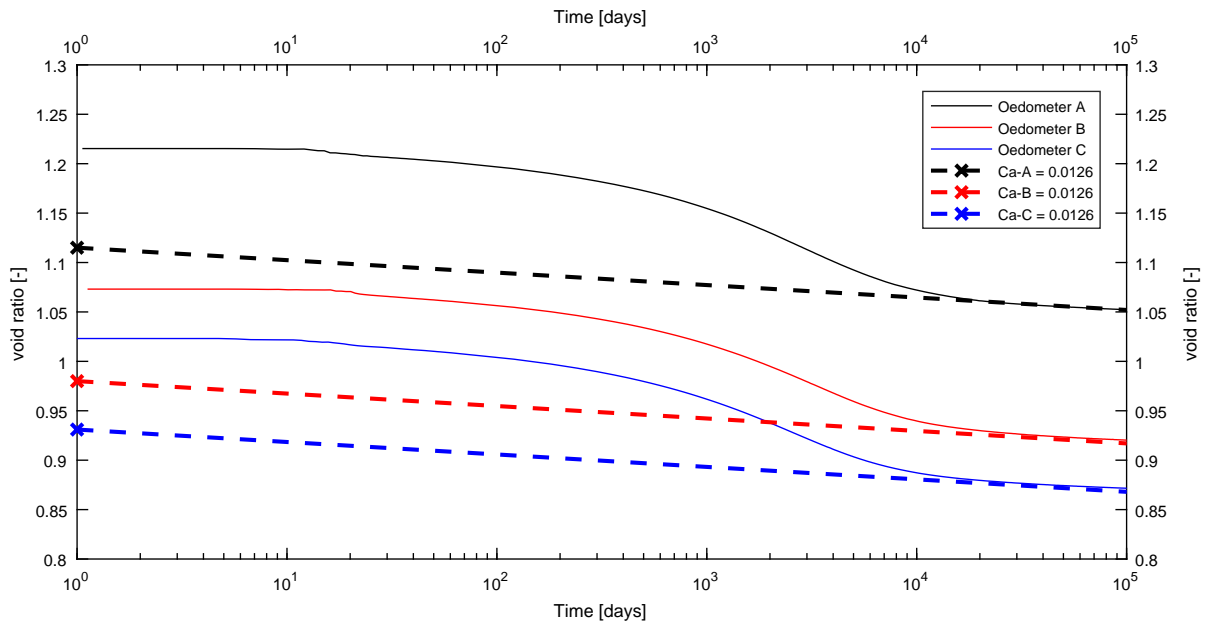
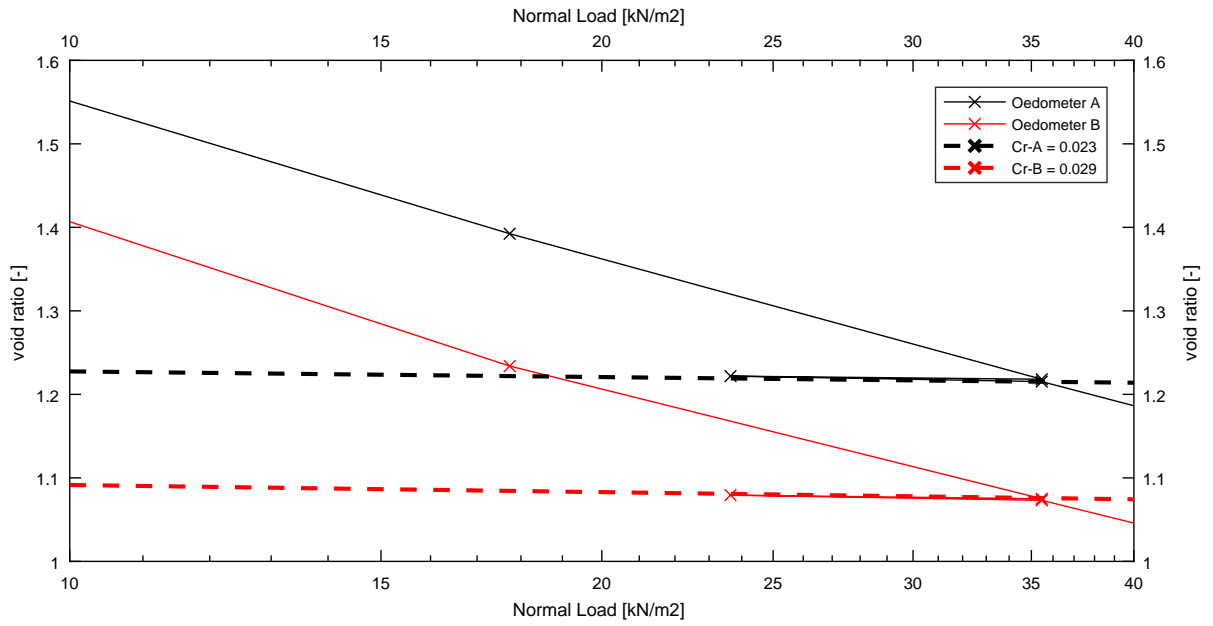

C.2 RESULTS OEDOMETER A

Testing data Oedometer A				
Mass	Load	Heigth	Volume	Void ratio
[g]	[kN/m ²]	[mm]	[mm ³]	[-]
0	0,00	20	66366,1	2,77
500	1,48	18,97	62960,2	2,57
1500	4,43	15,44	51245,6	1,9
3000	8,87	13,72	45543,2	1,6
6000	17,74	12,70	42157,4	1,4
12000	35,48	11,78	39086,4	1,2
8000	23,65	11,80	39152,2	1,2
12000	35,48	11,76	39037,1	1,2
24000	70,95	10,88	36091,3	1,0

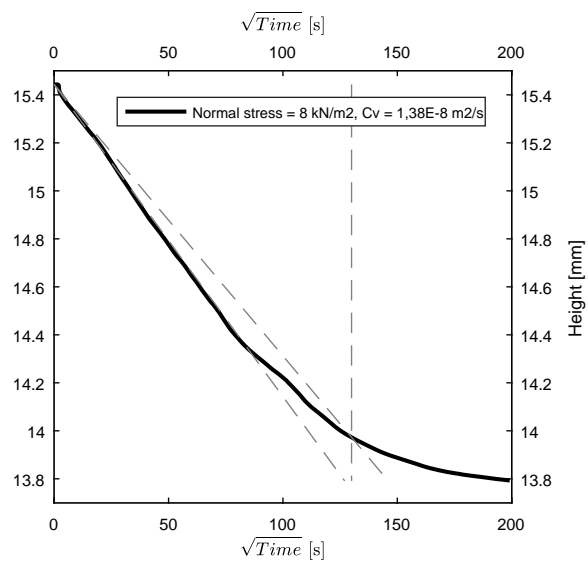
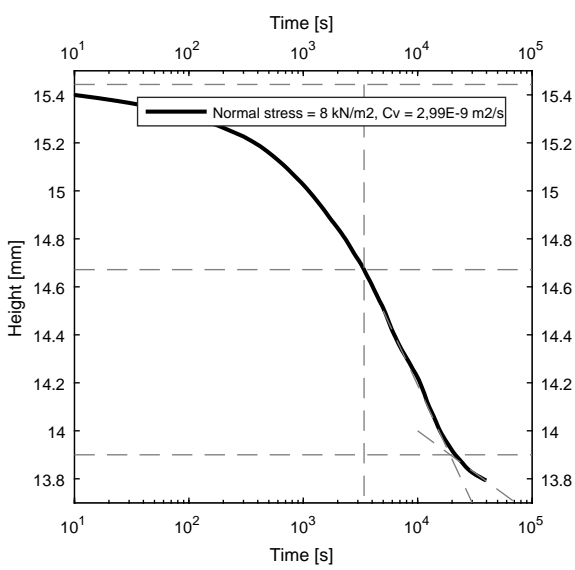

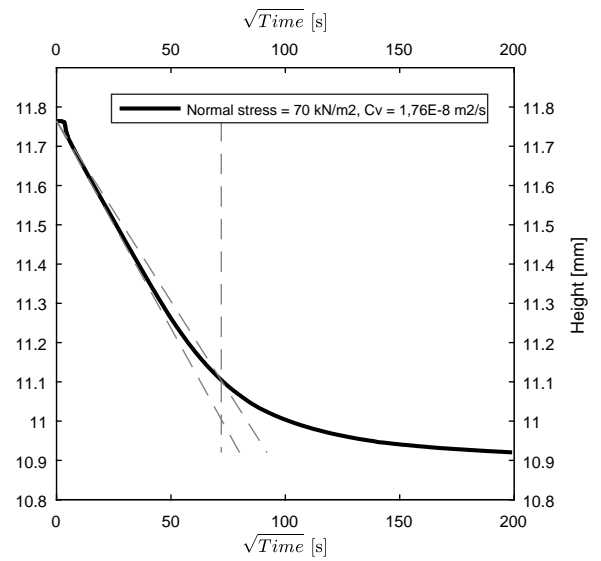
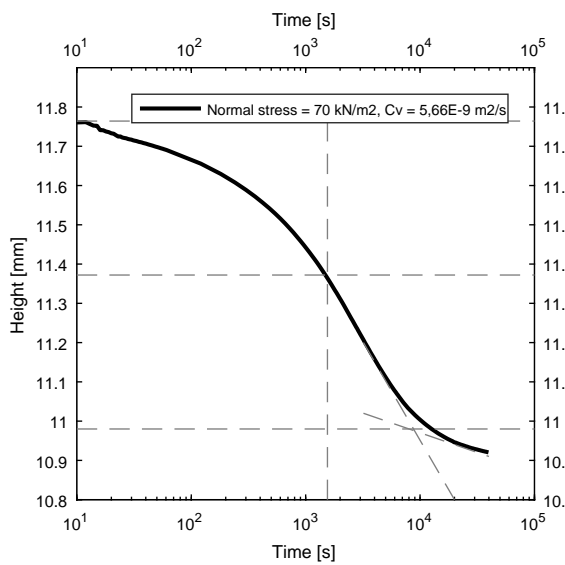
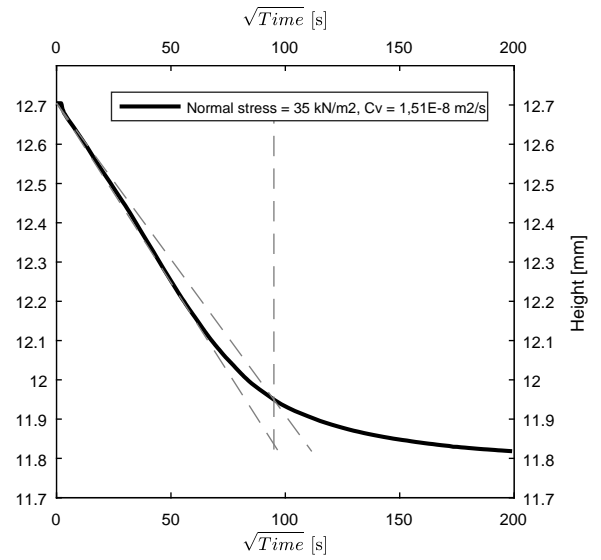
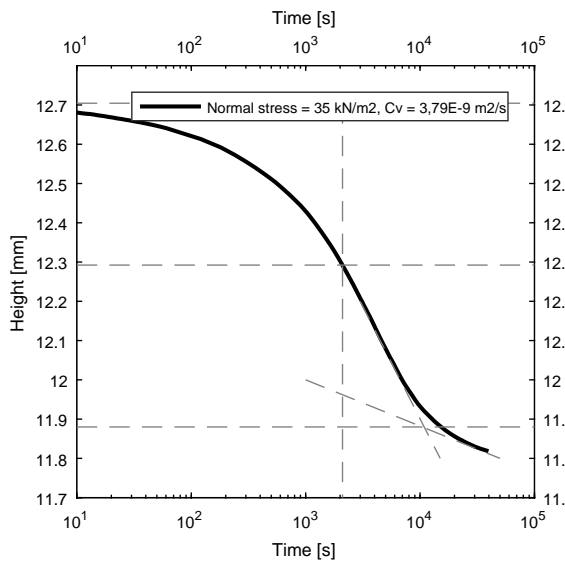
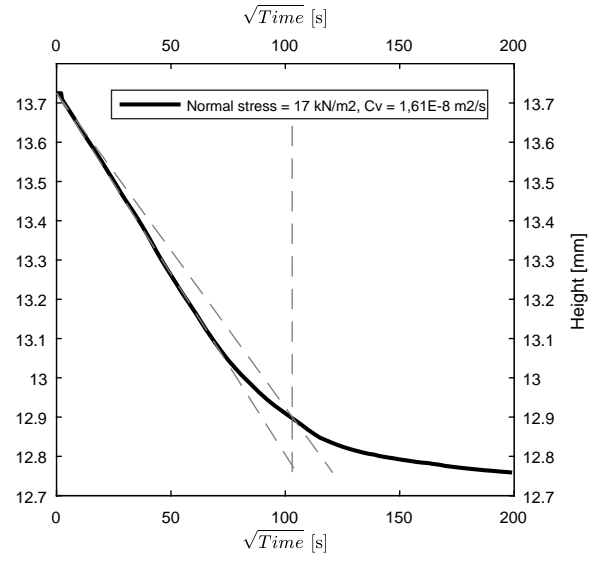
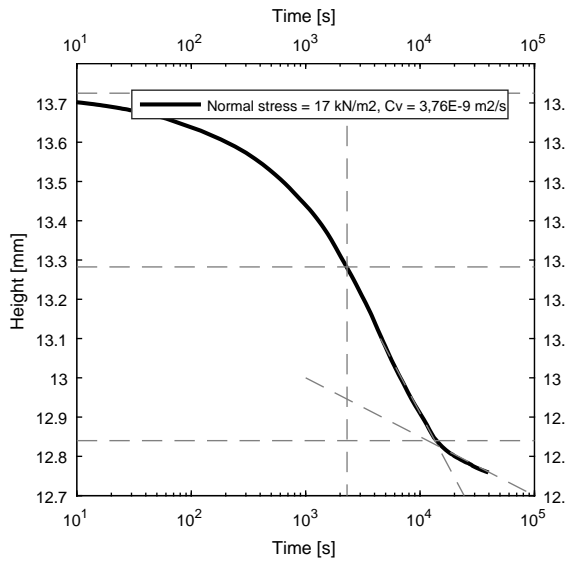

C.3 RESULTS OEDOMETER B

Testing data Oedometer B				
Mass	Load	Heigth	Volume	Void ratio
[g]	[kN/m ²]	[mm]	[mm ³]	[-]
0	0,00	20	66366,14	2,67
500	1,48	16,39	54389,89	2,01
1500	4,43	15,29	50731,05	1,80
3000	8,87	13,32	44207,78	1,44
6000	17,74	12,18	40424,24	1,23
12000	35,48	11,32	37549,75	1,08
8000	23,65	11,34	37627,63	1,08
12000	35,48	11,31	37514,73	1,07
24000	70,95	10,45	34671,24	0,92

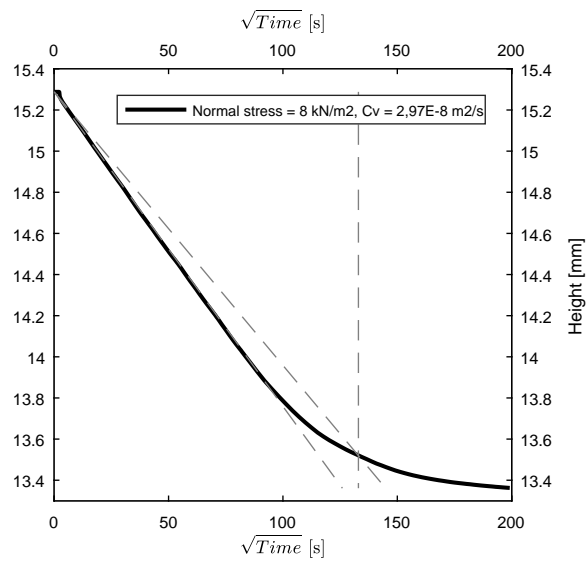
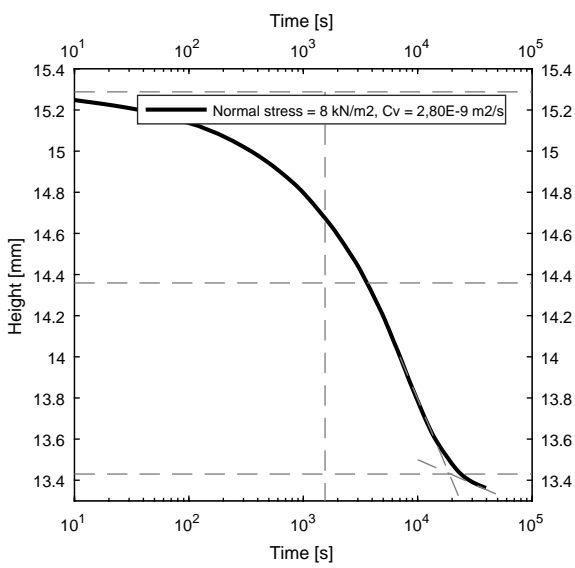

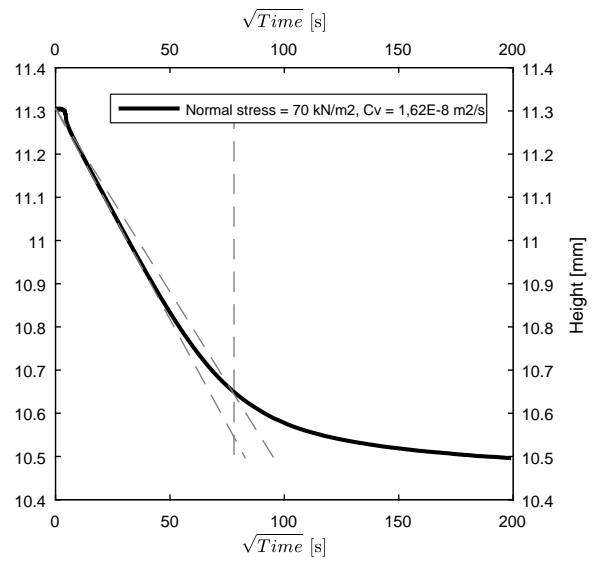
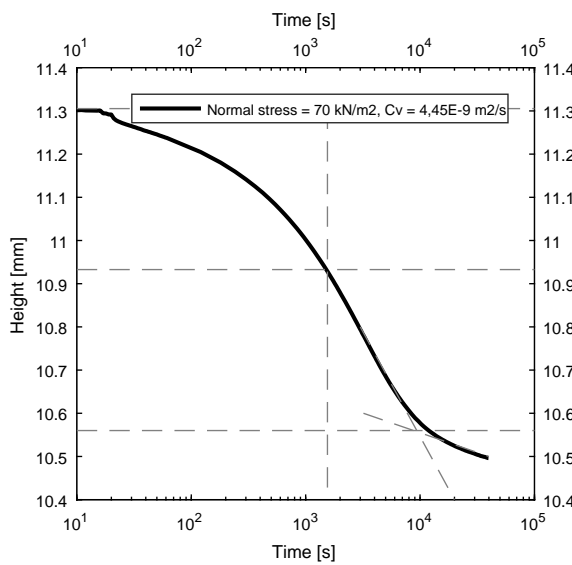
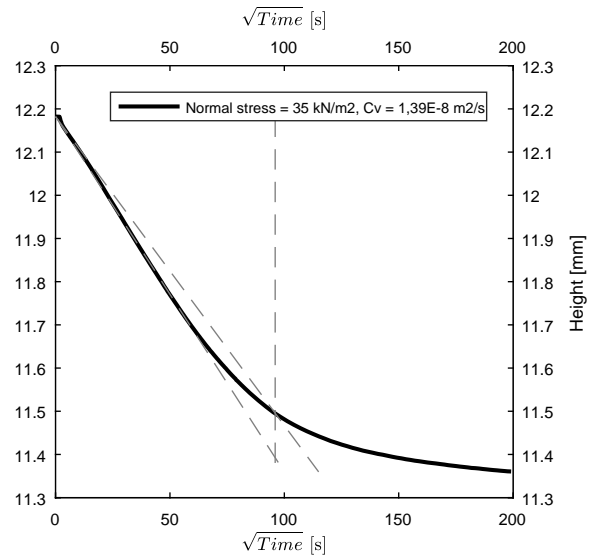
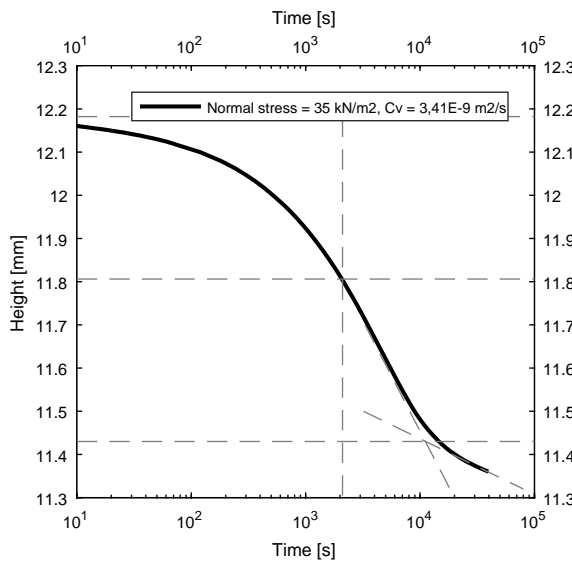
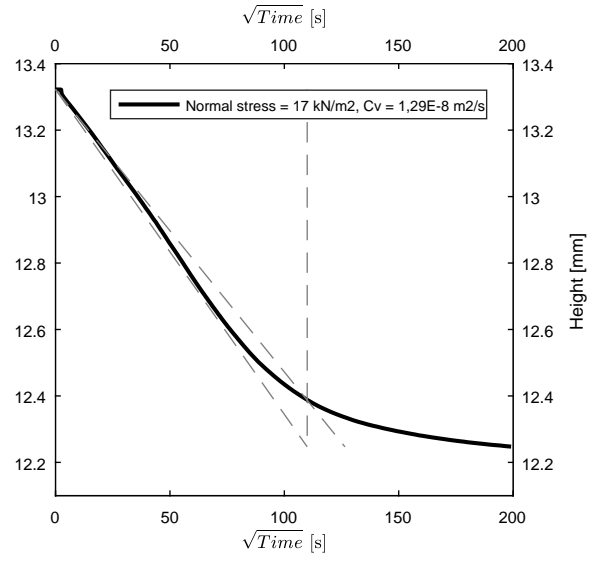
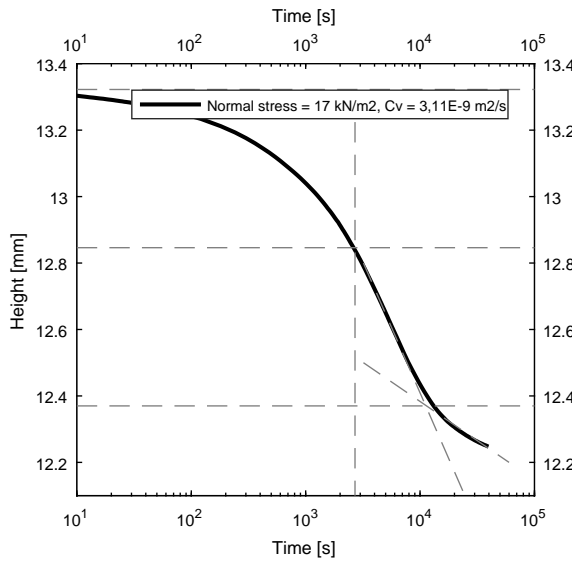

C.4 RESULTS OEDOMETER C

Testing data Oedometer C				
Mass	Load	Heigth	Volume	Void ratio
[g]	[kN/m2]	[mm]	[mm3]	[-]
0	0,00	20,00	66366,14	2,67
500	1,48	16,55	54933,06	2,04
1000	2,96	15,15	50263,17	1,78
2000	5,91	13,99	46409,30	1,56
4000	11,83	12,82	42534,83	1,35
8000	23,65	11,91	39505,25	1,18
16000	47,30	11,03	36609,63	1,02
32000	94,60	10,18	33795,66	0,87

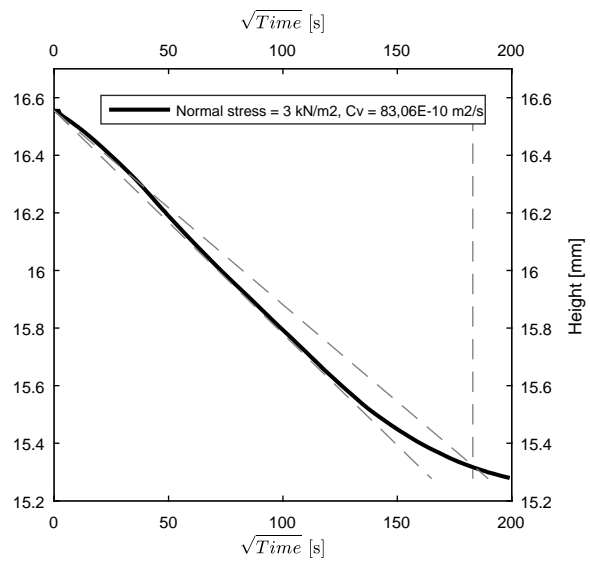
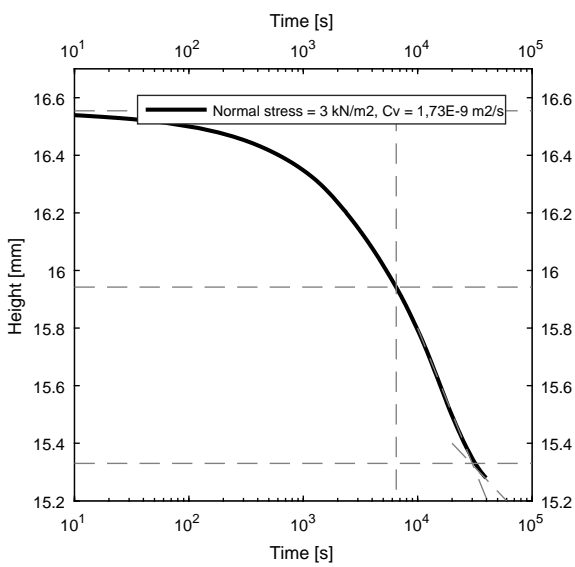

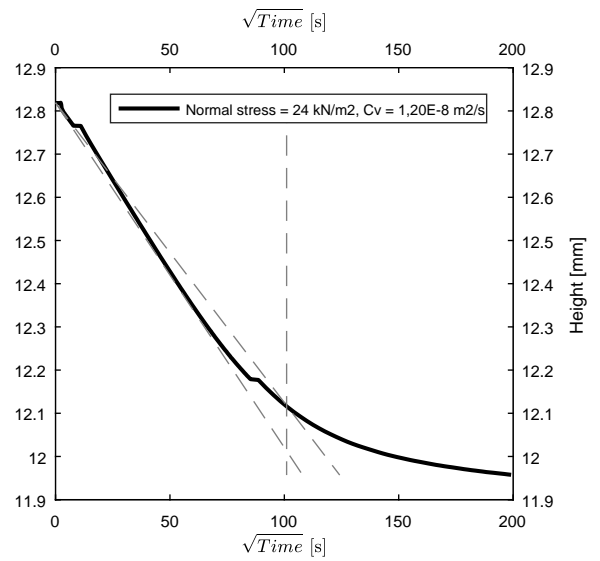
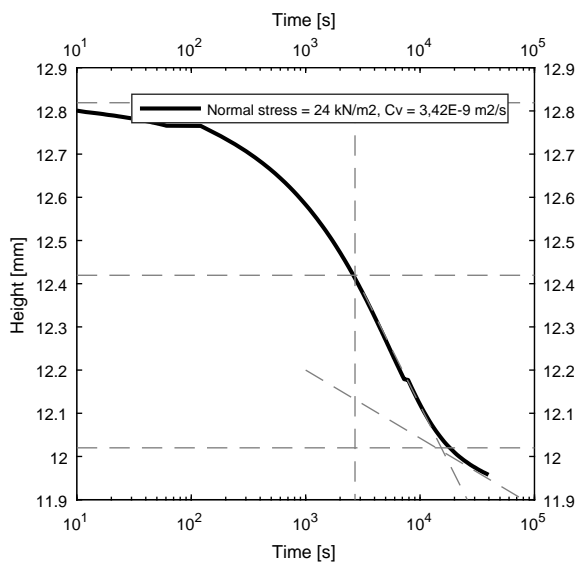
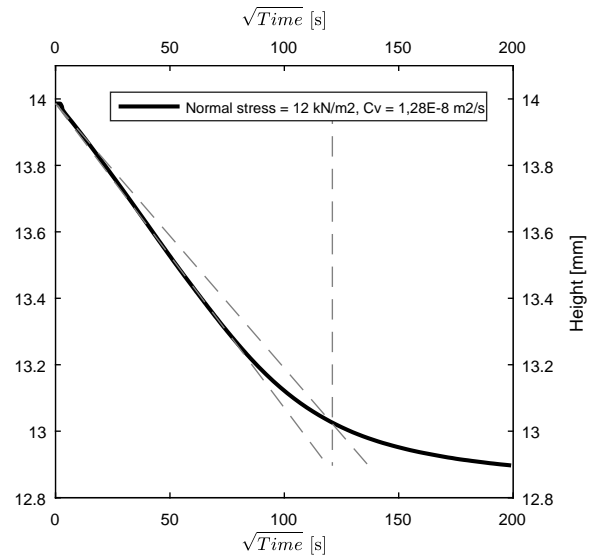
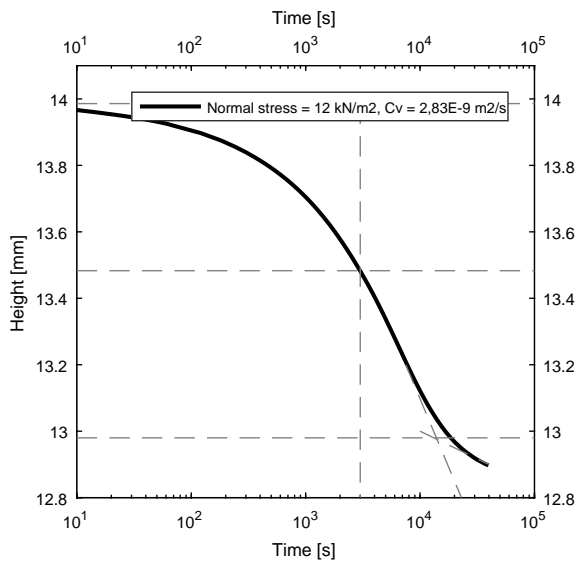
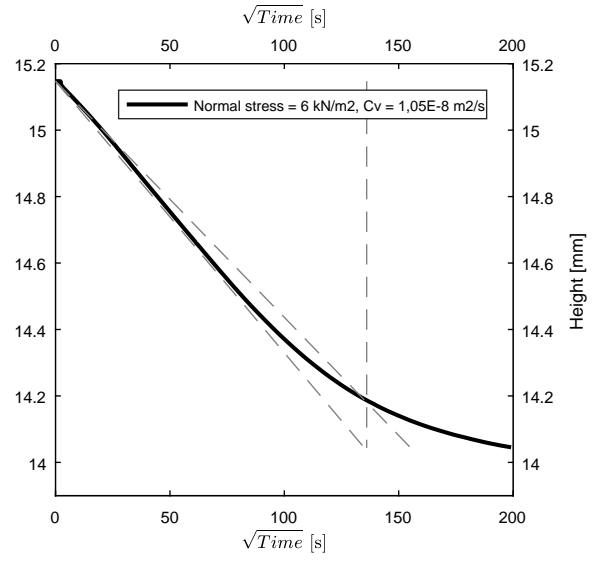
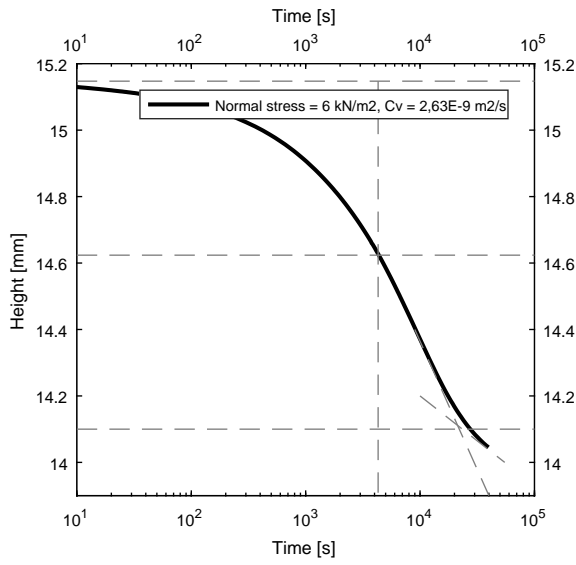

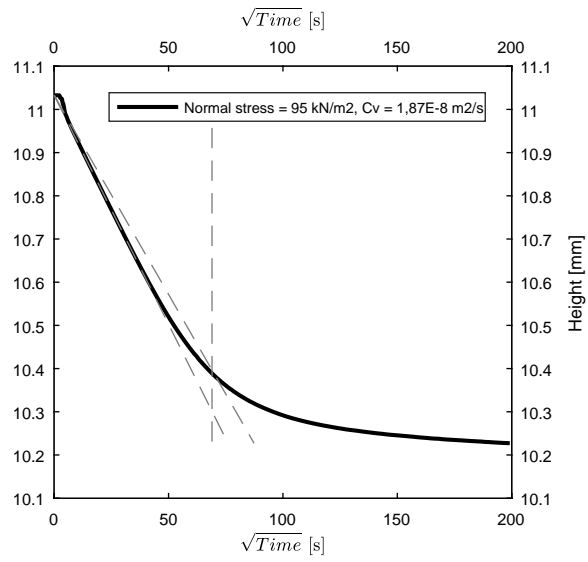
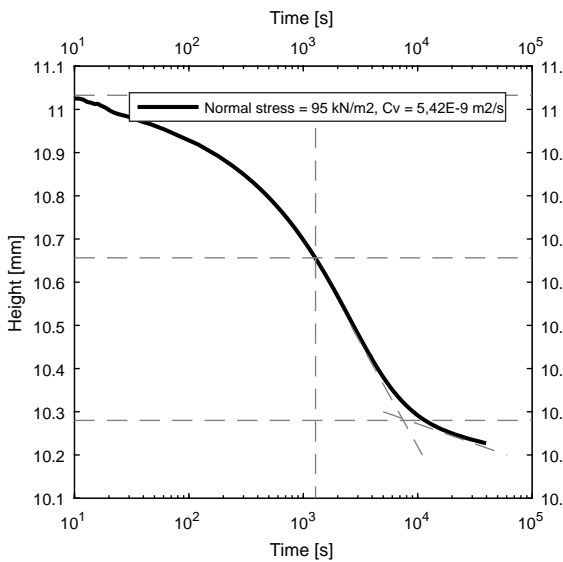
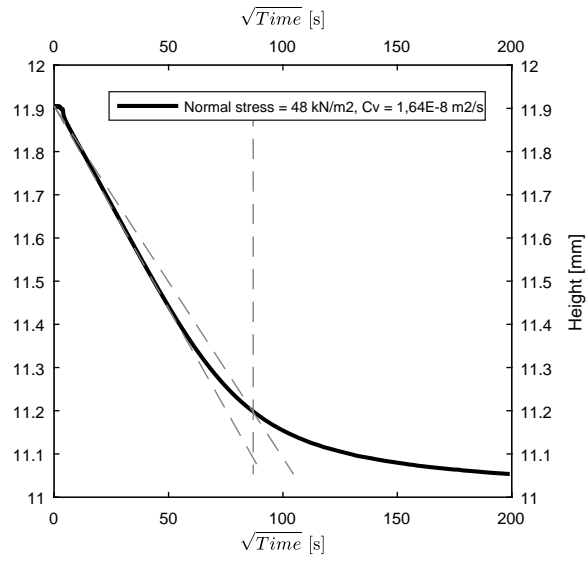
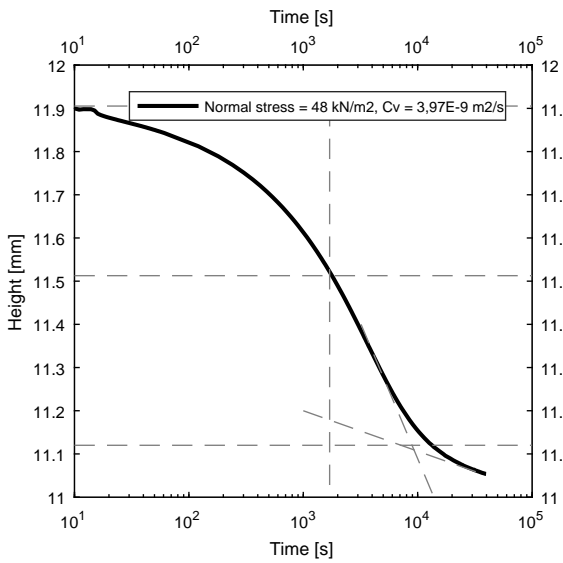

D

EXPERIMENTAL TESTING RESULTS

D.1 VERTICAL CONSOLIDATION WITHOUT DRAINS

Vertical consolidation test with no drains (ND) to determine the filter efficiency of three different filter types. Water was able to drain through the bottom filter. Surcharge load was maintained at 60 kN/m² during the whole test.

ND1	VD Typar 27. Opening size $O_{90} = 175 \mu m$.
ND2	BRWLA 050. Opening size $O_{90} = \dots \mu m$.
ND3	Thailand. Opening size $O_{90} = \dots \mu m$.

Remarks and observations

General	Water drains towards loading balloon (upward) until the volume is fully filled with water, afterwards water drains only through the filter (downward) is. This means that a two-way drainage situation occurs in the initial testing stages which converges towards a one-way drainage situation.
General	Maintenance at day 4 to reorientate the inclined loading plates horizontally, unloading and reloading affected consolidation.
General	No differences detected in rate of consolidation between the different filters.
General	Water content increases with height, consolidation process was not finished.
General	Ruler measurement resulted in more settlement, could be an indication of creep.
ND1	More fines detected in measuring cups ND1 compared to ND2 and ND3.
ND2 / ND3	Almost no fine detected in measuring cup and at the bottom of the filter.
ND1-2	Scale fluctuates in time, mean trend seems to be correct
ND3-2	Loading balloon was folded, surcharge load and settlement were lower.



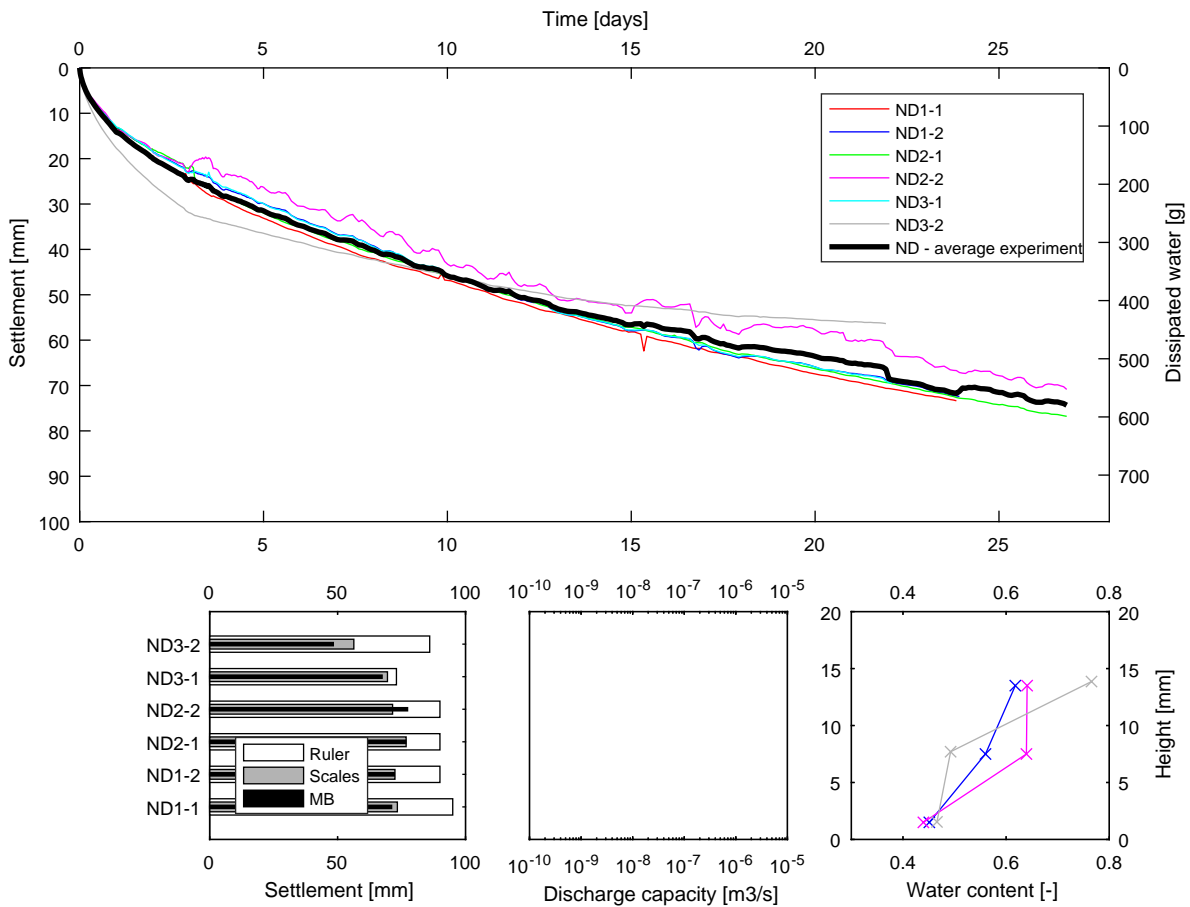

Water content				
Report tag	Height	Clay (wet)	Clay (dry)	w
[-]	[mm]	[g]	[g]	[-]
ND1-2	14	34,71	19,66	0,766
ND1-2	8	40,01	26,81	0,492
ND1-2	2	33,51	22,86	0,466
ND2-2	14	41,28	25,16	0,641
ND2-2	8	39,95	24,37	0,639
ND3-2	2	52,99	36,81	0,440
ND3-2	14	46,98	29,04	0,618
ND3-2	8	36,41	23,34	0,560
ND3-2	2	57,87	39,88	0,451

General data													
Report tag	Initial					End				Settlement			
	Tube	Date	All	Sample Height		Date	All	Sample Height		Ruler	Scales	MB	Time
[-]	[-]	[-]	[g]	[g]	[mm]	[-]	[g]	[g]	[mm]	[mm]	[mm]	[mm]	[days]
ND1 - 1	07	17-5-2017	5414	3005	240	10-6-2017	4855	2446	145	95	73	71	24
ND1 - 2	08	17-5-2017	5414	2999	240	10-6-2017	4847	2432	150	90	72	72	24
ND2 - 1	09	17-5-2017	5405	3007	240	13-6-2017	4803	2405	150	90	77	77	27
ND2 - 2	10	17-5-2017	5616	3003	240	13-6-2017	5008	2395	150	90	71	77	27
ND3 - 1	11	17-5-2017	5629	3022	240	8-6-2017	5100	2493	167	73	69	67	22
ND3 - 2	12	17-5-2017	5453	3006	240	8-6-2017	5074	2627	154	86	56	48	22

D.2 CONSOLIDATION USING A MINI MEBRADRAIN

Radial consolidation test with a single mini Mebradain to determine the enhanced dissipation of excess pore water pressure through a drain without well-resistance. The drain was 20 mm wide, approximately 240 mm long and made from a Mebradain MD7007. Water was only able to dissipate through the drain at the bottom of the sample tube. Surcharge load was maintained at 60 kN/m² during the whole test.

MMD-1	Mini Mebradain core = MD7007, filter = Typar VD27, sample column 03.
MMD-2	Mini Mebradain core = MD7007, filter = Typar VD27, sample column 04.
MMD-3	Mini Mebradain core = MD7007, filter = Typar VD27, sample column 05.

Remarks and observations

General	Excellent agreement between the three tests.
General	Consolidation process not fully finished.
General	Good agreement between the settlement checks.
General	Head difference based on a zero head at the bottom of the drain and a measured head (water height) at the top of the drain.
General	Reasonable agreement between results discharge capacity tests
MMD-1	Head difference did not reach the full 2000 mm, and was 1500 mm.
MMD-2	Head difference in discharge capacity test did not reach the full 2000 mm, and was 500 mm.



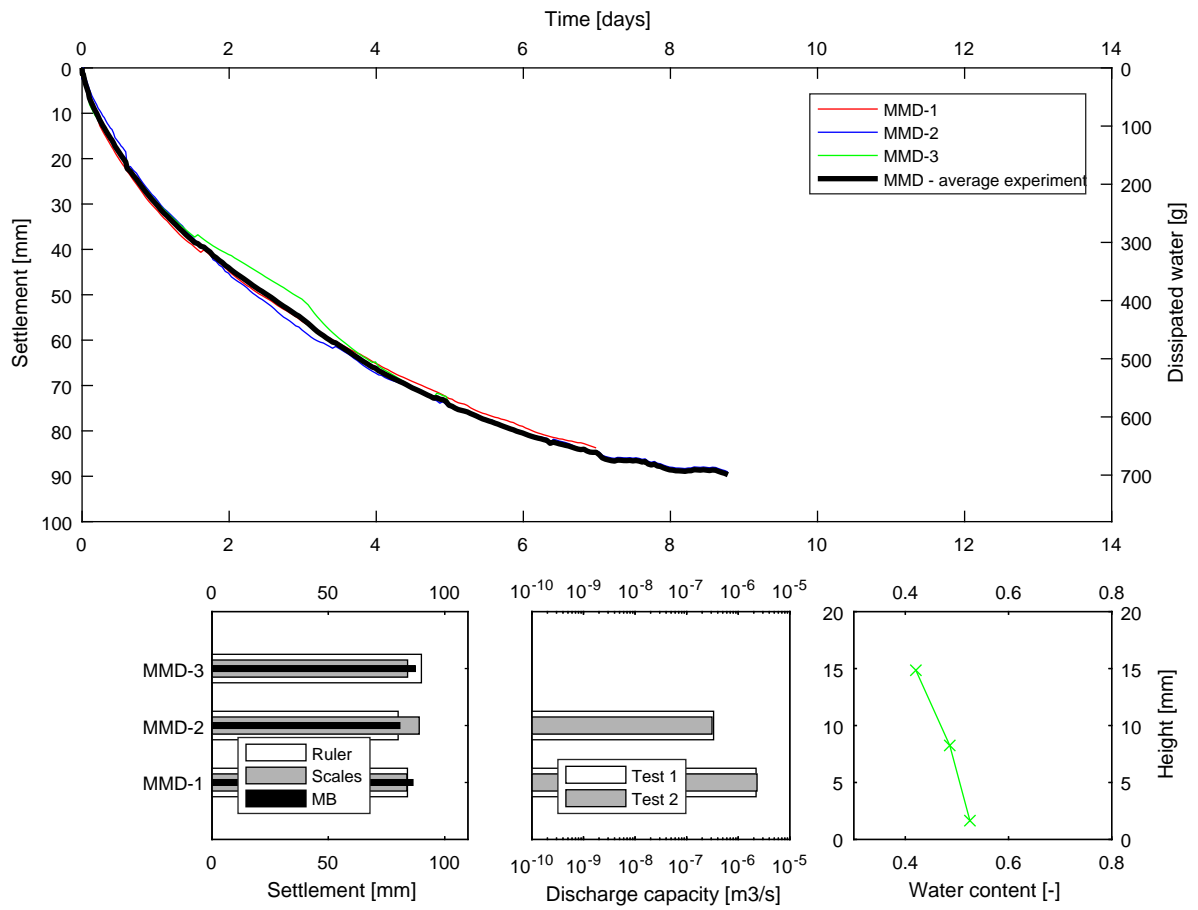

Water content				
Report tag	Height	Clay (wet)	Clay (dry)	w
[-]	[mm]	[g]	[g]	[-]
MMD-3	15	35,58	25,05	0,42
MMD-3	8	27,24	18,33	0,49
MMD-3	2	40,92	26,83	0,53

General data													
Test data		Initial				End				Settlement			
Report tag	Tube	Date	All	Sample Height		Date	All	Sample Height		Ruler	Scales	MB	
[-]	[-]	[-]	[g]	[g]	[mm]	[-]	[g]	[g]	[mm]	[mm]	[mm]	[mm]	[days]
MMD-1	03	9-6-2017	5771	3083	250	16-6-2017	5093	2405	166	84	84	86	7
MMD-2	04	7-6-2017	5454	3007	260	16-6-2017	4821	2373	180	80	89	81	9
MMD-3	05	9-6-2017	5716	3017	255	16-6-2017	5030	2331	165	90	84	87	7

Discharge capacity test									
Test data		Test 1					Test 2		
Report tag	Height	Area	delta h	Time	Q	qw	Time	Q	qw
[-]	[mm]	[mm ²]	[mm]	[s]	[g]	[m ³ /s]	[s]	[g]	[m ³ /s]
MMD-1	166	100	1500	420	1263	3,33E-07	181	507	3,10E-07
MMD-2	180	100	500	300	1848	2,22E-06	179	1151	2,32E-06

D.3 CONSOLIDATION USING A WOOL DRAIN

Radial consolidation test with a single wool drain to determine the enhanced dissipation of excess pore water pressure through a drain with potentially well-resistance. Water was only able to dissipate through the drain at the bottom of the sample tube. Surcharge load was maintained at 60 kN/m² during the whole test.

WD-1	Wool drain, no core, no filter, sample column 02
WD-2	Wool drain, no core, no filter, sample column 01
WD-3	Wool drain, no core, no filter, sample column 08

Remarks and observations

General	Maintenance at day 7 to reorientate the loading plates.
General	Mismatch in settlement check, mass balance check results in a more settlement. A broken air-conditioning and evaporation could be the cause. Ruler check is less exact compared to the scales and mass balances.
General	Low water content for both WD-1 and WD-2, another argument to suspect evaporation of water from the measurement cups.
General	Drain orientation in consolidated sample was random, inner part of the drain was not affected by infiltration of fines only the outer parts of the drain were.
General	The cross-section shape of the drain varied significantly in the consolidated sample.
WD-1	Lost some slurry during the loading phase, improved the connection for WD-2 and WD-3. Test results are not affected significantly.



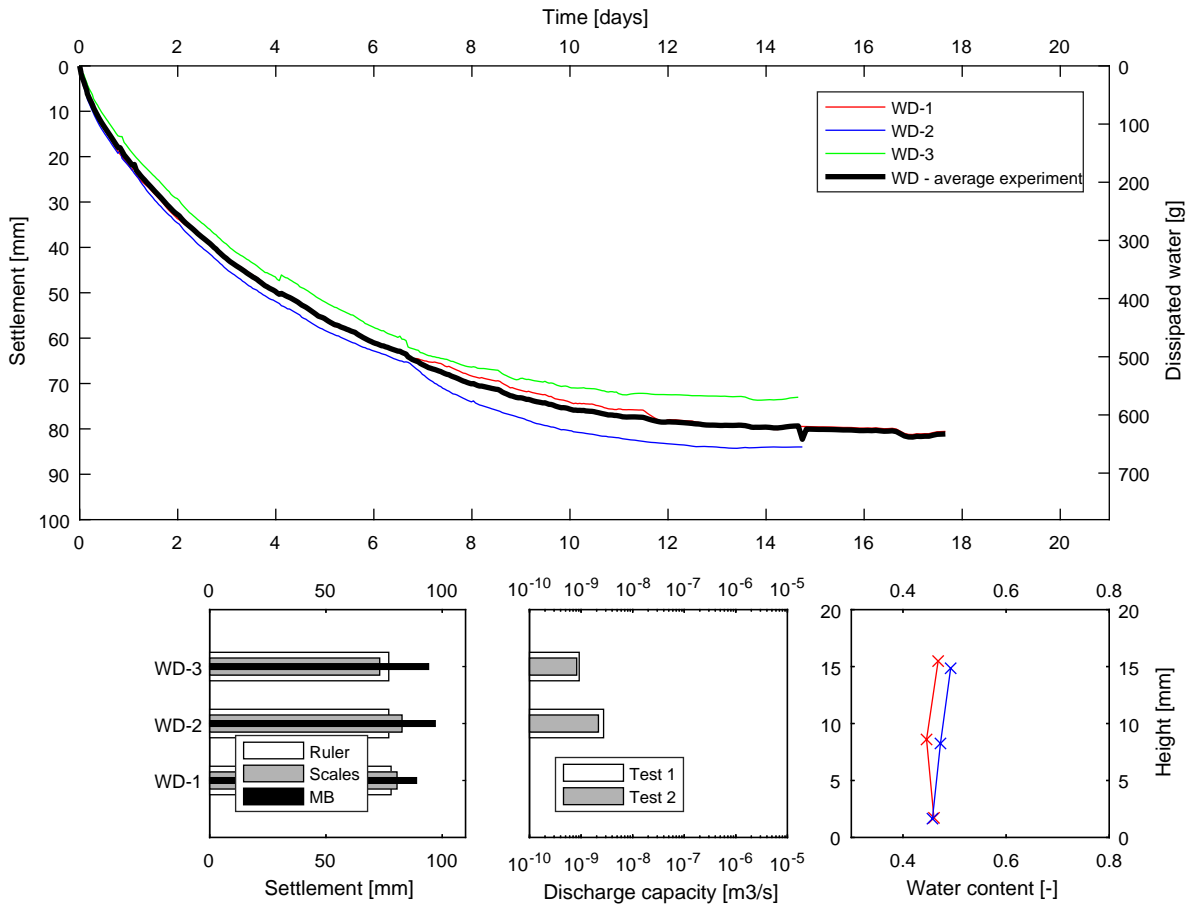

Water content				
Report tag	Height	Clay (wet)	Clay (dry)	w
[-]	[mm]	[g]	[g]	[-]
WD-1	15	41,99	28,60	0,47
WD-1	9	42,88	29,66	0,45
WD-1	2	45,73	31,32	0,46
WD-2	15	34,61	23,19	0,49
WD-2	8	37,73	25,62	0,47
WD-2	2	35,89	24,63	0,46

General data													
Test data		Initial data				End data				Settlement			
Report tag	Tube	Date	All	Sample Height		Date	All	Sample Height		Ruler	Scales	MB	
[-]	[-]	[-]	[g]	[g]	[mm]	[-]	[g]	[g]	[mm]	[mm]	[mm]	[mm]	[days]
WD-1	02	9-6-2017	5706	3099	250	27-6-2017	4908	2301	172	78	81	102	18
WD-2	01	12-6-2017	5703	3007	242	27-6-2017	4942	2246	165	77	83	97	15
WD-3	08	12-6-2017	5571	3087	252	27-6-2017	4831	2348	175	77	73	94	15

Discharge capacity test									
Test data		Measurment 1					Measurment 2		
Report tag	Height	Area	delta h	Time	Q	qw	Time	Q	qw
[-]	[mm]	[mm2]	[mm]	[s]	[g]	[m3/s]	[s]	[g]	[m3/s]
WD-1	170	113	2000	12900	414	2,73E-09	6360	162	2,17E-09
WD-2	170	113	2000	12900	140	9,19E-10	6360	62	8,23E-10

D.4 CONSOLIDATION USING A WOOL DRAIN ENCASED WITH A FILTER

Radial consolidation test with a single wool drain encased with a filter to determine the enhanced dissipation of excess pore water pressure through a drain with potentially well-resistance. Executed to close the knowledge gap regarding the impact of the filter or the core between the MMD and WD test. Water was only able to dissipate through the drain at the bottom of the sample tube. Surcharge load was maintained at 60 kN/m² during the whole test.

WDF-1	Failed, slurry tight connection failed during loading
WDF-2	Wool drain, no core, filter VD Typar 27, sample column 08
WDF-3	Wool drain, no core, filter VD Typar 27, sample column 12

Remarks and observations

General	Excellent agreement between WDF-2 and WDF-3, not another repetition needed to confirm results.
General	Good agreement between settlement checks, slightly underestimation of settlement based on the scales.
General	Good agreement between discharge capacity tests, full head difference reached.
General	Random orientation of drains in consolidated sample, wool drain was not affected by infiltration of fines.
General	Filter caused that wool material was encased and concentrated, which implies a constant draining cross-section.



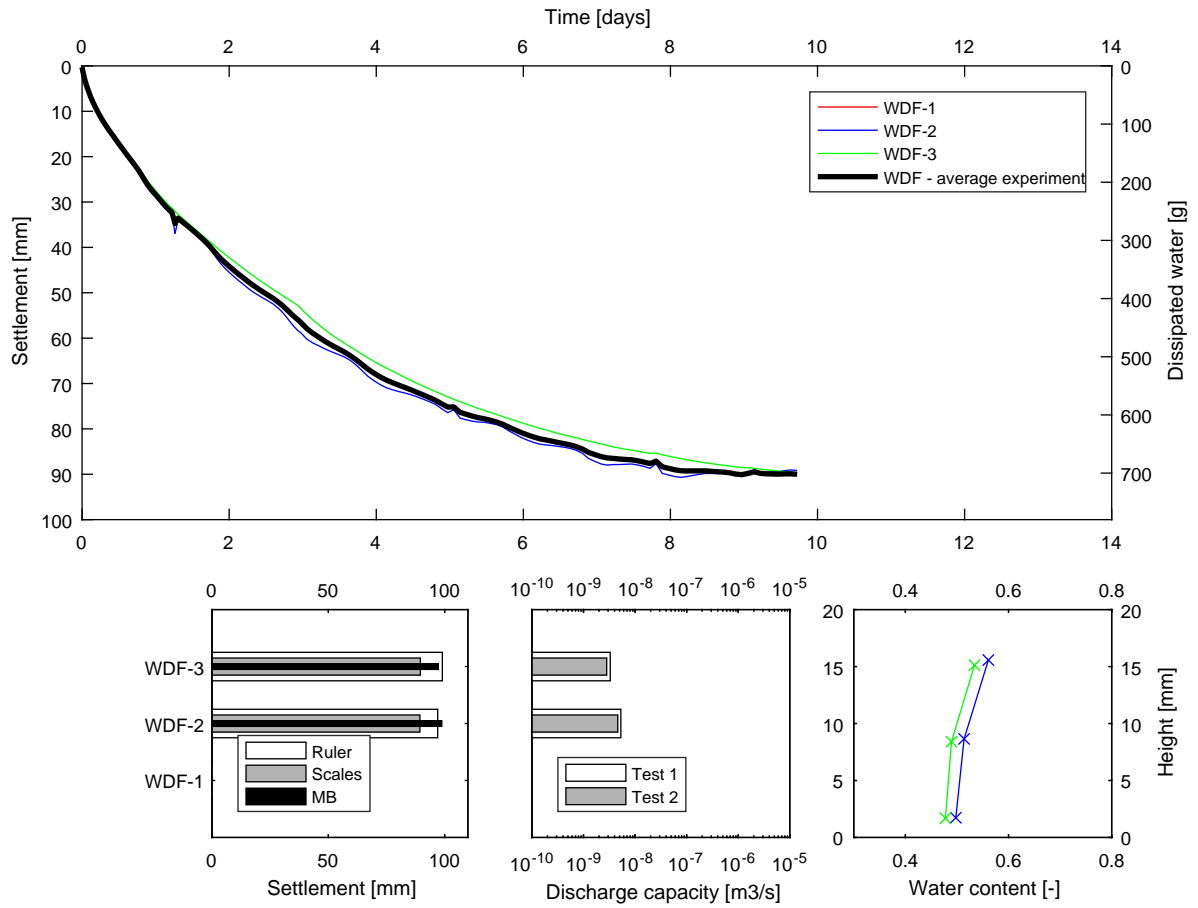

Water content				
Report tag	Height	Clay (wet)	Clay (dry)	w
[-]	[mm]	[g]	[g]	[-]
WDF-2	16	21,65	13,87	0,56
WDF-2	9	22,42	14,81	0,51
WDF-2	2	36,92	24,65	0,50
WDF-3	15	34,30	22,36	0,53
WDF-3	8	30,22	20,29	0,49
WDF-3	2	39,63	26,82	0,48

General data													
Test data		Initial data				End data				Settlement			
Report tag	Tube	Date	All	Sample Height		Date	All	Sample Height		Ruler	Scales	MB	
[-]	[-]	[-]	[g]	[g]	[mm]	[-]	[g]	[g]	[mm]	[mm]	[mm]	[mm]	[days]
Failed													
WDF-2	08	3-7-2017	5516	3007	270	13-7-2017	4740	2231	173	97	89	99	10
WDF-3	12	3-7-2017	5527	3019	267	13-7-2017	4763	2255	168	99	90	97	10

Discharge capacity test									
Test data		Measurment 1					Measurment 2		
Report tag	Height	Area	delta h	Time	Q	qw	Time	Q	qw
[-]	[mm]	[mm2]	[mm]	[s]	[g]	[m3/s]	[s]	[g]	[m3/s]
WDF-2	173	113	2000	1200	74	5,30E-09	9600	513	4,62E-09
WDF-3	168	113	2000	1200	47	3,30E-09	9600	322	2,82E-09

D.5 CONSOLIDATION USING THREE MINI MEBRADRAINS

Radial consolidation test with three mini Mebradrains to determine the enhanced dissipation of excess pore water pressure through three drains without well-resistance. Testing series executed as reference test for the series with three drain installed in a preconsolidated sample. Water was able to dissipate through three holes in the bottom plate at the drain location. Surcharge load was maintained at 60 kN/m² during the whole test.

3MMD-1	Three mini Mebradain, core = MD7007, filter = Typar VD27, sample column 05.
3MMD-2	Three mini Mebradain, core = MD7007, filter = Typar VD27, sample column 10.
3MMD-3	Three mini Mebradain, core = MD7007, filter = Typar VD27, sample column 11.

Remarks and observations

General	Maintenance at day 2-3 to reorientate the loading plates.
General	Excellent agreement between the three tests.
General	Good agreement between settlement checks.
General	Discharge capacity divided by three to correct for three drains.
3MMD-2	Some water did not reached the measurement cup because the foil captured some of it. Comparison with other tests confirmed the observation, the amount of measured dissipated water slightly less.
3MMD-1	Head difference during discharge capacity test did not reached 2000 mm, only 200 mm was observed.
3MMD-1	Head difference during discharge capacity test did not reached 2000 mm, only 500 mm was observed.



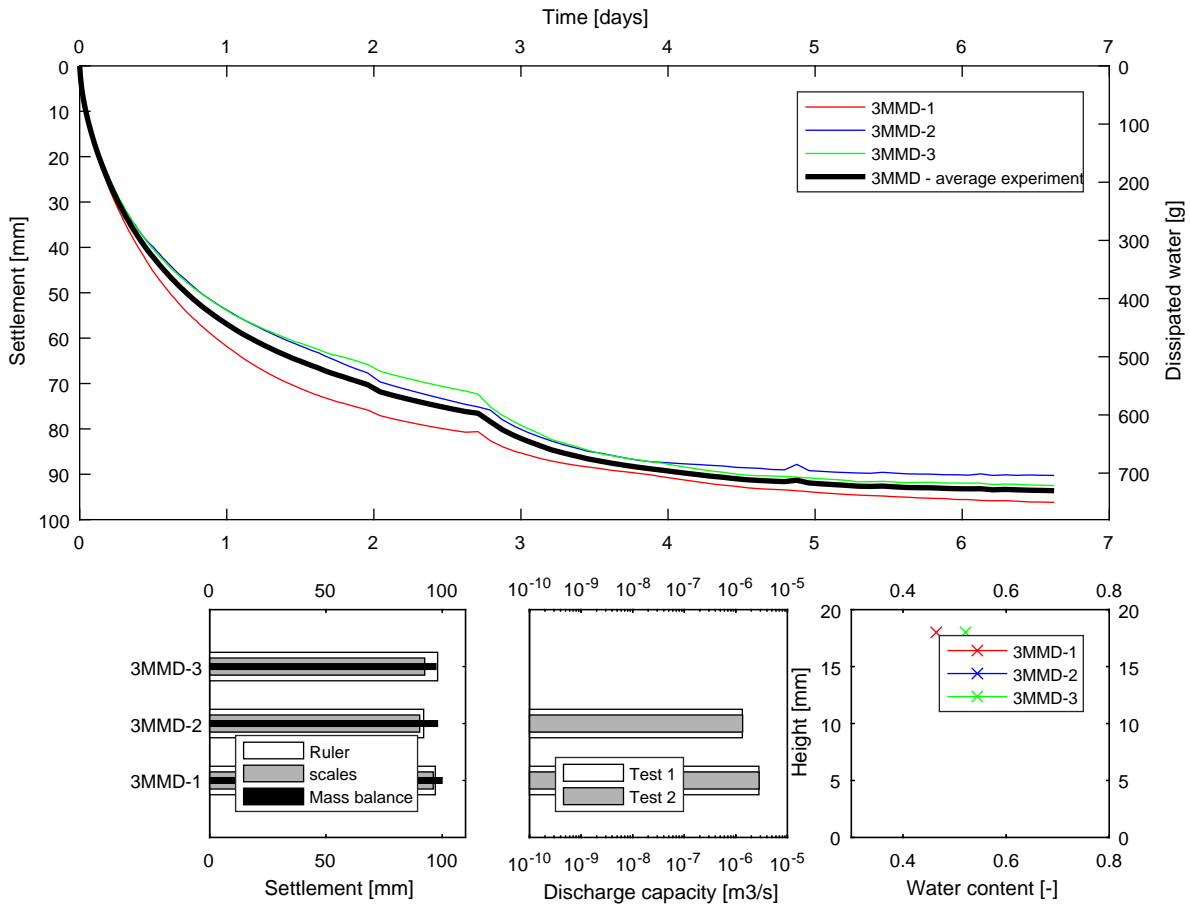

Water content				
Report tag	Height	Clay (wet)	Clay (dry)	w
[-]	[mm]	[g]	[g]	[-]
3MMD-1	18	0,00	2,00	0,50
3MMD-1	10	0,00	2,00	0,50
3MMD-1	2	0,00	2,00	0,50
3MMD-2	18	0,00	2,00	0,50
3MMD-2	10	0,00	2,00	0,50
3MMD-2	2	0,00	2,00	0,50

General data													
Test data		Initial data				End data				Settlement			
Report tag	Tube	Date	All	Sample Height		Date	All	Sample Height		Ruler	Scales	MB	
[-]	[-]	[-]	[g]	[g]	[mm]	[-]	[g]	[g]	[mm]	[mm]	[mm]	[mm]	[days]
3MMD-1	05	17-7-2017	5758	3040	271	24-7-2017	4974	2256	174	97	96	100	7
3MMD-2	10	17-7-2017	5728	3020	270	24-7-2017	4958	2250	178	92	90	98	7
3MMD-3	11	17-7-2017	5721	3007	270	24-7-2017	4957	2243	172	98	92	97	7

Discharge capacity test									
Test data				Measurment 1			Measurment 2		
Report tag	Height	Area	delta h	Time	Q	qw	Time	Q	qw
[-]	[mm]	[mm ²]	[mm]	[s]	[g]	[m ³ /s]	[s]	[g]	[m ³ /s]
3MMD-1	174	300	200	160	1547	2,80E-06	180	1753	2,82E-06
3MMD-3	178	300	500	160	1801	1,34E-06	180	2056	1,36E-06

D.6 CONSOLIDATION USING THREE WOOL DRAINS WITH FILTER

Radial consolidation test with three wool drains encased with a filter to determine the enhanced dissipation of excess pore water pressure through three drains with potentially some well-resistance. Testing series was executed to confirm the data obtained with the WDF test. Water was able to dissipate through three holes in the bottom plate at the drain location. Surcharge load was maintained at 60 kN/m² during the whole test.

WD-1	Three wool drains, no core, filter = VD Typer 27, sample column 01
WD-2	Three wool drains, no core, filter = VD Typer 27, sample column 02
WD-3	Three wool drains, no core, filter = VD Typer 27, sample column 03

Remarks and observations

General	Maintenance at day 2 to reorientate the loading plates horizontally.
General	Measured discharge capacity divided by three to correct for number of drains.
General	Good agreement between the three tests for the settlement.
3WDF-1	Loading balloon was twisted during reloading. Surcharge pressure probably did not reached the 60 kN/m ² .
3WDF-1	Settlement check indicates that potential problem with evaporation of water from measurement cup.

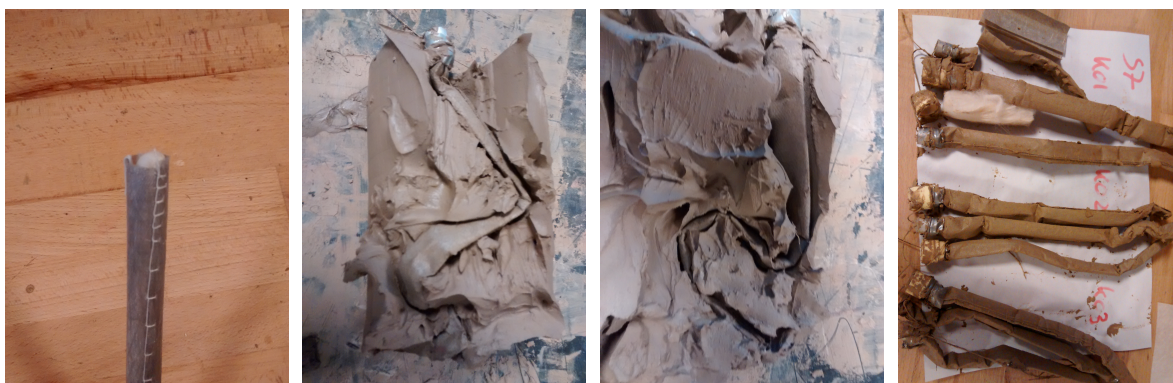

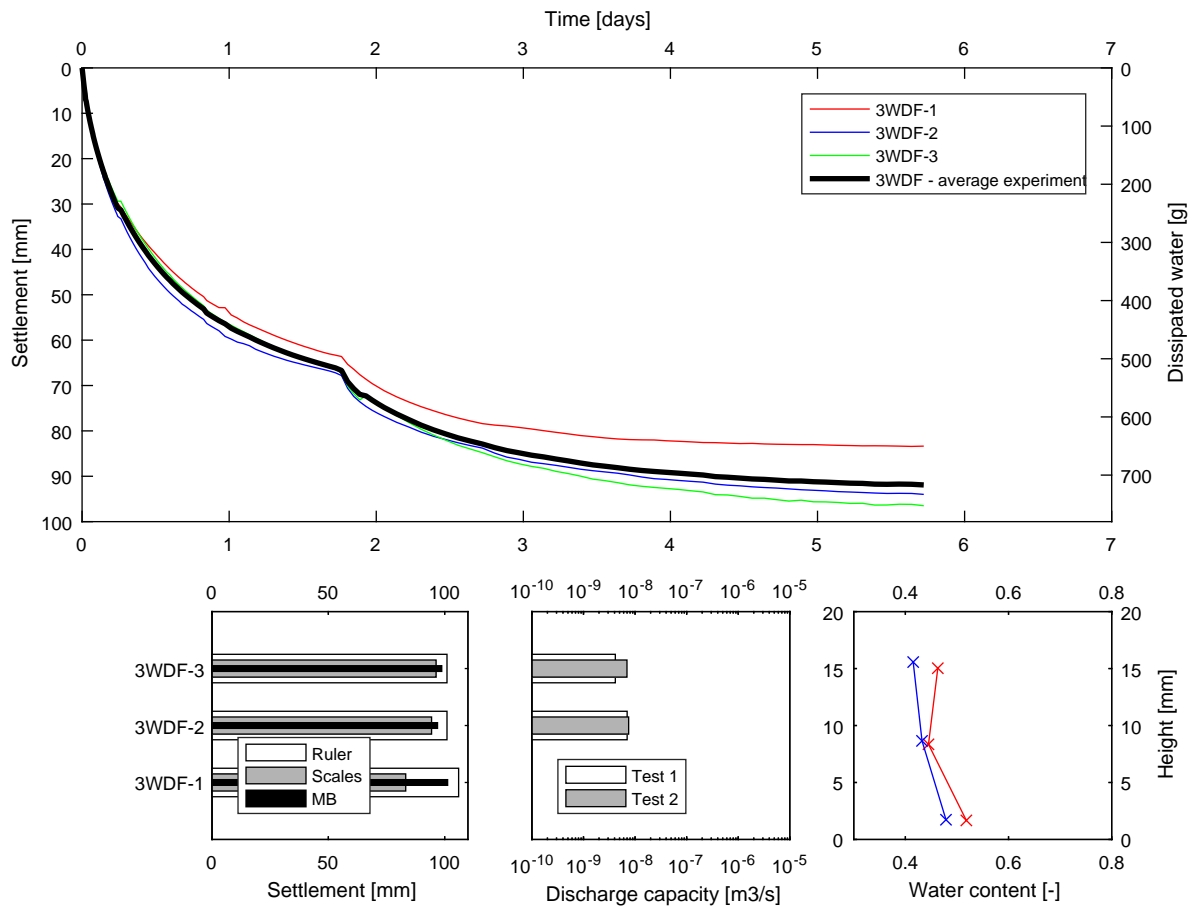

Water content				
Report tag	Height	Clay (wet)	Clay (dry)	w
[-]	[mm]	[g]	[g]	[-]
3WDF-1	15	29,17	19,94	0,46
3WDF-1	8	30,63	21,20	0,44
3WDF-1	2	23,32	15,36	0,52
3WDF-2	16	25,60	18,09	0,42
3WDF-2	9	23,16	16,17	0,43
3WDF-2	2	27,15	18,36	0,48

General data													
Test data		Initial data				End data				Settlement			
Report tag	Tube	Date	All	Sample Height		Date	All	Sample Height		Ruler	Scales	MB	
[-]	[-]	[-]	[g]	[g]	[mm]	[-]	[g]	[g]	[mm]	[mm]	[mm]	[mm]	[days]
3WDF-1	01	11-7-2017	5736	3032	273	17-7-2017	4940	2237	167	106	83	101	6
3WDF-2	02	11-7-2017	5698	3017	274	17-7-2017	4936	2256	173	101	94	97	6
3WDF-3	03	11-7-2017	5710	3013	270	17-7-2017	4934	2238	169	101	96	99	6

Discharge capacity test										
Test data					Measurment 1			Measurment 2		
Report tag	Height	Area	delta h	Time	Q	qw	Time	Q	qw	
[-]	[mm]	[mm ²]	[mm]	[s]	[g]	[m ³ /s]	[s]	[g]	[m ³ /s]	
3WDF-1	173	339	2000	2400	584	7,02E-09	3600	937	7,51E-09	
3WDF-2	169	339	2000	2400	353	4,14E-09	3600	891	6,97E-09	

D.7 CONSOLIDATION USING A MINI MEBRADRAIN WITH PRECONSOLIDATION

Radial consolidation test with a single mini Mebradrain installed in a preconsolidated sample to determine the impact of a single smear zone on the consolidation process. Initially water was able to drain through the bottom, and after the drain installation water was only able to dissipate through the drain itself. Surcharge load was maintained at 60 kN/m² during the whole test.

PC-MMD-1	Mini Mebradain core = MD7007, filter = Typar VD27, sample column 03.
PC-MMD-2	Mini Mebradain core = MD7007, filter = Typar VD27, sample column 04.
PC-MMD-3	Mini Mebradain core = MD7007, filter = Typar VD27, sample column 05.

Remarks and observations

General	Good agreement between the development of settlement, both during the preconsolidation phase and the radial consolidation phase with a drain.
General	Approximately 50 g slurry lost during the installation of the drains, i.e. stuck to the PVC mandrel. During drain installation the water on top of the sample drains quickly through the drain and the created hole. This water was captured, measured and added afterwards
General	Drain deformation were very consistent: straight near bottom and buckled in weaker/upper parts of the sample tube.
PC-MMD-2	Head difference during discharge capacity test did not reached 2000 mm, only 850 mm was observed.
PC-MMD-3	Head difference during discharge capacity test did not reached 2000 mm, only 500 mm was observed.

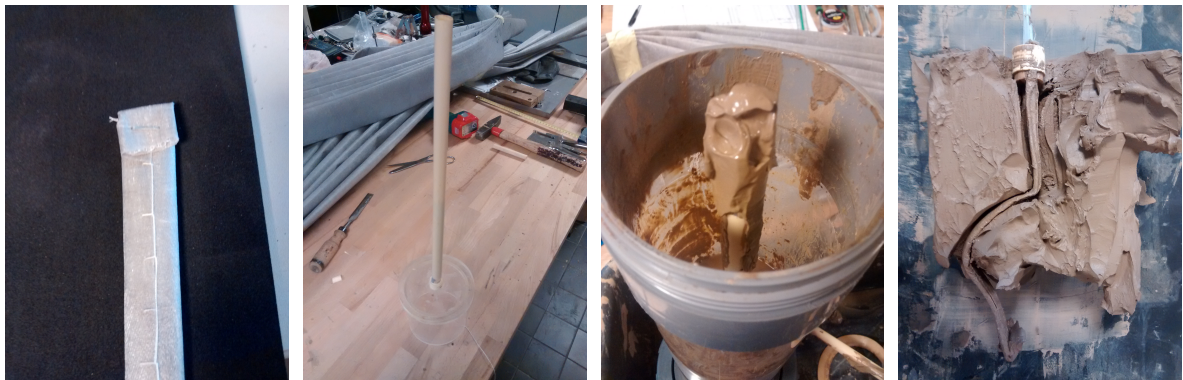

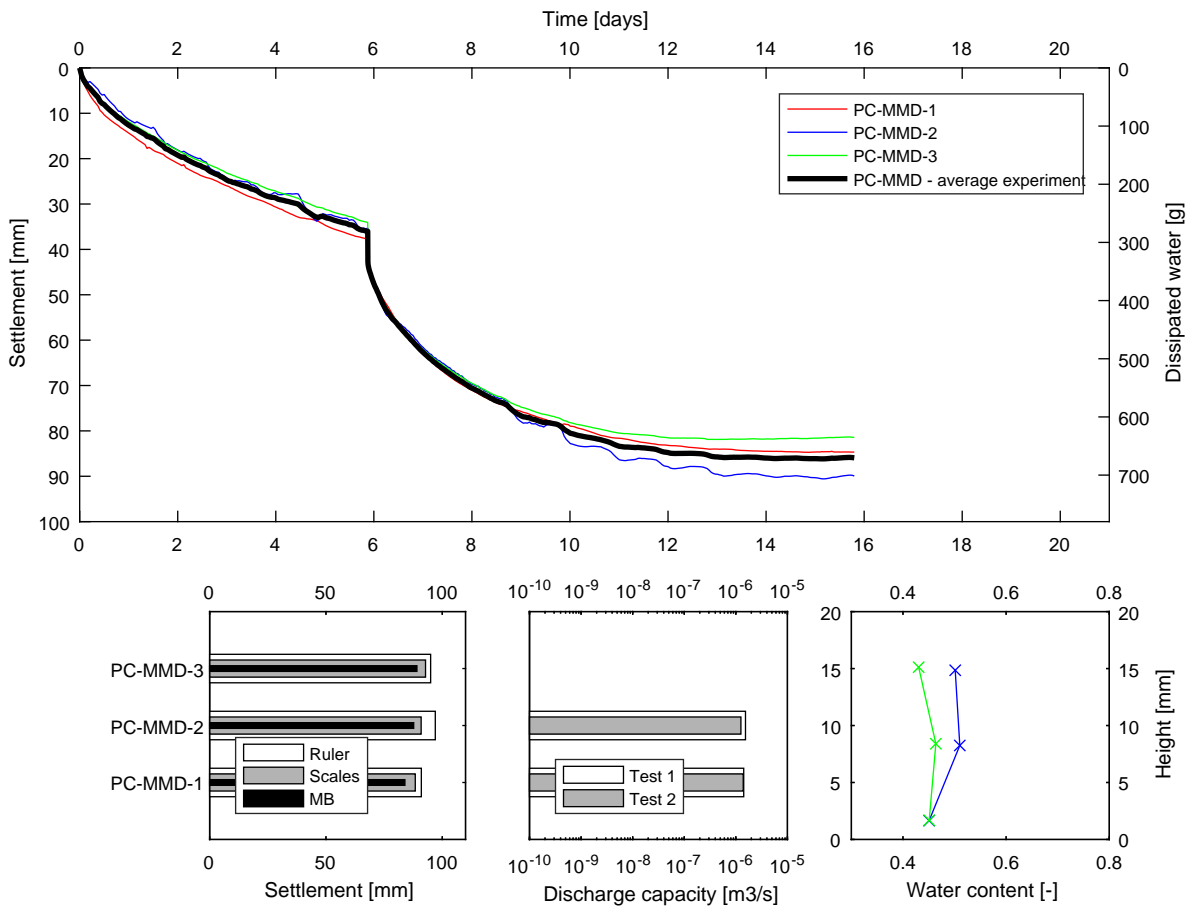

Water content				
Report tag	Height	Clay (wet)	Clay (dry)	w
[-]	[mm]	[g]	[g]	[-]
PC-MMD-2	15	35,01	23,32	0,50
PC-MMD-2	8	32,59	21,58	0,51
PC-MMD-2	2	25,30	17,44	0,45
PC-MMD-3	15	32,17	22,49	0,43
PC-MMD-3	8	38,54	26,33	0,46
PC-MMD-3	2	35,88	24,73	0,45

General data													
Test data	Initial data					End data				Settlement			
Report tag	Tube	Date	All	Sample Height		Date	All	Sample Height		Ruler	Scales	MB	
[-]	[-]	[-]	[g]	[g]	[mm]	[-]	[g]	[g]	[mm]	[mm]	[mm]	[mm]	[days]
Consolidation	06	16-6-2017	5754	3082	250	22-6-2017	5412	2740	210	40	42	43	6
Consolidation	09	16-6-2017	5418	2996	245	22-6-2017	5123	2701	208	37	36	38	6
Consolidation	12	16-6-2017	5432	2992	240	22-6-2017	5132	2692	207	33	37	38	6
PC-MMD-1	06	23-6-2017	5287	2740	210	2-7-2017	4862	2315	164	86	85	98	9
PC-MMD-2	09	23-6-2017	4996	2701	208	2-7-2017	4592	2298	165	80	91	89	9
PC-MMD-3	12	23-6-2017	5008	2692	207	2-7-2017	4644	2328	168	72	82	84	9

Discharge capacity test									
Test data				Measurment 1			Measurment 2		
Report tag	Height	Area	delta h	Time	Q	qw	Time	Q	qw
[-]	[mm]	[mm ²]	[mm]	[s]	[g]	[m ³ /s]	[s]	[g]	[m ³ /s]
PC-MMD-2	164	100	850	248	1828	1,42E-06	240	1730	1,39E-06
PC-MMD-3	165	100	550	248	1272	1,54E-06	240	1004	1,25E-06

D.8 CONSOLIDATION USING A MINI MEBRADRAIN AND FAKE DRAINS WITH PRECONSOLIDATION

Radial consolidation test with a single mini Mebradrain and three fake drains installed in a preconsolidated sample to determine the impact of a multiple smear zone on the consolidation process. Initially water was able to drain through the bottom, and after the drain installation water was only able to dissipate through the drain itself. Surcharge load was maintained at 60 kN/m² during the whole test.

PC-MMD-3FD-1	Mini Mebradain core = MD7007, filter = Typar VD27, sample column 06.
PC-MMD-3FD-2	Mini Mebradain core = MD7007, filter = Typar VD27, sample column 09.
PC-MMD-3FD-3	Not executed, only two repetitions

Remarks and observations

General	Excellent agreement between the development of settlement during the preconsolidation phase, and good agreement in the radial consolidation phase.
General	Approximately 50 g slurry lost during the installation of the drains, i.e. stuck to the PVC mandrel. During drain installation the water on top of the sample drains quickly through the drain and the created hole. This water was captured, measured and added afterwards
General	Mandrel holes detected around fake drains, holes were not closed during the reloading phase. Holes acted probably as preferential flow path during the consolidation phase, i.e. faster consolidation.
General	No hole detected around the drain itself, but this cannot be guaranteed. Could be because the installation direction of a fake drains was downwards, whereas the installation of the drain was upwards.
PC-MMD-3FD-1	Settlement check indicates potential problem with evaporation.
PC-MMD-3FD-1	Head difference during discharge capacity test did not reached 2000 mm, only 500 mm was observed.
PC-MMD-3FD-2	Head difference during discharge capacity test did not reached 2000 mm, only 1800 mm was observed.



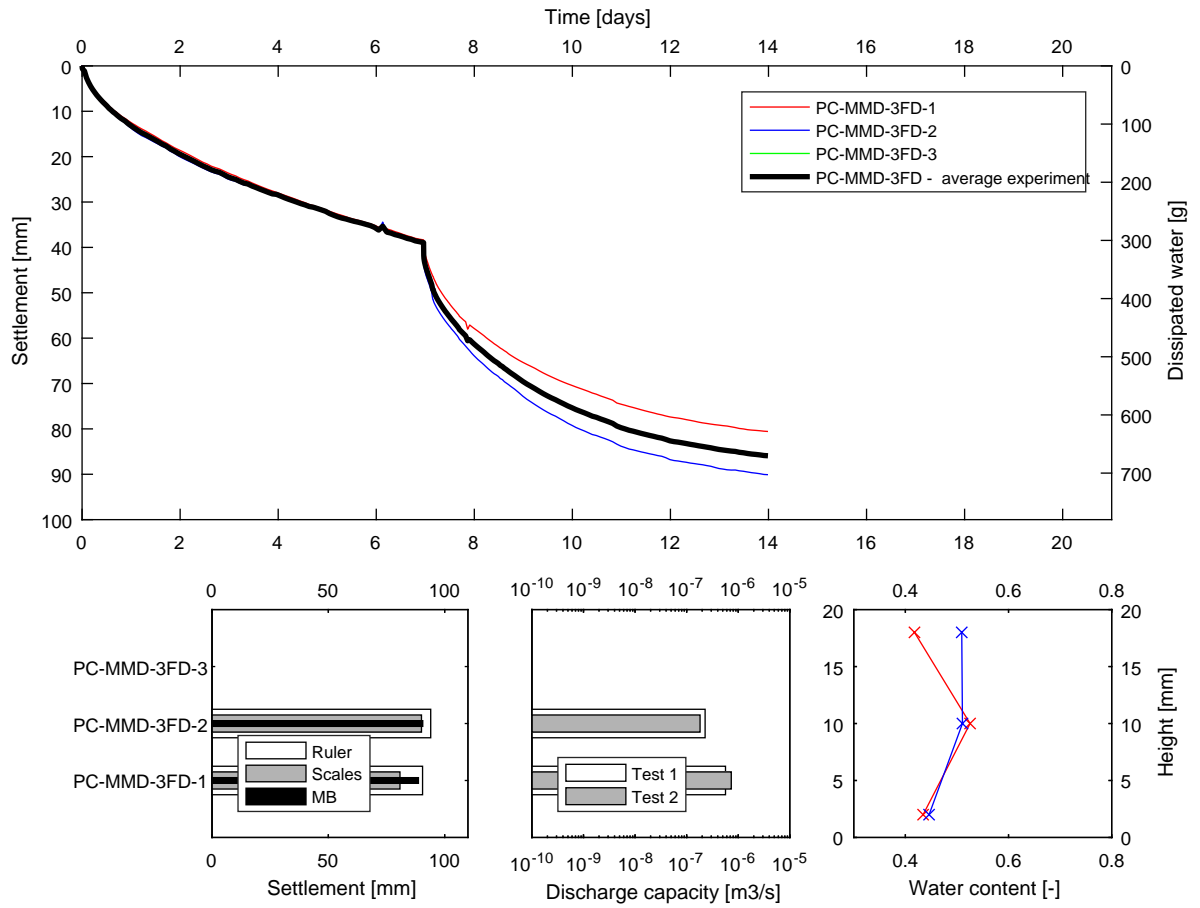

Water content				
Report tag	Height	Clay (wet)	Clay (dry)	w
[-]	[mm]	[g]	[g]	[-]
PC-MMD-3FD-1	18	32,11	22,65	0,42
PC-MMD-3FD-1	10	38,67	25,35	0,53
PC-MMD-3FD-1	2	51,15	35,66	0,43
PC-MMD-3FD-2	18	44,63	29,57	0,51
PC-MMD-3FD-2	10	40,35	26,71	0,51
PC-MMD-3FD-2	2	37,19	25,72	0,45

General data													
Test data		Initial data				End data				Settlement			
Report tag	Tube	Date	All	Sample Height		Date	All	Sample Height		Ruler	Scales	MB	
[-]	[-]	[-]	[g]	[g]	[mm]	[-]	[g]	[g]	[mm]	[mm]	[mm]	[mm]	[days]
Consolidation	06	20-7-2017	5770	3041	260	27-7-2017	5450	2721	215	45	38	41	7
Consolidation	09	20-7-2017	5553	3032	260	27-7-2017	5235	2714	210	50	38	40	7
PC-MMD-3FD-1	06	27-7-2017	5220	2721	215	3-8-2017	4843	2344	170	91	81	89	7
PC-MMD-3FD-2	09	27-7-2017	5052	2714	210	3-8-2017	4659	2321	166	94	90	91	7

Discharge capacity test									
Test data		Measurment 1			Measurment 2				
Report tag	Height	Area	delta h	Time	Q	qw	Time	Q	qw
[-]	[mm]	[mm ²]	[mm]	[s]	[g]	[m ³ /s]	[s]	[g]	[m ³ /s]
PC-MMD-3FD-1	169	100	500	630	1056	5,67E-07	810	1756	7,33E-07
PC-MMD-3FD-2	166	100	1800	630	1557	2,28E-07	810	1599	1,82E-07

D.9 CONSOLIDATION USING THREE MINI MEBRADRAINS WITH PRECONSOLIDATION

Radial consolidation test with three mini Mebradrains installed in a preconsolidated sample to determine the impact of a multiple smear zone on the consolidation process. Initially water was able to drain through the bottom, and after the drain installation water was only able to dissipate through the drains itself. Surcharge load was maintained at 60 kN/m² during the whole test.

PC-3MMD-1	Mini Mebradain core = MD7007, filter = Typar VD27, sample column 05.
PC-3MMD-2	Mini Mebradain core = MD7007, filter = Typar VD27, sample column 10.
PC-3MMD-3	Mini Mebradain core = MD7007, filter = Typar VD27, sample column 11.

Remarks and observations

General	Excellent agreement between the development of settlement during the preconsolidation phase, and good agreement in the radial consolidation phase.
General	Approximately 200 g slurry lost during the installation of the drains, i.e. stuck to the three PVC mandrels. During drain installation the water on top of the sample drains quickly through the drain and the created hole. This water was captured, measured and added afterwards
General	Size of the smear zone was determined to be at least 2.0 to 3.0 cm, based on a visual inspection on the disturbance of the paint layers around the drains. It is likely that the smear zones did overlap during the test. The amount of overlapping could not be determined.



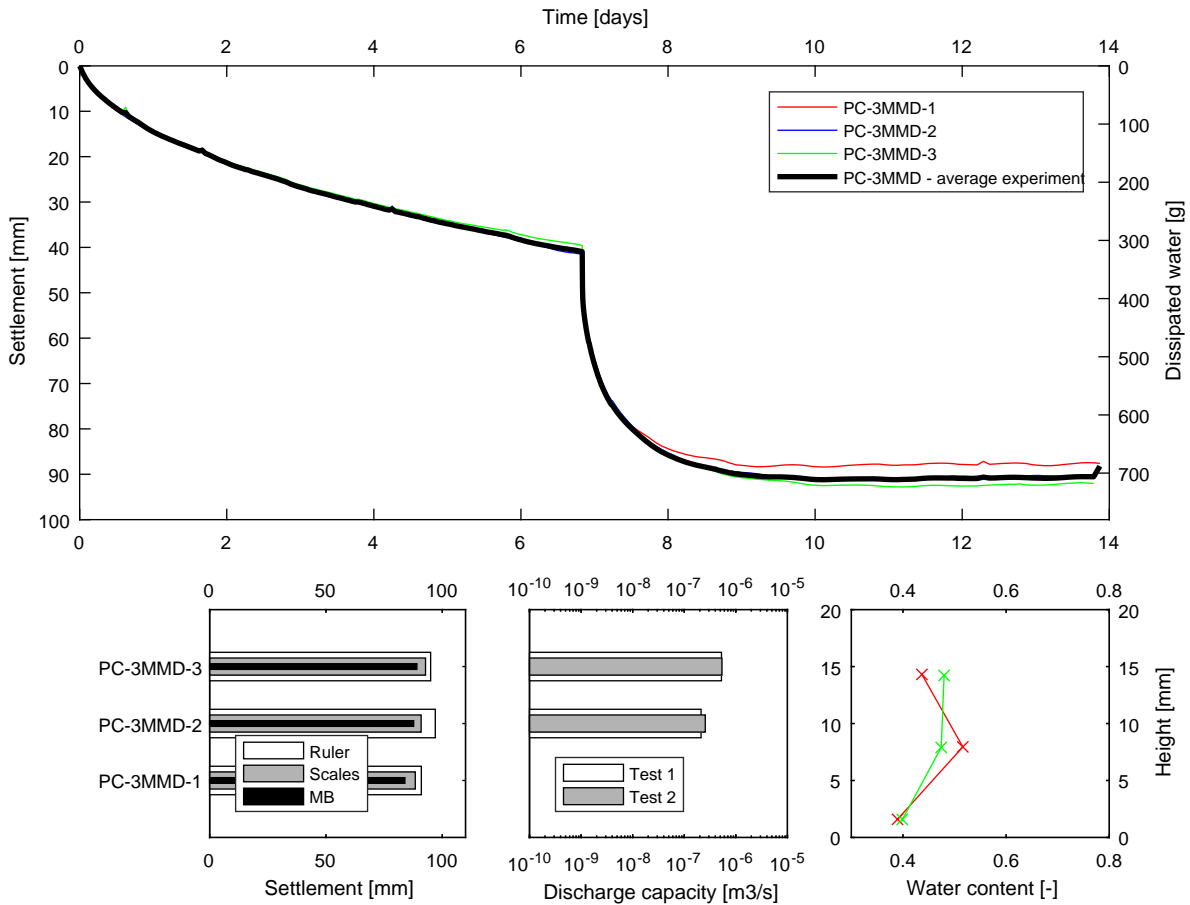

Water content				
Report tag	Height	Clay (wet)	Clay (dry)	w
[-]	[mm]	[g]	[g]	[-]
PC-3MMD-1	14	25,86	18,00	0,44
PC-3MMD-1	8	19,39	12,79	0,52
PC-3MMD-1	2	34,68	24,96	0,39
PC-3MMD-3	14	22,27	15,05	0,48
PC-3MMD-3	8	36,50	24,76	0,47
PC-3MMD-3	2	36,27	25,93	0,40

General data													
Test data	Initial data					End data				Settlement			
Report tag	Tube	Date	All	Sample Height		Date	All	Sample Height		Ruler	Scales	MB	
[-]	[-]	[-]	[g]	[g]	[mm]	[-]	[g]	[g]	[mm]	[mm]	[mm]	[mm]	[days]
Consolidation	05	27-6-2017	5675	2999	250	4-7-2017	5344	2667	202,5	47,5	41	42	7
Consolidation	10	27-6-2017	5695	3015	255	4-7-2017	5364	2683	208	47	41	42	7
Consolidation	11	27-6-2017	5675	3003	255	4-7-2017	5353	2681	205	50	40	41	7
PC-3MMD-1	05	4-7-2017	5054	2667	202,5	11-7-2017	4726	2339	159	91	88	84	7
PC-3MMD-2	10	4-7-2017	5096	2683	208	11-7-2017	4739	2326	158	97	91	88	7
PC-3MMD-3	11	4-7-2017	5114	2681	205	11-7-2017	4736	2303	160	95	93	89	7

Discharge capacity test									
Test data				Measurment 1			Measurment 2		
Report tag	Height	Area	delta h	Time	Q	qw	Time	Q	qw
[-]	[mm]	[mm ²]	[mm]	[s]	[g]	[m ³ /s]	[s]	[g]	[m ³ /s]
PC-3MMD-1	158	300	2000	240	1932	2,12E-07	210	2039	2,56E-07
PC-3MMD-3	160	300	2000	100	1975	5,27E-07	60	1210	5,38E-07

E

PLAXIS MODELS

E.1 EXPERIMENTS - SOFT SOIL

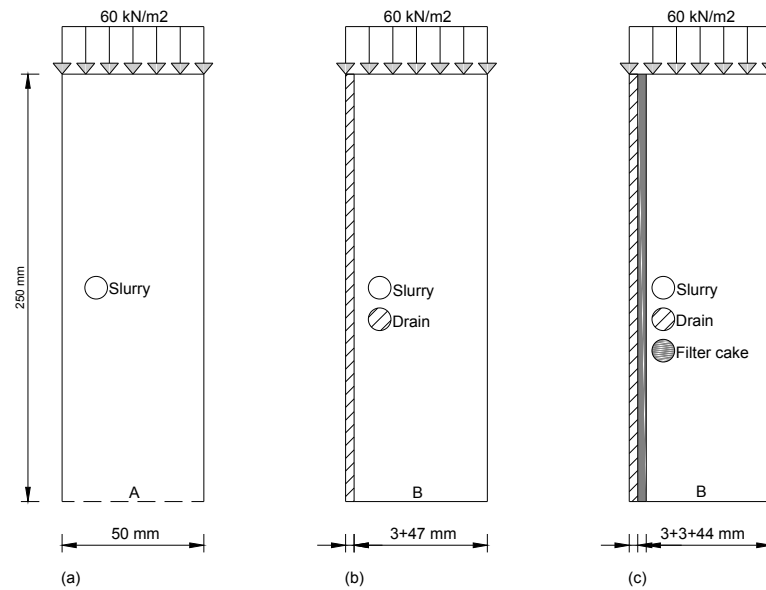

Figure E.1: Plaxis models: (a) Vertical consolidation, (b) Radial consolidation with a drain, (c) Radial consolidation with a drain and a filter cake (with A = Full open drainage, B = Open drainage at drain, closed elsewhere).

General			Slurry	Drain	Filter cake
Soil unit weight dry	γ_{unsat}	kN/m^3	12	12	12
Soil unit weight wet	γ_{sat}	kN/m^3	14	14	14
Initial void ratio	e_{ini}	-	2,8	2,8	2,8
Parameters			Slurry	Drain	Filter cake
Mod. compression index	λ^*	-	0,092	0,092	0,092
Mod. swelling index	κ^*	-	0,02	0,02	0,02
Cohesion	C'_{ref}	kN/m^2	0,1	0,1	0,1
Friction angle	ϕ'	$^\circ$	15	15	15
Dilatancy angle	ψ'	$^\circ$	0	0	0
Groundwater			Slurry	Drain	Filter cake
Mod. compression index	λ^*	-	0,092	0,092	0,092
Horizontal permeability	k_x	m/s	2,08E-09	2,3E-06	2,08E-09
Vertical permeability	k_y	m/s	2,08E-09	2,3E-06	2,08E-09
Change in permeability	C_k	-	2,00	5,00	0,58

E.2 DEFAULT CASE FOR DISCHARGE CAPACITY - LINEAR ELASTIC

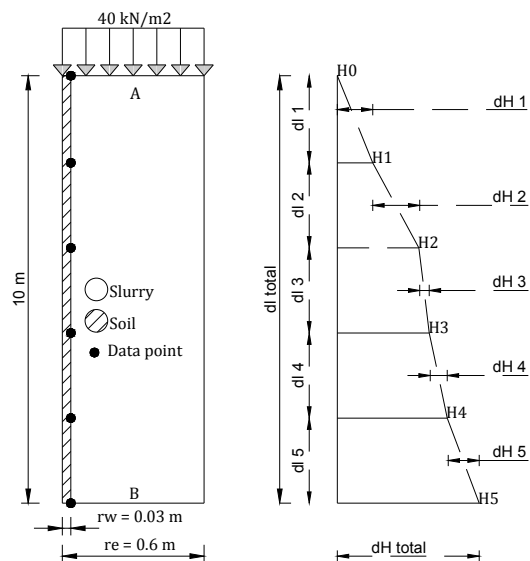

Figure E.2: Plaxis models for required discharge capacity and sampling points for back-calculation procedure (A = Drainage boundary open at drain, closed elsewhere, B = closed drainage boundary).

General			Soil	Drain
Soil unit weight dry	γ_{unsat}	kN/m^3	16	16
Soil unit weight wet	γ_{sat}	kN/m^3	18	18
Initial void ratio	e_{ini}	-	0,8	0,8
Parameters			Soil	Drain
Oedometer stiffness	E_{oed}	kN/m^2	1000	1000
Poissons ratio	ν'	-	0,3	0,3
Groundwater			Soil	Drain
Horizontal permeability	k_x	m/s	5E-09	1 to 1E-5
Vertical permeability	k_y	m/s	5E-09	1 to 1E-5
Change in permeability	C_k	-	1E+15	1E+15

E.3 DEFAULT CASE FOR DISCHARGE CAPACITY - SOFT SOIL

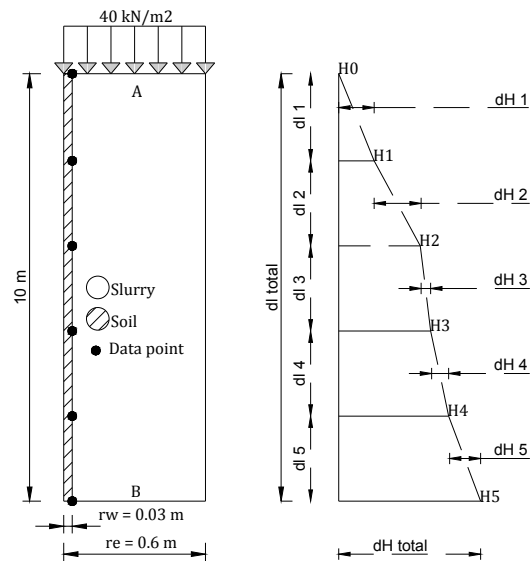

Figure E.3: Plaxis models for required discharge capacity and sampling points for back-calculation procedure (A = Drainage boundary open at drain, closed elsewhere, B = closed drainage boundary).

General			Soil	Drain
Soil unit weight dry	γ_{unsat}	kN/m^3	16	16
Soil unit weight wet	γ_{sat}	kN/m^3	18	18
Initial void ratio	e_{ini}	-	0,8	0,8
Parameters			Soil	Drain
Mod. compression index	λ^*	-	0,052	0,052
Mod. swelling index	κ^*	-	0,02	0,02
Cohesion	C'_{ref}	kN/m^2	5	5
Friction angle	ϕ'	$^\circ$	25	25
Dilatancy angle	ψ'	$^\circ$	0	0
Groundwater			Soil	Drain
Horizontal permeability	k_x	m/s	1E-09	1 to 1E-5
Vertical permeability	k_y	m/s	1E-09	1 to 1E-5
Change in permeability	C_k	-	0,3	1E15 to 0,05