

M A A S S I L O R O T T E R D A M

AN ANALYSIS ON
ARCHITECTURE, CULTURAL VALUE AND BUILDING TECHNOLOGY

PREFACE

This document is the result of a study that has been done within the heritage program at the TU-Delft faculty of Architecture and the built environment. It focuses on the redesign of industrial heritage in the former harbour district of Rotterdam South. The study was carried out during a two-month period from February until April. Amy Stuik, Kostis Vatanidis, Koen Hoogeveen, David van Weeghel and Simme Bruinsma studied the building and its surroundings.

This team came together due to the mutual interest to redesign the Maassilo complex, a huge silo complex for the storage, treatment and distribution of different types of grains. It tells the story of the historical development of the buildings and surroundings and explains the current situation and future opportunities.

This book is intended to educate the reader about the wealthy historical development and current situation of the harbour industry of Rotterdam and the Maassilo complex in particular. Most of the research was based on historical content. The existing value report that was done by the 'Transformers' in 2008 has been of great value for our understanding of the building. The size of the assignment and the limited amount of time proved to be a great challenge. Due to profound archival research and plain observations we managed to come to new and better understandings, however it also caused us to leave some questions unanswered.

The following people should be mentioned for their supporting role in this research: Alexander de Ridder, Sara Stroux, Frank Koopman and Lidy Meijer.

Simme Bruinsma,	Student nr: 4326903
Koen Hoogeveen,	Student nr: 4081935
Amy Stuik,	Student nr: 4429834
Kostis Vatanidis,	Student nr: 4521609
David van Weeghel,	Student nr: 4086627

TABLE OF CONTENTS

INTRODUCTION	7	SPACE PLAN		SERVICES	
STORY	8	grids & axes	58	conveyor belts	96
THE ARCHITECTS	9	relation between spaces	59	phase 1 - drainage	97
PART 1 - ARCHITECTURE & CULTURAL VALUE		SURFACES		phase 2 - drainage system & ventilation	98
INTRODUCTION ARCHITECTURE & CULTURAL VALUE	14	surface inventory	62	phase 3 - drainage system	99
SURROUNDINGS		traces of usage	63	phase 4 - drainage system	100
movement of industry	17	concealed presence	64	PART 3 - VALUE ASSESSMENT	
historical development - infrastructure	18	SERVICES & STUFF		HISTORICAL INTERPRETATION	102
historical development - buildings & water	20	displaced machinery	66	CULTURAL VALUE MATRIX	103
historical development - buildings by age	22	fixed machines	67	KEY DISCUSSIONS	
urban axes	23	fusion of static and dynamic	68	north / south	106
urban configuration	24	PART 2 - BUILDING TECHNOLOGY		public / private	108
district references	25	INTRODUCTION BUILDING TECHNOLOGY	70	static / dynamic	110
relationship to surroundings	26	STRUCTURE		readability / concealment	112
SITE		overview of different structures	72	REFLECTION	114
traffic	28	phase 1 - construction system	74	BIBLIOGRAPHY	116
the metropolitan approach	30	phase 1 - octagonal silos	75		
two-faced	32	phase 1 - static schemes	76		
SPATIAL COMPOSITION		phase 2 - construction system	77		
chronomapping	36	phase 2 - expansion joint	78		
an empty space	38	phase 2 - static schemes	79		
flow	39	phase 3 - 3D structural composition	80		
building functions	40	phase 3 - foundation methods	81		
composition of the north façade	41	phase 3 - structural loads	82		
symmetry	42	phase 4 - introduction	83		
SKIN		phase 4 - construction system	84		
hidden facades	44	phase 4 - static schemes	85		
lost façade openings	46	standard silo structure principles	86		
Inverse light	49	plofdak system / damage control	87		
concrete appearances	50	silo capacities	88		
painting lisa lux	51	MATERIAL			
'graansilo mij' signs	52	façade systems	90		
STRUCTURE		damage analysis	91		
unity of skin and structure	54				
tectonics	55				
ground floor interventions	56				

INTRODUCTION

The analysis of the Maassilo Rotterdam starts with a general introduction to the history of the Maassilo and the architects that were responsible for the different building phases. After this, the analysis is divided into three parts.

part 1: Architecture & Cultural Value

In order to come to a thorough understanding of architectural heritage - in this case the Maassilo - an analysis should value this heritage in all its multiplicity. Therefore, the first part of this analysis is carried out by interpreting the building through different layers. The structure that is used is given by Steward Brand, who defines architecture as a culmination of 'shearing layers'. Brand defines the following layers (Brand, 1994):

- Site: The geographical setting of the building, including the urban context and the building site itself.
- Structure: All the load-bearing elements of the building.
- Skin: The surfaces of the exterior, e.g. the facades and the roof.
- Services: All the service systems used for heating, plumbing, ventilation and electrical systems.
- Space plan: The elements that define the internal layout, like interior walls, doors, floors and ceilings.
- Stuff: All the things that are placed in the building but can move freely, like furniture and appliances.

In the particular case of the Maassilo, some additions and connotations were necessary to make clear distinctions between certain values. Hence, the layers used to structure this analysis are:

- Surroundings: The urban context of the Maassilo, which is Rotterdam, with an accent on the area south of the Maas.
- Site: The direct surroundings of the building, the Maashaven, the quays, elevator towers, and the public space adjacent to the building.
- Spatial composition: The main volumes the building is comprised of.
- Skin: The exterior surface of the building; the facades.
- Structure: The loadbearing logic and tectonics of the building.
- Space plan: The spatial logic of the interior.

- Surfaces: The skin of the interior spaces.
- Services/stuff: The remaining machinery and services, which are mostly out of order.

Each layer is placed in a historical perspective in order to clarify its present state. Consequently, meaning is ascribed to the architectural and cultural findings in each layer. It is important to mention that architecture and cultural value are not separated here, as the one is always present in the other.

part 2: Building Technology

Where part 1 focuses mainly on the meaning of the building in its historical context, part 2 is about the technical possibilities of the building. This part is further divided into:

- Structure, which focuses on the loadbearing structure of the building, both as a whole and in the detailing;
- Materials, in which an inventory is made of the material properties of the building and the state that they are currently in;
- Services, focusing on the way that machines, drainage and ventilation work or used to work in the building.

part 3: Value Assessment

After exploring the meaning of the different layers and the technical possibilities of the building, part 3 focuses on valuing these findings.

This part starts with a general qualitative interpretation of the building in its historical context and puts this into perspective towards the future.

After this qualitative historical embedding, the specific architectural, cultural and technological findings from part 1 and part 2 are weighed against each other in the value assessment. Since the ascribed values are impossible to put under one common denominator, they are divided into multiple categories. The division in categories is in this case provided by Alois Riegl. In his *The modern cult of monuments: its essence and its development*, the following cultural values can be found (Riegl, 1903):

- Age value: The extent to which existence through time, and therefore physical decay, is made visible. This value is

perceived immediately by both laymen and experts.

- Historical value: The extent to which valuable information about the past is provided. This information is mostly valued by experts and in most cases has to be explained to laymen.
- Intentional commemorative value: Value in the human endeavor to keep certain memories alive in the consciousness of the public.
- Unintentional commemorative value: Appreciation of the readability of unintended events in history that became part of the public consciousness.
- Newness value: The extent to which the triumph over the test of time is visibly present. This is the exact opposite of age value.
- Art value: The value of artistic meaning in historic artifacts.
- Use value: The extent to which certain aspects in the current situation are directly adaptable for new usage.

Again, in order to capture the essence of the Maassilo, different values had to be added to the set of values provided by Riegl. The values that have been added are:

- Aesthetic value. This value does not merely concentrate on the visual perception of the building, it rather involves everything that contributes to the current experience of space.
- Rarity value: Focuses on the uniqueness of certain elements.

In this analysis, the unintentional commemorative value is left out, because it did not significantly bring different values to light that were already ascribed to historical value. The layers as described by Brand and the values that are described by Riegl are used as a y- and x-axis in a matrix in which all the values are placed.

After the value matrix, the most important values are summarized in four condensed discussions. Together, these tension fields form the backbone for the development of the Maassilo in its historical setting. They lead to the key opportunities, conflicts and obligations. It is from these tension fields, that the possibility arises for a new design that is grounded in history while projecting towards the future.

STORY

Directly connected to the creation of the Maashaven, the Maassilo was part of a series of buildings, including the Sleeve Camp Building, Santos Warehouse and Coal Trade Association, which were clearly intended to link the port with the city and establish Rotterdam as a modern world port. Furthermore, they were meant to address the catalyst future role of warehouses, factories and offices in relation to the surrounding workers housing.

The implementation of the American model of construction techniques as well as overall infrastructural attributes (cup elevators and cranes, in constant interaction with conveyor belts and adjacent railway lines), would play a dominant role in this process.

1st Phase

In 1906, J.P. Stok was issued the design of a graansilo building by the N. V. Rotterdam grain silo society, which would be completed in 1910. This would include the creation of a series of three adjacent parts, serving the storage and distribution of grain in different scales and conditions. On the southeast corner of the Maashaven, the first part would provide flat storage space of 7 floors and also shape the main façade of the building. Following it, the second part would act as a continuous façade of the first volume, carrying 72 square silos. The third part, also carrying the main elevators in the west edge of the building, would include 30 octagonal cells, larger in storage space and distribution pressure. The total amount of cells and floors would provide storage space for 20.000 tones of grain. In addition, a small office and apartment wing was adjusted to the northeast part of the main façade.

As a protagonist figure in the shaping of the industrial language of the port during that time, Stok would be implementing a personal eclectic style in combination with the American functionalist influence throughout his buildings. In relation to the historic momentum of a formalization of the elevators attributes in a series of other buildings, the Maassilo stood as a clear emphasis of the American influence and one of the largest silo buildings in Europe

2nd Phase

With the ownership of the building being taken over by the Société Générale de Surveillance Geneve and the grain elevator company (AVG), a new silo extension was issued to the architects J.A. Brinkman & L.C. Van der Vlugt in 1929, reaching completion in 1931. This would be eventually doubling the capacity of the first phase to 44.000 tones and maximizing its overall storage and distribution efficiency. By establishing two continuous groups of silos, both taller and lighter, the new building would also include the implementation of cup elevators, securing faster loading (200 tones per hour), as a response to the higher frequency of the expected vessels and barges. This would also include the creation of a machine tower in the northeast end of the first part, as a central regulator and provider of the air and water pumps. Finally in an additional attic level, another set of conveyor belts and dump pipes would distribute the grain to the cells.

As primary figures in the translation of the New Objectivity, Brinkman and Van der Vlugt had been specialists in the adaptation of the American influence in the context of industrial harbor buildings. Particularly expressed in the Van Nelle factory, their designs would formalize building technology, guided by the functional production and good working conditions, as the main driver of the design. In the case of the Maassilo, the architects followed the same principles of construction efficiency and advanced technologies, by clearly expressing the separation of the realm of the silos from the minimum space of the workers, in the rational arrangement of the cells, adjusted to a machine tower and served by the cellar and attic. The launching of the McDonald method, involving a sliding framework for the casting of the silos, also reflected the state-of-the-art efficiency which was thoroughly applied.

3rd Phase

The third addition by the major independent office of A.G. & J.D. Postma in 1950, would attach to the south part of the complex another 50 large silos (arranged in two and three rows), offering an extra capacity of 22.000 tones. Symmetrically covering the complex and adjusted to the footprint of the previous transformer house this would also include another set of conveyor belts in the upper level, connected with bridges to the 2nd phase.

4th Phase

The addition of the office building by H. Haan in 1963 northeast from the first building, included an addition from a third generation modernist perspective. Established in three concrete pillars, adjacent to the waterfront, the building included 250m² of office space, also introducing pre-fabricated elements.

Current Activity

From 2003, the NOW&WOW dance club became the first tenant of the newly owned building. With most of the redevelopment taking place in the ground floor and basement, the club focused on the re-arrangement of the entrance, and the shaping of three main halls, throughout the footprints of the first and second phase. The attic of the 2nd phase would be also temporarily shaped into an extension of the club, whereas the third phase would be primarily used for circulation and services. Finally, making the second official tenant of the building in 2008, the Creative Factory would occupy the 2nd and 7th floors of the first phase and introducing an entrepreneurial platform for young artists in Rotterdam Zuid.

THE ARCHITECTS

J.P. STOK 1863-1942

Jacobus Pieter Stok designed the first part of the Maassilo, that was built in 1910. Stok was a practising architect from 1886 to 1917, so the Maassilo can be seen as one of the later works in his oeuvre. This oeuvre mainly consists of offices, warehouses and factories, most of them situated in Rotterdam. Since the second half of the nineteenth century Rotterdam was in the process of expanding and modernizing the industrial harbour; something that Stok evidently profited from.

Unfortunately, due to the bombing of Rotterdam in the Second World War, many of the buildings designed by Stok were lost.

In his oeuvre, a development can be traced which was exemplary for Dutch architecture at that time. From 1890 on, Dutch architects were searching for ways to simplify the architectonic form, as an answer to the more decorative and conservative styles in the years 1850-1890.

The first important commission that Stok received was for an office and factory building for the firm Lamings & Sons. Stok designed the building in a Neo-Renaissance style. The building was completed in 1889 and is one

of the few remaining works of the architect. The front facade shows a division in four parts and is made out of a combination of brick, bands of natural stone, diamond blocks and string courses. The entrance of this symmetrical facade is marked by two highly decorated pilasters and two bronze weapon shields.

In 1903, Stok designed the Santos warehouse on Kattendrecht, Rotterdam. This building was an example of the eclectic style, which was commonly used at that time. Eclecticism is characterized by an unrestrained use of different elements from different stylistic periods. However, compared to the Hulstkamp building, the Santos building has a more sober facade with less plasticity in the ornaments. The facade is flattened, so to say. This objectification is, for example, also clearly visible in the Beurs van Berlage in Amsterdam. It should be added here that the Santos building was once topped with a highly decorative, Jugendstil-inspired, iron construction, carrying the name of the firm. What the Hulstkamp building and the Santos building have in common, is the highly symmetrical facade.

Parallel to the stylistic tendency towards abstraction, the enormous growth of cities and industrial areas due to the industrial revolution asked for an architectural solution to build in a high tempo with an cost-efficient use of materials. Obviously, this was also the case for Rotterdam in the beginning of the twentieth century, with the expansion of the harbour area and the need for housing of workers. This need for efficiency explains the growing interest in 'the American way' of building during that time. According to Dutch architects, the stylistic development in America was inferior to the Dutch development, however their building techniques were far more advanced.

Slowly but steadily, architects started to adapt the idea that the architectural form should rather express structural and functional logic than a decorative style. For example, in the Dutch architectural magazine *Bouwkundig Weekblad* in 1910, an article titled "*The aesthetic character of civil structures*" ("Het aesthetische karakter van ingenieursbouwwerken") was placed, elaborating on the 'triumph of technique' in architecture.

Civil structures and industrial buildings found their way into the architectural discourse. And so, in 1910, J.P. Stok was commissioned for the design of the Graansilo in the newly built Maashaven in Rotterdam. However, the building was, much more so than the former examples, an expression of functionality. In the silo part of the building, no distinction is made between structure and skin. The building is structure, and this structure is made visible to the observer. The silo was mentioned in another article in *Bouwkundig Weekblad* in 1910, in which an enthusiastic case was made for reinforced concrete, the material of the future.

The part of the Maassilo that was designed by Stok plays a significant part in the oeuvre of the architect, as it is a meaningful work in his development, and parallel to that the development of Rotterdam, and Dutch architecture as a whole.

source: <http://zoeken.hetnieuweinstituut.nl/nl/personen/detail/?q=j.p.%20stok&page=1>



Hulstkamp building. Design by Stok for Lamings & Sons. Built in 1889.
source: https://nl.wikipedia.org/wiki/Hulstkamp-gebouw#/media/File:Rotterdam_maaskade119.jpg



Santos warehouse. Design by Stok for Blauwhoedenevem. Built in 1903.
source: <http://rijksmonumenten.nl/monument/513940/pakhuis-santos/rotterdam/>

Het is gebleken, dat het aesthetische karakter der ingenieursbouwwerken uit het innerlijk wezen naar buiten moet spreken en niet door uitwendige versierende details aangebracat moet worden. De wezenlijke grondslagen der architectuur, die bestaan in symmetrie, rhytmie, proportie en karakteristieke uitdrukking der functie gelden ook alle in 'na overspronkelijken zin voor de bouwwerken van den ingenieur. Beslist noodzakelijk is liet echter, dat degene, die ze aanwerdt, op den basis staat van het mathematische materiaalbegrip, van waaruit alleen de triomf der techniek zich heeft ontwikkeld. Want liet zou een onbegrijpelijke teruggang zijn, de mathematische gedachtegang te verlaten of eoz naar te verduisteren, ten gunste van een zogenaamd aesthetisch uiterlijk der ingenieurswerken. Derhalve kan ook eene hogere schoonheid der ingenieursbouwwerken slechts door hem bereikt worden, die den bouw van het begin af heeft geconcepceerd. Slechts wie het mathematische construeeren ten volle beheerscht, is in staat vormen te scheppen, die aan het wezen der zaak niet vreemd zijn. Den ingenieur moet echter anderzijds de

Fragment of the article "*The aesthetic character of civil structures*", *Bouwkundig Weekblad* 1910.



Graansilo Maashaven, photograph in *Bouwkundig Weekblad* 1910.

THE ARCHITECTS

J.A. BRINKMAN (1902-1949) & L.C. VAN DER VLUGT (1894-1936)

Brinkman & Van der Vlugt were an important architectural duo for the city of Rotterdam and for the architectural movement of The New Objectivity and 'Het Nieuwe Bouwen'. Their practice was active from 1925 until 1936.

When Michiel Brinkman (sr.) unexpectedly past away in 1925, his son Johannes Andreas Brinkman (jr.) had to step up and temporarily quit his studies in Civil Engineering at the the technical college in Delft to take his father's place at the office. Brinkman (jr.) started a collaboration with Leendert Cornelis Van der Vlugt who had studied at the Academy of Art in Rotterdam and had been a practicing architect since 1919, just like his father. In the beginning of this new dynamic, Brinkman mostly concerned himself with liaising with clients and running their business while Van der Vlugt did more of the actual designing ('Brinkman en Van der Vlugt', 2016). Brinkman went back to finish his studies in Delft and graduated as an engineer in 1931.

Their designs for grain silos and factories made Brinkman & Van der Vlugt into masters of The New Objectivity and functionalist architecture. They can be seen as pioneers of Het Nieuwe Bouwen. With designs like the Van Nelle factory they left a big impression on people like Walter Gropius, Le Corbusier and Richard Neutra (Molenaar, 2012). Le Corbusier also made 20th century functionalist

designs for industrial architecture like silos and factories, but it were Brinkman & Van der Vlugt who's designs actually got built (Hulsman, 2012).

Brinkman & Van der Vlugt received the design brief for the expansion of the grainsilo at the Maashaven in January of 1929. Their task was to create as much grain storage as possible on the available small plot, while seamlessly connecting to the machinery and grain circulation of the first building. On the 18th of July in 1929, the first foundation pile was put into the ground. (Brinkman, 1931)

One of the most prestigious designs of Brinkman & Van der Vlugt is the Van Nelle Fabriek, also situated in Rotterdam. Even though this factory was built in roughly the same period as phase 2 of the Maassilo, there is a striking difference between the two. Where the façades of the grainsilo are purely structural, the façades of the Van Nelle factory only function as a skin, with a separated structure behind it. This allowed the Van Nelle Fabriek to have large windows that let in a lot of daylight with the aim to create a pleasant and spacious working environment for the factory personnel. In the maassilo on the other hand, nearly the entire façade is closed off since the storage of grain didn't require any daylight. The top floor however, where the distribution of the grain to the

different silos took place, does have the similar characteristic horizontal strip windows. These types of windows, together with smoothly rendered façades, are a signature element in their oeuvre and appeared in many designs by Brinkman & Van der Vlugt, like huis Sonneveld (designed for one of the directors of the Van Nelle factory) and other villas.

It is quite curious to notice that over the years they designed many office buildings and villas, knowing that the movement of Het Nieuwe Bouwen was mainly focussed on mass production of dwellings for the less fortunate. ('Brinkman en Van der Vlugt', 2016).

Molenaar (2012) writes that the oeuvre of Brinkman & Van der Vlugt can be seen as a radical expression of a modern Rotterdam city-ideal that was shared by many entrepreneurs of their generation. This new generation was right in the middle of many new developments in the beginning of the 20th century (not only on an urban level but also with technological progress, Brinkman & Van der Vlugt for instance also designed the signature PTT telephone booth for the Netherlands) and wanted to create beauty and international credit for the city. After World War II, Brinkman & Van der Vlugt according to Molenaar didn't succeed in transforming the entire urban context of Rotterdam to their city-ideal and inter-

national style, amongst other things due to the fact that after WW II, architecture and urban design got firmly separated from each other. Fortunately the many individual works of Brinkman & Van der Vlugt remain important icons for the movement of Het Nieuwe Bouwen and for the city (Hogervorst, 2013).

When Van der Vlugt who had been suffering from Hodgkins disease suddenly dropped dead on the streets in April 1936, J.H. van den Broek took his place and teamed up with Brinkman until the death of the latter in 1949. After that, the name was changed to Broekbakema, an influential architectural firm that still exists today (Huisman, 2012).

Sources:

Kunstbus (2016) Brinkman en Van der Vlugt. Retrieved from <http://www.kunstbus.nl/architectuur/brinkman-en-van-der-vlugt.html> on 24 March 2017

Molenaar, J. (2012) Brinkman & Van der Vlugt Architects. Retrieved from <https://www.naibooksellers.nl/brinkman-en-van-der-vlugt-architects-joris-molenaar.html> on 1 April 2017

Hulsman, B. (2012) De zakelijkste van de zakelijken. Retrieved from <https://www.nrc.nl/nieuws/2012/12/14/de-zakelijkste-van-de-zakelijken-1185137-a1266833> on 24 March 2017

Brinkman, J.A. (1931) De nieuwe graansilo aan de Maashaven voor de N.V. Graansilo Maatschappij te Rotterdam. De Ingenieur; B. Bouw- en Waterbouwkunde, 32.

Hogervorst, L. (2013) Modern times in Rotterdam. Retrieved from <http://www.geschiedenis.nl/nieuws/artikel/3601/modern-times-in-rotterdam> on 1 April 2017



J.A. Brinkman (left) and L.C. van der Vlugt (right) (NAI (2013) Designers, Retrieved from <http://schatkamer.nai.nl/en/designers/> on 1 April 2017)

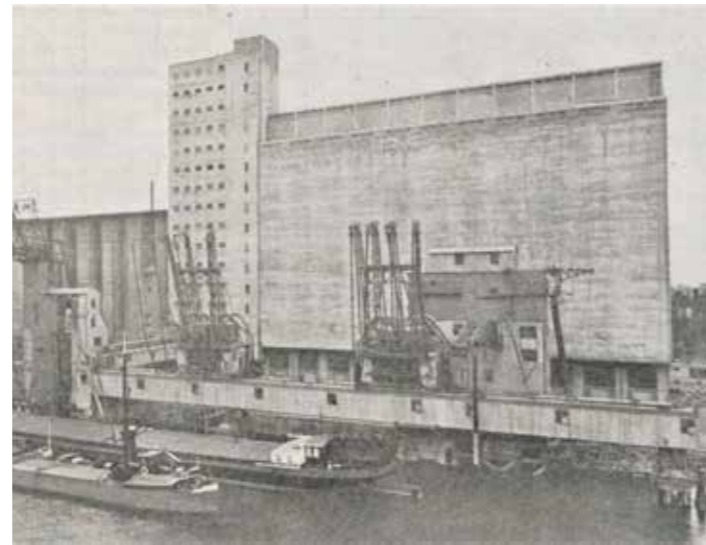

Phase 2 of the grainsilo at the Maashaven in Rotterdam, expansion on the existing building by Stok. Design by Brinkman & Van der Vlugt, for the N.V. Graansilo-Maatschappij. Built between 1929 and 1930. (Brinkman, J.A. (1931) De nieuwe graansilo aan de Maashaven voor de N.V. Graansilo Maatschappij te Rotterdam. De Ingenieur; B. Bouw- en Waterbouwkunde, 32.)



The Van Nelle factory in Rotterdam. Design by Brinkman & Van der Vlugt Architects. Built between 1926 and 1931. ('The Charnel-House' (2014) Van Nelle factory in Rotterdam (1926-1930). Retrieved from <https://thecharnelhouse.org/2014/02/04/van-nelle-factory-in-rotterdam-1926-1930/> on 1 April 2017)



Huis Sonneveld in Rotterdam. Design by Brinkman & Van der Vlugt, for A.H. Sonneveld - one of the directors of the Van Nelle factory. Built between 1929 and 1933. (NAI (2013) Museumwoning Sonneveld: monument van Het Nieuwe Bouwen. Retrieved from http://www.nai.nl/museum/museumwoning_sonneveld on 1 April 2017)

THE ARCHITECTS

J.D. POSTMA 1890 - 1962

Jan Diederik Postma senior started his own office in Deventer in 1919. He had participated in 1913 in this place to build an office building for the company of his father Ae.E. Kluwer.

Postma was soon in a circle of big national financial families. Postma specialized in designing industrial and office buildings and developed a great knowledge for new construction methods and materials. He had a good sense of business, making him nationally renowned to acquire large clientele. He built offices for various utilities. He also worked abroad, amongst others in Germany, Belgium, France and Ireland. In the latter country he built state alcohol plants. Thanks to his contacts with industrialists Postma developed a second specialty, designing houses.

A good example is the mansion with thatched roof that he is in front of his brother-Evert Kluwer (1892-1964) designed in Epse.

On August 15, 1939 Aebele Postma joined and in 1941



Jan Diederik Postma Senior (<http://amsterdamse-school.nl/personen/architecten/jan-diederik-postma/>)

the office Postma & Van Kempen was founded in Amsterdam. On August 1, 1950 came the J.D. Postma jr. Working at the desk. In 1951 they built the second expansion of the 'Graansilo Maashaven'.

Postma had a big production of structurally often innovative buildings. Architecturally, he showed himself a craftsman with a sense of proportion and balanced spatial structures, but he did not develop a distinct style. He followed the mainstream, such as the Amsterdam School, Art Deco, an English country style and the Gooi country style. Factory buildings he designed in the inter-war period in the style of The Hague School, a commercial variant of the Amsterdam School.

In the thirties, forties and fifties the Delft School had influence on his work. The choice of style and idiom Postma customized to the building type. He chose the austere Hague School for production buildings and factories, he was inspired by the offices of electricity companies by the more representative Delft School.

In the fifties Postma worked in the typical reconstructi-



Villa E. Kluwer ; Postma 1890-1940 : aangeboden door bouwheeren en belangstellenden aan den heer J.D. Postma, architect te Deventer t.g.v. diens 50sten verjaardag (druk. L van Leer & Co., N.V. Amsterdam)

on-form language: plain brick building with concrete cornices and concrete frames around windows and doors, combined with references to classical architecture.

WPC Knuttel explained in his obituary on Postma emphasis on technical and organizational skills, "Beautiful are his floorplans that show an empathy for the company, daring, mostly new construction methods and beautifully finished interiors and facades." Furthermore Knuttel writes about Postma: "He was blessed with a robust body and a sharp, quick mind, an indomitable work ethic, thoroughness and indestructible optimism. **This work ethic demonstrated by the number of buildings he designed, in total more than 1,500.**

source: http://zoeken.hetnieuweinstituut.nl/nl/personen/detail?q=postma&fq%5Bsearch_s_occupation%5D%5B%5D=architect&page=13

Luxor Theater Deventer ; (<https://bioscoopgeschiedenis.com/wp-content/uploads/2012/05/350.jpg>) →

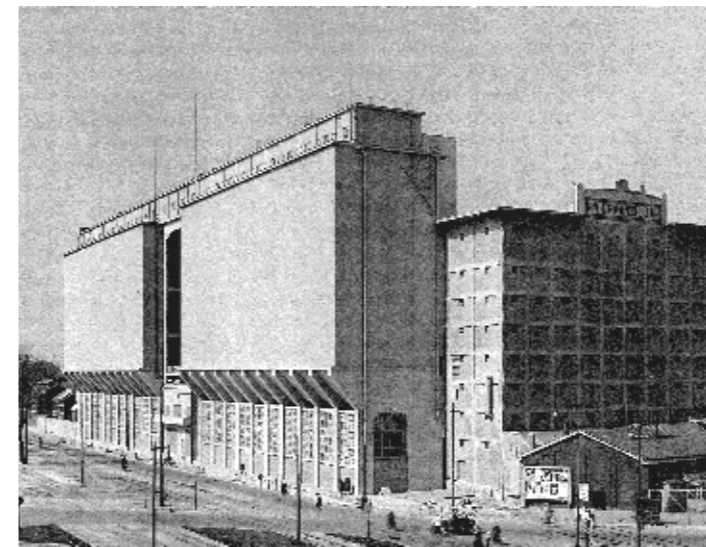

Graansilo Maatschappij N.V., Rotterdam. Silo-uitbreiding (foto: van Borselen) (Postma Deventer : A.E. Kluwer, 1960.)

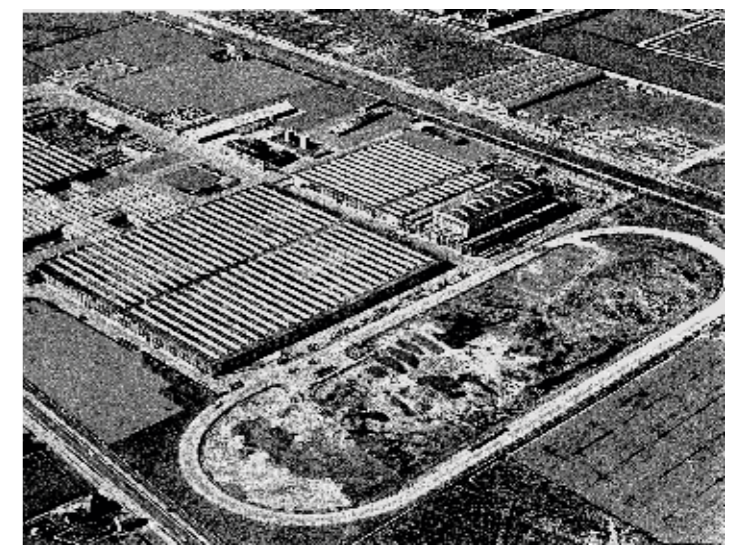

Van Doorne's Automobiefabriek N.V., Eindhoven. (foto: KLM Aerocarto N.V.) (Postma Deventer : A.E. Kluwer, 1960.)

THE ARCHITECTS

H. HAAN 1914 - 1994

Herman Petrus Coenraad Haan was born in Amsterdam on the 22nd of May 1914. After leaving several studies unfinished he decides to become an architect in 1932. His drawing skills are the main drive for this and hence without an official diploma he starts his own office in 1935 named 'H.P.C. Haan, architect'. His father was the manager of a big stone factory in Groningen and through his contacts Haan got his first big projects. Just before the bombing in 1940 Haan moves to Rotterdam where he helps Ph. Kanters an architect/contractor with an office building, a silo and a warehouse. In 1941 Haan subscribes himself for the Amsterdam Academy. And it is only after the war that his own practice really starts off. Mainly through his contacts in the Rotterdam resistance, the fight club Rotterdam-Zuid. The '50 could be seen as his most vibrant, also as an architect this is when he built a few bigger housing complexes. In 1948 he marries the artist/designer Hansje Fischer living together in an apartment in the centre. In 1953 they move into their own house, designed by Haan, in a more quiet neighbourhood. This is where he also establishes his new office: atelier aA.



Haan in Africa (Vollaard, P. (1995). *Herman Haan : Architect*. Rotterdam: Uitgeverij 010).

Haan's second passion besides architecture has always been Africa. As a fifteen-year-old boy he became fascinated by the desert cultures of the Sahara. He frequently returns to Africa, often more than once per year. He organised expeditions, taking architects and friends with him. It seems logical to find the relation with architecture. However often this is subtle and indirect. He did incorporate the basic principles to survive by working with minimum amount of materials and to use (building)materials as little as possible. Besides that the relation between inside and outside is most prominent in his work.

Haan's work can roughly be divided into three different periods. In the start he is searching for his own 'position' in relation to the pre-war modernistic idiom. The second phase is characterized by a series of villa's, which is introduced by the designing, and building of his house in 1951. In this phase he really finds a way to develop a personal architectural language. In the last phase he dares himself to work on bigger housing projects in which he is able to incorporate his passion and interest of the African culture more explicitly.



Haan's own house built in 1950 (Vollaard, P. (1995). *Herman Haan : Architect*. Rotterdam: Uitgeverij 010).

The office and two dwellings at the Maashaven silo complex. The old office had to make way for the metro line that started construction in the early '60s. That's why, in 1963, Herman Haan got the assignment to design 250 m² new office space combined with two staff accommodations and a garage. Since there was no space left on the wharf the building had to be built on the water.

The building is a rectangular block of two floor levels. The dwellings and garages are housed on the ground floor and the office space was placed on top of that. The whole volume is placed on a base structure of three big pillars.

This building should be placed in the second phase of Haan's oeuvre. It does at least bare the characteristic simple layout and spaces. Also its location on the water is of great influence as is expressed in placement and orientation, as a result of Haan's preoccupation for the relation between inside and outside. Besides that his feeling for detail is visible in several elements. The floor base that becomes thin towards the edges, to emphasize this

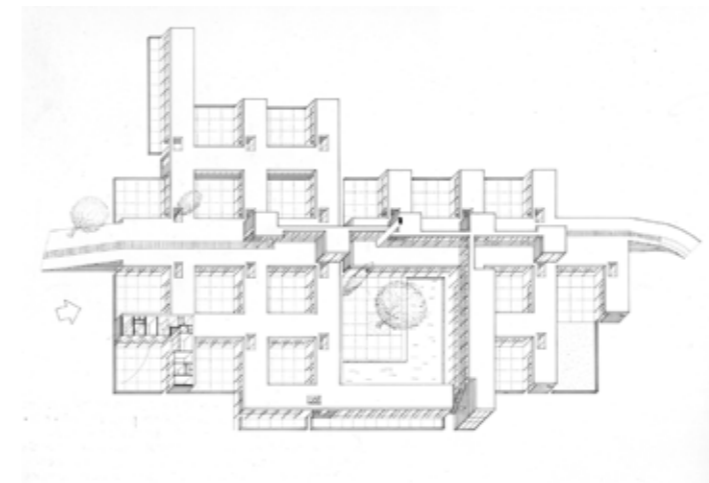

Student housing University Twente in 1963 (Vollaard, P. (1995). *Herman Haan : Architect*. Rotterdam: Uitgeverij 010).

submerged appearance above the water. An architectural language that is very similar to Haan's self-designed house.

What is interesting is that this office building comes closest to the architecture of Le Corbusier. The pilotis principle, the open layout and freedom in the open facade. But even the 'roof garden', as it is said that due to loose grain seeds, grain was used to grow on the roof.

sources:

Vollaard, P. (1995). *Herman Haan : Architect*. Rotterdam: Uitgeverij 010.

<http://zoeken.hetnieuweinstituut.nl/nl/personen/detail/?q=herman%20haan-&page=1>

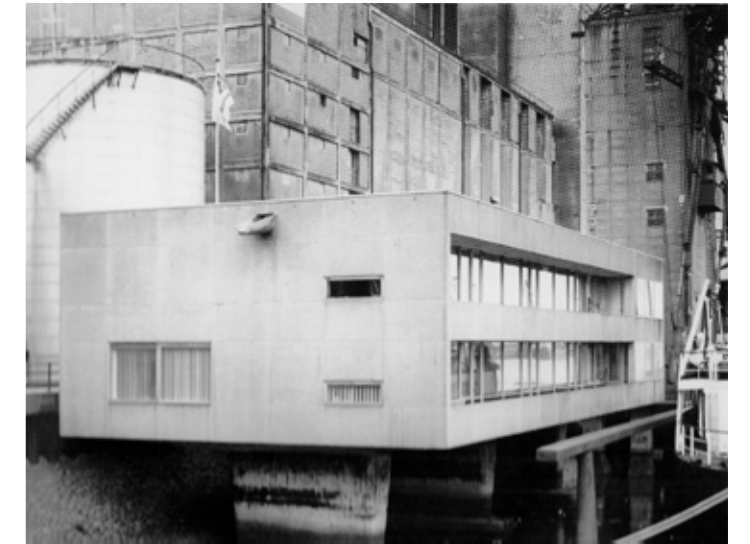

Office building Maassilo complex 1963 (Vollaard, P. (1995). *Herman Haan : Architect*. Rotterdam: Uitgeverij 010).

PART 1

A R C H I T E C T U R E

&

C U L T U R A L V A L U E

INTRODUCTION ARCHITECTURE & CULTURAL VALUE

In part 1, the architectural qualities and cultural values of the Maassilo are described. The structure of this part is given by the Brand layers, as described in the general introduction. Stewart Brand used these layers to indicate the general life span of each layer, thereby providing a useful framework to think of buildings as existing in time. Another usable feature of these layers is that they more or less work their way from the big scale to the small scale. Part 1 will start with the big scale, which is the city of Rotterdam.

S U R R O U N D I N G S

MOVEMENT OF INDUSTRY

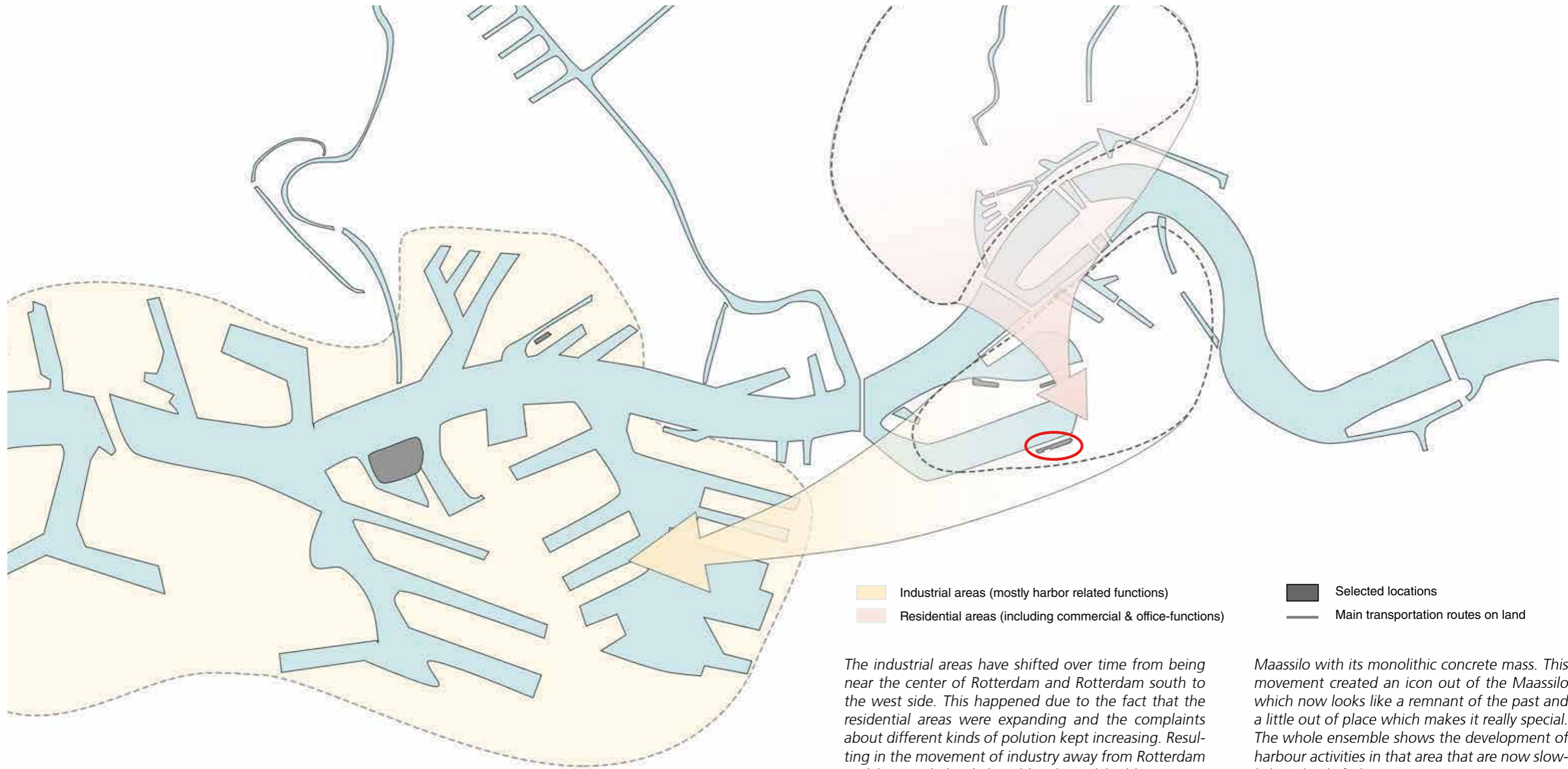

HISTORICAL DEVELOPMENT

INFRASTRUCTURE

The maps that are shown on the next two pages give an idea of the development of the infrastructure between 1708 and today in the south of Rotterdam. We see how this area developed from being the small Feyenoord village to the metropolis it currently is. It involves the creation of harbours and the implementation of train and metro lines and bridges and tunnels that came with them. The more the south grew the more important became the connection between the two sides of the river. At first it was mainly about train tracks as a result of the growing industry. But in the 70's a turning point occurred in this development. Industry shifted away and made place for the city to expand. Finally the development of the 'Kop van Zuid' recreates the image of the city with a strong visual connection that really makes the south part of Rotterdam.

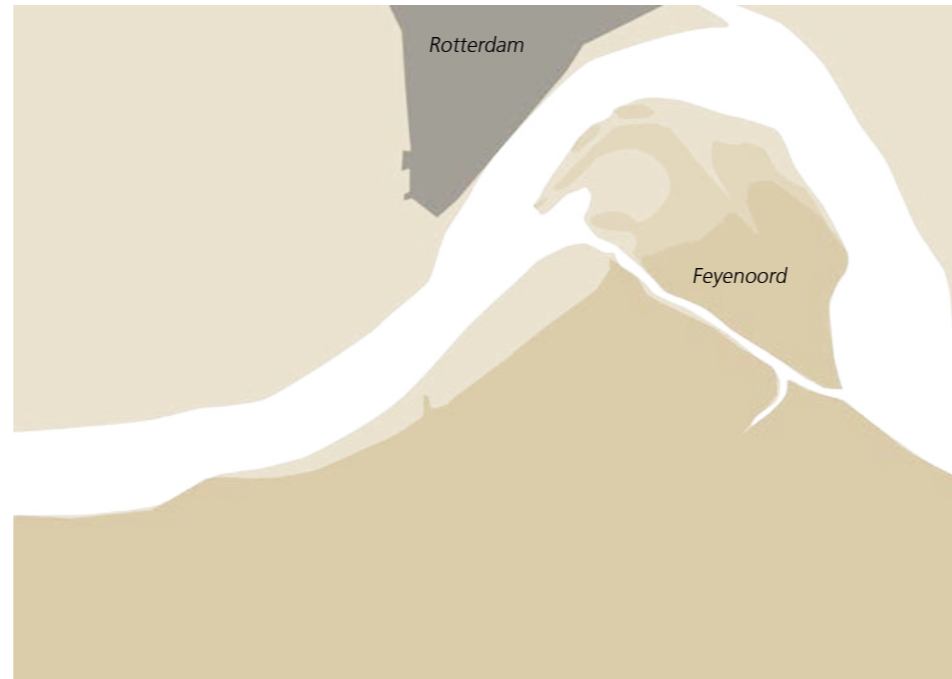

1708, Rotterdam is a city as big as Delft at the time, only connected by boats to the south side of the river

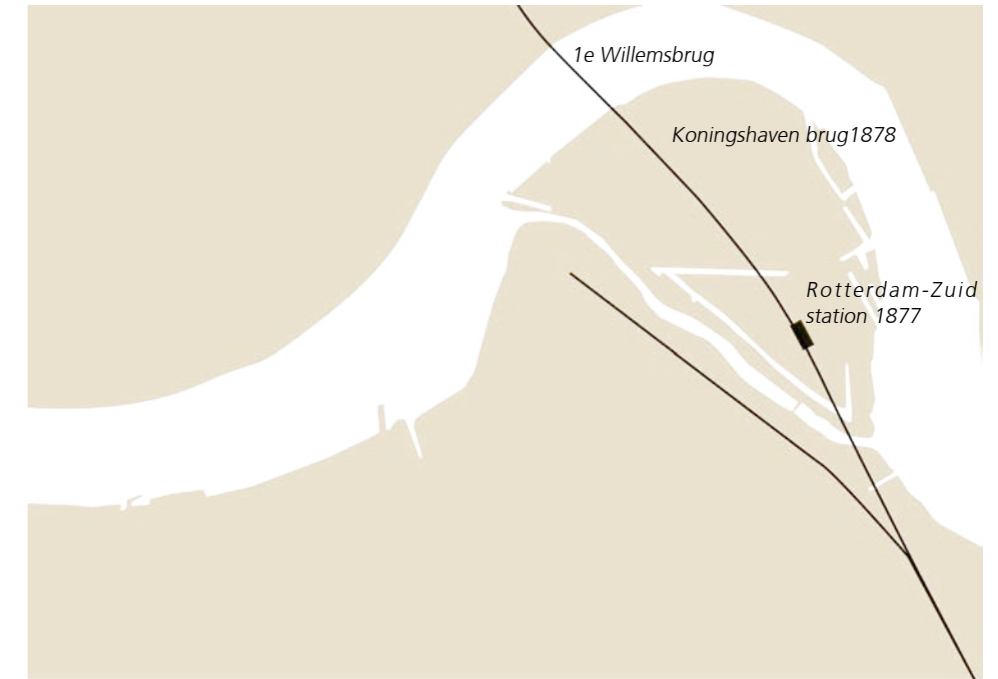

1878, On of the first trains with two connecting bridges from Rotterdam to Feyenoord (Rotterdam-zuid)



1895, Design for the Maashaven



1896, Design for plots around the Maashaven

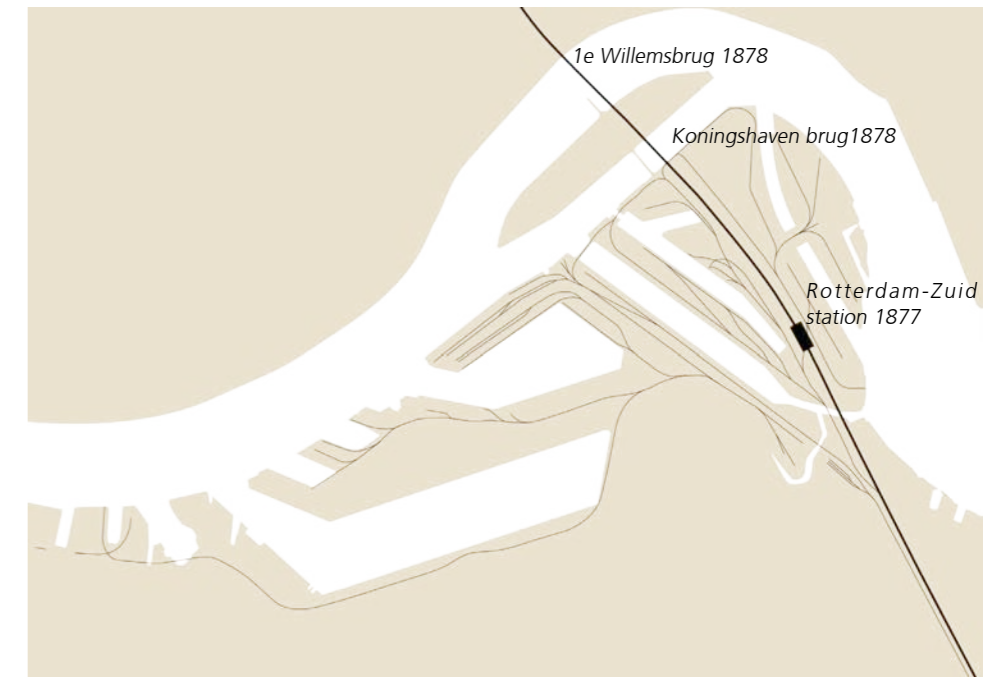

1898, Meanwhile the development of the train network in

(Source: Topographical maps of different times retrieved from <http://stadsarchief.rotterdam.nl/collectie/beeld-en-geluid>)

HISTORICAL DEVELOPMENT

INFRASTRUCTURE

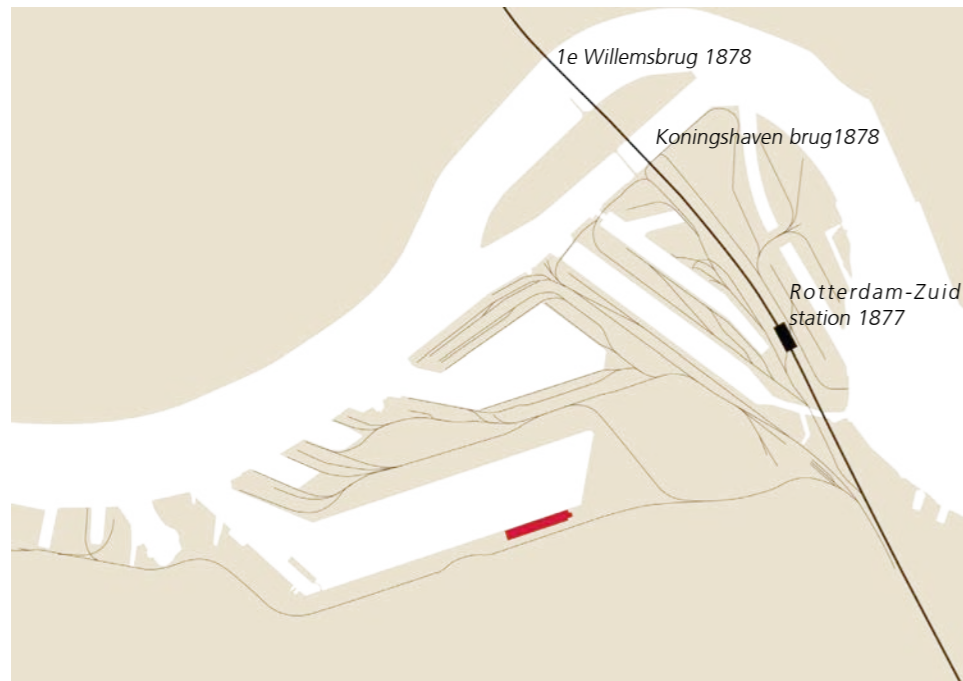

1911, Further development of Network and building 1st phase of the Maassilo

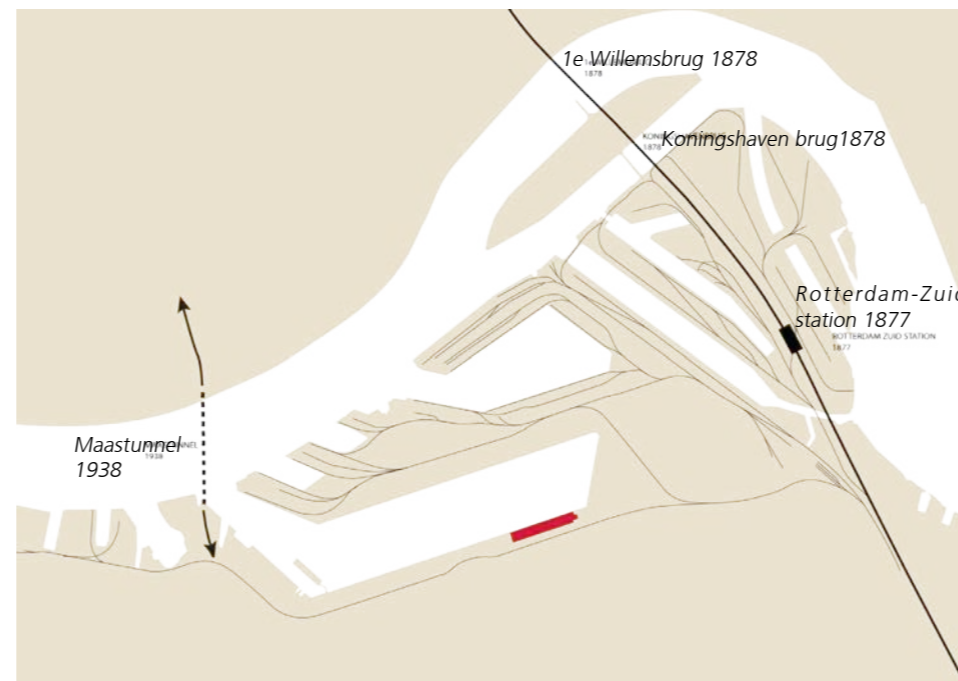

1938, Construction of the Maastunnel is finished + 2nd phase Maassilo

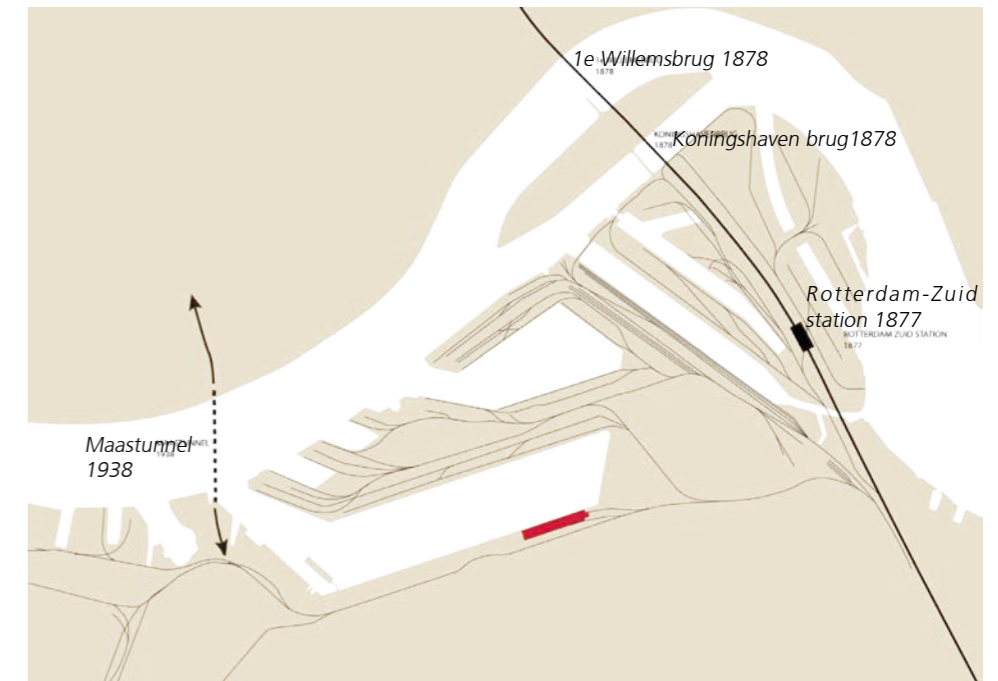

1944, Development of the harbour continues mainly to the west

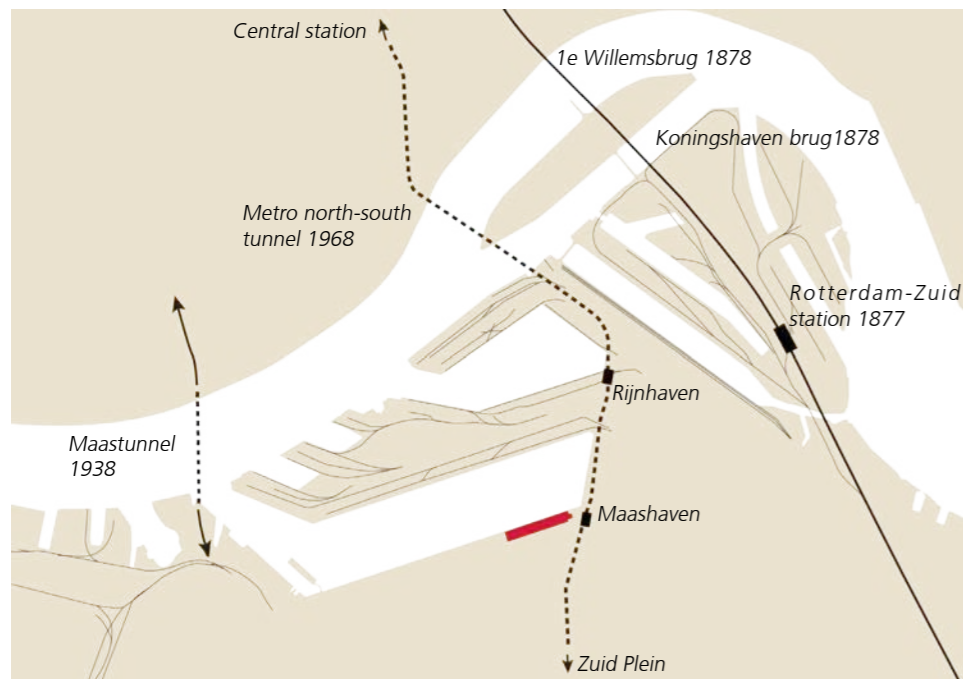

1968, The Metroline from central station to south plein is finished, traintracks are slowly disappearing

(Source: Topographical maps of different times retrieved from <http://stadsarchief.rotterdam.nl/collectie/beeld-en-geluid>)

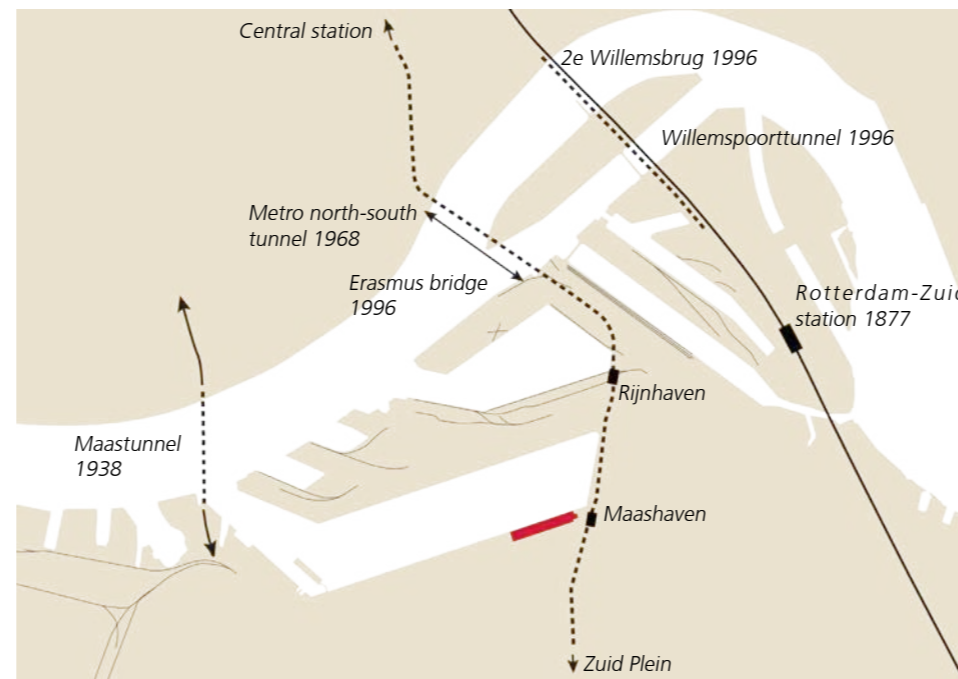

1996, Erasmus bridge and the 2e Willemsbrug are constructed, but also train tracks are disappearing rapidly due to the moving harbour industry.

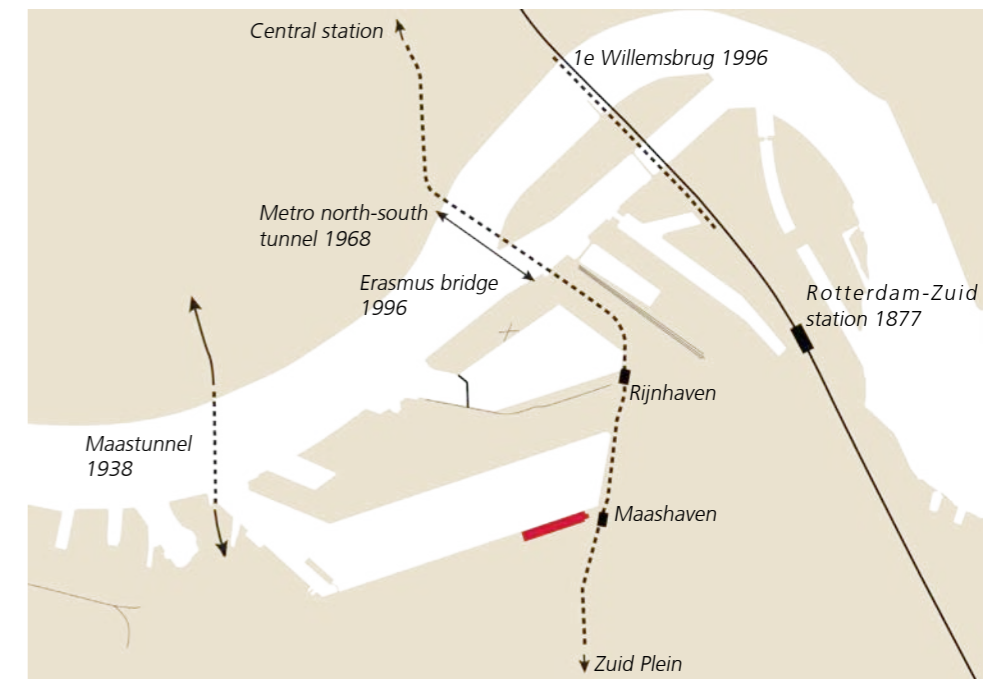

2017, Most of the harbour activities have moved away. New developments have taken place by the transformation of 'De Kop van Zuid'. The Rijnhaven brug has been constructed in 2012.

HISTORICAL DEVELOPMENT

BUILDINGS AND WATER

The following maps show the development of water and buildings in Rotterdam, focussed on the southside of the Maas and the areas around the Maassilo. The four analy-

sed times show the area before the Maashaven was dug (1900), after the first phase of the Maassilo by Stok was built (1910), after the second phase by Brinkman & Van

der Vlugt was built (1930) and after the third phase by Postma & Postma was built (1951). On the maps we see that the Maassilo was one of the first buildings in the sou-

th of Rotterdam and that with its expansion in building volumes and in harbour activity, the surrounding neighbourhoods attracted working people and grew as well.

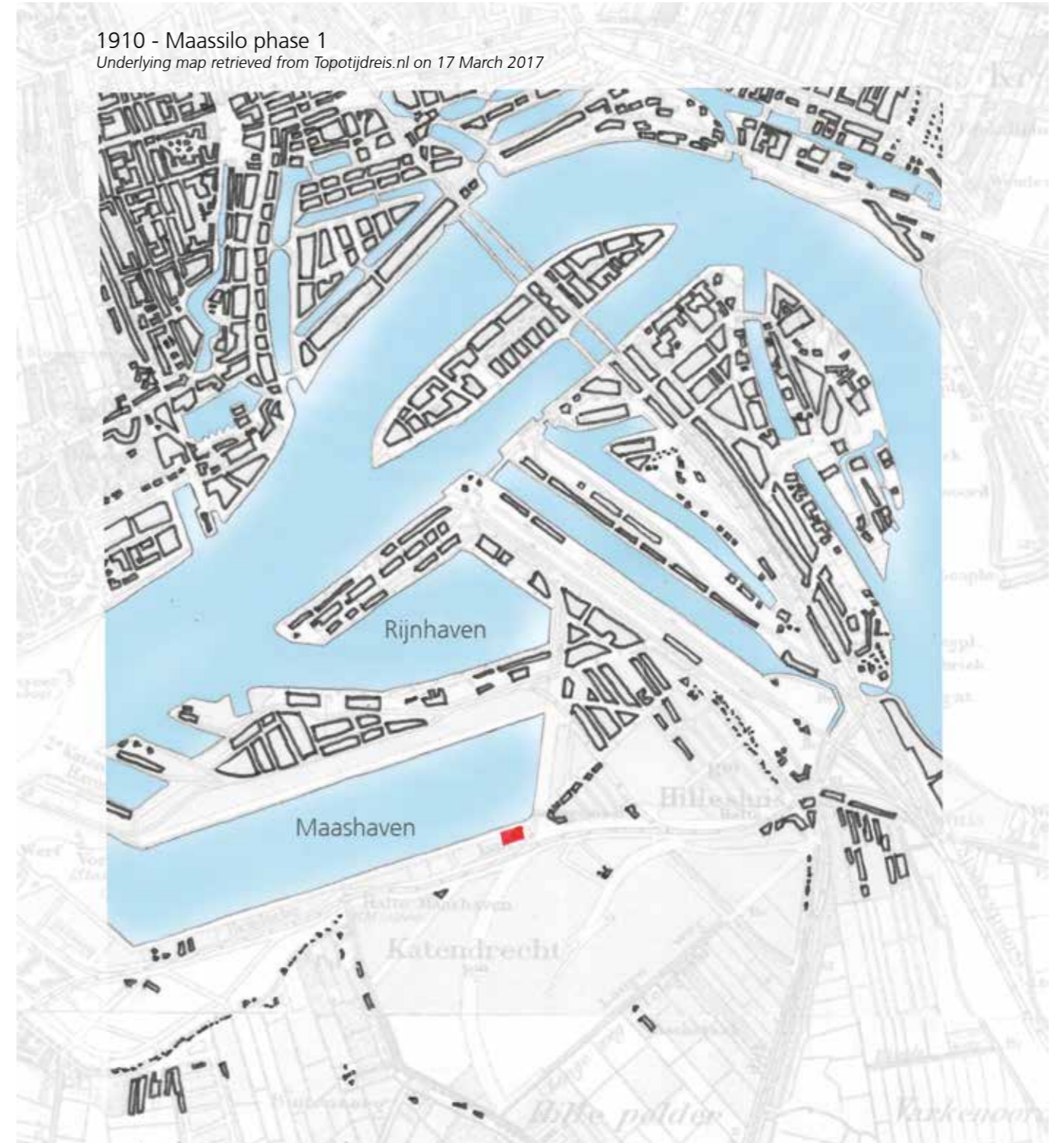
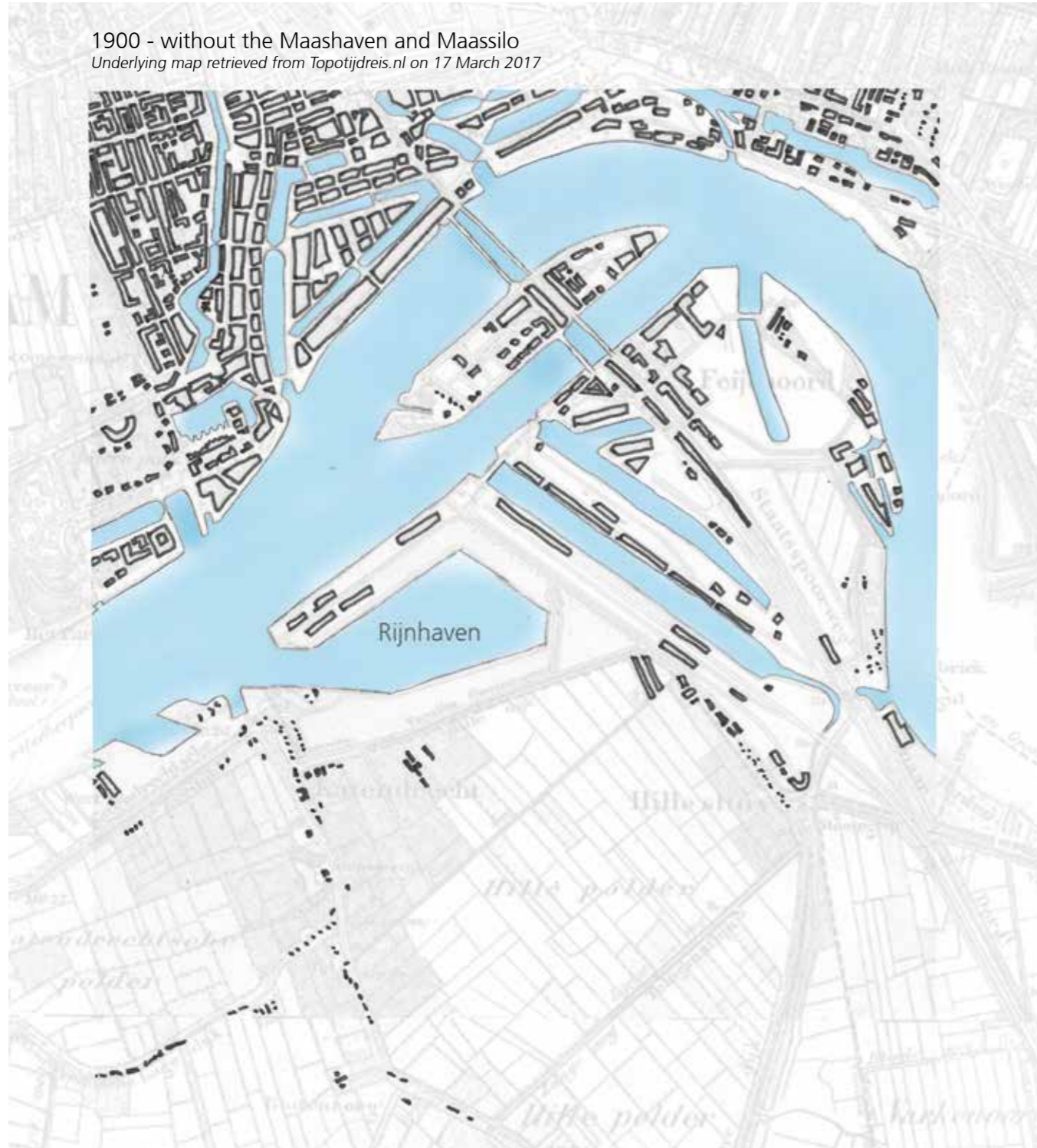

HISTORICAL DEVELOPMENT

BUILDINGS AND WATER

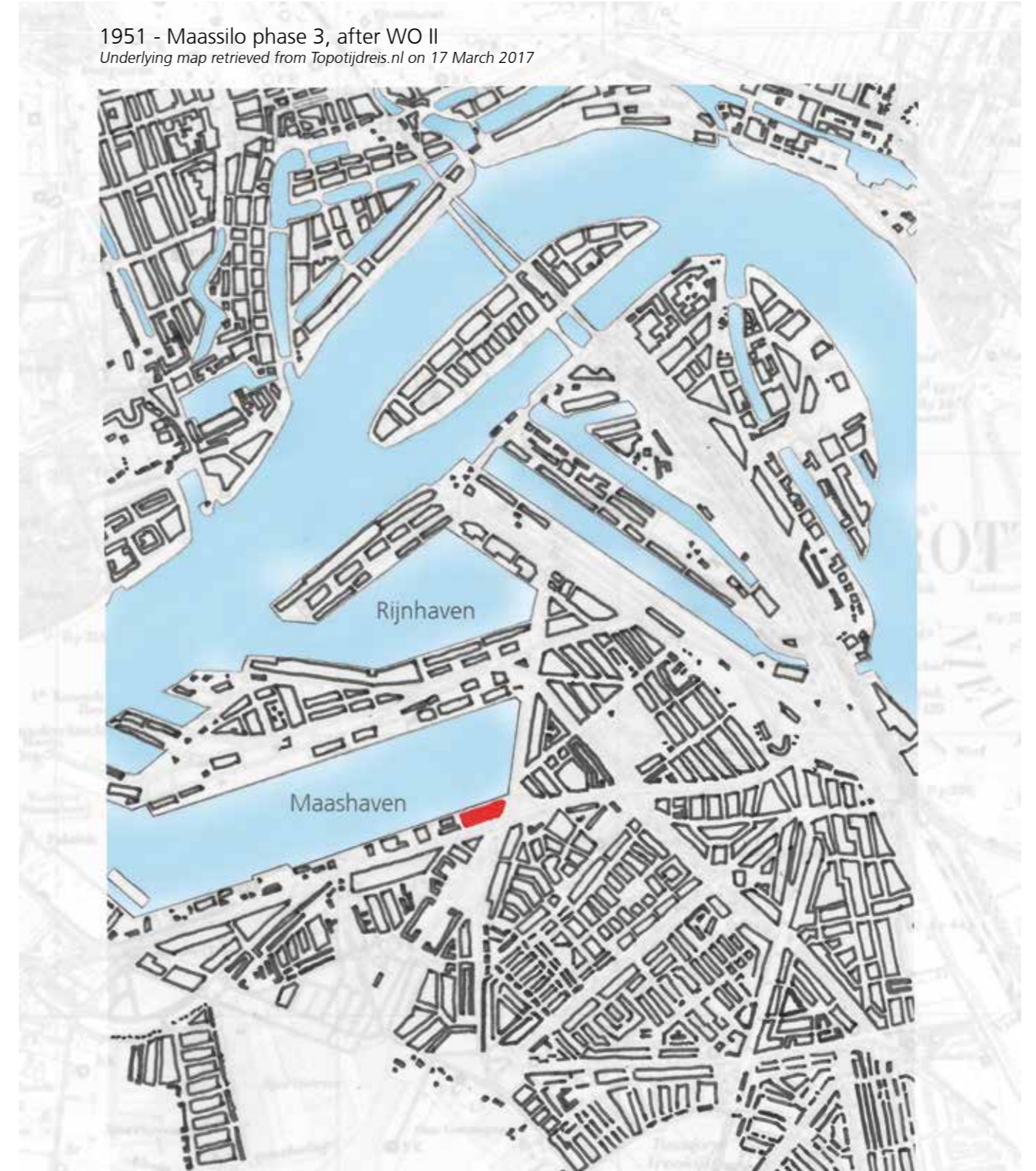
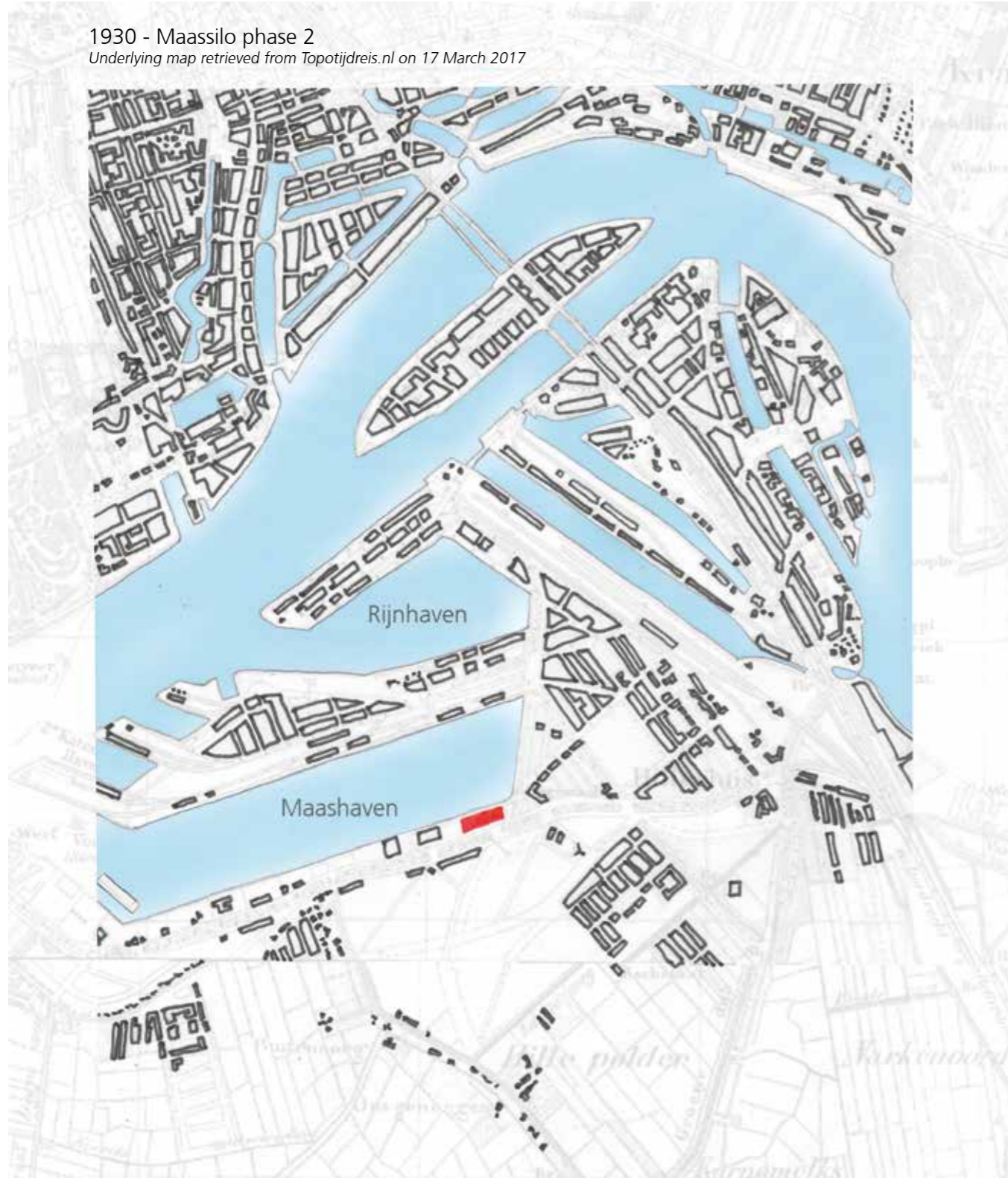

HISTORICAL DEVELOPMENT

BUILDINGS BY AGE

This map illustrates all current buildings in Rotterdam-South based on the time in which they were constructed. We see a vibrant mix but also hard contrast of buildings from 1850 and buildings that have been built in the last 5 years. It illustrates what we also experience when we move around the city. Rotterdam is a city of a contrasting built environment which is not only visible in architectural style and the use of material but also in the height of buildings as we see on the earth image on the right.

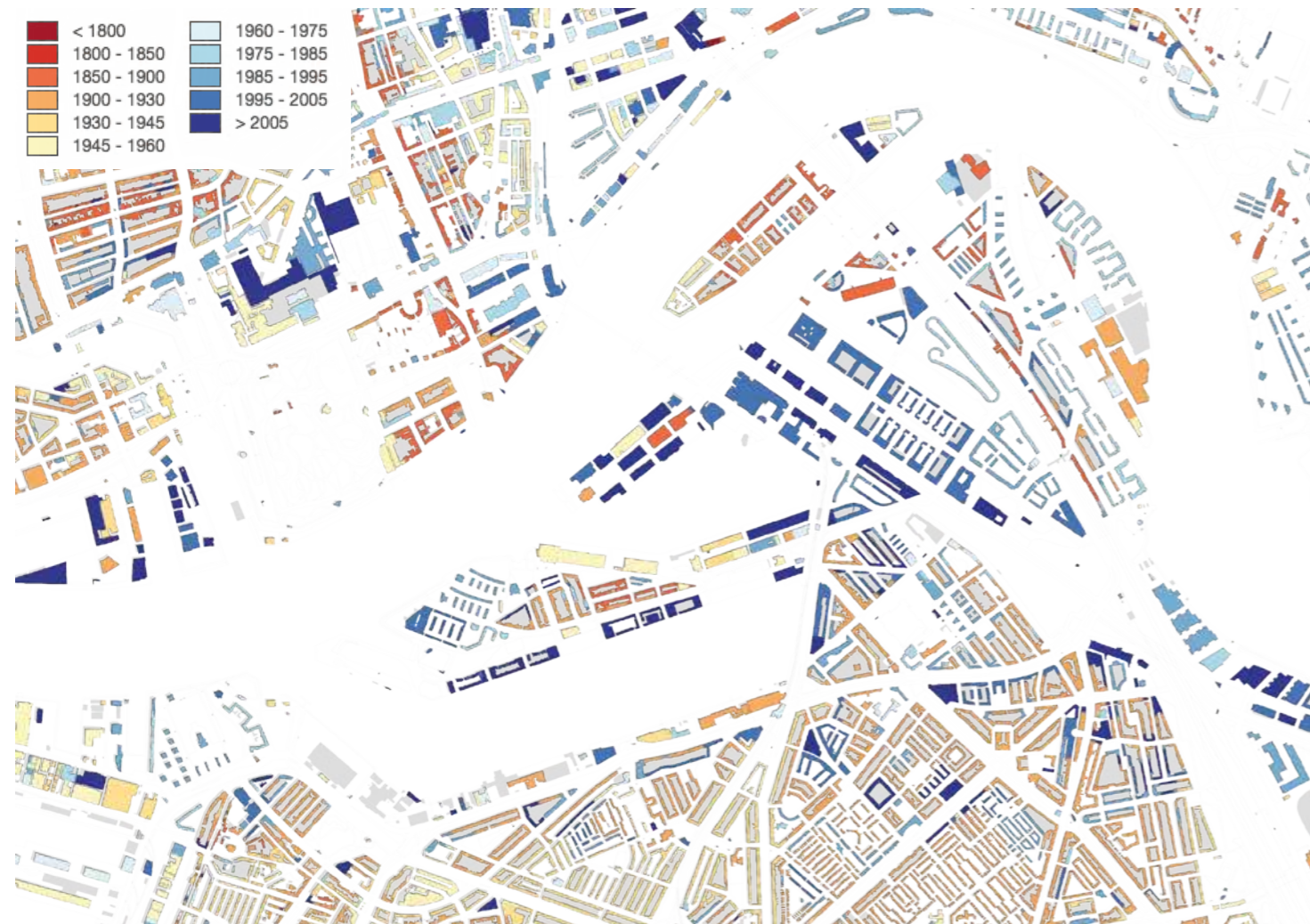

All buildings in Rotterdam-South shaded by year of construction
(Source: <http://code.waag.org/buildings/#51.9235,4.4986,13>)



Google earth satellite view
(Source: <https://www.google.nl/maps/place/Maassilo/@51.9030482,4.4858529,2893m/data=!3m1!1e3!4m5!3m4!1s0x47c4337412c24c2b:0xf20fd330ec6548d4!8m2!3d51.8980338!4d4.4949491?hl=en>)

URBAN AXES

In the morphological map on this page, the most significant urban axes towards the Maassilo (red) are highlighted. From this map, a clear set of axes emerges that connects the Maashaven area to the city centre of Rotterdam.

When coming from the north part of the river Maas, the 'path' starts at the Coolsingel (1). Here, the observer is enclosed from all sides by the dense urban grid. After crossing Blaak, the Coolsingel continues as the Schiedamsdijk (2). Here the axis opens up towards the docks of the Leuvehaven. When moving alongside the edge of the urban grid, the observer's view is directed towards the boats in the inner harbour.

The Schiedamsdijk leads to the Erasmus Bridge (3), where the urban grid completely opens up to grant the observer a panoramic view of the river Maas. After crossing the Maas and moving straight ahead, the observer reaches the Tillemakade (4). This axis is opened to one side, just like the Schiedamsdijk. In this case, the observer's view is directed towards the Rijnhaven. Moving along, the observer reaches the eastside of the next industrial harbour, the Maashaven, where the Maassilo is situated (5). Moving along the edge of the urban grid at the eastside of the Maashaven, the viewer's gaze is directed towards the harbour. A view that is dominated by the colossal appearance of the Maassilo. When the Maassilo is reached, the route dissolves in a system of crossing axes. When choosing to continue the path along the Brielselaan (6), the axis has the potential of providing the observer with a view on the Maashaven. In this particular case however, the view is hindered by a string of buildings, situated closely to the Maashaven. The Maassilo is one of these buildings.

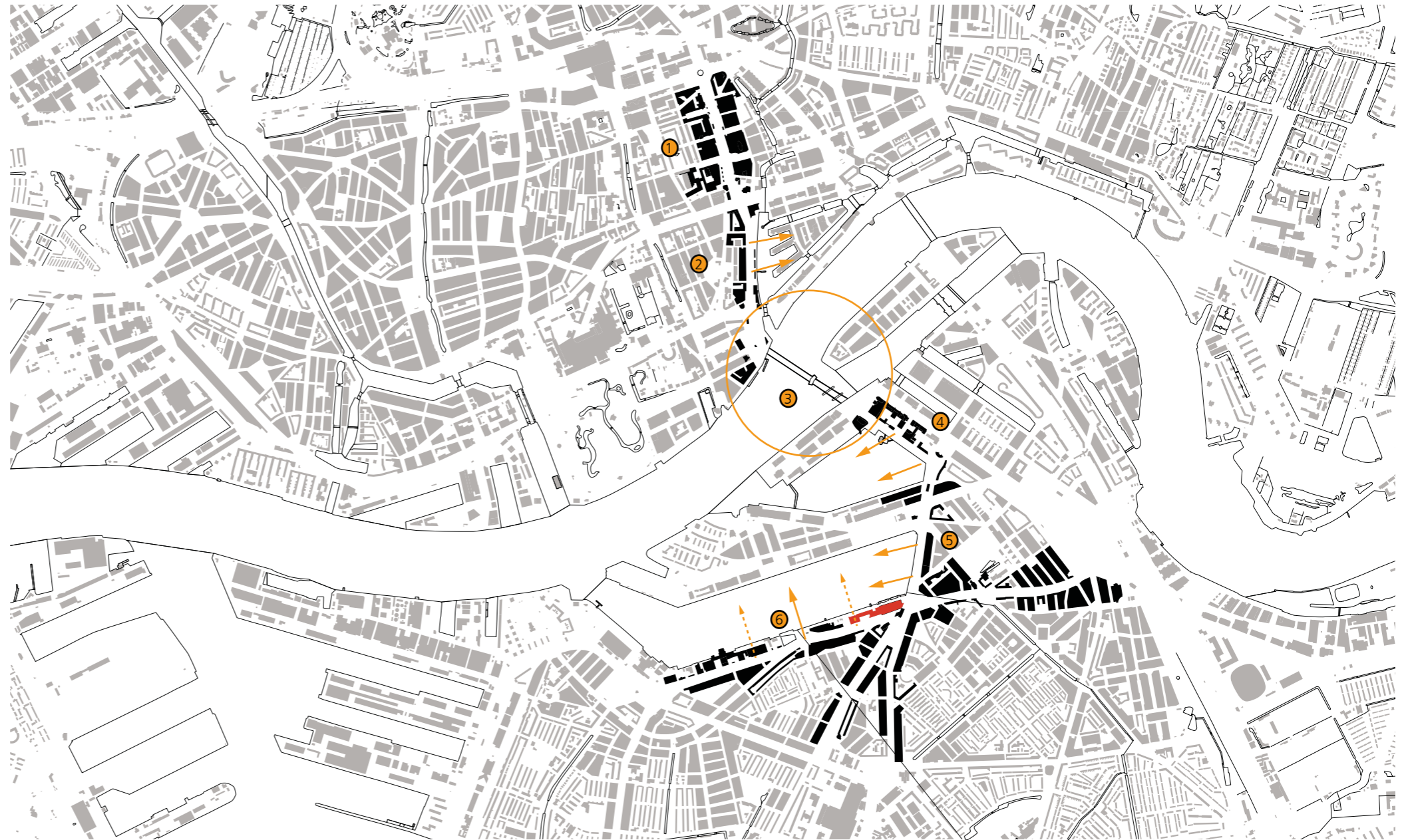

1. Coolsingel, enclosed axis



2. Schiedamsdijk, axis along edge



3. Erasmus Bridge, axis in open field



4. Tillemakade, axis along edge



5. Maashaven eastside, axis along edge



6. Brielselaan, hindered axis

URBAN CONFIGURATION

Directly connected to the creation of the Maashaven and defining its southern edge, the Graansilo acted as the generator of the southern working class neighborhoods of Tarwewijk and Bloemhof.

In this context, the building assumed a central pivotal role towards the city and harbour, also acting as a 'gate' between north and south.

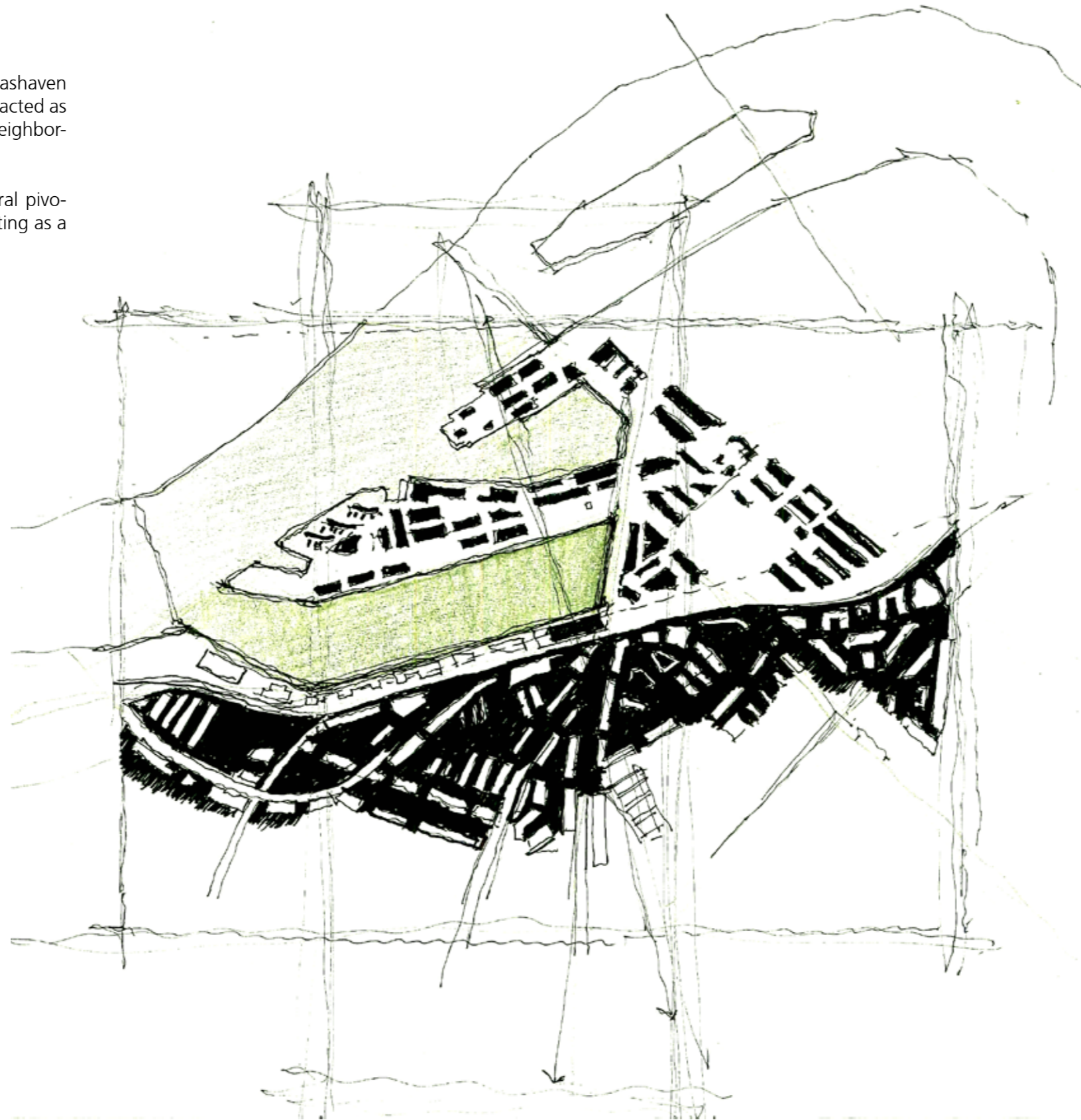

DISTRICT REFERENCES

The industrial development was so important in this south district of Rotterdam it really shaped the urban context. The importance of the specific industry (grain) is still found back now a days in the districts surrounding the site of the Maassilo as well in the street names of the surrounding districts which reflect what kind of goods were going through the Maashaven. This commemorative value just shows that the Maassilo holds alot of value for

the surrounding and the municipality of Rotterdam.

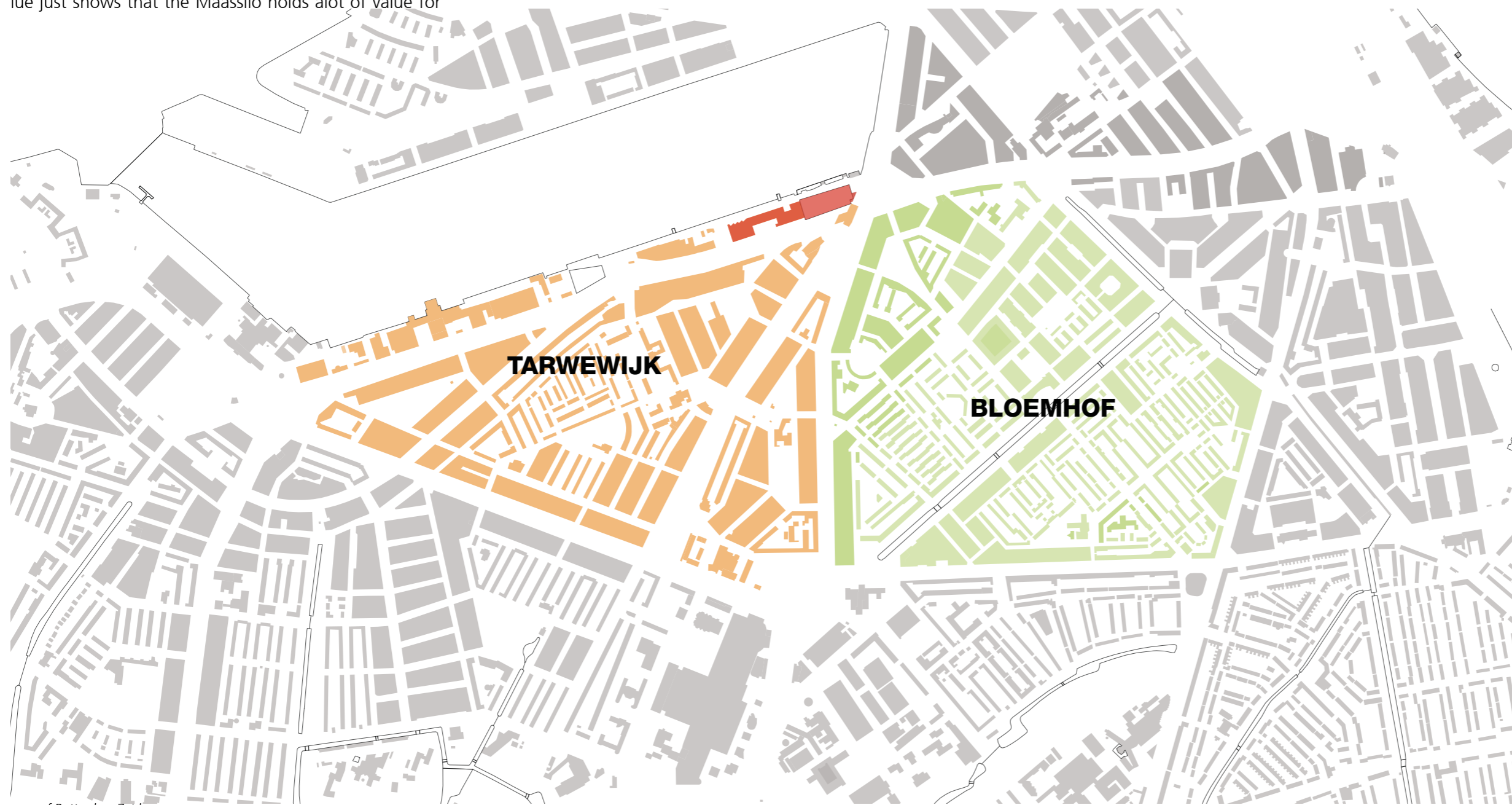

map of Rotterdam Zuid



streetname in the surrounding district (<https://www.google.nl/maps/@51.8933608,4.4855752,18.67z?hl=nl>)



streetname in the surrounding district (<https://www.google.nl/maps/@51.8933608,4.4855752,18.67z?hl=nl>)



streetname in the surrounding district (<https://www.google.nl/maps/@51.8933608,4.4855752,18.67z?hl=nl>)



streetname in the surrounding district (<https://www.google.nl/maps/@51.8933608,4.4855752,18.67z?hl=nl>)

RELATIONSHIP TO SURROUNDINGS

Being strictly defined by the arteries of Maashaven Oostzijde and Brielselaan and bordered by the railway, the building becomes clearly separated from

the eastern neighborhoods of Bloemhof and acts as a northern terminal (yet abstracted) for the southern district of Tarwewijk.

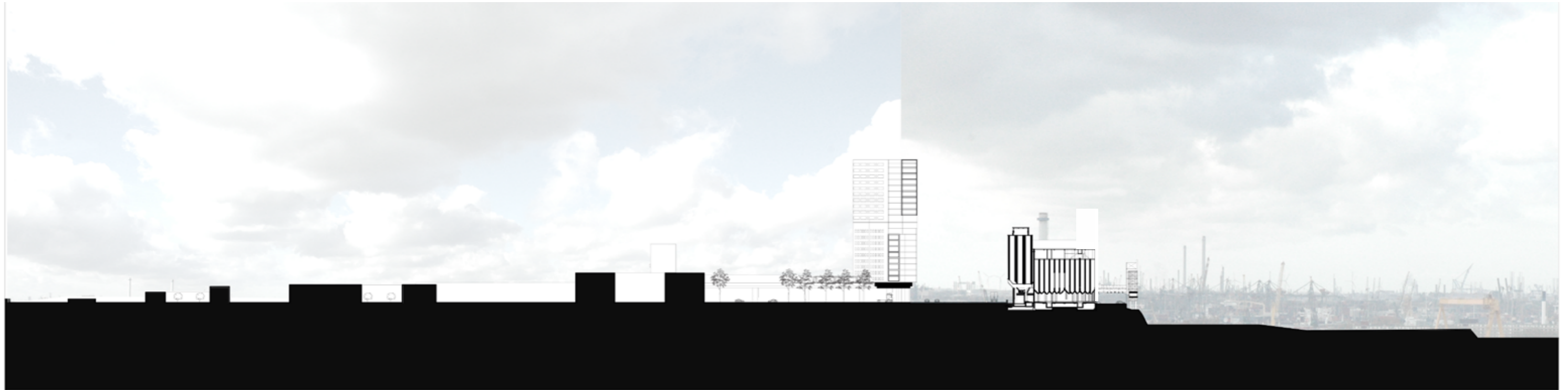

Sectional relationship with Tarwewijk



Maashaven Oostzijde and waterfront profile

S I T E

TRAFFIC

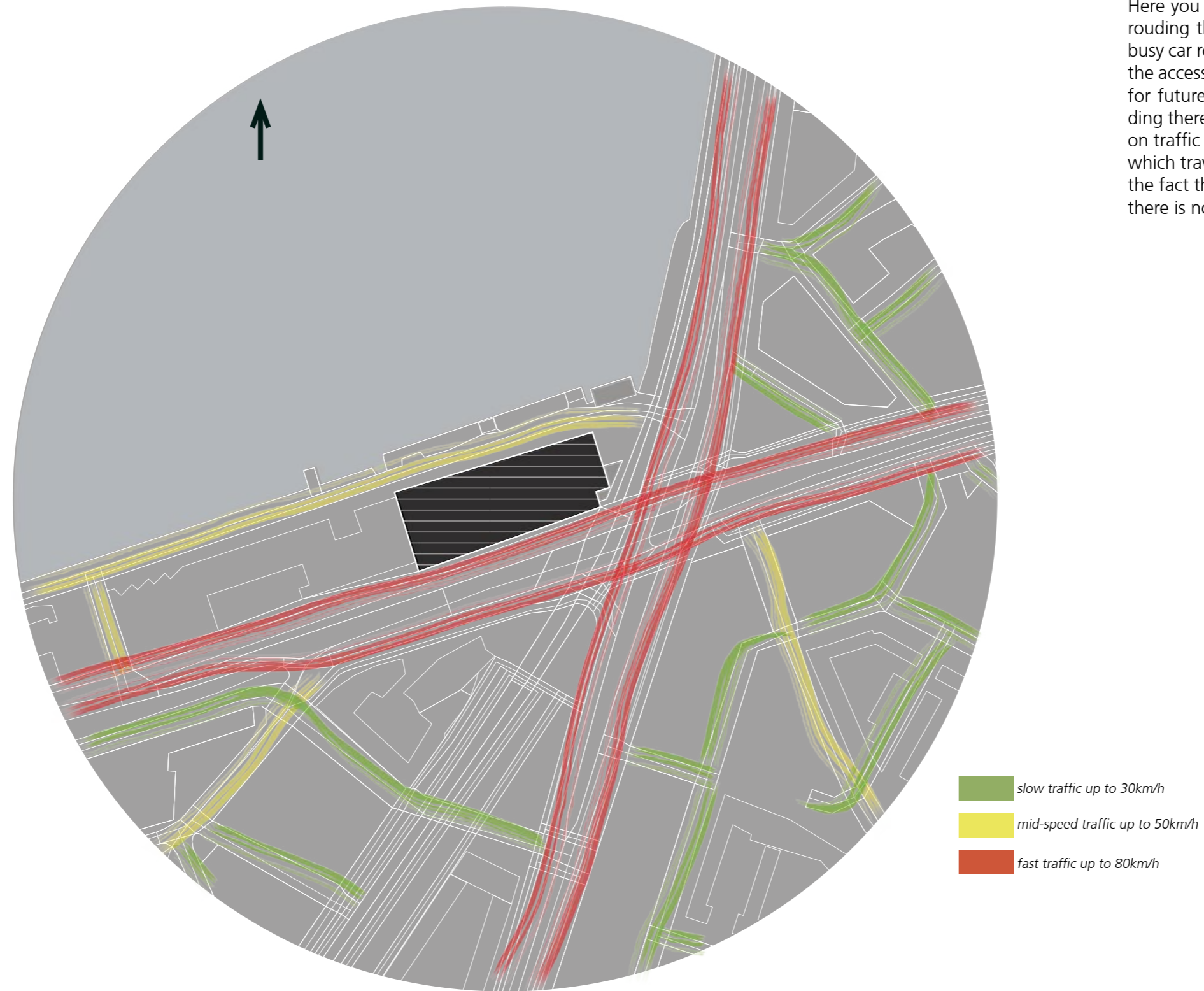

Here you can see the different speeds of the traffic surrounding the site. Next to the south facade there runs a busy car road in close proximity to facade, this could limit the accessibility of pedestrians and might be a challenge for future development. On the north side of the building there runs an industrial road only used for destination traffic and trucks. This less used road still has vehicles which travel faster than through an dwelling area due to the fact that there is no clear speed limit other than that there is no separation of different means of transport.

Shown here are the speed indication of the roads surrounding the Maassilo.

TRAFFIC



traffic flows at 9.00 AM (<https://www.google.nl/maps/place/Maassilo/@51.8980338,4.4927604,17z/data=!4m5!3m4!1s0x47c4337412c24c2b:0xf20fd330ec6548d4!8m2!3d51.8980338!4d4.4949491!5m1!1e1>)



traffic flows at 5.00 PM (<https://www.google.nl/maps/place/Maassilo/@51.8980338,4.4927604,17z/data=!4m5!3m4!1s0x47c4337412c24c2b:0xf20fd330ec6548d4!8m2!3d51.8980338!4d4.4949491!5m1!1e1>)

- normal pace
- slow pace
- no movement

Next to the site are multiple important traffic veins for the city of Rotterdam, especially for the connection between north and south as well as a connection towards the Maastunnel and the A13 highway. Shown on the left are the two busiest traffic times of the day on average most likely due to workers commute. The top image is 9 AM and the bottom image is 5 PM. What is clear in these two images is that on the south side of the building there seems to be problem with the traffic flow, maybe its due to the fact that it is only 1 lane for each traffic direction.

THE METROPOLITAN APPROACH

ELEVATION

The approach of the Maassilo by metro is essential to the experience of the building and its surroundings. The metro is the fastest way to reach the Maassilo from the city centre at the other side of the Maas.

After the metro emerges from the underground at the Rijnhaven, the metro passenger is presented with a dramatic view on the Maashaven, completely dominated by the concrete mass that is the Maassilo. The observer is literally elevated from daily life. The scale is one of urban giants. It is the scale of the mass (Maassilo) and the void (Maashaven), not that of the human. No people are visible on the docks, all is swallowed by the enormous scale. The Maashaven, once humming with activity, is abandoned.

When the metro station adjacent to the Maassilo is reached, the observer may walk to the end of the platform, in order to look back to the distant skyline of the Kop van Zuid. When entering the station, a glimpse is given on a completely different face of the building. It is here that the human scale is reintroduced to a certain extent. People are waiting for their tram on the platform, others walk their dogs and bikers go by.

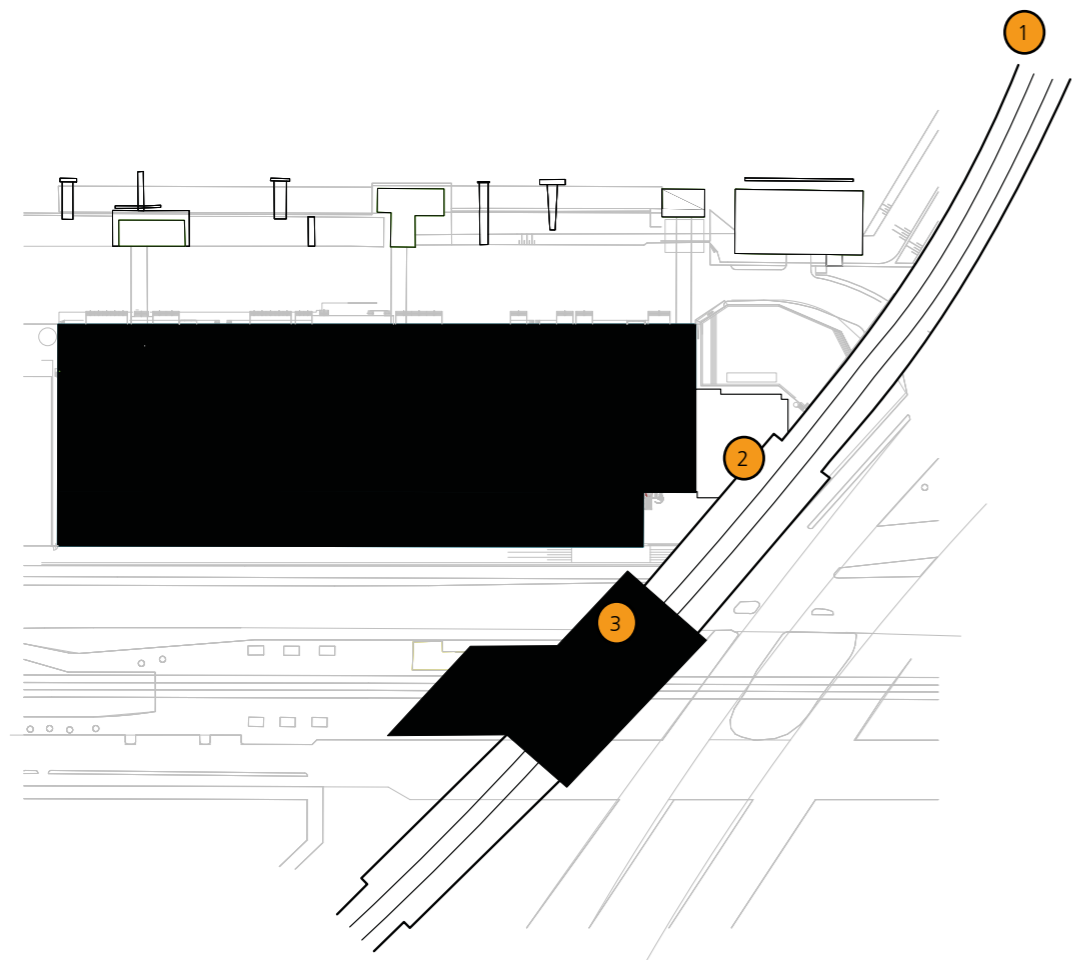

Maassilo and metrostation at level of metroline

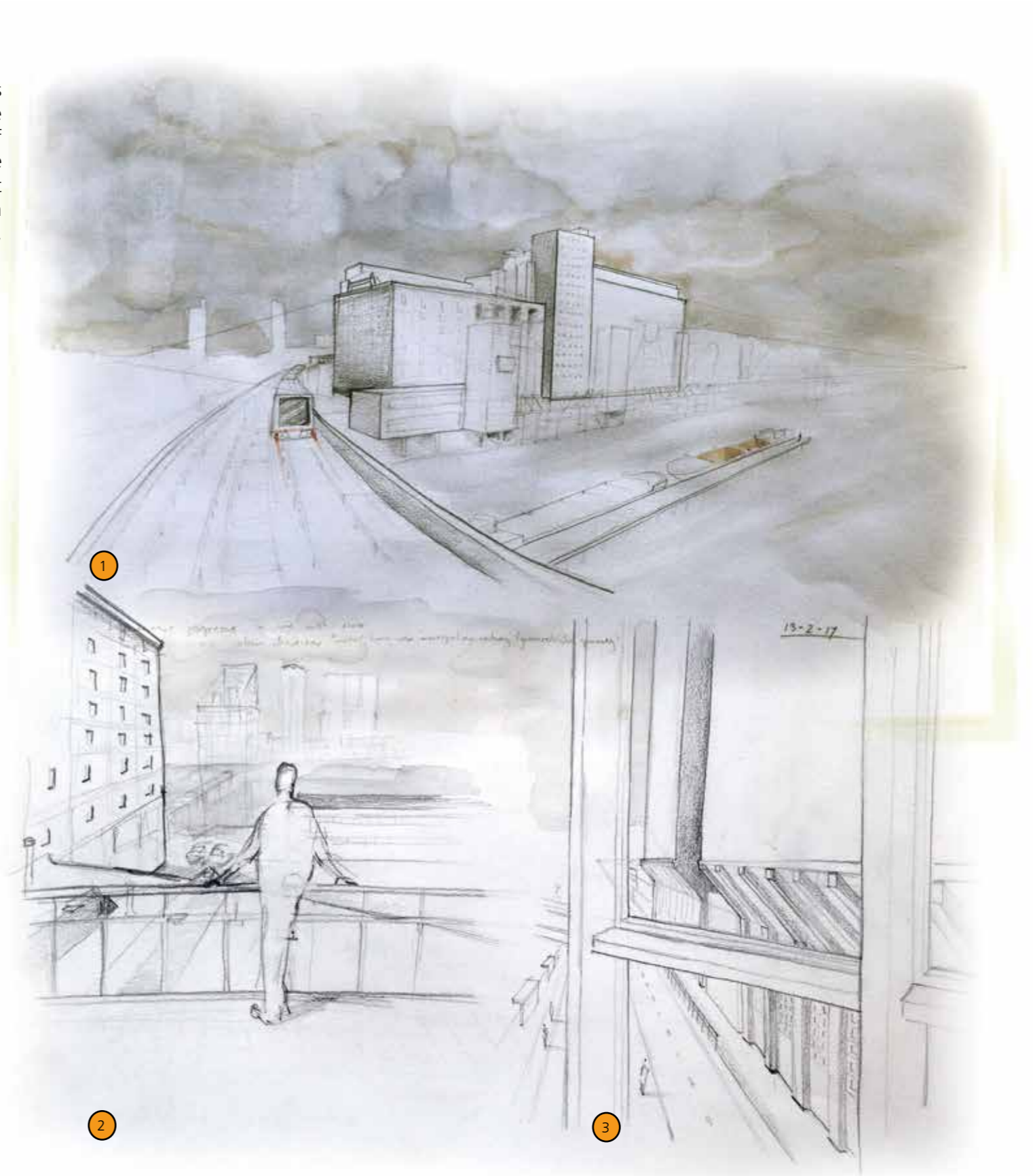

THE METROPOLITAN APPROACH

DESCENT

On ground level, the scale and complexity of things has changed completely. No longer is there a dominant scale to be perceived. The scale is here that of the buildings and the brutalist construction of the metroline, as well as that of the posters, of the streetlights, of emergency stairs. The observer's view is not directed; it is continuously distracted. Paradoxically, the Maassilo building perfectly adapts to this unreadability, since there is no clear entrance. It is only through remembering the place of the docks and the water, that the observers is drawn to the other side of the building. A somewhat awkward entrance emerges.

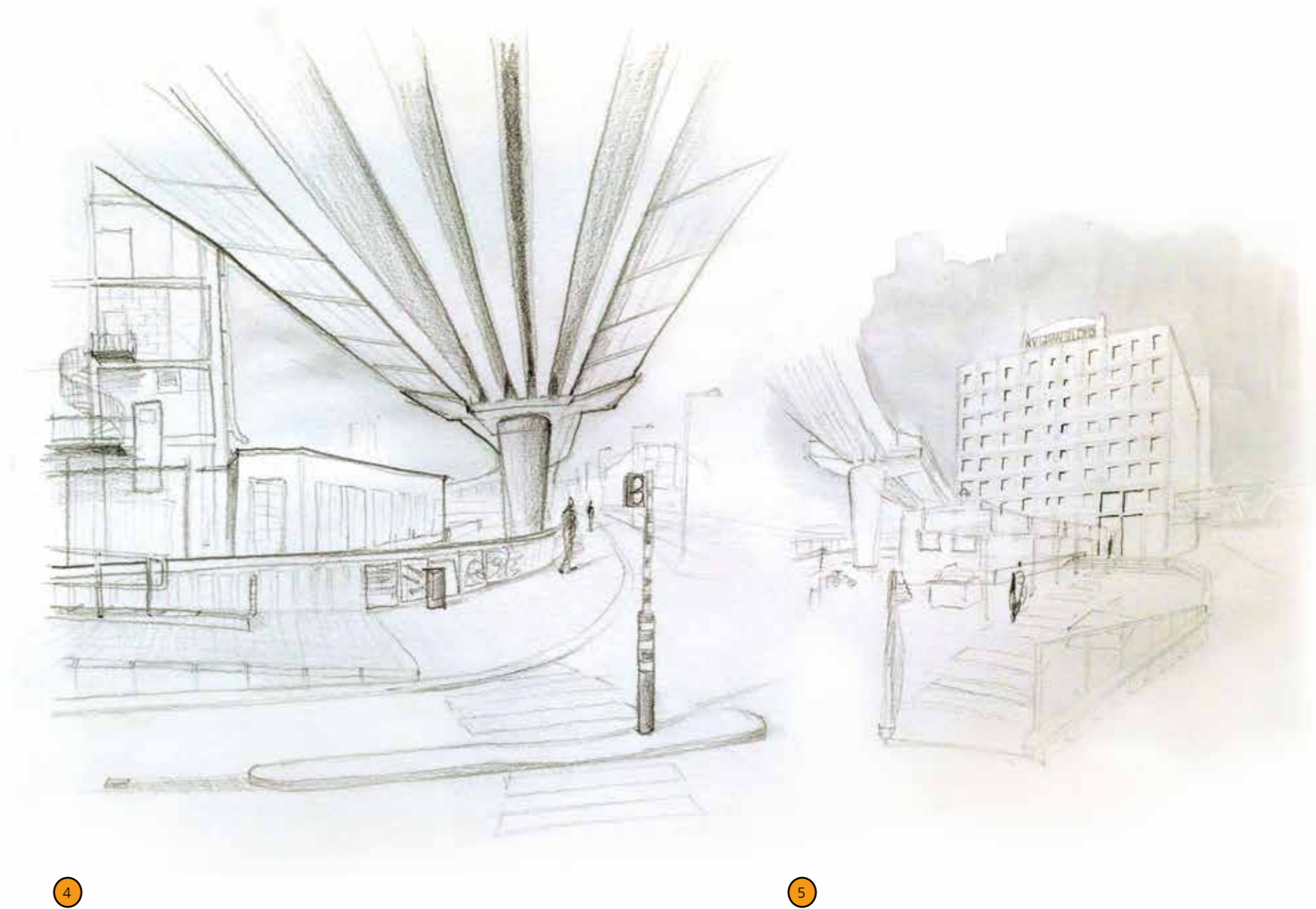
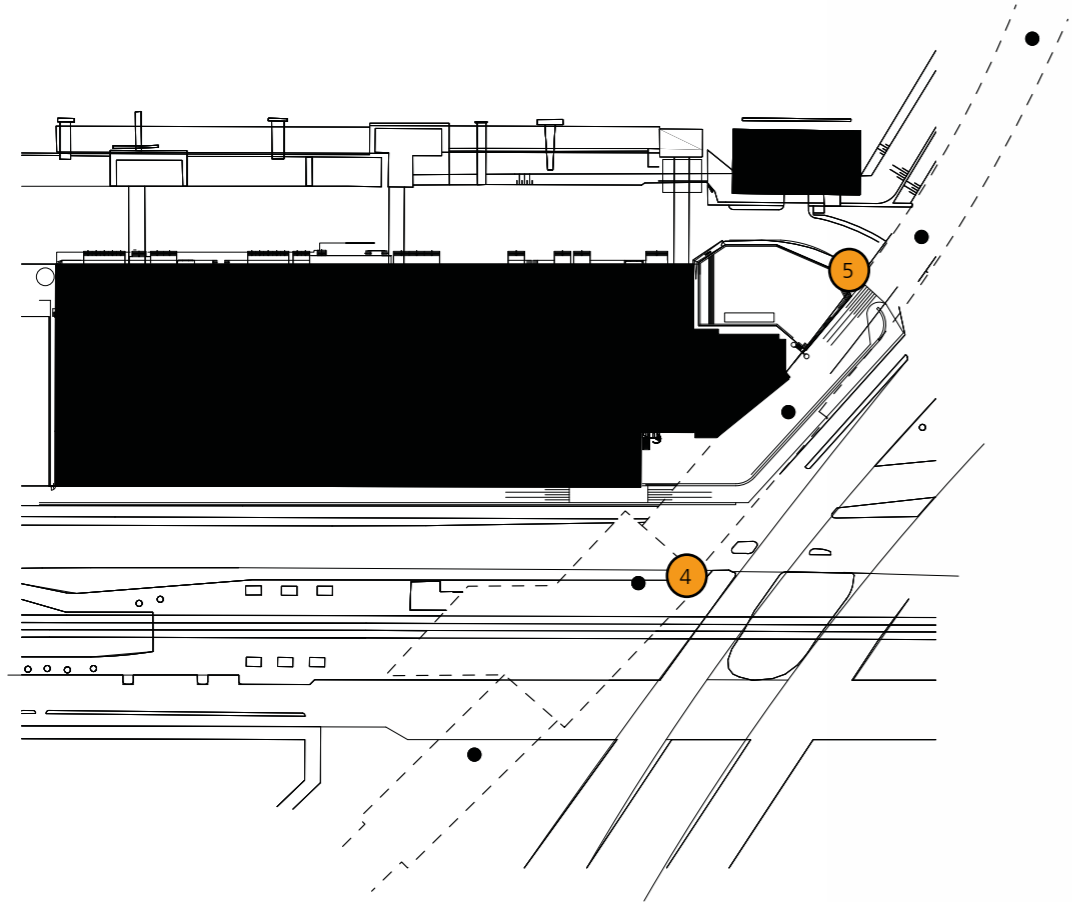

Maassilo and metrostation at ground level

TWO-FACED

The main linear layout of the building is closely related to its position towards the Maashaven and the former railways. The result is that the building has two long facades, each with a particular relation to the public space. The public space on the south side (left in the section above) has a strong linear character and is enclosed from both sides. The repetition of concrete columns in the facade enhances this linearity. In terms of scale, the building has an ambivalent relation to this public space. On the one hand, the human scale is introduced through the so-called "plofroosters", the concrete ornament tiles in the lower part of the facade. On the other hand, the division in two parts, mirrored in the high bridge in the middle, imposes a colossal scale.

The north side of the building is perhaps a more challenging public space, mainly because of the distance to the water. The space is narrow, certainly in relation to the height of the building, and is completely cast in shadow. The original elevator constructions block the view towards the Maashaven, and so the space is now used for parking. The facade does not have an articulated expression of the human scale as the south facade has. The result is that the building becomes inconceivable. Its totality disappears because of its swallowing scale in relation to the narrow public space.

Both facades have one thing in common, they completely conceal their interior. The relation between inside and outside is almost non-existent in the Maassilo, certainly in this section.

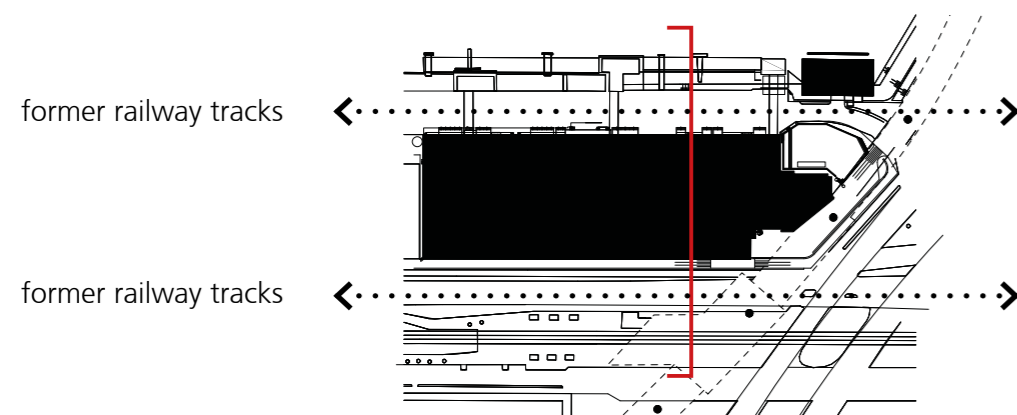

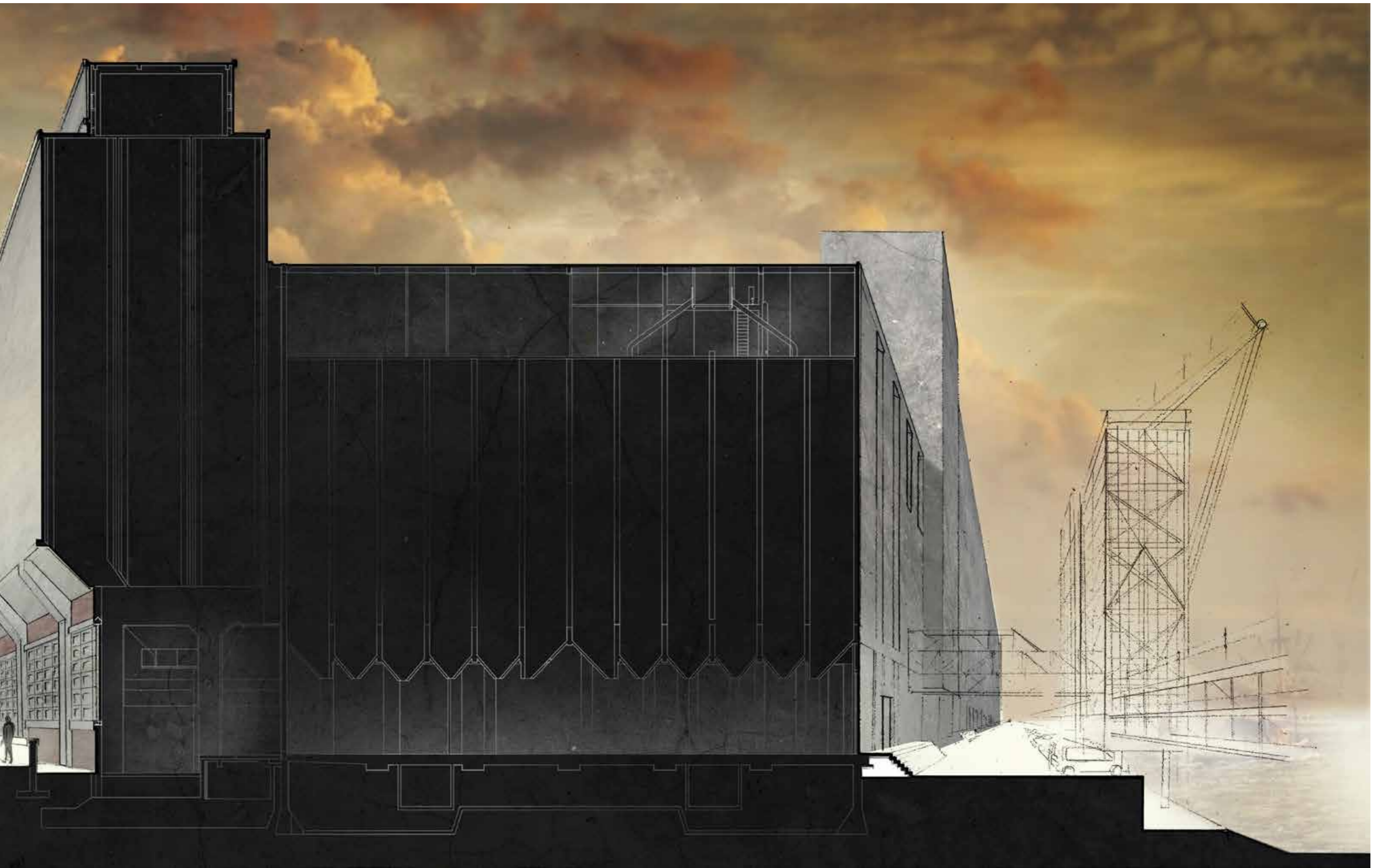

S P A T I A L C O M P O S I T I O N

CHRONOMAPPING

The following image should be read as a chronological map that explains the physical growth of the Maassilo as an accumulation of different buildings. The scheme is put into a time line that runs from left (past) to right (current). This time line highlights some of the major historical events of the last century and by this puts the evolution of the building into perspective.

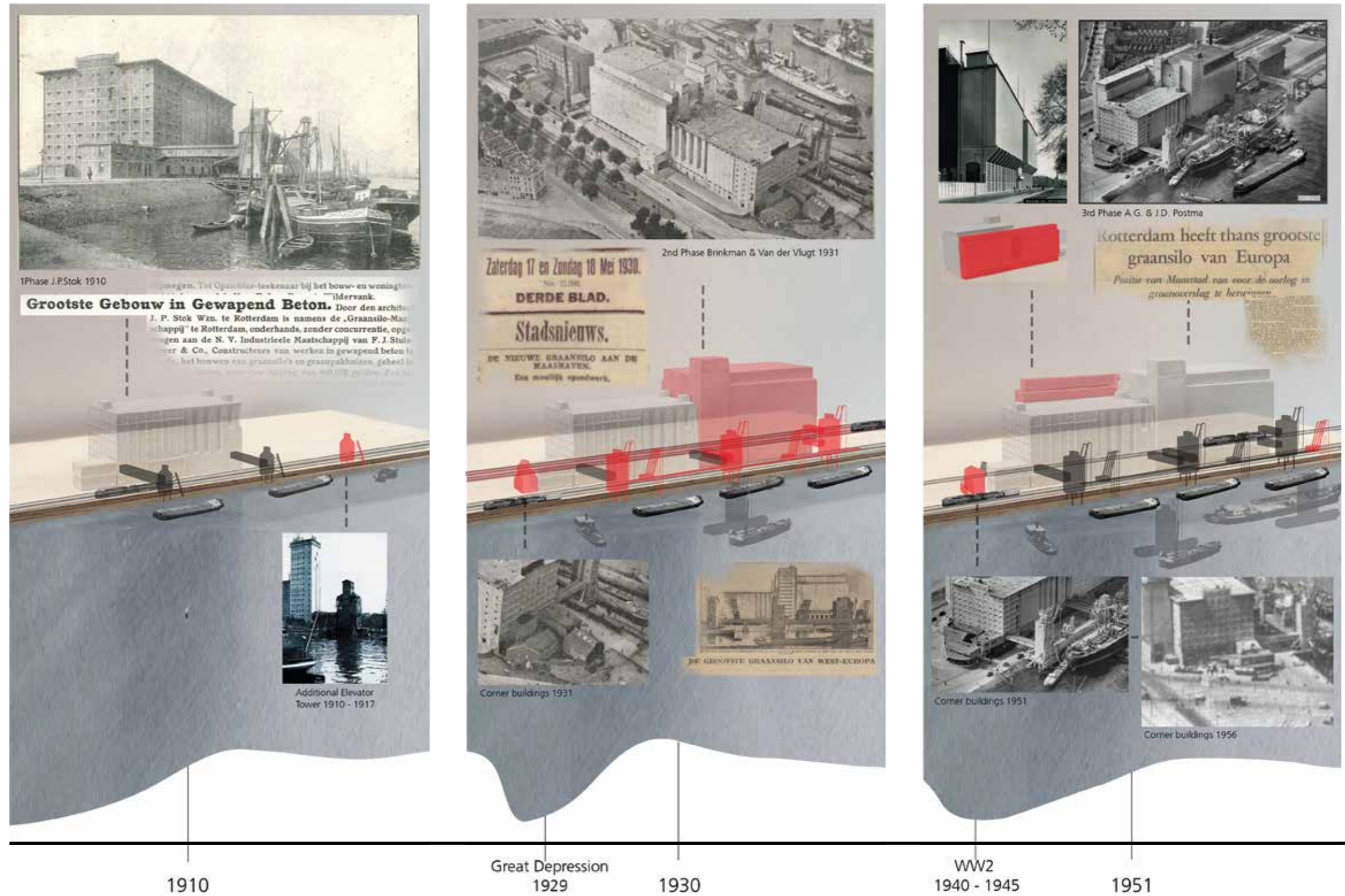

Sources:
 Transformers (2008), Cultural Value report
 Website: (2017) www.delpher.nl/kranten
 Brinkman, J.A. (1931) De Ingenieur
 J.Keijnemans (2004) Springend van bestaand naar nieuw, Cement
 Selfconstructed image

5th Phase Office Herman Haan 1963

Werkplaats Postma 1956

Extra elevator Postma 1958

Nieuw kantoor Graanelevator Maatschappij

ROTTERDAM, 20 okt. — De Graanelevator zal de nieuwe kantoorruimte van de Maatschappij 'Graanelevator' (GEM) aan de Bredastraat in Rotterdam.

De firma, naar het ontwerp van Herman Haan, is een der grootste aannemers in Rotterdam.

De Maatschappij 'Graanelevator' (GEM) zal de kantoorruimte van de Maatschappij 'Graanelevator' (GEM) aan de Bredastraat in Rotterdam.

De Maatschappij 'Graanelevator' (GEM) zal de kantoorruimte van de Maatschappij 'Graanelevator' (GEM) aan de Bredastraat in Rotterdam.

1963

Oil storage 1963 - 1971 (foto taken 1971)

GRAAN ELEVATOR MAATSCHAPPIJ IN HET NAUW

NRC HANDELSBLAD

Company shrinks 1983 NRC HANDELSBLAD

Office groundfloor after renovations (dwelling to office)

Office 1st floor original

1971

Groundfloor removing and adding columns and fortifying floor for Now & Wow 2004

10th floor party 010 factory 2008

Danceclub Now & Wow, door publiek en pers uitgeroepen tot de beste club van Nederland

Creative-Factory new main entrance 2008

Global Financial Depression 2007 - 2008 2008

AN EMPTY STAGE



Maassilo in the midst of former activity

It is said that in the mid-twentieth century one could walk from Katendrecht to the Maassilo over the boats in the Maashaven. The harbour used to hum with activity, and the Maassilo has always functioned as a static colossal mass in the midst of this activity. Together with the Maashaven, it formed the stage on which the boats, the grain elevators and the workers were the actors. In the current situation however, all this activity has vanished. The Maassilo remains as an empty stage. The elevator towers, once used to connect the static building to its vibrant surroundings, are the only remaining elements that refer directly to the industrial activity in the harbour.

The question should be raised if the current stage should be regarded as the absence of a scene. It could also be stated that the absence of industrial activity itself forms a new scenic presence.

source: <https://www.youtube.com/watch?v=8hROr2RkTpM>



Maassilo as an empty stage

FLOW

On the pictures on this page, the movement of grain and workers through the building is made visible per building phase. In the first phase, the grain was transported into the building using mostly the west grain elevator. Two

elevators transported the grain to the attic, where the grain was distributed among the silos. In the east part of the building the grain was weighed and cleaned. The former entrance was located at the north facade.

This entrance is not present anymore. In the second building phase, the horizontal transport was connected to the first phase, so the building worked as a whole. In the machine tower, machines were placed to weigh,

filter and dehumidify the grain. An extra entrance with a rounded wall was added, an interesting detail that is not present anymore. In the third phase, two extra silo clusters were added.

Grain flow phase 1 (1910)

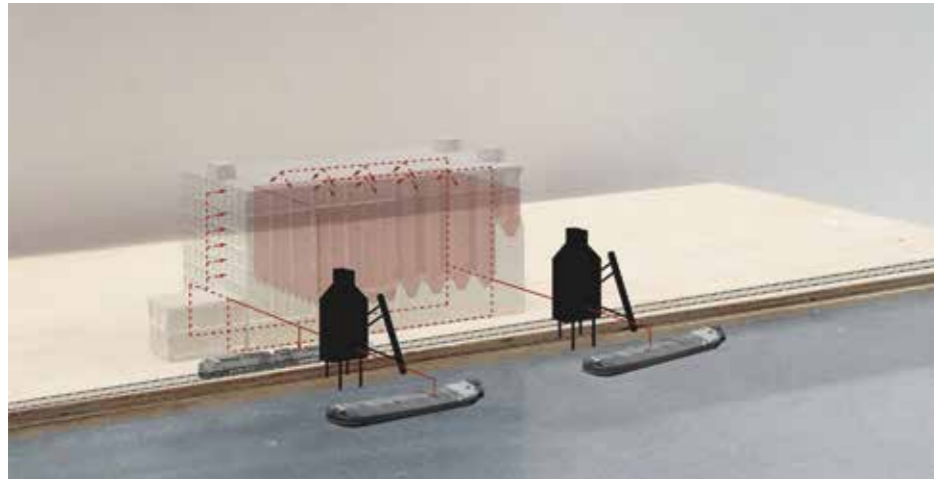

Grain flow phase 2 (1931)

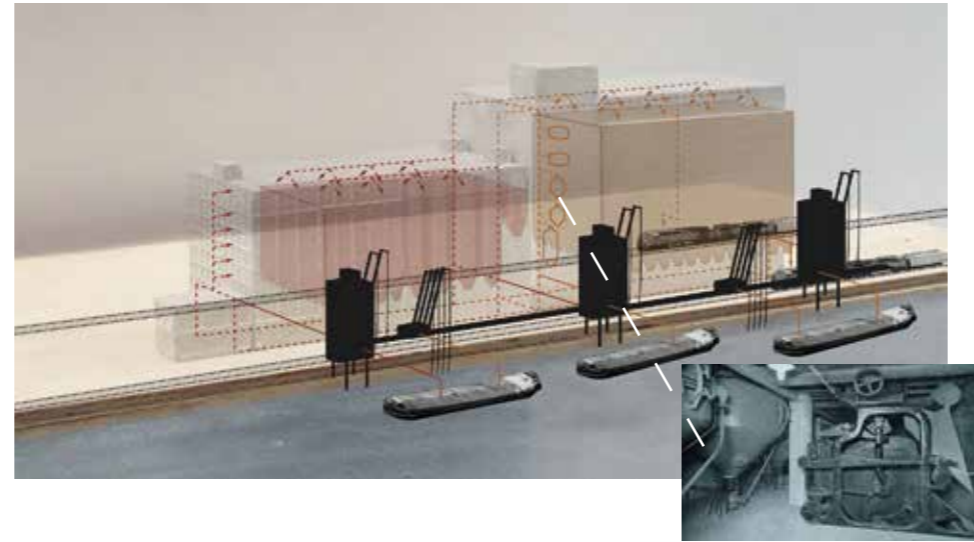

dehumidifiers and automatic weighing scale in the machine tower

Grain flow phase 3 (1951)

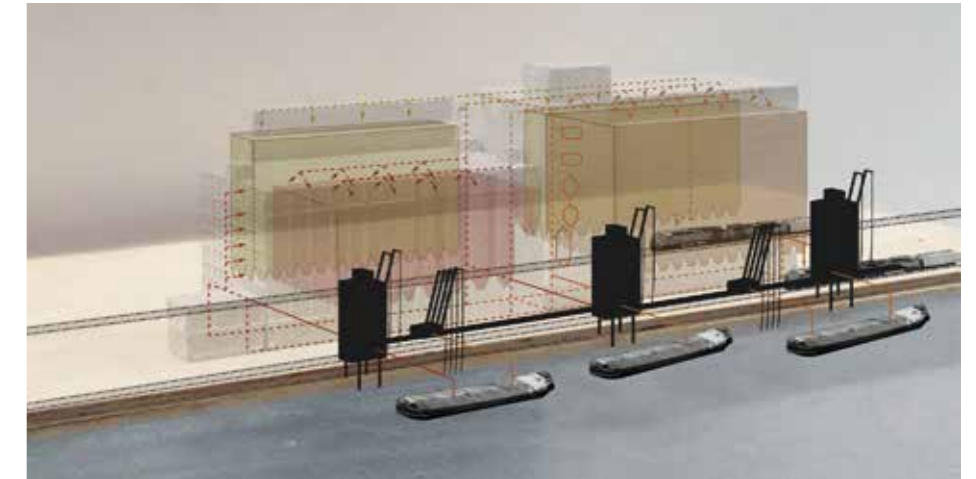

Workers flow phase 1 (1910)



former entrance in the first building part

Workers flow phase 2 (1931)

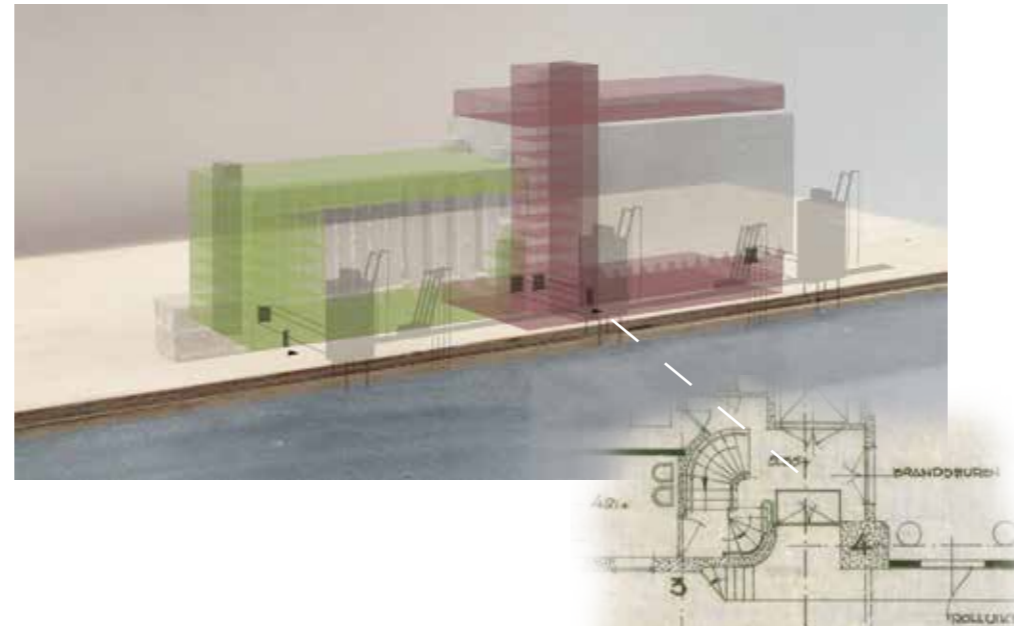

former entrance in the second building part

Workers flow phase 3 (1951)

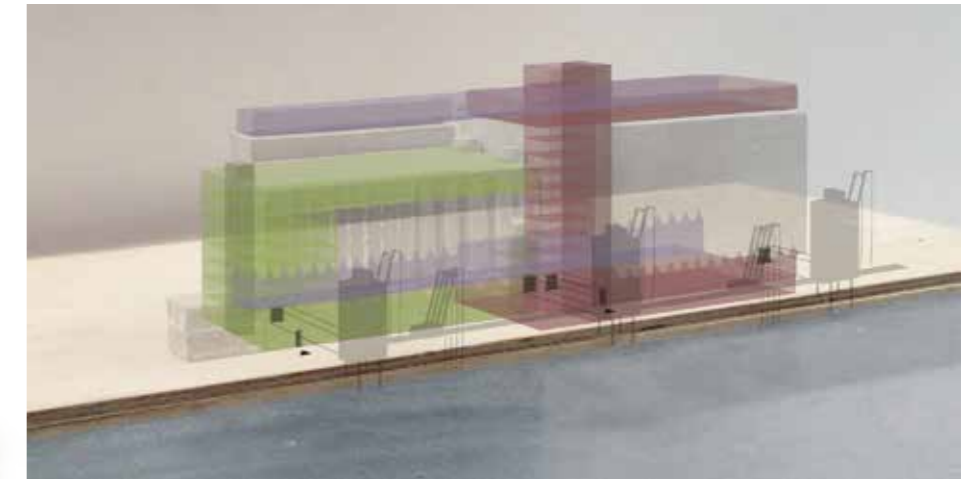

BUILDING FUNCTIONS

The functions within the Maassilo are pretty much all build up the same way in each phase. The basement and groundfloor of the buildings are used to transport grain horizontally as well as allow workers to move about and have access to the funnels, machines and train tracks. The middle 'floors' of the building or in the case of the Maassilo the silo's take up the most space in the building. The top floor of each building phase gives room to distribute grain to the silo's and also for workers to adjust the grain pipes and have access to the machines. As for the two vertical exceptions, they are used as rising cores for the workers as well as storage and other activities such as washing grain. The office and former dwelling were situated over the water due to the lack of space on the site.

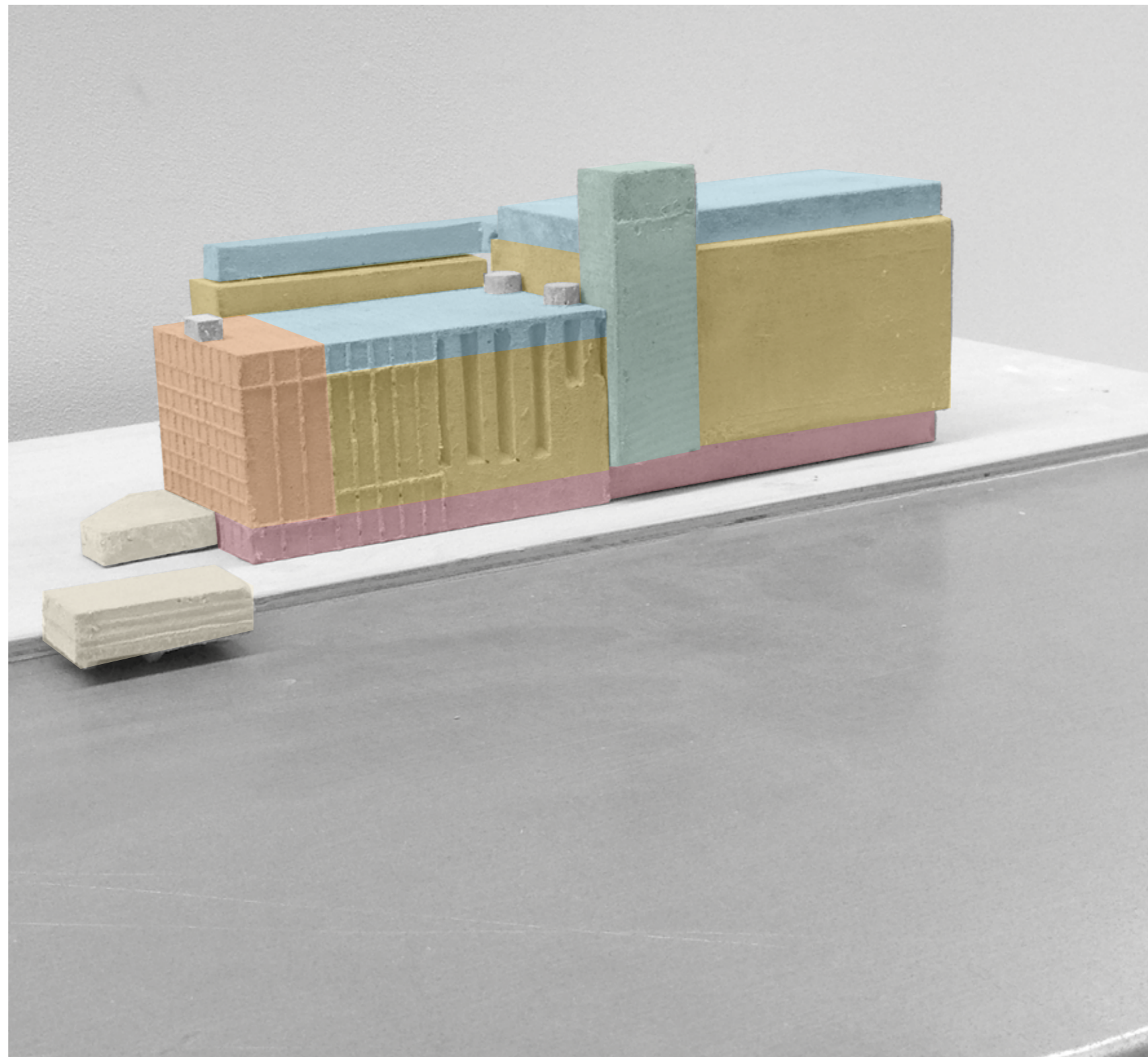

North-East birdview

COMPOSITION OF THE NORTH FACADE

There is a clear change from left to right, the vertical elements are slowly decreasing and stop at the tower, followed by a giant horizontal mass which really shows the ensemble working as a whole entity but still being separate design phases. Stok really wanted to show the elements which were inside the building as seen in the facade the vertical lines which represent the silo's can be seen through the whole facade of phase 1. Phase 2 from Brinkman shows no sign of what might be present on the inside of the building and because of this shows a wide horizontal surface which really diverse in orientation compared to the first facade.

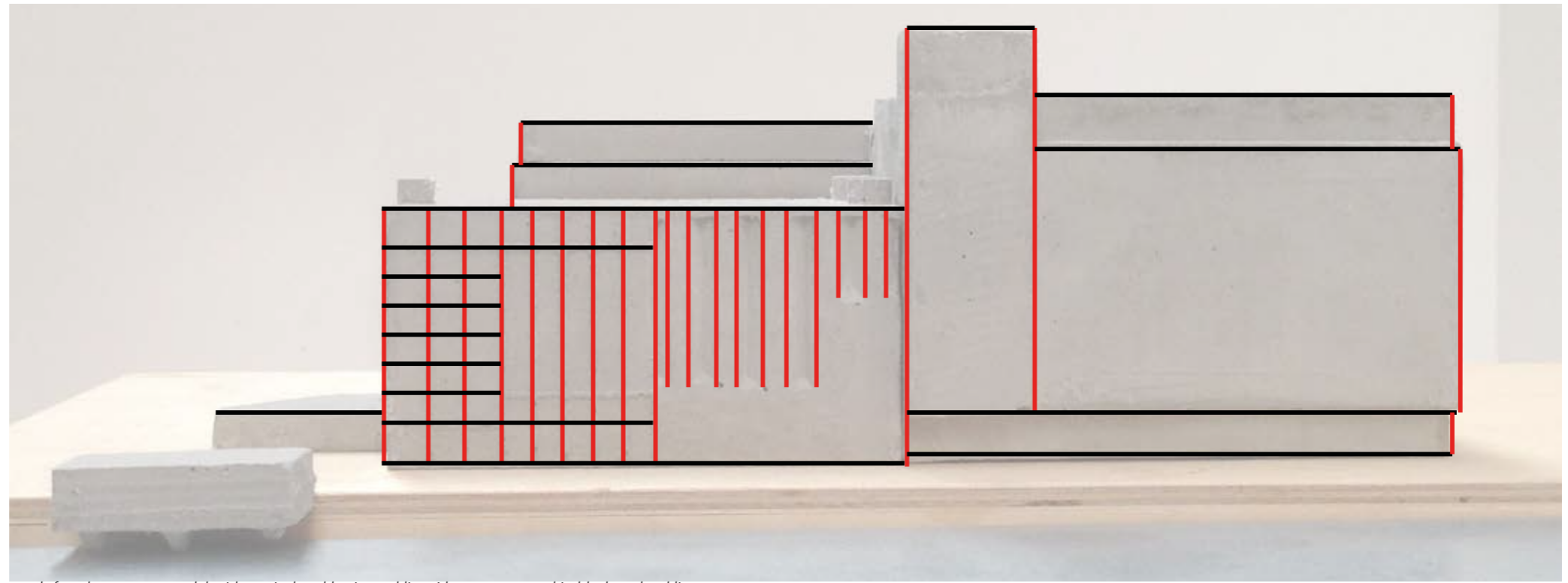

north facade concrete model with vertical and horizontal lines/shapes expressed in black and red lines

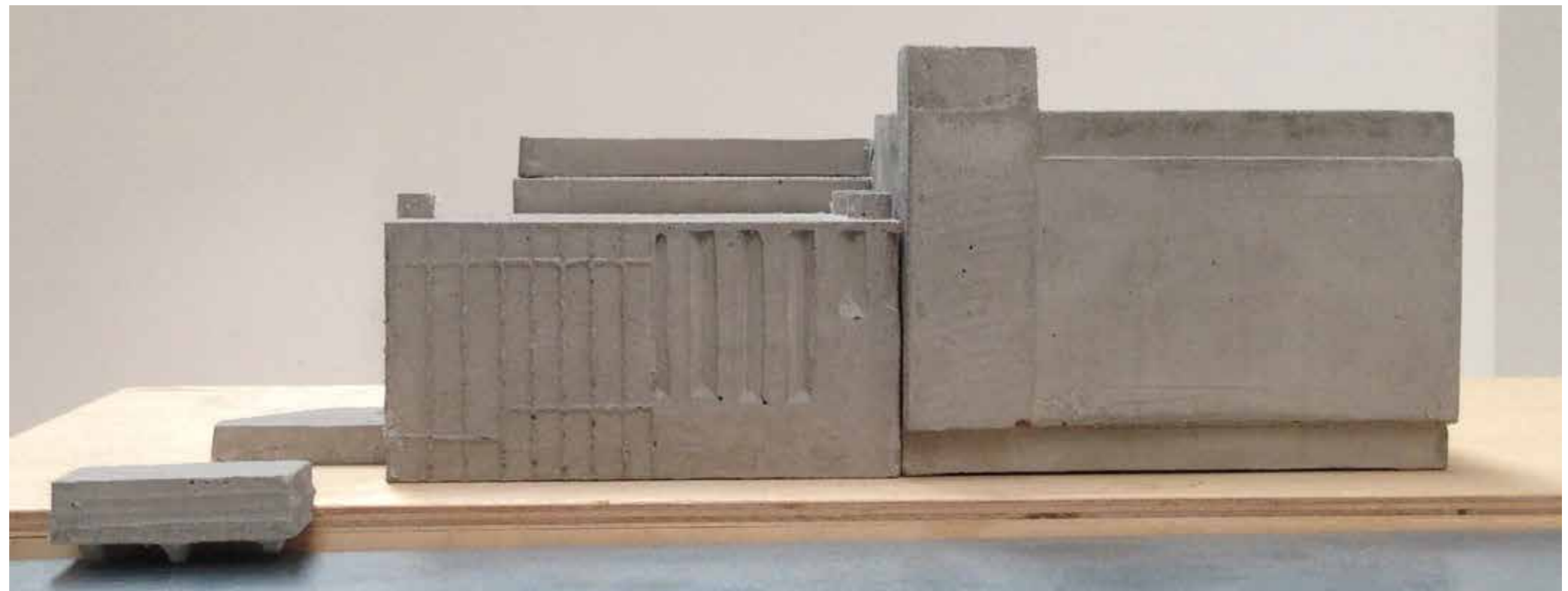

north facade concrete model

SYMMETRY

Symmetry is something that is present in all the building phases of the Maassilo. But the third phase by Postma is more meaningful in its symmetry than the other phases. Where as in phase one and two there are certainly elements that show symmetry like the grid in the facade of Stok or the giant surface of Brinkman in the south facade. The ensemble of these two phases is not really symmetrical anymore, than comes Postma which puts his third phase in front of both south facades with a structure and mass that shows rhythm and alot of symmetry. By emphasizing the hole between the two masses it really feels like a repetition of two and the same facade. The smooth surfaces also make it easier to see symmetry, rather than making alot of texture and depth in the facades. So Postma tries to combine the ensemble on the southside by creating a homogenous south facade for the whole building.

Later on the symmetry was destroyed a little when Lisa Lux made a wall painting on the left side of the facade creating a disbalance and difference between the two parts.

south facade

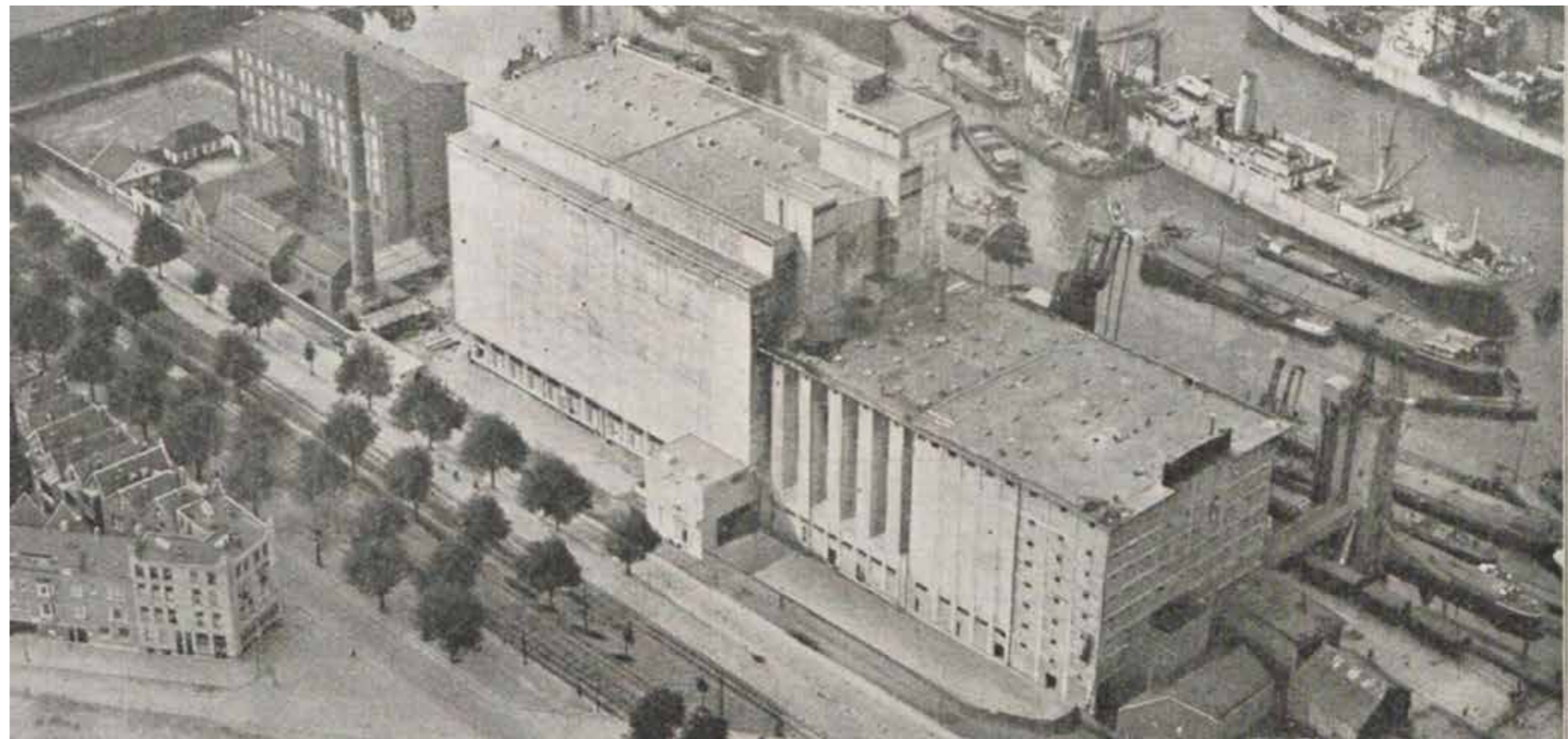
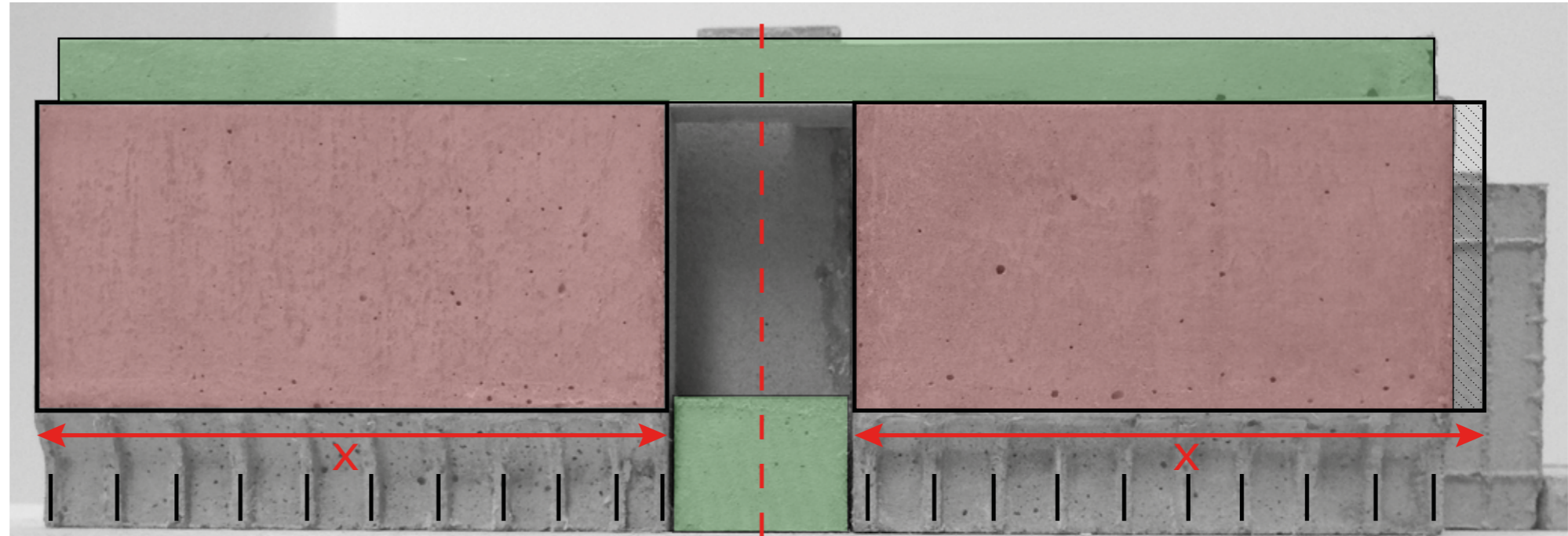

south facades phase 1 & 2 (1931 de Ingenieur)



south facade left part with the Art work of Lisa Lux

S K I N

HIDDEN FACADES

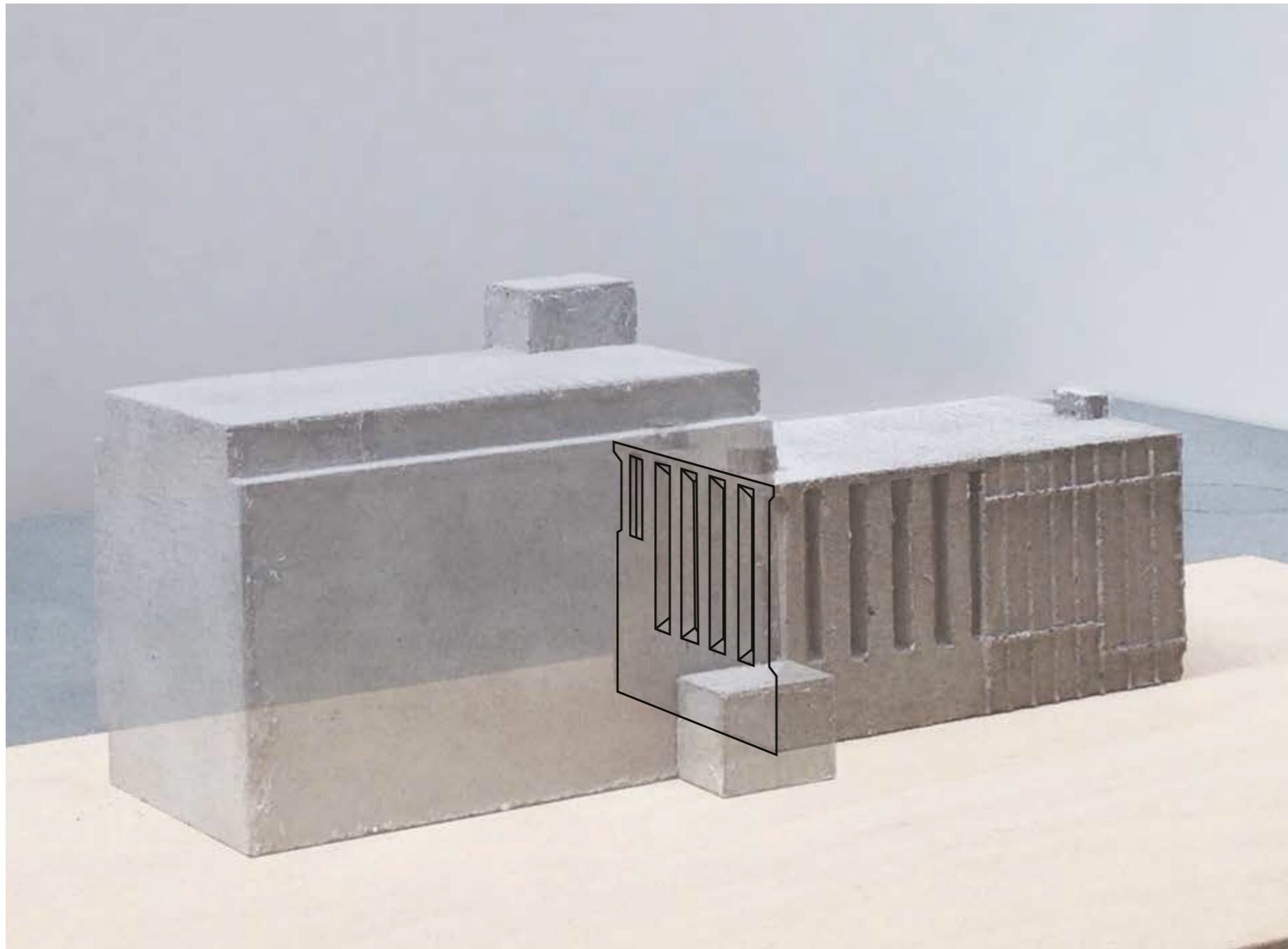

Phase two of the Maassilo by Brinkman is directly build against the western facade of Phase one from Stok. This facade of phase one is rather unique as it shows signs in the facade which clear up certain questions about a shorter silo in phase 1. In the north facade the same silo

pattern can be found as on the western and south facade, but on the left side of the western facade you can clearly see a shorter silo pattern being present which is also visible in the north facade. But without the context of the western facade it would have been very hard to

determin wether or not the shorter pattern in the north facade was just an anomaly. Thus making it very valuable as to telling a story about the internal workings of building phase one.

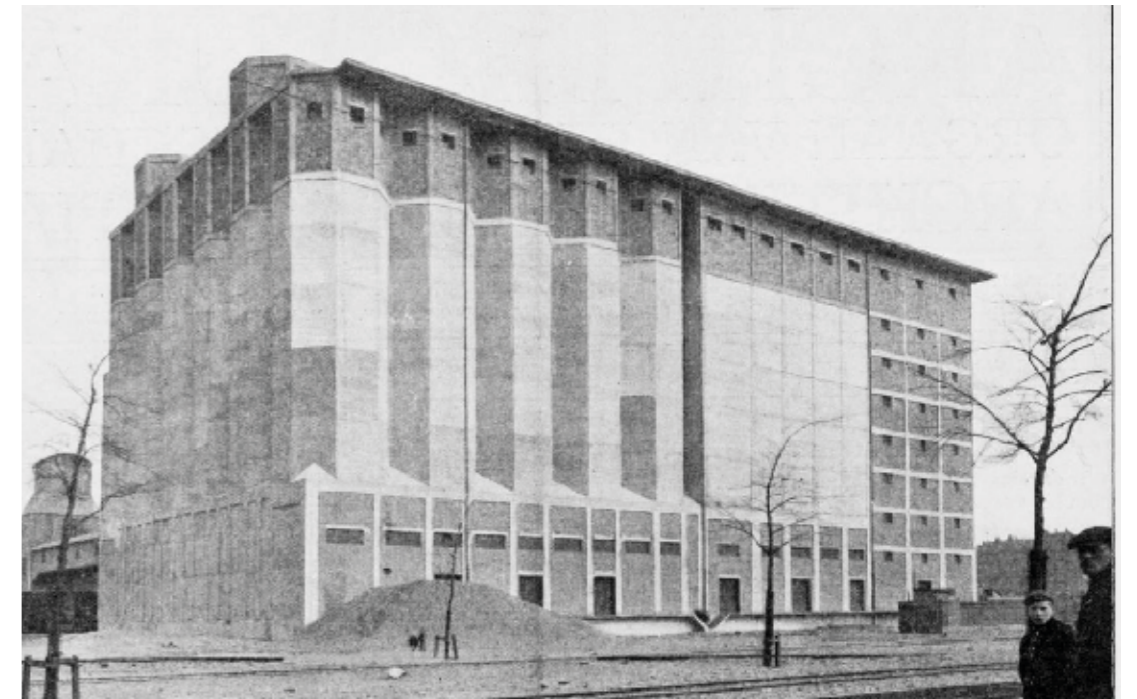

south facade phase 1 (architectura pages. 240)

south facades phase 1 & 2 (1931 de Ingenieur)



HIDDEN FACADES



The south facades of the first and second phase have been hidden due to the third phase being directly built against them. The facades of the Stok part which are now hidden show the same facade elements as the north facade of the Stok part, it is a shame that those

beautiful silo imprints in the facade are lost. But it also is part of the character of the building itself hiding a lot of mysteries within for those who have only witnessed the buildings exterior.



construction of phase 3 against the south facade of phase 1 & 2 (Cultural value report pages 74. Transformers)

LOST FAÇADE OPENINGS

PHASE 1: J.P. STOK WZN. 1910

The following pages show per phase where in the buildings the façade openings got lost and filled up over

time. This resulted in less and less natural daylight being able to enter the building when the Maassilo continued

to develop. In the current situation there are hardly any windows left.

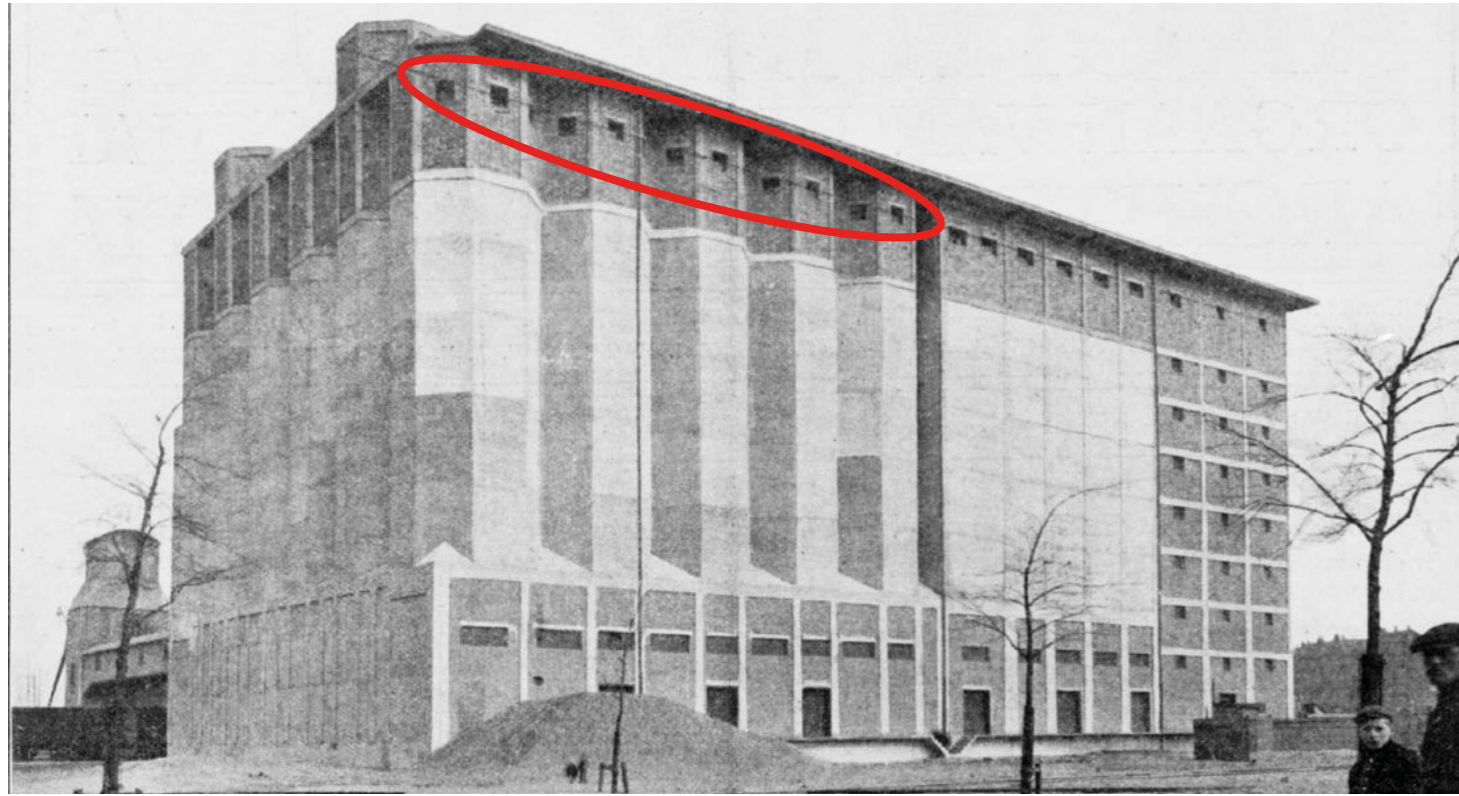

The grainsilo as seen from the Brielseaan (Baanders, H.A.J. (1912) Architectura. Gebroeders Binger: Amsterdam)
Original - exterior: square windows in ell attic above octagonal silos on the seventh floor, situated in multiple walls with three different orientations.

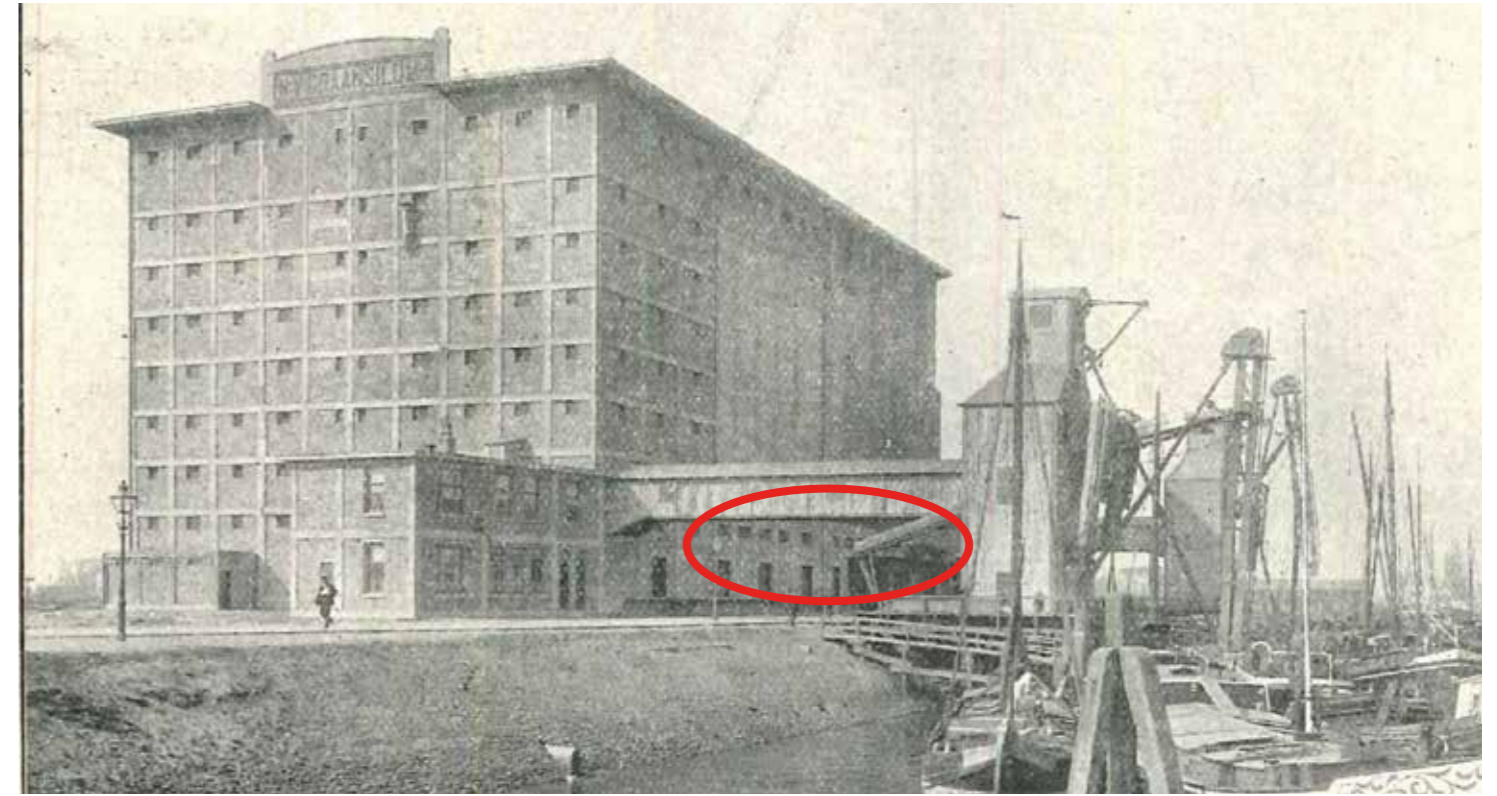

The grainsilo as seen from the Maashaven O.Z. ('Gewapend beton en bouwkunst' (1912) Bouwkundig Weekblad)
Original - exterior: rectangular windows placed high up in the façade of the ground floor.



Current - exterior
Former façade openings have been filled up with concrete.



Current - interior
Former façade openings have been filled up with concrete.



Current - exterior
Former façade openings have been filled up with concrete.



Current - interior
Original windowframes remain visible in front of / on the surface of new concrete filling.



LOST FAÇADE OPENINGS

PHASE 2: BRINKMAN & VAN DER VLUGT 1930

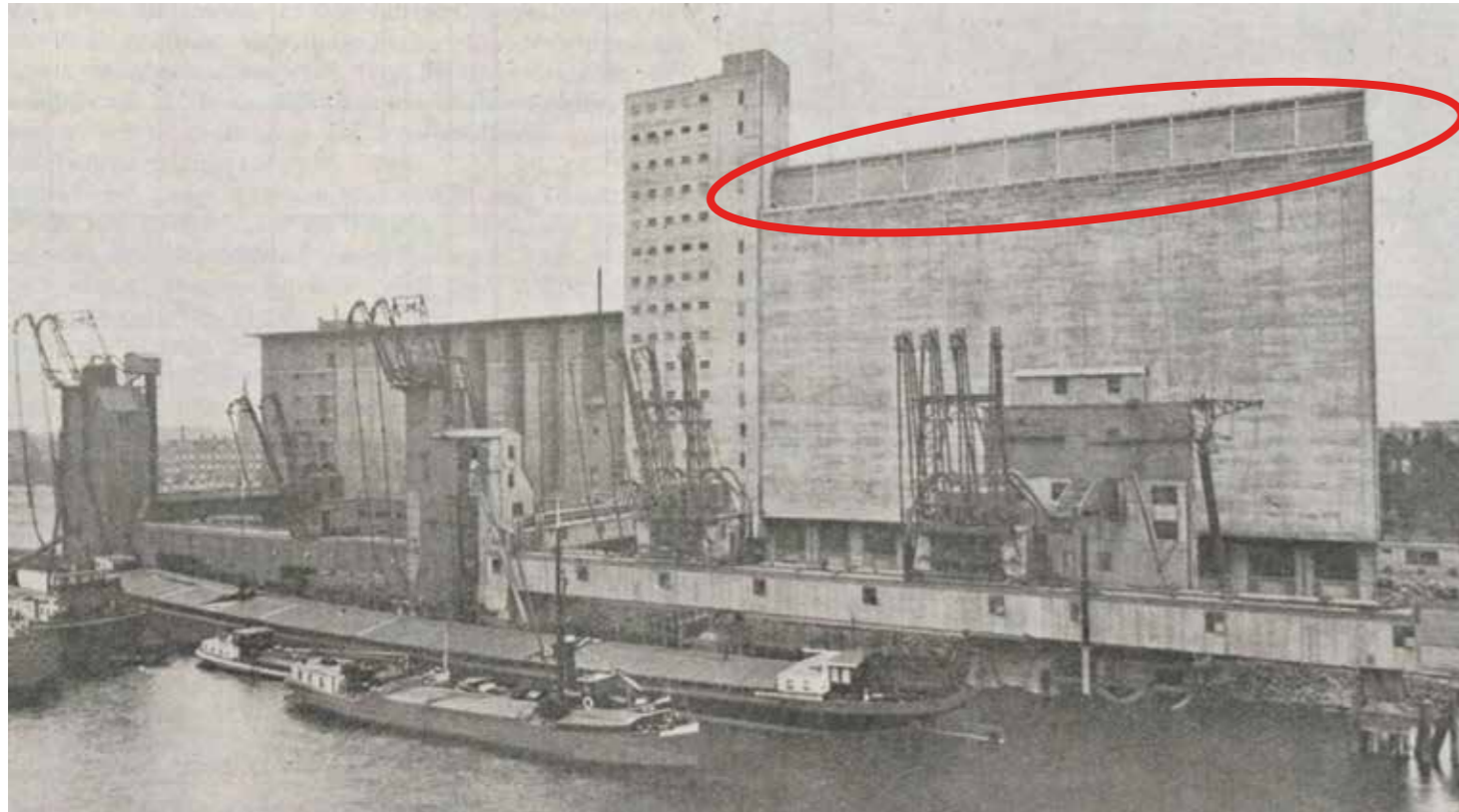

The grainsilo as seen from the Maashaven. (Brinkman, J.A. (1931) De Ingenieur; B. Bouw- en Waterbouwkunde, 32.)

Original - exterior: long horizontal window strips on the top floors of phase 2, similar on the back façade on the Brielselaan.

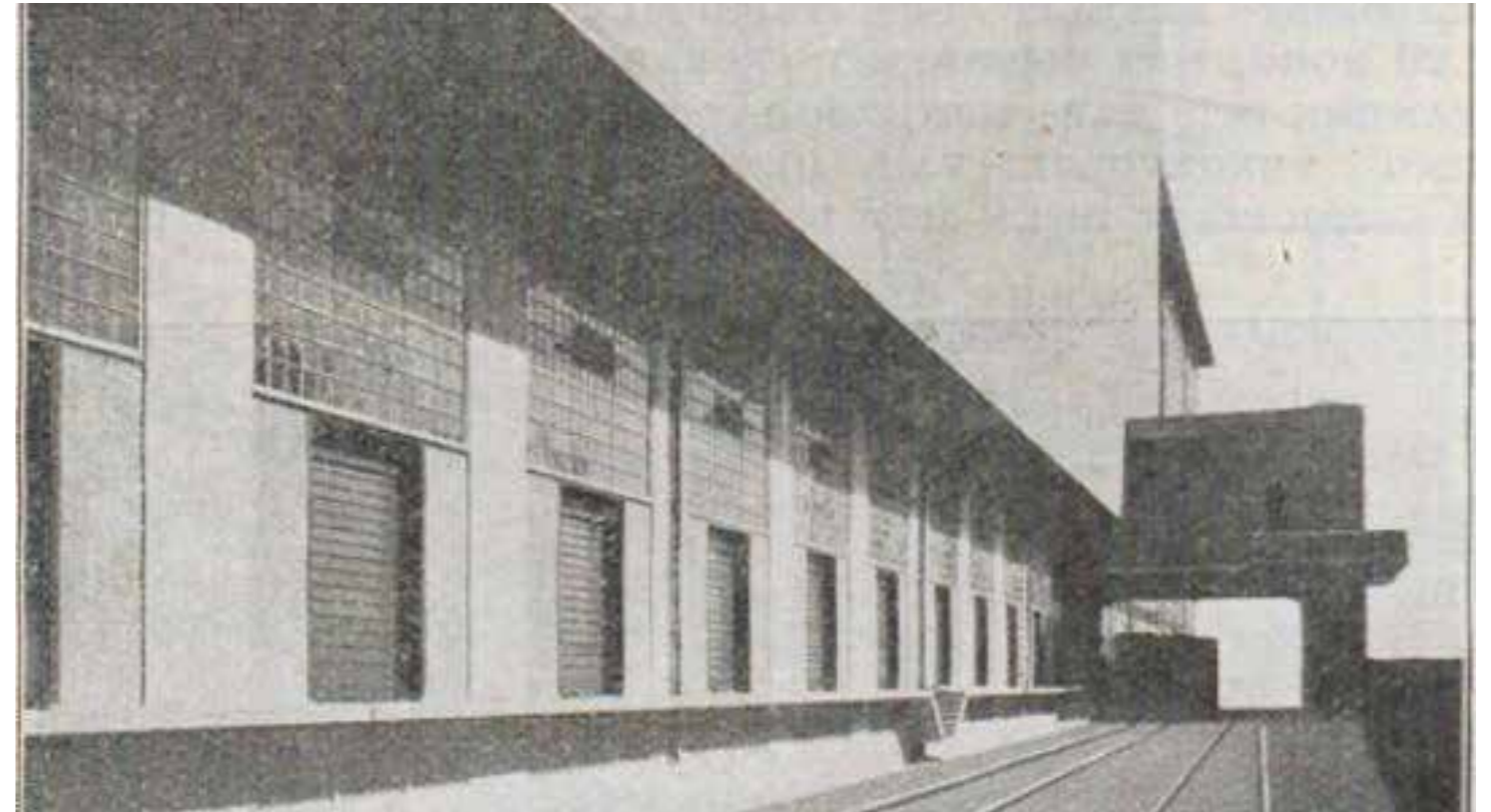

Façade of phase 2, Brielselaan. (Brinkman, J.A. (1931) De Ingenieur; B. Bouw- en Waterbouwkunde, 32.)

Original - exterior: rolling shutters with large windows, divided by mountins in small glass panes.



Current - exterior
The top row of horizontal window strips is closed off on both the Maashaven side and Brielselaan.



Current - interior
Space behind former windows is filled with insulation.



Current - exterior - Maashaven
Concrete or plastered brick infill in façade.

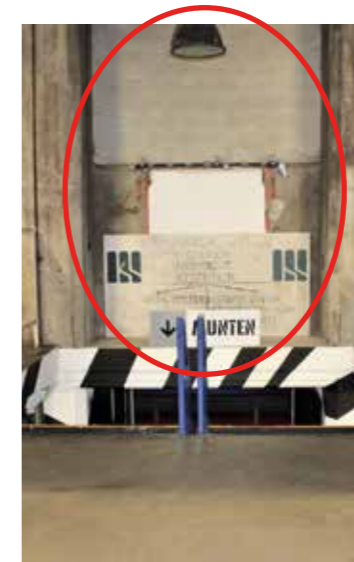

Current - interior - Brielselaan
The rolling shutterdoor and window above are replaced by bricked walls and sliding doors.



LOST FAÇADE OPENINGS

PHASE 3: A.G. POSTMA & J.D. POSTMA 1951

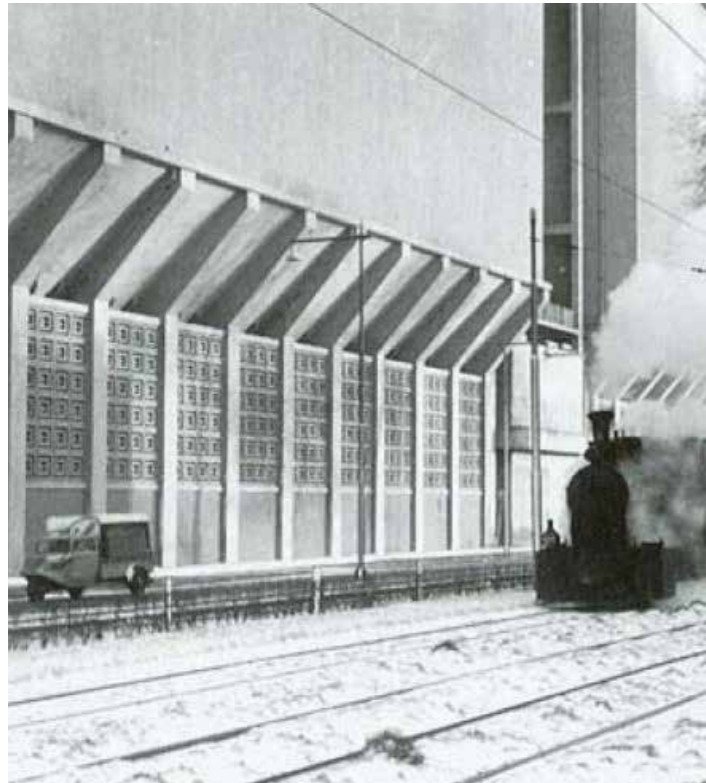

The grainsilo from the Brielselaan in 1953 ('Rondom Charlois' (n.d.) Retrieved from forum.beneluxspoor.net/index.php?topic=65536.60 on 17 March 2017)
Original - exterior: the characteristic plofroosters on the ground floor.



The grainsilo as seen from the Brielselaan (Transformers (2008) Cultuurhistorische verkenning graansilo Maashaven. Rotterdam)
Original - interior: daylight coming through plofroosters and creating patterns.

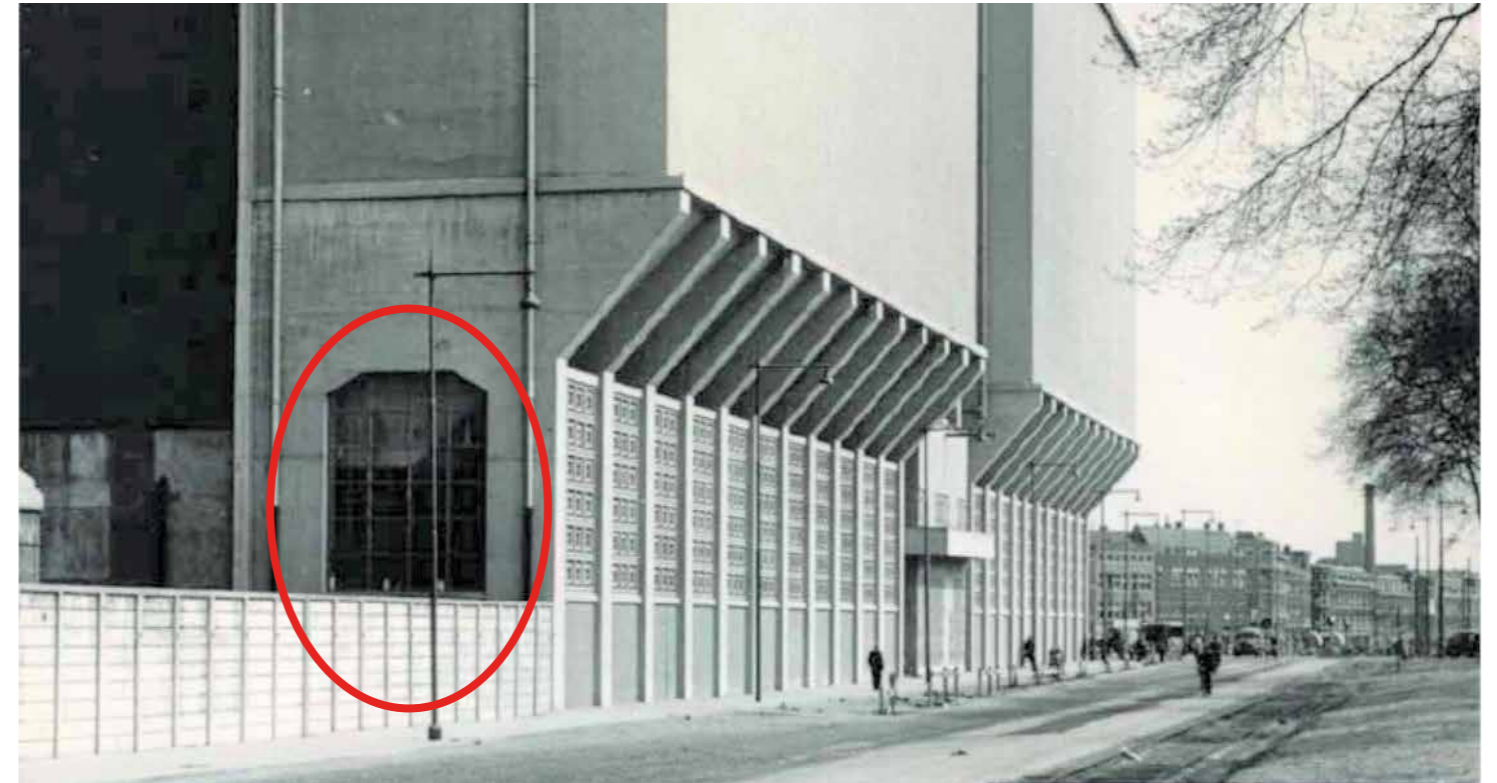

The grainsilo as seen from the Brielselaan. (Transformers (2008) Cultuurhistorische verkenning graansilo Maashaven. Rotterdam)
Original - exterior: large sash-window in the west façade of the third phase, similar on the east façade at the other end of phase 3.



Current - exterior
Metal plates visible behind all the plofroosters.



Current - interior
The plofroosters are closed off with metal plates on the inside.



Current - exterior
Due to new buildings close to the west façade of the silo building, the façade opening is now filled in by a brick wall and steel plate above.

INVERSE LIGHT

In the original situation, daylight penetrated the concrete mass, in order to provide a more pleasant working environment for the workers. Obviously, the silos were completely dark on the inside, in order to protect the grain from growing into little plants. The bundled rays of light, together with the rigid lines of columns must have been a powerful spatial interplay. Unfortunately, little historic photos can be found to verify this. However, an impression can still be found on the seventh floor in the Stok building part, see image to the right.

In the current situation, many of the openings in the facade have been closed off, mainly in order to prevent noise pollution coming from the disco. This disco completely inverts the system of light penetrating the building. In the current situation, artificial coloured light and laserbeams come from the very center of the building and shine on the inner surfaces of the building.



seventh floor building part Stok - current situation



ground floor building part Postma - before plovroosters were closed off

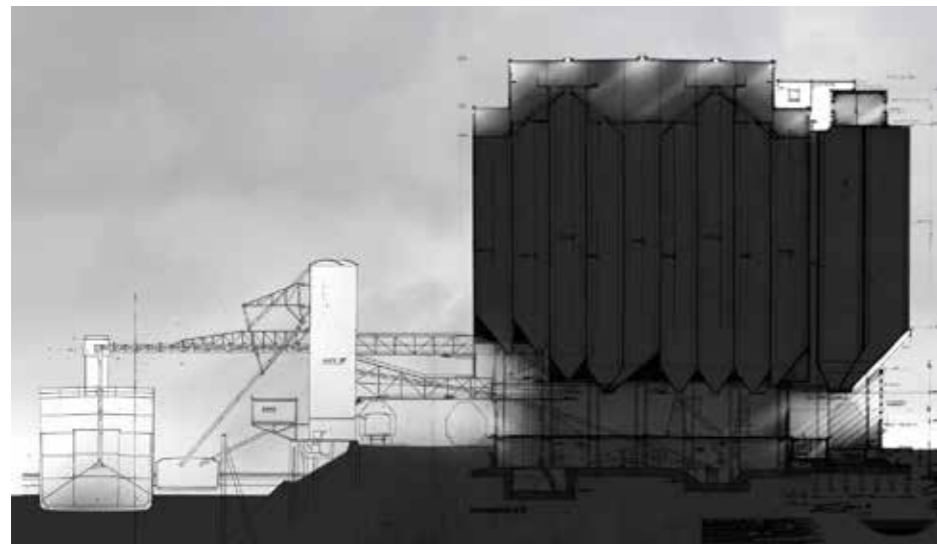

daylight former situation

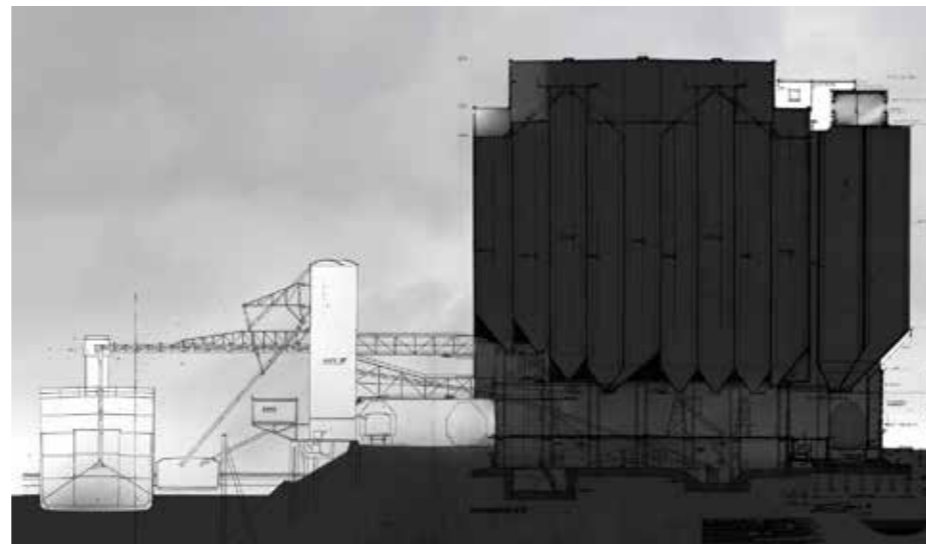

daylight current situation



artificial light current situation

CONCRETE APPEARANCES

From the urban and site scale, the building is conceived as a monolithic mass of concrete. At a closer look however, the concrete has multiple appearances in the Maassilo. These appearances point to the developments in the economy of the building, the different stylistic choices of the architects and the development of the material itself. All these appearances have their own texture, scale, and relation to the observer.

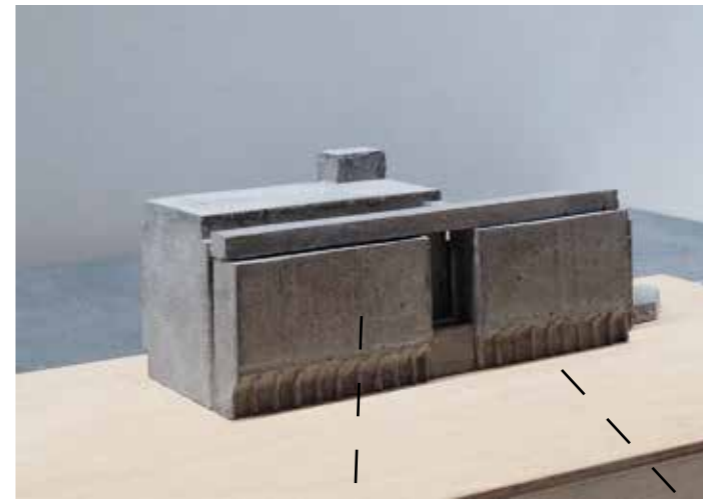
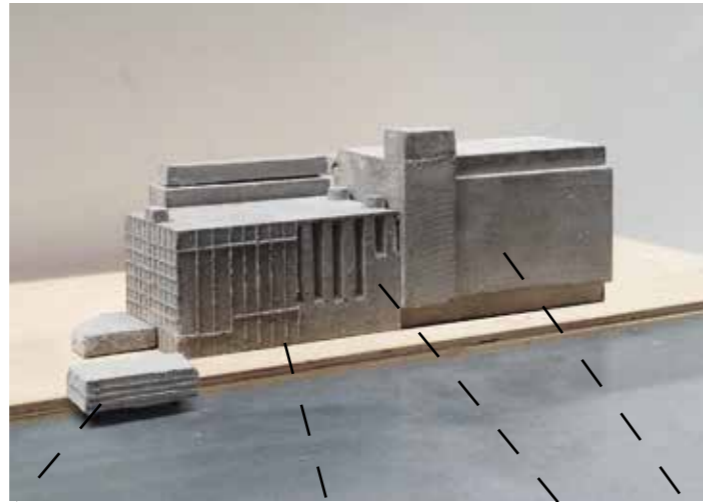

concrete tiles - part 4 (Haan) - rational - indifferent - sober

hollow concrete stones - part 1 (Stok) - tactile - human scale - contingent

plastered concrete surface - part 1,2,3 - damaged - inconceivable scale - worn

plofroosters - part 3 (Postma) - lively - human scale - active - transparent

PAINTING LISA LUX

PHASE 3: A.G. POSTMA & J.D. POSTMA 1951

Lisa Lux is an artist that resides in Rotterdam, the Netherlands where she does most of her work. She makes mosaics, sculptures, art commissions for public spaces, national and international exhibitions, art commissions, and work featured in collections. She basically describes her work as "Emo-Form-Structures" as the forms and structures are a result of an emotional process.

On the south facade of the building by Postma, she designed a wall painting of 55 by 35 meters. She explains

how she is always interested to place her art in public spaces that appear as dull, grey and overall gruesome in nature. Her biggest challenge was to adapt the building to fit a modern visual context that would blend in with renovation program that was being carried out in the urban area at the time.

To carry out the project in 1999 she started looking out for sponsorships and organised permission from the municipality. Maashaven Silo bv was the first party she as-

ked for permission. They did not only give permission to do the work, they also became her very first sponsor. Ultimately after a long process it was only in 2002 that the financial side of matters was tied up and she could finally carry out her work.

Later she explains: "I am an artist with a profound spiritual approach and this monumental artwork is a symbol of my deepest wish to contribute my work to this world, in order to promote universal harmony and bring

together human kind as one". Her wall painting is one of Europe's largest and called: "Flyers of Hope for Universal Love"

Source: <http://www.academy-of-the-13-essenian-arts-of-healing.org/home/kunst/frameprovae.html>.



Lisa Lux wall painting
(Source: <https://wraf.nl/tag/rotterdam/>)



Lisa Lux in front of one of her other works
(Source: Maasstad 11-11-1998)

'GRAANSILO MIJ' SIGNS

PHASE 1: J.P. STOK WZN. 1910 & PHASE 3: A.G. POSTMA & J.D. POSTMA 1951



Facade changed over time, photo from 2008
(Source: Transformers (2008), Cultural Value report)



Facade drawing made when making changes in 1969
(Source: Postma (1931) retrieved from the Rotterdam archive (1969))



Remade logo

When club Now & Wow took the initiative to reuse the Maassilo complex in 2004 the sign on the main facade said "Maashaven Silo bv" and included their green logo. The original sign however for the building in 1910 said: "N.V. Graansilo Mij". On the facade drawings from that where made in 1969 for the design of a workshop space by Postma we see this logo. All though when we take a good look at historical photos the IJ seems to be a bit different. In 2008 when the Creative Factory moved in to the building this sign was restored in that way. In this sense the original is restored as good as possible. This building is all about the change and growth of the company in that sense the "Maashaven Silo bv" sign is also an element that resembles. This element however has become intangible now.

Another intangible element is the "Graansilo Mij" sign that use to stand in giant steel letters on the steel beam above the electricity transformer house. The beam is still there but the letters are gone.

(Source: Transformers (2008), Cultural Value report)

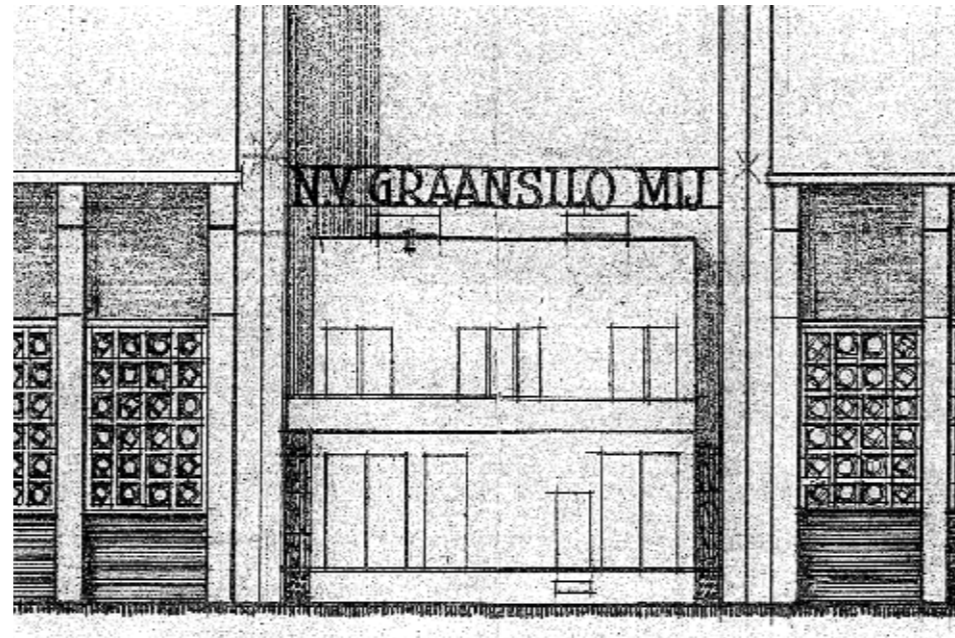

Phase 3 south facade drawing by Postma showing the illustration of the N.V. Graansilo Mij sign
(Source: Postma (1931) retrieved from the Rotterdam Archive)



Phase 3 steel beam on which the steel 'Graansilo Mij' used to be

S T R U C T U R E

UNITY OF SKIN AND STRUCTURE

The Maassilo is built as a highly functional building. Not only in its layout, but also in its appearance. Many buildings have a skin that can be regarded separately from the structure. This has to do with the fact that these buildings should represent something more than merely the technical logic of the building itself. These buildings have a face.

The Maassilo does not have such a face. The facade is no more than the functional limit of silo groups. In the most parts, it has exactly the same thickness and structure as the inner silo walls. As can be seen in the drawing to the right, the beams extend in the facade. Thus, the facade presents us with a functional and structural logic rather than an aesthetic principle. It should be noted however, that although the facade hints at the internal logic of the building, it does not in any way tell the observer anything about the spatial composition of the silos and the rest of the interior.

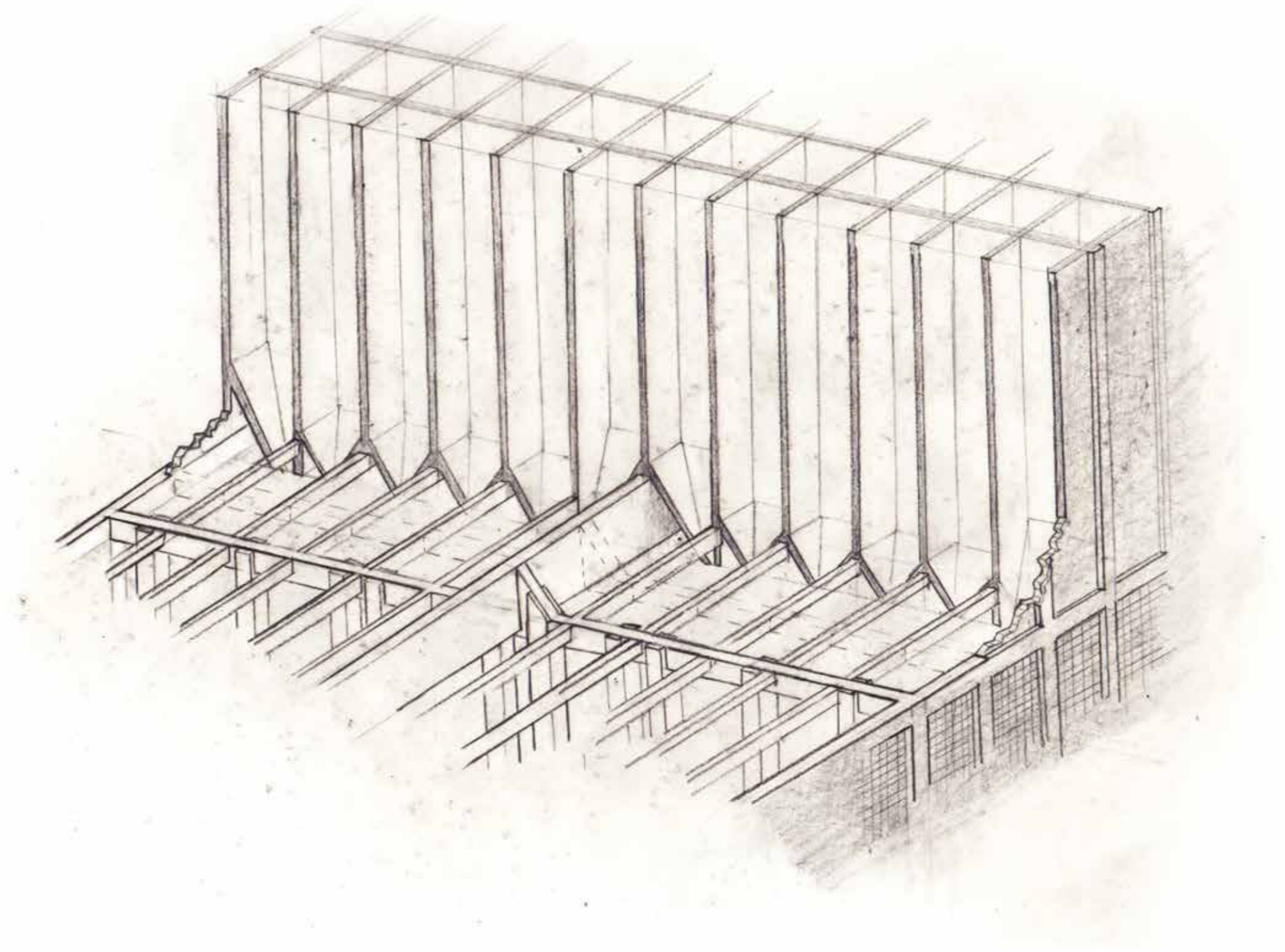

TECTONICS

The ground floor provides the most direct spatial experience of the silos. As the place where the previous moment of tension between the vertical distribution of grain and its horizontal transportation took place, the spatial experience is a collision between two different languages: the linear grid of concrete columns and beams and the multiple shapes of funnels with which these are fixed.

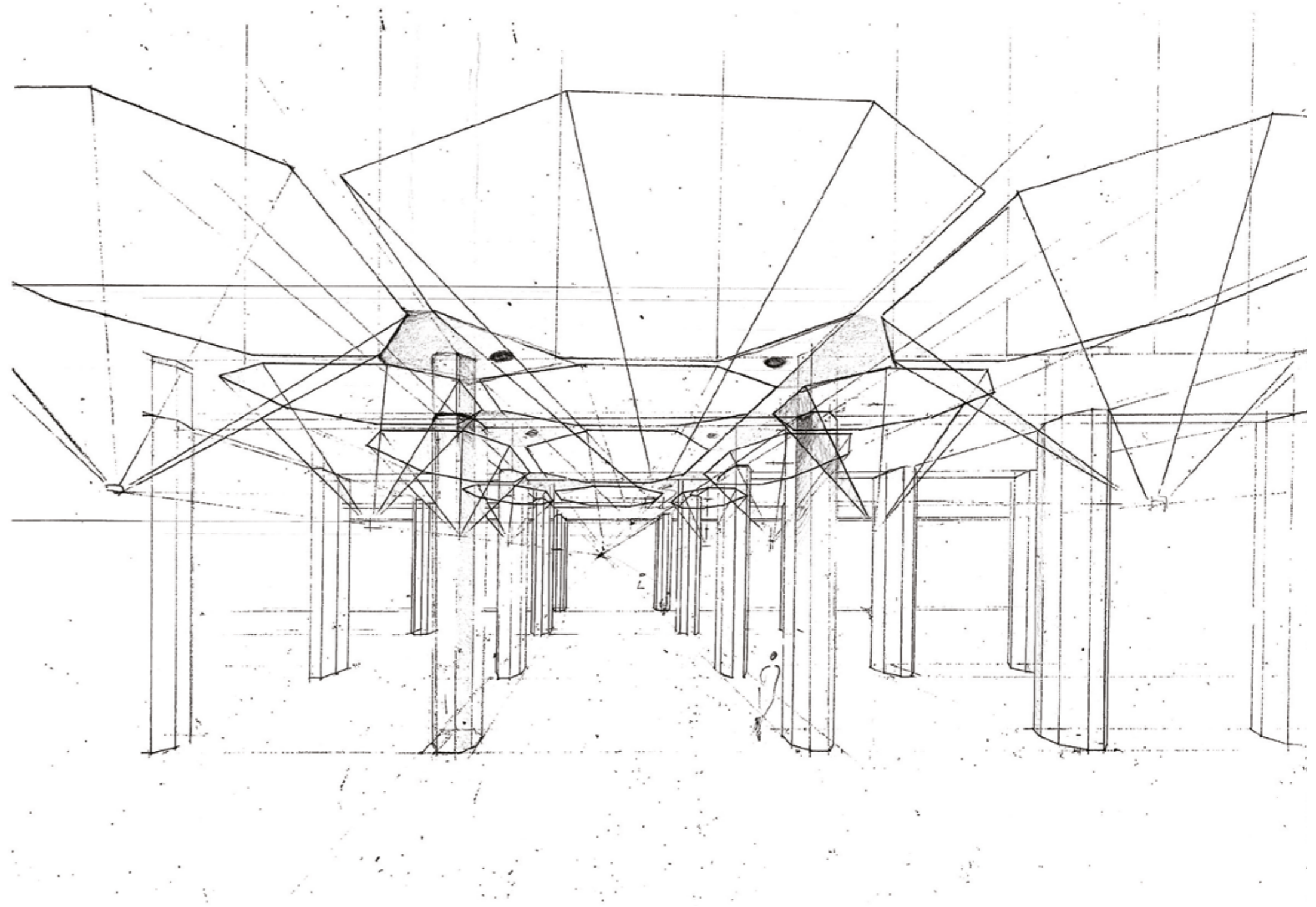

GROUND FLOOR INTERVENTIONS

PHASE 1: J.P. STOK WZN. 1910 & PHASE 2: BRINKMAN EN VAN DER VLUGT 1930



Existing situation columns groundfloor phase 2
(Source: Transformers (2008), Cultural Value report)



construction work on columns phase 2
Source: J.Keijneans (2004) Springend van bestaand naar nieuw, Cement



reinforcement ready to pore concrete for the fortified floor phase 2
Source: J.Keijneans (2004) Springend van bestaand naar nieuw, Cement



construction work finished phase 2

When club Now & Wow moved into the building in 2004 it to be adapted to the new use. The structure was meant to carry the load of more than 300 silos full of grain. To bare these loads the reinforced concrete columns where massive. The floor on the other hand would only have to carry the equipment and about a hundred people. For the club the frequency of people would increase tremendously. To be able to bare these extra loads the floor had

to be reinforced with a new top floor. The silo's however stood empty and wouldn't have to carry the same loads. To visually create one space, 35 columns have been demolished of which a majority with the use of explosives. Thin steel columns have replaced some of the columns. They are filled up with concrete and forced to tension to secure their loadbearing capacity.

Source: J.Keijneans (2004) Springend van bestaand naar nieuw, Cement

S P A C E P L A N

GRIDS & AXES

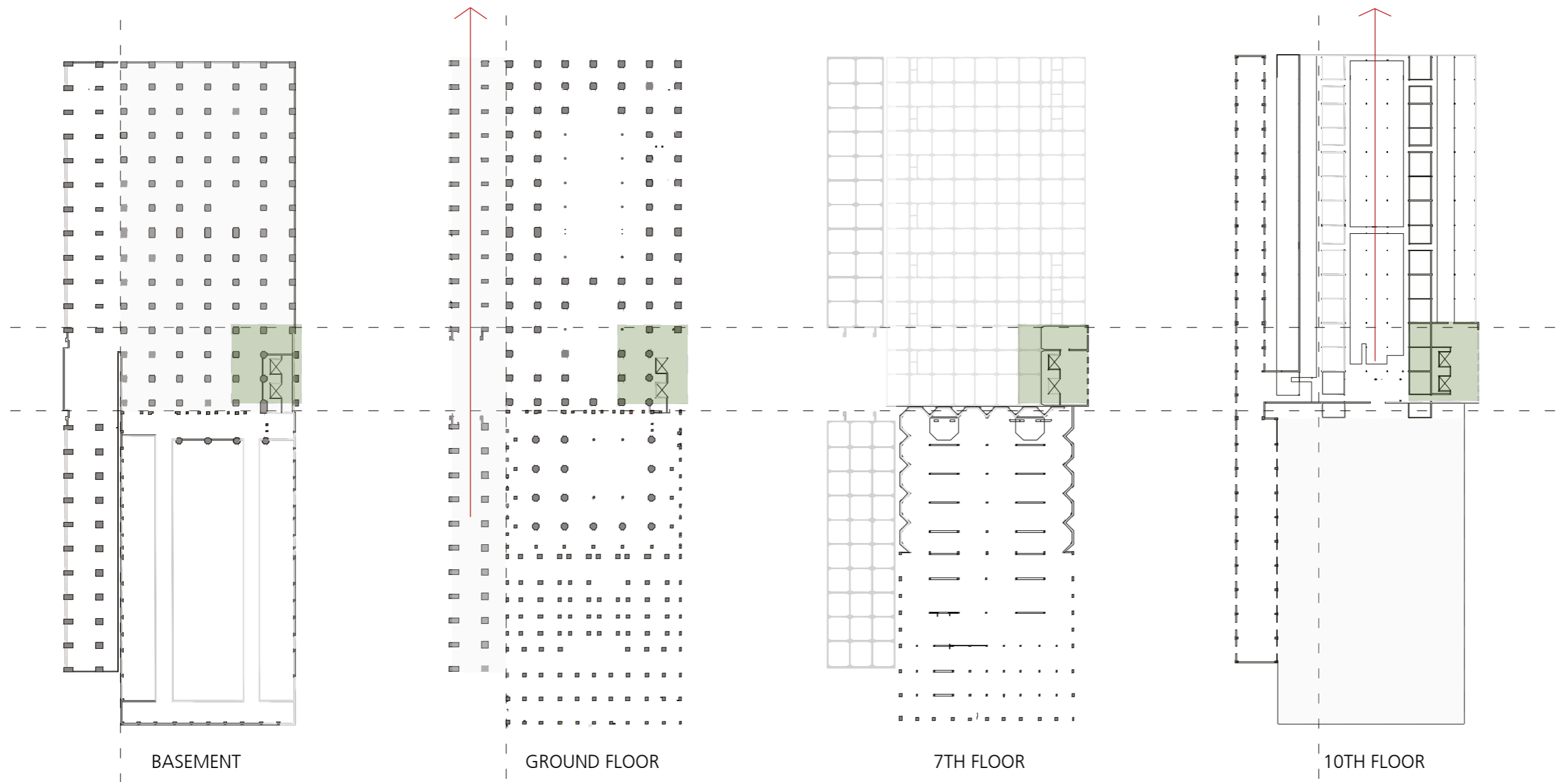

conveyor belts in the basement, Graansilo report, p.50-52

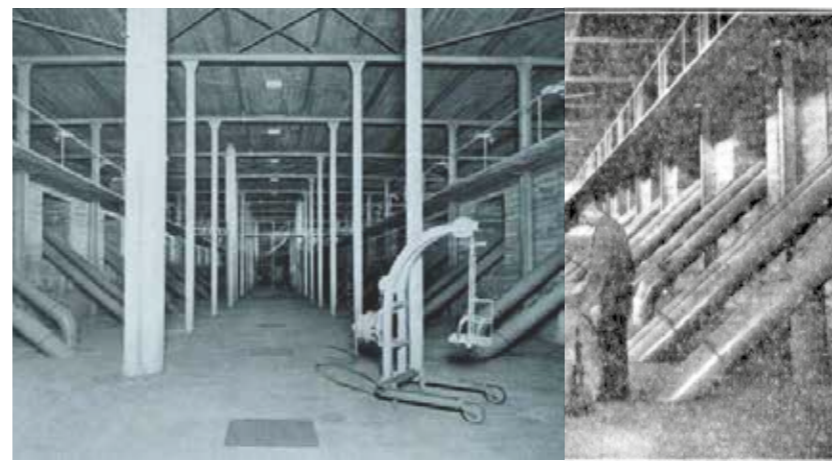

view of the attic of the 2nd phase, Transformers report, p.174

The historical sequence of the multiple grids, has resulted into an 'open plan', continuous hierarchy in the lower levels, which becomes split and mirrored in the attic levels of the 1st and 2nd phase, with the machine tower as mediator.

RELATION BETWEEN SPACES

This experimental drawing is based on a cubistic style that Aldo Rossi developed to explain some of his projects. He uses different perspectives and 2 dimensional drawings to get a new idea of the spatial arrangement of a building or object. This drawing was made in the preliminary phase to get a better idea of the personal interpretation of spaces and elements in the building and the relation between them. It clearly shows the accumulation of building layers, characteristic for the Maassilo complex. The silos take up about 80% of the building volume, whereas in the section we see they are dark spaces that are inaccessible and not experienced by the user. A view on the rooftop looks over on the harbour and skyline of 'De kop van Zuid'.

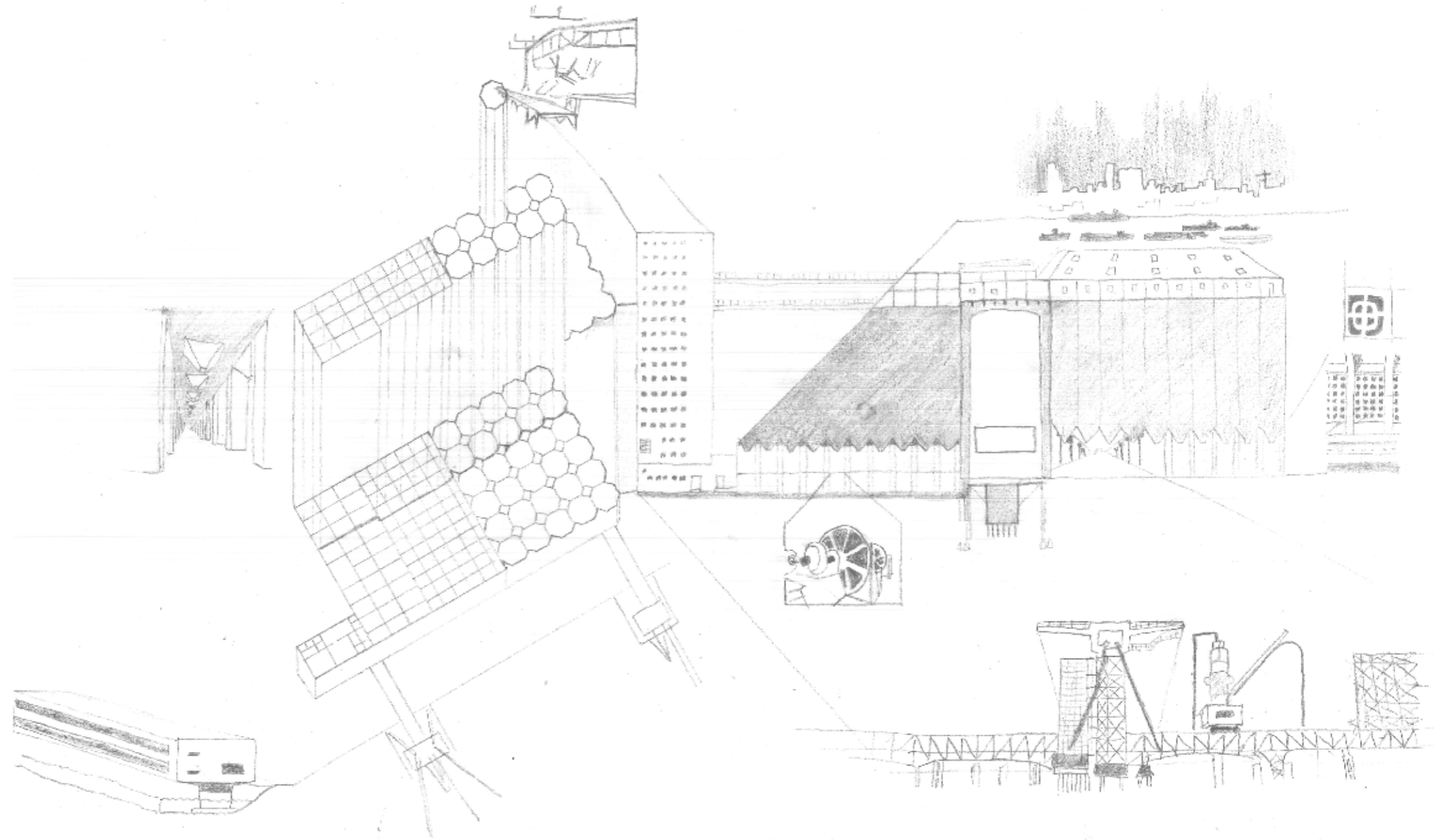

Experimental collaged drawing of perspectives, axonometries and 2D drawings of the Maassilo complex.

S U R F A C E S

SURFACE INVENTORY

A collection of surfaces that stand out or represent multiple surfaces that are unique throughout the building. Showing original surfaces and new surfaces and their use. also on the 10th floor there are some graffiti art-

works which need further investigation.



New paint stripes throughout the basement of the second phase/ Brinkman to make a contrast between the existing rough surfaces of the bare concrete and the newly painted surfaces which highlights the texture differences.



Original elevator machine room door in the basement of the second phase Brinkman. Special because of its locking mechanism and steel door and hinges as well as original lettering.



Original tiles on the structure/surfaces surrounding the machines for hygienic reasons, for cleaning up fluids which may have come out of the machine or were present during maintenance.



Original door with original unique lettering showcasing the function of that room and giving a clear view of the font used throughout the building.



Original elevator door with original lettering. Steel doors of the original personnel elevators for maintenance staff and machinery.



Original octagonal funnel of a silo in the first phase with original metal spout and lettering. The weathered surface due to dirt and usage is valuable because it shows its activities from the past.



New graffiti artwork for pepsi max by Graffitinetwerk.nl. Advertisement for pepsi max due to the high frequency of parties. (september 2016)



Original square funnels at the new entrance hall for the creative factory. Shows really well the concrete cast of the funnels as well as dirt and a little bit of damage.

TRACES OF USAGE

Throughout the structure, evidence of movement of the machinery in relation to the supervising role of the workers can be traced. Based on the fact that most of the machines' activity was concentrated on the ground floor, traces of their movement are still present in the lower parts of the concrete columns. Additional steel elements attached or embedded to the columns provide further proof of that. Similarly other indications of the workers activity can be spotted in the various objects and additional services in the basement and machine tower.



Objects adjacent to the former conveyor belts still present in the basement



Series of service openings primarily in the basement



Additional services in the machine tower control room



Lower parts of concrete columns and surrounding walls still carrying traces of the machines movement



Columns carrying multiple elements for serving the surrounding functions such as steel coverings, railings and extensions



CONCEALED PRESENCE

On the ground floor of the building, the surface that imposes its presence to the greatest extent is the ceiling. The particular character of this presence lies in the fact that it conceals a void that lies above. It is through this hiding of space, that this surface attains its meaning.

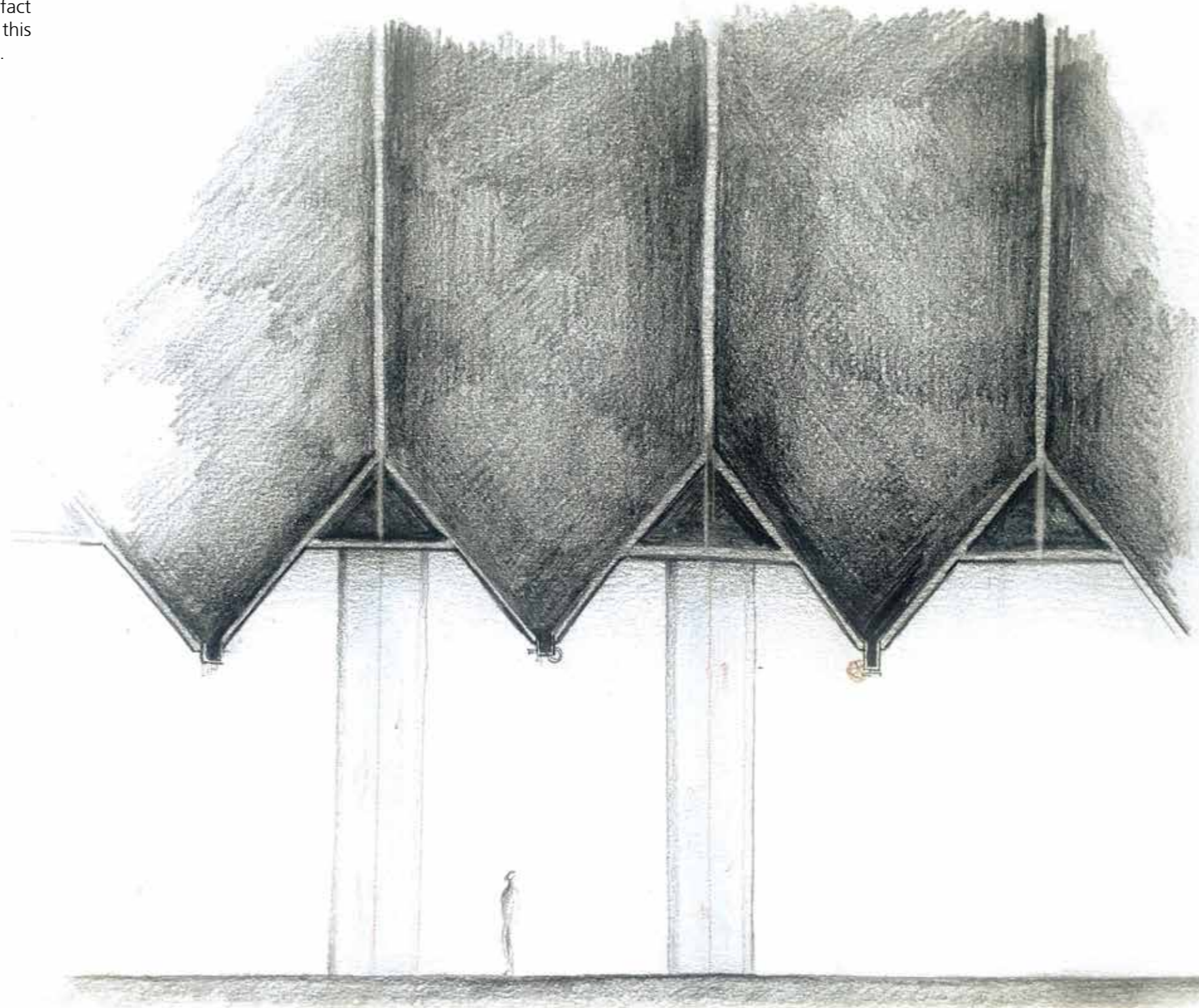

S E R V I C E S & S T U F F

DISPLACED MACHINERY

Some of the machines have been lost during the renovations for Now & Wow and the creative factory. Many have been kept original though and some are still in place while others have been repositioned to form an exhibition. Throughout the complex and the site there are a number of tools, equipment and machines that can be found. These all served different purposes and were crucial for process of cleaning storing or distributing the grain.

The purpose of the conveyer belts is quite clear. Grain was placed on them and distributed through the building the exact way grain got onto the belt and was taking of is a bit trickier. Some of these belts needed to make space and have simply been thrown away. There are still some original belts to be found on the top floors of the 1st and 3rd phases.



Moveable telescope tube to collect grain from the silos
(Source: Transformers (2008), Cultural Value report)

A moveable telescope tube was used to collect grain from the silo. The angle of the tube could be changed to guide the grain onto different conveyer belts to distribute it through the building, either to go through a cleaning process and get packaged or go back into storage.

The moveable scale could be used outside to weigh the grain on the spot so that it could be packaged afterwards and immediately sold on the spot.

For other equipment its purpose is less clear. The picture on the right shows two tools that seem to be able to collect grain from the silos. To probably further clean, package or distribute the grain in some way.



Moveable scale to weigh the grain
(Source: Transformers (2008), Cultural Value report)

During the renovations carried out to make space useable for the Creative Factory many machines and tools have been saved. On every floor of the Creative Factory a space has been kept in original state in which these machines are save guarded. Further investigations on these tools and machines still needs to be carried out.

Source: (Transformers 2008, Cultural Value report)



Machines to collect grain and packaged or further distribute through the building?

FIXED MACHINES

Here are some of the fixed in place machines that really showcase former functions of the spaces that they are in. The combination of these machines within the building are the major components in moving the grain through the whole building. From sucking the grain out of the boats through vaccum pumps to delivering the grain on

the top level of the building, and moving it horizontally throughout the building and distributing the grain to the divider pipes which put the grain in the top of the silo's in each phase of the Maassilo.



Electro-motors with flywheels which power the pneumatic pumps they were cooled by cooling pumps which used water of the Maashaven. These motors really give meaning to the basement as to what it function was.



Conveyer belts which transport the grain from the Cup elevators to the distribution pipes for the silo's

Pneumatic pumps which create a vaccum (suction) which make it possible for the elevators and cranes outside to suck 400 tons of grain out of the boats per hour and transport them indoor. the machines were made by SIEMENS

FUSION OF STATIC AND DYNAMIC

On the scale of the site, it was concluded that the building has always functioned as a static and sturdy mass in the midst of economic activity and rapid change. This contradiction becomes particularly interesting when these two extremes meet, or 'touch' each other.

An interesting example in this case is the inlay of the iron gliding rails in the columns and beams on the ground floor and in the cellar in building part 1 and 2. These rails were presumably installed to mount a variety of temporary installations to the concrete construction. It shows that flexibility was not only sought in the structural layout of the building, it also became part of the detailing.

This shows that from the beginning, the building was made to facilitate functional change in the future. The building was comprehended as existing in time. Consequently, in this particular case, the static and the dynamic fused together.

On a practical level, the rails may prove to be useful for future interventions, as is already shown in the montage of the new signage.



original and new usage of the integrated gliding rails



column section, building part Brinkman & Van der Vlugt

PART 2

B U I L D I N G T E C H N O L O G Y

INTRODUCTION BUILDING TECHNOLOGY

Building technology is one of the most essential aspects to research in the Maassilo. In the case of the Maassilo the structure is the building and vice versa. Due to the functional nature of the building, the structure lies bare almost everywhere in the building. Also the dimensions of the structural elements like the columns and the silo's give an indication of the massive loads it has to bear.

By creating a framework of all the structural elements and showcasing these in an analyses, it already gives a slight glimpse towards the possibilities for future use/interventions in the structure of the Maassilo.

B T 1 : S T R U C T U R E

OVERVIEW OF DIFFERENT STRUCTURES

The following two pages give an overview of the different types of structures that can be found on the site of the Maassilo, as 3D axonometrical sections that show

the characteristic structures of phase 1, 2, 3 of the silo buildings and phase 4 as the detached office building.

phase 1 - 1910

J.P. Stok Wzn.

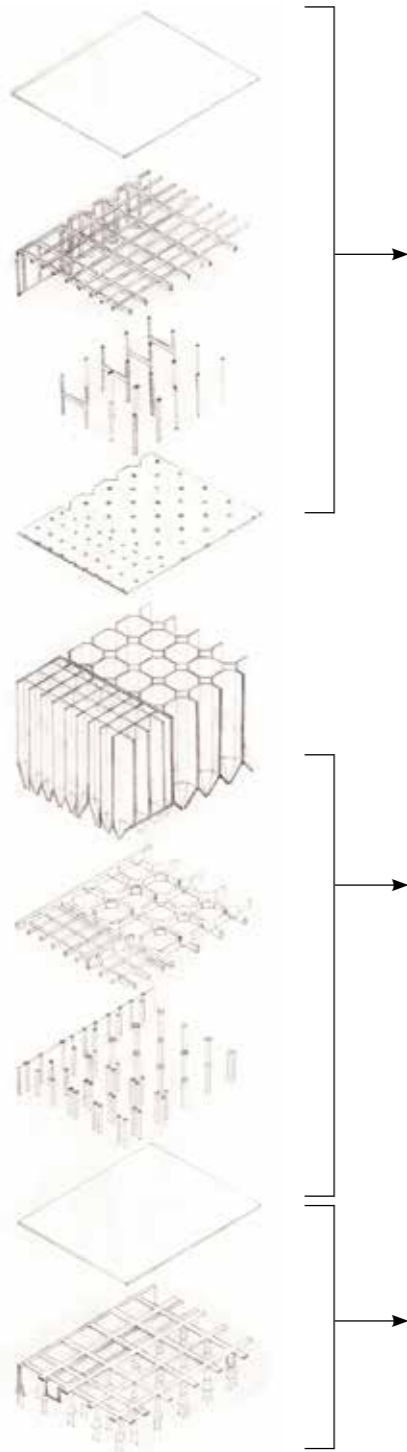

Top floor



Ground floor

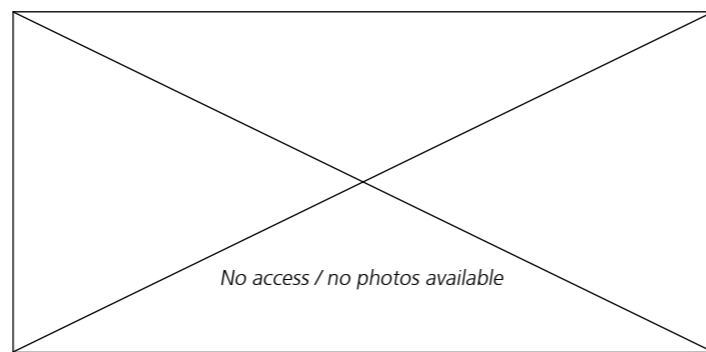

Basement

phase 2 - 1930

Brinkman & Van der Vlugt

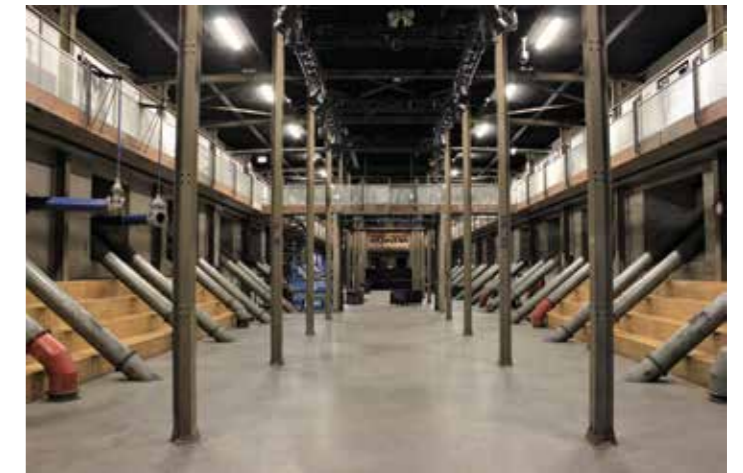
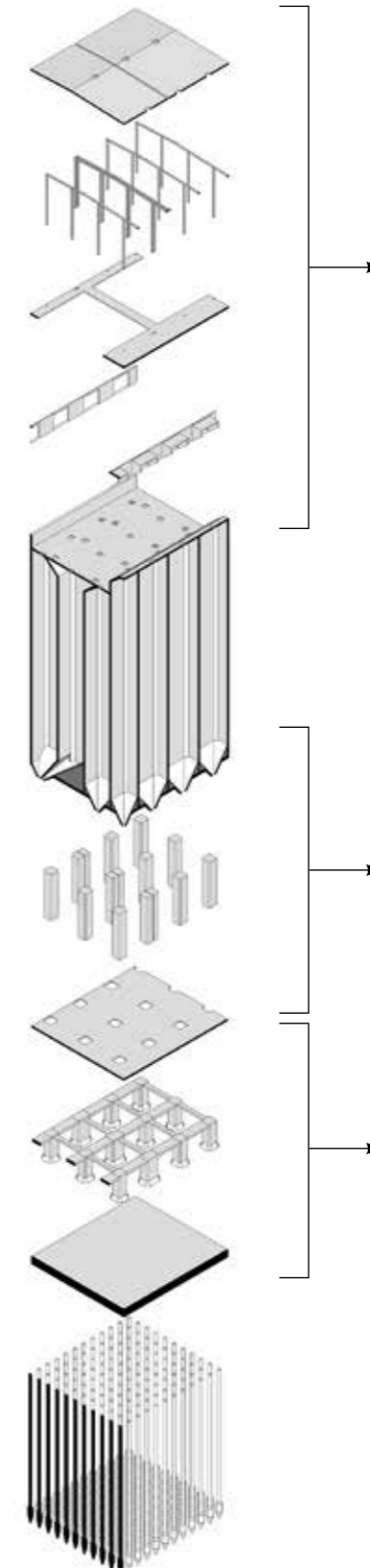

Top floor



Ground floor



Basement

OVERVIEW OF DIFFERENT STRUCTURES

phase 3 - 1951

A.G. Postma & J.D. Postma

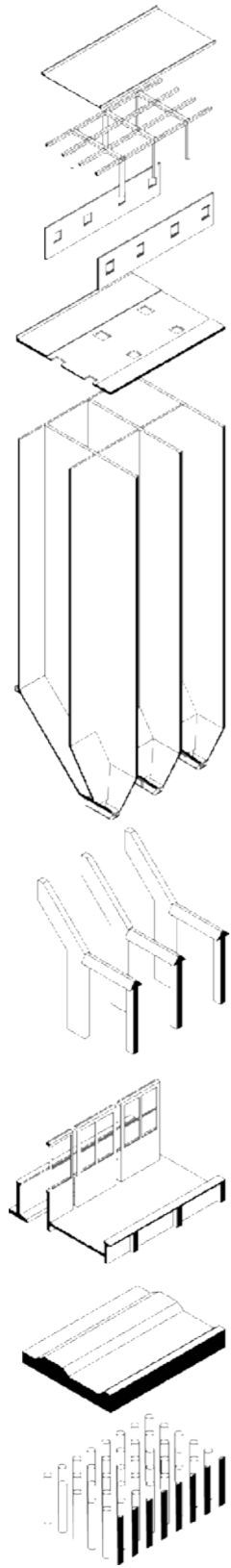

Top floor



Ground floor



Basement

phase 4 - 1963

H. Haan

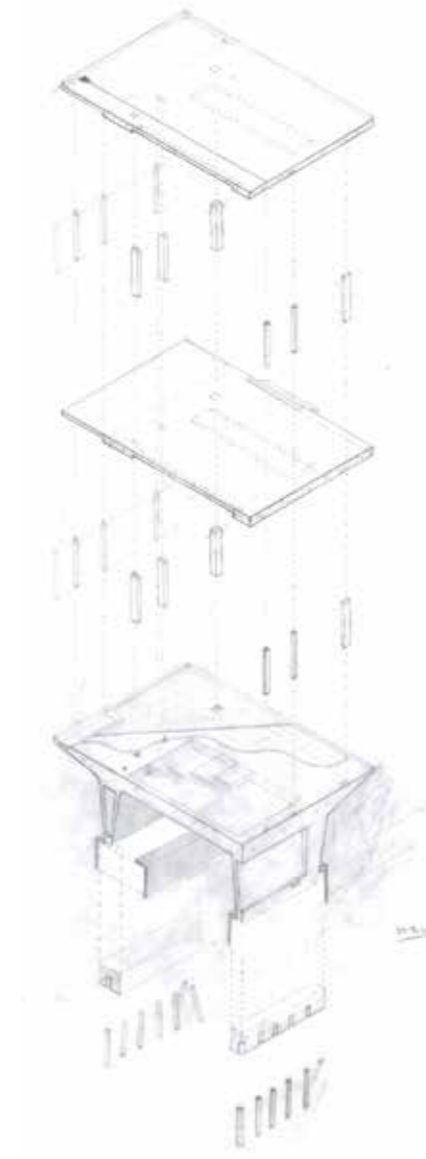

Top floor



Ground floor

CONSTRUCTION SYSTEM

PHASE 1: J.P. STOK WZN. 1910

The picture to the right shows all the different elements in the concrete construction system of building part 1. It must be noted that in reality these systems are not separated. The whole building is cast in situ, so all the elements are one monolithic concrete mass. By separating them however, insight is given in the way that the construction functions. In order to maximize the grain capacity of the silos, everything below the silos is built as strong as possible, everything above the grain load is built as light as possible.

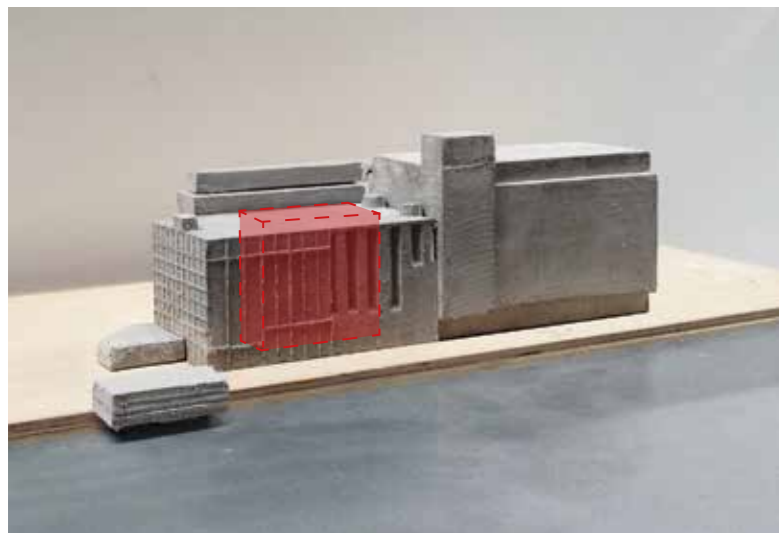

isolated silo section to be analysed

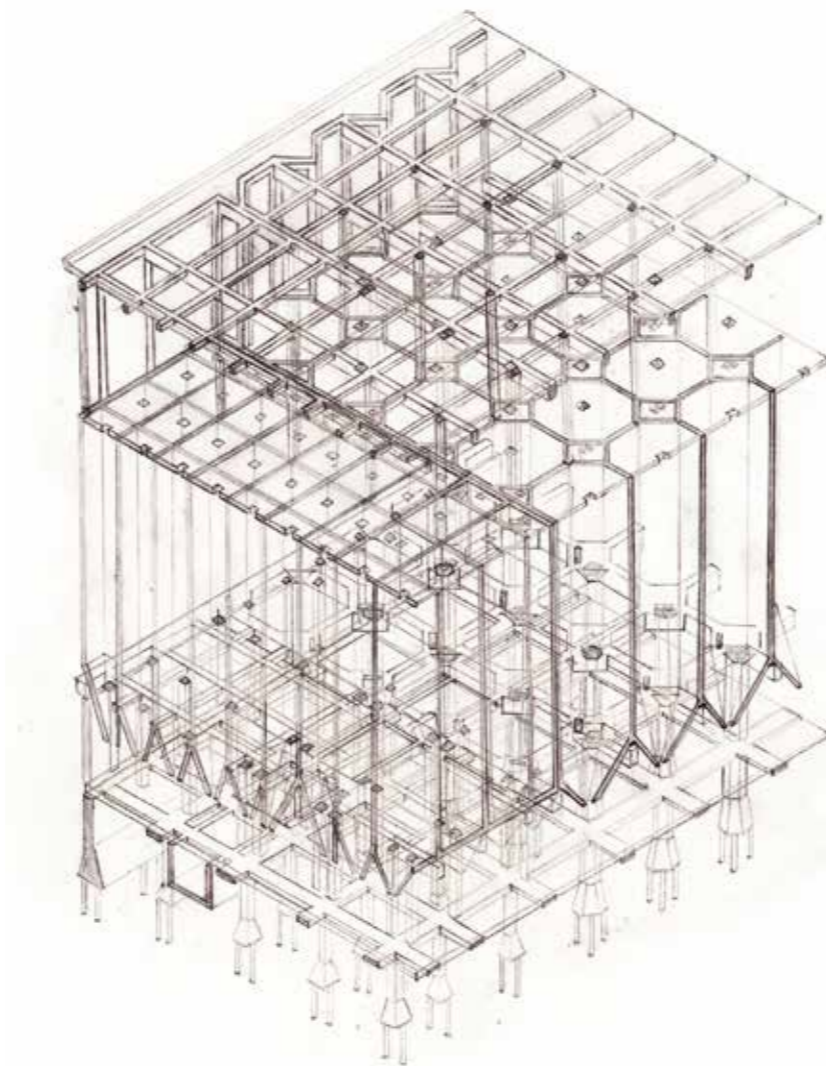

silo section showing all the construction elements

above the grain load:
structure as **light** as possible

below the grain load:
structure as **strong** as possible

concrete roof

concrete beams and columns in facade

concrete columns

concrete floor

concrete silocells

concrete beams

concrete columns

concrete floor

concrete foundation

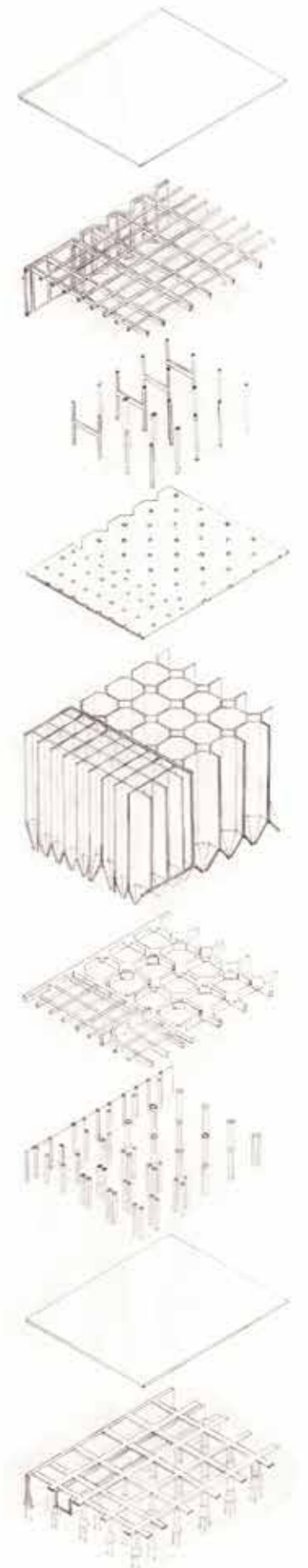

OCTAGONAL SILOS

PHASE 1: J.P. STOK WZN. 1910

Resting on the lower grid structure, the main octagonal silos are fixed between the beams and infilled with additional concrete on their perimeter. In addition, smaller, secondary silos are shaped from the negative space created above the columns.



Octagonal silos, Transformerts report, cover

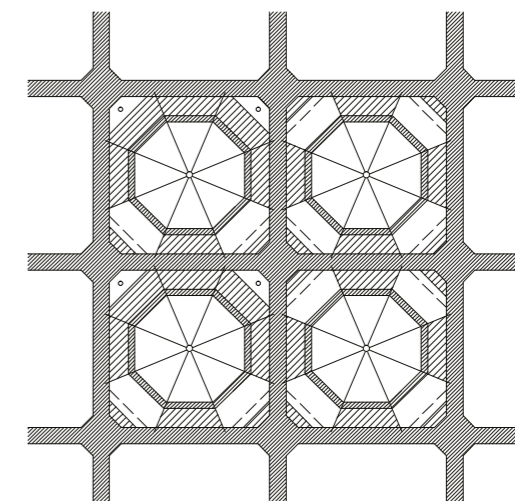
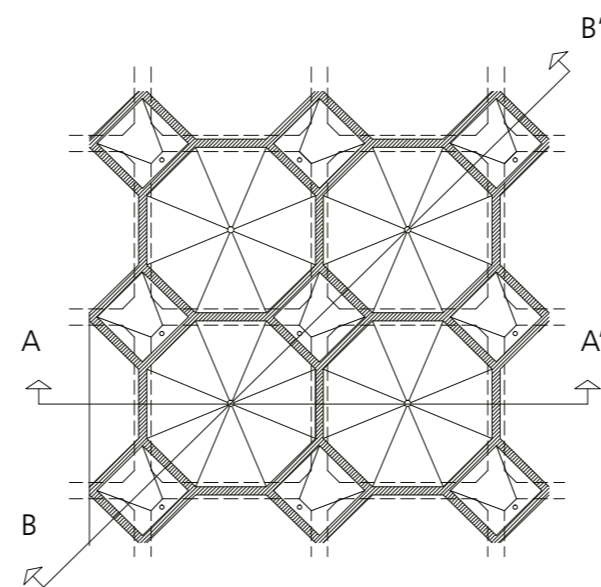
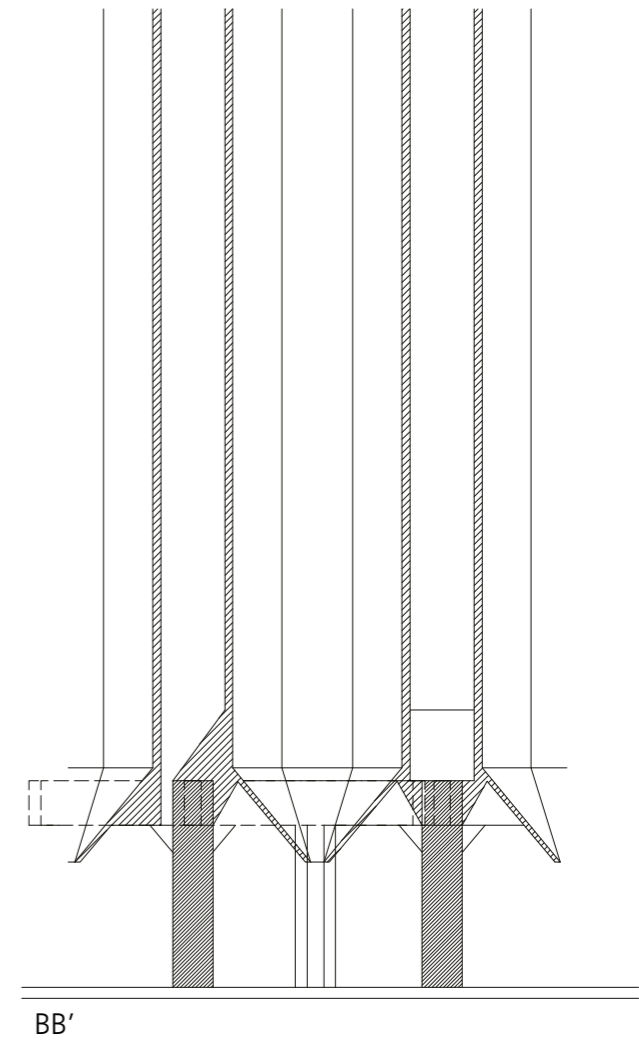
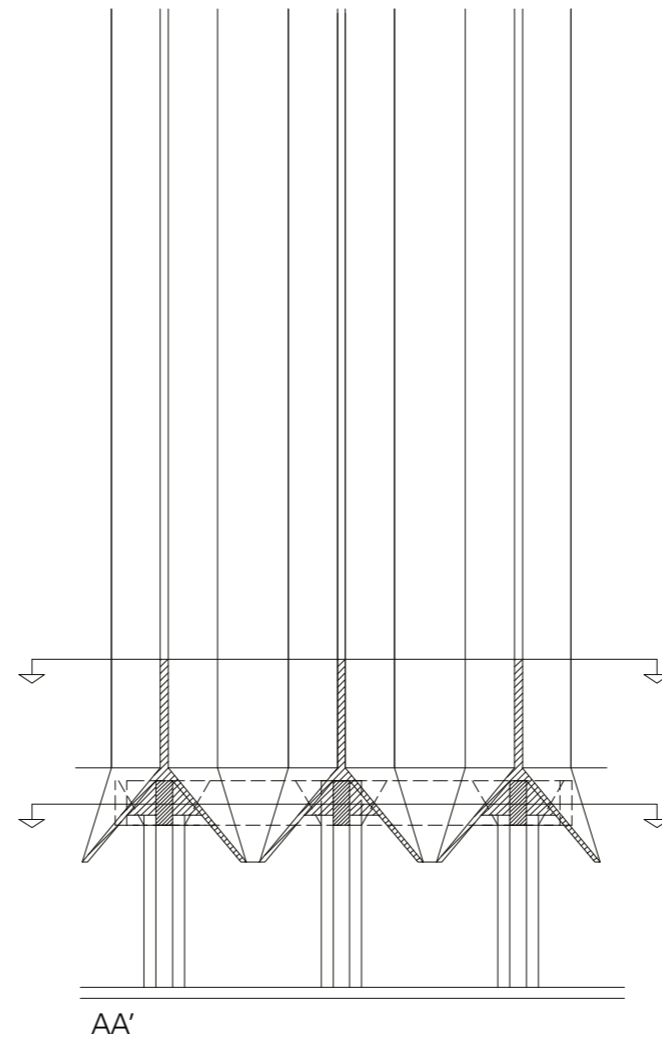

STATIC SCHEMES

PHASE 1: J.P. STOK WZN. 1910

The images on this page show the flow of the horizontal and vertical forces building part 1. These drawings show the original situation, in order to show for what forces the construction was calculated and dimensioned initially. The arrows do not represent actual calculated values, they are more a general estimation. The pink fields show surface loads.

In the sections for the vertical loads, it is shown how the weight of the grain in the silos is taken up by the construction and ultimately the foundation. The section with the horizontal loads shows how the wind is taken up by the construction. In the case of windloads, the silowalls work as a whole, as one big wall, in order to take up the bending moment that results from the wind. This results in vertical loads on the foundation. It can safely be assumed that the vertical forces resulting from the wind loads are much smaller than the vertical forces caused by the load of the grain and the dead loads of the building. This means that the resulting forces in the foundation will always be compressive stress, and not tensile stress.

vertical loads

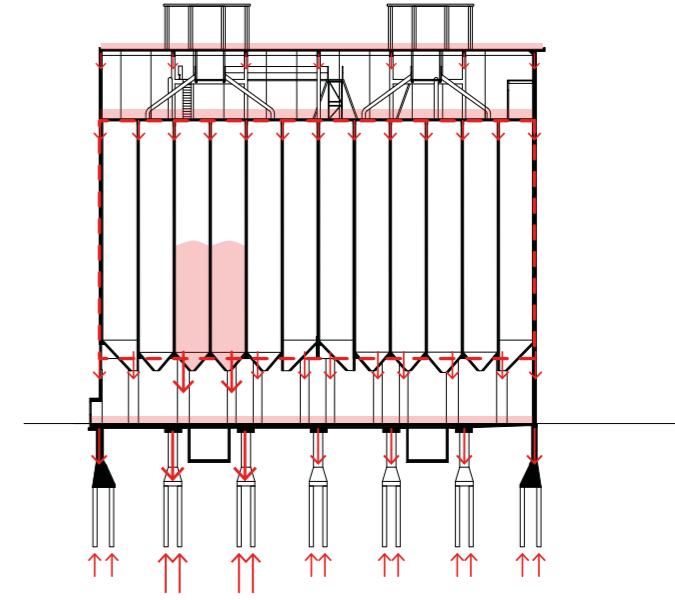
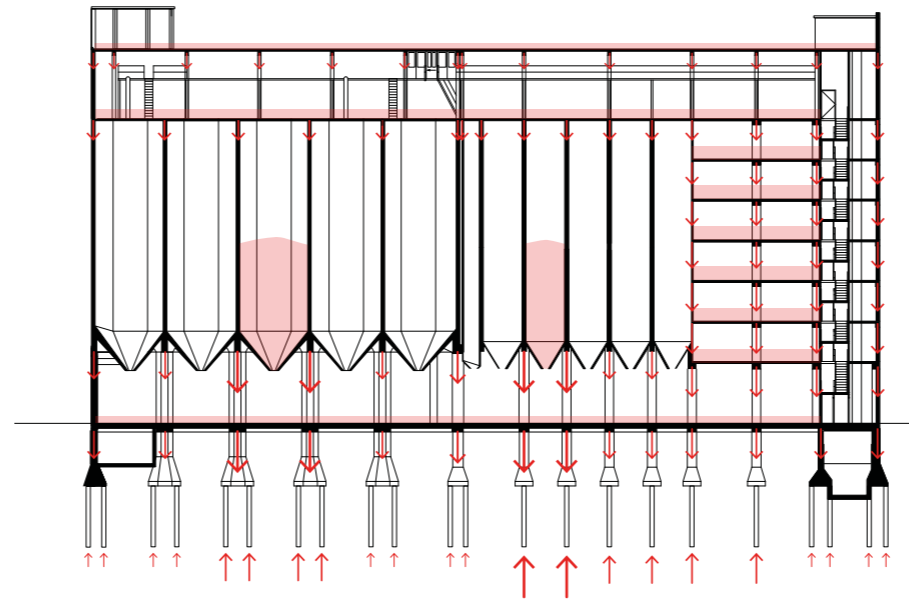

horizontal loads

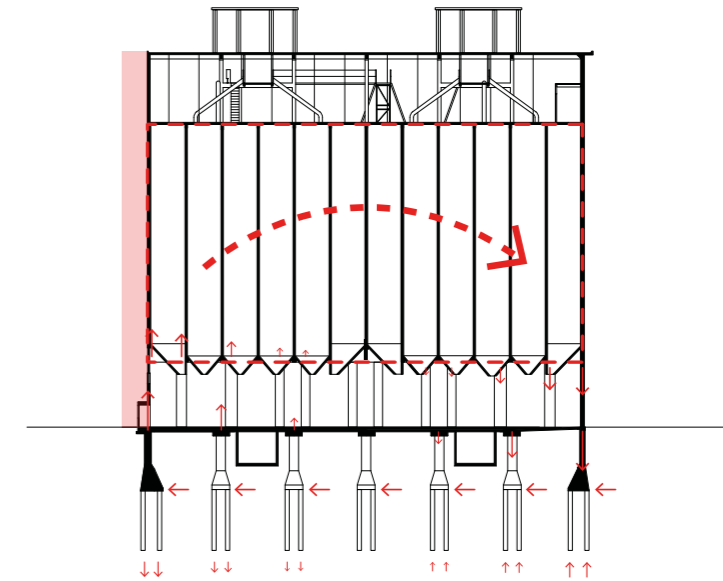

total resulting forces in foundation due to vertical and horizontal loads

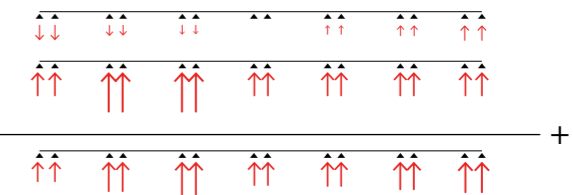

CONSTRUCTION SYSTEM

PHASE 2: BRINKMAN & VAN DER VLUGT 1930



foundation

The foundation system for phase 2 was chosen to be as affordable as possible while having a load-bearing capacity that was as high as possible since this determined the amount of grain that could be stored in the silos on top. A special type of foundation piles was chosen for this: the Sprengerpil (Brinkman, 1931). With a thickened head, this pile could carry up to 60 tons of weight instead of the maximum 50 tons in regular piles ('Graansilo te Rotterdam Brinkman vd Vlugt', 1931). On top of a total of 1366 Sprenger piles (De Maasbode, 1929), a massive concrete plate of one meter in height was built. This system was chosen because details of the superstructure were not precisely known at that time yet since the building method of the superstructure depended on the contractor that would be chosen. The thick concrete slab would just evenly distribute the building's loads over the foundation piles.

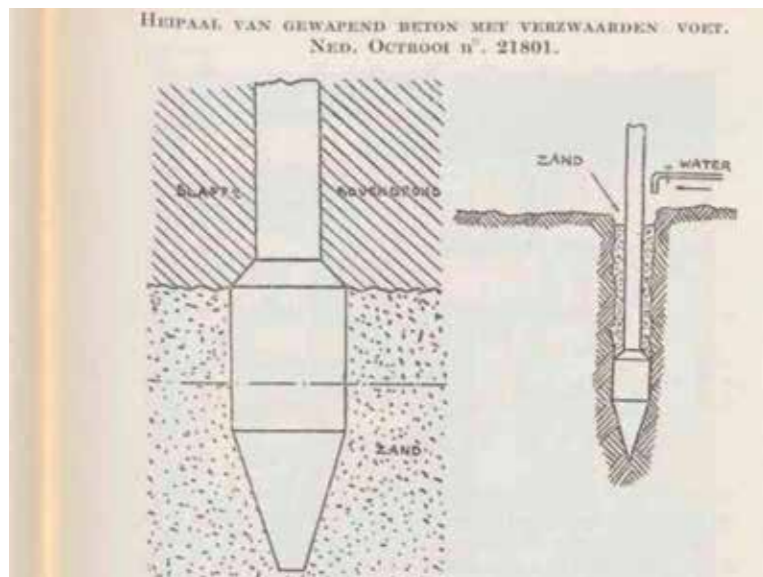

Brinkman, J.A. (1931) De nieuwe graansilo aan de Maashaven voor de N.V. Graansilo Maatschappij te Rotterdam. *De Ingenieur*; B. *Bouw- en Waterbouwkunde*, 32.

silo structure

Aside from the roof structure, the entire superstructure is made out of reinforced concrete. (Partially) making the silos out of iron was no option, not only because of its costliness but also with regard to cooling and condensation the Graansilo-Maatschappij did not want silos out of sheet metal (Brinkman, 1931). The 146 nearly square silos have thickened corners that together with the corners of adjacent silos act as columns. The total load bearing capacity of the building was set with the chosen foundation system. This included the building's own weight and the weight of grain that could be stored inside. To maximize the grain capacity, it was important to keep the structure of the building as light as possible. The silo walls are connected to the concrete ceiling of the groundfloor and together they form an upside down T-beam in which more or less the full height of the silo walls can be included, meaning that these composed T-beams are very strong. This allowed the structure of the silos to be made up of very thin walls of 165 mm which saved a lot of weight. The weight of the building turned out to be roughly the same as the weight capacity of grain it could store: 44.000 tons (Brinkman, 1931). When looking at the short section of phase 2, in the middle row of silos the funnels are alternating between two sides. One sloping towards the north, the next sloping to the south. This was probably done to bring the grain closer to the two main distribution lines that run parallel to each other on the north and south side of the building. The superstructure was built with the 'Gleitbau' or 'Macdonald' system. This method was only chosen at a later stage, when the construction of the new building did not go fast enough with regular methods ('Nog niet snel genoeg', 1930). The Gleitbau made it possible to add around one meter in height to the building each day (Brinkman, 1931).

roof structure

The roof of phase 2 is supported by a construction of iron trusses in order to save weight for maximal grain capacity and for a short construction time (Brinkman, 1931). The building was topped off with an extremely thin roof that acts as plofdak in case of dust-explosions from the grain so that the roof can fly off and pressure of an explosion can quickly be released, thereby sparing the silos and the rest of the structure.

Brinkman, J.A. (1931) *De nieuwe graansilo aan de Maashaven voor de N.V. Graansilo Maatschappij te Rotterdam. De Ingenieur*; B. *Bouw- en Waterbouwkunde*, 32.
 Graansilo te Rotterdam, Brinkman en Van der Vlugt, Architecten. - *Overzicht constructie. (1931) Bouwkundig Weekblad.*
 De Maasbode (1929) 61e jaargang, Rotterdam.
 Nog niet snel genoeg (1930) *De Tijd*.

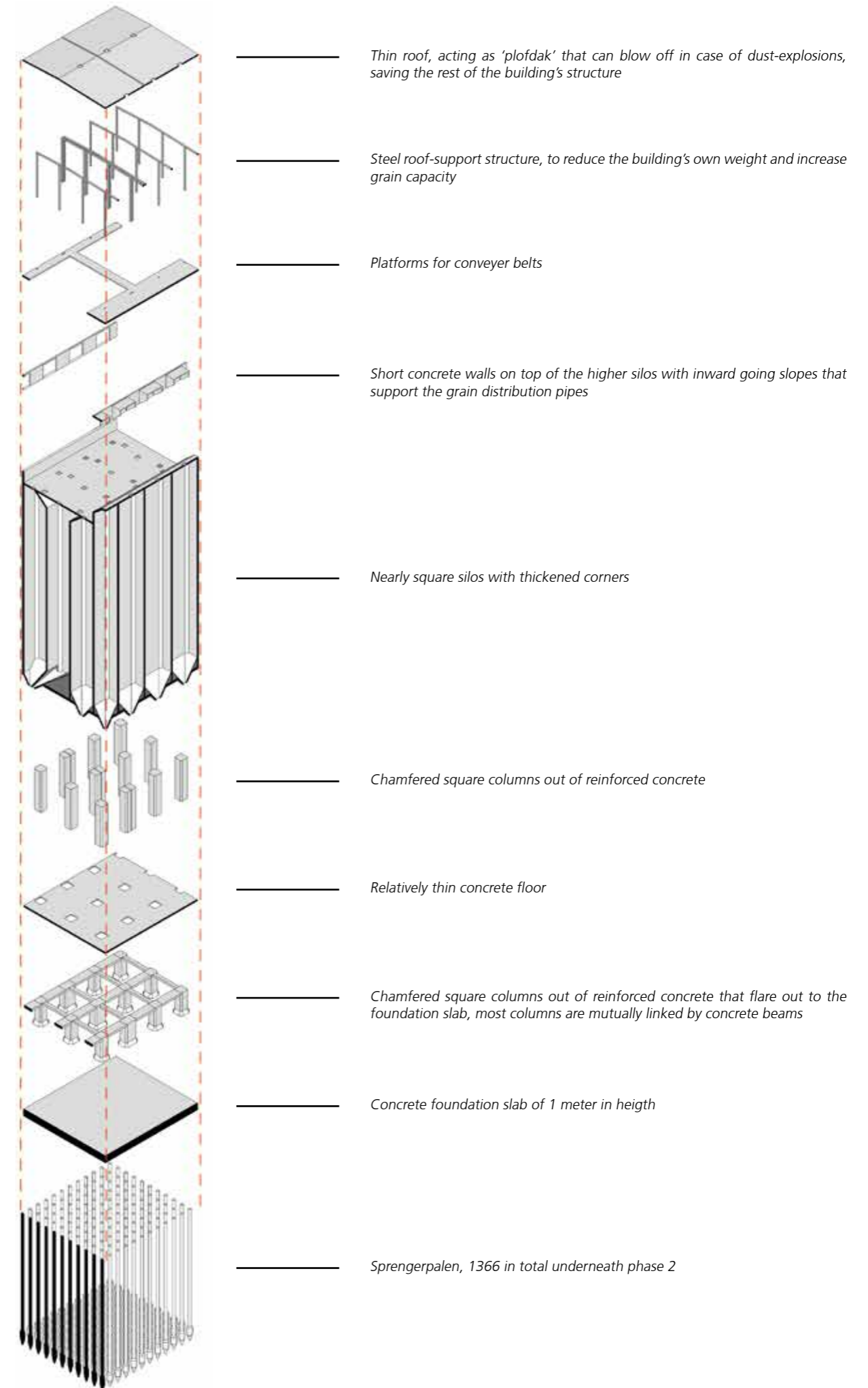

EXPANSION JOINT

PHASE 2: BRINKMAN & VAN DER VLUGT 1930

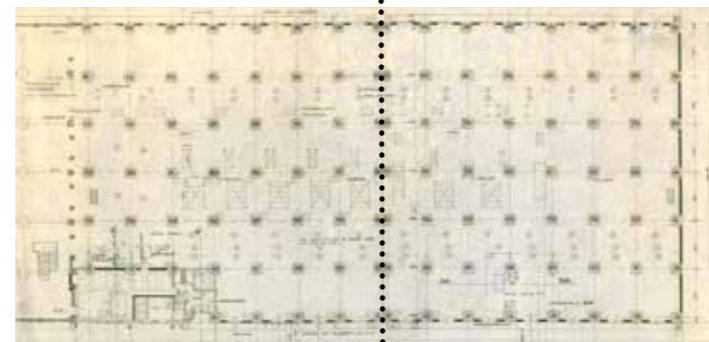
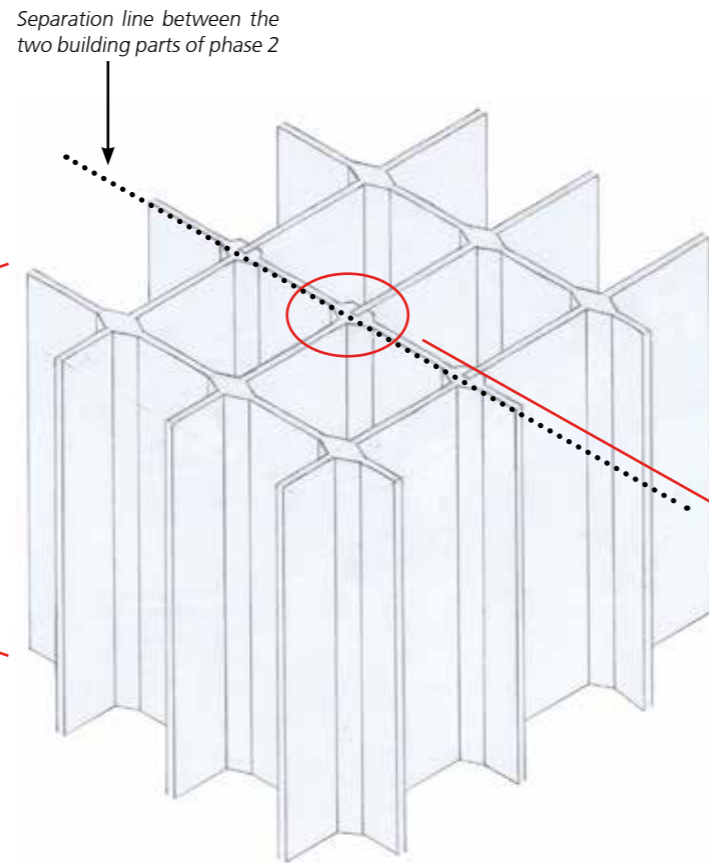
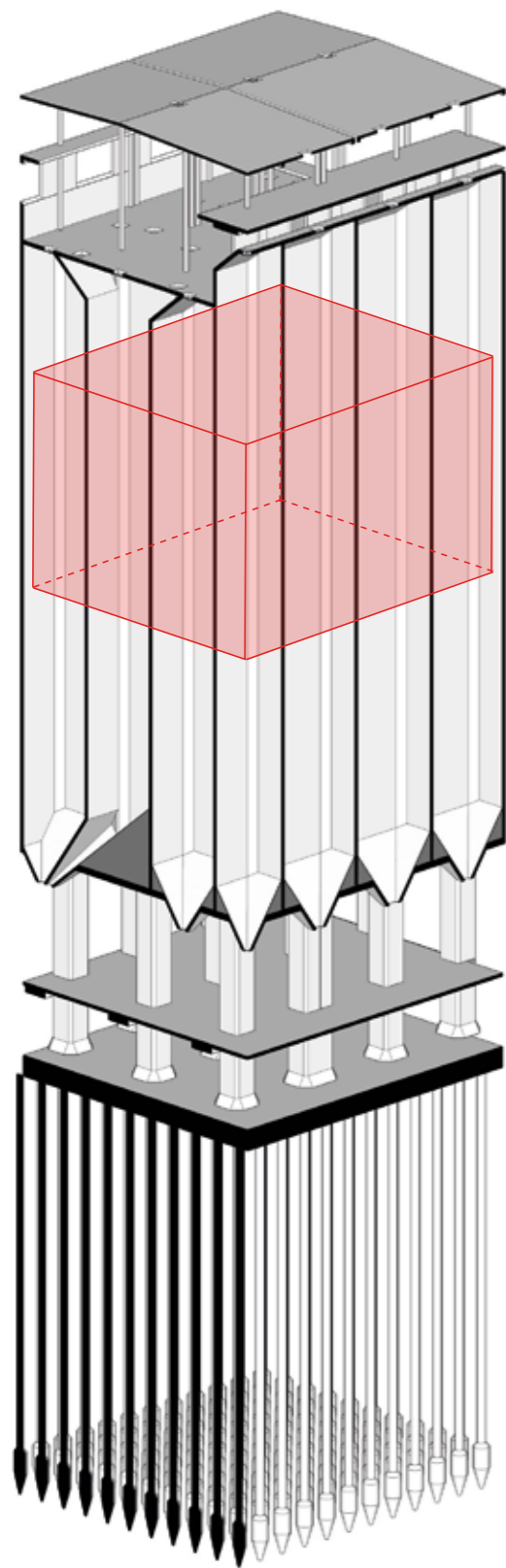

Location of expansion joint in plan view

Settlement in the structure occurs due to temperature change. In phase 1, a settlement of 8 cm was measured (Brinkman, 1931). To prevent the structure from cracking or otherwise deforming, an expansion joint was added in the middle of phase 2, throughout all levels of the building except for the basement, since temperature change is less beneath ground level.

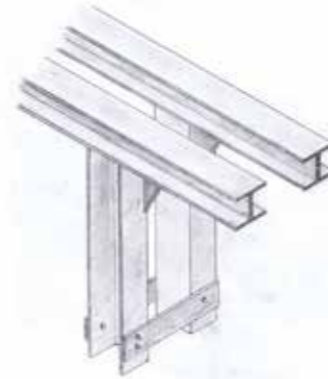

Separate supporting structure of columns and roof beam on both sides of the expansion joint, connected by thin horizontal metal plates.

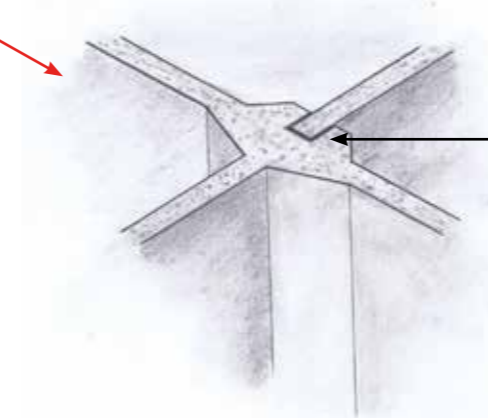

Expansion joint solution for silos in the center of the building.

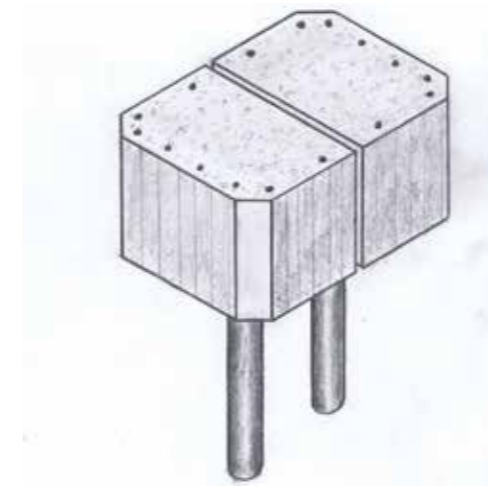

Expansion joint solution in original concrete columns and recently placed steel columns on the ground floor.

Phase 2 can be seen as two structurally separate buildings. On the top floor the separation is realised by building two iron trusses close to either side of the expansion joint. In the levels of the silos the walls of the silos are slid into one another without being structurally connected. And on the ground floor level the columns underneath the expansion joint are wider than the rest of the columns and are split down the middle with a few cm of space inbetween.

A for now unexplainable/curious detail in the roof structure are the thin horizontal metal plates that connect the iron trusses on both sides of the expansion joint. The whole purpose of this expansion joint is to allow free movement and settlement of the structure, the linking metal plates prevent this.

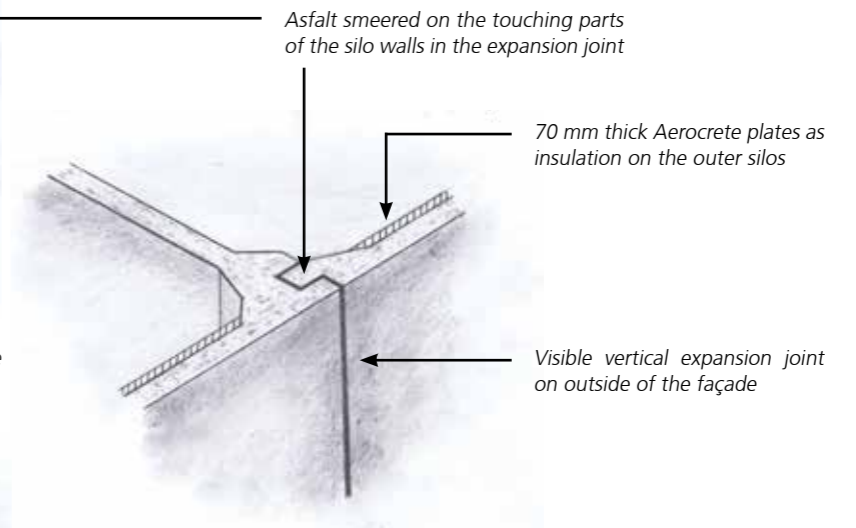

Expansion joint solution for silos on the side of the building, with a visible joint running down the façade.

measurements

Silo walls: 165 mm

Original concrete columns with steel reinforcement:

Standard columns: 1250 x 1250 mm

Columns with expansion joint: 1250 x 1800 mm

New steel columns under regular silos: Ø 270 mm

New steel columns under expansion joint: 2x Ø 190 mm

STATIC SCHEMES

PHASE 2: BRINKMAN & VAN DER VLUGT 1930

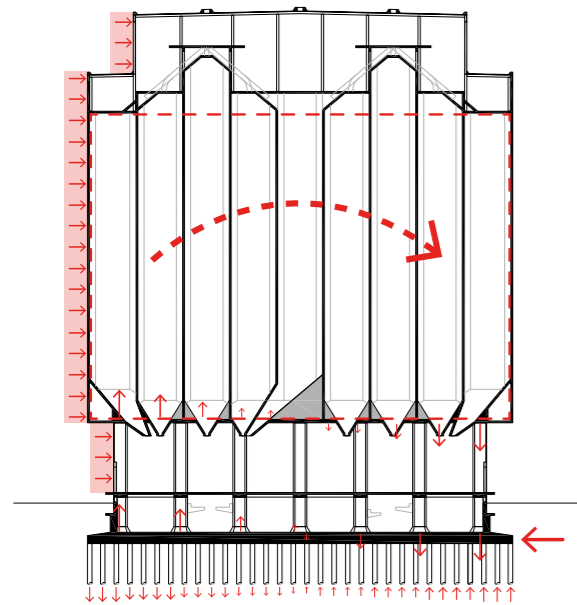

Original situation - short section
Horizontal wind loads on the building that functions as a whole with an imaginary hinge in the middle

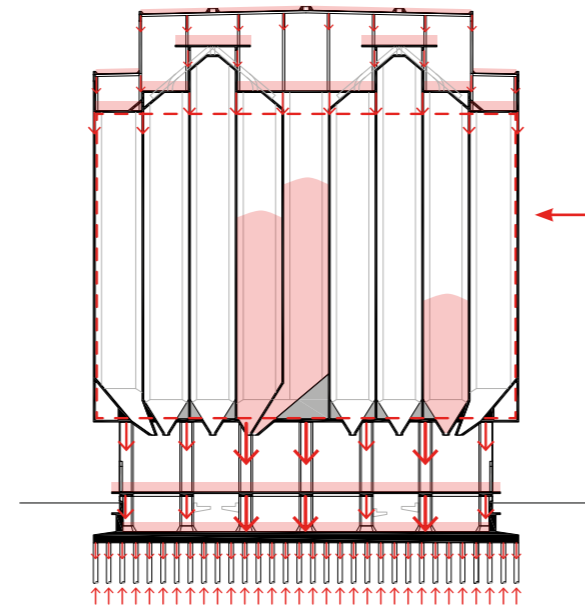

Original situation - short section
Vertical loads

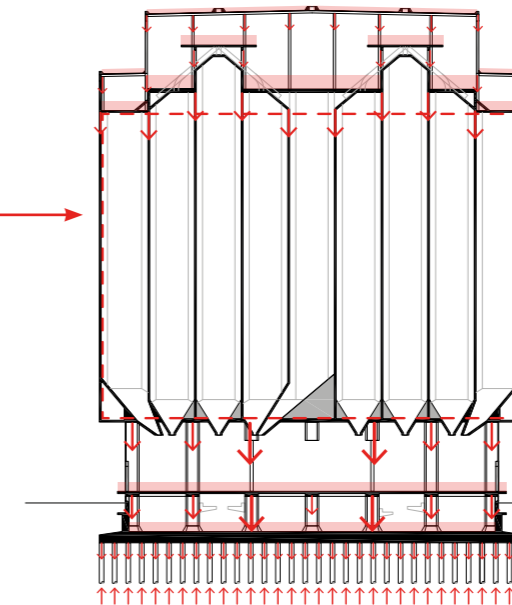

Thicker top floor for new function

Chopped off concrete columns in the center row, new slender steel columns in the adjacent rows

Thicker groundfloor for new function

Current situation - short section
Vertical loads

- = Q loads (variable forces spread out over a surface)
- = indication of direction and magnitude of the accumulation of forces
- = direction of rotating moment in the building

By removing the concrete columns in the middle row of the building, the loads on these former columns are now distributed to the new slender steel columns in the rows next to them. These columns bear more forces than the remaining original concrete columns further away from the center of the building, but less than in the original situation since there are no longer massive amounts of grain stored in the silos above.

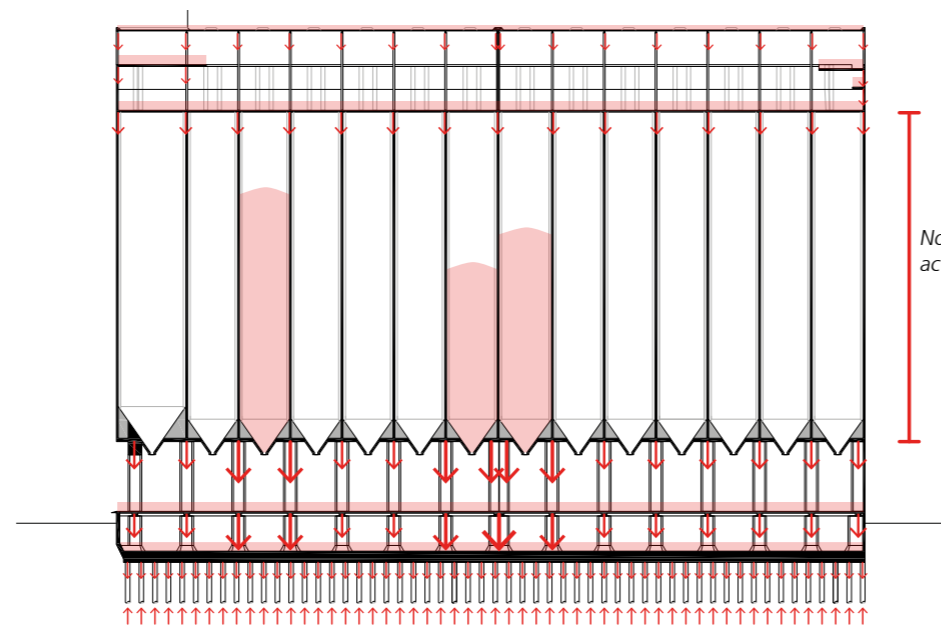

Original situation - long section
Vertical loads

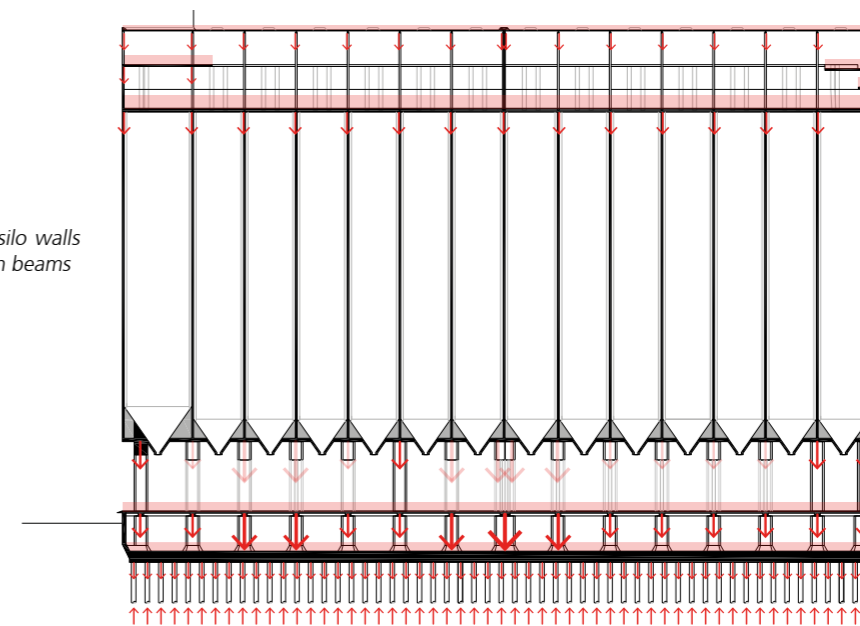

Thicker top floor for new function

Loads above chopped off concrete columns are distributed to columns in the adjacent rows

Thicker groundfloor for new function

Current situation - long section
Vertical loads

3D STRUCTURAL COMPOSITIONS

PHASE 3: A.G. POSTMA & J.D. POSTMA 1951

An isometric exploded view of the stability 'gate' between the two main volumes of phase 3, built because of the existing transformer house and the need of the structure to support a floor crossing from one part of phase 3 to the other part of phase 3 for the distribution of grain on the top floor.

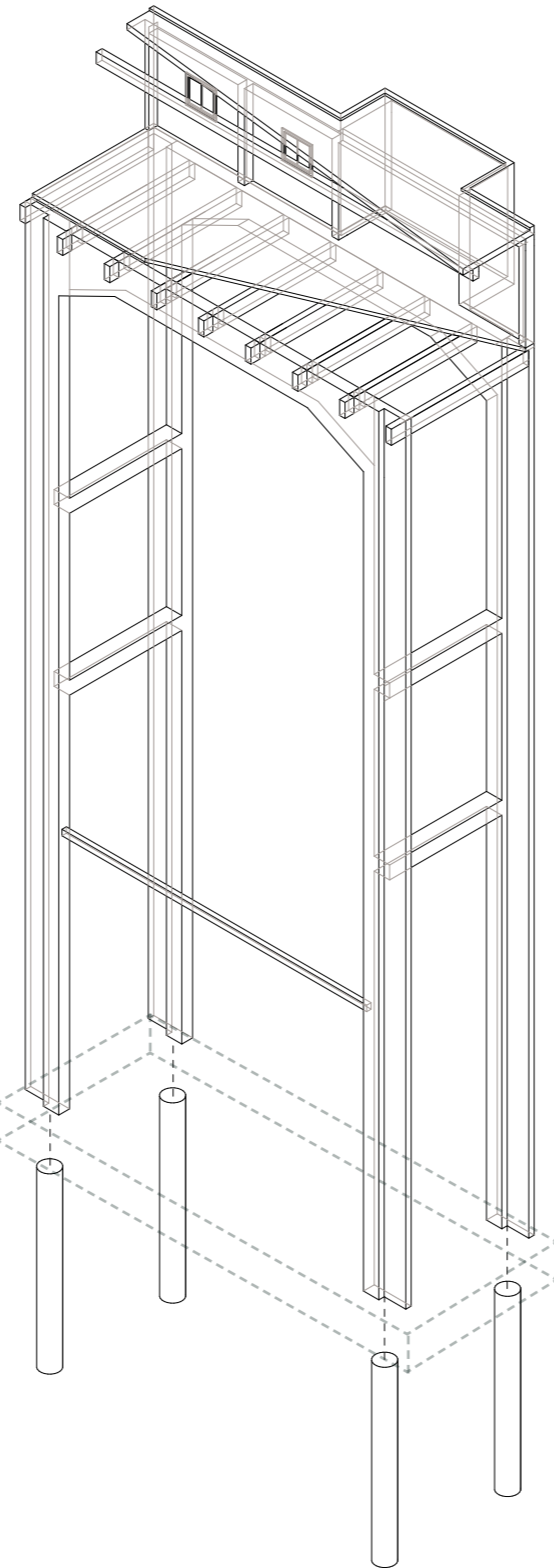

An exploded view of a standardized section of the Postma phase of the Maassilo

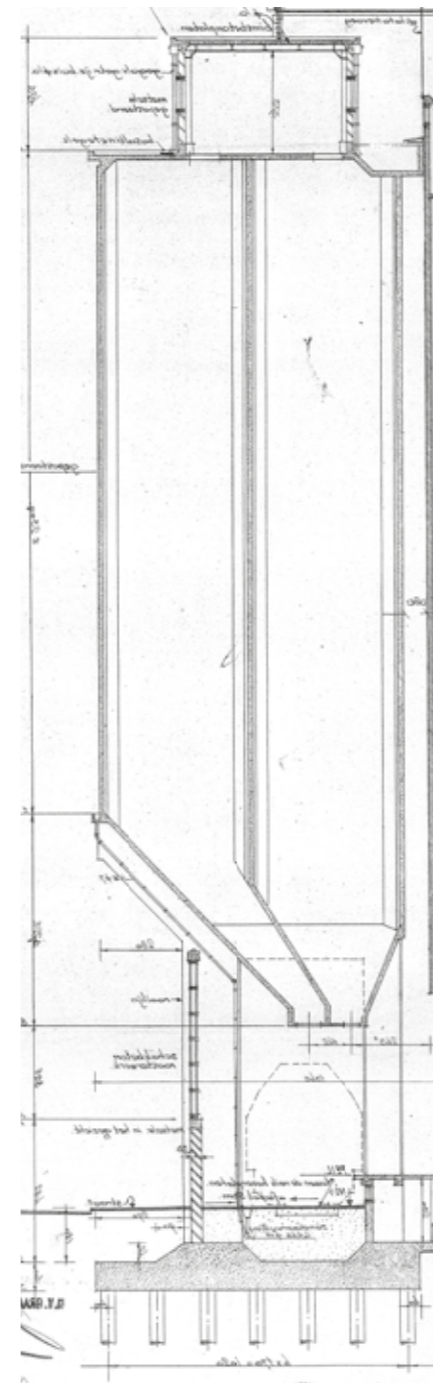

original 'bestek' drawing (Rotterdams gemeentearchief)

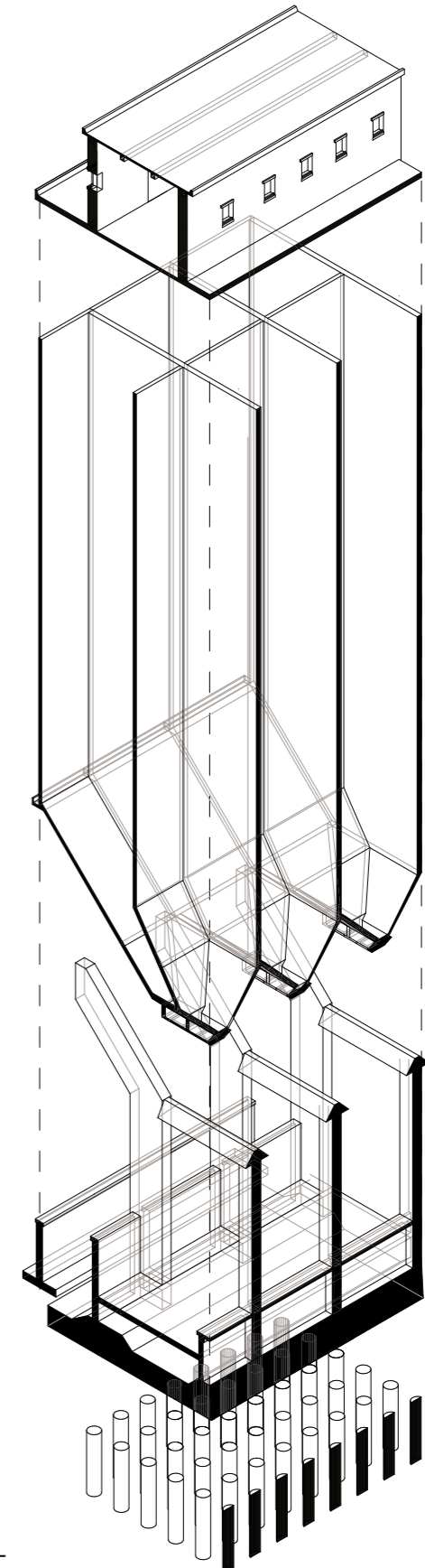

FOUNDATION METHODS

PHASE 3: A.G. POSTMA & J.D. POSTMA 1951

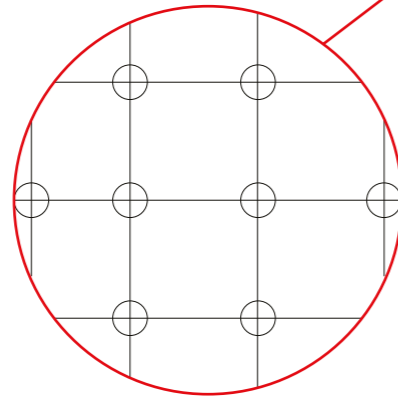
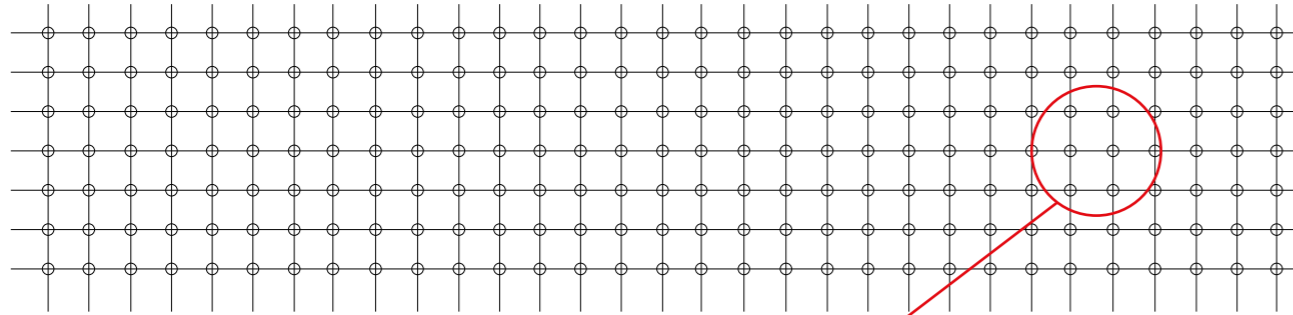

piller schemes

there are two different divisions of the pillers within the foundation. on the left side there are strokes of 2 silo's next to each other which leaves a little more room in between the pillers when compared to the scheme of the right side which holds strokes of 3 silo's next to each other. (own drawings)

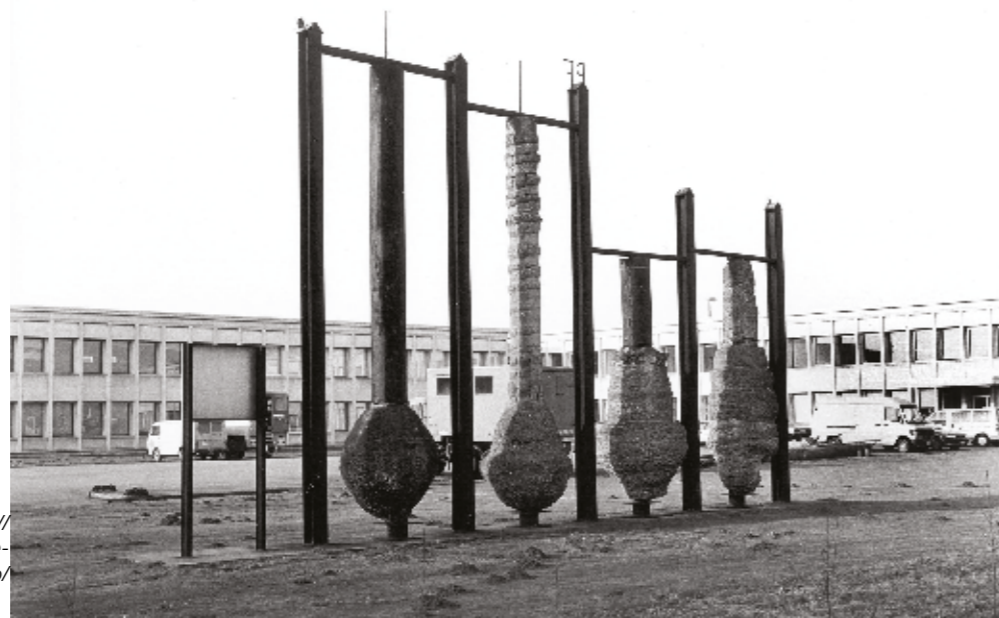
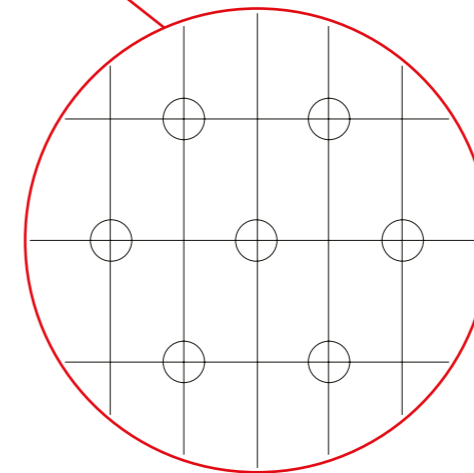
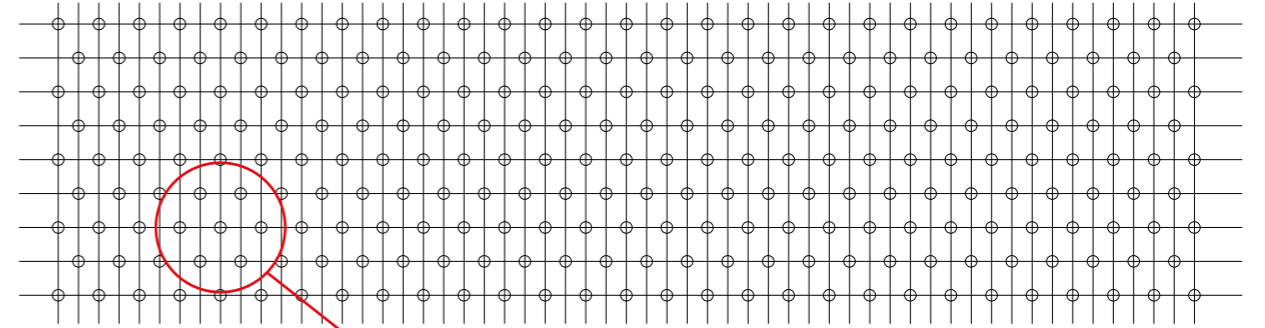

franki-palen above ground (<http://www.ugentmemorie.be/sites/default/files/styles/large/public/foto/g23b013.jpg?itok=FQhOCp53>)

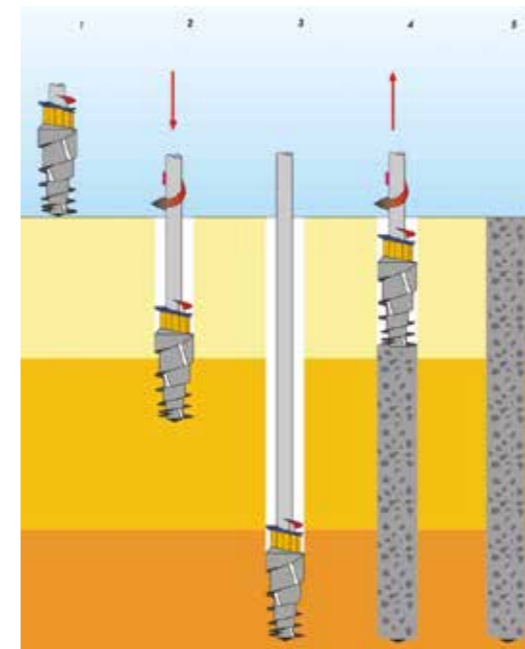

franki-palen

foundation pillers which are made by first digging out a hole in the sand and then filling the negative space with concrete to create a solid piller over time.

explanation of the installation of franki-palen (http://www.franki-grondtechnieken.nl/Franki/media/Franki_Media/Products%20sheets%20Piles/products%20jpg/BU%20Piles/versteven%20inluisel/Inclusion-Rigide.jpg)

STRUCTURAL LOADS

PHASE 3: A.G. POSTMA & J.D. POSTMA 1951

The structure of the third phase does not have any particular innovations or different building methods other than the usage of a meter thick foundation and the usage of Franki-palen. What is special about phase one is that it blocks the wind loads for building phases one and two.

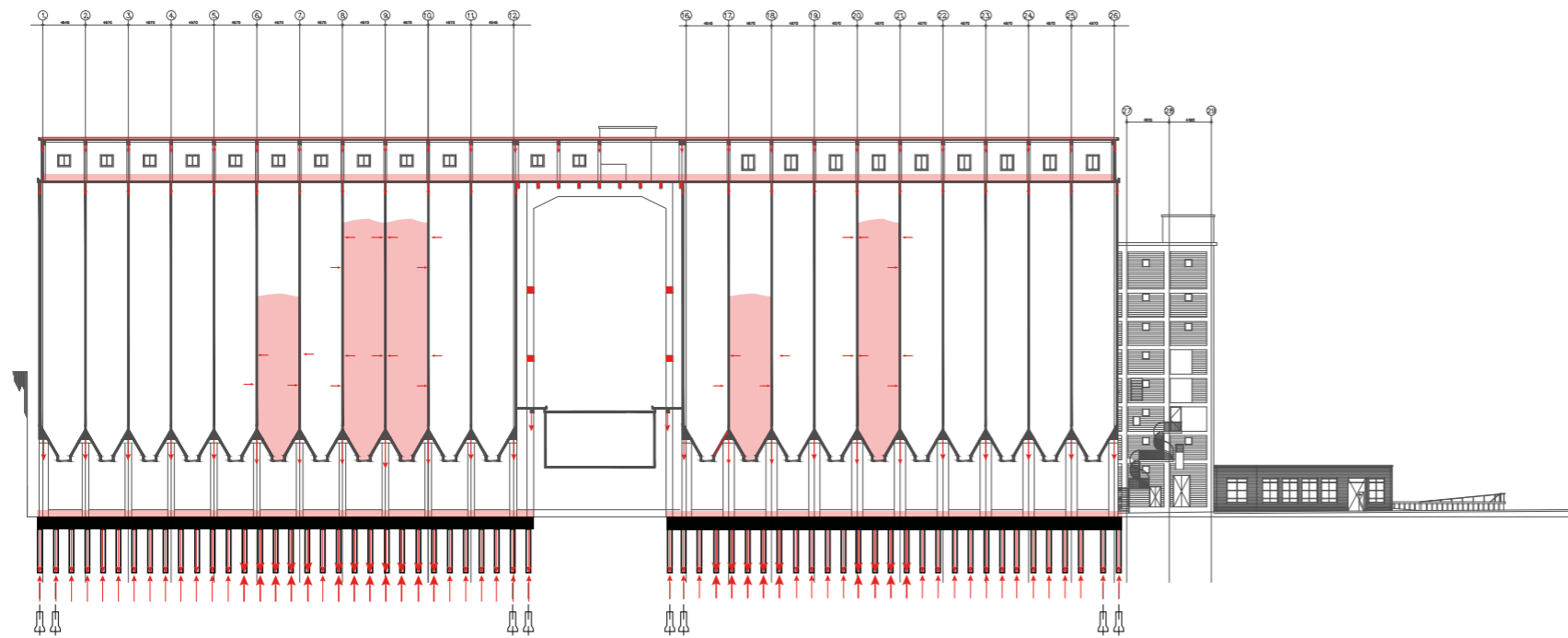

section with static forces

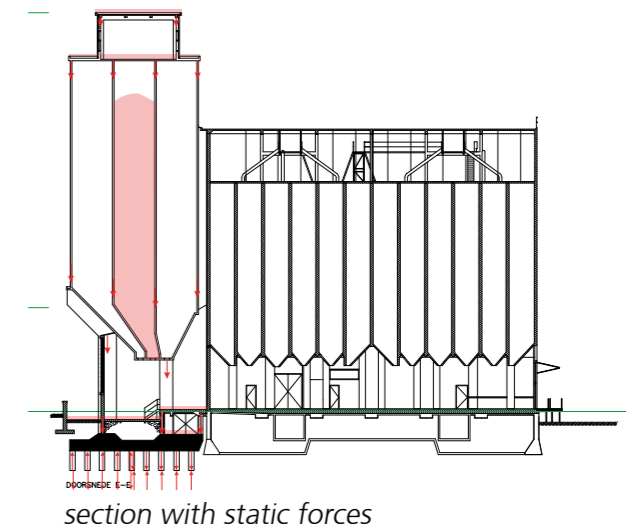

section with static forces

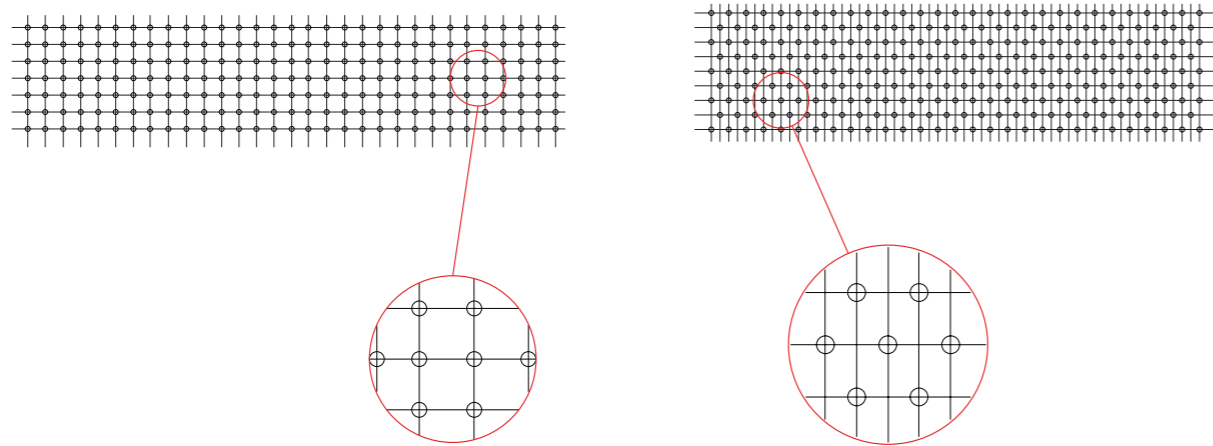

foundation piles plan

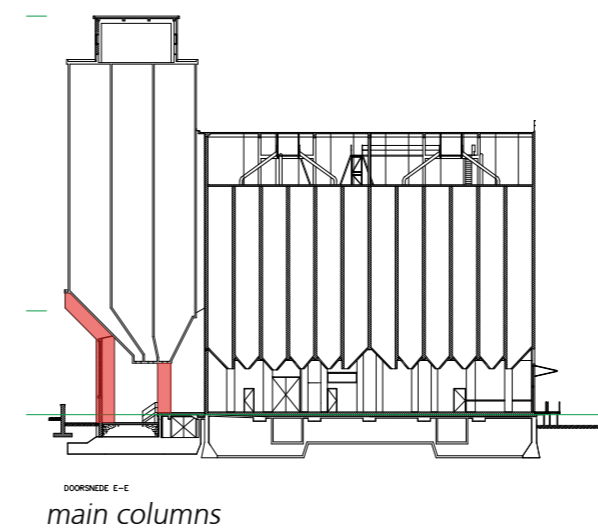

DOORSNED E-E
main columns

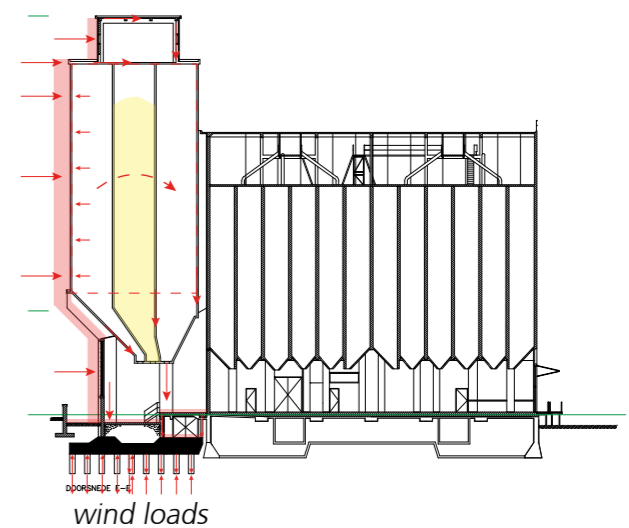

DOORSNED E-E
wind loads

INTRODUCTION

PHASE 4: H. HAAN 1963

office and dwellings

The architect Herman Haan designed a two story building for the 'Graan Elevator Maatschappij' in 1963. This building was meant to host the growing need of office space. The office was located on the 1st floor, on the ground floor two Haan designed two apartments of which the layout was mirrored. The need for office space kept growing, and in 1971 the two dwellings were converted into office space as well.

context

Due to a lack of space the building had to be built in the water what made it an interesting structural challenge. Located on the eastside of the site in the very far corner of the harbour looking over the water.

groundwork and foundation poles

Already in 1957 several cone penetration tests were made to determine the length of foundation poles. According to the foundation pole reinforcement drawing these were made 20 meters long so that the buildings loads would stand on the second sand layer.



Drawing of reinforcement for foundation pile 1963
(Source: Rotterdam Archive)

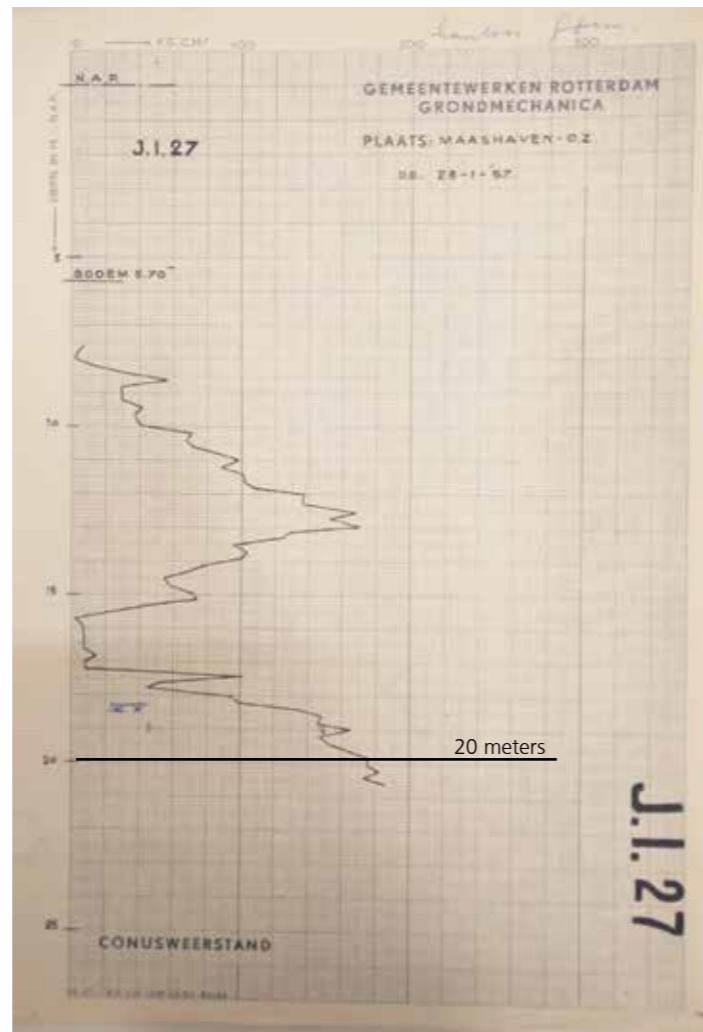

Cone penetration test at the Maashaven from 1957
(Source: Rotterdam Archive)

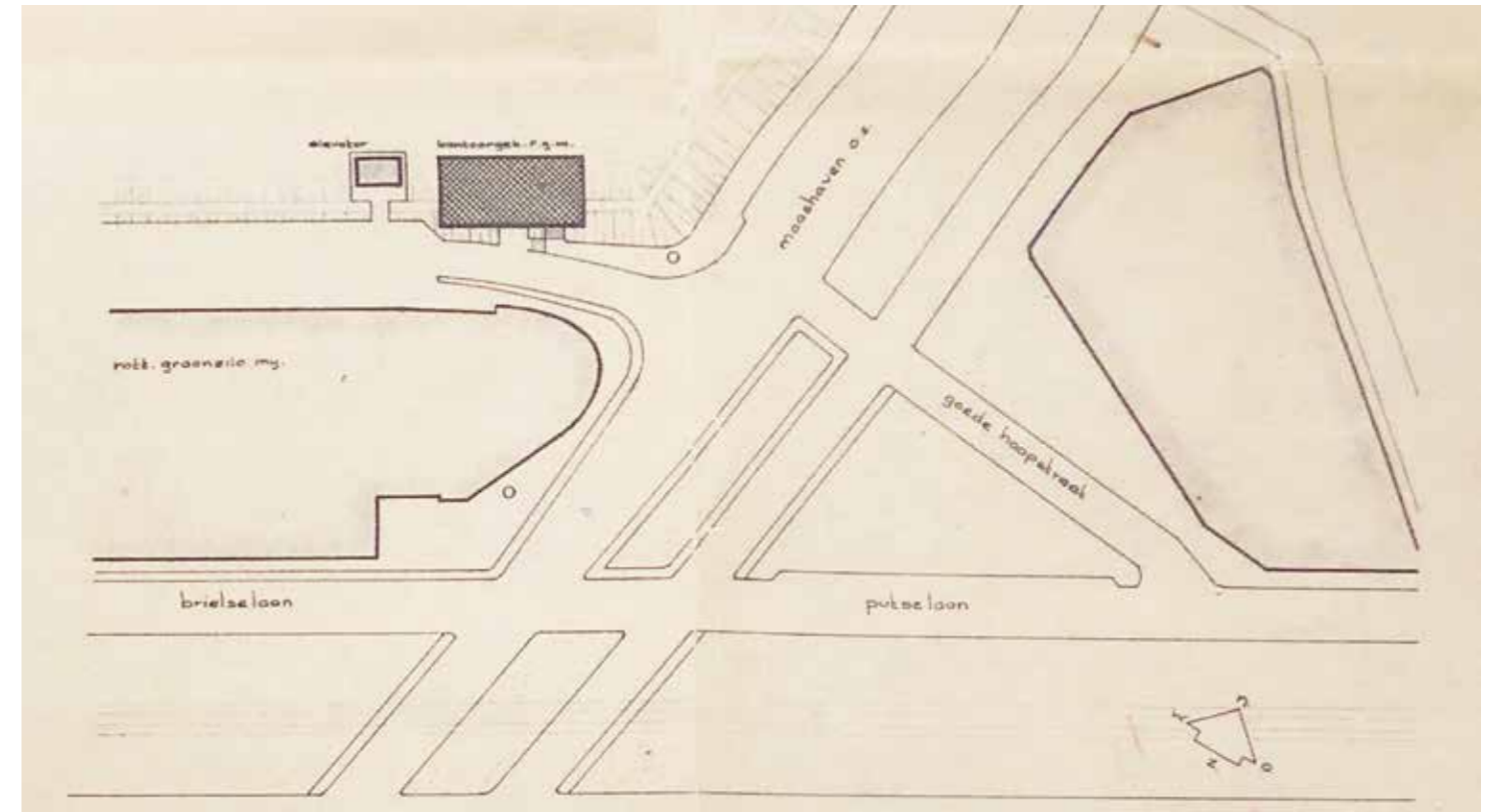

Context drawing Maassilo Office building 1963
(Source: Rotterdam Archive)



Maassilo in 1971
(Source: Haan, H (1971) Photo collectie, retrieved from 'Het Nieuwe Instituut')

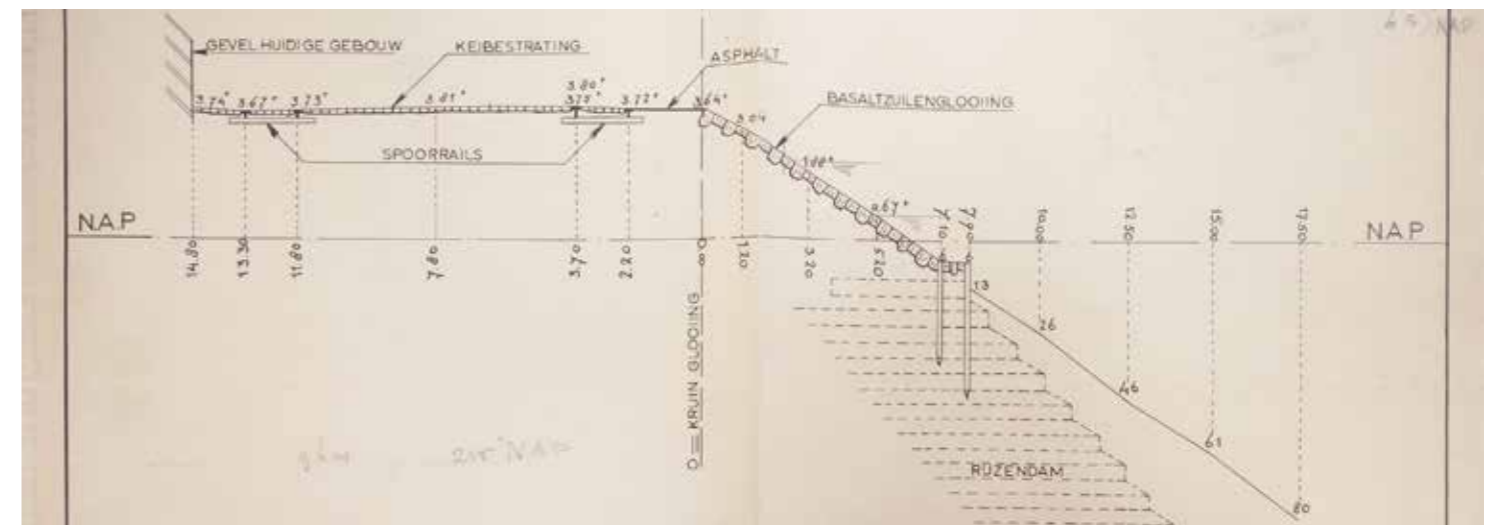

Section of wharf and water where the office has been positioned 1963
(Source: Rotterdam Archive)

CONSTRUCTION SYSTEM

PHASE 4: H. HAAN 1963

As the building stands on the water and needed to remain connected to the wharf it is placed on an elevated structure. This base consists of three hollow pillars that are shaped as a wall and become wider towards the top. The structure stands on 20-meter long foundation piles. The prefabricated beam-cover proves Haans eye for detail. Also the sloping ground floor that stands on the base structure was an aesthetic intention to make the building seem to float above the water. However it also testifies Haans intentions to be economical with building materials. As do the columns that have different sizes.

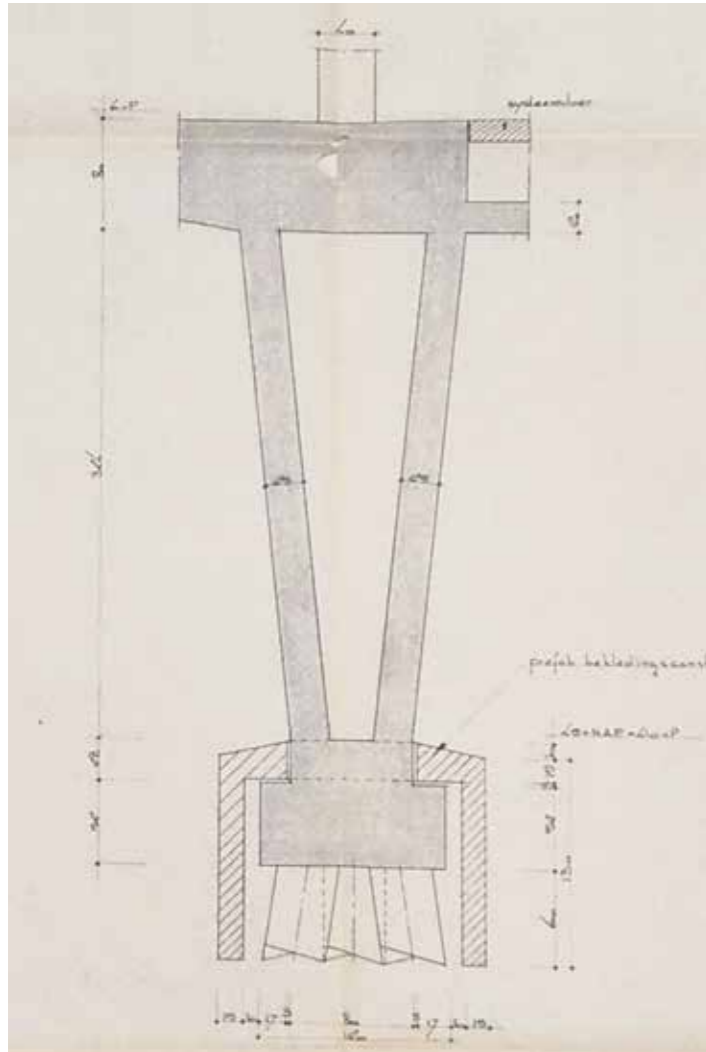

Short section of the base structure and foundation illustrating the hollow space in the pillars and the prefabricated cover beam.
(Source: Haan, H (1959) Graansilomaatschappij Rotterdam Maashaven Bestekening retrieved from Rotterdam Archive)

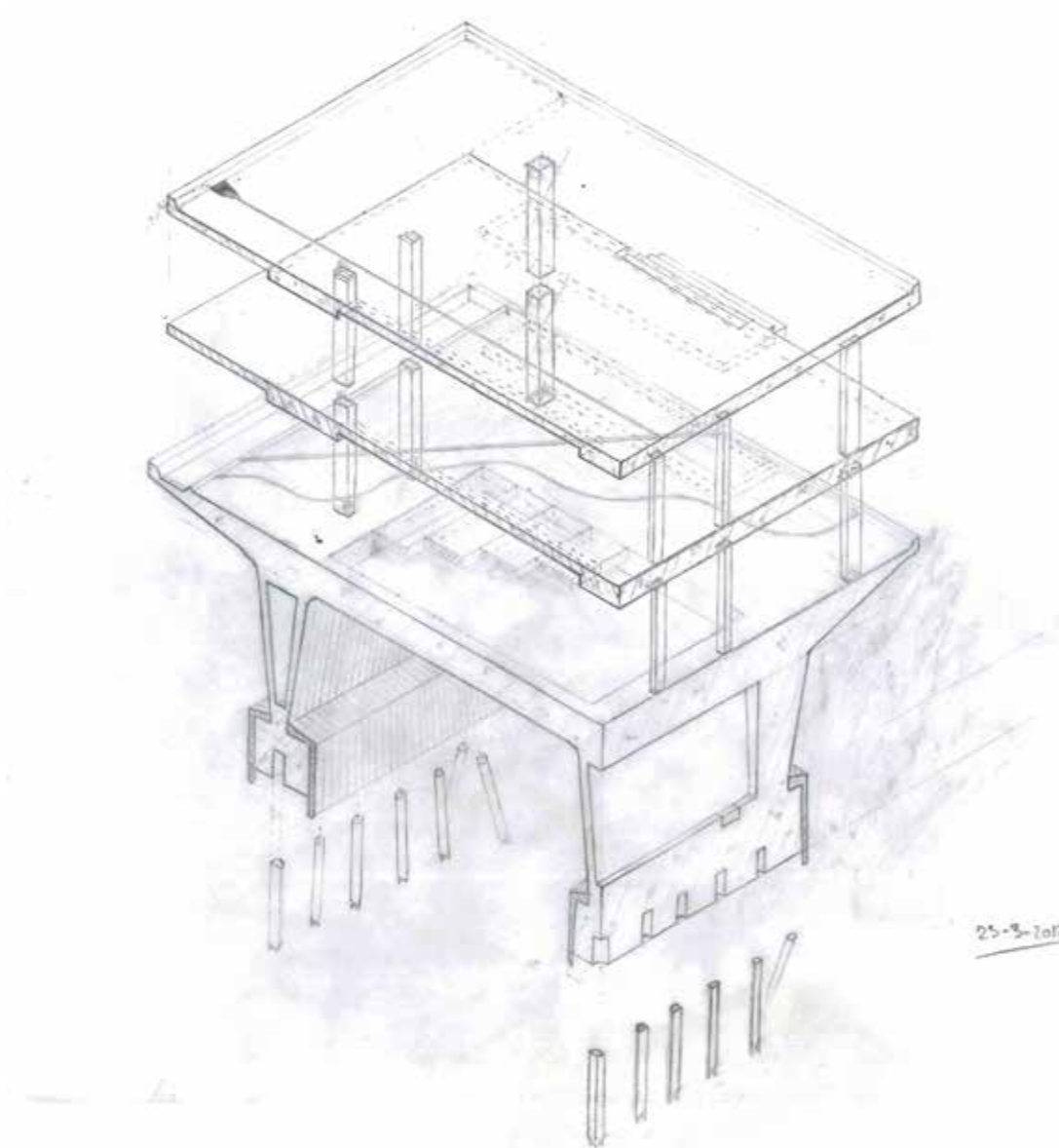

3D axonometrie of a part of the structure

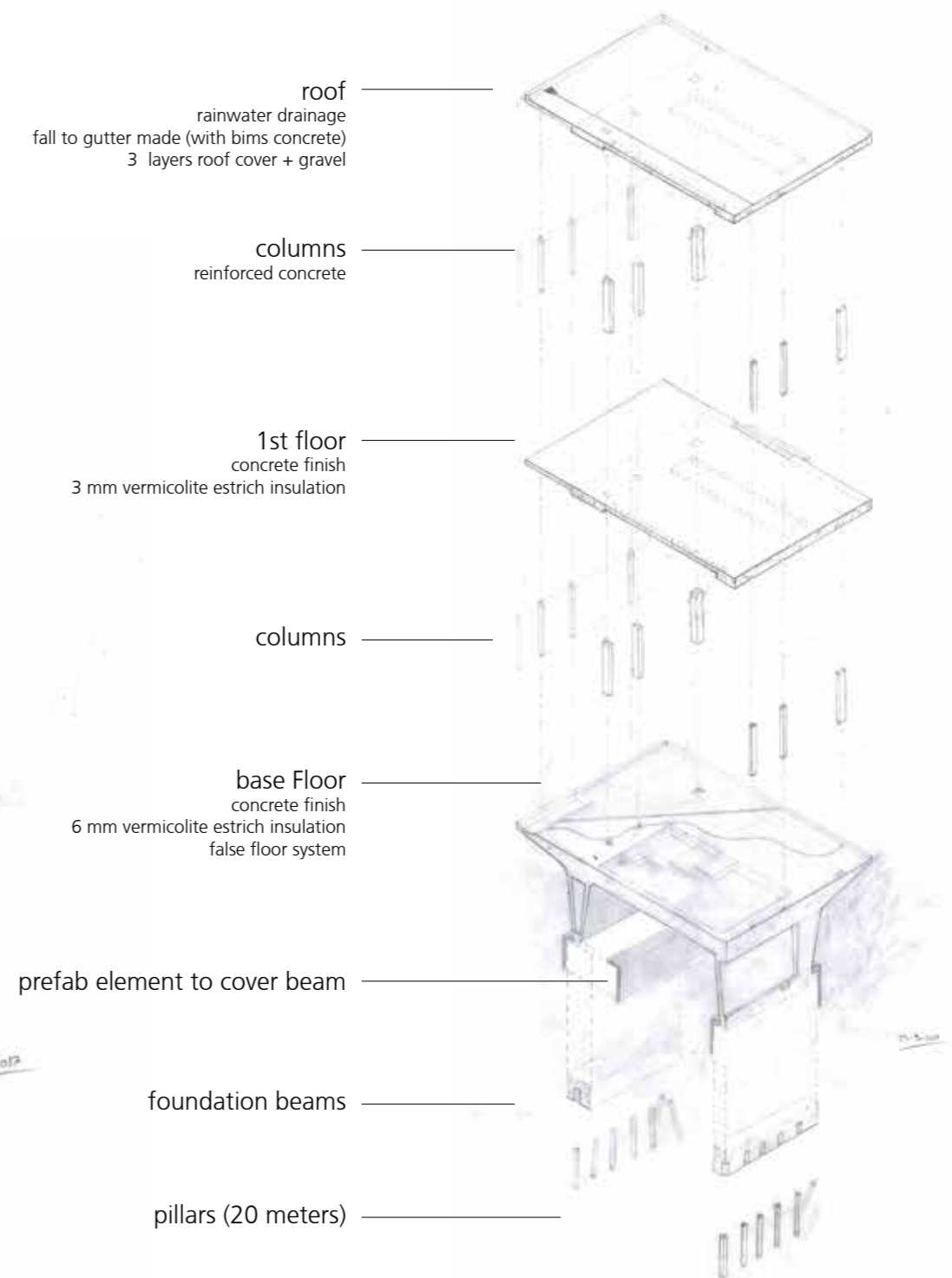

3D explode view of a part of the structure

STATIC SCHEMES

PHASE 4: H. HAAN 1963

main structure

The main structure of the building is based on Le Corbusiers Pilotis system of columns and floors. Columns carry all the vertical loads that allow a free open layout in the facade. The whole structure works as one fixed element of reinforced concrete. It was casted over several stages in which the reinforcement is connected throughout the solide structure.

vertical loads

Vertical forces are as usual, based on the weight of the structure and the varying loads of people defined by the function. These so called surfac loads are taken by the floors and distributed to the columns. Finally these forces end up in three big pillars that stand on three foundation beams. Consequently the foundation beams rest on 42 pillars that stand on sand layer 20 meter down in the ground. These pillars provide the reaction forces to keep the building standing.

horizontal loads

It should be mentioned that except from wind in this case also some water pressure is forced on the structure.

Water pressure and passing wind that creates a draft are both illustrated in the diagram but can almost be discarded. The main horizontal load is the wind pressure on the facade. These load are illustrated in both the short and the long section. The horizontal wind pressure basically results in two forces that have to be contrasted by the foundation pillars.

Firstly the building tends to tilt over. If we dramatize this behaviour the wind pressure causes forces to go up on the side of the wind and down on the other side. The foundation has to compensate these forces by pulling on one side and pushing on the other.

Secondly the horizontal wind pressure tends to 'push' the building a side. All foundation pillars have to compensate these tencile force with a reacting force that works in the opposite direction.

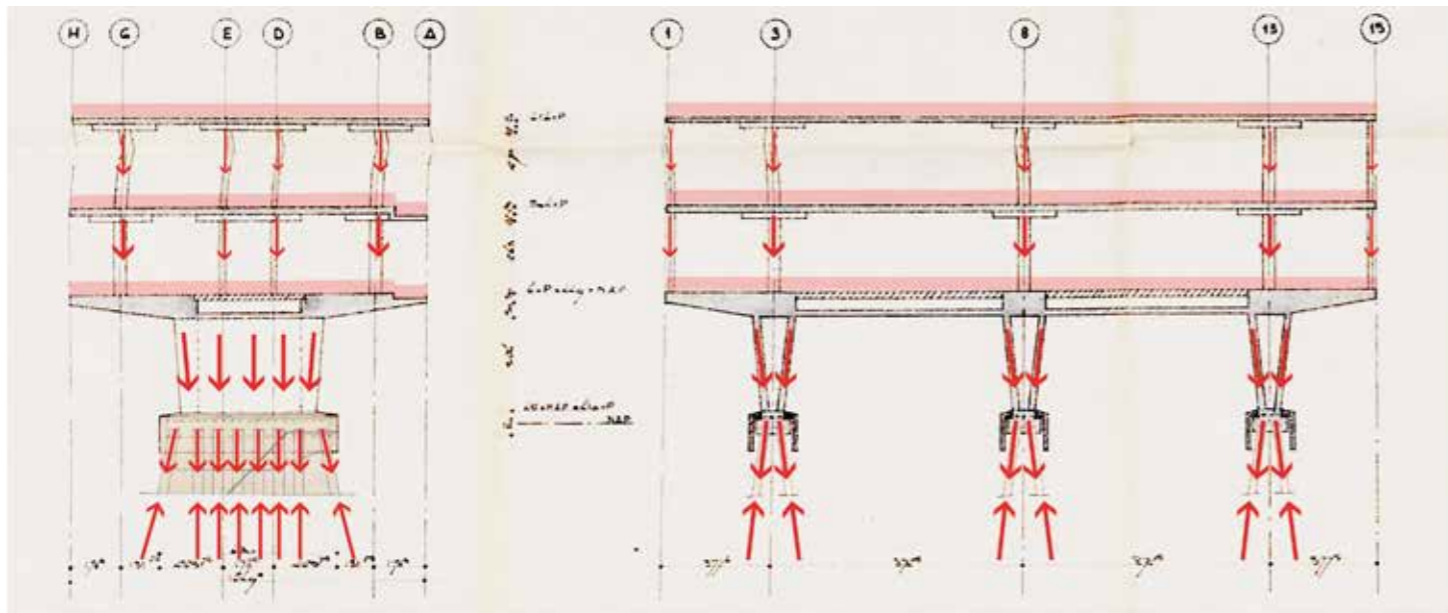
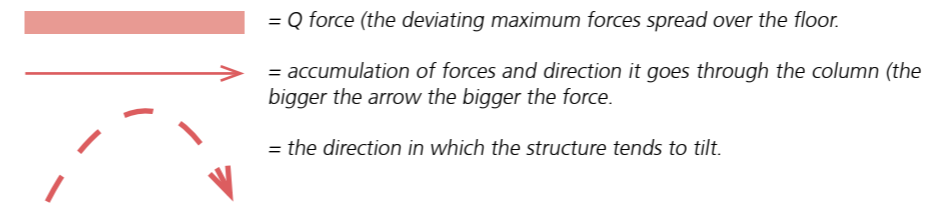

Long and short section illustrating the vertical forces

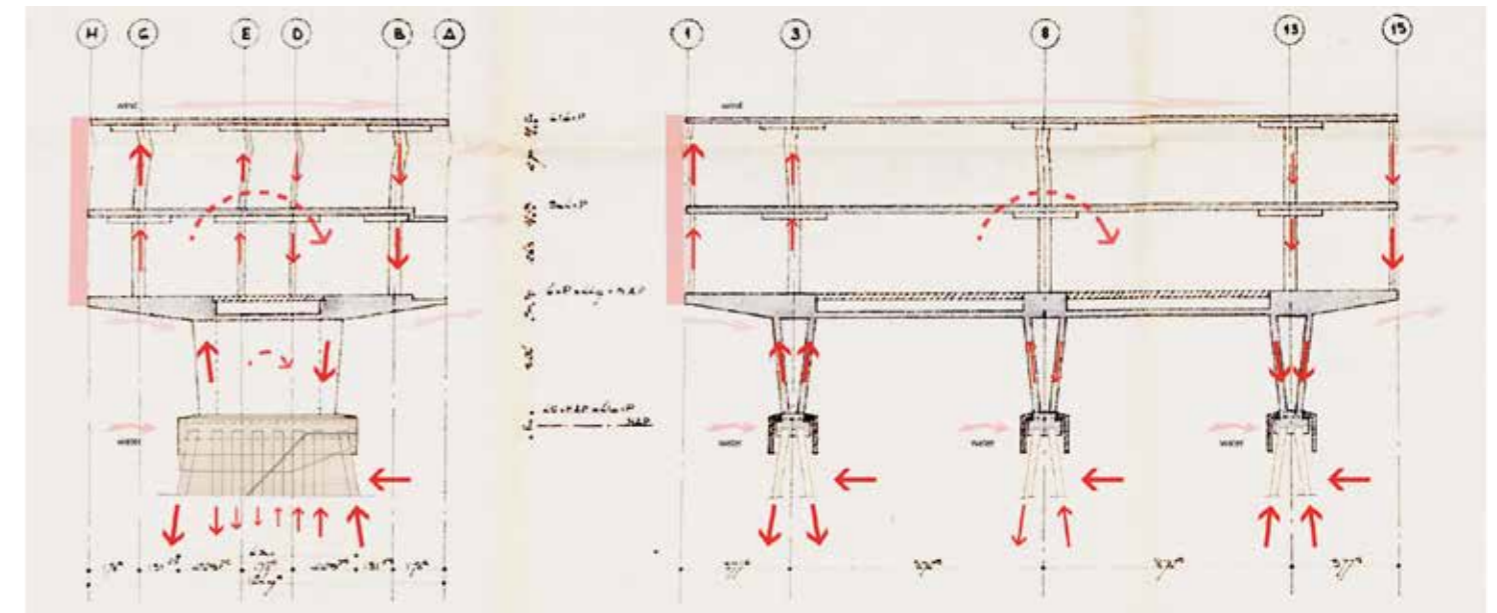

Long and short section illustrating horizontal forces

(Source of drawings: Haan, H (1959) Graansilomaatschappij Rotterdam Maashaven Bestekening retrieved from Rotterdam Archive)

STANDARD SILO STRUCTURE PRINCIPLES

GENERAL

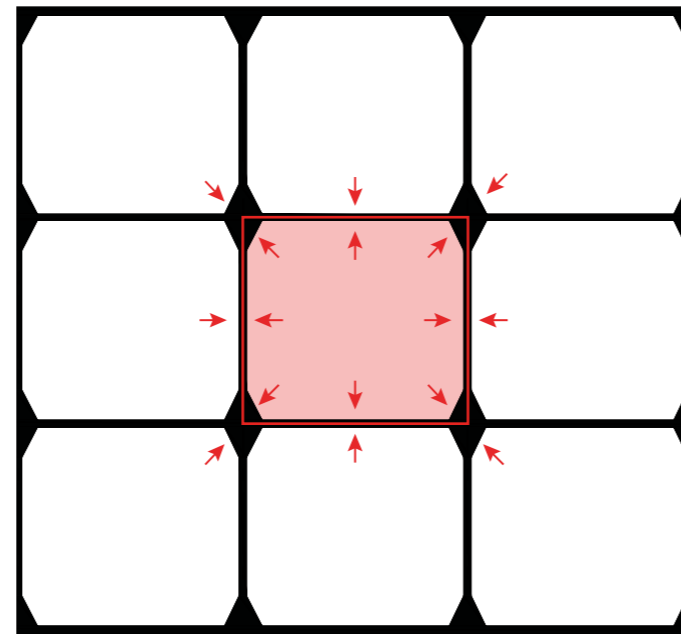
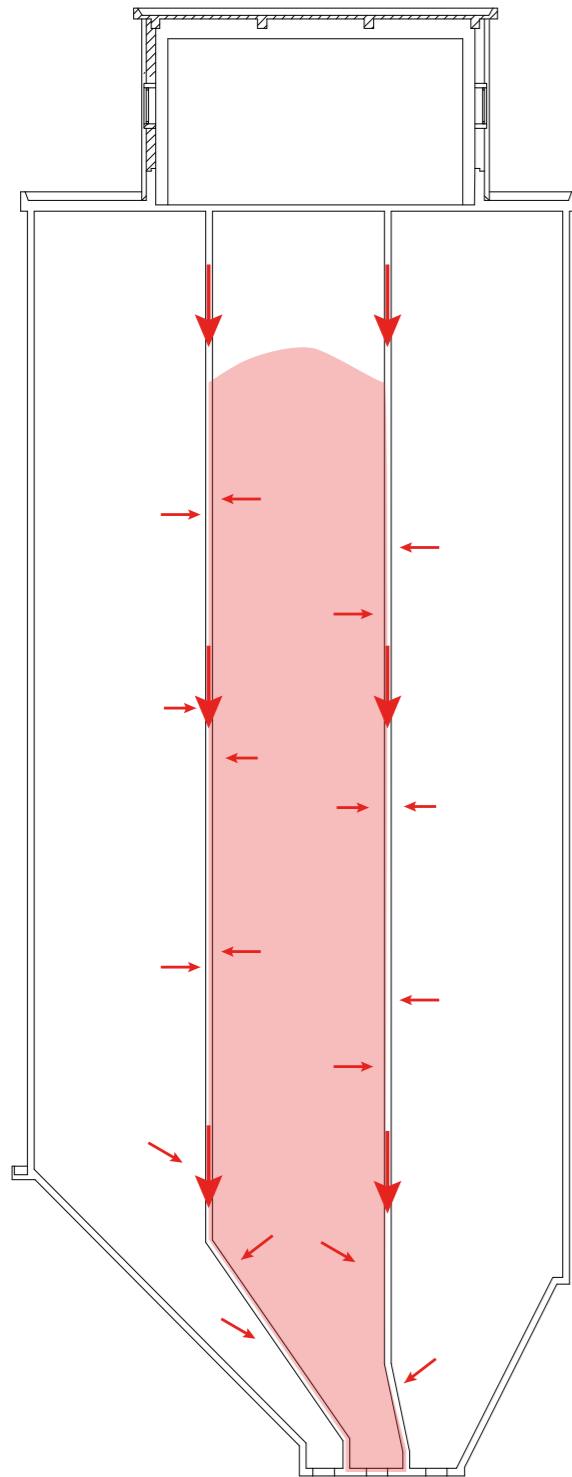

the structure of the silo's are made up of concrete cells with a rebar structure consisting of horizontal rings and vertical bars to also being able to hold tensile stress. This structure allows for variable loads since certain silo's arent always next to other filled silo's and need to be able to support their own forces instead of being dependend on the horizontal pressure of neighboring filled silo's.

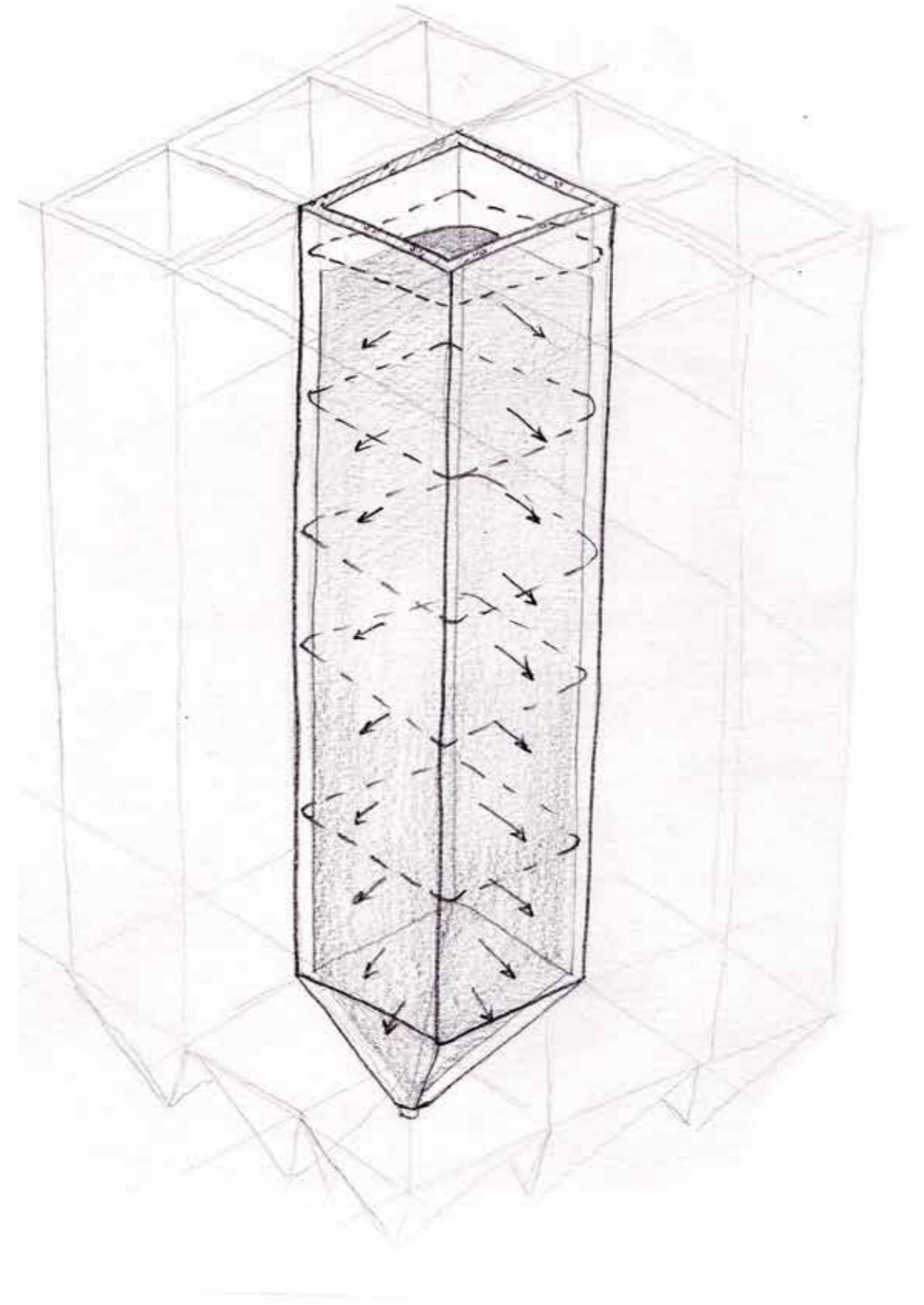

PLOFDAK SYSTEM / DAMAGE CONTROL

GENERAL

A 'plofdak' is a very light and thin roof structure which allows pressure to escape incase of an explosion in the building. The roof parts will come off from the structure creating space for the pressure from the explosion to be relieved. The reason for this roof method to be implemented is the cause of dust explosion which happen very fast and can expand in a matter of milliseconds. So for the structural integrity of the building the explosion must go upwards and not damage the silo's or concrete structure.

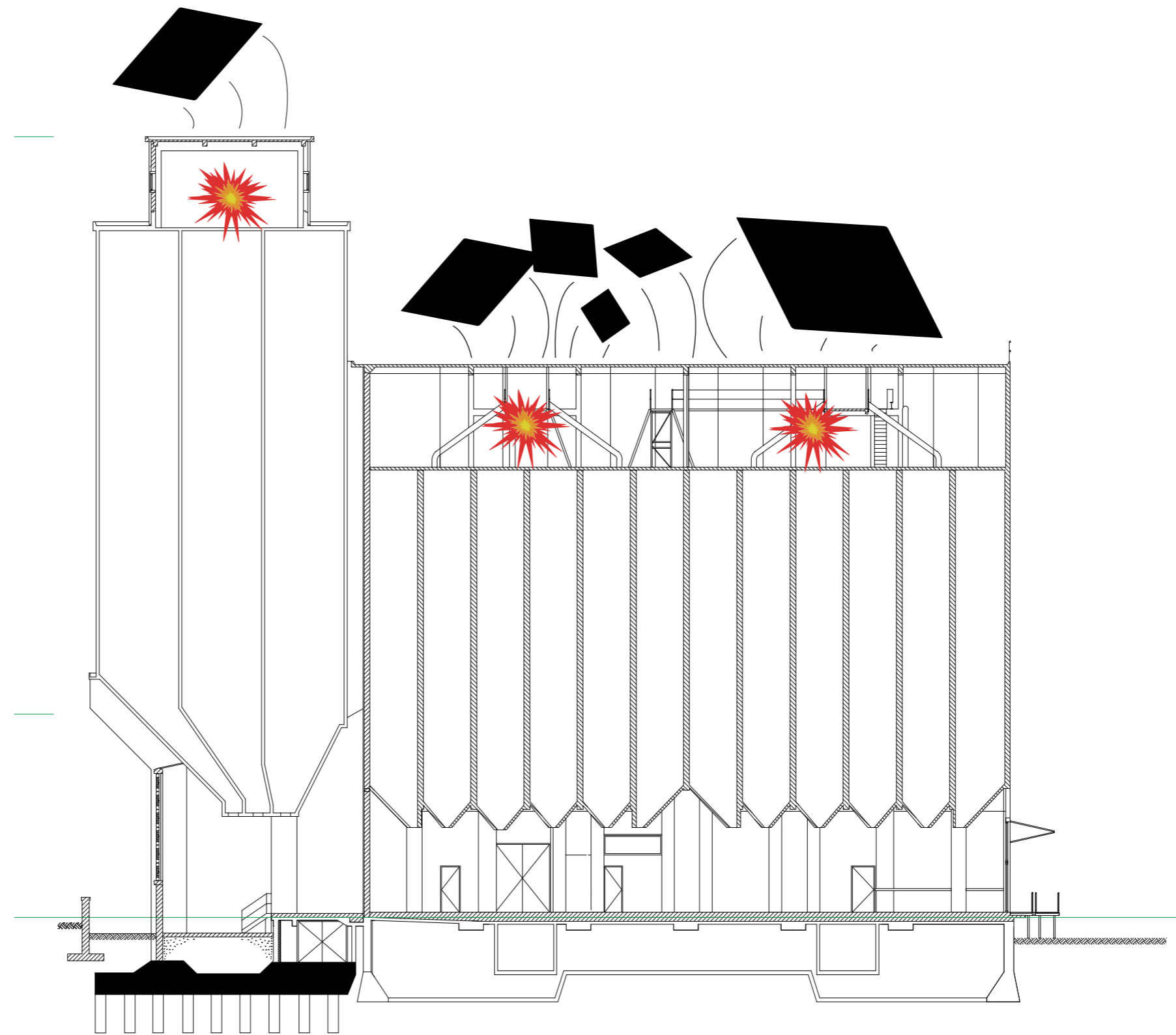

DOORSNEDE E-E

SILO CAPACITIES

The silo capacities show really well what this structure can handle in terms of loads and also shows with its sheer number of tons how massive this complex really is in terms of cubic meters of space. 86.000.000 KG of grain could be stored in the Maassilo making it Europe's largest grain storage facility when the three phases were completed. To give some kind of scale to that gigantic number, a full grown elephant weighs 6000 KG. So that would mean that the building could possibly house 14.333,3 elephants in the building. which could also be translated to housing floors on top of the Maassilo because it is no longer used as a storage.

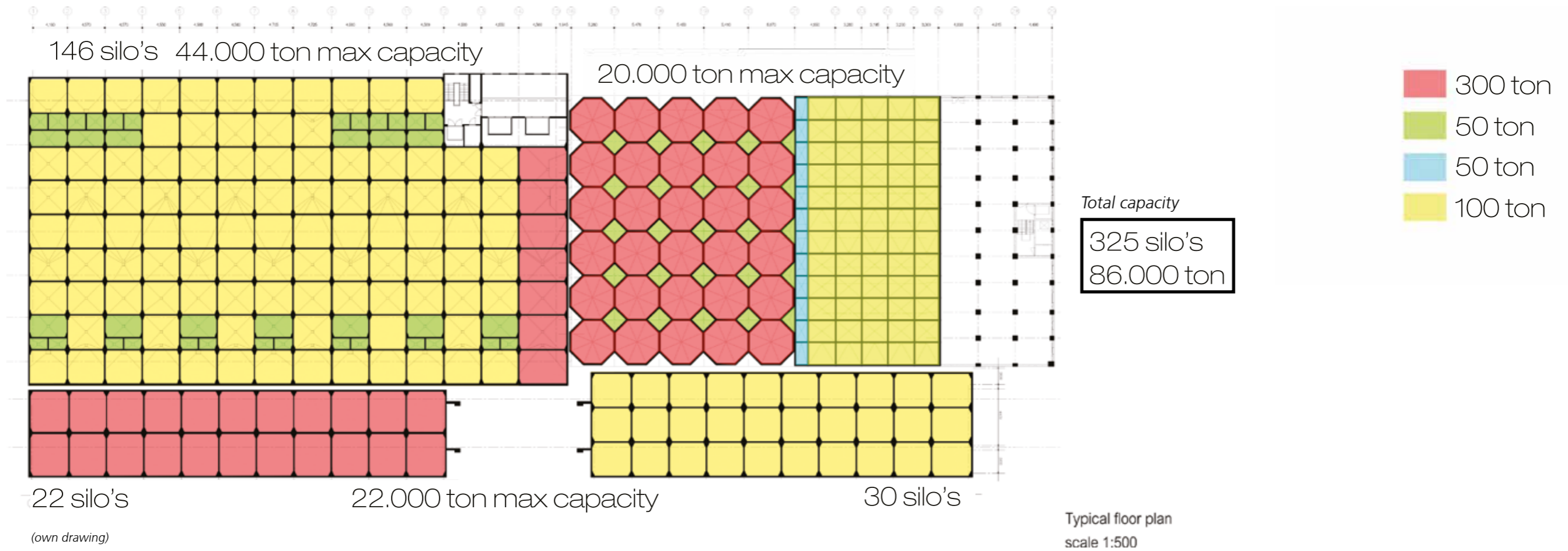

B T 2 : M A T E R I A L

FACADE SYSTEMS

This page shows the inventory of the different facade systems that have been used for the Maassilo in the different phases. Further research needs to be done on the exact dimensions in the sections. Also, on the drawings of part 2 insulation is shown. For now, it is not certain if this is also the case for building part 1 and 3.

attic & ground floor part 3

- brick, cross bond
- &
- columns, cast in situ

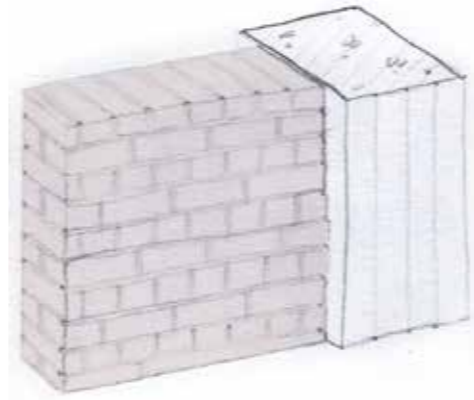

silos

- (70 mm aerocrete insulation in part 2)
- concrete, cast in situ
- plaster

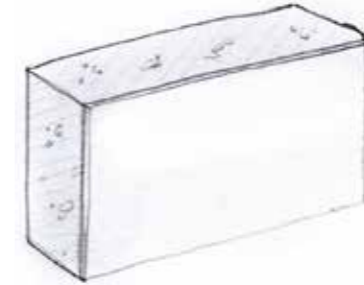

west facade

- concrete, cast in situ
- plaster
- corrugated sheet

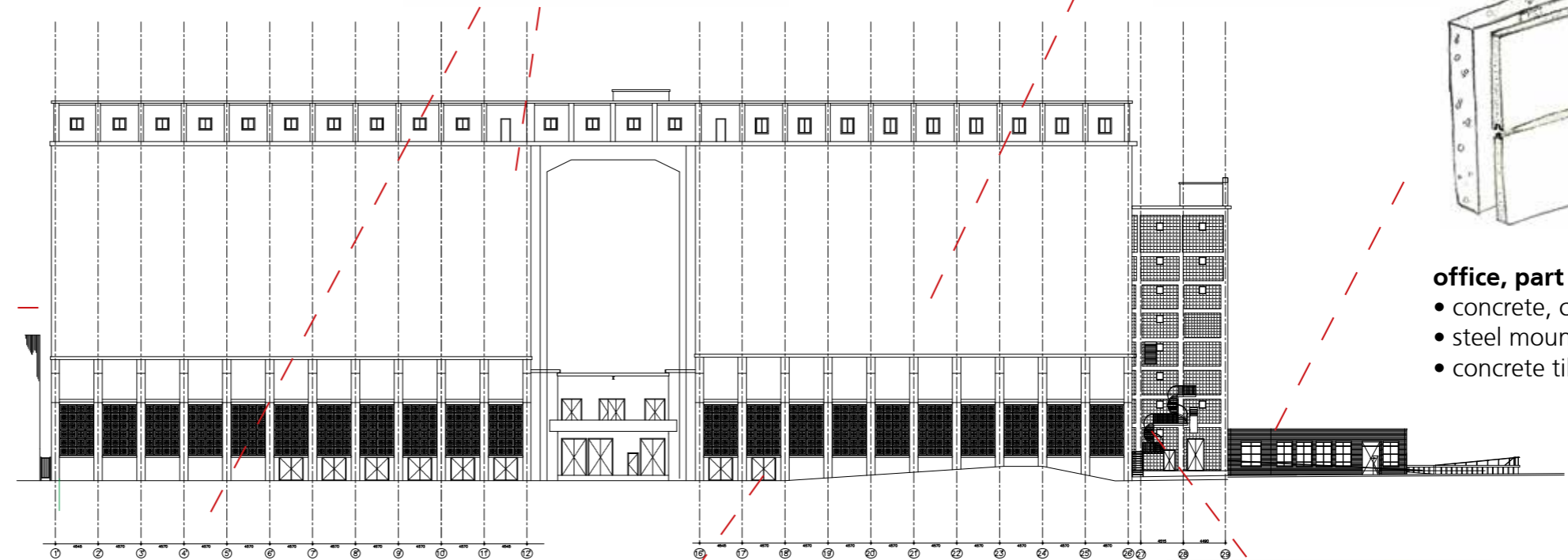

office, part 4

- concrete, cast in situ
- steel mounting construction
- concrete tiles

ground floor part 3

- plofroosters, concrete

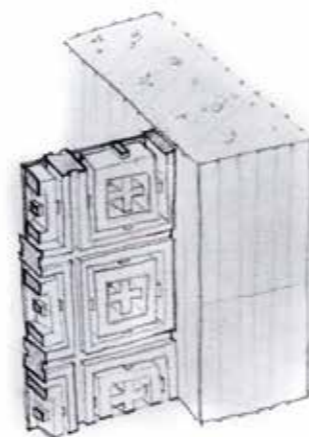

part 1

- hollow concrete blocks
- &
- columns, cast in situ

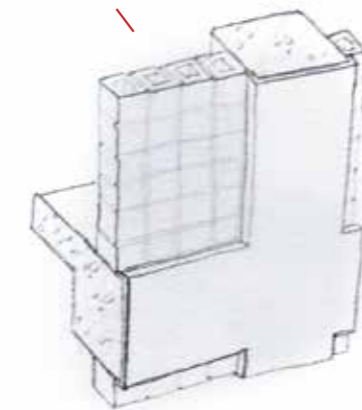

DAMAGE ANALYSIS

PHASE 1: J.P. STOK WZN. 1910



Exterior - east façade

Damage type: Soiling (black) on hollow concrete blocks in façade
 Hypothesis cause: Air pollution from harbour activities or traffic
 Possible solution: Brushing, washing, steaming or abrasive cleaning



Exterior - east façade

Damage type: Erosion
 Hypothesis cause: Rainwater runs along the façades
 Possible solution: Add a small water gutter underneath the protruding beams in the façade



Exterior - north façade

Damage type: Exfoliation
 Hypothesis cause: Corroding reinforcement increases in volume, pushing off the top layer of concrete and plaster
 Possible solution: Check integrity of rebar, replace if necessary and fill with repair mortar



Exterior - northwest façade

Damage type: Soiling (black)
 Hypothesis cause: Air pollution from harbour activities, occurs on inward walls with a roof above where rain doesn't wash it away
 Possible solution: Brushing, washing, steaming or abrasive cleaning



Exterior - north façade

Damage type: Biological growth - Algae
 Hypothesis cause: Oriëntation of façade (north) - no sun and little rain
 Possible solution: Brushing, washing, steaming or abrasive cleaning



Exterior - north façade

Damage type: Corrosion
 Hypothesis cause: Rain and air combined with chloride ions (salts) from brackish water in the Maas
 Possible solution: Replacement of iron parts or de-rusting



Interior - ground floor ceiling

Damage type: Exfoliation
 Hypothesis cause: Corroding reinforcement increases in volume, pushing off the top layer of concrete and plaster
 Possible solution: Check integrity of rebar, replace if necessary and fill with repair mortar



Interior - ground floor column

Damage type: Mechanical damage
 Hypothesis cause: Accidental impact load through use of the building
 Possible solution: Fill with repair mortar

DAMAGE ANALYSIS

PHASE 2: BRINKMAN & VAN DER VLUGT 1930



Exterior - north façade

Damage type: Soiling (black) - gradient in darkness from top west to bottom east
 Hypothesis cause: Air pollution from harbour activities, more severe on the west side due to the prevailing wind direction
 Possible solution: Brushing, washing, steaming or abrasive cleaning



Exterior - west façade

Damage type: Soiling (black)
 Hypothesis cause: Air pollution from harbour activities, severely occurs on west façade due to the prevailing wind direction
 Possible solution: Brushing, washing, steaming or abrasive cleaning



Exterior - north façade

Damage type: Exfoliation
 Hypothesis cause: Corroding reinforcement increases in volume, pushing off the top layer of concrete and plaster
 Possible solution: Check integrity of rebar, replace if necessary and fill with repair mortar



Exterior - north façade

Damage type: Exfoliation
 Hypothesis cause: Corroding reinforcement increases in volume, pushing off the top layer of concrete and plaster
 Possible solution: Fill with repair mortar



Exterior - north façade

Damage type: Biological growth - Algae
 Hypothesis cause: Orientation of façade (north), no sun and little rain
 Possible solution: Brushing, washing, steaming or abrasive cleaning



Exterior - north façade

Damage type: Corrosion
 Hypothesis cause: Rain and air combined with chloride ions (salts) from brackish water in the Maas
 Possible solution: Replacement of iron parts or de-rusting



Interior - column

Damage type: Corrosion
 Hypothesis cause: Moisture from the air combined with chloride ions (salts) from within the concrete
 Possible solution: Replacement of iron parts or de-rusting



Interior - north façade, tower, 7th floor

Damage type: Erosion
 Hypothesis cause: Possibly rainwater damage due to a broken window, only occurs on this one location
 Possible solution: Check windows on leakage

DAMAGE ANALYSIS

PHASE 3: A.G. POSTMA & J.D. POSTMA 1951



Exterior - west façade

Damage type: Soiling (black)
 Hypothesis cause: Air pollution from harbour activities, severely occurs on west façades due to the prevailing wind direction
 Possible solution: Brushing, washing, steaming or abrasive cleaning



Exterior - south façade

Damage type: Soiling (black) and erosion
 Hypothesis cause: Air pollution from traffic on plofroosters, rain washes dirt and the surface layer away on plofroosters located at the right side of open space in the façade
 Possible solution: Brushing, washing, steaming or abrasive cleaning



Exterior - south façade

Damage type: Exfoliation
 Hypothesis cause: Corroding reinforcement increases in volume, pushing off the top layer of concrete
 Possible solution: Check integrity of rebar, replace if necessary and fill with repair mortar



Exterior - south façade

Damage type: Exfoliation
 Hypothesis cause: Corroding reinforcement increases in volume, pushing off the top layer of concrete
 Possible solution: Check integrity of rebar, replace if necessary and fill with repair mortar



Exterior - east façade

Damage type: Biological growth - Algae
 Hypothesis cause: Orientation of façade (east) means little rain, proximity of metrostation prevents a lot of sunlight
 Possible solution: Washing or steaming to remove the algae



Exterior - south façade

Damage type: Spalling
 Hypothesis cause: Accidental impact load through use of/surrounding the building
 Possible solution: Replace with new masonry



Exterior - west façade

Damage type: Corrosion
 Hypothesis cause: Rain and air combined with chloride ions (salts) from brackish water in the Maas
 Possible solution: Replacement of iron parts or de-rusting



Interior - column

Damage type: Corrosion
 Hypothesis cause: Moisture from the air combined with chloride ions (salts) from within the concrete
 Possible solution: Replacement of iron parts or de-rusting

DAMAGE ANALYSIS

PHASE 4: H. HAAN 1963



Exterior - north façade

Damage type: Soiling (black) - west side of façade
Hypothesis cause: Air pollution from harbour activities, more severe on the west side due to the prevailing wind direction
Possible solution: Brushing, washing, steaming or abrasive cleaning



Exterior - east façade

Damage type: Dead algae (black)
Hypothesis cause: Varying contact with water due to changing tides, little sunlight with the building on top
Possible solution: Brushing, washing, steaming or abrasive cleaning



Exterior - west façade

Damage type: Biological growth - Algae
Hypothesis cause: Oriented to the west but a lot of sun and rain is obstructed by proximity an elevator
Possible solution: Washing or steaming to remove the algae

B T 3 : S E R V I C E S

CONVEYOR BELTS

The process of the conveyor belts can be understood as the primary generator of the building's purpose as a constant field of interaction with the infrastructure of the waterfront (cranes & bridges). With the two elevator towers at the west edge of the first phase acting as the central points for the vertical circulation of the grain, a main set of conveyor belts were established in the basement for the weighting and transportation of the cereal. In the same logic, the conveyor belts in the attics (1st and 2nd phase) would be connected to a series of tubes, distributing the grain in the various cells.

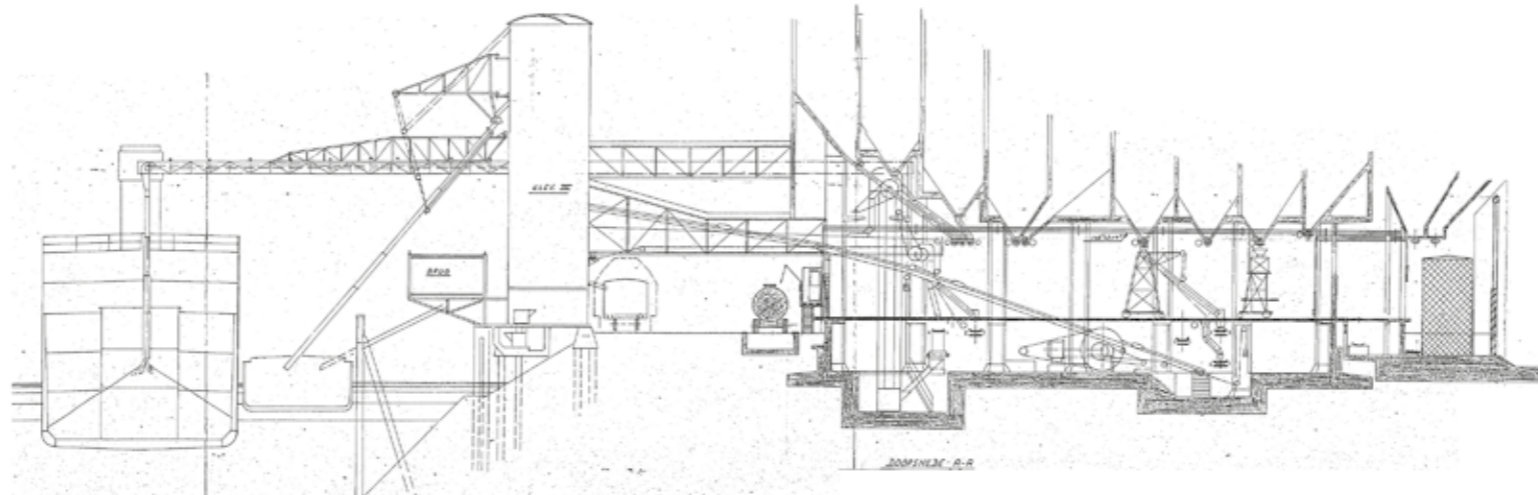

With the machine tower as the main reference for both the first and second phase, the conveyor belts on the attic would transport cereal into the cells via tubes.

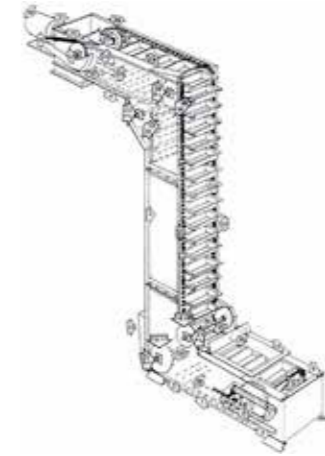

functioning of bucket elevators in the machine tower, Transformers report, p.13

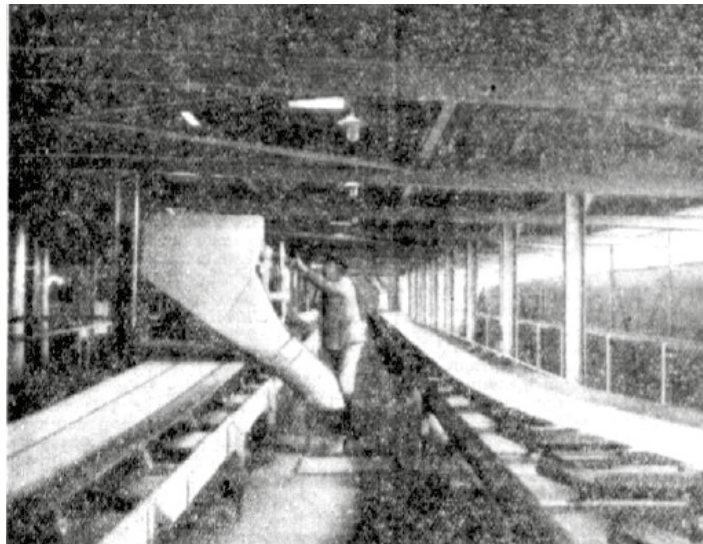

conveyor belts in the basement, Rotterdamsch nieuwsblad 1930



conveyor belts in the basement, Transformers report, p.27



view of the tubes and conveyor belts in the attic of the 1st phase



conveyor belts in the basement, Transformers report, p.72

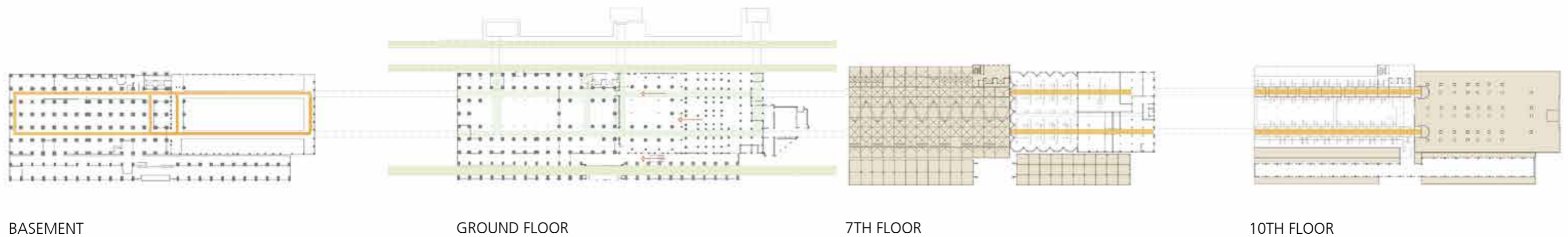

BASEMENT

GROUND FLOOR

7TH FLOOR

10TH FLOOR

DRAINAGE

PHASE 1: J.P. STOK WZN. 1910

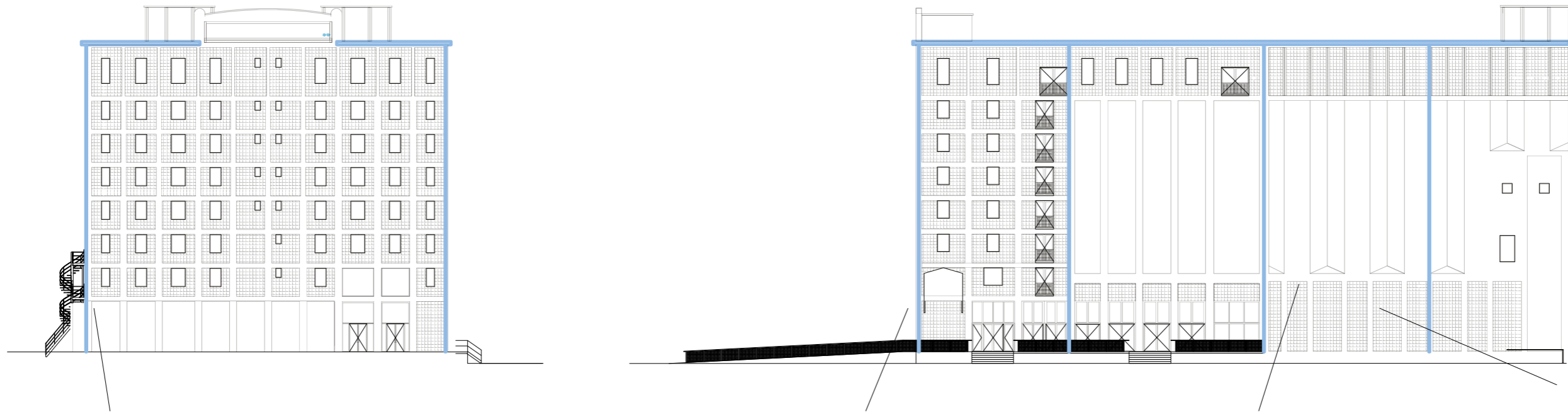

Drainage system in the 1st phase is rationally positioned at the edges of the roof and extended to the corners of the building, as well as the sides of the silos

DRAINAGE SYSTEM & VENTILATION

PHASE 2: BRINKMAN & VAN DER VLUGT 1930

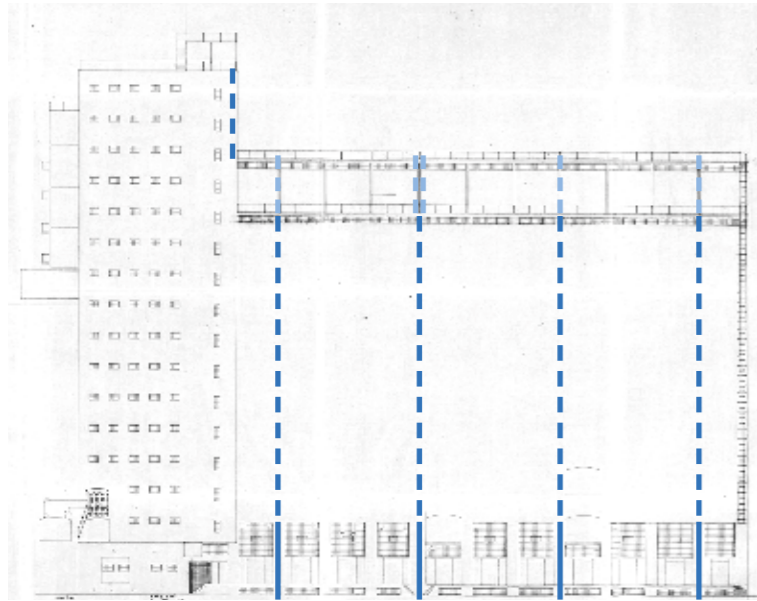

Rainwater drainage indicated on the north façade of phase 2.

- Route of rainwater, in front of the façade
- - - Route of rainwater, behind the façade

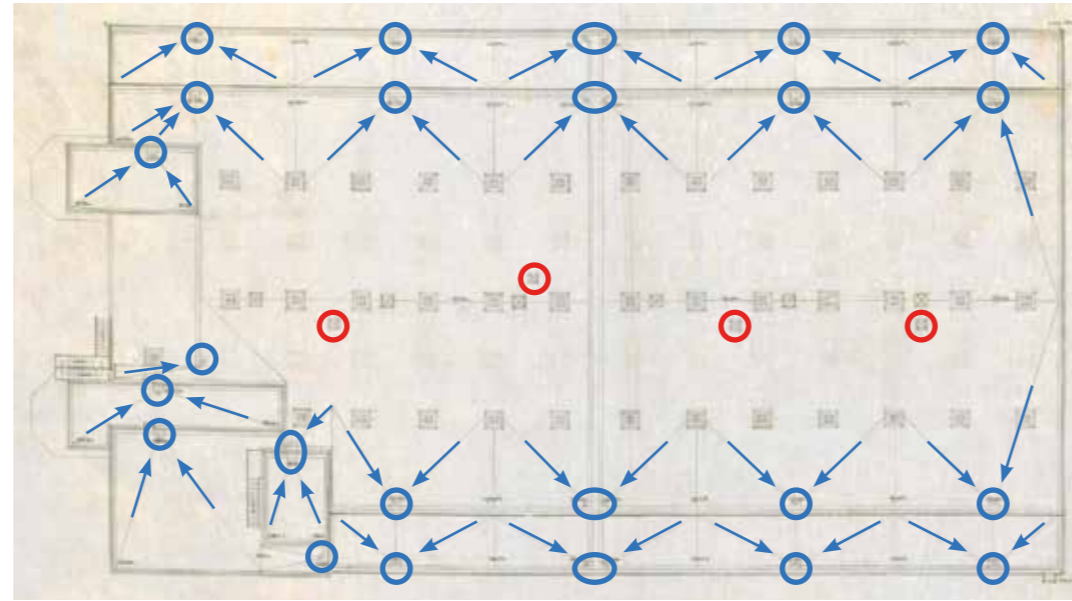

Rainwater drainage and ventilation indicated on the roof plan of phase 2.

- Fall direction for rainwater
- Rainwater drainage pipes
- Basement ventilation shafts

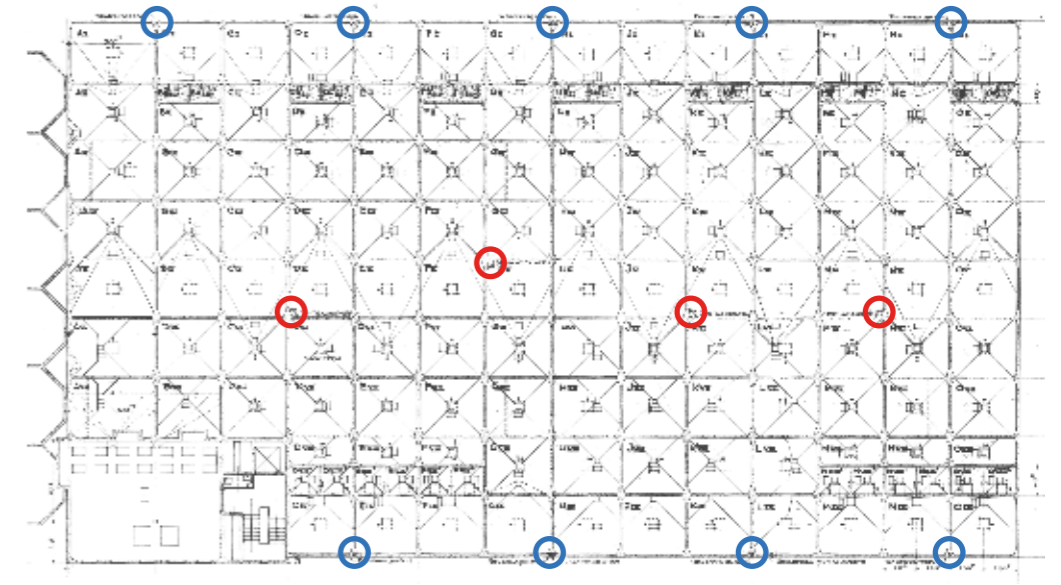

Rainwater drainage and ventilation indicated on the silo plan of phase 2.



Rainwater drain visible on the roof above the grain distribution level in phase 2 which goes down to the level below and will there enter the silo wall.



Rainwater drainage pipe visible on the outside of the tower. Direction of fall (slope) on the roof visible by the accumulated rainwater on the left.



Rainwater drainage pipe visible on the outside of the façade of phase 2, coming down from inside the silo wall above.

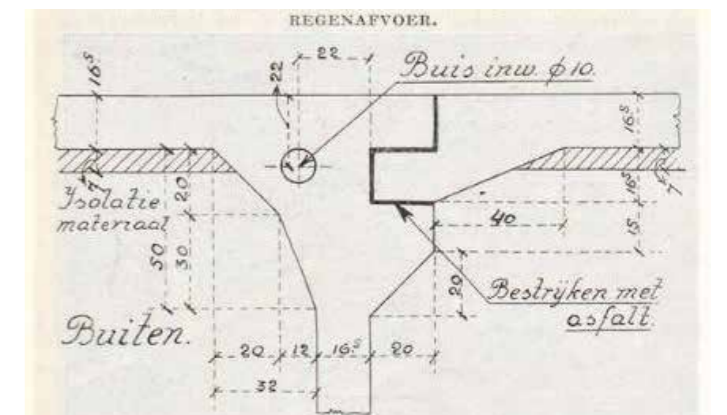

Horizontal detail indicating the location and dimensions of drainage pipes embedded in the silo wall.

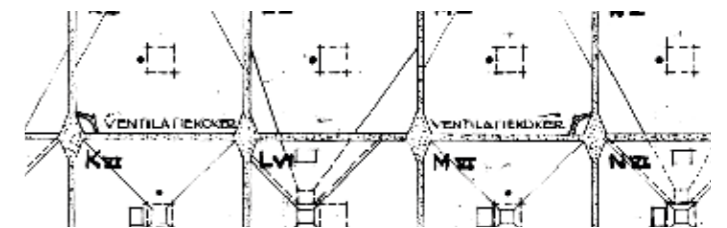

Cut-out of the silo plan indicating ventilation shafts for ventilating the basement.

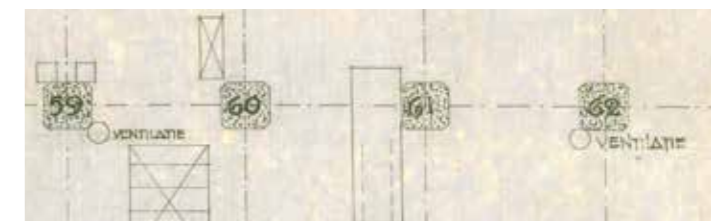

Cut-out of the groundfloor plan indicating ventilation shafts for ventilating the basement.

DRAINAGE SYSTEM

PHASE 3: A.G. POSTMA & J.D. POSTMA 1951

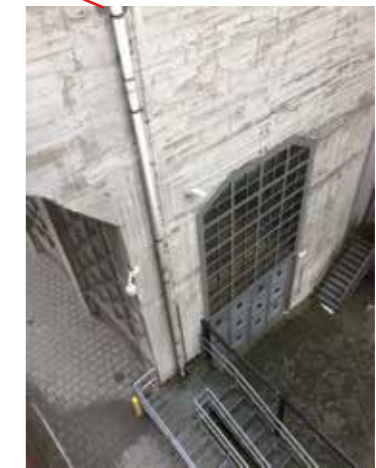
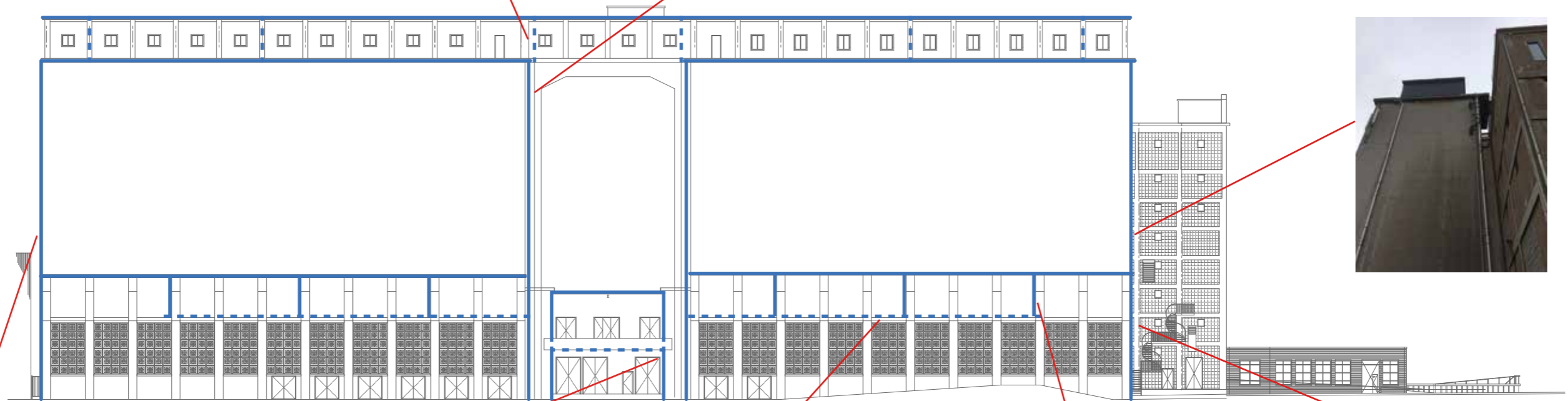

It's not really clear if there are more branches of the drainage system inside. We think a horizontal pipe runs all the way towards the transformer house and then goes through the side facade and then joins a vertical drainage pipe and goes down.

DRAINAGE SYSTEM

PHASE 4: H. HAAN 1963

septic tank

As explained the building stands on three wall structures that are hollow to use a minimum of concrete. Besides that the wall in the middle serves another purpose, it houses the septic tank to deal with wastewater treatment. Since the building was put on water it was probably more difficult to connect it to the main sewage system at that time.

drainage

water drainage is quite straightforward in the office building. Most characteristic are the gutters that 'spray' the water from the roof on either end. On the balconies the water is drained through a pipe in the concrete straight into the water underneath.

pipng

All sanitary cells are ventilated through pipes with air vents on the roof. The waste water is lead through pipes into the septic after which it is treated and disposed. Two pipes are connected with the main land, one provides the building with electricity and water the other disposes the wastewater.

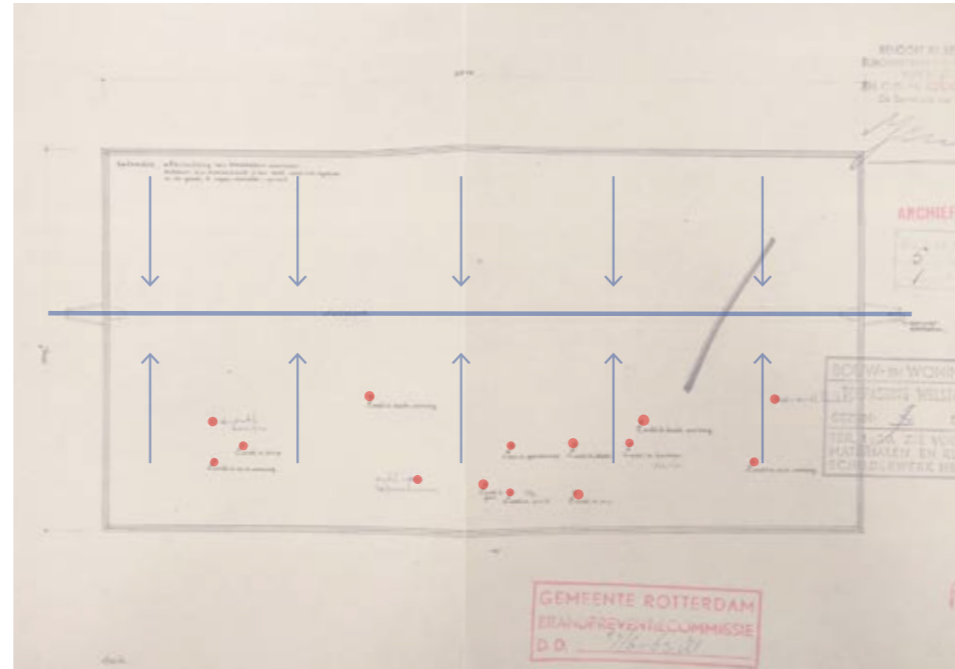

Roof top, in red the different air vents, the blue line is the gutter and the arrows indicate the fall direction

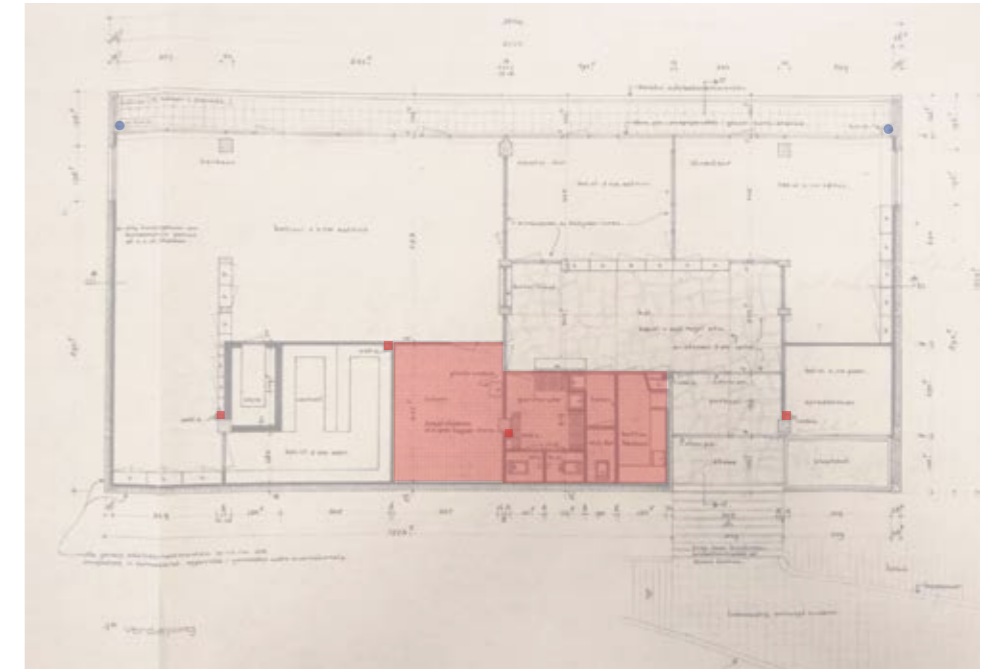

1st Floor, red surfaces indicate the sanitary cell units and the blue dots indicate the drainage pipes.

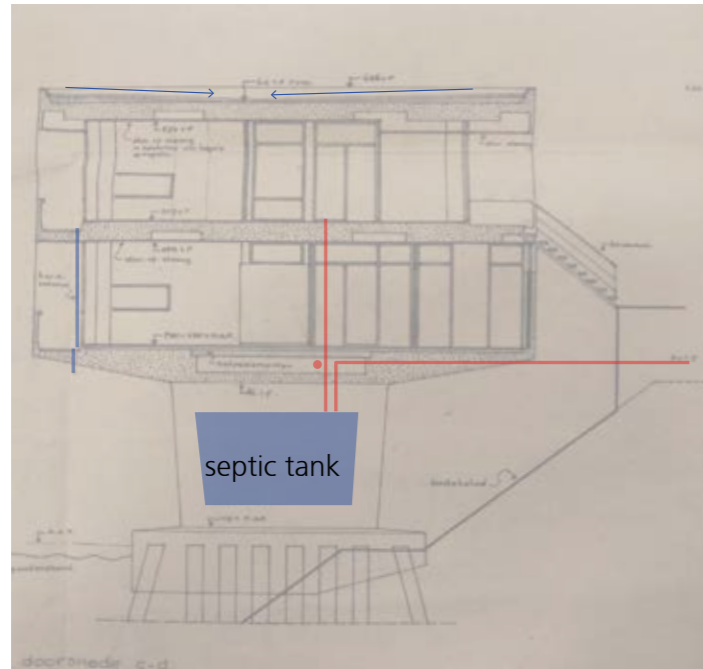

Maassilo in 1971
(Source: Haan, H (1971) Photo collectie, retrieved from 'Het Nieuwe Instituut')

short section, indicating the septic tank in blue, the redlines indicate the piping and the bleu lines and arrows illustrate the way the water drains down.

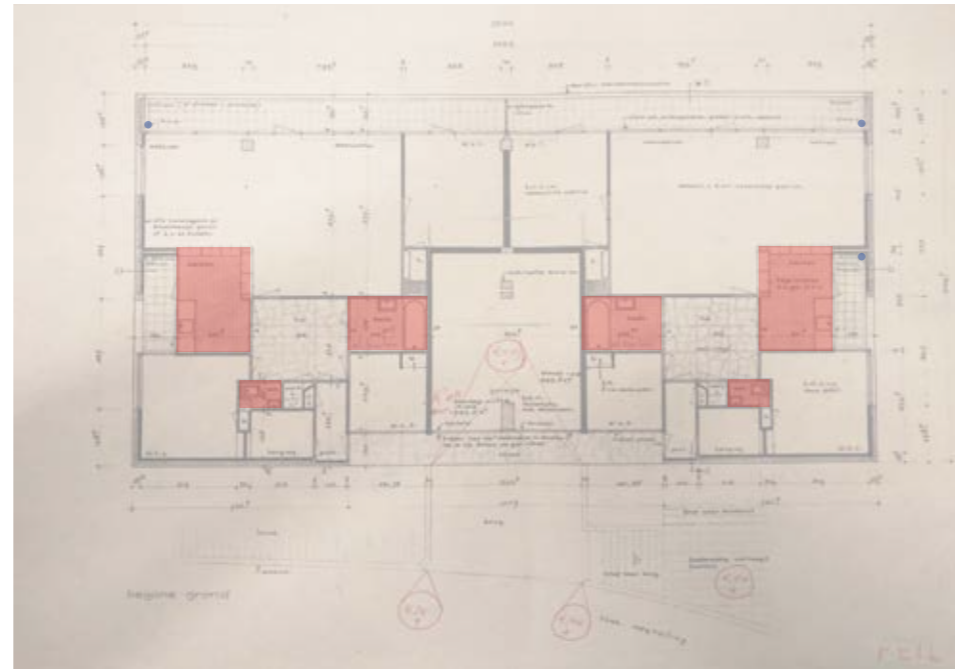

Ground floor, red surfaces indicate the sanitary cell units and the blue dots indicate the drainage pipes.

(Source of drawings: Haan, H (1959) Graansilomaatschappij Rotterdam Maashaven Bestektekening retrieved from Rotterdam Archive)

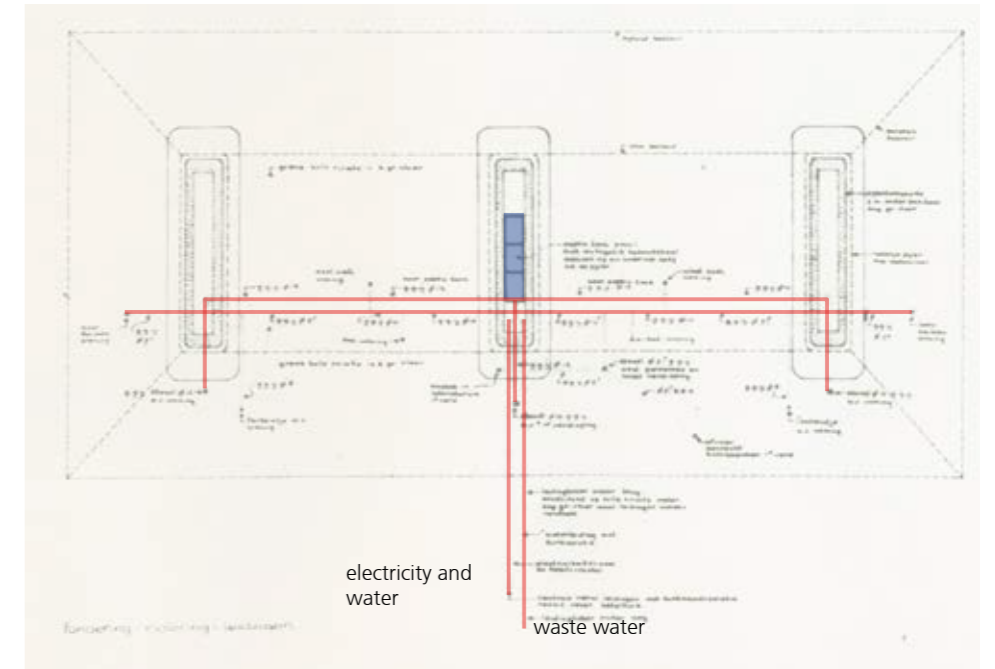

Foundation with the three hollow wall structures, in blue the septic tanks and red shows the piping.

PART 3

V A L U E A S S E S S M E N T

HISTORICAL INTERPRETATION

introduction (City-Building-Elements)

As an historic ensemble of grain silos, office spaces and grain elevators built in different phases between 1910 and 1964, the Maassilo complex in Rotterdam Zuid carries a multilayered historical value. Directly linked to the rapid growth of the harbor in the early 20th century as well as the creation of the Maashaven, the complex stands as a key actor in the socioeconomic development of the city. Located in the infrastructural heart of the harbor area, the building also played a catalyst role for the creation of the southern (working class) neighborhoods of Tarwewijk and Bloemhof (Charlois, Rotterdam Zuid).

Within a span of almost 50 years of its construction, taking place in 4 different phases, the building also stands as a physical record of evolving typologies, construction methods and technological possibilities in the context of silo buildings. Providing by definition a clearly (uncompromising) functional context, the building directly reflects the climaxing functionalist approach which accompanied the expansion of the harbor, as seen in the oeuvre of its architects: J.P. Stok, J.A. Brinkman & L.C. Van der Vlugt, A.G. & J.D. Postma and H. Haan.

Addressing this historical momentum of the harbor's evolution, the first building by J. P. Stok (1910) marks the transition from the late eclecticism to an American influence driven by an overall need for structural and cost-efficiency. In the context of this accelerating functionalist interest, the extension by Brinkman and Van der Vlugt (1930) also including a machine tower, is part of a formalization of a more consistent industrial language, as expressed in the Van Nelle factory. In the context of the newly introduced New Objectivity, whereas Stok's part stands as a subtle proof of these gradual changes, the second phase boldly expresses the manifestation of the functionalist approach as the very (industrial) ideal of the city at the time. The third addition of J. D. Postma in 1950 further homogenizes the initial phases in the south part by occupying the footprint of the adjacent railway, subsequently followed by the smaller addition of an office building at the waterfront by H. Haan in 1963.

Parallel to encapsulating these successional architectural languages, the complex also provides a record of the evolving construction processes and building technology of silo making. Furthermore, in the context of a historical revolution in the use of reinforced concrete, the building marked one of the largest in situ constructions in Europe.

present

As an originally uncompromising functional environment, the atmosphere that constitutes Maassilos' present situation is characterized by the stripping-off of its initial activity. Today the building stands as a weathered, decayed mass, concealing the empty cells of the silos.

In the context of a cultural initiative triggered by Transformers and the local municipality, the building started to attract attention during the 1980s as a significant case of a rarely condensed, large scale ensemble of silos, expressing exceptional industrial caliber. The restoration of the central elevator in the waterfront and the original sign by Stok, as well as, the re-arrangement and displaying of the machinery, marked the first series of (fragmented) commemorative interventions.

The involvement of the music venue (NOW&WOW) in the space, from 2003 onwards, remains the most consistent act of interaction and possible re-programming of the building so far. The re-shaping of the ground level and partial replacing of the central columns, made an attempt to infill and take advantage of the linear nature of the space plan.

Although giving the impression of a not yet conceived or developed to its full potential cultural initiative, particularly involving the role of the silos, it nevertheless emphasized an overall cultural intention, as a new profile for the building.

Based on that, and in addition to its alienation from its surroundings and developments at Kop van Zuid, the complex continues to convey a simultaneously ambiguous and intriguing atmosphere, rooted in its imposing mass and the historical tension which it bares.

MATRIX

K E Y D I S C U S S I O N S

NORTH / SOUTH

The Maassilo was one of the instigators for the industrial development of the Maashaven and the south of Rotterdam. Around this industry, the development of the residential areas increased exponentially. After the industry moved to the west, the reminiscence of industrial activity remained, because of industrial artifacts like the Maassilo. The former industrial area is undergoing an intense process of gentrification, while the adjacent workers' districts remain underdeveloped. The Maassilo exists on the border between these two contrasting areas. This border is spatially defined by a heavy traffic line (Brielselaan). Since this is the result of the infrastructure that was connected to the Maassilo, the Maassilo is historically bound to this barrier.

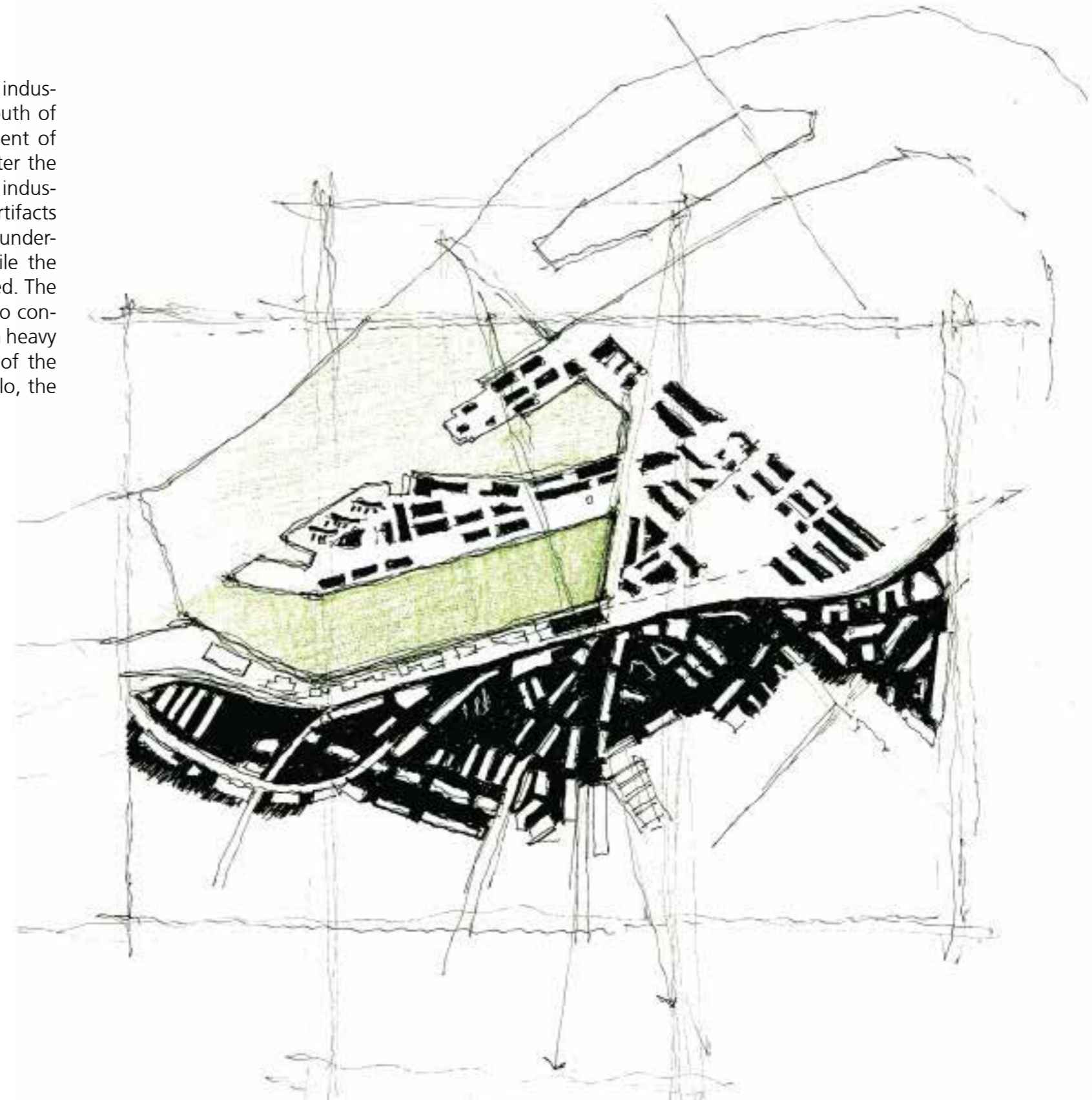

conflict

The two-faced character of the Maassilo and its historical relation with the public space and infrastructure have historical significance. On the other hand, they form a barrier that makes it difficult to connect the southern districts to the harbour area north of the building.

opportunity

The Maassilo could be treated as a gate, mediating between two different stages of development and help gentrify the districts with a low social standing.

OBLIGATION

The areas north and south of the Maassilo have completely different characteristics and show opposite states of socio-economic development. If the aim is to develop the workers' districts to the harbour area, the right balance must be sought between connecting the two neighborhoods and respecting their historical separation. The Maassilo, historically connected to both the districts and the border itself, plays a key role in this respect.

PUBLIC / PRIVATE

The Maassilo is, in heart and soul, not a public building. This was already the case in the first phase, when a small and insignificant entrance located to the side of the building was withheld from the eyes of the public. This unpublic character was - and is still - even more present in the enormous closed concrete surfaces of the facades.

In 2004 the NOW&WOW disco opened their doors in the Maassilo. Formally though, they did the opposite, as all the windows and openings in the facade were closed to counteract noise pollution.

Thus, while the formal characteristics became even more uninviting, the building assumed, for the first time in its history, a public function. It is debatable how public this new function is.

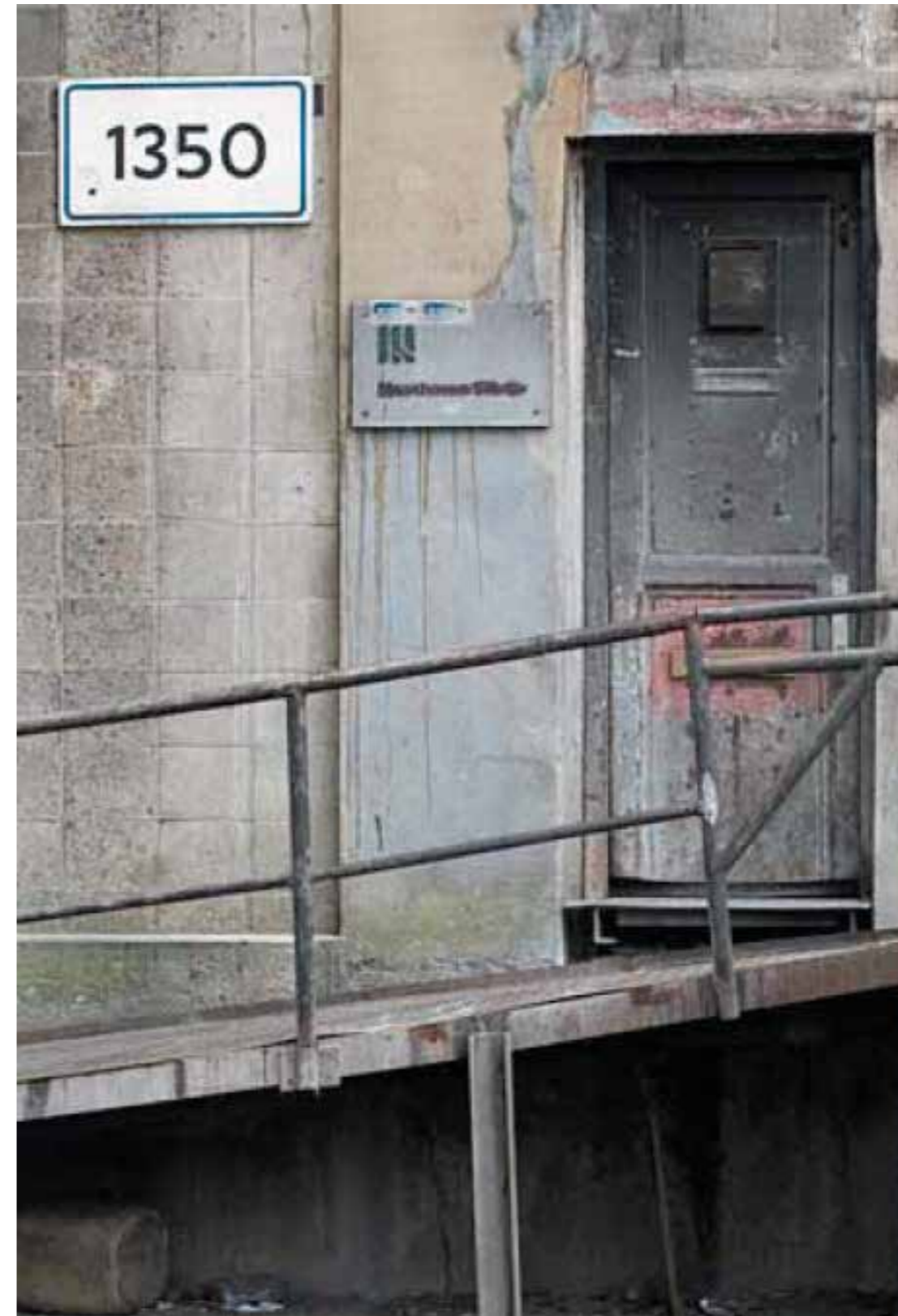

conflict

The formal characteristics of the exterior appearance of the Maassilo are impressive, but uninviting to the public. Also the original function of the building is non-public. Opening the building up visually would undermine the specific historical and aesthetic character of the Maassilo. However, keeping the building closed off to the public may hinder the efforts to make the Maassilo a meaningful building in the development of Rotterdam south.

opportunity

The closed-off character of the building could be turned to an advantage instead of a hindering factor. A solution could be finding a function that is both meaningful to the public and in need of closed-off space.

OBLIGATIONS

The character of the Maassilo, as a closed-off mass, is grounded both historically and aesthetically. Therefore, this character should be cherished and, if possible, turned to an advantage. If the building should assume a public role in the city, the solution could be found in finding the right program or function. One that requires little or no daylight, but is still accessible to the public.

STATIC / DYNAMIC

The Maassilo in its historic setting can be comprehended as a heavy static mass in a highly dynamic environment. The very essence of a silo building comes down to this tension between the static and the dynamic. The silo is a place where the grain *waits*: it is in temporal rest, stored securely, protected from external forces, until it is set in motion again by workers, conveyor belts, elevators, trains and boats. Both rest and movement of grain were accommodated by the Maassilo.



conflict

The material sturdiness of the Maassilo is something that cannot be avoided. The heavy structure, the adamant concrete and the impenetrability of the silos hinder spatial flexibility in new developments. Paradoxically, the heaviness of the building was one of the reasons why it has not been destroyed after it got out of use.

opportunity

The architects of the Maassilo were well aware of the obstinate character of the concrete structure. They understood it was essential for each building phase to implement flexibility and maximize efficiency in the space plan. Another measure was the integration of rails in every beam and column on the ground floor and the basement. Since these measures are inscribed in the current state of the building, they allow for flexibility in new developments. In addition, the loadbearing capacity of the construction is very high, which opens up a wide array of possibilities.

OBLIGATION

The Maassilo has existed for more than a century, and it still stands strong. This has to do with the fact that different strategies, like a structured open space plan and integrated flexible detailing, have been used to make flexible space with rigid material. In a new design, one would do well to built upon these qualities, in order to make this building stand the test of time, like it has always done.

READABILITY / CONCEALMENT

The Maassilo knows a strong contrast and interplay between readability and concealment. This tension field is played out on multiple scales. On a large scale, it is clearly visible from the exterior that the building was built in multiple phases. However, without proper research, it remains unclear what the exact order of this development was. The skin of the building has exactly the same structure as the internal silo walls, and in that sense it does not mask the interior. However, the skin completely hides the internal spatial logic of the building. In the interior, the signage on the funnels give a direct indication of historical use, while the enormous void above the funnels in the ceiling remains hidden from the eye.

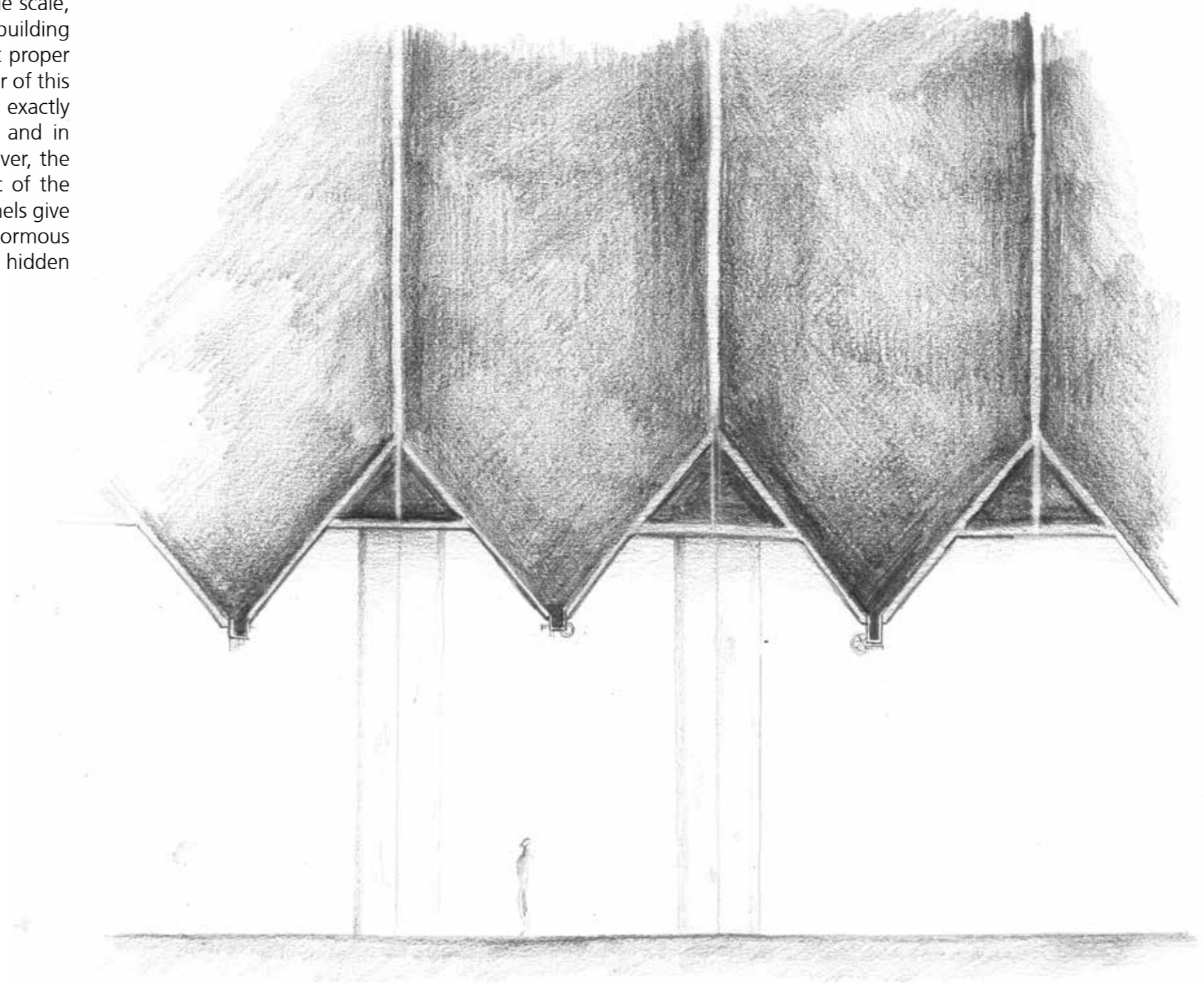

conflict

When the quality of the experience of the Maassilo lies partially in its secrets, then it becomes difficult to intervene spatially, as the value of a secret lies in its concealment.

opportunity

The interplay between hiding and revealing can be enhanced, for example by *partially* revealing the formerly unseen. The unknown could be made even more exciting by revealing parts of it, and thereby strengthening the sense of curiosity and wonder. This could be a powerful tool in establishing an architectural route through the building.

OBLIGATION





The interplay between readability and concealment plays a very important role in both the experience of the building as the possibility to read its history. This tension should be taken in high regard, and if possible made even stronger, as it constitutes the mysterious atmosphere in and around the building.

REFLECTION

group statement vs. cultural value report

Since the cultural value report by the Transformers has been the main source of information for our own understanding of the building, it is only logical to reflect on their statement and compare it with our own position as a group.

Generally we can concur with most statements made by the transformers. This is exactly because their conclusion is still quite general. The most concrete statements they make are illustrated in the elevation, section and plan drawings. In these drawings they use the colours: red (pinkish), green, yellow and blue to determine their importance (see right of this page).

-  Preserve and conserve in original state. These elements are essential for the experience of the silo complex and are of great historical value.
-  Redevelopment is possible with to the original structure and materialisation. The original design ideas should remain readable.
-  Maintain if possible. These aspects contribute to the total understanding of the ensemble.
-  These elements interfere with the total understanding of the complex. When intervening in these parts it should be designed more in the spirit of the building.

That this assessment is not directly referred to in the text makes it more difficult to understand. This leaves us to only make assumptions based on the explanations in the text. We can agree on the way different elements are ordered on their importance. However we are not architectural historians, thus we presume our interpretation of possible interventions in relation to the value assessment is not completely on the same wave length. A few of these aspects deserve a more elaborate explanation.

To our interpretation the Transformers seem to have the tension to freeze the building in time. This, by recommending total preservation and conservation of the different elements that are coloured red. We are of the opi-

nion however that also in these parts we wouldn't want to judge so black on white. We don't want to exclude small interventions, if really found necessary. Even to these aspects that are regarded as extremely important, there are other possibilities to maintain the essence of the building. This goes especially for the interference in the facade on the north side of the Brinkman en Van der Vlugt building. As long as it is in line with the spirit of the place. For this we believe our bold statements provide a more specific description of the tangible and intangible aspects that consciously and unconsciously form the essence of the building.

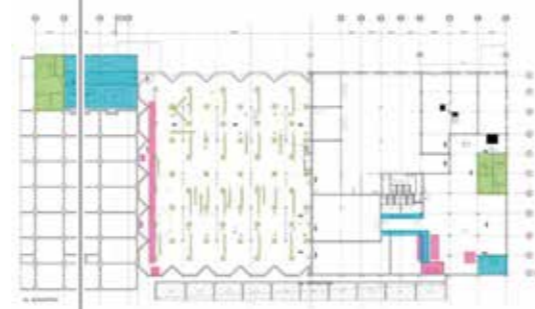
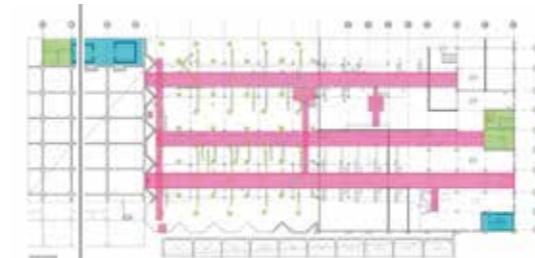

7th floor 1st phase

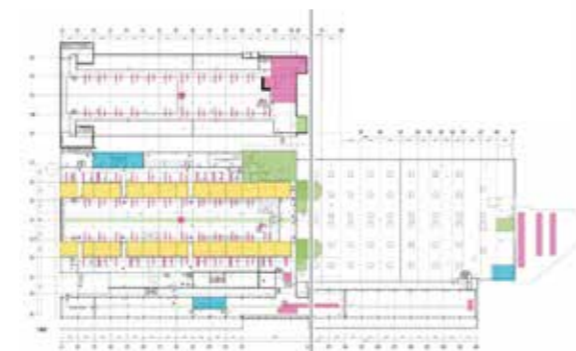

Ground floor

Images provided in the cultural value report

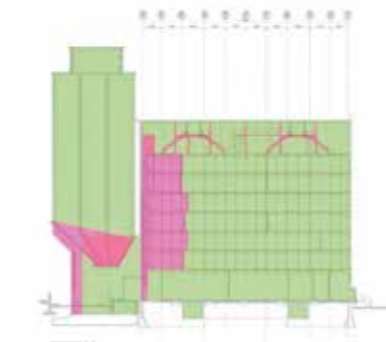

Section 1st & 3rd phase



2nd - 7th floor 1st phase east side

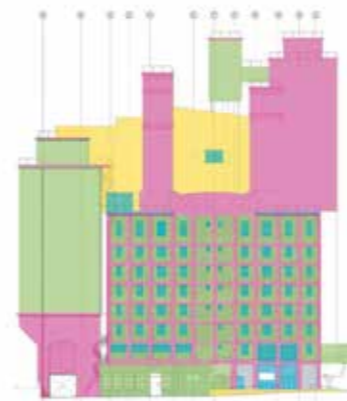

East Facade

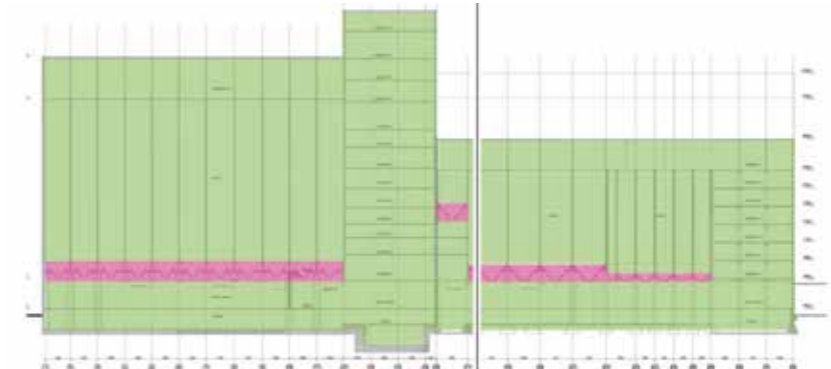

Section 1st & 2nd phase

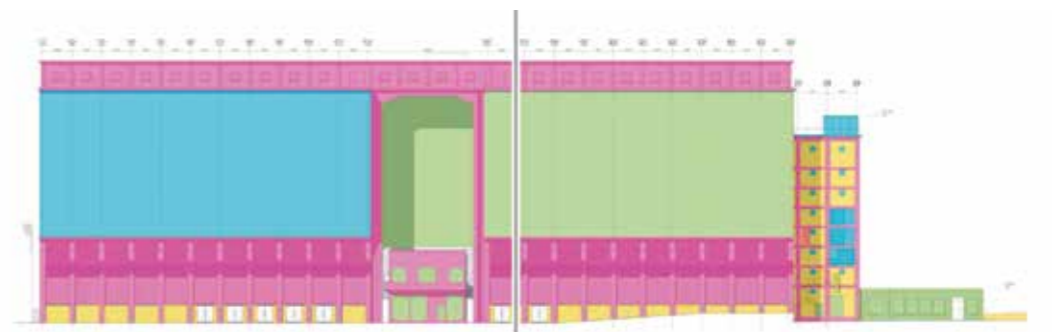

South Facade



North Facade

REFLECTION

sources

Initially our information on the Maassilo was provided through the study program. This included a cultural value report that was carried out by the Transformers in 2008, which proved to be our main source of information. Additional information consisted of a document that discussed several future perspectives for the Maassilo (also carried out by the Transformers), a technical report on the renovation of the elevator towers, and a set of digital drawings that more or less indicate the recent intervention in 2004 and the state of the building 2008.

We started our research by mastering the information in the cultural value report. As mentioned by the Transformers, their time was limited as well. Consequently this resulted in some unclear and ambiguous information of which sources were also hard to trace back. It does however provide a profound basic knowledge of the Maassilo Complex that proved to be essential for our own research. Improving our knowledge of the matter required looking into original sources. We mainly gathered these from: the Rotterdam Archive, the 'New Institute' in Rotterdam, books and articles. Some of these sources are mentioned in the bibliography. In hindsight however, we do regret not consulting this bibliography right at the start of our research. Ultimately it should be mentioned that the cultural value report dates back to 2008. To provide a good understanding of the current situation, a documentation of today's building, site and surroundings through photos, drawings and observations was essential.

value matrix and methodology

Finally it should be mentioned that the TU-Delft study program also initiated the theoretical background of this research. To carry out this research on the building we were introduced to the concept of value assessment and the value matrix by Marieke Kuipers.

The structure of the matrix is flexible and we created a personal interpretation to it. We established a more specific set of layers that fitted better to the Maassilo complex. We introduced spatial composition to the building layers because of the ensemble of different building phases. We also drew a more transparent line between structure and skin because these can almost be regarded as one. The reality is more complex though, and some aspects always fit in more than one box.

This framework provided a helpful structure for the analysis on the building and its surroundings on every scale. It was a helpful tool to put different values from different layers into perspective. This allowed us to get a better understanding of the hierarchy in the importance of values. This knowledge will help us to make well thought-through decisions in the design process. It is a source of inspiration and will help us to defend our decisions.

BIBLIOGRAPHY

'The aesthetic character of civil structures' (1910) Bouwkundig Weekblad.

Baanders, H.A.J. (1912) Architectura. Gebroeders Binger: Amsterdam.

Brand, S. (1994) How buildings learn: what happens after they're built. Penguin Group USA: New York.

Brinkman, J.A. (1931) De nieuwe graansilo aan de Maashaven voor de N.V. Graansilo Maatschappij te Rotterdam. De Ingenieur; B. Bouw- en Waterbouw-kunde, 32.

'The Charnel-House' (2014) Van Nelle factory in Rotterdam (1926-1930). (Image) Re-trrieved from <https://thecharnel-house.org/2014/02/04/van-nelle-factory-in-rot-terdam-1926-1930/> on 1 April 2017.

Conijn, R. (n.d.) J.D. Postma. (Image) Retrieved from <http://amsterdamse-school.nl/personen/architecten/jan-diederik-postma/> on 2 April 2017.

Delpher (2017) Kranten. Retrieved from <http://www.delpher.nl/nl/kranten> on 27 March 2017.

Franki Grondtechnieken (n.d.) Verstevigende insluiting. (Image) Retrieved from http://www.franki-grondtechnieken.nl/Franki/media/Franki_Media/Products%20sheets%20Piles/products%20jpg/BU%20Piles/verstev%20insluiting/Inclusion-Rigide.jpg on 27 March 2017.

'Franki-palen op Campus Ardoyen.' (Image) (1968) Retrieved from <http://www.ugentmemorie.be/sites/default/files/styles/large/public/foto/g23b013.jpg?itok=FQhOCp53> on 27 March 2017.

'Gewapend beton en bouwkunst' (1912) Bouwkundig Weekblad.

Google Maps (n.d.) (Image) Retrieved from <https://www.google.nl/maps/> on 5 April 2017.

'Graansilo te Rotterdam, Brinkman en Van der Vlugt, Architecten. - Overzicht constructie.' (1931) Bouwkundig Weekblad.

Haan, H. (1971) Foto collectie. (Image) Retrieved from Het Nieuwe Instituut.

Haan, H. (1959) Graansilomaatschappij Rotterdam Maashaven Bestektekening. (Image) Retrieved from Stadsarchief Rotterdam.

Het Nieuwe Instituut (n.d.) Haan, Herman Petrus Coenraad. Retrieved from <http://zoeken.hetnieuweinstituut.nl/nl/personen/detail?q=herman%20haan&page=1> on 2 April 2017.

Het Nieuwe Instituut (n.d.) Postma, Jan Diederik. Retrieved from http://zoeken.hetnieuweinstituut.nl/nl/personen/detail?q=postma&fq%5Bsearch_s_occupation%5D%5B%5D=architect&page=13 on 2 April 2017.

Het Nieuwe Instituut (n.d.) Stok, Jacobus Pieter (Wzn.) Retrieved from <http://zoeken.hetnieuweinstituut.nl/nl/personen/detail?q=j.p.%20stok&page=1> on 30 March 2017.

Hogervorst, L. (2013) Modern times in Rotterdam. Retrieved from <http://www.geschiedenis.nl/nieuws/artikel/3601/>

modern-times-in-rotterdam on 1 April 2017.

Hulsman, B. (2012) De zakelijkste van de zakelijken. Retrieved from <https://www.nrc.nl/nieuws/2012/12/14/de-zakelijkste-van-de-zakelij-ken-1185137-a1266833> on 24 March 2017.

'Hulstkamp-gebouw' (Image) (2016) Retrieved from https://nl.wikipedia.org/wiki/Hulstkamp-gebouw#/media/File:Rotter-dam_maaskade119.jpg on 30 March 2017.

Kadaster (n.d.) Tijdreis over 200 jaar topografie. (Image) Retrieved from <http://topotijdreis.nl/> on 17 March 2017.

Keijnemans, J. (2004) Springend van bestaand naar nieuw, Cement.

KLM Aerocarto N.V. (n.d.) Van Doorne's Automobielfabriek N.V., Eindhoven. (Image) In A.E. Kluwer (1960). Deventer.

Kunstbus (2016) Brinkman en Van der Vlugt. Retrieved from <http://www.kunstbus.nl/architectuur/brinkman-en-van-der-vlugt.html> on 24 March 2017.

'Lisa Lux en haar ingelijste abstracte emotie' (Image) (1998) Maasstad.

Lux, L. (n.d.) The Drawings, Paintings, Mosaics and Sculptures of the Artist. (Image) Retrieved from <http://www.academy-of-the-13-essenian-arts-of-healing.org/home/kunst/frameprovae.html> on 26 March 2017.

'Luxor Theater Deventer' (Image) (n.d.) Retrieved from <https://bioscoopgeschiedenis.com/wp-content/uploads/2012/05/350.jpg> on 2 April 2017.

De Maasbode (1929) 61e jaargang, Rotterdam.

'Maashaaven fietsenstalling' (n.d.) (Image) Retrieved from <https://wraf.nl/tag/rotterdam/> on 26 March 2017.

Molenaar, J. (2012) Brinkman & Van der Vlugt Architects. Retrieved from <https://www.naibooksellers.nl/brinkman-en-van-der-vlugt-architects-joris-mole-naar.html> on 1 April 2017.

NAI (2013) Designers, (Image) Retrieved from <http://schatkamer.nai.nl/en/designers/> on 1 April 2017.

NAI (2013) Museumwoning Sonneveld: monument van Het Nieuwe Bouwen. (Image) Retrieved from http://www.nai.nl/museum/museumwoning_sonneveld on 1 April 2017.

'De nieuwe graanburcht aan de Maashaven.' (Image) (1930) Retrieved from Rotterdamsch Nieuwsblad.

'Nog niet snel genoeg' (1930) De Tijd.

Postma (1969) Bestaande toestand gevel pand 1. Retrieved from Stadsarchief Rotterdam.

Postma (1950) Bestektekening Westgevel, linker ged. Zuidgevel en doorsnede A-A. (Image) Retrieved from Stadsarchief Rotterdam.

BIBLIOGRAPHY

Riegl, A. (1903) *The Modern Cult of Monuments: Its Essence and Its Development*. In Stanley-Price, N., Kirby Talley jr., M. & Vaccaro, A.M. (1996): *Historical and Philosophical Issues in the Conservation of Cultural Heritage*. Getty Conservation Institute: Los Angeles.

Rijksmonumenten.nl (2014) Pakhuis Santos in Rotterdam. (Image) Retrieved from <http://rijksmonumenten.nl/monument/513940/pakhuis-santos/rotter-dam/> on 30 March 2017.

'Rondom Charlois' (n.d.) Retrieved from forum.beneluxspoor.net/index.php?topic=65536.60 on 17 March 2017.

RTVRijnmond (2013) Verhalen van Staal en Steen - Maassilo. (Video) Retrieved from <https://www.youtube.com/watch?v=8hROr2RkTpM> on 13 March 2017.

Spaan, B. (2015) All 9,866,539 buildings in the Netherlands, shaded according to year of construction. (Image) Retrieved from <http://code.waag.org/buildings/#51.9235,4.4987,13> on 22 March 2017.

Stadsarchief Rotterdam (n.d.) Beeld en geluid. (Image) Retrieved from <http://stadsarchief.rotterdam.nl/collectie/beeld-en-geluid> on 22 March 2017.

Transformers (2008), *Cultuurhistorische verkenning graansilo Maashaven*. Rotterdam.

Van Borselen (n.d.) *Graansilo Maatschappij N.V., Rotterdam. Silo-uitbreiding* (Image). In A.E. Kluwer (1960). Deventer.

Villa E. Kluwer (n.d.) *Postma 1890-1940 : aangeboden door bouwheeren en belangstellenden aan den heer J.D. Postma, architect te Deventer t.g.v. diens 50sten verjaardag*. (Image) L van Leer & Co., N.V. Amsterdam.

Vollaard, P. (1995). *Herman Haan : Architect*. Rotterdam: Uitgeverij 010.

All other photo's and images are the authors' own material.

