

Facade 2018 - Adaptive!

Proceedings of the COST Action TU1403 Adaptive Facades Network Final Conference

Luiblé, Andreas; Gosztónyi, Susanne; Overend, Mauro; Aelenei, Laura; Krstić-Furundžić, Aleksandra; Perino, Marco; Goya, Francesco; Wellershoff, Frank; Attia, Shady; Pottgiesser, Uta

Publication date

2018

Document Version

Final published version

Citation (APA)

Luiblé, A., Gosztónyi, S., Overend, M., Aelenei, L., Krstić-Furundžić, A., Perino, M., Goya, F., Wellershoff, F., Attia, S., Pottgiesser, U., Knaack, U., & Louter, C. (Eds.) (2018). *Facade 2018 - Adaptive! Proceedings of the COST Action TU1403 Adaptive Facades Network Final Conference*. TU Delft OPEN Publishing.

Important note

To cite this publication, please use the final published version (if applicable).
Please check the document version above.

Copyright

Other than for strictly personal use, it is not permitted to download, forward or distribute the text or part of it, without the consent of the author(s) and/or copyright holder(s), unless the work is under an open content license such as Creative Commons.

Takedown policy

Please contact us and provide details if you believe this document breaches copyrights.
We will remove access to the work immediately and investigate your claim.

Facade 2018 - *adaptive!*

Editors in Chief:

Andreas Luble
Susanne Gosztanyi

Editors:

Mauro Overend
Laura Aelenei
Aleksandra Krstic-Furundzic
Marco Perino
Francesco Goia
Frank Wellershoff
Shady Attia
Uta Pottgiesser
Ulrich Knaack
Christian Louter

Lucerne University of
Applied Sciences and Arts

**HOCHSCHULE
LUZERN**

Engineering and Architecture
FH Zentralschweiz

Proceedings of the COST Action TU1403

Adaptive Facades Network Final Conference

Proceedings of the COST Action TU1403 – Adaptive Facades Network Final Conference:

Facade 2018 - Adaptive!

This book is based upon work from COST Action TU 1403 adaptive facade network, supported by COST (European Cooperation in Science and Technology).

COST (European Cooperation in Science and Technology) is a pan-European intergovernmental framework. Its mission is to enable break-through scientific and technological developments leading to new concepts and products and thereby contribute to strengthening Europe's research and innovation capacities.

It allows researchers, engineers and scholars to jointly develop their own ideas and take new initiatives across all fields of science and technology, while promoting multi- and interdisciplinary approaches. COST aims at fostering a better integration of less research intensive countries to the knowledge hubs of the European Research Area. The COST Association, an international not-for-profit association under Belgian Law, integrating all management, governing and administrative functions necessary for the operation of the framework. The COST Association has currently 36 Member Countries.

www.cost.eu

Editors in Chief

Andreas Luible
Susanne Gosztanyi

Cover image

Susanne Gosztanyi

Layout

Usch Engelmann

Publisher

TU Delft Open

The editors and/or authors worked intensively to collect all copyrights of pictures/graphs. In the unforeseen case of using unauthorized pictures/graphs the editors ask to get in contact with them.

This work is subject to copyright. All rights are reserved, whether the whole or part of the material is concerned, specifically the rights of translation, reprinting, re-use of illustrations, recitation, broadcasting, reproduction on microfilms or in other ways, and storage in data banks. For any kind of use, permission of the copyright owner must be obtained.

Facade 2018 - Adaptive!

Lucerne University of Applied Sciences and Arts
Lucerne, Switzerland
26-27 November 2018

Editors in Chief

Andreas Luible (Lucerne University of Applied Sciences and Art, Lucerne, Switzerland)
Susanne Gosztanyi (Lucerne University of Applied Sciences and Art, Lucerne, Switzerland)

Editors:

Mauro Overend (University of Cambridge, Cambridge, United Kingdom)
Laura Aelenei (Laboratório Nacional de Energia e Geologia, Lisbon, Portugal)
Aleksandra Krstic-Furundzic (University of Belgrade, Belgrade, Serbia)
Marco Perino (Politecnico di Torino – DENERG, Torino, Italy)
Francesco Goia (NTNU, Trondheim, Norway)
Frank Wellershoff (HafenCity University, Hamburg, Germany)
Shady Attia (Université de Liège, Liège, Belgium)
Uta Pottgiesser (University of Antwerp, Antwerp, Belgium)
Ulrich Knaack (TU Delft, Delft, Netherlands)
Christian Louter (TU Delft, Delft, Netherlands)

Contents

Preface	9
Conference Organisation	10
Scientific Committee	10
Conference Sponsors	11
Supporting Organisations	15

Adaptive Facades Network 17

COST Action TU1403 - Adaptive Facades Network	19
Activity report Working Group 1 (WG1) - Adaptive Technologies and Products	25
Activity report Working Group 2 (WG2) - Component Performance and Characterization Methods	29
Activity report Working Group 3 (WG3) - Whole Building Integration and Whole-Life Evaluation Methods of Adaptive Facades	33
Activity report Working Group 4 (WG4) - Dissemination and Future Research	39

Keynote Presentations 43

Cities Alive: Green Envelope	45
The Maersk Tower Facade	47
High Comfort - Low Impact	49
Multidisciplinary Approach Towards Design of Kinetic Lightweight Sun Shading Facade	51
Adaptive Solar Facade	53

Sessions 55

S 1

What is an Adaptive Façade? – Analysis of Recent Terms and Definitions from an International Perspective	57
Towards New Metrics for the Characterisation of the Dynamic Performance of Adaptive Façade Systems	59
Smart and Multifunctional Materials and their possible application in façade systems	61

S 2.1

Passive Adaptive Façades – Examples from COST TU1403 Working Group 1	63
Practitioners' View on the Implementation Potential of Adaptive Façades with focus on The Netherlands	73
Energy efficient and user oriented pre-fabricated facade extensions	81

Designing an adaptive shading pavilion for hot arid climates 93

S 2.2

Parametric nodes from idea to realization 101

Development of an adaptive shading device based on flexible structural elements and SMA springs 113

Possibilities and constraints for the widespread application of solar cooling integrated façades 121

Possible benefits of capillary flow glazing in translucent wall elements 123

S 2.3

Comparison of conventional and adaptive façades: Increasing application of adaptive facades in R. of Macedonia 131

Who is Driving an Adaptive Building Envelope 139

Opportunities and Challenges for Performance Prediction of Dynamic Complex Fenestration Systems (CFS) 147

Analysis of Heating Effects and Deformations for a STAF Panel with a Coupled CFD and FEM Simulation Method 149

S 2.4

An innovative adaptive multilayer façade: evaluation in the test cell LABIMED 151

Study of Building Integrated Photovoltaic/Thermal Double-Skin Facade for Commercial Buildings in Sydney, Australia 163

Ageing of adhesive connections for façade applications 175

Possibilities and challenges of different experimental techniques for airflow characterisation in the air cavities of façades 181

S 3.1

Solar Energy Balanced Façade 183

An initial study for the development of an adaptive timber device for moisture buffering applications 195

Adaptive window block for residential use: optimization of energy matching and user's comfort 203

ACT Façade – Interior sun shading for energy efficient fully glazed façades 215

S 3.2

Biological strategies for adaptive building envelopes 223

Multi-functional biomimetic adaptive façades: Developing a framework 231

Multi-functional biomimetic adaptive façades: A case study 241

The Role of Geometry for Adaptability: Comparison of Shading Systems and Biological Role Models 251

S 3.3

Innovations in façade engineering and a glass façade for the future 253

Application of Hollow Glass Blocks for Facades, Full Scale Test of Wall Created with Vitralock System 265

Thermo-mechanical analysis of GFRP-glass sandwich facade components 277

Thermal assessment of glass façade panels under radiant heating - Experimental and preliminary numerical studies 289

S 3.4

Dynamic Analysis of Climatic Conditions for deriving suitable Adaptive Façade responses 291

Optimising parameters for dynamic solar shading 303

Modelling Envelope Components Integrating Phase Change Materials (PCMs) with Whole-Building Energy Simulation Tools: a State of the Art 313

Performance Evaluation of Adaptive Facades: A case study with electrochromic glazing 315

S 4.1

An insight on possible classification and metrics, experimental testing and numerical modelling for adaptive facades - Activity report from the 'Structural' Task Group 325

A simulation tool for the façade aesthetic appearance – BIO4ever project approach 337

Thermal response of the bionic façade in different climatic conditions 347

Experimental Testing of Dissipative Façade Brackets 357

S 4.2

Post-Occupancy Evaluation for Adaptive Façades 369

Occupant-Adaptive Façade Interaction: Relationships and Conflicts 371

Impact of façade types on user comfort and health in office buildings 379

Future Façades of Hospital Buildings: A User-Centered Approach to Identify New Performance Requirements 391

S 4.3

Responsive facades evolution: the microscale to the macroscale 403

Temperature-responsive systems: passive strategies for building envelopes 425

Potentials for the use of ferrofluids in instantly-reacting solar shading 433

Technological and Economic Assessment of Different Models of Geometrically Complex Forms of Glass Envelopes 441

S 4.4

Updated Urban Facade Design 453

A Redesign Procedure to Manufacture Adaptive Façades with Standard Products 463

Designing Adaptive Facades with a new holistic Eco-Design Approach 465

Adaptive Façades and Topology Optimization 473

S 5

Dynamic and Climate-Sensitive Bionic Façade 487

Preface

Lucerne University of Applied Science and Arts, the European Façade Network and the European research network COST Action TU1403 “Adaptive Facades Network” have joined forces in the organisation of the FAÇADE 2018 – Adaptive! Conference. This international scientific conference - held on November 26-27, 2018 at the culture and convention centre Lucerne (KKL), Switzerland – focuses on adaptive, multifunctional and dynamic building envelopes. It gathers excellent architects, engineers, researchers and representatives from the façade industry to discuss recent façade projects, the advances in the design, new adaptive technologies and future developments in research.

Within the FAÇADE conference series, this is the fifth edition – following the editions in 2010, 2012, 2014 and 2016 - held in Lucerne and organized by Lucerne University of Applied Science and Arts. Within the COST Action TU1403, it follows the mid-term conference held at the TU Munich in 2017. This book provides the proceedings of the FAÇADE 2018 – Adaptive! Conference and, as such, it forms one of the final publications of the COST Action TU1403 with the booklets ‘3.1. Cases Studies’, ‘3.2 Performance Simulation and Characterisation of Adaptive Facades’, ‘3.3. Research and Education’, and the Special Edition Adaptive! of the Journal of Façade Design and Engineering (JFDE), which is dedicated to the conference FAÇADE 2018.

Nearly 60 peer-reviewed papers, published by more than 150 authors from 30 different countries, provide a profound state-of-the-art on adaptive facades. Thirteen high quality papers have been selected by the scientific committee to be published in the special edition of the JFDE journal. The papers are divided over five subthemes, which address products and materials for adaptive facades, strategies for design, performance assessment, experimental tests and post occupancy evaluation of adaptive facades. Moreover, five keynote presentations provide inspiring projects and ideas for further reflection.

Organising this conference and editing the conference proceedings has once again been an enjoyable experience. We would like to acknowledge all authors for their contributions, the scientific committee members for their valuable comments, our esteemed keynote speakers for their inspiring presentations, and of course, all conference participants for their interest in this event. In addition, we are grateful to our Sponsors Stahlbau Pichler, MHZ and HALIO, as well as the non-profit organisations Suisse Innovation Agency (Innosuisse) and the Swiss association for windows and facades (SZFF) for supporting the organisation of this conference. We also would like to thank the editors in chief of the JFDE journal, Ulrich Knaack, Tillmann Klein, Thaleia Konstantinou and Alejandro Prieto for their great support and the special edition dedicated to the FAÇADE 2018 – Adaptive! conference.

Finally, we would like to acknowledge COST for supporting both the conference and publication of these conference proceedings, and all COST Action TU1403 members for their contributions to make this happen. Particularly we would like to thank science officer, Mickael Pero, and administrative officer, Carmencita Malimban, for their great and valuable support during the course of COST Action TU1403.

We wish you an enjoyable conference and we hope you will find inspiring publications in these proceedings.

Andreas Luible, Susanne Gosztanyi & Stephanie Ly-Ky
Conference Organisers

Andreas Luible, Mauro Overend, Laura Aelenei, Aleksandra Krstic-Furundzic, Marco Perino,
Francesco Goia, Frank Wellershoff, Shady Attia, Ulrich Knaack, Uta Pottgiesser, Christian Louter
Chairs and Working Group chairs of COST Action TU1403

Conference Organisation

Prof. Dr. Andreas Luible	Lucerne University of Applied Sciences and Arts, Switzerland
Susanne Gosztanyi	Lucerne University of Applied Sciences and Arts, Switzerland
Stephanie Ly-Ky	Lucerne University of Applied Sciences and Arts, Switzerland

Scientific Committee

(in alphabetical order)

Dr. Laura Aelenei	National Energy and Geology Laboratory (LNEG), Portugal
Prof. Dr. Shady Attia,	Université de Liège, Belgium
Ass. Prof. Dr. Francesco Goia	Norwegian University of Science and Technology, Norway
Prof. Dr.-Ing. Ulrich Knaack	Delft University of Technology, The Netherlands
Prof. Dr. Aleksandra Krstic-Furundzic	University of Belgrade, Serbia
Dr. Christian Louter	Delft University of Technology, The Netherlands
Prof. Dr. Andreas Luible	Lucerne University of Applied Sciences and Arts, Switzerland
Dr. Mauro Overend	Cambridge University, United Kingdom
Prof. Dr. Marco Perino	Politecnico di Torino, Italy
Prof. Dr. Uta Pottgiesser	University of Antwerp, Belgium
Prof. Dr.-Ing. Frank Wellershoff	HafenCity University Hamburg, Germany

Conference Sponsor



more facade projects on
www.stahlbaupichler.ch

steel structures. façades. more.



Conference Sponsor

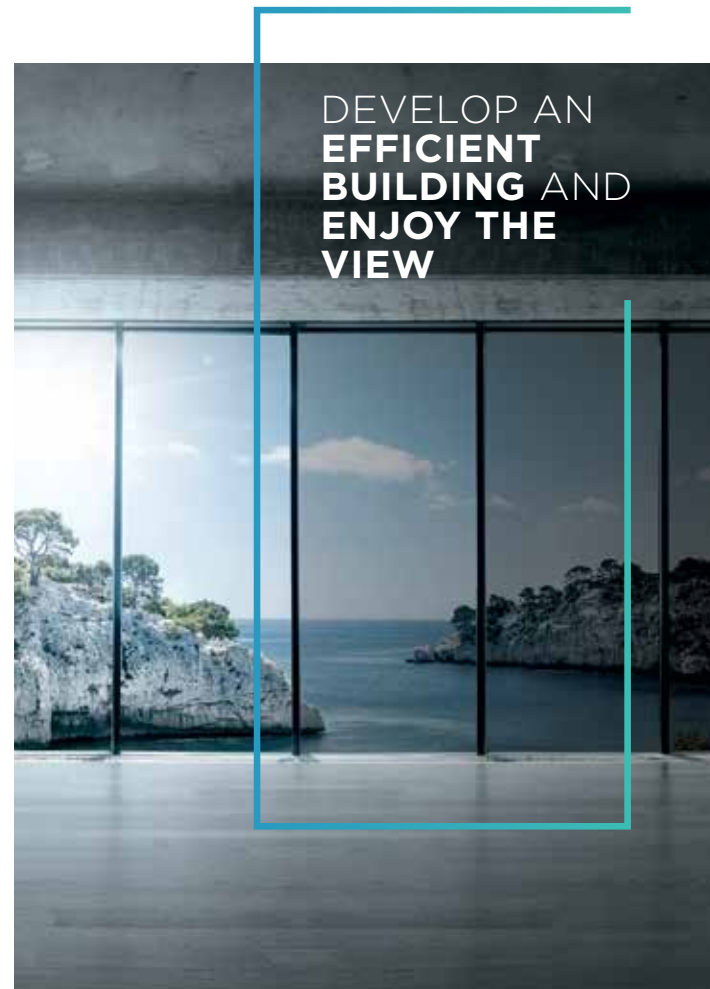

The most advanced natural light management system

Incorporating the most advanced technologies, the glass transitions from clear to dark in under three minutes. Users enjoy sun blocking, anti-glare protection and near-privacy while staying in touch with the outdoors. Halio™ enables the appearance and energy performance of glazing to be controlled either at the touch of a button or automatically thanks to its smart management algorithms. Architects get the freedom to design buildings with harmonious lines without the need for solar protection. Investors benefit from more points in green building certifications and increased financial and aesthetic value of the building.

www.halioglass.com
infoEUME@halioglass.com

Halio™ International
Avenue Jean Monnet 4
1348 Louvain-la-Neuve - Belgium

HALIO™

Conference Sponsor

GREAT PROJECTS. STRONG ASSOCIATION.

In «FASSADE/FAÇADE», the trade magazine for window and façade construction, we provide you with concentrated expertise and exciting projects four times a year, keeping you right up to date on the latest developments.

Subscribe now!
www.fassade.ch



SZFF/CSFF is the organiser of the «PRIXFORIX» façade award.
www.prixforix.ch



SZFF/CSFF
Swiss Centre for
Windows and Façades
Ringstrasse 15
CH-4600 Olten
Tel. 062 287 40 00
www.szff.ch

Conference Sponsor

High up: the Upper West Berlin

The Upper West Berlin is the new landmark of Berlin's City West district. 118 metres high and with 33 storeys, the building, built in 2016, is one of the tallest in Berlin.



architect Langhof Architektur und Stadtentwicklung
KSP Jürgen Engel Architekten
builder Strabag Real Estate

The s_enn metal blind supplements the building in its aesthetic appeal. As the stainless steel blind is designed to be extremely stable in the wind, it provides efficient sunshade even on high buildings. With its high level of transparency, it ensures utmost visibility through to the outside.

s_enn Highlights

- Sunshade product with high transparency for optimum visibility to the outside
- Modern stainless steel look
- High reduction in solar energy ($g_{tot} = 0,05$ for glazing $g = 0,36$)
- Extremely wind resistant, suitable for tall buildings

MHZ Hachtel GmbH & Co. KG www.mhz.de



Supporting Organisations

COST
European Cooperation in Science and Technology
<http://www.cost.eu>



SZFF/CSFF
Schweizerische Zentrale Fenster und Fassaden
<http://www.szff.ch>



efn
European Facade Network
<http://facades.ning.com>



Hochschule Ostwestfalen-Lippe
University of Applied Sciences
<https://www.hs-owl.de>

Hochschule Ostwestfalen-Lippe
University of Applied Sciences

Innosuisse
Suisse Innovation Agency
www.innosuisse.ch

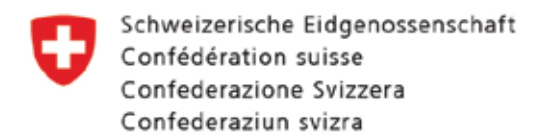

Adaptive Facades Network

- COST - European Cooperation in Science and Technology
- COST Action TU1403 - Adaptive Facades Network
- Activity reports:
 - Working Group 1 - Adaptive Technologies and Products
 - Working Group 2 - Component Performance and Characterization Methods
 - Working Group 3 - Whole Building Integration and Whole-life Evaluation Methods of Adaptive Facades
 - Working Group 4 - Dissemination and Future Research

COST - European Cooperation in Science and Technology

COST - European Cooperation in Science and Technology is an intergovernmental framework aimed at facilitating the collaboration and networking of scientists and researchers at European level. It was established in 1971 by 19 member countries and currently includes 37 member countries across Europe, and Israel as a cooperating state.

COST is an EU-funded programme that enables researchers to set up their interdisciplinary research networks in Europe and beyond. These networks, called 'COST Actions', promote international coordination of nationally funded research.

By fostering the networking of researchers at an international level, COST enables breakthrough scientific developments leading to new concepts and products. It thereby contributes to strengthening Europe's research and innovation capacities.

COST's mission focuses in particular on:

- Building capacity by connecting high quality scientific communities throughout Europe and worldwide
- Providing networking opportunities for early career investigators
- Increasing the impact of research on policy makers, regulatory bodies and national decision makers as well as the private sector.

Through its inclusiveness, COST supports the integration of research communities, leverages national research investments and addresses issues of global relevance. COST is thus a building block of the European Research Area, instrumental for successful innovation strategies and global cooperation.

As a precursor of advanced multidisciplinary research, COST plays a very important role in building a European Research Area (ERA). It anticipates and complements the activities of the EU Framework programs, constituting a "bridge" towards the scientific communities of COST Inclusiveness Target Countries. It also increases the mobility of researchers across Europe and fosters the establishment of scientific excellence.

COST's interdisciplinary bottom-up research and innovation networks are effectively bridging the innovation divide and participation gaps in Europe and are providing a large spectrum of opportunities for young generations of researchers and innovators. Involvement in COST Actions both anticipates and complements the activities of the EU Collaborative Framework Program (FP), spreading excellence across Europe and beyond.

Every year thousands of European scientists benefit from being involved in COST Actions, allowing the pooling of national research funding to achieve common goals. COST does not fund research itself, but provides support for networking activities carried out within COST Actions. COST Actions are bottom-up science and technology networks open to researchers and stakeholders, with a four-year duration and a minimum participation of seven COST Member States.



COST Action TU1403 - Adaptive Facades Network

Andreas Luible a), Mauro Overend b)

a) Lucerne University of Applied Science and Arts, Switzerland, andreas.luible@hslu.ch

b) University of Cambridge, United Kingdom

Multi-functional and adaptive building envelopes can provide step-change improvements in the energy efficiency and economic value of new and refurbished buildings, while improving the wellbeing of building occupants. In 2014, the research network COST Action TU1403 "Adaptive Facades Network" with more than 210 participants from 27 COST countries was successfully launched. The European Union (EU) Horizon 2020 Programme supported the COST Action. The main objectives of COST Action TU1403 "Adaptive Facades Network" were to harmonise, share and disseminate technological knowledge on adaptive facades, leading to increased knowledge sharing between European research centres and between these centres and industry, the development of novel concepts, technologies and new combinations of existing technologies for adaptive facades, as well as the development of new knowledge such as effective evaluation tools / design methods for adaptive facades.

Keywords: COST Action TU1403, Adaptive, Façade, Network

1 Introduction and Background

Approximately one third of all end-user energy in Europe today is consumed by space heating / cooling, ventilation and lighting of buildings. Therefore, the energy performance of future building envelopes will play a key role in order to meeting the EU climate and energy sustainability targets. Whereas most of our today's facades are passive systems and are largely exhausted from an energetic point of view, multifunctional, adaptive and dynamic facades can be considered as the next big milestone in façade technology.

Adaptive building envelopes are able to interact with the environment and the user by reacting to external influences and adapting their behaviour and functionality over time in response to transient performance requirements and boundary conditions with the aim of improving the overall building performance: the building envelope insulates only when necessary, it produces energy when possible, it shades or ventilates when the indoor comfort so demands. The timescales of the transient conditions to which an Adaptive Façade responds (i.e. the dynamic frequency) may vary from: a few minutes or hours (e.g. cloud cover or transient lighting requirements in a room); to diurnal and seasonal (e.g. air temperature and radiation cycles); through to several years (e.g. climate change and change of use of building). The degree of adaptiveness may range from a relatively low level, such as an operable window in a façade or a manually operated curtain behind the façade, to systems with a high degree of adaptiveness. A façade is considered fully adaptive if it can respond to all the transient conditions in such a way that it maintains occupant satisfaction without imposing additional loads on the building services. Adaptivity can be achieved by means of self-adaptation (smart materials), or active control (intelligent systems).

In practice, the development and realisation of adaptive building envelopes is still in the initial stage. In addition to new technologies that enable the adaptive behaviour of facades, for example, new

types of glazing, simulation tools and suitable testing methods need to be developed, and existing standards and regulations must be adapted. The integration of adaptive facades in the overall building system requires a holistic view due to the many interfaces with other subcontracts such as building services, for example.

There is a critical mass of European knowledge, expertise, resources, and skills in the fields relevant to adaptive facades, but the research efforts across the multi-disciplinary topics and the wide range of novel technologies are scattered across several R&D centres in Europe. In order to overcome this situation COST Action TU1403 was successfully launched in 2014 (COST 2014).

2 COST Action TU1403 objectives

COST Action TU1403 aimed to harness knowledge in the field of adaptive facades and thereby generated new ideas and concepts at a fundamental and product/system development level. This was achieved by creating a collaborative research network with a strong multidisciplinary approach, involving academics, industrial partners from the façade supply chain, and other stakeholders. The main objectives of COST Action TU1403 were:

- Harmonize the European research and knowledge in the area of adaptive façades between industry and academia and foster their collaboration.
- Share and disseminate technological knowledge at a European level between the different stakeholders in the façade industry and the academia in order to foster the development of novel concepts, technologies and new combinations of existing technologies for adaptive facades.
- Share and develop more holistic approaches, metrics and tools to evaluate the performance of adaptive facades with the purpose of standardisation and feasibility assessment of novel concepts.
- Develop an effective means of disseminating the work of the COST Action on adaptive facades with an emphasis on engaging with early-stage researchers, industrial partners and the wider public.
- Align and organize the efforts between the stakeholders and academia and initiate new research projects in the area of adaptive facades

3 Networking

The networking activities, such as meetings, workshops, industry workshops, training schools, short term scientific missions and conferences, within COST Action TU1403 enabled the immediate sharing of nationally based research and enabled the establishment of common platforms to accelerate trans-national research projects in the area of adaptive facades. It also allowed sharing of experimental data; development of modelling and simulation techniques; sharing of common evaluation methods; thereby leading to real and significant advances in adaptive facades and their application in energy efficient buildings.

4 Scientific programme

4.1. Scientific Focus

COST Action TU1403 focused on the coordination of current research undertaken through national programmes in three identified scientific areas:

- Development of new technologies and concepts for adaptive facades
- Multi-disciplinary characterization methods of novel adaptive façade technologies and concepts at a component level

- Whole-life evaluation methods of novel adaptive façade at the building level and building/user integration.

Based on these identified areas three scientific Working Groups (WG) have been established to coordinate research within each area. A fourth working group was dedicated to dissemination activities.

4.2. Working Group 1

The objective of Working Group 1 (WG1) - Adaptive technologies and products, was to provide a database of different technological solutions and applications of adaptive facades, constituting a state-of-the-art literature review of either new market technologies and possible developments of adaptive facades. This supporting database is a first stage to evaluate the current and future trends of adaptive facades. Activities in WG1 should also pursue and support the development of novel adaptive technologies. These may consist of novel adaptive technologies that are new to the façade research community and/or new combinations of existing adaptive technologies. The objectives of WG1 were: to map out the different technologies (available either on the market, or as prototypes or concept) allowing a façade to be adaptive and responsive, in terms of materials and systems (including control systems); to provide an overview of the performance of each technology compared to the state-of-the-art high performance facades; to identify and pursue new concepts and new products for adaptive façades; to provide a selection of applications of technologies already adopted in existing projects identifying the strongest and weakest points.

4.3. Working Group 2

The objective of Working Group 2 (WG2) - Component performance and characterization methods, was to provide a unified approach for characterizing and evaluating the performance of an adaptive and multi-functional façade, at the component level. This will include the various physical characteristics that affect the wide range of transient performance requirements of a façade. Further objectives of WG2 were: to identify for each aspect of façade performance (energy efficiency, structural, safety, fire, weather protection, durability, aesthetics) where the adaptive technologies would be most beneficial; to establish and standardise numerical and experimental ways of characterizing their performance (with an emphasis on performance related to energy efficiency); to evaluate the suitability of conventional performance parameters to fully address the behaviour of adaptive facades; to develop new metrics that are able to capture the transient and multi-parameter performance of adaptive façades and thereby enable quantitative comparisons between different facades, where the adoption of conventional metrics is not satisfactory; to develop new numerical tools for evaluating the most promising adaptive technologies.

4.4. Working Group 3

The main objective of Working Group 3 (WG3) - Whole building integration and whole-life evaluation methods of adaptive facades, was to evaluate the integration and interaction of an adaptive façade with the building (aesthetics, structure etc.), the building services, the building users and the environment, thereby providing an account of the whole-life performance of an adaptive façade. The quality of future energy efficient buildings depends on the performance of each component but also on the interaction between these components in the entire façade system and how the façade interacts with the internal / external environment and users. The task of WG3 was thus the evaluation of the pros/cons of adaptive façades when these technologies are analysed

with a wider perspective, i.e. the impact of the adaptive façade when: integrated into a building; under realistic boundary conditions and users' interaction; in a multidisciplinary, holistic perspective.

4.5. Working Group 4

The main objective of Working Group 4 (WG4) - Dissemination and future research, was the dissemination of Action results. WG4 maintained and organised the Action website, the workshops, the Short Term Scientific Missions (STSM), the Training Schools and the Early Career Investigator workshops and co-ordinate the International conference, publication of journal papers and guidelines, and finally coordinate the application for future research projects.

More details about the activities within each working groups and the results can be found in the WG reports in this proceedings (Aelenei 2018, Perino 2018, Wellershoff 2018, Pottgiesser 2018).

5 Activities

Over the past four years of COST Action TU1403 a large number of networking activities have been carried out.

During the period of the whole project, the Working Groups and the Management Committee met twice a year. Additional ad-hoc working group meetings were organised by smaller task groups within the working groups. As a means to involve not only research but also the industry, two industry workshops were held.

One aim of COST Action was to support early career investigators and the next generation of researchers. Many of them have been trained during the two one-week training schools and workshops, have participated in PhD workshops. As a result of the training schools, an educational pack, with many lectures and educational material, could be established and made available for the education of future façade engineers in Europe.

A mid-term and a final conference was organized in order to disseminate the results of the Action to a wider audience.

Exchange visits of young researchers have been promoted with Short Term Scientific Missions. Short Term Scientific Missions allowed to strengthen the network and fostering the contact between researchers. At the same time young researchers got the chance to learn new techniques, gain access to specific data, instruments and methods, which are not available in their own institutions.

More information about the COST Action TU1403 networking activities, all outputs and results is available on the action webpage (www.tu1403.eu) and in the WG reports in this proceeding book.

6 Conclusions

Looking back, we are proud to see that COST Action TU1403 succeeded to create a strong European specialist network on adaptive facades. Compared to the situation four years ago, many action participants were able to build up their network, to bundle and coordinate ongoing research activities and establish new research fields. The collaboration between research and industry in this COST Action enabled knowledge transfer. Façade-related research and industry across Europe will greatly benefit from the network initiated by this COST Action.

The Action could provide a significant contribution to the development of innovative products, façade systems and more holistic evaluation methods. Consequently, the scientific research reports, publications and outcomes will provide researchers, academics, architects, engineers, fabricators, construction firms, building owners and policy makers with up-to-date overviews of research results on materials, advanced methods for the design and evaluation of adaptive facades. In addition, an educational pack could be developed in order to support university curricula and professional development programmes across Europe.

7 Acknowledgements

The chairs of COST Action TU1403 would like to acknowledge the support and excellent networking opportunities provided by COST Action TU1403 "Adaptive facades network" as well as COST (European Cooperation in Science and Technology) and EU (European Union) for the financial support. Particularly we would like to thank science officer, Mickael Pero, and administrative officer, Carmencita Malimban, for their great and valuable support during the course of COST Action TU1403. Finally, we would like to thank all Action WG chairs, WG vice-chairs, WG members, invited experts, trainings school participants and STSM candidates for their active participation and their contribution to the success of COST Action TU1403.

8 References

- COST, Memorandum of Understanding for the implementation of a European Concerted Research Action designated as COST Action TU1403: Adaptive Facades Network, COST Association, www.cost.eu, Brussels, 2014.
- Aelenei, L., Krstic-Furundzic, A., Working Group 1 Adaptive technologies and products, Proceedings FAÇADE 2018 – Adaptive! & COST Action TU1403 Final Conference. Lucerne, 2018.
- Perino, M., Goia, F., WG2 - Component performance and characterization methods, Proceedings FAÇADE 2018 – Adaptive! & COST Action TU1403 Final Conference. Lucerne, 2018.
- Wellershoff, F., Attia, S., Working Group 3 Whole building integration and whole-life evaluation methods of adaptive facades, Proceedings FAÇADE 2018 – Adaptive! & COST Action TU1403 Final Conference. Lucerne, 2018.
- Pottgiesser, U., Knaack, U., Louter, C., Working Group 3 Dissemination and future Research, Proceedings FAÇADE 2018 – Adaptive! & COST Action TU1403 Final Conference. Lucerne, 2018.

Activity report Working Group 1 (WG1) - Adaptive Technologies and Products

Aelenei, L., Krstic-Furundzic, A.

Objectives

The fundamental objectives of this WG are to collect information of a wide range of existing adaptive facade technologies and present it in a systematic manner taking into account a characterization matrix of adaptive features. The information collected is structured and presented in a database form of different technological solutions and application of adaptive facades, this supporting database is a first stage to evaluate and map the current and future trends of adaptive facades and provide input material for all the all the tasks of this WG.

Other objective of this WG is to identify and pursue new and promising adaptive concepts. These may consist of novel adaptive technologies that are new to the façade research community.

Work structure

Based on these two objectives of WG1 and the main operational activities of the project, the work was structured in four sub-groups (SG) represented in the Figure 1 together with the main activities developed in each sub-group:

Sub-Group 1 (SG1) – Data base

Sub-Group 2 (SG2) – Educational Pack

Sub-Group 3 (SG3) – Publications and Reports

Sub-Group 4 (SG4) – Short Term Scientific Missions (STSM)



Figure 1 WG1 Sub-Groups

Sub-Group 1 (SG1) – Data base

Led by: J.M.Rico Martinez, M. Brzezick, D. Aelenei, R. Romano, L. Aelenei, E. Mazzuchelli

Within this sub-group an extensive work of collection information about existing adaptive façade is developing. The collected information are based and structured according with a characterization matrix of adaptive features and an online survey which contemplate different characterization topics. For each case study is produce a factsheet with the information collected. All the case studies are insert in a google map, in this manner it can be observed and analyzed the distribution of the existing technologies according with the geographical location.

Main outputs

Data base adaptive façade case studies

- On-line survey
- Extended information case study datasheet
- Mapping - batchgeo

Sub-Group 2 (SG2) – Educational Pack

Led by: T. Klein, D. Aelenei, A. Krstic-Furundzic, C. Menezo, J.M. Rico Martinez

This sub-group work is focused on developing of the educational material for the training schools organized within the project. The material developed is based on the case studies information and structured according with different features and finding from database case studies from architectural integration of adaptive façade, design features, lessons learned and other.

Main outputs

Contributions for the two training summer schools:

Training School Hamburg, HCU HafenCity University, September 12-17, 2016:

- 1 Introduction to adaptive facades: General introduction, History of adaptivity in Facades and windows, Definitions, The adaptive façade survey
- 2 The state of the art of adaptive facades
- 3 Design of adaptive facades - Lessons learned from survey case studies

Training School 2018, University of Belgrade, September 03-07, 2018:

- 4 Smart and Multifunctional Materials and their possible application in facade systems
- 5 Adaptive Facade Concepts / Kinetics
- 6 Climate, Daylighting, Thermal
- 7 Retrofitting Façades

Sub-Group 3 (SG3) – Publications and Reports

Led by: D. Aelenei, A.Krstic-Furundzic, T. Karlessi, T. Klein

Scientific publications are developing with the coordination of this sub-group, including papers in conferences and journal, posters, participation at project organized conferences, presentation in different workshops. Contributions for the booklets developed by project and also reports of WG1 are coordinated also by this sub-group.

Main outputs - publications with Cost Action Acknowledgments

Juaristi M, Gómez-Acebo T, Monge-Barrio A. (2018) "Qualitative analysis of promising materials and technologies for the design and evaluation of Climate Adaptive Opaque Façades". Build Environ 2018;144:482–501. doi:10.1016/J.BUILDENV.2018.08.028

Mazzucchelli E.S. , Alston M., Doniacovo L., (2017) "Study of a BIPV adaptive system: combining timber and photovoltaic technologies", Advanced Building Skins Conference 2017

Gosztanyi, S. (2017) "Adaptive Facades and Spatial Morphology", ICBEST International Conference on Building Envelope Systems and Technologies, Istanbul, Turkey (15.-18.05.2017).

Aelenei, D., Aelenei, L., Pacheco Vieira, C., (2016) "Adaptive Façade: concept, applications, research questions", Energia Procedia, 91: 269 – 275. DOI: 10.1016/j.egypro.2016.06.218.

Gosztanyi, S. (2015) "Adaptive Façade – which criteria are needed?", In: Proceedings, façade 2015: Computational Optimization, Detmold, Germany, 27.11.2015

Loonen, R.C.G.M., Rico-Martinez, J.M., Favoino, F., Brzezicki, M., Menezo, C., La Ferla, G., Aelenei, L., (2015) "Design for façade adaptability – Towards a unified and systematic characterization", Energy Forum 2015.

Sub-Group 4 (SG4) – STSM

Led by: L. Aelenei

A number of Short Term Scientific Missions have been developed with the main objective to contribute to the work and objective of the WG1. Starting with the first scientific missions related with the collected information and developing survey of the case studies data base, state of the art, characterization matrix, developing of training material until mapping the case studies and innovative approaches of adaptive features characterization as eco-design based, the work developed contribute not only to the objectives of the WG1 but also to the successful collaboration between different institutions.

Main outputs

- 1 State of the art and research about adaptive facades, J.M. Rico-Martinez (1st STSM Call)
- 2 Sharing the experience in visions, material technology, façade design of the future building envelope, M. Brzezicki (1st STSM Call)

- 3 Kick-off for investigation and publication on functional and architectural characteristics of adaptive facades targeting at the term "intelligence", S. Gosztanyi (2nd STSM Call)
- 4 Review of the Adaptive Facade database, development of the educational pack draft plan and teaching material WG1, S. Persiani (3rd STSM Call)
- 5 Adaptive facades towards Med Area: the analysis of an innovative scientific approach, R. Romano (4th STSM Call)
- 6 WG1 support to the development of a series of lectures material WG1, P. Molter (4th STSM Call)
- 7 Contribution towards development of current state of the art adaptive façade materials and systems, Claudio Aresta (5th STSM Call)
- 8 Eco-design approach for designing adaptive façade with a unified and systematic characterization, Nitisha Vedula (5th STSM)
- 9 Mapping out existing and future technologies – harmonizing, sharing and disseminating, Marcin Brzezicki (5th STSM)
- 10 The state-of-the-art of adaptive and/or multifunctional materials, Miren Juaristi (5th STSM)
- 11 Elastocaloric cooling systems for buildings and the built environment & Adaptive structural systems for high-performance buildings, Theoni Karlessi (6th STSM)

WG1 Participants

Name	Contact	WG1 sub-group
Laura Aelenei	laura.aelenei@lneg.pt	SG1, SG3
Aleksandra Krstic-Furunzic	akrstic@arh.bg.ac.rs	SG2
Daniel Aelenei	aelenei@fct.unl.pt	SG2, SG3
Marcin Brzezicki	marcin.brzezicki@pwr.edu.pl	SG1
Tillmann Klein	T.Klein@tudelft.nl	SG1, SG2
Josemi Rico Martínez	j.rico@ehu.eus	SG1, SG3
Theoni Karlessi	karlessith@phys.uoa.gr	SG2, SG3
Christophe Menezo	christophe.menezo@univ-smb.fr	SG2
Susanne Gosztanyi	susanne.gosztanyi@hslu.ch	SG1
Jerry Eriksson	Jerry.Eriksson@Glafo.se	SG1
Rosa Romano	arch.rosaromano@gmail.com	SG1
Maria da Glória Gomes	mgloria@civil.ist.utl.pt	SG1
Alston Mark	M.E.Alston@salford.ac.uk	SG2, SG3
Luc Traonvouez	contact@insula-france.com	SG1
Matej Banožić	banozic@tugraz.at	SG2
Enrico Sergio Mazzucchelli	enrico.mazzucchelli@polimi.it	SG1
Sandra Persiani	sandra.persiani@yahoo.it	SG1
Claudio Aresta	claudio.aresta@tum.de	SG2, SG3
Nitisha Vedula	vedulantsh@gmail.com	SG3
Miren Juaristi	mjuaristi@alumni.unav.es	SG1, SG2

Activity report Working Group 2 (WG2) - Component Performance and Characterization Methods

Perino, M., Goia, F.

Working Group 2 aimed at defining robust and meaningful methods, techniques, and procedures for the characterisation and performance evaluation of adaptive, multifunctional facades, at sub-component and system level.

The domain of interest of WG2 covered different aspects of the façade (e.g. thermal and visual domain, structural-mechanical domain, durability domain) where adaptive technologies can improve the system's performance.

The main goal was to provide a unified approach for characterizing and evaluating the performance of an adaptive and multi-functional façade, at the component level. This included the various physical characteristics that affect the wide range of transient performance requirements of a dynamic façade.

The activities of the WG2 were organised in 5 scientific Tasks dealing with different aspects of characterisation and performance evaluation and 1 Task shared with other WG aimed at the fund raising activity.

Specifically, tasks were:

- Task 2.1 Map out performance metrics and requirements for adaptive facades ,
- Task 2.2 Evaluate current simulation tools for adaptive facades performance assessment,
- Task 2.3 Analysis of current experimental procedures for the evaluation of adaptive facades,
- Task 2.4 Develop new simulation tools,
- Task 2.5 Develop standardised experimental procedures and metrics for evaluating the performance,
- Task 2.6 Identify sources of European and national funding and apply for funding for new research projects in the field of adaptive facades

From a practical point of view, tasks 2.2 and 2.4 were grouped in a unique research unit (since the first task was instrumental to the second, being a state of the art review of existing simulation tools). For the same reasons also tasks 2.3 and 2.5 were grouped together and were the object of study of a unique research units.

In practice 4 research units were formed. One taking care of Task 2.1, one covering Tasks 2.2 and 2.4 in relation to the energy and thermophysical simulation of dynamic facades, one covering all the experimental aspects dealing with energy, comfort, thermal and fluid dynamic phenomena (that is tasks 2.3 and 2.4) and finally one research group aimed at investigating all the structural subjects (grouping both experimental and simulation approaches, that is, all the tasks from 2.2 to 2.5).

Task (2.1) focused on the mapping of performance metrics and requirements for adaptive facades as well as the potential development of new performance metrics capable of better representing the behaviour of adaptive facades, in contrast to conventional performance metrics based on steady-state and time-independent performance.

The main output of this Task is an online tool – a database - that collects Key Performance Indicators (KPIs) related to adaptive facades.

Tasks (2.2) and (2.4) were dedicated to the physical-mathematical modelling and numerical simulation of adaptive facades. Within task (2.2), the state-of-the-art of simulation techniques and tools for different domains of the facade were analysed, and the limitations of current tools and approaches highlighted. At the same time, the research group addressed the development of more advanced modelling and simulation procedures to better replicate the physical behaviour of adaptive facades (task 2.4).

In detail, the first part of the work (Task 2.2) consisted in reviewing the current methods for an accurate and comprehensive quantification of the performance of adaptive facades and technologies by means of building performance simulations. This was done by means of an extensive literature review focused on the following aspects: i) simulation requirements based on intrinsic characteristics of adaptive facade technologies and their control during building operations; ii) ability of building performance simulation software to respond to these requirements and easiness of implementation; iii) advanced features for modelling adaptive facades, future outlook and implementation needs. This work (presented in the deliverable 2.1) was summarized in an open access publication (Loonen et al. 2017) and is published in Booklet 3.2 A (see Chapter 1).

The second part of the work (Task 2.4) focused on developing and documenting new simulation models and methods to assess the performance of adaptive facades. These models were either developed by the WG members, or adopted by them during their research activity. A questionnaire distributed among the WG members allowed to map all the specific capabilities and expertise, as well as the current activities regarding the development of novel simulation methods and models for adaptive facades. This questionnaire also fostered the networking between different members, creating opportunities for STSMs dedicated to Task 2.4. Chapters 2 to 14 of the Booklet 3.2 A document all the different models and methodology developed, adopted and reviewed by this Task group divided by specific adaptive facade technology (this represents Deliverable 2.3 of the COST project).

The work of WG2 Task groups 2.1, 2.2 and 2.4 resulted from 27 contributors, from 8 different countries, from 12 universities and research institutions and 5 industry contributors.

Research articles (dealing with both review and new simulation approaches) and a database with information on modelling and simulation of different adaptive facade technologies are among the most relevant outputs of the Tasks 2.2 and 2.4.

As far as the activities within Task (2.3) and (2.5), they focused on the experimental assessment of adaptive facade systems. In task (2.3), the state-of-the-art of experimental analysis methods (thus including facilities and procedures) was mapped, and challenges related to the characterisation through measurements were identified, with a particular focus on testing of full-scale mock-up and sub-system components.

The activities in these Tasks were focused on research infrastructures and the connection between experimental facility and experimental methods for characterisation of different aspects of the performance of an adaptive facade. In particular, research articles on typologies and related experimental methods for different categories of full test facilities (outdoor and indoor test cells) have been developed during the activities, and presented to relevant conferences and/or published in scientific journals. In addition to this, activities have also been carried on in relation to modelling and simulation of experimental facilities (test cells) to identify the relevant parameters for the optimal construction and management of these systems

These research outputs are based on both extensive literature reviews and on first-hand experience of the participants with different types of experimental facilities, and are continuing beyond the activities of the action. At the present, an article on indoor test facilities for adaptive facade characterisation is under development and will be finalized for the end of the COST action.

Some specific experimental techniques and methodologies, primarily developed for full-scale testing in test-cells or real buildings have also been analysed, among them methods for airflow characterizations in ventilated cavities and methods for the in-situ determination of thermal characteristics of facades were developed.

The work of WG2 Task groups 2.2 and 2.5 has seen the contribution of nearly 40 researchers from 8 countries, primarily employed in research institutions.

On parallel, the research unit dealing with structural topics developed a mirror structure of tasks 2.2 & 2.4 and of tasks 2.3 & 2.5. Main outputs are a collection of performance indicators, information on structural issues and durability as far as adaptive facades are concerned.

WG 2 also significantly contributed in the educational activities of the Action. Contributions were given in the form of: lectures delivered during the two summer schools organized by the COST action, preparation and supervision of the teaching material within the WG 2 domain.

Finally, members from WG2 actively participated in a series of STSM.

Activity report Working Group 3 (WG3) - Whole Building Integration and Whole-Life Evaluation Methods of Adaptive Facades

Wellershoff, F., Attia, S.

Objectives

Work Group 3 aims to evaluate the performance and quality of integration of adaptive façades within buildings, building services, in relation to building users. The group is focused on the construction and operation phase and seeks to develop experience from facades contractors and facades users. The key contribution of the group includes the identification of the requirements for building integration and user interaction for adaptive and multifunctional facades. The group documented three case studies for unique building with dynamic facades and interviewed more than 10 international experts of adaptive facades. Also the group organized the first training school for dissemination of expertise to early stage researchers. With a focus on post-occupancy evaluation methods and occupancy interaction Work Group 3 published several papers looking at whole-life evaluation methods for adaptive facades. The tasks of WG3 can be identified as:

- T 3.1 Requirements for building integration and user interaction for adaptive facades
- T 3.2 Assessment of adaptive facades based on case studies analysis
- T 3.3 Current and proposed post-occupancy evaluation methods
- T 3.4 Develop new performance evaluation method for adaptive facades

Activities

Between 2014 and 2018 from 10 to 15 work group members participated actively in the some of the following main activities:

- Research activities and scientific publications
- Ad-hoc meetings for research and proposal writing activities (2)
- Organisation of the first summer school in Hamburg under the leadership of Prof. Frank Wellershof
- Organizing and hosting events and giving lectures in academia and professional world
- Preparing proposal for new national and European research projects
- Preparation of the Mid-term Conference
- Contribution to the Final Conference review and publications
- Contribution to education pack
- Contribution to the two summer schools
- Contribution to Industry workshop
- Contribution to Workgroup 1 database
- Hosting or sending early stage researchers for short scientific missions (2 STSMs)

Results

T 3.1 Requirements for building integration and user interaction for adaptive facades

Attia, S., Favoino, F., Loonen, R., Petrovski, A., Monge-Barrio, A., 2015, Adaptive Facades System Assessment: An initial review, 10th Conference on Advanced Building Skins, 3-4 November, 1265-1273, Bern, Switzerland.

Struck C., Almeida M. G., Monteiro da Silva S., Mateus R., Lemarchand P., Petrovski A., Rabenseifer R., Wansdronk R., Wellershoff F., de Wit J., 2015, Adaptive facade systems – review of performance requirements, design approaches, use cases and market needs, 10th Conference on Advanced Building Skins, 3-4 November, 1254-1264, Bern, Switzerland (pdf).

T 3.2 Assessment of adaptive facades based on case studies analysis

Attia, S. (2017) Evaluation of adaptive facades: The case study of Al Bahr Towers in the UAE, Shaping Qatar's Sustainable Built Environment, Hamad Bin Khalifa University Press, Volume 2, Issue 6, P1-13.

Attia, S., Bashandy, H., 2016, Evaluation of Adaptive Facades: The case study of AGC Headquarter in Belgium, Challenging Glass 5 Conference on Architectural and Structural Applications of Glass, 16 & 17 June 2016, Ghent University.

Attia, S., Bilir, S., Safy, T. (2019) Adaptive Facades performance assessment: Interviews with Façade Experts, SBD Lab, Liege University, Belgium. ISBN: 9782930909097. Retrieved from <https://orbi.ulg.ac.be/handle/2268/213736>.

Bilir, S., Attia, S. (2018) Performance Evaluation of Adaptive Facades: A case study with electrochromic glazing, Next Facades COST Action TU1403 Adaptive Facades Network Conference, Lucerne University, 26-27 November 2018. Lucerne, Switzerland.

Juaristi M., Monge-Barrio, A., 2016, Adaptive façades in temperate climates. An in-use assessment of an office building, 11th Conference on Advanced Building Skins, 10-11 October 2016, 419-428, Bern, Switzerland.

T 3.3 Current and proposed post-occupancy evaluation methods

Attia, S., Luna Navarro, A., Juaristi, M., Monge-Barrio, A., Gosztonyi, S., Al-Doughmi, Z., (2018b) Post-Occupancy Evaluation for Adaptive Facades, Journal of Façade Design and Engineering.

T 3.4 Develop new performance evaluation method for adaptive facades

Attia, S., Bilir, S., Safy, T., Struck, C., Loonen, R., Goia, F. (2018) Current Trends and Future Challenges in the Performance Assessment of Adaptive Façade Systems, Energy and Building.

Attia, S, F. (2019) European approach" to occupant-centered adaptive façades assessments and interaction, Energy and Building.

Publications

2018

Attia, S. (2018) Challenges and Future Directions of Smart Sensing and Control Technology for Adaptive Facades Monitoring. Next Facades COST Action TU1403 Adaptive Facades Network Conference, Lucerne University, 26-27 November 2018. Lucerne, Switzerland.

Attia, S., Bilir, S., Safy, T. (2019) Adaptive Facades performance assessment: Interviews with Façade Experts, SBD Lab, Liege University, Belgium. ISBN: 9782930909097. Retrieved from <https://orbi.ulg.ac.be/handle/2268/213736>.

Attia, S., Luna Navarro, A., Juaristi, M., Monge-Barrio, A., Gosztonyi, S., Al-Doughmi, Z., (2018b) Post-Occupancy Evaluation for Adaptive Facades, Journal of Façade Design and Engineering.

Attia, S., Bilir, S., Safy, T., Struck, C., Loonen, R., Goia, F. (2018) Current Trends and Future Challenges in the Performance Assessment of Adaptive Façade Systems, Energy and Building.

Bilir, S., Attia, S. (2018) Performance Evaluation of Adaptive Facades: A case study with electrochromic glazing, Next Facades COST Action TU1403 Adaptive Facades Network Conference, Lucerne University, 26-27 November 2018. Lucerne, Switzerland.

Juaristi, M., Monge-Barrio, A., Sánchez-Ostiz, A., & Gómez-Acebo, T. (2018). Exploring the potential of Smart and Multifunctional Materials in Adaptive Opaque Facade Systems. Journal of Façade Design and Engineering, 6(2), 109–119.

2017

Grynning, S. Lolli, N., Wågø, S., Risholt, B., (2017) Solar shading in low energy office buildings - design strategy and user perception, Journal of Daylighting, 4, p. 1–14.

Rabenseifer, R., 2017, Glazing with Low-Emissivity Layers and its Performance Simulation, In: Applied Mechanics and Materials, Vol. 861, copyright 2017 Trans Tech Publications, Switzerland, pp 206-212, ISSN: 1662-7482, doi:10.4028/www.scientific.net/AMM.861.206

Attia, S. (2017) Evaluation of adaptive facades: The case study of Al Bahr Towers in the UAE, Shaping Qatar's Sustainable Built Environment, Hamad Bin Khalifa University Press, Volume 2, Issue 6, P1-13.

2016

Attia, S. 2016, Evaluation of adaptive facades: Case study, Al Bahar Towers, UAE, 2nd Qatar Green Building Council Conference, 13-15 November, Doha, Qatar.

Attia, S., Bashandy, H., 2016, Evaluation of Adaptive Facades: The case study of AGC Headquarter in Belgium, Challenging Glass 5 Conference on Architectural and Structural Applications of Glass, 16 & 17 June 2016, Ghent University.

Juaristi M., Monge-Barrio, A., 2016, Adaptive façades in temperate climates. An in-use assessment of an office building, 11th Conference on Advanced Building Skins, 10-11 October 2016, 419-428, Bern, Switzerland.

Schober, H., Brandl, D., Zellinger, M., Mach, T. & Englhardt, O., 2016, Integrale Gebäudehüllen – Entwicklung eines solarthermisch aktivierten, multifunktionalen Fassadenpaneels. in 12. Internationale Konferenz für solares Heizen und Kühlen – Gleisdorf Solar 2016.

Struck, C., Wit de, J., Weersink, A., Blok de, K., Owczarek, P. and Berkhout, H., 2016, Towards the application of thermoacoustic cooling in office buildings: performance governing parameters and models for performance predictions, 12th REHVA World Congress, CLIMA 2016, Aalborg, Denmark, 2016, accepted for publication

Struck, C., Frei, B. Seerig, A., 2016, The Missing Link: Connecting Building Technology to Social-Psychology, 34rd Annual ACM Conference Extended Abstracts on Human Factors in Computing Systems, San Jose, USA, 2016, accepted for publication

Wellershoff, F., Friedrich, M., Labaki, L.; Fernandes, L., 2016, Façade design for night cooling by natural ventilation in different climate zones, SBE Conference Hamburg.

2015

Attia, S., Favoino, F., Loonen, R., Petrovski, A., Monge-Barrio, A., 2015, Adaptive Facades System Assessment: An initial review, 10th Conference on Advanced Building Skins, 3-4 November, 1265-1273, Bern, Switzerland.

Struck C., Almeida M. G., Monteiro da Silva S., Mateus R., Lemarchand P., Petrovski A., Rabenseifer R., Wansdronk R., Wellershoff F., de Wit J., 2015, Adaptive facade systems – review of performance requirements, design approaches, use cases and market needs, 10th Conference on Advanced Building Skins, 3-4 November, 1254-1264, Bern, Switzerland (pdf).

Struck, C., Jurt, D. and Seerig, A., 2015, Resilience of Swiss offices to climate change: A comparison of four buildings with different façade typologies, 10th Conference on Advanced Building Skins, 3-4 November, Switzerland.

Proposals

EU, H2020-MSCA-ITN-2018, Marie Skłodowska-Curie Innovative Training Networks, European Training Networks, FAB Facades, Proposal number: 813673

EU, H2020-MSCA-ITN-2018, Marie Skłodowska-Curie Innovative Training Networks, European Training Networks, AsPECT, Active People-Centred Facades.

Call 2017. Explora Ciencia (National-Spain) "AdaptoDIN. "Validation of ADAPTive Opaque Facade concept through the experimental assessment of multifunctional materials and their DYNAMIC performance" (Not selected).

Call 2016. Interreg Atlantic Area (international-European). "Sailor Facades. Design and Assessment of Adaptive Facades that take advantage of the resources in the Atlantic Area". Partners: University of Navarra (Spain), University of Cardiff (UK), and Universidade do Minho (Portugal) (Not selected).

Events and Lectures for Dissemination

Innovative Facades Seminar, Smart adaptive façades between predictive control and user interaction, Shady Attia, 4 September 2018, Brussels, Belgium.

Workshop in MDGAE 2015-16 (University of Navarra, Spain). 8-10th March 2016. "Adaptive Facades. Built experiences" Craig Schwitter. (Buro Happold NY, and Columbia University)

Workshop in MDGAE 2016-17 (University of Navarra, Spain). 20-22th March 2017 "Adaptive facades and facades in extreme conditions". Invited lecturers: Ulrich Knaack (Delf University - TU Darmstadt) and Thomas Auer (Transsolar and TU Munchen)

Workshop in MDGAE 2017-18 (University of Navarra, Spain). 14-15th March 2018. "Adaptive Envelopes: innovative concepts and performance evaluations". Invited lecturer: Marco Perino (Politecnico di Torino)

Activity report Working Group 4 (WG4) - Dissemination and Future Research

Pottgiesser, U., Knaack, U., Louter, C.

Tasks and Deliverables

Working Group 4 was responsible to organise and manage the overall dissemination, networking and communication of the COST-Action, including the website, the Short Term Scientific Missions (STSM), the Training Schools and symposia for Early Career Investigators (ECI), industry workshops, and related surveys to link the COST action to stakeholders in the industry. It also took care of the coordination of international conferences, publication of journal papers and guidelines and finally the initiation and coordination of the applications for future research projects within the Action and by connecting with other networks and the related academic environments. The tasks and deliverables of Working Group 4 were the following, which were all fulfilled:

T 4.1 Organisation and coordination of Action events

D 4.2 Organisation of all meetings and related minutes reports

D 4.5 Organisation of Action Mid-term Conference (beginning of 3rd year)

D 4.6 Organisation of Action Conference (end of the 4th year) and production of proceedings

Until the end of the Action in November 2018 the following meetings and conferences took place:

- 9 MC/WG meetings in Brussels, Prague, Delft, Le Bourget du lac, Lucerne, Wroclaw, Munich, and Lisbon.
- 6 ad-hoc meetings of work group members in Hamburg, Detmold, Bern, Dessau, Liège and Lisbon from 2015-2018
- 2 industry workshops in Delft 2015 and Lisbon 2018
- 1 Mid-term conference and proceedings (Booklet 2) in Munich in November 2017
- 1 Final conference and proceedings (Booklet 4) in Lucerne in November 2018

T 4.2 Educational Pack and Training School

D 4.3 Organisation of 3 Training Schools (1 per year except the first year) and related material published

D 4.3 Educational pack content definitions and development

Until the end of the Action in November 2018 two Training Schools took place, one Training School had to be skipped due to budget shortage:

- Training School 1: September 2016 in Hamburg (HafenCity University)
- Training School 2: September 2018 in Belgrade (Belgrade University)

Both Training Schools attracted more than 35 participants each and can be considered as very successful. Among them about 85 Early Career Researchers (ECR), who took part in specific scientific workshops at the beginning of the Training Schools to present and discuss their research. The Educational Pack was developed as individual lectures for the Training Schools with contributions from each Working Group. It consists of 20 lectures with more than 800 slides that are available digitally at the Action Website with a password for the 210 Action Members. Separate documentations of the Training Schools are accessible online.

An overview of Educational Pack, Training Schools, ECR-Workshops and STSM is given in the final publication of Work Group 4 (Booklet 3.3 Research and Education), published open access.

T 4.3 Coordination of Short Term Scientific Missions (STSMs)

D 4.4 Completion of at least 20 STSMs by the end of the Action

Until the end of the Action in November 2018, 31 Short Term Scientific Missions (STSM) were initiated through 6 separate calls for STSMs. The STSMs involved 46 individuals, 16 different EU countries, 1 near neighbour country (AU) and 34 different institutions. Furthermore, The STSMs have contributed to the MoU deliverables and have resulted in joint journal and conference publications, new collaboration initiatives and active contributions to the Education Pack. The STSM represented all Working Groups and the results are summarized in the final publication (Booklet 3.3 Research and Education).

T 4.4 Database of research project and experimental facilities in the domain of the Action

The database of research projects and experimental facilities in the domain of the Action was produced for in the beginning of 2015 and was presented during the 3rd meeting in Delft as a poster exhibition and as a print version (Booklet 1 Adaptive Façade Network - Europe), published open access.

T 4.5 Creation and management of Action website

D 4.1 Creation and maintenance of the Action specific website

The Action specific website was installed in 2014 and is available under: <http://tu1403.eu/>. It will be further used and contains the produced materials such as database, booklets and Education Pack.

T 4.6 Dissemination through journal, conference, trade publications and website

Until the end of Action the following conferences were organised or attended by Action members with lectures and keynotes:

- Advanced Building Skins, Graz 23-24/04/2015 (Keynote Andreas Luible)
- International Conference on Architectural Envelopes (ICAE), San Sebastian 22-24/05/2015
- Future Envelope, Delft 18/06/2015
- Glass Performance Days (GPD), Tampere 24-26/06/2015
- Challenging Glass, Ghent 16-17/06/2016
- Future Envelope, Bath 03/06/2016
- ICSA 2016, Minho Portugal, 27-29/07/2016
- Engineered Transparency, Düsseldorf 24/10/2016

- Facade2016, Lucerne 06/10/2016 (COST meeting)
- PowerSkin@BAU, München 19/01/2017
- ICBEST 2017, Istanbul 15-18/05/2017 (Keynotes Uta Pottgiesser / Ulrich Knaack)
- Future Envelope, Delft 22/06/2017
- Next Façades, Munich 08/11/2017 (COST mid-term conference)
- facade2017 Resilience, Detmold 24/11/2017
- Engineered Transparency, Düsseldorf 25/10/2018
- Facade2018, Adaptive, Lucerne 26-27/11/2018
- GSE Glass Structures & Engineering Journal ([link](#))
- JFDE Journal of façade Design and Engineering ([link](#))

D 4.7 16 peer reviewed scientific journal papers and conference publications

Until the end of Action in November 2018 the more than 70 peer reviewed scientific conference and journal papers were delivered and published in each Working Group, accessible online:

D 4.8 Submission of at least two research proposals at the end of the Action

Until the end of Action in November 2018 the 15 joint research proposals were submitted or an in preparation as a result of the networking with in Action on national and European level.

Group Members and Roles

- Thomas Henriksen, Denmark - ESR/ECR
- Ulrich Knaack, The Netherlands - Chair (2015-16)
- Thaleia Konstantinou, Greece - ESR/ECR
- Christian Louter, The Netherlands - Vice-Chair, STSM Coordinator
- Andreas Luible, Switzerland - Website, Meetings
- David Metcalfe, United Kingdom - Training Schools
- Uta Pottgiesser, Germany - Chair (2017-18)

Keynote Presentations

- Cities Alive: Green Building Envelope
Rudi Scheuermann, Arup, UK
- The Maersk Tower Facade
Mads Mandrup Hansen, C.F. Møller, Denmark
Johann Sischka, Waagner Biro, Austria
- High Comfort - Low Impact
Thomas Auer, Transsolar, TUM, Germany
- Multidisciplinary Approach Towards Design of Kinetic Lightweight Sun Shading Facade
Miriam Dall'Igna, Foster + Partners, UK
- Adaptive Solar Facade
Arno Schlüter, ETHZ, Switzerland

Cities Alive: Green Envelope

Rudi Scheuermann, Arup, UK

"City green has a serious influence on the micro-climate in our built environment and the sustainability of building operation."

In ever denser cities the space for "green infrastructure" such as parks, green recreational spots and trees in street canyons is being depleted. What is often considered and belittled as "green architectural decoration" is however an important element in our built environment which must not be underestimated. Besides the many health and well-being aspects resulting in significant stress relief for human beings, there are a number of effects which have serious influence on the micro-climate in our built environment and the sustainability of building operation.



Existing situation in Manchester



Optional greening of the city

The reduction of urban up-heating (heat island effects), and the filtering of fine dust in the streets where people move about are just two of the most important aspects. Reduced noise levels can also be an additional benefit if green infrastructure is applied in the right way.



The idea of "Cities Alive: Green Envelope" is to investigate and pursue the initiative of "Cities Alive: Rethinking Green Infrastructure", started by Tom Armour, to offer additional areas in the form of building envelopes and provide the dense inner city with surfaces for effective and applied green infrastructure.

The Maersk Tower Facade

Mads Mandrup Hansen, C.F. Møller, Denmark
 Johann Sischka, Waagner Biro, Austria

Text not available at time of print.



© gettyimage

These roof and façade areas aim to improve the environment by replacing a significant amount of the ground on which cities have been built in dense urban agglomerations. If we imagine that we could replace 30% of the total sealed areas of cities by offering about 20 - 25% of the buildings and making use of about 20 - 25% of each building envelope, i.e. façade and roof areas, we could achieve significant benefits to improve the micro-climate in cities.



© Eddie Jacob

Indeed, if we consider that plants grow on substrate which also contributes to dampening the inner city traffic noise, we are creating an environment of cooler and cleaner air with less noise, from which people benefit in cities, but also within buildings, as improved conditions allow for extended periods of natural ventilation, thus reducing the amounts of energy required for cooling all year round; and giving building occupants more freedom to control their individual environment by means of healthier and more beneficial natural

ventilation. Furthermore, green envelopes can be applied to both existing and new buildings, and therefore the overall improvements to the micro-climate of cities can be much reinforced, as the majority of the built fabric consists of existing buildings of considerable age. Activating them to contribute to improved and more sustainable performance is an important aspect in the design of existing cities. Additional benefits such as better stormwater management avoiding flood risks, improved biodiversity, significant absorption of CO2 etc. will follow.



© Arup/D. Imade

But the real focus for us at Arup is on improving and providing healthier, more pleasant living conditions for a better and more comfortable existence for human beings in cities. And we feel that making the benefits measurable is an important aspect of bringing individually considered effects together, being able to quantify rather than just qualify benefits as a whole. The outcome allows

a clearer cost-benefit analysis to put cities and their building authorities, and also developers and investors, in a position where they understand that investment in green infrastructure – as an important element of the built city environment – is no longer just “architectural decoration”, but an essential, urgently needed element to improve the sustainable operation of buildings with lower energy consumption, and much improved and significantly healthier living conditions for cities’ inhabitants.

High Comfort - Low Impact

Thomas Auer, Transsolar, TUM, Germany

Towards a robust building performance

On average, people spend 80 to 90% of their time in buildings [1]. The basic requirement for architecture is to provide healthy interior spaces, ideally with an exceptional environmental quality. At the same time, the building sector in the western world accounts for 20 to 40% of the total energy demand [2]. The European Union's Carbon Roadmap envisages a 90% reduction of CO₂ emissions from the building sector by 2050 compared to 1990 levels [3].

For this purpose, all countries of the European Union have issued energy saving regulations. However, numerous scientific studies show that the measured energy consumption is sometimes three times higher than the predicted consumption [4] [5]. This difference is called performance gap. It mainly results from the difference between design and reality. E.g. just considering the user behavior: the difference between the assumed and the real user preferences – indoor temperatures, opening windows, operating shading devices, etc. – contributes significantly to the performance gap [6]. At the same time, the complexity of building construction is constantly increasing. Numerous publications show that the predicted energy consumption during operation – if at all – is only achieved after a monitoring and fine tuning phase.

In summary, it can be stated that the goal – to minimize the energy demand of the building sector by means of technology with a simultaneously optimized environmental quality – does not provide the desired success. Too often systems do not work as designed; and even if they do what they should, it does not necessarily lead to user satisfaction!

Robustness

The balance between “high-tech” and “low-tech” increasingly determines the discourse on the appropriateness of technical systems with regard to the aim of a CO₂-neutral building stock. The question is whether the complexity in construction and operation of buildings will potentially provide the desired goal. Unfortunately there is no definition what “low-tech” or “high-tech” means. The intuitive feeling of what “low-tech” is can be better and more effectively described by the term robustness. Previous design processes aim to find the so-called global minimum for the respective task. At the same time, uncertain boundary conditions can considerably influence the result. In contrast, in case of a robust optimization, uncertain boundary conditions only marginally affect the results (fig. 1).

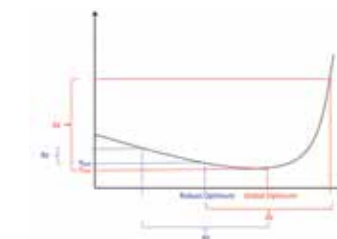

Fig. 1: Difference between a global and a robust optimum, in accordance to Rhein (2014) [7]

By definition, technology reduces robustness when the result is dependent e.g. on a deficient building management system (BMS), or user behaviour significantly impacts the result. For example, the research project e% of the Technical University of Munich (TUM) shows user behavior in the differently equipped buildings (affordable multi-story apartment blocks). In the buildings with mechanical ventilation and heat recovery the user still opened the windows, so that the measured energy demand exceeds the predicted one by approx. 100%. On the other hand, in the naturally ventilated buildings the predicted energy demand is maintained or even slightly lower. Mechanical ventilation does therefore not lead to a robust solution for this type of building program in this kind of climate.



Fig. 2: Kletterhalle Brixen, designed by the architects Wolfgang Meraner and Martin Mutschlechner

Conclusion

Passive, user-controlled systems potentially result in reduced energy consumption and lower installation costs. At the same time they increase the robustness of buildings, if design accordingly. This leads to a improved user satisfaction and reduces the performance gap. Due to the large number of deficiencies that one can see in the construction industry, robust solutions are absolutely necessary. In addition, the human being must again be placed into the center of consideration. Maybe we should trust the wishes and the “human sensory perception” more than control algorithms, which the user can no longer understand.

Literature

- [1] EPA (1989). Report to Congress on Indoor Air Quality. Volume II: Assessment and Control of Indoor Air Pollution. United States Environmental Protection Agency. EPA/400/1-89/001C
- [2] Pérez-Lombard L., et al. (2008). A review on buildings energy consumption information. Energy and Buildings Volume 40. 394-398.
- [3] European Commission (2018). 2050 low-carbon economy
URL: https://ec.europa.eu/clima/policies/strategies/2050_en
Website besucht am 09.02.2018
- [4] Oberste Baubehörde im Bayerischen Staatsministerium des Innern, für Bau und Verkehr (2017). e% - Energieeffizienter Wohnungsbau. Abschlussbericht der wissenschaftlichen Begleitung des Modellbauvorhabens. Technische Universität München. Hochschule Augsburg. Hochschule Coburg.
- [5] Schneider B., (2015). Nutzerverhalten bei Sanierungen berücksichtigen. Bine-Projektinfo 02/2015. E.ON Energy Research Center der RWTH Aachen University.
- [6] Delzendeh E., et al. (2017). The impact of occupants' behaviours on building energy analysis: A research review. Renewable and Sustainable Energy Reviews Volume 80. 1061-1071.
- [7] Rhein B. (2014). Robuste Optimierung mit Quantilmaßen auf globalen Metamodellen. Dissertation. Universität Köln.

Multidisciplinary Approach Towards Design of Kinetic Lightweight Sun Shading Facade

Xiaoming Yang, Golnaz Ighany, Miriam Dall'Igna
Specialist Modelling Group – Foster + Partners

The presentation describes multidisciplinary collaboration and challenges to address the design of a large deployable lightweight sun shading system for a retail unit. The device responds to four main parameters: solar radiation, views outwards, structural loads and motion. The methodology involved close collaboration between structural, mechanical, environmental and architectural design disciplines and fabricators. A series of collaborative workshops took place to validate the design for fabrication. During those, an immediate response to the design development was possible through algorithmic anticipation of environmental and structural performance, simulation of motion and development of the packaging mechanical parts and physical prototyping to validate high precision geometry of design details. The challenge was resolved by creating an adaptive kinetic envelope, one that could respond to the sunlight on a south-west facing glazed façade. The idea was to engineer a visually exciting external shading system that could reduce the direct solar radiation within the store. Through multicriteria geometrical optimisation and motion simulation the team created a collaborative framework and enhanced the client's intent not to disconnect the retail unit from its urban context. Furthermore, the material application made the scheme unique, and with no precedent in the field. Our presentation will explore the challenges, the journey and the results and give some insights on how collaborative approach can help in the process of designing a performative and adaptive building envelope.



Figure 1: Installed shading system during store opening. Photograph – Nigel Young, Foster + Partners.

The challenge

The client's retail units are known for their elegant use of glass. However, in harsh climate of Dubai where the store is located, use of south-west facing glazed façades creates many challenges. For better energy performance, an outer shading device should be designed, one that would together with the glazing skin and terrace overhang avoid introducing excessive sunlight into the space. The store's site is adjacent to the Burj Khalifa and the façade faces The Dubai Fountain Water Show, an event that occurs throughout the day into the evening attracting thousands of visitors.

Adaptive Solar Facade

Arno Schlüter, ETHZ, Switzerland

Text not available at time of print.

The client intent was to keep visual connection with immediate surroundings and when there is no direct solar incidence on the façade, the screens should retract and allow complete connection with external context. The two conflicting parameters, sun avoidance and views outwards as well as the façade size and the need to adapt to the environment conditions posed the main challenges to the problem. Another important aspect of the design was the interaction between the movable structure and the supporting fixed balcony structure which was in an advanced stage of design by F+P structural engineering team.

The journey

Several design options were investigated by the architects in close connection with the client. At schematic design stage the team concentrated on shading performance, views outwards and kinetics. When the design direction became clear, a close multidisciplinary team was formed and using state of the art software and hardware techniques assessed the environmental, structural and mechanical performance. In addition, physical prototyping was exhaustively explored on design coordination and decision.

For this large scale deployable structure, the successful installation and first year of operation proved that the design approach was successful. Design to high levels of geometric precision on all disciplines helped the smooth transition between digital and physical realms.

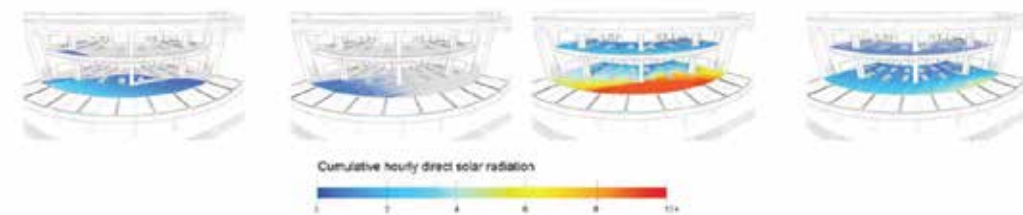

Figure 2: Cumulative hourly direct solar radiation results. left & center left - summer solstice without and with shading system, center right & right - winter solstice without and with shading system

The result

The development of this innovative operable external shading system required the close coordination of a number of design and specialist engineering disciplines. The geometric and weight limitations imposed by the constraints of the existing structure drove the design towards the extensive use of light weight carbon fibre and compact mechanisms and incorporating these with an optimised shading system.

From tailoring software and optimisation routines, utilising state of the art design techniques and constant communication, the team tapped innovation on diverse aspects of the system's development. However, the application of carbon fibre for a large scale kinetic shading device was the main structural breakthrough that made the design unique to the field.

While less ambitious than other kinetic systems considered, the final design selected was delivered within the tight time scale demanded by the client's store opening date. The result is a distinctive large scale carbon fibre shading system that is both functional and in keeping with store's architecture and the client's desire for innovation and quality.

Sessions

Session 1 Miscellaneous topics

Session 2.1 Strategies for Design

Session 2.2 Products and Materials

Session 2.3 Performance Assessments

Session 2.4 Experimental Tests

Session 3.1 Products and Materials

Session 3.2 Strategies for Design - Biomimetics

Session 3.3 Experimental Tests - Glas

Session 3.4 Performance Assessments

Session 4.1 Tests

Session 4.2 User and Post-occupancy Evaluation

Session 4.3 Products and Materials

Session 4.4 Strategies for Design

Session 5 Miscellaneous topics

What is an Adaptive Façade? – Analysis of Recent Terms and Definitions from an International Perspective

Romano Rosa 1, Aelenei Laura 2, Aelenei Daniel 3, Mazzucchelli Enrico Sergio 4

1 Department of Architecture/University of Florence, rosa.romano@unifi.it

2 LNEG-NATIONAL Energy and Geology Laboratory, laura.aelenei@lneg.pt

3 Faculty of Science and Technology/ Universidade Nova de Lisboa, aelenei@fct.unl.pt

4 Politecnico di Milano, enrico.mazzucchelli@polimi.it

Adaptive façades can improve the building's energy efficiency and economics, through their capability to change their behaviour in real time according to indoor-outdoor parameters, by means of materials, components, and systems. Therefore, adaptive façades can make a significant and viable contribution to meeting the EU's 2020 targets. Several different types of adaptive façade concepts have already been developed, and an increase in emerging, innovative solutions is expected in the near future. According to recent research, the word 'adaptive' in the context of building façades is often associated in the literature with a long list of similar words. Moreover, there is no consistent definition of façade adaptability, although studies exist in relation to characterisation issues, design parameter, and classification. Even within the discipline of architecture and engineering, words such as 'smart', 'intelligent', 'interactive', 'adaptive', or 'responsive' have been used loosely and interchangeably, creating confusion as to their specific meaning and their conceptual relationship to building performance and design. In response to this, the goal of this paper is to build a provisional lexicon, or descriptive, behavioural, and methodological words, to assist researchers and designers in navigating the field of high-performance façades that incorporate materially innovative and feedback-based systems. It offers a brief overview of current advances in this nascent and rapidly evolving field and articulates a broader conceptual territory for the word 'adaptive', used in many cases to describe the technological systems that interact with the environment and the user by reacting to external influences and adapting their behaviour and functionality. The objective of this paper is to contribute to these developments by presenting the findings. Furthermore, common definitions will be proposed, based on the characterisation design parameters, classification approaches, and real case studies.

Keywords: Adaptive Façade, Energy Efficiency, Comfort, Passive Design, Intelligent Buildings, Sustainable Architecture

Full paper available in the Journal of Facade Design and Engineering, Vol 6 No 3 (2018): Special Issue FAÇADE 2018 – Adaptive!

Towards New Metrics for the Characterisation of the Dynamic Performance of Adaptive Façade Systems

Bianco Lorenza 1, 2, †, Cascone Ylenia 1, Avesani Stefano 3, Vullo Pascal 3, Bejat Timea 2, Loonen Roel 4, Koenders Stefan 4, Goia Francesco 5, Serra Valentina 1, Favoino Fabio 1

1 Politecnico di Torino, Department of Energy, Torino, Italy. *fabio.favoino@polito.it

2 Univ Grenoble Alpes, CEA, LITEN, DTS, SBST/LCEB, INES, Grenoble, France

3 Institute for Renewable Energy, Eurac Research, Bolzano, Italy

4 Eindhoven University of Technology, the Netherlands

5 Department of Architecture and Technology, Faculty of Architecture and Design, Norwegian University of Science and Technology, NTNU, Trondheim, Norway

Traditional façade characterisation metrics such as U-value and g-value are of limited value in the design process of buildings with adaptive façades. This issue is particularly important for adaptive façade components that have the capability of controlling thermal energy storage in the construction thermal mass. Building performance simulations can help to analyse the performance of buildings with adaptive façades, but such studies usually only provide information about the energy and comfort performance at room level. Consequently, there is a need for development and testing of new façade-level performance metrics that can be used to compare the performance of different adaptive façade components. This paper presents experiences and lessons learned from four European R&D projects that have introduced novel metrics to capture the dynamic performance of adaptive opaque façades. Characteristics of the different metrics are described, and their similarities and differences are compared and contrasted. The paper highlights the main benefits of metrics that can capture dynamic effects, and concludes by providing directions for future work.

Keywords: Adaptive façade, double skin, adaptive insulation, performance metrics, experimental characterisation.

Full paper available in the Journal of Facade Design and Engineering, Vol 6 No 3 (2018): Special Issue FAÇADE 2018 – Adaptive!

Smart and Multifunctional Materials and their possible application in façade systems

Miren Juaristi 1, Aurora Monge-Barrio 1, Ulrich Knaack 2, Tomás Gómez-Acebo 3

1 Universidad de Navarra, School of Architecture, Spain, mjuaristi@alumni.unav.es

2 Faculty of Architecture and The Built Environment, TU Delft, the Netherlands

3 Universidad de Navarra, TECNUN School of Engineers, Spain

Today's society needs to face challenging targets relating to environment and energy efficiency, and therefore the development of efficient façade systems is essential. Innovative concepts such as Adaptive Building Façades might play a role in the near future, as their dynamic behaviour could optimise the performance of a building. For their successful development, a balance between sophistication and benefit is necessary and the implementation of Smart and Multifunctional Materials in building envelopes could be the key, as they have the ability to repeatedly and reversibly change some of their functions, features, or behaviours over time in response to environmental conditions. However, these materials were predominantly developed for use in other fields, and there is a lack of specific technical information to evaluate their usefulness in façade engineering. The aim of this paper is to collect the critical information about promising responsive materials for use in the design of Adaptive Façades, in order to help designers and technicians in decision-making processes and to scope possible future applications in façades. Investigated materials were analysed from the Building Science standpoint; their weaknesses and threats in the built environment were highlighted, and their technical feasibility was examined through the study of their availability in the current market.

Keywords: Responsive, autoreactive, intelligent, adaptive, design, innovation

Full paper available in the Journal of Facade Design and Engineering, Vol 6 No 3 (2018): Special Issue FAÇADE 2018 – Adaptive!

Passive Adaptive Façades – Examples from COST TU1403 Working Group 1

Enrico Sergio Mazzucchelli a), Rosa Romano b), Laura Aelenei c), Maria da Gloria Gomes d), Theoni Karlessi e), Mark Alston f), Daniel Aelenei g)

- a) Politecnico di Milano, Italy
- b) University of Florence, Italy
- c) LNEG-National Energy and Geology Laboratory, Portugal
- d) Universidade de Lisboa, Portugal
- e) National and Kapodistrian University of Athens, Greece
- f) University of Nottingham, United Kingdom
- g) Universidade Nova de Lisboa, Portugal, aelenei@fct.unl.pt

Buildings often adopt strategies based on the integration of solutions and technologies in façades capable of changing their behaviour in time to improve energy efficiency and comfort. Considering that the envelope is the main parameter that influences the energy performance of buildings, façade elements with adaptive features can provide the buildings the necessary flexibility needed in terms of energy flow and thermal comfort in the context of nZEB, where the buildings must be interactive in the zero energy and smart city context. Several different types of adaptive façade concepts have already been developed, and an increase in emerging, innovative solutions is expected in the near future. However, when referring to adaptive technologies, two main categories can be distinguished. Adaptive technologies, which rely on passive design to improve building energy efficiency and comfort, and active technologies which include renewable harvesting. The aim of this paper is to provide several examples of passive adaptive technologies and their performance features from COST TU1403 Working Group 1 database.

Keywords: adaptive façades technologies, energy efficient design concepts, examples

1 Introduction

The buildings energy demand as well as its environmental impact can be reduced and modified by employing passive and active measures. In this context energy-efficient adaptive façades emerge which are designed to adequately react to daily and seasonal changing external conditions. Moreover, depending on the climate where the building is located, the requirements on the façade can be completely opposite during summer and winter, as well as during night and day. For example, in winter solar energy gain may be allowed into the building during the day while together with a high level of thermal insulation in order to allow the energy to be stored. During summer, however, excessive solar gain should be avoided to prevent overheating in most cases. According to literature, adaptive façades consist of multifunctional highly adaptive systems, where the building envelope is able to change its functions, features or behaviour over time in response to transient performance requirements and boundary conditions, with the aim of improving the overall building performance (Loonen et al. 2015). Façade elements with adaptive features can provide the buildings the necessary flexibility needed in terms of energy flow and thermal comfort in the context of nearly zero energy buildings (nZEB) (Garde et al., 2017) or energy-efficient interactive buildings, both of which are essential parts of any smart city initiative. Several different types of adaptive façade concepts have already been developed, and an increase in emerging, innovative solutions is expected in the near future. However, when referring to adaptive technologies, two main categories can be distinguished. Adaptive technologies, which rely on passive design to

improve building energy efficiency and comfort, and active technologies which include renewable harvesting. The aim of this paper is to provide several examples of passive adaptive technologies and their performance features from COST TU1403 Working Group 1 database.

2 Passive Adaptive Façades

We can refer to passive adaptive façades as the façades provided with technological systems which do not require power, controls and require little or no maintenance. Some of these façades are designed with moving parts to allow the increase of the energy performance and indoor comfort of the new or existing buildings where they are integrated. The passive façades falling into this category are: double skin façades; wood based responsive building skins; glass surface with silk-screened patterns of ceramic-based paints; brise-soleil and fixed or pivot-mounted louvres; light-directing systems and Trombe wall. The passive facade mostly designed to react to changes from external factors should be able to:

- Maximize direct solar gains as it is fitted with extensive glass surfaces with high thermal insulation and should be equipped with shielding systems to control the glare effects and provide protection from solar radiation in summer;
- Accumulate solar energy even when it does not directly penetrate the room, using technologies such as Trombe walls, or air- and water-based solar collectors;
- Provide buffer zones between the transparent and opaque closure systems in order to increase the protection against the cold and exploit solar energy in winter;
- Reduce indoor overheating during the summer months through the presence of artificial and/or natural solar screens;
- Increase natural lighting by creating transparent openings of suitable sizes;
- Encourage natural ventilation by reducing energy consumption for summer air conditioning;
- Integrate solutions for the adoption of passive cooling systems that ensure a temperature reduction inside the building in the summer months by night free-cooling.

Passive envelopes are usually integrated in residential buildings, with low energy demand, where the users assume the management responsibility for the regulation of the moving parts which enable the envelope to perform in a number of different ways according to daily or seasonal changes. These envelope solutions, however, can have some drawbacks as they could:

- Restrict the aesthetic/architectural design due to adoption of standard technological solutions;
- Be closely linked to the user's management and behaviour, if not connected to building management systems that can be set up to assume the various "bioclimatic" configurations autonomously;
- Require a specific regulation to change their performance in relation to the changing outdoor weather conditions (and these interventions are not always simple);
- Not make efficient use of solar energy due to both the reduced uptake ability of the passive building components and the absence of effective systems for heat accumulation and distribution.

3 Passive Adaptive Technologies and Performance Features

As mentioned above, among the most common examples of passive adaptive façades there are: double skin façades; wood based responsive building skins; glass surface with silk-screened patterns of ceramic-based paints; brise-soleil and fixed or pivot-mounted louvres; light-directing systems and Trombe wall.

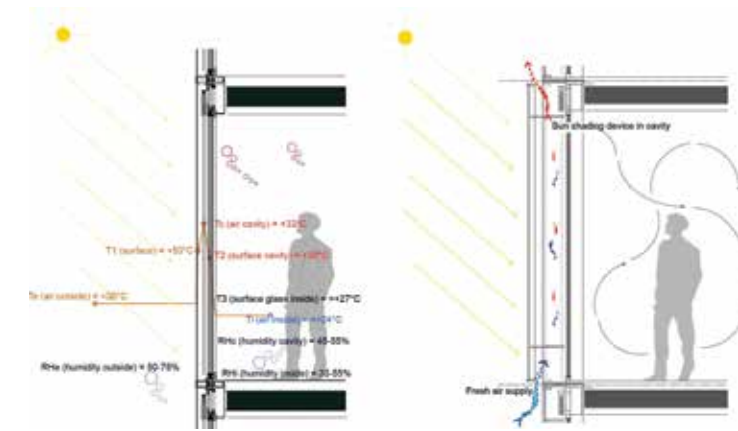

Fig. 1 Closed and opened cavity. The autoreactive façade system adapts its U-value to changing exterior climate conditions and allows natural ventilation of the cavity to avoid overheating due to stack effect (Molter and al. 2017).

Double skin façades consist of three functional layers. Typically, the exterior façade layer is made of single glazing. It is separated from the interior glazing, which is the really "indoor" envelope and usually consists of a double glazing. The distance between interior and exterior façade layer can vary as it depends on the specific design. In order to utilise the effect of a thermal buffer in the space between the two façades, ventilation openings are installed in either one of the exterior and interior façade or in both. The air in the gap between the façades heats up due to solar radiation and in this way, it works as a buffer toward the interior space (Knaack et al. 2007). Due to the thermal difference, the warm air can be used, for example, as a generator of natural ventilation of the indoor room. However, overheating of the cavity in double skin façades could be an important issue. Due to absorption of the solar radiation of sun shading devices, often installed in the cavity, a so-called stack effect can raise the temperature in the cavity itself. These indirect solar gains have a major impact on the indoor comfort, as the raising temperatures of the cavity are transferred into the adjacent internal spaces creating additional cooling loads to the building (Molter et al. 2017).

In this regard an interesting application has been studied by Molter and al. 2017: within a unitized double skin façade system, four thermal cylinders are warmed up by the raising temperature in the cavity and expand at a temperature of 23°C. By a telescopic movement, the outer skin of the façade is pushed outwards (see Fig. 1). This allows external air ventilation of the cavity and, at the same time, an evacuation of the absorbed heat. In case of a fall of temperature, the thermal cylinders redress and close the cavity, which creates a buffer zone and improve the U-value of the glazed façade unit. The temperature range of the triggered components can be adapted to specific contextual requirements as climate zones, façade orientation and user preferences. This process can be repeated several times within one hour since the paraffin has a relatively short reaction time. In this regard, the kinetic components have been used as ventilation elements in greenhouses for decades and show an almost maintenance free and unpowered solution (Molter and al. 2017).

Other applications based on wood responsive building skins have been investigated by Bridgens et al. 2017 and Mazzucchelli and Doniacovo 2017. These components can be used as cladding panels, sunscreen, passive layer (see Fig. 2) for photovoltaic systems (Mazzucchelli and Doniacovo 2017), etc. It should be considered that usually, depending on species and natural durability, timber cladding is often treated with fungicide and/or waterproofing oils. This is not possible in adaptive use, because any surface treatment would prevent the wood from responding to changes in ambient moisture, for example. The exact requirements for each property varies depending on the specific application. For instance, hygromorphs with high responsiveness (i.e. producing large curvature changes at small changes in relative moisture content) may be required

for indoor applications, where the materials need to react to relatively small changes in ambient humidity, but for these applications the requirements for strength and durability are not onerous. In contrast, the focus of the material design criteria for outdoor applications shifts towards increased durability and structural resistance, where a comparatively lower responsiveness may be sufficient considering larger fluctuations in external humidity and exposure to precipitation. Similarly, hygromorphs with a rapid response that is completed within minutes allows adaptation to abrupt sporadic changes in the ambient moisture conditions (i.e. a rain shower) whereas a much slower response is needed for periodic daily and seasonal weather patterns (Bridgens et al. 2017).

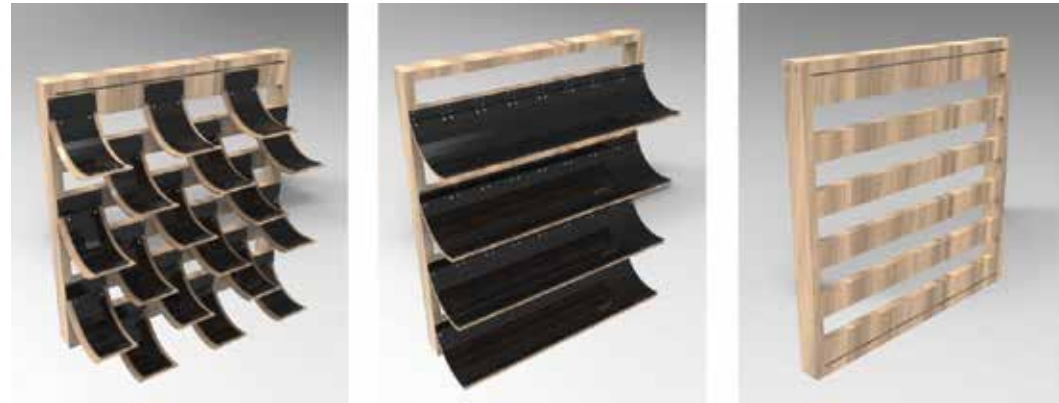

Fig. 2 Render of the 15x10 cm lamellae panel (on the left) and 15x60 cm flakes panel (on the center). Wooden panel substructure (on the right). The wood layer is used to optimize the photovoltaic layer curvature in relation to the external environmental conditions. In this case passive and active technologies are combined together.

Among the technologies to optimize the use of solar energy by the building envelope technologies, thermochromic materials, of which optical properties vary at a characteristic temperature value, assume a relevant position. These materials can adapt to the variations of temperature by the effect of solar radiation during the day and throughout the different seasons of the year. Thermochromic glass have been widely studied. Specifically, for the opaque envelope, materials with high solar absorptance (low reflectance) for low temperatures and low absorptance (high reflectance) for high temperatures are of interest (Gavira et al. 2017). There are different technological approaches to optimize the use of solar energy in building elements, with the aim of improving the energy efficiency and to reduce the effect of solar absorption in buildings on the warming of urban areas. Such use depends directly on the optical properties of the exterior surface of the facade, which include not only its color but also its reflectance and absorbance over the entire wavelength range of solar radiation. This effect has been studied (Gavira et al. 2017) with the goal to determine the temperature for which it is favorable to change from the grey cement properties in the facade to those of the belitic cement, as a first approximation for a critical temperature of a thermochromic mortar. The study showed that the northern orientation, with almost coincident surface temperatures with the outdoor temperature, is considered the optimal to take advantage of thermochromic coatings. The surface temperature of the exterior coating is adequate in this case as the trigger parameter for the change in optical properties of the coating material.

The energy demand of a building can be further optimized by a façade system that can change its permeability to solar energy, using sunscreens. Fixed sun protection provides a good opportunity for shading. Horizontal elements mounted at ceiling level that protrude far out of the façade are known as brise-soleil. Another solution is fixed, or pivot-mounted louvres mounted onto the façade. However, they do not achieve the same protection values as those that can be adjusted by angling. In any case, the maintenance and cleaning of the glass panes needs to be considered at an early stage. Using plants or trees is another method of providing fixed shading. In this regard,

deciduous plants are the best choice as they lose their leaves in winter, increasing the possibility of solar radiation to enter the building during the heating period (see Fig. 3). However, it should be considered that plants must be trimmed regularly and that an irrigation system should be planned too.



Fig. 3 Example of seasonal green sunshield.

A further simple method of sun protection is to imprint the glass surface with silk-screened patterns of ceramic-based paints that consist primarily of pigmented glass particles, called frit, that only affects the glass pane itself. Graphic elements of any pattern or grid can be applied to the glass to reduce the incident sunlight. This method offers a wide range of possible variations and in this way the sun protection can be adapted to the requirements of the specific usage (Knaack et al. 2007).

Quite often, natural lighting is insufficient for very deep rooms, especially if work places are located on the far side of the façade. In these cases, systems that direct the light into those areas can be used. Light-directing systems work in different ways: some are horizontal elements that direct the light by reflection, some are vertically inserted into the sun protection system or the glass layer. These elements do not reflect the light but re-direct it at a different angle. Many solutions are available, all based on this principle: holographic foils, fine prismatic surfaces and reflective louvres arranged in specific geometries, etc.

Among the passive systems, the Trombe wall is probably the most simple and well-known collector wall. It uses the greenhouse effect (Konstantinou et al. 2018): short-wave sunlight penetrates the glass panes on a sun-facing wall and hits on a dark absorbent layer, where it is absorbed and transformed into long-wave heat radiation. The heat in the gap between the façade layers is transmitted through the wall into the room behind it.

Depending on the structure of the wall and its storage capacity, the heat gained can be discharged quickly or over a long period of time, well into the evening hours. If there are openings at the top and the bottom of the wall, then the thermal difference within the gap causes the room air to circulate. If additional openings are installed in the exterior glass layer, the air circulation within the gap feeds warmed fresh air into the room. The same principle applies to leading exhaust air out of the exterior façade.

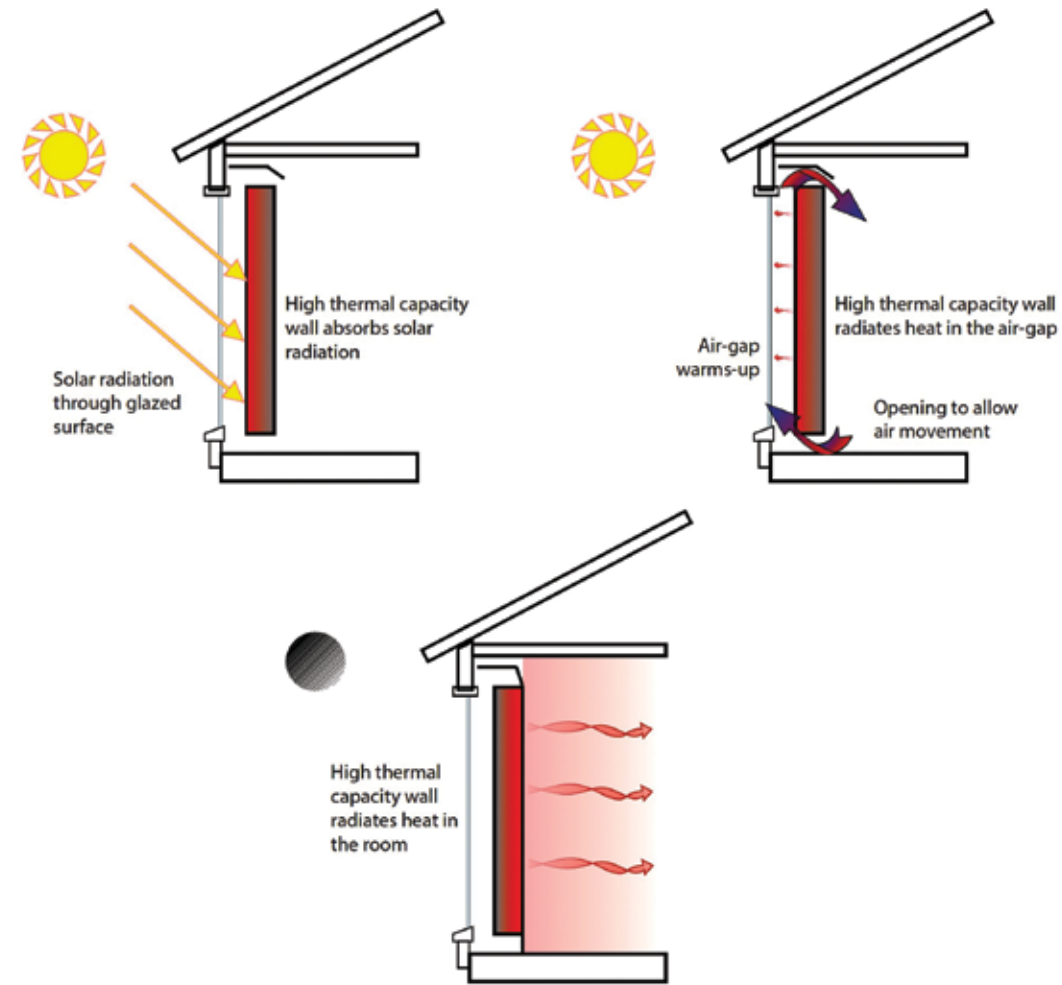

Fig. 4 Principle of Trombe wall and attached sunspaces (Konstantinou et al. 2018).

One can mention in the same context the Transparent heat insulation (THI). THI elements are usually installed in front of the absorbing wall (for example a Trombe wall). In this way the solar radiation penetrates the THI elements and heats the absorbing wall while the THI elements minimize heat loss toward the exterior. However, in order to prevent overheating in summer, sun protection has to be installed in front of the THI itself.

THI elements can also be used alone without a collector wall to light the room with diffused light and to improve heat insulation at the same time. Transparent heat insulation can be based on different operating principles whereby the geometric arrangement of the THI layer varies. All THI elements increase heat insulation and let diffuse light enter the room, depending on the method of construction. In order to protect the materials used, they are all installed between two layers of glass (Knaack et al. 2007).

Another example is a triple glass component, where prismatic panels reflect the solar radiation during summer and instead allow the heating of a thermal storage module (PCM in a polycarbonate box) in the winter season (Fig. 5). An outer insulated glazing unit (IGU) has a suspended prismatic filter between the panes of glass that reflects higher-angle sunlight back out while transmitting low-angle sunlight. This offers a passive solar-control mechanism for south-facing glass to keep out most of the high summer sun, while benefiting from the lower-angle winter sun.

Sunlight that makes it through this outer IGU passes into an inner IGU that is filled with sealed polycarbonate channels into which a translucent salt-hydrate PCM is encapsulated. PCMs store heat as they change phase from solid to liquid (melt) over a narrow temperature range, then they release that heat as they cool off.

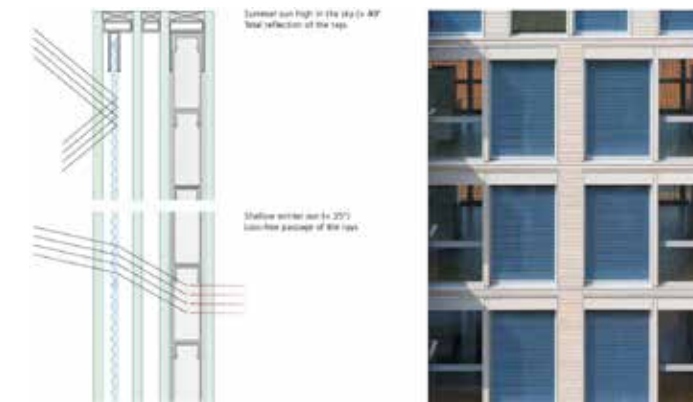

Fig. 5 Example of triple glass component. The prismatic panel reflects the radiation during summer and instead allows the heating of the thermal storage module (PCM in a polycarbonate box) in the winter season. The whole system, which looks like a translucent window, has a thickness of 80 mm, a thermal transmittance of 0.48 W/m²K and a light transmission coefficient that can reach up to 45% (GlassX AG technical documentation - www.glassx.ch).

4 Examples of Passive Adaptive Technologies from COST TU1403 Working Group 1 Database

In this section some case studies of passive adaptive façades from COST ACTION TU1403 WG1 database are selected based on the typologies presented in the section 3 above.

A first example is the ENERGYbase building (Architekten ZT KG, Vienna, 2008). ENERGYbase design is based on the following adaptive passive façade approach. A stepped façade acts as solar generator and sunshield together with a solar cooling plant and plants filtering the air indoors for top quality. The passive thermal gain goes to the south-facing rooms directly and to the north-facing rooms indirectly, via the ventilation system. With its special form, the stepped façade delivers these gains only in winter; in summer sunlight cannot enter the rooms directly, as each step in the façade is overshadowed by the step above. Just behind the stepped façade perforated anti-dazzle slats are located, with the air exhaust for the entire storey above them. This arrangement means that warmed air behind the façade is exhausted directly, not drawn into the centre of the room. On sunny winter days this air passes through a heat exchanger, so its heat content is transferred to fresh air and thus reaches the north-facing rooms, too.



Fig. 6 a) ENERGYbase building (Architekten ZT KG, Vienna, Austria). b) Detail of the South façade.

Another example is the GSW Headquarters (Sauerbruch Hutton, Berlin, 1999) with its double skin colored panels on the west façade which creates a cavity that helps to manage solar heat gain and natural lighting. An integrated system of closures, construction technique of low energy consumption inside the wall, allows natural cross ventilation, facilitating the passage of air from front East to West through the interior spaces and through specially designed openings in the corridors. The louver system on the west facade has an important role in reducing the use of artificial heating and cooling. The western facade has a second glass skin that ventilates and cools the building, dispelling hot and stale air. In addition, the double façade serves as a second buffer for thermal and acoustic variations. Convection in the double west façade of the building creates a negative pressure that can pull cool air through the building. When the two facades windows open, fresh air flows flowing from East to West. Because of control fins on the top and bottom of the solar chimney this air flow is independent of the external conditions and allows the air change to be comparable to the mechanical systems.



Fig. 7 Façade example, GSW Headquarters (Sauerbruch Hutton) in Berlin (Germany).

A third example is provided by Solar Building XXI (Architects Pedro Cabrita and Isabel Diniz), built in 2006 at LNEG (National Energy and Geology Laboratory) Campus in Lisbon. Solar XXI is an example of a low energy building using passive systems both for heating and cooling (ground cooling) towards a Net Zero-Energy Building (NZEB) (Aelenei and Gonçalves, 2014). From the NZEB goal perspective, the building, whose design is based on a combination of passive design techniques with renewable energy technologies (PV, solar collectors) may be currently considered, a nearly Zero Energy Building.



Fig. 8 Solar Building XXI in Lisbon (Portugal).

One of the strategies adopted in the design of solar XXI building in order to reduce the thermal loads and provide a good thermal comfort conditions consisted in optimization of building envelope. The set of ventilation strategies (day and night) provide a high comfort level in the summer, especially when applicable during night period minimizing the thermal loads accumulated during daytime within the building and its temperature. The location and dimension of central skylight as a main light distributor in the central hall is fundamental, as also the translucent vents in the doors, which communicate from south and north spaces to corridor and the glazing areas distributed all over the building envelope. These important features adopted in the building design led to a reduction of the electric light building consumption. The building shows how in modern construction passive active adaptive technologies are combined together in order to achieve the Zero Energy goal.

5 Conclusions

When referring to adaptive technologies, two main categories can be distinguished. Adaptive technologies, which rely on passive design to improve building energy efficiency and comfort, and active technologies which include renewable harvesting. This paper provides several examples of passive adaptive technologies and their performance features from COST TU1403 Working Group 1 database. Current typologies based on passive adaptive technologies found in the international projects include double skin façades, wood based responsive building skins, glass surface with silk-screened patterns of ceramic-based paints, brise-soleil and fixed or pivot-mounted louvres, light-directing systems and Trombe wall. However, because façade elements with adaptive features can provide the buildings the necessary flexibility needed to deal with all the challenges buildings face in terms nearly zero energy buildings (nZEB) and energy-efficient interactive buildings, an increase of new innovative passive adaptive solutions is expected in the near future.

6 Acknowledgements

The authors would like to gratefully acknowledge COST Action TU1403 "Adaptive Facades Network" for providing excellent research networking.

7 References

- Aelenei, D., Aelenei, L., Pacheco Vieira, C. (2016). SHC 2015, International Conference on Solar Heating and Cooling for Buildings and Industry Adaptive Façade: concept, applications, research questions, Energy Procedia 91, 269 – 275.
- Aelenei, L., Gonçalves, H. (2014). From Solar building design to Net Zero Energy Buildings: Performance insights of an office building. Energy Procedia 48: 1236-11343.
- Bridgens, B., Holstov, A., Farmer, G. (2017). Architectural application of wood-based responsive building skins. Proceedings of the 12th Conference on Advanced Building Skins, 2-3 October 2017, Bern, Switzerland, 190-200.
- Garde, F., Ayoub, J., Aelenei, D., Aelenei, L., Scognamiglio, A. (2017). Wilhelm Ernest & Sohn, Solution Sets for Net-Zero Energy Buildings: Feedback from 30 Building Worldwide, Wiley.
- Gavira, M., Pérez, G., Acha, C., Guerrero, A. (2017). Color change temperature in thermochromic facades for the energy efficiency of buildings. Proceedings of the 12th Conference on Advanced Building Skins, 2-3 October 2017, Bern, Switzerland, 201-209.
- Knaack, U., Klein, T., Bilow, M., Auer, T. (2007). Façades – Principles of construction, Birkhäuser Verlag AG.
- Konstantinou, T., Prieto, A. (2018). Environmental Design Principles for the Building Envelope and More: Passive and Active Measures. In T. Konstantinou, N. Cukovic, & M. Zbasnik (Eds.), Energy - Resources and Building Performance, 147-180.
- Loonen, R., Rico-Martinez, J., Favoino, F., Brzezicki, M., Menezes, C., La Ferla, G., et al. (2015). Design for façade adaptability – Towards a unified and systematic characterization. Proceedings of the 10th Energy Forum – Advanced Building Skins, Bern, Switzerland, 2015, 1274–1284.
- Mazzucchelli, E.S., Doniacovo, L. (2017). The integration of BIPV Adaptive Flakes in the building envelope. Proceedings of the 12th Conference on Advanced Building Skins, 2-3 October 2017, Bern, Switzerland, 1331-1340.
- Molter, P., Bonnet, C., Wagner, T., Reifer, M., Klein, T. (2017). Autoreactive components in double skin facades. Proceedings of the 12th Conference on Advanced Building Skins, 2-3 October 2017, Bern, Switzerland, 133-141.

Practitioners' View on the Implementation Potential of Adaptive Façades with focus on The Netherlands

Christian Struck, Twan Rovers, Roy Exterkate, Mark Voortman, Marwan Al Alkam, Robert Timmerman

Saxion University of Applied Science, The Netherlands, c.struck@saxion.nl

The adaptivity of façades is increasingly recognized as an important functional feature to be integrated with the state-of-the-art building technology. The aim is thereby to control its reversible system states in real-time to adapt to current indoor and outdoor conditions. Concepts reported elsewhere integrate two or more functions related to structural integrity, ventilation, heating and cooling, solar protection, as well as energy generation and storage. Although advantages are perceived obvious, the number of realized case studies remains limited. Triggered by this observation, the authors of this contribution report research findings from a literature study and interviews with stakeholders in the field, including contractors, building consultants and architects. The three key-findings suggest that (1) the functions daylighting and energy generation/storage are most commonly integrated into façades or façade components characterized as being adaptive, (2) interviewees are divided on the implementation potential of most of the designs/concepts and (3) the aesthetics of the design, (investment) costs, durability and required maintenance are critical for a widespread market uptake. Herewith, this paper contributes new knowledge to the discussion related to finding the right level of system integration in building technology.

Keywords: adaptive façades, practitioners view, building integration, market uptake, façade functions

1 Introduction

Whilst conventional, static façades do not have the ability to respond to varying meteorological conditions and comfort wishes, climate adaptive façades can utilize this variability to reduce the energy demand and improve indoor air quality and comfort (Loonen, Trčka, Cóstola, & Hensen, 2013). The climate adaptive façade concept may take a wide variety of physical forms (Loonen, Hensen, Trčka, & Cóstola, 2010; Loonen et al., 2013), with each adaptive façade or component thereof having its own characteristics. Concepts reported elsewhere (Loonen et al., 2010) integrate two or more functions related to structural integrity, ventilation, heating and cooling, solar protection, as well as energy generation and storage. These functions correspond with the six ideal functions of an adaptive façade as identified by Struck et al. (2015).

Despite the diversity in the manifestation of adaptive façades and the many available options, it has been noted that the concept has yet to mature (Loonen et al., 2010); thus far, the number of realized case studies remains limited (e.g. Prieto, Klein, Knaack, & Auer, 2017). In the literature, a number of barriers have been identified that underlie this observation. Haase, Andresen, & Dokka (2009) mention issues with integration into the building, such as aesthetics, functionality, economy and flexibility. Prieto et al. (2017) also mention physical integration as an issue, but found that the

development process is more critical; coordination among different disciplines and stakeholders is problematic.

In the present study, the authors aim to investigate the practitioners' view on the implementation potential of climate adaptive façades to increase comfort and reduce energy demand. Three research questions are formulated accordingly:

- A Which functions are most commonly integrated into façades or façade components characterized as being adaptive?
- B How do stakeholders assess the advantages and disadvantages of a number of specific façade concepts?
- C Where do the addressed stakeholders see the obstacles hindering a widespread market uptake?

2 Research methods

To answer these research questions, a literature study is undertaken and interviews are conducted. The inventory of climate adaptive building shells from Loonen et al. (2010) is used as a starting point. To answer the first research question (a), the hundred climate adaptive buildings shells are analyzed and categorized.

From the hundred climate adaptive building shells, the eight most promising designs or concepts are selected by conducting a multi criteria analysis (MCA), using technology readiness, complexity and the potential to be integrated with the buildings' energy generation and distribution system, as criteria.

To answer the second (b) and third (c) research questions, semi-structured interviews are conducted with relevant stakeholders in the field. In these interviews, the previously selected eight specific climate adaptive façades or façade elements are discussed. The interviewees include architects (2), building consultants (3), contractors (2) and a representative of a maintenance company (1). Table 1 contains background information on the interviewees. Although the study is geographically limited to the Netherlands, several interviewees indicated their company has projects abroad.

Interviewees	# years experience	Background	Project locations
Architect 1	10 - 15	Architecture	Netherlands
Architect 2	> 25	Architecture	Netherlands, Germany
Building consultant 1	15 - 20	Structural engineering	Globally (e.g. Netherlands, China, Poland)
Building consultant 2	20 - 25	(Structural) engineering, drafting, building physics	Netherlands
Building consultant 3	0 - 5	Structural engineering, building physics	Globally (e.g. Netherlands, China, UAE, Germany)
Contractor 1	> 25	Sales	Netherlands
Contractor 2	> 25	Aluminum/steel engineering	Netherlands
Maintenance	> 25	Building services engineering	Netherlands, Germany

Table 1: Eight concepts/designs with highest MCA scores

Each interviewee's assessment of each of the eight designs and concepts is rated on a five point Likert scale (-2 to +2). Consequently, the mean of every stakeholder group is calculated using these numeric values.

3 Introduction to adaptive façade designs and concepts

Fig. 1 shows a categorization of the hundred climate adaptive building shells from Loonen et al. (2010) according to eight functions, in accordance with Struck et al. (2015). The functions daylighting and energy generation/storage are most commonly integrated. (Note that climate adaptive building shells may have multiple functions.)

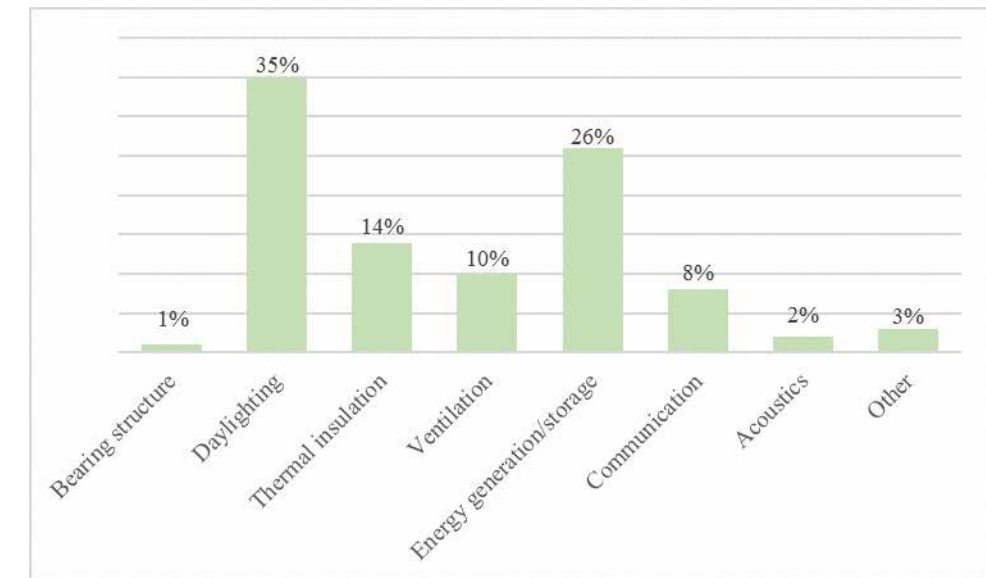

Fig. 1: Functional categorization of adaptive façades

Using technology readiness, complexity and the potential to be integrated with the buildings' energy generation and distribution system as criteria, a multi criteria analysis (MCA) is conducted on the hundred aforementioned concepts/designs. The eight concepts with the highest scores are selected for further analyses. See Table 2.

Concept/Design	Technology readiness (1-3)	Complexity (1-3)	Energy (1-3)	Total (sum)
GlassX Crystal	3	3	3	9
Blight	3	2	3	8
EWE Arena	3	2	3	8
Smart Energy Glass	3	3	1	7
Climate Adaptive Skin	3	1	3	7
Beadwall	3	2	2	7
Bloomframe Balcony	3	3	1	7
Kameleon Concept	2	2	3	7

Table 2: Eight concepts/designs with highest MCA scores

The eight concepts from Table 2 are described briefly below. For more extensive descriptions, see Loonen et al. (2010).

GlassX Crystal is a transparent façade part which contains a phase change material (PCM) that stores heat during the day and releases heat at night. The functions daylighting, thermal insulation and energy generation/storage apply to this design. See Fig. 2.



Fig. 2: GlassX Crystal

The blight design comprises blinds which are equipped with photovoltaic cells. The electricity that is generated during the day is stored in a battery. At night, this electricity is used to illuminate the interior via electroluminescent foil.

The EWE Arena refers to a concept in which a kinetic second skin of photovoltaic panels is placed around a building. Besides generating electricity, this systems also provides shading to rooms that are – at a certain time of day – exposed to direct sunlight.

The Smart Energy Glass allows occupants to switch its optical properties. The energy needed is generated by photovoltaic cells at the edges of the window. The functions daylighting and energy generation/storage apply to this design.

The Climate Adaptive Skin refers to a concept in which all functions for heating, cooling, solar protection, energy generation/storage and ventilation are integrated into a single skin. Also see Hasselaar & Looman (2007).

The Beadwall comprises a design in which moveable insulation material can – on demand – be blown into the space between two window panes to provide shading and insulate the window. See Fig. 3.



Fig. 3: Beadwall

The Bloomframe Balcony is a window frame that can be transformed into a balcony. Besides adding daylighting and ventilation, the floor area of a building is – temporarily – increased with this system.

The Kameleon concept consists of an aluminum box with replaceable covers that can perform different functions, such as energy generation/storage, air purification, advertising (communication in Fig. 1) and rainwater drainage.

4 Stakeholders' assessment of adaptive façade designs and concepts

The stakeholders' assessment of the eight adaptive façades concepts/designs is summarized in Table 2, and discussed below. The results are presented using a five point Likert scale. The extreme positive and negative responses are associated with the +2 and -2 accordingly. The results allow to identify differences in the perception of adaptive façade concepts by four different stakeholder groups. See Fig. 4.

The assessment of the concepts/designs are more differentiated. Fig. 5 shows that six out of eight concepts/designs are assessed slightly positive whilst two concepts, Beadwall and Kameloen concept, are assessed moderately negative. A more detailed summary of the feedback per concept/design is provided below.

	Architect 1	Architect 2	Building consultant 1	Building consultant 2	Building consultant 3	Contractor 1	Contractor 2	Maintenance
GlassX Crystal	-1	-1		1	-1	2	1	1
Blight	0	1		-1	-1	1	1	-1
EWE Arena	-1	1	-1	-1	2	1	0	1
Smart Energy Glass	-1	0		0	-1	1	1	1
Climate Adaptive Skin	-2			-1	1	2	1	1
Beadwall	0			-2	-2	-1	-1	-2
Bloomframe Balcony	2	-2	-1	1	1	0		
Kameleon Concept	0	-1		-2	-2	-2	0	-1

Legend		
	2	Positive
	1	Moderately positive
	0	Neutral
	-1	Moderately negative
	-2	Negative
		No answer

Table 3: Results of interviews

GlassX Crystal: Architect 1 highlighted the aesthetical aspect and noted that, even if certain materials are considered aesthetically pleasing at one point, these may grow out of fashion. The advantage that this system combines light-weight construction with comfortable indoor climates was noted by building consultant 2 and the contractors. Building consultant 3 finds it more obvious to apply phase change materials (PCMs) in floors than in windows. The limited durability of PCMs is a concern of both contractor 2 and the maintenance company.

Blight: Multiple interviewees noted the fact that blinds are more effective when these are placed on the exterior, though this requires more intensive maintenance. Many interviewees also noted that occupants are generally not content with automated systems like these, in particular when these obstruct the view. Contractor 1 mentioned the advantage that this system can be sold as a component, and building consultant 3 mentioned its applicability for renovation purposes. Architect 1 noted the importance of having choice in dimensions and colors for a widespread market uptake.

EWE Arena: Both architects, as well as building consultant 3, positively assessed this design. These interviewees expressed their enthusiasm on the idea of a building following the sun path. Building consultants 1 and 2 mentioned the high costs of the system as being large obstacles for a widespread market uptake, whilst the contractors wondered how this concept might work on a rectangular building.

Smart Energy Glass: Both the contractors and the architects consider the high costs of the system relative to simple solutions (such as curtains) disadvantageous, though architect 2 noted the interesting aesthetic effect that could be accomplished upon application in e.g. hotels. Building consultant 3 mentioned that the desired visual comfort conflicts with the wish to reduce the solar heat gain.

Climate Adaptive Skin: The interviewees were highly divided on the (dis)advantages of the Climate Adaptive Skin concept. Contractor 1 positively assessed the fact that this could be a modular system. Architect 1, however, felt this concept restricts design freedom. Whereas building consultant 3 noted this concept could imply savings on distribution pipes and channels, the costs of the system were of concern to building consultant 2. With regard to maintenance, the importance of accessibility to individual systems was stressed.

Beadwall: This concept is not assessed positively. Architect 1 and Contractor 2 were negative about the aesthetics. Building consultant 2 anticipates practical and technical problems, whilst building consultant 3 and the maintenance company did not see the advantage of this system over currently available highly insulating glazing.

Bloomframe Balcony: Architect 2, as well as building consultant 1, did not see the advantage of this design over a traditional balcony. This is in line with the statements of contractor 1 and building consultant 3, who called it a 'nice gadget' without much added value. Building consultant 2 and architect 1, on the other hand, were positive as they felt this system can enhance the experience of an indoor space by connecting it to the outdoors.

Kameleon Concept: None of the interviewees were positive on this concept. Architect 2, contractor 1 and building consultant 3 found it illogical to integrate these functions in a façade. The representative of the maintenance company mentioned the required extensive maintenance on filters and moving parts as disadvantageous.

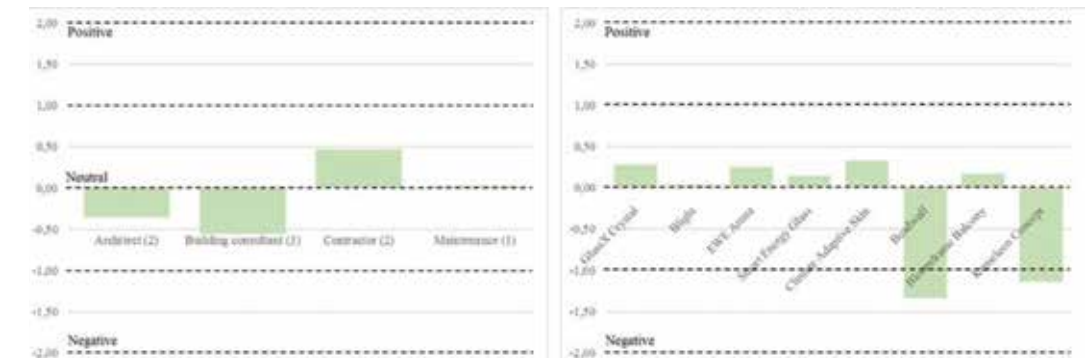

Fig. 4: Average scores by stakeholder group

Fig. 5: Average scores by concept/design

5 Discussion

Although the number of stakeholders interviewed does not allow to provide statistically significant results, the data does allow some indicative conclusions. The results show that, within stakeholder groups (e.g. architects), the assessments of certain concepts/designs varies strongly.

The individual scores in Table 3 show a great diversity of scores from -2 relating to a negative perception to +2, indicating a positive perception. It can also be noticed that stakeholders did not give an opinion on all concepts. There are two possible reasons to for this. The interviewee did assess himself, at the time being, not knowledgeable enough to give an educated assessment or as observed in a different case the interviewer was not able to discuss the concept/design within the time available for the interview.

Fig. 4 indicates that, from the pool of interviewed stakeholders, the building consultants response to the eight chosen adaptive façade concepts/designs was the most critical with an average score of -0.56. The most positive score came from the contractors with an average score of +0.47. The response from the façade maintenance professional was overall neutral. None of the scores were extremely positive or negative.

From Section 4, a number of parameters can be extracted which were found to be of interest to the stakeholders. The aesthetics of the design, (investment) costs, durability and required maintenance were identified as critical for a widespread market uptake. This is in line with the findings of Haase et al. (2009).

6 Conclusions

In this paper, the authors qualitatively investigated the practitioners' view on the potential of climate adaptive façades to increase comfort and reduce energy demand.

It has been investigated which functions are most commonly integrated into façades or façade components characterized as being adaptive. To that end, the hundred climate adaptive building shells from Loonen et al. (2010) were categorized in eight functions. The functions daylighting (35%) and energy generation/storage (26%) are most commonly integrated. Few concepts/designs have a bearing (1%) or acoustic (2%) function.

It was furthermore investigated how stakeholders assess the advantages and disadvantages of eight specific façade concepts and where these stakeholders see obstacles hindering a widespread market uptake. To that end, eight promising designs/concepts were used as input for the interviews with eight professionals, which included architects, building consultants, contractors and a representative of a maintenance company.

It has been found that the interviewees are highly divided on the implementation potential of most of the designs/concepts. Remarkably, it is found that – on the whole – the two interviewed contractors were most positive, whilst the building consultant stakeholder group was found to be most negative on the implementation potential of the eight designs/concepts.

Aesthetics, (investment) costs, durability and required maintenance have been identified as critical parameters for a widespread market uptake

7 Acknowledgements

The authors would like to express their gratitude towards the interviewees who participated in this research project.

8 References

- Haase, M., Andresen, I., & Dokka, T. H. (2009). The Role of Advanced Integrated Facades in the Design of Sustainable Buildings. *Journal of Green Building*, 4(1), 76–98. <https://doi.org/10.3992/jgb.4.1.76>
- Hasselaar, B., & Looman, R. (2007). The Climate Adaptive Skin, the integral solution to the conflict between comfort and energy performance. In *CIB World Building Congress* (pp. 1115–1125). Cape Town, South Africa.
- Loonen, R. C. G. M., Hensen, J. L. M., Trčka, M., & Cóstola, D. (2010). Overview of 100 climate adaptive building shells. *Technische Universiteit Eindhoven- University of Technology*. Retrieved from <http://repository.tue.nl/841522>
- Loonen, R. C. G. M., Trčka, M., Cóstola, D., & Hensen, J. L. M. (2013). Climate adaptive building shells: State-of-the-art and future challenges. *Renewable and Sustainable Energy Reviews*, 25, 483–493. <https://doi.org/10.1016/j.rser.2013.04.016>
- Prieto, A., Klein, T., Knaack, U., & Auer, T. (2017). Main perceived barriers for the development of building service integrated façades: Results from an exploratory expert survey. *Journal of Building Engineering*, 13(April), 96–106. <https://doi.org/10.1016/j.jobe.2017.07.008>
- Struck, C., Guedes Almeida, M., Silva, S., Mateus, R., Lemarchand, P., Petrovski, A., ... de Wit, J. (2015). Adaptive facade systems – review of performance requirements, design approaches, use cases and market needs. In *Advanced Building Skins* (pp. 1254–1264). Bern, Switzerland.

Energy efficient and user oriented pre-fabricated facade extensions

Dimitra Papadaki a, Silvia Ruggiero b, Rosa Francesca De Masi b, Theoni Karlessi a, Anastasia Fotopoulou c, Annarita Ferrante c, Margarita-Niki Assimakopoulos a

a) National & Kapodistrian University of Athens, Physics Department, Building of Physics - 5 Athens 157 84, Greece, email: dpapadaki@phys.uoa.gr

b) University of Sannio, DING - Department of Engineering, Benevento, Italy

c) Department of Architecture, School of Engineering and Architecture, University of Bologna, Italy

This research work aims to demonstrate the attractiveness of a safe renovation strategy based on new façade additions combining integrated Efficient Technologies- (GETs). The research project proposes the highest transformation of the existing building's shell with external strengthening structures, which generate energy efficient buffer zones and at the same time increase the building's volume (with balconies, sunspaces and extra rooms, according to users' needs or expectations).

The building model is defined by using the building energy simulation software, EnergyPlus v8.4, with the graphical definition of the geometry, dimensions and positions of the thermal envelope assigned by means of the interface of Design Builder v4.6. More specifically in this report 4 different GET configurations were considered, with a specific focus on their energy efficiency's evaluation. These GET configurations include the first scenario of an extra room and a balcony, the second scenario consists of the extension of the existing room with window; the third scenario is the sunspace, and lastly, the fourth scenario represents a balcony. Based on the results, for the third facade scenario the heating load of the total building is calculated to be 203.68 kW, while for the fourth scenario this drops to 158.73kW, a reduction of 41% from the current state of the building. The obtained results prove the sensitivity of the energy outputs based on the different façade configuration. These results can be combined and associated to the specific architectural design configurations.

Keywords: Exoskeleton, user oriented prefabricated facades, energy performance

1 Introduction

Buildings are responsible for approximately 40% of the energy consumption and 36% of the CO₂ emissions in the EU. More in detail, about 35% of the EU's buildings are over 50 years old while considering also the poor maintenance conditions globally almost 75% of the building stock has very low energy efficiency performance. Moreover, only 0.4-1.2% of the building stock is renovated each year (European Commission). It is clear that the renovation of existing buildings has highest potential to lead to significant energy savings in order to keep the European Union competitive, as the clean energy transition changes global energy markets.

As underlined by Eliopoulou and Mantziou (2017), the refinement of architectural space plays a catalytic role in the building's energy balance. By applying solely architectural interventions, a reduction of 44% of the energy demands was achieved for an old and energy-consuming school complex selected as case study. The use of prefabricated timber façade elements in the renovation of buildings for Belgium climate has been investigated by Coupillie et al. (2017). Sandber et al. (2016) have compared a newly developed wood façade element system with traditional façade renovation solutions and evaluated on two buildings in Finland. Especially technical areas have

been investigated and compared, such as adaptation to existing building and connections to underlying material, roof and base.

The potential of remodeling of glass facades, along with applying the concept of smart technologies has been analyzed by Tovarovic et al. (2017). Hachem and Elsayed (2016) have presented a study of the effect of geometric design of equatorial-facing, double skin facade on energy performance of multi-story office buildings, showing that the position of fold and the depth of the cavity have a significant effect on thermal load and energy generation potential. Instead, Dermentzis et al. (2018) have analyzed the performance of an innovative heating and ventilation system integrated into a prefabricated timber frame façade; this was developed and installed in a flat during the renovation of a multi-family house in Ludwigsburg, Germany. A compact solar thermal facade module with the internally extruded flow channel suiting for solar renovation concept in buildings has been studied by Shen et al. (2016).

This paper aims to demonstrate the attractiveness of a safe renovation strategy based on new façade additions combining integrated Efficient Technologies- (GETs). This solution has been developed in the frame of “Pro- GET- one” a Horizon 2020 project. The research project Pro-GET-onE is based on the integration of different technologies to achieve a multi-benefit approach through the closer integration between energy and non-energy related benefits, promoting a holistic vision based on the integration of different technologies where numerous requirements (energy, structural, functional) are managed as a whole. Thus, by implementing a same holistic and integrated system based on pre-assembled components, the research project aimed to achieve the highest performances in terms of energy requirements, social and economic sustainability and safety.

2 GET-system - a multi benefit solution

The GET structure (exoskeleton) will address both energy and space requirements issues. To this aim, energy simulations performed have demonstrated that enclosing the structure with solar spaces that can be opened in summer may provide an energy reduction of up to the 75% in the cold winter season while reducing solar gains and increasing natural ventilation rates, results to about 35% energy consumption. Furthermore, simulations have been performed for different climatic zones ranging from northern climates to the Mediterranean area, reaching nZEB performances with traditional thermal insulation coating combined with controlled mechanical ventilation (VMC). Many references in the literature have also confirmed this potential energy reduction (Hilliaho et al. 2015). Fotopoulou et al. (2008) investigated an individual residential unit in a set of various hypotheses for targeted energy retrofitting interventions with different options both individually and in combination. The study was executed for three different climatic zones (Athens, Riga, Bologna) and showed that energy savings were larger during the winter period in southern climatic conditions while northern countries showed a larger energy saving during summer. Undoubtedly, in all three different climatic conditions, a zero energy building with the extension on the façade and with a standard retrofit seems to be an achievable goal.

One of the main shortcomings of deep retrofitting towards nearly zero energy is that they generally rely on separate clusters of technologies that are difficult to integrate. To overcome these barriers and create a roadmap for cost effective renovation through a well-balanced strategy of mass customization, the research project has envisaged an integrated modular system, composed of components manufactured off-site, that can be customized and optimized for different cases in a user-oriented perspective (by adding balconies, loggias, sunspaces according to the users' needs and expectations) (Figure 1).

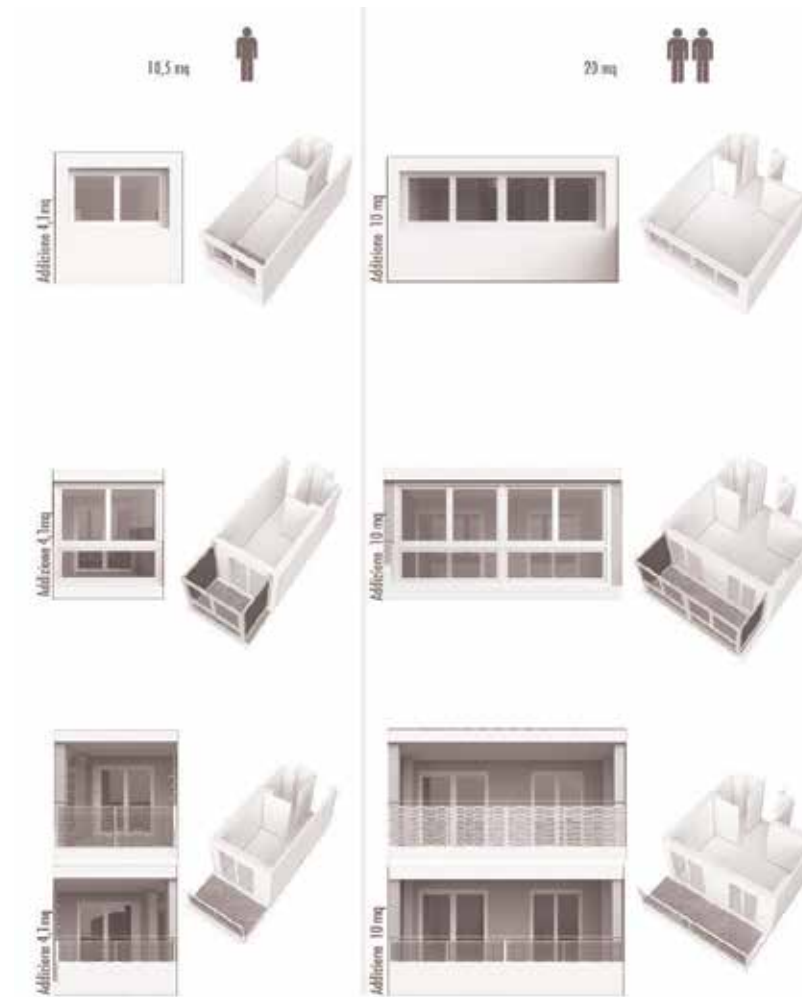

Fig. 1 Get-system abacus scenarios.

The integration of the system will focus on the interfaces between the different components to ensure their collective performance according to the project requirements. Standardized interfaces will also ensure the flexibility of the system, as different components can be interchanged and adjusted as a function of different climate conditions and urban context, as well as according to the inhabitants' choices.

Regarding the investigated building, different architectural solutions have been realized. In each of these solutions, several additional volumetric units were hypothesized and divided into three functional types: sunspace, extra-room, and balcony. Figure 2 shows a possible functional and therefore architectural variation of the same external volumetric addition.



Fig. 2 Architectural verification.

3 Current state of the case study and methodology

The investigated building belongs to the National and Kapodistrian University of Athens, in the University campus of Zografou, a suburb of Athens (Lat. 37.98, Long. 23.73). The building, named B Building FEPA is a student dormitory hosting 138 single-beds for students. It has 4 floors (including the ground level) and a basement. The building is located near Taxilou street, Zografou, with an altitude of 153 m on sea level, in an area of around 4,500 m². The construction works started on 1986. It has been in continuous operation since the year of its construction. The net height of each room is 2.40 m while at basement floor the net height is 2.60 m. The main entrance is on the North West side. Input data were inserted in our model, designed by energy simulation software, EnergyPlus v8.4 (U.S. Department of Energy), with the graphical definition of the geometry, dimensions and positions of the thermal envelope assigned by means of the interface of Design Builder v4.6 (“DesignBuilder - Simulation Made Easy”). The model was calibrated using actual data from collected bills from the building under investigation.

Thermal, extra space and also lighting performance indexes have been calculated for the whole building, and thus:

- Heating index: total heating load (kW);
- Cooling index: total cooling load (kW);
- Space index: total floor area (m²);
- Daylight index: mean daylight factor weighed on the floor surface (%).

Heating and cooling loads represent the energy demand to set comfort operative temperature during the summer and winter period considering heat losses through building envelope, ventilation and inner gains. Heating design calculations were carried out in order to determine the size of the heating equipment required to meet the coldest winter weather conditions likely to be encountered at the site location. These design calculations are traditionally carried out using steady-state methods. The simulation calculates heating capacities required to maintain the temperature set points. In the present analysis the total heat loss, shown for each zone, is multiplied by a safety factor equal to 1.25. Cooling design calculations are carried out in order to determine the capacity

of the mechanical cooling equipment, required to meet the hottest summer weather conditions, likely to be encountered at the site location. These design calculations are traditionally carried out using periodic steady-state methods such as the admittance and response factor methods provided by CIBSE and ASHRAE. The simulation calculates half-hourly temperatures and heat flows for each zone and determines cooling capacities required to maintain any cooling temperature set points in each zone. The maximum cooling load, calculated in each zone, is multiplied by a safety factor equal to 1.15. Only the occupied and cooled zones are taken into account in the total cooling load.

The boundary conditions of heating load calculation are: outdoor dry bulb air temperature 1.8°C and indoor air temperature 20°C. For the summer period, indoor temperature has been set to 26°C, instead for outdoor condition the 15th July has been considered as design day (see Figure 3).

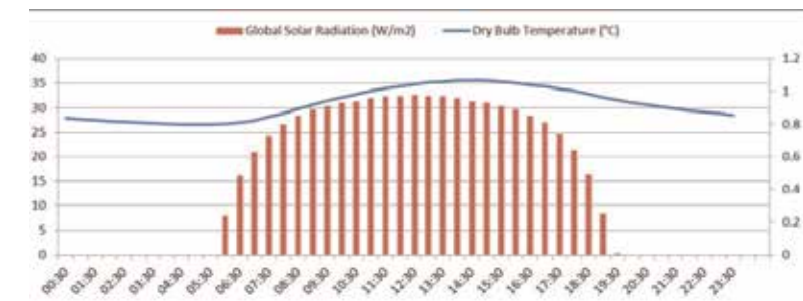

Fig.3 External data for summer design day.

The Daylight Factor (DF) is an index carried out for orienting users to select the GET system under comfort-light point of view. The average daylight factors are generated for each zone, calculated by using the Radiance ray-tracing simulation engine by means of Design Builder interface. The calculations allow light to be transmitted through exterior and interior windows and the shading and reflective effect of local shading devices and component/assembly blocks is included. Window shading options such as slatted and diffusing blinds are not included in Radiance calculations. The height of the working plane above floor level for each zone in the daylight simulation is set to 0.7 m. The sky model selected is an overcast day with luminance at the Zenith equal to 10000 lux (see red chart in Figure 4).

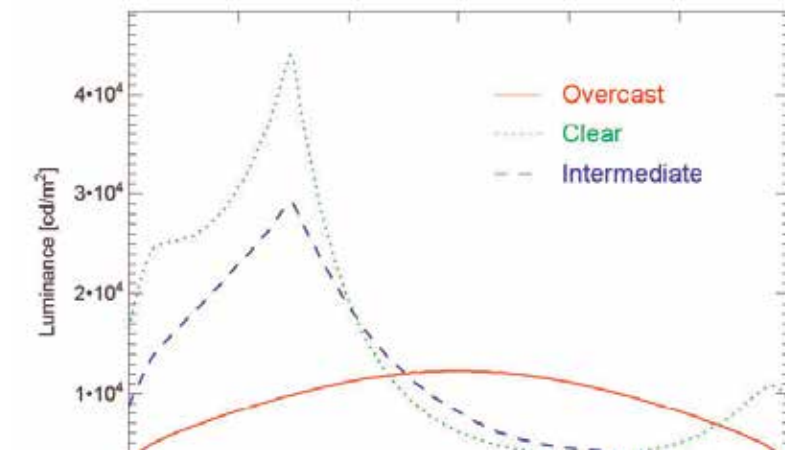

Fig.4 Sky luminance profiles for three sky models.

In this research, four different façade additions combining inteGrated Efficient Technologies- (GETs) have been considered. These GET configurations include the first scenario combination of an extra room and a balcony (GET 1), the second scenario consists of the extension of the existing room with window (GET 2); the third scenario is the sunspace (GET 3), and lastly, the fourth scenario represents a balcony (GET 4). Figure 5 depicts these shapes, in frontal view, for a single room; while their geometrical features are reported in Table 1.

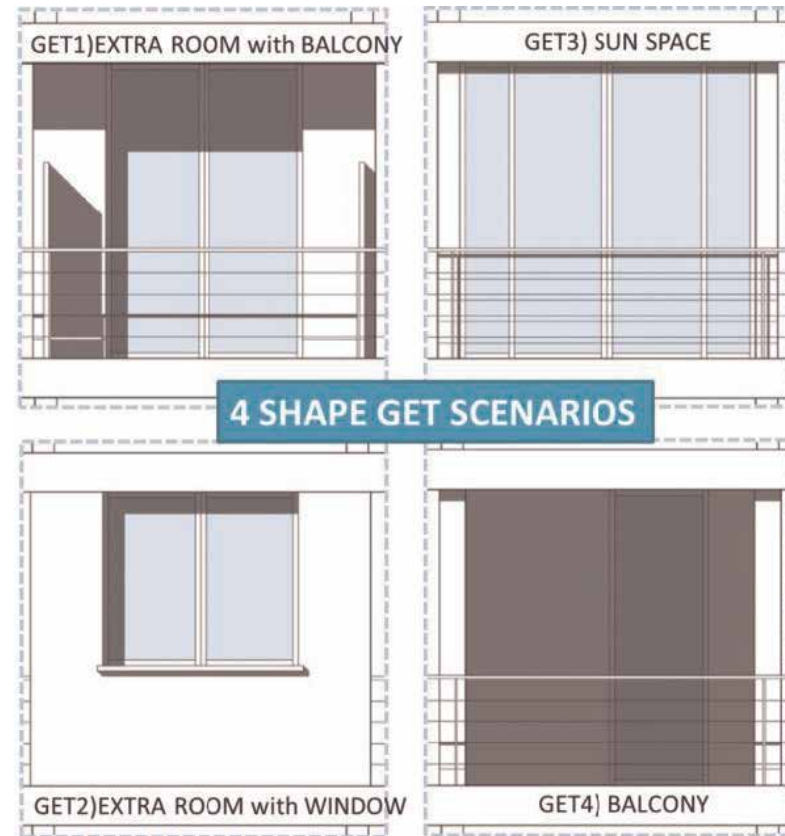

Fig 5. Get-system scenarios.

	Depth space	Balcony overhangs	Window-wall ratio	Glazing size
GET 1	1.5 m	0.5 m	35%	High fixed 2.2 m
GET 2	2.0 m	0.0 m	25%	High fixed 1.1 m
GET 3	1.7 m	0.3 m	100%	-
GET 4	0.0 m	2.0 m	As state of fact	As state of fact

Table 1: Geometrical features of GET scenarios

In regards to the envelope materials of the GET system, thermal transmittance law limit values, of different envelope elements, for the country under investigation were used. More specifically for Greece, the values can be found in Table 2. Table 3 reports the thermo-physical characteristics of the external wall for GET 1 and 2. This configuration is characterized by total thickness of 0.33 m, thermal transmittance value of 0.348 W/ m² K and internal thermal capacity equal to 140.91 kJ /m² K.

Thermal Transmittance [W/ m ² K]			
External Wall	Floor basement	Roof slab	External Windows
0.50	0.90	0.45	3.00

Table 2: Limit values of thermal transmittance in Greece-Athens

Material	Thickness [m]	Conductivity [W/mK]	Specific Heat [J/kg K]	Density [kg/m ³]
Drywall ³	0.015	0.200	1000	680
Insulation - mineral wool ²	0.080	0.035	1030	50
X-LAM ¹	0.090	0.120	1600	420
Insulation mineral wool ²	0.080	0.035	1030	50
Aluminum coating	0.002	160	880	2800

Table 3: Thermal-physics characteristics of GET external wall, from the inside

For case number 4, the external wall taken into account was the one as the state of fact incorporating insulation materials of Wall 1 and 2, with a thickness that allow to be within the limit value.

The glazing used on the GET system was double glass low emissive with argon filled windows. The frame is made by aluminum and polyurethane foam, with a thickness of 70 mm. Moreover the choice of shading system type, affects the cooling load, therefore the integrated shading systems designed was internal blinds with high reflectivity slats.

4 Results

4.1. Results of the current state

The geometrical features of all elements of the building are illustrated in Figure 6. The rendering pictures of the model for each orientation side are being depicted.

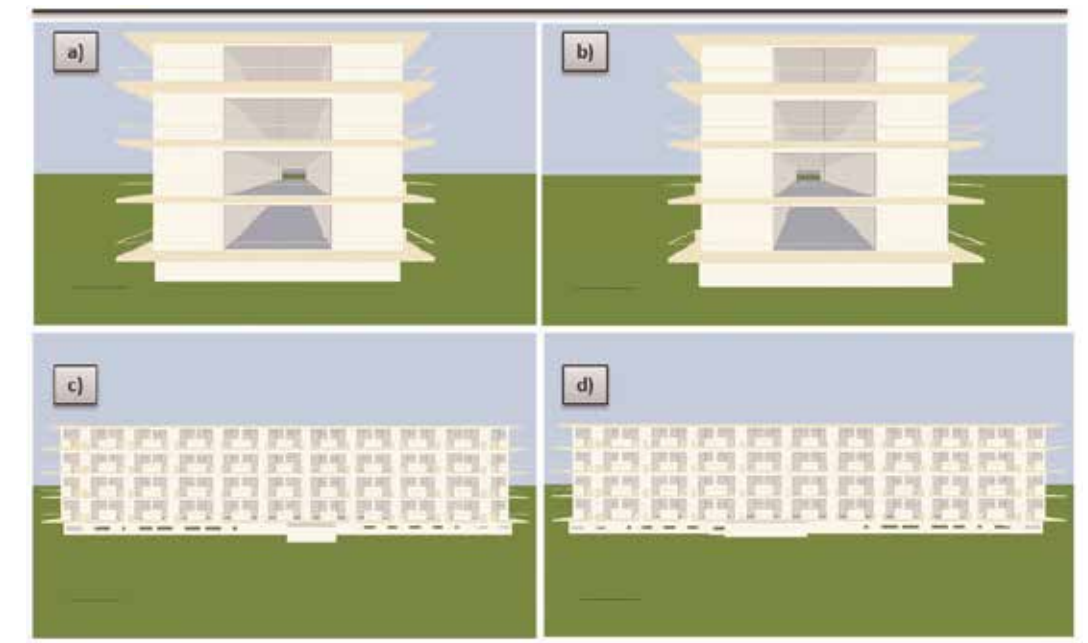

Fig 6. Rendering of the model: a) North-East side; b) South-West side; c) North West side; d) South-East side

In order to take into account shading, surrounding buildings are also designed, and shown in Figure 7.



Fig 7. View of the shading made by surrounding buildings: a) real view b) rendering.

In the building under investigation, three thermal zones have been created, the ones consisting of the bedrooms of the building, or else the rooms of each student, the common areas and the basement. In figure 8 the visualization of the different thermal zones modeled for one floor is depicted.

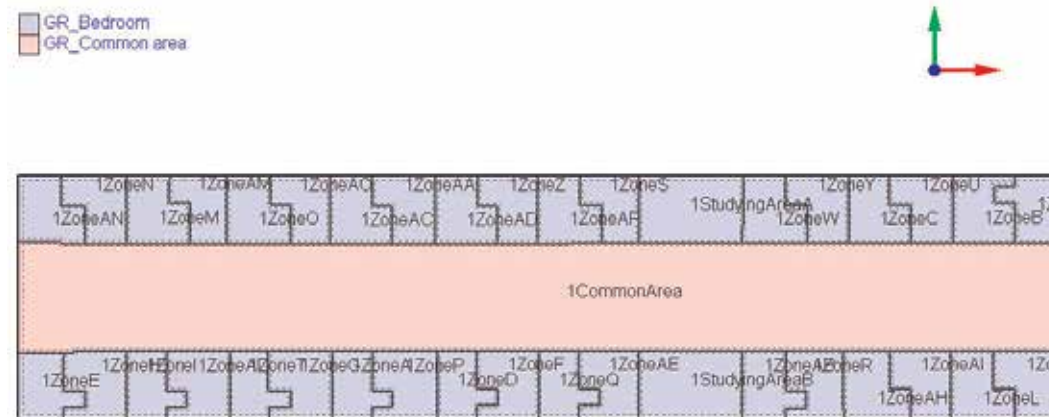

Fig. 8. Thermal zones for a typical floor

The total building area is 3349.27 m², of which 2584.25 m² is the net conditioned one. The area designed as occupied by the persons is equal to the net conditioned one. The total heating load of the current state of the building is equal to 269.86 kW. The total cooling load, considering all cooled areas, is equal to 216.59 kW. In Figure 9, the daylight distribution contour map for the Daylight Factor (DF) on the working plane (0.7m), is reported for the second floor. The area with a DF lower than 2% is depicted in grey. For the whole building the percentage of area with a DF greater than 2% is equal to 12.7% and the total average DF weighted on the floor area of each zone is equal to 1.83%.

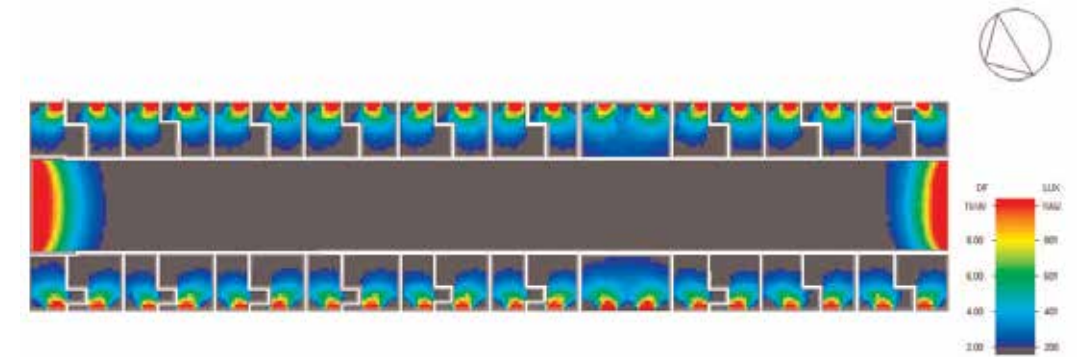

Fig 9. Daylight distribution contour map of the second floor.

4.2. Results based on different GET facades

Simulations were carried out concerning different façade configurations. The results were displayed according to four specific indexes, based on energy perspectives and also indoor comfort. The heating and cooling load, the space and daylight index, all being affected by the new suggested facades extensions.

The process that was followed involved an independent study for each zone, per floor, according to the four aforementioned indices. The investigation included the hypothesis that different units or zones may influence the heating, cooling, daylight and space index of the new GET scenarios. Nonetheless this was proved not to be the case, since all units/zones performed best at a specific GET scenario per index. Therefore the different façade expansion influences the thermal, cooling, daylight and space factors as a whole, and not independently in units. In Table 4, only some typical results are being presented. These include the 1st floor based on heating loads index. As it is observed, for all zones the best scenario for implementation is GET 4, scenario with balcony.

Floor	Zone	Current State	HEATING INDEX [kW]			
			GET1	GET2	GET3	GET4
1st Floor	IstFloor:1StudyingAreaB	1.61	0.94	0.99	1.15	0.74
	IstFloor:1CommonArea	16.12	12.02	11.99	12.18	10.21
	IstFloor:1ZoneL	0.87	0.47	0.5	0.57	0.38
	IstFloor:1ZoneAG	1.06	0.81	0.85	0.92	0.42
	IstFloor:1ZoneAI	0.78	0.45	0.48	0.56	0.36
	IstFloor:1ZoneAH	0.91	0.49	0.52	0.6	0.4
	IstFloor:1ZoneAB	0.76	0.43	0.45	0.54	0.34
	IstFloor:1ZoneR	0.85	0.45	0.48	0.55	0.37
	IstFloor:1ZoneAE	0.87	0.45	0.48	0.56	0.39
	IstFloor:1ZoneQ	0.72	0.41	0.43	0.51	0.33
	IstFloor:1ZoneF	0.9	0.48	0.51	0.59	0.4
	IstFloor:1ZoneD	0.69	0.39	0.42	0.49	0.31
	IstFloor:1ZoneA	0.71	0.41	0.44	0.52	0.32
	IstFloor:1ZoneP	0.94	0.51	0.54	0.62	0.42
	IstFloor:1ZoneG	0.91	0.48	0.51	0.59	0.4
	IstFloor:1ZoneT	0.69	0.4	0.43	0.5	0.31
	IstFloor:1ZoneI	0.7	0.41	0.43	0.51	0.32
	IstFloor:1ZoneAL	0.92	0.49	0.52	0.6	0.41
	IstFloor:1ZoneH	0.92	0.51	0.53	0.61	0.41
	IstFloor:1ZoneE	1.02	0.76	0.8	0.87	0.39
	IstFloor:1ZoneN	0.85	0.46	0.49	0.56	0.37
	IstFloor:1ZoneM	0.79	0.47	0.5	0.57	0.38
	IstFloor:1ZoneAM	0.76	0.42	0.45	0.52	0.33
	IstFloor:1ZoneO	0.79	0.46	0.49	0.57	0.38
	IstFloor:1ZoneAO	0.78	0.42	0.45	0.53	0.34
	IstFloor:1ZoneAC	0.78	0.46	0.48	0.56	0.37
	IstFloor:1ZoneAA	0.83	0.45	0.48	0.55	0.37
	IstFloor:1ZoneAD	0.77	0.46	0.48	0.56	0.37
	IstFloor:1ZoneZ	0.81	0.44	0.46	0.54	0.36
	IstFloor:1ZoneAF	0.77	0.46	0.48	0.57	0.37
IstFloor:1ZoneS	0.77	0.4	0.42	0.5	0.33	
IstFloor:1StudyingAreaA	1.57	0.92	0.98	1.14	0.74	
IstFloor:1ZoneW	0.78	0.47	0.49	0.57	0.38	
IstFloor:1ZoneY	0.81	0.43	0.46	0.53	0.36	
IstFloor:1ZoneC	0.77	0.46	0.49	0.57	0.37	
IstFloor:1ZoneU	0.84	0.45	0.47	0.55	0.37	
IstFloor:1ZoneB	0.89	0.5	0.53	0.6	0.4	
IstFloor:1ZoneJ	0.98	0.76	0.8	0.87	0.38	
IstFloor:1ZoneAN	1.04	0.8	0.83	0.9	0.42	

Table 4: Results displaying different GET scenarios for each zone of the 1st floor

In Table 5, the overall results of the Total Building, per index and per GET scenario under investigation are being reported. In regards to the cooling load, the building in its current state has a load of 216.58 kW. According to the simulations, this load was reduced by 14% with the use of a new façade, with extra room and balcony (GET 1). The extension of the existing room with window (GET 2) reduced the cooling load by 15%, whereas the use of sunspace (GET 3) increased it by 35% from the current state. Sunspace is considered to be occupied heated space. Lastly the balcony scenario reduced the cooling load by 40%.

Similar results are met in the heating load, where GET 4, reduced the initial thermal load of 269.86 kW to 158.73 kW, representing a reduction of 41%. Other GET scenarios contribute also to the reduction of the heating load, but in a smaller overall percentage. More specifically GET 1 lowered the thermal load by 31%, GET 2 by 30% and GET 3 scenario by 25%.

According to daylight factors, all GET scenarios decreased the daylight factor inside the building, except in GET 3, where the sunspace would increase it by 37%. Lastly, as expected, the floor area increased the most in GET 2 by a percentage of 21% extra space for its initial stage.

	Index results of current state and different GET scenarios					Percentage difference from the current state			
	CURRENT STATE	GET1	GET2	GET3	GET4	GET1	GET2	GET3	GET4
Cooling load [kW]	216.58	187.19	184.77	291.83	129.76	-14%	-15%	35%	-40%
Heating load [kW]	269.86	186.46	190.15	203.68	158.73	-31%	-30%	-25%	-41%
Daylight index [%]	1.83	1.13	1.22	2.51	1.07	-38%	-33%	37%	-42%
Space index [m2]	3349.26	3852.97	4058.06	3935.01	3349.26	15%	21%	17%	0%

Table 5: Total Building results

5 Conclusions

Overall, façade expansions can be used to target different aspects for building improvement. The expansions contribute of course to the overall space gains for the user. Nonetheless, façade volumetric expansions can also target goals as energy performance of a building, since different configurations can decrease the heating and the cooling load. Indoor comfort is also a factor that is being influenced on different façade configurations. Taking into account the daylight index, different façade increases or decreases the light inside the building, enhancing the quality of life in the interior and also indirectly affecting the energy demands of the building, with the reduction of the lighting energy needs. In this research study, the extra room with balcony and extra room with window, reduced both cooling and heating load to 40% and 41% respectively; while the use of sunspace increased the daylight factor by 37% indoors. Lastly the use of balcony as a façade extension leads to space gains of around 21%.

By combining—in one prefabricated solution—energy and structural together with the possibility of integrating the personalization of different components within the same mass-produced product, Pro-GET-onE opens a methodological revolution in the retrofitting practice. This highly innovative and effective technology offers the possibility of re-launching the renovation sector and foster its application on a broader scale in Europe.

The studied solutions aim at enabling the conditions to create attractive, self-financing schemes to support deep renovation actions; in fact, the GET system represents a possible standardized solution with a highly replicable strategy, especially for the Mediterranean countries of the EU and all the induced seismic areas of the EU. It is the authors' considered opinion that this strategy could more easily convince the users, the urban dwellers, and investors in the energy regeneration and major architectural revamp of the existing buildings. The research project aims at ensuring the proper exploitation of a ground-based knowledge to boost the European strategic aim of mobilizing investment in the energy renovation of the existing building stock.

6 Acknowledgements

This project has received funding from the European Union's Horizon 2020 Innovation action under grant agreement No. 723747.

7 References

- Coupillie, C., Steeman, M., Van Den Bossche, N., Maroy, K., Evaluating the hygrothermal performance of prefabricated timber frame façade elements used in building renovation, *Energy Procedia* 132 (2017) 933–938.
- Dermentzis, G., Ochs, F., Siegele, D., Fei, W. Renovation with an innovative compact heating and ventilation system integrated into the façade – An in-situ monitoring case study, *Energy and Buildings* 165 (2018) 451–463.
- DesignBuilder - Simulation Made Easy, Design Builder v. 4.6, <http://www.designbuilder.co.uk/>, Accessed on 29 July 2018.
- Eliopoulou, E., Mantziou, E., Architectural Energy Retrofit (AER): An alternative building's deep energy retrofit strategy, *Energy and Buildings* 150 (2017) 239–252.
- European Commission, Topics: Buildings, <https://ec.europa.eu/energy/en/topics/energy-efficiency/buildings>. Accessed on 29 July 2018.
- Fotopoulou, A., Semprini, G., Cattani, E., Schihin, Y.; Weyer, J., Gulli, R.; Ferrante, A. Deep Renovation in Existing Residential Buildings through Façade Additions. A Case Study in a Typical Residential Building of the 70's, (2008). <https://doi.org/10.1016/j.enbuild.2018.01.056>
- Hachem, C., Elsayed, M., Patterns of facade system design for enhanced energy performance of multistory buildings, *Energy and Buildings* 130 (2016) 366–377.
- Hilliaho, K.; Mäkitalo, E.; Lahdensivu, J. Energy saving potential of glazed space: Sensitivity analysis. *Energy Build.* (2015), 99, 87–97.
- Sandberg, K., Orskaug, Y., Andersson, A., Prefabricated Wood Elements for Sustainable Renovation of Residential Building Façade, *Energy Procedia* 96 (2016) 756–767.
- Shen, J., Zhang, X., Yang, T., Tang, L., Shinohara, H., Wu, Y., Wang, H Pan, S. Wu, J. Xu, P. Optimizing the Configuration of a Compact Thermal Façade Module for Solar Renovation Concept in Buildings, *Energy Procedia*, 104 (2016) 9–14
- Tovarovic, J. C., Sekularac, J. I., Sekularac, N., Renovation of existing glass facade in order to implement energy efficiency and media façade, *Energy and Buildings* 152 (2017) 653–666.
- U.S. Department of Energy, Energy Plus simulation software, 960 Version 8.1.0.

Designing an adaptive shading pavilion for hot arid climates

Marta D'Alessandro, Ingrid Paoletti

Politecnico di Milano, Architecture, Built Environment and Construction Engineering Department (ABC), Italy martadalessandro87@yahoo.it

This paper illustrates the design generation process of an outdoor shade-providing small pavilion, which is specifically conceived to host several ancillary functions at exhibition or event spaces and provide a comfortable outdoor microclimate in hot arid regions. The process delineates an approach to the project that through the analysis of the climatic, cultural and socio-economic context of a specific region is able to propose affordable and novel constructive solutions. Adaptability features have been incorporated in every step of the design process. The analysis of traditional solutions for arid climate has lent a series of interesting strategies to explore in terms of architectural possibilities. The result is Dune: a system of small-scale modular umbrellas able to change its functional and performance features, either through a short and long period of time.

Keywords: design process; outdoor comfort; shading strategies; adaptive system

1 Introduction

The bid processes to host large world-scale events have seen a growing participation of countries in the tropical and subtropical area. Just think of Expo 2020 Dubai (UAE) or 2022 and 2026 FIFA World Cup that will take place respectively in Qatar and, probably, in Morocco. The organization of a world event requires huge investments: millions of people come from all over the world and the host countries have the opportunity to show their infrastructural progress, primarily through major urban transformations. One of the major challenges that tropical and subtropical countries will have to face in order to allow full use of their outdoor event spaces will be the human bodily comfort, in order to make visitors feel comfortable and improve their event experience. With the aim of limiting thermal stress, for example, Qatar 2022 will be the first World Cup scheduled for the winter period. However, despite the fierce heat conditions, literature exposes a strong lack of knowledge related to thermal comfort in such climates (Djongyang et al. 2010; Kwong Qj et al. 2014), and a generalized dependence on HVAC systems in indoor environment (JRAIA 2017).

With the aim of contributing to the search for possible solutions that allow a comfortable use of outdoor spaces in dry climates, this paper shows the design generation process of the shading pavilion Dune, a system of small-scale modular structures, mainly characterized by an adaptive roofing component. The name Dune evokes the exceptional changeable nature of sand surface interacting with environmental conditions. In fact, the system has been designed incorporating adaptability features in every stage of design, ranging from a functional and performance change to a physical modification, either through a short and long period of time.

2 Context of the Study

2.1. Climatic characterization

UAE, Qatar, Morocco together with neighbouring countries in Western and Southern Asia and Northern Africa, as well as minor portions of other country territories in Australia, Southern Africa and America, are part of the hot desert climatic zone identified as BWh, according to the Köppen-Geiger's climate classification system. BWh zones are characterized by arid climate with constantly high mean temperatures throughout the year. In the particular case of Dubai the average annual temperature is 26.7 °C. Temperature easily reach maximum average values of 40 °C in the summer months. BWh zones generally receive a great amount of direct sun exposure, present low relative humidity values, and very scarce rainfall. Precipitation is often even absent in summer months.

Aiming to cope with such uncomfortable conditions and obtain comfortable outdoor microclimate, vernacular climate control strategies have emerged over time. Many of these solutions already involved the use of active and adaptable elements from their origin. Through the passing time, due to evolving history and customs, these design principles have been refined and improved.

2.2. Traditional strategies for hot arid climate

Traditional solutions for outdoor hot environment are generally based on the generation of buffer zones, for cooling purpose. Increasing the amount of shaded area is still one of the most effective strategies to reduce thermal stress in hot climate. Awnings are used, for example, as shading covering on street walkways to protect pedestrians from the arid hot climate of Andalusian summer and envelope traditional solutions, like the Arabian mashrabiya, have a series of contemporary adaptive interpretations that allow changes in the architectural surfaces' porosity and transparency.

Studying vernacular traditions from a general climatic approach open up a series of interesting alternatives to explore in terms of architectural possibilities. For hot arid climate, these strategies can be summarized as follow:

- Shading for sun protection
- Buffer zones with operable layers to mitigate thermal stress
- Water spring and vegetation for adiabatic cooling
- High and ventilated roofing to obtain the stack effect

3 Design generation process

3.1. Adapting to existing building layout

In the first step, Graham definition of adaptability has been adopted. According to him, the main objective behind adaptation in architecture is to diminish the likelihood of an architectural component of becoming obsolete over the longevity of time (Graham 2005). Approaching Graham's definition means operate on a medium-long temporal term, providing the system with the capacity to be adjusted to several conditions and locations.

Thus, each module of the proposed system has a pentagonal plan, with a surface area of 7 m². This solution provides the possibility to combine modules creating different space configurations. Assembling the modules along a longitudinal axis, a walkway configuration is obtained. Using a more compact pattern a resting areas with a covered square configuration is provided (figure

1a). Alternating full and empty modules always-different spaces can be installed. In this way, the system can easily be adapted to the existing building layout (figure 1b).

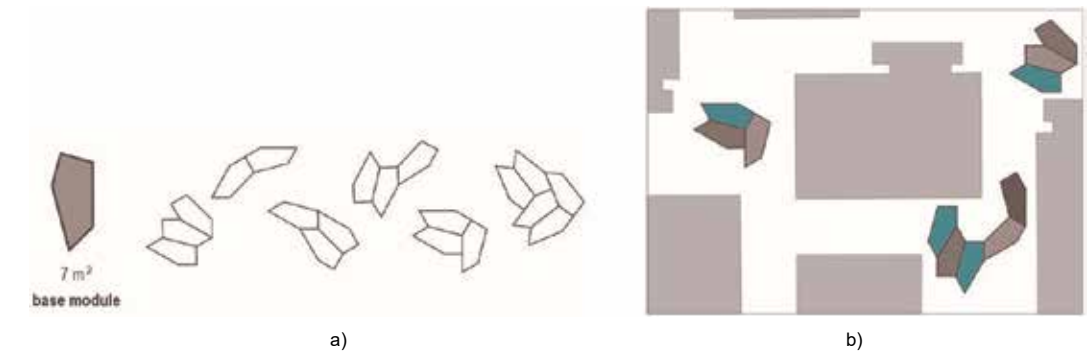

Fig. 1a) Base module and assembled solution, b) system adaptation to existing building layout.

3.2. Acting like a context mediator

Each module of the system consists of a pentagonal self-standing umbrella. Base modules assembly constitutes a light horizontal canopy. Due to great diversity of individual preferences and needs in a world-wide event, the system should adapt dynamically to different use and requirements. In this step, adaptability has the rationale of "context mediator" (Rodríguez & D'Alessandro 2014), which means that the component should transform in order to facilitate communication and interaction between the context, the architectural space and the users and improve their event experience.

Previous exhibition experiences have shown an increasing demand for multipurpose spaces able to respond to contemporary human changing patterns and technologically influenced lifestyles. Using both, the canopy and the shaft elements, every module will host a series of functions. The shaft is configured as an equipped element hosting the function of charging electronic devices, information point, and water distribution point, among others. On the other hand, the canopy elements provide the possibilities to achieve different activities, like rest, contemplation, meetings, and small-scale events. In fact, each canopy element consists of a triangulated surface capable to fold along hinge elements (figure 2). Folding, the elements re-define space boundaries and alter the level of intimacy and opening of the space. In addition, due to the reduced scale of each module, that reach the maximum height of 4.5 metres, moving elements can really engage in communication with the space occupants.

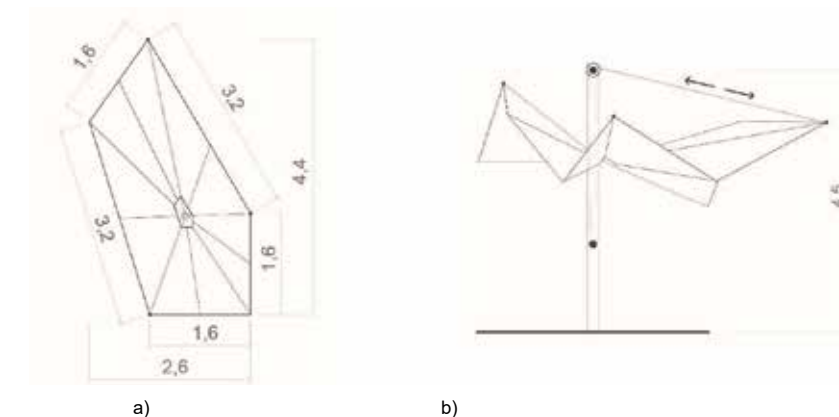

Fig. 2 Dune module a) plan b) section with a cables and pulleys system.

3.3. Acting like a climate regulator

A “climate regulator” is a system that adapts itself to control basic physical factors of the climate, allowing human bodily comfort (ibid. 2014). Climatic strategies have been identified in the early stage and have constituted the main drivers of the design process. In its essence, the system constitutes an operable shading structure. The related movement of folding panels progressively transforms canopy configurations, increasing or decreasing the size of the shady area (figure 3).

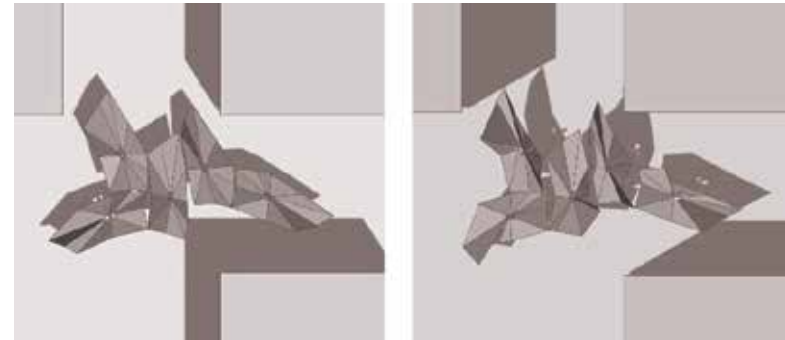

Fig. 3 Shaded area in two different configurations.

Aiming to undertake a human bodily comfort oriented design, the system has been analysed through the energy simulation program Energy Plus. An assembly of three Dune units has been modelled.

How it is widely proven, the thermal sensation is the result of multiple environmental factors. In this stage, the temperature has constitute a priority for the analysis, because in arid hot climates it achieves peak values, strongly affecting thermal comfort conditions. However, other climatic factors will have to be successively integrated into the analysis, such as humidity, which can drop to very low values, especially in the summer months. In fact, some traditional Arabic architectural solutions generally include water surfaces or fountains to get a cooling down effect of the incoming air, as ambient air temperature can be reduced by absorbing heat in the evaporation process through water masses. A research carried out in China in 2011 has demonstrated, by theoretical and experimental studies, the benefits of the application of spray cooling technology in Shanghai Expo 2010, highlighting its effectiveness when ambient temperature is above 30 °C and relative humidity is below 70% (Huang et al. 2011). Because of the climatic characteristics under study and the human scale of the proposal (cooling effect will be weakened with the increase of distance), the implementation of the spry cooling technology along each roofing element could represent an effective strategy with the aim of obtaining a comfortable microclimate.

The environmental simulations have been initially directed at showing potential benefits of different roof configurations. In fact, unlike a continuous roofing system, the canopy can operate has an operable surface: each module is able to acquire different configurations, defining changeable fissures with adjacent modules. During the design generation phase it had been hypothesized that these fissures would have promoted a stack effect, speeding up the air movement. The simulations have shown instead that the advantages of a discontinuous roofing system on thermal performance are paltry (figure 5). This is probably due to the reduced size of the covered area: a different performance can be expected if a larger surface is covered through Dune units.

Strategies for Design

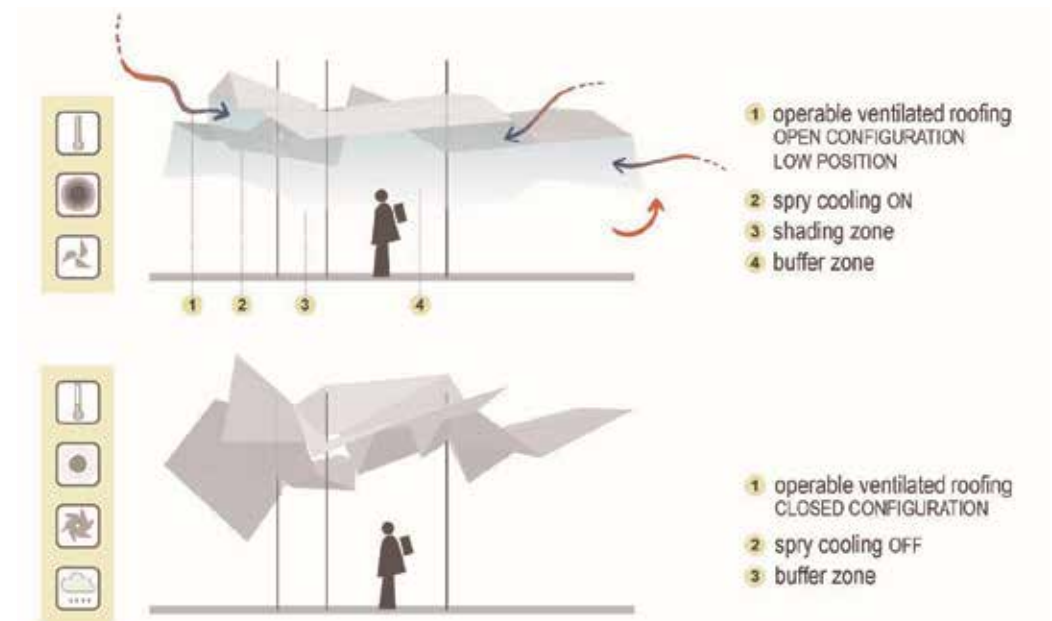

Fig. 4 Dune: microclimate control strategies.

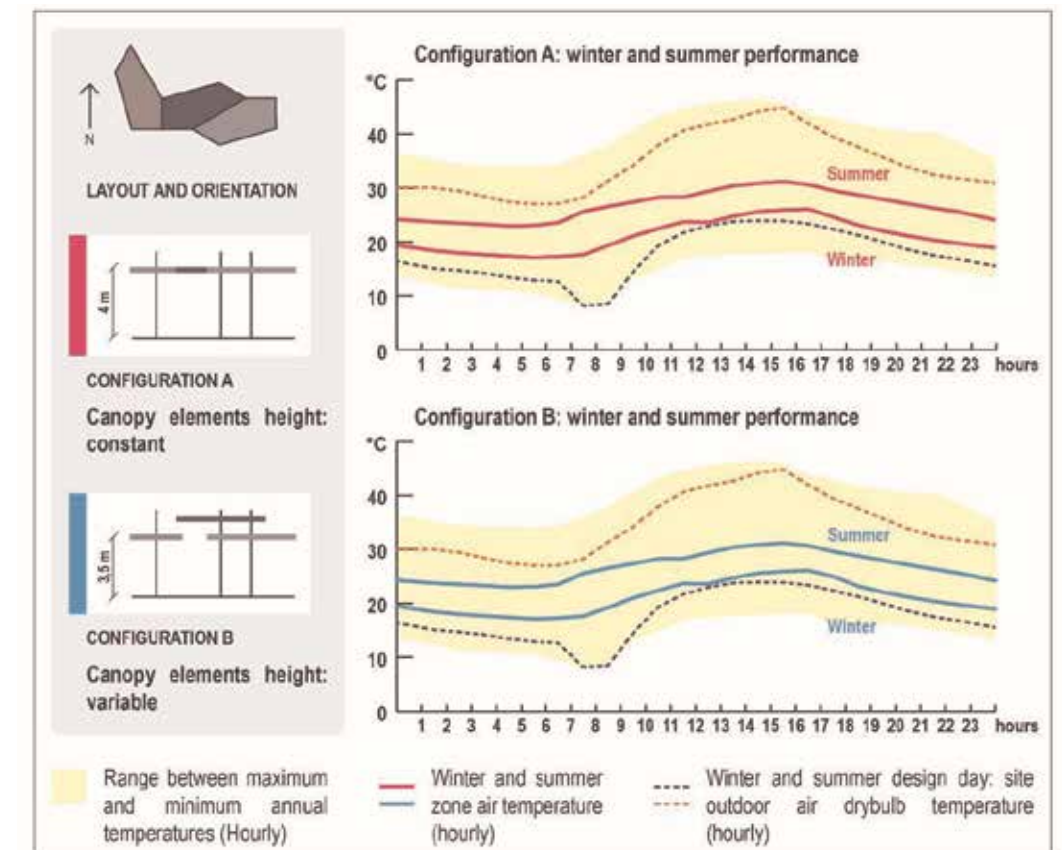

Fig. 5 Dune: winter and summer performance of configuration A and B (Zone Air Temperature_hourly)

3.4. Adaptable materials

In this step different ways to generate, transfer and control movement within adaptive components have been investigated, in relation to technological system, transformation actuator and material chances. The design generation process has been inspired by a 3D folding panels system. Due to the great amount of direct sun exposure in the context of study throughout the year, a photovoltaic layer combined with rigid panels' technology could drive the system and provide energy to carry out the activities of electronic devices charging, digital screen for information, etc. Movement could be achieved through cables and pulleys or a piston system. In the same way, the users, whom become more actively engaged in the control process, could directly actuate movement or this can be integrally scheduled by an automated system.

Nevertheless, the hot arid climatic region shows great disparity in terms of wealth and development. Thus, the choice of a specific technologies and materials may not be appropriate to the socio-cultural conditions where the system could be implemented. In addition, the use of local and more sustainable technologies should receive increasing attention. Thus, given the essential conditions of lightness, easy transportability, dismantling and speed installation, the challenge is to explore potential compromises between available materials and resources, new technologies and traditional craft.

Figure 6 shows the simulation results obtained using different materials for the canopy elements. Three possibilities have been analysed: wooden panels with a 13 mm thickness, polyester fabric (prestressed textile panels) and wooden panel (13 mm) with a reflective membrane on the outside. The three solution has shown a similar performance during the winter design day. When outdoor temperatures do not exceed 20°C, the structure mitigates the zone temperature preventing heat losses. An overheating condition could occur between 12:00 and 17:00 in the design options involving wooden panels. During the summer period, the use of a fabric material with a certain level of reflectance seems to have the best performance, keeping the temperature of the pavilion zone constantly below the outside temperature.

4 Conclusion

The design generation process documented in this paper aims to delineate an approach to the project that, through the analysis of the climatic, cultural and socio-economic context of a specific region, is able to propose affordable and novel architectural solutions. The proposed solution mainly aims at providing adequate outdoor space usability conditions, respecting the principles of environmental sustainability. Long and medium-term transformability and transportability, short-term flexibility of use and performance, and implementation of new technologies and local materials are the attributes that provide the component with adaptation capacity. Thus, through the adaptability requirements, the proposal seeks to respond to the principles of environmental and economic sustainability. At the same time, the design aims to respond to a cultural imaginary: large umbrella structures have been already used for shading outdoor spaces in Arabic countries in successful projects, as the umbrellas shading the two large courts of the Prophet's Holy Mosque in Madinah (1992) by SL-Rasch GmbH. It is necessary to underline finally that some of the strategies and the hypothesis adopted in this process need to be tested, and their results quantified in the following phases of the design process.

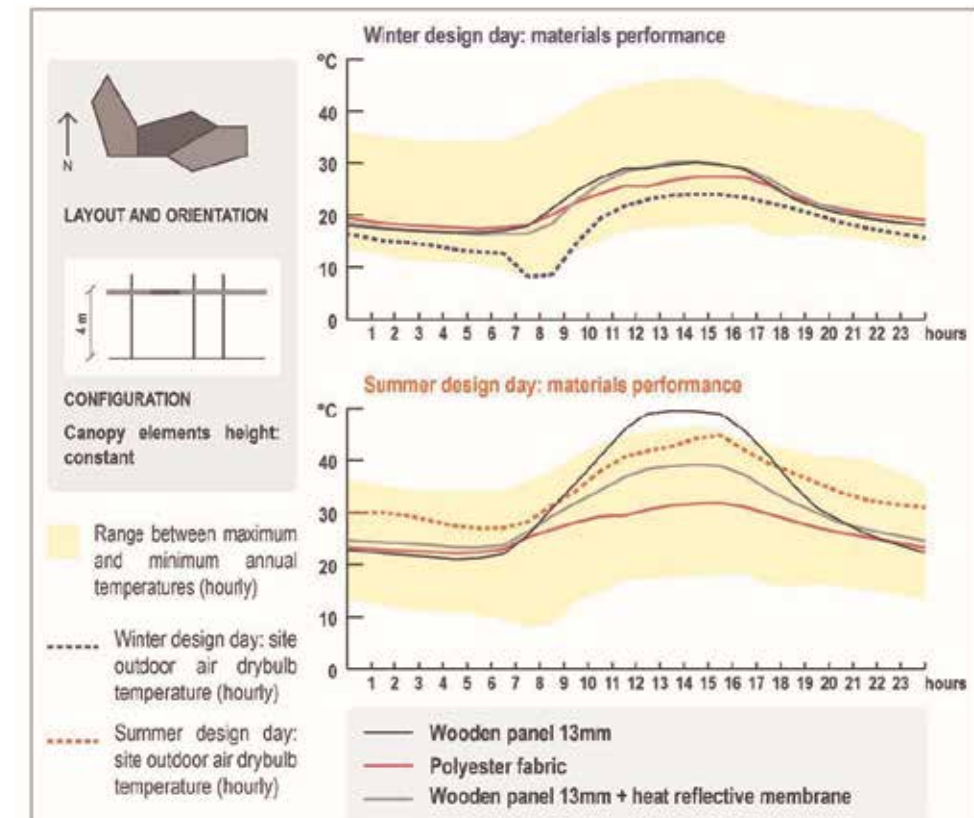

Fig. 6 Material options performance (Zone Air Temperature_hourly)

5 References

- Djongyang N, Tchinda R, Njomo D. Thermal comfort: A review paper. *Renew Sustain Energy* (2010). doi:10.1016/j.rsener.2010.07.040.
- Huang, C., Ye, D., Zhao, H., Liang, T., Lin, Z., Yin, H., & Yang, Y. The research and application of spray cooling technology in Shanghai Expo. *Applied Thermal Engineering*, 31, 17–18 (2011)
- Japan Refrigeration and Air Conditioning Industry Association (JRAIA). *World air conditioner demand by region* (2017).
- Kwong QJ, Adam NM, Sahari BB. Thermal comfort assessment and potential for energy efficiency enhancement in modern tropical buildings: A review. *Energy Build* (2014). doi:10.1016/j.enbuild.2013.09.034.
- Megahed, N. A. Understanding kinetic architecture: typology, classification, and design strategy. *Architectural Engineering and Design Management*, 13, 130–146 (2017)
- Nicosia, E. Le esposizioni universali: mercati globali tra riqualificazione e innovazione. *Milano 2015 un esmpio vincente?* AGEI-Geotema, 38 (2015)
- Rodríguez Stevenson, C. M., & D'Alessandro, M. Everyday interactive-kinetic environments: Examples in Latin America. *Proceedings of the 9th International Conference on Design and Emotion 2014: The Colors of Care*, Bogotá, Colombia (2014)
- Rodríguez Stevenson, C. M. & D'Alessandro, M. Climate and Context Adaptive Building Skins for Tropical Climates: a review centred on the context of Colombia. *Proceedings of the 9th Energy Forum on Advanced Building Skins 2014*, Bressanone, Italia (2014)
- Graham, P. Design for Adaptability: An introduction to the principles and basic strategies. In *The Environmental Design Guide GEN 66*. Royal Australian Institute of Architects (2005)

Parametric nodes from idea to realization

Alamir Mohsen, Ulrich Knaack

Institute of Structural Mechanics and Design, Germany, mohsen@ismd.tu-darmstadt.de

The radical change in architectural design transcends the individuality of design towards multi-various individuation. The immersion of parametric diagrams in the representation of architectural objects leads into a process that could be grasped and manipulated with a high degree of efficiency. Computational advanced design techniques are becoming necessary; therefore new techniques need to be implemented to work on retooling the traditional ways of manufacturing elements. To formulate the problem; Architects, façade engineers and manufacturers need a speculated new solutions and be their liaison for collaboration. Complex designs driven out of parametric potentials are characterized by the various angles and inclinations that form the mullions/sub-construction, which forms the desirable design. Accordingly, having a flexible connection that can provide a full range of proper angles, is requisite. Additive manufacturing also is known as 3D printing, is based on the theory that any object could be synthesized by breaking it down to multilayers that are needed to be laid at the top of each other to form the final object. Metal- Based additive manufacturing has significant growth in the last couple of years, based on the advantages that AM offers, which is producing complex 3D objects directed from CAD data without the need for that careful and detailed analysis that is needed by the other manufacturing processes. A unique collaboration between architects, façade engineers and manufacturers could be achieved by following a whole new aspect, which is how to move from Design to Production. The merge between design and manufacturing could revolutionize the building process of complex buildings. Moreover, the elimination of several constraints, which usually show up in the planning phases. Additively manufactured parts still need some verification to reach the level that the market and the user can accept and trust.

Keywords: Parametric, Nodes, Free-form, Additive manufacturing, Adaptive solutions

1 Introduction

New parametric design software tools nowadays, provide architects with unlimited possibilities to explore the unlimited potential of their creative vision. Accordingly, the design and engineering process of such sophisticated geometries became more complicated. This complexity placed façade planners and manufacturers in a challenging position as they are subjected to an exhaustive negotiation process with the architects in the process. The results of these negotiations are facing either rejection or reverting to individualization. Thus the final results can be costly most of the time. According to the evolvement of parametric software that the architects benefited from, façade planners and manufacturers need a similar mechanism that helps them to cope with these developments.

This paper is dedicated to the exploration of the design and engineering process of single-layered shells. Concerning economic aspects, single-layered shells consist of straight connecting bars, planar glass surfaces, and connecting nodes. Based on that description, the primary challenge is the design and engineering of the connected nodes. The main idea of industrial construction is the standardization of systems and products arbitrarily. This standardization aims to the increase of economic efficiency of the produced elements; through the developments of merely assembled and standard building parts. (Wachsmann 1959, Mengeringhausen 1966)

The trend in architectural design and façade technology is the increase in complexity. Baccarini stated in his review in the International Journal of Project Management “ Construction projects are invariably complex and since World War II have become progressively more so” (Baccarini 1996). Complex projects demand special treatment, therefore that traditional project management found inadequate. Hough claimed, “complex projects demand an exceptional level of management, and that the application of conventional systems developed for ordinary projects have been found to be inappropriate for complex projects.”(Morris and Hough 1987)

Project complexity has no precise definition. Different papers have discussed the definition of project complexity. It is concluded that project complexity defined by two dimensions, each of which has two sub-dimensions, Fig.01. (Williams 1999)

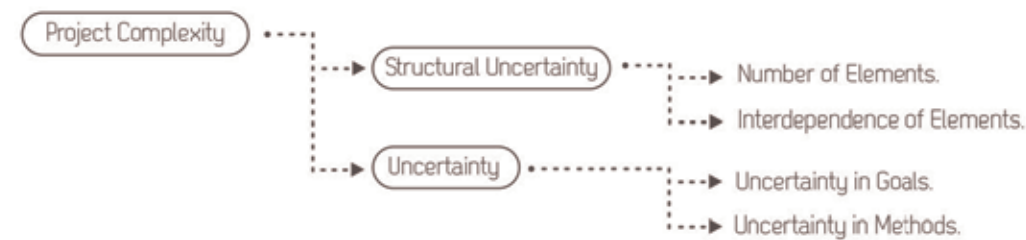

Fig. 1 The dimensions of Project complexity

The complexity of the requested geometry defines the structural uncertainty of the project. The increase in number and interdependency of the elements –e.g., connecting bars and surfaces- bring the planning process towards additional processes that cost time and money. The uncertainty in goals and methods comes through the post- processing of customized building parts, which requests additional testing and proofing.

Computational design has evolved immensely over the past few years and has been effectively used in designing complex geometries. However, constructing these geometries remains a challenge. Computational design has the potential to generate and optimize parts of complex geometries unrelated to its level of complexity.

Construction technologies do not develop as quickly or coordinated as Computational design tools. Accordingly, an adequate solution is needed to fill the gap between construction technologies and detailed geometric design, and to move forward towards a more homogenous design and engineering process.

2 Methodology

Free-form envelopes are transformed into free-form structural network. This structural network is made out of straight bars that have to be connected to one another through structurally designed and force-fitted connections. These connections are the node points, which form the required geometry and ease the orientation and the assembly of the connecting bars. The generation of these components can be parametrically designed using decent software, e.g. Rhinoceros© and grasshopper. This means that any geometry can be translated into its three main components – bars, surfaces, and nodes -. Complex geometries characterize by the various angles and inclinations, which the mullions/sub-construction have; to achieve the desired design. As a result, having a flexible connection that can provide a full range of proper angles is requested.

The idea of a universal node is still not been achieved, but many interested parties are working on the idea. Geometrical conditions and structure integrity define the design of nodes. Nodes connections are bolted, welded or specially fabricated. Each building regulation prefers a specific type of connection. The regularity of the structure determines the geometry of the nodes that determine the suitable fabrication technique, such as casting, extrusion, folding, special working and so forth. As well, the digital representation of the nodes in the parametric design phase, is sufficient for additive manufacturing techniques to manufacture the nodes.

Standardization, as defined in the business dictionary, means “Formulation, publication, and implementation of guidelines, rules, and specifications for common and repeated use, aimed at achieving the optimum degree of order or uniformity in a given context, disciplines, or field” (standardization 2018). Accordingly, designing a unique node connection – either part or process - that has the capability of being standardized and the flexibility to be applied to many geometries, will be the objective.

3 Design Development

3.1. Engineering Design

“Form follows function” has been the banner of designers since the Bauhaus (Lesko 2007). Based on that statement, the central concept is that function lead the form. Accordingly, the form position is lowered in the hierarchy of product design.

“Restated, it might read ‘Form is the resolution of functions’ where the function has two major components: (1) performance specification demands, including all user-friendly aspects, and (2) cost and manufacturability” (Lesko 2007)

The statement “Form is the resolution of functions” gives the form its dynamic and interactive properties, rather than “Form follows function”, which showed the form as a passive party in the process. As a result, the designer has to observe manufacturability and its influence.

3.2. Parametric software programs

Drawings express architectural designs. The drawing medium is the primary constraint for drawing acts and organizing ideas, spaces, functions, and so forth. CAD software introduces a new definition for the drawing medium, which is the direct translation of drawings within the digital realm. Those drawings still just a digital representation (code) of the main ideas. The code creates geometry as a result, and this is direct Modeling, which presents the additive logic of traditional drawings.

Parametric as a term is related to various disciplines from mathematics to design. The term means using parameters to define range. Parametric in design refers to the use of parametric modeling, where parameters define the geometric rules and result in geometrical form. This form is controlled through algorithm, which could be changed through the defined parameters.

Algorithmic is a term that defined by the use of procedural techniques to solve design problems. An algorithm is a set of instructions that lead the design process. Codes instead of sketches and forms drive the design process here. These allow the usage of the power of computer programming languages, where the capacity of computers is operated as a search engine to allow difficult tasks to be performed in a small amount of time. Patrick Schumacher claims “the goal of parametric

design is to establish a complex spatial order, using scripting to differentiate and correlate all elements and subsystems of design” (Schumacher 2009).

3.3. Traditional manufacturing processes

The commonly used materials in façade industry are steel, stainless steel, timber, PVC and aluminum. Each kind of material has its suitable manufacturing and handling techniques.

For example, when metal forming is discussed, casting processes – such as expendable molds, nonexpendable molds, die casting – are commonly used. Also, there are machining processes - such as drill, bore, mill, lathe, broach, and grinding (Lesko 2007).

In the façade industry, the used material defines the needed manufacturing technique and its process planning. In the case of complex projects, the traditional manufacturing techniques become inadequate. Accordingly searching for new or innovative solutions are required.

3.4. Additive manufacturing – 3D printing

Additive manufacturing is a process that is steered by the power of virtual 3D CAD data. This CAD data is transformed into layers, where the parts are made by adding these layers at the top of each other to form the final object (Gibson 2010).

The 3d printing process consists of several steps. These steps are as follows, Fig.02:

- Creating a digital model that defines the geometry’s external surface.
- Exporting the targeted model in STL (stereolithography) format; this is suitable for nearly all AM technologies.
- Importing the STL file to the 3D printer’s software - if provided- considering that each 3D printer may have its way to manipulate digital data and generate the appropriate G-code that is needed to run the 3D printer.
- The printing process starts after receiving the data generated by the step before.
- Creating the final model, which in some instances will require post-processing to finalize and prepare for end-use.

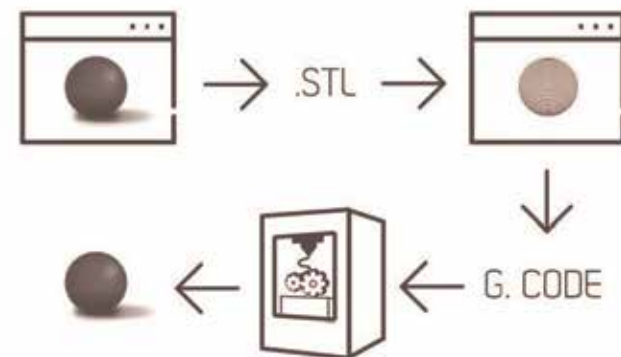

Fig. 2 3D printing steps

Additive manufacturing contains several techniques, which all used to help the generation of complex three- dimensional objects. Some of these techniques are extrusion and sintering-based

processes. Each technique has its limitations and capabilities, which should be accurately observed to accommodate the purpose and the usage of the generated object (Knaack 2016).

Selective Laser Sintering (SLS) and Selective Laser Melting (SLM) are the leading technologies that handle metals in the additive manufacturing method. Both technologies offer considerable possibilities to manufacture metal complex parts that can be beneficial for façade industry.

4 Solutions

The research generated Two generations of connecting elements, called N-AM 1st generation and N-AM 2nd generation. In the first generation, the idea was to define a solution that is represented as the connecting node with an irregular number of connecting bars. Rhinoceros© and grasshopper were used to parametrically define the location of the node inside the structure and accordingly define the exact profiles’ lengths. The node was defined as a free hinge connection until it finds its perfect place related to the connecting profile and the whole form. The node design was intended to be traditionally manufactured, which affected the design because of its limitations but for economic reasons; traditional manufacturing techniques were adequate at that time of the research.

In the second generation, the idea is to define the connection node as a digital volume that is completely form related, which offers more freedom but as well as increase the range of node forms and its complexity. The size of the node can be defined based on its structural performance in the used case. The nodes can be directly manufactured by additive manufacturing machines, which help to reduce the process planning for the customized nodes.

4.1. N-AM 1st Generation

The spherical shape is round geometry in the three-dimensional space. Therefore, any object runs parallel to the surface of a sphere, could have complete freedom in the X, Y and Z planes. Moving from this point, having a ball connection embedded in a façade node connection, will be sufficient to provide enough freedom for the nodes’ connecting arms. Based on the shape of the node, the inclination range could be defined. Several designs had been developed to achieve the maximum range of inclination that increases the range, where the node could be applied. As well the node should proof structural stability.

N-AM 01



Fig. 3 N-AM 01 Model

N-AM 01, Fig.03, consists of a rectangular plate that is connected to four spherical housings at each corner. The spherical housing contains a ball connected to insertion profile through metal stud. The arms of the node have 360° rotation around itself and $\pm 25^\circ$ in every other direction.

N-AM 01 could be used as an attachment to the main structure. A bracket then needs to be used to accommodate the structure tolerances. It could be fixed as a free point, putting particular attention on the subjected loads and adopting its size accordingly.

N-AM 04



Fig. 4 N-AM 04 Model

N-AM 04, Fig.04, consists of a metal plate connected to four balls at each corner. The insertion profiles have to be integrated with the node that they contain the housing of the balls at the same time.

N-AM 04 prototype presented 360° rotation along the insertions' axes and $\pm 45^\circ$ in every other plane. N-AM 05



Fig. 5 N-AM 05 Model

In N-AM 05, Fig.05, the distance between the center of the balls and the top side of the node, is decreased to lower the eccentricity. Accordingly, the location of the kern is raised, which gives more control over the connecting planes.

This modification allowed widening the range of freedom with about 10°.

The functionality had been checked by parametrically positioning the node in a façade element and observing different scenarios. These scenarios defined the maximum range for the nodes, Fig. 06-right. The design of the node considered traditional manufacturing techniques limitations. To study the structural performance of the nodes, a design for façade element was suggested and analyzed under the common load conditions that affect building envelopes, Fig. 06-left, such as own weight, wind load and so forth.

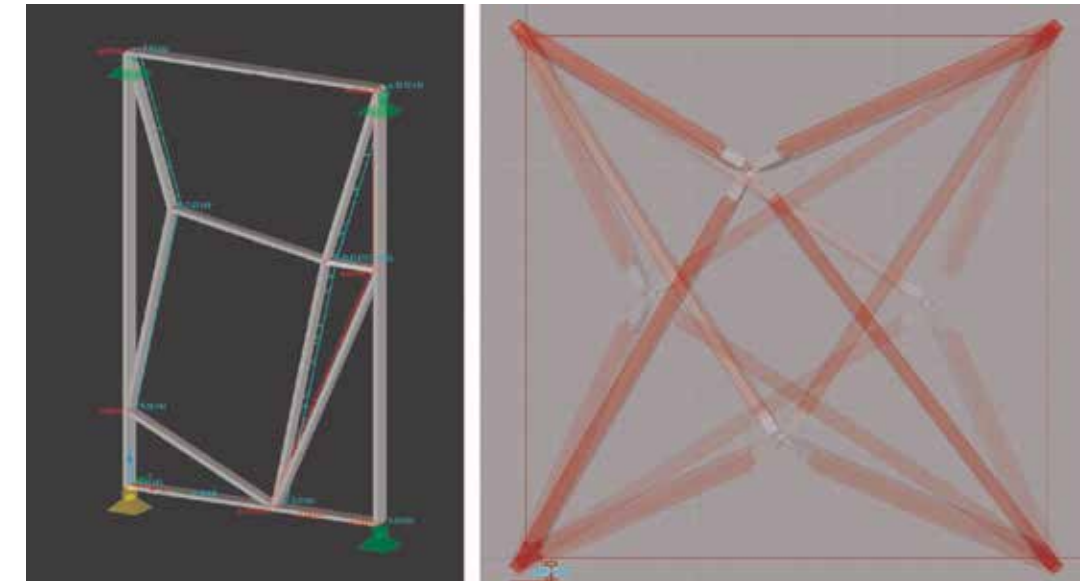

Fig. 6 Node different positioning scenarios

The structural integrity had been verified by finite element analysis to predict the behavior of the nodes. Figure 7 and 8 shows the stress analysis of the node that is connected to three bars. The load case was extracted from the analyzed model.

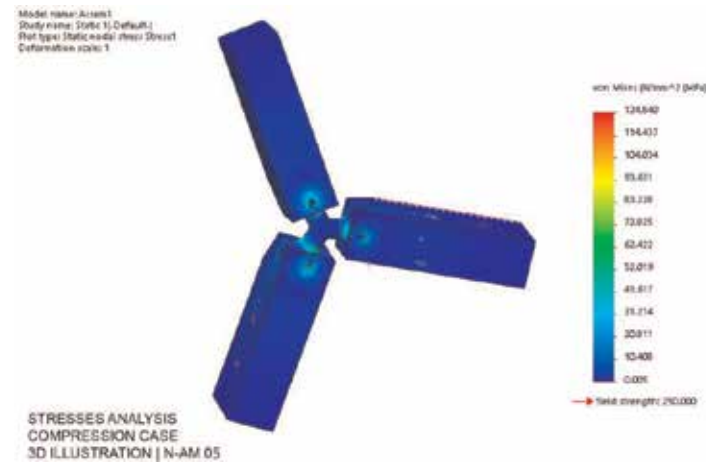

Fig. 7 Stress analysis – Compression case

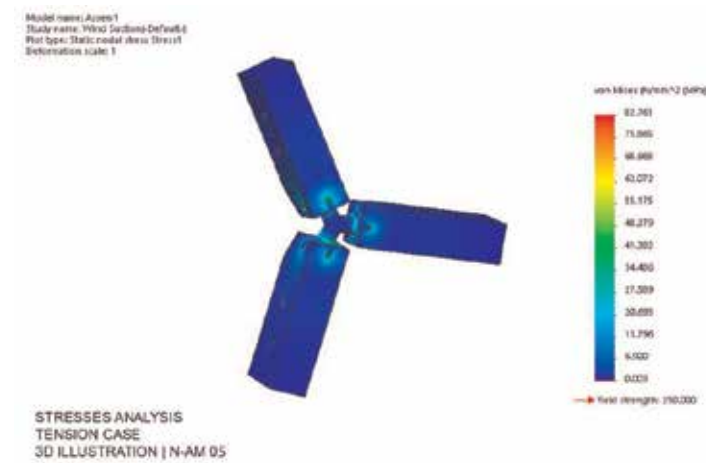

Fig. 8 Stress analysis – Tension case

The rotation caused by the ball connection is locked by screws when the required angles are achieved.

4.2. N-AM 2nd Generation

The 2nd generation idea was released from the traditional manufacturing techniques, and at this point, additive manufacturing and parametric design were used solely to move the nodes from design to physical product. The idea of the 2nd generation is to parametrically generate the node as a volume and use additive manufacturing to manufacture that volume. Additive manufacturing is considered costly in comparison to traditional manufacturing techniques. As a result, topology optimization has been investigated as a cost reduction factor.

In the field of topology optimization, there are prominent algorithms, e.g., Solid Isotropic Material with Penalization (SIMP). Its stress criterion should be as simple as possible, e.g. the stiffness density relation. The 0-1 formulation is a function called density and associated with the design domain on each element in the finite element formulation. The density of 0 and 1 is viewed as solid and void material (Bendsone 2003).

N-AM 10 was the first generated prototype that utilized the aspects mentioned above. The node printed in Stainless steel GP1 using EOSINT M270 machine. The node consists of 4 arms. Each

arm is subjected to tension forces after the analysis; the areas subjected to less stress were diminished.



Fig. 9 N-AM 10 Model

The investigation started with analyzing irregular forms and the digital generation of the connecting nodes. Therefore, Voronoi diagrams were used to divide a free-form surface. Voronoi is called after the mathematician Georgi Feodosijewitsch Voronoi. It encodes proximity information to help find closest objects to certain points rather than others (Okabe 2000). Voronoi based façade was developed to come up with the lightest structure possible using the Voronoi tessellation rules.



Fig. 10 Voronoi Façade

The nodes were generated using Rhinoceros© and optimized using Solidthinking inspire. The kern of the node had been defined as the design space and made out of steel 355JR. Under the subjected loads that are extracted from

the structural analysis of the facade, the welded and bolted scenarios had been investigated to determine the effect of the connection art on the topology optimization process, in a matter of weight reduction that is resulted from its effect on additive manufacturing costs.

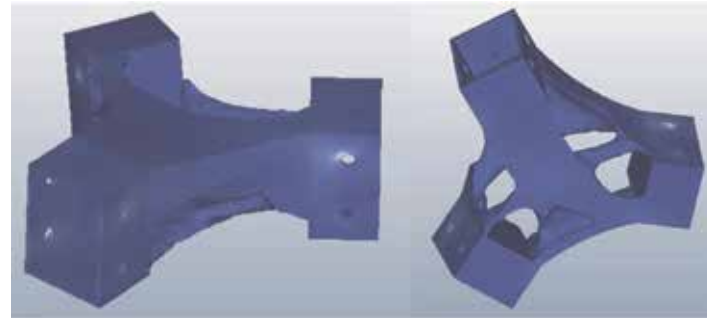

Fig. 11 Bolted node

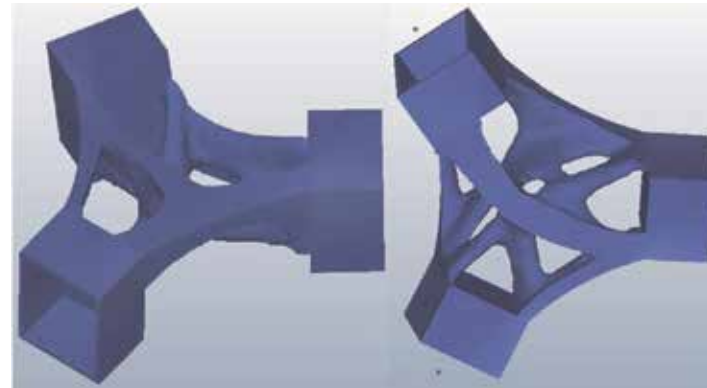

Fig. 12 Welded node

Figure 11 and 12 show a slight change in the generated volume, which provides that connection art can be a factor that affects production costs of additively manufactured connections.

The 1st generation achieved good results reaching a point that approved that having a parametric node is conceivable. The challenge occurred, when the basic shape of the façade element does not form regular geometrical forms. The kernel of the node could not be accommodated because of the irregularities that showed up inside the façade element. Accordingly, a mind-shifting strategy represented by the 2nd generation, had to be followed to overcome these limitations. The strategy is to use additive manufacturing and parametric design solely for the generation of the nodes. Accordingly, additive manufacturing has to be carefully investigated to define its controlling parameters, such as material properties and geometrical limitations, and parametric design has to form the digital generation process that has to be subject to further investigations and developments, such as covering more extensive range of geometrical conditions, and merging topology optimization and structural analysis to the digital generation process.

5 Summary

A middle ground between architects, façade planners, and manufacturer; needs to be achieved. This will keep the compromises to a minimum and will grant a smooth transition from the design phase to the construction phase. This middle ground is achieved through the integration of different planning software and different digital manufacturing techniques. The power of parametric design is increasing, and the gap between design and construction is getting bigger. A new product/system is needed to fill this gap and create a symbiotic relationship. This product/system has to respect the increase of complexity and to try to accommodate these challenges.

With the tendency to have more transparent structures and complex geometries, single layered shells gained more interest. These shells are transformed into straight connecting bars, straight surfaces, and connecting nodes. There is no universal solution for the connecting nodes so far, but many architects, façade planners and façade manufacturers are competing to offer different connecting solutions to the market. 1st generation represented the merge between parametric design and traditional manufacturing techniques to follow a trusted process planning. The results offered an adaptive nodal solution, yet it was geometrically limited to uniform façade elements. 2nd generation represents the merge between parametric design and additive manufacturing, eliminating process planning from the whole process, and widen the geometrical conditions that could be manufactured. The parametric planning is defined through; geometric design parameters – such as form, complexity, and variation of connecting angles-, structural design parameters- such as material properties-, and manufacturing parameters – such as size of the printer and printing angles limitations-.

The search for a parametric node that can ease the design and engineering process of complex façade constructions, is feasible. Many factors need to be investigated to complete the concept. These factors are defined through the whole process of parametric planning and additive manufacturing. For parametric design concept, integrating different façade functions – such as drainage channels and fixation method- is important, as well the relationship between topology optimization, structural analysis, and material properties. This relation introduces material testing to the additive manufactured parts to get more understanding concerning the material behavior. Design for manufacture is the factor that will convert the manufacturing limitations as parameters to improve the digital representation of the nodes. Once these factors are investigated a planning concept for complex geometries can be formulated and with the further development of additive manufacturing technology and parametric solutions, the concept can be further developed.

6 References

- Baccarini, D. (1996) The concept of project complexity – a review " International journal of project management", 201-204.
- Bendsoe, M. P., Sigmund, O., (2003) Topology optimization | Theory, Methods and Application. Springer.
- Gibson, I. Rosen, D.W. Stucker, B., (2010) Additive Manufacturing Technologies | Rapid Prototyping to Direct Digital Manufacturing. Springer.
- Lesko, j. (2007). Industrial design – materials and manufacturing guide. WILEY, New Jersey.
- Morris, P. W. and Hough G. H. (1987). The anatomy of major projects: A study of the reality of project management.
- Okabe, A., Boots, B., Sugihara, K. and Chiu, S. N. (2000) Spatial Tessellations-Concepts and Applications of Voronoi Diagrams. WILEY.
- Schumacher, P. (2009) <http://www.patrikschumacher.com/Texts/Parametric%20Patterns.html> . Accessed 11 May 2018.
- standardization. BusinessDictionary.com. WebFinance,Inc. (2018). <http://www.businessdictionary.com/definition/standardization.html> . Accessed 11 May 2018.
- Knaack, U., De Witte, D., Mohsen A., Tessman, O., Bilow, M., (2017) Rapids 2.0, imagine 10. nai010.
- Mengerhausen, M. (1966). Kompositionslehre räumlicher Stab-Fachwerke. The International Conference on Space Structures. Surrey: Blackwell Scientific Publications.
- Morris, P. W. and G. H. Hough (1987). "The anatomy of major projects: A study of the reality of project management."
- Wachsmann, K. (1959). Wendepunkt im Bauen, Krausskopf-Verlag.
- Williams, T. M. (1999). "The need for new paradigms for complex projects." International journal of project management 17(5): 269-273.

Development of an adaptive shading device based on flexible structural elements and SMA springs

Gianluca Ranzi a), Francesco Fiorito b), Osvaldo Vallati a)

a) The University of Sydney, Australia
b) Politecnico di Bari, Italy

This paper presents the initial development of an adaptive shading device whose morphing capabilities are provided by combining shape memory alloy (SMA) springs with flexible structural components. With this arrangement, the shading device moves from an initial configuration to a deformed shape by means of an actuation provided (through heating) by the SMA springs. The 'cool' reference shape of the device is defined by the deformability of the structural components and of the SMA springs. Once the SMA springs are heated, they shorten and induce elastic deformations in the structural components. The consequent change in shape is mainly produced by the flexural deformations that occur along the thin-walled components. The particularity of the proposed system is that, upon cooling of the SMA springs, the shading device returns to its 'cool' configuration by releasing the flexural elastic strain stored in the deformed conditions. After introducing the basic morphing component, the proposed shading device is presented followed by its possible applications on a building envelope.

Keywords: Adaptive shading device, thin-walled structural components, SMA springs

1 Introduction

There is an increasing interest in the construction industry at enhancing the performance of buildings that, in some cases, has the potentials to lead to higher investment returns and increased productivity of occupants (Fuerst and McAllister 2011; Reichardt et al. 2012). Distinctive performance attributes of buildings include, among the others, energy conservation, environment, safety, security, durability, accessibility, cost-benefit, productivity, sustainability, functionality and operational considerations. Extensive research is underway in different disciplines to enhance these performance attributes. Most of this effort has been dedicated to minimising energy consumption, which is particularly important in countries like Australia where modern building facades are characterised by floor-to-ceiling glazing, leading to onerous energy consumption by heating, ventilation and air-conditioning (HVAC) systems. Alternative ventilation strategies are gaining popularity in Australia, including natural ventilation and chilled-water approaches. A specific area of research, relevant to this paper, focuses on typologies of shading devices that undergo morphing to influence the daylighting availability of a particular space by engaging their structural flexibility. With this approach, structural phenomena that are conventionally avoided, such as lateral and distortional buckling, could be exploited to achieve new elegant and fascinating functional forms for shading components by developing new technologies that engage and manipulate the structural stiffness. The potential of this reversed approach has been applied and reported in the literature, for example in the Flectofin® concept described in (Lienhard et al. 2011). Morphing and adaptive techniques have been extensively applied to mechanical engineering, with particular focus on aircraft and space structures, e.g. (Barbarino et al. 2011; Luo and Tong 2013; Golabachi and Guest 2009; Balkcom et al. 2004; Miura 2009), while only limited work has been carried out

for building applications, e.g. (Del Grosso and Basso 2010; Khoo et al. 2011). Morphing building skins have been suggested for modifying the building skin roughness to facilitate natural ventilation, e.g. (Lignarolo et al. 2011; Teuffel 2011), and reducing the mechanical operations of responsive architectural skins, e.g. (Kirkegaard et al. 2011; Fiorito et al. 2016). Likewise, a morphing air inlet device has been developed to control the air flow used for the natural ventilation of a building (Daynes et al. 2011). Morphing structural systems have also been employed to reduce the weight and improve the efficiency of structures (Sobek 2006). When dealing with light-weight structures, tensegrity structures are often preferred due to their natural ability to change shape when stress conditions vary in the tensile members, e.g. (Buckminster Fuller 1978; Skelton and Aliverira 2009; d'Estree Sterk 2006).

The overarching objective of this research is to develop and optimize an hingeless lightweight solar shading component capable of morphing its shape, by adopting, in its simplest implementation, two stable configurations – linear and curved – as a function of induced temperature change. In this context we propose to combine the use of shape memory alloy (SMA) springs with the flexibility of thin-walled components (Ranzi et al. 2018). The actuation of the SMA spring is carried out by heating the spring through the application of electrical current. In this manner, the proposed solution undergoes morphing by the actuation (i.e. heating) of SMA springs that, by contracting, induce flexural deformations in the thin-walled elements. Upon cooling of the SMA springs, the shading device returns to its original configuration by releasing the flexural elastic strain stored in the morphed (deformed) condition. This paper presents the initial prototyping that has been carried out to identify simple and practical detailing related to the fabrication and assembling of the thin-walled components and how these connect to the SMA springs, and to gain insight into the morphing process exhibited by the prototypes. Work currently underway is aiming at the optimization of the shape-morphing solar shading by considering several configurations of SMA springs and flexible thin-walled metal modules to minimize the ratio between required actuation force and overall deformation, while guaranteeing the stability of the shading under its own weight. In the first part of the paper key features of this solution are outlined, together with initial tests carried out on laboratory prototypes. In the second part of the paper the proposed shading device is presented, followed by an outline of how the device could be used on a building envelope.

2 Key components of the basic morphing module

The proposed shading device has been conceived as a modular system in which components can be added and removed depending on the shading requirements. For clarity, the basic module of the system is depicted in Figure 1 without the smart memory alloy (SMA) spring and consists of a 1.1 mm thick thin-walled galvanized steel element cut using a water jet cutter and deformed by hand into its final layout. The holes included in the upper part of the module, e.g. eight holes in Figure 1b, enable different basic components to be bolted to each other at constant or varying inclinations between adjacent modules.

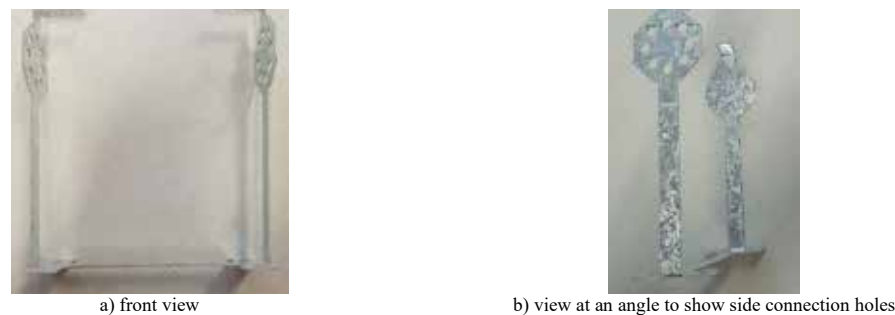

Figure 1: Example of the basic morphing module

The SMA springs consist of NiTi tension springs made from 750 μm diameter wire. The SMA is activated in the temperature range of 55°C 85°C. In its 'cool' condition the spring can elongate to a maximum length of about 140 mm, while when heated it contracts to a length of 29 mm. For the purpose of this study, the activation of the SMA spring is performed by generating heat by means of an electrical current applied through the spring.

The SMA spring is inserted near the top part of the module as depicted in Figure 2a. The 'undeformed' configuration is defined by the deformability of the structural component and of the SMA spring in its 'cool' state. Upon application of the electrical current, the SMA heats up and, consequently, contracts. The consequent change in shape is produced by the flexural deformations that occur along the thin-walled component and the resultant 'deformed' shape is illustrated in Figure 2b. Upon cooling of the SMA spring, the shading device returns to its initial undeformed configuration by releasing the flexural elastic strain stored in the deformed conditions.

For the purpose of this study, it is envisaged that also in a building installation the SMA of the proposed shading device would be activated through the heating generated by electrical current running through the spring. With such a setup, the main advantage of proposed adaptive solution is to avoid the use of mechanical components that might lead to high maintenance costs.

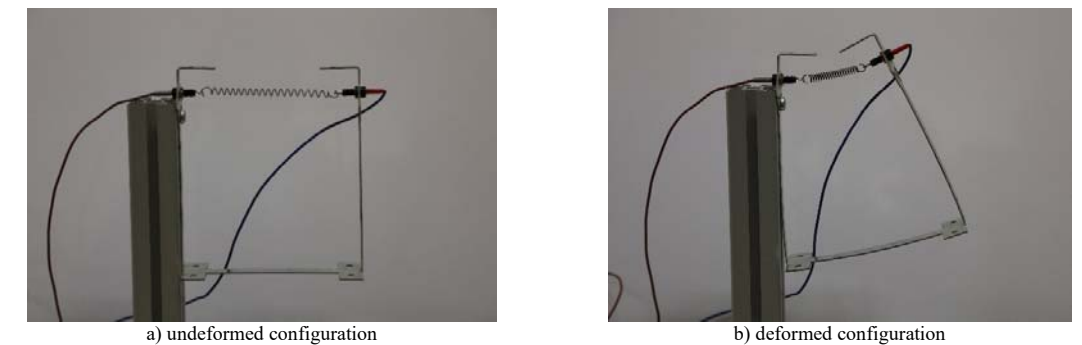

Figure 2: Overview of the morphing of the basic module

Different module arrangements were investigated during the prototyping of the device aimed at identifying available morphing capabilities and at gaining insight into how these were influenced by the geometry and shapes of the thin-walled module. For example, by maintaining the same cross-sectional geometry of the metal element, the use of a waved-shape pattern for the bottom horizontal element (instead of the flat horizontal element shown in Figure 2) increased the flexibility of the module and increased the curvature achieved by the same SMA spring. Such a module is illustrated in its deformed state in Figure 3.



Figure 3: Example of using a waved-shape layout for the bottom layer of the thin-walled module

3 Prototype of the shading device

The proposed shading device has been developed by concatenating basic modules (Figure 2) as shown in Figure 4 for a four-module device. In such an arrangement it is possible to activate individual or all SMA springs to achieve different morphing and shading effects. Other arrangements could be possible, for example, by combining different geometries of the modules and by changing the inclination of the modules along the length of the component that might lead to tapered profiles.

When dealing with different modules in a cantilever configuration (e.g. Figure 4), the self-weight of the system plays an important role in the ability of the device to return to its initial 'undeformed' configuration. To simplify the loading path and to ensure that the undeformed configuration remains unchanged between adjacent morphing cycles, a thin plastic strip has been attached to the top parts of the metal components as shown (with an orange strip) in Figure 4. In this manner, the top plastic layer acts as a tensile top chord when the device is deployed in the undeformed horizontal layout (e.g. Figure 4a).

The structural skeleton has been then covered with a flexible opaque lycra fabric, whose transparency modulates the shading properties of the device. The initial prototyping has been based on a shading solution with the fabric depicted in Figure 5. In the deformed shape, the fabric is supported by the plastic strips that enable the formation of the wave-pattern on the top side of the device, therefore avoiding the possible wrinkles that could form with the lycra when folded.

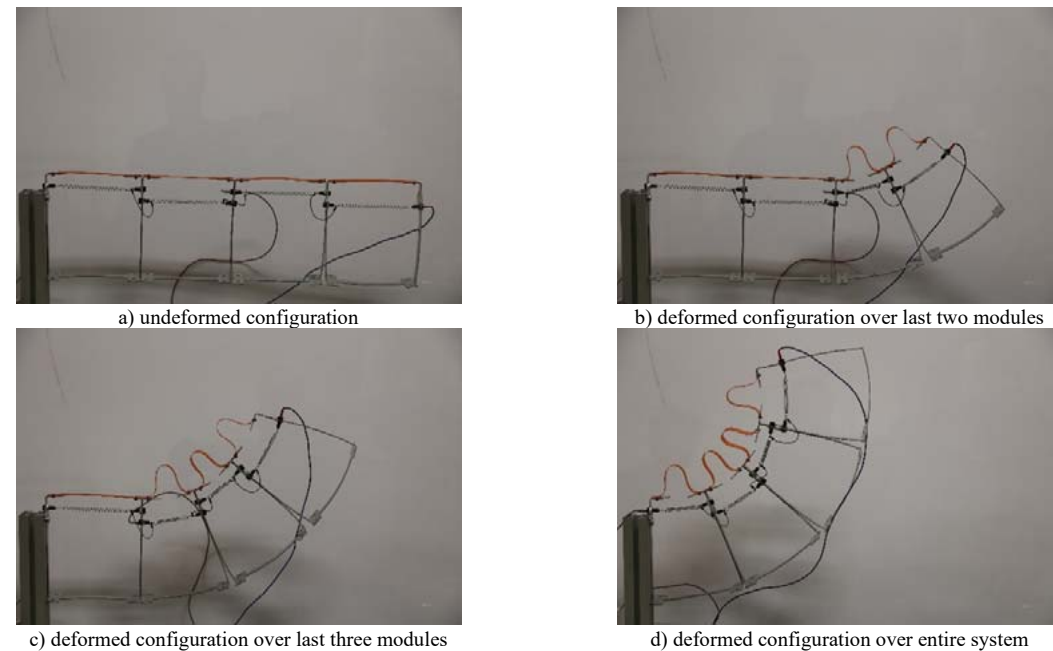

Figure 4: Example of a four-module morphing system when modifying the number of modules being deformed

A possible arrangement for the proposed shading prototype is illustrated in Figure 6 considering three parallel modular systems covered by a lycra fabric placed around the thin-metal skeleton. Upon activation of the SMA springs, the structural component is deformed to the morphed configuration shown in Figure 7. Upon cooling down of the SMA material, the system returns to its undeformed configuration as illustrated in Figure 8.



Figure 5: Four-module morphing system with a thin strip of shading fabric

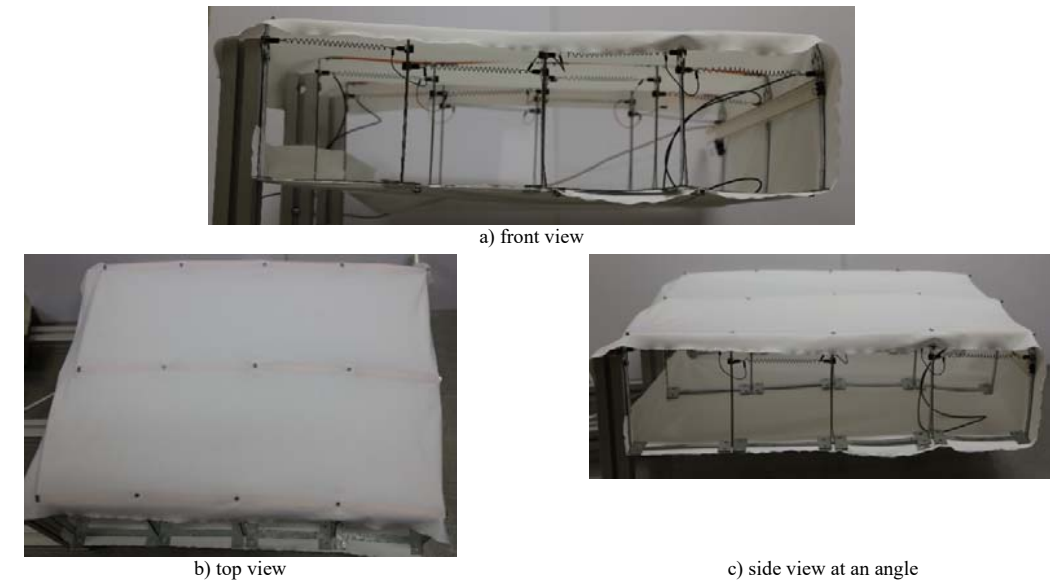

Figure 6: Shading prototype in its undeformed configuration



Figure 7: Shading prototype in its deformed configuration



Figure 8: Shading prototype after recovery of the initial undeformed configuration (i.e. after the morphing depicted in Figure 7)

4 Shading configurations on a building envelope

This section introduces selected shading configurations to highlight the possible applications of the proposed shading device on a building envelope. For this purpose, Figures 9-11 show the possible device configurations applied as an external shading of a conventional transparent building skin. While the shading device of Figures 9 and 10 are installed as single and independent components, the shading devices of Figure 11 are installed in a coupled arrangement and are able to obtain more complex movements and configurations.

In Figure 9 the undeformed configuration of the shading device is horizontal (Figure 9a). In its deformed state, it produces a concave up shape that can contribute to both shading and to an upward redirection of solar rays incident on the upper side of the device. This arrangement can be achieved with a shading device such as the one presented in Figures 6-8.

The shading layout of Figure 10 relies on an initial undeformed configuration based on a concave down geometry. In this case, two sets of SMA springs can be installed next to each other to achieve different deformed patterns by being activated at different temperatures. Gradually varying deformed profiles can also be obtained by individually activating different SMA springs placed in series as, for example, outlined in Figure 4 for a four-module solution. Overall, this arrangement allows for a better outdoor view factor that could be positively perceived by building occupants. The configuration presented in Figure 11 takes advantage of and combines the shading typologies previously introduced in Figures 9 and 10. This solution can produce the complete blinding of windows when the coupled devices are spaced so as to meet one another in the deformed profile.

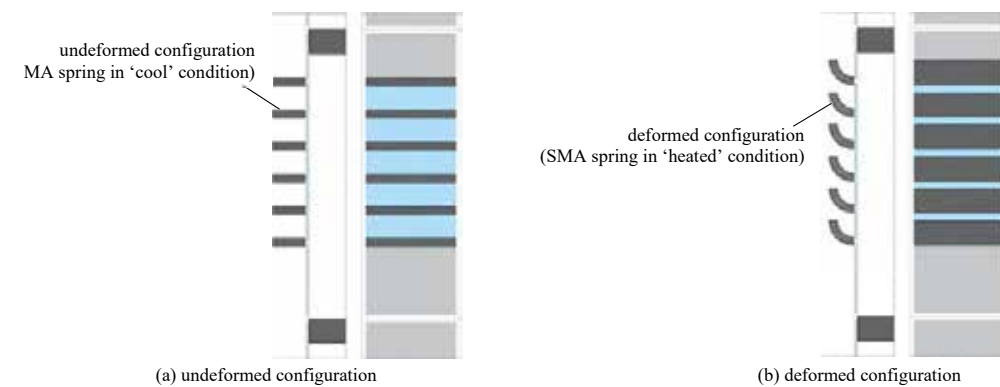

Figure 9: Side and front view of the shading installation with horizontal undeformed configuration and concave up deformed configuration

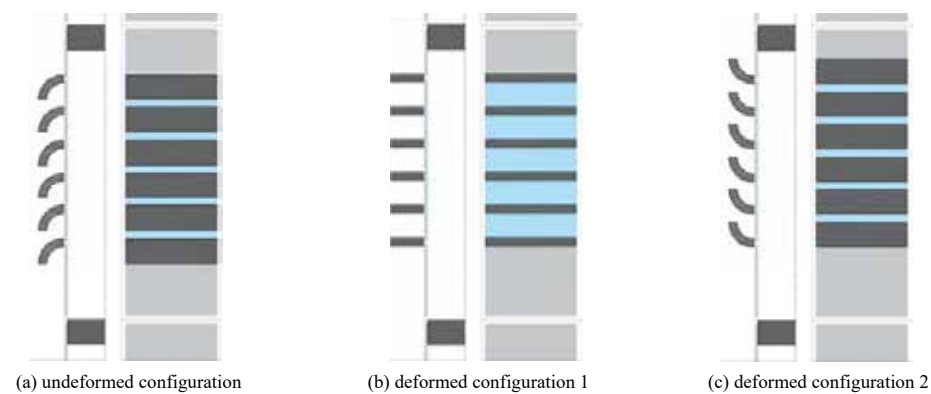

Figure 10: Side and front view of the shading installation with a concave down undeformed configuration and two deformed configurations

5 Conclusions

This paper presented part of the work carried out for the development of a shading device prototype. The particularity of the adopted solution is to combine the morphing capabilities of SMA springs to the flexural deformation of thin-walled components. In particular, the principle at the basis of this solution relies on the use of the SMA spring for the activation of the morphing to achieve a deformed configuration. Upon cooling of the SMA component, the system returns to its undeformed state by releasing the elastic deformation energy stored during the morphing process. At the moment, this solution is currently being refined for indoor applications and further work is required to improve the stability of the system to function in outdoor spaces subjected to environmental actions, such as wind and rain.

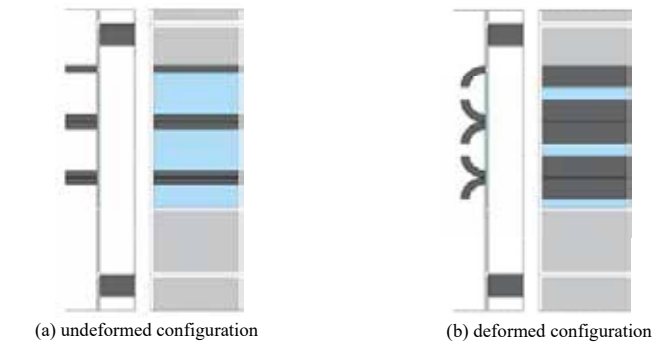

Figure 11: Side and front view of the shading installation that combines the use of the shading typologies of Figures 9 and 10

6 Acknowledgments

The work presented in this paper was supported by the Australian Research Council through its Future Fellowship scheme (FT140100130) and by CDIP of The University of Sydney under its CDIP Funding scheme.

7 References

- Balkcom DJ, Damaine ED, Demaine ML (2004) Folding paper shopping bags, Proceedings of the 14th Annual Workshop on Computational Geometry, Cambridge (US), November 2004.
- Barbarino S, Bilgen O, Ajaj RM, Friswell MI, Inman DJ (2011) A review of morphing aircraft, *Journal of Intelligent Material Systems and Structures*, 22, 823-877.
- Buckminster Fuller R (1978) *Synergetics Explorations in the Geometry of Thinking*, Collier Macmillan Publishers, London.
- Daynes S, Weaver PM, Trevarthen JA (2011) A morphing composite air inlet with multiple stable shapes, *Journal of Intelligent Material Systems and Structures*, 22, 961-973.
- Del Grosso AE, Basso P (2010) Adaptive building skin structures, *Smart Materials and Structures*, 19, 1-12.
- d'Estree Sterk T (2006) Shape control in responsive architectural structures, Proceedings of the International Conference ACA-DIA 2006, Louisville (US), 12-15 October 2006.
- Fiorito F, Sauchelli M, Arroyo D, Pesenti M, Imperadori M, Masera G, Ranzi G (2016) Shape morphing solar shadings: A review, *Renewable and Sustainable Energy Reviews*, 55, 863-884.
- Fuerst F, McAllister P (2011) Eco-Labeling, Rents, Sales Prices and Occupancy Rates: Do LEED and Energy Star Labeled Offices Obtain Multiple Premiums, *Ecological Economics*, 70(6), 1220-1230.
- Golabachi MR, Guest SD (2009) Morphing multistable textured shells, Proceedings of the IASS Symposium, Valencia (Spain) September 2009.
- Khoo CK, Salim F, Burry J (2011) Designing Architectural Morphing Skins with Elastic Modular Systems, *International Journal of Architectural Computing*, 9(4), 397-419.
- Kirkegaard PH, Worre Foged I (2011) Development and evaluation of a responsive building envelope, Proceedings of the Adaptive Conference 2011, Longon (UK), 3-5 March 2011.
- Lienhard J, Schleicher S, Poppinga S, Masselter T, Milwich M, Speck T, Knippers J (2011) Flectofin: a hingeless flapping mechanism inspired by nature, *Bioinspiration & Biomimetics*, 6, 045001.
- Lignarolo LEM, Lelieveld CMJL, Teuffel P (2011) Shape morphing wind-responsive façade systems realised with smart materials, Proceedings of "Adaptive Architecture: An International Conference, London, UK, 3-5 March 2011.

- Luo Q, Tong L (2013) Adaptive pressure-controlled cellular structures for shape morphing I: design and analysis. *Smart Materials and Structures*, 22(5), 1-16.
- Miura K (2009) Triangles and quadrangles in space, Proceedings of the IASS Symposium, Valencia (Spain) September 2009.
- Ranzi G, Fiorito F, Sauchelli M (2018) Adaptable assembly, US 2018/0051511 A1.
- Reichardt A, Fuerst F, Rottke N, Zietz J (2012) Sustainable Building Certification and the Rent Premium: A Panel Data Approach. *Journal of Real Estate Research*, 34(1), 99-126.
- Sobek W (2006) Adaptive and Lightweight, Proceedings of the International Conference on Adaptable Building Structures, Eindhoven (The Netherlands), 3-5 July 2006.
- soma (2012) Theme Pavilion Expo Yeosu, Yeosu South Korea, 2012: http://www.soma-architecture.com/index.php?page=theme_pavilion&parent=2
- Skelton RE, de Oliverira (2009) *Tensegrity Systems*, Springer, Dordrecht.
- Teuffel P (2011) From adaptive to high-performance structures, Proceedings of the 6th International Symposium on Steel Structures, Seoul (Korea), 3-5 November 2011.

Possibilities and constraints for the widespread application of solar cooling integrated façades

Alejandro Prieto 1, Ulrich Knaack 1, Tillmann Klein 1, Thomas Auer 2

1 Delft University of Technology, Faculty of Architecture and the Built Environment, Department of Architectural Engineering + Technology, Architectural Façades & Products Research Group, The Netherlands, A.I.PrietoHoces@tudelft.nl

2 Technical University of Munich, Department of Architecture, Chair of Building Technology and Climate Responsive Design, Germany.

Cooling demands in buildings have drastically increased in recent decades and this trend is set to continue into the near future, due to increasing standards of living and global climate change, among the most relevant factors. Besides energy consumption, the use of refrigerants in common vapour compression cooling technologies is a source of concern because of their environmental impact. Hence, there is a need to decrease cooling demands in buildings while looking for alternative clean technologies to take over the remaining loads. Solar cooling systems have gained increased attention in recent years, for their potential to lower indoor temperatures using renewable energy under environmentally friendly cooling processes. Nonetheless, their potential for building integration has not been fully explored, with the exception of scattered prototypes and concepts. This paper aims to address these knowledge gaps by presenting the results of the PhD research project 'COOLFAÇADE: Architectural integration of solar technologies in the building envelope'. The research project explored the possibilities and constraints for architectural integration of solar cooling strategies in façades, in order to support the design of climate responsive architectural products for office buildings, driven by renewable energy sources. This paper explores different aspects related to façade integration and solar cooling technologies, in order to provide a comprehensive understanding of current possibilities for façade integration, while drafting recommendations based on identified barriers and bottlenecks at different levels.

Keywords: solar cooling, integrated façades, façade design, renewables, barriers

Full paper available in the *Journal of Facade Design and Engineering*, Vol 6 No 3 (2018): Special Issue FAÇADE 2018 – Adaptive!

Possible benefits of capillary flow glazing in translucent wall elements

Nikolaus Nestle a), Sorin Pulbere a), Mark Alston b)

a) BASF SE Advanced materials and Systems Research, Ludwigshafen, Germany, nikolaus.nestle@basf.com

b) University of Nottingham, Faculty of Engineering – Architecture and Built Environment, UK

In many cases, artificial lighting and cooling are the two main factors for energy consumption in office buildings. This is even true for fully glazed buildings where directly transmitted natural light often needs to be controlled by shading in order to avoid glare problems and an unfavorable distribution of light within the room. Furthermore, transmitted solar irradiation leads to additional solar gains which in turn increase the cooling load of buildings. Replacing transparent elements in the facade by translucent elements where no visual contact with the exterior is needed, will lead to considerable improvements with respect to better light distribution over the depth of the room and to reduction of glare problems. However, issues with solar gains remain essentially the same. As visible light makes up only half of the incident solar irradiation, solar gains associated with incoming daylight could be seriously reduced by filtering out the invisible irradiation which predominantly is in the so-called near IR (NIR) range of the electromagnetic spectrum.

In principle, filtering out this part of the solar irradiation spectrum can be achieved by selective reflection or by selective absorption. Due to the physics of the underlying effects, spectrally selective reflection of NIR is more challenging than absorption. However, absorption will lead to heating of the absorber. Especially in translucent elements with good thermal insulation, heating will lead to a lot of unwanted issues with thermal stresses induced into the absorber material. Like that, reducing the heat load in the absorber layer is desirable and might even come with the additional benefit of using the absorber layer as a translucent solar thermal collector. In this contribution, we present the use of capillary flow glazing as a possible solution to this problem. A bio-inspired engineering approach for a channel system with optimized hydrodynamics is presented. Furthermore, we will discuss the optimal position of the capillary layer in static and adaptive translucent glazing elements for different climate conditions and possible approaches to use the heat collected by the capillary system within a holistic energy management concept for a building.

Keywords: Adaptive building envelope, solar radiation management, capillary, hydrodynamics, heat management

1 Introduction

Both living plants and buildings are challenged with management of solar irradiation which on the one hand is highly beneficial for them in providing energy supply but on the other hand needs to be managed to cope with its changing intensity and to avoid overheating. Furthermore, energy gained from solar irradiation needs to be transported into other regions of the structure to make optimal use of it. Leaf vasculature formations are an absorption system for solar irradiation which consists of capillary monolayers that control a chemical energy conversion process, photosynthesis. Leaves use negative pressure to induce flow that scales linearly in channel networks for fluidic transport. A major mechanism in avoiding of overheating is evaporation of water which is transported through a fine network of capillary channels – the xylem - from the roots up to the leaves in a tree for example. Each leaf in this system is acting as an individual photosystem that is defined by rule

based geometry, canopy volume and total leaf area density. For transport of stored chemical energy down to the roots, another capillary system, the phloem is used.

An individual leaf structural geometry is aligned to the angular distribution of leaf surfaces by solar orientation for daylight capture. This is characterized by the intimate relationship between capillary leaf patterns and leaf foliage scale. That are highly regulated with species-specific vascular pattern formations. In buildings, by contrast, energy storage is often limited to heating and cooling of the building's thermal mass and shading is used to reduce unwanted solar energy gains. In contrast to plants which manage to produce additional energy for growth from the solar irradiation, most buildings require energy from external sources for artificial heating and cooling.

In contrast to plants with their capillary vascular system, most buildings have some central infrastructure for water and energy supply and an outer skin without capabilities for active energy transport. Like that, heat absorbed from solar irradiation leads to rather high local temperatures in the building envelope that even can result to material failure from stress due to inhomogeneous thermal expansion. Furthermore, high temperatures on the building envelope will result in higher unwanted conductive heat flow into the building and thus to even higher cooling loads. Even higher energy flows into the building arise from solar irradiation transmitted through transparent elements of the building skin into the building. While solar irradiation in the visible range of the spectrum (about half of the incoming solar irradiation) is useful for the provision of natural light into the building, the invisible other half of the incoming solar irradiation (in the near-infrared range of the spectrum) will only lead to solar heat gains (which might be useful in a cold environment but are unwanted in hot conditions). Various coatings and pigments are available for glazing in order to reduce the transmission of solar near infrared irradiation into a building. Most frequently, selectively reflecting metal and metal-oxide layers are used for this purpose. By reflecting the solar infrared irradiation, heat gains inside the building are avoided but the incident energy is also lost when heat gains would be favourable and furthermore, the reflected IR radiation will be absorbed by other structures around the building and thus might contribute to the formation of urban heat islands. Using IR absorbing glazing with a vascular heat transport system provides an alternative, in which the incident solar irradiation can be used to heat up a liquid inside the capillaries and thus be stored for buffering fluctuations in the available solar energy or for uses that otherwise would have needed heating of water by use of other energy sources. At the same time, the presence of a vascular system inside the IR absorbing glazing can be used to reduce the maximal temperatures inside the IR absorber and thus avoid issues like destructive thermal stresses from overheating. A similar effect can also be achieved by fully flooding the interpane space with a liquid, however this comes with a range of technical difficulties such as the need to deal with large hydrostatic pressure differences inside the interpane space (Chow and Li (2013), Sierra and Hernandez (2017)). Furthermore, controlling the flow distribution within the interpane space is much more complicated than within a channel network. On the other hand, the capillary system compromises the optical appearance of the glazing while a fully liquid-filled interpane space comes with transparency properties comparable to conventional glazing. Perfect transparency properties are only needed for those parts of the building envelope that are important for optical contact with the outside environment. For translucent elements of a building skin and also for glazing in the spandrel or skylight parts, fully transparent glazing is not needed and capillary glazing provides sufficient optical quality.

This paper will focus especially on exploring the potential of capillary glazing elements in translucent wall elements with switchable glazing that have been described (Nestle et. al. 2018). When such as element with realized with conventional single pane glazing on the outside, a substantial part of both visible light and NIR radiation will be transmitted into the interior of the

building. By replacing the outer pane with an IR absorbing glazing with integrated capillaries, only the solar gains from the transmitted light will be unavoidably realized inside the building. The IR part of the solar irradiation spectrum, by contrast, will lead to heating of the IR absorbing glazing and the liquid inside the capillaries. The heat transferred to the capillaries can now be lead to different uses depending on the needs of the building. In the heating season, the warm water may be used to further heat the building, in the cooling season, the warm water can be transported into a local heat storage tank where it can be used for heating water for use in sanitary applications, laundry or dishwasher systems which presently still mainly rely on water heating using energy from external sources. Furthermore, heating of water in the capillary system is decoupled from the amount of daylight transmitted into the building as the IR absorber will still be active in the external pane when the metallized foil insulation is rolled down in order to eliminate solar irradiation into the building.

2 Concept of the adaptive element and of the vascularized IR absorber, material issues

In figure 1, the adaptive wall element according to Nestle et al. 2018 and the integration of the vascularized IR absorber are shown. A prerequisite for achieving a high U-value of the wall element in the non-insulating state requires an exterior glass pane with a high heat transfer coefficient. As the vascularized IR absorber comes with a thickness in the range of about 1 cm and is made up of materials with thermal conductivities in the range 1 W/Km, it fits with this requirement. Furthermore, only a minor impact on light transmission in the visible spectral range should result from the IR absorber and the capillary system. For a heat carrier liquid with no absorption (such as water doped with simple antifreeze salts) in the visible range and an appropriate IR absorber (such as the metallic ions used in many car windshields), this is also well achievable.

Regarding the capillary system, the following considerations need to be made:

- The capillaries need to be spaced in a way that ensures sufficiently effective heat transfer by conduction inside the IR absorbing glass pane and the solid walls of the capillary layer to achieve an efficient cooling of the whole absorber layer and a good energy transfer to the heat carrier liquid. This is a reason to use many and „wide“ capillaries.
- The capillary cross-section should be sufficiently large to ensure a low pressure loss in the capillary systems (and thus minimize the energy needed for pumping the heat carrier liquid through the capillary system). This is again a reason to go for „wide“ and „deep“ capillaries. For laminar flow inside a rectangular channel, with dimensions b and h the flow resistance is given as

$$R = \frac{12\eta l}{K \min(b, h)^3 \max(b, h)}$$

with K denoting a correction factor depending on the ratio of b and h and with a value between 1 and 0.42.

- The amount of water inside the capillary system should be „small“ in comparison to the amount of water needed for an appropriate heat transfer per hour in order to allow sufficiently fast adaptation of the water flow rate to changes in irradiation. This actually is rather in favour of limiting the width and depth of the capillaries.
- As the flow path from the inlet and outlet openings to individual capillaries also needs to be taken into account, the thickness of the capillaries will need to increase with increasing distance from these openings in order to allow equal pressure loss and thus equal flow rates along all capillaries.

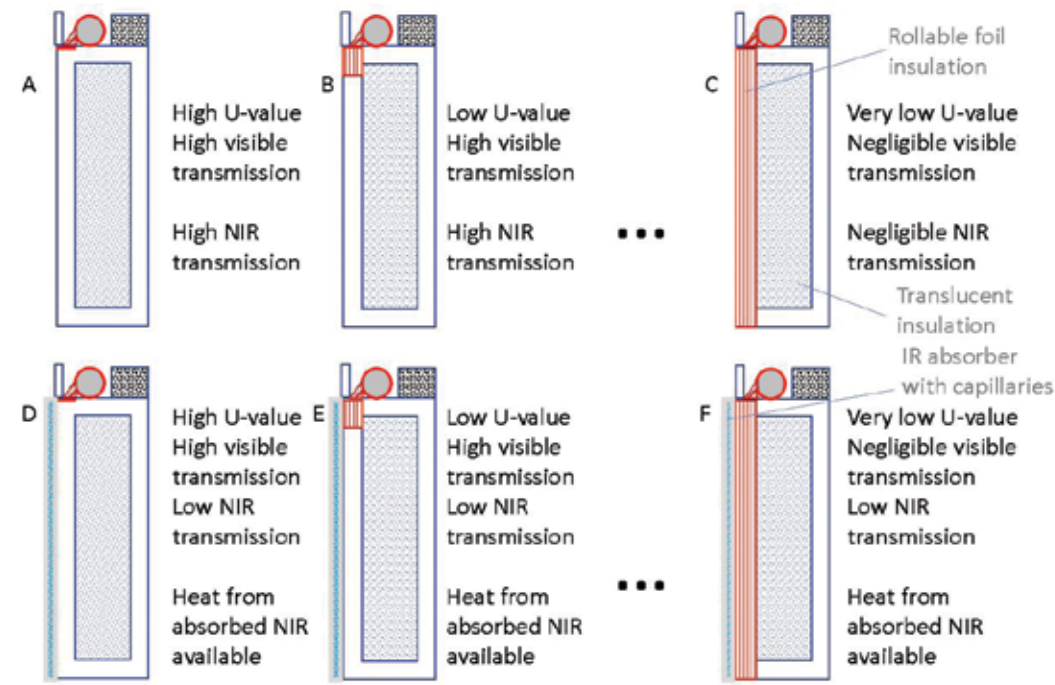

Fig. 1. A to C: adaptive wall element from Nestle et al. 2018 without vascularized IR absorber; D to F: with vascularized IR absorber integrated into front pane. While solar gains from NIR and visible light are coupled in the standard element, the vascularized IR absorber decouples the use of NIR and visible irradiation energy from each other

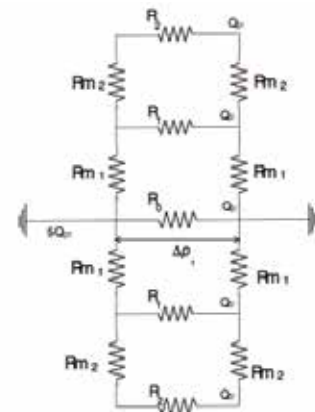

Fig. 2. Micro-Fluidic Device as a Resistor Circuit in Determining Pressure Driven Flows

Achieving a unified volumetric flow rates can be simulated by electrical circuit theory (Oh et al. 2010) through flow target resistance analysis by an iterative procedure. By hierarchical resistance scaling to determine pressure equalization in diminishing flow pressure variation across the network to gain laminar, smooth flow. Through optimization of active flow networks, defined by pressure drop as a method of regulating fluidic flow. Each slot channel (wide and depth succession sequence) is aligned to a specific resistance order in response to pressure loss that linearly increases with flow rate within longitudinal channels (Murray 1926). This analysis will establish an optimal network to attain minimum energy (pumping power) output for reduced pressure drop for unified flows in multi capillary channels. Using precise hydro-dynamic control of a microfluidic platform is governed by fluidic feed in (manifold) channels that can be simulated as a resistor, figure 2.

R_{mi} denotes the fluidic resistance in the feed extracts channels and R represents the longitudinal channels as parallel fluidic resistors. Δp denotes the pressure drop over the whole device. In order to ensure laminar flow, it is important to design feed and extract lines in a way that avoids turbulence and non-linearities. An optimization method was chosen that follows the principles of leaf vein hierarchy of non-uniform channel cross-sectional geometry (Hickey 1973) and results in a channel distribution that comes with minimum energy dissipation, low-pressure drop and uniform flow velocity (Noblin et al. 2008).

This channel network allows heat transport from the absorber pane with minimal pressure loss. Linear flow with absence of turbulence is important to easily vary the heat removal by means of setting the volumetric flow rate through the network. Figure 3 depicts a simple design for a capillary network that takes into account these considerations. In the next chapter, we will provide some quantitative considerations for the dimensions of the channels and also simulation results validating the assumptions.

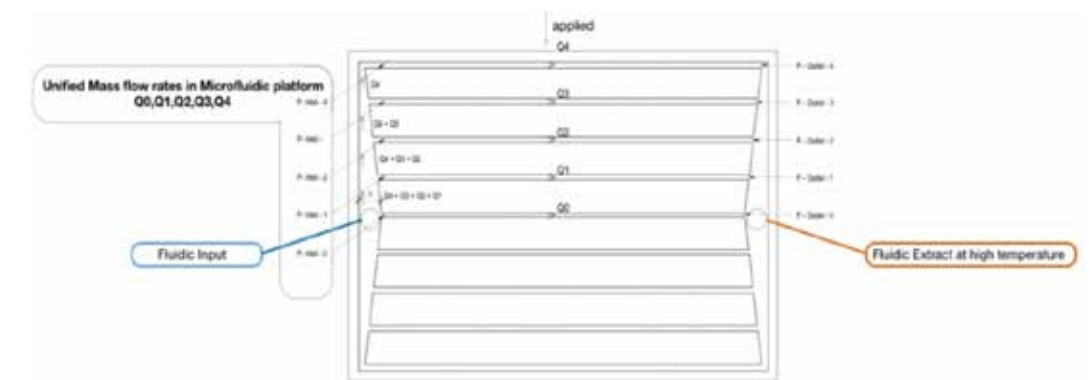

Fig. 3. Simple capillary network layout for flow-cooling of IR absorbing pane

A further issue are the materials to be used for the IR absorbing layer and the capillary layer. For the IR absorbing layer which would be located at the outer face of the element, glass is the most obvious material of choice as it comes with favourable scratch resistance and mechanical properties and also is non-combustible and thus solves many possible issues with fire resistance. Furthermore, the relatively high thermal conductivity of about 1 W/Km is favourable for lateral heat transfer to the capillaries. For the capillary layer, glass may be used as well. However, cutting capillaries into a PMMA (thermal conductivity 0.19 W/Km) layer is much simpler (and therefore it was used in the construction of the prototypes studied in chapter 4) and also the lower density of PMMA can be considered favourable as well. By contrast, the lower thermal conductivity of PMMA is unfavourable for optimal lateral heat transfer. Last but not least, the large difference in thermal expansion coefficients between glass (about $5 \cdot 10^{-6} \text{ 1/K}$) and PMMA (about $7 \cdot 10^{-5} \text{ 1/K}$) may lead to delamination problems that can be avoided in an all-glass system. To laminate the IR absorbing glass layer and a capillary layer made of glass, polymer foils similar to those used in laminated safety glazing can be used. The polymer of choice in this case would not be PVB which comes with poor moisture stability but rather TPU foils such as they are used in laminated glazing for low-temperature applications.

3 Analysis of the element's potential

The most important consideration for the element is the amount of water needed for cooling and heat transfer. For this, we need to compute the temperature increase for the water at a given heating rate from absorbed solar IR as a function of the flow rate in the capillaries. This calculation

is depicted in figure 4 for heating rates of 100 W/m² and 200 W/m² (which seem realistic for half of the solar irradiation incident on a vertically oriented wall element).

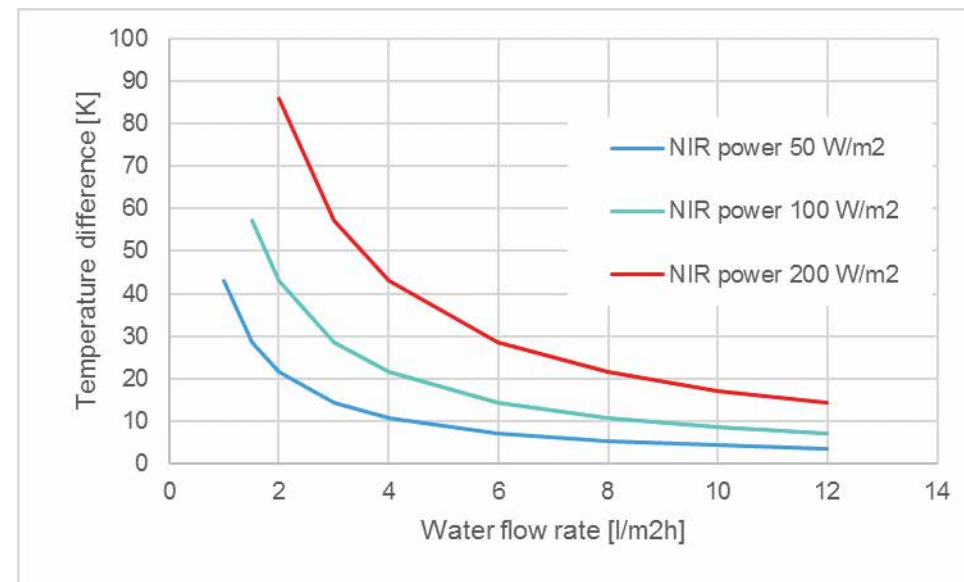

Fig. 4. Temperature gain in K for solar absorption rates of 50 W/m², 100 W/m² or 200 W/m² as a function of water flow rate (calculation neglecting radiative heat losses)

If a heating of the water by 30 K is intended, a flow rate of a few liters of water per hour and square meter is needed. Assuming 5 hours of such irradiation onto a facade area of 10 m², this would result in about 200 litres of warm water which seems to be an attractive quantity for use in a residential context.

In Lab tests with a sun simulator and the capillary system shown in figure 3, an almost complete heat transfer from the capillary glazing into a water reservoir could be demonstrated even with very rudimentary insulation.

4 Conclusion

Capillary cooled IR-absorbing glazing provides an attractive way to decouple the energetic use of visible solar irradiation on a translucent wall element from that of NIR irradiation. While visible radiation is transmitted in a redirected way into the building and thus contributes to reducing the building's need for artificial lighting, the NIR part is absorbed and can be locally buffered by storage units with a capacity in the range of 200 l for use in heating or hot water applications within the building. At the same time, the capillary flow in the NIR absorbing glazing avoids overheating of the absorber layer during peak irradiation periods. Pressure losses inside the capillary system can be minimized by optimization of channel width and depth and the spacing of the channels can be optimized to achieve uniform and efficient heat extraction. Material optimization to ensure long-term water-tightness of the capillary system is still under way.

5 Acknowledgement

This work was stimulated by the EU COST action TU1403.

6 References

- Chow, T.T., & Li, C. (2013). Liquid-filled solar glazing design for buoyant water-flow, *Building and Environment* 60, 45–55.
- Hickey, L.J. (1973). Classification of the architecture of dicotyledonous leaves. *American Botanical Journal*, 60, 17-33.
- Murray, C.D., (1926) The physiological principle of minimum work. I. The vascular system and the cost of blood volume. *Proc Natl. Acad Sci, U.S.A.* 12, 207-214.
- Nestle, N., Pflug, T., Maurer, C., Prissok F., Hafner, A., & Schneider, F. (2018) Concept for adaptive wall elements with switchable U- and g-value. *Proceedings of the VIII International Congress of Architectural Envelopes, San Sebastian, 20.-22.6.2018.*
- Noblin, X., Mahadevan, L., Coomaraswamy, I.A., Weitz, D.A., Holbrook, N.M., & Zwienieck, M.A., (2008) Optimal vein density in artificial and real leaves. *Proc. Natl. Acad. Sci.* 105, 9140 – 9144.
- Oh, K.W., Lee, K., Ahn, B., & Furlani, E.P., (2010) Design of Pressure-driven Microfluidic Networks using Electric Circuit Analogy. *Lab on a Chip*. 12, 515-545
- Sierra, P., & Hernández, J.A., (2017) Solar heat gain coefficient of water flow glazings. *Energy and Buildings*, 139, 133–145.

Comparison of conventional and adaptive façades: Increasing application of adaptive facades in R. of Macedonia

Aleksandar Petrovski a), Aleksandra Krstić-Furundžić b)

a) Faculty of Architecture / Ss Cyril and Methodius University, R. of Macedonia, petrovski.aleksandar@arh.ukim.edu.mk
b) Faculty of Architecture / University of Belgrade, Serbia, akrstic@arh.bg.ac.rs

The adaptive facades offer possibilities to improve the buildings energy performance and their overall sustainability. As a relatively novel concept, it is essential to strengthen the understanding of their possibilities, techno-economic aspects and performance capacities in order to stimulate their utilization in a moderate continental climate such as R. of Macedonia. Therefore in this research an overview is made regarding their potential for application in order to select most appropriate ones for the given context. Also, during the early design phase of buildings, one of the most common aspects that is analyzed by architects is their energy performance. But, in the current architectural design practice the complexity of the software simulation of the performance of adaptive facades disables their appropriate utilization during the design process. To overcome these obstacles, in this research several software models of a case-study of an office building are developed and tested with different types of façades. Their comparison regarding energy performance provides an insight for most appropriate facade types in the climatic context. Therefore, this paper contributes to the architectural design process in means of supporting designers decision-making when choosing the type of façade regarding the energy performance.

Keywords: Adaptive facades, Sustainability, Energy efficiency, Software simulation, Case-study

1 Introduction

The construction industry is one of the main contributors to the waste creation and emission of pollutants to the atmosphere. In order to tackle these conditions in the construction, the concept of sustainability is introduced, which means reducing the adverse impact onto the environment by control of the exploitation of resources, considering the human wellbeing and health, the economic and the social circumstances as well. Many authors have stressed the benefits of sustainability in the creation of healthy built environment and the benefits to the mental and physical health of the inhabitants, (Evans 2003; Handy et al. 2002 Jackson 2003; Northridge et al. 2003; Petrovski et al. 2014; Petrovski et al. 2015; Srinivasan et al. 2003; Furundžić et al. 2015). With the Energy Performance of Buildings Directive (EPBD) 2010/31/EU it is defined that by the end of 2020 (2018 for public buildings) all new constructions should be “nearly Zero Energy Buildings” (n-ZEBs) (Directive 2010/31/EU of the European Parliament and of the Council of 19 May 2010 on the energy performance of buildings 2010). For achieving this aim, two strategies are proposed in general, such as: to reduce the energy demand within the building and to provide the energy demand by means of on-site renewable energy sources (Sartori et al 2012).

The building's façade has been a significant research question throughout the entire architectural history regarding the possibilities of using appropriate external climatic conditions and providing the comfort in the interior. The advent of the adaptive facades and their technological advancement

offers means and possibilities to improve buildings performance and to support the drive towards realization of the EPBD Agenda and achieving the sustainability goals in buildings.

In order to increase the application of adaptive façades in moderate continental climates such as R. of Macedonia, it is necessary to improve the knowledge of their possibilities and performance capacities for such a context. This imposes the need to assess their performance potential in order to select which of them is most appropriate for the given context.

One of the most common aspects that is analyzed by architects at an early design phase is the energy performance. Considering that the assessment of adaptive facades by software simulation of all of the facades' aspects is a complex process, it disables the appropriate utilization of adaptive facades during the design process. Therefore, in this research, a software model of an office building is developed in order to test different types of conventional facades and an appropriate type of an adaptive façade and to analyze the models' energy performance.

2 Overview of adaptive façade types

Various authors have made a classification of adaptive facades. Addington and Schodek (2004), have categorized several ways for adaptivity of the structure, such as: folding, sliding, expanding, transforming, while the means to achieve them are listed as: pneumatic, chemical, magnetic, natural and mechanical, respectively. Ramsey and Fayed (2011), discuss the potential of the system to act as a kinetic one, its control technique, limit and possibilities for systems configuration.

One of the most common definitions defines them as a climate adaptive building shell that has the ability to repeatedly and reversibly change some of its functions, features or behavior over time in response to changing performance requirements and variable boundary conditions and does this with the aim of improving overall building performance, (Loonen et al. 2013). As complex systems that have the ability to simultaneously influence multiple physical domains such as: thermal, luminous, indoor air quality etc., their performance is in direct relation with the surrounding climate context of the building and with the interaction with users. However, they are not widely used in practice due to many restrains, such as: economical, technological as well design factors.

Other authors state that: "this new generation of façades (or building envelopes) consists of multifunctional and highly adaptive systems, where the physical separator, or part of it, between the interior and exterior environment is able to change its functions, features or behavior over time in response to transient performance requirements and boundary conditions, with the aim of improving the overall building performance" (Loonen et al. 2013).

Effective control is one of the key aspects that determine the performance of the adaptive facades. Two different control types are distinguished in the analysis: extrinsic and intrinsic control, (Loonen et al. 2013). Extrinsic control means that there is a presence of an external decision making component that could trigger the adaptive mechanisms according to a programmed set of rules. This type of control is often called "intelligent" including systems like: electro-chromic glazing, movable shading devices, kinetic facades, etc., (Loonen et al. 2013). These kind of intelligent systems require a control management system for them to respond in an adaptive manner. Therefore they consist of: sensors, processors and actuators. Intrinsic control indicates that the adaptive mechanism is automatically triggered by a stimulus (surface temperature, solar radiation, etc.), i.e. this property is chemically embedded in the material and the switching mechanism is activated by a variation in its internal energy. Due to this characteristic the material are usually titled

"smart" (e.g. thermochromic, photochromic and PCMs), and there is no need for an intervention from an external system/user, (Loonen et al. 2013).

3 Model of an office space with conventional and adaptive façade

The case-study of this analysis is an existing office building situated in Skopje, R. of Macedonia, with skeleton structure with column distance of 8m, office depth of 6 m and office height-to-ceiling of 3 m. The office modules are arranged around a central foyer. A typical space module of an office has floor plan dimensions of 6 m by 16 m and 14 workstations are arranged in an open office plan. The existing building is under the process of renovation and therefore has the potential to implement adaptive façade and improve the overall building performance. For the purposes of this research, the company that is using the office spaces has provided the schedules for using the office spaces, Table 1. The data are inputted into OpenStudio software which is chosen for conducting the simulation, due to the possibilities for applying materials with extrinsic control types and simulating certain types of adaptive facades. Also it gives possibilities to simulate movable shadings.

Office building - occupancy profile

	Monday to Friday	Saturday	Sunday and holidays
00:00 - 08:00	0%	0%	0%
08:00 - 11:45	100%	50%	0%
11:45 - 12:15	50%	50%	0%
12:15 - 16:00	100%	50%	0%
16:00 - 18:00	70%	20%	0%
18:00 - 00:00	0%	0%	0%

Table 1 Occupancy profiles of the office Office building - occupancy profile

The south facing office space is analyzed as a characteristic one, where the south facing window is the only external wall and the rest are interior partition walls, because there are offices next to the reference model as well as above and below the analyzed office module, Fig. 1.

The opaque part of the external wall is consisted of: facade plaster, 20 cm rockwool, lightweight blocks and internal gypsum board. The heat transmission coefficient is $U = 0.220 \text{ W/m}^2\text{K}$, and is in compliance with the regulations that prescribe that it must be lower than $U = 0.3 \text{ W/m}^2\text{K}$ for the facade wall of a building.

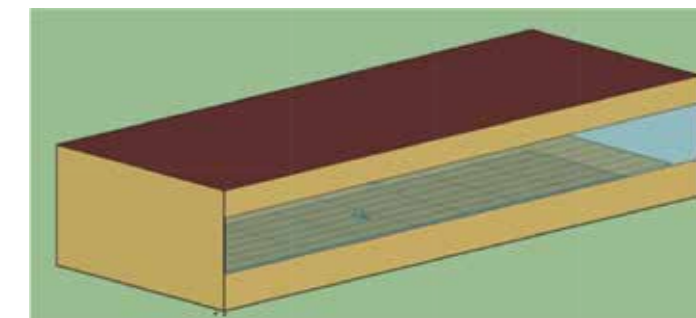

Figure 1 Office space with existing window size

The existing glazing type is double glazing and with a window to wall ratio (WWR) of 46% and is taken as a reference model with which the design solutions are compared. In the analysis WWR is varied from 46% to 66% and 100% and for each WWR three types of glazing are used such as: double glazing, double glazing lowE, electrochromic and triple glazing lowE. The characteristics of the glazing together with the metal frames are shown in Table 2.

Glazing type	U value (W/m ² K)	SHGC	g value
Double glazing on metal framework	3.12	0.32	0.252
Double glazing Low-E , electrochromic on metal framework	1.318	0.428	0.634
Triple glazing Low-E	1.062	0.579	0.698

Table 2 Characteristics of the glazing used in the models

Also, an option of the model with a fixed horizontal shading is developed and analyzed, where the angle of the louvers are designed according to the geographical position of the building, Fig. 2. For the 6 models which are developed, a set of three values for the WWR are assigned to each of them, thus amounting to a total of 18 models which are analyzed, Table 3.

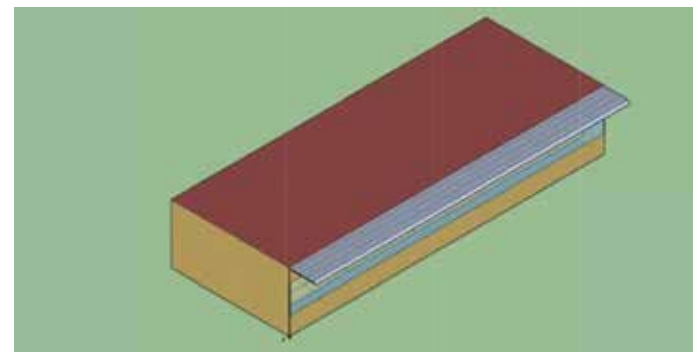

Figure 2 Model with louver shading (horizontal louver layout) Table 3 Characteristics of the models

	Glazing type/shading	Control type	WWR
1	Double glazing	-	46%, 66%, 100%
2	Double glaz. electrochromic	extrinsic	
3	Triple glazing lowE	-	
4	Triple glaz. lowE and louvers	-	
5	Triple glaz. lowE and exterior screen	extrinsic	
6	Triple glaz. and switchable glass	extrinsic	

Table 3 Characteristics of the models

4 Analysis of results

The results from the energy simulation are aggregated according to the glazing type, Fig. 3. The double glazing model shows highest energy consumption when compared with the other models, for each of the three WWRs respectively. The total energy demand is lowest in models with 46% WWR, with Triple glazing and louvers or exterior screen, Fig. 2, 3. Slightly larger energy consumption has the model with double glazing electrochromic glass.

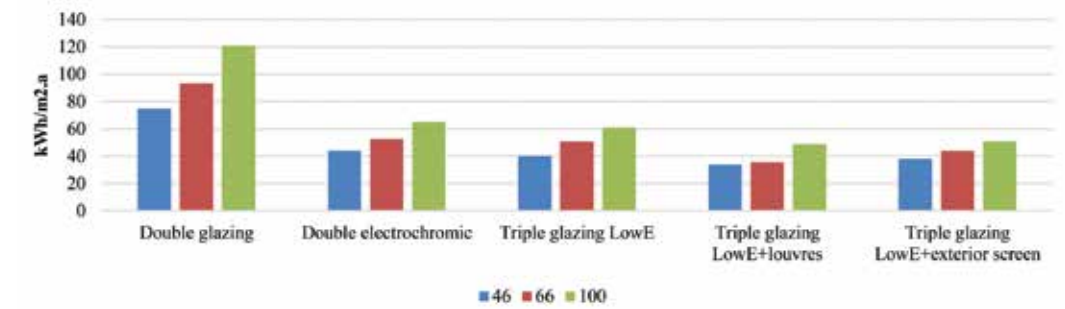

Figure 3 Total energy demand

From the results shown in Fig. 4, it is clear that the heating demand is dominant in the office space. The heating demand is significantly higher in the reference model with double glazing compared to the other types of glazing.

The energy consumption is analyzed in terms of energy needed per conditioned area, heating energy, cooling energy and interior lighting energy, Fig. 4. The models with glazing type such as: double electrochromic, triple glazing lowE, triple glazing lowE with louvers and triple glazing lowE with exterior screen, in all of their 3 variants such as: 46%, 66% and 100% show similar performance regarding the heating demand and interior lighting needs. There is a significant difference regarding the energy needed for cooling which is largest in the models which are not protected with external shading from direct solar gains. Additionally, the larger cooling needs can be explained due to the lowE foil which disables dissipation of the internal gains through the glazing, thus putting a load on the HVAC system for cooling the interior space.

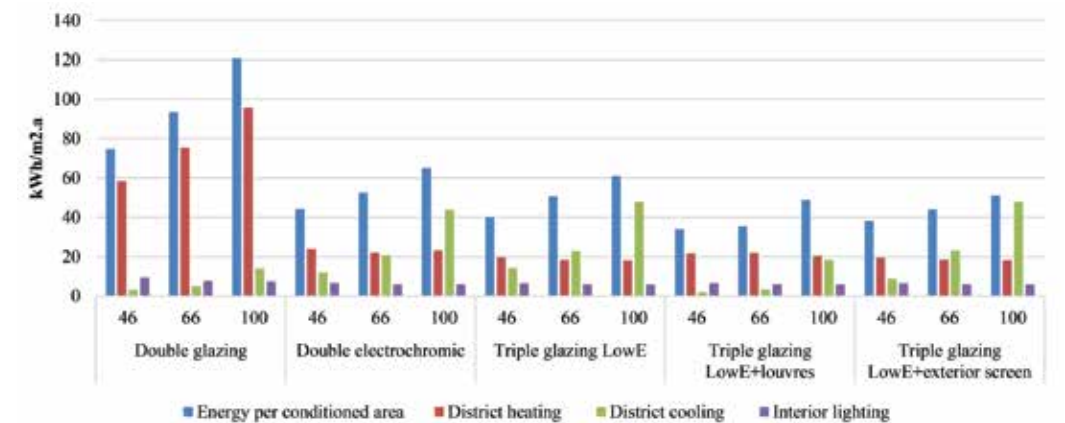

Figure 4 Results of type of energy consumption

The monthly heating demand for the six models is shown in Figure 5, from which it could be noted the significant decrease of energy needed for the models with low conductivity such as the electrochromic, lowE as well as in the models with an external shading. It is evident that there is a slight difference between façade types such as: double glazing lowE, electrochromic glazing, triple glazing lowE, triple glazing lowE with louvers and triple glazing lowE with external shading.

The difference in model 1 with double glazing 46% and with 66% WWR is 23,56%, between 46% and 100% WWR is 39,82% and between 66% and 100% WWR is 21, 27%. The difference in model 2 with double glazing lowE electrochromic with 46% and with 66% WWR is 23.98%, between 46% and 100% WWR is 23.33% and between 66% and 100% WWR is 1.52%. The difference in model

3 with triple glazing 46% and with 66% WWR is 1.36%, between 46% and 100% WWR is 6.45% and between 66% and 100% WWR is 5.16%. The difference in model 4 with triple glazing lowE and louvers, with 46% and with 66% WWR is 3.40%, between 46% and 100% WWR is 2.52% and between 66% and 100% WWR is 0.91%. The difference in model 5 with triple glazing lowE and exterior shading, with 46% and with 66% WWR is 1.62%, between 46% and 100% WWR is 1.08% and between 66% and 100% WWR is 0.53%. Finally, the difference in model 6 with triple glazing and switchable glazing of 46% and with 66% WWR is 0.8%, between 46% and 100% WWR is 0.05% and between 66% and 100% WWR is 0.74%.

From the comparison it is evident that there is a large difference in heating demand in the models with double glazing and double glazing electrochromic and different WWR's. However, there is a slight difference in heating energy demand with different WWR within the models with triple glazing or triple glazing combined with louvers, exterior shading and switchable glazing, ranging from 0.8-6.45%. This gives the conclusion that the WWR does not affect in a large portion the heating demand of the building.

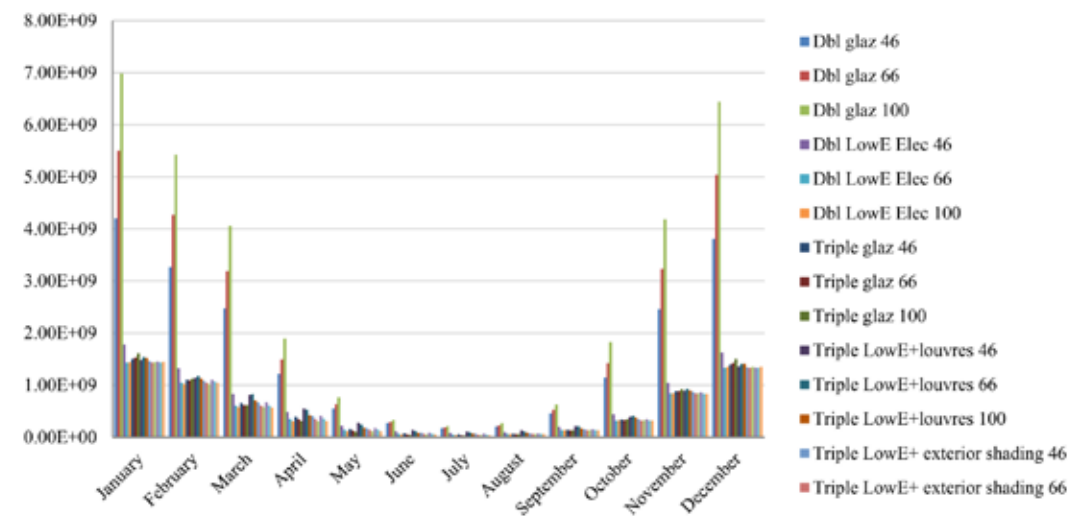

Figure 5 Monthly heating energy demand

The cooling loads for the 18 analyzed models are shown in Figure 6. It could be observed that within a same model, that is a model with a same glazing type, the increase of the WWR contributes to a significant increase in cooling needs from 19.96% to 75%.

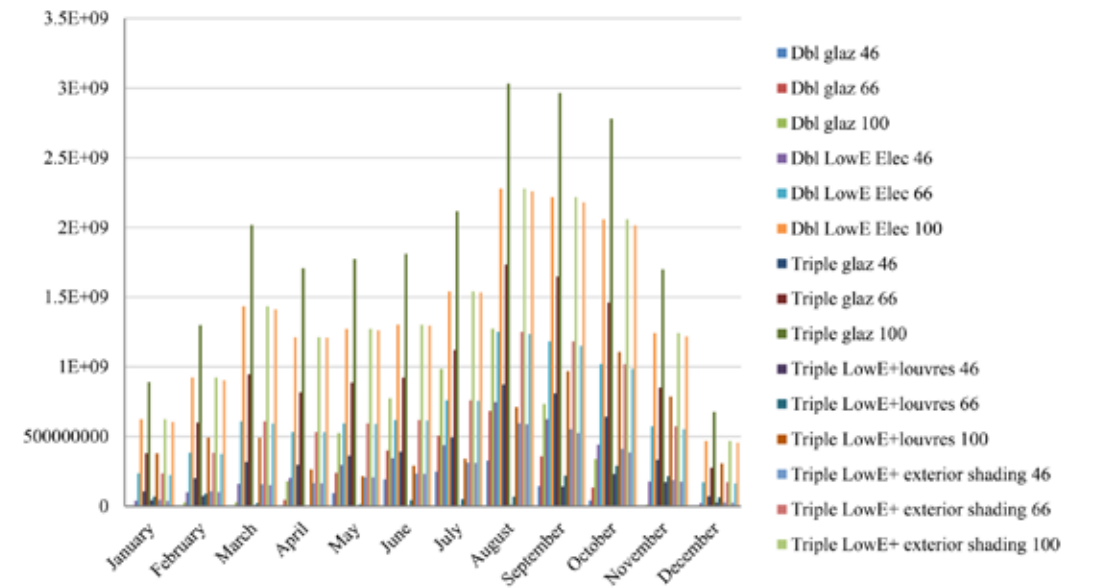

Figure 6 Monthly cooling energy demand

The difference in model 1 with double glazing 46% and with 66% WWR is 52.45%, between 46% and 100% WWR is 74.47% and between 66% and 100% WWR is 46.31%. The difference in model 2 with double glazing lowE electrochromic with 46% and with 66% WWR is 40.32%, between 46% and 100% WWR is 67.26% and between 66% and 100% WWR is 45.13%. The difference in model 3 with triple glazing 46% and 66% WWR is 49.60%, between 46% and 100% WWR is 71.20% and between 66% and 100% is 42.85%. The difference in model 4 with triple glazing lowE and louvers, with 46% and with 66% WWR is 19.96%, between 46% and 100% WWR is 79.09% and between 66% and 100% WWR is 73.86%. The difference in model 5 with triple glazing lowE and exterior shading, with 46% and with 66% WWR is 52.46%, between 46% and 100% WWR is 73.92% and between 66% and 100% WWR is 45.13%. Finally, the difference in model 6 with triple glazing and switchable glazing of 46% and with 66% WWR is 52.61%, between 46% and 100% WWR is 74.08% and between 66% and 100% WWR is 45.31%.

From the comparison it is evident that there are large differences in cooling demands in each model with different WWR, contributing to the overall energy demand in the building more than the heating demand, since it is an office building in which internal loads are more apparent.

5 Conclusion

The analysis of the 18 models of an office space with static or adaptive façade and variable glazing size on the south side wall provides a significant insight onto their energy performance for the given context. The experimental analysis of adaptive facades shows that they outperform conventional facades in terms of energy performance. The triple glazing with lowE and louvers had lowest energy demand compared with the other models, followed by the model with triple glazing lowE and exterior movable screen. The double glazed electrochromic glazing had slightly more energy consumption annually. Considering the lower price for the triple glazing altogether with the louvers/ exterior screen it could be noted that they could be more economical design solution in terms of return of the investment compared with the double glazed electrochromic glass, but further analysis needs to be made in this regard. The triple glazing system without movable shading has the highest cooling demand due to the low emission foil that tends to keep the internal generated heat gains from the lighting, equipment, people as well as solar gains inside the office, not letting the heat to dissipate to the outside. However the double and triple glazing with lowE foil have significantly

lower energy demand for heating the space when compared with the baseline model with double glazing. By analyzing the cooling it could be concluded that in the models with glazing with lowE foil, by increasing the window-to-wall ratio, the cooling demand exponentially rises. As for the electricity for interior lighting there is a slight decrease when increasing the WWR ratio. From the comparison of the different types of facades applied on a model of an office space it could be noted that passive cooling strategies need to be implemented in order to decrease the cooling energy demand and thus decrease the overall energy demand. Therefore, further analyses are needed to examine the potential of passive and active design solutions of the façade that enable its natural ventilation. Additionally, the adaptive facades need to simultaneously satisfy multiple design requirements such as: energy performance, daylight performance, glare, natural ventilation, solar shading, passive solar gains etc. Common software simulation tools do not support simulation of all of these design aspects at the same time. Therefore, it is necessary to improve and upgrade the current performance simulation tools in a way that it will enable optimization of design solutions and help designers in making an informed design decision when choosing the optimal adaptive façade solution.

6 Acknowledgement

This research was supported European Cooperation in Science and Technology Action TU 1403. The authors would like to gratefully acknowledge COST Action TU1403 “Adaptive Facades Network” for providing excellent research networking. Also, the research is done within the scientific research project “Physical, environmental, energy, and social aspects of housing development and climate change–mutual influences”(TR36035), financed by Ministry of Education, Science and Technological Development of the Republic of Serbia.

7 Bibliography

- Addington, D. M., and Schodek, D. (2004). *Smart Materials and Technologies: For the Architecture and Design Professions*. Routledge, Amsterdam ; Boston.
- Directive 2010/31/EU of the European Parliament and of the Council of 19 May 2010 on the energy performance of buildings. (2010). 153.
- Evans, G. W. (2003). “The built environment and mental health.” *Journal of Urban Health: Bulletin of the New York Academy of Medicine*, 80(4), 536–555.
- Furundžić, Z. N., Furundžić, P. D., and Krstić-Furundžić, A. (2015). “Responsibility to the employees’ health unavoidable in the creative and innovative design of office spaces.” *The 2nd International Academic Conference Places and Technologies 2015 – Keeping up with technologies to make healthy places*, University of Ljubljana, Faculty of Architecture, 18-19 June 2015, Nova Gorica, Slovenia, 610-616.
- Handy, S. L., Boarnet, M. G., Ewing, R., and Killingsworth, R. E. (2002). “How the built environment affects physical activity: views from urban planning.” *American Journal of Preventive Medicine*, 23(2 Suppl), 64–73.
- Jackson, R. J. (2003). “The Impact of the Built Environment on Health: An Emerging Field.” *American Journal of Public Health*, 93(9), 1382– 1384.
- Loonen, R., Trčka, M., Cóstola, D., and Hensen, J. L. M. (2013). “Climate adaptive building shells: state-of-the-art and future challenges.” *Renewable and Sustainable Energy Reviews*, 25, 483–493.
- Northridge, D. M. E., Sclar, D. E. D., and Biswas, M. P. (2003). “Sorting out the connections between the built environment and health: A conceptual framework for navigating pathways and planning healthy cities.” *Journal of Urban Health*, 80(4), 556–568.
- Petrovski, A., Kochov, A., and Zileska - Pancovska, V. (2014). “Sustainable improvement of the energy efficiency of an existing building.” *Mechanical Engineering - Scientific Journal*, 32(1).
- Petrovski, A., Marina, O., Dimkov, G., and Papasterevski, D. (2015). “Sustainable design for improvement of healthy built environment.” *Proceedings of 2nd International Academic Conference on Places and Technologies*, University of Ljubljana - Faculty of Architecture, Nova Gorica, 52–58.
- Ramzy, N., and Fayed, H. (2011). “Kinetic systems in architecture: New approach for environmental control systems and context-sensitive buildings.” *Sustainable Cities Soc.*, 1, 170–177.
- Sartori, I., Napolitano, A., and Voss, K. (2012). “Net zero energy buildings: A consistent definition framework.” *Energy and Buildings*, 48, 220–232.
- Srinivasan, S., O’Fallon, L. R., and Deary, A. (2003). “Creating Healthy Communities, Healthy Homes, Healthy People: Initiating a Research Agenda on the Built Environment and Public Health.” *American Journal of Public Health*, 93(9), 1446–1450.

Who is Driving an Adaptive Building Envelope

Robert Buck, Peter Lenk

Arup, London United Kingdom, rob.buck@arup.com, peter.lenk@arup

The external environment changes constantly with the time of day, the climate and the seasons therefore an adaptive approach to solar shading would seem a logical solution. The façade that could maximise the daylight into the space when available to do so whilst reducing the heat gain to acceptable levels would reduce the energy consumption of the building and improve the wellbeing of the occupants. However, relatively few projects are solved with an adaptive solution resulting in a passive approach of solar control glazing and limitation of window to wall ratio. The paper, through a case study, explores the decision process when considering an adaptive approach to solar shading and highlights the barriers to its implementation on projects in London. This includes the current attitude towards daylight, cost and reliability. The paper identifies alternative kinetic systems that would overcome some of the barriers and suggests an alternative commercial approach to the implementation of adaptive shading system based on a leasing model.

Keywords: Adaptive, movable, drivers, leasing

1 Introduction

The temperature, sun intensity, daylight and wind speed varies through-out the day and with the seasons. The ultimate façade would be able to adapt to the external conditions, taking advantage of the external conditions when it is desirable to do so and protect it when not. Adaptable, movable systems are not new, and there are a number of different products on the market that control the amount of sunlight / daylight into the space. Some are standard off the shelf products where as others are more elaborate and developed for the individual project. This paper explores the views when considering a movable system.

1.1. A passive approach

Many architects would consider a passive approach to the façade design, employing window sizing and position, solar control glass, fixed solar shading or large reveals and orientation as tools to control the heat gain and maximise daylight. And in many cases, this achieves an acceptable performance. However, the approach leads to a compromise with either lower light levels in winter or greater heat gains in summer resulting in larger cooling plant and running cost than would otherwise be required. Also, the occupants are not able to maximise the benefit from the intrinsic value that daylighting can bring.

1.2. An active approach

The building envelope has a very significant and direct impact on occupants beyond energy-efficiency. As multisensorial filters, façades have the potential of simultaneously moderating the energy and mass flow to positively impact occupant comfort, satisfaction and productivity whilst

reducing energy consumption. Recent research [1] has been focusing on providing means for quantify holistic and transient benefits of adaptive facades on human factors.

The issues associated with the decision making when considering an adaptive façade are many and some of these issues are illustrated with the following case study in which the façade design was based on external movable solar shading blinds at concept stage but were eventually removed at design stage.

2 Architectural design and performance requirements

The case study describes a speculative office building with retail on the ground floor located on a very busy road in central London. The overall height of the building is approximately 38m and consists of 10 floors with the first 2 floors set to retail. The building has 5 elevations which twist and create terraces on the 6th floor.

The environmental drivers were to reduce the energy loads on the building with a target to achieve outstanding with the BREEAM 2014 [2] and a minimum of excellent for when the building is delivered in 2020. The façade is to be designed to meet the current standards and be aware of how the relevant standards will change in the future with the onset of global warming.

The principle of cooling of the building was based on chilled ceilings to cope with internal gains and displacement ventilation to cope with solar gains, which required careful control over the gains produced in the building and entering the building.

Due to the depth of the floor plan it was unlikely that the BREEAM credit for daylighting which requires for 80% of floor area to have a daylight factor of 2% would be achieved. However, the architect understood the benefit of daylight and was interested in to achieve acceptable performance.

2.1. Architect's initial façade proposal

The architect had developed the design of the façade during the concept stage, driven by energy, aesthetics and achieving planning permission. The typical façade module or bay on the building consists of large format glazing accounting for 40/45% of the façade area. Below the window is a spandrel in travertine stone. Adjacent to the large format glazing are opening windows to provide natural ventilation when the conditions are suitable. A perforated panel was mounted in front of the window opening, providing shading and the windows open inwards. Opening windows were also mounted below the large format glazing. These windows were not protected by the external solar shading blind.

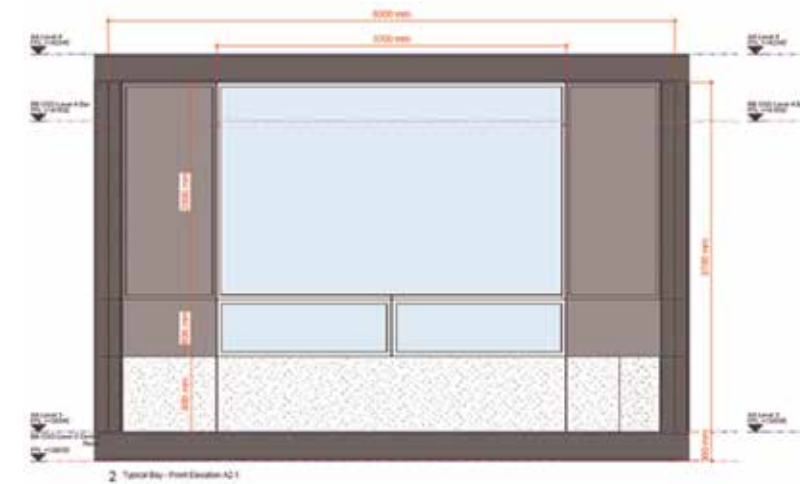

Figure 1 Typical façade bay with external roller blind

2.2. Façade engineers initial proposal

At concept stage of the design, the method for controlling the heat gain was with external blinds in-front of the large format glass. This is a solution which is common in continental Europe but rare in central London.

The client was concerned with the potential damage to the blinds during windy conditions and the solution was to include an additional layer of glass to the outside of the blind. Therefore, the façade behind the blind required the facility to open to provide access and maintenance to the blind and for cleaning of the glass.

2.3. Daylight Performance and Solar Gains

Although daylighting was not a requirement, the benefit of raising the blinds when the solar heat gains were at acceptable levels was desirable. A study was undertaken to identify how often the blinds would need to be deployed.

The cooling capacity of the mechanical system recommended by the Mechanical, Electrical & Plumbing (MEP) Engineer in order to achieve BREEAM credits was limited to 30 W/m² of peak solar gains on a depth of 4.5m.

An annual simulation was carried out by means of Arup Solar [3], an in-house parametric Radiance-based tool. The software allowed the parametric study of multiple permutations of input parameters at once and present to the design team and ultimately client in a clear way, outlining benefits and drawbacks of each investigated scheme.

The weather file used was the Design Summer Year for London (DSY) by CIBSE (Chartered Institution of Building Services Engineers) [4].

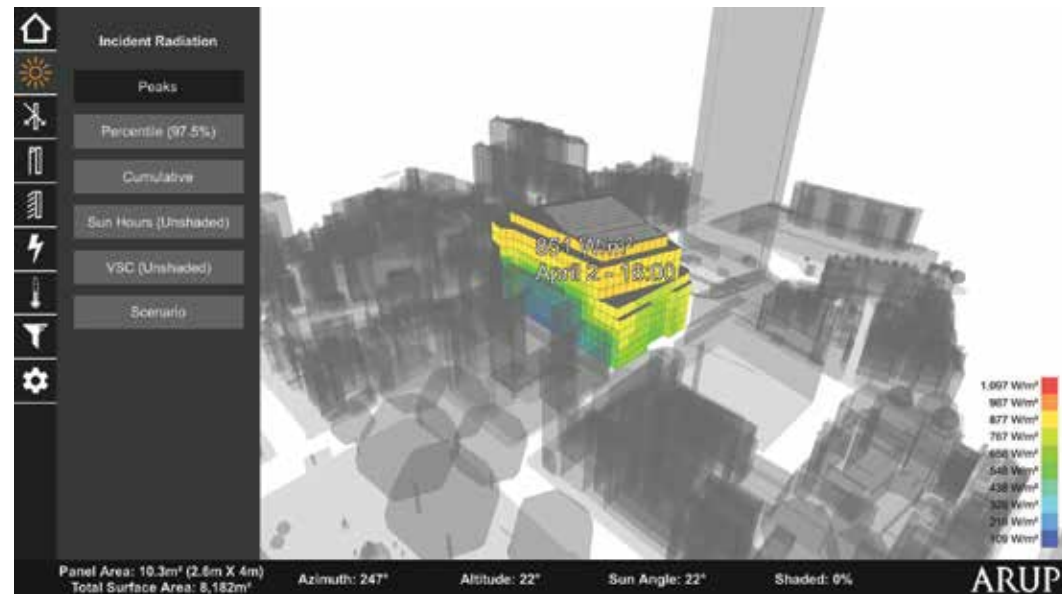

Figure 2 – Incident solar radiation - SW elevation.

Since the peak solar radiation as presented on figure 2, occurs only for very few periods during the year, a common method is to consider a percentile value of 97.5 % of the maximum heat gain as recommended by CIBSE TM 37 – Design for improved solar shading control [5]. The resulting g-value required to cope with the mechanical system and window to wall ratio around 40/45% were on the SW elevation around 0.15 as shown in figure 3.

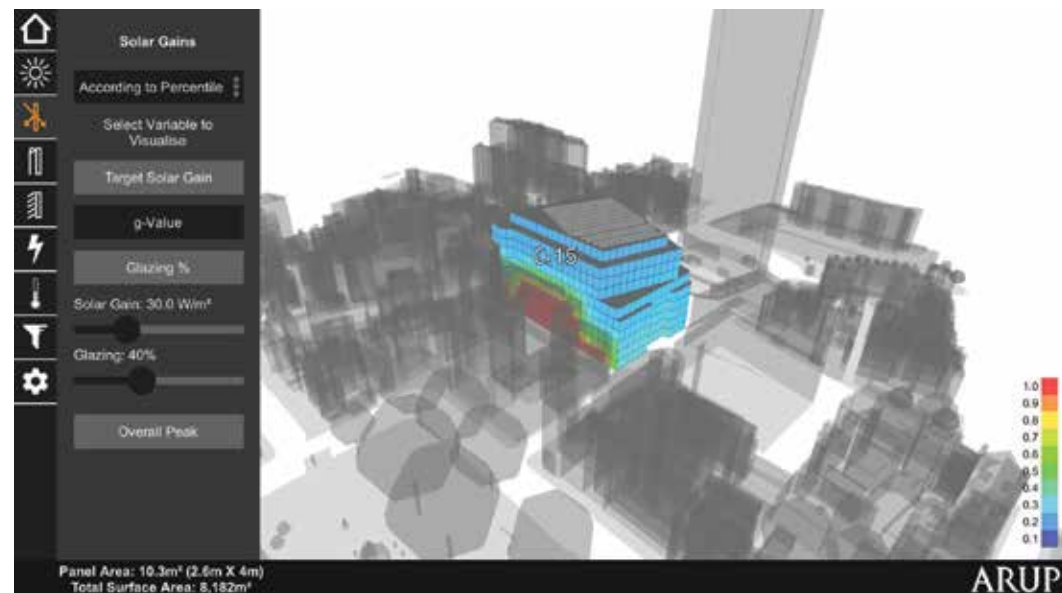

Figure 3 - g-value required to cope with the design requirements - SW elevation.

An assessment was undertaken to evaluate how often the blinds would be deployed during the year for the most exposed orientation (SW - Figure 4, 5). The time identified in red represents the number of hours that the blind is fully deployed compared to the elements in white representing the time that the blinds are raised. The time represented in blue is the night time. The evaluation was based on the following glass:

Double skin façade (Clear single glazing + Cavity + DGU with a g-value of 0.39), with the blinds

Performance Assessment

deployed the g-value reduced to 0.12. The opening windows which were not protected by the blind had a DGU with a g-value of 0.39.

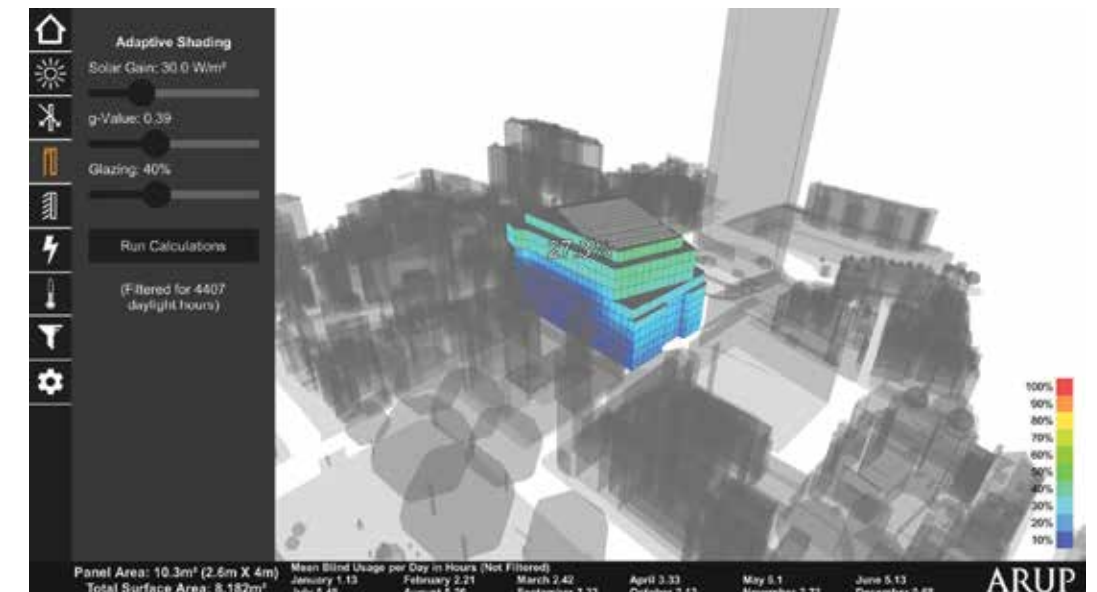

Figure 4 - SW elevation - adaptive shading requirements (Arup Solar)

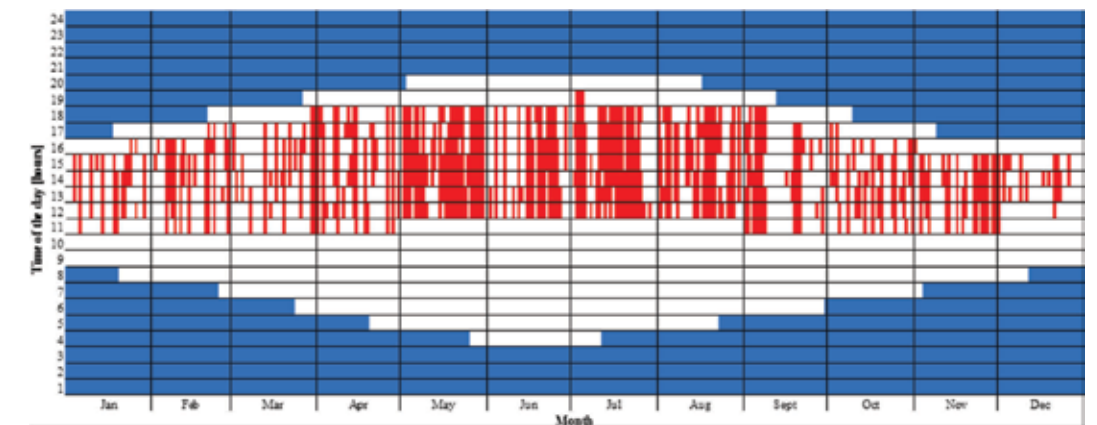

Figure 5 SW elevation – hours that the blinds would be deployed throughout the year

With a g-value of 0.39 for the DGU, the blind will be deployed for approximately 27% of the sun hours. During the summer months between May and August the blinds will need to be deployed for the entire work day. Decreasing the g-value of the glass would reduce the time that the blinds were deployed and the results were different for each elevation.

The blinds could be deployed less often in the summer months by reducing the g-value of the glass. The negative result of this is a reduction in the daylight levels into the space when the blinds were raised.

3 Cost Evaluation

The cost of the façade was evaluated based on a module of 6m wide by 4m (24m²) of façade and a blind area of 8.5m² (3.7 x 2.3). The price is based on area of façade.

The façade is relatively expensive comprising a bespoke unitised curtain walling system with opening windows, feature channels and travertine stone. The total cost of the façade was estimated as £1300 per m² with the cost of the external blinds to the façade including the glass to protect the outside of the blinds contributed to approximately 35% of the façade cost.

The maintenance cost to servicing the blinds was also an issue. To maintain the guarantee the blinds required to be serviced once a year. Although the maintenance was limited and consisted generally of checking operation, cleaning, lubrication this was not an insignificant cost. As the blinds were accessible from the inside there was no cost for external access but the maintenance of the blind would cause disturbance to the occupants requiring the servicing to be conducted out of working hours with security presence and at additional cost.

Due to the relative short duration that the motors will be in operation with low power motors, the electrical cost for operating the blinds are insignificant. The control panel will be in constant operation monitoring the input signals and this would draw similar power to a lap top computer.

4 Decision from the client.

The client was not convinced with the use of external motorised blinds and cited the reasons below:

- The cost to purchase the blinds and to maintain them is not insignificant and the fear of poor reliability of movable electronic systems is a barrier to increased uptake. The client was provided with many examples of large buildings where blinds had operated for many years and were in good working order but this did not fully relieve their concerns.
- When the blinds are deployed the view is invariably compromised; and the amount of times that the blind would need to be in the deployed position during the summer month concerned the client.
- External blinds in the centre of London are not common place unlike the cities of continental Europe, and there was a fear from the client that his building will be referred to as the 'building with the blinds'. There is, of course the Shard, which is similar with blinds mounted behind glass. On the Shard, the blind head boxes are painted vibrant colours to act as a feature whereas our client wanted the blinds to disappear.
- Consistency of appearance was also important for the client ensuring that all the blinds on the elevation were deployed at the same time to the same position and were reliable. Countering this argument is that there are also internal blinds for glare control and these blinds would also be down for long periods of time in the summer compromising the view out. However, generally the user has control of the internal blinds and can raise the blind to benefit from the views when desired which would not be possible with the external shading blinds. Also, the opening windows below were not protected by the blinds and would provide uninterrupted views out.

Alternative blind types were considered to reduce the cost which included micro louvres which are more resilient than the fabric and thus not requiring the additional layer of protection glass and zipped fabric systems that can withstand higher wind load. There is also the possibility that the micro louvres could also be deployed in-front of the opening windows currently below the blind and thus reducing the solar heat gain into the space further. However, the confidence of the reliability nor the aesthetic of an external blind was accepted by the client.

The blinds were eventually removed from the glazing during the design stage and replaced with a high-performance glass which would normally be used in the middle east with a g-value of 0.14 and a light transmission value of 0.32. The main driver for requiring the blinds was the high target of reducing the heat gain below 25W/m² to allow the displaced ventilation and chilled ceilings to operate. This glass did not quite achieve the desired performance and the services was later changed to low energy fancoils.

5 Alternative approaches not considered.

There are alternative systems that could address some the concerns that that the client raised but were not fully considered for this project but worthy of consideration for the next project.

5.1. Kinetic systems

One method of overcoming the concerns associated with electronic and control systems is to have products that respond automatically to the environment such as temperature and moisture variation. Kinetic structures that have multiple states of stability are attractive for building facades because of the lack of framing or folding gear and moving parts that are typically needed. Omni-stable systems eliminate the need for multiple moveable parts, which tend to have a detrimental effect on their appearance, but also on other important aspects such as system maintenance and durability.

Three innovative reference projects that employ kinetic multi-stable forms are:

- HygroSkin [6] explores a novel mode of climate-responsive architecture where the dimensional instability of wood in relation to moisture is researched;
- Bloom where Sung [7] proposed new uses for bimetals, creating tessellated skins comprising small geometrically fitted tiles that react to the Sun;
- Movable Thin Glass Canopy very first practical applications of thin glass was a deployable canopy developed by Neugebauer [9];
- One Ocean Pavilion [8] was realised as a permanent building, where more than one hundred individually moveable louvers that are set to respond to changing sunlight conditions.

The potential of kinetic omni-stable glass structures, could be applied in fully glazed double skin facades. The outer skin of a double skin facade could be formed from the glass sheets that can deform and thus breathe, releasing heat from the cavity when required. This deformation can be triggered either by the movement introduced in the supports or spontaneously by lamination of glass with different absorptivity, or thermal expansion. Another alternative is that glass surface coating may increase glass temperature locally.

5.2. Switchable glazing

Switchable glazing appears to be the ideal solution. Maximising daylight levels when able and shading when required without compromising the architectural aesthetics or the natural ventilation principles. However, with some systems, the reduction in solar control may not fully achieve the desired performance or the speed deemed to be too slow or the colour of the glass does not fit with the aesthetics of the building. Also, with a relatively new technology entering the market there is a prohibitively high initial cost and concern over the reliability of the system.

6 An alternative purchasing model for the future.

The concerns over reliability and the on-going maintenance cost is one of the main barriers for the uptake of dynamic façade systems. An alternative approach could be that the products are not purchased but are leased. The products remain the ownership of the manufacturers. The manufacturers would be responsible for repairing and maintaining of the system as part of the leasing agreement.

The additional benefit to this type of agreement is that it is in the manufacturer's interest to build reliable products and minimise the down time for which the client will not be paying. Further, there is currently a lack of information that is passed to the manufacturers to improve the product design as generally their products are installed and maintained by others. This would also have benefits on environmental grounds allowing the manufacture to recycle or reuse the product at the end of its life and develop a true circular economy. A further option to consider is selling the system on performance grounds. With better and less expensive sensors, the solar gain into the space could be monitored and the system performance measured against these values with the leasing arrangement based on achieving a performance criteria.

7 Conclusion

The façade design of the case study was driven by the building services energy model and the specification to achieve an energy level meeting BREEAM outstanding. The daylighting and the quality of the light was not a governing factor which resulted in a high solar control glass replacing the clearer glass and a dynamic solar control system. To achieve greater uptake of dynamic systems the benefits of daylight and the productivity and wellbeing of the occupants must be placed as a higher priority when specifying a new building and studies are required to quantify the benefits and make them widely distributed. The WELL V2 standard goes somewhere towards this, however it's take up in the speculative market is relatively slow.

There is concern, especially with speculative developers, that movable systems are unreliable and require expensive maintenance and thus make the building less desirable to rent. To overcome the fears of reliability, more case studies are required although this is difficult to achieve when the manufacturer is removed from the eventual owner or user of the building. Kinetic systems that move using the environmental conditions as the energy source is an exciting development but the fear of the innovative technology and potential reliability will be a barrier to greater adoption. Leasing the equipment could be one approach that removes these fears, especially for innovative products where the initial purchasing cost is probative as with the switchable glazing. This approach also has sustainability benefits allowing the manufacturer to upgrade when necessary and establish a process for recycling equipment.

8 Acknowledgment

We thank to Mattia Donato, Alessandra Luna-Navarro, for their contribution to this paper.

9 References

- [1] Luna-Navarro A., Meizoso M., DeBleecker H., Verhoeven Y., Donato M., Overend M., (2018) Façade impulse: experimental methods for stretching the envelope beyond human comfort. In: Proceeding of VIII International Congress on Architectural Envelope, June 20, 21, 22 2018. San Sebastian-Donostia, Spain.
- [2] BREEAM (Building Research Establishment Energy Assessment Method) UK New Construction – Non- Domestic Buildings, Technical manual SD5076:01 2014.
- [3] Mattia Donato, Giovanni Zemella, Gianluca Rapone, Jak Hussain, Conor Black (2017) An innovative app for a parametric, holistic and multidisciplinary approach to early design stages. February 2017.
- [4] CIBSE, (2016). CIBSE Design Summer Year 1 (London Weather Centre)- <https://www.cibse.org/weatherdata>.
- [5] CIBSE, (2006). Technical Memorandum - TM 37, Design for improved solar shading control. London (United Kingdom), <http://www.cibse.org/Knowledge/knowledge-items/detail?id=a0q2000000817eIAAC>.
- [6] Krieg, O. Zachary C & Zuluaga C, Menges, D (2014). HygroSkin – Meteorosensitive Pavilion, In: Fabricate 2014: Negotiating Design and Makin, Zurich 2014.
- [7] Galloway, A. (2014) When Biology Inspires Architecture: An Interview with Doris Kim Sung, In ArchDaily, 2014 <https://www.archdaily.com/505016/when-biology-inspires-architecture-an-interview-with-doris-kim-sung>.
- [8] Maier, F. (2012) One Ocean – Thematic pavilion for EXPO 2012, In Detail <https://www.detail-online.com/article/one-ocean-thematic-pavilion-for-expo-2012-16339>.
- [9] Neugebauer, J. (2015) Movable Canopy, In: GPD 2015, Tampere Finland, 2015.

Opportunities and Challenges for Performance Prediction of Dynamic Complex Fenestration Systems (CFS)

Giuseppe De Michele 1, Roel Loonen 2, Hemshikha Saini 2, Fabio Favoino 3, Stefano Avesani 4, Luca Papaiz 5, Andrea Gasparella 1

1 Free University of Bolzano/Bozen, Faculty of Science and Technology, giuseppe.demichela@eurac.edu

2 Eindhoven University of Technology, Department of the Built Environment

3 Politecnico di Torino, TEBE research group, Department of Energy

4 Eurac Research, Institute for Renewable Energy

5 glassAdvisor

This article presents an overview of possibilities and points of attention for modelling the performance of dynamic CFS in building performance simulation software. Following a detailed analysis of the unique requirements that are associated with modelling of CFS, a comparative study of the capabilities in different software implementations is presented. In addition, we present an overview of state-of-the-art approaches to obtain the necessary Bi-directional Scattering Distribution Functions (BSDF), involving experimental characterisation, databases, and component-level ray-tracing approaches. The second part of the paper provides a detailed discussion of a case study of a high reflective lamella system. This case study complements the review with hands-on information from a practical example and highlights the importance of developing models at the right level of complexity, taking into account the type of questions that the simulation intends to answer and the required accuracy level to do so.

Keywords: Complex Fenestration Systems (CFS), building performance simulation, bi-directional scattering distribution functions, reflective lamella, modelling complexity

Full paper available in the Journal of Facade Design and Engineering, Vol 6 No 3 (2018): Special Issue FAÇADE 2018 – Adaptive!

Analysis of Heating Effects and Deformations for a STAF Panel with a Coupled CFD and FEM Simulation Method

Brandl Daniel 1, Schober Helmut 2, Hochenauer Christoph 1

1 Graz University of Technology/ Institute of Thermal Engineering, Austria, daniel.brandl@tugraz.at

2 Graz University of Technology/ Institute of Building Construction, Austria

Conventional sandwich panels are one of the cheapest and easiest solutions for forming the thermal building envelope of industrial buildings. They are pre-fabricated façade elements, of which millions of square metres have been produced and mounted every year. There is great potential to reduce the consumption of fossil fuels and CO2 emissions through the solar thermal activation of such a sandwich panel. In the course of the research project ABS-Network SIAT 125, a Solar Thermal Activated Façade (STAF) panel was designed which is to be optimised both thermally and structurally. This study shows a first version of a so-called 'one way coupled' thermal and structural analysis of a conventional sandwich panel compared to the STAF panel. For this purpose, the numerical methods of Computational Fluid Dynamics (CFD) and Finite Element Method (FEM) are used together in one simulation environment. Furthermore, results from an outdoor test facility are presented where a first version of a STAF panel is tested under real climate conditions. The CFD model was positively evaluated by comparing measured and computed temperatures.

Keywords: Solar Thermal Activated Façade (STAF) Panel, Computational Fluid Dynamics (CFD), Finite Element Method (FEM), outdoor measurements,

Full paper available in the Journal of Facade Design and Engineering, Vol 6 No 3 (2018): Special Issue FAÇADE 2018 – Adaptive!.

An innovative adaptive multilayer façade: evaluation in the test cell LABIMED

Rosa Romano, Paola Gallo, Alessandra Donato

Department of Architecture, University of Florence, Italy, rosa.romano@unifi.it

Sustainable energy efficient building policies have shown a significant growth in recent years, deeply changing the way to design buildings. Directive 2010/31/EU prescribes more stringent commitments to increase energy efficiency in the construction sector to achieve EU standards nearly Zero Energy Building (nZEB). New technologies and design solutions need to be developed to meet highest performance levels for components and building envelope systems requirements. However, for advanced hybrid façades there are no established evaluation strategies and characterization methods to assess their energy performances. Evaluation of dynamic behaviour of adaptive façades using full-scale outdoor test facilities can significantly help to overcome these issues contributing to their performance assessment. This paper presents the evaluation of an adaptive multilayer façade by mean of LABIMED, a PASSLINK outdoor test cell at Florence University able to assess energy performances of full scale façade systems through a well-controlled realistic room sized environment equipped with advanced measuring instruments, providing a high quality of output data coming out from the dynamic monitoring test. Furthermore, a detailed description of the Test Cell LABIMED will be shown. Finally, the experimental test performed on a multilayer hybrid façade will be described, discussing the monitoring strategies adopted to evaluate the case study energy behavior.

Keywords: Adaptive envelope, Outdoor Test, Test Cell, Monitoring activities, Energy Performance.

1 Introduction

The building sector has a significant impact on energy saving. European strategies moving towards nearly Zero Energy Buildings (nZEB), as defined by the Energy Performance of Buildings Directive (EPBD) 2010/31/EU, also promoting smart technologies integration in buildings and product innovation in the construction sector. In this framework, the research in the field of adaptive building components, advanced materials and nanotechnologies, shows a great potential, and lately led to significant results, completely changing the way to conceive and to design the building envelope (Perino 2007; Becker 2014; Aelenei 2014). However, for these advanced façade systems there are no yet established evaluation strategies and characterization methods to assess their energy performances. In many case, in fact, results from traditional laboratory tests are very different from the real operating conditions applied in a full scale building, because they don't take into account the effects due to the changing outdoor conditions (AA. VV. 2015). Therefore, evaluation of dynamic behavior of adaptive façades using full scale outdoor test facilities, can significantly help to overcome these issues, contributing to their performance assessment (Bloem 2007).

This paper shows ongoing research activities carry on an adaptive multilayer façade system SELFIE, developed by Abita Interuniversity Research Centre of Florence University, involving several partners such us research institutes on materials technology and construction industries. The first aim of the research SELFIE (Smart and Efficient Layers for Innovative Envelope) has been the improvement of more efficient architectural solutions, developed to be integrated both in new construction and existing buildings, to achieve high energy efficiency performances and to satisfy

the construction market trend requirements for buildings energy saving and indoor environment quality (Gallo and Romano 2017). In detail, the first part of the paper presents the design and technology features of a full scale test facility for the Mediterranean area: the Test Cell LABIMED, an outdoor laboratory built to study innovative façade systems under real climatic conditions (Alcamo and Donato 2011; Baker and Van Dijk 2008). The second part is focused on the experimental activities provided for the outdoor test in order to analyse at the full scale the energy performances of an adaptive façade system developed in the frame of SELFIE research.

2 The Test Cell LABIMED

2.1. The project of a test cell for Mediterranean climate

The Test Cell LABIMED was realized in the frame of the research project Abitare Mediterraneo, funded by the Tuscany Region and developed by the Architecture Department of the Florence University jointly with 12 Italian companies of building sector in 2010. The main aim of this project was to create a system in which technological innovation and architectural quality could finding real application in the construction field, increasing energy saving and promoting a close collaboration between manufacturing companies, builders and research centres (Gallo 2014).

Test Cell LABIMED can be considered a significant result of this research. It was realized in order to investigate the overall energetic and thermo-physical performances of opaque and transparent façade systems, testing full scale products by means of dynamic measurements in real climatic conditions.

The advantages offered by using test cells, compared to other methods, depend on the possibility to test full scale envelope systems by means of well-controlled realistic room sized environment equipped with advanced measuring instrumentations, providing a high quality of output data coming out from the dynamic monitoring test (Bloem 2007). Moreover, these reliable data sets can be largely used for data analysis and to validate the most common building energy simulation tools.

The project of Test Cell LABIMED gone arise to the outcomes of the research activities carried out during PASSYS and PASSLINK projects (Baker and Van Dijk 2008; AA.VV. 2015). They were focused on development of agreed quality procedures for full scale test and dynamic data analysis, investigating the energy quality and thermo-physical properties of passive solar building components as: thermal transmittance, solar factor, and behaviour associated to its thermal inertia. Therefore, the test Cell LABIMED has been designed likewise the other EU PASSLINK Test cells, but improvements were achieved to overcome some critical aspects such as: indoor overheating, thermal bridges effects, problems due to infiltrations and heat conductive parts. For these reasons, it was built with a wooden structure in platform frame, where it is possible to integrate an insulated removable wood façade for placing the test sample (Fig.1).

All the envelope components were realized with the same material and had the same thickness (0.30 cm) and same U-value (0.32 W/m² K). They were provided of wooden external solar shading device to avoid overheating which could affect the accuracy of results during the test.

The test cell was positioned on a rotating system to evaluate differences in building component performances corresponding to different orientations. (Fig.2)



Fig. 1. a) The platform frame structure of Test Cell; b) The insulated removable wood façade for placing the test sample.

Furthermore, the LABIMED was equipped only with a heating system and an axial fan, which have the function to heat the air volume of the Test Room and to ensure the indoor air convection in order to reduce interior temperature stratifications. During the test, indoor ambient conditions of test room can be considered homogeneous. The electrical heater warms the air volume inside the test room and the air temperature sensors measure data to compare air temperature profiles at different heights. In order to establish an overall energy balance, the heater can be switched on and off from the data acquisition system and a power transducer measures the power consumption. During the test, the thermal power generated inside the test room by the heater and the heat flux rate through the envelope of the test room are instantaneously measured; the heat flow through the test component may be derived indirectly applying the overall heat balance equation.

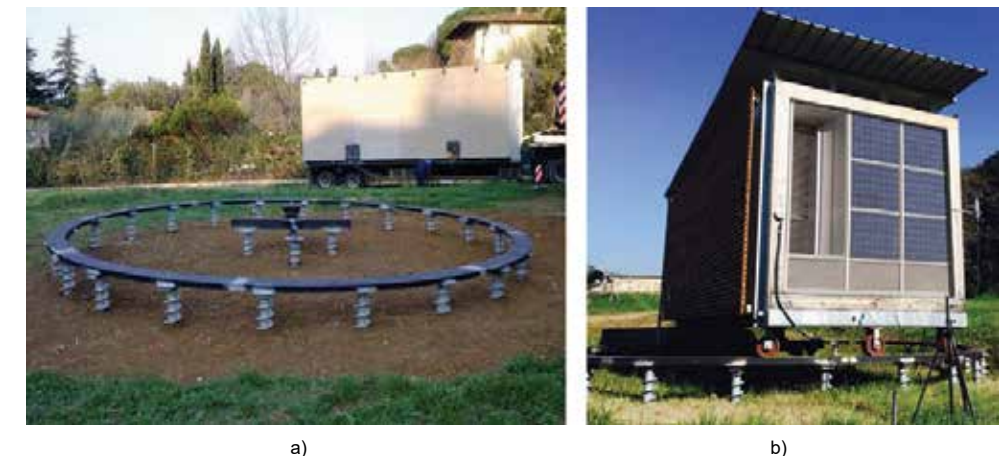

Fig.2. a) The rotatable platform to assess dynamic behavior of test sample corresponding to different orientations; b) An external view of the Test Cell LABIMED

2.2. Monitoring apparatus and Data Acquisition System

PASSYS protocol (Maldonado 1993) established highly standardized set of physical test parameters and experimental procedures. Therefore, the minimum set of sensors have been

installed inside and outside to the Test Cell in order to monitor and to record all parameters required by PASSLINK method: each sensor is identified univocally by mean of an alphanumeric code which refers to PASSLINK specifications about both its location and type of parameter measured by sensor (Tab.1).

The south wall test sample requires an additional set of sensors (such as: thermocouples, heat flux sensors, humidity sensors, air speed sensors, etc.) depending on the test purposes.

Sensor	Quantity	Position	Parameter Measured	Unit of Measures	Accuracy	Range
Thermoresistance PT100	6	1 for each surface of the test room, 50 cm distance	Air temperature	°C	±0.1 °C	-20°C...80°C
Thermocouples type T	26	5 for each wall, 3 on the roof and 3 on the floor of the test room	Surface temperature	°C	±0.5 °C	-20°C...60°C
Miniature probe	1	Centre of the test room	Relative humidity	%	±0.5 %	0%...100%
			Air temperature	°C	±0.1°C	-20°C...80°C
Globe thermometer (PT100 sensor)	1	Centre of the test room.	Radiant temperature	°C	±0.1°C	0°C...120°C

Table 1: basic monitoring equipment installed inside the Test Cell

The measurement of radiant temperature allows monitoring the comfort indoor, providing some additional information such as data on radiative heat exchanges that take place through the surface of the globe and the inner surface of the test room. Furthermore, during the analysis of the data set, it is possible to suppose a single value of internal surface temperature obtained from the average value of all measured values.

A workstation unit is located inside the service room, it allows to manage monitoring equipment during the test and includes control and measuring devices such as:

- Data Logger which scans and records signals of all internal and external sensors connected. This is also able to control the switching mode (on and off) of the heating system inside the test room.
- Host computer to store all signals into a daily file for the post processing and analysis of data.

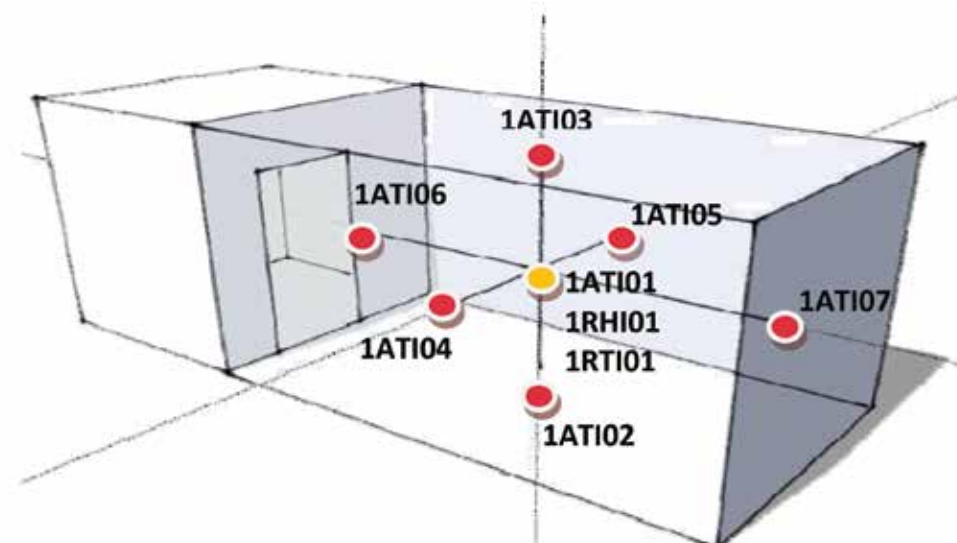

Fig.3. Scheme of Pt100 thermoresistances (1ATI_n), globe thermometer (1RHI01) and miniaturized transmitter (1RTI01) located inside the test room



a)



b)

Fig.4. Pictures of: a) The globe thermometer to measure indoor radiant temperature; b) The PT100 thermoresistance to measure indoor air temperature

A Data Acquisition system (DAQ) has been configured using Labview software to acquire data from more than 80 sensors each minute and to manage all the system. An user interface permits to observe graphical profiles of all the monitored signals in real time to verify accurate functioning of all sensors and to identify eventually fails during the test. Moreover, DAQ system allows checking the switching of the heater inside the Test Room and to apply the heating test sequence including those defined by the PASSLINK procedures.

3 The Heat Flux Tiles System

Compared to other PASSLINK Test cells, the main improvement of LABIMED concerns the presence inside the test room of Heat Flux Tile (HFT) sensors (Linden, Dijk, Lock and Graaf 1995) developed from the Industrial Engineering Department of the University of Florence (DIEF) using Peltier cell as sensitive element (with a surface of 1600.00 mm and a thickness of 4.00 mm). In this innovative technological solution the Peltier cell was applied in the centre of HFT into a filling structure composed of two aluminium layers of 3.00 mm thickness, which have the same overall thermal conductivity as the Peltier cell ($\lambda=0.8$ W/mK). Furthermore, according to PASSLINK methodology, a layer of polyurethane foam was applied with the purpose to fill any air cavity behind HFT that would cause errors in the measurement of heat flow. An accommodation to allocate flat cables and connectors needed to wire the tiles in series and to join groups of signals for the measurements acquisition was obtained in the cavity. Therefore, the main feature of this type of sensor was that its sensitive component region and its surrounding area were characterised by the same thermal resistance. In this configuration, it is reasonable to assume the unidirectional heat flow and homogeneous surface distribution of heat flow through the tile and the measure can be considered reliable around the effective surface of the primary sensor up to the edge

The 230 prefabricated HFT sensors covered all the inner surfaces of the test room except the test wall (Fig. 5). In this way, during a test, the thermal power generated inside the test room by the heater and the heat flux rate through the envelope of the test room can be measured instantaneously; the heat flow through the test component may be derived indirectly applying the heat balance equation. Quality and accuracy of measurements data sets depends directly on the precision with which heat flow rate is measured through the envelope of the test room (Erkoreka,

Bloem, Escudero, Martin, Sala 2015). Any rapid changes of heat flux measurements may be possible thanks to the small thermal inertia of the tiles.

The calibration values of the mentioned HFT sensors were obtained through laboratory tests (Donato 2016) performed by University of Florence, using a standard calibration device that consists of a hot plate apparatus with a guard ring. Moreover, the sensitivity of this new heat-flux sensor was optimised for the use in the test cell leading to an output signals in the range of mVolts, with high reproducibility of the measurements. (Fig. 6)

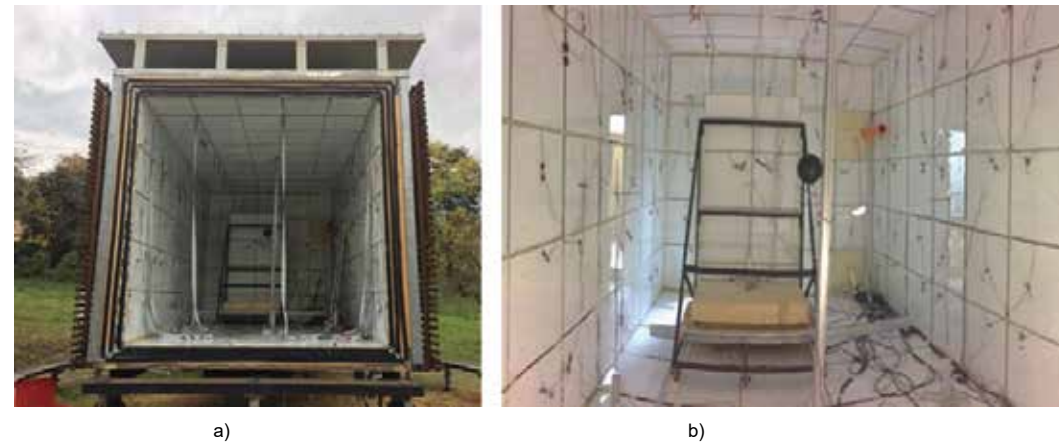

Fig.5. Overview of: a) the Heat Flux Tiles system inside the Test Room; b) Connection in series by means of flat cables and interface modules to obtain final signals.

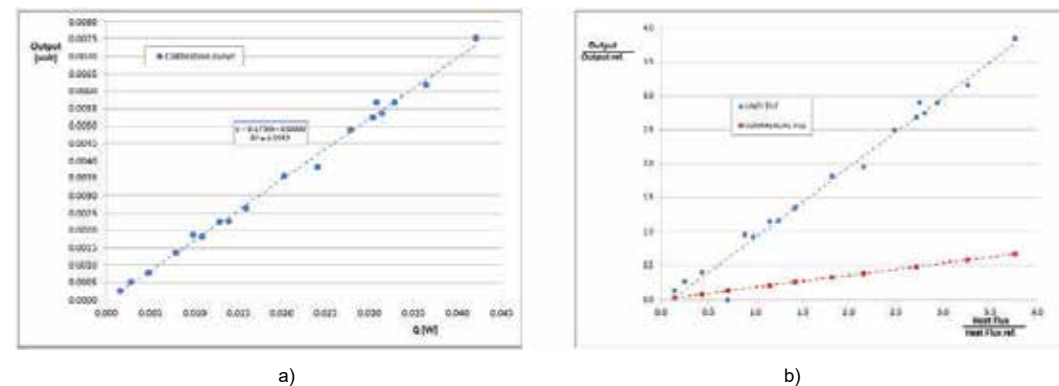

Fig.6. a),b)Results of calibration process of UNIFI Tiles in hot plate apparatus with a guard ring and comparison with a commercial tiles.

4 The SELFIE façade test

4.1 Features and operational functions of the façades

The research SELFIE, has been started since April of 2016 with the aim to develop three innovative envelope components that can be assembled, with different geometric configurations in the SELFIE façade (280.0 cm x 280.0 cm). The concept of the three SELFIE components (Tab. 2) foresees several functionalized layers that could be separately assembled depending on the architectural design of the building where they will be installed. In the integrated solutions, the layers considered all together and performances tested as a whole. (Romano and Gallo 2018)

In order to analyze their energy performance, SELFIE system prototypes have been designed and evaluated in the concept phase, by mean of dynamic energy simulation tools considering several

operation strategies; in the executive phase, the façade prototype realized with the three innovative components has been tested under real outdoor conditions in the test cell LABIMED.

4.2 Experimental set-up and monitoring results

The prototype of the SELFIE façade, has been installed in the Test Cell since December 2017 with the aim to analyse its thermal performances.

The experimental set-up of the system for winter measurements concluded at the end of March 2018. In these months we analyzed the energy performances of the winter façade configuration, when the ventilation grid was closed. The objective was to investigate the thermal performance of the modules in order to store heat into the air cavity keeping the system warm for a longer period of time and reducing thermal losses from inside to outside.

In detail in this paper, we shown the results of the analysis carried out during a monitoring campaign started on 24/02/18 and ended on 18/03/2018.

Type	Description	Operating mode
SELFIE 1	<p>The component SELFIE 1 is an opaque panel composed of following layers from outside to inside:</p> <p>a) An outer glass layer assembled by two simple glass sheets coupled through a Poly Vinyl Butyral (PVB) film merged with nano-materials able to maintain the transmittance of the visible light and to reflect in the IR zone;</p> <p>b) A first internal layer realized with a panel of honeycomb, in the form of a porous ceramic charged with Titanium Dioxide (TiO₂) material able to be activated with visible light a purification effect of indoor air;</p> <p>c) An insulated panel of closure applied on a support frame in aluminum thermal break;</p> <p>d) A heat exchanger system is also integrated in order to reduce building energy consumptions in the winter months and increase micro-ventilation in the inner space in the summer months.</p>	<p>In winter, the module is expected to work as a preheating air supply façade: during the day air ventilation grids on the outer surface allow the air to flow into the cavity; the outer glass surface preheats the air coming from outside activating natural ventilation of airflow, which by the effect of TiO₂ coating on the honeycomb structure, purifies air that supplied into indoor zones. During the night, module works as a thermal buffer.</p> <p>In summer in the SELFIE 1, air is not exchanged between the inside room and outside, but comes from outside, cross the cavity and then is released outside again to dissipate the heat. Furthermore, the outer glass surface with a low-emission (low-e) coating reflects infrared radiation avoiding overheating.</p>
SELFIE 2	<p>The component SELFIE 2 is an opaque panel composed by following layers:</p> <p>a) An outer layer in Dye-Sensitized Solar Cell (DSSC) photovoltaic panels (PV), to produce renewable energy;</p> <p>b) An insulating layer in porous ceramic tiles integrating Phase Change Material (PCM);</p> <p>c) An insulated panel of closure applied on a support frame in aluminum thermal break.</p>	<p>The expected behavior of this module is to work as a thermal buffer in winter: during the day the DSSC PV panels absorb solar radiation generating heat into the cavity which is stored by the (PCM) during the melting process; when PCM solidifies during the night, the heat into the cavity keeping the system warm for a longer period of time.</p> <p>In summer, with high levels of solar radiation, the SELFIE 2 is expected to work as an outdoor air curtain: air is not exchanged between the inside room and outside, but comes from outside, cross in the cavity and then is released outside again to dissipate the heat. Insulation layer with PCM minimizes the effect of large fluctuations of temperature levels into the building and also shifts the heating and cooling loads to off peak electricity periods.</p>
SELFIE 3 Transparent module	<p>The component SELFIE 3 is a transparent panel composed by following layers:</p> <p>a) A window with thermal break frame with transmittance values of 1.2 W/m²K and a layer with a glass laminated sheet, with self-cleaning external treatment, coupled with PVB in order to maintain the transmittance of the glass visible light and to reflect in infrared;</p> <p>b) An electric venetian blind designed to optimize daylighting inside the building and to reduce thermal overheating phenomena in the summer months.</p>	<p>During winter, the double glazed window reduces heat losses from inside to outside thanks to a total transmittance of 1.2 W / m²K.</p> <p>During summer, the low-e treatment of outer glass reflected Infrared Reflective (IR) light and the solar shading system allows light transmission improving indoor lighting comfort and reducing thermal overheating phenomena.</p>

Table 2: Description and operating mode of SELFIE modules

Forty-two sensors (Fig. 8) were integrated into the test sample during these three weeks, according to the pictures shown in the Figure 7 and connected to a Datalogger to measure each 10 minutes the following parameters:

- 4 thermo-resistances PT100 located behind the inner grids and the upper grids to measure the temperature of the air entering and leaving the gap of SELFIE 1 and SELFIE2;
- 20 thermo-resistances to measure surface temperatures of each layer constituting the three SELFIE components;
- A Nitrogen Oxides (NOx) sensor behind the inner grid of SELFIE 1 (measurement range 0...4000 ppm, accuracy ± 0.1 ppm);
- 6 hot-wire anemometers to monitor air flows inside the gap in SELFIE 1 and SELFIE 2 at three different heights (measurement range 0...1.0 m/s, accuracy ± 0.02 m/s);
- 4 heat flux meters to measure the thermal flows through the components in W/m², in the centre of each SELFIE module, facing the indoor environment (measurement range -2000...2000 W, accuracy $\pm 3\%$);
- A pyranometer located on the vertical plane of the test sample to measure the global solar radiation W/m².

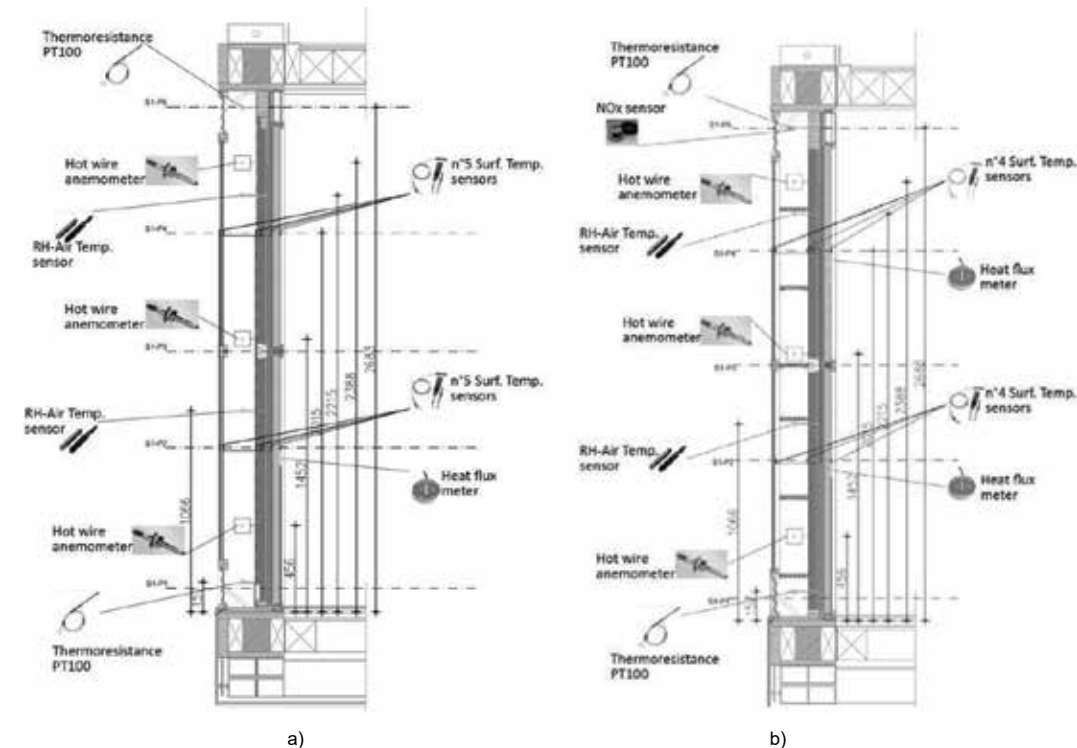

Fig.7. Scheme of the sensors integrated in the SELFIE system prototype: a) SELFIE 1; b) SELFIE 2.

The measured values were compared with data sets from another weather station located on the roof of a nearby university building, 15,00 m height above the ground. The global solar radiation over the plane of test wall was included in the overall balance of heat exchanges that take place between outside and inside through the test cell envelope and the test wall. This data is recorded by means of a pyranometer located on the vertical plane of test sample. The area surrounding the Test Cell is a green area; however, measurement does not take into account the reflected part of solar radiation on the façade due to the grass covering the ground.

The analysis on dynamic behavior of the façade prototype refers to the 9th of March 2018 (sunny conditions) and the 17th of March 2018 (partially covered sky conditions). The heating system was switched on between 7:00 am and 7:00 pm in weekdays (Temperature set point of 20°C) and turned off during the weekend. Comparing Indoor Air Temperature and Outdoor Air Temperature during both the days (Fig. 9), the graphs show that even during nighttime, when the heater is turned off, the indoor temperature never goes down below 18°C. Consequently, the thermal performance of the SELFIE prototype can be considered good, with respect to the reduction of thermal losses in winter, keeping the indoor environment close to comfort conditions (temperature range 18°C-24°C).

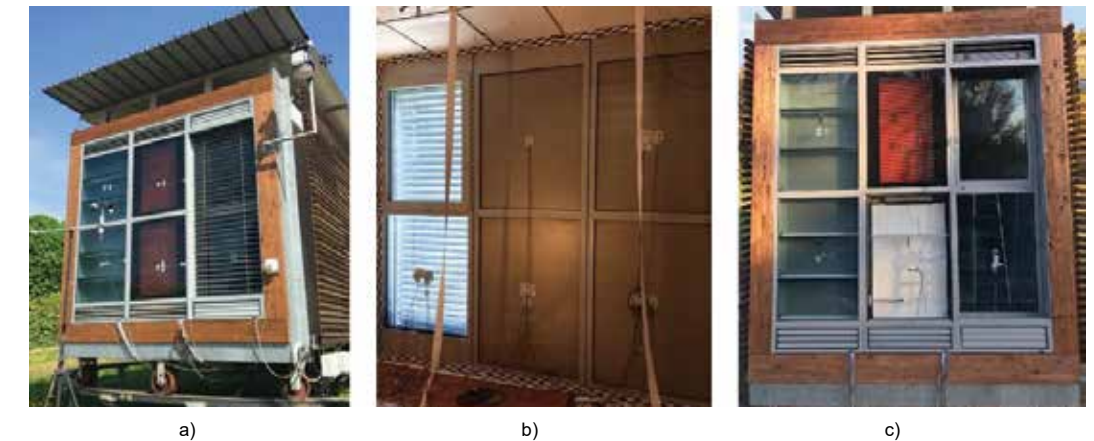

Fig.8. a) Picture of The SELFIE prototype in the test cell LABIMED;b) overview of sensors installed on inner surface of SELFIE façade (b); overview of sensors installed on external surface of SELFIE façade.

The temperature profiles through the cross section of SELFIE 1 and SELFIE 2 modules are shown in Figure 10 at different hours during two representative days of winter period. As a result of thermal buffer operative configuration, the air temperature inside the air cavity of SELFIE 1 is between 40°C and 50°C during the day, with a temperature difference (ΔT) of 45°C from 9:00 am to 3:00 pm in sunny day conditions. Under overcast conditions, during the day, the air cavity temperature changes between 20°C and 25°C with a ΔT of 15°C from 9:00 am to 3:00 pm. The SELFIE 2 module, during sunny day, shows high temperature on the PV module, in particular in the period between 12:00 am and 4:00 pm, when the surface temperatures reach values close to the melting temperature of the PCM. The PCM layer works as thermal storage, decreasing the temperature inside the buffer zone by 6°C - 7°C without changing its temperature.

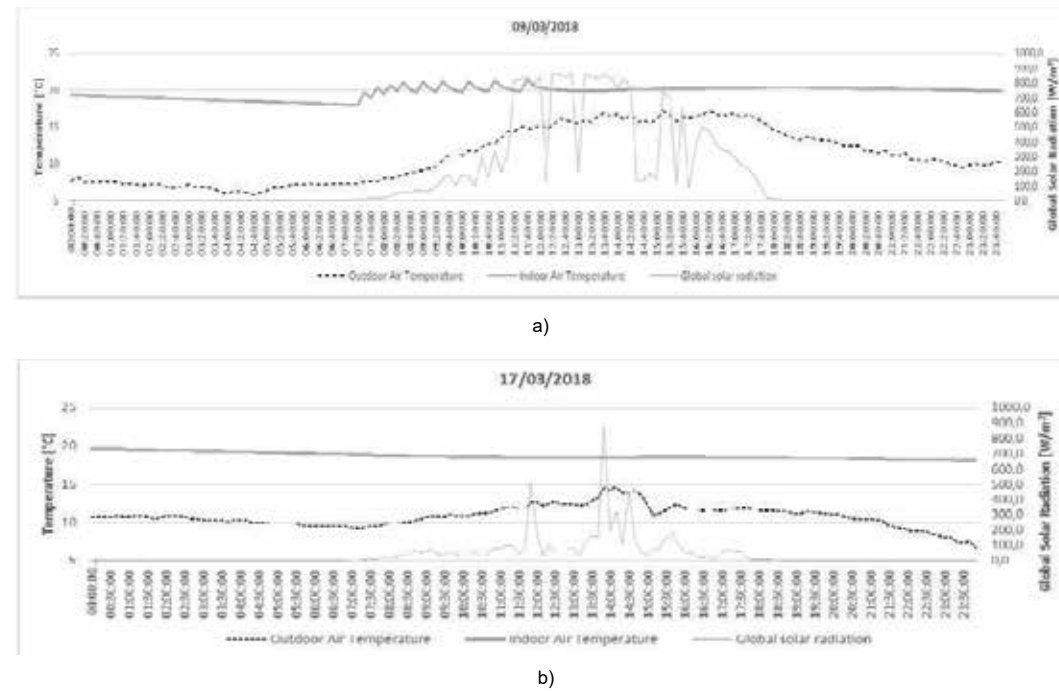

Fig.9. Indoor and Outdoor Air temperature and global solar radiation time profiles during a typical winter period: a) sunny day conditions and b) partially covered sky conditions.

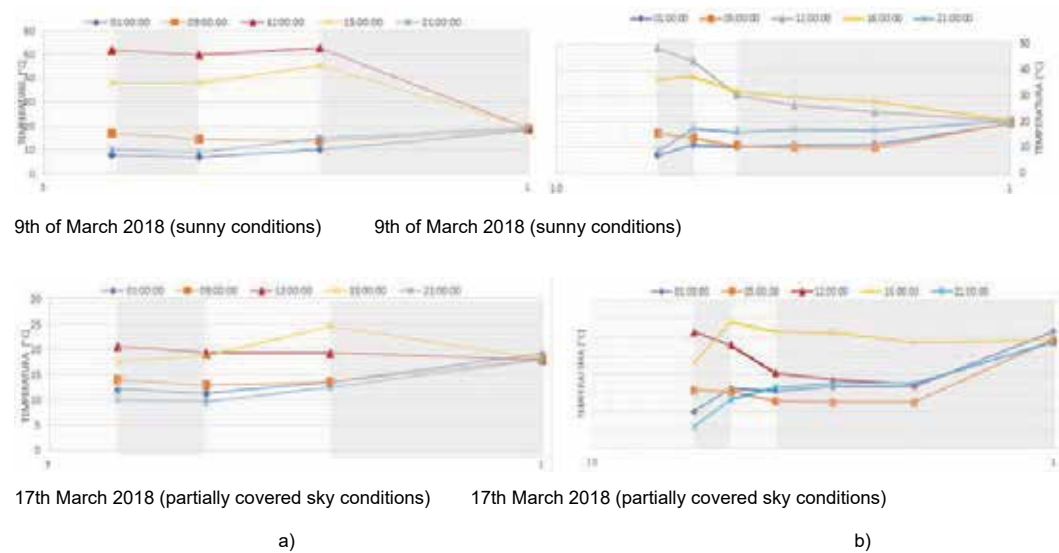

Fig.10. Temperature profiles through the cross section of a) SELFIE1 and b) SELFIE 2 components at 9th of March 2018 (sunny conditions) and the 17th March 2018 (partially covered sky conditions)

5 Conclusion

The monitoring results during winter season show a good performance of SELFIE system (specially for SELFIE 2 module integrating PCM) in reducing thermal losses keeping the indoor environment close to comfort conditions also during the night, when the heating system is turned off. The experimental set-up of the system for summer measurements will be concluded at the end of August 2018. Furthermore, we hope to start the overall data comparison in September so to know exactly the thermoigrometric performances of the SELFIE façade in order to eventually improve its design concept.

6 Acknowledgements

The present research is funded by MIUR (Ministry of Education, University and Research) and Tuscany Region (FAR-FAS 2014). The authors would like to acknowledge all partners involved in the consortium that working in synergy to study, design, test and build the innovative SELFIE façade solutions: CL'A S.C.; Colorobbia Consulting s.r.l.; MAVO Soc. Cop., ERGO s.r.l., CNR-ICCOM (Institute for the Chemistry of OrganoMetallic Compounds); DIF (Department of Industrial Engineering of University of Florence); CNR-ISTI (Institute of Paola Gallo and Rosa Romano / Procedia Engineering 180 (2017) 1274 – 1283 1283 information science and technologies "Alessandro Faedo); CNR-IPCF (Institute for the Chemical and Physical Processes); Rober Glass s.r.l. Furthermore, The authors would like to acknowledge the PASSLINK EEIG network members for technical support for Test Cell LABIMED development.

7 References

Perino, M., " IEA-ECBCS Annex 44. Integrating Environmentally Responsive Elements in Buildings", State of the art Review, (2007)

Becker, R., Improving thermal and energy performance of buildings in summer with internal phase change materials , J. Build. Phys., 37, pp. 296–324, (2014)

Aeleneia L., Pereira R., Ferreira A., Gonçalves H., Joycea A., Building Integrated Photovoltaic System with integral thermal storage: a case study, Renewable Energy Research Conference, RERC 2014, Energy Procedia 58, pp. 172 – 178 (2014)

IEA ECB Annex 58, Reliable Building Energy Performance Characterization Based on Full Scale Dynamic Measurements, (2015)

Bloem J.J., Evaluation of a PV-integrated building application in a well-controlled outdoor test environment, Building and Environment, 43 (2), pp. 205–216, (2007)

Gallo P., Romano R., Adaptive Façade, Developed with Innovative Nanomaterials, for a Sustainable Architecture in the Mediterranean Area, Procedia Engineering ,180, pp. 1274-1283, (2017)

Alcamo G., Donato A., Test facilities for evaluation of building component energy performances - TEST CELL in Florence, in: S. Roels, L. Vandaele, etc. Full scale test facilities for evaluation of energy and hygrothermal performances, Gent, pp. 75-79, (2011)

Baker P.H., Van Dijk H.A.L., PASSLINK and dynamic outdoor testing of thermal and solar properties of building components, Build Environ, 43, pp.127-236, (2008)

Gallo P., Sustainable habitat: market trends and testing of innovation products, 30th International PLEA Conference, Ahmedabad, 16-18 December, Cept University Press, vol. 4, pp. 23-25, (2014)

AA.VV., Inventory of full scale test facilities for evaluation of building energy performances, Ed. By A. Janssens , S. Roels, L. Vandaele , IEA EBC Annex 58 Subtask 1, (2015)

Maldonado E., PASSYS Operations Manual, FEUP, CEC DGXII, Brussels, (1993)

Van der Linden G.P., Van Dijk H.A.L., Lock A.J., Van der Graaf F., COMPASS Installation guide HFS Tiles for the PASSYS Test cells., TNO. JOULE2 Programme, Brussels, (1995)

Erkoreka A., Bloem J.J., Escudero C., Martin K., Sala J.M., Optimizing full scale dynamic testing of building components: measurement sensors and monitoring systems, Energy Procedia 78, pp. 1738-1743 (2015)

Erkoreka, A., Escudero, C., Flores, I., Garcia, C., Sala, J.M. Upgrading and calibration of two PASSLINK test cells. Evaluation through the "IQ-TEST" round-robin test. In: DYNASTEE workshop on Dynamic Methods for Building Energy Assessment Proceedings. Brussels: DYNASTEE, (2010)

Donato A., PhD thesis: Analisi e monitoraggio a regime dinamico delle performance energetiche di componenti di involucro mediante outdoor test, University of Florence, (2016)

Study of Building Integrated Photovoltaic/ Thermal Double-Skin Facade for Commercial Buildings in Sydney, Australia

Siliang Yang a), Francesco Fiorito b), Alistair Sproul c), Deo Prasad d)

a) The University of New South Wales, Australia, siliang.yang@unsw.edu.au

b) Polytechnic University of Bari, Italy

c) The University of New South Wales, Australia

d) Cooperative Research Centre for Low Carbon Living, Australia

Research activities previously performed on shorter simulation timeframe had shown that building-integrated photovoltaic/thermal double-skin façade (BIPV/T-DSF) could maintain a comfort temperature within a building, by adopting a fan-assisted ventilated air cavity in summer, and a non-ventilated air cavity during winter in order to reduce overheating phenomena in the air cavity and consequently in the building. In this paper, a naturally-ventilated BIPV/T-DSF commercial type of building was studied using TRNSYS simulation for enhancing the indoor thermal performance. The TRNSYS building model was calibrated by using in-situ experimental results taken from the existing published studies. Comprehensive comparisons among the naturally-ventilated BIPV/T-DSF, single-skin BIPV/T façade and non-ventilated BIPV/T-DSF for whole year period were presented thoroughly in terms of annual energy demand as well as comfort operative temperatures for commercial buildings in Sydney. Comparative analysis showed that the naturally-ventilated BIPV/T-DSF could significantly reduce cooling demand throughout the year and maintain a better operative temperature in summer compared to the single-skin BIPV/T facade, whereas the non-ventilated BIPV/T-DSF could always reduce heating demand as well as maintain a better operative temperature in the relative cold periods.

Keywords: building-integrated photovoltaic/thermal system, double-skin façade, energy demand, indoor thermal comfort, TRNSYS simulation

1 Introduction

The operation of residential and commercial buildings in developed countries accounts for 20% to 40% of energy consumption. This consumption has largely exceeded the one of other sectors such as industry and transportation (Pérez-Lombard, Ortiz, & Pout, 2008). In Australia, commercial buildings consume large amount of energy, and it is expected that the share of energy consumed by tertiary buildings will increase of 24% over the period 2009 to 2020, while the share of energy consumption of this sector accounts for the 3.5% of the overall yearly energy usage (Council of Australian Governments, 2012). A high number of commercial buildings are high-rise buildings, and the majority of Australia's high-rise commercial buildings are located in the states of New South Wales, Queensland and Victoria, of which the city of Sydney hosts the highest number of high-rise buildings in the country (Wikipedia: The Free Encyclopedia, 2018).

Building energy efficiency can be improved by either active or passive strategies. The use of energy efficient HVAC and lighting systems and building control systems, e.g. occupancy sensors and CO2 sensors, are categorized as active strategies, whereas the improvement of building envelope can be classified as a passive strategy. Active strategies are the most commonly adopted ones,

however in recent years a renewed interest for passive strategies has drawn more attention within the general framework of environmentally friendly design (Sadineni, Madala, & Boehm, 2011).

Building façade is the key component of the building envelope, and it provides thermal and acoustic comfort for a building (Sadineni et al., 2011). In many façade technologies, double-skin building façade (DSF) has been recognized as a solution for improving the performance of building through energy saving by means of the ventilating cavity as well as wind protection in terms of the additional external skin (Gratia & De Herde, 2007). Many researches had been conducted for finding the optimal configuration of a DSF, by modifying parameters such as supporting structure, geometry of the cavity, and functionality of the air inlet/outlet openings in the cavity (Mingotti, Chenvidyakarn, & Woods, 2011; Saelens & Hens, 2001; Saelens, Roels, & Hens, 2008; Viljoen, Dubiel, Wilson, & Fontoynt, 1997; Zollner, Winter, & Viskanta, 2002). However, few studies had been performed focusing on change of materials for the DSF (Chan, Chow, Fong, & Lin, 2009). In recent years, building-integrated photovoltaic/thermal (BIPV/T) systems have been used to serve as building envelope materials, which are able to produce electrical power and useful thermal energy. Additional advantages of this technology can be achieved by integrating itself onto a DSF so as to provide additional shading, solar heating, and even lighting (Agathokleous & Kalogirou, 2016). Several studies had been reported the performance of the combination of BIPV/T and DSF in cold climates (Charron & Athienitis, 2006; Ioannidis, Buonomano, Athienitis, & Stathopoulos, 2017). A few studies investigated a range of climatic conditions for the application of the BIPV/T-DSF (Gaillard, Giroux-Julien, Ménézo, & Pabiou, 2014; Peng et al., 2016; Saadon, Gaillard, Giroux-Julien, & Ménézo, 2016), but only a few of them were related to the subtropical climate or temperate climate in southern hemisphere, such as Sydney. As an example, Fossa, Ménézo, and Leonardi (2008) reported the results of a research on the thermal behavior of the BIPV/T-DSF system in Sydney, however performing only an indoor test.

The proposed research falls within a general framework aimed at analyzing a new façade concept of BIPV/T-DSF for commercial buildings in Sydney. The previous works focused on two operational modes of the novel building facade system (BIPV/T-DSF) comprising fan-assisted ventilation mode in summer and non-ventilation mode in winter respectively for a mock-up building in Sydney (Yang, Fiorito, Sproul, & Prasad, 2017). It was found that the BIPV/T-DSF system maintained not only appropriate indoor air temperature, by means of the active mechanical ventilated air cavity that buffered the building from summer heat gains, but also controlled the overheating issues of building during winter time in Sydney (Yang et al., 2017). The aim of the present paper is to explore the performance of the BIPV/T-DSF by comparing its annual energy demand as well as the indoor thermal comfort with a standard building façade.

2 Methodology

The study was conducted through a computational analysis, which was carried out using TRNSYS (thermal modelling software) and TRNFlow (airflow simulation software). The test building model was developed in TRNSYS and was fully described by Yang et al. (2017). In the study described in this paper, it concentrated on the modelling of different ventilation mechanisms (i.e. non-ventilation, naturally ventilation) within the air cavity, which was carried out by coupling TRNSYS engine with TRNFlow. TRNFlow is able to perform airflow calculation in naturally ventilated thermal zones by accounting for both buoyancy driven and pressure driven air movement, and is fully integrated with TRNSYS engine, which manages the dynamic thermal model (Weber, Koschenz, Holst, Hiller, & Welfonder, 2002).

The focus of the study presented in this paper is on the comparison of the computational simulations of three building models in Sydney: (1) Non-ventilated single-skin BIPV/T building façade model (reference building), (2) Non-ventilated BIPV/T-DSF model and (3) Naturally-ventilated BIPV/T-DSF model. To confidently predict a long-term performance of the system, the TRNSYS model (the integration of TRNFlow model) must be calibrated. The non-ventilated operation of the computational model in TRNSYS had already been calibrated in previous studies by using in-situ experimental results taken from the existing published studies (Peng et al., 2016; Peng, Lu, & Yang, 2013; Peng, Lu, Yang, & Ma, 2015; Yang et al., 2017). In the current paper, the calibration of the model with naturally-ventilated mode of operation was presented using a similar approach.

The in-situ experiment of a test bed with a ventilated BIPV/T-DSF under different ventilation modes was conducted in Hong Kong. The BIPV/T-DSF system used a semi-transparent amorphous silicon (a-Si) PV module (Peng et al., 2013). The schematic diagram of the BIPV/T-DSF system is shown in Fig. 1. As can be seen, the entire double-skin facade envelope of the building consisted of two air cavities which were separated by a vertical insulation; therefore, the two air cavities were used for the comparative analysis for different operational modes of ventilation without affecting one another (Peng et al., 2013). The simulation conditions (for the calibration) of the naturally-ventilated operational mode of the BIPV/T-DSF building, are shown in Table 1.

Ventilation Mode	Specifications
Naturally-ventilated mode	The inlet and outlet louvers on left hand side (cavity 1) were closed, while the inlet and outlet louvers on right hand side (cavity 2) were opened; all internal windows were closed; indoor air temperature was maintained at 22°C by use of the air-conditioner.

Table 1: Simulation condition of the naturally-ventilated operation mode of the test bed (Peng et al., 2013).

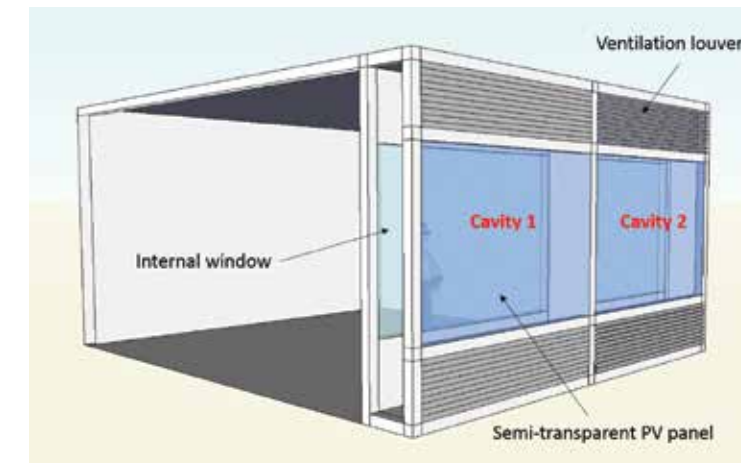

Fig. 1 Schematic diagram of the BIPV/T-DSF system for the test bed (Peng et al., 2016).

3 Experimental Parameters and Model Calibration

The TRNSYS model for the calibration was established based on the dimensions of the BIPV/T-DSF test bed as well as the physical characteristics of the semi-transparent PV panel given in Table 2 and Table 3 respectively.

Parameters	Values
Width of PV panel	1.1 m
Height of PV panel	1.3 m
Thickness of PV module	0.006 m
Width of louver	1.1 m
Height of louver	0.5 m
Depth of air flow duct (air cavity)	0.4 m
Dimension of the test bed (W x L x D)	2.4 x 2.5 x 2.3 m
Orientation	Due south
U-value of the walls	0.876 W/m ² K
R-value of the walls	1.14 m ² K/W

Table 2: Dimensions and properties of the BIPV/T-DSF test bed (Peng et al., 2016).

Parameters	Values
Maximum power under STC (W_p)	85
Open circuit voltage, V_{oc} (V)	134.4
Short circuit current, I_{sc} (A)	1.05
Voltage at the maximum power point, V_{mp} (V)	100
Current at the maximum power point, I_{mp} (A)	0.85
Efficiency, η (%)	6.2
Power temperature coefficient, T_k (%/K)	-0.21
Dimensions (L x W x D), (mm)	1300 x 1100 x 6
Visible transmittance (%)	5.7
Thermal conductivity, ($Wm^{-1}K^{-1}$)	0.486
Infrared emittance	0.85

Table 3: Physical characteristics of the semi-transparent a-Si PV panel for the test bed (Peng et al., 2016).

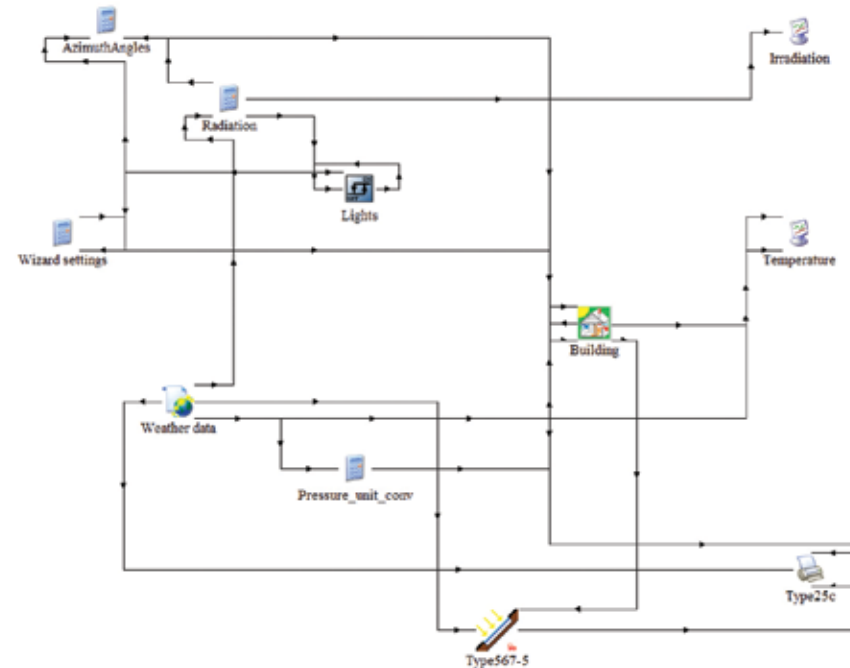

Fig. 2 Schematic of the test bed model integrated with the BIPV/T-DSF system in TRNSYS.

Referring to the previous study (Yang et al., 2017), the TRNSYS simulation (for calibration) adopted real-time meteorological data (on-site historical weather data for Hong Kong) of the site during the experiment, which were provided by Peng et al. (2013). The proposed BIPV/T-DSF building model was developed in the TRNSYS Simulation Studio (the user interface to create the simulation model) as shown in Fig. 2.

Type 56-TRNFlow (the green “building” icon in Fig. 2) includes the details of the building such as building geometry, construction and window glazing properties, and the airflow input values in TRNFlow. Type 567-5 contains the physical characteristics of the semi-transparent PV panel which is connected to the test bed (Type 56-TRNFlow) in the TRNSYS model. Based on the previous study, an additional glazing model with the exact identical thermal and optical properties of the semi-transparent a-Si PV panel was created using Window tool (Lawrence Berkeley National Laboratory, 2018) and replaced the external window on the DSF as the type of semi-transparent PV glazing was not available in TRNSYS (Yang et al., 2017). The electricity production as well as the collected useful thermal energy of the PV will be calculated in the next stages of the research.

As depicted in Fig. 1, the model has been divided into two separate sections. The right-hand side (cavity 2) was used for the model calibration. According to the previous calibration activities performed on the non-ventilated operational mode, both PV module (back-surface) temperature and internal window back surface temperature were selected as control parameters for the calibration. The two control parameters predicted by the software were then compared to the results of the experiment conducted by Peng et al. (2013) between 28 January 2013 and 31 January 2013. The major parameters that might affect the accuracy of the simulation results, such as equipment and occupancy schedule, building envelope properties, internal heat gains and system operation settings, were modified in the calibration procedures. Comparisons are presented in Fig. 3 and Fig. 4. As shown in Fig. 3, the simulated PV module temperature and the measured PV module temperature show good agreement although a certain extent of discrepancy exists. The hourly Mean Bias Error (MBE) and Cumulative Variation of Root Mean Squared Error (CVRMSE) (ASHRAE, 2002) are used as the criteria for assessing the acceptability of the agreement between simulated and measured data. The MBE and CVRMSE are calculated as follows:

$$MBE = \frac{\sum_{i=1}^{N_p} (M_i - S_i)}{\sum_{i=1}^{N_p} M_i} \quad (1)$$

$$\overline{M_p} = \frac{\sum_{i=1}^{N_p} M_i}{N_p} \quad (2)$$

$$CVRMSE_{(p)} = \frac{\sqrt{\sum_{i=1}^{N_p} ((M_i - S_i)^2 / N_p)}}{\overline{M_p}} \quad (3)$$

Where M_i and S_i are measured and simulated data at instance “i” respectively; p is the interval (e.g. monthly, weekly, daily and hourly); N_p is the number of values at interval p (e.g. $N_{month} = 12$, $N_{day} = 365$, $N_{hour} = 8760$) and $\overline{(M_p)}$ is the average of the measured data (Rafferty, Keane, & Costa, 2011). The both hourly acceptance thresholds of MBE and CVRMSE are within $\pm 10\%$ and $\leq 30\%$ respectively based on (ASHRAE, 2002).

Comparing with the experimental data, the MBE and CVRMSE are respectively 2.76% and 12.67% for the PV module temperature in cavity 2, so the simulated results of PV module temperature are acceptable. Similarly, as can be seen in Fig. 4, the hourly values of internal surface temperature of window 2 (the internal window on inner skin) also show good agreement with the experimental results and the corresponding hourly MBE and CVRMSE are -3.03% and 5.95% respectively. Therefore, the TRNSYS model (integrated with TRNFlow) for the naturally-ventilated BIPV/T-DSF building can be considered as calibrated.

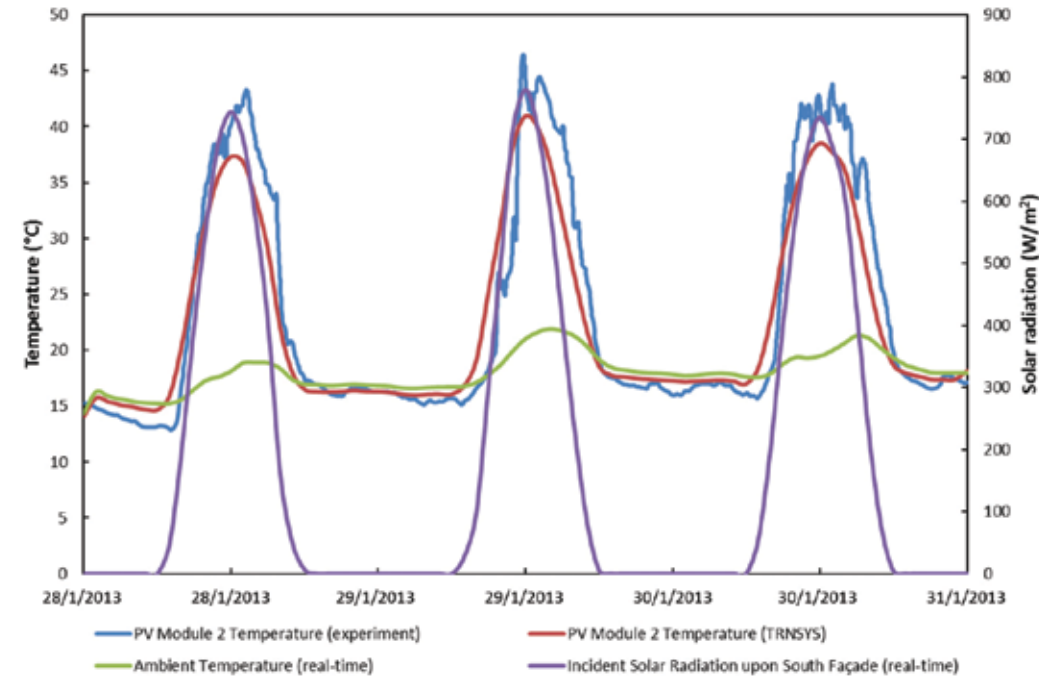

Fig. 3 Comparison between the simulated and measured PV module temperature for naturally-ventilated mode.

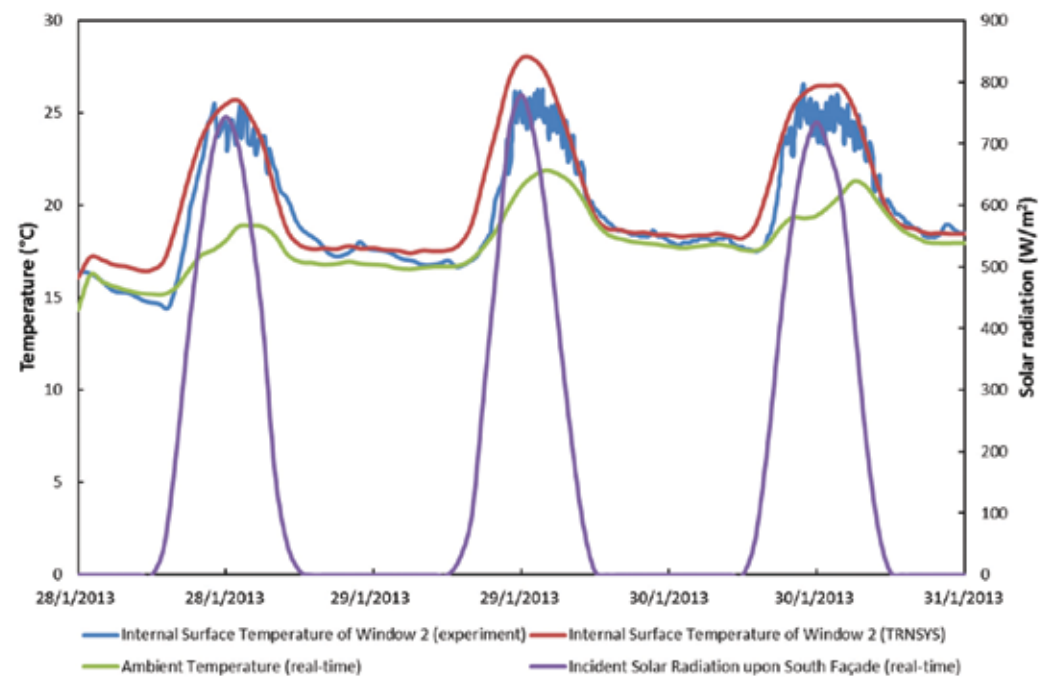
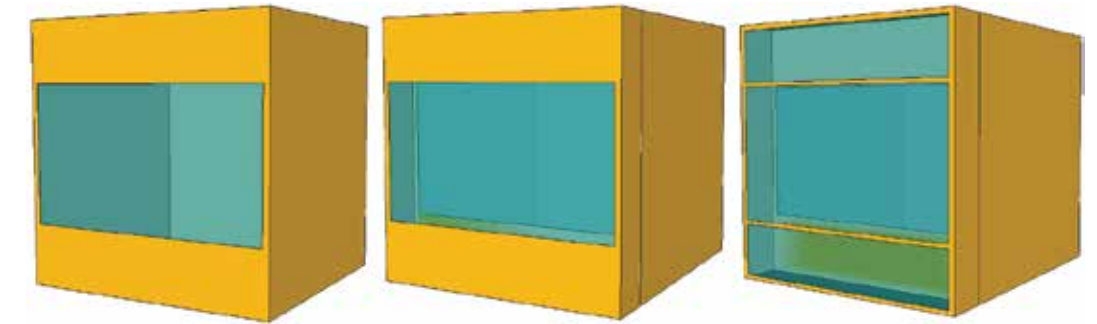

Fig. 4 Comparison between the simulated and measured internal surface temperature of window 2 for naturally-ventilated mode.

4 Results and Discussion

Based on the calibrated TRNSYS model, the three models shown in Fig. 5 were developed for investigating the cooling/heating energy demand of the novel BIPV/T-DSF building envelope and its impact on indoor thermal comfort for commercial buildings in Sydney.



a) Non-ventilated single-skin facade b) Non-Ventilated BIPV/T-DSF c) Naturally-ventilated BIPV/T-DSF
Fig. 5a), b) and c) Schematic diagrams of the three building models.

The dimensions and envelope properties of the models are presented in Table 4. The building fabric and window glazing of the three models, except for the PV glazing on the north-facing wall, were modified in the generic settings of thermal properties for a better evaluation of the indoor thermal response by use of the BIPV/T-DSF system which satisfied the requirements of Australian National Construction Code (Australian Building Codes Board, 2016). All the internal heat gains from people, equipment as well as artificial lightings were defined by using the representative values of an office building for typical operation hours from 8am to 6pm. The cellular room model was deemed as a narrowed simplistic office building, which was used for predicting the performance of the proposed BIPV/T-DSF system for office type of buildings.

Parameters	Model a)	Model b)	Model c)
Width of the building	2.44 m	2.44 m	2.44 m
Depth of the building	2.3 m	2.3 m	2.3 m
Height of the building	2.47 m	2.47 m	2.47 m
Width of the external window	2.32 m	2.32 m	2.32 m
Height of the external window	1.3 m	1.3 m	1.3 m
Width of the internal window	N/A	2.32 m	2.32 m
Height of the internal window	N/A	1.3 m	1.3 m
Width of the DSF	N/A	2.44 m	2.44 m
Depth of the DSF	N/A	0.4 m	0.4 m
Height of the DSF	N/A	2.47 m	2.47 m
Width of the louver	N/A	2.32 m	2.32 m
Height of the louver	N/A	0.5 m	0.5 m
U-value of the external window (PV/T)	5.12 W/m ² K	5.12 W/m ² K	5.12 W/m ² K
U-value of the internal window	N/A	5.68 W/m ² K	5.68 W/m ² K
U-value of the external wall	0.51 W/m ² K	0.51 W/m ² K	0.51 W/m ² K
U-value of the internal wall	N/A	0.508 W/m ² K	0.508 W/m ² K
U-value of the roof	0.316 W/m ² K	0.316 W/m ² K	0.316 W/m ² K

Table 4: Dimension parameters and envelope properties of the three models for simulation.

5 Annual Energy Demand Analysis

The cooling and heating setpoint temperatures were set at 26°C and 22°C respectively for the calculation of energy demand. Both external window and internal window were closed for all the three models, whereas the louvers were fully opened for the naturally-ventilated BIPV/T-DSF model. Fig. 6 shows the annual cooling demand of the three building models. Evidently, the cooling demand of the single-skin BIPV/T façade building was noticeably higher than the one of the other two buildings in each single month because single-skin façades are more sensitive to the outdoor environment. Although the cavity formed a thermal buffer zone could store passive solar heat gain in the non-ventilated BIPV/T-DSF, the shading effect of the PV glazing on the outer skin mitigated the direct solar radiation into the cavity, also compensating with the cavity's buffer effect so that the non-ventilated BIPV/T-DSF had lower cooling demand than that of for single-skin BIPV/T façade model in hot months. Among the two DSF models, the naturally-ventilated one required the relative lower cooling demand. Clearly, in naturally-ventilated mode, the airflow in the cavity removed the heat by means of stack effect through the inlet/outlet louvers. At this point, the naturally-ventilated mode of the BIPV/T-DSF is the best option for operating in Sydney's hot periods as well as for the other subtropical climate areas in Australia.

Also in Fig. 6, the trend of cooling energy demand for single-skin BIPV/T façade model was nonlinear due to the high sensitive reaction of the single-skin façade to the inverse variation between the ambient temperature and incident solar radiation on the vertical window during certain hot months in Sydney, which was also happened to the non-ventilated DSF in November.

The annual heating demands of the three building models are compared in Fig. 7. It can be seen that all the three buildings have relatively high heating demand from May to September, but the non-ventilated BIPV/T-DSF model has the lowest heating demand throughout the year. This indicates that the non-ventilated BIPV/T-DSF can reduce the heat loss of the space, due to the fully sealed cavity and the consequent increase of temperature due to the greenhouse effect, hence the less energy demand is required to heat the space up. Therefore, the BIPV/T-DSF in non-ventilated mode provides passive heating energy, and this operational mode is recommended during cold months. The heating demand of the single-skin BIPV/T façade model was mostly higher than the one in naturally-ventilated BIPV/T-DSF, which was a demonstration that the overshadowing of the PV glazing combined with non-buffering zone led to the lesser useful solar heat gain of the single-skin façade model in the cold winter months.

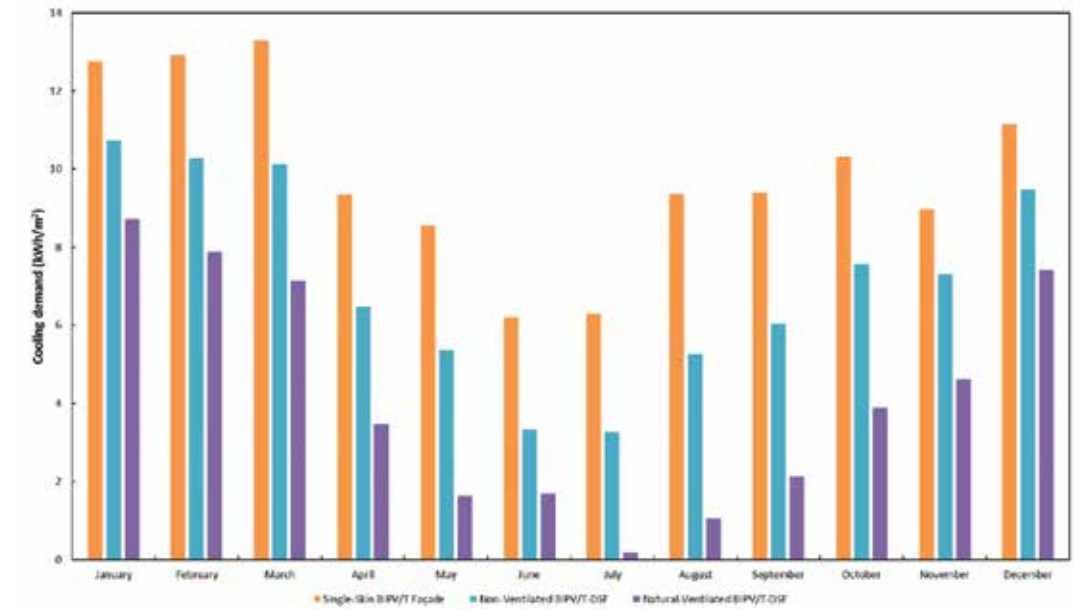

Fig. 6 Comparison of monthly cooling demand of the three models in Sydney.

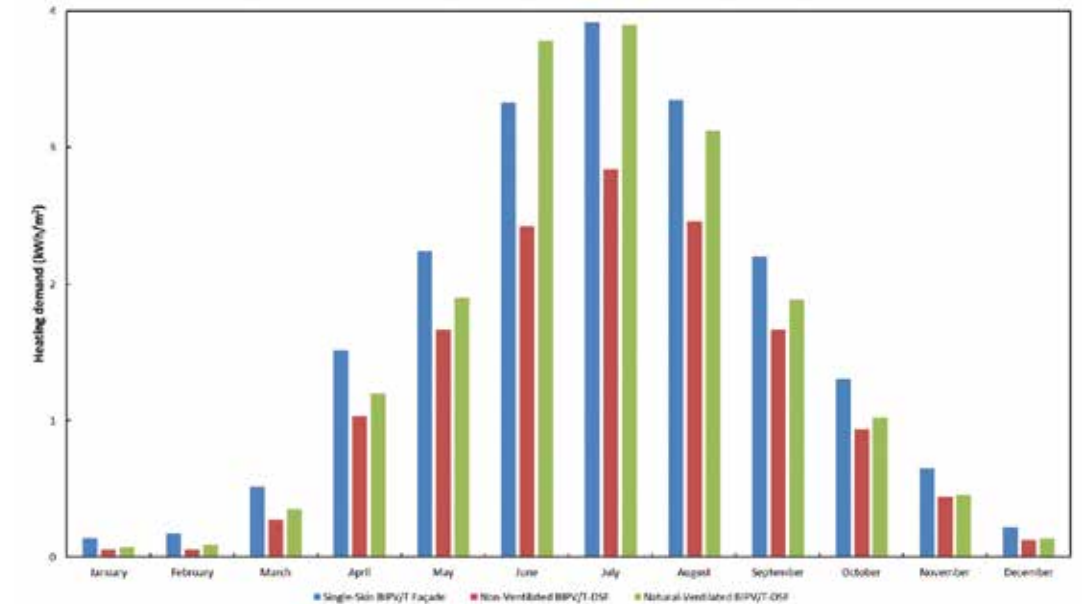

Fig. 7 Comparison of monthly heating demand of the three models in Sydney.

6 Indoor Thermal Comfort Analysis

The cooling and heating systems were turned off for investigating the indoor comfort temperatures passively. Both external window and internal window were closed for all the three models, whereas the louvers were fully opened for the naturally-ventilated BIPV/T-DSF model. Fig. 8 presents the monthly discomfort hours for the indoor operative temperature in accordance with the adaptive comfort standard of ASHRAE 55 (ASHRAE, 2017) for the three building models in Sydney. As can be observed, most of the discomfort hours are a consequence of too hot conditions throughout the year for all the three models. In contrast, smaller number of too cold hours were predicted, and they were concentrated in the cold months from May to September, which is normal for the subtropical climates. Generally, the both BIPV/T-DSF systems especially the naturally-ventilated

BIPV/T-DSF could always reduce the amount of discomfort hours for too hot conditions, particularly when compared to the single-skin facade. On the other hand, in a few months concentrated in the shoulder period, the double-skin systems could lead to a higher number of discomfort hours for too cold conditions in comparison to a single-skin solution. This is an effect of the lower solar gains of the double-skin façade (due to the presence of the PV which acts like a shading) which does not compensate the increased thermal resistance. By comparing the two BIPV/T-DSF modes of operation, it can be highlighted that the non-ventilated one produces a lower number of discomfort hours for too cold conditions; consequently the mixed use of the two DSF modes of operation is needed for optimizing indoor comfort conditions.

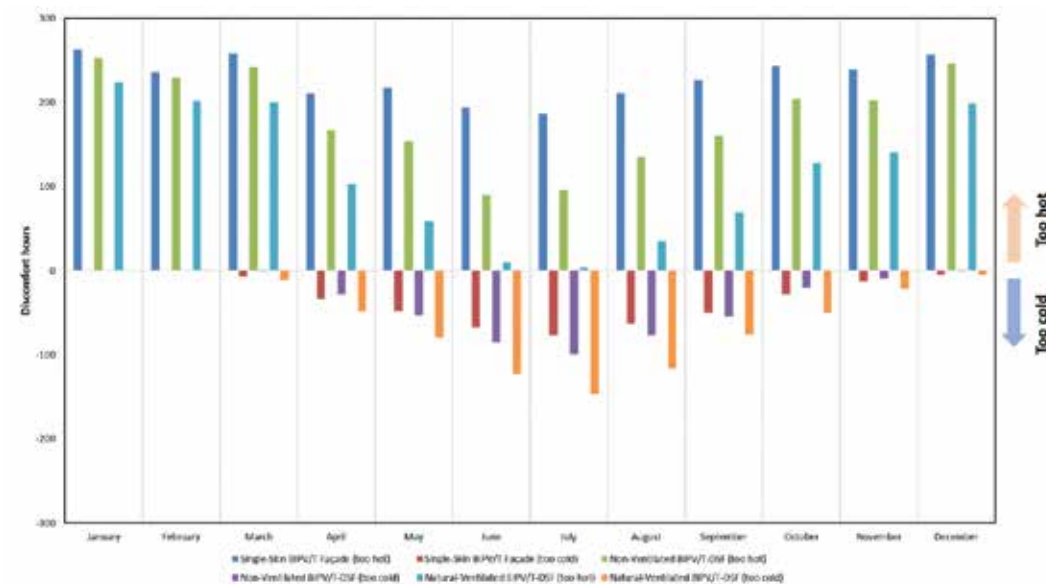

Fig. 8 Comparison of monthly indoor discomfort hours of the three models in Sydney.

7 Conclusion

This paper presents a comparative study for the single-skin BIPV/T façade, non-ventilated BIPV/T-DSF and naturally-ventilated BIPV/T-DSF for commercial buildings in Sydney, Australia. It shows that the BIPV/T-DSF in non-ventilated mode provides passive heating energy, which can be effectively used for the building during cold months in Sydney hence reduces the heating demand. On the other hand, the cooling demand can be considerably reduced using naturally-ventilated BIPV/T-DSF system as the ventilated cavity is able to lower the internal surface temperature of the building. The both BIPV/T-DSF systems can control the thermal discomfort hours for the building to a certain extent, but the mixed use of the two systems is needed for optimizing the indoor comfort conditions. The PV glazing with low visible transmittance (5.7%) has been used for the model calibration and preliminary analysis of the BIPV/T-DSF in this paper, further studies will adopt high visible transmittance PV glazing without affecting the daylighting condition.

8 Acknowledgements

Financial support for this research project was provided by the Faculty of Built Environment, University of New South Wales (Australia) and the Cooperative Research Centre for Low Carbon Living (CRC-LCL). In-kind support was also given by Dr. Jinqing Peng – Hunan University, China.

9 References

- Agathokleous, R. A., & Kalogirou, S. A. (2016). Double skin facades (DSF) and building integrated photovoltaics (BIPV): A review of configurations and heat transfer characteristics. *Renewable Energy*, 89, 743-756. doi:10.1016/j.renene.2015.12.043
- ASHRAE. (2002). Guideline 14-2002. In *Measurement of Energy and Demand Savings*. Atlanta, Georgia: American Society of Heating, Refrigerating, and Air Conditioning Engineers.
- ASHRAE. (2017). Standard 55-2017. In *Thermal Environmental Conditions for Human Occupancy*. Atlanta, Georgia: American Society of Heating, Refrigerating and Air Conditioning Engineers.
- Australian Building Codes Board. (2016). National Construction Code Volume One. In *Building Code of Australia, Class 2 to Class 9 Buildings*. Canberra: Australian Building Codes Board.
- Chan, A. L. S., Chow, T. T., Fong, K. F., & Lin, Z. (2009). Investigation on energy performance of double skin façade in Hong Kong. *Energy and Buildings*, 41(11), 1135-1142. doi:10.1016/j.enbuild.2009.05.012
- Charron, R., & Athienitis, A. K. (2006). Optimization of the performance of double-façades with integrated photovoltaic panels and motorized blinds. *Solar Energy*, 80(5), 482-491. doi:10.1016/j.solener.2005.05.004
- Council of Australian Governments. (2012). *Baseline Energy Consumption and Greenhouse Gas Emissions in Commercial Buildings in Australia (Part 1)*. Canberra: Department of Climate Change and Energy Efficiency.
- Fossa, M., Ménézo, C., & Leonardi, E. (2008). Experimental natural convection on vertical surfaces for building integrated photovoltaic (BIPV) applications. *Experimental Thermal and Fluid Science*, 32(4), 980-990. doi:10.1016/j.expthermflusc.2007.11.004
- Gaillard, L., Giroux-Julien, S., Ménézo, C., & Pabiou, H. (2014). Experimental evaluation of a naturally ventilated PV double-skin building envelope in real operating conditions. *Solar Energy*, 103, 223-241. doi:10.1016/j.solener.2014.02.018
- Gratia, E., & De Herde, A. (2007). Guidelines for improving natural daytime ventilation in an office building with a double-skin facade. *Solar Energy*, 81(4), 435-448. doi:10.1016/j.solener.2006.08.006
- Ioannidis, Z., Buonomano, A., Athienitis, A. K., & Stathopoulos, T. (2017). Modeling of double skin façades integrating photovoltaic panels and automated roller shades: Analysis of the thermal and electrical performance. *Energy and Buildings*, 154, 618-632. doi:10.1016/j.enbuild.2017.08.046
- Lawrence Berkeley National Laboratory. (2018). WINDOW: A computer program for calculating total window thermal performance indices. *Windows & Daylighting*. Retrieved from <https://windows.lbl.gov/software>
- Mingotti, N., Chenvidyakarn, T., & Woods, A. W. (2011). The fluid mechanics of the natural ventilation of a narrow-cavity double-skin facade. *Building and Environment*, 46(4), 807-823. doi:10.1016/j.buildenv.2010.09.015
- Peng, J., Curcija, D. C., Lu, L., Selkowitz, S. E., Yang, H., & Zhang, W. (2016). Numerical investigation of the energy saving potential of a semi-transparent photovoltaic double-skin facade in a cool-summer Mediterranean climate. *Applied Energy*, 165, 345-356. doi:10.1016/j.apenergy.2015.12.074
- Peng, J., Lu, L., & Yang, H. (2013). An experimental study of the thermal performance of a novel photovoltaic double-skin facade in Hong Kong. *Solar Energy*, 97, 293-304. doi:10.1016/j.solener.2013.08.031
- Peng, J., Lu, L., Yang, H., & Ma, T. (2015). Comparative study of the thermal and power performances of a semi-transparent photovoltaic facade under different ventilation modes. *Applied Energy*, 138, 572-583. doi:10.1016/j.apenergy.2014.10.003
- Pérez-Lombard, L., Ortiz, J., & Pout, C. (2008). A review on buildings energy consumption information. *Energy and Buildings*, 40(3), 394-398. doi:10.1016/j.enbuild.2007.03.007
- Raftery, P., Keane, M., & Costa, A. (2011). Calibrating whole building energy models: Detailed case study using hourly measured data. *Energy and Buildings*, 43(12), 3666-3679. doi:10.1016/j.enbuild.2011.09.039
- Saadon, S., Gaillard, L., Giroux-Julien, S., & Ménézo, C. (2016). Simulation study of a naturally-ventilated building integrated photovoltaic/thermal (BIPV/T) envelope. *Renewable Energy*, 87, 517-531. doi:10.1016/j.renene.2015.10.016
- Sadineni, S. B., Madala, S., & Boehm, R. F. (2011). Passive building energy savings: A review of building envelope components. *Renewable and Sustainable Energy Reviews*, 15(8), 3617-3631. doi:10.1016/j.rser.2011.07.014
- Saelens, D., & Hens, H. (2001). Experimental Evaluation of Airflow in Naturally Ventilated Active Envelopes. *Journal of Thermal Envelope and Building Science*, 25(2), 101-127. doi:10.1106/cu0x-xl16-6qta-29qc
- Saelens, D., Roels, S., & Hens, H. (2008). Strategies to improve the energy performance of multiple-skin facades. *Building and Environment*, 43(4), 638-650. doi:10.1016/j.buildenv.2006.06.024
- Viljoen, A., Dubiel, J., Wilson, M., & Fontoynt, M. (1997). Investigations for improving the daylighting potential of double-skinned office buildings. *Solar Energy*, 59(4-6), 179-194.
- Weber, A., Koschenz, M., Holst, S., Hiller, M., & Welfonder, T. (2002). TRNFLOW: Integration of COMIS into TRNSYS TYPE 56. Paper presented at the Proceedings of the 3rd european conference on energy performance and indoor climate, EPIC 2002.
- Wikipedia: The Free Encyclopedia. (2018, 22 April). List of tallest buildings in Australia. Retrieved from https://en.wikipedia.org/wiki/List_of_tallest_buildings_in_Australia
- Yang, S., Fiorito, F., Sproul, A., & Prasad, D. (2017). Studies on Optimal Application of Building Integrated Photovoltaic/Thermal Facade for Commercial Buildings in Australia. Paper presented at the Solar World Congress 2017, Abu Dhabi.
- Zollner, A., Winter, E. R. F., & Viskanta, R. (2002). Experimental-studies-of-combined-heat-transfer-in-turbulent-mixed-convection-fluid-flows-in-double-skin-façades. *International Journal of Heat and Mass Transfer*, 45(22), 4401-4408.

Ageing of adhesive connections for façade applications

Klára V. Machalická a), Miroslav Vokáč a) Martina Eliášová b)

a) Czech Technical University in Prague, Klokner Institute, Czech Republic, klara.machalicka@cvut.cz

b) Czech Technical University in Prague, Faculty of Civil Engineering, Czech Republic

Building façade is a very specific type of usage for adhesive connections due to the requirements for durability, strict geometrical imperfections and joining of unconventional materials often used in the façade design. At the same time, an adhesive joining by semi-flexible and semi-rigid adhesives is still relatively new bonding method in facade applications in comparison with usage in aerospace and automotive industry. For that reason, extensive experimental study was performed to assess residual shear strength of adhesives exposed to three various ageing procedures. Two adhesives with different mechanical characteristics were chosen to the study – two-part acrylate and silane terminated polymer (STP). The adhesives were applied in double lap shear connections with aluminium and galvanised steel substrates; the materials that are very often used both in façade substructure and cladding. Galvanized steel and blank aluminum substrates were used with a smooth and roughened surface and a special set of aluminum specimens were prepared with an anodized covering to find out the effect of roughening and aluminum anodization on adhesion and ageing effect. Specimens were exposed to immersion in demineralised water (45 °C) for 21 days, 3 weeks in salt-fog and last set of specimens was exposed to cataplastm test. The paper is focused on the evaluation of the effects of various accelerated ageing procedures on the residual shear strength and failure modes of adhesive connections with various substrate materials and surface treatments. It was showed that salt-fog test had the most harmful effect on STP adhesive joints with galvanized steel substrate (lowering by up to 50%) while aluminium substrate showed almost no reducing of the shear strength. The most critical ageing method for STP adhesive joints with aluminium substrates was cataplastm test where lowering of shear strength was measured by 30%. In contrary to STP adhesive, two-part acrylate showed the best resistance to cataplastm test in case of roughened aluminium joints (max. 10% reduction of strength) and the worst resistance was proved to salt-fog conditions for almost all substrates (reduction of strength by 70%) and immersion to warm water which reached reduction by 70% for galvanized steel and anodized aluminium joints..

Keywords: Accelerated ageing; adhesive connection; double-lap shear

1 Introduction

Contemporary architecture often requires adhesive connections as a bonding method of façade cladding elements to the supporting substructure, due to their visually smooth surface without the interruption by bolts. But performance of adhesive joint is highly influenced by surrounding environment and weathering action has a significant role. Water and humidity could probably be considered the most critical degrading factors because water is very polar and permeates most polymers. Higher temperatures accelerate the diffusion process into the adhesive layer, resulting in increased degradation at a shorter time (Heshmati et al. 2015, Comym 2005). Moisture can change bulk material properties of the polymer, ductility is increased and the elastic modulus and strength are reduced due to a decrease in the glass transition temperature and reduction of the attractive forces between the molecules of the polymer. Swelling and deformation due to the water

content were also observed in flexible polymers, which are more prone to higher permeation of moisture than rigid adhesives (Petrie 2009). Both of these effects are reversible when the polymer is dried (Petrie 2009, Calvez et al. 2012). Polymeric adhesives can also chemically change due to hydrolysis under the long-term action of moisture and higher temperatures. This change causes a permanent reduction in mechanical properties and a resulting cohesive failure. Moisture has a serious effect on the interfacial region between the adhesive and the substrate (Calvez et al. 2012, Ashcroft and Comym 2011). Water molecules that permeate the polymer have a tendency to preferentially migrate to the interface displacing the adhesive at the interface. Therefore, the adhesive failure is typical after several days in a humid environment. Resistance to moisture can be improved by reaching better durability of the interface itself (e.g. by coating, using primers or chemical treatment of the substrate surface to increase adhesion) (Petrie 2009, Davis 2011, Kwakernaak et al. 2010). Corrosive environments (e.g. in sea coast locations) can be more serious than the influence of moisture. Corrosion of metal interfaces results in a weak boundary layer and the adhesive failure mode of the bond. Surface preparation can significantly influence the resistance of the joint to the salt environment (Petrie 2009).

The presented paper provides a summary of extensive experimental analysis of adhesive connection specimens with aluminum and galvanized steel substrates with various surface treatments (anodizing of aluminum) and surface conditions (roughening) exposed to three various ageing procedures. The substrate materials of specimens were chosen with regards to materials often used for façade supporting structure. There is no guidance or code for testing of semi-flexible or semi rigid adhesive joints particularly for façade applications. For that reason, three different laboratory ageing procedures (immersion in warm demineralized water, salt fog spray and cataplasma test) were performed to assess and compare their effect on structural adhesive connection. Due to time consuming experimental program, results are published by parts. Specifically, results for ageing in demineralized water and salt fog spray were described in more detail in previous publications (Machalická et al. 2018). The main goal of the paper is a brief overview of all results for all three performed laboratory ageing procedures to provide summary and comparison.

2 Experimental program

Experimental program contained four batches of specimens – reference set of double lap shear specimens to evaluate influence of surface material and its roughness on adhesive joint strength. Three different laboratory aging procedures (= three batches of specimens) were chosen for the research study, immersion in water (ETAG 002) and salt fog spray (ISO 9142, Procedure E4), and extended cataplasma test (ISO 9142, Procedure E2) to compare the effects of various ageing methods on the mechanical properties and failure mode of adhesive joints. Laboratory ageing was applied on all types of specimens with different substrates and different surface treatment to evaluate the influence on not only the bulk adhesive in the connection but also the adhesive-metal interface and the mode of failure.

2.1. Adhesive

Two adhesives were selected to research program. The first one, Silane Terminated Polymer (Sikaflex® 552) combines the properties of polyurethanes and silicones and provides an elastic, gap-filling hybrid adhesive with higher strength in comparison with silicones. It cures on exposure to atmospheric humidity to create an ageing and weather resistant elastomer. Overall geometrical arrangement of joint is influenced by the curing mechanism and thus maximal thickness of cure is dependent on curing time, surrounding conditions (temperature and relative humidity).

Second, two-part acrylate adhesive (SikaFast® 5215 NT) is a structural adhesive with a higher flexibility that cures by chain polymerization when both components are mixed. The acrylate adhesive is optimally applied in bond line thicknesses from 0.5 to max. 3 mm. An exothermic reaction during the curing process can affect the polymer properties or the substrate when an excessive volume of adhesive needs to be cured.

2.2. Substrate material and surface treatment

A substrate material and its preliminary surface treatment have a great influence not only on adhesion and, thus, the strength of the joint but also on the failure mode, behavior, safety and ageing resistance of a particular joint. For this reason, two basic substrate materials, which are often used in the façade industry, aluminum (blank and anodized) and galvanized steel, were chosen for the study. All contact surfaces of the specimens were cleaned, degreased and activated by Sika® Cleaner 205 in case of STP adhesive and Sika® ADPrep in case of acrylate adhesive. Some series of the specimens were also mechanically pretreated with roughening (by Scotch Brite) to analyze the influence of roughening on the mechanical properties of the joint and its failure mode.

2.3. Double lap shear test

The specimens were produced as a double lap shear joints, to eliminate cleavage stresses at the edge of the bond layer caused by the eccentricity in the joint. The adhesive was applied in a two bonded areas with dimensions 12 x 50 mm, where the overlap length was 12 mm. The bond line thickness was 0.8 mm for the two-part acrylate (average value for a reference set of specimens) and 4.99 mm (average value for a reference set of specimens for the STP adhesive).

The specimens were subjected to a displacement controlled test, where shear loading of bonded area arose from tensile loading of the whole specimen fixed to jaws of the testing machine. The specimens were loaded at a crosshead speed of 5 mm/min for the Silane Terminated Polymer (STP) adhesive and 1 mm/min for the two-part acrylate glue, continuously until the total failure of the joint. The loading rates were chosen to achieve similar strain rates for both adhesives applied in different thicknesses. Displacement was measured by two linear potentiometric transducers at both ends of one overlap joint, therefore, four transducers per one specimen were used. The average value of displacement was calculated for the evaluation of engineering shear strain.

2.4. Laboratory Ageing procedures

During the ETAG002 procedure, one batch of specimens were immersed in demineralized water at a temperature of water 45 °C for 21 days. After immersion, the specimens were conditioned at 23 °C and 50% relative humidity for 24 ± 4 hours and they were subsequently subjected to shear loading.

To assess the influence of the salt fog corrosive environment, the second batch of specimens was exposed to neutral salt spray and elevated temperature and humidity in accordance with ISO 9142, Procedure E4. First, the specimens were exposed to neutral salt spray (NSS) at 35 °C in the corrosive chamber according to ISO 9227 for 21 days. After the corrosive environment exposure, the specimens were moved to the climatic chamber with 95% relative humidity and 40 °C for 7 days. The specimens were stored under room conditions (21 °C, 40% relative humidity) for 10 days before shear tests were performed.

Last batch of specimens was exposed to extended cataplast test which contained 7 days of conditioning at 23°C and 50 % relative humidity, then 7 days immersion in demineralized water of 20 °C and subsequent conditioning at 23 °C and 50 % rel. humidity for two hours. Subsequently, 1 day in climatic chamber in 80 °C and 2 hours in room conditions (23 °C / 50 % relative humidity) followed. Then specimens were exposed to 70 °C and 100 % relative humidity performed as a cataplast test (ISO 9142, Procedure E2) for 7 days. Cataplast test was followed by shock cooling to -20 °C (whithin 3 minutes) and specimens remained in freezing condition for 15 hours. Artificial ageing was terminated after subsequent 24 hours of conditioning in 23 °C and 50 % relative humidity and specimens were tested according to paragraph 2.3.

3 Experimental Results

Summarized results of the shear tests are presented in the graphs in Figs. 1 and 2, where representative curves of the shear stress-strain diagrams of the joints are drawn for each of the adhesives, their tested substrate material, and surface treatment and condition. The graphs and Tables 1 and 2 also provide the comparison of the results for all three batches of specimens exposed to laboratory aging conditions and for the reference set of specimens. Tables also provides the comparison of failure modes for all batches of specimens where A means the adhesive mode of failure, C is the cohesive mode of failure and A-C is the combined mode of failure. For the combined mode of failure, the bold font of letter A or C depicts the prevailing manner of failure.

Type of specimens (substrate/treatment)	Reference set		Immersion in water		Salt spray test		Cataplast test	
	Shear strength [MPa]	Failure mode	Shear strength [MPa]	Failure mode	Shear strength [MPa]	Failure mode	Shear strength [MPa]	Failure mode
Roughened aluminum	1.87	C	1.25	A-C	1.82	A-C	1.27	A-C
Smooth aluminum	1.89	C	1.38	A-C	1.93	A-C	1.35	A-C
Anodized aluminum	1.87	C	1.65	C	1.95	A-C	1.48	A-C
Roughened galv. steel	1.69	C	1.16	A-C	1.15	A-C	0.93	A
Smooth galv. steel	1.72	C	1.07	A-C	0.84	A-C	1.16	A-C

Table 1: Average shear strength values and failure modes for STP adhesive.

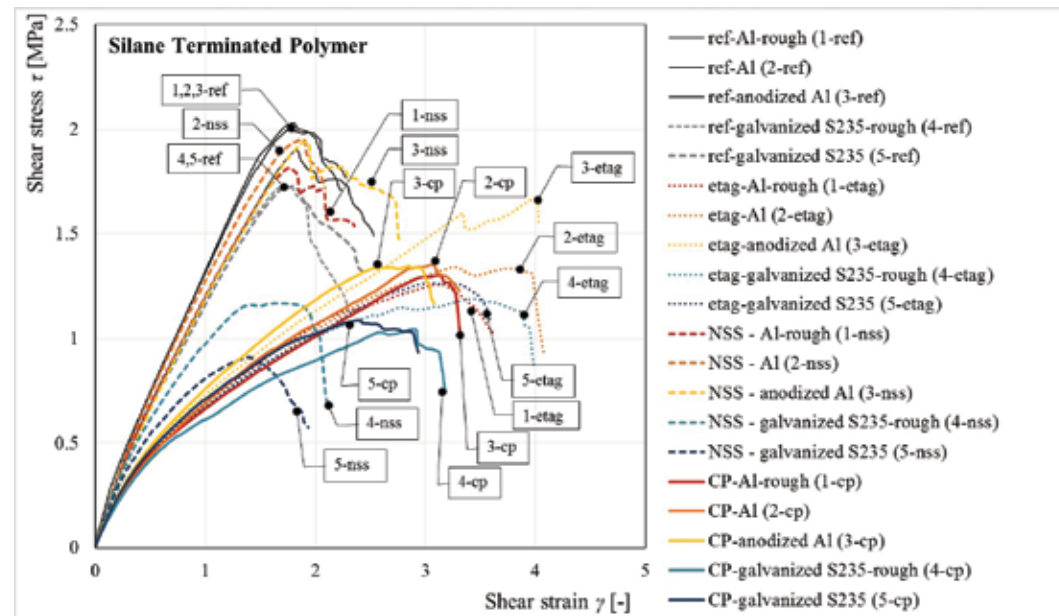

Figure 1. Stress-strain diagram for STP adhesive, where ref is referece set of specimens, etag is ETAG002 ageing, NSS is neutral salt spray ageing CP is cataplast test ageing set of specimens, Al signs aluminum and S235 steel substrate material.

3.1. STP adhesive

All joints of the STP polymer adhesive were affected significantly by immersion in demineralized water and cataplast test. The reduction of shear strength by up to 33% was measured for roughened aluminum and 38% for smooth Zn-electroplated steel specimens by immersion in water and similarly 32% for roughened aluminum and Zn-electroplated steel by cataplast test. It can be noted that the reduction in maximum shear stress and plasticization of adhesive was caused by the water molecules permeated into the polymer structure. Neutral salt spray test had a significant negative effect only for Zn-electroplated steel specimens, where reduction of shear strength was measured by 51% for smooth Zn-electroplated steel specimens. Aluminum specimens showed almost no deterioration after three weeks in NSS conditions. Importance of material substrate and its influence on adhesion which can be worsened by corrosive product at the surface of substrate was observed.

3.2. Acrylate adhesive

In contrary to STP adhesive neutral salt spray test cause the most serious deterioration of mechanical properties of specimens bonded by acrylate adhesive. The maximum reduction of shear strength was observed for Zn-electroplated steel by 73%. The rest of the specimens showed reduction of shear strength by app. 60%. Zn-electroplated steel specimens showed also substantial strength reduction (by 60 %) for both cataplast test and immersion in water. However, only 5% strength reduction was observed for roughened aluminum specimens exposed to cataplast test and 20% for immersion in water.

Type of specimens (substrate/treatment)	Reference set		Immersion in water		Salt spray test		Cataplast test	
	Shear strength [MPa]	Failure mode	Shear strength [MPa]	Failure mode	Shear strength [MPa]	Failure mode	Shear strength [MPa]	Failure mode
Roughened aluminum	9.3	C	7.44	C	4.84	A-C	8.84	C
Smooth aluminum	8.43	A-C	5.78	A-C	3.36	A-C	6.80	A-C
Anodized aluminum	8.47	C	2.28	A	3.48	A	4.75	A
Roughened galv. steel	6.24	A-C	2.40	A-C	2.48	A-C	2.22	A
Smooth galv. steel	4.68	A-C	1.39	A	1.27	A	1.69	A

Table 2: Average shear strength values and failure modes for acrylate adhesive.

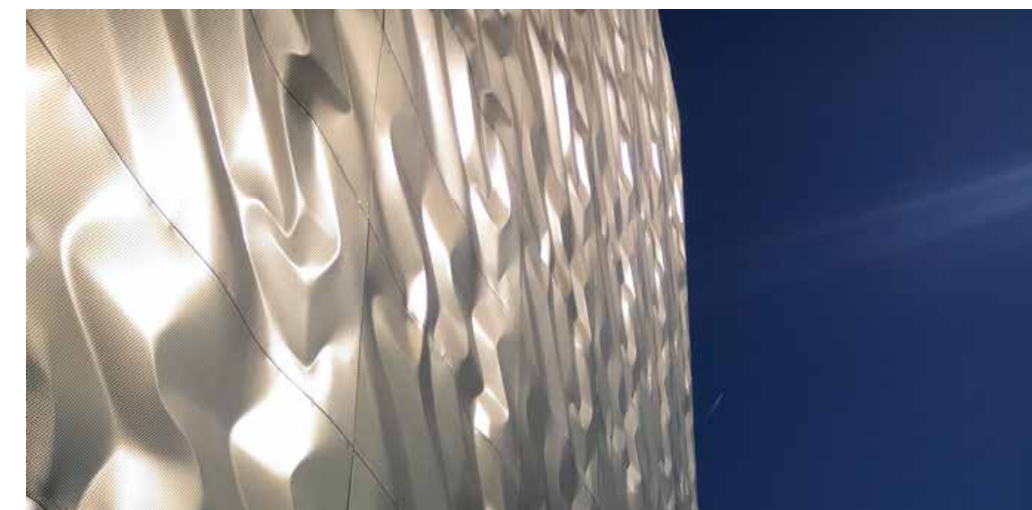

Figure 2. Stress-strain diagram for acrylate adhesive, where ref is referece set of specimens, etag is ETAG002 ageing, NSS is neutral salt spray ageing CP is cataplast test ageing set of specimens, Al signs aluminum and S235 steel substrate material.

4 Conclusion

The main objective of this investigation was to evaluate the laboratory aging effect by immersion in warm demineralized water according to ETAG 002, by the salt spray test (NSS) according to ISO 9142 - Procedure E4, and by extended cataplast test according to ISO 9142 - Procedure E2 for structural adhesive joints. The study also assesses the influence of substrate materials and surface condition on the mechanical properties of selected adhesives. The following conclusions have been drawn from the findings of the tests:

- for the STP adhesive, the degrading effect of demineralized water immersion or cataplast test were more crucial than the salt spray test. On the contrary, for the acrylate adhesive, the effect of the salt spray test was the most serious for almost all tested substrates;
- it was proved that the degrading effect of a particular aging procedure can be more harmful to one adhesive than the others in dependence on the time of exposure
- surface roughening had a positive effect on adhesion, especially for the acrylate adhesive;
- joints with aluminum substrates showed better durability than Zn-electroplated steel substrates. Anodized aluminum showed better adhesion and environmental resistance for connections with the STP polymer only.
- the most critical ageing method cannot be identified easily because it is not same for adhesives of different chemical base.

5 Acknowledgements

The authors acknowledge the funding by the Czech Science Foundation, under the grant GAČR 18-10907S. In addition, the authors are grateful to the COST Action 1403 – Adaptive Facades Network, for the added value to the international dissemination and outreach of the research.

6 References

- Ashcroft, I., Comym, J. (2011) Effect of Water and Mechanical Stress on Durability. in: Silva LFM, Öchsner A, Adams RD, eds. Handbook of adhesion technology, Heidelberg: Springer, p. 789-822.
- Calvez, P., Bistac, S., Brogly, M., Richard, J., Verchère, D. (2012) Mechanisms of Interfacial Degradation of Epoxy Adhesive/ Galvanized Steel Assemblies: Relevance to Durability. The Journal of Adhesion, 88:145-170.
- Comym, J. (2005) Environmental (durability) effects. in: Adams R, ed. Adhesive bonding: science, technology and applications., Cambridge: Woodhead Publishing.
- Davis, G. (2011) Surface Treatments: Surface Treatments of Selected Materials. in: da Silva LFM, Öchsner A, Adams RD, eds. Handbook of adhesion technology, Heidelberg: Springer, p. 119-147.
- Heshmati, M., Haghani, R., Al-Emrani, M. (2015). Environmental durability of adhesively bonded FRP/steel joints in civil engineering applications: State of the art. Composites Part B: Engineering; 81:259-275.
- Petrie, E. (2009) Handbook of adhesives and sealants. New York: McGraw-Hill.
- Kwakernaak, A., Hofstede, J., Poulis, J., Benedictus, R. (2010) Improvements in bonding metals (steel, aluminium). in: Dillard D, ed. Advances in structural adhesive bonding. 1st ed., Cambridge: Woodhead Publishing, p. 185-236.
- Machalická, K., Vokáč, M., Eliášová, M. (2018). Influence of artificial aging on structural adhesive connections for façade applications. International Journal of Adhesion and Adhesives, 83: 168-177. doi 10.1016/j.ijadhadh.2018.02.022
- Machalická, K., Vokáč, M., Kostelecká, M., Eliášová, M. (2018). Structural behavior of double-lap shear adhesive joints with metal substrates under humid conditions. Int J Mech Mater Des, doi 10.1007/s10999-018-9404-y
- Sika AG. <http://gbr.sika.com/dms/getdocument.get/585a2bd8-c58b-3470-a01f-6a4039e1cbee/Sikaflex%20552AT.pdf> (2012). Accessed 25 July 2018
- Sika AG. <http://gbr.sika.com/dms/getdocument.get/b0af16be-8b4b-376a-a11d-f4bb0811e04f/SikaFast%205215NT.pdf> (2013). Accessed 25 July 2018

Possibilities and challenges of different experimental techniques for airflow characterisation in the air cavities of façades

Emanuela Giancola 1, M. Nuria Sánchez 1, Matthias Friedrich 2, Olena Kalyanova Larsen 3, Alessandro Nocente 4, Stefano Avesani 5, Francesco Babich 5, Francesco Goia 4

1 Ciemat, Department of Energy, Energy Efficiency in Buildings Unit, Spain, emanuela.giancola@gmail.com, nuria.sanchez@ciemat.es

2 Hafencity University Hamburg, Germany, matthias.friedrich@hcu-hamburg.de

3 Aalborg University, Denmark, ok@civil.aau.dk

4 Norwegian University of Science and Technology, Norway, francesco.goia@ntnu.no, alessandro.nocente@ntnu.no

5 Eurac Research, Institute for Renewable Energy, Italy, stefano.avesani@eurac.edu, Francesco.Babich@eurac.edu

Ventilated façades are applied in both new and existing buildings. It has been claimed that these components help to reduce energy use in buildings and improve occupant comfort. However, their performance strongly depends on the airflow passing through the cavity. In order to characterise and to model the behaviour of the ventilation and its effectiveness, the components need to be tested in the laboratory, as well as under real dynamic weather conditions. Despite the steadily growing research in this area, there are few studies with conclusive results about the reliability of existing experimental procedures for characterisation of airflow in the ventilated cavities. The aim of this paper is to describe and review recent state of the art experimental assessments for the airflow characterisation in ventilated cavities. The paper starts with a short introduction on the potentialities and limitations of different experimental methodologies, and continues with a detailed classification and description of the most relevant monitoring techniques for airflow in air cavities of façades that have been developed in recent years.

Keywords: Façade Characterisation, Experimental Techniques, Airflow Monitoring, Tracer Gas, Velocity Profile, Ultrasound, Pressure Difference, PIV, LDV, Temperature Profile & Heat Flux.

Full paper available in the Journal of Facade Design and Engineering, Vol 6 No 3 (2018): Special Issue FAÇADE 2018 – Adaptive!

Solar Energy Balanced Façade

Thomas Wüest, Andreas Luible

Lucerne University of Applied Sciences and Arts, Department of Engineering and Architecture, thomas.wueest@hslu.ch

The ongoing project "Solar Energy Balanced Façade" (SEBF) at Lucerne University of Applied Sciences and Art aims at managing passive solar gains within double-skin facades (DSF). The SEBF is designed as a non-ventilated unitized element DSF with its performance advantages and the traditional full-glazing appearance to the outside. The inner appearance is divided into a glazed part for visual comfort and an opaque parapet for enhanced thermal performance. Simulations show that the insulated opaque element with thermal storage towards the air cavity improves both, the energy demand for heating and cooling. During heating season, the thermal storage always collects as much solar energy as possible. This results in passive gains during hours of sunshine and during the night, when the captured solar energy is released. This effect reduces heat losses by about 30% compared to a similar construction without thermal mass. In cooling seasons, an effective shading device minimizes passive gains and shields the thermal storage. In this case, the thermal mass acts as a damper for heat flux fluctuations and effectively reduces direct solar gains. The presented simulation results show significant benefits in energy balance compared to comparable facades with the same operational schedule. There is potential for further improvements if the standard materials comprising the assessed configuration are replaced by an optimized composition of thermal storage and insulation layers.

Keywords: Passive façade, Low-Tec, energy efficiency, adaptive façade, hybrid façade

1 Introduction

The aim of the European Union (EU) Energy Strategy 2020/2050 is a drastic reduction in the energy demand of buildings. The focus of the European Energy Roadmap 2050 (European Commission, 2011) is on decarbonization objectives, and it states that the buildings which will be used in 2050 are being designed and built now. During the past few years a lower energy demand (-6%) was observed for building services in Switzerland, mainly caused by a reduced heating load (-9%) but partly offset by ventilation and air-conditioning needs (Swiss Federal Office of Energy SFOE, 2015). However, the performance of the building envelope cannot be measured in terms of energy reduction alone. The façade of a building can also impact the health, security and satisfaction of the occupants. Hence, building envelopes can play a key role in achieving the EU climate change and energy sustainability targets for 2020 whilst enhancing the wellbeing of building tenants (COST Action TU 1403, 2014).

Adaptive façades are expected to have the potential to increase the performance of the building envelope.

Ongoing research in the field is carried out by many different approaches. Based on the fact that the solar radiation reaching the earth exceeds the energy demands of the planet by several orders of magnitude, it has been demonstrated that façades allow to utilize this resource, either passively or actively, with photovoltaic (PV) or thermal collectors (Quesada et al., 2012). Due to the high transparency of current double glazing units (DGUs) and triple glazed units (TGU's) a high daylight level is attained and the heating demand is reduced. However, solar gains do not

only occur in winter, and buildings with highly glazed façades tend to overheat during summertime (Winther et al., 2010) (Manz & Frank, 2005). Extensive building energy simulations have shown that the window-to-wall ratio (WWR) is a key parameter for the energy efficiency of the building envelope (Favoino et al., 2014) (Kim & Todorovic, 2013) (Goia & Cascone, 2014). Besides seasonal variations in solar energy availability (low in winter, high in summer) and usability (high in winter, low in summer), daily variations also make it more difficult to achieve beneficial solar gains without running the risk of overheating the building. The analysis of Schuler (2000) shows that more attention should be paid to cooling loads rather than to heating energy. Moreover, Struck et al. (2015) point out that the cooling loads and energy consumption of highly glazed office buildings are more affected by global warming than that of other building types.

Nevertheless, the modern architecture tends to highly glazed facades. Beside esthetic reasons, also technical reasons support the application of highly glazed double skin facades. To name a few, the outer surface is easier to clean and, in the case of non-ventilated DSF's, the cavity must not be cleaned. In addition, the external glass protects the shading device from dirt, damage or environmental restrictions for use. However, the disadvantages are still present and call for further development of DFS's.

The review of existing façade systems and ongoing research show that transparent and opaque façades are generally considered separately. Few exceptions apart, these are either transparent, translucent or opaque elements sharing a high degree of complexity. As facades are becoming smart, adaptive or enhanced with high tech materials, the application of simplified metrics such as static U- and g-Values can only provide insufficient descriptions of the systems' performance (Goia et al., 2017). On the other hand, the potential of low-tec facades, such as Trombe wall systems, is not fully exploited (Hu et al., 2017).

This is why a new hybrid transparent–opaque solar façade system, is proposed: the solar-energy balanced façade (SEBF) system. Based on a DSF, the SEBF features an integrated parapet that reduces the effective inner WWR. This parapet is composed of a thermal storage mass with internal insulation. Thus, the SEBF stores thermal energy in the façade to improve the building's energy balance. The solar gain management is daily and seasonally adaptive to achieve an improved energy balance for all seasons. The combination of active controls, passive strategies and high performance materials allows this innovative façade system to efficiently profit from solar energy.

Common building performance simulation (BPS) tools are not supposed to develop unique façade systems and do not support detailed transient models. For the investigation and assessment of the SEBF's performance, a simulation environment, which can deal with highly detailed physical systems, is needed. The object-orientated and equation-based Modelica modelling language is therefore chosen, as it offers the flexibility and power to analyze problem that are beyond the capabilities of traditional BPS (Wetter, 2009).

This paper presents the results of a simulation-based feasibility study on this novel façade system and compares it to other, more common, façade systems with the same solar gain management.

2 Design and operation of the Solar Energy Balanced Façade

The primary objective of the solar energy balanced façade is to reduce heating and cooling demands and to enhance the wellbeing of building occupants. Passive use and active control of solar gains shall be achieved by a combination of existing façade and technologies. It is essential not to create a pick and mix system, but rather employ a work-together approach. Coupling a

conventional ribbon-windows-and-parapet façade with a closed-cavity element façade, the hybrid SEBF effectively combines

- the improved thermal insulation and sun protection of a DSF
- the lower maintenance effort of a closed cavity façade (CCF)
- the lower WWR of ribbon windows and
- the high insulation standard of the parapet.

The functional role of the parapet as part of the SEBF is to reduce the amount of transparent façade area and to increase the opaque area which acts as a thermal storage. Therefore it is equipped with interior insulation so that the opaque element is used as thermal mass in the air gap of the façade. This results in the capability to compensate for daily energy flux variations.

The SEBF is equipped with two shading systems: one to manage solar gains through the transparent area and another to manage the thermal storages energy level in the opaque area. The double-skin structure ensures the shading functionality under all conditions. By attenuating heat flow variations the SEBF supports HVAC systems rather than hindering or restricting their function. This satisfies the basic requirement of system separation.



Figure 1 – Solar Energy Balanced Façade with its four main operating states (left to right): I) maximum solar gain, II) glare protection and maximum solar thermal gains, III) maximum sun protection, IV) daylight use and storage protection

The SEBF, as it is illustrated in Fig. 1, has two fundamental seasonal operating modes: summer, to avoid solar gains, and winter, where the maximum of solar gains is achieved. The orchestrated control of the two separate shading devices covering the facades opaque and transparent area allows four main operating states. In summer mode, the main objective is to block solar irradiance and to allow night-cooling. This is realized by closing both shades during daytime (Fig 1, Mode III) and opening them at nighttime (Mode I) to enlarge heat losses. Due to the thermal inertia of the storage mass, the overheating tendency is decreased even if solar irradiation hits the surface. In winter mode, as much solar energy as possible should be gathered. Daylight use is maximized and the thermal storage is heated up by solar irradiation (Fig. 1, Mode I or II). A high absorptive surface finish of the parapet increases the use of the available solar energy. At nighttime, the closed shadings reduce thermal losses and therefore effectively reduce overall energy losses from the façade (Fig. 1, Mode III).

The application of SEBF is not restricted to a specific building type. While the presented set-up is proposed primarily for office and educational buildings, it is potentially applicable in residential buildings with adapted WWR configurations.

3 Method of the simulation-based performance assessment

3.1. Simulation Environment

The choice of modeling approach and algorithms has a strong impact on design decisions based on the analysis of building energy simulations. Traditional BPS software offers big libraries of standard elements with varying degrees of transparency. The implementation and development of the proposed façade systems and its control mechanisms required an alternative approach offering more flexibility. The object oriented, equation based simulation language Modelica is completely open which means that users are free to create their own model libraries or modify the model libraries distributed with the software. Modelica's multi-domain nature allows to model arbitrary physical and electronic control systems. The customized shading control of the SEBF, could be modeled as a subcomponent and easily adjusted or replaced by alternative designs. The open implementation of the Modelica-Dymola environment gives the opportunity to understand every component's role within the system and to double check its behavior.

3.2. Modelling approach

Based on physical laws, current standards (mostly ISO 15099) and existing Modelica components, the SEBF's components were set up and an own component library, tailored to the project needs, was developed. These components range from simple window models ($U \cdot \Delta T$) up to full transient window and wall models. This allows a detailed analysis of the dynamic behavior of every component and provides valuable indicators for further improvement of the façade system. All components rely on physical laws and were compared to analytic solutions, other Modelica models and / or small-scale experiments to ensure error free functioning. Small scale experiments with an DGU comprising panes of acrylic glass in front of an oven showed high accuracy of the Modelica model in both, air filled and water filled cases. For further investigations and verification of the calculation mode, a real scale mockup is under construction.

The façade elements were modeled by their 1-dimensional heat fluxes under transient conditions. Heat fluxes through transparent and opaque areas are considered separately (see figure 2). This is due to the nearly impossible description of thermal lamination (the vertical temperature distribution) within the cavity. Previous simulations showed that the influence of separated heat fluxes compared to an ideal mixed gas temperature are insignificant for heating and cooling loads (<5%). The increased simulation complexity resulted in extended calculation times.

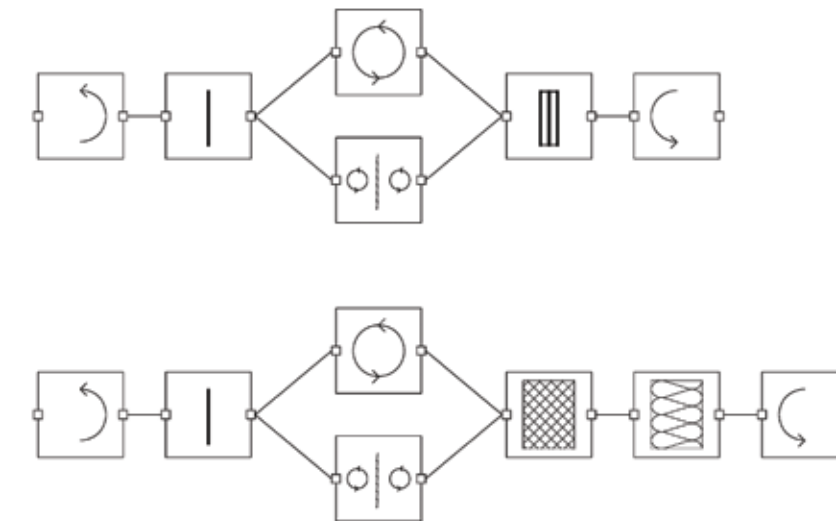

Figure 2 – Model scheme for transparent heat flux (upper row) and opaque heat flux (lower row)

According to figure 2 (upper row), the transparent facades are divided into external surface heat transfer, external single glazing, cavity with shading device, insulated glazed unit (IGU) and internal surface heat transfer. For opaque facades, see figure 2 lower row, two additional solid components for storage material and insulation are present. The following description gives an overview of the used façade components.

The internal and external surface heat transfer components follow the ISO 15099 description for natural and forced convection and radiative heat exchange. Simplified, the internal or external air temperature is assumed to be equal to the radiation temperature. Air and gas cavities are modeled according to ISO 15099 (2003) with temperature dependent gas properties and parallel radiative heat exchange.

The single glazing and all glass panes of IGU's are modeled with a centralized mass and two thermal resistances (surface 1 – mass and mass – surface 2). The solar gains for each glass pane are passed to the mass node. Solar properties for glazing are usually given for perpendicular irradiation and must be corrected according to Fresnel's law in dependence of the solar irradiation angle α for beam radiation as $\tau(\alpha)/\tau(90^\circ)$. This correction was applied only to the transmission τ , the resulting differences are accounted to the reflection ρ assuming that absorption does not significant change for incident angles up to 85° . Fig 3 shows the exemplary effect of varying incident angles for single and triple glazing.

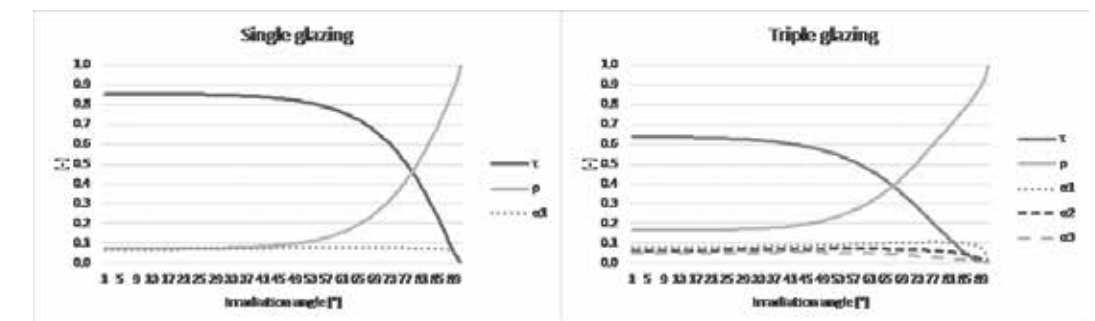

Figure 3 – Fresnel solution for single glazing (left) and TGU (right) with transmission τ , external reflection ρ and absorption coefficients for each glass pane a_i (where 1 is the external and 3 internal glass pane)

In the case of the DSF cavity, the two possible heat fluxes with and without shading device are modeled in parallel. The shading control determines whether the heat flow is through the shading device or air cavity by a factor from 0 to 1 in each heat flux model. A single aluminum layer of 1mm in the same manner as a single glass with solar gains applied on the external node and the corresponding solar properties represents the shading device. For tilted state, the calculation according to (Pfrommer, 1995) is implemented.

Solid components consist of several layers with resistors and masses. Heavy solid components, e.g. concrete, are represented by 10 equidistant resistors, two surface masses (1/20) and 9 core masses (1/10) in the model (see fig. 4 left). Insulation is regarded as a lightweight material and therefore modeled with five equidistant resistors instead of 10 and consequently adjusted masses (see fig. 4 right). A sensitivity analysis showed that the discrepancies on surface temperatures between five or ten resistors are marginal.

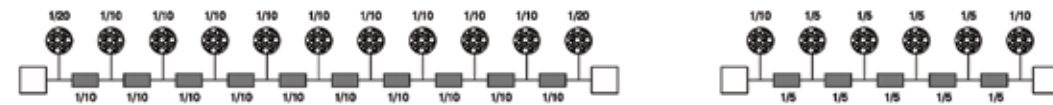

Figure 4 – Scheme of the opaque mass elements for heavy components (left) and lightweight components (right), with resistors and masses

3.3. Boundary Conditions

The following results are observed for one façade element of 2.5m height and 1m width (2.5 m²) with an inner parapet height of 1m. The double-skin façade consists of a triple glazing with a low-E coating in each gas space ($U_g \sim 0.7$) and a 6mm single glazing in front of it. The low absorptive ($\alpha=15\%$) shading device is mounted in the center of the 150mm deep, non-ventilated façade cavity. The parapet consists a high absorptive thermal mass ($\alpha=80\%$) of thickness $t=50\text{mm}$ and an interior insulation of $t=75\text{mm}$. Because of its high level of detail, the study is undertaken only at the façade level. Influences by the attached rooms, HVAC, occupancy and manual overriding of controls are disregarded. The climatic outdoor conditions are given by a standard design year for Zürich (CH) on an hourly basis from Meteonorm (Meteotest, 2018). All parameters, such as temperature, wind speed, façade irradiation and sun position, are interpolated linearly.

To the correct mode of the SEBF, the shading control must know whether the building is in 'heating' or 'cooling' mode. The mean outside temperature over the last 24h was chosen as the decision criterion. If the mean outside temperature is lower than 12 °C, which is the heating limit temperature in Switzerland, the system is in heating mode. If the mean outside temperature is higher than 15 °C, it is in cooling mode. The range between is a 'free floating' mode where the control strategy of transparent and opaque shadings is set to avoid high passive gains.

This control strategy allows to determine the different control set points according to seasonal needs. The outside temperature set points are adjustable to other climate regions. The following table 1 describes all control set points as used in the simulations presented in this paper.

	Heating Mode < 12 °C	Free Float Mode 12 °C < X < 15 °C	Cooling Mode > 15 °C
Transparent shading daytime tilted state	>350 W/m ² *	>250 W/m ² *	>250 W/m ² *
Transparent shading daytime closed state	>600 W/m ² *	>600 W/m ² *	>450 W/m ² *
Transparent shading night closed state	<25 W/m ²	no	no
Opaque shading closed state	-	>25 W/m ²	>25 W/m ²
Opaque shading night closed state	<25 W/m ²	no	no

*the set point to return to previous mode is 100 W/m² lower

Table 1: Global Radiation Set Points for Shading Control (on façade surface)

All of the material properties are set to typical values found in literature. The emissivity of surfaces are considered with $\epsilon=0.84$ for glass and $\epsilon=0.9$ for other materials. More specifically, the material properties are close to standard as possible in order to minimize distortion of the results.

4 Results

4.1. Thermal Storage Influence

Initial simulations with an attached concrete mass of 10cm within the cavity proved that the system provides an energy saving potential. Based on these first promising results, the simulation model was elaborated and a simulation study conducted to identify the influence of the thermal mass.

The parapet configuration, as described above, has an U-Value of approximately 0.4. During the heating period, which is defined as week 45 to week 10, the mean outside temperature in Zürich is 3.3 °C. With an inner room temperature of 22 °C, the heat loss per meter square façade is (static) 22.6 kWh. The simulation of the SEBF's parapet without consideration of solar gains predicts a heat loss of 23.2 kWh, which is a deviation of under 3%. By using the incident solar energy, the heat loss drop significantly (-60%).

Based on this result, a parametric study to identify the influence of the thermal mass properties is carried out. The thermal storage capability of the mass is given by the geometry, density ρ and specific heat capacity c_p . To simplify the parametric study, only one parameter is varied. For figure 5, the storage material is set to thermal conductivity $\lambda = 2.1 \text{ W/(mK)}$ (concrete) and density $\rho = 1000 \text{ kg/m}^3$. The specific heat capacity c_p is the varying parameter.

Heat loss per square meter parapet decreases in both summer and winter by increasing storage mass. To clarify, concrete with $c_p = 1000 \text{ J/(kgK)}$ and $\rho = 2400 \text{ kg/m}^3$ is equal to $c_p = 2400$ in figure 5. The upper end of the scale is $c_p = 4500$, which is slightly higher than water ($c_p = 4200 \text{ J/(kgK)}$), $\rho = 1000 \text{ kg/m}^3$.

The usual disadvantage of overheating in DSFs can be turned into an advantage, if thermal storage mass is attached to the cavity. However, it seems that this improvement might be limited to non-ventilated DSFs as determined by (Fallahi, Haghigat, & Elsadi, 2010).

Unfortunately, most materials within the range of $c_p = 1500$ to 3500 according to figure 5, with standardized density $\rho = 1000 \text{ kg/m}^3$, are massive stones (basalt, granite, concrete,...) or metals (steel, aluminum, copper,...). Those materials are highlighted because of their density and not for their heat storage capacity. On the other hand, water offers very high heat capacity while its density is significant lower than those of stones or metals. However, the use of water within a façade element may prove difficult.

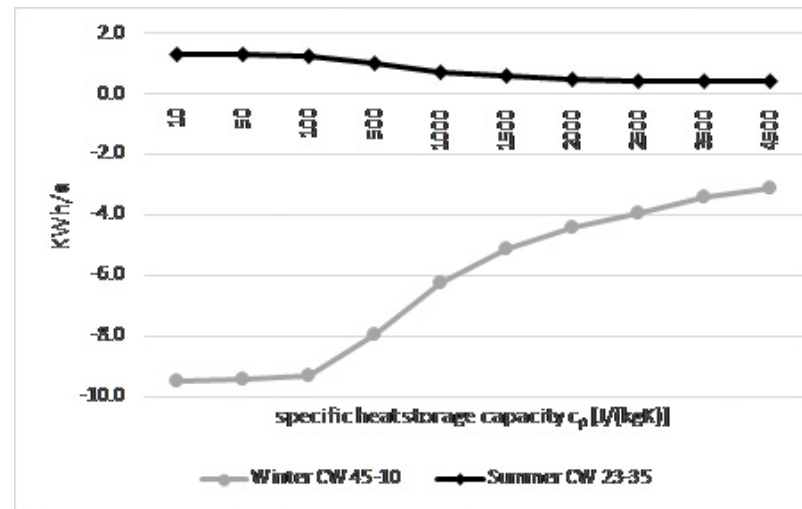

Figure 5 - Energy Balance per m2 parapet as function of specific heat storage capacity

4.2. Short Term Effects

Figure 6 and figure 7 show heat flux through the SEBF parapet in three different configurations; A) insulated panel covered with 2mm Aluminum, B) SEBF parapet with 5cm concrete and C) SEBF parapet with 5cm of non-convective water for a cloudy winter week (figure 6) and a sunny summer week (figure 7) each for south and north orientation. All three configurations operate with the same shading device and control.

In winter, the heat loss through parapets with additional mass is generally slightly lower because of their additional thermal resistance. Moreover, the attached thermal mass attenuates the heat flow fluctuation and stores even low solar irradiation. While configuration A quickly heats up and the heat flow fluctuation may irritates HVAC controls, the mass in configuration B & C slowly heats up, stores the energy and balances the heat flow. Upon closer look on the 11th January in figure 6, the release of stored energy is visible by slow decrease of energy flow in configuration B & C. Furthermore, the higher storage capacity of water leads to lower peaks and lower decrease of heat flux through the parapet.

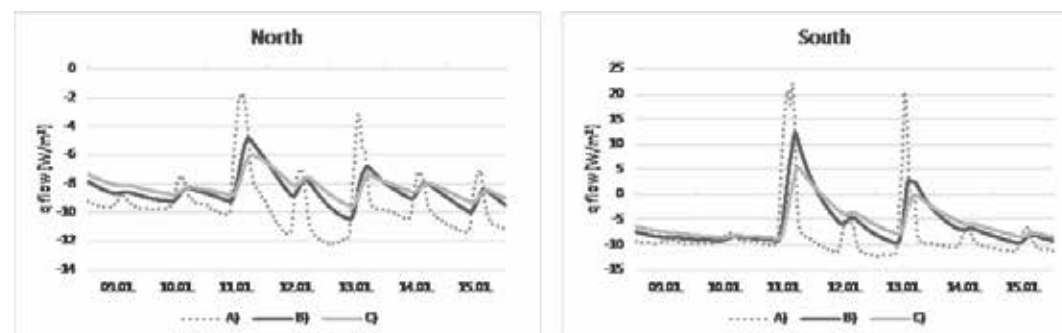

Figure 6 - Energy flow per m2 parapet on a cold and cloudy winter week (January 9th to 15th) for North and South orientation. Mean outside temperature -3 °C and peak solar radiation south 720 W/m2, north 115 W/m2, respectively.

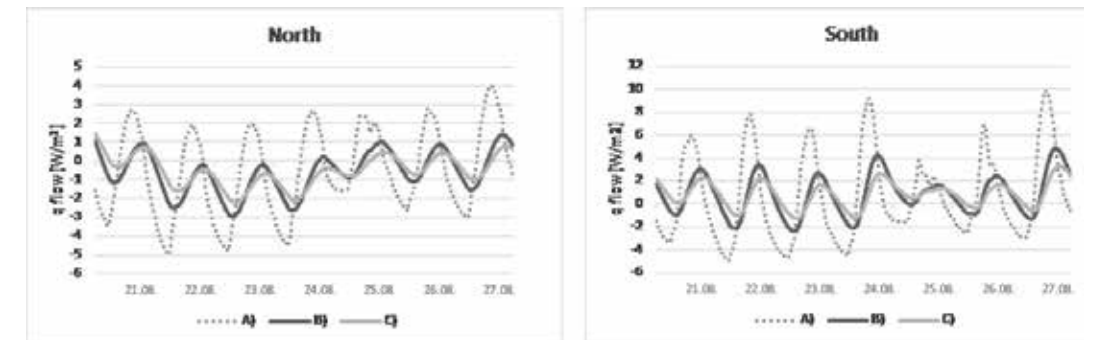

Figure 7 - Energy flow per m2 parapet on a hot and sunny summer week (August 21th to 27th) for North and South orientation. Mean outside temperature 19 °C and peak solar radiation south 700 W/m2, north 185 W/m2, respectively.

For summer days, an effective shading device must cover the high absorbing parapet to prevent overheating. Again, the mass reduces overheating, lowers inwards heat flux and balances the daily heat flow. The configuration C with water as storage mass once again outperforms configuration B slightly.

4.3. Long Term Effects

Because of its highly dynamic and unsteady characteristics, the SEBF does not fit the standard U- and g-Value calculations. Consequently, it would not be reliable to compare it to standard static energy balances of other façade types. Therefore, some of the most comparable façade constructions are added to the comparison see figure 8 D & E. Configurations A, B and C still correspond to the parapet constructions in section 4.2.

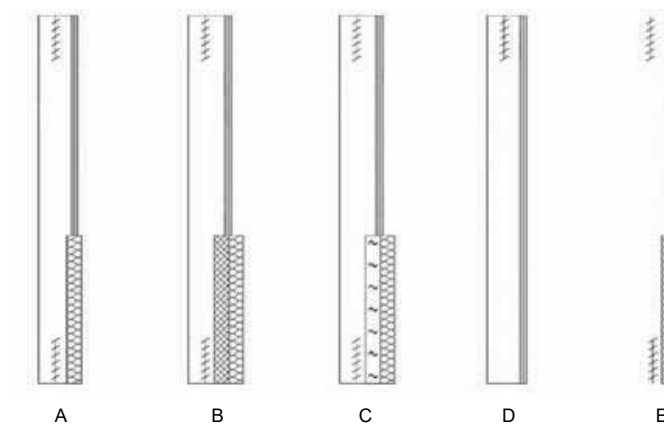

Figure 8 – Façade elements sketch; A) SEBF Element with TGU and insulated panel, B) SEBF Element with TGU and parapet with 5cm concrete, C) SEBF Element with TGU and parapet with 5cm of non-convective water, D) SEBF Element with TGU and without parapet, E) Single skin façade with TGU and insulated panel according parapet A.

For a direct comparison, all elements are modeled with the same basic components and controls. For better readability, the results of the five configurations are reduced to seasonal results. December to February are considered as winter, March to May as spring, June to August as summer and September to November as Autumn. The seasonal results are presented for the two most significant orientations: North and South.

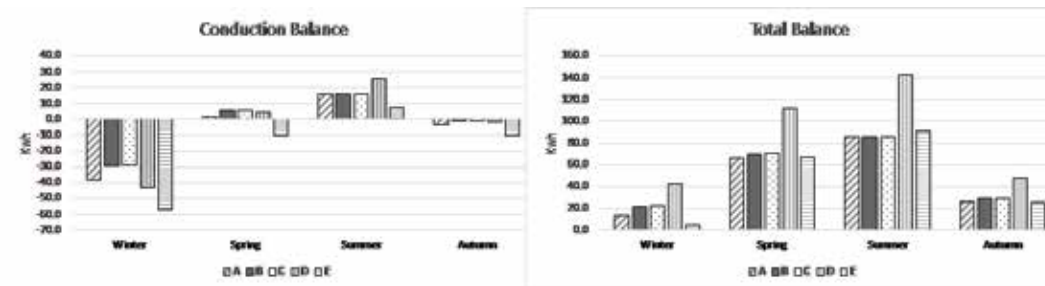

Figure 9 - Energy balance for South facing façade elements

According to figure 9 (left), for the case of orientations towards South the SEBF variants with concrete (B) and water (C) as storage material have almost the same energy balance for all seasons, nearly unaffected by short-term differences. Configuration A, without storage mass, has 30% higher conductive losses during the winter season, even with the same high absorptive panel surface and its own shading device. The fully glazed variant (D) and the single skin (E) show significant higher heat losses.

In summertime (figure 9 left), the energy balance for the three DSF systems with parapet (A, B & C) is very similar. This is due to the closed highly reflective shading, which renders the high absorption of the parapet ineffective. Configuration D, without parapet, has a 45% higher conductive heat loss during winter and 60% higher conductive heat inflow in summertime than variants B & C. The single skinned configuration E has the highest energy losses in wintertime. The conductive heat loss is nearly the double of the configurations B & C.

The total balance, figure 9 right, shows the result including direct solar gains. Here, configuration D can compensate heat losses by higher solar gains. Due to the higher glazing area, the total energy balance with solar gains shows always a significantly higher value, which indicates potential overheating problems.

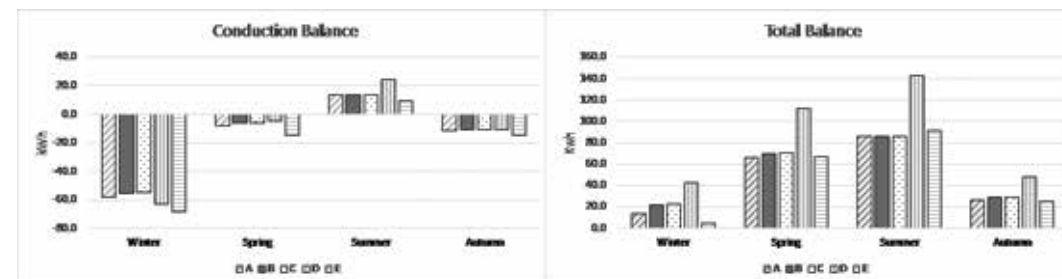

Figure 10 - Energy balance for North facing façade elements

Figure 10 shows the results for North facing elements. Due to lower solar irradiance, the SEBF systems (B, C) do not perform significantly better than configuration (A). However, the shown reduction of energy loss by 5% in winter is based on the assumption that the insulated panel in configuration (A) acts under the same conditions as the SEBF parapet in (B&C). The CCF (D) loses 13% more energy and (E) even 23% more compared to system B & C.

In the total energy balance, figure 10 right, all systems can effectively reduce heat losses due to solar gains by about 50%, configuration D even 77% due to high direct gains. Interestingly, all DSF configurations with highly absorptive parapet and two shading devices perform very similar. This

is due to the nearly identical simulation conditions and low solar irradiation on North facing facades, where the strength of the SEBF loses its weight.

5 Discussion & Conclusion

The effect of thermal mass within a non-ventilated DSF oriented to South and North directions and subjected to the moderate climate in Zürich was studied. The simulations for this adaptive façade system were conducted with the Modelica-Dymola software for a very detailed investigation of the thermal behavior. The reduction of effective glazed area by the parapet leads to significant reduction of direct and passive solar gains in hot seasons and thereby promises to reduce the building's cooling loads. By equipping the parapet with a thermal mass towards the DSF cavity, further benefits are observed.

The results demonstrate that thermal storage mass can reduce heating and cooling demand, if coupled to a suitable solar gain management. Unfortunately, most suitable masses are made of heavy materials and therefore not applicable in a curtain wall structure. On the other hand, water offers a high storage capacity and low density. However, water within facades raises other problems about freezing and leakage. Therefore, small-scale experiments with water gel are in progress.

The short-term results show that the SEBF's parapet, implemented with a thermal mass comprising either concrete or water, balances the heat fluxes and promises to reduce peak loads. The positive effect is clearly visible and holds on over more than 24h. On the long run, South-orientated SEBF facades can significantly reduce conductive heat losses due to solar energy storage, depending on the available solar irradiation. In a real system, the parapet in configuration A would not be high absorptive and managed by a shading device. Consequently, the heat losses in winter would be greater and heat gains in summer reduced.

The SEBF parapet with thermal mass reduces thermal flux fluctuations in winter as well as in summer periods. The thermal storage reduces heat losses during cold periods by releasing stored solar energy. Furthermore, the thermal mass acts as a damper for heat flow fluctuations, which promises to reduce load peaks for HVAC systems. The lower heat flow fluctuation and reduced HVAC peak loads support the HVAC function and could reduce installation sizes. Additionally, it could lead to an improved occupant's wellbeing.

Further research shall aim at improved the energetic performance by optimized selection of materials and composition. For example, the interior surface emissivity of shading devices can be reduced for decreased radiative transfer between shading device and thermal mass. This would potentially further decrease the heat loss in winter as well as the heat influx in summertime. In addition, the absorptive and reflective properties of storage mass and shading device shall be improved for better functioning.

The investigation of the application of water gel as thermal storage and a real scale mockup are planned. The mockup will be equipped with thermal sensors to compare it with the Modelica model and to further improve the accuracy and reliability of the calculations.

6 Acknowledgements

The authors gratefully acknowledge funding by the Swiss National Science Foundation (SNF Grant No. IZCNZ0-174562) and Lucerne University of Applied Sciences and Arts.

7 References

- Swiss Federal Office of Energy SFOE. (2015). Analyse des schweizerischen Energieverbrauchs 2000 - 2014 nach Verwendungszwecken. Bern: Bundesamt für Energie BFE.
- COST Action TU 1403. (2014). Memorandum of Understanding. Brussels: COST 060/14.
- European Commission. (2011). Communication from the Commission to the European Parliament, the Council, the European Economic and Social Committee and the Committee of the Regions – Energy Roadmap 2050. Brüssel: KOM(2011) 885.
- Fallahi, A., Haghigat, F., & Elsadi, H. (2010). Energy performance assessment of double-skin facade with thermal mass. *Energy and Buildings* 42, S. 1499-1509.
- Favoino, F., Jin, Q., & Overend, M. (2014). The route to an ideal adaptive glazing facade. Aachen, Germany: ICBEST 2014.
- Goia, F., & Cascone, Y. (2014). The impact of an ideal dynamic building envelope on the energy. *Energy Procedia*(58), S. 185-192.
- Goia, F., Romeo, M., & Perino, M. (2017). Simplified metrics for advanced window systems. Effects on the estimation of energy use for space heating and cooling. *Energy Procedia* 122, S. 613-618.
- Hu, Z., He, W., Ji, J., & Zhang, S. (2017). A review on the application of Trombe wall system in buildings. *Renewable and Sustainable Energy Reviews* 70, S. 976-987.
- ISO 15099. (2003). Thermal performance of windows, doors and shading devices - detailed calculations. Geneva: ISO copyright office.
- Kim, J. T., & Todorovic, M. S. (2013). Tuning control of buildings glazing's transmittance dependence on the solar radiation wavelength to optimize daylighting and building's energy efficiency. *Energy and Buildings*(63), S. 108-118.
- Manz, H. (2010). *Bauphysik II*. Horw: Heiner Manz.
- Manz, H., & Frank, T. (2005). Thermal simulation of buildings with double-skin facades. *Energy and Buildings*(37), S. 1114-1121.
- Meteotest. (2018). *Meteonorm 7.2*. Bern (Switzerland): Meteotest Genossenschaft.
- Pfrommer, P. (1995). *THERMAL MODELLING OF HIGHLY GLAZED SPACES*. Stuttgart: Department of Building-Physics Fachhochschule für Technik Stuttgart.
- Quesada, G., Rousse, D., Dutil, Y., Badache, M., & Hallé, S. (2012). A comprehensive review of solar facades. Opaque solar facades. *Renewable and Sustainable Energy Reviews* 16, S. 2820-2832.
- Schuler, M. (2000). Adaptive Gebäudehüllen: Optimierung des Nutzerkomforts und Minimierung der Gebäudetechnik. *Stahlbau*(69), S. 469-479.
- Struck, C., Jurt, D., & Seering, A. (2015). Resilience of swiss offices to climate change: A comparison of four buildings with different facade typologies. 10th Energy Forum on Advanced Building Skins. Berne.
- Wetter, M. (2009). Modelica-based Modelling and Simulation to Support Research and Development in Building Energy and Control Systems. *Journal of Building Performance*, S. 143-161. doi:10.1080/19401490902818259
- Winther, F. V., Heiselberg, P., & Jensen, R. L. (2010). Intelligent glazed facades for fulfilment of future energy. Towards 2020 - Sustainable Cities and Buildings: 3rd Nordic Passive House Conference.

An initial study for the development of an adaptive timber device for moisture buffering applications

Oswaldo Vallati, Arianna Brambilla, Giulia Spalletti, Giorgio Frigerio, Gianluca Ranzi

The University of Sydney, Australia

Humidity is a significant component in thermal comfort and it has great impact on the energy spent to cool a space, especially in high internal-load dominated buildings, such as offices. In this context, components that could contribute to the buffering of the indoor humidity could have a positive impact on the indoor comfort and might lead to reduction in energy consumption. Among different materials, timber has a natural ability to react to the environmental conditions by absorbing and releasing moisture and, therefore, for moisture buffering. This paper presents an initial study aimed at the development of a timber-based interior device that could assist the balancing of daily humidity variations that occur in hot-humid climates, such as the Australian one. The device is assumed to function as a shading device for building facades or windows, or as office partition or office ornament. The particularity of the proposed device is to combine different timber layers to enhance the area activated for moisture buffering. In the initial part of the paper, maple samples of different thicknesses have been considered and investigated experimentally to establish their moisture buffer values obtained by the NORDTEST method. This is followed by the presentation of three prototypes and their moisture buffer capability. The main features of these solutions and their ability to morph during the moisture buffering process have been described.

Keywords: indoor humidity, moisture buffering, morphing, timber

1 Introduction

Indoor humidity plays an important role in building performance as it significantly affects the energy consumption and the indoor environment (Janssen and Roels 2009). Latent heat loads contribute to the thermal performance of a building because influencing both air-conditioning needs and indoor thermal comfort (Rode and Grau 2008; Kunzel et al. 2005; Holm et al. 2004). A comprehensive hygrothermal assessment is necessary when evaluating the building thermal behaviour as the sole temperatures are not sufficient to describe the whole thermal model (Antretter et al. 2010). The evaluation of the indoor humidity accounts for different factors, such as the internal humidity generation given by occupants or other moisture sources, the moisture exchanged with the ventilation and the moisture exchanged with the room enclosures (Janssen and Roels 2009). The latter is often neglected as traditionally considered not significant, even if this can lead to biased results in the final energy demand (Moon et al. 2014). The moisture buffer performance of a room is given by the moisture buffer capacity of the different enclosures, which in turn results from the combination of the moisture buffering of the materials constituting the enclosure (Rode et al. 2005). Recent studies investigated the multiple effects of the interior moisture buffering produced by different building materials (Janssen and Roels 2009; Kunzel et al. 2005; Holm et al. 2004; Salonvaara et al. 2004; Rode et al. 2006) and suggested that the use of highly hygroscopic materials can reduce the energy consumption up to 30% (Zhang et al. 2017). The smart use of high moisture buffering materials can also contribute in reducing the condensation risk and maintaining

healthy indoor environment (Bairi et al. 2017). These effects are more significant when low air change rates are specified for the mechanical ventilation, as the ventilation itself is not able to reduce the moisture loads (Woloszyn et al. 2009; Zhang et al. 2017). The HVAC design is usually based on standard assumptions given by building codes that might lead to critical scenarios when the set ventilation rate is not sufficient to control the indoor humidity (Antretter et al. 2010).

In this context, highly responsive building components capable of buffering exceeding indoor humidity can be incorporated to contribute to the satisfaction of the indoor comfort and energy performance requirements. For this type of building components, timber products represent an attractive solution (Li et al. 2012). For example, it has been demonstrated that the correct use of porous timber-based interior cladding can contribute to the stabilization of indoor relative humidity between 43% and 50% when coupled with smart humidity-controlled ventilation systems (Woloszyn et al. 2009). Recent studies investigated the timber responsiveness to hygrothermal stress by using a special thin bi-layer timber element that exhibited morphing capabilities associated with the humidity variations (Reichert et al. 2015; Correa et al. 2015; Correa et al. 2013). Bespoke prototypes have also been developed that make use of the timber movement to enhance human experience, e.g. (Cronhjort et al. 2016). For building and façade applications, the use of bilayered wood systems have been proposed, e.g. , for shading and cladding modules (Reichert et al. 2015, Holstov et al. 2017, Vailati et al. 2018) and for self-constructing timber surfaces (Wood et al. 2016).

In this context, this paper presents an initial study aimed at the development of a possible timber device to be used for moisture buffering applications. The distinguishing feature of the proposed solution is to enhance the exposed timber surface area and, therefore, the surface available for moisture buffering functionalities. This is achieved by arranging the timber layers in closed proximity to each other or by placing them on top of each other, and by taking advantage of the timber morphing abilities to increase the exposure of underlying surface layers when subjected to humidity variations. In this study, three prototypes that fall within the characteristics of the proposed conceptual device are presented. One prototype has a flower arrangement to be applied on stems, such as office lamps, or to be used as indoor ornaments. The second prototype is devised to serve as a wall/partition component for office spaces and the third prototype represents a shading device that can be used on building facades and windows. In the initial part of the paper, the material characterisation of four maple samples of different thickness has been carried out to identify their moisture buffer values (MBVs) in accordance with the NORDTEST procedure (Antretter et al. 2014) and to classify their ability to operate for moisture buffering purposes. The second part of the paper provides a brief description of the three prototypes and how these could be used in buildings, followed by their moisture buffer characterisation over two different relative humidity ranges.

2 Characterisation of the MBV of the maple samples in accordance with the NORDTEST experimental protocol

The NORDTEST (Antretter et al. 2014) method is a protocol for evaluating the moisture buffering value (MBV) of materials exposed to indoor air by considering the moisture buffer value as the moisture uptake/release when the material is exposed to humidity cycles, normalised over the exposed surface and the variation of the relative humidity. In particular, the MBV is defined as the quantity of moisture transported to and from a material when exposed to cyclical daily variations of relative humidity, expressed in units of $\text{g m}^{-2} \%RH^{-1}$ (Rode et al. 2005). The method is designed to replicate the humidity patterns typical of an office building with a constant temperature of 23°C. In this study, the cycles have been carried out in an ATT climatic walk-in environmental chamber (model number WZH10A1C) based on following specifications: (i) 8 hours at high humidity level, RH 75%, representing the heavy occupancy period; (ii) 16 hours at low humidity level, RH 33%,

representing the hours where an office or space is not occupied; and (iii) constant temperature through the whole experiment at 23°C.

Four maple samples have been prepared with thicknesses of 10 mm, 4 mm, 3 mm and 2 mm (Table 1). Their dimensions were determined to fall within the rated capacity of 1 kg possessed by the adopted load cells. The specimens were sealed on one surface and on all four edges with acrylic adhesive with nominal thickness of 50 micron so that only one face of the sample was directly exposed to the humidity cycles. The specimens have been tested twice by changing the exposed surface (except for the 3 mm thick sample that was tested on one side only).

Sample ID	Wood type	Length (mm)	Width (mm)	Thickness (mm)	MBV (face A) ($\text{g m}^{-2} \%RH^{-1}$)	MBV (face B) ($\text{g m}^{-2} \%RH^{-1}$)
T1	Maple	841	148	10	1.36	1.48
T2	Maple	2000 ^a	148	4	1.42	1.54
T3	Maple	817 ^a	244	3	1.32	-
T4	Maple	2400 ^a	148	2	1.08	1.14

Note: ^atwo samples were prepared to accommodate the specified length.

Table 1: Description of samples and MBV values

An overview of the testing setup is depicted in Figure 1a, while a detail of the timber to load cell connection is illustrated in Figure 1b. Considering the large dimension of the samples, the specimens were subjected during the tests to slight movements produced by the air flow generated by the environmental chamber. These movements produced fluctuations in the mass measurements and, to eliminate this bias, the samples were protected by encasing them in large plastic tubes with a nominal external diameter of 230 mm or by enclosing them inside a timber barrier. Typical measurements recorded over a series of four cycles are reported in Figure 2. As required by the testing protocol, the moisture buffer value was calculated based on a stabilised mass variation. This was checked by ensuring that differences in mass measurements between adjacent cycles remained within 5% over at least three consecutive cycles. A slight shift in mass readings was observed when testing the performance of the load cells with the NORDTEST cycles while using a material not influenced by moisture variations. In this case, the readings' changes were in the opposite direction to those noted for the moisture mass variations subjected to the RH cycles and were small when compared to the latter measured masses. In this initial study, the measured masses were not corrected by this slight shift. The MBV calculated for the maple samples are reported in Table 1, from which it can be observed that different moisture responsiveness were measured for the two surfaces of the samples, referred to as A and B in the last two columns of Table 1.



(a) outline of the maple samples placed in the environmental chamber



(b) connection detail of the timber sample to the load cell

Fig. 1 Overview of the test setup for the evaluation of the MBV values

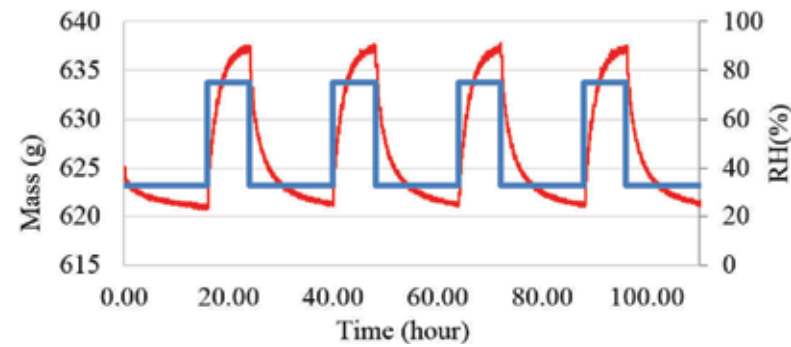

Fig. 2 Typical mass variations recorded over four cycles and plotted against RH variations

For the comparison of MBV values of different materials, Rode et al. (2006) proposed a classification system for the moisture buffering performance based on the experimental measurements that included the following categories: (i) negligible effect: MBV below 0.2 g m⁻²RH-1; (ii) limited effect: MBV ranges between 0.2 and 0.5 g m⁻²RH-1; (iii) moderate effect: MBV ranges between 0.5 and 1 g m⁻²RH-1; (iv) good effect: MBV ranges between 1 and 2 g m⁻²RH-1; (v) excellent effect: MBV above 2 g m⁻²RH-1. Based on this classification, the maple specimens characterised in this study are regarded as “good”, meaning that the material can effectively contribute in buffering the indoor moisture concentration.

3 Preparation of the prototypes for moisture buffering applications

In this initial study three types of prototypes have been developed and these are briefly presented below. The first prototype is depicted in Figure 3 and consists of a ‘flower’ concept that is achieved by combining in a vertical arrangement maple layers with thickness of 2 mm. This solution could be used, for example, around the stem of a lamp or similar objects. The external surface of each layer is sealed by means of a moist-proofing wax to establish an asymmetric exposure condition to the environment among the two opposite surfaces. When exposed to a relative humidity cycle, the prototype starts in the initial configuration shown in Figure 3a at a low relative humidity level (i.e. RH 33%) and moves, for example, to the configuration presented in Figure 3b during the initial part of the high relative humidity exposure (i.e. RH 75%). With the particular geometry adopted in Figure 3, the prototype has a footprint in its closed configuration (Figure 3a) of about 0.01 m² and it possesses an exposed surface area of about 0.24 m². In this manner, the volume within the footprint of the device is efficiently occupied to maximise the possible moisture buffering capability of the timber.



Fig. 3 Morphing process of the ‘flower’ prototype (low RH = 33%, high RH = 75%)

The second prototype is depicted in Figure 4 and intends to be a basic module of a modular solution. It has been prepared with three overlapping layers of maple sheets with thicknesses of 3 mm and 4 mm placed on a 10 mm thick maple base. The initial and morphed configurations are shown in Figures 4a and 4b, respectively. These have been obtained at levels of relative humidity equal to 33% and 85%, respectively. The flexural deformations of the different segments of each sheet have been obtained by sealing the timber surfaces on both sides with clear tape (polypropylene film) following a staggered arrangement. The advantage of this system is that it represents the basic module that could be used to cover walls and office partitions, also considering different morphing patterns among adjacent modules to achieve architecturally attractive solutions. With the geometry adopted in the system of Figure 4, the footprint of the module is about 0.08 m² and the exposed surface available is about 0.26 m² by considering the exposed areas of the three morphing layers and of the 10 mm thick base, therefore leading to a good utilisation of the module’s area for moisture buffering purposes.



Fig. 4 Morphing process of the prototype for a basic module for the modular wall/partition system (low RH = 33%, high RH = 85%)

The third prototype consists of a shading device that can be used on the interior side of building facades and windows. The sealing of selected maple surfaces for the morphing was carried out with the wax used for the flower prototype. The geometry of its components is identical to those specified for the wall/partition prototype with the difference that only 3 mm thick maple was used in its preparation. For this purpose, the footprint and the exposed area per square metre are those already provided for the wall/partition system. In the layout presented in Figure 5, the timber morphing components have been installed in a Venetian arrangement by attaching them to a transparent plastic skeleton. The device can vary from a fully shaded configuration (depicted in Figures 5a and b at relative humidities of 33% and 75%, respectively) to a fully open layout (shown in Figures 5g and h at relative humidities of 33% and 75%, respectively). Views at intermediate shading angles are provided in Figures 5c-f. For clarity, Figure 5 has shown the use of two Venetian components placed next to each other.

The moisture buffering capabilities of the proposed prototypes have been quantified by measuring the moisture mass variations occurred during cycles performed in the environmental chamber following the NORDTEST protocol (Antretter et al. 2014) while varying the relative humidity between 33% and 75% as well as in the range of 33% and 55%. The calculated MBV values have been reported in Table 2 and these were calculated based on the measurements obtained from two consequent cycles (instead of 3 consequent cycles as specified in the NORDTEST protocol). From Table 2 it can be observed that the MBVs of the prototypes are similar to those measured in maple panels (Table 1) even if the flower-type prototype produced a slightly smaller MBV and the shading

prototype led to a higher MBV when compared to the performance of the base material panel samples. The maple used for the panels of Table 1 and for the prototype preparation (Figures 3-5) was purchased through two separate procurements. The MBV values observed for the two intervals of relative humidities (i.e. for cycles between 33% and 55% the MVs reported in the second column of Table 2 and for the range 33%-75% MBVs tabulated in the third column) highlight the fact that the mass variation induced by the moisture occurs at a faster rate for the larger RH variation under the 8 hour window set by the specified test protocol.

4 Conclusions

This paper presented the development of three prototypes prepared from maple sheets that could contribute to the buffering of the indoor humidity in indoor building applications and that could be used as shading device for building facades or windows, or as internal wall/partition components or ornaments. The material selected for this work was maple because naturally capable of reacting to the environmental conditions by absorbing and releasing moisture.

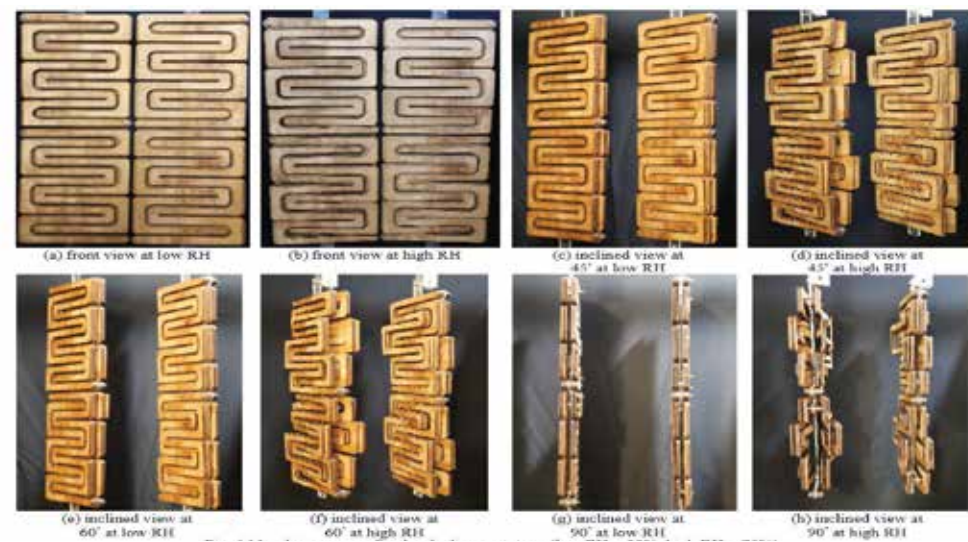

Fig. 5 Morphing process for the shading prototype (low RH = 33%, high RH = 75%)

Prototype	MBV (from RH cycle 33% - 55%) ($\text{g m}^{-2}\text{RH}^{-1}$)	MBV (from RH cycle 33% - 75%) ($\text{g m}^{-2}\text{RH}^{-1}$)
Flower-shaped prototype	0.83	0.96
Partition prototype	1.27*	1.43*
Shading prototype	1.27	1.47

*Note: * MBV based on values measured for shading prototype assuming same maple components (with 3 mm thickness).

Table 2: Description of MBV values of prototypes

In the first part of the paper the selected material (maple) has been tested in accordance with the NORDTEST method to determine its moisture buffer values for different thicknesses. This is followed by the presentation of the three prototypes that fall within the specification of the proposed device aimed at combining different layers of timber in different arrangements to enhance the activated area for the moisture buffering function. The first prototype described has the shape of a flower and possesses a large exposed area of timber (available for moisture buffering purposes). During its moisture buffering process, it changes shape by undergoing flexural deformations induced by the asymmetric exposure conditions of its surfaces to the environment (i.e. one surface is sealed and one is kept exposed to the environment). The second prototype consists of a basic module in which three maple sheets have been placed on top of each other and supported by a maple base. Also in this case, the exposed surface area available for moisture buffering is increased when compared to a standard wall/partition module with the same footprint and a

morphing process takes place during the functioning of the system. The third prototype represents a shading device built on a Venetian arrangement based on the proposed wall/partition component solution. It is envisaged that the prototypes could find applicability in office buildings.

5 Acknowledgments

The work presented in this paper was supported by the Australian Research Council through its Future Fellowship scheme (FT140100130).

6 References

- Alduchov, O.A. & Eskridge, R.E. (1996) Improved Magnus form approximation of saturation vapor pressure, *Journal of Applied Meteorology*, 35 (4), 601-9.
- Antretter, F., Holm, A., Karagiozis, D.A., Glass, S. (2010) Interior temperature and relative humidity distributions in mixed-humid and cold climates as building simulation boundary conditions. *Proceedings of the Thermal Performance of the Exterior Envelopes of Whole Buildings XI International Conference*, Clearwater Beach, FL, USA.
- Bairi, A., Gomez-Arriaran, I., Sellens, I., Odriozola-Maritorea, M., Perez-Iribarren, E. (2017) Hygroscopic inertia influence on indoor environments: moisture buffering. *Proceedings of the 13th International Conference on Heat Transfer, Fluid Mechanics and Thermodynamics*, Portoroz, Slovenia, 17-19 July 2017.
- Correa, D., David Krieg, O., Menges, A., Reichert, S., Rinderspacher, K. (2013) HygroSkin: A prototype project for the development of a constructional and climate responsive architectural system based on the elastic and hygroscopic properties of wood. *ACADIA 13: Adaptive Architecture*, Proceedings of the 33rd Annual Conference of the Association for Computer Aided Design in Architecture (ACADIA), Cambridge 24-26 October, 2013, 33-42.
- Correa, D., Papadopoulou, A., Guberan, C., Jhaveri, N., Reichert, S., Menges, A., Tibbits, S. (2015) 3D-printed wood: programming hygroscopic material transformations. *3D Printing and Additive Manufacturing*, 2(3), 106-116.
- Cronhjort, Y., Hughes, M., Paakkanen, M., Sahi, K., Tukiainen, P., Tulamo, T., Vahtikari, K. (2016) Functional Wood, School of Arts, Design and Architecture, Aalto University.
- Holstov, A., Farmer, G., Bridgens, B. (2017) Sustainability materialisation of responsive architecture. *Sustainability*, 9(435), doi:10.3390/su9030435.
- Holm, A.H., Kunzel, H.M., Sedlbauer, K. (2004). Predicting indoor temperature and humidity conditions including hygrothermal interactions with the building envelope. *ASHRAE Transactions*, 110, 820.
- Janssen, H., Roels, S. (2009). Qualitative and quantitative assessment of interior moisture buffering by enclosures. *Energy and Buildings*, 41, 382-394.
- Kunzel, H., Holm, A., Zirkelbach, D., Karagiozis, A. (2005). Simulation of indoor temperature and humidity conditions including hygrothermal interactions with the building envelope. *Solar Energy*, 78(4), 554-561.
- Li, Y., Fazio, P., Rao, J. (2012) An investigation of moisture buffering performance of wood paneling at room level and its buffering effect on a test room. *Building and Environment*, 47, 205-216.
- Moon, H.J., Ryu, S.H., Kim, J.T. (2014). The effect of moisture transportation on energy efficiency and IAQ in residential buildings. *Energy and Buildings*, 75, 439-446.
- Reichert, S., Menges, A., Correa, D. (2015) Meteorosensitive architecture: Biomimetic building skins based on materially embedded and hygroscopically enabled responsiveness. *Computer-Aided Design*, 60, 50-69.
- Rode, C., Grau, K. (2008). Moisture buffering and its consequence in whole building hygrothermal modeling. *Journal of Building physics*, 31(4), 333-360.
- Rode, C., Peuhkuri, R.H., Mortensen, L.H., Hansen, K.K., Time, B., Gustavsen, A., Ojanen, T., Ahonen, J., Svennberg, K., Harderup, L.E., Arvidsson, J. (2005). Moisture buffering of building materials. Technical report BYG-DTU R-126. Technical University of Denmark.
- Rode, C., Peuhkuri, R. (2006) The concept of moisture buffer value of building materials and its application in building design. *Healthy Buildings*. Proceedings of the Conference on Healthy Buildings, Lisbon, Portugal, 57-62.
- Salonvaara, M., Ojanen, T., Holm, A., Kunzel, H.M., Karagiozis, A.N. (2004). Moisture buffering effects on indoor air quality-experimental and simulation results. *Proceedings of Buildings IX*, Clearwater, Florida.
- Vailati, C., Bachtar, E., Hass, P., Burgert, I., Russenberg, M. (2018) An autonomous shading system based on coupled wood bilayer elements. *Energy and Buildings*, 158, 1013-1022.
- Woloszyn, M., Kalamees, T., Abadie, M.O., Steeman, M., Kalagasidis, A.S. (2009) The effect of combining a relative-humidity-sensitive ventilation system with the moisture-buffering capacity of materials on indoor climate and energy efficiency of buildings. *Building and Environment*, 44(3), 515-524.
- Woo, D.M., Correa, D., Krieg, O.D., Menges, A. (2016) Material computation - 4D timber construction: towards building-scale hygroscopic actuated, self-constructing timber surfaces. *International Journal of Architectural Computing*, 14(1), 49-62.
- Yoshino, H., Mitamura, T., Hasegawa, K. (2009) Moisture buffering and effect of ventilation rate and volume rate of hygrothermal materials in a single room under steady state exterior conditions. *Building and environment*, 44(7), 1418-1425.
- Zhang, M., Qin, M., Rode, C., Chen, Z. (2017) Moisture Buffering Phenomenon and its Impact on Building Energy Consumption. *Applied Thermal Engineering*, 124, 337- 345
- Zhang, H., Yoshino, H., Hasegawa, K., Liu, J., Zhang, W., Xuan, H. (2017) Practical moisture buffering effect of three hygroscopic materials in real-world conditions. *Energy and Buildings*, 139, 214-223.

Adaptive window block for residential use: optimization of energy matching and user's comfort

Annalisa Andaloro a), Stefano Avesani a), Annamaria Belleri a), Maider Machado b), Marco Lovati a)

a) Eurac Research, Institute for renewable energy, Italy, annalisa.andaloro@eurac.edu
b) Tecnalia Research and Innovation, Spain

European Union policy goals related to energy use in buildings are strongly promoting EU building stock renovation. In this framework, innovative solutions to energy retrofit in residential use are being sought, aiming at enhancing thermal performance, energy production and use, together with offering increased adaptability to continuously variable climate conditions and minimizing impact on building occupants, both during renovation works and service life.

Windows are a crucial component in the renovation process, as they are a strong geometrical constraint, but at the same time they provide space for active systems integration, together with significant opportunities to deliver major comfort enhancement to users, through the combined use of technical systems, such as shading and decentralized ventilation. This paper illustrates the concept of an adaptive, factory assembled solar window block, with a very limited impact on building occupants during installation, which makes it particularly appealing for residential use. In addition, the developed set of solutions allows to progress towards energy autonomy by combining an optimized passive performance (low thermal transmittance, solar control) and the integration of photovoltaic technology to reduce non-renewable energy demand of the window block system.

The adaptive solar window block design has been carried out with strong support from window framing, photovoltaic glazing, automated shading and decentralized ventilation manufacturers to develop a set of viable configurations for residential window retrofit use. Defined options are modular, flexible and easy to install, allowing for an optimal integration of several technical systems. The window block catalogue has been drafted through the following phases.

i) Preliminary catalogue: set of options including the integration of various technical components with the aim of maximizing internal comfort and energy performance. ii) Benchmarking of preliminary options against technical and economic criteria, such as thermal performance, ease of installation/maintenance, production and installation costs, energy production from renewable sources, impact on building tenants. iii) Cost/benefit analysis developed on one case study building. The results of this work also include a set of early design guidelines to promote the integration of adaptive solar window systems in future residential buildings renovation.

Keywords: prefabricated window, retrofit, energy harvesting, system integration, consumption optimization

1 Introduction

1.1. Background

Windows are responsible for a consistent part of energy consumption in the building sector, as the quality of these components affects several performance aspects, such as daylighting, heat

gains, unwanted or uncontrolled airflows, indoor air quality. All of the above parameters can be variedly controlled through the adoption of advanced window systems, aimed at optimizing the global envelope performance. Throughout Europe, around 50% of the windows installed in existing buildings still integrate a single glazing unit [1]. This fact can be easily translated in roughly the same amount of windows dating back to the 1960s, characterized by low or absent thermal insulation and poor installation technique. Such features have a substantial impact on the building performance, making the role of efficient windows crucial within the building stock renovation perspective. Such features have a substantial impact on the building performance, making the role of efficient windows crucial within the building stock renovation perspective. However, the evident benefits in terms of indoor comfort and energy efficiency of mounting new windows are threatened by the complexity of the window installation. As a result, a not correctly installed window can determine discomfort, energy losses as well as reduced material life time respectively because of undesired infiltration and condensation risk due to thermal bridges.

Since the 1970s, prefabrication of window blocks gradually entered the market offering several technical advantages, including but not limited to: simplified design phase, thanks to the standard installation of the window inside the insulated block, enhanced reliability during installation and easy compatibility with ETICS insulation systems, simplified installation thanks to the preliminary alignment of the block with the building façade plane, effective insulation and elimination of geometrical thermal bridges thanks to the continuous insulation layer on the façade. The window block system is more and more used in new construction, but also offers relevant opportunities for successful integration in existing buildings, allowing for quick and non-impactful window substitution to enhance building energy performance.

1.2. Objective

The aim of this research work, developed within the frame of the H2020 funded project Energy Matching, is to develop innovative window solutions for building energy retrofit in residential use. Solutions developed are based on the window block concept, minimizing the risk of mistake in the window's replacement, thus increasing energy efficiency compared to the traditional window. Window block is pre-assembled, minimizing the impact on building occupants, and is designed to integrate a set of active components, to support the achievement of improved envelope performance together with increased comfort and adaptive functionalities.

The window block is thought as a way to facilitate the integration of: a new shading systems, a decentralized ventilation machine and a PhotoVoltaic (PV) element with battery. The first two components are key element in a comfortable and energy efficient building. Having a decentralized ventilation machine gives the possibility of minimizing the impact of the renovation on the inhabitants, avoiding the use of ducts. The integration of the photovoltaic in the window block system tackle the topic of facilitating the integration of renewable energies, especially focusing on the advantages of the self-consumption triggered by the presence of a battery. As further advantage, the installation of such multifunctional system would not require any electric cabling.

The work presented in this paper describes the concept of "solar window block", its design methodology and first preliminary analysis of different window block configurations. More in specific, some technical features are reported besides the performances in terms of energy matching between the PV energy production and the ventilation machine through the electric battery

2 Methodology

2.1. Window block concept and requirements

The window block defined within the frame of the project has been developed based on a set of requirements related to the specific project objectives of matching solar energy generation and loads, but more in general to respond to the increasing need for adaptive and multifunctional building components. More in detail, the design phase is aimed at achieving the following targets: (i) adaptability to changing indoor and outdoor conditions; (ii) off-site fabrication, with most of the assembly work carried out in a manufacturing environment maximizing the fabrication precision;

(iii) minimized impact on building occupants, thanks to the reduction of on-site works and most of the installation related operations carried out on the outside of the building; (iv) timely matching between energy production from Renewable Energy Sources (RES) and energy consumption, thanks to the optimization of system production and on-site self-consumption; (v) design flexibility and modularity, to guarantee easy integration and boost replicability of the technological concept also after project end.

One relevant topic in the field of window renovation is the useful daylight transparent area, which turn out being a major requirement in the design of the window block. The design flexibility allows shaping the window block case by case trying to preserve or if possible to enlarge the window's hole sizes. As general approach in the case of an existing roller shutter, the integration of a venetian blind into the insulating block - or directly in the Insulated Glazing Unit (IGU) - allows to increase the height of the window.

The research work methodology has started with a preliminary literature and technical research to identify various commercial technical components to be integrated with the aim of maximizing internal comfort, optimizing energy performance and accommodate various external and internal conditions. The second step has been the schematic design of the above options, with the aim of identifying technological interferences, geometrical constraints and validate the compatibility of the selected system components for each of the options. The technical add-ins has been combined defining a larger set of viable options for a general adaptive and advanced window block system. Finally, benchmarking of these options against both technical and economic criteria has resulted in a sort of catalogue. A comprehensive cost-benefit analysis for the defined window block applied on a case study building is also in scope, as well as the definition of early design guidelines, which will not be presented in this paper due to project execution timing.

2.2. Components and combination options

The window block has been designed integrating the following three main active components: (i) semitransparent or opaque glass-based photovoltaic module directly coupled to a battery, and to a charge controller, to better exploit RES energy production; (ii) bidirectional ventilation unit with heat recovery to support indoor comfort; (iii) automated shading system. The whole concept is built around the idea of adaptability, with the aim of a shared control system for the different devices installed in the window block, such as ventilation unit and shading system, so that the component can better react to changing environmental conditions, without requiring user intervention. In addition, medium/long-term adaptability is also guaranteed by the technological design, which allows to access most of the removable components with simple operations, so to ease the maintenance and change of use during the product life cycle.

Photovoltaic integration	Mechanical ventilation	Shading system
Window glass 1 – 70% transparency	VMC above window	Lamella
Window glass 2 – 90% transparency	VMC in window jamb	No shading
Window glass 3 – opaque	No VMC	
Window sill 1		
Window sill 2		
Window shutter		
Overhang		
No photovoltaic integration		

Table 1: Active components options for the designed window block system. The difference between window glass 1 (trans.) and window glass 2(trans.) is the varied degree of transparency, 70% vs 90% opaque surface with respect to the total surface. The difference between Window sill 1 and Window sill 2 is both in module dimension and tilt angle.

Preliminary definition of the possible options to combine the three active components led to the definition of around 40 different possibilities, which provide an early design guideline of the many chances to integrate such components in a prefabricated window block. The designed window block is represented in Figure 1 for one of the envisaged options. Components integrated in the window block are the following: insulating block, to be fabricated off-site and installed from the outside of the building; triple glazing mounted on a timber window frame integrating automated shading system; photovoltaic modules in a variety of configurations (see Table 1); battery for energy storage of the excess production from RES; decentralized ventilation machine with power supply coming from the PV production; shared control unit for enhanced energy management strategy and user experience (this component is still under development and will allow the user to control both the shading system and the ventilation machine through the same device).

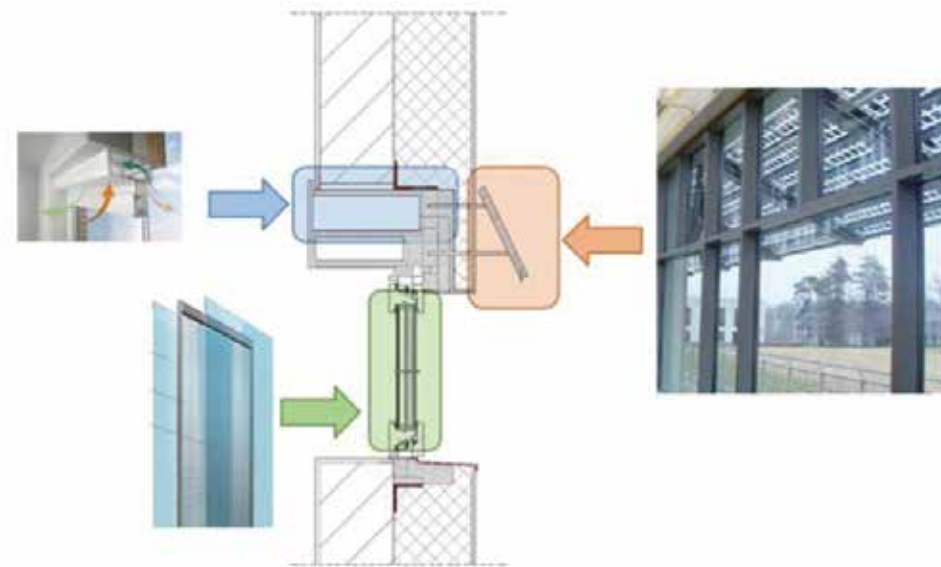

Fig. 1 Window block concept design for a random option among the proposed alternatives.

2.3. Whole construction process breakdown

The cradle to gate process for the window block development is presented according to the following phases. The preliminary design phase consisted of requirements definition and schematic

drawings production for a set of preferred options among the 40 defined in Table 1. The technical detailing phase has been case-study focused on the one side, with geometrical constraints and other interaction with the existing building components, and on the other side it made a point on particular technical systems to be integrated in the block. The following phases are still to come with regards to the current project status, but have been already analysed in order to identify possible interferences during the construction works. Window block assembly will be mainly carried out at the manufacturer's site, and will produce a semi-finished component (insulated window block) with all the necessary slots and support components for the integration of PV modules, battery and decentralized ventilation unit. The remaining part of the work will be completed at the construction site, with a minimum impact on building occupants. According to the manufacturer estimation, the expected average duration to complete a single window block substitution will be around four hours with two builders working on it. This provides a clear view on the minimized impact for tenants, as at least 50% of this work can be carried out from the outside.

2.4. Window block performance evaluation through Key Performance Indicators (KPIs) and configuration selection procedure

Besides the technological development based on building product requirements, the choice of the most promising solar adaptive window block configurations has to be calculated on the basis of their corresponding expected performances. Hence, the design process has been carried out according to varied performance drivers, such as visual indoor comfort (daylight), indoor air quality (in terms of CO₂ concentration), electric energy matching between photovoltaic generation and electric load, heating and cooling energy demand and costs analysis, which must be considered for all configurations. Due to project timing, only indoor air quality and electric energy matching are presented in this paper. Given that the RES energy potential largely depends on location and orientation of the façade, an extended number of parametric simulations have been carried out based on an interdisciplinary work between ventilation strategy design and RES production, consumption and storage. In most of the analysed PV configurations, performance evaluation is carried out with separate calculation and output integration, as they solely related to the existing window hole orientation, dimension and type of integration. However, in the case of PV overhang, a multi-physics approach is adopted, in order to determine the optimal tilt angle with respect to the above mentioned window features, including height and the presence of eventual obstructions, on the basis of a coupled simulation optimizing PV production, daylighting and heating/cooling demand as discussed in [2] [3] and in [4] to determine the most appropriate sizing and tilting. In the following list, the calculation methodology is reported for each KPI field:

- Daylight performance has been calculated with Radiance on the basis of a Rhino-Grasshopper parametric model [5]. The adopted KPIs are: (i) Daylight Factor (DF) to select only the viable solutions in compliance with [6] and (ii) Useful Daylight Illuminance (UDI) to better characterize daylight levels in different room measurement spots during the whole year [7]. These parameters are not in scope for this paper.
- Indoor air quality has been set as requirement in terms of maximum CO₂ concentration allowed for different occupancy profiles (bedroom and living room) and indoor environmental quality classes. CO₂ concentration is calculated according to a simple mass balance equation assuming: "well mixed" condition for the reference room, constant ventilation rates during each time step (hour), constant infiltration rates during whole year, equal to 0.47 h⁻¹ (n₅₀ = 2 h⁻¹), constant outdoor pollutant concentration (400 ppm), constant emission of indoor sources during each time step, outdoor CO₂ concentration equal to 400 ppm. Indoor CO₂ sources are generated in the living room at 26.7 g/h-pers considering an activity metabolic rate equal to 1 met and in the bedroom at 18.7 g/h-pers considering an activity metabolic rate equal 0.7 [8].

- Electric energy matching has been evaluated with two KPIs: (i) number of hours with more than one hour of no ventilation in a year, to discard those configurations unable to autonomously provide the needed power supply for the decentralized ventilation machine; (ii) self-consumption and (iii) self-production, useful to evaluate the energy matching. These latter are calculated according to the formulas below.

$$\text{Self Consumption: } SelfC = \frac{\sum_{\text{hours in a year}} (En_{PVtoLoad} + En_{BattToLoad})}{\sum_{\text{hours in a year}} En_{PVgeneration}}$$

$$\text{Self Production: } SelfP = \frac{\sum_{\text{hours in a year}} (En_{PVtoLoad} + En_{BattToLoad})}{\sum_{\text{hours in a year}} En_{ElectricDemand}}$$

These KPIs have been determined from the calculation of the PV power production and the battery state of charge for each hour of the year with the model described in [9]. The model gives priority to self-consumption of the electricity produced by the PV. When the electrical load exceeds the power provided by the PV production, a battery can be used. In case of PV over production with respect to on-site self-consumption, the battery is charged (when present, as not all of the options include a battery) and the eventual other excess energy is not transformed by the PV module thanks to a production control device. Inputs required for this simulation are: irradiance on the PV area, outdoor temperature, battery size, PV module efficiency, temperature correction factor as well as ventilation machine electric load profile. The latter has been generated from the mechanical ventilation airflow schedules considering the Specific Power Input of the ventilation unit (0.35 W/(m³/h)).

Within the next project steps, the same options will be also evaluated against other relevant KPIs related to thermal performance (heating and cooling demand) and investment cost evaluated on the basis of installed components and works to be performed on site.

2.5. Reference case

The reference building used for the energy production and demand simulation is one of the three demo-cases in the Energy Matching project. It is a residential use building dating back to 1984, located in Campi Bisenzio – Florence, Italy. The building has four elevations and three of them are occupied by residential units, four per floor. Currently, total energy consumption of the building is in the range of 145-175 kWh/m²y. Windows are located on two facades, respectively facing south-east and north-west and can be divided in three main categories as summarized below:

Window type	Dimension
Window 1	1,40 x 1,60 m²
Window 2	1,15 x 1,60 m²
French window (door)	0,90 x 2,50 m²

Table 2: Window geometric features for the selected case-study building

3 Results and discussion

3.1. Catalogue of solutions and design choice

A set of options has been defined according to the technical elements illustrated in 2.2, and a subset for detailed performance analysis has been identified from the extended set. In this phase, the main drivers were: (i) integration of a decentralized ventilation unit; (ii) different photovoltaic integration options, such as: opaque overhang with an optimized tilt angle, opaque window shutters

with vertical inclination to be used as blinders, opaque sill in two different sizes, opaque portion of a window glass with crystalline silicon technology, semitransparent BIPV glass integrated in window frame (see Table 3). For all of the above options, a lamella-based shading can be integrated or not, according to specific project needs. The main technical features of the seven simulated scenarios for PV integration are summarized in Table 2, with an indication of positioning with respect to the window block, tilt angle, azimuth and active surface area, together with peak power and expected power production over the year. This data served as an input in the option selection process, as seen in Figure 2.

PV integration	Short name	Dimension (m x m)	Tilt (°)	Efficiency	Peak power (W/m²)	KWh/year
Sliding shutter	aziS_S1	1.8 x 1.6	90	0.13	137.8	290.2
Overhang	aziS_S2	1.4 x 0.4	26	0.13	126.8	103.7
Opaque sill 1	aziS_S3	1.4 x 0.16	3	n.a.	n.a.	47.1
Opaque sill 2	aziS_S4	1.4 x 0.35	20	0.14	143.3	72.3
Opaque window glass	aziS_S5	1.3 x 0.35	90	0.14	143.3	30.8
Window glass 1 -70% opaque	aziS_S6	1.4 x 1.6	90	0.03	26.2	40.9
Window glass 1 -90% opaque	aziS_S7	1.4 x 1.6	90	0.04	37.8	59.8

Table 3: PV integration options and power production details (based on Florence weather data, for South orientation)

The simulated options have been filtered on the basis of their performance in terms of PV production with the aim of providing the necessary power needed to make the decentralized ventilation unit installed in the same block work according to two requirements: (i) no electrical load increase for the occupant; (ii) hours without ventilation below two (see 2.4). The simulation has been carried out using input data of the load profile generated as shown in 3.2, according to the following phases:

- **Load profile generation:** the electrical load profile has been calculated for a sample reference volume with varied occupancy scenarios and acceptable levels of comfort;
- **Electrical production for the specific window block configuration:** the expected power production has been calculated for the Southern orientation (future work will include a parametric simulation performed on several orientation and geographies) based on the irradiation data related to the case study building;
- **Energy production vs. demand matching:** this calculation determines the hours without ventilation parameters based both on a self-consumption/self-production scenario and with the use of a battery, with the aim of proposing adaptive solutions to benefit the early design stage

Based on simulation results, single configurations can be ranked according to the energy-driven design approach. In the next project steps, further parameters such as thermal performance, investment costs and operation & maintenance will be accounted for when proposing a design guideline.

3.2. Application on a demo case

Two of the selected technical solutions are reported in Fig. 3-4, with a complete description of integrated components. Both of them represent the full optional scenario, with all the proposed active components integrated in the window block (VMC, lamella shading, PV module). Of course,

it will be also possible to install downgraded options with less integrated components according to specific project requirements, such as technical feasibility or budget constraints.

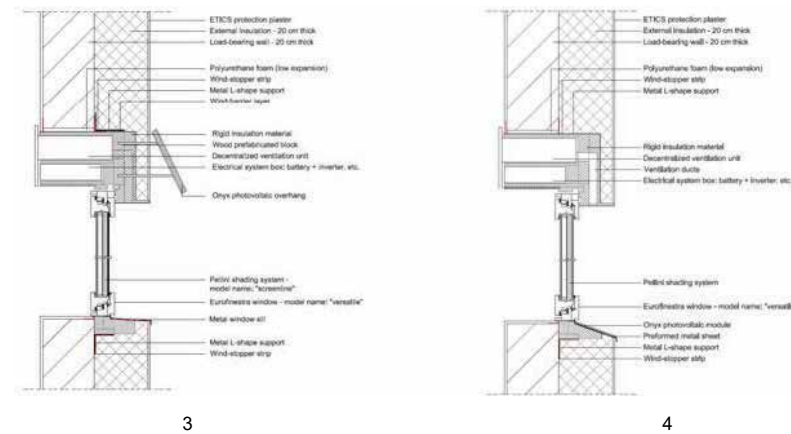

Fig. 3 Window block schematic design for the selected option with photovoltaic overhang integration.
 Fig. 4 Window block schematic design for the selected option with photovoltaic sill integrated at the bottom edge of the window block.

The proposed ventilation unit has five operating speeds supplying up to 42 m³/h with a maximum power consumption equal to 20.6 W. In order to verify the self-sufficiency of the whole PV-battery-ventilation system, electricity demand profiles of the ventilation unit are generated by selecting the optimal fan speed on an hourly basis, able to ensure acceptable CO₂ concentration according to Indoor Environment Quality category II and III [10].

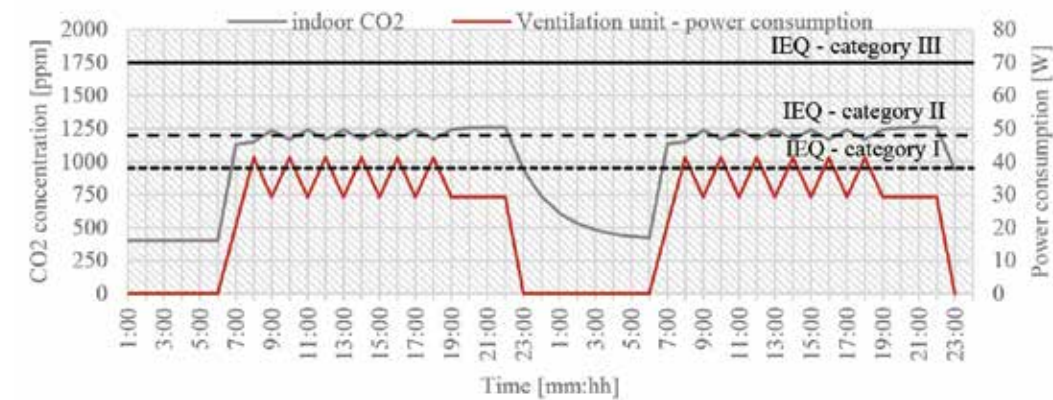

Fig. 5 Predicted CO₂ concentration level for a reference living room with 4 people occupancy plotted against power consumption of 2 ventilation units.

The graph in Fig. 5 shows predicted CO₂ concentration level for a 65 m³ reference living room occupied by 4 people from 7:00 to 22:00 h considering the power consumption of 2 ventilation units installed in the room to ensure CO₂ concentrations below 1250 ppm. Ventilation speed control is running intermittently between fan speed 4 and 5 to increase battery charging. Fig. 6-7 show the energy matching KPIs for the seven different PV integration options for the simulated reference living room, considering the integration of a 250Wh battery which allows to fine tune no power supply hours. Battery use reduces the number of hours with no power supply by 250. As expected, the matching is less frequent for all configurations in the case of higher indoor air quality conditions, as the ventilation machine is working at higher speed rates and consuming more energy. In addition, the number of hours without ventilation (intervals longer than one hours) is

Products and Materials

also higher over the year in the case of IEQ II, since higher ventilation rates are required. Further analysis should be performed on the distribution of such hours over different day times (morning, afternoon, night) in order to make more realistic evaluation on the impact this behavior can have on occupants. It is easily inferred that configuration S1 is the most productive one, with a minimum number of no operating ventilation hours.

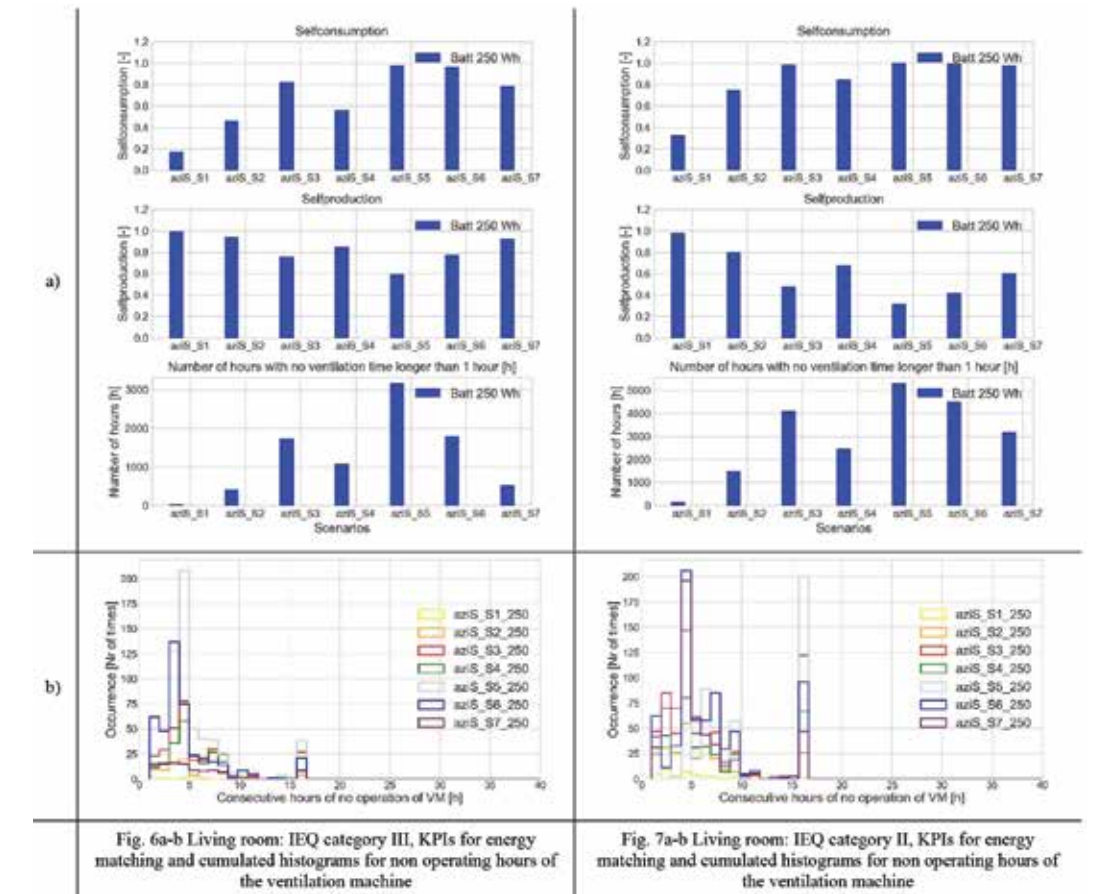

Fig. 6-a-b Living room: IEQ category III, KPIs for energy matching and cumulated histograms for non operating hours of the ventilation machine

Fig. 7-a-b Living room: IEQ category II, KPIs for energy matching and cumulated histograms for non operating hours of the ventilation machine

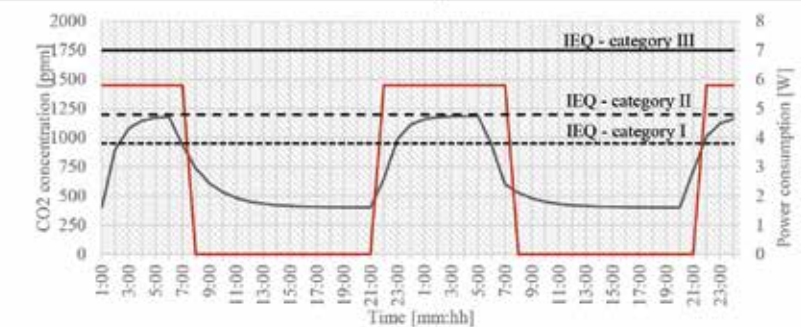
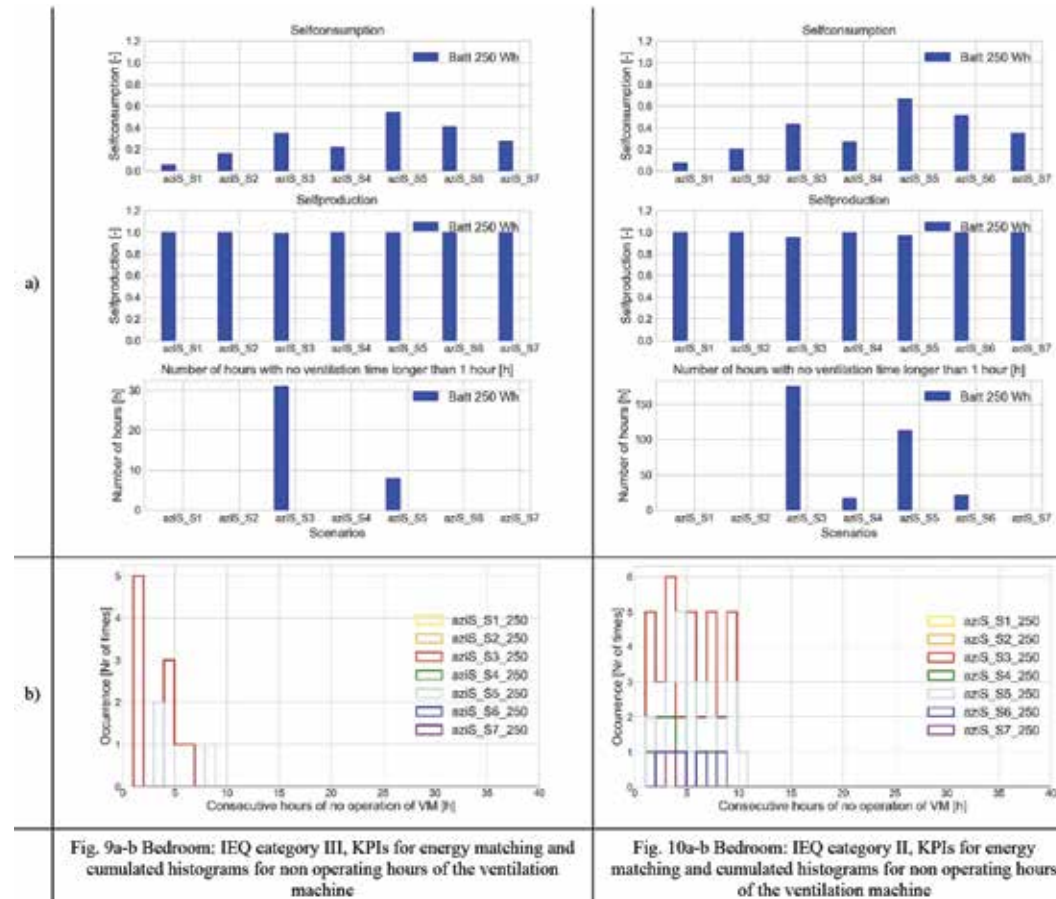

Fig. 8 Predicted CO₂ concentration level for a reference bedroom with 2 people occupancy plotted against power consumption of 1 ventilation unit.



The graph in Fig. 8 shows predicted CO₂ concentration level for a 40 m³ reference bedroom occupied by 2 people from 22:00 to 08:00 h and power consumption of a single ventilation unit installed in the room to ensure CO₂ concentration below 1250 ppm. In this case, ventilation speed is lower compared than the living room (level 2) to keep indoor noise level below 30 dB as recommended by [11]. Fig. 9-10 show the energy matching KPIs for the seven different PV integration options for the simulated reference living room, considering the integration of a 250 Wh battery which allows to fine tune no power supply hours. Also in this case, battery use reduces the number of hours with no power supply by 250. In the case of bedrooms, the energy matching is closer in both indoor air quality scenarios, due to lower occupancy in terms of people/hour. The number of hours without ventilation is rather limited in many options and it is equal to zero in the case of configuration S1, S2 and S7 for both IEQ scenarios.

Simulations performed so far show interesting perspective for the integration of energy autonomous window blocks in existing buildings, as there is sufficient room for system optimization which allows designers to pick up technological options equipped with both PV modules and ventilation units able to operate without adding any further electrical load to building occupants. Further steps within project development will include multi-parameter system optimization to account for other relevant features, such as heating and cooling demand, daylighting and investment cost (both in terms of installed components, works to be performed on site and operation/maintenance costs in a life cycle perspective).

4 Conclusions

This paper presented the overall design process for an innovative, adaptive and parametric window block for energy retrofit in residential buildings, developed within the frame of the H2020 Energy Matching project. The window block has been designed in a variety of configurations to accommodate several active components, such as ventilation unit, photovoltaic modules for RES exploitation and automated shading devices. The main aim of this design process is to create a flexible concept able to guide designers during the early stages of decision making when selecting viable options for energy efficient renewal of buildings. The proposed solutions are characterized by medium level of prefabrication, they allow to minimize the impact on building occupants both during the installation and the operation phases, and tend to be autonomous in terms of energy consumption, promoting self-consumption of the electricity produced by the PV modules. The design process is based on the definition of a baseline of technical requirements for the window block, then optimized according to several parameters measured through relevant KPIs, with the aim of ranking the diverse options against one another. To date, the window block has been optimized on an energy-based approach, with the sole scope of matching energy production and load over the year, minimizing non-operating hours for the ventilation unit installed. Simulations have been performed on a set of configurations for the PV modules to be integrated, but on a single geographic location. In the next months, further work will be analysis will be replicated along different geographies and case study buildings, in addition to including the missing parameters in the evaluation.

5 Acknowledgment

This work has received funding within the H2020 project Energy Matching under grant agreement N° 768766. Authors kindly acknowledge the technology providers involved in the definition phase for the proposed solutions shown in this work, Eurofinestra for providing schematic design and technical know-how on installation procedures, Pellini for providing details on the shading system and control strategy sharing between electronic components, Onyx Solar for providing power production details for the different PV configurations illustrated in the work. Authors also acknowledge David Moser and Jennifer Adami from Eurac Research for supporting the simulation work on RES electrical production.

6 Reference

- [1]. TNO Built Environment and Geosciences – Glazing type distribution in the EU building stock – TNO report TNO-60-DTM-2011- 00338
- [2]. 32st European Photovoltaic Solar Energy Conference and Exhibition Munich, Germany, 20-24 June 2016 A MULTI CRITERIA OPTIMIZATION TOOL FOR BIPV OVERHANGS Marco Lovati*, Jennifer Adami, Giuseppe De Michele, Laura Maturi, David Moser
- [3]. J. Adami, "A support tool for the early design phase of BIPV towards nearly zero energy districts", 2016, Università IUAV Venezia, Italy
- [4]. Lovati, Marco & Adami, Jennifer & De Michele, Giuseppe & Maturi, Laura & Moser, David. (2016). A MULTI CRITERIA OPTIMIZATION TOOL FOR BIPV OVERHANGS.
- [5]. Ward, J. G., 1989. The RADIANCE Lighting Simulation and Rendering System. 21st annual conference on Computer graphics and interactive techniques, pp.459–472. Available at: <http://radsite.lbl.gov/radiance/papers/sg94.1/Siggraph1994a.pdf>.
- [6]. prEN 17037:2016: daylight of buildings
- [7]. Nabil, Azza & Mardaljevic, John. (2006). Useful daylight illuminances: A replacement for daylight factors. Energy and Buildings - ENERG BLDG. 38. 905-913. 10.1016/j.enbuild.2006.03.013.
- [8]. ASHRAE – Handbook of Fundamentals, 2009
- [9]. M. Lovati, R. Albatici, L. Maturi, D. Moser, and others, "EFFECT OF MODULE ORIENTATION AND BATTERIES ON PERFORMANCE OF BUILDING INTEGRATED PHOTOVOLTAIC SYSTEMS.," in 33rd European Photovoltaic Solar Energy Conference and Exhibition, 2017.
- [10]. prEN 16798-1: 2016

ACT Façade – Interior sun shading for energy efficient fully glazed façades

Paul-Rouven Denz, Wolfgang Priedemann, Lars Anders

Priedemann Facade-Lab GmbH, Germany, paul.denz@priedemann.net

In classical modernism the dream of a fully glazed high-rise was within reach thanks to the emerging curtain walls. Mies van der Rohe already designed his vision of a glazed high-rise in the early 20th century. Nowadays realizing such a single-layered, fully glazed façade considering current sustainability criteria and energy regulations seems impossible. But with the Active Cavity Transition (ACT) Façade an interior sun-shading system was developed, tested, built and is in operation at the Festo AutomationCenter. This façade system not only protects from summer overheating but also improves user comfort and energy efficiency of the building. To enable more varieties of the ACT Façade to meet individual project demands the façade solution is being further developed. Moreover several office buildings are already under planning and the ACT Façade adjusted accordingly.

Keywords: High performance, low maintenance design; interior sun-shading; fully glazed facade; user comfort; exhaust air façade; solar thermal air collector

1 Background

In contemporary office buildings cooling accounts for the majority of the energy consumption because of internal heat sources. High solar income during summer or at low winter sun heat up the inside of these buildings additionally (BINE 2007).

As known solar control glazing alone is not sufficient to guarantee summer heat protection and meet the guidelines of workplace regulations concerning sun protection and anti-glare protection. Thus typical façades respond by reflecting unwanted solar radiation to the outside by elaborate sun-shading devices (Kuhn 2017) and a higher ratio of opaque façade area. In contrast, the Active Cavity Transition (ACT) Façade works on the principle of absorbing the unwanted solar radiation and extracting it for further use within the building. Thus providing a basis for not only more energy-efficient buildings but also improved micro-climate of cities by counteracting urban heat islands (Jung 2018).

2 Concept

Based on the classical air-exhaust façade consisting of an external insulated glazing plus an internally ventilated glazing, which was yet built e.g. at the Treptowers high-rise buildings in Berlin in the late nineties (Spangenberg 2017), a new concept of an internal blind was developed to act as adequate internal sun-shading. Bringing together façade functions / requirements and building services as proposed by (Klein 2013) in this case sun-shading and mechanical ventilation.

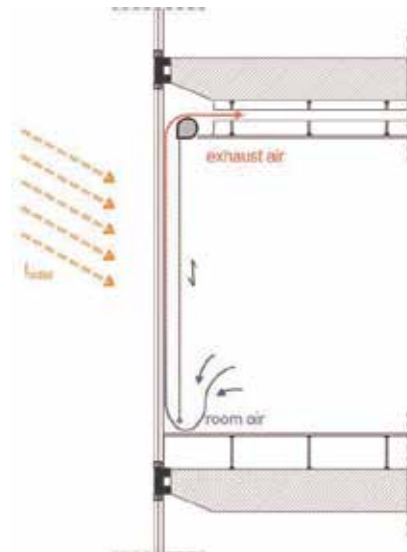

Fig. 1 Operation mode Active Cavity Transition Facade

The mandatory inner blind for glare protection is being “activated” and becomes a separation layer in the façade buildup to generate an air-exhaust corridor between blind and external glazing. Enabling an internal sun-shading by generating a buffer zone for solar radiation and heat. Thus thermal load from the sun does not enter the actual office space starting behind this textile barrier but gets sucked out through the mechanical ventilation for exhaust air necessary for the office space anyhow (see Fig. 1).

3 Implementation and operation

The newly developed Active Cavity Transition (ACT) Façade is an efficient combination of typical façade components such as insulated external glazing, glare control blinds and mechanical ventilation into an adaptive façade system as proclaimed by (Knaack et al. 2015).

Solar radiation causing overheating of the interior space is captured within the given corridor between blind and glazing. On the surface of the blind the solar radiation is being absorbed and changed into long-wave heat radiation. The exhaust air from the office is then sucked into and through this interspace leading away the generated heat by its air flow (see Fig. 1). Thus preventing unnecessary heating-up of the indoor space. In addition the surface of the blind facing the interior has a low emissivity due to low-e coating and is cooled by air-flow creating lower radiation temperatures to the inside of the building. This enables a higher quality in comfort preventing radiation asymmetry within the office space. Thus reducing energy consumption by less cooling demand and raising user comfort through an intelligent façade system as characterized by (Böke et al. 2018).

To ensure a controlled air flow through the textile screen and project-individually planned air intake zones into the cavity (Denz, 2016) the screen runs within a tight ZIP guiding rail e.g. (WAREMA, 2018) as shown in Fig. 2.

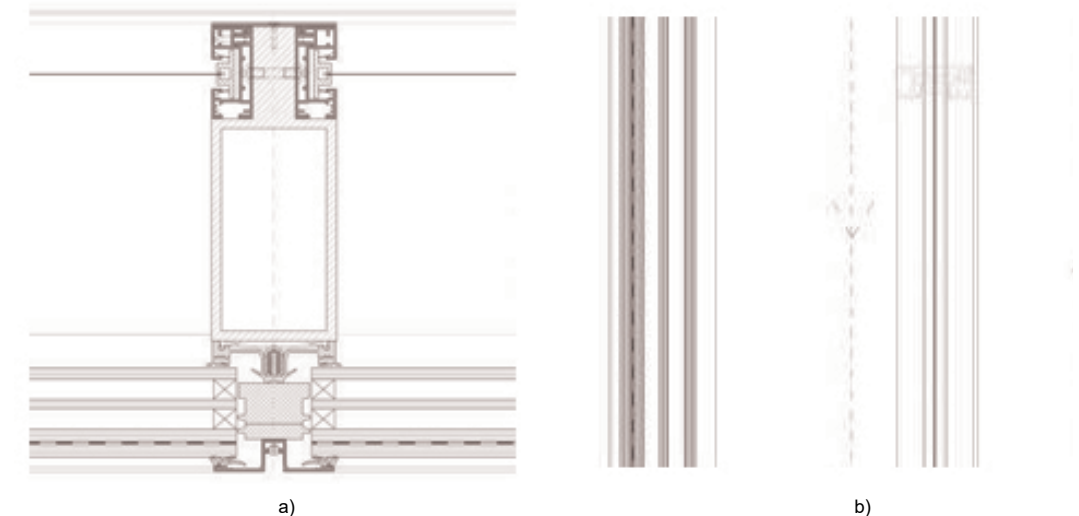

Fig. 2 a) Horizontal and b) vertical section for ACT Façade with mullion-integrated ZIP guiding rail

Since the blind and exhaust air system can be operated individually this façade solution creates a variable g-value according to position of blind and operation of the ventilation system. An optimized operation of the ACT Facade is likely to be controlled by building automation system nevertheless being possible to overwrite manually by the user (Architekturbüro Jaschek et al. 2016). Due to the inner installation the system can be operated regardless of weather conditions like wind and is also less exposed to pollution or damage like external systems.

4 Testing and benefits

To verify the efficiency of the ACT Facade and to define the ideal layout and combination of parameters such as screen choice (color, openness factor, transmission, reflection, view etc.) dimensions for the corridor and the intake width for the exhaust air etc. several simulations and scientific testing have been executed and further planned.

At the Fraunhofer Research Institute on Building Physics in-situ testing facility VERU (Fraunhofer IBP 2018) close to Munich, Germany, different set ups of the ACT Facade had been analyzed. A unitized façade element of 3.0 m width and 3.5 m height including a fixed glazing of 2.3 m width as ACT Facade and a parallel opening window out of electrochromic glazing was installed (see Fig. 3). This combined with a room behind of 7.5 m in depth served as test layout. Installing building service units for heating, cooling and ventilation, adding heat sources representing office usage and measuring instruments for temperature, air velocity and radiation plus thermographic camera and smoke tests to detect air movement (Eberl et al. 2017) enabled the all-over understanding of operating principle and performance of an ACT Facade for office buildings.

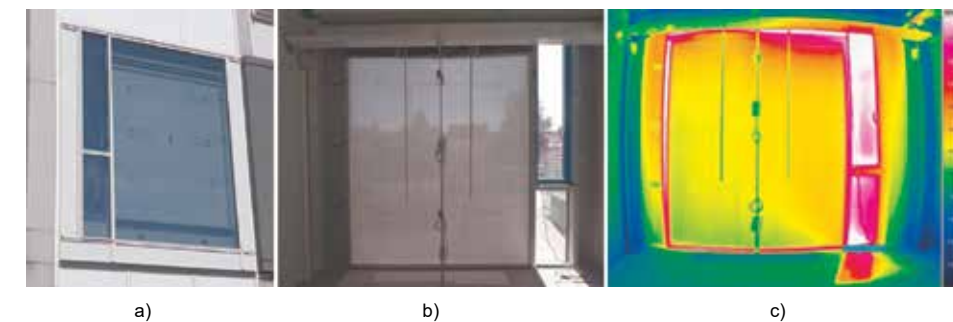

Fig. 3 a), b) and c) Testing of ACT FACADE at Fraunhofer IBP VERU building

Showcasing that with the right air speed, constructional detailing and blind materials a majority of the solar radiation could be exhausted before entering the room. During October, having a high direct solar radiation towards the south facing façade, because of the low sun angle in Germany, from a global radiation of 800 W up to 380 W could be extracted through the exhausted air not including the reflection from the external glazing.

In addition to this testing also a parallel measuring at the Fraunhofer IBP Twin-Rooms, ensuring exact same external and internal conditions for both set-ups, has been conducted (see 4 a)). Giving a direct comparison between a ventilated inner blind, as Active Cavity Transition Façade with air exhaust, and a non-ventilated inner blind, as state of the art system only serving as glare protection, behind the glazing. As screen a SecuTex fabric with inside silver (low-e) and outside white color was used. During these measurements with an airstream of 120 m³/h the ACT Facade consumed up to 25 % less energy for cooling in comparison to the compared standard solution (see Fig. 4 b)).

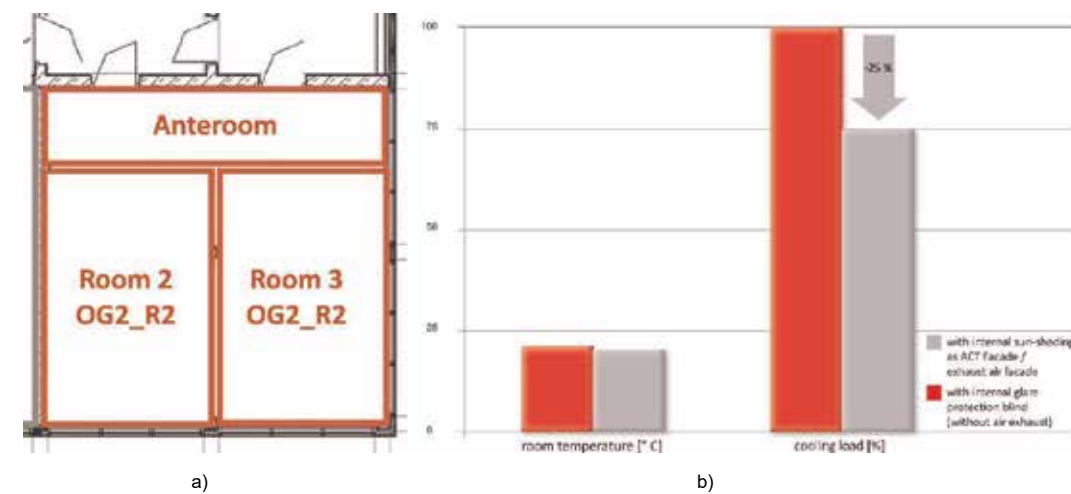

Fig. 4 a) Fraunhofer IBP Twin Rooms and b) Reduction in cooling load through ventilated blind (© Fraunhofer IBP)

Besides the in-situ testing also simulations and calculations have been performed. These also confirm the effect of the ACT Facade as a fully working sun-shading generating a variable g-value, enabling summer heat protection and lowering the indoor temperature as well as cooling loads.

For example calculation with WinSLT software of the ACT Facade system results into a g-value of 0,16 whereas the same set-up as standard system without the air exhaust through the corridor only has a g-value of 0,32 (see Fig. 5). As façade buildup a triple glazing with solar control coating and the same screen as used for the Twin-Room testing was put into WinSLT. Only difference in calculation set-up is for ACT Facade extracting the air from the corridor between glass and screen to the exterior (see Fig. 5 a)) while for the customary interior blind letting the air from the corridor flow to the interior (see Fig. 5 b)) thus resulting in a higher total energy transmittance.

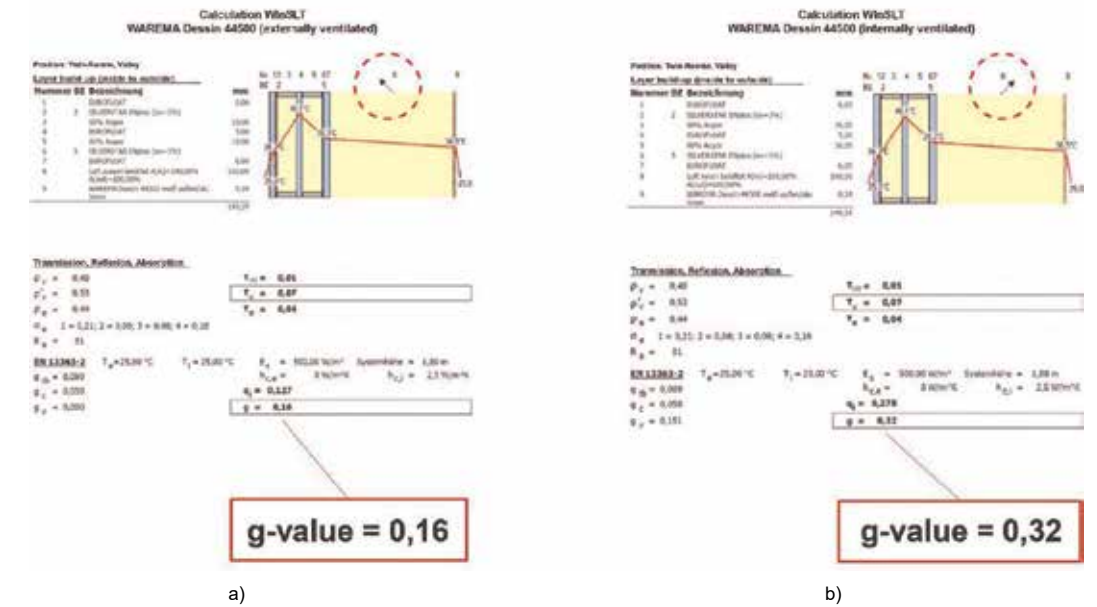

Fig. 5 WinSLT comparison of a) ACT FACADE and b) non-ventilated façade with internal blind

It should be considered that WinSLT is calculating a static situation whereas the ACT Facade due to absorption properties, air velocity and stream, screen positioning and sun path should be seen as a dynamic system in combination with the all-over building. Therefore for planning of construction projects more elaborate software for thermal simulation and CFD simulation are used in combination, also taking into account individual project and location criteria.

5 Buildings realized and in planning

The previously described ACT Facade could already be realized for new buildings and refurbishment projects.

The first project of this kind is the extension of Festo Headquarter Campus in Esslingen, Germany (see Fig. 66). Realizing a 60 m high-rise meeting its companies thrive for innovation. Showcasing the efficiency and at the same time little installation effort of the Active Cavity Transition Facade as unitized façade system. Festo AutomationCenter been finished in 2015 is now in operation for over three years never exceeding 26 °C room temperature. Feedback from users, owner and HVAC planers, who also put the building into operation and monitor it up to now confirms the proper functioning of the system (Denz et al. 2016). This being underlined by DGNB platinum certificate for Festo AutomationCenter (DGNB 2017).

But the ACT Facade is also an appropriate solution for retrofitting. As seen at Eurotower (see Fig. 7), former European Central Bank Headquarter in Frankfurt, Germany. Only the interior shading system had to be exchanged and the air exhaust ducts extended to reach an up-to-date façade system as ACT Facade.



Fig. 6 Festo AutomationCenter, Esslingen (© Festo AG)

Fig. 7 Eurotower, Frankfurt (© Epizentrum)

Besides the above mentioned built projects further construction projects featuring the ACT Façade in Germany and worldwide are under planning. Such as the Ardex Tower, with inclined façade units and two-layered screen system enabling different transmission and view properties (see Fig. 88), and the Continental Headquarter, as first low-rise building with an ACT Façade, due to more consistent façade design and lower operation and maintenance costs compared to an external sun-shading (see Fig. 9).



Fig. 8 Ardex Tower (© Ardex GmbH)

Fig. 9 Continental Headquarter (© HENN GmbH)

6 Current application boundaries

As mentioned under 4. the complexity of ACT Façade lies within the planning and interaction of components to fulfill current façade and energy requirements as well as individual project goals for performance and design. Therefore an intensive collaboration of architect, façade planer, building climate planer, building service planer, façade product providers and client is crucial (Betti et al. 2018).

Given the state-of-the-art façade components required for ACT façade implementation several limitations have to be considered. First a glazing with solar control coating has to be used while for certain external sun-shading systems thermal insulation glazing is sufficient. Main boundaries by the ACT Façade arise from the textile screen and its role for the efficiency of the all-over system. Respecting relevant façade properties as described by (Knaack et al. 2014) requirements to maximize view (through screen), minimize glare, maximize daylight autonomy and minimize heat gain into the office space while maximizing heat gain from corridor for following thermal energy exploitation counteract easily (see Fig. 10).

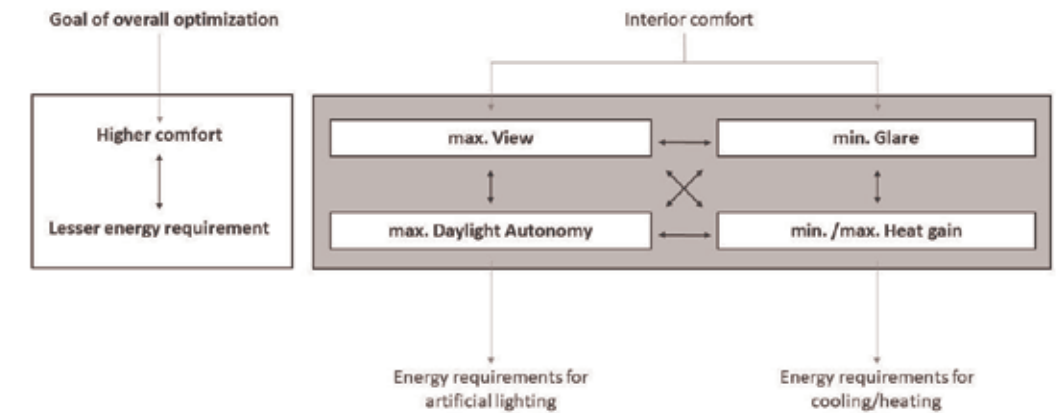

Fig. 10 ACT Façade optimization for building implementation

Optimization of the above mentioned topics directly correlate with the screen properties such as openness factor, transmission, reflection and absorption, color, technical coatings, fire resistance etc. and therefore limiting the selection of available textiles feasible for ACT Façade.

7 Conclusion and Outlook

Undertaken measuring and simulation plus realized and operating buildings show that the Active Cavity Transition Façade is capable of creating high values of comfort and energy efficiency meeting the demand of future building envelopes (Loonen et al. 2013). In addition the system is cost efficient in investment due to the usage of state-of- the-art components, therefore also executable by various façade contractors, and in operation, due to energy and operation efficiency but also due to gain of maximized rentable area compared to e.g. Double-Skin-Facades (Priedemann 2016).

But as every façade system ACT Façade request certain compromises linked to detailing such as guiding for the screen (see 2.), to screen choice (see 6.) and others arising from individual architectural designs and construction projects.

Therefore Priedemann Façade-Lab and various partners from research, planning and industry conduct further research to optimize and / or newly develop textiles for the screen (Denz 2015), investigate possible usage of different screen guidance, various combination of overflow and through the screen and also considering ACT Façade planning guidelines and simulation tools up to holistic concepts for usage of the gained solar thermal energy within building services (Maurer 2013).

8 Restricted disclosure

Part of the above mentioned engineering, simulation and testing is property of building clients, planning partners and / or relevant to currently ongoing construction projects and therefore unfortunately can't be disclosed in this paper. However the authors will try to explain further findings within the speech as possible and gladly respond to questions brought forward at the conference and thereafter.

9 References

- Architekturbüro Jaschek, Pfeil & Koch Ingenieurgesellschaft, Priedemann Fassadenberatung, Klinger, S.: Festo AutomationCenter, Esslingen. *xia Intelligente Architektur* 4-6/2016. pp. 42-51. (2016)
- BINE Informationsdienst: Thermoaktive Bauteilsysteme, Nichtwohnungsbauten energieeffizient heizen und kühlen auf hohem Komfortniveau. BINE themeninfo I/2007 (2007)
- Betti, G., Holst, S., Denz, P.-R.: An integrated approach to high performance façade design: the Continental Headquarter in Hannover. *Advanced Building Skins 2018*, conference proceedings (submitted).
- Böke, J., Knaack, U., Hemmerling M.: State-of-the-art of intelligent building envelopes in the context of intelligent technical systems. In: *Intelligent Buildings International* (2018). doi: 10.1080/17508975.2018.1447437
- Eberl, M., Grün, G., Sinnesbichler, H.: Mock-Ups zur Absicherung integraler Planungskonzepte von Fassaden. *Fassade Technik und Architektur*, 2/2017, pp. 18-20. Verlagsanstalt Handwerk, Düsseldorf. (2017)
- Denz, P.-R., Beccard, A., Anders, L.: Fully glazed high-rise – an architectural vision stays reality!. *Engineered Transparency 2016*, pp. 151-159. Ernst & Sohn, Berlin. (2016)
- Denz, P.-R.: Intelligente Gebäudehüllen und Smart Textiles - eine ideale Kombination. Retrieved from <https://smartex-netzwerk.de/en/events/199-workshop-on-22-09-2015> (2015)
- DGNB (Deutsche Gesellschaft für Nachhaltiges Bauen): Automation Center <https://www.dgnb-system.de/de/projekte/automationcenter> (2017). Accessed: 05 August 2018
- Fraunhofer IBP: Versuchseinrichtung für energetische und raumklimatische Untersuchungen (VERU). <https://www.pruefstellen.ibp.fraunhofer.de/de/energieeffizienz-und-raumklima/veru.html> (2018). Accessed: 14 August 2018
- Jung, M.: Die Fassade stadtplanerisch denken! *Fassadentechnik*, 2/2018, pp. 20-23. Cubus Medien Verlag, Hamburg. (2018)
- Klein, T.: *Integral Facade Construction - Towards a New Product Architecture for Curtain Walls*. Delft: TU Delft. (2013)
- Knaack, U., Luible, A., Overend, M., Aelenei, L., Perino, M., Wellershof, F.: *Adaptive facade network Europe*. Delft: TU Delft Open. (2015)
- Knaack, U., Klein, T., Bilow, M., Auer, T.: *Facades: Principle of Construction*. 3rd edition. Birkhäuser, Basel. (2014)
- Kuhn, T. E.: State of the art of advanced solar control devices for buildings. *Solar Energy*. In: *Solar Energy* (2017). doi: 10.1016/j.solener.2016.12.044.
- Maurer, C., Baumann, T., Hermann, M., Di Lauro, P., Pavan, S., Michel, L., Kuhn, T. E.: Heating and cooling in high-rise buildings using facade-integrated transparent solar thermal collector systems. *Journal of Building Performance Simulation*, 1-9. (2013)
- Loonen, R. C. G. M., Trčka, M., Cóstola, D., & Hensen, J. L. (2013). Climate adaptive building shells: State-of-the-art and future challenges. *Renewable and Sustainable Energy Reviews*, 25, 483-493. doi:10.1016/j.rser.2013.04.16
- Priedemann, W.: *Passende Parameter*. *Fassadentechnik* 3/2016. pp. 28-31. (2016)
- Spangenberg, G.: Treptower, Berlin. <http://www.gerhardspangenberg.de/index.php?id=5> (2017). Accessed: 10 June 2017
- WAREMA Renkhoff SE: *Fenster-Markisen mit ZIP-Führung*. https://www.warema.de/Produkte/Aussen/Fenster-Markisen/Fenster-Markisen_ZIP-Fuehrung.php (2018). Accessed: 13 August 2018

Biological strategies for adaptive building envelopes

Estelle Cruz a),b), Kalina Raskin a), Fabienne Aujard b)

a) CEEBIOS, European Centre in Biomimetics, France, estelle.cruz@ceebios.com

b) MECADEV UMR CNRS 7179 - National Museum of Natural History of Paris, France

Buildings account for a significant part of the total energy consumption in developed countries. As interfaces between the indoor and outdoor environment, building envelopes play a major role in the energy efficiency of the building. They must be multi-functional and adaptive through days and seasons to achieve multi-regulation. Shaped by environmental pressures, biological organisms have developed sophisticated adaptations, specifically through their interfaces called integuments. Teguments of living organisms, as diverse as skin, hairs, cuticles, etc can manage the same environmental factors as building envelopes. Their thermal, acoustic, light, humidity and air regulation capacities can be quantified using physical parameters such as hygrometry, thermal conductivity, porosity, compacity, etc. This paper presents a biomimetic approach through the study of existing bio-inspired building envelopes in the light of multi-regulation, then a draft analysis of integumentary systems to facilitate the generation of design concepts to enhance the development of efficient building envelopes.

Keywords: biomimetics, building envelope, adaptation, integumentary systems, multi-regulation, environmental factors

1 Introduction

1.1 Conventional building envelope

The building envelope represents an interface between the exterior environmental factors and the interior demands of the occupants (Fernández, Rubio, & González, 2013). The envelope comprises building elements in interaction with the external environment such as the basement, walls and roof. Each type of interface has many different constraints to manage at once such as temperature, humidity, noise, light, air speed and quality. These five fundamentals environmental factors – air, light, water, noise, heat – have significant influence on the occupant comfort, building needs and impact on global energy consumption (Badarnah, 2012). Unlike climatic characteristics, most of the conventional solutions for building envelopes provide static design solution. These essentially static systems should be replaced by more reactive systems in order to guarantee a better level of energetic performance. (Yannas, 2011)

1.2 Biological interface: integumentary systems

Shaped by environmental pressures, biological organisms are well adapted to their living environment. Their survivals heavily depend on adaptation to their environment. They can adapt their morphology, behaviour and physiology at the scale of the day and seasons to maintain their internal environment in a stable state. This regulation process is called homeostasis. Many factors and biological regulation systems are involved to maintain homeostasis of the organism, specifically, at their interfaces the so-called integuments. It comprises the skin and its appendages

such as hair, scales, feathers, hooves, nails, horn, and horns. They have different functions such as protecting the deeper tissues, evacuating wastes, thermal regulation, detecting climate change to adjust body regulation, etc. Therefore, they are rich in properties and can control humidity, temperature, brightness, mechanical strength, climate change detection (Badarnah, 2017) (McCafferty, Pandraud, Gilles, Fabra-Puchol, & Henry, 2017).

1.3. Research project

In this research project, we investigate the application of the biomimetics approach on the development of building envelopes for multi-regulation. We first analyse the existing bio-inspired and adaptive building envelopes from a multi-regulation standpoint. Secondly, we identify the physical parameters that the building envelope must regulate. These parameters guide the identification of the main families of biological interfaces. Thirdly, we sort biological interfaces according to their performance with a systemic and multi-regulation analysis. Gathered information will be sorted in a data base adapted to building designers and architects' needs.

This research is undertaken with different partners with complementary field of expertise. The laboratory MECADEV of the National Museum of Natural History of Paris, specialist in adaptation mechanisms of living organisms, is a key player on the selection and analysis of the integumentary systems. The CEEBIOS – European Centre in biomimetics – brings an expert knowledge of the concrete needs of building designers providing and developing support for the integration of biomimetics in architecture. The international cement company VICAT supports the research with feedback on the development of the research as a cement manufacturer for building construction.

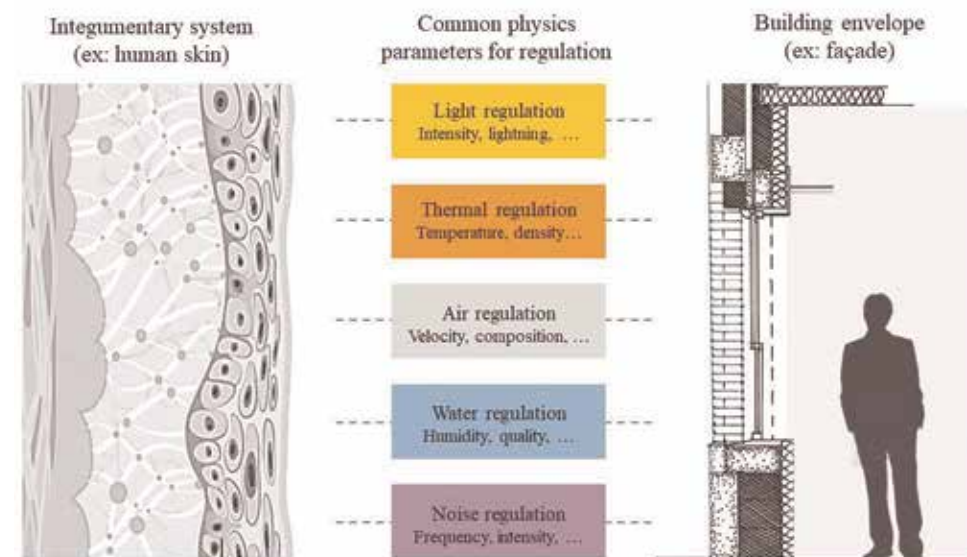

Fig. 1 Common physical parameters regulated by integumentary systems and building envelopes. Diagram adapted from (Badarnah 2012).

2 Bio-inspired envelopes: towards multi-regulation

2.1. Biomimetics in architecture

Applying observations made in nature to architecture has always been done by architects. Many movements in the history of architecture found inspiration in nature such as organic, bioclimatic, biomorphic or vernacular architecture. All of them refer to a biological paradigm (Gruber, 2011).

Biomimetics bring a significant and disruptive evolution from these previous movements in terms of methods and sustainability goals (CEEBIOS, 2016). Biomimetics is defined as the transfer of scientific knowledge and principles of living strategies to development of innovative and sustainable design (Benyus, 2002). This approach has a strong potential to both develop new disruptive models, and integrate sustainability. (Fayemi et al., 2017) (ISO 18458, 2015). In architecture, explorations have been carried out at the scale of cities, buildings, envelopes and materials. In each case, biomimetics could help to tackle various challenges such as water, light, noise, temperature and air regulation, structures lightening, energy efficiency, flow optimization, etc. (Pawlyn, 2011) (Chayaamor-Heil, 2018).

2.2. Existing bio-inspired envelopes

The development of biomimetic building envelopes has gained increasing interests among researchers in recent years. As an interface between the indoor and outdoor environment, they account for a significant part of the total energy consumption of the building. They must be multi-functional and adaptive through days and seasons to achieve multi-regulation. Biomimetic envelopes have already been built and their performances and design processes have been well-documented (Al-Obaidi, 2017). This is the case of the Eastgate Building in Zimbabwe, the Council House 2 in Melbourne, the Yoesu Pavilion in South Korea, the fine art Museum of Tainan, the HygroSkin Pavilion and more generally the research work at ITKE in Germany.

The Eastgate Centre is a shopping center and office block in central Harare, Zimbabwe conceived by architect Mick Pearce. The building is almost entirely self-cooled and ventilated by natural means. The ventilation and thermoregulation systems are inspired by the ventilation system of termites' mounds and cactus' geometry for thermal management. (Turner & Soar, 2008).

In the same vein, the CH2 - Council House 2 – is an administrative building in Melbourne, Australia designed by DesignInc in partnership with architect Mick Pearce. It was the first building in Australia to achieve the highest rating of six stars in Australia's Green Star environmental accreditation. The building emulates some nature principles for energy efficiency, thermal regulation, water and light management. (Rayner, Raynor, & Williams, 2010)

The Flectofin® developed by ITKE, is a hinge-less louver system that can shift its fin 90 degrees by inducing bending stresses in the spine caused by displacement of a support or change of temperature in the lamina. The system is inspired by the valvular pollination mechanism in the *Strelitzia reginae* flower, known as the Bird-Of-Paradise. The system has been used for the envelope of the pavilion One Ocean Thematic Pavilion for Yeosu Expo in 2012 (Knippers & Speck, 2012)

In the same field, the research group ITKE developed a prototype of responsive envelope. Based on the physical properties of wood and its instability to humidity, the research team developed the HygroSkin Pavilion. This meteorosensitive envelope can autonomously open and close in response to humidity variations. (Correa, Krieg, Menges, & Reichert, 2013)

Sierpinski Forest is a sun roof made of Sierpinski Tetrahedrons. Inspired by fractal geometry of trees, the roof has the same fractal dimension which allows to entirely shade the roof at 1:00 PM in the summer. The arrangement, size and shape of tetrahedrons prevent the building and roof from overheating. (Sakai, 2016).

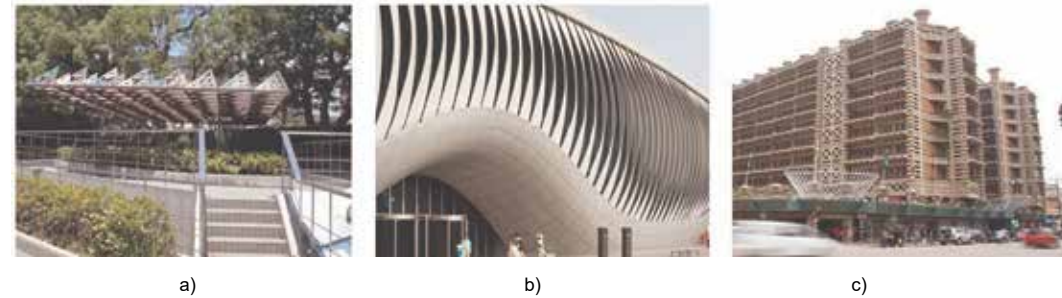

Fig. 2 Existing biomimetic envelopes, a) Sierpinski Forest b) Yoesu pavilion c) the Eastgate Centre. Courtesy of Satoshi Sakai, ITKE and Mick Pearce.

Based on the work of (Badarnah 2012, 2017), the regulation needs that the envelope must achieve are sorted in five categories: light, heat, noise, water, air. Existing biomimetic projects are analysed using these five categories to provide an overall analysis of the implementation of biomimetics. Results are summarized in Table 1. The symbol “+” corresponds to a bio-inspired regulation process through the envelope. The symbol “-” means that the regulation is achieved without any bio-inspired system.

This table shows that most of the existing biomimetic envelopes regulate one to two environmental factors at one using bio-inspiration. Regulated environmental factors are often interrelated such as the combination of heat and air regulation. None of them have biomimetic systems for noise management. This analysis highlights the need of development of a method for a systemic biomimetic design for multi-regulation.

Building envelopes	Description	Air	Light	Water	Heat	Noise
Eastgate Centre	Office building inspired by termites' mounds and cactus morphology	+	-	-	+	-
Council House 2	Administrative building inspired by natural principles	+	-	-	+	-
Yoesu Pavilion	Façade system with hinge-less louver inspired by the bird-paradise flower	+	+	-	-	-
HygroSkin	Responsive envelope using wood as a sensitive material to moisture	-	+	+	-	-

Table 1: Comparative analysis of bio-inspired envelopes for regulation of environmental factors

2.3. Systemic analysis of bio-inspired envelopes

Table 1 and Figure 3 summarize in-depth analysis of each bio-inspired envelopes. They have been analysed using the five environmental factors, then represented by the web diagrams. Each one shows the level of regulation for each environmental factor. Biological models are analysed based on a rating scale from one to three. Rate 3 corresponds to a high regulation for the factor which is involved in the survival of the organisms. Rate 2 corresponds to a medium regulation by the organism. The environmental factor is regulated by the organism, but little involved in its survival. Rate 1 reflects that the environmental factor is not regulated by the organism. In this case, the factor does not affect the survival of the organism. The green circles mean that the principle observed in the biological model has been extracted by the architect then applied to the building.

In this paper, the analysis method is presented through the case study of the Eastgate Centre in Zimbabwe. (Figure 2). The Eastgate centre is inspired by the ventilation system of termites' mounds and the thermal regulation of cactus' geometry. *Odontotermes transvaalensis* is a subterranean macrotermite common in the arid grasslands of South Africa. These termites feed on cellulose which is extracted by fungi they eat. These fungi require constant moisture and oxygen renewal to grow. The colony's survival is highly dependant of fungi farming. Thus, the mound serves as a

climate-control infrastructure (J. S. Turner, 1994). This type of mound regulates three environmental factors “Air”, “Light” and “Water”. They correspond to rate 3 because their regulations have a high impact on the colony's survival. “Water” and “Air” affect fungi growing and hence directly, termites' feeding. Light impacts termites' metabolism: they avoid sun exposition by building mounds and galleries. The factor “Thermal” is not regulated through the mound. The temperature of the mound tracks the temperature of the soil according to seasons. In fact, thermal variations do not affect termites' metabolisms (Ocko et al., 2017). “Noise” is not regulated by termites. The same method was used for the cactus where all the environmental factors – except “Noise” - are highly regulated for the survival of the organism. The Eastgate Centre regulates two environmental factors emulating the air regulation system of termites' mounds and the thermal regulation achieved by cactus' geometry.

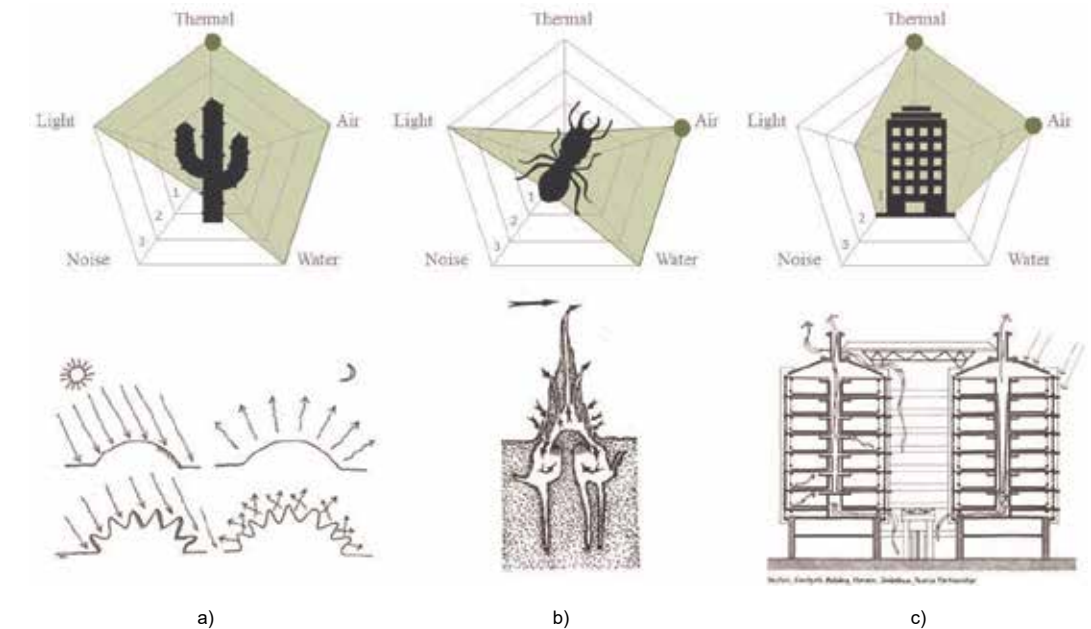

Fig. 3 Overall analysis of regulated environmental factors using web diagrams and Mick Pearce's drawings a) Cactus b) termites' mounds, c) Eastgate Centre. Drawings: courtesy of Mick Pearce.

3 Integumentary systems

3.1. Biological interfaces

Living envelopes are defined as interfaces between the external environment and inside the organism. For plants and animals, they have different biological functions such as protection of the deeper tissues, evacuating wastes (gas or solid matter), thermal regulation, detecting climate change to adjust organism regulation, etc. Based on this definition, there are many types of envelope in nature such as integumentary systems, animals' architecture, wall of organs, membranes, etc.

The closer the metabolic needs between humans and living organisms are, the more the functions regulated by biological organisms will regulate the environmental factors as building envelopes. For example, endotherms animals – commonly termed warm-blooded animals – regulate almost the same environmental factors as human body because they have a close metabolism. Conversely, the mound of the termites *Odontotermes transvaalensis* does not regulate the air temperature inside the mound because temperature variation does not affect termite metabolism. Animals'

architecture as diverse as nests, mounds, borrows etc also belong to the category of living envelopes. External envelopes of organs such as wall of respiratory and digestive systems, plant cuticle, etc belong to the category of living envelopes. The family of integumentary systems gathers different type of teguments such as skin, hair, cuticle, scale, feather, etc. Research demonstrated, that they are widely involved in regulation of environmental factors. For example, furs are well known for thermal regulation, feather for thermal and water management, etc.

3.2. Integuments

The integumentary system comprises the skin and the appendages. The appendages include hairs, scales, feathers, hoovers and nails. They are multi-functional and rich in properties. They can address multiple environmental aspects simultaneously through day and season. Each type of appendage regulates the same environmental factors but, with a different degree of performance. For example, feathers and furs of birds under tropical climates have different thermal conductivity compared to birds living in polar environments.

To fill the lack of transversal vision on integuments and their performance, this research will gather several types of biological data. They will be sorted in a data base in three categories: physical quantification of the performances of the integuments (thermal conductivity, temperature, thermal resistance, light absorption etc), type of climates (humidity, temperature, rainfall precipitation, etc) and type of metabolism (ectotherms, endotherms, etc). Combining collected data, the data base will offer an overview of multi-regulation strategies according to the type of integuments and their performance, climate and metabolism of the organisms. This structured view of biological data will help a rational choice of the adapted biological model for the development of multi-functional building envelopes.



Fig. 4 Diversity of integumentary systems, a) scale of snake, b) fur of coyote c) feather of bird. Free of copyrights pictures.

4 Conclusion

This research project focuses on the development of biomimetic envelopes studying living interfaces and quantifying their properties. Living interfaces have been chosen because of the analogy with building envelopes. They also have close performances for the regulation of environmental factors. The research project aim to provide a systemic analysis of living interfaces based on the five environmental factors. It will help to select with a rational approach the adapted biological model for the development of multi-functional building envelopes.

Beyond gathering and sorting existing data, this research project will highlight the lack of biological data in some fields. The results will encourage biologists to go further in biological data collection. Rather than focusing on one model for the development of biomimetic projects, the data basis will offer a wide overview of the potential living interfaces to study.

5 Acknowledgements

This research project is funded by the CEEBIOS, MNHN - National Museum of Natural History of Paris, the international cement group VICAT and the ANRT – French National Research Agency. We are particularly grateful to Dr. Lidia Badarnah and Dr. Pierre-Yves Henry for enriching discussions, Mick Pearce for data sharing of Eastgate building (design method, evaluation of building performance, etc), and Dr. Laura Magro for her suggestions for this document.

6 References

- Al-Obaidi, K. M., Azzam Ismail, M., Hussein, H., & Abdul Rahman, A. M. (2017). Biomimetic building skins: An adaptive approach. *Renewable and Sustainable Energy Reviews*, 79, 1472–1491. <https://doi.org/10.1016/j.rser.2017.05.028>
- Badarnah, L. (2017). Form Follows Environment: Biomimetic Approaches to Building Envelope Design for Environmental Adaptation. *Buildings*, 7(2), 40. <https://doi.org/10.3390/buildings7020040>
- Badarnah, L. (2012). Towards the living envelopes: biomimetics for building envelopes. Retrieved from http://docs.wixstatic.com/ugd/ef2c31_d5e8c9aae836469e99adaa954b607090.pdf
- Benyus, J. M. (2002). Biomimicry : innovation inspired by nature. Perennial. CEEBIOS. (2016). Etat de l'art habitat bio-inspiré.
- Chayaamor-Heil, N., ... F. G.-L. C. de, & 2018, undefined. (2018). Biomimétisme en architecture. État, méthodes et outils. *Journals.Openedition.Org*, (1). <https://doi.org/10.4000/craup.309>
- Correa, D., Krieg, O. D., Menges, A., & Reichert, S. (2013). HygroSkin: A Climate Responsive Prototype Project Based on the Elastic and Hygroscopic Properties of Wood. *ACADIA 2013 Adaptive Architecture*, 33–42. Retrieved from http://papers.cumincad.org/data/works/att/acadia13_033.content.pdf
- Fayemi, P.-E., Wanieck, K., Zollfrank, C., Maranzana, N., Fayemi, P. E., Maranzana, N., & Aoussat, A. (n.d.). Science Arts & Métiers (SAM) Biomimetics: process, tools and practice. Retrieved from <http://sam.ensam.eu>
- Fernández, M. L., Rubio, R., & González, S. M. (2013). Architectural envelopes that interact with their environment. In *Conference and Exhibition - 2013 International Conference on New Concepts in Smart Cities: Fostering Public and Private Alliances, SmartMILE 2013*. <https://doi.org/10.1109/SmartMILE.2013.6708189>
- Gruber, P. (2011). Biomimetics in Architecture [Architekturbionik], (June). ISO 18458:2015 - Biomimetics -- Terminology, concepts and methodology. (n.d.). Retrieved from <https://www.iso.org/standard/62500.html>
- Knippers, J., & Speck, T. (2012). Design and construction principles in nature and architecture. *Bioinspiration & Biomimetics*, 7(1), 015002. <https://doi.org/10.1088/1748-3182/7/1/015002>
- McCafferty, D. J., Pandraud, G., Gilles, J., Fabra-Puchol, M., & Henry, P.-Y. (2017). Animal thermoregulation: a review of insulation, physiology and behaviour relevant to temperature control in buildings. *Bioinspiration & Biomimetics*, 13(1), 011001. <https://doi.org/10.1088/1748-3190/aa9a12>
- Ocko, S. A., King, H., Andreen, D., Bardunias, P., Turner, J. S., Soar, R., & Mahadevan, L. (2017). Solar-powered ventilation of African termite mounds. *The Journal of Experimental Biology*, 220(Pt 18), 3260–3269. <https://doi.org/10.1242/jeb.160895>
- Pawlyn, M. (2011). *Biomimicry in Architecture*. (R. Publishing, Ed.). Retrieved from <https://books.google.fr/books?id=41HyjgEA-CAAJ&dq=michael+pawlyn&hl=en&sa=X&ved=0ahUKEwjLs8f-1M3ZAhXJ8AKHwXUA0sQ6AEIKTAA>
- Rayner, J. P., Raynor, K. J., & Williams, N. S. G. (2010). FAÇADE GREENING: A CASE STUDY FROM MELBOURNE, AUSTRALIA. *Acta Horticulturae*, (881), 709–713. <https://doi.org/10.17660/ActaHortic.2010.881.116>
- Sakai, S. (2016). *Urban Heat Island and Fractal Sunshade* (pp. 1–15). Springer, Cham. https://doi.org/10.1007/978-3-319-33310-6_1
- Turner, J. S. (1994). Ventilation and thermal constancy of a colony of a southern African termite (*Odontotermes transvaalensis*: Macrotermitinae). *Journal of Arid Environments*, 28(3), 231–248. [https://doi.org/10.1016/S0140-1963\(05\)80060-6](https://doi.org/10.1016/S0140-1963(05)80060-6)
- Turner, J., & Soar, R. (n.d.). *Beyond biomimicry: What termites can tell us about realizing the living building*. Digital.Library. Adelaide.Edu.Au. Retrieved from https://digital.library.adelaide.edu.au/dspace/bitstream/2440/84302/2/hdl_84302.pdf#page=247
- Yannas, S. (2011). Adaptive Strategies for an Ecological Architecture. *Architectural Design*, 81(6), 62–69. <https://doi.org/10.1002/ad.1321>

Multi-functional biomimetic adaptive façades: Developing a framework

Aysu Kuru ^a, Francesco Fiorito ^{a,b}, Philip Oldfield ^a, Stephen P. Bonser ^c

^a Faculty of Built Environment, University of New South Wales, Sydney, Australia

^b Department of Civil, Environmental, Land, Building Engineering and Chemistry, Polytechnic University of Bari, Bari, Italy

^c School of Biological, Earth and Environmental Sciences, University of New South Wales, Sydney, Australia

The façade is the key element in a building to control energy use and deliver comfort, while acting as a filter between external conditions and internal requirements. A successful façade design should be capable of adapting to changes in the external and internal environments and be multi-functional to regulate multiple variables. However, while many adaptive façades have been developed, most adapt to only a single variable, with few dealing with multi-functionality. Nature offers an array of organisms with adaptations allowing them to survive under multiple environmental stresses. However, the identification and translation of these multi-functional adaptations in nature to an adaptive building façade remain a challenge.

This research aims to develop a framework for designing multi-functional biomimetic adaptive façades. The framework comprises of: (1) the identification of boundary conditions for a climate and building typology; (2) selection and mapping of multi-functional dynamic and static processes of organisms; and (3) design generation for multi-functional biomimetic adaptive façades. The mapping of organisms classifies a number of multi-functional adaptations in nature and their adaptive functional features. These include their morphological, physiological and behavioural properties, adaptation levels and dynamic and kinetic processes responding various physical stimuli. This study then provides a framework that others can follow in the creation of multi-functional biomimetic adaptive façade design.

Keywords: Biomimetics, adaptive building skins, multi-functionality, façade design, architecture

1 Introduction

Biomimetics is a biological approach to engineering, essentially the grasping of natural principles to aid in the comprehension of technical questions, which can be solved by developing optimised strategies (Pohl and Nachtigall, 2015; Lepora et al., 2013; Vincent et al., 2006). There are extensive studies on nature-driven innovation in many subjects, especially architecture, where natural sciences inspire the current frontier of research (Bar-Cohen, 2012; Gruber & Jeronimidis 2012; Gruber 2011). Recently, many architects and researchers have integrated biomimetics in their work (Hays and Miller, 2008), which have included, for example, sustainable design strategies and innovative envelope solutions (Jeronimidis & Atkins 1995; Gruber & Gosztonyi 2010; Badarnah 2017; Pawlyn 2011; Mazzoleni 2013; Kapsali 2016).

Designing façades using biomimetics is, in particular, a field gaining interest. However, most existing designs focus on the regulation of a single environmental factor, often solar radiation, limiting applications to mono-functionality. There is a need for further development in the area of multi-functional façade systems inspired by nature, that control multiple environmental variables simultaneously. This paper presents a new approach for the development of multi-functional adaptive façades. To achieve this, a new basis for the classification of natural mechanisms controlling multiple environmental factors has been developed.

2 Biomimetic adaptive building skins

The elimination of load-bearing walls has led to the creation of the 'building skin' as its primary enclosure (Tietz, 1999; Del Grosso and Basso, 2010). Its functions include managing daylight, ventilation, energy conservation, and thermal inertia (Del Grosso & Basso, 2010; Schittich 2001). A related technology is adaptive building skins (ABS) which can be described as a façade with the capability to change its functions, features or behaviour in response to variant performance requirements and boundary conditions to improve building performance (Loonen et al., 2015). There are also a number of concepts defined similarly, and include 'Climate Adaptive Building Shells' (CABS), 'Kinetic Architecture', 'Variable Geometry Structures' (VGSs) and 'Climate Adaptive Skins' (CAS) (Del Grosso & Basso, 2010; Fiorito et al., 2016; Loonen et al., 2015, Addington and Schodek, 2005; Hasselaar, 2006).

Biomimetic adaptive buildings skins (Bio-ABS) implies a type of adaptive façade in which a biomimetic approach is used for design generation. Both organisms and buildings withstand environmental stresses. Organisms survive with adaptations controlling various environmental factors simultaneously, by having multiple functions at different levels. Similarly, adaptive façades aim to adapt a building's thermal and morphological properties to changing climatic conditions. Therefore, implementing biomimetics to adaptive façades shows great potential for achieving high performance façade designs.

A comprehensive review of existing biomimetic adaptive façades developed over the last decade in both academia and industry is presented in Figure 1 (various sources, including Lienhard et al., 2011; Wiscombe 2012). The design stages of the applications and the number of environmental factors they control are given identifying the amount of multi and monofunctional systems. The graph suggests that multi-functional applications are under-developed with a ratio of less than 30%. Existing designs aim to regulate the environmental factors of heat, light, air, water and energy, meaning they control solar gains, ventilation, daylight and humidity levels. Light management is comprehensively developed, typically managing solar gains designed as shading systems that adapt to sunpath (Fig. 2) (Suralkar 2011; Grobman 2013; Schleicher 2016; Pesenti et al. 2015; Decker and Yeadon 2010; Schinegger et al. 2012;).

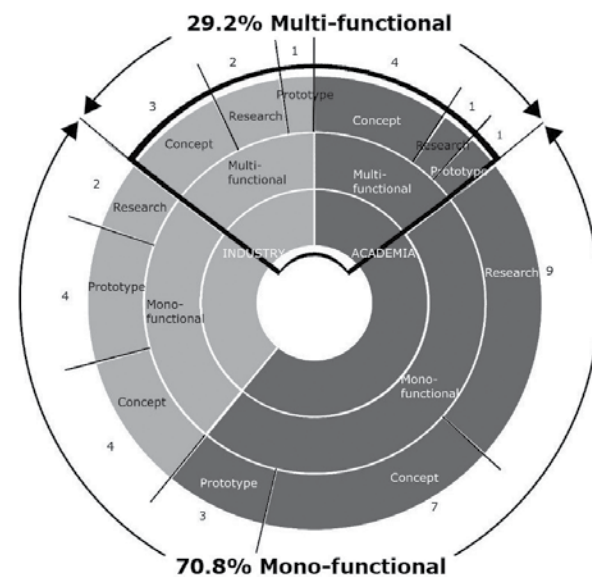

Fig. 1 The status and number of multi and monofunctional biomimetic façade applications developed in academia and industry

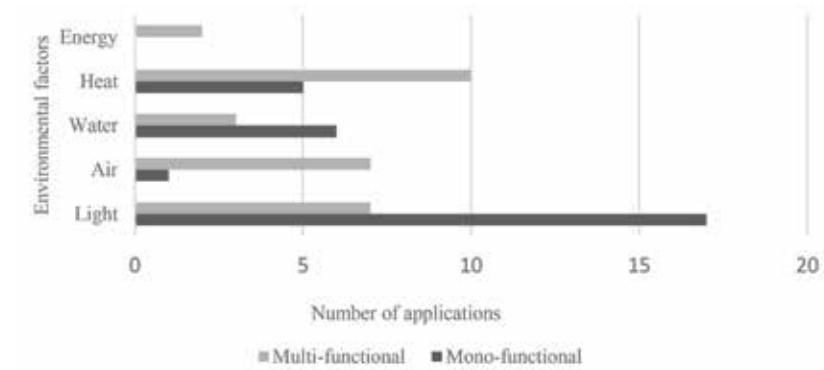

Fig. 2 Regulated environmental factor according to the number of functions of applications

This paper suggests that the under-development of multi-functional systems is a result of the lack of: (1) clarity in terms of multi-functionality in nature from a designer's perspective, (2) expression of how a system is considered multi-functional, (3) a method for the development of multi-functional systems. Many biomimetic design frameworks are either 'top-down', 'bottom-up' or a combination of the two (Al-Obaidi et al., 2017). Top-down approaches start with identifying a technical problem. On the contrary, bottom-up approaches first explore organisms in a broader context, and then exploring their potential in building design (Biomimicry 3.8, 2010). Some of these top-down approaches are used for façade design. Vincent et al. (2006) introduced BioTRIZ as a systematic technology transfer from biology to engineering using TRIZ (translated as Theory of Inventive Problem Solving) that has been applied and further developed by researchers for façades (Sheta 2010; Craig et al. 2008). Mazzoleni focused on the skins of organisms for the design of building systems (Mazzoleni 2013). Badarnah and Kadri created a systematic methodology for the generation of biomimetic design concepts called BioGEN identifying successful biological adaptations in a categorical database (Badarnah & Kadri, 2014). Gruber et al. developed the concept 'Bionametics' defining the transfer of multi-functional nanostructured patterns from nature into surface materials in architectural design (Gebeshuber et al., 2015). Lopez et al. presented biomimetic principles derived from micro and macro adaptations of plants for the design of adaptive architectural envelopes (Lopez et al., 2017).

The existing problem-based biomimetic approaches often result in the creation of mono-functional façade systems due to two reasons: (1) focusing on one technical problem only to simplify the process for investigating biological models; (2) not exploring organisms' multi-functional mechanisms in a way that designers and engineers can make use of them (Knippers and Speck, 2012).

3 Developing a new framework for designing multi-functional biomimetic adaptive façades

The framework consists three steps: (1) definition of boundary conditions as functional requirements, (2) selection and mapping of corresponding multi-functional biological models, and (3) design generation for multi-functional biomimetic adaptive façades (Fig. 3). The boundary conditions define technical problems, and biological models present design inspiration, followed by the creation of a multi-functional biomimetic adaptive façade. The framework is an iterative design process until the most promising result is achieved by returning back to the second step of selecting a biological model. Environmental performance analyses are conducted for each option, followed by a performance comparison amongst the results to identify the most promising one.

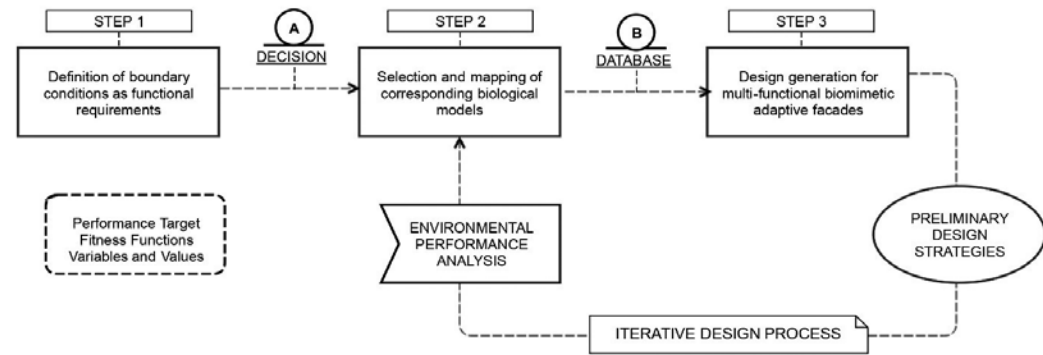

Fig. 3 A new framework for designing multi-functional biomimetic adaptive façades

3.1. Step 1: Definition of boundary conditions

The framework starts with the definition of boundary conditions as a design input aiming to provide a context for the climate and building. The boundary conditions involve climate, location, building typology, architectural design, local building regulations and ventilation type of the building. The climate and location define the environmental conditions of a scenario. The typology will define occupants' activity patterns and internal gains. The architectural design and local building regulations define more specific input of the features at the building scale. The ventilation type of the building defines the parameters and goals for building performance analysis.

3.2. Step 2: Mapping multi-functional biological mechanisms

An extensive number of dynamic and static patterns of organisms have been mapped to develop a database for transferring multi-functionality in nature into façade design. This growing database aims at investigating and delivering biological adaptations for the development of Bio-ABS. A schematic representation of the process for biological model selection is presented in Fig. 4. The decision-making process is comprised of the environmental factors and their controls to identify the functional requirements in a simplified manner and find organisms with corresponding properties. To select the biological model, an extensive database of adaptations in nature is mapped. The map consists of organisms and their multi-functional mechanisms for regulating multiple environmental factors (Fig 5). The mechanisms are categorised into three sections: (1) multi-functionality, (2) adaptability, and (3) performance. Multi-functionality gives the mechanism's biological organisation level, responding environmental factor and stimulus. Adaptability identifies the type, level and pattern of the mechanism. Performance presents the biological mechanism, its functional strategy in detail and a measured variable to quantitatively define the system.

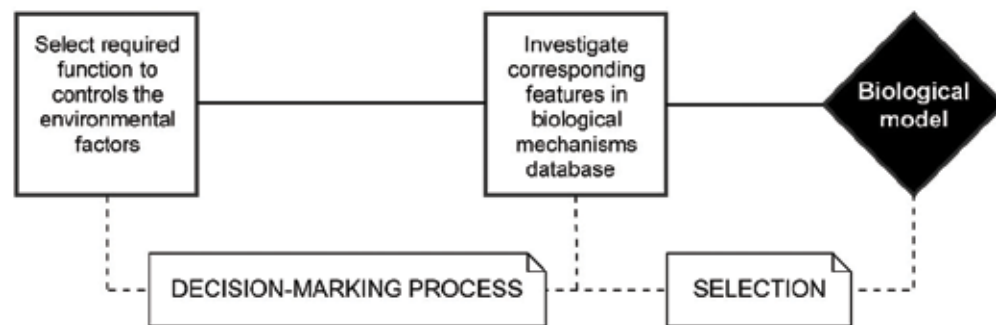

Fig. 4 Process for selecting multi-functional biological models from the database

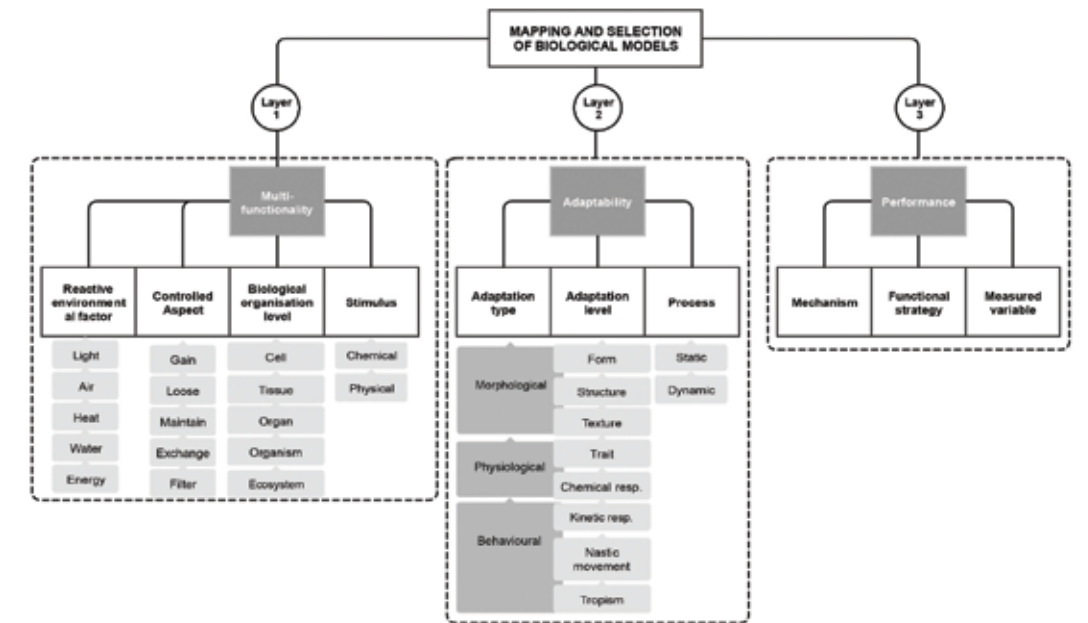

Fig. 5 Layers of mapping multi-functional biological models

Layer (1) Multi-functionality

The multi-functionality level of biological models gives the regulated environmental factor, its control, the stimulus triggering the mechanism and the biological organisation level within which it is situated. All adaptations aim at regulating environmental factors and they are developed in response to physical or chemical stimuli. A physical stimulus refers to an environmental trigger such as a change in temperature, light intensity, water content, oxygen level and sensitivity to abiotic stresses. A chemical response refers to an internal physiological feature such as a change in pH level. These triggers are further explored as reactive environmental factors. The environmental factors are categorised as light, air, heat, water and energy. There are several control aspects identified that represent the functions organisms developed to regulate these environmental factors. These functions are to gain, lose, maintain, exchange and filter. Gain identifies an increase; loose identifies a decrease while maintain identifies a stabilisation of an environmental factor. Exchange defines a diffusion, effusion or transfer. Filter defines an extraction of a matter from another substance. The functions together with the environmental factors they control are the pillars of the decision-making process. A cross combination of environmental factors and controls generate the investigation and selection of a solution from nature using the map.

For example, the barrel cactus (*Echinocactus grusonii*) survives in a hot and arid desert climate and has developed mechanisms to help adapt to its environment (Fig 6). Three include the swell and shrink movement of the cortex (plant stem), self-shading properties of areoles and spines (some morphological features); and microscopic openings of stomata (permeable cells) (Fig 7). The cortex is an organ maintaining water content by gaining water and swelling for conservation purposes. The swell and shrink movement of the cactus is stimulated by physical factors such as water content, heat gain and light exposure. With the help of the cortex morphology, the barrel cactus decreases its surface temperature by substantial amounts. It also creates shaded areas to cool itself down by managing light intensity. The areoles and spines are specialised tissues on the outer surface of the barrel cactus' cortex that help self-shading to lose light and heat through their morphology, triggered by physical environmental factors. The stomata are cells exchanging heat, gas and light through permeable pore structures located on the external epidermal layer of

the stem tissue. They are composed of guard cells in charge of the opening and closing movement of the stoma. Stomatal movement is activated by chemical stimuli such as the internal changes of the plant. These are oxygen and carbon dioxide levels in the cells needed for photosynthesis which is an energy generating feature of plants. The barrel cactus has not only advanced mechanisms that regulate multiple environmental factors at a time, but also developed multi-layered structures devoted to various functional requirements present in the same composition.

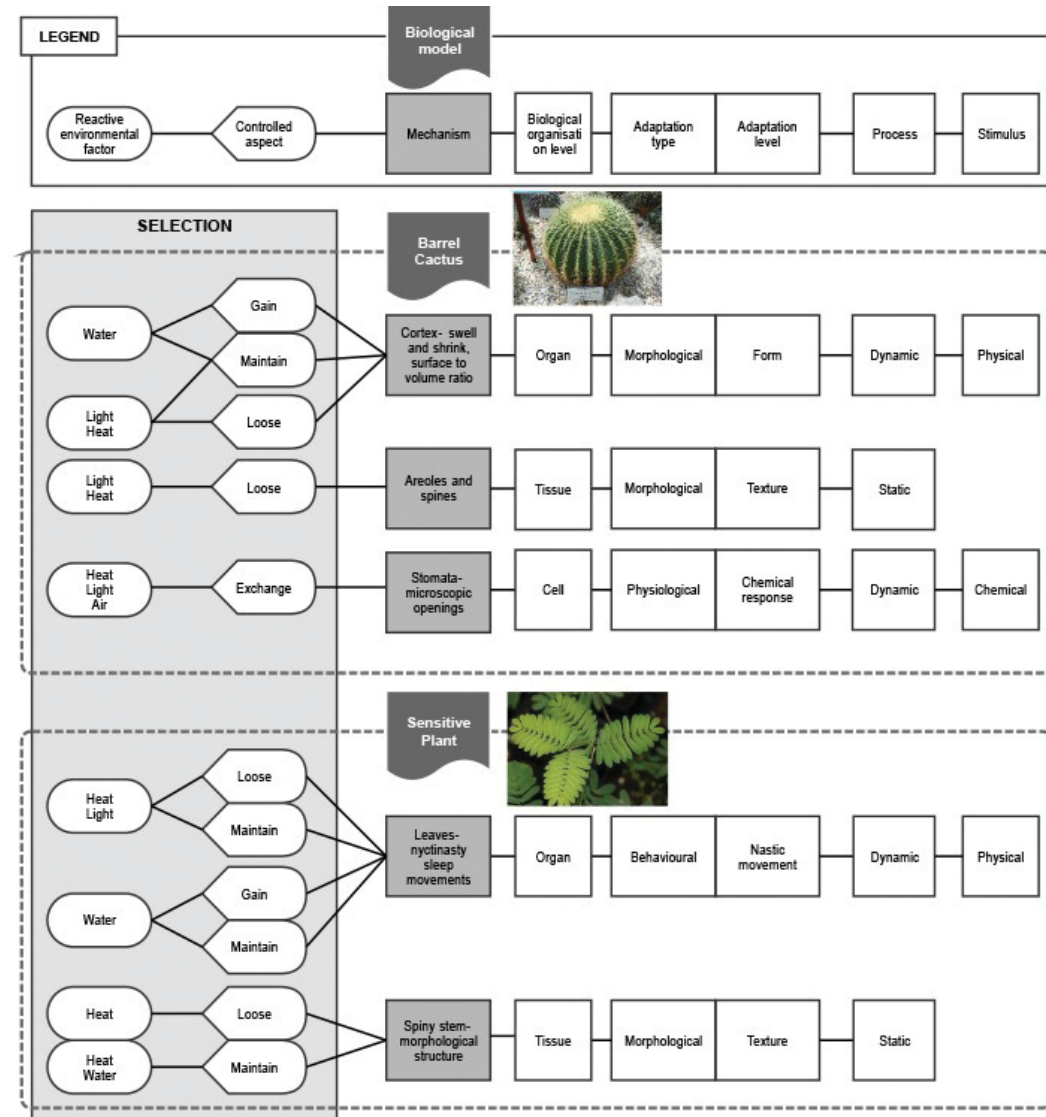

Fig. 6 Mapping of the barrel cactus (*Echinocactus grusonii*) and the sensitive plant (*Mimosa pudica*)

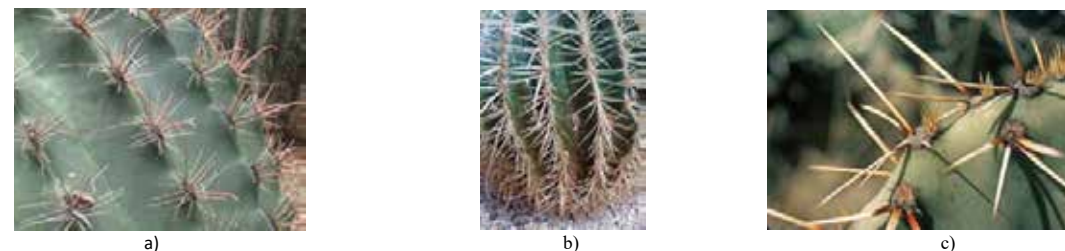

Fig. 7 The barrel cactus (*Echinocactus grusonii*) a) swollen, b) shrinking; and c) shading areoles and spines (Source: New York Botanical Garden)

Layer (2) Adaptability

Biological models adapt to tolerate the environmental changes in their natural habitats. These adaptations are categorised in three types as morphological, physiological and behavioural. Morphological adaptations relate to a form, structure or texture; physiological adaptations refer to a characteristic (trait) or chemical response; behavioural adaptations refer to a kinetic response to a stimulus. The types of adaptations are categorised as adaptation levels referring to these characteristics. Each biological mechanism is identified as dynamic and static processes. Dynamic processes refer to the presence of a change or a movement while static processes refer to functional nanostructures and surface segmentation trends.

The biological mechanisms of the barrel cactus are mapped as an example. The swell and shrink movement of the cortex is identified as a dynamic process that serves a high surface to volume ratio supporting heat loss and maintaining water content at a constant rate. The cortex movement is a morphological adaptation at the level of the form of the cactus. The outer surface structure of ribs generates the required form for the cortex movement. Ribs are vertical stem structures of the barrel cactus giving it its well-known shape. They remain consistent in quantity during expansion and contraction while the depth and distance between the ribs change. The areoles and spines are structures on top of the ribs. Areoles are unique structures bearing spines. Areoles and spines together create a textured morphology as a static process regulating heat and light by self-shading. They also create a microclimate by improving airflow close to stem surface. Microscopic stomatal openings are dynamic features of plants on the stem's epidermis layer exchanging air, heat and light as a chemical response to the requirements for photosynthesis to take place. They are physiological adaptations resulting from chemical internal processes.

Layer (3) Performance

The performance of organisms is explored to identify their multi-functional mechanisms, functional strategies and measured variables. Change may present as an opening ratio in percentage; a reflectance value for light in microns or percentage; relative humidity level in % RH or an increase/decrease of temperature in °C. These values present a complete understanding of how and how much the biological mechanisms perform, therefore the potential of their translation into design. The barrel cactus controls various environmental factors with multiple mechanisms. It manages heat, light and water through the morphology of its ribs structure. It maintains a high surface-to-volume ratio to lose heat and cool down. The expansion of the surface area can be up to 54%. The cactus cools down its stem surface with the presence of its spines and ribs. The average hourly temperature of the stem surface is 16°C less in summer and 6°C less in winter with spines and ribs compared to not having these structures. The ribs, spines and areoles together decrease the average hourly surface temperature by 5°C for a summer day and 0.2°C for a winter day (Lewis and Nobel 1977). In order not to lose so much of its water content to conserve water in the hot and dry desert climate, it possesses fewer stomata that other plants, with between 15 to 70 stomata per square millimetre on its epidermis.

3.3. Stage 3: Design generation of multi-functional biomimetic adaptive façades

Two of the reasons for failure in transferring natural processes into a design are identified by Gruber as mistaken ideas due to superficial research and lack of information from life sciences available or accessible (Gruber, 2008). This failure applies to both finding organisms for biological inspiration and abstracting the principles as a strategy. The key is to simplify the functional requirements and identify the biological adaptations. The proposed framework investigates corresponding biological mechanisms that can be translated into adaptive façade designs. It uses

a simple terminology to describe the biological features guiding the designer to select the most promising biological mechanism, detailed explanation for the comprehension of its identification and performance.

Mapping multi-functional biological models simplifies the process of creating a system with multiple functions. Biological organisation levels of each mechanism show how multiple strategies are situated in one system. This can be achieved by scaling the façade system in macro-to-nano. In other words, biological organisation levels can be translated at a façade system scale, component scale or material scale. Adaptation types help forming the layers where the adaptive feature takes place. Morphological and behavioural adaptations can take place at any scale while physiological adaptations are likely to take place at smaller scales. Adaptation levels show how the adaptive feature work in conjunction with biological organisation levels. For instance, a morphological feature of a leaf texture is in the level of a tissue. Therefore, it is likely to be translated as a surface structure at a micro level.

4 Conclusion

This research collated and classified 41 academic and industrial applications of biomimetic adaptive façades developed in the last decade. This demonstrated that mono-functional façades are the most common outcomes of existing biomimetic approaches. These façade applications are commonly shape morphing shading devices. It is suggested that this is a result of a lack of clarification of multi-functionality in nature from non-biologists' perspectives, while few existing approaches allow defining multiple technical problems as input. Therefore, this paper has presented a new framework for the development of biomimetic adaptive façades with a focus on multi-functionality.

The proposed framework is comprised of three steps: (1) definition of boundary conditions, (2) selection and mapping of biological models, and (3) design generation of biomimetic façades.

The framework suggests that an extensive investigation and mapping of multi-functionality in biological adaptations is the key to achieving multi-functionality in biomimetic adaptive façades. The adaptability and performance of the biological models already suggests the way to generate individually controlled mechanisms regulating different parameters. Natural adaptations in accordance to their biological composition as hierarchical and multi-functional structures are mapped as a result of an extensive survey of organisms. It is found that various functional requirements take place in living systems at different levels of the same biological structure. The hierarchy and multi-functionality of biological composites is highly promising to be transferred to the design generation of multi-functional biomimetic adaptive façades. This is demonstrated in the second paper of this research entitled 'Multi-functional biomimetic adaptive façades A case study' (also as part of FAÇADE 2018 Final Conference of COST TU4103 "Adaptive Façades Network").

5 Acknowledgement

The authors would like to acknowledge financial support from Wightman Bequest School of Architecture and Design Scholarship and Postgraduate Research Student Support funded by the Faculty of Built Environment at UNSW Sydney.

6 References

- Addington, M. and Schodek, D. (2005). *Smart Materials and New Technologies – For Architecture and Design Professions*. Al-Obaidi, K. M., Azzam Ismail, M., Hussein, H., & Abdul Rahman, A. M. (2017). Biomimetic building skins: An adaptive approach. *Renewable and Sustainable Energy Reviews*, 79(April), 1472–1491. <https://doi.org/10.1016/j.rser.2017.05.028>
- Badarnah, L. (2017). Form Follows Environment: Biomimetic Approaches to Building Envelope Design for Environmental Adaptation. *Buildings*, 7(2), 40. <https://doi.org/10.3390/buildings7020040>

- Badarnah, L., & Kadri, U. (2014). A methodology for the generation of biomimetic design concepts. *Architectural Science Review*, 8628(January), 1–14. <https://doi.org/10.1080/00038628.2014.922458>
- Bar-Cohen, Y. (2012). *Biomimetics: Nature-Based Innovation*. CRC Press Taylor and Francis Group.
- Biomimicry 3.3. (2010). Biomimicry Institute. <http://biomimicry.net/> Accessed on 09/05/2018.
- Craig, S., Harrison, D. and Cripps, A. (2008). Two new environmental building technologies, one new design method: infrared transparent insulation, biodegradable concrete formwork and BioTRIZ. In *Proceedings of the Conference for the Engineering Doctorate in Environmental Technology*, University of Surrey, UK.
- Decker, M. and Yeadon, P. (2010). *Projects Smart Screen: Versions I, II and III*.
- Del Grosso, a E., & Basso, P. (2010). Adaptive building skin structures. *Smart Materials and Structures*, 19(12), 124011. <https://doi.org/10.1088/0964-1726/19/12/124011>
- Dunlop, J. W. C., & Fratzl, P. (2010). Biological Composites. *Annual Review of Materials Research*, 40(1), 1–24. <https://doi.org/10.1146/annurev-matsci-070909-104421>
- Fiorito, F., Sauchelli, M., Arroyo, D., Pesenti, M., Imperadori, M., Masera, G., & Ranzi, G. (2016). Shape morphing solar shadings: A review. *Renewable and Sustainable Energy Reviews*, 55(April), 863–884. <https://doi.org/10.1016/j.rser.2015.10.086>
- Gebeshuber, I. C., Gruber, P., Imhof, B., & Architecture, T. (2015). Biomimetics : Architecture Defined by Natural Patterns. In *Encyclopedia of Nanotechnology* (pp. 1–17). <https://doi.org/10.1007/978-94-007-6178-0>
- Grobman, Y. J. (2013). Cellular Building Envelopes. *ICoRD'13*, 951–963.
- Gruber, P. (2008). *Transfer of Nature to Architecture - Analysis of Case Studies*.
- Gruber, P. (2011). Biomimetics in architecture: architecture of life and buildings. *Biomimetics–Materials, Structures and Processes*, 245. <https://doi.org/10.1007/978-3-7091-0332-6>
- Gruber, P., & Gosztonyi, S. (2010). Skin in architecture: Towards bioinspired facades. *WIT Transactions on Ecology and the Environment*, 138, 503–513. <https://doi.org/10.2495/DN100451>
- Gruber, P., & Jeronimidis, G. (2012). Has biomimetics arrived in architecture? *Bioinspiration & Biomimetics*, 7(1), 010201. <https://doi.org/10.1088/1748-3182/7/1/010201>
- Hasselaar, B. L. H. (2006). Climate Adaptive Skins: TOWards the new energy efficient façade. *WIT Transactions on Ecology and the Environment*, 99: 351-60.
- Hays, K. M. and Miller, D. (2008). *Buckminster Fuller - Starting with the Universe*. New York, Whitney Museum of American Arts and Yale University Press.
- Jeronimidis, G., & Atkins, a G. (1995). Mechanics of biological materials and structures: Nature's lessons for the engineer. *Proceedings of the Institution of Mechanical Engineers, Part C: Journal of Mechanical Engineering Science*, 209(4), 221–235. <https://doi.org/10.1243/PIME>
- Kapsali, V. (2016). *Biomimetics for Designers*. Thames and Hudson, London.
- Knippers, J., & Speck, T. (2012). Design and construction principles in nature and architecture. *Bioinspir. Biomim. BIOINSPIRATION & BIOMIMETICS Bioinspir. Biomim.*, 7(7), 15002–10. <https://doi.org/10.1088/1748-3182/7/1/015002>
- Lepora, N., Verschure, P., & Prescott, T. (2013). The state of the art in biomimetics. *Bioinspiration & Biomimetics*, 8, 1–11. <https://doi.org/10.3905/jpm.1974.408489>
- Lienhard, J., Schleicher, S., Poppinga, S., Masselter, T., Milwich, M., Speck, T., & Knippers, J. (2011). Flectofin: a hingeless flapping mechanism inspired by nature. *Bioinspiration & Biomimetics*, 6(4), 045001. <https://doi.org/10.1088/1748-3182/6/4/045001>
- Loonen, R. C. G. M., Rico-Martinez, J. M., Favoino, F., Brzezicki, M., Menezes, C., La Ferla, G., & Aelenei, L. (2015). Design for façade adaptability – Towards a unified and systematic characterisation. *Proceedings of the 10th Conference on Advanced Building Skins*, (November), 1284–1294.
- López, M., Rubio, R., Martín, S., & Ben Croxford. (2017). How plants inspire façades. From plants to architecture: Biomimetic principles for the development of adaptive architectural envelopes. *Renewable and Sustainable Energy Reviews*, 67, 692–703. <https://doi.org/10.1016/j.rser.2016.09.018>
- Mazzoleni, I. (2013). *Architecture Follows Nature*. Biomimetics Series, Taylor and Francis Group Publishing, California.
- Pawlyn, M. (2011). *Biomimicry in Architecture*. London, RIBA Publishing.
- Pesenti, M., Masera, G., Fiorito, F., & Sauchelli, M. (2015). Kinetic Solar Skin: A Responsive Folding Technique. *Energy Procedia*, 70, 661–672. <https://doi.org/10.1016/j.egypro.2015.02.174>
- Pohl, G. and Nachtigall, W. (2015). *Biomimetics for Architecture and Design*. Springer International Publishing, Switzerland.
- Schleicher, S. (2016). Bio-inspired compliant mechanisms for architectural design: transferring bending and folding principles of plant leaves to flexible kinetic structures. University of Stuttgart.
- Schinegger, K., Rutzinger, S., Oberascher, M. and Weber, G. (2012). *One Ocean: Theme Pavilion EXPO 2012*. Yeosu, Residenz Verlag.
- Speck, T., Harder, D. L., Milwich, M., Speck, O. and Stegmaier, T. (2006). *Bionik: Die Nature als Innovationsquelle für Technische Textilien*, edited by P. Knecht, 83-101. Technische Textilien, Frankfurt, Deutscher Fachverlag.
- Suralkar, R. (2011). Solar Responsive Kinetic Facade Shading Systems inspired by plant movements in nature. ... of Conference: People and Buildings Held at ..., (September), 1–6. Retrieved from http://nceub.commoncense.info/uploads/MC2011_MC69.pdf
- Tietz, J. (1999). *The Story and Architecture of the 20th Century*. Konemann.
- Vattam, S., Helms, M. and Goel, A. K. (2006). Biologically inspired innovation in engineering design: a cognitive study. Technical report, Graphics, Environment.
- Vincent, J. F. V., Bogatyreva, O. A., Bogatyrev, N. R., Bowyer, A., & Pahl, A.-K. (2006). Biomimetics: its practice and theory. *Journal of The Royal Society Interface*, 3(9), 471–482. <https://doi.org/10.1098/rsif.2006.0127>
- Vincent, J. F. Biomimetics: its practice and theory. *Journal of the Royal Society*, 3(April), 471–482. <https://doi.org/10.1098/rsif.2006.0127>
- Wiscombe, T. (2012). Beyond assemblies: system convergence and multi-materiality. *Bioinspiration and Biomimetics*, 7.015001.

Multi-functional biomimetic adaptive façades: A case study

Aysu Kuru ^a, Francesco Fiorito ^{a,b}, Philip Oldfield ^a, Stephen P. Bonser ^c

^a Faculty of Built Environment, University of New South Wales, Sydney, Australia

^b Department of Civil, Environmental, Land, Building Engineering and Chemistry, Polytechnic University of Bari, Bari, Italy

^c School of Biological, Earth and Environmental Sciences, University of New South Wales, Sydney, Australia

*Adaptive façades can be described as being able to express changes in form and function, and these changes are associated with desired aspects of building performance. Perhaps the best place to search for innovations in adaptive façades is in nature, where every organism has evolved multiple adaptations to survive in stressful environments. These strategies can be classified as dynamic or static depending on how they are induced by environmental stimuli. Translating strategies that control multiple parameters in biological organisms to the design of multi-functional biomimetic adaptive façades shows great potential. Given this, the research here explores dynamic and static mechanisms in nature to develop the design of a multi-functional biomimetic adaptive facade to improve thermal comfort in naturally ventilated buildings. A specific case study is designed from the principles of the morphological and physiological adaptations found in the barrel cactus (*Echinocactus grusonii*). These include: the form of the cortex; the morphology of areoles and spines; and plant responses to stressful conditions through opening and closing stomata. These adaptations are translated into a design of a multi-functional biomimetic adaptive façade. An environmental analysis for the case study is conducted with a defined performance target to improve thermal comfort in naturally ventilated school buildings. Simulations demonstrate there is a 51.5% improvement in 'ASHRAE55-2010 90% Acceptability Limits', and 67.5% in '80% Acceptability Limits' when incorporating the multi-functional biomimetic façade, as compared to traditional construction. The study demonstrates the performance potential of design generation from mechanisms in nature in the development of multi-functional adaptable facades.*

Keywords: Biomimetic adaptive facades, case study, multi-functional, architecture, design

1 Introduction

One of the primary aims of environmental design is to deliver comfort. Thermal comfort is related to building performance and determines the well-being and productivity of occupants in different environments (Health and Safety Executive 1999). Moreover, discomfort may bring health issues due to low standards such as sick building syndrome (Environmental Protection Agency 2009). Thermal comfort can be improved through the successful design of building envelope and systems (Holmes and Hecker, 2007).

The façade is the barrier between the inside and outside of a building. Similar to the skin of animals or epidermal tissue of stems, the building façade withstands fluctuating climatic conditions. A successful façade design is expected to meet several functional requirements and regulate multiple environmental factors. In nature, there is an extensive array of organisms specialised in different functions. The translation of biological solutions into adaptive façades would benefit from billion years of evolution. Given this, the research here aims to develop an approach for designing multi-functional biomimetic adaptive facades. The first paper in this series (Multi-functional biomimetic adaptive façades: Developing a framework is also written as part of FAÇADE 2018 Final Conference of COST TU1403 "Adaptive Façades Network"), describes the development of a design

framework that others can follow to design multi-functional biomimetic adaptive façades. This paper expands this, by demonstrating the implementation of the framework through a case study school building. The resultant multi-functional biomimetic adaptive façade is simulated to demonstrate its performance improving thermal comfort.

2 Multi-functionality in nature and architecture

Organisms have in-built adaptations with various functions in order to survive. The most efficient way to procure as many survival strategies as possible lies at the intersection of hierarchy and multi-functionality. Hierarchy in nature is having independent functional features in a multi-level structure from nano-to-macro scales. Each level in biological structures is comprised of similar elements but generates different parts (Knippers & Speck 2012). For instance, in plants, the stem structure is in the macro level of the hierarchy, followed by tissue, cell, cell wall and the biochemical composition of the cell wall which serves as the smallest scale (Speck and Rowe 2006). Multi-functionality in nature is the integration of more than one function into a single system where a unified structure is capable of controlling a variety of functions (Knippers & Speck 2012). Almost every organism has diversified functions at multiple levels of a single component in the hierarchy to withstand stresses, mostly caused by the thermal environment. In nature, efficiency in material and matter are vital for advancement; organisms evolved their adaptations as hierarchical and multi-functional structures as structure, function and form being often carried in the same substance with quite fluid boundaries. It is difficult to determine the function of an element in isolation of its other uses.

While this is the case in nature, on the contrary, in architecture, buildings are composed of individual components with separate functions often performing single tasks. Current studies concentrate on mono-functional elements assembled into a single system that is subsequently multi-functional. For instance, components of a window are designed separately fulfilling different requirements, such as daylighting and external view controlled by glass' properties, while glaring and solar gains controlled using shadings. The façade needs to manage multiple aspects to meet the functional requirements of a building and protect the indoors from environmental factors such as wind, precipitation, humidity, outdoor temperature and solar radiation (Aelenei et al. 2016). Façade systems aim at meeting a wide range of various functional requirements that are often contradictory. For example, achieving optimum illuminance with minimum glare and having high thermal storage with lightweight, permeable structures (Gosztonyi et al. 2010).

The concept of adaptive façades is an emerging area integrating various functions into the building envelope with a focus on adaptability. The definition of adaptability in façades is the ability to meet various functional requirements to improve building performance to changing climatic circumstances. On the other hand, the successful design of an adaptive façade is substantially associated with multi-functionality. Multi-functionality in façades refer to façade systems having more than one functional requirement controlled independently. Therefore, the development of multi-functionality in façades can benefit from the integration of lessons learnt from biological structures.

3 Implementation of a framework for the development of multi-functional biomimetic adaptive façades

A new framework for the development of multi-functional adaptive façades is proposed to promote the translation of multi-functionality in nature into architecture. The framework consists three main steps: (1) the definition of boundary conditions and functional requirements, (2) selection

and mapping of corresponding multi-functional biological adaptations, and (3) design generation for multi-functional biomimetic adaptive façades (Fig 1). The boundary conditions determine the required functions through a base-case model with a selected climate and building typology. The biological model is selected through a map provided as a growing database that is comprised of the investigation and classification of numerous multi-functional mechanisms in nature with their specific features such as their biological organisation levels, stimulus, adaptation types and levels. Design generation for multi-functional biomimetic adaptive façades is achieved through a series of translation of the biological adaptations. The biological organisation levels help transferring different functions in a hierarchical multi-level structure of an adaptive façade. The first two steps of the framework serve as the inputs for design. Boundary conditions give the technical design input and biological models give the biological design input. These steps define the technical problem as functional requirements to be solved by natural adaptations. The third and last step, the design generation, gives the strategy, therefore the output of the framework.

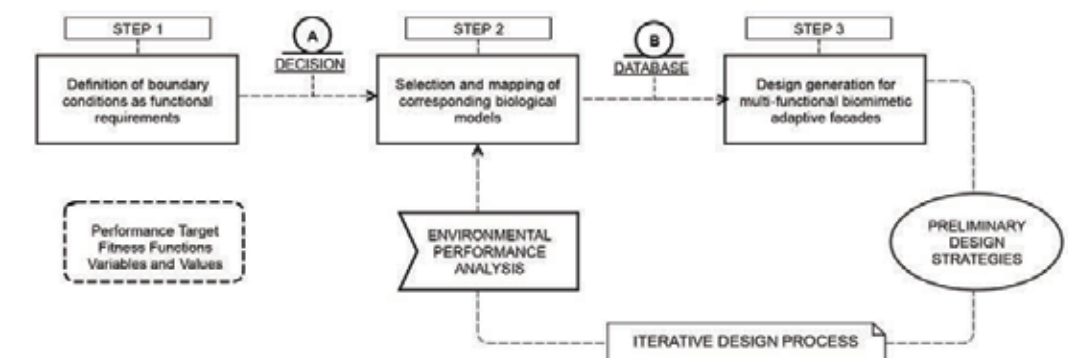

Fig. 1 A new framework for designing multi-functional biomimetic adaptive façades

In addition to the three main steps, the framework proposes a quantitative analysis of the developed façade design to analyse its environmental performance and determine the most promising design strategy. It is suggested that through a series of design generations of façades, the most promising option will be selected in terms of its performance through simulations. The target of the performance analysis and fitness functions are determined according to the boundary conditions identified. In this case study, the target is improving thermal comfort standards by controlling solar gains and ventilation. The fitness functions for the comfort analysis are ventilation rate, temperature, visible light transmittance and solar heat gain. The variables set for the building performance simulation are opening ratio and schedule, shading geometry and schedule; and materiality for thermal resistance and conductivity of the glazing. The case study acts as an example of implementing the framework demonstrates a design option and its performance as an outcome.

4 Definition of boundary conditions and functional requirements

4.1. Boundary Conditions

The boundary conditions are identified to determine the functional requirements to improve thermal comfort. This comprises the selection of a climate, location, building typology, architectural design of a specific building, local building regulations and the ventilation type. This paper focuses on Western Sydney, Australia. With the positive impact of being a coastal city, Sydney has mild winters and warm summers due to the presence of sea breeze (Glasow, 2013). In contrary to the situation on the coastline, inland areas especially the western part of the city suffer from hot temperatures

in dense precincts (Santamouris et al. 2018). In this case, naturally ventilated buildings can be highly affected by the extreme climatic conditions resulting in greater occupant discomfort. A high-performing dynamic system regulating multiple environmental factors demonstrates a higher chance of improving comfort compared to a conventional approach (Fiorito & Santamouris 2017). Therefore the focus of this research is implementing dynamic façade systems in naturally ventilated buildings.

To determine the reference scenario of what happens in Sydney, a digital reference building from the United States Department of Energy (US DoE) was selected to serve as a base-case model. The typology was selected as an educational building. The reference building was located in Atlanta, USA, as Atlanta shows climatic similarity to Western Sydney. It is anticipated that the geometry of the reference building is suitable for a similar climate. Only one thermal zone, a corner classroom in the reference building, is modelled to simplify the simulation and modeling processes. The classroom was originally located in the South-West corner of a primary school. The corner classroom is rotated by 180° due to Sydney and Atlanta being in different hemispheres. Therefore, the corner classroom is now located in the North-East corner. The ventilation type is switched to natural ventilation from mechanical ventilation with 50% operable windows and external louvers to provide shading. Glazing type and its thermal properties, aperture ratio, shading's slat data and dimensions and ventilation rate are compliant with National Construction Code (NCC) of Australian Building Codes Board (ABCB 2018).

4.2. Performance Analysis

The specifics of the reference building's architectural and technical properties are listed in Table 1. The information provided in this table are not changed with the implementation of the new façade design. The values are taken from the original base-case digital building model from US DoE, followed by a compliance process for NCC of ABCB. Some changes are made to comply with the local building standards in Australia and to convert the ventilation type from mechanical to natural. The building simulation is conducted targeting thermal comfort analysis using Adaptive Comfort Model measures of ASHRAE 55-2010 Standards as simulation output. To demonstrate the climatic situation in Western Sydney, the weather file for Sydney Airport is used. Sydney Airport serves as a benchmark for the Western Sydney climate throughout a typical year similar to Bankstown and Sydney Olympic Park, which are located further in the west (Santamouris et al. 2017).

Parameter	Value
Floor area	97 m ²
Volume	388 m ³
Floor-to-ceiling height	4.00 m
Lighting load	15.06 watts/m ²
Internal equipment load	15 watts/m ²
Occupants density	0.4 people/m ²
Construction of external walls	Steel frame structured walls
External walls R-value	1.469 m ² K/W
External walls U-value	0.681 W/m ² K
Air change rate for natural ventilation	7.5 ac/h
Ventilation operation schedule	Always on when occupied
Infiltration rate	0.00302 ac/h

Table 1: Corner classroom zone data summary.

The openings data for the base-case building comprising of glazing, aperture and shading is provided in Table 2. A double glazed low emittance clear glass is replaced with the original digital reference model due to the previous glazing's obsolete typology which was a single glazing with a poor performance. The double-glazed openings reflect the case of a high-performing scenario suitable for a comparison with an adaptive façade design. High solar reflecting and low transmitting louvers are also placed on the exterior of the façade and switched to always on throughout the year. The thermal properties of the shading system are kept the same for the new façade design to be able to compare the results for changes made in the typology and geometry of the biomimetic façade.

Glazing	Parameter	Shading	Parameter
Type	LoE double glazed with 3 mm clear glass and 13 mm air gap	Type	High reflectance low transmittance louvers
Solar heat gain coefficient (SHGC)	0.598	Orientation	Horizontal external
Visible light transmittance (VLT)	0.769	Slat angle	45 – 90° (maximum)
U-value	1.798 W/m ² K	Slat width	50 mm
Window-to-wall ratio (WWR)	35% glazed	Slat thickness	0.2 mm
Aperture	90% of the glazing	Slat conductivity	0.900 W/mK
Aperture location	Top	Shading schedule	Always on
		Solar reflectance	0.800
		Solar transmittance	0.100

Table 2: Base-case glazing and shading properties summary.

The results for the performance analysis show that the total energy consumption of the building is 123.13 kWh/m² (Table 3). A significant amount of the energy use is due to lighting and equipment needs with 50.87 kWh/m² and 58.43 kWh/m² respectively. In contrast, heating is the least energy consuming element with a value of 2.77 kWh/m². The analysis is run to determine thermal comfort therefore the mechanical ventilation is out of operation. The analysis for the adaptive comfort model presents the number of discomfort hours annually in a typical year in two different categories for the acceptable range of indoor temperatures to the outdoor conditions. The results show that 1112.50 hours in total fall in the ASHRAE 55 90% acceptability limits and 685.50 hours in the 80% acceptability limits.

Energy Demand	Energy Usage	Number of Discomfort Hours	
Internal Gains		ASHRAE 55 90% Acceptability Limits	ASHRAE 55 80% Acceptability Limits
Heating	2.77 kWh/m ²		
Lighting	50.87 kWh/m ²		
Internal equipment	58.43 kWh/m ²		
Total	123.13 kWh/m ²	1112.50 hours	685.50 hours

Table 3: Results of energy demand and discomfort hours for the base-case model.

5 Selection and investigation of corresponding biological model

5.1. Selection

Simulation results show that solar gains and ventilation are major concerns affecting the performance. Therefore the functional requirements are maintaining and losing light and heat and gaining and exchanging air with the purpose of decreasing operative temperatures and increasing

ventilation for cooling. The environmental factors and their controls assist in investigating the corresponding biological models mapped in a database. The database is further explained and explored in detail in 'Multi-functional biomimetic adaptive façades: Developing a framework' also as part of FAÇADE 2018 Final Conference of COST TU 1403 "Adaptive Façades Network"). As a result of a selection from the database, some organisms were identified such as the barrel cactus (*Echinocactus grusonii*), sensitive plant (*Mimosa pudica*) and big pine cone (*Pinus coulteri*). For the purposes of this research, the barrel cactus was chosen as the biological model to pursue.

5.2. Investigation

The selected organism is investigated in the database to comprehend its multi-functional, adaptive and performative features. The database offers an extensive mapping and classification of organisms with various functions present at different biological levels regulating multiple environmental factors. Fig 2 shows the classification of the barrel cactus and its three primary mechanisms to regulate environmental factors; the expanding dynamic mechanism of the cortex; the self-shading static mechanism of areoles and spines; and the dynamic microscopic stomatal openings on the epidermal layer of the stem (Fig 3).

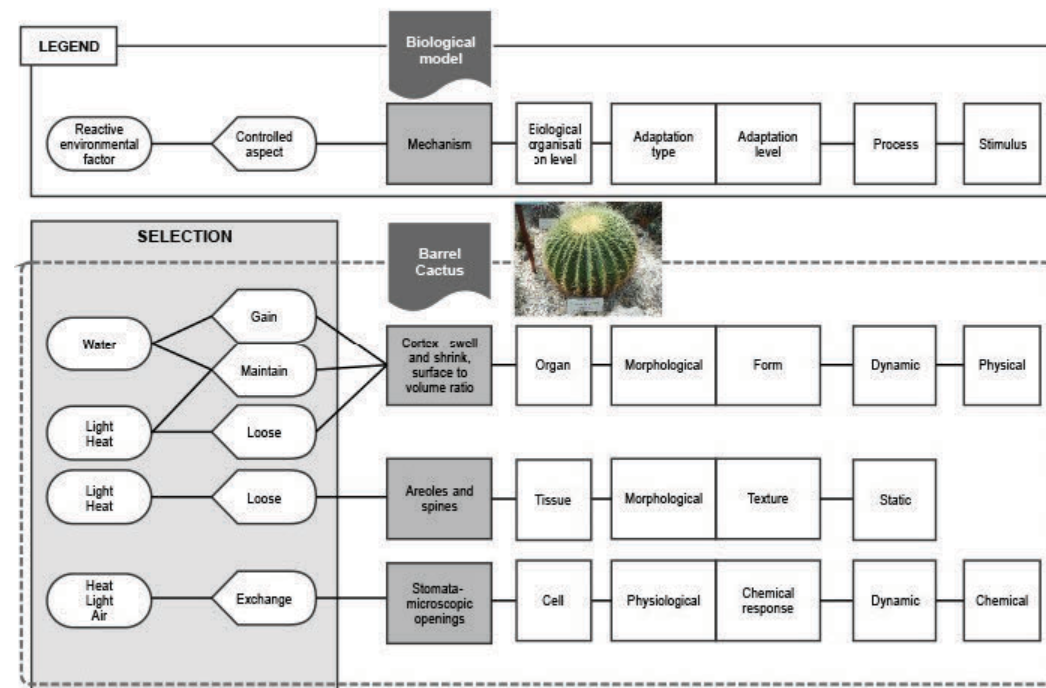

Fig. 2 Mapping biological mechanisms of the barrel cactus (*Echinocactus grusonii*)

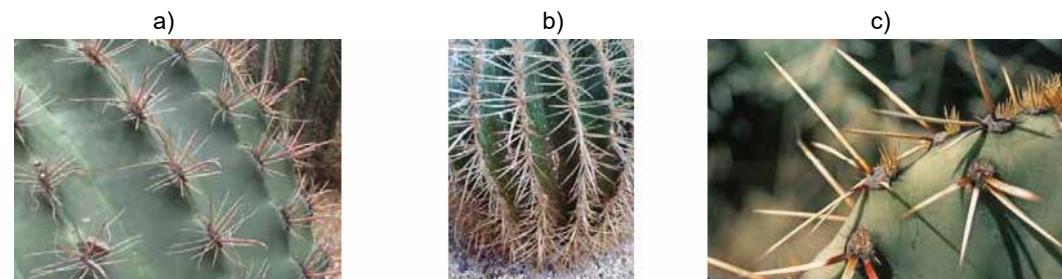

Fig. 3 The barrel cactus (*Echinocactus grusonii*) a) swollen, b) shrinking; and c) areoles and spines (Source: New York Botanical Garden)

The cortex is the stem of the cactus that is covered with a unique ribbed morphology. This structure of the ribs give the plant the ability to swell and shrink in response to changing internal water content and outside temperature. The barrel cactus is capable of expanding its surface area up to 54% helping losing heat by having a high surface-to-volume ratio (Nobel 1977). Ribs decrease the average plant surface temperature for both winter and summer days about 1-2°C. With the help of its areoles and spines, the barrel cactus creates shaded areas increasing this cooling effect. Areoles are unique structures to cacti situated on the epidermal layer of stems where spines grow. In fact, the difference between the hourly surface temperature of the stem with spines compared to without spines is 16°C in summer and 6°C in winter (Nobel and Gibson, 1986). The ribs, spines and areoles together decrease the average hourly surface temperature by 5°C for a summer day and 0.2°C for a winter day (Nobel, 1988; Nobel and Gibson, 1986). The stoma is a reversible, nastic structure operating as a valve on cactus` stem to balance the intake of carbon dioxide with water loss (Lee, 2010; Hopkins, 1995). The barrel cactus, like vascular plants, uses the stomatal openings to cool its stem surface and collect air by generating negative pressure through evaporation (Bar-Cohen, 2005; Stahlberg and Taya, 2006). There are between 15 to 70 stomata per/mm² in a cactus (Park et al., 2016). This number is much less than in other plants since cacti need to conserve water in their typically hot and arid habitat.

6 Design generation for multi-functional biomimetic adaptive façade

The two dynamic mechanisms of the barrel cactus which are ribs-structured expanding cortex and stomatal openings are transferred into a façade component to form a pattern replacing the whole façade of the base-case building. The stomatal openings are transferred into a dynamic opening system and the cortex morphology is transferred into an expanding shading system. The façade component is duplicated along x and y-axes to replace a whole façade. The shape of the component is a hexagon with a maximal radius and side length equal to 500 mm. Therefore, the height of a whole component measures 1 meter and four components will be covering the length of the whole façade. The two functional requirements of the façade are controlled individually through the difference in axes of displacement as movement in y-axis for ventilation and x-axis for shading.

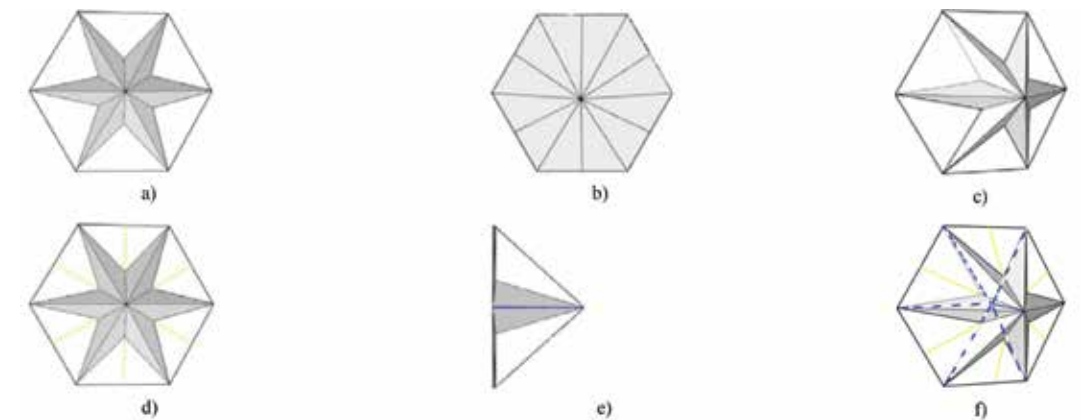

Fig. 4 a) Fully open/ventilating, b) fully closed/shading, c) intermediate/shading ventilating states, d) displacement in y-axis, e) displacement in x-axis, and f) displacement in both x and y-axes of the façade component

The thermal and material properties of the glazing are kept the same as the base-case model to determine the improvement by implementing the biomimetic adaptive façade as a new morphology (Table 4). The aim of the analysis is to focus on the different geometry and typology of the implemented façade. The whole façade is replaced with the biomimetic adaptive façade with a window-to-wall ratio (WWR) of 90%. The shading is modelled as a horizontal shading module

mimicking the geometry with a dynamic movement following the occupancy schedule. When solar gains are higher than 120 W/m² the shading mechanism is activated. The mechanism allows maximum shading and ventilation at noon with an angle of 90° gradually reaching closure in the morning and the evening (Fig 5). The width of the slats are calculated as 500 mm and the thickness is 0.2 mm. The fully open configuration is measured as a 90% maximum opening. The expanding mechanism for is equal to the radius, side length and slat width of the component.

Glazing	Parameter	Shading	Parameter
Type	LoE double glazed with 3 mm clear glass and 13 mm air gap	Type	Expanding internal and external shading
Solar heat gain coefficient (SHGC)	0.598	Orientation	Horizontal
Visible light transmittance (VLT)	0.769	Slat angle	45 – 90° (maximum)
U-value	1.798 W/m ² K	Slat width	500 mm
Window-to-wall ratio (WWR)	90% glazed	Slat thickness	0.2 mm
Aperture	90% of the glazing	Slat conductivity	0.900 W/mK
Aperture location	Top	Shading setpoint	On when solar gains are higher than 120 W/m ²
		Shading control	Following occupancy schedule

Table 4: Façade design modeling summary.

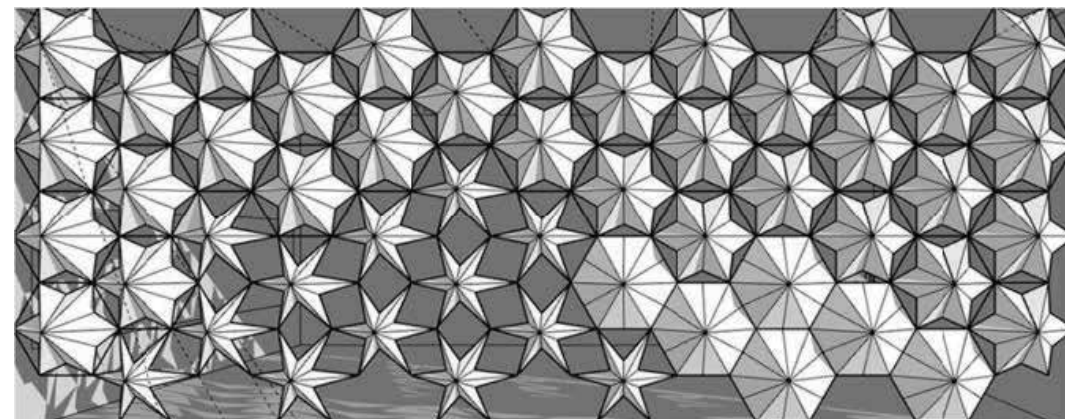

Fig. 5 Shading study of the whole façade design

7 Environmental performance analysis

An environmental performance analysis for an entire typical year in Sydney is conducted and the results show that there is a substantial improvement in comfort levels with the implementation of the biomimetic adaptive façade design (Table 5). The ventilation type and operation of the building are kept same as the base-case model as naturally ventilated with the same air change rate of 7.5 ac/h. The total number of discomfort hours are reduced according to the adaptive thermal comfort model by ASHRAE 55-2010 (Fig 6). The discomfort hours for Acceptability Limits 90% are reduced from 1112.50 to 540.50 (51.5%) and for Acceptability Limits 80% are reduced from 865.50 to 282.00 hours (67.5%). On the other hand, the total energy use is quite similar with an increase of 3.4% while the heating demand is more than doubled. It increased by 60.8% reaching 7.05 kWh/m² from the initial case of 2.77 kWh/m². This comparison shows that the summer discomfort hours are reduced substantially while winter discomfort hours are increased slightly with a need for additional heating.

Energy Demand	Value	Difference	ASHRAE 55-2010	Number of discomfort hours	Difference
Heating	7.05 kWh/m ²	60.8% increased	90% Acceptability Limits	540.50 hours	51.5% reduced
Total energy usage	127.41 kWh/m ²	3.4% increased	80% Acceptability Limits	282.00 hours	67.5% reduced

Table 5: Results of energy demand and discomfort hours for the façade design.

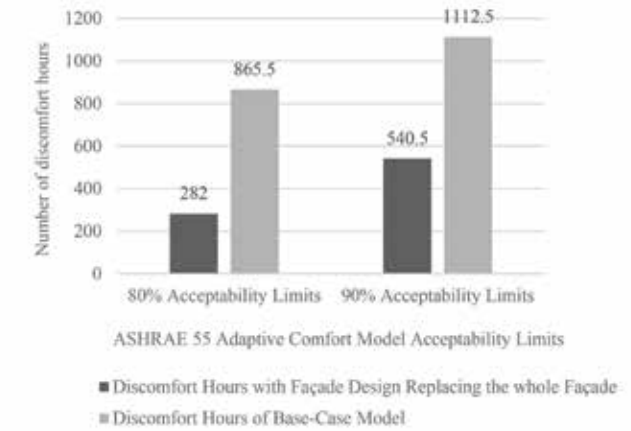

Fig. 6 Number of discomfort hours comparison between the base-case model and the façade design

8 Conclusion

This research demonstrates the implementation of a proposed framework discussed in the paper 'Multi-functional biomimetic adaptive facades Developing a framework'. A double-side oriented corner classroom in a naturally ventilated primary school in Western Sydney is the reference scenario due to its high energy use and low comfort. An environmental analysis is conducted to calculate the number of hours not meeting Adaptive Thermal Comfort model for ASHRAE55-2010. The results show that discomfort hours are 1112.50 hours in the ASHRAE 55 90% acceptability limits and 865.50 hours in the 80% acceptability limits with solar gains and ventilation being primary reasons. To improve these results, the functional requirements of a new biomimetic adaptable façade are defined as managing and losing light and heat and gaining and exchanging air. Through an investigation from an extensive database of multi-functional mechanisms in nature, the barrel cactus (*Echinocactus grusonii*) is selected as biological inspiration. The expanding dynamic mechanism of the cortex and the dynamic microscopic stomatal openings on the epidermal layer of the stem are translated into a multi-functional biomimetic adaptive façade design. The design is used to replace the façade of the base-case model and an environmental analysis is conducted to demonstrate the improvement. The results show that the total number of discomfort hours with ASHRAE55-2010 Adaptive Thermal Comfort model input are reduced substantially by 51.5% for 90% limits having 540.50 discomfort hours and 67.5% for 80% limits having 282.00 discomfort hours. On the other hand, the total energy consumption shows similar values. The heating load is more than doubled demonstrating that winter comfort levels are dropped slightly with a need for more heating. The improvements in comfort levels are related to warm and hot seasons in a year, ranging from October to April. The next steps for this research are to generate different design options for the façade derived from the same biological principles to identify the most promising biomimetic design strategy.

9 Acknowledgement

The authors would like to acknowledge financial support from Wightman Bequest School of Architecture and Design Scholarship and Postgraduate Research Student Support funded by the Faculty of Built Environment at UNSW Sydney.

10 References

- ABCB, 2018. NCC Volume One. Energy Efficiency Provisions. Handbook (2014). Australian Building Codes Board.
- Aelenei, D., Aelenei, L. & Vieira, C.P., (2016). Adaptive Façade: Concept, Applications, Research Questions. *Energy Procedia*, 91, pp.269–275. Available at: <http://dx.doi.org/10.1016/j.egypro.2016.06.218>.
- Bar-Cohen, Y. (2005). *Biomimetics: Biologically Inspired Technologies*. CRC Press, Taylor and Francis Group Publishing, Florida.
- Environmental Protection Agency (2009). Sick building syndrome: buildings and their impact on the environment. A statistical summary. Available at: <http://www.epa.gov/greenbuilding/pubs/gbstats.pdf>. Accessed on 10/05/2018.
- Fiorito, F. and Santamouris, M., (2017). High performance technologies and the future of architectural design. *Techne*, 13(August).
- Gosztonyi, S., Brychta, M. & Gruber, P., (2010). Challenging the engineering view: Comparative analysis of technological and biological functions targeting energy efficient facade systems. *WIT Transactions on Ecology and the Environment*, 138, pp.491–502.
- Health and Safety Executive (1999). *Thermal Comfort in Workplace. Guidance for Employers*, HSE Books, C250 7/99.
- Herrel, A., Speck, T. and Rowe, N. P. (2006). *Ecology and Biomechanics: A Mechanical Approach to the Ecology of Animals and Plants*. CRC Press, Taylor and Francis Publishing Group, ISBN 9780849332098.
- Holmes, M. J. and Hecker, J. N. (2007). Climate change, thermal comfort and energy: meeting the design challenges of the 21st century. *Energy and Buildings*: 39, 7: 802-814.
- Hopkins, W. G. (1995). *Introduction to Plant Physiology*. John Wiley and Sons, Canada.
- Knippers, J. & Speck, T., (2012). Design and construction principles in nature and architecture. *Bioinspir. Biomim. BIOINSPIRATION & BIOMIMETICS Bioinspir. Biomim.*, 7(7), pp.15002–10. Available at: <http://iopscience.iop.org/1748-3190/7/1/015002>.
- Lee, J. S., Kuroha, T., Hnilova, M., Khatayevich, D., Kanaoka, M. M., McAbee, J. M., Sarikaya, M., Tamerler, C. and Torii, K. U. (2012). Direct interaction of ligand-receptor pairs specifying stomatal patterning. *Genes and Development*.
- Nobel, P. S. (1988). *Environmental Biology of Agaves and Cacti*. Cambridge University Press. ISBN-13: 978-0521343220.
- Nobel, P. S. and Gibson, A. (1986). *The Cactus Primer*. Harvard University Press. ISBN-13: 978-0674089914.
- Nobel, P.S., 1977. Water relations and photosynthesis of a barrel cactus, *Ferocactus acanthodes*, in the Colorado desert. *Oecologia*, 27(2), pp.117–133.
- Park, C. H., Lee, S. Y., Hwang, D. S., Shin, D. W., Cho, D. H., Lee, K. H., Kim, T., Lee, M., Kim, D., Doherty, C. M., Thornton, A. W., Hill, A. J., Guiver, M. D. and Lee, Y. M. (2016). Nanocrack-regulated self-humidifying membranes. *Nature*: 532, p. 480-3.
- Santamouris, M., Haddad, S., Fiorito, F., Osmond, P., Ding, L., Prasad, D., ... Wang, R. (2017). Urban heat island and overheating characteristics in Sydney, Australia. An analysis of multiyear measurements. *Sustainability (Switzerland)*, 9(5). <https://doi.org/10.3390/su9050712>.
- Stalberg, R. and Taya, M. (2006). *Nastic structures: the enacting and mimicking of plant movements*. *Biomimetics - Biologically Inspired Technologies*, CRC Press, Taylor and Francis Group Publishing, Florida, p. 473-493.
- Santamouris et al. (2018). On the energy impact of urban heat island in Sydney: Climate and energy potential of mitigation technologies. *Energy & Buildings* 166, 154–164.
- Santamouris, M. et al., (2017). Urban heat island and overheating characteristics in Sydney, Australia. An analysis of multiyear measurements. *Sustainability (Switzerland)*, 9(5).
- United States of America Department of Energy. *Commercial Reference Buildings. New construction, primary school*. Available at: <https://www.energy.gov/eere/buildings/commercial-reference-buildings>. Accessed on 11/05/2018.
- Von Glasow, R.; Jickells, T.D.; Alexander, B.; Carmichael, G.R.; Church, T.M.; Gallardo, L.; Hughes, C.; Kanakidou, M.; Liss, P.S.; Mee, L.; et al. (2013). Megacities and Large Urban Agglomerations in the Coastal Zone: Interactions Between Atmosphere, Land, and Marine Ecosystems. *Ambio*, 13, 13–28.

The Role of Geometry for Adaptability: Comparison of Shading Systems and Biological Role Models

Susanne Gosztonyi 1, 2

1 Competence Center Building Envelope, Institute of Civil Engineering, Lucerne University of Applied Sciences and Arts Engineering and Architecture, Technikumstrasse 21, 6048 Horw, Switzerland, susanne.gosztonyi@hslu.ch

2 Architectural Facades and Products Research Group, Design of Construction, Architectural Engineering and Technology, TU Delft, Julianalaan 134, 2628 Delft, The Netherlands, s.gosztonyi@tudelft.nl

Dynamic shading systems represent the majority of realised adaptive façades. It seems that geometrically complex kinetic solutions have increased in recent years, mainly due to the use of parametric design tools and digital production. In most shading systems, however, geometry rarely plays a guiding role in the design. The kinetic mechanisms are confined to linear or planar geometries. Geometry plays an important role in biological organisms, because it is the decisive factor for efficiency and growth. Their growth patterns could provide new insights for dynamic shading designs. For this, spatial morphology criteria for shading systems were identified to obtain criteria directly related to geometry. These were supplemented by criteria on kinetic mechanisms. Then, biological analogies that correlate geometrical structures with adaptability were sought. Using biomimetic methods, particularly from functional morphology, principles in growth patterns were analysed and compared to shading systems. It revealed that the restriction to space, location, and material-inherent properties does not affect the solution diversity, but follows an evolutionary objective: Plants, for example, use ingenious geometrical structures to allow adaptation, mainly over lifetime but also dynamically. Whether these principles can be applied to the design of dynamic shading systems is then discussed. The aim of the paper is to provide impulses for further studies on adaptive shading systems that focus on the innovative use of space with greater flexibility in motion. The overall premise of the paper is to demonstrate the applicability of biomimetic methods for architectural engineering.

Keywords: adaptive facades, shading systems, biomimetics, geometry, growth pattern, kinetic mechanisms, spatial morphology

Full paper available in the *Journal of Facade Design and Engineering*, Vol 6 No 3 (2018): Special Issue FAÇADE 2018 – Adaptive!

Innovations in façade engineering and a glass façade for the future

Daniel Pfanner a), Ümit Esiyok b), Teodora Vatahska c)

a) Frankfurt University of Applied Sciences, Bollinger + Grohmann, Germany, daniel.pfanner@fb1.fra-uas.de

b) Bollinger + Grohmann, Germany

c) HTCO, Germany

Today it feels that the dream of façades with a maximum transparency is further away from reality than ever. Clear and unobstructed views from the inside into the outside environment and maximum daylight autonomy are in clear contradiction to available technologies of today. The main reason is the inevitable requirement of solar protection to avoid solar heat gains and consequently high cooling capacities in buildings. Solar coatings, tinted glass, switchable windows and classic interior and exterior sun shading devices all have the same general effect: The quality of the views to the outside is reduced, the amount of available daylight decreases. The contribution concentrates on a project funded by the European Union (InDeWaG - Industrial Development of Water Flow Glazing Systems) within the framework of the European research program HORIZON 2020. An international consortium incorporating research institutes, industry and designers is developing a new insulation glass unit. In the cavity of this unit, a fluid mixture is circulating within a closed loop. It absorbs the infrared radiation of the sunlight and thus reduces the solar gains into the interior. Maximum daylight use with appealing glass façades and at the same time meeting nearly zero energy building (nZEB) performance is the main objective of the InDeWaG approach. The contribution gives an overview of the current state of the project and enlightens the possible potential of the technology.

Keywords: Daylight, energy efficiency, fluid flow glazing (FFG)

1 Introduction

Glass façades play a significant role in terms of energy losses and gains of buildings. The ideal glass has optical properties that can easily adapt to changing climatic conditions. Concepts for multifunctional building envelopes try to come close to this ideal, using motorized shading elements, switchable glasses and multi-layer façade systems with and without ventilation. In most systems, the implementation of summer heat protection usually leads to a deficit in the daylight autonomy inside the building as well as to constraints of the views from the inside to the outside environment. Both have an impact on the well-being, health and productivity of building users (Boubekri et al. 2014).

Fluid Flow Glazing (FFG) allows the control of solar heat gains through the glass without significantly impairing its transparency. A water-based fluid is circulating through one of the glass cavities of the IGU within a closed loop. Due to its spectral properties, it captures most of the infrared solar radiation. It is transparent to visible wavelengths of the sunlight but opaque to NIR wavelengths. Consequently fluid flow glazing has almost the same natural light transmission as conventional glazing whilst reducing the heat transfer towards the interior space. This leads to energy savings in building operation. The objective of InDeWaG is to contribute to the building envelope of nZEB (nearly Zero Emission Buildings) by means of FFG. In addition, FFG offers potential to absorb and use energy, as well as to reduce cold radiation of the inner glass pane in winter.

The current research project InDeWaG is not the first to deal with fluid-filled insulating glazing units. Pilkington filed the first patent for a fluid flow façade in 1972: a fluid circulating in a glass cavity with spacers (Woods 1972). Another patent was filed by Frederick McKee in 1982 (McKee 1982) for windows filled with a dyed heat-transfer fluid which is connected to a closed fluid loop and to the MEP system of the building. Test results and parameters have been published in depth (McKee 2007). Another patent, called “All season window” was also filed in 1982 by

R. Seemann. A triple glazing unit was placed in a fluid-filled frame. The absorbing fluid was either filled into the exterior cavity during summer or the interior cavity during winter (Seemann, 1982).

Over the past few years, different emphases have been put on fluid flow façade systems, two of which mentioned below. First, the project FLUIDGLASS which is based on the extensive research activities of Dietrich Schwarz who developed the patent „Method for Transparent Heat Insulation in a Building“ (Schwarz 1998). The focus of Fluidglass is a solar-thermal glass façade with adjustable transparency (Stopper 2018).

Second, the research focus of the Universidad Politécnica de Madrid (UPM), where fluid flow glazing has been investigated during more than the past ten years with regard to its physical behavior, the construction practice and the long-term behavior during the life-time of such glazing units (Del Ama Gonzalo 2016). At UPM, also participating as a research partner in the InDeWaG project, research results have already been implemented in the built environment, e.g. a façade in Carcagente, Spain, which was completed in 2010. With regard to thermal simulations, Chow and Li carried out studies of water flow façades, in which the performance of a water-filled insulation glass unit has been simulated and compared with experimental data (Chow and Li 2011).

2 Structural behavior

The composition of the insulating glass unit for the FFG modules is shown schematically in Figure 1. Each of the two laminated glass panes consists of 2x8 mm of heat-strengthened glass and a 1.52 mm thick Sentryglas plus interlayer. The water chamber is located in between two laminated safety glass panes and there is an argon-air mixture in the second cavity.



Fig. 1 Schematic composition of the insulating glass unit (IGU).

Due to the aspired story-high unit dimensions of approximately $W \times H = 1300 \times 3000\text{mm}$, the hydrostatic pressure in the water-filled cavity represents as a matter of fact the relevant load case for the structural design of the pane. The above-mentioned dimensions of the unit would lead to a hydrostatic pressure of 30kN/m^2 which is 10 to 20 times higher than the relevant wind load for a typical high-rise façade. The chosen approach to react to the high hydrostatic loads is the filling process for the glass units. The units are filled lying down in a first step. After the fluid has been degassed, parts of the fluid are extracted via a pump and a vacuum is established before the unit is set up. This vacuum is currently being investigated within the following limits. An exemplarily resulting pressure curve shown in Figure 2.

- Compensation of the entire hydrostatic pressure of 3m height, 30kN/m^2
- Compensation of half of the hydrostatic pressure, 15kN/m^2

The following boundary conditions have been assumed for the calculation:

- The third glass pane of the triple insulation glass unit has been neglected in order to simplify the simulation model
- Interactions between the adjacent glass panes through the water have not been taken into account.
- Temperature changes have not been taken into account.
- Linear hinged support conditions on all four sides.
- Square shell finite elements with geometric non-linearity.
- Conservative shear modulus $G = 0$ in accordance with the certification of SGP (Sentryglas plus) for overhead glazing (overhead glazing is the only practical reference for glass panes constantly under bending stress due to permanent loads).

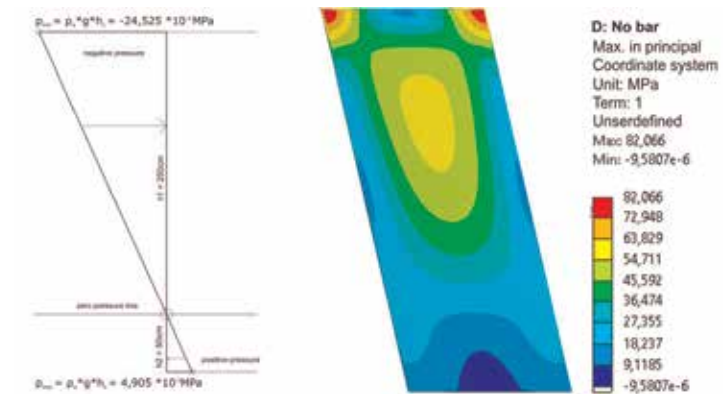

Fig. 2 Pressure distribution in the cavity (left) and corresponding equivalent tensile stresses (right).

The simulation models were calibrated with the Finite Element software tools ANSYS and DLUBAL. The structural analysis has been conducted in accordance with the German DIN 18008: “Glass in buildings” for the following additional loads:

- Dead load of the glazing
- Wind pressure $0,65\text{kN/m}^2$ / wind suction $1,1\text{kN/m}^2$
- Horizontal line load 1kN/m in $0,9\text{m}$ and 1m height representing people impact and the fall protection requirements.

The equivalent bending stresses for all tested configurations of the pressure distribution in the cavity show clearly too high bending stresses and deformations in the glass, even assuming high stress limits as for heat strengthened and tempered glass. It has to be mentioned that exceeded stress and deformation limits could be easily eliminated by increasing the number of laminated single glass layers for the panes adjacent to the fluid-filled cavity, i.e. leading to triple or even quadruple laminated safety glass panes. However, this would significantly increase the thickness and especially the weight of the units. Consequently, the development of a lighter and thus smarter solution by means of additional bracing measures within the fluid-filled cavity of the IGU.

2.1. Bracing components in the cavity.

Different alternatives for bracing the fluid cavity are currently under investigation. Both, the geometrical variations and the material opportunities have been developed and tested. Geometrically, punctual pin-like elements and linear fins have been integrated in between the two adjacent glass panes, consisting of glass or UV-resistant polycarbonate materials (Figure 3). The

connection to the glass panes depends on the resulting stresses between bracing component and glass pane: the negative pressure in the cavity ensures no or only very little locally limited tension stresses. Consequently, pure contact between the two glass panes would satisfy their deformation compatibility. On the other hand, in the case of higher tension stresses in the bracing components, they have to be mechanically glued to the glass panes. Then, particular attention must be paid to the connection between glass panes and bracing component and especially to the compatibility of any adhesives with the fluid mixture. The Fraunhofer Institute for Solar Energy Systems ISE carries out extensive testing series for this purpose. Merchantable adhesives are screened for the influence of the heat carrier fluid by means of accelerated aging tests and mechanical characterization of the material properties. The material test specimen are designed based on the application in the glazing unit and allow a maximum transfer of the obtained results into the development process. The investigated adhesives are butyl rubbers and two component silicones.



Fig. 3 Prototypes for punctual (left) and linear (right) bracing components in the cavity.

The calculation results (Fig. 4) show that the limits for the glass bending tensile stresses can be easily met by means of the bracing measures in the cavity. A very accurate simulation of the transition areas using high-resolution FE models leads to a better distribution and thus a reduction of the maximum stresses. However, the crucial and decisive factor for the bracing system will be the compatibility of the materials (adhesive, sealants, fluid) used in order to ensure the durability of the mechanical connection.

3 Flow simulations

3.1. Modelling of the FFG modules

In order to ensure the optimal integration of the FFG modules into the climate concept of the entire building, the understanding of their exact spectral, thermal, mechanical and fluid dynamic properties is indispensable. For this purpose mathematical models for the relevant physical processes (heat exchange, fluid flow dynamics, optical and structural behavior as well as environmental influences) are represented within a software model of the FFG unit using highly complex flow simulations (CFD = Computational Fluid Dynamics). The results are validated by spectrophotometer and calorimetric measurements (Chapter 5).

Experimental Tests

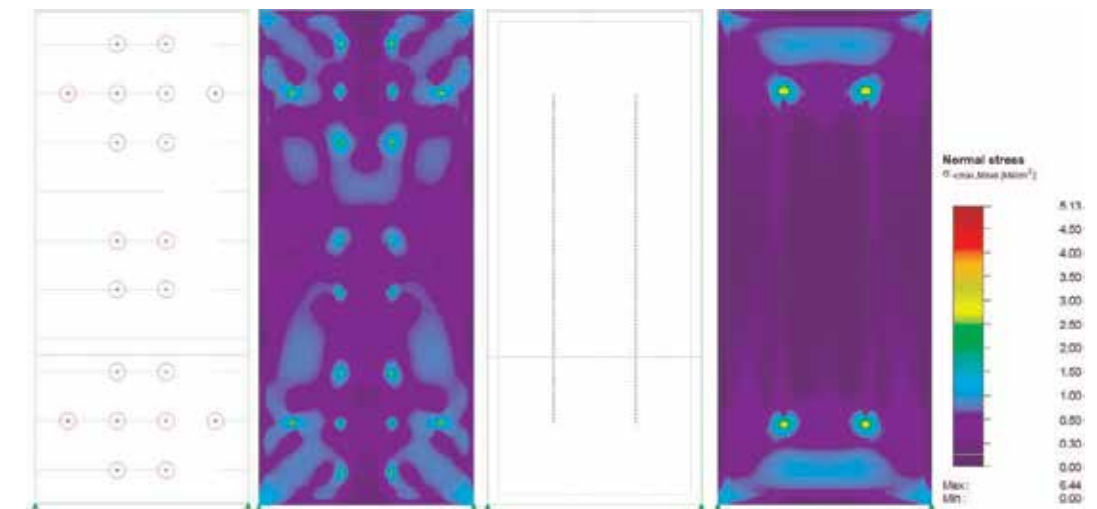

Fig. 4 Bracing in the cavity: geometry and resulting glass bending stresses for punctual pins (left) and linear fins (right).

The CFD simulations are also required to derive an optimum geometry and flow through the FFG units with regard to heat capacity, reduction of the thermal loads and total energy consumption. Different alternatives for the flow of the fluid with inlets and outlets are represented in Figure 5. It is essential for the efficiency of the system to produce the most laminar and homogeneous possible flow distribution in the cavity. Numerous parameter studies helped to optimize the FFG components, to understand and visualize the exact flow distribution and to predict the resulting solar heat gains before building physical prototypes for metrological validation.

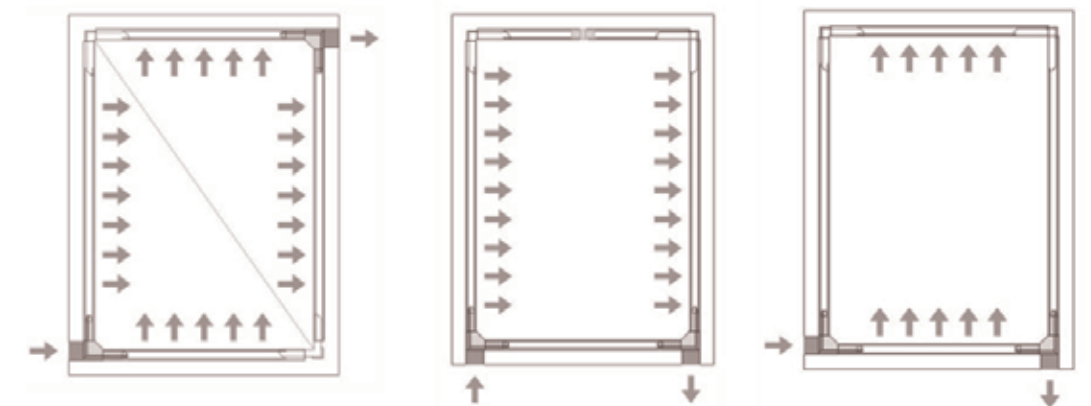

Fig. 5 Investigation of possible flows through the FFG.

The shape of the spacer turned out to be crucial for the optimized flow of the fluid within the cavity. Perforated standard elements lead to unsatisfactory results. Out of dozens of investigated geometrical alternatives, a newly developed spacer leads to a considerably more even flow and a minimized pressure drop of 87 mbar for the maximum flow rate of 8 l/min in the fluid chamber (Fig. 6).

3.2. Local climate simulations

The interaction between the FFG modules and the outside climate is calculated by means of solar altitude and weather modelling for different climate zones to provide a performance prediction for different scenarios. Parametric studies of different operating conditions with regard to geometry,

material properties, fluid flow rate and ambient conditions complete the understanding of the behavior of the FFG modules for future consideration in the overall thermal dynamic building simulation.

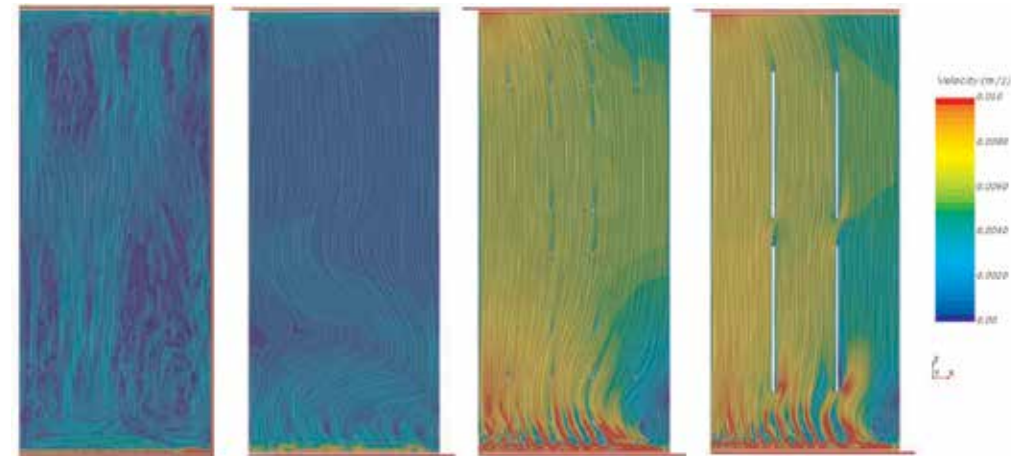

Fig. 6 Flow distribution for (a) perforated standard spacer, (b) optimized spacer, (c) with punctual bracing, (d) with linear bracing..

3.3. Spectral and thermal modelling

A newly developed optical simulation tool based on years of metrological experience (Sierra 2017) allows the prediction of the optical performance (absorption, transmission and reflection) of the various FFG modules from the InDeWaG Glazing catalogue. Fig. 7 shows the calculated absorption of each layer of the FFG unit as well as its transmission properties, its SHGC and U-value and the resulting temperature profiles (as an example for the winter period).

These optical properties form the input parameters for the CFD simulations of the single FFG unit as described above. The results of the CFD simulations serve as information input for the thermal dynamic building simulation.

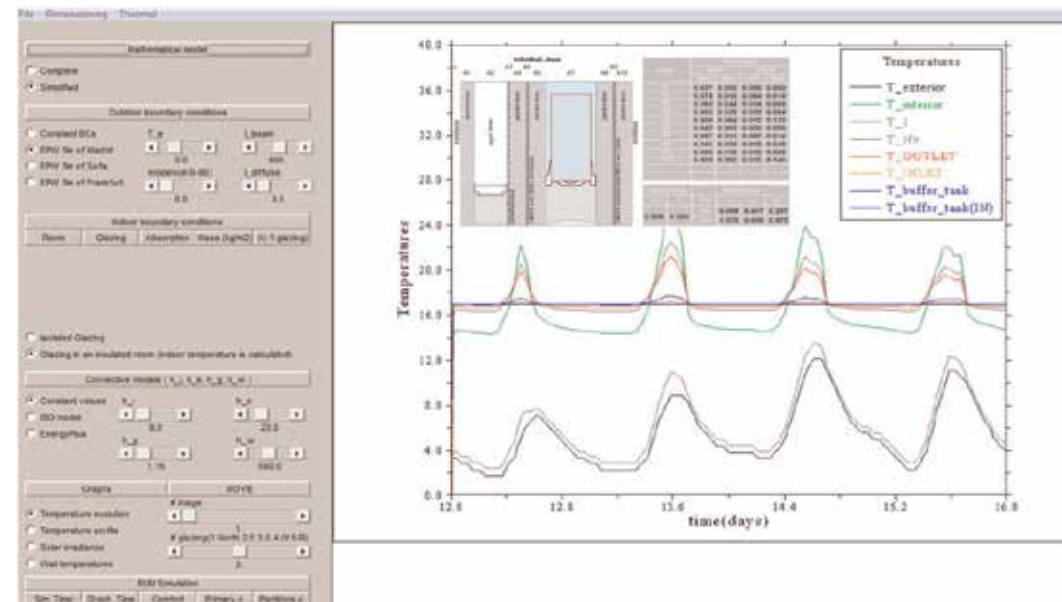

Fig. 7 Software for the calculation of spectral and physical characteristics and temperature profiles in FFG modules.

3.4. CFD simulation of room climate

Figure 8 shows the spatial temperature distribution in the InDeWaG demonstrator pavilion under construction (see chapter 5) on a summer day, while the FFG modules operate in cooling mode (high flow velocity). All physical effects such as solar radiation, shading, etc have been considered. The simulated temperatures and air velocities for this scenario show comfortable results. Due to the widespread but very moderate cold radiation, neither uncomfortable temperature stratification nor negative draft effects will occur.

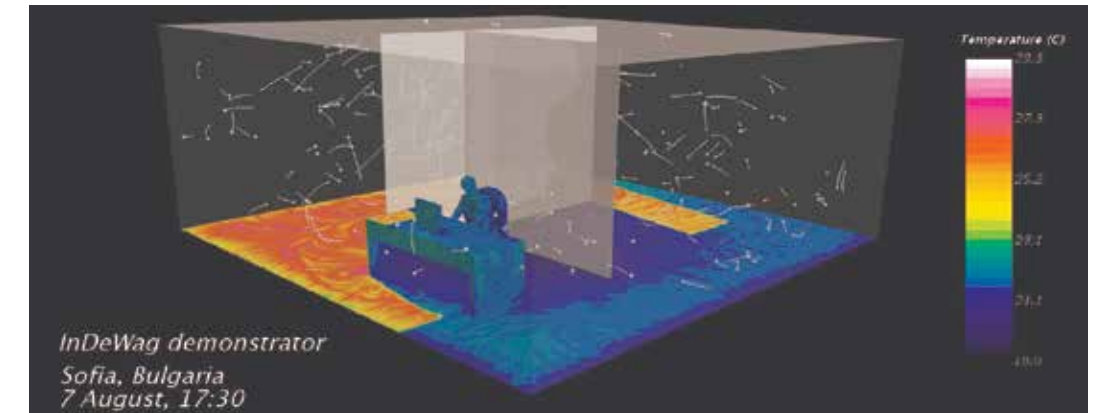

Fig. 8 Temperatures and air movements in the demonstrator pavilion resulting from CFD simulation.

4 FFG in thermal-dynamic building simulation

One of the primary goals of the InDeWaG research project is the implementation of the thermal behavior of the FFG modules into the thermal building simulation, which is becoming more and more the standard design tool for summer heat protection analysis, climate engineering and dimensioning of the cooling and heating components. Commercial software tools for thermal simulation do not have the appropriate components for FFG modules, since these modules are dynamic and do not have constant spectral and (solar) thermal properties. Properties of the FFG units are changing in interaction with the exterior site-specific and climate conditions. In the present project InDeWaG, the behavior of the FFG modules was coded in a special modeling language called NMF (Neutral Model Format) and then compiled into Fortran. Subsequently, a DLL file has been generated and implemented within the popular simulation software IDA ICE (Equa 2013). Detailed information of a possible implementation of elements with time variant properties in IDA ICE can also be taken from (Plüss 2014). The enhancement of the simulation software will provide engineers and specialists with the possibility to model FFG modules physically correct within thermal simulations. This feature will be indispensable in order to establish the FFG technique not only as an industrial product but also within modern design and planning processes for buildings.

4.1. Modelling of FFG modules within the building model

The following boundary conditions are essential for the performance of the FFG modules and must therefore be considered in the modelling process:

- Outside and inside temperature (climate database),
- Solar radiation (climate database),
- Flow rate in $[kg/m^2s]$ of the fluid in the cavity,
- Fluid inlet temperature in $[K]$.

The implementation of the FFG modules within the IDA-ICE overall model for the demonstrator pavilion with 15 modules (Figure 14) is represented schematically in Figure 9.

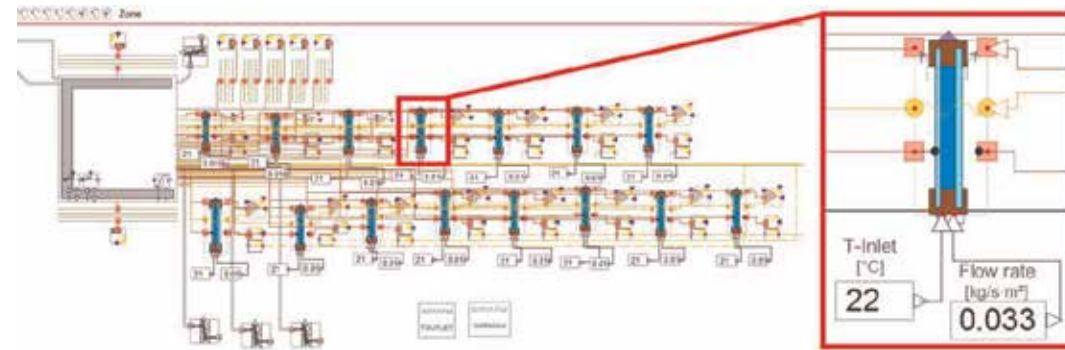

Fig. 9 Schematic representation of the FFG modules within the building simulation model.

4.2. Results of the thermal building simulation

At building or room level, the changes in heat flow and energy demand caused by the FFG modules are of importance. These changes are documented in the following for the reference of the demonstrator pavilion described in chapter

5. Simulations for different variations of the parameters described in chapter 4.1 have been carried out for this pavilion. The input parameters (number of reference modules with standard solar coating, number of FFG modules, fluid inlet temperature and fluid flow rate) and the resulting energy demands for heating and cooling are shown in Figure 10.

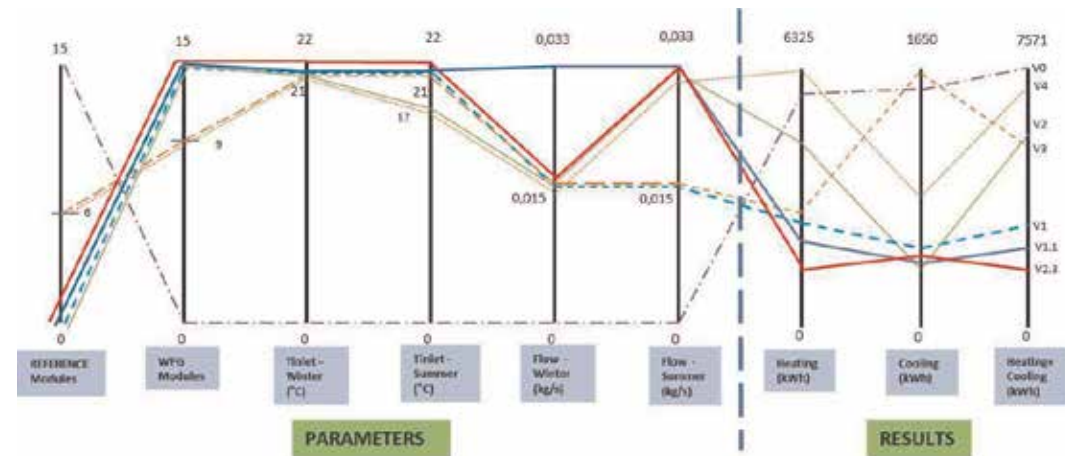

Fig. 10 Parameter study for the energy consumption of the demonstrator pavilion.

The significant reduction of the energy demand for heating and cooling by the integration of FFG modules into the façade is clearly visible. The flow rate and fluid inlet temperature can be adjusted to the exterior conditions and thus react to the outdoor climate.

A higher flow rate in summer allows the absorbed solar energy to be transported away quickly. During wintertime, the flow rate is reduced so that the fluid in the cavity gets heated by diffuse and direct radiation, leading to positive effects on the heating demand. The exact fractions of the heat

flow and energy demand are shown in Figure 11 and give an idea about the potential of the FFG technology.

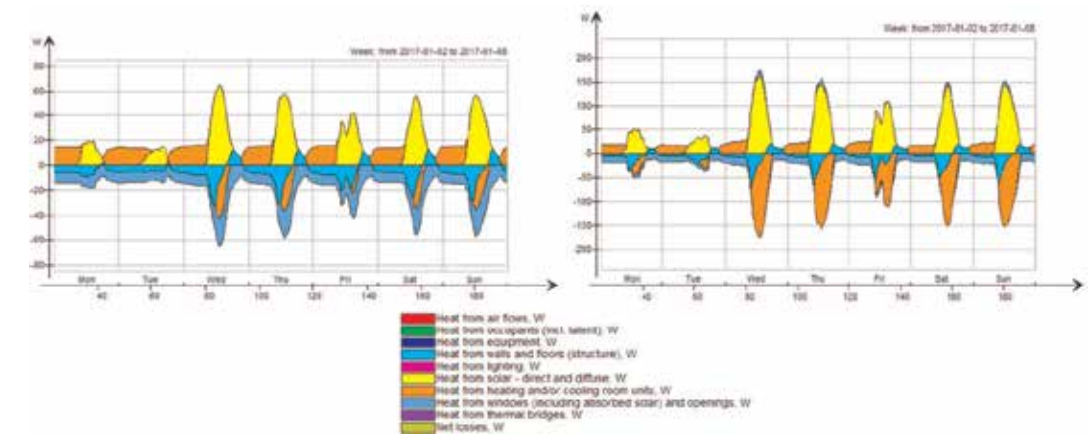

Fig. 11 Results for 100% FFG modules (left) and solar coated standard glazing (right).

In the current project phase, the simulation results are verified and quantified on the one hand by optimized modelling of the FFG modules within realistic over-all mechanical system concepts for buildings, on the other hand by means of comparison and calibration with physical testing procedures. Moreover, the outlet temperature and possibilities to use these energy gains will be investigated in detail (shown in figure 12 for the south façade).

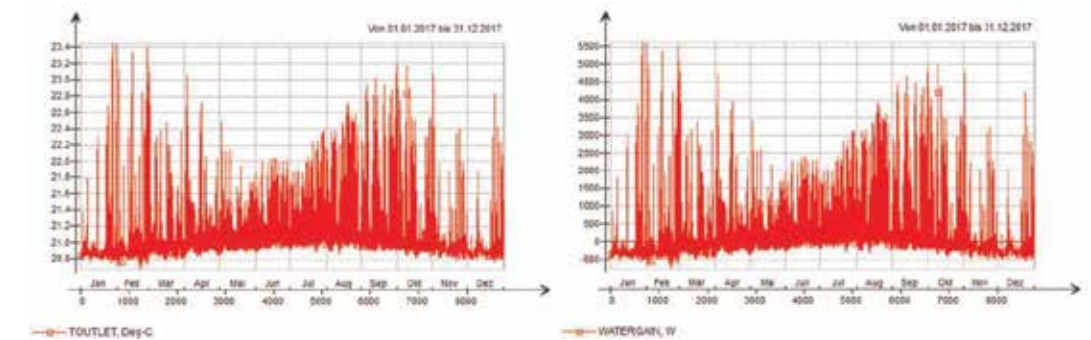

Fig. 12 Outlet temperature and heat gain of the FFG on the south façade.

5 Measurement, calibration and construction

The FFG modules directly influence the temperature and light conditions in the building and thus the energy consumption in terms of heating, cooling, lighting, etc. In addition to the numerical evaluation of this influence in low energy buildings, the project InDeWaG calibrates the results of the CFD simulations as well as the thermal dynamic building simulations by means of measured values determined on prototypes (Fig. 13).



Fig. 13 Left: Indoor calorimeter, Fraunhofer ISE, right: Test chamber, Valencia, Spain.

In the indoor calorimeter, the solar-thermal loads can be directly compared to the heat gains in the test chamber in order to derive the total solar heat gain coefficient of the system as well as the energy absorbed by the fluid. Similar tests are carried out in a test chamber in Valencia under real exterior climate conditions.

Moreover, a demonstrator pavilion is currently being built at the Academy of Sciences in Sofia, Bulgaria (Fig. 14). FFG elements will be installed on the entire eastern, western and southern façades and on the interior walls used for additional radiant heating and cooling. The building will allow extensive monitoring and thus provide valuable information for both the calibration of the simulation tools and the operation and durability of the modules.



Fig. 14 Demonstrator Pavilion in Sofia, Bulgaria, scheduled completion in August 2018.

6 Conclusion

The ongoing simulation and monitoring works within the research project show that water flow glazing is a very promising system regarding energy savings. The studied simulation variations help to define the optimal flow rate and inlet temperature for the hot climate (Madrid) and the cold climate (Sofia), which will be compared with measurements of the Bulgarian Pavilion and the small prototype in Madrid in the next project phase. The development of control strategies for inlet flow

and temperature will be the next step in order to adjust the flow according to seasonal and energy needs, (e.g. lower flow rate in winter and higher flow rate in summer).

7 References

- Boubekri, M., Cheung, I.N., Reid, K.J., Wang, C.-H., Zee, P.C.: Impact of Windows and Daylight Exposure on Overall Health and Sleep Quality of Of-fice Workers: A Case-Control Pilot Study, *Journal of Clinical Sleep Medicine*, Vol. 10, No. 6, 603-611 (2014).
- Del Ama Gonzalo, F., Hernandez Ramos, J. A.: Testing of Fluid Flow Glazing in Shallow Geothermal Systems. *World Multidisciplinary Civil Engineering-Architecture-Urban Planning Symposium 2016*, Elsevier *Procedia Engineering* 161, 887 – 891 (2016).
- EQUA Simulation AB: *Handbuch IDA ICE Version 4.5* (2013).
- McKee, F. B.: Improvements in or relating to windows, McKee, Frederick Brian (Applicant), Patent 0075464A1 (1982). McKee, F. B.: *Environmental Control of Low Energy buildings. Glazing & Cladding, Façades, Curtain Wall Natural* (2007).
- Plüss, I., Kräuchi, Ph., Bionda, D., Schröcker, M., Felsenstein, S., Zweifel, G.: Modellbildung eines Phasenwechsel-Fassadenelements in IDA- ICE. *Fifth German-Austrian IBPSA Conference, RWTH Aachen University, BauSim*, 374–378 (2014).
- Schwarz, D.: *Vorrichtung zur transparenten Wärmedämmung an einem Gebäude*, Schwarz, Dietrich (Applicant), Patent WO98/51973 (1998). Seemann, R.: *All season window*, Seemann, Robert (Applicant), Patent US4347835 (1982).
- Sierra, P., Hernandez, J. A.: Solar heat gain coefficient of Fluid Flow Glaz-ings. *Energy and Buildings* 139, 133–145 (2017).
- Stopper, J.: *FLUIDGLASS: Flüssigkeitsdurchströmte Fassadenelemente*. Dissertation, München (2018).
- Woods, L.: *Liquid filled double glazed units*, Pilkington Brothers Limited (Applicant), Patent GB 1424533 (1972).

Application of Hollow Glass Blocks for Facades, Full Scale Test of Wall Created with Vitralock System

Zdeněk Sokol, Martina Eliášová

Faculty of Civil Engineering, CTU in Prague, Czech Republic, sokol@fsv.cvut.cz

The paper is focused on application of hollow glass blocks in various structures: windows, walls, skylights, sidewalk lights and facades. The hollow glass blocks were developed at the end of 19th century and soon gained popularity, especially in modern architecture in 1920's. New applications followed in 1960's and their popularity is ever growing with new colours, sizes, textures and forms available on the market. Brief description of the available construction methods is given in the paper. The traditional method is based on assembling the blocks together in a Portland cement-based mortar with steel reinforcing rods placed within the mortar bed. This is complicated process requiring skilled workers and considerable time for the mortar hardening. To avoid these difficulties, several proprietary methods were developed by glass blocks producers. The modern construction methods are based on assembling the glass blocks with plastic or aluminium elements and silicone glue which replace the mortar. Advantages and disadvantages of various methods are briefly summarized in this paper. Research on Vitralock system by Seves is in progress at CTU in Prague. Full scale wall test (size approx. 2.8 × 2.4 m) was performed recently. The test was aimed to resistance of the wall exposed to horizontal load and it proved excellent performance of the system. The test would be used as a background for development of component based finite element model to predict the performance of the wall, however, additional tests of the components are necessary. Details of the full-scale test are given in the paper.

Keywords: Facades, Hollow glass blocks, Experiments.

1 Introduction

Although flat glass has been used for structural elements for only few years, the application of glass blocks dates back to the end of the 19th century. The first hollow glass blocks patent was handed over by Gustave Falconnier in Switzerland in 1886 but he applied for more patents all over Europe and even in United States [58]. The blocks were blown into the rectangular or hexagonal metal molds and sealed to be airtight. However, this method of production was not very effective and it was not suitable for the mass production. The increasing popularity and application of these blocks led to improvement of manufacturing methods which allow larger quantities to be produced at low price. As a result of this effort, the two halves of glass blocks were manually molded and then welded together as the glass edge was heated to soft state and the two pieces were pressed together. Later, this process has been automated, and today the pressing and joining of both mold halves together is fully automated.

The paper gives an overview of application of hollow glass blocks for facades. Basic properties of hollow glass block are listed where their advantages are highlighted. It proves the hollow glass blocks represent a competitive solution compared to other types of facades. This is documented by few examples of buildings which were designed with facades made from hollow glass blocks.

The other part of the paper is focused on various assembling methods trying to find an alternative for the traditional method using cement based mortar and steel reinforcement. Full scale test of the wall assembled with Vitralock system is described in details as there is limited knowledge of the behaviour of this structure.

2 Properties of hollow glass blocks

The use of hollow glass blocks is particularly advantageous for their good thermal and acoustic properties. Standard types of hollow glass blocks have the coefficient of heat transmission in range 2,6 - 3,2 W/m²K. When lower value is required, special thermal insulating blocks are available which have argon filled cavity split by additional glass layer. The coefficient of heat transmission of these blocks is in range 1,1 - 1,5 W/m²K which is similar value achieved for double glazing.

Glass blocks offer high level of sound insulation, even superior to that of brick walls of identical thickness. This makes them suitable even in very noisy environments (discos, manufacturing facilities, etc.) because they provide sound insulation equal to 40 dB.

In terms of load-bearing capacity, hollow blocks are unsuitable for structural purposes. They are only used for fillings of openings or partition walls. The hollow glass blocks transmit only their own weight and horizontal loads as wind load and may not be allowed to assume any additional loads from the main structure, the load bearing function of the building is provided by steel or concrete frames.

New applications are developed as the fire resistant hollow glass blocks providing fire resistance rating up to EI90.

3 Facades from hollow glass blocks - point of view of an architect

The hollow glass blocks were used by architects for building envelopes since the beginning of the 20th century. These early applications include the 1914 Glass Pavilion of the Werkbund Exhibition in Cologne by Taut and the 1929 Immeuble Clarté in Geneva by Le Corbusier. One of the first non-industrial buildings where hollow glass blocks were used on façades in conjunction with a steel structure was the 1932 Maison de Verre in Paris by Chareau and Bijvoet [2]. Recently, hollow glass blocks are becoming popular again as new generation of architects discovered their aesthetic qualities and functionality. Recently, many projects have arisen in which glass blocks have been used on facades. Modular glass blocks are now manufactured in various patterns and colors which can create polychrome and translucent skin of buildings. The glass blocks can be easily adopted by architects to create irregular and curved shapes etc. New use in architecture is characterized by the connecting of buildings to the outer space, combining natural and artificial light.

New trends in architectural design can be seen in buildings completed recently. This chapter shows some applications which document the wide range of buildings with the hollow glass blocks facades including apartments, offices, shops, museums, concert halls and even industrial buildings.

First to mention is the Maison Hermés in Tokyo, Japan, by Renzo Piano, finished in 2001 [3]. The concept of this building was inspired by traditional Japanese paper lamps, and for that purpose the facade was coated by 13,000 translucent glass blocks sized 428 × 428 × 120 mm and produced to order for this structure by Seves company, see Fig. 1. This skin has also significant acoustic effect, providing insulation from the street noise of the busy streets.



Fig. 1 Maison Hermés, Tokyo, a) Front view, b) Detailed view on the shop window, c) Interior.



Fig. 2 Station of the Orselina-Cardada cableway, Locarno, a) Front view, b) Internal steel structure of the station.

Facades made of hollow glass blocks appear not only on administrative or representative buildings in city centers, but can also be found in public facilities, such as Station of the Orselina-Cardada cableway in Locarno, Switzerland by Mario Botta, 2002 [4]. Front view of the building is presented on Fig. 2a) while Fig. 2b) shows details of the interior with visible steel load bearing structure.

Another example of the creativity of architects and the use of the glass block is the project of Reception Centre of TaiChung named Updown Court in Taiwan by Gong Shu Zhang, Aura Architects and Associates, 2007 [5]. The building was designed with the idea to create energy-efficient and low-maintenance building. This was achieved with the facade created from 31,000 pieces of clear glass blocks, see Fig. 3. The reception center is located in the city and serves as place where weddings ceremonies, meetings and other events are organized. The resulting energy-efficient building creates an oasis of tranquility with its exterior, which is constructed almost entirely from translucent glass blocks with a wave pattern. This creates an interior flooded with natural light whilst providing thermal and acoustic insulation.

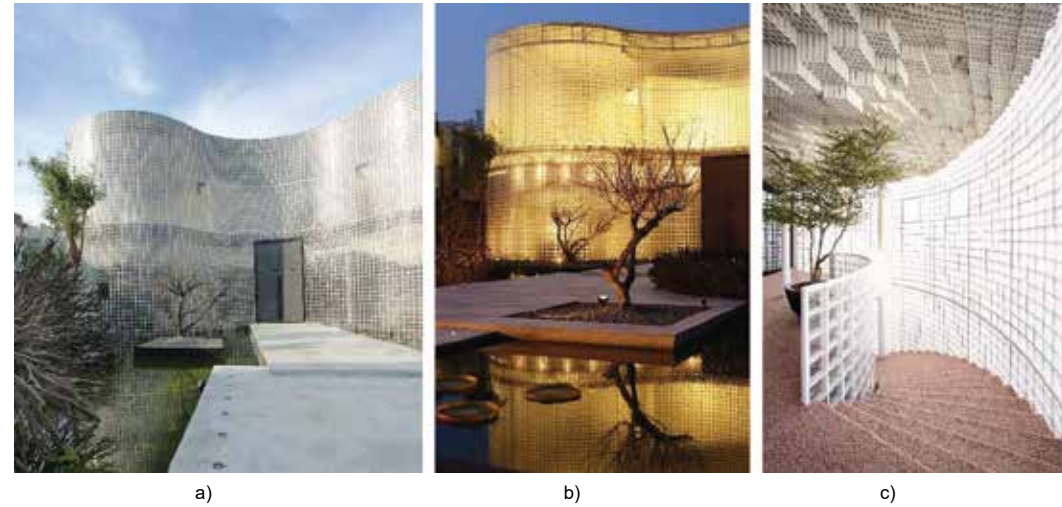

Fig. 3 Updown Court, Taiwan, a), b) External appearance of façade, c) Interior of the building.

Beautiful combination of steel load bearing structure and hollow glass blocks on building facade is Sabah Media Centre in Izmir, Turkey by Halidun Uyak, 1996. The facade consists of 3D steel supporting structure to which the facade is attached. It is made from 9,900 pieces of glass blocks decorated with wavy pattern, see Fig. 4.

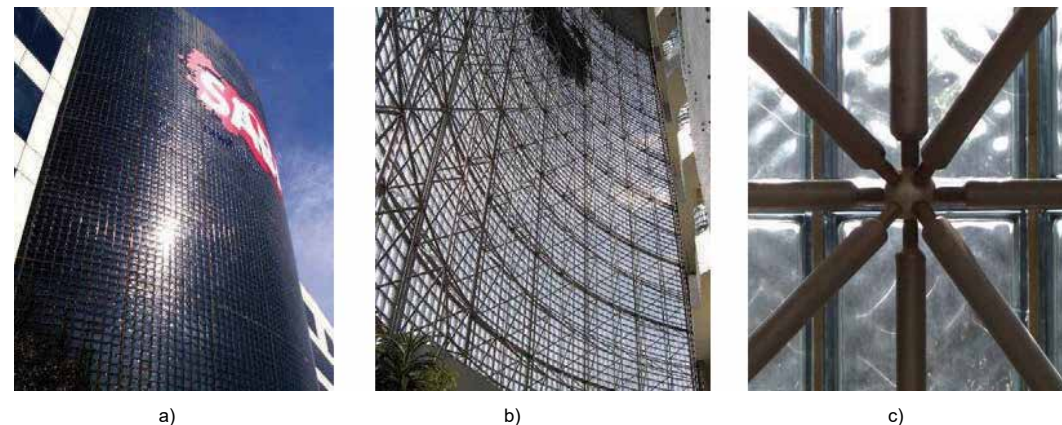

Fig. 4 Sabah Media Centre in Izmir, Turkey, a) Exterior, b) Interior, c) Detail of the steel structure.

The newest building in this short overview is the Congress Center in Zlín, Czech Republic by Eva Jiříčková and Petr Vágner, AI Design, 2011 [6]. It is the part of Cultural and University Centre and serves multiple functions: concert hall, conference centre, home for the administration of the Philharmonic Orchestra, the Centre's own offices, rehearsal and recording studios, exhibition spaces, and bars. The main hall accommodates 850 seats. Since the building is situated close to a major intersection, the main auditorium had to be fully isolated from all external noise and vibrations. This was achieved by the plan arrangement where the oval central space is surrounded by offices, rehearsal rooms etc., all in need of natural ventilation and daylight. Another external layer created from hollow glass bricks was required to provide extra sound insulation, sun protection and to create visual effect, see Fig. 5.



Fig. 5 Congress Center Zlín, a) Overview of the building, b) Night view.

The main advantage of using steel supporting structures for building envelopes made of transparent materials such as flat glass, hollow glass blocks, plastics (e.g. PMMA, ETFE foil) is their shape variability, low self-weight and subtle construction, which does not interfere the flow of the light to the interior of the building. However, concrete frames or masonry can also be used for this purpose.

4 Installation methods for hollow glass blocks

Traditional installation of hollow glass blocks is carried out using cement mortar in similar way the walls from ceramic bricks are made [7], [8], [9]. Steel bars are inserted into the joints to increase the strength of the wall. Zinc coated or stainless steel bars might be used to avoid corrosion. The installation can be facilitated by using plastic spacers which help to keep uniform width of the joints and prevent contact of the reinforcing bars with the glass. Although it is the cheapest method and leads to stiff structure resistant to significant horizontal load, it has some disadvantages. Experience of the workers and precise planning are required. Time necessary for the mortar to get hard needs to be considered, the cement-based mortar needs 28 days to reach its full strength. For these reasons, alternative methods have been developed by various companies, see Fig. 6. These are either based on using silicone glue and aluminum/plastic components or using plastic components joined without glue combined with steel reinforcement to create a rectangular grid to which the glass blocks are placed to.

- Quicktech [10], Block Lock [11] and Quick Fix [12] Systems by Seves are based on joining the glass blocks with plastic profiles using single compound glue. No steel reinforcement is used.
- Vitralock System [13] by Seves is dry installation system consisting of two plastic pieces, the spacer and the connector. No glue is used. Creation of curved walls is not possible with this system.
- Ezylay Silicone System [14] by Glass Blocks Construction is another system using T and X shaped spacers and aluminum stiffeners which are bonded by silicone glue.
- Metal Joint Installation System [15] by Electric Glass Building Materials is based on using aluminum stiffeners to which glass blocks are bonded by silicone glue.

These methods are mostly suitable for small areas (windows replacement, etc.) and are used mostly in interiors. The joints of the wall need to be filled with grout for ceramic tiles or silicone sealant. It represents an alternative solution in situations when waterproof finishing is required, as in bathrooms. These systems provide much smaller joint thickness from 2 to 5 mm therefore allow more light to be transmitted through the wall compared to traditional method where the joint thickness is not smaller than 10 mm.

Another method of application should be also mentioned. Prefabricated panels of various size assembled by the traditional method are available from various glass blocks manufacturers. They are placed in metal frame and should be installed in the window opening the same way as standard windows. Size of the panel is limited by the size 6 by 4 glass block to limit the weight, which is 83 kg in this case [16].

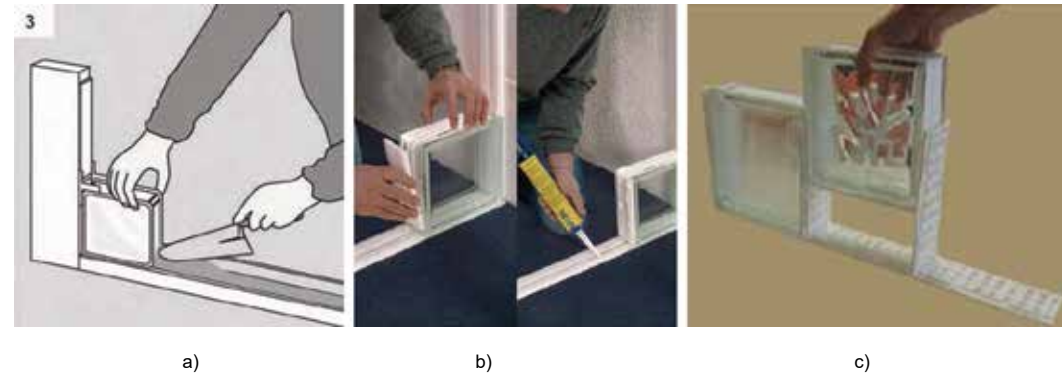

Fig. 6 Installation methods for hollow glass blocks, a) The traditional method [7], b) Quicktech System [10], c) Vitralock System [13].

5 Test of wall assembled with Vitralock System

Test of the wall assembled with Vitralock system was performed at laboratory of Faculty of Civil Engineering, CTU Prague [16], [17]. The system is intended for indoor use and certainly might be used as the interior layer of double layered facades. However, there seems to be no reason for the limitation of indoor use and application for single skin facades is considered. The performance of the wall exposed to horizontal load was investigated by the test.

The partition walls might be acting as a barriers and are loaded by horizontal line load as given in [19]. According to this standard, the magnitude of the line load depends on the occupancy, for apartments, offices, restaurants and similar use (Category A, B and C1), the load should be considered equal to 0,5 kN/m, for lecture rooms, museums, shops and other buildings where people may congregate (Category C2-C4 and D) it should be 1,0 kN/m and load equal to 3,0 kN/m should be considered in areas susceptible to large crowds (Category C5). These loads represent characteristic values. This type of load should be applied also on the interior of the facades. In addition, the wind load (positive or negative pressure) is applied on the exterior surface.

The wall was assembled in the laboratory using 12 rows, each containing 14 glass blocks sized 190×190×80 mm. The dimensions of the wall were 2,81 m (width) and 2,42 m (height). The wall was fixed to a timber frame made from 50×80 mm sections, see Fig. 7.

Experimental Tests



Fig. 7 The Vitralock system used for the wall assembly, a) The components of the system, b) The grid before the blocks are installed.

The wall was reinforced by steel bars diameter 5 mm located on both surfaces. The yield limit of the steel was 235 MPa, ultimate strength 360 MPa and ductility 26% according to material certificate [20]. The bars are located in the grooves of the plastic spacers.

The Vitralock system allows arranging the reinforcing bars in either vertical or horizontal directions, therefore the loaded side was reinforced by bars in vertical direction and the non-loaded side by bars in horizontal direction. In this arrangement, the active reinforcing bars (i.e. the bars loaded in tension) span over the large dimension of the wall.

The reinforcing bars were anchored to the timber frame. The end of the bars was bended at 90 degrees (at least 80 mm of the bar was used to create the L-shaped end) and clamped by the spacer which was attached to the timber frame by 4 screws 4×35 mm located in the holes of the spacer, see Fig. 7a. No pre-drilling of the holes in the timber frame took place.

The wall was firmly connected to the ceiling represented by rigid steel frame by three sets of wooden wedges, see Fig. 9a. Horizontal deformation of the top of the frame was measured during the test but no displacement was recorded which proves there was no movement of the supports of the wall during the test.

The joints were filled by grout for ceramic tiles. Commercially available grout for joints width 2 to 20 mm of beige colour was used which is suitable for indoor and outdoor use (facades, swimming pools, etc.).

The wall was assembled in the same way it would be used in real building adopting the procedures and recommendations for the Vitralock system [13].

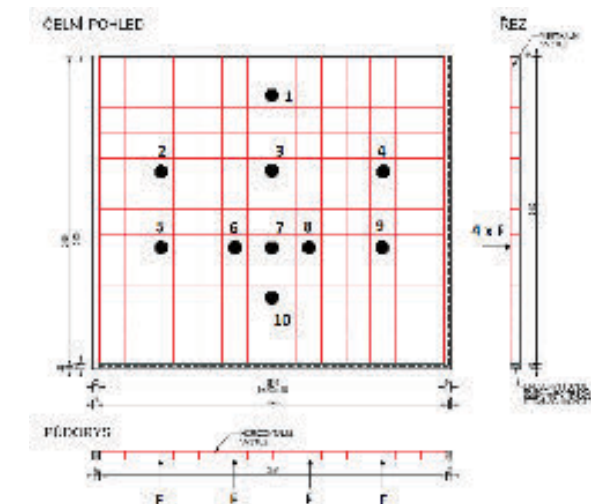

Fig. 8 Dimensions of the wall, location of the load (No. 5, 6, 8, 9) and the displacement transducers (No. 1-10).

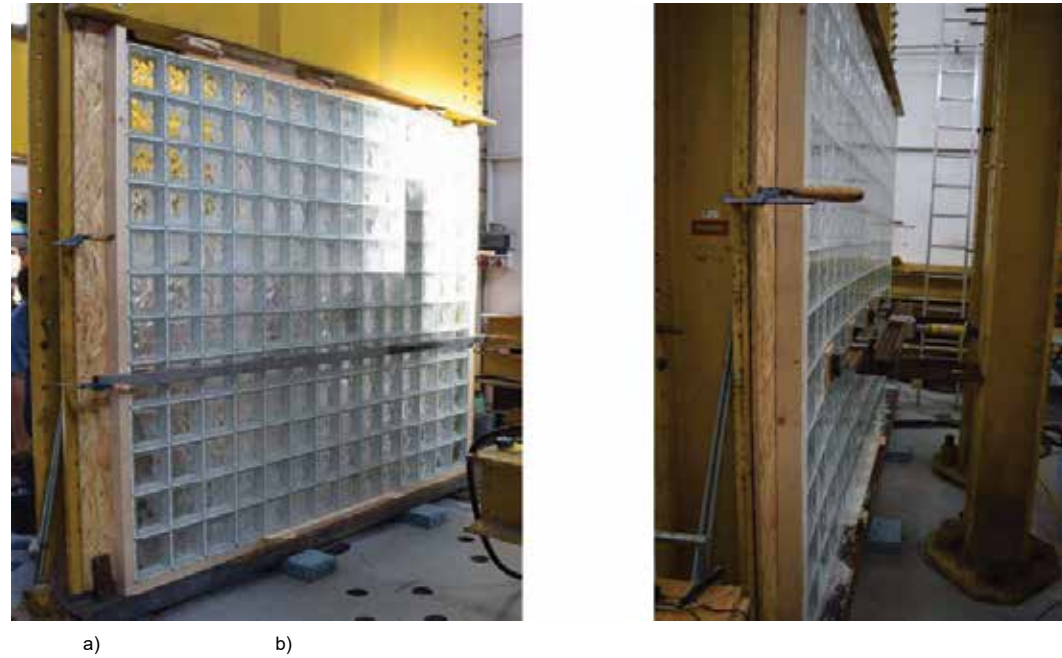

Fig. 9 The tested wall, a) The completed wall prior to filling of the joints, b) The wall during the test.

The wall was loaded by horizontal load at height 900 mm above the floor, see Fig. 7b) to represent the line load described earlier in this chapter. This arrangement was chosen as it was easier to introduce and control the load compared to wind pressure which represents load uniformly distributed over the total area of the wall. Moreover, the total wind load for typical office building according to [21] (only simplified prediction of the wind load for terrain category III or IV, wind velocity up to 30 m/s and wind pressure applied to the wall of building on the area D - see c_{pe} factor- at height 30 m above the ground is given here) is

$$W = AREA \cdot q_p \cdot c_{pe} \cdot z = 2,81 \cdot 2,42 \cdot 0,5 \cdot 1,25 \cdot 30^2 \cdot 0,8 \cdot 2,5 = 6120 \text{ N}, \quad (1)$$

which is smaller than the total highest horizontal line load for category C5 according to [19]

$$F = LENGTH \cdot load = 2,81 \cdot 3000 = 8430 \text{ N}. \quad (2)$$

The situation giving the higher load was therefore considered as more critical.

The load was introduced by single hydraulic jack and distributed by steel beams to 4 points in the middle of the glass blocks (marked as numbers 5, 6, 8 and 9 on Fig. 8). The distance between the loads was 585 mm.

Horizontal deformations at 10 locations were measured during the test, see Fig. 8 for the location of the transducers. The load was applied in 22 cycles. The loading was controlled by horizontal deformation at the point number 7. As soon as the required deformation was reached, the constant deformation was maintained for 1 minute and then the wall was unloaded. The magnitude of the load increased over the load cycles, see Fig. 10.

Experimental Tests

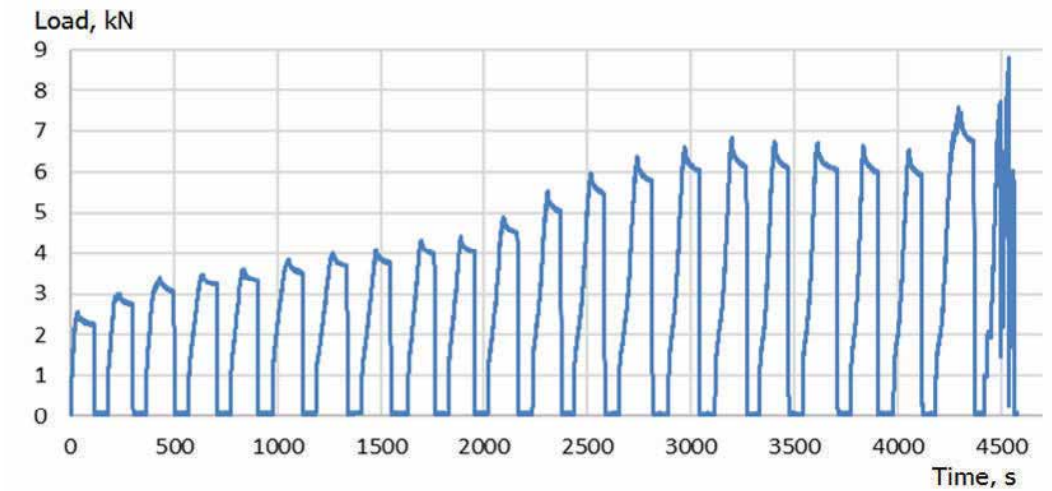

Fig. 10 The load procedure.

The behaviour of the wall was linear for small deformations (up to 3 mm). Assuming the limit for horizontal deformation according to [22] is

$$\delta_{lim} = L/200 = 2410/200 = 12,0 \text{ mm}, \quad (3)$$

the load to reach the limiting deformation was 3,58 kN which correspond to line load 1,27 kN/m.

At the horizontal deformation approx. 10 mm first crack in the joint sealing appeared which grew in the following load cycles, see Fig. 13c. As the load increase, highly non-linear behaviour and significant permanent deformation was measured after each cycle, see Fig. 11. This is caused by plastic deformation of the spacers and connectors (bearing stresses on the contact) and slip of the reinforcement at the anchoring to the timber frame, see Fig. 13a and 13b. Local damage of the spacers at anchoring of the reinforcement was also observed but no yielding of the reinforcement was found even for the highest load. It should be also considered the wall could not return to its initial state when the load was removed because of the friction arising in the loading system. If this could be avoided, the permanent deformation would be smaller, however, it is not possible to estimate this effect. The permanent deformation was probably also influenced by small pieces of broken joint filling which were stacked and prevented the return of the wall to initial shape. This would improve if silicone sealant would be used.

However, the wall was able to resist the maximum load 8,8 kN (this corresponds to line load 3,13 kN/m) which resulted in horizontal deformation of 93 mm when the loaded hollow blocks at locations No. 6 and 8 were pushed out of the Vitralock grid, see Fig. 8. The test was stopped for this reason.

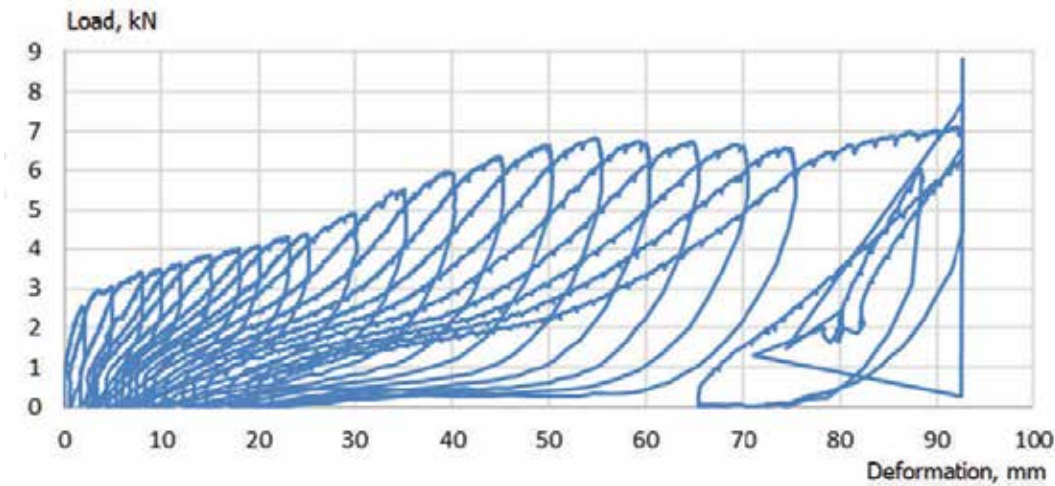

Fig. 11 Load - deformation diagram for the point 7.



Fig. 12 The wall after the test.

Experimental Tests

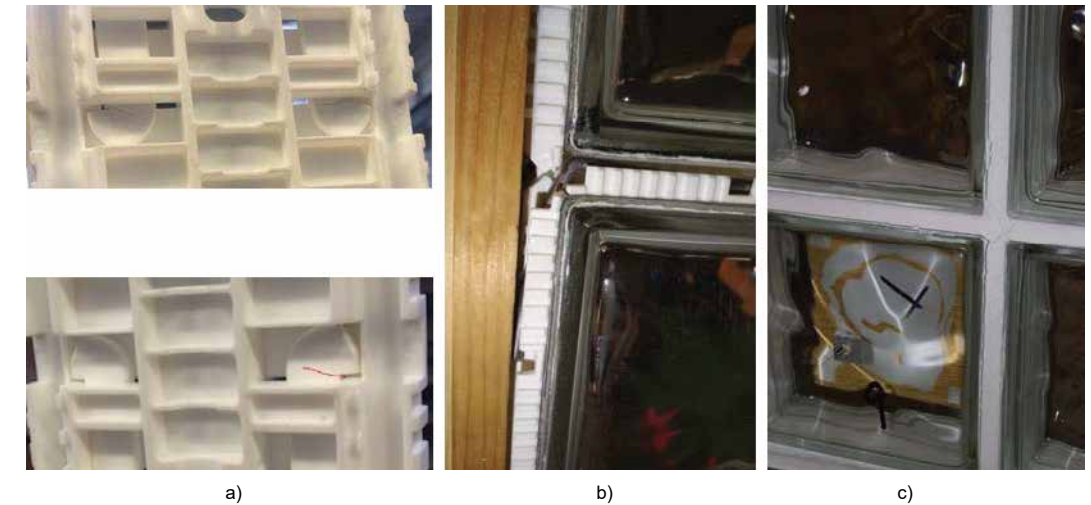

Fig. 13 Details of the damage of the wall after the test [17],
a) Crack of some connectors after the test, b) Deformation of the reinforcing bar at the anchoring, c) Cracks in the joint.

6 Conclusions

Load-bearing test of partition wall made from hollow glass blocks using Vitralock system exposed to horizontal load was performed and is described in this paper. The experiment shows linear behaviour for small loads but no-linear response was found in later stages of the test. Cracks in the joints appear with increasing load but they do not indicate failure or reduced strength. When cracks in the wall joints should be avoided as they may represent an aesthetic problem or have influence on the durability in wet environment (bathrooms, facades) an elastic silicone sealant should be used to replace the grout for ceramic tiles used for the test.

Highly non-linear behaviour was observed at later stages of the test when permanent deformations were also encountered. However, the wall was able to resist the applied load up to maximum load 8,8 kN (corresponding to 3,13 kN/m). Failure of the wall was observed at horizontal deformation 93 mm (i.e. L/26) when the hollow bricks were pushed out of the Vitralock grid.

The test proved the Vitralock System is suitable for partition walls and facades loaded by horizontal load (wind load, pressure induced by humans), however, the serviceability limit state (horizontal deformation) is the limiting design criteria. Development of design model is in progress at CTU in Prague. The model is based on component method commonly used for design of steel beam to column endplate joints. The model would be used to determine the resistance of the wall of variable dimensions and to predict the deformation of the wall exposed to (any) horizontal load.

7 Acknowledgement

The paper has been written with support by grant No. 18-10907S of the Czech Science Foundation (GAČR). The authors would like to thank Vitralok s.r.o for supplying the components used for the test.

8 References

- [1] Falconnier, G., Glass building block. US Patent No. 402.073. approved on 23. April 1889.
- [2] Zeitoun, X.G.M., Glass Block Handbook, Builder's Book, Canoga Park, 1995.
- [3] <http://www.galinsky.com/buildings/hermes/index.htm>
- [4] <http://www.botta.ch/en/CITT%C3%80%20E%20TERRITORIO?idx=6>

- [5] <http://www.adelaideglassblocks.com.au/portfolio-item/updown-court-reception-centre/>
 [6] <https://www.archiweb.cz/en/b/kongresove-centrum-zlin>
 [7] <http://en.sevesglassblock.com/installation-methods/traditional-installation-3/>
 [8] <https://www.glassblockconstruction.com/installation-type/ezylay-products/ezylay-mortar-system/>
 [9] http://www.negb.co.jp/en/images/catalog/pdf/gb_en_catalog.pdf
 [10] <http://en.sevesglassblock.com/installation-methods/diy-quicktech-system/>
 [11] <https://www.glassblocks.cz/content/63-block-lock>
 [12] <https://www.glassblocks.cz/content/64-quick-fix>
 [13] <http://en.sevesglassblock.com/installation-methods/diy-vitalock/>
 [14] <https://www.glassblockconstruction.com/installation-type/ezylay-products/ezylay-silicone-system/>
 [15] http://www.negb.co.jp/en/images/catalog/pdf/gb_en_catalog.pdf
 [16] <https://www.glassblocks.cz/content/19-horizontalni-plochy->
 [17] Eliášová, M., Sokol Z., Fíla J., Zatěžovací zkouška stěny z dutých skleněných tvárnic, Research report, CTU Prague, 2016, (in Czech language).
 [18] Sokol, Z., Fíla, J., and Eliášová, M. Load bearing test of wall from hollow glass blocks using Vitralock installation system. In: FUIS, V., ed. Engineering Mechanics 2017 - Book of full texts. Engineering Mechanics 2017, pp. 902-905.
 [19] EN 1991-1-1 Eurocode 1. Actions on Structures. General Actions. Densities, Self-weight, Imposed Loads for Buildings
 [20] Polata S., Vitralock System for Hollow Glass Blocks, MASTER'S THESIS, CTU Prague, 2018 (in Czech language)
 [21] EN 1991-1-4 Eurocode 1: Actions on structures - Part 1-4: General actions - Wind actions
 [22] EN 13116:2001 Curtain walling. Resistance to wind load. Performance requirements

Thermo-mechanical analysis of GFRP-glass sandwich facade components

Chiara Bedon a), Fabio Favoino b), Mauro Overend c)

a) University of Trieste, Italy, chiara.bedon@dia.units.it

b) Polytechnic University of Turin, Italy

c) University of Cambridge, United Kingdom

Building envelopes are becoming more and more high engineered systems that need to meet strict requirements regarding architectural intent, structural capacity, energy-efficiency and comfort, durability etc.. In this regard, the research study presented in this paper assess the performance of novel engineered unitised systems for curtain walls, as compared to traditional aluminium unitised systems with infill panels. The proposed facade systems instead has a sandwich design, made of two outer glass face sheets bonded to glass fibre-reinforced polymer (GFRP) pultruded profiles. This arrangement results in a lightweight and slim structure that can potentially provide high structural and thermal performances. Finite Element (FE) numerical results, summarised in the paper, give evidence of the potential of the novel design concept, with improved thermal and structural performances compared to traditional non-integrated systems (up to +10% and +15% the reference performance parameters, respectively). Future work is needed to take into account further facade design aspects, as those related to installation, re-glazing, durability, climatic loading etc.

Keywords: GFRP-glass sandwich panel, Unitised Facades, Thermal performance, Mechanical performance, Numerical modelling

1 Introduction and state-of-the-art

The design of transparent unitised facades (Figure 1(a)) nowadays requires a more multidisciplinary approach that takes into account multiple performance requirements, including structural performance and safety, energy efficiency and occupant comfort, water and air tightness, durability, fire resistance, installation, maintenance, re-glazing and whole life costs (Jin 2013; Bedon et al. 2018a; Bedon et al. 2018b; etc.).

Existing regulations encourage the reduction of energy use in buildings (EU Directive EPBD 31/2010), resulting among the others in most instances in the reduction of heat transmission losses by minimising the thermal transmittance of the building envelope (especially for highly glazed buildings). Curtain walls can be responsible for a major part of building thermal losses, e.g. by thermally bridging the inside/outside of the building through their highly conductive metallic framing components (Ge 2002 and EN ISO 10211). Hence designing optimised framing components with improved thermal properties can be beneficial to both energy savings and occupant thermal comfort. At the same time, structural requirements should be however accounted (Bedon et al. 2018c).

In order to improve the thermal performance of the facade components, the use of materials with reduced thermal conductivity, such as plastics or Glass-Fiber Reinforced Polymers (GFRP), can represent a valid alternative to traditional steel or aluminium frames, and can be crafted into various shapes, giving a large freedom of engineering design (Jesus et al. 2013; Cordero 2015; etc.). Additionally minimising the frame sizes (width and depth) can be beneficial not only in terms of

energy efficiency and thermal performance, but can enhance view out and relatively daylight, as well as achieving the architectural intent of slim curtain wall system and profiles. Such design goals strictly influence structural aspects as well, whereas an appropriate choice of materials, shape and size of the profiles, careful attention for detailing their supports and movement accommodation, is required to ensure appropriate load-bearing performance and contain the deflections of the facade system (Speranzini & Agnetti 2013; Bedon & Louter 2018; etc.).

The aim of this paper - derived from a research collaboration started in 2016 between University of Cambridge (United Kingdom) and University of Trieste (Italy) - is to investigate structural (deflections, stresses and self-weight) and thermal (U-value, ψ -value and condensation risk) properties and performance of a novel GFRP-glass sandwich panel for unitised construction. The panel is designed in such a way that two glass face sheets are bonded to glass fibre-reinforced polymer (GFRP) pultruded profiles. This arrangement results in a lightweight and slim structure that potentially provides high structural and thermal performances. Due to its facade application, design optimisation of these sandwich structures should take into account combinations of geometrical, thermal and mechanical properties for each component. Therefore Finite Element (FE) numerical analysis is adopted to perform a sensitivity study to understand the influence of the different design parameters of this novel facade system, resulting in 400 parametric configurations, which are partially herewith presented.

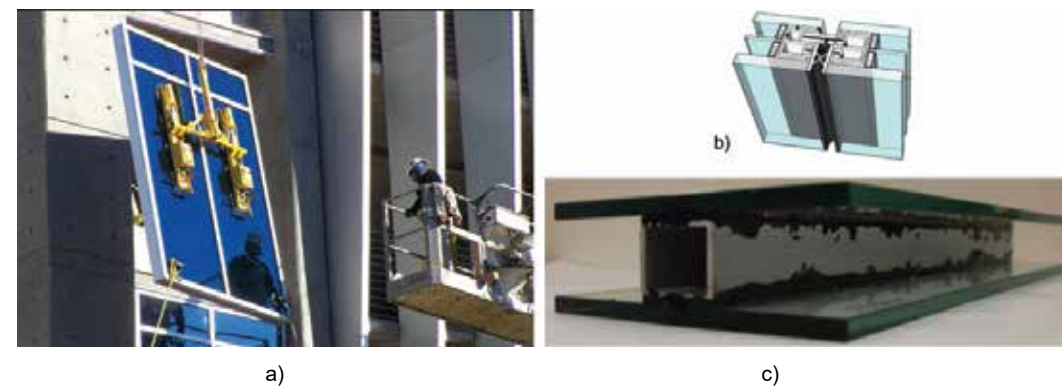

Fig. 1 a) Installation of traditional non-integrated frame unitised panels for curtain wall systems, with b) connection detail between adjacent facade modular units and c) GFRP-glass design concept, according to (Pascual et al. 2017).

2 Design concept and research goals

Novel GFRP-glass sandwich panels (Pascual et al., 2017) represent a potential solution to structurally and thermally outperform traditional unitised panels. The GFRP-glass panel investigated by Pascual et al. (2017) was intended to optimize multi-functional aspects in facades, and consisted of two monolithic glass face sheets structurally bonded to GFRP pultruded core profiles (Figure 1(b)). In such a robust and structurally efficient load-bearing component configuration, it was shown that light transmittance can be largely unimpeded and the air cavity between the two glasses can offer potential for high thermal insulation – in this configuration the GFRP component is effectively protected from weathering and acts essentially as a structural spacer between the glass face sheets. Although the energy and structural performances of façades are both fundamental for design, so far these performances have generally been mainly considered as independent aspects. For instance, Zajas & Heiselberg (2014), presented a sensitivity study aimed at assessing and optimising FRP framing geometry to improve the thermal efficiency of the glazing. On the other side, several literature documents focus on the structural performance only

of glass curtain walls subjected to various mechanical loads, see for example (Behr 1998; Navar et al. 2013; etc.). Although limited research studies are available in the literature about the interaction between structural and energy efficiency requirements within the design of structural frames of innovative unitised systems.

3 Parametric numerical investigation

3.1. Reference systems

Three different frame configurations are considered for the same unitised glazing panel size (width $B=1.5\text{m}$, height $H=3\text{m}$):

- D frame-integrated sandwich GFRP-glass solution (Figure 2(a));
- E non-integrated layered GFRP-glass solution (Figure 2(c));
- F aluminium-glass capped unitised system as a standard reference solution (Figure 2(d)), equivalent to $b=60\text{mm}$ wide mullion commercial product.

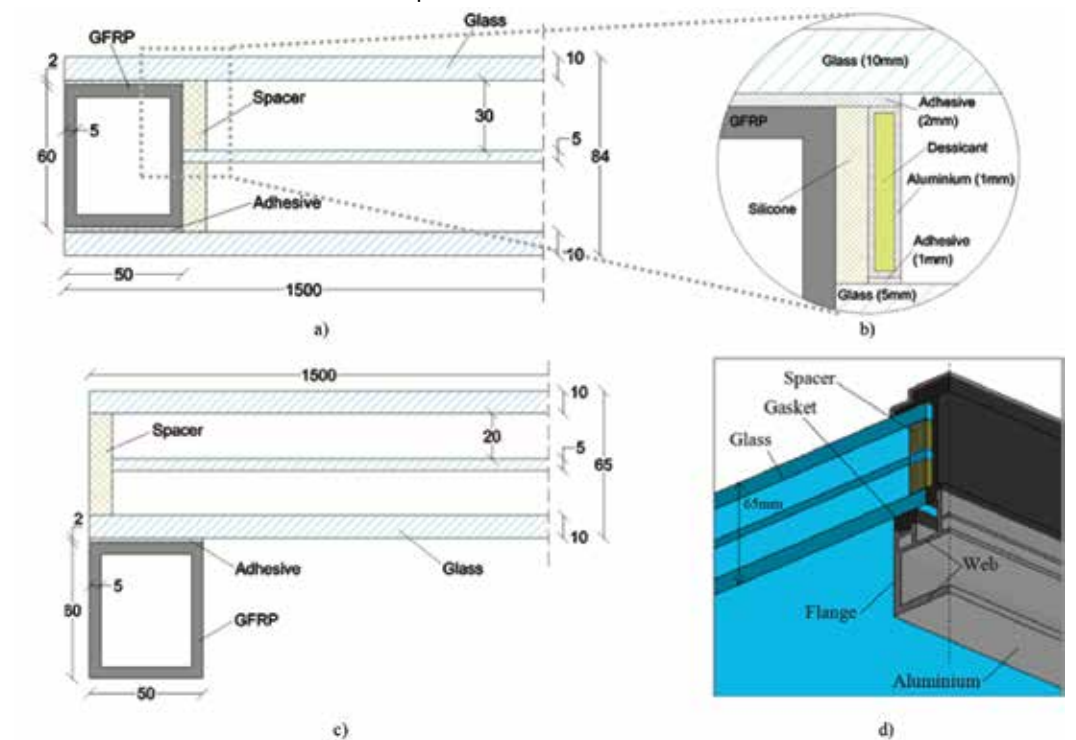

Fig. 2 Sandwich configurations of a) a frame-integrated GFRP-glass sandwich panel, with b) detailed view of a typical aluminium spacer, with c) non-integrated GFRP-glass and d) reference non-integrated aluminium-glass panels (all dimensions in mm).

A detailed view on the spacer is shown in Figure 2(b), consisting of metallic tubes with desiccant, including primary and secondary seals (see also (Van Den Bergh et al. 2013)).

The so assembled, reference frame-integrated GFRP-glass sandwich solution hence comprises (see Figure 2(a)):

- two outer panes, 10mm their thickness, monolithic (annealed) glass;
- an inner pane, 5mm thick, monolithic (annealed) glass;

- a continuous GFRP frame (two mullions and two transoms) within the two outer glass panes, with 50×60×5mm hollow cross-section. The GFRP frame namely consists in two vertical mullions (3m in nominal height H) – allowing for the structural connection to the primary structure – and two horizontal transoms (1.4m their actual nominal length B, being representative of the internal distance between the mullions);
- adhesive joints bonding the GFRP to the outer glass panels: nominally 2mm-thick adhesive layers;
- aluminium spacer tubes with dessicant, with primary butyl seal and secondary silicon one.

The non-integrated GFRP-glass (layered) solution reported in Figure 2(c) has identical GFRP profile dimensions of the integrated solution, and has a typical triple glazing unit bonded to the frame. The reference aluminium-glass panel (Figure 2(d)) for comparative purposes consists of a structural aluminium frame with similar sizes of the GFRP-glass panels object of analysis.

In this first stage of the research study, the design of the unitised system and of the glass panel has not been optimised for structural and safety purposes, nor for installation, re-glazing and thermal shock considerations yet. In fact, the use of annealed monolithic glass panes in place of tempered and/or laminated glass layers able to offer enhanced pre/post-fractured performances can be rationally justified by the limited magnitude of the assigned external loads. Such an assumption is in line with equivalent thickness formulations in use for the structural analysis of laminated glass sections, where monolithic plies can be taken into account for design purposes (Feldmann et al. 2014). In addition, the thermal performance of the glass panels is only slightly dependent on their total thickness. Nevertheless, at the same time it is also expected to further extend the research investigation by including large-displacement scenarios and different mechanical loading conditions.

3.2. Parametric study

The parameters considered for the sensitivity analysis are the following:

- geometrical properties of the GFRP profiles:
 - o GFRP section width b (40mm, 50mm),
 - o GFRP section height h (40mm, 50mm, 60mm, 70mm),
 - o GFRP section thickness t (1/10, 1/15, 1/20 of the maximum section size, i.e. from 2 to 7 mm),
- type of adhesive (structural silicone, acrylate, epoxy),
- adhesive thickness tadh (1mm, 2mm, 3mm),
- spacer details (aluminium bar, steel bar, thermoplastic spacer).

In this paper, FE models with structural silicone adhesive joints and aluminium bar spacers are primarily discussed. As far as variations in the adhesive material and/or thickness and spacer features are considered, additional extended discussion would be required, since major effects manifest in a combination of thermal and structural performance modifications. In terms of adhesive material, the joint shear stiffness is in fact strictly related to the bending performance of the reference modular unit. Variations in the adhesive thickness tadh have both structural and thermal effects, that should be combined with material properties. The spacers features, finally, further affect the thermal performance of the modular units object of analysis.

3.3. Boundary conditions

Structural and thermal numerical analyses are developed by taking into account the loading and boundary conditions herein described:

- Structural boundary conditions
 - o Short-term wind pressure (1kN/m²)
 - o Supports at the panel corners
 - o External loads distributed between the three glass panes, by accounting for gas cavity ('load sharing') effects
 - o Internal (climatic, i.e. temperature variations) loads are neglected
- Thermal boundary conditions
 - o Relative Humidity: 65%
 - o External condition: T= 0°C, surface heat transfer coefficient he= 23 W/m²K
 - o Internal condition: T= 20°C, surface heat transfer coefficient (glass) hi = 8 W/m²K

Table 1 summarises the performance metrics adopted to evaluate the parametric study.

STRUCTURAL PERFORMANCE	THERMAL PERFORMANCE
a) Maximum deflection u_s [mm]	a) Linear heat transfer coefficient Ψ [W/m K] (EN ISO 10211-2)
b) Maximum stress σ in the system components (glass, adhesive, frame) [MPa]	b) Overall Thermal transmittance value U_T [W/m ² K] (EN ISO 12631)
c) Panel weight w [kg/m ²]	c) Thermal Transmittance value at the centre of panel U_c [W/m ² K] (EN 673)
	d) Lowest indoor surface temperature T_{min} (surface condensation risk) [°C]

Table 1: Performance metrics

4 Numerical modelling assumptions and methodology

The full numerical investigation is carried out in ABAQUS/Standard (Simulia). Two separate FE simulations are implemented to evaluate the thermal and structural performance of each facade configuration. Due to symmetry, only 1/4th of the panel is numerically simulated in both the cases, with appropriate thermal/mechanical boundaries and symmetry constraints.

4.1. Thermal analyses

Typically, thermal simulations are carried out in steady-state heat transfer analyses, carried out on FE models composed of 8-node brick solid elements (heat transfer elements, DC3D8 type from ABAQUS library). In accordance with the schematic drawings of Figure 2, solid elements with thermal properties summarised in Table 2 are used. Assuming the modular system being part of a continuous facade, the presence of a linear silicon gasket on the external face of GFRP mullions is also schematized, see Table 2 and (Asdrubali et al. 2013; Bedon et al. 2018).

FE Model	Property	Glass	GFRP	Aluminium	Adhesive	Silicon	Dessicant	Air
T	Conductivity λ [W/mK]	0.8	0.3	240	0.3	0.3	0.03	Equivalent value, see (Bedon et al. 2018)
	Emissivity ϵ	0.95	/	0.8	/	/	/	/
S	Young's modulus E [MPa]	70000	26500 (major) 9900 (minor)	70000	150 *	/	/	/
	Shear modulus G [MPa]	28455	1900 (major) 3000 (minor)	26315	53.5 *	/	/	/

Table 2: Thermal and mechanical material properties for FE modelling (ABAQUS). T= thermal; S= structural; (*)= structural silicone

4.2. Structural analyses

The static bending performance of the examined facade systems is assessed under ordinary wind loads. To this aim, the typical FE model consists in C3D8R solid elements from ABAQUS library. The module components having a crucial role for the thermal performance assessment, but mostly negligible mechanical contributions, are fully neglected, hence the typical structural FE model consists of:

- GFRP or aluminium framing members;
- outer and inner 10mm-thick glass panes;
- a middle 5mm thick glass layer;
- a set of bonding adhesive joints.

In the case of the aluminium curtain wall only (Figure 2(d)), a special attention is spent for the FE description of gaskets and additional details, in accordance with commercial technical system specifications.

Since the imposed external load is of limited magnitude, for the modular unit object of analysis, the materials are mechanically characterized by linear elastic constitutive laws, as also reported in Table 2 and (Bedon et al. 2018). For the GFRP members only, an orthotropic mechanical model is taken into account (engineering constants option from ABAQUS library). Finally, for the reference system in Figure 2(d), the gaskets are described as rubber components (i.e. EPDM type), with a linear elastic behaviour (30MPa the nominal modulus of elasticity, and 0.3 its Poisson ratio).

5 Discussion of numerical results

5.1. Integrated vs. non-integrated system performances

In Figure 3, a selection of FE results is compared for the geometries schematized in Figure 2. The load bearing performance is highlighted by giving evidence of the actual bending stiffness of each modular system, as obtained by comparing the total imposed external load with the maximum deflections at the centre of the glass panel exposed to the wind pressure. In the same figure, the total U-value (UT) is also reported for the same modular systems.

As shown, the structural capacities of the GFRP-glass sandwich system are promising, especially in comparison with traditional curtain wall solutions. Maximum deflections of the examined glazing systems - which are only subjected to a limited external pressures - are mostly negligible ($\approx H/750$) with respect to the design provisions ($H/60$ the allowable deflection at the centre of the panel). Preliminary conclusions on the potential of the GFRP-glass solution can indeed be derived, compared to non-integrated systems.

Both the bending performances of the sandwich and the layered GFRP-glass systems, for example, show marked variations in their overall bending stiffness (in the range of 0.53kN/mm and 0.30kN/mm respectively). The activation of the bending contribution of the outer glass layers due to the sandwich configuration, in this regard, results in an overall stiffness up to 1.8 times larger than the layered GFRP section. In addition, the sandwich system offers minor local bending effects compared to the layered one, hence resulting in a more stable bending performance.

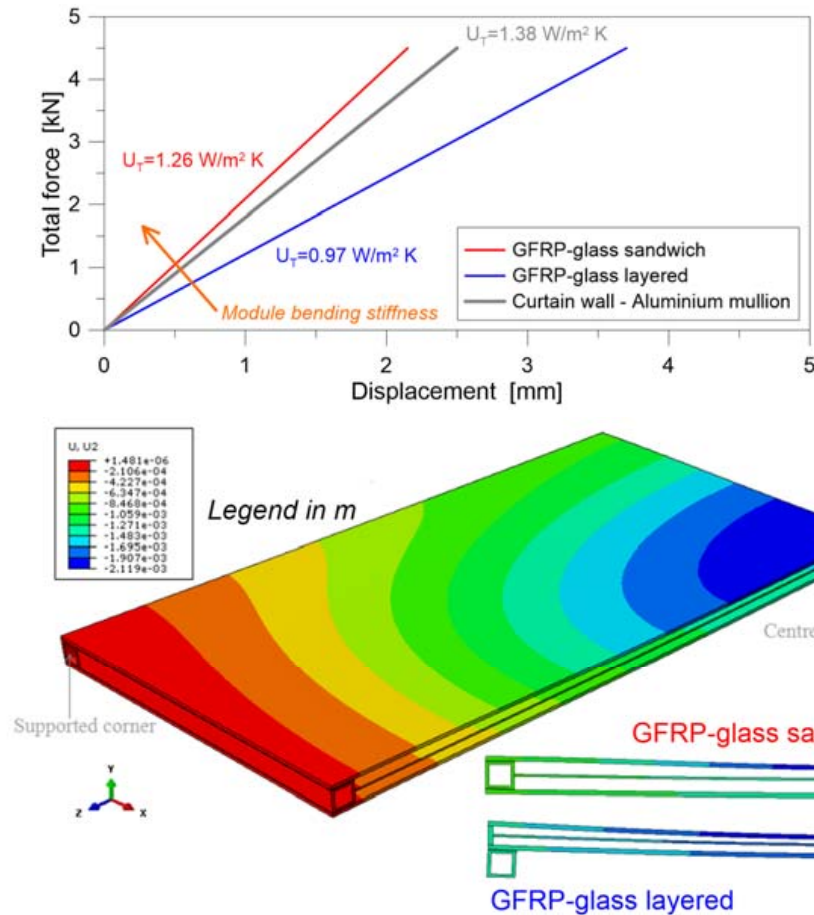

Fig. 3 Force-displacement response of the selected facade systems, including total U-values (ABAQUS).

FE model	Parameter	GFRP sandwich panel	GFRP layered panel	Curtain wall with aluminium frame
T	U_c at the centre of panel [W/m ² K]	0.99	0.92	0.98
	U-total U_T [W/m ² K]	1.26	0.97	1.38
	Minimum surface temperature T_{min} [°C]	15.65	12.63	15.90
	Condensation	No	Yes	No
T	Cross-section total thickness [mm]	84 ($\approx H/35$)	125 ($\approx H/24$)	138 ($\approx H/22$)
	Frame weight w [Kg] ($B \times H$ module)	≈ 16	≈ 16	≈ 20
	Module bending stiffness [kN/mm]	0.53	0.30	0.45

Table 3: Thermal and mechanical material performances of selected FE models (ABAQUS). T= thermal; S= structural

Worth of interest is also the overall thermal performance assessment of the selected configurations. As shown in Figure 4, GFRP frames show to be beneficial for the estimated total U-value, due to their typically low thermal conductivity, especially compared to metal frames. The layered GFRP system gives evidence of an enhanced thermal behaviour, compared to the aluminium curtain wall, but it is able to offer only a limited bending stiffness, compared to the sandwich GFRP-glass system. Table 3 reports additional FE results and analyses that provide data for a further feasibility assessment of the explored GFRP-glass system. The examined sandwich concept, even with a

mostly identical cavity and sealant spacer detailing, offers a safer temperature distribution (see also Figure 4) and suggests the higher potential also in terms of condensation risk.

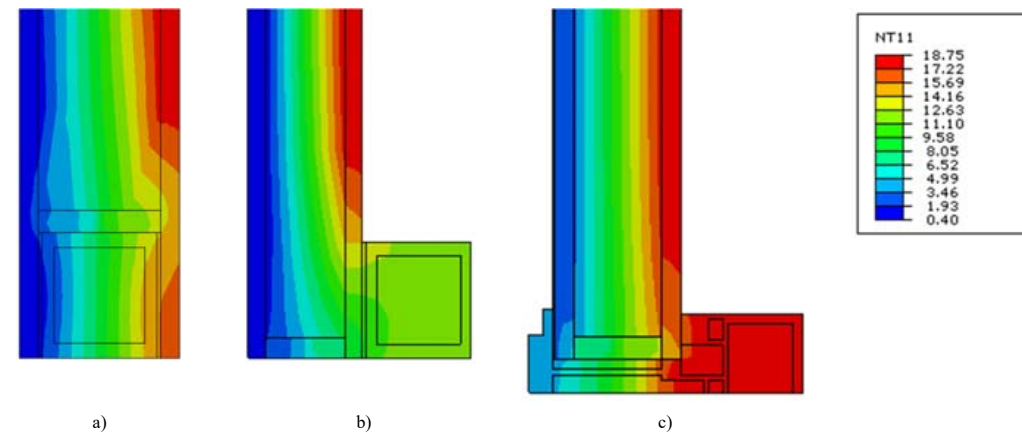

Fig. 4 Cross-sectional detail of temperature distribution (ABAQUS, legend in °C), as obtained for the a) GFRP-glass sandwich, b) GFRP-glass layered and c) non-integrated curtain wall with aluminium frame systems.

5.2. Summary of the sensitivity study

Given the promising results summarised in Section 5.1, a concise sensitivity study is herein also discussed, as a part of the extended analysis of parametric FE result, for the sandwich GFRP-glass panel.

In general, even small variations in the input parameters according to Section 3.2 proved to have a certain effect on both thermal and structural aspects for the GFRP-glass sandwich systems object of analysis, hence suggesting detailed investigations for an optimisation of the same design concept.

In Figure 5, selected FE comparative data are reported for GFRP-glass systems according to Figure 2(a), with $h=70\text{mm}$ the frame members height. Geometrical variations are represented by:

- the GFRP framing members width (i.e. FE dots labelled with $b=40\text{mm}$ or 50mm respectively);
- the GFRP framing members thickness ($t=3.5\text{mm}$ or 7mm , corresponding to $1/20$ and $1/10$ the member size h respectively);
- The thickness of adhesive joints ($t_{adh}=1\text{-to-}3\text{mm}$)

FE results are proposed in Figure 5 in the form of total UT value, as a function of the R_u ratio, being defined as:

$$R_u = \frac{H}{u_c - u_m} \quad (1)$$

with H the modular unit height, while u_c and u_m denote the measured deflections at the center of glass and at the mid-span section of mullions.

According to design standards and regulations for curtain wall system, two important deflection limits should be generally taken into account for structural purposes, being namely associated to the maximum deformations u_{max} that should be checked:

1) at the centre of glass panel (with $H/60$ the limit value for glazed infills)

2) or in the supporting frame members (with $H/125$ - or $H/175$ for frames sustaining glass panels edges - the limit value, or anyway $H/200$)

In this study, given that the glass panels and the GFRP frame members for the proposed sandwich solution are expected to work in the form of a composite system, with respect to the traditional aluminium-framed curtain wall, the R_u ratio of Eq.(1) is taken into account as a parameter well representative of the overall flexibility of the system. Such a non-dimensional ration, in addition, allows for comparative discussion of results for the full set of examined geometrical and mechanical configurations, being inclusive of flexibility effects deriving from the deformation of the framing members, as well as of the glass panels or the interposed adhesive joints. For the parametric FE configurations investigated through the full research study, the assigned wind pressure typically resulted in small deformations, in the range of $H/400$ -to- $H/1300$ in terms of deflections at the centre of glass panels.

As far as the size and/or thickness of GFRP framing members decreases, see Figure 5, marked variations in the expected bending stiffness are recorded, leading to mostly grouped $b \times h$ FE dots for each set of framing configurations. The adhesive joints thickness, in this regard, proved to have limited effects on the mechanical performance of the examined systems, as also emphasized by the (R_u, U_T) linear trend of the selected FE dots. Largest R_u variations with t_{adh} , still in the range of 1-3%, were observed for the 50×70 framing members, compared to the 40×70 solutions. Worth of interest, in Figure 5, is the bending performance of the set of $b=40\text{mm}$ frames with $t=3.5\text{mm}$. There, the GFRP frame members are so flexible (compared to the full sandwich system) that an increase in t_{adh} results in an increase of R_u , hence resulting in a beneficial structural effect for the overall assembly.

In terms of thermal performance assessment, it can be clearly noticed in Figure 5 that decreasing the adhesive thickness t_{adh} typically manifests in increase of U_T values. In any case, for the analysed cases ($h=70\text{mm}$), given same the frame section width b and type of adhesive, variations in t_{adh} contribute to vary the U_T values only marginally, in the order of 3-4% absolute scatter. In conclusion, both the examined GFRP framing members and the adhesive joints thicknesses typically resulted in minor variations of the total transmittance values U_T , hence suggesting a mostly stable thermal performance for the investigated modular units.

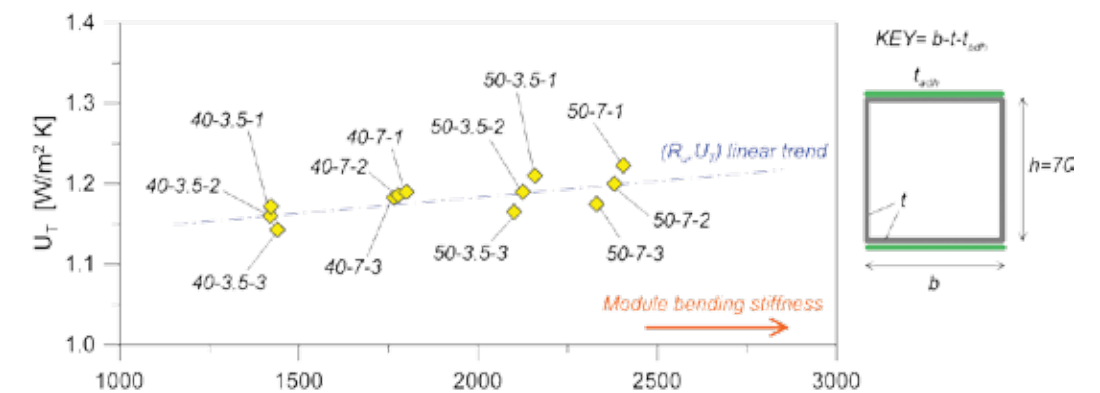

Fig. 5 Selected parametric results for sandwich GFRP-glass systems (ABAQUS), as obtained by changing the frame and adhesive joint sizes. Variations of U_T values. All dimensions in mm.

This is not the case of temperature performance assessments. When the temperature distribution is explored for the same GFRP-glass systems, largest sensitivity of FE results was in fact found to derive from even small geometrical variations of the modular components. In Figure 6, the same selection of FE model predictions is proposed in the form of R_u values, as a function of the minimum recorded surface temperature T_{min} . In the figure, the reference temperature to ensure a possible condensation risk is also emphasized, as also in accordance with the EN provisions. As shown, the selected FE dots are still grouped by geometrical input parameters, having a crucial effect on the bending stiffness of the modular units and hence on the corresponding R_u values. Some important outcomes can indeed be derived from Figure 6. First, it can be seen that only for some of the selected geometrical configurations the condensation risk can be prevented. In addition, the (R_u, T) linear trend suggests an highest sensitivity of measured temperatures, with respect to the U_T values of Figure 5. Differing from Figure 5, a decrease in the adhesive thickness t_{adh} is typically associated to a decrease of temperature T (-3-4% the measured temperature variations, for each group of framing sections, when moving from 1mm to 3mm of adhesive thickness).

When the linear heat transfer coefficient ψ is considered, even largest sensitivity of FE results can be noticed, to the geometrical features of the modular components, see Figure 7. While ψ still increase with t_{adh} decrease, like for the corresponding U_T values, variations in the order of 30% were calculated for each grouped set of configurations. In this context, it is possible to perceive the importance of coupled thermal and structural considerations for the optimal design of similar systems.

Through the parametric FE simulations herein discussed, in conclusion, variations in the maximum stresses σ achieved in all the modular unit components were also typically observed, being strictly dependent on the flexibility of the assembled systems. Given the limited magnitude of the imposed wind pressure, however, such a kind of variations was generally associated to a full linear elastic performance of the modular members. It is expected, in this regard, that the discussion of sensitivity studies could offer additional background for the optimisation of the GFRP-glass sandwich design concept, as far as further thermo-mechanical loading and boundary configurations are explored.

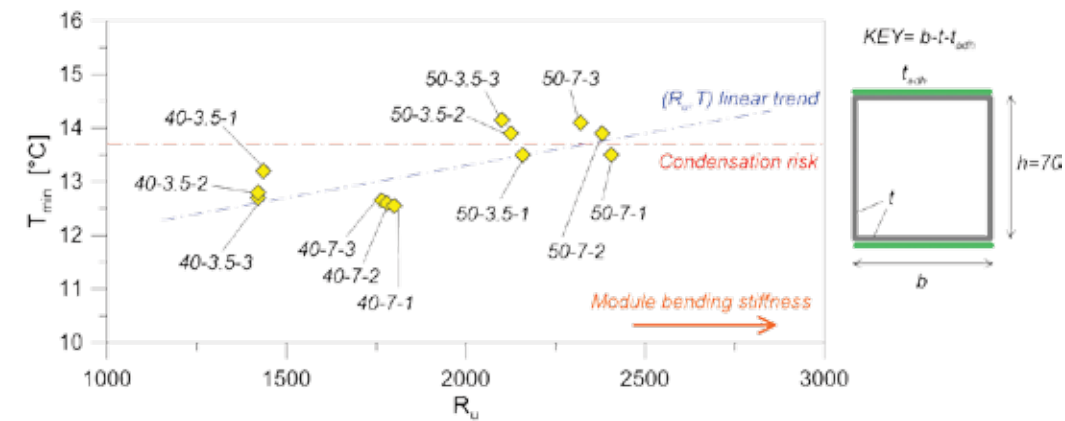

Fig. 6 Selected parametric results for sandwich GFRP-glass systems (ABAQUS), as obtained by changing the frame and adhesive joint sizes. Variations of T_{min} values. All dimensions in mm.

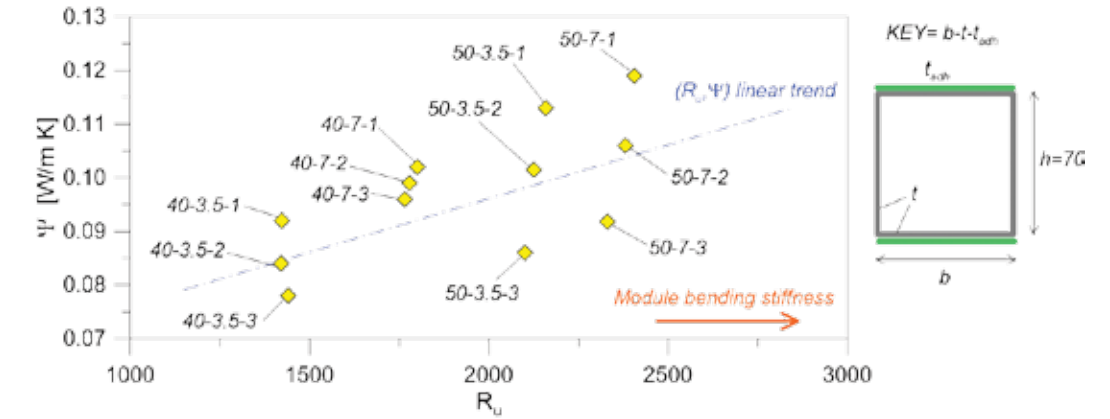

Fig. 7 Selected parametric results for sandwich GFRP-glass systems (ABAQUS), as obtained by changing the frame and adhesive joint sizes. Variations of ψ values. All dimensions in mm.

6 Conclusions

In this paper, a Finite Element (FE) study aimed to assess the potential and feasibility of a novel GFRP-glass sandwich facade component was reported, based on parametric thermal and structural numerical simulations. In particular, the thermo-mechanical performance of novel GFRP-glass sandwich components was assessed towards two selected systems, namely consisting of a traditional aluminium curtain wall and a non-integrated, GFRP-layered curtain wall system. A concise sensitive study was then briefly discussed, as obtained from an extended parametric investigation.

As shown, the GFRP-glass sandwich system proved to offer enhanced structural performances, compared to the GFRP-layered and aluminium solutions. Even small variations in the geometrical and / or mechanical properties of the modular unit components, on the other hand, gave evidence of a certain sensitivity of both structural and thermal performance parameters for the same facade systems, hence emphasizing the key role of thermo-mechanical evaluations as well as the need of additional discussion of parametric FE results.

Further work is needed to carry out a full analysis of the parametric study results, aiming at understanding also the importance of the shape of the GFRP frame on structural and thermal performance.

7 Acknowledgements

The paper results from an ongoing collaboration between the involved researchers, as well as from a Short-Term Scientific Mission (Coupled structural & thermal optimisation of a multifunctional building skin) of the first author to University of Cambridge (UK) - April 2016.

In this regard, the European COST Action TU1403 'Adaptive Facades Network' (2014-2018, <http://www.tu1403.eu>) is gratefully acknowledged for financially supporting the research study and for providing excellent research networking between the involved authors, as well as with international experts.

8 References

- Asdrubali, F., Baldinelli, G., & Bianchi, F. (2013). Influence of cavities geometric and emissivity properties on the overall thermal performance of aluminum frames for windows. *Energy and Buildings*, 60: 298-309
- Bedon, C., & Amadio, C. (2017). Enhancement of the seismic performance of multi-storey buildings by means of dissipative glazing curtain walls. *Engineering Structures*, 152: 320-334
- Bedon, C., & Louter, C. (2018). Numerical investigation on structural glass beams with GFRP-embedded rods, including effects of pre-stress. *Composite Structures*, 184: 650-661
- Bedon, C., Zhang, X., Santos, F., Honfi, D., Kozłowski, M., Arrigoni, M., Figuli, L., & Lange, D. (2018a). Performance of structural glass facades under extreme loads - Design methods, existing research, current issues and trends. *Construction and Building Materials*, 163: 921-937
- Bedon, C., Pascual Agullo, C., Luna-Navarro, A., & Overend, M. (2018b). Thermo-mechanical investigation of novel GFRP-glass sandwich facade components. *Proceedings of Challenging Glass Conference*, vol. 6, p. 501-512, doi: 10.7480/cgc.6.2172, ISSN 2589-8019. Available online at (last accessed May 2018): <https://journals.library.tudelft.nl/index.php/cgc/article/view/2172>
- Bedon, C., Honfi, D., Kozłowski, M., Vokáč Machalická, K., Santos, F., Wüest, T., Eliášová, M., & Vokáč, M. (2018c). Key Structural Aspects for Adaptive Facades - Activity Progress from the EU-COST Action TU1403 'Structural' Task Group. *International Journal of Structural Glass and Advanced Materials Research*, published online (last accessed July 2018): <http://thescipub.com/abstract/10.3844/ofsp.12034>
- Behr, R. (1998). Seismic performance of architectural glass in mid-rise curtain wall. *Journal of Architectural Engineering*, 4(3): 94-98
- Cordero, B. (2015). Unitised curtain wall with low thermal transmittance frame integrated within the Insulating Glass Unit through structural adhesives. Ph.D. Dissertation, Polytechnic University of Madrid, available online: http://oa.upm.es/38429/1/BE-LARMINO_CORDERO_DE_LA_FUENTE.pdf (last accessed May 2018)
- Correia, J.R., Valarinho, L., & Branco, F.A. (2011). Post-cracking strength and ductility of glass-GFRP composite beams. *Composite Structures*, 93: 2299-2309
- EN ISO 10077-2:2017. Thermal performance of windows, doors and shutters - Calculation of thermal transmittance - Numerical methods for frames. CEN, Brussels, Belgium
- EN ISO 12631:2017. Thermal performance of curtain walling - Calculation of thermal transmittance. CEN, Brussels, Belgium
- EN ISO 10211-1 Thermal bridges in building construction - Heat flows and surface temperatures - Part 1: General calculation methods
- BS EN ISO 10211-2 Thermal bridges in building construction - Calculation of heat flows and surface temperatures - Part 2: Linear thermal bridges
- EN 673 Glass in building - Determination of thermal transmittance (U-value) - Calculation method
- EN ISO 12631:2012 - Thermal performance of curtain walling. Calculation of thermal transmittance
- EPBD 31/2010, Directive on Energy Performance of Buildings Recast, European Parliament and European Council, Bruxelles, 2010
- Feldmann, M., Kasper, R., Abeln, B., Cruz, P., et al. (2014). Guidance for European Structural design of glass components – support to the implementation, harmonization and further development of the Eurocodes. Report EUR 26439, Joint Research Centre–Institute for the Protection and Security of the Citizen, doi: 10.2788/5523, Pinto Dimova, Denton Feldmann (Eds.)
- Ge, H. (2002). Study on overall thermal performance of metal curtain walls. PhD thesis, Concordia University.
- Jesus M. Cerezo, M., Nunez, M.A. (2015). Fiber Reinforced Polymer (FRP): A New Material Used in Facades of Tall Building. *Proceedings of BTBUH 2015 New York Conference*, pp. 636-644
- Jin, Q. (2013). Towards a whole-life value optimisation model for facade design. Ph.D. Dissertation, University of Cambridge, available online (last accessed May 2018): http://www-g.eng.cam.ac.uk/gft/media/PhD%20Thesis/PhD%20Thesis_Final.pdf
- Navar, M., Salim, H., Lusk, B., & Perry, K. (2013). Modeling and testing of laminated curtain wall systems under blast loading. *Structures Congress 2013*, <https://doi.org/10.1061/9780784412848.016>
- Pascual, C., Montali, J., & Overend, M. (2017). Adhesively-bonded GFRP-glass sandwich components for structurally efficient glazing applications. *Composite Structures*, 160: 560-573
- Simulia (2017). ABAQUS v. 6.14 computer software and online documentation, Dassault Systems, Providence, RI, USA
- Schüco (2018). Schüco Façade FW 60+ - System solutions for vertical facades and skylights, https://www.schueco.com/web2/de-en/architects/products/facades/mullion_transom_facades/schueco_fw_60plus_hi
- Speranzini, E., & Agnetti, S. (2015). Flexural performance of hybrid beams made of glass and pultruded GFRP. *Construction and Building Materials*, 94: 249-62
- Van Den Bergh, S., Hart, R., Petter Jelle, B., & Gustavsen, A. (2013). Window spacers and edge seals in insulating glass units: A state-of-the-art review and future perspectives. *Energy and Buildings*, 58: 263-280
- Zajas, J., & Heiselberg, P. (2014). Parametric study and multi objective optimization of window frame geometry. *Building Simulation*, 7(6): 579-593

Thermal assessment of glass façade panels under radiant heating - Experimental and preliminary numerical studies

Chiara Bedon 1, Marcin Kozłowski 2, 3, Dániel Honfi 4

1 University of Trieste, Italy, chiara.bedon@dia.units.it

2 Lund University, Sweden

3 Silesian University of Technology, Poland

4 RISE - Research Institutes of Sweden, Sweden

Nowadays, glass is increasingly being used as a load-bearing material for structural components in buildings and façades. Different structural member solutions (such as panels, beams, columns) and loading conditions were the subjects of several research studies in recent years. Most of them, however, were typically limited to experimental testing and numerical simulations on glass elements and assemblies at room temperature. Thermo-mechanical investigations, inclusive of the temperature-dependent behaviour of visco-elastic interlayers used in laminated glass solutions, as well as the typical thermo-mechanical degradation of glass properties in line with temperature increase, in this regard, are still limited. Such an aspect can be particularly important for adaptive façades, in which the continuous variation of thermal and mechanical boundary conditions should be properly taken into account at all the design stages, as well as during the lifetime of a constructed facility. Given the key role that thermo-mechanical studies of glazing systems can use of glass in façades, this paper focuses on Finite Element (FE) numerical modelling of monolithic and laminated glass panels exposed to radiant heating, by taking advantage of past experimental investigations. In the study discussed herein, being representative of some major outcomes of a more extended research project, one-dimensional (1D) FE models are used to reproduce the thermal behaviour of selected glass specimens under radiant heating, as observed in the past experiments. Given the high computational efficiency but very basic assumptions of 1D assemblies, a critical discussion of experimental-to-numerical comparisons is then proposed for a selection of specimens.

Keywords: monolithic glass, laminated glass, thermal loading, radiant heating, experimental testing, Finite Element (FE) numerical modelling

Full paper available in the *Journal of Facade Design and Engineering*, Vol 6 No 3 (2018): Special Issue FAÇADE 2018 – Adaptive!.

Dynamic Analysis of Climatic Conditions for deriving suitable Adaptive Façade responses

Miren Juaristi a), Roel Loonen b) Aurora Monge-Barrio a), Tomás Gómez-Acebo c)

a) Universidad de Navarra, School of Architecture, Spain, mjuaristi@alumni.unav.es

b) Eindhoven University of Technology, Department of the Built Environment, The Netherlands

c) Universidad de Navarra, TECNUN School of Engineers, Spain

Highly insulated buildings, combined with efficient HVAC systems, represent the mainstream approach to achieve low-energy buildings. However, if façades block energy exchange, the climatic resources surrounding the built environment remain untapped. Adaptive opaque façades seem promising to enhance whole building performance while reducing energy demand by their dynamic behaviour. The usual approach when defining their desired adaptive response is to test independent technologies by energy simulations, to calibrate their best adaptation range for a specific climate. Such technology-oriented approaches do rarely make a conscious analysis of the potential of local natural resources, which could lead to a weak adaptation strategy. Besides, the enhancement of combining responsive elements is usually omitted. This paper proposes a new approach for systematic analysis of dynamic climatic conditions, aiming to enable better decision-making at early design stages to ensure the proposed façade solution will have the maximum positive impact. To do so, we analysed the impact of combinations of climatic agents on the hygrothermal performance and we clustered them into Climatic Scenarios. Moreover, we examined the influence of studying not only these scenarios but also their transience. We carried out this systematic analysis for a specific temperate climate and we studied the sequences of three summer days using a screen tool that links the climate data with promising Adaptive Façade Responses. We observed how the meaningful candidate multi-responses changed in the sequence examination due to different past and future scenarios, which strengthen the need of a Dynamic Climate Analysis to properly define new adaptive façades.

Keywords: Climate response, environmental resources, hygrothermal performance, dynamic façades, temperate climate

1 Introduction

There is an acute necessity to achieve low-energy buildings in order to meet the energy conservation and emissions reduction agenda. Such a key challenge urges a paradigm change for the architecture and construction industry, not only by integrating low-carbon technologies and innovative solutions (Aschehoug et al., 2008), but also by understanding the benefits and implications of building with new high-performing elements.

In recent times, a notable part of research in the built environment has focused on the development of promising building technologies that can improve the energy performance and users' comfort. Among the emerging technologies with high potential are adaptive opaque façades (Juaristi, Monge-Barrio, Sánchez-Ostiz, & Gómez-Acebo, 2018; Loonen, Trčka, Cóstola, & Hensen, 2013). For instance, with the use of energy simulations, Favoino et al. have demonstrated that by applying new dynamic components that can adjust the direction and intensity of thermal flux, the annual energy use could be reduced between 25-35% in Shanghai (Favoino, Jin, & Overend, 2017; Jin, Favoino, & Overend, 2017), while Park et al. have shown that such technologies could offer a reduction of 15% to 39% in cooling energy use and 10% for heating in some temperate climates

in the USA (Park, Srubar, & Krarti, 2015). Current approaches for analysing the performance of adaptive opaque façades are mostly based on assessment of already proposed solutions instead of the exploration of new ideas (Loonen, Singaravel, Trčka, Cóstola, & Hensen, 2014). Such studies can be used for sizing of components and fine-tuning of configurations, but tend to be carried out in the later phases of building design or product development when many of the important decisions have already been made. As a consequence, it can be argued that many of the decisions are based on intuition instead of analysis, and that fundamental links between calculations and architects or façade engineers are missing, which hinders the successful application of such technologies in construction. One of the most evident problems is that designers, who aim to design an adaptive façade at the initial design stage, have little guidance and no decision-support tools to make strategic choices about suitable adaptive façade responses for the given location, without running a detailed building simulation that would normally be incompatible in terms of (i) simulation time and (ii) input requirements for physical properties and control strategies.

Meanwhile, when designing with well-known technologies and strategies in Architecture, various systematic methods exist to support conscious design decision-making. Generally, the first approach is to analyse the plot (e.g. climate, urban morphology, local characteristics and constraints) in connection with the specific needs of the client (Fig. 1). This first holistic study should enable the utilization of natural resources to get a more energy efficient and comfortable building. At this early design stage, a comprehensive understanding of the climate resources plays a fundamental role, and for this reason, several methods and software tools (NREL, 2017; UCLA, 2017) have been developed that can be used to analyse weather files in relation to climate-aware architecture strategies, such as natural ventilation and static shading elements (Belleri, Avantaggiato, Psomas, & Heiselberg, 2017; Causone, 2016; Upadhyay, 2018). A limitation is that these methods propose climate-based design solution according to mainstream concepts, while they are not considering new paradigms such as adaptive building envelopes. These approaches work well when designing passive static strategies, as they interact with the ambient environment in the same way all over the year, but it is ineffective for dynamic strategies, that shift from a protecting to an energy and/or matter exchange role according to the environmental conditions.

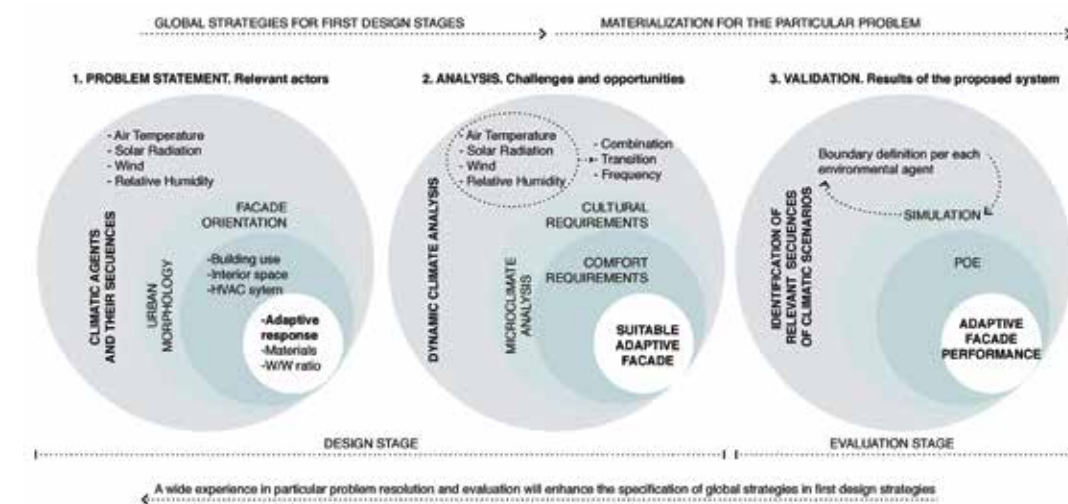

Fig. 1 Dynamic Climate Analysis allows the definition of global strategies at first design stages.

The aim of this paper is to propose a new methodology, which is under development, that analyses the dynamic/periodic characteristics of a specific climate (section 3) in order to support the design of suitable Adaptive Façade Responses (section 4). Thus, the design option space will be efficiently

reduced in order to make a good choice of responsive technologies, even if this dynamic analysis would be only a first stage study that needs to consider the other relevant actors in the further design process (Fig. 1).

2 Research methods

Several research steps were carried out to conceive a new approach to study environmental resources that interact with Adaptive Facades, consisting of (i) a critical evaluation of the capabilities and limitations of existing climate analysis tools (section 1), (ii) formulation of the requirements based on analysis of dynamic characteristics and considerations that need to be taken into account (section 3.1), (iii) identification of potential development directions, and (iv) iterative development of the approach, using a concrete case study as an example (section 3.2 - section 4).

We detected that the main limitations of current methodologies were that existing climate analysis tools (a) suggest mostly mainstream concepts, (b) summarize the variations of the climate in averages or cumulative values and (c) as a consequence do not capture the transience of environmental agents. Besides, detailed simulations are (d) too time consuming and (e) need high definition of the envelope regarding their properties, which usually is not developed at first design stages.

All the same, it is important to consider the following three aspects when applying climate analysis to identify the suitable dynamic behaviour of adaptive building envelopes:

- The combined impact of different climatic agents on the hygrothermal behaviour,
- The transition characteristics from one scenario to another (climatic sequences),
- The frequency of these sequences and the time of the day/year at which they occur.

Different development directions for the new dynamic climate analysis approach were examined in an iterative way, by testing ideas and gathering feedback on the basis of a hands-on case study. To face this challenge, we chose the location of San Sebastian, Spain, and we compared the climatic conditions of each season. This was done by analysing Typical and Extreme weeks (U.S. Department of Energy, 2017) of the Typical Year Weather Files IWEC2, which are based on measured data between 1983-2008 (Huang, 2011). We verified how the dynamic climate analysis, which considers both the combined impact of different climatic agents and the transition between different climatic scenarios, affects the desired façade response, and how such effects can be visualized. Therefore, one of the initial research steps involved clustering different combinations of climatic agents into Climatic Scenarios (CS), according to a set of ranges and their relevance in the hygrothermal performance (section 3.1). The analysis of these clusters enabled the detection of the diversity of scenarios in this climate and the differences between seasons. Secondly, we demonstrated the relevance of studying the transience between different CS and we examined visually the climatic sequences of three summer days (section 3.2). Finally, through the development of a mock-up of a software tool, we assessed how the previous environmental conditions and future trends modify the characterization of the hygrothermal performance of the façade and therefore, the suitable Adaptive Façade Response (section 4).

3 A systematic analysis of dynamic climatic conditions

3.1. Including the adaptive and dynamic aspects in the climate analysis

The dynamic analysis of climate conditions can help to define the most promising Adaptive Façade Response (AFR) of an opaque façade focused on its high hygrothermal performance, as such an analysis considers the impact of different combinations of climatic agents, not as isolated events, but as transient episodes. This new approach could help to determine (i) the suitable multifunctional adaptive behaviour, (ii) the operational scenario at which this AFR should take place (i.e. when a function should be activated or deactivated), (iii) the adaptation range that would be necessary to meet the demands in all the relevant circumstances, and (iv) the speed of adaptation that would be required for an optimal performance.

The first step to find the promising multifunction combinations is to analyse the diversity of CS along the whole year for a specific climate. Climatic Scenarios were defined in this study by dividing relevant climatic agents (solar radiation, air temperature, wind velocity and humidity content) into ranges with the use of threshold, and looking at their combined impact on the hygrothermal performance of the building. For example, at an ambient air temperature of 16°C, the indoor environment is not always affected in the same way. Whether thermal exchange is desirable or not depends on the amount of solar radiation that is concurrently available, as well as the possible convective losses as a result of wind velocity. Similarly, if it is 22°C outside, then it looks profitable to have a thermal exchange between indoor and outdoor environment, unless the solar radiation is causing the overheating of the surrounding environment of the façade, or the wind action is not enough to avoid that possible overheating scenario. Consequently, depending on the specific combination, the impact of each climatic agent on the hygrothermal performance will vary, and therefore it should be analysed in an integrated way to facilitate scoping of the suitable adaptive façade.

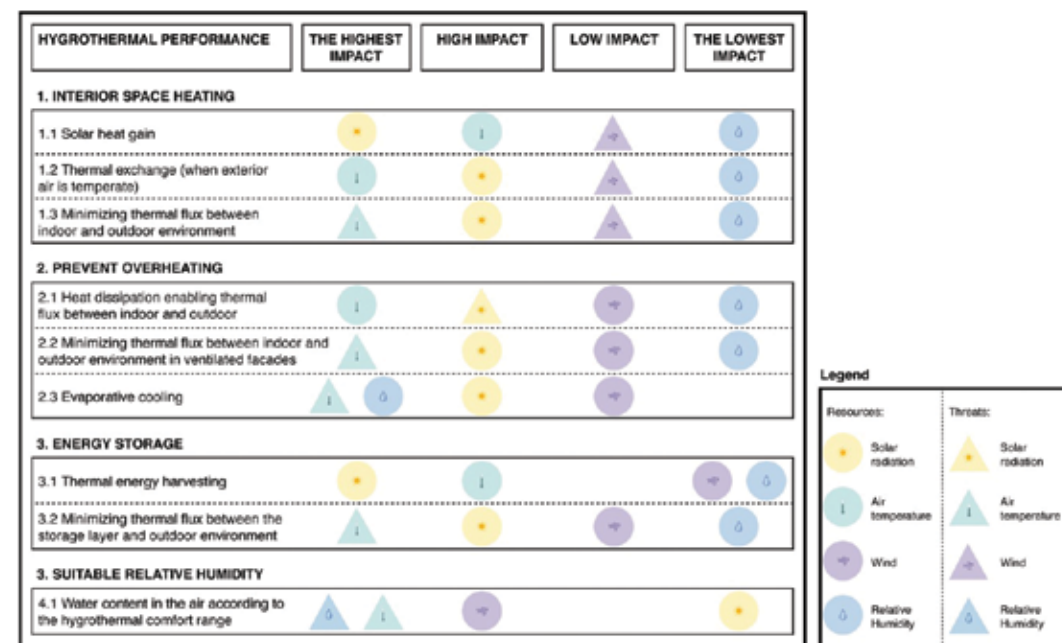

Fig. 2 Climatic Agents and their impact ratio on the hygrothermal performance of the façade system

However, as it is summarized in Fig. 2, most of the times air temperature has the highest impact on the hygrothermal performance of opaque façades related to achieve comfort, followed by solar radiation, while wind velocity tends to modify the overall performance in a secondary way. The humidity has the lowest impact unless when considering evaporative cooling strategies or in overheating periods with high humidity levels.

Therefore, to be able to study in a systematic way the Weather Files and to identify the different CS, a preliminary boundary definition per each climatic agent was done according to the effect of each of them on the cooling and heating demand of a residential building. In the light of the results of Fig.2, air temperature and solar radiation were considered as main lines to differentiate CS. On the one hand, air temperature was divided into four regions: (A) <13°C the heating demand would be generally inevitable, (B) ≥13°C<16°C the heating demand could be diminished or avoided if the other climatic agents enhanced solar heat gains, (C) ≥16°C<24°C generally under comfort indoor conditions, although there might be an overheating risk if solar radiation is high, (D) ≥24°C temperature is outside the comfort boundary and a cooling demand or overheating risk is likely to occur. On the other hand, the influence of vertical solar radiation per orientation (since the research is focused in AFR) was graded in three levels: (1) <25W/m2 solar radiation has no heating effect on the interior environment, (2) ≥25W/m2 < 275W/m2 mainly diffuse, but no direct solar irradiance incident on the façade, so its effect on the thermal energy balance is of moderate importance (3) ≥275W/m2 there is direct solar irradiance that would significantly enhance solar heat gains. Combining these two climatic agents, an assessment was made for every scenario to determine whether the temperature and solar radiation had a positive (+) or negative (-) influence on heating or cooling demand. In cases where different scenarios had the same effect, they were combined in order to reduce the total number of CS (Fig. 3).

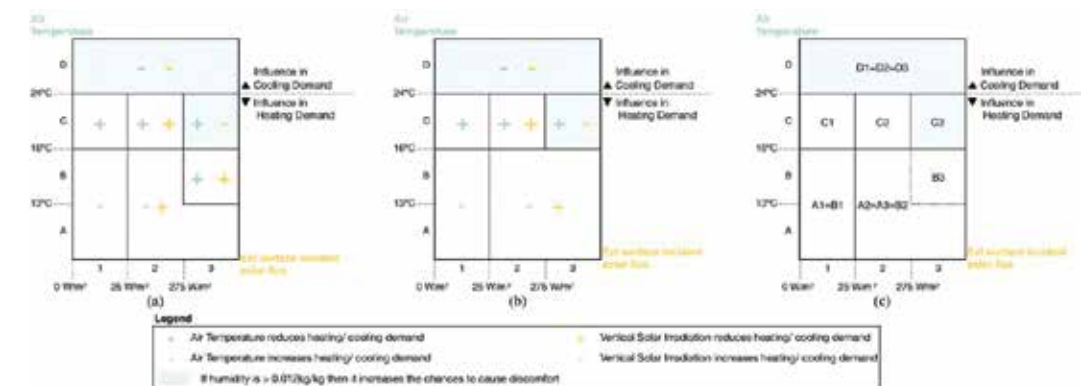

Fig. 3 Boundary definition when wind velocity is <2,5m/s (3a), when wind velocity is ≥2,5m/s (3b) and naming approach (3c) to cluster different combinations of climatic agents

Besides, the wind effect modifies the impact of air temperature when it is above 2,5 m/s, as it produces substantial thermal losses (Ibañez-Puy, Vidaurre-Arbizu, Sacristán-Fernández, & Martín-Gómez, 2017). Indoor maximum recommended relative humidity of 70% and the limit of absolute humidity in 0,012 kg/kg (EN15251, 2007) makes even more energy demanding and uncomfortable the scenarios where overheating might occur. With the holistic analysis of the impact of each environmental agent, final boundaries were set and named accordingly. For example A1=B1 means that there is not significant solar radiation and that there is a heating demand as the temperature is below 16°C with no potential for utilization of solar heat gain. If wind velocity exceeds a value of 2,5m/s, then this scenario would be even more demanding, as thermal losses would occur due to convective movements, and it would be called as A1w=B1w, but the adaptive façade behaviour would still aim to prevent thermal losses. D1=D2=D3 is a scenario with overheating risk, even more

demanding with high humidity (D1h=D2 h =D3 h) that might need a dehumidification strategy, while if wind would be over 2,5m/s, it might be a profitable resource to face this challenge (D1wh=D2 wh =D3 wh).

Despite this CS analysis presented above, the AFR cannot be captured yet, as the suitable dynamic performance does not only depend on the current situation, but also on the previous state of the façade and the future boundary conditions. Only by analysing the sequence of CS, detrimental adaptive reactions can be avoided and climatic resources can be fully exploited. The study of sequences enables to understand if the building is moving from a more demanding to a milder situation, or vice versa. For instance, it is not the same to be in a C2 climatic scenario (mild temperature and no direct solar irradiance) after being in a A1=A2, heating demanding scenario, or after being in D1=D2=D3, a cooling demanding scenario. The reaction of the façade would be different (as will be described in section 3), so the whole path from one CS to another needs to be assessed, as it is shown in the following case study (section 2.2). Moreover, if the façade would have a forecast-based future prediction ability, AFR could be further optimized scoping the most probable climate trend.

3.2. A Case Study: analysis of San Sebastian's climate

San Sebastian is a seaside location in the north of Spain, which has a temperate climate (Cfb, following Köppen-Geiger classification) dominated by the heating season (1885 heating degree days, with base 18°C) and with weather conditions that are to a large extent influenced by the ocean. We used the Dynamic Climate Analysis to explore its climate resources and threats before defining the suitable adaptive façade responses. We started studying the diversity of different climatic scenarios, according to the climatic agent combinations (Fig. 4). In total, 16 climatic scenarios were found and A1(W)=A2(W)=A3(W) and C1(W) scenarios took place in all the typical weeks. Moreover, Typical and Extreme Winter Weeks were dominated by heating demand and they had less variety of CS, though the Typical Spring Week, Typical Autumn Week and Typical Summer Week had both heating demand CS and mild CS. Besides, Typical Autumn Week and Extreme Summer Week were the most diverse seasons regarding the CS, which could mean a larger number of different AFRs and higher change frequency. New and more challenging scenarios appeared in Extreme Summer Week, as overheating periods were even combined with too high humidity ratios. If the AFR strategy would not address this extreme scenario, as this climate doesn't require till now the installation of cooling systems, overheating risk with consequences on health could happen, or additional active systems could be settled by users, as already occurs in heat waves and hot spells (Monge-Barrio & Sánchez-Ostiz Gutiérrez, 2018).

Performance Assessment

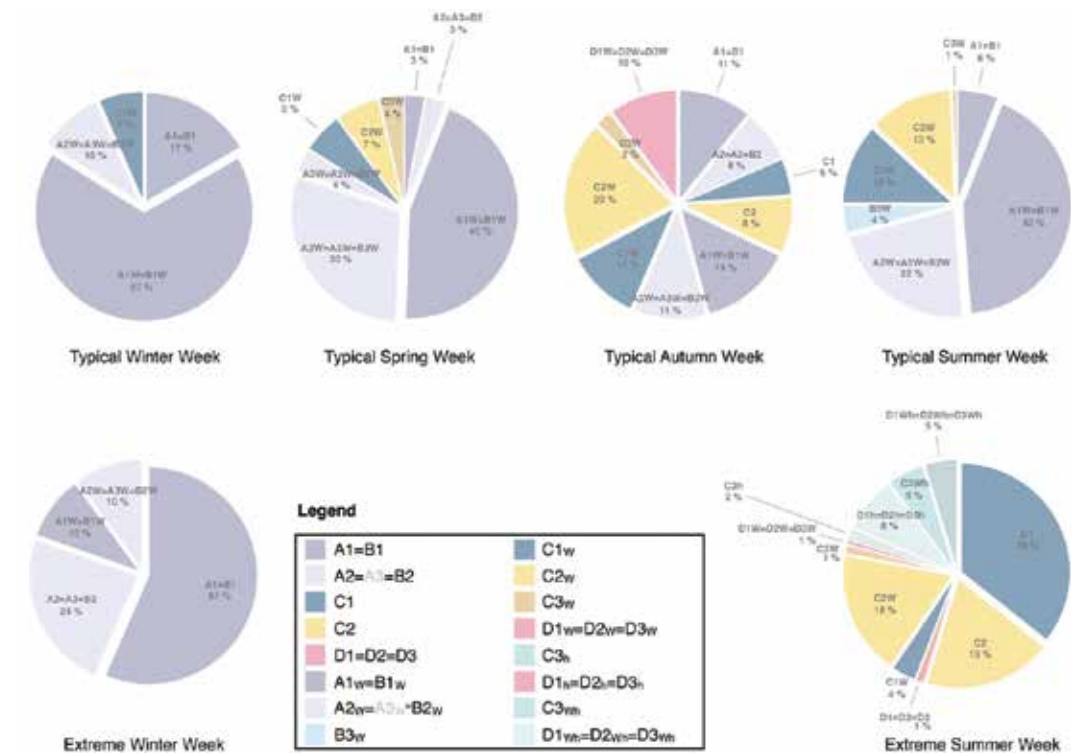

Fig. 4 Cluster analysis. Some climatic agent combinations are not exclusive for one season, which might mean that same AFR would be desirable for different seasons.

Together, these results provide important insights into the different roles that the envelope should have in each season in the climate of San Sebastian. In winter, a clear heating demand season, the façade should act mainly as a protective thermal barrier. In mild scenarios, it could perform as a selective filter that activates the thermal flux after a more demanding CS sequence, as it occurs in autumn or spring, and even in summer periods. But to detail more the AFR, it is important to analyse the specific sequences of CS that happen in those seasons. We took as a case study three different summer days, two from the Typical Design Week and one from the Extreme Summer Week in order to compare the implications that it would have to arrive to the same scenario (C2) from different paths (Fig. 5). On the 3rd of June, this scenario happens firstly at 8:30 and this mild period, with diffuse vertical solar radiation, comes after a A1=B1 climatic scenario, an overnight period which has more heating demand. As a result, the envelope develops into a less exigent scenario. On the 7th of June, this scenario appears firstly at 12:30 and it also supposes a milder situation, although this time it arrives from a diurnal overheating risk stage (D1w= D2w= D3w) before going to a warm afternoon with high levels of solar irradiance and wind (C3w). Finally, on the 17th of July, the C2Wh scenario also introduces a chance to dissipate possible undesired heat gains that might occur in the afternoon (D1Wh=D2 Wh=D3 Wh), when temperatures are above 24°C and there is high relative humidity ratios. As the evening is dominated by mild temperatures and windy climatic scenarios, these natural resources can be exploited to balance the negative impacts of previous sequences.

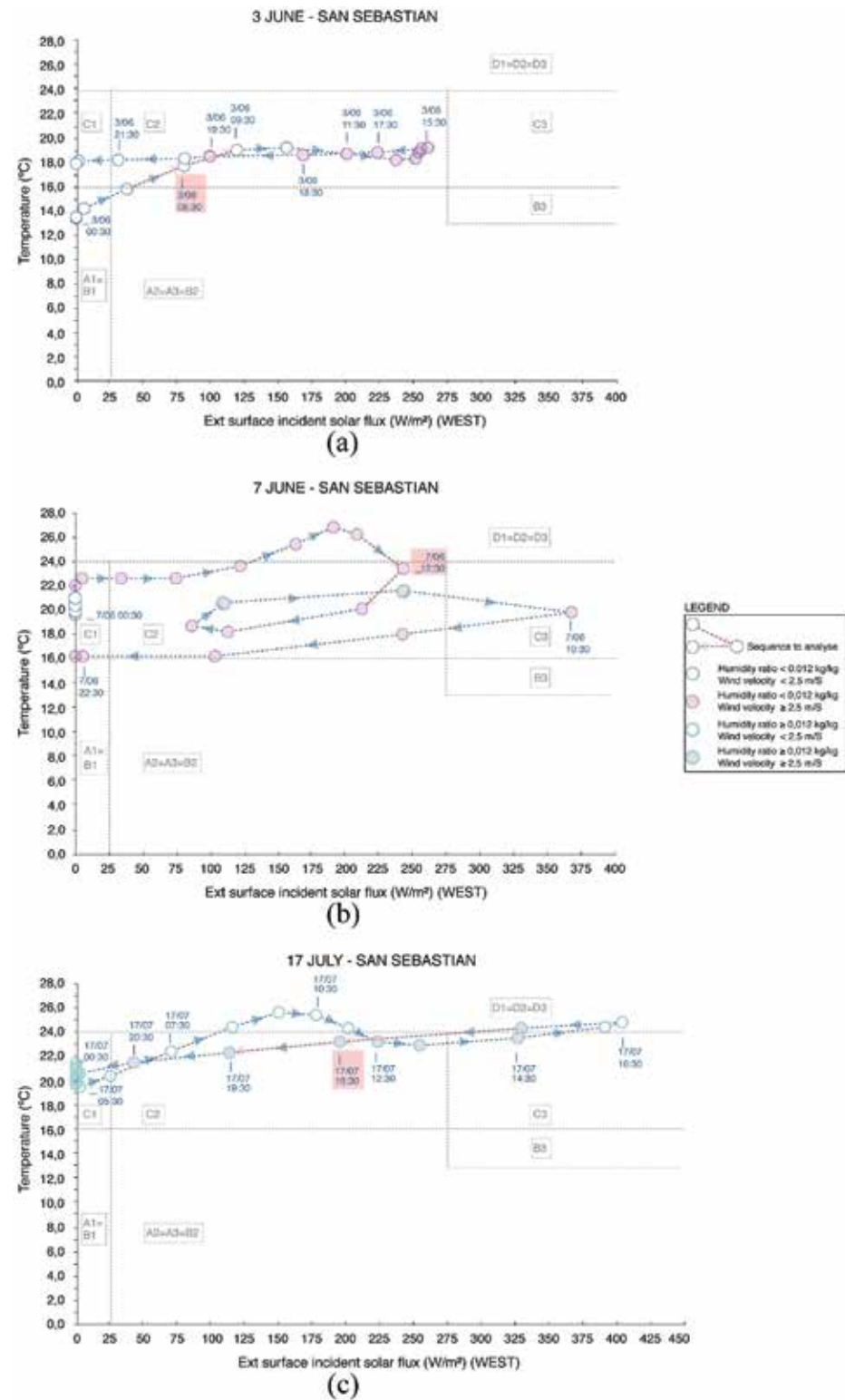

Fig. 5 Sequence analysis. This dynamic analysis is necessary to choose the adequate AFR as previous states and future trends also determine the suitable performance of the façade.

4 Defining the Adaptive Responses of an opaque adaptive façade

Once that the climate data is organized in different CS and the different impacts that CSs will have according to the previous and future CSs are better understood, a new screen tool was developed in order to suggest global strategies at initial design stages, considering the combinations of climatic agents and their transience. The screen tool (Fig. 6) was divided into three sections: the Dynamic Climate Analysis, where the climatic agents of a complete sequence were classified according to the defined boundary conditions (Fig. 3), the characterization of the hygrothermal performance, which shows what ideally the façade should provide at that specific CS and the Adaptive Façade Response. Whereas the Dynamic Analysis would allow to detect when and how many times each CS happens (and therefore, the proposed Adaptive Façade Response), the section of characterization helps to make a holistic input-output analysis, that would enable in future design stages the comprehensive understanding when defining the control of the Adaptive Façade, when determining the operational scenarios of these performances and when setting the boundaries in numerical simulations in validation stages.

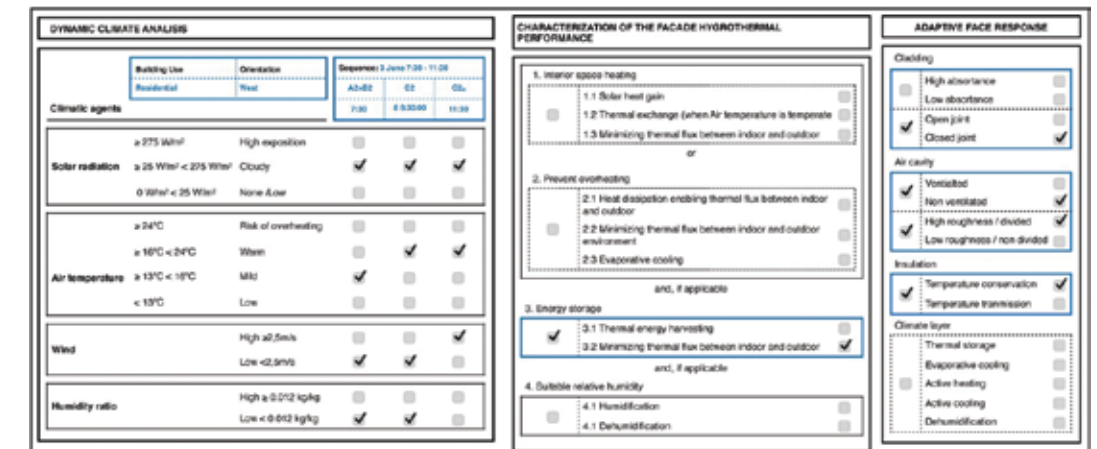

Fig. 6 Screen tool to suggest global strategies at initial design stages.

The main output of this tool is to relate directly the climate data with suitable AFR. This link is viable as adaptive opaque façades can react in a limited way to enhance their hygrothermal performance. Based on literature review, we identified the possible or desirable dynamic responses that, provided they are properly set, would lead to an optimization of the energy performance and to a better indoor comfort. Considering the opaque façade as a multi-layer system, the cladding could change its colour to enhance the solar heat gains. In a ventilated façade, the joints could be opened or closed depending on the opening degree that is desirable to address the CS, thus to act as a convective insulation or on the contrary, to dissipate thermal gains (Juaristi et al., 2018). The insulation layer could be set to minimizing thermal flux or to enable the thermal flux between the indoor and outdoor environment (Elsarrag, Al-horr, & Imbabi, 2012; Fantucci, Serra, & Perino, 2015; Favoino et al., 2017). Finally, a climate layer could be fitted to store thermal energy (Cabeza, Castell, Barreneche, De Gracia, & Fernández, 2011), to provide active heating or cooling (Hafez, 2016; Prieto, Knaack, Auer, & Klein, 2017) or to dehumidify the indoor environment (Maeda & Ishida, 2009; Watanabe, Fukumizu, & Ishida, 2008).

The results in Figure 6 show the initial design strategy that the screen tool would suggest to face a sequence from the Typical Summer Week illustrated previously on Fig. 5a (A2=B2 → C2 → C2W sequence). According to the Dynamic Climate Analysis, the hygrothermal performance was characterized and using that information we proposed a suitable Adaptive Façade Response. The Dynamic Climate Analysis revealed that on this cloudy and mild-warm summer day, the wanted hygrothermal performance of the façade would be to store the thermal energy and to minimize the energy flux, as it is coming from a heating demanding scenario and there are no overheating periods in the near future. Accordingly, the insulation would behave as a conservation layer and the cladding would be set with closed joints to provide a non-ventilated façade. However, if we consider the sequences from 7th of June or 17th July (from Fig. 5b and Fig. 5c), then the adaptive façade response would be different for a C2W scenario. Due to the overheating risks, in these sequences the climatic scenario C2w would require the façade to enable the thermal flux between the interior space and the exterior. Then, the best AFR would provide a ventilated façade configuration that boosted convective air movements in the cavity and thereby stimulate thermal losses. To achieve this performance, as the wind is over 2.5m/s, the cladding would have an open joint configuration with a continuous, non-rough air cavity. Last but not least, the insulation would be in transmission mode to enhance the thermal dissipation.

5 Conclusions and further researches

The present study is concerned with narrowing down the possible design strategies that could be pursued when defining an adaptive opaque façade for a specific location. As the suitable hygrothermal performance of the building does not only depend on the environmental conditions of a specific instant, this Dynamic Analysis took into account the Climatic Scenarios, as combinations of different climate agents, but particularly also their transition sequences in order to scope the suitable Adaptive Façade Response. Moreover, we illustrated the use of a screen tool to determine the AFR for a chosen sequence, and possible façade configurations were proposed accordingly. We illustrated the usability of this screen tool by applying it to a specific location, San Sebastian, and we followed the systematic method to understand in a comprehensive way its climate resources and threats in three summer days. The current study found out that even if San Sebastian has a heating demanding dominant climate, there are also promising mild periods in Spring, Autumn and Summer seasons that make the use of Climate Adaptive Façades advisable. Even though the tested case study considered only one climate and had a relatively limited scope, we can appreciate from it that the tool offers novel benefits compared with conventional methodologies as it is (i) easy to use, (ii) needs only widely available data as input, and (iii) can provide a type of results/analysis that was impossible to obtain with existing climate analysis tools.

A natural progression of this work is to detect the relevant sequences throughout the whole year, to focus on the most desired adaptive reactions for this specific location and to determine which roles could be static, if most of the times their performances are not changing. Besides, in order to define more accurately the AFR, the speed of adaptation also needs to be detected. For that purpose, we should analyse in a systematic way the periodicity of relevant sequences. This would allow an optimal hygrothermal behaviour and it would also help to establish the fatigue life that responsive elements should have according to the adaptation cycles per year. Moreover, this methodology needs to be further developed to make the automated application of the tool possible for other locations. On balance, the former climate analysis tools did not enable the consideration of the dynamic characteristics of the environmental resources. The approach proposed in this paper addresses this shortcoming. To demonstrate the validity of the proposed new methodology in a more comprehensive way, a comparison of the results using both detailed simulations and the presented tool is needed in further research.

6 Acknowledgements

This paper is part of the ongoing PhD research project titled “Adaptive Opaque Facades: a design and assessment method”. The research project is being funded through a scholarship granted by Asociación de Amigos of the Universidad de Navarra. In addition, the authors would like to gratefully acknowledge COST Action TU1403 “Adaptive Facade Network” for providing excellent research networking.

7 References

- Aschehoug, Ø., Andresen, I., Heiselberg, P., Li, Y., W. Olesen, B., Perino, M., ... Zhang, J. (2008). Annex 44. Integrating Environmentally Responsive Elements in Buildings. Aalborg, Denmark.
- Belleri, A., Avantaggiato, M., Psomas, T., & Heiselberg, P. (2017). Evaluation tool of climate potential for ventilative cooling. *International Journal of Ventilation*, 1–13. <http://doi.org/10.1080/14733315.2017.1388627>
- Cabeza, L. F., Castell, A., Barreneche, C., De Gracia, A., & Fernández, A. I. (2011). Materials used as PCM in thermal energy storage in buildings: A review. *Renewable and Sustainable Energy Reviews*, 15(3), 1675–1695. <http://doi.org/10.1016/j.rser.2010.11.018>
- Causone, F. (2016). Climatic potential for natural ventilation. *Architectural Science Review*, 59(3), 212–228. <http://doi.org/10.1080/00038628.2015.1043722>
- Elsarrag, E., Al-horr, Y., & Imbabi, M. S. (2012). Improving building fabric energy efficiency in hot-humid climates using dynamic insulation, 127–134. <http://doi.org/10.1007/s12273-012-0067-6>
- EN15251. (2007). EN 15251 Indoor environmental input parameters for design and assessment of energy performance of buildings addressing indoor air quality, thermal environment, lighting and acoustics.
- Fantucci, S., Serra, V., & Perino, M. (2015). Dynamic insulation systems: Experimental analysis on a parietodynamic wall. *Energy Procedia*, 78, 549–554. <http://doi.org/10.1016/j.egypro.2015.11.734>
- Favoino, F., Jin, Q., & Overend, M. (2017). Design and control optimisation of adaptive insulation systems for office buildings. Part 1: Adaptive technologies and simulation framework. *Energy*, 127, 301–309. <http://doi.org/10.1016/j.energy.2017.03.083>
- Hafez, A. H. (2016). Integrating Building Functions into Massive External Walls. A+BE: Architecture and the Built Environment, Vol 6, Iss 9, Pp 1-294 (2016) VO - 6. Delft University of Technology. <http://doi.org/10.7480/abe.2016.9>
- Huang, J. (2011). ASHRAE Research Project 1477-RP Development of 3,012 typical year weather files for international locations. Final Report.
- Ibañez-Puy, M., Vidaurre-Arbizu, M., Sacristán-Fernández, J. A., & Martín-Gómez, C. (2017). Opaque Ventilated Façades : Thermal and energy performance review. *Renewable and Sustainable Energy Reviews*, 79(April 2016), 180–191. <http://doi.org/10.1016/j.rser.2017.05.059>
- Jin, Q., Favoino, F., & Overend, M. (2017). Design and control optimisation of adaptive insulation systems for office buildings. Part 2: A parametric study for a temperate climate. *Energy*, 127, 634–649. <http://doi.org/10.1016/j.energy.2017.03.096>
- Juaristi, M., Monge-Barrio, A., Sánchez-Ostiz, A., & Gómez-Acebo, T. (2018). Exploring the potential of Smart and Multifunctional Materials in Adaptive Opaque Façade Systems. *Journal of Façade Design and Engineering*; Vol 6 No 2: ICAD2018 Special Issue DO - 10.7480/jfde.2018.2.2216 .
- Loonen, R. C. G. M., Singaravel, S., Trčka, M., Cóstola, D., & Hensen, J. L. M. (2014). Simulation-based support for product development of innovative building envelope components. *Automation in Construction*, 45, 86–95. <http://doi.org/10.1016/j.autcon.2014.05.008>
- Loonen, R. C. G. M., Trčka, M., Cóstola, D., & Hensen, J. L. M. (2013). Climate adaptive building shells: State-of-the-art and future challenges. *Renewable and Sustainable Energy Reviews*, 25, 483–493. <http://doi.org/10.1016/j.rser.2013.04.016>
- Maeda, H., & Ishida, E. H. (2009). Water vapor adsorption and desorption of mesoporous materials derived from metakaolinite by hydrothermal treatment. *Ceramics International*, 35(3), 987–990. <http://doi.org/10.1016/j.ceramint.2008.04.007>
- Monge-Barrio, A., & Sánchez-Ostiz Gutiérrez, A. (2018). Passive energy strategies for Mediterranean residential buildings : facing the challenges of climate change and vulnerable populations. New York, NY : Springer, cop. 2018.
- NREL. (2017). DView.
- Park, B., Srubar, W. V., & Krarti, M. (2015). Energy performance analysis of variable thermal resistance envelopes in residential buildings. *Energy and Buildings*, 103, 317–325. <http://doi.org/10.1016/j.enbuild.2015.06.061>
- Prieto, A., Knaack, U., Auer, T., & Klein, T. (2017). SOLAR COOLFACADES Framework for the integration of solar cooling technologies in the building envelope. (April). <http://doi.org/10.1016/j.energy.2017.04.141>
- U.S. Department of Energy. (2017). Auxiliary Programs.
- UCLA. (2017). Climate Consultant.
- Upadhyay, A. K. (2018). Climate information for building designers: a graphical approach. *Architectural Science Review*, 61(1–2), 58–67. <http://doi.org/10.1080/00038628.2017.1389690>
- Watanabe, O., Fukumizu, H., & Ishida, E. H. (2008). Development of an Autonomous Humidity Controlling Building Material, 19–29.

Optimising parameters for dynamic solar shading

Christiane Wermke

Institute For Buildings and Energy / TU Graz, Austria, christiane.wermke@tugraz.at

The integration of daylight analysis and building performance simulation together with optimisation techniques has been a problem for simulating adaptive building envelopes. This is currently only possible by combining different analysis tools and software as there are no conventional all-encompassing programmes available on the market. There have been recent advances in simulating adaptive façade technologies by combining EnergyPlus simulation software with MATLAB as well as GenOpt to perform optimisations. This work is adopting software frameworks developed by previous researchers, applying a similar method but using Grasshopper for Rhinoceros interface. The main goal of this study is to develop a tool that can help optimise the control of an external shading device by minimising the energy demand for cooling and lighting (during the cooling period of the year) as well as maximising the occupants comfort (daylight availability and room temperature). The simulation tool designed for this work integrates EnergyPlus (by means of Grasshopper plug-in Honeybee) for building performance simulation as well as Daysim (Grasshopper plug-in based on Radiance) to undertake daylight analyses and an optimisation plug-in for Grasshopper namely Octopus and OctopusLoop. The results of the optimized controlled external shading in comparison to static shading show significant improvements in energy reduction and occupants comfort.

Keywords: dynamic solar shading, optimization, daylight, SHGC, visible transmission, cooling and lighting energy

1 Introduction

The building envelope is a crucial part of the design of a building, it accounts for (solar) energy gains as well as energy losses. This is particularly evident for transparent building components as they allow daylight to partly enter the interior of the building depending on the size of the opening and the transparency and translucency of the material [24]. Adaptive facades can help improve the occupants' comfort whilst minimising building energy by means of dynamic adaptability of façade components and/or materials [30]. In office building design, glazed façades are highly popular but can cause thermal and visual discomfort due to large amounts of incoming direct solar radiation onto the façade [9]. Strategies such as active air-conditioning [31] alongside switchable/adaptive [10, 11, 14-16] glazing or internal/external solar shades [19, 30] are capable of simultaneously maintaining the temperatures at comfort level and regulate visual comfort for the users of the building.

Dynamic adaptive external shades were chosen for this analysis for various reasons. These include, a) external shades are a conventional method to reduce solar heat gain [7] in rooms, b) external shades are part of the architectural design in a lot of existing buildings as well new constructions and c) there are a broad range of control strategies for external shades such as manual, automated (timer-controlled) control strategies or external shades that work with sensors for temperature and/or radiation [34].

Research by A. Prieto [31] found that designers of office building façades prefer to use lightweight building components with high transparency that rely on active air-conditioning. Besides internal gains, solar radiation and high external temperatures are responsible for high cooling demands in office buildings [31]. A climate responsive building design could reduce energy demands for lighting, cooling and heating by up to 60% by means of orientation, insulation and the use of exterior shading [31]. The correct operation of shading devices can be crucial for the overall energy reduction [25]. Research on fixed and dynamic shading found that using an adaptive dynamic shading have the greatest impact on reducing overall annual energy demands as opposed to fixed shades or no shading at all [30].

Although very beneficial from an energy saving point of view, shading devices applied onto a window decrease the amount of daylight that will be transmitted through the window [30]. This will usually result in the reduction of the cooling energy use, but as the availability of daylight will be affected [20], this will likely result in an increase of energy demand for electrical lighting.

The present work examines an optimised control strategy of an external shading device on a south facing office room in Graz. It will be looking for the ideal set of parameters namely: Solar heat gain coefficient (SHGC) and visible transmission (Tvis) for every hour of the simulation period which is the hottest week during the year in Graz (first week of August).

The choice of a south facing room is to allow maximum daylight access inside the office whilst limiting solar heat gain. Undertaking this analysis required the creation of a bespoke building performance simulation tool that allows for dynamic adaption of the shading devices' angles during the simulation to control the simulation and optimise the shading by using Grasshopper for Rhinoceros.

The Energy Performance of Buildings Directive [8] requires all (non-government) new buildings must be nearly zero-energy buildings by the end of the year 2020. Dynamic adaptable façades inherit a large potential in contributing significantly to achieve the EPBD's goal.

2 Simulation Model

The study is conducted using a two people office room (4m x 5m x 3m) with one fully glazed south facing façade (95% glazing, 5% window frame) for the location of Graz/Austria (Fig. 1). The desired lighting level is set to 500 Lux (according to ÖNorm EN 12464-1: Lighting of work places pt.1 indoor work places [18]) constantly (illuminance on work-plane @ 0.75m height in the middle of the room) when the office room is occupied by one or more employees to allow good working conditions. There is one sensor point in the middle of the room at the height of an employee's desktop/work-plane (2m;2.5m;0.75m) for the daylight analysis (Figure 2). Work-plane illuminance has been used as a control strategy for external shading by Fiorito et al. [19]. The occupancy schedule is based on a typical austrian calendar year including holidays. Employees work 8 hours each day (monday to friday between 7am and 5pm) allowing for 1-hour lunch break. The physical values for SHGC and Tvis of combined window and blinds at various angles were calculated with LBNL Window [23]. The combined parameters for glazing and shading (SHGC, Tvis) are variable and part of the optimisation whereas the opaque part of the glazed façade consists of a wooden frame that is static (see Table 1 and Table 2, respectively, for physical parameters). The simulation model shall be able to switch between glazing only and different shading angles (0°-90°). The different shading angles represent different values for SHGC and Tvis (see; Figure 3 and Table 2).

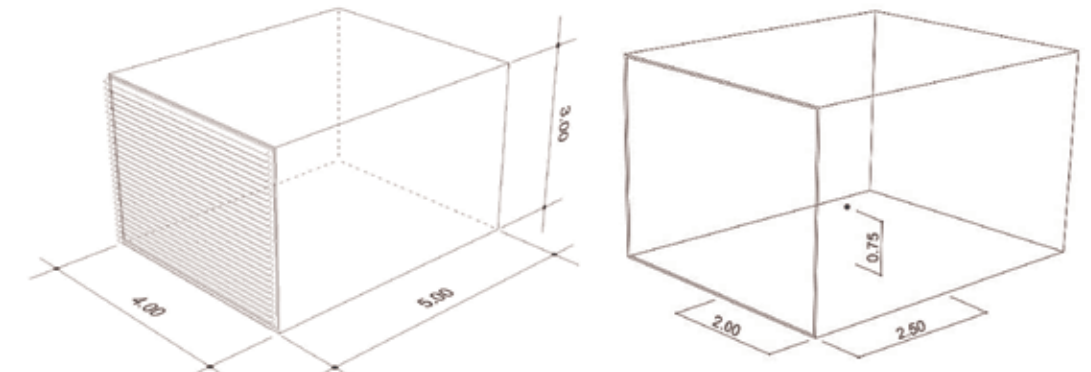

Fig. 1 Geometry of test cell (office room with south facade with 95% glazing) Figure 2 Sensor for illuminance test in the office room

component	parameter
Glazing	Low-E Glass
U-Value	1.386 W/m ² K
SHGC	0.635

Table 1 Physical parameters of the glazing

Software framework and simulation process

Wienold et al. [37] found that simulating daylight dynamically is greatly time consuming and even more so when shading devices are simulated and concluded that dynamic simulations that consider different shading positions are not possible with conventional software. He overcame some of the simulation issues in a later work using a 3- step simulation approach [38] separating the simulation process into three individual simulations using a database of results from the previously conducted simulation.

A more advanced simulation method to evaluate the performance of the adaptability of a façade/ façade component was used by other researchers who implemented the receding horizon (or model predictive) control technique [12, 13, 15, 22, 29, 32, 39] whilst also overcoming the thermal history management problem [2, 10, 28]. Receding horizon control [29] is a control technique that involves continually updating predictions and states such as temperatures that are involved in the decision making process for the optimisation/multi-objective optimisation problem [26] involving the implementation of algorithms to optimise the façade adaption in multiple steps [27].

Glazing/Blind type	SHGC	T
Blinds 0°	0,648	0,844
Blinds 15°	0,475	0,595
Blinds 30°	0,294	0,343
Blinds 45°	0,126	0,114
Blinds 60°	0,073	0,047
Blinds 75°	0,041	0,012
Blinds 90°	0,04	0

Table 2 Parameters for window with different blind configurations according to WINDOW 7.6

In order to integrate building energy performance with daylight analysis [19] and to overcome current building performance software restrictions to evaluate the performance of adaptive facades [12], a bespoke simulation tool was developed using the software add-on Grasshopper (GH) [3] for Rhinoceros for this study.

The concept of the simulation was adopted from previous research such as Favoino et al. using an evaluation, an optimisation and a coordination layer [12].

The tool consists of Honeybee [33] a plug-in for Grasshopper, to implement EnergyPlus Version 8.8.0 [4] to run the building energy performance and Radiance based DAYSIM [21] for daylight analyses. Ladybug [33] was used to read and analyse the epw- weather file [5] for EnergyPlus [4]. These GH-add-ons form the evaluation layer to assess the performance of the shading control for this study. In EnergyPlus The EMS tool (Energy Management System) [6] was used to simulate the adaptive behaviour of the shading and hence to allow for different physical parameters during the simulation. The optimisation layer is composed of the Grasshopper plug-in Octopus [36]. Octopus was used for the optimisation process. Furthermore OctopusLoop [35] was used to re-integrate optimised preliminary results of the preconditioning, into the following optimisation loop 2 and hence allow incorporating the thermal history [17]. The coordination layer is set up by components that are part of the GH interface.

Simulation process The simulation runs in two circles or loops. Loop 1 calculates potential results for energy demands (cooling, lighting) and takes current weather data (external temperature in °C, solar radiation W/m2), internal temperature (°C) and (day-) light conditions (Lux) (inside the office room) into account. The best results for the façade parameters (shading angles) of the 'pre-selection' are stored and used in loop 2 where the actual optimisation process is taking place. The (stored) parameters (shading angles) of the 'pre-selection' will be fed into loop 2 where the (multi-objective) evolutionary algorithm (SPEA-2 core algorithm [36]) of Octopus will pick the combination of the best parameters (shading angles) for the glazing and shading. The results will then show that at different times of the day, different properties of the façade parameters are required to reduce energy demands (especially cooling and lighting) and to maintain the user's comfort. The simulation process is rather time consuming for the afore-mentioned reasons. Therefore, the simulation period was reduced to one week that is the hottest week in Graz during the annual cooling period. The optimisation however was undertaken on an hourly basis [14].

$$\min \begin{cases} f(x) = E_{tot} = E_{cool} + E_{light} \left[\frac{kWh}{m^2y} \right] \\ X(t) = (g - value(t), \tau_{vis}(t)) \end{cases} \quad \text{Eq. 1 cost function}$$

The cost function of the optimisation problem to be solved is as following: The model has previously been validated undertaking various simulations for the adaptive façade research project at Graz University of Technology. [1]

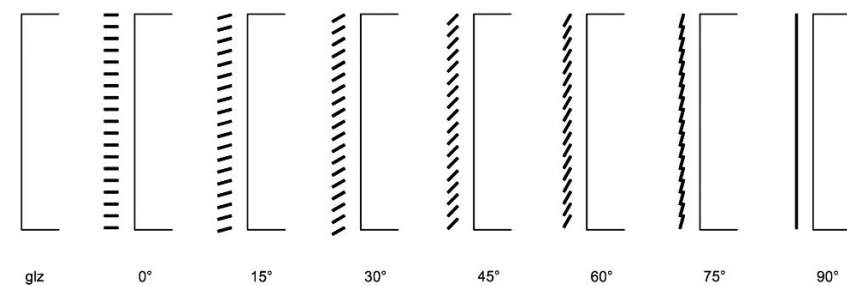

Figure 3 Glazing and straight blinds configuration

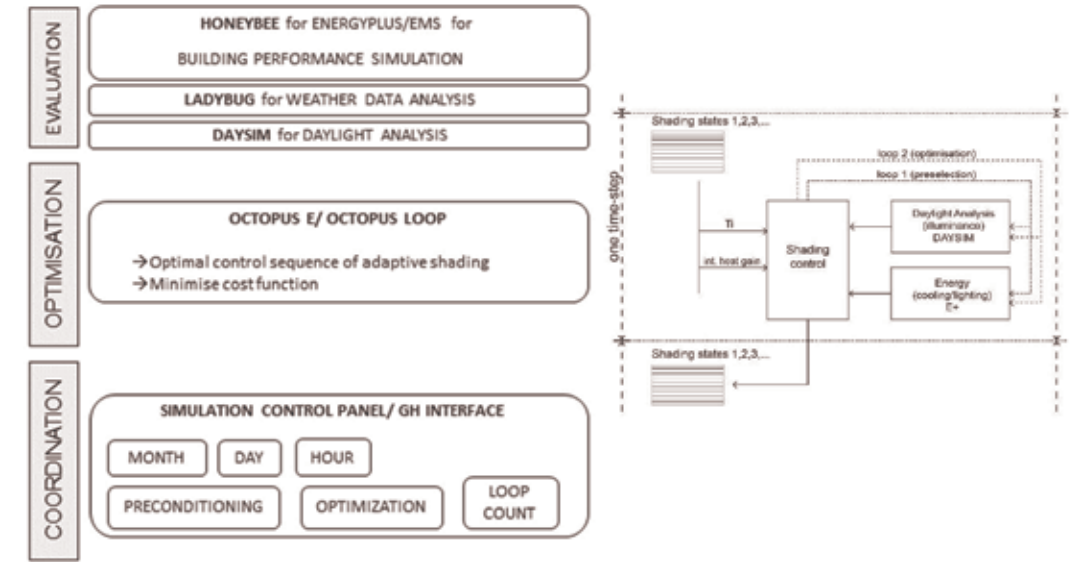

Figure 4 simulation framework

Figure 5 simulation approach

Weather data The weather file (*.epw) [5] is retrieved from the US-government website for EnergyPlus for the location of Graz/Austria and data for the temperature (mean, maximum and minimum temperature in °C) and solar radiation (direct and diffuse radiation) are used within the simulation environment.

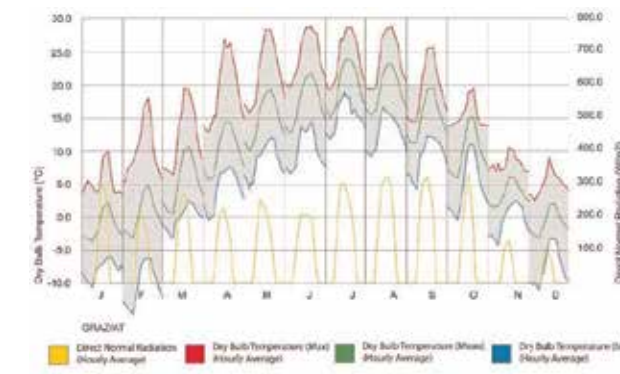

Figure 6 Weather data Graz (Temperature and radiation)

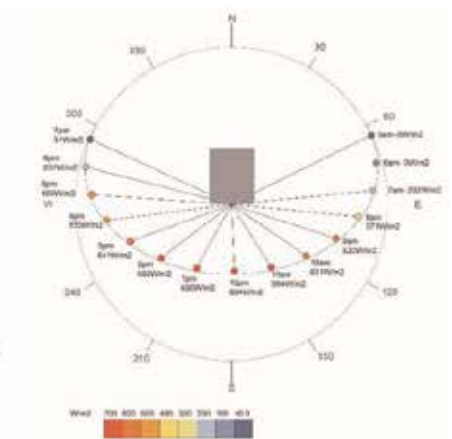

Figure 7 Sunpath and sun vectors in Graz on 6th August show the amount of direct solar radiation at each hour of the day (5am- 7pm)

3 Results

Prior the optimisation simulation, (static) simulations for each shading state including no shading at all were undertaken for reference. The results shown in Table 3 and Figure 8 show an expected decrease of cooling energy and a slight increase in lighting energy, respectively, with increasing closure of the shading slats in front of the glazing for the simulation period of the hottest week in Graz (3rd to 9th August) for a south-facing façade.

The cooling energy drops at two states significantly, when the blinds start closing at 15° and when they block the sun vectors efficiently at 45° angle of the blinds. The cooling energy keep

on decreasing the further the shading is closed but the difference is much less (state 45° to 90°) compared to blinds at 0° to 30° angle.

The increase in lighting energy is linear but not as dramatic as the cooling energy for the hottest week. There is a clear increase in energy demand from 45° closure onwards to 90° when the blinds are completely closed. The best results however are achieved with the optimised shading control achieving energy savings for cooling and lighting of close to 42% compared to closed blinds at 90° (static). What these figures are not representing is the quality and quantity of daylight inside the office room during active occupancy. Table 4 gives an example of daylight quality of one representative day during the hottest week at 9am, highlighting the intense morning sun (glazing only) with potential glare probability (not examined within the scope of this work) and no useful daylight at all when shades are completely shut (blinds closed at 90°). Not only does Table 4 emphasise different daylight qualities at different shading angles, but it also clearly shows the potential of a sophisticated shading control that would allow enough natural daylight to penetrate the office room whilst limiting solar heat gain to heat up the room beyond the comfort level of the occupants.

Considering a cooling period for Graz from April to September (compare Figure 6, Figure 7 and Figure 10) the overall energy savings for cooling and lighting for an office room with a south-facing façade with a dynamic adaptive solar shading will most likely increase. Figure 9 represents the schedule of the optimised shading control showing the degree of opening of the shading slats at every hour of the hottest week in the summer in Graz with internal and external temperatures. The internal temperatures (TZone in °C) are fairly stable and do not follow the outside temperature extremes. The shading schedule is adequate to the external temperatures and the shading slats are more closed with increased temperatures. The schedule during the working week (Monday-Friday) ranges mostly between 45° and 90° with few exceptions. Only on the weekend the blinds are almost fully closed at all times. This result may not show a dramatic improvement for scheduling external shading devices but proves 1) that significant energy savings with optimised schedules are possible and 2) that the proposed simulation framework is running as suggested. The actual quality of the proposed software needs much further investigation such as a) running an annual analysis to present energy demands not only for cooling and lighting but also heating energy. Further aspects of the office's user must be undertaken like a) visual comfort, b) DGP (daylight glare potential), c) UDI (useful daylight illuminance) to comprehend the influence of optimised adaptive façade parameters for transparent components.

Glazing/Blind type	Cooling (kWh)	Lighting (kWh)
Glazing	84,9	5,1
Blinds 0°	86,4	5,1
Blinds 15°	61,1	5,1
Blinds 30°	47,1	5,1
Blinds 45°	35,3	5,2
Blinds 60°	28,5	6,0
Blinds 75°	25,3	7,4
Blinds 90°	25,1	7,8
Optimized shading	17,18	1,8

Table 3 Energy demands for the hottest week in Graz (3rd – 9th August)

Performance Assessment

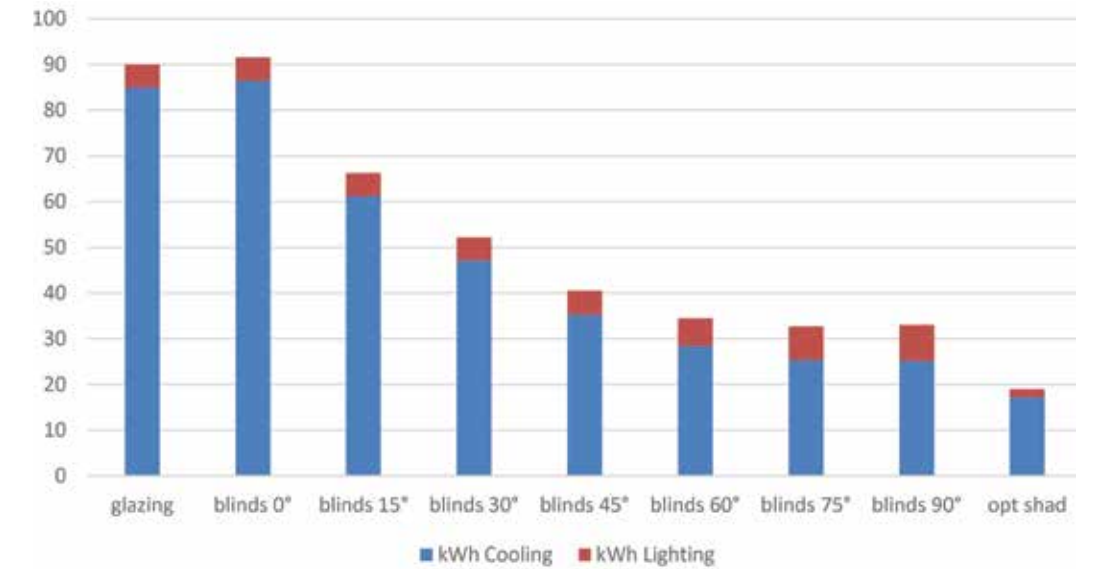

Figure 8 Energy demand for cooling and lighting for south-facing office room in Graz (hottest week 3rd august to 9th august)

Another aspect that has been neglected within this study is the user acceptance of adaptive shadings. This study shall solely focus on 1) a strategy/simulation framework to evaluate adaptive façade components (shading device in this case) and 2) figure out the potentials of adaptive façades/ façade components and possible energy savings with 3) control strategies.

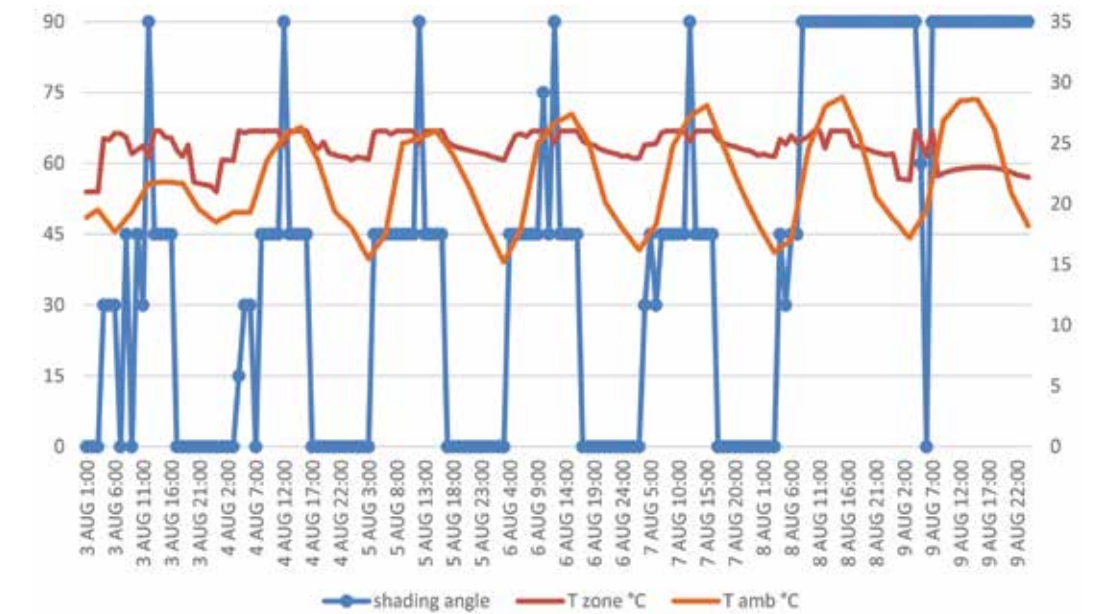

Figure 9 Shading schedule for south facing façade in Graz (3rd to 9th august)

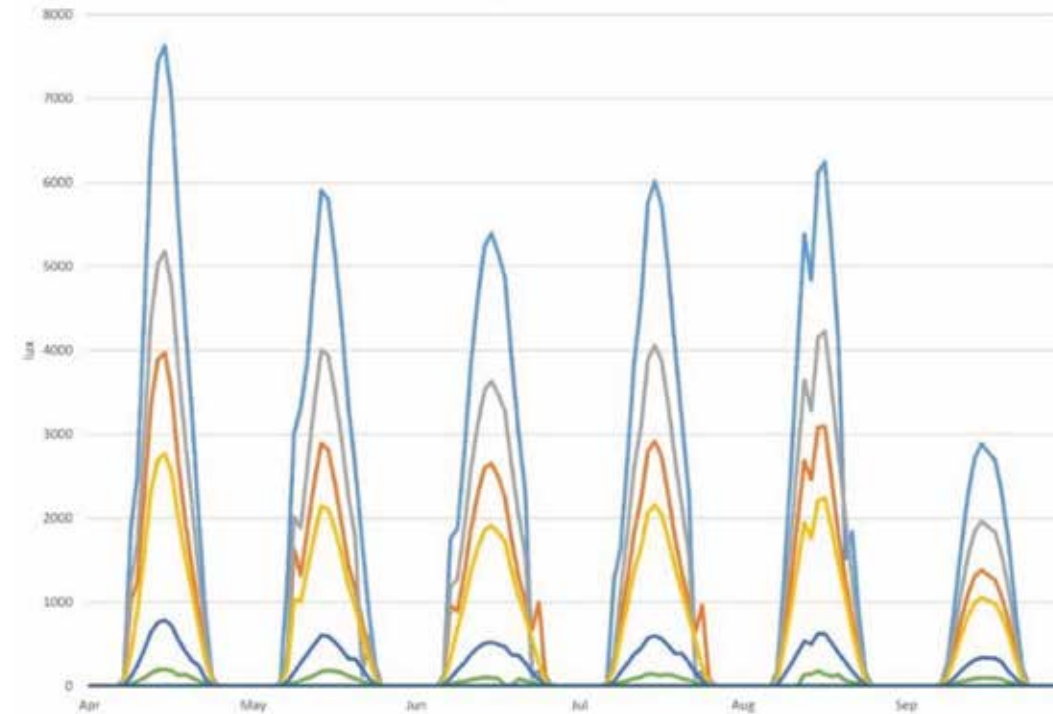

Figure 10 Lighting levels inside the office during the cooling period

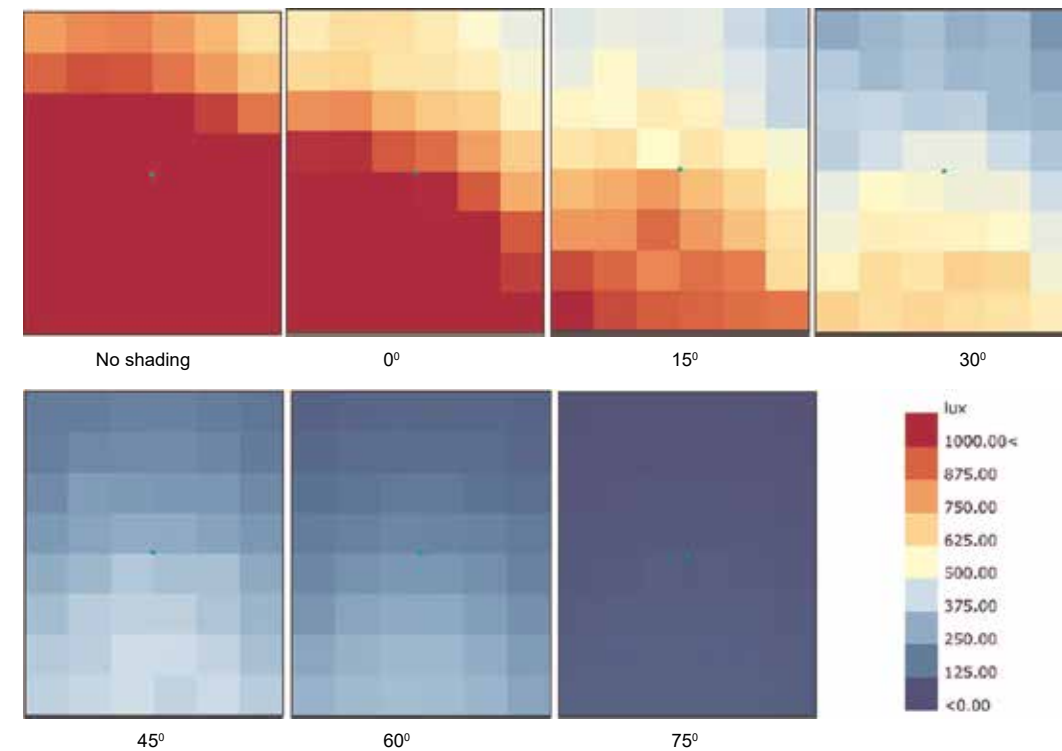

Table 4 Illuminance on 6th August @ 9am at various shading angles

4 Discussion

The physical parameters for SHGC and Tvis of the combined glazing and shading at various angles could be identified using LBNL window software. Based on these parameters the thermal building simulation combined with daylight analyses were conducted to find an optimal control

strategy for the blinds. Further thermal simulation shall be conducted on a monthly basis as well as on a yearly basis to fully understand the potentials of variable and adaptive façade parameters. Another aspect that should be considered is to take weather forecasts into account in order to compare a conventional 'real-time' optimization process as opposed to an optimized 'forecast' scenario. This analysis was based purely on hot weather (cooling period), where unwanted solar gains onto the south façade play an important role. The adaptability in a cold weather and the effectiveness of an adaptive façade in a cold climate should be further investigated to allow serious statements about the energy saving potentials of varying the g-value and visible transmission of a glazed façade. Control strategies for external shadings using a software framework that adopts optimisations should be further investigated to fully comprehend the potential of adaptive façades/ façade components and to evaluate optimal schedules and time horizons for the adaptability of the façades/ façade components. The annual analysis of the variable façade parameters would further allow to understand what the optimal time steps are to change a façade parameter and hence would help designers develop facades that could adapt to the changing seasons during the year or changing weather during the day. The focus of the present work lay on an optimised control strategy which should be compared with other control strategies such as control rule based strategies to evaluate the functionality, energy savings and effectiveness of the chosen technique.

5 References

- [1] B. Cody, S. Sautter, A. Tepavcevic and C. Wermke, "Smart facade- energetische potientiale von adaptiven fassadensystemen," Bundesministerium für Verkehr, Innovation und Technologie (Austria), Vienna, Austria, Tech. Rep. 38/2017, 2017.
- [2] C. D. Corbin, G. P. Henze and P. May-Ostendorp, "A model predictive control optimization environment for real-time commercial building application," *Journal of Building Performance Simulation*, vol. 6, (3), pp. 159-174, 05/01, 2013.
- [3] S. Davidson, "Grasshopper: Algorithmic Modelling for Rhino," .
- [4] DoE US, "EnergyPlus Documentation Engineering Reference . EnergyPlus engineering reference." vol. 8.8.0, 2015.
- [5] DoE US (U.S. Department of Energy), .
- [6] P. G. Ellis and P. A. Torcellini, "Simulation of energy management systems in EnergyPlus," in Beijing, China, 2007, .
- [7] A. Eltaweel and Y. Su, "Controlling venetian blinds based on parametric design; via implementing Grasshopper's plugins: A case study of an office building in Cairo," *Energy and Buildings*, vol. 139, pp. 31-43, 15 March 2017, 2017. . DOI: <https://doi.org/10.1016/j.enbuild.2016.12.075>.
- [8] EPBD 2018, "Directive (EU) 2018/844 of the European Parliament and of the council of 30 May 2018," 2018.
- [9] G. Evola, F. Gullo and L. Marletta, "The role of shading devices to improve thermal and visual comfort in existing glazed buildings," *Energy Procedia*, vol. 134, pp. 346-355, October 2017, 2017. . DOI: <https://doi.org/10.1016/j.egypro.2017.09.543>.
- [10] F. Favoino, "Towards the future generation of adaptive glazed building envelope," in Lucerne, CH, 2014, .
- [11] F. Favoino, Y. Cascone, L. Bianco, F. Goia, M. Zinzi, M. Overend, V. Serra and M. Perino, "Simulating switchable Glazing with Energy Plus: An empirical validation and calibration of a thermotropic glazing model," 2015.
- [12] F. Favoino, F. Fiorito, A. Cannavale, G. Ranzi and M. Overend, "Optimal control and performance of photovoltachromic switchable glazing for building integration in temperate climates," *Applied Energy*, vol. 178, pp. 943-961, 15 September 2016, 2016. . DOI: <https://doi.org/10.1016/j.apenergy.2016.06.107>.
- [13] F. Favoino, Q. Jin and M. Overend, "Design and control optimisation of adaptive insulation systems for office buildings. Part 1: Adaptive technologies and simulation framework," *Energy*, vol. 127, pp. 301-309, 15 May 2017, 2017. . DOI: <https://doi.org/10.1016/j.energy.2017.03.083>.
- [14] F. Favoino, Q. Jin and M. Overend, "Towards an Ideal Adaptive Glazed Façade for Office Buildings," *Energy Procedia*, vol. 62, pp. 289-298, 2014.
- [15] F. Favoino and M. Overend, "A simulation framework for the evaluation of next generation Responsive Building Envelope technologies," pp. 1-8, 06/15, 2015.
- [16] F. Favoino and M. Overend, "The route to an ideal adaptive glazing facade," in Aachen, Germany, 2014, .
- [17] F. Favoino, M. Overend and Q. Jin, "The optimal thermo-optical properties and energy saving potential of adaptive glazing technologies," *Appl. Energy*, vol. 156, pp. 1-15, 10/15, 2015.
- [18] Fördergemeinschaft Gutes Licht, Deutsche Lichttechnische Gesellschaft e.V., Ed., *Guide to DIN EN 12464-1 Lighting of Work Places – Part 1: Indoor Work Places*. (2nd edition ed.) Frankfurt a.M.; Berlin (DE): 2005.
- [19] J. Gonzales and F. Fiorito, "Daylight Design of Office Buildings: Optimisation of External Solar Shadings by Using Combined Simulation Methods," *Buildings*, vol. 5, pp. 560-580, 21/05/2015, 2015.
- [20] W. N. Hien and A. D. Istiadji, "EFFECTS OF EXTERNAL SHADING DEVICES ON DAYLIGHTING AND NATURAL VENTILATION," in Eindhoven, NL, 2003, pp. 475-482.
- [21] J. A. Jakubiec and C. F. Reinhart, "Diva 2.0: Integrating daylight and thermal simulations using rhinoceros 3d, daysim and energyplus," in Sydney, Australia, 2011, pp. 2202-2209.

- [22] Q. Jin, F. Favoino and M. Overend, "Design and control optimisation of adaptive insulation systems for office buildings. Part 2: A parametric study for a temperate climate," *Energy*, vol. 127, pp. 634-649, 15 May 2017, 2017. . DOI: <https://doi.org/10.1016/j.energy.2017.03.096>.
- [23] LBNL, "WINDOW 7.6 simulation manual accessed online in Sep 2018," .
- [24] B. A. Lomanowski, "Implementation of window shading models into dynamic whole-building simulation," 2008.
- [25] K. J. Lomas and S. M. Porritt, "Overheating in buildings: lessons from research," *Buildings Research & Information*, vol. 45, 2017.
- [26] (). Exploring the potential of climate adaptive building shells.
- [27] R. C. G. M. Loonen, "Considerations regarding optimization of dynamic facades for improved energy performance and visual comfort," 2014.
- [28] R. C. G. M. Loonen, S. Singaravel, M. Trčka, D. Cóstola and J. L. M. Hensen, "Simulation-based support for product development of innovative building envelope components," *Automation in Construction*, vol. 45, pp. 86-95, September 2014, 2014. . DOI: <https://doi.org/10.1016/j.autcon.2014.05.008>.
- [29] J. Mattingley, Y. Wang and S. Boyd, "Receding Horizon Control- Automatic Generation of High-speed solvers," *IEEE Control Systems Magazine*, vol. 31, (3), pp. 52-65, 2011.
- [30] M. V. Nielsen, S. Svendsen and L. B. Jensen, "Quantifying the potential of automated dynamic solar shading in office buildings through integrated simulations of energy and daylight," *Solar Energy Materials & Solar Cells*, vol. 85, pp. 757-768, 2011.
- [31] A. Prieto, U. Knaack, T. Klein and T. Auer, "25 Years of cooling research in office buildings: Review for the integration of cooling strategies into the building façade (1990–2014)," *Renewable and Sustainable Energy Reviews*, vol. 71, pp. 89-102, May 2017, 2017. . DOI: <https://doi.org/10.1016/j.rser.2017.01.012>.
- [32] J. Qian, F. Favoino and M. Overend, "Study in the potential of opaque adaptive facade for office building in a temperate climate," in *At Hyderabad, India*, 2015, .
- [33] M. S. Roudsari, "Ladybug: A parametric environmental plugin for Grasshopper to help designers create an environmentally-conscious design," pp. 3128-3135, 2013.
- [34] G. van Moeseke, I. Bruyère and A. De Herde, "Impact of control rules on the efficiency of shading devices and free cooling for office buildings," *Building and Environment*, vol. 42, (2), pp. 784-793, February 2007, 2007. . DOI: <https://doi.org/10.1016/j.buildenv.2005.09.015>.
- [35] R. Vierlinger, "OctopusLoop," vol. 0.1, 2015.
- [36] R. Vierlinger, "Multi Objective Design Interface," 2013, 2013.
- [37] J. Wienold, "Dynamic simulation of blind control strategies for visual comfort and energy balance analysis," in *Beijing*, 2007, pp. 1197-1204.
- [38] J. Wienold, F. Frontini, S. Herkel and S. Mende, "Climate based simulation of different shading device systems for comfort and energy demand," in *Sydney, Australia*, 2011, pp. 2680-2687.
- [39] T. Zakula, P. R. Armstrong and L. Norford, "Modeling environment for model predictive control of buildings," *Energy and Buildings*, vol. 85, pp. 549-559, December 2014, 2014. . DOI: <https://doi.org/10.1016/j.enbuild.2014.09.039>.

Modelling Envelope Components Integrating Phase Change Materials (PCMs) with Whole-Building Energy Simulation Tools: a State of the Art

Albert Castell 1, Marc Medrano 2, Francesco Goia 3

1 Department of Computer Science and Industrial Engineering, University of Lleida, Lleida, Spain, acastell@diei.udl.cat

2 Department of Computer Science and Industrial Engineering, University of Lleida, Lleida, Spain, mmedrano@diei.udl.cat

3 Department of Architecture and Technology, Faculty of Architecture and Design, Norwegian University of Science and Technology, Trondheim, Norway, francesco.goia@ntnu.no

Building envelope systems that integrate Phase Change Materials (PCMs) are solutions aimed at increasing the thermal energy storage potential of the building envelope while keeping its mass reasonably low. Building envelope components with PCMs can be either opaque or transparent and can be based on different types of PCMs and integration methods. In opposition to conventional building components, these elements present thermal and optical properties that are highly non-linear and depend to a great extent on the boundary conditions. Such a characteristic requires the system development and optimisation process during the design phase to be carried out with particular care in order to achieve the desired performance. In this paper, a review of the existing modelling capabilities of different building energy simulation (BES) tools for PCM-based envelope components is reported, and the main challenges associated with the modelling and simulation of these systems through the most popular BES tools (among them, EnergyPlus, IDA-ICE, TRNSYS, IES-VE, and ESP-r) are highlighted. The aim of this paper is to summarise the evidence found in the literature of the latest development in the successful use of BES to replicate the thermal and optical behaviour of opaque and transparent components integrating PCMs, in order to provide the community of professionals with an overview of the tools available and their limitations.

Keywords: Phase Change Materials, building envelope, modelling, simulation

Full paper available in the *Journal of Facade Design and Engineering*, Vol 6 No 3 (2018): Special Issue FAÇADE 2018 – Adaptive!

Performance Evaluation of Adaptive Facades: A case study with electrochromic glazing

Senem Bilir a),b), Shady Attia a)

a) Sustainable Buildings Design Lab, Department UEE, Faculty of Applied Sciences, Univeristé de Liège, Belgium
b) Technical University of Istanbul, Department of Civil Engineering, Division of Construction Management, Ayazaga Campus, Maslak, 34469 Istanbul, Turkey

Adaptive facades are performance based envelopes that are able to respond dynamically to climatic conditions. One of the recognized adaptive façade technologies is electrochromic (EC) glazing. However, very few studies evaluated the performance of EC glazing on the building level. Therefore, we selected a case study of a certified educational building with a nearly zero energy building performance that includes an EC facade. The overall aim of the research is to understand the performance requirements of EC glazing and its overall contribution to energy savings and thermal and visual comfort improvement. The performance of the Swiss International School in Dubai was analyzed based on interviews with the design and build team, monitored data and post occupancy evaluation. A systematic process mapping took place to review the performance indicators, simulation tools and team responsibilities during the design, construction and operation stages of the building. The paper identifies the key performance criteria of EC glazing in relation to energy and comfort. Finally, we assess the significance of using EC glazing from a technical point of view and share the learned lessons for architects and façade engineers.

Keywords: Dynamic façade, electrochromic glazing, post-occupancy evaluation, façade assessment, monitoring

1 Introduction

Nowadays, there are a great number of dynamic and adaptive façades and envelopes technologies that are easily available in the market (Loonen et al. 2013 and Attia et al. 2018a). The decision as to how they are designed, operated, maintained and evaluated remains a challenge. Our case study presented in this paper aims better understanding of its design process, modeling and real performance. It will help present the benefits as well as the challenges seen in specific solutions with respect to energy use, comfort, and user experience. Currently, only a limited number of case studies of adaptive facades have been evaluated and documented (Attia, 2016a). There are few studies that performed post-occupancy evaluation for dynamic facades includes Al Bahr Towers in Dubai (Karanouh & Kerber, 2015; Attia, 2016b), AGC Building in Louvain La Neuve (Samyn & De Coninck, 2014a), AGC Glass Building (Attia and Bashandy, 2015) and the BIQ house in Hamburg (Wurm, 2013). The decision as to how they are designed, operated, maintained and assessed remains undisclosed and this in turn affects the wide expansion and market penetration of adaptive façades. The paper is part of the research activities of Workgroup 3 of the European COST Action 1403 on Adaptive Facades, which is mainly concerned with the adaptive facades system design and assessment (Luble 2014). The work group is figuring out how adaptive facades were designed and assessed during the major project delivery phases.

For this paper, different research methods were used for the case study documentation, this include: literature review, interviews with the architect, façade engineer, glazing manufacturer, commissioning agents, reviews of standards and codes and systematic process mapping and post-occupancy evaluation (POE). In this context, we present a case study description and technical details for the Swiss International School of Dubai (SISD) project façade system (Figure 1ab). The case study provides significant insights of electrochromic (EC) glazing façade design process and explains the effect of EC glazing on the indoor environmental quality (IEQ) in such harsh climate conditions of Dubai.

2 Methodology and Objectives

The goal of this work is describe in detail the process of design, construction and use of an adaptive EC glazing façade – in this case Swiss International School of Dubai - and evaluate its performance. As well as to propose a generic performance process map that could be used as a visual guideline support by companies in the building industry.

First of all several existing documents were reviewed. The Minergie standards and some applications have been reviewed (Beyeler et al., 2009; Hall et al. 2016) this includes: Planning and Project the Minergy-Standard for Buildings. Secondly, the project delivery process was mapped using the software MindMap to realize global and specific maps. This software allowed drawing clearly hierarchical scales, tasking charges suite and information flows. To limit the scope of the process map we focused on the identification and modeling of generic processes that was associated with the SISD project delivery. The generic process identification can generalize and used as a check-list to future designs of adaptive facades. Creating a process map involved systematic data-based interviews. Interviewees where asked to explain exactly what they did during the SISD project delivery, as well as share their technical challenges and express their expectations. For every interviewee, a scope was defined identifying the parameters he or she was dealing with during the project. A technical drawing software program was used to visualize the process. After completing a first round of interviews, interviewees were asked for feedback (reviews) and confirmation to validate the process maps.

Finally, a POE following ASHARE-55 survey (2013) was conducted for 43 person (39 responses) in relation to occupant comfort (visual and thermal) and façade operation. ASHRAE questionnaire focused on subjective responses of user's experience with a focus on the clothing and activity levels and visual and thermal comfort perception. Due to the difficulty to assess the effectiveness of control strategy with respect to visual and thermal comfort and energy use the POE questionnaire was amended with questions based on a previous study conducted by Attia et al. (2018b and 2019). The POE was conducted between December 2016 and February 2017 and May and July 2017 to represent the summer and winter season. Also, we based our assessment on real measurements following the Fanger ISO 7730 model using the predictive mean vote (PMV) and predicted people dissatisfied (PPD) methods. Testo Kit for Indoor air quality and comfort level measurement was used. Also, we conducted several interviews with the architect, façade engineer as well as the technical control specialist.



Fig. 1a: SISD Campus general view (Rendering | ARCHILAB – Gabriele M. Rossi Sa), 1b: 110 square meters of electronically tintable glass installed in the façade of the offices at SISD, Architect: ArchiLab, DSA, UA, Source: dubaioursandbox.com

3 Case Study

SISD is an eco-friendly campus, meeting the sustainable standards and reflects a comfortable and healthy interior climate with highest standards of energy consumption. The school is located in a quiet part of Al Jaddaf, close to the Business Bay Bridge, adjacent to Dubai Creek. It has a capacity to host over 2000 students and received the Happy Healthy School award from the Knowledge and Human Development Authority recently.

3.1 Concept of the project

SISD is the Middle East's first low-energy building in the education sector and campus includes more than 55.000 sq m teaching area and has eight main plants which are: primary school, secondary and high school, auditorium (700 seats), sport center and boarding house (3 residential blocks). The design submitted by Archilab - Gabriele M Rossi, with DSA Architects and engineering services including structural, building services, fire, infrastructure and traffic engineering, plus sustainability consultancy are provided by WME Consultants. The construction was completed in 2017.

3.2 The envelope

Although it is not formally needed, the client demanded that the primary and secondary school buildings meet the Minergie (a renowned international certificate for the pursuit of sustainable standards) use guidelines, together other intimate international and local standards. The primary school building, which has earned the Swiss MINERGIE certification, consumes one-third the energy of standard buildings. According to the client's demands SISD energy concept was determined in brief: envelope optimization depending on day lighting and load minimization, HVAC by zone, building simulation and MINERGIE target. Thus, the design team of SORANE SA who took developing an energy concept for SISD project, also considered efficient protection from the sun, cooling demand reduction (optimization of the glazed surface), tight envelope, reducing outside air the strict minimum, using high efficient ventilation systems, controlling the ventilation schedules (only during occupations), avoiding the use of air cooling systems and increasing chilled water temperature (higher EER) within the energy strategy of the SISD campus project.

By using this energy strategy the performance of the envelope can be summarized as followings:

- Highly tight envelope with air well designed air locks;
- U value of opaque surface (including spandrel) is lower 0.3 W/(m2.K) (equivalent 10 cm of thermal insulation);
- U value of roof is 0.2 W/(m2.K) (equivalent of 15 cm of thermal insulation);
- U value of glazing is 1.0 W/(m2.K);
- g value of glazing is 0.16 (SHGC);
- Visible light transmittance is 0.3;
- U value of framing is 1.6 W/(m2.K).

3.3 Day lighting level

During the initial design of the building envelope the design team wanted to use EC glazing panels in all four orientations of the façade openings as the base case scenario. However, direct solar radiation duration (in hours) was found to be too long in Dubai with an increasing effect on cooling loads (Table 1). The daylight factor was above 1,5% and the 95% autonomy was ensured in most school classes. In order to ensure daylight and reduce cooling load, it was decided to use EC glazing in the office building in its North and West Façades of the secondary school (Figure 1b). 110 square meters of electronically tintable glass was installed in both façade with a Window-to-Wall Ratio (WWR) of 85%. Dynamic glass controls sunlight in order to optimize daylight and maintain outdoor views while simultaneously enhance occupant comfort by preventing glare and solar heat.

Table 1: Difference of solar radiation in Base Case and North lights (Bourdoukan, 2016)

	Solar gains(kWh)	Cooling demand (kWh)	Psol max (kW)	Qcold max (kw)
Base Case	383 770	373 559	195	144
Northlights	16 442	54 912	8	27

Table 1: Difference of solar radiation in Base Case and North lights (Bourdoukan, 2016)

3.4 Building Simulation

Three dimensional modeling and dynamic thermal simulation of the secondary school, auditorium and library were prepared in order to observe thermal comfort of the blocks according to the Dubai's climatic data. Also, with the usage of the building simulation thermal coupling and integration of the detailed HVAC system were checked. Hourly dynamic thermal simulations of building parts including classrooms, kitchen, library and auditorium were gained. Depend on the simulation results it was obtained that FAHU are operational from 7 AM till 5-6 PM; lighting is 10W/m2 with dimming; plug loads are 4W/m² during occupation (except the kitchen and labs). Furthermore, the temperature is controlled in between 24-25°C and humidity ratio.

4 Results

Several interviews have been conducted to identify exactly the roles of the project's main stakeholders in different stages. This included the architect, energy consultant, building's users, adaptive façade designer, commissioning agent and the facility manager. The key steps of the adaptive facades delivery process are identified including decisions, checklists and teams engaged in each stage respectively.

4.1 Swiss International School of Dubai Project stakeholders and process map

The process mapping was completed by interviewing seven project stakeholders representing, the façade designer, architect, general contractor, energy and building physics consultant, commissioning agency, and facility manager. Figure 2 shows the results of the interviews and represents the different stakeholders of the project. The process map, shown in Figure 3, indicates that there were seven major design stages in this project, named according to the AIA (AIA, 2007). The figure shows the process map after being validated, illustrating the design and construction stages of the adaptive façade as a whole. Based on this step we identified the key stakeholders to start the façade performance evaluation.

4.2 Façade design process description

The interviewees revealed that the SISD project delivery process went through a linear process with experimental validation approach. The linear approach did not allow a holistic integrated and iterative approach. For example, the EC glazing was selected to optimize day lighting, thermal comfort and energy consumption for the Minergie energy target prior to the aesthetical concerns. In order to optimize day lighting, thermal comfort and energy consumption, three-dimensional modeling was prepared and according to this model facades design was developed. Also, the energy consultant had to conduct several simulations models and experiment with a climate data of Dubai and test bed in the Switzerland, to optimize the DF factor and daylight autonomy. Firstly, the

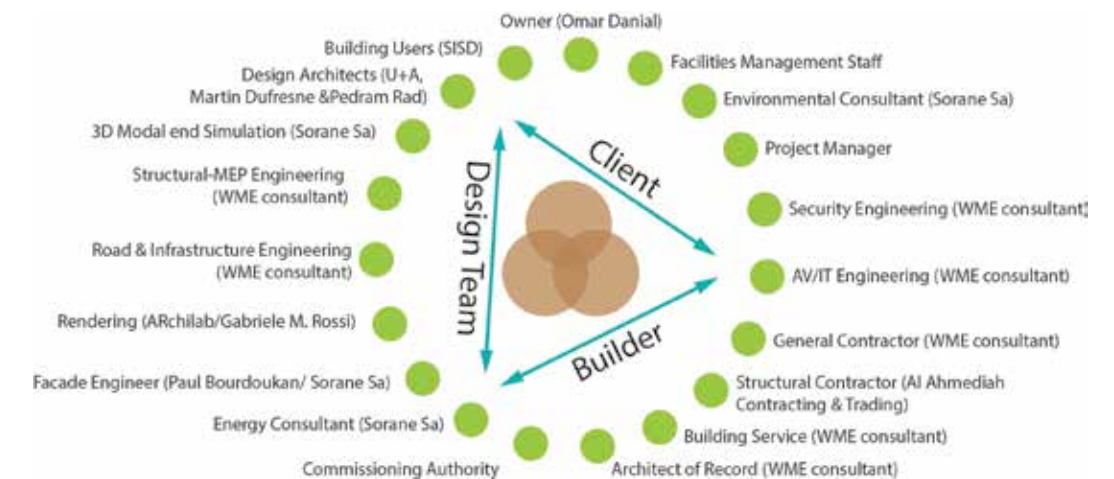

Figure 2: General composition of SISD adaptive façade team

architects designed the auditorium and library facades entirely from EC glazing. Later on, the energy consultant had to optimize the EC glazing to avoid overheat due to the long solar radiation durations. For instance, EC glazing inclined to the north was preferred for reducing the solar heat and optimize day lighting at roof of the secondary school. Similarly, the glazed surfaces were optimized to reduce cooling demand at auditorium block and library. Thus, the façade design was detailed and validated in a late stage of the design process. This was until the façade subcontractor was invited, when the final façade system design decision was made. The involvement of the glass façade subcontractor at the end of the design process resulted into a complicated situation. Therefore, it is very important to engage the façade engineers from the beginning of the design to guarantee hands on feedback and follow the shortest and the most cost effective design path.

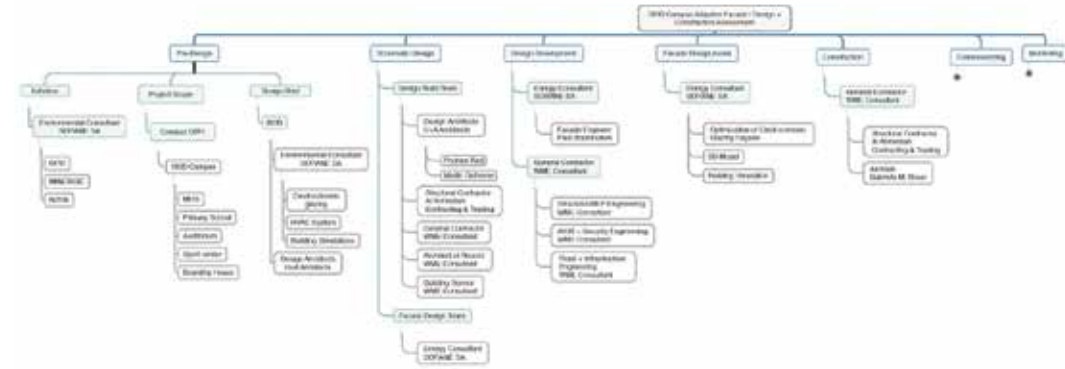

Figure 3: Process mapping of the integrated design process of the SISD's adaptive façade

4.3 Façade assessment process description

The façade assessment and commissioning was mainly on the hand of façade subcontractor. Despite the expertise of the building commissioning firm, the façade testing remained in the hand of the adaptive façade supplier. Prior to commissioning and during the pre-assist phase the main contractor and subcontractor had to build a test bed for a façade module. The main contractor was responsible for the structural, MEP engineering, infrastructure, IT, Security and building services. The façade subcontractor was responsible for the design and testing of the façade and preparing the building simulations. Once the initial design is completed by U+A architects the façade subcontractor started to conduct the façade optimization measures.

The process includes using an EC insulating glass unit wired with a Pigtail cable that extends from one edge of each IGU and connects to the frame cable. It also stores an electronic serial number and glass unit specific data that can be used for system start-up, commissioning and troubleshooting.

4.4 Energy Performance and Façade Control

After the completion of the first phase of the SISD project, the facade subcontractor Sorane provided Minergie compliance data (see Table 2). According to the façade subcontractor, chilled water consumption was calculated as 126 kWh/m², which is less than the Minergie requirements (140 kWh/m²). However, air cooling electricity must be compensated by PV, that's why 300 m² PV was taken out in the SISD project by façade engineer. As a result of Minergie application, the total electricity consumption was calculated as 22.8 kWh/m². Half of the electricity consumption is due to the fans consumption of the FAHU and avoiding air cooling (FCU and AHU) reduces by 20% the electricity demand in the project. Initially, contractors were hesitant to work with these connecting cables, but with the help of a supervising team, they have been able to get comfortable with the process and install the glass panels with ease.

Regarding the energy consumption associated with EC glazing, a comparison was made with between conventional office spaces and our office case study. The conventional office space consumed 99.2 kWh/m² for the year 2017 compared to 126 kWh/m² for the EC glazing office space. As shown in Table 3, the façade with EC glazing resulted in a more consumption due to the high WWR that is 85%. Moreover, the North façade was exposed to significant solar radiation without solar protection as shown in Figure 4. The red and blue colored lines represent the summer and winter incident radiation on the North façade. On the other hand, the lighting loads were

decreased significantly to the presence of EC glazing. The presence of EC in our case resulted in effectively decrease the dependence on artificial lighting.

Electricity Consumption Breakdown	
Electricity consumption	22.8 kWh/m ²
Cooling coil of FAHU	91 kWh/m ²
Cooling coil of FCU and AHU	The remaining 35 kWh/m ² (eq. 9 kWh/m ² electricity)
Total chilled water energy consumption	126 kWh/m ²

Table 2: Monitoring results

Example	Conventional Façade	EC glazing Façade
Cooling Load	99,2 kWh/m ²	126 kWh/m ² (+27%)
Lighting Load	8.0 kWh/m ²	5.3 kWh/m ² (-34%)

Table 3: Monitoring results

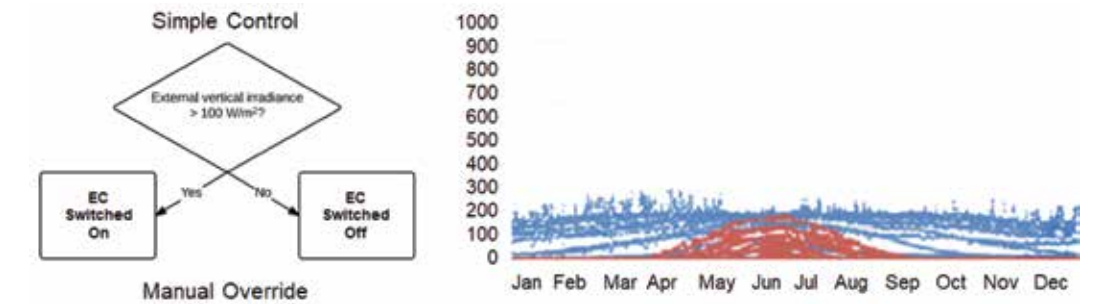

Figure 4a: the EC glazing control system depends on external sensors placed on the North and West facades, 4b: the monitored solar radiation expressed in wattage for the North façade of the office building (red=summer radiation; blue=winter radiation).

	External Venetian Blinds	Venetian Blinds in sealed Triple Glazing Frame	Fixed Shading	Solar Glazing	Electrochromic Glazing (SISD)
g/SHGC(Nominal)	0.12	0.12	min 0.30	0.60	0.05 - 0.16 - 0.40
g/SHGC (Real)			Variable		approx.0.25
Vlt (Nominal)	0.05	0.00	0.10	0.50	0.00 - 0.24 - 0.60
Vlt (Real)			Severely Minimized		approx.0.1
Comments	Sand blocks movable mechanism Expensive	Increased Temp. in the cavity No guarantee Expensive	Robust	Robust	Robust Expensive

Table 4: Façade Performance and Sun Protection (Summer 2017)

Based on the monitoring results we performed an analysis to investigate the correlation between SHGC (g-value) and Vlt as shown in Table 4. Our analysis indicates a significant disparity between the nominal and real performance of EC glazing regarding SHGC. This is mainly caused by the high surface temperature of the glazing surface. Our analysis confirms that the EC glazing reduced the visible transmittance from 70% to around 10% and g-value from 0.60 SHGC to 0.25. However, the high WWR (85%) effect contradicted the whole purpose of installing EC glazing regarding energy efficiency. This resulted into an energy consumption increase of 27% more than the conventional façade (Table 3). Moreover, the EC glazing blocked the passive solar heating effect during winter. Since the building has no heating system, occupants complained from overcooling during winter.

4.4 Post-Occupancy Evaluation

A total of 39 anonymous respondents filled in the POE questionnaire by employees of the SISD. The occupancy density in this building was 4.5m².person compared to 10m².person in Europe. For most respondents, the general IEQ conditions were evaluated as very good, except during the winter. As shown in Figure 5, there is a significant discomfort (36% of occupants) during the winter season. This can be explained by the low conductivity of the glazing and the low g-value that blocks the passive solar heating. In the same time, the lack of a heating system did not allow users to feel satisfied (Bourdoukan 2016).

Daylight availability was also assessed as very good; however the user control regarding sunlight control was assessed as a cause of problems. A conflict between maintaining the view and blocking the direct sunlight radiation occurred during winter. Our observation revealed a conflict between the user's personal control and automatic control strategies.

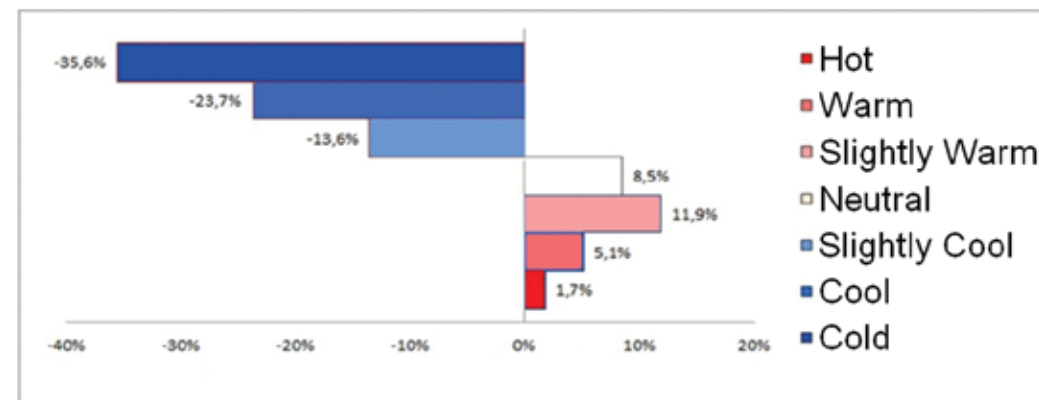

Figure5: POE results

5 Discussion and Conclusion

The primary objective of this study was to improve our understanding of electrochromic glazing façades. From the POE results we evaluated the real performance of an EC glazing façade in relation to energy consumption, comfort and façade system control. One case study is statistically not representative; however, based on the best available data in literature we present significant and incremental contribution that can support the decision making of façade designers and owners. We summarize the study findings under the following objectives:

5.1 Understanding the performance requirements of EC glazing

- The EC glazing did not block the solar radiation enough in the South. In a climate like the one of Dubai, the direct solar radiation and heat transfer cannot be blocked by using EC glazing. After several design and performance modeling iterations, the design team decided to place the EC glazing mainly in the North and avoid placing any EC glazing in the west, east or south facades.
- Installing EC glazing in a highly energy efficient envelope was counterproductive. The EC glazing blocked the passive solar heating effect during winter. Since the building has no heating system occupants complained from overcooling during winter. The EC glazing eliminated any chance of passive heating during the winter because it orientation (North). Designers should better estimate the effect of EC glazing on thermal comfort during winter.

- Energy consumption was increased by 27% due to the use of EC glazing. The high WWR (85%) effect contradicted the whole purpose of installing EC glazing regarding energy efficiency. The POE results indicate that the consumption would increase much more if the building had a heating system. Installing EC glazing should not be associated with increasing the WWR.

5.2 Key performance criteria of EC glazing

- The key performance criteria of EC glazing should be the energy use intensity and indoor environmental quality in the glazed spaces. The use of nominal values of SHGC or VIt is meaningless. In this project, TRNSYS failed to estimate the effect of EC glazing and did not allow modeling the dynamic variation of SHGC and VIt, which is in line with literature.
- There was an unexpected level of difficulty in assuring the POE in building with EC glazing. We need much more knowledge on EC glazing performance and user interaction with EC facades. We need independent studies on user's well-being and dynamic visual comfort (incl. color rendering) for dynamic glazing. The nature and the effects of these mutual interrelationships between occupants and façades are yet to be completely defined.

5.3 The significance of using EC glazing

- The use of EC glazing in their current technological status is seriously questionable. Firstly, because there are no conclusion studies on their energy saving effects in relation to comfort improvement.
- Secondly, the automatic control of AF and users response caused in many cases conflicts. The overriding algorithm control settings and users need did not match during the early morning and end of the working days. Due to the multi-sensorial effects of façades and the highly-individual response of occupants, designing for user interaction with dynamic envelopes is a challenging task and conflicts and inconsistencies often arise.

5.4 Learned lessons for architects and façade engineers

- The window to wall ratio was 85% in the North façade and windows are not operable. We advise to reduce the WWR and include fixed shading even in the extreme heat and intense glare from the sun in the Middle East.
- The EC façade cost 7-8 times more than a curtain wall façade in Dubai including the controls.
- EC glazing remains an aesthetically-appealing technology. However, the WWR and solar shades and blinds remain the most influential regarding thermal comfort and energy savings for adaptive facades in hot climates. An efficient sun protection from the sun and an adequate glazing surface are required for the envelope.

6 Acknowledgement

The author expresses their thanks to Paul Bourdoukan and all anonymous interviewees. The author appreciates their valuable comments and feedback. The author would like to gratefully acknowledge COST Action TU1403 "Adaptive Facades Network" for providing excellent research networking. The authors would like to acknowledge the support of Workgroup 3 members. Also we would like to acknowledge the Sustainable Building Design Lab for the use of monitoring equipment in this research and the valuable support during the experiments and the analysis of data.

7 References

- ASHRAE (2013). 55: Thermal Environmental Conditions for Human Occupancy, American Society of Heating Refrigeration and Air Conditioning Engineers. Inc., Atlanta.
- Attia, S., Bilir, S., Safy, T., Garat, S (2019) Adaptive Facades performance assessment: Interviews with Façade Experts, SBD Lab, Liege University, Belgium. ISBN: 9782930909097.
- Attia, S., Bilir, S., Safy, T., Struck, C., Loonen, R., Goia, F. (2018a) Current Trends and Future Challenges in the Performance Assessment of Adaptive Façade Systems, Energy and Building, in press.
- Attia, S., Luna Navarro, A., Juaristi, M., Monge-Barrio, A., Gosztonyi, S., Al-Doughmi, Z., (2018b) Post-Occupancy Evaluation for Adaptive Facades, Journal of Façade Design and Engineering, in press.
- Attia, S. (2016a) Evaluation of Adaptive Facades: The case study of a glass building in Belgium. Challenging Glass 5 - Conference on Architectural and Structural Applications of Glass. 11.05.2017.
- Attia, S. (2016b) Evaluation of Adaptive Facades: The case study of Al Bahr Towers in UAE. Qatar Green Building Conference 2016 – The Action. 11.05.2017.
- Attia, S., Favoino, F., Loonen, R., Petrovski, A. & Monge-Barrio, A. (2015) Adaptive façades system assessment: An initial review. In Advanced Building Skins. Economic Forum. 1226–1233.
- Attia, S. and Bashandy, H. (2015) Evaluation of Adaptive Facades: AGC Building a case study of an automated glass façade - Interviews and process mapping of the design team. 11.05.2017.
- Beyeler F., Beglinger N., Roder U. (2009) Minergie: The Swiss Sustainable Building Standard. 11.05.2017. Retrieved from <http://www.mitpressjournals.org/doi/pdf/10.1162/itgg.2009.4.4.241>.
- Bourdoukan, P., (2016) Swiss International School of Dubai Design and simulation of a Minergie building in Dubai. Qatar Green Building Conference 2016 –The action.
- Hall, M., Geissler, A., Burger, B. (2016) Two years of experience with a net zero energy balance – analysis of the Swiss MINERGIE-A® standard. Energy Procedia. 48, 1282 – 1291.
- Loonen, R., Trčka, M., Cóstola, D. & Hensen, J. L. M., (2013) Climate adaptive building shells: State-of-the-art and future challenges. Renew. Sustain. Energy Rev. 25, 483–493.
- Luible, A. (2014) Memorandum of Understanding for the implementation of a European Concerted Research Action designated as COST Action TU1403: Adaptive Facades Network. 11.05.2017
- Karanouh, A. & Kerber, E. (2015) Innovations in dynamic architecture. J. Facade Des. Eng. 3, 185–221.
- Samyn & De Coninck (2014). AGC Glass Building. Lannoo. 11.05.2017.
- Wurm, J. (2013) Developing bio-responsive façades: BIQ House — the first pilot project. The Arup Journal 90–95.

An insight on possible classification and metrics, experimental testing and numerical modelling for adaptive facades - Activity report from the ‘Structural’ Task Group

Chiara Bedon a), Dániel Honfi b), Marcin Kozłowski c,d), Martina Eliášová e), Klára Vokáč Machalická f), Miroslav Vokáč f), Filipe Santos g), Thomas Wüest h)

a) University of Trieste, Italy, chiara.bedon@dia.units.it

b) RISE - Research Institutes of Sweden, Sweden

c) Lund University, Sweden

d) Silesian University of Technology, Poland

e) Czech Technical University in Prague, Prague, Czech Republic

f) Klokner Institute, Czech Technical University in Prague, Prague, Czech Republic

g) New University Lisbon, Lisbon, Portugal

h) Institute of Civil Engineering, Lucerne University of Applied Sciences and Arts, Lucerne, Switzerland

Adaptive facades are getting more and more widespread in modern buildings. These facade systems, among many others, need to fulfil the requirements of several structural considerations, such as structural safety, serviceability, durability, robustness and fire safety, being typically defined for standard facades and building enclosures in general. The paper discusses special structural characteristics that need to be taken into account when designing adaptive facades, and summarises some recent efforts of the activities carried out by the ‘Structural’ Task Group within the European COST Action TU1403 ‘Adaptive Facades Network’.

Keywords: Adaptive facades, structural performance, classification, metrics, experimental facilities and testing, numerical modelling

1 Introduction and motivation

Modern envelopes are high-tech components that must meet several requirements and constraints with regards to architecture / urban planning / aesthetics, energy efficiency, indoor environmental quality, buildability and value. In this regard, as far as a facade can respond to all the transient conditions in such a way that it maintains occupant satisfaction without imposing additional loads on the building services can be considered as ‘adaptive’. Within the requirements an adaptive facade needs to provide, however, a fundamental role is assigned to the structural performance (see (Bedon et al. 2018b)). Most of the systems representative of the next generation of facades in buildings, in fact, typically consists of highly adaptive envelopes, generally involving advanced use of smart materials, kinematic mechanisms, etc. (see for example Figure 1).

The current lack of standardised procedures and regulations for structurally related issues in adaptive facades represents a critical aspect for design. This is especially true in the case of facades of strategic buildings (i.e., governmental facilities, banks, terminals, landmark structures, hospitals, etc.), or buildings that could be exposed to exceptional loads (both accidental or man-made) during their whole life-time. In general terms, from a structural point of view, facades are often the most vulnerable components of a building, providing the physical separation between the interior and exterior spaces and conditions (Kassem & Mitchell 2015; Zhang & Bedon 2017; etc.).

A given facade should in fact be able to respond to basic requirements under the assigned design loads, namely consisting in self-supporting capacity and appropriate stability (also with respect to vibrations); security and protection of the occupants and customers; strength and robustness, for the transmission of the external loads to the foundation systems; flexibility, so as to adapt to the external loads; durability; insulation capacity, etc. The facade itself could then contribute to the robustness or enhanced dynamic performance of the whole building it belongs to (see for example (Stepinac et al. 2016; Bedon & Amadio 2018; etc.)). Within the full design project, such structural requirements and performance parameters should be properly combined with a multitude of aspects, requiring multidisciplinary approaches and expertises.

In this context, as an ongoing activity of the EU COST Action TU1403 'Adaptive facades network' ('Structural' Task Group), this paper aims to provide some first recommendations towards the definition of structural-focused guidelines for these novel skins. Major outcomes from the 'Structural' TG are hence briefly summarised in Section 2. Special consideration is then spent for classification and metrics, being adaptive facades related to specific static and dynamic behaviours that can be easily distinguished from traditional cladding systems (Sections 3 and 4). Key aspects and parameters for experimental testing of structurally adaptive facades are then discussed in Section 5. Finally, some general recommendations are given for Finite Element (FE) numerical modelling purposes (Section 6), where - in addition to traditional cladding systems - careful attention should be paid to transient system states and to the dynamic effects on materials, as resulting from variable loading and restraint conditions.



Fig. 1 Examples of adaptive facade concepts. Figures adapted from (a) Ribeiro, 2016 (Copyright @ Ribeiro Silveira 2016), and (b) Kormaniková et al., 2017 (reproduced with permission from Elsevier, Copyright © license n. 4412500174098, August 2018)

2 'Structural' Task Group

2.1. Task topics and goals

Within the TU1403 network (2014-2018), the need to account for structural aspects has been recognised. This is particularly related to development, design, testing and standardisation of adaptive facades. Therefore, the 'Structural' Task Group has been established in the Lucerne MC meeting (October 2016), as a transversal sub-group of Working Group 2 (WG2), see Table 1.

WG	Topic
#1	Adaptive technologies and products
#2	Component performance and characterization methods
	TG2.1 Map out performance metrics and requirements for adaptive facades
	TG2.2 Evaluate current simulation tools for adaptive performance assessment
	TG2.3 Analysis of current experimental procedures for the evaluation of adaptive facades
#3	Whole building integration and whole-life evaluation methods of adaptive facades
#4	Dissemination and future research

Table 1: Overview of Working Groups for the COST Action TU1403.

In particular, while the main goal of WG2 as a whole was to develop and provide a unified approach for characterizing and evaluating the performance of adaptive and multi-functional facades (at the component level), the 'Structural' TG activity was aimed at assessing the structural and durability domains, in terms of classification and metrics developments, assessment of experimental testing methods, numerical modelling, etc.

Such a general goal was addressed by accounting, on one side, for standard approaches in use for structural applications in traditional static facades. On the other hand, major influencing parameters were collected for structurally adaptive facades, based on a selection of case studies and on the available literature research efforts. Given such a background, a possible extension (and/ or adaptation) of the existing methods and approaches (i.e. for testing, modelling, etc., static facades) were hence considered for adaptive systems.

2.2. TG activities and outcomes

So far, the 'Structural' TG actively contributed to the Action initiatives, in several forms.

- Educational Pack (slides in progress)
- Training Schools: the TG joined the first successful event at HafenCity University (Hamburg, Germany, September 2016), with a lecture focused on basic structural aspects and case studies for adaptive facades, including fundamentals, general numerical procedures, design philosophies, etc. The second Training School edition, planned for September 2018 at Belgrade University (Serbia), further confirmed the TG involvement.
- Journal and Conference Proceeding publications: so far, some of the collected TG outcomes and efforts have been already published in international conference proceedings. In the same period, several documents from TG2.4 members have been published (or are currently under review) for publication in peer-reviewed, international scientific journals. For the full list of co-authored scientific publications, literature details and major outcomes are summarized in (Bedon et al. 2018b).

- COST mobility grants: the financial support from COST was exploited for successful networking opportunities, mainly in the form of Short-Term Scientific Missions (4 in total, see Table 2), but including also a conference grant for Early Career Researchers (Dr. Kozłowski the beneficiary in April 2018, for the oral presentation of a TG contribution (Kozłowski et al. 2018b) at the 'Places and Technologies 2018' event, Belgrade University (Serbia)).

Table 2: COST networking support for Short-Term Scientific Missions within the 'Structural' TG.

Year	STSM Title & Topic	Involved Institutions (*= hosting)
2015	Numerical modelling of structural adhesives for hybrid steel-glass beams <i>The STSM activities were focused on the numerical analysis and calibration of different material models for adhesive connections. Careful consideration was spent - based on available experimental tests - for the assessment of key input parameters of constitutive laws for adhesive connections in use for glazing assemblies.</i> Ref: (Firmo et al. 2016)	Univ. of Coimbra (PT) & Univ. of Trieste (I)*
2016	Coupled structural & thermal optimization of a multifunctional building skin <i>The goal of this STSM was to assess the potential and feasibility of novel GFRP-glass modular units for curtain walls, to use in place of traditional, non-integrated glass-aluminium systems. The parametric numerical study (400 the configurations with different geometrical/ mechanical input features) generally gave evidence of the high sensitivity of both thermal and structural performance parameters to even small variations. At the same time, the GFRP-glass sandwich modular units proved to offer enhanced thermal response and well-promising structural behaviour, compared to traditional solutions.</i> Ref: (Bedon et al. 2018c)	Univ. of Trieste (I) & Univ. of Cambridge (UK)*
2018	Coupled thermo-mechanical models for structural glass <i>The aim of the STSM was to collect and extend the existing knowledge about behaviour of monolithic and laminated glass at elevated temperatures and fire conditions. These included literature study on the properties of glass and interlayers at elevated temperatures. Moreover, the STSM was focused on simulation tools regarding modelling of glass at elevated temperatures and fire scenarios, in particular thermo-mechanical model for glass based on the results of experiments carried out at RISE Research Institutes of Sweden (monolithic and laminated glass panes exposed to radiant heating).</i> Ref: (Bedon et al. 2018a; Kozłowski et al. 2018a)	Silesian Univ. of Technology (PL) & Univ. of Trieste (I)*
2018	Thermo-mechanical numerical modelling of adaptive facade assemblies under high temperatures and fire <i>Following the previous STSM, the research activities were focused on additional numerical modelling and analysis of adaptive facade assemblies under thermal loading. Key effort was derived from experimental results available at RISE.</i> Ref: (Bedon et al. 2018a; Kozłowski et al. 2018a)	Univ. of Trieste (I) & RISE (SE)*

Table 2: COST networking support for Short-Term Scientific Missions within the 'Structural' TG.

From Table 2, it is apparent that one of the major efforts of the 'Structural' TG is related to the effect of temperature variations on the structural performance of constructional systems, especially glass elements, due to their huge use in building envelopes. This aspect could be particularly important, for example, for modern energy efficient glass facade systems in case of extreme temperatures, as a result of changing climate or also accidental fire scenarios. Further research topics that have been exploited (or still in progress) from the TG members include the performance of several connection types and systems, both at the component and assembly levels (especially adhesives), with careful consideration for long-term effects and ageing. Another set of issues addressed by the TG members was then related to facades in which the load-bearing structural system adapts to changing conditions, i.e. with regards to the external loading. This typically includes non-traditional materials and hybrid structural components (see for example (Santos et al. 2016; Ribeiro Silveira et al. 2018; etc.)). Novel design principles are also subject of ongoing research studies, aiming at extending bio-mimetic and nature-based principles to structural claddings (Schleicher 2011; Lopez et al. 2017; etc.).

3 Definitions and classification criteria for structural adaptive facades

3.1. Background

Adaptive facades have been an attractive topic in research dealing with the behavior and performance of buildings (Favoino et al. 2015; Aelenei et al. 2016; Marysse 2016; Attia et al. 2017; etc.). However, or rather naturally, what adaptivity actually refers to depends on the particular research topic and/or the specific application. Therefore, it is important to define a common terminology with the relevant definitions, so to develop a common understanding among researchers and practitioners with different background and focus.

A rather generic definition of adaptivity for facades and building envelopes is given in (Loonen et al. 2013), as the ability to change their 'functions, features or behavior over time in response to transient performance requirements and boundary conditions, with the aim of improving the overall building performance'. The above general definition is also adopted by Aelenei et al. (2016), with a further specification for the functional requirements which adaptivity aims to improve, such as heat, air and water vapor flow, rain penetration, solar radiation, noise, fire, strength, stability and aesthetics, etc. Despite these rather broad definitions, most of the scientific papers available in literature and related to facade adaptivity typically focus on energy, climate and comfort related aspects (i.e. energy performance, thermal comfort, Indoor Air Quality (IAQ), visual and acoustic performance), hence to configurations that are typically characterised by gradual changes in the environment (see for example (Hasselaar & Looman 2007; Kim 2013; Park & Dave 2014; Barozzi et al. 2016; etc.)).

3.2. Proposal

Adaptiveness can be beneficial regarding the structural performance of buildings, if it reflects to - often abrupt - changes in the boundary conditions of the load-bearing system. Structural adaptivity, in this context, is beyond traditional structural engineering which typically deals with systems in static and/ or dynamic equilibrium. In a structurally adaptivity system, the equilibrium might change gradually involving large deformations and movements. The system is thus often a mechanism where the stiffness, the geometry or the external forces are controlled either 'manually' or 'automatically'. By 'manually' and 'automatically' here refers to what extent the structural response to the changes in the environment is regulated.

A specific classification for adaptive facades systems was proposed by Velasco et al. (2015), by considering both movement and control as performance parameters. New classification rules were then suggested by the 'Structural' TG members in the TU1403 Educational Pack in progress (<http://www.tu1403.eu>) - see Figure 2 for an updated version.

According to the TG classification, as shown in Figure 2, a key role is assigned to three different aspects / level, namely represented by (A) system changes, (B) activation type and (C) loading conditions. Their features and effects (including possible combinations) should be properly taken into account at the design stage, since these are responsible for multi-phase configuration changes (even cyclic) during the whole life-time of a given facade. The first main aspect of classification relates to possible 'system changes' regarding geometry and stiffness (i.e., being explicitly related to the adopted facade details, and hence responsible of different types of deformations under the assigned design loads). The second main aspect then refers to the 'activation system', where the

classification could be carried out by distinguishing facade systems with prevalent self-change materials (i.e. thermo-sensitive materials like shape memory alloys, thermo-bimetals, etc.), rather than mechanical actuators (i.e. Figure 1(a)) or inflatable systems. The latter solution can include soft pneumatic actuators (i.e. detail of Figure 1(b)) or consist of full pneumatic chambers and air cushions (i.e. Figure 3). In both cases, inflatable facades should be separately investigated, since these are typically characterised - with respect to the other types of envelopes - by pressurized units composed of novel / unconventional materials whose performance should be properly assessed, in which both mechanical and thermal loads apply (i.e., load sharing phenomena in the air cavities, etc.).

The third aspect focuses then on the 'triggering events', where possible loading scenarios of interest for the full life-time of the structure should be properly evaluated, including ordinary thermo-mechanical actions and possible extreme events (even natural or accidental).

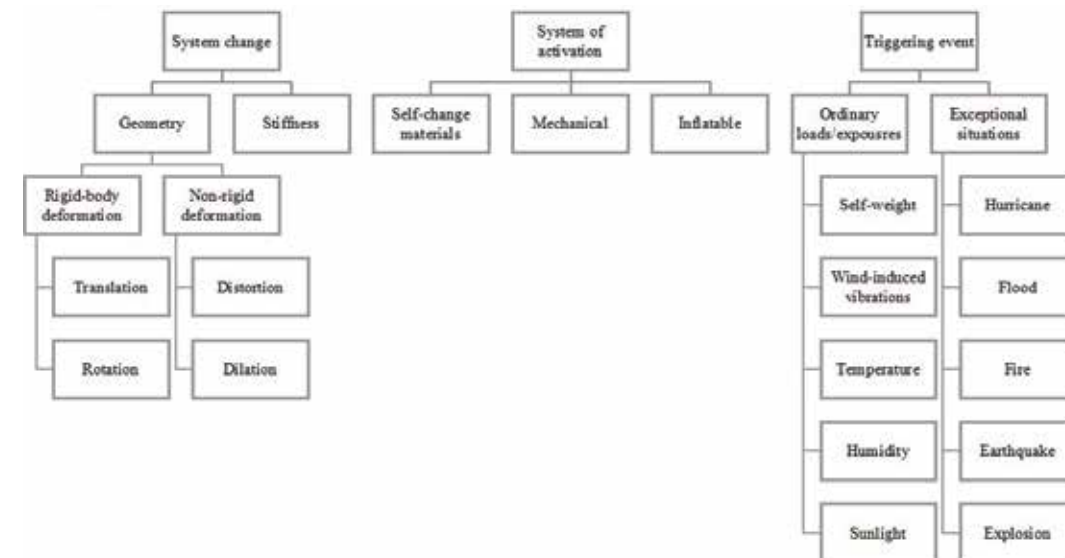

Fig. 2 Classification system of adaptive facades ('Structural' TG proposal).



Fig. 3 Example of inflatable adaptive facade (Media ICT building in Barcelona, Spain). (a) General view and (b)-(c) details (figures reproduced from (Marysse, 2016)).

4 Metrics

4.1. Summary of design concepts, standards and guidelines

Building envelopes are commonly required to resist self-weight, environmental actions (i.e. thermal effects and wind load), natural (i.e. earthquake) and man-made (i.e. impact and explosion) hazards. Moreover, structural design of adaptive facades has to resolve structural consequences due to adaptive / movable systems, together with structural and cost consequences for the supporting substructures. Wind loading, for example, is a highly dynamic phenomenon and therefore a very interesting driver for adaptive architecture. Actuators of adaptive facades can also significantly affect dead loads to account for design: mechanically driven kinematic systems will lead to heavy complex construction components, while lightweight shape morphing elements are possible to construct with smart materials (Lignarolo et al. 2011).

For building envelopes and components, structural criteria are specified at different levels: general harmonised conditions for construction products in Europe (EU 2011), national building standards (EN 1990) and recommendations from facade organisations (CWCT 2018). The most general regulatory framework for the performance of all the building products in Europe is represented by the Construction Products Regulation (EU 2011). It specifies basic requirements for construction works, namely related to mechanical resistance and stability, safety in case of fire, hygiene, health and environment, safety and accessibility in use, protection against noise, energy economy and heat retention, sustainable use of natural resources. The EN 1990 document defines then the conventional requirements for safety, serviceability and durability of structures, including regulations for the design, verification and reliability of structural systems. While inclusive of reference design loads for structures, however, the EN 1990 does not account for specific aspects of facades and envelopes, and moreover should be used in conjunction with specific standards related to fire design, accidental situations (i.e., earthquakes) and execution. The Centre for Window and Cladding Technology (CWCT) is an example of industry funded centre providing more specific performance criteria for facades. It publishes both standards and guidelines developed together by leading architects, consultants, contractors and manufacturers.

4.2. Structural performance metrics for facades

In building engineering, 'metrics' are conventionally assumed to represent - for facades and envelopes - specific performance parameters that are strictly related to the thermal comfort, energy performance and lightning response of a given cladding system, with respect to the whole building it belongs to. In the last years, the increasingly development of adaptive systems attracted the attention of several research studies. Compared to 'static' performance metrics for thermal and lightning assessment of facades (i.e., U-value, g-value, daylight factor, etc.), a series of 'dynamic performance metrics' have been proposed in the literature (see for example (Reinhart et al. 2006; Wagdy et al. 2016; Goia et al. 2013; etc.)), so as to properly capture and optimise the expected behaviours, towards enhanced sustainability and comfort levels.

Structurally speaking, see Section 4.1, the overall performance of a traditional facade is conventionally optimised - under the assigned ordinary design loads (i.e. self-weight, wind, crowd, etc.) - so as to accomplish specific deflection values in service conditions (M1), that should be implicitly accounted for appropriate resistance performances of the load-bearing components. The same deflection limits, at the same time, are generally recommended by design standards so as to provide reasonable comfort for the building occupants (i.e. limitation of perceived movements and minimisation of potential failure risk). Another key structural performance parameter to

account in the design is then represented by the weight (M2) of the structural (and non-structural) components. A series of additional (and more specific) performance metrics can then be defined and accounted for the optimal design of a given facade typology, especially adaptive facades. Horn (2015), for example, focused on the design of truss facade structures and emphasised how 'structural performance metrics' can be merged and related to 'buildability metrics', so as to enhance their cost and efficiency. In doing so, Horn proposed six additional metrics, namely related to (Mi) a standardised length for the facade members, (Mii) trucking requirements, (Miii) number of structural connections to build on-site, (Miv-Mv) structural joints geometry and connectivity, (Mvi) variations in the cross-sectional features of the load-bearing components.

4.3. Considerations for adaptive facades

Actually, the lack of specific regulations and guidelines to standardise the load-bearing mechanisms and performance of adaptive facades represents one of the major issues for their optimal design. Differing from traditional static facades (namely consisting in regular structural schemes), the variability in possible kinematic effects, materials (and related properties), morphology (including free-form facade systems), on the other hand, does not allow and facilitate the possible grouping of adaptive facade systems by boundary conditions.

Given the intrinsic features of adaptive facade systems, however, both the M1 and M2 metrics discussed in Section 4.2 can be reasonably accounted as reliable performance parameters. The M2 minimisation, in particular, is herein recommended especially in presence of kinematic mechanisms involving rotations and torsional effects, that could induce fatigue phenomena. The trouble arises indeed in terms of deflection limit values (M1), since static facades are required to satisfy specific deformations that are strictly related to their loading and boundary condition (i.e. curtain walls, cable-supported facades, etc.). In this context, lateral deflection limits in adaptive systems should be generally related to the involved shape change and joint detailing, being responsible of local and global stress peaks that can be hardly controlled via standardised reference values. For preliminary estimations, the limit of 1/100 the bending span could be taken into account for adaptive facades. Even if experimental testing and / or numerical modelling can provide further support and feedback to design, in addition, lateral deflections should be related to stress peaks in the structural components, so to ensure (depending on the used materials) minimum stress-to-resistance ratios (i.e. less than 30% the allowable stress values) in operational conditions, and sufficiently wide safety levels.

Given the intrinsic features of adaptive systems, (M3) vibrations are then recommended as potential metrics for optimal structural performances. According to the EN 1991-1-4:2005 provisions, for example, glazing facades and roofs with natural frequency lower than 5Hz (condition that typically occurs for glazed spans smaller than 3m) should be properly verified against vibration effects, even due to ordinary wind pressures. A specific calculation method is provided for these systems in the Annex F - Dynamic characteristics of structures.

Special care, finally, should be spent for (M4) fatigue phenomena. In this case, however, specific probabilistic studies are required, for each facade typology, being fatigue effects strictly related to boundaries, loads and materials. In addition, no standardised design methods for fatigue assessments are available for (even static) facades, being explicitly calibrated in the literature - in most of the cases - for bridges under vehicle loading. Nakagami (2003), in this regard, proposed a new method to account for the loading cycle of wind pressures in traditional glazing envelopes. The research investigations highlighted that such a probabilistic method can be very effective when the

resonance component for a given facade system is relevant, compared to the assigned load wind spectrum. Extended analyses should be however carried out, for adaptive facade systems.

5 Design of structural adaptive facades by testing and numerical simulation

5.1. Experimental testing: regulations, methods and issues

From a structural perspective concerning experimental testing, the most important is that the test results should provide useful information about the expected structural behavior of a given adaptive facade component or system. This information could be related to the load carrying capacity, stiffness, dynamic properties, fatigue resistance, fire performance or any other parameter affecting structural safety. It is, however, important that the significance and relevance of the tested properties should be well understood and interpreted.

For example, measurement of the resistance of a component or a joint for a given loading and boundary configuration might provide useful data about certain failure modes, whereas completely neglect some others. It should also be kept in mind that each experiment has a random outcome and what is observed is just a single realization of a probabilistic distribution. In structural design, however, typically some representative values of such distributions are required, e.g. the characteristic values of strength which is typically based on the 0.05 fractile in the lower end. Therefore, the proper design of experiments might require consideration of uncertainties on a statistical basis.

Since adaptive facades are hardly standardised products or assemblies, standard test procedures for claiming compliance with safety requirements might not always be applicable. Therefore, customised solutions might be required which are consistent with the main principles of the established testing methods. The development of such experiments requires a clear communication between the involved parties, such as the facade engineer, the manufacturer of the components, the testing laboratory etc., to ensure that the performance requirements to declare adaptivity match with the measured engineering parameters.

Standard procedures for testing conventional facade systems can be considered as a starting point of verifying the performance of adaptive facades. These are typically product standards for CE marking in the European Economic Area (EEA), such as the EN 13830 'Curtain walling - Product standard' and ETAG 034 'Guideline for European Technical Approval of Kits for External Wall Claddings' issued by European Organisation for Technical Approvals (EOTA). The former defines tests and procedures for testing air permeability, watertightness, wind load serviceability and wind load resistance. The latter includes methods for testing mechanical resistance and stability, safety in case of fire, hygiene, health and environment, safety in use, protection against noise, energy economy and heat retention, aspects of durability and serviceability.

When adjusting this procedures for adaptive facades, both the applicability of the procedure and relevance to the adaptive performance needs to be considered. For example, out-of-plane movement of the facade, might involve joints that allow water penetration without impacting water-tightness; however, water could be trapped when the facade regains its original geometry. The fatigue assessment of movable parts requires a thorough assessment of anticipated stress regimes and planning of testing cycles and load levels accordingly. Complex and changing forms of adaptive facades might require wind tunnel testing combined with computational fluid dynamics (CFD) modeling to obtain relevant wind loads required for subsequent testing. Some more details on specific considerations about adaptive facade testing is given in (Bedon et al. 2018b).

5.2. Numerical modelling: issues and general recommendations for structural adaptive facades

The FE analysis of an adaptive facades differs significantly from that of traditional ones, since the analysis should properly define some key aspects which are representative for various key input parameters. On the other hand, several other questions should be considered. Such aspects are strictly related to the classification parameters summarised in Figure 2, and include additional aspects depending on the variability of reference conditions (materials, boundaries, loading).

For example:

- Material properties should be properly selected and defined via reliable mechanical models (i.e. linear elastic, damage mechanisms, degradation under cyclic loads and/or time/temperature variations, etc.), depending on the main goal of the analysis, as well as on the features of the examined facade. The lack of general recommendations and guidelines for modelling (see (Larcher et al. 2016) for glass facades) is further enforced by the use - in most of the cases - of a combination of different materials, requiring specific analysis methods and calibrations (to experiments, when available).
- Loads: even in presence of ordinary loads only, adaptive facades are first associated to cyclic and / or kinematic behaviors that should be properly accounted.
- Boundaries: being generally described via ideal restraints, the FE modelling of adaptive facades assemblies or components could be responsible of unreliable assumptions, or not able to account for specific parameters such as possible premature failure mechanisms, etc.

Finally, special care should be spent for:

- The definition of an appropriate mechanical interaction between the facade components: connections and joints should be properly reproduced (even in a simplified way) so to describe the actual response of each facade component, but also the mutual interaction between components, as part of the entire adaptive assembly.
- The choice of a reliable solving strategy: FE simulations can provide useful support for the structural assessment of adaptive facades under extreme loading conditions, including accidents as well as natural hazards. In this case, the FE modelling complexity further increases, since strong efforts should be spent both on the adaptive facade side (i.e., see the points above) as well as on the loading description side.

6 Conclusions

Although adaptive facades are getting gradually more common in modern building skins, their design still represents a challenging task. Engineers have to keep in mind that current standards and procedures cannot always be applied or, for some cases, these do not exist. Differing from traditional cladding systems, the multiple ways in which adaptive facades can interact with the environment - and change their intrinsic mechanical features - need to be properly taken into account, both for experimental testing and numerical modelling. The recent activities of the 'Structural' Task Group, briefly summarised in the paper, provide some first ideas towards highlighting structural aspects the design of these novel skins.

7 Acknowledgements

The paper collects some major outcomes of the 'Structural' Task Group, within the ongoing European COST Action TU1403 'Adaptive Facades Network' (2014-2018, <http://www.tu1403.eu>).

In this regard, the COST association is gratefully acknowledged for providing excellent research networking between the involved authors, as well as with international experts.

All the Network members or the external experts that supported even part of the TG activities - throughout the full TU1403 project - are finally gratefully acknowledged for their valuable cooperation.

8 References

- Aelenei, D., Aelenei, L., & Pacheco Vieira, C. (2016). Adaptive Façade: concept, applications, research questions. *Energy Procedia* 91: 269-275
- Attia, S., Eleftheriou, P., Xeni, F., Morlot, R., Ménézou, C., Kosopoulos, V., Betsi, M., Kalaitzoglou, I., Pagliano, L., Cellura, M., Almeida, M., Ferreira, M., Baracu, T., Badescu, T., Crutescu, R., & Hidalgo-Betanzos, J.M. (2017). Overview and future challenges of nearly zero energy buildings (nZEB) design in Southern Europe. *Energy and Buildings*, 155: 439-458
- Barozzi, M., Lienhard, J., Zanelli, A., & Monticelli, C. (2016). The sustainability of adaptive envelopes: developments of kinetic architecture. *Procedia Engineering*, 155: 275-284
- Bedon, C., & Amadio, C. (2018). Numerical assessment of vibration control systems for multi-hazard design and mitigation of glass curtain walls. *Journal of Building Engineering*, 15: 1-13
- Bedon, C., Honfi, D., & Kozłowski, M. (2018a). Numerical modelling of structural glass elements under thermal exposure. *Proceedings of the 3rd International Electronic Conference on Materials Sciences*, doi: 10.3390/ecms2018-05241
- Bedon, C., Honfi, D., Kozłowski, M., Vokáč Machalická, K., Santos, F., Wüest, T., Eliášová, M., & Vokáč, M. (2018b). Key structural aspects for adaptive facades - Activity progress from the EU-COST Action TU1403 'Structural' Task Group. *International Journal of Structural Glass and Advanced Materials Research*, published online (accessed August 2018); <http://thescipub.com/abstract/10.3844/ofsp.12034>
- Bedon, C., Pascual Agullo, C., Luna-Navarro, A., Overend, M., & Favoino, F. (2018c). Thermo-mechanical investigation of novel GFRP-glass sandwich facade components. *Proceedings of Challenging Glass 6 - Conference on Architectural and Structural Applications of Glass*, TU Delft (The Netherlands). Available online (accessed August 2018): <https://doi.org/10.7480/cgc.6.2172>
- CEN (2005a). EN 1990 - Eurocode - Basis of structural design. CEN - European Committee for Standardization, Brussels, Belgium
- CEN (2005b). EN 1991-1-4:2005 - Eurocode 1: Actions on structures - Part 1-4: General actions - Wind actions. CEN - European Committee for Standardization, Brussels, Belgium
- CWCT - Centre for Window and Cladding Technology, 2018. *Intelligent Facades*. Available online (accessed August 2018): <http://www.cwct.co.uk/ibcwindow/adaptive/adapt.html>
- European Parliament, 2011. Regulation (EU) No. 305/2011 of the European Parliament and of the Council of 9 March 2011 laying down harmonised conditions for the marketing of construction products and repealing Council Directive 89/106/EEC, *Official Journal of the European Union*, 88: pp. 5-43
- Favoino, F., Overend, M., & Jin, Q. (2015). The optimal thermo-optical properties and energy saving potential of adaptive glazing technologies. *Applied Energy*, 156: 1-15
- Firmo, F., Jordão, S., Costa-Neves, L., & Bedon, C. (2016). The effect of adhesive joints on the performance of hybrid steel-glass beams - An analytical and experimental study. *Proceedings of Challenging Glass 5 - Conference on Architectural and Structural Applications of Glass*, Ghent University (Belgium), pp. 171-185, ISBN: 978-90-825-2680-6
- Goia, F., Bianco, L., Serra, V., & Perino, M. (2013). Energy performance assessment of advanced integrated facades by means of synthetic metrics. *Proceedings of the 8th International Symposium on Heating, Ventilation and Air Conditioning*. Lecture Notes in Electrical Engineering, vol. 263. Springer, Berlin, Heidelberg, doi:10.1007/978-3-642-39578-9_3
- Morales-Beltran, M., & Teuffel, P. (2013). Towards smart building structures: adaptive structures in earthquake and wind loading control response - a review. *Intelligent Buildings International*, 5(2): 83-100, doi:10.1080/17508975.2013.778193
- Hasselaar, B., & Looman, R. (2007). The Climate Adaptive Skin, the integral solution to the conflict between comfort and energy performance. *Proceedings of CIB World Building Congress 2007*, pp. 1115-1125
- Kassem, M., & Mitchell, D. (2015). Bridging the gap between selection decisions of facade systems at the early design phase: issues, challenges and solutions. *Journal of Facade Design and Engineering*, 3: 165-183
- Kim, J. (2013). Adaptive facade design for the daylighting performance in an office building: the investigation of an opening design strategy with cellular automata. *International Journal of Low-Carbon Technologies*, 10(3): 313-320
- Kormaniková, L., Kormaniková, E., & Katunský, D. (2017). Shape Design and Analysis of Adaptive Structures. *Procedia Engineering*, 190: 7-14
- Kozłowski, M., Bedon, C., & Honfi, D. (2018a). Numerical Analysis and 1D/2D Sensitivity Study for Monolithic and Laminated Structural Glass Elements under Thermal Exposure. *Materials* 2018, 11(8), 1447. Available online (accessed August 2018): <https://doi.org/10.3390/ma11081447>
- Kozłowski, M., Bedon, C., Machalická, K., Wüest, T., & Honfi, D. (2018b). Structural aspects of adaptive facades. *Proceedings of Places and Technologies 2018, Keeping up with technologies to adapt cities for future challenges - 5th International Academic Conference*, University of Belgrade (Serbia), pp. 493-499, ISBN: 978-86-7924-199-3

- Horn, A. (2015). Integrating constructability into conceptual structural design and optimization. Master Thesis, Massachusetts Institute of Technology (MIT), Cambridge (MA), USA. Available online (accessed August 2018): <http://hdl.handle.net/1721.1/99598>
- Larcher, M., Arrigoni, M., Bedon, C., van Doormaal, A., Haberacker, C., Hüsken, G., Millon, O., Saarenheimo, A., Solomos, G., Thámie, L., Valsamos, G., Williams, A., & Stolz, A. (2016). Design of blast-loaded glazing windows and facades: a review of essential requirements towards standardization. *Advances in Civil Engineering*, article ID 2604232. Available online (accessed August 2018): <https://www.hindawi.com/journals/ace/2016/2604232/>
- Lopez, M., Rubio, R., Martin, S., & Croxford, B. (2017). How plants inspire facades. From plants to architecture: Biomimetic principles for the development of adaptive architectural envelopes. *Renewable and Sustainable Energy Reviews*, 67: 692-703
- Marutaa, E., Kandaa, M., & Sato, J. (1998). Effects on surface roughness for wind pressure on glass and cladding of buildings. *Journal of Wind Engineering and Industrial Aerodynamics*, 74-76: 651-663, doi: 10.1016/S0167-6105(98)00059-2
- Marysse, C. (2016). Structural Adaptive Facades, Master thesis, Ghent University, Belgium. Available online (accessed August 2018): <https://lib.ugent.be/en/catalog/rug01:002300621>
- Morales-Beltran, M., & Teuffel, P. (2013). Towards smart building structures: adaptive structures in earthquake and wind loading control response - a review. *Intelligent Buildings International*, 5(2): 83-100, doi: 10.1080/17508975.2013.778193
- Nakagami, Y. (2003). Probabilistic dynamics of wind excitation on glass facade. Ph.D. Thesis, Technische Universität, Darmstadt, Germany. Available online (accessed August 2018): <http://tuprints.ulb.tu-darmstadt.de/343/>
- Park, J.J., & Dave, B. (2014). Bio-inspired Parametric Design of Adaptive Stadium Facades. *Australian Journal of Construction Economics and Building Conference Series*, 2(2): 27-35
- Reinhart, C.F., Mardaljevic, J., & Rogers, Z. (2006). Dynamic daylight performance metrics for sustainable buildings. *The Journal of the Illuminating Engineering Society*, 3(1): 7-31, doi: 10.1582/LEUKOS.2006.03.01.001
- Ribeiro Silveira, R. (2016). Flexible transparency: A study on thin glass adaptive façade panels. Master Thesis, Delft University of Technology, The Netherlands. Available online (accessed August 2018): <https://doi.org/10.1007/s40940-016-0016-3>
- Ribeiro Silveira, R., Louter, C., & Klein, T. (2018). Flexible Transparency - A Study on Adaptive Thin Glass Facade Panels. *Proceedings of Challenging Glass 6*. Available online (accessed August 2018): <https://doi.org/10.7480/cgc.6.2129>
- Santos, F., Bedon, C., & Sacadura, M. (2016). Adaptive glass panels using shape-memory alloys. *Glass Structures & Engineering*, 1(1): 95-114, doi: 10.1007/s40940-016-0016-3
- Schleicher, S. (2011). Adaptive facade shading systems inspired by natural elastic kinematics. *Proceedings of the International Adaptive Architecture Conference*, Building Centre, London, March 2011
- Stepinac, M., Rajcic, V., & Zarnic, R. (2016). Timber-structural glass composite systems in earthquake environment. *Gradevinar*, 68(3): 211-219
- Velasco, R., Brakke, A.P., & Chavarro, D. (2015). Dynamic Façades and Computation: Towards an Inclusive Categorization of High Performance Kinetic Facade Systems. *Computer-Aided Architectural Design Futures. The Next City - New Technologies and the Future of the Built Environment*. Springer-Verlag Berlin Heidelberg, pp. 172-191
- Wagdy, A., Fathy, F., & Altomonte, S. (2016). Evaluating the daylighting performance of dynamic facades by using new annual climate-based metrics. *Proceedings of PLEA 2016 Los Angeles - Cities, Buildings, People: Towards Regenerative Environments*, 32th International Conference on Passive and Low Energy Architecture, 11-13 July
- Zhang, X., & Bedon, C. (2017). Vulnerability and Protection of Glass Windows and Facades under Blast: Experiments, Methods and Current Trends. *International Journal of Structural Glass and Advanced Materials Research*, 1: 10-23, doi:10.3844/sgamrsp.2017.10.23. Available online (accessed August 2018): <http://thescrip.com/abstract/10.3844/sgamrsp.2017.10.23>

A simulation tool for the façade aesthetic appearance – BIO4ever project approach

Anna Sandak a),b), Jakub Sandak a),b),c), Paolo Grossi a), Marta Petrillo a)

a) CNR-IVALSA, Italy, e-mail: anna.sandak@ivalsa.cnr.it

b) InnoRenew CoE, Slovenia

c) University of Primorska, Faculty of Mathematics, Natural Sciences and Information Technology, Slovenia

This work demonstrates an original modelling and simulation approach for visualization of the changes in a building's appearance during its service life. In its present form it is focused on bio-based materials, however, the same approach might be applied to any type of façade. The performance of 120 selected façade materials, provided by over 30 industrial and academic partners, were evaluated for 18 months of the exposure to natural weathering conditions. Experimental data were used for the development of the numerical models simulating the material degradation as a function of time and exposure. Weather data calculated according to the ASHRAE 2013 database allows numerical simulation of cumulative radiation and temperature on building facades situated in 6000 locations all over the World. Dedicated algorithms simulating material deterioration by taking into account specific material characteristics and the intensity of weathering process as well as specific architectonic details (shading, orientation) were extensively tested and validated. The resulting visualization software is designed for investors, architects, construction engineers, professional builders, suppliers and other relevant parties, including final customers. It will assist architects/customers to select optimal bio-materials assuring satisfactory performance and high aesthetical value. Additionally, it provides guidance regarding realistic maintenance scheduling as well as possible recycling options of façade elements after the end of their service life.

Keywords: service life prediction, modelling, visualization, aesthetics, facades

1 Introduction

A building façade is the first protective layer against environmental degradation agents, and has a fundamental role in the performance of the entire building. The external components are often called the “skin” of the building to emphasize its roles in both hygro-thermal balance and physical protection. Very frequently designers and architects base their decision regarding façade selection on technical/commercial documents, that describe the “brand new state” of materials. The long-term interaction between environmental conditions and the elements that constitute the façade system and the potential effects of changes in a material's performance in the overall performance of the assembly is rarely taken into account during design phase. However, according to Hovde (2002) an increasing interest for accurate determination of durability and service life of materials, components, installations, structures and buildings has been identified in the last decades. External layers like any other building elements undergo deterioration and suffer loss in their decorative and protective functionalities. A significant proportion of the total maintenance cost of a building is spent on maintenance of façades (Teo, 2005). This statement is valid for all façade materials, since all of them require cleaning, maintenance, repair and replacement. Therefore, better understanding of the service life of buildings results in more efficient building maintenance and reduced environmental costs (Silva et al. 2016).

Previous studies clearly demonstrate that aesthetical aspects play an important role when making decisions about renovation. According to Aikivuori (1999), the decision to intervene is taken based on the building's deterioration only in 17% of cases. A relatively high (44%) amount of maintenance actions are performed based on subjective criteria. Later studies by Bruderhofer et al. (2000) and Rametsteiner et al. (2007) concluded that visual appearance is the key product attribute, followed by service life, price and maintenance interval. Finally, in some cases, the reasons for replacement or maintenance are due to changes in architectonic fashion and the components (or entire façades) are replaced before functional failure (Ebbert et al. 2007). Building aesthetics are therefore one of the principal aspects considered in architecture. The fundamental elements regarding aesthetics in architecture are related to mass and space, proportion, symmetry, balance, contrast, pattern and decoration (Mohan 2006). The appeal of a building includes the combined effects of the shape, color, contrast, type of material, symmetry and simplicity of the repeated patterns used in design, etc. It is important, however, to guarantee the aesthetical performance of building elements along their functional service life. (Sandak et al. 2017a, Sandak et al. 2017b). Therefore, the understanding how the materials will change due to environmental exposure is crucial for their successful long-term architectural application. Nevertheless existing studies provides limited information regarding effects of environmental factors on the appearance, especially these of bio-based building materials (Bridgens et al. 2017, Holstov et al. 2017).

The trend for constructing sustainable buildings and increasing of environmental awareness observed nowadays leads to the reactivation of bio-architecture as an alternative to other construction techniques. The unique properties and the natural beauty of bio-based materials make these a desired substance for various applications including construction, interior/exterior design or other uses. Wood and other bio-based building materials products have the advantage of a significantly lower carbon footprint than steel, glass or concrete (Tellnes et al., 2017). Trees are capable of absorbing CO₂ from the atmosphere and store carbon in the wood tissue; consequently, wood generates lower environmental impact in comparison with other building materials. Mass timber tall buildings (over 40 stories and more) are under investigation as an alternative to steel and reinforced concrete structural systems. Recent advances in biomaterials research have delivered several innovative solutions for the construction sector. Comparing with traditional timber preservation system, they cause less environmental problems at the end of the service life of wooden elements. Consequently, a range of different treatments have been developed to enhance the durability and service life of timber. However, a deep understanding of the material properties, structure, assembly and its performance along the service life is indispensable to increase confidence in the use of bio-based materials.

The overall goal of the BIO4ever project is to contribute to public awareness, by demonstrating the environmental benefits to be gained from the knowledge-based use of bio-based materials in buildings façades. The project merges several disciplines: wood science, architecture, building physics, chemistry and mathematics, as well as psychology and customer preferences in order to deliver validated solutions closer to user-defined expectation. Hundred twenty bio-based materials were extensively tested in outdoor environment. The multi-sensor approach was used for characterization of investigated materials in order to provide reliable experimental data related to their appearance (color, gloss, roughness) as well as chemical changes (near infrared spectroscopy). In parallel, the Finite Element Method (FEM) model was prepared for model house, containing surface temperature distribution, solar irradiation and surface moisture maps. Those parameters were converted in to single parameter corresponding to the weather dose D and combined with experimental data obtained from materials performance. The core output of the BIO4ever project is an interactive software simulating the aesthetic performance of bio-materials integrated with LCA interactive calculation for maintenance operations. The tool, dedicated for

investors, architects, construction engineers, professional builders, suppliers and other relevant parties, including also final customers is now under extensive validation and integration with the BIM software.

2 Material and methods

2.1. Experimental samples

The 120 samples investigated within the project were provided by over 30 industrial and academic partners from 17 countries. The experimental samples include different wood species from various provenances, thermally and chemically modified wood, composite panels, samples finished with silicone and silicate based coatings, nanocoatings, innovative paints and waxes, melamine treated wood, copper treated wood, bamboo cladding, reconstituted slate made with bio-resin and samples prepared according to traditional Japanese technique: shou-sugi-ban 焼杉板 (<http://shousugiban.com/>) The treatments were classified in seven categories and are presented in table 1.

Modification technology	Sample example	Number of tested materials
Natural	Untreated wood, bamboo	19
Chemical modification	Acetylation, furfurylation	5
Composites	Panels, bio-ceramics, tricoya, wood plastic composites	7
Coating & surface treatments	Different coatings, carbonized wood, nanocoatings	16
Impregnation	DMDHEU, Knittex, Madurit, Fixapret	28
Thermal modification	Vacuum, saturated steam, oil heat treatment	20
Hybrid modification	Thermal treatment + coating, thermal treatment + impregnation, acetylation + coating etc.	25

Table 1. Categories of façades materials investigated within BIO4ever project. Note: hybrid modification include combination of at least two different treatments.

2.2. Characterization of materials

The investigated bio-materials were characterized before, during and after degradation by biotic and abiotic agents (natural weathering in San Michele, Italy, 46°11'15"N, 11°08'00"E), in order to provide experimental data to be used for better understanding the bio-materials performance/ degradation in a function of time. The weathering stands are presented in Figure 1. Each month high resolution photos (Nikon D5500 equipped with lenses Nikor AF-S 35mm) were acquired to capture the real progress of appearance change. Additionally, part of exposed samples (three replicas per cycle) was exchanged every 3 months, scanned with office scanner HP Scanjet G2710, and stored in climatic chamber before characterization. Materials characterization included measurement of color, gloss, roughness, wettability and spectroscopy in VIS, NIR and IR ranges.



Figure 1. Experimental samples exposed to natural weathering

2.3. Finite Element Modelling

The amount of solar radiation, temperature and the moisture content forecast on the façade surface was simulated with support of a FEM (Finite Element Method) software (COMSOL Multiphysics V.5.3), presented in Figure 2a. The weather data (relative humidity of air, diffuse and direct solar irradiance, sun path during the day) were calculated according to the ASHRAE 2013 database, containing meteorological data for more than 6000 weather stations all over the world. The map of the surface temperature, solar irradiation and air humidity at the border of the façade element were determined with CFD (Computational Fluid Dynamics) module. The simulation of the surface wetting by wind driven rain was performed with the particle-tracing module.

The 3D model of a house, as shown in Figure 2b, has been defined as a simple geometry representative of a small single family building with a gable roof and with some shade elements (balcony, pillars, eaves). The mesh was defined with square elements in order to compromise a decent mesh quality with a minimum number of elements, thus restricting the degrees of freedom (DOF) in the model. The number of DOF is one of the essential parameters that influence the time needed to numerically resolve the model, or to find the numerical solution of the equations set with iterative methods. This operation is usually carried out directly in the “mesh editor” where the specific distribution is defined by the user.

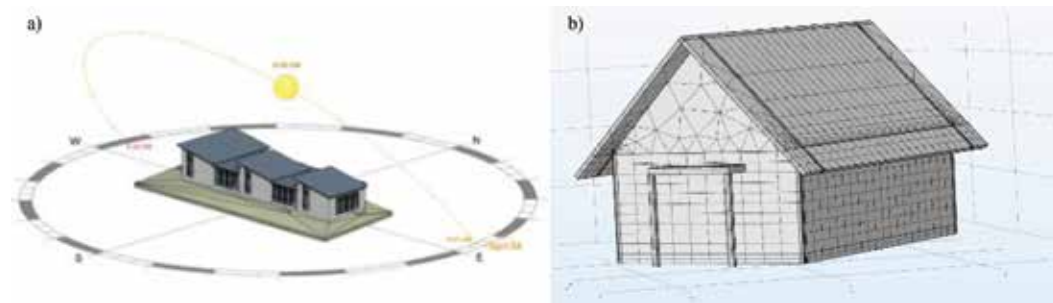

Figure 2. FEM modelling of radiosity, temperature and moisture on the surface (a) and 3D model of the house with defined mesh as used for numerical simulation (b)

3 Results and discussion

The flowchart of concept for visualization of building façade changes during service life is presented in Figure 3.

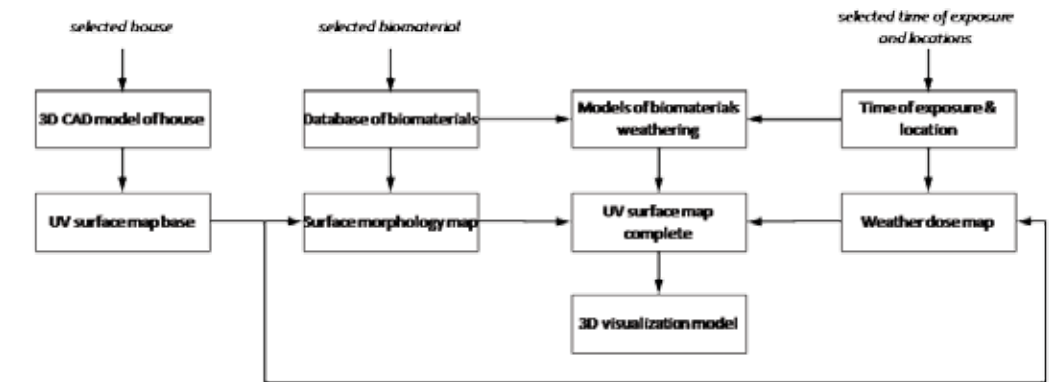

Figure 3. Flowchart of the data for 3D visualization of the building exposed to natural weathering

The 3D CAD model house presented in figure 2b is first unfolded in order to create UV surface map (first column of the flowchart). The UV mapping is the 3D modeling process of projecting a 2D image to a 3D model's surface for texture mapping. The letters “U” and “V” represent the axes of the 2D texture since “X”, “Y” and “Z” are previously used to indicate the axes of the 3D object in model space. For each material from BIO4ever data base surface morphology map is created (second column on the flowchart). It is relatively easy in case on samples having uniform appearance, however in case of many bio-based materials the map is very complex. Our goal is to develop highly realistic visualization, therefore in several cases, when a natural wood structure is visible, the surface map reflects the natural pattern of material (Figure 4)



Figure 4 Surface morphology map for natural wood

The natural weathering process of 120 materials conducted for 18 months provided input for the detailed RGB colour changes that were measured with the progress of natural exposure. Such an extensive database allows the determination of specific kinetics of aesthetic changes for every

material category and consequently can be used as a fit to a dose-response model. The weather dose D is defined as an amount of “energy” provided to the system that affected the changes of material due to weathering. The value of D is a function of the combined surface temperature, solar radiation and moisture content (Sandak et al. 2017c). The value of response is numerically determined on the base of the measured material characteristic, such as CIE L, CIE a, CIE b, CIE ΔE , near infrared spectrum or RGB colour coordinates (Sandak et al. 2018).

The numerical simulation for a one-year exposure period of the model building was carried out in order to quantify effect of weathering factors in different seasons. Both, heat and mass transfer modules of the FEM software were involved for the simulation. Each point of the mesh, as presented in Figure 2b, was independently resolved considering the combined effects of sun irradiation, the relative humidity of the air, air temperature and exposure/shading at each time during the year. Time dependent analyses was carried out with a time step of one hour and were conducted with a standard iterative solver. Interpolations between the nodes values were performed in order to map the values out of the mesh points. Example results of the surface temperature distribution and the sun-related surface irradiation in two diverse months (January and June) are presented on Figure 5 and 6 respectively. It is evident that diverse parts of a building exposed to weather conditions (at a given location) receives different amounts of solar radiation depending on season, hour and architectural details. Accordingly, the surface temperature varies noticeably on the façade affecting the weather dose D distribution. Consequently, the deterioration of different materials used for the building façade will occur with different kinetics, depending on the cumulative dose ΣD accumulated at diverse locations within the building skin.

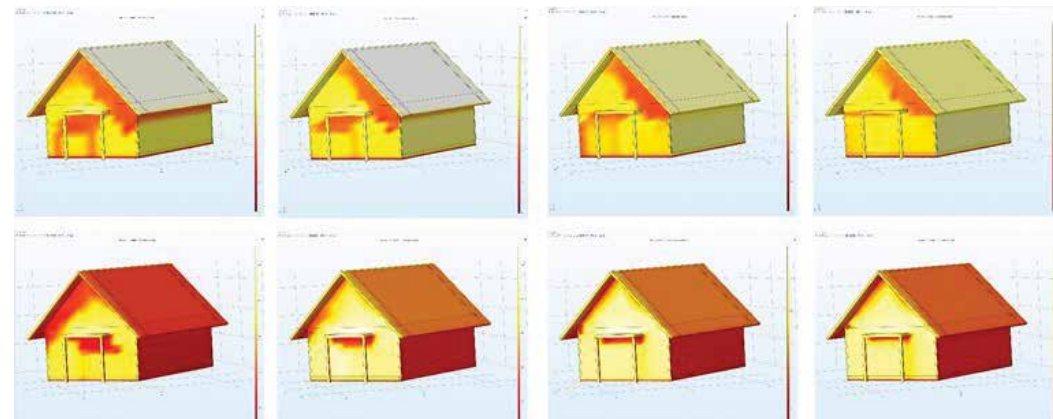

Figure 5. FEM simulations temperature changes in Johannesburg in January (up) and June (down)

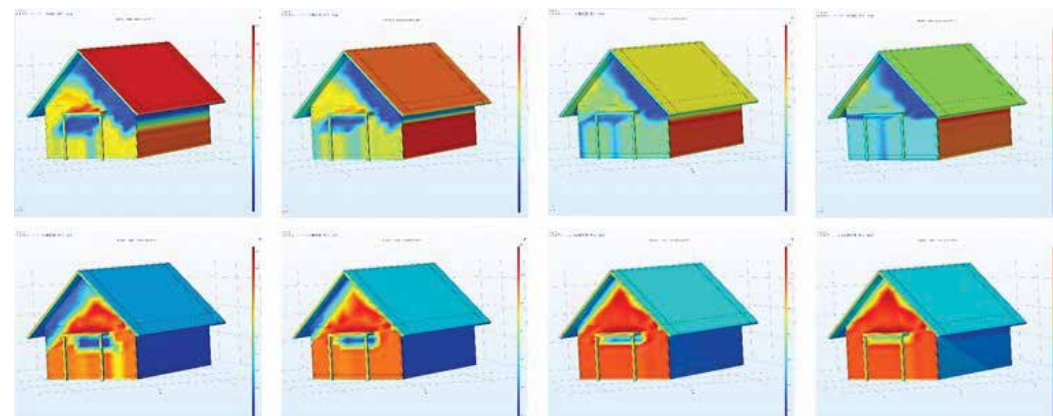

Figure 6. FEM simulations radiosity changes in Johannesburg in January (up) and June (down)

Outputs of the FEM model, containing surface temperature distribution, solar irradiation and surface moisture maps were converted in to single parameter corresponding to the weather dose D . The dose map was extracted (unfolded) for each wall of the building and was then considered as input data for the visualisation tool capable of simulating the weathering results in each pixel of the 3D building model.

The prototype software was developed in LabView 2017 (National Instruments), but it is recently accustomed as BIM (Building Information Modelling) plugin. At this stage of the software development, all the available data regarding appearance change of each biomaterial in time, weather dose map and specific building layout (UV surface map) are merged together allowing 3D model visualization. Time series of pictures that were acquired during exposure of tested materials are used for the interactive simulation of façades appearance. Software users will be able to choose a material from the database, select the building location and then simulate the structure outlook at the brand new stage (Figure 7).

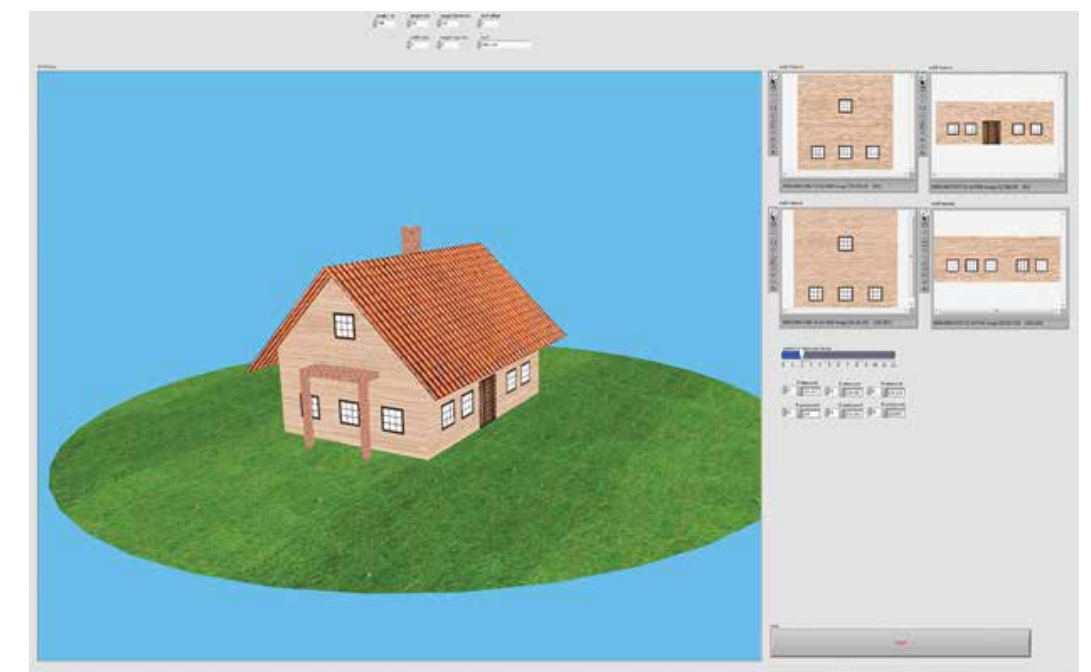

Figure 7. Print screen of the software for 3D simulation of building appearance

Numerical simulations performed in COMSOL, in combination with other custom algorithms, allow visualization of the appearance changes related to the period of service, specific exposure direction and microclimate. By changing the geographical location of the building site, the software will automatically re-compute the orientation of the incident sunlight over the course of the intended period. Figure 8 presents façade of model house at the new stage (Figure 8a) and after 12 months of exposure (Figure 8b). For this simulation, unprotected Norway spruce wood was used, knowing that it will change appearance significantly due to weathering (Figure 9). However, during weathering experiments, several samples (e.g. hybrid modification) exhibit perfect performance and their aesthetic appeal did not change. If such materials were selected, the appearance after one year shall be similar to the brand new stage.

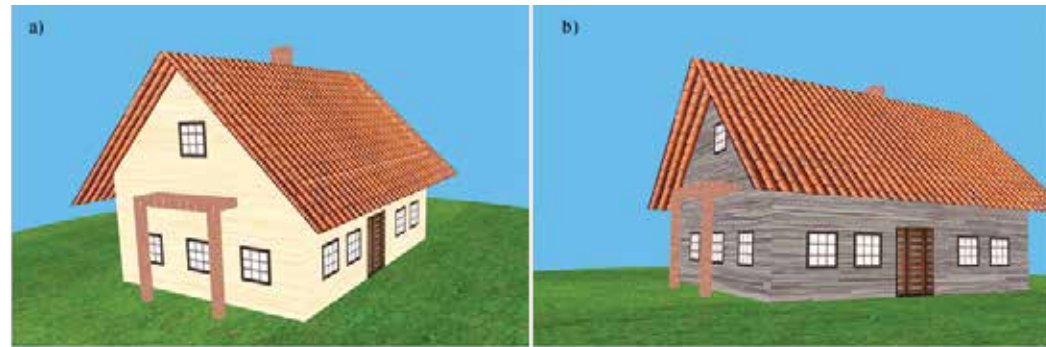

Figure 8. Visualization of building façade appearance of natural spruce wood at the brand new stage (a) and after 12 months of natural weathering (b)



Figure 9. Changes of appearance of natural wood (Norway spruce) due to weathering process. Note: Photo correspond to brand new stage – left and 1, 3, 6, 9 and 12 months of natural weathering – southern exposure.

One of the biggest challenges for the realistic visualization of building appearance in time, is consideration of architectural detailing of the structure and their influence of weathering intensity. Specific parts of the façade (e.g. parts protected by the roof) are less exposed to ambient conditions (receive less rain and less UV and solar radiation). Their degradation is therefore slowed, which results in less intense degradation processes. It is especially evident for natural materials, such as unprotected spruce wood. An example simulation of non-uniform weathering on the building façade is presented in Figure 10.

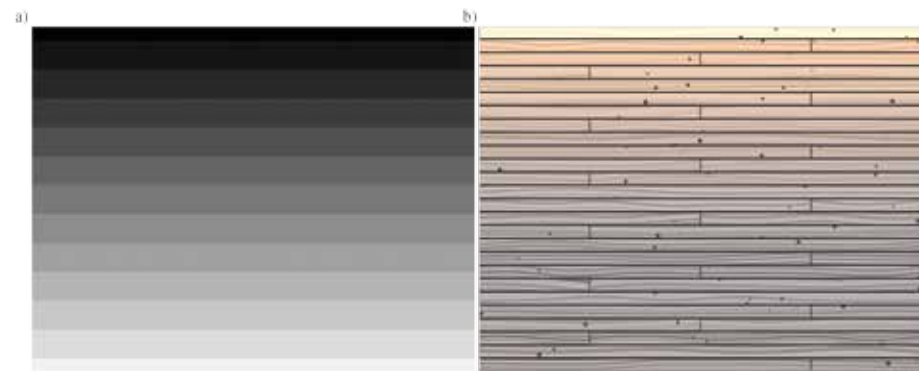

Figure 10. Approach for uneven weathering of building façade; a) dose map, where dark parts correspond to new, non degraded material, and bright to weathered parts; b) simulation of non uniform weathering on wood cladding.

In addition to simulation and visualization of materials appearance The BIO4ever software includes guideline regarding realistic maintenance scheduling and possible recycling/reuse options for the wide range of biomaterials (Petrillo et al. 2018). The concept is based on an interactive LCA (Life Cycle Assessment) tool, where the basic blocks for maintenance operations can be combined and multiplied by the maintenance frequency, being the specific combination of climate, material properties and owner needs. Additionally, traditional and alternative recycling options are provided for each material, where information regarding potential cascading and/or energy recovery are supplied. Based on this, it is possible to optimize specific strategy regarding the use and end of life

phases for defined customer preferences and needs. Recent efforts are directed toward integration of the software functionalities developed within BIO4ever project with Building Information Modelling philosophy in order to provide new complementary dimensions for the BIM utilities, such as 6D (sustainability) and 7D (facility management), in addition to 4D (construction sequencing) and 5D (costs).

4 Conclusions

The objective evaluation under realistic conditions of various biomaterials usable for façades performed within BIO4ever project was conducted in order to create comprehensive database. It contains a list of technical material characteristics as well as degradation pattern of their changes during the use phase. Surface deterioration is unavoidable, but its negative impact can be minimized by the appropriate maintenance or replacement. The large portfolio of bio-based building materials allows selection of materials that possess constant appearance during service life and require minimum maintenance effort. The definition of proper strategy in terms of cost and benefit can be analysed only if all the technical parameters (material properties) and human factors (acceptability of the appearance that influence the intervals between maintenances) are combined in the first steps of the design.

Calculation of weathering response specific for each tested material, combined with numerical modelling of climatic effect on building façades allowed realistic simulation of the façade appearance simultaneously considering time, geographic location and intrinsic material characteristic. Accurate performance models, allowing aesthetical visualization of buildings along their service lifetime are indispensable to convince architects, developers and investors for confident use of building biomaterials. A similar approach might be used for any other façade material, assuming the integration of reliable database of its performance during its service life with the BIO4ever software algorithms.

5 Acknowledgements

The BIO4ever (RBSI14Y7Y4) is ongoing project funded within a call SIR by MIUR. The authors gratefully acknowledge the European Commission for funding the InnoRenew CoE project (Grant Agreement #739574) under the Horizon2020 Widespread-Teaming program. Special acknowledgments to COST FP1303, COST FP1407 and COST TU1403 for networking opportunity and funding STSMs that contributed to the project.

BIO4ever project partners: ABODO (New Zealand), Accsys Technologies (Netherlands), Bern University of Applied Sciences (Switzerland), BioComposites Centre (UK), CAMBOND (UK), Centre for Sustainable Products (UK), Drywood Coatings (Netherlands), EDUARD VAN LEER (Netherlands), FirmoLin (Netherlands), GraphiTech (Italy), Houthandel van Dam (Netherlands), ICA Group (Italy), IMOLA LEGNO (Italy), Kebony (Norway), KEVL SWM WOOD (Netherlands), Kul Bamboo (Germany), Latvian State Institute of Wood Chemistry (Latvia), Lulea University of Technology (Sweden), NOVELTEAK (Costa Rica), Politecnico di Torino (Italy), RENNER ITALIA (Italy), Solas (Italy), SWM-Wood (Finland), Technological Institute FCBA (France), TIKKURILA (Poland), University of Applied Science in Ferizaj (Kosovo), University of Gottingen (Germany), University of Life Science in Poznan (Poland), University of Ljubljana (Slovenia), University of West Hungary (Hungary), VIAVI (USA), WDE-Maspel (Italy).

6 References

- Aikivuori, A.M.: Critical loss of performance—what fails before durability. In: 8th International conference on durability of buildings materials and components, Vancouver, Canada, pp 1369–1376 (1999)
- Bridgens B., Holstov N., Farmer G.: Architectural application of wood based responsive building skins. In: 12th International Conference on Advanced Building Skins, Bern, Switzerland, 10p, (2017)
- Bruderhofer M.: Marktanalyse und Marktchancen von Fassadensystemen mit Holz und Holzwerkstoffen. Master's thesis, University of Applied Sciences and Natural Resource Management BOKU, Vienna (2000)
- Ebbert, T, Knaack, U (2007): A flexible and upgradeable façade concept for refurbishment. In: Proceedings of the SB07 Lisbon - Sustainable Construction, Materials and Practices: Challenge of the Industry for the New Millennium, ed. Bragança, L., Pinheiro, M, Jalali, S, Mateus, R, Amoêda, R and Guedes M C Rotterdam, Netherlands, 2, 147-154.
- Holstov N., Farmer G., Bridgens B (2017): Sustainable Materialisation of Responsive Architecture. Sustainability 9, 435; doi:10.3390/su9030435
- Hovde, P J (2002): The Factor Method For Service Life Prediction From Theoretical Evaluation to Practical Implementation. In: Proceedings of the 9DBMC International Conference On Durability of Building Materials and Components, Brisbane, Australia 10p.
- Mohan, G M S (2006): Principles of Architecture. Oxford University Press, New Dehli.
- Petrillo, M., Sandak, J, Grossi, P., Kutnar, A., Sandak, A.: Long service life or cascading? The environmental impact of maintenance of wood-based materials for building envelope and their recycling options. Proceedings IRG Annual Meeting (ISSN 2000-8953), IRG/WP 18-50336 (2018)
- Rametsteiner, E., Oberwimmer, R., Gschwandtl, I.: Europeans and wood: What Do Europeans Think About Wood and its Uses? A Review of Consumer and Business Surveys in Europe. ISBN: 978-83-926647-0-3
- Sandak, A., Sandak, J.: Aesthetics. In: Jones, D., Brischke, C. (eds) Performance of Bio-based Building Materials, pp. 285-294. Elsevier, (2017a)
- Sandak, A., Sandak, J.: Prediction of service life – does aesthetic matter? Proceedings IRG Annual Meeting (ISSN 2000-8953) IRG/WP 17-20618 (2017b)
- Sandak, J., Sandak, A., Burud, I.: Modelling of weathering. In: Jones, D., Brischke, C. (eds) Performance of Bio-based Building Materials, pp. 502-510. Elsevier, (2017c)
- Sandak, J., Sandak, A, Grossi, P, Petrillo, M.: Simulation and visualization of aesthetic performance of bio-based building skin. Proceedings IRG Annual Meeting (ISSN 2000-8953), IRG/WP 18-20633 (2018)
- Silva, A., de Brito, J., Gaspar, P. L.: Methodologies for Service Life Prediction of Buildings with a Focus on Façade Claddings. Springer International Publishing, Switzerland (2016)
- Teo, E.A.L.: An Assessment of Factors Affecting the Service Life of External Paint Finish on Plastered Facades. 10DBMC International Conference On Durability of Building Materials and Components. (2005)
- Tellnes, L.G.F., Ganne-Chedeville, C., Dias, A., Dolezal, F., Hill, C., Zea Escamilla, E.: Comparative assesment for biogenic carbon accounting methods in carbon footprint of products: a review study for construction materials based on forest products. IForest 10: 815-823 (2017)
- <http://shousugiban.com/>. Accessed 12 May 2018

Thermal response of the bionic façade in different climatic conditions

Tomaž Šuklje a), Ciril Arkar a), Sašo Medved a)

a) University of Ljubljana, Faculty of Mechanical Engineering, Slovenia, tomaz.suklje@fs.uni-lj.si

Bionic façade presented in the paper is a technological system which mimics functions of vertical greenery systems and, comparatively, enhances cooling potential and reduces of building's footprint. In the paper, a numerical investigation of the cooling potential of the bionic façade in three different climates in summer conditions is performed. The comparative analysis showed that applying bionic façade results in a 65% reduction of the heat flux amplitude on the inner side of the building envelope in Ljubljana and Eindhoven. It can also be ascertained that heat flux is predominantly negative, which indicates on the high cooling potential of the proposed bionic system. Even though meteorological conditions in Madrid impact higher cooling load of a building, the amplitude of the heat flux on the inner side of the building envelope reduces by up to 60%. Compared to the other two cities, the heat flux is never negative during the highest cooling load of a building. Air temperatures in the building boundary of the bionic façade are up to 1 K lower compared to outdoor air temperatures during the highest of the cooling load of a building.

Keywords: bionic façade, adaptive façade, energy efficiency

1 Introduction

Improved quality of indoor and outdoor environment can be achieved, in part, by reducing energy use in buildings and substituting conventional energy sources with renewable energy sources (RES). Currently, building envelopes have a great impact on the reduction of energy use and minor impact on the utilization of RES. Until recently, the development of the building envelopes has been pointed towards the separation of the indoor from the outdoor environment by means of lower U-values as well as high building airtightness. Since further separating indoor and outdoor environment is not expected to reduce energy use in buildings as required by the legislation, scientists and developers are in search for future steps in development. Adaptive façades hold a potential to further improve the energy efficiency of buildings, by making the most from the outdoor and indoor environment from heat and mass transfer point of view.

In precedent studies, vertical greenery systems (VGS) have been presented as a step towards adaptive building envelopes (Šuklje, Arkar and Medved, 2014; Šuklje, Medved and Arkar, 2016). The results showed that façades with vertical greenery incorporate adaptive properties; such as evaporative cooling, shading of a building envelope, selective absorption of solar radiation and sink of CO₂ emissions. Among listed properties, evapotranspiration and shading of the building envelope develop a microclimatic layer at building boundary, which decreases the energy consumption for cooling. Despite innovative architectural solutions, there are some drawbacks of VGS that are most commonly related to the maintenance. In order, to overcome the drawbacks of the natural systems and limitation of the technological solutions researcher employ new approaches. One of the approaches is bionics, which is about the nature observation of its properties and principles, and the transformation and the development of these principles into sophisticated technological solutions (Badarnah and Kadri, 2015). Review on the applicability

of bionic principles in buildings showed that there are numerous possibilities for buildings to adapt to climate and natural environment to achieve harmonious coexistence with nature, utilize natural energy sources and reduce energy use in buildings (Yuan et al., 2017). Architects and designers are progressively searching inspirations for adaptive façade solutions in natural systems, developing methodologies to transfer biological principles to architectural solutions (EIDin, Abdou and ElGawad, 2016; Al-Obaidi et al., 2017; Fechey-Lippens and Bhiwapurkar, 2017; López et al., 2017). In addition, bio-inspired concepts and working prototypes of building envelopes as well as corresponding building energy simulation approaches are already reported in the literature (Loonen, 2015; Zuazua-Ros et al., 2017; Webb, Aye and Green, 2018).

As an alternative to VGS, (Šuklje, Medved and Arkar, 2013) presented a bionic system, which mimics positives and eliminates some of the disadvantages of VGS. A bionic leaf, a basic structural element of the bionic façade, consists of a polycrystalline photovoltaic cell and an evaporative matrix. Enabling evaporative cooling, shading of the building envelope and reduction of CO₂ footprint of the building (Šuklje, Medved and Arkar, 2013). In the current study, a numerical model for the thermal response of the bionic façade (Šuklje, 2015) has been utilized to determine the performance of the bionic façade in three different climatic conditions.

2 The bionic system

2.1. Bionic leaf

The basic element of the bionic system is a bionic leaf (Fig. 1). The bionic leaf is designed based on the observation of natural leaves. It consists of a photovoltaic cell (mimicking CO₂ absorption of photosynthesis), an evaporative matrix and a supporting stem with water transport system.



Fig. 1 The bionic leaf, consisting of a photovoltaic cell (top), a evaporative matrix (bottom) and a supporting stem for water transport.

The evaporative matrix is made of a calcium silicate material. To increase water vapor transfer, the surface area is enlarged. The back of the evaporative matrix is shaped as vertical fins with dimensions as presented in Fig. 2. With the evaporative surface equal to 0.068 m² and volume equal to 0.00037 m³ per bionic leaf. The evaporative surface area is 2.7 times larger as the surface area of the photovoltaic cell.

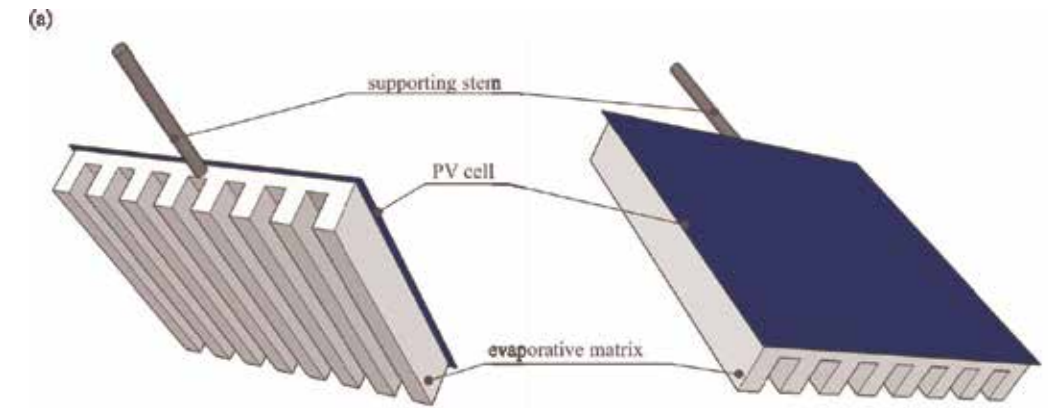

Fig. 2 (a) Front and back view of the bionic leaf and (b) schematic of the cross section of the evaporative matrix with vertical fins for enhanced heat and mass transport with dimensions in mm.

2.2. The bionic façade

Bionic leaves are used as basic elements of the bionic façade as presented in Fig. 3. It has been found that the optimal inclination angle of the bionic leaves is 75° as further reduction of the inclination does not increase evaporation from the bionic leaves. In the present study, the inclination of the leaves is maintained constant at 75°. The spacing between bionic leaves is determined experimentally in a way that enables the highest surface area of bionic leaves per surface area of the façade and at the same time preventing shading of bionic leaves in the row below.

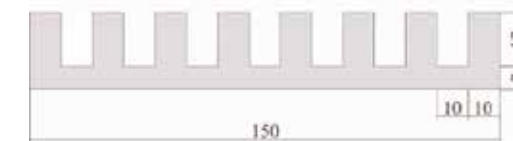

Fig. 3 Rendered picture of the bionic façade applied to the test facility at University of Ljubljana, Faculty of Mechanical Engineering.

2.3. The building envelope

For the building envelope, a wall of the test facility at the University of Ljubljana, Faculty of Mechanical Engineering was chosen (Šuklje, 2015). The building envelope is assembled of 4 layers with thermo-physical properties as presented in Table 1. The solar absorptivity of the reference façade equals 0.75. The building envelope also served as reference façade for the comparative analysis.

Table 1: Thermo-physical properties of the building envelope.

	d [cm]	λ [W/(mK)]	ρ [kg/m ³]	c _p [J/(kgK)]
layer 1	0.8	1.1	1800	880
layer 2	15	0.34	30	1200
layer 3	7.5	0.13	450	1000
layer 4	0.4	1.1	1800	880

Table 1: Thermo-physical properties of the building envelope.

3 Methods

In the study, thermal response and temperature conditions of the bionic façade in different climatic conditions are investigated. The study is performed based on the validated numerical models of the VGS and the bionic façade, presented in detail in references (Šuklje, 2015; Šuklje, Arkar and Medved, 2015; Šuklje, Medved and Arkar, 2016). For the study meteorological data for three European cities were chosen; Ljubljana, Madrid and Eindhoven.

3.1. Evaporation rate of the bionic façade

The mass-flow-rate of the evaporated water from the bionic façade m_{BF} has been determined as a function of the meteorological data; outdoor air temperature θ_e and relative humidity ϕ , net radiation heat flux \dot{q}_{net} and wind velocity v . The parametrical model has been derived from the experimental data measured at the dedicated indoor experimental setup as presented in reference (Šuklje, Arkar and Medved, 2015).

3.2. Boundary conditions

The meteorological data has been taken from test reference year of the chosen cities for July and August. In the analyses south- and west-orientated façade has been considered. Boundary conditions on the exterior surfaces of the bionic façade $\dot{q}_{bc,bf,e}$ and on the interior surface of the building envelope $\dot{q}_{bc,si}$ are expressed as follows:

$$\lambda \frac{\partial \theta}{\partial x} = \dot{q}_{bc,bf,e}; \quad t > 0 \quad (1)$$

$$\lambda \frac{\partial \theta}{\partial x} = \dot{q}_{bc,si}; \quad t > 0$$

The solar absorptivity of photovoltaic cells $\alpha_{sol,bf}$ is assumed to be 0.7 and the emissivity ϵ_{bf} equals to 0.9. The same emissivity is considered for the back of the bionic leaves. View factors of the front and the back of the bionic façade in relation to the building envelope and surroundings are calculated using the Monte Carlo method. The corresponding view factors for the 2D space are presented in Table 2. The transmissivity of solar radiation through the bionic façade τ_{bf} is considered equal to the view factor F_{se-amb} (Šuklje, 2015).

inclination	$F_{bf-back}$	$F_{bf-front}$	F_{se-amb}
75°	0.8614	0.0039	0.1347

Table 2: View factors for the surfaces included in the longwave and the shortwave radiation.

The convective heat transfer coefficient on the exterior surface of the bionic façade $h_{bf,e}$ is determined as a function of the wind velocity as follows:

$$h_{bf,e} = 5.62 + 3.9 \cdot v \quad (2)$$

The indoor air temperature θ_i is assumed to be constant at 25°C. The convective heat transfer coefficient on the interior surface of the building envelope h_i , taking convective and longwave radiation heat transfer into account, is assumed to be equal to 7.7 W/(m²K).

4 Results and discussion

In the study, the heat flux on the inner surface of the building envelope \dot{q}_i has been compared for the cases with and without the bionic façade in three different European cities; Ljubljana, Madrid and Eindhoven. In addition, air temperatures at the building boundary have been compared to the outdoor air temperature, which impacts the potential for the heat island mitigation. For the purpose of the presentation only simulation results from the 23rd to the 30th July are presented, which corresponds to the hottest period in the analyzed cities.

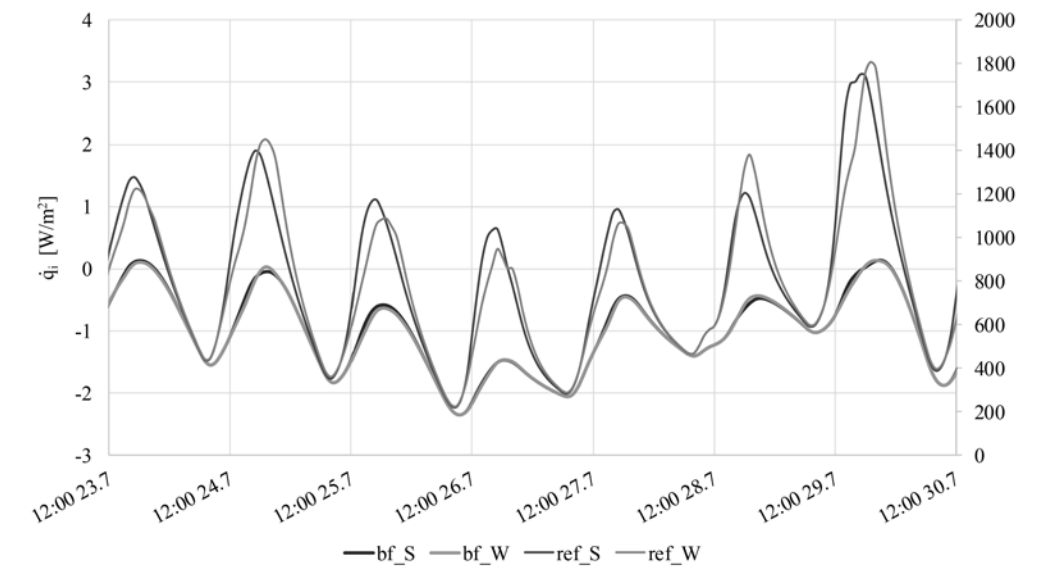

Fig. 4 Heat flux on the inner surface of the south- and west-oriented façade with (bf) and without (ref) the bionic façade in Ljubljana.

Results for thermal response of the building envelope with and without the bionic façade in Ljubljana in Fig 4 show that heat flux on the inner side of the building envelope is mostly negative, with the exemption of two days. Despite the difference in the heat flux of the south- and west-orientated reference façade the heat flux is nearly the same in the case of the bionic façade regardless the façade orientation. That is due the low solar transmissivity and effective evaporative cooling of the bionic façade. The heat flux on the inner side is up to 3.1 W/m² and 3.3 W/m² lower for south- and west-orientated façade, respectively. In addition, air temperatures at building boundary (in the vicinity of the building envelope) are up to 1 K lower, as shown in Fig 5, due the evaporative cooling effect.

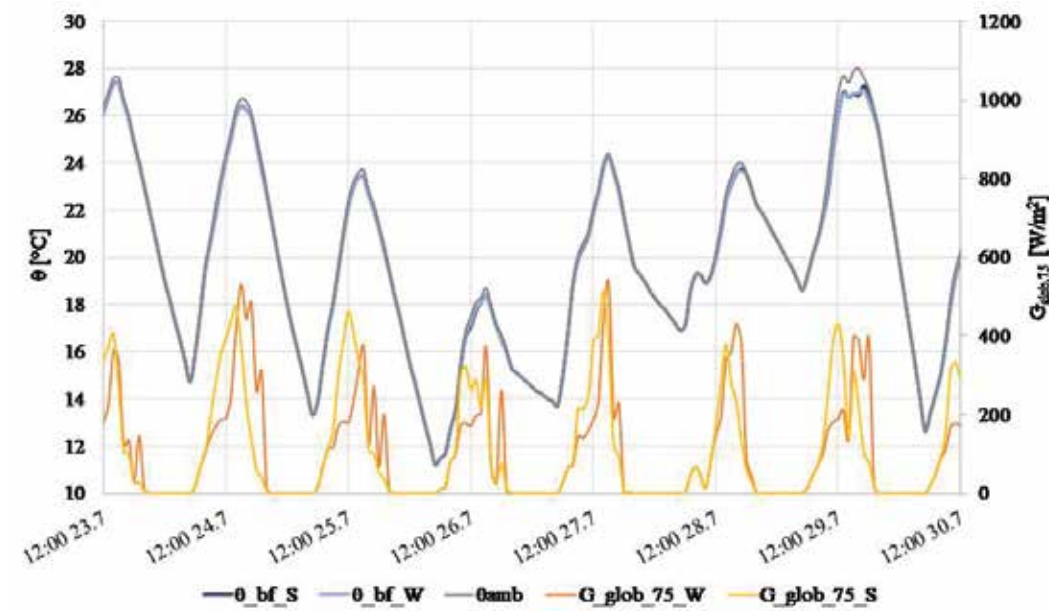

Fig. 5 Air temperatures at the building envelope boundary of the south- and west-orientated bionic façade in comparison to the outdoor air temperatures, global solar radiation on south- and west orientated surface tilted at 75° angle in Ljubljana.

In contrast to Ljubljana, the meteorological conditions in Madrid are characterized by higher air temperatures and higher global solar radiation, which results in greater heat flux on the inner surface of the building envelope. In the chosen period the heat flux on the inner side of the reference façade is between -1.2 and 4.2 W/m² for south-orientated façade and between -1.1 and 5.4 W/m² west-orientated façade (Fig 6), respectively. Meanwhile, the heat flux on the inner side of the bionic façade is up to 3 to 4 W/m² lower. Air temperatures at the building boundary (in the vicinity of the building envelope) are up to 0.9 K lower than outdoor air temperature during the day (Fig 7).

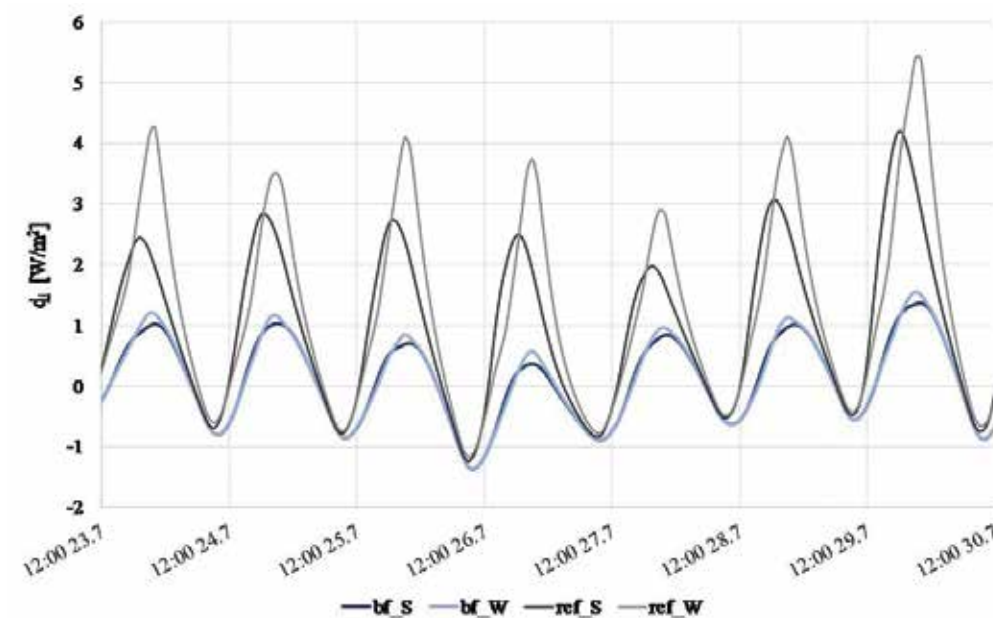

Fig. 6 Heat flux on the inner surface of the south- and west oriented façade with (bf) and without (ref) the bionic façade in Madrid.

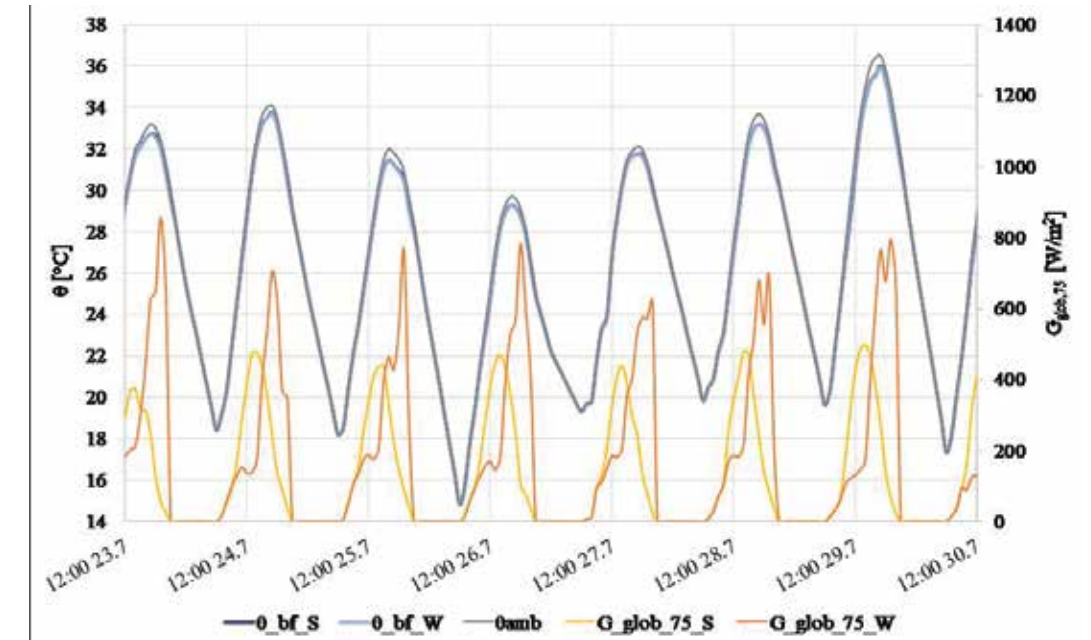

Fig. 7 Air temperatures at the building envelope boundary of the south- and west-orientated bionic façade in comparison of the outdoor air temperatures, global solar radiation on south- and west orientated surface tilted at 75° angle in Madrid.

Meteorological conditions in the chosen period in Eindhoven are, compared to Ljubljana, characterized by lower outdoor air temperatures, higher relative humidity and comparable global solar radiation. Heat flux on the inner side of the bionic façade is negative during the entire period except on the 29th July (Fig 8). The heat flux on the inner side of the reference façade is between -2.6 W/m² and 3.6 W/m² for south-orientated façade and between -2.6 W/m² and 3.1 W/m² for the west-orientated façade. The heat flux on the inner side of the bionic façade is up to 4 W/m² lower in comparison with the reference façade. In Fig. 9 the air temperatures at the building boundary are shown. Similar to the previous cases, the air temperatures at the building boundary with the bionic façade (in the vicinity of the building envelope) are up to 1 K lower compared to outdoor air temperatures during the highest cooling load of a building.

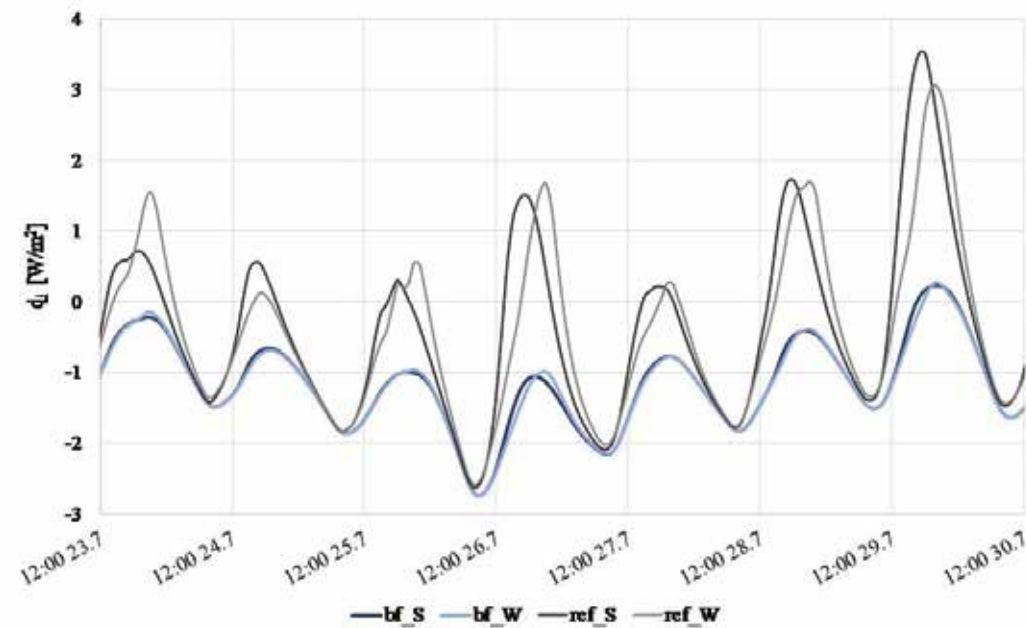

Fig. 8 Heat flux on the inner surface of the south- and west oriented façade with (bf) and without (ref) the bionic façade in Eindhoven.

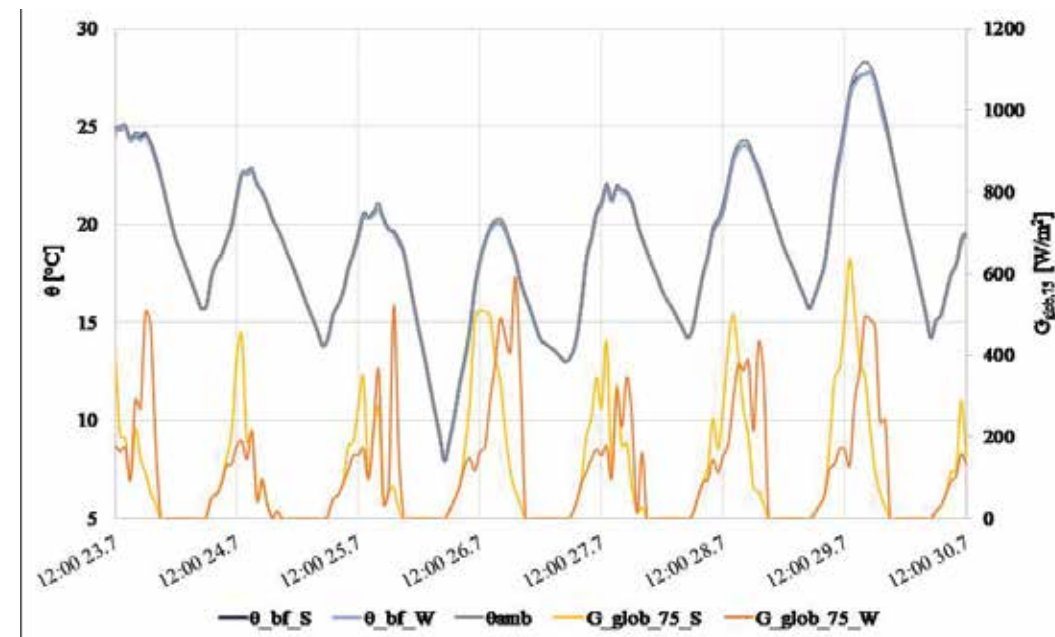

Fig. 9 Air temperatures at the building envelope boundary of the south- and west-orientated façade in comparison of the outdoor air temperatures, global solar radiation on south- and west orientated surface tilted at 75° angle in Eindhoven.

5 Conclusions

In the paper, a numerical investigation of the cooling potential of the bionic façade in three different climatic conditions has been performed. The comparative analysis showed that applying the bionic façade results in a 65% reduction of the heat flux amplitude on the inner side of the building envelope in Ljubljana and Eindhoven. It can also be ascertained that the heat flux is predominantly negative, which indicates to the high cooling potential of the proposed bionic system. Even though meteorological conditions in Madrid, in comparison to the other two cities, impact higher cooling

load of a building, the amplitude of the heat flux on the inner side of the building envelope can be reduced by up to 60%. Also compared to the other two cities, the heat flux is never negative during the highest cooling load of a building. Air temperatures at the building boundary of the bionic façade (in the vicinity of the reference façade) are up to 1 K lower the outdoor air temperature during the highest of the cooling load of a building for all compared climates. Thus, the cooling potential of the bionic façade could be utilized for local ventilation of a building or for urban heat island mitigation. In the future study, the outdoor surface temperature of the bionic façade will be compared against surface temperatures of the reference façade to better understand the heat island mitigation potential. In addition, an impact of the biofouling and precipitate formation in the evaporative matrix on the evaporative cooling effect should be investigated in a long-term study.

6 Acknowledgements

The authors would like to acknowledge the financial support provided by the Slovenian Research Agency within the research program P2-0223 (C) 'Heat and Mass Transfer' and the networking opportunities given by the Cost Action TU1403 'Adaptive Façades Network'.

7 References

- Al-Obaidi, K. M., Azzam Ismail, M., Hussein, H. and Abdul Rahman, A. M. (2017) 'Biomimetic building skins: An adaptive approach', *Renewable and Sustainable Energy Reviews*. Pergamon, 79, pp. 1472–1491. doi: 10.1016/J.RSER.2017.05.028.
- Badamah, L. and Kadri, U. (2015) 'A methodology for the generation of biomimetic design concepts', *Architectural Science Review*. Taylor & Francis, 58(2), pp. 120–133. doi: 10.1080/00038628.2014.922458.
- EIDin, N. N., Abdou, A. and ElGawad, I. A. (2016) 'Biomimetic Potentials for Building Envelope Adaptation in Egypt', *Procedia Environmental Sciences*. Elsevier, 34, pp. 375–386. doi: 10.1016/J.PROENV.2016.04.033.
- Fecheyr-Lippens, D. and Bhiwapurkar, P. (2017) 'Applying biomimicry to design building envelopes that lower energy consumption in a hot-humid climate', *Architectural Science Review*. Taylor & Francis, 60(5), pp. 360–370. doi: 10.1080/00038628.2017.1359145.
- Loonen, R. C. G. M. (2015) 'Bio-inspired Adaptive Building Skins', in *Biotechnologies and Biomimetics for Civil Engineering*. Cham: Springerlink.
- López, M., Rubio, R., Martín, S. and Ben Croxford (2017) 'How plants inspire façades. From plants to architecture: Biomimetic principles for the development of adaptive architectural envelopes', *Renewable and Sustainable Energy Reviews*. Pergamon, 67, pp. 692–703. doi: 10.1016/J.RSER.2016.09.018.
- Šuklje, T. (2015) *Thermal response of adaptive building envelope*. PhD Thesis, University of Ljubljana, Slovenia.
- Šuklje, T., Arkar, C. and Medved, S. (2014) 'The local ventilation system coupled with the indirect green façade: a preliminary study', *International Journal of Design & Nature and Ecodynamics*. WIT Press, 9(4), pp. 314–320. doi: 10.2495/DNE-V9-N4-314-320.
- Šuklje, T., Arkar, C. and Medved, S. (2015) 'A Hydro-Thermal Study of the Bionic Leaf - A Basic Structural Element of the Bionic Façade Inspired by Vertical Greenery', in *Energy Procedia*. Elsevier Ltd, pp. 1195–1200.
- Šuklje, T., Medved, S. and Arkar, C. (2013) 'An Experimental Study on a Microclimatic Layer of a Bionic Façade Inspired by Vertical Greenery', *Journal of Bionic Engineering*, 10(2), pp. 177–185.
- Šuklje, T., Medved, S. and Arkar, C. (2016) 'On detailed thermal response modeling of vertical greenery systems as cooling measure for buildings and cities in summer conditions', *Energy*, 115, pp. 1055–1068. doi: 10.1016/j.energy.2016.08.095.
- Webb, M., Aye, L. and Green, R. (2018) 'Simulation of a biomimetic façade using TRNSYS', *Applied Energy*. Elsevier, 213, pp. 670–694. doi: 10.1016/J.APENERGY.2017.08.115.
- Yuan, Y., Yu, X., Yang, X., Xiao, Y., Xiang, B. and Wang, Y. (2017) 'Bionic building energy efficiency and bionic green architecture: A review', *Renewable and Sustainable Energy Reviews*. Pergamon, 74, pp. 771–787. doi: 10.1016/J.RSER.2017.03.004.
- Zuazua-Ros, A., Martín-Gómez, C., Ramos, J. C. and Gómez-Acebo, T. (2017) 'Bio-inspired Heat Dissipation System Integrated in Buildings: Development and Applications', *Energy Procedia*. Elsevier, 111, pp. 51–60. doi: 10.1016/J.EGY-PRO.2017.03.007.

Experimental Testing of Dissipative Façade Brackets

Matthias Förch a), Frank Wellershoff a), Guido Lori b), Marc Zobec b), Daniele Casucci c), Philipp Grosser c)

a) Hafencity University Hamburg, Façade Systems and Building Envelopes, Germany, matthias.foerch@hcu-hamburg.de
 b) Permasteelisa Group, Italy
 c) Hilti Corporation, Liechtenstein

Design requirements for bomb blast protection are a challenge for façade engineers because of complex interaction of various elements with different mass and nonlinear stiffness. There are different mitigation techniques available depending on the hazard rating. Rigid protecting structures are neither accepted by architectural design demands, nor by occupants who do not want to be affected by obvious protection in daily life. As a result, smart blast enhanced façade solutions that cannot be distinguished from conventional facades are required, being capable of providing the required safety level. With introduction of dissipative façade brackets the dynamic analysis of the façade MDOF system can be balanced due to beneficial inertia effects. The dissipative bracket attracts the blast wave energy in lieu of the glazing, so that a switch of the typical load chain becomes possible. The probability that the glazing remains in uncracked state increases while the dissipative bracket dissipates the energy. In addition, the reaction to the primary structure can be mitigated. Objective of this paper is a characterization of different dissipative materials with respect to applicability in dissipative bracket design for bomb blast protection. Therefore, experimental tests of different crash absorbing materials in low-speed and high-speed mode are performed. . On the basis of single component test results, material characteristics are identified and transferred to hybrid systems, because single crash absorbing materials have advantages in combination with disadvantages for blast enhancement design. Hybrid systems can benefit from positive dissipative effects by attenuating the disadvantages at the same time. In addition, dynamic increase factors (DIF) between 1.0 and 1.30, depending on component materials, are observed in the experimental tests.

Keywords: Bomb blast, Dissipative bracket, Blast enhanced façade, Crash absorption, True balanced design

1 Introduction

Today, blast protection for façades is recognized as a performance requirement in sensitive areas around the world, as blast enhanced façades can provide significant protection against blast wave effects. Typical curtain wall façades may remain nearly unchanged from an architectural point of view while being upgraded to optimized blast protecting design. During the 1990's banks and financial institutions in London were frequently targets of terrorism. Usually, the terrorist objective was the disruption of the economic and politic leadership of the British capital, while the lives of occupants were preserved by terror warnings. At that time, blast protection focused on office buildings by minimizing financial losses in form of exterior and interior damage, to preserve business activities. With the beginning of the 21st century, the crowded places have become more exposed to the terrorist threat (National Counterterrorism Security Office 2012), where the lives of human beings are considered as the primary terrorist target. In general, blast enhanced façades are capable of protecting occupants from blast wave overpressure and they are rated in terms of hazard criteria, e.g. ISO 16933 (2007). Here, the possible impact of glass fragments striking the

occupants has to be mitigated as more than 80 percent of injured people may be lacerated by flying glass (Harpole 1995). However, although the main threat for occupants is resulting from glass fragments, all façade components influence the dynamic behavior of the façade under blast action. Mass and stiffness of glass panel, mullion and transom and façade bracket may be balanced within the MDOF system to reduce the probability of glass failure.

2 Blast Load

Henrych (1979) describes an explosion as „a sudden physical or chemical change of the state of mass, accompanied by a release of energy and by motion“. Most terror attacks near buildings are committed by detonating chemical explosives, where the velocity of propagation within the explosive compound is beyond the speed of sound of the material. After the reaction of the explosive compound an overpressure wave is generated in the surrounding air with an instantaneous rise of pressure. Most explosive charges detonate near ground surface, so the pressure wave propagates by hemispherical shape and the overpressure is decreasing with respect to the increasing air volume until the overpressure is equalized to atmospheric pressure. Clearly, the peak overpressure is decreasing with increasing stand-off distance from the centre of explosion. A negative pressure is generated due to mass inertia effects of air particles after equalization to the atmospheric pressure as air particles are still moving. Encountering a rigid surface like a building the blast wave is reflected, resulting in pressure increase due to abrupt stop of air molecules. The reflected pressure on a surface may be up to 20 times amplified in comparison to the incident pressure. Figure 1 presents a typical time-pressure history of blast waves encountering buildings, while all pressure is expressed with respect to the atmospheric pressure. The duration of positive phase depending on the blast load scenario is in a range between 5 to 20 ms, while the negative phase is a multiple of the positive one.

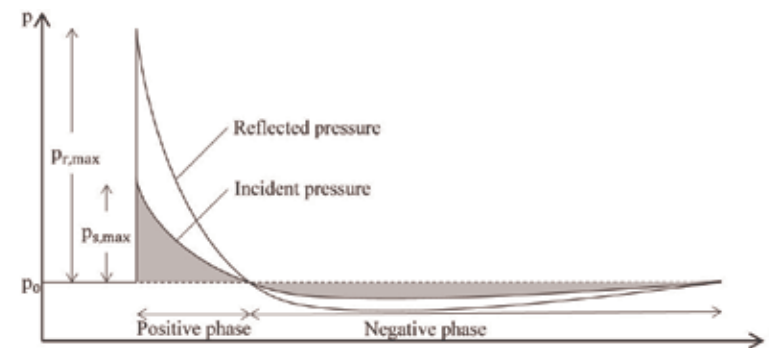

Fig. 1 Typical time-pressure history of blast wave encountering a building.

Usually, only the positive phase is considered in blast design by idealized blast load, assuming a maximum reflected overpressure $p_{r,max}$ dropping linearly to zero. Failure of the façade to the outside of the building due to underpressure phase is accepted within this assumption (Wellershoff et al. 2012). However, some project performance specifications recommend consideration of positive and negative phase effects as the specific impulse is approximately on the same level. The specific impulses for each phase consist of the integral of pressure difference over time, shown as grey areas in Figure 1. Although the minimum peak pressure of the negative phase is much lower than the one of the positive phase, rebound forces may overlap with the longer lasting negative phase.

Depending on the hazard rating criteria applied to the façade, various scenarios may be discussed. Here, the boundary ratings range from “façade remains undamaged” to “severe façade damage

in case of bomb blast event is accepted”. In this context, the negative phase may become design relevant within the structural calculation.

3 Façade Connection to Concrete Slab

3.1 Dissipative Bracket

A typical situation for the fixing of the façade to the concrete slab is presented in the Figure 2. The façade is provided with a variable joint connection to the bracket. This joint connection is able to compensate tolerances in height (z-direction). The bracket transfers the dead load of the façade and the wind loads in inward and outward direction to the anchor channel, which is embedded as cast-in solution into the concrete slab. Tolerances in position can be compensated by the anchor channel in x-direction and by the bracket in y-direction.

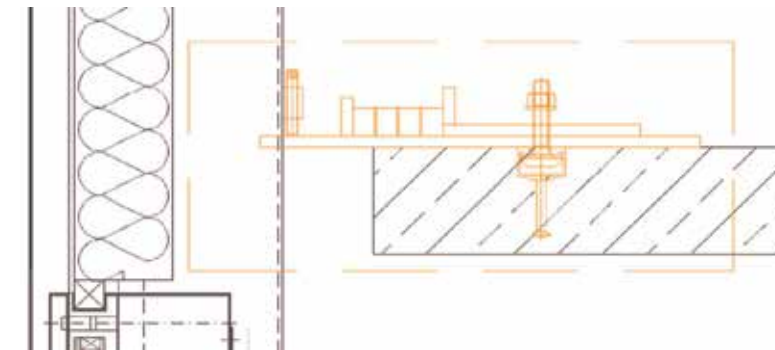

Fig. 2 Typical connection of façade element to concrete slab substructure.

In most cases, the façade connection to concrete slab tolerates enough space for a novel dissipative bracket design (Lumantarna et. al 2017). This development is inspired by crash absorption principle known in automotive applications and implemented in blast enhanced cable facades (Wellershoff 2011).

The system consists of a bracket with a rigid behavior under conventional non-blast loads, while it deforms in a controlled way when the external force exceeds a certain threshold value. Due to the combination of energy dissipation and façade movement towards the concrete slab, the MDOF system of the façade can be balanced to a beneficial behavior of inertia effects. In general, the dissipative bracket deformation capacity is limited by the façade to slab distance. Within this space the full façade can move towards the concrete slab in case of a blast wave impinging the façade.

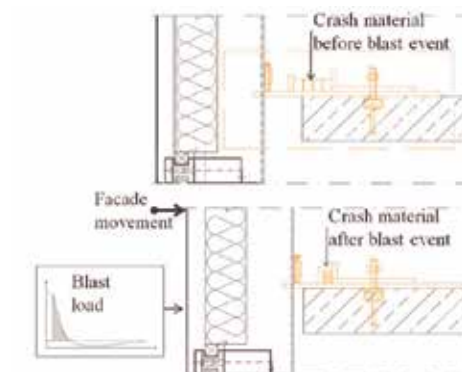

Fig. 3 Dissipative bracket principle.

3.2. True Balanced Design Approach with Dissipative Bracket

Since the 1990's blast enhanced façades have been used to avoid the risk of blast waves entering the building during a blast event. Initially the enhancement has been applied by rigid behavior concept in the first generation of blast enhanced façades. The second generation "balanced design approach" takes advantage from the energy dissipation capability of the glass panels. Here, the glass panels are regarded as sacrificial elements, which in case of a blast event dissipate energy by controlled permanent deformations. Major characteristic for second generation of blast enhanced façades is that the dominant element for the blast wave energy dissipation is the laminated glass, designed to crack in compliance with hazard requirements. Framing and connections are designed with respect to the maximum glazing capacity, resulting in stiff supporting structures. Usually, glazing performance is assessed considering rigid glass supports on the safe side. In contrast, the "true balanced design approach", a third generation for the calculation assessment of blast enhanced façades, is an upgrade of the second generation. In particular, the third generation takes advantage of the benefits from the dissipative bracket.

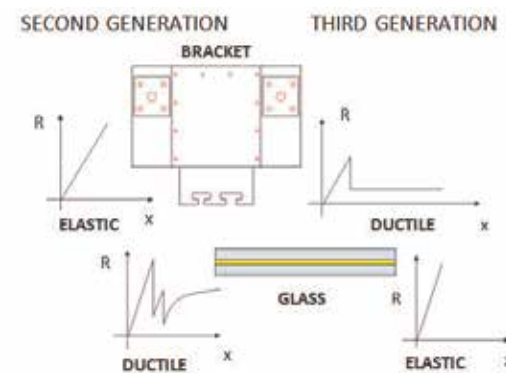

Fig. 4 Energy dissipation balance in glazing (bottom) and bracket (top) for second (left) and third (right) generation enhanced façades.

Due to the energy dissipating façade movement towards the concrete slab, the MDOF system of the façade can be balanced to a beneficial behavior with the help of inertia effects. In particular, stresses within façade components can be controlled up to a certain extent. The dissipative bracket attracts the blast wave energy in lieu of the glazing, so that a switch of the typical load chain (glass - transom/mullion – bracket – concrete slab) becomes possible. The probability that the glazing remains in uncracked state increases while the dissipative bracket dissipates the energy. In addition, the reaction to the primary structure can be mitigated, if the available dissipative deformation within the bracket is not exceeded. Under these circumstances the dissipative bracket can be a key component to realize a controlled scheme for blast protection in façades. For instance, it can be calibrated to be activated beyond water tightness requirements. Here, post event inspection may be done with the help of the final bracket status. In this way, the façade units without activated brackets would not require replacement. The façade units with activated brackets would require replacement, but in general they will not require slab repair if the available dissipative deformation is not exceeded. When the available dissipative deformation is exceeded, a replacement of the fixation and repair of the slab is required as the elastic conditions of the fixation are exceeded. However, the fixing remains a critical component in order to provide robustness and stability to the façade after a blast event.

4 Experimental Testing

4.1. Experimental Setup

The experimental testing was performed in the laboratory of HafenCity University Hamburg (HCU) with piston speed of a servo hydraulic machine from low-speed mode (3E-05 mm/s to 1 mm/s) to high-speed mode (1 m/s to 3 m/s). The piston speed represents the travelling velocity of the façade towards or away from the concrete slab in a blast event. The experimental tests consist of four different experimental setups:

- Component testing of crash absorbing materials
- Bracket testing in stiff steel substructure
- Bracket testing in concrete slab substructure
- Anchor channel testing in concrete slab substructure

Objective of experimental testing is the characterization of different crash absorbing components with respect to applicability in dissipative bracket design for bomb blast protection. Here, the selection of suitable crash absorbing components is relevant for true balanced façade design, as a reliable component is crucial for the performance of the façade under blast load. Therefore, different crash absorbing components with distinctive characteristics were tested. Research focus of component testing was the identification of loading capacity, standard deviation and dissipative behavior of different crash absorbing materials. Bracket testing in stiff steel substructure is used to analyze the total bracket behavior in low-speed and high-speed mode, so that dynamic effects are identified. Both directions – inward and outward – are examined for realistic blast load scenario. Here, advantages and disadvantages of different crash absorbing components are combined in hybrid variations, in order to achieve a suitable bracket behavior under high-speed condition. Bracket testing in concrete slab substructure is dedicated to the overall behavior of the bracket system in combination with the anchor channel and concrete slab. Moreover, the anchor channel behavior under low-speed and high-speed conditions is examined separately. In this way, the performance of different types of anchor channels with regard to various load directions and loading speed can be examined.

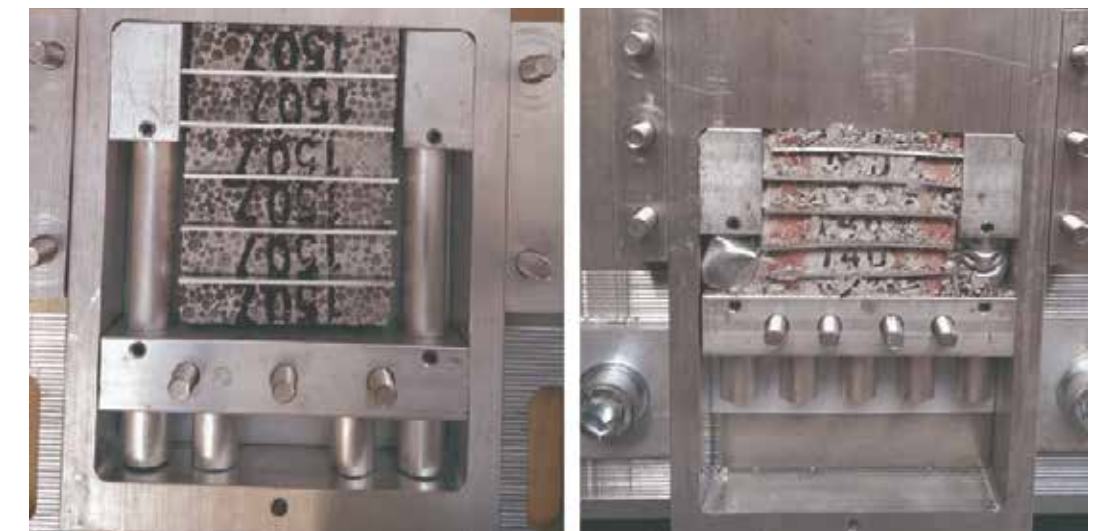

Fig. 5 Dissipative bracket. a) Dissipative bracket in undeformed state with hybrid crash components aluminium sleeves and dissipative concrete. b) Dissipative bracket after inward testing.

4.2. Crash Absorbing Components

The idea of crash absorbing components is well known in engineering applications, for instance in improving crush zones in car design. Alghamdi (2001) reviews common shapes and deformation modes of energy absorbers, e.g. circular tubes, square tubes, truts and foam. Pled et al. (2007) investigate in a numerical study the crushing behavior of circular aluminum tubes with and without aluminum foam fillers and predict post-buckling behavior with respect to buckling mode classification. Applications in façade design are shown in Amadio & Bedon (2012) and Viefhues et al. (2014). There are various materials available, being capable of absorbing energy with large deformation capacity. The focus of the presented investigation was on aluminum foam, aluminum tubes and dissipative concrete elements (Fig. 6). The dissipative concrete is a further development of HafenCity University Hamburg on the basis of Viefhues et al. (2014).

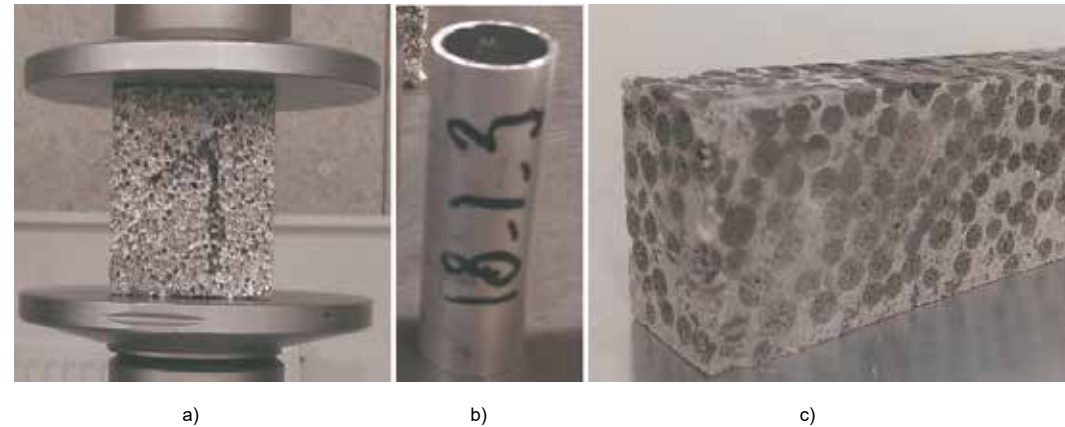

Fig. 6 Crash absorbing components. a) Aluminum foam. b) Aluminum tube. c) Dissipative concrete.

In order to ensure a suitable crash behavior in a blast event, several criteria should be fulfilled by the crash absorbing components. Firstly, the load-deformation gradient should have a small drop Δp after the first peak p_{max} in order to reduce uncontrolled dynamic response of the façade system (Fig. 7a). Secondly, the energy dissipating horizontal absorbing plateau should be horizontal, stable and consisting of a wide plastic range l_{pl} , to allow absorption of a big amount of energy within the dissipative bracket. Thirdly, the standard deviation of load- deformation behavior should be low, as the design load range between maximum wind load and minimum blast load can be small, requiring a reliable and predictable design. Figure 7b presents four different crash absorbing components with their distinctive load-deformation gradients under low-speed testing of single test specimens (Fig. 6a). The y-axis is normalized to the value of 1.0 for p_{max} in order to facilitate the comparison. The aluminum tube in local buckling mode has a wide range l_{pl} to dissipate energy, but a drop after p_{max} in combination with an unstable plateau. Both aluminum foams have almost no drop after p_{max} , but the absorbing range l_{pl} especially of aluminum foam (supplier 1) is comparatively small. Finally, the developed dissipative concrete has a stable plateau combined with a small drop Δp after the first peak p_{max} .

Experimental Tests

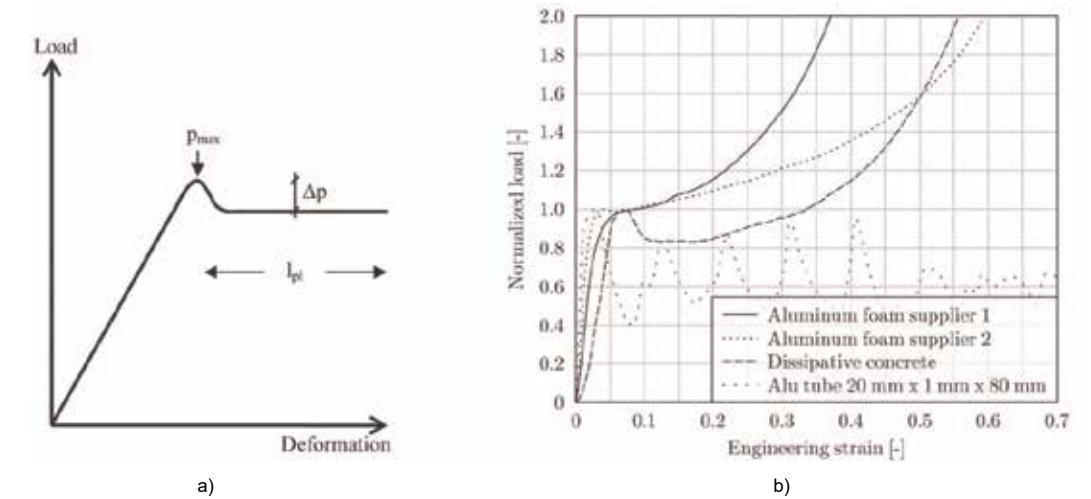
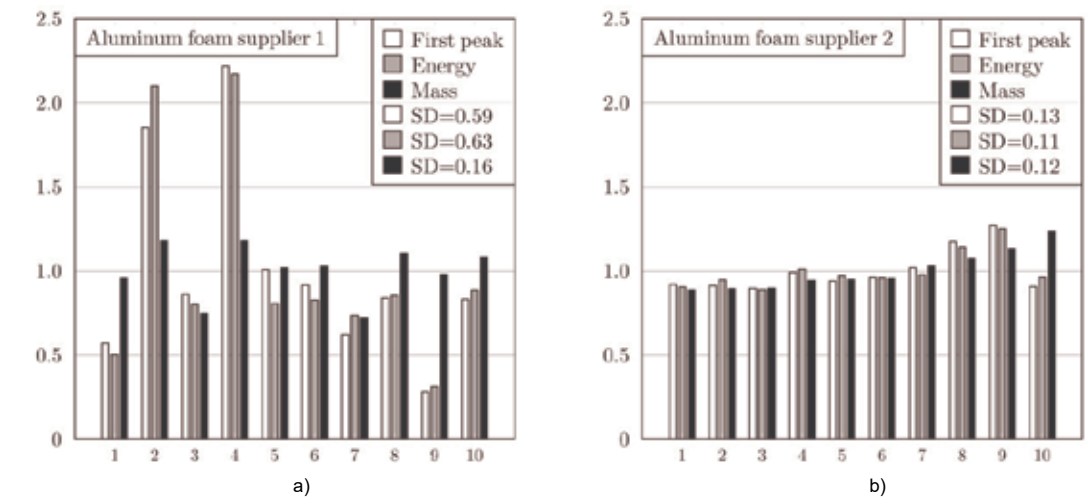

Fig. 7 Load-deformation gradient. a) Characteristics of load-deformation gradient. b) Gradients of low-speed tested crash absorbing components.

An investigation of the mean values, standard deviations of first peaks p_{max} , dissipated energies and component masses shows obvious differences between the crash absorbing components in low-speed testing (Fig. 8). Depending on the manufacturing process the standard deviation may be high for aluminum foam, low for dissipative concrete and very low for aluminum tubes. Therefore, the number of tested specimens is reduced for dissipative concrete and aluminum tubes in contrast to aluminum foam. For comparison reasons, all mean values are normalized to a relative value of 1.0. Aluminum foam (supplier 1) has a big scatter in p_{max} and dissipated energy which proves the material to be inappropriate to secure blast protective design. The scatter of aluminum foam (supplier 2) is significant lower, but not reaching to the level of dissipative concrete or even aluminum tubes, having the least standard deviation.



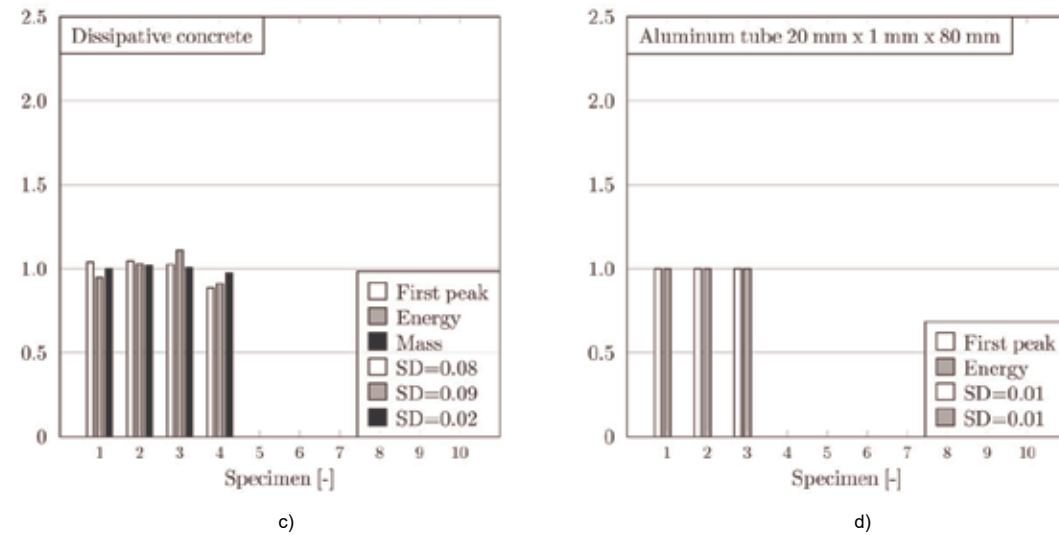

Fig. 8 Low-speed test results of crash absorbing components. First peak p_{max} , according to Fig. 7a, dissipated energy at 30 % engineering strain, component mass and standard deviation SD. a) Aluminum foam (supplier 1). b) Aluminum foam (supplier 2). c) Dissipative concrete. d) Aluminum tube 20 mm x 1 mm x 80 mm.

4.3. Hybrid Systems

Hybrid systems consisting of different crash absorbing component combinations were tested within the bracket on the stiff steel and concrete slab substructure. Aluminum foam, dissipative concrete and various types of metal tubes were combined. All tests were recorded for optical control with cameras up to 20,000 fps for high-speed mode. In order to combine the benefit of positive effects of aluminum foam (supplier 2) and dissipative concrete, with the ones of aluminum tubes by mitigating at the same time the disadvantages, different hybrid combinations are investigated. However, focus of the investigation was on dissipative concrete in combination with aluminum tubes. Dissipative concrete has the advantage that the failure strength level is 10 times higher than the failure strength level of aluminum foam, so that the dimensions of the bracket can be kept in a reasonable and economic size. Two different recipes of dissipative concrete with high and low compression strength were developed. Here, expanded clay material is used as main ingredient to control the dissipative characteristic of the concrete. The hybrid system, consisting of dissipative concrete and aluminum tubes, shows an average dynamic increase factor on the first peak p_{max} of approximately 1.20 (Fig. 9a), while the dissipative concrete is bearing approximately 2/3 of the loading. The dynamic increase factor (DIF) for dissipative concrete crash absorbers only cannot be determined with reliable statistical validity due to few tests, but it can be expected to range in between 1.15 and 1.30. The DIF for aluminum tubes in local buckling has a lower extent, in between 1.0 and 1.15 (Fig. 9b).

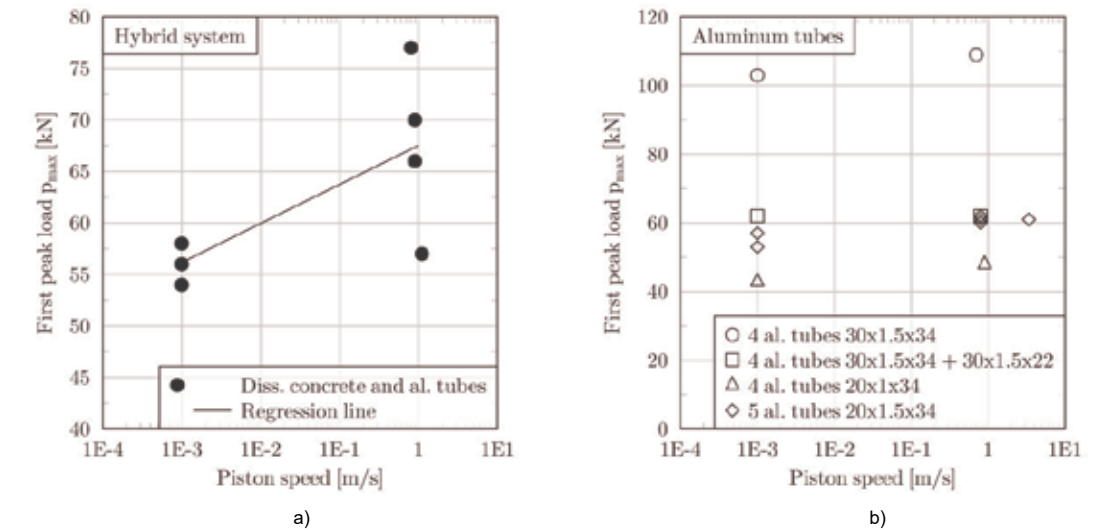

Fig. 9 Low-speed and high-speed first peak loads p_{max} . a) Dissipative concrete and 2 aluminum tubes 20 mm x 1,5 mm x 110 mm. b) Different aluminum tube constellations.

4.4. Anchor Channels

Anchor channels are often used to fasten Curtain wall façades to concrete structures. The anchor channels are installed surface flush either top of slab (TOS) or front of slab (FOS) into the concrete element. The channel profiles are available in different length equipped with at least two anchors to transfer the loads acting on the channel bolts via the channel profile into the concrete. In the research described in this paper, two different types of anchor channels were tested: 1) standard channels with a length of 350 mm 2) rebar channels with a length of 450 mm. So called rebar channels are anchor channels with reinforcing bars attached to the channel profile in order to increase the shear resistance close to the edge. The anchor channel systems were loaded with two channel bolts M20 (steel grade 8.8) tightened with 100 Nm with different rates, low- and high-speed loading both with and without a dissipative bracket. The concrete specimens were produced with strength class C30/37 in heights of 150 mm and 200 mm. Since the amount or reinforcement is typically not known, the tests were performed with the minimum reinforcement required. Shear loads up to 250 kN were applied to the system. In all tests steel failure characterized by local failure of the channel lips with subsequently pullout of the channel bolts occurred. The test results are shown in Figure 10. It can be seen that for the standard channels the mean dynamic increase factor is 1.1 whereas for the rebar channels no dynamic increase could be observed. Also, the direction of loading (inward or outward) does not seem to have an influence on the dynamic increase factor.

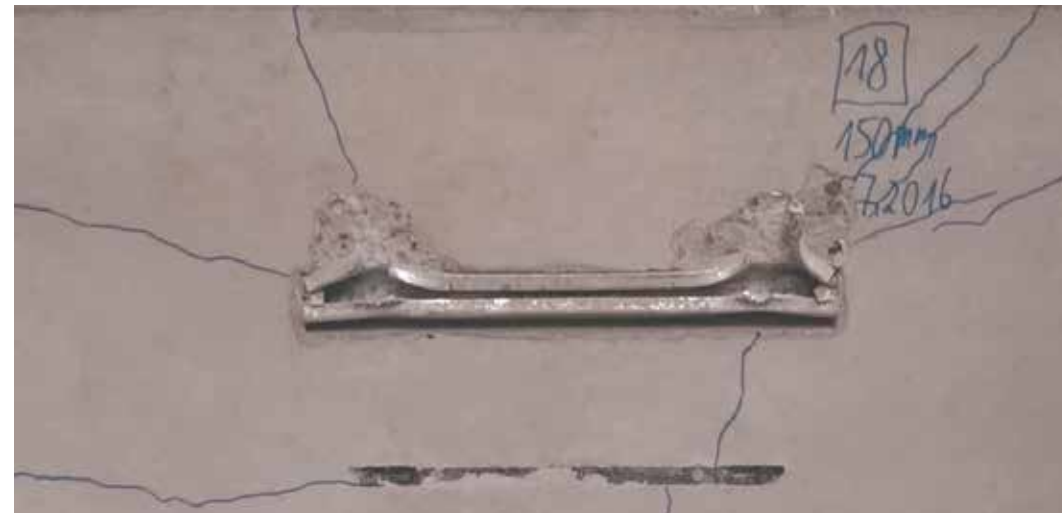

Fig. 10 Typical failure mode for both standard and rebar channels in the experimental investigations.

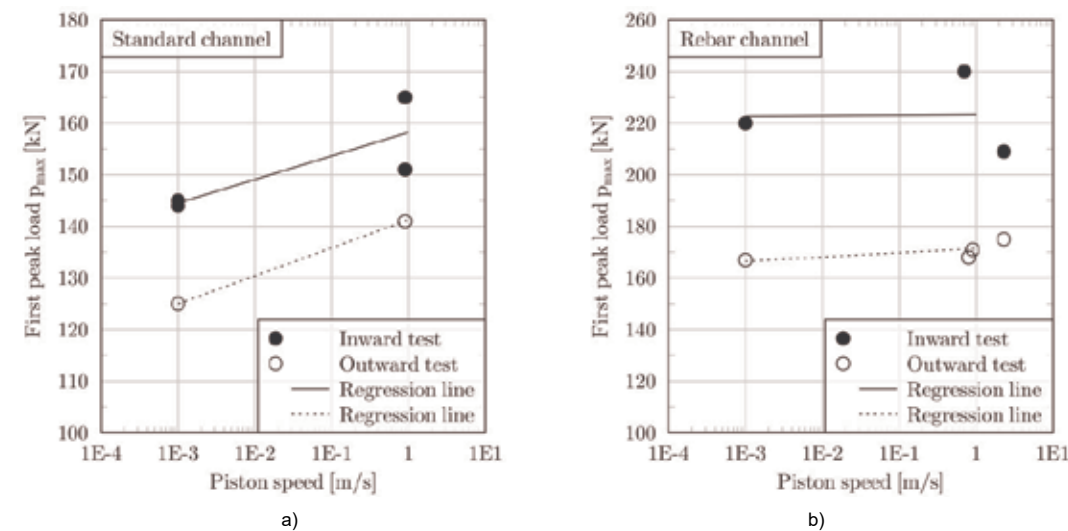

Fig. 11 Low-speed and high-speed failure load of cast-in anchor channels. a) Standard channel b) Rebar channel.

5 Conclusions

The true balanced design approach is one method to enhance a façade in order to resist bomb blast loads. By means of the dissipative bracket integration the dynamic analysis of the MDOF system can be balanced with respect to inertia effects, so that the blast wave energy is controlled and partially dissipated. There are different crash absorbing components available with distinctive characteristics. A suitable crash absorbing component should be selected, depending on the hazard requirements of the façade and the crash absorbing component characteristics, i.e. suitable load-deformation gradient and low statistical scatter of its behavior. Within the tested crash absorbing components, dissipative concrete and aluminum tubes show better characteristics for dissipative façade brackets than both aluminum foam components. As a single component usually does not comply with all requirements, hybrid systems may be proposed as an effective alternative. Here, positive effects can be combined, while mitigating negative characteristics. The investigated hybrid system consisting of dissipative concrete and aluminum tubes showed a good low-speed and high-speed performance with a DIF of 1.20 and additional advantage that the dimensions of the bracket can be kept in compact size due to the high strength of dissipative concrete. Knowledge with regard to DIF and scatter of the crash absorbing component enable engineers to realize a specific bracket

design with regard to a considered blast event. In terms of façade refurbishment after a blast event, one concept may be, that the plateau of the dissipative bracket is designed to stay within the elastic limit of the anchor channel, having the possibility to replace the façade and the bracket after a blast event, whereas the cast-in anchor channels can be reused to fasten a new façade system.

6 References

- Alghamdi, A. A. A. (2001). Collapsible impact energy absorbers: an overview. *Thin-Walled Structures*, 39, 189- 213.
- Amadio, A. & Bedon, C. (2012). Viscoelastic spider connectors for the mitigation of cable-supported facades subjected to air blast loading, *Engineering Structures*, 42, 190-200.
- Harpole, T. (1995). A Safety Lesson from Oklahoma City. *Progressive Architecture*, 65-66.
- Henrych (1979). *The dynamics of explosion and its use. Developments in civil engineering 1*. Elsevier, Amsterdam.
- ISO 16933 (2007). *Glass in building. Explosion-resistant security glazing. Test and classification for arena air- blast loading*. International standard, Geneva.
- Lumantarna, R., Zobec, M., Lori, G., Larcher, M. & Morison, C. (2017). Innovative energy dissipative bracket for façade blast enhancement design. *12th International Conference on Shock and Impact Loads on Structures*.
- National Counterterrorism Security Office (2012). *Crowded Places: the planning system and counter-terrorism*. Guidance 1 Jan 2012.
- Pled, F., Yan, W. & Wen, C. (2007). *Crushing Modes of Aluminium Tubes under Axial Compression*. 5th Australasian Congress on Applied Mechanics, 10-12 December 2007, Brisbane, Australia.
- Viefhues, E., Wellershoff, F. & Mehidianpour, M. (2014). Energiedissipierende Fassadenverankerung mit Crashmaterial für explosionsbeanspruchte Gebäude. *Bautechnik*, 91, 8, 561-566.
- Wellershoff, F. (2011). *Blast Enhanced Cable Facades*. Glass Processing Days, Tampere.
- Wellershoff, F., Teich, M., Nehring, G. & Gebbeken, N. (2012). *Konstruktion und Berechnung von explosionshemmenden Seilnetzfassaden*. *Stahlbau*, 81, 1, 13-25.

Post-Occupancy Evaluation for Adaptive Façades

Shady Attia 1, Alessandra Luna Navarro 2, Miren Juaristi 3, Aurora Monge-Barrio 3, Susanne Gosztonyi 4, Zein Al-Doughmi 5

1 Sustainable Buildings Design Lab, Department UEE, Faculty of Applied Sciences, University of Liege, Belgium, shady.attia@uliege.be

2 University of Cambridge, UK,

3 Universidad de Navarra, School of Architecture, Spain, mjuaristi@alumni.unav.es; amongeb@unav.es

4 Lucerne University of Applied Sciences and Arts, Engineering and Architecture, Switzerland, susanne.gosztonyi@hslu.ch

5 Cardiff University, UK, Al-DoughmiZO@cardiff.ac.uk

Post-occupancy evaluation is a valuable method of generating information on the performance of adaptive building façades in relation to users. This evaluation technique involves both procedural methods, such as soft-landing, and empirical measuring, such as environmental monitoring or self-reporting techniques including surveys. Several studies have been carried out in recent decades to identify the most appropriate methods for occupant comfort, well-being, productivity, satisfaction, and health assessments in workplaces. Post-occupancy evaluation of adaptive façades can, however, be a challenging task and information on this topic is still scarce and fragmented. The main contribution of this paper is to bring together and classify the post-occupancy evaluation methods for adaptive façades and suggest a framework for their holistic evaluation. Specific recommendations for improving current standards and guidelines are outlined here to enhance occupant satisfaction and environmental conditions in workplaces for future design projects. Finally, we discuss various ongoing trends and research requirements in this field.

Keywords: advanced façades, user interaction, measurement, surveys, criteria, framework, indoor comfort

Full paper available in the Journal of Facade Design and Engineering, Vol 6 No 3 (2018): Special Issue FAÇADE 2018 – Adaptive!

Occupant-Adaptive Façade Interaction: Relationships and Conflicts

Alessandra Luna-Navarro a), R.C.G.M Loonen b), Shady Attia c), Miren Juaristi d), Aurora Monge-Barrio d), Mattia Donato e), Roman Rabenseifer f), Mauro Overend a)

a) University of Cambridge, UK, al786@cam.ac.uk
 b) Eindhoven University of Technology, The Netherlands
 c) Université de Liège, Belgium
 d) University of Navarra, Spain
 e) Arup, London, UK
 f) Slovak University of Technology in Bratislava, Slovakia

Adaptive or Intelligent façades are those that can interact with users and dynamically vary their performance or properties (controlling thermal or solar energy, air flow and/or daylight) in response to changing external conditions and indoor demands. Consequently, adaptive façades could help to ensure occupant comfort, health, well-being and satisfaction, while allowing resource-efficient building operation. However, effective adaptive façade solutions that provide an optimal balance between user comfort, satisfaction and energy efficiency cannot be achieved without knowledge of the multidisciplinary complexity of the user-façade interaction. The main objective of this paper is to preliminary review and analyse the existing literature on user interaction with intelligent buildings, especially with façades, and to propose a conceptual framework to capture the multi-disciplinary and multi-domain complexity of user interaction with adaptive façades. The interaction between adaptive façades and occupants is then modelled as a closed loop of information and action exchange. This paper concludes indicating which are the future research needs to be addressed in order to define what is a satisfactory interaction strategy between occupants and façades.

Keywords: adaptive façade, user interaction, dynamic control, occupant satisfaction

1 Introduction

Adaptive façades are smart and responsive systems where an IT control strategy can vary façades performance to increase buildings resource-efficiency (Favoino et al., 2013), but also to interact with occupants in order to tailor environmental conditions to dynamic demands for comfort and well-being (Konis & Selkowitz, 2017). The interaction between occupants and façades is a multidisciplinary and complex relationship with multi-domain effects and conflicts (Loonen et al., 2013). However, the nature and the effects of these mutual interrelationships between occupants and façades is yet to be completely defined (Attia 2018) and also their impact on other building components, such as building management systems (BMS), needs to be investigated. The clear definition of which are the potential interactive relationships between occupants, façades and, additionally, BMS systems is a crucial step towards satisfactory adaptive and smart buildings in both design and operational stages.

The aim of this paper is to review the existing literature on this topic and to initially define which are the potential interactive relationships between occupant, adaptive façades and other building systems and, consequently, identify potential conflicts in the level, mode, frequency of those interactions. Section 2 presents the methodology applied to develop this preliminary review. Section 3 discusses the main conflicts in selected interactive relationships. Section 4 proposes then a

conceptual model to frame the interactive relationships between occupant and adaptive façades as a closed loop. Finally, Section 5 indicated the future research efforts to be made on this topic and concludes with the main finding from this review.

2 Methodology

This paper is the result of a literature review on the interactive relationships between occupants and adaptive façades, which was developed within the COST TU 1403 “Adaptive network” participants. For the purpose of this study, adaptive façades are considered as composed by both a hardware (the façade) and a software (the ensemble of embedded IT - information technologies). The literature review has been structured then according the overlapping conceptual areas within Façades, IT systems and Occupants in the Vern diagram in Figure 1: 1) Relationships and conflicts within IT systems and Occupants, which includes the interaction of occupants with the control logic of the façade either requiring action and information or providing feedback; 2) Relationships and conflicts within IT systems and Façades, which includes the logic control actions towards the facades and potential information exchange on its performance; 3) Relationships and conflicts between Occupant and façades, which includes any direct interaction of occupants with facades, similarly to occupant interaction with traditional facades. In addition, the interaction within BMS systems and Façade control strategies was also preliminary included (Figure 1, number 4). This literature review was considered by the authors as a preliminary attempt to investigate the mutual relationships between IT systems or control strategies, occupants and façades and with the full-awareness that this is an initial work and it could serve as basis for a more comprehensive understanding of the multidisciplinary complexity of the interaction between occupants and façades.

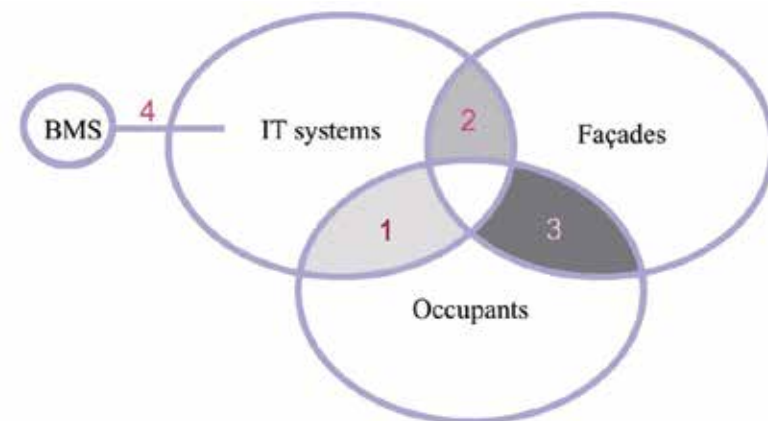

Figure 1 Vern diagram of the literature review topics addressed in this work

3 Literature review on Occupant-Adaptive Façade Interaction

3.1 Relationships and conflicts between occupants and adaptive façades IT systems or control strategies

Due to the multisensorial effects of façades and the highly-individual response of occupants, designing for user interaction with dynamic envelopes is a challenging task and conflicts and inconsistencies often arise (Day & Heschong, 2016). In the literature review, two different types of conflicts have been identified when occupants interact with intelligent façades: 1) Conflicts among users in relation to their personal control; 2) Conflicts between users and automatic control strategies.

Conflicts among users often arise in shared office spaces (Galasiu & Veitch, 2006), since comfort expectations tend to be highly individual and, hence, ensuring appropriate environmental conditions and control for all users can be burdensome. The wealth of research on individual based environmental services in modern office environments is a response to this challenge. However, façade are usually considered as a shared components and, consequently, just designed to avoid severe discomfort scenarios (Fabi et al., 2014). Moreover, their effect on users strongly depends on occupant location. Defining a control strategy that can satisfy all users demands is then a challenging task and a question arises as whether the level of control required for user satisfaction is dependent on the occupant position (Cohen et al, 1998). For instance, the occurrence of fully raised lower blinds was found to be dependent on the distance between occupants desktop and the external façade by Haldi and Robinson (2010). However, several studies have also shown that users in open space offices can be either active or passive independently from their location in the space. Active users tendency to take responsibility of controlling the environment on behalf of others co-workers, depends more on personality features than occupants position among the space. Hence, providing different interfaces and degree of control according to the position to the façade might not be the most appropriate solution for a satisfactory interaction.

Identifying which is the appropriate balance between personal control and automatic strategies is one crucial aspects, as shown from the literature review. Occupants inclusion in the “control loop” is widely recognized as being paramount to occupant satisfaction (Heerwagen & Diamond, 1992; Norman, 1994) and when their environmental control is denied users tend to become “infuriated” with automatic control strategies (Cole & Brown, 2009). The appropriate balance between personal and automatic strategy is not, however, easily generalised, since it depends on several factors. Day and Heschong (2016) report that there is no clear universal tendency for user preferences between manual and automatic controls. Nonetheless, there are two valid principles identified in literature (Day et Heschong, 2016): a) automated controls are more accepted if users can override them; b) automatic controls are highly accepted if they meet user preference, otherwise they are perceived as strongly uncomfortable.

The type of control is also influencing user acceptance of automatic strategies (Day & Heschong, 2016). For example, several studies have shown that people are more likely to accept blinds being raised rather than lowered (Galasiu & Veitch, 2006; Venkatesh et al., 2003; Reinhart & Voss, 2003). The balance between personal and automatic control can also be adjusted at different stages of the building life. Levels of automatic control could gradually increase together, and in parallel, with their users acceptance. In this sense, Matthew and Vic (2012) reported a user evaluation of an “adjustable autonomy system” (Matthew & Vic, 2012), whose levels of control were gradually increased, as the user gained confidence with the interactive system. Consequently, allowing for the most appropriate personal control is important for a satisfactory interaction of active users in intelligent buildings. Users preferences on personal control modalities are also influenced by the type of intelligent façades and the frequency with they would like to interact and override automatic systems. Meerbeek (Meerbeek et al., 2014) showed that users can be classified according “different usage patterns and attitudes”, namely: minimal users control, regular user control, active user control and system control with manual override. Several factors can influence usage patterns and attitudes. For instance, Bakker underlined the importance of the distance from the façade in defining the desired interaction frequency (Bakker et al., 2014). The effect of the distance from the façade on occupants’ level of perceived control was identified, as well, by Boestra (2016). The influence of space typology on user behaviour (O’Brien et al., 2013) or acceptance of automatic controls has also been widely reported in literature (Attia 2015 and 2016ab). Occupant behaviour has also been shown to depend on orientation (Fabi et al., 2012).

3.2. Relationships and conflicts between façades and occupants

The existing wealth of research on occupant interaction with windows or façades has already largely investigated the relationships between occupant and window or façade operation. For instance, Wymelenberg reported an extensive review of the patterns of occupant interaction with window blinds (Wymelenberg, 2017) or Fabi et al. (2012) for occupant window opening behaviours. Conflicts are usually related to: a) user misunderstanding of window and façade operation or means for their personal control; b) the simultaneous and multi-domain effects of façades on occupants; c) conflicts within multiple users in shared spaces (Stazi et al., 2017).

Occupant misunderstanding of personal control modes can often generate frustration and strong environmental dissatisfaction, while also undermining passive energy-efficiency strategies (Janda, 2011). In this sense, occupants training on building operational strategies plays a crucial factor, as shown by Day and Gunderson (2015), who reported that occupants with effective training were significantly more satisfied with their office environment. Window signalling systems are also one example of new communication modes between façades and users that can better inform user on optimal window operation (Ackerly & Brager, 2013).

Since any change in façade operation and performance can potentially affect more than one environmental domain, discrepancies with conflictive occupant demands often arise when an optimal balance in façade environmental performance is not achieved. Conflicts between acoustic comfort and natural ventilation are an example of these discrepancies. Successful façades should allow satisfactory operational modes, ensuring for instance outside view while preventing glare discomfort and maintaining energy efficient building operation (Loonen et al., 2013). Studies on the motivation behind user behaviour driven by discomfort (Fabi et al., 2012; Zhang & Barrett, 2012; Stazi et al., 2017) are in this sense useful to inform automatic control strategy about which control employ, even in conflictive scenarios.

As already mentioned for the conflicts within occupant and façade control strategies, the social dynamics of shared office space can also have strong impact on user operation of façades (Fabi et al., 2012). For instance, Cohen et al. (1998) reported that all manual controls in open-plan offices tend to follow operational pattern that minimise conflicts among users but do not optimise building performance.

3.3. Relationships and conflicts between BMS systems and façades IT systems

BMS and façade control strategies are strongly related since façades are the primary origin of heat losses and the principal building component in modulating solar radiation intake and natural ventilation strategies. Consequently, BMS are designed in response and completion to façade performance to ensure acceptable indoor conditions. Optimal façade control strategies can minimise peaks in cooling and heating loads and reducing over-lighting due to control of direct solar penetration (Halawa et al., 2018). Pervasive Sensing (Kumar et al., 2016) and Building Automation (Merz et al., 2009) allow to develop reactive and even predictive integrated control strategies where BMS and façades IT systems can communicate to mutually adapt their performances and potentially predict future control patterns. Integrated lighting and façade control strategies are an example of these adaptive integrated building controls.

Discrepancies between BMS and façade control strategies often arise when the granularity of communication between both logics is not sufficient either in space or in time. For instance, there is a need for a sufficient number of façade sensors in space and for them to communicate with

BMS in order to correctly align both control strategies. BMS systems or façade automatic controls are often only relating on central weather stations, which are not sufficient to read significant changes on façade performance according to the distance from or the orientation of the façade. The role and location of façade and BMS sensors and actuators need also to be update in time in order to ensure scalable and flexible exchange of information and feedback between both logics (Comminges & Dugué, 2015). For example, this happens when occupancy pattern changes or either presence of new obstruction on the façade are not recorded by BMS system or, alternatively, when open and flexible spaces are commonly designed in office buildings. Conflicts arise when inconsistencies in the flexibility of the layout and the adaptability of the façade exist (Juaristi & Monge-Barrio, 2016), and in addition, BMS system are not consistent with this relation. Therefore, façade and BMS should also be compatible enough with the re-design of the open space, providing as much flexibility as possible. To conclude, there is a need for connecting both façade and BMS intelligences from early design stages (Puglisi & Ciaramella, 2016), in order to ensure their smooth interaction through a flexible and scalable exchange of data.

4 Proposed framework of relationships within occupant, adaptive façades and BMS systems

For the purpose of this paper, the interaction between adaptive façades and occupants has then been modelled as a closed loop of mutual relationships amidst the façade, the occupant and the IT control strategy. As shown in Figure 1, the user-façade interaction embraces different type of interchanges between occupants and the intelligent façades. A satisfactory interaction between occupants and intelligent envelopes fulfills all needs of the system for interacting in a closed loop between occupants and the adaptive façades (Konis & Selkowitz, 2017). From the review, the interaction between users and dynamic façades has been divided in (Figure 1): 1. The interaction between users and the IT system, both as capability of the user of overriding and personally control the IT strategy (a) and of the IT system to read user feedback and demands (b); 2. The interaction between the IT system and the façade, both as active capability of IT to control the façade (a) and read data from its performance (b); 3. The interaction between the user and the physical interface of the façade, including the façade opportunity for being an information hub for users (a) or the possibility of occupants for changing the façade properties (b); 4. The interaction between façade control strategies and BMS systems, façade control strategies can read performance data from façades and change the BMS inputs (a) or the BMS can change the façade behaviour to improve energy efficiency strategies (b). Depending on the façade and IT technology, all these features need to be present and characterise in terms of level, mode, frequency and space in order to ensure a satisfactory interaction strategy.

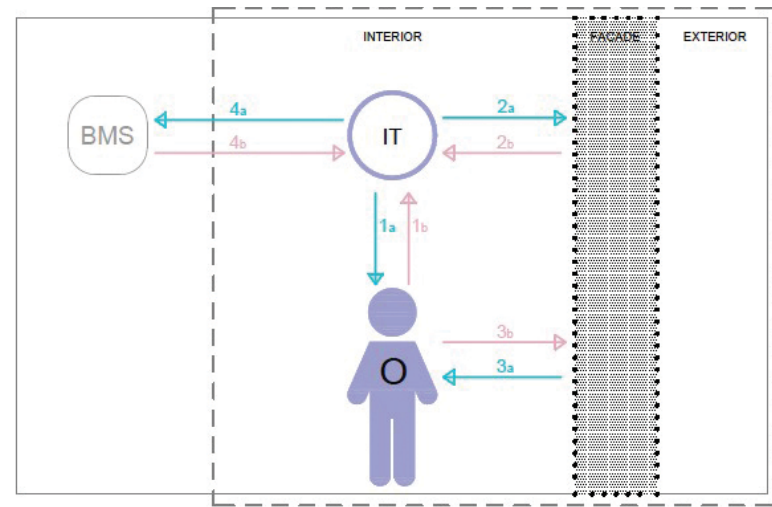

Figure 2 Proposed framework of relationships within occupant, adaptive façades and BMS systems.

In order to minimise the discrepancies and conflicts highlighted in Section 3, whilst maximising occupant satisfaction with the environment and building operation, this conceptual model has been framed as a closed loop of mutual information and controls exchange between users, adaptive façades (considering both the IT central intelligence and the façades components and actuators) and potentially BMS systems. The implementation of this closed loop of interaction strategies is considered fundamental for the delivery of satisfactory intelligent buildings, where alternative intelligences (BMS, occupants and adaptive façades) are connected and communicating with each other. This closed-loop of interactions could allow multiple responsive system to share their real-time sensorial information or stored database and simultaneously inform any responsive or adaptive control strategy within the building, even to predict future occupant demands or energy-efficiency strategies. Nevertheless, this model is still an initial framework and there is a need for its further development in order to include in detail the multi-domain and multi-disciplinary complexity of alternative scenarios and directions of interaction.

5 Conclusion

This paper reports initial findings on the relationships and conflicts generated by the occupant interaction with adaptive façades. This ongoing work is part of the Working group 3, COST Action TU1403 “Adaptive Facades Network”, and aims to investigate which are the main drivers of a satisfactory interaction between occupants and façades. This review has been focusing on the main relationships and conflicts between occupants and adaptive façades. Given the existence of multiple potential conflicts within IT and BMS control strategies, adaptive façades and occupants, this paper proposes a conceptual model of interaction strategies as a closed loop of information and actions exchanges in order to connect all the intelligences involved and ensure a smooth and satisfactory interaction strategy.

Next work will further investigate the multi-disciplinary complexity of those interactive relationships, defining which are potential exchanges of feedback and controls between occupants and adaptive façades. Consequently, further work is needed to define which are then the satisfactory modes and frequency of those flow of information and controls.

6 Acknowledgements

The author would like to gratefully acknowledge COST Action TU1403 “Adaptive Facades Network” for providing excellent research networking. The authors would like also to acknowledge the support of Ove Arup & partners and Permasteelisa in supporting this research.

7 References

- Attia, S. (2018) Challenges and Future Directions of Smart Sensing and Control Technology for Adaptive Facades Monitoring. Next Facades COST Action TU1403 Adaptive Facades Network Conference, Lucerne University, 26-27 November 2018. Lucerne, Switzerland.
- Attia, S., (2016a) Evaluation of Adaptive Facades: The case study of a glass building in Belgium. Challenging Glass 5 - Conference on Architectural and Structural Applications of Glass. 11.05.2017. Retrieved from <http://orbi.ulg.ac.be/handle/2268/198431>.
- Attia, S., (2016b) Evaluation of Adaptive Facades: The case study of Al Bahr Towers in UAE. Qatar Green Building Conference 2016 – The Action. 11.05.2017. Retrieved from <http://orbi.ulg.ac.be/handle/2268/203448>.
- Attia, S. & Bashandy, H., (2015). Evaluation of Adaptive Facades: AGC Building a case study of an automated glass façade - Interviews and process mapping of the design team. 11.05.2017. Retrieved from <http://orbi.ulg.ac.be/handle/2268/196359>.
- Bakker, L. G., Oeffelen, E. C. M. H., Loonen, R. C. G. M., & Hensen, J. L. M. (2014). User satisfaction and interaction with automated dynamic facades : A pilot study. *Building and Environment*, 78, 44–52. <http://doi.org/10.1016/j.buildenv.2014.04.007>
- Boerstra, A. (2010). Personal control in future thermal comfort standards. *Adapting To Change: New Thinking on ...*, (April), 9–11. Retrieved from <http://www.seedengr.com/documents/Personalcontrolinfuturethermalcomfortstandards.pdf>
- Cohen, R., Ruyssevelt, P., Standeven, M., Bordass, W., & Leaman, a. (1998). Building intelligence in use: lessons from the probe project. *Proceedings EIBG Conference*, 98.
- Cole, R. J., & Brown, Z. (2009). Reconciling human and automated intelligence in the provision of occupant comfort. *Intelligent Buildings International*, 1(1), 39–55. <http://doi.org/10.3763/inbi.2009.0007>
- Day, J., & Heschong, L. (2016). Understanding Behavior Potential: the Role of Building Interfaces. In *ACEEE Summer study on Energy Efficiency in Buildings* (pp. 1–13).
- Fabi, V., Andersen, R. V., Corgnati, S., & Olesen, B. W. (2012). Occupants' window opening behaviour: A literature review of factors influencing occupant behaviour and models. *Building and Environment*, 58, 188–198. <http://doi.org/10.1016/j.buildenv.2012.07.009>
- Fabi, V., Maggiora, V., Corgnati, S., & Andersen, R. (2014). Occupants' behaviour in office building : stochastic models for window. 8th Windsor Conference: Counting the Cost of Comfort in a Changing World Cumberland Lodge, Windsor, UK, 10-13 April 2014. London: Network for Comfort and Energy Use in Buildings, (April), 10.
- Favoino, F., Jin, Q., & Overend, M. (2014). Towards an ideal adaptive glazed façade for office buildings. In *Energy Procedia* (Vol. 62, pp. 289–298). <http://doi.org/10.1016/j.egypro.2014.12.390>
- Galasiu, A. D., & Veitch, J. A. (2006). Occupant preferences and satisfaction with the luminous environment and control systems in daylight offices: a literature review. *Energy and Buildings*, 38(7), 728–742. <http://doi.org/10.1016/j.enbuild.2006.03.001>
- Haldi, F., & Robinson, D. (2010b). Adaptive actions on shading devices in response to local visual stimuli. *Journal of Building Performance Simulation*, 3(2), 135–153. <http://doi.org/10.1080/19401490903580759>
- Heerwagen, J. and R. Diamond (1992). Adaptations and coping. Occupant response to discomfort in energy efficient buildings. Paper presented at the American Council for an Energy Efficient Economy, Alsilomar, CA, August, 1992.
- Heydarian, A., Pantazis, E., Carneiro, J. P., Gerber, D., & Becerik-Gerber, B. (2016). Lights, building, action: Impact of default lighting settings on occupant behaviour. *Journal of Environmental Psychology*, 48, 212–223. <http://doi.org/10.1016/j.jenvp.2016.11.001>
- Juaristi, M., & Monge-Barrio, A. (2016). Adaptive façades in temperate climates . An in-use assessment of an office building. 11th Conference on Advanced Building Skins. <https://doi.org/10.13140/RG.2.2.29634.99527>
- Loonen, R. C. G. M., Trčka, M., Cóstola, D., & Hensen, J. L. M. (2013). Climate adaptive building shells: State-of-the-art and future challenges. *Renewable and Sustainable Energy Reviews*. <http://doi.org/10.1016/j.rser.2013.04.016>
- O'Brien, W., Kapsis, K., & Athienitis, A. K. (2013). Manually-operated window shade patterns in office buildings: A critical review. *Building and Environment*. <http://doi.org/10.1016/j.buildenv.2012.10.003>
- Konis, K., & Selkowitz, S. (2017). Effective Daylighting with High-Performance Facades. In *Effective Daylighting with High-Performance Facades* (pp. 251–269). Springer International Publishing. <http://doi.org/10.1007/978-3-319-39463-3>
- Matthew, B., & Vic, C. (2012). Managing control, convenience and autonomy. *Ambient Intell Smart Environ*, 12, 159–196.
- Meerbeek, B. W., de Bakker, C., de Kort, Y. A. W., van Loenen, E. J., & Bergman, T. (2016). Automated blinds with light feedback to increase occupant satisfaction and energy saving. *Building and Environment*, 103, 70–85. <http://doi.org/10.1016/j.buildenv.2016.04.002>
- Reinhart, C. F., & Voss, K. (2003). Monitoring manual control of electric lighting and blinds. *Lighting Research and Technology*, 35(3), 243–258. <http://doi.org/10.1191/1365782803li064oa>
- Stazi, F., Naspi, F., & D'Orazio, M. (2017). A literature review on driving factors and contextual events influencing occupants' behaviours in buildings. *Building and Environment*, 118, 40–66. <http://doi.org/10.1016/j.buildenv.2017.03.021>
- Venkatesh, V., Morris, M. G., Davis, G. B., & Davis, F. D. (2003). User Acceptance of Information Technology: Toward a Unified View. *MIS Quarterly*, 27(3), 425–478. <http://doi.org/10.1017/CBO9781107415324.004>

Impact of façade types on user comfort and health in office buildings

Nikola Z. Furundžić a), Aleksandra Krstić-Furundžić b), Dijana P. Furundžić a)

a) Dental practice "Furundzic ordinacija", Serbia, stomordinacija227@gmail.com

b) University of Belgrade, Faculty of Architecture, Serbia, akrstic@arh.bg.ac.rs

Offices are the daily work environments for a majority of the working population in all societies. Considering that employees often spend more than 40 hours per week at work in offices, it is clear that workplaces greatly influence their mental status, actions, abilities and performance. It is obvious that for these people work comfort is essential for quality of work, greater productivity and creativity and the preservation of health. Façade concept and structure should be designed to provide satisfactory user comfort. Authors of this article conducted a survey in order to assess how employees evaluate the achieved comfort in the case of different office types and facade technologies and to highlight factors that interfere with a pleasant atmosphere for work, or in other words disrupt comfort, and to perceive how it affects human health. These factors act as stressors on humans and can be physical-temperature, noise, light, air-quality and social-privacy and personal environment. New technology and design can be generators of stress for people working in the office space. The research highlights some effects of these stressors. The paper discusses the questionnaire created by authors in order to clarify the sources of stressors, and the effects that these stressors have on human behaviour, to his personality, especially on oral hygiene. The fact that emotional states can be associated with comfort conditions confirms the importance of integrated design and presents the architectural challenge.

Keywords: office types, facade types, comfort, stressors, questionnaire, employee's health

1 Introduction

The satisfaction of the human being has always been the sense of architectural creativity. The relationship between architecture and people is very multiplex and its quality is perceived through pleasantness. It is a very complex topic and can be treated from different angles. Contemporary approach in architecture is defined for energy efficiency and environmental responsibility and thus introduces new space organization schemes, functional patterns, and design and construction technologies, mainly requiring creation of new materials.

Architectural design has a significant impact in everyday life. In this regard should be noted the observation by Ernest Dimnet that of all arts the architecture is the one which acts the most slowly, but the most surely, on the soul (www.brainyquote.com/quotes/ernest_dimnet_161039). Also, it is appropriate to mention the following statement by Steve Jobs: "Design is not just what it looks like or feels like. Design is how it works." (www.brainyquote.com/authors/steve_jobs). Cities and buildings are architectural creations. These creations make a complex dialogue between themselves and with their environment and users. Innovative concepts of architectural objects aim to meet many requirements such as energy efficiency, eco-friendliness, use of advanced materials and user satisfaction. Architect Bjarke Ingels declares in an interview for ArchDaily: "Architecture is the art and science of making sure that our cities and buildings actually fit with the way we want to live our lives: the process of manifesting our society into our physical world." (Basulto 2014).

Today, the relationship between comfort in the space and the well-being of users is a topic of great interest for contemporary research, and this is the focus of research in this paper. Internal space is argued as the main factor that affects physiologically and psychologically the human health (Elbailuomy et al. 2017). A space's form and design determines its positive as well as its negative effects, which everyone can experience in their own way (Holzer 2013).

When it comes to comfort, more and more new buildings have dynamic envelopes thanks to the potential of innovative building envelope technologies and materials, and this concept is called an adaptive facade. Adaptive facades are building envelopes that can adjust to changing climatic conditions on an hourly, daily, seasonal, or annual basis (Attia 2017). Conventional building shells typically have static properties and no ability to behave in response to these changes (Loonen et al. 2013). In the case of conventional curtain walls, indoor comfort is most often achieved artificially, as a function of mechanical and electrical systems – HVAC and artificial lighting, indicating a need for further development in terms of user activation/contribution. Contemporary orientation is natural heating, lighting and ventilation of the inner space. Adaptive facades respond mechanically or chemically to external climate dynamics to meet inside load requirements (cooling, heating, lighting, or ventilation) and occupants' needs (Attia 2017; Loonen et al. 2013). Their functioning in terms of responding to external climate, daily and annual changes are mainly computer controlled, thus controlling integrated ventilation, air-conditioning, heating technology and adjusting the sun protection to the prevailing conditions. Most automated facades invite little bodily participation both from the occupants' perspective within the building and larger urban participation from the outside (Anshuman 2005). Baker and Steemers (2000), exploring the roles of occupant controls in the environmental performance of buildings, concluded that provision of personal or local controls over the internal environment can extend the range of comfort. They indicated that buildings should be designed in a way that provides building users with good adaptive opportunity, which refers to the scope for adaptive interventions to environmental conditions.

Examining possible impacts by analyzing people's experiences in relation to the various existing spaces can provide indicators important for sustainable design and construction at all levels - city, urban block, street, building and individual rooms. Architects need to be aware of the fact that the shape, lighting, colours, materials, design, and the way of combining components of the structure affect the creation of a positive/pleasant or negative/unpleasant experience of space. It is important to keep this in mind when it comes to designing buildings and spaces for different purposes, both in the case of new ones as well as in renewing existing ones.

Post-occupancy evaluation (POE) draws on an extensive quantitative and qualitative toolkit: measurements and monitoring, on the one hand, and methods such as walk-throughs, observations and user satisfaction questionnaires on the other (Attia et al. 2015).

Authors of this paper were specifically interested in the concepts of modern architectural technologies represented in the design and construction of office buildings such as glass curtain walls, static and adaptive concepts and how they can effect on factors defined as generators of stress. The authors believe that providing occupants with the possibility to control the indoor environment improves overall user satisfaction with comfort conditions and contributes to user well-being by minimizing presence of stress generators. The aim of the paper is to assess how employees evaluate the achieved comfort in the case of different office types and facade technologies and to highlight factors that interfere with a pleasant atmosphere for work, or in other words disrupt comfort, and to perceive how it affects human health. For this purpose, a user satisfaction questionnaire was created and used.

A number of authors define stress as a real or perceived imbalance between environmental demands required for survival and an individual's capacity to adapt to these requirements (Lazarus and Folkman 1984; Chrousos and Gold 1992; Lovallo 1997; Pearlin, Lieberman, Menaghan, and Mullen 1981; Weiner 1992).

Long-term exposure to stress generators leads to unpleasant feelings and disturbances of comfort, which is gradually reflected on many health problems and the occurrence of the illnesses. Perceived stress might increase the risk of developing the disease in three ways as it may activate physiological, behavioral, and psychological processes (Cohen and Rodriguez 1995; Cohen et al. 2002; Krantz et al. 1985; McEwen et al. 1993):

- Physiological process changes the function in the whole organism causing illness and disease in different systems and organs, such as the orofacial region. Experimental stress in normal individuals increases masticatory muscle (EMG) activity, supporting the theory that stress induces muscular hyperactivity (Intrieri et al 1994). This muscular hyperactivity is the cause of bruxism (Kesikburun et al. 2014) which leads to damage of teeth, periodontal tissues, as well as cervical pain and temporomandibular disorders (Manfredini et al. 2005).
- Behavioral process is related to the behavior of people under stress such as altered eating and sleeping habits and heavier consumption of alcohol and other substances (Conway et al. 1981). A study has shown that depression affects patients' dietary choices and that these patients tend to increase their intake of food with more fermentable carbohydrates further encouraging the growth of cariogenic bacteria (Anttila et al. 1999).
- Psychological processes including depression and anxiety. The influence of emotional factors, such as anxiety, has been widely emphasized, for both triggering and perpetuating bruxism, resulting in an increase in muscle tension caused by emotional stress during moments of anxiety (Fissmer et al. 2008). Anttila et al. (1998) found a correlation between depressive symptoms and an abundant growth of salivary lactobacilli, a microorganism that has been implicated in dental caries.

The facade is a structural element of the building that separates outer and inner space and strongly affects the comfort of the interior space, and is particularly important for creating high-grade working space. If it is not designed in user friendly manner to provide pleasant natural ventilation and daylighting, protection against sun and noise, these factors can arouse unpleasant feelings and presence of generators of stress on people. As aforementioned, a number of authors considered these factors as stressors that influence human health. Some authors clearly justify the connection between stress and processes in human body that lead to different health problems.

The paper refers to the consideration of the influence of some elements of design and construction of office buildings on the feeling of comfort. Authors of this article conducted a survey to assess how employees evaluate the achievement of comfort, as well as to perceive how it affects human health. New technology and design can be generators of stress for people working in the office space. This research involves several factors that influence the psychological situation of the respondents, which relate to their perception of the inner space in which they are located. Accordingly, a questionnaire and questions were created. Insight into relevant literature shows that consideration of the influence of some elements of design and construction of office buildings on the employees feeling of comfort has not been sufficiently explored through questionnaires, especially not in the way it was done in this paper. The study highlights some effects of these stressors.

1.1. Research methodology

The research was conducted using the questionnaire created by the authors of this paper to perceive the individual experience of physical and social factors, i.e. stressors. The results, i.e. experiences of employees in relation to various issues are considered, and a comparative analysis of the results is performed and presented through the charts. It is important to note that constraints were noted regarding the response to conducting the survey, and non-acceptance is most often justified by the difficulty of devoting time to the survey due to significant work obligations. It was extremely important that the respondents know and believe that the research is anonymous, so that the sincerity of replies was possible.

The most important part of the paper presents the analysis of the results of the original survey carried out in 2017. The authors prepared a questionnaire and conducted a survey, as well as processed the collected data. Because of this, but also because of the dilemmas that can create professional issues, the authors have decided to personally distribute questionnaires on-site and then collect them after about 15 minutes. The questionnaire contained a brief instruction regarding the procedure for selecting and marking the offered responses. Respondents showed interest in the content of the questionnaire and only about 1.5% did not fully answer the questions. Many have orally expressed the importance and support to parts of the questionnaire that were related to the health aspect.

The questionnaire contained three parts:

- Information on the characteristics of the workspace (orientation, number of employees, view of surrounding, way of lighting and ventilation, presence of noise) and possibilities of controlling temperature, ventilation, lighting and protection against sunshine.
- Questions aiming at assessing the presence of anxiety or depression – according to The Hospital Anxiety and Depression Scale (HADS) devised by Zigmond and Snaith (1983). The beauty of the HADS score is its simplicity, speed and ease of use. Very few (literate) people have difficulty completing it, on paper or electronically. It assesses both anxiety and depression, which commonly coexist (McManus et al. 2007).
- Questions that give information about the oral health.

This structure of the questionnaire enabled the authors to receive information about the personal experience of the respondents about their workplace and achieved comfort regarding the experience of lighting, ventilation and noise, factors considered as stress generators. Also, providing information about their mental state and the state of health of the oral cavity, a number of respondents have indicated the presence of health problems. These information can be linked to their negative feelings in terms of aforementioned factors that are stress generators in the workspace, that originate from an unfavourable comfort, which is also affected by the building façade concept.

In 2000, the U.S. Surgeon General's report Oral Health in America highlighted numerous ways in which oral and general health are linked (2000). Careful examination of the oral cavity may reveal signs and symptoms of different health disorders and identifying these oral findings may allow for early diagnosis and treatment (CHI et al. 2010). For this reasons, the authors accept that oral cavity examination is one of the methods that can detect health problems that are related to stress, such as periodontal disease, tooth loss or bruxism. They point out that the examination of oral cavity is economically available, safe for the patient and can be repeated many times as needed.

2 Case study

Offices are the daily work environments for a majority of the working population in all societies. Considering that employees often spend more than 40 hours per week at work in offices, it is clear that workplaces greatly influence their mental status, actions, abilities and performance. It is obvious that for these people work comfort is essential for quality of work, greater productivity and creativity and the preservation of health (Furundžić 2015).

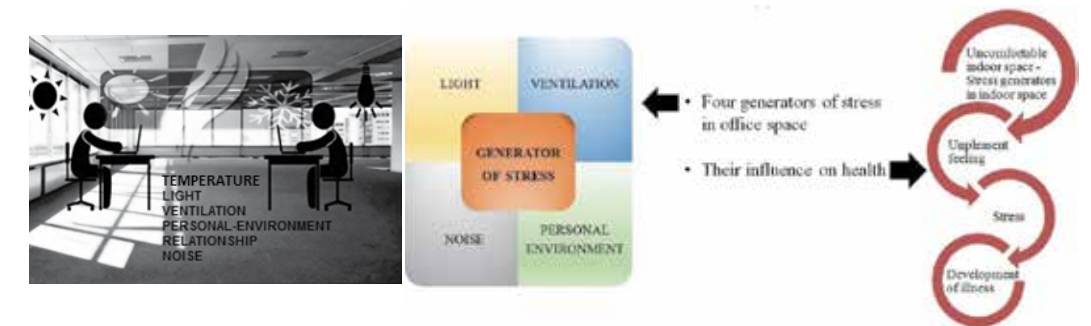

Fig. 1 Generators of stress in the office space

The research focuses on assessing how employees evaluate the achievement of comfort in the case of different office types and facade technologies and highlighting factors that interfere with a pleasant atmosphere for work (Fig. 1), or in other words disrupt comfort, and to perceive how it affects human health. These factors act as stressors on humans and can be physical - temperature, noise, light, air-quality, and social - privacy and personal environment. The relevant data are generated through a survey.

Authors of this paper conducted a survey in local conditions. The buildings that are located in city blocks in New Belgrade and Novi Sad were the subject of research. Buildings positioned as a detached or in a row are selected for case studies. Case studies include buildings built after 1980, during the period of intensive construction of modern office buildings in New Belgrade and other cities in Serbia. Regarding spatial organization, the following types of office buildings have been selected for the research: corridor type, with atrium and structures inside the shell (Fig. 2). For each type of building, a number of representative samples was selected and amounted to 9 business units with between 20 and 50 respondents each. The survey was conducted with 235 respondents.

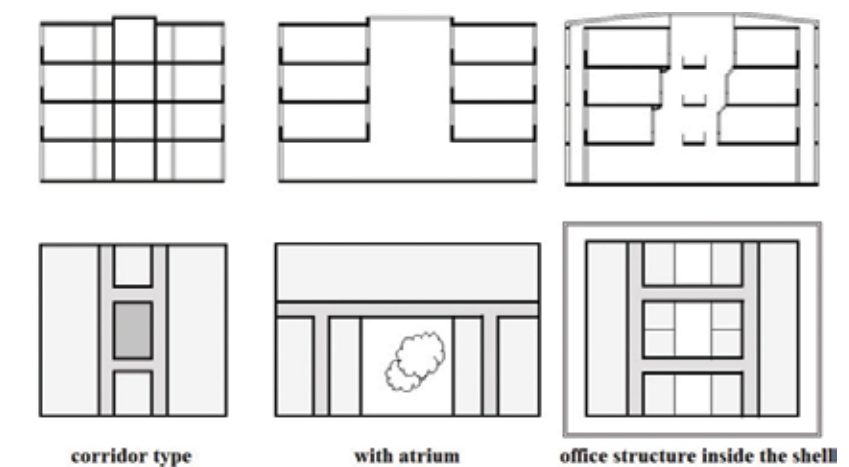

Fig. 2 Considered types of office buildings

For the survey three types of offices were taken in consideration: private, shared - up to four and team room-between four and nine employees.

In offices, combined natural and artificial lighting is mostly in use. When it comes to ventilation, the presence of the following options is noticed: only mechanical or a combination of mechanical and natural ventilation. In the case of the structure inside the shell, mechanical ventilation and artificial lighting are mainly present.

The type of façade that is represented is curtain wall with thermally insulating glass and metal sections. The most case studies are conventional curtain walls with insulating glass. Combination of fixed and operable window areas is mainly present which enables natural ventilation in addition to mechanical ventilation. Internal venetian blinds are solutions for sun protection. When it comes to the structure inside the shell, the outer layer of glazing is at a considerable, several meters, distance from the inner glass wall. Venetian blinds and curtains are sunshading devices placed on the inside of the inner layer of glazing of offices. The windows in the offices open to the space inside the outer envelope-shell to simulate the impression of the possibility of natural ventilation, as only mechanical ventilation is available. The case of an office building with an adaptive facade is also taken into account. Inner façade layer is conventional curtain wall with insulating glass and metal sections. Glass transparent panels extend from the floor to the ceiling. Fixed glass panels are mostly present, while operable windows are at a greater distance so that flexible space sharing is limited. External horizontal movable louvres are placed on the substructure set at a distance of about one meter from the glass façade and the gap presents the outer space. Movement of louvres is mechanical and can also be controlled by employees.

2.1. Results – analysis of user assessment of comfort

Several factors that influence the psychological situation of the respondents and are relate to their perception of the inner space in which they are placed, are subjects of the observation. The analysis highlights factors that interfere with a pleasant atmosphere for work, or in other words, comfort and how it affects human health. These factors act as stressors on humans. These stressors can be physical and social (Fig. 1). Physical are temperature, noise, light, air-quality. Social are privacy and personal environment. The research points to some effects of these stressors.

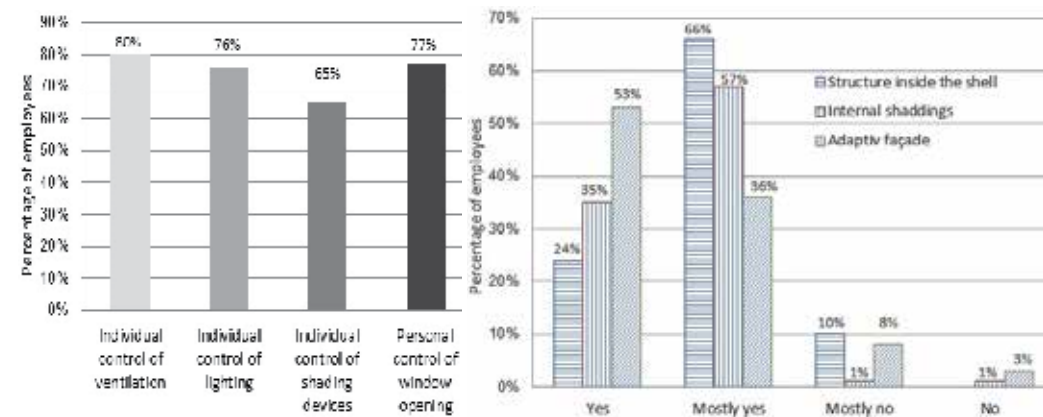

Fig. 3 Positive statement for the individual control of the indoor environment facade types Fig. 4 Satisfaction with lighting for different facade types

The analysis of the survey showed that respondents feel comfortable when they have control over room temperature, ventilation and lighting, in other words, employees give priority to the possibility of individually adjusting the indoor environment (Fig. 3).

Façade concept and structure should be designed to provide satisfactory user comfort. In order to achieve high work comfort, advanced facade technologies are being developed that allow adaptation to a changing external environment. Thanks to new technologies, such facade concepts can be adapted to the external environment using a system which is controlled manually, as well as semi-automatically and automatically usually using centralized control systems (Building IT). However, such facade devices can be a psychological stressor for employees who need/want to individually adjust the indoor environment for comfortable work. Certain case studies covered by the survey relate to adaptive facades with movable louvres, semi-automatically controlled, and in this case, the results of the survey show that the largest number of employees feel lighting as completely pleasant (Fig. 4) compared to facades with internal shadings and structure inside the shell. Respondents attribute importance of aligning the division of space and the distribution of the modules of the shading devices; otherwise, in the case of individual control systems, there may be a problem of synchronization between users, resulting in poor comfort conditions and user dissatisfaction.

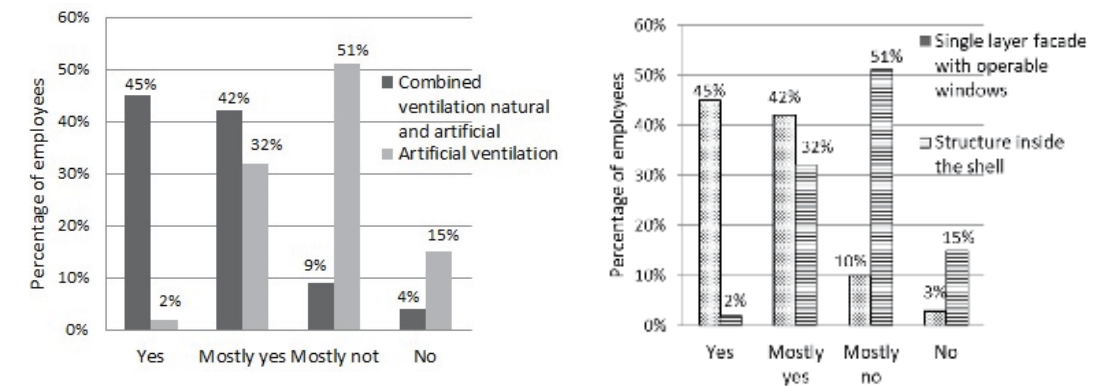

Fig. 5 Employees assessment of the comfort of ventilation in relation to ventilation type, a) and satisfaction with ventilation for different facade types, b).

The possibility of opening windows and combining natural ventilation with mechanical enables employees to feel the ventilation as pleasant (Fig. 5a), while in the case of office structure in the shell, employees feel that ventilation is mostly unpleasant and often noisy (Fig. 5b). The reasons for the unpleasant feeling are: air flow, air temperature incompatible with personal feeling, stuffy and odours (Fig. 6a).

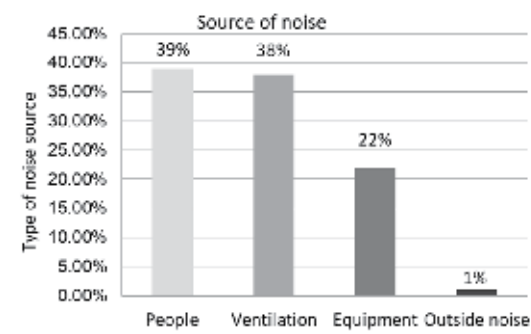
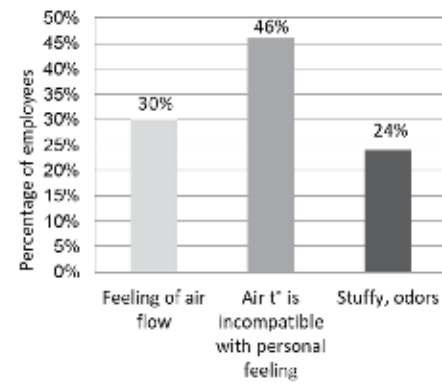

Fig. 6 The reasons for the unpleasant feeling of ventilation, a) and for the noise in working space, b).

Employees experience that sources of noise are mostly people, usually in team offices, as well as ventilation, and less equipment (Fig. 6b). Most employees agree that there is a decreased ability to work in the noise, especially when working on new tasks (Fig. 7).

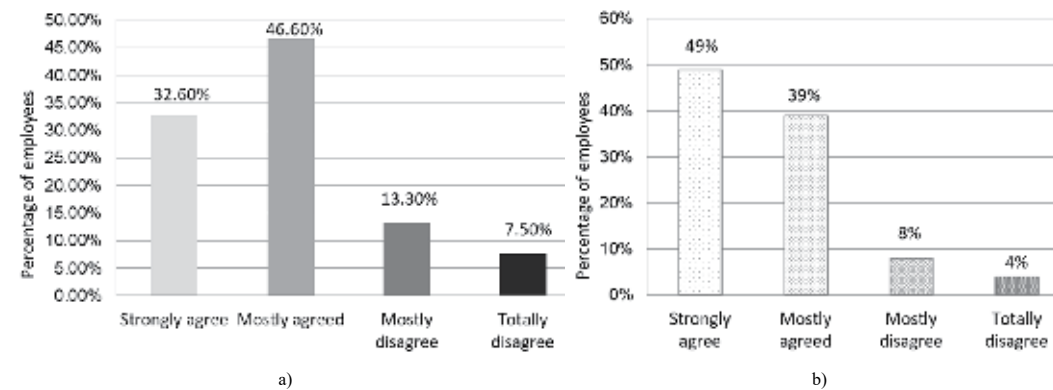

Fig. 7 Employee statement of the impact of noise on working ability, decreased ability to work a), desirable noiseless space for new tasks b).

Some effects of impact of these stressors were analyzed through the survey and correlations between emotional state and periodontal problems observed. The participants, whose responses were associated with unpleasant emotion, noticed the presence of psychological problems and oral cavity problems at the same time. From the aspect of the emotional state of employees, the following cases are selected: normal, borderline abnormal (presence of anxiety and depression) and abnormal (presence of anxiety and depression). Considering the group with normal emotional state 26% reported periodontal problems, while this percentage was 39% in the case of borderline abnormal and 75% in the case of abnormal (Fig. 8).

This consideration was chosen because people with a changed emotional state are less likely to maintain hygiene, which is especially reflected in the oral hygiene and the appearance of rapid manifestations - periodontal problems. Emotional conditions can be associated with comfort conditions, which confirm the importance of integrated design. The fact that emotional states can be associated with comfort conditions confirms the importance of integrated design approach that focuses on meeting a list of objectives related to mitigation of stress generators and thus reducing stress-related illnesses (Fig. 9).

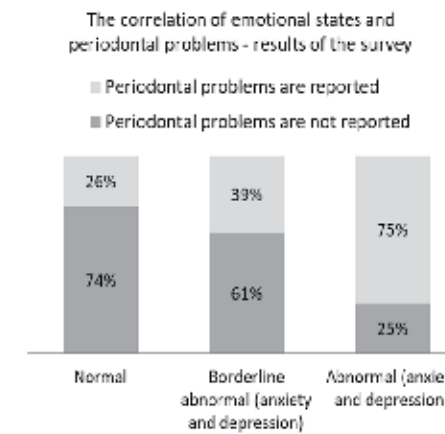

Fig. 8 The correlation between emotional state and periodontal problems

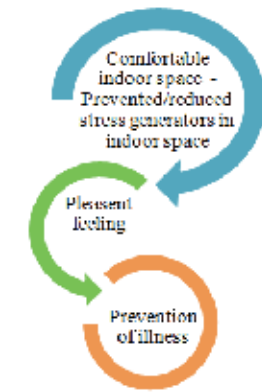

Fig. 9 Mitigation of stress generators reduces stress-related illnesses

3 Conclusion

The purpose of the research presented in the paper was to evaluate how employees assess the achievement of comfort in the case of different office types and facade technologies in order to point out the presence and effects of the stress generators. The applied methodology included the implementation of the questionnaire created by the authors of this paper. Based on the analysis of user assessment of comfort, the paper highlighted the harmful environmental factors that are generators of stress in office spaces. The authors noted that emotional conditions may be associated with comfort conditions.

Based on the analysis of the results of the survey/questionnaire, the following conclusions can be made:

- It has been confirmed that employees have a positive attitude towards the individual control of the indoor environment, they feel comfortable when they have control over room temperature, ventilation and lighting, in other words, employees give priority to the possibility of individually adjusting the indoor environment (as shown in Fig. 3).
- Respondents mostly expressed complete satisfaction with the lighting in the case of the workspace with façade with movable louvres - adaptive façade (as shown in Fig. 4). They attribute importance of aligning the division of space and the distribution of the modules of the shading devices; otherwise, in the case of individual control systems, there may be a problem of synchronization between users, resulting in poor comfort conditions and user dissatisfaction.
- The employees give a positive assessment of the comfort achieved by the presence of natural ventilation, as well as a combination of natural and mechanical ventilation, while the presence of only mechanical/artificial ventilation is negatively assessed (as shown in Fig. 5a). Figure 5b shows that this is in line with employees' assessment of satisfaction with ventilation for different facade.
- It was noticed that the presence of factors that generate stress, i.e. stress generators, is manifested through an unpleasant feeling of users because of unpleasant lighting and ventilation, presence of noise, the inability of individual control of the indoor environment, which challenge stress and changes emotional state. Authors also pointed out in the paper that long term exposure to stress can activate physiological, behavioural, and psychological processes that lead to oral health problems-periodontal problems (survey results presented in Fig 8).

- It can be concluded that the facade affects the indoor space, making it more or less pleasant for users. The facade can modulate light, temperature, ventilation and noise, which represent stress generators, and thus indirectly affect the level of stress. This indicates the complexity of perceiving the impact of the indoor environment on human health.

Through the analysis and presentation of the results of the survey, the authors of this paper pointed to the importance of developing and accepting an architectural design that takes into account the prevention of stress generators in the interior. Also, the intention was to point out that user's feeling of comfort can be one of the key parameters for the assessment and holistic evaluation of adaptive facades as actors in achieving user well-being and a high quality built environment. By connecting the condition of the oral cavity, as a mirror of the psycho-physical state, with the occurrence of psychological disorders, it is possible to recognize the presence of stress generators. Such experiences point out harmful environmental factors and should therefore be taken into account when creating user-friendly guidelines for architectural design. Accordingly, the authors of this paper think that the comfort and well-being of the users behave as related and key measurable indicators for assessing the usefulness of new technologies, such as adaptive facades.

4 Acknowledgment

The research is done within the COST Action TU1403 "Adaptive Facades Network" supported by European Cooperation in the field of Scientific and Technical Research and the scientific research project "Physical, environmental, energy, and social aspects of housing development and climate change—mutual influences"(TR36035), financed by Ministry of Education, Science and Technological Development of the Republic of Serbia.

5 References

- Anshuman, S. (2005). Responsiveness and Social Expression; Seeking Human Embodiment in Intelligent Facades. *Association for Computer Aided Design in Architecture*, 4 (46), 12-23.
- Anttila, S., Knuutila, M., & Sakki, T. (1999). Depressive symptoms favor abundant growth of salivary lactobacilli. *Psychosomatic Medicine*, 61, 508-512.
- Anttila, S., Knuutila, M., & Sakki, T. (1998). Depressive symptoms as an underlying factor of the sensation of dry mouth. *Psychosomatic Medicine*, 60, 215-218.
- Attia, S. (2017). Evaluation of adaptive facades: The case study of Al Bahr Towers in the UEA, QScience Connect, Shaping Qatar's Sustainable Built Environment – 2, 2017:6. <http://dx.doi.org/10.5339/connect.2017.qgbc.6>. Accessed 10 July 2018.
- Attia, S.G., Favoino, F., Loonen, R.C.G.M., Petrovski, A., & Monge-Barrio, A. (2015). Adaptive façades system assessment: An initial review. In: *Proceedings of the 10th Conference on Advanced Building Skins*, 3-4 November 2015, Bern, Switzerland, pp. 1275-1283. Munich: Economic Forum.
- Baker, N., & Steemers, K. (2000). *Energy and environment in architecture: a technical design guide*. Taylor & Francis.
- Basulto, D. (2014). AD Interviews: Bjarke Ingels/BIG, ArchDaily. <https://www.archdaily.com/477737/ad-interviews-bjarke-ingels-big/>. Accessed 10 January 2018.
- CHI, C.A., NEVILLE, W.B., KRAYER, W.J., & GONSALVES, C.W. (2010). Oral Manifestations of Systemic Disease. *American Family Physician*, 82(11), 1381-1388.
- Chrousos, G.P., & Gold, P.W. (1992). The Concepts of Stress and Stress System Disorders Overview of Physical and Behavioral Homeostasis. *Journal of the American Medical Association*, 267, 1244-1252. <http://dx.doi.org/10.1001/jama.1992.03480090092034>.
- Cohen, S., & Rodriguez, M.S. (1995). Pathways Linking Affective Disturbances and Physical Disorders: The Interface of Mental and Physical Health. *Health Psychology*, 14, 374-380.
- Cohen, S., Hamrick, N., Rodriguez, M.S., Feldman, P.J., Rabin, B.S., & Manuck, S.B. (2002). Reactivity and vulnerability to stress-associated risk for upper respiratory illness. *Psychosomatic Medicine*, 64, 302-310. doi: 10.1097/00006842-200203000-00014.
- Conway, L. T., Vickers, R. R., Ward, W. H., & Rahe, H. R. (1981). Occupational Stress and Variation in Cigarette, Coffee, and Alcohol Consumption, Article in *Journal of Health and Social Behavior*, 22(2), 155-165. DOI: 10.2307/2136291.
- Elbaiuomy, E., Hegazy, I., & Sheta, S. (2017). The impact of architectural spaces' geometric forms and construction materials on the users' brainwaves and consciousness status. *International Journal of Low-Carbon Technologies*, 1-9.

- Fissmer, J.F.W., Garanhani, R.R., Sakae, T.M., Traebert, J.L., Filho E.J.S. (2008). Relação entre ansiedade e bruxismo em acadêmicos de odontologia. *ACM Arq Catarin Med*, 37, 25-29.
- Furundžić, Z. N., Furundžić, P. D. & Krstić-Furundžić, A. (2015). Responsibility to the employees' health unavoidable in the creative and innovative design of office spaces. In: Fikfak, A., Vaništa Lazarević, A., Fikfak, N., Vukmirović, M., Gabrijelčić, P. (eds.) *The Proceedings of 2nd International Academic Conference Places and Technologies 2015 – Keeping up with technologies to make healthy places*, University of Ljubljana, Faculty of Architecture, Slovenia, pp. 610-616.
- Holzer, B. (2013). *Architectural Interface: Space – Architect – Humans*. Published in Adreizehn. <http://holzerkobler.com/process/architectural-interface-space-%E2%80%93-architect-%E2%80%93-humans>. Accessed 16 January 2018.
- Huber, M., Knottnerus, J. A., Green, L., Horst, H., Jadad, R. A., Kromhout, D., Leonard, B., Lorig, K., Loureiro, M.I., Meer, J., Schnabel, P., Smith, R., Weel, C., & Smid, H. (2011). *BMJ*. 343:d4163.
- Intrieri, R.C., Jones, G.E., & Alcorn, J.D. (1994) Masseter muscle hyperactivity and myofascial pain dysfunction syndrome: a relationship under stress. *J Behav Med*, 17(5), 479-500.
- Kesikburun, S., Alaca, R., Aras, B., Tuğcu, I., & Tan, A.K. (2014). Botulinum toxin injection for bruxism associated with brain injury: case report. *J Rehabil Res Dev*, 51 (4), 661-664.
- Krantz, D. S., Grunberg, N.E., & Baum, A. (1985). *Health Psychology. Annual review of psychology*, 36 (1), 349-83.
- Lazarus, R. S., & Folkman, S. (1984). *Stress, Appraisal, and Coping*. New York: Springer.
- Loonen, R., Trčka, M., Cóstola, D. & Hensen, JLM. (2013). Climate adaptive building shells: State-of-the-art and future challenges. *Renew Sustain Energy Review*, 25, 483-493.
- Lovallo, W. R. (2005). *Stress & health: Biological and psychological interactions*. 2nd-ed. University of Oklahoma, Thousand Oaks, CA, US: Sage Publications, Inc.
- Manfredini, D., Landi, N., Fantoni, F., Segù, M., & Bosco, M. (2005). Anxiety symptoms in clinically diagnosed bruxers. *Journal of Oral Rehabilitation*, 32 (8), 584-588.
- McEwen, B.S. & Stellar, E. Stress and the individual. (1993). Mechanisms leading to disease. *Arch Intern Med*, 153, 2093-101.
- McManus, S., Meltzer, H., Brugha, T., Bebbington, P.E., & Jenkins, R. (2009). Adult Psychiatric Morbidity in England 2007: Results of Household Survey. The NHS Information Centre for Health and Social Care. DOI: 10.13140/2.1.1563.5205.
- Pearlin, L. I., Lieberman, M., Menaghan, E. & Mullan, J. (1981). The stress process. *Journal of Health and Social Behavior*, 22, 337-356.
- Steemers, K. (2017). Architecture for well-being and health. Daylight, Velux, July 23. <http://thedaylightsite.com/architecture-for-well-being-and-health/>. Accessed 10 January 2018.
- U.S. Department of Health and Human Services. (2000). *Oral health in America: a report of the Surgeon General*. Rockville, Md.: U.S. Department of Health and Human Services, National Institute of Dental and Craniofacial Research, National Institutes of Health.
- Weiner, H. (1992). *Perturbing the Organism: The Biology of the Stressful Experience*. Chicago: University of Chicago Press.
- Zigmond, A.S., & Snaith, R.P. (1983). The Hospital Anxiety and Depression Scale. *Acta Psychiatr Scand*, 67, 361-370. https://www.brainyquote.com/quotes/ernest_dimnet_161039. Accessed 04 February 2018.
- https://www.brainyquote.com/authors/steve_jobs. Accessed 04 February 2018.

Future Façades of Hospital Buildings: A User-Centered Approach to Identify New Performance Requirements

Viktoria Krastel (M.Sc.)^a), Prof. Dr.-Ing. Winfried Heusler ^b), Prof. Dr.-Ing. Klaus-Peter Sedlbauer ^a),

a) Technical University of Munich, Chair of Building Physics, Germany, viktor.krastel@tum.de

b) Schüco International KG, Germany

Nowadays façade design is still substantially based on humans' primary need for shelter and focuses on physical comfort. Aspects with regard to functional and/or psychological comfort seem to play a subordinate role. However, given research shows that environmental misfits do not only occur whenever environmental conditions harm the user physically, but also as the user's functional and/or psychological comfort is impaired. The goal of our research is to identify user-specific environmental misfits that involve the façade and examine whether these environmental misfits can be used to guide the design process towards an appropriate, user-centric façade design that provides physical, functional as well as psychological comfort. In-situ field observations and expert interviews were conducted to collect data. Methods from the field of design thinking, such as persona creation were used for processing the collected data. Using the example of a geriatric inpatient, the results of this work show that all three types of misfits may equally result from direct as well as indirect interaction with the façade, but are always related to users physical and psychological constitution. Thus, environmental misfits can initiate the development towards appropriate façade design, however a generalization across user groups is not effective to do so. On the contrary, effective façade design requires a user-centric approach and therefore, an in-depth analysis of user groups. The paper concludes that A user-centered adaptive façade can be envisioned as a façade that 'recognizes' the user groups in the room, 'analyses' users' present abilities and needs and 'takes action' in order to compensate prevailing environmental misfits considering temporally, occupationally as well as personally varying requirements.

Keywords: Hospital, Adaptive Façade, User-Centered, Global Comfort, Environmental Misfit, User needs, Persona, Interaction, Human-Façade-Interaction, User-Façade-Interaction, Design Thinking

1 Introduction

Dealing with performance optimizations of building façades, a linear chain of argument, which depicts a relation between the entities 'external environment' and 'user', is commonly used. The underlying principle of this argument is the notion of protecting the user within the building from the exterior environment. The entities 'exterior environment' and 'user' are indirectly connected by the entities 'façade' and 'indoor environment' (Fig. 1). According to this chain of argument the exterior and indoor environments get separated by the façade and the user is directly influenced by the resulting indoor environmental conditions.



Fig. 1 Linear chain of argument within performance optimization of building façades

It is well established that the façade influences the interior environment and is decisively responsible for prevailing interior conditions, such as temperature levels, indoor air quality, and use of daylighting. In order to ensure stable indoor environmental conditions in terms of façade design, fundamentally different approaches can be pursued: from massive, static as well as non-technical constructions, e.g. lowtech office building '2226' in Lustenau by Baumschlager Eberle Architects, to dynamic façade designs, e.g. office building 'Al Bahr Towers', Abu Dhabi Island, Aedas architects.

Just as the façade's influence on the indoor environment has been scientifically examined, the many-faceted effect of the indoor environment on the users has also been confirmed. It is a consensus that us humans are influenced by our surrounding environments, both in a physical and a psychological manner. Among others, the review on evidence-based architecture and healthcare design by Ulrich et al. [1] exemplarily illustrates such findings.

However, the effects of a (in)direct interaction between the façade and the user are often underestimated. Following a design approach that is performance-based as well as user-centered, this paper focuses on the relation between the entity 'façade' and 'user'. By using the example of geriatric inpatients, the occurrence of environmental misfits as defined in Vischer's Global Comfort Model (2007) are illustrated and examined whether these can serve as a point of reference for new functions and design features of future hospital facades.

2 State of the Art

2.1. Adaptive Façades

Besides all aesthetic considerations, façade design is still substantially based on humans' primary need for shelter and is optimized to external loads (Knaack, Klein, Bilow, & Auer 2014). Conceptual, technical, and constructive developments in the field of adaptive façades reflect this notion. Adaptive façades, often referred to as 'Climate Adaptive Building Shells' (CABS) (Loonen, Trčka, Cóstola, & Hensen 2013), react to their environment and change their functional properties depending on the prevailing environmental weather conditions (Attia, Favoino, Loonen, Petrovski, & Monge-Barrio 2015). Loonen et al. define adaptive façades as '(...) multifunctional and highly adaptive systems, where the physical separator between the interior and exterior environment, i.e. the building envelope, is able to change its functions, features or behavior over time in response to transient performance requirements and boundary conditions, with the aim of improving the overall building performance.' [6]. The performance of adaptive façades is no longer static over time, but dynamic within different time periods, i.e. within the range of seconds, minutes, day/night change up to seasons, years or decades.

Various conceptual approaches to implementing adaptivity into the façade are currently being pursued in research, e.g. integration of adaptive glazing, phase change materials and shape memory alloys, to name a few technologies. Loonen et al. suggest a comprehensive matrix for the classification of these different approaches [6]. Following this classification scheme, adaptivity can be characterized with regard to the overall objective, such as improved thermal environmental conditions, (overheating, heat loss reductions, etc.), indoor air quality (ventilation, filtration, etc.), visual comfort (view, glare reduction, etc.), acoustic quality (especially airborne sound) or energy performance (loss reduction, energy generation, etc.).

Generalizing across all conceptual approaches, the overall objective of adaptive façades can be summarized as reducing impairing influences of (extreme) exterior fluctuations on the interior environmental conditions. Thus, steady indoor environmental conditions can be ensured and serve as a prerequisite for an effective user-room interaction. 'Steady' should not be misunderstood as 'static', but rather as conditions that do not exceed certain thresholds with respect to frequency and amplitude. Following the adaptive comfort model by de Dear and Brager [7], the user can adapt to this range of environmental conditions through behavioral adjustments and psychological adaptation.

2.2. Performance-Based (Façade) Design

The inherent goal of most design processes – including façade design – is to ensure a well-designed product that serves the user's activities, satisfies additional user needs. As introduced by the International Council for Building (CIB) W60 commission in 1982, the performance concept allows for the implementation of such a need-centered design [18]. The performance approach is about precisely defining the intended product performance, which should be based on user needs. While prescriptive design approaches predefine technical solutions, performance-based design approaches analyze needs and enables a more precise definition of intended behavior and performance. A functional concept, which is worded using common language, states all functionalities required by the user. The functional needs are translated into statements of requirements and subsequently, into performance requirements. The performance requirements formulate the requested functionalities that have to be fulfilled by the construction in the end. Consequently, the targeted performance-in-use serves as basis for all design decisions made within the design process.

By applying a performance based approach to façade design one ensures that user needs are considered appropriately within the façade design. Consequently, façade design and all design decisions primarily need to be about performance rather than aesthetics.

2.3. Indoor Environmental Quality, Global Comfort Model and Performance-Based Design

Within the discipline of building physics, the term "indoor environmental quality" (IEQ) is usually used to address the four major topics of thermal quality/indoor climate, visual and lighting quality, indoor air quality (IAQ) and acoustic quality. Within each topic, differing performance indicators are defined that can be used to measure and evaluate the prevailing conditions. For example, operative temperature, relative humidity, global temperature and air speed, serve as performance indicators for measuring thermal quality. There is a large number of studies and reviews that have examined single aspects of indoor environmental quality. Bluysen [8] as well as the Harvard T.H. Chan School of Public Health [9] provide comprehensive literature reviews. Studies that have investigated the interconnection between various space qualities are rare [10].

The objective of any comfort optimization – regardless of contexts and usage specific boundary conditions – is to maximize the overall level of comfort. Applying Vischer's Global Comfort Model (2007), IEQ as defined within the discipline of building physics, can be referred to as physical comfort. Physical comfort typically addresses health, safety, hygiene and accessibility issues. These requirements are addressed within building codes and can be understood as minimum comfort levels describing habitability thresholds. Indoor environmental conditions that do not fulfill the physical performance requirements lead to an uninhabitable or non-usable building. Consequently, these requirements are mostly universal, addressing general human needs and, therefore, do not necessarily incorporate user-specific abilities or needs.

When capturing the user's experience, one notices that a mere assessment and maximization of ambient environmental conditions in terms of physical comfort is neither sufficient, nor satisfying. In the context of hospital buildings, a growing body of research in the field of 'Evidence-Based Healthcare Design' acknowledges that indoor environmental conditions have a considerable influence on the user's health, well-being and outcomes. These are, for example, safer as well as more healing environments for inpatients and they decrease stress as well as increase effectiveness for staff members [1], [12], [13]. The study conducted by Ulrich [14] examined the influence of viewing nature on patient's postoperative recovery rate, length of hospital stays, perception of pain and pain medication intake, finding that viewing nature instead of brick walls positively influences all outcomes. Therefore, the evaluation of the user's experience requires a global, more complex comfort model. According to Vischer, global environmental comfort ensues as a result of three related, complementary categories of comfort: physical comfort, functional comfort, and psychological comfort [11] (Fig. 2). The three categories of comfort form an analytic framework in order to assess the performance, quality and effectiveness of a built environment (Vischer 2008).

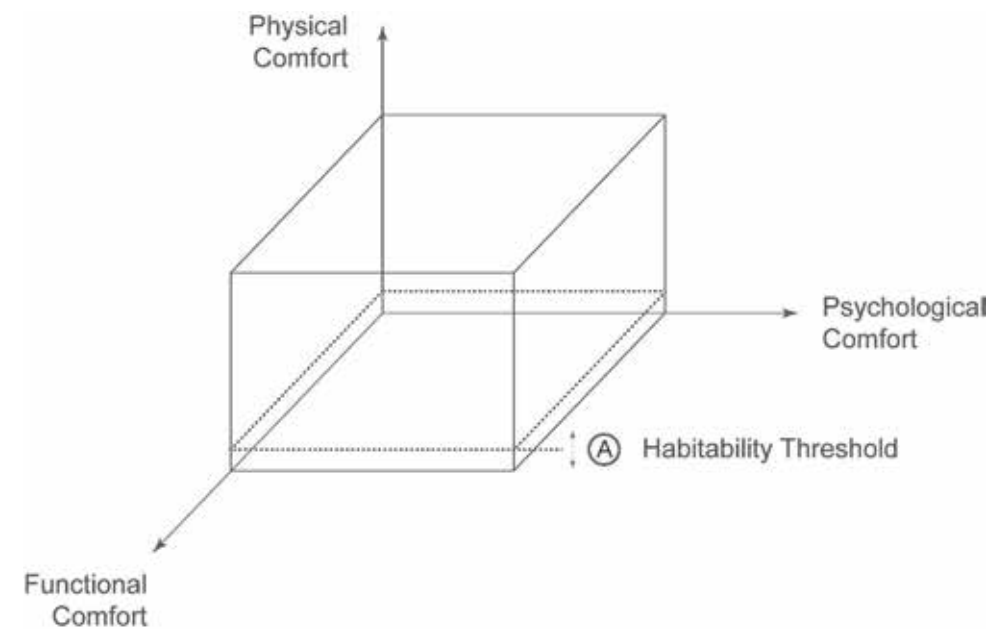

Fig. 2 Global comfort model: modes of comfort and habitability threshold

Functional comfort results from environmental conditions that support the user's task and enhance user performance (Vischer 2007). In contrast to physical comfort and its more generalizing conditions, functional comfort goes along with rather task-, usage- and user-specific conditions. The functional comfort conditions are project-specific and cannot be consolidated across various use cases and scenarios. Within the specialty of (interior) architecture and design, functional comfort poses implications in terms of layout, floor plans, colors, surface materials, visuals, signage, etc. Physical and functional comfort are complemented by the mode of psychological comfort. It expands the dimensions of comfort by feelings of belonging, ownership as well as control issues. While the feeling of psychological comfort is, to a certain degree, dependent on the individual's habits and socialization, some aspects can be shared across user (sub-)groups. In this paper, the aspect of control over an environment and its effects on the perceived comfort level should be emphasized. Following the classification of 'control' by Paciuk, distinguishing between 'available control', 'exercised control' and 'perceived control', Boerstra et al. examined that people who perceive more control over indoor environmental conditions, such as operative room temperature, indoor air quality, and noise levels, perceive the indoor environment as more comfortable [15]. A

User and Post Occupancy Eval

number of other studies confirm these findings (Bluyssen, Aries, & van Dommelen 2011; Boerstra et al. 2013; Brager & Baker 2009). Strongly linked to the aspect of control is the aspect of automation. As the degree of automation increases, the user's participation and control is likely to decrease.

The highest environmental comfort and quality is achieved whenever comfort is simultaneously assured across all three comfort modes; the relevance of each comfort mode depends on the context and the associated usage as well as user-specific conditions. Based on the context, the importance, scope and complexity of comfort requirements varies and the three comfort modes have different shares in global comfort (Fig. 3). For example, the highest hygiene standards (physical comfort) are requested within the context of operating rooms, whereas inpatient rooms set higher requirements in regard to a feeling of belonging and control through the user. While most aspects of physical comfort can be regarded as universally applicable, the specific requirements of functional and psychological comfort can only be generalized to a limited extent. Achieving high levels of functional and psychological comfort requires extensive contextualization with in-depth analysis of user (sub-)groups, including users' abilities, restrictions, dominant activities and needs.

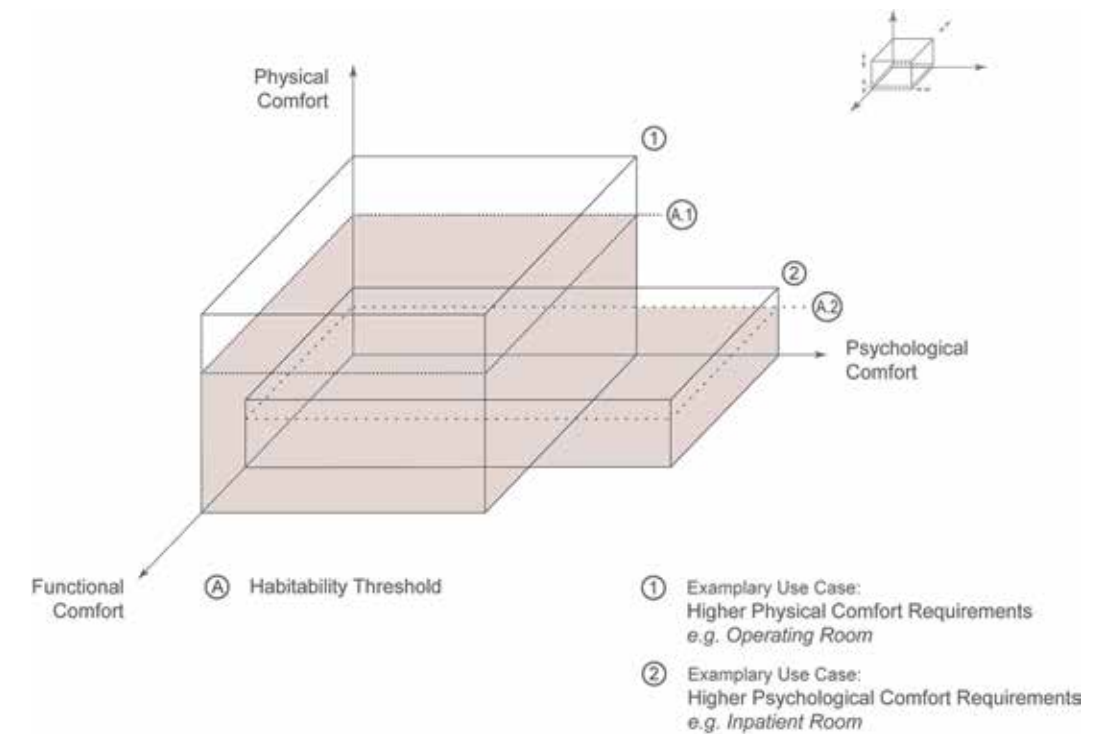

Fig. 3 Two exemplary use cases and their qualitative combinations of comfort modes and variable habitability thresholds

The term 'environmental stress', as used within this paper, can be defined as a consequence of environmental misfit (Vischer 2007). Within the discipline of environmental psychology, 'environmental misfit' defines adverse environmental effects that occur within environments and do not fit the users' abilities and needs, but rather places additional and excessive stress on the user (Vischer 2007).

3 Methods

The focus of this paper is on the interaction of the entities 'façade' and 'user' through examining environmental misfits. Following a human-centered approach, our research's first focus was on identifying the various users within the context of hospital buildings and distilling main user (sub-)

groups. Second, a user analysis followed that examined abilities and restrictions as well as context-specific needs for each user (sub-)group. Third, in order to conclude the phase of problem analysis, the user analysis was broadened by user-specific environmental misfits that occur between façade, room and user.

The process of data collection built on a literature review on indoor environmental quality (IEQ) in hospitals and adaptive façades. Given the research's user-centeredness, the research design was primarily influenced by methods lent from qualitative sociology and frequently applied in Design Thinking, such as expert interviews, in-situ field observation that includes shadowing and 'fly on the wall' approaches, etc. On the one hand, essential data was collected throughout a four-week period of in-situ field observations within two hospitals of a basic and maximum level of care. The field observations covered special hospital services (laboratory, supply and stock), specific departments (emergency, general surgery and diagnostic imaging) and inpatient units (neurology, stroke, intensive care, palliative care, geriatric care, obstetrics and gynecology, and emergency room). On the other hand, data was extended through semi-structured expert interviews with members of various stakeholder groups, such as healthcare professionals as well as architects and digital health experts. While the field observations allowed for the identification of implicit user needs and environmental misfits, the expert interviews were used to focus on explicit user needs, future developments and more general design recommendations.

Methods from the field of design thinking were also used for processing the collected data. Based on the resulting observation protocols, photos taken on-site as well as interview notes and recordings, data were analyzed in the form of personas. Personas are fictitious representatives of a user group and contain information on the background of the user, outline characteristics and daily experiences, including special needs, scope of abilities and mobility. Persona profiles were developed for all relevant user (sub-)groups; in terms of interaction profiles differentiating between extreme and mainstream users. Subsequently, data analysis was completed by listing environmental misfits for each persona.

4 Results

4.1. Users within Hospitals

In Germany there are 1,956 hospitals, ranging from basic to maximum care facilities, providing 499,351 beds for inpatient treatment, treating 19.2 million patients per year and employing 1.8 million employees, 17.8% in medical services (Statistisches Bundesamt 2016). Hospitals can correctly be compared to small cities and are characterized by their immense complexity that increases with the hospital's level of care. In general, hospital buildings are subject to mixed use modes, combining workplace, diagnosis, therapy and nursing spaces as well as hospitality and accommodation. This mixed-use mode results in a large number of diverse users. For one thing, user diversity is evident in different functional requirements, but manifests itself in the differing initial conditions under which users encounter the building. While physicians and nursing professionals regularly enter the hospital as their workplace, for patients, staying in a hospital is associated with stress. These different circumstances result in different levels of familiarity with the environment and require different assistance with orientation.

Functional zones	Functional units
Diagnostics and therapy	Emergency room
	Laboratory
	Operating room
	Diagnostic imaging
	Delivery room
Care	General care
	Maternity and neonatal care
	Infant and pediatric care
	Intensive care
	Geriatric care
	Palliative care
General services	Cafeteria
	Changing room
	On-call service
Other facilities	Integrated outpatient facilities

Table 1: A hospital's relevant functional zones and units, in accordance with DIN 13080 terminology and classification

Despite all hospitals' complexity and mixed-use mode, across hospitals there are common zones that are correlated with certain user groups. Usually, there are three main departments - surgery, internal medicine and gynecology -, which treat about two thirds of patients and diseases (Statistisches Bundesamt 2016). In accordance with the terminology and classification of DIN 13080 [20], most important functional zones and units are listed in Table 1.

Within each of these functional zones and subordinated functional units, representatives of the main user groups – patients, caregivers and medical professionals – are present. Depending on the functional unit, special subgroups of users are present (Fig. 4).

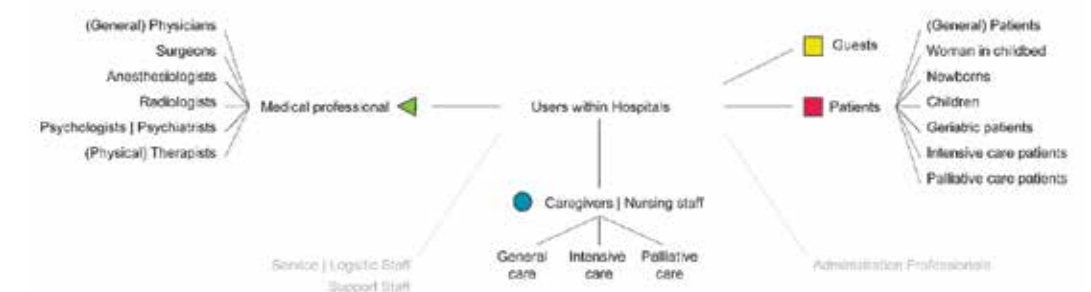

Fig. 4 Groups of users within the context of hospitals

4.2. User-Analysis: Persona of a Geriatric Inpatient

Not all user groups are depicted within this paper; the dissertation in the context of which this paper was created, will comprehensively provide the user analysis for different user groups. Within this paper, an exemplary persona depicts a representative geriatric inpatient (Fig. 5). As demographic change in western societies is causing inpatients to become increasingly older, the average patient is already 55 years old and the majority of patients are over the age of 60 (Statistisches Bundesamt 2016). Geriatric patients bring about special challenges for hospital environments: Their perception of the environment differs significantly from that of younger patients and hospital-specific symptoms, e.g. Delir, which otherwise play a subordinate role, are a non-negligible issue. Elderly people, especially those suffering from dementia, may be considered an extreme group of users who place special demands on their surrounding environment. Fig. 6 shows two photographs that give an impression of the situation a geriatric inpatient experiences within the hospital context and the geriatric ward.

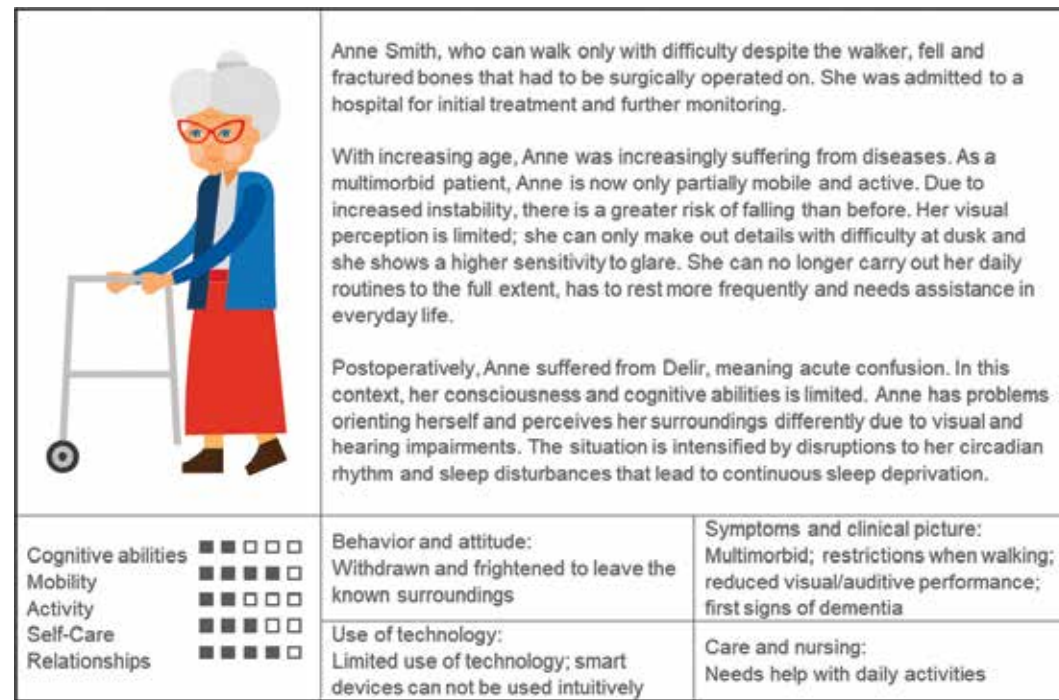

Fig. 5 Exemplary persona of a female geriatric inpatient



Fig. 6 a) Bed-ridden patient with physiotherapist and b) continuously closed curtains within an inpatient

4.3. Environmental Misfit of Geriatric Patients

Table 2 provides different environmental misfits that can occur to a geriatric patient within an inpatient room. In many cases, there is not one unambiguous assignment of a particular comfort mode possible, but rather several modes are impacted. Misfits as results of different causes are included: (a) directly by the façade, e.g. sun protection, (b) from indoor conditions, e.g. room temperature, that are directly linked to existing façade functions and (c) such conditions that are not directly linked, e.g. orientation.

The data show that while geriatric patients in hospitals face environmental misfits in terms of all three modes of comfort, misfits in the mode of functional comfort are predominant. It is noteworthy that the inability to control or interact directly with the façade leads to a multitude of environmental misfits. In the context of hospitals, environmental misfits can not only cause stress in the user interacting directly with the environment but can also lead to stress in indirectly involved parties that help the user cope with the misfit, such as nurses helping patients.

Environmental Misfit	Physical Comfort	Functional Comfort	Psychological Comfort
¹ The lack of mobility up to being bedridden prevents access to the façade.		x	
² The lack of mobility that results in limited access and control over the interior conditions increases the feeling of independency and being at the mercy of others. Help by nurses is required.			x
³ Due to the use of assistive equipment, such as walkers, hands are not free to grip window handles. Free hands are accompanied by a moment of insecurity and loss of stability.		x	
⁴ Window handles are not recognized as such by dementia patients, i.e. they lack affordance and result in windows that cannot be operated by patients.		x	
⁵ Insufficient window ventilation leads to poor indoor air quality, feeling of stuffy air and basis for the spread of infection.	x		
⁶ Too high of temperatures in combination with a lack of ventilation lead to dry room air, i.e. low relative humidity.	x		
⁷ High solar radiation through the glazing leads to high temperatures, especially when the windows cannot be opened independently.	x		
⁸ Closed curtains and no connection to the exterior make orientation in time more difficult. The assessment of times of day, but also seasons, is becoming increasingly difficult for the patient and can lead to sleep deprivation.		x	
⁹ Patients show an impaired day and night rhythm, which is additionally worsened by poor lighting conditions and background noise.	x	x	
¹⁰ Orientation in the hospital, especially when transferring from in-patient wards to therapy and examination rooms, presents a challenge and often leads to patients getting lost.		x	x
¹¹ Patients experience a lack of familiarity with the room and lack individual design options that create a homely feeling.			x
¹² Patients lying in bed cannot see directly outwards because the window's sill is too high.		x	
¹³ The limited view from the bed or the room by lack of mobility prevents access to and a view of the outdoors and nature.		x	
¹⁴ At night and in the dark, reflections of light in floor-deep glazing can cause irritation, especially in patients with dementia.		x	
¹⁵ Shadows thrown by the shading system lead to irritating patterns on the floor that obstruct movement and prevent one from walking.		x	
¹⁶ Patients have the feeling that it is too dark in the room more quickly. Levels of illumination are perceived as too low.	x	x	
¹⁷ Strong variations in brightness in the immediate proximity to the façade and deeper in the room cause difficulties in orientation and movement. A hard edge of light is particularly disturbing.	x	x	
¹⁸ Patients are sensitive to glare and even small degrees of glare can cause discomfort.		x	
¹⁹ In multi-bed rooms high illumination levels directly at the window and lower levels deeper in the room lead to a disadvantage of those patients who are accommodated further away from the façade.	x		

Table 2: Environmental misfits occurring in geriatric wards for geriatric inpatients

5 Discussion

In the results chapter, the specific group of geriatric inpatients as well as the relation between the characteristics of this user group and the occurrence of environmental misfits were illustrated. It should be noted that the list of environmental misfits refers to this particular persona and thus can only be transferred to other user groups to a limited extent. With regard to the transferability of the results, it is necessary to keep in mind that the data collection was not carried out as a representative study, but is rather of a case-study character examining two hospitals of different

sizes and care levels. Also, another aggravating factor within hospitals is that individual groups of people, especially palliative patients or intubated patients in intensive care units, cannot be interviewed personally. For such cases, observation in the field is the only tool used to collect data.

Patients are not patients: The persona of a geriatric inpatient showed that, while speaking about user groups, patients are not patients. A generalization across user groups, meaning generalizing across all patients and referring to them as 'patients', is not effective. The general constitution of body and mind differs widely between different user groups. When compared to middle-aged elective patients, geriatric patients show distinctly different conditions in terms of mobility, cognitive abilities and help needed. For example, while middle-aged elective patients usually do not struggle with 'Delir', this clinical picture stands for geriatric patients.

Impaired abilities can result in environmental misfits: Physical and psychological differences have a significant influence on the environmental misfits the individual user groups encounter. One can say that the prevailing environmental misfits are resulting from the users' general conditions. A direct correlation between a persona's specific abilities as well as constitution and the prevailing environmental misfits is given. For example, the lack of mobility in geriatric inpatients leads to the misfit of impaired interaction with the façade. This impairment of interaction in turn effects the already impaired day and night rhythm of geriatric inpatients as constantly closed curtains, high window sills and insufficient window openings further amplify the phenomenon. Thus, in order to address the relevant environmental misfits, an in-depth analysis of user groups needs to include an identification of key user groups as well as an analysis of main user differences in terms of abilities and limitations.

With regard to geriatric inpatients environmental misfit does not only occur in terms of physiological comfort, but especially to a functional and psychological degree. Besides the three different modes of comfort, environmental misfits can occur directly due to the façade's construction, e.g. high solar transmission, non-operable windows. Second, one can also consider environmental misfits that are not immediately or only partly caused by the façade, but however can be improved by appropriate façade design. The exemplary loss of orientation when transferring between hospital zones can be used to illustrate such mediate misfits. To put in a nutshell, on the one hand inappropriate façade design can result in intermediate environmental misfits; on the other hand, appropriate façade design can help reduce mediate misfits.

Appropriate façade design by rewriting environmental misfits into new functionality:

Using 'the Vischer terminology' it can be said that well-designed facades need to serve all user's requirements in terms of physical, functional as well as psychological comfort by reducing façade-direct and mediate environmental misfits. Thus, environmental misfits can guide the design process and provide a starting point for translating user needs into performance requirements and for initiating the development of new functionalities as well as a more need-oriented design of the façade. While physiological comfort gets already comprehensively addressed by prescriptive design approaches, such as normative rules in building codes and standards, functional and psychological environmental misfits provide the biggest leverage for context and user specification and, thus, an increase of comfort and usability of a façade's design. Trying to solve functional and psychological misfits on a façade-direct and/or a mediate level allows for expanding the potential functional scope far beyond the so far existing functional scope of the façade. However, this requires an evolution of the performance-based design approach towards an even more user-centered understanding of performance. Especially the explicit consideration of functional and psychological comfort aspects represents a significant broadening of the performance concept. For example, a façade that provides orientation and navigation while transferring from one room to another represents a new

façade functionality. In this example, performance is understood as providing functional as well as psychological comfort to the geriatric inpatient.

User-centric scope of functionality: By using the example of a geriatric inpatient, it was made apparent that a generalization across all patients is not effective when designing facades that are intended to sufficiently support user-specific abilities and limitations. The strongly varying abilities of subgroups, as geriatric patients, and the resulting user-specific sets of environmental misfits require need-specific façade design in order to provide sufficient support. The functionality and features need to be specifically designed for a certain group of end users and their misfits. Referring to our example, when interacting with the façade geriatric inpatients are often handicapped, which in turn requires additional forms of interaction suiting these impaired abilities. Additional mechanisms in easily accessible places or operable by voice or gesture in order to control and interact with the façade need to be considered. A user-centric scope of façade functionality that responds to users' scope of abilities is needed.

Additional façade adaptivity in terms of user-centricity: As hospitals can metaphorically be compared to small cities, the spaces are characterized by the simultaneous presence of different user groups with various constitutions, different purposes for using the indoor environment and concurrence of different requirements for global comfort. In order to address this challenge, an additional façade adaptivity in terms of user-centricity is suggested. The term adaptivity might not be misunderstood and requires clarification. In contrast to adaptivity as in climate adaptive facades, user-centric adaptivity inevitably is triggered by the changing users within a room. A user-centered adaptive façade can be envisioned as a façade that 'recognizes' the user groups in the room, 'analyses' users' present abilities and needs and 'takes action' in order to compensate prevailing environmental misfits considering temporally, occupationally as well as personally varying requirements. This notion of user-centered adaptivity is strongly linked to interaction and matched levels of automation. While the degree of automation depends for the most part on the abilities of the various user groups, interaction can be immediate between the façade and direct users (human-façade-interaction, HFI) or between the façade, the room and its object, such as e.g. the hospital bed or furniture.

6 Conclusion

Focusing on the relation between the entity 'façade' and 'user', the paper analyzed in an exemplary manner the relevant sub-user group of geriatric hospital inpatients. In order to identify new and necessary performance requirements of future hospital facades a user-centered approach was developed. The approach includes an in-depth analysis of user abilities and the identification of corresponding environmental misfits in terms of physical, functional and psychological comfort. The results show that a generalization across user groups or sub-user groups, such as patients, is not effective and leads to façade designs that increase the presence of environmental misfits. In fact, the prevailing environmental misfits can be used to guide the design process and derive user-specific functions that increase the façade's user-centered performance. The translation into performance requirements is still a subject of research.

7 References

- [1] R. S. Ulrich et al., "A Review of the Research Literature on Evidence-Based Healthcare Design," *Heal. Environ. Res. Des. J.*, vol. 1, no. 3, pp. 61–125, 2008.
- [2] J. C. Vischer, "Towards a user-centred theory of the built environment," *Build. Res. Inf.*, vol. 36, no. 3, pp. 231–240, 2008.
- [3] U. Knaack, T. Klein, M. Bilow, and T. Auer, *Façades: principles of construction*, 2nd ed. Basel: Birkhäuser, 2014.

- [4] R. C. G. M. Loonen, M. Trčka, D. Cóstola, and J. L. M. Hensen, "Climate adaptive building shells: State-of-the-art and future challenges," *Renew. Sustain. Energy Rev.*, vol. 25, pp. 483–493, 2013.
- [5] S. Attia, F. Favoino, R. Loonen, A. Petrovski, and A. Monge-Barrio, "Adaptive façades system assessment: An initial review," *Adv. Build. Ski.*, no. November, pp. 1265–1273, 2015.
- [6] R. C. G. M. Loonen et al., "Design for façade adaptability – Towards a unified and systematic characterization," *Proc. 10th Conf. Adv. Build. Ski.*, pp. 1284–1294, 2015.
- [7] R. J. de Dear and G. S. Brager, "Indoor Environmental Quality (IEQ) Title Developing an adaptive model of thermal comfort and preference," *ASHRAE Trans.*, vol. 104, pp. 1–18, 1998.
- [8] P. M. Bluyssen, *The Indoor Environment Handbook*, vol. , no. 3, 2012.
- [9] Harvard T.H. Chan School of Public Health, "The 9 Foundations of a Healthy Building," *Sch. Public Heal.*, 2017.
- [10] M. Frontczak and P. Wargocki, "Literature survey on how different factors influence human comfort in indoor environments," *Build. Environ.*, vol. 46, no. 4, pp. 922–937, 2011.
- [11] J. C. Vischer, "The effects of the physical environment on job performance : towards a theoretical model of workspace stress," *Stress Health*, vol. 23, pp. 175–184, 2007.
- [12] M. Rashid and C. Zimring, "A Review of the Empirical Literature on the Relationships Between Indoor Environment and Stress in Health Care and Office Settings: Problems and Prospects of Sharing Evidence," *Environ. Behav.*, vol. 40, no. 2, pp. 151–190, 2008.
- [13] A. S. Devlin and A. B. Arneill, "Health Care Environments and Patient Outcomes: A Review of the Literature," *Environ. Behav.*, vol. 35, no. 5, pp. 665–694, 2003.
- [14] R. S. Ulrich, "View through a window may influence recovery from surgery," *Science (80-)*, vol. 224, no. 4647, pp. 420–421, 1984.
- [15] A. Boerstra, T. Beuker, M. Loomans, and J. Hensen, "Impact of available and perceived control on comfort and health in European offices," *Archit. Sci. Rev.*, vol. 56, no. 1, pp. 30–41, 2013.
- [16] G. Brager and L. Baker, "Occupant satisfaction in mixed-mode buildings," *Build. Res. Inf.*, vol. 37, no. 4, pp. 369–380, 2009.
- [17] P. M. Bluyssen, M. Aries, and P. van Dommelen, "Comfort of workers in office buildings: The European HOPE project," *Build. Environ.*, vol. 46, no. 1, pp. 280–288, 2011.
- [18] R. Becker and G. Foliente, "Performance Based Building International - State of the Art. PeBBu 2nd International SotA Report," Rotterdam, 2005.
- [19] Statistisches Bundesamt, "Statistisches Bundesamt: Gesundheit, Grunddaten der Krankenhäuser," 2016.
- [20] DIN Deutsches Institut für Normung e.V., DIN 13080. Gliederung des Krankenhauses in Funktionsbereiche und Funktionsstellen. 2016.

Responsive facades evolution: the microscale to the macroscale

John E. Villegas a) b), Juan Camilo Restrepo Gutierrez a), Henry A. Colorado b)

a) Materials research group, Architecture School, Universidad Nacional de Colombia, Medellin, Colombia, joerodriguezvil@unal.edu.co

b) CCComposites Lab, Engineering School, Universidad de Antioquia (UdeA), Calle 70 No. 52-21, Medellin, Colombia

This decade has beheld significant advancements in adaptive and multifunctional facade systems through the incorporation of smart materials, which do not need an additional energy supply because they are kinetic systems. This work is driven by transposition of properties from the microscale to the macroscale realized by architects through the hand of the state of the art technology of material science and engineering to improve building performance. This article presents an introduction to the building envelope and the active system developed in the last decades, then a comprehensive review of passive and adaptive facade systems is performed through new tables and figures. The study is focused on the systems which use smart materials with shape memory features reported in the last decade. The current progress in their incorporation to enhance buildings adaptation to its environment are discussed as well as, advantages and disadvantages, limitations and future research directions.

Keywords: Responsive facades; Adaptive facades; Passive protocol; smart material

1 Introduction

Architecture has had evolved and developed to satisfy human and city necessities since its origin. Every day new essentials in addition to severe weather changes need to be taken into consideration by designers to ensure the comfort of the building. In the last decade, this process has taken interest by the scientific community and the construction industry due to the complexity of the "modern life" and their impacts on the environment (Brager and de Dear 1998). For those reasons in response to these fluctuating variables, the architecture needs to adapt permanently to satisfy these needs.

The buildings adaptation as the relationship between architecture and the environment is through its envelope, the element which limits the inside and the outside (Douglas 2006), design to afford comfort and security inside buildings. It's a crucial component that relates the buildings aesthetics with its internal environment. Like the skin is to the human body, an envelope has the responsibility to regulate internal physical conditions (Koçlar et al. 2004). Since the last century, it has become a lightweight and flexible component, instead of robust and heavy system, to improve its performance (Sadineni et al. 2011). These buildings' systems are being developed together with disciplines such as materials science and engineering achieving every time more interactive and efficient interface (di Salvo 2016; Fortmeyer and Linn 2014).

This review article addresses the systems and materials used in the building's adaptation to the environment in concordance with the state of art technology of last decades. Methods, structures, as well as, experimental projects and remarkable examples focused on the facade or the architectural envelope are highlighted. A brief overview of facade development in the last century is introduced, and passive dynamic systems as the most promising research direction are presented.

The reported systems are classified, described and analyzed by every variable of control and the physical or chemical principle followed to obtain a dynamic response.

2 Responsive building facades

Until recent times the attention to improving a building's envelope was focused on increasing thermal insulation. Nevertheless, those systems are not enough to solve the efficiency challenges in the nowadays buildings (Perino and Serra 2015) because of the remarkable use of glass and the increasing of additional energetic dependence on HVAC systems after the modern architecture movement.

A noticeable change on architectural skins appeared during the second half of the XX century by some postmodern architecture movements (Bertens 1996). Systems equipped with sensors, processing units, and actuators that can be programmed and have the ability to answer to real-time weather conditions were incorporated into the envelope. These systems allowed the obtention of a new dynamic interface between the building and their surrounding environment (Henriques 2015). They are based on Data Acquisition Systems (DAS) of a closed loop protocol (Hoover and Rempfer 2015), based on an integrated system where the stimuli are sensed, and their processing is used as a control device.

The versatility of the DAS protocol has been demonstrated in the last decades, as seen in several building active facades (AEDAS 2012; Giselbrecht 2007; Godsell and Franklin 2012; JSWD Architekten and Chaix & Morel et Associés 2010; Nouvel 1987; SOMA 2012), which enables the development of systems with different kind of actuators (mechanical, pneumatic, and hydraulic). Broad-Spectrum envelope materials and sizes from brise-soleil unto laminar structures of some floors have been used. Moreover, multi-layer systems have been used to achieve a real-time response to solar radiation and outdoor temperature firstly (Aelenei et al. 2016), because of their influence on thermal and visual comfort.

Nevertheless, all of them requires, firstly an external electric current source to operate (Hasselaar 2006), and secondly, they are made of mechanical systems with multiple components with high maintenance rate. Both conditions take these active systems to a rapid state of obsolescence (Meagher 2014), for instance, the Arab World Institute, 70's pioneer building, where the active elements on the envelope were abandoned a few years after the project opened because of the burdensome maintenance. For these reasons, current research developments of building envelopes are focused on more efficient systems exploring flexible and jointless solutions with no electronic components by the hand of other disciplines.

2.1. Passive responsive facades

Even when active systems changed the conceptualization of architectural envelopes in the second half of the XX century and continued being used nowadays, the energy supply dependence and obsolescence triggered a new change on the perspective of the building skins development (Ogwezi et al. 2011). So that, now to translate properties from nano- to macro-scale is the new challenge to architecture as a discipline to adapt in a passive way (Ng 2013), by the hand of material science and engineering as an active member of this multidisciplinary development (Momoda n.d.), this work has been focused on the research and application of smart materials with a reversible change in shape triggered by external activation, these systems come as a response due to the increase in energy demand in buildings by the use of HVAC systems.

A hierarchical classification of this materials can be seen in Fig. 1, Ritter (2007) proposed a classification of smart materials by their use in architecture and a brief overview was done, but it was not focused on shape memory properties, and a review of the new reports must be done. It is based on the study and application of materials from microscopic to the macroscopic scales, presents kinetic systems that can move without motors, electricity or mechanical parts improving buildings' performance (Maragkoudaki 2013).

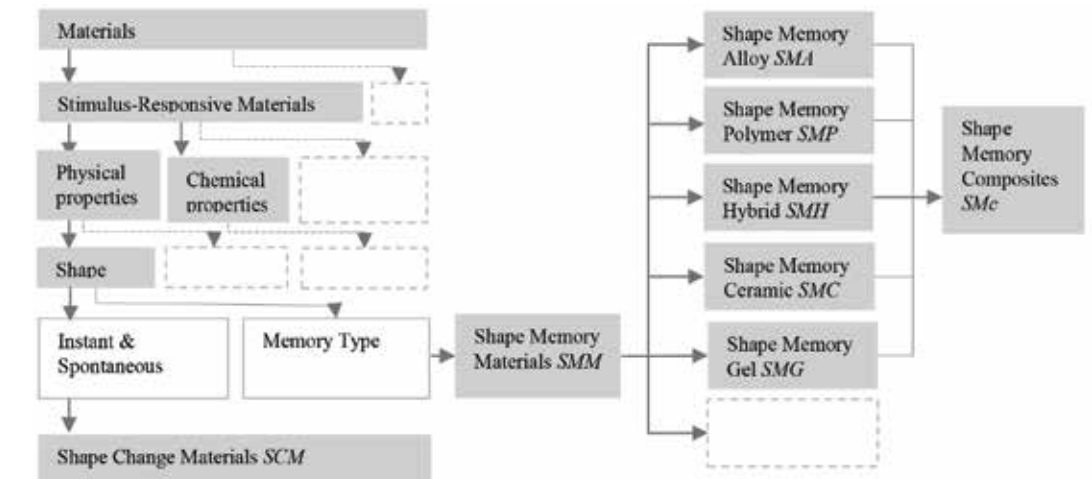

Fig. 1 Hierarchical location of stimuli-responsive materials on the materials world. Adapted from(Sun et al. 2012).

In accordance with Kolarevic and Parlac (2015), passive systems of dynamic activation that works with intrinsic properties of materials are perhaps the most promising direction for the development of adaptive building envelopes. Hence, at this moment building envelope can be considered a protective barrier just like the skins is for the human beings, this kind of systems can take buildings to an autonomous homeostatic state without additional energetic sources and be able to adapt to their specific environment.

3 Passive responsive activation protocols

Building performance can be improved with the use of passive systems to reduce energy consumption levels, and greenhouse gas emissions can be decreased (Kim Sung 2008), new dynamic building interfaces that control outdoor conditions (Doumpiotti 2011). Prior to the application in buildings, performance prediction must be made (Loonen et al. 2017), nevertheless this field is in an early stage. New developments must be focused on the integration of design, material selection and operational features (Aksamija 2016) because of the substantial differences between active and passive kinetic systems.

In active systems sensors and actuators are part of an integrative system, but in the case of passive ones they are the system by itself, for this reason, they do not follow a general activation protocol it is relative to the each material's properties, because from microscopic to macroscopic scale they merge sensing and actuating functions (Drossel et al. 2015).

Nano- and smart-materials application into architecture and building as a new field have been classified by (Daveiga and Ferreira 2005 ; R.C.G.M. Loonen et al. 2015 ; Bahar BASARIR and M. Cem ALTUN 2017 ; Fiorito et al. 2016). Despite those classifications, in architecture skins these systems are being used to control physical variables, for this reason, the classification of the newest reports is done by control weather variables and the chemical or physical protocol followed

by the material proposed to achieve it. As can be seen in table 2, the passive systems reported are listed and then break down by each protocol of activation.

Variable	Protocol	Class / effect	Material	Author	
Humidity/Rainwater Control/ Airflow Control			Co-polyester composite with high cellulose content	(Correa Zuluaga and Menges 2015)	
			<i>Fagus sylvatica</i> veneer - Polyethylene Terephthalate	(Nicola Augustin 2018)	
			<i>Lime</i> veneer - nylon - plastic	(Chao 2015)	
			<i>Birch</i> veneer - Epoxy resin- Fiberglass textile	(Torres 2014)	
			<i>Fagus sylvatica</i> , <i>Acer pseudoplatanus</i> , <i>Picea abies</i> veneer - polyurethane HBS309 / HB-S709 Henkel®	(Wood et al. 2018)	
	Hygroscopy	Shape memory Hybrid	<i>Picea abies</i> , <i>Fagus sylvatica</i> veneer - polyurethane HB-S709, Henkel	(Vailati et al. 2018)	
	Hydrophilicity			Sodium Polyacrylate	(Y. Kyriakou et al. 2016)
				Sodium Polyacrylate 1mm powder, 7mm Crystals, 20 mm Spheres - Clay - Rubber	(Mitrofanova et al. 2014)
				Sodium Polyacrylate - Gelatin - Glycerin - Elastic hydrophobic fabric	(Ayala Castro et al. 2017)
				Shape memory Gel	
Shape memory Hybrid				Silicon - Latex - Expanding Hydromorph composite	(Roth 2015)
Temperature / Air flow control / Heat-gain control	Differential Thermal Expansion	Shape memory Hybrid	Thermobimetal strips	(Garcia Garcia et al. 2014; Kim Sung 2008)	
	Reversible non-diffusional phase-change	Shape Memory Alloy	Nickel-Titanium NiTi	(Abdelmohsen et al. 2016; Diniz et al. 2007; Formentini and Lenci 2018; Gonzales and Shreyas 2015; Jun et al. 2017, 2015; Khoo et al. 2011a, 2011b; Khoo and Salim 2013, 2012; Sushant and Pradeep 2014; Verma and Devadass 2013)	
Sunrays / Heat-gain control	Reversible non-diffusional phase-change	Thermo-chromic effect	Al-doped VO ₂	(Ji et al., 2018)	
			VO ₂ -ZnO	(Zhu et al. 2018)	
			VO ₂ Single Crystals W- and F-doped VO ₂ VO ₂ /SiO ₂ composite	(MacChesney and Guggenheim, 1969) (Burkhardt et al. 1999) (Cao et al. 2017)	
Sunrays / Heat-gain control	Reversible non-diffusional phase-change	Thermo-chromic effect	VO ₂	(Costanzo et al. 2016; Hoffmann et al. 2014; Lee et al. 2013; Seyfour and Binions 2017; Yang et al. 2018)	
			W- VO ₂	(Liang et al. 2017)	
			Zr-doped VO ₂	(Lu et al. 2017)	
			Eu/Tb/W- codoped VO ₂	(Wang et al. 2017)	

Table 1: Passive control systems reported

Products and Materials

Variable	Protocol	Class / effect	Material	Author
Sunrays / Heat-gain control	Reversible non-diffusional phase-change	Thermo-chromic effect	Hydroxypropyl cellulose	(Allen et al. 2017)
			Crosslinked polymer	(Allen et al. 2017)
			WO ₃ - O ₂ /Ar - H ₂ /Ar	(Feng et al. 2016)
			Thermochromic pigments	(Bhaktavatsala 2015)
			Waxes, Paraffin, Salt hydrates	(Bianco et al. 2018; Pascha 2008)
			Shape-stabilized PCM	(L. Li et al. 2016)
			Paraffin wax/expanded graphite	
			Paraffin wax/polyurethane	
			1-Tetradecanol	(L. Li et al. 2016)
			Hexadecanol	
Sunrays / Heat-gain control	Phase-change	Latent heat thermal energy storage	Caprylic acid	
			Capric acid	
			Butyl Stearate	
			Capric-stearic acid/White Carbon Black	(Liu et al. 2018)
			Paraffin	(Fateh et al. 2018; Lee et al. 2018)
			Paraffin / polymeric matrix	(Royon et al. 2014)
			MgCl ₂ ·6H ₂ O / CaCl ₂ ·2H ₂ O	(Erlbeck et al. 2018)
			1-Tetradecanol / bisphenol A /Wood	(Yang et al. 2018)
			Paraffin-wax capsule / Concrete matrix	(D'Alessandro et al. 2018; Laura Pisello et al. 2017; Leang et al. 2017)
			Organic paraffin	(Rao et al. 2018)
Sunrays / Heat-gain control	Attraction-repulsion electrostatic forces	Shape memory Hybrid	Paraffin MG29	(S. Li et al. 2016)
			Azobenzene dopant - Paraffin /Wax	(Han et al. 2017)
			Elastomer- Corrugated Silver Electrodes	(Decker 2013)
			VHB Elastomer / Carbon Black / Silicone - Cooper electrodes	(Decker 2017; Franzke et al. 2016; Joucka, 2016; Kretzer, 2010; Kretzer and Rossi 2012)
			EAP/PET/ETFE	(Biloria and Sumini 2009)
			Alumina	(Khoo et al. 2011b)
			W oxide /Ni oxide	(Azens and Granqvist 2003)
			Sage® Glass	(Sbar et al. 2012)
			WO ₃	(Lee and Tavitl 2007)
			Polyurethane	(Beites 2013)
Light / heat-gain control	Elongation Induced by thermal transitions	Shape memory polymer	Veritex® SMP	(Arnellou et al. 2015; shambayati et al. 2014)
			Polyolefin shrink tape	(Tang et al. 2016)

Table 1 cont.: Passive control systems reported

Physic Variables, protocol, and materials used by passive responsive systems. Current uses and experimental proposals in architecture. It does not mean that other variables which affect building comfort cannot be controlled with this kind of passive responsive systems.

3.1. Humidity passive control systems

3.1.1. Hygroscopic-based protocol

Hygroscopy is the ability of physical systems to absorbed humidity from the environment or gives it back. Systems that attract water such as steam or liquid from their medium are hygroscopic. Wood is a material with that feature through the cellulose as its constituent; it can attract water molecules from the environment when it is dry and give them to the environment when it is wet to

be in equilibrium (Skaar 2012). Hygroscopy properties of different classes of wood were evaluated by Samuel V. Glass and Samuel L. Zelinka (2010).

This property is usually seen as a disadvantage for building materials, so thermal treatment was elaborated to study its effect on the hygroscopic properties of some wood species to inhibit it to react with moisture (Kamperidou et al. 2013). Nevertheless, the cellular structure and the wood fiber orientation allow a dimensional change up to 10% in the grain perpendicular orientation (Dinwoodie 2000). Expansion and contraction in a specific direction can be obtained by anisotropic deformation controlled by cell wall architecture through cellulose swelling and shrinkage (Burgert and Fratzi 2009). In this way, changes in the cellulose volume by humidity exchange allows movement, for instance, the pine cone scales hydrated/dried behavior (Le Duigou and Castro 2016) is presented in Fig. 2.

Recently by this protocol different authors have reported the application of hygroscopic properties on buildings passive control (Marshall 2015 2010; Ogwezi et al. 2013). As remarkable examples, three types of individual laminate pieces systems with specific fibers direction were reported as a principal component to obtain moisture responsive with autonomous movement. On the one hand, architectural skin with closed modules under low humidity conditions and open modules under high humidity conditions as can be seen in Fig. 3 was reported (Correa Zuluaga and Menges 2015). On the other hand, Chao (2015) achieved a dynamic architectural surface and a sensor of moisture made of a matrix of tiles elaborated with lime veneer, nylon, and plastic with hydro-sensitive capabilities because of different porous densities.

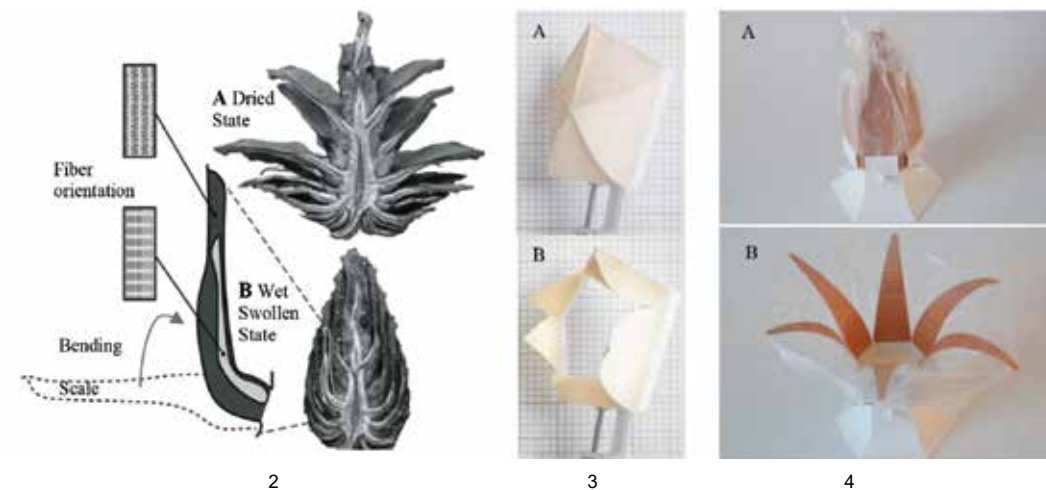

Fig. 2 pinecone scales. Axial cut view, dried and swelled state, upper and lower tissue cellulose orientation can be seen on one scale. The first one is located parallel to the scales axis, and the second one found perpendicular. Because both tissues are linked, the system shrinks in the axial direction of each tissue allowing bending when are wet.

Fig. 3 3D printed programmable hygroscopic material, through additive manufacturing of a co-polyester composite thermoplastic with high cellulose content from wood fibers, layers with different orientation and thickness was obtained as well as a multidirectional movement (Correa Zuluaga and Menges 2015) with two positions A low humidity, B high humidity

Fig.4 Motion with Moisture. Responsive biomimetic bilayer module view, A close final module, B completed open final module (Nicola Augustin 2018)

Several classes of veneer wood: *Prunus serotinal*, *Acer saccharum*, *Juglans nigra* and *Fagus sylvatica* with specific fiber orientation were evaluated and analyzed to shaped up a bilayer dynamic system with Polyethylene Terephthalate layer as support (Nicola Augustin 2018). This bilayer composite allows the development of a module that can be seen in Fig. 4 in a closed and open position; this system can be applied in an envelope system sensible to humidity. Other studies focused on different bilayer veneer made of *Picea abies* Karst, *Fagus sylvatica*, and Birch veneer

were reported (Vailati et al. 2018 ; Torres 2014), and hygroscopic actuated wood elements with simple upscaling shape (Wood et al. 2018).

3.1.2. Hydrophilic Swelling/shrinkage-based protocol

Synthetic superabsorbent polymers such as hydrogels were introduced in the 70's in replace of cellulosic fibers, which based their absorption properties in their hygroscopic behavior without significant swelling of their fibers (Staples and Chatterjee 2002). Hydrogels are water-absorbing polymers that can swell in water, for instance, crosslinked sodium polyacrylate gel is the most used in the pharmaceutical industry and can absorb 10 -1000 % of water above their original weight (Ahmed 2015).

The polyacrylic hydrogels are commonly obtained by aqueous polymerization of acrylic acid and crosslinked with vinyl groups. the result is an anionic polyelectrolyte with negative charged carboxylic groups in the main chain (Ahmed 2015). Carboxylic group ionizes with water, and the negative charge makes they repel each other compelling the polymer net to expand, then polar water molecules are attracted to the negative charged carboxylic groups, and stay caught into the chains between crosslinks as can be seen in Fig. 5, without those crosslinks, the polymer would collapse (Staples and Chatterjee 2002), and dissolution would be obtained. So that, more crosslinks conduce a less water absorption.

This class of environmentally-sensitive polymers (Qiu and Park 2001), were incorporated in dynamic envelope systems with two different approaches based on their properties. The first focused on the capacity of the material to retain large amounts of water, and the second one on the change of volume by swollen. The first approach consist of a multi-cavity system that catches rainwater; it is made of clay and filled with hydrogel spheres (Mitrofanova et al. 2014). The system is focused on the passive cooling of an envelope module looking for the storage of water in a long-term and their slowly release through the day to improve thermal exchanges between the building and the external as shown in Fig. 6.

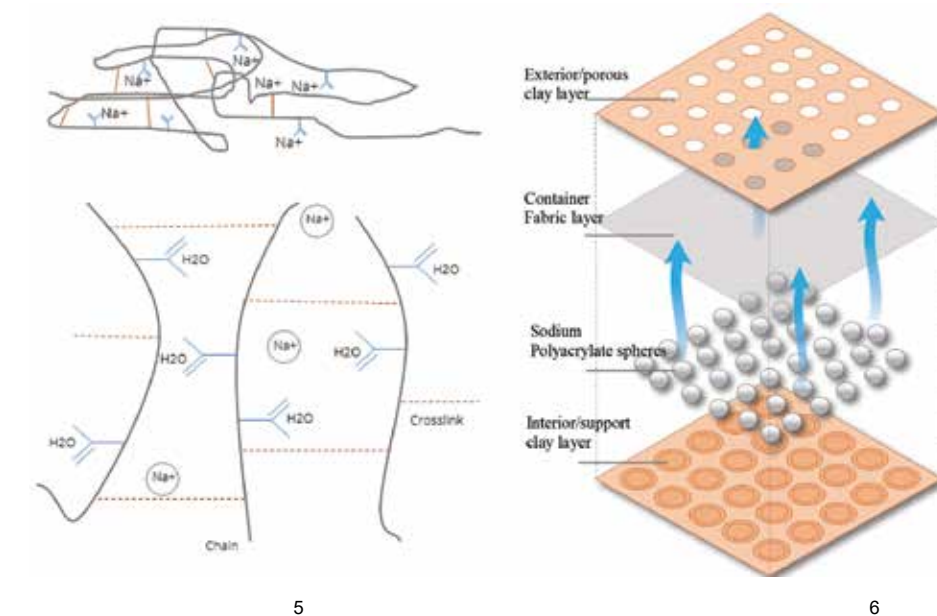

Fig. 5 Sodium Polyacrylate Swollen process. A. Polymer chains in coiled chains state (dry). B. Swollen polymer ionized with water molecules caught by carboxylic groups into their crosslinked network (wet)

Fig. 6 Hydroceramic. Scheme of the components of the cooling systems module, sodium polyacrylate spheres held into clay layers for the slowly water/moisture releasing. Adapted from Mitrofanova et al. (2014).

The second approach consists of a force generating systems (Y. Kyriakou et al. 2016 ; Ayala Castro et al. 2017). The devices are based on an acrylic piece attached to hydrophobic fabric pockets filled with sodium polyacrylate spheres with a mesh in contact with it. When the humidity goes through the mesh, the change of volume of the pockets is triggered and the systems can allow movement from one side to another or can open to allows air-flow. A different system which uses the generating force of hydrogels was reported (Roth 2015), a surface made of a matrix of silicone scales fixed by a composite based on polyacrylates was proposed. When the surface is in contact with water or moisture the composites net points swell, and the scales can open and close when it shrinks.

3.2. Temperature passive control systems

3.2.1. Thermal expansion protocol

Hybrid shape memory material is a class of stimulus-responsive component made of two different materials which do not have shape memory independent capabilities (Sun et al. 2012). Bi-metallic shape memory strips are made of two metallic pieces with different thermal expansion coefficient bonded by an elastic adhesive. The system operation is based on the asymmetric stress distribution between both surfaces, because of the expansion/contraction of each strip independently by thermal gradient differences. This phenomenon allows shape changes such as bending, as shown in Fig. 7, by direct or indirect heating.

This principle has been applied to the scope of obtaining architectural surfaces with active thermal features triggered by sun rays as well as weather thermal changes. An early report focused on the behavior of thermo-bimetals in architecture was done by Kim Sung (2008), after that, a matrix made of crossing panel pieces of bimetallic strips were applied in an experimental pavilion (Kim 2012).

The proposed pavilion had a surface were closed modules were achieved when the temperature goes down and porous ones when it rises, as shown in Fig. 8, the proposed system enables sun-protect by shading and natural air circulation. Another bimetal application was reported, commercial bimetal flat springs were incorporated into a matrix of intertwined bar elements (Garcia Garcia et al. 2014), the system was developed to be a deployable windows system and enable sun-rays protection.

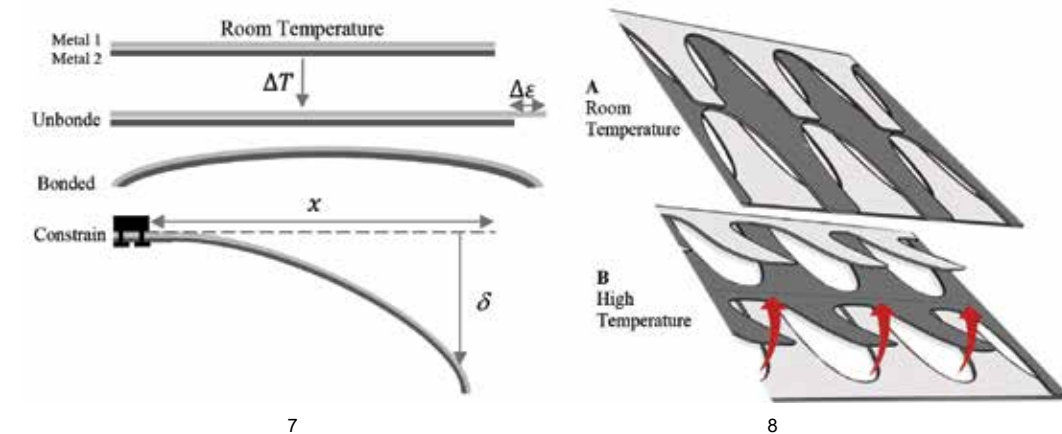

Fig. 7 Bimetal Strip. Two metals bonded together with different expansion coefficients.
 Fig. 8 Bloom Research Installation Los Angeles.
 Panel behavior Position A. Room temperature, closed module, Position B. High temperature, opened module.

3.2.2. Reversible phase transition protocol

Shape memory Alloys, stress-induced martensite

This protocol bases their operation on the use of Shape Memory Alloys (SMA) a class of SRM as their active component. SMA has several features such as shape memory effect (SME), superelasticity, and high- damping capacity (Liu et al. 1999). The first has been used to achieve a bi-directional movement by a martensitic reversible transformation because of warming or cooling. This phenomenon is responsible for the SME. The second has been applied in infrastructure like bridges, and robust behavior was demonstrated under dynamic loads (Cismaşiu and Amarante dos Santos 2008).

The process of change of shape starts with a martensitic transformation which takes place in a face-centered cubic unit cell structure, solid state austenite, by cooperative atoms movement without any compositional change. A uniform distorted crystalline network is achieved because atoms are moved within inter-atomic distances, producing a new martensite phase as can be seen in Fig. 9, it does not mean that the movement occurs at the same time, but, the transformation spreads through the network (Waitz et al. 2004).

The uses of SMA in architecture either as a dynamic system by itself or as a part of a bigger one has shown an important improvement in performance and energy consumption (Decker and Andrzej 2014). Nickel-Titanium alloy (NiTi) is the most reported SMA in responsive envelope systems following the non-diffusional phase transition protocol as an actuator because of its reliable mechanical performance (Sun et al. 2012). Several dynamic surfaces, focused on the control of heat and light on buildings reported using NiTi matrix as an actuator. These systems base their operation on prestressed springs or wires which try to recover their original shape because of thermal fluctuations generating mechanical force in the process.

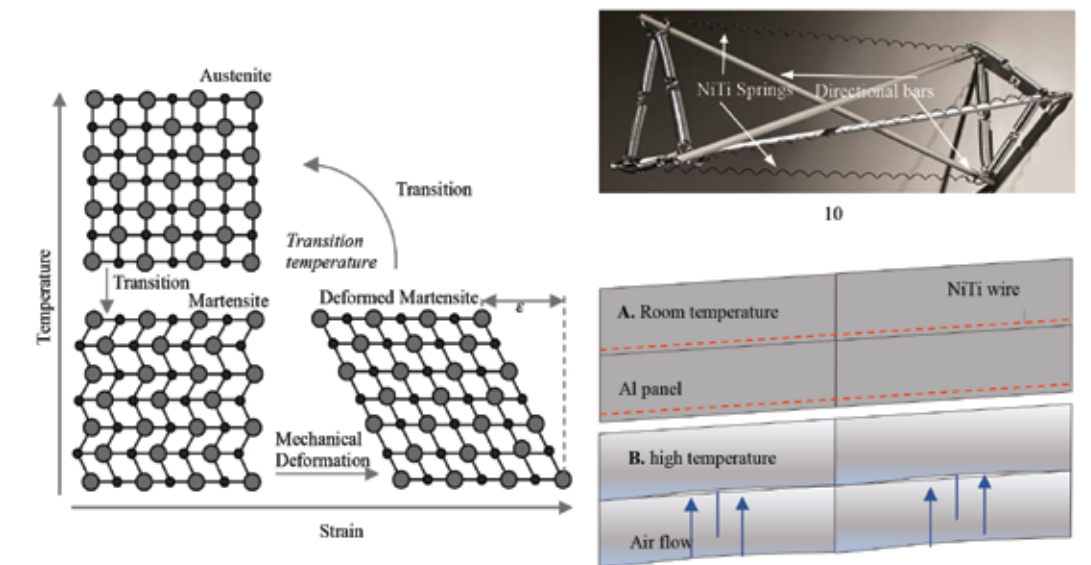

Fig. 9 non-diffusional phase change Austenite – Martensite deformed. The system changes shape macroscopically, as the martensite grows or decreases, with a mechanical strain. The evolution of form can be created in a specific direction obtaining deformed martensite; for this reason, the material needs to be deformed previously as training.
 Fig. 10 Adaptive [Skins]. The dynamic control unit, operated by NiTi springs, Adapted from Cohan, Joe (2013)
 Fig. 11 kinetic facade actuated by NiTi wires A. close module wire stressed. B. Open module wire contraction.

The use of prestressed springs as a bracket in a flexible laminate fabric were reported (Abdelmohsen et al. 2016) ; Jun et al. 2017, 2015 ; Sushant and Pradeep 2014 ; Verma and Devadass 2013). In these systems, when the temperature increases up to 45°C, the austenite phase for this composition, the springs return to their original shape allowing changes in the orientation of the laminate of every module as shown in Fig. 10. The use of NiTi as wires (Formentini and Lenci 2018) and springs (Gonzales and Shreyas 2015 ; Khoo et al. 2011b, 2011a ; Khoo and Salim 2013, 2012) were reported and was applied in more stiff and robust panels skins shown in Fig. 11, dynamic indirect illumination and heat-gain control by shadowing were obtained because of the mechanical force obtained by NiTi phase transformation. Finally, the relationship between building and users was explored as well using SMA actuators into integrative systems (Diniz et al. 2007).

The thermochromic effect, monoclinic to rutile phase

Inorganic materials can change their optical properties because of temperature variations. Electronic properties of these materials at different temperatures cause the thermochromic effect (Kamalisarvestani et al. 2013), some of them exhibit a more drastic change of color and variations on their optical properties such as transmittance and reflectance. For instance, vanadium dioxide VO₂ and trioxide VO₃, because of their drastic changes are the most studied inorganic materials with optical temperature-dependent properties (Feng et al. 2016; Parkin and Manning 2006; Wang et al. 2016).

Vanadium dioxide has a start critical temperature of 68°C for phase change from semiconductor low-temperature monoclinic phase to metallic high-temperature rutile phase shown in Fig 12. Differences in optical properties are achieved because of changes in V-V bonds angles and interatomic distances (Zhang et al., 2018). In applications where a thermochromic effect is needed such as smart windows, the critic temperature is too high in contrast with room temperature, decisive to ensure the building’s thermal comfort. This is not the only disadvantage of these class of smart coatings, the low transmittance in the semiconducting state and low reflecting rate in the rutile limits their applications on facades of buildings.

For those reasons to enable its use on smart windows, several investigations were focused on the most critic features as transition temperature, light transmittance rate, as well as alternative synthesis methods. The pure VO₂ polymorphous coating cannot achieve those goals, so the general performance has been improved by doping or adding other materials. The incorporation of zinc oxide polycrystalline film as a buffer layer between the glass and VO₂ (Zhu et al., 2018), and sol-gel alternative synthesis process with tungsten doping (Burkhardt et al. 1999; Liang et al. 2017; Seyfour and Binions 2017), has shown thermal transition reduction, higher transmittance rate, and improved hydrophilic properties of the coating. Likewise in the synthesis field, the introduction of impurities in the VO₂ single crystals growth (MacChesney and Guggenheim 1969) does not have effects on the energy behavior.

Critical transition-phase temperature has been studied through the doping of VO₂ with: Aluminum where a reduction of temperature and higher transmittance rate were found (Ji et al. 2018), Zirconium ions where the temperature is reduced without modifies the transmittance (Lu et al. 2017). Rare-earth and tungsten (Tb/w, Eu/W) codoping has shown temperature reduction and transmittance enhanced in 60% in the visible range as well as the doping with SiO₂ with a 55.6% of transmittance (Wang et al. 2017 ; Cao et al. 2017). Regardless of these limitations, the incorporation of thermochromic coatings to building glazing can reduce the energy dependence for HVAC (Casini 2018), through these systems, reduction on the thermal gain can be achieved

by blocking sunrays as shown in Fig. 13. For these reasons, their application in real buildings was studied through dynamic simulation (Hoffmann et al. 2014 ; Costanzo et al. 2016) and real scale application (Lee et al. 2013), they concluded that near-infrared spectrum thermochromic windows are more efficient than visible-light coatings, achieving 20% additional energy savings.

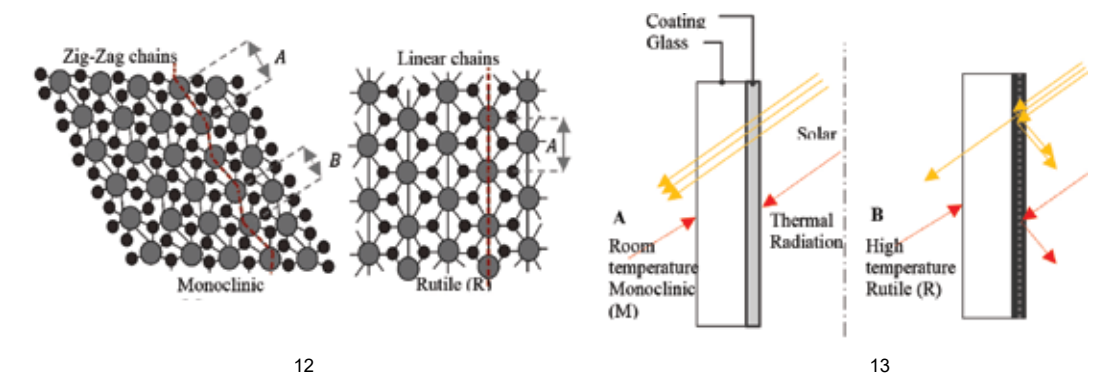

Fig. 12 Low-temperature, monoclinic phase (M) zig-zag V-V chains, with two different interatomic distances Insulator/Semiconductor to high-temperature Rutile (R) phase, linear V-V atom chains Metallic
 Fig. 13 Thermochromic glass coating. A transmittance mode, B reflectance mode

Furthermore, the critic temperature adjustments must look for the temperature of the glass surfaces and not the room temperature, and at least 50% transmittance is needed in the semiconductor state to achieve energetically efficient systems. Otherwise, different projects not based on vanadium dioxide have been developed as an alternative. Thermotropic smart windows based on hydroxypropyl cellulose with 22% of energy savings were reported (Allen et al. 2017), and thermochromic pigments incorporated into architectural surfaces (Bhaktavatsala 2015) to display real-time data through the building envelope.

Phase change protocol, liquid-solid.

Phase change materials (PCM) are substances with the ability to have a phase transition at a specific temperature range (Kuta and Wójcik 2015) from which a heat absorption or emission produces latent heat (LH). During the solid-liquid phase transition heat is absorbed and released induced by the weather changes as shown in Fig. 14, the LH can be stored, and this process has been classified as the most efficient way to store thermal energy with the highest storage density with small temperature changes (Iten et al. 2016) the temperature, and amount of LH are unique characteristics of a specific material (L. Li et al. 2016).

Once the efficiency of PCM was determined, this protocol has been used in buildings through the inclusion of PCMs in constructive elements with two different scopes. On the one hand, to store the heat gained through the day and release it during the night and vice versa. On the other hand, in the avoidance of direct thermal transfer from the outdoors to the indoors (Kasaeian et al. 2017), because the heat received for the PCM is used as LH to change of state rather than being transmitted. These developments are focused mainly on envelope elements (Liu et al. 2018 ; Akeiber et al. 2016).

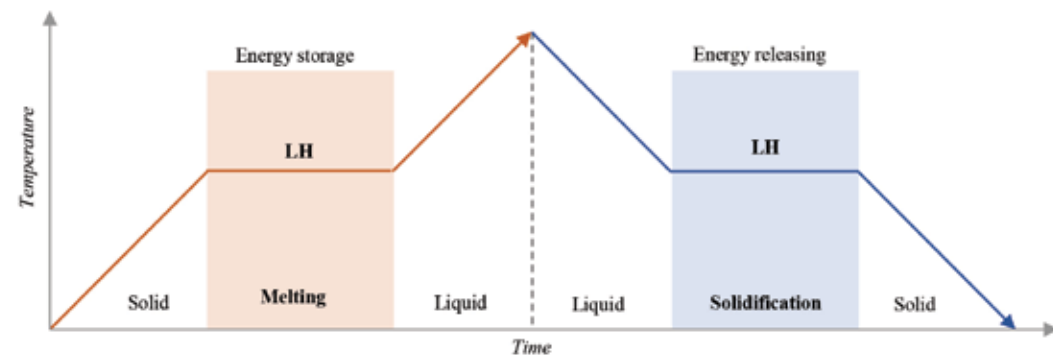

Fig. 14 Temperature against time PCM behavior. The Latent Heat is stored and released in function of the temperature of the medium, adapted from © Pazrev, 2014.

The inclusion of PCM on building elements has been assessed in envelopes as follow: window panels (S. Li et al. 2016), Dynamic shading systems (Bianco et al. 2018), opaque building envelope elements (Cascone et al. 2018; Fateh et al. 2018), Trombe walls (Leang et al. 2017), lightweight floors (Royon et al. 2014), concrete blocks (Erlbeck et al. 2018), and cellulose insulation (Lee et al. 2018). Besides, different elements based on wood composite materials were proposed (Yang et al. 2018), multifunctional concretes (D'Alessandro et al. 2018) doped concretes (Laura Pisello et al. 2017), and mortar based construction materials by Rao et al. (2018).

Likewise, simulation and evaluation methods are proposed for passive cooling envelopes based on PCM by Castell and Farid (2014), reduced scale evaluation of performance by Young, Falzone, Wei, Sant, & Pilon (2018), as well as, general optimization of buildings (Saffari et al. 2017). Detailed studies were carried out in residential and commercial establishments (Pasupathy et al. 2008), and performance studies in local weather were performed (Pascha 2008). Finally, the actual state of the art allows the life cycle assessment of PCM inclusions in buildings (Kylili and Fokaides 2016), and the improvement in the synthesis to obtain long-term heat storage systems (Han et al. 2017).

3.3. Light passive control systems

Attraction-repulsion electrostatic forces protocol

Following the Coulomb's law, with the use of Electro-Active Polymers (EAP) an elastomer with electric conduction features (Bobnar et al. 2007 ; Meng and Li 2013) a dielectric system has been obtained. The hybrid is a multilayer system defined by a dielectric elastomeric layer restricted both sides by electrodes. The dynamic behavior is triggered when an electric current, the stimuli, goes through the laminate rising the electrostatic forces generating a contraction of the elastomer. As a result, a dimensional change occurs going from a thick to a flat and thin plate as shown in Fig. 15, allowing the development of components that can be deformed in a predicted direction (Kolodziej and Josef 2013).

This protocol is presented as a route to enhanced reactive buildings with the outdoors and users as well (Decker 2017 ; Kriemeyer 2016). With the aim of control sunlight inside a building, a network made of an elastomer coated with silver electrodes limited by glass layers was developed by Decker (2013) as shown in Fig. 16. A bi-directional movement was produced, in the first position, when sunlight tries to enter the building; the elastomers are compressed blocking and reflecting the light, and in the second one, the elastomer recovers their original shape, allowing the direct contact from the inside to the outside as can be seen in Fig. 17.

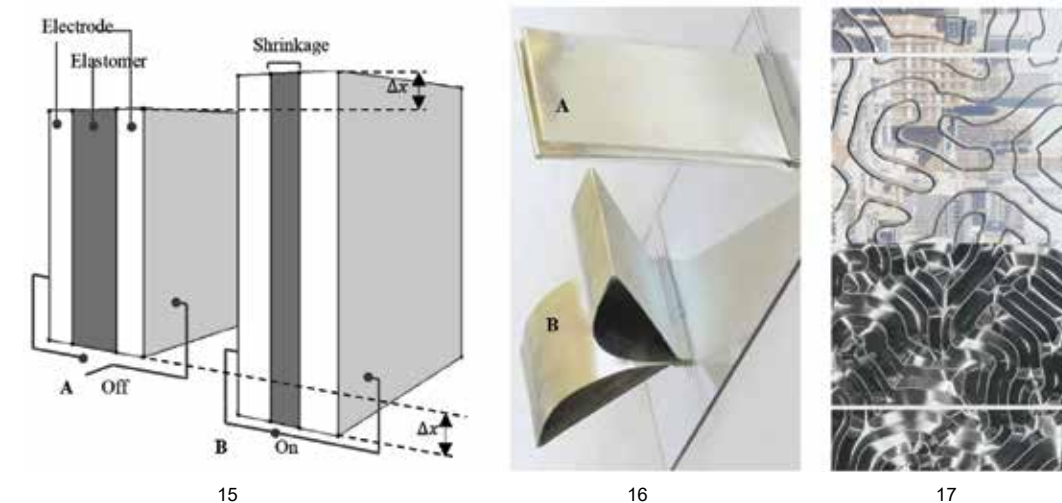

Fig. 15 Schematic dielectric electroactive mechanism of actuation. A position. The elastomer has a permanent shape. B position. The elastomer is compressed by electrostatic forces, changing their shape in X and Y direction. The performance of this kind of system can be improved by pre-strain training.

Fig. 16 Homeostatic Facade Prototype (New York) basic skin unit. Dielectric elastomer coated with silver electrodes. Open and close position view. Reproduced from (Decker, 2013)

Fig.17 Homeostatic Facade Prototype (New York). System operation, inside view. Top. Permanent shape and path (open position); Bottom, temporal shape after stimuli (closed position) reproduced from (Decker, 2013)

Several homeostatic skin projects with the use of electro-responsive elements were developed. A lightweight and semi-translucent actuator film defined by a high elastic elastomeric film, coated with a conductive carbon black powder and insulated by a liquid silicone layer was reported (Joucka 2016 ; Kretzer 2010 ; Kretzer and Rossi 2012). In another approximation, an EAP laminate was joined to water, also used as stimulus, (Franzke et al. 2016) to obtain a hydro-active responsive system. Finally, translucent ETFE cushions actuated by an EAP strip were reported (Biloria and Sumini 2009), and EAP plates into double glazing facade were simulated (Kriemeyer and Anna H. 2011) showing improvement in the energy performance. The reviewed proposals have one major disadvantage which is a high voltage needed to actuate the systems such that it limits the application and affects the detriment to the overall efficiency.

Electrochromic protocol

The change in optical properties is a characteristic of inorganic materials. The electrochromic effect, for instance, occurs in partially hydrated transition metal oxides (Svensson and Granqvist 1985). The effect is a reversible electrochemical reaction where oxides are formed by ion extraction and insertion. The process triggers changes in physical properties as, conductivity, IR absorption, and color. To obtain the effect a coating system made of several thin layers as shown in Fig. 18 must be done. The system shifts from an oxide insulator state to a quasi-metallic one when an external potential is applied.

The electroactive layers change their optical properties between their oxidized and reduced form because of electron flow in the system. In the case of tungsten oxide WO_3 , used in the amorphous state in electrochromic coatings, are the most studied (Svensson and Granqvist 1985), were ions exchange used to be H^+ or Li^+ (Azens et al. 2005), allowing the change in IR absorption as seen in Fig 19. The system can be customized to obtain different time response as well as absorbing / reflecting rate.

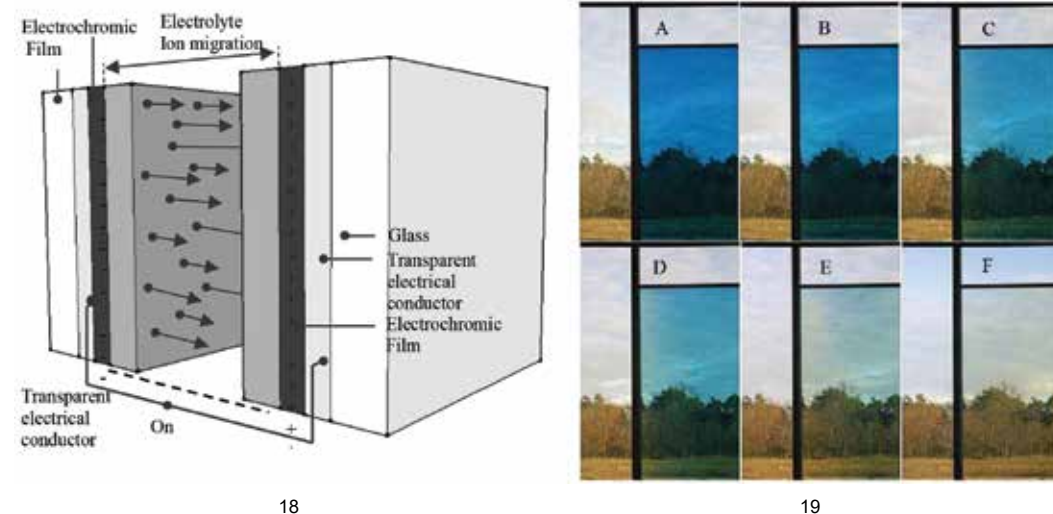

Fig. 18 The basis is a glass or plastic covered by a transparent conducting film, on multiple cathodic electroactive layers is affixed. A layer of ion conductor follows these, on its turn followed by an ion-storage film or one (or multiple) complimentary anodic electroactive layers and another transparent conducting film.
 Fig. 19 Tungsten Oxide Electrochromic coated window, the process of change of conductive and reflecting properties From A (blue) to F (transparent) $M_xWO_3 \leftrightarrow WO_3 + xM^+ + xe$ reproduced from Gesimat (2009).

Although, electrochromic thin layers were developed since 1973 (Deb 1973), their most promising application is electrochromic coated windows (ECW) (Granqvist 1995; Pittaluga 2015) which were designed and commercialized in the last decade. These systems are based on flexible layers that can be inserted into a glass or polymer as a substrate with transparent conductors with high electronic conductivity (Azens and Granqvist 2003), to allow performance of few volts. The performance of this system was evaluated in comparison to other glazing technologies as fritted glass (Malekafzali Ardakan et al. 2017), significantly better performance in ECW was reported because it provides a glare control in the areas of the facade which the sun is in contact with. Meanwhile, other zones remain in the visible mode allowing the entry of diffuse light avoiding the use of artificial light sources.

The use of ECW was evaluated in office buildings located in hot and cold areas (Sbar et al., 2012) achieving 45% of energy savings and from 35% to 50% of carbon emissions reduction using ECW panels in comparison with no- treated glass windows. Moreover, a long-term performance study of tungsten dioxide coating for 20 months period was performed (Lee et al. 2006) were and $26 \pm 15\%$ energy savings was obtained. Meanwhile, efficiency simulations conducted showed a 16% of energy savings (Aslihan and Eleanor 2018; DeForest et al. 2017; Lee and Tavil 2007).

Despite the use of electric current, this kind of passive system, Attraction-repulsion electrostatic forces, and electrochromic protocols differ from active ones, because the electron flow is used plainly as the stimulus, which triggers the change of shape and properties of the system and has shown important energy savings. In the case of active systems based on DAS protocol, electric current is used as an additional continuous resource to ensure the operation of the electronic components.

Elongation induced by thermal transitions.

Shape memory polymers (SMPs) are stable polymer networks with reversible switching transitions triggered by several stimuli as temperature, pH, electricity, magnetic field, light, and ions mainly (Meng and Li, 2013). There are multiple molecular structures which drive SME in polymers.

Nevertheless it is not a property of the material by itself, it is a result of a mix of chemical and processing features. They have been used in several technological areas because of their wide-range stimuli responsiveness.

In the case of thermal-responsive SMPs, are based on a polymer with molecular entanglement, chemical crosslinking, crystallization and interpenetrated network. The reversible switching transitions are crystallization/melting and vitrification/glass as shown in Fig. 20. During this process, a change of shape or mechanical force can be obtained.

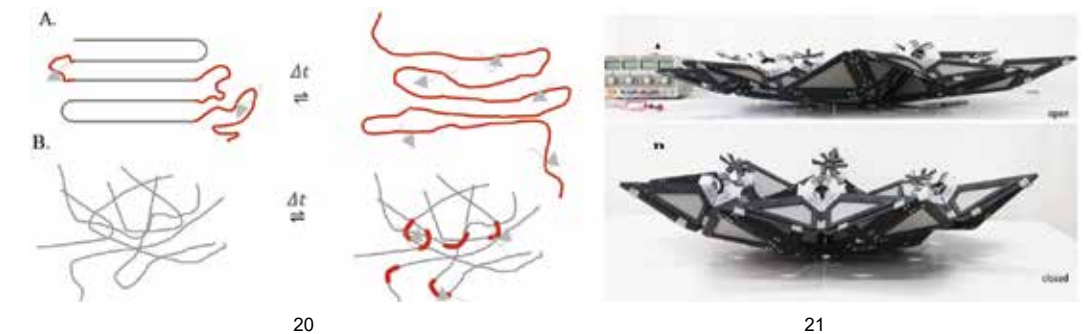

Fig. 20 Polymer Thermal-switching transitions. A. Crystallization/Melting B. Vitrification/glass. Under appropriate Δt the polymer chains gain mobility allowing a reversible change of shape.
 Fig. 21 Translated geometries. Standing structure actuated by SMP A. open position B. closed position, reproduced from (shambayati et al., 2014).

Based on these protocols, crystallization/melting, and Vitrification/glass transitions, commercial temperature SMP have been used to realize self-standing structures actuated by dynamic actuators as flexible hinges (Beites 2013; shambayati et al. 2014) as shown in Fig. 21, and a lightweight 2D structure with no structural elements embedded with prestressed SMP (Arnellou et al. 2015). SMP tape was proposed as an actuator of a flexible metamaterial used in indoors for light control (Tang et al. 2016).

4 Conclusions

As was seen, passive systems of dynamic control in buildings thus far developed has obtained favorable and promising results. On the one hand, passive systems use responsive materials that cannot be turned off or work just by one-user preferences, limitation to be recognized, likewise thermal, and comfort indexes must be evaluated on those new experimental projects. On the other hand, they have been created or applied in buildings in the last decades, for this reason, most of them are found in an experimental phase. Still, it is necessary to continued proving, verifying and optimizing to tuning and spread of this kind of envelopes systems massively, because nowadays, among others, the systems high costs limits their applications.

The reviewed systems are in different states of the art. On the one hand, PCM, as well as thermochromic and photochromic coated windows were incorporated in building for more than a decade and nowadays are in a stage of evaluation, alternative methods of synthesis are still being developed and studied to enhanced building performance. On the other hand, hygroscopic systems, shape memory alloys, bi-metallic strips, and shape memory polymers are in an experimental stage were measure systems units, legislation or robust commercial solutions cannot be found. All of them presents interesting and different ways to look at the issue of passive response to micro-environmental fluctuations.

The stimulus-responsive materials evaluated are just a part of the categories presented, reversible phase change protocol and elongation induced by crystallization or vitrification the rest are shape memory hybrids, the type of stimulus-responsive systems preferred in architectural envelopes. The use of hybrids can be explained because in the development of these systems a strong background is not needed, it is based on some basic concepts, and are made of easily accessible materials; for these reasons these types of responsive systems are extensively applied. Nevertheless, the other categories of the stimulus-responsive materials presented are still unknown by architecture. Therefore, the possibilities of new developments are broad to improve building efficiency and adaptation from ceramics to polymers.

The interest of the scientific community on the use of shape Memory/Responsive Polymers SMP has been growing in terms of research and development because it has some competitive differential features such as low density, wide-spectrum stimuli responsiveness, multiple reaction mechanisms, and programming versatility, among others. These features establish SMP as a group of materials to focus on future responsive building skins research because they can shape up active components independently, as composite materials or be part of hybrid ones. Studies and possibilities are not just for skins but for self-assembly building components (potential 4D printing), change of user interfaces shape or kinetic to electric building energy production.

5 References

- Abdelmohsen, S., Massoud, P., Elshafei, A., 2016. Using Tensegrity and Folding to Generate Soft Responsive Architectural Skins, in: Complexity & Simplicity. Presented at the 34th eCAADe Conference, Brussels: Education and Research in Computer Aided Architectural Design in Europe (eCAADe), 2016, Finland, pp. 529–536.
- AEDAS, 2012. Al Bahar Towers, The Abu Dhabi Investment Council.
- Aelenei, D., Aelenei, L., Vieira, C.P., 2016. Adaptive Façade: Concept, Applications, Research Questions. *Energy Procedia* 91, 269–275. <https://doi.org/10.1016/j.egypro.2016.06.218>
- Ahmed, E.M., 2015. Hydrogel: Preparation, characterization, and applications: A review. *J. Adv. Res.* 6, 105–121. <https://doi.org/10.1016/j.jare.2013.07.006>
- Akeiber, H., Nejat, P., Majid, M.Z.A., Wahid, M.A., Jomehzadeh, F., Zeynali Famileh, I., Calautit, J.K., Hughes, B.R., Zaki, S.A., 2016. A review on phase change material (PCM) for sustainable passive cooling in building envelopes. *Renew. Sustain. Energy Rev.* 60, 1470–1497. <https://doi.org/10.1016/j.rser.2016.03.036>
- Aksamija, A., 2016. Integrating innovation in architecture: design, methods and technology for progressive practice and research, AD smart. Wiley, West Sussex, United Kingdom.
- Allen, K., Connelly, K., Rutherford, P., Wu, Y., 2017. Smart windows—Dynamic control of building energy performance. *Energy Build.* 139, 535–546. <https://doi.org/10.1016/j.enbuild.2016.12.093>
- Arnellou, Z.D., Papakonstantinou, E.A., Sarantinoudi, P., 2015. Fabrication. Structuring textile techniques (Master Thesis). Institute for advanced architecture of Catalonia, Barcelona.
- Aslihan, T., Eleanor, S.L., 2018. The impact of overhang design on the performance of the electrochromic windows. Presented at the International Solar Energy Society (ISES) Solar World Congress, Orlando, Florida, pp. 199–206.
- Ayala Castro, I., Manosong, M., Chang, Y.C., 2017. Water-driven Breathing skin (Master Thesis). Institute for advanced architecture of Catalonia, Barcelona.
- Azens, A., Avendaño, E., Backholm, J., Berggren, L., Gustavsson, G., Karmhag, R., Niklasson, G.A., Roos, A., Granqvist, C.G., 2005. Flexible foils with electrochromic coatings: science, technology and applications. *Mater. Sci. Eng. B* 119, 214–223. <https://doi.org/10.1016/j.mseb.2004.12.085>
- Azens, A., Granqvist, C., 2003. Electrochromic smart windows: energy efficiency and device aspects. *J. Solid State Electrochem.* 7, 64–68. <https://doi.org/10.1007/s10008-002-0313-4>
- Bahar BASARIR, M. Cem ALTUN, 2017. A Classification Approach for Adaptive Façades. Presented at the Interdisciplinary Perspectives for Future Building Envelopes, Istanbul, Turkey.
- Beites, S., 2013. Morphological Behavior of Shape Memory Polymers Toward a Deployable, Adaptive Architecture, in: Adaptive Architecture. Presented at the 33rd Annual Conference of the Association for Computer Aided Design in Architecture, Cambridge, Ontario, pp. 121–128.
- Bertens, J.W., 1996. The idea of the postmodern: a history, Reprinted. ed. Routledge, London.
- Bhaktavatsala, N., 2015. Colourmorph (Master Thesis). Institute for advanced architecture of Catalonia, Barcelona. Bianco, L., Komerska, A., Cascone, Y., Serra, V., Zinzi, M., Carmelo, E., Ksionek, D., 2018. Thermal and optical characterisation of dynamic shading systems with PCMs through laboratory experimental measurements. *Energy Build.* 163, 92–110. <https://doi.org/10.1016/j.enbuild.2017.12.015>
- Biloria, N., Sumini, V., 2009. Performative Building Skin Systems: A Morphogenomic Approach towards Developing Real-Time Adaptive Building Skin Systems. *Int. J. Archit. Comput.* 7, 643–675. <https://doi.org/10.1260/1478-0771.7.4.643>
- Bobnar, V., Levstik, A., Huang, C., Zhang, Q.M., 2007. Enhanced dielectric response in all-organic polyaniline–poly(vinylidene fluoride–trifluoroethylene–chlorotrifluoroethylene) composite. *J. Non-Cryst. Solids* 353, 205–209. <https://doi.org/10.1016/j.jnoncrysol.2006.10.003>
- Brager, G.S., de Dear, R.J., 1998. Thermal adaptation in the built environment: a literature review. *Energy Build.* 27, 83–96. [https://doi.org/10.1016/S0378-7788\(97\)00053-4](https://doi.org/10.1016/S0378-7788(97)00053-4)
- Burgert, I., Fratzl, P., 2009. Actuation systems in plants as prototypes for bioinspired devices. *Philos. Trans. R. Soc. Math. Phys. Eng. Sci.* 367, 1541–1557. <https://doi.org/10.1098/rsta.2009.0003>
- Burkhardt, W., Christmann, T., Meyer, B., Niessner, W., Schalch, D., Scharmann, A., 1999. W- and F-doped VO₂ films studied by photoelectron spectrometry. *Thin Solid Films* 345, 229–235. [https://doi.org/10.1016/S0040-6090\(98\)01406-0](https://doi.org/10.1016/S0040-6090(98)01406-0)
- Cao, Z., Lu, Y., Xiao, X., Zhan, Y., Cheng, H., Xu, G., 2017. Tunable simultaneously visible-light and near-infrared transmittance for VO₂/SiO₂ composite films to enhance thermochromic properties. *Mater. Lett.* 209, 609–612. <https://doi.org/10.1016/j.matlet.2017.08.113>
- Cascone, Y., Capozzoli, A., Perino, M., 2018. Optimisation analysis of PCM-enhanced opaque building envelope components for the energy retrofitting of office buildings in Mediterranean climates. *Appl. Energy* 211, 929–953. <https://doi.org/10.1016/j.apenergy.2017.11.081>
- Casini, M., 2018. Active dynamic windows for buildings: A review. *Renew. Energy* 119, 923–934. <https://doi.org/10.1016/j.renene.2017.12.049>
- Castell, A., Farid, M.M., 2014. Experimental validation of a methodology to assess PCM effectiveness in cooling building envelopes passively. *Energy Build.* 81, 59–71. <https://doi.org/10.1016/j.enbuild.2014.06.011>
- Chao, C., 2015. Reacting architectural surface.
- Cismaşiu, C., Amarante dos Santos, F.P., 2008. Numerical simulation of superelastic shape memory alloys subjected to dynamic loads. *Smart Mater. Struct.* 17, 025036. <https://doi.org/10.1088/0964-1726/17/2/025036>
- Cohan, Joe (Photographer). (2013, August). Adaptive Architectural skins [digital image]. Retrieved 12 February 2018, from / www.evolo.us/architecture/adaptive-architectural-skins-and-dynamic-environmental-conditions/
- Correa Zuluaga, D., Menges, A., 2015. 3D Printed Hygroscopic Programmable Material Systems. *MRS Proc.* 1800. <https://doi.org/10.1557/opl.2015.644>
- Costanzo, V., Evola, G., Marletta, L., 2016. Thermal and visual performance of real and theoretical thermochromic glazing solutions for office buildings. *Sol. Energy Mater. Sol. Cells* 149, 110–120. <https://doi.org/10.1016/j.solmat.2016.01.008>
- D'Alessandro, A., Pisello, A.L., Fabiani, C., Ubertini, F., Cabeza, L.F., Cotana, F., 2018. Multifunctional smart concretes with novel phase change materials: Mechanical and thermo-energy investigation. *Appl. Energy* 212, 1448–1461. <https://doi.org/10.1016/j.apenergy.2018.01.014>
- Daveiga, J., Ferreira, P., 2005. Smart and Nano Materials in Architecture. Presented at the 2005 Annual Conference of the Association for Computer Aided Design In Architecture, Savannah, Georgia, pp. 58–67.
- Deb, S.K., 1973. Optical and photoelectric properties and colour centres in thin films of tungsten oxide. *Philos. Mag.* 27, 801–822. <https://doi.org/10.1080/14786437308227562>
- Decker, M., 2017. Soft Human Computer Interfaces - Towards Soft Robotics in Architecture. Presented at the 35th eCAADe Conference, Rome, Italy, pp. 739–744.
- Decker, M., 2013. Nanotechnology and Emergent Materials in Architecture. Presented at the Tectonics of Teaching, Building Technology Educators Society (BTES), Tectonics of Teaching, pp. 1–7.
- Decker, M., Andrzej, Z., 2014. Designing Resilient Buildings with Emergent Materials. Presented at the 32nd eCAADe Conference, England, The U.K., pp. 179–184.
- DeForest, N., Shehabi, A., Selkowitz, S., Milliron, D.J., 2017. A comparative energy analysis of three electrochromic glazing technologies in commercial and residential buildings. *Appl. Energy* 192, 95–109. <https://doi.org/10.1016/j.apenergy.2017.02.007>
- di Salvo, S., 2016. Smart Materials in Architecture. *Int. J. Eng. Res. Afr.* 23, 72–79. <https://doi.org/10.4028/www.scientific.net/JERA.23.72>
- Diniz, N., Cesar, B., Miguel, S.D., Alasdair, T., 2007. Morphosis: A responsive membrane. Presented at the 12th International Conference on Computer Aided Architectural Design Futures, Springer Netherlands, Sydney, Australia, pp. 489–498.
- Dinwoodie, J.M., 2000. Timber, its nature and behaviour, 2nd ed. ed. E & FN Spon ; BRE, with the support of the Centre for Timber Technology and Construction at BRE, London ; New York : [England].
- Douglas, J., 2006. Building adaptation, 2nd ed. ed. Butterworth-Heinemann, Elsevier, Amsterdam.
- Doumpiotti, C., 2011. Responsive and Autonomous Material Interfaces, in: ACADIA 11: Integration through Computation. Presented at the 31st Annual Conference of the Association for Computer Aided Design in Architecture (ACADIA), Banff, Alberta, pp. 318–325.
- Drossel, W.-G., Kunze, H., Bucht, A., Weisheit, L., Pagel, K., 2015. Smart3 – Smart Materials for Smart Applications. *Procedia CIRP* 36, 211–216. <https://doi.org/10.1016/j.procir.2015.01.055>
- Erlbeck, L., Schreiner, P., Schlachter, K., Dörnhöfer, P., Fasel, F., Methner, F.-J., Rädle, M., 2018. Adjustment of thermal behavior by changing the shape of PCM inclusions in concrete blocks. *Energy Convers. Manag.* 158, 256–265. <https://doi.org/10.1016/j.enconman.2017.12.073>
- Fateh, A., Borelli, D., Devia, F., Weinläder, H., 2018. Summer thermal performances of PCM-integrated insulation layers for light-weight building walls: effect of orientation and melting point temperature. *Therm. Sci. Eng. Prog.* <https://doi.org/10.1016/j.tsep.2017.12.012>

- Feng, W., Zou, L., Gao, G., Wu, G., Shen, J., Li, W., 2016. Gasochromic smart window: optical and thermal properties, energy simulation and feasibility analysis. *Sol. Energy Mater. Sol. Cells* 144, 316–323. <https://doi.org/10.1016/j.solmat.2015.09.029>
- Fiorito, F., Sauchelli, M., Arroyo, D., Pesenti, M., Imperadori, M., Maserà, G., Ranzi, G., 2016. Shape morphing solar shadings: A review. *Renew. Sustain. Energy Rev.* 55, 863–884. <https://doi.org/10.1016/j.rser.2015.10.086>
- Formentini, M., Lenci, S., 2018. An innovative building envelope (kinetic façade) with Shape Memory Alloys used as actuators and sensors. *Autom. Constr.* 85, 220–231. <https://doi.org/10.1016/j.autcon.2017.10.006>
- Fortmeyer, R.M., Linn, C.D., 2014. Kinetic architecture: designs for active envelopes. Images Publishing Group, Mulgrave, Victoria.
- Franzke, L., Rossi, D., Fratinovic, K., 2016. Fluid Morphologies: Hydroactive Polymers for Responsive Architecture, in: *POSTHUMAN FRONTIERS: Data, Designers, and Cognitive Machines*. Presented at the 36th Annual Conference of the Association for Computer Aided Design in Architecture (ACADIA), Ann Arbor, Michigan, pp. 478–487.
- García García, A., Srinivas, M., Juárez, M.A., 2014. Thermatrix bimetal (Master Thesis). Institute for advanced architecture of Catalonia, Barcelona.
- Gesimat (2009), retrieved 12 February, 2018 www.gesimat.de/ Giselbrecht, E., 2007. Kiefer Technic Showroom.
- Godsell, S., Franklin, H., 2012. RMIT Design Hub.
- Gonzales, N., Shreyas, M., 2015. Self - Adaptive membrane - A passive kinetic system (Master Thesis). Institute for advanced architecture of Catalonia, Barcelona.
- Granqvist, C.G., 1995. Handbook of inorganic electrochromic materials. Elsevier, Amsterdam; New York.
- Han, G.G.D., Li, H., Grossman, J.C., 2017. Optically-controlled long-term storage and release of thermal energy in phase-change materials. *Nat. Commun.* 8. <https://doi.org/10.1038/s41467-017-01608-y>
- Hasselaar, B.L.H., 2006. Climate Adaptive Skins: towards the new energy-efficient façade. WIT Press, pp. 351–360. <https://doi.org/10.2495/RAV060351>
- Henriques, G.C., 2015. Responsive systems, relevance, state of the art and developments. Presented at the 19th Conference of the Iberoamerican Society of Digital Graphics, SIGRADI 2015, Florianópolis, Brasil, pp. 200–206.
- Hoffmann, S., Lee, E.S., Clavero, C., 2014. Examination of the technical potential of near-infrared switching thermochromic windows for commercial building applications. *Sol. Energy Mater. Sol. Cells* 123, 65–80. <https://doi.org/10.1016/j.solmat.2013.12.017>
- Hoover, G., Rempfer, W., 2015. Closed loop control with data acquisition systems, in: *Analog Circuit Design*. Elsevier, pp. 807–808. <https://doi.org/10.1016/B978-0-12-800001-4.00376-8>
- Iten, M., Liu, S., Shukla, A., 2016. A review on the air-PCM-TES application for free cooling and heating in the buildings. *Renew. Sustain. Energy Rev.* 61, 175–186. <https://doi.org/10.1016/j.rser.2016.03.007>
- Ji, C., Wu, Z., Wu, X., Wang, J., Gou, J., Huang, Z., Zhou, H., Yao, W., Jiang, Y., 2018. Al-doped VO₂ films as smart window coatings: Reduced phase transition temperature and improved thermochromic performance. *Sol. Energy Mater. Sol. Cells* 176, 174–180. <https://doi.org/10.1016/j.solmat.2017.11.026>
- Joucka, H., 2016. Sound to Polymer 1.0 (Master Thesis). Institute for advanced architecture of Catalonia, Barcelona. JSWD Architekten, Chaix & Morel et Associés, 2010. Q1 ThyssenKrupp Quarter.
- Jun, J.W., Alcover, J., Silverio, M., 2015. Remembrance (Master Thesis). Institute for advanced architecture of Catalonia, Barcelona.
- Jun, J.W., Silverio, M., Llubia, J.A., Markopoulou, A., Chronis, A., Dubor, A., 2017. Remembrance: A Shape Changing Adaptive Structure. Presented at the 7th International Conference, CAAD Futures 2017, Proceedings, Springer, Istanbul, Turkey, pp. 180–198.
- Kamalisarvestani, M., Saidur, R., Mekhilef, S., Javadi, F.S., 2013. Performance, materials and coating technologies of thermochromic thin films on smart windows. *Renew. Sustain. Energy Rev.* 26, 353–364. <https://doi.org/10.1016/j.rser.2013.05.038>
- Kamperidou, V., Barbutis, I., Vasileiou, V., 2013. Response of colour and hygroscopic properties of Scots pine wood to thermal treatment. *J. For. Res.* 24, 571–575. <https://doi.org/10.1007/s11676-013-0389-y>
- Kasaian, A., bahrami, L., Pourfayaz, F., Khodabandeh, E., Yan, W.-M., 2017. Experimental studies on the applications of PCMs and nano-PCMs in buildings: A critical review. *Energy Build.* 154, 96–112. <https://doi.org/10.1016/j.enbuild.2017.08.037>
- Khoo, C.K., Burry, J., Burry, M., 2011a. Soft responsive kinetic system: An elastic transformable architectural skin for climatic and visual control. Presented at the Annual Conference of the Association for Computer Aided Design in Architecture (ACADIA 11), Bangff, Canada, pp. 334–341.
- Khoo, C.K., Salim, F., 2013. Responsive Materiality for Morphing Architectural Skins. Presented at the 33rd Annual Conference of the Association for Computer Aided Design in Architecture (ACADIA), Riverside Architectural Press, Cambridge, Ontario, pp. 243–252.
- Khoo, C.K., Salim, F., 2012. A responsive morphing media skin, in: *Beyond Codes and Pixels*. Presented at the 17th International Conference on Computer Aided Architectural Design Research in Asia, CAADRIA, Hong Kong, pp. 517–526.
- Khoo, C.K., Salim, F., Burry, J., 2011b. Designing Architectural Morphing Skins with Elastic Modular Systems. *Int. J. Archit. Comput.* 9, 397–419. <https://doi.org/10.1260/1478-0771.9.4.397>
- Kim, S.D., 2012. Bloom. Materials & Applications Gallery.
- Kim Sung, D., 2008. Skin Deep: Breathing Life into the Layer between Man and Nature.
- Koçlar, G., Yener, A.K., Bayazit, N.T., 2004. Building envelope design with the objective to ensure thermal, visual and acoustic comfort conditions. *Build. Environ.* 39, 281–287. [https://doi.org/10.1016/S0360-1323\(03\)00141-0](https://doi.org/10.1016/S0360-1323(03)00141-0)
- Kolarevic, B., Parlac, V. (Eds.), 2015. Building dynamics: exploring architecture of change. Routledge, London ; New York.
- Kolodziej, P., Josef, R., 2013. Responsive Building Envelope as a Material System of Autonomous Agents. Presented at the 19th Conference on Computer-Aided Architectural Design Research in Asia, by R. Stouffs,
- P. Janssen, S. Roudavski, and B. Tunçer, Singapore, pp. 945–954.
- Kretzer, M., 2010. towards a new softness The aesthetics of soft dielectric electroactive polymers and their application in an architectural context.
- Kretzer, M., Rossi, D., 2012. ShapeShift. *Leonardo* 45, 480–481. https://doi.org/10.1162/LEON_a_00451
- Krietemeyer, B., 2016. An Interactive Simulation Environment for Adaptive Architectural Systems, in: Dalton, N.S., Schnädelbach, H., Wiberg, M., Varoudis, T. (Eds.), *Architecture and Interaction*. Springer International Publishing, Cham, pp. 231–252. https://doi.org/10.1007/978-3-319-30028-3_11
- Krietemeyer, E.A., Anna H., D., 2011. Electropolymeric Technology for Dynamic Building Envelopes. Presented at the Parametricism (SPC) ACADIA Regional 2011 Conferenc, Lincoln, Nebraska, pp. 75–83.
- Kuta, M., Wójcik, T.M., 2015. Phase change materials in energy sector - applications and material requirements. *EPJ Web Conf.* 92, 02043. <https://doi.org/10.1051/epjconf/20159202043>
- Kylliä, A., Fokaides, P.A., 2016. Life Cycle Assessment (LCA) of Phase Change Materials (PCMs) for building applications: A review. *J. Build. Eng.* 6, 133–143. <https://doi.org/10.1016/j.jobe.2016.02.008>
- Laura Pisello, A., Fabiani, C., Cotana, F., 2017. New experimental technique to investigate the thermal behavior of PCM/doped concrete for enhancing thermal/energy storage capability of building envelope. *Energy Procedia* 126, 139–146. <https://doi.org/10.1016/j.egypro.2017.08.133>
- Le Duigou, A., Castro, M., 2016. Evaluation of force generation mechanisms in natural, passive hydraulic actuators. *Sci. Rep.* 6. <https://doi.org/10.1038/srep18105>
- Leang, E., Tittlein, P., Zalewski, L., Lassue, S., 2017. Numerical study of a composite Trombe solar wall integrating microencapsulated PCM. *Energy Procedia* 122, 1009–1014. <https://doi.org/10.1016/j.egypro.2017.07.467>
- Lee, E.S., DiBartolomeo, D.L., Klems, J., Yazdani, M., Selkowitz, S.E., 2006. Monitored Energy Performance of Electrochromic Windows Controlled for Daylight and Visual Comfort. Presented at the ASHRAE 2006 Summer Meeting, Quebec, Canada.
- Lee, E.S., Pang, X., Hoffmann, S., Goudey, H., Thanachareonkit, A., 2013. An empirical study of a full-scale polymer thermochromic window and its implications on material science development objectives. *Sol. Energy Mater. Sol. Cells* 116, 14–26. <https://doi.org/10.1016/j.solmat.2013.03.043>
- Lee, E.S., Tavil, A., 2007. Energy and visual comfort performance of electrochromic windows with overhangs. *Build. Environ.* 42, 2439–2449. <https://doi.org/10.1016/j.buildenv.2006.04.016>
- Lee, K.O., Medina, M.A., Sun, X., Jin, X., 2018. Thermal performance of phase change materials (PCM)-enhanced cellulose insulation in passive solar residential building walls. *Sol. Energy* 163, 113–121. <https://doi.org/10.1016/j.solener.2018.01.086>
- Li, L., Yu, H., Wang, X., Zheng, S., 2016. Thermal analysis of melting and freezing processes of phase change materials (PCMs) based on dynamic DSC test. *Energy Build.* 130, 388–396. <https://doi.org/10.1016/j.enbuild.2016.08.058>
- Li, S., Sun, G., Zou, K., Zhang, X., 2016. Experimental research on the dynamic thermal performance of a novel triple-pane building window filled with PCM. *Sustain. Cities Soc.* 27, 15–22. <https://doi.org/10.1016/j.scs.2016.08.014>
- Liang, Z., Zhao, L., Meng, W., Zhong, C., Wei, S., Dong, B., Xu, Z., Wan, L., Wang, S., 2017. Tungsten-doped vanadium dioxide thin films as smart windows with self-cleaning and energy-saving functions. *J. Alloys Compd.* 694, 124–131. <https://doi.org/10.1016/j.jallcom.2016.09.315>
- Liu, F., Zhu, J., Liu, J., Ma, B., Zhou, W., Li, R., 2018. Preparation and properties of capric-stearic acid/White Carbon Black composite for thermal storage in building envelope. *Energy Build.* 158, 1781–1789. <https://doi.org/10.1016/j.enbuild.2017.09.076>
- Liu, Y., Li, Y., Ramesh, K., Van Humbeeck, J., 1999. High strain rate deformation of martensitic NiTi shape memory alloy. *Scr. Mater.* 41, 89–95. [https://doi.org/10.1016/S1359-6462\(99\)00058-5](https://doi.org/10.1016/S1359-6462(99)00058-5)
- Loonen, R.C.G.M., Favoino, F., Hensen, J.L.M., Overend, M., 2017. Review of current status, requirements and opportunities for building performance simulation of adaptive facades. *J. Build. Perform. Simul.* 10, 205–223. <https://doi.org/10.1080/19401493.2016.1152303>
- Lu, W., Zhao, G., Song, B., Li, J., Zhang, X., Han, G., 2017. Preparation and thermochromic properties of sol-gel-derived Zr-doped VO₂ films. *Surf. Coat. Technol.* 320, 311–314. <https://doi.org/10.1016/j.surfcoat.2016.12.070>
- MacChesney, J.B., Guggenheim, H.J., 1969. Growth and electrical properties of vanadium dioxide single crystals containing selected impurity ions. *J. Phys. Chem. Solids* 30, 225–234. [https://doi.org/10.1016/0022-3697\(69\)90303-5](https://doi.org/10.1016/0022-3697(69)90303-5)
- Malekafzali Ardakan, A., Sok, E., Niemasz, J., 2017. Electrochromic glass vs. fritted glass: an analysis of glare control performance. *Energy Procedia* 122, 343–348. <https://doi.org/10.1016/j.egypro.2017.07.334>
- Maragkoudaki, A., 2013. No-Mech Kinetic Responsive Architecture: Kinetic Responsive Architecture with No Mechanical Parts. *IEEE*, pp. 145–150. <https://doi.org/10.1109/IE.2013.23>
- Marshall, M.T., 2015. Bi-directional thermo-hygroscopic facades: Feasibility for liquid desiccant thermal walls to provide cooling in a small-office building. Presented at the Architectural Research Centers Consortium FUTURE of Architectural Research, Perkins+Will, Illinois, Chicago, pp. 45–56.
- Marshall, M.T., 2010. HYGROSCOPIC CLIMATIC MODULATED BOUNDARIES: A Strategy for Differentiated Performance Using a Natural Circulative and Energy Captive Building Envelope in Hot and Moisture Rich Laden Air Environments. *Perkins Will Res. J.* 02.01, 41–54.
- Meagher, M., 2014. Responsive Architecture and the Problem of Obsolescence. *Int. J. Archit. Res. ArchNet-IJAR* 8, 95. <https://doi.org/10.26687/archnet-ijar.v8i3.498>
- Meng, H., Li, G., 2013. Reversible switching transitions of stimuli-responsive shape changing polymers. *J. Mater. Chem. A* 1, 7838. <https://doi.org/10.1039/c3ta10716g>
- Mitrofanova, E., Rathee, A., Santayanon, P., 2014. hydroceramic (Master Thesis). Institute for advanced architecture of Catalonia, Barcelona.
- Momodá, L.A., n.d. The future of engineering materials: Multifunction for performance: Tailored structure. Presented at the tenth annual symposium on Frontiers of Engineering, Washington D.C, pp. 47–52.
- Ng, R., 2013. Performative Materials in Architecture and Design. Intellect Ltd, Bristol.
- Nicola Augustin, 2018. Motion with Moisture: Creating Passive Dynamic Envelope Systems Using the Hygroscopic Properties of Wood Veneer (Master Thesis). University of Waterloo, Ontario, Canada.

- Nouvel, J., 1987. Arab World Institute.
- Ogwezi, B., Bonser, R., Cook, G., Sakula, J., 2011. Multifunctional, Adaptable Facades. Presented at the TSBE EngD Conference, University of Reading.
- Ogwezi, B., Jeronimidis, G., Cook, G., Sakula, J., Kilaire, A., 2013. Development of a passive and adaptable façade element for humidity control.
- Parkin, I.P., Manning, T.D., 2006. Intelligent Thermochromic Windows. *J. Chem. Educ.* 83, 393. <https://doi.org/10.1021/ed083p393>
- Pascha, K.S., 2008. The use of Phase-Change-Material as cooling-strategy for buildings in the Chilean climate. *Int. J. Low-Carbon Technol.* 3, 101–109. <https://doi.org/10.1093/ijlct/3.2.101>
- Pasupathy, A., Velraj, R., Seeniraj, R.V., 2008. Phase change material-based building architecture for thermal management in residential and commercial establishments. *Renew. Sustain. Energy Rev.* 12, 39–64. <https://doi.org/10.1016/j.rser.2006.05.010>
- Pazrev (Photographer). (2014, October) retrieved 18 March, 2018 https://commons.wikimedia.org/wiki/File:Phase_Change_Materials.png
- Perino, M., Serra, V., 2015. Switching from static to adaptable and dynamic building envelopes: A paradigm shift for the energy efficiency in buildings. *J. Facade Des. Eng.* 3, 143–163. <https://doi.org/10.3233/FDE-150039>
- Pittaluga, M., 2015. Electrochromic glazing and walls for reducing building cooling needs, in: *Eco-Efficient Materials for Mitigating Building Cooling Needs*. Elsevier, pp. 473–497. <https://doi.org/10.1016/B978-1-78242-380-5.00017-0>
- Qiu, Y., Park, K., 2001. Environment-sensitive hydrogels for drug delivery. *Adv. Drug Deliv. Rev.* 53, 321–339. [https://doi.org/10.1016/S0169-409X\(01\)00203-4](https://doi.org/10.1016/S0169-409X(01)00203-4)
- Rao, V.V., Parameshwaran, R., Ram, V.V., 2018. PCM-mortar based construction materials for energy efficient buildings: A review on research trends. *Energy Build.* 158, 95–122. <https://doi.org/10.1016/j.enbuild.2017.09.098>
- R.C.G.M. Loonen, J.M. Rico-Martinez, F. Favoino, M. Brzezick, C. Menezo, G. La Ferla, L. Aelenei, 2015. Design for façade adaptability – Towards a unified and systematic character. Presented at the 10th Conference on Advanced Building Skins, Bern, Switzerland, pp. 1284–1294.
- Ritter, A., 2007. Smart materials in architecture, interior architecture and design. Birkhäuser, Basel ; Boston. Roth, L., 2015. Hydromembrane (Master Thesis). Institute for advanced architecture of Catalonia, Barcelona.
- Royon, L., Karim, L., Bontemps, A., 2014. Optimization of PCM embedded in a floor panel developed for thermal management of the lightweight envelope of buildings. *Energy Build.* 82, 385–390. <https://doi.org/10.1016/j.enbuild.2014.07.012>
- Sadineni, S.B., Madala, S., Boehm, R.F., 2011. Passive building energy savings: A review of building envelope components. *Renew. Sustain. Energy Rev.* 15, 3617–3631. <https://doi.org/10.1016/j.rser.2011.07.014>
- Saffari, M., de Gracia, A., Fernández, C., Cabeza, L.F., 2017. Simulation-based optimization of PCM melting temperature to improve the energy performance in buildings. *Appl. Energy* 202, 420–434. <https://doi.org/10.1016/j.apenergy.2017.05.107>
- Samuel V. Glass, Samuel L. Zelinka, 2010. Moisture Relations and Physical Properties of Wood, in: *Wood Handbook : Wood as an Engineering Material*, 4.1. U.S. Department of Agriculture, Forest Service, Forest Products Laboratory, Madison, WI. <https://doi.org/10.2737/FPL-GTR-190>
- Sbar, N.L., Podbelski, L., Yang, H.M., Pease, B., 2012. Electrochromic dynamic windows for office buildings. *Int. J. Sustain. Built Environ.* 1, 125–139. <https://doi.org/10.1016/j.ijsbe.2012.09.001>
- Seyfour, M.M., Binions, R., 2017. Sol-gel approaches to thermochromic vanadium dioxide coating for smart glazing application. *Sol. Energy Mater. Sol. Cells* 159, 52–65. <https://doi.org/10.1016/j.solmat.2016.08.035>
- Shambayati, R., Tankal, ece, Efilena, B., 2014. Translated Geometries (Master Thesis). Institute for advanced architecture of Catalonia, Barcelona.
- Skaar, C., 2012. Wood-water relations. Springer, Place of publication not identified. SOMA, 2012. One Ocean.
- Staples, T.L., Chatterjee, P.K., 2002. Synthetic Superabsorbents, in: *Textile Science and Technology*. Elsevier, pp. 283–322. [https://doi.org/10.1016/S0920-4083\(02\)80011-1](https://doi.org/10.1016/S0920-4083(02)80011-1)
- Sun, L., Huang, W.M., Ding, Z., Zhao, Y., Wang, C.C., Purnawali, H., Tang, C., 2012. Stimulus-responsive shape memory materials: A review. *Mater. Des.* 33, 577–640. <https://doi.org/10.1016/j.matdes.2011.04.065>
- Sushant, V., Pradeep, D., 2014. Adaptive [skins]: Adaptation through smart systems. Presented at the 7th International Conference Proceedings of the Arab Society for Computer Aided Architectural Design, ASCAAD 2014, Jeddah, Kingdom of Saudi Arabia, pp. 275–289.
- Svensson, J.S.E.M., Granqvist, C.G., 1985. Electrochromic coatings for "smart windows." *Sol. Energy Mater.* 12, 391–402. [https://doi.org/10.1016/0165-1633\(85\)90033-4](https://doi.org/10.1016/0165-1633(85)90033-4)
- Tang, Y., Lin, G., Yang, S., Yi, Y.K., Kamien, R.D., Yin, J., 2016. Programmable Kiri-Kirigami Metamaterials. *Adv. Mater.* 1604262. <https://doi.org/10.1002/adma.201604262>
- Torres, B., 2014. Programmable Matter Hygroscopic actuation of multidirectional lattice structures (Master Thesis). University of Stuttgart, Stuttgart, Germany.
- Vailati, C., Bachtar, E., Hass, P., Burgert, I., Rüggeberg, M., 2018. An autonomous shading system based on coupled wood bilayer elements. *Energy Build.* 158, 1013–1022. <https://doi.org/10.1016/j.enbuild.2017.10.042>
- Verma, S., Devadass, P., 2013. adaptive[skins]: Responsive building skin systems based on tensegrity principles, in: *Future Traditions*. Presented at the 1st eCAADe Regional International Workshop, Portugal, pp. 155–170.
- Waitz, T., Kazykhanov, V., Karthaler, H.P., 2004. Martensitic phase transformations in nanocrystalline NiTi studied by TEM. *Acta Mater.* 52, 137–147. <https://doi.org/10.1016/j.actamat.2003.08.036>
- Wang, N., Goh, Q.S., Lee, P.L., Magdassi, S., Long, Y., 2017. One-step hydrothermal synthesis of rare earth/W- codoped VO₂ nanoparticles: Reduced phase transition temperature and improved thermochromic properties. *J. Alloys Compd.* 711, 222–228. <https://doi.org/10.1016/j.jallcom.2017.04.012>
- Wang, S., Liu, M., Kong, L., Long, Y., Jiang, X., Yu, A., 2016. Recent progress in VO₂ smart coatings: Strategies to improve the thermochromic properties. *Prog. Mater. Sci.* 81, 1–54. <https://doi.org/10.1016/j.pmatsci.2016.03.001>
- Wood, D., Vailati, C., Menges, A., Rüggeberg, M., 2018. Hygroscopically actuated wood elements for weather responsive and self-forming building parts – Facilitating upscaling and complex shape changes. *Constr. Build. Mater.* 165, 782–791. <https://doi.org/10.1016/j.conbuildmat.2017.12.134>
- Y. Kyriakou, A., Potter, A., Zhao, W., 2016. SoftSpaces.
- Yang, H., Wang, Y., Yu, Q., Cao, G., Yang, R., Ke, J., Di, X., Liu, F., Zhang, W., Wang, C., 2018. Composite phase change materials with good reversible thermochromic ability in delignified wood substrate for thermal energy storage. *Appl. Energy* 212, 455–464. <https://doi.org/10.1016/j.apenergy.2017.12.006>
- Young, B.A., Falzone, G., Wei, Z., Sant, G., Pilon, L., 2018. Reduced-scale experiments to evaluate performance of composite building envelopes containing phase change materials. *Constr. Build. Mater.* 162, 584–595. <https://doi.org/10.1016/j.conbuildmat.2017.11.160>
- Zhang, R., Yin, C., Fu, Q., Li, C., Qian, G., Chen, X., Lu, C., Yuan, S., Zhao, X., Tao, H., 2018. Metal-to-insulator transition and its effective manipulation studied from investigations in V_{1-x}Nb_xO₂ bulks. *Ceram. Int.* 44, 2809–2813. <https://doi.org/10.1016/j.ceramint.2017.11.024>
- Zhu, M., Qi, H., Wang, B., Wang, H., Guan, T., Zhang, D., 2018. Thermochromism of vanadium dioxide films controlled by the thickness of ZnO buffer layer under low substrate temperature. *J. Alloys Compd.* 740, 844–851. <https://doi.org/10.1016/j.jallcom.2018.01.066>

Temperature-responsive systems: passive strategies for building envelopes

Claudio Aresta

Associate Professorship of Architectural Design and Building Envelope / Technical University of Munich / Germany, claudio.aresta@tum.de, aresta.claudio@gmail.com

Temperature change is a key factor in adaptive façade design: many materials react to it by adapting their chemical and physical properties. Thus, analysing temperature-responsive systems is of primary importance for contractors, architects and engineers to develop passive devices.

This paper is a survey of temperature-responsive systems and their recent application in building envelopes. The first part offers a general overview of passive, or auto-reactive, materials (or more complex systems that include materials). All components are grouped according to their physical principle and sorted according to two main parameters of classification – input-Energy and output-Strategy. The second part focuses on temperature-responsive systems, part of passive materials, which are capable of adapting their shape as soon as temperature significantly increases or decreases – for instance materials with shape-memory effect, phase-change materials, composite bi-materials, chromogenic and thermoelectric materials. In comparison to materials that respond to other kind of stimuli, they are highly available on the market and their introduction in scientific applications has been already tested. More importantly, this group of materials show a strong potential for being used by the construction industry. Their special properties, e.g. the reaction time, the operating temperature range, the type of change, the durability and the recyclability, distinguish each system from another and allow a different use. The review of the features of each material is implemented and complemented by a collection of applications, in order to properly understand the purpose of passive strategies in contemporaneous architectural projects.

Keywords: passive, auto-reactive, temperature, input-output, catalogue

1 Introduction

The building envelope can react to a variety of inputs originated by the natural surrounding. Most envelope reactions imply transformations that enhance the building performances such as the thermal, visual and acoustic comfort and the air quality. From a design perspective, the issue is not so much to focus on the reactions as to question what kind of inputs set off them. In effect, Newton's third law of motion reminds us that a reaction never occurs alone, but always in pair with action – they are result of mutual interactions. Current adaptive solutions deal primarily with electric sources to trigger the reactions. The use of electricity and external mechanisms explains why the concept of adaptivity is mainly understood as a technical function, which involves an intricate development or complex use. Indeed, electricity has allowed architects a high degree of control over action-reactions and till now constitutes an economically affordable source. Although it provides a broad spectrum of alternatives, adaptive design often rests on countless small components regulated by computer-assisted systems. This process is articulated in three different steps, such as separate sensing, controlling and actuating procedures – to which correspond three components: a sensor, a controller and an actuator.

However, electricity “superimposes high-tech equipment on otherwise inert material,” as A. Menges, S. Reichers and O. D. Krieg (2014) state, and “in nature a fundamentally different, no-tech strategy can be observed.” This paper focuses on temperature as environmental input, relying on the evidence that temperature impacts material adaptation more than other environmental stimuli. If one considers that almost all energy in our environment comes from the sun, it is of the utmost importance to explore the potential offered by temperature changes. Once again, Newton’s principle helps us to simplify the adaptive process. If object A exerts a force on object B, B responds to A with an equal and opposite force. When they act on different objects, these forces do not neutralise each other. In other words, the façade materials can react autonomously to temperature thanks to their physical or chemical properties. These strategies – passive – do not need a third external input such as electricity, as soon as they exploit the characteristic resources of materials, whether raw or manufactured. Temperature changes can directly influence the inner comfort of buildings and the functions of insulating, energy harvesting and generating, sun-shading. Even other factors like the control of relative humidity, heat radiations and the quality of air are all related with the continuous temperature fluctuations. Far beyond sensors and monitoring systems, the new type of envelope can evolve toward thermo-responsive systems, that offer the potential to design building components with varied properties of density, translucency and elasticity. In order to give a general overview of the thermo-reactive systems which have been tested up to today in the building sector, this research surveys the properties of Phase Change Materials, Shape Memory Alloys, Composite Materials, Chromogenic Materials and Thermoelectric Materials.

2 Passive strategies

A review of the recent literature about passive systems reveals that the topic requires a clear and unambiguous definition. Various authors have applied the term ‘passive’, ‘smart’ or ‘auto reactive’, to describe many slightly different concepts. Among others M. Addington described in 2005 smart materials as “highly engineered materials that respond intelligently to their environment”. Writing about ‘interactive architecture’, M. Fox (2016) argued that “the adaptive capacity of their systems is ingrained in the material; no additional technical equipment is required”. D.H. Braun and B. Bader (2013) introduced auto-reactivity in building envelopes when “modern materials and on the basis of inspirations from technologies in fields of studies other than architecture, adjust to the individual needs of the users of a building”. S. Persiani (2016) defined auto-reactive systems as “an evolution of reactive systems, using latent unused Energy from their surrounding environment to achieve physical change through mechanical transmission or use of adaptive materials undergoing dynamic change in response to an external change of specific conditions”. Finally, M. Casini (2016) outlined passive adaptive components as “systems capable of changing their configuration autonomously without the need for external control and power supply. These systems usually employ smart materials able to vary their configuration according to external environmental stimuli.” Here, passive solutions are intended as the capability of materials to transform environmental resources into another type of energy.

Facing energetic issues, passive systems introduce two relevant topics. On one hand the necessity of reducing the use of non alternative sources. By operating simultaneously as sensor, controller and actuator, these components are in most cases self-sufficient and react directly to environmental factors following the gradual changes of the climate. On the other hand, passive systems open potential applications of such low-tech strategies to regions where advanced technologies are not so common. This results feasible, since the adaptive performance of buildings depends just on local factors and not on external control. But, the strong dependency from the environment also implies that users can in few cases interact with the adaptivity. Adaptive-passive components seem flexible to the changing environment, but cannot be manually regulated from building users whenever a change is required.

A fully comprehension of how passive strategies work starts from a survey of available materials and systems: it involves a collection of data based on previous catalogues, which need to be revised and updated. Since the nineties, H. Janocha has reported an overall picture of materials from different technical practices. His books “Aktoren. Grundlagen und Anwendungen” (1992) and “Unkonventionelle Aktoren. Eine Einführung” published in 2010 and in 2013 in its second edition, represent a complete collection of ‘controllable work-producing devices’, yet whose application can seldom fulfil building tasks. Here, physical properties and laboratory tests of components such as bi-metals, shape memory alloys and electroactive polymers are presented and evaluated. In 2007, A. Ritter analysed in his book “Smart Materials in Architecture, Interior Architecture und Design” an architecture-oriented state-of-the-art in the field of passive, ‘smart’, components. In this survey the range of materials is wide, but a systematic classification misses and an assessment of the different materials with one-to-one relationships is not possible. Furthermore, the book does not include recent products from other related disciplines and reveals that the spectrum of passive materials used in architecture is nowadays substantially low. In areas such as biology, medicine or automotive industry an intense research leads to a rapid development of innovative, cutting-edge technologies.

This work aims at bridging the lacks of previous publications, by providing a new catalogue that contains recent passive systems and, therefore, can be a useful tool for the design of new building envelope. Following other catalogues, all passive components are grouped according to their physical principle and sorted by their input-Energy. The input-Energy corresponds to the environmental source that triggers a chemical or physical reactive process and therefore to temperature, sunlight, wind pressure, humidity and precipitations, acoustic waves and electricity. In addition to this first parameter, passive materials and systems are classified according to a second parameter, the output-Strategy. It indicates the reaction generated by the material in response to a specific stimulus. All various possible strategies that passive materials can manifest implicate a physical and/or chemical, visible and/or invisible movement. In this research, these are grouped into three macro-categories: the dynamic change, the optical change and the exchanges of energy or matter with the environment. Table 1 displays a matrix of the passive systems, mapped through the two above mentioned parameters – input-Energy (rows) and output-Strategy (columns). The generated database assesses passive materials and their properties, but don’t focus on evaluating whether every single their application is feasible or not for architectural purposes. In order to analyse how external factors can influence façade components in specific environmental circumstances, further investigations are needed.

Passive systems	Change of Form	Optical Change	Exchange of Energy/Matter
Temperature	Shape Memory Materials Phase Change Materials Composite Materials	Chromogenic Materials	Phase Change Materials Chromogenic Materials Thermoelectric Systems
Sunlight	Shape Memory Materials	Chromogenic Materials	Chromogenic Materials Photoelectric Systems
Wind, Pressure	-	Chromogenic Materials	Shape Memory Materials
Humidity, Water	Composite Materials Super-absorbent Material	Chromogenic Materials	Super-absorbent Material
Acoustic Waves	-	-	Electroactive Materials
Electricity	Shape Memory Materials Electroactive Materials	Chromogenic Materials	-

Table 1: Matrix of the passive systems.

In the realm of passive systems, there is an external factor that mainly affects specific functions of the envelope – the temperature. The large number of action-reaction processes that involve

temperature changes reflects a great availability on the market of thermo-responsive materials. As recent studies indicate, the purpose of adaptive components in façades often addresses the improvement of thermal and visual comfort of interior spaces. Consequently, façade elements are mainly related with solar radiation and outdoor temperature (D. Aelenei, L. Aelenei, C. Pacheco Vieira 2016) – within this group, many case studies involve the integration of photovoltaic cells as adaptive element. External factors as humidity, wind pressure or noise are less investigated, since the combination with a specific function of the envelope is more problematic. In parallel with this tendency, the data collected in the catalogue of passive systems reflect a production of raw and manufactured materials that react mainly to temperature changes. In descending order, less elements react to electricity, sunlight (electromagnetic forces), humidity, wind pressure and acoustic waves.

3 Thermo-responsive strategies

The following section is a cross-sectional study of a class of materials – thermo-responsive materials –, that focuses on their peculiar characteristics and limitations. It is a survey of their recent applications and future potential uses in the field of adaptive façades. In this analysis five groups of materials are illustrated: Phase Change Materials, Shape Memory Alloys, Composite Materials, Chromogenic Materials and Thermoelectric Materials.

3.1. Phase Change Materials (PCM)

Among various solutions developed for passive-sustainable buildings, Phase Change Materials definitely show a wider range of applications, aimed at enhancing energy performances. These materials seem convenient for climates with high demand on both heating and cooling and have any specific restriction on the availability. If compared with other materials, PCMs exhibit some uncommon thermo-physical features during the phase transition, from a liquid to a solid phase and vice versa. Thanks to their temperature-enthalpy properties, some of those materials are able to gather latent heat for thermal energy storage purposes. Inorganic PCMs, the most efficient for this purpose, are already contained in several building components, such as wall boards, ceilings panels, windows curtains or dynamic glazings. New tests and analysis evidence that these materials can also be used for heat storage tanks, to accumulate and store thermal energy for numerous weeks.

While inorganic PCMs, such as salt hydrates, show higher energy storage capacity, organic PCMs, mainly paraffins, have longer stability and higher thermal expansion when heated. Organic materials manifest physical alterations with an 'active' adaptation, instead of 'latent'. Thanks to their chemical energy, Phase Change Materials, and particularly paraffins, expand in volume up to 20-25% (thermal expansion coefficient of nearly $500 \times 10^{-6} \text{ K}^{-1}$), providing large forces. Specific systems, such as thermal (linear) actuators, can convert thermal energy into mechanical energy by exploiting the phase-change properties of paraffin waxes. During melting, these materials expand and push a piston, causing a movement of the component. As soon as temperature decreases and goes below the freezing point, the waxes contract and the entire system returns to the initial state. Since melting point ranges can be customised, thermal actuators are suitable for applications in different climatic circumstances and temperatures. Such systems are already used in aerospace and automotive industry or in the greenhouse sector.

3.2. Shape Memory Alloys (SMA)

Despite their high presence on the market, Shape Memory Alloys don't exhibit many applications in the building sector. Their use appears dramatically restricted, since only a few materials can fulfil the requirements of envelopes. The reasons of these difficulties embrace among others the necessary manufacturing costs and a high hysteresis. The temperature difference between phase transformations – from austenite to martensite state and vice versa – upon heating and cooling reaches typically around 25-30°C. Nevertheless, the alloy with the greatest market presence is certainly Nitinol. Nitinol is usually composed of around 55% Nickel and 45% Titanium. By slightly varying the chemical composition, the alloy can also be adapted to different climatic circumstances and the transition-phase temperature modified. Nitinol's transformation occurs within the elastic phase and enables the alloy to be deformed without irreversible plastic deformations. Moreover, this transformation brings a change in Young's modulus of the solid material, modifying rapidly its stiffness. This abrupt change of stiffness boosts the damping capacity of Nitinol-based systems and allows them to convert kinetic energy into heat.

The recent application of SMAs in building industry reflects the two above mentioned features. For its pseudo-elastic, or super-elastic, property (passive effect), Nitinol can be integrated in damping systems for controlling seismic waves during earthquakes. Besides, SMAs have been recently used for their shape recovery characteristic (active effect). This application is limited to thermo-reactive textile curtains or window shutters, that fold and unfold depending on different temperature levels.

3.3. Composite Materials (CM)

Composite Materials combine at least two materials with different chemical or physical properties, in order to achieve a specific given purpose. This text deals with layered composites that integrate only two materials with greatly different thermal expansion coefficients. The aim of this combination is to generate a change of form – in this case a bending – when the materials are heated and cooled. The use of metals or plastics, as CMs respectively called bi-metals and bi-plastics, results in systems that produce significant deformation, but very small forces. On one side, bi-metals are a combination of a passive element, Invar or Super-Invar, and an active element, e.g. MnNiCu. This compound often reaches a high degree of curvature, but it cannot carry loads much heavier than their own weight. On the other, bi-plastics use a passive element, often Polyethylene terephthalate (PET), and an active polymer blend, Polyethylene (PE). Many studies show that these polymer composites can be reinforced with 3D-printed fibres.

Composite Materials appear also adaptable to several outer conditions, since the alteration of the two matching layers can originate different reaction temperatures. Even if stable and durable, this group of CMs still do not catch the attention of industries. Nowadays the application in façades is limited to window shutters integrated between two glass panes that fold and unfold depending on different temperature levels.

3.4. Chromogenic Materials

As the name would suggest, chromogenic materials react to a change of environmental parameters by altering their optical properties. The optical alteration refers to a change of colour as well as of the level of transparency. At present, this group of materials certainly presents a high number of solutions for the building envelope. The range of solutions encompasses components that react to different stimuli, such as temperature, electro-magnetic radiation (sunlight), mechanical pressure or electric power. But, focusing the attention on temperature-dependent systems (thermo-

chromic systems), the spectrum is reduced to a few materials. Thermo-chromic materials have been recently integrated as adaptive films between two or more glass panes, in order to passively control the fluxes of light and thermal energy in sustainable buildings. Maybe one of the most relevant test included of Vanadium dioxide in dynamic glasses, without providing the expected results. A lack of long-term stability and extremely high costs make their presence in the market currently not foreseeable. Similarly innovative are researches on poly(N-isopropylacrylamide), PNIPA hydrogels, since they show considerable results for the façade's requirements. A long-term stability, combined with a tailored adjustment of switching temperatures during the manufacturing process and a production of components with appropriate sizes for the building industry, allow thermotropic coatings like PNIPA hydrogels to contend with electrochromic materials in the sector of dynamic glasses. But, unlike electrochromic glasses, the process cannot be manually operated and the risk that the thermo-chromic glazing switches despite demand for heat in the building cannot be ignored. Furthermore, thermotropic glasses reach an almost-transparent state when switched off, while glasses with electrochromic elements, such as Tungsten oxide, remain perfectly transparent.

3.5. Thermoelectric materials

Thermoelectric systems, more commonly known as generators, transform heat flux directly and instantly into electricity – according to the Seebeck effect. By increasing the temperature gap on the two sides, the system become more efficient and, consequently, more electricity is generated. But, their low efficiency rate, around 8%, make these systems suitable in circumstances with strong heat fluxes. Due to the necessary high temperature differences and a low availability of their raw materials, mainly Bismuth telluride, this group of materials still doesn't exhibit potential applications in the building industry.

Table 2 provides an overview of the main properties of the above illustrated five groups.

Thermo-responsive systems	Reaction Type	Reaction Time	Temperature Dependence	Force	Cycling Stability	Application in Building Industry
Phase Change Materials: <i>Paraffin wax</i>	Change of Form	within a few minutes	linear trend	high	high	latent heat storage, ventilation opener
Shape Memory Alloys: <i>Nitinol</i>	Change of Form	a few seconds	nonlinear trend, abrupt change	middle	high (> 10M cycles)	seismic damper, window shutter (experimental tests)
Composite Materials: <i>FeNiCo+MnNiCu (Bimetal)</i>	Change of Form	less than one minute	linear trend	low	high (> 10M cycles)	window shutter (experimental tests)
Chromogenic Materials: <i>PNIPA</i>	Optical Change	more than ten minutes	linear trend	no forces	high	dynamic glass (experimental tests)
Thermoelectric Materials: <i>Bismuth telluride</i>	Exchange of Energy	instantaneous	nonlinear trend	no forces	-	-

Table 2: Matrix of the thermo-responsive systems.

4 Conclusions

The great challenge for passive strategies lies in the capacity of materials to 'act and react'. This means that materials can adjust their properties autonomously, yet controlled, in response to environmental conditions and flows. Nevertheless, as M. Kretzer (2014) claimed, "the factors that drive the adjustment of materials are often not directly perceivable, since they are based on internal reactions and actions." The proposed approach gives greater visibility to thermal reactions in materials developed for architectural purposes (PCM, SMA, CM, thermochromic materials and thermoelectric materials). Since temperature influences their behaviour, thermo-responsive systems play a lead role in enhancing the building performance and the interior comfort.

The first part of the paper focuses on providing an overview of passive strategies. Due to the lack of a clear definition of these strategies, the research introduces a systematic analysis proposing a method of classification. A detailed examination of thermo-responsive systems follows. The analysis of specific features and applications in a subgroup of passive systems (thermo-responsive systems) reveals an employment of façade components mainly in multi-layered glasses as sun-shading devices. Quite surprising is the fact that thermal expansion properties of PCMs and form change properties CMs (mainly polymer blends) are not applied at all in adaptive components.

To summarise, the employment of above mentioned properties could lead to promising results in architecture. Their integration in buildings is indeed more likely than other types of environmental sources. Future work needs to extend the survey of thermo-responsive to other types of stimuli.

5 Acknowledgements

This research couldn't be possible without the professional and financial support of the building envelope construction company Frener & Reifer. Furthermore, the author would like to acknowledge COST Action TU1403 "Adaptive Facades Network" for the provided research networking of WG 1.

6 References

- Addington, D. M., Schodek, D. L.: Smart Materials and New Technologies: for the architecture and design professions. Architectural Press (2005)
- Aelenei, D., Aelenei, L., Pacheco Vieira, C.: Adaptive Façade: Concept, Applications, Research Questions. Elsevier Ltd., 269-275 (2016). doi:10.1016/j.egypro.2016.06.218
- Braun, D.H., Bader, B.: Adaptive Skins – Adaptive and Autoreactive Building Facades. Proc. of the International Association for Shell and Spatial Structures (2013)
- Casini, M.: Smart Buildings: Advanced Materials and Nanotechnology to Improve Energy Efficiency and Environmental Performance. Woodhead Publishing (2016)
- Fortmeyer, R., Linn, C.: Kinetic Architecture: Designs for Active Envelopes. The Images Publishing Group (2014)
- Fox, M.: Interactive Architecture: Adaptive World. Princeton Architectural Press (2016)
- Janocha, H.: Unkonventionelle Aktoren. Eine Einführung. Oldenbourg Wissenschaftsverlag (2010)
- Knaack, U., Klein, T., Bilow, M., Auer, T.: Fassaden – Prinzipien der Konstruktion. Birkhäuser Verlag (2010)
- Kretzer, M., Hovestadt, L.: ALIVE: Advancements in Adaptive Architecture. Birkhäuser Verlag (2014)
- Loonen, R. C. G. M., Rico-Martinez, J. M., Favoino, F., Brzezicki, M., Menezo, C., La Ferla, G., Aelenei, L.: Design for façade adaptability – Towards a unified and systematic characterization. Proc. of the 10th Conference on Advanced Building Skins (2015)
- Loonen, R. C. G. M., Trčka, M., Cóstola, D., Hensen, J. L. M.: Climate adaptive building shells: State-of-the-art and future challenges. Elsevier Ltd., 483-493 (2013). doi:10.1016/j.rser.2013.04.016
- Persiani, S. G. L., Battisti, A., Wolf, T.: Autoreactive architectural facades – discussing unpowered kinetic building skins and the method of evolutionary optimization. Proc. of the 11th Conference on Advanced Building Skins (2016)
- Peters, S.: Material Revolution 2: New Sustainable and Multi-Purpose Materials for Design and Architecture. Birkhäuser Verlag (2014)
- Ritter, A.: Smart Materials in Architecture, Interior Architecture und Design. Birkhäuser Verlag (2007)
- Ruth, J., Gump, R., Heidenreich, C.: Aktive Faser-Verbundwerkstoffe für Adaptive Systeme. Fraunhofer IRB Verlag (2015)
- Vigna, I., Bianco, L., Gioia, F., Serra, V.: Phase Change Materials in Transparent Building Envelopes: A Strengths, Weakness, Opportunities and Threats (SWOT) Analysis. Energies (2018). doi:10.3390/en11010111
- Zupan, M., Ashby, M. F., Fleck, N.A.: Actuator Classification and Selection – The Development of a Database.

Potentials for the use of ferrofluids in instantly-reacting solar shading

Marcin Brzezickia

Wroclaw University of Science and Technology / Faculty of Architecture, Poland, marcin.brzezicki@pwr.edu.pl

Ferrofluids are colloidal liquids made of nanoscale ferromagnetic, or ferrimagnetic, particles (usually 10 nm particles of metallic elements) which are suspended in a carrier fluid (usually an organic solvent or water). The solution becomes strongly magnetized in a magnetic field. Ferrofluids are the focus of research carried out in a variety of fields (e.g. electronics, medicine), including projects such as adaptive shape-shifting magnetic mirrors.

The potential for the application of ferrofluids in façade shading design lies in two specific features of these substances. The first is the dark colour of the fluid (e.g. black in the case of iron nanoparticles), which makes it fully opaque, thus allowing it to function as a shading device. The second feature is the possibility to freely modify the ferrofluid shape in a magnetic field density ranging from 100 to 500 mT (mili Tesla) in a matter of milliseconds.

The proposed paper briefly describes the characteristics of ferrofluids and presents the available technologies for the abovementioned design. Based on previously developed prototypes of ferrofluid shading the article also illustrates the device's mode of operation.

Keywords: ferrofluid, adaptive façade, façade regulation, façade shading

1 Introduction

Energy efficiency in building design is becoming increasingly important as it may significantly contribute to low-carbon buildings and cities in the future. The state-of-the-art materials and technologies that are used in the design of dynamic glazing “optimize the energy behavior of buildings and at the same time meet the comfort needs of users” (Casini 2016). So far, the most popular technologies include suspended particle devices (SPD), liquid crystal device windows (LCDW) and micro-blinds. The use of expensive coating and the components made of rare-earth elements substantially increases the initial cost of these technologies which is why a relatively small number of them reaches the market.

Ferrofluids are colloidal liquids made of nanoscale ferromagnetic, or ferromagnetic, particles (usually 10 nm particles of metallic elements) which are suspended in a carrier fluid (usually an organic solvent or water). The solution becomes strongly magnetized in a magnetic field. The most comprehensive lecture on ferrofluids is given in the book titled “Colloidal Magnetic Fluids: Basics” by S. Odenbach (Odenbach 2009). Ferrofluids are the focus of research carried out in a variety of fields (e.g. electronics, medicine) including projects such as adaptive shape-shifting magnetic mirrors.

Ferrofluids are highly magnetic compounds which “can be precisely positioned and controlled by an external magnetic field” (Nam-Trung et al 2006). This opens a wide range of possibilities for the application of opaque ferrofluids in façade design. Another important feature of ferrofluids is that they “respond immediately to the changes in the applied magnetic field” (Nam-Trung et al 2006) and can therefore be used to design light valves that react instantly.

2 Existing technologies

The idea to use ferrofluids as a device that regulates light incidence is not new. In the past, several design concepts were proposed, some of which entered the prototype phase, while others are already on market. Many of these proposals feature the use of strong neodymium magnets to manipulate the ferrofluid. The idea of a 2-mm-thick container partially filled with a ferrofluid that is manipulated by a so-called transparent “magnetic actuator”, was presented by Zi Tong Teo, a student at the National University of Singapore, in his design of a “Magnetic Ferrofluid Pattern Facade Technology”. The project won an award in the RIBA President’s Medals Student Awards competition in 2013 (Zi Tong 2013).

An interesting application of a ferrofluid display was presented by the Ferrolic company, founded by Zelf Koelman from the Eindhoven University of Technology. The prototype, which was later marketed as the final product called Ferrolic clock, features a thin tank filled with a dark opaque ferrofluid and a non-mixing clear fluid (the viscosity depends on the surfactant used to compose the ferrofluid itself, e.g. silicone oil). The front wall of the tank is made of glass while the rear one is opaque and houses electromagnets that manipulate the droplets of ferrofluid. The fact that the magnets are arranged in a matrix makes it possible to influence the ferrofluid, i.e. “to pick it up and move it around” (Koelman 2015) so as to form shapes, such as digits or letters. This technology has been commercialized and a ferrofluid clock can currently be purchased. Of course this technology is non-transmissive but it proves that it is possible to manipulate the ferrofluid locally. A similar product was recently presented by Damjan Stanković (Stanković 2018), but it uses a complicated mechanical device with neodymium magnets to manipulate the ferrofluid.

2.1. Novelty of this paper

This paper presents two designs that involve the manipulation of ferromagnetic fluid acting as a solar shade integrated with e.g. façade glazing. In the second proposal a number of smaller compartments are used to store the ferrofluid in order to facilitate the said manipulation and reduce the density of the magnetic field required to do so. This, in turn, reduces energy consumption, both by reducing the heat gain and the power consumed by the system itself.

3 Technological feasibility

3.1. Ferrofluid manipulation

The research on the manipulation of micro- and nano-sized droplets of ferrofluid is developing dynamically. The potential for various technical applications of ferrofluid has been proved e.g. in valves without mechanical parts or in light-directing optical devices (Torres-Díaz & Rinaldi 2014). The ongoing research in the discipline of ferrohydrodynamics promises to make more scientific data available for review soon (Rosensweig 2014). The shape formation of ferrofluid under magnetic field has been considered to be one of most difficult problems to analyze. A number of papers were presented, that address this issue, e.g. a numerical solution for calculating equilibrium shapes of ferrofluid subjected to external magnetic fields (Sun Kim et al 2009; Tan 2010).

Controlling the ferrofluid orientation with help of magnetic field is tested for astronomical lenses and ferrofluid liquid seals. In both cases magnetic field can be used to control the motion of ferrofluids, but the care have to be taken about the surface chemistry of the nanoparticles during functionalization. Measures must be taken to prevent ferrofluid from losing its fluidic state and particles gets separated from the liquid during application of the magnetic field.

3.2. Transparent coils

The discipline of transparent conductive layers has been growing rapidly mainly in response to the push from the market of flat TV and cellphone displays. So far transparent electrode coils have been created to test wireless power transfer using coatings made of multilayered IZTO/Ag/IZTO, and have proved to be efficient in charging e.g. medical devices (Putri et al 2014). Planar loops and spiral coils were placed on the top and bottom of an acrylic substrate (Lee et al 2016). A typical fridge magnet with a magnetic field density of approx. 5 mT (militesla) is not powerful enough to manipulate the ferrofluid, but this can be done successfully by means of neodymium magnets with a magnetic flux density of approx. 1.2 – 1.5 Tesla. Similar density can also be achieved by a loudspeaker coil (1-1.5 Tesla). These numbers suggest that it is feasible to produce a density of approx. 500-700 mT using transparent coils, which is enough to manipulate the ferrofluid on a short few-millimeter distance, facilitating “easy manipulation of a micro-ferrofluid droplet with planar microcoils” (Nam-rung et al 2006). This manipulation is also possible due to a “high magnetic field gradient, that can be achieved with microcoils” (Nam-rung et al 2006).

Also micromagnetic arrays might be used to generate required magnetic field to manipulate ferrofluid. For the 1cm² façade compartment containing volume of 1 ml of ferrofluid the magnetic field required to activate ferrofluid will be 10 mT to 100 mT. Assuming that overall area of the façade element would be 3,6 m² – 3,6M micro magnetic arrays are required activate the overall volume of ferrofluid, if the system occupies the whole surface of the pane.

4 Conceptual proposals

In the course of the research two proposals were prepared and one was eliminated after the initial brief study.

4.1. Conceptual proposal no. 1

The proposal included a flat few-millimeter-thick vertical container with the ferrofluid and another non-mixing clear inert fluid floating between two panes of glass or acrylic and with transparent coils mounted on the walls inside the container. Assuming that there is 20% of ferrofluid between two standard, i.e. one-story-high, panes of glass, which are 1.2 m × 3.0 m in size and have approx. 5 mm of space between them, the ferrofluid, in the power-off state (no electrical current, no magnetic field generated) would form a non-light permeable spandrel at the bottom of the container that is 600 mm in height. After applying electrical current, the transparent coils mounted on the glass create a magnetic field and shape the ferrofluid.

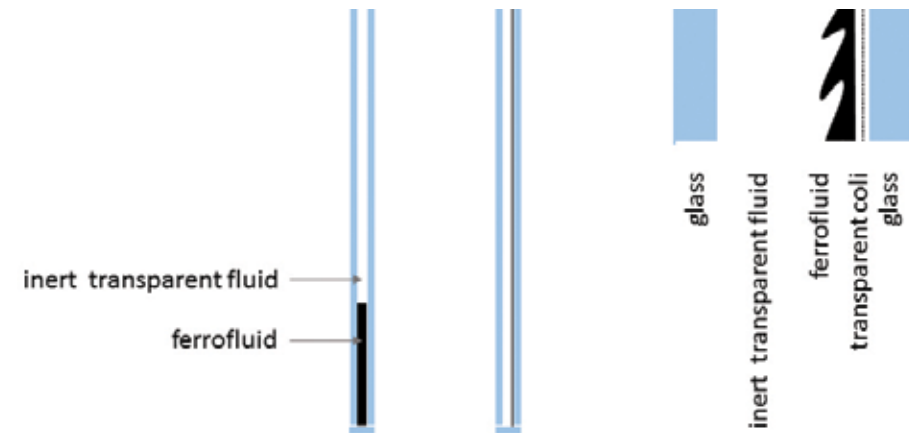

Fig. 1 Schematic diagram of the initial proposal no 1.

The proposal no 1. received negative feedback, because of the fact that surfactants used to coat the ferrofluid particles are usually oily substances (such as oleic acid or lecithin). In result ferrofluids are much more viscous than water. There is no doubt that the magnetic field density required to manipulate the ferrofluid can be produced by transparent pancake-coils but the so-called drag force might not be sufficiently strong to lift the ferrofluid from the bottom of the container as it would have to overcome the gravity and viscous friction (Nam-rung et al 2006). In the case of the Ferrolic clock mentioned above, large powerful electromagnets are used to perform this task and the process is effective on a much smaller scale of 150-200 mm.

In response to the negative feedback of the original design, the compartments holding the ferrofluid were reduced in size. This idea was explored in two separate proposals. The geometry of both proposals must take into account the fact that the volume of the ferrofluid is constant.

4.2. Conceptual proposal no. 2A

Proposal no. 2A features smaller ferrofluid compartments evenly scattered between two panes of transparent material (glass, acrylic), e.g. in a honeycomb pattern, which is perpendicular to the surface of the pane, as in previous proposal. Such compartments could store smaller volumes of the ferrofluid and would:

- allow for a shorter reaction time as a result of smaller travel distances of the ferrofluid,
- require lower values of magnetic field density for operation. The flow of the ferrofluid can be regulated by means of switching the current on and off in transparent coils mounted on the internal surface of one pane (on the internal wall of the compartment).

When powered off, the ferrofluid would sink to the bottom of the compartment, pulled by gravity, whereas in the power-on state, the magnetic field generated by the transparent coil would arrange the fluid into a rugged star with spikes (see Fig. 2). Such ferro fluid "stars" would block the light.

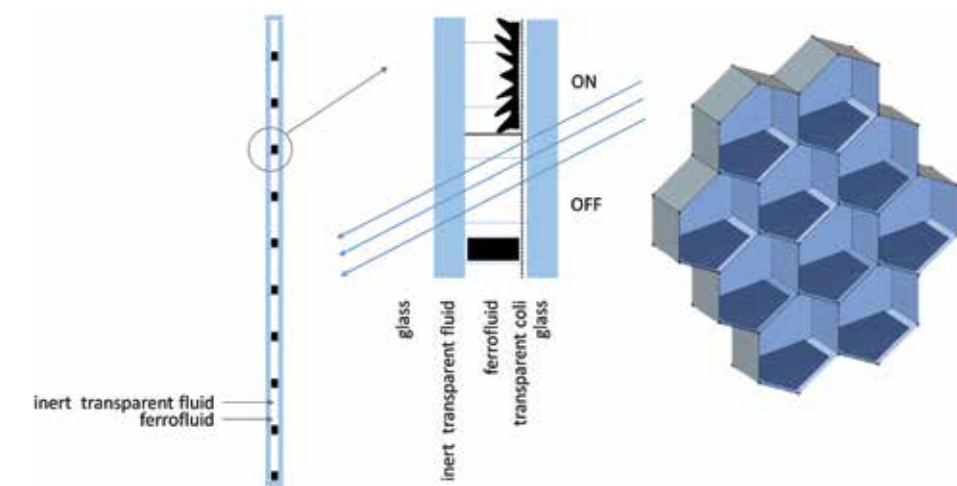

Fig. 2 Schematic diagram of proposal 2A. A) ferrofluid in the power-off state and power-on state B) axonometry of hexagonal compartments.

The drawback of this solution is that compartments with the ferrofluid would become clearly visible spots on the glass. Assuming that the ferrofluid takes up 20% of the entire volume, it would reduce the glass transparency by 20% when powered off, or the glass would have an even 20% tint (e.g. in a micro scale solution). Given that the average acuity of the human eye is roughly 1.2–1.8 arc minutes per line pair, the hexagonal cell would have to be smaller than 0,5 mm to remain imperceptible from a distance of 2 m. Another possibility would be to mount a second transparent coil on the other wall of the compartment. Such a solution would offer more options for the ferrofluid to be attracted to either coil, thus allowing more light to pass or to be redirected, see Fig. 2.

4.3. Conceptual proposal no. 2B

The solution no. 2B is to form cuboid horizontal compartments for the ferrofluid, spanning the whole width of the pane. In the power-off state the ferrofluid would form a flat layer, or "strip", at the bottom of each compartment (analogous to horizontal slats in venetian blinds but without mechanical elements) letting the light through. In the power-on state, the ferrofluid would be attracted by coils mounted along the width of the compartment wall (on both sides of the compartment) and would form a vertical strip that blocks the light. Adjacent vertical strips would form a continuous blind. A special controlling device would allow the current to be "switched on" in individual compartments, e.g. every second or every third compartment, in order to gradually regulate light penetration, see Fig. 3.

In prospective applications the coils that regulate the ferrofluid flow might be powered by light-transmitting PV cells mounted on the external wall of the compartment.

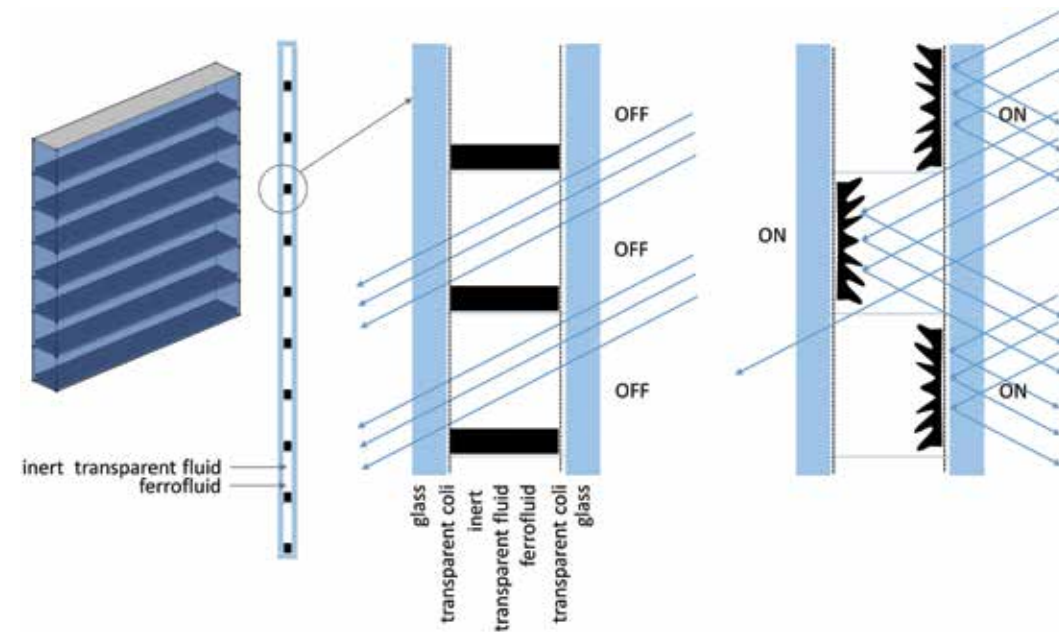

Fig. 3 Schematic diagram of the proposal 2B with two transparent coils. A) ferrofluid in the power-off state, B) ferrofluid in the power-on state

5 Conclusions

The paper is a general review of the existing technologies of ferrofluid manipulation and outlines the available solutions with respect to light controlling devices. In this work three designs were compared. The original one received negative feedback while the other two proposals allow the ferrofluid to be manipulated much more easily and at lower power consumption because smaller volumes of the ferrofluid have to travel shorter distances.

This solution has potential for development and would benefit from experiments involving transparent coils mounted on light-transmitting materials (e.g. glass, acrylic) as well as the study of the behavior of smaller volumes of ferrofluid in order to determine the required magnetic field density. Based on the data presented in this paper it can be concluded that the application of ferrofluid in light-regulation devices is theoretically possible but require further research and prototyping. It should be stressed that the use of a “fluid” requires any potential future application in a façade to guarantee the proper temperature of operation. This could be achieved, for example, by mounting a ferrofluid-based instantly-reacting shading device behind insulated glass units.

6 Acknowledgment

The paper was written as part of a research visit at TU Delft. The visit was financed by grant no.: S60401-0214-16-K0106 awarded by the Polish Ministry of Science and Higher Education.

The author of this paper wishes to acknowledge the help provided by Vikram S Raghavan, PhD Post-Doctoral Researcher, Dept. of Instrumentation and Applied Physics, Indian Institute of Science, Bangalore, India.

7 References

- Casini, M.: 9 - Dynamic glazing, In *Smart Buildings*, Woodhead Publishing, 305—325 (2016). doi 10.1016/B978-0-08-100635-1.00009-5
- Lee, H., Kang, S., Kim, Y. and Jung, C.: Small-sized metallic and transparent film resonators for MR-WPT system, *Electronics Letters*, 52, 8, 650—652 (2016)
- Magnetic Behavior of Ferrofluid (source: <https://ferrofluid.ferrotec.com/technology/> Accessed 8 May 2018)
- Nam-Trung, N., Kon Meng, N., and Huang, X.: Manipulation of ferrofluid droplets using planar coils, 89 (5): 052509—052509-3 (2006)
- Odenbach, S.: *Colloidal Magnetic Fluids: Basics, Development and Application of Ferrofluids*. Berlin: Springer Verlag, (2009)
- Putri, M., Young Koo, Ch., Lee, J-A, Kim, J-J, Lee H.Y.: Transparent conducting indium zinc tin oxide thin films with low indium content deposited by radio frequency magnetron sputtering, *Thin Solid Films*, 559, 30, 44-48 (2014)
- Rosensweig, R.E.: *Ferrohydrodynamics*. Dover edition. Mineola, New York: Dover Publications, Inc., (2014)
- Sun Kim, Y., Lee, S-H., Choi, H.S., Park I.H.: Shape formation of ferrofluid under external magnetic fields using level set method, *Journal of Applied Physics* 105, 07D539 (2009)
- Tan, S-H.: Formation and manipulation of ferrofluid droplets at a microfluidic T-junction. *Journal of Micromechanics and Microengineering* 20.4, 045004 (2010)
- Stankovic, D.: <https://www.damjanstankovic.com/> Accessed 8 May 2018
- Torres-Díaz, I., Rinaldi, C.: Recent progress in ferrofluids research: novel applications of magnetically controllable and tunable fluids, *Soft matter* 10, 43, 8584—8602 (2014)
- Koelman, Z.: Where Digital Meets Nature, <http://www.ferrolic.com/where-digital-meets-nature/> (2015) Accessed 8 May 2018
- Zi Tong T.: Magnetic Ferrofluid Pattern Facade Technology: Atmospheric light mitigating facade for digital art science museum, <http://www.presidentsmedals.com/Entry-34411> (2013) Accessed 8 May 2018

Technological and Economic Assessment of Different Models of Geometrically Complex Forms of Glass Envelopes

Tatjana Kosić a), Igor Svetel a), Milena Stavic b)

a) Innovation Center, Faculty of Mechanical Engineering, University of Belgrade, Serbia, tkosic@mas.bg.ac.rs

b) Institute of Architecture and Media, Graz University of Technology, Austria

The main concern of this research is to create links and interactive relationship between the design process on the conceptual level, materialization and realization of geometrically complex form of glass envelope. Based on established typology of complex form of building envelope in terms of geometry, as well as individual glass panels according to generating mode and type of curvature, different hypothetical models of materialization were created. The goal was to produce geometrically diverse but optimally balanced design solutions of surface panelization with respect to (similarity of) the original design idea, and in relation to the transparency of the glass surface, simplicity of nodal connection, shaping technology, use of material and costs. Based on defined goal, ten hypothetical models are created - models of different design variants of glass envelope regarding geometry and glass panels size, as well as different geometries of the entire envelope surface. As well, in terms of materialization of glass panels, the commonly used glazing variants are adopted. Parameters of geometrical features that vary according to models refer to the individual panels and include: panel shape, curvature of the panel surface, form of the panel edges and panel size. In order to evaluate technological and economic features of the different models, the following criteria are established: curved glass shaping technique and material efficiency (technological criteria); hard costs/m² and total investment costs of glass envelope (economic criteria). Finally, ranking of hypothetical models is done according to obtained results. The aim of this study is to establish the methodological approach to realization of geometrically complex form of glass envelopes in order selection of aesthetically satisfying and economically acceptable solutions.

Keywords: curved glass, structural glass, geometrically complex form of building envelope, materialization, Serbia

1 Introduction

Architectural structures of curvilinear forms set new requirements for application of curved and flat glass as an element of geometrically complex envelope of architectural structures. At first glance, the application of curved glass provides an exceptional freedom in the design of modern wavy shape, but set of constraints arises when it comes to the aspect of design, manufacture, use, performance and economy. Characteristics such as radius of curvature, minimum and maximum dimensions of the glass element, local regulations, available coatings, optical quality, and selection of the glass types significantly affect the final glass product. Concerning geometry of the glass envelope surface, today, there are no limitations in the process of their modeling. In fact, architectural practice continuously has followed the development of the geometry, and many architectural trends were inspired by the latest developments in this field. The word 'free form' says it is possible to create new forms, if the architects and designers are familiar with the geometry of basic geometrical forms, as well as with all elements of geometry. However there

are problems in the practical fabrication of the geometrically complex shapes, because unlike the abstract geometric forms, construction elements have physical characteristics that prevent the creation of any geometry (Kosić 2016). This is especially emphasized in the case of glass that is brittle and easily breakable material and therefore unable to produce in all shapes and sizes. Therefore, the design of a geometrically complex form of glass envelope is a compromise between different needs: fulfilment of design performance requirements, simpler production method, cost savings. More often, the relation between shape and fabrication poses new challenges and requires more sophistication from the underlying geometry (Liu et al. 2008). As a consequence, numerous architects have returned to being highly engaged in the fabrication process to ensure the design intent is carried through into the making (Dunn 2012). As well, the selection of glass envelope technologies is frequently a compromise between the intent of the architect, fabrication, shipping limitations and the project budget. Particularly, frequently different free form glass envelope typologies are compared by taking into account mostly geometrical properties and neglecting economic evaluation. Therefore, the necessity of a comprehensive method to calculate and compare economic and technological performance of different investment savings options for glass envelopes has arisen. In this work, the cost analysis method is applied to assess the overall economic and technology feasibility of different types of glass envelope technologies. The aim of this research is to apply this methodology in order to optimize the choice of free form glass envelope that minimizes the hard cost due to glass construction while complies with the optimal level of design requirements.

2 Research practice

This paper shows the comparison of ten different building glass envelope designs and technologies (that are the same materialization) of a residence building case study in terms of the cost analysis. The technological performance was evaluated following application of either flat glass or one of the five types of curved glass production methods proposed by Guidance for European Structural Design of Glass Components (Feldman et al. 2014). The economic evaluation was carried out following the investment cost calculation. The costs of the glass construction (taking into account materials and production) were acquired from the real offer prices of two largest Serbian curved glass manufactures. Finally, the relationship between construction costs and shaping technique is evaluated to define the economic effectiveness of each adopted design model of the geometrically complex glass envelope.

2.1. Case study (Real-world model)

Real-world freeform glass facade, proposed as a case study, is smart and energy-efficient residence building Infinity, located in city center of Belgrade. It is freely waves-shaped glass facade consisting of 238 geometrically different elements, as shown in Fig. 1a) and b). The glass elements are supported by load bearing steel structure behind the glass surface. According to the project team, the building design was inspired by water, which shaped the position, life and soul of Belgrade.



Fig. 1a) and b) Appearance of glass facade of the residential building Infinity.

The complex geometry is performed by curvilinear surface envelope produced by conversion of double-curved into ruled surfaces, which are generated by linear interpolation between two curves (Pottman et al. 2007). Not standardized single-curvature glass panels were produced at not very reasonable cost using all different concave and convex molds. This glass complexity is counterbalanced by the design of universal steel supporting system which is compatible with glass geometry contributing to the simplicity of the detail. Dimensions of glass facade panels are 980 mm x 1080 mm.

2.2. Geometry of created hypothetical models

The advanced geometry and technical possibilities are the basis for development of freely-developable surfaces. The fact is that the highest surface quality that can produce a perfectly smooth solution can be achieved using double curved panels. On the other side the most cost-efficient way to realize a freeform surface with glass is to use planar panels. The basis for creation of different models is free-form geometry of the real-world glass facade surface modeled with a commercially available modeling package, in this case, Rhinoceros 4D. The dimensions of the facade that fit to the existing building have been adopted for all models. Furthermore, the achieved surface curvature of all models is optimally balanced, respecting the similarity to the original model, i.e. the existing facade. Parameters of geometric characteristics that vary by models refer to individual panels and include:

- Panel shape (rectangular and triangular),
- Curvature of the panel surface (flat, single curved and double curved),
- Shape of the panel edge (all edges are flat, two straight and two curved edges and all curved edges), and
- Panel size (two adopted panel sizes in the case of rectangular and triangular panels).

For models, the most commonly used panel shapes of geometrically complex forms have been selected, including triangles and rectangles. Triangular shape of the panel allows simple modeling of the glass envelope given that their surface is always flat, while rectangular panelization creates nodes that are more constructively stable and allows application of curved glass.

The diversity of applied panels in terms of curvature implies flat, single and double curved panels. Flat panels are with straight edges which enable their easier matching, while in single curved panels (vertical and horizontal torsa) the two edges are flat and two are curved lines making more complex their fitting. In addition, the type of panel geometry - hyper (hyperbolic paraboloid) is

introduced, whose surface is double curved, while the edges are straight due to double curved surface has been cut through asymptotic curves. Two variants of panel size were adopted. In the case of quadrilateral panelization, the first variant corresponds to the dimensions of the panel of the existing envelope. The second adopted panel size has one dominant dimension - height which fits storey height. As well, in the case of triangular panelization, the first variant implies equilateral triangles, while the other is created by triangular refracting surfaces.

According to previously defined parameters, the following models are proposed (Fig. 2a-j) with purpose to adapt feasibility of a specified geometry of glass panels to appropriate technological process of curved glass production.

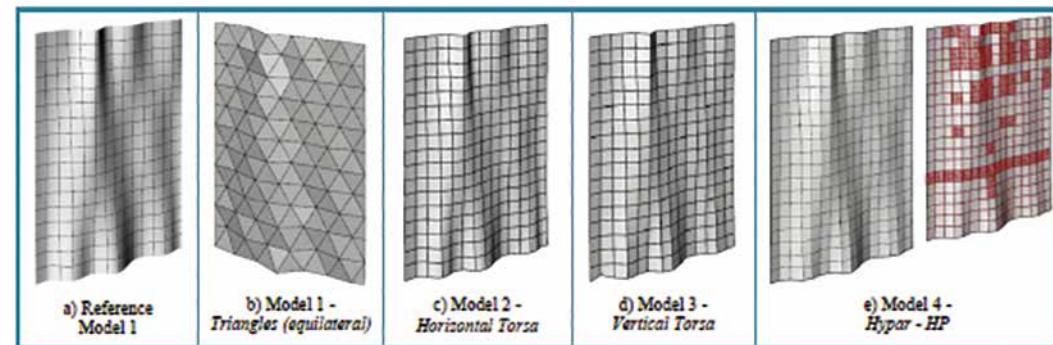

Fig. 2a), b), c), d) and e) Models of geometrically complex forms of the glass envelope (small-size panelization).

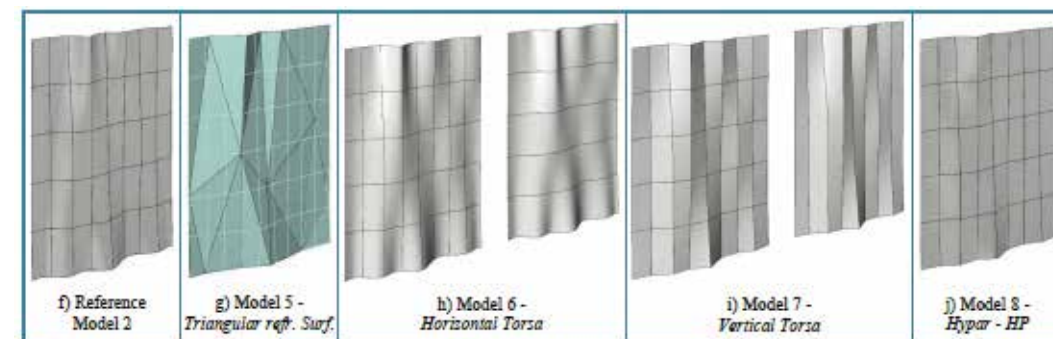

Fig. 2f), g), h), i) and j) Models of geometrically complex forms of the glass envelope (large-size panelization).

Geometrical features of ten models regarding glass panel dimensions and envelope surface, number of panels, and type of panel edges are presented in the Table 1.

Model	Type of geometry	Panel dimensions (cm)	Glass thickness (mm)	Envelope surface (m ²)	Number of panels	Glass panel edges
Ref Model 1	Freely-curved surface	94.4 x 111.4	6	270.20	238	curved edges
Model 1	Triangles (equilateral)	207 x 207 x 207	8	265.32	132 equ./22 righ.	straight edges
Model 2	Horizontal Torsa	94.4 x 111.4	6	269.88	238	2 curved / 2 straight
Model 3	Vertical Torsa	94.4 x 111.4	6	269.88	238	2 curved / 2 straight
Model 4	Hypar - HP	94.4 x 111.4	6	268.92	171 curv / 67 flat	straight edges
Ref Model 2	Freely-curved surface	166.4 x 382.6	10	270.20	40	curved edges
Model 5	Triangular refracting surfaces	147.7 x 318.5	10	271.20	6 ent./122 cut.	straight edges
Model 6	Horizontal Torsa	166.4 x 382.6	10	269.88	40	2 curved / 2 straight
Model 7	Vertical Torsa	166.4 x 382.6	10	269.88	40	2 curved / 2 straight
Model 8	Hypar - HP	166.4 x 382.6	10	268.92	40	straight edges

Table 1: Geometrical features of ten models of different glass envelope geometries.

2.3. Materialization

For materialization of adopted hypothetical models, the basic quality of glass - float glass, without coating and of appropriate thickness which is directly dependent on the geometry and the size of the panel, was selected. Three types of glazing, which are most commonly used depending on the place of application, are introduced according to complexity of the basic glazing element:

- Single glazing using laminated glass for materialization of non-thermal envelope, such as double facade in the case study. Laminated glass is selected meeting Serbian standards.
- Double glazing - IGU option using laminated panes of glass and one single glass pane (separated by air) for cladding. Laminated glass is selected for the external glass meeting Serbian standards.
- Double glazing - IGU option using two laminated panes of glass separated by air for cladding. Laminated glass is selected for the external glass meeting Serbian standards, as well as for inner glass when necessary (special requirements arising from the use of facility).

3 Evaluation methods

In order to evaluate the performances of the different glass envelope technologies, the adopted methodology is broken down into the following steps related to technology and economic aspects and criteria for the analysis:

- Technological evaluation criteria:
 - a Curved glass shaping technique, and
 - b Material efficiency.
- Economic evaluation criteria:
 - c Hard costs/m² due to glass envelope construction, and
 - d Total investment costs of entire glass envelope surface area.

Both groups of criteria are in direct correlation. Thus, a shaping technique that involves a less complex process (less time, labor and energy), implies a lower investment cost, both per m² and entire envelope. As well, material wastage, which is not related to the glass shaping technique, directly affects the cost.

3.1. Technological performance evaluation

The evaluation of technological characteristics for the ten variants of the case study is carried out concerning production method and material efficiency. For each model, the appropriate shaping technique was adopted in relation to panel geometry and availability of production methods in Serbia (Table 2). In the case of single curved panels in horizontal and vertical direction - Torsa models (Model 2, 3, 6, and 7), three possible shaping techniques are proposed. The first technique – thermal bending by mold, which was applied in case of real-world model, is available by only two curved glass manufacturers ‘Konkav Konveks’ and ‘Pavle’. Another technique adopted to create single curved panels of small curvature is cold bending which has not been known in Serbia, so far. The third adopted technique considered being suitable for Torsa geometry is thermal bending on the production line, but due to production availability of only one manufacturer (‘Beokom’) it was not possible to obtain the necessary data for further analysis. The appropriate technique for twisted geometry of the Hypar models is cold bending due to the small curvature and straight edges. According to above stated, the order of proposed techniques has been selected (Table 2).

Material efficiency is the percentage of material used after cutting the elements within the standard glass pane (321 x 600 cm), as shown in the case of panel cutting in the form of equilateral triangles (Fig. 3).

The shaping techniques and material efficiency will be given a number between 1 and 5 in each of the mentioned categories. The used convention implies 1 for poor performance (shaping technique requires the most labor, time and energy; minimum material-efficiency) and implies 5 for excellent performance (additional shaping is not necessary; maximum material-efficiency).

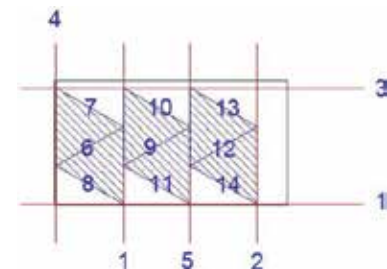

Fig. 3 Scheme of panel cutting in the form of equilateral triangles of the edge of 207 cm within the standard glass panel (321 x 600 cm).

An overview of the quantified estimate of different models of geometrically complex glass envelope in relation to the selected technological criteria is given in Table 2.

Model	Type of geometry	Selected curved glass shaping technique	Technological criteria		Overall quality from technological aspect
			Shaping technique	Material efficiency	
Ref. Model 1	Freely-curved surface	Thermal bending by mold	1	5	6
Model 1	Triangles (equilateral)	---	5	2.5	7.5
Model 2	Horizontal Torsa	1) Thermal bending by mold	1	5	6
		2) Cold bending	3	5	8
		3) Thermal bending on line	1.5	5	6.5
Model 3	Vertical Torsa	1) Thermal bending by mold	1	5	6
		2) Cold bending	3	5	8
		3) Thermal bending on line	1.5	5	6.5
Model 4	Hypar - HP	Cold bending (geometric optimization enabled a certain number of flat panels)	4	5	9
Ref. Model 2	Freely-curved surface	Thermal bending by mold	1.5	1	2.5
Model 5	Triangular refracting surface	---	5	3.5	8.5
Model 6	Horizontal Torsa	1) Thermal bending by mold	1.5	1	2.5
		2) Cold bending	3.5	1	4.5
		3) Thermal bending on line	2	1	3
Model 7	Vertical Torsa	1) Thermal bending by mold	1.5	1	2.5
		2) Cold bending	3.5	1	4.5
		3) Thermal bending on line	2	1	3
Model 8	Hypar - HP	Cold bending	4	1	5

Table 2: Quantified estimates of different models of geometrically complex glass envelope based on selected technological criteria.

Based on the evaluation, some general considerations can be drawn from these results:

- In terms of production method, apart from the models with flat panels (Model 1 and 5), the best quality show the Hypar models (Model 4 and 8) which panels can be shaped by cold bending - a method that does not require manufacturing process. As well, Torsa models with single curved panels (Model 2, 3, 6, and 7) can be shaped in the same way.

- Regarding material efficiency, the best characteristics show models with rectangular panels of small-size panelization (Ref. Model 1, Model 2, 3, and 4) using the largest part of the standard glass pane. Slightly worse features show model with Triangular refracting surface (Model 5), as well as model with equilateral triangles (Model 1) which imply greater material wastage. The worst characteristics show models with rectangular panels of large-size panelization (Ref. Model 2, Model 6, 7, and 8) since only one panel can be obtained from the standard glass pane due to its size.
- The best overall quality of technological characteristics show Hypar model of small-size panelization (Model 4) as well model with large refracting triangles (Model 5). As well, similarly are rated the models with single curved smaller panels (Model 2 and 3) which can also be shaped by cold bending.
- In terms of production availability in Serbia, due to limited dimensions of the thermal bending furnace, the largest panels can not be produced. Large panels of Hypar geometry (Model 8), as well as single curved panels (Model 6 and 7) are possible to shape by a cold bending technique, since their geometry it allows (considering small curvature, at least two straight edges and forced deformation – deviation from the plane) (Eekhout and Staaks 2012; Fildhuth and Knippers 2011; Rogers 2014).

3.2. Economic evaluation

The economic evaluation was carried out following investment costs calculation. The starting point for the evaluation of economic aspects is the quantification of the partial and total costs according to the individual constructions of the glass envelope related to the appropriate glass shaping technique that corresponds to geometry of the glass panels. The result is the determination of the corresponding economic features of the glass envelope i.e. the ranking of hypothetical models. The evaluation can be used for the following considerations:

- To evaluate economic performance of an overall design of the glass envelope (e.g. trade-off between aesthetical requirements and cost efficiency of technological process);
- To compare different solutions of glass shaping options in building envelopes,
- To assess the effect of possible cost savings, by cold bending techniques vs. hot bending that, in addition to more labor and time, needed necessary amount of the primary energy for curved glass production.

Concerning costs, each created hypothetical model has been assigned the appropriate technology and a selected type of glazing. Basic characteristics of adopted criteria and thus method of evaluation include:

- Hard costs/m² of glass envelope corresponding with the type of panelization, dimensions and geometry of individual panels, as well as the method of production and processing including curved glass forming techniques. The costs comprising the processing of flat glass (cutting and edges processing) and shaping of curved glass converted to m², without costs for delivery and assembly. Generally, it could be taken into the consideration that the assembly increases the cost by 20-30%. In addition, the reason is that cold bending, assumed as a part of assembly, has not been taken into consideration due to inability to calculate costs (unknown technique in Serbia, so far).
- Creation of the Total investment costs proceeds according to the form of the envelope and its associated surface.

The hard costs/m² and total costs for various models of glass envelopes and selected glazing types, as well as ranking of models are shown in Fig. 4a) and b). All costs are in EUR and come

from the real offer prices of two individual manufacturers of glass facade constructions and materials ('Konkav Konveks' and 'Pavle' - potential contractors).

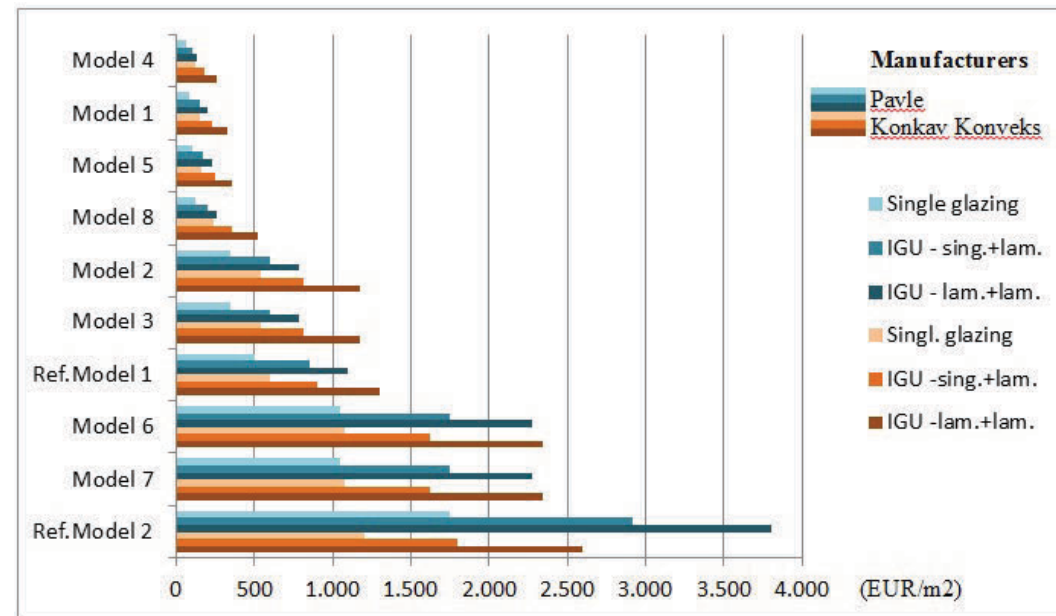

Fig. 4a) Ranking of various models of glass envelopes in relation to the hard costs/m2 of glass construction.

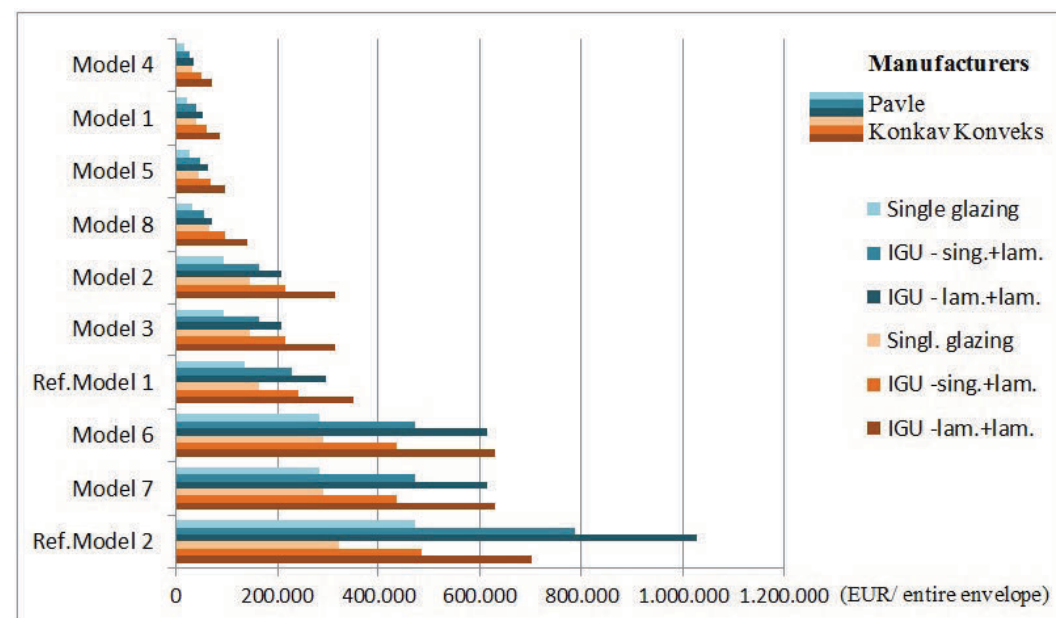

Fig. 4b) Ranking of various models of glass envelopes in relation to the total investment costs of glass construction.

From this analysis the following observation can be made:

- The difference in the costs saving potential by the application of flat glass panels in the model with equilateral triangles (Model 1) compared to the model with triangular refracting surfaces (Model 5) is negligible, even though greater material waste and number of panel cuts in case of Model 1. Furthermore, it is noticed that significant savings can be achieved in the flat glass panels application, while respecting the original form (more pronounced in Model 5), and that on the average a 69-81% (relative to single curved panels - Model 2 and 3) and a 72-83% (relative to double curved panels - Reference Model 1) in the case of small-size panelization, as well as on the average a 85-91% (relative to single curved panels - Model 6 and 7) and a 86-95% (relative to double curved panels - Reference Model 2) in the case of large- size panelization.
- As single curved panels are placed in horizontal and vertical direction in the case of Model 2 and Model 3, as well as in Model 6 and Model 7, only the difference in costs regarding the size of the panels is perceived. The significant difference between these models is noticed in respect to the perception of the envelope shape (part of the wider research). Concerning application of single curved panels in relation to double curved, on the average a 30% reduction of costs could be achieved in the case of small-size panelization (Model 2 and 3 in relation to Reference Model 1), while further on the average a 40% could be saved in the case of large-size panelization (Model 6 and 7 in relation to Reference Model 2).
- Comparing in Table 2 and ranking in Figures 4a) and b) the various hypothetical models of glass envelopes it is evident that the best overall quality of the technological and economic features shows the Hypar model with small-size panelization (Model 4). This is due to the fact that the most important savings can be achieved by using cold bending technology for glass bending in hypar form (Model 4 and 8), on the average a 78-89% (relative to single curved panels – Model 2 and 3) and a 80-90% (relative to double curved panels - Reference Model 1) in the case of small-size panelization, i.e. on the average a 78- 89% (relative to single curved panels - Model 6 and 7) and a 80-93% (relative to double curved panels - Reference Model 2) in the case of large-size panelization. In addition, by optimization (approximation) of the envelope surface (Model 4) it is possible to achieve a certain number of flat panels (Fig. 2e). The highest savings, of the almost a 97% is achieved by application of small cold bending panels (Model 4) in relation to large double curved hot bended panels (Reference Model 2).
- The costs saving potential by the application of cold bending glass panels in the most economical Hypar model (Model 4) compared to the model with double curved hot bended panels in the case of small-size panelization (Reference Model 1) is significant and amounts up to 88%, while in the Hypar model of large-size panelization (Model 8) compared to the model with double curved hot bended panels (Reference Model 2) amounts even up to 93%. Furthermore, a significant difference in costs is noticed between the small-size and large-size panelization, from nearly double ('Konkav Konveks'), up to more than triple ('Pavle'), both in single and doubled curved panels. Generally, there is a significant difference in costs between two manufacturers of curved glass processing. This is due to the fact that the curved glass technologies not have wider application in construction practice, yet.

4 Discussion of the results and conclusion

A study of hypothetical models has shown that certain geometries of glass envelopes can be achieved in a simpler way by application of geometric principles in combination with good understanding of the glass characteristics and shaping techniques. These principles enable visual effects of double curved glass surfaces, but at the same time are sustainable in terms of design, technology and cost, implying the coherence between geometry, construction and production. The basic conclusions of the research can be expressed in several ways:

- The principle of creating different (optimal) models of the design and technology solutions of geometrically complex glass envelopes can be applied adequately in practice. A model variants with flat and curved glass panels is offered, following the modern design guidelines based on defined typologies of glass panels according to geometry (surface generating mode) and curvature type as well as different shaping technique, further establishing the methodological approach to problem of their realization.
- Curved glass shaping technique by cold bending, which has not been known in Serbia so far, is a solution that matches the physical characteristics of the glass, while contributing to the economic efficiency, preventing the visual problems of the glass surface and the possibility of using most coatings and films. With cold bending it is possible to design glass panel models presented by the geometry of 'hypar' and 'torsa'. It is also possible to achieve savings in the production process up to 88% in the case of small-size panelization and even up to 93% in the case of large-size panelization (in Serbian conditions),
- The estimation of different visual and technological solutions and the selection of aesthetically satisfying and economically acceptable solutions of curved envelopes models are enabled by establishing the evaluation methods.

Future research will include application of method of multi-criteria compromise ranking of alternative solutions in order to choose the optimal variant solution of a geometrically complex glass envelope. This method is suitable in the case of multiple heterogeneous criteria (presented in the wider study), which are often mutually opposed, and a number of alternatives – variant solutions. The goal of optimization is to select the best variant solution in terms of adopted criteria and defined limits.

The methodology and results of the evaluation of different hypothetical models of geometrically complex forms of the glass building envelope can contribute to development of the practice of curved glass application and the design methodology of geometrically complex forms of glass buildings.

5 Acknowledgements

The research is done within the COST Action 1403 "Adaptive Facades" supported by European Cooperation in the field of Scientific and Technical Research and the scientific research project "Development of methods of project documentation of installation networks in buildings compatible with the BIM process and relevant standards"(TR36038), financed by Ministry of Education, Science and Technological Development of the Republic of Serbia. The part of present work has been developed in the framework of a PhD research project on application of glass in geometrically complex form of building envelopes at the Faculty of Architecture, University of Belgrade (Supervisors: Prof. Aleksandra Krstić-Furundžić, Prof. Ana Radivojević, Prof. Milena Stavić).

The authors are deeply grateful to B. Stojanovic and D. Taskovic from two Serbian glass facade producers ('Konkav Konveks' and 'Pavle') for providing continuous support and collaboration, enabling data for technological and economic analysis.

6 References

Dunn, N.: Digital Fabrication in Architecture. Laurence King Publishing Limited, London (2012)
 Eekhout, M. and Staaks, D.: Cold twisted glass panels in Engineered transparency. In: Schneider, J., Weller, B. (eds.) Proceedings of Engineered transparency, International Conference at Glasstec, pp. 213-222. TU Darmstadt, TU Dresden (2012)
 Feldmann, M., Kasper, R., Abeln, B., Cruz, P., Belis, J., Beyer, J.,... Zarnic, R.: Guidance for European Structural Design of Glass Components

- Support to the implementation, harmonization and further development of the Eurocode (Scientific and Policy Report by the Joint Research Centre of the European Commission). Publications Office of the European Union, Luxembourg (2014)
 Fildhuth, T. and Knippers, J. Double Curved Glass Shells from Cold Bent Glass Laminates. Proceedings of Glass Performance Days Conference. https://www.academia.edu/26070318/Double_Curved_Glass_Shells_from_Cold_Bent_Glass_Laminates (2011). Accessed 1 December 2014
 Kosić, T.: Application of glass in materialization of geometrically complex form of building envelopes. Faculty of Architecture, Belgrade University, Belgrade (2016)
 Liu, Y., Pottman, H., Wallner, J., Yang, Y., Wang, W.: Geometric Modeling with Conical Meshes and Developable Surfaces. ACM Transactions on Graphics. 25/3, 681-689 (2006)
 Pottman, H., Asperl, A., Hofer, M., Kilian, A.: Architectural Geometry. Bentley Institute Press, Exton, Pennsylvania, USA (2007)
 Rogers, E.: From Design to Testing to Installation, Experts Weigh in on Cold-Formed Glass. Industry Glass. http://www.glass.com/USGlass/2014/March/ColdPlay_Feature.htm (2014). Accessed 12 December 2014

Updated Urban Facade Design

Holger Techen 1, Jochen Krimm 1, 2, Ulrich Knaack 2

1 Frankfurt University of Applied Sciences, Department 1/Architecture-Civil Engineering- Geomatics, Frankfurt , Holger.Techen@fb1.fra-uas.de

2 Delft University of Technology, Faculty of Architecture and The Build Environment, Architectural Engineering

The increasing migration into cities leads to an increasing number of people stressed by noise. More and more people are moving into urban settings comprised of multiple noise sources and hard reflective glass and steel facades. The omnidirectional arrangement of noise sources like airborne noise or car traffic noise and their reflection on the facades neither composes urban arrangements with silent indoor areas nor comfortable quiet areas outdoor. To come up with requirements for silent areas inside and outside of buildings further design parameters have to be introduced. The facade is not only a shelter for the inside. It can also provide comfort spaces outside the building. As engineers and architects we cannot change the noise source, but we can influence the impact on the surrounding urban space by controlling the reflection of noise emissions on the urban surfaces like facades. In a facade design the capability of reflecting noise can be tuned by modifying the surface. In order to come up with the acoustical needs no radical new way of facade design has to be introduced. Mainly a shift of attention to the acoustic parameters is needed. Based on acoustic measurements of basic geometry principles this research presents known facade designs and their acoustic parameters regarding the reflection capabilities and the functions in a facade.

Keywords: Façade design, parameter, acoustics, urban, noise source, reflection, noise.

1 Introduction

The silhouettes of metropolitan areas are characterized by a high density of skyscraper facades made of glass, metal or stone. On the one hand, this high skyscraper density, which can be seen in Figure 1, stands for economic power, growth and work. On the other hand, these reverberant façade surfaces in urban space are responsible for increasing noise levels in their direct surroundings. In an urban development situation with reverberant façade surfaces, the most common source of noise by road traffic is increasingly perceptible.



Fig. 1 High rises with hard reflecting glass facades around an inner city park of Frankfurt

The processes in the growing metropolises that confront the architecture with tasks that it can not solve with the help of its own tools. Since re-densification in metropolises usually relies on areas of former industrial and commercial spaces, these are subject to increased noise emissions. Figure 2 shows a typical situation of a secondary consolidation project, using the example “Bürostadt Niederrad” in Frankfurt.

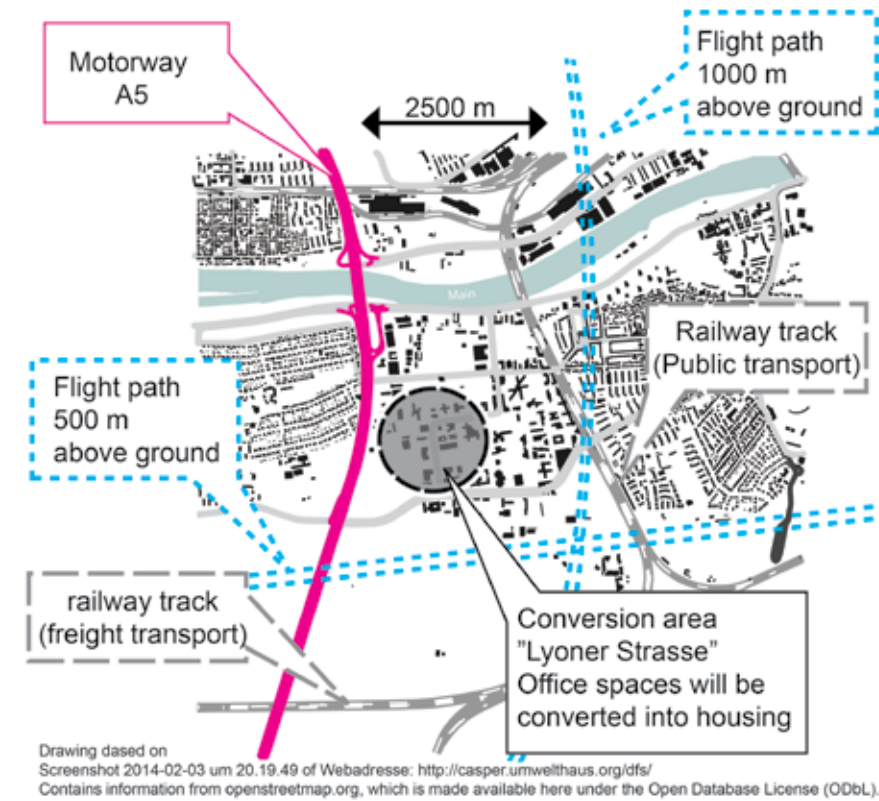
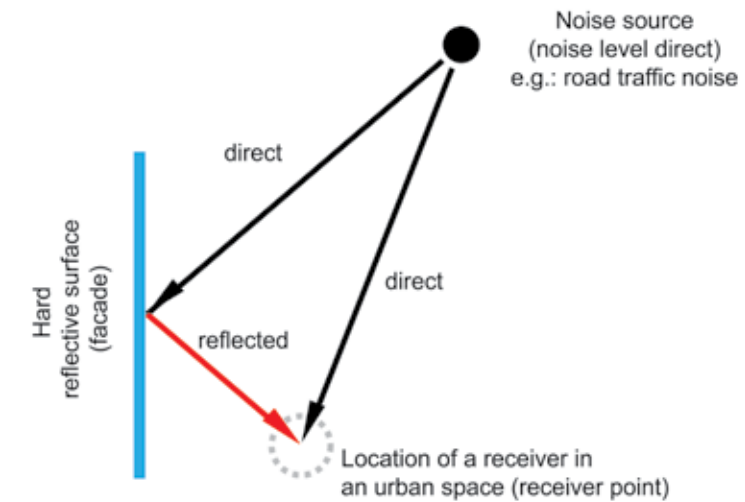

Fig. 2 Location of noise sources around the conversion area “Bürostadt Niederrad” in Frankfurt

Around the former commercial area are several traffic routes. The traffic noise sources such as road, rail and aircraft noise affect the area from different directions. Here the situation further exacerbated by aircraft noise since this type of noise generally acts from above on the urban space. In such characterized areas, the architecture is at its end with its general design tools. So the principle of the arrangement of the bedrooms on the quiet side of a building is only possible if there is still a quiet side. A quiet courtyard is affected by the influence of aircraft noise from above. The only option that is considered here is usually the use of highly sound-insulated facades and window constructions. However, such soundproof constructions generally prevent direct contact with the outside area.

2 Facades as a Noise Modulator in Urban Space

The direct sound and the sound reflecting off the façade surface add up in the urban space. The reflection of a direct signal from a noise source on a reverberant surface increases the measured level at the location of the receiver by up to 3 dB. This level increase is generated by the addition of incoming direct sound and reflected sound. A special arrangement of several reverberant surfaces makes this effect even more powerful. This phenomenon, as shown schematically in Figure 3, is well known.



$$\text{noise level at receiver point} = \text{noise level direct} + \text{noise level reflected}$$

Fig. 3 Acoustical reflection principle

The effect of increasing the level by reflection on reverberant surfaces has been researched in acoustics for a long time. Scientific articles of the last 50 years were evaluated in a literature study by the authors (Krimm, Tehen, Knaack, 2017 and Krimm 2018). It can be concluded from the study that intervention in the urban scale bear nearly the same potential as interventions in a building scale. The potential of the interventions ranges from maximum 10 dB level change in the urban planning scope to 12 dB in the building planning scope. In architecture, on the other hand, the topic of the reflection of noise on reverberant facades has so far received no attention. This status quo in urban spaces was used in several research projects at the Frankfurt University of Applied Sciences to deal with the topic of the façade and its acoustic qualities. In the course of the ongoing research, numerous field measurements were carried out in cooperation with the „Office for environmental affairs“ of the City of Frankfurt in order to record the effect of the acoustic reflection behavior of facades in urban space and to develop acoustically effective design parameters for façade surfaces.

3 Project Study: Refurbishment of an Office Building

This study of a former office building in the “Bürostadt Niederrad” shows the necessary steps in the facade design process with a focus on special acoustic effects. Figure 4 shows how close the approach route to Frankfurt Airport passes the building. The 100 m long, 8-storey high building is almost perpendicular to this approach route. For the vacant object a conversion was intended into an apartment building. In order to come along with the trend towards acoustic hard surfaces in architecture, only the influence of altered facade geometries was investigated in this study.



Fig. 4 Former office building in "Bürostadt Niederrad", Frankfurt

3.1. Design Basics

On-site inspections and noise measurements are imperative, as they can provide data on the time response of noise sources and the direction of their impact on to the building. Noise mapping data sources can only show tendencies in this context. They hardly provide acoustical information's for a detailed facade planning. This is partly due to the coarse resolution of the 10m grid, which makes it very imprecise to detect the direction of noise. On the other hand, reflection parameters used in noise mapping models are strongly location-dependent and lead to strong fluctuations in the resulting noise levels. Furthermore, the places of acoustic interest must be defined for the planned outdoor use. A higher quality of outdoor places can be for e.g. a coffee, playground or rest areas. In this case, such an outdoor place with higher acoustical demands was intended for the east side of the building. In Figure 5 this position is marked at the measuring point "EAST 2".

3.2. On-Site Measurement

In the on-site measurements, several receiver positions must always be measured simultaneously in order to be able to read the influence of the facade from the comparison of the level-time curves. Figure 5 shows the measurement values for a typical flyby. Significantly the differences in the level-time curves for the different sides of the building can be seen. The measurements show a level difference of about 5 dB between east and west side of the building. The level-time curves with a lower peak measured on the west side indicate that the passing aircraft is audible over a longer period of time.

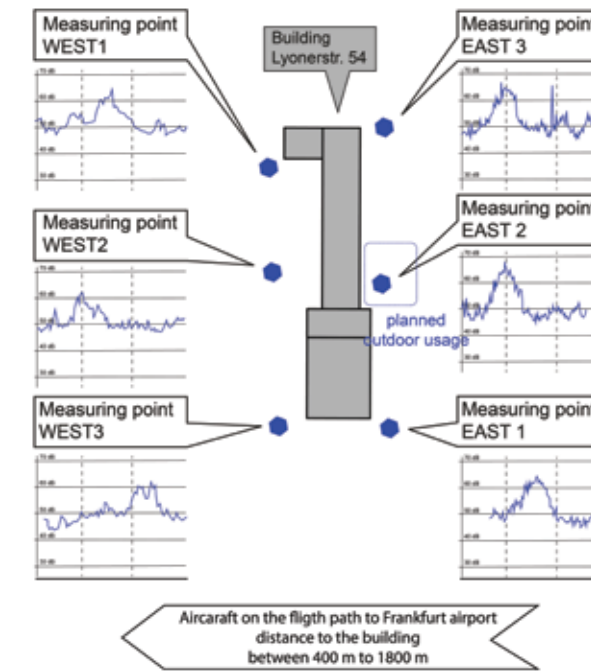

Fig. 5 Level-time curves of the 6 receiver positions / measuring points around the building

3.3. Façade Design

In this step, the first façade design variations are developed, which offer different facade geometries and structures from flat, reverberant facades. In the context of this study, a curtain-wall facade with story-high, folded glass surfaces was proposed, which effects by its geometry a different reflection direction. The differently inclined façade surfaces are shown in Figure 6.

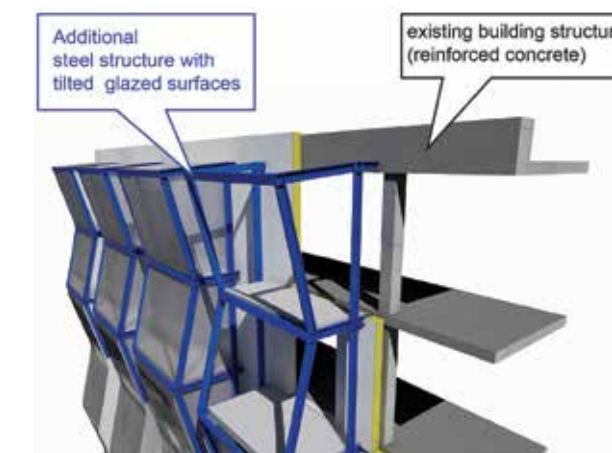

Fig. 6 Perspective of the facade design

3.4. Laboratory Tests for Façade Modifications

Since it is rarely possible to test façade alternatives on site on a scale of 1: 1, model studies are necessary for this step. With the scaled acoustic measurement method, models can be acoustically measured in scales from 1:10 to 1:100. In cooperation with the "Federal Highway Research Institute" (BAST) the scaled measurements were carried out in the Laboratory for Acoustic Measurement Technology. For the scaled measurement, the dimensions of the buildings as well as

the occurring sound wavelengths were scaled with the same scale factor. The floor plan and the arrangement of the measuring points of the on-site measurement serve as a basis for the scaled model structure in the measuring laboratory (Techen, Krimm, Knaack 2016). Due to the very high frequencies that are required for the measurement and the limitation by the measuring room, the traffic noise spectrum can only be reproduced up to 2,000 Hz. For the scale 1: 100, the traffic noise with a frequency range of 100 Hz to 2,000 Hz is scaled for the measurement to a frequency range of 10,000 Hz to 200,000 Hz. The moving noise source is replaced in the laboratory by a moving pneumatic generator and a high-frequency loudspeaker. By comparing the measurement results of the smooth façade with the measured values of a façade modification, statements can be made about the change in the noise input at the measuring points. The potential for noise input in the outdoor area, which can be achieved through a change in geometry, is shown in Figure 7 for the façade presented here. The largest level reduction is achieved at the measuring point "EAST 2", for which an outdoor café is planned.

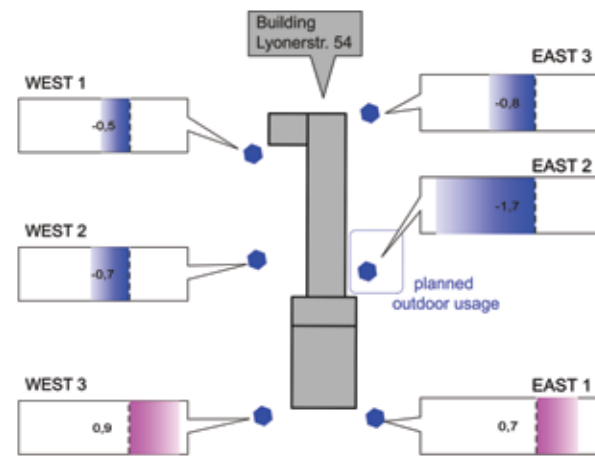

Fig. 7 Perspective of the facade design

The level changes shown here for the folded façade surface clearly show the need to always consider all measuring points. Thus, the folded façade reduces the level by up to -1.7 dB at four measuring points, but in two measuring points the level increases by up to 0.9 dB. For the facade construction, it is therefore imperative that these must be individually tailored to the places with defined outdoor use. The frequency curve shown in Figure 8 shows the level change per frequency band at the measuring point "EAST 2".

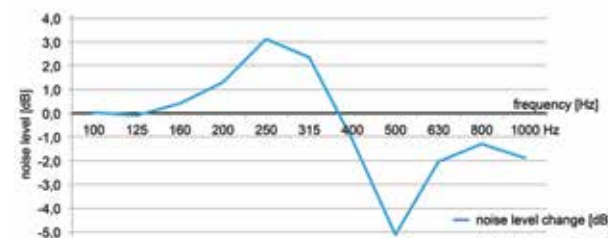

Fig. 8 Frequency response for the change in the noise input during a flyby at the measuring point "EAST 2"

The difference in the individual frequency bands makes it clear that single values are not sufficient to describe the acoustic effect of a facade. Decisive for a acoustical effect of the facade are level changes in the range of the highly sensitive hearing range of humans between 500 Hz to 4,000 Hz.

The level change shown here occurs in the frequency bands from 400 Hz. The level reduction at the measuring point "EAST 2" would ensure that aircraft noise events would not only be perceived as quieter but also as less disturbing.

4 Case Studies - Facade Surfaces

An alternative to changing the reflectivity of reverberant cladding surfaces is the introduction of absorbent material properties or internal geometries.

4.1. Facade absorber

The introduction of absorbent materials is not easy for a variety of reasons. Thus, most known absorbent materials are open-pored. This means that they do not have a closed surface, which meets the architectural desire for a slightly closed, less polluting and sufficiently resistant surface. An exception here is a special form of a green facade. This fully façade integrated revegetation, using substrate mats are from the acoustical point of view highly absorbent surfaces. Among others the effect of vertical greenery for acoustic purposes was investigated in numerical simulations by Smyrnova, Kang, Hornikx, Forssén (2012) or in case studies by Wong et al. (2010).



Fig. 9 Detail of the Green Façade at the Frankfurt University of Applied Sciences

The full façade integrated revegetation of 90DEGREEN® meets the requirements of a flat absorber. In order to determine the acoustic potentials of this system, a mock-up was installed in cooperation with the manufacturer on a busy inner-city street in at the Frankfurt University of Applied Sciences. The road traffic noise was measured in front of the green facade at time intervals with approximately constant resulting noise levels. The first measurement was made before the wall was attached. After establishment of the green facade, measurements were carried out without planting and subsequently with fresh planting. With more vegetation, another measurement was taken to get information about the influence of the density of the vegetation.



Fig. 10 a) Existing building b) Installation of substrate surface c) Green facade with fresh vegetation

From the locally measured traffic noise levels a noise reduction potential of -3 dB can be derived. In a frequency range of 100 Hz to 3,000 Hz, the measured level reduction remains in the range of -2.5 dB to -3.2 dB. The measurements with more or less vegetation show only very small differences. This means that in the case of using a green facade as a surface absorber, the substrate material decides the acoustic quality and not the planting. In order to use green facade systems acoustically effectively, system selection is crucial. The vertical green facade principle presented here, offers ideal absorber properties due to the full-surface coverage of the facade surface with absorbent materials. The green facade not only helps to improve the acoustic situation, it is also able to bind fine dust and to positively influence the urban climate by increasing the humidity in its environment.

4.2. Absorption through a highly structured surface geometry

As an alternative to a surface-bound vertical greening strongly structured surfaces can be used. Picaut & Simon investigated that to some extent, an absorption effect can be represented by these highly structured surfaces. (Picaut, Simon, 2001). In such surfaces, the sound field is deprived of energy by multiple reflections on many differently angled inner surfaces. Figure 11 shows a study of a precast concrete element with cuboids of 4 x 4 cm.



Fig. 11 Heavily textured surface of a prefabricated concrete facade element

The expected effect here is about a level reduction of -1.5 dB. The frequency of the level reduction is dependent on the size of the cuboid. The "grin-grid" should be on the order of the wavelength

of the frequency to be influenced. Many such structures are currently being installed, but without taking the acoustic effect into account. The surfaces in Figure 12 and Figure 13 show examples from current architectural facade designs.



Fig. 12 Heavily textured surface of a suspended stone element

Fig. 13 Creation of a highly structured surface through vacancies in the closed clinker wall dressing

5 Summary

The listed case studies show opportunities to reduce the noise input into the urban space by the facade. The study presented here of a folded reverberant facade surface clarifies that projects with acoustically effective facades must be designed differently.

- As a basis for this, sites have to be considered acoustically by on-site measurements
- Places with special acoustic qualities and demands must be defined
- It is always necessary to find individual solutions for individual locations.
- The effects achieved must always be considered for individual frequency bands in the highly sensitive human hearing range from 400 Hz to 4,000 Hz

A quieter city is possible!

6 Reference list

- Knaack, U., Techen, H., Krimm, J., (2017) Der urbane Raum in der Akustik als architektonische Gestaltungsgrundlage für leisere Städte, Fortschritte der Akustik - DAGA 2017, Deutsche Gesellschaft für Akustik e.V. (DEGA), Berlin
- Krimm, J. (2018) Acoustically effective facades design, TU Delft
- Knaack, U., Techen, H., Krimm, J., (2016) Tuning acoustical facade designs aiming for a controlled influence on the urban soundscape, Proceedings of the INTER-NOISE 2016, 45th International Congress and Exposition on Noise Control Engineering, Deutsche Gesellschaft für Akustik e.V. (DEGA), Berlin
- Picaut, J., & Simon, L., (2001) A scale model experiment for the study of sound propagation in urban areas, Applied Acoustics 62, 327-340
- Smyrnova, Y., Kang, J., Hornikx, M., & Forssén, J., (2012) Effect of Vegetation of noise propagation in streets and squares, Proceedings of the Institute of Acoustics, Vol. 34, Pt.1.
- Wong N.H., Tan A. Y. K., Tan P. Y., Chiang K., & Wong N. C., (2010) Acoustics evaluation of vertical greenery systems for building walls, Building and Environment, Volume 45, Issue 2, Pages 411-420

A Redesign Procedure to Manufacture Adaptive Façades with Standard Products

Bahar Basarir 1, M. Cem Altun 2

1 Graduate School of Science Engineering and Technology, Istanbul Technical University, Turkey, baharbasarir@gmail.com
2 Department of Architecture, Istanbul Technical University, Turkey, altunce@itu.edu.tr

Although their potential for high environmental performance is largely accepted, adaptive façades have not yet become widespread in practice. Most of the current examples are developed by engineer-to-order design processes, as project-oriented, custom, and complex solutions. More simple and reliable solutions are needed to support the reuse of technical solutions between projects and increase the feasibility of adaptive façades. Therefore, this research aims to develop a procedure to design adaptive façades whose parts are based on engineered standard products with the least number of parts and layers. The research is initiated through the generation of concepts for designing adaptive façades to be manufactured using standard products. From several concepts, 'redesigning dynamic adaptive façades' has been selected for further investigation, as it pursues the goals for a solution determined for this research. A preliminary case study is conducted to redesign an adaptive façade to be manufactured with standard products. Its process steps are captured and analysed, and the steps that need improvement are revealed. To systematise and improve the captured redesign process, façade design and product design methodologies are analysed in the context of adaptive façade design. Redesign and reverse engineering processes used in product design are adapted and merged with façade and adaptive façade design processes, and a 5-phase adaptive façade redesign procedure is outlined. Each phase is developed based on mature tools and methods used in product and façade design. An iterative loop of development, application test, and review process is carried out for development of the process steps. Thus, a redesign procedure is generated by the combined application of DFMA and TRIZ in the synthesis of reverse engineering and redesign processes. Consequently, the application of the redesign procedure is demonstrated through a case study. The case study revealed that the procedure has the ability to generate a façade redesign that has a higher constructability index than the reference façade.

Keywords: adaptive façade, constructability, redesign, standard product, reverse engineering, DFMA

Full paper available in the Journal of Facade Design and Engineering, Vol 6 No 3 (2018): Special Issue FAÇADE 2018 – Adaptive!

Designing Adaptive Facades with a new holistic Eco-Design Approach

Nitisha Vedula a), Laura Aelenei b), Uta Pottgiesser c)

a) Hochschule Ostwestfalen-Lippe, University of Applied Sciences, Germany, vedulants@gmail.com

b)LNEG-National Energy and Geology Laboratory, Portugal

c)University of Antwerp, Faculty of Design Sciences, Belgium

Implementing the Eco-designed approach in the field of adaptive façade systems, primarily aims for the future sustainable targets to develop eco-friendly and socio-responsive technologies. This will be only possible when the adaptive façade systems track design strategies endeavouring to imitate the philosophy of "the self-sufficient unit in the nature called eco-system." With the understanding of the future sustainable targets of adaptive systems and analysing its sustainably efficient elements with the help of already existing and scattered classification schemes from the data base developed within the work of the Cost Action TU 1403 Adaptive Façade Network (AFN), this approach attempts to develop a novel matrix for re-analysing these adaptive façade projects with an eco-design approach. The aim of this approach is to examine whether these adaptive façade projects from the data base are able to seamlessly integrate themselves in this approach and to what extent. The eco-design approach on the basis of the contiguous natural environment (i.e. location and climate type), conceives the adaptive façade projects as a unit-cell in the eco-system, which should naturally attempt to be a self-sufficient unit. Understanding this approach, the various principles of the adaptive façade systems in the projects from the database are analysed. This leads to characterizing the approach in a matrix of the biotic components of eco-system (producers, consumers and decomposers) and abiotic components of eco-system (air, soil, water, temperature, pressure, inorganic substances, etc.). These two components work collectively due to the naturally occurring energy transfer principles in amidst, known as conduction, indirect-solar, direct-solar and ventilation. The matrix also further characterizes the biotic components into active and passive systems, in order to avoid any error in analysing both, the direct and in-direct influences of the adaptive façade systems inside the project. The eco-design approach attempts to thoroughly analyse the extent of integration of this approach in the field of adaptive façade systems and to apprehend the further scope of research and development for the related industry.

Keywords: Ecological approach, eco-friendly, adaptive, active and passive design systems.

1 Introduction

Recent studies show that in developed countries people spend on an average 90% of their time indoors (EU 2003). This trend reflects the exceptional requirement of a healthy indoor environment, which in turn will help in ensuring larger prospect of society welfare. Statistics of the countries represented at International Energy Agency (IEA), reveal that the 'buildings' peak as the primary energy dissipater at around 40% of the total energy (IEA 2013). In this context, it is of fundamental importance to devise strategies for the building stock that can be instrumental in achieving the energy efficiency and climate change goals set by different countries (IEA 2012). Building envelopes are positioned at the interface between exterior and interior, thus they have a dominant impact on a building's energy balance and can therefore play a large role in making the transition towards sustainable, energy-neutral buildings (EU 2015, IEA 2013-2). Until recently, the main focus of the building envelope design and development was on structural, passive and robust performance aspects (Knaack 2007). However nowadays, it is increasingly recognized and

desirable to have a more flexibly behaving façade system, with “responsive, adaptive and dynamic” as the key words in disposition (Heiselberg 2012, Schumacher et. al. 2010, Wigginton and Harris 2002). Aiming to enhance the overall building performance, this next generation of façade technology consists of multifunctional and highly adaptive systems; wherein the building envelope possess the audacity to change its functions, features and behavior overtime in response to the transient performance requirements and boundary conditions.

Within this context, the European initiative- COST Action TU1403 “Adaptive Facades Network (AFN 2014)” was commissioned in the framework of EU COST (European Cooperation in Science and Technology). The main aim of this action plan is to harmonize, share and disseminate technological research on adaptive facades at a European level. By harnessing this source of knowledge, countries will contribute to the generation of new ideas and concepts at a fundamental and product/ system development level.

One of the goals of this initiative is to collect information about different types of existing adaptive façades (materials, components and systems), aggregating them in a case study data base and developing a detailed analysis. This process stretches boundaries in innovative solutions, characterizing methods and approaches for the near future.

In accordance to the initiative, a novel and appealing characterizing perspective for the adaptive façades termed as eco-design approach, is being proposed by the authors. With the understanding of the sustainable targets in adaptive systems and analyzing the green elements in already existing scattered classification schemes (from the data base of Cost Action TU 1403-Adaptive Façade Network), this holistic approach is being proposed to design adaptive facades with a unified and systematic characteristic. This approach is applied on some of the case studies at the Adaptive Façade Network data base to analyze their existing effectiveness. The aim of this paper is to examine whether the existing adaptive façade projects are able to seamlessly integrate themselves in the Eco- design approach and if yes, to what extent.

2 Methodology of Eco-Design Approach

The basis of the Eco-designed approach relies in the use of ecological design principles and strategies to design the built environment and the ways of life, keeping up the benign and seamless integration with the natural environment including the biosphere (Yeang, 2006). As per eco-design approach: the eco-system is a self- sufficient and independent unit in nature which includes the living entities (plants, animals, decomposers) and the non-living environment (soil, air, water). This system requires only the input of solar energy for its functioning. The main components of eco-System are classified as follows:

- A Abiotic Components, the non-living environment: Consists of the physical environment in the form of soil, water, air along with the inorganic substances like CO₂, Nitrogen, O₂, Water, Phosphorus, Sulphur, Sodium, Potassium, Calcium, etc. Climatic factors like light, temperature, pressure and humidity accompany it.
- B Biotic Components, the living environment (Fig.1): This consists of a community of inter-dependent living organisms:
 - - Producers: Synthesize their own food. E.g. Plants.
 - - Consumers: Dependent on others for food. E.g. Human beings.
 - - Decomposers: Consume the waste remains and produce required raw material for the producers.

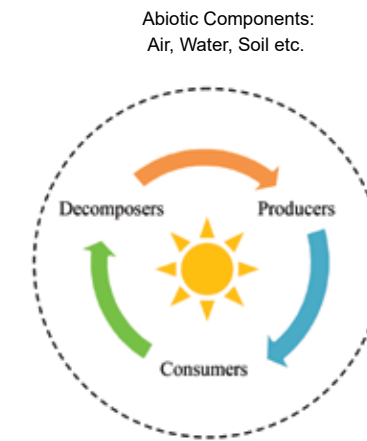
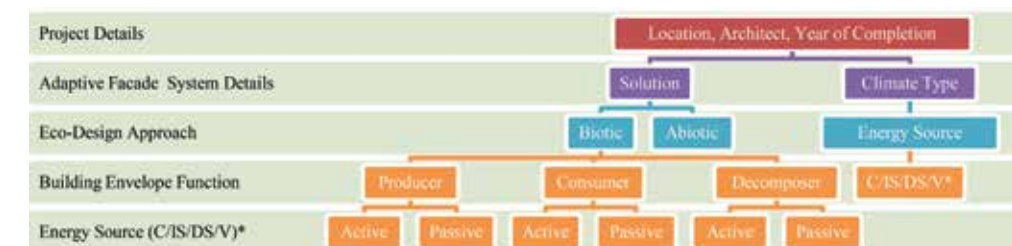

Fig. 1 One-way cycle of biotic components which function with the support of abiotic components and sun as source of energy

The eco-design approach for adaptive façade systems replicates the same principle and believes that the already acknowledged novel adaptive systems and principles implied in the projects should be analyzed as a unit-cell in the eco-system, which naturally attempts to be self-sufficient and follows the cycle of the eco-system as explained earlier in Fig 1. This leads to the characterization of the following matrix:

- Abiotic components of the adaptive façade: It consists of the supporting environment required for the system to function seamlessly, this includes air, soil, water, temperature, pressure, inorganic substances, etc., which evidently is governed by the climate and location of the project.
- Biotic components of the adaptive facade: It consists of the novel ideas and approaches involved in the adaptive façade system, which functions in tandem with the Abiotic components. However, eco-design approach suggests further characterizing of its biotic components in order to analyze its natural competency to be a self-sufficient component. These can be classified as follows:
 - Competency as producers: To synthesize the adaptive façade system, either actively (E.g. mechanized and computerized adaptive façade systems) or passively (E.g. vernacularly adapted façade systems).
 - Competency for consumers: To extract the benefits from the adaptive façade system for the users, either actively or passively. (E.g. in the form of thermal or visual comfort).
 - Competency as decomposers: In consuming the extracts from the façade system and producing raw ingredients to support the adaptive façade system as an independent unit cell, either actively or passively.

The abiotic and biotic components of the adaptive façade system work collectively due to the naturally occurring principles of energy transfer within, termed as conduction, indirect-solar, direct-solar and ventilation. This comprehensive description of the eco-design approach in adaptive façade system has been created as a matrix and is shown below in Fig. 2.



*Where; Heat Flow: C = Conduction; S= Indirect Solar; DS= Direct Solar; V= Ventilation







Fig.2. Matrix developed for eco-design approach to design adaptive facades with a unified and systematic characterization.

Consequently, the eco-design approach is applied to some of the existing case studies from the Cost Action data base. Taking into account the main goal of the overall performance of the adaptive façade system with respect to usability and acceptance by the users, the approach has been classified into following objectives:

- Analyzing –The case studies of the available adaptive façade elements.
- Evaluating and refining - With respect to the previously investigated information on new approaches and technologies.
- Re-Analyzing - As per Eco-design approach where development of adaptive façade systems can be improved with a holistic approach, leading to investigation and implementation of high-potential innovative components, materials, control systems in the course of the action.

The following projects from the already existing data base, were sought for the analysis under this new holistic approach:

- A Oval Cologne Offices, Cologne, Germany (Albajar 2012)
- B Altra Sede Regione Lombardia, Milan, Italy (Renato 2010)
- C Campus Kolding, SDU University, Kolding, Denmark (Arch Daily 2015)
- D Allianz Headquarters, Wallisellen, Switzerland (Frearson2014, WAA 2017)
- E Media-TIC, Barcelona, Spain (Archi Travel online architecture guide 2013, Ruiz-Geli 2011)
- F KfW Westarkade, Frankfurt, Germany (Wainwright 2012)
- G WaMaFat - Switchable Insulation, Ludwigshafen, Germany (Thibault 2015)

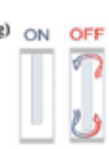
Examples	Name / Location / Architect / Year/ Climate	Energy Source/ Abiotic Components	Eco-Design Approach		
			Biotic components		
			Producer	Consumer	Decomposer
	Oval Cologne Offices / Cologne, Germany / Sauerbruch Hutton Architekten, Berlin / 2010/ Marine West Coast; Cfb	Direct Solar Radiation, Ventilation/ Temperature, Wind, Air Pressure	Double Skin Ventilated Façade ^(P) / Automated Serigraph printed vertical Louvers. ^(A)	Visual/ Thermal Comfort/Indoor Air Quality. ^(P) Individual Comfort Control. ^(A)	Improves energy performance. ^(P)
	Altra Sede Regione Lombardia / Milan, Italy / Pei Cobb Freed & Partners, Caputo Partnership, SD Partners / 2009/ Marine West Coast; Cfa	Solar Radiation, Conduction/ Temperature	BIPV (Building Integrated Photo-Voltaic) into Structural Glazing System. ^{(A)(P)}	Visual/ Thermal Comfort. ^{(A)(P)}	Improves energy performance. ^(P) Produces clean energy. ^(A)
	Campus Kolding, SDU University / Kolding, Denmark / Henning Larsen Architects / 2014/ Marine West Coast Cfb	Direct Solar Radiation, Ventilation/ Wind, Temperature	Dynamic, perforated & triangular vertical shading for solar insulation ^(A) , also performing as a windbreak during cold climate. ^(P)	Visual/ Thermal comfort. ^{(A)(P)}	Improves energy performance. ^(P)
	Allianz Headquarters / Wallisellen, Switzerland / Wiel Arets Architects (WAA) / 2014/ Marine West Coast; Cfb	Solar Radiation/ Temperature, Aluminum, Silver	Solar heated close cavity glazing system with highly conductive& reflective Aluminum-Coated Silver overhangs ^(P) ;controlled by computer algorithm. ^(A)	Thermal/ Visual comfort. ^{(A)(P)}	Improves energy performance. ^(P)
	Media-TIC / Barcelona, Spain / Enric Ruiz Geli, Cloud 9 / 2007/ Mediterranean; Csa	Solar Radiation/ Temperature, Liquid Nitrogen.	Nitrogen Pneumatic Light sensor ETFE facades. ^(A)	Thermal/ Visual comfort. ^(A) 90% less solar gain ^(A) , efficient solar transmittance. ^(A)	Improves energy performance. ^(P) 65% less Co2 emission. ^(A)
	KfW Westarkade / Frankfurt, Germany / Sauerbruch Hutton Architekten, Berlin / 2010/ Marine West Coast; Cfb	Solar Radiation, Ventilation/ Temperature, Wind, Air Pressure	Automated ^(A) Saw-Toothed double skin ventilated Façade, creating an air pressure ring to regulate the prevailing wind movement through it. ^(A)	Indoor Air Quality; annually 8 month's natural ventilation. ^(A) Thermal Comfort. ^(P)	Improves energy performance. ^(P) Captures 5 differentwind directions to maintain an air flow never exceeding 6 m/s. ^(A)
	WaMaFat - Switchable Insulation / Ludwigshafen, Germany / Nikolaus Nestle, BASF SE & WaMaFat consortium / 2014/ Marine West Coast; Cfb	Conduction/ Temperature, BASOTECT (a melamine foam, faintly conductive) insulation panel.	Façade element with switchable U-value, with multiple BASOTECT Insulation panels to maintain controlled convection inside a closed module. ^(A)	Optimized or non-optimized thermal comfort. ^{(A)(P)}	When non-optimized; 10% reduction in the cooling demand. ^(P) When optimized 33.3% reduction in the cooling demand. ^(A)

Wherein,
Cfb = Warm temperate, fully humid, warm summer; Cfa = Warm temperate, fully humid, hot summer; Dfb = Snow, fully humid, warm summer; Csa = Warm temperate, fully humid, hot summer; (A) = Actively performing biotic components in Eco-design approach; (P) = Passively involved biotic components in Eco-design approach.

Table 1: Eco-design matrix: Comparison of the selected projects under the eco-design approach, as presented in fig. 2

3 Results and further Developments

As per the Köppen Climate Classification System (Hans, C. 2007), the double skin adaptive facades presented in projects a), c), d), f) fall under the same climatic type i.e. Cfb (Warm temperate, fully humid, warm summer), supported with similar energy source (Direct & Indirect Solar Radiation and Ventilation), evidently leading to similar abiotic components (i.e. the supporting environment; Temperature, Wind, pressure).

Despite that, these 4 projects do not utilize the abiotic components correspondingly and efficiently, as defined below in the Table 2. The resulting biotic components of the adaptive façades (i.e. the

novel ideas and approaches of these adaptive façade system) although share a resemblance, but when deeply analyzed, the projects c) and d) do not absorb the supporting natural environment effectively.

	Abiotic components attainable in Climate type; Cfb	Abiotic Components applied		
		Temperature	Wind	Air pressure
a)	Oval Cologne Offices, Cologne, Germany	✓	✓	✓
c)	Campus Kolding, SDU University, Kolding, Denmark	✓	✓	x
d)	Allianz Headquarters, Wallisellen, Switzerland	✓	x	x
f)	KfW Westarkade, Frankfurt, Germany	✓	✓	✓

Table 2: Comparison of the abiotic components applied in the projects falling under the same Climate Type Cfb (Warm temperate, fully humid, warm summer) in the Eco-design matrix in Table 1.

Under the section biotic components in the eco-designed matrix, as shown in Table.1, the dissimilar competency of the adaptive facades, evolved as a producer, is also effortlessly observable. Likewise, its consequential impacts and efficiency of the adaptive façade system (as a self-sufficient unit cell) with its active and passive results and involvement are furthermore divergent.

Under the section biotic components in the eco-designed matrix, as shown in Table.1, the competency of the adaptive facades as a decomposer, shows the inefficiency of most of the projects, in actively consuming the extracts from the façade system and producing back the raw constituents to support it as an independent unit cell.

The adaptive façade projects b), e), g) in relation to the previously discussed projects, belong to other different climate types. They share some similar abiotic components, resulting to comparable competency as a producer, on the other hand resulting to completely different and novel concepts.

In this way, the eco-design approach can compile the vast and scattered information about the adaptive façade systems under the same matrix. And it can aid to extract and analyze multiple information at the same time.

4 Conclusion

In the framework of the European Initiative COST Action TU1403 “Adaptive Façade Network (AFN2014)” a number of examples of adaptive façade elements (materials, components and systems) were collected in a data base for developing a detailed analysis to support an increase in innovative solutions, characterizing methods and approaches for the near future.

Some of these case studies were selected in order to test a new holistic approach for charactering the adaptive façades, termed as, Eco-design approach. This approach generates the possibility of channelizing the already existing, vast and scattered information on the adaptive facades. It follows a qualitative methodology which can also lead to a quantitative analysis (in terms of energy performance) for future developments and research.

With this approach it will be possible to lead the future adaptive façade technologies to derive from ecological design principles and strategies, which could be integrated benignly and seamlessly with the natural environment that includes biosphere.

5 Acknowledgements

This research paper is the outcome of the Short Term Scientific Mission (STSM) held under COST Action TU 1403 in the year 2017. The authors would like to cordially thank the European Union and COST for all the opportunities and support.

6 References

- Adaptive Façade Network (AFN): EU COST-ACTION TU 1403 (2014). <http://tu1403.eu/>. Accessed 13 July 2017.
- Albajar, B.: Colourful glass louvers on office in Colonia, S&H [212]. FILT3RS Design of windows Web. <http://filt3rs.net/case/colourful-glass-louvers-office-colonia-sh-212> (2012). Accessed 17 July 2017.
- Arch Daily: SDU Campus Kolding / Henning Larsen Architects. [https://www.archdaily.com/590576/sdu-campus-kolding-henning-larsen-architects\(2015\)](https://www.archdaily.com/590576/sdu-campus-kolding-henning-larsen-architects(2015)). Accessed 18 July, 2017.
- Archi Travel online architecture guide: Media-TIC. [http://www.architravel.com/architravel/building/media-tic\(2013\)](http://www.architravel.com/architravel/building/media-tic(2013)). Accessed 20 July 2017
- Architect Science: Towards a new architecture+ Energy. Science for Sustainable Architecture. http://www.architectscience.com/images/Towards_A_New_Architecture_Energy_-_Part_2.pdf (2012). Accessed 17 July, 2017.
- Arch Record + Sauerbruch Hutton: Prismatic Sustainable Buildings Imitate the changing Seasons. ALPOLIC Metal Composite Materials Web. [http://www.alpolic-americas.com/prismatic-sustainable-buildings-imitate-the-changing-seasons\(2012\)](http://www.alpolic-americas.com/prismatic-sustainable-buildings-imitate-the-changing-seasons(2012)). Accessed 17 July 2017.
- European Commission (EU): IP/03/1278. Indoor air pollution: new EU research reveals higher risks than previously thought. http://europa.eu/rapid/press-release_IP-03-1278_en.htm (2003). Accessed 01 August 2018
- European Commission (EU): Energy-efficient buildings. Multi-annual roadmap for the contractual PPP under Horizon 2020. http://ectp.ectp.org/cws/params/ectp/download_files/36D2981v1_Eeb_cPPP_Roadmap_under.pdf (2015). Accessed 01 August 2018
- Frearson, A.: Allianz Headquarters by Wiel Arets features glass fritted to reference Mies' Barcelona Pavilion (2014). <https://www.dezeen.com/2014/03/26/allianz-headquarters-wiel-arets-architects/> Accessed 19 July 2017.
- Hans, C.: Koeppen climate classification: as a diagnostic tool to quantify climate variation and change. <http://hanschen.org/koppen/#classification> (2007). Accessed 08 August 2018
- Heiselberg, P.: IEA ECBCS Annex 44. Integrating Responsive Elements in Buildings. Project Summary Report. http://www.ecbcs.org/Data/publications/EBC_Annex_44_PSR.pdf (2012). Accessed 01 August 2018
- International Energy Agency (IEA): Transition to Sustainable Buildings. Strategies and Opportunities to 2050. Executive Summary. [https://www.iea.org/Textbase/npsum/building2013SUM.pdf\(2013\)](https://www.iea.org/Textbase/npsum/building2013SUM.pdf(2013)). Accessed 01 August 2018
- International Energy Agency (IEA). World Energy Outlook 2012. <https://webstore.iea.org/world-energy-outlook-2012-2> (2012). Accessed 01 August 2018
- International Energy Agency (IEA): Technology Roadmap. Energy efficient building envelopes. <https://www.iea.org/publications/freepublications/publication/TechnologyRoadmapEnergyEfficientBuildingEnvelopes.pdf> (2013-2). Accessed 01 August 2018
- Knaack, U.: Facades - Principles of Construction, Birkhäuser, Basel (2007).
- Renato, M.: Vetri Fotovoltaici per Integrazione Architettonica (Building Integrated Photovoltaics). Energy glass Solar and Glass Architecture <https://www.fresialluminio.it/images/Fresia2009/ConvegnoPoli270309/relazione-macconi-27-03-09.pdf> (2010). Accessed 17 July 2017.
- Reardon, C.: Passive Cooling. Your Home. Australia's guide environmentally sustainable homes. <http://www.yourhome.gov.au/sites/prod.yourhome.gov.au/files/pdf/YOURHOME-PassiveDesign-PassiveCooling.pdf> (2013). Accessed 18 July, 2017
- Ruiz-Geli, E.: Media-ICT building CZFB, 22@. Barcelona. Ruiz-geli projects. [http://www.ruiz-geli.com/projects/built/media-tic\(2011\)](http://www.ruiz-geli.com/projects/built/media-tic(2011)). Accessed 20 July, 2017.
- Schumacher, M., Schaeffer, O., Vogt, M.: Move: Architecture in Motion - Dynamic Components and Elements, Birkhäuser, Basel (2010).
- Thibault, P.: Closed translucent facade elements with switchable U-value - A novel option for energy management via the façade. Energy and Buildings 86 (2015) 66–73. [www.elsevier.com/locate/enbuild\(2015\)](http://www.elsevier.com/locate/enbuild(2015)). Accessed 24 July 2017.
- WAA: Allianz Headquarters. http://www.wielaretsarchitects.com/en/projects/allianz_headquarters/ (2017). Accessed 19 July 2017.
- Wainwright, O. (2012). KfW-Westarkade banking HQ, Frankfurt, by Sauerbruch Hutton. Bdonline.co.uk. <https://www.bdonline.co.uk/technical/> Accessed 24 July 2017.
- Wigginton, M., Harris, J.: Intelligent Skins, Butterworth-Heinemann, Oxford (2002). Yeang, K.: Eco Design: A Manual for Ecological Design: Wiley Academy, London (2006).

Adaptive Façades and Topology Optimization

Ingrid Paoletti, Massimiliano Nistri

Politecnico di Milano / Department of Architecture, Built Environment and Construction Engineering, Italy

The study examines the main possible approaches for a generative use of topology optimization aimed at the study of the conditions of “adaptability” of façades in architecture. The analysis regards the possibilities of technological transfer of topology optimization methods and strategies to the conception of framing and enclosure components of building envelopes, through the explanation of some experiments and applications. The topology optimization is analyzed and supported as the possible area within which it should be possible to sustain new forms of calibration of material densities, of morpho-typological sizes and structural performances with the least material used and energy wasted.

Keywords: Topology optimization; Technological transfer; Modelling and executive design; Additive manufacturing; Lattice and cellular structures.

1 Introduction

The thematic proposal deals with the contents and experimental procedures of development aimed at topology optimization with the aim of defining some methodological approaches and strategies for the conception, the design and the construction of building envelope systems, components and connective interfaces within the frame of the advanced contemporary architectural scenario. The study aspires to a possible contribution to the technological transfer of some planning, managing and solving issues, by laying down criteria relating to “digital/virtual design” procedures (Zheliazkova, Naboni, Paoletti 2015), “productive/constructive customization” technics (Paoletti 2013) and “executive design” methods (Nistri 2009; 2017), relating to the scope of the adaptive façades. According to this study, the adaptive character concerns the design, productive and constructive methodology, which is able to make the structural and envelope components of building envelope systems adjustable, in respect of specific parameters regarding:

- The mechanical loads expected and established during operating conditions;
- The needs of connection between supporting elements and connectors;
- The specific characteristics of framing materials and building envelope and cladding systems.

The study examines the “adaptive” character of the described systems as a model that should lead to a research in order to define a methodology able to be:

- Used in different types of frames, junction devices and their respective materials;
- Flexible and adaptable to specific design needs.

The scientific contribution of this research consists in the analysis of certain applications concerning topology optimization, in order to identify a possible approach for study and development, both methodological and procedural, in order to deal with particular needs regarding morpho-typological, expressive, functional, productive and constructive aspects for a new approach to building envelope and cladding systems design within advanced architecture. Furthermore, this research aims to

bring out the potential of topology optimization in order to identify possible developments within the productive environment up to:

- The specific conception of systems, technical elements, technical interfaces and junction devices;
- The design (not only bi-dimensional, but three-dimensional as well) of building enclosure and cladding systems according to a variable, flexible and innovative configuration of building curtains.

In this respect, the study focuses on the characters of topology optimization in order to define some possible actions to develop building envelope systems, components and connective interfaces (in the field of Industrial Mass Customization) through:

- The adoption of techniques making it possible to synthesize the formal determination that from a given volume will produce both productive and constructive innovation and customization processes;
- The methodology aimed at shaping the geometric, structural, and physical constitution according to the expected performance, in terms of mechanical strength and material distribution considering the lowest weight, with regard to feasibility constraints and in conjunction with automotive manufacturing practices, which can provide mass production of customized solutions;
- The practice of “interoperability” between structural, thermal and/or environmental modeling, aimed at predicting the performance assessment of technical systems.

The object of dealing with the topology optimization regards the development of methodological approaches directed to the “adaptability” of the building envelopes proposed to :

- The interaction between the conceptual references supporting “manipulation” and “exploration of phenomenal reality” activities and cognitive and operational procedures based on digitalization and virtual composition (morpho-typological, performance oriented, physical and aggregative) processes and tools;
- The implementation of cognitive and operational “models” aimed at the simultaneous cognitive acquisition (through predicting and anticipation aspects), assessment and executive simulation of the project;
- The strategies of “artificial reproduction”, in order to predict and control the “operational modes” using “modeling representation” (through “predictive/executive models”, aimed both at “indirect” observation and at analytical and operational formulation; Naboni and Paoletti 2015).

The thematic proposal, which implies the theoretical references gained from a series of projects, researches and experiments considering reality of production and construction as something “manipulable” and “calculable”, aiming for the next step of “empirical education” and “executive materialization” of data, is expressed through the strategies directed to the morpho-typological, geometric, structural and connective “calibration” of the building envelopes (as an intended form of “adaptability” according to the shape-size-structural optimization activities; Paoletti 2017). Therefore, the technological design culture of topology optimization processes is further explored and proposed to the “adaptive” conception of the building envelopes, according to:

- The activity based on principles acquired in industries that extensively use digital technologies (i.e. the automotive, aerospace and biomedical industries), in order to manage in a coordinated manner the design, production and construction stages of composition, systemic and connective solutions;

- The simulation and predicting anticipation methods of design solutions in order to assess procedures and economic aspects, “optimize” production lines (reducing the amount of material employed, viewed from the viewpoint of the effective functional needs), thus reducing polluting emissions and the use of energy supply;
- The qualification, certification and standardization prospects of management, design, production and construction processes within the AEC industry (Architecture, Engineering and Construction Industry), in order to identify possible references and avenues for a normative formulation concerning innovative products.

The study is developed through a series of contents organized according to the analytical articulation of the main themes regarding the possibility to apply some topology optimization methods and strategies to the “adaptability” of the design of building façades (1) and the in-depth treatment of some examples regarding the design of the building envelope joints (1.1) and of the reinforced concrete sections and “shells” (1.2). Thereafter, the study focuses on the topology optimization and the design through the periodic base cells (2) and through the lattice structure (3) as a strategy for the “adaptability” of the building envelopes to the morpho-typological and mechanical needs: in particular, this theme regards the development and the possible technological transfer of the lattice structures and cellular materials (3.1), the lattice micro-structured architecture (3.2), the material system of additive manufactured lattice structures (3.3) and the research on lattice cell typologies (3.4). Moreover, the study examines the topology optimization through modular systems and opens to the multi-objective optimization and “adaptability” of the building envelopes (4).

2 Topology optimization: strategies and methods for the possible technological transfer to the “adaptability” of building envelopes

The study is based on the cultural and scientific field related to the development of the design methods aimed at the generation of new forms in architecture, where performances are integrated not merely into an evaluative discourse, but as generative “parameters”. Within this context:

- The topology optimization process has emerged as a scientific approach to evaluate form and structure jointly (on the basis of aerospace and automotive industry, where the optimization of mechanical parts is performed in connection with an efficient material usage);
- Topology optimization should be directed to the study of the building envelopes as a new approach for the morphogenesis and for the calibration of structural elements, considering the potential of creating shapes that can complement and inspire the generation of architecture.

The study of the technology transfer and of the application of the “adaptive” strategies to the building envelopes contemplates:

- The developing load-bearing systems that economically satisfy the design performance objectives and safety constraints;
- The minimization of resource consumption that refers to the selection of the best element from some sets of available alternatives (Radman 2013);
- The purpose of the topology optimization as an approach focused on shaping in order to find the optimal thickness distribution (e.g. the optimal member areas in a truss structure). The optimal thickness distribution that minimizes (or maximizes) a physical quantity such as the external work, the peak stress and deflection, while equilibrium and other constraints on the state and design variables are satisfied;

- The approach focused on sizing, according to the development of the design model as a fixed parameter throughout the optimization process;
- The determination of features such as the number and location and shape of holes and the connectivity of the domain (Bendsoe and Sigmund 2003).

In this way, the contribution to the design methods related to the “adaptability” of the building envelopes pertaining to the specific requirements and conditions regards the aim to optimize the structural contents by finding ideal topology configurations that suggests a layout of framing and enclosure elements and, eventually, a specific material distribution given by specific design conditions. The topology optimization processes transferred to the context of structural needs and problems of the building envelopes constitutes an approach that optimizes material layout within a given design space, for a given set of loads and boundary conditions such that the resulting layout meets a prescribed set of performance targets (Radman 2013). Moreover, the responses of structural systems to the external loading conditions are highly dependent on the material they are built from.

On this basis, the strategies for the topology optimization aimed at the “adaptive” design procedures of the building envelopes are intended as an aid to generate architectural structures, framings and components, so that the output of the process should be strictly morphogenetic and suggest actual forms in relation to a defined spatial boundary and requires the needed integration of the structural problem with the architectural one. According to this proposal, therefore, the topology optimization aimed at the composition of the building envelopes should consider:

- The definition of the boundary conditions, such as the applied external loads, the support conditions, the volume of the bounding box including the structure and, eventually, some additional design restrictions such as the location and size of prescribed holes or solid areas;
- The determination of the optimal organization of a specific material in space most often according to structural compliance or stiffness (Figure 1).



Fig. 1 Strategies for topology optimization directed to the building envelopes to generate architectural structures and components.

2.1. The topology optimization approach to the “adaptability” of the building envelopes joints

The study supports the technological transfer of the topology optimization directed to the “adaptability” of the design conditions of the building envelopes through the development of structural connections, as exemplified by the technique to realize the 3D printing steel joints.

In order to point out the possible contribution to the design of the framings and of the technical interfaces, the analysis considers the results achieved through a project by Arup Engineering in collaboration with WithinLab, CRDM/3D Systems, expert in additive manufacturing, and EOS; Paoletti 2017). In particular, the study examines the pioneering proposal by Arup Engineering that represents a solution for steel nodes in lightweight envelopes characterized by complex shapes and customized design: the shaped elements are optimized by SIMP method and topology optimization results in an organic form using less material while the original functions are still ensured (Block et al. 2015). Compared to traditional design, the technological transfer opportunity suggested to the “adaptive” conditions of the building envelopes joints should regard:

- The approach capable of providing the calibration of material and causing an increase of the node stiffness;
- The process based on the principle of the additive laser sintering, employing the steel derivatives as the printing material. The structural nodes have been originally conceived in stainless steel and later produced with steel, compatible with the technology of the machine (owned by the partner CRDM). This material is about four times stronger than a normal construction steel, which made Arup Engineering eager to experiment with it and further explore its potentials;
- The additive manufacturing that report how this technological solution guarantees a 40% reduction of CO2 emissions over the whole lifecycle compared to the traditional casting processes;
- The process of the direct metal laser sintering (DMSL) satisfies many design requirements, reducing weight and preserving geometrical freedom. Due to the nature of additive manufacturing techniques, the production of waste materials is minimized and the weight of the final product reduced by 30% (Figure 2).



Fig. 2 3D printed structurally optimized steel joints “adaptable” to the design process of the building envelope joints (credits: Arup)

2.2. The topology optimization approach to the “adaptability” of the building envelope sections

The study supports the technological transfer of the topology optimization aimed at the “adaptability” of the design conditions of the building envelope sections, as exemplified by the application to the reinforced concrete sections, through an integral approach in which the generative design was essentially supported by a fabrication setup of robotic CNC-milling of EPS moulds (as the result of an interdisciplinary project led by the Aarhus School of Architecture; 2007). To prove this approach, a concrete structure (which required the use of self-compacting concrete and of steel reinforcements) was designed and built in the form of an asymmetrical, doubly curved slab structure, where the shape resulting from the topology optimization was then re-modelled and used as negative form to generate the EPS mould forms to be cut. According to this experiment, which finally ended up with the construction of a full-scale prototype (with a complex shape

that would be difficult to manufacture with typical methods), the study intends emphasizing the possibilities of forming an “adaptive” strategy for the building envelope sections through:

- The emergent structural design that provides a new tectonic language where the natural load path is immediately visible;
- The construction realized with high precision and ease of mould production (with the use of the robot CNC milling);
- The reduction of material consumption up to 70% in comparison with massive equivalent structures subjected to loading conditions and requirements by international standards (Figure 3).



Fig. 3 The topology optimization directed to the building envelope sections according to the application of the reinforced concrete, supported by a fabrication setup of robotic CNC-milling of EPS moulds.

3 Topology optimization and design through the periodic base cells aimed at the development of the building envelopes

The study examines and supports the topology optimization directed to the building envelopes regarding the methodological approach to “adapt” the material organization at the micro-scale: this strategy is experimentally extended to the Periodic Base Cell (PBC) that represents a heterogeneous continuum structure comprised of different constituent materials or phases (Bendsøe and Sigmund 2003). The topology of the PBC is what influences the properties of materials; hence the major challenge in the design of these materials would be the determination of the optimal spatial distribution of the constituent materials within the PBC. In the simplest form, the periodic composite materials consist in a 2D or 3D scaffold of matrix, in which the other phases are included: therefore, it is reasonable to apply the structural topology optimization methodologies for the determination of the spatial distribution of the phases (Radman 2013). According to these applications, the study means to support the “adaptive” conditions of the building envelopes considering that:

- The materials with repeating or periodic microstructures usually consist of one constituent phase and a void phase (known as porous or cellular materials), or combinations of two or more different constituent phases with or without the void phase (also named “periodic composites”);

- The overall properties of these types of materials are controlled by the spatial distribution of the constituent phases within the PBC, as well as the properties of the constituent phases;
- The periodic composites, in comparison with traditional composites, demonstrate greater flexibility in terms of their capability to be tailored for prescribed physical properties, by controlling the compositions and/or the microstructural topology of the constituent phases. They can also be easily tailored to have gradation in their functional properties, in the form of a Functionally Graded Material (FGM) through gradual changes in the microstructural topologies (Figure 4).



Fig. 4 The topology optimization directed to the building envelopes according to the optimal spatial distribution of the constituent materials within the Periodic Base Cell (PBC).

4 Topology optimization and design through the lattice structure directed to the development of the building envelopes

4.1 Topology optimization of the lattice structures and cellular materials directed to the development of the building envelopes

The study examines and supports the topology optimization approach by considering the “adaptability” of the building envelopes in respect of the lightweight of framing and sections, through the analysis and the application of cellular materials, which might be characterized by advanced physical, mechanical and thermal properties that extend far beyond those of solid materials. According to this approach, the “adaptability” of the building envelope should be analyzed in relation to the physical characteristics of the materials that can vary by changing the distribution within their microstructure: in order to make the best use of the resources, the spatial distribution of the constituent phases within the microstructures can be defined by using topology optimization techniques. These types of cellular solids should be transferred and used for the building envelopes due to their high structural stiffness, high strength-to-weight ratio, low energy absorption, good thermal conductivity, and acoustic insulation; although the structural weight is not generally a functional property, it might happen to be one of the important design factors. In particular, the study intends to support the “adaptive” conditions of the building envelopes considering that:

- The material is composed of Periodic Base Cell (PBC), which is the smallest repeating unit of the structures;
- The dimensions of the base cells are assumed to be much less than the overall length scales of the material body, and at the same time much larger than the atomic length scale;

- The PBC's are discretized into a finite elements model under periodic boundary conditions, where the finite element analysis is performed to extract necessary information for the calculation of the effects of individual elements (within the PBC) on the variation of homogenized (average) properties of material: this through the appropriate distribution of the solid phase within the PBC, subject to a prescribed volume fraction of the solid phase (Radman 2013) (Figure 5).

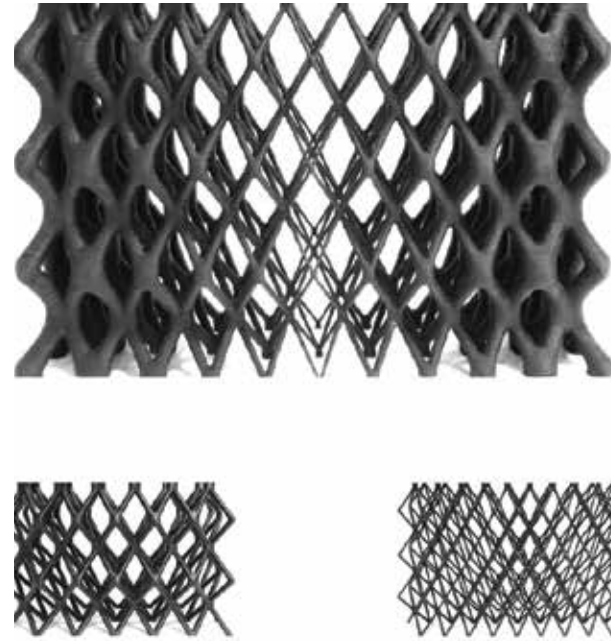

Fig. 5 Topology optimization directed to the building envelopes considers the study of the lightweight cellular materials (credits ACTLAB, Politecnico di Milano)

4.2. Topology optimization of the lattice micro-structured architecture for the concept design of building envelopes

The study examines and supports the topology optimization approach considering the “adaptability” of the building envelopes in respect of the technological transfer and application of a specific type of cellular solids, identified as the lattice microstructure. The potential of this system relies on its implicit resistance and reduced use of material, combined with the possibility to be “adapted” to a large variety of façade shapes. The study observes, for possible application to the building envelopes, the lattice microstructures both as a structure and as a material, consisting in an interconnected network of struts, pin-jointed or rigidly bonded at their connections. At one level, they can be analyzed using classical methods of mechanics, as typical space frames; on the other side, within a certain scale range, lattice can be considered as a material, with its own set of effective properties, allowing direct comparison with homogeneous materials: in particular, the mechanical properties of lattice materials are governed, in part, by those of the material from which they are made, but most importantly by the topology and the relative density of the cellular structure.

The study contemplates that applications of the lattice structures in construction, for possible use in “adaptability” of materials and structures of the building envelopes, are developed in connection with new fabrication methods, involving additive manufacturing and industrial robotic arms, often based on polymer pultrusion in space to create façade reinforcements (Hack et al. 2015): these are based on the use of fiber-reinforced composites to produce modular struts, assembled by

robots (Cheung 2012) and based on the employment of additive manufacturing to produce sand mold halves casted with Ultra High Performance Concrete (UHPC) for the realization of three-dimensional spatial lattices (Morel and Schwartz 2015). The topology optimization strategies, considered in terms of the “adaptable” physical constitution of the building envelope enclosures, are intended and supported as an early-stage design tool to give the designer an insight into an efficient and continuous lattice microstructure layout. In particular, the study means to support the “adaptive” conditions of building envelopes considering that:

- Topology optimization is fed with two-dimensional free-form shapes, which represent a possible “draft” of the building envelope configurations to be evaluated, along with a description of the specific boundary conditions such as loads, constraints and material properties (Bendsøe and Sigmund 2003);
- The representation directed to the building envelope configurations should be converted into a Functionally Graded Lattice structure, where the mechanical behaviour provides the needed information to evolve a polyhedron into highly specific cells with locally optimized cell dimensions and orientation, struts diameter and section as well as material characteristics (Figure 6).

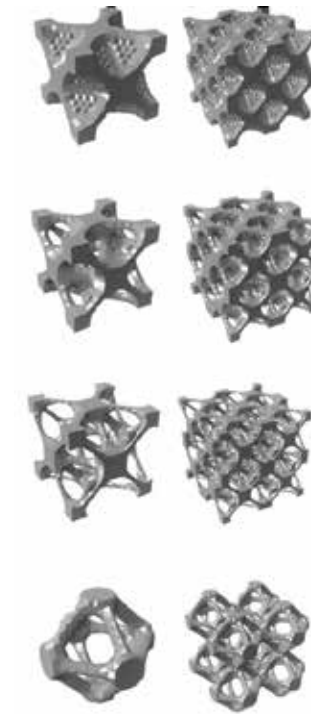

Fig. 6 3D base cells, 2 x 2 x 2 cells and effective elasticity matrices of 3D cellular materials with maximum shear modulus; volume fraction is (from top): 45% ; 35% ; 25% ; 15% (Radman 2013).

4.3. The material system of additive manufactured lattice structures for the concept design of building envelopes

The study looks at how, within the field of the “adaptive” characters of the building envelopes, the shift from prototyping to direct manufacturing is mainly connected to material improvement, which in comparison with product design is more complicated to achieve: material characteristics and behaviour, mechanical properties and dimensional requirements are key elements in evaluating the use of additive manufacturing for large scale applications (Naboni and Paoletti 2018). Therefore, the exploration of a material system should be carried out in order to understand the way it can

be exploited, with a rigorous multi-scalar analysis of the material coupled with the fabrication system that will be used. This process starts with analyzing the materialization process through the fabrication experiments and the observation of their geometrical and mechanical characteristics. As result, a set of specific boundary conditions for the fabrication systems, involving mechanical, software and material interdependencies, is defined. Within the frame of this research, use is made of a delta-robot, a typology of printer intrinsically agile that guarantees an ideal travel speed for the production of discontinuous geometries such as the lattice structures.

In particular, according to the technological transfer to the “adaptive” characters of the building envelopes, the employed material, experimented and indicated, should be the High Performance PLA (Polylactic Acid), a polymer with discrete mechanical properties that are leveraged by its superior printability. An extensive campaign of the fabrication tests has been conducted with it to define print settings in relation to geometric constraints, printing time, printing resolution and mechanical resistance of the lattice microstructure. Among various aspects, an important one emerged as the necessity of evaluating models to be printed according to the geometry limitations in overhanging angles, to avoid the need for support geometries with resultant inefficiency in the use of material. The relation between the deviation angle from the vertical axis and the number and thickness of shell elements is fundamentally driving the resolution and refinement of the production (Figure 7).



Fig. 7 The material system of additive manufactured lattice structures based on the multi-scalar analysis of the material coupled with the fabrication system (credits ACTLAB, Politecnico di Milano)

4.4. The research on lattice cell typologies directed to the building envelopes

The study, focused on the architecture of the lattice structure directed to the “adaptable” development of the micro-structure of the building envelopes, proposes to analyze:

- The definition of the base unit cell, which implies that the above-mentioned geometry constraints of FDM are to be taken into account first in this evaluation;
- The conduction of the comparative multi-criteria analysis of typical three-dimensional cells, with an evaluation of printability, relative density and visual permeability (considering different typologies as orthogonal grid, star, tesseract, octahedron, cross, octet, ventiles and diamond);

- The evaluation of the overhanging angles and of the visual permeability, which is measured in relation to the projection of the unit cells on a vertical plane (using a 30° angle of view) (Figure 8).

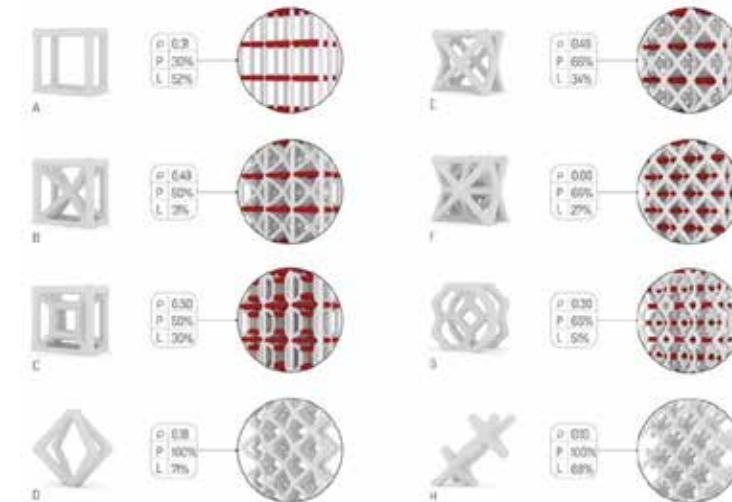

Fig. 8 The image shows eight different unit cell typologies for the Cellular Lattice Structure and their observed characteristics; first column shows unit cell types: A - orthogonal grid, B - star, C - tesseract, D - octahedron, E - cross, F - octet, G - ventiles and H - diamond; second column shows the relative density (p), printability (P) and light permeability (L); third column shows the repeated unit cell in a skin system, highlighting in red elements that are not possible to be fabricated with FDM. (credits: ACTLAB, Politecnico di Milano)

5 Topology optimization of the building envelopes through modular systems

The topology optimization strategies are studied for the application to the building envelopes through use of modular systems, intended as “open” and “adaptive”, such as the STRUNA (word born from the crasis of “STRUcture” and “NAture”) which shows the contemporary opportunities of computational design techniques combined with advanced manufacturing systems. The methodological approach is directed to the concept of “adaptive” modular building envelopes, capable of combining and accommodating “adaptable” structures, which conforms to the space. The STRUNA system (developed at the Politecnico di Milano, in collaboration with the Faculty of Agraria of the Milan State University) recalls the names of the modular pieces of furniture of the famous Swedish brand, but it surpasses its Fordist logic to become a mass-customizable system, lively and flexible. Accordingly, structure and envelope components joined in a system that is dynamic, self-bearing and can be configured as a filter between exteriors, interiors and between spaces. In line with the most advanced trends in high yield crop cultivation with the least ecologic footprint, the STRUNA system is also “adaptable” - besides traditional and hydroponic cultivation methods - for the cultivation of micro-algae, whose photosynthesis is made possible not only by the sunlight, but also by a low consumption LED system, ensuring non-seasonal yield (Figure 9a, b, c).

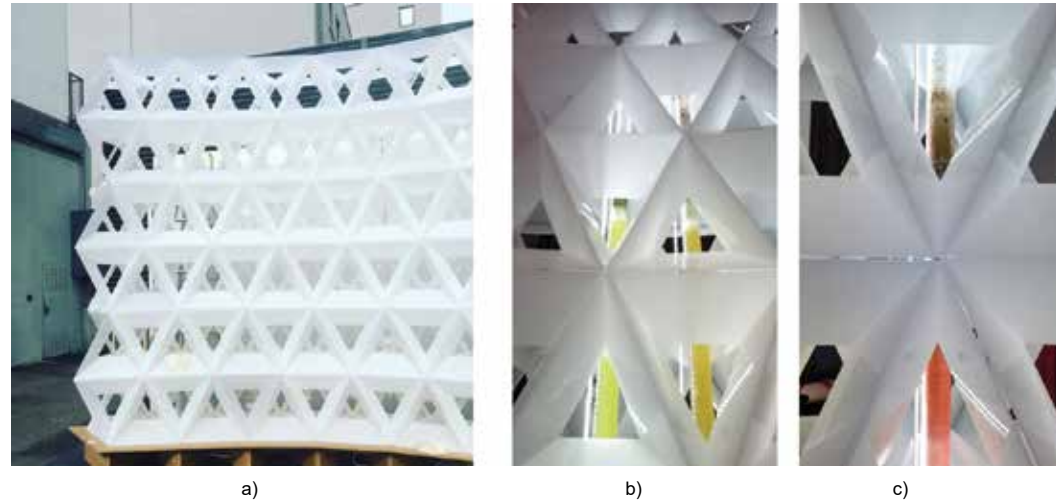

Fig. 9a), b) and c) The STRUNA structure developed as a result of computational design techniques combined with advanced manufacturing systems. (credits: SAPERLab, ABCLaboratorio, Politecnico di Milano)

6 Conclusion

The study, attempting to categorize the use of topology optimization (experimented in different areas), aims to support the technological transfer and the methodological approach to the conception of new morphogenesis, production and construction strategies for the structural framings and enclosures of building envelopes, observing:

- The topology optimization process that is analyzed as a possible technique to achieve the characters of “adaptability” to façades while creating efficient physical, material and structural organization;
- The integration of additive manufacturing methods that have introduced innovative materialization processes, where logics of sustainability and efficiency (typical of mass-production) are no longer applicable: taking inspiration from the remodeling process of bones, a design methodology based on topology optimization that “adapts” to different shapes and loading conditions is developed;
- The experimental approach finalized to complex shapes neither pre-optimized by shape, nor post-rationalized to meet manufacturing constraints, supporting the manufacturing process with increased chemical, mechanical and weather resistance.

This promising research ambit can widen designers competences and capacity to inform their design with performances from the very beginning of the design phase.

7 References

- Bendsøe, M. P., & Sigmund, O. (2003). *Topology Optimization: Theory, Methods and Application*. Springer, Berlin.
- Block, P. et al. (2015). *Advances in Architectural Geometry 2014*. Springer, Berlin.
- Cheung, K. C. (2012). *Digital Cellular Solids: reconfigurable composite materials* [Doctoral thesis]. Massachusetts Institute of Technology.
- Hack, N., et al. (2015). Mesh Mould: Differentiation for enhanced Performance, in *Proceedings of the 11th International Symposium on Ferrocement and 3rd ICTRC International Conference on Textile Reinforced Concrete*. Rilem, Aachen.
- Morel, P., Schwartz, T. (2015). Automated Casting Systems for Spatial Concrete Lattices, in M.R. Thomsen, M. R., Tamke, M., Gengnagel, C. et al. *Modelling Behaviour - Design Modelling Symposium*. Springer, Berlin, 213-225.
- Naboni, R., Paoletti, I., (2015). *Advanced Customization in Architectural Design and Construction, IX*, Springer, Berlin.
- Naboni, R., Paoletti, I. (2018). Architectural Morphogenesis Through Topology Optimization, in *Handbook of Research on Form and Morphogenesis in Modern Architectural Contexts*, pp. 69-92, IGI Global.
- Nastri, M. (2009). *La realtà del progetto: Orientamenti metodologici ed euristici per la “modellazione”, il “disvelamento” e la formulazione tecnica dell’architettura sperimentale*. Maggioli, Santarcangelo di Romagna (RN).

- Nastri, M. (2017). Executive design and hermeneutics of técnica. *Técnica. Journal of Technology for Architecture and Environment*, n. 13, 182-193.
- Paoletti, I. (2013). Two case studies of mass customisation and digital fabrication in building industry, in Piroozfar, P. A. E., Piller, F. T. *Mass Customisation and Personalisation in Architecture and Construction*. Taylor & Francis, London, New York, 184-193.
- Paoletti, I. (2017). Mass customization with additive manufacturing: New perspectives for multi performative building components in architecture. *Procedia Engineering*, 180, 1150-1159.
- Radman, A. (2013). Bi-directional Evolutionary Structural Optimization (BESO) for Topology Optimization of Material's Microstructure. School of Civil, Environmental and Chemical Engineering, College of Science, Engineering and Health, RMIT University.
- Zheliazkova, M., Naboni, R., Paoletti, I. (2015). A parametric-assisted method for 3D generation of as-built BIM models for the built heritage, in Brebbia, C. and Hernandez, S. *Structural Studies, Repairs and Maintenance of Heritage Architecture XIV*. WIT Press, 693-704.

Dynamic and Climate-Sensitive Bionic Façade

Andreas Hammer

University of Applied Sciences Mainz, Germany, andihammer@web.de

Designs by architectural students from the Frankfurt University and their future potential for adaptable and solar photovoltaic implemented façades are portrayed. The paper is showing how they act and react to climatic changes at the specific sites. The different aspects, as well as limitations with regard to costs, technical and functional restrictions, are named. The design process for the two different courses in architectural design containing a refurbishment of an existing building "high-rise apartment building, Mainz" and a case study for a "bikers lodge, Bingen" critically outlines and displays how the designs were developed step by step towards an overall energy strategy that firstly is pushing the design to a plus-energy building and secondly to incorporate one bionic aspect into the building skins' design. Both main parameters needed to be reviewed and refined during the whole design process. Various basic bionic approaches are given [e.g. solar ivy TM [S.M.I.T. 2011], flectofin TM [Knippers 2012] or hygroskin TM [Menges 2012]], which are to be experimented with, regarding the use of bendable photovoltaic elements as parts of a hybrid, kinetic façade system. As we need to collect energy in future buildings, the complete building envelope has to work like the human skin, adapting at the right time to the right functional need, with the minimum amount of energy input or physical power. This paper would like to make a contribution to these ideas by showing how our modern architecture can contribute to this and naming those implications that need to be closely looked at.

Keywords: bionic building shell design, bio-kinetic façade, climate adaptive façade, self-regulating shading system

1 Introduction

During two separate courses, students in the bachelor program were asked to deal with a specific design project.

The main aim of the module was to explore and enhance the boundaries of architectural expression when using natural low-tech systems inspired by bionics. The design requirements were very challenging, for there were different functional needs that were to be incorporated in a convincing energy strategy that should use photovoltaic [pv] thin-film cells in a very unconventional way into the building skin. The design studies show their bionic approach and their attempt to balance the users' needs and communication with the façades and the technical requirements of hinge-less, adaptable shading devices. This can be a trigger for new design methods and future ways of incorporating self-adapting and self-regulating building components in architecture.



Fig.1: biker lodge design – perspective with south facing bionic façade [Korpa-design]



Fig.2: biker lodge design – hill side perspective with south facing façade collecting sun energy [Korpa-design]

2 Specifications, research frame and effectiveness

2.1. Towards a global impact

The essential question for the future is how architects can contribute to overcoming the problem of an increasing waste of energy in the face of fast population growth. One challenging and promising aspect that has already been started in the academic field and vividly discussed among a minority of architects, is the goal of developing, in a time range of approximately 50 years, buildings that never again use up and waste energy and other resources. Instead they themselves should become a mean of generating the necessary output for themselves and for other intentions as well. This is the so called “plus-energy building” or “active house”.

The strategy would be to concentrate on the development of the inherent principles regarding the most promising element of the buildings for reaching this goal – the “building envelope”.

Future façades will have to massively collect energy in a very economical way, while at the same time fulfilling all amenities for the users. All aspects like transparency, translucency, opacity, building physics to meet the comfort of the human users, technical restrictions to meet fire-safety regulations, and so on, need to be researched and their reciprocity. Especially when it comes to

the original matters of architecture, like described by Vitruvius, and as one of them is beauty, the differentiation of the mere technical elements of the bionic façades needs to be discussed and researched with regard to proportions, harmony in appearance and excellence. This will explicitly be true for the parts of the building and even for the smaller details they are made of. And so, the whole building concept and its appearance will be in close design relationship with its smallest parts and their interaction with the surroundings. Even more, we must explore building techniques and materials to operate in a mode of adjusted flexibility. This kind of adaptability to what is happening climate-wise in the surrounding area will be the most difficult and challenging part for architects and engineers in the future, because we need a visionary understanding of how to create these effects with lowest power input and minimum maintenance while at the same time solving all the problems of bending, rotating and other kinetic issues. So, this is the point where biology starts to intrude into architecture, because evolution has, although during long times, developed and optimized, yet on different scales, wonderful and harmonious plants and plant-parts that have been made to work in an absolutely efficient way with regard to very specific functions and the natural law of minimizing energy losses wherever possible [see fig. 3].

The broad field within the discipline of bionics has already discovered some very inspiring answers that have been adapted to the field of engineering and building works.

2.2. Preparatory work for the design-statements

The first step in this architectural research study on building façades was done by explicitly collecting weather and climate data as well as doing research on natural sources of the given site or in its vicinity.

Having closely looked at and discussed natural parameters worth exploiting at the given site and using the building itself as an energy supplying factor, an energy strategy for every single design was individually developed to give ground for the main bionic principle [e.g. hygroskin TM [Menges 2012]; solar ivy [S.M.I.T 2011] or flectofin [Knippers 2012]] that had to be aimed for. These principles and their constructive elements had to allow the possibility for further attachment or improvement as a natural energy collecting device. Most of the design research was aiming for the exploitation and use of solar power within or on top of these elements of the building shell, e.g. by designing the case study towards a plus-energy building or heading within the design frame for a non-heated and non-cooled building [see fig. 1+2].

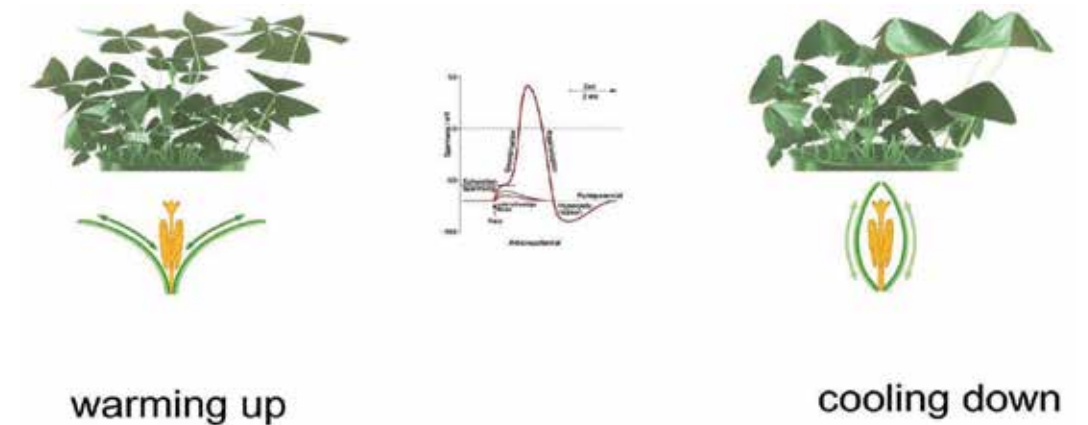

Fig.3: natural opening and closing mechanism of clover during day and night-time triggered by sunlight/ sun radiation - a one-day cycle

2.3. Existing parameters and focus on façade performance

In order to verify an acceptable approach, every student was asked to undergo a specific research procedure to meet the limitations of his or her specific design, e.g. power outcome with regard to element sizes, rotation angles towards the sun [during winter and summer time], of the façades less oriented towards the sun. The integration of the roof surfaces in all case studies was principally neglected in order to maintain the focus on those parts of the façade that are always much harder to implement with regard to user interference and transparency or opacity issues. This means, basically what will work on the building façade, will also work on the opaque roofs as well. By focusing on the façades for all cardinal directions, the students had to undergo a process of refinement including the question of the main parameters that the chosen façade has to meet and what the initial output and target will be.

2.4. Bionic mechanism, activated by direct solar radiation, in combination with pv cells

Despite taken into consideration one primary bionic principle, it became very obvious right from the beginning that simplification was needed; the biological mechanism was completely converted to a shading device in front of the building façade. Having a closer look at the “high-rise studies” we can realize, that two different approaches were taken by the students.

“solar ivy” – a bionic principle that was directly derived from the ivy plant and its imitation of the photosynthesis effect by implementation of pv thin film cells onto the artificial leaves’ surfaces. A pre-commercial development for the building sector was initiated by SMIT-New York [see fig. 5 and 7].

The “Müller” design [see fig. 4+6] had completely taken into consideration as a design-driving force the “solar-ivy”; we can clearly see the manifestation within the façade design of a rather unusual and unique way of treating opaque, transparent and translucent parts. Moreover, it is also clear that this bionic principle does not offer the options of flexibility towards a changing climate and weather situation and so has to be accepted as a rather static device. Still unsolved in case of fire is the problem of electrical tension and voltage during fire-fighting efforts.

2 Basic data of specific building parameter

Allgemeine Gebäudedaten					
Location/ weather data		Region 12, Mannheim			
Building mass c_effect.	W/(m²K)*h	mittelschwer			
Air tightness n50	1/h	mit Dichtelvlend und raumlüftetechnischer Anlage			
Therm. bridge ΔU_WB	W/(m²K)	pauschal - gering (DIN 4108 Beiblatt 2)			

U-Werte und Gebäudedaten		Süd	West	Nord	Ost	Horizontal
Type of glazing Ug	W/(m²K)	U=1,1lg=0,6	U=1,1lg=0,6	U=1,1lg=0,6	U=1,1lg=0,6	U=1,1lg=0,6
Energy-transmission grade gt		0,60	0,60	0,60	0,60	0,60
U-Value frame Uf	W/(m²K)	0,70	0,70	0,70	0,70	0,70
Frame comp. value	W/(m²K)	0,060	0,060	0,060	0,060	0,060
U-Value Window Uw	W/(m²K, Ref.:1,30)	1,16	1,16	1,16	1,16	1,16
U-Value ext. walls	W/(m²K, Ref.:0,28)	0,16	typische Dämmstoffdicke: 27 cm		0,16	0,16
U-Value Roof (F _x =1)	W/(m²K, Ref.:0,20)	0,11	typische Dämmstoffdicke: 31 cm		0,11	0,11
U-Value ground (F _x =0,6)	W/(m²K, Ref.:0,35)	0,35	typische Dämmstoffdicke: 10 cm		0,35	0,35

Verschattung und Sonnenschutz		Süd	West	Nord	Ost	Horizontal
Double glazed Facade		ja	ja	ja	ja	ja
Shading horizontally		hoch (ab 35°)	hoch (ab 35°)	hoch (ab 35°)	hoch (ab 35°)	keine (bis 5°)
Shading overhang		keine (bis 10°)	keine (bis 10°)	keine (bis 10°)	keine (bis 10°)	keine (bis 10°)
Sun protection screen		L_T_weiß	L_T_weiß	L_T_weiß	L_T_weiß	L_T_weiß
Total Energy Transmission g_tot	0g, max 0,31	0,31	0,31	0,31	0,31	0,31
Screen controlling		strahlungsweiss				
Glare Shield		manuell				
Execution of Sun Screens and Glare Shield		Sonnenschutz dient auch als Blendschutz				

Angaben zu Lüftungsanlagen		Zuluft	Abluft
Efficiency -Standard	EnEV	ΔP_Zuluft 960 Pa	ΔP_Abluft 640 Pa
Heat Recovery gains of technical systems	70%	n_Zuluft 0,64	n_Abluft 0,64
Power demand	kWh/(m²a)	SFP_Zuluft 1,50 kW/(m³/s)	SFP_Abluft 1,00 kW/(m³/s)
Primary Power demand	kWh/(m²a)	SFP_total: 2,5 kW/(m³/s) 0,69 Wh/(m²h) ΔT_Zuluft: 1,23 K	

Fig.20: enerCalc- program: basic data for specific building parameter - 3rd configuration

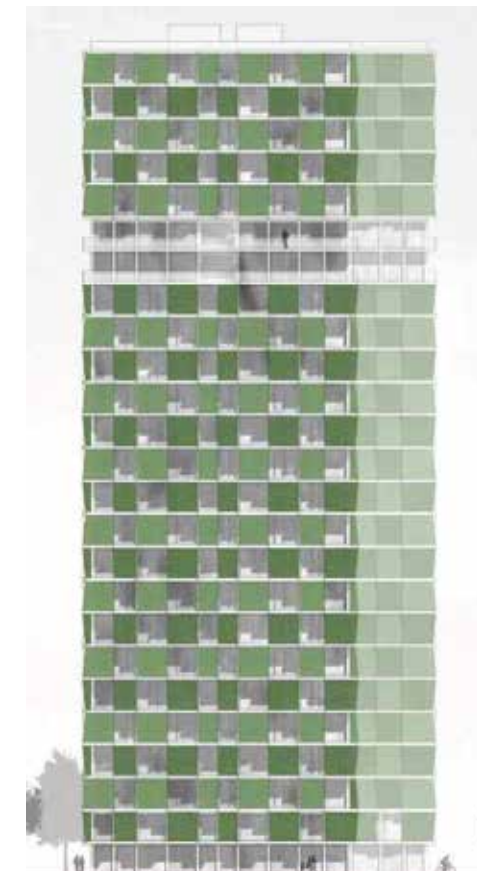

Fig 4: solar ivy– south-facing façade design [Müller design]



Fig 6: high rise apartment building - perspective [Müller design]

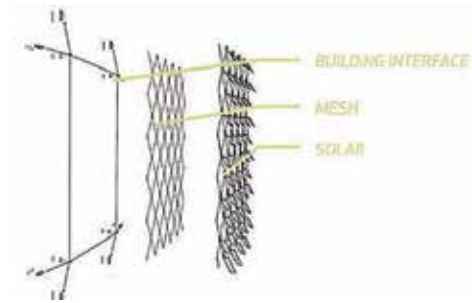

Fig.5: parts of the solar ivy application mesh

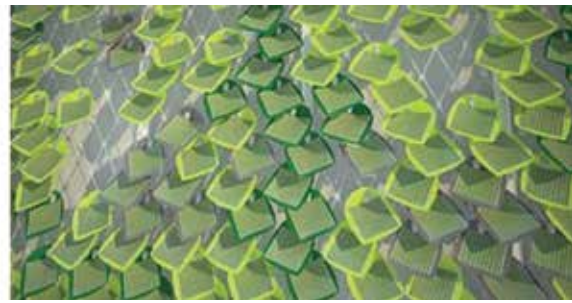

Fig.7: solar ivy under realistic conditions in New York

“flectofin™” – a bionic principle that has been adapted and transformed from the Bird-of-Paradise-Flower “strelizia reginae”. A pre-commercial development for the building sector was initiated and a prototype was built by ITKE-University Stuttgart | Albert-Ludwigs- University of Freiburg | ITV-Denkendorf | Clauss-Markisen [see Figs. 18+19].

This research study has won the International Bionic Award 2012 and the Tectextil Innovation Prize 2011 and will be the bionic principle which this scientific research will mainly focus on. Strategies to apply bendable thin-film pv modules onto these textile “wings” or “flaps”, opaque or translucent and with different shapes and sizes, need to be researched in detail.

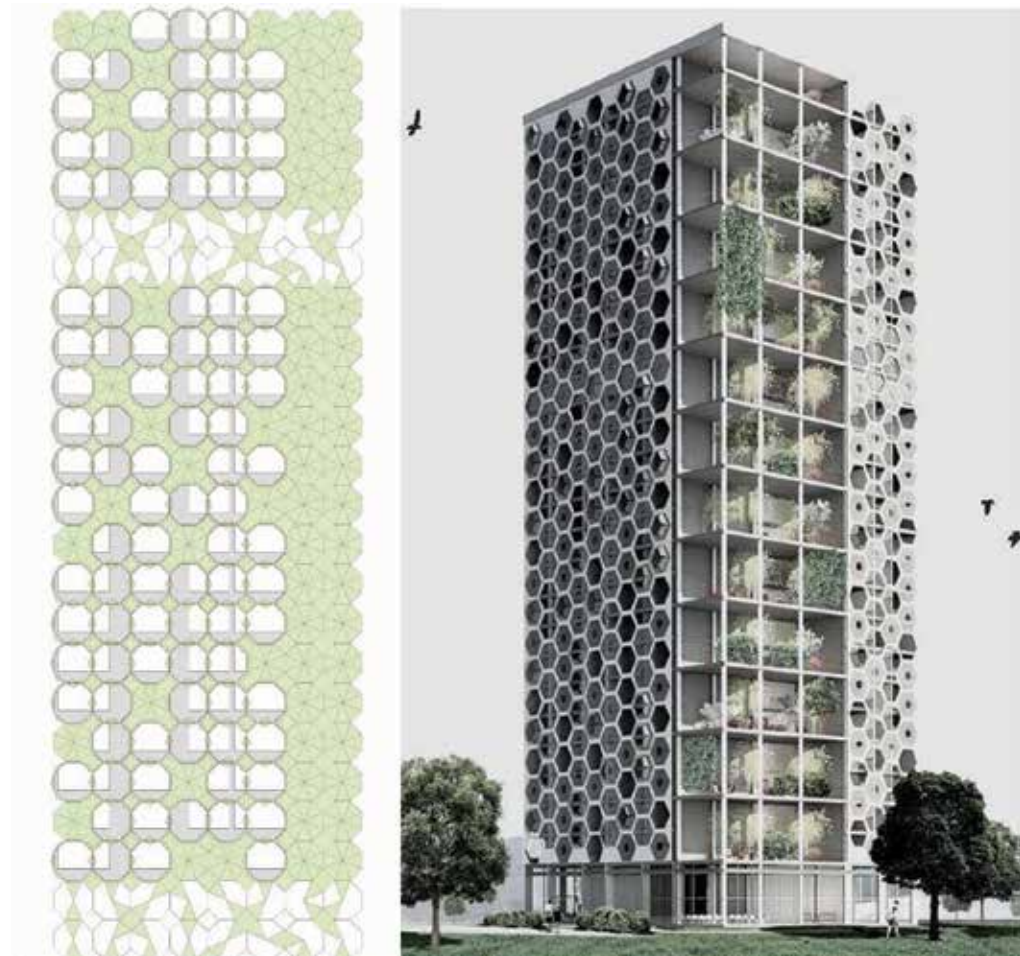

Fig 8: octagonal flectofin modules [Dittmar design] Fig 10: hexagonal flectofin modules – perspective [Neverbickaite design]

Strategies for Design

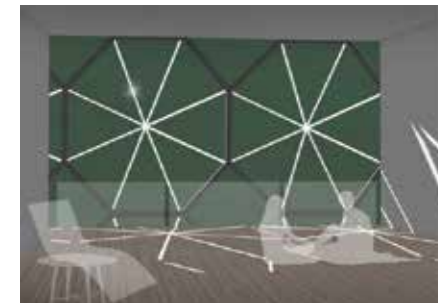

Fig.9: high-rise interior perspective [Dittmar design]



Fig.11: interior view– closed flectofin shading at midday [Neverbickaite design]

Very important will be the aspect of the materials working together in their behavior to bend together, comparable to bi-metallic material. As the sunlight hits the pv modules and the “hinge-less flaps” [made of a mixture of carbon textiles and layers of synthetic resins], the increasing temperature on the surface starts to curl the “flaps” and makes the photovoltaic modules expose themselves more and more directly and unobstructed to the sun. All other students “Neverbickaite” [see fig. 10+11] – “Dittmar” [see fig. 8+9] - established their designs on the “flectofin-principle” as described beforehand under paraphrase number 2.4 -“flectofin” and added an energy-collecting pv system onto the sun-facing surface of each element of the flapping mechanism [see fig. 16].

The power collection would also work on days with little sunshine, because the output and efficiency of the thin film pv modules works under a wide range of climatic conditions. An electrically induced manual override gives the opportunity of accomplishing human user behavior. A “nithinol-wire gaze interwoven into the flaps” [see fig. 16], works as a kind of resistor and because of its electrical conductivity, which starts to build up an internal constraint when hit by sun rays, the flaps steadily change their state of condition from “completely open” to finally “completely closed”. And having reached this last position, the full shading for the space behind is completed – overheating is absolutely minimized and the parallel work of collecting solar energy is at its peak.

Astonishingly, two of the three designs – namely the “Neverbickaite” design and the “Dittmar” design, have come to end up with a hexagonal [see fig. 11] and an octagonal [see fig. 9] structure as the primary [storey-high] module to arrange the flapping-mechanism of the flectofin-flaps.

By having a closer look at the “biker lodge studies” we can realize that all students were focusing on the “flectofin” bionic mechanism and surprisingly, we learn that all of them had started an individual approach and improvement, which finally resulted in differentiated and convincing design statements. The shading devices have become an integral part of the design process for the appearance of the building as a whole.

So, for example we find the “Aubertin” design [see fig. 12+13] came up with a star-like module derived from the opening and closing mechanism of pine cones. By choosing different element sizes, a playful and variable appearance gives a unique expression to the building.

The “Frischholz” design [see fig. 14], on the other hand, uses upright standing elements in a very slender triangular- shaped version, each overlapping the other by a certain amount of the element. As we can see from the interior perspectives [see fig. 14], there is great potential for interplay of “intimacy and transparency” and a high design potential for the appearance of the whole building itself. The “adaptable appearance” or the “changing face of the building due to climatic conditions” represents a topic for further research studies. This means that, according to the sunpath, different

successive parts of the same façade are activated and adapt themselves to the specific solar condition at that very hour of the day.

2.5. Technical proposal and detailing for a bionic shading mechanism

As this technology of the “flectofin”-mechanism is based on carbon and fiberglass materials, the detailing work within the students’ range was very limited because of still unknown or undeveloped knowledge of how to merge an aluminum or concrete substructure with a carbon-like material. The proof that these new technologies can be fitted to the most common building materials and construction techniques has already been supplied by Foster and Partners “Walbrook-Project” in the City of London which used carbon-fiber lamellas to build, for the first time in the world, a complete shading structure for a façade made of this lightweight material.

The first question that arises is whether to choose “thin film” or “monocrystalline” pv cells [photovoltaic cells]. As the driving factors will be the efficiency of the cells for all weather situations and the bendability, (i.e. the flexibility of the material to follow the kinetic movement of the flaps), we concentrate the research work on the solar thin film pv technology. But as the solar industry can produce small patches of 0.5mm thick layers of “mono/polycrystalline”- pv cells mounted on foils [sizing 7-12cm in both directions], linking them together to work as a big panel, the choice for this latter option is made very easy, because the output of the solar induced energy can be assumed at an efficiency rate of about 14-16%, rather than 5-9% when choosing the thin film technology.

A first suggestion therefore would be the lining up of parallel arranged solar cells [see fig 16+17], each strip with a width of 12cm and an intermediate spacing of 3cm, in order to create a 15cm axial grid in one direction. Within each strip the single cells with a length of 12cm and an additional spacing of 3cm, would be linked together by imprinted wiring. In order to achieve an overall flexibility for the whole flap as well as the attached pv cells, this would be sufficient. In this case our flap-format [triangular shape with approx. 1.5m length on all sides] could be filled as shown, reaching a maximum collecting area of about 80% of the whole flap size.

The wiring of all stripes on one flap as well as the adding up of all flaps within a module [6 flaps for the hexagonal and 8 flaps for an octagonal module] could be done by imprinted wiring and accumulation of all electrical connections into an electrical bus system. The phase change components of each storey and façade should be arranged within the central, so called, BMZ [fire-alarming center - Brandmeldezentrale] on ground level.



Fig.12: biker lodge hillside perspective with bionic elements derived from pine cones [Aubertin design]

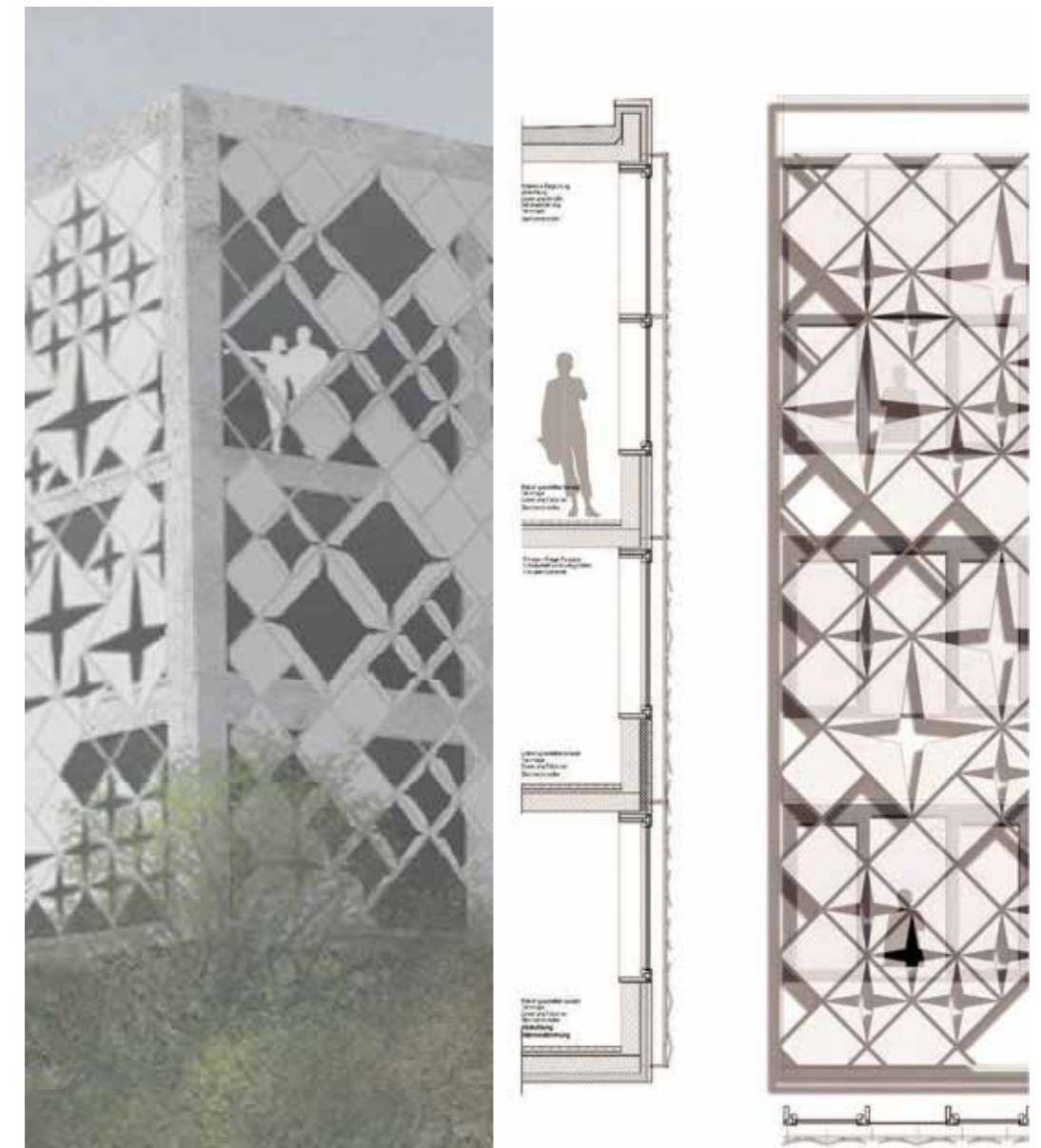

Fig.13: partial elevation and section with shading elements designed from pine cone mechanism [hygroskin]



Fig.14: biker-lodge flectocollect façade south-facing, two storeys high triangular shaped modules [Frischholz design]

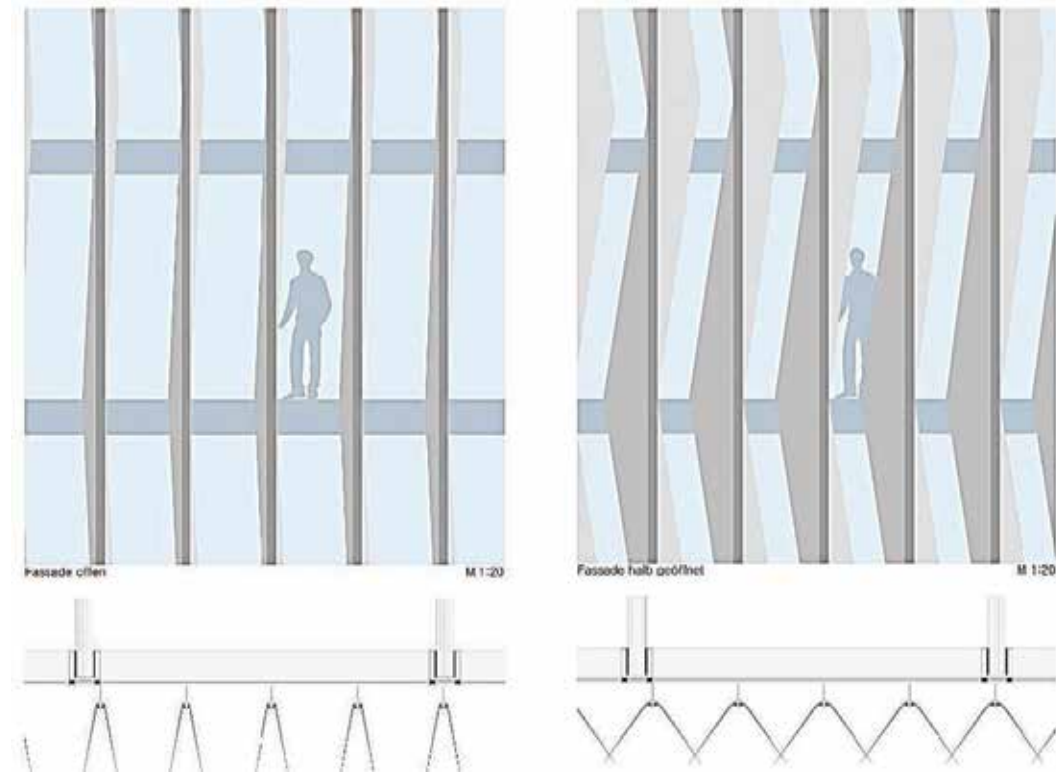

Fig.15: interior view with almost completely opened up flaps



interior view with half closed flaps

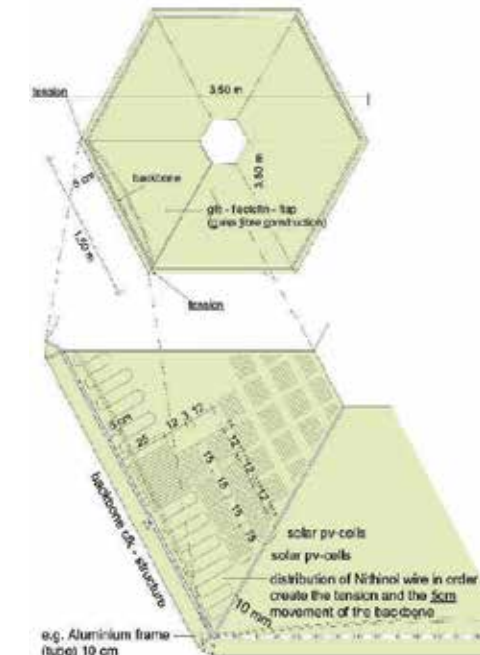

Fig.16: proposal for electrical activation by sun power

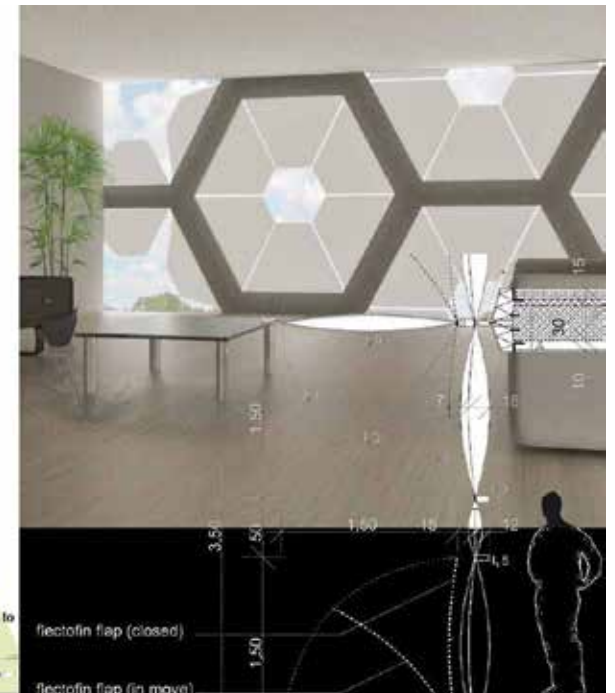

Fig.17: hexagonal shading system with air cushion façade

As the primary aim of flectofintm, is to create kinematic bending and form movements in an adaptation process that is linked to the daily path of the sun, the further step towards FlectoCollecttm [proposed energy-generating shading device by A. Hammer] needs to find a balanced answer on the question: “which sides of the flaps and which orientation [cardinal directions] would make a useful application strategy?”

Considering the following points:

- Flectofin flaps closing at night, to minimize air circulation heat losses
- Flectofin flaps closing to prevent over-heating at midday
- Flectofin flaps closing to follow individual needs of human beings

the current assumption would mainly see pv cells attached on the “outside surface”, the surface being exposed to the sun when the system is stretched out in – fully open position [maximum shading].

First efforts made in 2012 to activate the mock-up flaps of the first flectofin prototype were realized by a linear motoric device using a hub of 55-100mm, which was sufficient to make the flaps bend by an angle of 90° [see fig. 18]. However, this operating mechanism is still much too complex and too costly and so more efficient systems have to be developed. Currently there are two promising but very different paths which are subject to research.

Strategy I: operating mechanism using compressed air:

The strategy to inflate cushions with pressurized air and thus achieve a force to bend the middle of the backbone of the flaps by 4-5cm is currently being researched by the ITKE- Stuttgart University and ITV-Denkendorf and supported by a DFG [Deutsche Forschungs- Gemeinschaft] research

program. The creation of a 1:1 mock-up [see fig. 19] has just been built and a large presentation in September 2017 took place in Stuttgart, Germany.

Strategy II: operating mechanism using thermal constraint (nithinol or similar bimetallic principle):

Having the vision that the bionic flaps will be opened and closed naturally in the future by the sun itself [by its intensity and its path during the year with respect to the different exposed façades], allowing for individual interference by users and the complete system [see fig. 16] working on a low-tech principle, the major focus therefore needs to be given to the development of advanced smart materials. Dynalloy, a US-based company, offers all different products e.g. nithinol wires that can be attached to technologies when needing a kind of bimetallic reaction [Grinham, 2014]. Although this proposal needs advanced engineering with SMA [smart material], representatives of the company clearly see a chance for realization after intensive research. Moreover, the proposal for this opening mechanism seems to be very clever and efficient in their eyes. Detailed information exchange and preparation for financial support is on the agenda.

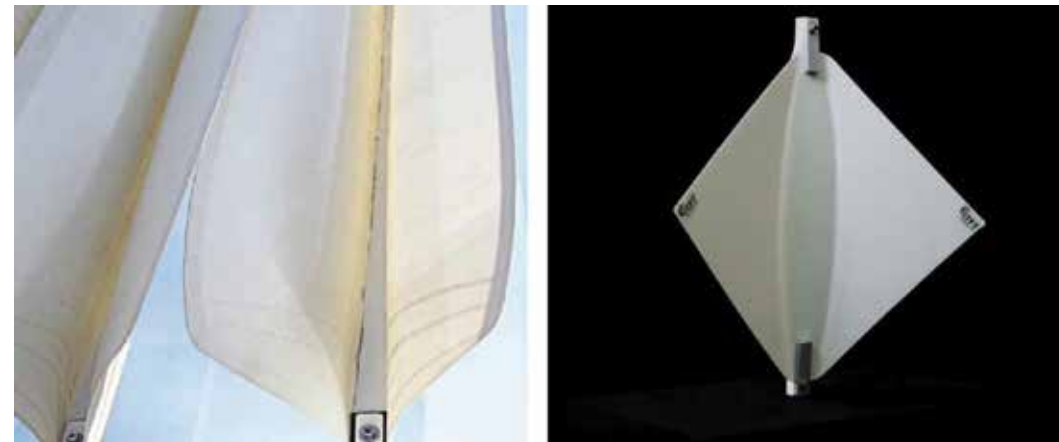

Fig.18: prototype of flectofin flaps first generation [ClausMarkisen] Fig.19: activation of flaps by pressurized air cushions [IT-KE-Stgt.]

2.6. Comparison of energy performance of 3 PV configurations

The intention of this paper is also to show and confirm the useful application of bendable pv [photovoltaic] cells on a movable façade system. In order to compare a standard skin with pv cell distribution only on the roof and the advanced building skin with pv cell distribution on the roof and on the façade [minimum 70% of the total area of the façade], calculations of the energy output of three different situations have been established. As a reference for all calculations, the full design of the proposed bionic façade [see fig. 10+16], has been taken as the basic scheme.

The calculations included the following steps:

- Collecting the basic data of the design, like floor area, location of the façades towards the cardinal directions, measures for the four elevations, roof area, and orientation towards the sun. [see fig. 20]
- Determination of the pv active façade and roof area [see table 1]
- Determination of the effective pv active façade and roof area [see table 1]
- Calculation of the theoretical maximum amount for the energy output in the specific façade areas for a complete year. [Zentgraf, 2009 - see fig. 24]

- Summing up all partial façades and the roof to give a figure for total energy output [see table 1 e.g. for 3rd configuration].

Assuming that all four sides of the building would be taken into consideration for power collecting, there has been a reduction in the efficiency factor according to the presumed sun-time intensity on the specific façade area and the climate effectiveness [see table 1 – second column from right side]. The calculations also take into consideration a reduced effectiveness when flap-shape is in the middle of the kinetic movement. There is a significant difference in the energy outcome between FIRSTLY a conventional treatment of pv adaption with mono/polycrystalline solar-panels ONLY on the roof-top [total energy output: 87.500 kWh/a]; SECONDLY the additional pv adaption of thin film cells on the flectofin façade [total energy output: 186.000 kWh/a] and THIRDLY the additional pv adaptation of polycrystalline cells on the flectofin façade [total energy output: 443.981 kWh/a - see table 1 for 3rd configuration].

In order to compare the three configurations an assumption was made for the energy output of the chosen pv cells. This was done by applying the given options [Zentgraf, 2009 - see fig. 24] and their realistic power outcome as stated per year and sqm. In the next step a table was established [see table 1 – second column from right side] to collect all effective building skin area the assigned power-collecting area as well as the averaged efficiency rate for each cardinal direction. So northeast and northwest façades were treated with a reduced efficiency factor of about 6%, whereas all other cardinal directions were assumed to have a full efficiency rate of 16%. There has also been made a reduction in harvesting area in order to maintain a net pv generating area since some parts of the building skin can not be prepared for pv cells (constructive elements, edges, etc.). The determination of the efficiency reduction and the gross-to-net-area reduction was made due to experience and assumption on my behalf.

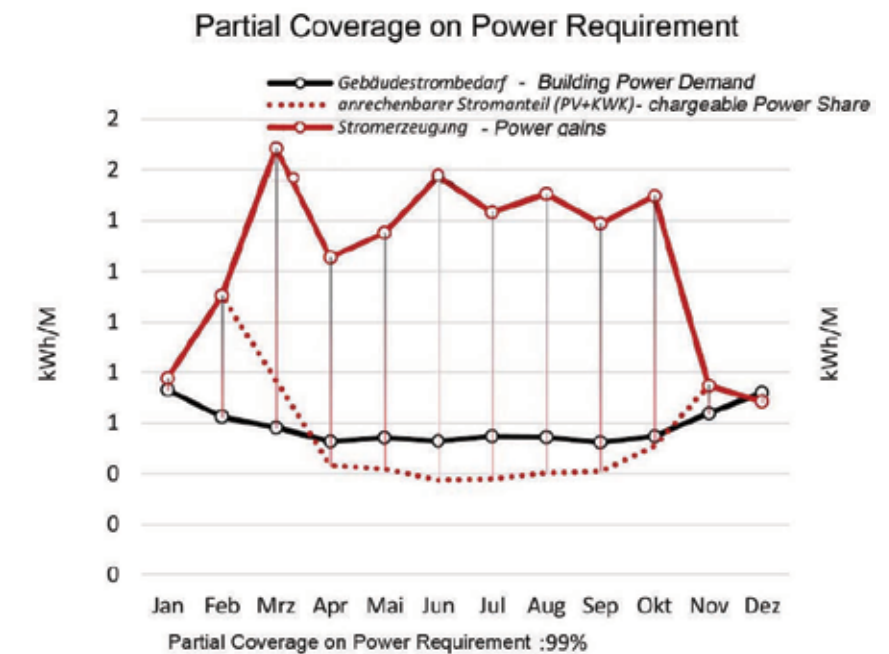

Fig.21: enerCalc-program: final energy balance - partial coverage on power requirements - 3rd configuration

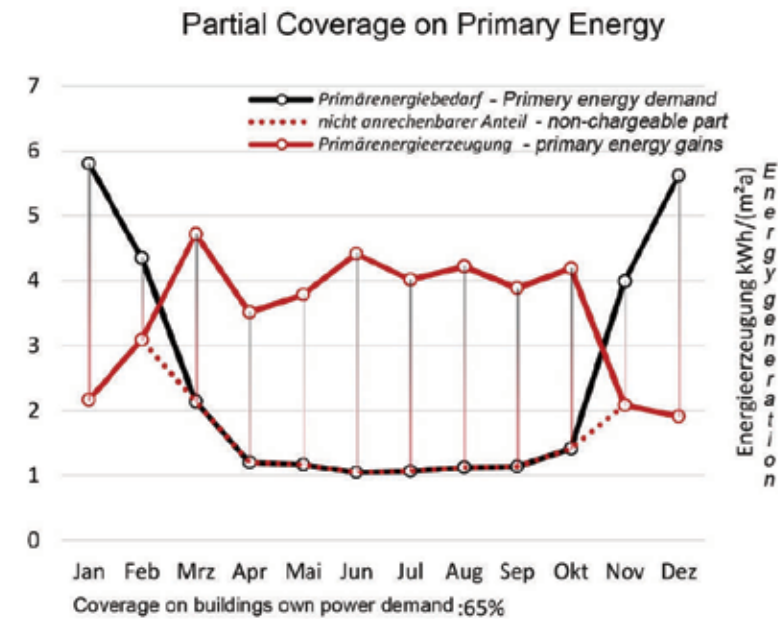

Fig.22: enerCalc-program: final energy balance - partial coverage on primary energy - 3rd configuration

These assumptions are insofar theoretical as the proposal for this new flectofin façade has never been tested under realistic conditions with collecting all the necessary data for weather, climate and sun-shine-rates. Furthermore, no energy output has been detected in a real long-time analysis which could verify or falsify the presumptions made in theory. Overall this was not the point at that stage. Primarily we wanted to know in which direction the technical side of the architectural skin design has to be shifted in future and which findings on this theoretical way for an energy balance presumption needed to be refined and more closely looked at. That could then end up in different treatments of the flectofin elements or in another way of assembling the modules during the design process.

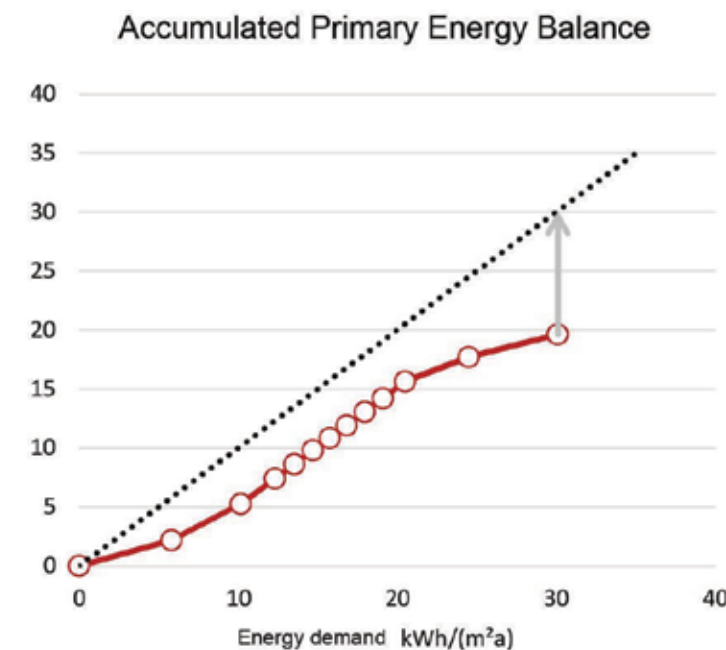

Fig.23: enerCalc-program: final energy balance - accumulated primary energy balance - 3rd configuration

Having calculated the yearly energy gains of the three different configurations, an energy calculation for the building itself was done, also for each of the three configurations and all basic data for the specific buildings parameters have been applied in the chosen energy calculation program [enerCalc], like e.g. U-values for windows, walls, roof, etc; the heat-recovery values of the technical equipment, the absence of a cooling system, assumptions for air tightness and thermal bridges, and so on [see fig. 20].

The calculations given by the enerCalc program have been promising insofar as we could find, at this early stage of the design process, an almost equal consumption of energy as the buildings own demand. So, the current finding was that the 3rd configuration is starting to gain a surplus of energy. With some more detailed adjustments in the overall energy strategy, an "active house", in our case for the typology of a high-rise building, is actually within reach.

Finally, it can be stated that the energy output of polycrystalline cells on the flectofin façade with a total energy output of 443.981 kWh/a, reaches almost the approximate amount that is necessary for the provision of all power within the building itself e.g. plants, lighting, cooling and heating system etc., when using an energy concept for the building that is striving to support an "active house" strategy [reducing consumption to a minimum]. This has been verified with the help of "enerCalc" a simulation program for energy calculations of buildings [see fig. 20,21,22,23].

Moreover, the total sum already suggests a surplus of energy that could either be stored within the building in battery storages or transferred into another repository material or be passed to adjoining houses and living quarters. That is exactly the turning point for a future plus-energy building and its embedding within a "smart city" concept. Nowadays, urban and spatial planners all over the world try to suggest smart grid metering as a specific network to shift electricity to where it is currently needed.

2.7. Future perspectives

Climate adaptive Building façades in the future will not only work with regard to shading devices but with regard to an overall adaptability by using multi-tasking layers as has been outlined in the dissertation by Prof. Dr. Henning Braun and his ideas for completely new material and surface combinations to meet different functionalities that are needed for highly adaptable and energy-minimizing building shells.

The development of an enhanced design strategy according to proposal in this paper, as a shading device, will be needed to clarify and verify the basic principles, in order to prepare the ground for mock-ups and testing series to show practicability. The relationship of the human factor with its need for natural daylight, transparency, intimacy, physical comfort and its interaction with technical systems ought to be balanced with accuracy. Further unresolved questions regarding fire resistance and the shut-down capabilities of façades entirely covered with electricity- inducing flexible pv systems, need to be answered in the near future.

In future research, the question of how this can be applied and of how the gap between research and real construction can be bridged, will be an essential one. Highly interesting proposals show a sensitive shading device according to the surface specifications of the species "snake-star-Ophiocoma wendii" [Braun 2008] or the vasomotoric and thermo-regulating multi-layered system of the "Rete Mirabile" [Braun 2008] derived from the seal skin.

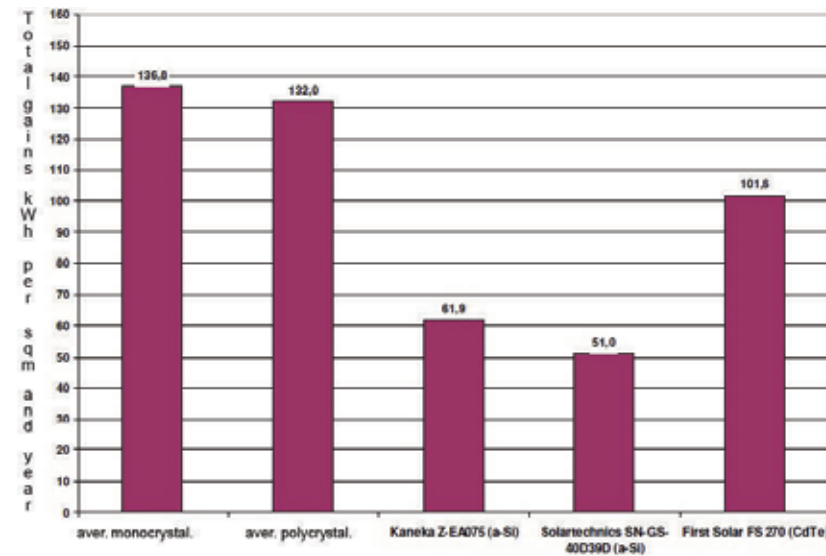

Fig.24: table for sun power gains per sqm due to effectiveness coefficients of different pv cell types

Building Part	Width in meter (m)	Height or Length in meter (m)	Area in sqm (m²)	Harvesting area in m² for PV-Mono/Polycryst surface approx. 70%	Annual energy output- kWh per 1m² acc. to table-fig 2 middle value for polycryst. cells	Annual total energy output of PV-Facade-surface in kWh/a
Facade-Southwest PV-active	23,6	26	1290,6	1256	130	163218
non PV-active	7,4	26	562,4		with 10% efficiency factor (approx. 10%)	
non PV-active	31	6	186			
Facade-Southwest PV-active	10,9	26	828,4	800	130	75384
non PV-active	20,1	26	1527,6		with 10% efficiency factor (approx. 10%)	
non PV-active	31	6	186			
			2542			
Facade-Northeast PV-active	23,6	26	1290,6	1256	87	109239
non PV-active	7,4	26	562,4		with reduced efficiency factor - 10% (approx. 10%)	
non PV-active	31	6	186			
			2542			
Facade-Northwest PV-active	10,9	26	828,4	800	15	3680
non PV-active	20,1	26	1527,6		with reduced efficiency factor - 10% (approx. 10%)	
non PV-active	31	6	186			
			2542			
FACADE - TOTAL SUM			7626			
FACADE-TOTAL WITH PV-ACTIVE in sqm				3671		
Energy-Output (computed value) per year for mono- or polycrystalline cells						356530
ROOF - TOTAL SUM	31	31	961			
ROOF-TOTAL WITH PV-ACTIVE in sqm				673	130	87451
Energy-Output (computed value) per year for mono- or polycrystalline cells					with 10% efficiency factor (approx. 10%)	87451
Total amount of energy gains in kWh/a from roof and facade for a flectofin-shading system						443981

Table 1: enerCalc-program: basic data for roof and façade area with pv adapted flectofin system - 3rd configuration

2.8. Conclusion

As we need to collect energy in future buildings, to shift those man-made artificial objects towards plus-energy buildings, the complete building envelope has to work like the human skin, adapting at the right time [of the day, of the season, to the weather and the climate] to the right functional need, with the minimum amount of energy input or physical power. As we find these concepts already hidden in natural systems [flowers close at night and open up during the day [see fig. 3], clover at

daytime [left] and clover at nighttime [right]], it is our task to identify them and transfer these brilliant ideas, evolved during millennia, into our building concepts.

A clear case, can be made for implementing a natural – low-tech system, with the ability of naturally adapting to the specific climate that is prevailing on the outside and while doing that, using as little energy as possible and at the same time generating as much natural energy [solar power in this case] as possible. This strategy seems intriguing and simple at the same time. The great opportunity comes with the use of a single medium [electricity] in order to respond to different functional and technical needs [pv power collection, electrical internal constraint for bending, manual override for human users, etc.]

Because one cannot yet tell if this theoretical suggestion works or not, a field-testing phase has to be taken into consideration in the near future. Currently a research team together with an architect is trying to set up the constructive parameters to test the flectofin flaps as a shading device within a small project for a modern church building in Flörsheim/Main, Germany, in order to find out more about real costs and to do some intensive monitoring after finishing the building. The challenging task has just started.

3 Acknowledgements

The author wishes to thank the University of Applied Sciences, Mainz for their support, as well as all students from Frankfurt University of Applied Sciences, for using and discussing their work in this paper.

4 References

- Braun D.-H., Dissertation – Bionisch inspirierte Gebäudehüllen; IBK2- Institute for Building Construction, Faculty of Architecture, Stuttgart University, Germany 2008; pp.186-187 and pp.293-306 and pp.365
- Grinham J., Blabolil R., Haak J. (2014). Harvest Shade Screens: Programming material for optimal energy building skins, Conference proceedings of the 9th Energy Forum on Advanced Building Skins, Bresannone, Italy, 2014
- Knippers J., Lienhard J., Schleicher S., Poppinga S., Masselter T., Müller L., Sartori J., Speck T., Milwich M. (2012). flectofinTM: A Hinge-less Flapping Mechanism Inspired by Nature; ITKE- Institut für Tragkonstruktionen und konstruktives Entwerfen, Faculty of Architecture, Stuttgart University, Germany 2012
- Menges A., Krieg O.D.; Reichert S.; HygroSkin- Meteorosensitiver Pavillon für FRAC Centre Orleans; ICD-Institute of Computational Design, Faculty of Architecture, Stuttgart University, Germany; 2012
- S.M.I.T [Sustainably Minded Interactive Technology]. Solar IvyTM, New York, USA 2011
- Zentgraf, E. (2009). Vergleich der Energie- Erträge von kristallinen und Dünnschicht-Modulen, bezogen auf die jeweils gleiche Flächeneinheit von 1m2, TEC-Institut für technische Innovationen, Waldaschaff, Deutschland, p.9 Fig.7, 2009

Challenges and Future Directions of Smart Sensing and Control Technology for Adaptive Facades Monitoring

Shady Attia

Sustainable Buildings Design Lab, Department UEE, Faculty of Applied Sciences, University of Liege, Belgium, shady.attia@uliege.be

Smart sensors with embedded microprocessors and wireless communication links have the potential to fundamentally change the way dynamic façade systems are monitored, controlled, and maintained. According to our review presented in this paper the use of networked systems of embedded computers and sensors throughout society could well dwarf all previous milestones in the information revolution and improve the work place experience, user interaction and empower building occupants. However, a framework does not yet exist that can allow the distributed computing and automation paradigm offered by smart sensors to be employed for dynamic facades monitoring and control systems. Such an approach does not scale to user interactions, smart grid interaction and monitoring systems with densely instrumented arrays of sensors that will be required for the next generation of adaptive facades monitoring and control systems. This paper provides a brief introduction on automated control and users' interaction of smart sensing technology for adaptive facades and identifies some of the opportunities and associated challenges.

Keywords: advanced facades, smart sensing, automation, user interaction, building control, framework

1 Introduction

The classical way to monitor adaptive facades (AF) is based on ad-hoc measuring approaches that are not integrated within the façade (Attia et al. 2018a and 2018b). Traditionally, introducing measuring devices and sensors to assess AF's performance happens after construction. Based on our investigation of several cases studies, we found that building systems are not networked and the performance of most buildings in relation to the adaptive façade performed is rarely actively monitored (Attia and Bashandy 2016, Attia 2017 and Bilir et al. 2018). Even in the case of centralized control the automation systems are not integrated and user interaction is neglected. The abundance of data and sensors can overwhelm any facility manager leading to simple control rules that overrides users' preferences. The complication of automation and building management systems (BMS) leads to poor performance and conflicts between occupants' satisfaction, energy efficiency and cost effective maintenance. The interaction between the smart grid and the building management systems requires connecting, monitoring and controlling all active building services and elements including AF elements and components. In this context, the acceleration of market uptake of smart buildings and modernization of grids can lead to an increase of AF to benefit from cost signals or well-being signals. Consequently, the monitoring and assessment of AF will become much easier and accessible due to optimized and predictive control of smart buildings.

Therefore, there is a strong need to develop environmental BMSs that empower building occupants and allow user interaction. As we enter the era of smart and connected facades, much more

interaction between users and their living, working or learning environment is emerging (Attia et al. 2018a and Stanza 2009). Providing occupants with control over the office indoor environment increases productivity and satisfaction. With the modernization of grids and buildings towards smart interaction AF can benefit from the building users as sensors next to the embedded sensors and abundant devices that became part of any smart building. The Internet of Things IoT and signals oriented communication between appliances, building systems, building services, users and grids will make it easier to monitor and assess AF. Understanding the dynamics of façade operation, BMS and programs for building occupants is an operational challenge that grows more continuously important. The workplace experience is the key to the market penetration of AF (Attia 2018a).

This paper is part of the COST Action TU 1403 on AF and aims to share the experience learned from analyzing several case studies regarding smart sensing and control technology. Therefore, in this paper we present a short introduction on smart sensing and control technology for AF. Then, we propose an initial framework for smart sensing and control technology for AF and identify some of the opportunities and associated challenges.

2 Methodology

The research methodology builds up on previous work that has been introduced in COST Action TU 1403 on adaptive facades systems assessment (Attia et al. 2015, Attia 2018a and Attia et al. 2018b) and reviewed case studies (Attia and Bashandy 2016, Attia 2017 and Bilir et al. 2018) of AF where experts were interviewed (Attia et al. 2019). The concept of this study was built around three axes in the context of developing an initial framework to combine smart sensing with control technologies for adaptive facades and identify the challenges and opportunities for future directions. The study concept adapted in this research borrowed from the review continuum that will be presented in Section 3. The study concept focused on three key approaches for data collection and validation of the proposed assessment framework. The earliest step of the methodology comprised a literature review, passing by the analysis of the literature and identification of challenges and opportunities until the articulation of a framework for AF that groups the operation system components and connects the façade's operation stakeholders.

3 Background of adaptive facades operation conflicts

There are three types of conflicts related to AF. The first conflict is related to the individual nature of the façade delivery and operation stakeholders. The second conflict is related to the conventional delivery process of buildings. The third conflict is related to the conflict of interest between owners, users and operators. In the following paragraphs, we will elaborate on each type of conflict in detail.

The first conflict related to adaptive facades operation is related to the linear and chopped project delivery process. Over the whole life cycle of AF, design and construction stages are considered as too short compared to the operation stage. As shown in Figure 1, the operation stage for a continuously maintained AF lasts in average between 20 to 40 years. In the same time, the complexity and duration of operation stage requires the integration of several disciplines and stakeholders to make sure the building is smartly connected and managed. As shown in Figure 2, building automation involves 8 aspects and requires the communication between installers, operators and users. This brings a complexity to building management and makes the automation for building performance optimization and user satisfaction a serious challenge.

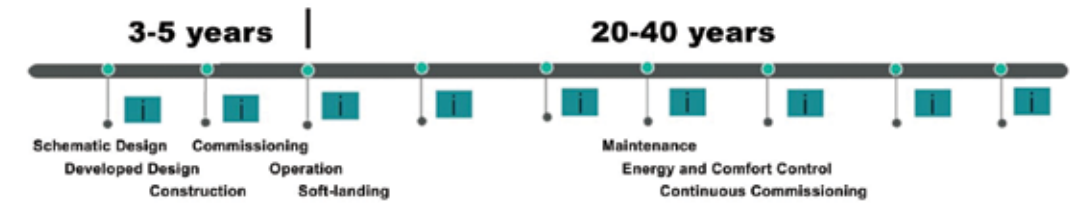

Fig. 1 Adaptive Façade life cycle

Early on during the concept development, owners and design team focus on the aesthetical and architectural value of the building and often neglect the operation stage of the façade. There is a serious disconnect between architects and facades subcontractors. As shown in Figure 2, we developed a generic performance process map that could be used as a visual guideline support by companies in the building industry based on our analysis of three case studies of AF (Attia and Bashandy 2016, Attia 2017 and Bilir et al. 2018). The map was validated and tested through interviews with different project stakeholders. To realize global and specific maps of the project delivery we drew hierarchical scales, task charges suite and information flows. To limit the scope of the process map we focused on the identification and modeling of generic processes that was associated with adaptive facades project delivery. Creating a process map involved systematic data-based interviews. Interviewees were asked to explain exactly what they did during the construction and operation stage, as well as share their technical challenges and express their expectations. We conducted several interviews with architects, façade engineer, façade contractors as well as facility managers and electrical engineers. As seen in Figure 2, the process is linear and does not allow architects, builders, occupants and operators to communicate in an iterative and integral way. The design-bid-build process shifts the responsibility and disconnects users from designers and builders from operators. As a result, we can identify a serious conflict related to the façade delivery and operation process.

The second conflict is directly related to separate actions of the design team, builders and operators. As shown in Figure 3, there are several performance requirements for AFs that requires different types of expertise. There are too many players involved in the value chain of AF. Façade designers do not collaborate with façade builders. More importantly, building operators cannot empower building occupants. A major challenge of AF is to monitor their responsiveness and empower the building occupants. The limited interaction between the user (demand the façade (response) and the overriding control models of black box BMS systems are serious barriers that hinders the market uptake of AF. Already, the management of building systems became increasingly complex in the recent years with the new dynamic and variable controls features of high performance buildings (Attia 2018b). Facility managers do not have the knowledge and means to meet occupants' expectations regarding comfort and satisfaction, which requires a high flexibility of the response. In most investigated cases of AF, there was a conflict of interest between owners and occupants regarding the operation of the AF.

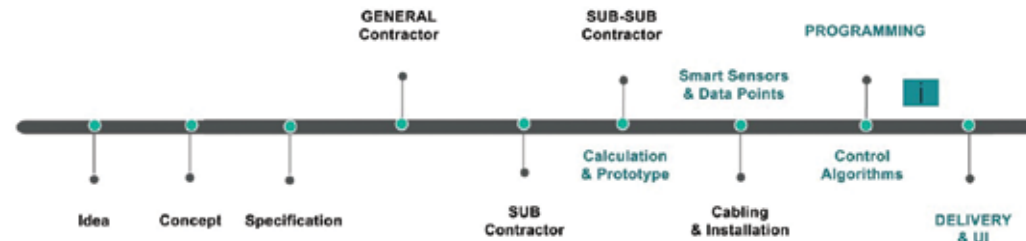

Fig. 2 a schematic process map of conventional AF delivery



Fig. 3 Adaptive Façade performance requirements and the involved stakeholders

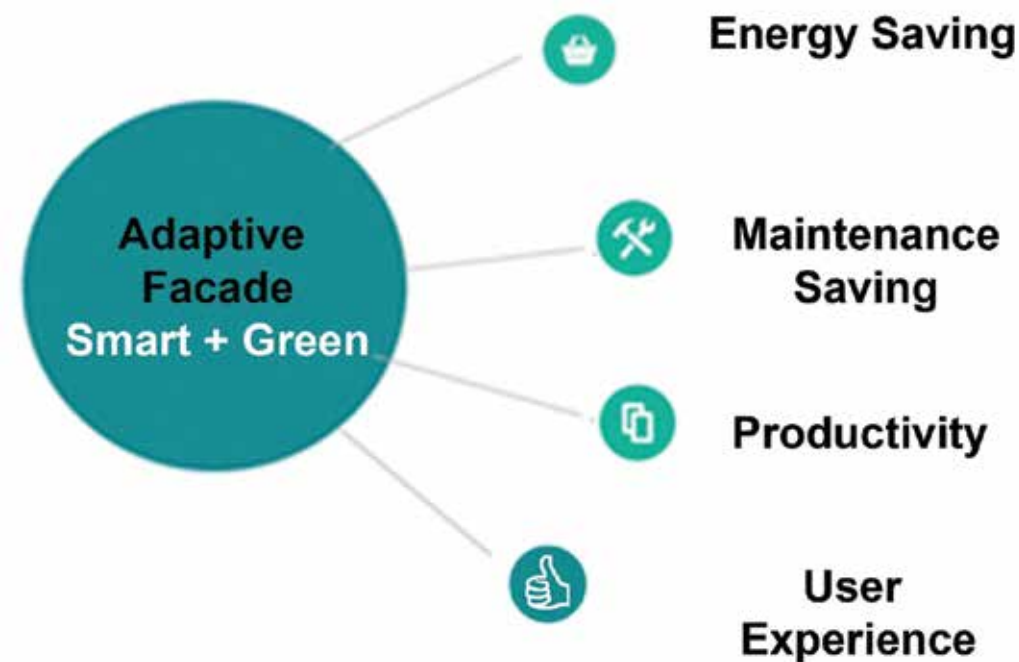

Fig. 4 Adaptive Facades multiple operation objectives

The third conflict is related to the different interests of stakeholders. Historically, operators are responsible to control building systems. Building operators want to save on running cost and reduce the stress of equipment maintenance. However, in most investigated cases (Attia et al. 2018a) operators alienate occupants by make the building too uncomfortable. This case gets magnified in workspaces with AF where adaptive responses of building occupants are not addressed. In the same time, the awareness about well-being and occupant's feedback and the proliferation of low-cost sensors and interactions devices changed the game rules and allowed to empower occupants. As shown in Figure 4, there are different aims and actions required in relation to the operation of

a building with an AF. In most investigated cases of AF projects, owners and building operators focus in most of the time on the energy savings and the cost effectiveness of maintenance. On the other hand, occupants are concerned with their satisfaction, productivity or experience in the case of being customers. With the increase of awareness about the importance of productivity there is serious need to empower and enable occupants and make sure they gain greater control over their desk environments (Attia 2018b).

To sum up, the three previously mentioned conflicts require a modern approach to manage this complex problem. This conflict requires allowing continuous feedback and flexible building management systems and control software. There is a need to create a balance between running the facades actuators and responding to user's needs. Operating AF requires making users central and requires that BMS should not only respond to operators.

4 Smart Sensing and Control Technology for Adaptive Facades Monitoring

Following the background section on adaptive facades operation conflicts we identify in this section the components of smart sensing and building control technology. Building controls are normally instigated with mechanical and electrical and plumbing (MEP) system controls. Additionally, the AF automation components are part of the overall regulation of the building environment. Therefore, we wanted to answer two research questions here:

- What are the components of an integrated system of smart sensing and control technology for adaptive facades monitoring?
- What is the architecture/framework of such a system?

In the following section we present the soft and hard components and present an initial proposition for a framework for smart sensing and control.

1. Data Collection

The data collection for smart sensing of AF is mainly based on conventional or smart sensors.

Smart Sensors (Measuring): Smart Sensors can be grouped into three parts: (i) the sensing element (e.g. resistors, capacitor, transistor, piezo-electric materials, photodiode, etc.), (ii) signal conditioning and preprocessing (e.g. amplifications, linearization, compensation and filtering), and (iii) a sensor microprocessor (e.g. on-board microprocessor, wires, plugs and sockets to communicate with other electronic components) (Kirianaki 2002 and De Paola et al. 2009). Microelectromechanical systems (MEMS) sensor devices (i) can embody both mechanical and electrical functions. MEMS can be used to sense and actuate as a reaction to physical or chemical phenomenon and convert actions into electrical signal for display, processing, transmission and recording. The sensors' microprocessor (iii) is used to signals code conversions, calculations and interfacing functions, which can facilitate decision making functions. Smart sensors are wireless, with data transmission based on radio frequency (RF) communication.

2. Connection to the Network

Various transmission protocols such as an on/off switching controller, i.e., thermostats, proportional-integral and proportional-integral-derivative, have been used in BMS (Bernard et al. 1982, Levenmore 1992, Mathews et al. 2000, Salsbury 1998 and Kasahara et al. 1999).

Transmission Protocol (Communication): There exist several protocols for transmitting data. These protocols are typically met by appropriate requirements. There are many variable requirements of different sensor data streams and applications. But there are also some basic functionality that are common, such as registering sensors at a receiver, time stamping of sensor data as well as synchronization of all nodes. The transmission involves signal conditioning, filtering, sampling, quantization and processing.

5 Processing and Visualization of Data

Building control systems and control models are basic components for AF management.

Actuator (Control): An actuator is a component of a device that is responsible for controlling a mechanism or system. An actuator requires a control signal and a source of energy. The control signal is relatively low energy and may be electric voltage or current, pneumatic or hydraulic pressure. The control system can be simple (a fixed mechanical or electronic system), software-based, a human, or any other input (Jang et al. 2013).

Control Algorithms (Computation): The control models are based on preprogrammed decision algorithms and user-defined algorithms. The control model can have a learning component or predictive component to control the façade system. The purpose of algorithms is to monitor and control AF. In closed loop control, the control action from the controller is dependent on feedback from the process in the form of the value of the process variable (Figure 5). Control algorithms deal with the control of continuously operating of dynamic facade in engineered processes and machines. Control algorithms are based on models for controlling AF using a control action in an optimum manner without delay or overshoot and ensuring control stability.

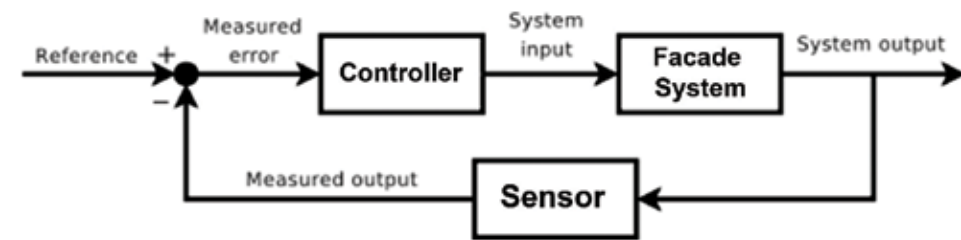

Fig. 5 a block diagram of a feedback control system using a feedback loop to control the process variable

Voiceover Technology (Control): Voiceover technology is based on control algorithms that can better control the amount of redundancy and allow users to react and override the automated operation program.

6 Interaction with Data

As shown in Figure 6, AF smart sensing and control require the collection of data from various sources, from metering information to contextual data sets (weather, building usage, energy prices ...) as well the interaction of users and operators. The following components are essential to achieve that.

Building Management System (Processing and Control): A building management system (BMS), is a computer-based control system installed in buildings that controls and monitors the

building's mechanical and electrical equipment such as ventilation, lighting, and shading louvers. A BMS consists of software and hardware; the software program, usually configured in a hierarchical manner, can be proprietary, using such modeling protocols.

User Interface and Dashboards: User interfaces are screens that show and interpret the data to inform the decision making of users and operators. Training and continuous coaching is recommended for the occupant to make sure they will be able to engage with the façade system. Investment in soft-landing and educational briefing regarding the operation and interaction with the operation system are essential (Attia 2018b).

To answer the two questions mentioned earlier, we propose a framework that groups the four work components and sub-components mention above in one scheme. As shown in Figure 6, the framework identifies the basic components of AF operation and connects them through an opportune construct. The significance of this framework compared to others is that it can operate the exchange through a set of sensors and actuators while involving users through direct interaction. The user involves facility managers and occupants who both provide implicit feedback that guide the operation and allows predictive control. The suggested framework benefits from the presence of specialized sensors for monitoring and operating users interactions with the actuators. The ultimate purpose of such framework is to provide explicit feedback to users about environmental conditions and allows to facilitate the interaction between the user and the indoor and outdoor environment and achieve the expected energy saving and carbon reduction.

7 Challenges and future directions

In this section, we present a framework for future POE for AF and suggest a User Interface (UI) for a dynamic online. Also, we suggest some key recommendations for future POE for AF.

The industry is not ready for adopting AFs. There are successes with smart sensing and control of dynamic solar shading solution. However, there is a lack of proven systems that live up to their expected performance promises. The serious conflicts during operation in relation to overheating, glare and personal control make many users and architects don't trust the automation of AF. The control solutions are limited to shading control but there is no established solution that goes beyond shading. Control strategies do not consider the comfort factors and users interactions and are more concerned with energy consumption savings. Ensuring thermal comfort and limit set-point overshoots with energy savings has been investigated in the 1980s on predictive (Chen 2001, Henze et al. 1997), adaptive (Curtis et al. 1996 and Nesler 1986) and optimal controllers (Zaheer-Udin et al. 2000 and Dounis et al. 2001). There has been no industrial development of optimal and user interaction based controllers followed with the introduction of AF (Shaikh et al. 2014).

The complexity of AF solutions and smart sensing and control technologies is another challenge that hinders AF for market penetration. Each building with an AF possesses non-linear thermal behavior related to its dynamic façade technology, construction material, location operation and climatic conditions. The capability of the self-regulation and adaption of the environmental conditions in many adaptive facades buildings is non-linear and highly uncertain. Therefore, there is a need for adaptive and intelligent control techniques to maintain a constant performance of AF under continuous variations of MEP and occupants control parameters. Additionally, many stakeholders in the AEC industry are not used to deliver and operate complex solutions such as AF. The segmented project delivery process and the multiple stakeholder approach is creating a serious complexity. The low awareness about smart sensing and control technology for adaptive

facades monitoring among operators reduce their market uptake significantly. The steep learning curve that operators have to go through is part of this problem.

The main challenge of the AF community is to come up with a holistic smart sensing and intelligent control concepts for adaptive control properties and make the full use of the environmental and energy management potential.

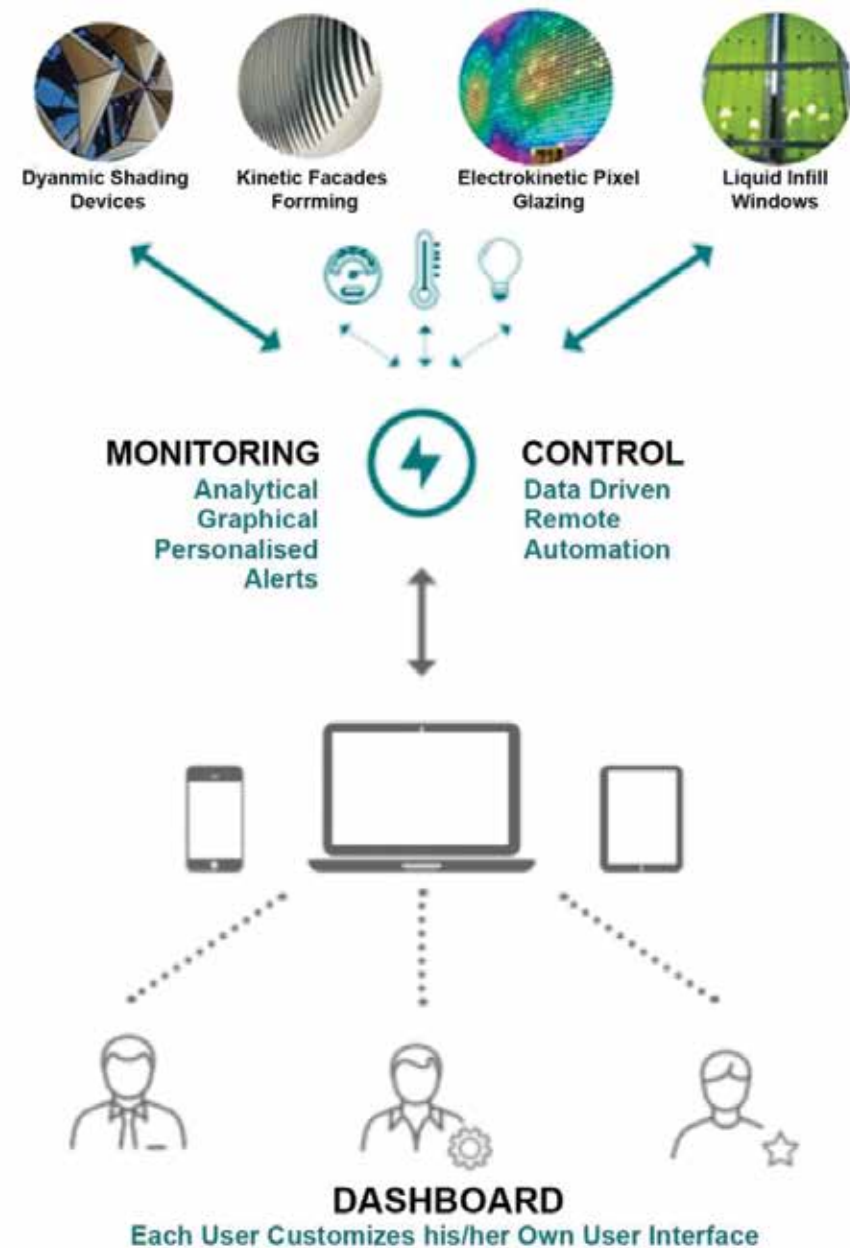

Fig. 6 Adaptive façade framework for smart sensing and control

Finally, our study did not test the proposed framework through a case study but this can be the next step for future research. More importantly, we defined the basic components of smart sensing and control and articulated a frame to guide the interaction of different stakeholder.

8 Conclusion

This paper provided a brief introduction to smart sensing and control technologies for adaptive facades monitoring. We identified a number of the opportunities, as well as some of the associated challenges. Personal control strategies for AF, occupant comfort, energy management and occupant experience/satisfaction are currently overly burdensome and often neglected. Smart sensing and building automation technologies became a necessity that provides building owners, managers and users a control of AF. Voiceover technologies, where users can interact with the façade automation system directly and the integration of artificial intelligence in the form of predictive control models into those façade automation systems are considered as the promising technology to smart sensing and control technologies for adaptive facades.

9 Acknowledgements

The author appreciates the valuable comments and feedback of Dr. Nikolaus Nestle during several discussions related to this paper. The author would like to gratefully acknowledge COST Action TU1403 "Adaptive Facades Network" for providing excellent research networking. The authors would like to acknowledge the support of Workgroup 3 members.

10 References

- Attia, S., Favoino, F., Loonen, R., Petrovski, A., Monge-Barrio, A. (2015) Adaptive Facades System Assessment: An initial review, 10th Conference on Advanced Building Skins, 3-4 November, 1265-1273, Bern, Switzerland.
- Attia, S. and Bashandy, H. (2016) Evaluation of Adaptive Facades: The Case Study of AGC Headquarter in Belgium. Challenging Glass 5 – Conference on Architectural and Structural Applications of Glass, Belis, Bos & Louter (Eds.), Ghent University, Belgium, ISBN 978-90-825-2680-6.
- Attia, S. (2017) Evaluation of adaptive facades: The case study of Al Bahr Towers in the UAE, Shaping Qatar's Sustainable Built Environment, Hamad Bin Khalifa University Press, Volume 2, Issue 6, P1-13.
- Attia, S., Bilir, S., Safy, T., Struck, C., Loonen, R., Goia, F. (2018a) Current Trends and Future Challenges in the Performance Assessment of Adaptive Façade Systems, Energy and Building, in press.
- Attia, S., Luna Navarro, A., Juaristi, M., Monge-Barrio, A., Gosztonyi, S., Al-Doughmi, Z. (2018b) Post-Occupancy Evaluation for Adaptive Facades. Journal of Dacades Design and Engineering, in press.
- Attia, S., (2018c) Net Zero Energy Buildings (NZEB): Concepts, frameworks and roadmap for project analysis and implementation, Elsevier, ISBN: 978-0128124611.
- Attia, S., Bilir, S., Safy, T., Garat, S (2019) Adaptive Facades performance assessment: Interviews with Façade Experts, SBD Lab, Liege University, Belgium. ISBN: 9782930909097.
- Bilir, S., Attia, S. (2018) Evaluation of Adaptive Facades: A case study with electrochromic glazing, Next Facades COST Action TU1403 Adaptive Facades Network Conference, Lucerne University, 26-27 November 2018. Lucerne, Switzerland.
- Bernard C, Guerrier B, Rasset-Louerant MM. (1982) Optimal building energy management. Part II: control. ASME J Solar Energy Eng, 114:13–22.
- Buckman, A. H., Mayfield, M., & B.M. Beck, S. (2014). What is a Smart Building? Smart and Sustainable Built Environment, 3(2), 92–109. <https://doi.org/10.1108/SASBE-01-2014-0003>
- Chen T. Real-time predictive supervisory operation of building thermal systems with thermal mass. Energy Build 2001;33:141–50.
- Curtis PS, Shavit G, Kreider K. (1996) Neural networks applied to buildings—a tutorial and case studies in prediction and adaptive control. Proc ASHRAE Trans; 102:1.
- De Paola, A., Gaglio, S., Re, G. L., & Ortolani, M. (2009, May). Human-ambient interaction through wireless sensor networks. In Human System Interactions, 2009. HSI'09. 2nd Conference on (pp. 64-67). IEEE.
- Dounis AI, Manolakis DE. (2001) Design of a fuzzy system for living space thermal comfort regulation. Appl Energy;69:119–44.
- Henze GP, Dodier RH, Krarti M. (1997) Development of a predictive optimal controller for thermal energy storage systems. HVAC&R Res ;3(3): 233–64.
- Jang, S. Y., Lee, S., & Kim, S. A. (2013, September). Collaborative Responsive Façade Design Using Sensor and Actuator Network. In International Conference on Cooperative Design, Visualization and Engineering (pp. 11-18). Springer, Berlin, Heidelberg.
- Kasahara M, Matsuba T. (1999) Design and tuning of robust PID controller for HVAC systems. Proc ASHRAE Trans105(2):154–66.
- Kim, J., de Dear, R., Candido, C., Zhang, H., Arens, E. (2013) Gender differences in office occupant perception of indoor environmental quality (IEQ), Build. Environ. 70, 245–256. doi:10.1016/j.buildenv.2013.08.022.

- Kirianaki, N. V., Yurish, S. Y., Shpak, N. O., & Deynega, V. P. (2002). Data acquisition and signal processing for smart sensors. John Wiley & Sons, 1st Edition.
- Levermore GJ. (1992) Building energy management systems: an application to heating and control. London: E & FN SPON.
- Loonen, R. C. G. M. C. G. M., Trčka, M., Cóstola, D., & Hensen, J. L. . L. M. (2013). Climate adaptive building shells: State-of-the-art and future challenges. *Renewable and Sustainable Energy Reviews*, 25, 483–493. <https://doi.org/10.1016/j.rser.2013.04.016>
- Mathews EH, Arndt DC, Piani CB, Heerden E. (2000) Developing cost efficient control strategies to ensure optimal energy use and sufficient indoor comfort. *Appl Energy*; 66:135–59.
- Nesler CG. (1986) Adaptive control of thermal processes in buildings. *IEEE Control Syst Mag*; 6(4):9–13.
- Salsbury TI. (1998) A temperature controller for VAV air-handling units based on simplified physical models. *HVAC&R Res*; 3(3):264–79.
- Shaikh, P. H., Nor, N. B. M., Nallagownden, P., Elamvazuthi, I., & Ibrahim, T. (2014). A review on optimized control systems for building energy and comfort management of smart sustainable buildings. *Renewable and Sustainable Energy Reviews*, 34, 409–429.
- Stanza (2009) PUBLIC DOMAIN RESPONSIVE ARCHITECTURE FACADE BY STANZA <http://www.stanza.co.uk/facade/index.html>
- Zaheer-Uddin M, Zheng GR. (2000) Optimal control of time scheduled heating, ventilating and air conditioning processes in buildings. *Energy Convers Manage*;41:49–60.

Study of a BIPV Adaptive System: Combining Timber and Photovoltaic Technologies

Mazzucchelli Enrico Sergio 1, Alston Mark 2, Brzezicki Marcin 3, Donacovo Luisa 4

1 Politecnico di Milano, enrico.mazzucchelli@polimi.it

2 University of Nottingham, mark.alston@nottingham.ac.uk

3 Wroclaw University of Science and Technology, marcin.brzezicki@pwr.edu.pl

4 General Planning SRL, l.donacovo@generalplanning.com

The paper presents the first results of research that was partly conducted within the framework of European COST Action TU1403 – Adaptive Façades Network, on the development of an adaptive BIPV (Building Integrated Photovoltaic) solution able to change its curvature in relation to the external environmental conditions, orientating itself in order to optimise the energy production without the aid of any mechanical and electrical systems. After analysing the characteristics of the main adaptive materials that are currently used for such applications, the contribution outlines the main features of the proposed system, which consists of thin film solar cells coupled with a thin layer of hygromorphic material, manufactured from two wooden slats joined together and produced from different types of wood and trunk cuts. The hygromorphic layer thus obtained can change its shape as a function of temperature and relative humidity of outdoor conditions, thanks to the different expansion coefficients of the two wooden slats. To evaluate the performance of the component, three shape configurations for the adaptive strips have been assumed. For each hypothesis, the lamellae have been modelled using the Rhinoceros 5 Software, according to the curvatures taken during the different months of the year. The Rhino models have been imported into Autodesk Ecotect Analysis to calculate the incident solar radiation and to study the self-shadowing effect in the various configurations (in relation to the climatic conditions of the city of Milan). The paper outlines the system and PV energy production optimisation process, as well as possible applications in the field of façade design.

Keywords: adaptive façades, adaptive component, hygromorphic materials, BIPV technology, wood, timber

Full paper available in the *Journal of Facade Design and Engineering*, Vol 6 No 3 (2018): Special Issue FAÇADE 2018 – Adaptive!

Author Index

Aelenei, Daniel	65
Aelenei, Laura	23, 65, 471
Al Alkam, Marwan	75
Al-Doughmi, Zein	373
Alston, Mark	65, 125
Altun, M. Cem	469
Andaloro, Annalisa	205
Anders, Lars	217
Aresta, Claudio	431
Arkar, Ciril	351
Assimakopoulos, Margarita-Niki	83
Attia, Shady	319, 373, 375, 511
Auer, Thomas	47, 123
Aujard, Fabienne	227
Avesani, Stefano	149, 183, 205
Babich, Francesco	183
Basarir, Bahar	469
Bedon, Chiara	281, 293, 329
Belleri, Annamaria.....	205
Bilir, Senem	319
Bonser, Stephen P.	235, 245
Brambilla, Arianna	197
Brzezickia, Marcin	439
Buck, Robert	141
Castell, Albert	317
Casucci, Daniele	361
Colorado, Henry A.	409
Cruz, Estelle	227
da Gloria Gomes, Maria	65
D'Alessandro, Marta	95
Dall'Igna, Miriam	49
De Masi, Rosa Francesca	83
De Michele, Giuseppe	149
Denz, Paul-Rouven	217
Donato, Alessandra	153
Donato, Mattia	375
Eliášová, Martina	177, 329
Esiyok, Ümit	257
Exterkate, Roy	75
Favoino, Fabio	149, 281
Ferrante, Annarita	83
Fiorito, Francesco	115, 165, 235, 245
Förch, Matthias	361
Fotopoulou, Anastasia	83
Friedrich, Matthias	183
Frigerio, Giorgio	197

Furundži, Dijana P.	385
Furundži, Nikola Z.	385
Gallo, Paola	153
Gasparella, Andrea	149
Giancola, Emanuela	183
Goia, Francesco	183, 317
Gómez-Acebo, Tomás	63, 295
Gosztonyi, Susanne	255, 373
Grosser, Philipp	361
Grossi, Paolo	341
Gutierrez, Juan Camilo Restrepo	409
Hammer, Andreas	493
Hansen, Mads Mandrup	45
Heusler, Prof. Dr.-Ing. Winfried	397
Honfi, Dániel	293, 329
Ighany, Golnaz	49
Juaristi, Miren	63, 295, 373, 375
Karlessi, Theoni	65, 83
Klein, Tillmann	123
Knaack, Ulrich	37, 63, 103, 123, 459
Kosi, Tatjana	447
Kozowski, Marcin	293, 329
Krastel, Viktoria	397
Krimm, Jochen	459
Krsti-Furundži, Aleksandra	133
Kuru, Aysu	235, 245
Larsen, Olena Kalyanova	183
Lenk, Peter	141
Loonen, R.C.G.M.	375
Loonen, Roel	149, 295
Lori, Guido	361
Lovati, Marco	205
Luiblé, Andreas	17, 185
Luisa, Donacovo	521
Machado, Maider	205
Machalická, Klára V.	177, 329
Marcin, Brzezicki	521
Mark, Alston	521
Mazzucchelli, Enrico Sergio	65
Medrano, Marc	317
Medved, Sašo	351
Mohsen, Alamir	103
Monge-Barrio, Aurora	63, 295, 373, 375
Nastri, Massimiliano	479
Navarro, Alessandra Luna	373, 375
Nestlé, Nikolaus	125
Nocente, Alessandro	183
Oldfield, Philip	235, 245
Overend, Mauro	17, 281, 375
Paoletti, Ingrid	95, 479

Papadaki, Dimitra	83
Papaiz, Luca	149
Perino, M.	27
Petrillo, Marta	341
Petrovski, Aleksandar	133
Pfanner, Daniel	257
Pottgiesser, Uta	37, 471
Prasad, Deo	165
Priedemann, Wolfgang	217
Prieto, Alejandro	123
Pulbere, Sorin	125
Rabenseifer, Roman	375
Ranzi, Gianluca	115, 197
Raskin, Kalina	227
Romano, Rosa	65, 153
Rovers, Twan	75
Ruggiero, Silvia	83
Saini, Hemshikha	149
Sánchez, M. Nuria	183
Sandak, Anna	341
Sandak, Jakub	341
Santos, Filipe	329
Scheuermann, Rudi	43
Schlüter, Arno	51
Sedlbauer, Dr.-Ing. Klaus-Peter	397
Sergio, Mazzucchelli Enrico	521
Sischka, Johann	45
Spalletti, Giulia	197
Sproul, Alistair	165
Stavric, Milena	447
Struck, Christian	75
Šuklje, Tomaž	351
Svetel, Igor	447
Techen, Holger	459
Timmerman, Robert	75
Vallati, Osvaldo	115, 197
Vatahska, Teodora	257
Vedula, Nitisha	471
Villegas, John E.	409
Voká, Miroslav	177, 329
Voortman, Mark	75
Wellershoff, F.	31
Wellershoff, Frank	361
Wüest, Thomas	185, 329
Yang, Siliang	165
Yang, Xiaoming	49
Zobec, Marc	361

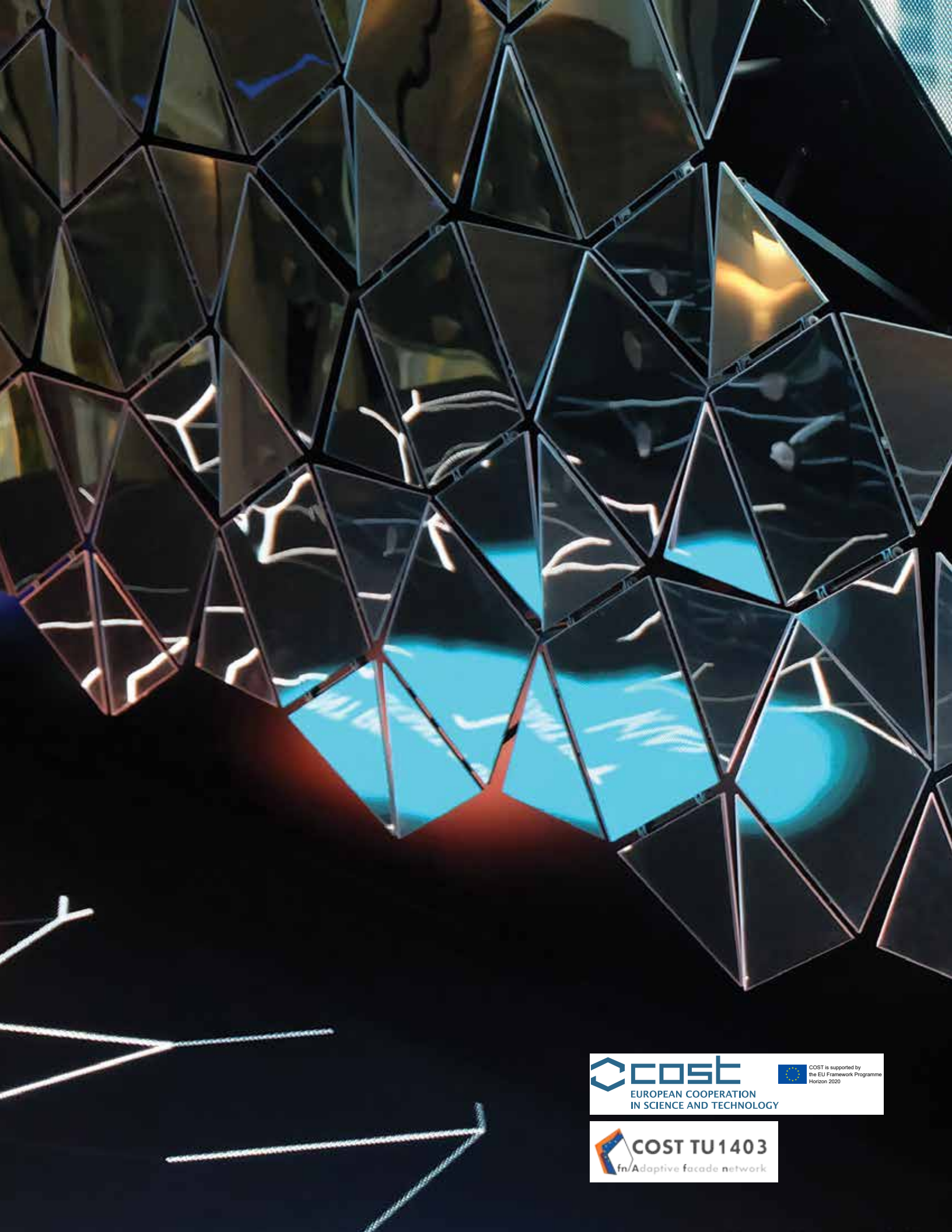

 **COST**
EUROPEAN COOPERATION
IN SCIENCE AND TECHNOLOGY

 COST is supported by
the EU Framework Programme
Horizon 2020

 **COST TU1403**
fn/Adaptive facade network