

The hydrodynamic comparison between a conventional and an Axe Bow frigate hull

Rijkens, A.A.K.; Mikelic, A.

DOI

[10.24868/10651](https://doi.org/10.24868/10651)

Publication date

2022

Document Version

Final published version

Published in

Proceedings of the International Naval Engineering Conference

Citation (APA)

Rijkens, A. A. K., & Mikelic, A. (2022). The hydrodynamic comparison between a conventional and an Axe Bow frigate hull. *Proceedings of the International Naval Engineering Conference*, 16, Article 31. <https://doi.org/10.24868/10651>

Important note

To cite this publication, please use the final published version (if applicable). Please check the document version above.

Copyright

Other than for strictly personal use, it is not permitted to download, forward or distribute the text or part of it, without the consent of the author(s) and/or copyright holder(s), unless the work is under an open content license such as Creative Commons.

Takedown policy

Please contact us and provide details if you believe this document breaches copyrights. We will remove access to the work immediately and investigate your claim.

The hydrodynamic comparison between a conventional and an Axe Bow frigate hull

Dr. Ir. A.A.K. Rijkens* and A. Mikelic**

* *Delft University of Technology, Ship Hydromechanics and Structures, Delft, The Netherlands*
Corresponding Author. Email: a.a.k.rijkens@tudelft.nl

** *Damen Naval, Research & Technology Support, Vlissingen, The Netherlands*

Synopsis

This article presents a hydrodynamic comparison between two frigate designs. The hydrodynamic performance of a more conventional frigate hull is compared to an alternative frigate hull with an AXE Bow design. Model tests are performed in calm water, regular waves and in irregular waves to find the differences in seakeeping behaviour. The models were tested using a more conventional towed configuration and also in a free sailing configuration in which the models were equipped with their own propulsion and steering systems. The frigates have been compared with respect to calm water performance, ship motions in head waves and added resistance -or added thrust- in waves.

Keywords: Frigate, Seakeeping, Added resistance, Experiments, CFD

1. Introduction

The seakeeping behaviour of naval ships is an important factor for its operational effectiveness, as vessels with good seakeeping abilities are able to go to sea and successfully execute their missions despite possible adverse weather conditions. Hence, it is not surprising that the hydrodynamic assessment of new frigate type hulls is often based on motion levels and motion related phenomena like sustained speed in waves and deck wetness.

One of the design concepts that has been quite successful on all of these hydrodynamic aspects is the so-called AXE Bow concept. This concept has already been applied on many smaller fast vessels, like Fast Crew Suppliers and Offshore Patrol Vessels, and it is featured by a strong modification of the bow which has deep, almost vertical V-shape sections. The largest AXE Bow designs built today are about 70 meters in length, so it has not yet been applied to a vessel the size of a frigate. However, previous studies indicated that an AXE bow application on a frigate type hull has quite a number of hydrodynamic benefits (Eefsen, et al., 2004); (Keuning & Van Terwisga, 2015).

In the current study a more detail hydrodynamic comparison is made between a conventional frigate and an AXE Bow frigate in calm water and in regular and irregular head waves using model experiments. In addition, also a number of CFD simulations are computed in regular waves by Damen Naval Shipbuilding to learn and asses the capabilities of these numerical tools in computing motions, and more specifically, the added resistance in waves for frigate type hulls.

The hull of the conventional frigate was initially designed by the Defence Material Organisation (DMO) of the Ministry of Defence of the Netherlands and this model is used as a parent design and benchmark in the current study. The AXE Bow version of the frigate has been developed by the Delft University of Technology (DUT) with special attention to keep the functionality of the two combatants the same as much as possible. The two models were tested in different configurations in the towing tank of the Delft University of Technology.

2. The designs

In 2014, DMO started with the initial design process for the replacement of their M-Class Frigates. The effort of this initial study resulted in a hull design referred to as Frigate Standard Conventional (FSC). This FSC design is slightly bigger than the M-Class frigate presently employed by the Royal Netherlands Navy and it is used as a parent model in this comparison study.

Author's Biography

Albert Rijkens obtained a PhD in Ship Hydromechanics from Delft University of Technology in 2016. He has been working at Damen Shipyards since 2015 and currently holds the position of Research Program Manager, combining this role with a research position on Advanced Ships at the Delft University of Technology.

Andrea Mikelic graduated with a master degree from ENSTA-Bretagne in 2014 as a naval architect and offshore engineer. She has been working at Damen Naval since 2016 and currently hold the position of Specialist Hydrodynamics in the R&TS department. She started her carrier at MARIN and has been involved in CFD related work since then.

Based on the FSC design the AXE Bow version of this frigate has been developed by the DUT making use of the extensive knowledge that has been gained in all previous studies involving this kind of bow shape and all full-scale know-how available thanks to the increasing number of realised ships adopting the AXE Bow design.

In the design process of the AXE frigate, it was decided to keep the functionality between the two models the same as much as possible. This meant that both models needed a similar deck area and internal hull volume to install equipment and accommodate personnel. Moreover, in order to be able to compare the two models just for the difference in the forward sections, the aft part of the hulls is kept completely identical for both designs.

In correspondence to the design philosophy behind the AXE Bow concept (Keuning, 2006), the AXE frigate was about 15% longer at the waterline compared the FSC. This allowed the design space necessary to optimize the bow sections from a hydrodynamic point of view. A small increase of displacement was included (6 %) to account for the addition steel work of the extended hull construction. Both the size of the deck area and the internal hull volume were slightly bigger as well to compensate for loss of functional area and volume in the fore ship due to the very narrow bow sections. Experience with full scale AXE bow ships has shown that these modification to the hull will not make any significant difference in the building costs of the ship. Table 1 presents a comparison of the main ship characteristics and a comparison of the lines plans is shown in Figure 1. Two 1:40 model scale versions of these designs were used during the towing tank experiments.

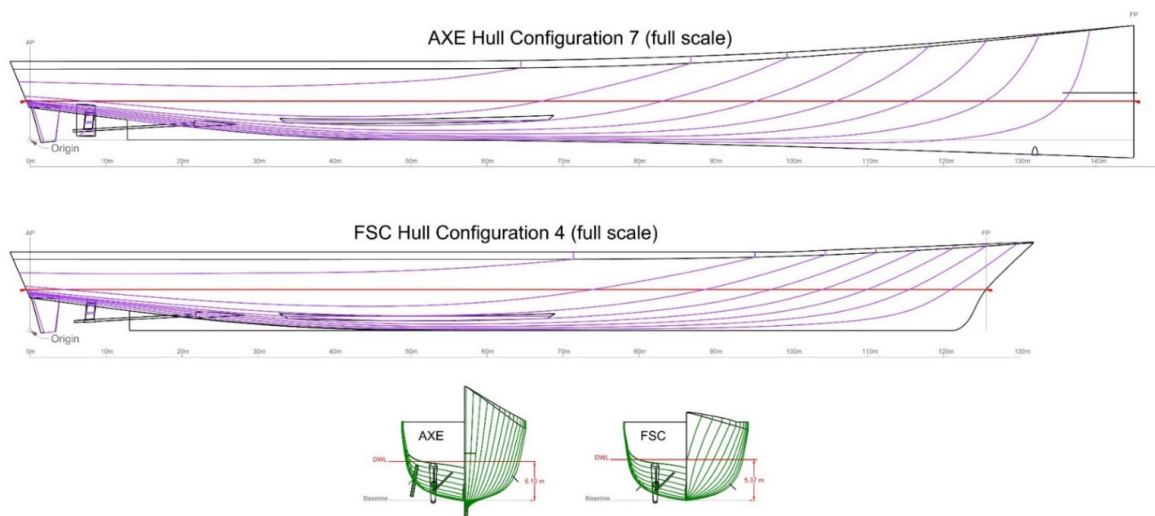

Figure 1: Lines plans of the FSC and AXE frigates

Table 1: Main dimensions of the FSC and AXE frigates

Parameter	FSC	AXE	Comparison
Length WL [m]	126.07	145.46	115%
Beam WL [m]	15.41	15.37	100%
Draft midship [m]	5.37	5.10	95%
Displacement [ton]	5198	5496	106%
Wetted surface [m ²]	2124	2461	116%
Main deck area [m ²]	1828	1845	101%
Hull volume below main deck [m ³]	11235	12127	108%

Both models are constructed from glass fibre reinforced composite and are equipped with two rudder and two four-bladed counter rotating stock propellers. There was one centreline tapered skeep on the aft ship of the FSC which is also included on the AXE frigate. Two bilge keels, one on each side, were installed to increase roll damping which are positioned around midship and extend over roughly 25% of the length of the hull.

In addition, the AXE frigate was also fitted with two fixed skegs just outside the propellers area to increase the course keeping ability that might be partly compromised by the deep and sharp bow sections. Finally, a spray rail was added on the AXE frigate to intercept the water pile-up at the bow. Figure 2 highlights the various hull appendages on both models.

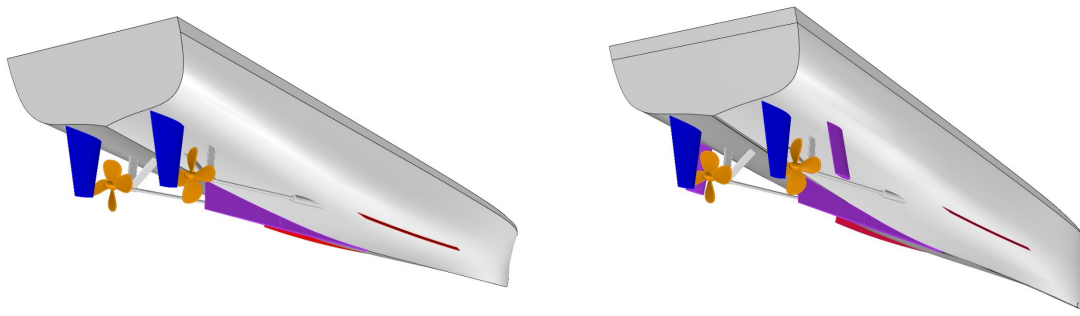

Figure 2: Hull appendages on the FSC (left) and AXE frigate (right)

3. Experimental setup

All model experiments were carried out in the #1 towing tank of the Ship hydromechanics laboratory of the DUT. For the tests two different setup configurations were employed. First, a more conventional towed configuration was used in which the models are directly connected to the towing carriage in a way that the models are free to heave and pitch but are restrained in all other modes of motion. Thereafter, a free sailing configuration was used in which the models were self-propelled and kept on course using autopilot steering.

In Figure 3 an illustration of the measurement setup is given for the case of the conventional towed configuration. The models are connected to the towing carriage via a linear guidance bearing at the Longitudinal Centre of Gravity (LCG) allowing the models to heave and pitch. A yaw restriction at the stern keeps the models on a straight course. The motions of the models are recorded via an optical tracking system and the accelerations are measured with two accelerometers, one at LCG of the models and the other in the bow at 85% of the waterline length. In this configuration the models are towed at a constant forward speed by the carriage and the propellers were omitted.

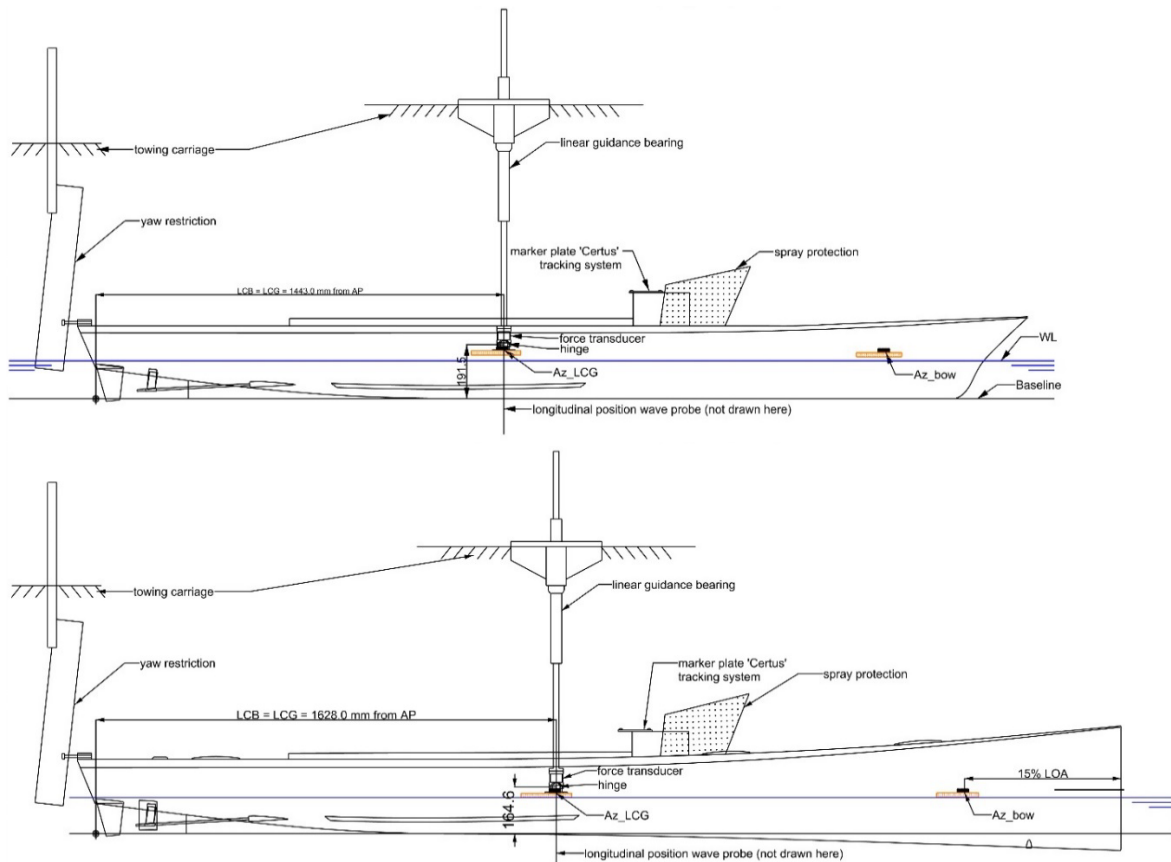

Figure 3: Towed configuration of the FSC and AXE frigates

In the second configuration the models are completely self-propelled and they were kept on course using autopilot steering. Hereto, the models were equipped with a single brushed DC electromotor and a gearbox with a reduction ratio of 1:3 that mechanically connects the motor with the two shafts and propellers. A water-cooling system was put in place to prevent overheating of the motor. Powering was provided by a replaceable onboard battery pack that was placed behind the propulsion unit and could provide power for about two hours of sailing.

The data acquisition was handled onboard and the recorded signals could be transmitted by a telemetry system to the operator to enable live monitoring of the measured signals. The models were fitted with an Xsens motion sensor and a dedicated accelerometer in the bow at the same position as for the models in the towed configuration. Both propeller shafts were fitted with a thrust force and torque sensor and the angle of the rudders were servo controlled. The signals of the optical tracking system on the carriage were used as an input for the onboard autopilot that controlled the rudders to keep the models on track with the direction of travel in the towing tank. The carriage was programmed to follow the model on a predefined distance which was again monitored by the optical tracking system mounted on the carriage.

An overview of the different instruments in the models during this measurement setup is displayed in Figure 4. The models were covered by a watertight closure to prevent water getting inside the model. Finally, a non-watertight superstructure was placed on top of this closure.

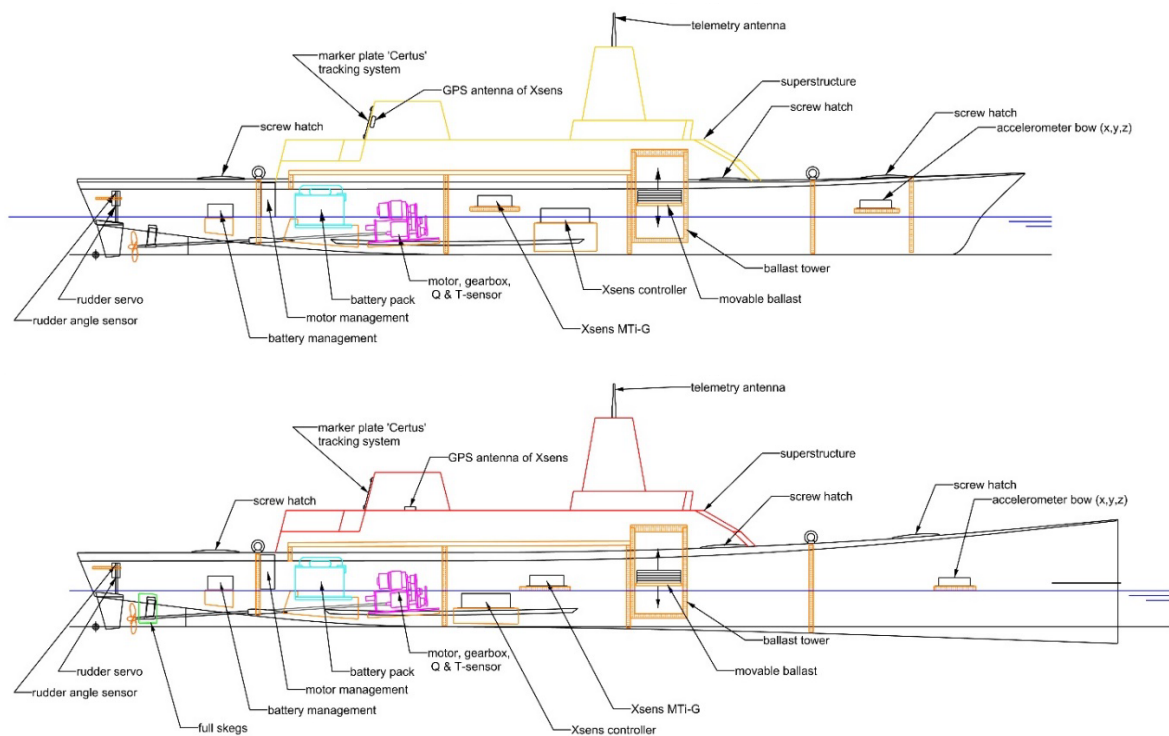

Figure 4: Self-propelled configuration of the FSC and AXE frigate

4. Measurement program

The measurement program consists of experiments in the following conditions.

For the towed model configuration:

- Calm water tests at speeds between 10 and 35 knots, measuring the calm water characteristics.
- Tests in regular waves at a wave frequency range of 0.5 – 1.0 rad/s and three wave amplitudes of 0.5, 1.0 and 2.5 meters. In these conditions the added resistance, motions and accelerations were measured at a ship speed of 15 and 26 knots.
- Irregular wave tests at a forward speed of 26 knots in two Pierson-Moskowitz wave spectra. The first spectrum has significant wave height (H_s) of 5.0 m and wave peak period (T_p) of 9.5 s, while the second spectrum also has a significant wave height of 5.0 m but a longer wave peak period of 13.6 s. These spectra were considered representative for severe sea conditions on the Atlantic Ocean. During these tests the motions, accelerations and the added resistance of the models were recorded.

The self-propelled models were tested in:

- Calm water measuring the thrust and torque on the propeller shafts as well as the calm water position of the models at speeds ranging between 5 and 30 knots.
- Irregular wave tests with the free sailing models at approximately 26 knots were done in the same wave conditions as the towed models but a JONSWAP spectral shape was accidentally applied during these tests instead of the Pierson-Moskowitz wave spectra.

5. Results

A selection of the obtained results will be presented in this article, in which the emphasis will be on the more significant differences in the behaviour of the two designs.

5.1. Calm water tests

Figure 5 present the comparison of the calm water characteristics of the FSC and the AXE frigate. At low speed the resistance between the two models is very similar, but slightly larger for the AXE frigate. This can be explained by the larger wetted surface of this model which results in a higher frictional resistance, while the contribution of the residual resistance is rather small at lower speed. However, as speed increases to the mid and high-speed region (> 15 knots) the difference in resistance becomes in favour of the AXE frigate. Apparently, the longer waterline length results in a lower residual resistance at higher speed which outweighs the additional frictional resistance. At the design speed of 26 knots the total resistance of the AXE frigate is approximately 9% lower compared to the FSC frigate. Moreover, the trim and sinkage of the AXE frigate are lower over the entire speed range tested.

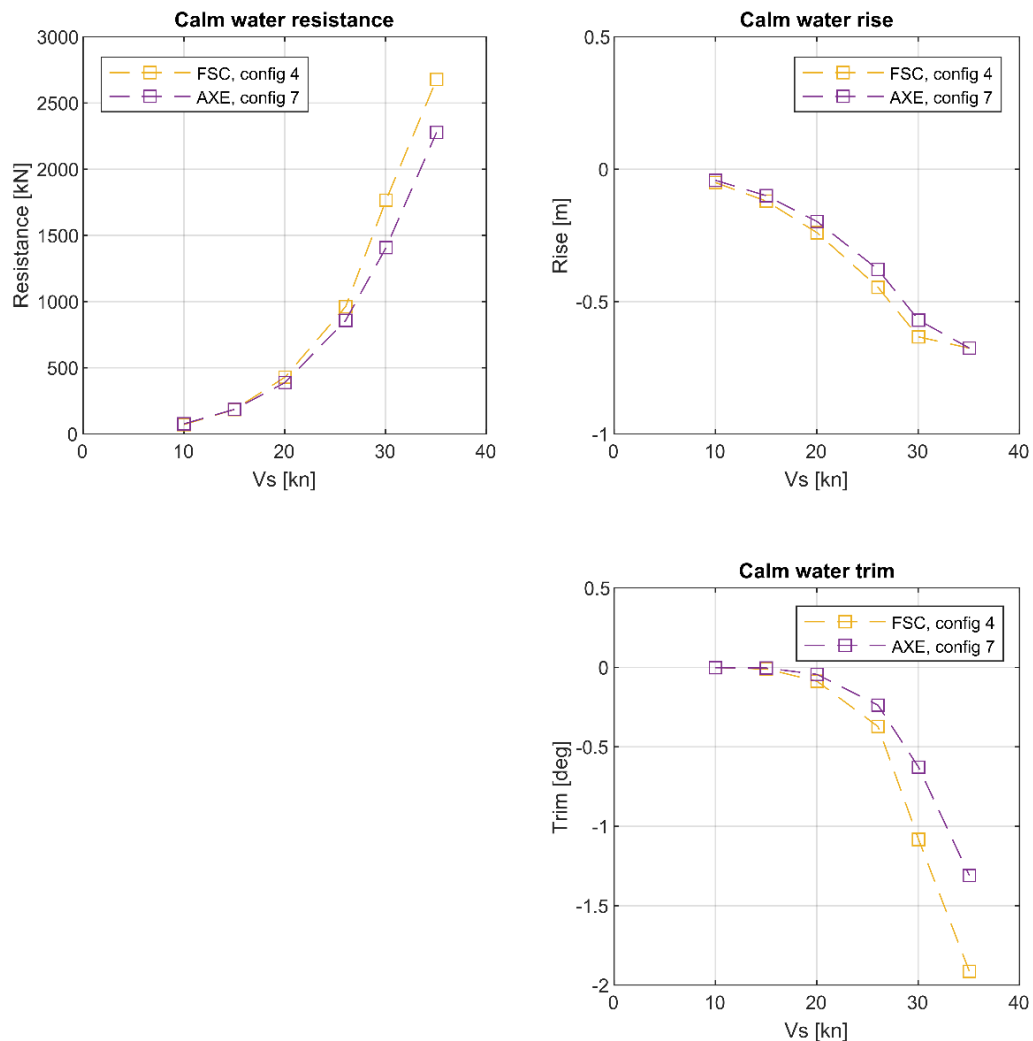

Figure 5: Calm water test results

5.2. *Regular wave tests*

Though the calm water resistance is in favour of the AXE frigate at the design speed, the particular interest between the two designs are the differences in motion behaviour in waves. To make this comparison a series of tests in regular waves were carried out. An advantage of making this comparison in regular waves is that the relative simple, predominantly harmonic signals are easier to compare and interpret than the more complex irregular signals obtained during testing in a wave spectrum, as the generated regular waves are easily deterministic quantifiable in terms of frequency, amplitude and phase angle. In addition to the fact that these conditions allow a thorough comparison of motion characteristics between the two designs, it also provides a proper set of experimental results for the validation of CFD simulations.

The tested frequencies differ for each model and wave amplitude in an attempt to capture the peak of the response of each model as good as possible. The quantification of the peak responses was preferred for validation of the numerical simulations, however the differences in wave frequencies make a direct performance comparison between the two models a little bit more cumbersome.

The response characteristics of the measured quantities were determined by applying a harmonic analysis at a single frequency to the output signals. The single frequency at which to perform this analysis was based on the encountered frequency of the incident waves, which was extracted from the measured wave signal by a least squared fit of a sine function. In this way the amplitude of the input and the output as well as their relative phase angles were obtained. During this processing special attention was paid that the signals were sufficiently captured by this linear harmonic analysis procedure, i.e. no significant non-harmonic and/or non-linear behaviour was observed in the measured motion and acceleration response signals.

As an example, the harmonic fit of one the more severe wave conditions is displayed in Figure 6. The first time trace shows the measured wave elevation (blue line) and the harmonic fit (red line). The frequency of the fitted sine function on the wave elevation is used in the harmonic analysis of the motion and acceleration response signals.

Motions and accelerations characteristics are well described using this linear harmonic analysis as may be seen from the correlation in the time traces (less severe wave conditions usually have an even better fit). The measured resistance indicated in the second time trace, however, does not have a proper fit with the harmonic signal. The explanation of this lies in the test setup. The model is restrained in surge which means that the surge energy is transferred to the force transducer and the restraining mechanism. These mechanical components are typically excited in their own natural frequency modes resulting in significant disturbances in the measured resistance signal making it difficult -or impossible- to determine the amplitude of the surge force in this test setup. For this reason only the average increase in resistance is reported, also known as the added resistance in waves.

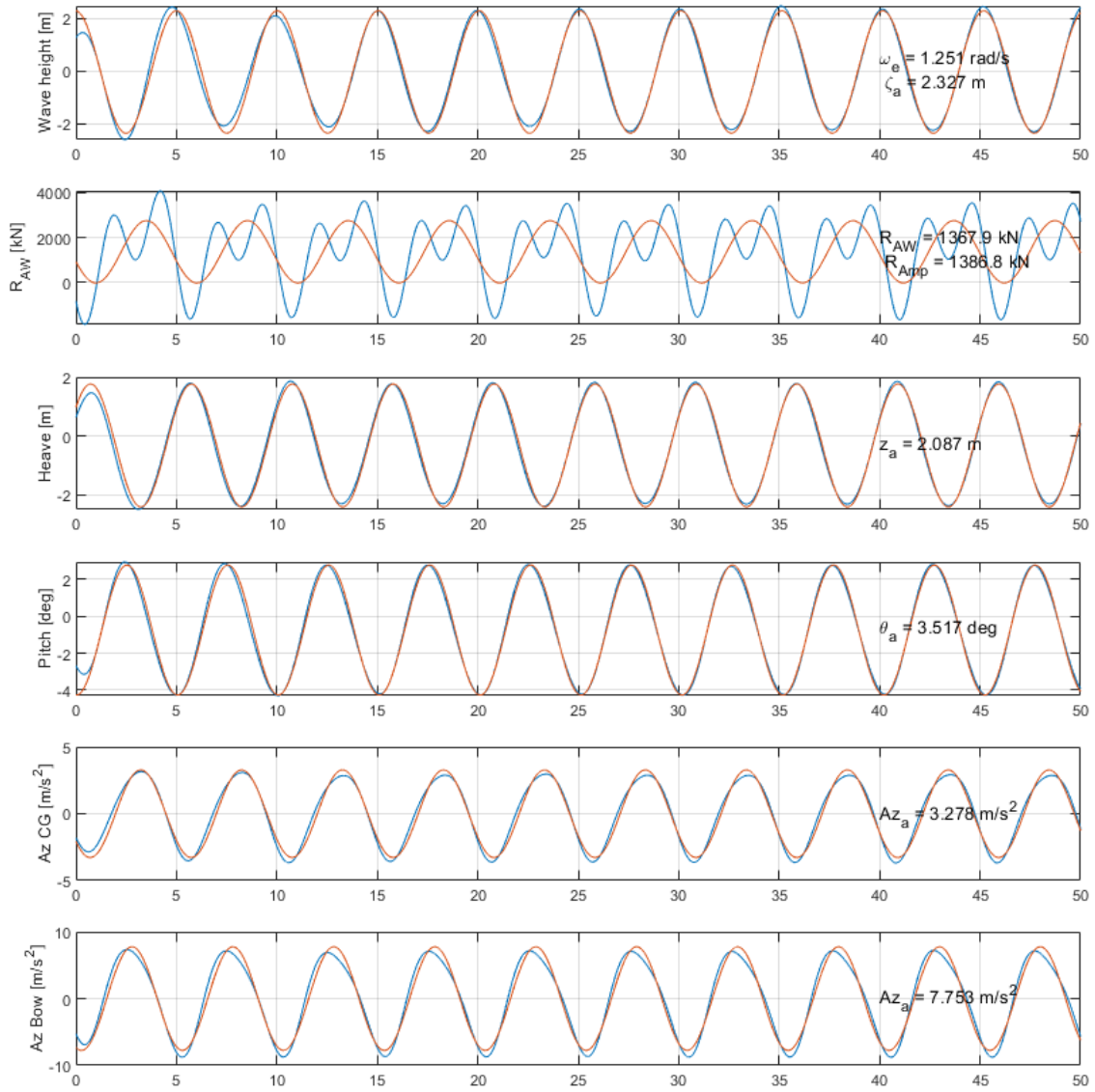

Figure 6: Time trace of the measured signals (blue) and the results of the harmonic fit (red) for a test with the FSC frigate at 26 knots in 2.5 m wave amplitude at a frequency of 0.66 rad/s

5.2.1. Experimental results in regular waves

Figure 7 shows the added resistance in waves together with the motion and acceleration response characteristics of the two frigates at a forward speed of 15 knots in non-dimensional form. The general observation is that all response signals are lower for the AXE frigate and that motions and accelerations responses are quite linear with the wave amplitude. The added resistance shows a quadratic dependency on the wave amplitude. Please note that, for the sake of clarity, the added resistance results for the lowest wave amplitude are disregarded in this figure as the results are quite volatile due to the very small difference in forces and consequently the large measurement uncertainty involved.

Comparing the results of the two designs it can be concluded that the AXE frigate has less added resistance in waves and values close to the maximum response are typically 30-35% lower. Also heave and pitch motions are smaller for the AXE frigate, the response characteristics are roughly 10-20% lower for the area close to the natural frequency. Similar differences are found for the accelerations at COG and at the bow, where accelerations of the AXE frigate are typically 10-20% lower.

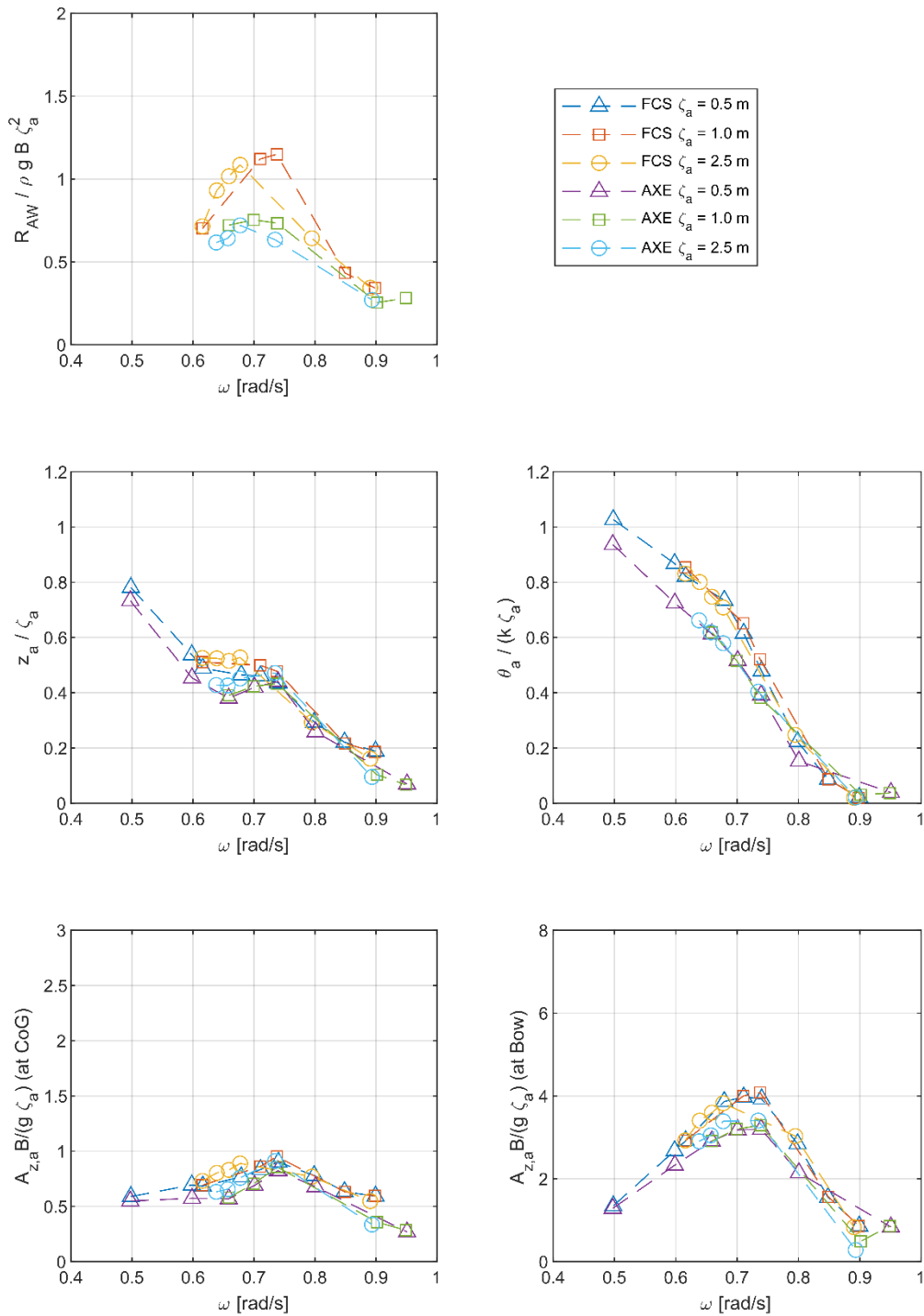

Figure 7: Comparison of the ship response between the FCS and AXE frigates at a forward speed of 15 knots

The same harmonic analysis was performed on the test results at the higher ship speed of 26 knots presented in Figure 8. Comparison of the added resistance graphs show again that the values of the AXE frigate are lower although differences are slightly less pronounced with a 20-25% difference. Motion levels are much more comparable between the two models at these higher speeds, only the pitch motion in the lower wave amplitudes still show distinct lower values for the AXE frigate of 10-15%. The accelerations more or less follow the trend of the motions. For the lower wave height the accelerations are quite comparable but for the highest wave amplitude a slight increase is seen in the acceleration level of the AXE frigate.

Non-dimensional motions and accelerations responses coincide well for different wave heights for each model, only the combination of the highest speed in the highest waves shows some deviations for the FSC frigate as may be seen in Figure 8. This condition shows some minor effects of non-linear motion behaviour.

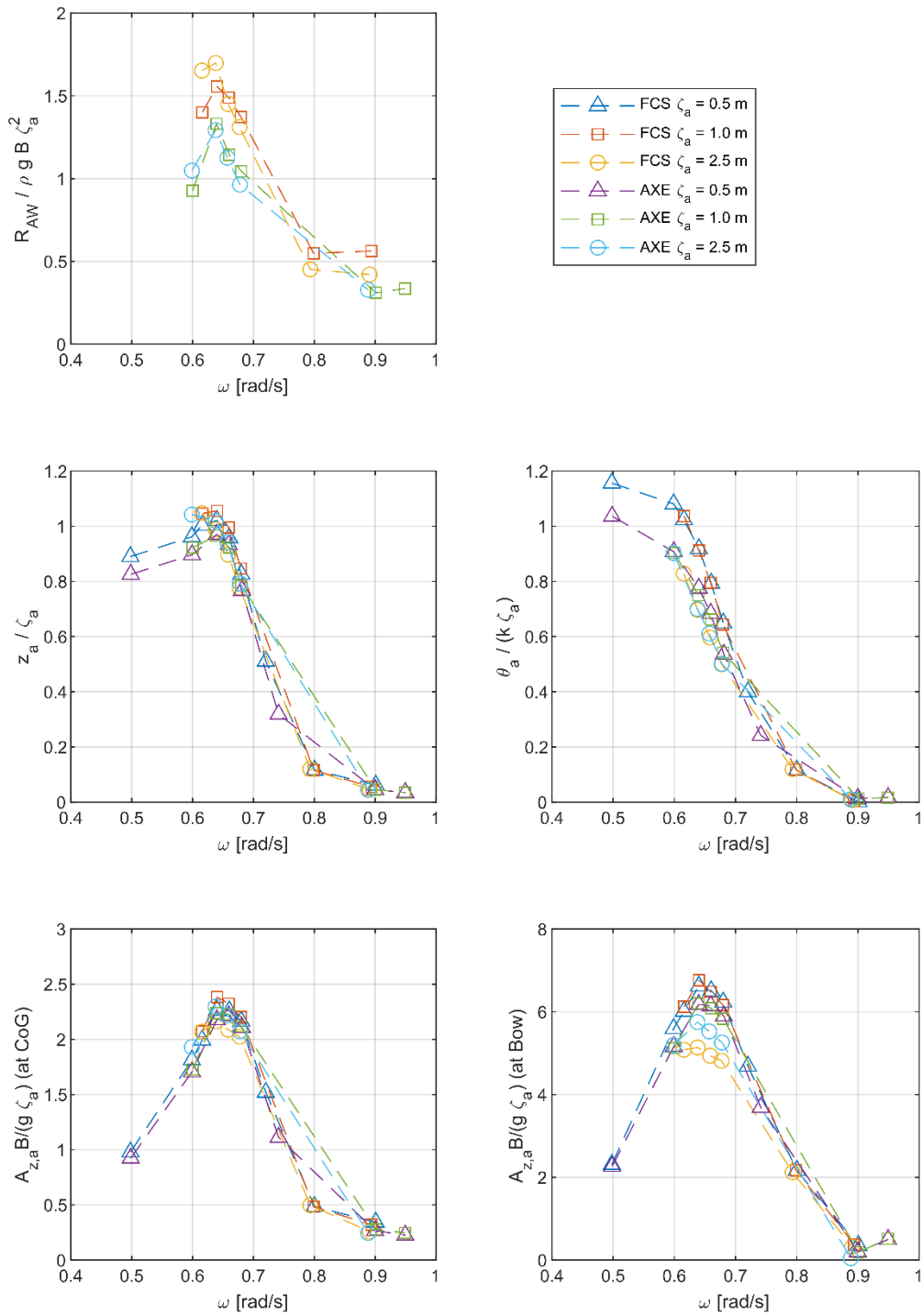

Figure 8: Comparison of the ship response between the FSC and AXE frigates at a forward speed of 26 knots

5.2.2. Deck wetness in regular waves

All tests in regular waves were recorded on video and these recordings were used to determine the shipping of water on deck. Hence, no dedicated measurement equipment or threshold value was used to determine deck wetness, but its estimate was based on the expert opinion by visual observations of this video material. Only some tests with the largest wave amplitude suffered from deck wetness. Shipping of water was significantly more severe for the FSC frigate, this model had water on deck during tests on both the lower and higher forward speed. In contrast, the AXE frigate only had water on deck during the high speed tests, but the amount was considerably less compared to the FSC frigate. Table 2 shows an overview of the runs suffering from deck wetness for the tests with the largest wave amplitude.

The explanation for the difference between the models is most likely the difference in freeboard height at the bow. Figure 9 and Figure 10 show some snapshots of the video recordings, showing deck wetness for both models in one of the most severe regular wave conditions.



Figure 9: Snapshots of the video recordings of the FSC (upper pictures) and AXE frigate (lower pictures) showing deck wetness in regular waves with a frequency of 0.66 rad/s and a wave amplitude of 2.5 m at a forward speed of 15 knots

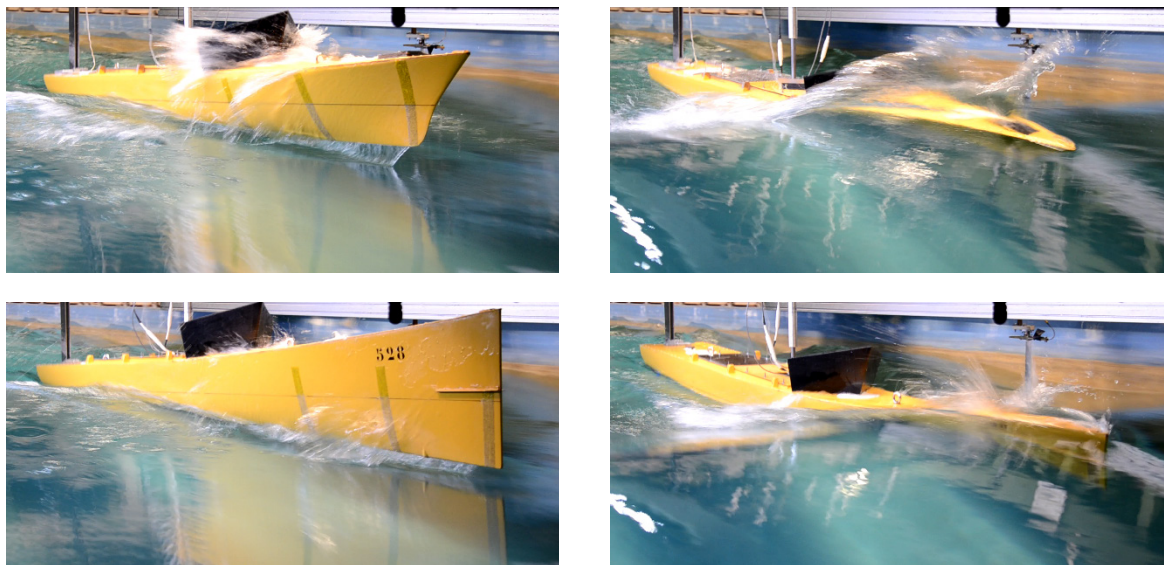

Figure 10: Snapshots of the video recordings of the FSC (upper pictures) and AXE frigate (lower pictures) showing deck wetness in regular waves with a frequency of 0.66 rad/s and a wave amplitude of 2.5 m at a forward speed of 26 knots

Table 2: Overview of conditions in wave amplitudes of 2.5 meter that suffer from deck wetness

FSC frigate wave freq (ω)	Deck wetness 15 knots	Deck wetness 26 knots	AXE frigate wave freq (ω)	Deck wetness 15 knots	Deck wetness 26 knots
0.61	x	x	0.60		x
0.64	x	x	0.64		x
0.66	x	x	0.66		x
0.68	x	x	0.68		x
0.79			0.89		
0.89					

5.2.3. CFD computations in regular waves

The CFD URANS computations were performed following the model test setup in regular incoming head waves. The fluid domain for free surface computations consists of a rectangle representing air and water. The size of the domain is made in such a way that the incoming wave and the wave system made by the ship can develop without being reflected by the side wall or the outflow.

The mesh is the “filter” of the quality of CFD computation results. The better it is the more accurate the computation will be. The meshing strategy is focused to capture the energy of the wave accurately. For added resistance in waves, the refinement on the surface of the ship is of a smaller importance than the refinement in the volume. However, this does not mean that coarser meshes on the surfaces are advised. Gradients of pressure still need to be captured accurately and the integration of the forces lead to requirements on the cell size on the surface.

Grid refinement studies showed that the incident wave should be captured as accurately as possible. To achieve this, enough cells per wavelength and wave height should be in place but also an additional box should be in place underneath the free surface to capture the energy of the wave. Additional refinement boxes under the free surface were set up to guarantee wave transportation and to capture wave amplitudes close to the targeted wave amplitude.

In addition to the incoming wave energy and amplitude, boxes are in place to guarantee enough cell density to capture the bow wave and the stern wave system in detail. As a remark, the additional refinements are based on the stagnation wave height of the wave made by the vessel while sailing.

FINE/Marine by Cadence (former Numeca) was used using the advised the best practice guidelines of the developer of the codes. To verify the quality of the simulation a check is performed whether the incoming wave is properly captured and propagated along the ship, since the added resistance is known to be very sensitive to the incident wave height.

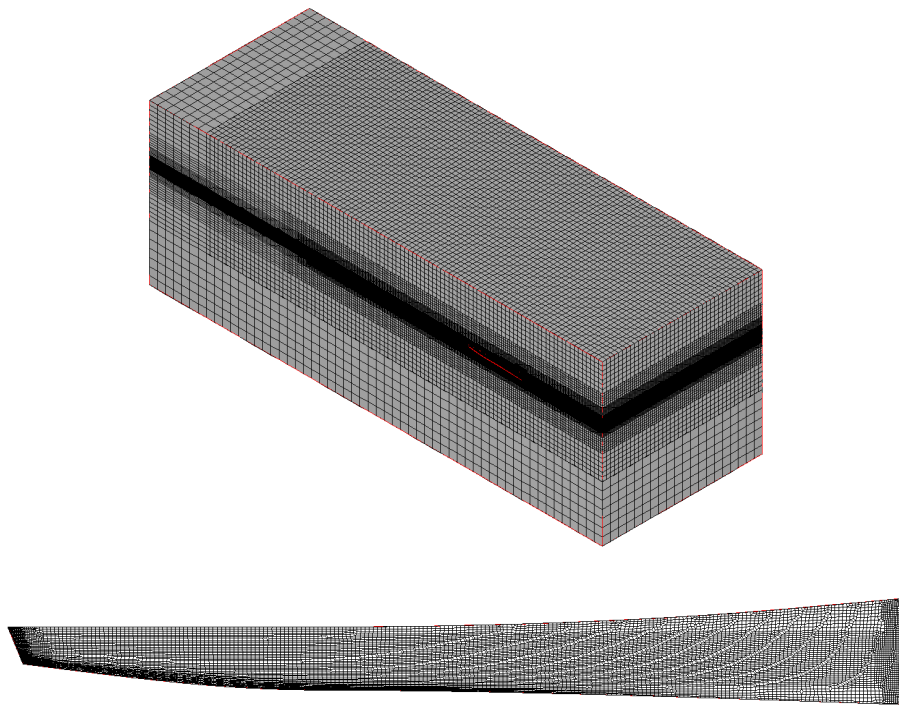

Figure 11: View of the mesh for the applied fluid domain volume and the for the AXE frigate surface

The comparison of the CFD computations with the experimental results for the 1.0 m wave amplitude and a ship speed of 26 knots are presented in Figure 12 and Figure 13 for the FSC and AXE frigate respectively. The correlation between the experimental and CFD results is rather good, both for the added resistance and the heave and pitch motions, particularly for the FSC frigate. For the AXE frigate some deviation exists close to the peak of the response, where the CFD computations are slightly over predicting the motions of the ship compared to the experimental results.

Though, in general it must be stated that CFD is able to predict the added resistance in waves of these type of ships satisfactory and can be used to design and optimize the hull for this phenomenon.

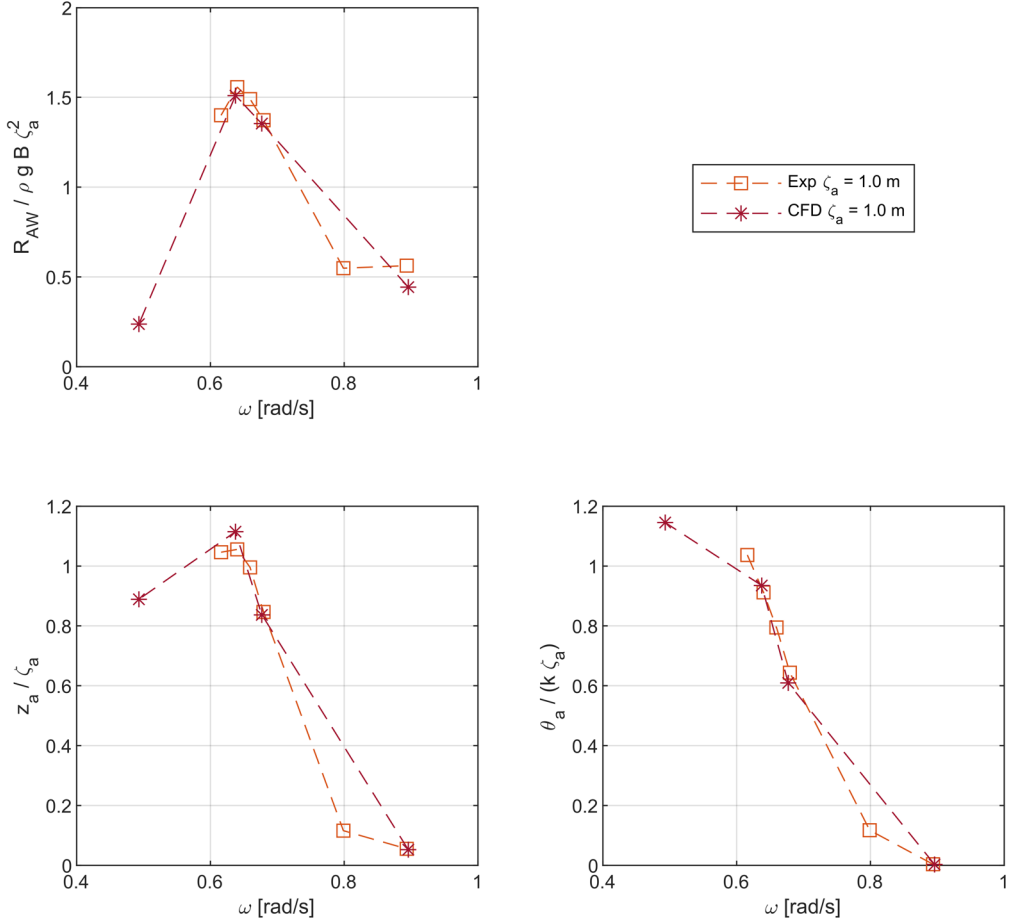

Figure 12: Comparison of experimental and CFD results for the FSC frigate

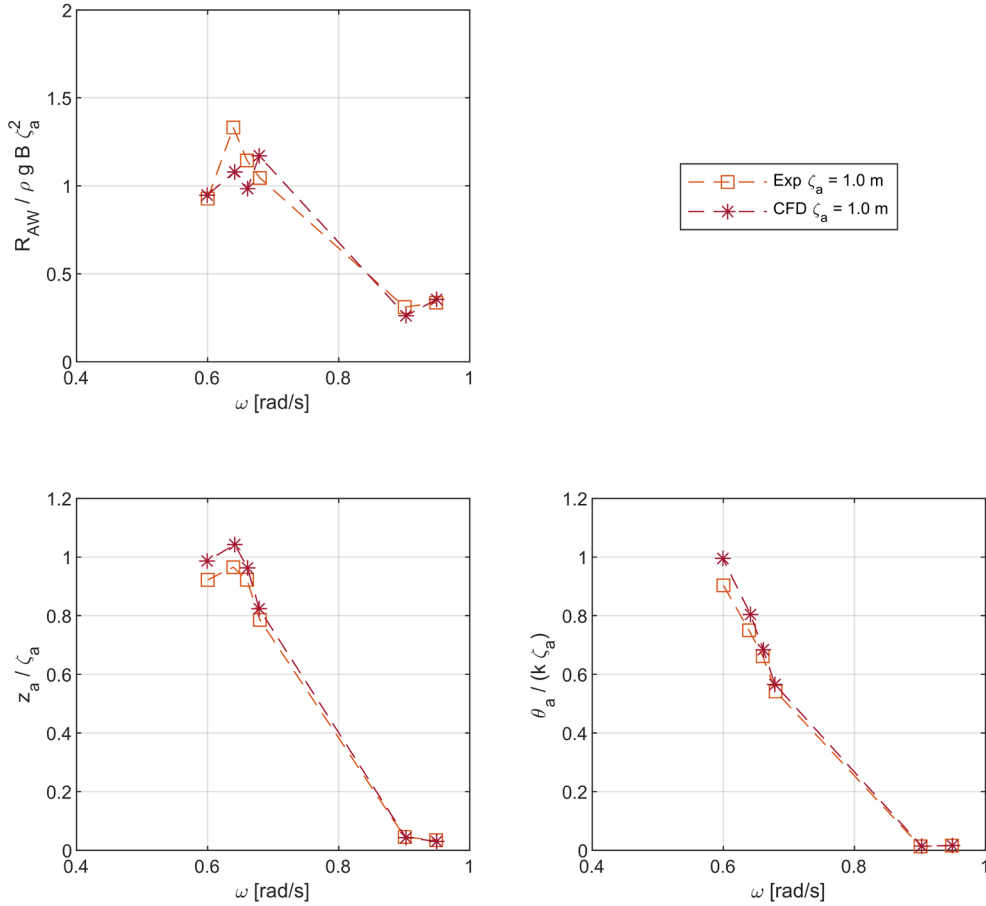

Figure 13: Comparison of experimental and CFD results for the AXE frigate

5.3. Irregular wave tests

The tests in irregular waves are performed to compare the performance of the two designs in realistic environmental conditions. A comparison is made of the motions and accelerations, but the main focus is on the mutual differences in the added resistance and the variation of the resistance in waves. The measurements are performed in the towed configuration and with the free-sailing models.

The measured time series are digitally filtered and further analysed to find the crests and troughs in the irregular signals. A peak finding algorithm is used to identify the relevant crests and troughs in the signals associated with the rigid body motions of the vessels. This is a delicate process and requires careful filtering to remove noise and any artificial effects in the time traces.

The identified crests and troughs are then sorted and plotted in distribution plots presented below. These distribution plots have a modified horizontal scale that present Rayleigh distributed minima and maxima as a straight inclined line. Wave elevations of narrow-banded wave spectra are generally considered Rayleigh distributed and the distribution of the wave amplitudes will thus be visualized according to a linear relation in these plots. Ship response amplitudes will also show as a straight inclined line as long as the vessel behaves linearly with respect to the incoming wave amplitudes. The crests and troughs of non-linear ship responses will however deviate from this line and the level of deviation can be used as a visual indicator for the extent of non-linearity of the particular response signal.

The processed data of the free sailing models is presented in the distribution plots of Figure 14 for the FSC and in Figure 15 for the AXE frigate for the first -and most severe- wave spectrum. The top graphs in these figures show the variations of the thrust and torque on the propeller shafts. The middle graphs show the vessel heave and pitch motions and finally the bottom graphs show the accelerations at COG and at the bow.

It may be seen from these figures that both the thrust and torque as well as the heave and pitch motions follow the linear trend for most amplitudes, only some non-linear behaviour is seen for more extreme amplitudes with a low probability of exceedance. For the accelerations, in the two bottom graphs, the non-linearity in the signals is a bit more pronounced.

Comparison of the FSC graphs to the results of the AXE frigate show that the motion response of the AXE frigate is more linear particular for the more extreme motion amplitudes. The same is seen for the acceleration signals and this coincides well with the general knowledge on AXE bow designs; the particular shape of the AXE bow causes it to react more linear with respect to incoming waves.

For smaller (and faster) vessels with a conventional bow the accelerations can show quite extreme values for peaks with a low probability of occurrence. The FSC frigate, however, does not show this type of behaviour. Apparently the combination of the very high L/B ratio and sharp bow sections of this frigate type hull together with the relative low Froude number does not result in wave slamming events in these wave conditions.

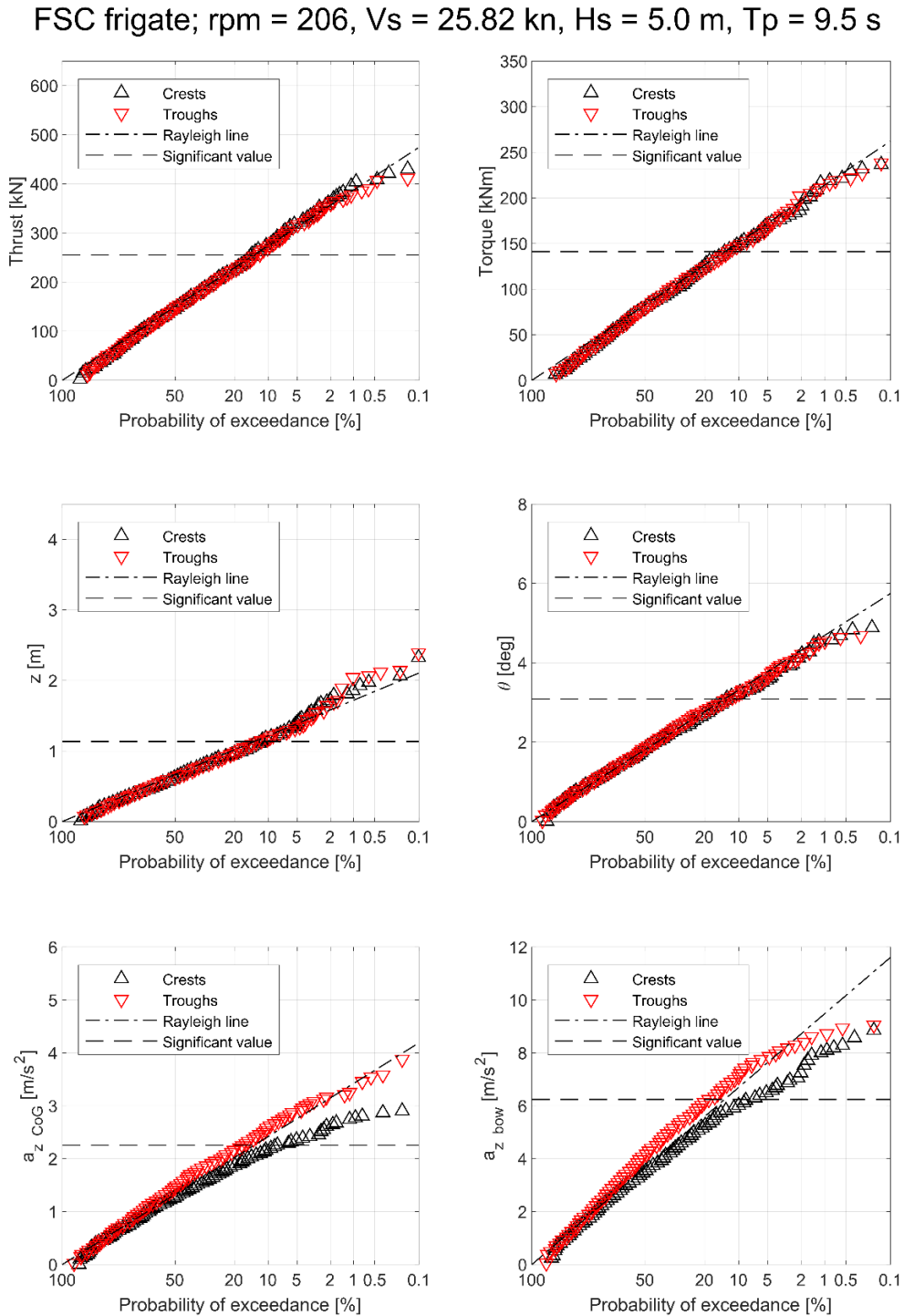

Figure 14: Distribution plots of the FCS frigate

AXE frigate; rpm = 205, $V_s = 25.40$ kn, $H_s = 5.0$ m, $T_p = 9.5$ s

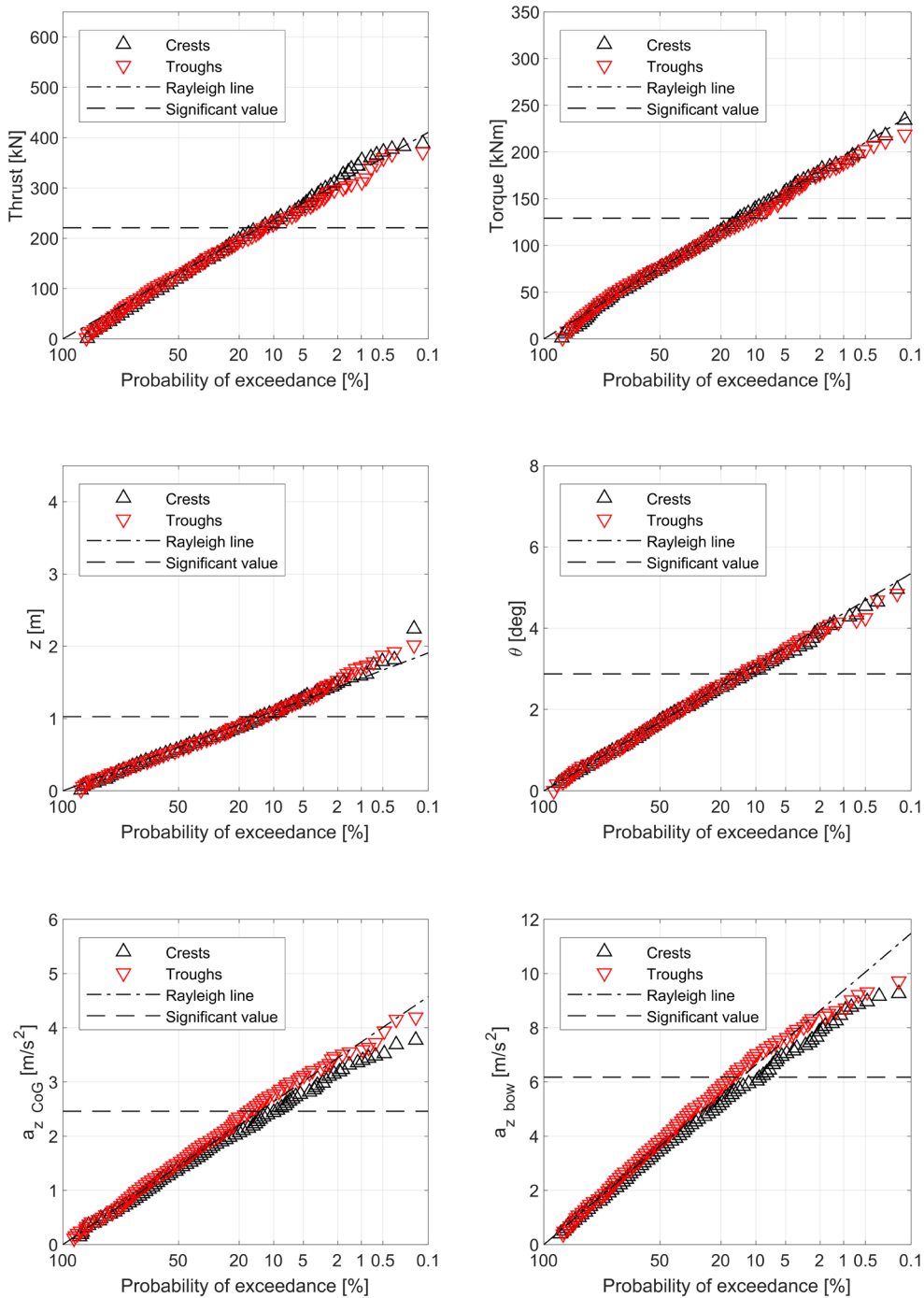

Figure 15: Distribution plots of the AXE frigate

As motions and added resistance behave much in a linear fashion a proper assessment of the designs can be made by comparing the significant values of the response signals. In Figure 16 the significant values for the heave and pitch motions are presented for the free sailing models at a speed of 26 knots in the two wave spectra. It may be noticed that for all conditions tested the motions of the AXE frigate are lower (this is also the case for the results at the lower speed of 15 knots). The significant values of the heave motions of the AXE frigate are approximately 10% lower compared to the FSC frigate and the pitch motions are roughly 5% smaller. Differences in the added resistance are slightly more pronounced with 10-20% lower values for the AXE frigate, while the variation in the thrust is almost 15% less.

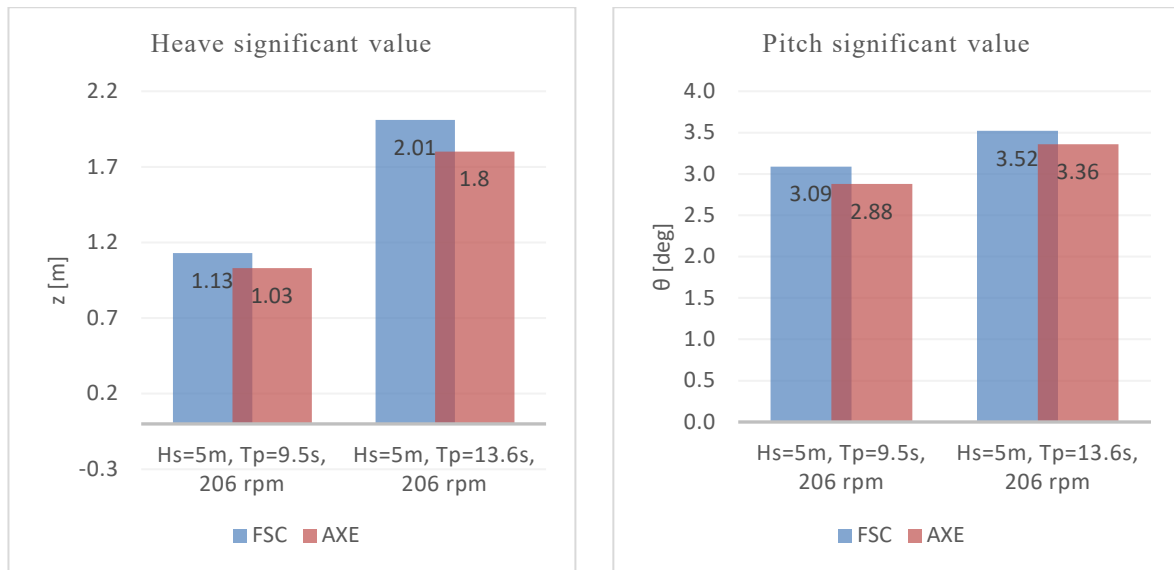

Figure 16: Comparison the motions of the FSC and AXE frigate at 26 knots

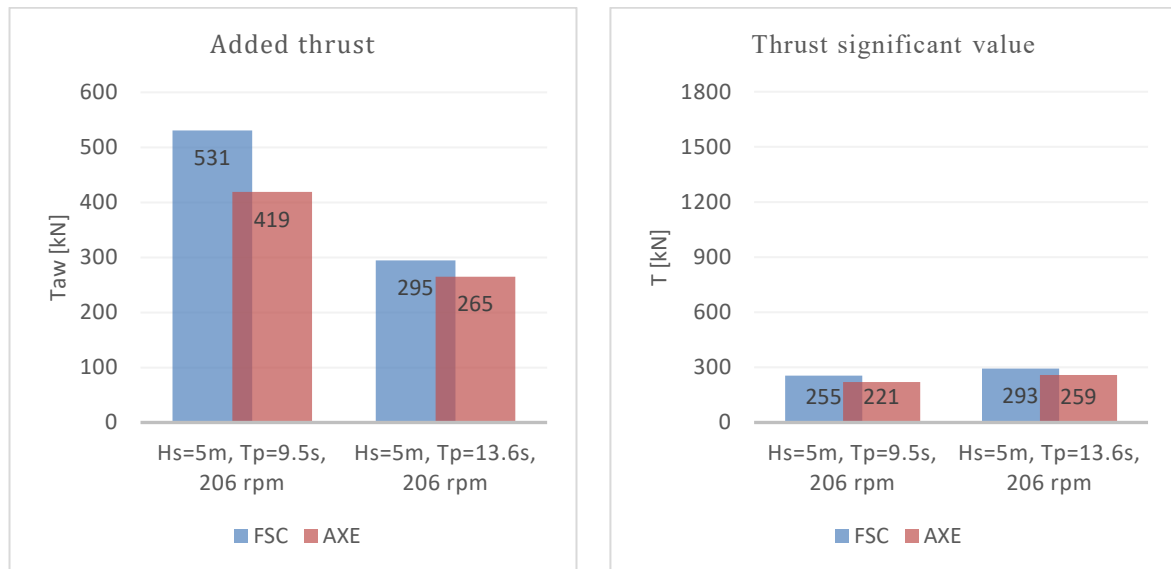

Figure 17: Comparison of the thrust of the FSC and AXE frigate at 26 knots

Finally, an interesting outcome can be found in the comparison of the added thrust and its variation, obtained during the free sailing experiments, with the results of the added resistance and its variation measured during the towed model tests. Figure 18 presents the added resistance results and the significant value of the resistance for the towed configurations. If these results are compared to the results of Figure 17 it may be seen that the added thrust is significantly higher for both models, particularly for the wave spectrum with the shorter wave period. An even bigger difference can be observed between the variation of the thrust and the variation of the resistance. As expected, in the towed configuration the inability to surge, results in a rather strong variation of the surge forces as the model is forced to keep a constant speed in waves. In the free sailing model the freedom to surge gives lower surge forces on the shafts of the model. These variations in thrust forces also include the variations in the velocity distribution in the propeller plane.

However, the mutual difference between the models show the same trend for the both test configurations; the AXE frigate always has a lower added resistance (thrust) and also less variation in the resistance (thrust). Apparently, towing a model at constant speed gives a reasonable indication of the mutual ranking in added resistance between the two designs. However, if one wants to determine the absolute values of the added thrust, and particularly the variation of the thrust signal, free sailing experiments are required.

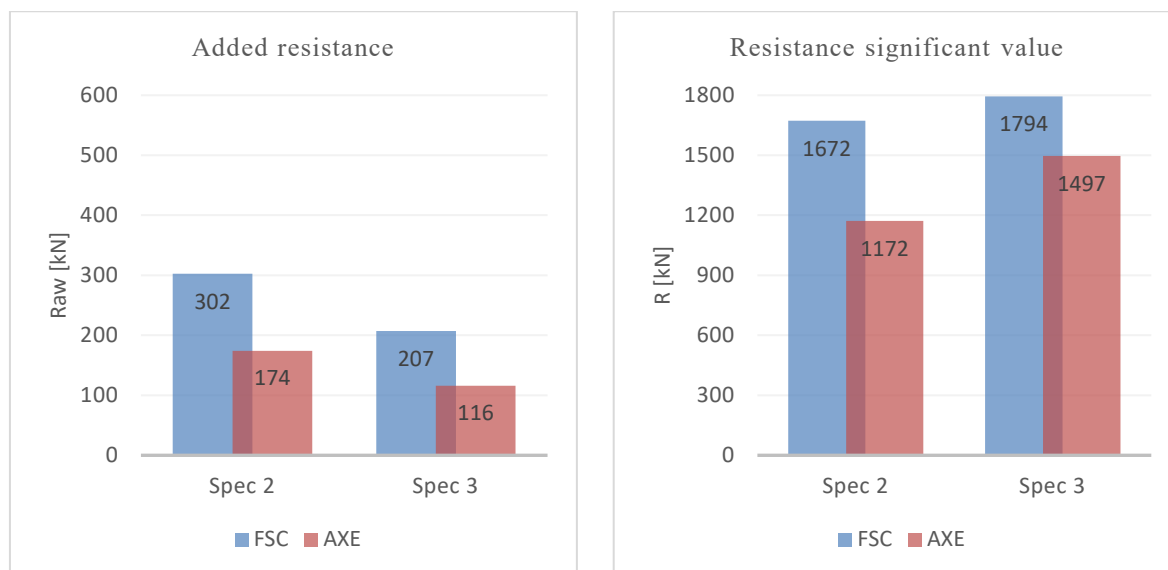

Figure 18: Comparison of the resistance of the FSC and AXE frigate at 26 knots

6. Conclusions

The results presented in this article compare the results of a conventional frigate type hull (FSC) to a frigate with an AXE bow design. During the design of these models it was made sure that the functionality of the two platforms was the same as much as possible for the execution of military missions, i.e. both ships had similar main deck area and hull volume to install equipment and to accommodate personnel. The shape of the aft ship was kept identical for this comparison, but the waterline length of the AXE frigate was extended to enable a modification of the bow sections according to the AXE bow design philosophy. The AXE bow design was also fitted with a pair of course keeping skegs that are usually applied on AXE bow ships.

The experimental results show that the calm water resistance of the AXE frigate is about 9% lower at the design speed, which can be mainly attributed to the longer waterline length of the AXE frigate. The tests in regular and irregular head waves show that the heave and pitch motions of the AXE frigate are lower. Moreover, it was shown that in large waves the deck wetness is reduced for the AXE frigate due to its larger freeboard height in the bow area. Though, the most pronounced differences between the two models was the reduced added resistance in waves and the lower variation in surge force of the AXE frigate in a towed configuration. Self-propelled tests with these models confirmed that the added thrust in waves as well as the variations in the thrust are noticeably lower for the AXE frigate. These lower variations in thrust will most likely also reduce the load variations on the propeller blades which could potentially result in a lower noise signature of the ship.

Interestingly, the effect of the test configuration on the added resistance –or added thrust- is large. This is most likely caused by the fact that the models were not able to surge in the towed test configuration, while the models can surge in the free sailing configuration. The measured differences between two test configurations are even stronger for the variation of the resistance and thrust signals. It is therefore advised to perform free sailing experiments if one wants to determine the specific added thrust in waves, however it seems that the less complex towed model configuration can be used for mutual ranking of hull designs in a comparative study.

The numerical CFD simulations correlate well with the experimental results for the motions and added resistance in regular waves in the towed configuration. Hence, these simulations can provide a valuable tool to assess the performance of frigate type hulls with respect to motions and added resistance in waves during the initial design phase of the ship.

Acknowledgements

The authors would like to express their appreciation to Damen Naval for their kind permission to allow publication of the experimental and numerical results. Special thanks goes out to Prof. Dr. -Ing S. Sigmund for his work on the CFD computations for the Axe bow frigate.

References

Eefsen, T. et al., 2004. *Development of frigate designs with good seakeeping characteristics*. Luebeck-Travemuende, 9th Symposium on Practical Design of Ships and other Floating Structures.

Keuning, J., 2006. "Grinding the Bow" or "How to Improve the Operability of Fast Monohulls. *International Shipbuilding Progress*, 53(4), pp. 281-310.

Keuning, J. & Van Terwisga, P., 2015. *The possible application of an AXE Bow on a 5000 ton frigate*. Washington D.C., Proceedings of the 13th International Conference on Fast Sea Transportation.