

Advancing Transparency

Connecting glass with heat – An experimental approach to the implementation of heat bonding into glass connection design for structural applications

Rammig, L.M.

DOI

[10.7480/abe.2022.09](https://doi.org/10.7480/abe.2022.09)

Publication date

2022

Document Version

Final published version

Citation (APA)

Rammig, L. M. (2022). *Advancing Transparency: Connecting glass with heat – An experimental approach to the implementation of heat bonding into glass connection design for structural applications*. [Dissertation (TU Delft), Delft University of Technology]. A+BE | Architecture and the Built Environment. <https://doi.org/10.7480/abe.2022.09>

Important note

To cite this publication, please use the final published version (if applicable). Please check the document version above.

Copyright

Other than for strictly personal use, it is not permitted to download, forward or distribute the text or part of it, without the consent of the author(s) and/or copyright holder(s), unless the work is under an open content license such as Creative Commons.

Takedown policy

Please contact us and provide details if you believe this document breaches copyrights. We will remove access to the work immediately and investigate your claim.

An abstract, low-angle photograph of a complex glass structure, possibly a modern architectural element or a piece of art. The structure is composed of several thick, clear glass panels and rods that intersect and curve, creating a dynamic, geometric form. The background is a solid, deep blue color, which makes the transparent glass stand out. The lighting is dramatic, highlighting the edges and surfaces of the glass, creating strong reflections and shadows.

Advancing Transparency

Connecting glass with heat –
An experimental approach
to the implementation of heat bonding
into glass connection design
for structural applications

Lisa Rammig

Advancing Transparency

Connecting glass with heat –
An experimental approach
to the implementation of heat bonding
into glass connection design for
structural applications

Lisa Rammig



22#09

Design | Sirene Ontwerpers, Véro Crickx

Cover photo | Vidre Slide, sculpture 2016. Design Lisa Rammig, fabrication Cricursa.
Image Frank Kretschmann

ISBN 978-94-6366-551-3

ISSN 2212-3202

© 2022 Lisa Rammig

This dissertation is open access at <https://doi.org/10.7480/abe.2022.09>

Attribution 4.0 International (CC BY 4.0)

This is a human-readable summary of (and not a substitute for) the license that you'll find at:
<https://creativecommons.org/licenses/by/4.0/>

You are free to:

Share — copy and redistribute the material in any medium or format

Adapt — remix, transform, and build upon the material

for any purpose, even commercially.

This license is acceptable for Free Cultural Works.

The licensor cannot revoke these freedoms as long as you follow the license terms.

Under the following terms:

Attribution — You must give appropriate credit, provide a link to the license, and indicate if changes were made. You may do so in any reasonable manner, but not in any way that suggests the licensor endorses you or your use.

Unless otherwise specified, all the photographs in this thesis were taken by the author. For the use of illustrations effort has been made to ask permission for the legal owners as far as possible. We apologize for those cases in which we did not succeed. These legal owners are kindly requested to contact the author.

Advancing Transparency

Connecting glass with heat –
An experimental approach to the
implementation of heat bonding
into glass connection design for
structural applications

Dissertation

for the purpose of obtaining the degree of doctor
at Delft University of Technology
by the authority of the Rector Magnificus, prof.dr.ir. T.H.J.J. van der Hagen
chair of the Board for Doctorates
to be defended publicly on
Tuesday 17 May 2022 at 10:30 o'clock

by

Lisa Maraike RAMMIG
Master of Arts, Master of Engineering,
TH OWL Detmold School of Architecture, Germany
born in Paderborn, Germany

This dissertation has been approved by the promotor.

Composition of the doctoral committee:

Rector Magnificus,
Prof. dr.-ing. U. Knaack
Prof. dr.-ing. T. Klein

chairperson
Delft University of Technology, promotor
Delft University of Technology, promotor

Independent members:

Prof. J. O'Callaghan
Prof. dipl.ing. S. Behling
Prof. dr. M. Overend
Adjunct Assist. Prof. J. Liu
Prof. dr.ing. L. Blandini
Prof.ir. M.F. Asselbergs

Delft University of Technology
University of Stuttgart
Delft University of Technology
Columbia University
University of Stuttgart
Delft University of Technology,
reserve member

Preface

In light of the climate crisis our planet is currently facing and the effect our use of resources has on our lives, the association with transparency is not only related to its physical attributes but with a metaphorical meaning of providing transparency into economical and political action.

In an architectural context transparency is primarily considered on a material level. We often take the availability of daylight for granted and the effect it has on our health.

This dissertation is focused on and around a material that has fascinated me for many years - glass. It's a material of contrast. It creates tension. It makes us feel uncomfortable. I like that.

Glass is very strong but brittle, when used as a window it forms an invisible layer of protection but it also exposes us, making us vulnerable to views. It is resistant to many substances, it doesn't corrode. But when it breaks, results can be consequential. But most importantly: it lets light pass through - glass is transparent.

As with the material itself, the transparency of glass structures is fascinating and daunting at the same time. The emotional distrust towards a transparent material opposes the rational knowledge that the material would be sufficiently strong to form a structure.

When designed traditionally, due to its brittleness glass requires an additional material to form a connection that can transfer loads.

These antagonisms are what has driven me for the last few years with the goal to learn about the material glass and to explore how some of its properties can be exploited further to showcase its purity, transparency and beauty in its clearest manifestations to form connections that are nothing but glass – and transparent. To focus on the value the material has had for centuries before it became a commodity as a perfect, flat sheet and to explore which other forms it could take to remain a valuable building material that is both durable and fragile and yet sustainable.

You wouldn't be reading this book if it wasn't for the many amazing people who have supported me over the years – to whom I am extremely grateful.

It's been a very personal experience and I have learned a lot. Not only contextually, but also about myself; and most importantly I have met amazing people on the way, who have challenged and inspired me – many of whom have become friends.

First and Foremost Ulrich, who from the beginning believed that I would be able to do it (at least he made me feel that way), despite my full time professional involvement and aspirations to develop and grow professionally, which would (and did) take a lot of my energy. Even in the moment I called to let him know that I would move to the other side of the world to start a new adventure, not knowing how I would find the time, focus and energy to finish this research, he stayed calm and assured me he had my back. In his very personal and approachable way he's been motivating, critical, forceful when needed and incredibly supportive in so many ways that he has become a friend that I feel I can turn to not only for academic support. He's gone out of his way to make it possible for me to get here- to the point that he's let me borrow his apartment in Rotterdam for a week of writing. So I am very grateful for his support and trust and the friendship and connection that we have established over the last few years.

I also want to thank Mauro who, when he saw me struggling with finding the time to travel to Delft to set up and carry out experimental testing, offered that I could use his lab and equipment in Cambridge and supported me in every possible way discussing set-ups, expected results and ideas when my experience with experimental testing was close to nothing; without asking for anything in return. Thank you Mauro for being so approachable and available and thanks to the entire team at the FGRg in Cambridge who have helped me through various challenges in the process.

I owe particular thanks to James. Despite my ignorance towards his work when I first started some very crude welding experiments that were purely driven out of an interest in glass as a material and the way it could be connected, I quickly realised that he was the person I needed to learn from. It's then been a move to London and a few years and detours before I had the opportunity to join EOC, which ever since has been a challenge and source of inspiration that's been driving me every day. Despite knowing that this research might take up some of my energy that he would (understandably) rather see focused on my professional work and despite his initial criticism towards the topic, James has become a great support. He's had to go through the pain of working through significant portions of this book with me and I am very grateful for the time he has taken to share his knowledge about glass and

his creative approach to engineering and talent of working with people with me and for an inspiration to become better, as a designer and as a person- through rigour and focus every day.

I want to thank everybody else at EOC who had the patience to deal with me through this research, for everything I've learned and for inspiring work and countless conversations. Thank you Brian and Damian for your positivity and support with my sometimes wild ideas and thanks to Graham for letting me scratch the surface of your impressive knowledge about glass. I also have to thank the team in San Francisco who had to deal with a lot of moaning and bad moods over the last couple of years, in particularly Gregor for very useful discussions about the principles of structural engineering and Isabelle for review and comments on the interpretation of experimental data output.

I am grateful that some of my heroes of the industry have agreed to be part of my doctoral committee.

I am honoured that Stefan, who's work on glass and beyond I have admired ever since I started tapping into the field of architecture has agreed to join the committee. I value every conversation we have had over the last few years and the opportunity to learn from his experience and talent through many discussions and presentations on the design of some of the most challenging structural glass projects ever built. His clarity of design principles and understanding of how far a material can be challenged and how to express its best is truly impressive. So is his ability to inspire and convince everyone around him to go the extra mile for extraordinary results.

My thanks also go to Jing, who I have had the pleasure to meet and work with on one of my favourite projects. A source of design inspiration, precise and forceful in her very humble way. Her way of designing with a purity of concept in mind that is not distracted by technical limitations but evolves through the design criteria a material offers. I have learned a lot through the process of working through material constraints and pushing the industry to achieve the design intent without limitations, its been inspirational.

For many years I have been following Lucio's work, both professional and academic. The design of his glass sphere is still one of the most important examples of experimental structural glass, so I am grateful that he agreed to join the doctoral committee when we first met in person (it did take me a few gin and tonics to be brave enough to ask.). The comments and thoughts he provided are very much appreciated.

A lot of this research would not have been possible without friends in the glass industry who have supported me with the little (sometimes quite big) experiments around the connectivity of glass.

Schott have provided the glass for the heat bonding experiments that are part of this research, special thanks to Folker who has been available for any questions about borosilicate and who supported me with insight into the chemistry of the material as well as creative solutions to the use and adaptation of their standard products to fit the needs of any of the case studies I have been working on.

Many thanks also to the team at Cricursa, particularly Joan, Ferran and Beatriz for believing in a crazy idea that admittedly took a lot of effort, precision, experimentation and bravery to become successful.

Also to the team at Sedak for continuously supporting my ideas and experimentation and particularly Ulrich, Michael and Siegfried who have all gone out of their way to be able to continuously test and realise some of the ideas outlined in this research.

Valerie and Rico as well as the rest of the team from Dow and Florian and Werner from Sika, your support is equally appreciated and I can't wait for the next challenge.

Academic research to me is quite a fearsome thing. The fact that I have managed to get through this is thanks to a special group of people. The Facade Research Group has been the best support network one could ask for. Critical discussions in a safe environment have allowed me to progress beyond my comfort zone and have helped me to get back on track whenever I went off-piste. Thanks to everybody who is part of this family, in particular Tillmann as head of the group for creating this space for review and discussions and for his very critical scope reviews. Thaleia and Thomas for questioning the precision of my research questions in endless iterations and discussions, and Ale for helping me through the jungle of academic formalities.

Part of the FRG are two special friends who have supported me with this research and I want to express particular gratitude to Linda and Marcel. Linda's ability to break down any content, as complex and foreign as it might be, into its primary and most important components has helped structure my thesis. She has spend endless evenings with me reviewing my research methodology, providing sharp comments that dug deep and at the same time has managed to be just an amazing friend.

Marcel is an absolute rock who keeps reminding me of the importance of friendship and to be humble and grounded but also appreciate my achievements at times when my focus drifts more towards my failures. He's provided guidance where necessary and distraction when needed, so thanks Marcello for being around.

I spend a lot of time on planes. And I am grateful for the plane time I have had in the last years, as for me it's been a time of focus with little distraction, without which I wouldn't have been able to write this dissertation. I've learned to set up my office anywhere in any conditions, whether it's a seat on a plane, the jungle in Thailand, a rooftop in LA, a museum in Seoul, the café around the corner or a shuttle bus to the South Bay. And I always look forward to the next one...

Last but not least I want to thank my parents, who have instilled curiosity into me forever and my friends and family that with the excuse of 'writing' I have delayed, let down, cut short, ignored - just to then call at inhumane times from a random airport in a more random place. And yet, whenever I turn up in the middle of the night with a jet lag and only 12 hours at hand before I have to leave again, they will take turns at entertaining me through the night, often compressing months full of events (and bottles of Cremant) into a very intense few hours- still with the ability to ground me- leaving me with the feeling that wherever I might be in the world once I have taken off again, they are still close. Without this support I would have struggled to keep my sanity throughout this process, so I am endlessly grateful and feel lucky to be surrounded by so many amazing humans.



Contents

List of Tables	18
List of Figures	19
Summary	31
Samenvatting	39

1 Introduction 47

1.1	Research background	47
1.2	Problem statement	48
1.3	Research Objectives	51
1.4	Research Questions	51
1.5	Approach and methodology	52
1.6	Outline	54

2 The Nature of Glass 57

2.1	The material	57
2.1.1	Composition	58
2.1.2	Molecular structure	58
2.2	Why borosilicate	62
2.3	Technical Values	63
2.3.1	Coefficient of linear thermal expansion	63
2.4	Strength	66
2.4.1	Strength in connections	67
2.5	Stiffness	67
2.6	Development of Glass	68
2.7	Modern Glass Fabrication	71
2.7.1	The Float Glass Process	71
2.7.2	Glass Processing	73

2.7.3	Mechanical Processing	74
2.7.3.1	Cutting	74
2.7.3.2	Grinding	74
2.7.3.3	Drilling	74
2.7.3.4	Polishing	75
2.7.3.5	Edge treatment	75
2.7.3.6	Polished edges for visual reasons:	76
2.7.4	Thermal Processing	76
2.7.4.1	Annealing	76
2.7.4.2	Thermal tempering	77
2.7.4.3	Heat Soak Testing	79
2.7.5	Chemical Processing	79
2.7.5.1	Chemical tempering	79
2.7.5.2	Acid Etching	80
2.7.6	Laminating	80
2.8	What is transparency	82
2.8.1	Refraction	83
2.8.2	Absorption	83
2.8.3	Scattering	83
2.8.4	BSDF	84
2.8.5	Perception of light and colour	84
2.9	Perception of colour in glass	85
2.10	Summary	87
3	The use of glass in the built environment	89
3.1	Transparency in glass architecture	89
3.2	Glass in architecture	92
3.2.1	Roman	94
3.2.2	Middle Ages	94
3.2.3	Industrial Revolution	95
3.2.4	Early 20 th Century	98
3.2.5	Mid 20 th Century	102
3.2.6	1980's-2000's	106
3.2.7	Recent developments	107

3.3	Curved and deformed glass to increase structural capacity	120
3.3.1	Vakko Headquarters, Istanbul	120
3.3.2	Casa de Musica, Porto, OMA/ABT	122
3.3.3	CTS Museum, Hong Kong, SO-IL/EOC	124
3.4	Glass as a solid material	126
3.4.3.1	Atocha Station Memorial Madrid	126
3.4.3.2	Crystal Houses, Amsterdam	128
3.4.3.3	Further development of Brick approach at TU Delft	129
4	Glass connection development	133
4.4.1	Bearing connections	135
4.4.2	Friction connections	135
4.4.3	Bonded connections	136
4.4.4	Linearly supported	139
4.4.4.1	Rebate glazing	139
4.4.4.2	Shuffle glazing	140
4.4.4.3	Rebate glazing with glazing bead	141
4.4.4.4	Leaded glazing	142
4.4.4.5	Wrought Iron T-profiles (Victorian)	143
4.4.4.6	Patent glazing	144
4.4.4.7	Dry glazed stick curtain wall system	144
4.4.4.8	Clamped glass base	146
4.4.5	Bonded connections	148
4.4.5.1	Structural silicone joints	148
4.4.5.2	Large sliding doors: tension rod in silicone joint	149
4.4.6	Point fixed	150
4.4.6.1	Clamp fittings for suspended glazing	150
4.4.6.2	Clamp fittings in cable nets	151
4.4.6.3	Clamp fittings to mullions	152
4.4.7	Bolted connections	154
4.4.7.1	Pinned glass beam connections	157
4.4.8	Laminated fittings	157
4.4.8.1	Mortise and tenon joint, 1994	160
4.4.8.2	TSSA bonded connections	161
4.4.8.3	Glass corners	163

5 The concept of heat bonding 169

5.1	Introduction	169
5.2	History of heat bonding / technology of scientific glass blowing	171
5.2.1	Additive Manufacturing	173
5.2.2	Fibre Optics	175
5.2.3	Laser based gravity bending (distorting) of glass	176
5.3	Residual Stress induced in the bonding process	178
5.3.1	Introduction	178
5.3.2	Material Properties	179
5.3.2.1	Borosilicate	180
5.3.2.2	Material Properties Comparison at Ambient Temperature	180
5.3.3	Thermal Material Properties	181
5.3.3.1	Thermal Shock	181
5.3.3.2	Specific heat capacity	181
5.3.4	Mechanical Material Properties	182
5.3.4.1	Thermal Expansion	182
5.3.5	Optical properties	184
5.3.5.1	Refractive Index	184
5.4	Test setup	185
5.4.1	Heat impact on material structure and residual stress after heat bonding	185
5.4.1.1	Annealing	188
5.5	Test results	190
5.5.1	Visual assessment of residual stress	190
5.5.2	Residual stress measurements	191
5.5.2.1	SCALP calibration	191
5.5.2.2	Measurement results	192
5.5.3	Data analysis	193
5.6	Summary of results and further research	195

6 Capacity of heat bonded connections 197

6.1	Introduction	197
6.2	Initial experimental investigation (pre-validation)	198
6.2.1	Initial set-up	200
6.2.2	Connections tested	200
6.2.2.1	Joint appearance	201
6.2.2.2	Load capacity of the connections	205
6.2.2.3	Assessment criteria	206
6.3	Optimised test scope	208
6.3.1	Test configurations	208
6.3.2	Manufacture of specimens	209
6.3.3	Annealing	211
6.4	Bending strength of heat bonded glass connections	212
6.4.1	4-point bending test	212
6.4.1.1	Test preparation:	212
6.4.1.2	Description of the heat bonding process to manufacture butt jointed specimens.	213
6.4.1.3	Visual assessment of bond:	217
6.4.1.4	Predicted results:	219
6.4.1.5	Test Set-up	219
6.4.2	Results	221
6.4.3	Coaxial Double Ring (CDR) Test	223
6.4.3.1	Test set-up	227
6.4.3.2	Test Procedure	229
6.4.4	Results	229
6.4.5	Pull out test	231
6.4.5.1	Specimen preparation	231
6.4.5.2	Monitoring of temperatures during the welding process	233
6.4.5.3	Thermal stress fractures	233
6.4.5.4	Adjusted temperature profile	234
6.4.5.5	Test preparation	236
6.4.5.6	Predicted Results	237
6.4.5.7	Test Results: Pull out	238
6.5	Summary and future research	240

7 Implementation of transparent connections 245

7.1	Application of Heat Bonded Connections	246
7.2	Limitations of the application of heat bonded connections on a project scale	246
7.2.1	Design Variability	247
7.2.2	Structural Design and load assumptions	247
7.2.3	Redundancy	248
7.2.4	Code compliance	249
7.2.5	Fabrication and Processing	250
7.2.6	Handling	253
7.2.7	Transport	253
7.2.8	Assembly and Installation	254
7.2.9	Water and Air tightness	254
7.2.10	Replacement	255
7.2.11	End of Life	255
7.3	Design of Heat Bonded connections	256
7.3.1	Glass point fixing	256
7.3.2	T-Connection for Glass Facade Applications	257
7.3.3	Butt joints for facade applications	258
7.3.4	Glass to glass corner	259
7.3.5	Heat bonded stair treads	260
7.3.6	Summary - Heat Bonding	263
7.4	Alternatives to Heat Bonding	265
7.4.1	Making connections transparent	265
7.4.2	Transparent corner bond	268
7.4.3	Transparent composite bonded 'hinge'	273
7.5	Transparent edge seals	276
7.6	Thin glass	280
7.6.1	Summary - Alternatives to Heat Bonding	283
7.7	Summary	285

8 Summary 289

8.1 **Summary by Chapter** 289

8.2 **Discussion of the Research Question and sub-questions** 296

Appendix A **Case Studies** 308

Appendix B **Terms** 329

References 331

Curriculum Vitae 337

List of Tables

- 2.1 Composition of soda lime glass 58
- 2.2 Transition Temperatures Soda Lime Silicate and Borosilicate 62
- 2.3 Comparison of technical values for soda lime silica and borosilicate 63
- 2.4 CaptionHere 67
- 2.5 Characteristic tensile strength of glasses with different heat treatments 78
- 5.1 Material properties for soda lime silicate and borosilicate as obtained from (Petzold et al., 1990) 180
- 5.2 Annealing temperatures for several glass compositions (Greil, E., 1964) 189
- 5.3 Principle residual stress on specimen 194
- 6.1 Summary Pre-Validation 199
- 6.2 Summary Pre-Validation 205
- 6.3 Comparison of connections and their performance in pre-validation assessment 207
- 6.4 Additional test configurations 208
- 7.1 Comparison of feasibility of fabrication and suitability for intended application for various heat bonded connections 264
- 7.2 Mechanical properties TSSA and traditional structural silicone (Sitte et al, 2014, Haldimann et al, 2008) 267

List of Figures

- 1.1 Comparison of transparency and reflectivity single layer of glass vs multiple layers stacked 50
- 1.2 Structure of the dissertation 54
- 2.1 Molecular structure SiO crystal (quartz) 60
- 2.2 Molecular structure SiO glass (amorphous silica) 60
- 2.3 Molecular structure Borosilicate 60
- 2.4 Molecular structure SiO Na glass (Soda lime) 60
- 2.5 Schematic representation of the ratio of Volume and Temperature showing the viscous performance of glass compared to crystalline materials 61
- 2.6 Stress strain relation of steel and glass 66
- 2.7 Hot lava (Flickr) 68
- 2.8 Natural glass; obsidian (Flickr) 68
- 2.9 Goblet 'Tuthmosis III', the oldest known glass vessel, 1500 BC (Wikipedia) 68
- 2.10 Cylinder Glass Process 70
- 2.11 Crown Glass Process 70
- 2.12 Float glass process as developed by Pilkington 71
- 2.13 Glass Processing 72
- 2.14 Common glass edge treatments 75
- 2.15 Process of thermal tempering 77
- 2.16 Pattern of pre-stress through the material thickness for 1. Heat Strengthened (HS), 2. Fully Tempered (FT) and 3. Chemically Tempered (CT) glass 77
- 2.17 Glass breakage patterns with different degrees of strengthening 78
- 2.18 Light passing through a material 82
- 2.19 The electromagnetic spectrum with visible light 84
- 2.20 Comparison of glass with varying iron content 86
- 2.21 Comparison of glass edges with varying iron content 86
- 2.22 2 x12mm low iron at the on glass with VLT=88%* 86
- 2.23 5 x12mm low iron glass with VLT=83%* 86
- 2.24 20 x12mm low iron glass with VLT=57%* 86
- 3.1 Tantau Entrance Pavilion to Apple Park 91
- 3.2 Fitness centre glazing Apple Park 91
- 3.3 Perception of Transparency inside vs. outside 91
- 3.4 Day view Time Warner Facade, Columbus Circle, NY 92
- 3.5 Night view Time Warner Facade, Columbus Circle, NY (JCDA/Carpenter Lowings) 92
- 3.6 Time line Glass in architecture 93
- 3.7 St Paulus chapel, Rome 94
- 3.8 Rose Window, Chartres 94

- 3.9 Bicton Gardens glass house 96
- 3.10 Shingles 96
- 3.11 Close-up of 2-side supported overlapping shingles 96
- 3.12 Ceramic frit close up 97
- 3.13 Ceramic frit from a distance 97
- 3.14 Palm house Kew Royal Botanic Gardens (Kew Gardens) 97
- 3.15 Crystal Palace, London (Brittanica) 97
- 3.16 Faguswerk, Gropius/Meyer (worldheritage.edu) 98
- 3.17 'Glass Skyscraper' concept, Berlin, Mies v.d.Rohe (Phaidon) 98
- 3.18 Hallidie Building San Francisco 99
- 3.19 Glass pavilion Bruno Taut, external and internal view 100
- 3.20 Caption 100
- 3.21 Caption 100
- 3.22 Bauhaus Dessau, 1926 101
- 3.23 Johnson Wax Headquarters, Racine, WI, Frank Lloyd Wright 101
- 3.24 Farnsworth House, v.d. Rohe, 1951, (M. Kaletka, Flickr) 103
- 3.25 Lehmbbruck Museum, Duisburg (Knaack) 103
- 3.26 Lehmbbruck Museum, Duisburg, Base detail (Knaack) 103
- 3.27 Centre Point Link Bridge, London, 1965, Richard Seifert 104
- 3.28 Centre Point Link Bridge, fin and clamp detail 104
- 3.29 Willis Faber and Dumas headquarters, Ipswich (Foster Architects) 104
- 3.30 Willis Faber and Dumas headquarters, Ipswich (Archilove) 105
- 3.31 Sainsbury Centre of Visual Arts, F+P (F+P) 105
- 3.32 Sainsbury Centre, Glass fin facade, F+P (F+P) 105
- 3.33 Les Serres, Parc de la Villette, Paris (Knaack) 106
- 3.34 Bridle joint assembly diagram Keats Grove 108
- 3.35 Keats Grove Extension, London, RMA/DMP (image RMA) 109
- 3.36 Keats Grove Extension, London, RMA/DMP (image Brian Eckersley) 109
- 3.37 Assembly diagram Yurakucho Canopy 110
- 3.38 Yurakucho canopy, (image Glasslimited) 111
- 3.39 Facade Jong Ro building, Seoul, South Korea RVA/DMP 111
- 3.40 Development of structural glass connections over time 112
- 3.41 Apple Cube 5th Avenue version 1.0 (CB1) schematic 113
- 3.42 Apple Cube 5th Avenue version 2.0 (CB2) schematic 113
- 3.43 Apple Cube, 5th Avenue version 1.0 NYC, BCJ, 2006 (EOC) 114
- 3.44 Apple Cube, 5th Avenue version 2.0 NYC, BCJ, 2011 (EOC) 114
- 3.45 Clamped fitting George street (comparable to CB1) 116
- 3.46 Laminated fitting CB2 116
- 3.47 A-D comparing the transparency of the two structures at night and day shows the visual impact of the glass edges and the effect of light levels on the appearance of transparency 117
- 3.48 Apple Shanghai, BCJ/EOC, 2012 (EOC) 118
- 3.49 Apple Zorlu Istanbul, F+P/EOC ,2014 (EOC) 118

3.50	Dilworth Plaza subway entrance, Philadelphia (Kieran Timberlake/EOC)	119	3.70	Interlocking cast glass bricks shown at Glasstechnology Live, Duesseldorf, 2018	130
3.51	Dilworth Plaza subway entrance, detail glass support	119	3.71	Interlocking cast glass brick footbridge (Snijder, TU Delft)	130
3.52	Vakko HQ, REX (Betanzos, A.)	120	4.1	Connection typologies	134
3.53	Vakko HQ, REX (Betanzos, A.)	121	4.2	Glass connections	137
3.54	Facade Casa da Musica, Porto, OMA & ABT, 2005	123	4.3	Soldered (a), bonded (b) and welded (c) IGU edge seal	139
3.55	Close up, Facade Casa da Musica, Porto, OMA & ABT, 2005	123	4.4	Rebate glazing with wet seal (putty)	140
3.56	Facade MAS Antwerp, OMA & ABT	123	4.5	Steel channel shuffle glazing with wet seal (silicone)	140
3.57	Facade Qatar National Library, Riyadh, OMA & ABT	123	4.6	Timber window with glazing bead	141
3.58	External view of glass tube facade at CTS Museum, Hong Kong (SO-IL/ EOC)	124	4.7	Timber window	141
3.59	Laminated glass tube prior to unit assembly	125	4.8	Steel window fixed, wet sealed	142
3.60	Connection detail	125	4.9	Steel window operable, wet sealed	142
3.61	Detail of two half tubes after installation. The glass is protected with an adhesive film	125	4.10	Aluminium window, operable, dry sealed	142
3.62	Half tube detail	125	4.11	Leaded connection of two glass panels	142
3.63	Atocha Station Memorial, Madrid, FAM Architectura y Urbanismo + SBP	127	4.12	Stained glass window, Notre Dame, Paris	142
3.64	Atocha Station Memorial, brick design	127	4.13	Bicton Gardens glass house	143
3.65	Atocha Station Memorial, borosilicate bricks (image estudio sic)	127	4.14	Glass shingles at Bicton Gardens	143
3.66	Crystal Houses, Amsterdam, MVRDV, ABT, TU Delft	128	4.15	Close-up of 2-side supported overlapping shingles	143
3.67	Crystal Houses, Amsterdam, window frames made of glass extrusions	128	4.16	Detail wrought iron profile, putty glazed	143
3.68	Crystal Houses, Amsterdam, window frame and sill.	129	4.17	Detail patent glazing, dry sealed	144
3.69	Crystal Houses, Amsterdam, close-up	129	4.18	Image patent glazing	144
			4.19	Capped aluminium mullion, dry glazed	145
			4.20	Capped steel mullion, with aluminium CW mount, dry glazed	145
			4.21	Toggle fixed stick CW system	145

4.22	Clamped base shoe	146	4.45	Laminated point fitting, Apple Hamburg, 2015, (EOC)	158
4.23	Clamped base shoe with bent plates	147	4.46	Laminated longitudinal stair fitting, Apple Westlake 2016, (EOC)	158
4.24	Clamped base shoe with standard angles	147	4.47	Laminated longitudinal stair fitting, Apple Westlake 2016, (EOC)	158
4.25	Head restraint bent plates	147	4.48	Laminated fitting with clamping plate	159
4.26	Aluminium extrusion head restraint	147	4.49	Laminated fitting with clamping plate	159
4.27	Structural silicone joint	148	4.50	Laminated fitting in fin and face glass with offset stainless steel plate connection	159
4.28	Tension rod embedded in glass build-up	149	4.51	Laminated fitting in fin and face glass with offset stainless steel plate connection	159
4.29	Tension rod bonded to glass with structural silicone	149	4.52	Schematic bridle joint	160
4.30	Clamp fitting	150	4.53	Close-up of bridle joint	160
4.31	Centre Point Link bridge clamp fittings	150	4.54	Sketch detail TSSL fitting	162
4.32	Close-up of clamp fitting	150	4.55	Close up of TSSL bonded point fitting (Sitte)	162
4.33	Clamp fitting Icon Siam Wisdom Hall	151	4.56	Close up of TSSL bonded point fitting through glass (Sitte)	162
4.34	Facade Icon Siam Wisdom Hall, Bangkok	151	4.57	Sketch detail TSSL tread connection	162
4.35	Sketch detail clamp fitting Icon Siam Wisdom Hall, Bangkok	152	4.58	Close-up of bonded TSSL metal to glass connection (Hayez, Kassnell-Henneberg)	162
4.36	Close-up of clamp fitting	152	4.59	TSSL metal to glass connection (Hayez, Kassnell-Henneberg)	162
4.37	Clamped glass fitting to glass fin with pocket lamination	153	4.60	Sketch detail TSSA tread connection	163
4.38	Clamped glass fitting to glass fin with pocket lamination	153	4.61	Close-up of bonded glass tread connection	163
4.39	Bolted stair point fitting, Apple Soho, 2004 (EOC)	154	4.62	Butt joined corner	164
4.40	Grout insertion (Hilti, 2018)	154	4.63	Stepped glass corner	164
4.41	Bolted stair point fitting, circular stair	155	4.64	Stainless steel edge protection	164
4.42	Bolted base shoe	156	4.65	Image structural silicone mitred corner	164
4.43	Corner through glass connection	157	4.66	Sketch detail structural silicone mitred corner	164
4.44	Corner though fitting	157			

4.67	Sketch detail structural silicone mitred corner	164	5.15	Refraction through a material	185
4.68	ME Hotel London Foster + Partners (image Bellapart)	165	5.16	Refractive indices for Water, Borosilicate and Soda Lime Silicate	185
4.69	ME Hotel London Foster + Partners (image Bellapart)	165	5.17	Test specimen with measuring points	186
4.70	SG laminated corner - sketch detail	166	5.18	Specimen in welding jig	187
4.71	SG laminated corner outside (sedak)	166	5.19	Annealing cycle for borosilicate specimen	188
4.72	SP laminated corner inside (sedak)	166	5.20	A, B and C: residual stress under polarisation filter before and after welding and after annealing	190
5.1	Glass laboratory ware heat bonded connection	170	5.21	Temperature at 45, 405, and 675 seconds	192
5.2	Glass tube ends used to allow the manual handling of tubes	172	5.22	Temperature profile for 5 tested specimen	192
5.3	Connection of two tubes in a manual process without lathe	172	5.23	Principal residual stress on specimen prior to welding, after welding at 24° C and after annealing at 20° C	194
5.4	Lathe with custom jig for welding of straight joints	172	6.1	Initial connections manufactured to understand glass and connection behaviour	200
5.5	Welded glass tube fabricated by Schott	172	6.2	3-point bending test set-up	201
5.6	Examples of objects created with 'G3DP' process at MIT	174	6.3	Adapted vertical shear set-up	201
5.7	3D- printed objects as presented at Glasstec by QSIL, Netherlands	175	6.4	Butt joint of two 40mm tubes (2mm wall thickness). - This connection was selected as it is a common connection crafted in the manufacture of laboratory ware and it could be assessed in flexure comparing to an AR tube with the same dimensions.	202
5.8	Cross section of laser welded glass cable bundle prior and after the elongation process	176	6.5	First connection involving flat glass, 5mm rod attachment. - As welding or heat bonding flat glass is uncommon in the typical scientific glass blowing craft, thin solid rods were used to initially verify the suitability of the flat glass specimens for heat bonded connections. Due to the small diameter of the rod (D=5mm) it was assumed, that it would prove difficult to verify the strength of the connection through fracture mechanical testing.	202
5.9	Glass deformed in a CO2 laser heat induced gravity bending process (Schott, 2016)	177			
5.10	Chemical composition of Borofloat 33	179			
5.11	Specific heat capacity of Borofloat 33	182			
5.12	Thermal elongation as obtained from (Schott, 2013)	183			
5.13	Coefficient of linear thermal expansion over a temperature range up to 600°C	183			
5.14	Borosilicate rod and tube submerged in oil	184			

- 6.6 20mm tube (2mm wall thickness) attached to 50 x 200mm flat glass. - Tubular sections are commonly used in scientific glass blowing, so a tube with a small radius and wall thickness was chosen to continue feasibility studies on the manufacturing of the connections. 202
- 6.7 40mm tube attached to 50x200mm flat glass. - Increasing the area of the bond and hence the area that required heating to working temperature, larger tubes were chosen, as it was predicted that these would provide sufficient material stiffness so that load could be introduced into the connection through a shear test. 203
- 6.8 T-joint with 50mm x 200mm glass sheets - this connection was chosen, as it often occurs in architectural glass structures, i.e. glass fins connected to a facade panel or roof beams supporting flat roof panels. 203
- 6.9 'Additive' manufacturing of thin glass layers on 50mm x 200mm flat glass - Due to the absence of a 3D printing process for glass at the time the experiments were carried out, this connection was chosen to mimic an additive manufacturing process and verify the possibility of connecting thinner layers of glass. 203
- 6.10 8mm point fitting on 50mm x200 mm flat glass sheet. - The point fitting was chosen as glass in structural architectural applications is commonly connected in a discrete fashion. 204
- 6.11 50mm x 50mm fused connection - This connection was chosen to establish whether the surfaces of two sheets could be fused together without significantly distorting the appearance of the specimens. 204
- 6.12 Butt joint manufactured from two sheets of 5mm Borofloat 50mm x 200mm Butt joints are commonly used when connecting glass panels to each other in facade applications. Typically these joints are opaque silicone adhesive joints, which allow to accommodate movement as well. Despite its rigidity, this connection was chosen, as it suggests an opportunity to limit or even mitigate the reflection if light on the edge of the two glass sheets to be connected and hence increasing the perceived transparency. 204
- 6.13 Mean Load Capacity of initial connection validation 206
- 6.14 Steel clamps to allow fixation of glass in lathe 209
- 6.15 Jig set-up with steel clamps fixed to lathe to allow for rotation of specimen during welding process 209
- 6.16 Large nozzle creating wide, low temperature flame (Flame 1) 210
- 6.17 Small nozzle creating narrow, high temperature flame (Flame 2) 210
- 6.18 Both flames in use to assure consistent heating of specimen (Flame 1) whilst manufacturing the bond (Flame 2) 210
- 6.19 Annealing curve for specimens 211
- 6.20 Schematic illustration of heat bonding process 214
- 6.21 Various stages of the heat bonding process starting with adjustment of the sheets, a low temperature flame to pre-heat the glass, focused high temperature flame to perform the bond and reduced heat for cooling down. 216
- 6.22 Temperatures measured at 15 , 450 and 510 seconds 216
- 6.23 Average temperature profile for Butt-joint manufacture 216
- 6.24 Residual stress visualised through polarisation filter 216
- 6.25 Typical specimen with central butt joint 217

6.26	Specimen showing edge distortion and hairline at joint	218	6.47	First specimen with original temperature profile shows thermal fracture after release from jig	233
6.27	Distorted edge due to temperature impact and fusing of the cut edge	218	6.48	Temperature at 15, 270 and 630 seconds	234
6.28	Visible Hairline at the joint	218	6.49	The process of heating up the two glass sheets, manufacturing the bond with a focused high temperature flame and cooling down to room temperature	234
6.29	Specimen showing edge distortion and hairline with visible inclusions at joint	218	6.50	Average temperature profile for T-joint production	235
6.30	Distorted edge due to temperature impact and fusing of the cut edge	218	6.51	Residual stress visualised with polarisation filter	235
6.31	Hairline with visible inclusions (dark spots)	218	6.52	Typical T-beam specimens	235
6.32	Specimen showing slight edge distortion	218	6.53	Schematic test setup Pull-out test vertical and horizontal section	237
6.33	Slightly distorted edge due to temperature impact and fusing of the cut edge	218	6.54	Expected Moment diagram	237
6.34	Hairline not visible in this specimen	218	6.55	Test set-up with specimen prior to test	237
6.35	Schematic of 4-point bending test set-up	220	6.56	Test set-up with specimen post failure	237
6.36	4-point bending test set-up	220	6.57	Fracture patterns for T-beam specimens showing breakage origin in joint	238
6.37	Mean Fracture Load 4 Point Bending Test AR and HB specimens	221	6.58	Mean Fracture Load T- Beam Pull out test	239
6.38	Specimens after 4 point bending test. Left side heat bonded specimens (HB), right side as received (AR)	222	6.59	Mean fracture strength of specimens tested in 4Pt Bending, RoR and Pull-out test	240
6.39	Schematic illustration of HI process	224	7.1	Design process	247
6.40	Specimen in welding jig	226	7.2	Stair tread assembly	248
6.41	Schematic test set-up	227	7.3	3D printed glass objects exhibited at Glasstec 2018	252
6.42	Images test sequence CDR test	228	7.4	Detail Glass Point Fixing	256
6.43	Mean fracture Load for AR and HB specimens	230	7.5	Image HB glass Point Fixing	256
6.44	Fracture Pattern specimen 4 AR	230	7.6	Detail heat bonded glass fin connection	257
6.45	Fracture Pattern specimen 1 AR	230	7.7	Image HB T-joint	257
6.46	Schematic HB process	231	7.8	Image HB T-joint	257

- 7.9 Detail heat bonded butt joint in a laminate assembly with redundancy principles applied by staggering the bonded joints 258
- 7.10 Image heat bonded butt joint 258
- 7.11 Existing glass clad steel structure 101 California Street, San Francisco, designed by Philip Johnson 259
- 7.12 Suggested replacement with a corrugated all-glass structure 259
- 7.13 Corrugated glass roof design (image BCJ) 259
- 7.14 Detail serrated facade 259
- 7.15 Heat bonded stair tread 261
- 7.16 Arrangement of stair treads for lamination 261
- 7.17 Monolithic stair 'beam' 261
- 7.18 Arrangement of laminated mitre over welded mitre. 261
- 7.19 Cantilevered stone stair, Convento Della Carita, Venice, Palladio 1561 (image Gardiner Hallock) 262
- 7.20 Typically glass structures consist of many layers of glass, connected with opaque fittings that transfer the load. 266
- 7.21 Glass to glass connection bonded with TSSA. 266
- 7.22 Joint thickness comparing a traditional silicon joint with a TSSA joint 267
- 7.23 Monolithic stair 'beam' 268
- 7.24 Arrangement of stair treads for lamination 268
- 7.25 Lamination of SG and TSSA adjacent leading to air bubbles 269
- 7.26 Initial Stair Mock-up at sedak 270
- 7.27 Stair geometry with stepping of plies 271
- 7.28 Horizontal sketch detail at stringer ply step. Riser bonded ro stringer with SG 271
- 7.29 Sketch of updated stair concept based on a palladian cantilevered stone staircase. 272
- 7.30 Initial sketch GlasWippe 273
- 7.31 Detail of central acrylic bearing block 274
- 7.32 Acrylic bearing block and rod 274
- 7.33 Transparent composite pivot connection 275
- 7.34 Concept of transparent edge seal in vertical joints, while horizontal concealed joints contain desiccant 276
- 7.35 Transparent edge seal made by Scholl Glas 278
- 7.36 Glass edge seal Sedak Isopure 278
- 7.37 Transparent Glass edge seal presented by DowSil, as seen at Glass Performance Days, Tampere 2019 279
- 7.38 Lightweight IGU made with ultra thin glass laminates (0.7mm+0.7mm/CAV/0.7mm+0.7mm) 281
- 7.39 Model of flexible ventilation panel 282
- 7.40 Concept of flexible ventilation panel 283
- 7.41 Precedent External skin Unilever HQ Hamburg, Behnisch Architekten, 2009 283
- 8.1 Time line Glass in architecture 300
- 8.2 Finalised seesaw installed at BAU Munich, 2019 328



Wayfarers Chapel, Rancho Pálos Verdes, CA, Lloyd Wright



Stained Glass Wall, MIT Chapel, Boston MA, Eero Saarinen

If we knew what it was we were doing,
it would not be called research, would it?

Albert Einstein



Orion E. Scott Memorial Chapel, Drake University, Des Moines, IA, Eero Saarinen

Summary

The nature of glass and its transparency has fascinated architects and builders for centuries. The nature of the material is also what has been the limiting factor for its use. Particularly its brittleness and hence its tendency to break has been the limitation for the design with glass.

Glass differs from other (building) materials in the way that it is not defined by its composition but its molecular state. Glass has an amorphous molecular structure as opposed to the crystalline structure metals and other solids are characterised by. This is what makes it isotropic as well as transparent.

Theoretically glass is very strong - about 50 times as strong as steel - but due to structural defects and surface scratches, the practical load capacity is significantly lower (30-80 MPa for annealed glass). This means that the processing of glass and the quality of the edges, where cuts have been made, is of fundamental importance to the quality of the material and to its design strength.

Thermal and chemical tempering processes are available to increase the strength of the material, however these come with visual implications and other risk factors like NiS inclusions that might lead to spontaneous breakage. Despite those, for structural use, typically strengthened glass is used. To increase redundancy and avoid collapse of all-glass structures, the glass in structural applications is typically laminated.

Whilst the bending strength is limited by surface flaws, glass remains strong in compression; but in typical envelope applications, it is primarily used in bending.

Its transparency is the property that differentiates glass from most other building materials. There are various factors that affect the perception of transparency, however its basic metric is the quantity of light that passes through a material, which can be described as transmission. In addition to the transmitted light, there is a percentage of light being reflected and absorbed. The absorbed light is what is visible as colour in the glass, which plays a significant role in the way we perceive its transparency.

Next to the transparency, one of the most important properties of glass is its excellent chemical resistance to many aggressive substances, which explains its popularity in the chemical industry.

Glass does not corrode, making it very durable - in fact one of the most durable materials used in construction. Furthermore, because glass is a homogeneous material which can be molten and reshaped, glass is highly recyclable and therefore sustainable when it can be broken down sufficiently and recycled with use of renewable primary energy.

The use of glass has typically brought designers engineers and builders to the limits of their abilities, whether this was driven by the processing and handling of the material, or the limitation in the understanding of its design capacity.

Although glass is one of the oldest man-made materials, which has been used for more than 1000 years to provide shelter from the environment in buildings, its structural use has only developed over the past 150 years and as a formally structural material over the past 40-50 years.

Transparency however, has always played a role in the design with glass and often design was driven by the aim to optimise and increase the transparency of a structure. As I.M. Pei expressed it in relation to the design of the Louvre Pyramid; *"The scope for the structural engineer, [...] was that of building a structure as transparent as technology could reach"* (Knoll, 1990)

Through analysis of the development of glass architecture over time, this thesis concludes that the use of glass can be categorised into the following 4 categories:

- 1 **Bracing:** Glass to brace a (steel) frame
 - a Informally (Glass is used to brace slender iron structures despite the fact that no means of analysing it's performance was available)
 - b Formally (Glass is used to brace a steel structure and provide lateral stability knowingly and with a good understanding of the load path)
- 2 **Tertiary:** Glass transferring wind loads
- 3 **Secondary:** Glass supporting itself
- 4 **Primary:** Glass as a primary structure

Given the manufacture and processing of glass and its availability as a sheet material, its connectivity becomes the primary importance in its design, both from an architectural and engineering perspective because:

- 1 Connections, particularly if discrete, induce large stresses into the glass
- 2 Connections are typically opaque and hence have a significant impact on the design language

Common forms of glass connections are not transparent and typically involve the use of other materials. This means that the design and appearance of a glass structure is largely defined by the way it is connected.

A significant evolution can be noted in the way glass is being connected from the first use as an infill material to its use as a structural component supporting itself, but also other materials or building components.

A differentiation in typology can be made between linear and discrete connections, describing the occurrence of the connection made, which will lead to a difference in appearance.

Within each typology the following categories occur:

- 1 Bearing connections
- 2 Friction connections
- 3 Bonded connections

Whilst bearing and friction connections typically rely on an opaque material on the surface of the glass or embedded within it to transfer the load, bonded connections provide the opportunity to achieve fully transparent connections either by:

- 1 Use of a transparent adhesive
- 2 Use of heat (heat bonding)

To date, fully transparent connections have primarily been explored on an experimental basis, although few built examples using transparent bonding materials (primarily UV resin) to connect glass to glass exist.

The approach of using a heat-based process, which could be described as welding or more precisely heat bonding, is a common process in the manufacture of laboratory ware for chemical testing and analysis.

Typically, this is a manual process, in which glass is heated and then bonded and formed into its final shape. The basis for this process is extruded borosilicate tube material and solid rods.

This approach has been explored in this thesis and tested on an experimental basis as relates to its relevance and appropriateness to flat glass for building applications.

Various connections were manufactured using flat borosilicate as a base material and the standard equipment available in a glass blowing lab (burner and lathe) utilising custom jigs that allow to fit flat glass into the lathe.

Prior to experimental testing of the connections themselves, the impact of a thermal bonding process on the material properties was assessed. It was found that residual stress induced during the bonding procedure can be released through an annealing process and results suggest, that both stress levels and distribution are comparable to untreated float glass. The results summarised in this thesis are only indicative and limited to the capacity and tolerances of the measurement equipment as well as the quality and quantity of the specimens tested. Furthermore, tests have not been carried out on full size specimens, which means that further research is required to verify the applicability of the results to full scale building components.

Following the assessment of residual stress, the strength of the connections was established through fracture-mechanical testing. The results suggest that it can be assumed that heat bonded connections can be as strong as the parent material if processed carefully and annealed sufficiently. However, as with the residual stress tests, these results are only indicative, as the number of specimens tested and the scale of the specimens tested is not sufficiently representative to the architectural scale of connections required to make a fully conclusive statement, suggesting that further research will be required.

As relates to the quality of the connections themselves, the manual process used for their fabrication in this research bears a high risk, as it is relying on manual control of temperatures and pressure when establishing the bond, hence achieving fully homogeneous connections that are geometrically consistent, proved to be challenging. Due to the brittleness of the material, this in turn might lead to a reduction in load capacity, as stress concentrations might occur around areas of inconsistency.

The practical implementation from a design perspective must consider redundancy, which is a common aspect of glass engineering and which can be approached similarly to the way it is typically approached when designing with glass, by introducing:

- 1 A safety factor and hence over-designing connections
- 2 Additional connections and additional means of connection like the lamination with polymer interlayers
- 3 Designing to allow a secondary load path should the primary load path be compromised
- 4 Risk management: evaluating the risk of failure and the risk of potential damage in case of failure. This includes the categorising of risk for the use of the application. (i.e. a public building or highly trafficable structure like a stair in a commercial application would require a larger amount of built-in redundancy than a balustrade in a private house).
- 5 Engineering precision: The more detailed the load path and the loads and building movements are understood, the smaller can the margin be for a safety factor. Detailed FE analysis and well understood loading criteria are the basis for this approach, which is typically used in other industries of high performance engineering like aviation or competitive transport like motor sport and racing yachts.

The fundamental improvement that the heat bonding process offers over traditional glass connections is that it allows to reduce the amount of visible edges, as the material is not only bonded on the surface, but an atomic bond is achieved. This increases the perceived transparency, as the reflection is limited to the external surface.

In addition to the physical possibility and verification of the feasibility of heat bonded connections, jurisdiction related to the design of building structures needs to be considered locally and globally. Given that structural glass engineering is a relatively young discipline, very few codes and guidelines specific to the material are available.

Despite the initial results, which suggest that heat bonded connections can be nearly as strong as the parent material and hence could be designed based on established material values, it has to be assumed that the sufficient homogeneity of the bond is not achievable in a manual process. The use of laser technology appears to provide a good opportunity to improve the quality in the bond and the appearance, due to a much smaller area that is exposed to the temperature impact compared to a manual welding process. Other issues around fabrication and quality control might also be resolved with the implementation of laser technology; however, this has not been assessed in this research and the judgement is purely based on the application of comparable technology in the connection process of glass in different fields.

Fibre optics are relevant here and particularly a laser based gravity bending process that is being used on a comparable scale to the specimens tested in this research.

When assessing design possibilities however, it is understood to be of fundamental importance to evaluate a technology at full scale.

Various concepts were developed for the design applicability of heat bonded connections, which theoretically (verified through initial design analysis) appear to be feasible, however it was not possible to translate them into full scale physical studies as part of this dissertation.

During the time of this research however, transparent structural silicones became commercially available and particularly a Transparent Structural Silicone Adhesive (TSSA) which is a sheet material produced by Dow. Although TSSA has various limitations in its processing, i.e. the requirement for autoclaving under temperature impact to trigger the curing process, the fabrication of transparent connections with TSSA was more accessible, hence some of the concepts outlined for a heat bonding process were tested using a transparent adhesive and specifically TSSA.

The case studies outlined in the Appendices to this document indicate the degree of transparency achievable with transparent structural bonds.

When connecting glass to glass with a transparent bonding material, it is primarily the colour of the glass that is visible, mostly through the reflection of light on the edge that is being connected.

This reflection of light on the glass edge is the fundamental difference in the appearance of heat bonded connections compared to a transparent adhesive bond. This is where heat bonding can achieve a higher degree of perceived transparency than adhesive bonds.

Due to the availability of long term test data for silicone materials in relation to the application with glass in buildings, it is assumed that the transparent structural silicones might offer a faster and more reliable route for the implementation of fully transparent connections, despite the limitation that a fully transparent appearance to the degree heat bonding can achieve is not possible.

This however should be understood as a mid-term solution only, which comes with additional limitations like susceptibility to moisture as well as long term (UV-) stability and particularly recycling when compared to a pure glass-glass connection.

The primary goal of this research is the intention to identify and assess the technical feasibility and constraints of transparent mono-material glass connections, demonstrating current possibilities for fabrication and application whilst identifying technical limitations to overcome to allow an implication for their use in glass structures. Heat bonded connections are manufactured, evaluated and tested at an experimental scale to indicate opportunities for the fabrication and application. Possibilities for design and application are outlined. However, to further assess the viability of heat bonded connections, additional research is required in various fields. It is suggested that experimental testing is carried out in larger series of replicable connections to verify and further elaborate on the results gained through this research.

Whilst the implementation of heat bonded connections appears theoretically feasible, the exploration of this field is at its very beginning and further research is required to assess the implementation of the process into glass fabrication and processing.

This does not only include the scalability of the connections and technology but also involves considerations around transport, handling, installation, the accommodation of building movements and tolerance as well as maintenance, replacement and recyclability.

Whilst many of the factors described appear to be feasible, there is currently and within the scope of this research no possibility to assess this in practice, as the fabrication of connections to assemble full scale components has not been possible as part of this research; However the outcomes of this dissertation may serve to outline and guide further exploration of the specific topic as well as the wider research field.

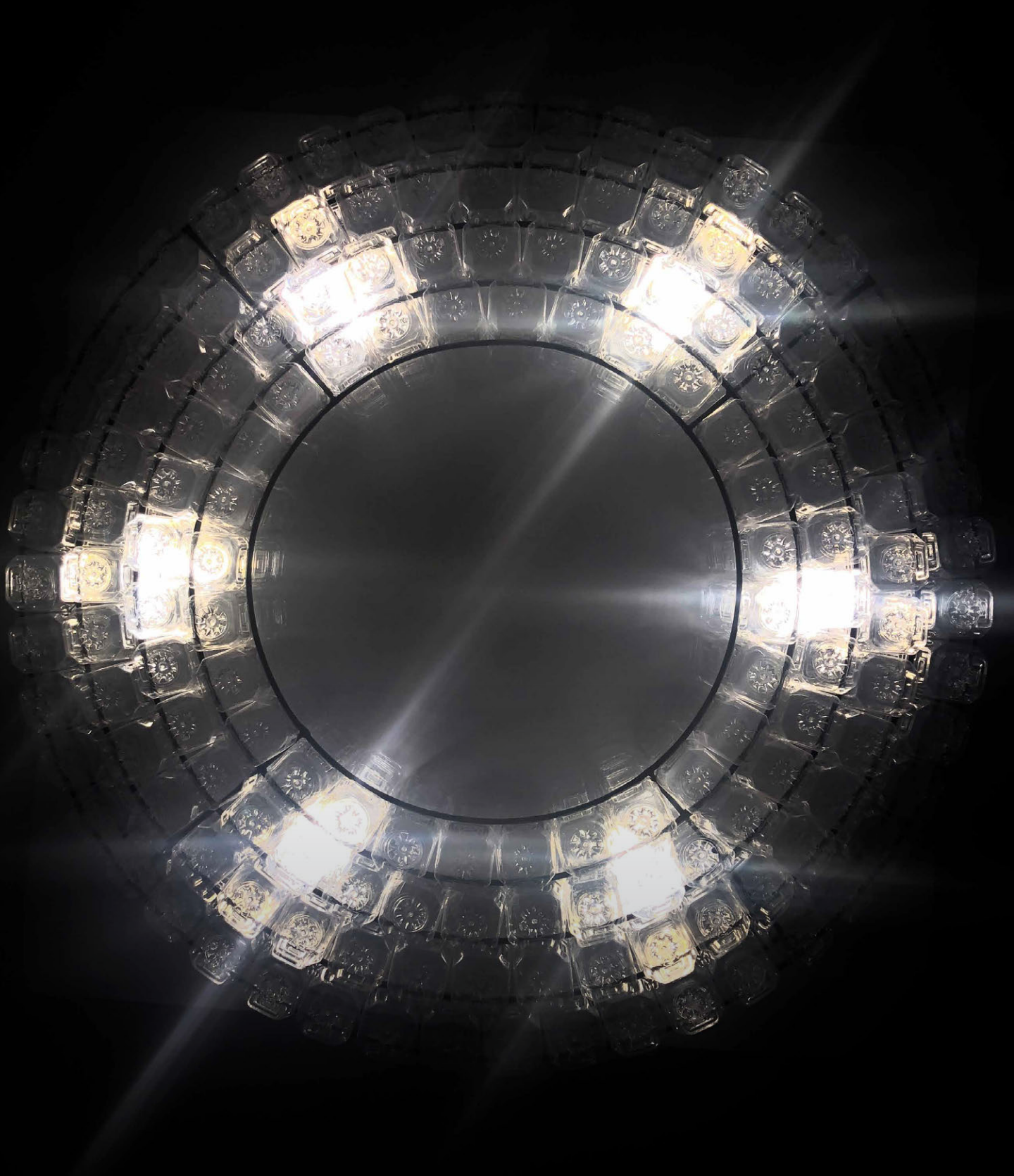

Light Installation, Marta, Herford

Samenvatting

Het karakteristieke van glas, namelijk zijn doorzichtigheid, heeft architecten en bouwers al eeuwenlang gefascineerd. De eigenschappen van het materiaal beperken daarnaast ook het gebruik. Met name de broosheid en de daaruitvolgende breekbaarheid zijn eeuwenlang beperkende factoren geweest om met dit materiaal te ontwerpen en praktisch toe te passen.

Glas onderscheidt zich van andere (bouw)materialen doordat het niet door zijn samenstelling, maar door zijn structuur wordt gekenmerkt. De moleculaire structuur is amorf in tegenstelling tot de kristallijne structuur van metalen en andere vaste stoffen. Dit maakt het zowel isotroop als transparant.

Theoretisch is glas bijzonder sterk, namelijk ongeveer 50 keer zo sterk als staal, maar door structurele defecten en oppervlakkige krassen is het praktische draagvermogen aanzienlijk lager (30–80 MPa voor gegloeid glas). Dit betekent dat bij de verwerking van glas de kwaliteit van de randen, waar de snedes worden gemaakt, van essentieel belang zijn voor de kwaliteit en de sterkte van het materiaal.

Thermische en chemische hardingsprocessen zijn beschikbaar om de sterkte van het materiaal te vergroten, maar deze hebben visuele implicaties. Andere risicofactoren, zoals NiS-insluitingen, kunnen tot spontane breuk leiden. Desondanks wordt voornamelijk gehard glas voor constructies toegepast. Om de betrouwbaarheid te vergroten en het instorten van volledig glazen constructies te voorkomen, wordt het glas in constructieve toepassingen nagenoeg altijd gelamineerd.

Terwijl de capaciteit voor buigspanning laag is en voor drukspanning hoog, wordt glas in facade toepassingen voornamelijk op buigspanning belast.

Transparantie is wat glas onderscheidt van de meeste andere bouwmaterialen. Er zijn verschillende factoren die de waarneming van transparantie beïnvloeden, maar in de kern gaat het om de hoeveelheid licht die door het materiaal valt. Dit kan worden omschreven als transmissie. Naast het doorgelaten licht wordt een percentage hiervan gereflecteerd en geabsorbeerd. Het geabsorbeerde licht is zichtbaar als de kleur van het glas, wat een belangrijke invloed heeft op hoe wij de transparantie ervan waarnemen.

Een van de meest belangrijke eigenschappen van glas, naast die van de transparantie, is de uitstekende chemische bestendigheid tegen agressieve stoffen, wat de populariteit in de chemische industrie verklaart. Glas corrodeert niet, waardoor het zeer duurzaam is. Het is in feite een van de meest duurzame materialen die in de bouw wordt gebruikt. Omdat glas een homogeen materiaal is, dat kan worden gesmolten en opnieuw gevormd, leent het zich goed voor hergebruik. Het is duurzaam als het wordt afgebroken en gerecycled met gebruik van hernieuwbare energie.

Het toepassen van glas heeft ontwerpers, ingenieurs en bouwers vaak tot het uiterste van hun expertise gedreven. Dit komt door de speciale kennis die voor het verwerken en behandelen van het materiaal en het vereiste inzicht van de beperkingen bij het ontwerpen nodig is.

Glas is een van de oudste door mens gemaakte materialen, dat al meer dan duizend jaar wordt gebruikt om in gebouwen beschutting te bieden, is structurele beglazing pas in de afgelopen 150 jaar ontwikkeld. Daarnaast wordt glas als constructie materiaal pas sinds de laatste 40-50 jaar toegepast.

Transparantie heeft echter altijd een rol gespeeld in het ontwerp met glas. Het werd vaak toegepast om de transparantie van een constructie te optimaliseren. Zoals I.M. Pei het uitdrukte in relatie tot het ontwerp van de Louvre-piramide; “The scope for the structural engineer, [...] was that of building a structure as transparant as Technology could reach” (Knoll, 1990)

Bij het beschouwen van de ontwikkeling in de tijd van de glasarchitectuur komt deze dissertatie tot een verdeling van glastoepassingen in vier categorieën:

- 1 **Verankering:** Glas om een (stalen) constructie te verstevigen.
 - a Informeel (glas wordt gebruikt om slanke ijzeren constructies te ondersteunen ondanks het feit dat er geen mogelijkheid was om de prestaties ervan te analyseren)
 - b Formeel (Glas wordt gebruikt om een staalconstructie te verstevigen en om bewust en met een goed inzicht van het krachtswerking voor zijdelingse stabiliteit te zorgen)
- 2 **Tertiair:** Glas dat windbelastingen overdraagt
- 3 **Secundair:** Glas dat zichzelf ondersteunt.
- 4 **Primair:** Glas als primaire constructie.

Gezien de productie en verwerking van glas en het beschikbaar zijn als plaatmateriaal, zijn de verbindingen van groot belang in het ontwerp, zowel vanuit architectonisch als technisch oogpunt omdat:

- 1 als deze discreet gebruikt zijn, veroorzaken de verbindingen grote spanningen in het glas.
- 2 doordat zij meestal niet transparant zijn, beïnvloeden zij in hoge mate het esthetische beeld.

Veel voorkomende glasverbindingen zijn niet transparant. Zij bestaan meestal uit andere materialen. Dit betekent dat het ontwerp en de uitstraling van een glasconstructie voor een aanzienlijk deel wordt bepaald door de manier waarop deze is verbonden. Er is in de loop der tijd veel veranderd in de manier waarop glas wordt verbonden. In het begin wordt glas gebruikt als invulmateriaal, tegenwoordig als een constructief element dat zichzelf, dat ook ander materiaal of bouwelementen draagt.

De kenmerken van een lineaire of een discrete verbinding zorgen ieder voor zich een ander soort aanblik. Bij iedere verbindingstype kunnen de volgende categorieën onderscheiden worden:

- 1 Dragende verbindingen
- 2 Klemmende verbindingen
- 3 Verklevende verbindingen

Terwijl dragende en klemmende verbindingen doorgaans van een ondoorzichtig materiaal op het oppervlak of in het glas voorzien zijn, kunnen verbindingen volledig transparantie bieden bij gebruik van:

- 1 Gebruik van een transparante lijm.
- 2 Gebruik van warmte (heat bonding).

Tot op heden zijn volledig transparante verbindingen voornamelijk op experimentele basis onderzocht. Om glas met glas te verbinden zijn bijvoorbeeld transparante hechtmaterialen (voornamelijk UV-hars) gemaakt. Een op warmte gebaseerd proces, zoals lassen of beter gezegd versmelten, is een veelgebruikt proces bij de productie van laboratoriumglas voor chemische proeven en analyses. Meestal is dit een handmatig proces, waarbij glas wordt verwarmd en vervolgens verlijmd om zo zijn definitieve vorm te krijgen. De basis voor dit proces zijn buisglas en massieve glasstaven van geëxtrudeerd borosilicaat (hittebestendig glas). Deze bewerking is in dit proefschrift onderzocht en experimenteel getoetst op zijn relevantie en bruikbaarheid voor glaspanelen in de bouw.

Verschillende verbindingen met borosilicaat plaat als basismateriaal worden vervaardigd met de standaard uitrusting uit een glasblaaslaboratorium (brander en draaibank) en met behulp van aangepaste mallen waarmee glaspanelen in een draaibank kunnen worden geplaatst.

Voorafgaand aan het experimenteel testen van de verbindingen zelf, wordt de impact van een thermisch hechtproces op de materiaaleigenschappen beoordeeld. Het blijkt dat een opbouw van spanning in het materiaal na het hechten achterblijft, maar dit kan door uitgloeien worden verminderd. De resultaten laten zien dat zowel het spanningsniveau als de verdeling hiervan vergelijkbaar zijn met onbehandeld floatglas. De resultaten samengevat in dit proefschrift zijn slechts indicatief en beperkt tot de capaciteit en toleranties van de meetapparatuur, evenals de kwaliteit en kwantiteit van de geteste monsters. Bovendien zijn er geen tests uitgevoerd op monsters op ware grootte, zodat verder onderzoek nodig is om de toepasbaarheid van de resultaten op volwaardige bouwcomponenten te verifiëren.

Na de beoordeling van de opgebouwde spanning werd de sterkte van de verbindingen door mechanische testen op breuk bepaald. De resultaten lijken aan te tonen dat versmolten verbindingen net zo sterk kunnen zijn als het moedermateriaal als ze zorgvuldig worden toegepast en voldoende worden uitgloeid. Echter, net als bij de test op opgebouwde spanning, zijn deze resultaten slechts indicatief, aangezien het aantal en de omvang van de geteste exemplaren niet voldoende representatief zijn voor de verbindingen die in de praktijk gebruikt worden. Dit toont aan, dat ook op dit onderdeel verder onderzoek nodig is.

Met betrekking tot de kwaliteit van de verbindingen zelf is het handmatig vervaardigen hiervan minder betrouwbaar. Het handmatig controleren van de temperatuur en ook van de druk bij het tot stand brengen van de verbinding vormen een uitdaging om een volledig homogene verbinding te verkrijgen die geometrisch consistent is. Spanningsconcentraties kunnen optreden rond gebieden met een inconsistente hechting. Spanningsconcentraties kunnen hierin optreden, wat op zijn beurt kan leiden tot een vermindering van het draagvermogen vanwege de broosheid van het materiaal.

Na het ontwerp stadium moet bij een praktische toepassing van glasverbindingen met een aantal reserves rekening worden gehouden. Men moet, wat in glastechniek gebruikelijk is, hierbij denken aan:

- 1 veiligheidsfactoren: door verbindingen te overdimensioneren.
- 2 extra verbindingen en technieken zoals laminering: met een polymeer als tussenlaag.
- 3 een tweede draagweg implementeren als de primaire opvang het begeeft.

- 4 risicomanagement: het evalueren van het risico op falen en het risico van gevolgschade. Zoals een risico inventarisatie van een applicatie. Met andere woorden, een openbaar gebouw of een begaanbare constructie zoals een trap in een openbare/commerciële toepassing vergt een grotere hoeveelheid ingebouwde redundantie dan een balustrade in een woonhuis.
- 5 technische precisie: hoe gedetailleerder de krachtswerking en bewegingen van het gebouw in kaart gebracht worden, hoe kleiner een veiligheidsfactor hoeft te zijn. Een nauwkeurige „FE analyse“ en helder omschreven belastingscriteria vormen de basis voor deze aanpak, die zo typerend zijn bij technisch hoog ontwikkelde industrieën zoals de luchtvaart, de competitieve motorsport of racejachtbouw.

De fundamentele verbetering die het versmelten biedt ten opzichte van traditionele glasverbindingen, is dat het de hoeveelheid zichtbare randen vermindert. Het materiaal hecht niet alleen aan het oppervlak maar gaat ook een moleculaire binding aan. Dit verhoogt de waargenomen transparantie, omdat reflectie beperkt wordt tot het glasoppervlak.

Naast het onderzoek naar de eventuele haalbaarheid van smeltverbindingen zal ook de lokale en internationale wet- en regelgeving met betrekking op het ontwerp van bouwconstructies moeten worden aangepast. Aangezien constructieve glastechniek een relatief jonge discipline is, zijn er zeer weinig codes en richtlijnen beschikbaar die specifiek gericht zijn op dit materiaal.

De eerste resultaten suggereren dat smeltverbindingen nagenoeg net zo sterk kunnen zijn als het moedermateriaal en deze daarom kunnen worden ontworpen op basis van vastgestelde materiaalwaarden. Een voldoende homogene binding is echter met een handmatige techniek niet haalbaar. Het gebruik van lasertechnologie blijkt een goede oplossing te bieden om de kwaliteit van de verbinding en het uiterlijk te verbeteren. Dit komt omdat een kleiner gebied wordt blootgesteld aan de temperatuurimpact in vergelijking met een handmatige techniek. Andere problemen rond fabricage en kwaliteitscontrole kunnen ook worden opgelost met de implementatie van lasertechnologie; dit is echter in deze studie geen onderwerp geweest. Deze veronderstelling is puur gebaseerd op de toepassing van vergelijkbare technologie voor het verbinden van glas bij andere vakgebieden. Glasvezel optiek is hierbij een relevant voorbeeld en met name een op laser gebaseerd zwaartekracht buig proces dat op een vergelijkbare schaal wordt toegepast als de test exemplaren van dit onderzoek.

Voor het beoordelen van de ontworpen toepassingen wordt het echter van essentieel belang geacht om de technologie in de praktijk op grotere schaal te evalueren. Er zijn daarom verschillende concepten ontwikkeld voor de toepasbaarheid van de ontworpen smeltverbindingen, die theoretisch (geverifieerd door initiële ontwerpanalyse) haalbaar lijken. Maar het is niet mogelijk om dit als onderdeel van dit proefschrift te vertalen naar fysieke studies op volwaardige schaal.

Tijdens deze studie kwamen er echter transparante siliconen voor de bouw op de markt, in het bijzonder de „Transparant Structural Silicone Adhesive“ (TSSA), een plaatmateriaal geproduceerd door Dow. Hoewel TSSA bij de productie verschillende beperkingen kent, zoals het moeten autoclaveren onder invloed van temperatuur om het uit te harden, is het aanleggen van verbindingen met transparante TSSA meer toegankelijk. Vandaar dat ook sommige concepten die voor op hitte gebaseerde verbindingen zijn ontworpen, met behulp van een transparante lijm zoals specifiek TSSA getest zijn.

De case study's die in de bijlage van dit document worden beschreven, geven de mate van transparantie aan die kan worden bereikt met doorzichtige constructieve verbindingen.

Bij het hechten van glas aan glas met een transparant hechtmateriaal wordt de kleur van het glas zichtbaar, meestal door de weerkaatsing van licht op de hechtvlak.

Deze lichtreflectie op de glasrand is het voornaamste verschil in het uiterlijk tussen warmtegebonden verbindingen en transparante lijmverbindingen. Dit is waar warmtebinding een hogere mate van waargenomen transparantie kan bereiken dan lijmverbindingen.

In de toekomst worden testgegevens voor siliconen hechtmaterialen bekend die betrekking hebben op glastoepassingen in de bouw. Verondersteld wordt dat de transparante constructieve siliconen een snellere en meer betrouwbare route kunnen bieden voor het realiseren van meer transparante verbindingen. Maar ook een smeltverbinding zal zijn beperking in een volledige transparantie hebben.

Dit moet echter beschouwd worden gezien als een oplossing voor de middellange termijn. Er zullen beperkingen bestaan in de gevoeligheid voor vocht, als ook langdurige (UV-) stabiliteit en met name hergebruik wanneer men het vergelijkt met een puur glas-op-glas-verbinding.

Het primaire doel van dit onderzoek is om de technische haalbaarheid en beperkingen van transparante mono-materiaal glasverbindingen vast te stellen en te beoordelen, de huidige mogelijkheden voor fabricage en toepassing aan te tonen en tegelijkertijd technische beperkingen te identificeren die moeten worden overwonnen om een implicatie voor hun gebruik in glas constructies mogelijk te maken. Door warmte verkregen verbindingen worden op experimentele schaal vervaardigd, geëvalueerd en getest om de mogelijkheden voor fabricage en toepassing aan te geven. Daarnaast worden de opties voor ontwerp en toepassing geschetst. Om de duurzaamheid van warmte gebonden verbindingen verder te beoordelen zal aanvullend onderzoek op verschillende gebieden nodig zijn. Voorgesteld wordt dat experimenten met een groter aantal repeterende verbindingen worden opgezet om de resultaten die met dit onderzoek zijn verkregen, te verifiëren en verder uit te werken.

Hoewel de implementatie van warmte gebonden verbindingen theoretisch haalbaar lijkt, staat de verkenning van dit veld nog aan het begin. Verder onderzoek is nodig om de implementatie van het proces in glasfabricage en -verwerking te beoordelen. Daarbij gaat het niet alleen om de schaalbaarheid van de verbindingen en techniek, maar ook om afwegingen rond transport, verwerking, installatie, het opvangen van bewegingen en toleranties, verder om onderhoud, vervanging en herwinbaarheid.

Terwijl veel van de beschreven factoren haalbaar lijken, is het nu binnen het bestek van dit onderzoek niet mogelijk om dit in de praktijk te beoordelen, aangezien het op grote schaal vervaardigen van verbindingen niet mogelijk was. De resultaten van dit proefschrift kunnen echter als basis dienen om het specifieke onderwerp verder te verkennen en ook als bron voor een breder onderzoeksveld.

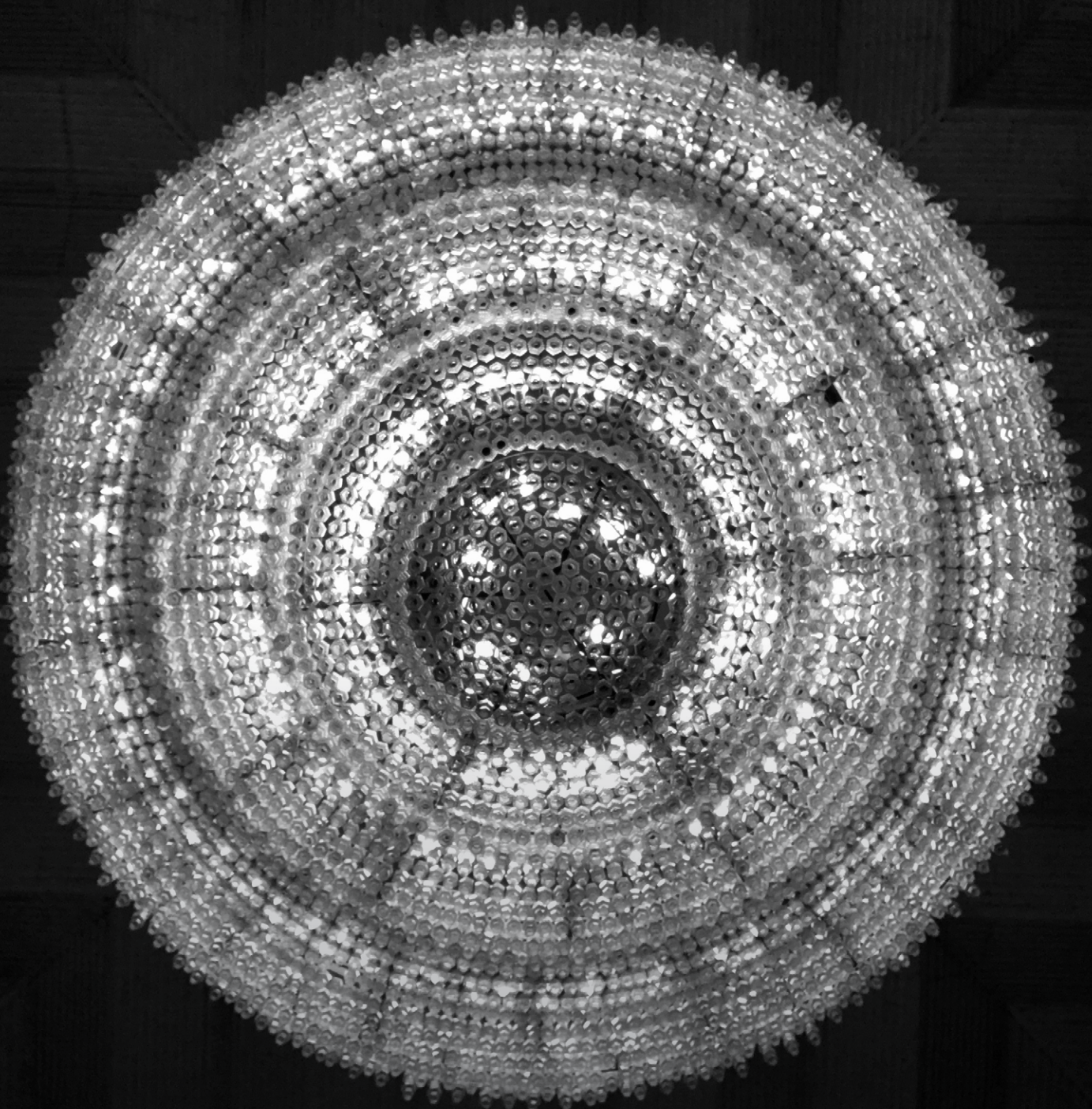

Chandelier, Santuário Dom Bosco, Brasília, Carlos Alberto Naves

1 Introduction

1.1 Research background

Glass is one of the oldest man-made materials known (Schittich et al, 2007), with beads and vessels dating back to 3500 BC , however in buildings it can only be found since approximately 1000 years. Even more significantly, it's use as a structural component is a recent development, which started with the glass and wrought iron structures developed at the end of the 19th century. In those early glass structures, the glass served not only to form an envelope but to also participate in bracing the slender iron framing elements. It took another 100 years before the first all-glass structures were built.

Although more recently, in the last 30 years, glass has increasingly been used as a structural component, its inherent brittleness still requires opaque metal connections to transfer loads. This is due to the fact that glass is very strong in compression but not in bending. (Petzold, 1990) The connections used are commonly stainless steel or titanium fittings that are bolted through or embedded in the glass build-up to transfer loads. These connections define contemporary glass architecture – firstly, because they are immediately apparent in a transparent structure and, secondly, they are part of the engineering design language. Because glass is transparent, any form of connection becomes visible. Meaning that if glass is not set in a frame around its perimeter, which leaves the frame to transfer any load implied on the surface, but connected locally to another glass panel, these connections become very evident in the overall architectural language. Although the development in glass technology has allowed the production of larger glass panels and reduced the need for joints and consequentially connections required to create large facades or structures, these still dominate the appearance. Designers and architects aim to increase the transparency of building envelopes and structures, hence there is a strong demand to reduce the visibility of structural connections in glass.

1.2 Problem statement

Various technical developments related to the fabrication and processing of the material, as well as a better understanding of its mechanical behaviour increased the transparency in glass structures; This is driven primarily by a significant change in fabrication technology, allowing for the manufacture of larger panels, which in turn reduces joints and connections. In addition, the connections themselves became smaller.

However, the evolution of structural glass connection design has reached a point where developments are marginal as relates to the improvement of transparency within the connection itself.

To achieve a sufficient advancement towards more transparent connections, it is required to move away from metal connections and towards other - more transparent - means of connecting glass to glass.

To achieve this, various approaches are feasible. One would be to produce a mono-material connection which would not rely on a different material to transfer loads from one glass panel to the next.

Although atomic bonds achieved through welding have been used in scientific glass blowing labs for a long time to fabricate, alter and repair glass laboratory ware, statistical data about the visual and structural performance of these connections is not widely available.

Welding is a fabrication process in which materials are joined using heat. The material is molten and sometimes pressure is used to form a joint (weld). Typically also a filler material is used in addition to melting the base material, forming a pool of molten material typically referred to as the weld pool.

In the process of scientific glass blowing however, no additional material is added to form the bond, hence the term heat bonding is used to describe the process explored in this dissertation.

Welded or heat bonded connections offer a significant potential for creating transparent connections, which is understood because it is a common technique used in the production of laboratory ware. Extensive research was undertaken in the field of lamination with viscoelastic materials and bonding with different types of transparent adhesives (Puller, 2012; Santasiero, 2015), however thermal bonding is a relatively unexplored field.

A gap can be identified between available technology for one field of application (production of glass laboratory ware) and another field of application (glass structures and envelopes) for which this technology is currently not available; There are various reasons why the technology transfer between the two fields previously described has not occurred. Firstly, the float glass fabrication process has not changed significantly since its invention in 1952, it is optimised to produce high quality glass in large quantities. The processing is also primarily a highly engineered and largely automated process, whereas the fabrication process for laboratory ware in a scientific glass blowing lab is a predominantly artisan procedure.

Secondly there is a significant difference in size of the components – laboratory ware is small enough to be easily handled to allow for manual processing using heat and keeping the entire specimen in the flame to avoid thermal shock, whilst larger components would require an oven to carry out the process of bonding to avoid breakage caused by temperature differentials.

These are not technical limitations driven by the material though, but are purely equipment based, which suggests that they could be overcome.

Although the size to which glass can be fabricated and processed has increased significantly and connections have reduced in size and developed in their appearance and performance, the principle of the connectivity remains very similar and developments are marginal as relates to the improvement of transparency within the connection itself.

Wherever connections are made, not only the fitting, but also the glass edges are visible, causing reflections that reduce the perception of transparency. This is due to the fact that the transparency of a material is a result of the combination of transmission, absorption and reflection. When more light is reflected, the component not only transmits less but it also appears less transparent (Figure 1.1). A mono-material connection that allows to bond two pieces of glass and reducing or eliminating the visibility of the edge, could increase the perception of transparency significantly.



Single sheet



2 sheets

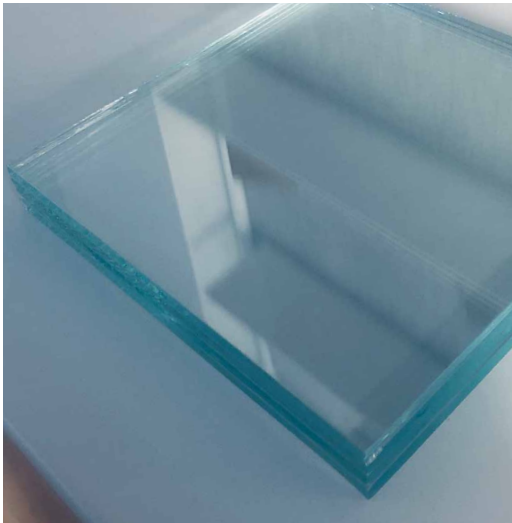

4 sheets



Multiple sheets stacked

FIG. 1.1 Comparison of transparency and reflectivity single layer of glass vs multiple layers stacked

1.3 Research Objectives

The research seeks to expand the knowledge focusing on the investigation of existing glass connections and the development and evaluation of more transparent, primarily mono-material glass-glass connections. The central objective is to determine whether the current state of the art in connection design and fabrication can be improved by implementing a heat bonding technique, aiming to achieve glass connections with an increase in transparency.

The overall goal of this research is to improve the perceived transparency of glass envelopes and structures by exploring heat bonding and evaluating its potential through experimental testing.

This dissertation addresses the knowledge gap between available technology for one field of application (production of glass laboratory ware) and another field of application (glass structures and envelopes) for which this technology is currently not available.

It contributes by aiming to develop an approach for mono material glass connections and exploring its potential in respect to transparency and structural properties.

1.4 Research Questions

The central objective of the research is to identify whether the current state of the art in connection design and fabrication can be improved by implementing a heat bonding technique, aiming to achieve glass connections with an increase in transparency.

The methodology outlined in this document is based on the main research question as follows:

‘With heat bonded glass connections which criteria increase the perceived transparency and what is their potential for implementation in the design of glass structures?’

The above stated research question is supported by the following sub-questions:

- 1 *What are the most important properties for the application of glass as a building material in respect to its physical properties, its material origin and the properties defining transparency?*
- 2 *In which categories can the structural use of glass be characterised?*
- 3 *With which techniques is glass commonly connected in contemporary glass structures and using which of these can the transparency of glass connections be enhanced?*
- 4 *What is the impact of heat bonding on the physical properties of glass, specifically in relation to residual stress?*
- 5 *What is the strength of heat bonded connections in relation to the strength of the parent material?*
- 6 *What are the opportunities and limitations for the application of transparent connections in respect to Design, Fabrication, Installation and End of Life?*

1.5 Approach and methodology

This research aims to evaluate the technological possibility of achieving fully transparent glass connections and the feasibility for application of certain transparent connections.

The research is divided into 3 sections:

- A Background – the nature and use of glass (Q1-3)
- B Assessing the feasibility and structural performance of heat bonded connections (Q4-5)
- C Application opportunities of transparent connections in glass structures (Q6)

Section A - Background explains the nature of glass and what differentiates it from other building materials as well as the history of its use and the connectivity relating to that, specifying the motivation of this research. In this section, existing glass technology and connection typologies as well as transparency in the context of glass connections are evaluated. This section is based on literature research, meaning scientific and technical publications are the primary source of information. Technical codes and Guidelines used are primarily European.

Section B – As opposed to common adhesive based bonding techniques, heat bonding allows to reduce or potentially eliminate the visibility of the glass edge, hence offers a potential to improve the perception of transparency in glass connections. Evaluating the performance of heat bonded connections assesses the suitability of these connections in an experimental process. Material parameters are outlined and the impact of the bonding process on the performance of the glass as a building material assessed, before connections are manufactured and structurally assessed through fracture mechanical testing. The connections are formed manually in a welding lab using borosilicate glass.

Through evaluation of previous tests and the tests carried out in this research, the technical requirements for mono-material glass-glass connections shall be defined. Physical and chemical properties form the basis of this whilst it can be proven through existing literature that a chemical bond can be achieved in theory (Lohmeyer et al., Paetzold et al.). The practical tests of forming the bond between two glass panels and non-destructive as well as destructive testing of the connections were carried out at the University of Cambridge, UK in the Chemistry and Engineering Department.

Section C – This section transfers and explores the findings generated in Section B and outlines potential applications for transparent connections and the potential and limitations of the implementation of heat bonded connections. The experimental use of transparent connections on a product level is shown with examples, theoretically assessed and practically tested using available transparent bonding techniques, outlining opportunities of these adhesive bonds to be replaced with thermal bonds in the future.

Appendix - Case Studies – Appendix A describes the full scope of the case studies undertaken throughout this research. These can be used to add background and detail to the extracts that are part of the chapters.

1.6 Outline

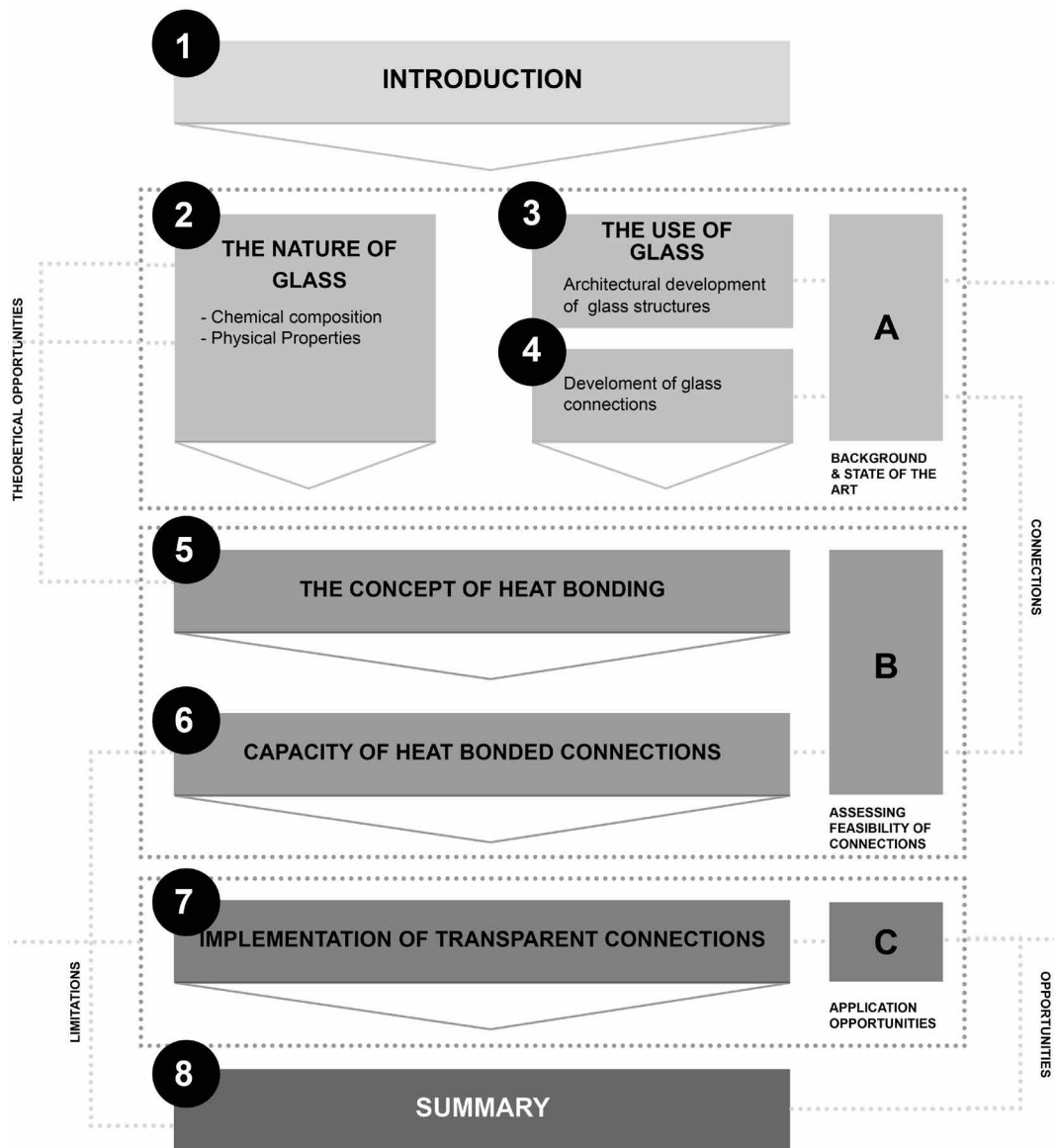
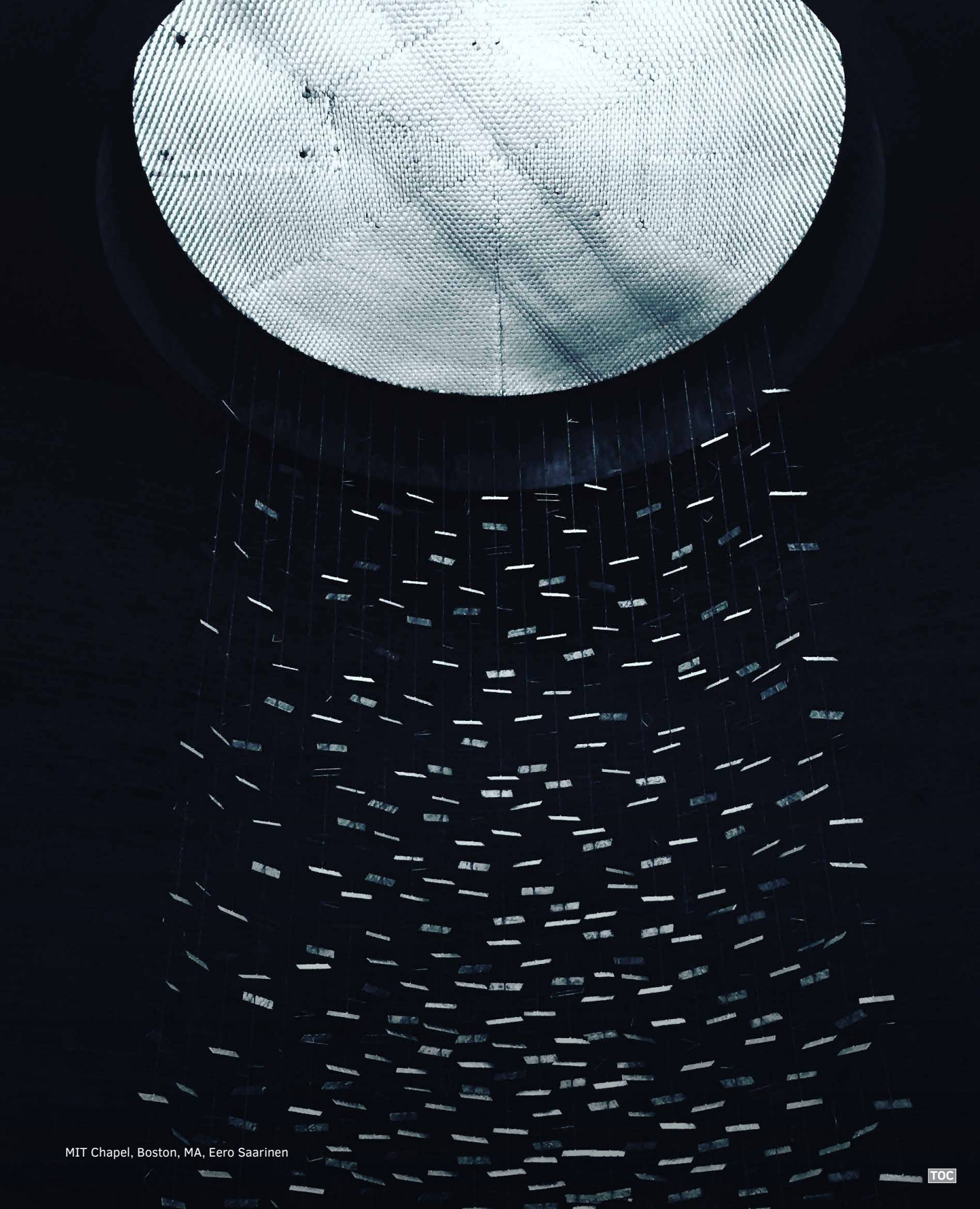

FIG. 1.2 Structure of the dissertation

- 1 Chapter One outlines the structure of this thesis, with six distinct content chapters and a summary chapter to follow. Further to that, it contains the approach and methodology this research follows.
- 2 Chapter Two introduces the material glass with its composition and inherent material properties, providing background on production and processing of the material. It also includes an introduction into the physics and metrics of transparency outlining basic parameters and their relevance in relation to the perception of transparent glass connections. Further to that it provides background to the motivation for an increase in transparency in buildings and building envelopes.
- 3 Chapter Three summarises the development of the use of glass in architecture with a focus on glass in structural applications. It evaluates the state of the art, analysing and categorising the structural use of glass.
- 4 Chapter Four provides background on the impact of connections on the appearance of glass structures in the context of transparency. In this chapter, current and novel connection methodologies are discussed, categorised and compared.
- 5 In Chapter Five the concept of heat bonding is discussed to create transparent mono-material connections. The impact of the heat bonding process on the material is evaluated in an experimental process including non-destructive and fracture mechanical testing.
- 6 Chapter Six takes the experimental testing one step further; here specific connection typologies are manufactured in a heat bonding process and fracture mechanically tested to assess the load bearing capacity of the connections and their appropriateness for structural use.
- 7 In Chapter Seven the future for transparent connections is briefly outlined, deriving a perspective on the use of transparent glass connections.
- 8 Chapter Eight summarises the findings of previous chapters and provides conclusions on the scope of this research.



MIT Chapel, Boston, MA, Eero Saarinen

2 The Nature of Glass

Chapter Two introduces the material glass with its composition and inherent material properties, providing background on production and processing of the material. It also includes an introduction into the physics and metrics of transparency outlining basic parameters and their relevance in relation to the perception of transparent glass connections. Further to that it provides background to the motivation for an increase in transparency in buildings and building envelopes.

2.1 The material

Physically glass can be considered a rigid inorganic silicate melt with an amorphous molecular structure (Lohmeyer, 1979). In contrast to crystalline materials, it is characterised by its isotropy, which means that all properties or measured values are the same in each direction of the structure. In contrast to that, readings of crystalline materials are dependent on the direction of the measurement.

Glass primarily consists of silica sand, lime and soda which all are natural raw materials. By the addition of other materials, properties like stiffness or colour can be influenced and adapted (Shelby, 2005).

In comparison to other substances like metal or plastics, which can be defined by their chemical composition only, glass instead is a description of the material state on a molecular level, irrespective of its chemical composition. The intrinsic materials of glass, like its transparency, light transmittance but also thermal behaviour and solidity are a result of this material state more than the composition. (Petzold et al, 1990).

Theoretically glass can be manufactured from many materials, as long as the melt can be cooled fast enough to remain amorphous in structure, while avoiding crystallisation. Most commonly silica sand is used as a base material.

2.1.1 Composition

Soda lime glass with Silicon Oxide as main component (Table 2.1) is still the most common on the market, particularly in the building industry, however, other glasses based on carbon or metal oxides offer new possibilities as relates to material properties and application.

TABLE 2.1 Composition of soda lime glass

Component		
Silica sand	SiO ₂	69-74 %
Sodium	Na ₂ O	10-16 %
Calcium oxide (lime)	CaO	5-14 %
Magnesia	MgO	0-6 %
Alumina	Al ₂ O ₃	0-3%
Others	NA	0-5%

A 3D pie chart illustrating the composition of soda lime glass. The chart is divided into six segments, each corresponding to a component listed in the table. The largest segment is SiO₂ (69-74%), followed by Na₂O (10-16%), CaO (5-14%), MgO (0-6%), Al₂O₃ (0-3%), and NA (0-5%). A legend to the right of the chart identifies each component with a colored circle: SiO₂ (light gray), Na₂O (medium gray), CaO (dark gray), MgO (black), Al₂O₃ (white), and NA (dark gray).

2.1.2 Molecular structure

As opposed to most solids, glass molecules do not form a crystalline structure, because they cool down and stop moving before crystallisation can occur. This description of glass does not limit itself to the transparent silica based material commonly called glass. Theoretically, every material can form glass if it is cooled from liquid to solid state at a rate high enough to avoid crystallisation.

Glass has a transformation range, a temperature range in which it changes from a liquid to a 'frozen solid' or 'super-cooled liquid'. Materials that crystallize have a melting point, a temperature at which the material remains until the phase change is complete, comparable to ice transforming to water (Figure 2.5).

The described transformation range allows the forming of the material into shape through several production methods like blowing or casting. By using the gradually changing viscosity over a temperature range, the shape in which the glass solidifies can be controlled.

As previously described, physically, a glass could be made from any material. However, the term glass is widely reserved for the silicate based material.

The components that glass is made of (atoms, groups of atoms and molecules) are the same as those that describe the structure of a crystal. To change from the liquid to the hardened glass state, a considerably fast cooling is required. This transition should not be understood as a physical transformation, but as a freezing process of the structure of pure liquid. The high viscosity of the silicate melt complicates the crystal formation significantly (Shelby, 2005).

As a result, the molecules and ions cannot regularly assign within the structure. The actual transition of the glass shows a cooling of the melt to a temperature which lies below the melting temperature and where the cooled fluid still has the same properties as the initial melt at the beginning of the cooling process. Being cooled down further, the structure 'freezes' and the melt reaches the state of glass.

Silica glass is the glass with the simplest structure; it consists only of silicon dioxide. Every silicon atom is bounded to four oxygen atoms.

Whilst the structure of a silica crystal or quartz crystal is organised, the atoms in the glass are not organised anymore, indicating that the structure is not crystalline but amorphous instead. However, even if the structure appears to be "liquid", the material does not tend to creep or flow.

Single-component glasses are not used very often because they tend to crystallise (Quartz glass tends to transform to become a quartz crystal). Other components are integrated to the structure; In soda lime glass, sodium oxide and calcium oxide break the oxygen bonds.

The high proportion of silica sand (around 75%) is indicative for the hardness and the strength of the glass, but also for the brittleness inherent to the material. This brittleness leads to a breakage of the glass based on minimal exceeding of the elastic deformation capacity, because the material cannot elongate.

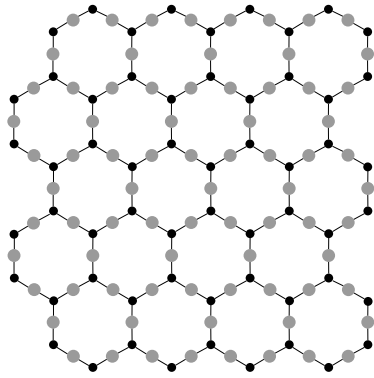

- Silicon
- Oxygen

FIG. 2.1 Molecular structure SiO crystal (quartz)

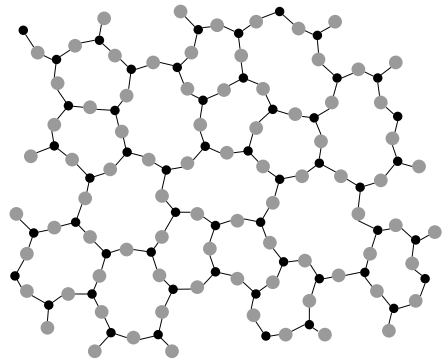

- Silicon
- Oxygen

FIG. 2.2 Molecular structure SiO glass (amorphous silica)

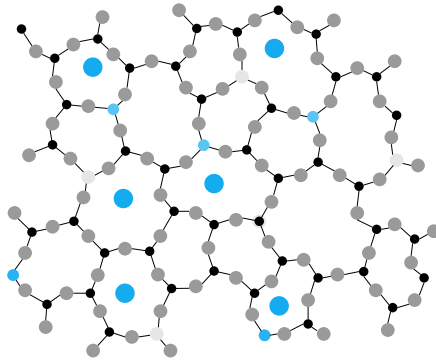

- Silicon
- Oxygen
- Aluminium
- Sodium
- Boron

FIG. 2.3 Molecular structure Borosilicate

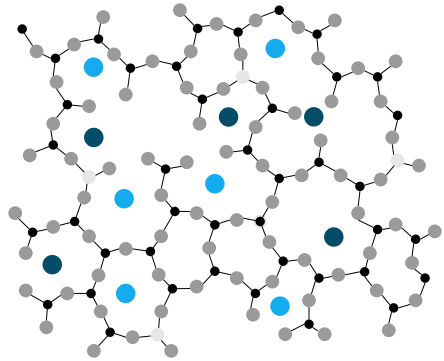

- Silicon
- Oxygen
- Aluminium
- Sodium
- Calcium

FIG. 2.4 Molecular structure SiO Na glass (Soda lime)

The primary ingredient is silicium dioxide (SiO_2), assembled in tetrahedral configurations. Each oxygen atom is connected to two silicone atoms, linking all tetrahedra. The irregularity that results in amorphous structures is caused by different bond angles and rotations.

Glass consisting (almost) solely out of these tetrahedra are quartz glasses. Other types of glass materials contain silicium dioxide and other salts.

Borosilicate glass contains boron trioxide (B_2O_3) (Figure 2.3). This material is used for its high resistance to thermal shock. It is applied in laboratory equipment and cooking vessels.

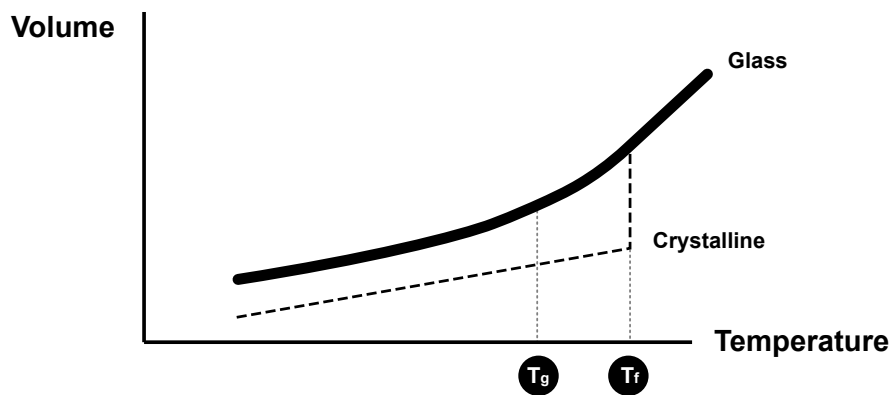

FIG. 2.5 Schematic representation of the ratio of Volume and Temperature showing the viscous performance of glass compared to crystalline materials

As opposed to crystalline materials, glass does not have a melting point but it becomes viscous above the glass transition Temperature T_g (Figure 2.5).

Transition temperatures for Soda Lime and Borosilicate vary slightly with Borosilicate being resistant to higher temperatures (Table 2.2).

TABLE 2.2 Transition Temperatures Soda Lime Silicate and Borosilicate

State	Temperature Soda Lime [°C]	Temperature Borosilicate [°C]
Working point	1040	1280
Softening Point	720	830
Annealing Point	540	570
Transformation temperature T_g	530	560
Strain Point	506	530

One of the most important properties of glass is its excellent chemical resistance to many aggressive substances, which explains its popularity in the chemical industry.

Glass does not corrode, making it a very durable material and in fact one of the most durable materials in construction. Furthermore, because the glass is a homogeneous material which can be molten and reshaped, glass is highly recyclable and therefore sustainable when it can be broken down sufficiently and recycled with use of renewable primary energy.

2.2 Why borosilicate

Borosilicate glass is primarily used in chemical and pharmaceutical industries because it offers a better chemical resistance and a lower coefficient of linear thermal expansion. This makes it more resistant to large temperature differentials than soda lime glass, which is commonly used in the building industry. Whilst the coefficient of linear thermal expansion (α) of soda lime glass is around 8.5×10^{-6} (K^{-1}), borosilicate has an expansion coefficient of $\alpha = 3.3 \times 10^{-6}$ (K^{-1}).

Pure quartz or silica glass has an expansion coefficient of $0.5 \times 10^{-6} K^{-1}$, (however as previously described, it tends to crystallise and is therefore difficult to maintain in the glass phase).

International regulated 'Borosilicate 3.3' glasses i.e. Pyrex® or Duran®, are offered by companies like Schott or GVB according to ISO 3585. Standard products are glass tubes for chemical uses but also Borofloat 33 (Schott) or Boroplate (GVB), a borosilicate sheet material, is offered. The materials generated by this floating procedure are usually used as display materials, windows for fireplaces or fire protection glass because of the beneficial thermal properties (2.3.1).

2.3 Technical Values

The composition of the described glasses with percentage of constituents (Table 2.3).

TABLE 2.3 Comparison of technical values for soda lime silica and borosilicate

	Soda lime Glass	Borosilicate Glass
Density [kg/m ³]	2490	2230
Scratch hardness on the Mohs hardness scale	6-7	4.5
Coefficient of mean linear expansion $\alpha \cdot 10^{-6}$ [K ⁻¹] (20-300 °C)	8.4	3.3
Thermal conductivity [W/mK]	1.06	1.14
Softening point [°C]	720	830
Processing temperature [°C]	1040	1280
Modulus of elasticity E [N/mm ²]	70000	63000
Poisson Ratio μ	0.2	0.2
Bending Strength [N/mm ²]	30	30
Compressive Strength [N/mm ²]	700-900	700-900
Tensile strength [N/mm ²]	30-80	70
(at constant load)	7	7

2.3.1 Coefficient of linear thermal expansion

The coefficient of linear thermal expansion is a very important value for the application of glass in practice; especially for the analysis of the material in respect to a heat bonding process.

It describes the proportion of length difference to total length [L_0] within a temperature change of one Kelvin. For isotropic materials this substance specific value is defined by:

$$\alpha = \frac{\Delta L}{L_0 \Delta T}$$

- Where ΔT is the temperature difference
- ΔL is the change of length
- L_0 is the total length of the material.

As for the evaluation of a manufacturing process the change of the length (ΔL) for a glass is important; For a tube or rod that primarily expands two-dimensionally this can be calculated as follows:

$$\Delta L = \alpha * \Delta T$$

For a soda lime glass with a thermal expansion coefficient of 8.4×10^{-6} and with a temperature difference of 1015 K it would mean:

$$\begin{aligned} \Delta L &= 8.4 * 10^{-6} \\ \Delta L &= 8.4 * 10^{-6} * 1015 \\ \Delta L &= 0.0000084 * 1015 \\ \Delta L &= 0.008526 \end{aligned}$$

For a total length of 1m that would mean that L_0 changes to L which is the total length in the expanded situation.

$$\begin{aligned} L &= L_0 (1 + \alpha * \Delta T) \\ L &= 1 \text{ [m]} (1 + 8.4 * 10^{-6} [K^{-1}] * 1015 [K]) \\ L &= 1 \text{ [m]} (1 + 0.0000084 [K^{-1}] * 1015 [K]) \\ L &= 1.008526 \text{ [m]} \end{aligned}$$

Comparing soda lime glass to borosilicate glass it is apparent, that the halved thermal expansion coefficient leads to a reduction of change of length by approximately half, although the larger processing temperature has to be accounted for

$$\begin{aligned} \Delta L &= 3.3 * 10^{-6} * 1260 \\ \Delta L &= 0.0000033 * 1260 \\ \Delta L &= 0.004158 \\ L &= L_0 (1 + \alpha * \Delta T) \\ L &= 1 \text{ [m]} (1 + 3.3 * 10^{-6} [K^{-1}] * 1260 [K]) \\ L &= 1 \text{ [m]} (1 + 0.0000033 [K^{-1}] * 1260 [K]) \\ L &= 1.004158 \text{ [m]} \end{aligned}$$

While only a part of the glass is heated, this part will expand but this will be detained by the rest of the glass which still has the original temperature. This causes a stress σ that corresponds with ΔL . ($\Delta L \sigma = \Delta L$)

When a glass pane instead of a glass rod has to be calculated, the lateral contraction known as Poisson's ratio μ has to be taken into account.

This means that the stress is

$$\sigma = \frac{\alpha \times E \times \Delta T}{(1 - \mu)}$$

When the stress caused by the temperature change is higher than the mechanical strength of the material, the glass breaks.

Considering the above, the maximal thermal shock resistance for soda lime glass would be as follows:

$$\begin{aligned} \Delta T_{\max} &= \frac{\sigma}{\alpha \times E} (1 - \mu) \\ \Delta T_{\max} &= \frac{50}{8.4 \times 70} (1 - 0.2) \\ \Delta T_{\max} &= 68.02 \text{ [K]} \end{aligned}$$

As mentioned above, the maximal thermal shock resistance of borosilicate glass is significantly higher.

$$\begin{aligned} \Delta T_{\max} &= \frac{\sigma}{\alpha \times E} (1 - \mu) \\ \Delta T_{\max} &= \frac{50}{3.3 \times 63} (1 - 0.2) \\ \Delta T_{\max} &= 207.9 \text{ [K]} \end{aligned}$$

The results above suggest that the use of borosilicate would be more appropriate for a heat bonding process, given that the risk of thermal shock would be reduced.

Despite the expansion coefficient and hence the risk of thermal shock breakage being even lower for pure silica glass, due to its tendency to crystallise if not cooled very slowly, it would not be suitable for a manual connection process. Further to that, given that minimal to no additives are being used, the transformation and working temperature are significantly higher, which suggests additional complications for a manual heat bonding process.

2.4 Strength

The theoretical strength of the glass is the strength of the bond of its individual components and assumes a crack-free and inclusion-free glass. Following this, theoretically glass is stronger than any other common structural material. Based on the energy required to break the atomic bond, the material strength would be 16 GPa, which is approximately fifty times stronger than steel (Lehmann, 2007).

However, in practice, due to structural defects on the surface of the material, commonly called (Griffith) flaws, the material capacity is significantly lower. Given the brittleness of the material which doesn't allow the redistribution of large stress concentrations, the practical bending strength of annealed glass lies between 30-80 MPa (Feldmann et al, 2014) According to EN 572-1:2004, its characteristic bending tensile strength is 45 MPa. This difference is due to the high sensitivity of glass to the flaws on its surface. These flaws are microscopic and randomly distributed and cause stress concentrations, typically described as peak stress. Figure 2.6 illustrates the stress strain relation for steel and glass.

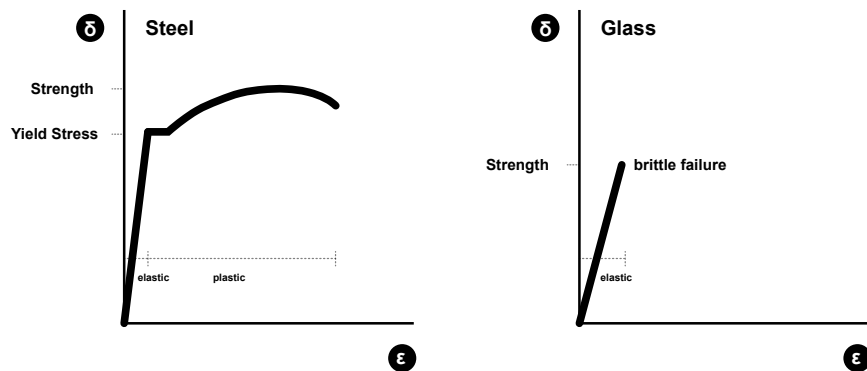

FIG. 2.6 Stress strain relation of steel and glass

Whilst other materials compensate these peaks with plastic strain, glass does not deform plastically. This leads to the brittleness and fragility commonly associated with the material.

2.4.1 Strength in connections

Due to the brittle failure of the material, the connection design is one of the major drivers for the performance as well as appearance of a glass structure. The stronger the connection material, the smaller it can be. However, if the connection is stronger than the material it connects, the glass member will fail under load, where stress concentrations are the highest. This is typically the case with glass structures. Balancing the strength of the connection, to allow the transfer of loads while allowing for sufficient movement is one of the most important factors when designing with glass. However, the strength of the connection is not solely driven by the strength of the connection material. The load capacity is rather based on the allowable stress in the material. Typically, stainless steel and titanium are used to transfer loads, both are stronger than glass. Adhesives typically are weaker, including Sentry Glas (Stelzer, 2010), TSSA (Carnagy, 2016), and structural silicone (Dow Corning, 2014).

Heat bonded connections are assumed to be as strong as the parent material (Rammig, 2012) which suggests that they would be classified between mechanical metal connections and bonded connections using the adhesives described above.

TABLE 2.4 CaptionHere

Connection type	Strength	Failure
Metal fittings	+++	In glass
Adhesives (incl, SG, PVB, Silicone, TSSA)	+	In adhesive (cohesive)
Glass-Glass	++	In glass around connection

2.5 Stiffness

To be able to predict and control deformations in the structure, stiffness is the key parameter. As for strength, the stiffness of the material does not define the stiffness of the connection. It is included as a criterion to indicate relative differences. A stiff material can be advantageous because it will minimize deformations in the structure. A more flexible material can be advantageous because prior to failure, large deformations can be an indicator that failure might occur. Similar to strength, the stiff properties of steel and flexible properties of adhesives can be directly

extrapolated to the mono-material connections. Silicone is hyper-elastic and often applied because of its ability to compensate for thermal deformations. Its stiffness is therefore very low. The bonded point fixing is for this criterion judged by its weakest link: the lower stiffness of the adhesive.

2.6 Development of Glass



FIG. 2.7 Hot lava (Flickr)



FIG. 2.8 Natural glass; obsidian (Flickr)



FIG. 2.9 Goblet 'Tuthmosis III', the oldest known glass vessel, 1500 BC (Wikipedia)

Glass is considered one of the oldest artificial substances known. The development of the material started in a time when humans explored the fire as a technical facility for the production of goods. It is presumed that the development of glass production started parallel to the development of ceramic proceedings, which means, that man-made glass has been existing for several thousand years (Haldimann et al, 2008).

Determining the intrinsic origin of glass in relation to time is difficult, because the oldest discoveries of glass were natural glasses consisting of solidified volcanic lava, which were then post-processed by humans to form tools or weapons (Haldimann et al, 2008). This natural glass is ;presumed to have existed for millions of years.

Silicate ceramic products can be seen as precursors of glass. Raw materials were desert sands with a high amount of lime and clay.

Assyrians, Babylonians and Egyptians developed the first glass products around 2000 BC by using their knowledge about ceramic goods which exists since 5000 BC. The first written documents about the production of glass, which were cuneiform inscriptions in clay boards also originate from Assyria.

During ancient times glass was mainly used as sacral ornaments or vessels, which were formed by rolling the glass melt around a stone. By adding metal or mineral compounds, coloured glass was developed, which though did not have the transparent properties that are associated with modern glass.

The development of forming the glass with a blowing iron around 30 BC led to a fundamental progress in the technical development. It was possible to fabricate a variety of shapes and transparent material by polishing the surface.

The first window glazing was found in Pompeii in the region of Napoli and in Aquincum near Budapest. These plates were presumably cast on a table and dragged out with iron hooks before they were polished to become transparent.

The application of glass in buildings grew in the following centuries particularly in the area today considered as northern Europe, where window openings were covered with glass. At the time, the primary production methods for glass are known as the:

- A Cylinder glass process (Figure 2.10)
- B Crown glass process (Figure 2.11)

Sheet glass was discovered by a German craftsman around 1100 AD. A narrow cylinder with a length of circa 1.50 m and a diameter of 0.3 m was blown, the ends were cut off and the cylinder was cut in its longitudinal direction. After that, it was spread out in an oven to a flat glass sheet and polished to become transparent.

Crown glass was produced by blowing glass into a 'crown' or narrow bowl and then spinning it out until it was flat. The circular sheets of glass achieved by this technique were 1.5 to 1.8 metres in diameter and of varying thickness. The thinnest, best quality glass was found on the outside of the disc, while the inner circle glass with the thickening in the centre around the punty mark is known as 'bullseye' glass. To make larger windows with better quality glass, smaller pieces from the outer circle of the disc were connected in a lead lattice as described in 4.4.4.4 of this document.

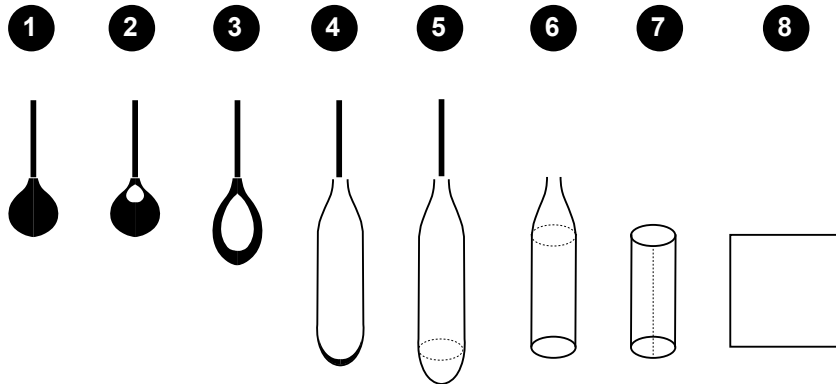

FIG. 2.10 Cylinder Glass Process

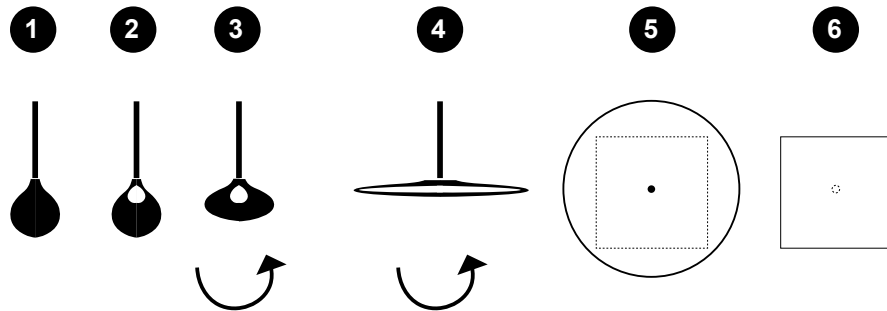

FIG. 2.11 Crown Glass Process

In the middle ages, windows were used as an element of architectural value and expression. This is represented specifically in the large colourful leadlight of the Gothic cathedrals, which achieved a new level of design in architecture through the introduction of coloured light (Knaack et al, 2007).

Until the end of the 17th century glass was produced primarily as previously described. The size of the glass panels achievable was dependant on the skills of the craftsmen.

Later, larger panes were cast on a metal table, milled with rolls, then ground and polished to achieve transparent sheets, known as mirror-glass. The invention of continuous pultrusion techniques for sheet glass led to a better glass quality and

increased the application of glass in buildings. The use of glass extended beyond churches, although glass was still an expensive material, and the basic conditions for industrialised glass architecture were set.

2.7 Modern Glass Fabrication

2.7.1 The Float Glass Process

The most important revolution to the industrialisation of glass and towards the commodity application that we see today, was the invention of the float glass process in 1957 by Alastair Pilkington. By using this process, in which glass is floated on a tin bath, the previous post-processing techniques became redundant and glass could be produced in large quantities while maintaining incredible surface quality. The process that is still the 'state of the art' production process for flat glass, is illustrated in Figure 2.12.

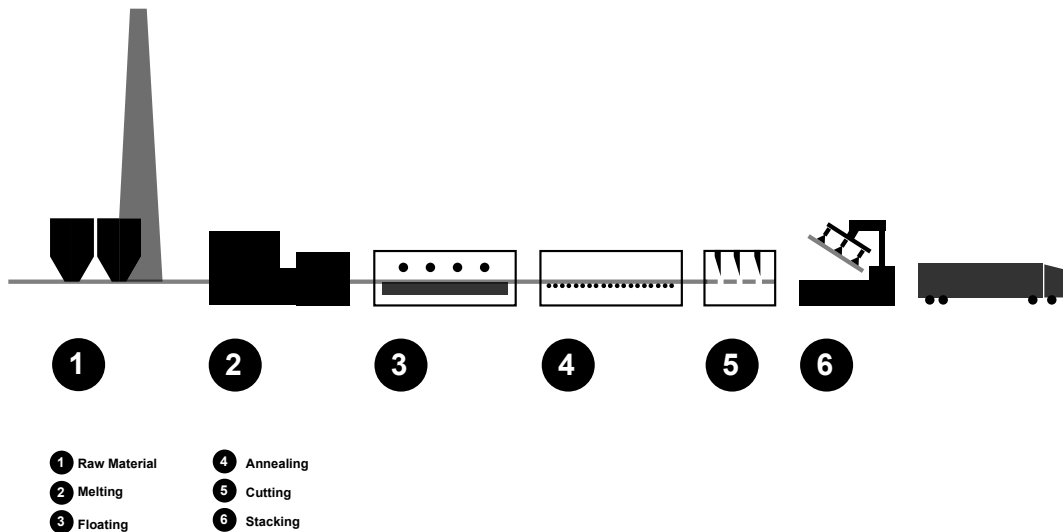

FIG. 2.12 Float glass process as developed by Pilkington

A significant amount of the flat glass production (approx. 90%) is manufactured using the float glass process. (Wurm, 2007). Until the development of the float glass process, glass was primarily produced as crown and sheet glass. The float process allowed glass to be produced in larger quantities at consistent quality, hence it is seen as one of the major inventions in the glass industry.

Silica sand and additives are molten in a large furnace and the melt is then poured on a bath of liquid tin. Due to the difference in density of the two materials, the glass will float atop the tin bath, which also explains the origin of the name of this process. The thickness of the material is determined by the amount of glass that is poured and the speed at which it is taken through the process. The melt is poured at approximately 1100°C and it solidifies at 600°C allowing it to be moved to the annealing lehr, where it is moved on rollers and cooled down slowly, before being cut and packed.

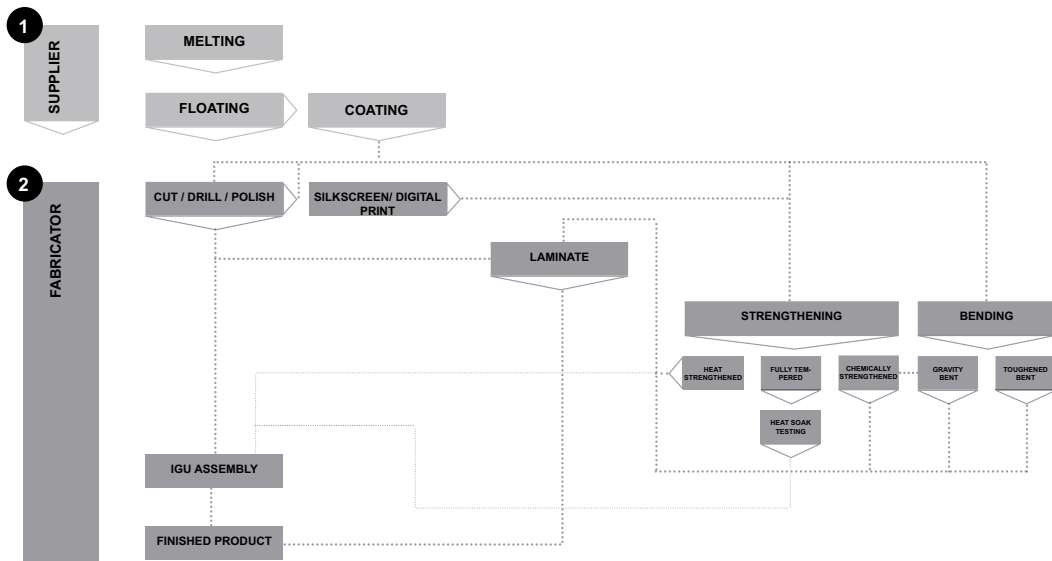

FIG. 2.13 Glass Processing

2.7.2 Glass Processing

Given that the amount of surface flaws and micro-cracks determine the strength of the material, the quality of the processing is of significant importance. The cutting process, in which the glass is typically scratched with a wheel to initiate a crack propagation introduces shells, so called shark teeth, to the edge of the glass. This is where the material is the weakest, so it is common that the edges are ground and polished after cutting to reduce the risk of cracking. Good edge quality is also important for any heat treatment process, as the resistance to thermal shock is also influenced by the edge strength.

Therefore, glass cannot redistribute peak stress, making its strength highly dependent of the flaws on the material surface.

Due to the processing of a floated glass panel that involves cutting and machining processes, the flaws tend to be larger and occur more often at the edge of the panel than on the face of the material.

To ensure the panel's strength relates to the assumed design strength, the quality of the edge finishing, grinding and polishing is of great importance.

Experiments typically show a large scatter in the strength of glass, which is associated with the influence of surface and edge defects.

The practical consequence of the large scatter is the probability that a glass member fails at a much lower stress than its characteristic strength. The consensus among structural glass engineers is that failure of a glass element should always be considered and a redundancy strategy developed.

Glass can be thermally or chemically treated to improve its stress capacity. This process is called tempering or toughening.

2.7.3 Mechanical Processing

2.7.3.1 Cutting

Typically glass is cut into so called jumbo sheets (6m x 3.21m) after floating and cooling and then stored. When the glass is further processed into the required sizes, it is cut to size. In most cases a diamond scratching wheel with an accuracy of about 0.1 millimetres is used. The glass is on the rollers of the end of the line (or in a cutting section of a processing line) and scratched with the wheel, after which it is heated or tapped, so that the resulting tensile stress leads to a crack propagation and hence breakage through the thickness producing the 'cut'. Other common forms of cutting are water-jet cutting, for which a high pressure water jet is used in which abrasive particles are added and laser cutting, which produce higher quality edges and tend to be used for special applications or when a particularly good edge quality is required.

2.7.3.2 Grinding

To grind the edge of the glass, typically a belt or wheel with diamond or carborundum surface is used. Depending on the desired finish, multiple grades of abrasives might be used, starting with rough and ending with a fine grain. (Wurm, 2007) Ground edges are typically not transparent. Grinding can improve the edge strength if cracks and flaws are ground smooth. However, it also damages the surface, so it is important to choose the appropriate grain (Schuler, 2013).

2.7.3.3 Drilling

If the support of the glass requires bolts through the surface, any holes need to be drilled prior to heat treatment, as if drilled after tempering, the glass would fracture.

As with grinding, for drilling diamond coated wheels, water jets and lasers can be used. Here the use of water-jet cutting and laser cutting is more common.

2.7.3.4 Polishing

Polishing is typically considered the final treatment for the edge and can also be used to treat certain impurities on the surface of the glass.

2.7.3.5 Edge treatment

Due to the fact that the failure strength of the glass is determined by the flaws in the material surface, the edge quality is of significant importance (Feldmann et al, 2014). Typical steps of edge treatment are illustrated in Figure 2.14.

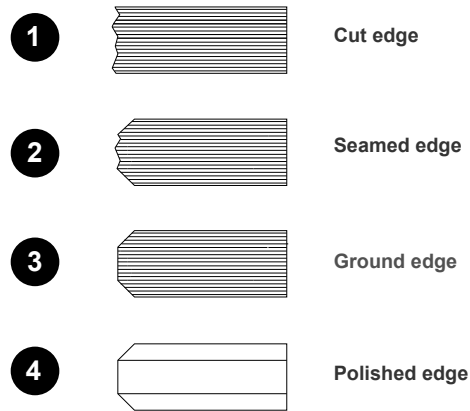

FIG. 2.14 Common glass edge treatments

The typical edge treatments with increasing quality are:

Cut edge: this is the raw edge cut exposing the broken edge, which is sharp and requires treatment even to make handling safe.

Seamed edge: when the edge is seamed, only the top and bottom edge are ground to reduce the risk of injury, the face will still be the broken edge.

Ground edge: A smoothly ground edge is typically specified for curtain wall applications where the glass is 4 side supported. The edge is arrised and ground smooth, meaning no blank spots are visible.

Polished edge: When glass is used structurally, typically polished edges are specified. Here the arris as well as the edge are polished to be fully transparent. This has been assumed to provide the best edge strength, however recent research shows this might not always be the case (Schuler, 2013).

In addition to providing better edge strength, a good edge treatment will also reduce the risk of thermal shock fracture during the tempering process.

2.7.3.6 Polished edges for visual reasons:

Depending on visual requirements, certain structural glass projects require special edge treatment. Typically this is the case when edges are visible. Here the glass will be polished flat after lamination, which results in a fully flat surface without any visible arrises. This will also diminish any visible differential in the plane of the edge caused by lamination tolerances. Typically, this process is more expensive than standard polished edges as it requires polishing after heat treatment and/or lamination. Due to the risk of breakage in toughened glass it is typically only carried out on annealed or heat strengthened glass and by very few fabricators.

2.7.4 Thermal Processing

2.7.4.1 Annealing

Annealing is part of the float production process and it is required to release any locked in stress out of the material. In the annealing process, the glass is cooled very slowly from approximately 650°C to room temperature, which leaves the material practically stress free. Improper annealing can result in glass cracking on the cutting table or during handling and processing. As any processing imposing heat on the material will result in stress in the material, annealing is also used after gravity bending of glass. The process is further described in chapters 5 and 6 of this document, as it is crucial to the reduction of stress locked in the glass through the heat bonding process.

2.7.4.2 Thermal tempering

In the thermal tempering process glass is heated to approximately 650°C and rapidly cooled, taking advantage of the fact that cooling a material leads to shrinkage (Figure 2.15). When glass is cooled rapidly, the outer surface is cooler and shrinks more than the inside of the panel. When the inside cools afterwards, the outer surface of the panel is compressed. The compressive pre-stress through the thickness of the glass is illustrated in Figure 2.16.

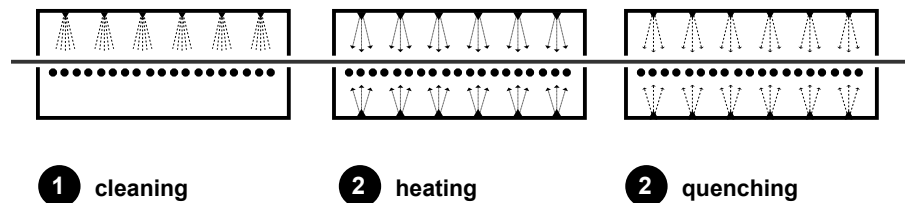

FIG. 2.15 Process of thermal tempering

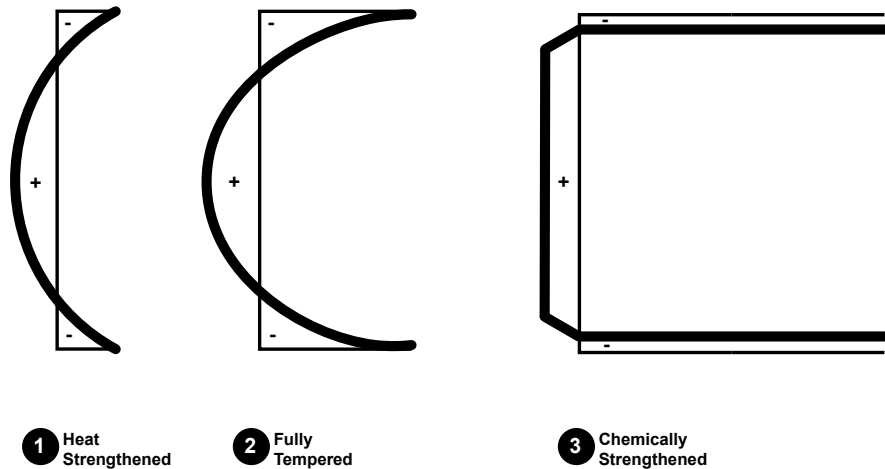

FIG. 2.16 Pattern of pre-stress through the material thickness for 1. Heat Strengthened (HS), 2. Fully Tempered (FT) and 3. Chemically Strengthened (CT) glass

TABLE 2.5 Characteristic tensile strength of glasses with different heat treatments

Glass type	Characteristic tensile strength
Annealed	45 MPa
Heat Strengthened	40-80 MPa (24-52 acc. to ASTM C 1048-04)
Fully Tempered (toughened)	150 Mpa
Chemically tempered	Up to 700 MPa

Small flaws on the glass surface can grow into cracks when the glass is under an effective tensile stress. By thermally pre-stressing the material, this tensile stress is achieved at a larger load, making the glass stronger.

Typical breakage patterns associated with the most common glass types used in construction:

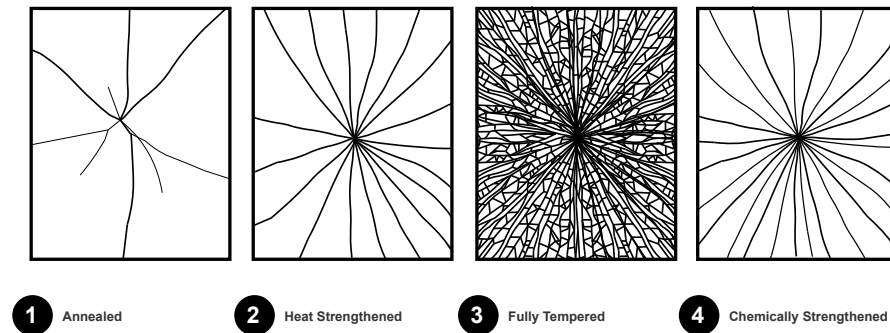

FIG. 2.17 Glass breakage patterns with different degrees of strengthening

When annealed glass cracks, the crack propagation is typically slow, as there is little stress released, whereas the stress differential through the thickness of toughened or fully tempered (FT) glass leads to a shattering into many small dice once the energy balance of tension in the core and compression on the surfaces of the glass is disrupted and energy is released (Figure 2.17). Toughened glass will shatter instantaneously and the release of energy will lead to disintegration of the panel. The classification of FT glass as safety glass is rather related to the fact that small dice are judged less harmful in case of human impact than providing post failure strength and integration. To achieve good post breakage behaviour with FT glass, it is commonly laminated with a polymer interlayer that would avoid any fragments to dislocate and allow a minimum required load transfer in case of failure to avoid collapse.

Whilst toughened glass is classified as safety glass without lamination, it is to be noted that is subject to a spontaneous failure phenomenon caused by nickel sulphide (NiS) inclusions in the glass. These crystals, which are always part of the composition, change their state during the toughening process, which in combination with temperature exposure over time can lead to spontaneous failure. In heat strengthened glass the risk of NiS failure is significantly reduced (DIN 15318).

Although closer to fully toughened glass in strength, the breakage pattern of heat strengthened glass is very similar to the pattern annealed glass shows. This suggests that the pre-stress required to achieve the characteristic breakage pattern of FT glass is relatively close to the 150 MPa characteristic strength.

2.7.4.3 Heat Soak Testing

Whilst technology is emerging that allows to detect NiS inclusions this is currently not a process available online during glass production, so a Heat Soak Test is commonly carried out to detect any panels with inclusions. In Europe the impurities are around 1 in 10.000 tonnes of glass (Feldmann et al, 2014). After the toughening, the glass is heated again, which leads to failure in the affected panels. While this is time intensive, the cost of a loss while the glass is still in the factory is insignificant compared to the cost of glass replacement once installed.

2.7.5 Chemical Processing

2.7.5.1 Chemical tempering

Another common process of increasing the glass strength is a chemical tempering process. In this case the stress differential is not achieved through heat but through an ion exchange on the surface of the glass.

The glass is placed in a salt bath (typically potassium nitrate) at around 300degC. The sodium ions on the surface of the glass are replaced with the potassium ions in the salt bath, which causes compression on the surface and tension in the core of the glass, as the potassium ions are larger than the sodium ions. As opposed to thermal toughening processes, the layer of pre-stress achieved through chemical toughening

is much thinner (approximately a minimum of 13 micrometres), which makes it very susceptible to scratches. Whilst the pre-stress of chemically tempered glass is significantly larger than the pre-stress achievable with a thermal process, the associated breakage pattern is more similar to annealed or heat strengthened glass, which can be explained by the thickness (or thinness) of the compression layer.

2.7.5.2 Acid Etching

Acid Etching is a common processing technique in which the surface of the glass is exposed to an acidic material that will work like an abrasive and remove particles on the surface of the glass. Typically this leads to a non-transparent surface appearance, that can be described as 'milky' or translucent. The glass remains translucent. Often Acid etching is used for privacy glazing, due to its light transmitting properties, while not allowing the direct view through the material.

Acid Etching is also used to produce safety-frits for stair treads and glass floors. These are manufactured by exposing part of the surface (in a particular pattern) to the acid and allowing it to remove the surface on these areas whilst keeping the covered area, which will then lead to a surface roughness that is slip-resistant. Whilst typically the glass would be translucent, the frit can be polished in a consecutive step, so that a transparent patterned glass can be produced.

2.7.6 Laminating

When glass is used structurally, or as a barrier, it is crucial to design with redundancy, as the material can fail due to its lack of ductility. Although toughened glass can be classified as safety glass, it is good practice to use laminated glass where it acts as a barrier. Laminated glass typically consists of two or more layers of glass, bonded together with a polymer interlayer. Should one of the glass panes or even all of them break, the interlayer will bond them together and will make sure that fragments will not dislocate.

Next to the strength of the interlayer, transparency is also an important criteria.

Common interlayer materials are:

- Polyvinylbutyral (PVB)
- Ethylene vinylacetate (EVA)
- SentryGlas (SG)
- Cast-in-place resin (CIPR)

When transferring load through the glass, it is important that the interlayer is capable of transferring the load. For occasions where load transfer is required, typically SentryGlas is used.

For the first three lamination materials described above, the process will be carried out in an autoclave, as both temperature and pressure are required to achieve a sufficient bond. This is why autoclave size is often the limiting factor for availability of glass products. The interlayer material comes as a sheet material that is placed between two layers of glass and then cured under pressure and temperature.

For bulk material, jumbo stock sheets are laminated with PVB and then cut to size afterwards. Due to the cutting process however, this leads to a lower edge quality, which has a significantly higher risk of delamination. To achieve better quality edges and higher durability and longevity, cut-to-size sheets are wrapped in separate vacuum bags to assure that both the edge tolerances and the bond are of good quality. For lamination with SG this is a requirement, as the material is very viscous at lamination temperatures of 150degC and would otherwise flow out of the laminate. Cast-in-place resins are typically two component resins that cure after being mixed. Given their liquid form rather than being available in sheets they are often used for complex geometries, when curvature or tolerance is difficult to accommodate with a sheet material. However, due to the chemical curing process, the temperature development needs to be taken into account to avoid thermal fracture of the glass during curing of the resin.

Although glass is one of the oldest man-made materials, its use as a structural element is relatively new. Hence often design codes and legislations are not entirely clear on how to design with glass. This often leads to requirements for detailed FEM analysis of the global structure and localised stress concentrations as well as physical testing.

2.8 What is transparency

Transparency can be defined as the physical property of allowing light to pass through the material without being scattered. Light interacts with matter in different ways. Metals appear shiny while water is clear. So is float glass. Stained glass however, similar to gemstones transmits some colours, while others are absorbed and reflected. Other materials such as milk or acid etched glass appear white, because the light is scattered in all directions (Fox, M. 2001).

The optical properties observed in most solid-state materials can be described as a small number of general phenomena. The simplest group being reflection, propagation (absorption) and transmission which are the primary factors described in this chapter (Figure 2.18). The graphic illustrates how light is distributed when hitting an optical medium. Part of the light is reflected at the external surface, while the remainder enters the medium. Depending on the properties of the medium, a portion is absorbed within (or rather reflected back into the material from the internal surface) and the remainder will be transmitted through the medium.

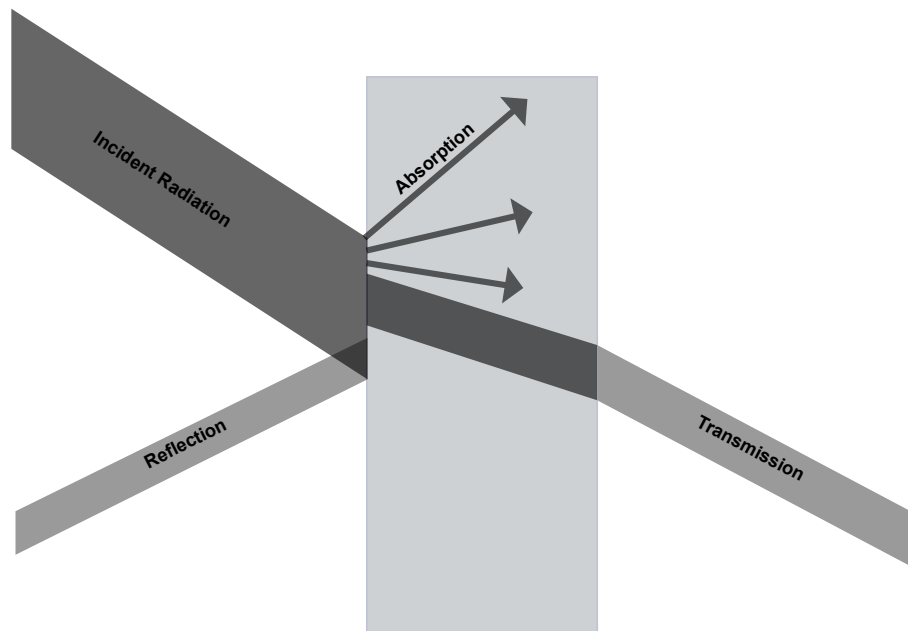

FIG. 2.18 Light passing through a material

When light passes through a medium, the following criteria are to be considered:

- Refraction
- Absorption
- Scattering
- Perception of light and colour

2.8.1 Refraction

Refraction leads to a reduction in velocity of the light waves which in turn leads to bending of the light rays. This effect is described in Snell's law of refraction which states that for two media, the ratio of the sines of the angle of incidence (θ_1) and angle of refraction (θ_2) is equivalent to the opposite ratio of the indices of refraction:

$$\sin\theta_1/\sin\theta_2=n_2/n_1 \text{ (Reinhart, 2014).}$$

2.8.2 Absorption

When the light propagates through a material, absorption occurs if the frequency of the light is resonant with the frequency of the atoms in the medium it is passing. Absorption is related to transmission, as only unabsorbed light will be transmitted. In glass, selective absorption will lead to the body colour that is perceived as well as the colour of the transmitted light (Shelby, 2005).

2.8.3 Scattering

When a material scatters the light, this means that the light changes direction and potentially its frequency after interacting with the medium (material). A medium that scatters the light, typically does not appear transparent. In glass this effect is achieved with surface treatments such as acid etching or sand blasting. Here the light is scattered on the surface of the glass which means that a portion of the light will still be transmitted, (the other portion will be scattered backwards) but the transparency of the glass is lost, the material becomes translucent.

The quantity and orientation of the scattering can be described with a Bidirectional Scattering Distribution Function (BSDF) value.

2.8.4 BSDF

The Bidirectional Scattering Distribution Function (BSDF) is a mathematical description of the way light is scattered on a surface. The angle of scattering both of the reflected light as well as the transmitted light plays a role in the appearance of the scatter. For glass this relates to the homogeneity as well as the translucency of a scattering surface.

2.8.5 Perception of light and colour

The function of transparency does not accurately describe what is commonly referred to when the term 'Transparency' is used in an architectural context. Often neutrality or clarity is what is described when transparency is used as terminology. The body colour of the glass as well as the colour of the transmitted light play a significant role in how transparent we perceive a glass surface, a glazed facade or a window.

To understand how we perceive colour it is important to understand how human vision works in relation to the perception of light. As opposed to other mammals with dichromatic vision allowing them to perceive blue and green light, humans have so called trichromatic vision allowing us to perceive blue, green and red light.

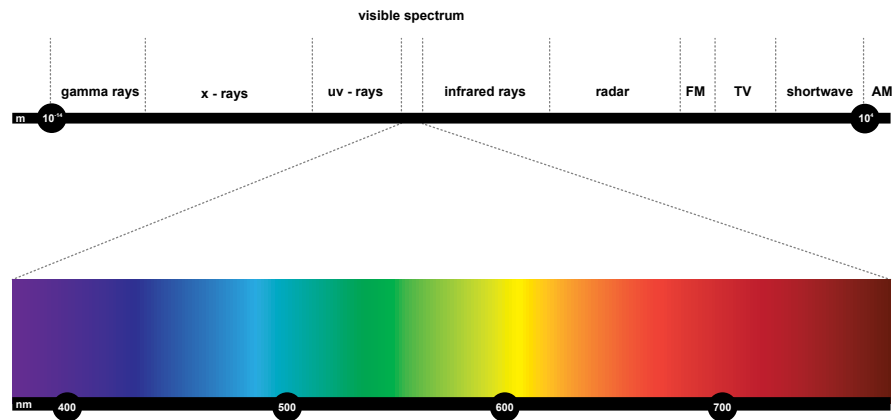

FIG. 2.19 The electromagnetic spectrum with visible light

Electromagnetic radiation occurs in a variety of forms. Humans can see light that is composed of electromagnetic radiation with wavelengths between 380 and 780 nanometres (nm). This is what is typically described as the visible light spectrum.

The visible light spectrum sits between the ultraviolet spectrum (UV) and the infrared (IR)spectrum (Reinhart, 2014).

Light itself is not coloured. Colour is a perception that is created in the human brain when light enters the human eye. Therefore, perception of colour varies significantly in different people.

There are three types of cones in the eye with sensitivity to light of specific wavelengths. When light enters the eye, it will stimulate to a greater or lesser extent all there of these receptors.

These signals are processed by the cells in the eye and then forwarded to the brain where the impression of colour arises.

Light with a wavelength of about 570 nanometres will affect the red and the green cones, and will be interpreted by the brain as a yellow light. The human eye can only perceive light with wavelengths between 380 and 780 nanometres. (Reinhart, 2014)

2.9 Perception of colour in glass

As discussed in Chapter (2.1) glass is transparent, but it is not colourless. This is primarily due to metal oxides that are part of its chemical composition (Shelby, 2005). Conventional soda lime float glass has a slight green tint, caused by the iron content in the raw material (silica sand). Glass with reduced iron content is available in the market as semi-low iron, and low iron glass.

When a glass with a regular iron content (float) is hit by sunlight, the residual greenish colour becomes most evident, particularly at the glass edge.

The iron content of the described traditional float glass is approximately 800 ppm (parts per million), while the iron content of low iron glass is reduced to approximately 200 ppm.

The thicker the layer the light has to pass, the more visible the colour becomes (Figure 2.22, 2.23, 2.24)



FIG. 2.20 Comparison of glass with varying iron content

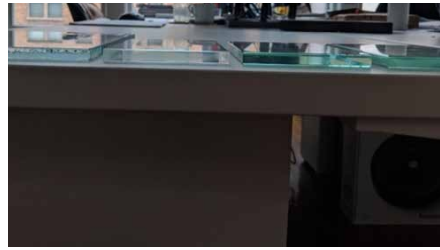

FIG. 2.21 Comparison of glass edges with varying iron content

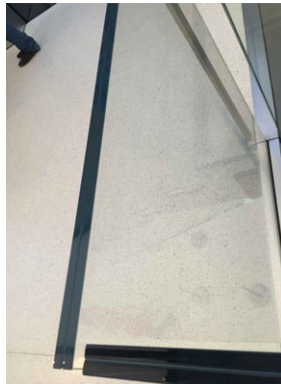

FIG. 2.22 2 x 12mm low iron glass with VLT=88%*

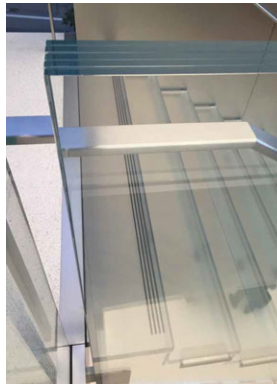

FIG. 2.23 5 x 12mm low iron glass with VLT=83%*

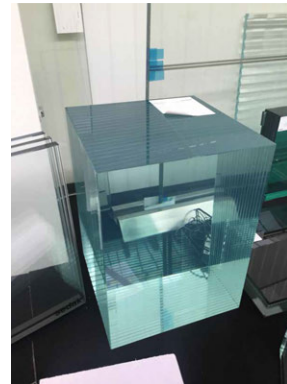

FIG. 2.24 20 x 12mm low iron glass with VLT=57%*

*VLT calculated based on Pilkington Optiwhite accessed from LBNL database

Figure 2.20 and Figure 2.21 show how the difference in iron content manifests itself in the appearance of the material. This is most notably in the glass edge (Figure 2.21), in which even glass that on the surface is notably clear, shows the appearance of colour. This is the reason why low iron glass is very commonly used for structural glass applications using multi-ply laminates and where the edges of the material are exposed, as opposed to fenestration or curtain wall applications in which the glass edges are typically hidden by a frame or a silicone joint.

Whilst the colour of the glass is most noticeable at the material edge, it becomes visible through the thickness in the plane of the material as well (Figure 2.22, 2.23 and 2.24). Comparing the Visual Light Transmission (VLT) of increasing thickness shows the relationship of tint to material thickness. The thicker the material and the more light is absorbed, the more visible the greenish tint appears.

2.10 Summary

The nature of glass and its transparency has fascinated architects and builders for centuries. The nature of the material is also what has been the limiting factor for its use. Particularly its brittleness and hence its tendency to break has been the limitation for the design with glass.

Glass differs from other building materials in the way that it is not defined by its composition but its molecular state. Glass has an amorphous molecular structure as opposed to a crystalline structure metals and other solids are characterised by. This is what makes it isotropic in its properties as well as transparent.

Theoretically glass is very strong- about 50 times as strong as steel- but due to structural defects and scratches in its surface, the practical capacity is significantly lower (30-80 MPa for annealed glass) (Haldimann, 2014). This means that the processing of the glass and the quality of the edges, where the material has been cut, is of fundamental importance to the quality of the material and to its design strength.

Thermal and chemical tempering processes are available to increase the strength of the material, however these come with visual implications and other risk factors. Despite that, for structural use, typically strengthened glass is used.

Whilst the bending strength is limited by surface flaws, glass remains strong in compression, but in typical envelope applications, it is primarily used in bending, hence bending strength will be the criteria used to determine performance in this dissertation.

Its transparency is the property that differentiates glass from most other building materials. There are various factors that affect the perception of transparency, however its basic metric is the quantity of light that passes through a material, which can be described as transmission. In addition to the transmitted light, there is a percentage of light being reflected and absorbed. The absorbed light is visible as colour in the glass, which plays a significant role in the way we perceive its transparency, or more precisely its clarity.



Skylight, Oreon E.Scott Memorial Chapel, Drake University, Des Moines, IA, Eero Saarinen

3 The use of glass in the built environment

Chapter Three summarises the development of the use of glass in architecture with a focus on glass in structural applications. It evaluates the state of the art, analysing and categorising the structural use of glass.

In the context of construction, glass can fulfil various functionalities ranging from an infill material to protect the inside of a building from weather to a structural element supporting itself and even other building components.

This development can be observed through the history of architecture in a pattern that follows the historical development chronologically.

The use of glass as relates to its structural function can be categorised into four primary categories along which projects are identified and analysed in this chapter.

3.1 Transparency in glass architecture

Glass plays a significant role in the development of architecture, given that its use is not only driven by its functionality as a protective layer but by its ability to let through light and hence define spaces.

In 'An Engineer Imagines', Peter Rice describes the importance of transparency and glass in relation to transparency with the following: "For a surface to be transparent, the presence of the surface must be clearly defined" (Rice, 1998). According to (Rice 1990) the only element that can sufficiently define a surface is light.

Two distinct forms of transparency are described in (Rice, Dutton, 1990) as:

- 1 One-way transparency and
- 2 Two-way transparency.

Openings in a solid wall which are used to provide light to the interior space are understood as providing transparency one way only. Glass is only used to provide a weather barrier, but does not affect the performance of the transparency. Historically, openings were typically small and infills often consisted of even smaller panels, driven by availability of glass up to a limited size, which means the surface was divided by framing members and largely defined by those in its aesthetics (Knaack, 1997). Whilst opening sizes in Gothic cathedrals became larger, their functionality remains providing light to the interior space.

Two-way transparency is defined by (Rice, 1990) as the functionality of providing light to the interior space, and in addition allowing views out of the space and blurring the boundary between inside and outside. This has remained the ultimate goal and driver for glass architecture until today. Increasing transparency and creating invisible boundaries that provide weather protection but do neither obstruct the view nor the perception of connection between inside and outside (Figure 3.1).

This view is largely determined by the reflectivity of the material as well as the amount of light present either side of the material, which means, that the perception changes significantly between night and day as well as inside and outside (Figure 3.3). Figure 3.1 and Figure 3.2 show the difference between outside and inside during the day: whilst the building is dark on the inside and the sunlight externally is significantly brighter, the view from inside out is very clear, with the boundary between inside and outside disappearing (Figure 3.1), while in daylight conditions the view towards the inside of the building is dark and the glass becomes a mirror, reflecting the external conditions (Figure 3.2). The use of reflective and solar coating as well as body tinted glass increase this effect, but even clear glass will appear dark or black from outside in during bright daylight conditions.

The opposite effect can be observed at night, when the inside of a building is illuminated, while its dark outside. The surface close to the brighter light is reflective, while the surface close to the darker light will appear transparent and allow views through the glass (Knaack, 1997).

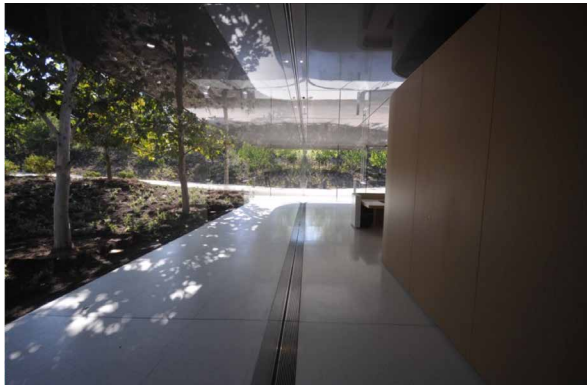

FIG. 3.1 Tantau Entrance Pavilion to Apple Park

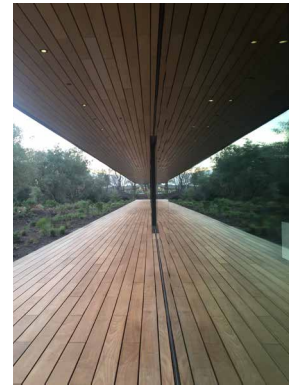

FIG. 3.2 Fitness centre glazing Apple Park

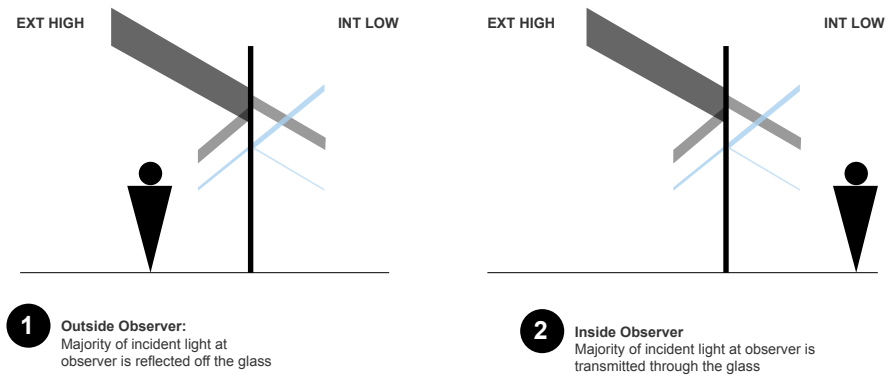

FIG. 3.3 Perception of Transparency inside vs. outside

This phenomenon becomes particularly apparent in glass facades with minimal structure, like the Time Warner building at Columbus Circle, NY designed by JCDA. Figure 3.4 and Figure 3.5 illustrate this effect where in the daylight the facade looks reflective and opaque, whereas in the night when illuminated from the inside, the glass surface visually disappears.



FIG. 3.4 Day view Time Warner Facade, Columbus Circle, NY

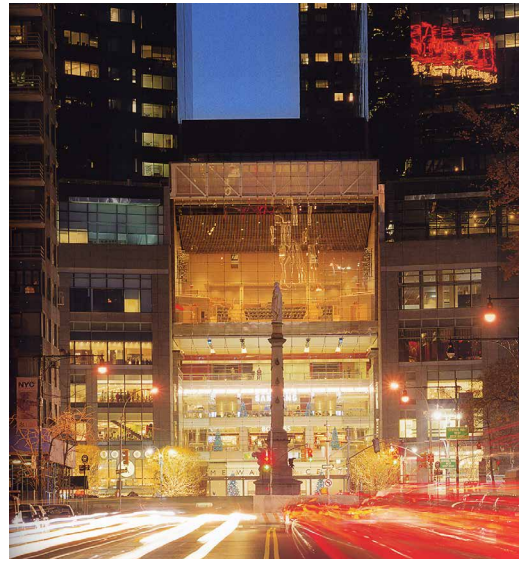

FIG. 3.5 Night view Time Warner Facade, Columbus Circle, NY (JCDA/Carpenter Lowings)

3.2 Glass in architecture

Although a building material since the beginning of the common era, the way glass has been used has undergone significant changes and developments, particularly in its connectivity. While initially not used as a structural component, the development of the structural use of glass can be classified into four main groups:

- 1 Glass to brace a steel frame
 - a Informally
 - b Formally
- 2 Glass transferring wind loads
- 3 Glass supporting itself
- 4 Glass as a primary structure

The following sections describe the development of the use of glass through different historical phases, following the analysis of the structural use of the material and categorisation into functionality groups

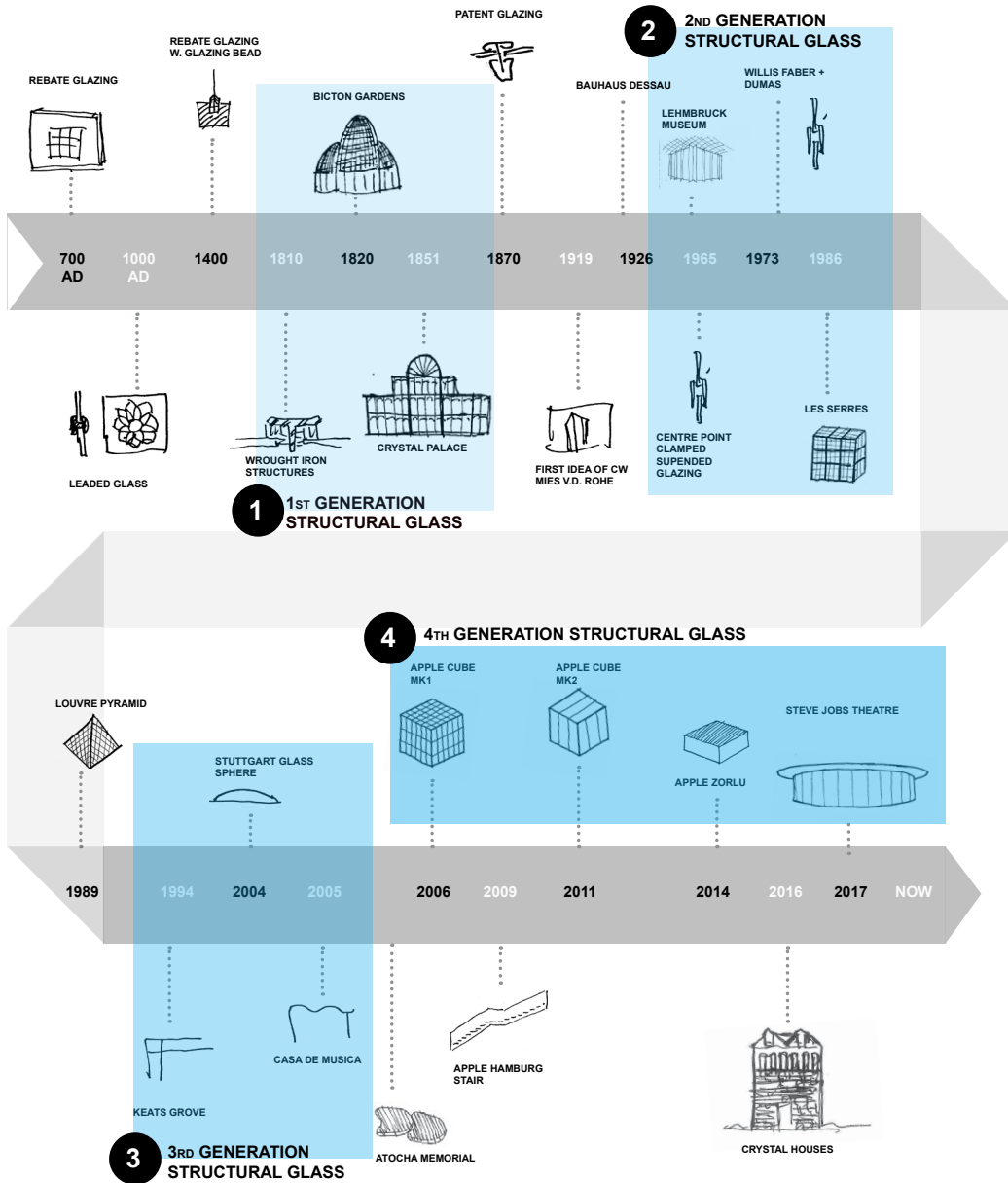

FIG. 3.6 Time line Glass in architecture

3.2.1 Roman

For the use of glass as an architectural element colour played an important role as windows became pieces of art depicting primarily biblical scenes. In the Mediterranean glass as an illuminated coloured surface became more important than clear glass sheets providing protection against weather influences. This can be seen in the church of St. Paulus in Rome by Konstantin, first built 337 BC and later extended and rebuilt after large parts were destroyed in a fire. The final version opened in 1854 (Figure 3.7, Schittich et al., 2007)



FIG. 3.7 St Paulus chapel, Rome

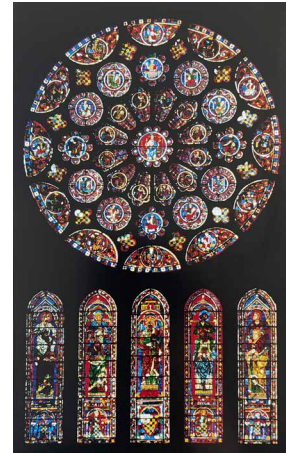

FIG. 3.8 Rose Window, Chartres

3.2.2 Middle Ages

Romanesque churches were built with solid masonry walls, using perforations to let light into the building. Driven by the compact construction, openings were relatively small. Gothic cathedrals on the other hand were intended to create spaces that were flooded with light and provided a feeling of grandeur. This is achieved with a slender skeleton of arches and columns on which the load of the vaults is supported. The solid wall is broken up into a skeleton of tiers and arches, which is the first representation of a modern skeleton. (Schittich, et al., 2007). The use of light played a significant role for the creation of space in these cathedrals. Stained glass was used to create a mystical atmosphere inside, breaking the barrier between god and man (Schittich, 2007). However, the glass was also used to portray biblical scenes

and stories and hence functioned as a medium of education. The large window openings were filled with small fragments of coloured glass that were connected with lead, hence the description leaded glass. This method allowed to accommodate the complex geometries that can be found in Gothic stained glass windows, famously represented in the Rose window of the cathedral of Chartres (Figure 3.8).

The development of the large Gothic cathedrals might be one of the most significant steps in the history of architecture, particularly considering the ability to create such filigree constructions despite the absence of advanced structural analysis and validation methods. However, it has to be considered that these were built on the basis of trial and error leading to failures on a sometimes catastrophic scale.

During Baroque and Renaissance, the exposure of glass in architecture changed again. Clear glass was used to create space with light and to go beyond the limits of physical space by using light as an instrument of illusions to create the artificial perception of space.

3.2.3 Industrial Revolution

With the industrial revolution, cast and wrought iron became available as a building material, which facilitated the construction of larger, lighter, longer spanning structures using the skeletal approach of Gothic cathedrals and applying it to steel skeletons capable of transferring tensile load, which led to the construction of the first very slender structures.

Glass had been applied in conservatories to grow exotic fruit previously, however these were initially based on solid walls with glass infills (Liddell, 2000). With the slender Victorian greenhouses, in which the glass is used to brace the structure laterally, the first 'structural' use of glass can be noted.

This led to not only the opening but the omission of the traditional wall, which allowed the use of glass as an infill panel within slender steel structures and achieve very transparent buildings (Behling, 1999).

John Claudius Louton patented the wrought iron sash bar in 1816, that allowed to create curved large-span structures, as the iron was formable (Whalley, 2000). The iron structure was significantly more efficient than previous timber structures and by using the glass to provide lateral stability, the iron skeleton could be extremely slender.



FIG. 3.9 Bicton Gardens glass house



FIG. 3.10 Shingles



FIG. 3.11 Close-up of 2-side supported overlapping shingles

One of the early highly transparent glass structures and one of the most significant remaining Victorian glass house is Bicton Gardens Glass House in Devon, England.

Designed by John Claudius Louton and built in cooperation with W + D Bailey (Whalley, A., 2000) in the 1820s the glass house is based on a slender skeleton of wrought iron mullions and shingled glass infills which achieves a remarkable degree of transparency despite the density of the structure

The glass braces the structure laterally, however it cannot formally described as a structural use of glass, as it was not intentionally designed this way.

The 8m tall structure has a rectangular floor plan of 9m x 4m with a semicircle of 4m radius to one side. The structure of the vault is supported on a 2.5m tall framework consisting of cast iron pilasters on which the skeleton structure of iron T-bars is supported. These are spaced at approximately 150mm centres, making it a dense but slender grid which is then filled in with approximately 18,000 glass shingles (Kohlmaier et al, 1991).

Despite the density of the structure, the slenderness of the individual profiles leads to a remarkable transparency when looking out of the glass house.

This has to do with the scale of the structure, which similarly to a mosquito net in front of a window, or a ceramic frit on a sheet of glass is less noticeable for the human eye than larger members at wider spacing.

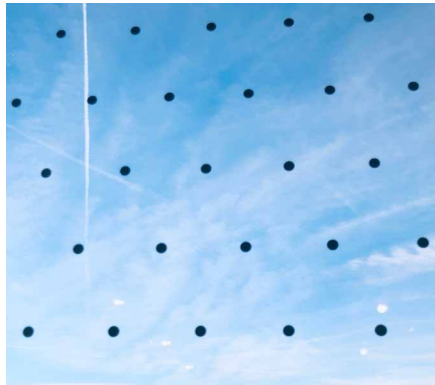

FIG. 3.12 Ceramic frit close up



FIG. 3.13 Ceramic frit from a distance



FIG. 3.14 Palm house Kew Royal Botanic Gardens (Kew Gardens)



FIG. 3.15 Crystal Palace, London (Brittanica)

Important for the appearance and perception of transparency is the scale and the proportion between structure and infill. The glass panels are very small, which allows the structure to be incredibly slim and lightweight. The resulting grid allows the eye to predominantly perceive the transparent component, whereas the opaque structure disappears visually, comparable to the effect a mosquito net or ceramic frit has on the perception of the human eye (Figure 3.12 and 3.13).

As relates to size and spans, this development initially reached its peak with the Palm house in the Kew Royal Botanical Garden of London which was designed and engineered by Richard Turner and Decimus Burton 1844-1848 and the crystal palace built by Joseph Paxton for the Great Exhibition 1851. Both examples offer a maximum transparency by the minimum of structure (Kohlmaier 1991).

3.2.4 Early 20th Century

The beginning of the 20th century led to the next major change in architecture driven by a cultural revolution. In Germany the Deutsche Werkbund, founded in 1907 with the idea to establish an entity of art, design and production drove this development. The Faguswerk by Walter Gropius and Adolf Meyer 1911/12 was one of the first examples of the dramatic change in the design of buildings. Glass became a major element being used in large areas of the factory building and although used as an infill panel within the brick walls, the solidity is broken up by glazed corners with slender steel frames (Schittich et al, 2007).



FIG. 3.16 Faguswerk, Gropius/Meyer (worldheritage.edu)



FIG. 3.17 'Glass Skyscraper' concept, Berlin, Mies v.d.Rohe (Phaidon)

Bruno Taut's glass pavilion for the Werkbund exhibition in Cologne 1914 demonstrated the importance of glass as the building material of the future. The bohemian poet Paul Scheerbart published his book about Glass architecture which described the prospective use of glass in architectural application in 111 chapters (Glasarchitektur, 1914) as an addition to the exposition. In 1919 a manifesto about glass was composed by Berlin artists and architects called 'Die Gläserne Kette' (crystal chain). After their denouement in 1920, the idea using glass as central component lived further. Mies van der Rohe started a revolution for the office

building of the 20th century with his proposal for an office tower in Berlin 1919 (Figure 3.17), which was the theoretical materialization of Scheerbart's theory of architecture. Instead of using glass as an infill, the glazing was hung from the slab edge to form a continuous slim glazed envelope comparable in its principle to a fixed curtain supported from the ceiling. This can be seen as the first concept of the curtain wall, although it was not built at the time.

The first fully glazed facade that can be classified as a curtain wall was built in San Francisco in 1918. The Hallidie Building by Willis Jefferson Polk was a reinforced concrete structure from which the facade is suspended (Figure 3.18).



FIG. 3.18 Hallidie Building San Francisco

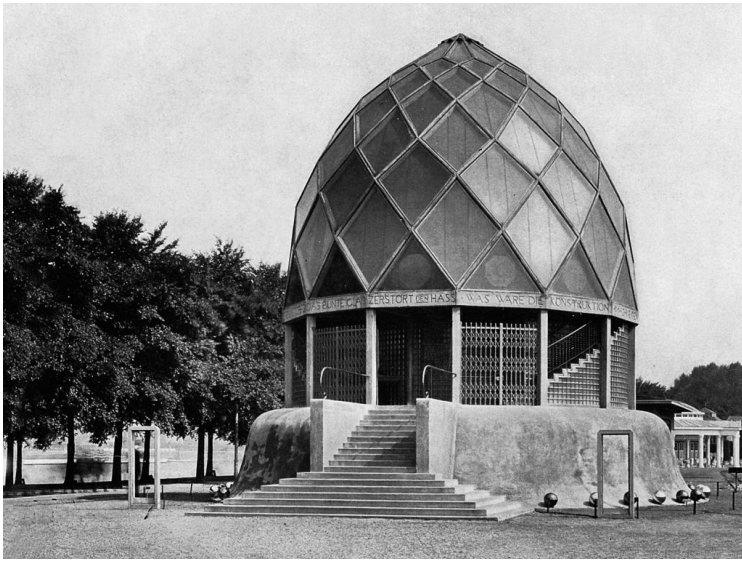

FIG. 3.19 Glass pavilion Bruno Taut, external and internal view



FIG. 3.20 Caption



FIG. 3.21 Caption

After the Bauhaus Building in Dessau by Walter Gropius (Figure 3.22), the Villa Savoye and with the Cité de Refuge by Le Corbusier another very important building for the development of the use of glass in architecture occurred in Paris; La Maison Dalsace, renamed as Maison de Verre was built in 1931 and designed by Pierre Chareau and Bernard Bijvoët. The steel structure filled with translucent glass bricks on the courtyard and garden elevations allowed to provide the residential building with sufficient daylight, while still providing privacy (Figure 3.20 and 3.21).



FIG. 3.22 Bauhaus Dessau, 1926

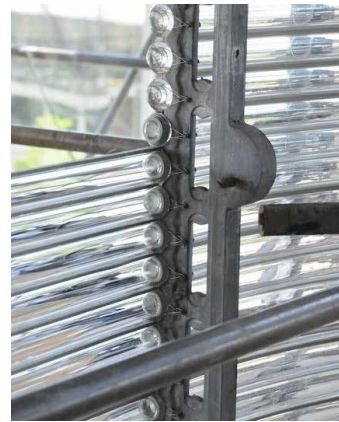
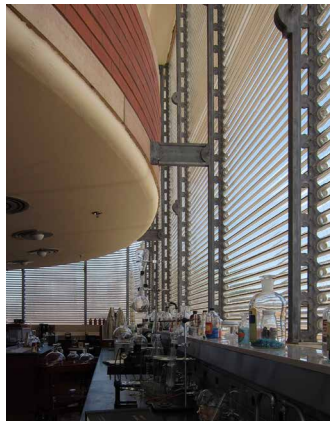

FIG. 3.23 Johnson Wax Headquarters, Racine, WI, Frank Lloyd Wright

In 1936 Frank Lloyd Wright used glass in a more unconventional way; the facade for the Johnson Wax headquarters in Racine, WI consists of horizontal borosilicate tubes that are stacked on top of each other to form a wall. Due to the circular shape though, the tubes don't function like a brick wall, being loaded in compression, instead they span horizontally between steel mullions which they fix to. The result is a translucent facade that provides limited views out but with very little visible framing. Joints are sealed with a transparent adhesive, which over time has deteriorated (Figure 3.23).

3.2.5 Mid 20th Century

Glass architecture became significantly more common after World War II, when the development of the float glass process (as described in 2.7.1) made glass more widely available and more economical to use in larger quantities.

One of the world's most widely-recognized mid century structures is Farnsworth House (Figure 3.24), designed by Ludwig Mies van der Rohe and finalised 1951. The fully glazed single-room weekend house achieves the connection of inside and outside through the transparency of the glass.

Another important example is the Crown Hall of the Illinois Institute of Technology which is also designed by Mies van der Rohe and built in 1956. Panel sizes of 3 x 3.25 metres and steel frames characterise this prominent architecture.

In the middle of the 20th century the second generation of structural glass facades was established. As opposed to the four-side supported use in windows and curtain walls, glass was now supported locally with metal clamps that were used to transfer load between panels.

An early example for this approach is the Wilhelm Lehmbruck museum in Duisburg designed by Manfred Lehmbruck (1964). Glass fins are introduced to reduce deflection due to wind load. The fins are suspended as well and the load is transferred through structural silicon which is used to bond the fins to the facade glass. The suspension of the face panels is achieved with clamp fittings that use friction to transfer loads. This way of supporting the glass increased transparency due to local connections, however, at the time was limited to a single storey (Schittich et al, 2007).

One of the first projects to employ this strategy was the armour plate link bridge glazing at Centre Point in London designed by Richard Seifert which was finalised in 1965. The facade comprises two rows of glass panels of which the upper panel is suspended from the roof structure whereas the lower panel is clamped to the top panel. In the upper portion, suspended glass fins are used as wind load restraints.



FIG. 3.24 Farnsworth House, v.d. Rohe, 1951, (M. Kaletka, Flickr)



FIG. 3.25 Lehmbrock Museum, Duisburg (Knaack)



FIG. 3.26 Lehmbrock Museum, Duisburg, Base detail (Knaack)

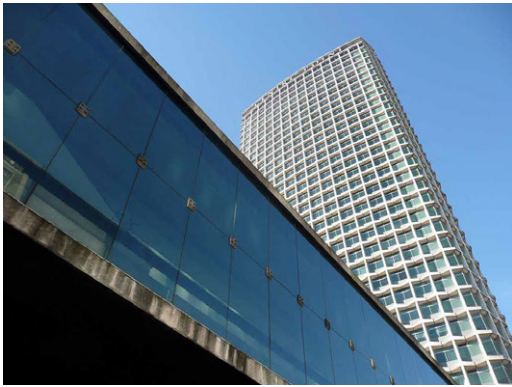

FIG. 3.27 Centre Point Link Bridge, London, 1965, Richard Seifert



FIG. 3.28 Centre Point Link Bridge, fin and clamp detail



FIG. 3.29 Willis Faber and Dumas headquarters, Ipswich (Foster Architects)

A more commonly published example of larger scale is Willis Faber and Dumas headquarters in Ipswich, UK designed by Foster Architects, this however was nearly 10 years later (1973). 5 panels are suspended through friction clamps at the glass corners from the top panel (Schittich et al, 2007, Brookes et al, 2008).



FIG. 3.30 Willis Faber and Dumas headquarters, Ipswich (Archilove)



FIG. 3.31 Sainsbury Centre of Visual Arts, F+P (F+P)



FIG. 3.32 Sainsbury Centre, Glass fin facade, F+P (F+P)

In 1978 the Sainsbury Centre for Visual Arts was completed in Norwich, UK. The large column free space is designed by Foster Architects, by using a 3-dimensional truss structure, spanning 35 metres with two fully glazed facades to the east and west.

The base supported glazing is 7.5m tall and is laterally restrained at the truss structure above. Monolithic glass fins are suspended to limit glass deflection at the joints. The fins are bonded to the face panels with silicone.

3.2.6 1980's-2000's

In the 1980's a new trend towards transparency developed with cable trusses allowing for visually slender structures the glass panels would be supported off.

At Les Serres in the Parc de la Villette in Paris three winter gardens are representative of this development. Adrien Fainsilber and RFR designed the glass cubes of 32 x 32m and 8m depth. The primary structure consists of steel tubes on an 8 x 8m grid. Each 8 x 8m square is glazed with 16 2 x 2m toughened glass panels. The top row of panels is suspended from the primary structure, while the panels below are hung from the glass above, with a cable truss behind each horizontal joint taking the wind load. The glass is drilled and bolted with H-fittings, which also connect the cable trusses with stainless steel struts (Knaack, 1998). The joints are sealed with a transparent weather seal, suggesting load transfer through the fittings in the glass corners only.



FIG. 3.33 Les Serres, Parc de la Villette, Paris (Knaack)

3.2.7 Recent developments

Currently the development in glass connections has reached a point where the actual joining pieces have become very small in relation to the size of the glass panels themselves. However, it appears that with this, a stagnation on the way to ultimate transparency is reached, which is not easy to overcome using common technology. The development has gone from framing elements holding the glass with discrete connections that can be clamps on the surface, bolts through a drilled hole or laminated into the glass panel back to a linear fixing that relies on a structural bond, most often with silicone. Examples of transparent bonding exist too, however these are usually very small and primarily experimental projects.

A very important example for this experimental approach is Keats Grove, a glass extension in Hampstead, London designed by Rick Mather in 1992 and engineered by Dewhurst Macfarlane and Partners.

This relatively small residential structure can be seen as the first structure fully supported by glass. All loads are transferred by the glass and no other framing material is used to provide either vertical or lateral stability.

The glass conservatory can be described as a portal frame that leans against the building with all loads being transferred through the glass. Wind loads imposed on the facade panels are transferred in bending through the panels to the glass columns. The load is then transferred through the columns into the roof beams which then distribute it into the roof panels. The roof acts as a stiff diaphragm which allows to transfer the loads into the side walls and back into the building.

The enclosure consists of base supported glass fins and glass beams that span between the fin and the building as well as insulated face and roof panels. No visible steel is used in the entire enclosure and all sealants are transparent. This also applies to the IGU spacer, which is a glass bead bonded to the glass lites with and sealed with transparent silicone.

At the base, the glass is supported in a steel shoe capturing the IGU, which is laterally restrained at the top by the clear silicon bond to the fin and the roof panel.

The glass fins and beams are joined by using traditional timber approach of a mortice and tenon joint, meaning that each of the 3-ply laminate is stepped in a way that it allows to slide into the other one, forming a dry connection (Macfarlane, 2004).

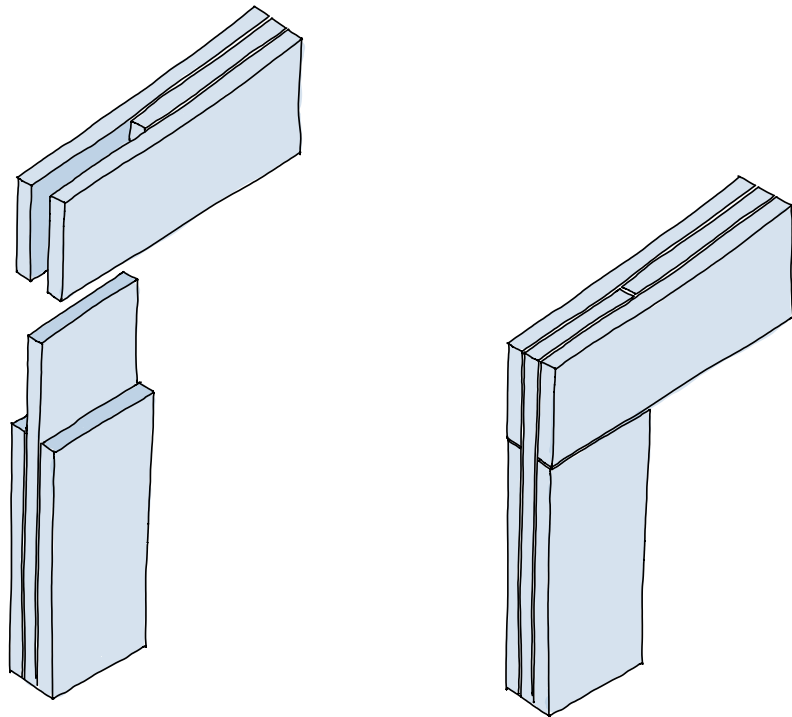

FIG. 3.34 Bridle joint assembly diagram Keats Grove

The outer plies of the columns are cut short by the thickness of the beam and the inner ply of the beam is cut short by the thickness of the column, which allows for the column to fit in the pocket of the beam. The connection is a dry joint, which is assembled on site and relies on the connection of the beams to the primary structure for stability. In a later project that uses a similar approach, the joints are filled with UV resin after assembly on site to achieve a stiff connection. As with the bond of the spacer to the glass face, these connections are very brittle, so cannot accommodate large movements.

The toughened glass beams are laminated with a UV curing resin interlayer, which was a common approach at the time.

Given that no metal is used to connect the glass and all weather seals are transparent, a very transparent structure is achieved and only the varying thickness of the elements resulting in a variance in colour and reflection of the face/roof panels and the beams and fins impacts the overall transparent appearance of the structure.



FIG. 3.35 Keats Grove Extension, London, RMA/DMP (image RMA)



FIG. 3.36 Keats Grove Extension, London, RMA/DMP (image Brian Eckersley)

Yurakucho Station Canopy, Tokyo

The structures previously described were small scale domestic structures with minimal load impact, which allowed the experimental approach using dry connections, resin bonded glass spacers and transparent weather seals in lieu of structural silicone bonds. The first commercial structure in a public space to be all glass is the Yurakucho canopy in Tokyo designed by Rafael Vinoly Architects (RVA) with Dewhurst Macfarlane and Partners (DMP) (Figure 3.38).

The canopy was the first significant step towards commercial and public all glass structures and as opposed to the earlier European structures, significant wind and seismic forces had to be accommodated.

The canopy roof is supported on three 10m long cantilevering laminated glass beams. This structure was the first to use load bearing bolted connections in a laminated assembly. Previously this had proven to be difficult due to the fabrication tolerances around drilled holes in laminates (2.7). The beams cantilever from a stainless steel torsion tube at ground level.

Each beam consisting of 4 bolted elements consists of two 19mm sheets of toughened glass laminated with a UV curing resin. The 15 mm thick roof panels were laminated using a PVB interlayer.

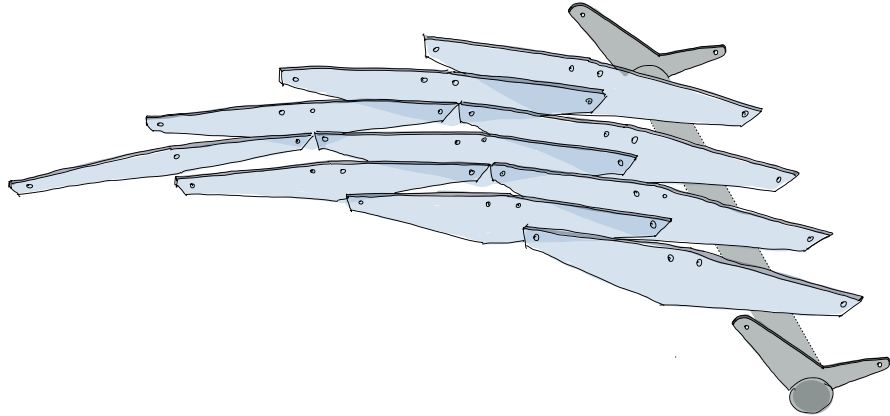

FIG. 3.37 Assembly diagram Yurakucho Canopy

The blades are approximately 750mm deep at the deepest point and overlap with the respective neighbouring blade by approximately 2 metres, meaning that even if a glass segment failed, load would be transferred to the adjacent segment and not lead to a complete failure of the beam (MacFarlane, 1994).

The most significant development in this project is the connection that allows the load transfer through the beam segments. The cam bezel is a fitting that allows the misalignment of laminated thermally strengthened glass layers to be accommodated through a continuous shear pin, thus providing a predictable load share into more than one layer of glass.

This demonstrated that more load could be carried by the overall laminate and that there was significant redundancy in load bearing capacity because of the load share mechanism. This concept solved a fundamental problem of tolerance in load bearing glass holes and therefore led to more ambitious structures being considered. The Samsung Jong Ro building (Figure 3.39), also designed by RVA, utilised this concept in a significantly larger scale facade application.



FIG. 3.38 Yurakucho canopy, (image Glasslimited)

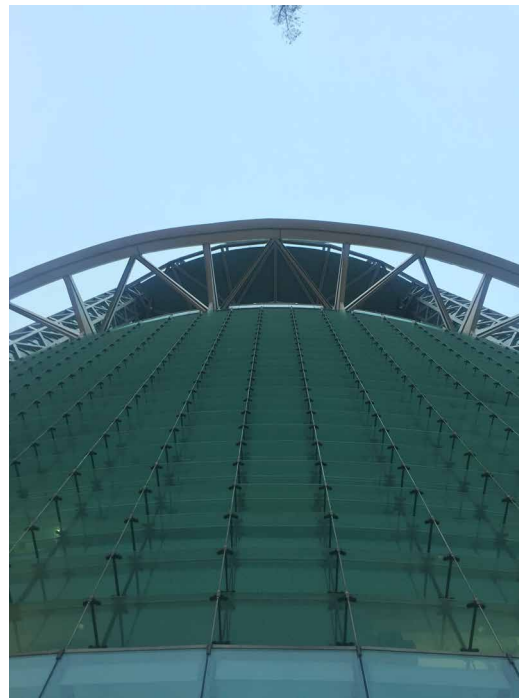
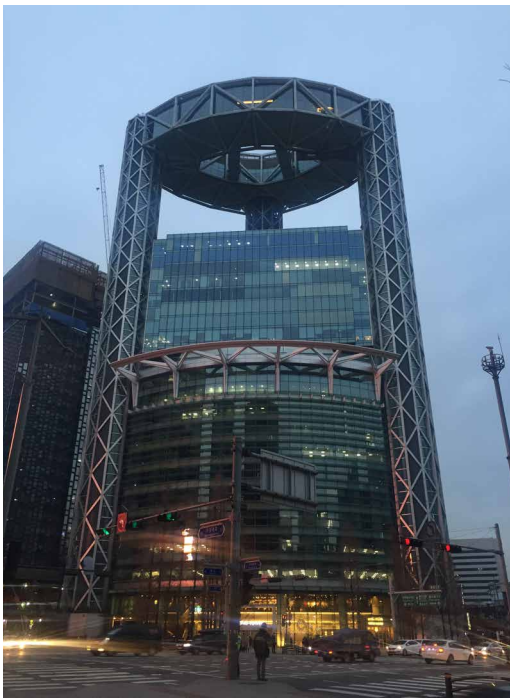

FIG. 3.39 Facade Jong Ro building, Seoul, South Korea RVA/DMP

4th generation structural glass

The development of the structural use of glass can be defined over a period of approximately 180 years starting with the Victorian wrought iron greenhouses. Although glass was not knowingly used as a structure, it is used to brace the slender frames.

Figure 3.40 shows this development on a scale indicating the transparency that was achieved with these structures. Generally the trend that is visible here is over time structures and envelopes typically have become more transparent, however it must be acknowledged that the projects discussed in this chapter and used to show the development in the following graph do not represent the majorities of projects built in the time but resemble the state of the art at their time as relates to the structural use of glass.

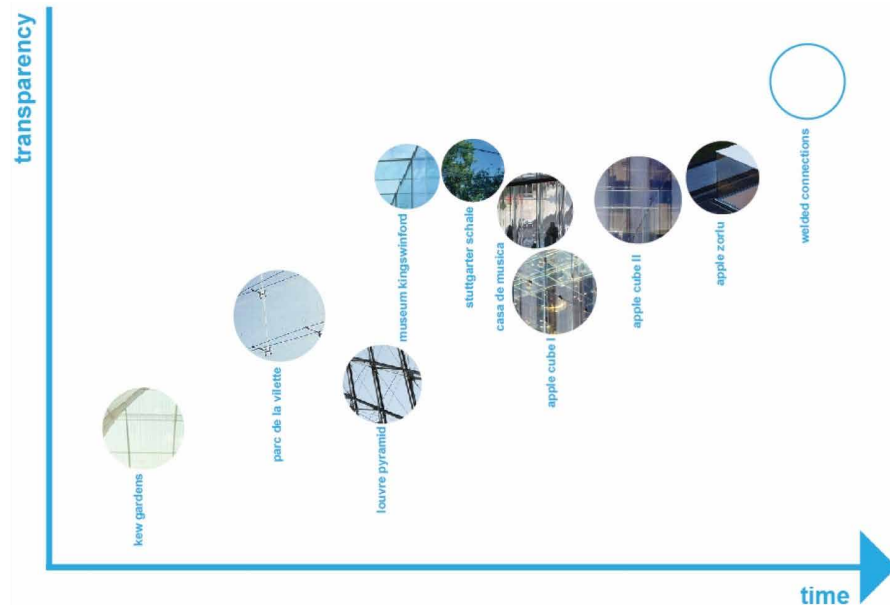

FIG. 3.40 Development of structural glass connections over time

During the past two to three decades, a significant development in structural glass envelopes and enclosures can be observed, aiming to achieve an increase in transparency.

Apple 5th Avenue, New York

The development from an infill material to a structural material described previously, enabled designers to develop buildings and envelopes that are based on using a large amount of glass i.e. atriums, skylights and structural glass enclosures. This is perhaps best demonstrated in the development of the Apple retail stores in which glass is used as a fundamental part of the store design.

The glass structures merge with their surroundings and become invisible, nearly de-materialised if the connections are kept to a minimum. This requires a large amount of engineering analysis and precise detailing to achieve safe and transparent structures.

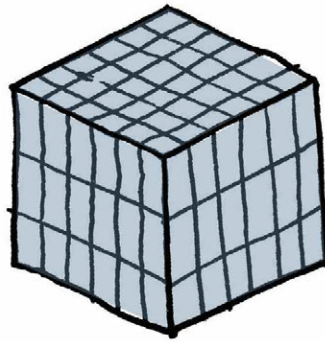

FIG. 3.41 Apple Cube 5th Avenue version 1.0 (CB1) schematic

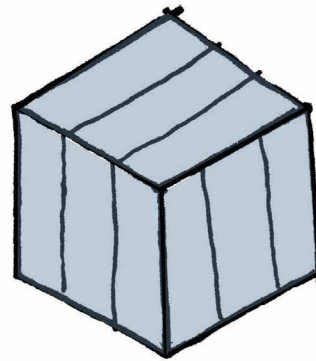

FIG. 3.42 Apple Cube 5th Avenue version 2.0 (CB2) schematic



FIG. 3.43 Apple Cube, 5th Avenue version 1.0 NYC, BCJ, 2006 (EOC)



FIG. 3.44 Apple Cube, 5th Avenue version 2.0 NYC, BCJ, 2011 (EOC)

As shown in Figure 3.44, current technology achieves the design and construction of glass structures that are highly transparent. However, depending on the position these structures are observed from, metal fittings still have a large visual impact on the overall perception of the glass enclosure (Figure 3.47 and 3.48).

However, a stagnation in the development of those glass structures and in the technology involved can be observed. A good example to demonstrate this development is the Apple Store on 5th Avenue in New York City, originally designed by Bohlin Cywinsky Jackson (BCJ) and Eckersley O'Callaghan (EOC) and finalised in 2006.

This first version used bolted connections and splice laminated glass fins, as at the time glass was typically produced in maximum lengths of 6 metres and lamination capacity was limited to that size. For the fins, a splice lamination process was developed in which, like in plywood, shorter pieces of glass are laminated in a staggered manner, bridging the joint with the next glass layer. This allowed the use of the limited glass lengths of 6m, to produce 10m tall fins. This was reliant not only on an autoclave long enough to fit a 10m element, which at the time was only available in the aviation industry, but also on an interlayer material allowing load transfer between the layers. This was achieved with SentryGlas by Kuraray which is an ionoplast interlayer developed for windows in hurricane and typhoon affected areas.

Despite the possibility of splice lamination, only the fins were manufactured in that way and the panel size remained small for the facade and roof panels with a typical size of approximately 1.6m x 3.3m for the facade and 1.6m x 1.6m for the roof. The facade panels were clamped to the fins and to each other at the edges (O'Callaghan et al, 2012). Five splice laminated fins supported the facade panels and the roof grillage.

This project and other structures created a demand in the market which led to the development of larger processing equipment.

The availability of larger sheets of glass led to a re-design of the same structure 5 years later, maximising the panel size and reducing the number of panels used from 106 panels in 2006 to 15 panels in 2011 (Figure 3.43 and Figure 3.44)

Whilst all panels are full height, the wind load is still transferred into the fins through metal fittings. Compared to the first version those are laminated into the thickness of the glass, allowing for a flush glass surface externally, which for the appearance of transparency is a significant improvement, as the reflectivity of the glass surface is not interrupted.

This approach demonstrates an improvement in the appearance of transparency which is evident when comparing the two structures (Figure 3.47) as both the quantity of opaque fittings and the amount of visible glass edges are reduced.

Comparing the fittings themselves shows that the size has not changed significantly, however the continuous glass surface on the outside of the laminated fittings helps to increase the perception of transparency, whilst the measured opaque area or overall VLT would only be affected by the quantity of the fittings.



FIG. 3.45 Clamped fitting George street (comparable to CB1)

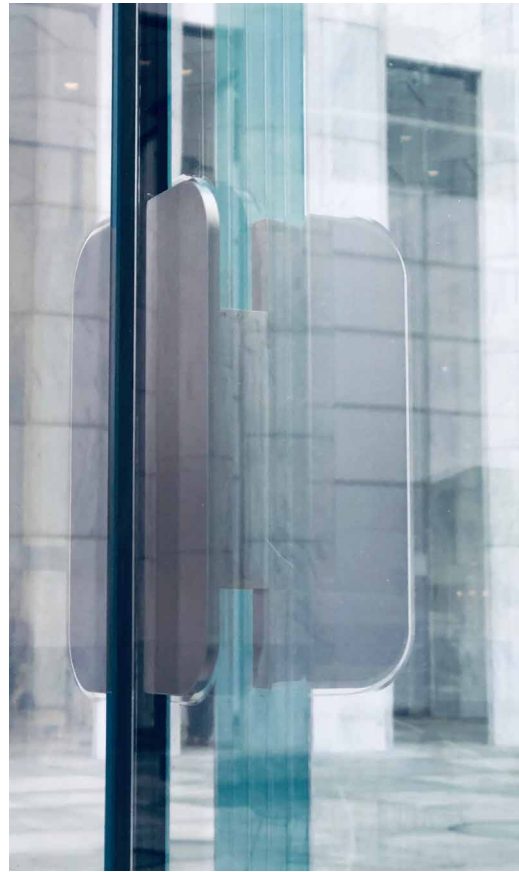

FIG. 3.46 Laminated fitting CB2

Currently a third version of the cube is under construction, however no changes will be made to the glass structure itself or its connections, which shows the stagnation in the development of transparent structures previously mentioned. This is not only driven by technical limitations but also by architectural trend and requirements that have progressed beyond the focus on the improvement of transparency only.

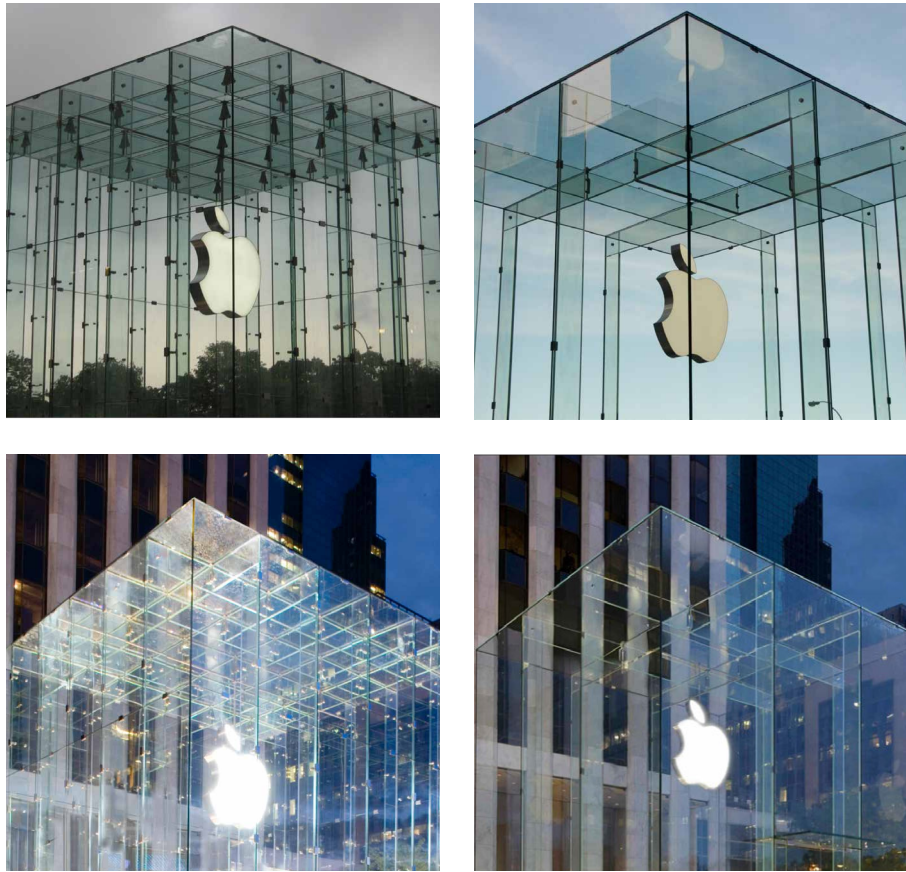

FIG. 3.47 A-D comparing the transparency of the two structures at night and day shows the visual impact of the glass edges and the effect of light levels on the appearance of transparency

When comparing the two versions of the 5th Avenue Cube, one factor that appears to be of significant importance for the transparent appearance of a structure appears to be the visibility of the glass edges. Figure 3.47 indicates that not only the quantity of the connections hence the area of opacity in the structure define the perception of transparency, however, the appearance and light refraction on the edges of the glass have a significant impact as well, both in day and night-time conditions.

Apple Zorlu, Istanbul

With availability of glass sizes of up to 16m length in 2014, the lantern for the store in Zorlu, Istanbul, designed by Foster + Partners (F+P) and EOC did not utilise the full panel size available, yet a new approach to achieve a more transparent structure was followed.

The floor plan of the pavilion with approximately 9 x 9m is the same as the 5th Avenue entrance pavilion, however, the height is reduced to allow the use of a single panel for each side. The glass is base supported in a steel shoe on a sprung base, which is achieved with a series of springs between two steel beams to mitigate movement and bonded with structural silicone at the corners. The glass edges are mitred in the corners to allow for a minimal impact of the black silicone (Figure 3.49).

Despite the opaque tapered carbon fibre composite (FRP) roof, which is supported only on the glass, the structure achieves impressive transparency by avoiding joints in the glass surface and not using metal fittings but silicone joints in the corners only.

Although this development overcomes the apparent problem of visible metal connections within the structure, it does not substitute the development of new fixing technologies and typologies as it is only applicable to a specific scenario.



FIG. 3.48 Apple Shanghai, BCJ/EOC, 2012 (EOC)



FIG. 3.49 Apple Zorlu Istanbul, F+P/EOC ,2014 (EOC)

Dilworth Plaza Subway Entrance, Philadelphia

The Dilworth Plaza subway entrance in Philadelphia is a glass structure built without mechanical connections (Figure 3.50 upper). Dead load is transferred from one panel to the adjacent one through blocks and bending through the structural silicone joints. The roof panels are supported on the glass walls (Figure 3.51). It is visible though that roof panels have slipped on the wall panels leading to misalignment of joints (Figure 3.50 lower).



FIG. 3.50 Dilworth Plaza subway entrance, Philadelphia (Kieran Timberlake/EOC)

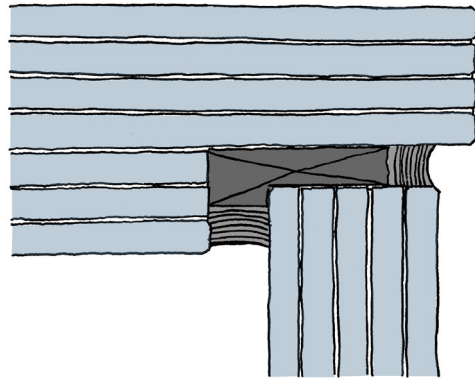

FIG. 3.51 Dilworth Plaza subway entrance, detail glass support

3.3 Curved and deformed glass to increase structural capacity

3.3.1 Vakko Headquarters, Istanbul

The external glazing of the Vakko HQ in Istanbul, designed by Rex and Front is slumped to increase its stiffness. Over the length and width of the entire panel, an X is formed into the surface which reduces the deflection under wind load and hence allowed to design this facade without vertical mullions. The external deformed glass panel is 19mm monolithic annealed, while the inner pane of the IGU is flat and fixed with countersunk point fittings, bonded into the monolithic glass. This means the external panel is supported through the IGU edge seal only. The fact that the inner FT panel is point supported with countersunk fittings is more questionable though, given that any fracture on the inner panel- which given the risk of NiS in FT glass has a reasonable probability, the entire unit would be at risk of dislodging.

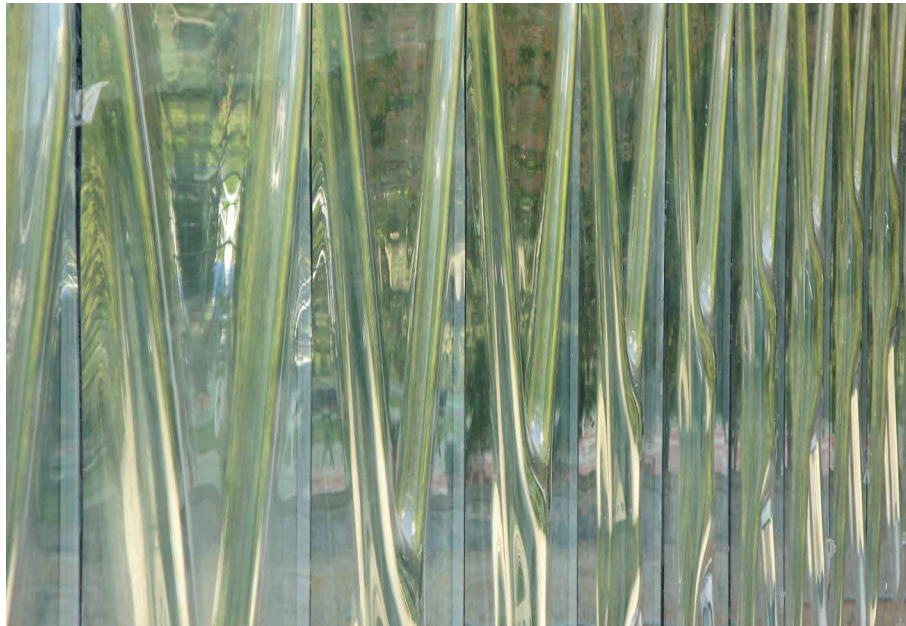

FIG. 3.52 Vakko HQ, REX (Betanzos, A.)



FIG. 3.53 Vakko HQ, REX (Betanzos, A.)

3.3.2 Casa de Musica, Porto, OMA/ABT

In the concert hall in Porto designed by OMA for the city's time as European capital of culture, large corrugated glass walls mark the areas of the building that have a connection to the external (Figure 3.54).

As typical for a concert hall, the building is primarily solid, with white concrete and travertine facades, however, two large openings in the facade are filled with corrugated glass panels, to allow light into the building and provide an unobstructed view to the outside. The 25 x 12.5 m opening is filled with 3 rows of 4.5 m tall glass panels (Nijssen et al, 2014).

The glass is gravity bent (slumped) into shape in an oven and annealed as part of the process to release locked-in stresses. The annealing process is of significant importance to guarantee that the glass will not fracture due to stress differentials when installed on site and subject to building movement, wind and thermal loads. The structural engineers for the glazed walls (ABT) made use of the geometric stiffness that is gained by corrugating the glass, which omitted the requirement of vertical mullions due to the limited deflection achieved through the geometry.

The glass panels are base supported in a steel shoe, which is made of bent plates and at the head restrained to a circular steel beam that also provides the dead load support for the panels above (Figure 3.55).

Given the geometrical stiffness, the wind loads can be resisted with a monolithic 12 mm annealed glass panel, which however poses the question of resilience in case of fracture, given that annealed glass could break due to thermal stress, localised stress concentrations caused by movement of the structure or impact. Laminating the panels would seem like an approach that would have reduced the risk of dislodging, however it is understood that the approach taken was driven by the assessment that in case of fracture, due to its geometry and capture the glass wouldn't dislodge.

OMA and ABT employed the same approach of creating geometrically stiff glass walls by using corrugated panels on various other projects. Best known examples are the Museum aan de Stroom, Antwerp (Figure 3.56) and the University Library in Doha (Figure 3.57).

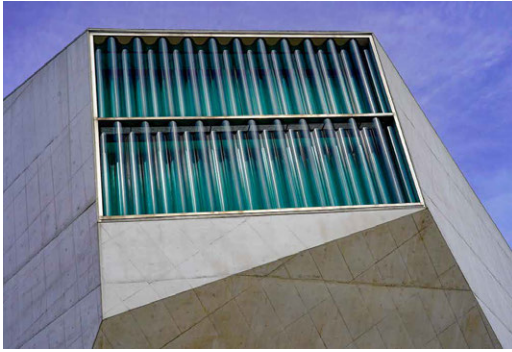

FIG. 3.54 Facade Casa da Musica, Porto, OMA & ABT, 2005

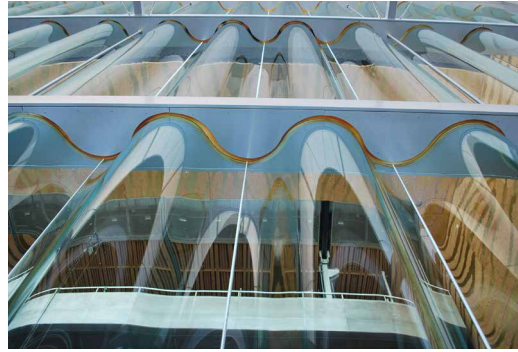

FIG. 3.55 Close up, Facade Casa da Musica, Porto, OMA & ABT, 2005

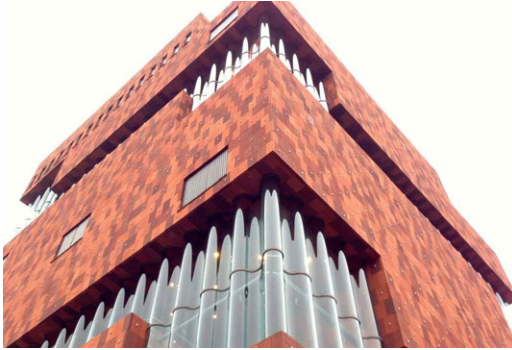

FIG. 3.56 Facade MAS Antwerp, OMA & ABT



FIG. 3.57 Facade Qatar National Library, Riyadh, OMA & ABT

3.3.3 CTS Museum, Hong Kong, SO-IL/EOC

As part of a development in Kowloon designed by KPF, the CTF museum facade is designed by SO-IL together with EOC. The museum is set on the 8th floor of the mixed-use development and non-typical for a museum, the facade along the perimeter is fully glazed, to allow transparency out of and into the space. 475 nine meter tall glass tubes are set next to each other around the perimeter of the museum to form the envelope. As with the projects previously shown the geometrical stiffness achieved by curving the glass to a radius of 450 mm, which allows to omit any additional structure despite hurricane loads in Hong Kong.

Most tubes are fabricated of two 12 mm sheets of low iron glass and laminated with Sentry Glass. Here SG was used not only due to its load transfer capacity but also because it's lower viscosity and flow rate in the autoclave allows to better allow for tolerances in the glass surface radius.



FIG. 3.58 External view of glass tube facade at CTS Museum, Hong Kong (SO-IL/ EOC)

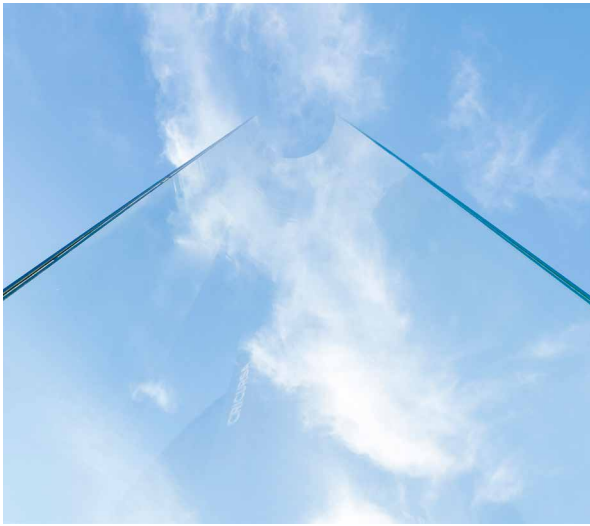

FIG. 3.59 Laminated glass tube prior to unit assembly

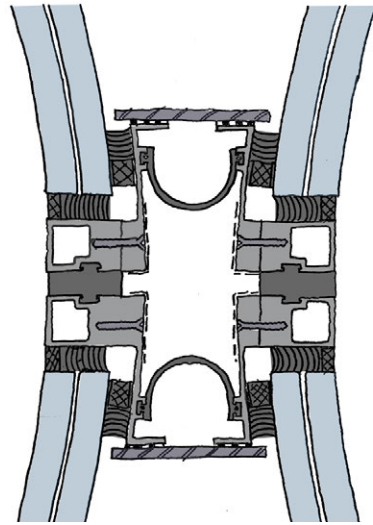

FIG. 3.60 Connection detail



FIG. 3.61 Detail of two half tubes after installation. The glass is protected with an adhesive film

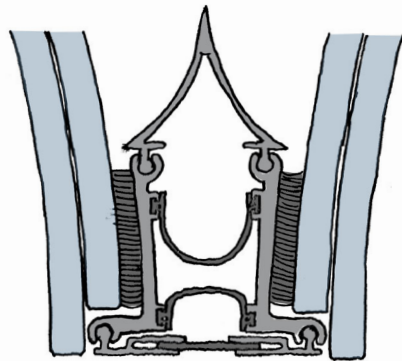

FIG. 3.62 Half tube detail

3.4 Glass as a solid material

Despite the fact that glass in architectural applications is typically used as a thin sheet, examples of the use of glass as a solid material are available. In these applications, glass typically occurs in blocks or bricks, which due to the thickness as well as the small size and increase of joints leads to a reduction of transparency. However, instead of using the glass in bending as is typically the case when designing with sheet material, it is used in compression in which it is much stronger than in bending (Feldmann et al, 2014).

3.4.3.1 Atocha Station Memorial Madrid

The memorial for the victims of the terrorist attacks at Atocha station in Madrid in 2004 is designed using approximately 15,000 clear borosilicate bricks that are bonded with a UV adhesive to form a cylinder, which provides light into an underground exhibition space. Within the cylinder, messages left at the station after the attack are engraved in to a translucent fabric structure that is suspended from the transparent glass roof.

The cylinder is formed using a glass brick that was specifically designed and fabricated for the project (Schott, 2018). Each brick measures 300 x 200 x 70mm with a concave and a convex end which allows the bricks to be aligned in a cylinder shape with varying radii and creating a slight interlocking effect. The bricks are bonded using a transparent acrylic adhesive, which is cure with UV light on site. The choice to go with borosilicate glass was made due to its low thermal expansion coefficient compared to soda lime glass.

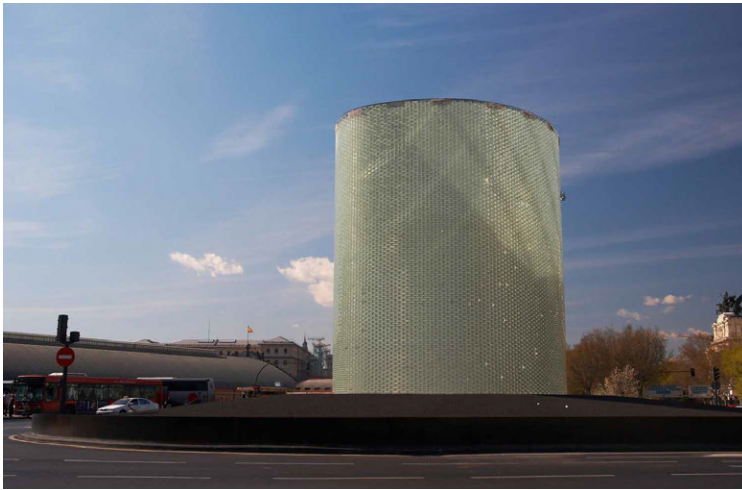

FIG. 3.63 Atocha Station Memorial, Madrid, FAM Arquitectura y Urbanismo + SBP

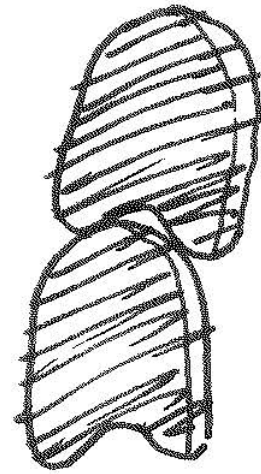

FIG. 3.64 Atocha Station Memorial, brick design



FIG. 3.65 Atocha Station Memorial, borosilicate bricks (image estudio sic)



3.4.3.2 Crystal Houses, Amsterdam

The Crystal Houses are designed by MVRDV to resemble a historic facade in Amsterdam's Hoofstraat in a novel interpretation. The brick facade is made entirely of glass, including the window and door frames.

The bricks are made of solid soda lime glass, bonded with a transparent acrylic glue that is cured with UV light on site (Oikonomopoulou et al, 2014). This technique is comparable to the way the Atocha memorial in Madrid was assembled.

The design makes use of the large compressive strength of the glass (2.4), which is a very intuitive way to use the material compared to the use of glass as thin sheets, which results in bending stress being induced. To resist wind loads, additional buttresses are used, stiffening the wall (Oikonomopoulou et al, 2014).



FIG. 3.66 Crystal Houses, Amsterdam, MVRDV, ABT, TU Delft

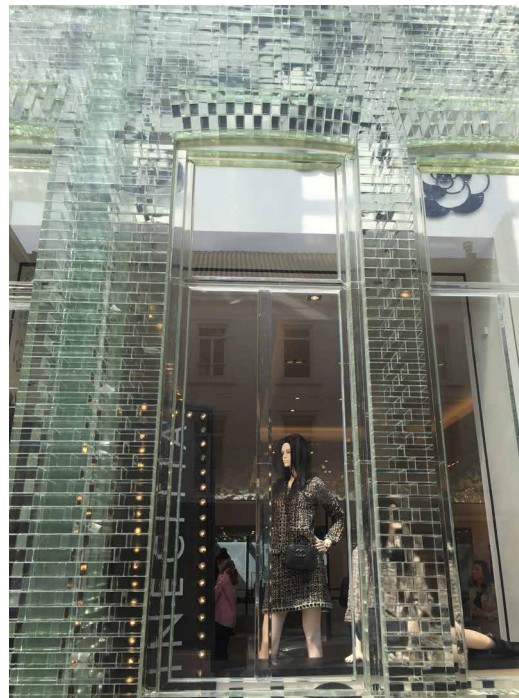

FIG. 3.67 Crystal Houses, Amsterdam, window frames made of glass extrusions



FIG. 3.68 Crystal Houses, Amsterdam, window frame and sill.

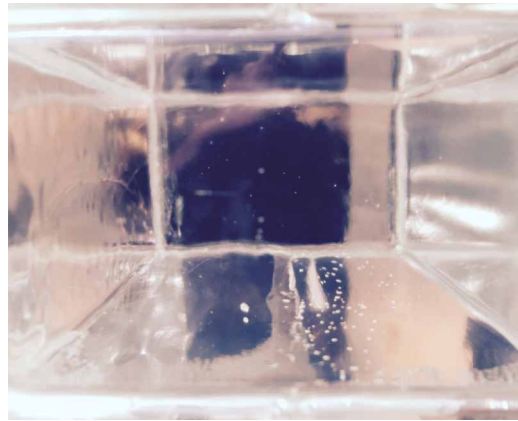

FIG. 3.69 Crystal Houses, Amsterdam, close-up

3.4.3.3 Further development of Brick approach at TU Delft

After the construction of the Crystal Houses, Oikonomopoulou and Bristogianni continued the research in glass bricks and developed methodologies of casting bricks out of recycled glass

In their ongoing research they tested melting and casting glass with varying compositions at different temperatures and further developed the casting into interlocking shapes (Bristogianni et al, 2018). Examples of the research were exhibited as part of the Glasstechnology live exhibition at Gastec in Duesseldorf 2018 (Figure 3.70).

Various shapes, colours and opacity levels have been explored as well as the cooling rates required to achieve transparent bricks, as well as glass ceramics at slow cooling rates (Bristogianni et al, 2018). The research indicates a significant potential for the recycling of glass into building components in the form of bricks and blocks, which can be transparent, translucent or coloured.

Another stream of research at TU Delft investigates the use of interlocking bricks for a bridge design (Figure 3.71) As opposed to the assembly in the Atocha Memorial and the Crystal Houses, the bridge is designed to be assembled dry, meaning no adhesive will be used to bond the bricks together, but they rely on the geometry of the bricks as well as the bridge to create sufficient friction to keep the glass assembled within an arch (Snijder et al, 2018).

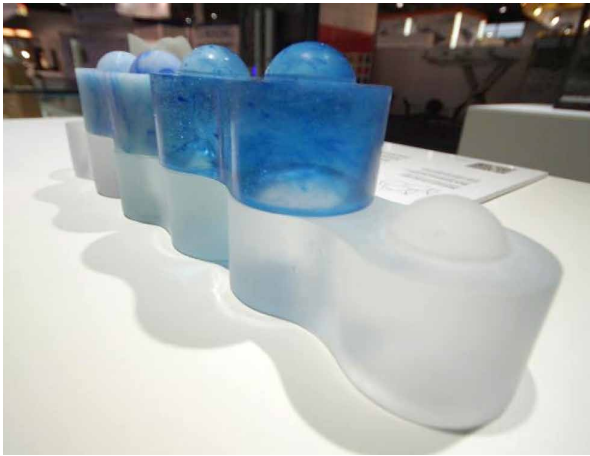

FIG. 3.70 Interlocking cast glass bricks shown at Glasstechnology Live, Duesseldorf, 2018

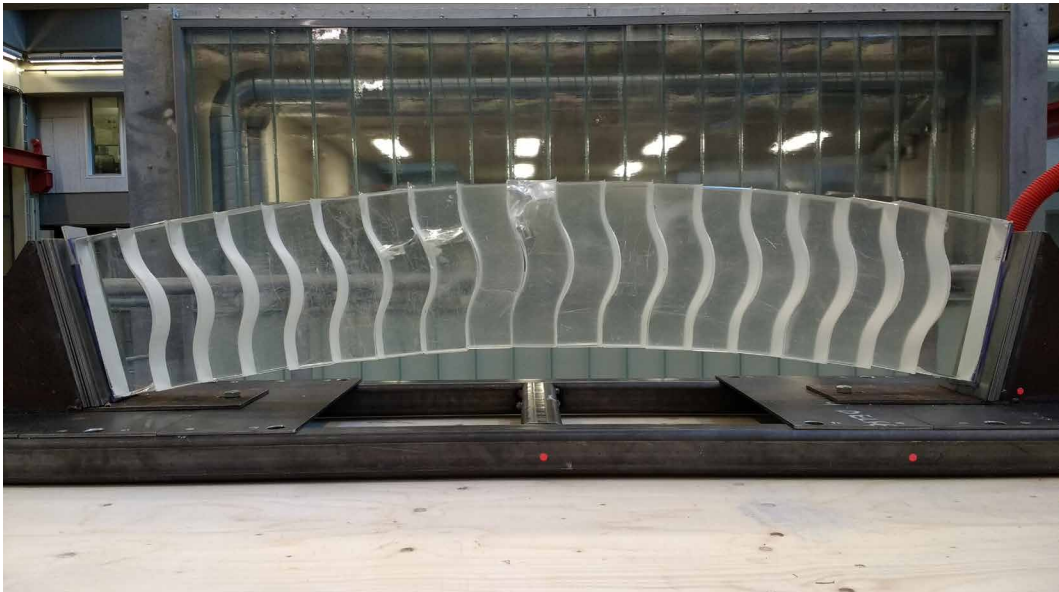

FIG. 3.71 Interlocking cast glass brick footbridge (Snijder, TU Delft)



Okalux Skylight, California

TOC



4 Glass connection development

As described in chapter 2.7, glass elements can only be manufactured, processed, delivered to site and installed in situ in limited sizes. On site, the glass elements are either individually fixed to a load bearing construction or they are joined together to form a self-supporting structure.

To make sure that a fully functional envelope is achieved, the glass elements must be connected in a way that air and water tightness is achieved as well. Due to the transparency of glass, the discontinuity at joints is particularly noticeable; particularly when load transfer between panels is required which traditionally limits the sealant to be opaque. The detailing of glass structures and envelopes therefore requires special care, to be able to achieve minimal details with a maximum of transparency.

Further to that, fixings for glass and load-bearing connections between glass panels introduce forces into either the edge or the centre of the glass. Given the brittle nature of the material (2.1), it is crucial that stress concentrations are limited. To achieve this, a minimum size of stress transfer zone is always essential. Local stress peaks, i.e. as a result of unintentional contact with other materials with hard surfaces (steel, glass etc..) or torsion at the supports, must be avoided in glass construction. This means that in the design of glass structures, the connection details are one of the major elements that will define not only the functionality but also the appearance of the entire structure.

Within the development of glass architecture, the connection typologies might not typically occur in a chronological order, hence they shall be classified into categories. The main categories shall be:

- Discrete connections
- Linear connections

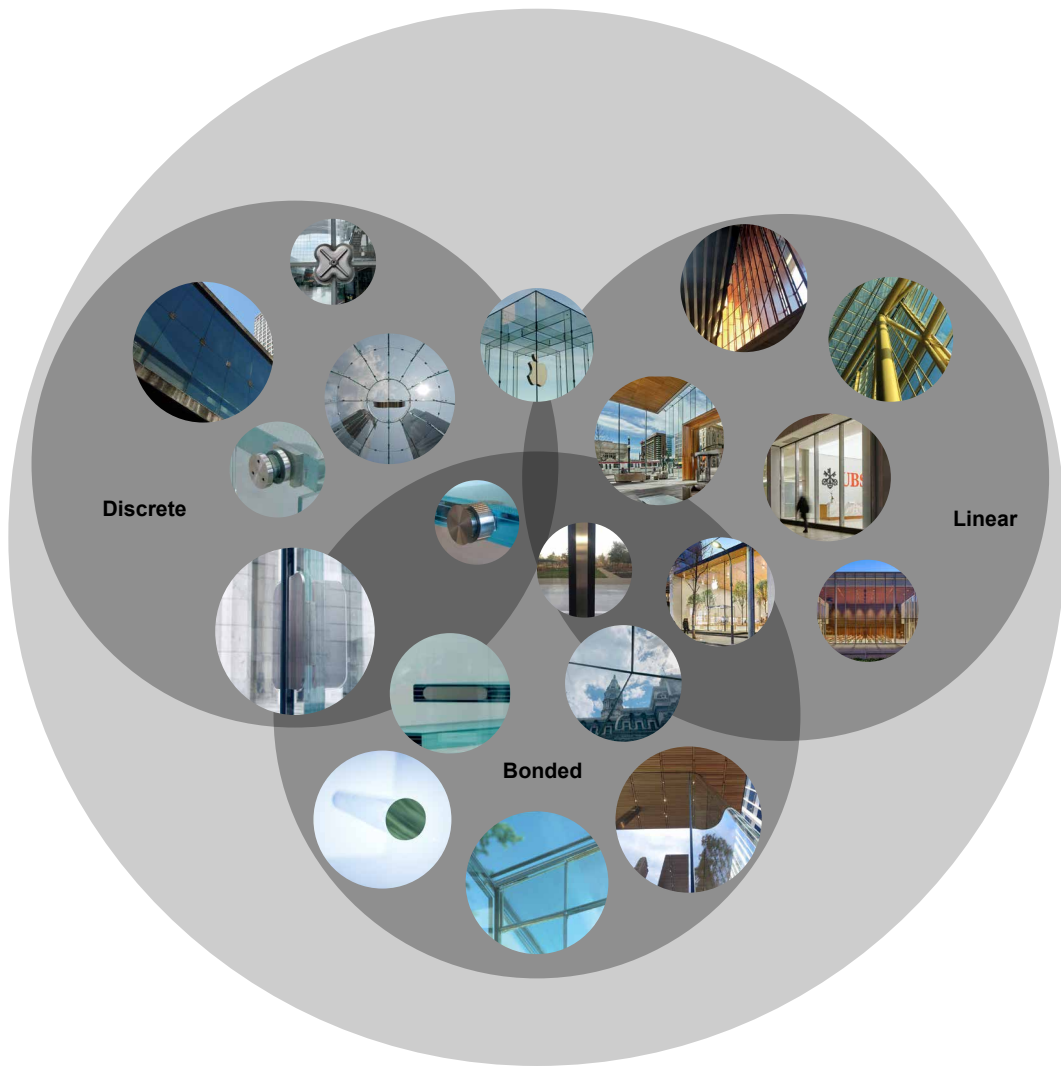

FIG. 4.1 Connection typologies

In addition, a differentiation between mechanical and adhesive connections can be made (Figure 4.1), with mechanical connections being divided into contact connections and friction connections. That leaves us with the following categories:

- Bearing connections
- Friction connections
- Bonded connections

4.4.1 **Bearing connections**

Bearing connections can only transfer compressive forces acting perpendicular to the glass faces to be joined. A pre-compressed bearing face accommodates external tensile forces up to the point of neutralisation of the pre-stress. To make sure that local stress in the glass occurring in the area of load transfer remains sufficiently low, the contact faces must be of appropriate size. With hard bearings (glass-steel or glass-glass contact) or when movements and tolerances have to be absorbed, an elastic pad is typically used to avoid fracture caused by stress peaks.

A bearing fixing only fails, if the materials in contact themselves fail as a result of the compression, or if the contact faces are displaced in relation to each other as a result of vibrations or severe deformation and movement.

4.4.2 **Friction connections**

Another way to transfer loads in a glass element is through friction, i.e. the mechanical interlocking of the microscopic surface imperfections at the interface. The relationship between the axial force present and the shear force, which is transmitted to the glass element through friction is approximately linear. As glass cannot be placed directly on steel, the elasticity and fatigue strength of the transfer material are crucial to the functionality of the friction joint. These buffers can be made from soft metals (pure aluminium), plastics (neoprene, EPDM, POM) or products made from natural materials (cork, leather, cardboard, sandpaper). All these materials must remain permanently within the elastic zone of the stress-strain curve when in use (Knaack, 2007).

Friction joints can fail for various reasons: The glass might slide out of the fixing due to changes in the friction characteristics of the joined surfaces, or the friction could be reduced by moisture infiltration or fading of the clamping forces, i.e. due to creep of the interlayer in laminated safety glass, or relaxation of the pre-stress in the clamp. Significant movement or tensile force could be another cause for the glass to slide out of its fixing. Fracture of the glass could be a result of thermal expansion in conjunction with fixings that are too rigid, or by a clamping force that is too high for clamping plates that are too soft, too stiff or incorrectly shaped.

4.4.3 Bonded connections

Instead of using mechanical connections, loads can be transmitted by bonding together glass elements or glass and support structure. There are many ways this material bond can be achieved. The main two categories are heat bonding and chemical bonding, with chemical bonding being significantly more common in the building industry.

In adhesive joints, loads are typically transferred perpendicular or parallel to the joined surfaces based on adhesion mechanisms. The forces between the molecules of a substance are generally called cohesion. Molecular interaction between the molecules of different substances is also possible, and this is known as adhesion. Typically, bonded connections are tested to fail in cohesion rather than in adhesion, meaning that the failure occurs within the bonding material rather than at the interface of bonding material to glass.

Adhesive joints for glass elements are often based on elastic adhesives. In the majority of adhesive joints the forces to be transmitted are clearly dependent on temperature, moisture and duration of loading.

Fully glazed facades with adhesive joints, known as structural glazing (SG) or structural sealant glazing (SSG) systems (typically unitised curtain walls), use the adhesive to transfer the wind loads back into the support system, hence the aluminium mullions and transoms. To guarantee the quality of the adhesive joints, they are commonly produced under controlled factory conditions.

In structural glass applications, the development has moved to spanning the glass between floors/vertical support points and using an adhesive butt joint to limit deflections and transfer shear between panels. This approach allows to eliminate the dominating metal fittings and the linear support of panes of glass with adhesive butt joints enables forces to be transferred in a way that is better suited to the material than local connections that result in significant stress concentrations around the fitting.

Current research and ongoing developments includes adhesives from all four of the major adhesive groups: polyurethanes, acrylates, silicones and epoxy resins. Silicone adhesives currently form the most popular group in practice. However, their strength is relatively low. Besides the development of adhesives with higher strength, better durability and good workability, the transparency of these adhesives is important as well, as it forms the basis of providing the opportunity to achieve fully transparent connections, so only highly transparent adhesive systems enable an increase of the de-materialisation of the building envelope or glass structure.

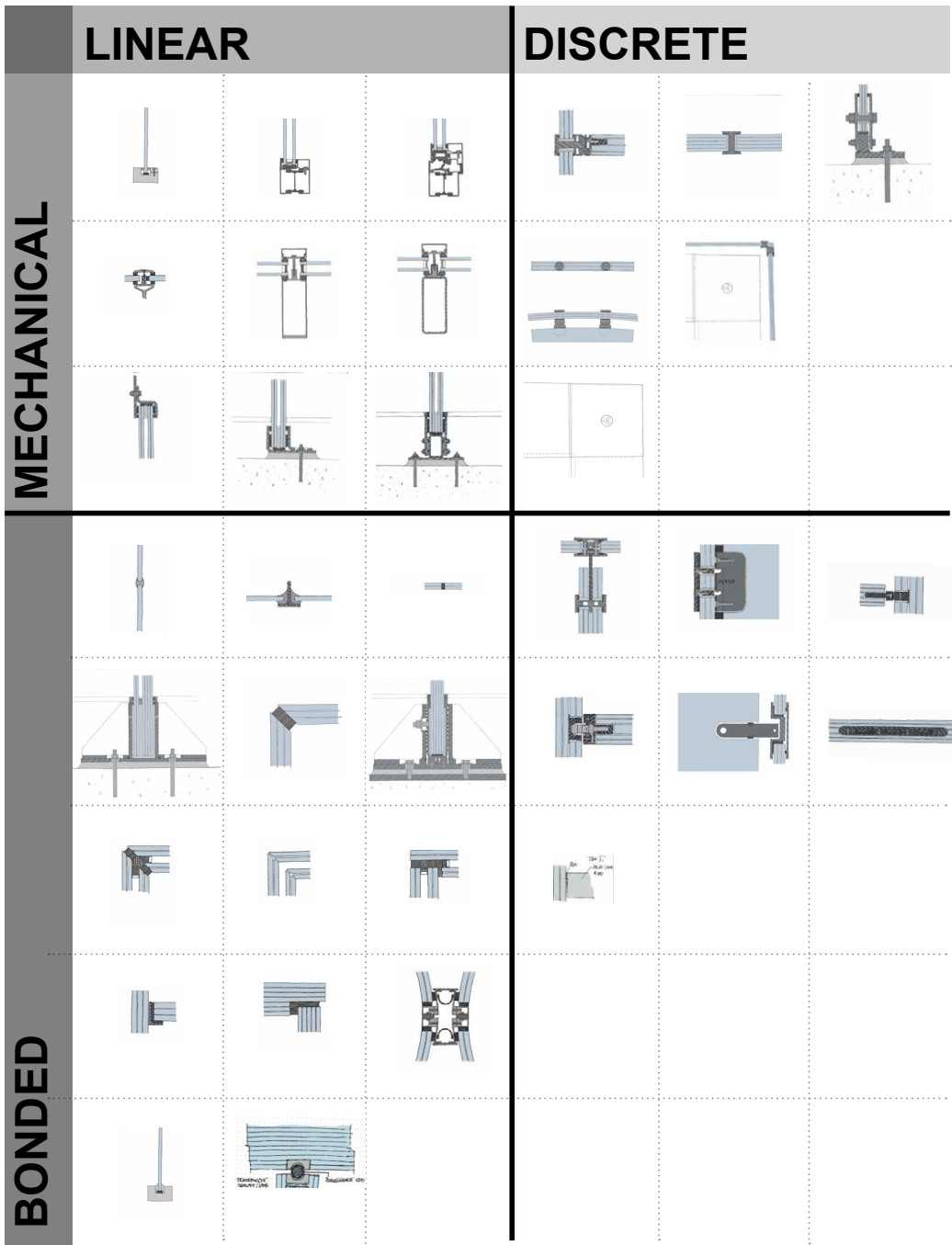

FIG. 4.2 Glass connections

Quasi-rigid glues are usually used in the load transfer zones of clamped glass balustrades and drilled individual fixings i.e. stair tread connections to glass stringers. Such connections can – through injection or filling – compensate for manufacturing- and construction tolerances. After curing, the adhesive forms a structural joint. The disadvantage is that such joints can accommodate only very small deformations and therefore stress concentrations are typically high around these fixings.

Transparent quasi-rigid glues have been used in experimental applications mainly. UV cured epoxy resins are very brittle and due to their liquid application, the thin layers can tolerate very little shear force. Hence in practical applications they mainly occur when primarily used in compression i.e. in glass brick walls (Crystal Houses, Amsterdam, Atocha Memorial, Madrid).

The failure of an adhesive joint is usually caused by inadequate preparation of the bonding surfaces or the incompatibility of the materials employed, e.g. between interlayer materials like PVB (polyvinyl butyral) and certain silicones. Adhesive joints are particularly susceptible to both problems.

Other transparent bonds have recently seen an increase in research applications, particularly transparent structural silicone sealants like TSSA and TSSL (Kassnel-Hennenberg, 2017). Further to that, edge bonding with interlayers such as Sentry Glas has been increasingly explored.

The adhesive can be applied to the whole surface, i.e. as in the manufacture of laminated or laminated safety glass, or linearly or at discrete points, to locally bond glass to glass or glass to metal.

In addition to using adhesive bonds, a material connection can be achieved through heat bonding- welding (glass to glass) or soldering (metal to glass). This has been used historically i.e. for the all-glass hermetic edge seals of insulating units. (Figure 4.2) Welded connections are also common in the production and repair of laboratory ware.

However, welding and soldering are currently not used for load bearing glass components in buildings, primarily due to the risk of temperature stresses in the elements to be joined, both during fabrication and after installation. This research will further evaluate the potential of heat bonded connections, because the welding process allows the fabrication of a fully transparent joint, which, if annealed appropriately should be free of residual stress after the manufacturing process (Rammig, 2017).

Similarly to the architectural use of glass, the way it was connected developed over time. Its specific properties require a specific connectivity, which however for the use of glass as a structure has only been developed very recently.

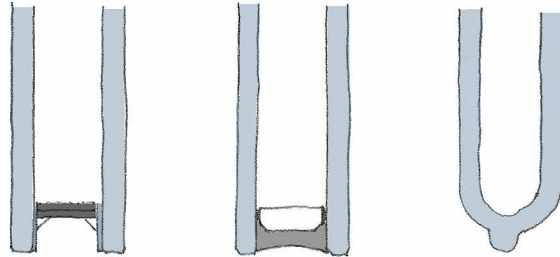

FIG. 4.3 Soldered (a), bonded (b) and welded (c) IGU edge seal

4.4.4 Linearly supported

Linearly supported glazing is characterised by a continuous linear support along the entire length of the panel. Typically this occurs along the edges, with two, three or four sides of the panel supported.

Balustrades, which cantilever from a base channel could be characterised as a 1 side linearly supported element.

4.4.4.1 Rebate glazing

4-side supported, wet sealed

Initially, glass was used as an infill material. This means the first connections were primarily used to keep the glass in position in the building opening it was supposed to cover, to protect from weather and other external influences. One of the early simple ways to create a 'window' and fix a glass, was to use a timber frame with a slot in which the glass would be inserted. A wet sealant called a 'putty' would then be used to keep the glass in position.

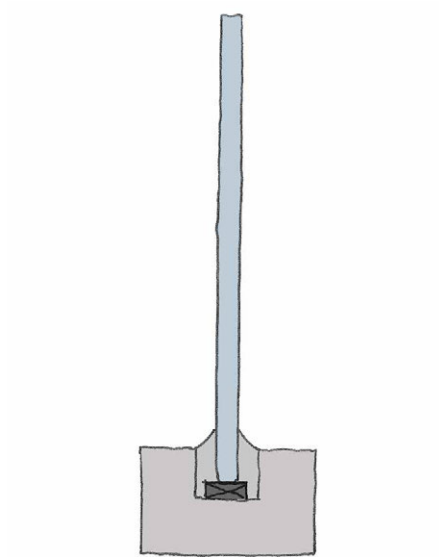

FIG. 4.4 Rebate glazing with wet seal (putty)

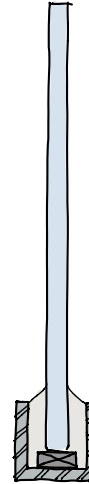

FIG. 4.5 Steel channel shuffle glazing with wet seal (silicone)

There is evidence of such connections being used in excavated villas in Pompeii (Schittich et al, 2007) where frames were formed from bronze and wood. Dimensions of the openings covered with this initial type of window are documented to be approximately 300 x 500 mm.

Fixing a sheet of glass in a rebated frame continued to be the default for a long time (Knaack et al, 2007), as solid walls had relatively small openings which did not provide sufficient levelness to support a piece of glass without a frame. In this case, the frame takes the tolerances of a stone, clay or brick wall.

4.4.4.2 Shuffle glazing

Shuffle glazing typically consists of a channel at the head and base in which the glass is 'shuffled' into. Traditionally this is a steel or aluminium C-channel, however, it could also be a broken channel consisting of angles to allow for easier glass installation and replacement.

4.4.4.3 Rebate glazing with glazing bead

4-side supported, wet or dry sealed

Using a glazing bead to fix the glass in a frame rather than a putty was a major innovation in the 17th century, as it made the installation of the glass significantly easier and allowed the use of bigger glass panes. Moreover, it separated the fixing and sealing functionalities, which allowed to replace the sealant without risking the glass to come out of the frame.

This type of connection has evolved over time, but in principle is still being used today for framed windows. (Schittich et al, 2007).

Most commonly beaded windows today are either timber, aluminium, steel or PVC, however also composites and other materials such as FRP are available. To avoid in situ wet sealing, dry gasketry was developed. Most commonly gaskets are extruded EPDM, which are clipped into a recess in the window frame (Figure 4.10) .

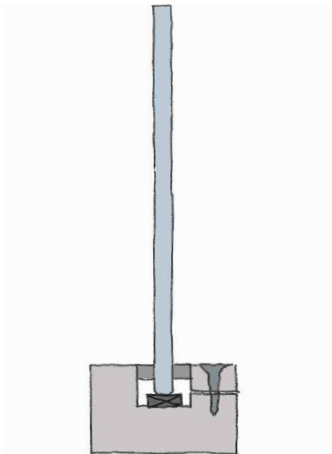

FIG. 4.6 Timber window with glazing bead



FIG. 4.7 Timber window

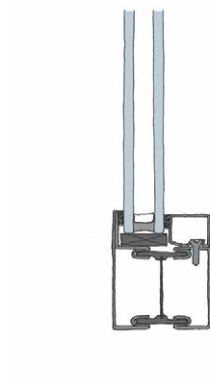

FIG. 4.8 Steel window fixed, wet sealed

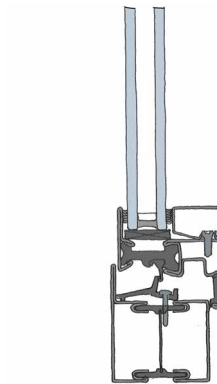

FIG. 4.9 Steel window operable, wet sealed

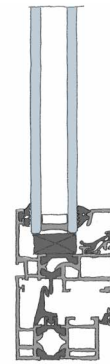

FIG. 4.10 Aluminium window, operable, dry sealed

4.4.4.4 Leaded glazing

4-side supported, wet sealed

Leaded glazing, often also referred to as stained glass, consists of a multitude of small glass panels, that are connected with lead to form a larger window. The most impressive representation of leaded glazing can be found in medieval churches and Gothic cathedrals (Knaack, 1998).

Stained glass was also used on a domestic scale, where smaller glass panels were connected to close larger openings. (The opening size in walls increased faster, due to stone or timber lintels being used, than the traditional ways of glass production allowed to increase the size of a sheet of glass (Knaack, Klein, Bilow, & Auer, 2007).



FIG. 4.11 Leaded connection of two glass panels

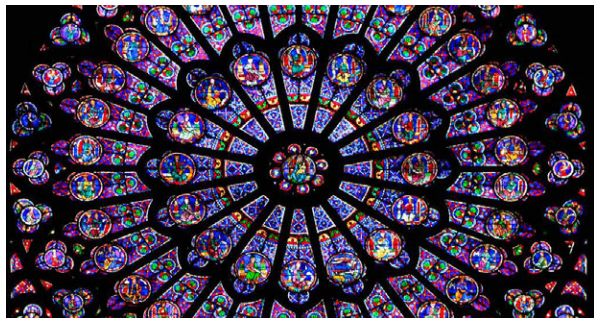

FIG. 4.12 Stained glass window, Notre Dame, Paris

4.4.4.5 Wrought Iron T-profiles (Victorian)

4-side supported, putty sealed, glass used as bracing (structural)

As described in section 3.2.3, the large and slender greenhouses built in after the industrial revolution presented the first though informal structural use of glass.

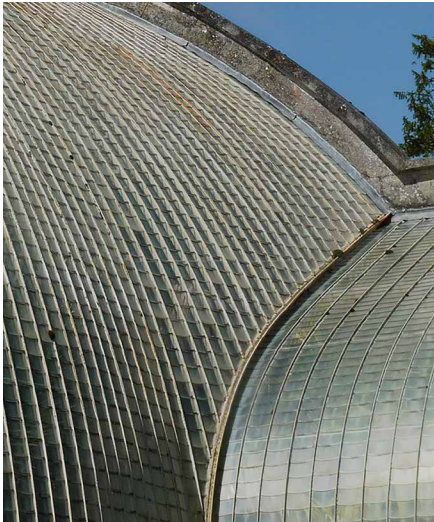

FIG. 4.13 Bicton Gardens glass house



FIG. 4.14 Glass shingles at Bicton Gardens



FIG. 4.15 Close-up of 2-side supported overlapping shingles

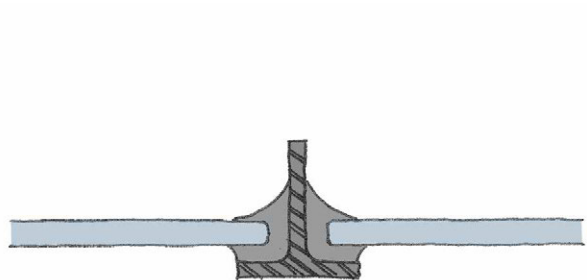

FIG. 4.16 Detail wrought iron profile, putty glazed

4.4.4.6 Patent glazing

The term patent glazing describes a non-load bearing framing system that is preliminary used for overhead glazing. The glass is 2-side supported on a substructure of beams and instead of being fixed with a putty, the glass is fixed with a pressure cap and a dry gasket system. This allows to drain and ventilate the system (Saint Gobain, 2017).

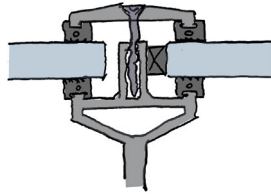

FIG. 4.17 Detail patent glazing, dry sealed



FIG. 4.18 Image patent glazing

4.4.4.7 Dry glazed stick curtain wall system

In a stick curtain wall system, the glass is supported on two or four sides and either clamped to the mullions and transoms with a continuous pressure plate or with local toggles that fix into the IGU cavity. Dead load supports are typically located at quarter points on the transom. The system is-as typical for curtain wall systems- suspended from the slab above and laterally supported at the base of each unit. Typically, the lateral support is solved through a spigot that connects the mullions to the unit below. Various options as relates to materiality of the mullions are available. Common systems include aluminium (extrusions) in multiple shapes, steel hollow sections or fabricated steel sections of varying shape as well as timber options, which primarily are cross laminated timber or wood veneer to increase the dimensional stability and strength of the material.

For steel and timber options, typically an aluminium extrusion is fixed to the structural member to allow for the clamping of the glass either with a pressure plate or toggles in the IGU cavity.

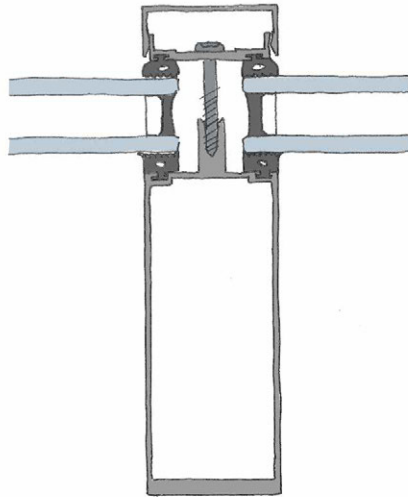

FIG. 4.19 Capped aluminium mullion, dry glazed

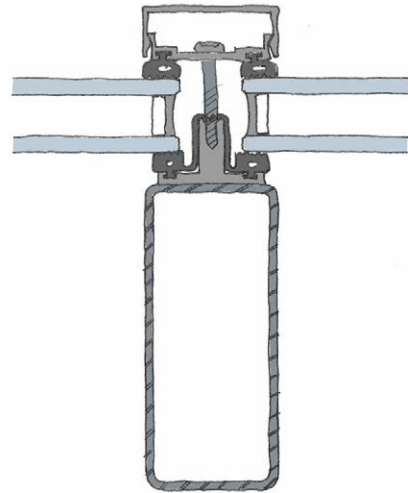

FIG. 4.20 Capped steel mullion, with aluminium CW mount, dry glazed

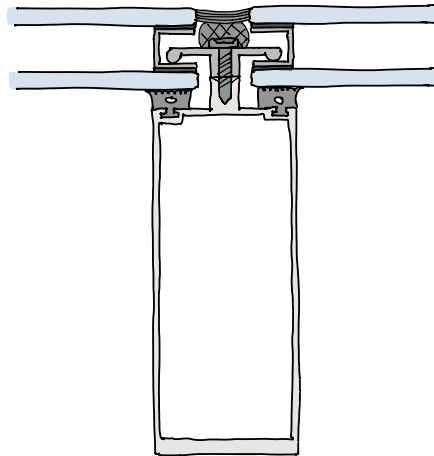

FIG. 4.21 Toggle fixed stick CW system

4.4.4.8 Clamped glass base

Similarly to shuffle glazed windows, structural glass envelopes are typically supported linearly at the base in a steel shoe. Typically, a linear head capture provides lateral restraint. Dead load is transferred in the base connection whilst wind load deflections can either be limited by the use of vertical fins or by the glass build-up itself. Whilst the use of glass or steel fins to limit glass deflections has been used for a while, the concept of unsupported vertical edges is for large spans a more recent development with fewer built examples.

As with many of the taller glass structures, fabrication, handling and installation become critical factors.

The glass packages become quite thick to reduce deflections to an acceptable limit and stress induction into the silicone joints is comparably high.

The following details show various concepts of clamping mechanisms for a base supported system.

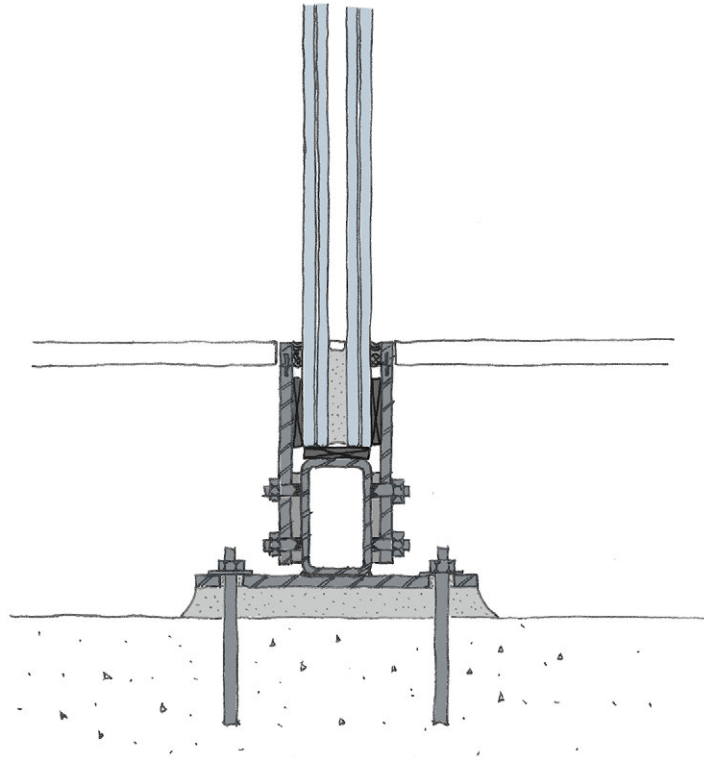

FIG. 4.22 Clamped base shoe

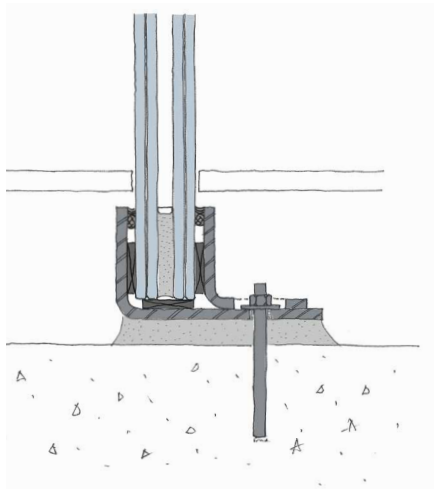

FIG. 4.23 Clamped base shoe with bent plates

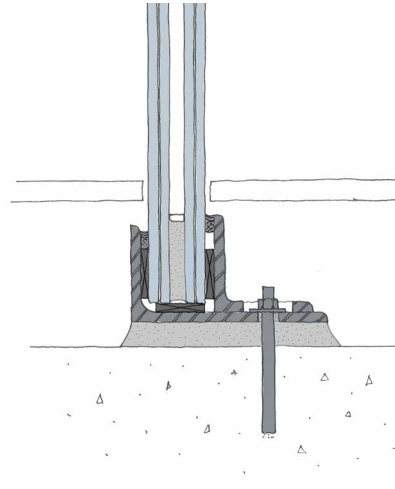

FIG. 4.24 Clamped base shoe with standard angles

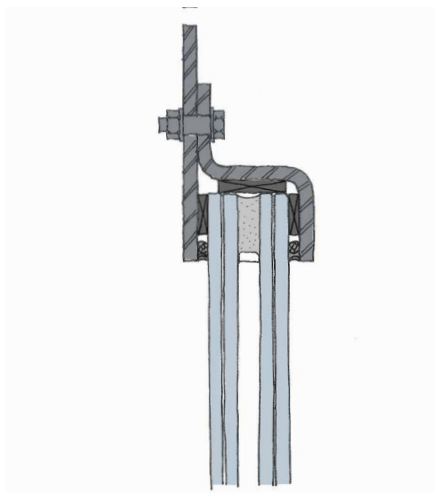

FIG. 4.25 Head restraint bent plates

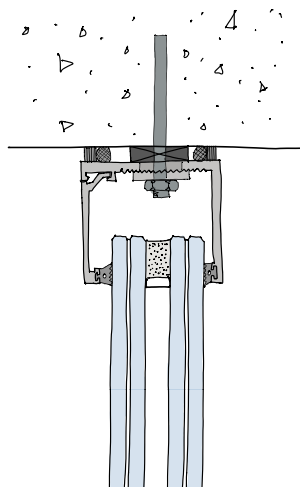

FIG. 4.26 Aluminium extrusion head restraint

Given the dead load support at the base, typically the lateral restraint at the head of the glass wall can be very minimal. Important is the sufficient accommodation of vertical movement, which can vary significantly depending on the movement of the building structure and the location of the facade.

4.4.5 Bonded connections

4.4.5.1 Structural silicone joints

The method of fixing external glazing with structural silicone which started to appear in the mid 1960s in the US, made it possible to clad the entire building envelope with a uniform glass skin. In case of structurally silicone glazed (SSG) curtain walls, the adhesive joint may only carry wind pressure and suction forces. The weight of the glass, is always supported mechanically avoiding permanent shear in the silicone joint, as this might lead to silicone failure. SSG curtain walls are the first application in which silicone is not only used as a weather seal but transfers wind loads into the structure.

As previously described, in some horizontal or vertical glazing systems, the panes are supported on two sides only. Here, the unsupported edges can be sealed flush with silicone. Linear structural silicone joints are a common way to transfer load between panels and to limit deflections of two side supported panels by tying glass panels together. As the silicone is applied along the edges, the compatibility with the interlayer material must be insured to guarantee a sufficient bond and maintain the longevity of the connection.

In the typologies described as structural glazing, the use of structural silicone has become very common because it allows to transfer loads from one glass panel into the next one without a mechanical connection, which always requires complex processing.

In a two side supported assembly, structural silicone might be used in joints between panels, but can also be used to bond fins to the face panel.

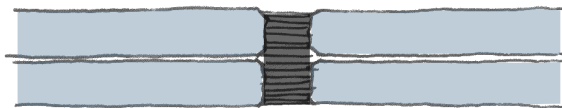

FIG. 4.27 Structural silicone joint

4.4.5.2 Large sliding doors: tension rod in silicone joint

With the desire for transparency and architectural designs omitting the use of vertical fins in the tall structural retail applications, glass packages have become very thick, as deflections need to be limited by the glass itself.

This has implications on the processing, handling and installation of the panels but also on their visual appearance. With layers of up to seven 12 mm sheets of glass (i.e. retail store, Hangzhou-5x12/CAV/2x12) the inherent colour becomes significantly more visible (see chapter 2.9). Further to that, when laminating with Sentry Glass, very thick assemblies have shown an occurrence of haziness caused by the curing process of the interlayer. This discussion is outside of the scope of this research, but a known phenomenon which has led to research and further development of the product (Trosifol, 2019).

To allow the use of thinner glass build-ups a technique is employed which is derived from cable net typologies. The principle works in such way, that a pre-tensioned stainless steel rod spans between the glass panels which are then bonded to the rod with structural silicone. This technique was developed for the cafeteria sliding doors on a corporate campus building, which form a 14 x 30 metre large opening. Each door is 14 m tall and 15 m long and to allow for the operation of the very large doors, the glass weight had to be reduced to a minimum. Like in a tennis racket, a large frame forms a boundary for the cables to tie into, which are then tensioned and allow for any wind load transferred into the glass to transfer through the cable back into the frame. This led to a significant reduction in glass thickness.

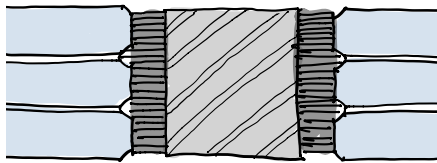

FIG. 4.28 Tension rod embedded in glass build-up

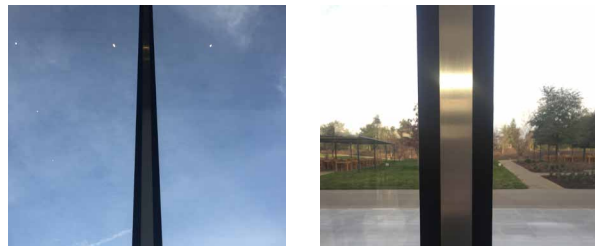

FIG. 4.29 Tension rod bonded to glass with structural silicone

4.4.6 Point fixed

To increase transparency, it was common practice in the past three decades to use discrete fittings to support glass or to transfer loads between panels. There are several ways in which to establish local connections and those have developed as the glass processing technology developed from clamped fittings on the surface of the glass, that transfer load through friction, to bolted connections and further to laminated fittings that are embedded within the glass build-up. The most common examples will be illustrated as follows.

4.4.6.1 Clamp fittings for suspended glazing

Clamp fittings connect to pieces of glass by using plates in the corners or along the edges of two pieces of glass which are then bolted together and tightened to the glazing joint, generating friction between the surface of the glass and the metal fitting surface, which allows to transfer loads. Clamp fittings are used to suspend glass sheets from each other, but also to provide lateral restrains for base supported structures.

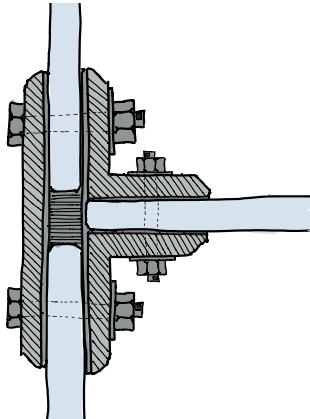

FIG. 4.30 Clamp fitting



FIG. 4.31 Centre Point Link bridge clamp fittings

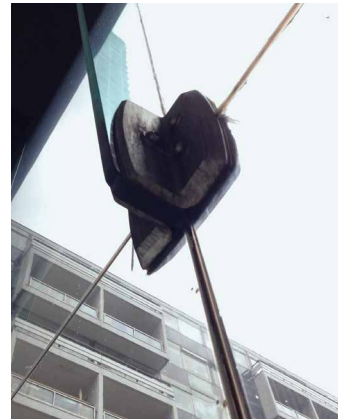

FIG. 4.32 Close-up of clamp fitting

4.4.6.2 Clamp fittings in cable nets

Cable nets are a typical typology in which clamp fittings are used. To allow a slender facade structure, stainless steel or carbon fibre cables are pre-tensioned to the main structure or an additional frame and the glass is then suspended from the cables. Typically glass panels are relatively small, as deflections of cable nets tend to be quite large, hence the larger the panels the higher the deflection the panels themselves have to accommodate, but also the joints, which have to be sized appropriately to avoid clashing of panels.

Glass clamps are available in many shapes and forms depending on the geometry of the panel. Clamps can be located along the joints to clamp two panels to each other and to the structure, but can also be located in corners to clamp 4 adjacent panels in a rectangular arrangement or 6 panels in a triangular arrangement.

The clamp consists of multiple clamping plates that are bolted together, clamping the glass to the cables. Typically the clamps also retain the cable in position, which can either be locked in place or sliding, depending on the design. Depending on the location of the clamp and glass arrangement, it includes dead load shelves to support the glass.

Figure 4.35 and 4.36 show the cable net and clamp arrangement for a triangular cable net at Icon Siam Wisdom Hall, Bangkok, designed by Carpenter | Lowings (C|L) with EOC. The cables are tensioned to a triangular mega-frame that is independent from the main structure of the building. The clamps are diamond shaped which is driven by the triangular arrangement.

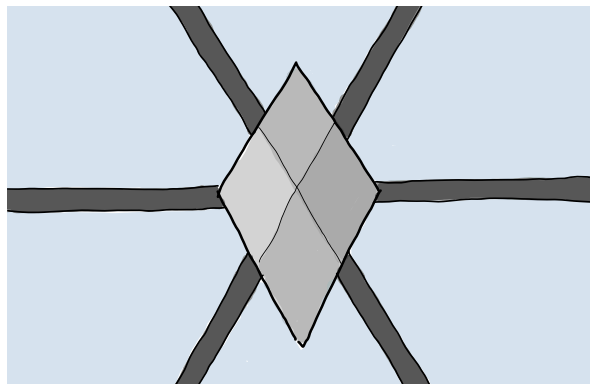

FIG. 4.33 Clamp fitting Icon Siam Wisdom Hall



FIG. 4.34 Facade Icon Siam Wisdom Hall, Bangkok

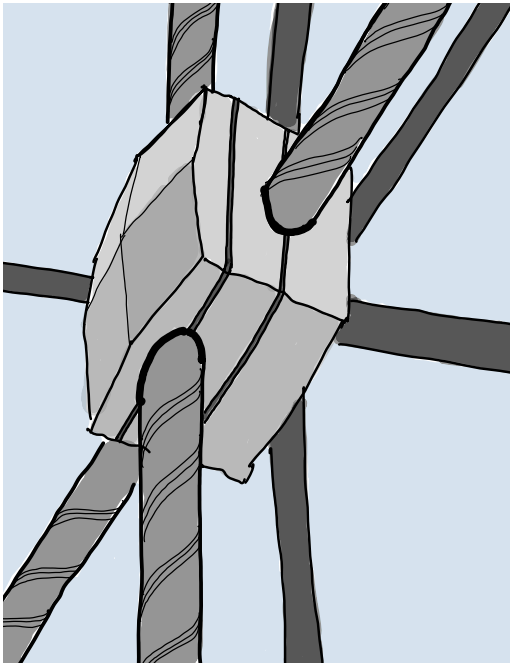

FIG. 4.35 Sketch detail clamp fitting Icon Siam Wisdom Hall, Bangkok

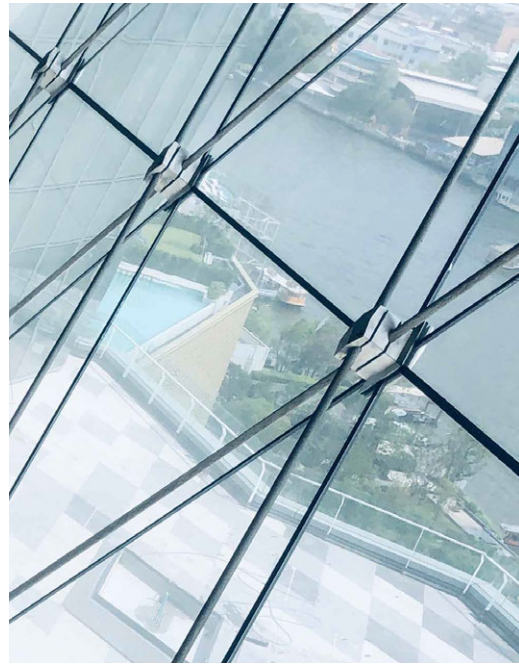

FIG. 4.36 Close-up of clamp fitting

4.4.6.3 Clamp fittings to mullions

Clamping glass locally to a steel or glass mullion is a common way of connecting the material locally, allowing for the remainder of the glass joint between fittings to be sealed with silicone only and hence reducing the appearance of the joint compared to a linearly clamped arrangement (4.4.4.7).

Clamps can be fitted to a steel or aluminium mullion or a glass fin as shown in Figure 4.38. The detail shown is based on laterally restraining the facade panel to a bolt that fixes through the laminated glass fin. To connect the bolt to the clamp, a stainless steel plate is used, which is inserted in a pocket in the glass which is left empty during lamination. This process called pocket lamination, allows to keep cavities between layers of glass in the lamination process in which fittings can be inserted afterwards. During the lamination process, the pocket is filled with a block, assuring that it is not filled with interlayer material during the process but also assuring that the pressure applied in the autoclave is distributed homogeneously and stress concentrations are avoided.

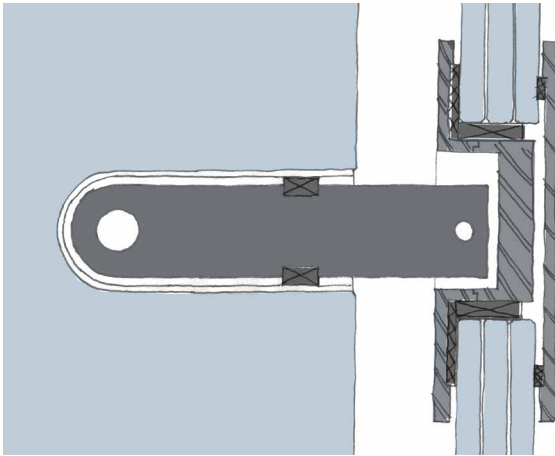

FIG. 4.37 Clamped glass fitting to glass fin with pocket lamination

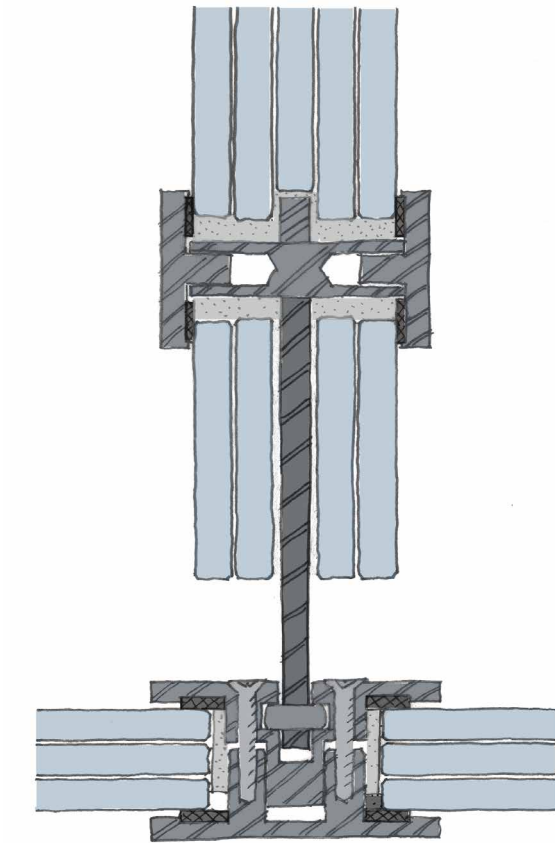

FIG. 4.38 Clamped glass fitting to glass fin with pocket lamination

4.4.7 Bolted connections

To transfer the loads from a glass tread assembly to the glass stringer, a bolt is used, fixing through a hole in the glass. Drilling glass and introducing loads through a bolted fitting results in significant stress concentrations around the perimeter of the hole. Therefore, it is crucial that the edge surface within the hole has a good quality polish, minimising surface flaws and therefore reducing risk of fracture (2.7.3). To accommodate the fabrication tolerance during lamination as well as installation tolerances on site, holes have to be larger than the bolts to allow for tolerance. Load transfer is achieved by injecting epoxy grout into the hole once the bolt is in place (Figure 4.40).

As described in 3.2.7, bolted fittings have a more significant visual impact on the transparency of the glass structure than flush fittings or fittings that sit behind a continuous glass surface, as the continuity of the reflective surface is interrupted.

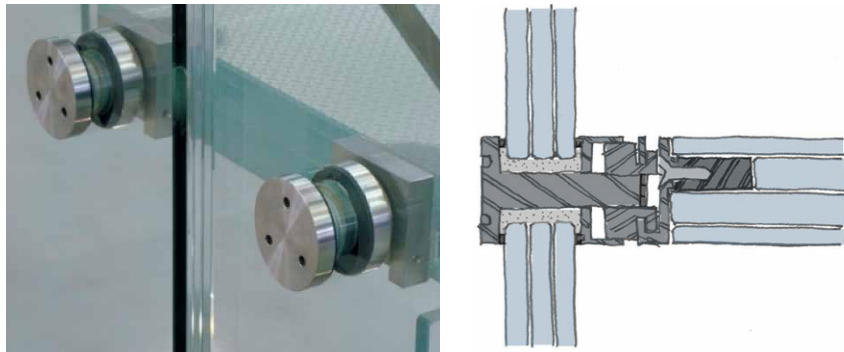

FIG. 4.39 Bolted stair point fitting, Apple Soho, 2004 (EOC)

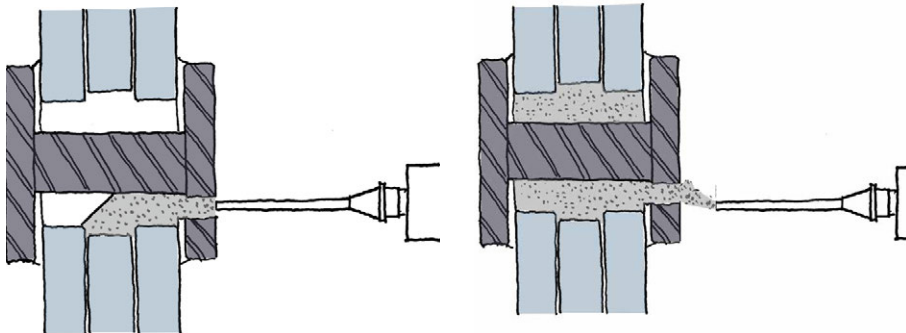

FIG. 4.40 Grout insertion (Hilti, 2018)

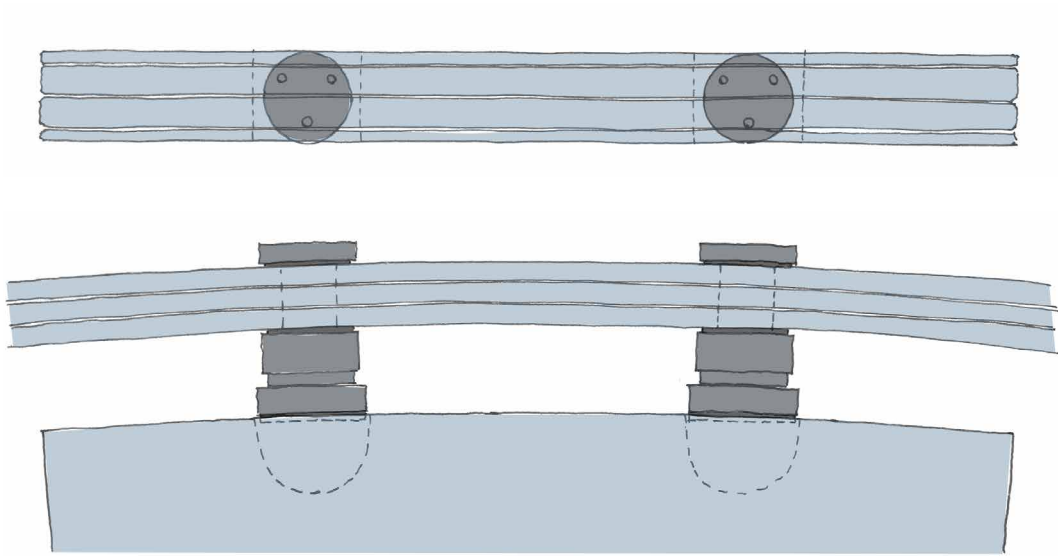

FIG. 4.41 Bolted stair point fitting, circular stair

The basis for the development of bolted connections transferring significant loads was the 'cam and bezel' connection developed by Tim MacFarlane for the Yurakucho canopy (3.2.7). This connection concept advanced the development of structural glass connections. The innovative bezel connection allows to transfer loads from multiple glass plies equally into a central pin using a cam which accommodates the processing based offsets in the laminate. These typically occur because glass has to be drilled prior to tempering and lamination process (2.7.3.3) meaning that holes might not always be perfectly aligned. The elliptical cam translates a rotary motion into a linear motion and hence allows to transfer the load equally to the central pin accommodating the hole misalignment.

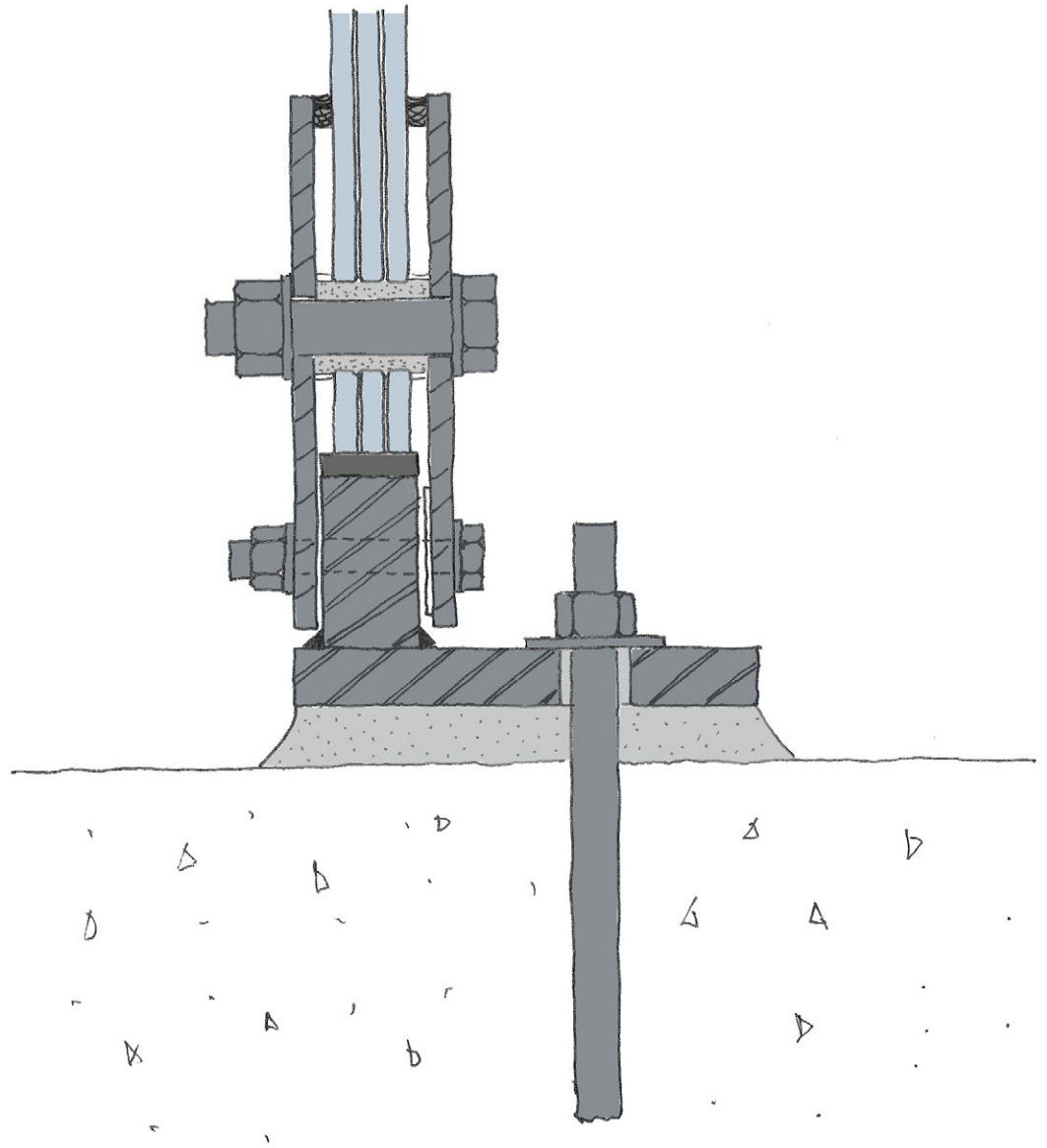

FIG. 4.42 Bolted base shoe

4.4.7.1 Pinned glass beam connections

To connect glass columns and beams creating an all glass structure, the corner connection between the two structural elements needs to be established. If a stiff connection can't be achieved, because differential movement needs to be accommodated between vertical and horizontal elements (facade and roof) pinned connections are used. These are typically metal fittings that are bolted through a hole in both elements. To refine the connection and allow a flush and continuous surface, typically the outer layers of the column and the inner layer of the beam would be cut short.

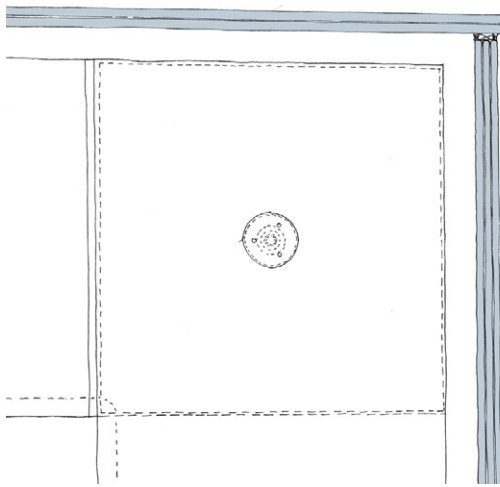

FIG. 4.43 Corner through glass connection

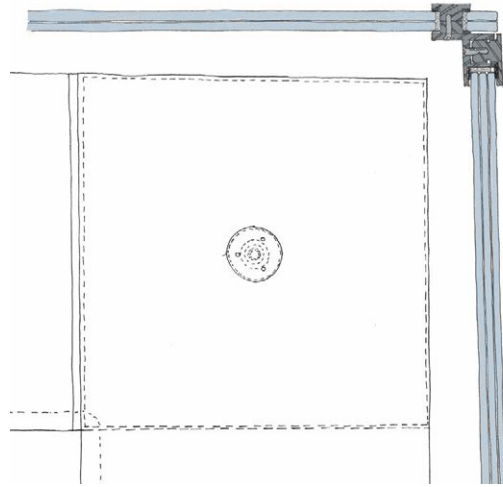

FIG. 4.44 Corner through fitting

4.4.8 Laminated fittings

The use of the ionomer interlayer SentryGlas made it possible to laminate the fitting not only into the tread but also into the stringer and then mechanically connecting the two parts of the fitting. These fittings do not only have to accommodate the fabrication tolerance, which in the productions is very small (approximately ± 0.5 mm) but also installation tolerance, which in this case is usually limited to ± 2 mm, which makes the installation of the base steel structure very complex. This is due to common construction tolerances being significantly larger than glass fabrication tolerances.

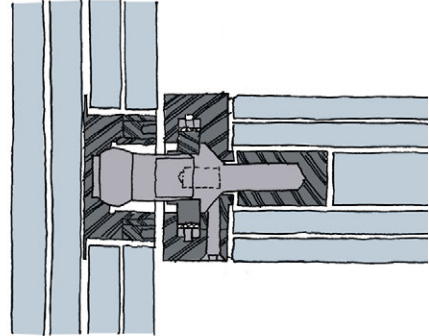
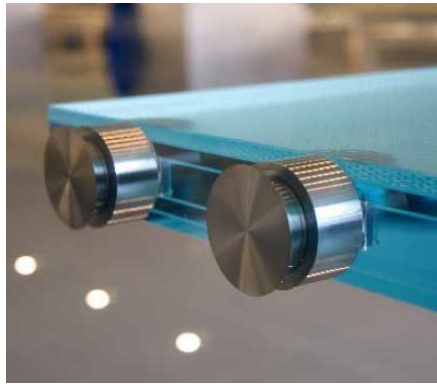

FIG. 4.45 Laminated point fitting, Apple Hamburg, 2015, (EOC)

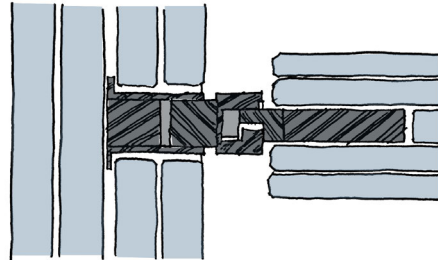
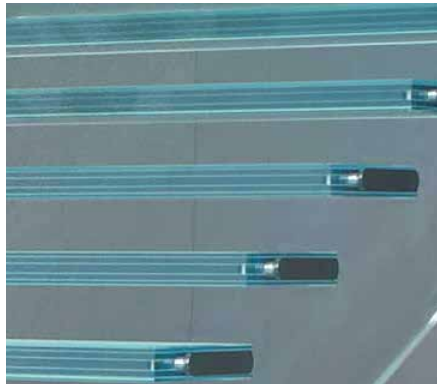

FIG. 4.46 Laminated longitudinal stair fitting, Apple Westlake 2016, (EOC)

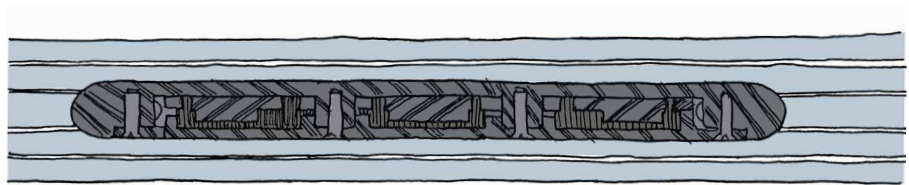

FIG. 4.47 Laminated longitudinal stair fitting, Apple Westlake 2016, (EOC)

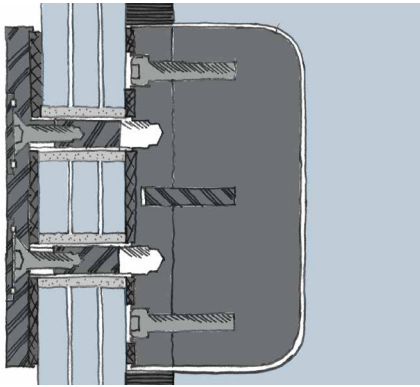

FIG. 4.48 Laminated fitting with clamping plate

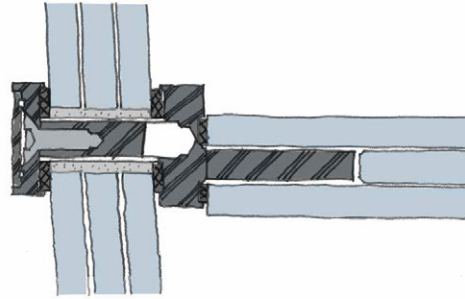

FIG. 4.49 Laminated fitting with clamping plate



FIG. 4.50 Laminated fitting in fin and face glass with offset stainless steel plate connection



FIG. 4.51 Laminated fitting in fin and face glass with offset stainless steel plate connection

4.4.8.1 Mortise and tenon joint, 1994

To avoid a metal bolt in the connections between vertical and horizontal structural elements, Dewhurst Macfarlane developed an experimental approach of applying timber detailing and dry-joining the beams and columns as a mortise and tenon joint. This idea was executed in a residential building in London, designed by Rick Mather Architects (3.2.7).

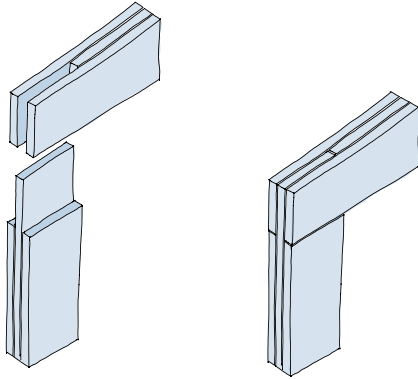

FIG. 4.52 Schematic mortise joint



FIG. 4.53 Close-up of mortise joint

Also visible in Figure 4.53 is the glass spacer that was used for the IGU. This was used instead of a desiccant filled aluminium or stainless steel spacer which is usually sealed with butyl and silicone, leaving the distinct black edge around the glass panel. The glass spacer is bonded to the glass panel with a UV curing glue to achieve the required airtightness. Reportedly the stiff bond led to a cracking of the glass panels under load and movement though. In a further development of the detail, the dry connection was bonded with a lamination resin, which at the time was more common than sheet lamination.

The use of lamination with sheet material to connect building components is limited by the lamination capabilities, which these days are less limited in length, (up to 20 m at Sedak, Germany and 18m TNG, China), but by the width of the object being created, as autoclaves are built to serve the standard float width of 3,21m although 3.50 m are available (4,00m in China).

4.4.8.2 TSSA bonded connections

A novel bonding material that offers great potential to achieve fully transparent glass connections is a silicone material developed by Dow Corning, called Transparent Structural Silicone Adhesive (TSSA).

TSSA is an optically clear and high strength silicone film. With a thickness of 1 mm, this adhesive film is designed to structurally bond glass to metal without any additional dead load support.

As opposed to common structural silicones that are one or two-component liquid applied and cured at room temperature, TSSA is a one- component material that is provided as sheets and cured under heat and pressure application. Temperatures of 120-130°C are applied for approximately 30 minutes simultaneously with applying pressure. This ideally occurs in an autoclave (Dow Corning, 2017).

In addition to its higher strength compared to traditional structural silicone, with a permanent design load approximately 50 times higher (Hayez, 2018), the major difference is the transparency of the material after curing. The film is optically clear with a refractive index very similar to glass (Sitte et al, 2011), which suggests that it offers the potential for connections to become invisible.

When overstressed, the material shows a whitening behaviour, which according to the manufacturer will return to its transparent appearance once the stress is released (Sitte et al, 2011). Given that visually this is an undesirable effect, it is expected to result in over-dimensioning of the connection.

Despite having been tested for a number of years in short and long-term exposure tests, the project applications of TSSA are still limited. It was intended to be used for point fixings, given its dynamic and static failure strengths that are substantially beyond what is observed for commonly available structural silicone materials.

Glass-Metal connections

As per the originally intended use, bonded metal point fittings have been the primary application of the material. The appearance is comparable with the appearance of laminated inserts, however the use of TSSA allows the connections to be manufactured significantly more economically. TSSA does not require the use of specific metal grades, in many cases titanium, which is necessary for insert lamination, due to its similarity to glass in thermal expansion behaviour. Further to that, the precise machining of the glass drives the cost of laminated inserts.

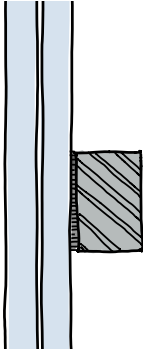

FIG. 4.54 Sketch detail TSSL fitting



FIG. 4.55 Close up of TSSL bonded point fitting (Sitte)

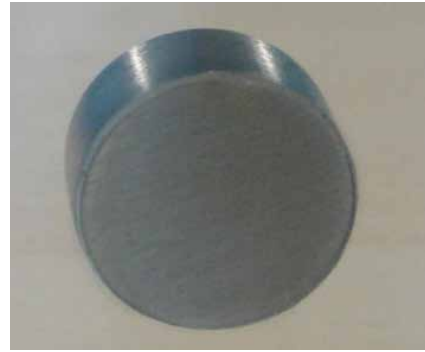

FIG. 4.56 Close up of TSSL bonded point fitting through glass (Sitte)

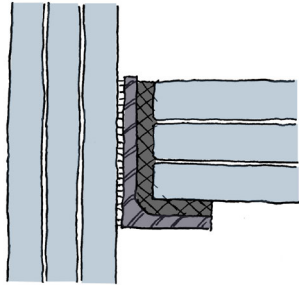

FIG. 4.57 Sketch detail TSSL tread connection



FIG. 4.58 Close-up of bonded TSSL metal to glass connection (Hayez, Kassnell-Henneberg)

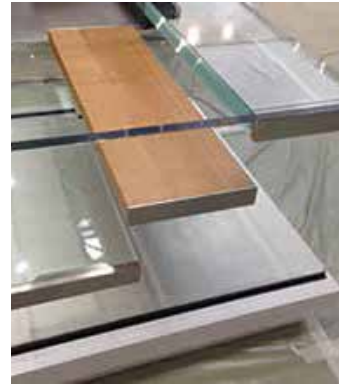

FIG. 4.59 TSSL metal to glass connection (Hayez, Kassnell-Henneberg)

Whilst many tested applications of the material are still in experimental stage (Santasiero, 2015), Glas Troesch have provided multiple solutions for project application which have been verified and tested (Kassnell-Henneberg, 2016).

Glass-Glass connections

An experimental use of a transparent structural silicone adhesive (in this case TSSL) was tested in a temporary installation for the Glasstechnology live exhibition in Duesseldorf in 2016. In a collaboration with Cricursa, borosilicate rods were bonded to a curved glass panel with TSSL to form the ladder of a slide. The fully transparent connections were achieved by polishing the rods to fit the shape of the large tube and with the initial application of pressure to get rid of any trapped air between the glass and the silicone sheet material and then autoclaving the assembly to initiate the curing process. The detailed design and fabrication process is described in chapter 7 and Appendix A2.

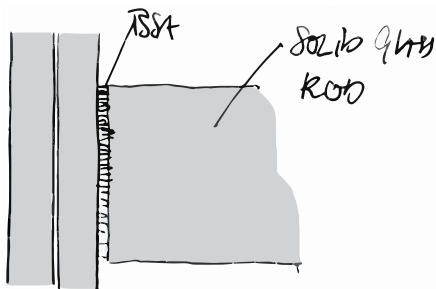

FIG. 4.60 Sketch detail TSSA tread connection

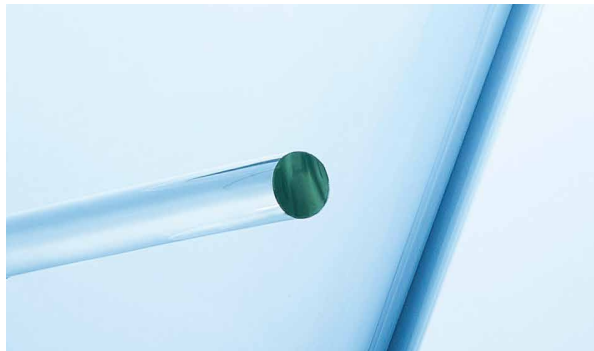

FIG. 4.61 Close-up of bonded glass tread connection

4.4.8.3 Glass corners

When considering glass corners, transparency is a primary concern, as the corner arrangement of glass allows a wide angled view out of a building.

Spanning the glass between floors and not relying on fins or mullions to limit deflections, allows to provide the view openness from corner to corner, therefore the transparency of the corners becomes more important.

In IGUs typically the edge seal limits the transparent appearance of the corner, while a monolithic build up will be limited by the silicone joint. There are various geometrical arrangements that all have a varying effect on the appearance of the corner transparency (Figure 4.62 - 4.67). A mitred corner can be considered as having the lowest visual impact, as no glass edges are visible in this arrangement.

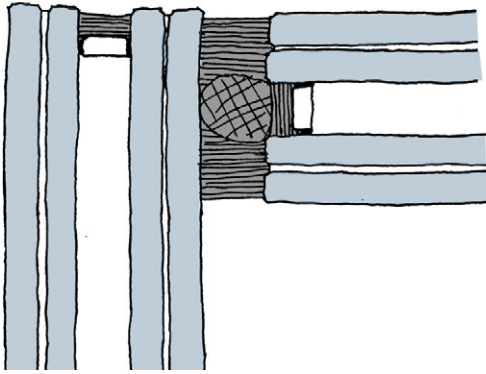

FIG. 4.62 Butt jointed corner

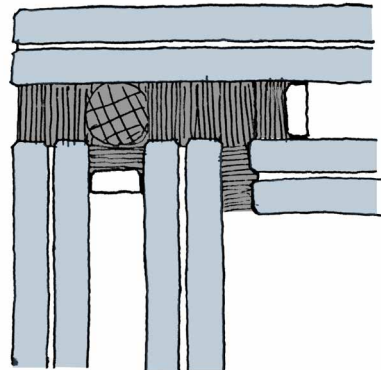

FIG. 4.63 Stepped glass corner

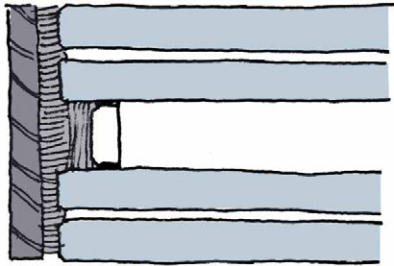

FIG. 4.64 Stainless steel edge protection

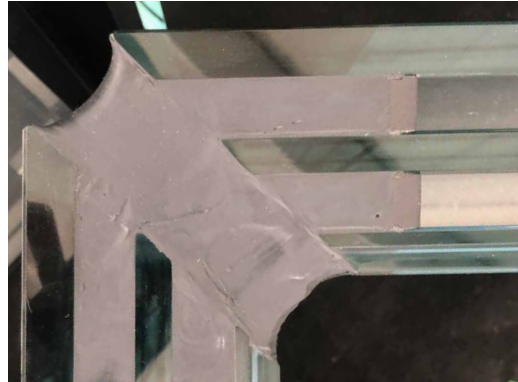

FIG. 4.65 Image structural silicone mitred corner

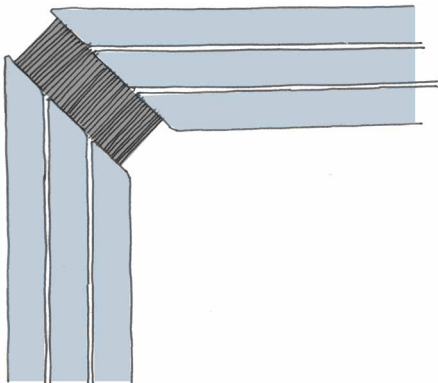

FIG. 4.66 Sketch detail structural silicone mitred corner

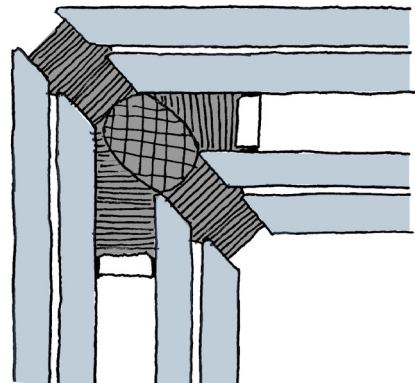

FIG. 4.67 Sketch detail structural silicone mitred corner



FIG. 4.68 ME Hotel London Foster + Partners
(image Bellapart)



FIG. 4.69 ME Hotel London Foster + Partners
(image Bellapart)

Recent experiments with clear bonding materials explore the possibility to increase the transparency of glass corners. One material that appears to have potential in achieving this is SG. Laminating the corner with SG appears to be a feasible solution, as it provides the desired stiffness as well.

Experimental studies were undertaken and the approach has been applied in the facade of the ME hotel in London, designed by Foster+Partners (Figure 4.68 and Figure 4.69).

Subsequent to the development of the window units for the ME hotel by Bellapart and Thiele Glass, this approach has been tested by various other fabricators including Interpane, Sedak and Agnora. Figure 4.71 and Figure 4.72 show an SG laminated corner sample at Sedak's factory in Gersthofen, Germany as per the detail illustrated in Figure 4.70 .

The spacer runs continuously around the perimeter of the unit and the mitred corner is laminated with SG. Due to its stiffness as a sheet material, the SG cannot be bent around a corner, so an additional sheet of SG is used to connect the mitred surfaces. Comparing the sample shown in Figure 4.71 and Figure 4.72 with the installed window units at the ME Hotel (Figure 4.68 and Figure 4.69) it becomes evident, that the view from the inside out is significantly clearer than the view from the outside in.

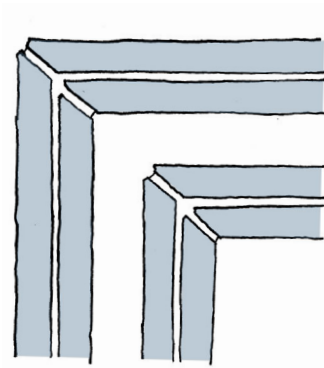

FIG. 4.70 SG laminated corner - sketch detail

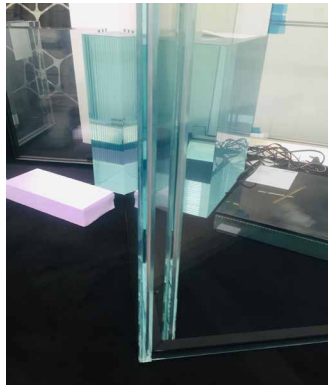

FIG. 4.71 SG laminated corner outside (sedak)



FIG. 4.72 SP laminated corner inside (sedak)

Inside out the corner is fully transparent and nearly invisible, while from the outside, the refraction on the glass edge makes both lites in the IGU visible and hence does not lead to a fully clear appearance.

Assuming that window units will not be viewed perpendicularly however, similarly to the ME Hotel precedent, this might not be a major drive, as the perpendicular view through the unit occurs from the inside. This would change in case of a retail concept, where a perpendicular view at the panels would be given and when the visibility of products or other displays inside the building is the primary driver. Still, the SG laminated corner units provide a visually more transparent corner than an opaque silicone joint would.

Given the load transfer capabilities of SG, a connection on the edge of the glass should be considered for other structural applications like bonding stair treads to a glass stringer or connecting treads to each other.

A few of these concepts were tested and will be described in chapter 7 of this document. The limiting factor in the fabrication of SG bonded joint is similarly to TSSA/TSSL applications the overall size of the component, as it will have to undergo a lamination process in the autoclave. Further to that, the material has a significantly higher stiffness compared to silicone materials which means it is less forgiving to fabrication tolerances and building movements as stress is induced in the glass more directly due to the higher shear stiffness.



Glass Wall, Rijksmuseum Schiphol Airport, Amsterdam



5 The concept of heat bonding

Chapter Four provides background on the impact of connections on the appearance of glass structures in the context of transparency. In this chapter, current and novel connection methodologies are discussed, categorised and compared

5.1 Introduction

The use of glass as a structural material has increased significantly over the past 30 years leading to a development in production and fabrication capabilities but also in the development of common connection typologies and strategies. With the increase of glass sizes an increase of transparency can be observed, which is driven by the reduction in the amount of (opaque) connections being made to form a building envelope or glass structure, but also significantly by the reduction of glass edges exposed on which the light will break, in turn leading to a perception of translucency.

Whilst novel connection technologies described in the previous chapter lead to a reduction in size of connections, create smooth external glass surfaces with consistent reflectivity and also allow to create entirely transparent connections using various clear bonding materials, the refraction of the edge of the surfaces connected still has a visual impact on the transparency of the connection.

Based on the transparency achieved with blown glass objects that form fully transparent surfaces even if components are added (glass laboratory ware, Figure 5.1), the approach of heat bonded glass connections will be explored. Experimental tests have shown that heat bonded glass connections can lead to highly transparent joints so their potential shall be explored in an experimental manner.



FIG. 5.1 Glass laboratory ware heat bonded connection

Welding is a fabrication process in which materials are joined using heat. The material is molten and sometimes pressure is used to form a joint (weld). Typically also a filler material is used in addition to melting the base material, forming a pool of molten material typically referred to as the weld pool.

In the process of scientific glass blowing however, no additional material is added to form the bond, hence the term heat bonding shall be used to describe the process explored in this dissertation.

In this chapter, the concept of heat bonding is discussed to create transparent mono-material connections. The impact of the heat bonding process on the material is evaluated in an experimental process including non-destructive testing.

5.2 History of heat bonding / technology of scientific glass blowing

The concept of heat bonding to connect glass is not new. It is a traditional craft used to fabricate, repair and customise laboratory ware and other equipment in chemistry laboratories. This craft is known as scientific glass blowing, which as opposed to traditional glass blowing used to produce art pieces, cups and vessels from molten glass, uses a pre-fabricated base material. Typically, this is industrially manufactured borosilicate as tubing and rods which are then fabricated into chemical instruments and laboratory containers. The driver behind the use of glass for these applications is its resistance against chemicals whilst offering transparency and visibility of chemicals in the containers. Typically, borosilicate is used, due to its better resistance to thermal shock compared with soda lime silicate. This is driven by the linear thermal expansion coefficient which is approximately a third compared to soda lime (5.3.4.1).

The manual heat bonding process is carried out by first preheating the two components to be connected, then locally bringing them to working temperature at which they are physically connected and cooling them afterwards in a colder flame before they are annealed to release the locked-in residual stress.

Typically, burners using a mixture of natural gas and oxygen are used for the process; the amount of oxygen added to the flame allows to control the temperature. Commonly the base material used are tubes and rods, flat glass is more likely to break due to its 3-dimensional expansion, while for tubes and rods only a two-dimensional expansion on opposite axes can be assumed. For the connection of larger tubes, typically a lathe is used to allow for continuous rotation and precise connection of the two tubes.

When connecting tubes with a large diameter and thicker radius the weld is visible as visual distortion (Figure 5.5), however, the material connection is homogeneous so the glass edge is not visible through the thickness of the material anymore, leading to the assumption that with an optimisation and potentially atomisation of the welding process, results with significantly higher visual quality could be achieved.



FIG. 5.2 Glass tube ends used to allow the manual handling of tubes



FIG. 5.3 Connection of two tubes in a manual process without lathe

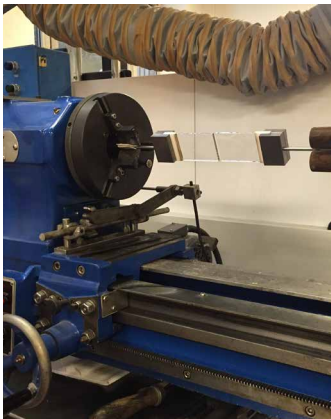

FIG. 5.4 Lathe with custom jig for welding of straight joints



FIG. 5.5 Welded glass tube fabricated by Schott



5.2.1 Additive Manufacturing

One possible approach to automate the process of heat bonding would be to use an additive manufacturing (AM) process.

The term 'Additive Manufacturing' dates back to the 1980's and includes various different technologies of layered construction, which as opposed to subtractive methods that involve the removal of material (cutting, milling, drilling etc.) uses an 'additive' process in which layers of material are used to create an object (Strauss, 2013).

Additive fabrication technologies do not use tools or moulds, but the object is created from a digital model directly, which is why the technology is also referred to as Direct Manufacturing (DM). This means that the technology is well suited for customisation and single-batch fabrication, as the cost for the fabrication of moulds and the additional design complexity coming with a multi step process is not required anymore.

Specifically, any additional complexity on a product scale is theoretically possible with additive processes without having a significant impact on speed of production cost or quality. Although geometrical freedom is already achievable in a single process, speed, cost and quality are yet to be optimised. However, Extruded material built in three dimensions has proven its commercial value with development of an entire consumer- level industry based on the principles of fused deposition modelling (FDM) (Klein et al, 2015)

FDM works on the principle of melting a polymer rod and depositing it in layers on top of each other to create objects after curing. It could be described as an automated hot glue gun.

Given the viscosity of glass at elevated temperatures and its ability to form mono-material bonds, this technology lends itself to the application of an FDM process. Mirroring the welding approach would suggest to use a process in which liquid material is deposited in layers on top of each other creating a bond to each adjacent layer at the same time.

A 3D printer to create glass objects has been developed in 2015 at the Media Lab at the Massachusetts Institute of Technology (MIT). A movable platform within a kiln allows to deposit layers of molten glass which flows through a hole in the container at the top of the kiln (Klein et al, 2015). Various objects of different size were created and initial studies on the performance of the connections of the adjacent layers were carried out. However, the application in glass structures or envelopes is not the main purpose of the research which is primarily centred around the creation of design objects, some of which are shown in Figure 5.6.

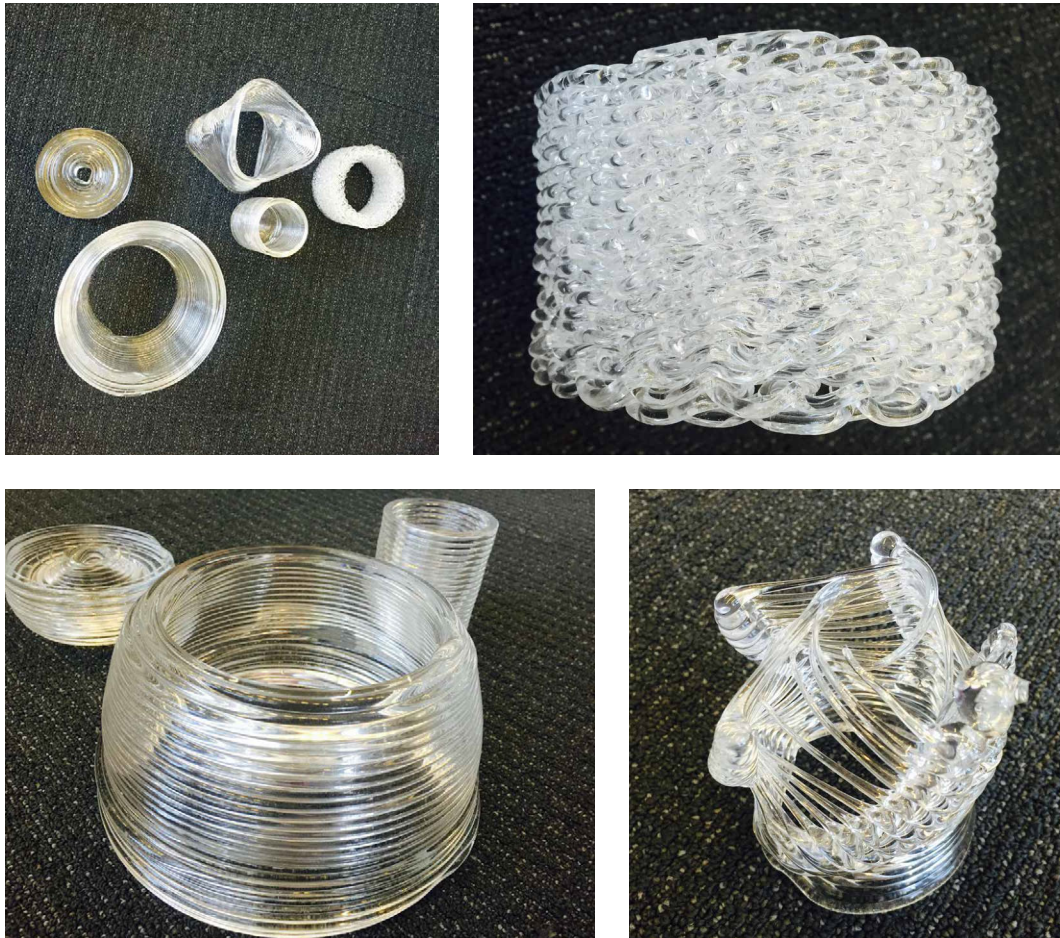

FIG. 5.6 Examples of objects created with 'G3DP' process at MIT

It could be imagined however, that objects produced in a 3DP process could form connections when deposited on a flat glass. Recent studies carried out at TU Darmstadt suggest the feasibility of this approach. (Seel et al, 2017).

None of the results so far however provide transparency in the sense that a distortion-free view through the material is provided. This might be a result of the scale of layers deposited, hence the 'resolution' of the printed object.

At Glasstec 2018 a technology was presented that would allow for printing at higher resolution.



FIG. 5.7 3D- printed objects as presented at Glasstec by QSIL, Netherlands

The specimens shown in Figure 5.7 suggest that a higher 'resolution' reduces the optical distortion and hence increases the transparency of the objects. To achieve a significantly higher resolution that is comparable to the quality of flat (float) glass, it might be necessary to introduce production technology that is not based on liquefying a strand of material, as this will be limited by flow rates through a nozzle. Based on knowledge on precision welding of other materials, a laser welding technique might be employed to improve the resolution of the AM products.

5.2.2 Fibre Optics

Other applications for heat bonded connections are fibre optics, in which the transparency of any connection point is of significant importance and in which the addition of any other bonding material leads to a distortion of the light transmission.

To fabricate bundles of fibre optics, typically transparent glues are used, however a heat bonding process has been established achieving results with reduced distortion. Typically, fibre optic cables are fabricated in a drawing process in which the fibres to be bundled are laid out parallel to each other and moved towards the heat source at constant speed. The viscosity caused by the heat impact leads to a connection of the fibres at their contact points. It is assumed however that cables are not welded but fused at their surface, which means that bonds can be easily broken down.

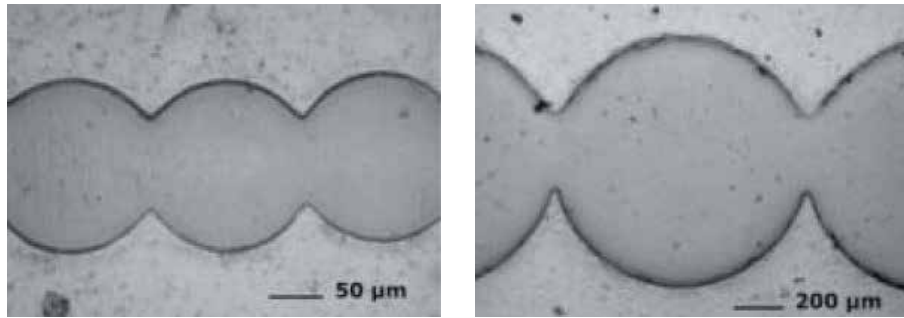

FIG. 5.8 Cross section of laser welded glass cable bundle prior and after the elongation process

An experimental process tested by the Laser institute of the University Mittweida, Germany, uses a CO₂ laser to connect bundles of fibre optic cables. The laser allows for a very short and precise heat impact which reduces the induction of residual stress significantly and allows for a precise maintenance of the desired geometry. The glass rods are clamped next to each other with marginal pressure, just to hold fibres in place and guarantee a contact point between each of the adjacent surfaces. To avoid thermal shock breakage, a pre-heating process with the laser is introduced. To simplify the process, the change in temperature is achieved by varying the process speed.

During a pre-heating phase and a welding phase of respectively seven seconds, a smooth and force-fit connection is achieved with a beam power of 100 W.

After testing the initial continuous welding process, it was found that spot welding prior to elongation of the cables would lead to satisfactory results achieving a continuous connection once the cables are drawn out and connections elongated to 24 times their original length (Laserinstitute Mittweida) (Figure 5.8).

5.2.3 Laser based gravity bending (distorting) of glass

At Glasstec 2016, Fraunhofer Institute presented a sample showing a new technique of gravity forming glass without the use of a mould. Instead, the glass is heated with a laser, wherever the heat impact is required to shape the glass.

The glass is placed in a kiln that pre-heats the entire sheet to avoid thermal shock during the induction of heat to bring the glass to its softening point. The laser can heat the glass to achieve the desired geometry and once at working temperature, the gravity brings it in position. The depth of the bend created is varied by the time the heat impact occurs.

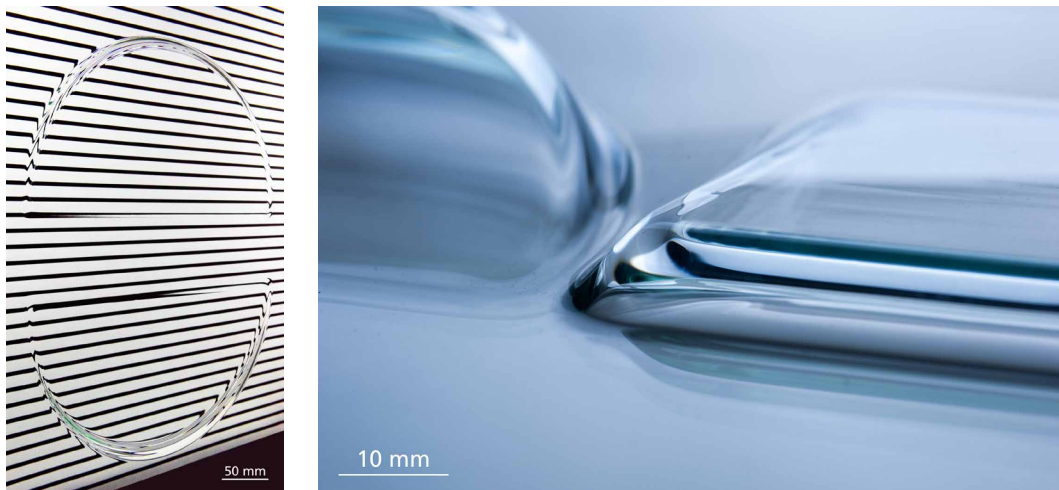

FIG. 5.9 Glass deformed in a CO₂ laser heat induced gravity bending process (Schott, 2016)

The laser used for this process is a CO₂ laser, which is commonly used in material processing in the industry. The laser beam is not applied to the workpiece directly, but rather directed via adjustable mirrors fitted to the interior of the oven. This provides an extremely fast and simple way of positioning the laser beam because it means the laser apparatus itself can remain static. The group's researchers are currently able to process sheet glass with edge lengths of up to 1000mm. The researchers' goal experiment with different types of glass and explore further manufacturing variations with a view to expanding the range of shapes products can take (Fraunhofer, 2016).

The process allows to achieve very precise shapes and whilst currently only available on a relatively small scale, it appears that the technical limitation primarily lies in the size of the annealing oven in which the process takes place. Given that the heat impact is only very local the glass remains distortion free in areas where it has not been formed.

One approach towards transparent glass connections is a heat bonding process based on the principles of welding; the application of a laser to curve glass suggests that it would be valuable to explore the laser technique for a heat bonding process as well.

5.3 Residual Stress induced in the bonding process

Due to the lack of availability of suitable laser technique at the beginning of this research, it was decided to explore the potential of heat bonding utilising a traditional manual welding process, as it is commonly used in the fabrication of laboratory ware.

This chapter investigates the level of residual stress in borosilicate glass caused by a heat-based connection or forming process. Nominal levels of residual stress prior to heat impact, directly after heat impact and after annealing are measured on small-scale samples, utilising a scattered light polariscope (SCALP). Material properties the large temperature range required for the heat bonding process have been identified to allow subsequent numerical modelling to verify the results obtained in this study.

5.3.1 Introduction

During the past decades a vast development in structural glass envelopes and enclosures could be observed, aiming to achieve a maximum amount of transparency.

The development from an infill material to a structural material enabled designers to develop buildings that are based on using a large amount of glass i.e. atriums, skylights and structural glass enclosures.

These Glass structures feature the ability to merge with their surroundings and become invisible, nearly de-materialised if the connections are kept to a minimum. This requires advanced structural engineering, comprehensive analysis and precise detailing to achieve safe sufficient structures. Although significant amount of research in transparent bonding materials and bonded connections has been undertaken in recent years, solid metal connections are still commonly used to form structural glass connections.

With the development that can be observed in structural glass, towards optimisation of connections and production capabilities. These in turn lead to a reduction of the amount of fittings and an increase in the transparency of glass structures, however, to overcome the necessity of opaque connections, further research is required to innovate in this respect as opposed to improve existing technology. One experimental proposal is the heat bonding (welding) of borosilicate components to achieve mono-material transparent connections. Borosilicate is chosen in this case, due to its low coefficient of linear thermal expansion (3.3 for Borofloat 33, 8.4 for soda lime silica, chapter 5.3.4.1).

5.3.2 Material Properties

To study the behaviour of a material at elevated temperatures, it is essential to understand the material properties in relation to temperature. Commonly, material properties are established for a small temperature range only, however, to understand the behaviour of the material when heat bonded, larger temperature ranges need to be considered. Key thermal and mechanical properties have been obtained from manufacturer's literature (Schott Borofloat 33, 2013) and will be introduced in this chapter. Material properties are highly dependent on the chemical composition of the material, and even relatively small variations in composition might result in significantly different behaviour. The chemical composition of the investigated glass (Schott Borofloat 33, 2013) is shown in Figure 5.10.

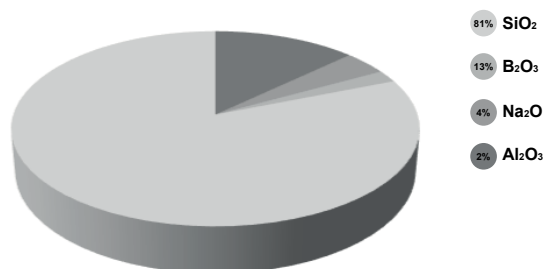

FIG. 5.10 Chemical composition of Borofloat 33

5.3.2.1 Borosilicate

Borosilicate glass is primarily used in chemical and pharmaceutical industries due to its high chemical resistance and low coefficient of linear thermal expansion, which is essential when substances are to be heated in test tubes.

For the same reason, borosilicate is commonly used as fire resistant glazing. However, due to a smaller production it is more expensive than soda lime. Until Schott developed a Micro-float process for borosilicate in 1993, it was produced in a drawing process resulting in larger surface deviations. Maximum available standard sizes here are smaller than for soda lime, however building relevant sizes can be achieved.

Thermal tempering of borosilicate is extensively more sophisticated than the thermal tempering of soda lime. However, by rapid quenching and a decrease of the quenching temperature, Schott have developed a process to overcome the limitations caused by the low thermal expansion and can produce thermally tempered borosilicate.

5.3.2.2 Material Properties Comparison at Ambient Temperature

TABLE 5.1 Material properties for soda lime silicate and borosilicate as obtained from (Petzold et al., 1990)

	Soda lime Glass	Borosilicate Glass
Density [kg/m ³]	2490	2230
Scratch hardness on the Mohs hardness scale	6-7	4.5
Coefficient of mean linear expansion $\alpha 10^{-6}$ [K ⁻¹] (20-300 °C)	8.4	3.3
Thermal conductivity [W/m ² K]	450 x 30	4500
Softening point [°C]	710-735	825
Processing temperature [°C]	1015-1045	1260
Modulus of elasticity E [N/mm ²]	70000	63000
Poisson Ratio μ	0.2	0.2
Bending Strength [N/mm ²]	30	30
Compressive Strength [N/mm ²]	700-900	700-900
Tensile strength [N/mm ²]	30-80	70
(at constant load)	7	7

5.3.3 Thermal Material Properties

5.3.3.1 Thermal Shock

Whenever glass is rapidly cooled, thermal shock is one of the immediately resulting issues causing a high breakage potential. During the process of tempering the cooling rate creates differing temperatures on the surface and in the core of the glass, leading to a stress differential, however, also temporary stress is induced in the glass through a temperature gradient. Although the stress formed during cooling is temporary, failure can occur caused by the differential of surface and core temperature. The maximum possible stress will occur if the surface is instantaneously cooled while the core remains at the higher temperature. Under these conditions stress is given by (Shelby, 2005):

$$\sigma = E\alpha\Delta T / (1 - \theta)$$

ΔT : difference between surface and core temperature

α : thermal expansion coefficient of the material

5.3.3.2 Specific heat capacity

The heat capacity of a material is the amount of energy required to alter (increase or decrease) the temperature of a volume by one Kelvin. The specific heat capacity for the borosilicate used in the tests described in this chapter is shown in Figure 5.11 was obtained from manufacturer's literature (Schott Borofloat 33, 2013) up to 500 °C.

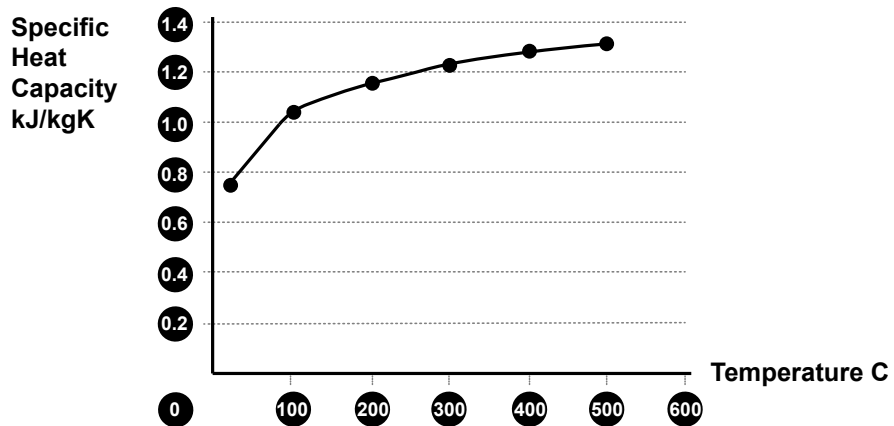

FIG. 5.11 Specific heat capacity of Borofloat 33

5.3.4 Mechanical Material Properties

5.3.4.1 Thermal Expansion

The thermal expansion of a material is understood to be the tendency of the material to change its length or volume due to the temperature increase (it can be differentiated between linear or volumetric thermal expansion). Typically measurements of the thermal elongations are provided up to the transition temperature as shown in Figure 5.11 provided by Schott (Schott Borofloat 33, 2013).

To describe the thermal expansion of a glass, three main factors are to be considered: the thermal expansion coefficient, the glass transformation temperature and the softening temperature. While the thermal expansion coefficient indicates the relation between the volume of the glass and its temperature, the glass transformation temperature indicates the beginning of the viscoelastic behaviour and the softening temperature (dilatometric) indicates the begin of flow under modest load (Shelby, 2005).

The thermal elongation as provided by the glass manufacturer (Schott, 2013) is shown in Figure 5.12 comparing the utilised Borofloat 33 with Pyrex borosilicate 3.3 and pure Silicon.

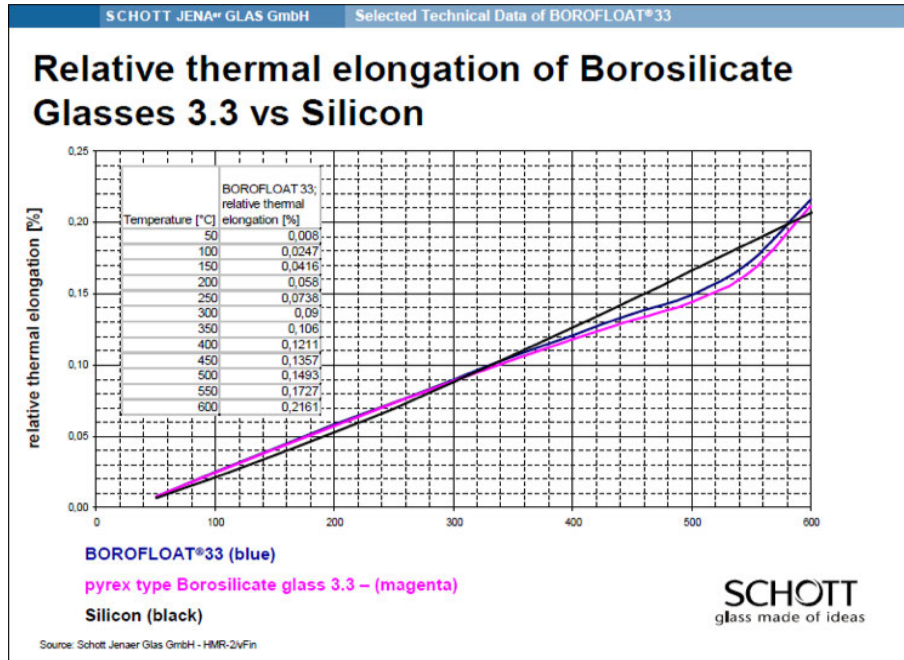

FIG. 5.12 Thermal elongation as obtained from (Schott ,2013)

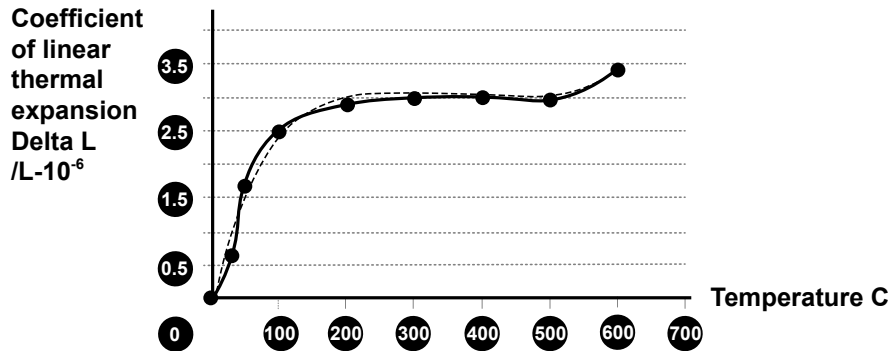

FIG. 5.13 Coefficient of linear thermal expansion over a temperature range up to 600°C

The thermal elongation data provided was utilised to calculate the coefficient of linear thermal expansion for a temperature range up to approximately 600 °C (Figure 5.13). Unfortunately, reliable values above these temperatures could not be obtained, although these would be required to verify test results with a viscoelastic numerical model.

5.3.5 Optical properties

Glass is a solid that transmits light in the visible spectrum, which has not only made it to be a great building material as it transmits light into the building while forming a protecting layer, but this also allows to measure stress in the material with the help of a visual light polariscope.

5.3.5.1 Refractive Index

The interaction of light with the electrons of the individual atoms of a glass determines the refractive index. If either electron density or polarization are increased, the refractive index increases, too. The RI of the borosilicate measured in this study is 1.47 according to data provided by the manufacturer, compared to 1.51 for soda lime glass. Air has a RI of 1.0, which means that when a ray of light hits the surface of a glass, the angle of this light ray is altered, ultimately leading to the visibility if the glass edge.

The following graphic depicts RI's for water, borosilicate and soda lime silica. Cooking oil has a similar refractive index to borosilicate (1.47), hence when a borosilicate object is submerged in cooking oil, it becomes invisible.



FIG. 5.14 Borosilicate rod and tube submerged in oil

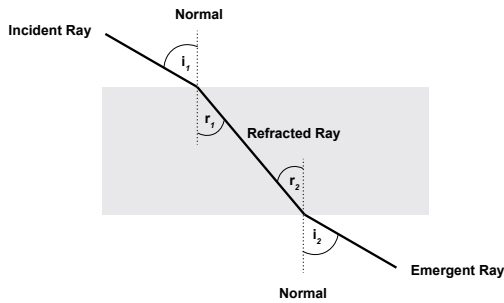

FIG. 5.15 Refraction through a material

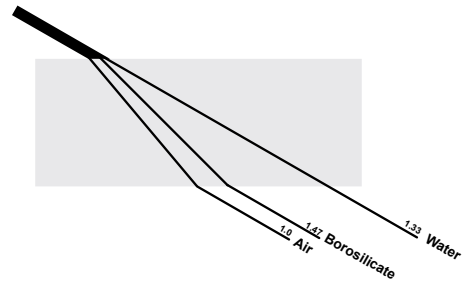

FIG. 5.16 Refractive indices for Water, Borosilicate and Soda Lime Silicate

5.4 Test setup

5.4.1 Heat impact on material structure and residual stress after heat bonding

To understand the local heat impact of a welding process on borosilicate components, experimental testing was performed. The focus in this chapter is on the influence of the temperature on the residual stress of the glass component irrespective of the geometry. Fracture mechanical testing of the connections will be described in chapter 6. To represent the heat bonding process while achieving a neutral geometry that would not influence residual stress measurements, flat specimens with a size of 100mm x 100mm were heated locally to working temperature and then undergone a controlled cooling process. Residual stress levels were measured after a local heat treatment using temperatures high enough to achieve a chemical bond between two specimens. Temperatures required to achieve a chemical bond have been established in previous experimental tests (Rammig, 2010) where specimens were heat bonded and underwent fracture mechanical testing to prove that the bond is stronger than the parent material. These tests were established on an experimental basis and further mechanical testing will be required to obtain significant results, however the initial results suggest, that chemical bonds can be achieved in a heat bonding process.

To achieve a heat bond between two borosilicate specimens, the glass requires local heating to working temperature. This is only possible if the entire specimen is heated to T_g to avoid thermal shock related breakage. To minimise visual distortion locally in the area where specimens have been heated to working temperature, it was experimented with temperature exposure prior to the manufacture of the specimens that were used for the stress measurements. For these experimental trials two components were bonded to understand temperature ranges required to achieve an atomic bond. Insufficient heating of the entire specimen easily leads to breakage, while the local temperature impact could be optimised for a short duration, reducing visual distortion and still achieving sufficient bond between two specimens.

10 specimens of 50mm x 50mm and 4mm thickness were tested, 5 of which underwent the heat treatment and 5 of which were measured untreated. Residual stress was measured on 5 points on the specimen as shown in Figure 5.17. Each point was measured in two directions, x and y at 90 degrees to each other and perpendicular to the edges of the specimen. Initial measurements were taken prior to the heat treatment to monitor residual stress levels of the fabricated glass, the second measurements were taken directly after the welding process, when the specimen had only undergone a controlled cooling process, but were not yet annealed, and the final measurements were obtained after the annealing process, to understand whether the stress induced could be fully released.

A fracture mechanical evaluation of the influence of the temperature on the strength of the material is anticipated through ring-on-ring tests (Ch. 6) however this chapter only discusses the impact of the process on residual stress.



FIG. 5.17 Test specimen with measuring points

The specimens were heated with a burner using earth gas and oxygen in adjustable quantities. The air-gas mixture was adjusted manually to gradually increase the temperature of the flame and heat up the specimen. Two different nozzles were used, a larger opening for a big, low temperature flame (up to 600-800°C) and a smaller nozzle to achieve a slim focused flame with temperatures up to 1500°C to locally heat a small area of the glass ($A=10\text{mm}$). As no heat gauge could be fitted on the nozzle of the burner or the specimen, a thermal camera (FLIR-T 640) was used in the heat range mode of 300°C-3000°C to monitor temperatures of the specimens. The camera offers three temperature ranges for operation; -40-100°C, 150°-600°C and 330°-2000°C. Given that required temperatures are significantly larger than 600°C, the highest temperature range was chosen for the measurements, despite the expectation of inaccuracies for measurements in the temperature range below 300°C.

To assure that the heating process is repeatable in the most similar way despite using a manual process, the specimens were retained in position in a welding jig (Figure 5.18). Two steel clamps keep the glass in position allowing expansion in length by utilising a non-combustible tape with low friction to separate the glass from the steel clamp and allow expansion while retaining the specimen in position.

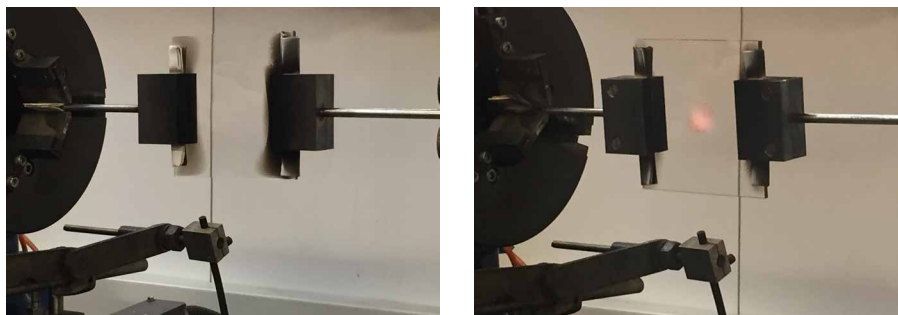

FIG. 5.18 Specimen in welding jig

To avoid breakage due to thermal shock during the process of temperature impact, the entire specimen requires heating up to temperatures 600-700°C prior to local heating of the specimen centres to working temperature ($\sim 1200^\circ\text{C}$). After the heat impact that typically was held for 35 seconds. Temperatures were monitored with a thermal camera to understand heat impact over time and max. temperatures are shown in Figure 5.22. After the heat impact in the centre of the specimen, the entire specimen requires controlled cooling to room temperature before the glass needs to be annealed in a full annealing cycle over 20 hours (Fig 5.19) to remove locked-in residual stress from the temperature impact.

5.4.1.1 Annealing

The annealing of glass is a method to ‘relax’ stresses that are locked in due to a heat impact i.e. a localised heating to replicate a bonding process. Annealing is equally important to commonly used glass processing techniques such as heat gravity bending (‘slumping’). After the heat impact the glass requires an additional cooling process in which controlled temperature drop leads to a relaxation of locked-in stress. The exact adherence to maximum temperature and different heating and cooling rates during the annealing cycle is of high importance to achieve a continuous annealing result with a homogeneous stress distribution in the component (Greil, E., 1964).

The relaxation temperature of the annealing cycle is defined by the glass composition. Table 5.2 indicates annealing temperatures for several glass compositions, including the Borofloat 33 utilised in the tests.

To achieve a relaxation of stresses, the glass requires a homogeneous heating of the entire component so that stress can be released through the plastic behaviour of the heated material. The cooling through the transformation phase of the glass has to be slow enough to avoid further stress being locked in. This means that the cooling rate is the crucial factor in the annealing process. It is dependent on the thickness of the material as well as the composition, which cooling rate is chosen. The annealing cycle used for the specimens tested is shown in Figure 5.19 and is based on material properties obtained from literature (Schott Borofloat 33, 2013) and (Greil, E., 1964).

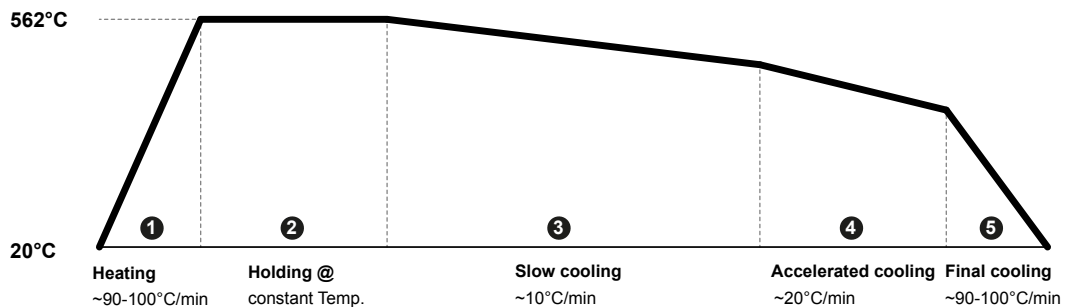

FIG. 5.19 Annealing cycle for borosilicate specimen

TABLE 5.2 Annealing temperatures for several glass compositions (Greil, E., 1964)

Glass type	Relaxation Temp. °C	Glass type	Relaxation Temp. °C	Glass type	Relaxation Temp. °C
Schott, Mainz:		Bulb glass	562	Quickfit:	
DURAN 50	575	Fluorescent bulb glass	530	Laboratory glass	565
Appliance glass 20	575	Coloured fluorescent bulb glass	510	Philips:	
Therm Gl 16	544	Ruhrglas		Light bulb glass 01	435
Therm. Gl 2954	596	Appliance glass	520	Light bulb glass 03	510
Supremax 56	750	Tube glass	496	Television bulb glass 162	465
Borofloat 33/ Supremax	722	Vial glass	538	Sovirel:	
Supremax	573	Fluorescent bulb glass	506	Pyrex	545
Fiolax clear	571	Osram:		Borosilicate glass 73201	562
Fiolax brown	566	Leadglass-M	435	Borosilikatglas 74001	550
Leadglass	429	Leadglass	425	Borosilicate glass 74644 et al	480
Uvioglass	452	Standard tube glass	505	Borosilicate glass 75001	508
Television bulb glass	445	Magnesium glass	515	Leadglass	438
Glaswerk Wertheim		Tungsten glass	528	Czech Glasses	
Appliance glass	538	Hard glass	743	SIMAX Glas	536
Tube glass for appliances	530	Thueringer Glasses:		SIAL Glas	562
Chemically resistant glass	582	Rasotherm	570	Neutral vial glass	581
Sterilisation glass	566	Appliance glass G52	605	Thermometer glass PN	550
Leadglass	550	Appliance glass 399	540	Regular window and container glass	530
Molybdaen-and Kovar Glass	428	Gegeef	560		
	512	Fischer Prima	530		

5.5 Test results

It was expected that residual stress would be relatively consistent on small specimens prior to the heat treatment and deviations and measurement errors were predicted to be low. Similarly it was anticipated that residual stress levels on the annealed specimens would be low, however deviations were expected to be larger. Directly after the heat impact, larger variation of residual stress within the specimens was predicted as well as significant stress in the glass due to the high Temperatures applied.

5.5.1 Visual assessment of residual stress

Residual stress was visually monitored under a polarisation filter prior to heat impact, just after heat impact and after annealing. All visual assessments were carried out at a constant room temperature of 24°C.

Residual stress at the three stages mentioned is shown in Figure 5.20.

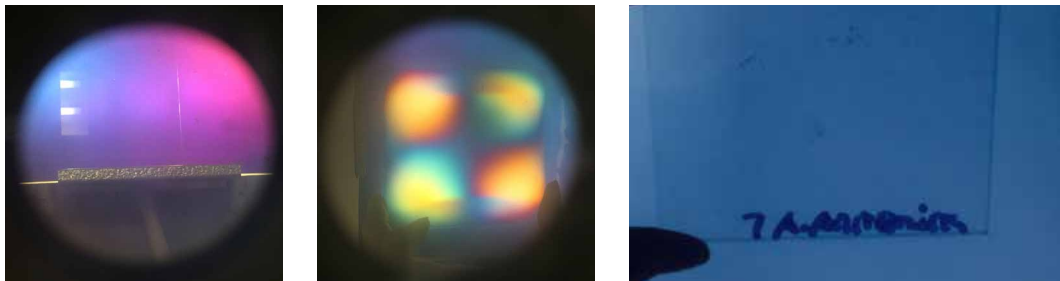

FIG. 5.20 A, B and C: residual stress under polarisation filter before and after welding and after annealing

Prior to the heat impact, no stress could be observed under the polarisation filter, the specimen appears to be evenly annealed with residual stress levels too small to be visible under a polarisation filter. Figure 5.20 B shows the distribution of residual stress immediately after the heat impact. The glass was cooled to room temperature in a controlled way (Figure 5.19), however, the fast cooling process leads to stress being locked in. Where the centre of the specimen underwent the heat treatment, the stress distribution appears relatively evenly in the opposite corners of the specimen, with slight non-uniformities in the areas the specimen was clamped to the jig.

After the annealing process, again, no visual stress could be observed in the visual assessment through polarised light (Figure 5.20 C).

5.5.2 Residual stress measurements

Non-destructive testing on the surface stress was carried out using a scattered light polariscope (SCALP 5) to understand the impact of heat induction and annealing on the residual stress of the glass.

The SCALP operates by sending a polarised laser through the thickness of the glass. The laser beam scatters on the particles of the glass and the intensity of this scattering is recorded through the thickness of the glass, the device obtains the absolute optical retardation at every point of the beam, which is then converted to stress values (GlasStress, 2013).

Residual stress measurements on the heat treated specimen were carried out immediately after the heat treatment, just allowing the specimen to cool down to room temperature (24°C) and were then repeated after the annealing process.

The annealing cycle used is optimised for the borosilicate used (Borofloat 33) and is illustrated in Figure 5.19.

Ideally residual stress levels prior to heat induction and after annealing should be identical, however, previous tests carried out on slumped (gravity bent) annealed glass showed that this might not be the case and the annealing process might not release locked- in stress evenly.

The general effects of thermal history on thermal and mechanical properties are well understood and as such should be taken into consideration.

5.5.2.1 SCALP calibration

As the refractive index (RI) of borosilicates differs from the RI of soda lime silicates, the polariscope requires adjustment to be able to measure borosilicates accurately. The RI of the borosilicates used is 1.48 as previously described, which according to the polariscope manufacturer requires a laser angle $<75^\circ$.

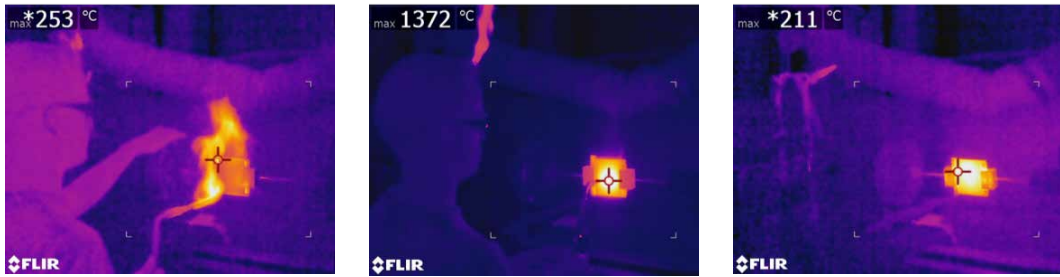

FIG. 5.21 Temperature at 45, 405, and 675 seconds

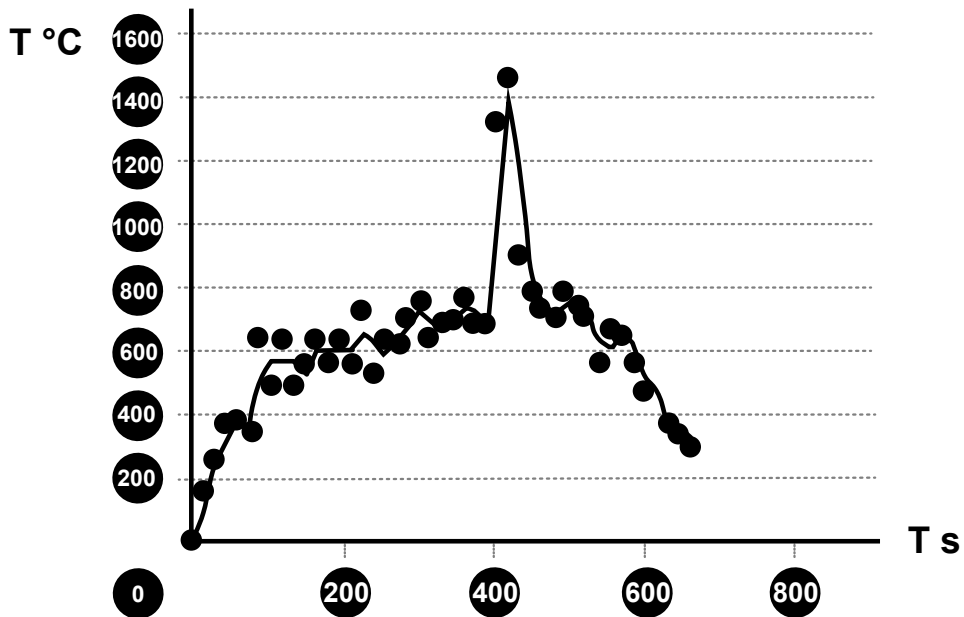

FIG. 5.22 Temperature profile for 5 tested specimen

5.5.2.2 Measurement results

To understand the impact of heat on the glass through a heat bonding or -deforming process, the same three conditions were analysed: prior to heat impact, directly after a local heat impact and after annealing of the specimen. The specimens were measured on 5 points (Figure 5.17) in x and y direction.

5.5.3 Data analysis

The data was analysed using the manufacturer's software (GlasStress SCALP Software version 5.8.1.4). Processing of the results was based on the fit error and the amount of pixels that were excluded from the measurement. The fit error refers to the root-mean-square error of the fitting curve that is used to smoothen retardation results and allow stress calculation. Large values indicate that measurement data is invalid. The manufacturer suggests that acceptable values are between 5 and 15% (GlasStress, 2013).

Pixels not sufficiently reliable for stress calculation are referred to as excluded pixels. Parasitic scattering of the light beam saturates the sensor and leads to an exclusion. Approximately 5 to 15% of the data is lost due to parasitic scattering preliminary at entrance and exit points of the laser (GlasStress, 2013).

Readings with a fit error >10% and excluded pixels of >20% were not considered in the data processing.

Results were separated based on the direction of stress measurement, average stress values were calculated for each direction and finally overall results were transferred into Excel format.

5 points were measured for each specimen in x and y direction. Then principal stress was calculated to:

$$\sigma_1, \sigma_2 = (\sigma_x + \sigma_y) / 2 \pm \sqrt{((\sigma_x - \sigma_y) / 2)^2 + \tau_{xy}^2}$$

Assuming that the shear stress = 0. The SCALP is not capable of measuring shear stress; hence this assumption has been made, as shear stress could not be verified.

Results are shown in Table 6, measurements of residual stress prior to heat treatment are very consistently in the acceptable range for annealed glass (Haldimann et al, 2008).

TABLE 5.3 Principle residual stress on specimen

Measurement point	Prior to heat impact		After heat impact		After annealing	
	Mean principal residual stress (MPa)	SD (MPa)	Mean principal residual stress (MPa)	SD (MPa)	Mean principal residual stress (MPa)	SD (MPa)
1	-3.51	0.68	5.39	1.30	-1.72	1.52
2	-3.24	0.14	-0.6	0.58	-1.10	0.50
3	-3.27	0.31	-0.08	1.76	-1.45	0.96
4	-3.39	0.45	2.51	1.96	-0.90	1.09
5	-3.35	0.51	1.34	0.97	-0.86	0.58

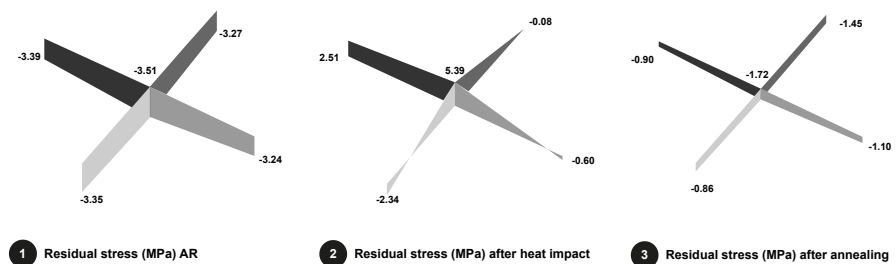

FIG. 5.23 Principal residual stress on specimen prior to welding, after welding at 24° C and after annealing at 20° C

Whilst the distribution of residual stress prior to heat impact is very even throughout the specimens (Figure 5.23), after welding, larger differentials can be observed, with compressive values in the corners of the specimen, surrounding the centre point that was exposed to localised heat impact. This matches results previously observed under a polarisation filter shown in Fig. 5.21 although distribution of stress after welding appears to be not as homogeneous as indicated in the polarisation image. However, stresses measured are much lower than expected; The significance of the results obtained is questionable though, as the measurement device has a tolerance of +/- 4 MPa for measurements <20 MPa (Aben, et al., 2010), which, given the small values measured, might have a significant influence on the results and suggests that the device is not reliable for measurements of the pre-annealed and annealed glass. After annealing, the stress distribution is more homogeneous again, with a higher standard deviation in results. Deviation in results directly after heat impact is comparably high. The experimental results shall be verified in a numerical model, which will, however require reliable material properties over the large temperature range the glass is exposed to.

5.6 Summary of results and further research

Temperature impact on the residual stress of glass specimen is shown in the results obtained through experimental testing of borosilicate specimen. The importance of an additional annealing process can be observed, as residual stress is clearly reduced. However, measurement results obtained in areas of large heat impact, where surface deformation of the specimen can be observed, show larger deviations and error rates, so further testing might be required to verify the results obtained in this study. Residual stress levels measured after the heat impact were significantly lower than expected and might not be reliable, as stress is below the threshold where the scattered light polariscope used (SCALP 5) can obtain reliable measurements. Through the process however, it could be verified that a controlled process needs to be followed to heat the glass to T_g , as thermal shock breakages were observed when specimen were heated too rapidly. This will require further studies to explore optimised exposure temperatures. The visual assessment of stress shows that a controlled annealing process reduces stress induced through a heat impact can be relaxed and components do not show significant residual stress or stress differentials that would make the glass unemployable as an annealed glass component for a building application. It is assumed that stress is sufficiently eased out for the glass to undergo further thermal treatment processes, however, this shall be verified in further tests. For application in an industrial process, controlled heating, temperature exposure at T_{max} and controlled cooling would require further optimisation and study.

Though not part of the scope of this research, advanced numerical analysis utilizing viscoelastic material models will have to be carried out to verify the current results. These rely on the availability of material properties in the temperature range explored, which could not be obtained for this study; hence further research is required. In practice, apart from the use shown in this study, the analysis methodology as well as material properties obtained for large temperatures have a wide variety of applications, including the study of fire resistant glazing or gravity curved (slumped) glass. The latter is commonly in use, however stress levels are not very well understood so further studies on residual stress of gravity formed glass shall be carried out.

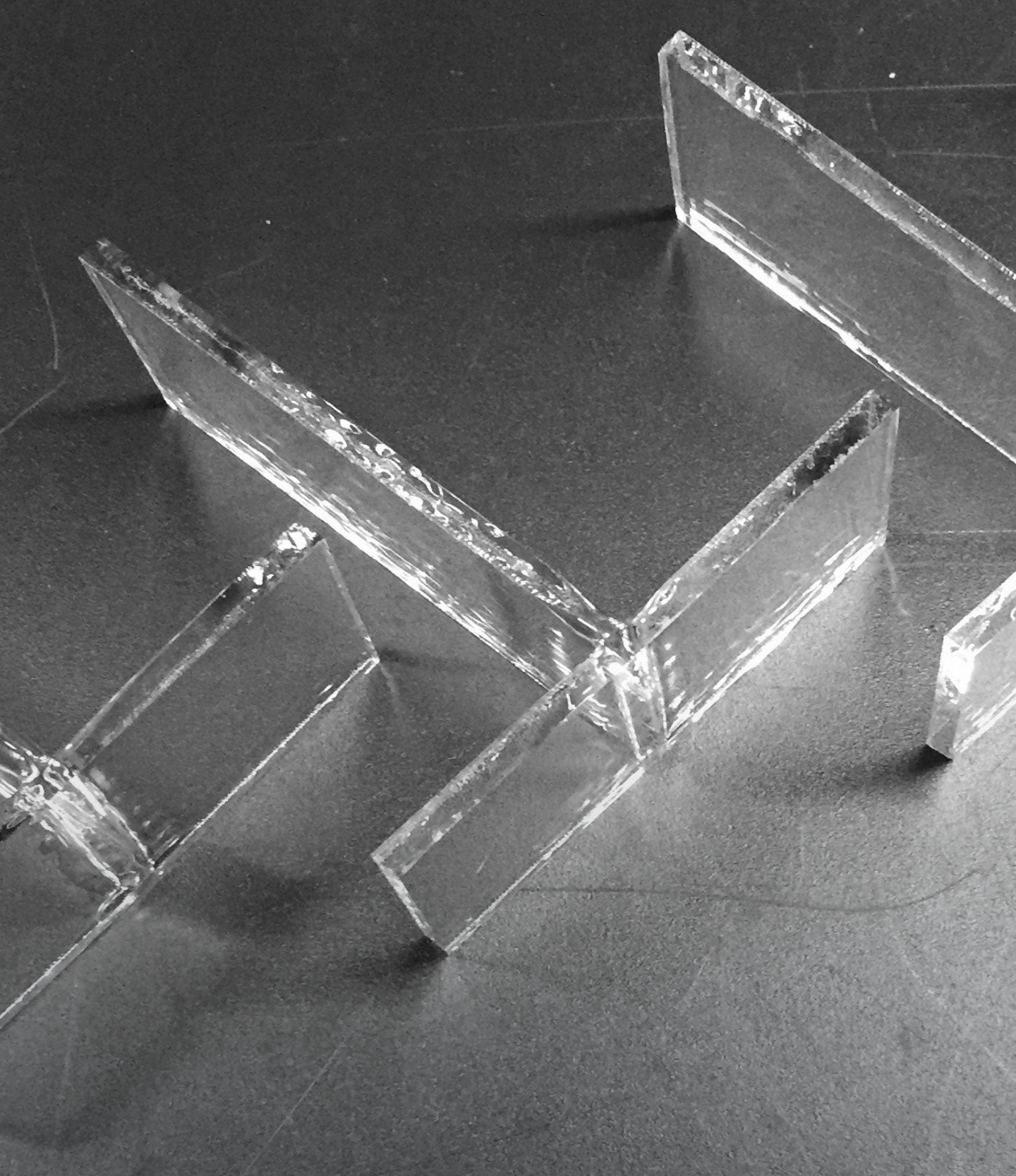

Heat Bonded T Joints

6 Capacity of heat bonded connections

Chapter Six continues to explore the capacity of heat bonded connections through experimental testing. Specific connection typologies are manufactured in a heat bonding process and fracture mechanically tested to assess the load bearing capacity of the connections and their appropriateness for application in glass structures. The primary purpose of the experimental testing is to understand whether the connection is as strong as the parent material.

6.1 Introduction

Based on the results from the previous experimental campaign presented in chapter 5, this chapter will discuss the structural capacity of the connections as well as the visual quality achievable with a manual manufacturing technique.

Within the scope of this research, a variety of connections have been investigated. As described in previous chapters, the base material used for all manufactured connections is borosilicate glass (Borofloat 3.3 and Pyrex).

When manually heat bonding glass in a scientific glass blowing lab, rods and tubes have the advantage over flat glass, that their expansion under temperature is predominantly one-dimensional, meaning that elongation occurs predominantly along the length of the rod, hence thermal shock fracture is less likely to occur (Shelby, 1997). At the beginning of the research, the experience with heat bonding flat glass was very limited, as in the traditional craft of glass blowing for the manufacture of laboratory ware, typically glass tubes and rods are used.

The objective of this chapter is to test whether heat bonded connections prove to be as strong as the parent material. The experiments are organised in 3 parts:

- 1 Pre-validation: 3 specimens of 9 series are manufactured and assessed, to understand their feasibility and applicability (Series 1-9, Table 6.1)
- 2 Material validation: temperature impact on glass samples is evaluated using a Ring on Ring set up in two series. (Series 10, Table 6.1 distributes into 10a and b, Table 6.4)
- 3 Connection validation: Two test series including two different connection types with a series of 10 specimens each. The connections were tested in flexure with a 4-point bending set up and in tension with a pull-out test (Series 5, 9 A+B, 10 A+B, Table 6.4) .











6.2 Initial experimental investigation (pre-validation)

To understand and validate the opportunities heat bonded connections would entail, initial tests were carried out bonding two tubes to each other and bonding tubes and rods to flat glass. After initial experimentation with different welding equipment and kilns, specimens were chosen at a size where they could be fabricated in a typical scientific glass blowing lab.

All connections were manufactured using borosilicate glass in a flame using a mixture of natural gas and oxygen with the possibility to adjust the temperature by regulating the amount of oxygen added. Whilst temperatures with the initial welding equipment (a large construction burner) could not be sufficiently monitored, a more precise result was achieved in the glass blowing lab. Flame temperatures were monitored and varied between 150°C at the beginning of the heating process and 1300°C for the bonding, based on the experience of the glass blower.

In this initial stage, only a small quantity of each connection was produced (three specimens each), as the intent was to establish which connections could be feasible in production and to understand how performance of the connections might vary.

TABLE 6.1 Summary Pre-Validation

Connection type	Series #	Preliminary test No of specimens	Test 1 4pt Bending No of specimens	Test 2 RoR No of specimens	Test 3 Pull-out No of specimens
 1	1	3			
 2	2	3			
 3	3	3			
 4	4	3			
 5	5	3			8
 6	6	N/A			
 7	7	3			
 8	8	3			
 9	9	3	8 +8		
 10	10	N/A		5+5	

6.2.1 Initial set-up

The initial connections were manufactured by the author using a burner allowing for adjustment of natural gas and air quantity and specimens were then annealed in a ceramic oven in a pottery studio. Iterations of the manufacturing process were required in order to establish annealing cycles appropriate for the size and shape of the specimens. In a second step, connections were manufactured by a technician in the glass blowing lab of the chemistry department at the university of Paderborn, Germany, using the annealing oven that was calibrated for the manufacture of borosilicate test tubes and distillation devices. Given the manual nature of the manufacturing process, precision of the joining was dependant on the skills of the technician and steadiness of the hand-held procedure.

The working temperature and annealing cycle were controlled manually and based on experience of the technician. The results of this first set-up of tested connections were published in (Rammig, 2010).

6.2.2 Connections tested

In this initial stage of the research the following connections were assembled and grouped into two groups based on their typology for assessment (shear and flexure, Figure 6.1):

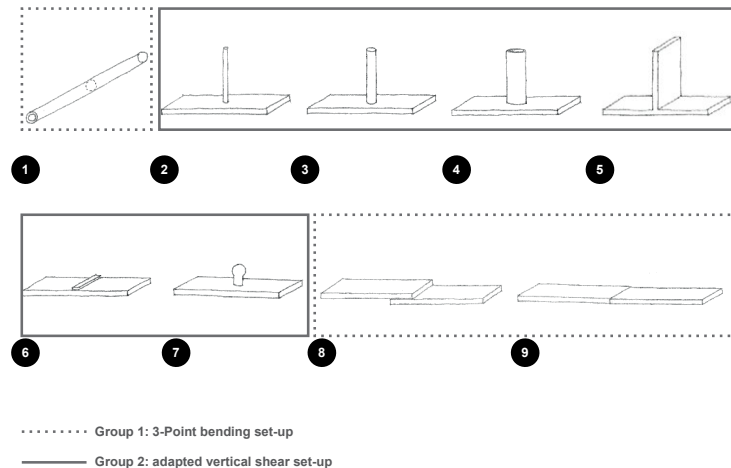

FIG. 6.1 Initial connections manufactured to understand glass and connection behaviour

6.2.2.1 Joint appearance

Three specimens of series 1-9 type were assembled, visually assessed and then tested for strength under static load impact. The assessment of all series can be grouped into two set-ups:

- 1 Bending strength
- 2 Shear strength

Due to the limitation in equipment available, a 3-point bending set-up was chosen to determine the bending strength for series 1, 8 and 9 and a vertical adaptation of the 3 point-bending set-up was chosen for series 2-7 (Figure 6.2). To be able to determine shear strength in a bending set-up, the load was applied as close as achievable to the flange of the specimens reducing the lever arm to the achievable minimum and get as close as possible to a shear test (Figure 6.3).

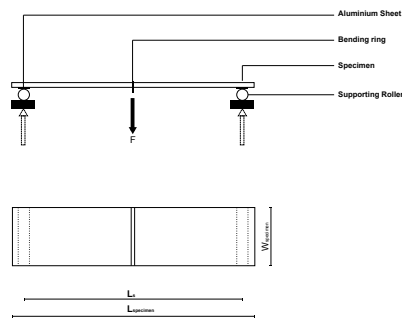

FIG. 6.2 3-point bending test set-up

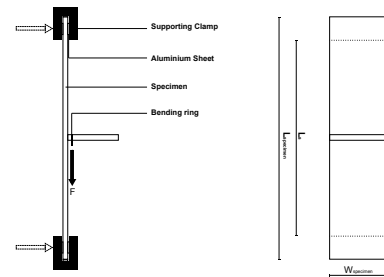

FIG. 6.3 Adapted vertical shear set-up

The connections represented in series 1-9 were chosen based on availability of material and to represent a variety of material thicknesses and shapes for an initial assessment of suitability. Connections were then assessed for their suitability as a structural connection in an architectural application. Selection criteria as well as dimensions of the specimens in each series are outlined in Figure 6.4–6.12.

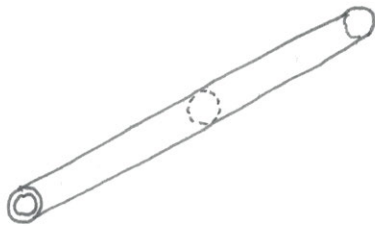

FIG. 6.4 Butt joint of two 40mm tubes (2mm wall thickness). - This connection was selected as it is a common connection crafted in the manufacture of laboratory ware and it could be assessed in flexure comparing to an AR tube with the same dimensions.

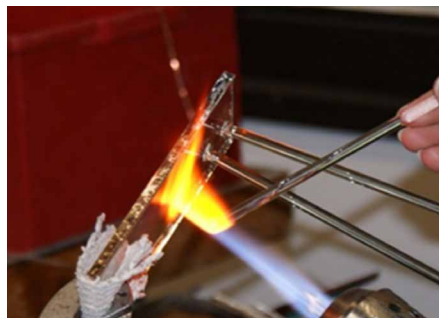
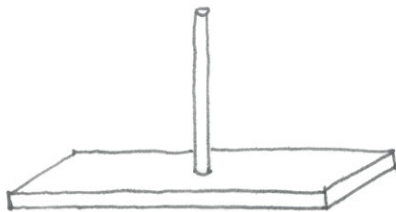

FIG. 6.5 First connection involving flat glass, 5mm rod attachment. - As welding or heat bonding flat glass is uncommon in the typical scientific glass blowing craft, thin solid rods were used to initially verify the suitability of the flat glass specimens for heat bonded connections. Due to the small diameter of the rod ($D=5\text{mm}$) it was assumed, that it would prove difficult to verify the strength of the connection through fracture mechanical testing.

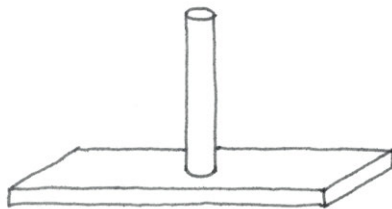

FIG. 6.6 20mm tube (2mm wall thickness) attached to 50 x 200mm flat glass. - Tubular sections are commonly used in scientific glass blowing, so a tube with a small radius and wall thickness was chosen to continue feasibility studies on the manufacturing of the connections.

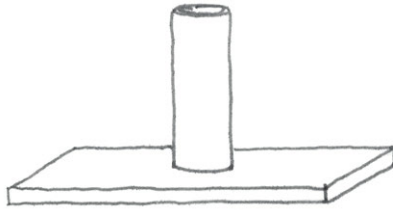

FIG. 6.7 40mm tube attached to 50x200mm flat glass. - Increasing the area of the bond and hence the area that required heating to working temperature, larger tubes were chosen, as it was predicted that these would provide sufficient material stiffness so that load could be introduced into the connection through a shear test.

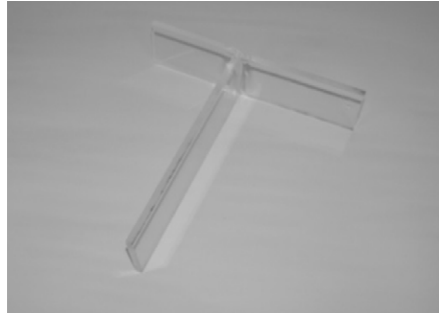
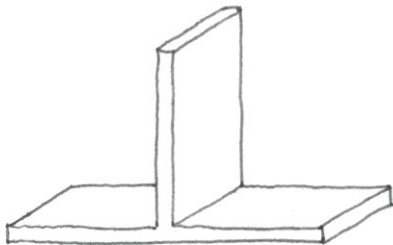

FIG. 6.8 T-joint with 50mm x 200mm glass sheets - this connection was chosen, as it often occurs in architectural glass structures, i.e. glass fins connected to a facade panel or roof beams supporting flat roof panels.



FIG. 6.9 'Additive' manufacturing of thin glass layers on 50mm x 200mm flat glass - Due to the absence of a 3D printing process for glass at the time the experiments were carried out, this connection was chosen to mimic an additive manufacturing process and verify the possibility of connecting thinner layers of glass.

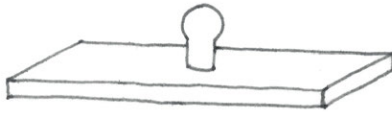

FIG. 6.10 8mm point fitting on 50mm x200 mm flat glass sheet. - The point fitting was chosen as glass in structural architectural applications is commonly connected in a discrete fashion.

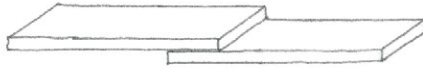

FIG. 6.11 50mm x 50mm fused connection - This connection was chosen to establish whether the surfaces of two sheets could be fused together without significantly distorting the appearance of the specimens.

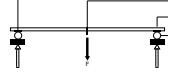

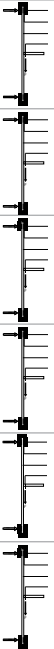







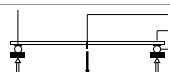

FIG. 6.12 Butt joint manufactured from two sheets of 5mm Borofloat 50mm x 200mm Butt joints are commonly used when connecting glass panels to each other in facade applications. Typically these joints are opaque silicone adhesive joints, which allow to accommodate movement as well. Despite its rigidity, this connection was chosen, as it suggests an opportunity to limit or even mitigate the reflection if light on the edge of the two glass sheets to be connected and hence increasing the perceived transparency.

6.2.2.2 Load capacity of the connections

Table 6.1 summarises the outcome of the pre-validation, which on its own, due to the small amount of specimens tested, is not conclusive. Therefore additional assessment criteria outlined in 6.1.2.3 have been established to identify the most appropriate connections for further assessment. As only 3 specimens per series were evaluated, no statistical evaluation of the strength data was performed. Data in table 6.1 show the mean values

TABLE 6.2 Summary Pre-Validation

Series #	Group #		Mean Load Capacity [kN]	Mean Bending Strength [MPa]	Notes	
 1	1		4.25			
 2	2		0.3			
 3	2		-		Fracture outside of connection area, data has been excluded	
 4	2		4.3			
 5	2		4.5			
 6	2		N/A		Test set up was not considered feasible, as load application was not possible in the area of the bond	
 7	2		3.3			
 8	1			N/A		Specimens fractured at marginal load application, suggesting no atomic bond is achieved
 9	1			4.2		

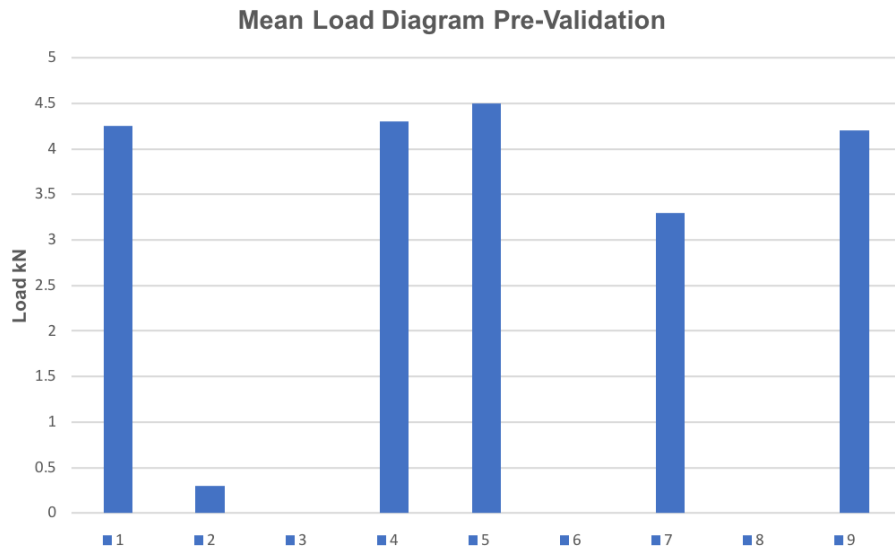

FIG. 6.13 Mean Load Capacity of initial connection validation

6.2.2.3 Assessment criteria

Connections were assessed to the following criteria:

- 1 Optical appearance: This first criterion assesses the amount of visual imperfections including but not limited to inclusions, pinholes, bubbles, distortions
- 2 Relevance of connection in architectural or structural glass application: this criterion assesses how relevant the connection is for an application in a glass structure of envelope
- 3 Transparency: the optical transparency of the connection itself is assessed including inclusions and visual distortions
- 4 Strength of connection: initial experiments (typically 3-point bending tests) were carried out to make a judgement on the indicative strength of the connections
- 5 Repeatability: this criterion assesses how consistently connections can be manufactured in the same manner, achieving comparable appearance and performance

TABLE 6.3 Comparison of connections and their performance in pre-validation assessment









Series #	Optical appearance of connection	Relevance	Transparency	Strength	Repeatability
 1	0	--	0	++	+
 2	+	--	+	0	+
 3	-	0	0	N/A	0
 4	-	+	0	++	+
 5	+	+++	++	++	++
 6	++	0	++	N/A	++
 7	++	+++	++	++	++
 8	0	-	-	--	-
 9	+	+++	++	++	++

Table 6.2 shows how the connections performed against the assessment criteria indicating that series 5, 7 and 9 perform significantly better overall. This suggests to further test these to verify the indicative results. Given that series 7 though is not only a connection between two glass components but a manufactured object on the surface of a glass sheet, it will be excluded from further assessment to make sure results can be interpreted as strength of the connection vs. strength of the parent material. In lieu of verifying series 7, the heat impacted specimens assessed in chapter 5 shall be tested in flexure to replicate a connection and compare as received (AR) with heat impacted (HI) specimens. This series will be evaluated as series 10.

6.3 Optimised test scope

The indicative results obtained from the pre-validation do not sufficiently validate the performance of the connections, so additional destructive tests are performed. The tests are performed. The focus is not solely on the performance of the destructive testing but as much on the manufacture of the connection as geometrical consistency and homogeneity of the material in the connection is assumed to have a significant effect on the performance of the test. .





6.3.1 Test configurations

The following paragraphs outline the test campaigns performed to evaluate connections 5, 9 and 10 in more detail. The following tests were performed:

- 1 Ring on Ring test (As received, series 10A)
- 2 Ring on Ring test (after heat impact and annealing, series 10B)
- 3 4-Point bending test (As received, series 9A)
- 4 4-Point bending test (with annealed butt joint, series 9B)
- 5 Pull out test of T-joint (series 5)

The following table outlines the number of specimens manufactured and tested for each series (Table 6.4).

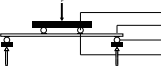
TABLE 6.4 Additional test configurations

Connection type	Series #	Schematic test set-up	Test 1+2 RoR No. of specimens	Test 3+4 4PB No. of specimens	Test 5 Pull-out No. of specimens
 5	5				8
 9	9A+B			8 + 8	
 10	10A+B		5+5		

6.3.2 Manufacture of specimens



FIG. 6.14 Steel clamps to allow fixation of glass in lathe

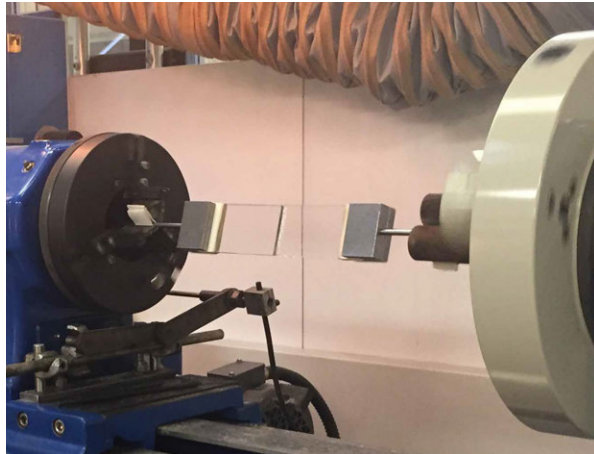

FIG. 6.15 Jig set-up with steel clamps fixed to lathe to allow for rotation of specimen during welding process

After the initial test phase with varied welding equipment that led to inconsistent results, the specimens for all test set-ups were manufactured in a scientific glass blowing lab that is specialised in making and repairing borosilicate laboratory ware. The scientific glass blowing lab at the Chemistry Department of the University of Cambridge kindly provided welding equipment and technology to manufacture the connections described in the following chapters.

As previously described, typically the glass is held manually and heated in a flame when connections are manufactured. To reduce the risk of thermal shock breakage and provide consistency in the production of multiple specimens, a jig was built that would allow to control the exposure to the flame when fixed to a lathe. This is illustrated in Figure 6.14 and 6.15.

The specimens are heated with a burner using natural gas and oxygen in adjustable quantities. The flow of oxygen cannot be measured, so the air-gas mixture was adjusted manually based on experience of the glass blowing technician, to gradually increase the temperature of the flame and heat up the specimen. Two different nozzles were used, a larger opening for a wide, low temperature flame (up to 600-800°C (Flame 1)) and a smaller nozzle generating slender focused flame with high temperatures up to 1500°C (Flame 2).

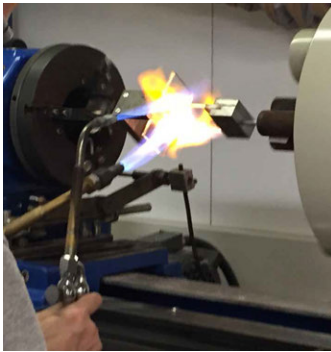

FIG. 6.16 Large nozzle creating wide, low temperature flame (Flame 1)

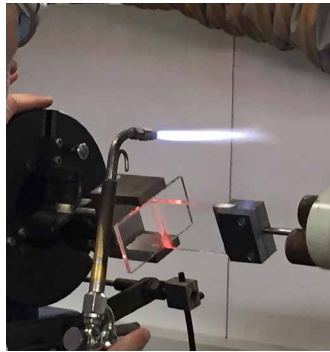

FIG. 6.17 Small nozzle creating narrow, high temperature flame (Flame 2)



FIG. 6.18 Both flames in use to assure consistent heating of specimen (Flame 1) whilst manufacturing the bond (Flame 2)

As no heat gauge could be fitted on the nozzle of the burner or the specimen, a thermal camera (FLIR-T 640) was used to monitor and document temperatures of the specimens. The camera offers three operational temperature ranges; $-40-100^{\circ}\text{C}$, $150^{\circ}-600^{\circ}\text{C}$ and $330^{\circ}-2000^{\circ}\text{C}$. Given that required temperatures are significantly larger than 600°C , only the highest temperature range was suitable for the measurements, accepting inaccuracies of measurements in the temperature range below 300°C .

To assure that the heating process is repeatable despite using a manual process, the specimens were retained in position in a bespoke welding jig (Figure 6.15). Each glass plate is fixed by a steel clamp (Figure 6.14) that is then fixed back into a rotating jig. A non-combustible anti-friction tape is used to allow expansion within the clamp while the glass is heated.

To achieve a heat bond between two borosilicate specimens, the glass requires local heating to working temperature T_w (1200°C). This is only possible, if the entire specimen is heated to T_g to avoid thermal shock related breakage. The preliminary experimental program served as guidance for establishing an optimised working temperature. However, it was relied upon the experience of the technician to assure the use of appropriate bonding temperatures and achieve sufficient bonds. Insufficient heating of the entire specimen easily leads to breakage, whilst a longer duration of heat impact can lead to distortions and inconsistencies. After a few connections were manufactured, through an initial adjustment phase the local temperature impact could be optimised for a short duration, reducing visual distortion and still achieving sufficient bond between two specimens.

Temperatures were monitored with a thermal camera to understand heat impact over time. After the connection was manufactured, the entire specimen required controlled cooling to room temperature before the glass was annealed in a full annealing cycle over 20 hours (Figure 6.19) to remove locked in residual stress from the temperature impact.

6.3.3 Annealing

The annealing of glass is a method to ‘relax’ stresses that were locked in through a heat impact i.e. the bonding process followed here. Annealing is equally important to commonly used glass processing techniques such as heat gravity bending (slumping). After the heat impact, the glass requires an additional cooling process in which controlled temperature drop leads to a relaxation of locked-in stress. The exact adherence to maximum temperature and different heating and cooling rates during the annealing cycle is of high importance to achieve a continuous annealing result with a homogeneous stress distribution in the component (Greil, E., 1964). The relaxation temperature of the annealing cycle is defined by the glass composition as well as thickness and dimensions of the specimens.

To achieve a sufficient relaxation of stresses, the glass requires a homogeneous heating of the entire component so that stress can be released through the plastic behaviour of the heated material. The cooling through the transformation phase of the glass must be slow enough to avoid further stress being locked in. This means that the cooling rate is the crucial factor in the annealing process. It is dependent on the thickness of the material as well as the composition, which cooling rate is chosen. The annealing cycle used for the specimens tested is based on material properties obtained from literature (Schott, 2013) and (Greil, E., 1964).

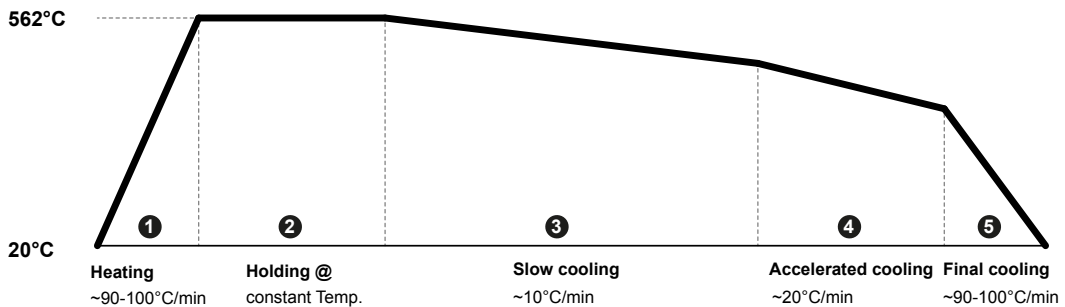

FIG. 6.19 Annealing curve for specimens

6.4 Bending strength of heat bonded glass connections

6.4.1 4-point bending test

The flexural performance of the heat bonded (HB) connection was evaluated in a 4-point bending (4PB) set-up. For comparison, a series of as received (AR) glass samples was tested. For this test, connection type 9 is considered. The scope of the test is to establish the bending strength of borosilicate specimens that have been connected under heat impact with a butt joint through the centre of the specimen. The specimens were fabricated from two sheets of 50mm x 100mm glass of 5mm thickness, resulting in overall dimensions of 50mm x 200mm.

To verify results, 200mm x 50mm borosilicate plates with a thickness of 5mm were tested in the same setup, which allows to compare the fracture strength but also origin of failure between a HB specimen and the AR glass.

The tests are carried out according to BS EN 1288-3 with a bespoke jig to accommodate the size of the specimens. The specimen size specified in the standard was not feasible in this application, as welded/heat bonded joints could only be fabricated using small borosilicate plates. This is due to limitations of the welding equipment and current scalability of the process.

6.4.1.1 Test preparation:

To make sure the glass can be heated evenly, reducing the risk of thermal shock and to achieve a good fit of the joint and hence a flat test specimen, steel clamps were used to fit the glass in a rotating jig. For the manufacture of the butt joint the same clamps described in chapter 6 were used.

6.4.1.2 Description of the heat bonding process to manufacture butt jointed specimens.

To achieve a transparent atomic bond, two glass plates 50mm x 100mm x 5 mm were fixed to a rotating jig that allows for horizontal movement while heating the glass.

All dimensions (length, width, thickness) were recorded using a handheld digital caliper prior to the HB process and prior to the 4PB test.

As a first step, both glass sheets were pre-heated slowly to avoid thermal shock. This occurred with the use of with a handheld burner producing a flame consisting of a mixture of natural gas and oxygen. The detailed manufacturing process of the joints is indicated in the following illustration.

A customised welding jig was manufactured for the heat bonding process. Figure 6.20 illustrates the welding jig and specimens through various stages of the HB process. The jig allows increased control over the dimensional and geometrical tolerances the joint can be achieved with. It also allows for a replicable sequence of movements with which the two pieces of glass are connected. Nonetheless, the heat bonding process remains manual, with limited possibility to accurately monitor and replicate pressure and speed at which the two specimen are pressed together and the connection is formed. Figure 6.21 shows a photographic summary of the bonding procedure illustrated below.

Whilst temperatures were controlled manually and adjusted throughout the bonding process based on the experience of the technician, monitoring the heat applied and temperatures of the specimens with a thermal camera helped to increase the repeatability of the procedure. Figure 6.22 shows images of the thermal imagery recorded at 15, 450 and 510 seconds into the process which resembles the heating, bonding and cooling phase. A full temperature profile is shown in Figure 6.23.

The temperature profile clearly shows the steady build up of temperatures and then a steep drop towards the end of the heat bonding procedure. Glass is more resistant to fast cooling than heating, hence the heating process requires significantly more time than the cooling. The temperature drop at 330 seconds can be associated with the change of the nozzle to flame 2 when the bond has been fabricated and the cooling process begins. Smaller subsequent drops are related to continued temperature adjustment and movement of the flame as well as intermittent rotation of the specimen in the jig.

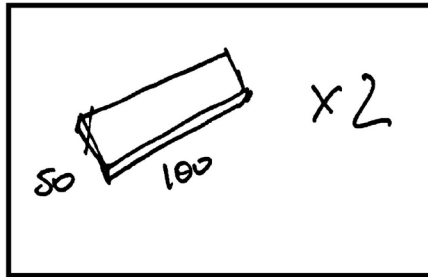

1. Two 50mmx100mm borosilicate sheets with 5mm thickness

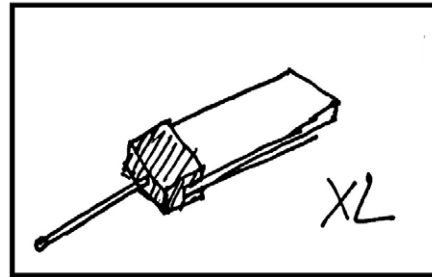

2. Borosilicate sheets are clamped into steel clamps, a fireproof anti friction sheet is inserted to allow the glass to expand within the clamps and to reduce stress concentrations.

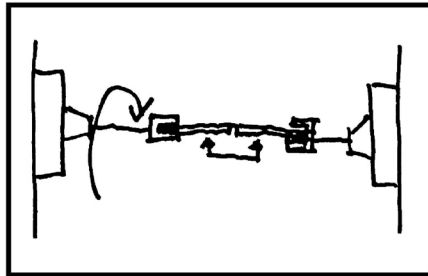

3. The clamps are inserted into a rotatable jig and levelled, so that the two glass edges are exactly butting against each other

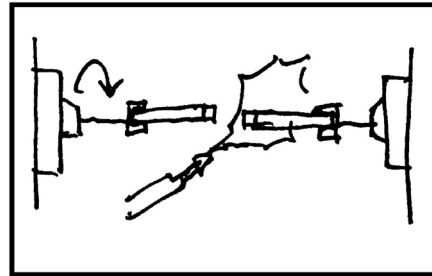

4. The jig is moved apart and both glass plates are heated with a burner very slowly to working temperature (T_w). To assure continuous and homogeneous heating of the specimens, the jig is being rotated at a slow and continuous rate.

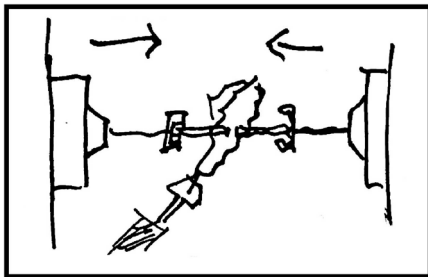

5. When T_w is reached, the rotation is stopped and the jig is moved together joining the two borosilicate plates in the centre. Slight pressure is applied to achieve a full bond.

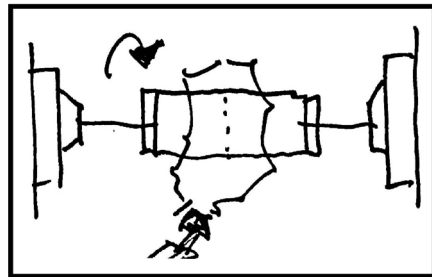

6. The rotation is started again to allow a continuous cooling of the glass and avoid thermal breakage. The temperature profile is documented in Figure 6.23.

FIG. 6.20 Schematic illustration of heat bonding process

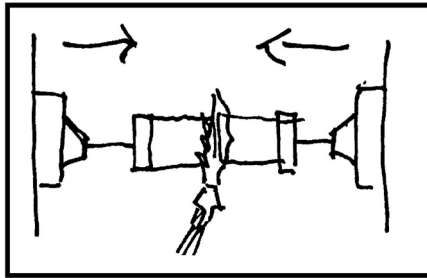

7. Once room temperature is reached, the jig is dismantled and the glass is removed from the clamps.

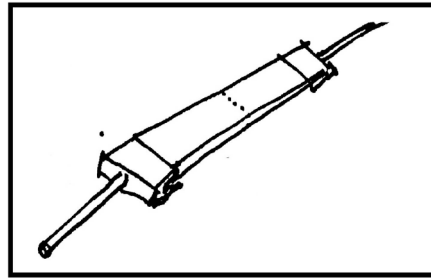

8. Once room temperature is reached, specimens are removed from the lathe and clamps are removed.

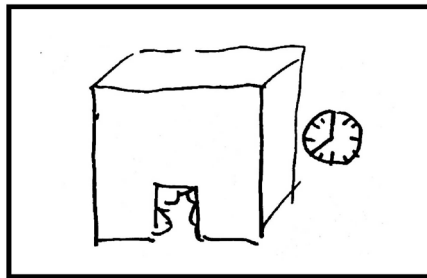

9. After the assessment of residual stress the glass is placed in an annealing oven to release any locked in stress. The annealing profile is shown in Figure 6.19

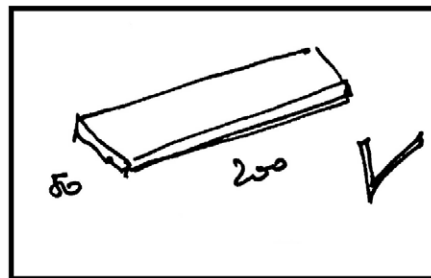

10. The preparation of the specimens is finalised. In total 10 specimens were fabricated of which have been included in the series.

FIG. 6.20 Schematic illustration of heat bonding process

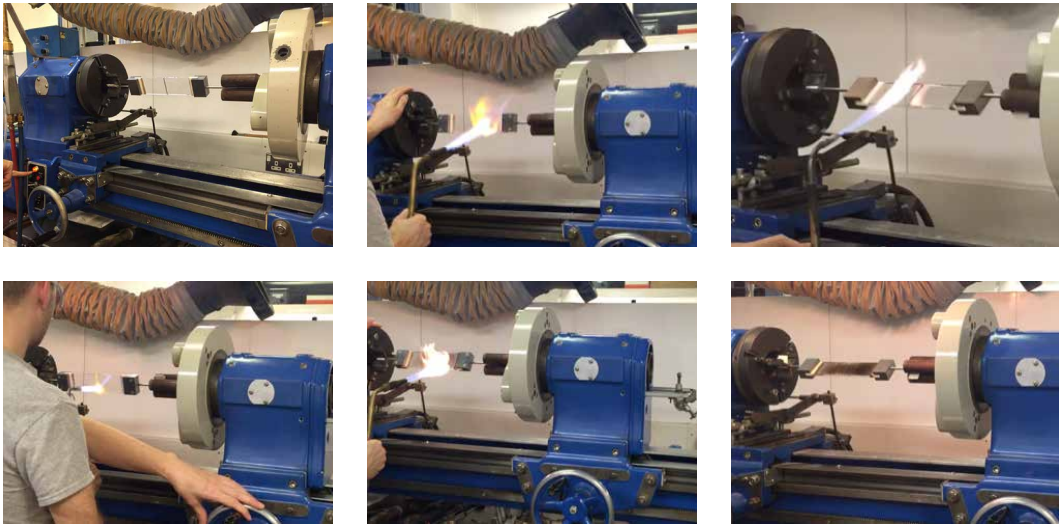

FIG. 6.21 Various stages of the heat bonding process starting with adjustment of the sheets, a low temperature flame to pre-heat the glass, focused high temperature flame to perform the bond and reduced heat for cooling down.

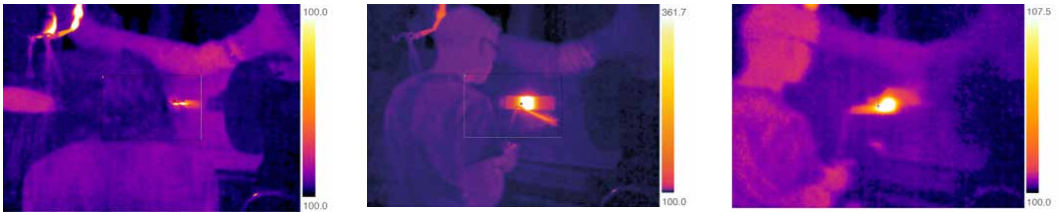

FIG. 6.22 Temperatures measured at 15 , 450 and 510 seconds

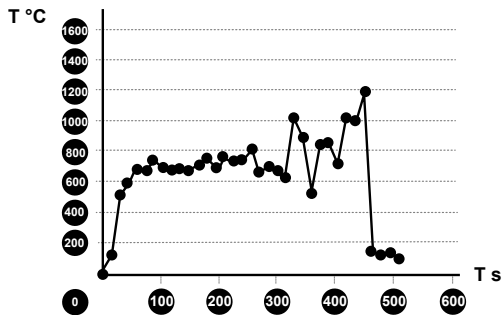

FIG. 6.23 Average temperature profile for Butt-joint manufacture

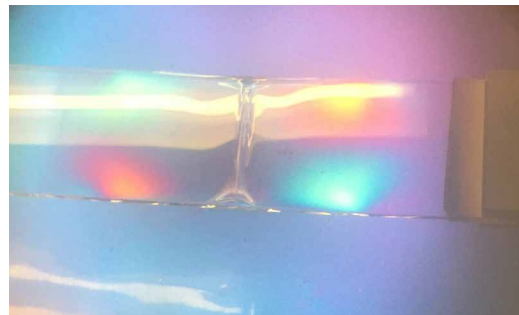

FIG. 6.24 Residual stress visualised through polarisation filter

Residual stress was visually assessed by means of a polarisation filter (Figure 6.24), before the specimens are annealed following the temperature profile indicated in Figure 6.19. The glass is initially heated up and then held at a temperature of 562°C before slowly cooling down to room temperature. The heating holding and cooling rates outlined have been established with help of the glass manufacturer (Schott).

Figure 6.24 indicates a stress differential between opposite edges of the specimen through the appearance of different colours in polarised light. A differential is visible across the bonded joint as well as across the height of the specimen, which suggests that temperature exposure has been regular throughout the process. The area covered by the clamps, was protected from direct heat, does not show any visible residual stress suggesting low stress levels.

6.4.1.3 Visual assessment of bond:

After the annealing process, the specimens and joints were visually assessed for inclusions within the joint area as well as distortions and geometrical inconsistencies caused by the heat impact of the bonding process.

Figure 6.25 illustrates the specimen with the bonded joint also illustrating distortions occurring around the glass edges in proximity to the bond. All specimens fabricated show a semi-elliptic distortion in the edge area caused by the continued heat impact in the area.

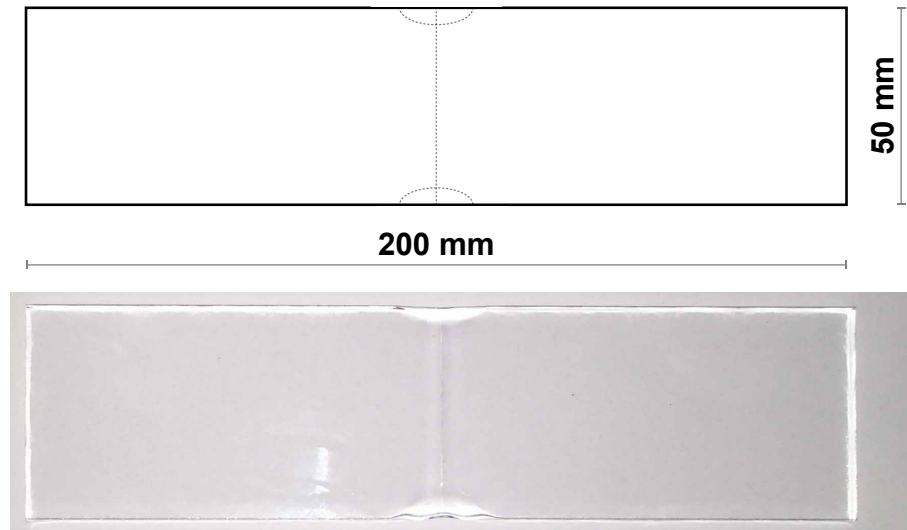

FIG. 6.25 Typical specimen with central butt joint



FIG. 6.26 Specimen showing edge distortion and hairline at joint

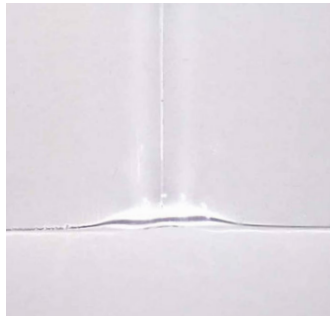

FIG. 6.27 Distorted edge due to temperature impact and fusing of the cut edge

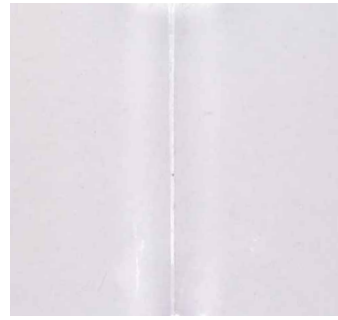

FIG. 6.28 Visible Hairline at the joint

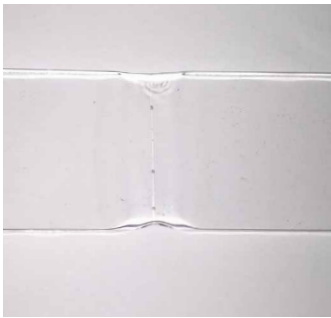

FIG. 6.29 Specimen showing edge distortion and hairline with visible inclusions at joint

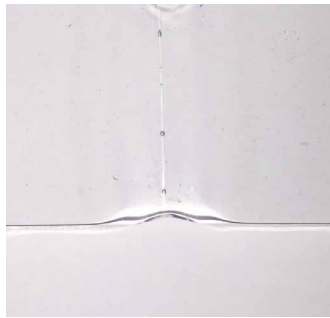

FIG. 6.30 Distorted edge due to temperature impact and fusing of the cut edge

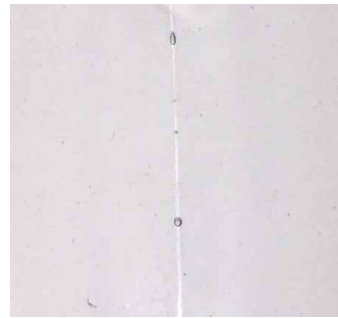

FIG. 6.31 Hairline with visible inclusions (dark spots)

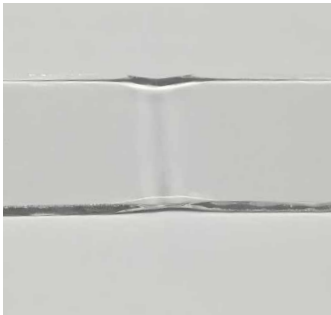

FIG. 6.32 Specimen showing slight edge distortion

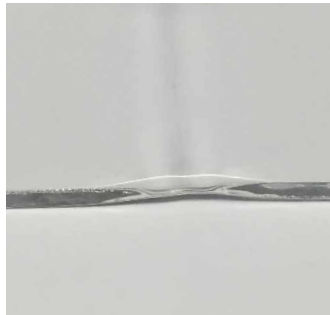

FIG. 6.33 Slightly distorted edge due to temperature impact and fusing of the cut edge



FIG. 6.34 Hairline not visible in this specimen

6.4.1.4 Predicted results:

It was expected that the heat bonded specimen would perform similar to the AR glass, despite the impurities in the joint that were partly visible (bubbles/ deformations) and partly assumed to be invisible inconsistencies within the connection. It is assumed that these would reduce the strength of the HB specimens compared to the as received glass. However, given that the heat impact would have fused or 're-annealed' flaws introduced to the edge in the cutting process, the edge strength is assumed to be higher than in the AR specimens. The assumption is that despite the inclusions in the welded joint that would reduce the strength of the connection, the fusing of the edge might lead to a comparable overall strength. To eliminate the influence of the edge strength from the test set-up, a ring on ring test in accordance with EN 1288-2 was used to investigate the specimens performance. (6.3.3).

6.4.1.5 Test Set-up

The four-point bending test was carried out in accordance with BS-EN 1283-3-2000, however dimensions of specimens were adapted to allow for the incorporation of the heat bonding process.

The rollers were located at quarter points, which resulted in a set up with $L_s=180$ mm and $L_b=90$ mm. (Figure 6.35) The test was carried out with an electromechanical universal testing machine fitted with a calibrated 30 kN load cell (series Instron 5567).

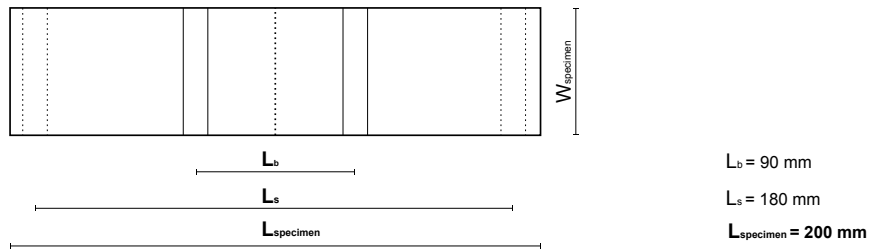
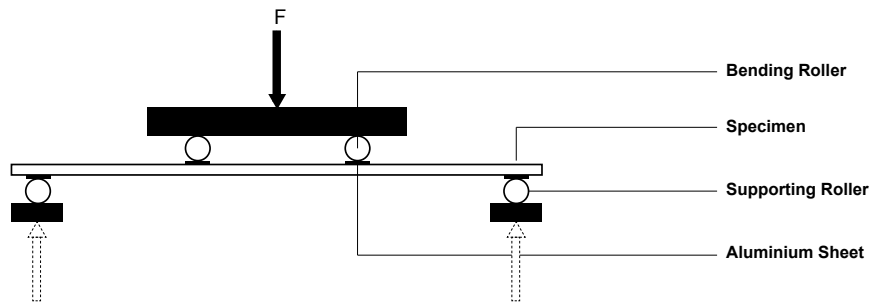

FIG. 6.35 Schematic of 4-point bending test set-up

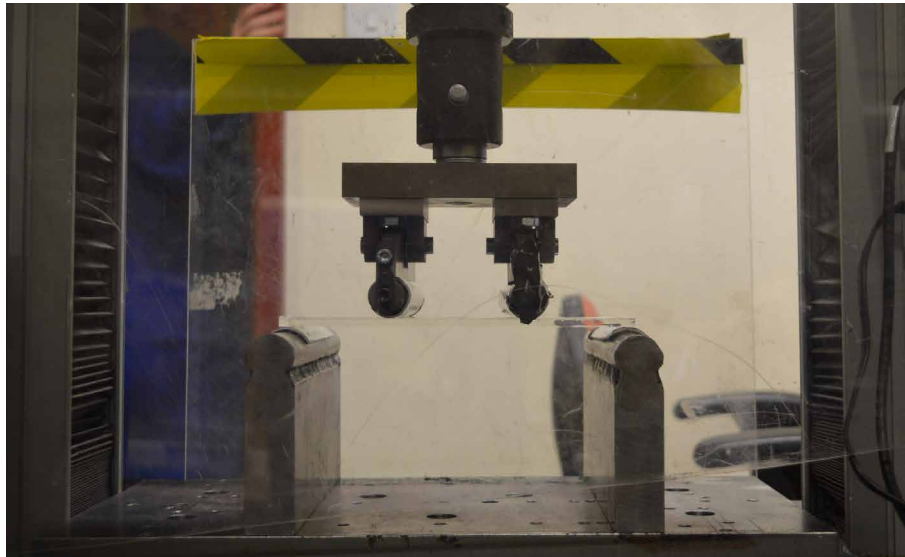

FIG. 6.36 4-point bending test set-up

Figure 6.36 shows the test set-up in the test jig, the glass is mounted on steel support rollers at a distance of 180 mm with an aluminium sheet placed between glass and steel roller for protection. The load span is 90mm corresponding to a quarter points loading set-up of 45mm from edge support.

Two different series were tested,

- 1 50 mm x 200 mm specimens as received (AR) and
- 2 50 mm x 200 mm specimens made up of two 50 mm x100 mm borosilicate sheets with a heat bonded (HB) joint at the centreline.

6.4.2 Results

Both AR and heat bonded HB series show similar fracture loads with failure loads for the AR series being slightly higher than for the HB series (approximately 4%). If a perfectly homogeneous bond between the two pieces of glass would be achieved, that is consistent through the thickness of the material, it could be assumed that the heat bonded connection should be as strong as the parent material. However, due to the manual manufacturing process, it is assumed that the bond would not be perfect, thus expecting a lower load capacity. However this assumption is not supported by the test results. Unexpectedly, the spread of results is lower in the HB series than in the AR series (Table 9). It is assumed that despite the lower capacity of the connections themselves, the heat impact on the edge of the specimens might have fused some of the typical surface flaws and micro-cracks in a cut glass edge, therefore leading to an improved surface quality. This in turn might allow for a smaller spread of results and a higher load capacity.

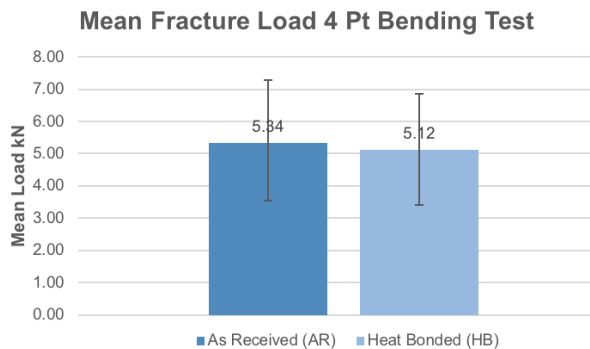

FIG. 6.37 Mean Fracture Load 4 Point Bending Test AR and HB specimens

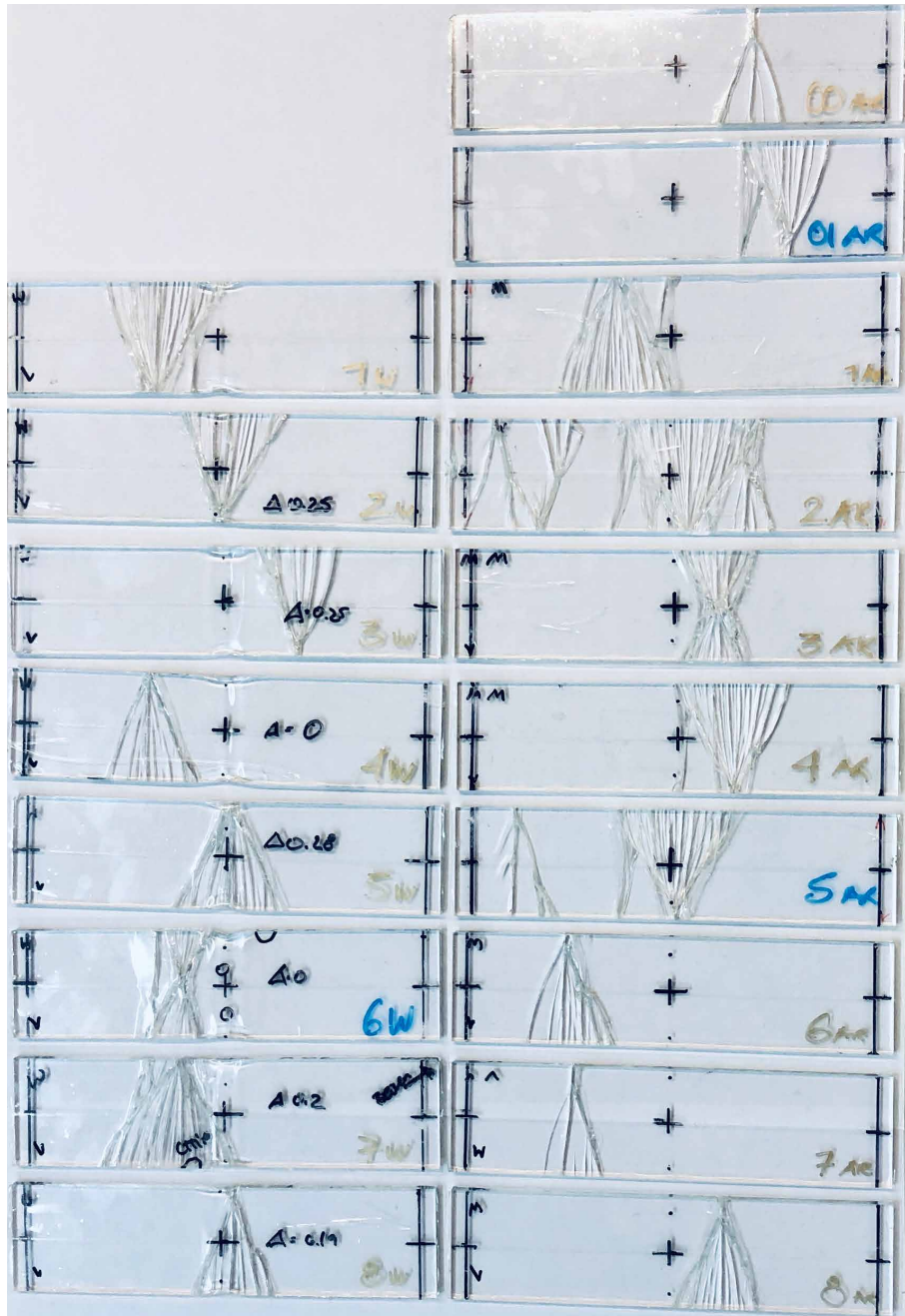

FIG. 6.38 Specimens after 4 point bending test. Left side heat bonded specimens (HB), right side as received (AR)

An issue this test set-up indicates is that the glass failure is initiated by imperfections which are likely to occur at the edge i.e. caused by cutting. Therefore the specimens don't fail at the point of highest stress but at the critical combination of critical stress with biggest flaw. This makes it difficult to evaluate the connection strength and results are to be treated with care. Comparing breakage patterns of the two set-ups however, it is evident that the crack initially occurred at the bond for only 38% of specimens whereas for the AR specimens the initiation in the centre of the specimen only occurred in 20% (Figure 6.38). The origin of breakage for all specimens can be observed at the edge.

To better understand the capacity of the connections themselves, an additional test set-up was chosen, that would allow to test the capacity without accounting for the edge strength.

To achieve this, a Coaxial Double Ring (CDR) or Ring on Ring (RoR) test was identified to fulfil this purpose.

6.4.3 Coaxial Double Ring (CDR) Test

To eliminate the edge effects that are present in a four point bending test, the CDR test in accordance with EN 1288-2 and EN 1288-5 is used.

To determine the strength of the tested glass without the effect of the edge flaws, a flat square specimen is rested on a supporting ring and loaded with a loading ring. Both rings are aligned concentrically, so that the load is applied centrally on the specimen.

The stresses are largest within the loading ring; outside the loading ring, radial and tangential stresses decrease towards the edge. Therefore failure is anticipated within the loading ring.

The test set-up is meant to establish the strength of a heat bonded connection, however, a full joint on a square panel that would be appropriate for a CDR set-up could not be manufactured, hence the specimens were heat impacted in the centre instead.

For the a CDR test, 100mm x 100mm specimens were prepared as described in chapter 6.4 using the following sequence.

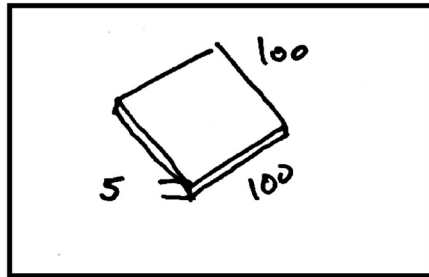

1. 100mm x 100mm borosilicate sheets with 4mm thickness are being used.

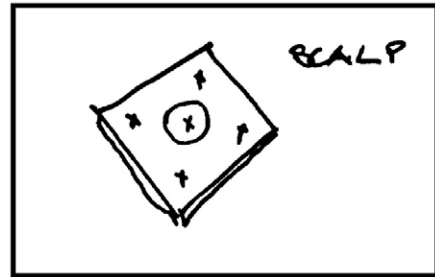

2. Residual stress is first visualised and documented with a polarisation filter and subsequently residual stress is measured with a reflected light polariscope (SCALP 5)

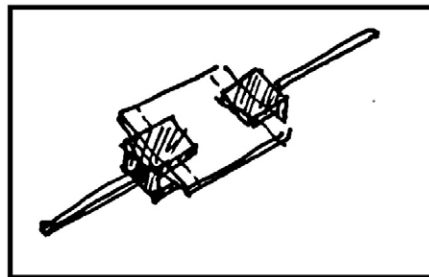

3. Steel clamps are attached to the glass to allow insertion in a rotating jig. A fire resistant anti friction sheet is placed between steel and glass to allow for expansion of the specimen during the welding process.

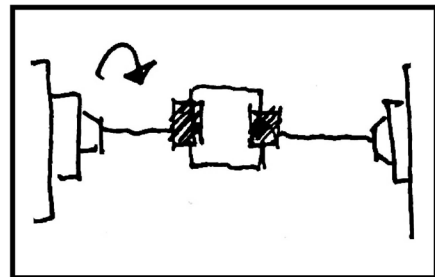

4. Subsequently the glass is fitted into a rotating jig

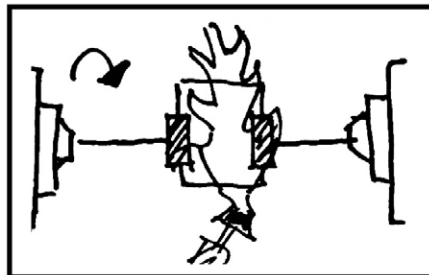

5. With a gas burner the glass is slowly heated consistently to transition temperature (T_g)

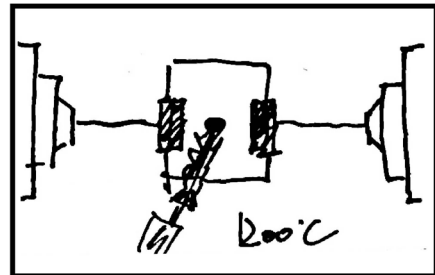

6. The temperature of the burner is increased by adjusting the ratio of oxygen to natural gas, resulting in a focused flame. The rotation is paused and the glass is heated with the focused flame at approximately 1200 deg C for 35 seconds

FIG. 6.39 Schematic illustration of HI process



7. The rotation is commenced and the flame temperature reduced, to slowly cool down the specimen to room temperature. The temperature profile is illustrated in Figure 5.22

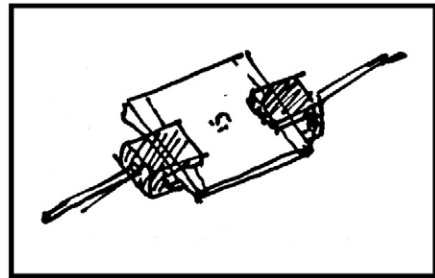

8. Once room temperature is reached, the jig is dismantled and the glass is removed from the clamps.

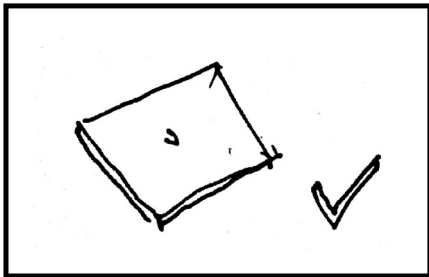

9. The manufacture of the component is finalised

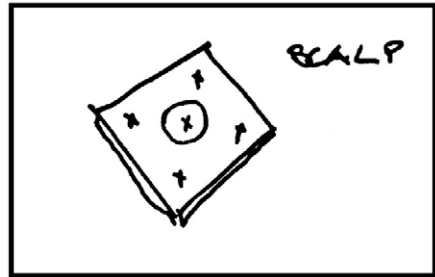

10. Residual stress is first visualised and documented with a polarisation filter and subsequently residual stress is measured with a polariscope (SCALP 5)

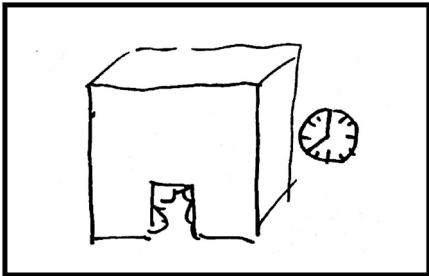

11. After the assessment of residual stress the glass is placed in an annealing oven to release any locked in stress. The annealing profile is shown in Figure 5.19.

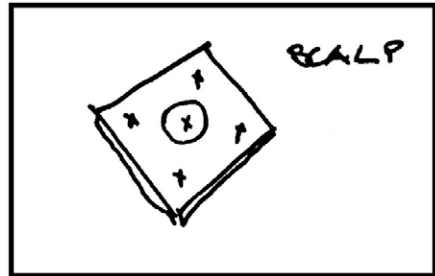

12. Residual stress is first visualised and documented with a polarisation filter and subsequently residual stress is measured with a polariscope (SCALP 5)

FIG. 6.39 Schematic illustration of HI process

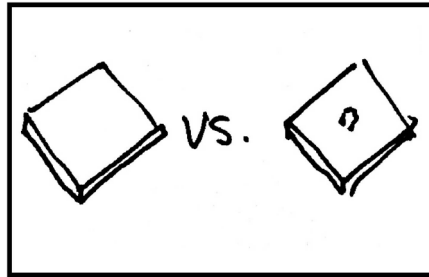

13. AR glass is compared to heat impacted glass through testing

FIG. 6.39 Schematic illustration of HI process

To represent the heat bonding process while achieving a flat specimen that would not influence the ring on ring test, flat specimen with a size of 100mm x100mm were heated locally to working temperature and then subjected to a controlled cooling process. The working temperature applied represent the exact temperatures previously identified and applied to achieve the chemical bond between two samples described earlier in this chapter. After the heat treatment, the specimens underwent an annealing process similar to the specimens used for the 4-point bending test. Again, residual stress was analysed (Rammig, L.; 2016) and are described in chapter 5 of this document.

A total of 10 specimens of 100mm x 100 mm and 4mm thickness were tested, 5 per series (HB and AR).

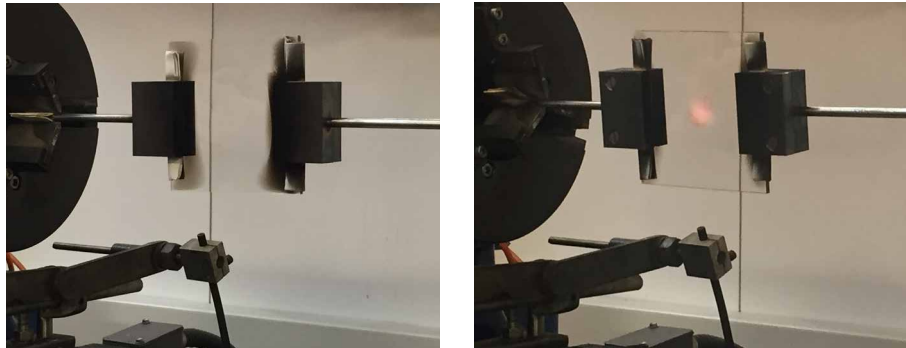
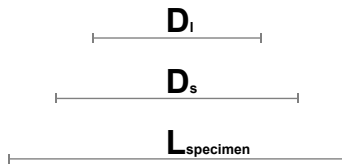
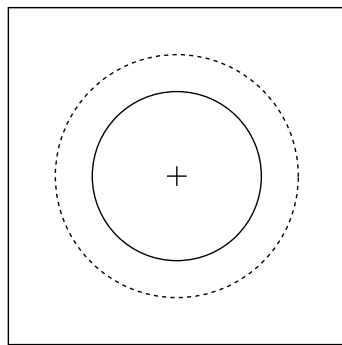
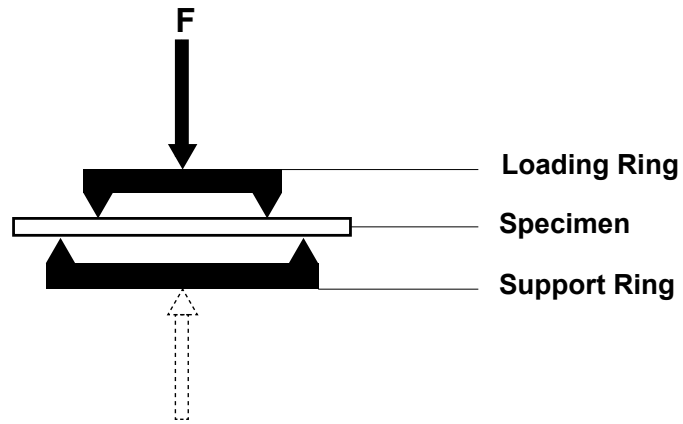

FIG. 6.40 Specimen in welding jig

6.4.3.1 Test set-up



$D_l = 51 \text{ mm}$

$D_s = 73 \text{ mm}$

$L_{specimen} = 100 \text{ mm}$

FIG. 6.41 Schematic test set-up

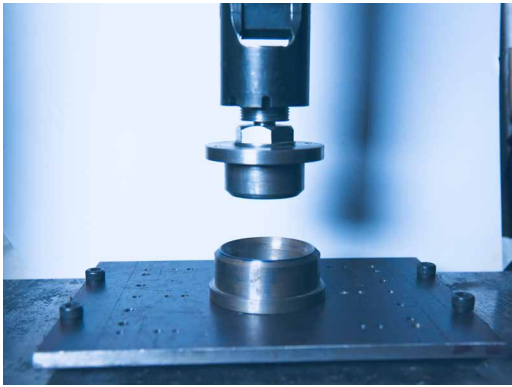

FIG. 6.42 Images test sequence CDR test

6.4.3.2 Test Procedure

As for the 4-Point Bending test, the tests is carried out using an Instron electro-mechanical universal testing machine with a maximum capacity of 30kN. An articulated joint is used above the loading ring to ensure uniform contact between the loading ring and the surface of the specimen. A displacement rate of 17.8mm/min is applied. This allows to nominally obtain the maximum equibiaxial strength at fracture of the material without the impact of time-dependent effects (sub-critical crack growth) in the test environment considered. The heat-impacted specimens are oriented so that the distorted side of the specimens is in tension.

Throughout the tests, the total applied load and the crosshead displacement are recorded by the testing machine until failure occurs without the use of additional instrumentation.

In order to validate the obtained results, a strain gauge is applied to the centre of the tensile surface for a limited number of specimens. The maximum strain recorded was used to calculate the maximum surface stress. This value is compared to that derived from the measured failure load. In addition, the location that fracture originates is recorded for each specimen to make sure appropriate repeatability occurred.

An adhesive film was applied to the tension side of the specimens to avoid dislocation of fragments.

6.4.4 Results

The fracture load of the specimens in the CDR test is generally slightly higher than for the 4 point bending test. The mean fracture load for the AR specimens is approximately 16% higher than for the HB specimens.

Similarly to what was observed in the 4-Point bending tests, the spread of results was smaller for the HB specimens (Figure 6.43).

Fractures generally occurred in proximity to the loading ring where the highest stress is expected for both series. This suggests that results for both series are comparable.

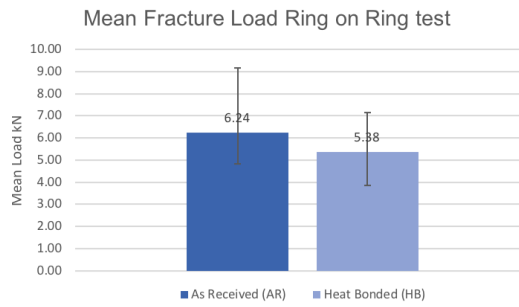

FIG. 6.43 Mean fracture Load for AR and HB specimens

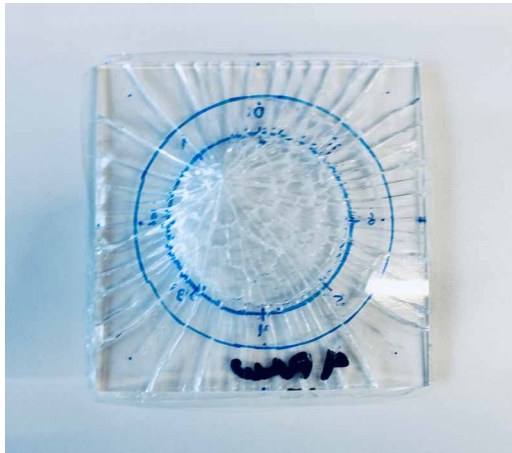
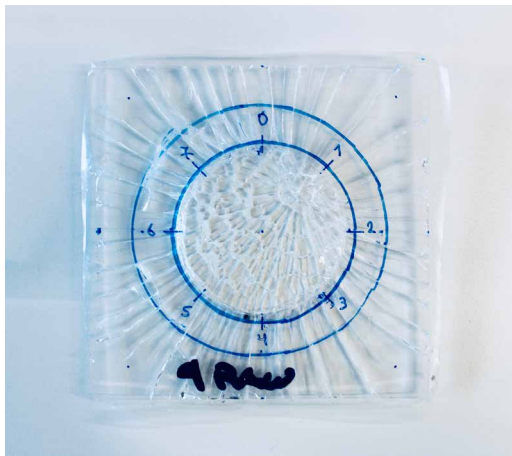

FIG. 6.44 Fracture Pattern specimen 4 AR

FIG. 6.45 Fracture Pattern specimen 1 AR

6.4.5 Pull out test

Facades utilising glass fins to resist wind load are very common in structural glass architecture. The fins offer greater transparency than steel or aluminium mullions while sufficiently forming a structural member. Load transfer between the facade panels and the fin is either achieved through a local mechanical connection (toggle insert or through a structural silicone connection. In both cases these connections are visible as solid elements within the transparent glass wall. The same typology can be applied to a glass roof, where structural glass beams are utilised to support horizontal glass panels. Again, linear or local connections appear as solid elements in a transparent glass ensemble.

6.4.5.1 Specimen preparation

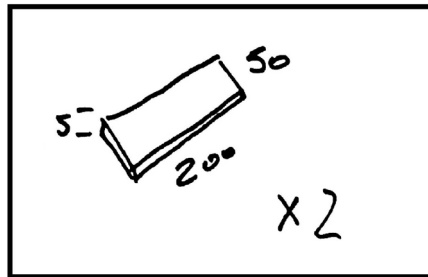

1. Two sheets of 50mm x 100mm borosilicate with a thickness of 5mm are being used.

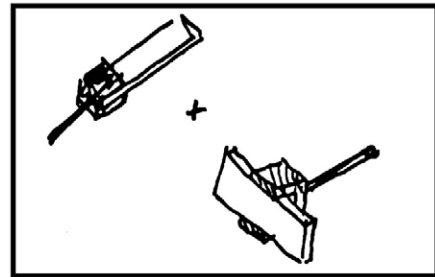

2. Borosilicate sheets are clamped into steel clamps, a fireproof anti friction sheet is inserted to allow the glass to expand within the clamps and to reduce stress concentrations.

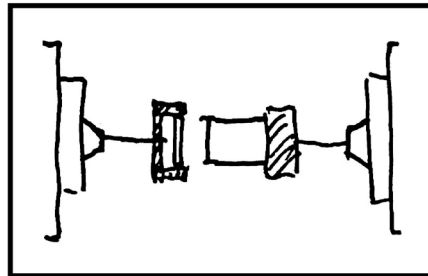

3. The clamps are inserted into a rotatable jig

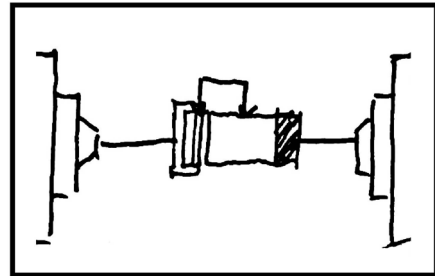

4. Subsequently, the two sheets are levelled, so that the edge of the flange exactly butts against the surface web

FIG. 6.46 Schematic HB process

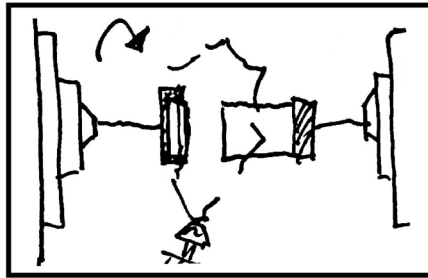

5. The jig is moved apart and both glass pieces are heated with a burner very slowly to working temperature. To assure continuous and homogeneous heating of the specimens, the jig is rotated

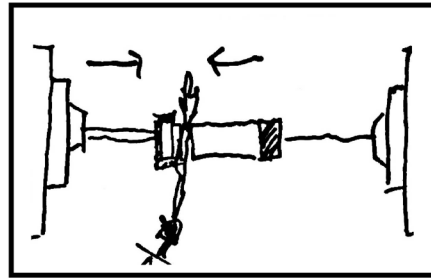

6. The temperature of the burner is increased by adjusting the ratio of oxygen to natural gas, resulting in a focused flame. The rotation is paused and the glass is heated with the focused flame at approximately 1200°C, while the jig is moved together to join the two components, applying slight pressure to achieve a continuous bond.

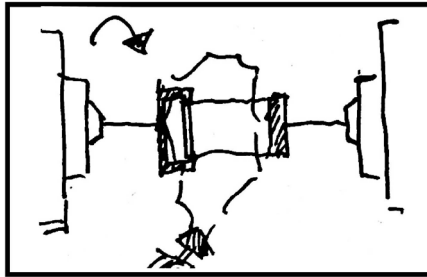

7. The rotation is started again to allow a continuous cooling of the glass and avoid thermal breakage. The temperature profile is shown in Figure 6.50.

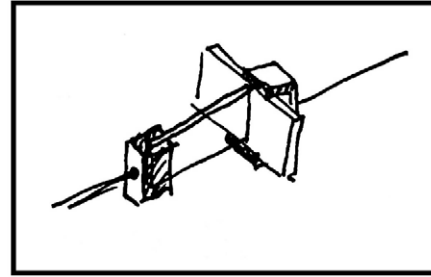

8. Once room temperature is reached, the jig is dismantled and the glass is removed from the clamps.

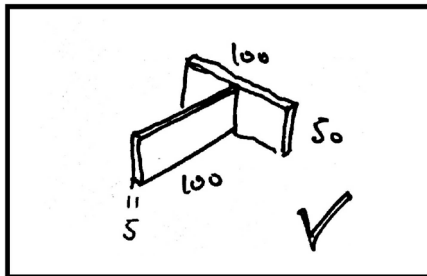

9. After the assessment of residual stress the glass is placed in an annealing oven to release any locked in stress. The annealing profile is shown in Figure 6.20.

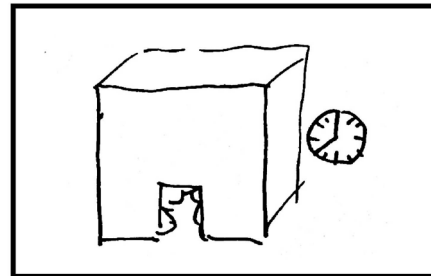

10. The manufacture of the component is finalised

FIG. 6.46 Schematic HB process

To test the connection typology described above as a glass-glass connection, 10 T-beam specimens were manufactured (100mm x 50mm flange, 100mm x 50mm web) and fracture mechanically tested with a pull-out test. The diagrams in Figure 6.46 show the manufacture of the connections.

6.4.5.2 Monitoring of temperatures during the welding process

As previously described, the temperatures were monitored with a thermal camera (FLIR-T 640, see 1.1.14) also during the manufacturing process of the T-joint connection. Using a temperature profile developed for the previous specimens led to thermal breakages in the heating or cooling process, which is attributed to the relatively complex geometry and three dimensionality of the specimens.

6.4.5.3 Thermal stress fractures

Figure 6.47 shows the first specimen that was manufactured using a temperature profile more similar to the previous tests. Immediately after release from the jig, fracture occurred, suggesting that the locked-in stress induced in the bonding process in combination with release of any stress induced by the clamps, led to the fracture. To avoid a full breakage, the specimen was reheated and the cooling process extended prior to the annealing process. This could avoid a full fracture, however the specimen was not used in any further assessment.

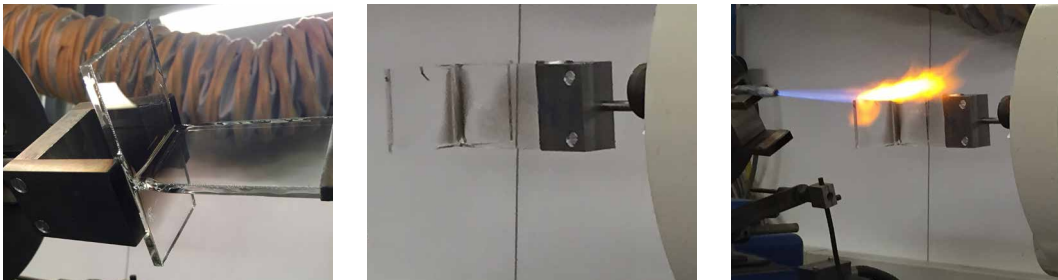

FIG. 6.47 First specimen with original temperature profile shows thermal fracture after release from jig

6.4.5.4 Adjusted temperature profile

After the occurrence of this fracture, the temperature profile was adjusted, to reflect a longer bonding time at high temperatures and a significantly longer cooling time to reduce the risk of thermal shock breakage.

The temperature profile is shown in Figure 6.50 and the main three steps of heating, welding and cooling process are indicated in Figure 6.48.

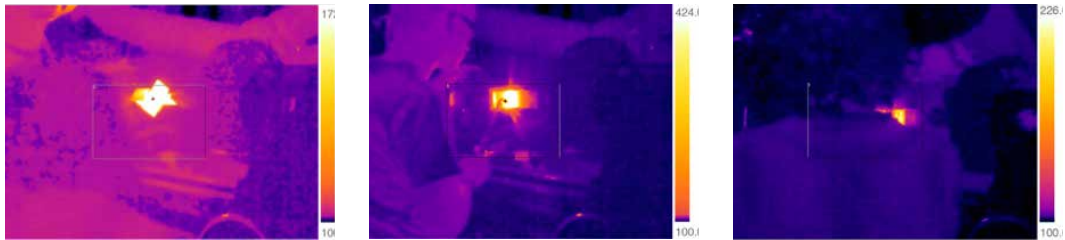

FIG. 6.48 Temperature at 15, 270 and 630 seconds

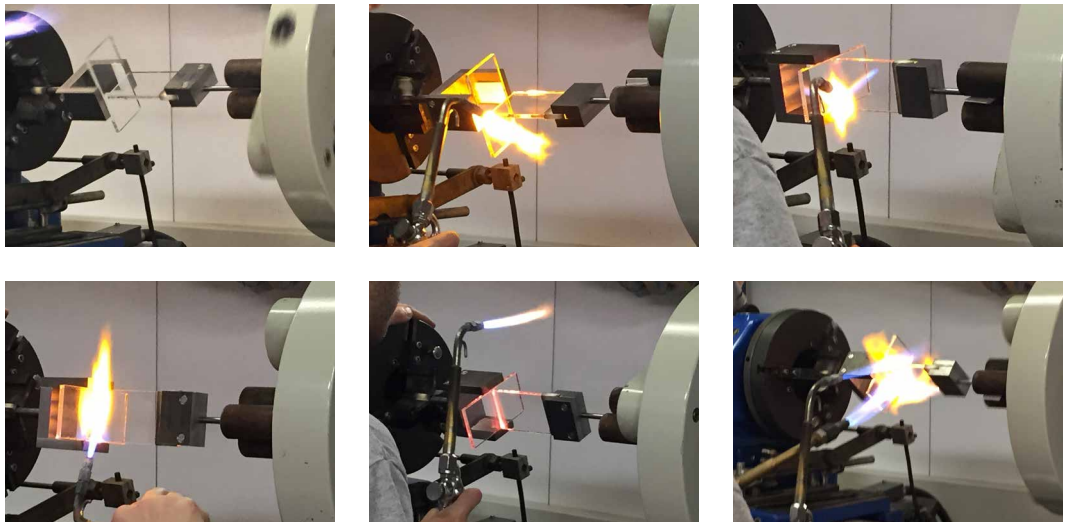

FIG. 6.49 The process of heating up the two glass sheets, manufacturing the bond with a focused high temperature flame and cooling down to room temperature

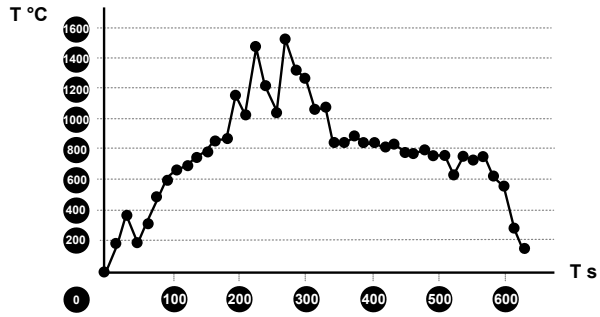

FIG. 6.50 Average temperature profile for T-joint production

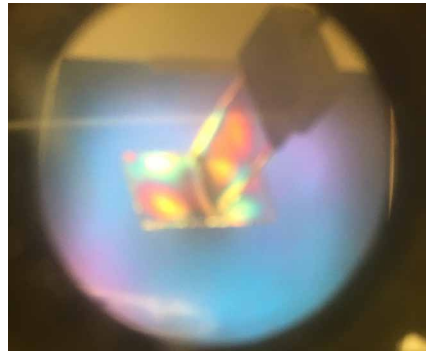

FIG. 6.51 Residual stress visualised with polarisation filter

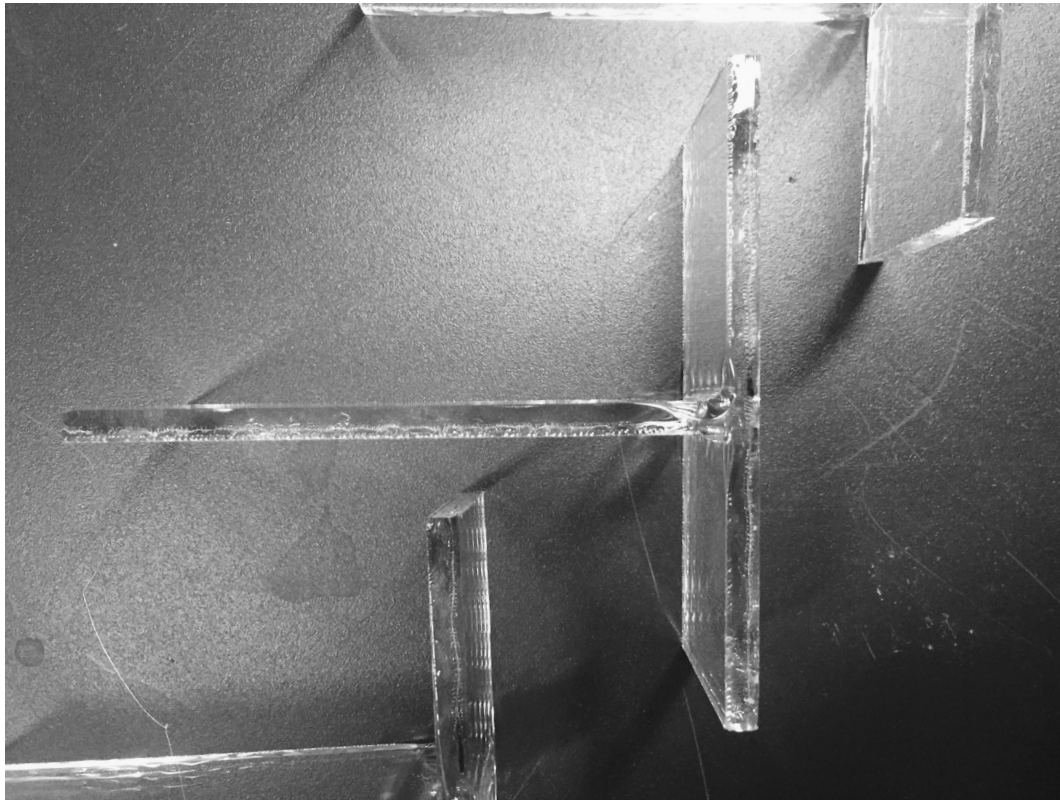

FIG. 6.52 Typical T-beam specimens

After the heat bonding process, residual stress was visually assessed using a polarisation filter, indicating stress differentials within the flange and between web and flange (Figure 6.51). It was found that the annealing process sufficiently released heat induced locked-in stress

The residual stress visible in the T-joints after the bonding process is less regular than in the flat heat impacted (series 10B) and heat bonded (series 9B) specimens assessed previously. Dark areas visible along the bonded joint suggest particularly high residual stress in this area. The more irregular distribution of residual stress is attributed to the increased complexity of the geometry compared to the flat specimens, as well as asymmetric exposure to heat.

6.4.5.5 Test preparation

This test is a standard test utilised for mechanical insert connections in glass fins and roof beams and a standard jig has been amended to fit the specimens. Typically glass fins would have to resist shear introduced through the wind load deflection of the face panel, hence a shear test would seem appropriate. However, given that the geometry of the specimens is not perfectly aligned due to the manual manufacturing process, it was deemed very challenging to test the connection in pure shear without introducing a bending moment that would lead to a fracture. This issue has been confirmed through tests carried out as part of a Master Thesis at TU Delft (Eskes, 2018). Due to the challenges with a shear test described above, a pull-out test was deemed more appropriate for these connections. An customised jig was adjusted, to allow a continuous load impact through the joint between web and flange. The web of the T-beam is fully clamped so that the pull-out force is directly applied to the connection and no bending moment is introduced.

In total, 5 T-shaped specimens were tested; The tests were carried out with the same Instron electro-mechanical universal testing machine (maximum capacity of 30kN) that was used for the previous configurations. An articulated joint was used to ensure that the applied tensile load is aligned with the longitudinal axis of the web and avoid eccentricities, although it is understood that this might be onerous to achieve given the geometrical inconsistencies of the specimens. The load is applied through a steel grip where steel jaws clamp the top part of the web. A 1 mm thick pure aluminium sheet was used between glass and clamp to protect the specimen and avoid stress peaks caused by direct contact between the clamp and the glass. This also allows for uniform load introduction. Steel plates are placed on the upper side of the flange which are bolted to the testing machine to hold the specimen into position, again with a protective aluminium strip to avoid direct steel and glass contact.

During the test, the total applied load and the crosshead displacement are recorded until failure occurs, the results are recorded by the Instron. The jig was assembled as illustrated schematically in Figure 6.53.

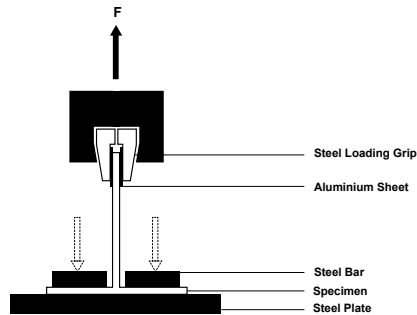

FIG. 6.53 Schematic test setup Pull-out test vertical and horizontal section

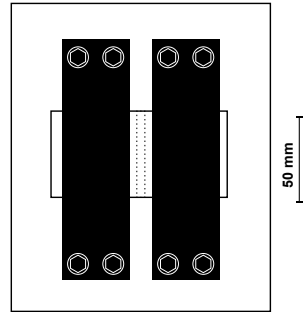

FIG. 6.54 Expected Moment diagram



FIG. 6.55 Test set-up with specimen prior to test

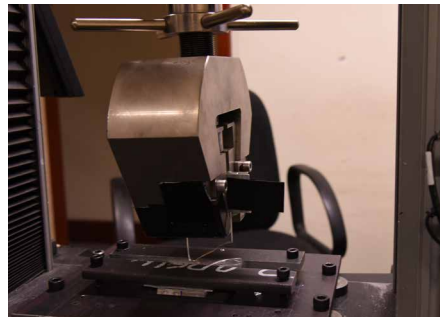

FIG. 6.56 Test set-up with specimen post failure

6.4.5.6 Predicted Results

The objective of the test is to understand whether the failure mode of the specimens is related to glass fracture (uniaxial tensile glass failure of the web) or to failure of the welded joint. Given the previous test results, the failure strength of the joints was expected to be reliant on the geometrical accuracy of the bond as well as the homogeneity of the connection as relates to bubbles and inclusions within the bond.

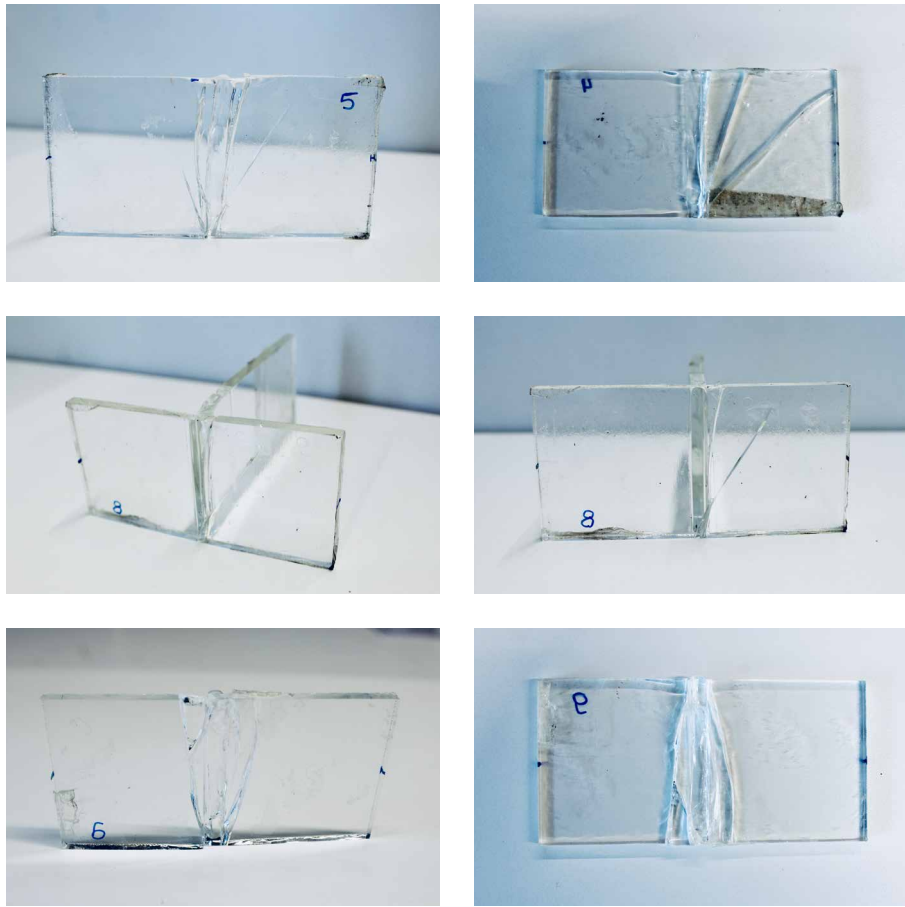

FIG. 6.57 Fracture patterns for T-beam specimens showing breakage origin in joint

6.4.5.7 Test Results: Pull out

Table 12 shows the mean fracture load obtained in the pull-out test, which proves to be significantly lower than the previous tests. It is assumed that this is partly due to potential inclusions within the bond but primarily due to the geometry of the specimens that might not be appropriate for a set-up of this kind.

Due to the thickening of material at the base, where web and flange form a connection, the steel plates could not be placed as close to the web as they should have been in an ideal scenario. This suggests that the specimens were subjected to bending in the heat affected area, ultimately leading to breakage due to a 3-point bending scenario.

The results suggest that the specimens were exposed to a secondary moment due to the 3-point bending scenario resulting from the location of the steel clamp not being located close enough to the 'web' of the specimen.

One specimen fractured prior to load application, which further suggests that potentially the annealing process had not been sufficient and fracture occurred due to uneven stress distribution or locked in stresses with the geometry of the specimens. Based on the fracture load in this series, a potential misalignment of the clamps could introduce sufficient load to cause a fracture.

A similar set up was tested in a shear set up carried out within the scope of a Master Thesis at TU-Delft (Eskes, 2018) comparing the performance of heat bonded, fused and resin bonded T-joints. Despite the very small series of tests carried out in the experimental research carried out by Eskes, the results gained are promising.

However, the shear test was expected to introduce similar bending stress and hence the pull out test was carried out in this research as an alternative. Eskes discusses the bending stress introduced into the specimen in the shear test.

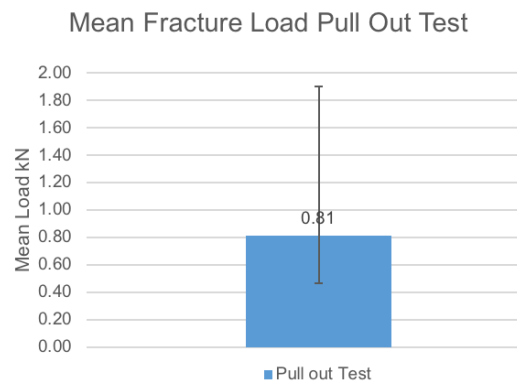

FIG. 6.58 Mean Fracture Load T- Beam Pull out test

6.5 Summary and future research

Comparing the mean fracture load of the three different tests, disregarding the Pull-out test, indicates that whilst the fracture strength of the AR specimens is typically slightly higher (4-16%) the spread of results is lower (-60%) for the HB specimens.

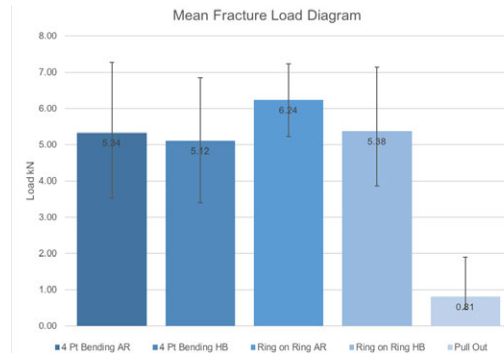

FIG. 6.59 Mean fracture strength of specimens tested in 4Pt Bending, RoR and Pull-out test

Following the assessment of temperature impact on the residual stress, the bending strength of the connections was assessed through fracture-mechanical testing in a conventional 4-point (beam type) and CDR (plate type) bending test. The results of the 4-point bending and CDR test suggest that it can be assumed that heat bonded connections can be as strong as the parent material if annealed sufficiently. However, as with the residual stress tests, these results are only indicative, as the number of specimens tested and the scale of the specimens tested is not sufficiently representative to the architectural scale of connections required to make a fully conclusive statement.

The fracture strength of the connections in the pull-out test was significantly lower (about 15% of the average strength in 4 PB and RoR) suggesting that either the connections were not formed sufficiently, or the geometrical inconsistency of the specimens did not allow for a consistent central load application hence introducing a bending moment into the connection.

A small series (3 specimens) of similar geometry was tested and evaluated as part of a Master Thesis (Eskes, 2018). The connections were formed with Soda Lime glass as opposed to borosilicate and a shear test setup was tested comparing heat bonded, resin bonded and mould-fused glass T-connections.

The results indicate a fracture strength higher or comparable to the initial results gained through 4PB and RoR test, suggesting that the low failure strength in the Pull-out test might be a result of the test set-up combined with geometrical inconsistencies in the samples leading to an inconsistent load application.

The performance of welded connections is currently undergoing comprehensive testing at the Technical University of Darmstadt (Seel, Akerboom, 2018) and it is expected that further conclusions can be drawn following these tests.

Whilst the implementation of heat bonded connections appears theoretically feasible, the exploration of this field is at its very beginning and further research is required to assess the implementation of the process into glass fabrication and processing.

This does not only include the scalability of the connections and technology but also involves considerations around transport, handling, installation, the accommodation of building movements and tolerance as well as maintenance, replacement and recyclability.

Whilst many of the factors described appear to be addressable, there is currently and within the scope of this research no possibility to assess this in practice, as the fabrication of connections to assemble full scale components has not been possible as part of this research.

As relates to the quality of the connections themselves, the manual process used for their fabrication in this research bears a high risk, as it is relying on manual control of temperatures and pressure when establishing the connection, hence achieving fully homogeneous connections that are geometrically consistent. Due to the brittleness of the material, this in turn might lead to a reduction in capacity, as stress concentrations might occur around areas of inconsistency.

The practical implementation from a design perspective must consider redundancy, which is a common aspect of glass engineering and which can be approached similarly to the way it is commonly approached when designing with glass, by introducing:

- 1 A safety factor and hence over-designing connections
- 2 Additional connections and additional means of connection like the lamination with polymer interlayers
- 3 Designing to allow a secondary load path should the primary load path be compromised
- 4 Risk management: evaluating the risk of failure and the risk of potential damage in case of failure. This includes the categorising of risk for the use of the application i.e. a public building or highly trafficable structure like a stair in a commercial application would require a larger amount of built-in redundancy than a balustrade in a private house.
- 5 Engineering precision: The more detailed the load path and the loads and building movements are understood, the smaller can the margin be for a safety factor. Detailed FE analysis and well understood loading criteria are the basis for this approach, which is typically used in other industries of high performance engineering like aviation.

The fundamental improvement that the heat bonding process offers over traditional glass connections is that it allows to reduce the amount of visible edges, as the material is not only bonded on the surface, but an atomic bond is achieved. This increases the perceived transparency, as the reflection is limited to the external surface.

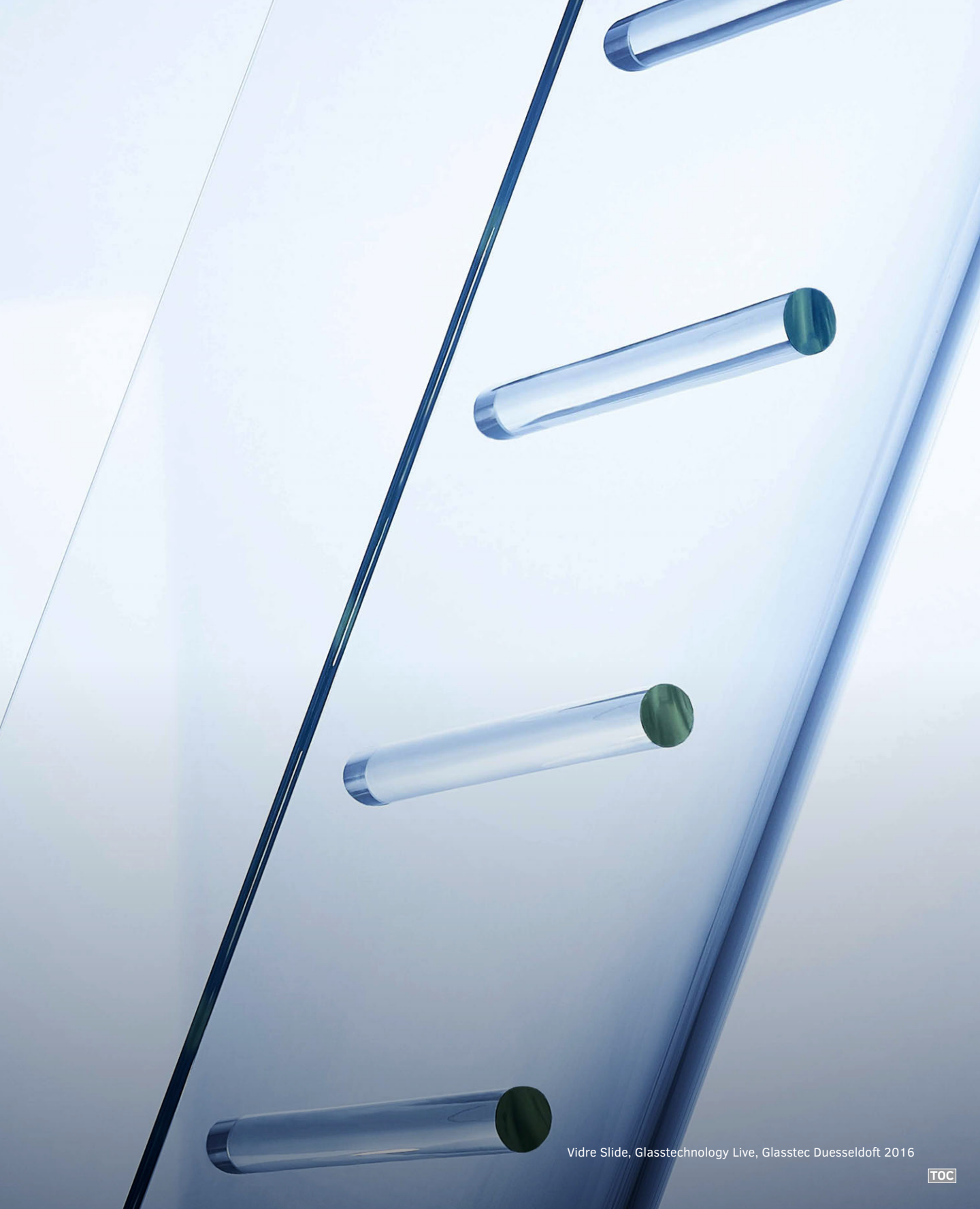



7 Implementation of transparent connections

In Chapter Seven the transparency of connections and the effect on the overall transparency of the structure is discussed by using a case study that uses primarily transparent means of connecting glass to glass.

Glass has always fascinated the creators of buildings due to its inherent defining property – transparency. From mystical spaces in Gothic cathedrals, to contemporary transparent building envelopes; glass continues to be a major design component in architecture.

In the past century, glass has increasingly been used as a structural component. However, its inherent brittleness still requires opaque metal connections to transfer loads, which commonly are stainless steel or titanium. These connections define contemporary glass architecture – firstly, because they are immediately apparent in a transparent structure and, secondly, as they are part of the engineering design language. However, designers and architects are still aiming to increase the transparency of building envelopes and structures, hence there is a strong demand to reduce the visibility of structural connections in glass.

7.1 Application of Heat Bonded Connections

Chapter 6 outlines the general feasibility of heat bonded connections, however all tests were carried out at a scale that allows the manual fabrication in a glass blowing lab. In addition to the size of the lathe available, the limitation was primarily the size of the annealing oven and handling capabilities in the lab. Given the availability of thermal treatment for large glass both in an online and a gravity process, it is assumed that the heat bonding process could be scaled up as well, as long as the process is maintained within an kiln that avoids thermal shock fracture.

Results of tests with soda lime silicate (Eskes, 2018) suggest that when temperatures are appropriately controlled and adjusted to the properties of the glass used, the use of traditional soda lime for heat bonded connections is feasible as well.

To assess the impact of transparent connections, a scale of structure is required that allows the assessment of not only the connection as an isolated component but the structure itself.

7.2 Limitations of the application of heat bonded connections on a project scale

When scaling the connections evaluated in chapter 6 to a size applicable to building structures, there are a number of parameters to be considered. They will be described and evaluated in the following paragraph.

The criteria to be assessed is as follows:

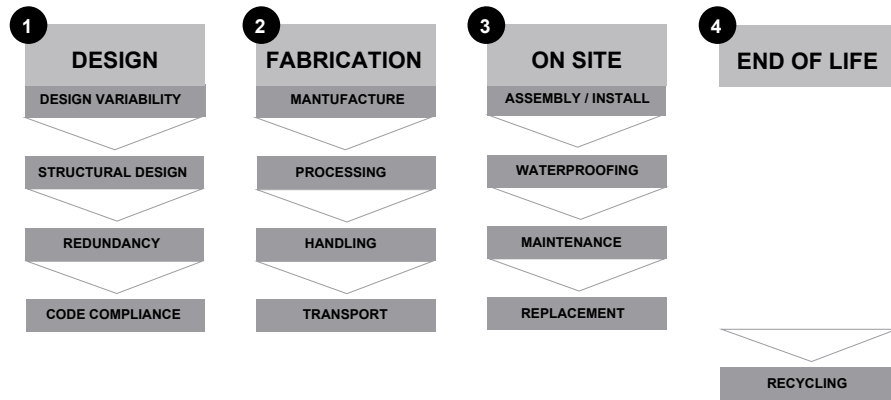

FIG. 7.1 Design process

7.2.1 Design Variability

Given the transparency of the connection itself and the fact that it consists of glass only, the variability in the shape and location of connections is primarily limited by their capacity as well as fabrication, handling and installation constraints.

7.2.2 Structural Design and load assumptions

The initial experimental testing suggests that the joints are as strong as the parent material (6.5). Based on this, the limit for the strength of the connection is the strength of the material itself. As opposed to traditional bolted connections, the local stresses around the connection points can be distributed better and a continuous strength of the connection will allow for a more homogeneous load distribution.

A good example is the development in steel, where the possibility of welding replaced the need for riveted connections and allowed to produce smaller and more homogeneous and reliable connections.

Due to the brittleness of glass however, the limitation lies in the movement and tolerance that can be accommodated within the connection. It is assumed that both building movement and installation tolerance will have to be accommodated around the perimeter of the system rather than within the heat bonded connection itself.

7.2.3 Redundancy

Redundancy is of major importance in the design of any glass structure, but particularly when relying on glass only, as due to the brittleness these connections would always bear the risk of failure. This however is not a problem specific to heat bonded connections, but applicable to all structural connections made between glass components.

Typically, there are two approaches to achieve redundancy in the design with glass:

- 1 Over design of the structure
- 2 Reliance on additional means of connection

In this case, it is suggested to use both redundancy approaches to design a safe structure. This will be explained through an exemplary design:

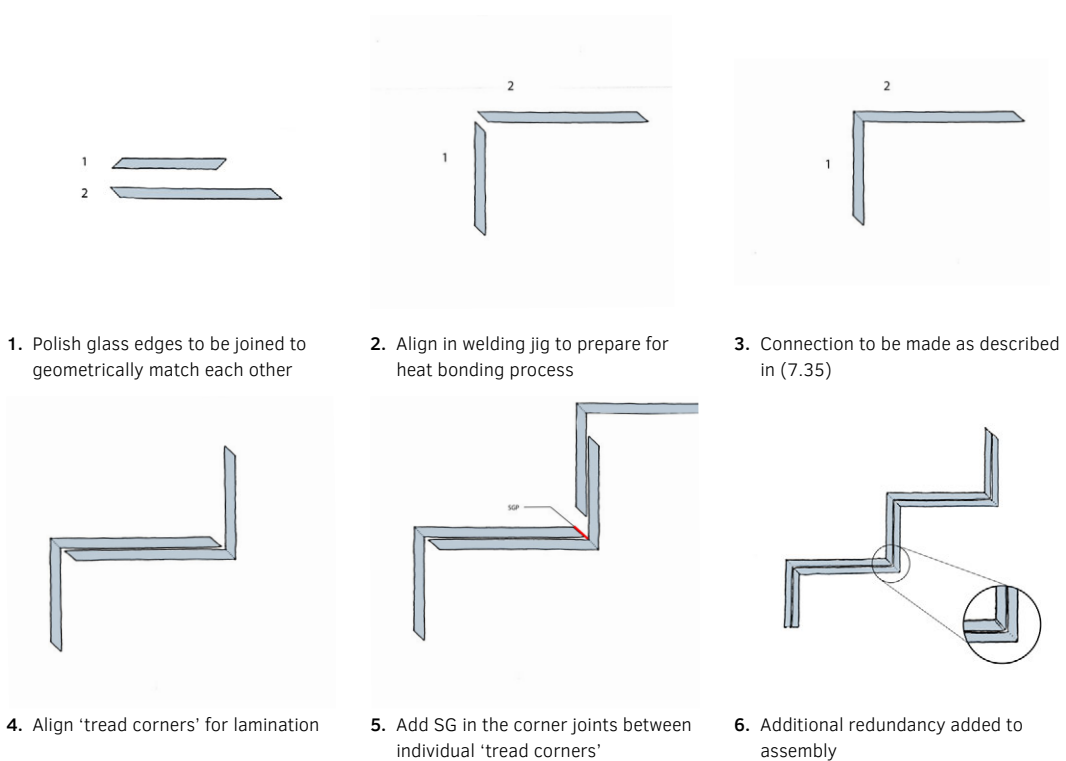

FIG. 7.2 Stair tread assembly

If the mitred corner connections were used to assemble a stair, it would be assumed that each 'flange' of the angle could be laminated with Sentry Glass to the next 'flange' to form a tread and a riser further described as a 'tread corner'.

Should the tread or riser develop a crack, the lamination and load transfer through the Sentry Glass interlayer would provide post failure capacity and hence redundancy.

The welded connections should be designed to have additional capacity and should never be designed at their limit to allow for reduction factors based on imperfections of the bond, which could be driven by lack of precision of the process, but also by an inconsistency in temperature control during the heating, welding and annealing process. Again, this is assumed to be the case whenever designing with glass as a structural component.

To make sure that the size of the joint itself is not relied on as a single factor, in addition, every other mitre that is not heat bonded should be laminated with an SG interlayer as well. This would provide redundancy should a failure occur at the heat bonded connection itself. This strategy is a common way of achieving redundancy in the design of glass structures.

7.2.4 Code compliance

The engineering with glass as a structural component is a very young field and although the use of glass as a structure has significantly increased over the last 20 years (3.7.2), only very recently the first drafts of codes and regulations specific to glass have been implemented. This has been both an opportunity and a limitation to the design with glass, as typically experimental testing is required to prove the safety of the structure in addition to an analytic approach.

The question arises whether common design criteria for glass would equally apply to the design of heat bonded connections;

Whilst theoretically heat bonded connections would allow the assumption that material properties for glass as outlined in the typical regulatory documents (E1300-3, PrEN 16612, DIN 18008) could be assumed, the manufacturing process bears the risk of inclusions and material inconsistencies that are currently difficult to control. And although the experimental tests carried out suggest that the connection is as strong as the parent material, this will require research and verification prior to the assumption that connections can be designed based on typical material values.

However, considering the time that it has taken to develop regulatory documents that are specific to the design with glass, it is assumed that it would take a significant amount of time until the design of heat bonded connections could be implemented in those. This might mean, that it would be more straight forward to implement the design with transparent silicone adhesives, which have become available during the time of this research and which offer great potential for achieving transparent connections. Although with the limitation of not being able to remove the reflectivity and hence visibility of the edge that is bonded to.

As these are silicone materials and although not tested in their specific composition and with exact properties, structural silicones have been relied on since the mid 1960s (Schmidt et al, 1989), hence the implementation of transparent connections designed with TSSA and the like might be easier than implementing heat bonded connection into codes.

7.2.5 Fabrication and Processing

Although the experiments carried out in this research are limited in size, the glass thicknesses used are relevant on an architectural scale, hence connections have not been produced on a micro-scale. Based on the process and typical production process of glass, it is assumed that the manufacture of the connections could be scaled up to an architectural scale relevant to the use in a glass structure.

Upscaling from a manual artisan process to an automated engineered production process is assumed to be possible based on the typical equipment used to manufacture and process glass.

Glass for structural applications is typically heat treated to increase its strength, hence tempering equipment could be used to provide the required ambient temperatures the connections are fabricated in. This would be assumed to be sequenced as follows:

- 1 Pre-heating of glass to be joined in a kiln (could be an on-line tempering kiln, depending on the geometry of the connection and the final component)
- 2 Local heating to bond glass
- 3 Annealing to release residual stress in the connection
- 4 Thermal heat treatment (or chemical treatment depending on geometry)

This process assumes that the connections would be manufactured within the kiln in an automated process that is largely a reproduction of the manual heat bonding process outlined in chapter 6.

To avoid the dependency on a kiln based environment to form the connections, it is suggested that a technology transfer from other industries would allow to use laser technology.

Based on technology used in other fields, i.e. fibre optics (5.2.2) and laser based gravity forming of glass (5.2.3) it is assumed that would a laser be used for the process, that the preheating and annealing process could be reduced or even eliminated. This is due to the laser heating the glass and achieving a bond locally on such a small area that the risk of thermal shock breakage is practically eliminated.

Further research and testing on architectural scale glass is required to support this assumption.

After the fabrication process, the glass can be processed as described in chapter 2.7. Although it is assumed that both the mechanical as well as the visual quality of the connection would be improved in an automated process when compared to the manual process used in the experimental part of this research, there might be options to post-process the weld in the same way it is common in steel. Glass edges are commonly polished, so the same process could be used to achieve a precise geometry in the connection. This is particularly applicable to the manual manufacturing of T-joints and point fixings, in which a chamfer of the joint similar to the appearance of a steel weld is difficult to avoid.

It is assumed that this step would not be necessary for a joint assembled with a laser, suggesting laser technology should be further investigated for feasibility to manufacture the described connections. .

For discrete connections, an additive manufacturing process could be imagined, based on Fused Deposition Modelling (FDM) concepts as published experimentally by (Oxman et al, 2015) and commercialised and shown on Glasstec 2018 by Qsil (Van Pelt, 2018), Figure 7.3.



FIG. 7.3 3D printed glass objects exhibited at Glasstec 2018

The lamination process would be applicable to heat bonded glass as it is to common flat glass, however special consideration should be given to the geometry of the components. The size of the autoclave available would limit the size of the overall component. This is the case with flat and curved glass produced in a traditional way as well, however, it is assumed that the geometrical complexity heat bonded components might come with would bear an additional limiting factor. This is equally the case for a thermal and chemical tempering process, where additional tests would be required, to understand the influence of the geometry of a component on the pre-stress and particularly the stress distribution across complex geometries.

However, given that glass is commonly hot bent toughened (2.7.4.2), and a continuous and reasonably homogeneous pre-stress throughout the curvature can be achieved, it is assumed that this would be achievable with a heat bonded component as well. Similarly, gravity bent glass with extremely tight radii (90 degree bend, $r=80\text{mm}$) has been tested to be chemically treated, which would suggest that the pre-stress through a chemical tempering process (2.7.5.1) for i.e. a heat bonded corner unit would be achievable.

7.2.6 Handling

The handling of heat bonded components could be a limitation as much as it is for any other glass unit. There are various factors that play a role in the handling limitations for glass. Firstly, size is to be considered. The larger glass panels become, the more complex is the handling.

Handling equipment for large glass panels is costly and requires appropriate space through all steps of processing. In addition to size alone, slenderness is a large risk factor for the handling of glass. A slenderness ratio of 1:10 is typically recommended, however, for special structures like glass fins, significantly higher slenderness ratios have proven to be feasible (Haldiman et al, 2008). The third limiting factor is the geometry. Whilst curved glass has become very common and its handling limitations well understood, panels with complex geometry often require special handling, as uneven stress distribution within a complex geometry bears the risk of breakage if not handled appropriately.

This is probably the factor that would be most applicable to the limitations that would apply to heat bonded components, should they become large and geometrically complex. Glass vacuum lifters require sufficient surface area to allow gripping the glass sufficiently and turning of the components has to be possible without significant risk of breakage.

7.2.7 Transport

Limitations for transport are similar to the handling limitations for glass and again complexity of the geometry and the space that a heat bonded component would require in transport would be considered the driving limiting factor. Using a glass corner as an example again, the first limitation would be the size of the component to fit in a crate that is suitable to be transported on the road, fitting on a standard truck.

The component needs to be packed into a crate safely and supported in a way that the risk of breakage during transportation is minimised (Sedak, 2019).

Assuming that the process of heat bonding would be carried out in a controlled factory environment, the size of a heat bonded component would be limited to the size that can be handled and transported on the road. In the case of the stair described in (7.3.4.1), this would mean that the entire component would have to be supported in a crate or on a truck safely enough to avoid cracking or failure in transit.

7.2.8 Assembly and Installation

As with 7.2.5 to 7.2.7, size and complexity of the component would be the primary limiting factor. The accommodation of movement and installation tolerance in the assembly.

Glass can be fabricated to very tight tolerances (EN 572), which is important to assure that the fit of glass components to each other is such that load path and stress concentrations are understood precisely in the design of the components, so that they can be sized appropriately.

Other materials and building components however typically come with significantly larger tolerance, both for fabrication and installation but particularly if produced in situ like concrete or steel primary structures often are (BS 5606).

Tolerances of +/- 25mm or larger and additional building movement cannot be accommodated in the glass, so typically those would have to be accommodated around the perimeter of a glass structure or in the joints between panels. The larger the components are, the larger joints become to accommodate movement and building tolerance (CWCT TN 56).

If load transfer between glass panels is required, these connections typically accommodate a certain amount of movement, either mechanically by allowing the components within a metal fitting to rotate against each other (4.4.7) or by the compression available in a sealant joint (4.4.5.1). This would not be possible with heat bonded connections, as they would always be brittle like the glass itself, so all movement would have to be accommodated around the component, which might require decoupling from the surrounding building structure, but will also drive the feasible size of the components to be heat bonded.

7.2.9 Water and Air tightness

When used as part of an enclosure or building envelope, glass connections also have to fulfil the function of providing a water and air barrier to the building (Schittich et al, 2007, CWCT, 2019).

Whilst the heat bonded connections themselves provide a seal that is as tight as the glass itself, waterproofing around the perimeter has to be solved as it does for any glass component. The limitation for complexity here again is driven by the geometry of the component installed as well as its accessibility.

7.2.10 Replacement

Replacement strategies are a fundamental part of the design of any glass structure, as the risk of fracture always remains, no matter the amount of redundancy designed into the glass component or structure.

One limitation with heat bonded connections as they are described in this document is the replacement of the connection, which is not possible; it would require the replacement of the entire component.

7.2.11 End of Life

Recycling of glass and glass building components is not as common as for other materials. This is primarily driven by the low cost of the base material, which makes the full recycling of building components more expensive than the production of new material. Through conversations with (AGC, 2019) it is understood that a primary driver for the lack of recycling of flat glass is the lack of infrastructure for the collection of glass units. Whilst the European glass container industry has a well working recycling scheme in place with collection points well spread, the amount of production facilities available allows an economical distribution of collected recyclable material, whereas due to the small amount of float plants and large distances between those, this proves more difficult for the flat glass industry (Van Marcke, G, 2019)

Other limiting factors are the metals and metal oxides that are used for solar and low-e coatings which present impurities in the melt when added back to the production process.

Interlayers and other bonding materials pose similar difficulties. Laminated glass can either be broken up into its components in an energy intensive process or added to the melt in which case the interlayer material burns off. The edge seal of insulating units however has to be removed manually to remove the spacer material as well as primary and secondary seal.

The heat bonded connections themselves provide excellent recycling potential, given that no secondary material is required to achieve the bond. This means they could easily be broken down and fed back into the original production process without the risk of introducing impurities. However due to the redundancy requirements described above (7.2.3), an interlayer material would be part of the component at the least which reduces the recyclability of the component, although it is not impossible (Hildebrand et al, 2019).

7.3 Design of Heat Bonded connections

Having explored the possibilities of heat bonding and their potential as relates to the feasibility of the process for architectural connections as well as the strength of the connections themselves, their potential for application will remain dependant on the suitability of the particular connection typology for the application. In the following paragraphs, exemplary typologies will be described, briefly discussing their potential.

7.3.1 Glass point fixing



FIG. 7.4 Detail Glass Point Fixing



FIG. 7.5 Image HB glass Point Fixing

The feasibility of heat bonded point fittings was assessed at an early stage in this research, as discrete connections for a significant part of the traditional connections used in structural glass applications (4.4.6).

Given that an atomic bond can be formed and no other material is used, the connections can vary in size and shape depending on visual as well as structural design parameters. The size of the connections is easily adjustable to represent this.

Depending on the design, a multitude of small fittings could be used as well as less larger fittings as it is commonly the case with clamped, bolted or laminated fittings.

Redundancy of the connections is assumed to be solved by the size and quantity, to allow for remaining connections to transfer the load should a connection fail.

Although current architectural trends are moving away from the use of point fittings in facade applications, the small size of these connections offers the potential for novel manufacturing methods like 3D printing. As the visual quality of 3D printing processes is not yet comparable with the visual surface quality that is achievable in a traditional float glass process, the technology would lend itself to be used to manufacture add-ons on a traditionally fabricated flat glass.

The panel size suitable for the process is dependent on the size of the annealing oven in which the process takes place. Currently available 3D printers are very limited in their size of substrate that material can be printed on, however, it could be imagined that a printing process is incorporated into an on-line tempering process, allowing to process significantly larger panels.

7.3.2 T-Connection for Glass Facade Applications

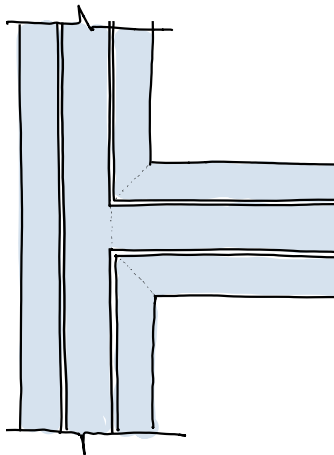

FIG. 7.6 Detail heat bonded glass fin connection



FIG. 7.7 Image HB T-joint



FIG. 7.8 Image HB T-joint

Heat bonded T- connections visually offer a great potential as they allow to omit the appearance of the glass edge that is typically apparent when viewing a glass fin supported facade, both internally and externally (3.2.7).

Whilst distortions around the bond are visible due to the manual manufacturing process, it is assumed that this could be improved using a laser-based welding technique.

Fins could be imagined to be heat bonded to a flat panel to limit deflections as in a typical fin based facade. Connections could be continuous or local, however the primary benefit might be in the possibility of achieving a continuous transparent connection.

7.3.3 Butt joints for facade applications

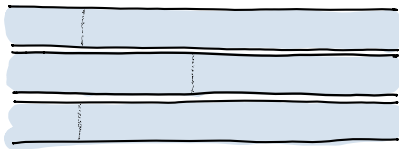

FIG. 7.9 Detail heat bonded butt joint in a laminate assembly with redundancy principles applied by staggering the bonded joints



FIG. 7.10 Image heat bonded butt joint

One of the very common connections in the use of structural glass for building envelopes, is as a joint between two panels that works structurally to limit deflections (4.4.5.1).

Assuming that heat bonded connections will be limited to fabrication in a factory, particularly if manufactured manually rather than using automated additive or laser technology, panel sizes will still be limited by common handling and transport restrictions as well as size limitations for lamination. In addition to that, the size of glass components within a building structure will be limited to the size that allows the accommodation of all differential movement whilst transferring wind and or other live loads.

7.3.4 Glass to glass corner



FIG. 7.11 Existing glass clad steel structure 101 California Street, San Francisco, designed by Philip Johnson

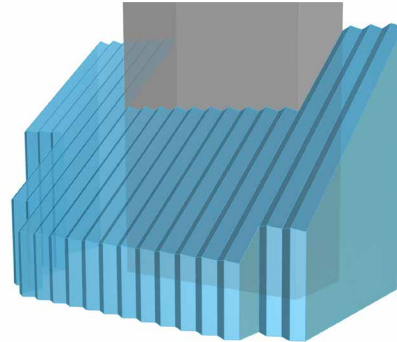

FIG. 7.12 Suggested replacement with a corrugated all-glass structure

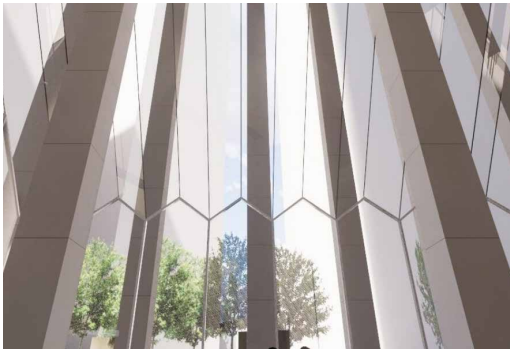

FIG. 7.13 Corrugated glass roof design (image BCJ)

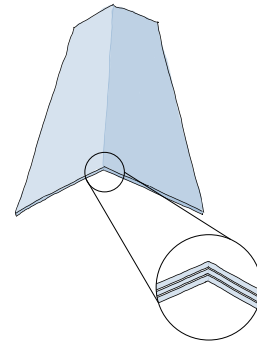

FIG. 7.14 Detail serrated facade

As described in 4.4.8.3 of this document, the corner detailing of glass structures has a significant impact on the appearance and perception of the transparency of the structure. Heat bonded corners could allow for the desired transparency, whilst also providing structural components that could be used as design elements in a building envelope.

Given the stiffness of the connections, these could be used to provide geometrical stiffness to a serrated facade. Corner connections provide a multitude of applications, as a corner within a larger facade assembly, as a window unit or as a serrated facade. In addition, corner units provide useful components to increase the redundancy of other components like fins, when laminated to these.

Similarly to traditional glass corner arrangements (4.4.8.3) several arrangements of the panels to each other are possible. Based on the principle of aiming to reduce the exposure of glass edges however, a mitred arrangement seems to be most suitable to achieve the highest degree of transparency.

Based on the corner connection typology, other assemblies could be imagined as well. One typology that has recently become less popular in structural glass is the form of a stair , which might be driven by the way that the design is limited to the use of opaque fittings to connect stair treads to the stringer. These can be local or linear, however, the appearance of the connection always drives the appearance of the stair itself.

The application of a heat bonding technique to achieve a fully transparent stair construction would open new possibilities for the design of glass staircases.

7.3.5 Heat bonded stair treads

Based on the principle illustrated in 7.3.4 in which geometrical stiffness is achieved through a heat bonded connection between two elements that are arranged orthogonally to each other, this type of connection is applied to another common application in which a structural connection between glass panels is required. A staircase design with heat bonded treads was explored as a possibility to achieve fully transparent connections between treads.

As a basis for the design, the heat bonded corner arrangement described in 7.3.4 of this document is assumed. Using a multitude of welded corners and arranging them such that they form a ladder while always overlapping with the adjacent corner. The overlapping surfaces could be laminated with an SG interlayer, which would provide the required redundancy of the construction (see principle outlined in 7.2.3).

In an ideal case, assuming that connections are as strong as the parent material, the glass stair would act as a beam that can span between floors without the need for additional support. Whilst this might be feasible in the scenario of a monolithic stair, that only relies on the welded connections (Figure 7.15), the introduction of redundancy through the lamination process would not allow for this scenario anymore (Figure 7.16).

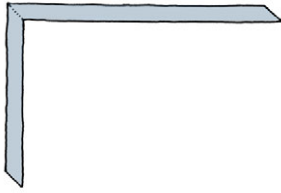

FIG. 7.15 Heat bonded stair tread

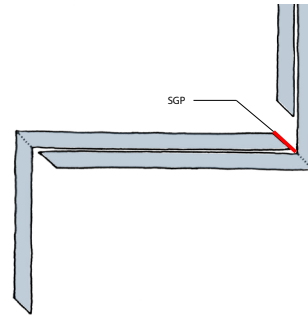

FIG. 7.16 Arrangement of stair treads for lamination

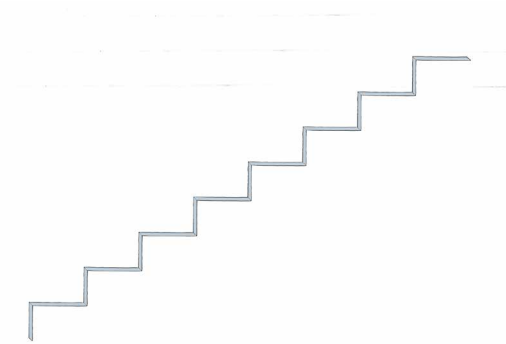

FIG. 7.17 Monolithic stair 'beam'

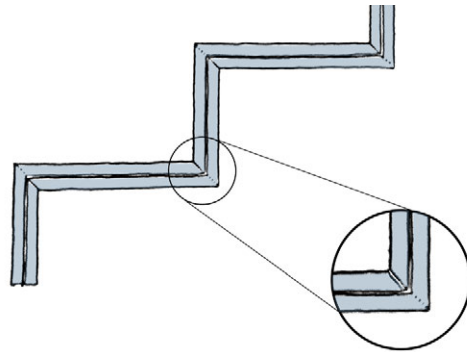

FIG. 7.18 Arrangement of laminated mitre over welded mitre.

This suggests that rather than spanning the stair between floors that the treads could be connected to a glass stringer, which they would cantilever from. Given that the dead load can be transferred through the treads directly at the end of the cantilever, meaning that structurally it is not considered a true cantilever. This concept is very similar in its functionality to the concept of a cantilevered stone staircase, in which treads cantilever in a circular arrangement from the surrounding walls or stringer, however the load is cascading through each tread into the next one on the free inside edge, significantly reducing bending moments introduced into the wall or stringer connection. One of the earliest and most prominent attribution to the development of this type of staircase is Palladio's stair in the Convento Della Carita in Venice, built in 1561 (Figure 7.19) (Campbell, J, Tutton, W., 2014) The tighter the internal radius, the smaller the moment at the tread stringer connection.

Whilst this stair concept appeared to be theoretically feasible, the production capabilities to test practical feasibility were not available, hence alternative connection methods have been explored, that would allow a realisation of the concept (see 7.4.2).



FIG. 7.19 Cantilevered stone stair, Convento Della Carita, Venice, Palladio 1561 (image Gardiner Hallock)

7.3.6 Summary - Heat Bonding

The application concepts discussed above all provide potential to increase the appearance of transparency of the connection itself. However they come with varying degrees of complexity in fabrication as well as differences in their suitability for the intended application when compared to a traditional connection as per the analysis in chapter 4.

Whilst discrete connections are more easy to manufacture, as they can be applied to a flat sheet of glass in an additive process which doesn't require complex jigs to achieve the geometry, redundancy within the design is primarily achieved by increasing the number of connections. As a sole solution this would not be feasible for typical building applications.

The fabrication of linear connections generally requires higher precision and additional equipment, but due to the nature of the very stiff bonds achieved over a larger area they appear more suitable for an application as a structural component within a building or building enclosure.

The complexity of the fabrication is driven by:

- A The size of the component
- B The intended geometry

Whilst the suitability for its intended application can primarily be judged by the applicability of the connection properties (its stiffness and inability to accommodate movement).

This means that whilst a larger glass corner component might be more complex in fabrication, due to the achievement of geometrical stiffness in a joint that doesn't require allowance of significant movement (assuming this can be accommodated in adjacent joints) it would be deemed more suitable for its application than a T-connection in the glazing field or a butt joint between two panels.

The application of the connections to bond stair treads to one another is more easy to fabricate due to the smaller size and would also appear more suitable to its application when assuming that the stair as a building component would be isolated from general building movements and differential movements between the floors that it connects. The following table summarises the assessment of the performance of the design intents described in this section, assessed based on the criteria outlined above.

TABLE 7.1 Comparison of feasibility of fabrication and suitability for intended application for various heat bonded connections

	Fabrication of connection in comparison to other HB connections	Suitability for application
Glass Point Fixing	+++	0
T-beam for roof application	-	+
T-connection for facade column application	-	+
Glass to Glass corner	--	++
Butt joints for Facade application	--	+
Stair treads	+	++

As a whole, heat bonded connections provide the potential for the advancement and development of glass connection typologies, which can be seen as a significant potential for the progression of design typologies for glass structures and their connectivity and therefore for the transparency achievable as a whole.

From a design perspective considering the complexity of understanding properties of composites which are made up of multiple materials that are potentially problematic to break down after a bond is achieved, heat bonded connections offer great potential, as no other material than glass is required to form a fully atomic bond.

Visually, the reduction of reflectivity on the bonded edge leads to a visual reduction and potential elimination of the visibility of the glass edge which in turn achieves greater perceived transparency of the connection but also the overall glass structure or component.

7.4 Alternatives to Heat Bonding

Due to the current practical limitations of fabricating the heat bonded connections at a scale that would allow to manufacture a full architectural component and based on the fact that transparent structural silicones have become commercially available over the past few years (Hayez, 2017), alternative transparent opportunities for the design of transparent glass connections are outlined in the following section.

7.4.1 Making connections transparent

In particular glass staircases have gained popularity in recent years, forming transparent structural features within buildings. Due to the loads they have to carry, coupled with safety regulations, these structures traditionally consist of multiple layers of glass, laminated into thick packages and then connected with opaque metal fittings.

Structural adhesives have become more and more common in facade applications, where loads are transferred from glass-to-glass, or from glass to supporting structure, through silicone. Transparent structural adhesives, however, have been primarily explored on an experimental basis and are not often found in building applications to date.

As discussed in chapter 4.4.8.2, TSSA provides the opportunity to achieve fully transparent connections when used to connect glass with glass. Table 7.2 compares TSSA properties with the properties of traditional structural silicone. Due to its increased strength it can be used in a thinner layer than traditional silicone. As shown in Figure 7.21 indicates the difference in joint thickness and bite required for a TSSA connection when compared to traditional structural silicone (Sitte et al, 2014).

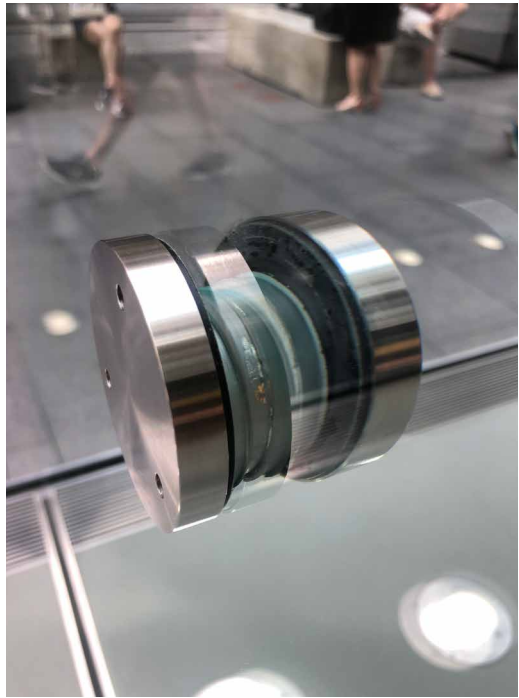
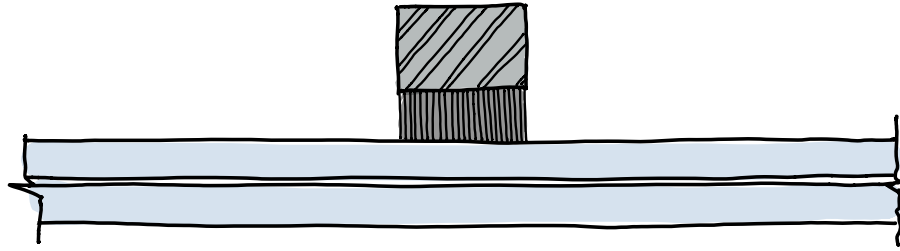

FIG. 7.20 Typically glass structures consist of many layers of glass, connected with opaque fittings that transfer the load.



FIG. 7.21 Glass to glass connection bonded with TSSA.



Joint thickness 8mm x 20mm with standard structural silicone

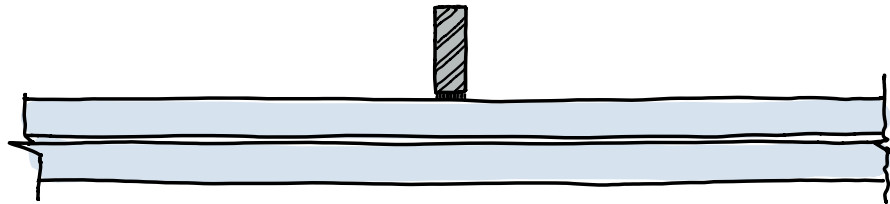

Joint thickness 1mm x 5mm with high strength TSSA

FIG. 7.22 Joint thickness comparing a traditional silicon joint with a TTSA joint

TABLE 7.2 Mechanical properties TSSA and traditional structural silicone (Sitte et al, 2014, Haldimann et al, 2008)

Property	Unit	Typical Value TSSA	Typical Value Structural Silicone
Indentation Hardness	JIS A	70	40
100% Modulus	MPa	4.0 – 9.0	1.4 - 4.0
Young's Modulus	MPa	9.3	1.0-2.5
Max. Tensile Strength	MPa	8.7	0.95
Elongation at Break	%	250	130
Tear Strength	N/mm	35	6
Poisson's Ratio		0.48	0.49
Thermal conductivity	W/mK	0.2	0.1-0.2

7.4.2 Transparent corner bond

Using the concept introduced in 7.3.5, alternative means of transparent connections were explored. Based on the experience with TSSL connections as outlined in Appendix A2 the possibility of using the material for the mitred tread connections as well as for the tread to stringer connections was explored in collaboration with Sedak in an attempt to build a full size stair with transparent connections for the Glasstechnology Live exhibition at Glasstec 2018.

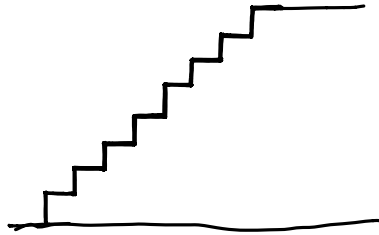

FIG. 7.23 Monolithic stair 'beam'

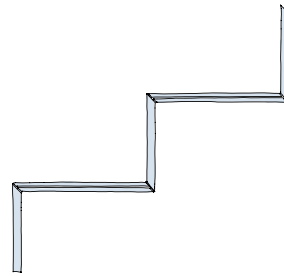

FIG. 7.24 Arrangement of stair treads for lamination

The initial design assumes a Sentry Glass corner lamination as described in 7.3.4 and 7.3.5, which is then bonded to the laminated glass stringer with TSSA.

However, tests carried out previously by Sedak (understood in discussion with Michael Riess, Research and Development Engineer, 2016) in an attempt to bond laminated glass elements to the face of a glass sheet with a TSSA connection, indicate that during the lamination process, the exposure of TSSA and SentryGlas to each other lead to the development of air bubbles within the connection (Figure 7.25). It was observed that every time TSSA and Sentry Glass are cured in the autoclave with close proximity to each other, bubbles develop where the materials join. A range of small scale samples (100x100mm) with a central joint was tested by sedak to determine the influence of temperatures and exposure time on the formation of bubbles, however within the limited study, no significant conclusions on the drivers for the bubble formation within the fabrication process could be drawn.



FIG. 7.25 Lamination of SG and TSSA adjacent leading to air bubbles

Whilst this observation was shared with the manufacturers of the two materials used (Sentry Glass and TSSA), the initial time frame set for the development of this case study did not allow for further testing on a material level to better understand the chemical reaction between the two materials that could be the cause for the bubbles.

This consideration led to a change in the design as the tread to tread connection would not be feasible with TSSA due to its lower stiffness, whereas a connection of the treads to the stringer would be too stiff using Sentry Glass introducing significant stress locally through a bending moment, unless the geometry of the stair would be changed to function similarly to Palladio's cantilevering staircases in which the load cascades down from one tread to the next (7.3.5, Figure 7.19).

Instead of changing the geometry however, in the initial exploration, the design of the connections was amended to avoid any contact between the two bonding materials Sentry Glas and TSSA. Given that the intended application for the full size staircase was an exhibition rather than a highly trafficable commercial application, it was decided to use a single 19mm thick monolithic sheet for the risers and only bond the risers to the stringer while keeping a distance of 2mm between stringer and laminated tread. Two 8mm sheets laminated with four layers of Sentry glass would hence result in an equal thickness of 19mm which allowed for the mitre joint to be geometrically accurate.

This change to the detail would allow to avoid the reaction between the two materials whilst not having significant impact on the design of the stair (Figure 7.24).

A 1m x 1m concept mock-up with three risers and two treads was produced at sedak to understand the feasibility from a fabrication perspective (Figure 7.26).

Given that all materials used to achieve the connections between glass panels in this scenario require lamination or curing in an autoclave, the anticipated fabrication steps are as follows:

- 1 Produce laminated glass stringer and treads separately
- 2 Produce laminated mitred corner with Sentryglass connection between 19mm monolithic riser and 19.04mm laminate.
- 3 Arrange laminated corners on stringer and produce TSSA joints between monolithic riser and stringer surface in a second autoclaving procedure.

Although the connections in the test turned out to be successful, the lamination process even at this scale indicated that keeping the mitred connections in a geometrically accurate arrangement would require a mould.

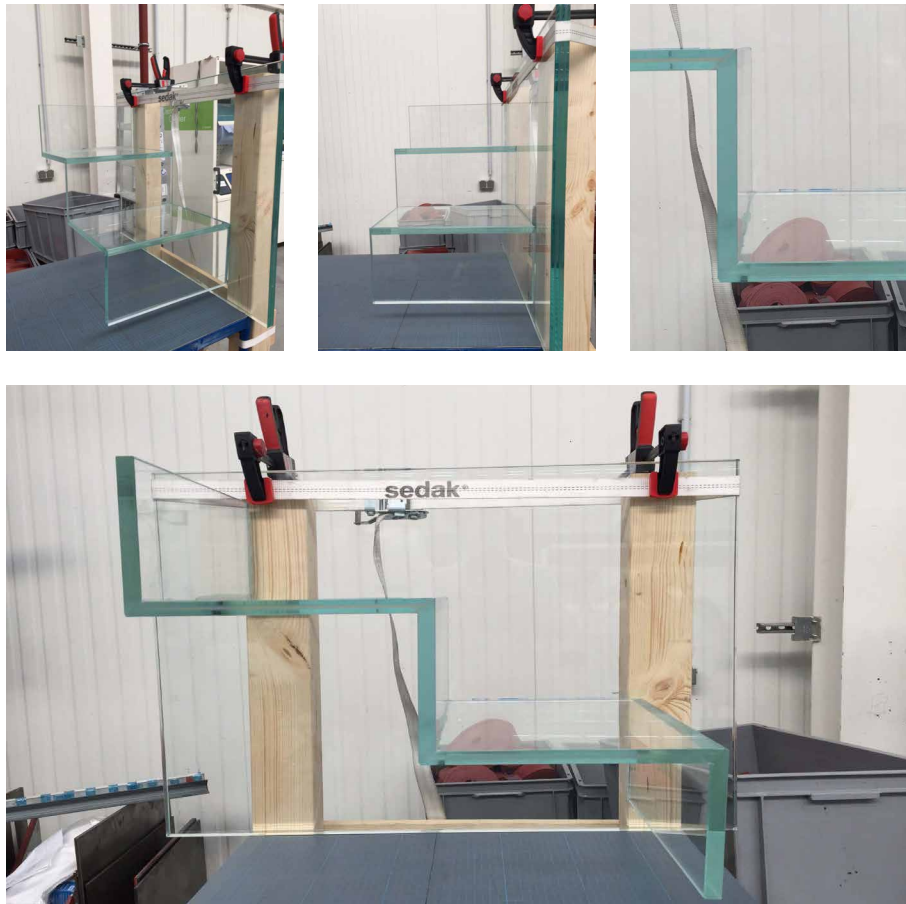

FIG. 7.26 Initial Stair Mock-up at sedak

Whilst from a visual perspective the accuracy might be desirable but not necessary to perfection, the avoidance of any inaccuracy is crucial for the performance of the connections, as inaccuracies could lead to stress concentrations both in the bonding material and the glass edges that would exceed the design strength.

This suggested that for the lamination of the entire staircase, a rigid steel mould would be required to assure that the geometry would be achievable without introducing tolerance to the orthogonality, which would lead to stress concentrations in the mitred connections under load impact.

Due to limited amount of time and resources, this concept did not prove feasible for fabrication in time for the exhibition, so it requires further optimisation from a geometry perspective to allow all joints to be bonded with a single material, avoiding the chemical reaction causing the formation of bubbles within the joint.

This has been initially tested by only laminating the treads and keeping the riser a monolithic ply which could then be bonded to the stringer with TSSA. However, after more detailed FE analysis of the sculpture, the TSSA bond did not appear stiff enough to appropriately transfer loads, and a Sentry Glass bond was tested instead. Fig 7.29 shows a sketch of the final geometry of the stair as well as a detail of the connection of the tread and stringer, which is butt joined with SG due to fabrication accuracy.

Based on the cantilevering concept of the sculpture, the weight at the top of the stringer had to be minimised. Therefore the stringer has various thicknesses, stepping from 5 plies at the lowest part through 4 and 3 plies until the upper part of the stringer reduces to 2 plies. (Figure 7.28)

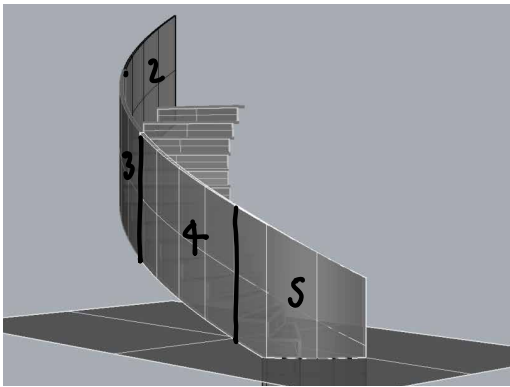

FIG. 7.27 Stair geometry with stepping of plies

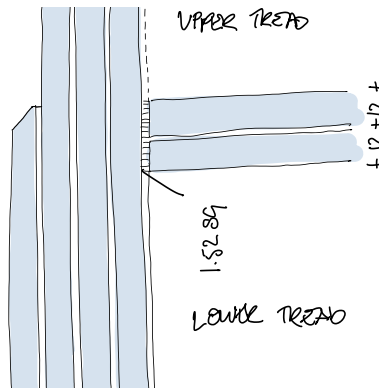

FIG. 7.28 Horizontal sketch detail at stringer ply step. Riser bonded to stringer with SG

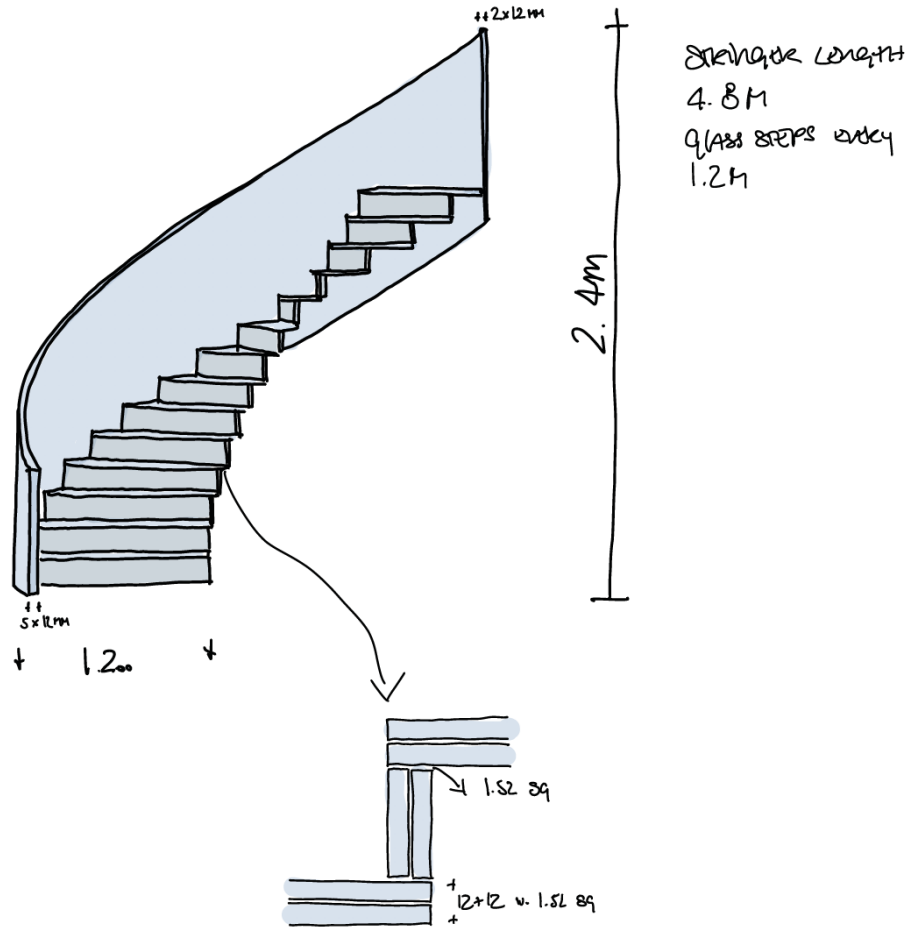

FIG. 7.29 Sketch of updated stair concept based on a palladian cantilevered stone staircase.

7.4.3 Transparent composite bonded 'hinge'

In addition to the transparent silicone materials to bond glass to glass previously described, for connections that are primarily loaded in compression, UV curing resins have proven successful results (3.4). The concept described in the following paragraphs utilises a transparent resin bond to connect glass through an acrylic bearing, leading to an incredibly transparent kinematic connection, that does not rely on opaque components.

In order to show the state of the art processing capabilities for glass, in combination with a fully transparent design, a concept for a glass seesaw was developed with sedak to be exhibited at the Glasstechnology Live exhibition at Glasstec 2018 in Duesseldorf, Germany.

Spanning 10 metres, the seesaw features a beam that weighs 1.3 tonnes yet moves weightlessly on its central pivot. Both components of the seesaw's assembly consist of multi-ply laminates bonded with SentryGlas, with the beam tapering from a thickness of 11 layers at its centre to just two at each end. Acrylic blocks machined to form bearings are fixed into the laminated glass assembly with a clear two-component epoxy adhesive, while silicone oil reduces friction within the bearing. The result is a fully transparent mechanism that allows the seesaw to gently dip and rise.

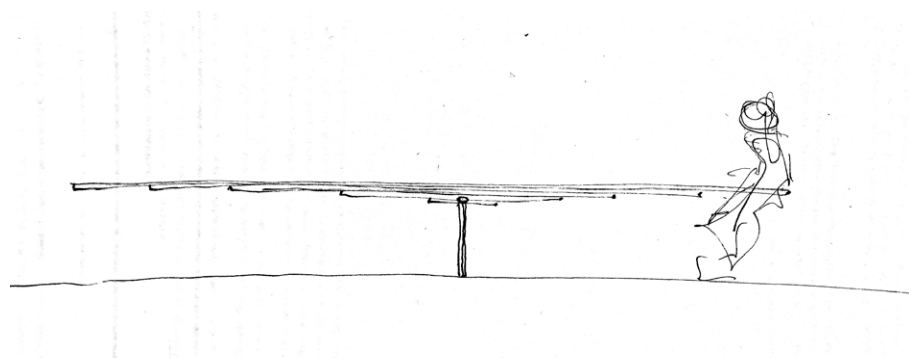

FIG. 7.30 Initial sketch GlasWippe

Structurally the design is straightforward, as the beam is simply supported on the bearing. Complexity primarily lies in the precision of the fabrication to allow the mechanism to function smoothly.

With a width of only 400 mm the beam is incredibly shallow. To avoid deflection under self-weight, the beam is designed to be thicker at the centre and taper out towards the edges, which at the very end only consist of two layers of glass. The glass steps are machined at a 45 degree angle and at 500 mm spacing over the length of the beam, showcasing the precision achievable with lamination and polishing equipment.

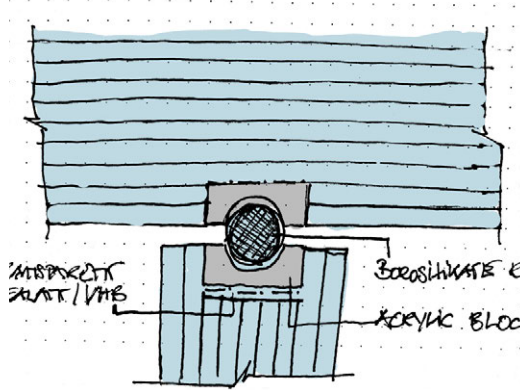

FIG. 7.31 Detail of central acrylic bearing block

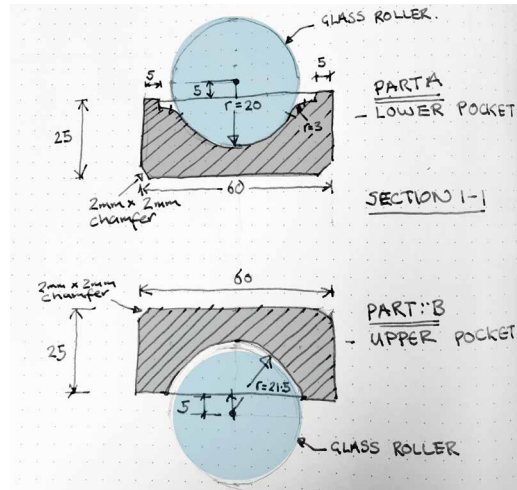

FIG. 7.32 Acrylic bearing block and rod

The central support consists of 11 plies, each 10mm thick, of which the middle 6 are stepped short, creating a pocket in the lamination process (4.4.8) in which the bearing is then bonded with a two-component UV curing epoxy resin.

Similarly, at the centre of the beam, two plies are cut back to create a pocket for the upper part of the bearing to be incorporated. Given that the connection is primarily in compression and very little torsion is applied only in case of a lateral impact to the seesaw, the brittleness of the epoxy resin is not considered problematic.

The initial design considered a borosilicate rod to be used as the bearing, as it is used in the treads of the slides, however, due to manufacturing tolerances on the rod (+/- 2mm over the length of 400mm) it was not considered feasible. Instead an acrylic rod was used, machined to fit the bearings precisely, leaving only 0.2mm between rod and bearing. To guarantee smooth movement a clear silicone oil is used as a lubricant. It was found that a considerable amount of lubrication and movement was required to avoid squeaking of the bearing.

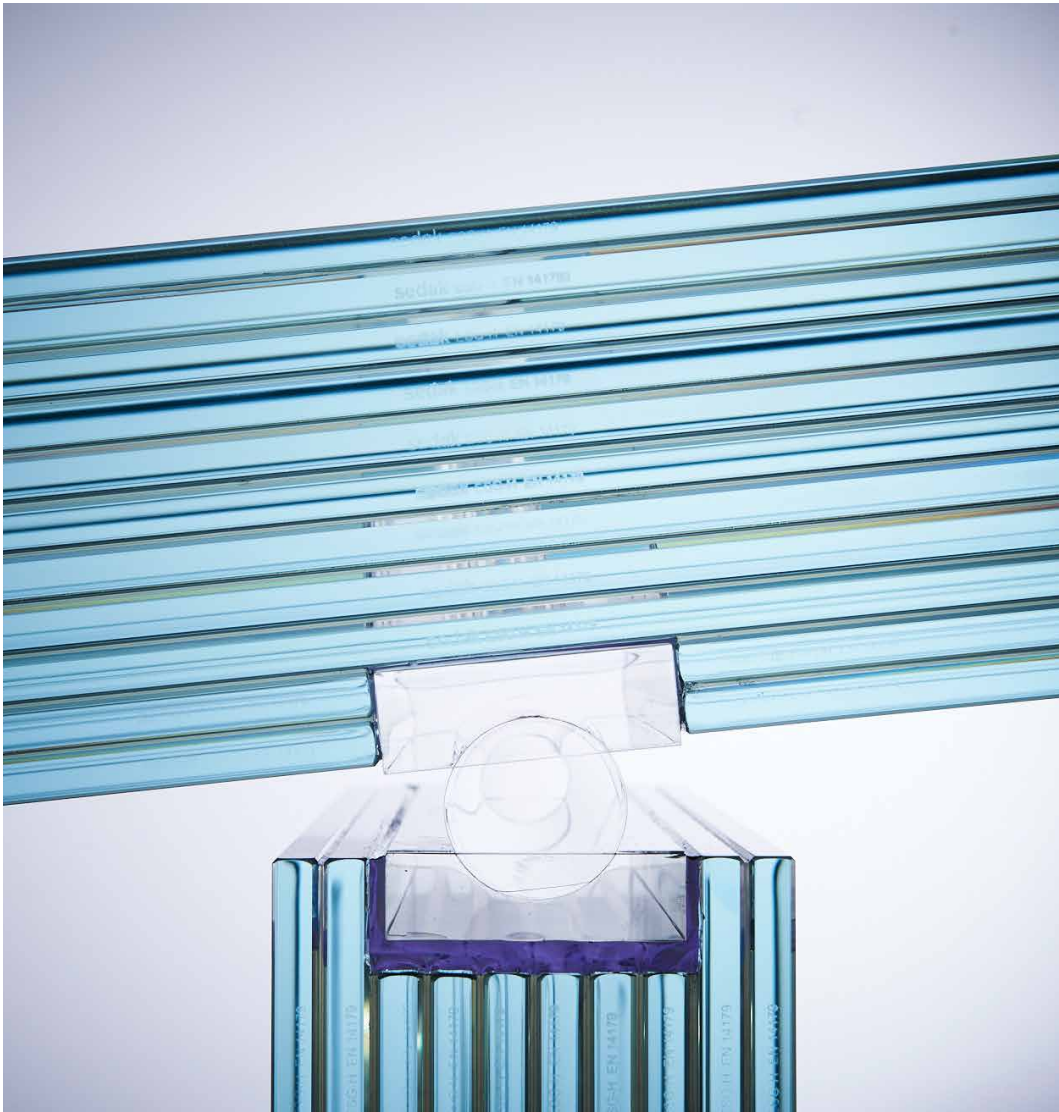

FIG. 7.33 Transparent composite pivot connection

Figure 7.33 shows the connection between the bearing and the glass, which in its appearance is primarily determined between the difference in colour between the glass and the acrylic. The resin bond is hardly visible, which makes it a very successful representation of the use of transparent bonding mechanisms in combination with multi layered glass components. However, a difference in clarity between glass and acrylic is clearly noticeable.

7.5 Transparent edge seals

Whilst for structural glass applications within a building the connection between glass elements is the primary consideration, when considering transparent connections for facade applications, thermal and solar performance of the glass element itself plays a fundamental role. Therefore typically IGU's are required for most building envelope applications. This particularly applies in the northern European climate, in which the thermal performance governs the design considerations.

The edge seal for IGU's typically consists of two parts: the primary seal, commonly butyl (polyisobutylene/PIB), that seals the spacer against the glass to provide an airtight cavity and the secondary seal that guarantees the structural integrity of the unit. The secondary seal is typically silicone, but can also be Polyurethane (PU), polysulphide (PS) or hot-melt butyl (LBNL, 2013). IGU spacers typically contain a desiccant which will absorb any moisture that might pass through the seal.

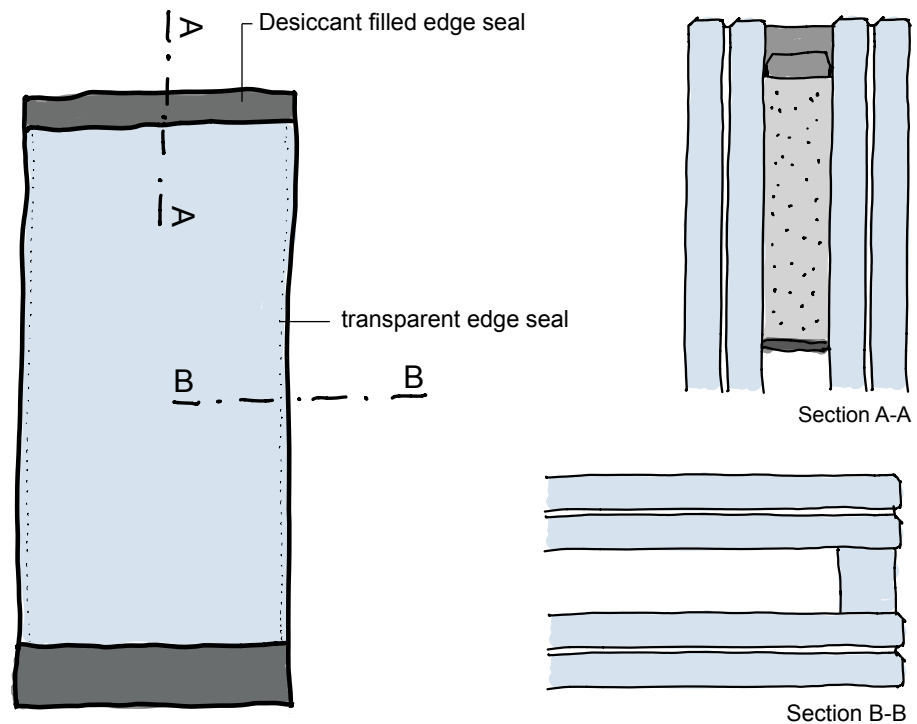

FIG. 7.34 Concept of transparent edge seal in vertical joints, while horizontal concealed joints contain desiccant

Whilst the bottom edge of a structural glass facade unit that spans floor to floor is embedded in a base shoe (as described in 4.4.4.8), this space could be used to house the majority of desiccant, with an additional amount in the area covered by the head restraint (Figure 7.34). Vertical edges could be sealed with a transparent material, considering airtightness as a primary concern. Various configurations and materials might be considered.

Figure 7.35 shows a mock-up of a transparent edge seal fabricated by Scholl Glas, Germany. The seal and spacer material is PMMA which is extruded onto the glass substrate. It provides sufficient transparency; however, application techniques could be improved to achieve a consistent spacing of the seal.

Another transparent edge seal concept was developed by Sedak, commercially available as Isopure (Figure 7.36, Sedak, 2019). The concept of using glass as a spacer material is a concept that has been explored various times and implemented for example in the Keats Grove glass extension in Hampstead, London designed by Rick Mather Architects and engineered by Dewhurst MacFarlane and Partners in 1992 (3.2.7). As described in 4.4.8.1, the UV resin however did not sufficiently accommodate the movement and deflection the IGU is exposed to which led to breakage of the spacer in some instances. This is assumed to be due to the limited amount of shear that can be accommodated in the resin bond, which led to cracking of the bond or the glass in other applications as well (see 3.4.3.2)

According to Sedak, their new development overcomes these issues and can sufficiently accommodate movements and wind load deflections. Whilst they have not shared the actual technology of how the units are assembled, it is assumed that the material used for the bond is an ionoplast interlayer, which despite its stiffness would allow for more deflection than the significantly thinner UV resin bond used in the Keats Grove units. The ionoplast interlayer would also provide a moisture barrier which in the case of the transparent silicone edge seal suggested by Dow in their exhibition at GPD 2019 in Tampere, Finland (Figure 7.37) would pose a weakness in the system, as silicone does not provide a sufficient moisture barrier.



FIG. 7.35 Transparent edge seal made by Scholl Glas



FIG. 7.36 Glass edge seal Sedak Isopure

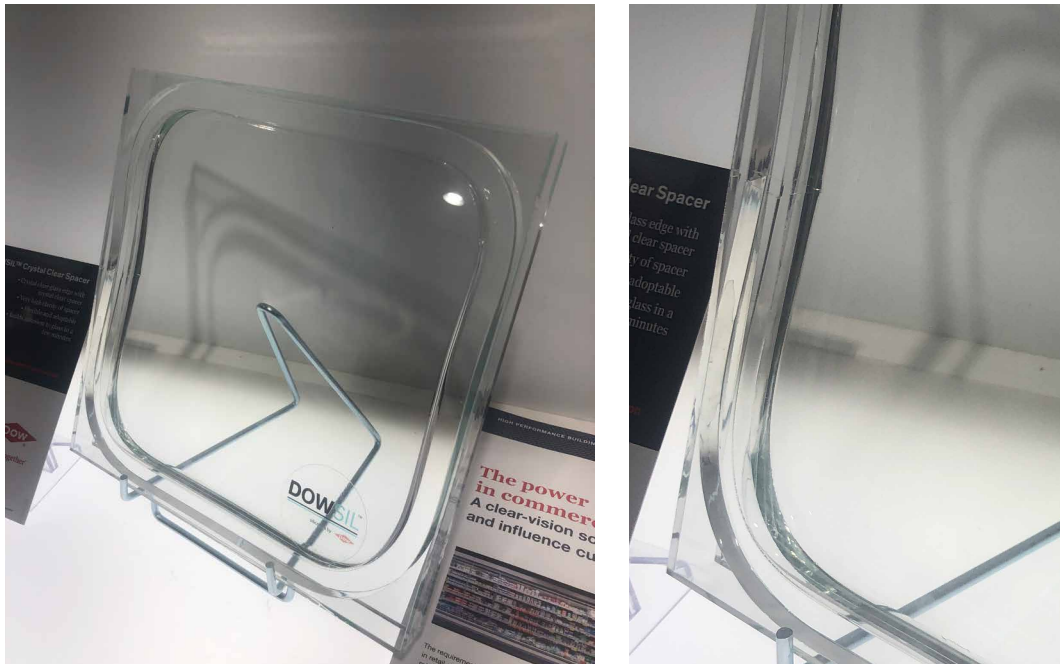

FIG. 7.37 Transparent Glass edge seal presented by DowSil, as seen at Glass Performance Days, Tampere 2019

All of the concepts discussed are currently explored on an experimental basis and despite the commercial availability of the Isopure product, further research and testing will be required to validate the feasibility of these concepts in long-term applications. To achieve increased transparency in glass components, not only the connections themselves become a consideration, but the transparency of the IGU edge seal will become more important with an increase in transparency of the glass connections themselves.

7.6 Thin glass

Chapter 2.9 outlines the importance of colour in the perception of transparency or more precisely clarity in glass assemblies. The thicker assemblies become and the more layers of glass are used, the larger the impact of the inherent colour on the appearance of the glass. Whilst a change in the composition can reduce that appearance of tint, low iron glass, in which the iron content is reduced to approximately a quarter compared to traditional soda lime silica, still displays an increased tint when multiple layers are stacked up.

Another way to achieve a clearer appearance in glass assemblies would be to use less material i.e. by making it thinner. To be able to use a thinner layer of the material though, its strength needs to be increased to be able to achieve the same structural performance.

The screen industry provides a solution here, an ultra-thin aluminosilicate produced in a fusion process, in which the melt flows down vertically. Without exposure to tin or other materials than air, it has a significantly higher bending strength than traditional soda lime silicate when chemically tempered (up to 750 MPa, Corning, 2013). Other thin and ultra thin glass products on aluminosilicate and soda lime silicate basis are available (Schott, AGC, Corning), however, the study described here is based on Gorilla Glass (GG).

At a thickness of 1mm GG can be bent to a radius as small as one metre in a cold bending process. It's high strength allows to use very thin layers of material, in turn reducing not only the inherent colour but also the weight, which makes it interesting for application in slender structures. As opposed to glass produced for the construction industry, sizes are limited to typical screen sizes and production is not geared towards custom sizes.

When using a very thin material, considerations of its connectivity have to be adapted to its properties. Although the surface bending strength of the material is very high, it remains fragile to load impact on the edge. This is a common experience with smartphone screens that shatter when impact occurs.

This suggests that load transfer through the edge is avoided and connections designed at the face of the glass.



FIG. 7.38 Lightweight IGU made with ultra thin glass laminates (0.7mm+0.7mm/CAV/0.7mm+0.7mm)

An important consideration further to the limitations on edge connectivity is the fact that in most cases the design of glass envelopes is deflection driven. And despite the increased design strength, an increase in flexibility would mean that the concept of a flat glass panel spanning between two slabs would not be achievable at scale. This should be considered an opportunity though to rethink the way glass is used both structurally and architecturally; Using its flexibility to gain geometrical stiffness without complex heat bending processed appears to be a major advantage over traditional flat glass.

The flexibility of the material offers a range of opportunities, including a reconsideration of windows and other operable units. Typically, these are framed and require specific hardware i.e. window handles and hinges for their operation. The use of thin glass would allow for an operation of a ventilation unit without the use of a frame. A bimetallic strip bonded to the face of the glass, that expands differentially to the glass itself could lead to a flexing of the material when heated up by the sun.

This would allow automated ventilation based on solar radiation. Various concepts similar to the one described have been mocked up in a Master course at TU Delft, (Christian Louter) and exhibited at Glasstechnology Live (Glasstec Duesseldorf, 2018).

Assuming glass to glass connections become more transparent, the transparency of the overall component becomes more important. This suggests that transparent edge seals as described in chapter 7.5 become more important to increase the overall transparency of a fixed glass facade. When considering kinetic components like windows and doors, which in their functionality play a fundamental role to the performance of the building envelope, the development has to move away from traditional framing elements to advance the transparency of these components. Here the thin glass concepts indicated in Figures 7.38–7.41 and outlined by (Louter, 2019) provide an opportunity for a development towards more transparent building envelopes.

Although the use of thin glass has been heavily explored structurally in the past years (Neugebauer, 2018), this primarily occurred in an experimental context with the focus on the exploration of the structural properties and potential opportunities related to those. However, a knowledge gap can be identified around the connectivity of thin glass and how typologies would have to be adjusted to accommodate its properties. Detailing will have to accommodate the lack of possibilities to support the glass on its edge, as well as through drilled holes, which suggest that the exploration of face bonding techniques with transparent bonds that can accommodate the dead load of the material would be an appropriate field of research.

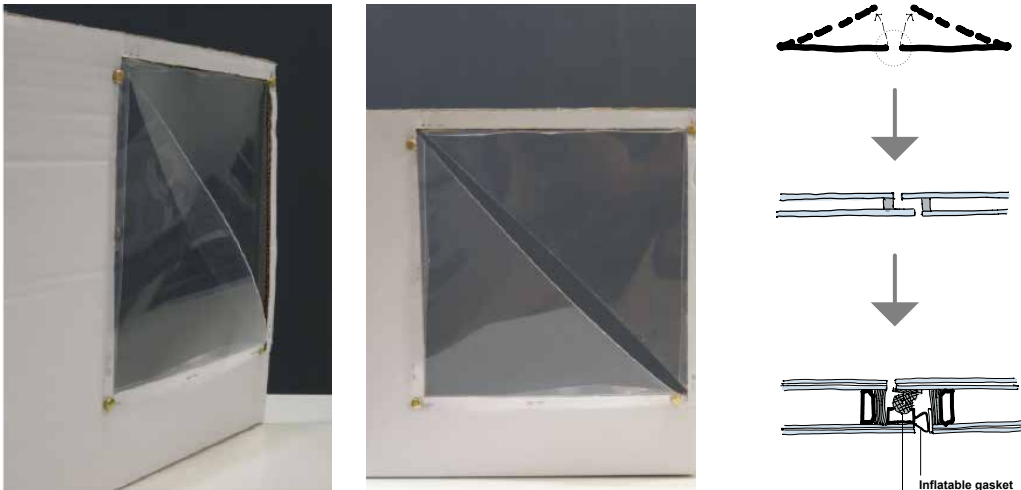

FIG. 7.39 Model of flexible ventilation panel

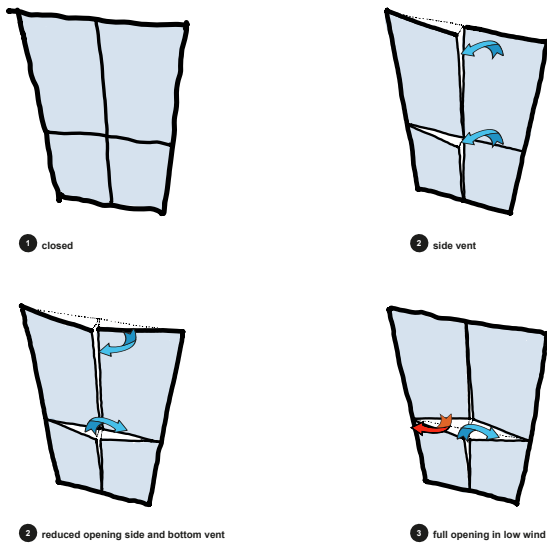

FIG. 7.40 Concept of flexible ventilation panel



FIG. 7.41 Precedent External skin Unilever HQ Hamburg, Behnisch Architekten, 2009

7.6.1 Summary - Alternatives to Heat Bonding

Despite the use of various adhesive bonding technologies, the application concepts discussed in this section provide potential to increase the appearance of transparency of the connection and hence the glass component itself.

Whilst most of the connections outlined in (7.5) would be translatable to an adhesively bonded concept, testing the feasibility of the translation of the heat bonded concepts is not the scope of the study outlined in this section. It is rather the exploration of alternative concepts driven by the availability of a bonding technology or -material and the translation of the properties that specific material offers into design concepts.

A direct translation has only been made for the corner connections intended to form stair treads with successful initial results indicating that a fully transparent stair assembly would be feasible with both heat bonded and adhesively bonded connections and manufacturable using current technology and fabrication equipment when diverting to transparent adhesive bonds. The same applies to the discrete connections illustrated through Chapter 6 and 7.

A UV resin is used for a connection that primarily works in compression which confirms previous experimental and project studies (Bristogianni, Oikonomopoulou, 2018) that for this type of application and connection and increase in transparency can be achieved over traditional connections (Chapter 4).

When the transparency of the connections between glass panels is increased, it becomes more important to also assure best possible transparency is achieved within the component itself. For building envelopes driven by thermal and solar performance, this requires a transparency of the edge seal in addition to seals or connections between glass panels. The concepts explored outline a potential for the use of transparent edge seals in a specific application, however a new field of research is outlined here, requiring significant amount of research to further investigate and compare the performance of various technologies available to allow an assessment and comparison.

This applies as much to the concept of using less material to achieve a more transparent overall component by introducing the use of thin and ultra-thin glass. Whilst the opportunity for an increase in perceived transparency can be concluded based on the reduction in thickness of the material and the principles of refraction transmission and absorption (see 2.9), however a conclusive comparison cannot be made within the scope of this research.

7.7 Summary

In addition to the physical possibility and verification of the feasibility of heat bonded connections, jurisdiction related to the design of building structures needs to be considered locally and globally. Given that structural glass engineering is a relatively young discipline, very few codes and guidelines specific to the material are available, so the design of glass structures relies heavily on the knowledge and experience of the engineer, as well as analytical modelling and physical testing.

Despite the initial results outlined in chapter 6, suggesting that heat bonded connections could be as strong as the parent material when manufactured under well controlled conditions and hence could be designed based on established material values, it has to be assumed that the sufficient homogeneity of the bond is not achievable in a manual process.

The use of laser technology appears to provide a good opportunity to improve the quality in the bond and in the appearance, due to a much smaller area that is exposed to the temperature impact compared to a manual welding process (see 5.2.2. and 5.2.3). Other issues around fabrication and quality control might also be resolved with the implementation of laser technology; however, this has not been assessed in this research and the judgement is purely based on the application of comparable technology in the connection process of glass in different fields. Fibre optics are relevant here and particularly a laser based gravity bending process that is being used on a comparable scale to the specimens tested in this research.

When assessing design possibilities however, it is understood to be of fundamental importance to evaluate a technology at full scale.

Various concepts were developed for the design applicability of heat bonded connections, which theoretically (verified through initial design analysis) appear to be feasible, however it was not possible to translate them into full scale physical studies.

With the more recent availability of transparent structural silicones, an additional field of opportunities for transparent glass to glass connections is opened up. Specifically with TSSA which is a sheet material produced by Dow that is cured under temperature and pressure impact in an autoclave similarly to ionoplast or polybutyl interlayers. Although TSSA has various limitations in its processing, i.e. the requirement for autoclaving under temperature impact to trigger the curing process,

the fabrication of transparent connections with TSSA was more accessible, hence some of the concepts outlined for a heat bonding process were physically explored using a transparent adhesive and specifically TSSA.

The case studies outlined in the Appendices to this document indicate the degree of transparency achievable with transparent structural adhesive bonds.

They take some of the concepts outlined in this chapter and further develop them into case studies showcasing the potential of the connections. The results are experimental structures illustrating one or multiple forms of transparent connections with the aim to explore the effect of the use of such connections at scale whilst not being overly conservative with design limitations driven by real-life project constraints such as code compliance, long term serviceability and longevity.

The primary finding when comparing the experimental studies indicated in this chapter with the connection studies outlined in chapter 6 is a difference in the appearance of the connection and the perception of its transparency. This conclusion can be drawn based on the following observations:

- 1 When connecting glass to glass with a transparent bonding material, it is primarily the colour of the glass that is visible, mostly through the reflection of light on the edge that is being connected.
- 2 This reflection of light on the glass edge is the fundamental difference in the appearance of heat bonded connections compared to a transparent adhesive bond.

Based on the observations above, it can be concluded that whilst both methods provide the opportunity to achieve fully transparent glass connections, and despite the constraints and limitations in its availability as a fabrication technology, and technological challenges outlined in this chapter, this is where heat bonding can achieve a higher degree of perceived transparency than adhesive bonds.

However, due to the availability of long term test data for silicone materials in relation to the application with glass in buildings, it is assumed that the transparent structural silicones might offer a faster and more reliable route for the implementation of fully transparent connections, despite the limitation that a fully transparent appearance to the degree heat bonding can achieve is not possible.



Santuário Dom Bosco, Brasília, Carlos Alberto Naves



GlasWippe, Glasstechnology Live at Glasstec 2018, Duesseldorf

8 Summary

This research aimed to evaluate the technological possibility of achieving fully transparent glass connections and the feasibility for application of certain transparent connections. The assessment was conducted through diverse qualitative and quantitative assessments that are used as a basis to provide an answer to the primary research question and the sub-questions that relate to the chapters of the thesis.

Chapter Eight summarises the findings of previous chapters and provides conclusions on the scope of this research as answers to the research questions.

8.1 Summary by Chapter

Chapter Two

The nature of glass and its transparency has fascinated architects and builders for centuries. The nature of the material is also what has been the limiting factor for its use. Particularly its brittleness and hence its tendency to break has been the limitation for the design with glass.

Glass differs from other building materials in the way that it is not defined by its composition but its molecular state. Glass has an amorphous molecular structure as opposed to a crystalline structure metals and other solids are characterised by. This is what makes it isotropic in its properties as well as transparent.

Theoretically glass is very strong- about 50 times as strong as steel- but due to structural defects and scratches in its surface the practical capacity is significantly lower (30-80 MPa for annealed glass). This means that the processing of the glass and the quality of the edges, where cuts have been made, is of fundamental importance to the quality of the material and to its design strength.

Thermal and chemical tempering processes are available to increase the strength of the material, however these come with visual implications and other risk factors. Despite that, for structural use typically strengthened glass is used. To increase redundancy and avoid collapse of all-glass structures, the glass in structural applications is usually also laminated.

Whilst the bending strength is limited by surface flaws, glass remains strong in compression but in typical envelope applications, it is primarily used in bending.

Its transparency is the property that differentiates glass from most other building materials. There are various factors that affect the perception of transparency, however its basic metric is the quantity of light that passes through a material, which can be described as transmission. In addition to the transmitted light, there is a percentage of light being reflected and absorbed. The absorbed light is what is visible as colour in the glass, which plays a significant role in the way we perceive its transparency.

Chapter Three

The use of glass has typically brought designers engineers and builders to the limits of their abilities, whether this was driven by the processing and handling of the material, or the limitation in the understanding of its design capacity.

Although glass is one of the oldest man-made materials, which has been used for more than 1000 years to provide shelter from the environment in buildings, its structural use has only developed over the past 150 years and as a formally structural material over the past 40-50 years.

Transparency however has always played a role in the design with glass and often design was driven by the aim to optimise and increase the transparency of a structure. As I.M. Pei expressed it in relation to the design of the Louvre Pyramid; Pei explicitly stated that the design objective for the pyramids was transparency: *“The scope for the structural engineer, as bluntly expressed by the architect I.M. Pei, was that of building a structure as transparent as technology could reach”* (Knoll, 1990)

The use of glass can be categorised into the following 4 categories:

- 1 Glass to brace a steel frame
 - a Informally (Glass is used to brace slender iron structures despite the fact that no means of analysing it's performance was available)
 - b Formally (Glass is used to brace a steel structure and provide lateral stability knowingly and with a good understanding of the load path)
- 2 **Tertiary:** Glass transferring wind loads
- 3 **Secondary:** Glass supporting itself
- 4 **Primary:** Glass as a primary structure

Chapter Four

Given the manufacture and processing of glass and its availability as a sheet material, its connectivity becomes the primary importance in its design, both from an architectural and engineering perspective because:

- 1 Connections, particularly if discrete, induce large stress into the glass
- 2 Connections are typically opaque and hence have a significant impact on the design language

Common forms of glass connections are not transparent and typically involve the use of other materials than glass. This means that the design and appearance of a glass structure is largely defined by the way it is connected.

A significant evolution can be noted in the way glass is being connected from the first use as an infill material to its use as a structural component supporting itself but also other materials or building components.

A differentiation in typology can be made between linear and discrete connections, describing the occurrence of the connection made, which will lead to a difference in appearance.

Within each typology the following categories occur:

- 1 Bearing connections
- 2 Friction connections
- 3 Bonded connections

Whilst bearing and friction connections typically rely on an opaque material on the surface of the glass or embedded within it to transfer the load, bonded connections provide the opportunity to achieve fully transparent connections either by:

- 1 Use of a transparent adhesive
- 2 Use of heat (heat bonding)

To date fully transparent connections have primarily been explored on an experimental basis, although few built examples using transparent bonding materials (primarily UV and Cast in Place (CIP) resin) exist.

Chapter Five

The approach of using a heat-based process, which could be described as welding or more precisely heat bonding, is a common process in the manufacture of laboratory ware for chemical testing and analysis.

Typically, this is a manual process, in which glass is heated and then bonded and formed to its final shape. The basis for this process is extruded borosilicate tube material and solid rods.

This approach has been explored and tested on an experimental basis as relates to its applicability to flat glass for building applications.

Various connections were manufactured using flat borosilicate as a base material and the standard equipment available in a scientific glass blowing lab (burner and lathe) utilising custom jigs that allow to fit flat glass into the lathe.

Prior to experimental testing of the connections themselves, the impact of a thermal bonding process on the material properties was assessed. It was found that residual stress induced during the bonding procedure can be released through an annealing process and results suggest that both, stress levels and distribution are comparable with as received glass. These results are only indicative and limited to the capacity and tolerances of the measurement equipment as well as the quality and quantity of the specimens tested. Furthermore, tests have not been carried out on full size specimens, so further research is required to verify the applicability of the results to full scale building components.

Chapter Six

Following this assessment, the strength of the connections was assessed through fracture-mechanical testing. The results suggest that it can be assumed that heat bonded connections can be as strong as the parent material if manufactured accurately and annealed sufficiently. However, as with the residual stress tests, these results are only indicative, as the number of specimens tested and the scale of the specimens tested is not sufficiently representative to the architectural scale of connections required to make a fully conclusive statement.

The performance of welded connections is currently undergoing comprehensive testing at the Technical University of Darmstadt (Seel, Akerboom, 2018) and it is expected that further conclusions can be drawn following these tests.

Whilst the implementation of heat bonded connections appears theoretically feasible, the exploration of this field is at its very beginning and further research is required to assess the implementation of the process into glass fabrication and processing.

This does not only include the scalability of the connections and technology but also involves considerations around transport, handling, installation, the accommodation of building movements and tolerance as well as maintenance, replacement and recyclability.

Whilst many of the factors described appear to be feasible, there is currently and within the scope of this research no possibility to assess this in practice, as the fabrication of connections to assemble full scale components has not been possible as part of this research.

As relates to the quality of the connections themselves, the manual process used for their fabrication in this research, bears a high risk, as it is relying on manual control of temperatures and pressure when establishing the connection, hence achieving fully homogeneous connections that are geometrically consistent. Due to the brittleness of the material, this in turn might lead to a reduction in capacity, as stress concentrations might occur around areas of inconsistency.

Chapter Seven

The practical implementation from a design perspective must consider redundancy, which is a common aspect of glass engineering and which can be approached similarly to the way it is commonly approached when designing with glass, by introducing

- 1 A safety factor and hence over-designing connections
- 2 Additional connections and additional means of connection like the lamination with polymer interlayers
- 3 Designing to allow a secondary load path should the primary load path be compromised
- 4 Risk management: evaluating the risk of failure and the risk of potential damage in case of failure. This includes the categorising of risk for the use of the application i.e. a public building or highly trafficable structure like a stair in a commercial application would require a larger amount of built-in redundancy than a balustrade in a private house.
- 5 Engineering precision: The more detailed the load path and the loads and building movements are understood, the smaller can the margin be for a safety factor. Detailed FE analysis and well understood loading criteria are the basis for this approach, which is typically used in other industries of high performance engineering like aviation and automotive industries.

The fundamental improvement that the heat bonding process offers over traditional glass connections is that it allows to reduce the amount of visible edges, as the material is not only bonded on the surface, but an atomic bond is achieved. This increases the perceived transparency, as the reflection is limited to the external surface.

In addition to the physical possibility and verification of the feasibility of heat bonded connections, jurisdiction related to the design of building structures needs to be considered locally and globally. Given that structural glass engineering is a relatively young discipline, very few codes and guidelines specific to the material are available. Despite the initial results, suggesting that heat bonded connections can be as strong as the parent material and hence could be designed based on established material values, it has to be assumed that the sufficient homogeneity of the bond is not achievable in a manual process. The use of laser technology appears to provide a good opportunity to improve the quality in the bond and in the appearance, due to a much smaller area that is exposed to the temperature impact compared to a manual

welding process. Other issues around fabrication and quality control might also be resolved with the implementation of laser technology; however, this has not been assessed in this research and the judgement is purely based on the application of comparable technology in the connection process of glass in different fields. Fibre optics are relevant here and particularly a laser based gravity bending process that is being used on a comparable scale to the specimens tested in this research.

When assessing design possibilities however, it is understood to be of fundamental importance to evaluate a technology at full scale.

Various concepts were developed for the design applicability of heat bonded connections, which theoretically (verified through initial design analysis) appear to be feasible, however it was not possible to translate them into full scale physical studies.

During the time of this research, transparent structural silicones became commercially available and particularly a Transparent Structural Silicone Adhesive (TSSA) which is a sheet material produced by Dow. Although TSSA has various limitations in its processing, i.e. the requirement for autoclaving under temperature impact to trigger the curing process, the fabrication of transparent connections with TSSA was more accessible, hence some of the concepts outlined for a heat bonding process were tested using a transparent adhesive and specifically TSSA.

The case studies outlined in the Appendices to this document indicate the degree of transparency achievable with transparent structural bonds.

When connecting glass to glass with a transparent bonding material, it is primarily the colour of the glass that is visible, mostly through the reflection of light on the edge that is being connected.

This reflection of light on the glass edge is the fundamental difference in the appearance of heat bonded connections compared to a transparent adhesive bond. This is where heat bonding can achieve a higher degree of perceived transparency than adhesive bonds.

Due to the availability of long term test data for silicone materials in relation to the application with glass in buildings, it is assumed that the transparent structural silicones might offer a faster and more reliable route for the implementation of fully transparent connections, despite the limitation that a fully transparent appearance to the degree heat bonding can achieve is not possible.

8.2 Discussion of the Research Question and sub-questions

The following section discusses the answers to the primary research question and the sub-questions that are supplemental to the main question.

With heat bonded glass connections which criteria increases the perceived transparency and what is their potential for implementation in the design of glass structures?

Heat bonding is a process that is commonly used to connect glass to glass in the fabrication of glass laboratory ware. It is a traditional craft carried out to fabricate, repair and customise laboratory ware and other equipment for use in chemical laboratories. This trade is typically referred to as scientific glass blowing, which as opposed to traditional glass blowing that is used to produce art pieces, cups and vessels from molten glass, uses a pre-fabricated base material. Typically, this is industrially manufactured borosilicate as tubes and rods which are then fabricated into chemical instruments and laboratory containers.

The manual heat bonding process is carried out by first preheating the two components to be connected, then locally heating them to working temperature at which they are physically connected. To avoid cracking after the connection is made, the glass is cooled in a flame with lower heat before an annealing process in an annealing lehr to release the locked-in residual stress.

Transparency as such is the physical property of allowing light to pass through the material without being scattered. Light interacts with matter in different ways. Metals appear shiny while water is transparent. So is clear glass. The optical properties observed in glass can be described as a small number of general phenomena. The simplest group being reflection, absorption and transmission.

Glass is transparent, but it is not colourless. Conventional soda lime float glass has a slight green tint caused by the iron content in the raw material (silica sand whilst the boroxide in borosilicate leads to a very slight yellow appearance.

The appearance of the colour is a result of the reflection of light spectrum that is not transmitted. For soda lime glass, the green spectrum is reflected, which leads to the greenish appearance. This is particularly visible on the edges of a glass panel, which is why structures with larger panels and less visible edges appear more transparent even if the VLT of the glass itself might be the same.

The amount of opacity created by the connections is what typically defines how transparent a glass structure appears. The smaller the connections themselves and the lower their frequency of occurrence, the more transparent the structure. For the connections themselves, assuming the glass is connected transparently, the transmission of sunlight is a primary factor; However, in addition its reflection plays a role. Firstly, because the colour of the reflected light makes the colour in the body of the glass visible. This is due to the absorption of certain spectra, which is defined by the composition of the glass; glass with lower iron content for example appears less green, as less of the green spectrum is reflected. Borosilicate glass has a tendency towards the yellow appearance due to the boroxide included in the melt. In addition to the visibility of colour, the reflection of light on the glass makes the glass edges visible as non-transparent surfaces. The more glass edges are visible the lower the perceived transparency.

When using heat bonded connections, the two surfaces of glass are melted together to become one component that is not only bonded or fused on the surface, but fully connected through the thickness of the material. This atomic bond reduces the perception of the glass edge as a reflective surface, which typically becomes visible in glass structures that are traditionally connected, as the light reflects off these surfaces. This effect cannot be achieved with transparent adhesive bonds like TSSA or UV curing resins and is the primary factor that differentiates the appearance of transparency in heat bonded connections from the appearance of other transparent bonds.

The material appears as one homogeneous component and despite visible distortions around the bond that are a result of the manual welding process, the reduction in reflection on the edge of the glass increases the perception of transparency within the connection when compared to transparent adhesive bonds.

The potential for implementation is limited within the process itself, size constraints of single components, as well as accommodation of movement on site.

Whilst the results of this research suggest, that theoretically the process of fabricating heat bonded connections is feasible, the assessment was limited to a limited number of small scale specimens, which were manually fabricated, leading to

inconsistency of the connections and hence in the test results. Significant amount of further research is required to fully evaluate the performance of heat bonded connections as relates to their structural capacity.

Further to this, the translation into a commercially viable fabrication process would require significant amount of further research and verification, despite the assumption that a heat based process could be integrated into current glass processing procedures.

A possible limitation requiring additional evaluation is the stiffness and brittleness of the connections, which significantly limits the amount of movement and tolerance that can be accommodated on site. Furthermore, component dimensions will be limited to sizes that can be handled and transported in one piece, assuming the manufacturing of the connections will have to be carried out as part of the thermal treatment in a controlled factory environment.

These however are limiting factors that can be accommodated in the design of the interfaces with the substructure, hence should be seen as a material inherent design criteria rather than a technological limitation. Using the specific example of a glazed corner which would become a very stiff component should the joint be heat bonded, movement could be accommodated at the perimeter of the panel with the majority of it as well as any installation tolerances in areas that are not visible i.e. base shoe and head connection. In this respect the brittleness of the connection can be seen as an opportunity for the development of typologies in the design of structural glass that will overall lead to greater transparency in the connection and as a whole.

Whilst heat bonded connections are visually advantageous over transparent adhesive connections due to the reduction of reflection on the glass edges, the limitations of the process and the performance of the connections themselves might mean that the commercial implementation of high performance transparent adhesives such as TSSA is more likely to occur in the near and semi-distant future.

What are the most important properties for the application as building material in respect to its physical attributes, its material origin and the characteristics defining transparency?

Glass is one of the oldest building materials known and it has been used continuously for more than 1000 years due to its transparency and the ability to provide a skin to buildings allowing light inside and views out. The ability to transmit light is a result of its molecular structure, which as opposed to metals and other solids is amorphous rather than crystalline. Whilst glass is theoretically very strong – about 50 times as strong as steel-, its practical strength is limited due to structural defects and surface scratches that reduce particularly its bending strength significantly (30-80 MPa for annealed glass).

This means, that the processing of the glass and the quality of the edges, where cuts have been made, is of fundamental importance to the quality of the material and to its design strength.

As an inert material, glass is often used in chemical laboratories and for processes where its corrosion resistance is required due to the use of highly reactive substances.

Its transparency is the property that differentiates glass from most other building materials. There are various factors that affect the perception of transparency, however its basic metric is the quantity of light that passes through a material, which can be described as transmission. In addition to the transmitted light, there is a percentage of light being reflected and absorbed. The absorbed light is what is visible as colour in the glass, which plays a significant role in the way we perceive its transparency.

In which categories can the structural use of glass be characterized?

Glass has gone through a development from being an infill material for openings in a wall (window) to a structural material. Up to 150 years ago, glass was primarily used in windows, without any structural function. The first structural application of glass can be observed in the slender Victorian greenhouses which were infilled with glass, bracing the wrought iron profiles. This was done unknowingly though, as at the time no means to establish the behaviour of the materials structurally were available. This can be described as an informal structural use of glass. It took another century before the first formally structural use of glass in the Lehmbruck Museum in Duisburg as a base supported glass fin wall (1964) and on the Centre Point Bridge as a suspended armour plate glazing (London, 1965). From then on, more experimentation with glass as a structural material can be observed.

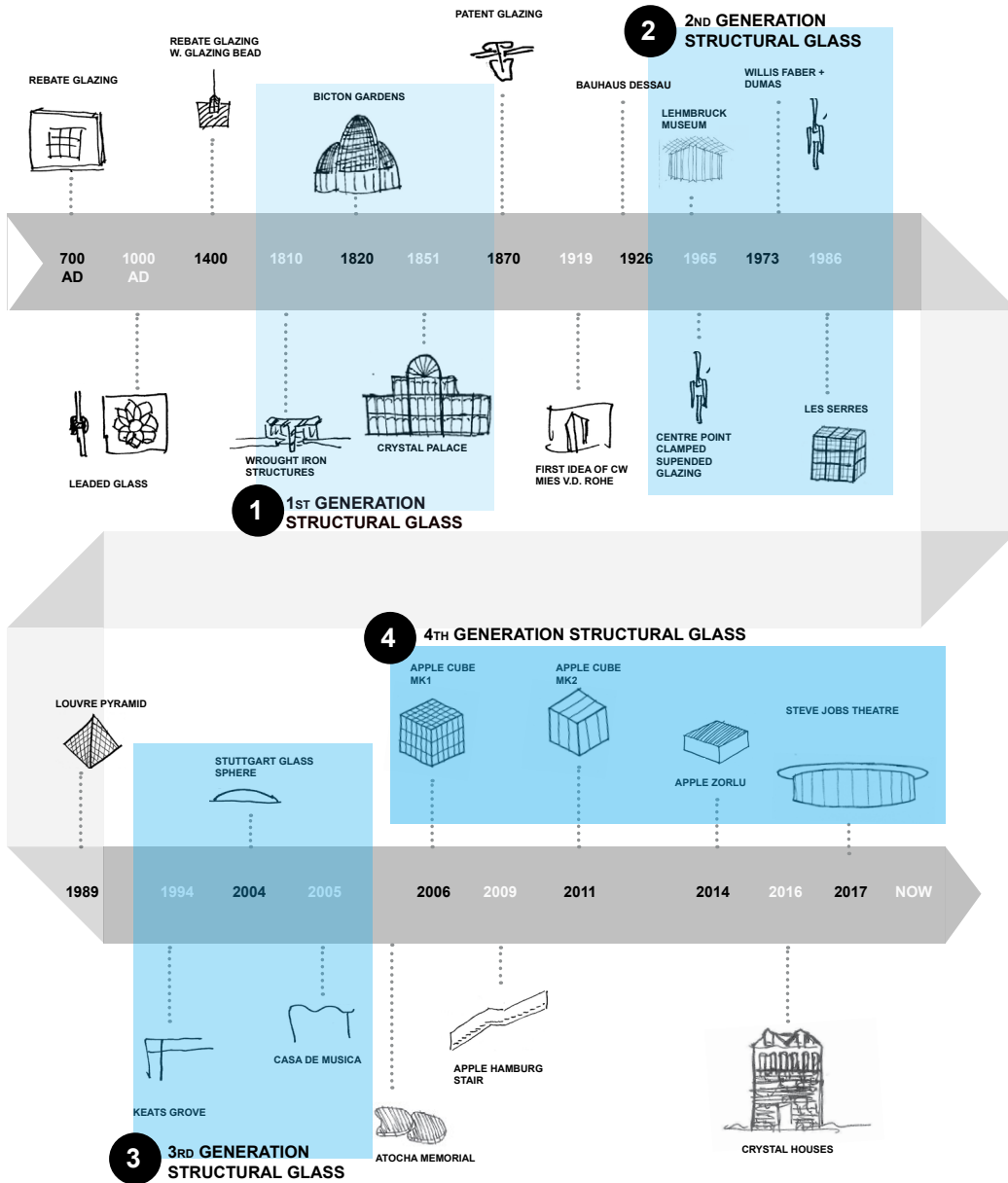

FIG. 8.1 Time line Glass in architecture

The structural use of glass can be categorised in 4 categories:

- 1 Glass to brace a steel frame
 - a Informally (Glass is used to brace slender iron structures despite the fact that no means of analysing it's performance was available)
 - b Formally (Glass is used to brace a steel structure and provide lateral stability knowingly and with a good understanding of the load path)
- 2 **Tertiary:** Glass transferring wind loads
- 3 **Secondary:** Glass supporting itself
- 4 **Primary:** Glass as a primary structure

The use of glass as a fully self-supporting structure or even as a primary structure supporting itself and other materials or components is a very young field of application that has only emerged in the past 15-25 years.

With which techniques are glass connections solved commonly in contemporary glass structures and with which of these can the transparency of glass connections be enhanced?

Glass connections can be categorised into linear and discrete connections and within each of these the following three sub categories can be noted:

- 1 Bearing connections
- 2 Friction connections
- 3 Bonded connections

For a long time (from the mid-1970's to 2010's) primarily discrete connections were used in structural applications to connect glass to glass and transfer loads from one glass panel to the adjacent one. This led to a distinct architectural language of glass structures that was primarily defined by the connections, typically referred to as point fixed glazing, as –due to the transparency of the glass itself- these are the obviously visible part of the structure. This is different for Curtain Wall applications where linear connections are the most common way of connecting glass to the substructure or framing.

Currently still, most commonly bearing and friction connections are used to connect glass and to transfer load from one glass panel to another or from the glass into the building structure. However, bonded connections have become more common, particularly the use of structural silicone, which now is a typical way of connecting glass to glass in 'specialist' or 'advanced' structures. Other bonded connections have

evolved and have been explored in recent years. Most tested and used in commercial applications is the use of Sentry Glas to bond a titanium fitting typically referred to as 'insert' into a laminate. To achieve the integration of this fitting within the glass build-up, the glass is machined to accommodate the fitting within a multi-ply laminate and during the lamination process it is then encapsulated by the interlayer. The Sentry Glass interlayer transfers the load into the insert and it can then locally be transferred into the bordering fitting and back through the Sentry Glas into the adjacent glass. This could be a connection of a glass tread to a stair stringer or a facade panel to a glass fin, the principle followed is that the load is locally transferred through the titanium fitting.

Transparent adhesive bonds are being explored but have primarily been used in experimental structures. When used in commercial applications, these are primarily structures in which the UV bond is used in compression (Atocha Memorial, Madrid; Crystal Houses, Amsterdam) and shear through wind load is only a minor factor. Transparent structural silicones which have become commercially available recently, particularly as a sheet material (TSSA) has been explored in experimental structures, but currently no commercial application is available, although this material offers great potential for achieving transparent structural bonds.

Using fully transparent bonds is the first way of enhancing transparency within the connection. However, even with a very thin bond, the reflection of light on the bonded edge will still be visible. To avoid the reflection on the edge to be bonded, the bond is required to be a full atomic material bond in which the molecules of one surface connect and form a bond with the molecules of the other surface. This can be achieved with a heat bonding technique which is basically a form of welding that is used in the fabrication and alteration of laboratory ware for chemistry labs.

What is the impact of heat bonding on the physical properties of glass relevant to its structural use and specifically in relation to residual stress?

This research focuses on the effect of heat bonding on the surface stress of the glass as well as the strength of the connections fabricated. The effect of the process on other mechanical properties, such as scratch resistance etc.. has not been established.

Due to the very high temperatures the glass is exposed to in the heat bonding process (up to 1200°C for borosilicate) this causes a stress differential on the surface of the material. This is an effect which is common in thermal strengthening

of glass as well, when due to the spacing of the cooling nozzles in the tempering process, a stress pattern becomes visible on the glass. As long as the differential between neighbouring stress fields within a panel is not larger than the capacity of the glass, this is not critical and primarily a visual issue, however when differentials extend the capacity of the material, this will lead to fracture.

Strain optical measurements comparing the residual stress prior to temperature impact, directly after the temperature impact and after annealing suggest that through the subsequent annealing process, the stress induced during the heat bonding can be released evenly for components with little geometrical complexity. For more complex geometries, only spot checks were carried out after the bonding process and no conclusion can be drawn at this point. Although it is assumed that stress release through an annealing process is more challenging for geometrically complex components, it is a common process to release locked-in stress from doubly curved panels fabricated in a gravity bending process.

What is the strength of heat bonded connections in relation to the strength of the parent material?

The results of the three different set-ups tested in this research (4-point bending, RoR, pull out) suggest that the connections could be as strong as the parent material if they are manufactured without inclusions and geometrical inconsistencies.

Results of the 4-point bending tests typically show a strength similar or higher than the parent material, despite connections being manually manufactured and hence inclusions and inconsistencies occurring within the bond. It is assumed that the results are driven by the fusing of the glass edges due to the welding process which might have increased the edge strength of the glass in comparison to the AR specimens.

Whilst this is a good indication, the quantity of specimens tested is not sufficient to provide fully statistically relevant results and should only be used as an indication. Further research and testing is required to provide more significant results. The impact of inclusions and geometrical inconsistencies on the performance of the connections requires further studies as well, which were not part of the scope of this research.

What are the opportunities and limitations for the application of transparent connections in respect to Design, Fabrication, Installation and End of Life?

The limitations for the implementation of heat bonded connections currently lie within the scalability of the process itself, however, it is assumed, given that thermal processing is a standard procedure in the glass industry, a heat bonding process could be included. This might add additional steps like an annealing process after the bond is manufactured, but theoretically this should be achievable.

Handling transport and installation limitations apply to heat bonded components as much as to any other glass components.

The major difference between a heat bonded connection and either a mechanical connection or the bond with a structural adhesive, is its brittleness and hence the lack of ability to accommodate building movement as well as construction tolerances. However, this should be understood as an inherent material characteristic and therefore an opportunity for the development of typologies that allow the accommodation of movement and tolerances at the interface with the support- and / or building structure.

Redundancy is an important design criteria when working with glass, as due to the brittleness of the material breakage has to be assumed as a possible scenario. Post failure performance must be considered when glass is used as a structure.

To achieve redundant connections, increasing either the quantity or the size of connections is required to achieve additional capacity, but in a scenario of complete failure this would not lead to sufficient redundancy, hence additional means of connection must be accommodated. This is not uncommon when designing glass to become a structural component. Typically, the use of a stiff interlayer that will prevent collapse of the component even if all layers of glass are fractured. It is assumed that connections would be designed such that the interlayer would provide sufficient post fracture capacity should the heat bonded connection fail. When considering end of life scenarios, heat bonded connections have a significant advantage over traditional structural glass connections, as the bond is formed by glass only. This means no additional material is used that requires breakdown or that could contaminate the glass melt in a recycling process. The glass component including its connections can be introduced in the recycling process without additional separation prior to that.

From a design perspective heat bonded connections offer great potential, as no other material than glass is required to form a fully atomic bond. Due to the reduction of reflectivity of the bonded edge this leads to an elimination of the visibility of the glass edge which in turn achieves greater perceived transparency of the structure.

Heat bonded connections offer a potential for the development of glass connections as relates to the typology of the connection which can be seen as a significant potential for the progression of design typologies for glass structures and their connectivity and hence the transparency achievable as a whole.

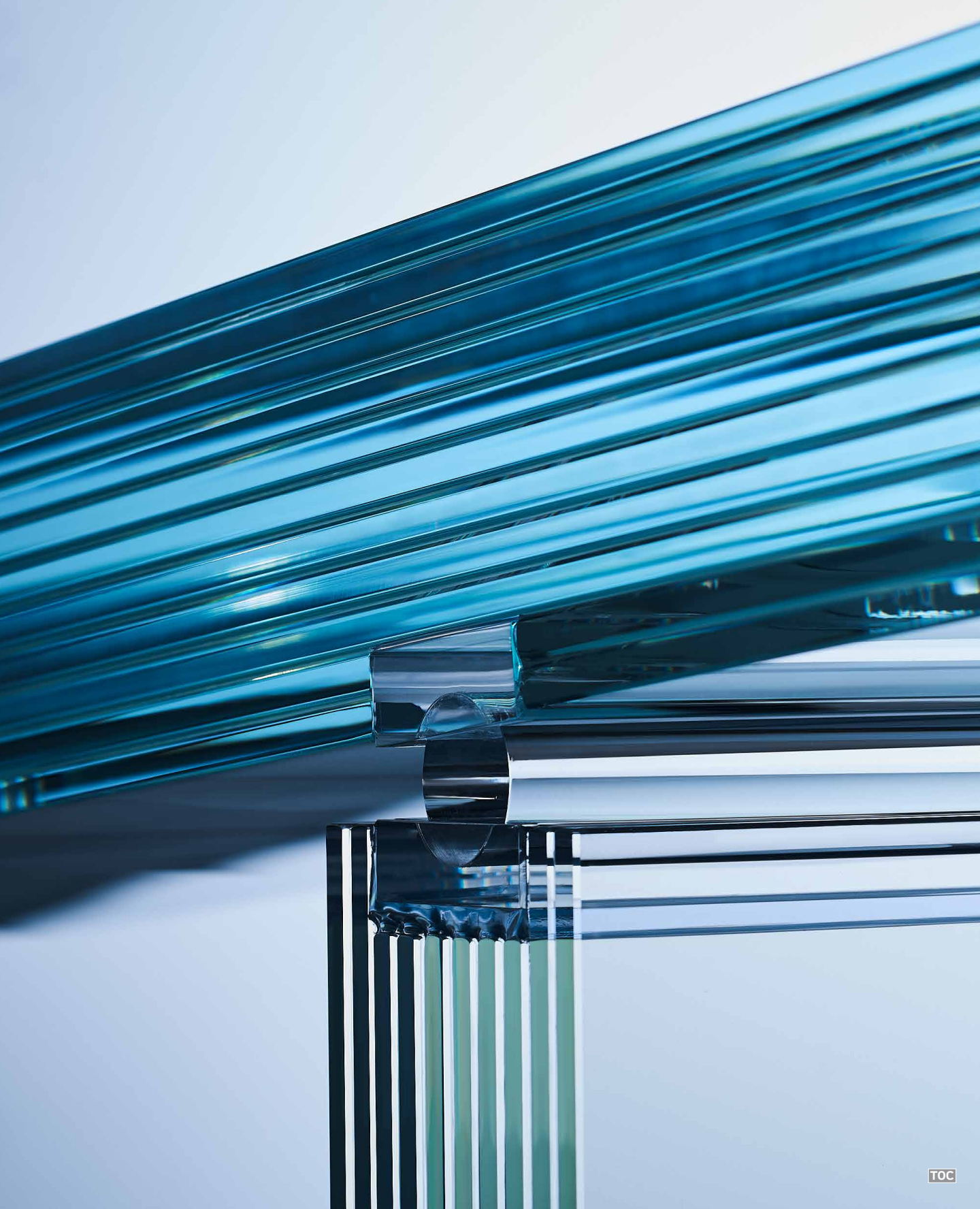

Appendices

Case Studies

1 Glass tubes CTF Museum Hong Kong

The initial design of the facade for the CTS Museum in Hong Kong designed by SO-IL with Eckersley O'Callaghan (3.3.3) was based on full tubes, so extruded borosilicate tubes were explored as an option (Figure APP.A.3).

Large glass tubes are used in other industries, i.e. for solar collectors where they are filled with oil storing heat generated by solar radiation or in chemical applications, when piping needs to be resistant to chemicals, which metal tubes typically can't provide.

The production of these tubes is a vertical drawing process in which the glass runs through a circular mould and is then gravity drawn to its full length. This is primarily a gravity based process, but tolerances and wall thickness can be controlled by the speed the drawing process is carried out at.

Whilst large diameter tubes are available as a standard product, with the possibility of increasing the diameter further, the length at which they could be produced, in this case was limited by the height of the fabrication space. As an increase in length would have required to increase the space downward and basically build an additional basement around the production line, this was not feasible for this project.

Typically, the tubes are fabricated in 3m segments which can then be welded into longer pipe segments. Given the availability of the process, this approach was explored and sample welds were produced for visual assessment (Figure APP.A.1 and Figure APP.A.2).



FIG. APP.A.1 Welded glass joint from above



FIG. APP.A.2 Welded glass tube fabricated by Schott



Given that the glass tubes are typically used in applications where the optical quality, transparency and distortion is not a primary criteria, the welds achieved were very visible due to the visual distortion that was created at the connection point. Due to the initial results an alternative approach was required.

Inspired by the approach of the early Apple stores using a splice lamination process to increase the length of glass fins, a similar approach was explored.

The concept in the schematic in Figure APP.A.4 indicated a splicing of 3 full tubes which would be surrounded with split tubes at slightly larger radius cut either in halves or three parts.

This approach was tested with a Sentry Glas interlayer as it was assumed that it would be able to take up tolerances due to its high viscosity during the lamination process.

However, dimensional tolerances in the tubes were significantly larger to flat glass tolerances, which is a result of the gravity production process and hence the first tests led to fracture. Schott had previously tested liquid resin lamination for smaller tubes, however the process also did not immediately prove translatable to these very tall units with large diameter, as the two component develops heat which can lead to fracture if the entire tube cannot be filled fast enough.

Although all parties involved were confident that with continued testing the splice lamination with either process could be achieved including an adjustment on the achievable tolerances in the glass production process, this was not achievable within the project schedule.



FIG. APP.A.3 3m long extruded borosilicate tube (Schott)

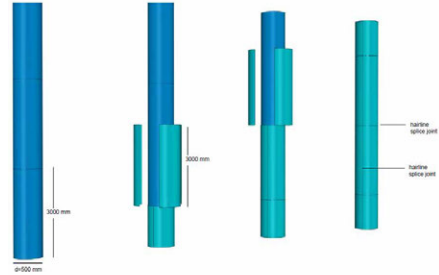

FIG. APP.A.4 Splice lamination schematic

After the initial tests with borosilicate tubing turned out to be not achievable without compromising the project schedule and the design, a gravity bending method of flat soda lime was explored. Glass manufacturer Cricursa, who had made the initial panels for the Casa da Musica (3.3.2) did not have a furnace large enough to bend the 9 m tall panels, but were able to extend their furnace to be able to produce 9m tall semi circles, two of which would form each full tube.

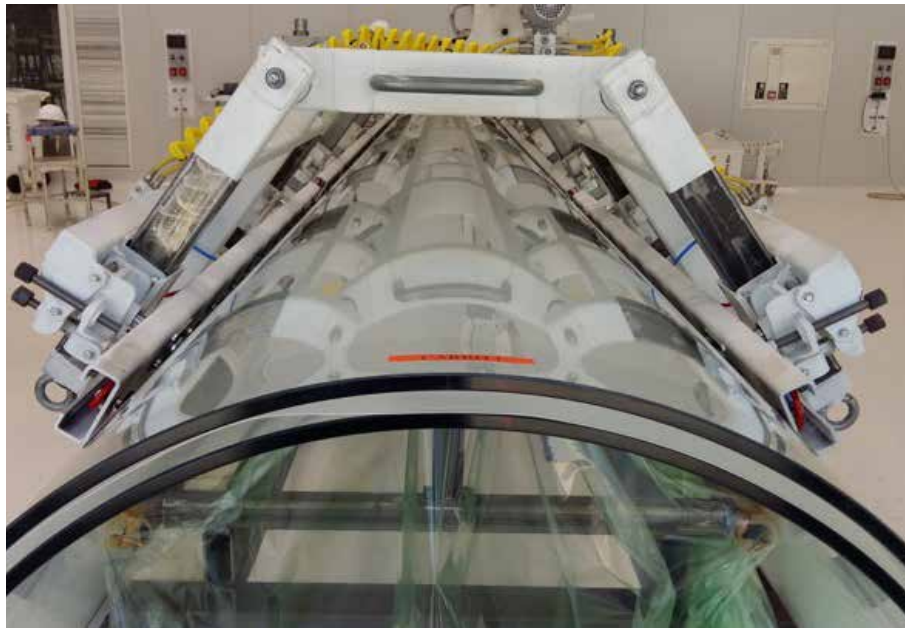

FIG. APP.A.5 Assembly of the tubes with Interlayer prior to lamination process (Cricursa)

The two sheets that would be laminated together were curved in the same mould using a release agent between the panels, so that surfaces would not fuse together. Given the length and tight radius of the semi-circular glass, handling equipment had to be developed that allowed the manufacture and processing of the tubes (Figure APP.A.4)

Given that annealed glass was used special care had to be taken during the annealing process to make sure all locked in stress was released and the distribution of residual stress on the panels was homogeneous (Rammig et al, 2015).

A test procedure was set up to measure residual stress as part of the QA/QC process. Chapter 5 of this document provides further information about residual stress measurements on annealed glass.



FIG. APP.A.6 Initial glass mock-up at the factory



FIG. APP.A.7 Visual mock-up with full and half tubes

To avoid condensation within tubes, a CCF approach was taken and tested by Seele, where a continuous flow of dry air would be fed into the tubes to prevent any surface condensation and dirt settlement within the cavity. During the development process, most full tubes were replaced by half tubes in which case the detail was amended to make the glass edges visible (Figure 3.62).

This project shows the technical feasibility of mono-material connections at a project scale and although these connections were not implemented, a proof of concept for the welded connection could be achieved. For the project schedule, development to achieve the required visual quality and length was not fast enough, however, it is assumed that with further investment and time for research and process adjustment, the initial concept could have been achieved.

2 Slide @ Glasstec 2016

Executive Summary

The transparency of glass structures is fascinating and daunting at the same time. The emotional distrust towards a transparent material opposes the rational knowledge that the material would be sufficiently strong to form a structure.

Recently, glass has increasingly been used as a structural component. However, its inherent brittleness still requires opaque metal connections to transfer loads, which commonly are stainless steel or titanium. These connections define contemporary glass architecture – firstly, because they are immediately apparent in a transparent structure and, secondly, as they are part of the engineering design language. However, designers and architects are still aiming to increase the transparency of building envelopes and structures, hence there is a strong demand to reduce the visibility of structural connections in glass.

In particular glass staircases have gained popularity in recent years, forming transparent structural features within buildings. Due to the loads they have to carry, coupled with safety regulations, these structures traditionally consist of many layers of glass, laminated into thick packages and then connected with opaque metal fittings.

This chapter discusses a novel approach to transparent connections for treads on a case study project- not a staircase but a glass slide with glass treads, bonded to the curved glass stringer with a transparent structural silicone creating a minimal and entirely transparent glass structure.

Introduction

Glass has always fascinated the creators of buildings due to its inherent defining property – transparency. From mystical spaces in Gothic cathedrals, to today's transparent building envelopes; glass continues to be a major design component in architecture.

In the past century, glass has increasingly been used as a structural component. However its inherent brittleness still requires opaque metal connections to transfer loads, which commonly are stainless steel or titanium. These connections define contemporary glass architecture – firstly, because they are immediately apparent in a transparent structure and, secondly, as they are part of the engineering design language. However, designers and architects are still aiming to increase the transparency of building envelopes and structures, hence there is a strong demand to reduce the visibility of structural connections in glass.

In particular, glass staircases have gained popularity in recent years, forming transparent structural features within buildings. Due to the loads they have to carry, coupled with safety regulations, these structures traditionally consist of many layers of glass, laminated into thick packages and then connected with opaque metal fittings.



FIG. APP.A.8 Typically glass structures consist of many layers of glass, connected with opaque fittings that transfer the load.

Structural adhesives have become more and more common in facade applications, where loads are transferred from glass-to-glass, or from glass to supporting structure, through silicone. Transparent structural adhesives, however, have been mainly explored on an experimental basis and are not often found in building applications.

In parallel to the development of structural glass design, architects have developed more and more organically-shaped buildings, leading to increasingly demanding requirements for the size and shape of the materials used for cladding.

This is also extended to the glass, a material that is traditionally produced as a flat element. Due to its inherent brittleness, glass has to be heated to curve to tight radii. Several curving technologies allow for different sizes and curvatures to be achieved. Automated curving ovens, shape and toughen the glass at the same time. The glass is placed on adaptable rollers inside a kiln that can form a radius down to approximately 1000mm. While the kiln heats up and the glass softens, the rollers bend it into shape. Then the glass is quenched, similar to a standard toughening process to create a stress differential through the thickness of the material, leading to higher allowable stress and therefore greater strength of glass.

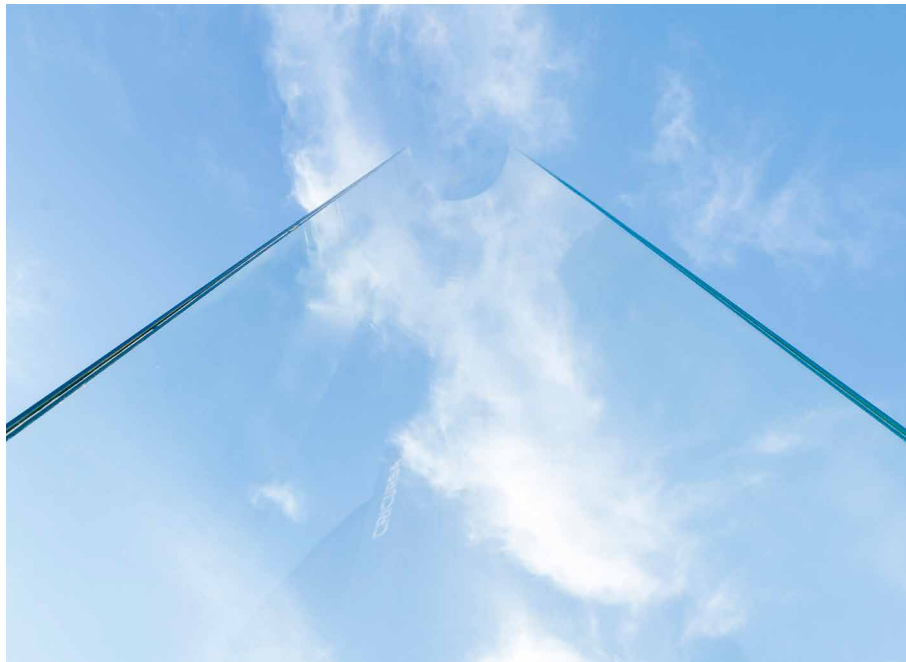

FIG. APP.A.9 Curved glass prior to installation

Due to the limitations of this process, very tight radii and double curvatures cannot be easily achieved. An alternative is a gravity bending process where flat glass sheet is placed over a mould and heated up in a kiln to slump the softening glass over the adapted the shape. Rather than rapidly cooling to achieve a pre-stress, the glass requires a slow annealing process to release any stress that has been induced in the process.

This bending process not only shapes the glass, but also increases its stiffness by adding structural depth whilst the material strength remains at the level of annealed glass.

Design process

The installation described here is intended to showcase the technical possibilities of curving and connecting glass as well as to expressing the beauty and transparency of the material at its best. In collaboration with Cricursa, Eckersley O'Callaghan have developed the design of a glass slide, which was exhibited at the glasstechnology live exhibition at Glasstec 2016.



FIG. APP.A.10 Exhibition of the slide at glasstechnology live

Curving the flat sheets to a very tight radius (450mm) makes them inherently stiff, meaning that the glass can span 9 metres in this triangulated configuration with only 2 layers of 10mm glass.

As a comparison, a flat glass would require approximately 10 layers of 10mm glass, to achieve a similar performance over the span of 9 metres.

Adding this amount of thickness to the glass reduces transparency significantly due to the increased absorption, so reducing the thickness of the glass by introducing a curvature increases the light transmission by 20% compared to the thicker flat build-up. Visual light transmittance however, is not the only factor playing a role in the appearance of a transparent object. The colour plays a very important role in the perception of transparency. The smaller the perceivable tint in a glass, the more transparent the glass appears. Even on a glass with a reduced iron content as used in this installation, a tint is existent, which becomes more visible, the more layers of glass are stacked.

The concept was to develop a structure that described a very simple shape while being functional and pure in its design language, using as little visible connections as possible.

Two half cylinders, leaning against each other in an asymmetric manner form the slide. The only visible connection of the two pieces is formed by a 12mm silicone joint at the top.

Structural concept

Structurally the installation works as a three-pinned arch, which is held at the bottom in stainless steel shoes connected to a continuous steel frame.

To make sure that a flush sliding surface would be achieved, the stainless steel shoes are located on the underside of the glass only. Dead load is supported through the rebate at the bottom of the shoe, which is bonded to the glass with structural silicone (DC 993).

The treads on the ladder part of the slide, are solid borosilicate rods that are machined to adapt the shape of the cylinder and fixed with a transparent silicone adhesive (TSSA). This material is much stronger than traditional structural silicone and can therefore be used in very thin layers. However, to achieve a sufficient bond, pressure and temperature are required, which means the connections require curing in an autoclave similar to common polymer interlayers.

TSSA had previously been tested on glass-metal connections [3], however, glass-glass connections had not been formed. Due to the complexity of exactly fitting a glass rod at a specific location into a cylindrical glass, which has fabrication tolerances up to 7mm, several design options were considered.

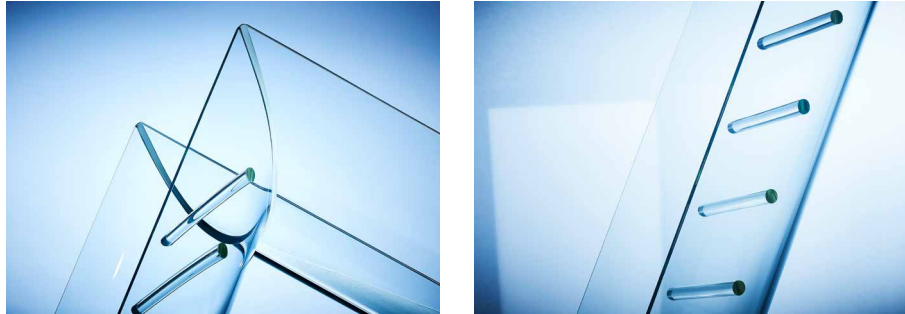

FIG. APPA.11 Connection at the top (grey structural silicone (SG 500) and at the treads (TSSA)

Using metal connections that would locally be laminated to the cylinder and then allow a ‘hooking on’ of the glass rods. This option was considered, as the lamination of the continuous glass rods requires very precise analysis of the existing glass geometry and significant amount of machining and adjustment of every single glass rod to achieve a close fit. The metal fittings would be more forgiving, as tolerance could be taken in the connection between metal fitting and glass rod.

Another advantage of the metal connection was the fact that it would have allowed for more movement inside the connection, reducing the stress concentrations in the glass bars. However, further to the desire to achieve transparent connections, which would have been compromised significantly by this approach, due to the requirement of an external fabricator supplying the metal fittings this options was not feasible.

Another option considered to reduce complexity with the TSSA connections was to notch the inner layer of glass to create transparent supports for the treads, which would have allowed movement again. A transparent silicone ring was suggested to provide friction between tread and glass support.

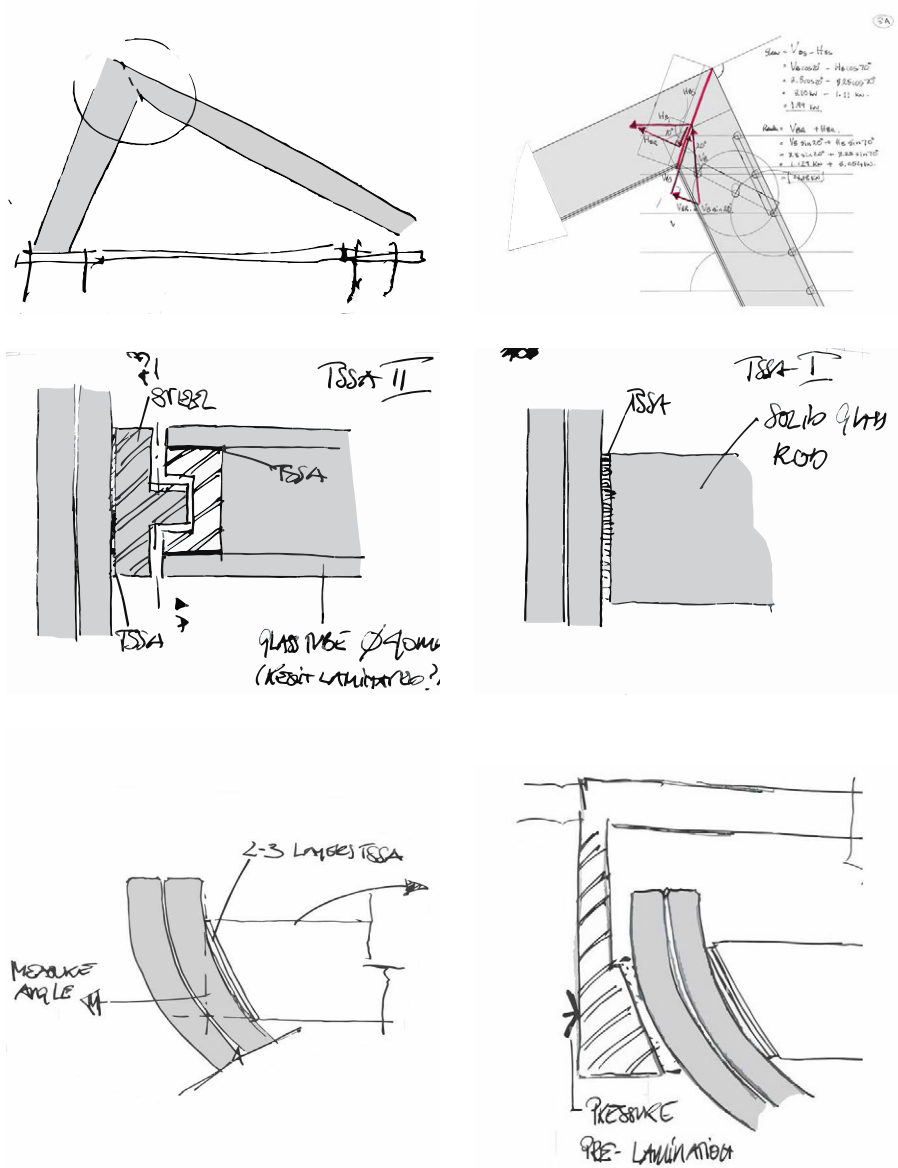

FIG. APP.A.12 Design and connection development

Although this option provided significantly simpler support conditions, the complexity of the bending process would have increased, as the glass would have to be notched prior to the bending process, which would have made the geometry of the support dependant on the precision of the curving process. Although this option

would have allowed for transparent connections, it would have compromised the simplicity of the design by adding complex shapes, exposing glass edges towards the inside of the slide, leading to increased reflection and refraction and reducing the perceived transparency of the construction.

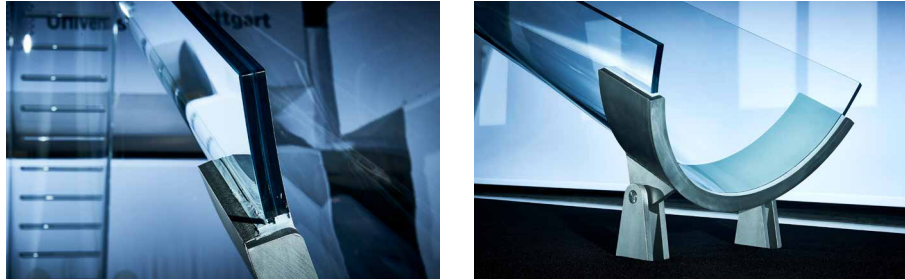

FIG. APP.A.13 Base detail with stainless steel shoe fixed to glass surface with structural silicone

Fabrication

The two main parts of the slide consist of two sheets of 10mm low iron glass each, laminated with 1.52 mm of SG.

To achieve the very tight radius of 450mm, the glass is bent in a gravity process over a steel mould. To achieve a good fit of both glass layers in the subsequent lamination process, both panels are bent together at a temperature of approximately 600°C. In an annealing cycle, in which the glass is cooled down from bending temperature to room temperature very slowly, the stress induced into the panels during the bending is released.

After bending, the two glass panels are separated and a polymer interlayer, in this case Sentry Glass Plus (SG) is placed in between. The bond is achieved by temperature and pressure for which the glass is placed in an autoclave.

After the lamination process, the top glass edge was polished to assure that the two glass edges that were to be siliconed together at the top were exactly perpendicular. This was possible due to the use of annealed glass. The treads had to be laminated in a separate step to better control quality during the lamination process and achieve maximum accuracy.

Testing

Due to the novelty of the fabrication method, components and materials used, physical testing was carried out on critical components.

The borosilicate treads are a non-typical component for architectural glazing, hence it was important to fully understand their fracture strength and breakage behaviour. To evaluate this, a 4-point bending test has been set up to test the flexure strength.

The test was set up to represent the actual conditions; the rods were tested on a 900mm span with supports at quarter points.

Given the limited time and material available, 10 specimens were tested, which were provided by Schott for this purpose.

Figure APP.A.14 shows the test set-up with a 4-point bending jig supporting the glass at 700mm and loading at quarter points. Given the circular shape of the specimens, a retention detail was adopted, assuring that the rods would stay in place on the rollers (Figure APP.A.15). To avoid direct contact between the glass and the steel jig, an aluminium strip was used as a separator between rollers and glass as well as glass and retention detail.

To be able to assess the fracture caused by the test rather than additional fractures caused by the rod hitting the ground, a soft support was created under the jig, avoiding further fracture of the glass (Figure APP.A.16).

Load and displacement were monitored through the test and the results are presented in Figure APP.A.18.



FIG. APP.A.14 Test set-up in 4 point bending jig



FIG. APP.A.15 Glass support on roller with sliding support for rod



FIG. APP.A.16 Fractured glass rod



FIG. APP.A.17 Fractured face of glass rod

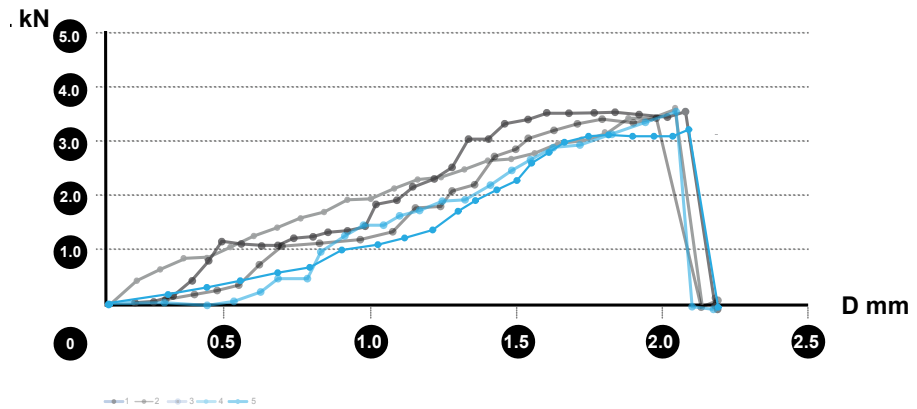

FIG. APP.A.18 Load displacement diagram on the tested specimens

The load displacement diagram of the tested specimens indicates a fracture under loads in the range of 3.4–3.6 kN on a 700 mm span. This relates to an average strength of 43 MPa which is very close to the assumed design strength of 45 MPa for annealed glass (2.4).

Deflection over the span is very small between 1.8 and 2.2mm max. (Figure APP.A.18).

TABLE APP.A.1 Test result summary

Specimen	Load [kN]
1	3.55
2	3.61
3	3.42
4	3.54
5	3.22
Mean load	3.47
SD	0.14

Summary

The goal of this case study was to design a glass structure using a minimum amount of material and connections to showcase the beauty of transparency that glass as a material offers.

Connections are reduced to a minimum and don't penetrate the glass surface which makes them less apparent because the continuous reflectivity of the surface is maintained where the shoes sit behind the glass. The 12mm silicone joint that connects both pieces at the top has a minimum visual impact due to the simplicity and linearity of the connection as well as the very apparent role it takes in connecting the two tubes together.

On the ladder, where a large number of connections occur, these are kept transparent, making it difficult to distinguish between the tube and the glass rods; they become one transparent component.

Most importantly however, a design has been developed, that allows reducing the amount of material used and increasing the transparency of the structure by making use of the geometrical stiffness gained by bending the glass into a tight curve.

The clarity achieved with this approach is significantly higher than using flat glass to span without additional support. This leads to the conclusion that the use of geometrical stiffness might be a useful approach for the design of glass structures, either by introducing stiffness through small amounts of cold bending, or for the work with thin and ultra-thin glass, which requires a design approach that limits the flexibility of the material. The significantly increased strength of these high strength ultra-thin glasses would allow curvatures to be introduced even through cold bending and might to even larger transparency.

The transparent silicone connections between two pieces of glass achieved for this experimental structure require further testing particularly relating to long term performance in weathered conditions to evaluate the appropriateness for long-term building applications. Further experimental testing is suggested on the actual connections as currently test data is only available for glass-metal connections.

Acknowledgements

The Author would like to thank Schott for the provision of glass rods to determine the structural performance in 4-point bending tests as well as Dow Corning for the provision of TSSA sheet material as well as extensive test results relating to the ageing of the material.

Further to that, the author would like to thank the engineering department of the university of Cambridge for the provision of test equipment and Cricursa for the collaboration on the execution of the project.

3 Seesaw @ Glasstec 2018

In order to show the state of the art processing capabilities for glass, in combination with a fully transparent design, a concept for a glass seesaw was developed with sedak to be exhibited at the Glasstechnology Live exhibition at Glasstec 2018 in Duesseldorf, Germany.

As previous experimental structures had shown that the interaction with a structure raises awareness and interest (Appendix A-2.), the concept of playful experiences with glass was continued.

Spanning 10 metres, the seesaw features a beam that weighs 1.3 tonnes yet moves weightlessly on its central pivot. Both components of the seesaw's assembly consist of multi-ply laminates bonded with SentryGlas, with the beam tapering from a thickness of 11 layers at its centre to just two at each end. Acrylic blocks machined to form bearings are fixed into the laminated glass assembly with a clear two-component epoxy adhesive, while silicone oil reduces friction within the bearing. The result is a fully transparent mechanism that allows the seesaw to gently dip and rise.

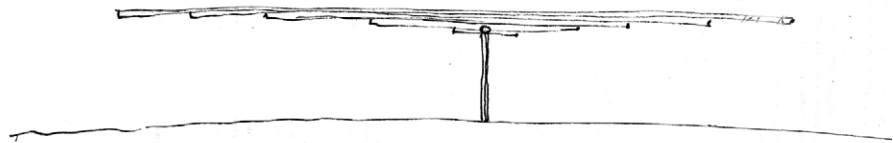

FIG. APP.A.19 Initial sketch GlasWippe

Structurally the design is significantly more simple than the slide or the stair design previously described, as the beam is simply supported on the bearing. Complexity primarily lies in the precision of the fabrication to allow the mechanism to function smoothly.

With a width of only 400 mm the beam is incredibly shallow. To avoid deflection under self-weight, the beam is designed to be thicker at the centre and taper out towards the edges, which at the very end only consist of two layers of glass. The glass steps are machined at a 45 degree angle and at 500mm spacing over the length of the beam, showing the precision of polishing possible.

The central support consists of 10 plies, each 10 mm thick, of which the middle 6 are stepped short, creating a pocket in the lamination process (1.1.5) in which the bearing is then bonded with a two-component UV curing epoxy resin.

Similarly, at the centre of the beam, two plies are cut back to create a pocket for the upper part of the bearing to be incorporated. Given that the connection is primarily in compression and very little torsion is applied only in case of a lateral impact to the seesaw, the brittleness of the epoxy resin is not considered problematic.

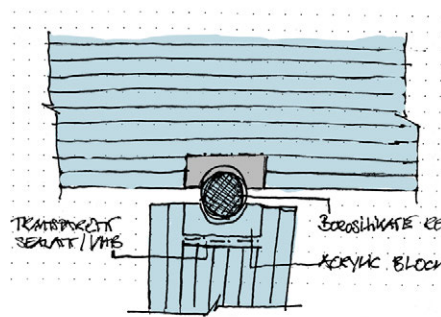

FIG. APP.A.20 Detail of central acrylic bearing block

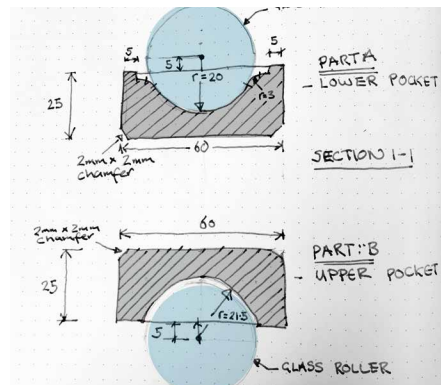

FIG. APP.A.21 Acrylic bearing block and rod

The initial design considered a borosilicate rod to be used as the bearing, as it is used in the treads of the slides, however, due to manufacturing tolerances on the rod (+/- 2mm over the length of 400mm) it was not considered feasible. Instead an acrylic rod was used, machined to fit the bearings precisely, leaving only 0.2 mm between rod and bearing. To guarantee smooth movement a clear silicone oil is used as a lubricant. It was found that a considerable amount of lubrication and movement was required to avoid squeaking of the bearing.

The assembly was the next critical item, as the functionality of the seesaw depended on the lifting of the beam onto the bearing precisely.

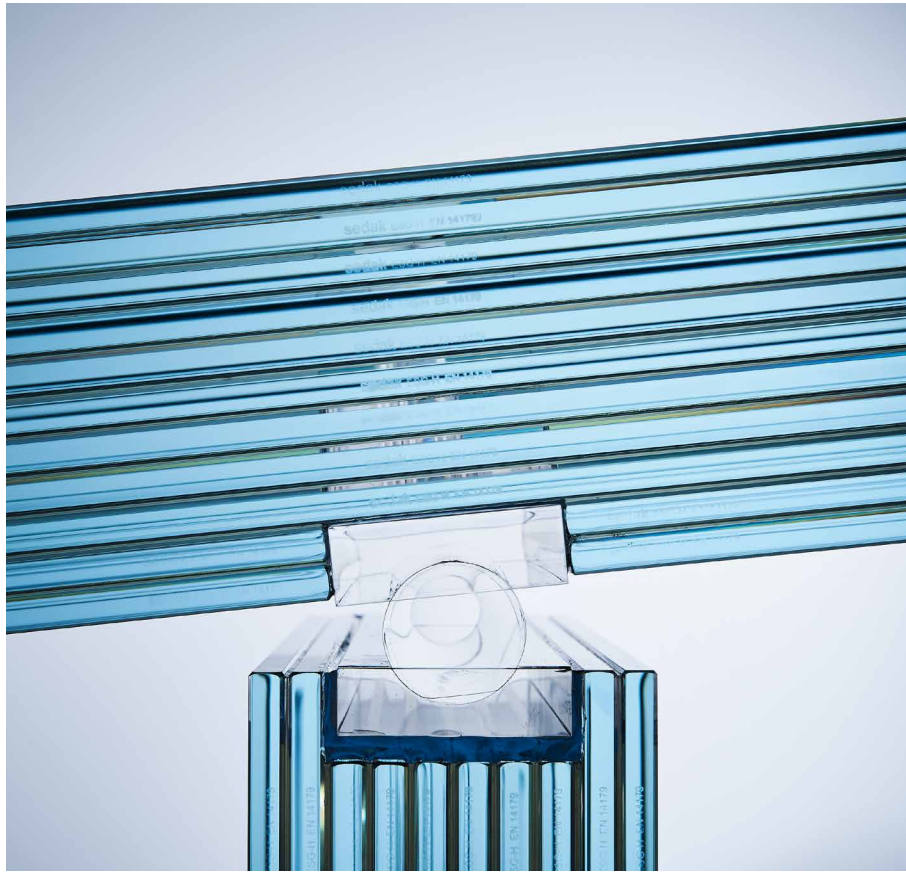

FIG. APP.A.22 Transparent composite pivot connection

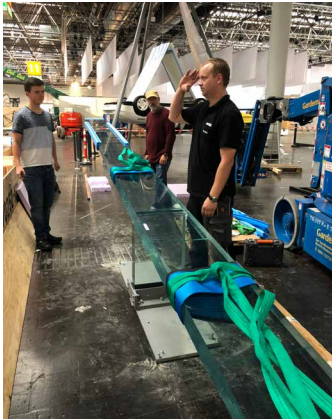
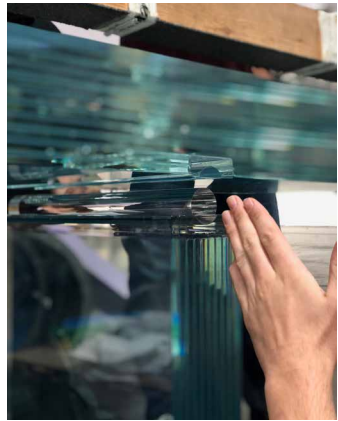
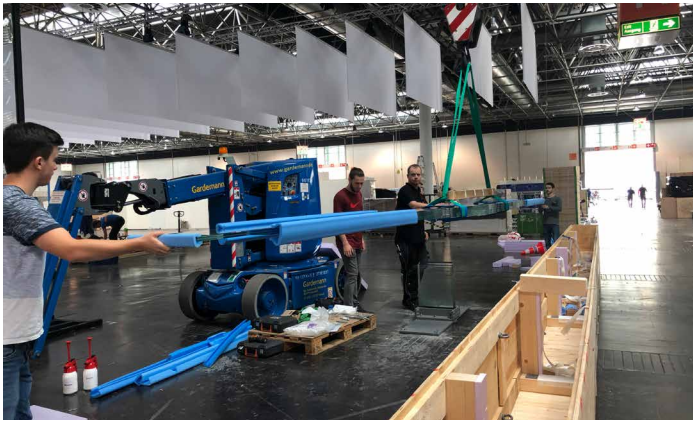
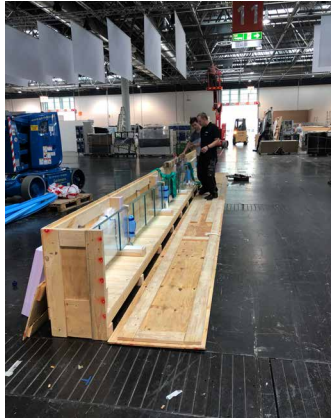
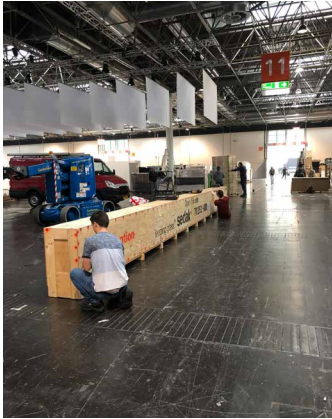

FIG. APPA.23 Installation and test run

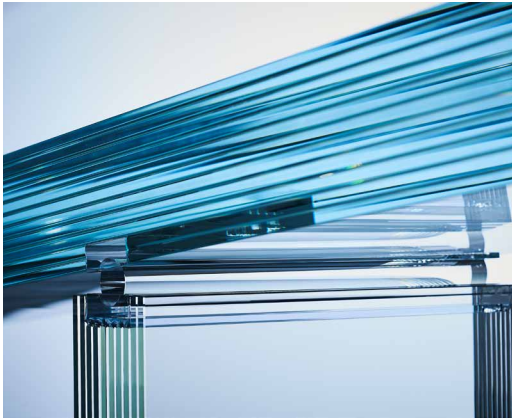
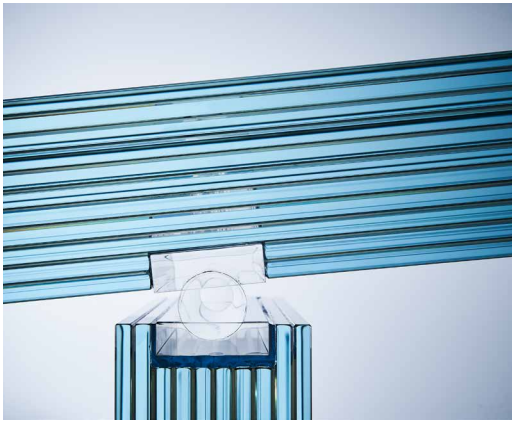

FIG. 8.2 Finalised seesaw installed at BAU Munich, 2019

Terms

Term	Symbol	Formula	Description	Unit
Annealing			The process of removing stresses by cooling the material slowly	
Annealing point			The temperature at which the internal strains in glass are reduced to an acceptable limit.	oC
Amorphous structure			As opposed to crystalline structure, atoms are not ordered	
Bending Strength	$f\sigma$		Bending strength, also known as flexural strength or modulus of rupture, is a material property, defined as the stress in a material just before it yields in a flexure test.	
Coefficient of thermal expansion	α	$\alpha = \frac{1}{L} \frac{dL}{dT}$	Most materials expand when they are heated. The thermal strain per degree of temperature change is measured by the linear thermal-expansion coefficient.	10 ⁻⁶ /K
Compressive strength	$c\sigma$		The normal stress at which a material, loaded in compression, crushes.	MPa
Covalent bonding			Covalent bonding is a form of chemical bonding that is characterized by the sharing of pairs of electrons between atoms	
Density	ρ		Mass per unit volume	Kg/m ³
Elasticity			Ability to take up expansion	
Endurance limit			The stress level below which a specimen will withstand cyclic stress indefinitely without exhibiting fatigue failure	
Fatigue ratio			The ratio of maximum cyclic stress to tensile strength	
Fracture toughness			The ability of a material containing a crack to resist fracture	
Glass Welding			See Heat Bonding	
Hardness	Hv		Resistance to permanent deformation	Vickers
Heat Bonding	HB		Connecting a material with the influence of heat only. In case of glass, the two components to be connected are heated to Transition temperature before being locally, in the areas to be connected, heated to softening temperature and then moved together to achieve a bond. (Also see Glass welding)	
Isotropy			The property of being independent of direction	
Yield strength (elongation 0%)	σ_y		The stress at which a material begins to deform	MPa
Young's modulus	E	$E = \sigma/\epsilon$	Measure of the stiffness of a material	MPa

>>>

Term	Symbol	Formula	Description	Unit
Poisson's ratio	ν	$\nu = -\epsilon_x / \epsilon_y$ $\epsilon_x = \Delta L_x / L_x$ $\epsilon_y = \Delta L_y / L_y$	When a material gets stressed, it will get thinner in one direction. This ratio gives a relative strain normal to the load, divided by the strain in the direction of the load.	
Refractive index	n		Ratio of speed of light through a vacuum and the speed of light through the material	-
Softening point			The temperature at which glass will elongate under its own weight.	$^{\circ}\text{C}$
Specific heat	C_p	$C_p = \Delta U / \Delta T$	The energy to heat 1 kg of material by 1°C	$\text{J}/\text{kg}\cdot\text{K}$
Strain	ϵ	$\epsilon = \Delta L / L$	The deformation of materials caused by stress	-
Strain point			The temperature at which the internal stresses in glass are reduced to low values in approximately 4 hours	$^{\circ}\text{C}$
Tensile strength	σ_t		The normal stress at which a material, loaded in tension, separates. Fracture strength.	MPa

References

- Aben, H., Anton, J., et al. (2010). On non-destructive residual stress measurement in glass panels, in *Estonian Journal of Engineering*, 16, 2, p150–156
- ABT Ingenieurs in Bouwtechniek (n.d.). Kasteel Ruurlo. doi: www.abt.eu/projecten/kasteel-ruurlo.aspx.
- Anderson, A. (2012). *Separation of Laminated Sheets*, Somerville, Australia.
- ASTM Standard C1401-09a, (2009), *Standard Guide for Structural Sealant Glazing*, Annual book of ASTM Standards, ASTM International, West Conshohocken, PA.
- Aurik, M. (2017). *Structural Aspects of an Arched Glass Masonry Bridge*, Delft, Netherlands.
- Baldini, A.; Lenk, P.; Rammig, L. (2015); *Temperature Effects on curved annealed glass*, Glass Processing Days, Tampere, Finland.
- Baldini, A.; Rammig, L. (2016); Santasiero, M.; *Structural assessment of temperature-dependent glass components: a contribution towards a systematic methodology*, in *Engineered Transparency*, Duesseldorf, Germany.
- Behling, S., Behling, S. (2000). *Glass: Structure and Technology in Architecture*, Prestel.
- Belis, J. et al. (2006). *Seamless Connection of Soda-Lime Float Glass by Welding: Preliminary Test Results*. In: *International Symposium on the Application of Architectural Glass*, Munich, Germany.
- Blandini, L. (2016). *Transparent, Complex, Sustainable Challenges for Contemporary Facade Engineering*. In: *Challenging Glass Conference*. Ghent, Belgium.
- Borger, A., Supancic, P., Danzer, R. (2002). The ball on three balls test for strength testing of brittle discs: stress distribution in the disc, *Journal of the European Ceramic Society*, vol. 22, no. 910, pp. 1425 - 1436.
- Borom, M. (1980). *De Mechanische en Chemische Aspecten van Glasverbindingen*. In: *Mikroniek*.
- Bos, F.P. (2009). *Safety Concepts in Structural Glass Engineering*. PhD thesis. Delft. ISBN: 978-90-8570-428-7.
- Bos, F.P., Giezen, C., et al. (2008). *Opportunities for the Welding and Hot-Shaping of Borosilicate Glass Tubes in Building Structural Applications*. In: *Challenging Glass Conference*, Delft, Netherlands.
- Bourhis, E. (2014). *Glass: Mechanics and Technology*. Wiley, London, UK.
- Brow, R.K. (n.d.). *Summary of Chapter 6, Viscosity, of Introduction to Glass Science and Technology by J.E. Shelby*. url: http://web.mst.edu/~brow/PDF_viscosity.pdf.
- Brown, A. (2001). *Peter Rice, The Engineer's Contribution to Contemporary Architecture*, Thomas Telford Publishing, London, UK.
- Bullseye Glass Co. (2009). *TechNotes 1 to 7. A Technical Supplement from Bullseye Glass Co.* August 2009. Bullseye Glass Co.
- Campbell, J., Tutton, W. (eds), (2014). *Staircases: History, Repair and Conservation*, Routledge, London, UK.
- Celarie, F., Prades, S., Bonamy, D., Ferrero, L., Bouchaud, E., Guillot C., Marliere, C. (2003). *Glass breaks like metal, but at the nanometer scale*, *Phys. Rev. Lett.*, vol. 90, p. 075504, Feb 2003.
- Choudhery, M.K., Potter, R. M., (2005). *Heat Transfer in Glass-Forming Melts*, Chapter 9, In: *Properties of Glass- Formation Melts*, eds: Pye, D.L., Montenaro, A., Joseph, I., CRC Press, Boca Raton, USA
- Christensen, R. (2013). *The theory of materials failure*. Oxford University Press.
- Ciccotti, M. (2009). *Stress-corrosion mechanisms in silicate glasses*, *Journal of physics D: Applied physics*, vol. 42, no. 21, p. 214006.
- CWCT (2007). *Technical Note No 56 Accommodation of structural movement*, CWCT Bath, UK.
- CWCT (2019) *Technical Note No 95: Weathertightness of windows, doors, window assemblies and curtain walls (pp12)*, CWCT, Bath, UK.
- Dispersyn, J., Belis, J. (2016). *Numerical Research on Stiff Adhesive Point-Fixings between Glass and Metal under Uniaxial Load*. In: *Glass Structural Engineering*. Cham, Switzerland: Springer International Publishing.

- Dossett, J. and H. Boyer (2006). Practical Heat Treating: Second Edition. Novelty, United States of America: ASM International.
- Dow Corning (2014a). Dow Corning 121 Structural Glazing Sealant, Product Information.
- Dow Corning (2014b). Dow Corning 993 Structural Glazing Sealant, Product Information.
- E. Bourhis. (2014) Glass: Mechanics and Technology. Wiley & Sons, London, UK.
- Electrotherm Electrical & Metal Products Ltd. (2018). High temperature Box Furnaces. url: www.electrothermindustry.com/High-Temperature-Box-Furnaces.
- EN 1288-2 (2000). Glass in building - determination of the bending strength of glass - part 2: Coaxial double ring test on specimens with large test surface areas.
- EN 1288-3 (2000). Glass in building - Determination of the bending strength of glass - Part 3: Test with specimen supported at two points (four point bending)
- EN 1288-5 (2000). Glass in building - determination of the bending strength of glass - part 2: Coaxial double ring test on specimens with small test surface areas.
- Fessler, H., Fricker, D. (1984). Multiaxial strength tests for brittle materials, The Journal of Strain Analysis for Engineering Design, vol. 19, no. 3, pp. 197-208.
- Fluegel, A., (2007), Glass Viscosity Calculation Based on a Global Statistic Modelling Approach, In: Europ. J. Glass Sci Technol. A, vol. 48, no.1, p.13-30
- Fluegel, A., et al., (2005), Statistical Analysis of Glass Melt Properties for High Accuracy Prediction: Density and Thermal Expansion of Silicate Glass Melts. In 79.Glastechnische Tagung der DGG, Wuerzburg, Germany
- Gardon, R. (1956). The Emissivity of Transparent Materials. In: Journal of the American Ceramic Society.
- Giezen, C. (2008). Development of a Structural Element of Glass with Glass Welding Processes, Delft.
- GlasStress (n.d.) Scattered Light Polariscopes SCALP Instruction Manual, Ver. 5.5. GlasStress Ltd.
- Hagl, A. (2012). Tensile Loading of Silicone Point Supports - Revisited. In: Challenging Glass
- Hagl, A. (2016). Development and Test Logistics for Structural Silicone Bonding Design and Sizing. In: Glass Structural Engineering. Springer International Publishing, Cham, Switzerland.
- Haldimann, M., Luible, A., Overend, M. (2008). Structural use of glass, Structural Engineering Document no. 10, International Association for Bridge and Structural Engineering, IABSE.
- Hartsuijker, H. Wellerman, F. (2007). Journal of Civil Engineering, and Geosciences, Mechanics of Structures: CT4145/CT2031 : Module: Introduction Into Continuum Mechanics. TU Delft, Netherlands.
- Hasselmann, D.P.H. (1969). Unified Theory of Thermal Shock Failure Initiation and Crack Propagation in Brittle Ceramics. In: Journal of the American Ceramic Society.
- Heller, P., J.C.G. Vervest, and H.F.Wilbrink (n.d.). Vademecum voor de Glastechniek. Leiden: Leidse Instrumentmakersschool and Kluwer Technische Boeken BV.
- Het Nederlandse Normalisatie-instituut (2011). NEN -EN 1991-1-1-2+C1: Belastingen op constructies- Algemene Belastingen - Belasting bij Brand.
- Het Nederlandse Normalisatie-instituut (2014). NEN 2608 - Vlakglas voor Gebouwen – Eisen en Bepalingsmethode.
- Hix, J. (1996) The Glasshouse, London: Phaidon
- Imanaka, Y. (n.d.) Advanced Ceramic Technologies & Products. SpringerLink : Bucher, Springer, 012.
- Jacobs, E. (2017). Structural Consolidation of Historic Monuments by Interlocking Cast Glass Components, Delft, Netherlands.
- Janssen, M., Zuidema J., Wanhill, R. (2004). Fracture Mechanics, Second Edition. Taylor & Francis.
- Kim J., Kim, D. Zi G., (2013). Improvement of the biaxial flexure test method for concrete. Cement and Concrete Composites, vol. 37, pp. 154-160.
- Klein, J., Oxman, N. (2015). Additive Manufacturing of Optically Transparent Glass. Cambridge, United States of America.
- Knaack, U., Klein, T., Bilow, M. & Auer, T. (2007). Facades: Principles of construction, Birkhäuser, Berlin, Germany.
- Kohlmaier, G., v Sartory, B. (1991). Houses of Glass, A Nineteenth-Century Building Type, Schmidt, C., Schoenherr, W. et al (1989). performance Properties of Structural Silicone Adhesives in Science of Glazing Systems, ASTM, Philadelphia.
- Krom, D. de (2014). Glazen Serre Kasteel te Ruurlo, Berekening Glasconstructies. Delft, Netherlands.
- Kupfer, H., Hilsdorf, H., Rusch, H. (1969). Behavior of concrete under biaxial stresses, in ACI Journal proceedings, vol. 66, ACI.

- Leidse Instrumentmakersschool (n.d.) Glasinstrumentmaken. Leiden, Netherlands.
- Liddell, I. (2000). Large environmental enclosures, the roof of the millennium Dome, in *Widespan Roof and structures*, Michael Barnes (Edit.)
- Louter, P.C. (2011). *Fragile yet Ductile*. PhD thesis. Delft. ISBN: 978-90-8570-743-1.
- Mecholsky, J. (1994). Quantitative fractographic analysis of fracture origins in glass, in *Fractography of Glass* (R. Bradt and R. Tressler, eds.), pp. 37-73, Springer US.
- Meyer Boake, T. (2012). *Understanding Steel Design: An Architectural Design Manual*, Birkhaeuser, Basel, Switzerland.
- Michalske, T. (1994). Fractography of stress corrosion cracking in glass, in *Fractography of Glass* (Bradt R., Tressler, R., eds.), pp. 111-142, Springer US.
- Mitchell, G. (n.d.). How is curved glass made? url: www.sciencefocus.com/science/how-is-curved-glass-made.
- Mitchell, J. (2015). *Precision Air Entrapment through Applied Digital and Kiln Technologies: A New Technique in Glass Art*. PhD thesis. Sunderland, United Kingdom.
- Molnar G., Molnar L., Bojtár I., (2012). Preparing a comprehensive analysis of the mechanical classification of structural glass, *Materials Engineering-Materialove inzinierstvo (MEMI)*, vol. 19, no. 2, pp. 71 -81.
- Molnar, G., Bojtár, I. (2013). Effects of manufacturing inhomogeneities on strength properties of float glass, *Mechanics of Materials*, vol. 59, pp. 1-13.
- Morrel, R. (1998). *Biaxial flexural strength testing of ceramic materials*, A National Measurement Good Practice Guide no. 12.
- Neugebauer, J., Wallner-Novak, Wrulich, C., Baumgartner, M. (2018). *Movable Thin Glass Elements in Façades*, in *Challenging Glass 6*, TU Delft.
- Nijssse, R. (2003). *Glass in Structures*. Basel, Switzerland: Birkhaeuser – Publishers for Architecture. ISBN: 3-7643-6439-4.
- Nijssse, R. (2008). *Corrugated Glass as Improvement to the Structural Resistance of Glass*. In: *Challenging Glass Conference*, Delft, Netherlands.
- Nodehi, Z. (2016). *Behaviour of Structural Glass at High Temperatures*. Delft, Netherlands.
- Nooru-Mohamed, M., Schlangen, E., van Mier, J. (1993). Experimental and numerical study on the behavior of concrete subjected to biaxial tension and shear, *Advanced cement based materials*, vol. 1, no. 1, pp. 22-37.
- NSG Group (2013). *Technical Bulletin, Properties of Soda-Lime Silica Float Glass*. Toledo, United States of America.
- O'Callaghan, J. (2008). *Glass Structures from Stairs to Cubes*. In: *Challenging Glass Conference*, Delft, Netherlands.
- O'Callaghan, J., Bostick C., (2012). *The Apple Glass Cube: Version 2.0*. In: *Challenging Glass Conference*, Delft.
- Oikonomopoulou, F., Bristogianni, T., et al (2017). *The Construction of the Crystal Houses Facade: Challenges and Innovations*. In: *Glass Structures and Engineering*.
- Oikonomopoulou, F., Bristogianni, T., et al. (2016). *Challenges in the Construction of the Crystal Houses Facade*. In: *Challenging Glass Conference*. Ghent, Belgium.
- Oikonomopoulou, F., et al. (2014). *A Completely Transparent, Adhesively Bonded Soda- Lime Glass Block Masonry System*. In: *Journal of Facade Design and Engineering*.
- Overend M., Louter, C. (2015). The effectiveness of resin-based repairs on the inert strength recovery of glass, *Construction and Building Materials*, vol. 85, pp. 165 -174.
- Patterson, M. (2011). *Structural Glass Facades and Enclosures*, John Wiley & Sons, Hoboken, NJ, USA.
- Pepi, J. (2014). *Strength Properties of Glass and Ceramics*. SPIE Press monograph, SPIE Press.
- Petzold, H. Marusch, B. Schramm, *Der Baustoff Glas*, Verlag für Bauwesen Berlin, 1990
- QSIL (2018) doi: <https://www.demcon-kryoz.nl/references/thermal-management-3d-glass-printer/>
- Quinn, G. (2007). *Fractography of ceramics and glasses*. NBS special publication, NIST. Shelby, J. (2005). *Introduction to glass science and technology*. Royal Society of Chemistry.
- Quinn, G. (2012). *A history of the fractography of glasses and ceramics*, in *Fractography of Glasses and Ceramics VI*, pp. 1-55, John Wiley & Sons, Inc.
- Rammig, L (2016); *Residual stress in glass components*, *Challenging Glass Conference 5*, Ghent, Belgium.
- Rammig, L. (2011).; *Materialecht verbonden*; in *Glaswelt Spezial: Innovative Fuegetechniken*, Glaswelt 07/2011.

- Rammig, L. (2012). Direct Glass Fabrication - New Applications of Glass with Additive Processes. In: Challenging Glass Conference, Delft, Netherlands.
- Rammig, L. (2013) Direct Glass Fabrication in Pottgiesser/Strauss (Eds.) Product Development and Architecture, Birkhaeuser, Basel.
- Rammig, L. (2016); Residual stress as a result of heat impact in borosilicate glass components, in Intelligent Glass Solutions , London, UK.
- Rammig, L. (2016); Transparency through geometry - a case study, in IGS Winter edition, London, UK.
- Rammig, L. (2016). Residual stress in Glass Components. In: Challenging Glass Conference. Ghent, Belgium.
- Rice, P. (1996). An Engineer Imagines, Ellipsis, London, UK.
- Rice, P., Dutton, H. (1995). Structural Glass, Spon Press, London, UK.
- Richet, P et al. (1997). Configurational Heat Capacity and Entropy of Borosilicate Melts. In: Journal of Non-crystalline Solids.
- Rick Mather Architects (n.d.). All Glass Extension. url:www.rickmather.com/project/search/all_glass_extension.
- Saint Gobain (accessed 14th October 2017, 20.55 BKK time) (<http://uk.saint-gobain-glass.com/trade-customers/patent-glazing>)
- Schipper, R. (2011). Large Transparent Glass Surfaces. Delft, Netherlands.
- Schittich, C., Staib, G., Balkow, D., Shuler, M. & Sobek, W. (2007). Glass Construction Manual (second edition), Berlin: Birkhäuser
- Schittig et al. (1999). Glass Construction Manual. Birkhaeuser - Publishers for Architecture. ISBN: 978-3-7643-8122-6. Basel, Switzerland.
- Schott Borofloat 33, (2013). The Versatile Float Glass - With an Infinite Number of Applications, Product Specification Material, Schott 2013, www.schott.com/borofloat, accessed December 2015
- Schott Duran (accessed August 2016). Versatile or multifunctional: DURAN® borosilicate glass 3.3 tubes, rods and capillaries url:<https://www.schott.com/en-nz/products/duran>
- Sedak (2019) doi: <https://www.sedak.com/en/skills/logistics>
- Shelby, J.E., (2005) Introduction to Glass Science and Technology
- Shinkai, N. (1994). The fracture and fractography of glass, in Fractography of Glass (Bradt, R. Tressler, R. eds.), pp. 253-297, Springer US.
- Shorr, B.F. (2015). Thermal Integrity in Mechanics and Engineering. Heidelberg, Germany: Springer Verlag. ISBN: 978-3-662-46968-2.
- Sitte, S. et al. (2011). Preliminary Evaluation of the Mechanical Properties and Durability of Transparent Structural Silicone Adhesive (TSSA) for Point Fixing in Glazing, in Journal of ASTM International.
- Sitte, S. Brasseur, M, Carbary, L, Wolf, A. (2014). Preliminary Evaluation of the Mechanical Properties and Durability of Transparent Structural Silicone Adhesive (TSSA) for Point Fixing in Glazing, Journal of ASTM International, Vol. 8, No. 10, Paper ID JAI104084
- Solla, I. (2011). The Louvre pyramids revisited. url:facadesconfidential.blogspot.nl/2011/10/louvre-pyramids-revisited.html.
- specific-heat-solids-d_154.html.
- Stanworth, J.E., (1950), Physical Properties of Glass, Clarendon Press, Oxford, UK.
- Stelzer, I. (2010). High Performance Laminated Glass. In: Challenging Glass Conference. Delft, Netherlands.
- Takeuchi, T., K. Sugizaki, and K. Yasuda (2012). Design of Suspended Glass Ceiling Structure in High Seismic Hazard Zones. In: Challenging Glass Conference. Delft, Netherlands.
- Teeuwen, A.S. (2016). An Edge-integrated Connection for Segmented Glass Beams. In: Challenging Glass Conference. Ghent, Belgium.
- The Engineering ToolBox (n.d.). Specific Heat of Solids. url: www.engineeringtoolbox.com/
- Trosifol, (2019) Sentryglas Xtra Interlayer (SGX) product information
- University of Mittweida (2010) doi: http://laz.hs-mittweida.de/3_forschung/50_keramik/4_glasschweissen/ (accessed 21.05.2010/10.11.2019)
- Van Pelt, W. (2018). US Patent for Printer head for 3D printing Patent (Patent # 10,029,937), doi: <https://patents.justia.com/patent/10029937>
- Veer, F. , Zuidema, J., (2003). The strength of glass, effect of edge quality, in Glass processing days 2003, (Tampere Finland), pp. 106-109.
- Veer, F. (2007).The strength of glass, a nontransparent value, HERON, vol. 52, no. 1/2, pp. 87-104

- Veer, F., Bristogianni, T., Justino de Lima C., (2018). A Re-evaluation of the Physiochemistry of Glass on the Basis of Recent Developments and its Relevance to the Glass Industry. In: Challenging Glass Conference. Delft, Netherlands.
- Wang, Y. et al. (2009). Convective Heat Transfer of the Bunsen Flame in the UL94 Vertical Burning Test for Polymers. In: Journal of Fire Sciences.162
- Weibull, W. (1951). A statistical distribution function of wide applicability, Journal of applied mechanics, pp. 293-297.
- Weller, B. Tasche, S. (2010). Experimental Evaluation of Ultraviolet and Visible Light Curing Acrylates for Use in Glass structures, Durability of Building and Construction Sealants and Adhesives, 3rd Volume, A.T. Wolf, Ed., ASTM International, West Conshohocken, PA
- Whalley, A. (2000); The Eden Project glass houses world environment, in Widespan Roof and structures, Michael Barnes (Edit.)
- Wigginton, M.(1996) Glass in Architecture, Phaidon.
- Wurm, J. (2007). Glass structures: Design and construction of self-supporting skins. Berlin: Birkhäuser
- Wurm, J.(2007) Glass structures: design and construction of self-supporting skins. Walter de
- Yin, W., Su, E., Mansur, M., Hsu, T. (1990). Fiber-reinforced concrete under biaxial compression, Engineering Fracture Mechanics, vol. 35, no. 1, pp. 261-268.



Curriculum Vitae

Lisa Rammig

MA Arch MEng IFDC MSFE

Lisa leads the teams in Eckersley O'Callaghan's San Francisco and Los Angeles offices. She joined EOC in 2013 to support the practice's emerging facade engineering group in London and played a significant role in the group's exceptional growth. In 2017 Lisa moved to San Francisco to grow the studio and its presence on the West Coast after spending significant amount of project-related time in the Bay-Area over the previous years.

Responsible for the successful expansion of EOC's West Coast presence, in 2020 Lisa established a new office for the practice in Los Angeles and leads many of the group's most challenging projects including high profile corporate campuses in California working with Google, Apple and LinkedIn.

Through her education and relationships within the European Facade Network(EFN), she remains heavily involved in academia and has built strong links between research and industry.

Lisa has the responsibility for directing Eckersley O'Callaghan's R&D efforts globally, focusing on innovative glass design and technology which maintain the practice's position as leaders in the field, but also identifying new fields of research including a variety of materials and novel analysis approaches.

She has built strong relationships with their most prestigious clients which include Apple and Google, both located in the San Francisco bay area.

Through her education and relationships within the European Facade Network, she remains heavily involved in academia and has built strong links between research and industry. This unique position enables her to identify and integrate innovative products and approaches for the practical application on cutting-edge building envelopes.

Lisa has the responsibility of directing EOC's R&D efforts globally, focusing on innovative glass designs and technology which maintain EOC's position as leaders in the field, but also identifying new fields of research including a variety of materials and novel analysis approaches. Whilst remaining heavily involved in her own research projects, she focuses the team in developing their own areas of technical enquiry.

Her background and engagement with academia has built links between research and industry; enabling her to identify and integrate innovative products and approaches for the practical application on cutting-edge building envelopes. She has demonstrated that specialist knowledge across the entire supply chain brings value to EOC's clients.

The success of this unique approach amongst EOC's peers has opened an opportunity to provide a dedicated R&D service which has proven to be very successful. EOC employs many professionals with an academic interest, and it is her role to encourage and direct them to continue their development.

Her close collaboration with industry and academia has led to significant investment in the industry, enabling the introduction of a new product on a high-profile project. This was only possible through a creative analysis approach and early stage testing regimes which she directed and saw through to completion.

Lisa is a member of the Society of Facade Engineers in the UK and an elected member of the Special Advisory Council of the Facade Tectonics Institute at the University of Southern California. She has been a guest lecturer at the University of Iowa, the California College of the Arts, San Francisco and University of Darmstadt, Germany.

Surname: Rammig
First Name: Lisa Maraike
Nationality: German
Date of birth: 17 June 1986
Place of birth: Paderborn / Germany
Place of Residence: San Francisco, USA
Languages: German (native), English (fluent)
Marital Status: single

University Education

- 2005-2008 BA Arch – Detmold School of Architecture
- 2008-2010 MA Arch – Detmold School of Architecture /TU Delft
- 2008-2010 MEng – Detmold School of Architecture/TU Delft
- 2012-present PhD Candidate, TU Delft

Professional Work

- 2009-2010: Schmehrsahl Biermann Pruessner, Oerlinghausen
- 2010-2011: Researcher, Construction Lab, HS OWL
- 2011-2012: Emoli Petroschka, London
- 2012-2013: Inhabit, London
- 2013-2017: Eckersley O'Callaghan, London
- 2017-2020: Eckersley O'Callaghan + Partners, San Francisco
- 2020 onwards Eckersley O'Callaghan Inc. Los Angeles

Projects (non-exhaustive summary)

- **Icon Siam Observation Tower, Bangkok**
2019-present
Carpenter | Lowings
New curved 16m tall glass facade for 350m observation tower in Bangkok. The design also includes a cantilevering glass floor and canopy.

- **South San Francisco Library**
2019-present
Smithgroup
Facade Engineering for public library project with focus on energy daylight and glare through a transparent glass skin.

- **200 Park Avenue, San Jose**
2019-present
Gensler
Facade engineering for commercial development in San Jose featuring glazed Canyons and articulated facade with stainless steel fins to provide shading and articulation.

- **San Francisco Flower Mart**
2018-present
Rios Clementi Hale / Adamson Associates
Facade Engineering for Major development in San Francisco housing the existing Flower Mart as well as a new retail and mixed use development.

- **Google Landings**
2018-present
Heatherwick Studio
Facade Engineering for new campus building consisting of arrangement of 'sheds' clad in glass and weathered steel, with a focus on shading and thermal performance and daylight provision. The glazed portion of the facade comprises CCF panels with integrated operable shading.

- **Icon Siam Wisdom Hall, Bangkok**
2016-2018
Carpenter | Lowings
New landmark museum of Thai history and culture, with a unique triangular cable-net facade designed to optimise transparency and user comfort.

- **GlassWippe**
2018
Experimental glass seesaw engineered in collaboration with glass manufacturer Sedak. All of the Wippe's components are fully transparent, including its bearing mechanism.

- **Linkedin Middlefield Campus**
2017-present
Studios Architecture
Facade engineering for new corporate Campus in California

- **Apple Marina Bay Sands, Singapore**
2015-present
Foster + Partners
New retail store floating on the water at Marina Bay Sands. Glass Dome with complex glass make-up using a combination of solar coatings and ceramic frit to achieve comfort in a fully glazed building in Singapore whilst complying with strict reflectivity limitations and providing views in and out of the store.

- **Vidre Slide**
2016
Playful sculpture created in collaboration with glass fabricator Cricursa to test the practical applications of emerging glass technology.

- **K11 Museum, Hong Kong**
2014-2018
KPF/SO-IL Architects
Design and Engineer of tubular structural glass facade that would span from the bottom to the top without additional supports meanwhile meeting the energy and performance requirements of the project. The facade wraps around half of the museum's footprint (approx. 170m).

- **Google Headquarters, California**
2015-present
BIG/Heatherwick Studio Architects
Technology and glazing consultancy for high profile headquarters in mountain view involving the development of novel glazing technology.

- **Google Headquarters, London**
2016-present
BIG/Heatherwick Studio Architects
Structural glass engineering and technology consultancy for googles London headquarters involving the design of large format structural glass facade including the development of novel shading approaches and implementation of technology.

- **Carlos Pellegrini 719, Buenos Aires, Argentina**
2014-2015
Grimaldi Nacht Architects
Design of unitised curtain wall for a new build office building on Carlos Pellegrini in Buenos Aires including a cantilevering glass structure to the sides and top of the building

- **Apple Dubai Mall, Dubai**
2014-2016
Foster + Partners
New retail store which has a 56.6m curved glass storefront with a high performance thermal coating, spanning over 2 floors and a 5.5m terrace. This is flanked by 18 38.5 foot high motorized 'Solar Wings' that respond to Dubai's extreme environmental conditions.

- **Kings Court and Carriage Hall, London**
2013-2016
Kohn Pedersen Fox Architects
Design of curtain wall and retail facades for part-new build, part-refurbishment scheme in Covent Garden including the design of a new minimised glass roof structure to enclose an existing courtyard

- **Centre Point, London**
2013-2017
Rick Mather Architects
Facade redesign of an existing building complex involving retention of a listed glass wall as well as new build precast concrete facades on a residential building and large scale retail glass enclosures

- **St Anthony's College Oxford, Middle East Centre**
 2013-2015
 Zaha Hadid Architects
 Facade consultant for the construction of a new 'Softbridge' building. The building contains study space, a library, auditorium and archive and is clad in a complex facade with doubly curved stainless steel panels.

- **1000 Trees, Shanghai**
 2012-2013
 Heatherwick Studios
 Facade Engineering for new Multi-use development next to Shanghai's Art District. Tree covered mountains that use the top of columns as planters for thousands of trees.

- **Honquiao Vantone Sunnyworld Centre**
 2012-2013
 Foster+Partners
 Facade consultant for two 43m tall office buildings, and one landmark building that are part of a major new sustainable master plan at the heart of the Shanghai Honquiao CBD.

- **Trinity Street**
 2011
 Emoli Petroschka
 A new mixed use residential development of two offices, four high specification apartments and one terraced house, bordering the Trinity Square conservation area in Borough, London.

- **Southwark College**
 2011
 Emoli Petroschka
 Conceptual Planning for New College for the Dept. of Hair and Beauty at Southwark College

- **Lewisham College**
 2011
 Emoli Petroschka
 Conversion of a 6,500 sqm warehouse in Deptford for Lewisham College of Construction and Sport.

- **Kreishaus Detmold**
Competition Winner, 2010
Re-cladding of a 1970's city hall building.

- **Facade Refurbishment, Hanover**
2009-2010
SBP Architects
Refurbishment initiative for 25 facades within the modernist building stock of the city of Hanover with the intention to improve the thermal performance and reduce operation expenses whilst retaining the modernist architecture.

List of publications

- Rammig, L.; Materialecht verbunden; in Glaswelt Spezial: Innovative Fuegetechniken, Glaswelt 07/2011
- Rammig, L.; Direct Glass Fabrication-New applications of Glass with additive processes; in 'Challenging Glass 3 ', 06/2012, Delft
- Rammig, L.; Direct Glass Fabrication in Pottgiesser/Strauss (Eds.) Product Development and Architecture, Birkhaeuser, Basel 2013
- Lenk, P.; Marinov, V.; Rammig, L.; Integrated design of structural glass envelopes, in 'Engineered Transparency', Duesseldorf 2014
- Rammig, L.; Lenk, P.; Marinov,V.; Structural glass envelopes – Implementation of environmental studies into viscoelastic analysis in 'JFDE', IOS Press, Delft, 2015
- Rammig, L.; A performance driven design process for glazed envelopes, in 'ICAE 2015', San Sebastian 2015
- Baldini, A; Lenk, P.; Rammig, L.; Temperature Effects on curved annealed glass, in 'Glass Processing Days', Finland, 2015
- Rammig, L. Baldini, A; Lenk, P.; Temperature Effects on curved annealed glass, in IGS, Autumn, 2015
- Rammig, L; Residual stress in glass components, in Challenging Glass Conference 5, Ghent, 2016
- Rammig, L; Residual stress as a result of heat impact in borosilicate glass components, in Intelligent Glass Solutions , London, 2016
- Baldini, A.; Rammig, L.; Santasiero, M.; Structural assessment of temperature-dependent glass components: a contribution towards a systematic methodology, in Engineered Transparency, Duesseldorf, 2016
- Rammig, L.; Transparency through geometry - a case study, in IGS Winter edition, 2016
- Rammig, L.; Transparency and Innovation – Challenging Glass Conference 5,Delft, 2018 / ICAE San Sebastian, 2018

Master Students

- Anna Eskes – Connecting Glass with Glass, 2018
- Willem Koenen- Additive Manufactured Glass Connection: The polyester glass connection, 2017

Conferences spoken at

- Challenging Glass 3, Delft 2012
- Fassade 2012, Luzern, 2012
- ICAE, San Sebastian, 2013
- FRG AIT, Vienna, 2013
- Future Envelope, Bath, 2014
- Engineered Transparency, Duesseldorf, 2014
- ICAE, San Sebastian, 2015
- Glass Performance Days, Tampere, 2015
- Think Tank on Additive Manufacturing, Darmstadt, 2015
- British Glass, Edinburgh, 2016
- Facade Research Group – session Copenhagen: meeting CINARK / Royal Art institute in Copenhagen, 2016
- Challenging Glass Conference 5, Ghent, 2016
- Engineered Transparency, Duesseldorf, 2016
- Facade Research Group – session Cambridge: meeting glass and façade research group / University of Cambridge, 2016
- Unbuilt- Considering the Unbuilt Contributions to the Built Environment, London, 2017
- IABSE Future of Design, London, 2017
- Thementage Glas, Duesseldorf, 2017
- RILEM Technical Committee and workshop on “3D Technologies in Construction”, Delft, 2017
- XMaterials, Rotterdam, 2018
- Facade Research Group – Pamplona: meeting University of Pamplona, 2018
- ICAE, San Sebastian 2018
- Challenging Glass Conference, Delft, 2018
- Facade Tectonics, Vancouver, 2018
- Summerschool Seminar “Transparency and Innovation” with Jing Liu (SO-IL) at California Academy of Arts (CAA), San Francisco, 2018
- Glasstechnology Life, Architecture Congress, 2018
- Adaptive Facades Symposium, Ames, 2018
- Facades+, Chicago, 2018

- Jefferson Facade Forum, Philadelphia, 2018
- Facades+, Seattle, 2018
- NGA Annual Conference, Naples 2019
- AIA Mentorship Programme, San Francisco, 2019
- Glass Performance Days, Tampere, 2019
- ZAK World of Facades, Seoul, 2019

Committees and Awards

- Committee COST Action TU 1403 Adaptive Facades, UK representative
- Best Descend-Wallpaper design of the year award for 'Vidre Slide', 2017
- WICE Award finalist, 2017
- Young Professional of the Year, Consultancy and Engineering Awards 2017 - Finalist
- Judge at World of Architecture Festival (WAF), Berlin, 2017
- Judge at World of Architecture Festival (WAF), Amsterdam, 2018
- ASTM Working Group Anisotropy, 2018
- Voted Member of Special Advisory Council, Facade Tectonics Institute

Advancing Transparency

Connecting glass with heat –

An experimental approach to the implementation of heat bonding into glass connection design for structural applications

Lisa Rammig

Glass is transparent and that differentiates it from most other building materials. As a result it has played a significant role in the development of architecture, given that its use is not only driven by its functionality as a protective layer, but by its ability to transmit light and hence define spaces. The use of glass has typically brought designers, engineers and builders to the limits of their abilities, whether this was driven by the processing and handling of the material, or the limitation in the understanding of its design capacity.

The transparency of the material is of incredible value but it also poses challenges when working with glass; The way it is connected is always visible. As a result, the connections and connectivity of glass are one of the most important considerations when designing with it, both technically and architecturally and in particular for structural applications.

In the past century, glass has increasingly been used as a structural component. However its inherent brittleness typically still requires opaque metal connections to transfer load. These connections define contemporary glass architecture – firstly, because they are immediately apparent in a transparent structure and, secondly, as they are part of the engineering design language.

However, designers and architects are still aiming to increase the transparency of glass enclosures and structures, leading to a demand to further reduce the visibility of structural connections within the glass.

This research aims to address the connectivity of glass through experimental testing of heat bonded glass-glass connections that form a fully transparent atomic bond. Applications for transparent connections are addressed through case studies that explore various novel transparent bonding techniques.