

## Seat Comfort Objectification

### A new approach to objectify the seat comfort

Wegner, M.B.

**DOI**

[10.4233/uuid:b772802d-b738-4312-8903-9eedfab62e6e](https://doi.org/10.4233/uuid:b772802d-b738-4312-8903-9eedfab62e6e)

**Publication date**

2020

**Document Version**

Final published version

**Citation (APA)**

Wegner, M. B. (2020). *Seat Comfort Objectification: A new approach to objectify the seat comfort*. [Dissertation (TU Delft), Delft University of Technology]. <https://doi.org/10.4233/uuid:b772802d-b738-4312-8903-9eedfab62e6e>

**Important note**

To cite this publication, please use the final published version (if applicable). Please check the document version above.

**Copyright**

Other than for strictly personal use, it is not permitted to download, forward or distribute the text or part of it, without the consent of the author(s) and/or copyright holder(s), unless the work is under an open content license such as Creative Commons.

**Takedown policy**

Please contact us and provide details if you believe this document breaches copyrights. We will remove access to the work immediately and investigate your claim.

DISSERTATION

# SEAT COMFORT OBJECTIFICATION

A NEW APPROACH TO OBJECTIFY THE SEAT COMFORT

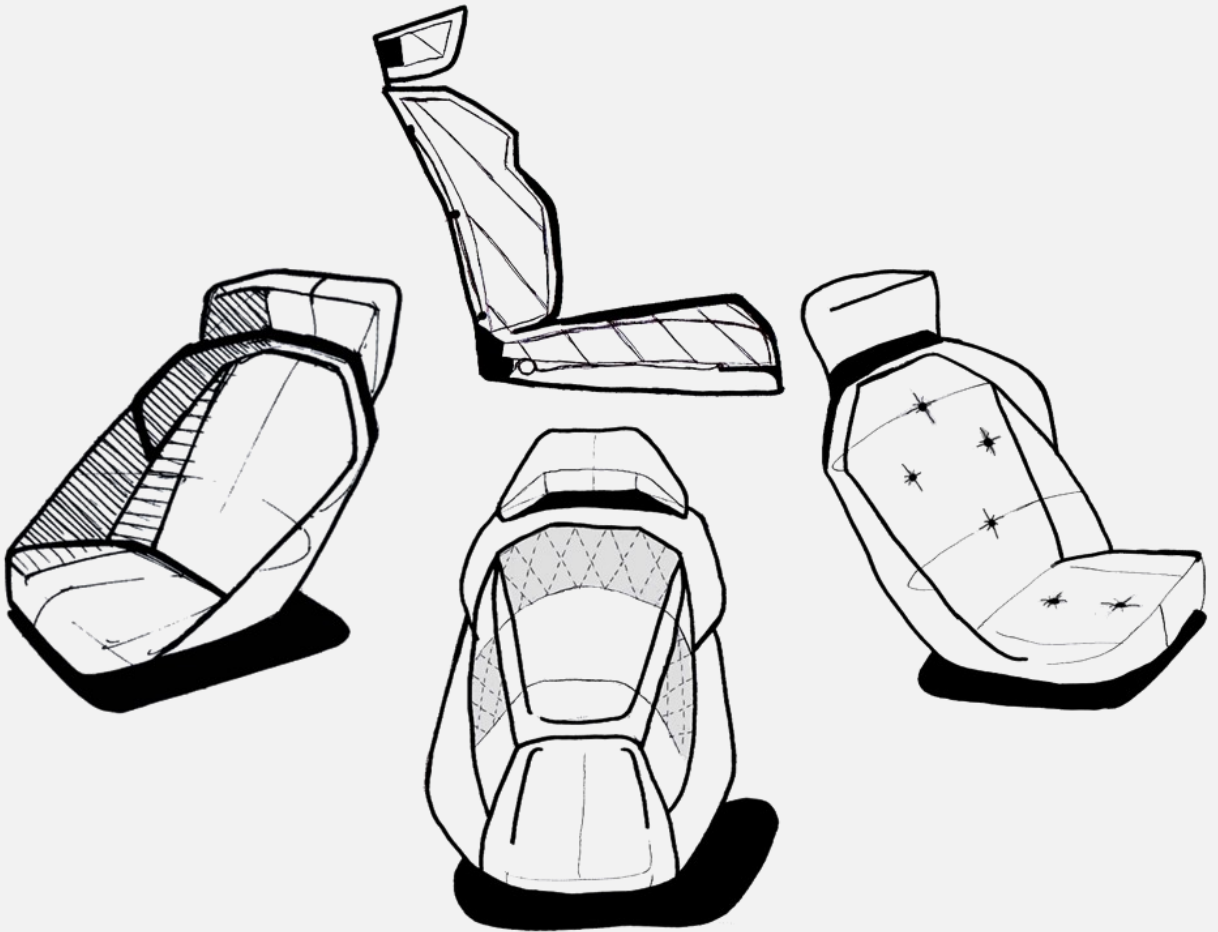

BY MAXIMILIAN WEGNER

# **SEAT COMFORT OBJECTIFICATION**

A NEW APPROACH TO OBJECTIFY THE SEAT COMFORT.



# **SEAT COMFORT OBJECTIFICATION**

A NEW APPROACH TO OBJECTIFY THE SEAT COMFORT.

## **Dissertation**

for the purpose of obtaining the degree of doctor  
at Delft University of Technology  
by the authority of the Rector Magnificus Prof.dr.ir. H.J.J. van der Hagen  
chair of the Board for Doctorates  
to be defended publicly on  
on Tuesday 29 September 2020 at 12:30 o'clock

by

**Maximilian Boris WEGNER**

Diplom Ingenieur (univ.)  
Technical University of Munich, Germany  
born in Warsaw, Poland.

This dissertation has been approved by the promoters.

Composition of doctoral committee:

Rector Magnificus,	chairperson
Prof. dr. P. Vink	Delft University of Technology, promoter
Prof. dr. G.W. Kortuem	Delft University of Technology, promoter

*Independent members:*

Prof. dr. ir. R.H.M. Goossens	Delft University of Technology
Prof. dr. ir. A. Naddeo	University of Salerno, Italy
Prof. dr. N.J. Mansfield	Nottingham Trent University, UK
Dr. M.M. Franz	BMW AG, Germany
Dr. ir. R. Happee	Delft University of Technology



*Design:* Vincent van der Voort and Maximilian Wegner

*Layout:* Maximilian Wegner

Copyright © 2020 by M. Wegner

All rights reserved. No part of this publication may be reproduced or transmitted in any form or by any means, electronic or mechanical, including photocopying, recording or any information storage or retrieval system, without permission from the author.

ISBN 978-94-6384-151-1

An electronic version of this dissertation is available at

<http://repository.tudelft.nl/>.

*When everything seems to be going against you,  
remember that the airplane takes off against the wind, not with it.*

Henry Ford





# CONTENTS

<b>1</b>	<b>General Introduction</b>	<b>1</b>
1.1	Challenges of seat design	2
1.2	The contact area between human and seat	2
1.3	How to define Comfort	3
1.4	How to measure Comfort	5
1.4.1	Fidgets, posture, contact shape and Muscle activity	6
1.4.2	Pressure and Pressure Sensitivity	7
1.5	Lack of knowledge	8
1.6	Aim of the the study	9
1.7	Outline of the thesis	10
<b>2</b>	<b>Framework of seat-human interaction parameters</b>	<b>15</b>
2.1	Definitions	16
2.1.1	Stress	16
2.1.2	Pressure	16
2.1.3	Shear	16
2.1.4	Friction	17
2.1.5	Elongation/Strain	18
2.2	Human	19
2.3	Seat	21
2.3.1	Seat Dimensions Adjustments and posture	22
2.3.2	Seat suspension	22
2.3.3	Foam	22
2.3.4	Cover	23
2.3.5	Lamination and layers	23
2.3.6	Loading a Seat	24
2.4	Modelling the seat-human-interaction	24
2.4.1	Loading the seat	25
2.4.2	Relative movements on the seat	25
2.4.3	Conclusion	25
<b>3</b>	<b>Comfort related to the height, hardness and contour of non-adjustable side supports in automotive seating</b>	<b>29</b>
3.1	Introduction	30
3.2	Method	32
3.2.1	Participants	32
3.2.2	Experimental setup	33
3.2.3	Experimental procedure	34
3.2.4	Measurement methods	36

3.3	<b>Results</b>	36
3.3.1	Relations between static and dynamic comfort and discomfort	36
3.3.2	The influence of side supports on comfort and discomfort.	38
3.3.3	The influence of a side support cover friction	40
3.3.4	Static comfort	41
3.3.5	Dynamic comfort	41
3.3.6	Seat Characterization	41
3.3.7	Pressure recordings	42
3.3.8	The influence of anthropometrics on comfort and discomfort	43
3.4	<b>Discussion</b>	44
3.4.1	Relations between static and dynamic comfort and discomfort	45
3.4.2	Relative influence of side support variables on comfort and discomfort.	45
3.4.3	Relative influence of side support cover friction	45
3.4.4	The optimal side support for static comfort and discomfort	46
3.4.5	The optimal side support for dynamic comfort and discomfort	46
3.4.6	The characterization of side supports	46
3.4.7	Pressure measurements	46
3.4.8	Anthropometrics.	47
3.4.9	Limitations.	47
3.5	<b>Conclusion</b>	47
3.6	<b>Acknowledgement</b>	48
<b>4</b>	<b>How does the seat cover influence the seat comfort evaluation?</b>	<b>53</b>
4.1	<b>Introduction</b>	54
4.2	<b>Methods</b>	55
4.2.1	Participants	55
4.2.2	Seats	55
4.2.3	Setup.	56
4.2.4	Procedure	56
4.2.5	Differentiation of the seat characteristics using various covers.	56
4.2.6	Overall impression of the seats.	57
4.2.7	Statistical analysis	57
4.3	<b>Results</b>	57
4.3.1	Subjective evaluation	57
4.4	<b>Discussion</b>	60
4.5	<b>Conclusion</b>	62
<b>5</b>	<b>A system to measure seat-human interaction parameters which might be comfort relevant</b>	<b>65</b>
5.1	<b>Introduction</b>	66
5.2	<b>Methods</b>	69
5.2.1	Measurement method	69
5.2.2	Capability study of the measurement method	72
5.2.3	Application example: The influence of seat cover and seat suspension on seat characteristics	74

5.3	Results . . . . .	75
5.3.1	Sensor Noise Floor . . . . .	75
5.3.2	Repeatability . . . . .	76
5.3.3	Reproducibility . . . . .	76
5.3.4	Detectability . . . . .	77
5.3.5	Results of the application example . . . . .	78
5.4	Discussion . . . . .	80
5.4.1	Capability study . . . . .	80
5.4.2	The influence of seat cover and seat suspension on seat characteristics . . . . .	80
5.5	Conclusion . . . . .	81
5.6	Acknowledgement . . . . .	81
<b>6</b>	<b>The influence of seat components on the seat-human interaction</b>	<b>85</b>
6.1	Introduction . . . . .	86
6.2	Methods . . . . .	88
6.2.1	Data gathering . . . . .	88
6.2.2	Data processing . . . . .	91
6.2.3	Data analysis . . . . .	94
6.3	Results . . . . .	95
6.3.1	Division of the Leather and Fabric Data set . . . . .	95
6.3.2	Cluster analysis . . . . .	95
6.3.3	Factor analysis . . . . .	108
6.3.4	How does the seat components influence the factors in each cluster? . . . . .	110
6.4	Discussion . . . . .	113
6.4.1	Leather Seat versus Fabric Seats . . . . .	113
6.4.2	Influence of the seat components on the interaction parameter . . . . .	115
6.4.3	Limitations . . . . .	116
6.5	Conclusion . . . . .	116
6.6	Acknowledgement . . . . .	116
<b>7</b>	<b>Effects of seat cover and suspension on the Seat-Human Interaction and Perception based on subjective ratings and objective measurements.</b>	<b>121</b>
7.1	Introduction . . . . .	122
7.2	Methods . . . . .	124
7.2.1	Participants . . . . .	124
7.2.2	Seat . . . . .	124
7.2.3	Setup . . . . .	124
7.2.4	Procedure . . . . .	124
7.2.5	Statistical analysis . . . . .	128
7.3	Results . . . . .	128
7.3.1	Subjective perception of the seats . . . . .	129
7.3.2	Objective characterization of the seats . . . . .	134
7.4	Discussion . . . . .	138
7.4.1	Discomfort of the seats . . . . .	138
7.4.2	Characterization . . . . .	139

7.5	Conclusion . . . . .	140
7.6	Acknowledgement . . . . .	141
<b>8</b>	<b>General Discussion</b>	<b>145</b>
8.1	Coming back to the main aim of the PhD . . . . .	146
8.2	Context of the seat . . . . .	147
8.3	How seat elements affect the seat-human interaction and the seat perception . . . . .	148
8.3.1	Shear Force . . . . .	148
8.3.2	Pressure . . . . .	149
8.3.3	Pressure vs. Shear Force . . . . .	150
8.3.4	A better fit to the contour, sensitivity and deformation of the human body. . . . .	150
8.4	A comparison of the current measurement systems and the developed measurement tool . . . . .	152
8.5	Conclusion . . . . .	153
8.6	Recommendation for future research . . . . .	154
<b>9</b>	<b>Summary / Samenvatting</b>	<b>159</b>
	<b>Acknowledgements</b>	<b>163</b>
<b>A</b>	<b>Appendix</b>	<b>165</b>
A.1	Technical specification of the measurement stamp . . . . .	166
A.2	Questionnaires . . . . .	168
A.2.1	Questionnaire of chapter 3 . . . . .	168
A.2.2	Questionnaire of chapter 4 . . . . .	171
A.2.3	Questionnaire of chapter 7 . . . . .	180
A.3	Detailed results of Chapter 6 and Chapter 7 . . . . .	200
	<b>Curriculum Vitae</b>	<b>205</b>
	<b>List of Publications</b>	<b>207</b>

# 1

## GENERAL INTRODUCTION



## 1 1.1. CHALLENGES OF SEAT DESIGN.

One of the challenges in seat design is to develop seats which meet the requirements of different occupants, cultures and regions in different use scenarios. Additionally, seats should meet regulations and all brand specific guidelines for instance regarding the design, safety or manufacturing. Therefore, it is essential for the seat development department to be aware of what comfort exactly is and how to integrate the seat comfort objectively into the development process to design seats as a symbiosis of all requirements and guidelines without neglecting the seat comfort. Meeting the requirements is also a dynamic process, which changes in time. To illustrate this, it is now more important taking Chinese use habits into account as these are getting more important. For a very long time the country with most cars has been the USA. Even in the year 2016 USA had the biggest carpark with around 268 million vehicles, but China has overtaken the USA in the year 2017 with 300.3 million registered vehicles in the country. 19 cities in China have more than 2 million cars and six cities have more than 3 million registered cars (Zheng, 2017). One of these cities is Beijing with an average travel speed of only 12.1 kilometers per hour (Guilford, 2014) and an average extra time to arrive at the final destination (TomTom Traffic Index, 2016) of 47 minutes. Another study (TomTom Traffic Index, 2016) shows that the amount of dynamic driving time with lateral and longitudinal accelerations is in Europe significantly higher as well as the amount of short distance rides than in other regions of the world. Hence, the interior and especially the automotive seats have to fulfill the demands caused by the large variation in driving conditions and offer people who spend significant more time in cars, sitting mostly in static conditions, as much freedom to use the time in an efficient way. Nevertheless, regardless of the region, the road or driving condition, while spending the time in the car and arriving at the destination, the occupants preferably should feel comfortable and fit.

## 1.2. THE CONTACT AREA BETWEEN HUMAN AND SEAT.

These requirements have consequences for the contact area between the human and the seat. The most applied technique to study the contact between human and seat is the pressure distribution. De Looze, Kuijt-Evers, and van Dieen (2003) illustrate and conclude in a literature review that a well-distributed pressure in a seat cushion is linked to the discomfort perception. Mergl (2006) and Zenk et al. (2006) defined an ideal pressure distribution and Kilinscoy (2019) confirms this ideal pressure distribution for rear seats. However, the pressure is only one of the factors describing the human seat interaction. Another factor mentioned often in studies studying decubitus is local shear. Local shear is understood to be one of the principle risk factors for the development of pressure sores (Goossens et al., 1997). In most studies on car seats the shear force and friction perception are not included, while the stretching of skin and tissue might influence the tactile sensors and thereby the perception as well. Goossens (2001) considered various seat pan materials measuring the resulting shear forces and Grujicic et al. (2010) correlates a higher cover friction to higher shear forces based on simulative results. However, shear force is hard to measure. In this PhD an attempt has been made to record shear forces and relate these to comfort.

### 1.3. HOW TO DEFINE COMFORT.

In this changing context, the definition of comfort is crucial to meet and understand the needs of occupants while sitting in a seat. Often comfort is incidental related to well-being and a pleasant state of the user, but concerning the interaction between the human and the seat a scientific explanation of 'comfort' is needed. Zhang et al. (1997) distinguished the difference between 'comfort' and 'discomfort' in their article. They stated based on research that 'discomfort' is related to biomechanical factors like the pressure distribution or the muscle tension and contraction, while 'comfort' is associated to well-being and relaxation. Also the visual interaction and aesthetic aspects of the seat may influence the comfort (Zhang et al., 1997 and Vink, 2014). Zhang et al. (1997) also mention that the elimination of discomfort does not necessarily produce comfort, but when discomfort is present it has a dominant effect and comfort factors might become secondary. Figure 1.1 illustrates Zhang's hypothetical model of discomfort and comfort.

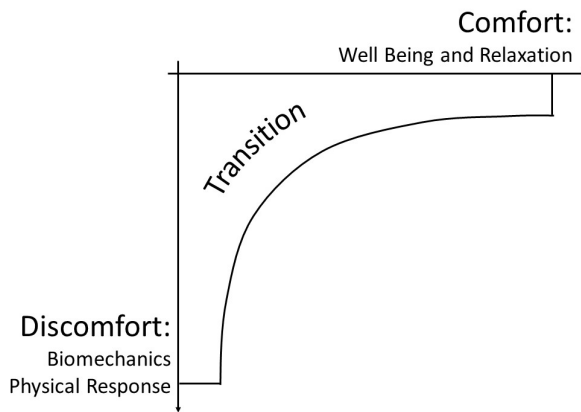

Figure 1.1: Hypothetical model of discomfort and comfort (Zhang et al., 1997).

Based on the study of Zhang et al. (1997) and other studies regarding comfort and discomfort, De Looze et. al (2003) developed a theoretical model of sitting comfort and discomfort referring to the human, the seat and the context, shown in Figure 1.2. This model is divided into a left part concerning the discomfort and a right part concerning the comfort. The comfort is related to expectation, emotions or the aesthetic design. For the left part (discomfort) De Looze et al. (2003) describe that sitting might evoke a cascade of mechanical, biomechanical or physiological responses, depending on the physical features of a seat, the environment and the task while sitting. The interaction (Human-Seat) while sitting (external loads) might yield to an internal dose and response depending on the physical capacity of the occupant. The internal dose can be described in terms of muscle activation, intra-discal pressure and blood flow provoking biomechanical, chemical and physiological responses like the stimuli of the skin sensors or the joints. De Looze et al. (2003) concludes that it can be expected that the relationship of objective measurements with discomfort would be stronger than for comfort.

Vink and Hallbeck (2012) developed a new comfort model inspired by the model of

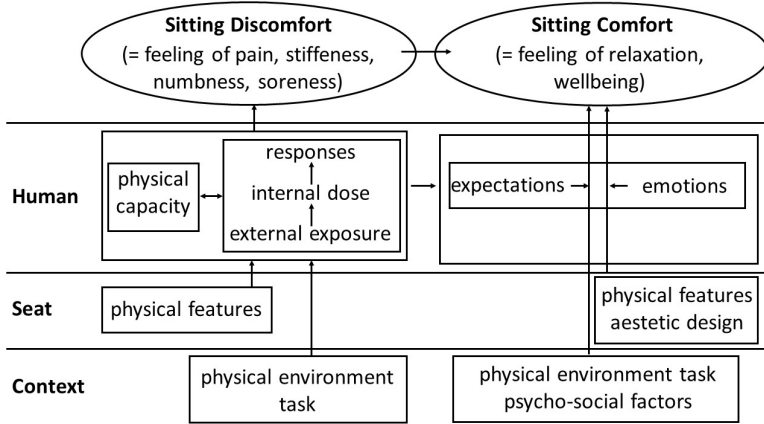

Figure 1.2: Comfort and Discomfort Model of De Looze et al. (2003).

De Looze et al. (2003) but also other models, like the comfort model of Moes (2005). Figure 1.3 illustrates the comfort model of Vink and Hallbeck (2012). The interaction

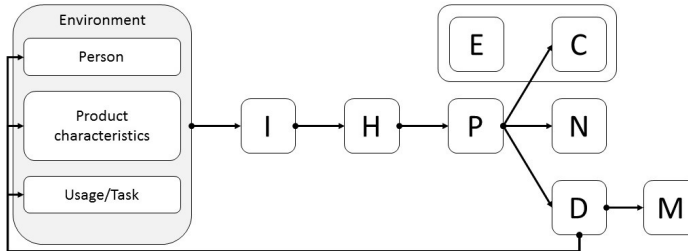

Figure 1.3: Comfort Model of Vink and Hallbeck (2012).

(I) is caused by the contact of the human, the product and the usage. In this case the product is the seat. The interaction (I) results in internal human body effects (H), such as muscle activation, postural changes or tactile sensation. The perceived effects (P) are not only affected by the human body effects (H) but also by the expectations (E) and can be interpreted as comfortable (C), neutral (N) and with a discomfort (D). The demand of the model is not a 'either or' decision, comfort and discomfort can be experienced at the same time. Hamberg et al. (2008) showed that on the long run discomfort can also result in musculoskeletal complains (M). If discomfort is perceived the model offers a feedback loop to shift in the seat, adapt the product or to change the task/usage. The comfort model of Vink and Hallbeck (2012) works out clearly how persons perceive and experience products while interacting with them. Unfortunately, the model does not take into account external forces and the duration of the interaction.



Based on the model of Ebe and Griffin (2000), Mansfield (2012) developed a discomfort model illustrating that the dynamic and temporal factors influence the seat discomfort, too. The model includes static factors, dynamic factors and temporal factors shown in Figure 1.4.

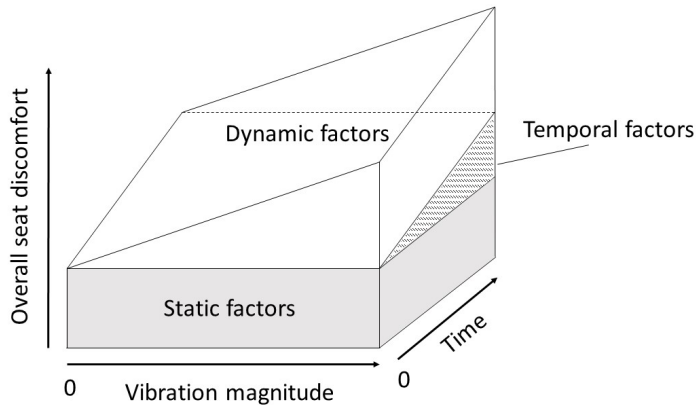

Figure 1.4: Seat Discomfort Model of Mansfield (2012) including merging aspects of static, dynamic and temporal factors.

Combining the models and statements of Vink and Hallbeck (2012), Mansfield (2012) and De Looze et al. (2003) this research proposes a model focused on objectifying seat comfort. The model is shown in Figure 1.5, it is mainly inspired by the comfort model of Vink and Hallbeck (2012). The discomfort block is replaced by the discomfort model of Mansfield (2012) to emphasize that the discomfort rating changes with time also affected by dynamic and temporal factors. For that reason a block was added with external forces caused by for instance dynamics like lateral or longitudinal acceleration. Not only the external forces but also the properties of the persons or the product characteristics can change over the time for instance due to the humidity, temperature or re-sitting. Therefore, the entire model has a time dependency. Referring to De Looze et al. (2003) who stated that the relationship of objective measurements should be stronger with discomfort than with comfort, the model highlights the discomfort relevant areas by a blue color. In this context, it is important to mention, that Naddeo et al. (2014) have already developed a model, a direct evolution of the Vink and Hallbeck (2012) model, that takes into account environmental factors over time. The model presented in this thesis is therefore a subset of the model of Naddeo et al. (2014) with the focus on objectifying seat comfort.

## 1.4. HOW TO MEASURE COMFORT.

Many existing studies investigated the correlation between subjective ratings of seat comfort and methods measuring the seat comfort. Most common approaches measuring the comfort are the occupants postural changes or fidgets, the analysis of the contact

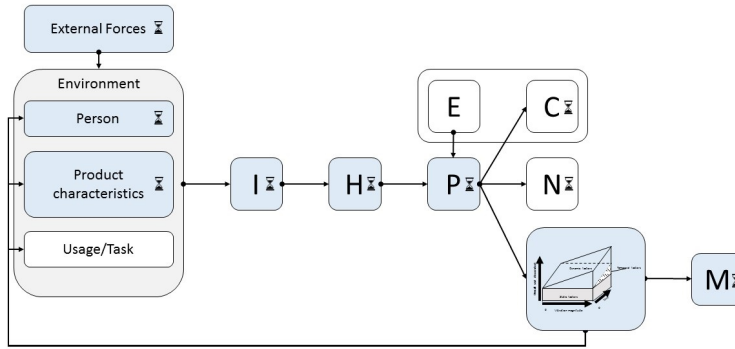

Figure 1.5: Scope which might influence the objectification of the comfort

shape, measurements of the occupants muscle activity, the sensitivity of pressure and seat pressure measurements. De Looze et al. (2003) compared 21 studies from the year 1982 until 2001 relating posture, muscle activity, pressure or spinal load to subjective comfort ratings, concluding that the pressure distribution appears to be the method with the most clear association to the subjective discomfort ratings. Since then many other studies were conducted not only focusing on the pressure distribution.

#### 1.4.1. FIDGETS, POSTURE, CONTACT SHAPE AND MUSCLE ACTIVITY

This paragraph shows an overview of studies that try to objectify (dis)comfort. Methods like recording fidgets, posture, contact shape and muscle activity are used. Sammonds et al. (2017) found a correlation between the increase of subjective discomfort ratings and the frequency of small movements (fidgets) and Hiemstra-van Mastrigt (2015) have shown that both active and passive motions during sitting have a positive effect on comfort and reduces discomfort. Vergara and Page (2002) concluded that changes in posture are good to indicate comfort, since two consecutive changes in an average time slot smaller than 5 minutes might be a predictor for a heavy lumbar pain. The study of De Carvalho and Callaghan (2011) recorded with a radiograph the position of subjects. The positions standing and sitting in a automotive seat frame with 0 cm, 2 cm and 4 cm lumbar support were tested with the result that a more neutral spine posture is typically more associated with discomfort. Naddeo et al. (2019) have shown on two tested lumbar supports, a removable and an integrated lumbar support, that a body-shaped lumbar support improves the comfort of an automotive seat, just as Hiemstra-van Mastrigt (2015), who had proven the positive effect of a lumbar support in train seats. Helander et al.(2000) mentioned in a study with office chairs that the users were very sensitive regarding proprioceptive responses to changes in single chair parameters. Yamazaki (1992) developed sensors to measure the contact shape between the occupant and the seat surface. The contact shape of thirty subjects was measured. The comfort did not correlate to one single parameter but to many parameters related to the deformation, posture and human body. Kee et al. (2010) demonstrate a connection between discomfort and

muscoskeletal loading. Grujicic et al. (2010) has shown in a computational analysis that the seat upholstery, the back support and the seat adjustments have complex influence on the muscle activation affecting also the comfort perception. In conclusion the studies contribute for a better understanding of the seat-human interaction investigating various approaches which might influence the seat comfort.

### 1.4.2. PRESSURE AND PRESSURE SENSITIVITY

In objectifying comfort it is important to notice that different parts of the human body prefer different pressures or have a different sensitivities. Vink and Lips (2017) presented that seated persons are significantly more sensitive in the area in contact with the shoulder and the area in contact with front of the seat pan than in other areas in contact with the seat. Furthermore, Vink and Lips (2017) showed a significant difference between female and male sensitivity values. Binderup et al. (2010) affirms the result of Vink and Lips (2017) testing the pressure pain threshold of eleven men and eleven women in various body regions. Goossens et al. (2005) studied the pressure sensitivity of the ischial tuberosity. The result of the study showed that pressure differences less than 1.9 kPa are not noticed in the ischial tuberosity. These studies show that the pressure sensitivities vary in the regions of the body. Thus, the different perception of pressure regions might influence the comfort evaluation.

Mergl (2006) reported that the pressure distribution in the cushion influences the pressure distribution in the backrest and vice versa. Moreover, the research worked out general guidelines for an ideal seat pressure distribution. The study recommends a pressure distribution in the cushion of 49%-57% in the buttock, <28% in femur area next to the buttock and <6% on the front femur area. Kilinscoy (2019) analyzed the ideal pressure distribution for rear seats with similar results. Naddeo et al. (2018) have shown that pressure distribution and load distribution affect (dis)comfort: the pressure distribution affects the physiological and tactile (dis)comfort and the load distribution affects the perceived postural and physical (dis-)comfort. Na et al. (2005) investigated with 16 male subjects the relationship between discomfort ratings and dynamic body pressure data during a 45 minute drive. The study has shown for specific body areas that the discomfort level increases as well as the changes of the pressure variables. The study concluded the usefulness of pressure distribution for dynamic discomfort evaluation and importance of time determining comfort. In further studies it is important to tackle the comfort into subcategories: initial, short-term and long-term comfort. Mergl (2006) defined the initial comfort as the first three minutes, the short term comfort up to 30 minutes and long term comfort starts after 30 minutes. Adler (2007) found that the long-term seating comfort is directly related to system stress by measuring the stress-induced postural modifications of the sitting person. Likewise, Hartung (2006) investigated the time dependency of the subjective seat comfort evaluation. The discomfort feeling was significantly higher ( $p < 0.05$ ) after 135 minutes compared to an evaluation after 15 minutes. Other authors like Smulders et al. (2016) also illustrated the time dependency of the seat-human interaction.

Most mentioned studies concern objectifying of comfort with the aim of improving the seat foam properties and the seat foam contour with focus on the pressure sense. However, other seat components, like the seat cover may affect other senses or the same senses in a different way and therefore influence the comfort and discomfort.

Although, Vink and Hallbeck (2012) mentioned that different sensory channels may influence the comfort experience, to our knowledge, no research in the field of seat comfort exists which considers more than the pressure sense. Though, a determination of more tactile receptors (Schmidt and Thews, 1980) might improve to characterize various stress conditions.

### 1.5. LACK OF KNOWLEDGE

Since the occupants are in interaction with the seat, all above mentioned approaches measuring the comfort or discomfort are relevant. But none of the studies examine the interaction stresses between the human and seat in detail.

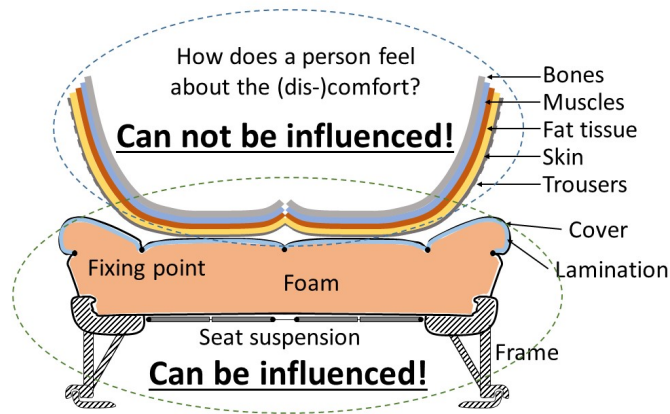

Figure 1.6: Section cut of a buttock and seat cushion illustrating the layers of each.

Figure 1.6 illustrates schematically the layer of the seat and occupant in interaction. All studies investigate the comfort experience but do not consider the translation into the seat elements or combinations of the seat elements. For designing a seat, it is essential to know how the seat components might influence the resulting seat-human interaction. A car or seat manufacturer can not influence the person who wants to sit into the seat, but the characteristics of the seat elements, like the foam hardness, the cover surface or the cover tension. Including other seat components into consideration results in the stimuli of more tactile senses. Therefore, a closer look at the seating process and the stressed seat-human interaction is needed. While loading the seat with a human body, the seat as well as the human body deform. The deformation of the human body highly depends on the seat properties. The lower the deformation of the seat the higher the deformations of the body including muscles, fat tissue and skin and vice versa might be. Schmidt and Thews (1980) presents four well known mechanoreceptors of the human skin, the Pacinian corpuscles for vibration, the Meissner's corpuscles, primarily providing information about tactile and sensitive changes, the Merkel disks for the pressure and the Ruffini corpuscles for the stretch and shear stresses. Additionally, information might be recorded due to the

sensors of the ligaments and the muscles. The Meissner corpuscles and the Pacinian corpuscles adapt comparatively in a fast manner (Klinke and Brenner, 2014). The Merkel disks and the Ruffini corpuscles are slowly adapting cutaneous mechanoreceptors. For the comfort rating the slowly adapting mechanoreceptors might be more critical than the fast adapting mechanoreceptors (Goossens et al., 2005). Therefore, the parameters of the seat-human interaction, which might be relevant are the pressure, the elongation, the shear stress and the friction coefficient.

This is in accordance with other studies which showed that shear force and pressure influence the deformation of the anatomical structure, like the tissue and skin of a sitting person. Chow and Odell (1978) explained that the interface shear force has a significant effect on pressure distribution. It is stated that frictionless interfaces produce much lower pressure. Zhang and Roberts (1994) mentioned that externally applied stresses to the skin affect the internal stress distribution. Also shear forces externally applied to the skin surface approximately have the same effects on underlying tissues as normal forces (pressure). Furthermore, Goossens (1994) measured a cut-off pressure of 11.6 kPa in the absence of shear stress. Including a shear stress of 3.1 kPa Goossens (1994) showed that the cut-off pressure was significantly reduced to 8.7 kPa. Also, Bennett and Worthen (1980) investigated in the palm of the hand that only half of the initial pressure is necessary to stop the blood flow if high shear forces are included. Also, confirmed by the study of Goossens (2000) which described a reduction of the skin blood flow with increasing shear forces.

The above mentioned studies illustrate that additional to pressure also shear force, elongation and friction might be relevant parameters to study for the comfort and discomfort. Extending the scope of the seat-human interaction might help analyzing the seat comfort evaluation as well as might improve the correlation of subjective ratings and objective measurements of comfort and discomfort.

## 1.6. AIM OF THE THE STUDY

The previous paragraphs demonstrate that several factors that could be measured (objectify) might influence comfort. Apart from the now often studied pressure distribution other factors might be important. Therefore, in this thesis the effect of shear forces, elongation, friction and pressure on the seat comfort perception is investigated with the aim:

1. to prove that the perception and the (dis-)comfort of a automotive seat is not only influenced by the foam properties but also by other seat components like the seat cover and the seat suspension.
2. to develop a measurement tool and method which records parameters that are relevant for skin (skin mechanoreceptors): shear forces, elongation, friction and pressure and analyses the correlation between the recorded parameters and seat elements.
3. to provide a measurements tool which is able to analyze more objectively the subjective ratings of occupants.

## 1.7. OUTLINE OF THE THESIS

Figure 1.7 illustrates the outline of the theses. **Chapter 2** provides a definition of pressure, shear forces, elongation and friction related to the human body and the layout of automotive seats. The output of this chapter is a framework of how forces, stresses and strains might affect the seat-human interaction. **Chapter 3**, **Chapter 4** and **Chapter 7** investigate in three case studies if and how differences in the pressure and shear force are perceived while interacting with the seat. **Chapter 3** shows how the contour, the foam hardness and seat cover surface of the side support influence the comfort and discomfort. **Chapter 4** demonstrates how the seat cover material and surface affect the perception of a seat and **Chapter 7** analyses how changes of the seat component properties affect the perception and interaction of a seat.

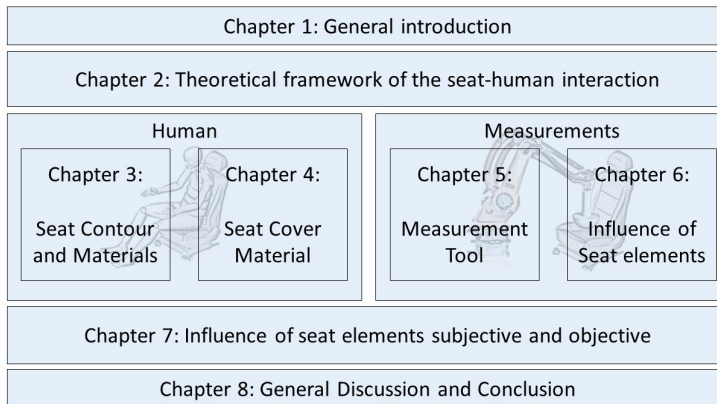

Figure 1.7: Outline of the theses.

Including the shear forces into the (dis-)comfort perceptions implies also an extension of the objective seat comfort measurement. **Chapter 5** presents a new measurement tool equipped with a stamp with various sensors measuring: pressure, shear force and elongation. With the help of this new measurement tool, **Chapter 6** presents how seat components with different properties affect the pressure, shear force and elongation. **Chapter 7** does not only analyse how changes of the seat component properties affect the perception of a seat but also uses the new measurement tool to record the individual seat properties of the seats used in the case study. **Chapter 7** validates the new measurement device referring to the result of the case study.

**Chapter 8** contains the discussion and conclusion based on the studies done in this PhD thesis.

## REFERENCES

- Adler, S., 2007. *Zusammenhang von Langzeitsitzkomfort und Fahrerbewegungen*. Dissertation. Friedrich-Schiller-Universität Jena.
- Bennett, T. and, Worthen, E. F., 1980. Shear vs. pressure as causative factors in skin blood flow occlusion. *Plastic and Reconstructive Surgery* 66, 1, 180.
- Binderup, A. T., Andreft-Nielsen, L. and, Madeleine, P., 2010. Pressure pain sensitivity maps of the neck-shoulder and the low back regions in men and women. *BMC Musculoskeletal Disorders* 2010, 11:234.
- Chow, W. W. and, Odell, E. I., 1978, *Deformations and Stresses in Soft Body Tissues of a Sitting Person*, 1978.
- De Carvalho, D. E. and, Callaghan, J. P., 2012. Influence of automobile seat lumbar support Prominence on spine and pelvic postures: A radiological investigations.
- De Looze, M. P. de, Kuijt-Evers, L. F. M., and, van Dieen, J., 2003. Sitting comfort and discomfort and the relationships with objective measures. *Ergonomics* 46, 10, 985–997.
- Ebe, K. and, Griffin, M. J. 2000. Quantitative prediction of overall seat discomfort. *Ergonomics* 43, 6, 791–806.
- Goossens, R. H. M., 1994. *BIOMECHANICS OF BODY SUPPORT. A study of load distribution, shear, decubitus risk and form of the spine*.
- Goossens, R. H. M., Teeuw, R., and, Snijders, C. J., 2000. Decubitus Risk: Is Shear More Important than Pressure? *Proceedings of the IEA 2000 IHFES 2000 Congress*.
- Goossens, R.H.M.: *Shear stress measured on three different cushioning materials*, Delft University of Technology (2001).
- Goossens, R. H. M., Teeuw, R., and, Snijders, C. J., 2005. Sensitivity for pressure difference on the ischial tuberosity. *Ergonomics* 48, 7, 895–902.
- Grujicic, M., Pandurangan, B., Xie, X., Gramopadhye, A. K., Wagner, D. and, Ozen, M., 2010. Musculoskeletal computational analysis of the influence of car-seat design / adjustments on long-distance driving fatigue. *International Journal of Industrial Ergonomics* 40, 345–355.
- Guilford, G., 2014. A big reason Beijing is polluted: The average car goes 7.5 miles per hour, QUARTZ, accessed 26 Mai 2019, <<https://qz.com/163178/a-big-reason-beijing-is-polluted-the-average-car-goes-7-5-miles-per-hour/>>
- Hamberg-van Reenen, H., 2008. *Physical capacity and work related musculoskeletal symptoms*. Proefschrift, Vrije Universiteit Amsterdam.
- Hartung, J., 2006. *Objektivierung des statischen Sitzkomforts auf Fahrzeugsitzen durch die Kontaktkräfte zwischen Mensch und Sitz*. Dissertation, Technischen Universität München.
- Helander, M. G., Little, S.E. and, Drury C. G., 2000. Adaptation and Sensitivity to Postural Changes in Sitting. *Human Factors*, 42, 4, 617–629.
- Hiemstra-van Mastrigt, S., 2015 *Comfortable passenger seats. Recommendations for design and research*. PhD thesis, TU Delft.
- Kilincsoy, Ü., 2019. *Digitalization of posture-based Seat Design*. Dissertation. Delft University of Technology.

- Klinke, R. and, Brenner, B. 2014. *Physiologie*. Thieme, Stuttgart, 624-675
- Lee, J., Grohs, T. and, Milosics, M., 1995. *Evaluation of objective techniques for automotive seat comfort*. In: SAE conference np. 950142. 1995.
- Mansfield, N.J., 2012. *Human response to vehicle vibration*. In: Gkikas, N., 2012. *Automotive ergonomics: driver-vehicle interaction*. CRC Press.
- Mergl, C., 2006. *Entwicklung eines Verfahrens zur Optimierung des Sitzkomforts auf Automobilsitzen*. Dissertation, Technischen Universität München.
- Moes, N. C. C. M., 2005. *Analysis of sitting discomfort, a review*. In: Bust, P.D., McCabe, P.T., (Eds.) *Contemporary Ergonomics 2005*, Taylor & Francis, London, pp. 200-204.
- Na, S., Lim, S., Choi, H. and, CHing, M. K., 2005. *Evaluation of driver's discomfort and postural change using dynamic body pressure distribution*. *International Journal of Industrial Engonomics* 35, 1085 - 1096.
- Naddeo, A., Cappetti, N., Vallone, M., and Califano, R., 2014. *New trend line of research about comfort evaluation: proposal of a framework for weighing and evaluating contributes coming from cognitive, postural and physiologic comfort perceptions*. In: Ahram, T., Karwowski, W., Marek, T. (Eds.), *AHFE 2014, Krakow, Poland*, 19-23 July 2014.
- Naddeo, A., Califano, R. and Vink, P., 2018. *The effect of posture, pressure and load distribution on (dis)comfort perceived by students seated on school chairs*. *Int J Interact Des Manuf* 12, 1179–1188.
- Naddeo, A., Di Brigida, L., Fontana, C., Montese, J., Quartuccia, M., Nasti, M., Pisani, M.M., Turco, V., De Stefano, M., Fiorillo, I. and Califano R., 2019. *A body-shaped lumbar-sacral support for improving carseat comfort*. 2nd International Comfort Congress, Delft.
- Sammonds, G. M., Fray, M. and, Mansfield, N. J., 2017. *Effect of long term driving on driver discomfort and its relationship with seat fidgets and movements (SFMs)*. *Applied Ergonomics* 58, 119–127.
- Schmidt, R.F und, Thews, G., 1980. *Physiologie des Menschen*. Springer Verlag; Springer, Berlin u.a..
- Smulders, M., Berghman, K., Koenraads, M., Kane, J. A., Krishna, K., Carter, T. K. and, Schultheis, U. 2016. *Comfort and pressure distribution in a human contour shaped aircraft seat (developed with 3D scans of the human body)*. *Work (Reading, Mass.)* 54, 4, 925–940.
- TomTom Traffic Index, 2016, *Traffic congestion statistics for Beijing based on TomTom's historical database for 2016*, TomTom Traffic Index, accessed 26 Mai 2019, < [https://www.tomtom.com/en\\_gb/trafficindex/city/beijing](https://www.tomtom.com/en_gb/trafficindex/city/beijing) >
- Vergara, M. and, Page, A., 2002. *Relationship between comfort and back posture and mobility in sitting -posture*. *Applies Ergonomics* 33, 1-8.
- Vink, P. and, Hallbeck, S., 2012. *Editorial: comfort and discomfort studies demonstrate the need for a new model*. *Applied Ergonomics* 43, 271-276.
- Vink, P., 2014, *The sweetness of discomfort: Designing the journey*. Inaugural Lecture, Delft University of Technology, June 4, 2014
- Vink, P. and, Lips, D., 2017. *Sensitivity of the human back and buttocks: The missing link in comfort seat design*. *Applied Ergonomics* 58, 287–292.



Yamazaki, N., 1992. *Analysis of sitting comfortability of driver's seat by contact shape. Ergonomics*, 35:5-6, 677-692.

Zenk, R., Mergl, C., Hartung, J., Sabbah, O. and, Bubb H., 2006. *Objectifying the Comfort of Car Seats*, SAE International.

Zhang, L., Helander, M. and, Drury C., 1996. *Identifying Factors of Comfort and Discomfort in Sitting. Human Factors* 38, 377-389.

Zhang, M. and, Roberts, V. C., 1994. *The effect of shear forces externally applied to skin surface on underlying tissues. Journal of Biomedical Engineering* 15, 6, 451-456.

Zheng, S., 2017, *China now has over 300 million vehicles... That's almost America's population*, *South China Morning Post*, accessed 26 Mai 2019, < <https://www.scmp.com/news/china/economy/article/2088876/chinas-more-300-million-vehicles-drive-pollution-congestion> >



# 2

## FRAMEWORK OF SEAT-HUMAN INTERACTION PARAMETERS

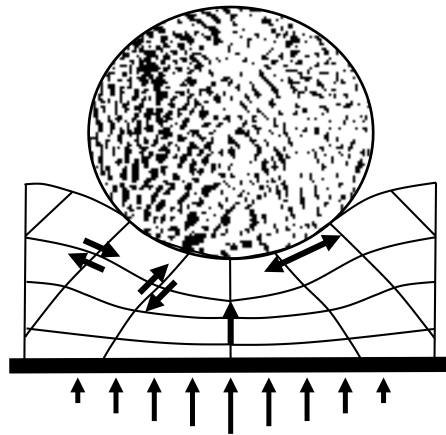

In this chapter an attempt is made to clarify the way the seat and human body interact. A description is made of forces, stresses and strains might affect the seat-human interaction to support the hypothesis that not only pressure, but also shear forces, friction and elongations might be relevant for the seat comfort. The defined terms are all related to the human body especially to the viscoelastic human tissue and to seat elements of a automotive seat.

## 2.1. DEFINITIONS

### 2.1.1. STRESS

Since all bodies are deformable, external forces create internal stresses in the body. Therefore, the stress can be described as an internal status and is equivalent to the internal forces that neighbouring particles of a continuous material exert on each other. Stress is represented by a Tensor in the unit  $N/cm^2$ . Bennett (1976) defines three states of stress: compressive stress, pinch shear stress and horizontal stress. Compressive stress results from normal forces, pinch seat stress occurs for uneven pressure distributions and the horizontal shear stress results from the friction forces.

### 2.1.2. PRESSURE

Pressure is in the mechanical engineering practice defined as a force per unit area, mostly known in units Bar (*bar*), Pascal (*Pa*) or Force per square ( $N/cm^2$ ). The force distributes normal to the surface. Figure 2.1 illustrates exemplary how a force can be distributed, it does not have to be necessarily equal, highly depends on the geometries of the compressed objects.

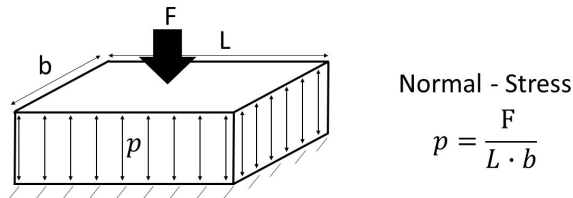

Figure 2.1: Exemplary illustration of Normal-Force and Pressure (Normal-Stress).

### 2.1.3. SHEAR

Shear force is a force which acts parallel or tangential to the surface. Figure 2.2 illustrates schematically the shear force and the shear stress. The shear force is denoted with a  $V$ . The average shear stress equals the shear force  $V$  divided by the area in contact. The shear stress acts also parallel or tangential to the surface and is often denoted with a  $\tau$ .

As long as the pressure is equally distributed only tangential shear stresses can occur. If the pressure distribution is unequal an additionally shear stress occurs, called pinch shear stress. The pinch shear stress evokes when two normal forces next to each other are very different with a high gradient. Related to the skin Nobel (1977) described the pinch shear

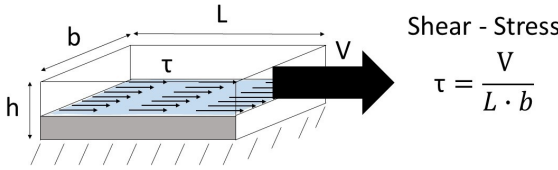

Figure 2.2: Exemplary illustration of Shear-Force and Shear-Stress.

stress as the shear stress with the component perpendicular to the skin, generated by the non-uniformity of the pressure distribution.

The tangential shear stress and the pinch shear stress cause both distortion. Dependent on the direction of both the stresses they can have additive effects (rise the shear strain) or even cancel each other (lower the shear strain).

**2.1.4. FRICTION**

Friction causes forces between two surfaces moving across another. Friction is the force that tries to prevent the movement between two surfaces. It is always opposite to the direction of movement respective to the direction of the indented movement. Two types of friction can occur: static and dynamic friction. **Static friction** is the force that prevent the movement in the absence of movement. **Dynamic friction** is the force that prevent the movement during a relative movement (sliding) of two surfaces. The static friction is always higher than the dynamic friction.

Static Friction

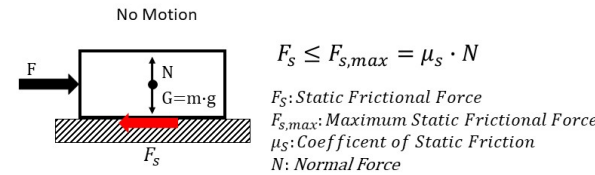

Dynamic Friction

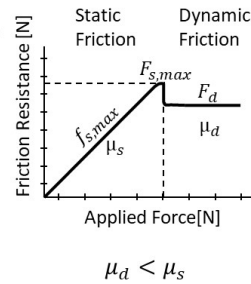
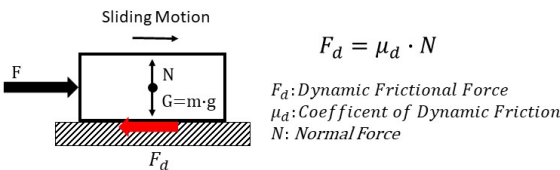

Figure 2.3: Illustration of static and dynamic friction forces.

### 2.1.5. ELONGATION/STRAIN

A applied stress to an object causes a deformation (Gross et al., 2017). The deformation is a measure of how much an object is stretched. The ratio between the deformation and the original length is calls strain or percent elongation. Strain can be either unit-less or in %. A negative value is compressive, while positive values comprehend to a tensile strain.

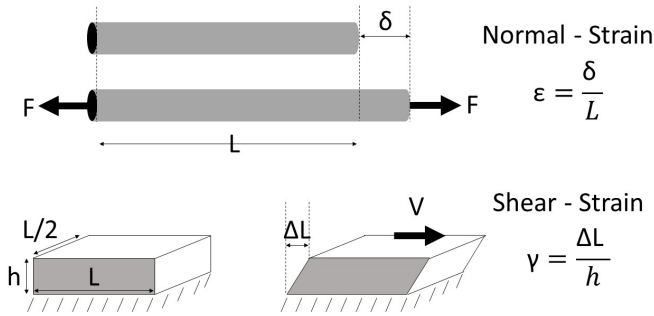

Figure 2.4: Exemplary illustration of Normal-Strain and Shear-Strain.

Two types of strain can occur, shown in figure 2.4. The normal strain is the response to an applied normal stress (perpendicular to surface) stretching the object, shear strain occurs when the deformation of an object is response to a shear stress (i.e. parallel to a surface). The normal strain is denoted with an  $\epsilon$  and the shear strain is denoted with a  $\gamma$ . The equations 2.1 and 2.2 show the linear, elastic relationship between stress and strain. This laws are defined for small values of strain. The deformation of the objects are dependent on the Young's Elastic Modulus ( $E$ ) and the Modulus of Elasticity in Shear ( $G$ ). Object with high modulus need higher stress for deformations respectively distortion. Object with a low modulus deform very easy. This applies for shear and normals stresses.

Hook's Law:

$$\sigma = E \cdot \epsilon \quad (2.1)$$

where:

$\sigma$  – normal-stress

$E$  – Young's Elastic Modulus

$\epsilon$  – normal strain

Hooke's Law in Shear:

$$\tau = G \cdot \gamma \quad (2.2)$$

where:

$\tau$  – shear stress

$G$  – Modulus of Elasticity in Shear

$\gamma$  – shear strain

As shown in Figure 2.4, an applied stress to an object causes an increase in length, but there is also a decrease in a lateral dimension perpendicular to the load. This material behavior is known as Poisson's ration (equation 2.3) and is a material property. Until now, we have only considered and described uniaxial deformations and strains, but in reality, pulling on a 3D-Object in one direction causes stress in only that direction, and causes strain in all three directions (x-, y-, z-direction).

Definition of Poissons's ratio ( $\nu$ ):

$$\nu = -\frac{\text{lateral strain}}{\text{axial strain}} \quad (2.3)$$

Based on the laws and definitions described above, it is also possible to define the relationship of materials changing the volume under hydrostatic pressure. The measure of how a material changes volume under pressure is defined by the Bulk modulus (K), shown in the equation 2.3.

Definition of the Bulk modulus:

$$K = \frac{E}{3(1 - 2\nu)} \quad (2.4)$$

where:

$K$  – Bulk Modulus

$E$  – Young's Elastic Modulus

$\nu$  – Poissons's ratio

Overall, section 2.1 gives a simplified overview of how objects with different material properties ( $E$  (eq. 2.1),  $G$  (eq. 2.2),  $K$  (eq. 2.4),  $\nu$  (eq. 2.3)) and with different material combinations (friction coefficient  $\mu$ , Figure 2.2) respond on external forces with deformations, strains and stresses. These relationships are essential to understand the material coherences during seat-human interaction.

## 2.2. HUMAN

Sitting on a seat evokes many reactions in the human body. From the first touch to the maximum load the body interacts with the seat. While loading the seat the human body will deform itself and not only experience pressure. Figure 2.5 illustrates stresses, strains and pressure induced by the load of a hemispheric object. It should be noted that the perceived intensity of these parameters can also be influenced by the temperature of the surface material and the climate around the seat. Takahsi et al.(2010) described that a pressure next to bones evokes tensile strain and shear strain in the tissue. Hence, we have to be aware that normal stress provokes indirectly shear strain in the tissue and tensile strain in skin and tissue. Additional, Brosh and Arcan (2000) showed by in vivo measurements that soft tissues are of lower stiffness under small contact stresses and of much higher stiffness under higher stresses, which would mean that the elastic modulus changes with load. Based on animal studies the literature (Bader and Bowker, 1983, Gefen and Haberman, 2007, Palevski et al., 2007) uses the following elastic modulus for the various body layers determined in kPa (Table 2.1).

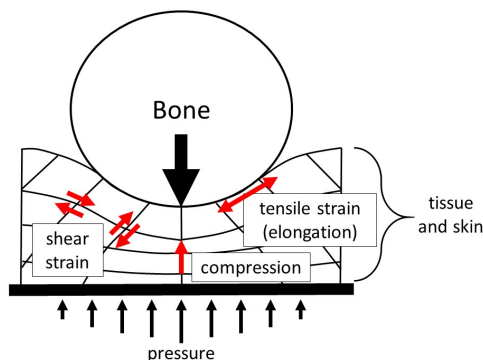

Figure 2.5: Strain and Stresses on the human tissue and skin induced by a (hemispheric) bone.

Table 2.1: Elastic Modulus of various body layers based on animal experiments (Bader and Bowker, 1983, Gefen and Haberman, 2007, Palevski et al., 2007).

	Elastic Modulus (kPa)
Bone	20 000 000
Muscle	7
Fat	0.3
Skin	2 - 5

Chow and Odell (1978) studied the influence of stresses like surface pressure, surface friction and hydrostatic pressure using a half of sphere with a radius of 100 mm. Most human bones do not have sharp edges. Figure 2.5 illustrates the effect of hemispheric bone geometries of bones on the human tissue and skin. Other studies investigated the impact of pressure and shear force using round or hemispheric objects (Kwiatkowska et al., 2009 and Takashi, 1999). In all the studies it is confirmed that sitting on a seat deforms the body and evokes internal stresses and strains in the skin and underlying tissues these effects in the human body are not only one directional forces but concern shear strain and tensile strain as well.

Additionally, externally induced shear forces can occur, which can be treated by adhesion friction mechanism. Kwiatkowska et al. (2009) investigated the skin friction and deformations behavior in-plan and perpendicular to the sliding direction with a smooth steel ball with various diameters. The results of the experiment have confirmed that the friction behavior can be explained by adhesion friction mechanism. Moreover, the externally induced shear forces influence not only the deformation of the skin and tissue but also the blood flow. Zhang and Robets (1993) have shown in an experimental study that the skin blood flow decreases approximately linear with increasing shear forces. Therefore, externally applied shear forces through moving on the seat have to be taken into account. Figure 2.6 illustrates two types of externally induced shear forces and a human body in contact with an object with no relative longitudinal movement (1.). 2.)



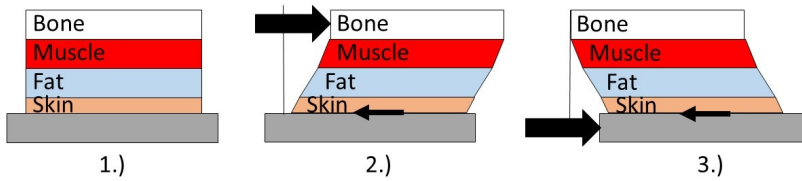

Figure 2.6: Overview how relative movements to the human tissue and skin result in deformation, strains and stresses.

illustrates a externally applied shear forces initiated through movements of the occupant. In illustration 3.) the shear force is externally applied by a moving object in contact with the human body. Especially 2.) might occur depending on the sitting position. This is also in line with Goossens and Snijders (1995) who have shown in their study and model that the normal force and the shear force are highly dependent on the position respectively the seat inclination. Additionally, the model also includes the position of the legs which also have a high impact on the resulting seat load. These findings are also confirmed by Hobson (1992) who have shown in a wheelchair study that the sitting posture and the body orientation have an evident effect on the seat-human interaction parameter pressure and shear force. The research explained also that changes in position or posture are likely to change the shear externally and internally. Additionally, Kobara et al. (2013) investigated in the field of decubitus the mechanism of variable shear forces applied to the buttock. The results of the study showed that the release of back support evokes shear forces.

The stresses and strains over time might have a high impact especially for decubitus. For that reason Reswick and Rogers (1976) presented in the field of decubitus guidelines for the maximum pressure over a certain period of time. In conclusion for time loadings the pressure can be much more higher than loadings with a longer duration.

## 2.3. SEAT

Many different variations of automotive seats exists with varying from very simple seats to very complex seats with different functions like a massage, heating or cooling. Basically, the layout of all automotive seats is nearly the same, extended by certain functions. Figure 2.7 shows schematically the basic layout of a seat. It is built on a steel or aluminum frame, fitted with a seat suspension mostly made out of spring steel and covered with foam. On top of the foam various layers like a heating mat and a seat cover with integrated laminations are placed. The cover is fixed on the seat frame and on integrated thin wires in the foam. To support a large variation of human sizes most seats offer a variety of adjustments. This section describes common elements of an automotive seat including the seat adjustments and dimension as well as the material properties of the individual seat elements. The last part of the section analyses the characteristics of a loaded seat.

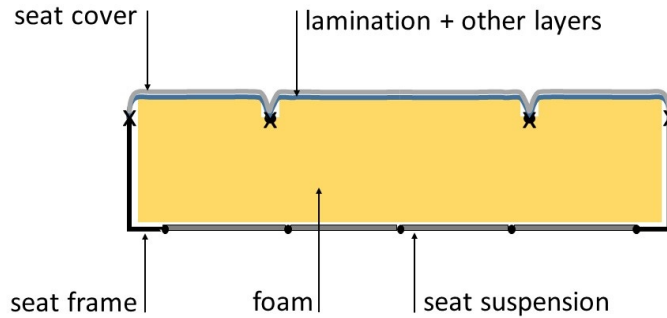

x: fixation of the cover

Figure 2.7: Illustration of basic seat components typically used in an automotive seat.

### 2.3.1. SEAT DIMENSIONS ADJUSTMENTS AND POSTURE

An automotive seat has to fulfill basic guidelines in order to fit as many occupants as possible. In general the seat surface should follow the human contours (Mazari, 2015). Furthermore, the seat has to be adjustable in seat height and should have a backward and forward adjustment. Also including an adjustable inclination of the seat pan and an adjustment system for the backrest is beneficial. Not only the adjustments of a seat but also the dimension of a seat are important. According to Reed et al. (1994) the length of a seat **seat cushion** should not be longer than 440 mm with an extension of 105 mm for larger percentiles. Depending on the side bolsters Reed et al. (1994) recommends a width of **seat cushion** between 500 mm and 432 mm. For the **backrest** Reed et al. recommends a width of 360 mm, 200 mm above the H-Point, and 456 mm, 320 mm above the H-Point.

### 2.3.2. SEAT SUSPENSION

On the seat frame and backrest frame often a suspension is mounted. The suspension is mostly out of a spring steel wire in a meander shape. The wire has diameters from 4 mm to 6 mm. The spring effect of the suspension can be controlled by the shape and the amount of meanders, by the number of wires and the fixation to the frame.

### 2.3.3. FOAM

The most common material in automotive seats for foam is polyurethane (PUR). These foams are open-celled, viscoelastic (Mills, 2007) and sensitive to changes in temperature and humidity. Polyurethane foams are manufactured as a chemical product of a polyol and a di-isocyanate with water. These materials are combined into shaped molds and expand within the enclosure and are then converted into a usable product like a backrest or cushion foam. This process is known as molding. Changing the ratio of the chemicals alter the characteristics of the PUR foams. Thus, the raw density, the foam stiffness, the foam hardness, the relaxation of the foam, the elastic properties and thermal properties

of foam can be adapted. Usually the foam properties are characterized with a deflection curve (hysteresis curve) shown in figure 2.8. The figure also illustrates the relationship between the different states of the foam cell deformation and the resulting deflection curve. Mansfield et al. (2015) suggests that foam composition is especially of significant importance to prevent discomfort on people undertaking journeys of durations longer than 40 minutes.

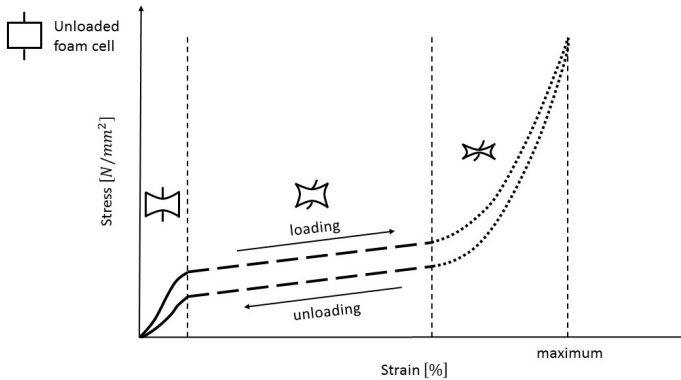

Figure 2.8: Hysteresis-Diagram

#### 2.3.4. COVER

The automotive seat covers consist of different materials also in various combinations. The most common seat covers are leather, artificial leather or fabric. Leather is a natural material with isotropic properties due to the varying orientation of the leather fibers. Even the processing of the leather is strictly controlled it has a huge fluctuation of the quality due to the natural properties. The properties and the quality of fabric covers can be controlled very precise by various parameters, like the type of yarn, the fibers or the woven structure. According to Powell (2006), Polyester is the dominant fiber in the industry due to its capability of meeting wear, fade and degradation, volume demand and cost pressures. Other materials are tricot, velour and Alcantara. The artificial leather is also a very common seat cover material. The optical appearance is similar to leather but the material itself is in contrast to real leather not natural but polyurethane (PUR) or polyvinyl chloride (PVC). Therefore, the properties of artificial leather are precisely adjustable to individual requirements, in contrast to real leather artificial leather has poor breath-ability properties.

#### 2.3.5. LAMINATION AND LAYERS

The cover of the seat has in most cases a lamination. The lamination shell ensures a constant lifetime quality of the seat cover and it prevents damage due to overload. Various

laminations exist for leather and fabric seats. Most laminations have a foam or a fleece layer. Due to the natural properties of leather especially for high loaded seat parts specific types of laminations are used. These laminations have mostly a stiff fabric grid structure which is glued or ironed on the bottom of the leather cover.

Moreover, additionally features like the heating mat are either fixed respectively glued on the foam part or integrated into the seat cover. The cover is fixed to the foam by metallic rings called 'cramps'. In the seat cover as well as in the foam part are thin metal wires which are connected by the 'cramps'.

### 2.3.6. LOADING A SEAT

While loading a seat various stresses and strains in the seat occur (see figure 2.5). Additionally, each layer in contact with an other layer may evoke a relative movement of the layers. The existence of the seat suspension and properties of various seat cover may influence the interaction of the components while loading, especially the foam interaction. Figure 2.9 illustrates a loaded seat with two cross-sections. Both sections illustrate a compression of the foam and a stretch of the cover while loading the seat. It is obvious that changing characteristics of the seat components will change the stresses. A very tight fixed seat cover for example may evoke a high tensile strain in the seat cover itself, which also affects the deformation of the human body while loading the seat. Also seat covers with materials of high friction may induce shear forces to the human body. What kind of interaction forces may occur in the seat-human interaction is described in the next section.

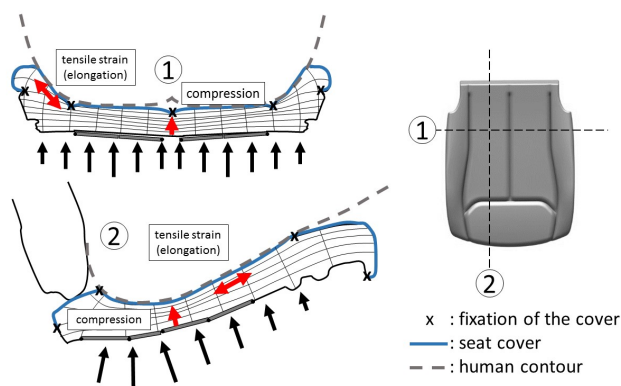

Figure 2.9: Strain and stresses induced into a seat by a human contour. Two cut-sections are shown, the first cut-section is along the cushion and the second cut-section is transversal to the cushion.

## 2.4. MODELLING THE SEAT-HUMAN-INTERACTION

To gain knowledge on the human-seat interaction a division of the seat-human interaction process might be helpful. It is divided into the process of loading the seat respectively sitting into the seat and moving on/in the seat.

### 2.4.1. LOADING THE SEAT

Figure 2.5 illustrates the stresses and strain that might occur while loading the tissue with a pressure. The pressure stress evokes a compression of the tissue and shear forces as well as tensile strains in the tissue. The analysis of the loaded seat, illustrated in Figure 2.9, show that the seat does not only induce a pressure but through a stretch of the seat cover with individual surface properties, also tensile strains in the human skin. Therefore, abrasive surfaces with high friction coefficient might induce an additional shear force into the seated body respectively into the skin and tissue.

### 2.4.2. RELATIVE MOVEMENTS ON THE SEAT

A relative movement between seat and human can be initiated through movements of the occupant or dynamic movements of the car. Figure 2.10 illustrates the feasible relative movements and their implications. 1.) is a loaded seat with a human body without relative movements. 2.) shows a relative movement initiated through the human body. The muscle, fat and skin deforms as well as the foam of the seat itself. Depending on the seat cover surface and the friction coefficient shear stress between the human and the seat is initiated. 3.) and 4.) illustrate a relative movement between seat and human initiated through dynamic movement of the seat evoked by lateral or longitudinal accelerations of the car. Also in this case, a shear stress between the occupant and the seat is initiated. Comparing illustration 3.) and 4.) it is noticeable that seat components of 4.) deform more than in 3.). Therefore the properties of the seat components might influence the overall stiffness of the seat, which might have together with the friction coefficient a impact on the shear stress and the elongation of the skin. The example in Figure 2.10 presents that the more energy the seat dissipates the lower the resulting shear stress and elongation of the human body. In the example it is evident that softer foams dissipate more energy than harder. Other possible factors influencing the stiffness of the seat might be the the foam height, the seat cover properties or the seat suspension, but also the lamination and the seat cover tension.

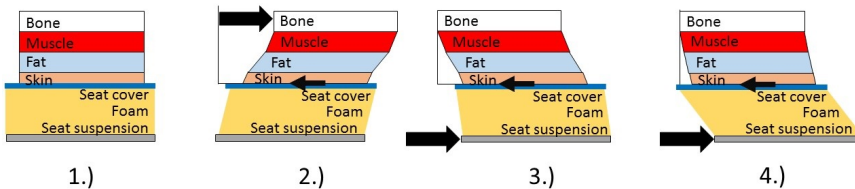

Figure 2.10: Illustration of various relative movements between seat and occupant.

### 2.4.3. CONCLUSION

The processes while a human interacts with a seat and resulting changes in the seat and the human body are very complex. In order to understand how the seat components influence the seat-human interaction and the resulting (dis-)comfort of a seat, it is necessary to characterize the reactions of seats objectively with a measurement tool through recording the parameters: pressure, shear force and elongation. A measurement tool is necessary

which measures the parameters: pressure, shear force and elongation constantly in the same quality. Thus, a comparable reaction of seat while loading is possible.

Key messages:

- The shear stress acts in a parallel to the surface and causes objects to slip over another.
- The result of shear strain is the distortion of tissue and/or seat.
- No Friction, no shear.
- No Pressure, no shear.
- Shear stress and pressure can be combined.
- Pressure evokes shear and tensile strain in tissue (passive shear).
- Movement influence the shear force.
- Most investigations gathering informations about the skin or tissue using spherical geometries.
- Spherical geometries induce shear stress.

## REFERENCES

- Bader, D. L. and, Bowker, P., 1983. *Mechanical characteristics of skin and underlying tissues in vivo*. *Biomaterials* 4, 305 - 308.
- Bennett, L., 1976. *Transferring load to flesh, part eight. Stasis and stress*. *Bulletin of Prosthetics Research*. 10-23:202-210.
- Brosh, B. and, Arcan, M., 2000. *Modeling the body/chair interaction - an integrative experimental- numerical approach*.
- Chow W. W. and, Odell, E. I., 1978, *Deformations and Stresses in Soft Body Tissues of a Sitting Person*, 1978.
- Gefen, A. and, Haberman, E., 2007. *Viscoelastic properties of ovine adipose tissue covering to gluteus muscles*. *J Biomech Eng*. 129, 924 - 930.
- Goossens, R. H. M. and, Snijders, C. J., 1995. *Design Criteria for the Reduction of Shear Forces in Beds and Seats*. *Journal of Biomechanics* 28, 225 - 230.
- Gross, D., Hauger W., Schroeder, J. and, Wall W. A., 2017. *Technische Mechanik 2*. Springer Verlag; Springer, Berlin u.a..
- Hobson, D. A., 1992. *Comparative effects of posture on pressure and shear at the body-seat interface*. *Journal of Rehabilitation Research and Development* 29, 21 - 31.
- Kobara, K., Fujita, D., Osaka, H., Ito, T. Yoshimura, Y., Ishida, H. and, Watanabe, S., 2012. *Mechanism of fluctuation in shear forces applied to buttocks during reclining of back support on wheelchair*. *Disability and Rehabilitation, Assistive Technology*, 8:3, 220 - 224.
- Kwiatkowska, M., Franklin, S. E., Hendriks, C. P and, Kwiatkowski, K., 2009. *Friction and deformation behaviour of skin*. *Wear* 267, 1264 - 1273.
- Mansfield, N., Sammonds G. and, Nguyen, L., 2015. *Driver discomfort in vehicle seats - Effect of changing road conditions and seat foam composition*. *Applied Ergonomics*, 50, 153 - 159.
- Mazari, F. B. and, Havelka A. 2015. *Pressure distribution of car seat at different angle of backrest*. *Vlakna a Textil*, 3-4, 33-39.
- Mills, N. J. 2007. *Polymer foams handbook. Engineering and biomechanics applications and design guide*. 1 st. edition Oxford: Butterworth Heinemann. accessed 28 Mai 2019, < <https://search.ebscohost.com/login.aspx?direct=true&scope=site&db=nlebk&db=nlabk&AN=193635> > .
- Nobel, P.C., 1970. *Some contributions of rehabilitation engineering to the pressure sore problem*. *Proceedings of a Rehabilitation Workshop, Royal Australasia College of Surgeons, Perth, Western Australia*, 169-180.
- Reed, M.P., Schneider, L.W. and, Ricci, L.L., 1994. *Survey of Auto Seat Design Recommendations for Improved Comfort*. *Technical Report UMTRI-94-6*. *University of Michigan Transportation Research Institute, Ann Arbor, MI*.
- Reswick, J. B. and, Rogers, J. E., *Experience at Los Amigos Hospital with devices and techniques to prevent pressure sore*. In: Kenedi, R. M., Cowden, J. M., Scales, J. T., (Editors), *Bedsore biomechanics*, London, Macmillan, 1976, 301 - 310.

*Palevski, A., Glaich, I. and, Portnoy, S., et al., 2006. Stress relaxation of porcine gluteus muscle subjected to sudden transverse deformation as related to pressure sore modeling. J Biomech Eng. 128, 782 - 787.*

*Powell, N. and, Cassill, N. 2006. New textile product development: Processes, practices, and products. Journal of the textile institute, 97,155 - 166.*

*Takashi, M., 1999. Pressure reduction and relief from a view point of biomedical engineering. Stoma 9, 1 - 4.*

*Takashi, M., Black, J., Dealey, C. and, Genfen, A., 2010. Pressure in context. In: International Review. Pressure ulcer prevention: pressure, shear, friction and microclimate in context. London: Wounds International.*

*Zhang, M. and, Roberts, V. C., 1994. The effect of shear forces externally applied to skin surface on underlying tissues. Journal of Biomedical Engineering 15, 6, 451–456.*



# 3

## COMFORT RELATED TO THE HEIGHT, HARDNESS AND CONTOUR OF NON-ADJUSTABLE SIDE SUPPORTS IN AUTOMOTIVE SEATING

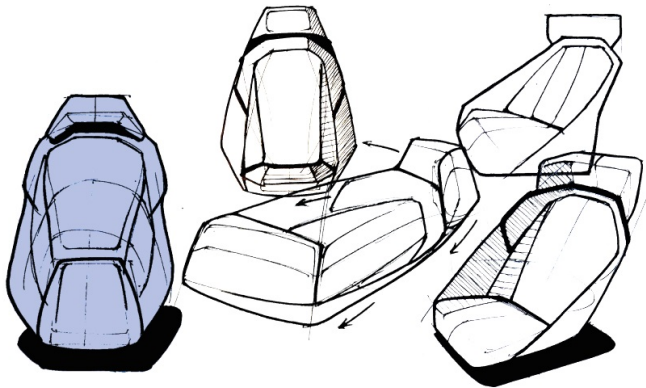

---

This chapter is accepted for publications in the journal Applied Ergonomics.  
Author: V.B. Van der Voort, M. Wegner, S.Anjani, and P. Vink

**Abstract**

*The objective of this study was to identify how side support variables foam height, hardness and contour relate to static and dynamic seating comfort and discomfort. Thirty subjects of varied anthropometrics participated in the study. Subjects sat in a seat with nine different side support configurations, subjectively rating the comfort and discomfort of each seat and choosing the characterization in a static and a dynamic test. In the static evaluation of the seat, low comfort and high discomfort were found to be highly correlated with  $r = -0.984$ . Additionally, the static and the dynamic discomfort evaluation were highly correlated with  $r = 0.981$ . In contradiction, the comfort evaluation in the static test has shown no correlation to the comfort evaluation in the dynamic test ( $r = 0.433$ ). For higher comfort and lower discomfort, this study recommends the use of a low side support (40 mm) made of soft foam (6 kPa). The use of high friction Alcantara cover material on the side supports had no significant influence on dynamic comfort and discomfort in this study. Furthermore, the characterization 'sportive' was most given to high side supports and extra convex side supports. The characterization 'relaxing' and 'luxurious' were mostly found at low and soft side supports. Many of the subjects had wide hips, which resulted in relatively much contact with the side supports. Further research in which the seat width can be adapted is advised to test the effect of side support variables more precisely. Also, long-term effects are still unknown, which should be studied further as well.*

**Keywords:** side support, bolster, wing, pressure, shear forces, comfort, discomfort

**3.1. INTRODUCTION**

An ejection seat, built in some movie stunt cars, can quickly eject a passenger from a seat. A popular scene in the James Bond movie Goldfinger features such an ejection seat, in which a 'bad guy' is ejected through the roof leading to a safe getaway. In a normal driving scenario, car seats are designed to comfortably hold its passenger in the seat during acceleration, deceleration and cornering (and in extreme cases during a crash) (Lueder, 1983). During sitting, the two factors: the human and the seat have complex interactions leading to the subjective experience of comfort (Le et al., 2014); which is a pleasant state or relaxed feeling of a human being in reaction to its environment (Vink and Hallbeck, 2012) and discomfort; which is an unpleasant state of the human body in reaction to its physical environment (Vink and Hallbeck, 2012).

This paper separates static comfort and discomfort from dynamic comfort and discomfort, due to different interactions between seat and passenger (Porter et al., 2003). During sitting in a static situation, mainly the pressure between seat and occupant is investigated when predicting the comfort and discomfort of a seat (Ebe and Griffin, 2001). Static comfort and discomfort is mainly affected by the seat hardness, its contour and the match to the body proportions of the human and their ability to acquire a proper sitting posture (Ebe and Griffin, 2001). The best static comfort is obtained by following an ideal pressure distribution, with higher pressure on the ischial tuberosities and lower towards the front and sides of the leg, according to Zenk and Mergl (2006). During sitting in a dynamic situation, the seat has to offer support in lateral and longitudinal accelerations to prevent the human from sliding off the seat (Beard and Griffin, 2013) by optimizing the seat angles (Mazari, 2015), seat surface contour (Mazari, 2015; Chen, 2007) and cover

friction (Akioka et al., 1994). In addition, the seat has to attenuate vibrations by optimizing the foam density, thickness and hardness (Mansfield, 2015). Might the seat fail to do so, the human increases muscle activity (Pollock et al., 2010) to stay upright. A seat with harder foam and higher sides following the human contour might offer better dynamic comfort (Kamp, 2012).

The first factor, namely the human, brings complexity to the seat design, due to its individual differences in age, gender, size and weight (Kolich, 2008). A small person could have a small contact area with the seat, related to lower comfort (Carcone and Keir, 2007). A large or heavy person with a larger contact area (Hiemstra-van Mastrigt, 2017), could have increased pressure discomfort at the location of seat surface irregularities such as the side supports at the hip (Kyung and Nussbaum, 2013). Next to body size, body posture influences their comfort and discomfort (Harisson et al, 2000). When sitting in a seat in a driving scenario, the human can experience the following factors: accelerations and vibration (Beard and Griffin, 2013; Xu et al., 2015), pressure (Chen, 2007) and shear forces (Akins et al. 2011; Goossens et al., 1994), which could cause skin deformation (Kwiatkowska et al., 2009), affect blood flow (Goossens et al., 1994), and muscle activity (Pollock et al., 2010) within the human body, which all contribute to the subjective interpretation and evaluation of seat comfort (Le et al., 2014).

The second factor, the seat, has to provide the optimal comfort and discomfort for every unique human being. Most cars are fitted with bucket seats, described as a separate seat to accommodate one person (Bergs and Kanaska, 2012). A standard bucket car seat usually consists of a frame, a suspension, different layers of foams and cover material on the seat bottom, headrest and backrest (Kolich, 2008). Bucket seats often offer a variety of adjustments to accommodate a large target group (Kolich, 2008). Only some seats provide adjustable backrest wings and no seats exist which have adjustable seat bolsters on the seat cushion. Therefore, it is essential to optimize the seat bolsters and backrest wings to provide the best comfort and discomfort for a large target group.

Seat bolsters, backrest wings, or simply side supports are found on any bucket seat. They are located on the side of the seat surface and are fabricated of foams, covered with fabrics. Their main functionality is offering lateral support, assisted by cover friction (Akioka et al., 1994); downward forces of the body at the ischial tuberosities (Porter et al., 2003); and muscle activity (Pollock et al., 2010). The nature of the side supports and their functionality defines its sitting characterization and could be matched with the type of vehicle it is designed for (Kolich et. al., 2005). Kamp (2012) already identified the height and the hardness (hardness is similar to stiffness and is the indentation as a result of a force (Ebe and Griffin, 2001)) of the side support being factors influencing the comfort and discomfort of a seat; being low and soft is characterized as luxurious; while hard and high is characterized as sporty (Kamp, 2012). A third and fourth factor could be the contour of the side support, which is related to the seat surface contour investigated by Chen, 2007 and the cover material (Goossens and Snijders, 1995). Current literature does not provide much information on the influence of the physical measurements of side supports: foam height, hardness and contour and cover material to static and dynamic sitting comfort and discomfort.

Therefore, this study investigates the following research questions:

- Does the foam height, hardness, contour and cover friction of a car seat side support influence comfort and discomfort and is there a preference?
- How are each of the factors foam height, hardness and contour characterized?

To answer these questions, an experiment is set up investigating side support variables foam height, hardness and contour and cover material in the second chapter ‘method’. The third chapter ‘results’ analyzes and characterizes the variables separately, and compares them to anthropometrics. The fourth chapter ‘discussion’ relates the results to other literature and the fifth chapter ‘conclusion’ relates results back to the research questions.

### 3.2. METHOD

#### 3.2.1. PARTICIPANTS

Thirty healthy subjects, twenty-two males and eight females participated in the experiment, simulating a representative population sample of drivers (Kamalanathsharma et al., 2015). Participants were asked not to wear a jacket during the evaluation of the seats. Informed consents were collected from all participants prior to testing. Anthropometric measurements are displayed in Table 3.1. Percentiles were derived from DINED (Molenbroek, 2004).

Table 3.1: The anthropometric measurements of the subjects.

Male(22)	Mean (stdev)	Range	Percentile (range)
Ages (y)	30(±9)	20 – 56	
Height (m)	1.8(±0.1)	1.65 – 2.01	42(2 – 99)
Weight (kg)	78(±11)	60 – 105	35(4 – 99)
BMI (kg/m <sup>2</sup> )	23.3(±1.9)	20.6 – 28.7	
Waist(cm)	87(±7)	77 – 105	29(6 – 89)
Hip (cm)	101(±7)	89 – 115	41(3 – 95)
Female(8)	Mean (stdev)	Range	Percentile (range)
Ages (y)	27(±5)	21 – 35	
Height (m)	1.68(±0.1)	1.60 – 1.80	40(16 – 98)
Weight (kg)	60(±6)	54 – 71	24(10 – 61)
BMI (kg/m <sup>2</sup> )	21.1(±1.4)	19.5 – 23.5	
Waist(cm)	73(±6)	67 – 86	18(8 – 55)
Hip (cm)	97(±5)	92 – 106	17(7 – 50)

### 3.2.2. EXPERIMENTAL SETUP

A BMW 5-series seat (see Figure 3.1) with leather upholstery is built into the passenger side of a BMW 540i for testing. The seat is modified to accommodate the placement of different side support foam inserts (see Figure 3.2), to change the bolster variables shown in Table 3.2 and wing variables shown in Table 3.3. The cover at the bolster and wing contour is fitted with a zipper to enable the placement of the foam insert and a stretch fabric in order to form to the according height and shape. With these adjustments, the seat looks unchanged to prevent that aesthetic qualities will influence comfort ratings (Zhang et al., 1996). The bolsters and wings can be fitted with a Velcro high friction Alcantara or low friction leather cover. The car interior is unchanged and both car and seat were pre-heated to 21°C using the on-board climate control for minimal influence of vehicle package (Rebiffe, 1975) and thermal comfort (Cengiz and Babalik, 2007). A BMW 5-series sport seat fitted at the driver side of the car functions as a benchmark seat in between tests.



Figure 3.1: Modified BMW 5-series set with zippers and exchangeable foam inserts and cover material.

Table 3.2: An overview of the bolster designs in the study.









Bolster	Height[mm]	Contour	Hardness [kPa]
B1 	55 (low)	Convex (round)	6 (soft)
B2 	40 (xlow)	Convex	6
B3 	90 (high)	Convex	6
B4 	55	Convex	12 (hard)
B5 	90	Convex	12
B6 	55	Concave (hollow)	12
B7 	90	Concave	12
B8 	55	x Convex	6
B9 	90	x Convex	6

Table 3.3: An overview of the wing designs in the study.



Wing	Height[mm]	Contour	Hardness [kPa]
W1-3 	85-105	Convex (round)	6 (soft)
W4-7 	85-105	Convex	12 (hard)
W8-9 	85-105	xConvex	6



Figure 3.2: An overview of the bolster and wing designs in the study.

### 3.2.3. EXPERIMENTAL PROCEDURE

In total 9 different side supports are individually tested in a three-minute static test, followed by a three-minute dynamic test. The total experiment (see Figure 3.3) takes around 90 minutes per participant. Prior to testing, anthropometric measurements are performed. The seat is then adjusted for each participant to their optimal seat proportions, defined as follows: the backrest is fixed to an incline of 120° and the seat pan to 15° (Harrison et al., 2000). The participant is asked to sit all the way back into the seat cushion, leaning with their back and shoulders on the backrest and their head on the headrest. Seat height and track are adjusted so the participant can reach the sloped feet rest comfortably with a knee angle of approximately 120° (Schmidt et al., 2014); the seat pan length is adjusted to reach a distance of 5 cm from the popliteal area (Reed, 1994). The experimental procedure, measurements and the questionnaire (A.2.1) are explained in a short introduction.

During the static test, the participant sits in the seat while the car is parked. A pressure recording is made. After the pressure recording equipment is removed, the participant sits for 1 minute before allowed to start the questionnaire (Appendix A.2.1); characterizing the seat and rating the static seat comfort and discomfort. Immediately after the static

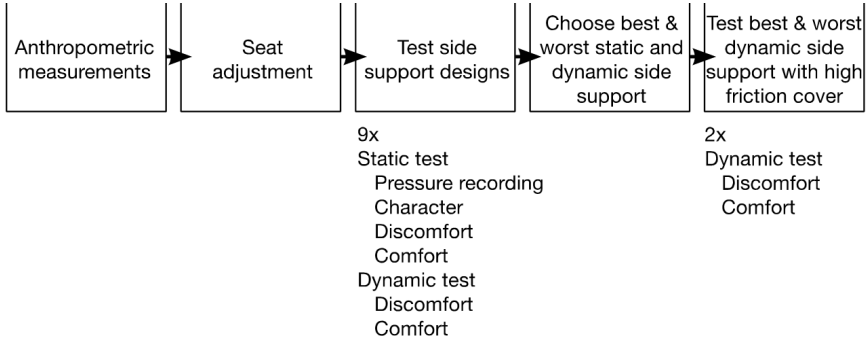

Figure 3.3: Experimental procedure.

test, the dynamic test is performed with the same side support. In the dynamic test, the participant is a passenger and does not partake in any driving activity, in order to focus on the assessment of the seat. The car is driven on a prescribed track of approximately eight-hundred meters on a private road. Corners are sharp with a radius of around five meters and speed is between thirty and forty kilometers per hour. In order to emphasize the bolster and wing influence on the dynamic sitting comfort, only the low friction cover is used to minimize the shear force and the seatbelt is not used. After completing the one minute drive, the participant is allowed to start the questionnaire (Appendix A.2.1) to rate the dynamic comfort and discomfort (see Figure 3.4).



Figure 3.4: A participant rating a seat after the dynamic test.

After completing both tests using the same side support, the side support is changed using systematical variation. In between the side support change, the participant is seated in the benchmark seat on the driver side of the car, preventing influence of the last seat as found by Veen and Vink (2016). A curtain separates the participant from the modified seat, while it is changed to the next setting. During the seat modification, the

participant is offered a break and the possibility to comment on the previous tests. The next round starts again with the static test, followed directly by the dynamic test, until all nine modifications are tested. When all modifications are tested, the participant may choose their favorite and least favorite seat in both static and dynamic situation. The two chosen seats in the dynamic test will be tested again, with the same procedure and questions as the other dynamic tests, but now with the high friction cover (Appendix A.2.1).

#### 3.2.4. MEASUREMENT METHODS

A pressure surface recording is made with each side support (9) and participant (30) using the XSENSOR Technology Corporation pressure mat X3 Seat Sensor Pad PX100 : 40.40.02 for the seat pan. All anthropometric measurements are based on the DINED method (Molenbroek, 2004). A questionnaire is used to investigate the characterization, comfort and discomfort of each seat in a static test and similar comfort and discomfort in a dynamic test. Each seat was characterized, by letting each participant choose the most fitting characterization out of six options: sportive, protective, relaxing, luxurious, tough and activating, similar to the characterizations of Kamp (2012). The overall comfort (1-7) of each seat in total is measured using a Likert 7-scale. A Local Postural Discomfort (LPD) body map was used to measure discomfort (Van der Grinten and Smitt, 1992), each area (A-I) accompanied with a Likert 7 scale (with 0=nothing) is combined into the total discomfort (0-63). Both comfort and discomfort scales were reinforced with guidance words such as “no comfort” and “very comfortable” validated for similar comfort and discomfort research by Pearson (2009). At the end, all seats were ranked by choosing the favorite and worst seat for the static and dynamic test separately. For statistical analysis, all data was imported to SPSS version 24. A Wilcoxon signed-rank test is done to assess whether the mean ranks differ significantly between different side support variables and clusters ( $p=0.05$ ) since the data was not normally distributed. A Pearson correlation analysis is also calculated between the static and dynamic tests. Characterization results are analyzed using a Chi-square test of independence.

### 3.3. RESULTS

The results of the experiment investigate the correlation between static and dynamic comfort and discomfort, as well as their relation to side support variables foam height, hardness, contour and cover friction and how they are characterized. Static and dynamic comfort and discomfort of side supports is also related to pressure concentrations in the seat cushion, to the hip and waist circumference and optimal measurements for non-adjustable side supports are determined.

#### 3.3.1. RELATIONS BETWEEN STATIC AND DYNAMIC COMFORT AND DISCOMFORT

The relation between static and dynamic comfort and discomfort is tested using a Pearson correlation analysis. In the static evaluation, low comfort and high discomfort are highly correlated with  $r=-0.984$  (see Figure 3.5). Additionally, the static and the dynamic discomfort evaluation are highly correlated with  $r=0.981$  (see Figure 3.6).



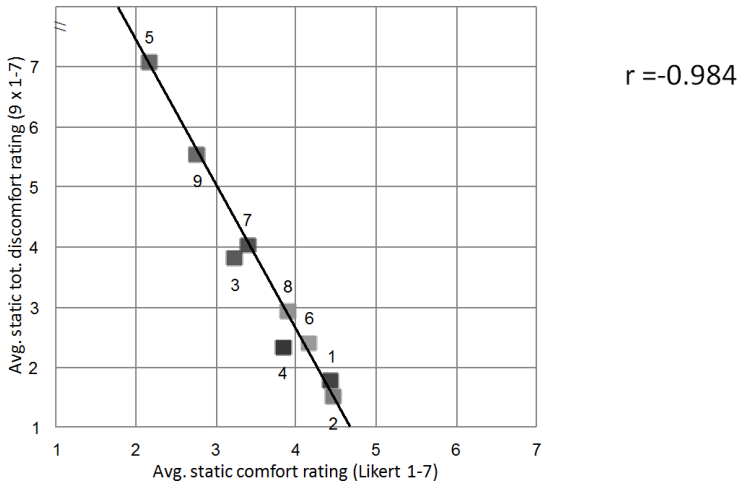

Figure 3.5: Correlation analysis of static comfort and discomfort ratings for seat 1-9.

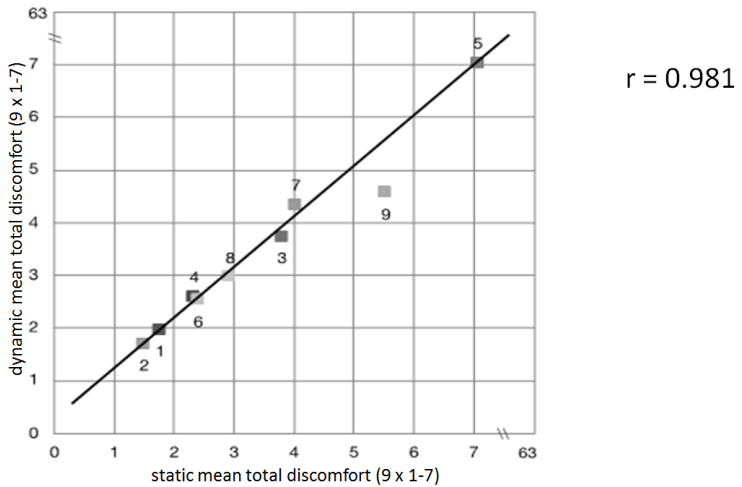

Figure 3.6: Correlation analysis of static discomfort and dynamic discomfort ratings for seat 1-9.

This affirms dependence between static discomfort, static comfort and dynamic discomfort. In contradiction, the comfort evaluation in the static test shows no correlation to the comfort evaluation in the dynamic test with  $r= 0.433$  (see Figure 3.7), proving the independence of static and dynamic comfort.

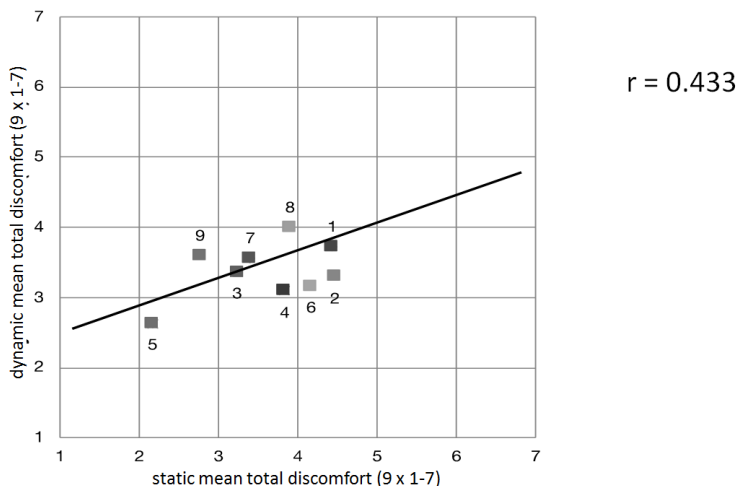

Figure 3.7: Correlation analysis of static comfort and dynamic comfort ratings for seat 1-9.

### 3.3.2. THE INFLUENCE OF SIDE SUPPORTS ON COMFORT AND DISCOMFORT

The mean of all participants' comfort ratings (1-7) for one seat is compared in percentual difference (%) to another seat and significance is tested using the Wilcoxon signed-rank test. The mean of all participants total discomfort (sum discomfort 0-7 of all LPD locations A-I = 0-63) is compared and analyzed in a similar way. Each variable (height, hardness, contour) is tested individually by comparing two seats with only one different variable. The results are described in the following subsections.

#### THE INFLUENCE OF A SIDE SUPPORT HEIGHT

In the static test, all low side supports are 41 % more comfortable ( $p= 1E-10$ ) and 49 % less uncomfortable ( $p= 6E-13$ ) than their high variants. In the dynamic test, there is a significant difference in discomfort, but not for comfort of low and high side supports. All low side supports are 6 % more comfortable ( $p= 0.230$ ) and 54 % less uncomfortable ( $p= 6E-11$ ) than their high variants. See Table 3.4 and Table 3.5.

#### THE INFLUENCE OF A SIDE SUPPORT FOAM HARDNESS

In the static test, soft side supports are more comfortable (low side support +16 %,  $p= 0.015$ ; high side support +49 %,  $p= 0.005$ ) and the soft side supports show less discomfort than their hard variants (low -24 %,  $p= 0.202$ ; high -46 %,  $p= 0.002$ ). Values are similar in the dynamic test: (+20 %,  $p= 0.032$ ; +28 %,  $p= 0.023$ ; -24 %,  $p= 0.183$ ; -47 %,  $p= 0.017$ ). The

Table 3.4: Low compared to high side support comfort ratings.

low and high	static	p=	dynamic	p=
 1 and 3	37 %	<b>0.001</b>	11 %	0.264
 4 and 5	77 %	<b>4E-5</b>	18 %	0.202
 6 and 7	23 %	<b>0.040</b>	-11 %	0.351
 8 and 9	41 %	<b>0.001</b>	11 %	0.187
total (1,4,6,8 - 3,5,7,9)	41 %	<b>1E-10</b>	6 %	0.230

Table 3.5: Low compared to high side support discomfort ratings.

low and high	static	p=	dynamic	p=
 1 and 3	-54 %	<b>0.003</b>	-47 %	<b>2E-4</b>
 4 and 5	-67 %	<b>1E-5</b>	-63 %	<b>6E-5</b>
 6 and 7	-40 %	<b>0.017</b>	-42 %	<b>0.006</b>
 8 and 9	-47 %	<b>0.002</b>	-35 %	<b>4E-5</b>
total (1,4,6,8 - 3,5,7,9)	-49 %	<b>6E-13</b>	-54 %	<b>6E-11</b>

effect is stronger for high side supports than it is for low side supports, see Table 3.6 and Table 3.7.

Table 3.6: Soft compared to hard side support comfort ratings.

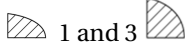
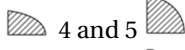
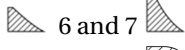
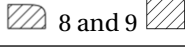
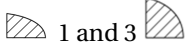
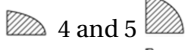
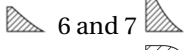
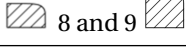
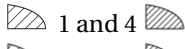
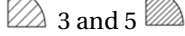
soft and hard	static	p=	dynamic	p=
 1 and 4	16 %	<b>0.015</b>	20 %	<b>0.032</b>
 3 and 5	49 %	<b>0.005</b>	28 %	<b>0.023</b>

THE INFLUENCE OF A SIDE SUPPORT CONTOUR

In the static test, extra convex side supports are the least comfortable and show most discomfort. The concave side supports are the most comfortable and show lowest discomfort values. The effect is only significant for the hard, high, concave contour. The convex contour is 36% less comfortable (p= 4E-4) and 75% more uncomfortable (p= 3E-4) than the concave contour. The dynamic test shows similar results, except the comfort of

Table 3.7: Soft compared to hard side support discomfort ratings.

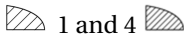
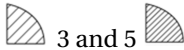
<b>soft and hard</b>	<b>static</b>	<b>p=</b>	<b>dynamic</b>	<b>p=</b>
 1 and 4	-24 %	0.202	-24 %	0.183
 3 and 5	<b>-46 %</b>	<b>0.002</b>	<b>-47 %</b>	<b>0.017</b>

the convex contour is now slightly lower than the extra convex contour (-7%, p= 0.395; -6%, p= 0.527), see Table 3.8 and Table 3.9.

Table 3.8: Contour side support comfort ratings.



<b>convex and xconvex</b>	<b>static</b>	<b>p=</b>	<b>dynamic</b>	<b>p=</b>
 1 and 8	14 %	0.089	-7 %	0.395
 3 and 9	17 %	0.141	-6 %	0.527
<b>convex and concave</b>	<b>static</b>	<b>p=</b>	<b>dynamic</b>	<b>p=</b>
 4 and 6	-8 %	0.333	-2 %	0.973
 5 and 7	<b>-36 %</b>	<b>4E-4</b>	<b>-26 %</b>	<b>0.002</b>

Table 3.9: Contour side support discomfort ratings.





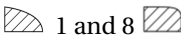
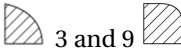
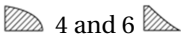
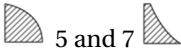
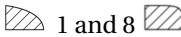
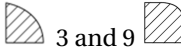
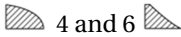



<b>convex and xconvex</b>	<b>static</b>	<b>p=</b>	<b>dynamic</b>	<b>p=</b>
 1 and 8	-40 %	0.192	-34 %	0.186
 3 and 9	-31 %	0.201	-18 %	0.55
<b>convex and concave</b>	<b>static</b>	<b>p=</b>	<b>dynamic</b>	<b>p=</b>
 4 and 6	-3 %	0.939	3 %	0.455
 5 and 7	<b>75 %</b>	<b>3E-4</b>	<b>62 %</b>	<b>0.001</b>

### 3.3.3. THE INFLUENCE OF A SIDE SUPPORT COVER FRICTION

Table 3.10 shows the mean comfort and mean total discomfort of all participants using side supports 1-9 with a low friction compared to a high friction cover. Significance is

tested using a Wilcoxon signed-rank test. Results show a slight increase of comfort for nearly all low side supports with the high friction cover. Nearly all high side supports are slightly less comfortable, but also less discomfortable with the high friction cover. The comfort of hard side supports are most influenced by the high friction cover, while soft side supports are almost not influenced by the high friction cover. However, none of these results were significant.

Table 3.10: Comfort and discomfort ratings of the high friction compared to low friction cover .

seat description	comfort	p=	discomfort	p=
 1 (soft, low, convex)	4 %	0.655	71 %	0.680
 2 (soft, x low, convex)	4 %	1	13 %	1
 3 (soft, high, convex)	-5 %	1	-14 %	0.655
 4 (hard, low, convex)	100 %	0.063	180 %	0.564
 5 (hard, high, convex)	-15 %	0.796	-12 %	0.355
 6 (hard, low, concave)	21 %	0.257	-31%	0.336
 7 (soft, high, concave)	-22 %	0.157	-8 %	0.785
 8 (soft, low, xconvex)	8 %	0.655	-14%	0.783
 9 (soft, high, xconvex)	-4 %	0.157	-20 %	0.574

### 3.3.4. STATIC COMFORT

In the static test, the lowest (40mm), soft (6kPa) and convex side support (seat 2, see Table 3.2 and Table 3.3 ) has the highest mean comfort and the lowest mean total discomfort. The high (90mm), hard (12kPa) and convex contour (seat 5) has the lowest mean comfort and the highest mean total discomfort.

### 3.3.5. DYNAMIC COMFORT

In the dynamic test, the low (55mm), soft (6kPa) and extra convex side support of seat 8 has the highest mean comfort. Similar to the static test, the lowest (40mm), soft (6kPa) and convex side support of seat 2 has the lowest mean total discomfort and the high (90mm), hard (12kPa) and convex contour of seat 5 has the lowest mean comfort and the highest mean total discomfort.

### 3.3.6. SEAT CHARACTERIZATION

Each seat characterization in Table 3.11 represents the percentage of subjects (X/30) who chose the characterization for a specific side support. Significance was tested using a Chi square test of independence. The characterization of the seats resulted in sportive (29 %)

as the most frequently chosen, followed by relaxing (22 %) and luxurious (14 %). Protective, tough and energizing were not frequently chosen and therefore shown as ‘other’. Table 11 shows the seat clusters for foam height, hardness and contour and their responds to the characterizations relaxing, sportive and luxurious. With 44 % of respondents characterizing high side supports as sportive, high side supports were significantly more sportive ( $p=4E-6$ ) than low side supports. In contrast, low side supports were significantly more relaxing (41 %,  $p=1E-10$ ) and luxurious (19 %,  $p=5E-7$ ) than high side supports. The convex contour was significantly more relaxing (23 %,  $p=0.011$ ) and luxurious (20 %,  $p=0.013$ ) than the extra convex contour.



Table 3.11: Characterization of side support clusters.

seat (cluster)	relaxation	sportive	luxurious	other
1 + 4 + 6 + 8 (low)	<b>41 %, p=1E-10</b>	17 %	<b>19 %, p=5E-7</b>	43%
3 + 5 + 7 + 9 (high)	6 %	<b>44 %, p=4E-6</b>	6 %	50%
1 + 3 (soft)	23 %	32 %, p=0.215	20 %, p=0.125	45 %
4 + 5 (hard)	30 %, p=0.409	22 %	10 %	48 %
4 + 5 (convex)	30 %	22 %	10 %, p=0.408	48 %
6 + 7 (concave)	33 %, p=0.781	27 %, p=0.522	15 %	40 %
1 + 3 (convex)	<b>23 %, p=0.011</b>	32 %	<b>20 %, p=0.013</b>	45 %
8 + 9 (xconvex)	7 %	42 %, p=0.256	5 %	42 %

### 3.3.7. PRESSURE RECORDINGS

The mean of maximum pressure recordings for a small sample (2nd percentile, 4x 50th percentile, 99th percentile) for the high, hard, convex bolster 5 was compared to the low, soft, convex bolster 2. A Wilcoxon signed-rank test is used to calculate the significance. The maximum pressure for the hip area on the seat cushion was significantly higher ( $p=2E-5$ ) for the hard, high bolsters (5) than it was for the soft, extra low bolster (2). In similar comparison, the mean discomfort was also significantly higher ( $p=5E-5$ ; see Table 3.12).

Table 3.12: Mean discomfort compared to maximum pressure measurements in the hip area.

seat	mean discomfort	max. pressure ( $N/cm^2$ )
 2 (soft, x low, convex)	0(±0.6)	0.57(±0.16)
 5 (hard, high, convex)	4(±2)	1.25(±0.51)
5 > 2	<b>p= 5E-5</b>	<b>p= 2E-5</b>

### 3.3.8. THE INFLUENCE OF ANTHROPOMETRICS ON COMFORT AND DISCOMFORT

To identify the influence of human anthropometrics on the static and dynamic comfort and discomfort of side supports, subjects were divided in three groups of 10; smallest, middle and largest percentiles. Focused on extremities, the smallest group was compared to the largest group. Only the high, hard, convex side support 5 and the low, soft, convex side support 2 are analyzed. The hip is in contact with the seat bolster and the waist with the backrest wing, so hip circumference and waist circumference were analyzed separately. A Wilcoxon signed-rank test is used to calculate the significance.

#### HIP CIRCUMFERENCE AND SEAT BOLSTER COMFORT AND DISCOMFORT

The mean static and dynamic comfort and discomfort is compared between two groups with a small hip circumference (93 cm  $\pm$ 2,5) and a large hip circumference (107cm  $\pm$ 4). In all cases, seat 2 was graded better for a large hip and seat 5 was graded worse for a large hip than a small hip (see Table 3.13). Large hip circumferences experienced significantly lower static (-83 %, p= 0.028) and dynamic discomfort (-79 %, p= 0.017) in seat 2 and lower static comfort (-44 %, p= 0.084) for seat 5.

Table 3.13: Small hip compared to large hip mean comfort and discomfort.

Static comfort	Small hip 93cm $\pm$ 2.5	Large hip 107cm $\pm$ 4	Difference %	Significance p
Seat 2	3.9 $\pm$ 1.5	4.9 $\pm$ 1.8	26 %	0.199
Seat 5	2.7 $\pm$ 1.6	1.5 $\pm$ 0.5	-44 %	0.084
<b>Static comfort</b>				
Seat 2	<b>3.0 <math>\pm</math> 2.3</b>	<b>0.5 <math>\pm</math> 1.0</b>	<b>-83 %</b>	<b>0.028</b>
Seat 5	6.9 $\pm$ 5.4	9.0 $\pm$ 7.0	30%	0.386
<b>Dynamic comfort</b>				
Seat 2	2.7 $\pm$ 1.9	3.9 $\pm$ 1.9	44 %	0.231
Seat 5	2.8 $\pm$ 1.5	2.1 $\pm$ 0.7	-25 %	0.321
<b>Dynamic comfort</b>				
Seat 2	<b>3.3 <math>\pm</math> 2.1</b>	<b>0.7 <math>\pm</math> 0.8</b>	<b>-79 %</b>	<b>0.017</b>
Seat 5	6.6 $\pm$ 4.0	8.1 $\pm$ 4.7	23 %	0.357

#### WAIST CIRCUMFERENCE AND BACKREST WING COMFORT AND DISCOMFORT

The mean static and dynamic comfort and discomfort is compared between two groups with a small waist circumference (73cm  $\pm$ 4,5) and a large waist circumference (93cm  $\pm$ 5.7). In most cases, large waist circumferences experienced lower comfort and lower discomfort than small waist circumferences (see Table 3.14). Large hip circumferences experienced significantly lower static (-41 %, p= 0.021) and dynamic comfort (-33 %, p= 0.040) in seat 5.

Table 3.14: Small waist compared to large waist mean comfort and discomfort ratings.

static comfort	Small hip 93cm ± 2.5	Large hip 107cm ± 4	Difference %	Significance p
Seat 2	4.7 ± 1.5	4.6 ± 1.6	-2 %	0.832
Seat 5	<b>2.9 ± 1.5</b>	<b>1.7 ± 0.8</b>	<b>-41 %</b>	<b>0.021</b>
<b>Static comfort</b>				
Seat 2	2.3 ± 2.5	1.0 ± 1.2	-57 %	0.088
Seat 5	7.7 ± 6.7	7.2 ± 7.0	-6%	0.953
<b>Dynamic comfort</b>				
Seat 2	3.5 ± 2.3	3.1 ± 1.8	-11 %	0.522
Seat 5	<b>3.3 ± 1.3</b>	<b>2.2 ± 0.8</b>	<b>-33 %</b>	<b>0.040</b>
<b>Dynamic comfort</b>				
Seat 2	2.3 ± 2.5	0.8 ± 0.6	-65 %	0.062
Seat 5	6.7 ± 4.5	7.7 ± 4.6	15 %	0.678

### ADDITIONAL INSIGHTS

Frequent comments are clustered in Table 3.15. Interesting- findings include that only the soft, extra convex backrest (8 and 9) had positive remarks, the rest was too wide. Only the soft, low and convex seat cushion (2) had positive remarks. Most seat cushions were argued too small (3,4,5,7,8,9) and others too wide (1,2,6).

Table 3.15: Frequent comments for each seat.

seat	positive remarks	negative remarks
1		5x too wide seat; 4x too wide backrest
2		2x too wide seat; 4x too wide backrest
3	3x good support	4x too small seat; 2x too wide backrest
4		6x too small seat; 5x too wide backrest
5		8x too small seat
6		3x too wide seat; 7x too wide backrest
7	4x good support	4x too small seat; 2x too hard seat
8	4x good backrest	2x too small seat
9	5x good backrest	2x too small seat

## 3.4. DISCUSSION

This study shows that foam height, hardness and contour of side supports of a car seat do influence discomfort and comfort. There is a difference of influence for the different parameters.



### 3.4.1. RELATIONS BETWEEN STATIC AND DYNAMIC COMFORT AND DISCOMFORT

The high correlation between high comfort and low discomfort during static sitting indicates that the absence of discomfort provokes comfort and vice-versa (Hertzberg 1958, Floyd and Roberts 1958). However, only initial comfort was tested in this study. Discomfort during static and dynamic sitting is also highly correlated, which could mean the influence of lateral accelerations, vibration and sliding on dynamic discomfort is marginal, in direct contradiction with findings of Ebe and Griffin (2001). But, it could also mean all of the seats were designed really well for dynamic conditions or accelerations and vibrations were too low in the dynamic test, than the results of the study would not be in direct contradiction to Ebe and Griffin (2001). The low correlation between static and dynamic comfort could mean there is a different interpretation of the comfort of side supports in the static situation and the dynamic situation, in line with finding of Ebe and Griffin (2001).

### 3.4.2. RELATIVE INFLUENCE OF SIDE SUPPORT VARIABLES ON COMFORT AND DISCOMFORT

The most significant results were found comparing low (55mm) with high (90mm) side supports. In most cases, a lower side support has significantly higher comfort and lower discomfort than the high variant. This indicates that high side supports are not a necessity for a car seat; instead they can cause discomfort, probably through increased pressure discomfort primarily in the side of the hip, shown in the pressure recordings in Table 3.12. This is in line with the findings of Zenk and Mergl (2006), who made an ideal pressure distribution with higher pressure under the ischial tuberosities and lower pressure at the side of the leg. Especially the upper thigh is more sensitive to pressure discomfort, according to Vink and Lips (2017). Many significant results were found comparing soft (6kPa) to hard (12kPa) side supports. In many cases, a soft side support has significantly higher comfort and lower discomfort than a similar hard side support. According to Cunningham et al. (1994) and Tan et al. (1996), this is a result of the favor for surface softness in short term comfort. Some significant results were found comparing extra convex to convex and concave side supports. When using hard foam, a concave contour is significantly better than a convex contour. Noro et al. (2012) found comparable results testing a prototype for a surgical seat, with a concave contour following the human buttock, resulting in a larger contact area and lower average pressure compared to a conventional surgical seat. When using soft foam, the convex contour was (however not significantly) better than the extra convex contour. This could be the result of increased contact area caused by the softness of the foam (Fang, 2016).

### 3.4.3. RELATIVE INFLUENCE OF SIDE SUPPORT COVER FRICTION

Another assumption is that high and convex side supports cause the highest shear discomfort in the dynamic test as a result to higher pressure (Goossens, 2001). The highest discomfort is found in high, convex side supports 5 and 3, as well as high, extra convex side support 9. However, it is unknown if this discomfort is a consequence of pressure or shear forces. No significant increase in discomfort is found for the high friction compared to the low friction cover. This is probably because of the small covered area of the high

friction cover, only on the side supports, while not all participants had an equal contact area with the side supports due to differences in hip breadth. Therefore, this assumption is not affirmed in this study. Further testing is advised with the entire seat surface in low friction (leather) or high friction (Alcantara) material.

#### **3.4.4. THE OPTIMAL SIDE SUPPORT FOR STATIC COMFORT AND DISCOMFORT**

Soft foam with a low profile should theoretically cause the least static discomfort (Fang, 2016), which is affirmed by this study. The results show significantly better comfort and discomfort for soft and low side supports.

#### **3.4.5. THE OPTIMAL SIDE SUPPORT FOR DYNAMIC COMFORT AND DISCOMFORT**

It is assumed that side supports made of hard foam with a high profile following the shape of the human body causes the highest dynamic comfort (Kamp, 2012; Noro et al., 2012). In this study, the low, soft and extra convex side support has the highest dynamic comfort, rejecting this assumption for this population. The results show significantly better comfort and discomfort for soft side supports, in line with findings of Fang (2016) and significantly better discomfort for low side supports. When using soft foam, the extra convex contour appears to have beneficial properties related to dynamic comfort, probably by the evoked feeling of 'holding' as a result of slightly compressing the soft foam on contact. Participants mentioned they especially liked this extra convexity in the backrest wings and much less in the seat bolsters. Long term effects should be investigated.

#### **3.4.6. THE CHARACTERIZATION OF SIDE SUPPORTS**

Another assumption is that lower and softer side supports are characterized as luxurious, while harder and higher side supports are sportive (Kamp, 2012). Results show that luxurious and relaxing are related to low and convex side supports. Sportive is only related to high side supports. No significant results were found connecting either of the characterizations to foam hardness, contradicting with the findings of Kamp (2012) and (Tada et al. 1999), who relate hard foam to sportive and soft foam to luxurious. Possibly, this is the result of a count based characterization rather than a rating for each characterization. For future characterization studies, it is advised to only use the characterizations relaxing and sportive and use a Likert scaled rating for each characterization, preferably opposing pairs e.g. 'basic' and 'luxurious'. In this study the previous assumption is partly true, excluding any significant effect related to foam hardness and including the effect of side support contour; stating convex side supports being more relaxing and luxurious as opposed to extra convex side supports.

#### **3.4.7. PRESSURE MEASUREMENTS**

It is assumed that soft and low side supports have a lower maximum pressure in the hip area than hard and high side supports, which is affirmed by this study. When maximum pressure at the hip area is lower, the discomfort is also lower, in line with the findings of Chen (2007).

### 3.4.8. ANTHROPOMETRICS

Coelho and Dahlman (1999) mentioned the importance of the right seat cushion width between the bolsters. When the seat cushion width between the bolsters is non-adjustable, comfort and discomfort within a wide range of hip widths has to be arranged by optimizing bolster height, hardness and contour. Soft and low bolsters cause worse comfort and discomfort for too small hip circumferences, due to insufficient contact area and lateral support during cornering at the hip (Fang, 2016). Hard and high bolsters cause worse comfort and discomfort for large hip circumferences, due to increased pressure at the hip (Chen, 2007). For optimal static and dynamic comfort and discomfort, the best compromise is the soft, low bolster, with a positive effect for large hip circumferences and a small negative effect for small hip circumferences. For this population, no conclusions can be formulated relating waist circumference to backrest wing comfort and discomfort, due to inconsistency of results and both lower comfort and discomfort for larger waist circumferences for the soft, low wing 2 and the hard, high wing 5.

### 3.4.9. LIMITATIONS

There were several limitations in this study. Firstly and most important, many participants did not have the right hip width matching the seat width, most of the seats were too narrow for them. Coelho and Dahlman (1999) also found this in their study. While this is expectable for non-adjustable bolsters, it made finding an ideal contour much harder. Participants mentioned frequently that some seats were too narrow; a few participants even mentioned all seats were too narrow (see Table 3.15). In an ideal situation, the seat width could be adjusted to make the contour fully express its support, with a large contact area and low maximum pressure and pressure gradient (Fang, 2016). Also, it would have been better to have used molded side supports, as they behave differently than the side supports in this study, cut from foam blocks (Kolich, 2008). Furthermore, in the dynamic test a significant linear correlation was found in discomfort compared to the static test ( $r = .981$ ; see Figure 3.6). This might have been the result of a too low speed in cornering, which implies it would have been better to move the research to a closed track, where a more drastic dynamic test could have been conducted. In addition, it would have been better to divide the overall comfort in seat cushion comfort and backrest comfort for more precise comfort ratings. Lastly, this study was only evaluated on initial comfort. Especially for the discomfort results, it would be better to test all seats long-term comfort, as discomfort is known to increase over time (Mergl et al., 2005)

## 3.5. CONCLUSION

This study provides evidence that the design of a side support influences static and dynamic comfort and discomfort. Static low comfort and static and dynamic high discomfort were found to be highly correlated, while dynamic comfort was notably different. This difference in dynamic comfort causes slightly biased results and withholds a simple conclusion. Nevertheless, for higher comfort and lower discomfort, it is recommended to use a low side support (40mm), made of soft foam (6kPa). The best contour of the side support is still to be determined, ideally in a similar study with subjects that have the exact right hip width or with adjustable seat width.

### **3.6. ACKNOWLEDGEMENT**

The authors thank Juergen Ringer for developing the seat for this study and Renato Martic for arranging a testing vehicle. Wenhua Li is thanked for providing the Chi-square test of independence as a means to analyze the characterization data.

## REFERENCES

- Akins, J. S., Karg P. E. and, Brienza D. M., 2011. *Interface shear and pressure characteristics of wheelchair seat cushions. J Rehabil Res Dev* 48(3): 225-234.
- Akioka, T., 1994. *Ergonomic evaluation of automobile driver's seat. Proceeding-Second International congress on physiological anthropology, Kiel.*
- Beard, G. F. and, Griffin M. J., 2013. *Discomfort during lateral acceleration: Influence of seat cushion and backrest. Applied Ergonomics* 44(4): 588-594.
- Bergs, J. and, Kanaska D., 2012. *Motor vehicle seats and their defect classification. Engineering for Rural Development* 11: 314-317.
- Carcone, S. M. and, Keir P. J., 2007. "Effects of backrest design on biomechanics and comfort during seated work. *Applied Ergonomics* 38(6): 755-764.
- Cengiz, T. G. and, Babalik F. C., 2007. *An on-the-road experiment into the thermal comfort of car seats. Applied Ergonomics* 38(3): 337-347.
- Chen, J., 2007. *Body pressure distribution of automobile driving human machine contact interface.*
- Coelho, D. A. and, Dahlman S., 1999. *A pilot evaluation of car seat side support: Leading to a redefinition of the problem. International Journal of Industrial Ergonomics* 24(2): 201-210.
- Cunningham, A., Huygens E. and, Leenslag J. W., 1994. *MDI comfort cushioning for automotive applications. Cellular polymers* 13(6): 461-472.
- Ebe, K. and, Griffin M. J., 2001. *Factors affecting static seat cushion comfort. Ergonomics* 44(10): 901-921.
- Fang, R., Gao J. and, Xie S., 2016. *Analysis of pressure distribution between human and seat for evaluation of automotive seating comfort. Lecture Notes in Electrical Engineering.* 364: 383-395.
- Floyd, W. and, Roberts D. 1958. *Anatomical and physiological principles in chair and table design. Ergonomics* 2(1): 1-16.
- Goossens, R., 2001. *Shear stress measured on three different cushioning materials. Delft, The Netherlands: University of Technology.*
- Goossens, R., Zegers R., Hoek van Dijk, G.A. and, Snijders C.J., 1994. *Influence of shear on skin oxygen tension. Clinical Physiology and Functional Imaging* 14(1): 111-118.
- Goossens, R. H. M. and, Snijders, C. J., 1995. *Design Criteria for the Reduction of Shear Forces in Beds and Seats. Journal of Biomechanics* 28(2): 225-230.
- Harrison, D. D., Harrison S. O., Croft A. C., Harrison, D. E. and, Troyanovich, S. J., 2000. *Sitting biomechanics, part II: optimal car driver's seat and optimal driver's spinal model. J Manipulative Physiol Ther* 23(1): 37-47.
- Hertzberg, H., 1958. *Seat comfort. Annotated bibliography of applied physical anthropology in human engineering," WADC Technical Report: 56-30.*

- Hiemstra-van Mastrigt, S., Groenesteijn, L., Vink, P. and Kujit-Evers, L.F.M., 2017. Predicting passenger seat comfort and discomfort on the basis of human, context and seat characteristics: a literature review. *Ergonomics* 60(7): 889-911.
- Kamalanathsharma, R. K., Rakha, H.A. and, Zohdy, I.H., 2015. Survey on In-vehicle Technology Use: Results and Findings. *International Journal of Transportation Science and Technology* 4(2): 135-149.
- Kamp, I., 2012. The influence of car-seat design on its character experience. *Applied Ergonomics* 43(2): 329-335.
- Kolich, M., 2008. A conceptual framework proposed to formalize the scientific investigation of automobile seat comfort. *Applied Ergonomics* 39(1): 15-27.
- Kolich, M., Esselmacher, S. D. and, McEvoy, J. T., 2005. Automotive seating: The effect of foam physical properties on occupied vertical vibration transmissibility. *Journal of Sound and Vibration* 281(1-2): 409-416.
- Kwiatkowska, M., Franklin, S. E., Hendriks, C. P. and, Kwiatkowski, K., 2009. Friction and deformation behaviour of human skin. *Wear* 267(5): 1264-1273.
- Kyung, G., Nussbaum, M. A. and, Barski-Reeves, K., 2008. Driver sitting comfort and discomfort (part I): Use of subjective ratings in discriminating car seats and correspondence among ratings. *International Journal of Industrial Ergonomics* 38(5-6): 516-525.
- Le, P., Rose, J., Knapik, G. and, Marras, W.S., 2014. Objective classification of vehicle seat discomfort. *Ergonomics* 57(4): 536-544.
- Lueder, R. K. (1983). "Seat comfort: a review of the construct in the office environment." *Human Factors* 25(6): 701-711.
- Mansfield, N., Sammonds, G. and, Nguyen, L., 2015. Driver discomfort in vehicle seats - Effect of changing road conditions and seat foam composition. *Applied Ergonomics* 50: 153-159.
- Mazari, F. B. and, Havelka, A., 2015. Pressure distribution of car seat at different angle of backrest. *Vlakna a Textil* 2015(3-4): 33-39.
- Mergl, C., Klendauer, M., Mangen, C. and, Bubb, H., 2005. Predicting Long Term Riding Comfort in Cars by Contact Forces Between Human and Seat.
- Molenbroek, J., 2004. *Dined. Anthropometric Database.*
- Molenbroek J. F. M., Albin, T. J. and, Vink, P., 2017. Thirty years of anthropometric changes relevant to the width and depth of transportation seating spaces, present and future, *Applied Ergonomics* 65, 130-138.
- Noro, K., Naruse, T., Lueder, R., Nao.i, N. and, Kozawa, M., 2012. Application of Zen sitting principles to microscopic surgery seating. *Applied Ergonomics* 43(2): 308-319.
- Pearson, E. J. M., 2009. Comfort and its measurement – A literature review. *Disability and Rehabilitation: Assistive Technology* 4(5): 301-310.
- Pollock, R. D., Woledge, R. C., Mills, K. R., Martin, F. C. and, Newham, D. J., 2010. Muscle activity and acceleration during whole body vibration: Effect of frequency and amplitude. *Clinical Biomechanics* 25(8): 840-846.

Porter, J. M., Gyi, D.E. and, Tait, H.A., 2003. *Interface pressure data and the prediction of driver discomfort in road trials*. *Applied Ergonomics* 34(3): 207-214.

Rebiffe, R., 1975. *The Driving Seat. Its Adaptation to Functional and Anthropometric Requirements*.

Reed, M.P., Schneider, L.W., and, Ricci, L.L., 1994. *Survey of Auto Seat Design Recommendations for Improved Comfort*. Technical Report UMTRI-94-6. University of Michigan Transportation Research Institute, Ann Arbor, MI.

Schmidt, S., Amereller, M., Franz, M., Kaiser, R. and, Schwirtz, A., 2014. *A literature review on optimum and preferred joint angles in automotive sitting posture*. *Applied Ergonomics* 45(2): 247-260.

Tada, M., Nisimatsu, T. and, Toba, E., 1999. *Relation between Seat Shape and Sitting Comfort Evaluation on Car Driver's Seat*. *Sen'i Gakkaishi* 55(9): 432-439.

Tan, A., Deni, L. and, Leenslag, J.,W., 1996. *Low density all-MDI polyurethane foams for automotive seating*.

Van der Grinten, M. P. and, Smitt, P., 1992. *Development of a practical method for measuring body part discomfort*. *Advances in industrial ergonomics and safety* 4: 311-318.

Veen, S. v. and, Vink, P., 2016. *Can Prior Experience Influence Seating Comfort Ratings?* *Ergonomics in Design* 24(2): 16-20.

Vink, P. and, Hallbeck, S., 2012. *Editorial: comfort and discomfort studies demonstrate the need for a new model*. *Applied Ergonomics* 43(2): 271-276.

Vink, P. and, Lips D., 2017. *Sensitivity of the human back and buttocks: The missing link in comfort seat design*. *Applied Ergonomics* 58: 287-292.

Xu, J., Yang, K. and, Lu, G., 2015. *An Experimental Study on Lateral Acceleration of Cars in Different Environments in Sichuan, Southwest China*. *Discrete Dynamics in Nature and Society* 2015: 16.

Zenk, R., Mergl, C., Hartung, J., Sabbah, O. and, Bubb, H., 2006. *Objectifying the Comfort of Car Seats*, SAE International.

Zhang, L., Helender, M. G. and, Drury C. F., 1996. *Identifying Factors of Comfort and Discomfort in Sitting*. *Human Factors* 38(3): 377-389.





# 4

## HOW DOES THE SEAT COVER INFLUENCE THE SEAT COMFORT EVALUATION?

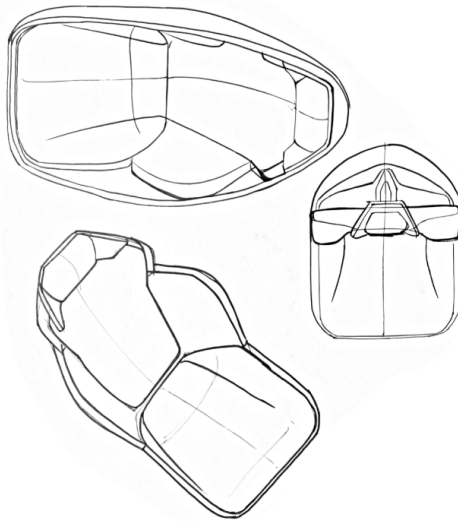

This chapter is published in the Proceedings of the 20th Congress of the International Ergonomics Association (IEA 2018) pp 709-717.

Author: M. Wegner, S. Anjani, W. Li, and P. Vink

**Abstract**

*This study investigates the tactile perceived influence of seat covers. Two identical BMW 3-Series seats are used, one with a leather cover and one with a fabric cover. Thirty healthy subjects participated in an experiment rating the tactile perceived properties of the seats while blindfolded. A discomfort test, a word pair rating and the overall experience of the seats were examined. The study has shown that not only the foam properties and the contour of the seat influences the seat characterization but also the seat cover material. The leather and the fabric seats were characterized different, but the pressure distribution did not show so much differences. Furthermore, the perceived differentiation of the seats are distinctive for the seat pan and for the backrest. Therefore, further research is needed to investigate other characteristics of the seat like shear force related to various cover properties in combination with different seat components and contour combinations.*

**Keywords:** Seat Cover, Seat Comfort, Cover materials.

**4.1. INTRODUCTION**

The best time to pick someone's pocket is, when a person reads a book or has another challenging visual search task to perform. The study of Murphy and Dalton (1994) has shown that people's ability to notice tactile stimuli is reduced when they are carrying out a demanding visual task. In contrast, the tactile information enables blindfolded people to perceive the environment (Wong et al., 2011). The interaction of the senses and the environment affect the tactile perception and the resulting (dis-)comfort rating (Vink and Hallbeck, 2012), especially while sitting in a seat with a huge number of contact area. For a subject based evaluation of seat properties it is important to emphasize the tactile senses and minimize all other environmental factors. Schmidt and Thews (1980) describe the four most investigated tactile receptors in the skin: Merkel disks for the pressure, Ruffini corpuscles for the stretch and shear stresses, the Meissner's corpuscles for the information about tactile and sensitive changes and the Pacinian corpuscles for vibration. Especially automotive seats have various attributes and shapes depending on diverse factors. Luxury seats are characterized more flat and soft, sporty seats more hard with pronounced bolsters (Kamp, 2012a). The different seat contours and foam characteristics affect the resulting seat-human interaction while causing individual deformation of the skin and tissue recorded by the tactile mechanoreceptors. The resulting interaction area depends on the individual person sitting in the seat as well as on the seat characteristics causing individual tactile stimuli and a personal subjective (dis-)comfort rating. Based on the described context research was done to design comfortable seats. The shape and the contour of a seat is an often investigated factor to improve the comfort. Franz et al. (2011) developed a light weight seat based on the human contour. Kamp (2012b) compared the developed seat (Franz et al., 2011) to existing seat concepts. Kolich (2003) compared five seats with different geometry characteristics, concluding that the seat designer should be aware of ergonomic relations. Additionally, the literature mentions ergonomic aspects investigating the right sitting and seat angles with appropriate seat dimensions (Reed and Ricci, 1994). The most investigated tactile receptor related to comfort is the pressure distribution. De Looze et al. (2003) illustrates and concludes in a literature review that a well-distributed pressure in a seat cushion is linked to the

discomfort perception. Mergl (2006) and Zenk et al. (2006) defined an ideal pressure distribution and Kilinscoy (2016) confirms this ideal pressure distribution for rear seats. In comparison, the shear force and friction perception are not investigated sufficiently. Goossens (2001) considers various seat pan materials measuring the outcome shear forces and Grujicic et al. (2010) correlates a higher cover friction to higher shear forces based on simulative results. There is also a limited group of studies examining the link between the comfort perception, the tactile perception and the seat properties. Most of these studies focus on the foam properties. Ebe and Griffin (2000, 2001) investigate the effects of various foam characteristics related to the comfort. Andreoni et al. (2002) used a large number of seats with different foam characteristics analyzing pressure and comfort, defining a correlation between the shape of the human body and the interface pressure. Zhang et al. (1996) illustrates that the discomfort perception is associated with various wordings, like posture, pain, stiffness or strained feeling, which implements that the comfort should also be related to other perceptions like the shear force and additional seat components like the seat cover. There is to our knowledge no study which considers the influence of the seat cover properties on the perceived comfort, even though it is the top seat layer that has most direct interaction with the human body. The aim of this paper is to highlight the tactile perceived seat cover properties of different seats. Therefore, the research question of this study is raised to: Does a person perceive a difference between two seats with different cover materials and which factors influence the differentiation of these seats?

## 4.2. METHODS

To answer the research question, two identical seats with different seat cover material properties were mounted on a setup, compared and rated by thirty different test persons. The participants performed the experiment blindfolded in order to focus on the tactile perceived properties of the seats.

### 4.2.1. PARTICIPANTS

Thirty healthy subjects, twenty males and ten females, participated in the experiment. The mean height of the participants was 1.73 m (1.55 m – 1.94 m) with a mean weight of 70.9 kg (47 kg – 110 kg). On the torso, the participants either wear a pullover (30%), a shirt (63%) or a dress (6.7%); on the bottom either jeans (70%), leggings/tights (13%), cloth pants (13%) or sweatpants (3%).

### 4.2.2. SEATS

Two basic BMW 3-series seats are used for the research with a simple, not distinctive contour in order to emphasize the properties of cover materials while sitting in the seat (see Figure 4.1). Furthermore, the seat layout is simple, consisting out of a seat frame, foam, heating mat and cover. The seats only differ in cover material: leather and fabric. Both seats are produced and assembled in the same factory on the same day and during a similar period fulfilling all specified requirements of the manufacturer. The foam hardness of the seat pan is 6 kPa in the main surface and 12 kPa in the bolsters. The backrest has a foam hardness of 5 kPa in the main surface and 10 kPa in the bolsters.



Figure 4.1: Setup of the experiment. Leather and fabric seat mounted next to each other in the H-Point-Position.

#### 4.2.3. SETUP

Figure 4.1 illustrates the research setup. The seats are mounted in the H-Point position on a frame next to each other. In front of the seats a platform is mounted for a reproducible positioning of the heels. The seats are placed behind a wall in order to prevent a visual impression of the seats before the test. Considering the differing heat transfer coefficients of leather and the fabric material, this could create a different temperature perception of the materials, both seats were pre-heated to human temperature by having persons sit on it before starting the experiment. The seat position of both seats is not changed.

#### 4.2.4. PROCEDURE

Before carrying out the test, anthropometric measurements are performed. The subjects are calibrated while sitting on the anthropometric chair for 3 minutes according to a procedure described in Molenbroek et al. (2017). During calibration, the participant is informed about the questionnaire and is blindfolded during the entire experiment to exclude visual impressions. The participant also did not get any information about the seats. The seats are named during the experiment: seat one and seat two. The order of naming the leather and the fabric seat, seat one and seat two, is changed systematically. The experiment always begins with seat number one. During the experiment the skin of the subject is not allowed to contact directly with the seat surface. An assistant guides the participants to the research setup and helps fill out the questionnaire (Appendix A.2.2). Initially each participant may rate the discomfort of both seats (leather and fabric) on a LPD body scale (0-6).

#### 4.2.5. DIFFERENTIATION OF THE SEAT CHARACTERISTICS USING VARIOUS COVERS.

In order to investigate how the seat cover influences the perceived experience, the participants have to assess the leather and the fabric seat with the following word pairs:

soft-hard; stiff-elastic; close-wide; formative-loose; sportive-lame; supporting-unstable; loose-firm, slippery-coarse

The word pairs are rated on a Likert scale (-3, -2, -1, 0, 1, 2, 3). The negative rating represents a tendency to the left word pair characterization, zero is neutral and a positive rate outlines a tendency to the right characterization of the word pair. For each word pair, the participant is allowed to change seats once, after completing the rating for the current seat. The participant switches to the next word pair if the previous word pair is rated for both seats. The seat pan and the backrest are rated separately.

#### 4.2.6. OVERALL IMPRESSION OF THE SEATS.

The subject assesses and characterizes the overall impression of the leather and fabric seat with one of the following descriptions:

restricted; cosy, sporty; protected, relaxed

The participant also has to estimate, separately for the seat pan and backrest, whether the contour of the compared seats is the same or different. The participant also has to conclude which of both seats is their favorite. Finally, the pressure distribution of each participant is recorded for the fabric and the leather seat with a FSA Pressure Measurement System from Force Sensing Array (FSA®). The maximum pressure is determined using the post processing tool of the FSA pressure mapping software and the mean maximum pressure of all participants is calculated by Microsoft Excel.

#### 4.2.7. STATISTICAL ANALYSIS

The statistical analysis of the word pair data is performed using the SPSS-Software. The chi-square distribution test is used to prove an unspecified distribution of the data. A Wilcoxon rank test with a statistical significance of  $\alpha < 0.05$  is used for the seat pan and backrest separately, to analyze whether the word pair ranking of the seats differ between the two cover materials.

### 4.3. RESULTS

#### 4.3.1. SUBJECTIVE EVALUATION

The initially performed discomfort rating using a LPD-body map has shown that none of the participants has discomfort complains for neither the leather nor the fabric seat.

#### DIFFERENTIATION OF THE SEAT WITH VARIOUS SEAT COVERS.

Figure 4.2 shows the results of the perceived seat pan rating. The upper part (a.) of the figure describes the results of the rated word pairs for the leather and the fabric seat pan. The mean rating of the leather seat pan differs to the mean rating of the fabric seat pan for every word pair. The lower part (b.) illustrates a statistical overview of the rating results in boxplots for each word pair and material (leather and fabric). The Wilcoxon signed-rank test has shown that the cover material significantly affects the perception of hardness (**soft-hard:  $z=-2.632$ ,  $p=0.008$** ) with an effect size of 0.48, the perception of the elasticity of the material (**stiff-elastic:  $z=-3.147$ ,  $p=0.002$** ) with an effect size of 0.57 and the perception of enclosing (**formative-loose:  $z=-2.032$ ,  $p=0.042$** ) with an effect size of 0.37. The leather seat pan was assessed to be neutral in hardness (mean value: 0.033, std. dev.=1.60), stiff (mean value: -0.9, std. dev.=1.24) and nearly neutral due to the

enclosing perception (mean value: 0.2, std. dev.=1.47). The mean rating of the fabric seat characterizes the seat pan as soft (mean value: -1.2, std. dev.=1.20), elastic (mean value: 0.522, std. dev.=1.25) and formative (mean value: -0.6, std. dev.=1.25).

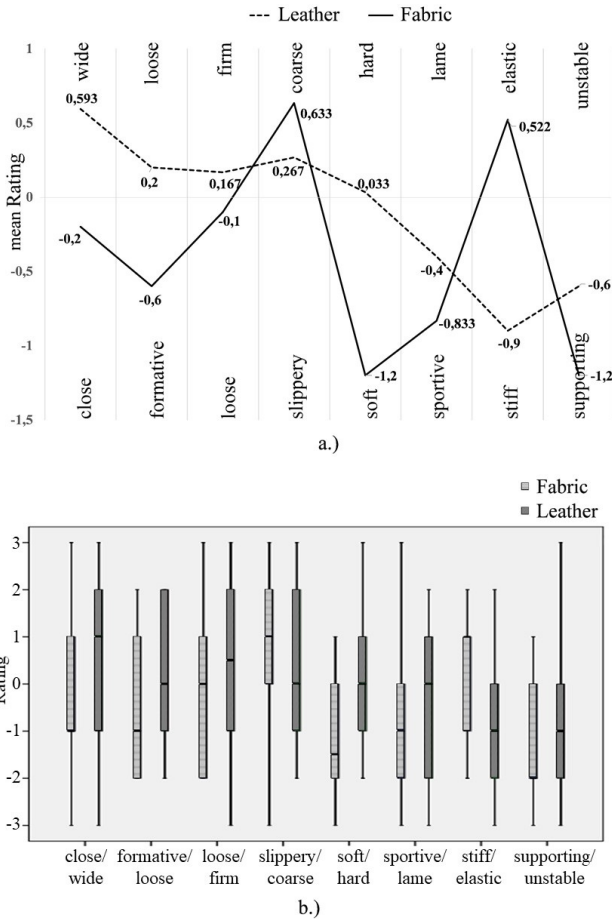

Figure 4.2: Comparison of the subjective seat pan ratings. a.) illustrates the mean rates of the word pairs for the leather and fabric cover material. b.) presents the statistical distribution of the ratings in boxplots.

Figure 4.3 shows the results of the rated word pairs for the backrest. The upper part of Figure 4.3 represents the differing mean rating of the leather and fabric backrest. The lower part of the figure (b.) emphasizes the statistical distribution of the leather and fabric backrest results. The Wilcoxon signed-rank test illustrates that the cover material significantly influences the differentiation between both backrests perceiving the elasticity of the material (**stiff-elastic:  $z=-2.755$ ,  $p=0.006$** ) with an effect size of 0.50, perceiving the surface roughness (**slippery-coarse:  $z=-2.461$ ,  $p=0.014$** ) with an effect size of 0.45, perceiving the breadth of the backrest (**close-wide:  $z=-2.147$ ,  $p=0.032$** ) with an effect size of 0.39 and perceiving the support of the backrest (**supporting-unstable:  $z=-1.959$** ,

**p=0.05**) with an effect size of 0.36. The backrest of the leather seat was rated stiff (mean value: 0.567, std. dev.=1.33), slippery (mean value: -0.233, std. dev.=1.59), nearly neutral for the backrest breadth (mean value: 0.133, std. dev.=1.72) and unstable (mean value: 0.667, std. dev.=1.37). The fabric backrest was characterised as elastic (mean value: 0.467, std. dev.=1.10), coarse (mean value: 1.067, std. dev.=1.53), close (mean value: -0.933, std. dev.=1.55) and supporting (mean value: -1.367, std. dev.=1.10).

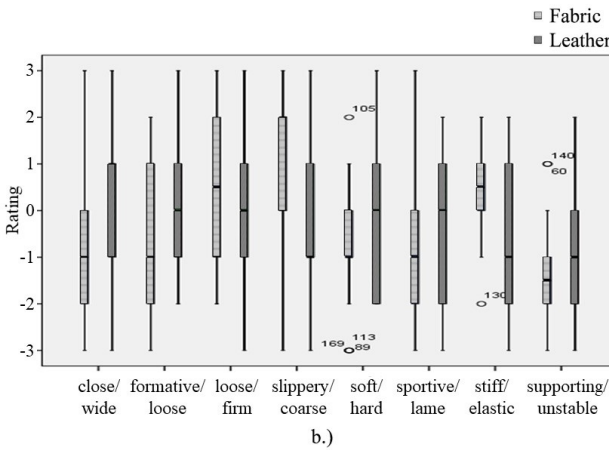
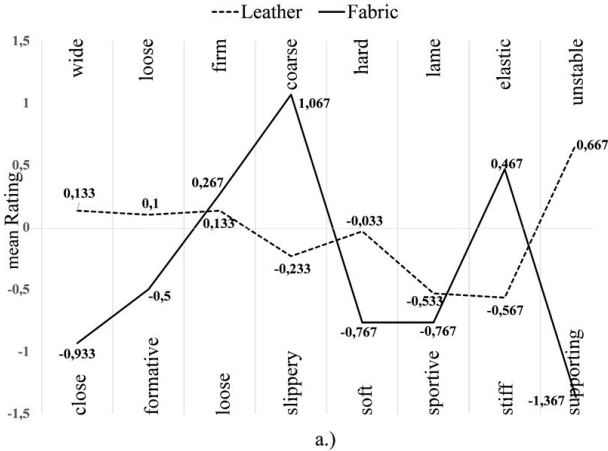

Figure 4.3: Comparison of the subjective backrest ratings. a.) illustrates the mean rates of the word pairs for the leather and fabric cover material. b.) presents the statistical analysis of the ratings in boxplots.

**GENERAL RESULTS.**

25 (83%) of thirty (N=30) participants are convinced that leather and fabric backrests have a different shape. For the seat pan 19 (63%) out of 30 participants assessed the shape of the seat pan as different. Figure 4.4 illustrates how the participants characterized the seats. For the characterization of the fabric seat the participants have chosen all offered

descriptions equally. The leather seat was mostly rated as relaxed, cosy and sporty. 16 of the participants preferred the leather seat, whereas 14 of the participants preferred the fabric seat.

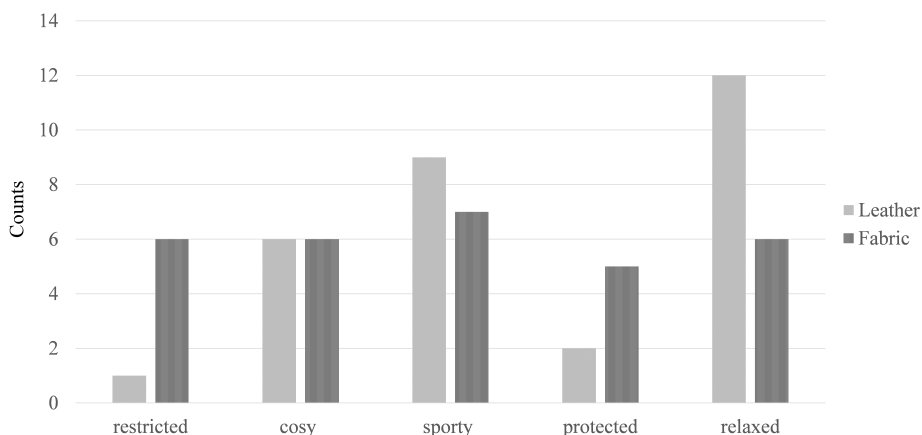

Figure 4.4: Overview of the subjective characterisation of the leather and the fabric seat.

#### PRESSURE MAT.

Figure 4.5 shows the mean maximum pressure of the thirty participants for the leather and fabric seat, separated for the backrest and the seat pan. The mean maximum pressure of the leather seat pan (mean =  $1.19 \text{ N/cm}^2$ , std. dev. =  $0.54 \text{ N/cm}^2$ ) is  $0.19 \text{ N/cm}^2$  higher than for the fabric seat pan (mean =  $0.99 \text{ N/cm}^2$ , std. dev. =  $0.37 \text{ N/cm}^2$ ). The mean maximum pressure for the leather and the fabric backrest is in both seats nearly the same (leather: mean =  $0.58 \text{ N/cm}^2$ , std. dev. =  $0.22 \text{ N/cm}^2$ , fabric: mean =  $0.62 \text{ N/cm}^2$ , std. dev. =  $0.21 \text{ N/cm}^2$ ). The heaviest person (110 kg) has the maximum pressure points in the fabric (max. pressure =  $1.76 \text{ N/cm}^2$ ) and not in the leather seat pan but the lightest person (47 kg) has the maximum pressure points in the leather seat pan (max. pressure =  $1.07 \text{ N/cm}^2$ ).

#### 4.4. DISCUSSION

The study has shown that not only the shape, contour and foam influence the comfort of a seat, but also the properties of the cover materials matter. This is in line with previous studies which confirmed that the stiffness, posture and hardness influence the discomfort of a seat. The results of the first test describe that no discomfort in the seats is felt. The other results of this study show the importance of the seat cover material as a component influencing the seat characteristics. Although, the seats were the same apart from the cover material, both were characterized totally different in the subjective rating of backrest



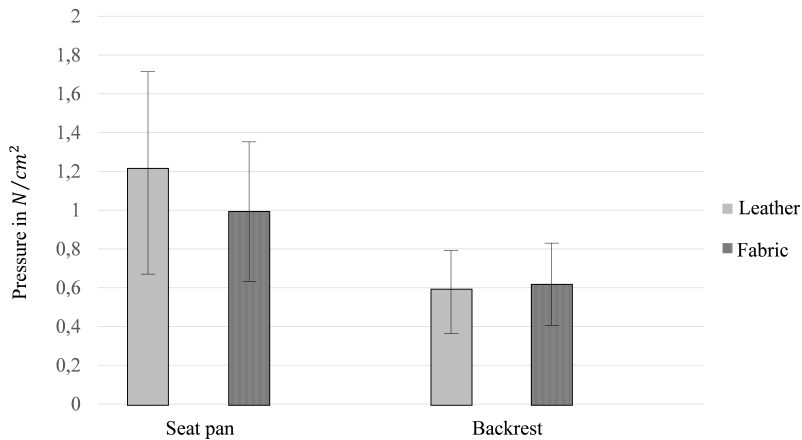

Figure 4.5: Overview of the mean max. pressure and std. dev. for seat pan and backrest.

and seat pan. The study also illustrates that the tactile perceived interaction parameters of the seat pan differ from the backrest. The subjects characterized the backrest and the seat pan using different descriptions of perception. The difference in the cover material of the seat pan is perceived due to the factors elasticity, hardness and enclosing factors whereas the backrest differentiates in the perceived elasticity, surface properties, support and breadth of the backrest. The elasticity is the only perception, which is perceived in seat pan and backrest. The rest of the perceived characterizations is different for the seat pan and backrest. On one hand this illustrates that the elasticity of the cover material is an essential factor for the seat characterization. On the other hand this example emphasizes that the backrest and the seat pan is perceived with a totally different focus. The factor 'pressure' is dominant for the seat pan, but not for the backrest, whereas the surface properties are only dominant for the backrest. It can be assumed that with less load the surface properties get more focus. It is noteworthy that the participants had various clothes on their bodies, nevertheless, the results of the study can be seen as significant. Therefore, this relations should be considered when designing seats. Higher bolsters should increase the effect of the various cover material properties (elasticity, surface properties etc.), directly and indirectly. Directly means stretching the Ruffini corpuscles, indirectly stands for influencing the sensitivity of the Merkel disks. Additionally, the elasticity of the cover material influences the mechanical indentation process of the person and effects the workspace of the underlying seat components, like the foam and the seat suspension with consequences to the resulting posture and pressure distributions of the passenger. Therefore, further investigations needs to be done to analyze the effects of the cover materials, in interaction with various foams and contours, on the perceived seat perceptions. The results of the pressure measurements do not correlate with the results of the perceived seat characterizations. The difference of the mean

maximum pressure in the seat pan and backrest for the leather and the fabric seat is much smaller compared to the large rating differences of the perceived seat characterizations of the leather and fabric seat. It can be assumed that additional to pressure, further tactile parameters like the shear force or elongation should be investigated for a better matching of objective measurements and subjective rated perceptions. The well-balanced distribution of the fabric seat characterizations (see Figure 4.4) shows that the seat adapts well to various percentiles who associate this feeling with a wide spectrum of descriptions. The leather does not adapt as good to the specific percentile shapes. Therefore, a more focused selection of the characterization is associated.

#### 4.5. CONCLUSION

This study shows that a seat cover has an important effect on how a seat is experienced. For instance, the fabric covered seat is experienced as more elastic, less wide, less slippery and less unstable than a leather cover in the backrest and in the seat pan the fabric is characterized as less stiff and less hard. The pressure distribution does not show so much differences. So, other factors might play a role here, which should be studied further.

## REFECERNCES

- Andreoni, G., Santambrogio, G.C., Rabuffetti, M. and, Pedotti, A., 2002. Method for the analysis of posture and interface pressure of car drivers. *Applied Ergonomics*.
- De Looze, M. P. de, Kuijt-Evers, L. F. M. and, van Dieen, J., 2002. Sitting comfort and discomfort and the relationships with objective measures. *Ergonomics* 46 (10), 985–997.
- Ebe, K. and, Griffin, M. J., 2000. Quantitative prediction of overall seat discomfort. *Ergonomics* 43, 6, 791–806.
- Ebe, K. and, Griffin, M. J., 2001. Factors affecting static seat cushion comfort. *Ergonomics* 44 (10) 901–921.
- Franz, M., Kamp, I., Durt, A., Kilincsoy, Ü., Bubb, H. and, Vink, P., 2011. A light weight car-seat shaped by human body contour, *International Journal of Human Factors Modelling and Simulation*, Vol. 2 (4),314–326.
- Grujicic, M., Pandurangan, B., Xie, X., Gramopadhye, A. K., Wagner, D. and, Ozen, M., 2010. Musculo-skeletal computational analysis of the influence of car-seat design/adjustments on long-distance driving fatigue. *International Journal of Industrial Ergonomics* 40(3) 345-355.
- Goossens, R. H. M., 2001. Shear stress measured on three different cushioning materials, *Delft University of Technology* (2001).
- Kamp, I., 2012. The influence of car-seat design on its character experience. *Applied Ergonomics*, Vol. 43 (2), 329-335.
- Kamp, I., 2012. Comfortable car interiors. Experiments as a basis of car interior design contributing to the pleasure of the driver and passenger. 88-105.
- Kilincsoy, Ü., Wagner, A.-S., Vink, P. and, Bubb, H., 2016. The Ideal Pressure Distribution for SUV and Sedan Rear Seats.
- Kolich, M., 2003. Automobile seat comfort. Occupant preferences vs. anthropometric accommodation. *Applied Ergonomics* 34 (2) 177–184.
- Mergl, C., 2006. Entwicklung eines Verfahrens zur Optimierung des Sitzkomforts auf Automobil-sitzen. *Dissertation, Technischen Universität München*.
- Molenbroek, J. F. M., Albin, T. J. and, Vink, P., 2017. Thirty years of anthropometric changes relevant to the width and depth of transportation seating spaces, present and future, *Applied Ergonomics* 65, 130-138.
- Murphy, S. and, Dalton, P., 2016. Out of touch? Visual load induces in attentional numbness. *Journal of Experimental Psychology: Human Perception and Performance*, 42(6), 761-765.
- Reed, M. P. S., Schneider, L. W. and, Ricci, L. L., 1994. Survey of auto seat design recommendations for improved comfort, *University of Michigan*.
- Schmidt, R.F. und Thews, G., 1980. *Physiologie des Menschen*. Springer Verlag; Springer, Berlin u.a. .
- Wong, M., Gnanakumaran, V. and, Goldreich, D., 2011. Tactile Spatial Acuity Enhancement in Blindness: Evidence for Experience-Dependent Mechanisms. *The Journal of Neuroscience*, 31:7028–7037 (2011).

Vink, P. and, Hallbeck, S., 2012. *Editorial: comfort and discomfort studies demonstrate the need for a new model. Applied Ergonomics* 43(2), 271- 276.

Zenk, R., Mergl, C., Hartung, J., Sabbah, O. and, Bubb, H., 2006 *Objectifying the Comfort of Car Seats, SAE International* (2006).

Zhang, L., Helander, M. G. and, Drury, C. G., 1996. *Identifying factors of comfort and discomfort in sitting. Human Factors, Vol. 38* (3), 377-389.

# 5

## A SYSTEM TO MEASURE SEAT-HUMAN INTERACTION PARAMETERS WHICH MIGHT BE COMFORT RELEVANT

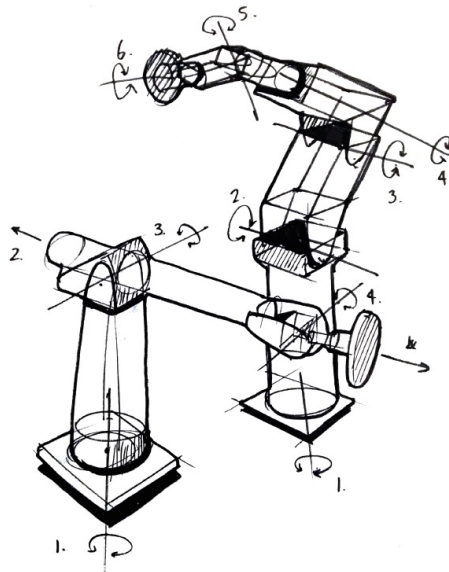

This chapter is published in the journal Applied Ergonomics.  
Author: M. Wegner, R. Martic, M. Franz and P. Vink

**Abstract**

*In this paper a measurement tool is described and tested to evaluate the characteristics of different elements of a seat. Many studies report a relationship between discomfort and pressure distribution, but it is unknown what exactly is happening in the interaction. The purpose of this study is to present a measuring device, which records the comfort relevant seat parameters pressure and elongation while loading a seat. The results of the study, including the repeatability, reproducibility and detectability show that the measurement method is appropriate for our purpose, although the reproducibility has to be improved by operator experience or by a more intuitive assembling of the measurement setup. An application example illustrates that the interaction of the seat components highly affect the resulting comfort relevant parameters. The question is whether this objectively recorded differences are also experienced by seat occupants, which is interesting to study in future research.*

**Keywords:** measurement method, objective seat comfort, seat characterization, comfort relevant parameter

## 5

**5.1. INTRODUCTION**

The European Union and the European Free Trading Association-States together have a population of 520.582.413 (Eurostat, 2017 and European Free Trading Association, 2015) individuals and about 259.834.000 (Jurado, 2014) vehicles in use. Statistically, nearly one out of two persons own a vehicle irrespective of whether they have a driver's license or not. Therefore, it is obvious that the automobile is an essential part of our everyday life. The results of the Market Research Institute: Consumer Science & Analytics with the title "OUR LIVES INSIDE CARS" underlines the rising importance of vehicles as a daily companion. On average, a person spends four years and one month in a vehicle during their lifetime (CSA Research, 2017), most of the time sitting causing a static load on the musculoskeletal system. In the future, autonomous driving opens opportunities to use this travel time in a more efficient way and facilitate variation in postures. Hence, it is important for the car manufacturers to emphasize the role of a comfortable, adaptable and pleasant car interior with a special focus on the seat as the main interface between human and vehicle. The challenge for seat design is to develop an ergonomic and comfortable product, avoiding discomfort in the seat interaction zone and facilitate a variety of postures.

The interaction between the human and the seat is influenced by the indentation process and the way the occupant behaves after indentation. There is a lot of literature on the subjective experience of this interaction zone (De Looze et al., 2003). The objective seat comfort evaluation is more complex as comfort experience is in principle a subjective experience (Vink and Hallbeck, 2012) and the meaning of objective recorded parameters for the comfort experience is often unclear. However, there could be seat characteristics which have a strong relationship with the subjective experience of comfort and more knowledge on the seat characteristics could be helpful in designing and testing seats. The complexity is caused by the fact that there are many seat characteristics and only one comfort or discomfort experience. The specific properties of the seated individual, the seat and the changes over time increase the complexity even further. To simplify the time aspect, some authors divide the evaluation of the seat into three time dependent

subcategories: the initial, the short-term and the long-term comfort. Mergl (2006) defined the initial comfort as the first three minutes, the short term comfort up to 30 minutes and long term comfort starts after 30 minutes. Sammonds (2017) stated that in a static situation, in 140 minutes the number of seat-movements rise as well as the discomfort scores. Furthermore, Adler (2007) found that the long-term seating comfort is directly related to system stress by measuring the stress-induced postural modifications of the sitting person. Likewise, Hartung (2006) investigated the time-dependency of the subjective seat comfort evaluation. The discomfort feeling was significantly higher ( $p < 0.05$ ) after 135 minutes compared to an evaluation after 15 minutes. Other authors also illustrated the time-dependency of the interaction zone (Smulders et al., 2016).

The seat usually consists of different components influencing the interaction zone. It is assumed that car manufacturers usually specify the components separately, though an overall specification of the seat describing the interaction of the combination of components is much more relevant as this is what the end user will experience. A seat can consist of the seat-frame, the adjustment systems of the seat, the foam hardness and dimensions, the cover materials with different tensions and friction coefficients as well as the different layers, the lamination, the heating system, the resistant layers and the cushion-suspension. These systems are often well tested individually, like the foam, which is characterized objectively with a test defined in DIN 53579 (2005). The factor making it complex is the non-linear behavior of certain components, such as the viscoelasticity of the foam (Gibson and Ashby, 2001). Additionally, it is unknown how the subsystems interact with each other and subsequently influences the total comfort perception.

The perceived comfort is not only influenced by the seat characteristics, but also by psychological factors such as the expectations, physical state and physical factors of the human body (Vink and Hallbeck, 2012). The human body influences the seat interaction by its individual weight, shape, anthropometric dimensions, gender and sitting position (Kilincsoy et al., 2014, van Veen, 2014, Vink, 2012). The reaction of the seat components during the indentation could deform the human skin and the underlying tissue, also affecting the blood flow, musculoskeletal system and tissues. Systems in the human body could react and amongst these the mechanoreceptors in the skin record the changes in the stressed surface and send the information to the brain (Diesing, 2006) influencing interpretation and evaluation of the seat comfort. Other systems, like proprioception could be influenced as well. The literature mentions four receptors in the skin (Schmidt and Thews, 1980), the Merkel disks for the pressure, the Ruffini corpuscles for the stretch and shear stresses, the Pacinian corpuscles for vibration and the Meissner's corpuscles, primarily providing information about tactile and sensitive changes. The Merkel disks and the Ruffini corpuscles are slowly adapting cutaneous mechanoreceptors. The Meissner corpuscles and the Pacinian corpuscles adapt comparatively in a slow manner (Klinke and Brenner, 2014). The sensors in ligaments and muscles gather information and form the proprioceptive input. For the comfort evaluation the slowly adapting mechanoreceptors are probably more critical than the fast adapting mechanoreceptors (Goossens et al., 2005). Therefore, the parameters in the interaction zone, which might be very relevant are the pressure, the elongation, the shear stress and the friction coefficient. Depending on the age or gender, the sensitivity and the signal power changes. In addition, Hartung (2006)

described that gender has a big influence on the comfort evaluation and Venkatesan et al. (2015) mentioned that the physical structure in the skin changes with age affecting the skin sensitivity. Furthermore, the location in the human body shows variation in sensitivity (Vink and Lips, 2017).

Most of the seat comfort studies focus on the foam characteristics, the seat dimensions or seat-adjustments and the correlation to the subjective seat discomfort evaluation as well as to the seat pressure distribution (probably related to Meissner corpuscles). The studies of Ebe and Griffin (2000 and 2001) use various cushions with different foam heights (50 mm, 70 mm, 100 mm, and 120 mm), hardness and densities to investigate the difference between the static and the dynamic seat comfort. Additionally, Kamp (2012) uses the contour and foam hardness in her experiment to describe how the geometrical characteristics of the seat influence the perception of a seat (sporty, luxurious and practical) and Kolich (2003) focuses on the contour and the geometrical parameter of a cushion. All the studies are based on subjective evaluations. Moreover, De Looze et al. (2003) discussed different studies and pointed out that most of them described a correlation between pressure and discomfort, predominantly with a limitation on special body parts. Zenk et al. (2006) and Kilinscoy et al. (2016) worked out general guidelines for an ideal seat pressure distribution. Zenk et al. (2006) presents guidelines recommending a pressure distribution in the cushion of 49%-57% in the buttock, <28% in femur area next to the buttock and <6% on the front femur area. Mergl (2006) also reported that the pressure distribution in the cushion influence the pressure distribution in the backrest and vice versa. Vink and Lips (2017) confirmed the results of the previous studies by studying sensitivity and described a higher sensitivity in the shoulders and at the front of the seat cushion. Less sensitivity was found in the middle area of the back close to the spine. All in all, the methodology to objectifying the seat characteristics is reduced to the evaluation of various foam properties, seat contours and the relation to individual pressure distributions. The interaction of the seat components and remaining mechanoreceptors of the skin are not taken into account. The individual pressure distribution is recorded with a pressure mat, which influences the seat properties itself (e.g. surface and stiffness of a seat) and thus, the results of the pressure measurement. A reproducible recording of the seat pressure distribution is only possible with an anthropometric test device and a pressure distribution mat.

To our knowledge no study considers the interaction of the various seat components and the changing properties while loading the seat. The cover characteristics and the cushion suspension caused by the foam might cause of a different effect than predicted by the foam alone. For instance, in most cases the cover is connected to the foam and the seat-frame. If the cover is stretchable and loosely connected, the foam characteristics could be more predominant as the foam is able to perform in a wide scope. In contrast, a stiff cover tightly connected to the foam could limit the foam deformation influencing its performance. Additionally, the comfort of a seat might not only be dependent on the foam and the cover, but also by the seat dimensions, seat adjustment and other seat components such as the seat suspension.

There are indications that shear force could influence comfort perception. In the field of decubitus (Diesing, 2006), especially in the wheelchair development (Goossens, 2001) studies show that shear stress on the human body influenced seat comfort. In the



past, the effects of pressure and shear stress on the human body were studied in-depth. Bennet and Worthen (1980) investigated in the palm of the hand that only half of the initial pressure is necessary to stop the blood flow if high shear forces are included. Additionally, Goossens (1994) measured a cut-off pressure of 11.6 kPa in the absence of shear stress. With a shear stress of 3.1 kPa he showed the cut-off pressure was significantly reduced to 8.7 kPa. Previous studies showed both stresses, the shear force and the pressure, influence the deformation of the anatomical structure, like the tissue and skin of a sitting person. Chow and Odell (1978) described the interface shear force has a significant effect on pressure distribution. It is underlined by the statement that the frictionless interface produces much lower pressure. Furthermore, Zhang and Roberts (1994) mentioned that the externally applied stresses to the skin alter the internal stress distribution. The shear forces externally applied to skin surface roughly have the same effects on underlying tissues as normal forces (pressure). Also, the skin blood flow reduces with the increase of shear force (Goossens, 2000).

Most of the studies use a small variety of seats and do not study the different seat components. To advise on the seat components or test the effect of these components in this paper it is assumed that the elongation (shear stress and friction coefficient) could be useful to study as well to make linkages with the seat components. Therefore, the elongation (shear force, friction coefficient) could be an important part in the evaluation of the seat comfort. *The objective of this paper is to describe a measurement method, which records reproducible comfort relevant parameters of a seat during the indentation process and during a static situation.* This work outlines the advantages and the limitations of the applied method.

First, the “Method” section presents in detail the measurement method, which measures parameters which might be relevant to comfort while loading a seat. Subsequently, to study its possibilities an application example of the measurement method is described as well. Followed by the declaration of the results which are analyzed and related to current studies in the “Discussion” part. At the end the findings are concluded in a short summary.

## 5.2. METHODS

### 5.2.1. MEASUREMENT METHOD

To explore the effects in the interaction zone between human and seat, a measurement method is developed. Figure 5.1 shows the measurement tool consisting of a material testing machine with a controllable spindle, a stamp with sensors and an adaptable measurement setup. The stamp is connected to a certified material testing machine, a Z005, made by the Zwick/Roell Company. The spindle of the machine allows an upward and downward movement of the stamp. A Zwick/Roell Software named testXpert II allows to define sequences of the test cycles. Typical parameters are the indentation velocity, the rest time, the force control and time control. The stamp simulates the initiated stress of the human body on the seat and the associated sensors simulate the recording of the skin-mechanoreceptors. On the fixing plate of the testing machine different seat elements and combination of seat elements can be mounted, such as different foams, covers or suspensions (shown in Figure 5.2). The testXpert II Software controls the specified testing

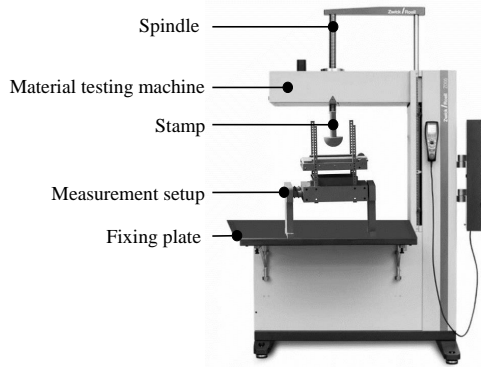

Figure 5.1: Elements of the measurement tool.

5

procedure getting information from the force sensor and the position of the spindle. During the increase of the load the stamp records the pressure and elongation signals, whereas the testing machine records the applied force and distance of the indentation.

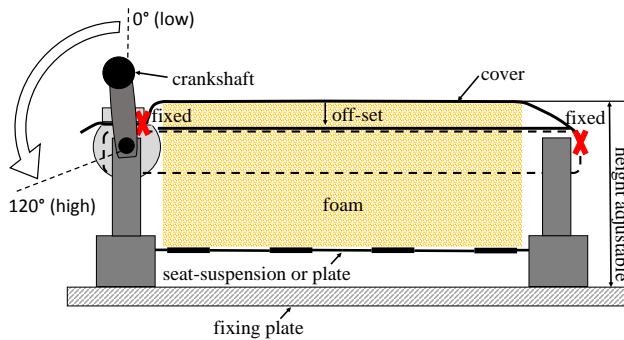

Figure 5.2: Schematical measurement setup, including the cover fixation, the foam, the seat suspension or plate as well as the cover height adjustment for various foams.

### STAMP

The shape of the stamp is a half sphere with a diameter of 75 mm. It follows the requirements of the Standard DIN 53579 (2005), which measures the foam hardness. The stamp (Appendix A.1), shown in Figure 5.3, is equipped with four elongation sensors (hereafter denoted with I, II, III, IV, V) and five pressure sensors (hereafter de-noted with 1, 2, 3, 4, 5). A microcontroller processes the recorded sensor signals and LabView visualizes these signals. For the synchronization of the sensor signals, the microcontroller processes the Zwick/Roell signals (force and the position information of the spindle) via an I/O-module.

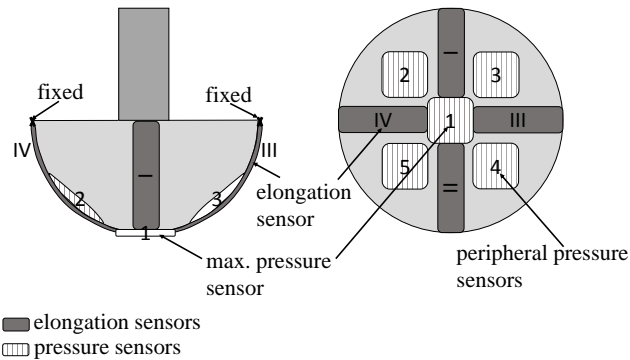

Figure 5.3: Overview of the pressure and elongation sensors location.

### MEASUREMENT SETUP

The measurement setup represents various combinations of the seat structure. The setup allows to use various foams with different degrees of hardness and heights, different cover materials with adjustable cover tensions as well as various seat suspensions (see Figure 5.2). Furthermore, it is possible to integrate different laminations, layers or interfering contours. The seat suspension is replaceable by a plate, which follows the requirements of the DIN EN ISO3386-1 (2009). The holes of the plate have a diameter of 6 mm and a distance of 20 mm.

### GUIDELINES FOR THE COVER FIXATION

The fixation of the cover is critical because the initial tension of the same cover type (same material, new fixation) has to be equal for each new fixation. During the increase of the load the fixation has to avoid any cover movements. Figure 5.4 shows the guidelines for each cover sample. The cover has a marked field to align the right position in the measurement setup. The marked fields 1 to 4 in Figure 5.4 are for the fixation of the cover. Field 1 is connected to a crankshaft to adjust the cover tension in 20° steps. The minimum cover tension is at the 0°-Position of the crankshaft and the maximum cover tension is at 120° crankshaft position. Field 2 to 4 are fixed with cover clamp devices. The surfaces of the devices have a high roughness in order to be able to keep the fixation pressure constant.

### MEASUREMENT PROCEDURE

The measurement procedure is based on the DIN 53579 (2005) and DIN EN ISO3386-1 (2009). The validity of the DIN requirements are restricted to foams and not to the overall seat layout. Therefore some parameters of the DIN requirements had to be adapted. The environmental conditions of the specifications are unchanged with a humidity of (50±5) % and the temperature of (20±2) C°. Other process parameter of the DINs like the indentation velocity, the time of the holding phase and the maximum force are adjusted to ensure a suitable process reliability. The original specification for the measurement procedure (DIN 53579 (2005) and DIN EN ISO3386-1 (2009)) has four cycles consisting

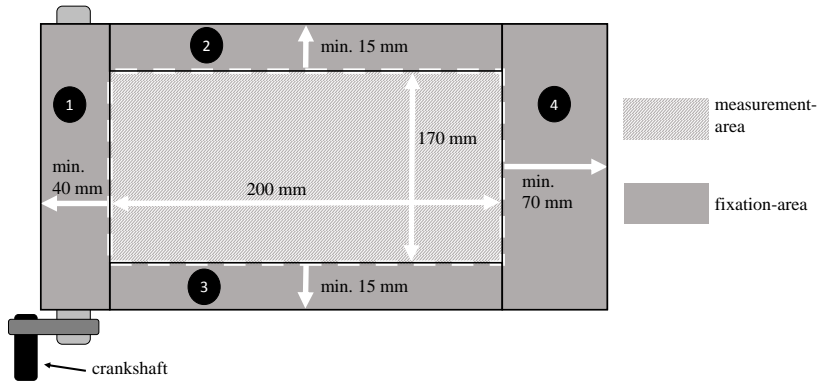

Figure 5.4: Geometrical guidelines for the cover sample.

5

of three pre-cycles and one measurement cycle. Figure 5.5 shows an exemplary curve of the specified measurement force. It is the same for each measurement. The curve specification is divided in three sectors: T1=stress-phase (stamp stresses the seat layout),  $T_{\text{hold}} = 30$  sec. holding phase (maximum stress) and T2=relief-phase (stamp relieves the seat layout). The indentation velocity for the pre-cycle is for the stress-phase as well as for the relief-phase  $300 \text{ mm/min}$ . For the measurement cycle the stress- and relief-velocity is  $100 \text{ mm/min}$ . Preliminary investigations with a pressure mat (XSensor X3 LX210) on a 4 kPa hard foam have shown that the stamp reaches the maximum measurable pressure of  $10.34 \text{ N/cm}^2$  at a force of  $350 \text{ N}$ . Therefore the predefined measurement range is  $0 \text{ N} - 350 \text{ N}$  and  $0 \text{ N/cm} - 10.34 \text{ N/cm}^2$ . To avoid lasting damages in the cover materials the maximum force for this research is defined to  $200 \text{ N}$ .

## 5.2.2. CAPABILITY STUDY OF THE MEASUREMENT METHOD

### RAW DATA PROCESSING

All sensors were developed by the Fraunhofer Institute (Boese et al., 2015) recording capacities in the range of pF (picofarad). The evaluation of repeatability, reproducibility and detectability is based on the recorded data during the holding phase ( $T_{\text{hold}}$ , see Figure 5.5) due to the fixed position of the stamp (maximum indentation). The data set content for each sensor and each measurement is 815 to 850 measurement values. To analyze the stress-dependency of the sensor noise floor due to the mechanical interaction of the integrated sensors into the stamp, the signal-to-noise-ratio (SNR) is calculated for each sensor in a stressed and an unstressed condition using the signal mean ( $\mu$ ) and the standard deviation of the noise ( $\sigma$ ):

$$SNR = \mu / \sigma \quad (5.1)$$

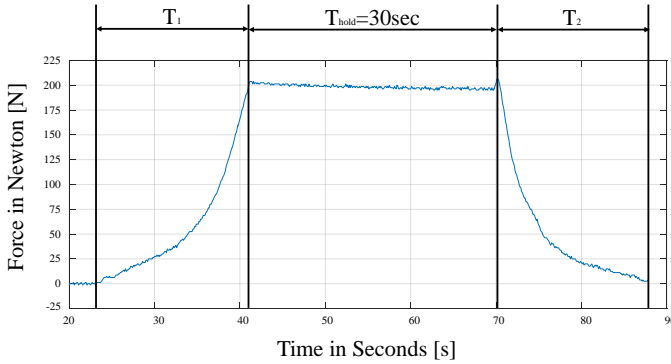

Figure 5.5: Prescribed force curve for the measurement cycles (without pre-cycles).

Each sensor has a basic capacity (unstressed capacity of the sensor in pF), which rises while pressing or stretching the sensors. The capacity of the pressure sensors converts into a pressure information by using a calibration curve (capacity-pressure-diagram) for each sensor. The capacity of each elongation sensors converts into an elongation information while calculating the percentage increase of the sensor based on the basic capacity and the capacity measured during the load (measured capacity in pF). All elongation sensors have in the initial position the same basic capacity within the sensor specification (Boese et al., 2015):

$$Elong.[\%] = MeasuredCapacity[pF] / BasicCapacity[pF] * 100\% \quad (5.2)$$

For further analysis the average elongation and pressure is calculated for each sensor using the 815 to 850 measurement values obtain during the holding phase.

#### REPEATABILITY

The repeatability is the ability of a measuring instrument to provide the closeness of the agreement between independent results on the same item under identical conditions (NIST TN 1297, 1994). This means that the measurements are made by the same operator, with the same measurement procedure using the same measurement instruments over a short period of time (ISO 5725-1, 1994).

In this experiment 12 measurements are performed under the same conditions, following the definition of repeatability. The stressed item is a seat layout consisting of a commercial suspension, a foam with a height of 100 mm and a hardness of 4 kPa with a fabric cover stretched to the maximum crankshaft-position of 120°. For each of the five pressure sensors (1-5) and the four elongations sensors (I-IV) the mean value ( $x_{(sensor,1-12)}$ ), the maximum deviation ( $x_{max} - x_{min}$ ), the standard deviation ( $s_{(sensor,1-12)}$ ) and the relative standard deviation ( $RSD = s_{(sensor,1-12)} / x_{(sensor,1-12)}$ ) of the 12 measurements (n=12) are

calculated. For the calculation of the confidence interval (CI) the significance level is set to 5% ( $t_c = 1.96$ ):

$$CI = \bar{x} * t_c * s / \sqrt{n} \quad (5.3)$$

#### REPRODUCIBILITY

Reproducibility is the closeness of the agreement between the results of measurements obtained with the same method on identical test item under changed conditions (NIST TN 1297, 1994). The changing conditions may be due to different measurement methods, miscellaneous instruments being used, different operators or measurements made over a certain period of time (ISO 5725-1, 1994). For the presented measurement method the reproducibility is ensured by assembling the measurement setup three times over a certain period of time with the same method, on the same item under the same conditions. The measurements are repeated three times ( $n=3$ ) for each assembled setup. The assembled setup includes the positioning of the measurement setup aligned to the material testing machine and the stamp as well as the positioning and fixation of the seat layout components. The seat suspension and the foam is adjusted by a mechanical stop and the cover is re-fixed following the guidelines described in section 5.2.1 (Guidelines for the cover fixation). The stressed item is identical to the seat layout of the repeatability test. Out of the three recorded measurements for each pressure (I-5) and elongation (I-IV) sensor the maximum and percentage deviation is calculated as well as the mean value ( $\bar{x}$ ) and the standard deviation ( $s$ ). Based on the results of the first assembling a confidence interval with a significance level 5% ( $t_c = 1.96$ ) is calculated according to equation (5.3).

#### DETECTABILITY

The section “Detectability” investigates if the elongation and the pressure sensors detect obvious changes of the seat layout. The initial layout is identical to the layout applied for the repeatability and reproducibility test. The second seat layout is nearly the same except of the cover tension, which is reduced by changing the crankshaft position from 120° to 0°. The third layout has a leather cover material with a crankshaft position of 120°. All other components remain unchanged.

### 5.2.3. APPLICATION EXAMPLE: THE INFLUENCE OF SEAT COVER AND SEAT SUSPENSION ON SEAT CHARACTERISTICS

Referring to the introduction, the seat cover and the seat suspension could affect the seat comfort as well as foam characteristics. In order to study the effect the stamp is used to investigate the influence of the different seat components. For an analysis of the seat-layouts the foam hardness (4 kPa and 12 kPa), the foam height (30 mm and 100 mm), the cover tension (0°- crankshaft-position: “low/loosely”, 120°- crankshaft-position: “high/tight”) and seat suspension (plate and suspension) were varied (see Table 5.1). The foam has a constant raw density of  $70 \text{ kg/m}^3$ . The cover is a smooth leather which is integrated in high class automotive seats. The seat suspension is a standard product used in all common automotive seats. It is a spring steel wire ( $\varnothing$  5mm) with a meander shape (two wires with 3 meander). The only difference to the above presented method is that the maximum force for the measurement cycle (section 5.2.1 (Measurement procedure))

is set to 100 N. This is to prevent exceeding the elastic range of the leather material during the deformation of the various seat layouts. The processing of the raw data follows the procedure of section 5.2.2 (Raw data processing). Furthermore, the sensor information is processed on specific demands of the study. The pressure information of all sensors are combined to a maximum pressure, measured by the pressure sensor 1, and a pressure distribution, calculating the ratio of the maximum pressure (pressure sensor 1) to the peripheral pressure (sensor 2 – sensor 4). This study focuses on the summed elongation information of the sensor I and sensor II. This direction of the elongation sensors recognizes changes in the crankshaft-position of the measurement setup.

Table 5.1: The anthropometric measurements of the subjects.

Foam hardness	Foam height	Cover tension	Suspension	Test-No.
4kPa	30mm	0°(low)	plate	1
			suspension	2
		120°(low)	plate	3
			suspension	4
	100mm	0°(low)	plate	5
			suspension	6
		120°(low)	plate	7
			suspension	8
12kPa	30mm	0°(low)	plate	1
			suspension	2
		120°(low)	plate	3
			suspension	4
	100mm	0°(low)	plate	5
			suspension	6
		120°(low)	plate	7
			suspension	8

## 5.3. RESULTS

### 5.3.1. SENSOR NOISE FLOOR

Table 5.2 shows the average values of the unstressed and stressed capacity of each elongation sensor (see Figure 5.3). These values are the base for the determination of the elongation by calculating the percentage increase of the capacity (elongation). All sensors show nearly the same magnitude in an unstressed condition (basic capacity). Only sensor IV shows a smaller standard deviation. In the stressed condition sensor I and sensor II (located in the direction of the same axes, see Figure 5.3) have nearly the same value with a four hundredth deviation in the standard deviation. The capacities of sensor III and sensor IV deviate for the stressed sensors due to the properties of the cover tension and the cover material. Still, the standard deviation of the signals are comparable. In conclusion, all SNR-values indicate a very low influence of the noise floor. The noise floor

of the pressure sensors is metrological negligible.

Table 5.2: Results of the unstressed and stressed elongation sensors.

	<b>Elongation Sensor I</b>	<b>Elongation Sensor II</b>	<b>Elongation Sensor III</b>	<b>Elongation Sensor IV</b>
<b>Average value</b> (unstressed)	240.24 pF	240.24 pF	240.24 pF	240.23 pF
<b>Std. deviation</b> (unstressed)	0.15 pF	0.15 pF	0.15 pF	0.11 pF
<b>SNR</b> (unstressed)	1620	1620	1620	2107
<b>Average value</b> (stressed)	257.42 pF	257.08 pF	260.35 pF	256.18 pF
<b>Std. deviation</b> (stressed)	0.15 pF	0.11 pF	0.15 pF	0.15 pF
<b>SNR</b> (stressed)	1776	2347	1797	1768

5

### 5.3.2. REPEATABILITY

Table 5.3 considers the repeatability of the stressed elongation sensor signals based on 12 measurements. The pressure sensors have no measurable deviations. The elongation sensors I and II have the same absolute maximum deviation of 0.24%. The sensor signals III and IV have a higher absolute maximum deviation up to 0.77%. In general, the maximum deviation of all signal is less than 1% , the relative standard deviation (RSD) for all sensors is between 1.2% -3.1%. The average elongation of the four elongation sensors for each of the 12 measurements are constantly in the calculated sensor specific confidence interval (CI).

### 5.3.3. REPRODUCIBILITY

Table 5.4 shows the exemplary results of the reproducibility test for the elongation sensor I. The results of the second and third assembling are compared to the reference results of the first assembling. The results of the first assembling are also used to calculate the confidence interval (CI). The range is calculated from 6.96% to 7.22%. All measurements results are in the confidence interval except one measurement of the first assembling and one measurement of the second assembling, both values are bold in Table 5.4. An addition, a noteworthy information is, the maximum deviation (percentage and absolute deviation) decreases with an increasing number of repeated assembling.



Table 5.3: Investigation of the repeatability of the sensor signal comparing the elongation sensor I-IV with the average elongation (in %), the absolute maximum deviation (in %), the standard deviation (in %) and the relative standard deviation (-).

	<b>Elongation Sensor I</b>	<b>Elongation Sensor II</b>	<b>Elongation Sensor III</b>	<b>Elongation Sensor IV</b>
<b>Average Elongation</b>	7.19 %	6.89 %	8.31 %	6.47 %
<b>Max. Deviation</b>	0.24 %	0.24 %	0.77 %	0.41 %
<b>Standard Deviation</b>	0.14 %	0.09 %	0.20 %	0.20 %
<b>RSD (relative standard deviation)</b>	0.019 (1.9 %)	0.012 (1.2 %)	0.024 (2.4 %)	0.031 (3.1 %)
<b>Confidence Interval</b>	7.05 % - 7.32 %	6.83 % - 6.96 %	8.16% - 8.46 %	6.32 % - 6.62 %

Table 5.4: Results of the reproducibility test exemplary for the elongation sensor I.

<b>Assem- bling</b>	<b>Elon- gation</b>	<b>Max. Percen- tage Devia- tion</b>	<b>Max. Absolute Devi- ation</b>	<b>Average Elon- gation</b>	<b>Stan- dard Elon- gation</b>	<b>Confidence Interval</b>	
1	7.21 %	3.74 %	0.26 %	7.09 %	0.11 %		
	7.11 %						
	<b>6.95 %</b>						
2	6.97 %	1.26 %	0.09 %	6.96 %	0.04 %	6.96 %	7.22 %
	7.00 %						
	<b>6.91 %</b>						
3	7.17 %	0.70 %	0.05 %	7.20 %	0.03 %		
	7.22 %						
	7.21 %						

#### 5.3.4. DETECTABILITY

The results of Table 5.5 show that the measurement system recognizes changes in the cover tension and the cover material, beyond that also the anisotropy of the surface materials. The exemplary results of elongation sensors I and II show that for the fabric

material the difference between sensor I and II (one axis, see Figure 5.3) is significantly smaller compared to the recorded elongation difference (between elongation sensor I and II) of the leather material. The results are compared for the same cover tension (120° crankshaft position). Additionally, the results of Table 5.5 point out the anisotropy of the cover material increases with a lower cover tension due to the higher difference of the elongation sensor I and II for a lower cover tensions.

Table 5.5: This table shows the three measurement results of the elongation sensor I and the elongation sensor II for three different cover versions defined in Table 5.1. For the anisotropy evaluation the difference between elongation sensor 1 and the elongation sensor 2 is calculated. Additionally, it is shown the indentation depth and the force.

Test-No.	Elon- gation Sensor I	Elon- gation Sensor II	Difference between Elongation Sensor I and Elongation Sensor II	Indenta- tion Depth	Force
	in %	in %	in %	in mm	in N
<b>Fabric High Cover Tension (120°-crankshaft- position)</b>	7.22	7.11	0.11	26.68	199.07
	7.11	6.88	0.23	26.88	199.13
	6.96	6.80	0.15	26.90	198.12
<b>Fabric Low Cover Tension (0°-crankshaft- position)</b>	10.45	9.90	0.55	30.00	198.54
	10.09	9.44	0.65	28.35	198.67
	9.97	10.37	0.40	29.43	198.80
<b>Leather High Cover Tension (120°-crankshaft- position)</b>	7.66	6.60	0.96	28.03	198.77
	7.66	6.46	1.20	27.65	198.78
	8.06	6.85	1.21	27.52	198.79

### 5.3.5. RESULTS OF THE APPLICATION EXAMPLE

This section presents the results of the application example defined in section 5.2.3. Table 5.6 shows the indications that the measurement system can discover differences in the behavior of the seat components and materials. The table compares the maximum pressure, the pressure distribution, the elongation and the indentation depth for different seat layouts at a maximum load of approximately 100 N. The seat suspension affects the maximum pressure only for the thin and soft foams. Test No. 1 and No. 3 without seat suspension show for thin and soft foams around  $1\text{N}/\text{cm}^2$  higher maximum pressure values than for Test No. 2 and No. 4 with a seat suspension. This may be due to the total compression of the foam itself. The harder and thinner the foams, the higher the effects of the seat suspension on the pressure distribution (Table 5.6: compare pressure distribution

Table 5.6: Result overview of the various seat layouts defined in Table 5.1.

Test- No.	Max. Pressure	Pressure Distribution	Elongation	Indentation Depth
	$N/cm^2$	Ratio	Sensor I [%] + Sensor II [%]	mm
1	9.20	71.3 / 28.7	1.3	25.2
2	8.00	66.5 / 33.5	2.2	33.9
3	9.10	77.8 / 22.2	0.9	24.6
4	8.10	74.5 / 25.5	2.0	32.4
5	5.40	51.4 / 48.6	3.4	40.0
6	5.30	55.5 / 44.5	5.6	39.9
7	6.00	65.5 / 34.5	1.9	36.2
8	6.10	68.3 / 31.7	2.1	35.6
9	6.20	59.9 / 40.1	1.8	18.2
10	6.20	49.8 / 50.2	2.2	27.6
11	7.60	85.8 / 14.2	1.3	16.00
12	6.90	67.1 / 32.9	2.0	25.00
13	6.50	58.4 / 41.6	1.9	22.1
14	6.20	52.1 / 47.9	3.1	25.3
15	7.70	77.3 / 22.7	1.5	20.4
16	8.00	70.2 / 29.8	1.2	23.2

of Test No. 9 and No. 10). High and soft foams in combination with a seat suspension influence an even pressure distribution in a negative way (Table 5.6: compare the pressure distribution of Test No. 5 and No. 6). The suspension results in all seat layouts in a higher indentation depth which also provokes a higher elongation, except for the seat layout with the 12 kPa hard and 100 mm high foam with a high cover tension. In this case the elongation decreases. An increasing cover tension increases predominantly the maximum pressure, generates higher pressure peaks in pressure distribution and decreases the elongation as well as the indentation depth. It stands out as for the maximum pressure, the pressure distribution, the elongation and the indentations depth differ for different seat layouts with a soft foam showing a higher range of values than seat layouts with a hard foam.

## 5.4. DISCUSSION

### 5.4.1. CAPABILITY STUDY

The raw data of this study show that all of the sensors have a small noise floor, which means the sensors are nearly independent of the load state. The results of the repeatability test show, that the repeated accuracy of the sensors is sufficient, while all sensor values are in the confidence interval (CI). Thus, no measurable interaction of the sensors influence the results of the measurement. The results of the reproducibility test have shown, that not all measurement values, especially the elongation data, are in the range of the confidence interval. Simultaneously, the maximum deviation reduces by the amount of assemblies, which indicates, the operator of the measurement method needs experience in assembling the measurement setup. A more precise and intuitive fixation of the cover would probably decrease the maximum deviation to <1%. The study also has shown that the measurement method recognizes changes in the cover material and cover tension. In conclusion, based on this study the measurement method seems sufficient for an objective recording of the comfort relevant parameters while loading a seat. An investigation of various seat components related to the comfort relevant parameters is viable with the described measurement method. Compared to the common method, taking measurements with a pressure mat, the presented method enables to measure additionally to pressure also the elongation, which is based on wheel chair research a relevant comfort parameter (Goossens, 2001). Moreover, the additional information of elongation in combination with the pressure information allows to recognize changes of the seat layout. The most current applied pressure mats are not able to detect these changes sufficiently.

### 5.4.2. THE INFLUENCE OF SEAT COVER AND SEAT SUSPENSION ON SEAT CHARACTERISTICS

Studies described above indicate that not only the pressure (maximum pressure and pressure distribution) but also the elongation, the shear stress and the friction coefficient might be comfort relevant parameters for the seat comfort. However, these parameters are difficult to measure. The results of Table 5.6 show that with the system developed in this study the elongation (the shear and friction coefficient is in this application example not explicit considered) can be recorded and it is influenced by the selection of the seat components. The exemplary test layout No.5 and No. 10 (see Table 5.6) determines two completely different seat layouts (see Figure 5.6) with almost the same pressure distribution and a similar maximum pressure but nearly with a 1.5-fold difference in the elongation, measured by our device. This means, the human skin in contact with the seat in the seat layout of test layout No. 5 probably stretches more, which could affect the blood flow, the musculoskeletal system and the tissue as well might influence the perceived seat comfort perception. The studies of Diesing (2006), Bennet and Worthen (1980) and Goossens (1994, 2001) stress the importance of shear forces. More studies are necessary to investigate whether this effect is noticed and experienced by subjects in a subjective comfort experiment. Previous seat comfort studies of Ebe and Griffin (2000 and 2001), Kamp (2012) or Kolich (2003) focus mostly on the foam characteristics, the seat contour, the seat dimensions and seat adjustments. The result of Table 5.6 illustrates that

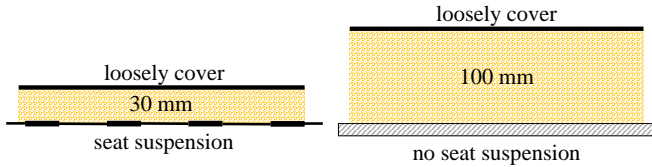

Figure 5.6: Two different seat layouts (No. 5 and No. 10) are shown with nearly the same pressure distribution and maximum pressure but with a 1.5-fold higher elongation for the seat-layout with 100 mm foam. The left seat layout (No. 10) has a loosely cover, a 30 mm high and 12 kPa hard foam and contains a seat suspension. The right seat layout (No. 5) has a loosely cover, 100 mm high and 4 kPa soft foam without a seat suspension.

the seat components do affect each other. The main question is whether this objectively recorded differences are also experienced by seat occupants, which needs to be studied in future research.

## 5.5. CONCLUSION

In this study a system (a stamp) is developed to measure the effects of combinations of different seat elements. The reproducibility and repeatability of the stamp sensors are appropriate for our purpose to study pressure and elongation (shear force and friction coefficient) of different components and component interactions. Nevertheless, the assembling procedure of the measurement setup and especially the fixation of the cover materials could be optimized in order to reach a better reproducibility of the measurement results. The new measurement procedure should be able to break down the effects of the surface (cover materials and layer) up to the anisotropy of the cover materials.

## 5.6. ACKNOWLEDGEMENT

This research was supported by the Fraunhofer Institut ISC. We are thankful to our colleagues Sven Ritter, Wolfgang Grüner, Rolf Lechner, Florian Fitzen, Tobias Englmaier and Mario Buljan who provided expertise that greatly assisted the research. We are also grateful to Erich Zerhoch for assistance organizing the measuring instruments.

## REFERENCES

- Adler, S., 2007. *Zusammenhang von Langzeitsitzkomfort und Fahrerbewegungen*. Dissertation. Friedrich-Schiller-Universität Jena.
- Bennet, T. and, Worthen, E. F., 1980. *Shear vs. pressure as causative factors in skin blood flow occlusion*. *Plastic and Reconstructive Surgery* 66, 1, 180.
- Boese, H., Fuß, E. and, Ehrlich, J., 2015, *Capacitive Sensors Mats for Pressure Detection with High Sensitivity*, Fraunhofer-Institut für Silicatiforschung, AMA Conference 2015.
- Chow W. W. and, Odell, E. I., 1978, *Deformations and Stresses in Soft Body Tissues of a Sitting Person*, 1978.
- CSA Research. 2017. *OUR LIVES INSIDE OUR CARS. EUROPEAN SURVEY*.
- De Looze, M. P. de, Kuijt-Evers, L. F. M., and, van Dieen, J., 2003. *Sitting comfort and discomfort and the relationships with objective measures*. *Ergonomics* 46, 10, 985–997.
- Diesing, P., 2006. *Prüf- und Bewertungsmethoden für Antidekubitus-Systeme*. Dissertation, Technische Universität Berlin.
- DIN 53579. 2005. *Testing of flexible cellular materials –Indentation test on finished parts*. DIN-Normenausschuss Materialprüfung (NMP).
- DIN EN ISO 3386-1. 2009. *Polymeric materials, cellular flexible –Determination of stress-strain characteristics in compression –Part 1: Low-density materials*. DIN-Normenausschuss Materialprüfung (NMP).
- Ebe, K. and, Griffin, M. J. 2000. *Quantitative prediction of overall seat discomfort*. *Ergonomics* 43, 6, 791–806.
- Ebe, K. and, Griffin, M. J., 2001, *Factors affecting static seat cushion comfort*. *Ergonomics* 44, 10, 901–921.
- EUROPEAN FREE TRADE ASSOCIATION. 2015. *This is EFTA*.
- Eurostat, 2017. *Population of the European Union 2014*, <http://ec.europa.eu/eurostat> (accessed 03.04.2017).
- Gibson, L. J. and, Ashby, M. F., 2001, *Cellular solids. Structure and properties*. Cambridge solid state science series. Cambridge Univ. Press, Cambridge u.a..
- Goossens, R. H. M., 1994. *BIOMECHANICS OF BODY SUPPORT. A study of load distribution, shear, decubitus risk and form of the spine*.
- Goossens, R. H. M., Teeuw, R. and, Snijders, C. J., 2000. *Decubitus Risk: Is Shear More Important than Pressure? Proceedings of the IEA 2000 IHFES 2000 Congress*.
- Goossens, R.H.M., 2001, *Shear stress measured on three different cushioning materials*, Delft University of Technology.
- Goossens, R. H. M., Teeuw, R. and, Snijders, C. J., 2005. *Sensitivity for pressure difference on the ischial tuberosity*. *Ergonomics* 48, 7, 895–902.
- Hartung, J., 2006. *Objektivierung des statischen Sitzkomforts auf Fahrzeugsitzen durch die Kontaktkräfte zwischen Mensch und Sitz*. Dissertation, Technischen Universität München.

ISO 5725-1. 1994. *Accuracy (trueness and precision) of measurement method and results - Part 2: General principles and definitions*. International Organization for Standardization.

ISO 5725-2. 1994. *Accuracy (trueness and precision) of measurement method and results - Part 2: Basic method for the determination of the repeatability and reproducibility of a standard measurement method*. International Organization for Standardization.

Jurado, A., 2014, EUROPEAN MOTOR VEHICLE PARC. VEHICLES IN USE(2009-2014). Anfac.

Kamp, I. 2012. *Comfortable car interiors. Experiments as a basis of car interior design contributing to the pleasure of the driver and passenger*. 88-105.

Kilincsoy, Ü., Wagner, A.-S., Bengler, K., Bubb H. and, Vink, P., 2014. *Comfortable rear seat postures preferred by car passengers*. *Proceedings of the 5th International Conference on Applied Human Factors and Ergonomics AHFE 2014*.

Kilincsoy, Ü., Wagner, A.-S., Vink, P. and, Bubb H., 2016. *The Ideal Pressure Distribution for SUV and Sedan Rear Seats*.

Klinke, R. and, Brenner, B. 2014. *Physiologie*. Thieme, Stuttgart, 624-675.

Kolich, M. 2003. *Automobile seat comfort. Occupant preferences vs. anthropometric accommodation*. *Applied Ergonomics* 34, 2, 177-184.

Mergl, C., 2006. *Entwicklung eines Verfahrens zur Optimierung des Sitzkomforts auf Automobilsitzen*. Dissertation, Technischen Universität München.

NIST TN 1297. 1994. *Guidelines for Evaluating and Expressing the Uncertainty of NIST Measurement Results*, United States Department of Commerce Technology Administration, National Institute of Standards and Technology.

Sammonds, G. M., Fray, M. and, Mansfield, N. J., 2017. *Effect of long term driving on driver discomfort and its relationship with seat fidgets and movements (SFM)*. *Applied Ergonomics* 58, 119-127.

Smulders, M., Berghman, K., Koenraads, M., Kane, J. A., Krishna, K., Carter, T. K. and, Schultheis, U. 2016. *Comfort and pressure distribution in a human contour shaped aircraft seat (developed with 3D scans of the human body)*. *Work (Reading, Mass.)* 54, 4, 925-940.

Schmidt, R.F. und Thews, G., 1980. *Physiologie des Menschen*. Springer Verlag; Springer, Berlin u.a..

van Veen, S. A. T., Hiemstra-van Mastrigt, S., Kamp, I. and, Vink, P., 2014, *Improving car passengers' comfort and experience by supporting the use of handheld devices*. *Work (Reading, Mass.)* 49, 2, 215-223.

Venkatesan, L., Barlow, S. M. and, Kieweg, D., 2015 *Age- and sex-related changes in vibrotactile sensitivity of hand and face in neurotypical adults*. *Somatosensory & motor research* 32, 1, 44-50.

Vink, P., 2012. *Advances in Social and Organizational Factors*. *Advances in Human Factors and Ergonomics Series*. CRC Press, Hoboken.

Vink, P. and, Lips, D., 2017. *Sensitivity of the human back and buttocks: The missing link in comfort seat design*. *Applied Ergonomics* 58, 287-292.

Zenk, R., Mergl, C., Hartung, J., Sabbah, O. and Bubb H., 2006. *Objectifying the Comfort of Car Seats*, SAE International.

Zhang, M. and, Roberts, V. C., 1994. *The effect of shear forces externally applied to skin surface on underlying tissues*. *Journal of Biomedical Engineering* 15, 6, 451–456.



# 6

## THE INFLUENCE OF SEAT COMPONENTS ON THE SEAT-HUMAN INTERACTION



---

This chapter is submitted in the journal *Theoretical Issues in Ergonomics Science*.  
Author: M. Wegner, R. Martic, M. Franz and P. Vink

**Abstract**

*This paper presents a method for relating relevant seat-human interaction parameter to seat components. Based on an existing measurement method recording pressure and elongation parameters, 648 different car seat layouts were recorded and analyzed. The specifications of the components were documented for each seat layout. The result of the analysis have shown that leather seats and fabric seats affect the seat-human interaction parameters differently. A dominant factor for the fabric seats are the foam hardness, seat suspension and cover tension and for leather it is the lamination, seat suspension and the cover tension. Moreover the choice of the seat component combination has a high impact on how the seat components interaction with each other and therefore influence the interaction parameter. The presented method is appropriate to identify the dominant seat components affecting the interaction parameters. For future studies this method has to be connected to comfort studies.*

**Keywords:** seat-human interaction, comfort, measurement tool, pressure, shear force

## 6.1. INTRODUCTION

The requirements to the interior of future cars will change fundamentally in order to capture the individual user needs. The study of Fraunhofer IAO and Horváth & Partners (2016) showing that sleeping, eating and working will be in future cars the most common non-driving activities, also called secondary tasks (Parliament of Victoria, 2006). Fitzen et al. (2017) outlines an overview of other secondary tasks like relaxing, reading or watching a movie, especially possible in the future in automated driving cars. Therefore, attention is needed for the future trends in designing the vehicle interior and implementing the requirements in the early phase of the development (Tomforde, 2007). As a consequence the development of the seats have to anticipate on the various loading situations. This could mean new adjusting possibilities in the backrest and cushion of a seat to support the different secondary tasks. There have been studies showing that different tasks are accompanied by specific sitting positions. Kamp et al. (2011) for example figured out that train travelers have a significantly more slouched position while relaxing than while using a mobile phone.

Johnson Controls (a 1-First Tire Supplier of automotive seating) conducted a study among 1.100 U.S. consumers regarding factors influencing the decision of vehicle purchasing (Johnson Controls, 2013). The major finding of the study is that the participant's interest is more in the comfort of the seat and in the number of seats than the configuration of the seats. Beyond that the study describes that the comfort remains an important interior factor. In order to be prepared for a higher range of use cases along with various loading states and comfort requirements it is necessary to be aware of the individual properties of the seat components and the interaction of the seat components and how these characteristics influence the comfort of a seat.

Many studies relate comfort to the seat component 'foam', varying the foam properties, the dimension of the foam and the contour of the foam. Zenk et al. (2006) varied the foam hardness in different regions of the seat, especially in the cushion, in the shoulder area and in the lumbar area. Mansfield et al. (2015) showed differences in foam perception. They state that after 40 min of continuous exposure it was possible to detect significant

differences in overall discomfort between the two seat compositions that were different regarding foam. Other aspects that are studied consider seat dimensions and relationships to anthropometry. Kolich (2003) compared five seats with various seat dimensions while rating the comfort of the cushion and backrest. Concluding that the seat designer should be aware of ergonomic relations and especially the anthropometry and the physiology. The study of Wang et. al. (2019) based on a multi-adjustable experimental seat investigates the optimal compressed seat pan surface including the effects of seat parameters and the anthropometric dimensions.

The investigation of the seat cover properties as a seat component is uncommon. Almeida Jr et. al. (2014) investigated the perception of different materials with a focus on dining chairs. The study illustrates that the materials are very relevant for the interaction between the user and the product. Wegner et. al (2018) has shown that seats with the same contour and foam properties but with different seat covers (leather and fabric) are perceived different. On the one hand this study has shown that the seat cover influences the resulting compression of the seat and on the other hand it illustrates that both seats are perceived and rated differently. Moreover Vink and Lips (2015) illustrate that different body areas in contact with the seat have various sensitivities. The human body touching the front of the seat pan is more sensitive than the rest of those parts in contact with the seat pan. For the backrest the area of the shoulders is significantly more sensitive than the rest of the backrest in contact with the body.

Although the human skin has four well known mechanoreceptors recording the pressure, the stretch and shear forces as well as recognizing sensitivity changes and vibration (Schmidt and Thews, 1980), most studies correlate the comfort and discomfort ratings to anthropometry and pressure. De Looze et al. (2003) concluded that many studies show a correlation between pressure distribution and discomfort. In contrast Kyung and Nussbaum (2007) analyzed several pressure variables and identified that the seat-human interface pressure is related to the comfort and the overall ratings especially for the short term comfort. Zemp et al. (2015) describe that pressure parameters like the peak pressure or the pressure distribution are decent to estimate the comfort and the discomfort. Paul et al. (2012) investigates, based on three different seats, 64 participants, including also the seat H-Points and anthropometric factors, that pressure mapping is sensitive enough to differentiate between seats. One results of the study is that the body mass and the hip circumference are good indicators for the contact area in the cushion.

Unfortunately, there is no study to our knowledge that correlates the discomfort and comfort in automotive seat to the parameters shear force, stretch and the pressure. Even though studies claim that pressure and the blood flow are affected by the stretch and shear. Zhang and Roberts (1993) conclude that the blood flow reduces with the increase of the shear force as well as that externally applied shear forces to the skin affect roughly the underlying tissues same as normal forces. Chow and Odell (1978) confirmed that the interface shear has a significant effect on the pressure distribution. Goossens (2001) investigated the shear stress on three different cushion materials. The result of his study was that LiquiCell cushions evoke significant lower shear stress than the foam cushions and gel cushions.

Most of the studies focus on the human perception and rating, which is very important but investigations on how the seat components and the interaction of the seat

components affect the pressure, shear and stretch while the seat is loaded is scarce. It is important to be aware of the impact of the seat components especially because new seat positions and loadings are required due to various future use cases in the automotive interior.

*The aim of this study is on one hand to illustrate how the seat components influence the parameter: elongation, pressure and shear and on the other hand to develop a method to predict the influence of the single seat components on the resulting pressure, elongations and shear force for random measured seat component combination.*

## 6.2. METHODS

A crucial aspect for the seat-human interaction and perception is the seat layout. Figure 6.1 illustrates that each seat component and the interaction of the seat components (INPUT) influence the seat-human interaction parameter, especially with an impact on pressure and shear force (OUTPUT). To handle the complexity of the coherences, it is necessary to gather data of various seat layouts. Therefore, in this study the seat components are varied, the interaction parameters for each seat layout are recorded and potentially relevant parameters are defined. This is done by analyzing the data to investigate the impact of the seat components on the seat-human interaction.

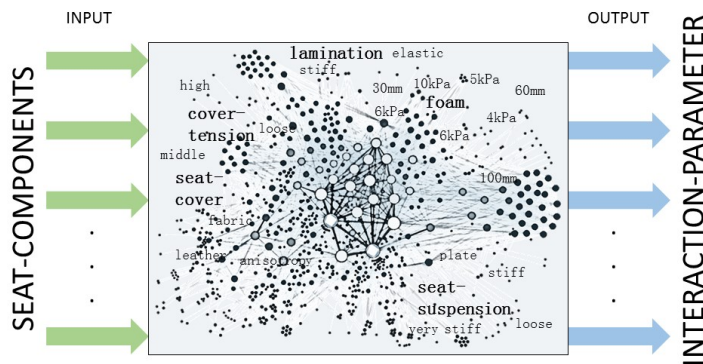

Figure 6.1: Semantical overview of the complexity of the combinations of the seat-components (INPUT) and the resulting interaction parameter (OUTPUT).

### 6.2.1. DATA GATHERING

This section presents the measurement set up and measurement device (Wegner et.al., 2017), the measurement procedure as well as the range of the seat components are combined with each other. The stamp records for each seat layout the range of the force,

indentation, pressure and elongation.

MEASUREMENT TOOL

For this study a measurement device presented by Wegner et. al. (2017) was used. Figure 6.2 illustrates the measurement tool which consists of a material testing machine made by Zwick Roall, a stamp equipped with sensors and a measurement setup. The stamp is connected to the controllable spindle of the testing machine which allows an upward and downward movement. On the fixing plate a system is made to vary the properties of the seat components (Figure 6.3): foam height, foam hardness, cover material, cover tension, lamination and seat suspension.

Turning the crankshaft increases or reduces the tension of the cover. 0°-Position is defined as low cover tension, 60°-position is middle cover tension and 120° is high cover tension. Figure 6.4 visualize the detailed stamp layout (Appendix A.1). The stamp can be positioned downwards and thereby it loads the cover and material under the cover. The stamp records the force, the indentation, the pressure at five different positions and the elongation in four directions positioned 90° to each other. The pressure and the elon-

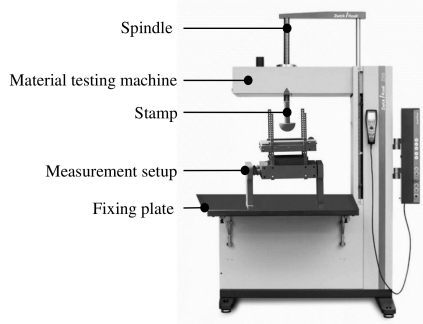

Figure 6.2: Illustration of the used measurement tool.

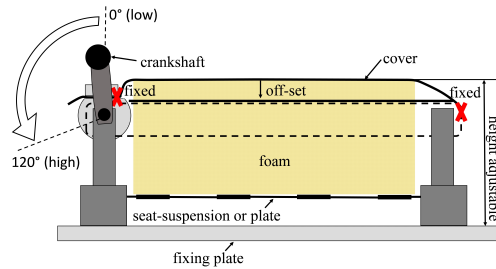

Figure 6.3: Detailed illustration of the measurement setup. It is used to vary the seat layouts.

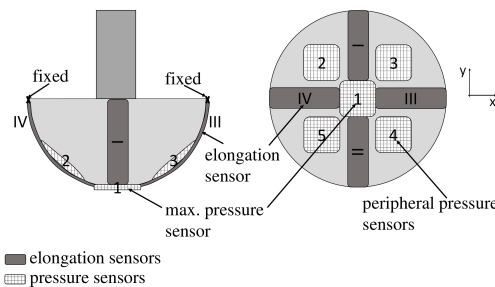

Figure 6.4: Detailed illustration of the stamp. Pressure sensor are named from 1-5 and elongations sensors from I-IV.

gation sensors are decoupled with a pressure independent sliding layer, nearly without rubbing. The elongation sensors are covered with a stretchable silicon material, which should simulate the surface of the human skin.

### MEASURING PROCEDURE AND RECORDING

The measurement procedure includes four cycles, three pre-cycles and one measurement cycle. The measurement cycle has four phases shown in Figure 6.5. During the first phase the stamp loads with a velocity of 100 mm/min the seat layout until 100 N is reached. During the second phase the stamps remains in the position for 30 seconds. Hereafter (phase 3), the machine adjusts the force again up to 100 N and moves the measurement setup 5 mm<sup>1</sup> in lateral direction relative to the stamp and remains 15 seconds in this position. The fourth phase is the relief phase.

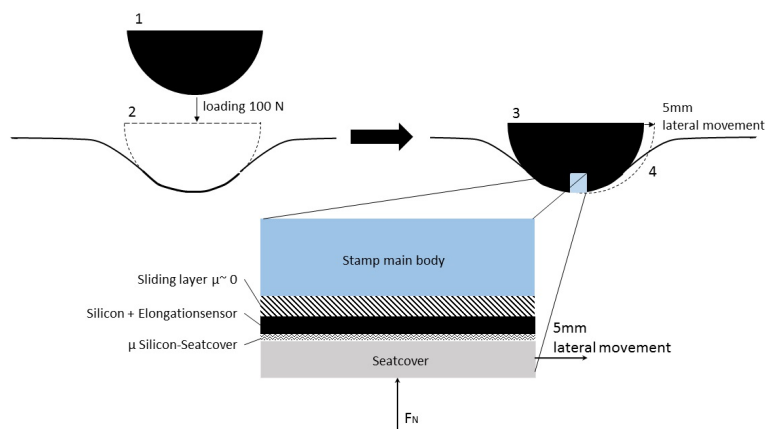

Figure 6.5: Illustration of the measurement procedure. The figure presents also a detailed section of the contact layers between stamp and seat layout.

### SEAT LAYOUTS

To get an idea of how the seat components influence the signals measured by the stamp, various seat layouts combining different components in the measurement setup were made (Figure 6.3). Table 6.1 shows the seat components which were used and systematically varied to record the effect of different seat layouts. All in all 648 different seat layout were recorded by the measurement tool.

### FRICTION COEFFICIENT

In order to check differences in shear stress the static and dynamic friction coefficient of the silicon-leather and silicon-fabric pairings have to be determined with the help of a rotating tribometer. Figure 6.6 shows the procedure how this is done. The leather/fabric

<sup>1</sup>In order to exclude the destruction of the stamp sensors and to ensure a long-term durability, especially of the pressure sensors, the lateral movement of the stamp was limited to 5 mm.

Table 6.1: Overview the varied seat layout characteristics. Six different foam hardness, three foam heights, two cover materials, three cover tensions, three cover laminations and two different options for suspension (in total 648 seat layouts).

foam hardness	4 kPa	5 kPa	6 kPa	8 kPa	10 kPa	12 kPa
foam height	30 mm		60 mm		100 mm	
cover material	fabric			leather		
cover tension	low (crankshaft position 0°)		middle (crankshaft position 60°)		high (crankshaft position 120°)	
lamination	fabric and leather without lamination		fabric with a fleece lamination, leather with a very stiff lamination (Kufner- Laminations)		fabric with an 5 mm foam-lamination, leather with an 5 mm foam-laminations	
suspension	seat suspension			plate		

sample is bounded to a flat round stamp (diameter: 25mm) and the silicon sample is glued to a plate. For the static friction coefficient the stamp is pressed with forces of 1 N, 5 N and 10 N to the plate, the stamp is stressed with a torque ramp (0-230 mNm) and the rotation angle is measured as the output. To define the static friction coefficient it is necessary to determine the point for an exponential rise of the torque angle. This procedure was repeated one time. For the dynamic friction coefficient measurement two rotational speeds were chosen (0.5 1/s and 2 1/s) with two normal forces (5 N and 10 N). The measured output is defined as the torque. With the help of the measured torque and the normal force the friction coefficient is calculated. This measurement was also repeated one time.

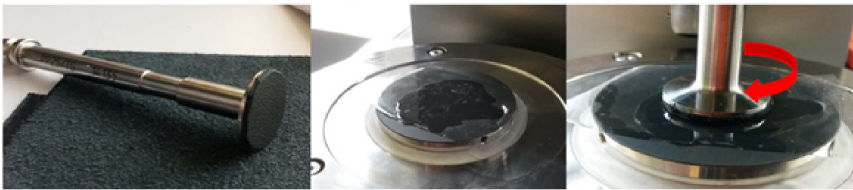

Figure 6.6: Illustration of the test to determine the frictions coefficients of leather-silicon and fabric-silicon.

### 6.2.2. DATA PROCESSING

Based on the recorded data of the measurement tool in this study the following parameters for each of the 648 seat layouts were identified and calculated: 1.) *first touch pressure*, 2.) *maximum pressure*, 3.) *transition of linear to exponential rise of the pressure defined as*

linear pressure, 4.) the pressure in the peripheral area defined as pressure distribution, 5.) elongation while loading the seat (phase 1) and 6.) elongation while moving the stamp lateral to the loading direction (phase 3) defined as elongation due to the lateral movement. Additionally, recordings were made of the 7.) maximum pressure and the 8.) transition in the indentation and estimates 9.) the hysteresis, 10.) relaxation and 11.) the anisotropy of the elongation sensors while loading. The following paragraphs describe the calculation of the parameters in detail.

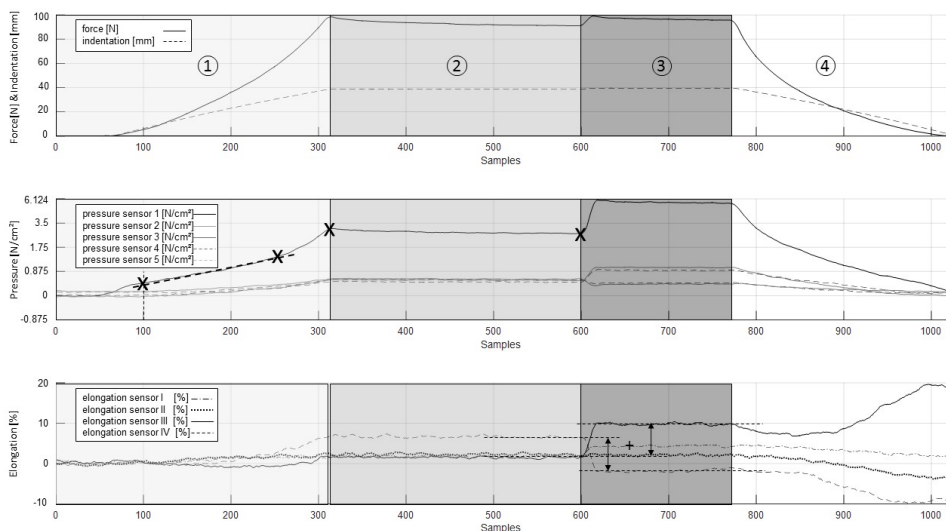

Figure 6.7: The top diagram illustrates the force and indentation, the middle diagram presents the sensor data of the five pressure sensors and diagram at the bottom presents the four elongations sensor data.

Figures 6.7 illustrates an example of the recorded data of one seat layout. The plot at the top shows the recordings of the force and indentation. This plot includes the division into the four measurement phases (see, Figure 6.5). The second plot shows the recordings of the five pressure sensors (Figure 6.4) and the plot at the bottom exposes the recording of the elongation sensors. On the basis of these plots the above mentioned parameters are calculated. Thus a characterization of each seat layout is possible.

**Pressure:** The 1.) *first touch pressure* is defined as the pressure information of pressure sensor one (Figure 6.4) after 5 mm indentation. The 5 mm is an empirical defined value of BMW internal Comfort-Experts. The 2.) *maximum pressure* has been defined as the value of pressure sensor one when 100 N Force are reached. The 3.) *linear pressure* identifies the shift from a linear rise of the pressure to an exponential rise of pressure based on the values of sensor one. The 4.) *pressure distribution* is defined as the average pressure of the peripheral pressure sensors (sensor 2-4, Figure 6.7) in phase 2. The maximum pressure and the linear pressure are linked to the indentation information (7.,8.).

**Elongation:** While loading (phase 1), the elongation of each of the four sensor is recorded. In the first step the information of sensor I and sensor II is summed up to y-elongation and sensor III and sensor IV is summed up to x-elongation. The sum of



y-elongation and x-elongation is the overall 5.) *elongation while loading the seat*. With the ratio of the x-elongation and the overall elongation the parameter 11.) *anisotropy* is defined. If the quotient is  $>0.35$  and  $<0.65$  the parameter is defined as isotropic otherwise the parameter is anisotropic. Values in between the defined range imply that the elongation in x-direction is similar to the y-direction. A ratio of 0.5 is an ideal distribution of the elongation in x- and y-direction. Values out of the range illustrate that the x-direction elongates noticeable different to the y-direction. Values of 0 or 1 state a elongation rather in y- or x-direction.

The information of the elongation sensor III and IV in phase 3 enables to calculate the change of the elongation while applying a shear stress. The change of elongation sensor III and IV is identified by calculating the difference between phase two and phase three of each sensor. Both values of sensor III and IV are summed up to an overall 6.) *elongation due to the lateral movement*.

**Hysteresis:** For the calculation of the 9.) hysteresis the force and indentation information of plot 1, Figure 6.7 is necessary. The force and the indentation recordings of phase 1 and phase 5 are combined in a force-indentation diagram. To calculate the hysteresis the integral of relief phase is subtracted from integral of the loading phase. Figure 6.8 shows the adjusted force-indentation diagram only including the loading and the relief phase and highlights the hysteresis with a hatched area.

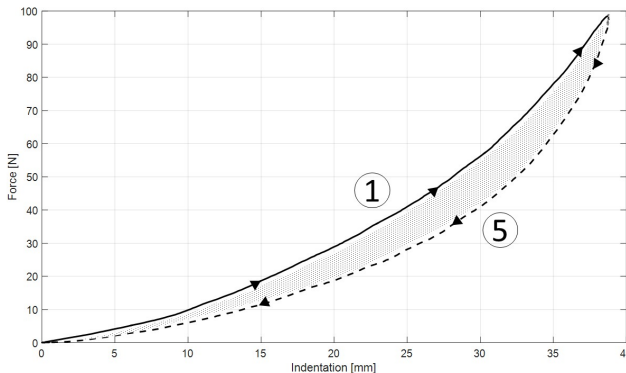

Figure 6.8: Hysteresis of the stress and relief phase.

**Relaxation:** The 10.) *relaxation* is defined as the decrease of the force during the stamp remains for 30 seconds (phase 2) in the same position. Therefore, the relaxation is the difference between the maximum and the minimum force in phase 2.

In summary each of the 648 layouts is defined by 17 criteria. The first six criteria specify the seat layout (Table 6.1) and the remaining criteria characterize the seat layout with the above mentioned 11 parameters. These parameters are divided. The first six parameters are directly related to the seat-human interaction and the parameter 7.) to 11.) provide additional material characteristics while loading the seat.

### 6.2.3. DATA ANALYSIS

Wegner et. al. (2017) have shown that passengers that sit in the same seat model with various cover materials (fabric and leather) perceive and characterize the seats differently. For this reason the leather and the fabric data set is divided for further statistic investigations. A MANOVA shell analyze which of the calculated parameters have a significant effect on the differentiation between the cover materials. For the leather data set as well as the fabric data sets a cluster analysis and a factor analysis is conducted. Finally the influence of the seat components on the statistically identified factors in each cluster is investigated with a Multiple Regression Analysis. All statistical test are conducted with IBM SPSS Statistics 25.

#### DIVISION INTO LEATHER AND FABRIC

For analyzing of the interaction of the various seat layouts the data set is divided into a leather data set and a fabric data set. This is done as participants perceived the same seat models only diverse regarding cover (fabric and leather) different (Wegner et al., 2017). A MANOVA test is conducted in order to study which parameters of the data set have the main effects on differentiation between the cover materials (leather/fabric). In this context the criterion of the Box's test of equality of Covariance Matrices has to be fulfilled for the combinations of the parameters. The null hypothesis that the group means vector of all parameters are equal for the leather data set and the fabric data set has to be rejected.

#### CLUSTER ANALYSIS

The cluster analysis focuses on the variables which are directly connected to the seat-human interaction. Therefore, we define the parameter (1.) - 6.) as the cluster parameter: *first contact pressure, max. pressure, linear pressure, pressure distribution, elongation and elongation after movement*. The IDs of 648 seat layouts are defined as cases. First, the leather and the fabric data set are adapted, deleting statistical outliers by using the single linkage method and creating a dendrogram. Differences greater than 5 in the dendrogram were defined as a statistical outlier. After, the Ward Method including the Squared Euclidean distance, the scree-plot and the Elbow-criterion defines the amount of necessary cluster for each of the adjusted leather and fabric data set. The Ward Method assign a cluster to each seat layout (ID). Afterwards each cluster is statistically descriptive analyzed regarding the characteristics of the seat layout and the seat-human-interaction parameters.

#### FACTOR ANALYSIS

To reduce the complexity of the parameter (1.) - 11.) defined in section 6.2.2 and to identify the structure of the relationships between the parameters a factor analysis is carried out for the leather and the fabric data set. Preliminary analysis tests for the factor analysis include the Pearson Correlation Matrix, the Kaiser-Meyer-Olkin and the Bartlett's Test as well as the Anti-Image Matrices. The procedure of the factor analysis itself starts with the factor extraction based on the Principal Component Analysis selecting factors on the criterion of eigenvalues over 1, a screen plot analysis and an orthogonal rotation of the 1 items (parameters). Factor loadings with less than 0.6 are not taken into account.

### MULTIPLE REGRESSION ANALYSIS

To understand the relationship between the factors and the seat component in each cluster of the leather and fabric data set a Multiple Regression Analysis is conducted.

## 6.3. RESULTS

### 6.3.1. DIVISION OF THE LEATHER AND FABRIC DATA SET

#### MANOVA IDENTIFICATION OF THE SURFACE

For the combination of the parameters 5.) *elongation while loading the seat* and 6.) *elongation due to the lateral movement* the Box-Test is statistically not significant ( $p > 0.05$ ), the null hypothesis that the covariance matrices of the dependent variables are equal across groups is not met. Thus, the assumptions for a MANOVA are fulfilled. The results of the MANOVA show a significant effect of the cover material on the parameters 5.) *elongation while loading the seat* and 6.) *elongation due to the lateral movement*,  $F(2, 638) = 63,507, p < 0.05$ . Separate univariate ANOVAs on the outcome variables revealed significant treatment effects on the parameters 5.) *elongation while loading the seat*,  $F(1, 33379.20) = 126.86, p < 0.05$  and 6.) *elongation due to the lateral movement*  $F(1, 44.89) = 8.94, p < 0.05$ .

#### FRICITION COEFFICIENT

The static friction coefficient for silicon-leather is determined to  $\mu_{static}$ , leather=0.4 and for silicon-fabric to  $\mu_{static}$ , fabric=0.3. The dynamic friction coefficient of silicon-leather was determined to  $\mu_{dynamic}$ , leather= 1.4 and for silicon-fabric to  $\mu_{dynamic}$ , fabric=1.1. Usually  $\mu_{static} > \mu_{dynamic}$ , but for this measurements  $\mu_{static} < \mu_{dynamic}$  due to the varying rotational speeds in the static and dynamic test.

### 6.3.2. CLUSTER ANALYSIS

The cluster analysis reveals for the fabric data set 5 cluster and for the leather data set 4 cluster. Each cluster for the fabric and the leather data set is a group of various seat layouts with a more similar set of the interaction parameter values: *first contact pressure, max. pressure, linear pressure, pressure distribution, elongation and elongation after movement* than to the other groups. This section presents for each cluster the cluster specific set of interaction parameter values and additionally shows the statistical dominant seat layout characteristics as well as material characteristics like the hysteresis and the relaxation.

#### FABRIC

With the help of the single linkage method and the criteria of the dendrogram 10 outliers were identified, the fabric data set is reduces to 314 seat layouts. The Elbow-criterion defines an optimal amount of 5 clusters. Afterwards, applying the Ward-Method each seat layout (ID) was allocated regarding the interaction parameter values to one of the five cluster. 65 of the layouts are in cluster one, 88 in cluster 2 two, 95 in cluster three, 49 in cluster four and 17 in cluster five. The next tables illustrate for each cluster a detailed overview of the cluster specific interaction parameter values as well as the predominant seat layout characteristics and material characteristics.

Table 6.2: Overview of the seat component, the interaction parameters and additional parameters of cluster 1 for fabric seat layouts.

<b>Components</b>	<b>Cluster 1 - Fabric</b>	
<i>Foam hardness</i>	foam hardness middle, predominantly 5 kPa - 6 kPa	
<i>Foam height</i>	equal distribution of foam height	
<i>Cover tension</i>	low cover tension	
<i>Lamination</i>	most common is no lamination and fleece lamination	
<i>Seat suspension</i>	predominantly with seat suspension	
<b>Summary</b>	<b>This seat layout is the softest cluster with middle soft foams, a low cover tension and a seat suspension.</b>	
<b>Parameter</b> - directly related to seat-human interaction	Average	Standard Deviation
1.) <i>first touch pressure</i>	0.67N/cm <sup>2</sup>	0.15N/cm <sup>2</sup>
2.) <i>maximum pressure</i>	5.25N/cm <sup>2</sup>	1.83N/cm <sup>2</sup>
3.) <i>linear pressure</i>	1.34N/cm <sup>2</sup>	0.41N/cm <sup>2</sup>
4.) <i>pressure distribution</i>	0.83N/cm <sup>2</sup>	0.08N/cm <sup>2</sup>
5.) <i>elongation while loading the seat</i>	8.78%	1.90%
6.) <i>elongation due to the lateral movement</i>	14.75%	5.33%
<b>Parameter</b> - additional parameter	Average	Standard Deviation
7.) <i>indentation for maximum pressure</i>	32.98mm	3.00mm
8.) <i>indentation for linear pressure</i>	20.21mm	2.67mm
9.) <i>hysteresis</i>	248.57Nm	32.88Nm
10.) <i>relaxation</i>	7.93N	0.71N
11.) <i>anisotropy</i>	0.74	0.13

Table 6.3: Overview of the seat component, the interaction parameters and additional parameters of cluster 2 for fabric seat layouts.

<b>Components</b>	<b>Cluster 2 - Fabric</b>	
<i>Foam hardness</i>	hard foams, predominantly 8 kPa – 12 kPa	
<i>Foam height</i>	mainly high foams 60 mm and 100 mm	
<i>Cover tension</i>	low and middle cover tension	
<i>Lamination</i>	predominantly no lamination and foam lamination	
<i>Seat suspension</i>	50 % of the seat layouts are with and 50 % without seat suspension	
<b>Summary</b>	<b>This cluster can be characterized as a high seat layout with harder foams and low cover tension.</b>	
<b>Parameter</b> - directly related to seat-human interaction	Average	Standard Deviation
1.) <i>first touch pressure</i>	0.90N/cm <sup>2</sup>	0.16N/cm <sup>2</sup>
2.) <i>maximum pressure</i>	5.24N/cm <sup>2</sup>	0.87N/cm <sup>2</sup>
3.) <i>linear pressure</i>	2.23N/cm <sup>2</sup>	0.47N/cm <sup>2</sup>
4.) <i>pressure distribution</i>	0.82N/cm <sup>2</sup>	0.04N/cm <sup>2</sup>
5.) <i>elongation while loading the seat</i>	5.51%	1.51%
6.) <i>elongation due to the lateral movement</i>	26.17%	8.84%
<b>Parameter</b> - additional parameter	Average	Standard Deviation
7.) <i>indentation for maximum pressure</i>	27.79mm	4.44mm
8.) <i>indentation for linear pressure</i>	20.21mm	4.00mm
9.) <i>hysteresis</i>	235.05Nm	29.57Nm
10.) <i>relaxation</i>	8.87N	1.42N
11.) <i>anisotropy</i>	0.59	0.20

Table 6.4: Overview of the seat component, the interaction parameters and additional parameters of cluster 3 for fabric seat layouts.

<b>Components</b>	<b>Cluster 3- Fabric</b>	
<i>Foam hardness</i>	soft foams, 4 kPa -5 kPa	
<i>Foam height</i>	middle foam heights 30mm and 60 mm	
<i>Cover tension</i>	high cover tension	
<i>Lamination</i>	equal distributed lamination	
<i>Seat suspension</i>	58.9 % of the seat layout have a seat suspension and 41.1% have a plate	
<b>Summary</b>	<b>This cluster has properties like a hammock very soft foams and a high cover tension.</b>	
<b>Parameter</b> - directly related to seat-human interaction	Average	Standard Deviation
1.) <i>first touch pressure</i>	0.82N/cm <sup>2</sup>	0.19N/cm <sup>2</sup>
2.) <i>maximum pressure</i>	9.64N/cm <sup>2</sup>	3.00N/cm <sup>2</sup>
3.) <i>linear pressure</i>	1.91N/cm <sup>2</sup>	0.49N/cm <sup>2</sup>
4.) <i>pressure distribution</i>	0.52N/cm <sup>2</sup>	0.15N/cm <sup>2</sup>
5.) <i>elongation while loading the seat</i>	5.60%	1.61%
6.) <i>elongation due to the lateral movement</i>	45.43%	12.90%
<b>Parameter</b> - additional parameter	Average	Standard Deviation
7.) <i>indentation for maximum pressure</i>	28.56mm	2.96mm
8.) <i>indentation for linear pressure</i>	18.98mm	3.33mm
9.) <i>hysteresis</i>	217.97Nm	16.63Nm
10.) <i>relaxation</i>	8.69N	2.96N
11.) <i>anisotropy</i>	0.65	0.19

Table 6.5: Overview of the seat component, the interaction parameters and additional parameters of cluster 4 for fabric seat layouts.

<b>Components</b>	<b>Cluster 4- Fabric</b>	
<i>Foam hardness</i>	hard foams, 8 kPa -12 kPa	
<i>Foam height</i>	foam heights are equal distributed	
<i>Cover tension</i>	middle to high cover tensions	
<i>Lamination</i>	either a fleece or a foam lamination	
<i>Seat suspension</i>	predominantly a plate instead of a seat suspension	
<b>Summary</b>	<b>This seat layout has hard foams, a high cover tension and no seat suspension (plate).</b>	
<b>Parameter</b> - directly related to seat-human interaction	Average	Standard Deviation
1.) <i>first touch pressure</i>	1.14N/cm <sup>2</sup>	0.20N/cm <sup>2</sup>
2.) <i>maximum pressure</i>	7.66N/cm <sup>2</sup>	1.92N/cm <sup>2</sup>
3.) <i>linear pressure</i>	3.78N/cm <sup>2</sup>	0.42N/cm <sup>2</sup>
4.) <i>pressure distribution</i>	0.65N/cm <sup>2</sup>	0.15N/cm <sup>2</sup>
5.) <i>elongation while loading the seat</i>	3.80%	0.93%
6.) <i>elongation due to the lateral movement</i>	39.18%	11.23%
<b>Parameter</b> - additional parameter	Average	Standard Deviation
7.) <i>indentation for maximum pressure</i>	23.45mm	3.82mm
8.) <i>indentation for linear pressure</i>	18.86mm	4.15mm
9.) <i>hysteresis</i>	205.95Nm	21.97Nm
10.) <i>relaxation</i>	7.66N	1.92N
11.) <i>anisotropy</i>	0.56	0.24

Table 6.6: Overview of the seat component, the interaction parameters and additional parameters of cluster 5 for fabric seat layouts.

Components	Cluster 5- Fabric	
<i>Foam hardness</i>	hard foams, 8 kPa -12 kPa	
<i>Foam height</i>	predominantly flat foam 30 mm	
<i>Cover tension</i>	high cover tension	
<i>Lamination</i>	either a fleece or a foam lamination	
<i>Seat suspension</i>	a plate instead of a seat suspension	
<b>Summary</b>	<b>Like cluster 4 with the difference that the foam height is low</b>	
<b>Parameter</b> - directly related to seat-human interaction	Average	Standard Deviation
1.) <i>first touch pressure</i>	1.54N/cm <sup>2</sup>	0.25N/cm <sup>2</sup>
2.) <i>maximum pressure</i>	10.72N/cm <sup>2</sup>	1.95N/cm <sup>2</sup>
3.) <i>linear pressure</i>	6.14N/cm <sup>2</sup>	1.11N/cm <sup>2</sup>
4.) <i>pressure distribution</i>	0.44N/cm <sup>2</sup>	0.09N/cm <sup>2</sup>
5.) <i>elongation while loading the seat</i>	3.42%	0.93%
6.) <i>elongation due to the lateral movement</i>	49.20%	4.31%
<b>Parameter</b> - additional parameter	Average	Standard Deviation
7.) <i>indentation for maximum pressure</i>	20.68mm	2.92mm
8.) <i>indentation for linear pressure</i>	16.93mm	3.68mm
9.) <i>hysteresis</i>	179.99Nm	14.89Nm
10.) <i>relaxation</i>	9.79N	1.71N
11.) <i>anisotropy</i>	0.81	0.24

The results of the fabric clusters illustrate the important impact of the combination of the seat components. The parameters (1.) - 6.) directly related to the seat-human interactions are influenced by various seat components. Cluster one illustrates that the parameter 1.) *first touch pressure* is low if the cover tension is low with middle hard foams and a seat suspension. The higher the cover tension and the harder the foam the higher the 1.) *first touch pressure*. The results of the cluster analysis illustrate that the parameter 2.) *maximum pressure* is predominantly influenced by high cover tension, the absence of the seat suspension and hard foams. Although the foam hardness is in cluster three soft the parameter 2.) *maximum pressure* is the second highest of all clusters due to the high cover tension. In contrast cluster five with a seat layout with hard and low foams, high cover tensions and no seat suspension has the highest 2.) *maximum pressure*. The



parameter 3.) *linear pressure* is influenced on one hand by the cover tension and on the other on the combination of the foam hardness and seat suspension. Cluster one illustrates that for low cover tensions and middle hard foams the 3.) *linear pressure* is the lowest, in contrast cluster three also with soft foams but with high cover tension has higher 3.) *linear pressure* values. The higher the foam hardness and the higher the cover tension the higher the values of parameter 3.) *linear pressure*. Cluster three with soft foams and high cover tensions has one of the lowest 4.) *pressure distribution* values, which means that the pressure is not spread. A high value of 4.) *pressure distribution* is achieved with low cover tensions, which indicates an more equal distribution of the pressure. The results of the parameter 4.) *pressure distribution* in cluster one and cluster two demonstrate that the combination of the foam hardness, the foam height and the seat suspension is an important factor to create an equal pressure distribution over a larger area. The 5.) *elongation while loading the seat* is in cluster two and cluster three nearly the same even though the seat layout is different, especially the cover tension and the foam hardness influence this. Cluster one has the highest 5.) *elongation while loading the seat* due to more indentation related to the softer foams, lower cover tension and the presence of the seat suspension. Seat layouts with harder foams, higher cover tensions and absence of the seat suspension evoke less indentation. The 6.) *elongation due to the lateral movement* is influenced by the components cover tension, foam height and foam hardness as well as the presence of the seat suspension. Comparing cluster one and three with soft foams but low cover tension in cluster one and high cover tension in cluster three, illustrates that the higher cover tension rises the 6.) elongation due to the lateral movement. A comparison of cluster one and two shows that higher foam hardness increase the 6.) elongation due to the lateral movement. The comparison of cluster two and cluster four presents the influence of the seat suspension, the presence of the seat suspension decrease the parameter 6.). The influence of the foam height is evident in the comparison of cluster four and cluster five. Lower foam heights increase the 6.) elongation due to the lateral movement.

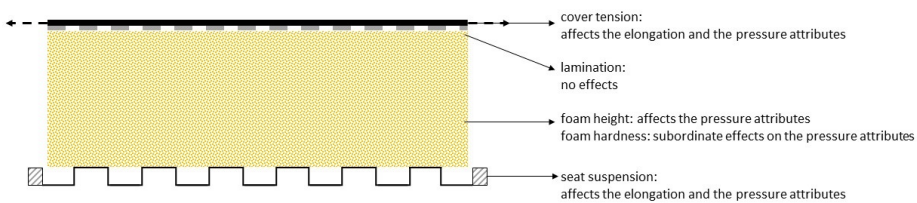

Figure 6.9: Effects of the seat components on the seat-human interaction parameter for fabric seat layouts.

All in all the cluster analysis illustrates that the interaction between the components is very complex and affects the seat-human interaction in various ways. A rough conclusion of how the components influence seat-human interaction is shown in Figure 6.9. The lamination has nearly no influence on the seat-human interaction parameters for fabric seats. The seat cover tension has a high impact on the seat components under the cover and on the seat-human interaction. A low cover tension encourage a low pressure (1.) *first touch*

*pressure, 2.) maximum pressure and 3.) linear pressure) and an equal pressure distribution (4.) pressure distribution) as well as low 5.) elongation while loading the seat and low 6.) elongation due to the lateral movement. The existence of a seat suspension evokes a higher 5.) elongation while loading the seat but a reduction of the 6.) elongation due to the lateral movement and a reduction of the pressure attributes as well as an equal pressure distribution. The effects of the foam properties are very much dependent on the properties of the seat suspension and seat cover. For lower pressure attributes, a well distributed pressure and low 5.) elongation while loading the seat middle hard (5 kPa – 8 kPa) and middle high (60 mm) foams are necessary. For low 6.) elongation due to the lateral movement high and softer foams are necessary. Foam hardness out of the middle hard range affect the listed interaction parameters negatively.*

## LEATHER

The single linkage method and the criteria of the dendrogram identifies for the leather data set 15 outliers, the data set is reduced to 309 seat layouts. With the help of the Elbow-criterion an optimal amount of 4 clusters is defined. Afterwards, the Ward-Method allocates to each leather seat layout (ID) on the basis of the interaction parameter values one of the five clusters. 41 of the layouts are in cluster one, 44 in cluster two, 96 in cluster three and 128 in cluster four. The next four tables present for each cluster a detailed overview of the cluster specific interaction parameter values as well as the predominant seat layout characteristics and material characteristics.

Table 6.7: Overview of the seat component, the interaction parameters and additional parameters of cluster 1 for leather seat layouts.

Components	Cluster 1- Leather	
<i>Foam hardness</i>	foam hardness middle, predominantly 5 kPa – 6 kPa	
<i>Foam height</i>	equal distribution of foam height	
<i>Cover tension</i>	low and middle cover tension equal distributed	
<i>Lamination</i>	no lamination	
<i>Seat suspension</i>	only seat suspension	
<b>Summary</b>	<b>Middle hard foams with low cover tension and a seat suspension and an elastic cover (leather with no lamination)</b>	
<b>Parameter</b> - directly related to seat-human interaction	Average	Standard Deviation
1.) <i>first touch pressure</i>	0.68N/cm <sup>2</sup>	0.28N/cm <sup>2</sup>
2.) <i>maximum pressure</i>	4.78N/cm <sup>2</sup>	2.94N/cm <sup>2</sup>
3.) <i>linear pressure</i>	1.53N/cm <sup>2</sup>	0.92N/cm <sup>2</sup>
4.) <i>pressure distribution</i>	0.62N/cm <sup>2</sup>	0.16N/cm <sup>2</sup>
5.) <i>elongation while loading the seat</i>	13.11%	1.84%
6.) <i>elongation due to the lateral movement</i>	32.78%	15.02%
<b>Parameter</b> - additional parameter	Average	Standard Deviation
7.) <i>indentation for maximum pressure</i>	32.68mm	3.82mm
8.) <i>indentation for linear pressure</i>	21.79mm	4.10mm
9.) <i>hysteresis</i>	288.02Nm	47.06Nm
10.) <i>relaxation</i>	8.72N	0.83N
11.) <i>anisotropy</i>	0.57	0.08

Table 6.8: Overview of the seat component, the interaction parameters and additional parameters of cluster 2 for leather seat layouts.

<b>Components</b>	<b>Cluster 2- Leather</b>	
<i>Foam hardness</i>	foam hardness is nearly equal distributed from 4 kPa tp 10 kPa	
<i>Foam height</i>	predominantly 60mm and 100mm foam heights	
<i>Cover tension</i>	low to middle cover tension	
<i>Lamination</i>	no lamination	
<i>Seat suspension</i>	nearly equal distributed seat suspension and plate	
<b>Summary</b>	<b>Dominance of the cover properties, elastic leather with low / middle cover tension</b>	
<b>Parameter</b> - directly related to seat-human interaction	Average	Standard Deviation
1.) <i>first touch pressure</i>	$0.69N/cm^2$	$0.19N/cm^2$
2.) <i>maximum pressure</i>	$5.10N/cm^2$	$2.65N/cm^2$
3.) <i>linear pressure</i>	$1.53N/cm^2$	$0.36N/cm^2$
4.) <i>pressure distribution</i>	$0.56N/cm^2$	$0.18N/cm^2$
5.) <i>elongation while loading the seat</i>	8.58%	1.10%
6.) <i>elongation due to the lateral movement</i>	38.13%	15.10%
<b>Parameter</b> - additional parameter	Average	Standard Deviation
7.) <i>indentation for maximum pressure</i>	$29.79mm$	$5.10mm$
8.) <i>indentation for linear pressure</i>	$19.05mm$	$3.13mm$
9.) <i>hysteresis</i>	$270.46Nm$	$43.04Nm$
10.) <i>relaxation</i>	$9.74N$	$1.43N$
11.) <i>anisotropy</i>	0.53	0.17

Table 6.9: Overview of the seat component, the interaction parameters and additional parameters of cluster 3 for leather seat layouts.

<b>Components</b>	<b>Cluster 3- Leather</b>	
<i>Foam hardness</i>	foam hardness is nearly equal distributed for 4 kPa tp 10 kPa, 12 kPa is the most frequented	
<i>Foam height</i>	equal distribution of foam height	
<i>Cover tension</i>	equal distribution of the cover tension low, middle and high	
<i>Lamination</i>	most common foam lamination	
<i>Seat suspension</i>	equal distribution of seat suspension	
<b>Summary</b>	<b>This cluster has no dominant seat component characterizing the seat layout</b>	
<b>Parameter</b> - directly related to seat-human interaction	Average	Standard Deviation
1.) <i>first touch pressure</i>	$0.91 N/cm^2$	$0.27 N/cm^2$
2.) <i>maximum pressure</i>	$9.40 N/cm^2$	$3.72 N/cm^2$
3.) <i>linear pressure</i>	$2.47 N/cm^2$	$0.96 N/cm^2$
4.) <i>pressure distribution</i>	$0.34 N/cm^2$	$0.15 N/cm^2$
5.) <i>elongation while loading the seat</i>	5.48%	1.13%
6.) <i>elongation due to the lateral movement</i>	45.02%	15.36%
<b>Parameter</b> - additional parameter	Average	Standard Deviation
7.) <i>indentation for maximum pressure</i>	26.10mm	3.72mm
8.) <i>indentation for linear pressure</i>	17.36mm	3.15mm
9.) <i>hysteresis</i>	242.07Nm	38.77Nm
10.) <i>relaxation</i>	9.80N	1.69N
11.) <i>anisotropy</i>	0.60	0.23

Table 6.10: Overview of the seat component, the interaction parameters and additional parameters of cluster 4 for leather seat layouts.

<b>Components</b>	<b>Cluster 4- Leather</b>	
<i>Foam hardness</i>	foam hardness is nearly equal distributed from 4 kPa tp 10 kPa	
<i>Foam height</i>	equal distribution of foam height	
<i>Cover tension</i>	predominantly, middle to high cover tension	
<i>Lamination</i>	most common is Kufner lamination (stiff lamination)	
<i>Seat suspension</i>	predominantly a plate	
<b>Summary</b>	<b>This cluster is characterized with the Kufner lamination and no seat suspension (plate)</b>	
<b>Parameter</b> - directly related to seat-human interaction	Average	Standard Deviation
1.) <i>first touch pressure</i>	$1.12N/cm^2$	$0.36N/cm^2$
2.) <i>maximum pressure</i>	$15.83N/cm^2$	$3.98N/cm^2$
3.) <i>linear pressure</i>	$3.61N/cm^2$	$1.62N/cm^2$
4.) <i>pressure distribution</i>	$0.20N/cm^2$	$0.12N/cm^2$
5.) <i>elongation while loading the seat</i>	8.78%	1.07%
6.) <i>elongation due to the lateral movement</i>	55.54%	13.30%
<b>Parameter</b> - additional parameter	Average	Standard Deviation
7.) <i>indentation for maximum pressure</i>	$24.42mm$	$4.64mm$
8.) <i>indentation for linear pressure</i>	$15.83mm$	$3.98mm$
9.) <i>hysteresis</i>	$215.85Nm$	$44.89Nm$
10.) <i>relaxation</i>	$9.40N$	$1.60N$
11.) <i>anisotropy</i>	0.70	0.36

The results of the leather clusters illustrate that the lamination has much impact for the leather seat. The parameter 1.) *first touch pressure*, 2.) *maximum pressure* and 3.) *linear pressure* are for cluster one and cluster two similar, although the seat layout differs from each other. For cluster one it is characteristic that the seat layout has a foam hardness focused on 5 kPa and 6 kPa, no lamination and a seat suspension. In contrast the cluster two has high foams (all foam hardness) and no laminations. For cluster three and four the three parameter 1.) *first touch pressure*, 2.) *maximum pressure* and 3.) *linear pressure* are determined by the lamination and the cover tension. These three parameter for cluster three are lower than for cluster four due to the lamination which is in cluster three a very stiff lamination called Kufner lamination instead of foam lamination. The 4.)

*pressure distribution* value is in cluster one the highest (more equal pressure distribution) due to the presence of the seat suspension, no lamination and soft foams. Cluster two has a slightly lower 4.) *pressure distribution* values because of the fact that this cluster has generally more layouts without a seat suspension but with higher foams. The value of the parameter 4.) *pressure distribution* decreases (tendency to an unequal pressure distribution) in cluster three and four, related to the absence of the seat suspension and the rising cover tension as well as the stiffer lamination. The parameter 5.) *elongation while loading the seat* has the lowest value in cluster three, which means little elongation. This cluster (cluster three) has no dominant seat component, the combination of the components seems to be more important here. In cluster four the elongation increases due to the higher stiffness of the lamination. Cluster one has the highest 5.) *elongation while loading the seat* because the seat suspension allows so in combination with the low cover tension which make more indentation possible. Cluster two has nearly the same elongation like cluster four with the difference that the seat layout of cluster four has more indentation because of less cover tension, lower cover stiffness and the presence of the seat suspension. The parameter 6.) *elongation due to the lateral movement* is in cluster one the smallest. The reason for that is the seat layout with low cover tensions, a seat suspension and no lamination. In cluster two to cluster four the values for the parameter 6.) increase. Meanwhile the stiffness of the lamination increases as well as the cover tension. The seat suspension is in cluster one present and in cluster two and three partly, cluster four has no seat suspensions.

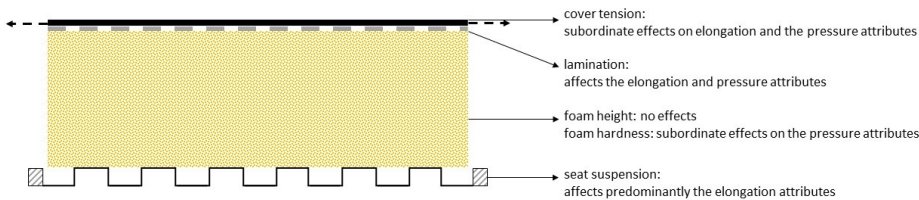

Figure 6.10: Effects of the seat components on the seat-human interaction parameter for leather seat layouts.

In sum the cluster analysis of the leather seat layouts equally illustrates that the interaction between the seat components is complex and affects the seat-human interaction in various ways. A rough conclusion of how the components influence seat-human interaction is shown in Figure 6.10. The lamination of the leather seat cover has a high and a dominant impact on the seat-human interaction parameters. Seat layouts without a lamination are in many cases independent of the cover tension and encourage the foam and seat suspension properties. For such seat layouts the pressure attributes (1.) *first touch pressure*, 2.) *maximum pressure* and 3.) *linear pressure*) are lower, the 4.) *pressure distribution* is more equal, the 6.) *elongation due to the lateral movement* is lower and the 5.) *elongation while loading the seat* is higher. Seat layouts with a lamination affect these parameters contrary, the higher the stiffness of the lamination the higher the contrary effect on the parameters. For laminated leather covers the following applies: low cover tensions encourage low pressure attributes and equal 4.) *pressure distributions*

as well as low 5.) *elongation while loading the seat* and low 6.) *elongation due to the lateral movement*. Furthermore, the pressure attributes and 4.) *pressure distribution* can be controlled by the foam hardness as long as the lamination is not too stiff and the cover tension not too high. The foam height has nearly no effect on the seat-human interaction parameters. The absence of the seat suspension rises the values of the pressure attributes, impairs the pressure distribution, rises the 5.) *elongation while loading the seat* and rise 6.) *elongation due to the lateral movement*.

### 6.3.3. FACTOR ANALYSIS

#### FABRIC

With the Kaiser–Meyer–Olkin the sampling adequacy is verified, which showed KMO = 0.73 ('good' according to Field, 2009). All KMO values for the 11 individual parameters were > 0.56, which is above the acceptable limit of 0.5 (Field, 2009). Bartlett's test of sphericity  $\chi^2(55) = 2642.58$ ,  $p < 0.001$ , indicated that correlations between items were sufficiently large for the factor analysis. An initial investigation was run to obtain eigenvalues for each component in the data. Three components have eigenvalues over Kaiser's criterion of 1 and in combination explained 73.46% of the variance. The scree plot confirms the three components for further analysis. Table 6.11 illustrates the factor loadings after rotation. Only the factors greater than 0.6 are shown.

Table 6.11: Factor loading of the fabric data set according to the principle component analysis.

	Components		
	1	2	3
1.) <i>first touch pressure</i>	-0,792		
2.) <i>maximum pressure</i>		0.745	
3.) <i>linear pressure</i>	-0.879		
4.) <i>pressure distribution</i>		-0.937	
5.) <i>elongation while loading the seat</i>	0.755		
6.) <i>elongation due to the lateral movement</i>		0.852	
7.) <i>indentation for maximum pressure</i>	0.719		
8.) <i>indentation for linear pressure</i>			0.809
9.) <i>hysteresis</i>			
10.) <i>relaxation</i>			-0.749
11.) <i>anisotropy</i>			

The first factor contains three of the directly related parameters and one of the additional parameter. The direct related parameters are the 1.) *first touch pressure*, 3.) *linear pressure* and 5.) *elongation while loading*, whereby the 5.) *elongation while loading* has



an opposite algebraic sign. The additional parameter is the 7.) *maximum indentation* and has the same algebraic sign as the 5.) *elongation while loading*. The second factor includes only directly related parameters 2.) *maximum pressure*, 4.) *pressure distribution* and 6.) *elongation due the lateral movement*. The algebraic sign of 4.) *pressure distribution* differ to the others. The third factor combines two additional parameters, the 8.) *linear indentation* and the 10.) *relaxation*, which have both opposite algebraic signs. The 9.) *hysteresis* and the 11.) *anisotropy* are not included due to factors smaller than 0.6.

### LEATHER

The MSA Index of Anti-Image Matrices was for the parameter relaxation low (0.268), therefore the relaxation is excluded for the factor analysis of the leather data set. The examined parameters reduced for the fabric data set from 11 to 10. With the Kaiser–Meyer–Olkin the sampling adequacy for the analysis is verified, KMO = 0.80 ('great' according to Field, 2009). All KMO values for the 10 individual parameters are > 0.71, which is also above the acceptable limit of 0.5 (Field, 2009). Bartlett's test of sphericity  $\chi^2(45) = 3032.97$ ,  $p < 0.001$ , indicated that correlations between items were sufficiently large for the factor analysis. The investigation of the eigenvalues for each component in the data shows that two components have eigenvalues over Kaiser's criterion of 1. The combination of both components explains 73.37% of the variance. The scree plot confirms the two components for further analysis. Table 6.12 illustrates the factor loadings after rotation. Only factors greater than 0.6 are shown. The first factor contains two of the direct related

Table 6.12: Factor loadings for the leather data set.

	Components	
	1	2
1.) <i>first touch pressure</i>	-0.898	
2.) <i>maximum pressure</i>		0.703
3.) <i>linear pressure</i>	-0.676	
4.) <i>pressure distribution</i>		-0.831
5.) <i>elongation while loading the seat</i>		-0.642
6.) <i>elongation due to the lateral movement</i>		0.770
7.) <i>indentation for maximum pressure</i>	0.957	
8.) <i>indentation for linear pressure</i>	0.873	
9.) <i>hysteresis</i>	0.888	
10.) <i>relaxation</i>		
11.) <i>anisotropy</i>		0.661

parameters and three of the additional parameter. The direct related parameters are the

1.) *first touch pressure* and 3.) *linear pressure*, both with the same algebraic sign. The additional parameters are the 7.) *maximum indentation*, 8.) *linear indentation* and 9.) *hysteresis* all with the same algebraic sign but opposite to the direct related parameters. The second factor includes four direct related parameters 2.) *maximum pressure*, 4.) *pressure distribution*, 5.) *elongation while loading* and 6.) *elongation due the lateral movement* as well as one additional parameter 11.) *anisotropy*. The 4.) *pressure distribution* and 5.) *elongation while loading* have an opposite algebraic sign to the other parameters.

The factor one of the leather and fabric seat layouts contains parameters related to lower or changing loadings and therefore describes more pressure related changes while loading. Factor two contains mostly parameters due to the maximum load and therefore describes more the effects of shear force (the shear force results among other things of 2.) *maximum pressure*, 4.) *pressure distribution*, 6.) *elongation due the lateral movement* and eventually 5.) *elongation while loading*).

#### 6.3.4. HOW DOES THE SEAT COMPONENTS INFLUENCE THE FACTORS IN EACH CLUSTER?

Based on a Multiple Regression Analysis Table 6.13 and Table 6.14 illustrate an overview of cluster specific relationships between the seat components and the factors of both data sets (fabric/leather) with the standardized B value (detailed overview in the appendix A.2 and A.3). This means that changes of some components in a specific cluster have more or less high impacts on the factors or rather the seat-human interaction parameters. Since the focus is on the direct related parameters which are all in the first two factors, Table 6.13 as well as Table 6.14 present only the results of the factor 1 and factor 2.

Table 6.13 shows the relationships for the fabric data set. The  $R^2$  of the cluster one, two and three for factor 1 is  $> 0.5$  with a significance of  $p < 0.01$ . The fourth and fifth cluster have a lower  $R^2 > 0.12$ . The ANOVA of both clusters is not significant,  $p < 0.05$ . For the first three clusters factor one (F1) is related to the foam hardness and to the seat suspension. Additionally the cover tension is related to the cluster one and to cluster three. In cluster two, factor one is also related to the foam height and the lamination. In cluster four only the foam hardness has a significant relationship to factor one. For cluster five it is the lamination.

The  $R^2$  is for the second factor (F2) for each cluster  $> 0.5$ , except for cluster four, which has an  $R^2$  of 0.419. The results of the ANOVA are for all clusters significant,  $p < 0.01$ . Factor two has a significant relationship to the foam hardness for all clusters except for cluster five. The seat suspension has only in cluster one and two a significant relationship to factor two. The cover tension has a relationship to factor two for all clusters without cluster one. Factor two is also connected to the first three clusters influenced by the lamination.

All in all the factors of the first three cluster can be influenced by many seat components, for cluster four and cluster five the factor one (F1) and factor two (F2) can only be influenced by specific seat components. In general it can be concluded that the foam hardness affects factor one the most and the cover tension has the highest effect on factor two. However, the foam hardness is present nearly in each cluster for factor one and two, which means that changes of the foam hardness would influence both factors. For independent changes of the factors it is necessary to choose seat components which have

only an impact on one factor, like for cluster two the seat suspension for factor one and the cover tension for factor two.

Table 6.13: Overview of the significant seat components which have the highest impact on the factors (F1 , F2) or rather the seat-human interaction parameters in specific frameworks of fabric seat layouts (cluster).

	Cluster 1	Cluster 2	Cluster 3	Cluster 4	Cluster 5
	<b>R Square: 0.615</b>	<b>R Square: 0.539</b>	<b>R Square: 0.536</b>	<b>R Square: 0.125</b>	<b>R Square: 0.136</b>
	ANOVA F(3,32)=21.5, p=0.000	ANOVA F(5,82)=19.2, p=0.000	ANOVA F(5,89)=20.6, p=0.000	ANOVA F(5,43)=2.4, p=0.055	ANOVA F(5,11)=1.5, p=0.265
<b>F1</b>	<b>foam hardness</b> std.B.:0.780, p=0.000 <b>seat suspension</b> std.B.:0.634, p=0.000 <b>cover tension</b> std.B.:0.248, p=0.003	<b>foam hardness</b> std.B.:0.771, p=0.000 <b>seat suspension</b> std.B.:0.682, p=0.000 <b>foam height</b> std.B.:0.158, p=0.040 <b>lamination</b> std.B.:0.171, p=0.039	<b>seat suspension</b> std.B.:0.616, p=0.000 <b>foam hardness</b> std.B.:0.454, p=0.000 <b>cover tension</b> std.B.:0.326, p=0.000	<b>foam hardness</b> std.B.:0.351, p=0.033	<b>laminations</b> std.B.:0.667, p=0.023
	<b>R Square: 0.670</b>	<b>R Square: 0.419</b>	<b>R Square: 0.630</b>	<b>R Square: 0.602</b>	<b>R Square: 0.576</b>
	ANOVA F(5,59)=24.0, p=0.000	ANOVA F(5,82)=11.8, p=0.000	ANOVA F(5,89)=33.0, p=0.000	ANOVA F(5,43)=15.5, p=0.000	ANOVA F(5,11)=5.4, p=0.010
<b>F2</b>	<b>foam hardness</b> std.B.:0.582, p=0.000 <b>seat suspension</b> std.B.:0.571, p=0.000 <b>lamination</b> std.B.:0.406, p=0.039	<b>cover tension</b> std.B.:0.393, p=0.003 <b>foam hardness</b> std.B.:0.342, p=0.000 <b>lamination</b> std.B.:0.246, p=0.009	<b>cover tension</b> std.B.:0.700, p=0.000 <b>foam hardness</b> std.B.:0.363, p=0.000 <b>seat suspension</b> std.B.:0.305, p=0.000 <b>lamination</b> std.B.:0.200, p=0.002	<b>cover tension</b> std.B.:0.639, p=0.000 <b>foam hardness</b> std.B.:0.247, p=0.000	<b>cover tension</b> std.B.:0.653, p=0.002

Table 6.14 illustrates the Multiple Regression Analysis results of the leather data set. For the first factor the  $R^2$  is for all four groups  $> 0.5$  and the results of the ANOVA are in all groups significant,  $p < 0.01$ . All four cluster groups have for factor one (F1) a significant relationship to the foam hardness and to the foam height. Additionally, cluster one, two and three are significantly connected to the seat suspension. Cluster one and two also has a relationship to the lamination and cluster five a relationship to the cover tension.

For factor two (F2) the  $R^2$  for cluster one and four is  $< 0.45$  and the results of the ANOVA are four both cluster significant,  $p < 0.01$ . Cluster two and three have a  $R^2 > 0.54$

and the ANOVA results of both clusters are also significant,  $p < 0.01$ . For cluster one, factor two has a significant relationship to the foam hardness and the cover tension. For cluster two factor two is connected to the foam hardness and the seat suspension. Factor two in cluster three has a relationship to all seat components except to the foam height. Factor two of cluster four has a relationship to the foam hardness, to the seat suspension and to the cover tension.

Table 6.14: Overview of the significant seat components which have the highest impact on the factors (F1, F2) or rather the seat-human interaction parameters in specific frameworks of leather seat layouts (cluster).

	Cluster 1	Cluster 2	Cluster 3	Cluster 4
	<b>R Square: 0.707</b>	<b>R Square: 0.790</b>	<b>R Square: 0.685</b>	<b>R Square: 0.500</b>
	ANOVA F(5,35)=20.3, p=0.000	ANOVA F(5,38)=33.4, p=0.000	ANOVA F(5,90)=42.3, p=0.000	ANOVA F(5,117)=25.4, p=0.000
F1	<b>foam hardness</b> std.B.: -0.699, p=0.000 <b>foam height</b> std.B.: 0.245, p=0.015 <b>seat</b> <b>suspension</b> std.B.: 0.230, p=0.019 <b>lamination</b> std.B.: -0.183, p=0.044	<b>foam hardness</b> std.B.: -0.858, p=0.000 <b>seat</b> <b>suspension</b> std.B.: 0.346, p=0.001 <b>foam height</b> std.B.: 0.304, p=0.000 <b>lamination</b> std.B.: -0.226, p=0.050	<b>foam hardness</b> std.B.: -0.778, p=0.000 <b>seat</b> <b>suspension</b> std.B.: 0.324, p=0.000 <b>foam height</b> std.B.: 0.172, p=0.000	<b>foam hardness</b> std.B.: -0.677, p=0.000 <b>cover tension</b> std.B.: -0.279, p=0.000 <b>foam height</b> std.B.: 0.186, p=0.004
	<b>R Square: 0.340</b>	<b>R Square: 0.714</b>	<b>R Square: 0.543</b>	<b>R Square: 0.444</b>
	ANOVA F(5,35)=5.1, p=0.000	ANOVA F(5,38)=22.4, p=0.000	ANOVA F(5,90)=23.6, p=0.000	ANOVA F(5,117)=25.4, p=0.000
F2	<b>cover tension</b> std.B.: 0.639, p=0.000 <b>foam hardness</b> std.B.: -0.582, p=0.000	<b>foam hardness</b> std.B.: -0.342, p=0.000 <b>seat</b> <b>suspension</b> std.B.: 0.305, p=0.000	<b>foam hardness</b> std.B.: -0.363, p=0.000 <b>seat</b> <b>suspension</b> std.B.: 0.305, p=0.000 <b>cover tension</b> std.B.: 0.700, p=0.000 <b>lamination</b> std.B.: -0.200, p=0.002	<b>foam hardness</b> std.B.: -0.612, p=0.000 <b>cover tension</b> std.B.: 0.192, p=0.006 <b>seat</b> <b>suspension</b> std.B.: 0.163, p=0.020

In sum the results for the leather seat layout illustrate that factor one can be affected by many seat components. Factor two can be only influenced by two seat components for the first two clusters but for cluster three and four the amount of the seat components influence factor two is manifold. It is evident that lamination and the cover tension

has nearly no significant influence on factors one and factor two, which might be due to the specific laminations characteristics: *no lamination*, *foam lamination* or *kufner lamination* in each cluster, yield in the cluster analysis.

All in all this overview presents the seat component with the highest impacts on the determined factors (seat-human interaction parameter) in predetermined clusters with a specific framework of seat layout. It strongly dependent on the combination of the seat components how changes of the seat components characteristics influence the factors or rather the seat-human interaction. In sum the results for the fabric and the leather seats have shown that changes of the foam hardness characteristics influence in most cluster the seat-human interaction parameters. But also changes of characteristics of the seat suspension, the cover tension, lamination and the foam height affect in some clusters the seat-human interaction.

## 6.4. DISCUSSION

The first section discusses the effects of the different characteristics of leather and fabric seat layouts regarding the seat-human interaction parameters: pressure, elongation and shear. The second section discusses the method predicting the seat components with the strongest effect on the seat-human interaction parameters.

### 6.4.1. LEATHER SEAT VERSUS FABRIC SEATS

This study has shown that the characteristic of the leather covered seat layouts and the characteristics of the fabric covered seat layouts have different performances while loading. This fact together with the various friction coefficients of diverse cover surfaces also affect the behavior of the seat-human interaction parameters: pressure, elongation and shear. The descriptive cluster analysis of the data set have shown for the fabric cover as well as for the leather cover seat layouts that the pressure parameters (1.) *first touch pressure*, 2.) *maximum pressure*, 3.) *linear pressure* and 4.) *pressure distribution*) of a seat while loading do not correlate necessarily with the elongation parameters (5.) *elongation while loading*, 6.) *elongation while moving on the seat*) or rather the shear force for each seat layout in the same manner. The statistic analysis have shown that cluster one and two of the fabric seat layouts for example have nearly the same 2.) *maximum pressure* and 4.) *pressure distribution* but differ for 5.) *elongation while loading* and 6.) *elongation while moving on the seat*. For this reason the ratio of the pressure, elongation and shear force depends on the seat layout. This should be taken into account while conducting comfort and discomfort studies, especially for future car seats with various positions and loadings. These findings are also approved with the findings of the study of Chow and Odell (1978) who showed with different cushion properties and a finite element model the interrelationship of the internal stresses of soft tissues as well as the study of Bennet and Worthen (1980) who investigated in the palm of the hand that in the presence of high shear forces just half of the initial pressure is necessary to stop the blood.

The results of the statistical descriptive cluster analysis have also shown, that the stiffer the seat layout (hard and thin foams without a seat suspension and high tension and stiff cover) the higher the parameter 6.) *elongation while moving on the seat*. Less stiff seat layouts absorb external dynamic forces better than stiffer seat layouts and have

floating characteristics, therefore the values of parameter 6.) are lower. This might be in line with the results of Goossens (2001) study. In the study, Goossens (2001) compared the shear stress of three different cushion materials. In Conclusion the LiquiCell cushion produces significant lower shear stress than a gel cushion or a foam cushion material.

The higher the friction coefficient the higher the shear forces in the seat-human interaction zone. Therefore, on one hand it is essential to be aware of the friction coefficient silicon-leather and silicon-fabric and on the other hand it is necessary to know the friction coefficients including the clothes of sitters for example jeans-leather or jeans-fabric to forecast the interaction behavior of the sitter. The 6.) *elongation while moving on the seat* is for leather seats higher than for fabric seat due to the higher friction coefficient. Also for the parameter 5.) *elongation while loading* the values for the leather seat layouts are generally higher than for fabric seat layouts also due to the higher friction coefficient of the leather. The statistical results illustrate that fabric cluster one has the same 5.) *elongation while loading* value like the leather cluster two. Comparing both clusters further parameters are very similar, like the 1.) *first touch pressure*, 2.) *maximum pressure* and 3.) *linear pressure* other parameters are different like the 4.) *pressure distribution* and the 6.) *elongation while moving on the seat*. This fact illustrates that it is conceptually hard to achieve the same seat-human interaction with two different cover materials which is in line with the results of Wegner (2019), who have illustrated that same seat models with a fabric cover and a leather cover are rated totally different.

6

The comparison of the statistical significance of the seat components and the seat-human interaction parameters in each determined cluster has shown that especially for the fabric seat layout the characteristics of the foam hardness, the seat suspension and the cover tension are pronounced in each cluster. For the leather seat layout the pronounced seat components are the lamination and the cover tension. The cover tension has an important impact on the seat-human interaction, therefore it is crucial to adjust the cover properties to the foam properties and vice versa. Cluster three of the fabric seat layout illustrates the importance of matching the foam properties to the seat cover properties (Table 6.4). The cluster has soft foams and a very high cover tension. For higher loadings the dominance of the seat cover rises and acquires for the maximum load nearly as high pressure values as in cluster five (Table 6.6) with very hard foams. The reason might be that the soft foam cannot create a counter-pressure which results in a point load due to the high cover tension. Especially, for the development of autonomous driving cars (Fraunhofer IAO and Horváth & Partners, 2016) and the high variation of seat positions it is essential to know how the seat components interact with each other and how the seat components results in the interaction parameter. Also the various sensitivity areas of the persons should be taken in to account (Vink and Lips, 2015).

Furthermore the factor analysis present that the factors of leather and fabric do not have the same set regarding interaction parameters. In particular the parameter 6.) *elongation while moving on the seat* belongs for the fabric seat layouts to the first factor, which combines more the pressure related parameters and for the leather seat layout the parameter 6.) is included to the second factor which combines more parameter related to the resulting shear force. This result illustrates that the interaction parameter change the focus with the cover material. In general it can be concluded that the results of the measurements illustrate that the ratio of pressure and elongation is for fabric seats and

for leather seats different.

#### 6.4.2. INFLUENCE OF THE SEAT COMPONENTS ON THE INTERACTION PARAMETER

The interrelationship between the seat components and human being interacting with the seat (parameter 1.) – 6)) is very complex. To find out, how various seat layout with different seat component affect the seat-human interaction 648 seat layout were recorded and statistically analyzed. A first conducted cluster analysis of fabric and leather data sets have shown that each cover material (fabric/leather) have various groups (cluster) with a specific set of seat-human interactions parameters (parameter 1.) – 6)), illustrated in Tables 6.2 – 6.10. Furthermore a descriptive analysis of the seat layouts of each cluster have shown that nearly every cluster has dominant seat component. In the second step a factor analysis was conducted to reduce the complexity of the interrelationship of the seat-human interaction parameters. Two factors were determined, the first factor (F1) describes parameters for more related to pressure and the second (F2) contains parameter mostly related to the shear force effects. In the third step, using a Multiple Regression Analysis it is possible to create a simple relationship between the interaction parameters (factor analysis) and the seat components for a specific combination of seat components (cluster analysis).

The Multiple Regression Analysis has shown that the factors in each cluster are affected by various combinations of seat components. But not every component affects the factor one and two for each cluster in the same way. In general the results of the Multiple Regression Analysis show that the foam hardness affect the factors of the seat-human interaction for both covers very much. This finding is in line with the fact that many studies in the literature focus on the foam, like the study of Zenk et al. (2006) which investigates the influence of foam hardness in various seat areas. However, this also implies that change of the foam hardness not only affect pressure attributes but also elongation and shear-force. But this study also shows that depending on the cover material and the clusters other seat components influence the factors of the seat-human interaction as well.

On one hand the cluster analysis have shown that the seat cover might be a highly relevant seat component for the comfort/discomfort of a seat, on the other hand the results of the Multiple Regression Analysis illustrate that the seat suspension affects the seat-human interaction in nearly every cluster. Thus, not only the seat cover should be taken into account but also the effects of seat suspension while interacting with the other seat components. As previously mentioned seat-human interaction parameters of factor one (F1) are more related to lower loading (pressure relevant) and for factor two (F2) to higher loading (shear force relevant) which also could be related to heavier and lighter persons sitting in the seat. Which means that heavier persons might differently interact with the seat and differently stress the seat components than lighter persons. This is also in line with the results of Wang et. al (2019) who confirmed that various percentiles with different BMIs evoke different seated contours. Based on all the results (cluster analysis, factor analysis and Multiple Regression Analysis) it can be concluded that the influence of seat components differs and should be adjusted to the seat-human parameters for lighter and for heavier persons. The algebraic signs in the factor analysis and in the

Multiple Regression Analysis are partly contrary which means that some seat component characteristics might affect the seat-human interaction for lighter persons more than for heavier person and vice versa. Therefore, it might be that a low cover tension with soft foams and an additional seat suspension does not affect the light weighting person but has a strong impacts on the pressure behavior of heavier persons. The algebraic sing of the factor analysis and the Multiple Regression Analysis enable to change the right component in the right direction to affect the interaction parameters. Altogether the described method enables to record the seat layout characteristics with a stamp, analyses this characteristics with the above described method consisting to identify the seat component with the highest impact on the seat-interaction parameters. In this manner it is possible to correlate the components to the seat interaction parameter and therefore focus on the right components affecting the comfort relevant parameters.

### 6.4.3. LIMITATIONS

The limitation of the study is that the stamp simulates the skin surface and it is unknown to what extend the results can be translated to the real situation including clothing, various skins, bones and tissues. Usually persons sitting in a seat have a maximum pressure in a range of  $1.2N/cm^2$  to  $2.0N/cm^2$ , Zenk et al. (2006) mentioned that participants rating discomfort do not tolerated a maximum pressures over  $1.73N/cm^2$ . Thus, the maximum force of the test procedure is only 100 N it evokes maximum pressure in a range  $4.78N/cm^2$  to  $15.93N/cm^2$ . In conclusion the study stresses the seat layout in maximum more than a person in reality, engendered by the shape of the stamp to highlight the material properties of the seat layouts. However, the method determines objectively effects of differences between various seat elements.

### 6.5. CONCLUSION

The study has shown that leather seats interact with humans differently as compared to fabric seats. The reason is not only due to the different surfaces but also to a different interaction between the seat components. Thus the leather seat has miscellaneous dominant components affecting seat-human interaction parameters than the fabric seat. This should be taken into account for future studies. Studies relating the comfort/discomfort as well as the seat-human interaction parameters to the foam properties are only in certain seat layout cases feasible. In all other cases the presented measurement and analytical method should be conducted to be aware of the seat layout characteristics and components influencing the seat-human interaction. The seat layout has a high impact on the ration of the pressure, elongation and shear-force parameters. Further studies should be conducted to include more seat components. Moreover the data base of friction coefficients should be extended to include contact between clothes and seat surfaces.

### 6.6. ACKNOWLEDGEMENT

This research was supported by the Fraunhofer Institut ISC measuring the frictions coefficients of the material pairing. We also would like to thank proseat GmbH+Co.KG. providing all the foams in specification. We are thankful to our colleagues Sven Ritter,



Wolfgang Grüner, Mario Buljan and Rudolf Rackl who provided expertise that greatly assisted the research.

## REFERENCES

- Almeida Jr., G. Alvares Dias, R. and, Camara J., 2014. *Material and Ergonomics in Chairs: Study Focusing on Identity of the Materials and Perception of Textures. Proceedings of the 5th International Conference on Applied Human Factors and Ergonomics AHFE 2014*, 229-240
- Bennet, T. and, E. F. Worthen. 1980. "Shear vs. pressure as causative factors in skin blood flow occlusion." *Plastic and Reconstructive Surgery* 66, 1, 180.
- Chow W. W. and, Odell, E. I., 1978, *Deformations and Stresses in Soft Body Tissues of a Sitting Person*, 1978.
- De Looze, M. P. de, Kuijt-Evers, L. F. M., and, van Dieen, J., 2003. *Sitting comfort and discomfort and the relationships with objective measures. Ergonomics* 46, 10, 985-997.
- Field, A. P., 2009. *Discovering statistics using SPSS (and sex and drugs and rock' n' roll) (3rd ed.)*. London: Sage. Field, A. P., & Davey.
- Fitzen, F., Amereller, M., and, Paetzold K., 2018 *Approximation of the user behaviour in a fully automated vehicle referring to a stationary prototype-based research study, Proceedings International Design Conference-Design 2018*, 2187 - 2196.
- Fraunhofer IAO and, Horváth & Partners (2016), *The Value of Time: Nutzerbezogene Service-Potenziale durch autonomes Fahren, Fraunhofer IAO and Horváth & Partners, Stuttgart, Germany*.
- Goossens, R. H. M., 2001, *Shear stress measured on three different cushioning materials, Delft University of Technology*.
- Johnson Controls, 2013, June 27, *Results of seat supplier's research guide automotive interior development*, Retrieved from <https://www.adiant.com/media/press-releases/2013/06/27-johnson-controls-automotive-seating-study-finds-comfort-and-number-of-seats-most-important-to-driver>
- Kamp, I., Kilincsoy, Ü. and, Vink P., 2011. *Chosen postures during specific sitting activities. Ergonomics* 54,11, 1029-1042
- Kolich, M. 2003. *Automobile seat comfort. Occupant preferences vs. anthropometric accommodation. Applied Ergonomics* 34, 2, 177-184.
- Kyung, G. and, Nussbaum, M. A., 2007. "Driver sitting comfort and discomfort (part II): Relationships with and prediction from interface pressure." *International Journal of Industrial Ergonomics* 38, 5-6, 526-538.
- Mansfield N., Sammonds G. and, Nguyen L., 2015. "Driver discomfort in vehicle seats-Effect of changing road conditions and seat foam compositions." *Applied Ergonomics* 50, 153-159.
- Mergl, C., 2006. *Entwicklung eines Verfahrens zur Optimierung des Sitzkomforts auf Automobilsitzen. Dissertation, Technischen Universität München*.
- Molenbroek, J.F.M., Albin, T. J. and, Vink, P., 2017. *Thirty years of anthropometric changes relevant to the width and depth of transportation seating spaces, present and future. Applied Ergonomics* 65: 130-138. <https://doi.org/10.1016/j.apergo.2017.06.003>.

Parliament of Victoria (2006), *Report of the Parliament of Victoria Road Safety Committee on the Inquiry into Driver Distraction*, Parliament of Victoria, Melbourne, Australia.

Paul G., Daniell, N. and, Fraysse F. 2012. Patterns of correlation between vehicle occupant seat pressure and anthropometry. *Work* 41, 2226 - 2231

Schmidt, R. E und Thews, G., 1980. *Physiologie des Menschen*. Springer Verlag; Springer, Berlin u.a..

Tomforde, J. (2007), "Entwicklung und Design von Freizeitmobilien", In: Braess, H.-H. and Seiffert, U. (Eds.), *Automobildesign und Technik: Formgebung, Funktionalität, Technik*, Friedr. Vieweg & Sohn Verlag, GWV Fachverlage GmbH Wiesbaden, Wiesbaden, Germany, pp. 202–216. <https://doi.org/10.1007/978-3-8348-9411-3-13>

Vink, P. and, Lips, D., 2017. Sensitivity of the human back and buttocks: The missing link in comfort seat design. *Applied Ergonomics* 58, 287–292.

Wang, X., Cardoso, M. and, Beurier, G. 2018. Effects of seat parameters and sitters' anthropometric dimensions on seat profile and optimal compressed seat pan surface *Applied Ergonomics* 73, 13-21.

Wegner M., Martic M., Franz M. and, Vink P., 2017. A new approach for measuring the sea comfort, 1th International Comfort Congress, Salerno.

Wegner M., Anjani S., Li W. and, Vink P. 2019. How Does the Seat Cover Influence the Seat Comfort Evaluation?. In: Bagnara S., Tartaglia R., Albolino S., Alexander T., Fujita Y. (eds) *Proceedings of the 20th Congress of the International Ergonomics Association (IEA 2018)*. IEA 2018. *Advances in Intelligent Systems and Computing*, vol 824. Springer.

Zenk, R., Mergl, C., Hartung, J., Sabbah, O. and, Bubb H., 2006. *Objectifying the Comfort of Car Seats*, SAE International.

Zemp, R., Taylor, W.R. and, Lorenzetti, S., 2015. Are pressure measurements effective in the assessment of office chair comfort/discomfort? A review. *Applied Ergonomics* 2015, 48, 273–282.

Zhang, M. and, Roberts, V. C., 1994. The effect of shear forces externally applied to skin surface on underlying tissues. *Journal of Biomedical Engineering* 15, 6, 451–456.



# 7

## EFFECTS OF SEAT COVER AND SUSPENSION ON THE SEAT-HUMAN INTERACTION AND PERCEPTION BASED ON SUBJECTIVE RATINGS AND OBJECTIVE MEASUREMENTS.

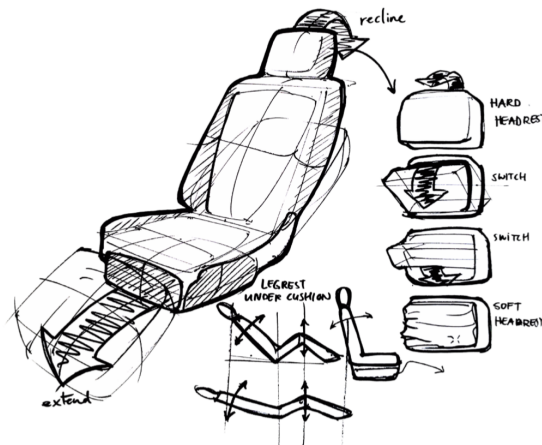

This chapter is submitted in the book "SpringerBriefs in Applied Sciences and Technology" with the title "Future Interior Concepts."

Author: M. Wegner, C. Reuter, F. Fitzen, S. Anjani and P. Vink

### **Abstract**

*This study investigates the tactile perceived seat-human interaction of four BMW 5-series seats with the same foam properties and contours but different seat cover and seat suspension properties; 38 healthy subjects participated in an experiment rating and ranking the tactile perceived properties of the seats while blindfolded. A discomfort test, a seat characterizing rating on a scale of word pairs, and the overall experience of the seats were examined in four different sitting positions. The results of the experiment were related with the outcome of an objective measurement method: a pressure measurement mat and the measurement tool of Wegner et al. (2017). The study showed that the perception of the surface while interacting with the seat is independent from the sitting position. In contrast, the perception of the hardness and the elasticity of the seat is position-dependent. The results of the seat characterization are in line with the results of the measurement tool of Wegner et al. (2017). Further research is needed to investigate the mutual interdependence of the various measurement points of the measurement tool and to improve the prediction accuracy of the seat characteristics.*

**Keywords:** pressure measurements, shear force, discomfort, seat perception

## **7.1. INTRODUCTION**

Most individuals, and particularly those with sedentary jobs, sit for nearly ten hours each work day and eight hours during their own, independent leisure time (McCrary and Levine, 2009). Typically, as long as the individual feels comfortable and supported, the seat on which an individual is seated is of little importance. Regardless of what seat and what position a person takes, the seat or chair should allow to vary and shift the posture easily. In this context Sammonds et al. (2017) showed that movements and seat fidgets correlate with the discomfort rating of a seat. The micro and macro movements rise over the duration of time as well as the poor subjective discomfort ratings.

The development of seats for automobiles that allow passengers to move and switch to various positions from sitting through to lying is crucial to the automotive industry. This could become even more important in autonomous driving cars as more seat positions will be possible when there is no driving task. For an individual to be comfortable in the car, a car seat must support the passenger in a dynamic driving situation but moreover provide enough space for postural changes in various loading situations. Hence, it should be considered to change loading of the area of the seat being in contact with the passenger as well as the interaction area including various sensitivity areas. A study by Vink and Lips (2017) proved that the pressure sensitivity of the area touching the shoulder and the area touching the front of the cushion close to the knees is significantly higher than all other body areas in contact with the seat. Furthermore, some parts of the body need more support than others. Biedermann (1984) claimed, inter alia, that the natural physiological curve of the spine should be supported in the lumbar area. There are more influencing factors (Wegner et al., 2019) making the discomfort and comfort perception of an automotive seat a multi-factorial problem with contributions occurring from effects of the seat layout including the foam properties, the contour, the cover properties, and the dynamic environment as well as effects on the human senses including the sitting, position, the sitting duration, pressure, shear force, and blood flow.

Most studies focus on the driver position and on the discomfort ratings of seat contours and seat foams relating the findings to pressure parameters (e.g. Hartung, 2006, Zenk, 2006 and Kilinscoy, 2019). However, the multi-factorial problem is often reduced to a mono-problem, not taking the seat cover and other seat components into account. Most studies neglect to address other interactions parameters of the human senses than pressure. Mansfield (2015) investigated the extent of which foam properties affect the discomfort rating. For his study he removed the seat cover in order to enable the foam being in direct contact with the subject's clothing. Also, Hiemstra-van Mastrigt (2015) compare the foam hardness of two train seats and checked the effect on comfort experience. Zenk et al. (2006) used various foams to evoke different pressure distributions and thus different discomfort ratings. In reference to this approach an ideal pressure distribution was developed and after validated in a long-term rating. The results represent that there is a link between the cushion, the discomfort rating, and the pressure distribution of the cushion. Notably, the correlation between the backrest was not significant. Both, Mansfield (2015) and Zenk et al. (2006) excluded the surface, cover properties of the seat, and the interaction of the seat components.

In contrast, Zuo et al. (2004) revealed that the tactile sensory properties of materials are relevant for the interaction between users and should be considered in the course of the material selection process. Regarding the gathered information he developed a method for an intelligent choice of materials based on holistic perceptual information of different materials. Likewise, Wegner et al. (2019) showed that the seat cover material has fundamental influence on the perception and the characterization of a seat. The study compares two seats with the same contour and the same foam properties but with different cover materials.

With reference to the human mechanoreceptors explained by Schmidt and Thews (1980), not only the pressure is an important tactile sensor but also the shear and the elongation have to be taken into account. Chow and Odell (1978) linked the pressure to shear stress stating that interface shear force significantly affects the pressure distribution. Based on simulative results Grujicic et al. (2009) correlated a higher cover friction to higher shear forces. Also, Goossens and Snijders (1995) showed that the shear force could be reduced by changing the seat position and seat angles on the one hand. On the other hand, Goossens (2001) presented that the shear force can be reduced by using the right cushion material, a LiquiCell cushion. Thus, not only the ideal seat angle (Harrison, 2000), seat pan angle of 10° and backrest angle of 120° is important but additionally the angle position in combination with the applied seat components.

In this study the seat perception is considered as a multi-factorial problem including various seat components as well as the seat-human interaction parameters: pressure, elongation and shear force (Schmidt and Thews, 1980). The aim for this study is to investigate how occupants rate and perceive seat characteristics and discomfort of car seats with equal foam properties and contours but different cover properties and seat suspensions in various loading states. Next, the study investigates whether the objective measurement methods with the pressure measurement mat and the measurement tool of Wegner et al. (2017) sufficiently explain the seat ratings. .

## 7.2. METHODS

In this section the study approach: the scope of participants, the seats used for the study, the procedure of the study, and the statistical analysis are presented. The description of the procedure also includes the presentation of two objective seat measurement methods: first, the pressure measurement mat and second the seat measurement with the measurement tool of Wegner et al. (2017).

### 7.2.1. PARTICIPANTS

38 subjects, 17 males and 21 females, participated in the experiment. The mean body height of the participants was 1.69 m (1.53 m - 1.86 m) with a mean body weight of 66.2 kg (48 kg - 98 kg). On the torso, the participants either wore t-shirts (60 %), pullovers (16 %), long sleeve t-shirts (11 %), polo shirts (8 %), or dresses (5 %); on the bottom either jeans (55 %), cloth pants (40 %), or leggings (5 %).

### 7.2.2. SEAT

Four BMW 5-series seats are used in this study. The standard contour of the seats was used, which is not distinctive. The seat layout was kept simple, consisting of a seat frame, foam, heating mat, and cover. All seats are produced and assembled in the same factory on the same day, and during a similar period fulfilling all specified requirements of the manufacturer, especially the foam hardness which is measured in kPa. One seat, defined as the reference seat, is without any modification (seat 1). Seat 1 is a leather seat with a specified foam hardness of 6 kPa in the main surface of the cushion and 10 kPa in the bolsters. The backrest has a foam hardness specification of 5 kPa in the main surface and 8 kPa in the bolsters. Compared to the reference seat, each seat differs in one parameter: One seat has an Alcantara cover instead of leather (seat 2), another seat (seat 3) has a looser cover tension, and the last seat has a metal plate installed instead of the original seat suspension (seat 4).

### 7.2.3. SETUP

The four seats are mounted next to each other on a base plate (Figure 7.1). The plate has a footrest following the geometric specifications of the BMW 5-series. All seats have an electrical seat adjustment which allows to adjust all seats equally to four different positions (Table 7.1). Position 1 is the driving position, containing the required seat angles for development of the seat and safety requirements. Position 2 and 3 have a flat cushion angle with the difference that the backrest angle in Position 3 is more horizontal than in Position 2. Position 3 and 4 have the same  $\gamma$ -angle but Position 4 has a higher cushion ( $\alpha$ ) and backrest ( $\beta$ ) angle. The reason for these position changes was to create changes in comfort perception and pressure distribution as by the variation of the angles the weight of the body loads the cushion and backrest differently.

### 7.2.4. PROCEDURE

#### SEAT EVALUATION

For gathering anthropometrics data, an anthropometric chair was used. Data regarding sitting height, hip width, buttock-popliteal length etc. were recorded using the procedure





Figure 7.1: The figure illustrates the setup of the study with all four seats in a row from left to right: reference seat (seat 1); Alcantara seat (seat 2); loose cover tension (seat 3), and the seat with the metal plate instead of the seat suspension (seat 4).

Table 7.1: Illustration of the four adjusted seat angles for the cushion and the backrest.

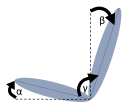
	$\alpha$	$\beta$	$\gamma$	
	Position 1	14°	20°	96°
	Position 2	3°	40°	127°
	Position 3	3°	55°	142°
	Position 4	4°	70°	142°

described by Molenbroek, Albin and Vink (2017). During the recording, which took several minutes, each participant was informed about the procedure and the questionnaire (Appendix A.2.3) but did not get any information regarding the setup and the differences of the seats. The participants were blind-folded wearing an eye mask during the entire experiment in order to exclude visual impressions. Only one participant at a time was going through the procedure. Once all tests were completed the next participant started. This way the participants could not exchange any information prior to the test. The study began with the participants discomfort rating of all four seats in Position 1. The order in which the participants rated the seats was changed for all tests systematically. The participants were not allowed to touch the seat surface. After sitting three minutes in each seat, the participants rated the discomfort of the seats through a Local Postural Discomfort (LPD) body map and a discomfort score from zero (no discomfort) to six (very heavy discomfort). Afterwards, for each seat and each participant a pressure measurement was conducted in Position 1. Regarding the pressure analysis the cushion is divided in three groups shown in Figure 7.2: *buttock Group*, *front Group* and *side Group*. The backrest is cumulated into another group, called *back Group*. For every participant the recorded

frames per each group were merged and the *average pressure*, *peak pressure*, and *contact area* calculated. The mean value and the standard deviation for the *average pressure*, *peak pressure*, and *contact area* over all 38 participants and for each seat were determined. Next,

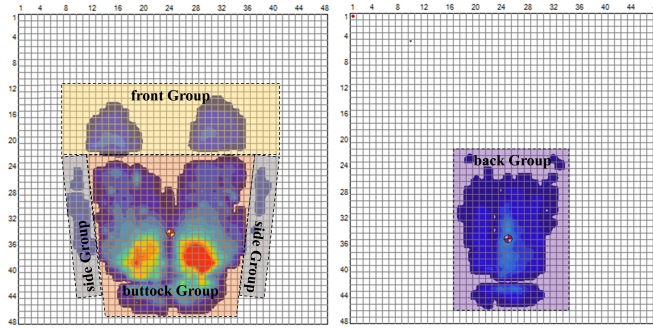

Figure 7.2: Considered areas of pressure defined in three groups for the cushion and one group for the backrest.

the participants had to rate with words each seat in all of the four positions (Table 7.1). Three pairs of words given for them to describe the cushion and the backrest: *soft-hard*, *elastic-stiff*, and *slippery-abrasive*. The word pairs are shown on a Likert scale (1 - 7). Ratings of 1, 2, or 3 represent a tendency to a soft, elastic, and slippery characterization whereas ratings of 5, 6, or 7 have a tendency to a hard, stiff, or abrasive characterization. A rating of 4 demonstrates a neutral rating without any tendency to one of the extremes. After rating all four seats the participants were asked to rank the seats from their favorite to their least favorite seat.

#### MEASURING THE SEATS WITH A MEASUREMENT TOOL

After the test was conducted the seats were analyzed with the measurement tool of Wegner et al. (2017). The measurement points (Figure 7.3) for the backrest are the shoulder (1), the lumbar area (2), and the bolster of the backrest (3). The measurement points for the cushion are at the area of the ischial tuberosity (4), the front of the cushion (5), and the bolster of the cushion (6).

The measurement procedure for each measurement point includes four cycles, three pre-cycles, and one measurement cycle (following the guidelines in DIN 53579, 2005 and DIN EN ISO 3386-1, 2009). The measurement cycle has four phases (see Figure 7.5). During the first phase (①) the stamp loads the seat with a velocity of 100 mm/min until 100 N is reached. During the second phase (②) the stamp remains in the position for 30 seconds. Hereafter, the machine adjusts during the third phase (③) the force again up to 100 N and moves the Seat 5 mm<sup>1</sup> in lateral direction relative to the stamp and remains 15 seconds in this position. The fourth phase (④) is the relief phase (300 mm/min).



Figure 7.3: Illustration of the measurement points.

<sup>1</sup>In order to exclude the destruction of the stamp sensors and to ensure a long-term durability, especially of the pressure sensors, the lateral movement of the stamp was limited to 5 mm.

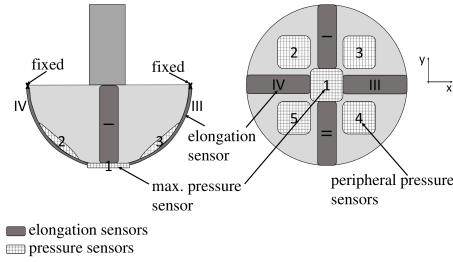

Figure 7.4: Detailed illustration of the stamp. Pressure sensor are named from 1-5 and elongations sensors from I-IV.

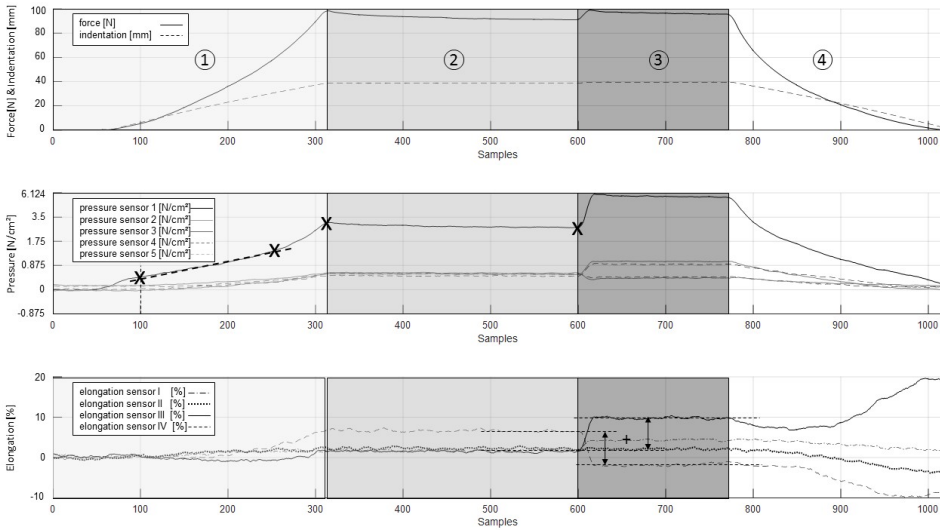

Figure 7.5: The top diagram illustrates the force and indentation, the middle diagram presents the sensor data of the five pressure sensors, and diagram at the bottom presents the four elongations sensor data.

During this measurement procedure the sensors of the stamp (five pressure sensors and fore elongations sensors, Figure 7.4 and Appendix A.1) record constantly the properties of the seats in each measurement point. The stamp has a silicon surface simulating the human skin. Figure 7.5 shows an example of the recorded data for a seat in one of the six measurement points. The first plot shows the recordings of the force and indentation. This plot includes the division into the four measurement phases (① – ④). The second plot shows the recordings of the five pressure sensors (1 – 5). Last, the third plot exposes the recording of the elongation sensors (I – IV). Based on these plots the following parameters for pressure and elongation are calculated.

**Pressure:** The 1.) *first touch pressure* is defined as the pressure information of pressure sensor 1 after 5 mm indentation (empirical defined value of BMW internal Comfort Experts). The 2.) *maximum pressure* has been defined as the value of pressure sensor 1

when a force of 100 N is reached. The 3.) *linear pressure* identifies the shift from a linear rise of the pressure to an exponential rise of pressure based on the values of sensor 1 (first phase (1)). The 4.) *pressure distribution* is defined as the average pressure of the peripheral pressure sensors (sensor 2-4, Figure 7.4) in phase two ((2)). The *maximum pressure* and the *linear pressure* are linked to the indentation information (7.) *linear indentation*, 8.) *maximum indentation*).

**Elongation:** While loading (first phase (1)), the elongation of each of the four sensors is recorded. The information of sensor I, II, III, and IV is summed to an overall elongation 5.) *elongation while loading the seat*. The information of the elongation sensor III and IV in phase three ((3)) enables to calculate the change of the elongation while applying a shear stress (moving the seat relative to the stamp in the direction of sensor III and IV). The change of elongation sensor III and IV is identified by calculating the difference between phase two ((2)) and phase three ((3)) of each sensor. Both values of sensor III and IV are summed up to an overall 6.) *elongation due to the lateral movement*.

For a better comparability of the seats the 2.) *maximum pressure* is normalized with the 8.) *maximum indentation* and the 3.) *linear pressure* is normalized with the 7.) *linear indentation*. The 5.) *elongation while loading the seat* and the 6.) *elongation due to the lateral movement* are both normalized with a factor consisting the multiplication of the 2.) *maximum pressure* and the *friction coefficient*. The 1.) *first touch pressure* and the 4.) *pressure distribution* are not normalized.

#### DETERMINATION OF THE FRICTION COEFFICIENTS

For an adequate comparison of both seat cover materials (leather and Alcantara) static and dynamic friction coefficient tests are conducted. The following material pairs are tested: *leather - silicon*, *Alcantara - silicon*, *leather - jeans*, *Alcantara - jeans*. By testing the friction coefficients of leather and Alcantara in combination with silicon and jeans a conclusion on the differences between silicon and jeans material could be made.

#### 7.2.5. STATISTICAL ANALYSIS

The data of the word pair ratings were analysed using a statistical analysis software program (IBM SPSS Statistics 25). The Friedman's Test was used to determine whether the participants detect differences in the perception of the four seats. The analysis was separately done for the cushions and the backrests ( $\alpha < 0.05$ ) regarding their sitting position. If the results of the Friedman's Test are significant a post-hoc analysis with a Wilcoxon signed-rank test is conducted for all six seat combinations (e.g., *seat1 - seat 2* or *seat 2 - seat 4*). The six seat combinations are treated as six separate and unrelated observations, therefore, the Bonferroni correction is not applied, and the statistical significance is set to  $\alpha < 0.05$ .

### 7.3. RESULTS

In the following section the results of the discomfort ratings are presented first. After this the descriptive results of the word pair ratings in each of the four positions is presented. Furthermore, the results of the Friedman's Test and the Wilcoxon signed-rank test are presented. Eventually, the last part illustrates the results of the pressure measurements

and the analysis of the four seats with the measurement tool of Wegner et al. (2019) as well as the results of the friction coefficient measurements.

### 7.3.1. SUBJECTIVE PERCEPTION OF THE SEATS

#### DISCOMFORT RATING

Table 7.2 shows the results of the discomfort rating of the four seats. Ratings higher than 0 indicate discomfort. Regions with more than two complaints ( $N > 2$ ) are bold. Regarding the cushion most participants have discomfort complaints in the second seat, the Alcantara seat. Discomfort appears to be large for the rear bolster region (H1 and H2) and in the front of the main surface (G1 and G2).

Table 7.2: Results of the discomfort rating with a Local Postural Discomfort (LPD) body map for all four seats in Position 1.  $N$  describes the number of participants with complaints and the  $\emptyset$ -Rating is the mean value of the  $N$  participants with complains.

		Seat 1 Ref.(leather)		Seat 2 Alcantara		Seat 3 loose cover (leather)		Seat 4 plate (leather)	
		N	$\emptyset$ -Rating	N	$\emptyset$ -Rating	N	$\emptyset$ -Rating	N	$\emptyset$ -Rating
backrest	A	0	0	0	0	2	2	2	1.5
	B1	<b>4</b>	<b>2.5</b>	1	1	2	1.5	2	3
	B2	2	2	1	1	<b>3</b>	<b>3</b>	<b>4</b>	<b>2.25</b>
	C	0	0	0	0	0	0	0	0
	D1	2	1	<b>3</b>	<b>1.33</b>	<b>5</b>	<b>2.8</b>	<b>3</b>	<b>1.33</b>
	D2	2	1	<b>3</b>	<b>1.33</b>	<b>5</b>	<b>2.8</b>	<b>3</b>	<b>1.33</b>
	E1	1	4	1	3	<b>3</b>	<b>2.76</b>	1	4
	E2	1	4	1	3	<b>3</b>	<b>2.76</b>	1	4
	F1	2	1	0	0	0	0	1	3
	F2	2	1	0	0	0	0	1	3
cushion	G1	2	1.5	<b>3</b>	<b>1.33</b>	1	2	2	2
	G2	2	1.5	<b>3</b>	<b>1.33</b>	1	2	2	2
	H1	1	1	<b>5</b>	<b>2</b>	1	1	1	1
	H2	1	1	<b>5</b>	<b>2</b>	1	1	1	1
	I1	0	0	0	0	1	1	1	1
	I2	0	0	0	0	1	1	1	1

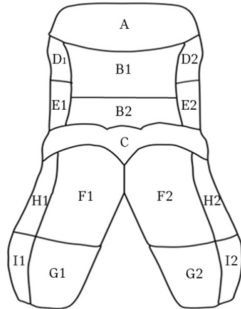

Regarding the backrest the reference seat (*seat 1*) has only one noticeable complaint; four participants mentioned discomfort in the upper back. The modified seats have all discomfort in the outer shoulder area (D1, D2), whereas *seat 3* has the most noticeable discomfort. For the same seat also in the backrest bolsters (E1, E2) noticeable discomfort complaints were issued. *Seat 4* (seat without seat suspension) has also noticeable discomfort complaint in the lumbar area (B2).

Among the Participants who mentioned discomfort, the discomfort was predominantly high, in more than two areas for one seat. Nevertheless, the Alcantara seat (*seat 2*) has most discomfort in the cushion area and the seat with the loose cover tension (*seat 3*) as well as the seat with a plate instead of the seat suspension (*seat 4*) have high discomfort in the backrest areas.

WORD PAIR RATING

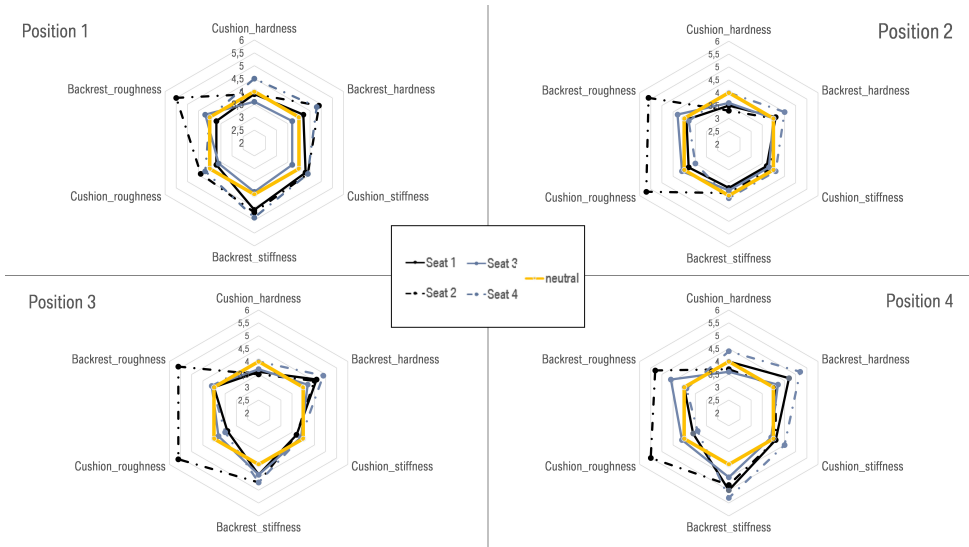

Figure 7.6: Illustration of the rated seat characteristics for the Position 1, Position 2, Position 3, Position 4.

**Descriptive:**

Figure 7.6 gives a descriptive overview of the seat and position characteristics. The orange circle represents the neutral rating (Likert scale rating of 4). Every characteristic which is rated hard, stiff, or abrasive lies outside the circle and the characteristics soft, elastic, and slippery lie inside the circle. Figure 7.6 illustrates that *seat 3* in Position 1, the driving position, is rated as the softest and the most elastic seat. In contrast, all other seats are rated stiffer for the backrest as well as for the cushion. *Seat 2* is rated as the most abrasive seat especially for the backrest. The seat rated the hardest regarding the cushion and the backrest is *seat 4*. As for Position 2 the abrasive surface of *seat 2* appears dominant for the participants. Furthermore, the hardness of the backrest of *seat 4* is dominant. Overall, in Position 2 all other ratings of the characteristics move closer to the neutral rating. In Position 3 the abrasive surface of *seat 2* is still dominant to the participants. Other than that, all seats in Positions 3 are rated harder and stiffer for the backrest than in Position 1 and 2. As opposed to Position 2 and 3, in which most characteristics for the four seats were rated similarly, the ratings and the characterizations in Position 4 are different for all four seat. For Position 4 *seat 1* is rated slippery in the cushion and hard and stiff in the backrest. *Seat 2* is rated abrasive in cushion and backrest and stiff in backrest. *Seat 3* is rated abrasive and stiff in backrest and *seat 4* is rated hard and stiff in the cushion and backrest.

A detailed listing of the means and the standard deviations for each seat in each position is presented in the appendix (A.4). All in all, *seat 1* received a rather neutral rating but has in some positions (Position 1 and Position 3) slippery characteristics. *Seat 2* is according to the ratings in each position the most abrasive seat regarding the cushion and the backrest and is also rated the softest either for the cushion or the backrest in

each position except for Position 1. *Seat 3* is rated as the softest seat in Position 1 for the backrest and cushion and for Position 2, 3, and 4 as the softest either for cushion or the backrest. *Seat 3* is moreover rated the most elastic seat. *Seat 4* is rated the hardest seat regarding cushion and the backrest and also the most stiff and most slippery for the cushion and the backrest.

**Statistical analysis:**

Position1: For the cushion the results of the Friedman’s Test indicated a significance for all three word pairs: *soft - hard* ( $\chi^2(3) = 12.77, p = 0.005$ ), *elastic - stiff* ( $\chi^2(3) = 8.21, p = 0.042$ ) and *slippery - abrasive* ( $\chi^2(3) = 32.55, p = 0.001$ ). Each word pair is used to differentiate between the four seats. Also for the backrest the differentiation of the four seats is for all three word pairs significant: *soft- hard* ( $\chi^2(3) = 20.61, p = 0.001$ ), *elastic - stiff* ( $\chi^2(3) = 19.22, p = 0.001$ ) and *slippery - abrasive* ( $\chi^2(3) = 30.68, p = 0.001$ ). Table 7.3 illustrates the results of the post-hoc analysis using the Wilcoxon signed-rank test ( $\alpha < 0.05$ ). The Wilcoxon test presents for the word pair *soft - hard* significances in the cushion for the following seat pairings: *seat 1 - seat 4*, *seat 2 - seat 4*, *seat 3 - seat 4*. Thus, it is clear that *seat 4* (metal plate instead of a seat suspension) has the highest load on the cushion in Position 1, because *seat 4* is present in each word pair that shows significance. The backrest shows significances for the same set of seat pairings and furthermore for

Table 7.3: Results of the Wilcoxon sign-rank test for Position 1.

Position 1	seat 1 - seat 2	seat 1 - seat 3	seat 1 - seat 4	seat 2 - seat 3	seat 2 - seat 4	seat 3 - seat 4	
soft-hard	<b>cushion</b>						
	z	-0.365	-1.222	-2.129	-0.802	-2.196	-3.412
	p	0.715	0.222	<b>0.033</b>	0.423	<b>0.028</b>	<b>0.001</b>
	<b>backrest</b>						
	z	-1.232	-2.202	-2.623	-1.020	-2.437	-3.868
	p	0.218	<b>0.028</b>	<b>0.008</b>	0.308	<b>0.015</b>	<b>0.000</b>
elastic-stiff	<b>cushion</b>						
	z	-0.440	-2.525	-0.243	-2.224	-0.058	-2.239
	p	0.660	<b>0.012</b>	0.808	<b>0.026</b>	0.954	<b>0.025</b>
	<b>backrest</b>						
	z	-0.208	-2.967	-0.037	-3.713	-4.274	-3.378
	p	0.835	<b>0.003</b>	0.356	<b>0.007</b>	0.266	<b>0.001</b>
slippery-abrasive	<b>cushion</b>						
	z	-4.382	-1.281	-0.037	-3.713	-4.274	-1.251
	p	<b>0.000</b>	0.200	0.970	<b>0.000</b>	<b>0.000</b>	0.211
	<b>backrest</b>						
	z	-4.060	-1.457	-0.726	-3.613	-4.030	-0.822
	p	<b>0.000</b>	0.145	0.468	<b>0.000</b>	<b>0.000</b>	0.411

seat pairing: *seat 1 - seat 3* (reference seat and the seat with a loose cover tension). For the word pair *elastic - stiff* the results of the Wilcoxon signed-rank test present the same significant seat pairings for cushion and backrest: *seat 1 - seat 3*, *seat 2 - seat 3*, and *seat 4 - seat 3*. In this case each seat pairing contains *seat 3* with the loose cover tension. For the

word pair *slippery - abrasive* the significant seat pairings of the Wilcoxon signed-rank test are the same also for the cushion and backrest : *seat 1 - seat 2, seat 2 - seat 3, seat 2 - seat 4*. In this case the seat 2 with the Alcantara cover is in each of the pairings present.

Position 2: For Position 2 the Friedman’s Test indicates significant differences of the seat cushion for the word pairs *soft - hard* ( $\chi^2(3) = 8.80, p = 0.032$ ) and *slippery - abrasive* ( $\chi^2(3) = 36.14, p = 0.001$ ). For the backrest the word pair *slippery - abrasive* ( $\chi^2(3) = 41.34, p = 0.001$ ) indicates significance in differentiation.

Table 7.4 demonstrates the results of the Wilcoxon signed-rank test for the cushion and the backrest in each seat pairing combination. Concerning the word pair *soft - hard* the Wilcoxon signed-rank test points out that there are significant differences for the seat pairings: *seat 1 - seat 4* and *seat 2 - seat 4*. Both seat pairings include *seat 4*. The Wilcoxon signed-rank test results referring to the word pair *slippery - abrasive* have the same significant seat pairings for the cushion and backrest: *seat 1 - seat 2, seat 2 - seat 3, seat 2 - seat 4*. All seat combinations contain the *seat 2*.

Table 7.4: Results of the Wilcoxon sign-rank test for Position 2.

Position 2	seat 1 - seat 2	seat 1 - seat 3	seat 1 - seat 4	seat 2 - seat 3	seat 2 - seat 4	seat 3 - seat 4	
soft-hard	<b>cushion</b>						
	z	-0.741	-0.502	-2.210	-1.230	-2.413	-1.749
	p	0.458	0.615	<b>0.027</b>	0.219	<b>0.016</b>	0.080
slippery-abrasive	<b>cushion</b>						
	z	-4.389	-0.962	-1.312	-3.940	-4.455	-2.064
	p	<b>0.000</b>	0.336	0.189	<b>0.000</b>	<b>0.000</b>	<b>0.039</b>
	<b>backrest</b>						
	z	-4.360	-1.852	-0.030	-4.094	-4.491	-1.715
	p	<b>0.000</b>	0.064	0.976	<b>0.000</b>	<b>0.000</b>	0.086

Position 3: The results of the Friedman’s Test are significant for the word pair *slippery - abrasive* for the cushion ( $\chi^2(3) = 56.01, p = 0.001$ ) as well as for the backrest ( $\chi^2(3) = 36.72, p = 0.001$ ). The word pair *soft - hard* ( $\chi^2(3) = 10.07, p = 0.018$ ) is only significant for the backrest.

Table 7.5 exposes for the backrest regarding the word pair *soft - hard* only one significant seat pairing: *seat 3 - seat 4*. With reference to the word pair *slippery - abrasive* the cushion as well as the backrest have the same seat pairings with significant results of the Wilcoxon signed-rank test. The significant seat pairings are: *seat 1 - seat 2, seat 2 - seat 3, seat 2 - seat 4*. In all seat pairings *seat 2* with the Alcantara cover is present.

Position 4: The Friedman’s Test is significant for the backrest for all three word pairs: *soft - hard* ( $\chi^2(3) = 21.54, p = 0.001$ ), *elastic - stiff* ( $\chi^2(3) = 16.22, p = 0.001$ ), and *slippery - abrasive* ( $\chi^2(3) = 29.25, p = 0.001$ ). As to the cushion the word pairs *soft - hard* ( $\chi^2(3) = 13.19, p = 0.004$ ) and *slippery - abrasive* ( $\chi^2(3) = 44.64, p = 0.001$ ) are significant.

The Wilcoxon signed-rank test shows, that in respect to the cushion and the word pair *soft - hard* the seat pairings *seat 2 - seat 4* and *seat 3 - seat 4* are significant for differentiation. *Seat 1* is not included in the differentiation of hardness (word pair *soft - hard*). Thus, for Position 4 the differentiation of the hardness for the cushion is perceived



Table 7.5: Results of the Wilcoxon sign-rank test for Position 3.

Position 3	seat 1 - seat 2	seat 1 - seat 3	seat 1 - seat 4	seat 2 - seat 3	seat 2 - seat 4	seat 3 - seat 4	
soft-hard	<b>backrest</b>						
	z	-0.751	-1.727	-0.931	-1.501	-1.437	-2.213
	p	0.453	0.084	0.352	0.133	0.151	<b>0.027</b>
slippery-abrasive	<b>cushion</b>						
	z	-5.100	-1.532	-0.787	-4.626	-5.049	-1.207
	p	<b>0.000</b>	0.125	0.431	<b>0.000</b>	<b>0.000</b>	0.228
	<b>backrest</b>						
	z	-4.511	-0.546	-0.559	-4.122	-4.448	-0.222
	p	<b>0.000</b>	0.585	0.576	<b>0.000</b>	<b>0.000</b>	0.824

Table 7.6: Results of the Wilcoxon sign-rank test for Position 4.

Position 4	seat 1 - seat 2	seat 1 - seat 3	seat 1 - seat 4	seat 2 - seat 3	seat 2 - seat 4	seat 3 - seat 4	
soft-hard	<b>cushion</b>						
	z	-1.255	-1.881	-1.588	-0.076	-2.931	-3.555
	p	0.209	0.060	0.112	0.940	<b>0.003</b>	<b>0.000</b>
	<b>backrest</b>						
	z	-1.807	-2.307	-1.900	-0.513	-3.006	-3.632
	p	0.071	<b>0.021</b>	0.057	0.608	<b>0.003</b>	<b>0.000</b>
elastic-stiff	<b>backrest</b>						
	z	-0.867	-2.664	-1.380	-1.066	-1.794	-3.391
	p	0.386	<b>0.008</b>	0.168	0.286	0.073	<b>0.001</b>
slippery-abrasive	<b>cushion</b>						
	z	-4.508	-2.029	-0.485	-3.947	-4.872	-2.895
	p	<b>0.000</b>	0.042	0.627	<b>0.000</b>	<b>0.000</b>	<b>0.004</b>
	<b>backrest</b>						
	z	-4.141	-2.504	-0.062	-2.617	4-143	-2.617
	p	<b>0.000</b>	<b>0.012</b>	0.951	<b>0.008</b>	<b>0.000</b>	<b>0.008</b>

between the *seat 4* with a plate instead of a seat suspension and *seat 3* with loose cover tension or *seat 2* with an Alcantara cover. As for the word pair *slippery - abrasive* all seat pairings are significant for differentiation, except seat pairing *seat 1 - seat 4*, which is the reference seat compared to the seat without a seat suspension. The backrests can be differentiated regarding the word pair *soft - hard* with the significant seat pairings: *seat 1 - seat 3*, *seat 2 - seat 4* and *seat 3 - seat 4*; the word pair *elastic - stiff* with the significant word pairings: *seat 1 - seat 3* and *seat 3 - seat 4*; and the word pair *slippery - abrasive* with the seat pairing: *seat 1 - seat 2*, *seat 1 - seat 3*, *seat 2 - seat 3*, *seat 2 - seat 4* and *seat 3 - seat 4*. The results for the cushion do not include the seat pairing *seat 1 - seat 4*. Referring to Position 1 and 4 the differentiation of the word pairs and seat pairings are more distinctive compared to the Position 2 and 3. In general, the results of the Wilcoxon signed-rank test show that the word pair *slippery - abrasive* is a differentiation factor independently from

the position and the load. In contrast, the significance for the differentiation of the seats for the word pair *soft-hard* and *elastic-stiff* changes with the position.

### OVERALL RATING

In Position 1 *seat 1* was rated as the best and *seat 4* as the worst seat. In Position 2 *seat 2* was rated as the best and *seat 4* as the worst seat. In Position 3 the best seat was *seat 3* and the worst one *seat 4*. Furthermore, in Position 4 *seat 1* was rated as the best and *seat 4* as the worst seat

### 7.3.2. OBJECTIVE CHARACTERIZATION OF THE SEATS

#### PRESSURE MEASUREMENT

Table 7.7: Results of the pressure measurements. The highest values are bold for each group and parameter.

		Seat 1		Seat 2		Seat 3		Seat 4	
		mean	std.	mean	std.	mean	std.	mean	std.
buttock Group	Average Pressure [N/cm <sup>2</sup> ]	<b>0.50</b>	0.10	0.45	0.11	0.44	0.10	0.47	0.10
	Peak Pressure [N/cm <sup>2</sup> ]	<b>1.20</b>	0.31	1.04	0.38	1.15	0.40	1.05	0.37
	Contact Area [N/cm <sup>2</sup> ]	579	40	574	72	<b>643</b>	89	600	80
front Group	Average Pressure [N/cm <sup>2</sup> ]	0.27	0.08	0.26	0.09	0.28	0.09	<b>0.32</b>	0.1
	Peak Pressure [N/cm <sup>2</sup> ]	0.53	0.17	0.49	0.18	0.55	0.18	<b>0.63</b>	0.26
	Contact Area [N/cm <sup>2</sup> ]	238	83	207	79	235	80	<b>264</b>	87
side Group	Average Pressure [N/cm <sup>2</sup> ]	<b>0.28</b>	0.08	0.27	0.09	0.22	0.07	0.27	0.08
	Peak Pressure [N/cm <sup>2</sup> ]	0.56	0.18	<b>0.59</b>	0.23	0.46	0.18	0.53	0.19
	Contact Area [N/cm <sup>2</sup> ]	240	105	<b>240</b>	111	217	119	228	167
back Group	Average Pressure [N/cm <sup>2</sup> ]	0.20	0.04	0.19	0.04	0.19	0.03	<b>0.21</b>	0.05
	Peak Pressure [N/cm <sup>2</sup> ]	0.67	0.38	0.67	0.41	0.67	0.26	<b>0.69</b>	0.43
	Contact Area [N/cm <sup>2</sup> ]	<b>530</b>	168	521	195	521	199	527	181

Table 7.7 shows the mean of all participants for each parameter: *average pressure*, *peak pressure*, and *contact area* for all four groups (*buttock Group*, *front Group*, *side Group* and *back Group*). The parameters with the highest values are made bold for each group. *Seat 1* (reference seat) has the highest *average pressure* and the highest *peak pressure* in the area of the buttock (*buttock Group*). Especially the difference between the *peak*

pressure of *seat 1* and *seat 4* is noticeable: even though *seat 1* has a seat suspension and *seat 4* a metal plate instead of the suspension, the peak pressure of *seat 1* is  $0.15\text{ N/cm}^2$  higher than for *seat 4*. For the *buttock Group* *seat 3* has the largest area in contact between person and seat. The measurement results for the front of the cushion (*front Group*), illustrate the highest *average pressure*, *peak pressure* and the largest *contact area* in *seat 4*. The lowest *average pressure*, *peak pressure*, and *contact area* has the Alcantara seat (*seat 2*). The values of *seat 1* and *seat 3* are close to the values of *seat 2*. Related to the bolster area of the cushion (*side Group*), the highest *average pressure* was found in *seat 1*, the highest *peak pressure* and *contact area* has the *seat 2*, and the lowest values for all three parameters has *seat 3*. The results regarding the backrest area (*back Group*) point out that the highest *average pressure* and the highest *peak pressure* is reached in *seat 4*. The largest area in contact between participant and the seat is found in *seat 1*. In general, most of the measured differences between the four seats are small. The *peak pressure* reaches in the *buttock Group* the highest, in the *back Group* the second highest and in the *front Group* and *side Group* the lowest values. In addition, the *buttock Group* has the highest values for the *average pressure* and the *back Group* has the lowest values. The values of the *front Group* and *side Group* are in between those values.

#### MEASUREMENT TOOL

Table 7.8 presents the results of the analysis of the four seats with the new developed measurement tool of Wegner et al. (2017). The results are divided into six blocks. Each block which contains the normalized values, compares the four seats through one appropriate measurement point. The detailed table without the normalized values is attached in the appendix (A.5). The maximum values are bold, and the minimum values are underlined.

The measurement results present that *seat 3* has the lowest pressure regarding the *first touch pressure* in cushion. As for the backrest, for most measurement points *seat 2* has the lowest *first touch pressure*. The *normalized linear pressure* (rise of pressure [ $\text{N/cm}^2$ ] per  $\text{cm}$ ) appears in most measurement points for the backrest and the cushion the highest in *seat 4*, except for the lumbar area and the wings. In this measurement point *seat 1* shows the highest *normalized linear pressure* but the highest *linear indentation* at the same time. The *normalized maximum pressure* (pressure rises per  $\text{cm}$  until the maximum pressure is reached) is in *seat 4* the highest, except for the area of the ischial tuberosity. For this measurement point *seat 3* has the highest values. The lowest *normalized maximum pressure* has *seat 2*, except for the bolster in the backrest. *Seat 2* distributes the pressure (*pressure distribution*) the best for most measurement points. For the bolsters in the backrest and cushion *seat 3* distributes the pressure the most. The *normalized elongation while loading the seat* is for all measurement points for *seat 2* (Alcantara seat) the highest. The lowest *normalized elongation while loading the seat* has *seat 3*, except for the measurement point in the lumbar area and the backrest bolsters. For the lumbar *seat 1* and for the backrest bolster *seat 4* have the lowest *normalized elongation while loading the seat*. Concerning the *elongation due to the lateral movement* *seat 2* has the highest values in most cases. The highest *elongation due to the lateral movement* for the shoulder is evoked by *seat 4* and for the front of the cushion *seat 3* has the highest values. The *linear indentation* is for *seat 3* the lowest and for *seat 1* the highest regarding the cushion. The lowest *linear indentation* mostly has *seat 4* in reference to the backrest.

Table 7.8: The Table illustrates the measurements results of the four seat in six measurement points. The highest values are highlighted bold numbers and the lowest values are highlighted with underlined numbers.

	max. pressure [N/cm <sup>2</sup> * 1/cm]	first touch [N/cm <sup>2</sup> ]	lin. pressure [N/cm <sup>2</sup> * 1/cm]	pressure distribution [N/cm <sup>2</sup> ]	elongation loading [%/(N/cm <sup>2</sup> )]	elongation move [%/(N/cm <sup>2</sup> )]	max. indentation [N/cm <sup>2</sup> ]	lin. indentation [N/cm <sup>2</sup> ]
1.) shoulder								
seat1	3.50	0.60	0.90	<u>0.70</u>	1.07	0.99	31.90	16.10
seat2	2.10	<b>0.80</b>	1.00	<b>1.10</b>	<b>2.01</b>	1.05	<b>34.70</b>	<b>26.70</b>
seat3	3.10	<u>0.40</u>	0.70	0.80	<u>0.77</u>	0.83	<b>34.70</b>	14.80
seat4	<b>4.20</b>	0.60	<b>1.10</b>	0.80	1.35	<b>1.48</b>	<u>31.40</u>	<u>13.20</u>
2.) lumbar								
seat1	2.90	<b>0.60</b>	<b>1.60</b>	0.50	<u>0.06</u>	<b>2.19</b>	<u>33.20</u>	<b>17.20</b>
seat2	<u>1.20</u>	<u>0.40</u>	0.80	<b>1.00</b>	<b>0.82</b>	<b>2.19</b>	<b>36.00</b>	15.70
seat3	1.80	0.50	<u>0.70</u>	0.70	0.59	1.92	35.70	14.40
seat4	<b>3.60</b>	0.50	0.90	<u>0.50</u>	0.14	<u>1.85</u>	<u>30.10</u>	<u>12.30</u>
3.) bolster backrest								
seat1	7.60	<b>0.80</b>	1.70	<u>0.60</u>	0.49	2.69	<u>23.40</u>	<u>12.00</u>
seat2	6.00	<u>0.40</u>	<u>0.90</u>	0.80	<b>0.55</b>	<b>2.81</b>	<b>26.1</b>	12.70
seat3	<u>5.50</u>	0.60	1.10	<b>0.90</b>	0.47	<u>2.50</u>	24.70	<b>14.20</b>
seat4	<b>7.70</b>	0.60	<b>2.20</b>	0.80	<u>0.24</u>	2.57	24.30	13.00
4.) ischial tuberosity								
seat1	3.30	0.70	1.70	0.50	0.42	1.86	<u>30.10</u>	<b>22.40</b>
seat2	<u>1.10</u>	<u>0.60</u>	<u>0.80</u>	<b>0.90</b>	<b>1.32</b>	<b>2.59</b>	<b>31.50</b>	19.60
seat3	<b>4.10</b>	<u>0.60</u>	1.00	<u>0.40</u>	<u>0.36</u>	1.78	30.30	<u>12.70</u>
seat4	3.80	<b>0.80</b>	<b>1.90</b>	<u>0.40</u>	0.53	<u>1.58</u>	30.30	18.90
5.) front of the cushion								
seat1	4.10	0.80	<b>2.70</b>	0.30	0.30	1.77	<u>28.50</u>	<b>22.80</b>
seat2	<u>2.10</u>	0.80	1.20	<b>0.80</b>	<b>0.60</b>	2.23	<b>29.70</b>	16.90
seat3	4.80	<u>0.50</u>	1.00	0.40	<u>0.08</u>	<b>2.25</b>	28.90	<u>14.30</u>
seat4	<b>8.90</b>	<b>0.90</b>	<b>2.70</b>	0.20	0.29	<u>0.55</u>	29.00	16.20
6.) bolster cushion								
seat1	3.30	0.50	<b>0.90</b>	<u>0.60</u>	0.89	<u>3.66</u>	<b>30.40</b>	<b>16.20</b>
seat2	<u>2.50</u>	<b>0.60</b>	0.80	<b>0.90</b>	<b>1.05</b>	<b>4.58</b>	28.80	19.00
seat3	3.70	<u>0.20</u>	0.80	<b>0.90</b>	<u>0.59</u>	3.73	28.60	<u>12.50</u>
seat4	<b>4.20</b>	0.40	<u>0.70</u>	0.80	0.88	4.55	<u>24.30</u>	15.40

In summary, the results show that *seat 4* can be identified as hardest regarding the pressure measurements with the new tool and *seat 2* and *3* the softest. *Seat 1* is in between. While loading the seat, *seat 2* shows the most elongation. *Seat 3* has the least elongation recorded by the stamp sensors (I-IV, Figure 7.4) or rather elongate the human skin. *Seat 3* shows also the least linear characteristics (*linear indentation* is the lowest) and *seat 1* has the most. Considering the backrest *seat 4* has the lowest linear properties.

### FRICITION MEASUREMENT

Table 7.9 presents the results of the friction tests. The *leather - silicon* and *Alcantara - silicon* combination showed no static friction even with forces over 100 N (the force used in all test) the combination skips immediately to sliding. The dynamic  $\mu$  is for the *leather - silicon* combination a bit higher than for *Alcantara - silicon*. For the jeans combinations with leather and Alcantara a static  $\mu$  could be detected. The  $\mu_{static}$  is for a leather cover three times lower than for Alcantara, the  $\mu_{dynamic}$  is nearly two times lower. The friction coefficient for *leather-jeans* is nearly the same for static and dynamic setups.

Table 7.9: Overview of the static and dynamic friction coefficient for various material pairings.

	$\mu_{static}$	$\mu_{dynamic}$
leather - silicon	-	1.38
Alcantara - silicon	-	1.30
leather - jeans	0.35	0.34
Alcantara - jeans	1.03	0.70

### THE INFLUENCE OF THE FRICTION COEFFICIENT ON THE MEASUREMENT DATA.

The *elongation while loading the seat* and the *elongation due to the lateral movement* base on the friction coefficient including silicon. Therefore, the measurement results of these parameter were normalized (see section "Measuring the Seats with a Measurement Tool" and Table 7.8). To include the jeans materials and to get an idea how a jeans surface influence the measurement data the values of the *normalized elongation while loading the seat* and the *normalized elongation due to the lateral movement* are multiplied with the dynamic friction coefficient of the jeans pairings. Table 7.10 presents the results exemplary for the cushion. The highest values are bold and lowest underlined.

Table 7.10: Results of the the parameters elongation while loading and elongation due to the lateral movement including the interaction with a jeans material. The highest values are bold and lowest underlined.

	seat 1	seat 2	seat 3	seat 4	seat 1	seat 2	seat 3	seat 4	seat 1	seat 2	seat 3	seat 4
	4.) ischial tuberosity				5.) front of cushion				6.) bolster cushion			
elongation loading (%)/(N/cm <sup>2</sup> )	0.14	<b>0.93</b>	<u>0.12</u>	0.18	0.10	<b>0.42</b>	<u>0.03</u>	0.10	0.30	<b>0.75</b>	<u>0.20</u>	<u>0.20</u>
elongation move (%)/(N/cm <sup>2</sup> )	0.63	<b>1.81</b>	0.61	<u>0.54</u>	0.60	<b>1.56</b>	0.76	<u>0.19</u>	1.24	<b>3.21</b>	1.27	<u>1.06</u>

The calculated parameter *elongation while loading the seat* and *elongation due to the lateral movement* for the jeans pairings (*leather - jeans* and *Alcantara - jeans*) are for each measurement point the highest in *seat 2*. The *elongation while loading the seat* is for each measurement point of the cushion in *seat 3* the least. For the *elongation due to the lateral movement* the lowest values are found for all measurement points in *seat 4*.

## 7.4. DISCUSSION

### 7.4.1. DISCOMFORT OF THE SEATS.

The discomfort ratings have shown that the seat components (foam, seat cover, seat suspension) of the reference seat (*seat 1*) are more balanced than the manipulated seats (*seat 2*, *seat 3*, *seat 4*). In particular, in the sensitive shoulder area (Vink and Lips, 2017) the participants perceived discomfort on the outer edge of the manipulated seats. The reason might be that a disharmony is perceived, meaning that particular parts of the seat do not match with other parts of the seat while sitting. Neither the pressure measurement nor the results of the measurement tool have data that clearly explain the discomfort in these parts. The pressure distribution of the participants, who stated discomfort in those areas, had no pressure peaks or points. The measurement tool did not measure remarkable characteristics in this particular area; therefore, exact predictions and explanation are hard to make. *Seat 2*, the Alcantara seat, has noticeable discomfort ratings in the rear bolster of the cushion. The implemented shear force through the higher friction coefficient (*leather - jeans* vs. *Alcantara - jeans*) might cause an additional force which results in a discomfort feeling. This is in line with Chow and Odell (1978) who linked the pressure perception to the shear force perception. Furthermore, the measurement tool of Wegner et al. (2017) confirms this perception. The measurement results in the bolster show a low pressure, but large elongations and therefore additional tensile strain might be felt, which could also evoke the shear force (Goossens, 2000). The explanation why only a few participants rated this as discomfort could be that some of these participants are shear sensitive or because the hips of the participants were wider. Another reason could be that the combinations of pressure and shear evokes a discomfort feeling (Chow and Odell, 1978). *Seat 3* has a noticeable discomfort in the bolsters of the backrest. The loose cover tension might evoke that some of the participants sink more into the backrest of the seat and thus feel the plastic plates of the side adjustments because of the higher compression of the foam. The pressure measurement of the participants does not explain the discomfort ratings, because the values of *seat 3* are not significantly different to the pressure values of *seat 1*, *seat 2* and *seat 4*. The pressure mat itself could influence the measurement by its thickness negatively and therefore might not record the *pressure distribution* in the right way. The results of the measurement tool illustrate that the bolster of *seat 3* has nearly the same pressure characteristics as the other seats. In combination with a softer lumbar area (higher tendency to sink into the seat) there is more contact with the bolsters and these are more compressed and therefore might be perceived more uncomfortable. *Seat 4* has a noticeable discomfort in the lumbar area. Replacing the seat suspension with a metal plate could influence this lumbar support experience, affecting the sitting posture not supporting the natural S-shape of the spine. This might be the reason why some participants perceived a discomfort in this region of the body. For the lumbar area the pressure measurements correspond to the experience. The *average pressure* and the *peak pressure* are both the highest in this area. The results of the measurement tool show that for higher loading the pressure for *seat 4* rises the most and has the highest value of all four seats. Overall, with the help of the measurement tool, which simultaneously records pressure and elongation information, it is possible to explain the discomfort rating better than the results of the pressure measurements alone. The correlation of the pressure mat measurements and discomfort is useful for only some parts (lumbar area) of the seat: in

most cases the recordings of the pressure mat are not useful for building a correlation because the pressure mat does not record the influence of the surface or even the tension of the cover leading to elongation and shear force. In contrast, the measurement tool records the influences of the surface and the cover tension but is only capable to measure in discrete points. In future it would be good to study the connection of the measurement points to what is happening in the human seat interface at that point and connected to pressure mat measurements for more precise statements.

#### 7.4.2. CHARACTERIZATION

Based on the word pair ratings, the results have shown that the Alcantara seat (*seat 2*) is characterized abrasive so that the abrasive surface differentiates *seat 2* in each position from the other seats. The differentiation of the surface might be independent from the position or the loading due to the significant results of the surface differentiation in each position. The pressure measurement does not record this perceived difference of the surface but the results of the measurement tool illustrate the difference presenting the highest elongation while loading the seat in each measurement point for the abrasive *seat 2*. In addition, the parameter *normalized elongation due to the lateral movement* is for the material pairing *silicon - Alcantara* for nearly every measurement point the highest. That is in line with the study of Goossens (2001) who stated that a LiquiCell cushion material evokes less shear stress (internal shear stress) than a foam cushion. Including the friction coefficient of all jeans-pairings demonstrate the high impact of the external applied shear force provoked by high friction coefficients. Therefore, the adapted parameter of Table 7.10 elongation due to the lateral movement including the friction coefficients of the jeans pairings (*Alcantara - jeans* and *leather - jeans*) have in each measurement point the highest shear force in *seat 2*. These measurement results are in line with the perceived differences of the participants. The results of the word pair rating for the hardness and elasticity show that the differentiation of both parameters depends on the position. For Position 1 and Position 4 the participants differentiate the hardness and elasticity of the seats most significantly. In both positions the cushion angle is high (15°- 18°). Therefore, the sensitive area of the body (front of the cushion) is in contact with the seat (Vink and Lips, 2017) and might be the reason for the differentiation. In contrast, Position 2 and 3 with a cushion angle of 3° and hence less sensitive contact area in the front of the cushion the participants notice less differences regarding the hardness and elasticity of the seats. Additional, in Position 1 the backrest is more upright than in Position 4 (but both high cushion angles). Therefore, the differentiation of the cushion is probably more related to the area being in contact than to the load. In Position 2 and 3 the participants were not able to differentiate the elasticity neither for the backrest nor the cushion. *Seat 4* characterized as the hardest seat differs in Position 2 regarding the cushion hardness from the other seat, but in Position 3 with the same cushion angle but a more horizontal backrest angle (less load on cushion) the hardness of the cushion cannot be differentiated anymore. Furthermore, the more horizontal angle in Position 3 than in Position 2 evokes a higher *contact area* with the sensitive shoulder area (same cushion angle). The results of the word pair rating suggest that in Position 3 the hardness of the backrest can be differentiated, whereas in Position 2 it cannot be differentiated. Therefore, it might be concluded that also the sensitive areas of the backrest evoke a better

differentiation of the seats. Position 1 and 4 are the most significant positions regarding the hardness and the elasticity differentiation. *Seat 3* with the loose cover tension and therefore with the best foam properties was rated as the most elastic seat. Unfortunately, the pressure mat measurements do not offer a connection to the seat elasticity but the results of the measurement tool of Wegner et al. (2017) demonstrate that the parameter *normalized elongation while loading the seat* is in almost every measurement point (except lumbar and backrest bolster) the lowest. Therefore, *seat 3* might not stress the skin as much as in the other seats. On the one hand, the low cover tension provokes the best foam properties and thus, the best spring/damper properties. On the other hand, it causes a high interaction between the seat suspension and the foam. This fact is illustrated by the results of the measurement tool in the measurement point of the ischial tuberosity. The results present the highest *maximum pressure* in *seat 3* hence to a high relative movement between the seat suspension and the foam. The foam is pressing through the suspension spring. For all other measurement points the results of stamp measurements show that *seats 2* and *3* both have the lowest pressure attributes or rather the best *pressure distributions*. On the contrary, *seat 4*, characterized as the hardest seat, has the highest maximum pressure in each measurement point and an unequal *pressure distribution*. The results of the measurement tool are in line with the results of the word pair ratings. Unfortunately, the results of the pressure mat measurements do not correlate with the results of the word pair ratings in most cases. However, for further studies the different loadings and the connection of the different measurement points of the measurement tool should be taken more into account. The study has shown that the position, the *contact area*, and the sensitivities of the human body influence the ratings and the characterizations of a seat. This should additionally be included into the measurement procedure of the measurement tool. Moreover, it is pointed out that the optimum position for an occupant in one specific seat is not necessarily the optimum position in another seat with different cover and seat suspension properties.

## 7.5. CONCLUSION

The study has shown that seats with the same contour and foam properties and differ in cover (surface and cover tension) and seat suspension are perceived different. The seat layout has a huge impact on the seat-human interaction and therefore influences the parameters for the seat characterization. Moreover, the positions evoke various significances for the differentiation due to different sensitivity areas in contact with the seat. The results of the objective measurement tool from Wegner et al. (2017) could be used to explain the rated characteristics of the seats. The correlations between the discomfort ratings and the stamp measurements could be improved by including the mutual interdependencies of the measurement points. Unfortunately, in most cases the pressure mat measurements neither correlate with the discomfort rating nor with the characterizations of the seats. In order to receive a more precise characterization as well as a more precise discomfort rating the results of the measurement points (measurement tool Wegner et al. (2017)) and the interdependencies of the measured parameter have to be correlated and evaluated in further studies with various participants and seats.



## 7.6. ACKNOWLEDGEMENT

We are thankful to our TU Delft colleagues and Rudolf Rackl, Renato Martic and Mario Buljan who provided expertise that greatly assisted the research. We are also grateful to Erich Zerhoch and Johann Sax for assistance organizing the measuring instruments and for assistance building up the setup.

## REFERENCES

- Biedermann, H. and, Guttmann G., 1984. *Funktionelle Pathologie und Klinik der Wirbelsäule, Band 1, Teil 2*, Elsevier; Munich
- Chow W. W. and, Odell, E. I., 1978. *Deformations and Stresses in Soft Body Tissues of a Sitting Person*, 1978.
- DIN 53579. 2005. *Testing of flexible cellular materials –Indentation test on finished parts. DIN-Normenausschuss Materialprüfung (NMP).*
- DIN EN ISO 3386-1. 2009. *Polymeric materials, cellular flexible –Determination of stress-strain characteristics in compression –Part 1: Low-density materials. DIN-Normenausschuss Materialprüfung (NMP).*
- Goossens, R. H. M. and, Snijders, C. J., 1995. DESIGN CRITERIA FOR THE REDUCTION OF SHEAR FORCES IN BEDS AND SEATS, *Journal of Biomechanics* 28, 2, 225 - 230.
- Grujicic, M., B. Pandurangan, G. Arakere, W. C. Bell, T. He and, X. Xie. 2009. *Seat-cushion and soft-tissue material modeling and a finite element investigation of the seating comfort for passenger-vehicle occupants. Materials & Design* 30 (10): 4273–85. <https://doi.org/10.1016/j.matdes.2009.04.028>.
- Goossens, R. H. M., 2001. *Shear stress measured on three different cushioning materials*, Delft University of Technology.
- Harrison D. D., Harrison S. O., Croft A. C., Harrison D. E. and, Troyanovich S.J., 2000. *Sitting Biomechanics part II: Optimal car driver's seat and optimal driver's spinal model*, *Journal of manipulative and physiological therapeutics*. 23(1): 37-47.
- Mansfield N., Sammonds G. and, Nguyen L., 2015. *Driver discomfort in vehicle seats- Effect of changing road conditions and seat foam compositions. Applied Ergonomics* 50, 153-159.
- McCrary S. K. and, Levine J. A, 2009. *Sedentariness at Work: How Much Do We Really Sit?. Obesity* 17, 11, 2103 - 2105.
- Molenbroek J.E.M., Albin T. J. and, Vink. P., 2017. *Thirty years of anthropometric changes relevant to the width and depth of transportation seating spaces, present and future. Applied Ergonomics* 65: 130-138. <https://doi.org/10.1016/j.apergo.2017.06.003>
- Sammonds, G. M., Fray, M. and, Mansfield, N. J., 2017. *Effect of long term driving on driver discomfort and its relationship with seat fidgets and movements (SFM)s. Applied Ergonomics* 58, 119–127.
- Schmidt, R.F. und Thews, G., 1980. *Physiologie des Menschen*. Springer Verlag; Springer, Berlin u.a..
- Vink, P. and, Lips, D., 2017. *Sensitivity of the human back and buttocks: The missing link in comfort seat design. Applied Ergonomics* 58, 287–292.
- Wegner M., Martic M., Franz M. and, Vink P., 2017. *A new approach for measuring the sea comfort, 1th International Comfort Congress, Salerno.*
- Wegner M., Anjani S., Li W. and, Vink P. 2019. *How Does the Seat Cover Influence the Seat Comfort Evaluation?. In: Bagnara S., Tartaglia R., Albolino S., Alexander T., Fujita Y. (eds) Proceedings of the 20th Congress of the International Ergonomics Association (IEA 2018). IEA 2018. Advances in Intelligent Systems and Computing, vol 824. Springer.*

Zenk, R., Mergl, C., Hartung, J., Sabbah, O. and Bubb H., 2006. *Objectifying the Comfort of Car Seats*, SAE International.

Zuo, H., Jones, M. and, Hope, T., 2004. *A Matrix of material representation*. In: *Proceedings of Futureground, Design Research Society International Conference*. Melbourne.



# 8

## GENERAL DISCUSSION

## 8.1. COMING BACK TO THE MAIN AIM OF THE PHD

In chapter 1 the aims of this PhD were formulated. The aims were:

1. to prove that the perception and the (dis-)comfort of a automotive seat is not only influenced by the foam properties but also by other seat components like the seat cover and the seat suspension.
2. to develop a measurement tool and method which records the skin relevant mechanoreceptors: shear forces, elongation, friction and pressure and analyses the correlation between the recorded parameters and seat elements. The goal of the system is to provide a measurements tool which is able to analyze objectively the subjective ratings of occupants.

Regarding the first aim, it is clear from the studies in this PhD thesis that other elements than foam play a major role in the perception of the seat by humans, which means that only recording pressure distribution is not enough and foam properties alone do not determine the comfort perception of a seat. It was proven in chapter 3, 4, 6 and 7. In chapter 3 the contour of the side-support in the seat has a significant effect on (dis)comfort as reported by the 30 participants. In chapter 4 the two covers (leather and fabric) were significantly different perceived by another 30 participants. In chapter 6 the measurement tool could clearly record differences due to cover, lamination and suspension in 648 combinations of seat components. Of course effects of the foam properties were shown as well, but these are already described many times in the literature. In chapter 7 38 participants were able to perceive differences between pre-stressed and normal leather covers, with and without seat suspension and other cover materials.

Regarding aim number 2 the developed tool looks promising as differences in properties in a seat could be measured as was shown in chapter 5, 6 and 7. Chapter 7 also shows that the tool measured properties that were relevant. Further research has to be done in optimizing the tool. Like using artificial intelligence to analyze the outcome and give guidance which properties of the seat need to be studied (see Figure 8.1) and to predict the perceived (dis)comfort. Also, the ideal measurement protocol needs attention.

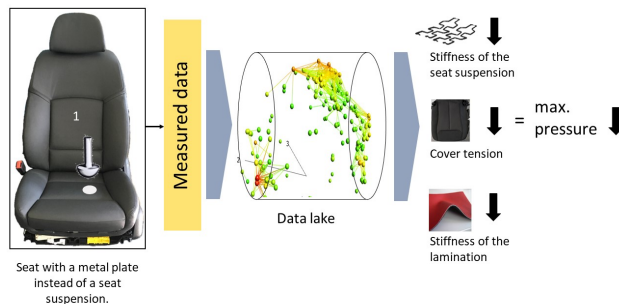

Figure 8.1: Sample of a procedure that provides guidance which properties of a seat need to be studied in order to improve the seating characteristics, e.g. reduction of pressure in the ischial tuberosity area of the seat.

## 8.2. CONTEXT OF THE SEAT

Comfort or discomfort is of course not only influenced by seat properties. Bouwens (2018) describes that for aircraft passengers various factors influence the comfort. She states that ‘Many factors influence passengers’ comfort, such as expectations and environment. According to Krist (1993) and Bubb et al. (2015), comfort is established through six factors: anthropometry, climate, sound, vibrations, light and smell. The seat is related to anthropometry and is one of the factors. But also regarding the seat not only the physical seat properties play a role. First sight and expectation play a role here as well. Many studies and investigations showed that the seat comfort is influenced by many factors including also the visual and aesthetic (Vink, 2014) aspects or historical background (van Veen, 2016) of the occupants. This multi factorial process leading to comfort or discomfort is difficult to study as a whole. Therefore, many approaches and models exist to breakdown the comfort understanding into basic elements (Zhang et al., 1997, Moes, 2005,). A majority of studies separate comfort and discomfort, where comfort is more connected to emotional and cognitive aspects and discomfort more to physical entities (Zhang et al., 1997). Based predominantly on the model of Vink and Hallbeck (2012), on Manfield’s dynamic discomfort model (Mansfield, 2012) and on the description of the skin mechanoreceptors (Schmidt and Thews, 1980), this research reifies the seat comfort analyzing the seat discomfort and seat perception based on the seat-human interaction parameters: pressure, elongation and shear force. Following the recording of

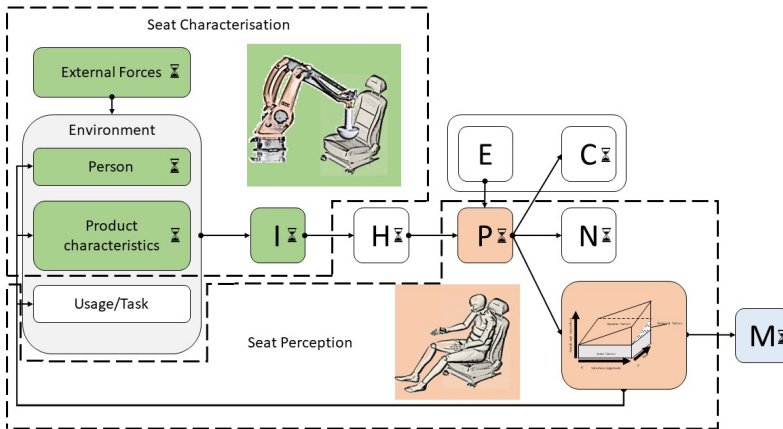

Figure 8.2: Overview of the theses scope.

the skin mechanoreceptors this research developed a measurement tool which is capable to record the parameters: pressure, elongation and shear force while loading a seat. The repeat accuracy is nearly 99 % (see chapter 5) ensuring a good comparability of the measurements. The sensors and the surface of the stamp simulate the human skin. The pressures and elongations are recorded during the loading until the maximum load of 100 N is reached, the shear force results out of a relative movement between the seat and

stamp. Thus, the measurement tool allows to characterize seats in various loads based on the seat-human interaction parameters and therefore enables a objective comparison of various seats. Based on the model of Vink and Hallbeck (2012) the measurement system provides an objective output of the interaction between human and seat (I) shown in Figure 8.2. The green colored sections illustrate the scope of the measurement tool. The red colored sections illustrate the scope of the case studies (see chapter 3, 4, 7) conducted in this research. The focus of the case studies was to investigate the perceived effects (P) and the discomfort (N or D) while interacting with the seats. The results of the case studies (P) allow an interpretation of the results of the measurement tool (H). All in all the research has shown that the results of measurement tool are capable of recording shear, elongation and pressure, which is relevant to understand more of the causes for discomfort and it is possible to compare seats regarding these aspects.

### 8.3. HOW SEAT ELEMENTS AFFECT THE SEAT-HUMAN INTERACTION AND THE SEAT PERCEPTION

Much attention has been paid to the foam density in improving comfort perception of a seat. However, the case studies as well as the objective measurements have shown that especially the seat cover has a huge impact on the seat perception. The seat cover includes the surface of the material, the elasticity and the cover tension (how tight the cover is fixed to the foam) but also the lamination which is fixed below the cover material. The effects on the seat-human interaction are huge and divers. The pressure perception is affected predominately by the cover tension or the lamination. The elongation is affected by the cover tension and the cover elasticity, and the shear force is affected by the friction coefficient and the stiffness of the overall seat layout. The literature review in chapter 2 have shown how skin, fat and tissue deform and distort while stressing the body with pressure and shear force. The results of the measurement tool are in line with the presented models in chapter 2.

## 8

#### 8.3.1. SHEAR FORCE

Figure 2.10 shows how the seat layout properties influences the deformation and the internal stresses in the body. It is assumed that the stiffer the set layout the higher the deformations of the human body. Regardless of friction coefficient the results of the measurement tool for stiff seat layouts with hard foams and/or high cover tensions illustrate higher elongations while moving on a seat respectively higher shear forces compared to seat layouts with more soft and flexible seat elements. Also Goossens (2001) investigated the shear force impact of cushion materials or rather the stiffness of the cushion materials and concluded that LiquidCell materials evoke less shear force than conventional foam cushions. It can be concluded that the measurement tool is able to record differences of seat layout stiffness and the resulting shear force impact. Moreover, the results of the measurement tool have also shown that the impact of the shear forces is predominantly evoked by the friction coefficient in the contact area between seat cover and occupant.

The case studies of this PhD thesis have shown that abrasive materials have positive effects in body regions in contact with the seats with low pressure. For the examined



seats in this study it can be concluded that the lower the pressure the better was the differentiation of the surface properties especially for sensitive body regions (Vink and Lips, 2017). For high loaded regions, especially with hard foams and abrasive materials, the examined seats have shown a negative impact on the seat perception and the seat comfort. Chapter 3 has shown that for low and soft bolsters, abrasive cover increase the comfort. In contrast for high and hard bolsters abrasive covers decrease the comfort rating. In this context it is important to mention that the seating position of the occupant has an high impact on the induced shear forces on the human body (Goossens and Snijders, 1995). A backward inclined backrest potentially evokes higher shear forces or a forward sliding at the cushion. The choice of the seat layout and especially the cover material has a significant influence on the resulting seat-human interaction. In accordance to the presented model in Figure 2.5 and the previous experiments the recorded elongation of the stamp sensors while loading the seat simulate the internal shear forces respectively the tensile strain in the tissue provoked by the seat layout properties. For seat layouts with soft foams and/or loose cover tension the elongations of the stamp sensors are lower than for seats with hard foams and tight covers, on condition that in both seats the indentation depth is the same. The existence of a seat suspension provokes a higher indentation and therefore higher elongation. The surface and the elasticity of the cover material have also a high impact on the resulting elongation.

It can be concluded that the selection and combination of seat components have a high impact on the shear force. In particular, the differences of the seat cover surface and elasticity of the seat cover were significantly perceived by the subjects and recorded by the measurement tool.

### 8.3.2. PRESSURE

In the literature the pressure in the seat-human interaction zone is mostly related to the foam properties (Kolic, 2003, Zenk et al., 2006). But the results of the current research have shown that also the seat cover and the seat suspension evoke high pressures in a seat, especially if the combination of the seat component properties are unbalanced. A typical example (also mentioned in chapter 6) is a seat layout with soft foams not supporting the body and tight covers with high cover tensions. Such a seat layout has properties comparable to a hammock, whereby the weight of the occupant is not well distributed and evokes very high pressure in a very small contact area, nearly as high as for seats with very hard foams. Also the properties of the seat suspension influence the pressure in the seat-human interaction very much. The results of the measurement tool have shown that for thin and hard foams changes of the seat suspension properties have the highest impact.

The results of the measurement tool as well as the case studies have shown that also the lamination of the seat covers have a high impact on the pressure perception. The results of chapter 4 provide that a seat with a leather seat cover and a very stiff lamination was rated much harder than a seat with fabric seat cover, although the seats were identical except for the seat cover. The case study in chapter 7 confirmed the results showing that although the foam properties and the foam geometry of seats are the same, other elements like the properties of the seat suspension, the seat lamination or the seat cover tension have a relatively high impact on the pressure perception.

The pressure can not only be controlled by the foam properties alone, other seat components influence the resulting seat-human interaction parameter as well. However, the case study in chapter 3 has shown that the contour of the foam in combination with appropriate foam properties influences the static and dynamic (dis-)comfort fundamentally. Therefore, the foam properties and contour have to match to the other seat components. Chapter 6 confirms that the interaction between the seat components is very complex.

### 8.3.3. PRESSURE VS. SHEAR FORCE

The pressure is not only a force distributed on a certain area, it is a strain provoking deformations and distortions in the human body. Especially, in the tissue as well as in the seat resulting in complex force and stress combination during the seat-human interaction. This seat-human interaction causes additional shear forces and shear strains in the human body due to the friction coefficient of the seated person and the seat. The case studies have shown that foam is the element of the seat which provides the support and the cover is element which affects the resulting seat perception and therefore both components/elements should be aligned with each other. The choice of the material characteristics have an high impact on the resulting seat perception.

The possible combination of shear force and pressure has many effects. On the one hand, the shear force can influence the perception of a seated person directly through the seat-human interaction in combination with a certain friction coefficient and, on the other hand, the shear force can influence the pressure perception, which was also shown by Goossens (1994), who showed that the cut-off pressure in the absence of shear force is 11.6 kPa, a shear stress of 3.1 kPa reduces the cut-off pressure to 8.7 kPa. Therefore seat areas with high pressures should not have abrasive materials to avoid high friction and high shear forces.

### 8.3.4. A BETTER FIT TO THE CONTOUR, SENSITIVITY AND DEFORMATION OF THE HUMAN BODY.

Many restrictions have to be fulfilled in designing an automotive seat. The individual customer is not interested in all the restrictions, the customer is interested in a seat that fit to the contour, sensitivity and deformation of the human body. The big challenge for the seat design is to be aware of the many different percentiles sit into the seat loading and stressing the seat in various combinations. As in the introduction mentioned (chapter 2) the seat development department can not influence the person who sits on the seat, but the seat department is able to influence with a smart choice of seat components a seat which offers a wide scope of comfort for various percentiles. However, this requires a detailed knowledge how the seat components influence each other and how the choice of the seat components affects the (dis-) comfort for a wide range of occupants.

Therefore, this research have investigated in chapter 6 how the seat component influence each other. Thereby the choice of the cover material has a huge influence. It affects the interaction of all components below. The research shows that the seat-human interaction parameters for leather seats are predominantly driven by the lamination properties and the fabric seat by the seat cover tension. Changes of seat component properties below the seat cover material, like the foam hardness, affect the seat-human interaction parameters for leather seat totally different compared to fabric seats. As shown

in chapter 3 the contour of the seat is important, especially for the design of the static and dynamic (dis-) comfort. Chapter 3 has also shown that the cover surface affects the resulting (dis-)comfort rating of different contours. Chapter 4 clarifies that the leather and fabric seat are characterised and perceived different although the contour and the foam properties are the same. Additional, chapter 7 includes how the seat suspension and the tension of the cover affect the perceptions of a seat. Concluding this studies, it is evident that the participants could clearly differentiate between the changes of the cover or seat suspension properties. This research illustrates that the interaction between the seat components is very complex and should be handled. Designing a seat it is essential to take this into account as the occupant feels the differences.

A simple example illustrates how the seat interacts with various percentiles and therefore provokes a different interaction between seat. Figure 8.3 illustrates on the left side a cut-section of a cushion and a hip of a light and a heavy person. On the right side the cut-section illustrates how the light and the heavy person load and stress the seat. In this simple example, the light person uses only the seat cover and a bit of the foam properties. The seat suspension is not in use. A change of the cover properties or a change of the cover tension might decisive affect the seat-human interaction for the light person. The foam and the seat suspension are in this case not relevant. In contrast, the heavy person indents much more into the seat. All seat components are in interaction. Dependent on the properties of seat suspension, the foam and the cover the interaction of the components and the interaction with the occupant can be very complex (see chapter 6).

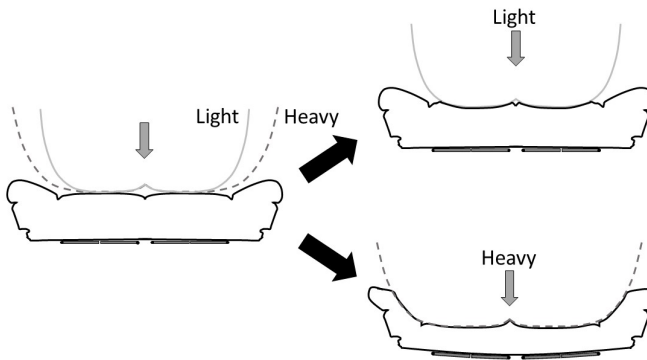

Figure 8.3: Illustration how different percentiles interact with automotive seat.

Although, the same seat is loaded and stressed, different percentiles get different feedbacks of the seat due to the individual weight and contour. Comparing the stressed seats in Figure 8.3 it is evident that light persons evoke in this example nearly only the pressure as a interaction parameter. Just moving on the seat could evoke shear forces. Occupants with higher weights load and stress the seat more, provoking higher pressures but inducing also higher shear forces. Higher fat tissue evoke additionally a higher internal

shear stress (Takahsi et al., 2010, Brosh and Arcan, 2000).

It can be concluded that the choice of the seat component characteristics as well as the occupant who sits on the seat influence significantly the seat-human interaction. The ratio of pressure, elongation and shear force differs for every person. Therefore, the developed measurement tool is suitable for the comparison of various seats regarding the interaction behavior. The case studies have shown that the subjects significantly felt differences between the seats (relative ratings) but especially for the case studies of chapter 7 and chapter 4 the results of the over all participant rating have not shown a significantly preferred seat. Which could be explained by differently loaded seats and therefore a individual pressure, elongation and shear force ratio.

#### 8.4. A COMPARISON OF THE CURRENT MEASUREMENT SYSTEMS AND THE DEVELOPED MEASUREMENT TOOL

Many studies focus on the correlation of pressure distribution and discomfort. Zenk et al. (2006) for example have shown in cushions a significant correlation between the discomfort ratings and the pressure distribution. Moreover, De Looze et al. (2003) pointed out a correlation between pressure and discomfort, predominantly with a limitation on special body parts. The current research also conducted for each case study and each person a pressure mat measurement. Focusing on the seat cover and the seat suspension the results of the pressure measurements were not significantly different. Only the pressure mat measurements in chapter 3 were significantly different, focusing on the bolster contour and the foam properties. Each seat from the case studies was also recorded with the measurement tool (chapter 5). Like presented in chapter 7 the measurement tool records differences appropriate to the different seat characteristics and seat ratings. The pressure mat measurements are not appropriate to detect differences of the cover material, the cover tension or the stiffness of seat suspension. Figure 8.4 illustrates a pressure measurement of the case study presented in chapter 7. It is evident that slight differences are visible, but with these differences the ratings of the seat can not be explained.



Figure 8.4: Comparison of the results of the pressure mat measurements related to the case study presented in chapter 7. From left to right: reference seat / original BMW 5-series seat (seat 1); Alcantara seat (seat 2); loose cover tension (seat 3), and seat with a metal plate instead of a seat suspension (seat 4).

All in all the pressure measurement mats are very good to compare seats with different foam contours or foam properties, but detecting the difference of other seat components is hard to do with a pressure mat. The effect of the shear force is largely excluded due to the specifications of the pressure mat itself (smooth texture and shear force independent pressure sensor). The measurement tool developed in this research enables to differentiate the seat properties and allows to compare the seat characteristics objectively.

## 8.5. CONCLUSION

Based on the objective and subjective results of this study Figure 8.5 shows qualitatively how seat components could influence the interaction parameters: pressure, elongation and shear force, which all have influence on the seat discomfort. On the x-axes the foam hardness and stiffness of the seat suspension are shown, on the y-axes the seat cover and the lamination and on the z-axes the discomfort are presented. The figure also takes into account that the discomfort is affected by other factors such as the seat contour. In summery, the graph shows that too hard foams create higher discomfort regardless of the seat cover. Foams that are too soft also cause discomfort, but in this case the seat cover (stiffness of the seat cover) is able to influence the experienced discomfort. Foam hardnesses between very hard and very soft create the lowest discomfort, in this case the stiffness of the seat cover / lamination has a high influence on the discomfort. The higher the stiffness of the cover, the higher the resulting discomfort.

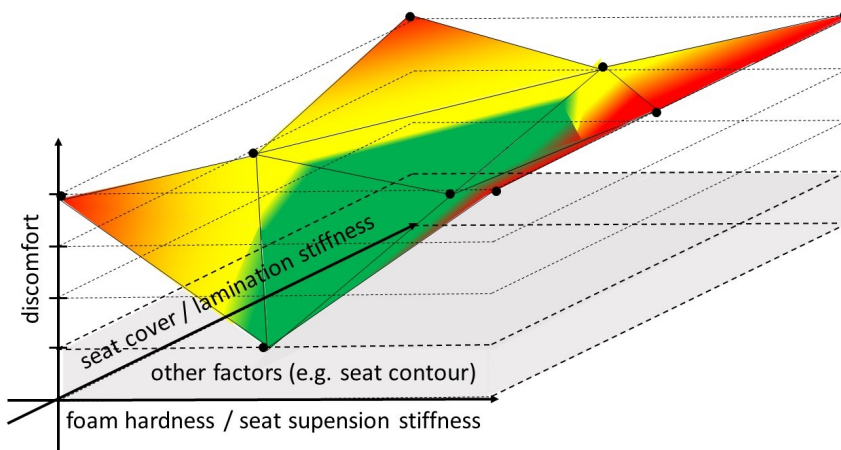

Figure 8.5: Qualitative visualization of how the discomfort might be affected by the seat cover/lamination and foam hardness/seat suspension.

This research has shown that the choice of the material of different components is essential because it affects the behavior of the shear forces, the pressure and the elongation in the seat-human interaction. The measurement tool developed in the context of this research is appropriate to measure the seat component specific differences of each seat recording simultaneously the pressure, elongation and shear force while

stressing the seat. Case studies of this research have underlined that the shear force is together with the pressure a relevant parameter for the perception and differentiation of the seat affecting also the seat discomfort. All in all a legitimated measurement tool exists which is able to measure reproducible differences of seat-human interaction parameters which are also felt by human beings. This measurement tool offers a wide range on new possibilities which are presented in the recommendations for the further research.

## 8.6. RECOMMENDATION FOR FUTURE RESEARCH

The research has shown that the measurement tool is adequate for a comparison and characterization of various seats. This opens a wide field of research. The statistical prediction of the seat components could be improved including more information about the materials and components like the spacer fabric materials for the ventilation into the analysis. The statistical analysis of the current project is based on linear relationships. Non-linear approaches and methods and the field of artificial intelligence might consistently improve the analysis.

The current research measures discrete measurement points in backrest and cushion. More measurement points might be useful for a detailed seat-human interaction parameter map. Additionally, it is necessary to investigate the interaction of the various measurement points based on the anthropometry of different percentiles in various body areas and unusual sitting positions. With this knowledge a software based analysis could be developed including various anthropometric data to predict the individual (dis-)comfort and seat perception.

A general limitation of this research is that most of the investigations are carried out in laboratories in static situations. The measurement tool is designed to record also dynamic data. Therefore, further investigations regarding dynamic situations and longterm comfort might be useful to verify the currently defined analysis parameter and extend the parameters if needed related to dynamic factors like vibration. The dynamic results could be verified based on the model of Mansfield (2012) which includes static factors, dynamic factors and temporal factors.

In addition, further case studies would be useful, which take up the manifold influence of shear forces and their interaction with existing findings. One conceivable example would be the study of Sammonds et al. (2017) which examined the relationship between fidgeting and seat comfort. The influence of shear forces could be integrated by examining a similar study with various seats with different seat covers.

Figure 8.6 summarizes most of the research findings. Based on this research it is recommended to design a flat contour in the shoulder area to enable a high percentile of the population to fit into the seat. A side support made out of the abrasive Alcantara material is preferable. The Alcantara material or other abrasive materials could be used in the bolsters and wings with soft and flat foam parts. For hard and high (convex) foam properties of the bolsters and wings no abrasive materials are allowed. The cover tension in the bolster and wing area should be loose or the cover should be very elastic. For the main surface of the backrest and the cushion the research recommends a non abrasive and elastic material with a loose cover tension. For the front of the cushion we recommend a loose cover tension and a supportive foam. The recommended seat characteristics should be validated in a further static and dynamic case study.

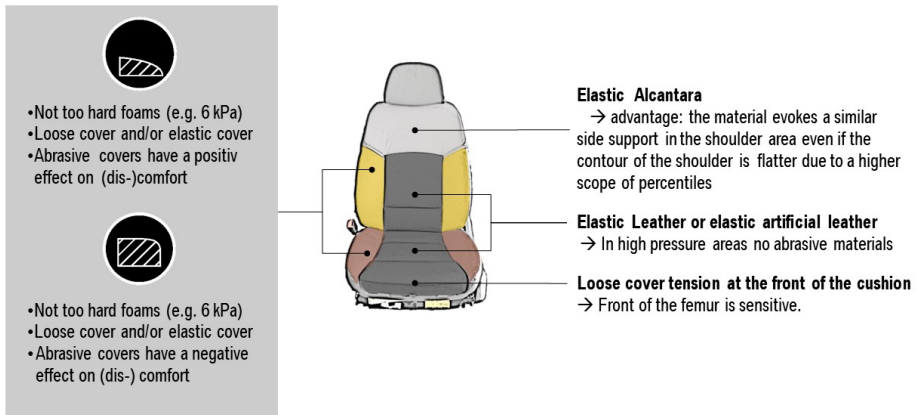

Figure 8.6: Recommendations based on the results of the research.

## REFERENCES

- Bubb, H., Bengler, K., Grünen, R. and, Vollrath, M., 2015. *Automobilergonomie*. Wiesbaden: Springer Vieweg
- Bouwens, J., 2018. *Design Considerations for Airplane Passenger Comfort*. Dissertation. Delft University of Technology.
- Brosh, B. and, Arcan, M., 2000. *Modeling the body/chair interaction - an integrative experimental- numerical approach*.
- De Looze, M. P. de, Kuijt-Evers, L. F. M. and, van Dieen, J., 2003. *Sitting comfort and discomfort and the relationships with objective measures*. *Ergonomics* 46, 10, 985–997.
- Goossens, R. H. M., 1994. *BIOMECHANICS OF BODY SUPPORT. A study of load distribution, shear, decubitus risk and form of the spine*.
- Goossens, R. H. M. and, Snijders, C. J., 1995. *Design Criteria for the Reduction of Shear Forces in Beds and Seats*. *Journal of Biomechanics* 28, 225 - 230.
- Goossens, R.H.M., 2001, *Shear stress measured on three different cushioning materials*, Delft University of Technology.
- Krist, R., 1993. *Modellierung des Sitzkomforts – eine experimentelle Studie*. Dissertation, Katholischen Universität Eichstätt, Eichstätt, Germany.
- Kolich, M. 2003. *Automobile seat comfort. Occupant preferences vs. anthropometric accommodation*. *Applied Ergonomics* 34, 2, 177–184.
- Mansfield N.J., 2012. *Human response to vehicle vibration*. In: Gkikas, N., 2012. *Automotive ergonomics: driver-vehicle interaction*. CRC Press.
- Moes, N. C. C. M., 2005. *Analysis of sitting discomfort, a review*. In: Bust, P.D., McCabe, P.T., (Eds.) *Contemporary Ergonomics 2005*, Taylor & Francis, London, pp. 200-204.
- Schmidt, R.F. und Thews, G., 1980. *Physiologie des Menschen*. Springer Verlag; Springer, Berlin u.a..
- Takashi, M., Black, J., Dealey, C. and, Genfen, A., 2010. *Pressure in context*. In: *International Review. Pressure ulcer prevention: pressure, shear, friction and microclimate in context*. London: Wounds International.
- van Veen, S., 2016. *Driver Vitalization: Investigating Sensory Stimulation to Achieve a Positive Driving Experience*. <<https://doi.org/10.4233/uuid:89e83a5d-804d-4563-8cd4-6aebc374f24d>>, 129 - 140.
- Vink, P. and, Hallbeck, S., 2012. *Editorial: comfort and discomfort studies demonstrate the need for a new model*. *Applied Ergonomics* 43, 271-276.
- Vink, P., 2014, *The sweetness of discomfort: Designing the journey*. Inaugural Lecture, Delft University of Technology, June 4, 2014.
- Vink, P. and, Lips, D., 2017. *Sensitivity of the human back and buttocks: The missing link in comfort seat design*. *Applied Ergonomics* 58, 287–292.
- Zhang, M. and, Roberts, V. C., 1994. *The effect of shear forces externally applied to skin surface on underlying tissues*. *Journal of Biomedical Engineering* 15, 6, 451–456.



Zenk, R., Mergl, C., Hartung, J., Sabbah, O. and, Bubb H., 2006. *Objectifying the Comfort of Car Seats*, SAE International.



# 9

## SUMMARY / SAMENVATTING

## SUMMARY

The seat is the largest contact area between a human and the car. Optimizing this contact area is therefore highly relevant for long term customer satisfaction. The share of the total production costs for the interior can be between 20% - 30% of which almost 40% is for the seats. The current literature of seat research is mostly on the properties of foam related to comfort and discomfort. In this PhD a study is done to prove that the perception and the (dis-)comfort of an automotive seat is not only influenced by the foam properties and contour. Other seat components like the seat cover, lamination and the seat suspension might play a role as well. To study the effect of different elements a measurement tool was developed which records properties that are relevant for some sensors in the skin. These mechanoreceptors in the skin are shear forces, elongation, friction and pressure.

A tool was developed, which is a stamp in the form of a half sphere. The half sphere is equipped with pressure and elongation sensors. This makes it possible to measure pressure and pressure distribution, elongation and shear forces. With the tool 648 samples of seats with different seat components were tested. Additionally 98 participants tested various seats with properties comparable to the 648 samples. The tests showed that it was able to measure differences in elongation, pressure and shear force.

It is clear from the studies in this PhD thesis that other elements than foam play a large role in the perception of the seat by humans, which means that only recording pressure distribution is not enough and foam properties alone do not determine the comfort perception of a seat. In an experiment on the effect of different side supports like bolsters and wings it was shown that other factors than foam properties play a role.

For instance, in dynamic driving it was found that more convex and soft side supports are preferred. In static conditions less convex forms were preferred. So, contour is certainly of importance as well.

In another study described in this PhD the effects of two covers (leather and fabric) were studied and these were perceived different by another 30 participants.

In the last experiment 38 participants were able to perceive differences between pre-stressed and normal leather covers, with and without seat suspension and other cover materials. It was in alignment with what the tool did record. For example the measurement data of the tool showed that the pre-stressed leather cover is least elastic and it was also experienced by participants as least elastic. And for the Alcantara cover the shear force was highest and was also experienced by the participants as abrasive. Deleting the suspension made the pressure parameters recorded by the tool more hard and it was experienced harder by participants.

The main result of the PhD is that there are certainly more factors than foam hardness relevant for perception of (dis-)comfort. In this PhD a device is developed which can measure other aspects as well. This is an important step towards objectifying seat (dis-)comfort. And as there is some evidence that discomfort is more related to physical factors, it could be that we are getting closer to the objectification of discomfort.

## SAMENVATTING

De stoel is het belangrijkste contact tussen een mens en de auto. Het is belangrijk dat dit contact optimaal voelt ook op lange termijn om klantentevredenheid te bereiken. De investering in het interieur, bij de ontwikkeling van auto's, kan variëren van 20-30% van de totale investering, waarvan bijna 40% voor de rekening komt van stoelen. De huidige onderzoek zoals beschreven in de literatuur over stoeloptimalisatie gaat grotendeels over de eigenschappen van schuim in relatie tot comfort en ongemak. Deze PhD bestudeert de perceptie van (dis)comfort van een autostoel, maar gaat verder dan de schuimeigenschappen genoemd in de huidige literatuur. Andere stoelcomponenten zoals de stoelhoes, laminering en de stoelvering worden ook meegenomen de bestudering van het effect op comfort. Om het effect van de verschillende elementen te kunnen onderzoeken is een meetinstrument ontwikkeld, dat nieuwe elementen registreert zoals schuifkrachten, rek, wrijving en druk. Ook het verband tussen de geregistreerde parameters en de stoelelementen zijn geanalyseerd.

Daartoe is een instrument ontwikkeld. Dat is een soort stempel in de vorm van een halve bol. De halve bol is uitgerust met druk- en reksensoren. Dit maakt het mogelijk om druk en drukverdeling, rek- en schuifkrachten te meten. Met het instrument zijn 648 stoelen die verschillen in samenstelling getest en 98 proefpersonen gaven comfort scores en andere belevingen aan bij de verschillende stoelen. Deze testen hebben aangetoond dat het meetinstrument succesvol de verschillen in rek-, druk- en schuifkrachten meet.

De studies in deze PhD thesis tonen aan dat naast schuim ook de andere elementen een rol spelen bij de comfort beleving. Dit houdt in dat alleen het registreren van drukverdeling niet voldoende is en schuimeigenschappen op zichzelf niet de gehele comfortperceptie van een stoel bepalen. Bij een experiment waarbij de zijkant van de zitting en rugleuning zijn aan gepast ('bolsters' en 'wings'), bleek dat andere factoren dan schuimeigenschappen een rol spelen. Zo bleek bij dynamisch rijden dat bolvormige en zachte zijkantsteunen de voorkeur hadden.

In een andere studie beschreven in dit proefschrift, bleken twee hoezen (leer en stof) aanzienlijk verschillend te worden waargenomen door 38 proefpersonen. In het laatste experiment bleek dat 38 proefpersonen verschillen konden waarnemen in voorgevormde en normale lederen hoezen, met en zonder stoelvering en andere hoesmaterialen. Dit kwam overeen met wat het meetinstrument registreerde. Om een voorbeeld te noemen: de meetgegevens van het meetinstrument toonden aan dat de voorgespannen, lederen hoes het minst elastisch is en dit werd ook door de deelnemers als minst elastisch ervaren. En bij de Alcantara hoes was de schuifkracht het hoogst en dit werd ook door de deelnemers ook als stroef ervaren. De verwijdering van de vering maakte de drukparameters die door het meetinstrument werden vastgelegd harder en dit werd ook als harder ervaren door de deelnemers.

Het belangrijkste resultaat van het onderzoek in dit proefschrift is dat er zeker meer factoren dan hardheid van het schuim in de stoel. Dit is relevant voor de perceptie van het (dis)comfort van een stoel. En het kan worden gemeten met het instrument ontwikkeld in dit proefschrift. Dit is een belangrijke stap in het objectiveren van zitcomfort. En aangezien er enig bewijs is dat ongemak meer gerelateerd is aan fysieke factoren, kan het zijn dat we dichtbij komen bij objectivering van ongemak.



# ACKNOWLEDGEMENTS

During the last four years of my thesis I was accompanied by people who supported, motivated and inspired me in a wonderful way. All these people have had a part in this work and I am grateful for that. The cooperation between Delft University of Technology and the BMW Group has been very positive. I have received trust and support from both sides.

First of all I would like to thank my promoter Prof. dr. Peter Vink, you have not only supported me with your immense knowledge and advices, but also with your enthusiasm for the research and projects of all your PhD students. Thank you for standing behind me! Then, I would like to thank my promoter Prof. dr. Gerd Kortuem, who always had very good comments from other perspectives, which helped me to plan my research with foresight.

I would like to thank my daily supervisors Renato Martic and Dr. Matthias Franz, who both inspired and motivated me in their own way. Two completely different characters whose views complemented each other. Thank you Renato for your honest words, your honest opinions and your engagement. Thank you Matthias for scientific help and support.

Dear doctoral committee members, thank you very much for taking the time to read my thesis in depth and for traveling to Delft to be a member of my committee. I feel very honored to have such knowledgeable people around me.

I would also like to thank my BMW colleagues and my TU Delft colleagues. You have helped me in many situations in a practical, uncomplicated and fast way. Without you, I would not have been able to carry out my experiments and studies so quickly and well. In particular I would like to thank Mario Buljan, Vincent van der Voort, Shabila Anjani, Bertus Naagen and Erich Zerhoch.

Finally, I would like to thank my family. My wife Denize, who always had my back. My children, who always made it clear to me to see everything with a smile and my parents, who always believed in me. And of course God, who has given me strength in any situation.

I would like to dedicate this work to my grandfather Wladyslaw Danielewicz, who was really excited about my work, but unfortunately passed away a month before my PhD-defense. Rest in peace, dziadku!





**A**

**APPENDIX**

### A.1. TECHNICAL SPECIFICATION OF THE MEASUREMENT STAMP

The basic spherical stamp is out of polyethylen plastic. The stamp is equipped with different layers of dielectric elastomer sensors; five pressure sensors and four elongations sensors. The five pressure sensors are glued to the surface of the spherical body with dimensions of 20 mm x 20 mm and a height of 2.2 mm (see Figure A.1). In order to increase the pressure sensitivity, the capacitive elastomer pressure sensors have an internal nub structure shown in Figure A.2 (left side of Figure A.2).

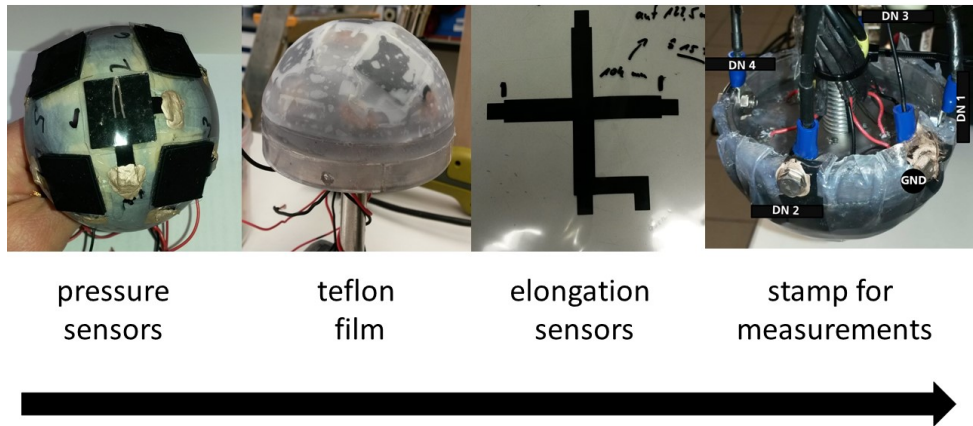

Figure A.1: Elements of the measurement tool.

The space on the stamp surface between the pressure sensors is filled with 1.8 mm high silicon. The pressure sensor / silicon-layer is coated with a teflon film (second picture in Figure A.1) and the teflon film is covered with a layer of graphite powder. On top of the graphite powder four elongation sensors are positioned. The elongation sensors have a length of 54 mm and a width in the unstretched state of 10 mm. When mounting these sensors on the spherical stamp a linear strain of about 15% is assumed. The individual layers of these dielectric elastomer elongation sensors, which also operate capacitively, were planarly aligned (right side of Figure A.2). The elongation sensors are embedded crosswise in an elastomer foil which is fixed to the edge of the stamp (third and fourth picture in Figure A.1). The sliding of the elongation sensors on the spherical stamp is determined by the friction of the graphite powder layer on the teflon coating. The selection of the "sliding materials" was made by empirical tests, whereby the most important selection criterion was the most complete possible resetting of the sensors after loading.

The electrical contacting of the pressure sensors is located inside of the basic spherical stamp. The electrical connection of the elongations sensors is located in the edge area of the stamp. The outer electrode layer of the elongations sensors is connected to the ground and serves as a shield against interference signals.

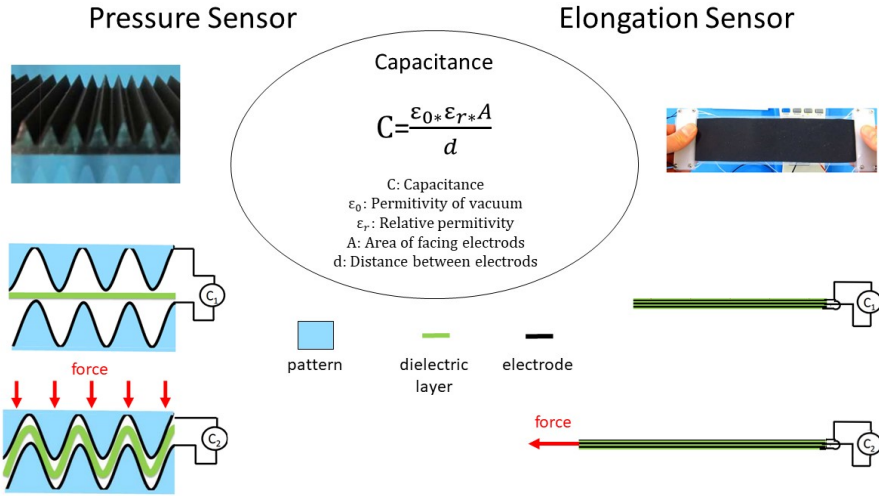

Figure A.2: Design overview of pressure and elongation sensors produced and developed by the Fraunhofer Institute (CeSMA) in Würzburg, Germany. Source: [http://files.messe.de/abstracts/62675\\_HMI2015WerkstoffForumDESBoese.pdf](http://files.messe.de/abstracts/62675_HMI2015WerkstoffForumDESBoese.pdf) (Date: 10.08.2020).

The adhesive S 7-2, 0.5 mmol DVS and the silicone Elastosil RT 625 (Wacker) were used. Table shows the specification of the silicon.

Table A.1: Specification of the silicon Elastosil RT 625 from Wacker. Source: <https://www.wacker.com/h/de/de/medias/ELASTOSIL-RT-625-AB-de-2020.07.01.pdf> (Date: 10.08.2020).

Property	Condition	Value	Method
<b>Linear Shrinkage</b>	-	<0.1%	-
<b>Elongation at break</b>	-	600 %	ISO 37
<b>Tensile strength</b>	-	6.5 $N/mm^2$	ISO 37
<b>Hardness Shore A</b>	-	25	ISO 868
<b>Density in water</b>	23°C	1.1 $g/mm^2$	ISO 2781
<b>Color</b>	-	translucent	-
<b>Tear strength</b>	-	30 $N/mm$	ASTM D 624 B

## A.2. QUESTIONNAIRES

### A.2.1. QUESTIONNAIRE OF CHAPTER 3

Participant number \_\_\_\_\_

*Please fill in:*

Age \_\_\_\_\_

Gender  Male  Female

Weight \_\_\_\_\_ kg

Length \_\_\_\_\_ cm

Waist circumference \_\_\_\_\_ cm

Hip circumference \_\_\_\_\_ cm

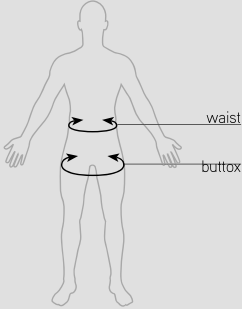

The diagram shows a human silhouette with two horizontal arrows indicating measurement points. The upper arrow is labeled 'waist' and the lower arrow is labeled 'buttox'.

---

*Fill in after all seats are graded*

In the static situation, the best seat was number:

In the static situation, the worst seat was number:

In the dynamic situation, the best seat was number:

In the dynamic situation, the worst seat was number:

Seat number \_\_\_\_\_

**Static test**

**Q1: Characterizing the seat**

How would you describe the qualities (softness, shape, height) of the seat - *pick one*

- |                                     |                                    |                                     |
|-------------------------------------|------------------------------------|-------------------------------------|
| <input type="checkbox"/> sportive   | <input type="checkbox"/> relaxing  | <input type="checkbox"/> protective |
| <input type="checkbox"/> energizing | <input type="checkbox"/> luxurious | <input type="checkbox"/> tough      |

**Q2: Body map**

In the body map, do you feel any points of discomfort and how would you grade them? - *write a grade 1-7 at the location of noticeable discomfort (more than 1 location possible)*

	almost right	just not right	irritating	annoying	very annoying	really annoying	pain
A	1	2	3	4	5	6	7
B	1	2	3	4	5	6	7
C	1	2	3	4	5	6	7
D	1	2	3	4	5	6	7
E	1	2	3	4	5	6	7
F	1	2	3	4	5	6	7
G	1	2	3	4	5	6	7
H	1	2	3	4	5	6	7
I	1	2	3	4	5	6	7

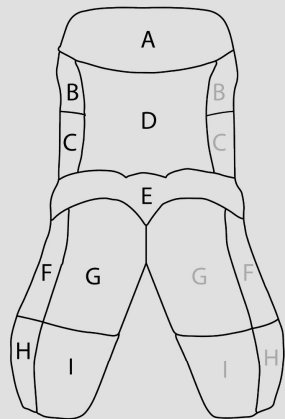

**Q3: Overall comfort score**

How would you grade the overall comfort of the seat - *pick one*

- 1: okay
- 2: moderate
- 3: feels right
- 4: pleasant
- 5: very pleasant
- 6: almost perfect
- 7: perfect

## Dynamic test

### Q4: Body map

In the body map, do you feel any points of discomfort and how would you grade them? - write a grade 1-7 at the location of noticeable discomfort (**more than 1 location possible**)

	almost right	just not right	irritating	annoying	very annoying	really annoying	pain
A	1	2	3	4	5	6	7
B	1	2	3	4	5	6	7
C	1	2	3	4	5	6	7
D	1	2	3	4	5	6	7
E	1	2	3	4	5	6	7
F	1	2	3	4	5	6	7
G	1	2	3	4	5	6	7
H	1	2	3	4	5	6	7
I	1	2	3	4	5	6	7

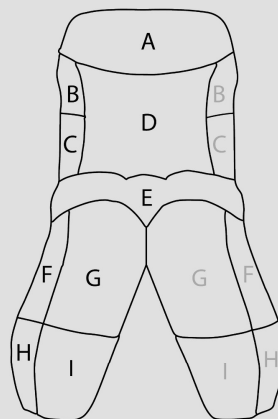

### Q5: Overall support score

During cornering, how would you grade the support of the seat - **pick one**

- 1: okay
- 2: moderate
- 3: feels right
- 4: pleasant
- 5: very pleasant
- 6: almost perfect
- 7: perfect

### Comments

**A.2.2. QUESTIONNAIRE OF CHAPTER 4**

Questionnaire

**1. Participant data:**

Name: \_\_\_\_\_

Number of the Participant: \_\_\_\_\_

a. Body parameter:

Gender: \_\_\_\_\_

Weight: \_\_\_\_\_

Height (a): \_\_\_\_\_

Shoulder height (b): \_\_\_\_\_

Thigh length (c): \_\_\_\_\_

Lower leg length (d): \_\_\_\_\_

Shoulder width (e): \_\_\_\_\_

Waist size (f): \_\_\_\_\_

Hip size (g): \_\_\_\_\_

b. Clothes

Trousers: \_\_\_\_\_

Top: \_\_\_\_\_

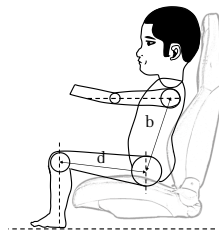
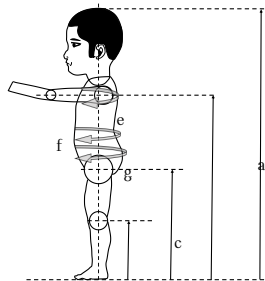

Seat one: \_\_\_\_\_

Seat two: \_\_\_\_\_

**2. Test 1 (Position 1):**

Dear participant, for the experiment it is necessary to sit blind into the experiment seats. You will get dimmed glasses. An experiment attendant will help you during the test to sit down in the right way. Execute the experiment barefoot, please. It is very important not to touch the seat with your hand. Sit into seat **one (for 2 min)**. If you have any discomfort complains remark the discomfort in table 1. Sit in seat **two (for 2 min)** and evaluate the discomfort in table 2, please.

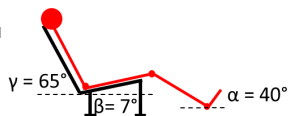

**Seat 1 (table 1):**

	0	1	2	3	4	5	6
A							
B							
C							
D <sub>1</sub>							
D <sub>2</sub>							
E <sub>1</sub>							
E <sub>2</sub>							
F <sub>1</sub>							
F <sub>2</sub>							
G <sub>1</sub>							
G <sub>2</sub>							
H <sub>1</sub>							
H <sub>2</sub>							
I <sub>1</sub>							
I <sub>2</sub>							

**Seat 2 (table 2):**

	0	1	2	3	4	5	6
A							
B							
C							
D <sub>1</sub>							
D <sub>2</sub>							
E <sub>1</sub>							
E <sub>2</sub>							
F <sub>1</sub>							
F <sub>2</sub>							
G <sub>1</sub>							
G <sub>2</sub>							
H <sub>1</sub>							
H <sub>2</sub>							
I <sub>1</sub>							
I <sub>2</sub>							

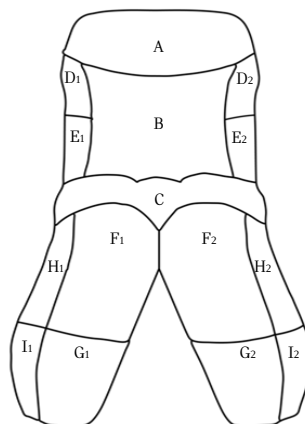



**3. Test 2 (Position 1)**

The seat is adjusted in the construction position. Your task is to compare seat **one** and **two**. Sit into the seats with the help of the experiment attendant. Move your upper body (backrest) and the buttock as well as your thigh in the seat pan to get an impression of the seat, but do not touch the seat with your handy, please. Before you assess the seats read all opposed relations. After, sit first in seat **one** and then in seat **two**. For each relation you can switch the seats. Assess the listed relations for the seat pan and backrest separate for both seats. (all together 8 switch, 1 min per switch).

Asses the Seat 1 and Seat 2 for the following relations:

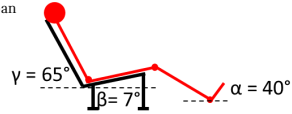

**Seat Pan:**

		neutral								
No.			-3	-2	-1	0	1	2	3	
1	Seat 1	soft	<input type="radio"/>	<input type="radio"/>	<input type="radio"/>	<input type="radio"/>	<input type="radio"/>	<input type="radio"/>	<input type="radio"/>	hard
	Seat 2		<input type="radio"/>	<input type="radio"/>	<input type="radio"/>	<input type="radio"/>	<input type="radio"/>	<input type="radio"/>	<input type="radio"/>	
2	Seat 1	stiff	<input type="radio"/>	<input type="radio"/>	<input type="radio"/>	<input type="radio"/>	<input type="radio"/>	<input type="radio"/>	<input type="radio"/>	elastic
	Seat 2		<input type="radio"/>	<input type="radio"/>	<input type="radio"/>	<input type="radio"/>	<input type="radio"/>	<input type="radio"/>	<input type="radio"/>	
3	Seat 1	loose	<input type="radio"/>	<input type="radio"/>	<input type="radio"/>	<input type="radio"/>	<input type="radio"/>	<input type="radio"/>	<input type="radio"/>	firm
	Seat 2		<input type="radio"/>	<input type="radio"/>	<input type="radio"/>	<input type="radio"/>	<input type="radio"/>	<input type="radio"/>	<input type="radio"/>	
4	Seat 1	supporting	<input type="radio"/>	<input type="radio"/>	<input type="radio"/>	<input type="radio"/>	<input type="radio"/>	<input type="radio"/>	<input type="radio"/>	unstable
	Seat 2		<input type="radio"/>	<input type="radio"/>	<input type="radio"/>	<input type="radio"/>	<input type="radio"/>	<input type="radio"/>	<input type="radio"/>	
5	Seat 1	sportive	<input type="radio"/>	<input type="radio"/>	<input type="radio"/>	<input type="radio"/>	<input type="radio"/>	<input type="radio"/>	<input type="radio"/>	lame
	Seat 2		<input type="radio"/>	<input type="radio"/>	<input type="radio"/>	<input type="radio"/>	<input type="radio"/>	<input type="radio"/>	<input type="radio"/>	
6	Seat 1	close	<input type="radio"/>	<input type="radio"/>	<input type="radio"/>	<input type="radio"/>	<input type="radio"/>	<input type="radio"/>	<input type="radio"/>	wide
	Seat 2		<input type="radio"/>	<input type="radio"/>	<input type="radio"/>	<input type="radio"/>	<input type="radio"/>	<input type="radio"/>	<input type="radio"/>	
7	Seat 1	formative	<input type="radio"/>	<input type="radio"/>	<input type="radio"/>	<input type="radio"/>	<input type="radio"/>	<input type="radio"/>	<input type="radio"/>	loose
	Seat 2		<input type="radio"/>	<input type="radio"/>	<input type="radio"/>	<input type="radio"/>	<input type="radio"/>	<input type="radio"/>	<input type="radio"/>	
8	Seat 1	slippery	<input type="radio"/>	<input type="radio"/>	<input type="radio"/>	<input type="radio"/>	<input type="radio"/>	<input type="radio"/>	<input type="radio"/>	coarse
	Seat 2		<input type="radio"/>	<input type="radio"/>	<input type="radio"/>	<input type="radio"/>	<input type="radio"/>	<input type="radio"/>	<input type="radio"/>	

A

Backrest:

No.			neutral							
			-3	-2	-1	0	1	2	3	
1	Seat 1	soft	<input type="radio"/>	<input type="radio"/>	<input type="radio"/>	<input type="radio"/>	<input type="radio"/>	<input type="radio"/>	<input type="radio"/>	hard
	Seat 2		<input type="radio"/>	<input type="radio"/>	<input type="radio"/>	<input type="radio"/>	<input type="radio"/>	<input type="radio"/>	<input type="radio"/>	
2	Seat 1	stiff	<input type="radio"/>	<input type="radio"/>	<input type="radio"/>	<input type="radio"/>	<input type="radio"/>	<input type="radio"/>	<input type="radio"/>	elastic
	Seat 2		<input type="radio"/>	<input type="radio"/>	<input type="radio"/>	<input type="radio"/>	<input type="radio"/>	<input type="radio"/>	<input type="radio"/>	
3	Seat 1	loose	<input type="radio"/>	<input type="radio"/>	<input type="radio"/>	<input type="radio"/>	<input type="radio"/>	<input type="radio"/>	<input type="radio"/>	firm
	Seat 2		<input type="radio"/>	<input type="radio"/>	<input type="radio"/>	<input type="radio"/>	<input type="radio"/>	<input type="radio"/>	<input type="radio"/>	
4	Seat 1	supporting	<input type="radio"/>	<input type="radio"/>	<input type="radio"/>	<input type="radio"/>	<input type="radio"/>	<input type="radio"/>	<input type="radio"/>	unstable
	Seat 2		<input type="radio"/>	<input type="radio"/>	<input type="radio"/>	<input type="radio"/>	<input type="radio"/>	<input type="radio"/>	<input type="radio"/>	
5	Seat 1	sportive	<input type="radio"/>	<input type="radio"/>	<input type="radio"/>	<input type="radio"/>	<input type="radio"/>	<input type="radio"/>	<input type="radio"/>	lame
	Seat 2		<input type="radio"/>	<input type="radio"/>	<input type="radio"/>	<input type="radio"/>	<input type="radio"/>	<input type="radio"/>	<input type="radio"/>	
6	Seat 1	close	<input type="radio"/>	<input type="radio"/>	<input type="radio"/>	<input type="radio"/>	<input type="radio"/>	<input type="radio"/>	<input type="radio"/>	wide
	Seat 2		<input type="radio"/>	<input type="radio"/>	<input type="radio"/>	<input type="radio"/>	<input type="radio"/>	<input type="radio"/>	<input type="radio"/>	
7	Seat 1	formative	<input type="radio"/>	<input type="radio"/>	<input type="radio"/>	<input type="radio"/>	<input type="radio"/>	<input type="radio"/>	<input type="radio"/>	loose
	Seat 2		<input type="radio"/>	<input type="radio"/>	<input type="radio"/>	<input type="radio"/>	<input type="radio"/>	<input type="radio"/>	<input type="radio"/>	
8	Seat 1	slick	<input type="radio"/>	<input type="radio"/>	<input type="radio"/>	<input type="radio"/>	<input type="radio"/>	<input type="radio"/>	<input type="radio"/>	coarse
	Seat 2		<input type="radio"/>	<input type="radio"/>	<input type="radio"/>	<input type="radio"/>	<input type="radio"/>	<input type="radio"/>	<input type="radio"/>	

**4. Test 3 (Position 2)**

The backrest is adjusted to an upright position, the seat pan stays in the construction position. Your task is to compare seat **one** and **two**. Sit into the seats with the help of the experiment attendant. Move your upper body in the backrest and the buttock as well as your thigh in the seat pan to get an impression of the seat, but do not touch the seat with your hand, please. Before you assess the seats read all characterizations. After, sit first in seat **one** and then in seat **two**. Assess the listed characterizations for the seat pan and backrest separate for both seats. (six switches, 6min)

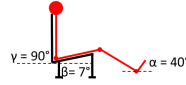

**Seat Pan:**

neutral

No.			-3	-2	-1	0	1	2	3	
1	Pressure on the body/skin	Seat 1	<input type="radio"/>	<input type="radio"/>	<input type="radio"/>	<input type="radio"/>	<input type="radio"/>	<input type="radio"/>	<input type="radio"/>	Seat 2
2	Stretch of the skin	Seat 1	<input type="radio"/>	<input type="radio"/>	<input type="radio"/>	<input type="radio"/>	<input type="radio"/>	<input type="radio"/>	<input type="radio"/>	Seat 2
3	Deformation of the tissue	Seat 1	<input type="radio"/>	<input type="radio"/>	<input type="radio"/>	<input type="radio"/>	<input type="radio"/>	<input type="radio"/>	<input type="radio"/>	Seat 2
4	Sliding feeling	Seat 1	<input type="radio"/>	<input type="radio"/>	<input type="radio"/>	<input type="radio"/>	<input type="radio"/>	<input type="radio"/>	<input type="radio"/>	Seat 2
5	Protected	Seat 1	<input type="radio"/>	<input type="radio"/>	<input type="radio"/>	<input type="radio"/>	<input type="radio"/>	<input type="radio"/>	<input type="radio"/>	Seat 2
6	Relaxed	Seat 1	<input type="radio"/>	<input type="radio"/>	<input type="radio"/>	<input type="radio"/>	<input type="radio"/>	<input type="radio"/>	<input type="radio"/>	Seat 2

**Backrest:**

neutral

No.			-3	-2	-1	0	1	2	3	
1	Pressure on the body/skin	Seat 1	<input type="radio"/>	<input type="radio"/>	<input type="radio"/>	<input type="radio"/>	<input type="radio"/>	<input type="radio"/>	<input type="radio"/>	Seat 2
2	Stretch of the skin	Seat 1	<input type="radio"/>	<input type="radio"/>	<input type="radio"/>	<input type="radio"/>	<input type="radio"/>	<input type="radio"/>	<input type="radio"/>	Seat 2
3	Deformation of the tissue	Seat 1	<input type="radio"/>	<input type="radio"/>	<input type="radio"/>	<input type="radio"/>	<input type="radio"/>	<input type="radio"/>	<input type="radio"/>	Seat 2
4	Sliding feeling	Seat 1	<input type="radio"/>	<input type="radio"/>	<input type="radio"/>	<input type="radio"/>	<input type="radio"/>	<input type="radio"/>	<input type="radio"/>	Seat 2
5	Protected	Seat 1	<input type="radio"/>	<input type="radio"/>	<input type="radio"/>	<input type="radio"/>	<input type="radio"/>	<input type="radio"/>	<input type="radio"/>	Seat 2
6	Relaxed	Seat 1	<input type="radio"/>	<input type="radio"/>	<input type="radio"/>	<input type="radio"/>	<input type="radio"/>	<input type="radio"/>	<input type="radio"/>	Seat 2

**5. Test 4 (Position 2-3) → (Focus on changes in shear and pressure)**

The backrest is adjusted to an upright position, the seat pan stays in the construction position. Pay attention if you feel any differences in your buttock or back, while lifting the feet until they are in a line with the thigh. Please do not touch the seat with your hand, please. Before you assess the seats read all questions. After, sit in the first seat and lift the feet, concentrate on the changes you feel. Answer each question (for seat one) for the seat pan and the backrest separate, please. For every characterization you can lift your feet one time. Then, sit in the second seat and use the same method.

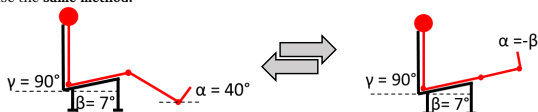

**Seat Pan:**

		Back of the seat pan							Front of the seat pan						
No.		-3	-2	-1	0	1	2	3	-3	-2	-1	0	1	2	3
1	Seat 1	Pressure on the body/skin													
	Seat 2														
2	Seat 1	Stretch of the skin													
	Seat 2														
3	Seat 1	Deformation of the tissue													
	Seat 2														
4	Seat 1	Sliding feeling													
	Seat 2														

less ← neutral → higher      less ← neutral → higher

**Backrest:**

		Lower part of the backrest							Upper part of the backrest						
No.		-3	-2	-1	0	1	2	3	-3	-2	-1	0	1	2	3
1	Seat 1	Pressure on the body/skin													
	Seat 2														
2	Seat 1	Stretch of the skin													
	Seat 2														
3	Seat 1	Deformation of the tissue													
	Seat 2														
4	Seat 1	Sliding feeling													
	Seat 2														

less ← neutral → higher      less ← neutral → higher

**6. Test 5 (Position 4)**

The backrest is adjusted to a lying position the seat pan is in a horizontal position. Your task is to compare seat **one** and **two**. Sit into the seats with the help of the experiment attendant. Move your upper body in the backrest and the buttock as well as your thigh in the seat pan to get an impression of the seat, but do not touch the seat with your hand, please. Before you assess the seats read all characterizations. After, sit first in seat **one** and then in seat **two**. Assess the listed of the characterizations for the seat pan and backrest separate for both seats. (six switches, 6min)

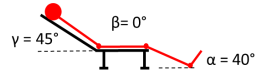

**Seat Pan:**

		neutral								
No.			-3	-2	-1	0	1	2	3	
1	Pressure on the body/skin	Seat 1	<input type="radio"/>	<input type="radio"/>	<input type="radio"/>	<input type="radio"/>	<input type="radio"/>	<input type="radio"/>	<input type="radio"/>	Seat 2
2	Stretch of the skin	Seat 1	<input type="radio"/>	<input type="radio"/>	<input type="radio"/>	<input type="radio"/>	<input type="radio"/>	<input type="radio"/>	<input type="radio"/>	Seat 2
3	Deformation of the tissue	Seat 1	<input type="radio"/>	<input type="radio"/>	<input type="radio"/>	<input type="radio"/>	<input type="radio"/>	<input type="radio"/>	<input type="radio"/>	Seat 2
4	Sliding feeling	Seat 1	<input type="radio"/>	<input type="radio"/>	<input type="radio"/>	<input type="radio"/>	<input type="radio"/>	<input type="radio"/>	<input type="radio"/>	Seat 2
5	Protected	Seat 1	<input type="radio"/>	<input type="radio"/>	<input type="radio"/>	<input type="radio"/>	<input type="radio"/>	<input type="radio"/>	<input type="radio"/>	Seat 2
6	Relaxed	Seat 1	<input type="radio"/>	<input type="radio"/>	<input type="radio"/>	<input type="radio"/>	<input type="radio"/>	<input type="radio"/>	<input type="radio"/>	Seat 2

**Backrest:**

		neutral								
No.			-3	-2	-1	0	1	2	3	
1	Pressure on the body/skin	Seat 1	<input type="radio"/>	<input type="radio"/>	<input type="radio"/>	<input type="radio"/>	<input type="radio"/>	<input type="radio"/>	<input type="radio"/>	Seat 2
2	Stretch of the skin	Seat 1	<input type="radio"/>	<input type="radio"/>	<input type="radio"/>	<input type="radio"/>	<input type="radio"/>	<input type="radio"/>	<input type="radio"/>	Seat 2
3	Deformation of the tissue	Seat 1	<input type="radio"/>	<input type="radio"/>	<input type="radio"/>	<input type="radio"/>	<input type="radio"/>	<input type="radio"/>	<input type="radio"/>	Seat 2
4	Sliding feeling	Seat 1	<input type="radio"/>	<input type="radio"/>	<input type="radio"/>	<input type="radio"/>	<input type="radio"/>	<input type="radio"/>	<input type="radio"/>	Seat 2
5	Protected	Seat 1	<input type="radio"/>	<input type="radio"/>	<input type="radio"/>	<input type="radio"/>	<input type="radio"/>	<input type="radio"/>	<input type="radio"/>	Seat 2
6	Relaxed	Seat 1	<input type="radio"/>	<input type="radio"/>	<input type="radio"/>	<input type="radio"/>	<input type="radio"/>	<input type="radio"/>	<input type="radio"/>	Seat 2

**7. Test 6 (Position 4-5)**

The backrest is adjusted to a lying position the seat pan is a horizontal position. Pay attention if you feel any differences in your buttock or back, while moving your feet forward and backward. Please do not touch the seat with your hand, please. Before you assess the seats read all questions. After, sit in the **first seat** and move the feet backward, **concentrate on the changes you feel**. Answer **each question (for seat one)** for the seat pan and the backrest separate, please. For every characterization you can move your feet one time. Then, sit in the **second seat** and use the **same method**.

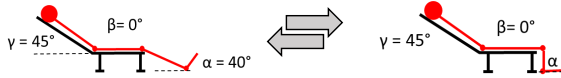

**Seat Pan:**

		Back of the seat pan							Front of the seat pan						
No.		-3	-2	-1	0	1	2	3	-3	-2	-1	0	1	2	3
1	Seat 1	Pressure on the body/skin													
	Seat 2														
2	Seat 1	Stretch of the skin													
	Seat 2														
3	Seat 1	Deformation of the tissue													
	Seat 2														
4	Seat 1	Sliding feeling													
	Seat 2														

less ← neutral → higher      less ← neutral → higher

**Backrest:**

		Lower part of the backrest							Upper part of the backrest						
No.		-3	-2	-1	0	1	2	3	-3	-2	-1	0	1	2	3
1	Seat 1	Pressure on the body/skin													
	Seat 2														
2	Seat 1	Stretch of the skin													
	Seat 2														
3	Seat 1	Deformation of the tissue													
	Seat 2														
4	Seat 1	Sliding feeling													
	Seat 2														

less ← neutral → higher      less ← neutral → higher

**8. Test 7 General Comparison**

1. How would you characterize seat 1?

- restricted
- cosy
- sporty
- protected
- relaxed

2. How would you characterize seat 2?

- restricted
- cosy
- sporty
- protected
- relaxed

3. How would you evaluate difference in the bolster contour of both seats?

- Same (in seat pan)
- different(in seat pan)
- Same (in backrest)
- different(in backrest)

4. If you could choose one seat for your car, which one would you take?

- Seat 1, why
- Seat 2, why

5. Pressure measurements

### A.2.3. QUESTIONNAIRE OF CHAPTER 7

**BMW  
GROUP**



#### **OBJECTIFICATION FUNCTION AND COMFORT. Questionnaires for Experimental Study**

This document contains all relevant questionnaires for conducting the study. It also serves as a script with a written story line. The Questionnaire is not to be read and filled out by the participant but to be read out loud by the conductor. Thus it is held in a spoken more colloquial language. All answers to questions of the questionnaires Part 1 through 3 and further possible information are to be filled in the scales and blank spots by the conductor. Questionnaire Part A is to be filled out by the participant directly before or after the 3D-scan measurement.

There are three different questionnaires for use in the Experimental Study at TU Delft. Each questionnaire belongs to a specific part of the study program.

- Questionnaire Part A: Participant
- Questionnaire Part 1: Characterization
- Questionnaire Part 2: Secondary Activity Sleeping
- Questionnaire Part 3a: Secondary Activity Working
- Questionnaire Part 3b: Secondary Activity Reading

Questionnaire Part A will be filled out by the participant after the 3D-Scan. The questions on Questionnaire Part 1 through 3b will be read out loud to the participants and filled out by the study conductor.





## Introduction

- Thank you for your participation.
- This study takes approx. 75min.
- Included are 3 short breaks of about 5min each.
- In total we are conducting the study here at TU Delft for two weeks with 40 participants; and you are one of them.
  
- We chose you for our study because your body height together with all other participants' body height represents very well the distribution of all people living in Europe.
  
- Before talking about the study itself I want to tell you a little bit more about the research question:

*The study deals with car seat concepts for the future of automatically driving cars. We want to gather more information and influencing factors on the comfort you perceive while sitting inside the car. We want to simulate 3 different non driving activities within this study.*

- The exact procedure we will explain to you right before every event.
- All I want to anticipate here is that during the first third of the study we're asking you to wear a sleeping mask. Don't worry, my colleague and me are taking care that you don't hit any obstacles.
  
- Before starting into the actual study we need to capture your exact measures especially your stature height.
- To save our time we are using a 3D-scanner to measure your body. It's much quicker than I could measure you and probably also more convenient for you.
- The 3D-scanner doesn't work with x-rays, it basically takes hundreds of pictures from all different kinds of angles.
- So no worries, the 3D-scanner doesn't work like the body scanner that you probably know from airport security checks, it's literally just a 360° camera.
  
- The data we're capturing is 100% anonymous and there won't be any connection possible to make between the data and your person.
- The data from the 3D-scanner, such as your stature height or length of your arms and legs, will be used only to connect it with your perceived comfort.
- It will allow us to draw conclusions about body measures and the answers given during the study procedure.
  
- Before we go on, do you have any questions regarding the use of the data or the study in total?

*[question and answering]*

- If you don't have any further questions regarding the data I want to ask you to sign this consent form. You find all the information about the study that I just discussed with you in the consent form. Feel free to skim through the text. If you agree to it please sign the form at the bottom.

*[signing consent form]*

- Wonderful, now we can start letting the 3D-scanner measure you...



**BMW  
GROUP**

**To be filled out by participant**



**Questionnaire Part A: Participant**

Please fill out the questionnaire about your person.

Participant's No.: \_\_\_\_\_

Gender:                    male                     female                     neutral

Age: \_\_\_\_\_

Weight: \_\_\_\_\_

Stature height [cm]: \_\_\_\_\_

Measurements [cm]    Upper leg: \_\_\_\_\_                    Lower leg: \_\_\_\_\_

Ethnicity (PoB): \_\_\_\_\_

Clothes (upper body): \_\_\_\_\_

Clothes (lower body): \_\_\_\_\_

Body complaints: \_\_\_\_\_

\_\_\_\_\_



### **Questionnaire Part 1: Characterization**

- We will start into the study with your first impression of the 4 different seats
- we will let you sit in all 4 of them
- there will be three runs
- In the first run we want you to tell us where you feel discomfort resp. uncomfortable
- In the second run we will also ask you 4 short questions about each seat
- And in the last run a pressure matt will help us understanding where exactly you experience high or low pressure in every seat.
- Lets start...
- Since we want you to tell us your thoughts you're having through the a haptical experience only, I want you to wear this sleeping mask
- I will guide you to the seat
- Be careful not to touch the seats.

So let's start with the pressure mat.

Participant's No.: \_\_\_\_\_

Order: \_\_\_\_\_

**2. Body Map**

- Please sit down in the first seat.
- Do you experience any discomfort? If so, please tell me where and describe the discomfort on a scale from 0 to 6 of which 0 stand for no discomfort at all, 1 for very light discomfort and 6 for very heavy discomfort. Continue with Seat 2 to 4.

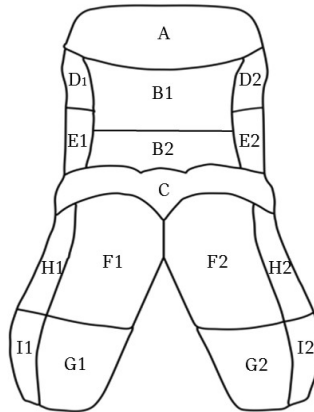

Pos.	Description (English)	Description (German)	Discomfort level 0-6			
			1	2	3	4
A	Shoulder	<i>Schulter</i>				
B1	Back	<i>Rücken</i>				
B2	Lordosis	<i>Lordose</i>				
C	Hip and Tailbone	<i>Hüftregion und Steißbein</i>				
D1	Upper Loin left	<i>Oberer Lendenbereich links</i>				
D2	Upper Loin right	<i>Oberer Lendenbereich rechts</i>				
E1	Lower Loin left	<i>Unterer Lendenbereich links</i>				
E2	Lower Loin right	<i>Unterer Lendenbereich rechts</i>				
F1	Gluteus and thigh left	<i>Gluteus und Oberschenkel links</i>				
F2	Gluteus and thigh right	<i>Gluteus und Oberschenkel rechts</i>				
G1	Knee pit left	<i>Kniekehle links</i>				
G2	Knee pit right	<i>Kniekehle rechts</i>				
H1	Upper Thigh outside left	<i>Oberschenkel außen links</i>				
H2	Upper Thigh outside right	<i>Oberschenkel außen rechts</i>				
I1	Outer Knee pit left	<i>Kniekehle außen links</i>				
I2	Outer Knee pit right	<i>Kniekehle außen rechts</i>				

- Going to the rest area and taking off the sleeping mask



**2. Participant's rating by pairs of words**

Order: \_\_\_\_\_

- Now, please again take place in the first seat
- How would you rate the current seat cushion/back rest in terms of [word pair right] on a scale from 1 to 7 of which 1 stands for very [word pair left] and 7 for very [word pair right]?

1	2	3	4	5	6	7
---	---	---	---	---	---	---

Seat cushion							
SEAT 1	Soft						Hard
SEAT 2							
SEAT 3							
SEAT 4							
SEAT 1	Elastic						Stiff
SEAT 2							
SEAT 3							
SEAT 4							
SEAT 1	Slippery						Abrasive
SEAT 2							
SEAT 3							
SEAT 4							
SEAT 1	Unstable (wide)						Supporting (close)
SEAT 2							
SEAT 3							
SEAT 4							
Back rest							
SEAT 1	Soft						Hard
SEAT 2							
SEAT 3							
SEAT 4							
SEAT 1	Elastic						Stiff
SEAT 2							
SEAT 3							
SEAT 4							
SEAT 1	Slippery						Abrasive
SEAT 2							
SEAT 3							
SEAT 4							
SEAT 1	Unstable (wide)						Supporting (close)
SEAT 2							
SEAT 3							
SEAT 4							

**Elastic / stiff** = stretch ability of surface, does the surface yield under pressure?

**Slippery / abrasive** = is the surface difficult to hold on? Does the surface stop from sliding?

**Participant's ranking seats**

Which of the 4 seats fits you best?

Please rank each seat from best to worst!

Seat	1	2	3	4
Rank				
Comments				

**3. Pressure mat**

- After this run we'll take a short break before we start with the study part secondary activities. You can take the sleeping mask off during break time. There are drinks and some candy on the table, just help yourself.
- On the seat we put a pressure mat.
- We use the map for recording areas of pressure
- Please sit down in the first seat again.



### Questionnaire Part 2: Secondary Activity Sleeping

Participant's No.: \_\_\_\_\_

Scenario: \_\_\_\_\_ / 9

Order: \_\_\_\_\_

- Now after we made you familiar with the seats we will start with the first secondary activity: sleeping.
- A secondary activity is an activity you can do while the car drives automatically without any intervention. Meaning anything but actively taking control of your car. You can basically think of anything you'd like to do besides driving but in this study we want you to focus on the activities sleeping, working and reading a book. We want to find out, which seat setups and configurations you like the most. We have 3 different seat configurations resp. backrest angles for you to sleep in.
- Just like before we'll ask you 3 short questions in the same manner as before.
- Furthermore though, we want you to rank the seats from best to worst after you've sat in each one of them for this particular configuration.
- Since people usually sleep in the dark and we want you to put the sleeping mask back on for this activity. For the activities afterwards, you can take the sleep mask off.

#### Participant's rating

How would you rate the current seat cushion/back rest in terms of **hardness** on a scale from 1 to 7 of which 1 stands for very **soft** and 7 for very **hard**?

*Pressure is the force applied perpendicular to the surface of an object per unit area over which that force is distributed. Meaning if you press your hands against one another you'll feel pressure on the skin of both of them.*

PRESSURE		1	2	3	4	5	6	7
<b>Seat cushion</b>								
SEAT 1	Soft							
SEAT 2								
SEAT 3								
SEAT 4								
								Hard
<b>Back rest</b>								
SEAT 1	Soft							
SEAT 2								
SEAT 3								
SEAT 4								
								Hard



How would you rate the current seat cushion/back rest in terms of **stiffness** on a scale from 1 to 7 of which 1 stands for very **elastic** and 7 for very **stiff**?

**SHEAR FORCE**      1   2   3   4   5   6   7

Seat cushion										
SEAT 1	Elastic									Stiff (inelastic)
SEAT 2										
SEAT 3										
SEAT 4										
Back rest										
SEAT 1	Elastic									Stiff (inelastic)
SEAT 2										
SEAT 3										
SEAT 4										

How would you rate the current seat cushion/back rest in terms of **the surface' roughness** on a scale from 1 to 7 of which 1 stands for very **slippery** and 7 for very **abrasive**?

*Surface in case of our study targets is the cover material of the seats.*

**SURFACE**      1   2   3   4   5   6   7

Seat cushion										
SEAT 1	Slippery									Abrasive
SEAT 2										
SEAT 3										
SEAT 4										
Back rest										
SEAT 1	Slippery									Abrasive
SEAT 2										
SEAT 3										
SEAT 4										

A

2

**BMW  
GROUP****Participant's ranking seats**

Which of the 4 seats fits you best while sleeping?  
Please rank each seat from best to worst!

Seat	1	2	3	4
Rank				

Comments
----------

2

**BMW GROUP**



A

Participant's No.: \_\_\_\_\_

Scenario: \_\_\_\_\_ / 9

Order: \_\_\_\_\_

**Participant's rating**

How would you rate the current seat cushion/back rest in terms of **hardness** on a scale from 1 to 7 of which 1 stands for very **soft** and 7 for very **hard**?

*Pressure is the force applied perpendicular to the surface of an object per unit area over which that force is distributed. Meaning if you press your hands against one another you'll feel pressure on the skin of both of them.*

<b>PRESSURE</b>		1	2	3	4	5	6	7
<b>Seat cushion</b>								
SEAT 1	Soft							
SEAT 2								
SEAT 3								
SEAT 4								
								Hard
<b>Back rest</b>								
SEAT 1	Soft							
SEAT 2								
SEAT 3								
SEAT 4								
								Hard

How would you rate the current seat cushion/back rest in terms of **stiffness** on a scale from 1 to 7 of which 1 stands for very **elastic** and 7 for very **stiff**?

<b>SHEAR FORCE</b>		1	2	3	4	5	6	7
<b>Seat cushion</b>								
SEAT 1	Elastic							
SEAT 2								
SEAT 3								
SEAT 4								
								Stiff (inelastic)
<b>Back rest</b>								
SEAT 1	Elastic							
SEAT 2								
SEAT 3								
SEAT 4								
								Stiff (inelastic)

A

How would you rate the current seat cushion/back rest in terms of **the surface' roughness** on a scale from 1 to 7 of which 1 stands for very **slippery** and 7 for very **abrasive**?

*Surface in case of our study targets is the cover material of the seats.*

SURFACE		1	2	3	4	5	6	7	
<b>Seat cushion</b>									
SEAT 1	Slippery								
SEAT 2									
SEAT 3									
SEAT 4									
		Abrasive							
<b>Back rest</b>									
SEAT 1	Slippery								
SEAT 2									
SEAT 3									
SEAT 4									
		Abrasive							

**Participant's ranking seats**

Which of the 4 seats fits you best while sleeping?  
Please rank each seat from best to worst!

Seat	1	2	3	4
Rank				
Comments				

2



A

Participant's No.: \_\_\_\_\_

Scenario: \_\_\_\_\_ / 9

Order: \_\_\_\_\_

**Participant's rating**

How would you rate the current seat cushion/back rest in terms of **hardness** on a scale from 1 to 7 of which 1 stands for very **soft** and 7 for very **hard**?

*Pressure is the force applied perpendicular to the surface of an object per unit area over which that force is distributed. Meaning if you press your hands against one another you'll feel pressure on the skin of both of them.*

PRESSURE		1	2	3	4	5	6	7
<b>Seat cushion</b>								
SEAT 1	Soft							
SEAT 2								
SEAT 3								
SEAT 4								
		Hard						
<b>Back rest</b>								
SEAT 1	Soft							
SEAT 2								
SEAT 3								
SEAT 4								
		Hard						

How would you rate the current seat cushion/back rest in terms of **stiffness** on a scale from 1 to 7 of which 1 stands for very **elastic** and 7 for very **stiff**?

SHEAR FORCE		1	2	3	4	5	6	7
<b>Seat cushion</b>								
SEAT 1	Elastic							
SEAT 2								
SEAT 3								
SEAT 4								
		Stiff (inelastic)						
<b>Back rest</b>								
SEAT 1	Elastic							
SEAT 2								
SEAT 3								
SEAT 4								
		Stiff (inelastic)						

How would you rate the current seat cushion/back rest in terms of **the surface' roughness** on a scale from 1 to 7 of which 1 stands for very **slippery** and 7 for very **abrasive**?

*Surface in case of our study targets is the cover material of the seats.*

SURFACE		1	2	3	4	5	6	7
<b>Seat cushion</b>								
SEAT 1	Slippery							
SEAT 2								
SEAT 3								
SEAT 4								
		Abrasive						
<b>Back rest</b>								
SEAT 1	Slippery							
SEAT 2								
SEAT 3								
SEAT 4								
		Abrasive						

**Participant's ranking seats**

Which of the 4 seats fits you best while sleeping?  
Please rank each seat from best to worst!

Seat	1	2	3	4
Rank				
Comments				

2



**Participant's ranking configurations sleeping**

Which of the 3 configurations fits you best while sleeping?  
Please rank each configuration from best to worst!

Configuration	1	2	3
Rank			
Comments			

Thank you for wearing the sleeping mask. For now and for the following tests you can take off the mask now.

Let's again take a short break before we go on with the next secondary activity working.

A

## 3a

**Questionnaire Part 3a: Secondary Activity Working**

Participant's No.: \_\_\_\_\_ Scenario: \_\_\_\_\_ / 9

Order: \_\_\_\_\_

- Now we go on with the secondary activity working.
- Please take a seat (in the given order) and take this laptop.
- There is this short task that we created for you.
- There is a powerpoint presentation opened up
- Cows that escaped the field need to be caught. You just have to move the numbered cows into the fields where they belong in.
- Concentrate while playing on how the seat supports you. Let's see how well you do...
- After "working" in every seat please rank them from best to worst before we go on to the next configuration.

**Participant's ranking seats**

Seat	1	2	3	4
Rank				
Comments				

Participant's No.: \_\_\_\_\_ Scenario: \_\_\_\_\_ / 9

Order: \_\_\_\_\_

**Participant's ranking seats**

Seat	1	2	3	4
Rank				
Comments				



Participant's No.: \_\_\_\_\_

Scenario: \_\_\_\_\_ / 9

Order: \_\_\_\_\_

**Participant's ranking seats**

Which of the 4 seats fits you best while working?  
Please rank each seat from best to worst!

Seat	1	2	3	4
Rank				
Comments				

**Participant's ranking configurations working**

Which of the 3 configurations fits you best while working?  
Please rank each configuration from best to worst!

Configuration	1	2	3
Rank			
Comments			

Let's again take a short break before we go on with the last secondary activity reading.

# 3b

## Questionnaire Part 3b: Secondary Activity Reading

Participant's No.: \_\_\_\_\_ Scenario: \_\_\_\_\_ / 9

Order: \_\_\_\_\_

- This is our third and last secondary activity, which is reading.
- It's going to be just as same as the activity before. Please take this magazine and read the first paragraph.
- Same procedure again, first grading seats then the configuration at last.

### Participant's ranking seats

Seat	1	2	3	4
Rank				
Comments				

Participant's No.: \_\_\_\_\_ Scenario: \_\_\_\_\_ / 9

Order: \_\_\_\_\_

### Participant's ranking seats

Which of the 4 seats fits you best while reading?  
Please rank each seat from best to worst!

Seat	1	2	3	4
Rank				
Comments				

Participant's No.: \_\_\_\_\_

Scenario: \_\_\_\_\_ / 9

Order: \_\_\_\_\_

**Participant's ranking seats**

Which of the 4 seats fits you best while reading?  
Please rank each seat from best to worst!

Seat	1	2	3	4
Rank				
Comments				

**Participant's ranking configurations reading**

Which of the 3 configurations fits you best while reading?  
Please rank each configuration from best to worst!

Configuration	1	2	3
Rank			
Comments			

**We came to the end of our study. Thank you very much for participating.  
We appreciate your help and hope you've had a pleasant time with us.**

**I'm happy to answer any further questions that you might have. Here is my business contact.**

**Thanks again and have a nice day!**

### A.3. DETAILED RESULTS OF CHAPTER 6 AND CHAPTER 7



Table A.3: Results of the Multiple Regression for the fabric data set including the seat components and the cluster (Chapter 6).

	G1			G2			G3			G4			G5				
	R Square ANOVA	F(3,32)=21.478, p=0.000	0.615	R Square ANOVA	F(5,82)=10.185, p=0.000	0.539	R Square ANOVA	F(5,89)=20.577, p=0.000	0.536	R Square ANOVA	F(5,43)=15.501, p=0.000	0.602	R Square ANOVA	F(5,11)=5.349, p=0.01	0.576		
F1	Constant	B	2.454	B	1.475	B	1.550	B	-0.550	B	-1.109	B	-1.009	B	-2.732		
	t	t	8.238	t	4.605	t	8.100	t	-9.912	t	-1.404	t	-0.009	t	-3.662		
	Sig.	Sig.	0.000	Sig.	0.000	Sig.	0.000	Sig.	0.000	Sig.	0.167	Sig.	0.999	Sig.	0.011		
	foam hardness	B	-0.780	B	-0.771	B	-0.454	B	-0.427	B	-0.073	B	-2.198	B	0.290	B	0.063
	t	t	-9.170	t	-8.205	t	-5.987	t	-5.987	t	0.033	t	0.238	t	0.063	t	1.193
F2	Constant	B	-0.163	B	0.003	B	0.201	B	0.003	B	0.003	B	0.003	B	0.003		
	t	t	-2.021	t	0.048	t	0.017	t	0.000	t	0.200	t	0.842	t	0.000	t	0.842
	Sig.	Sig.	0.048	Sig.	0.969	Sig.	0.986	Sig.	0.999	Sig.	0.406	Sig.	0.406	Sig.	0.999	Sig.	0.406
	foam hardness	B	0.571	B	0.762	B	0.201	B	0.194	B	1.845	B	0.069	B	0.201	B	0.194
	t	t	6.635	t	6.635	t	0.201	t	0.194	t	1.845	t	0.069	t	0.201	t	0.194
seat suspension on laminari on cover tension	B	-0.406	B	-0.140	B	-0.246	B	-0.067	B	-2.689	B	0.009	B	0.200	B	0.886	
t	t	-5.226	t	-0.800	t	-2.689	t	0.009	t	0.009	t	0.200	t	0.200	t	3.174	
Sig.	Sig.	0.000	Sig.	0.423	Sig.	0.009	Sig.	0.999	Sig.	0.999	Sig.	0.999	Sig.	0.999	Sig.	0.002	
foam hardness	B	0.112	B	0.201	B	0.393	B	0.340	B	3.846	B	0.000	B	0.700	B	0.786	
t	t	1.433	t	0.157	t	0.393	t	3.846	t	0.000	t	0.000	t	0.700	t	10.059	
Sig.	Sig.	0.157	Sig.	0.876	Sig.	0.699	Sig.	0.000	Sig.	0.999	Sig.	0.999	Sig.	0.999	Sig.	0.002	

Table A.4: Descriptive results of the word pair ratings for position 1 – position 4 (Chapter 7).

Pos. 1	Seat 1		Seat 2		Seat 3		Seat 4	
	Mean	Std. dev.	Mean	Std. dev.	Mean	Std. dev.	Mean	Std. dev.
Cushion								
Soft-hard	3.9	1.4	3.9	1.4	3.6	1.4	4.5	1.4
Elastic-stiff	4.3	1.3	4.4	1.2	3.7	1.5	4.4	1.5
Slippery-abrasive	3.7	1.4	4.4	1.4	3.6	1.7	3.2	1.5
Backrest								
Soft-hard	4.2	1.4	4.0	1.4	3.7	1.3	4.8	1.4
Elastic-stiff	4.6	1.3	4.7	1.4	3.9	1.5	4.9	1.5
Slippery-abrasive	3.7	1.5	5.5	1.4	4.2	1.5	4.0	1.5

Pos. 2	Seat 1		Seat 2		Seat 3		Seat 4	
	Mean	Std. dev.	Mean	Std. dev.	Mean	Std. dev.	Mean	Std. dev.
Cushion								
Soft-hard	3.5	1.3	3.3	1.4	3.6	1.4	4.0	1.4
Elastic-stiff	3.7	1.2	3.9	1.4	3.8	1.3	4.1	1.4
Slippery-abrasive	3.8	1.6	5.7	1.1	4.1	1.4	3.5	1.4
Backrest								
Soft-hard	4.1	1.2	4.0	1.4	4.0	1.2	4.5	1.4
Elastic-stiff	3.7	1.2	3.9	1.3	3.8	1.3	4.1	1.4
Slippery-abrasive	3.9	1.3	5.6	1.0	4.3	1.3	3.8	1.3

Pos. 3	Seat 1		Seat 2		Seat 3		Seat 4	
	Mean	Std. dev.	Mean	Std. dev.	Mean	Std. dev.	Mean	Std. dev.
Cushion								
Soft-hard	3.6	1.4	3.5	1.3	3.7	1.3	4.0	1.5
Elastic-stiff	3.7	1.4	3.7	1.4	3.9	1.2	3.9	1.4
Slippery-abrasive	3.4	1.4	5.6	0.9	3.8	1.3	3.5	1.3
Backrest								
Soft-hard	4.6	1.2	4.5	1.3	4.2	1.3	4.9	1.3
Elastic-stiff	4.4	1.3	4.7	1.2	4.4	1.2	4.7	1.3
Slippery-abrasive	4.0	1.4	5.6	0.9	4.1	1.4	4.1	1.3

Pos. 4	Seat 1		Seat 2		Seat 3		Seat 4	
	Mean	Std. dev.	Mean	Std. dev.	Mean	Std. dev.	Mean	Std. dev.
Cushion								
Soft-hard	4.0	1.5	3.7	1.3	3.6	1.5	4.4	1.3
Elastic-stiff	4.1	1.4	4.1	1.2	3.9	1.4	4.5	1.5
Slippery-abrasive	3.6	1.6	5.5	1.2	4.11	1.3	3.4	1.5
Backrest								
Soft-hard	4.7	1.5	4.1	1.4	4.2	1.2	5.2	1.4
Elastic-stiff	5.0	1.1	4.8	1.3	4.5	1.2	5.3	1.3
Slippery-abrasive	4.0	1.4	5.3	1.1	4.6	1.3	3.9	1.3

Table A.5: Overview of the non-normalized measurement results of the four seats in six different measurement positions of the seat (Chapter 7).

	max. pressure [N/cm <sup>2</sup> ]	first touch [N/cm <sup>2</sup> ]	lin. pressure [N/cm <sup>2</sup> ]	pressure distribution [N/cm <sup>2</sup> ]	elongation loading [%]	elongation move [%]	max. indentation [mm]	lin. Indentation [mm]
1.) shoulder								
Seat 1	11.10	0.60	1.50	0.70	16.40	15.20	31.90	16.10
Seat 2	7.20	0.80	2.80	1.10	18.80	9.80	34.70	26.70
Seat 3	10.60	0.40	1.10	0.80	11.20	12.10	34.70	14.80
Seat 4	13.20	0.60	1.40	0.80	24.60	27.00	31.40	13.20
2.) lumbar								
Seat 1	9.60	0.60	2.80	0.50	0.80	29.00	33.20	17.20
Seat 2	4.40	0.40	1.20	1.00	4.70	12.50	36.00	15.70
Seat 3	6.40	0.50	1.00	0.70	5.20	17.00	35.70	14.40
Seat 4	10.80	0.50	1.10	0.50	2.10	27.50	30.10	12.30
3.) bolster backrest								
Seat 1	17.70	0.80	2.00	0.60	12.00	65.80	23.40	12.00
Seat 2	15.70	0.40	1.20	0.80	11.30	57.30	26.10	12.70
Seat 3	13.70	0.60	1.60	0.90	8.80	47.30	24.70	14.20
Seat 4	18.80	0.60	2.90	0.80	6.10	66.60	24.30	13.00
4.) ischial tuberosity								
Seat 1	10.00	0.70	3.80	0.50	5.80	25.70	30.10	22.40
Seat 2	3.60	0.60	1.60	0.90	6.20	12.10	31.50	19.60
Seat 3	12.40	0.60	1.30	0.40	6.10	30.50	30.30	12.70
Seat 4	11.50	0.80	3.50	0.40	8.40	25.10	30.30	18.90
5.) front of the cushion								
Seat 1	11.60	0.80	6.20	0.30	4.80	28.30	28.50	22.80
Seat 2	6.30	0.80	2.00	0.80	4.90	18.30	29.70	16.90
Seat 3	14.00	0.50	1.50	0.40	1.50	43.40	28.90	14.30
Seat 4	25.70	0.90	4.40	0.20	10.40	19.50	29.00	16.20
6.) bolster cushion								
Seat 1	10.10	0.50	1.40	0.60	12.40	51.00	30.40	16.20
Seat 2	7.30	0.60	1.60	0.90	10.00	43.50	28.80	19.00
Seat 3	10.70	0.20	1.00	0.90	8.70	55.10	28.60	12.50
Seat 4	10.10	0.40	1.10	0.80	8.40	43.30	24.30	15.40



# CURRICULUM VITÆ



MAXIMILIAN  
WEGNER

DATE OF BIRTH:  
07.02.1988

NATIONALITY:  
German,  
Polish

MARITAL STATUS:  
Married

CHILDREN:  
Three (one month,  
four and  
eleven years old)

## EXPERIANCE

- 06/2019 – present **BMW Group (Finance Department), Budget Manager / Business Controller**  
Setting and tracking target costs for the car interior and for tooling / business case calculation / Consultant for the Development and Purchasing Department as well as reporting to the Management and steering committees.
- 06/2016 – 05/2019 **BMW Group (Seat Development Department), Product Engineer and Consultant**  
Product Engineer and Consultant for predevelopment projects and developments processes / Mentor of 24 doctoral students from various development department of the BMW Group (1 Y, 8M).
- 06/2015 – 05/2016 **EVO GmbH, Project Manager**  
Seat-Specialist for the BMW Group including production process planning and quality management for BMW Z4 / Toyota Supra.
- 10/2012 - 01/2013 **Audi AG / Chair of Automotive Technology Technical, University Munich, Research Assistant**  
Test planning, test realization and data evaluation of vibration test rigs for chassis development.
- 05/2011 - 07/2012 **BMW Group (Tire Pressure Monitoring System and Hitch), Internship and Trainee**  
Analysis and investigation of quality improvement methods/ Development of algorithms to detect tire pressure.
- 05/2010 - 08/2011 **Founding of an import and export company in cooperation with a Chinese partner**  
Textiles and memorabilia.

## EDUCATION

- 06/2016 – present **PhD Candidate Delft University of Technology (The Netherlands)/ Faculty of Industrial Design Engineering**  
Research Topic: Objectification of seat comfort
- 10/2007 - 09/2014 **Diploma in Engineering Sciences (Diplom-Ingenieur) Technical University Munich, Germany**  
Mechanical Engineering and Management.

# LIST OF PUBLICATIONS

1. **Van der Voort V., Wegner M., Anjani S. and, Vink P.**, 2020. Comfort related to the height, hardness and contour of nonadjustable side supports in automotive seating, Applied Ergonomics 84.  
(Chapter 3 of this PhD)
2. **Wegner M., Anjani S., Li W. and, Vink P.**, 2019. How Does the Seat Cover Influence the Seat Comfort Evaluation?. In: Bagnara S., Tartaglia R., Albolino S., Alexander T., Fujita Y. (eds) Proceedings of the 20th Congress of the International Ergonomics Association (IEA 2018). IEA 2018. Advances in Intelligent Systems and Computing, vol 824. Springer.  
(Chapter 4 of this PhD)
3. **Wegner M., Martic M., Franz M. and, Vink P.**, 2020. A system to measure seat-human interaction parameters which might be comfort relevant, Applied Ergonomics 84.  
(Chapter 5 of this PhD)
4. **Wegner M, Martic R, Franz M. and, Vink P.**, The influence of seat components on the seat-human interaction, submitted to Theoretical Issues in Ergonomics Science.  
(Chapter 6 of this PhD)
5. **Wegner M., Reuter C., Fitzen F, Anjani S. and, Vink P.**, 2021. Seat-Human Interaction and Perception: A Multi-factorial-Problem. In: Fuchs A., Brandstätter B. (eds) Future Interior Concepts. SpringerBriefs in Applied Sciences and Technology. Springer, Cham.  
(Chapter 7 of this PhD)
6. **Wegner M., Martic M., Franz M. and, Vink P.**, 2017. A new approach for measuring the sea comfort, 1th International Comfort Congress, Salerno. abstract
7. **Theodossiadis, G.D., Wegner M. and, Zaeh M.E.**, 2016. Thermal Joining of Highly Conductive Bonds by Using Reactive Al-Ni Nanofolios. Materials Science Forum 879, 1927–1932.

