

Collective inclusion

Introduction

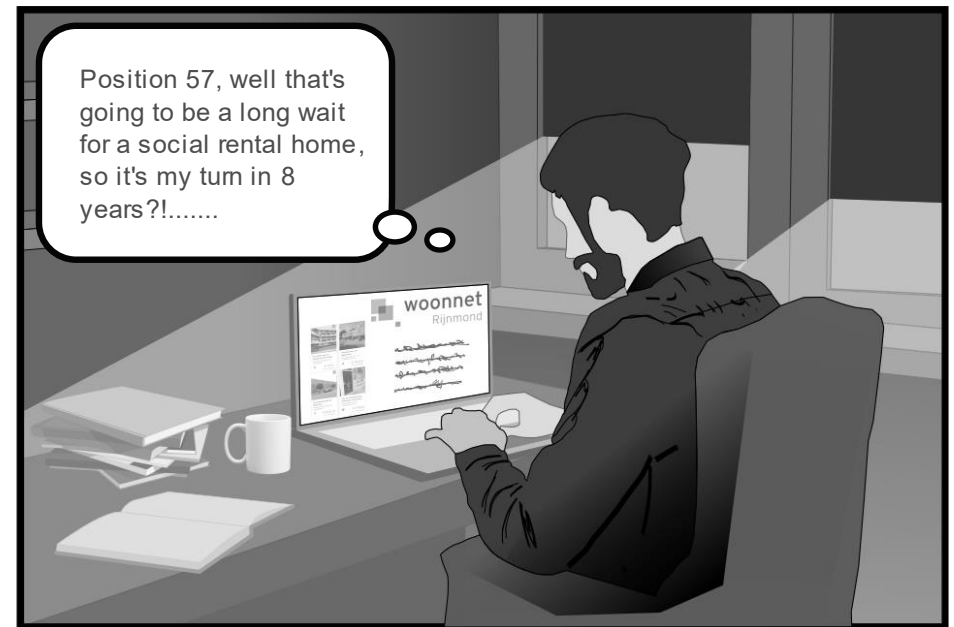

I can't find a house

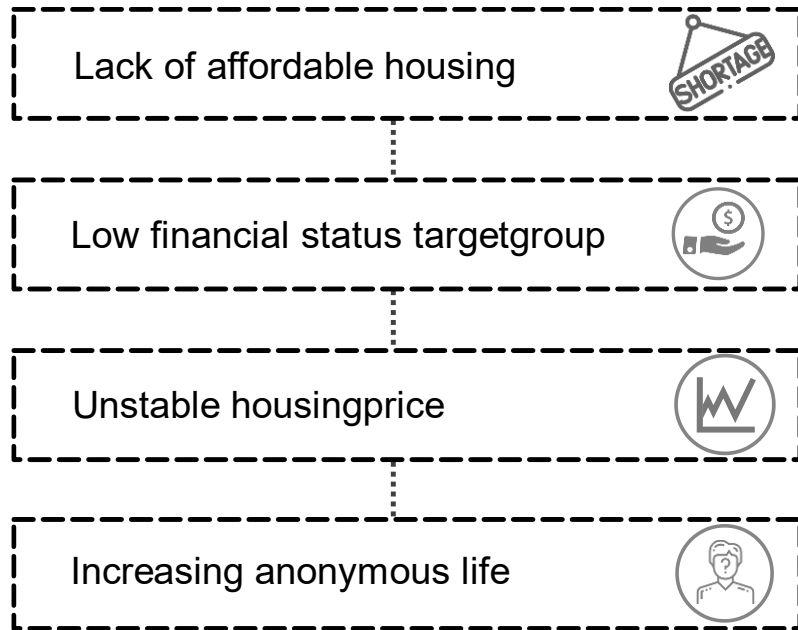

Searching for solutions?

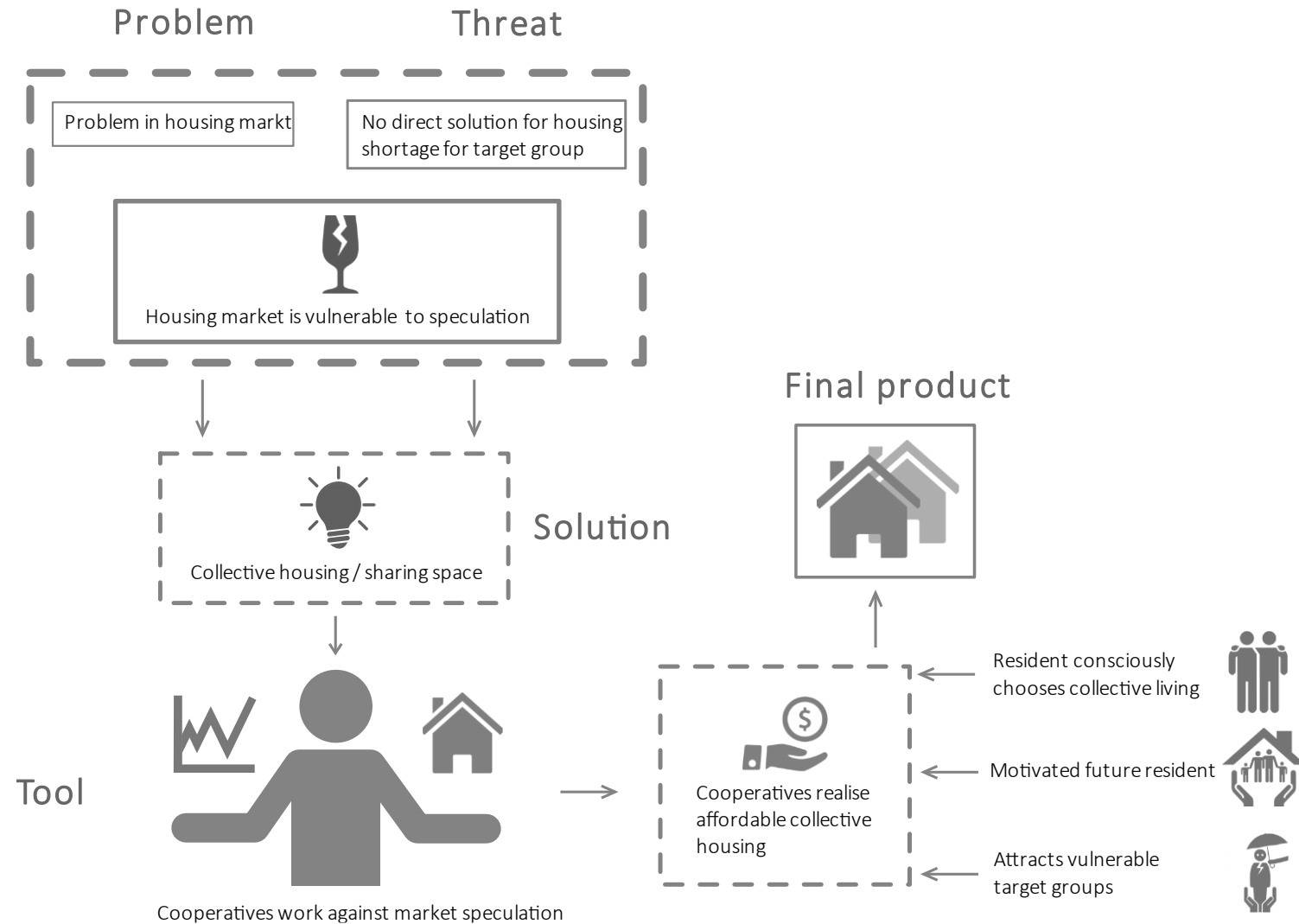

Research frame and goals

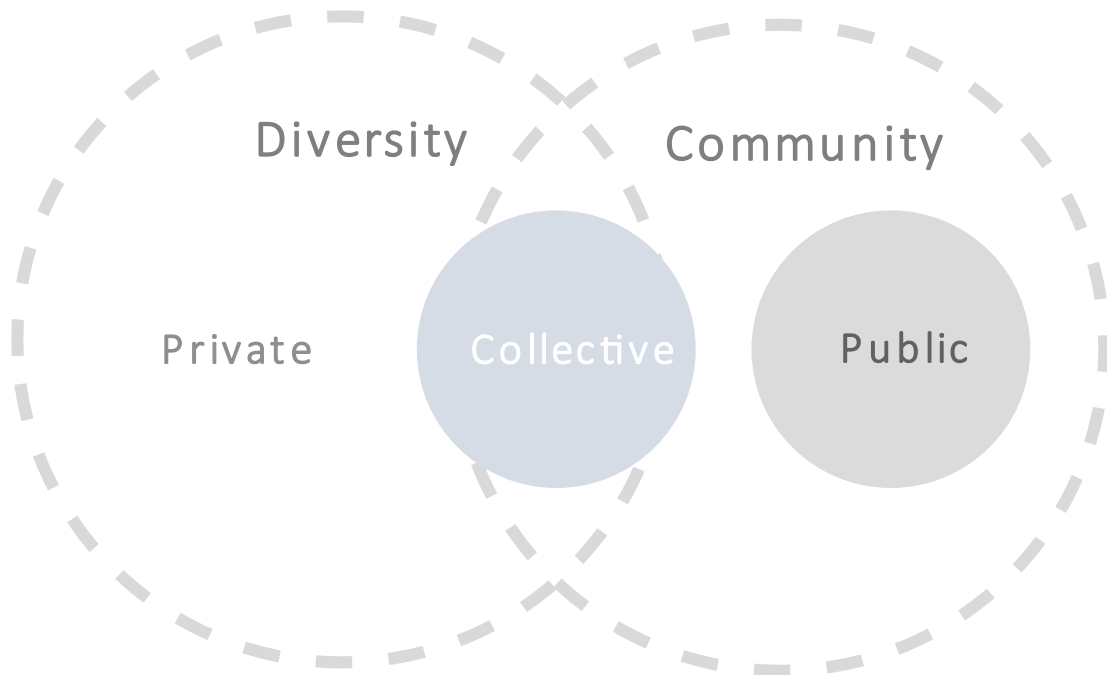

Housing requirements of target groups

Shared living space and facilities

Collective space in the building

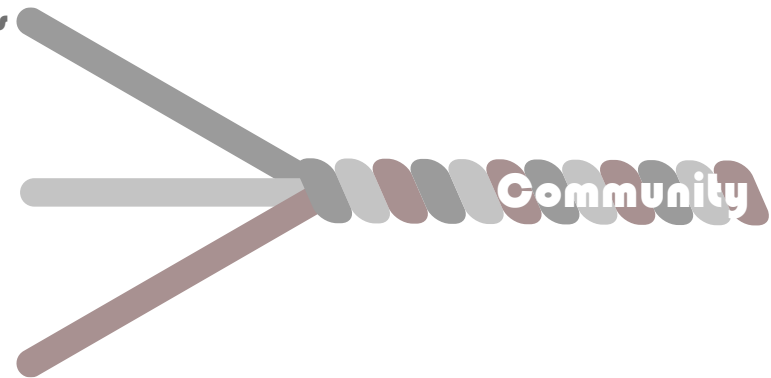

Research question

“ How can the programming of collective and shared spaces in co-housing enhance interaction and social cohesion among the residents?”

Dweller profiles



Solo

Couple

New form of living, co-living



Space typology



Private			Private space inside housing unit			
Semi- private			Shared space in a (cluster) house			
Semi- public			Collective space outside (cluster) houses			
Public			Public space in the building			

Take aways from research (case studies) to design

- Housing unit
- Staircase
- Collective space
- Shared space

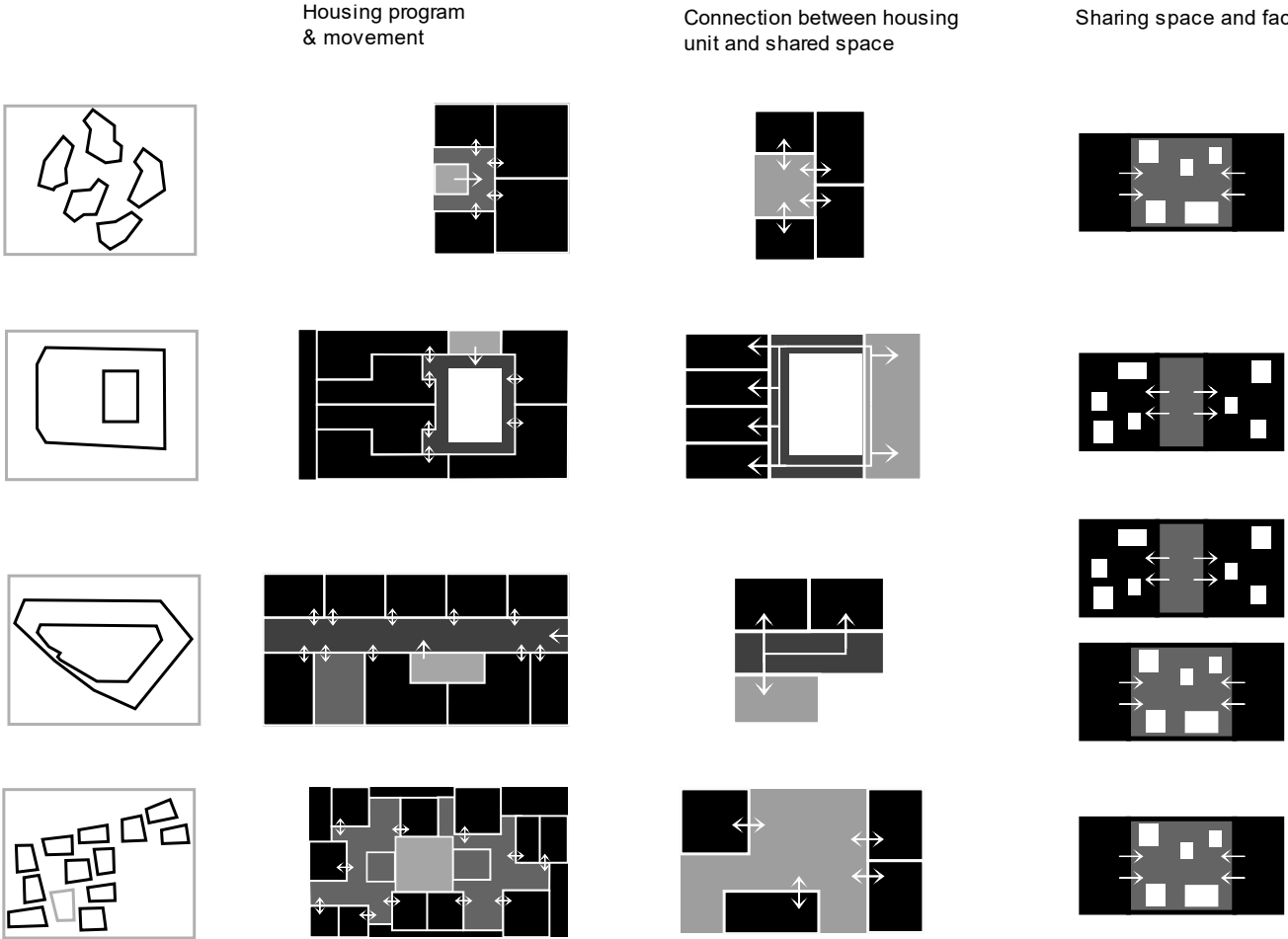

Position urban masterplan

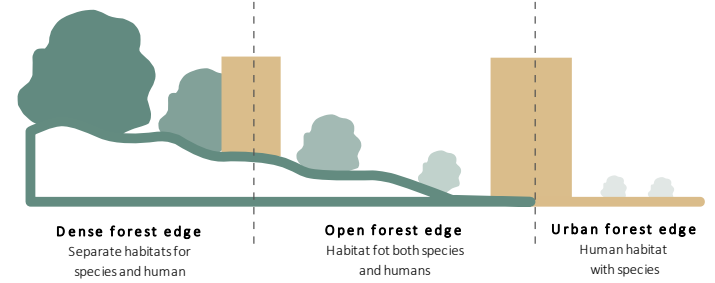
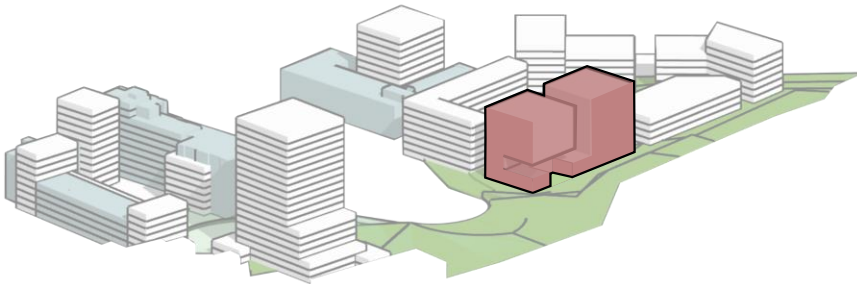

Role with masterplan

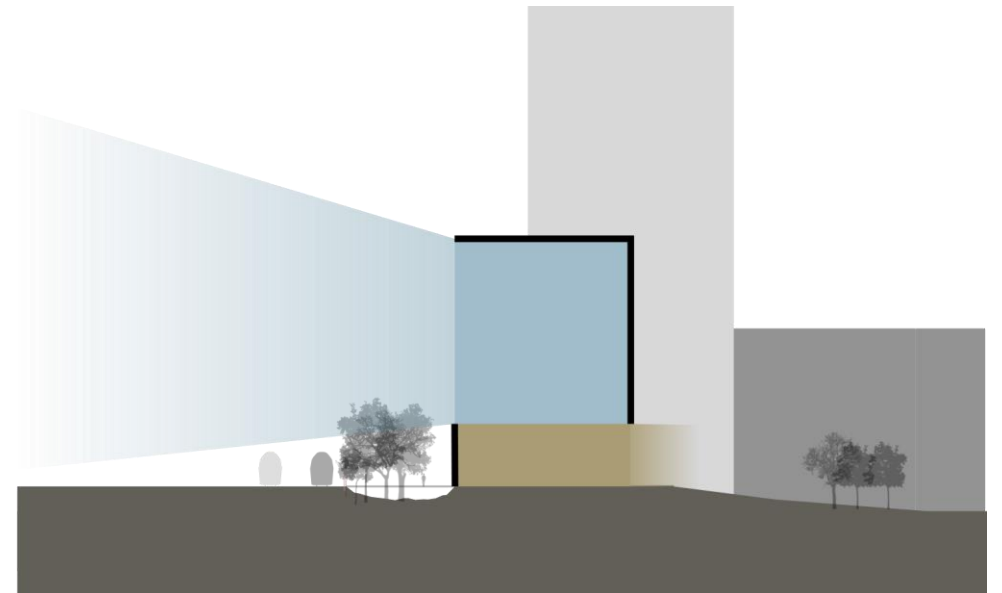
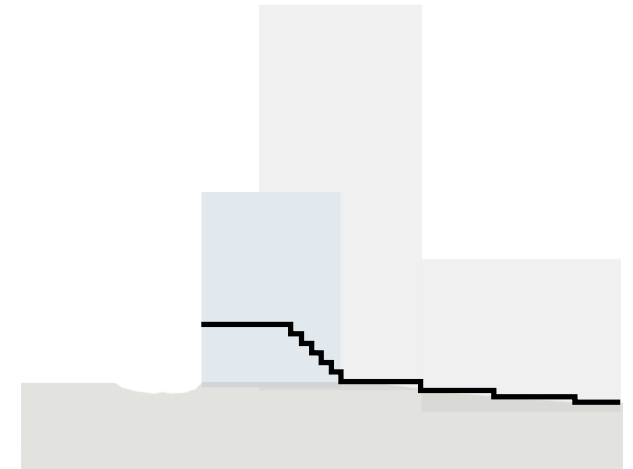
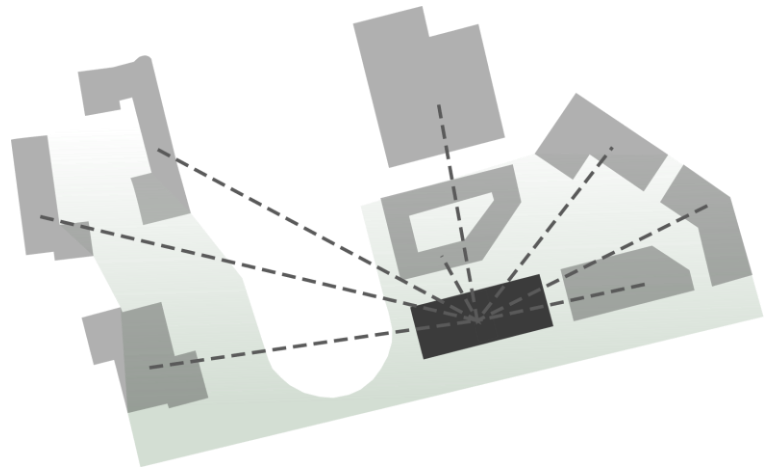

Design principles and Building concept



Private & Collective living

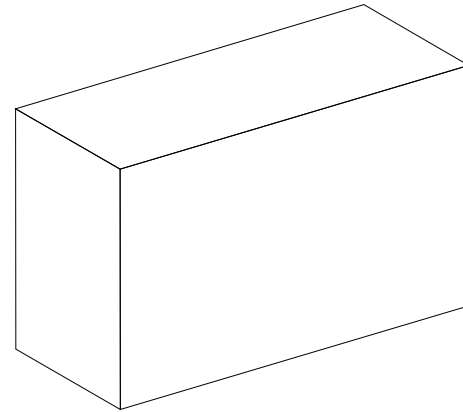

Maximum building volume

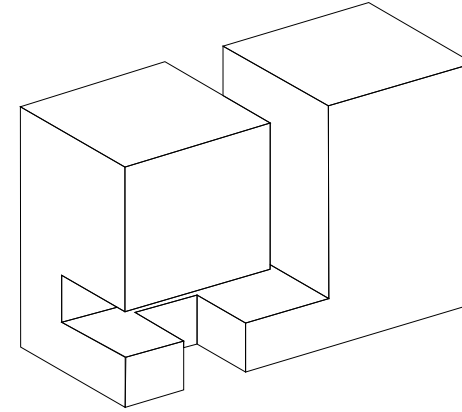

Openings according to public/collective space

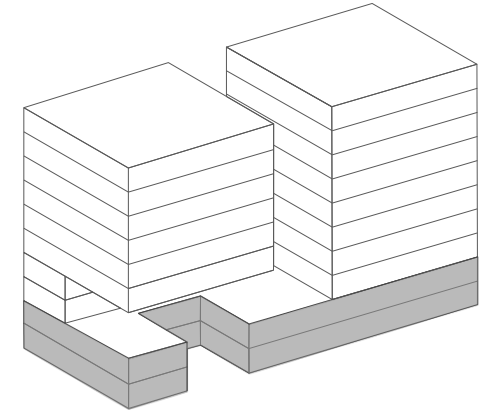

Collective plinth



Public & commercial functions

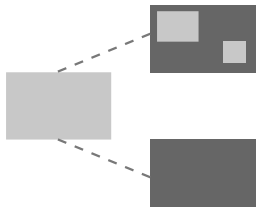

Different sharing typologies

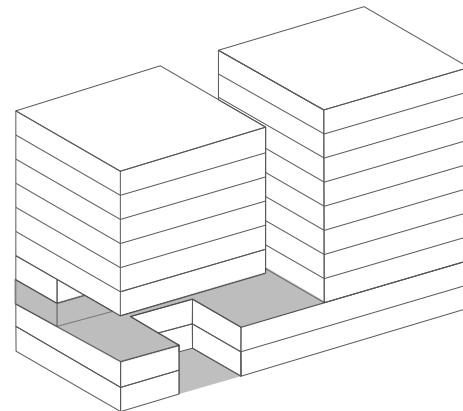

Public and collective outdoor space

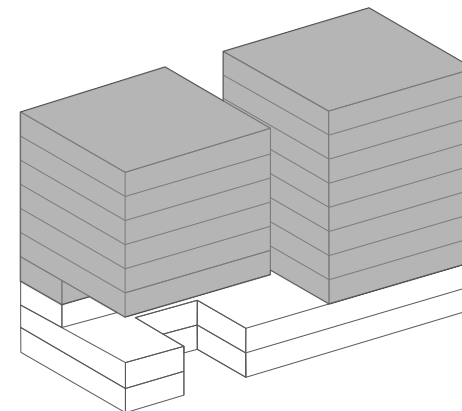

Residential space

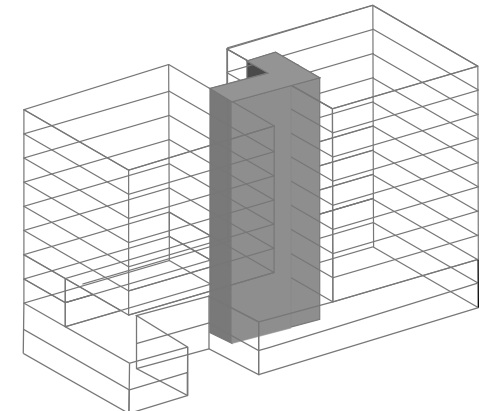

Circulation

Ground floorplan Urban surrounding



Public entrance to the café (north façade)



Entrance for residents (east façade)



Floorplan public café/terrace (2. level)

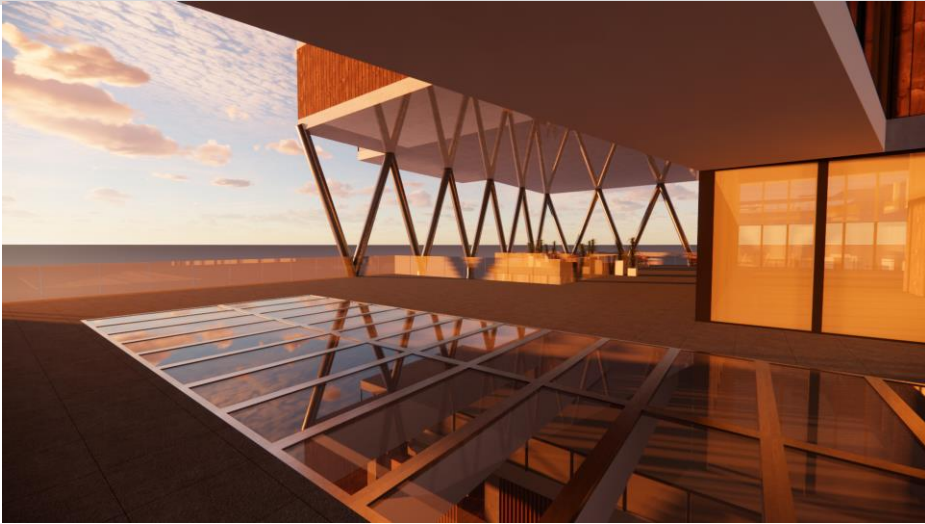

Program of collective/public plinth

Ground floor

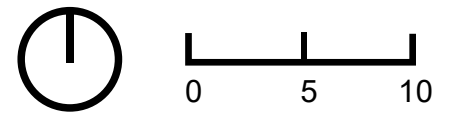
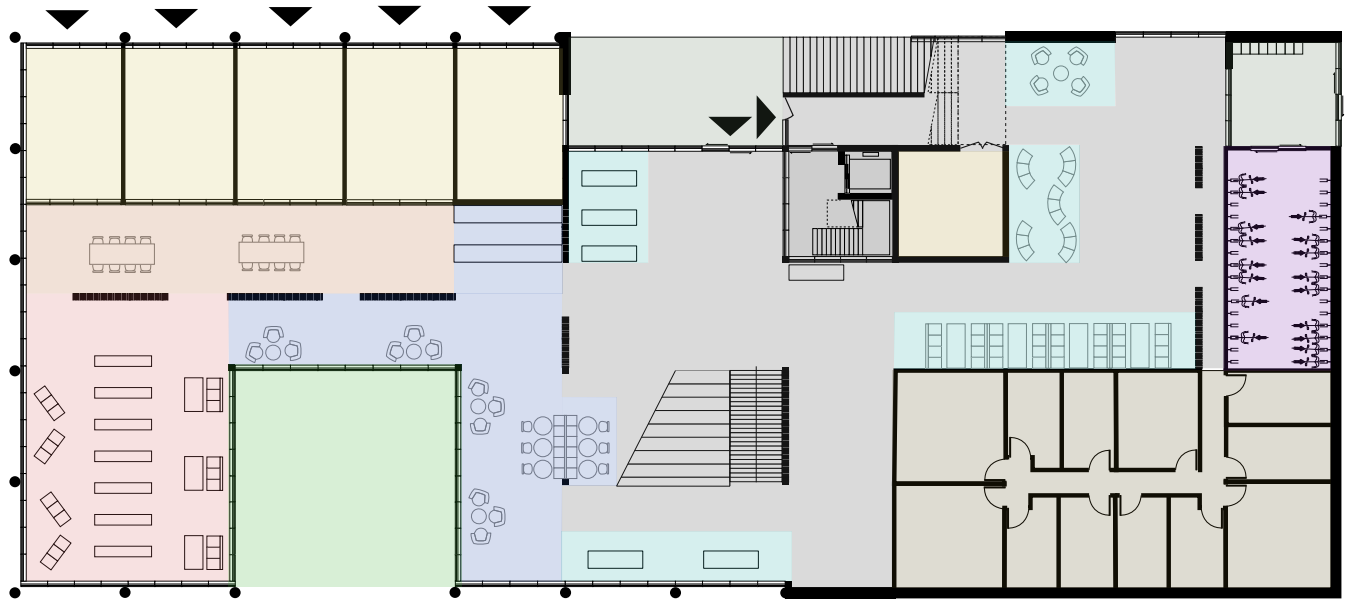

Atriumgarden Ground floor



Coffee corner Ground floor

Section

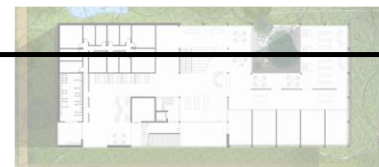

10. level	33000
9. level	30000
8. level	27000
7. level	24000
6. level	21000
5. level	18000
4. level	15000
3. level	12000
2. level	9000
1. level	4500
Ground floor	0



Program of housing and dwelling typology

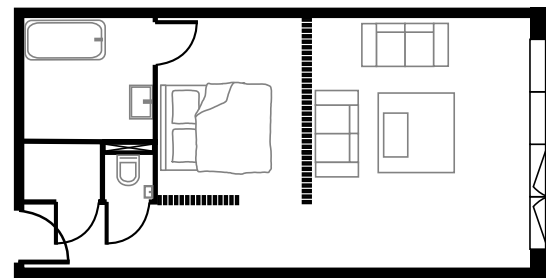
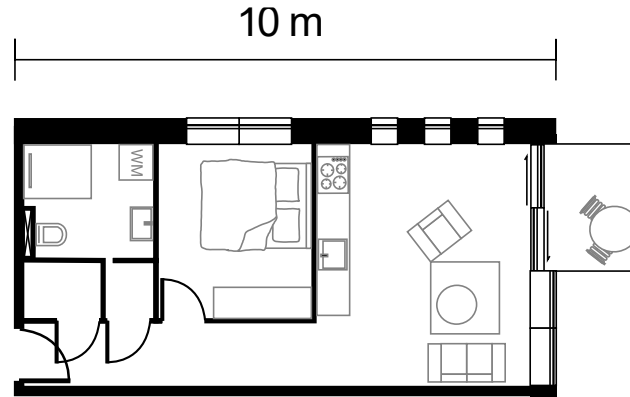
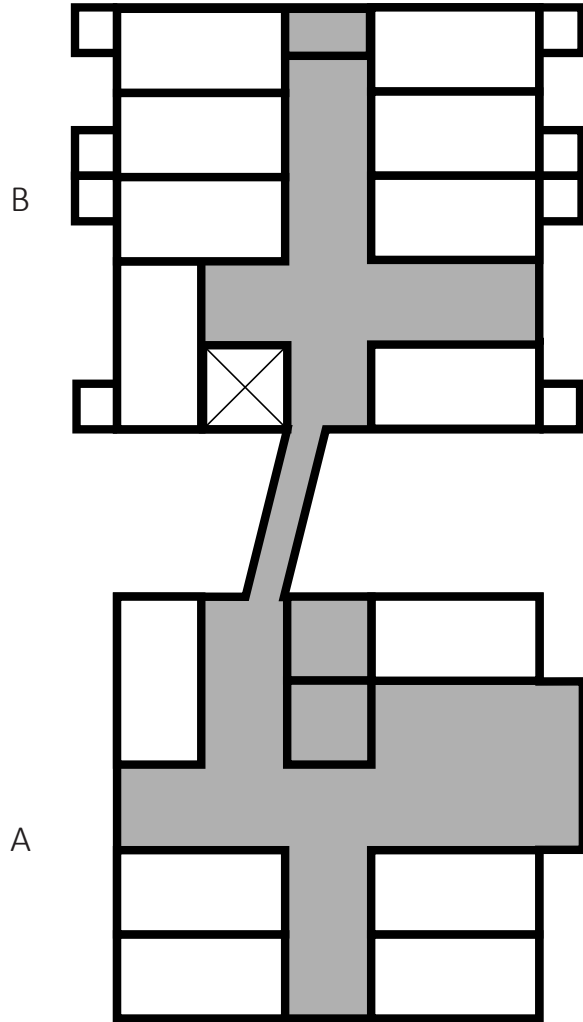
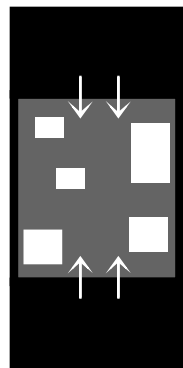
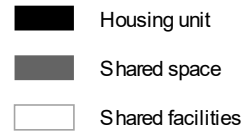
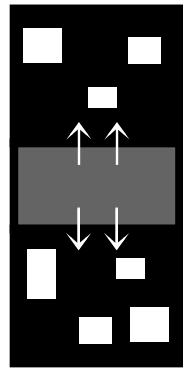

Program of shared space in cluster housing A and B

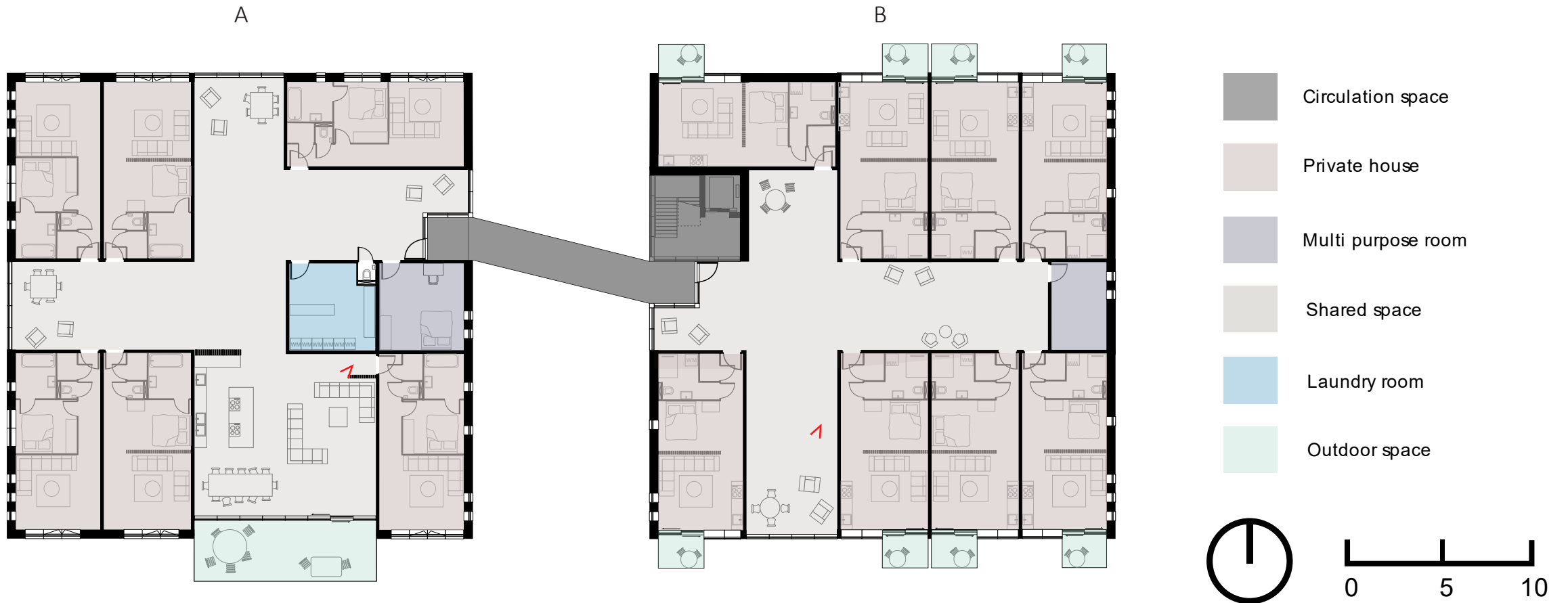

6 private housing units per level
 35-45 m2
 Couples and solo's
 Less private facilities
 Collective outdoor space
 Large shared space and facilities

8 private housing units per level
 45 m2
 Couples and solo's
 Private facilities
 Private outdoor space
 Less shared space and facilities
 Linger space for interaction

Shared space cluster housing A



Linger space cluster housing B





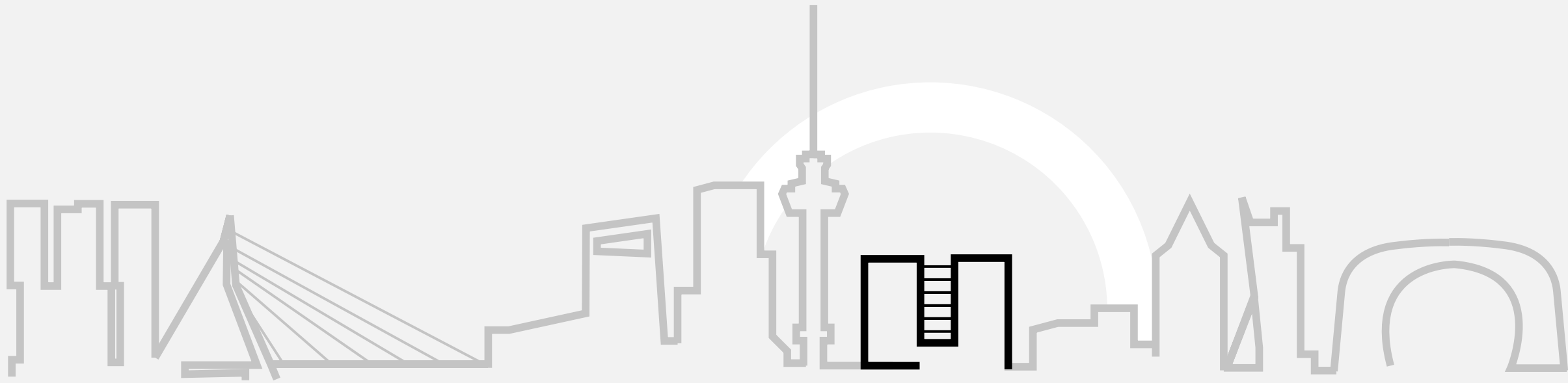

The introduction of the new housingform to make living affordable by sharing space