

Biointegration of architecture and ecology system

AR3A010
Architectural Engineering

Yuxin Yang
5550459

Problem statement

Design for the ecosystem

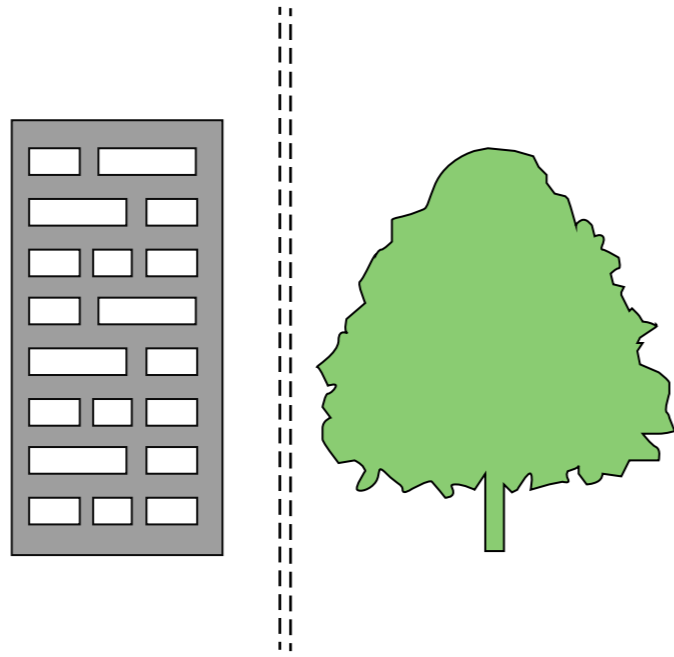

Architectural denaturalisation

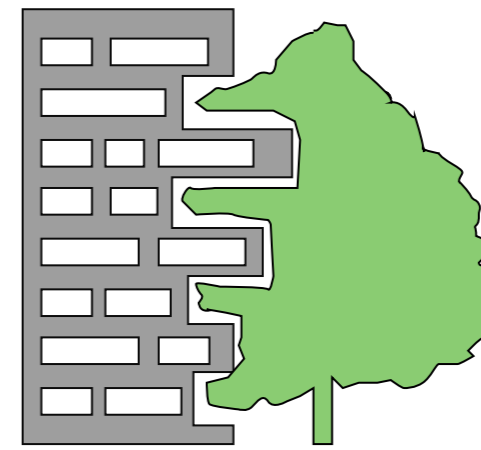

Symbiotic bio-integration

Problem statement

Three ways of designing plants and non-human biomass into built systems



Juxtapositioning

Juxtapositioning is the concentrated placement of greening material at one or a few locations in the built form

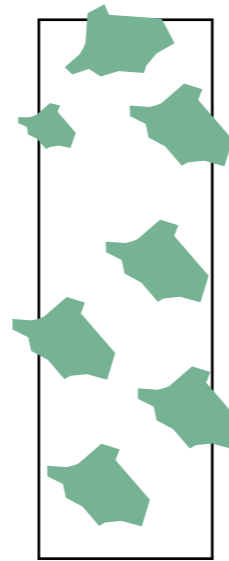

Intermixing

Intermixing is the distributed and patchy placement of green material

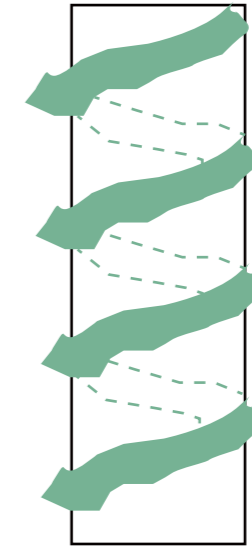

Integrating

Integrating consists of a woven blending of the greening material with the built form

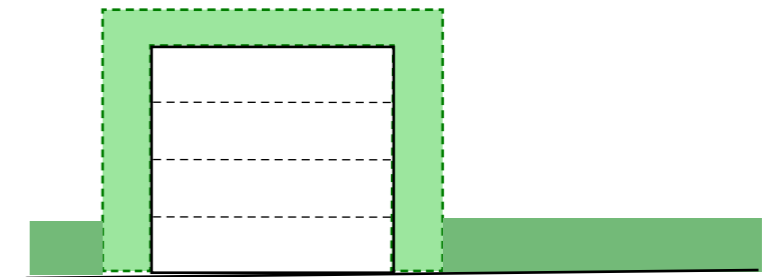

The greening material is linked to the existent vegetation at the ground plane and enables species interaction and migration, thereby engendering a more diverse and stable ecosystem

Problem statement

Green Connections

Urban animal

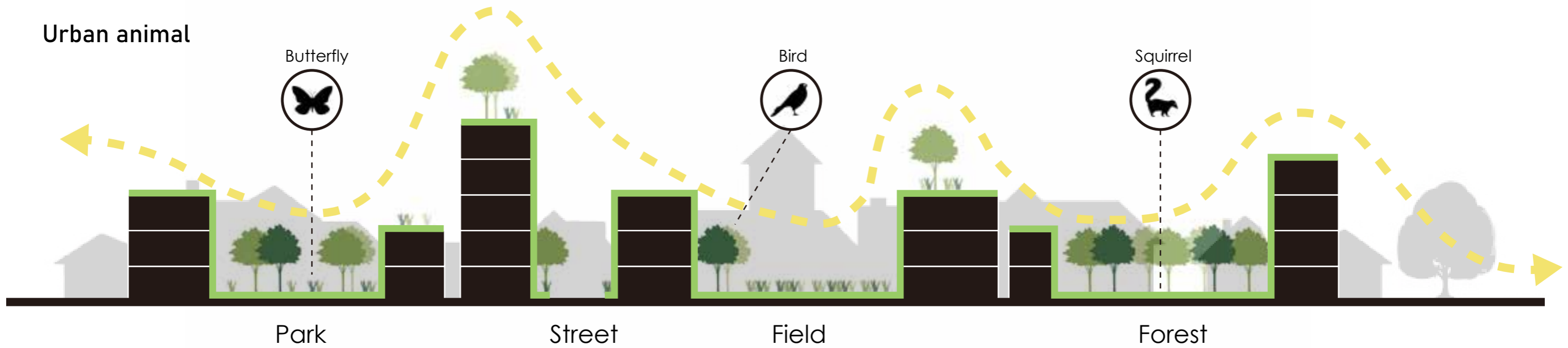

Human

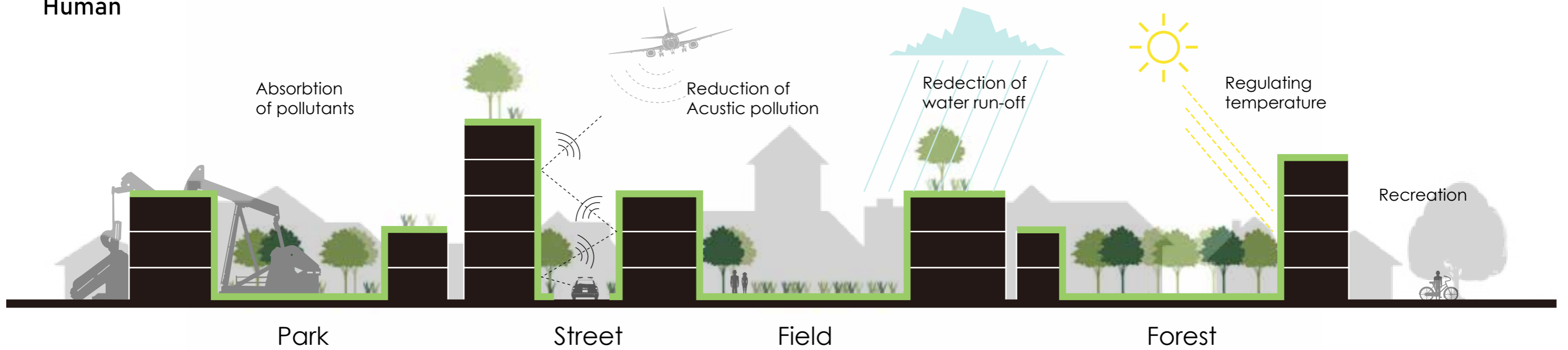

Why Modularity

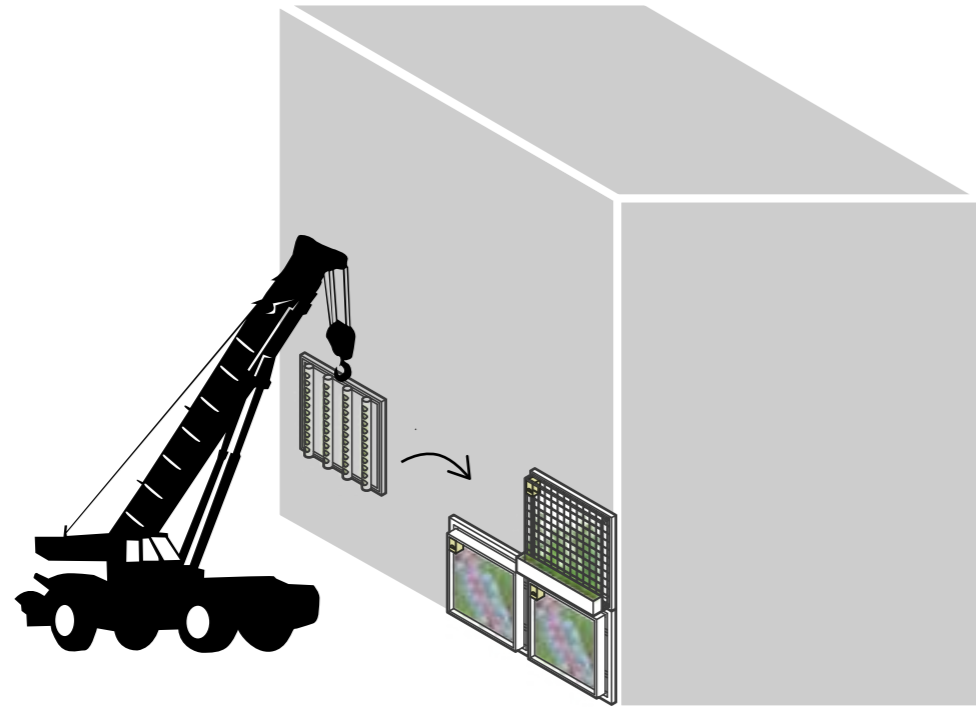

Quick installation without disturbing surrounding people and animals

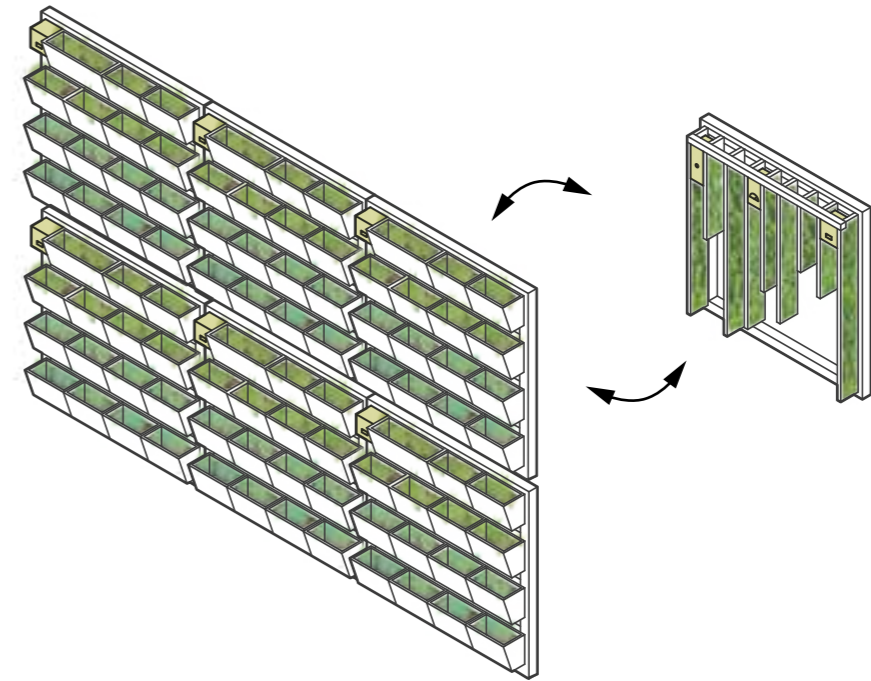

Flexibility (to respond to changes in animal needs)

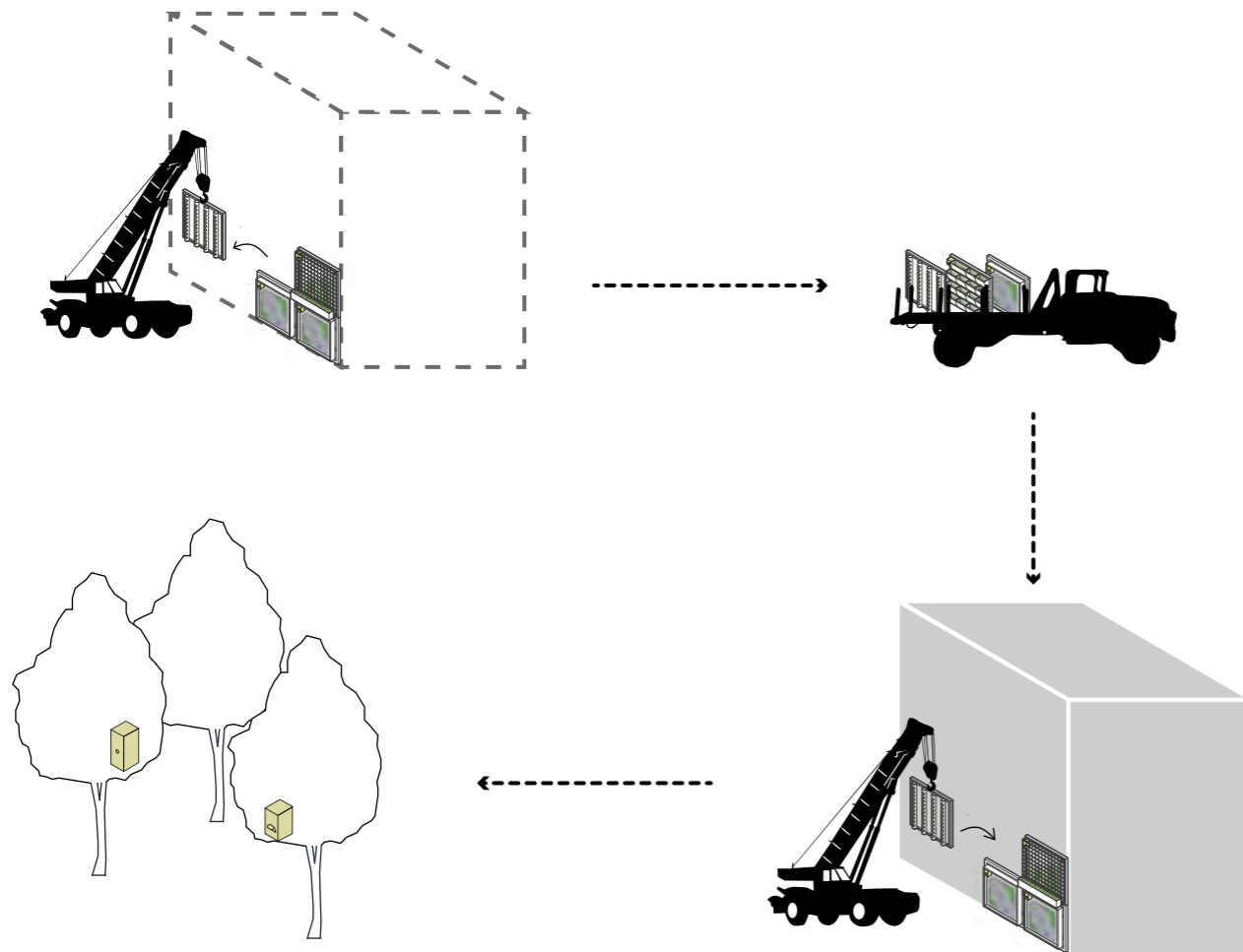

Recoverable and recyclable

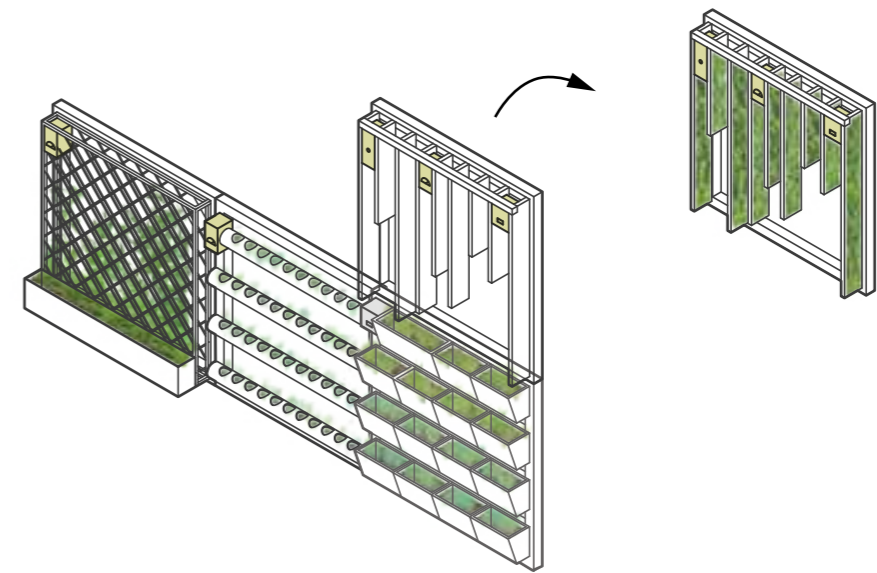

Easy to maintain

Research

Research question: How to use flexible modular vertical greening system to enhance the biodiversity of the city and build an ecological system on the building scale?

Sub question:

1. What is local biodiversity?
2. What is modular vertical greening?
3. How to combine the needs of urban animals with modular vertical greening system?

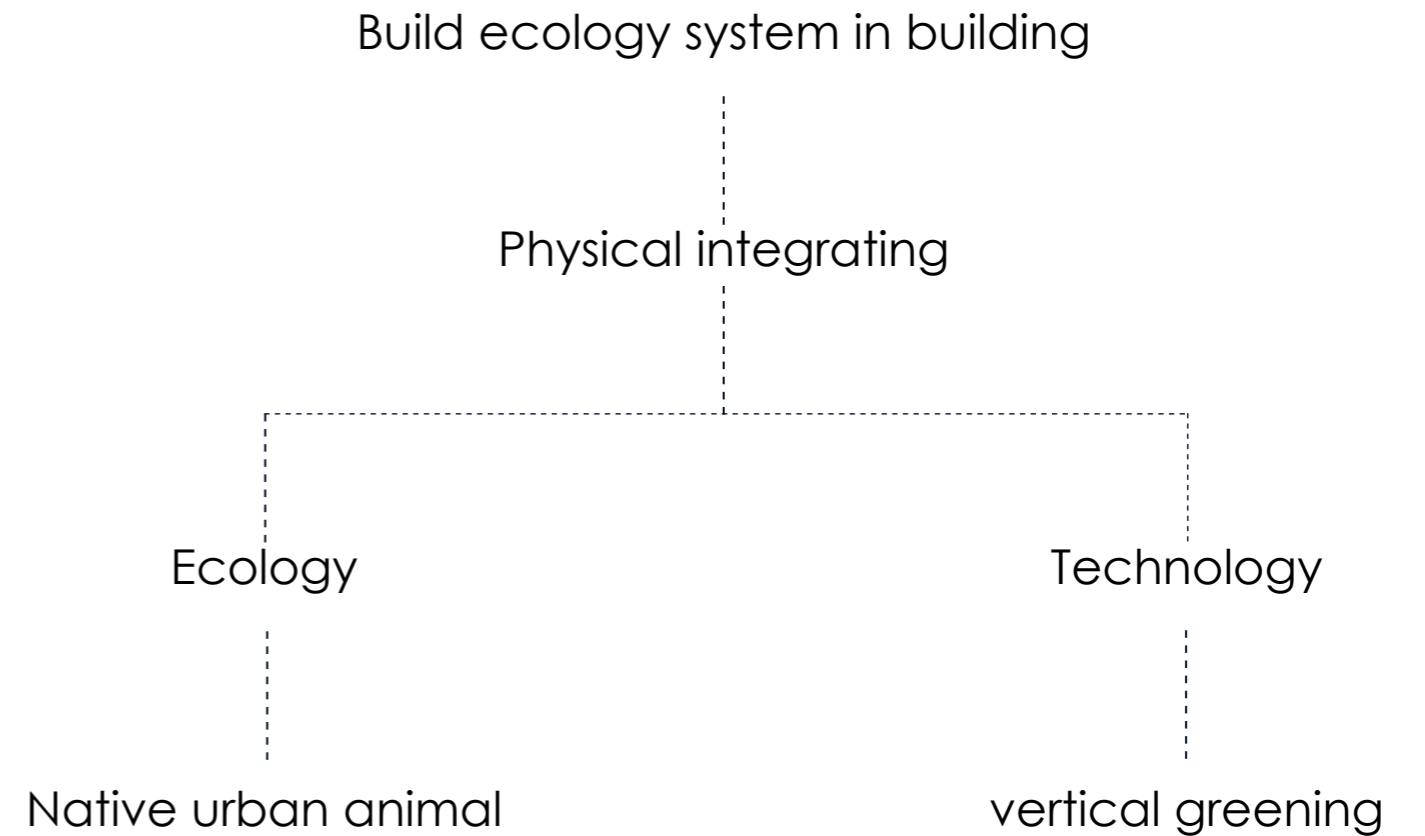

Research

Target species

Birds:



House sparrow



Black redstarts



Common swift



Oystercatcher

Bats:



Common pipistrelle

Insects: Wild bees

Plants: Native plant species

Result1

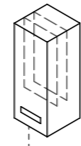
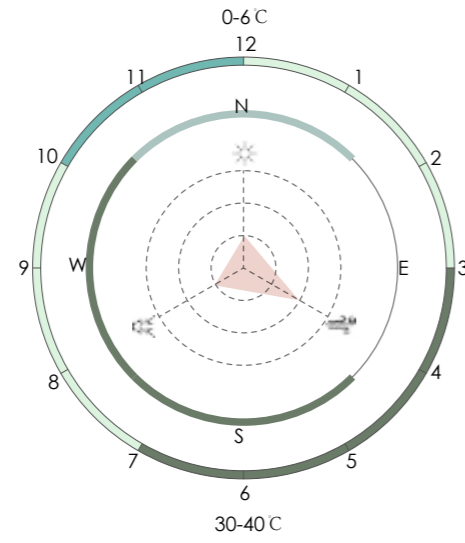
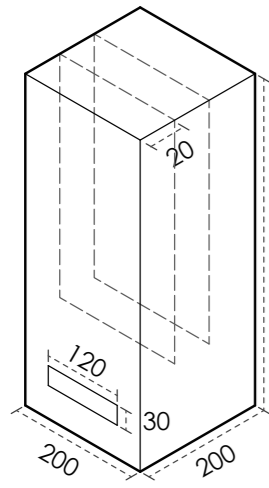

2-7m

Flying area
5m x 5m x 2.8m
Material:
Rough (for grip)



- Breeding
- Nursing
- Active
- Hibernate
- Migrate

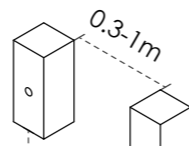
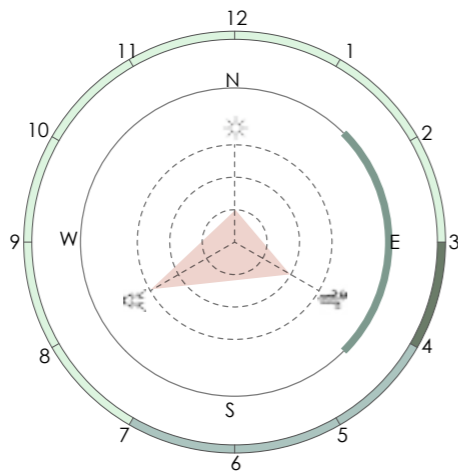
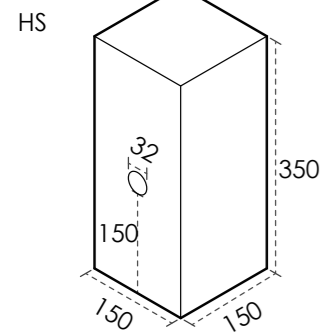

2m

0.3-1m
10-20 pairs
loose colony

CS

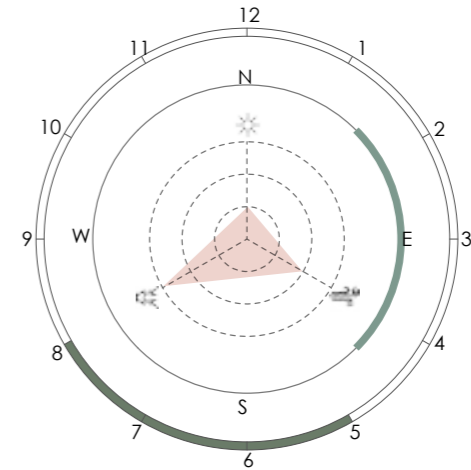
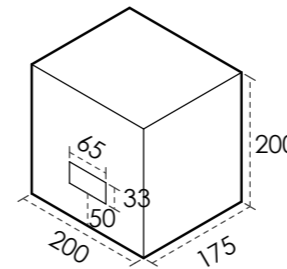

5m

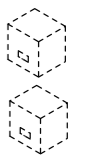

several
potential
nests

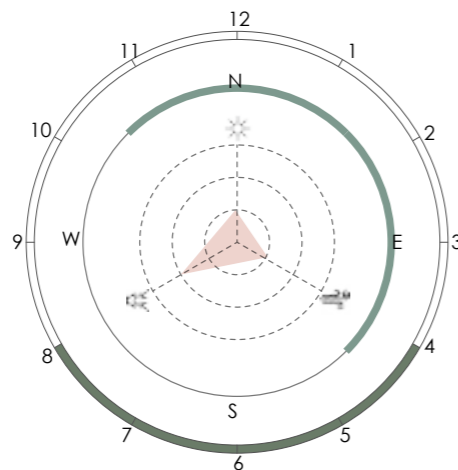
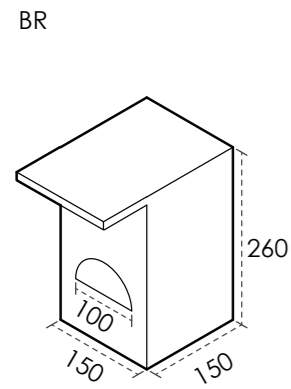

tbd
(sheltered
ledges)

Attracted to
brown roofs or
ecoroofs

OC

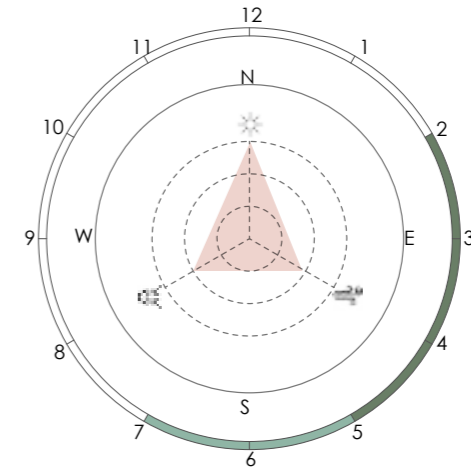
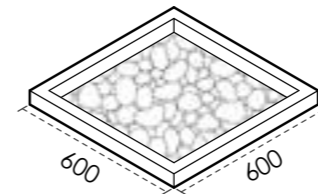

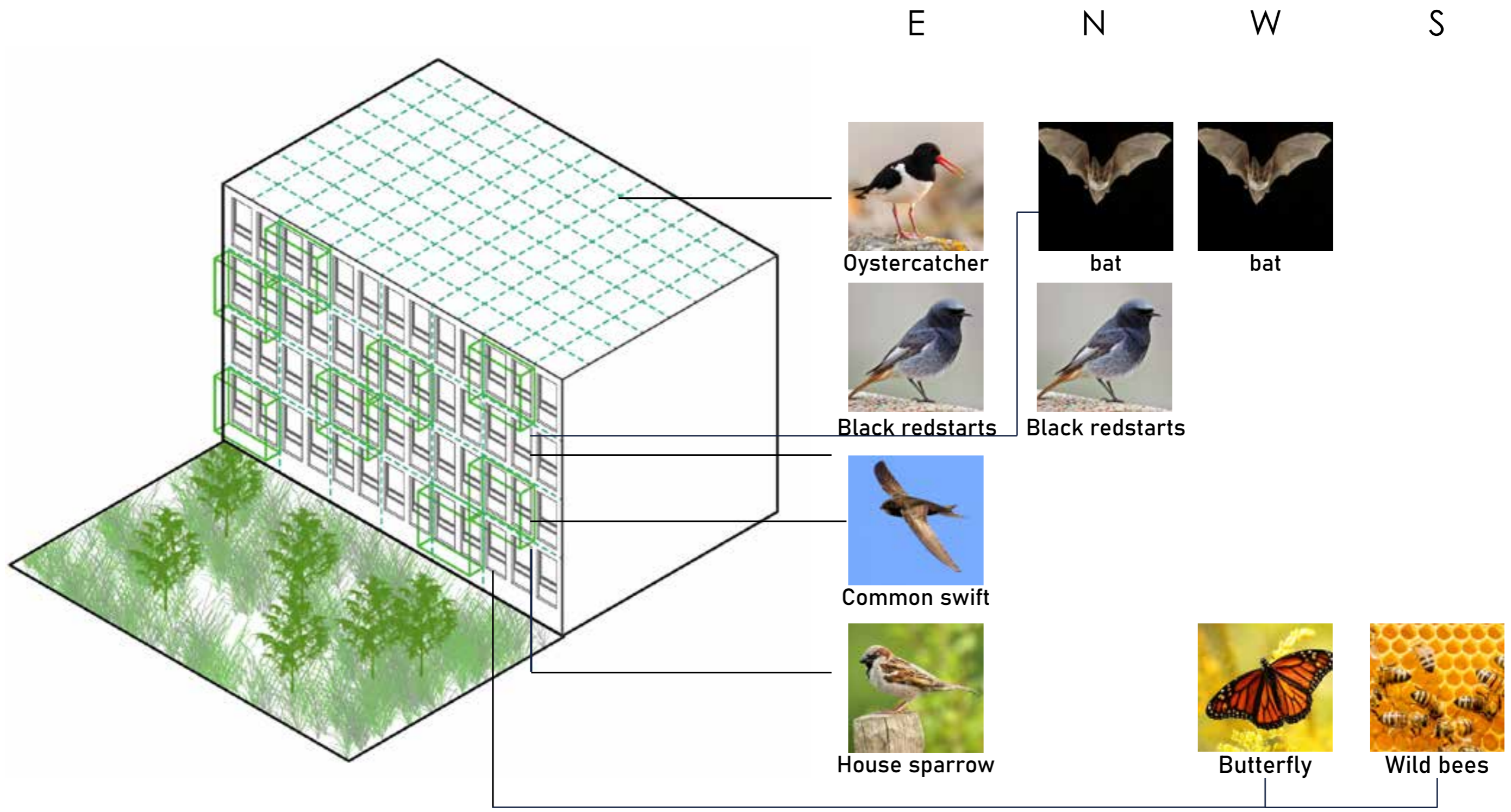

Design scale

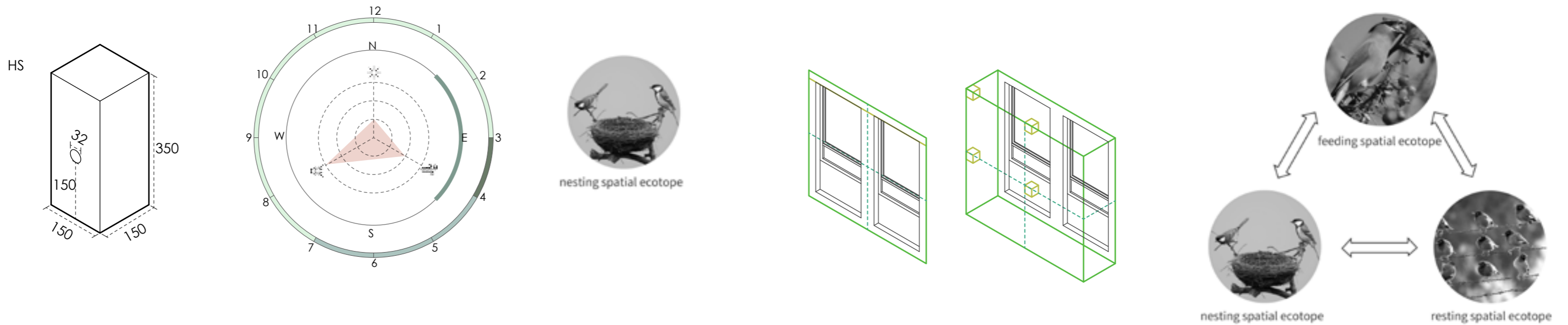

Element

Unit

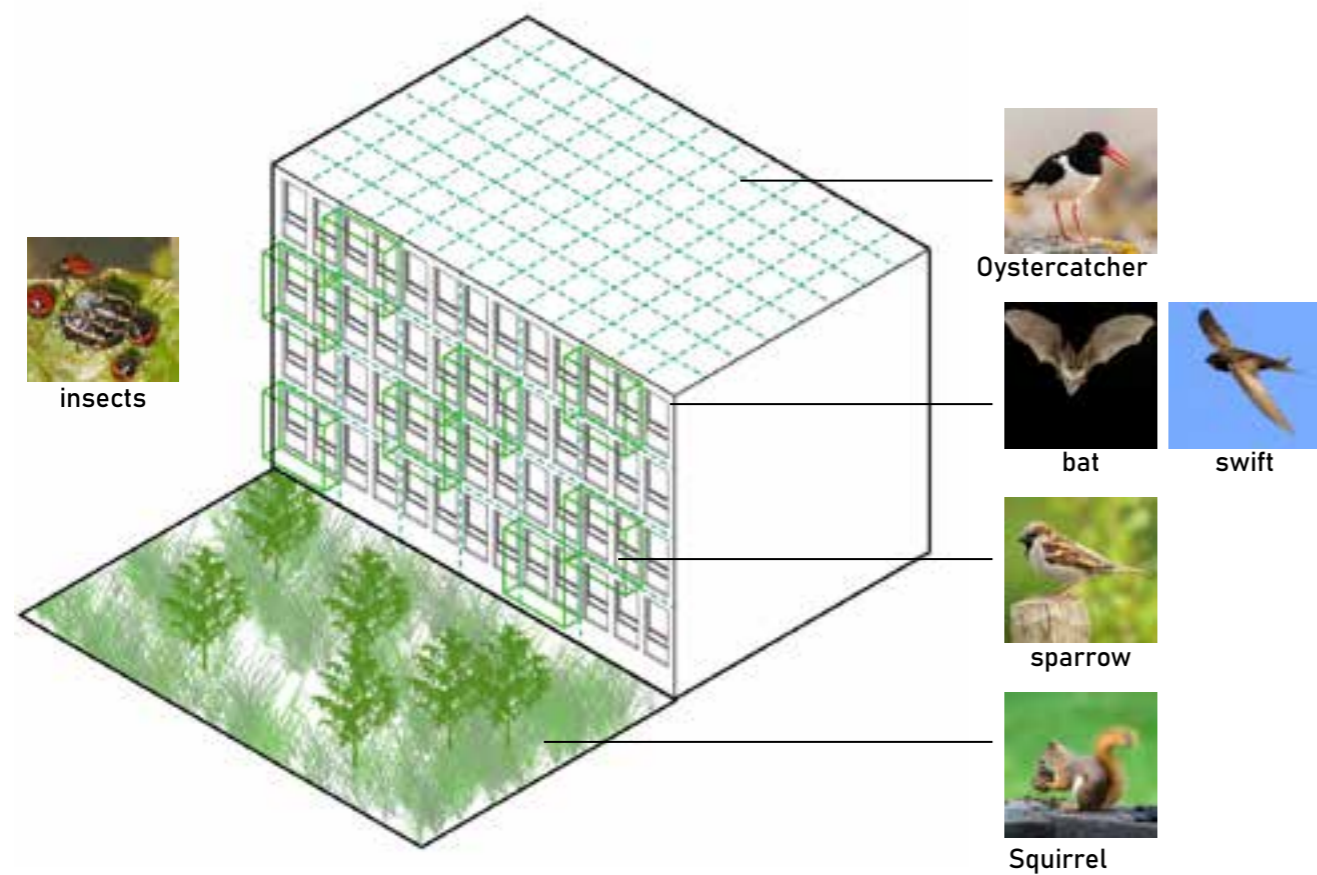

Building

Creating better habitats for building-dependent species

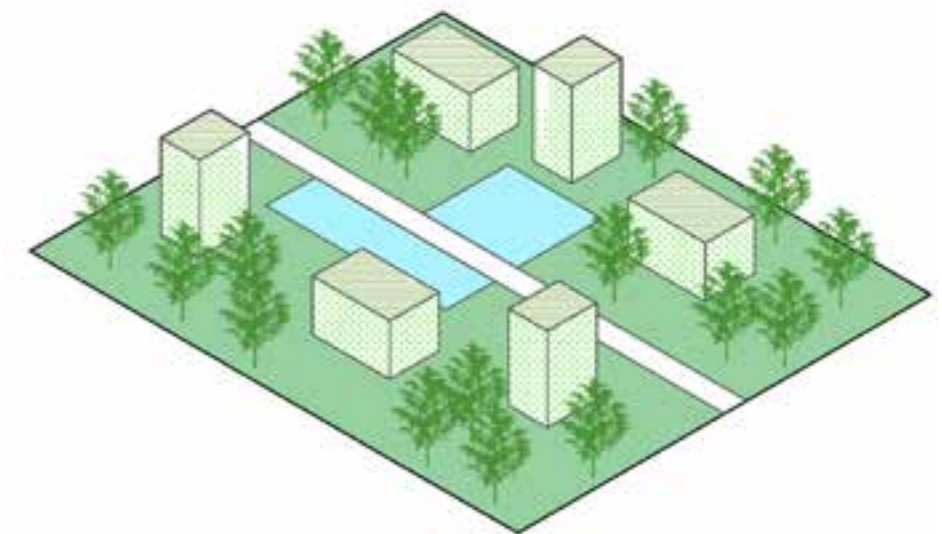

Neighbourhood

Result2

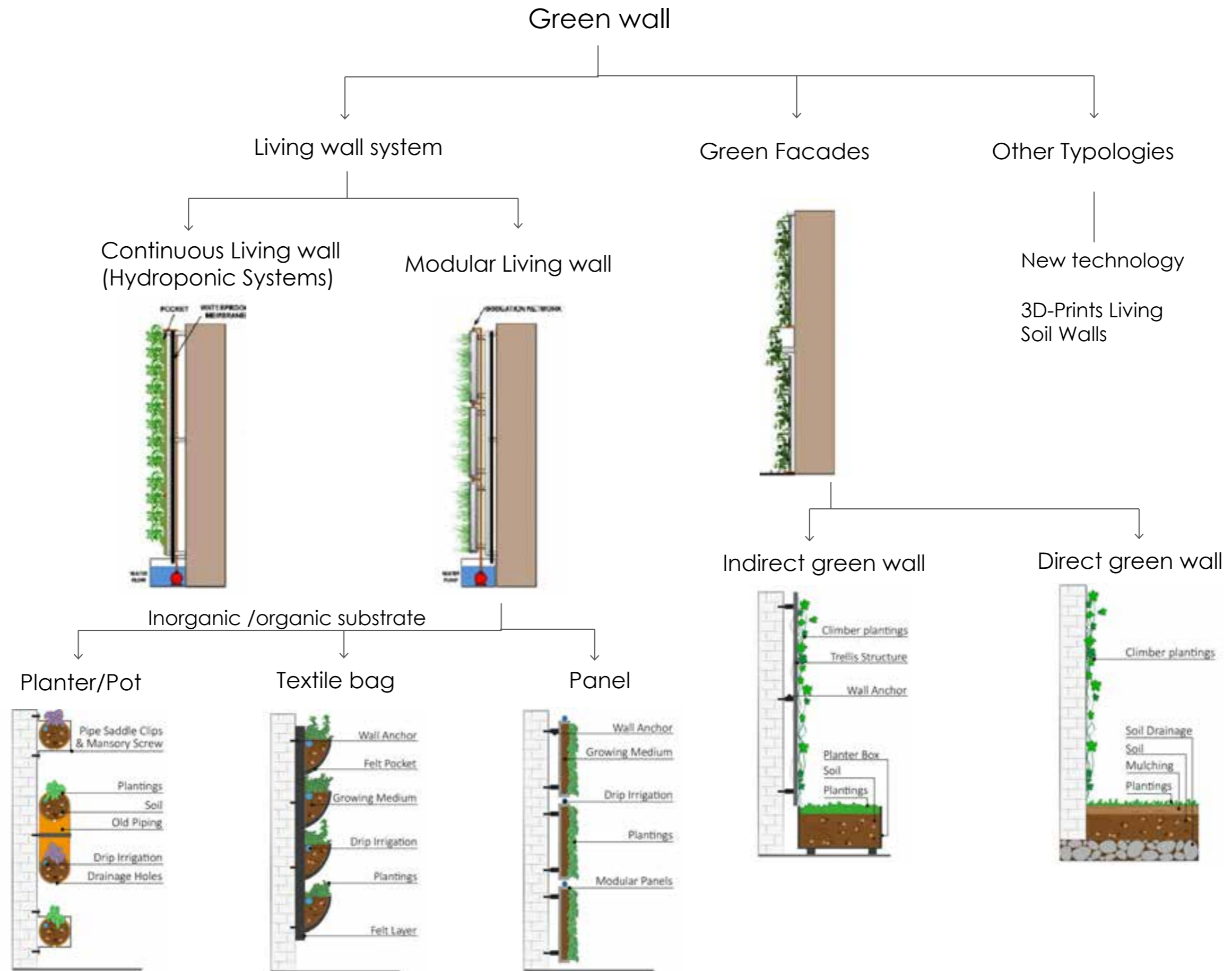

Planter/pipe

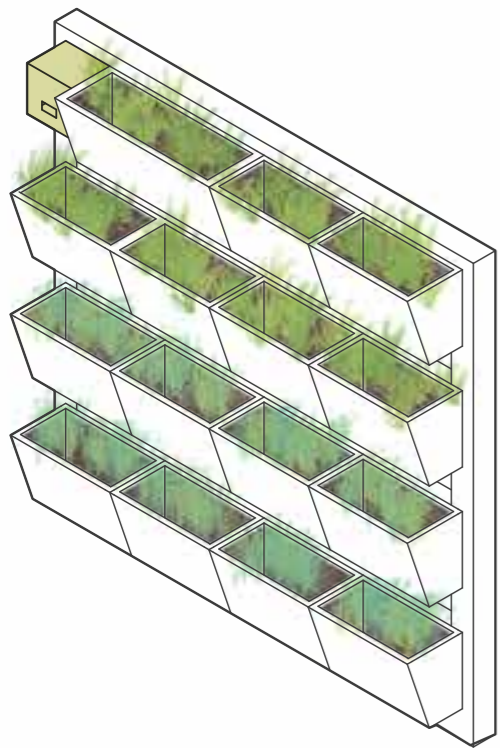
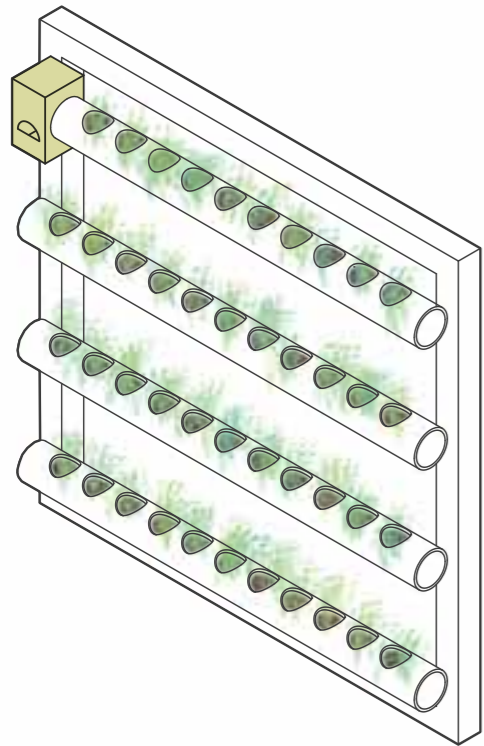

Panel

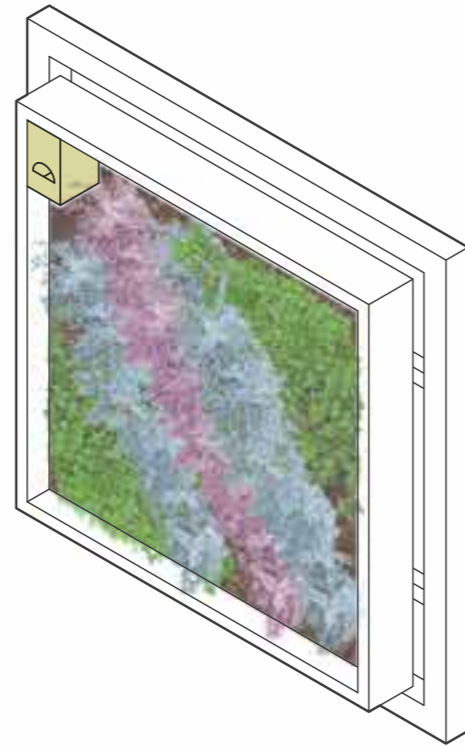

Indirect
green wall

mesh support

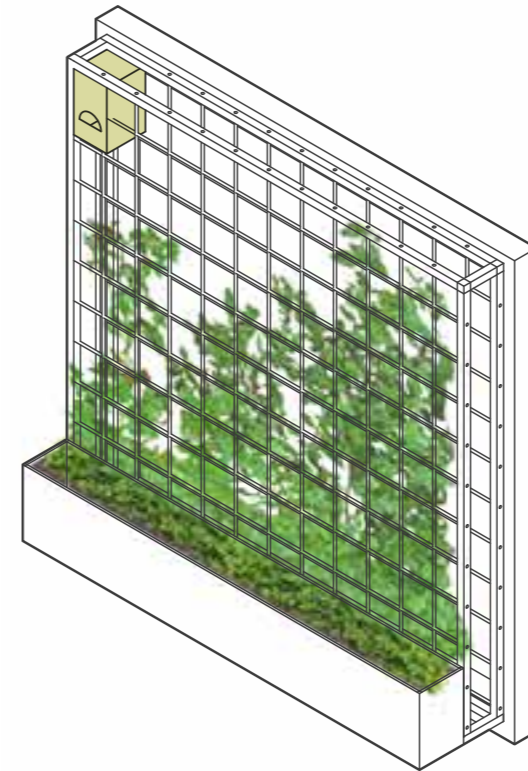

3D-prints living
soil wall

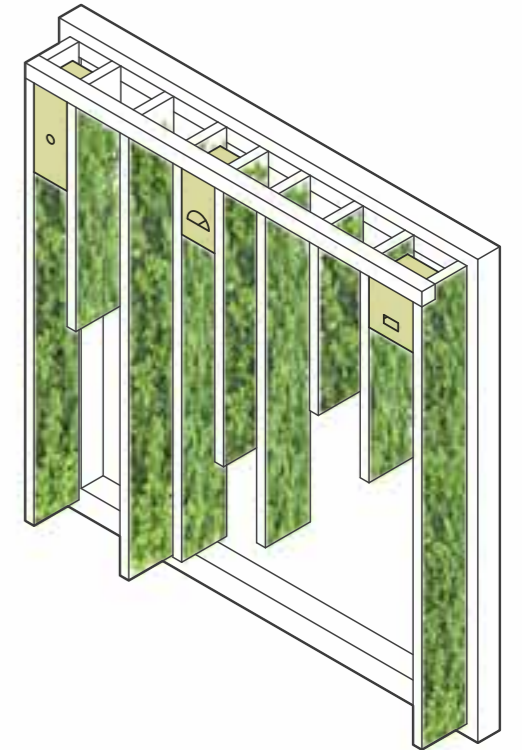

Build ecology system in building

Biointegrating

Physical integrating

system integrating

Integration of human habitat with plants and animals

Architecture should make use of natural resources in a sustainable way, so that resource use coincides with natural recovery and renewal cycles.

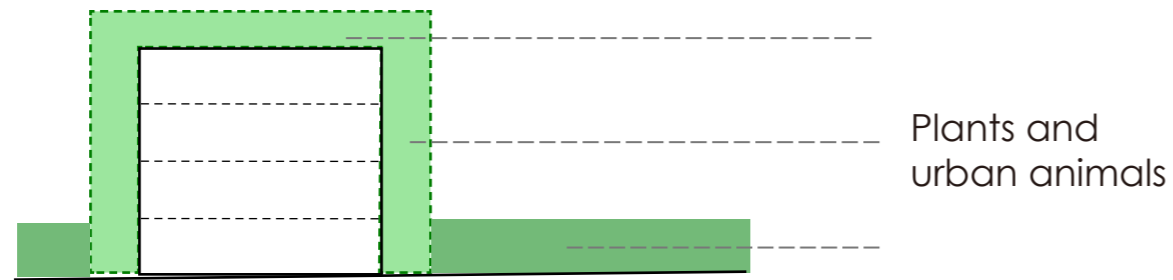

Modelling biological structures in ecosystems

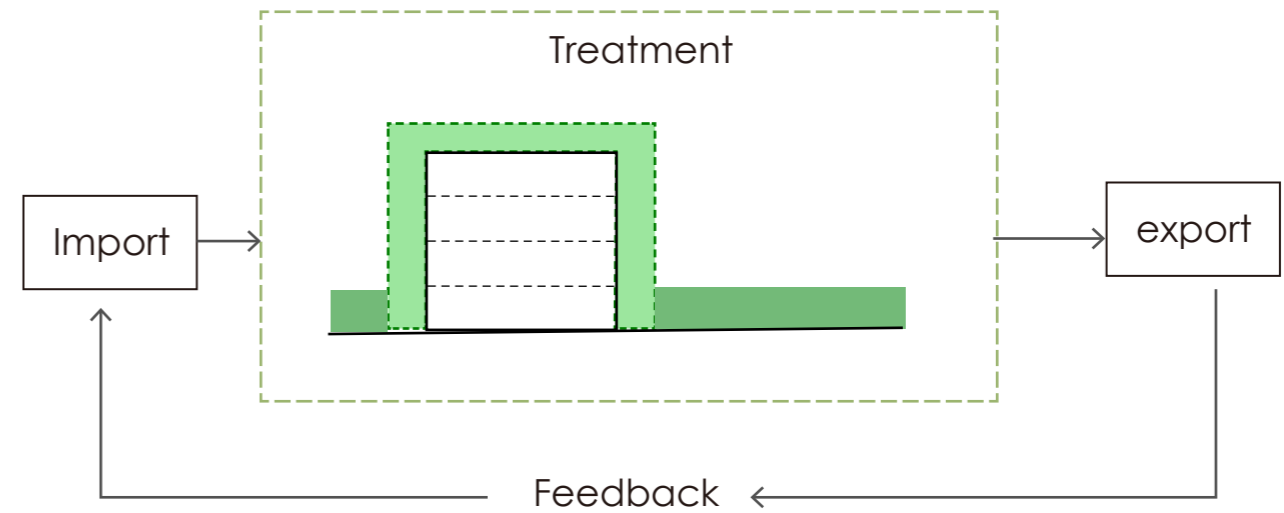

Modelling energy cycles in ecosystems

Context

Delft campus-Green types

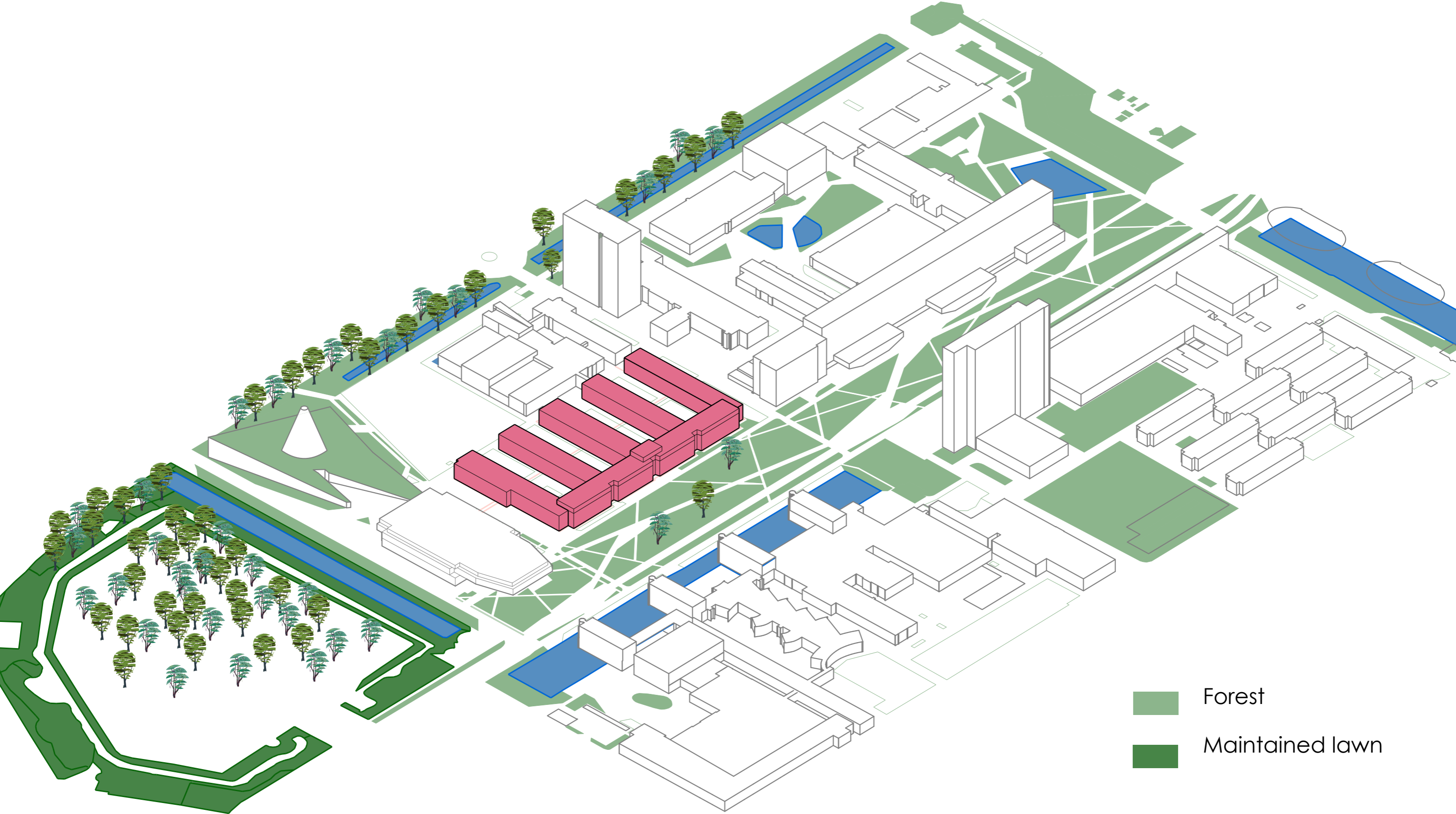

- Forest
- Maintained lawn

Context

TNW

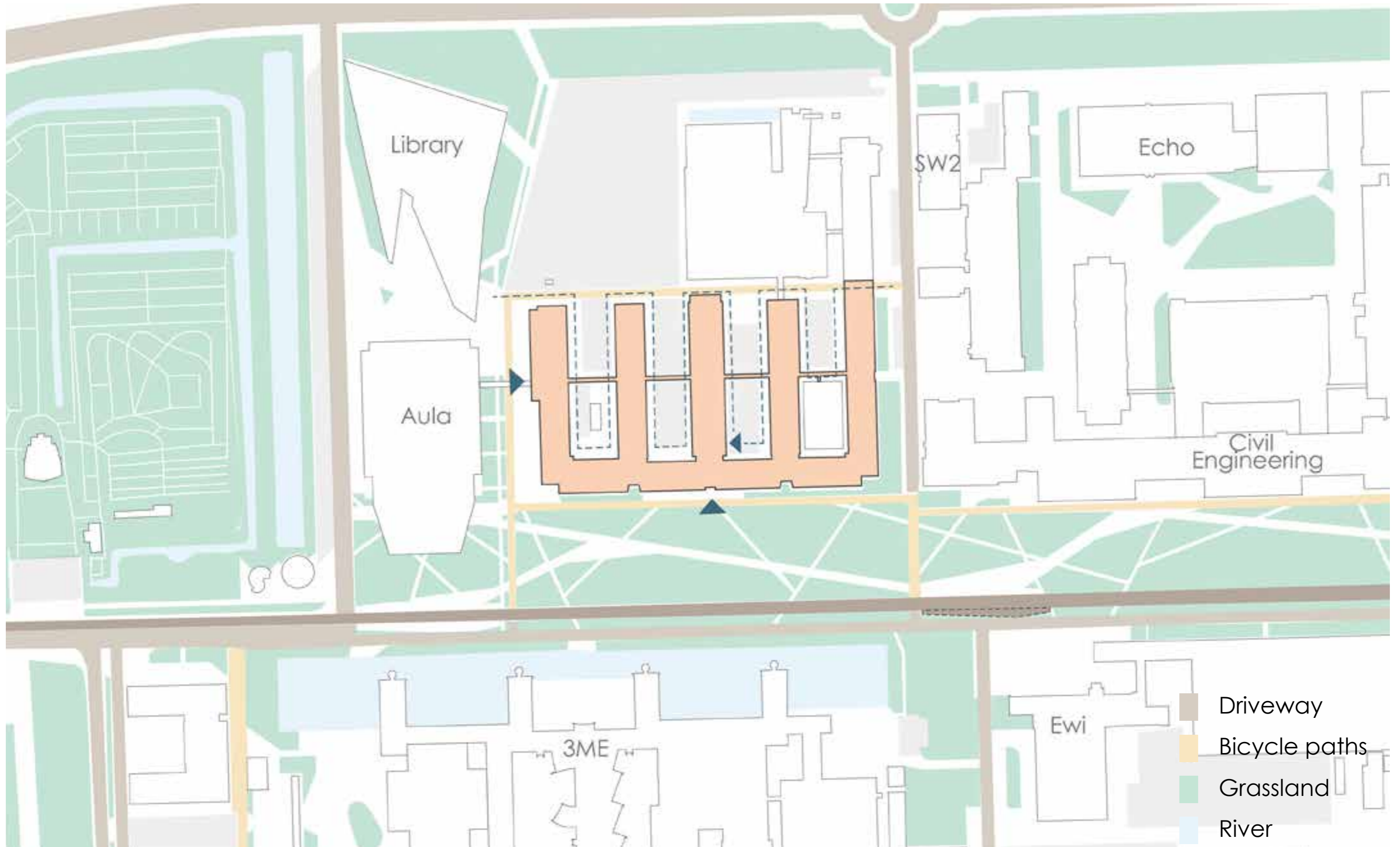

Design Concept

Make TNW building
integrating with
ecology system

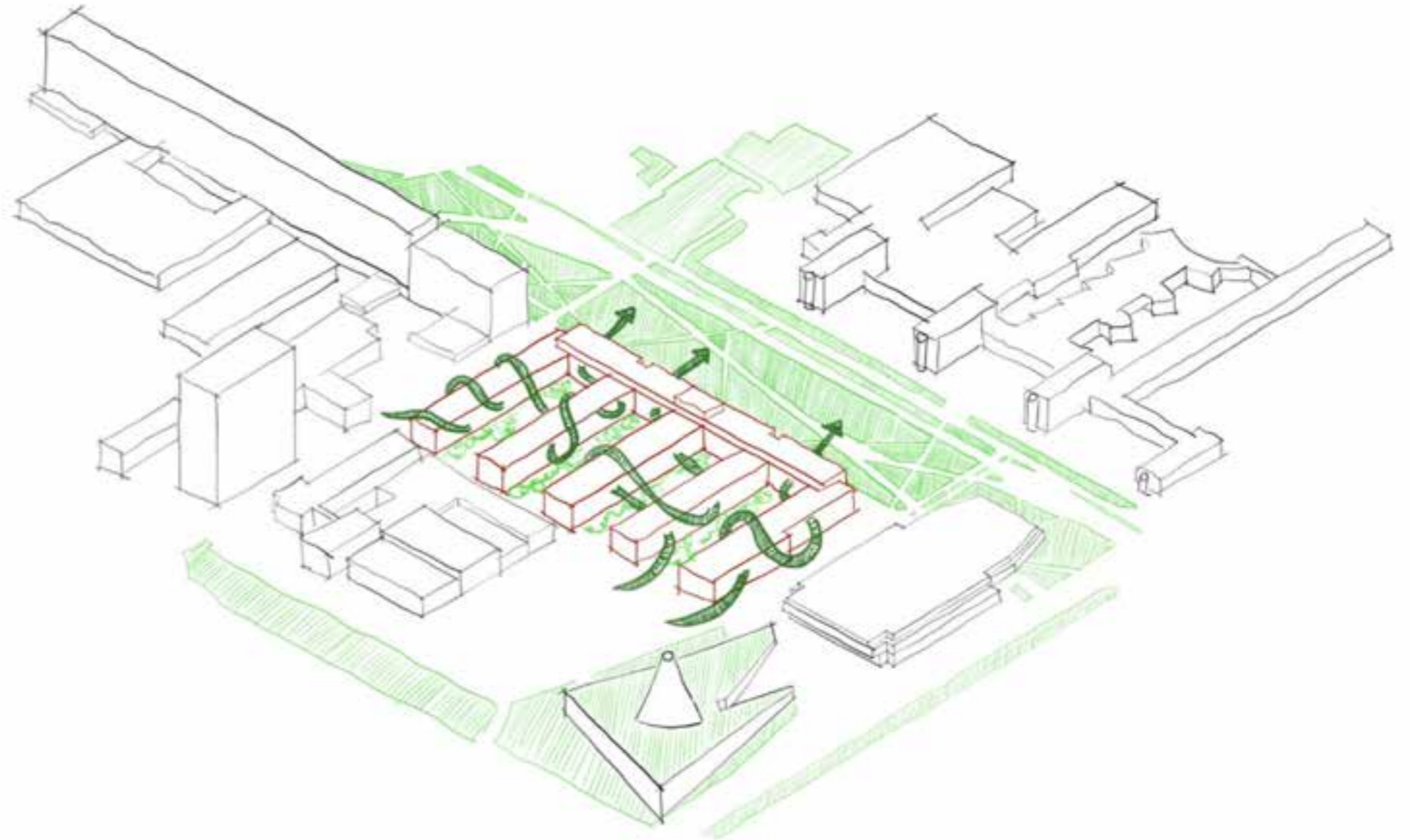

Design Program

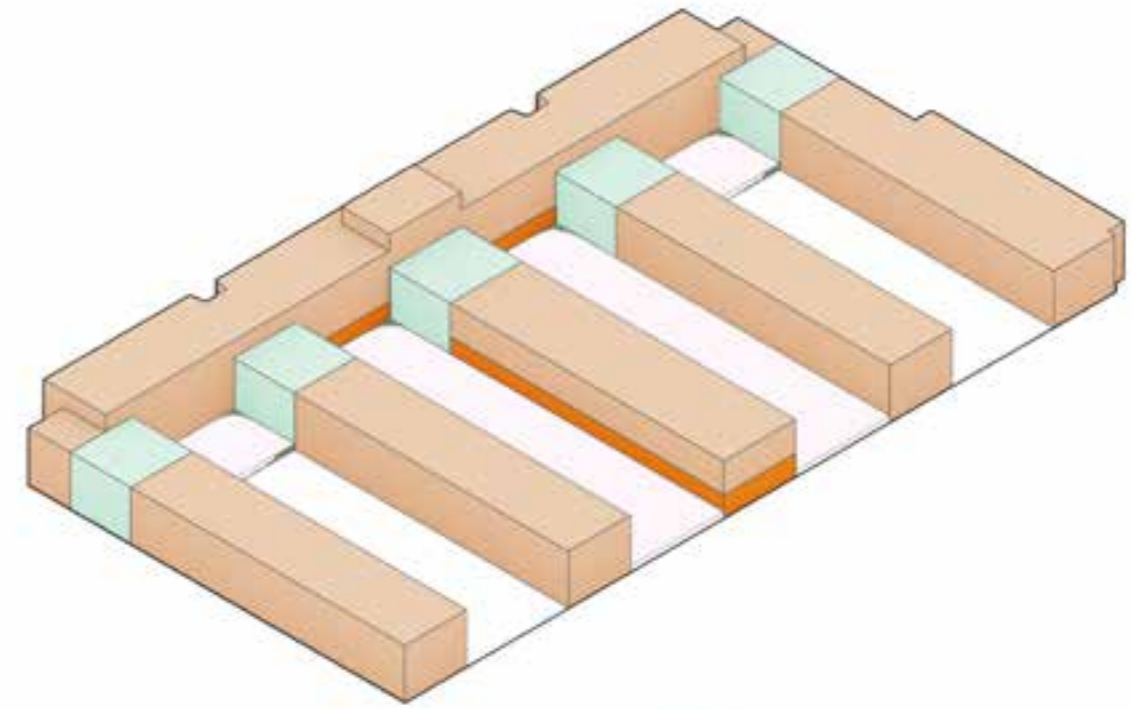
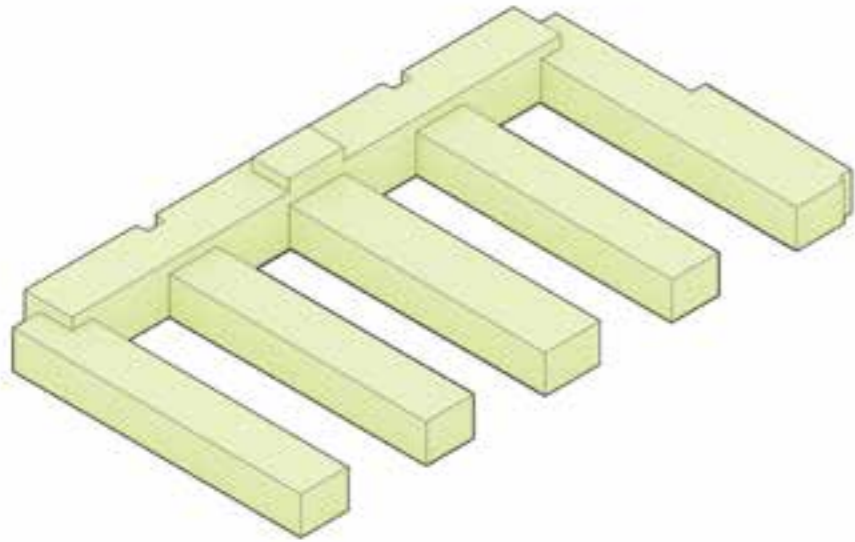

- Student Housing
- Green Atrium
- Public Functions

Educational

Collective housing+Urban gardening

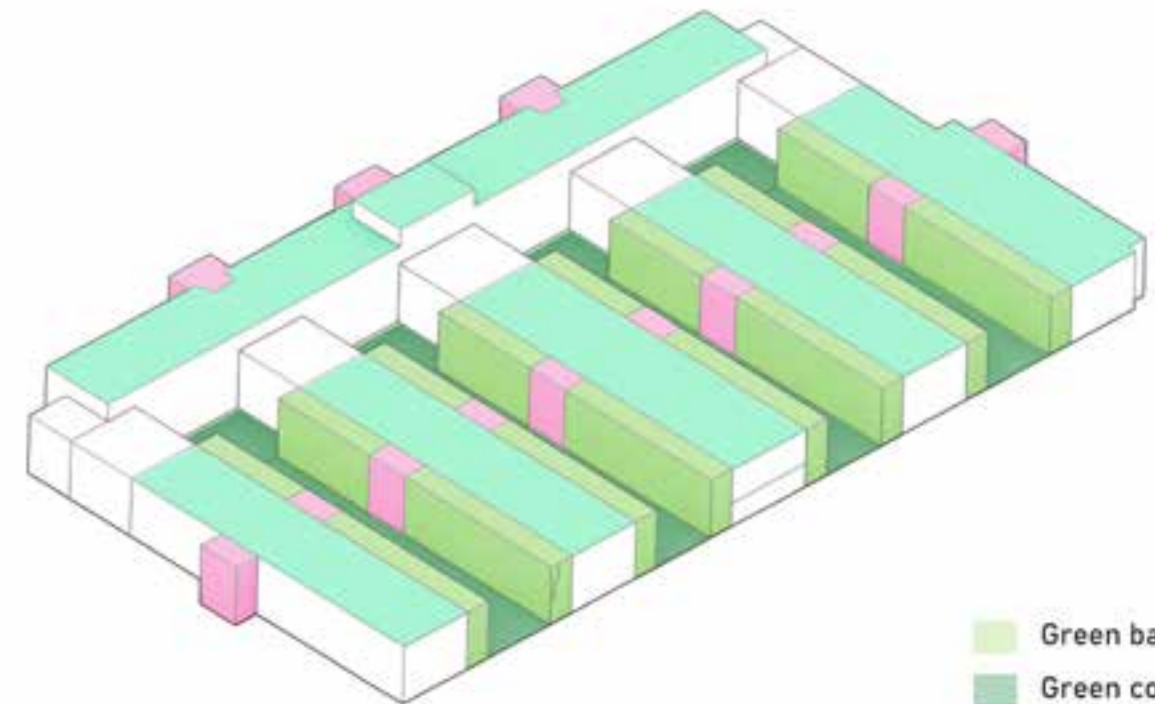

- Green balcony
- Green courtyard
- Green roof
- Winter garden

Design

Three main intervention

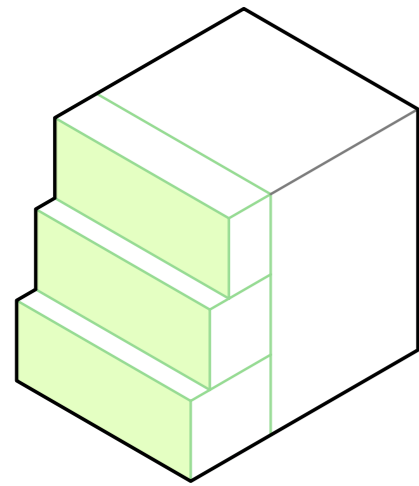

Modular green balcony

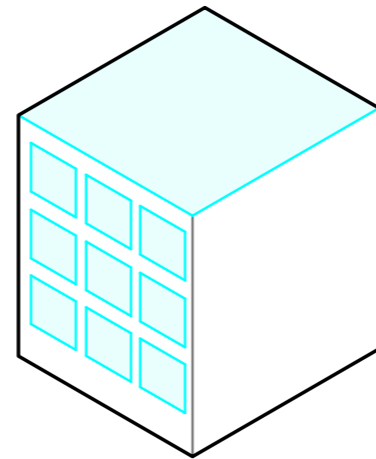

Green Atrium/Winter garden

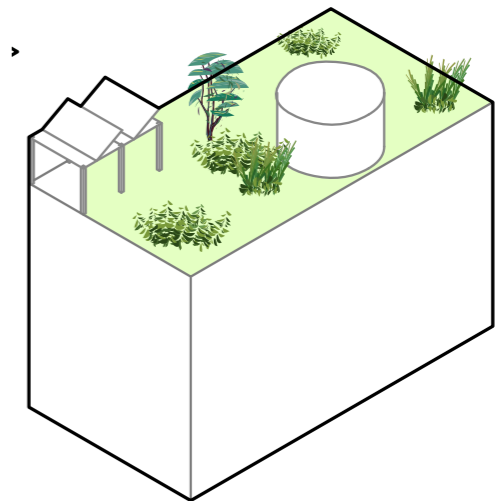
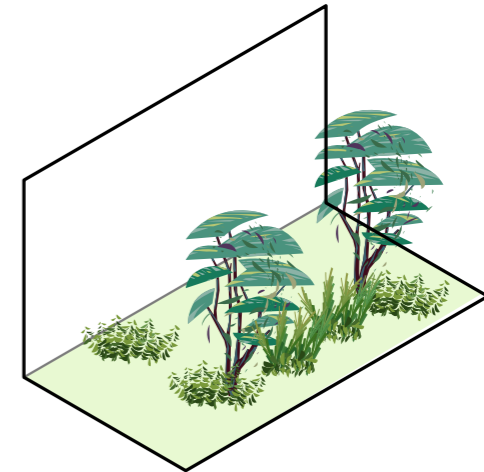

Green roof/Green courtyard

Design

Site design



- Driveway
- Bicycle paths
- Grassland
- River

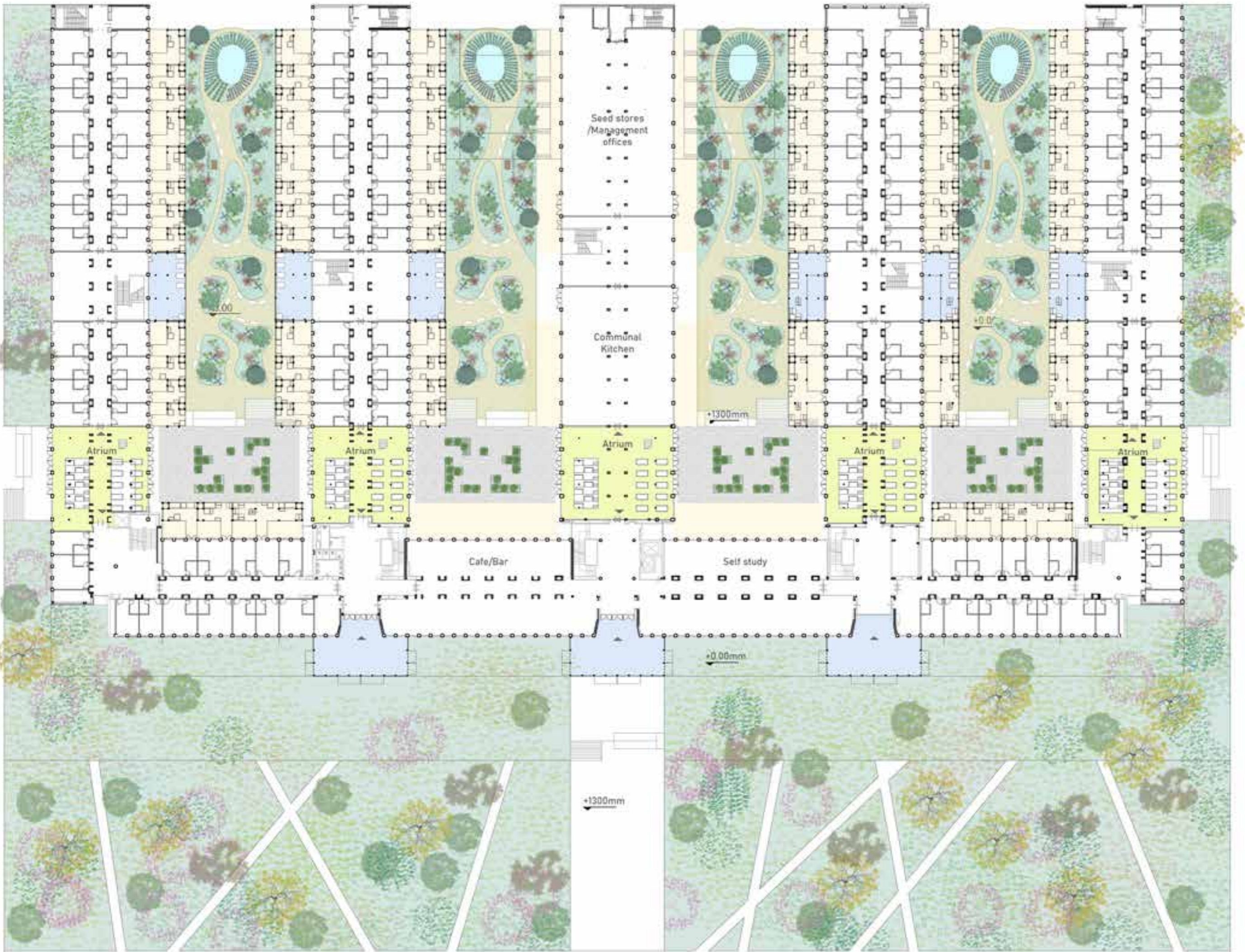

Design

Modular green balcony



Design

Modular green balcony

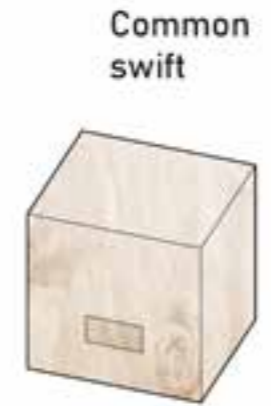
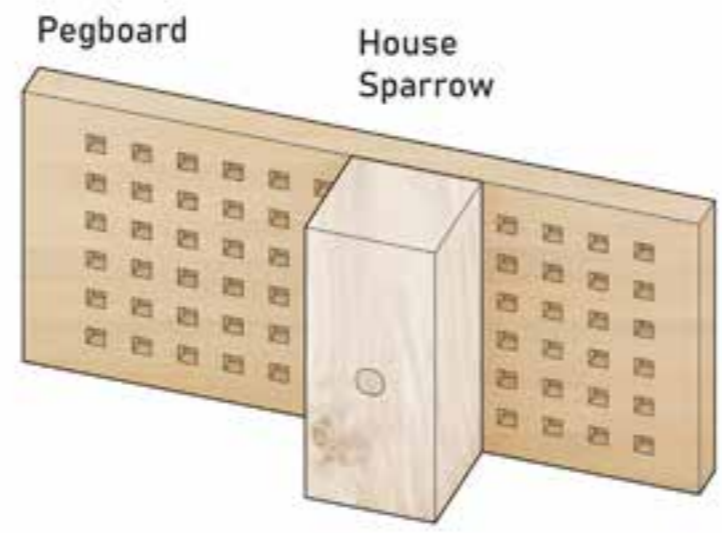
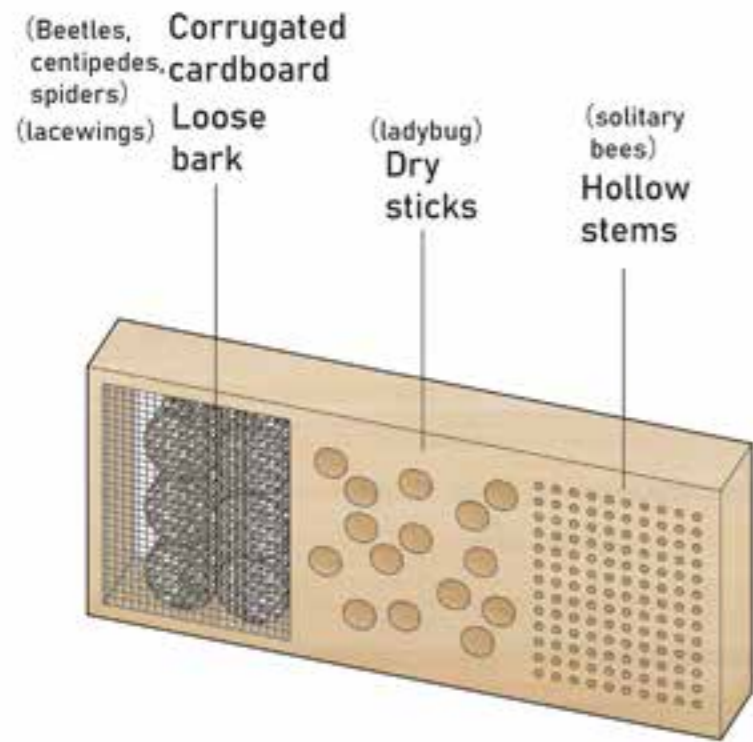

nesting spatial ecotope

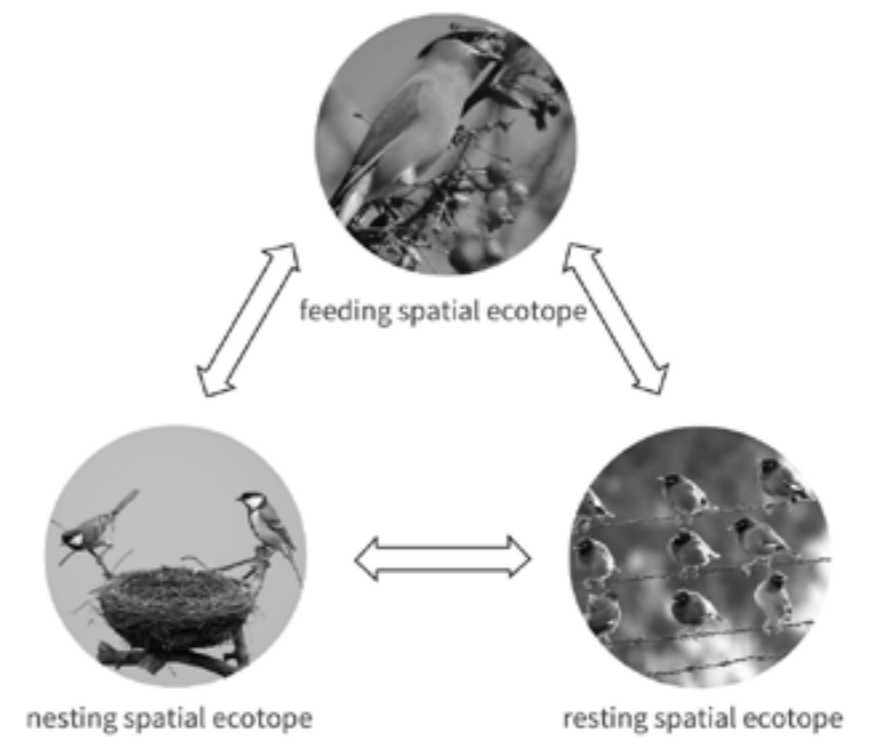
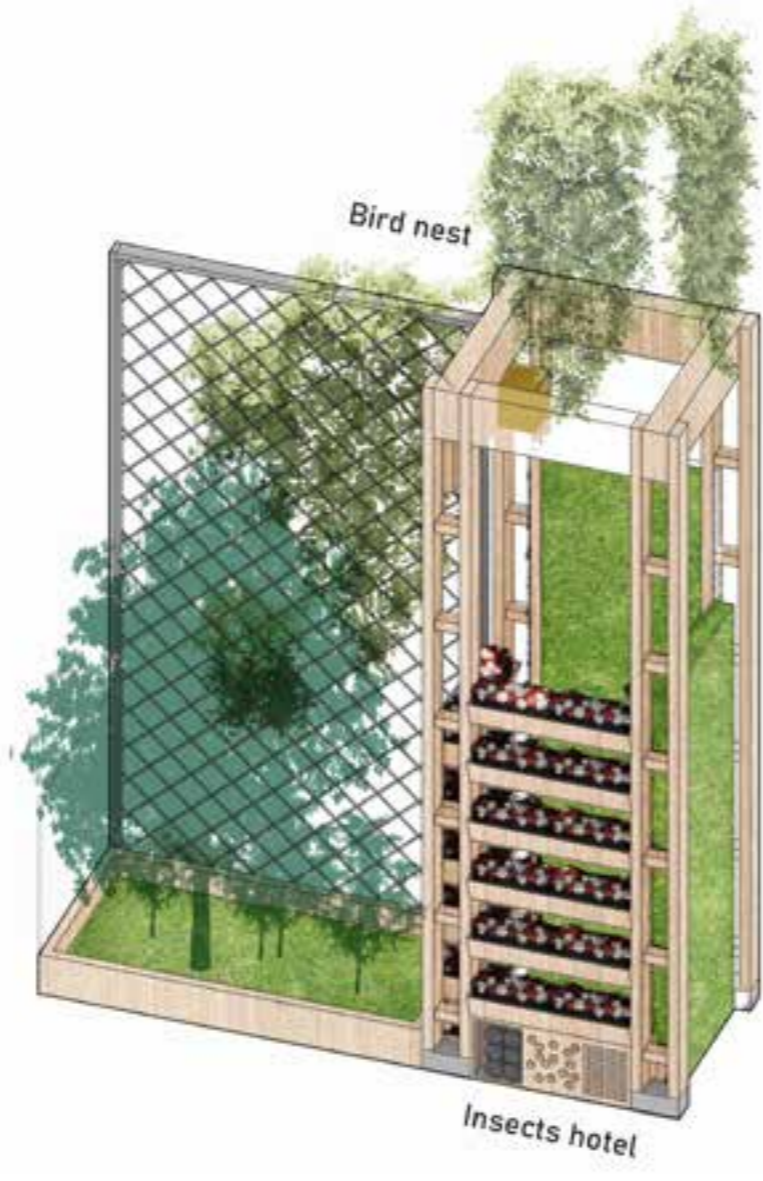
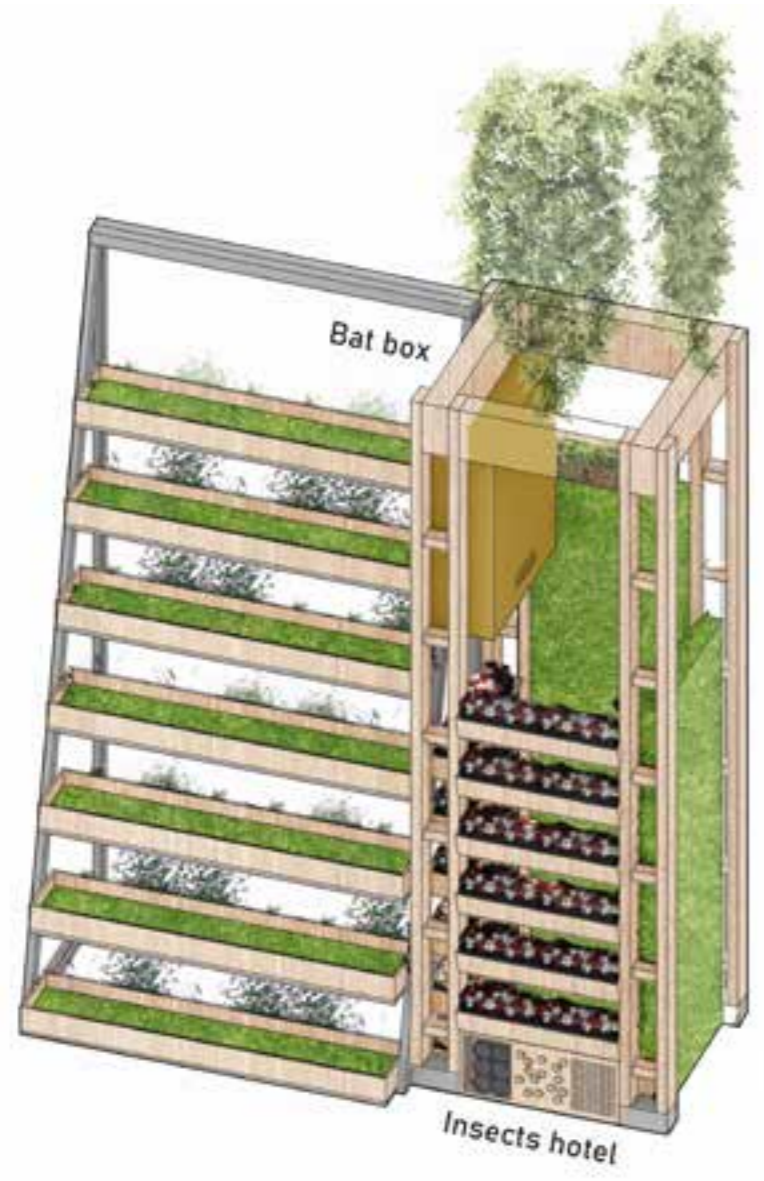

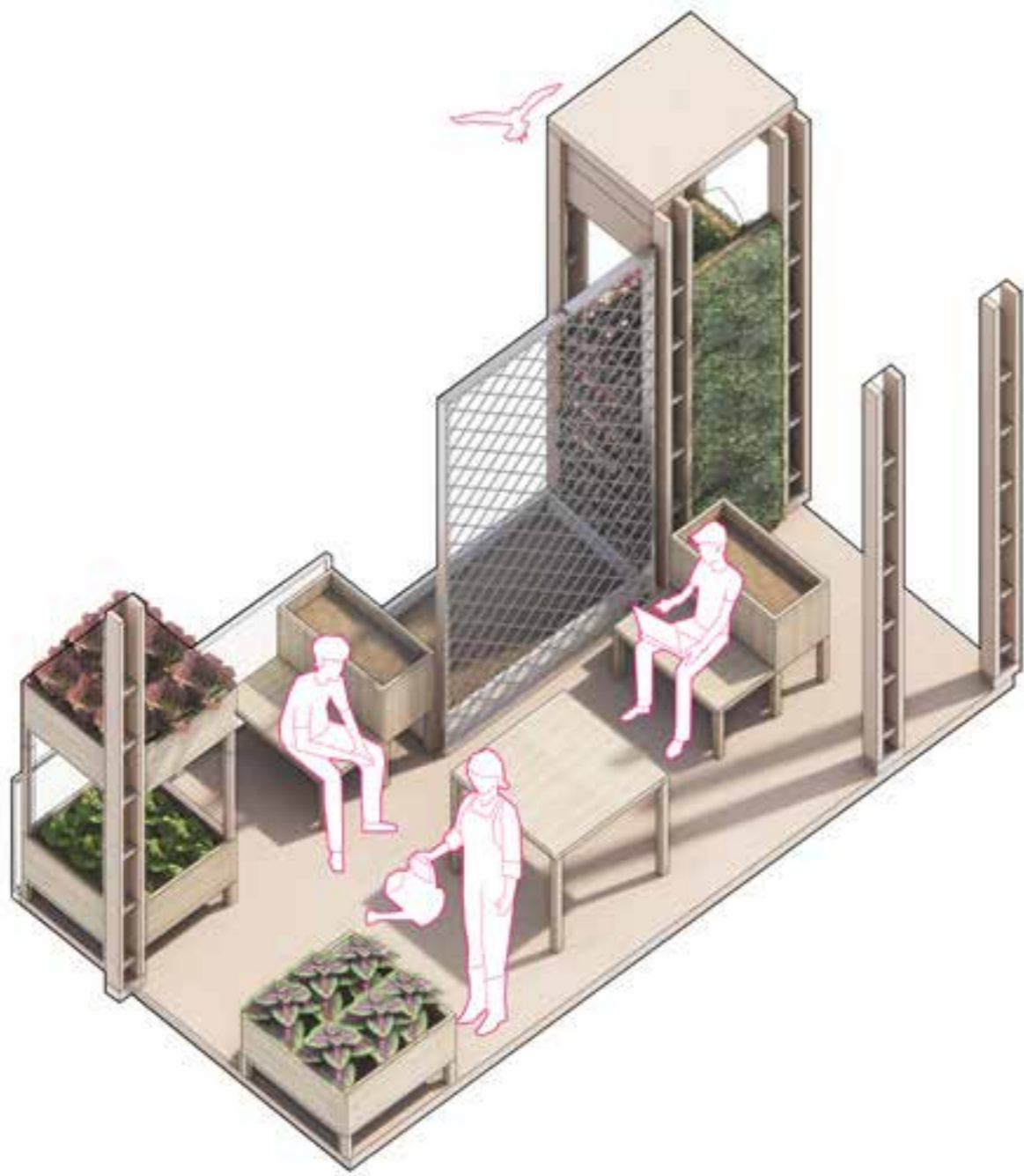

HumanU



urban animal

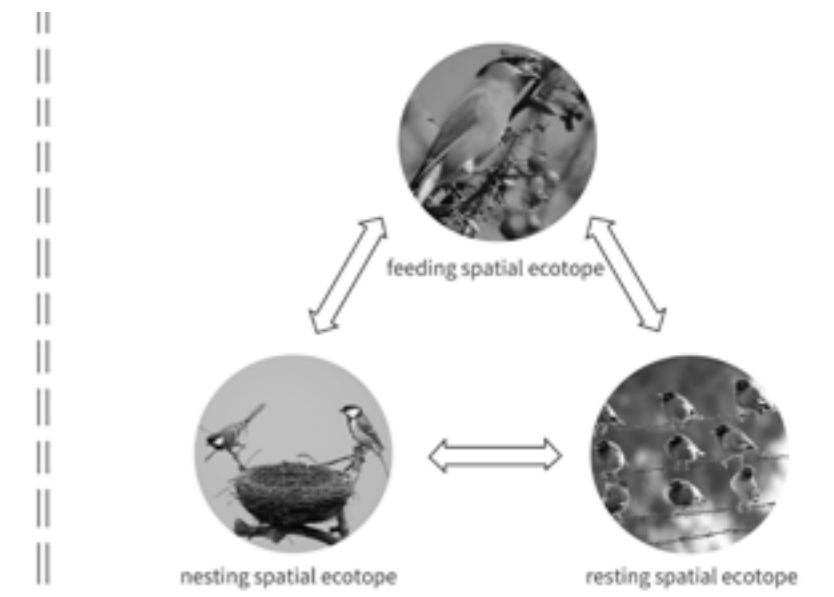





Oystercatcher



Black redstarts



Bat



Common swift



Butterfly



Wild bees



House sparrow

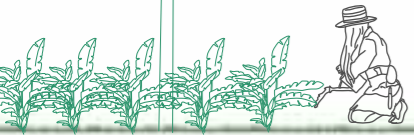
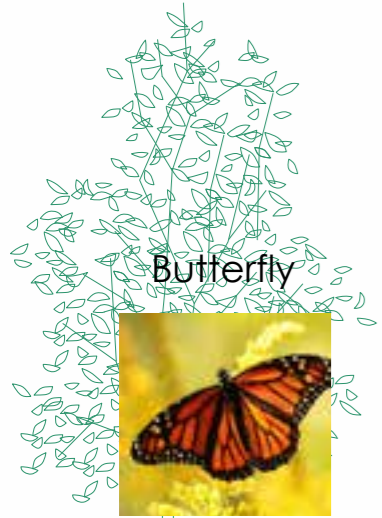
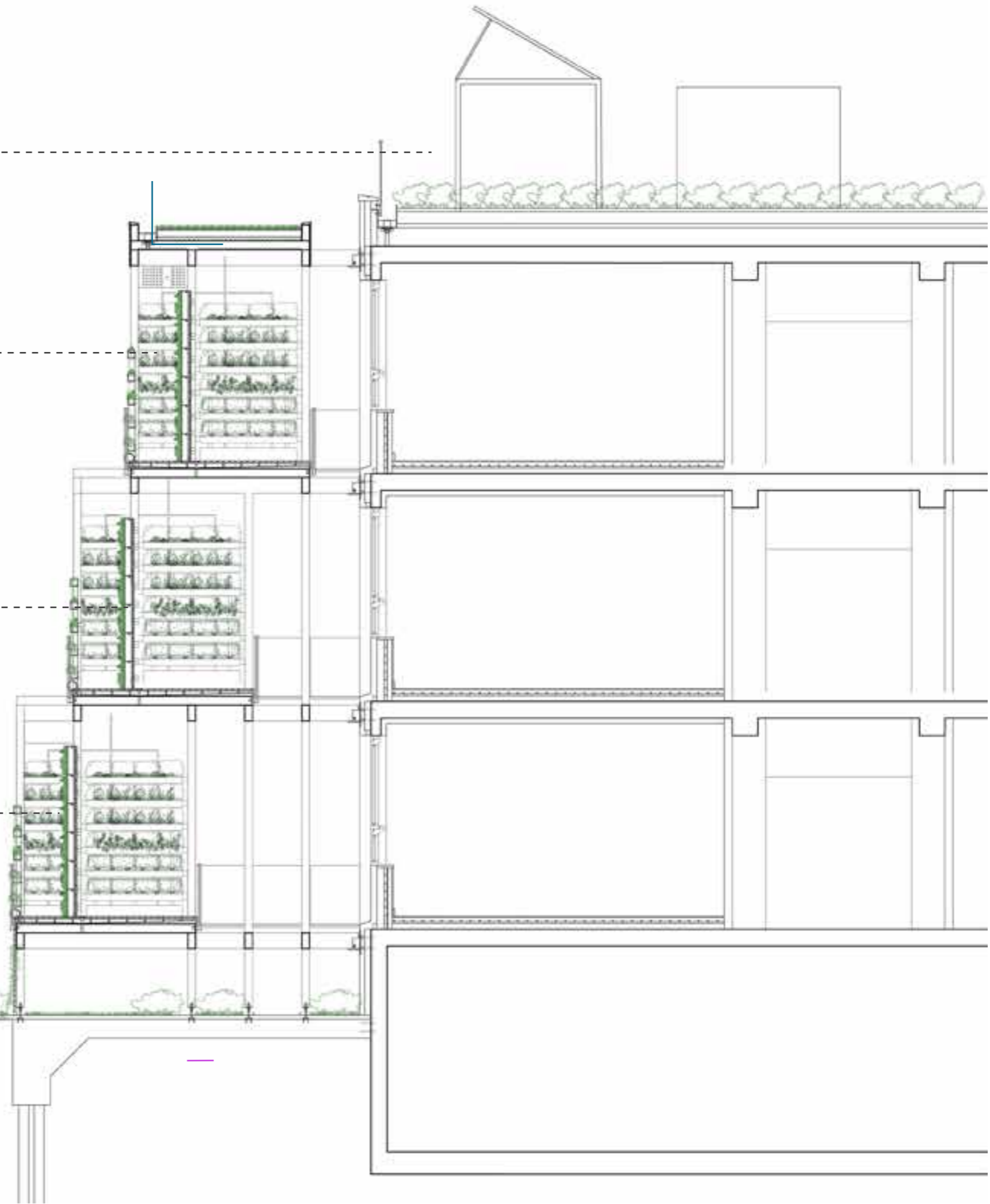

Studio A



Studio B

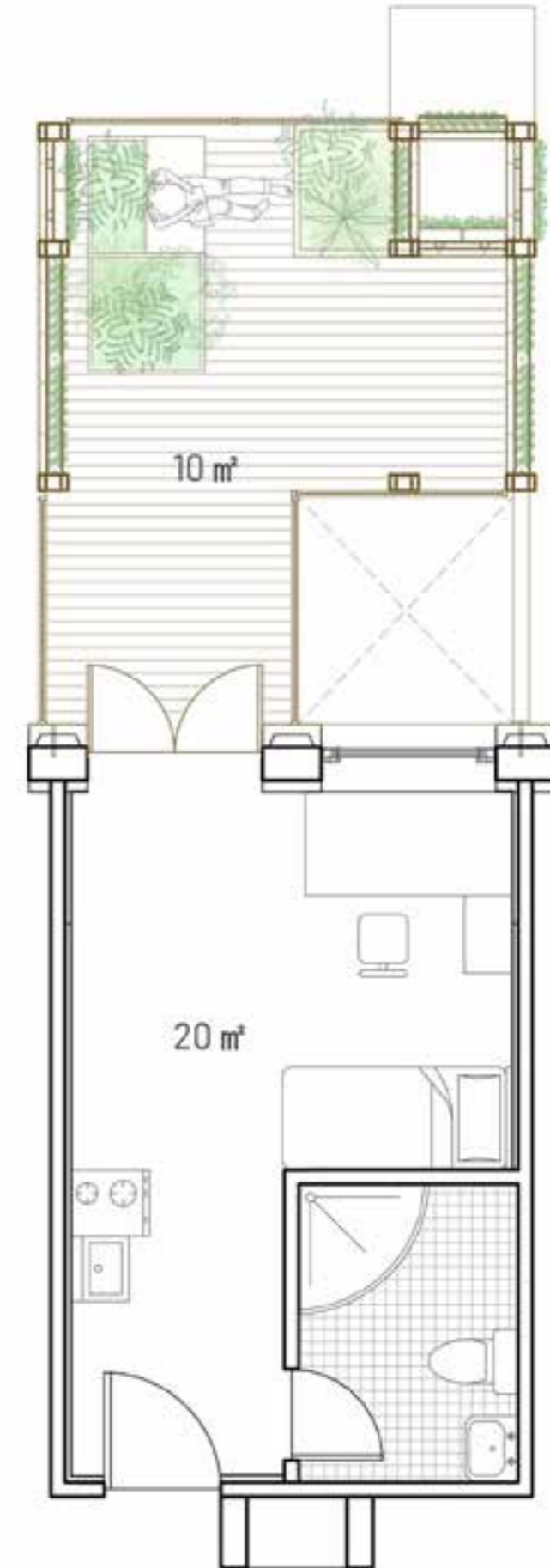

Shared cluster

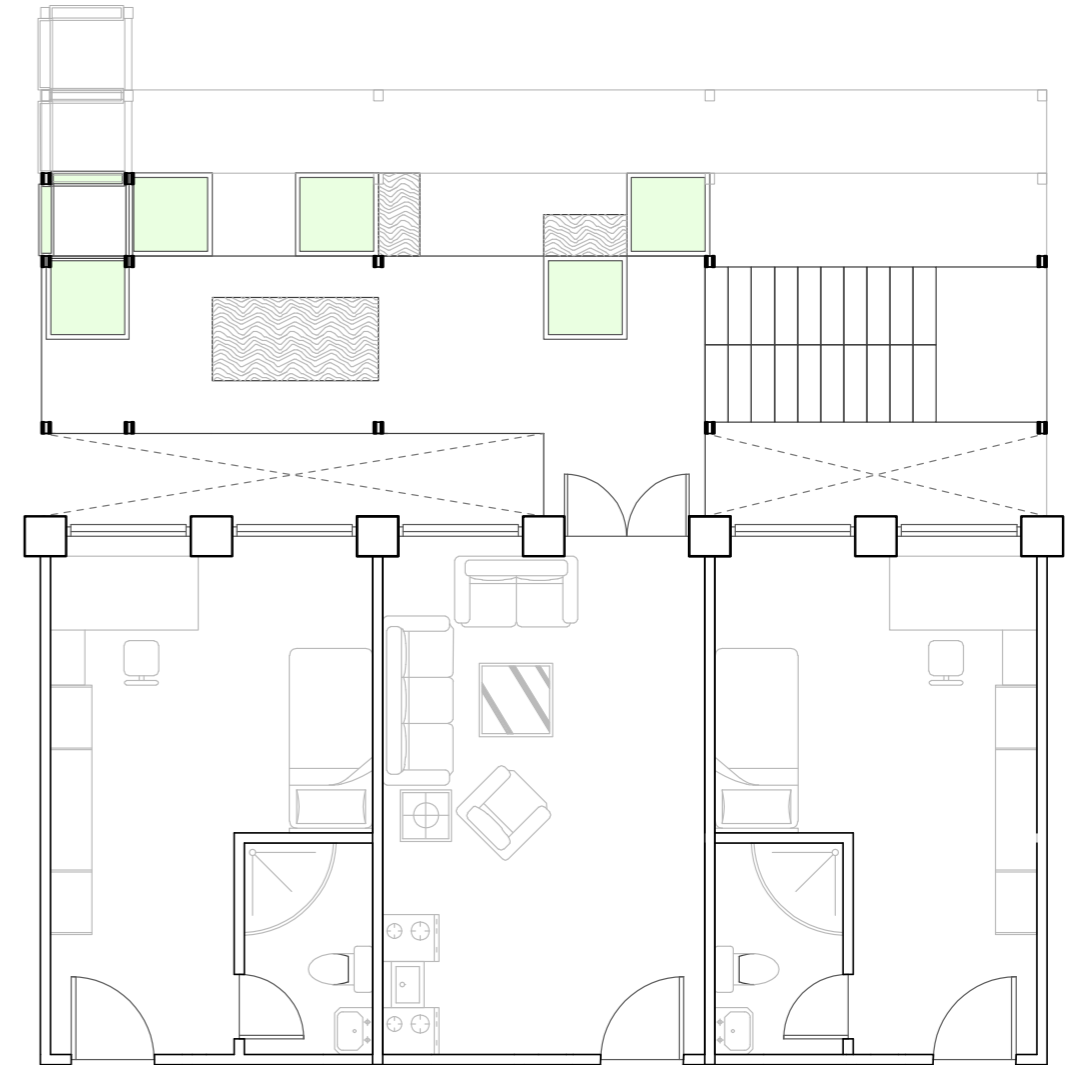

Modular unit for different space

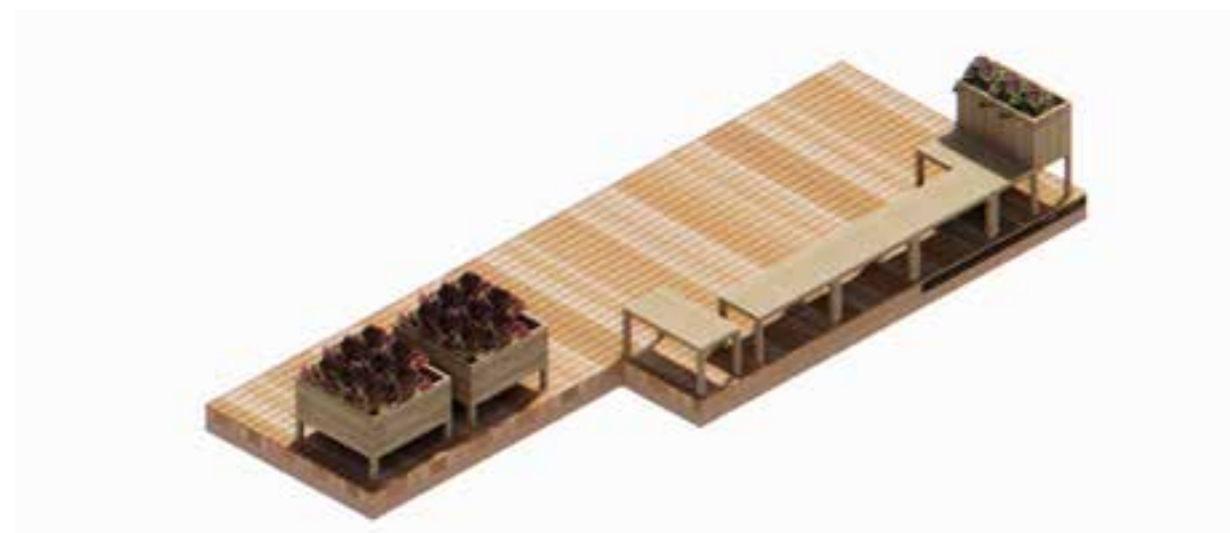
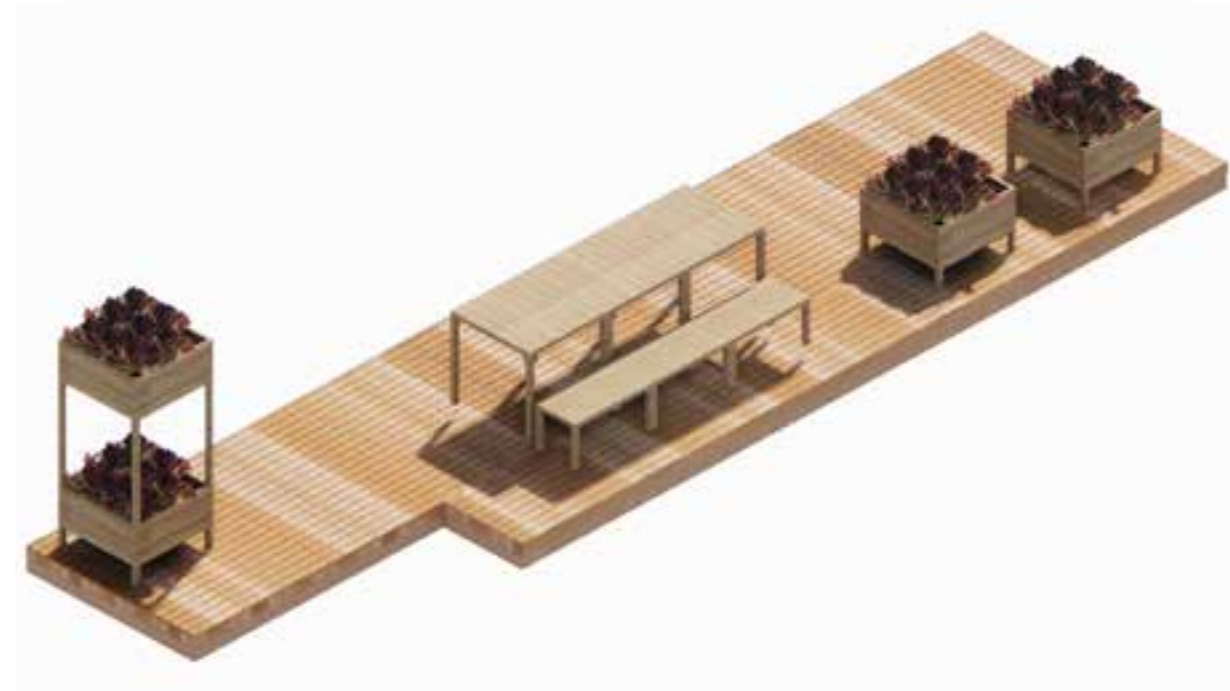







Green atrium

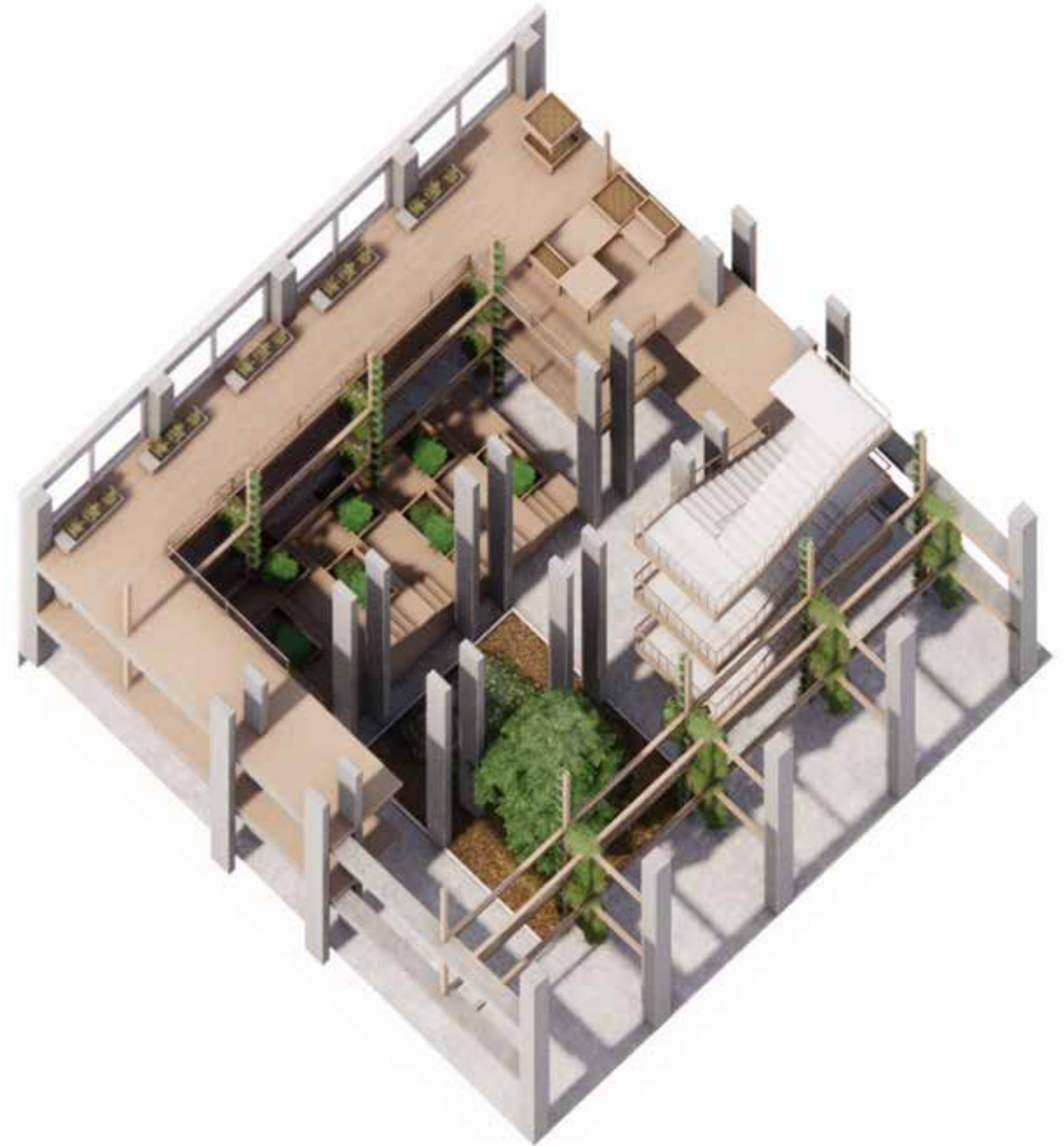
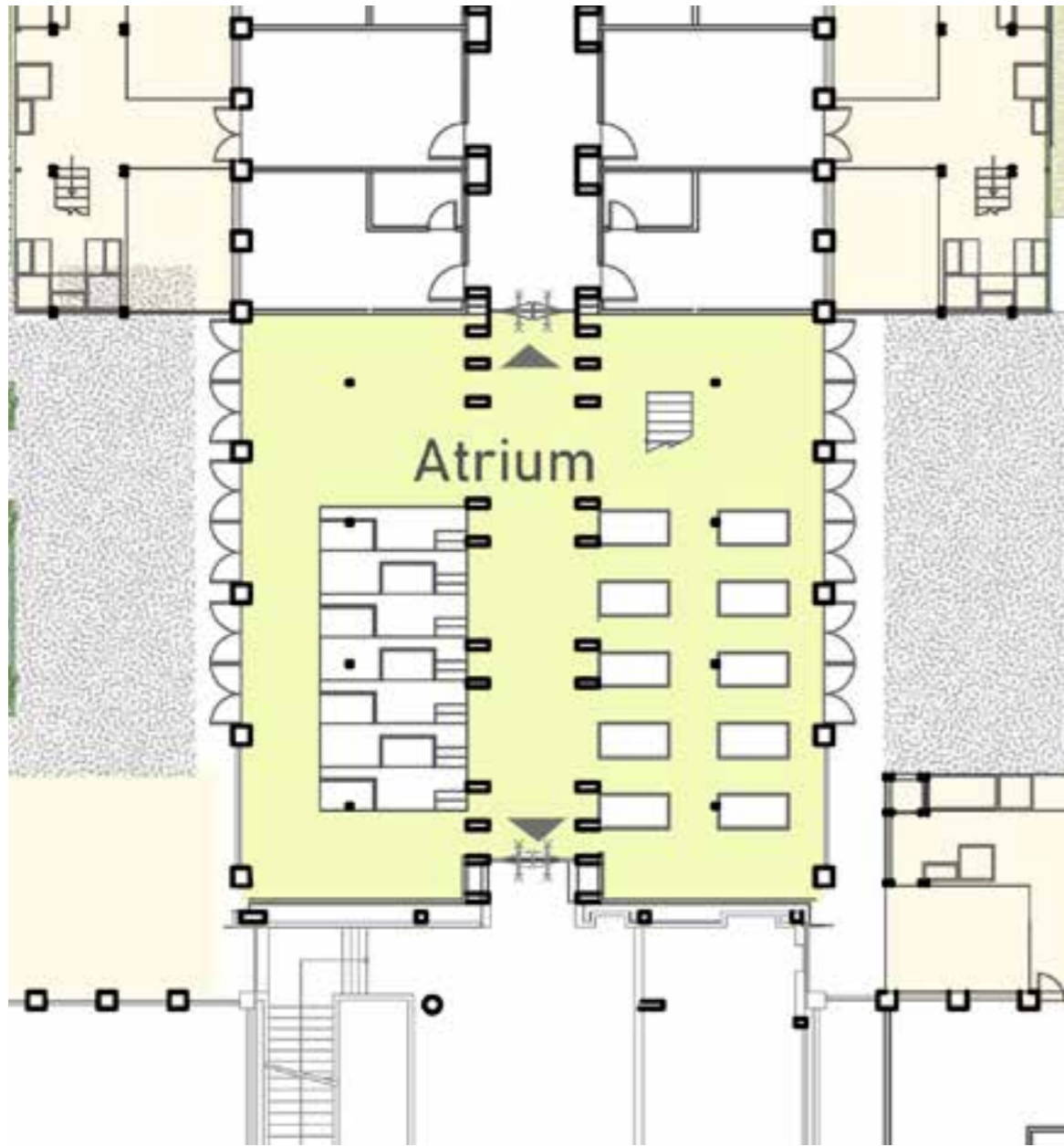





winter garden







Section

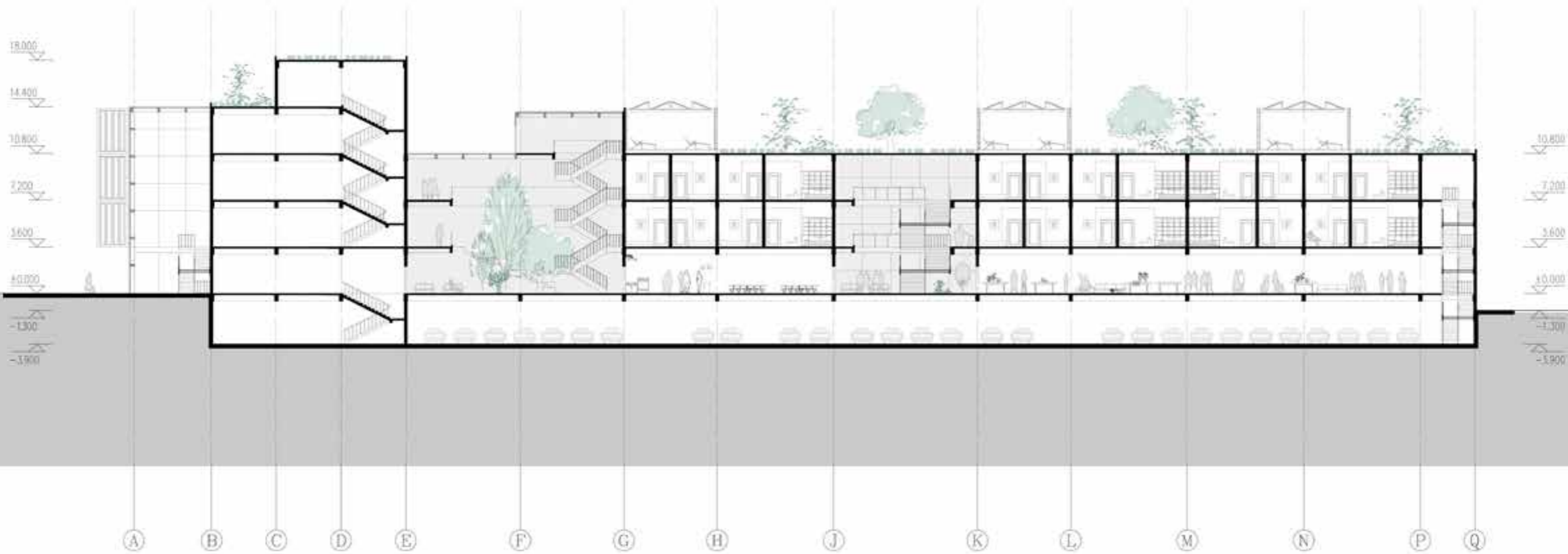



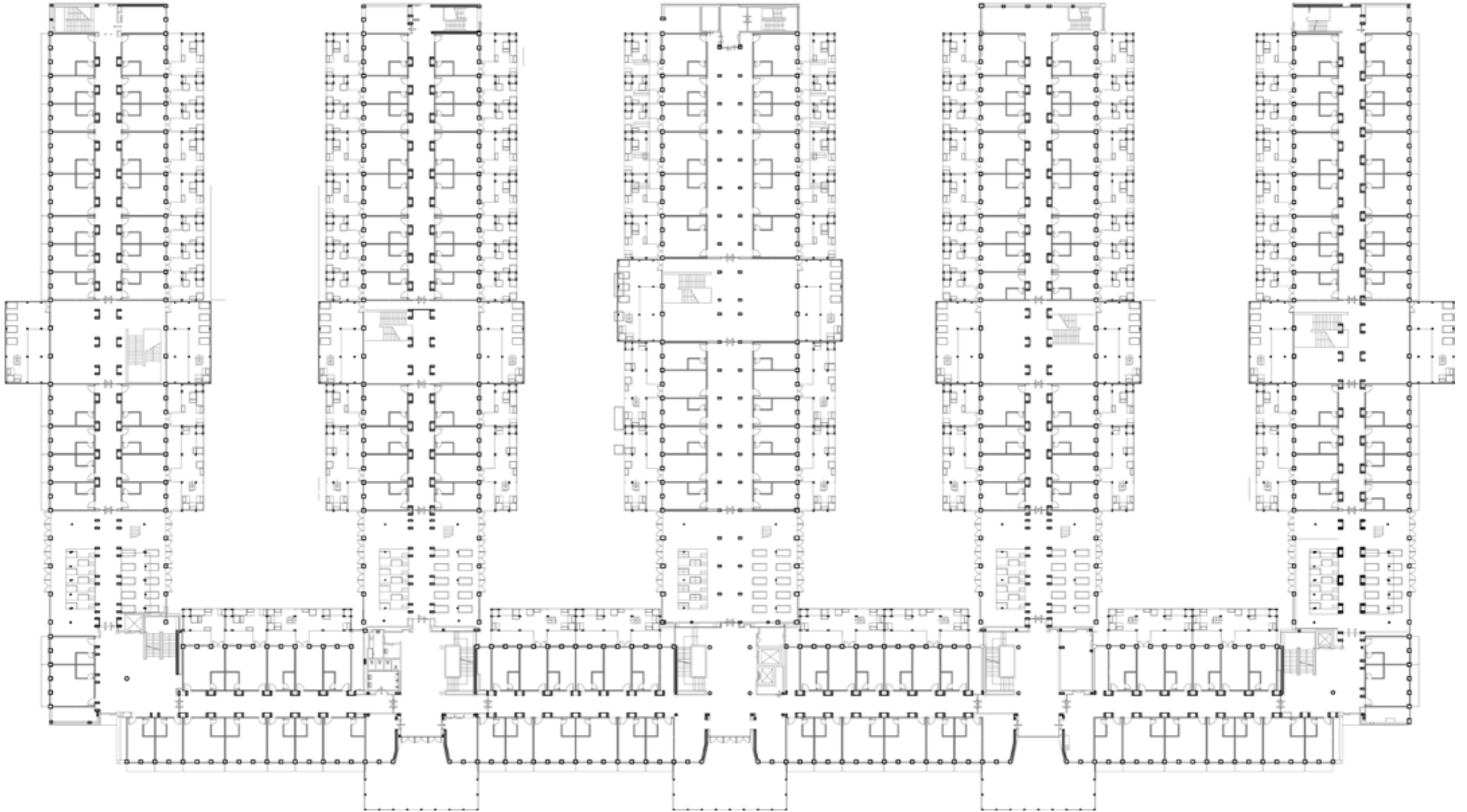

First floor plan







 Building Unit  Main Entrance  Entrance  Existing staircases  New staircases

Elevation west



Elevation south



Green courtyard

Design principles of permaculture

Site climate

Fruit Tree Guild

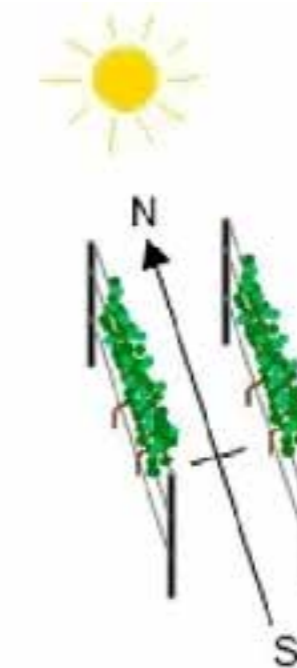
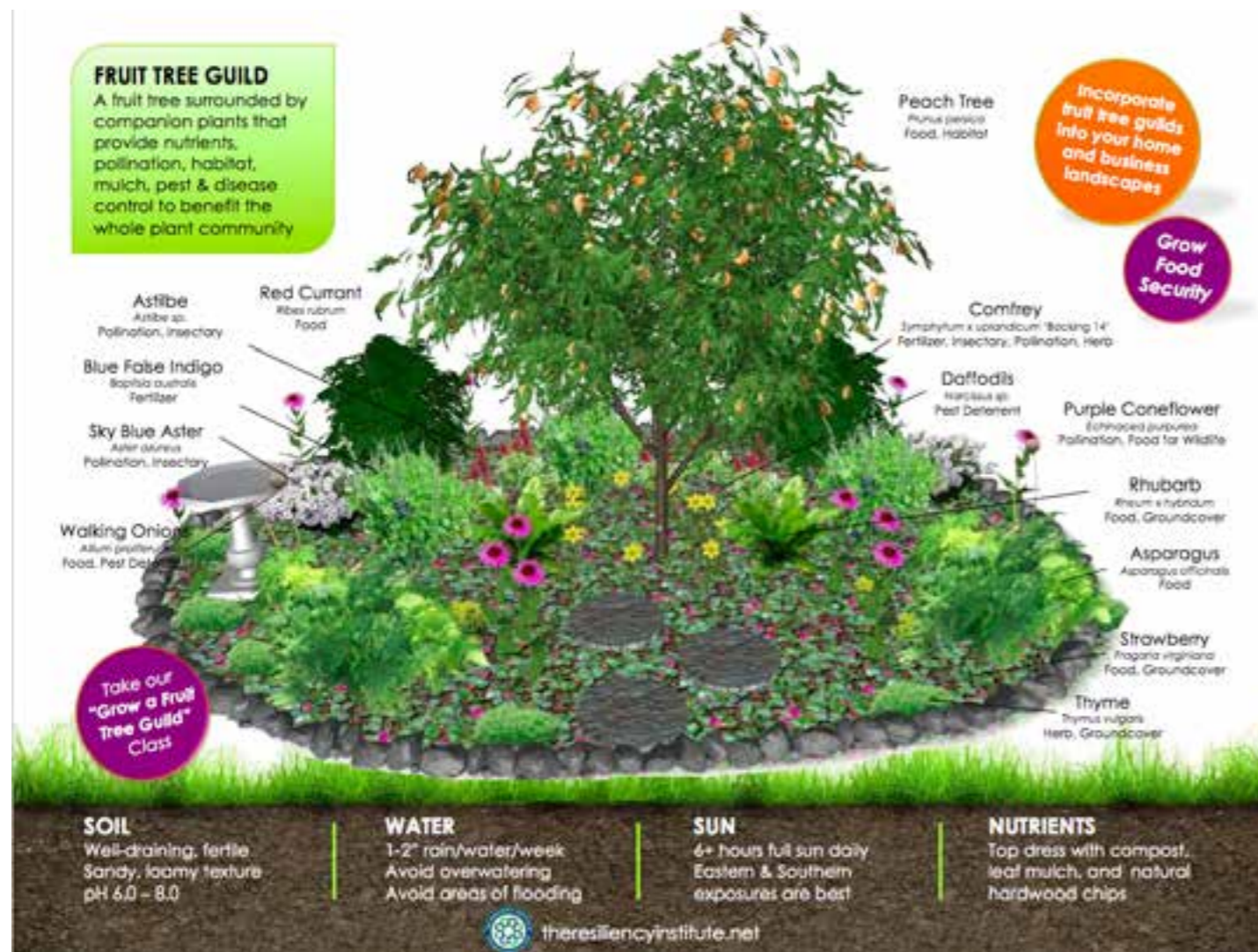

North-South orientation of trellises so plants do not shade each other and sun shines along full length of trellised plant



Scent of wormwood carried by wind over garden bed, masking scent from pests

Fertilizing plants, mulching plants, pest confusing plants, pollinator attracting plants, and - most importantly - food plants for you. One simple fruit tree guild can produce up to 200 pounds of food

wind

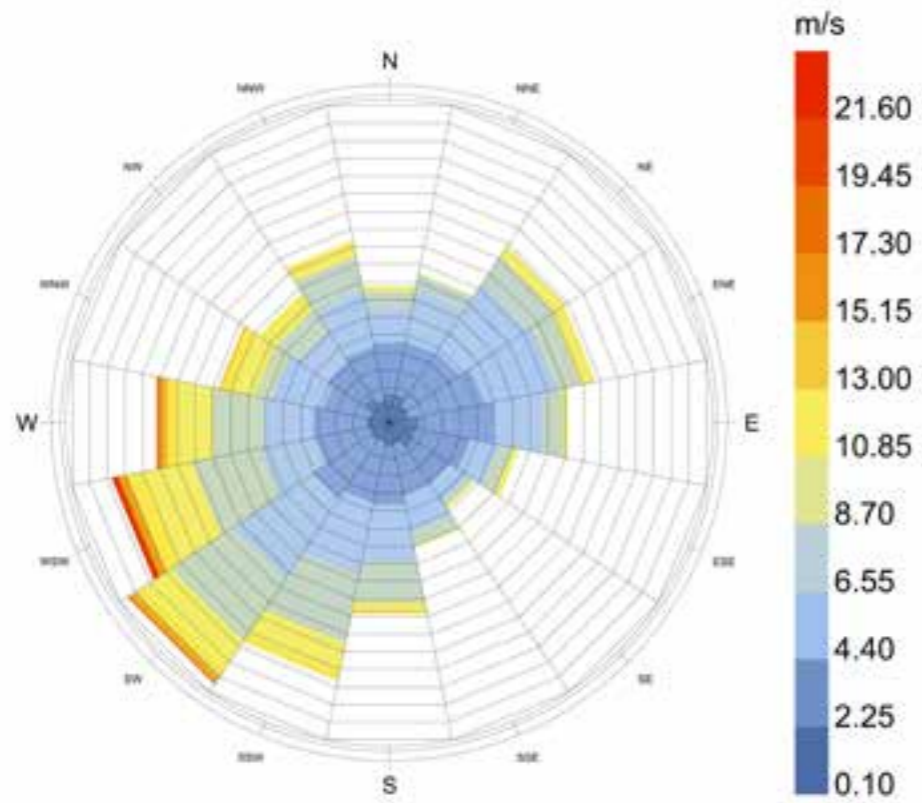

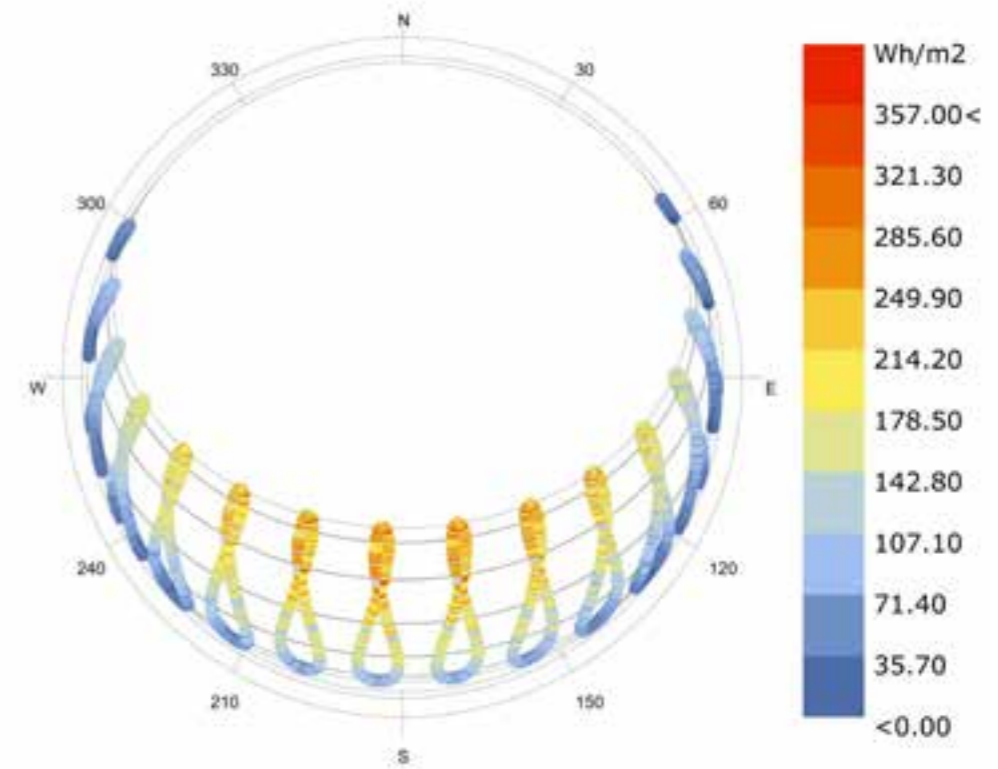

Wind Speed (m/s)
city: Ypenburg
country: NLD
time-zone: 1.0
source: SRC-TMYx
period: 1/1 to 12/31 between 0 and 23 @1
Calm for 2.51% of the time = 220 hours.
Each closed polyline shows frequency of 0.6% = 50 hours.

sun

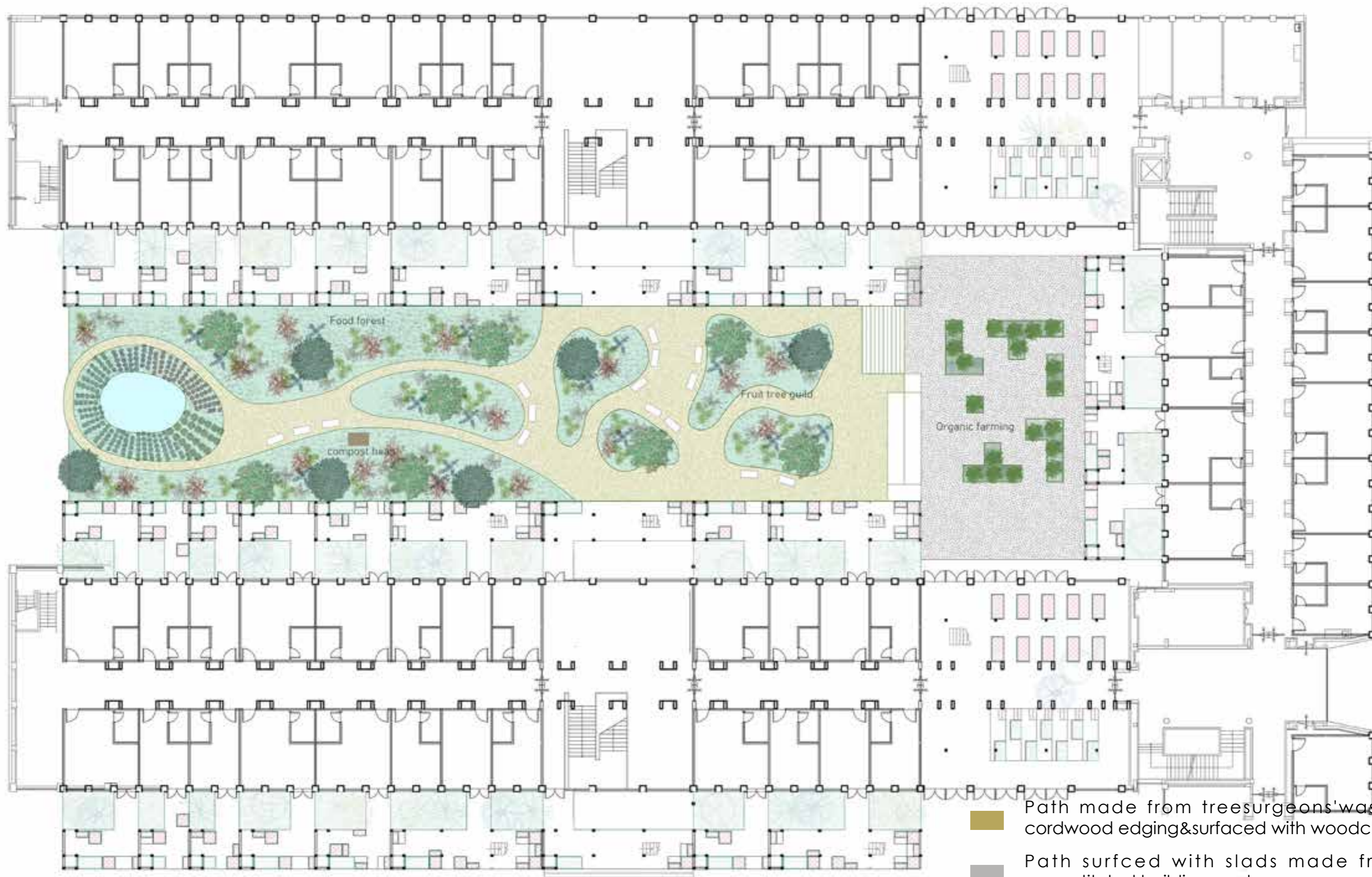

Sun-Path Diagram - Latitude: 52.033000000000001
Hourly Data: Diffuse Horizontal Radiation (Wh/m2)
Ypenburg_ZH_NLD



-  Path made from treesurgeons'waste-cordwood edging&surfaced with woodchip
-  Path surfced with slads made from reconstituted building waste





Watertreatment

VertECO technology treats waste/greywater within a vertically constructed plant-based wetland. The underlying principle is the employment of specific plant species in a special sequence to encourage the cleansing of polluted water through microbiological activity occurring in the root-zone.

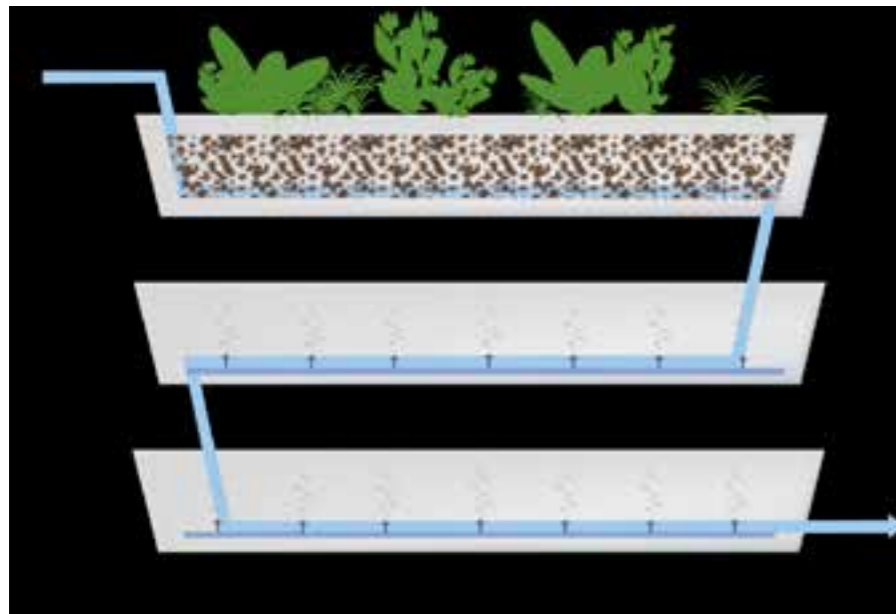

Eleocharis Palustris



Juncus Effusus



Carex Pendula



Lysimachia Vulgaris



Lythrum Salicaria



Caltha Palustris

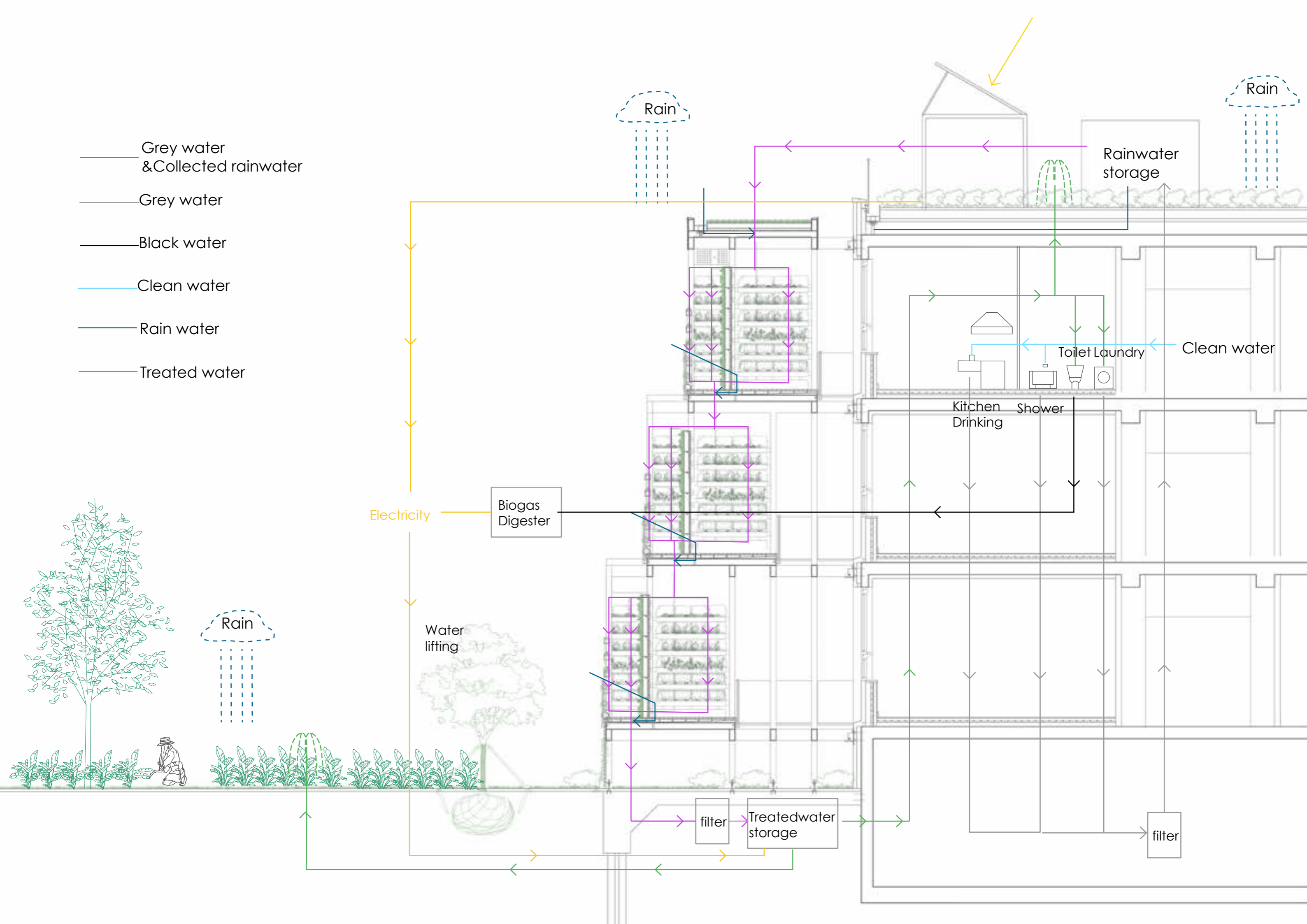

winter

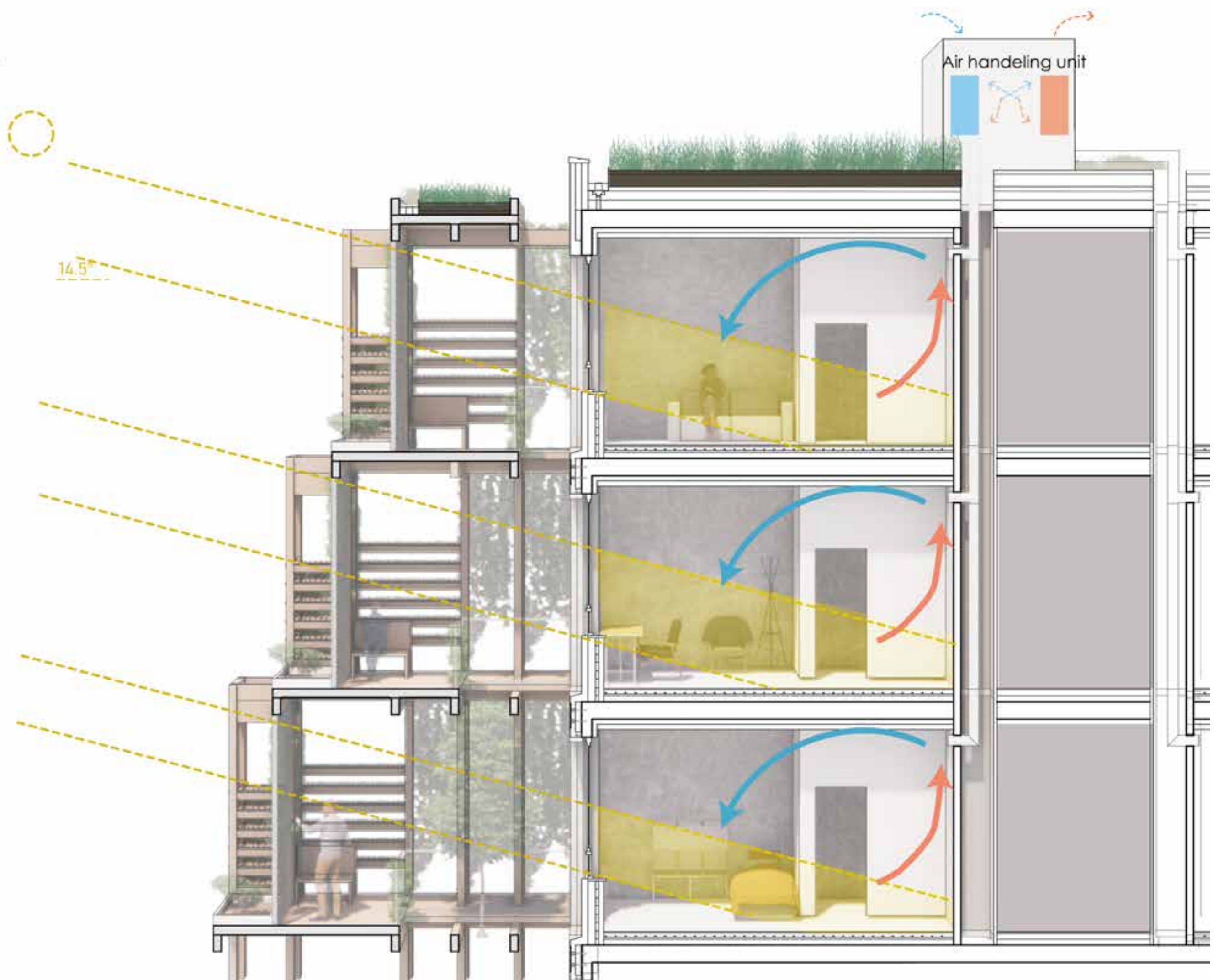

Indoor thermal comfort (UTCI) during extremely hot weeks
Before renovation

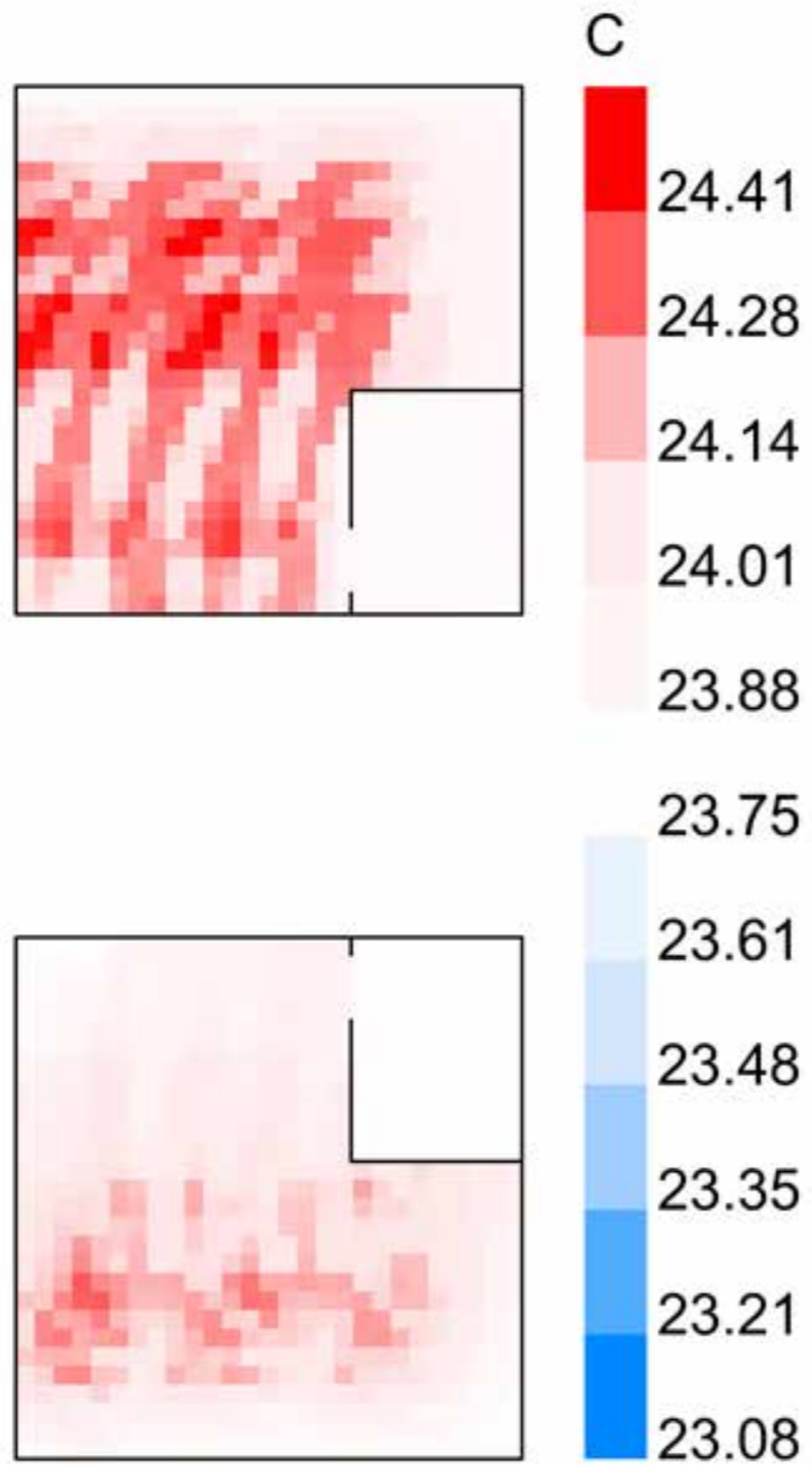

Indoor thermal comfort (UTCI) during extremely hot weeks
After renovation

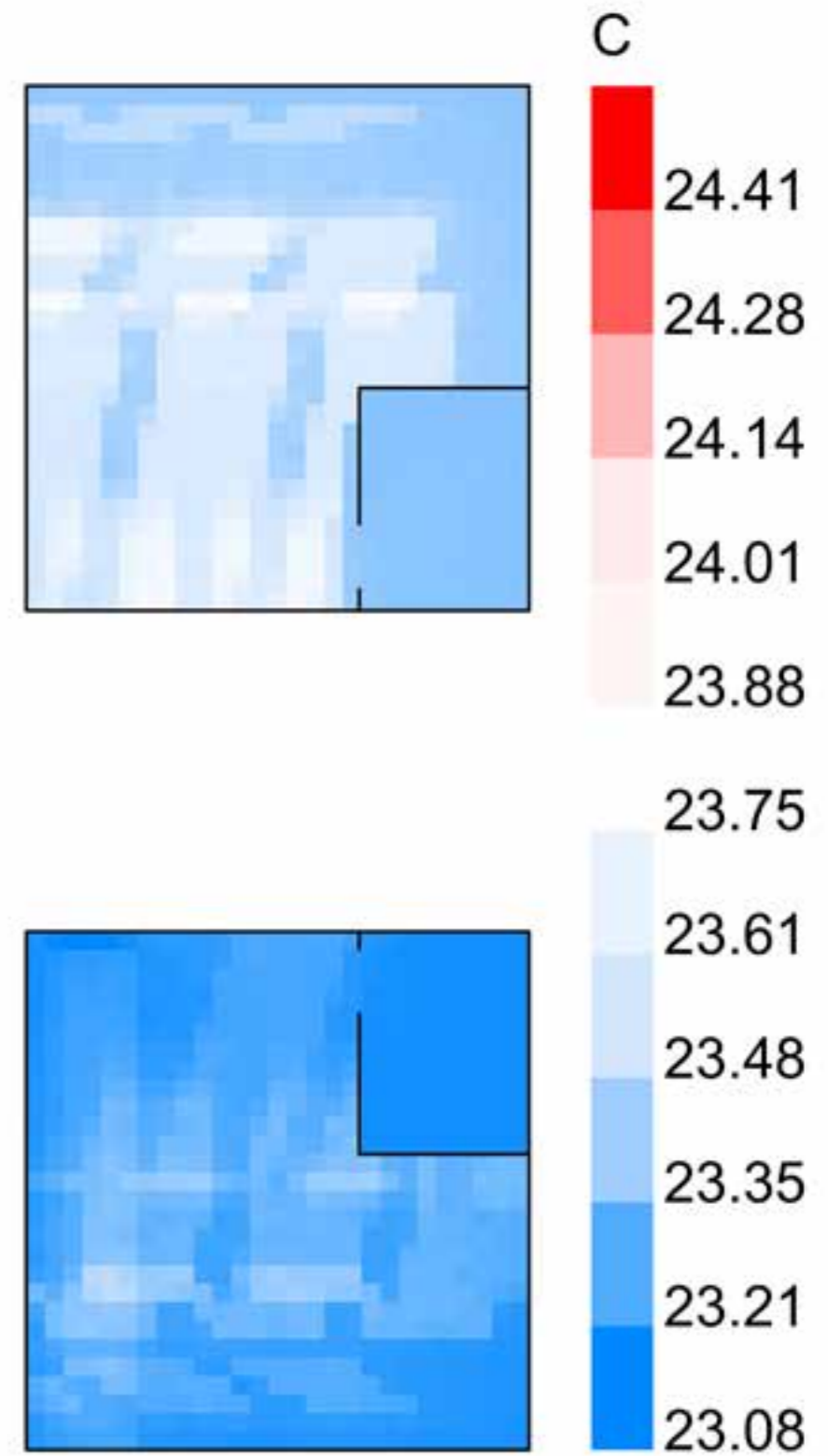

Summer

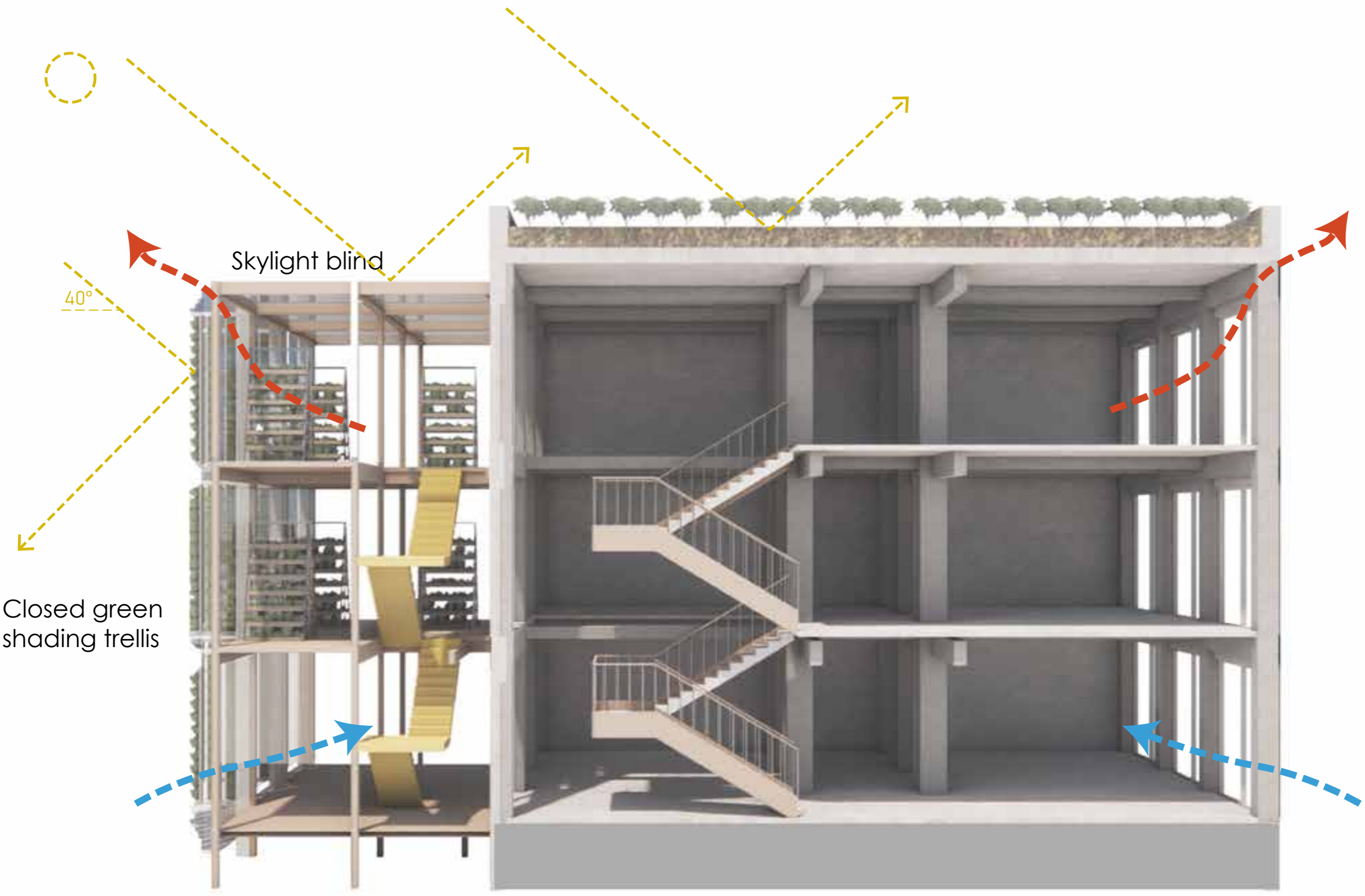

Skylight blind

40°

Closed green shading trellis

winter

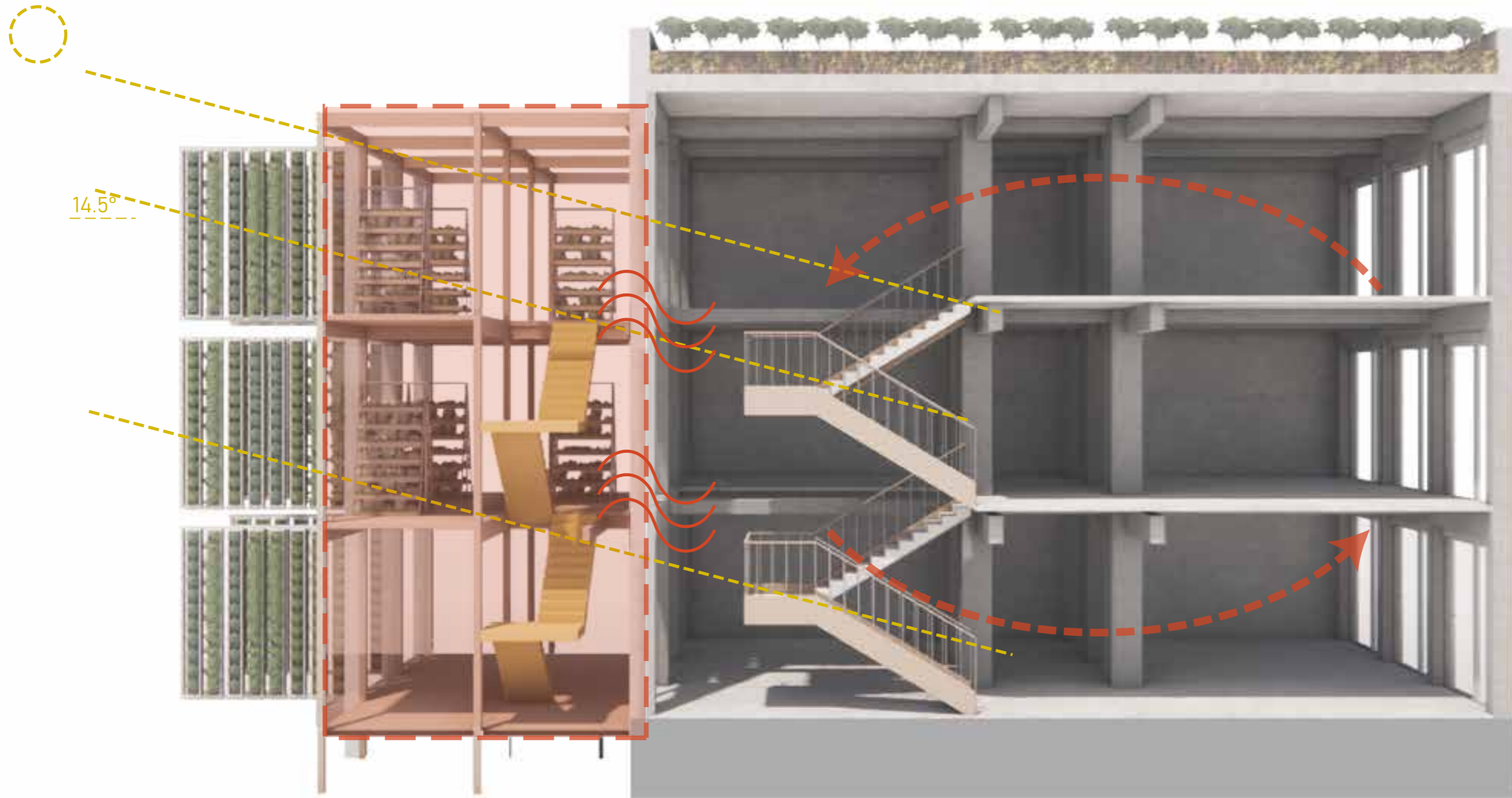

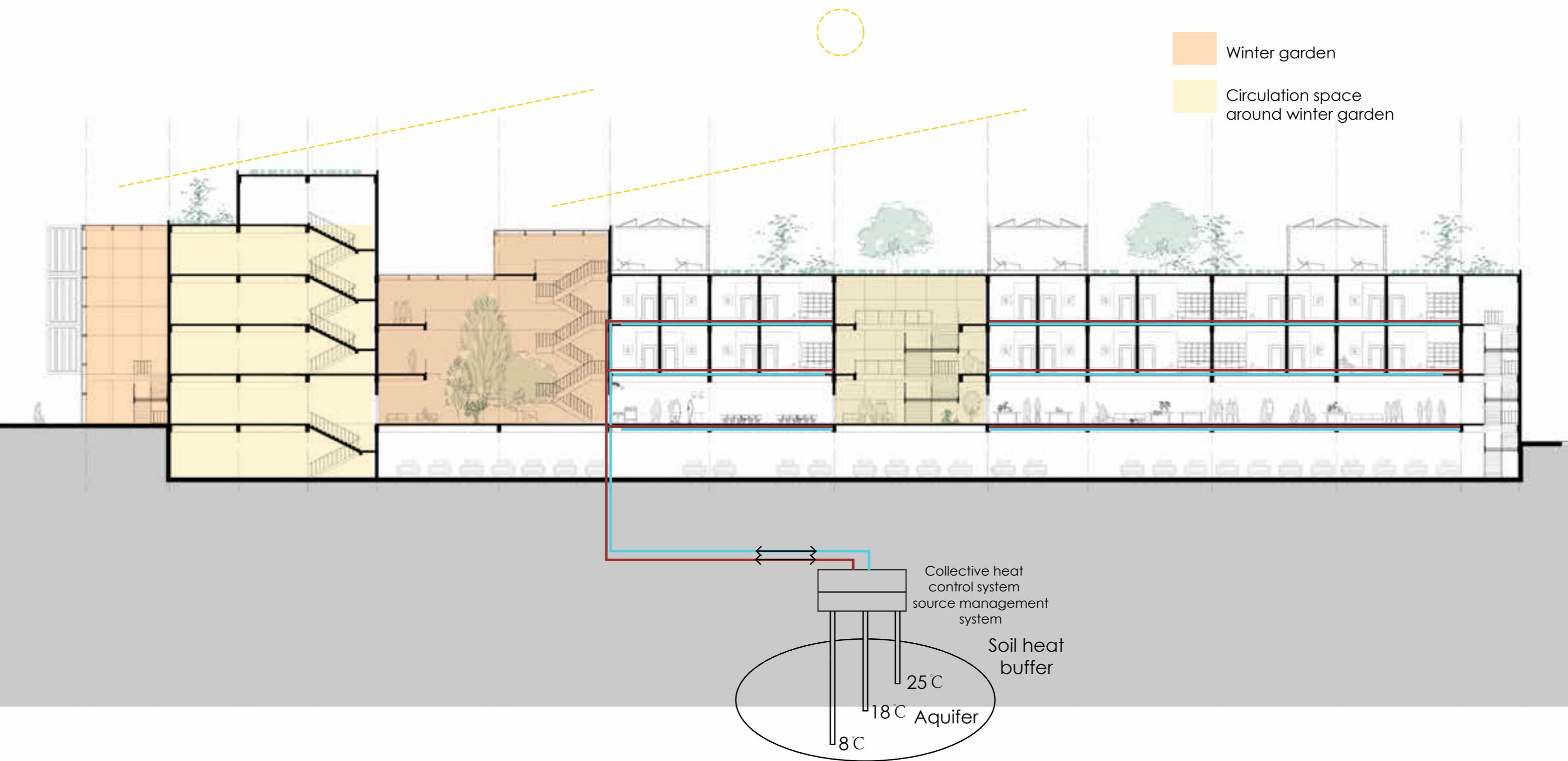

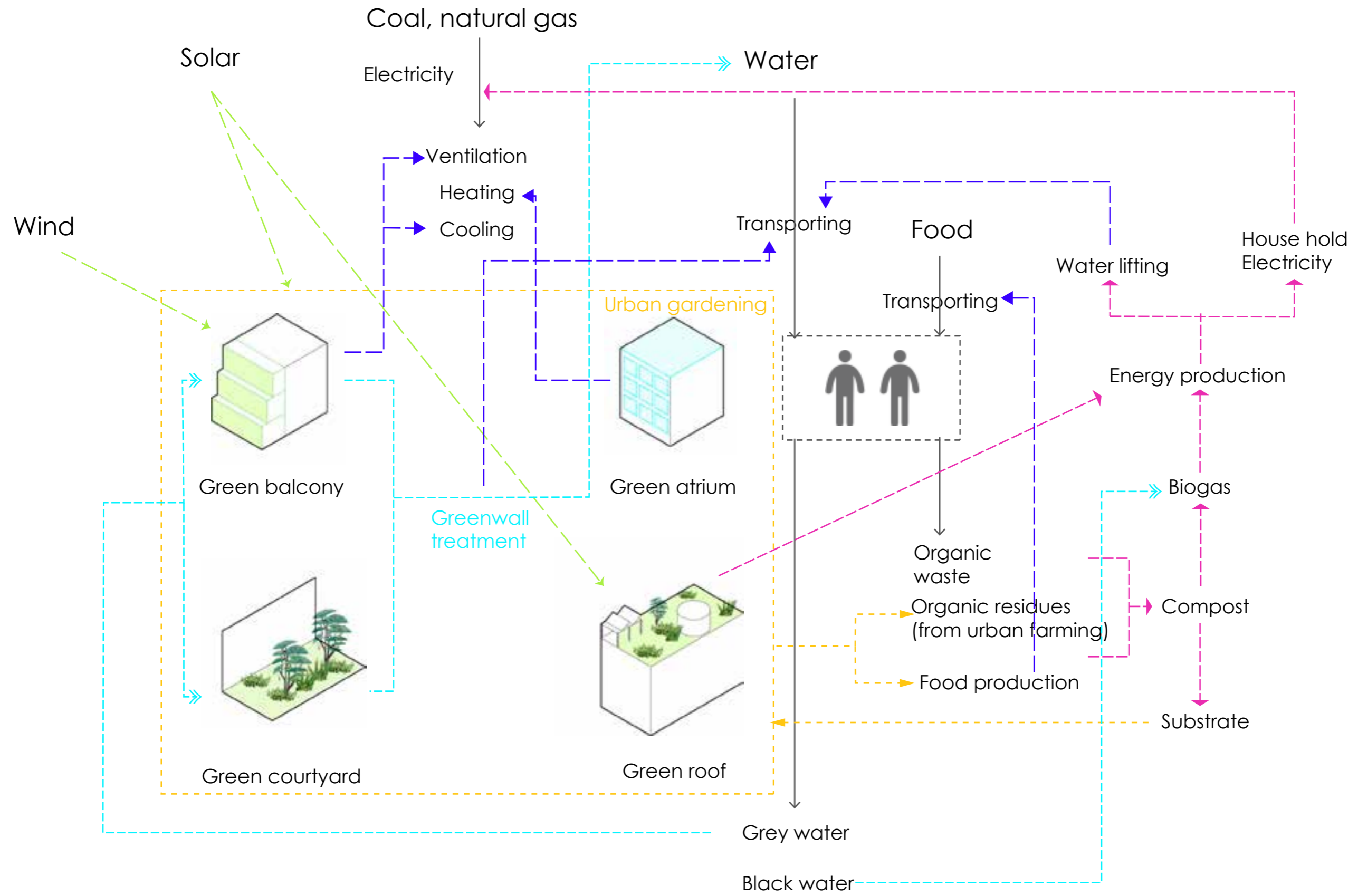

————> Energy input to the site

- - - - -> Water

- - - - -> Saving energy (compared with existing system)

- - - - -> Energy exported from the site

- - - - -> Urban gardening outputs

- - - - -> Onsite energy

Material

Existing material



Poriso stone



Black glazed bricks



Natural stone



Polished concrete

Path surfced with slabs made from reconstituted building waste

New material



CLT panel



Wood decking



Reclaimed wood planter

Principles



Local materials



Carbon storage



Nature material



Recyclable



Aesthetic value



Reduce reverberation

Plants

Roles of Plants Dominant trees, shrubs and groundcovers	Ecological control						Production			Wildlife		
	Oxygen/carbon dioxide	Filters air	Controls water flow	Filters water	Cools water	Forms still air pockets	Holds soil	Food	Fibre	Energy	Food	Cover
<i>Pinus pinea</i>	●	●	○	○	○	○				○	○	○
<i>Sophora</i>	○	○	○	○	○	○				○		○
<i>Ginkgo biloba</i>	●	●	●	○	○	○						○
<i>Acacia</i>			○	○	○							○
<i>Avocado (Persea)</i>	●	●	●	○	○	○		●			●	○
<i>Citrus spp.</i>	○	○	○	○	○	○		●			●	○
<i>Arbutus unedo</i>	○	○	○	○	○	○					○	○
<i>Cassia artemisioides</i>							○					○
<i>Cistus spp.</i>			○	○			○				●	○
<i>Canissa grandiflora</i>		○	○	○			○					○
<i>Heteromeles arbutifolia</i>	○	○	○	○			○				○	●
<i>Rhus integrifolia</i>	○	○	○	○			○					○
<i>Yucca whipplei</i>								○				○
<i>Romneya coulteri</i>			○									○
<i>Baccharis pilularis</i>			○				●					
<i>Rosmarinus officinalis</i>			○				○	●				
<i>Gazania spp.</i>			○				○					○
Strawberries			○				○	●			○	
Vegetables								●			●	
Herbs								●				

● Major

○ Significant

Ecological Unit

1. Provide food for birds and insects
2. Provide cover for birds and insects
3. Native plants

Winter Garden

1. Produce oxygen
2. Filters air
3. Produce food
4. Able to grow in winter

Private Garden(modular planter)

1. Produce oxygen
2. Filters air
3. Produce food

Water treatment

1. Filters water
2. Produce oxygen

Green courtyard and green roof

1. Holds soil
2. Controls water flow
3. Produce oxygen
4. Filters air
5. Food forest

Soil

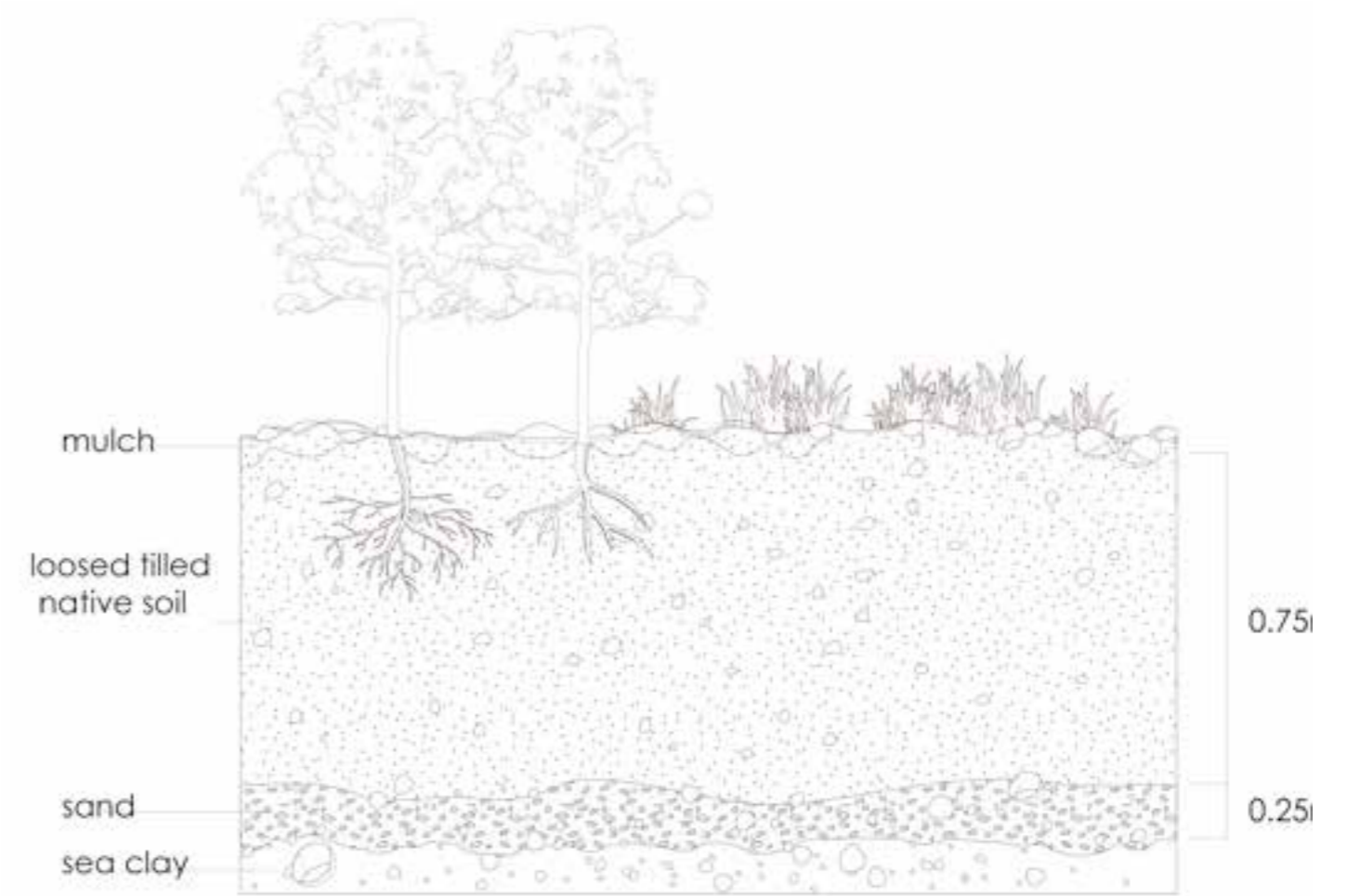
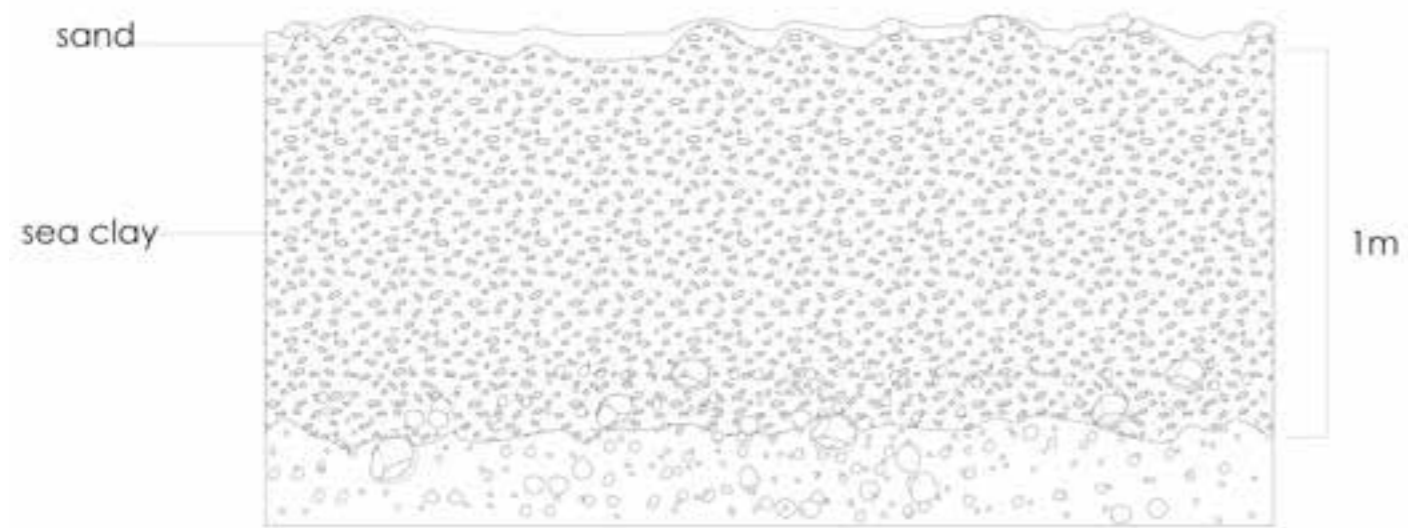

Ecologica unit



Common Sage



Sheep Grass



Hyssop



Chives



Lavender



Flowering Rush



Hornwort



Willow



Bulrush



Yellow Loosestrife



Avocado (Persea)



Citrus app



Carissa grandiflora

Green roof and green courtyard



Red Currant



Astilbe



Blue False Indigo



Sky Blue Aster



Walking Onions



Daffodils



Purple Coneflower



Rhubarb



Peach Tree



Asparagus



Thyme



Strawberry

Winter garden



Pinus pinea



Arbutus unedo



Gazania spp



Avocado (Persea)



Cassia Artemisioides



Cistus Spp



Carissa Grandiflora



Romneya Coutten

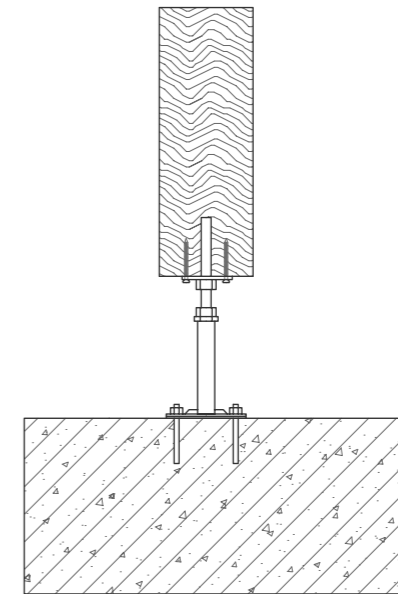
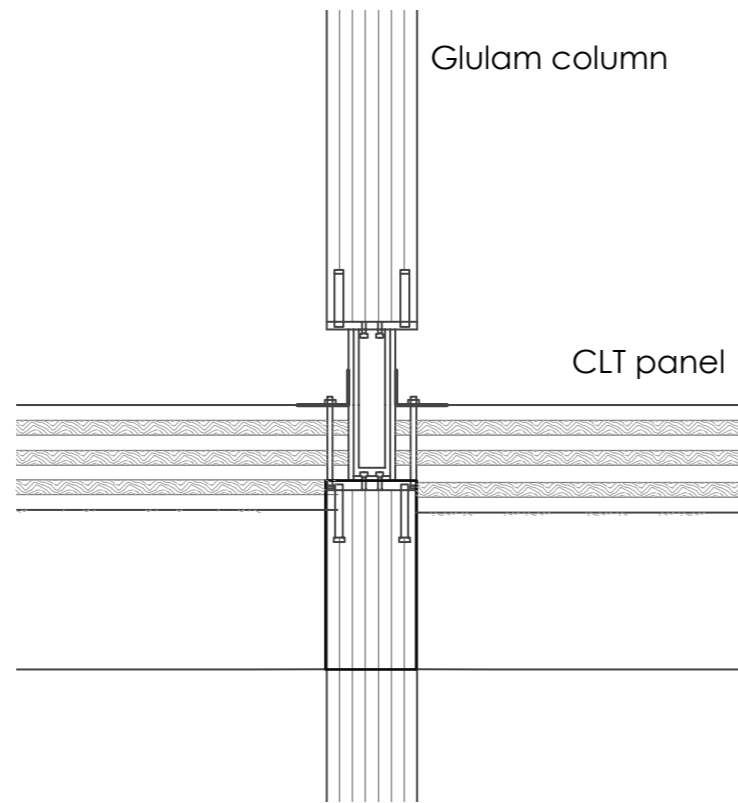



A

- 1. light vegetation
 - 20mm mulch
 - 100mm growing medium
 - filter fleece
 - drainage element, water reservoir and roof barrier
 - waterproof membrane
 - Clt panel 140mm
 - Acoustic insulation
- 2. Wood decking
 - 3. Duct/pipe

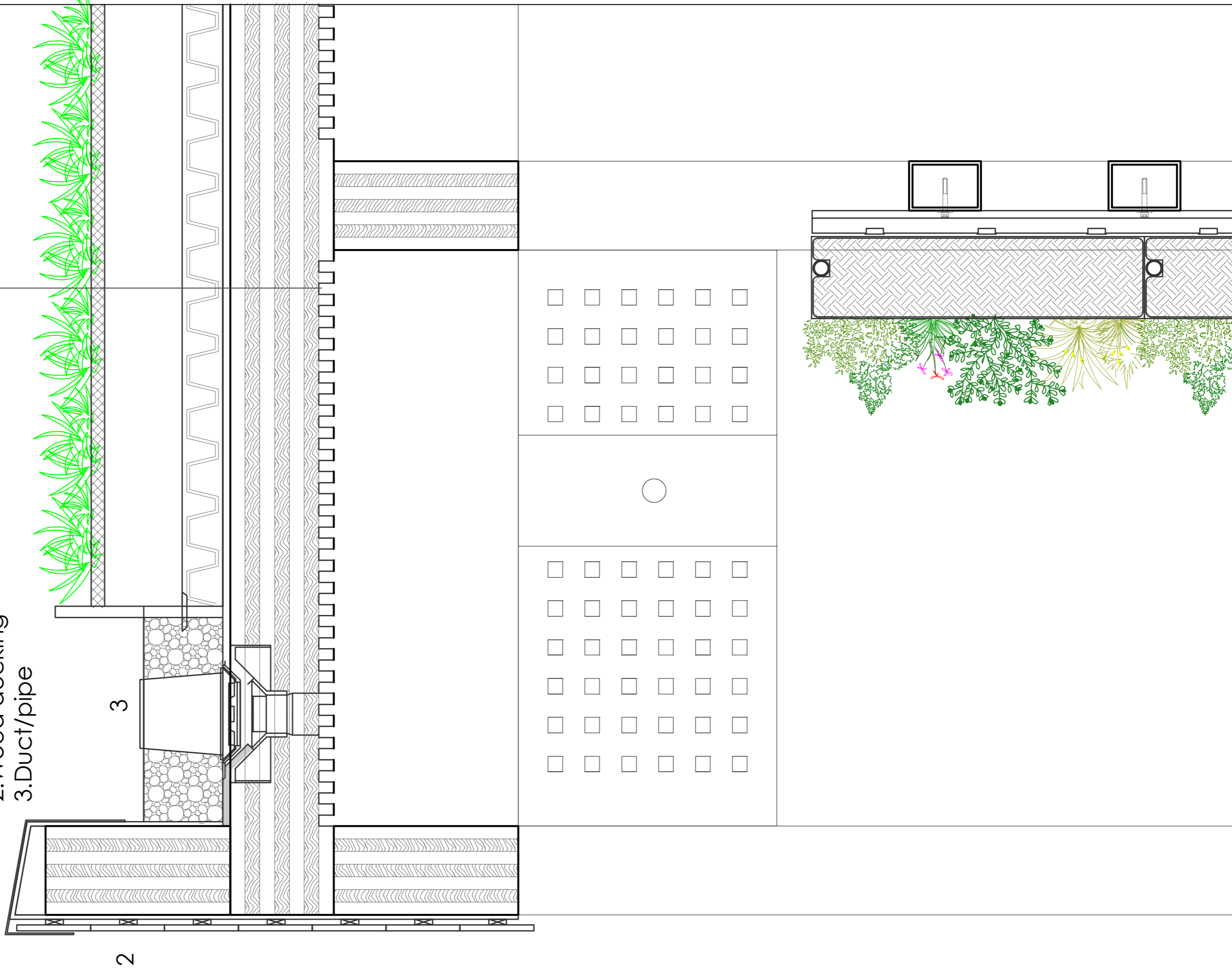

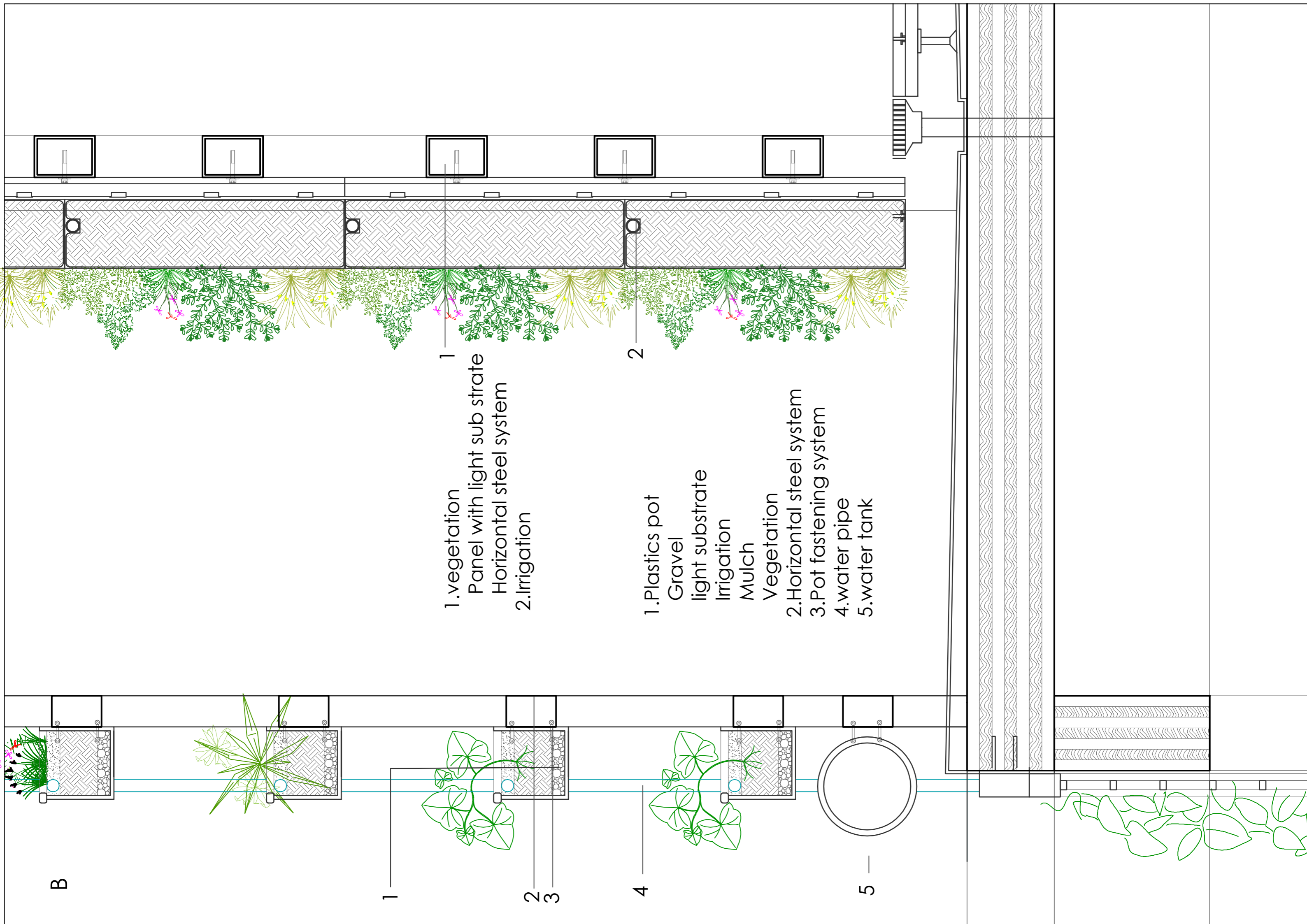

1.vegetation
 Panel with light sub strate
 Horizontal steel system
 2.Irrigation

1.Plastics pot
 Gravel
 light substrate
 Irrigation
 Mulch
 Vegetation
 2.Horizontal steel system
 3.Pot fastening system
 4.water pipe
 5.water tank

B

1

2
3

4

5

C

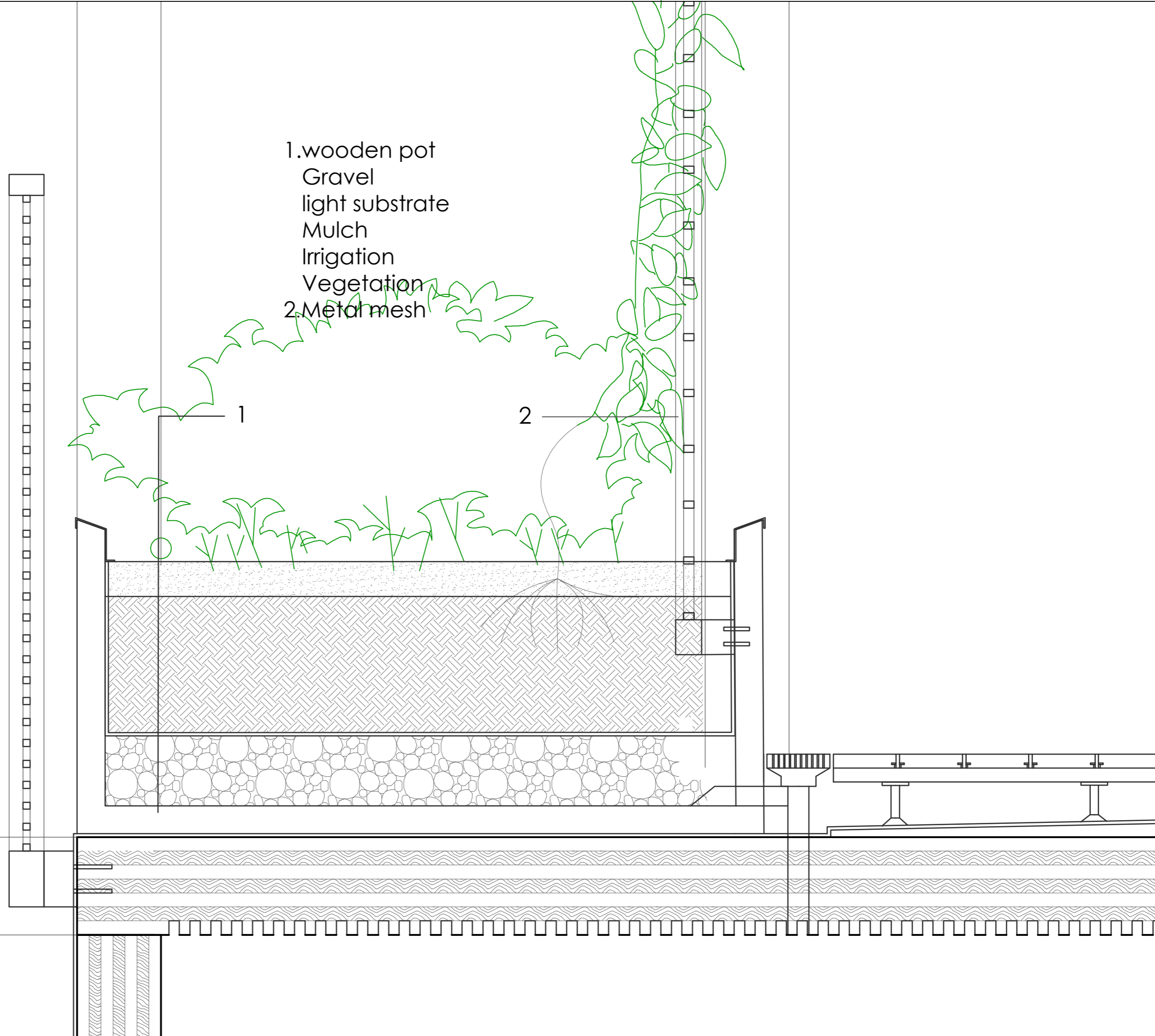

D

1. wood deck 25mm
wood decl substructure 60mm
pli-coating
water proof layer
CLT panel 140mm
2. duct/pipe

1

2

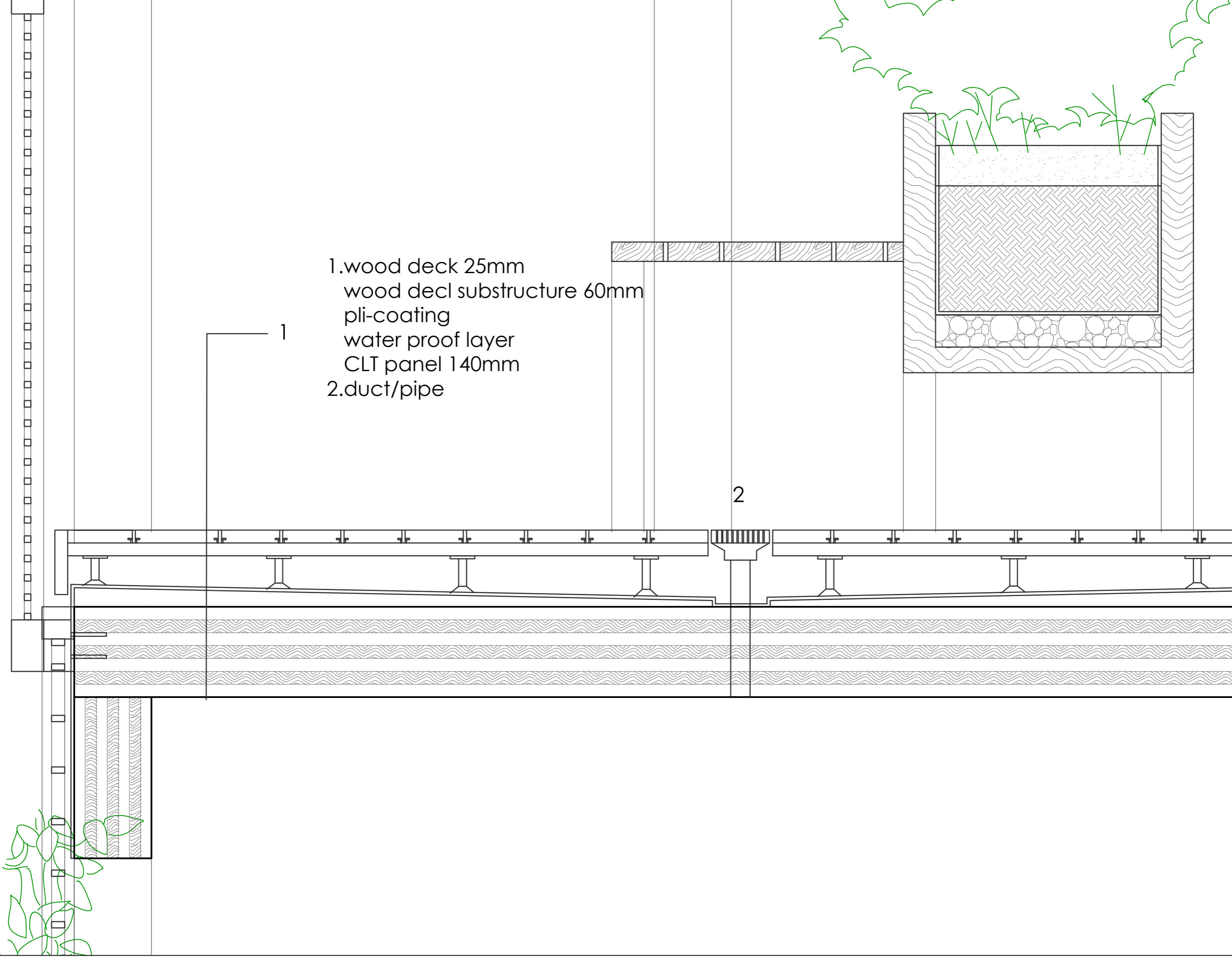

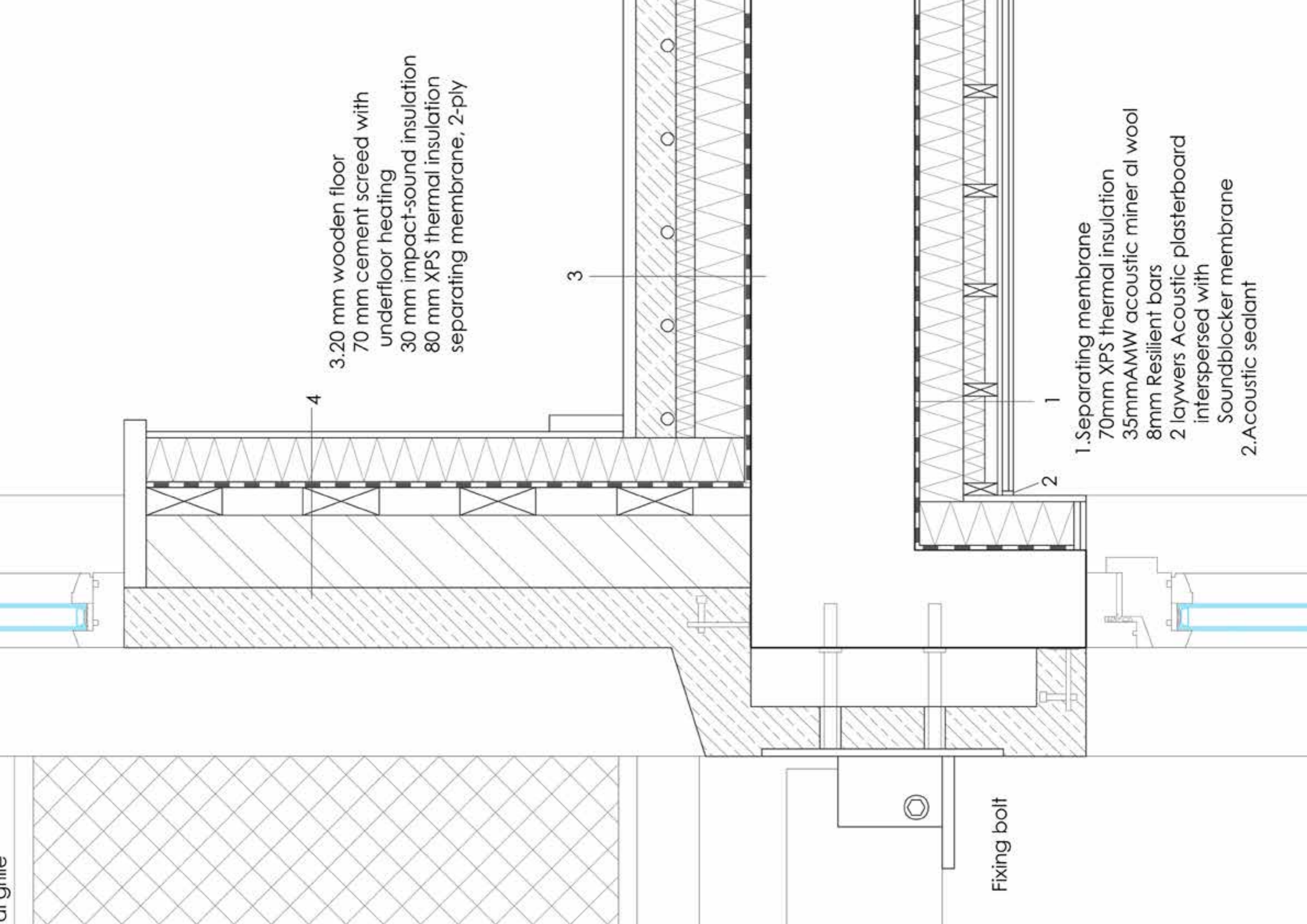

3.20 mm wooden floor
 70 mm cement screed with
 underfloor heating
 30 mm impact-sound insulation
 80 mm XPS thermal insulation
 separating membrane, 2-ply

4

3

1

2

1. Separating membrane
 70mm XPS thermal insulation
 35mmAMW acoustic mineral wool
 8mm Resilient bars
 2 layers Acoustic plasterboard
 interspersed with
 Soundblocker membrane
 2. Acoustic sealant

Fixing bolt

Structure

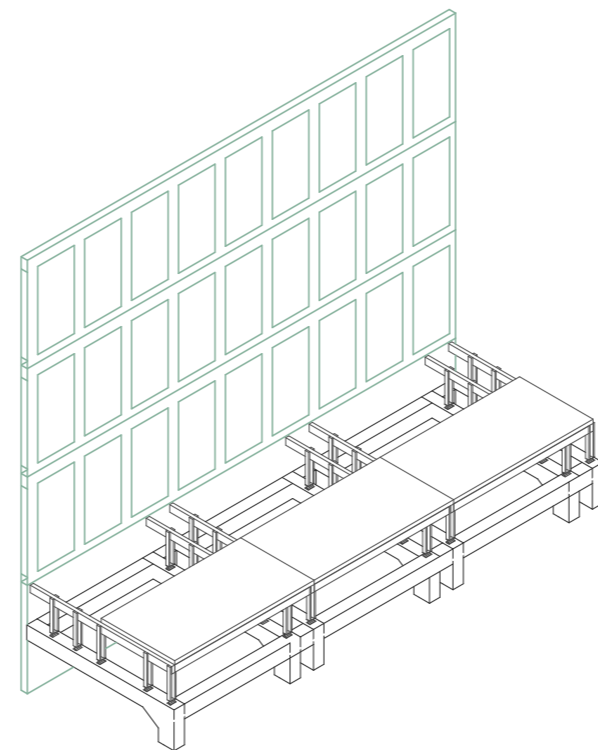
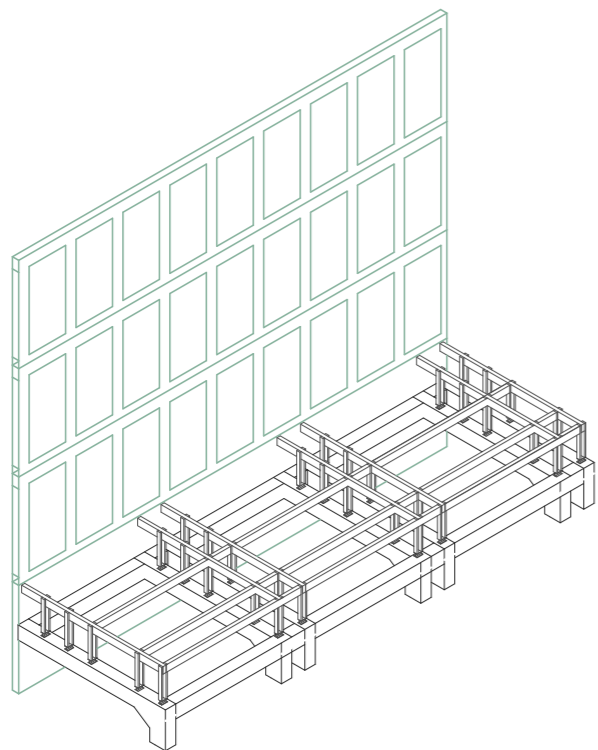
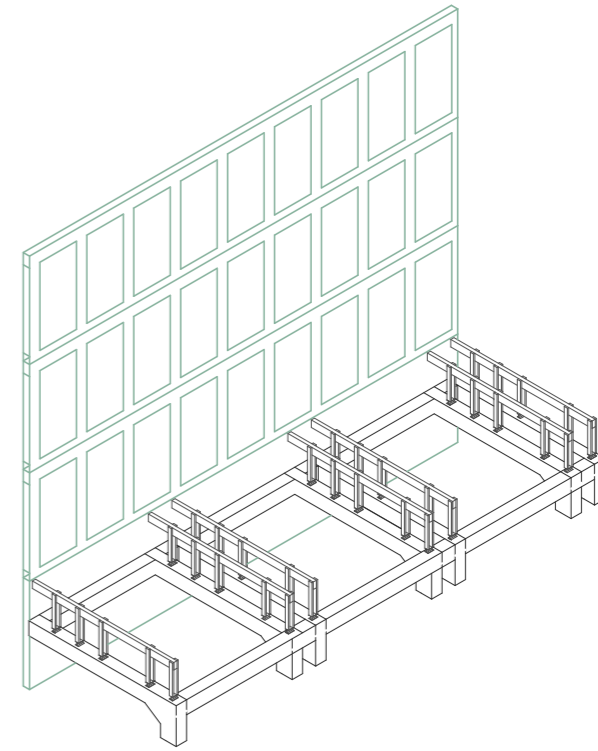
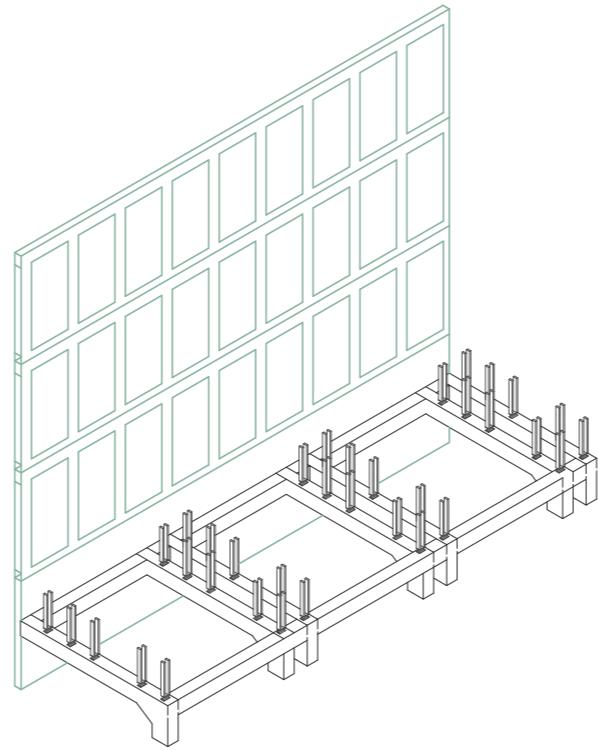
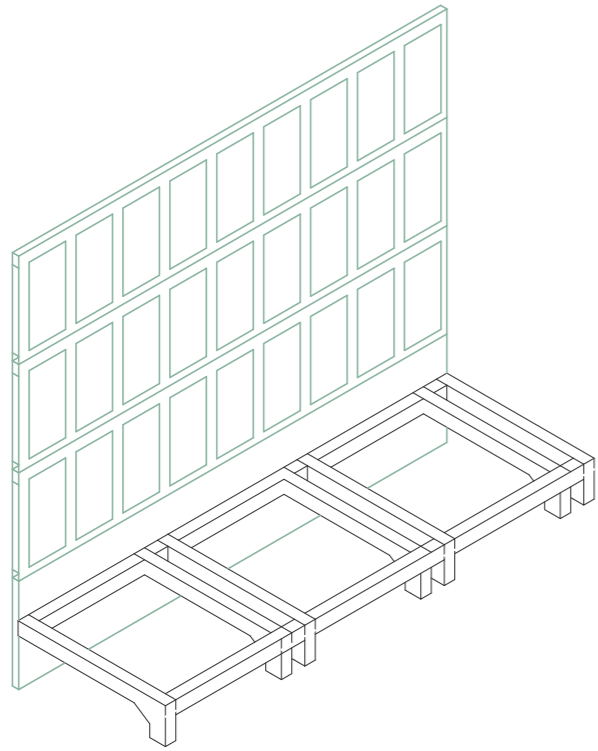

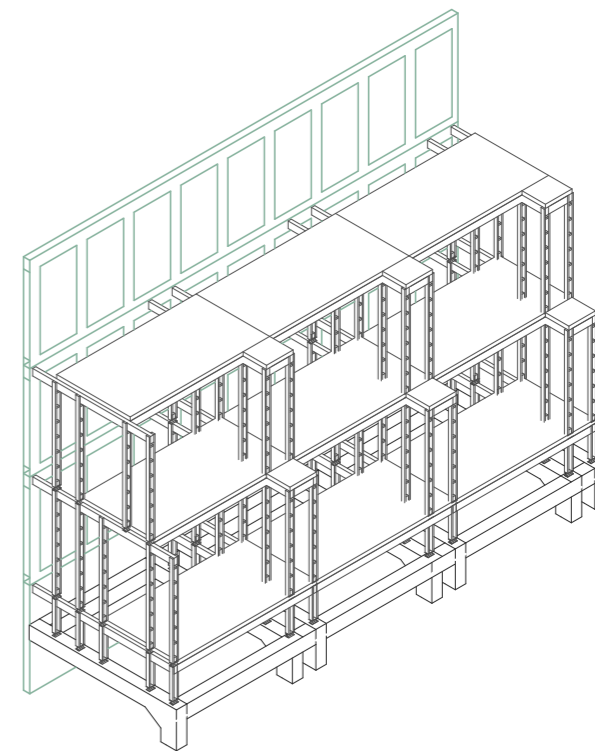
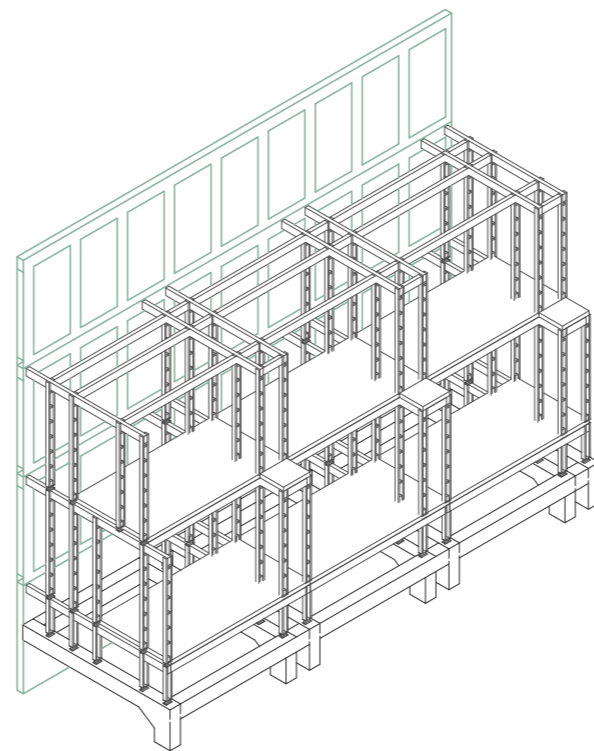
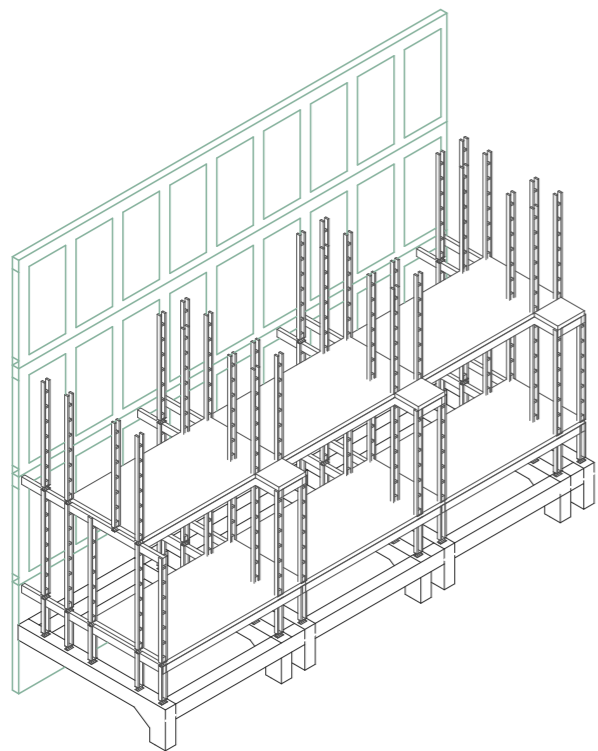
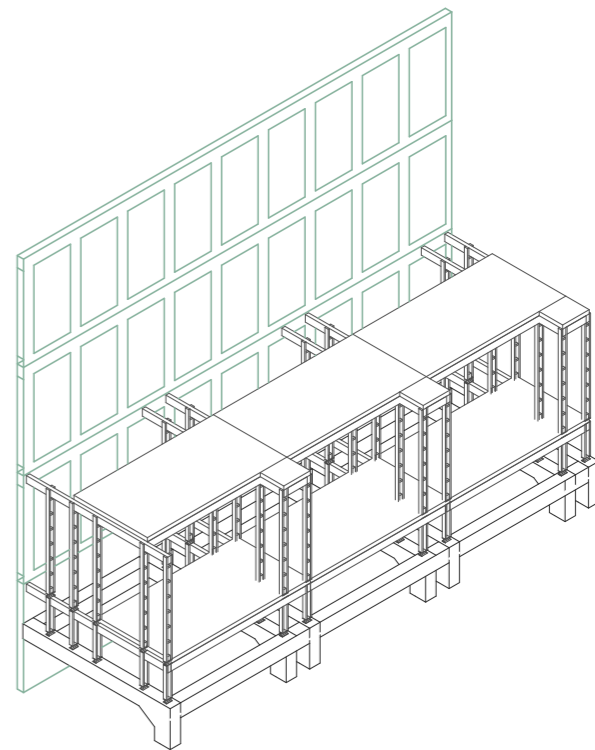
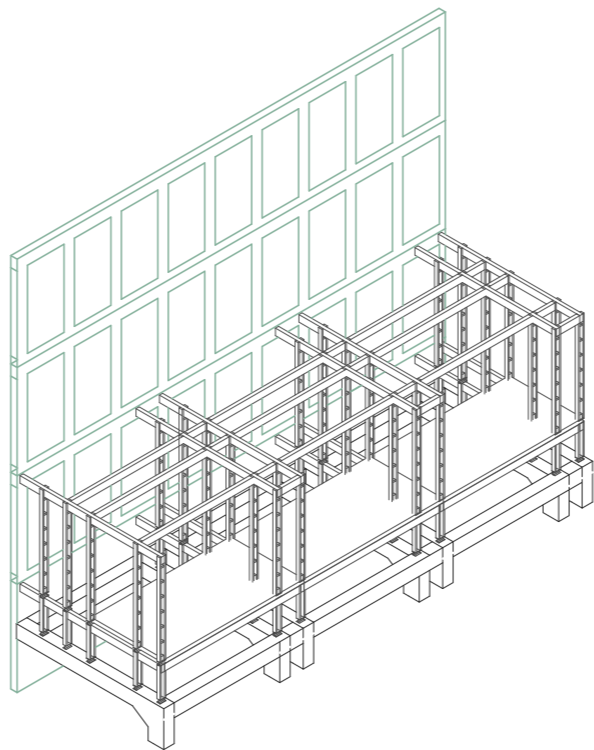
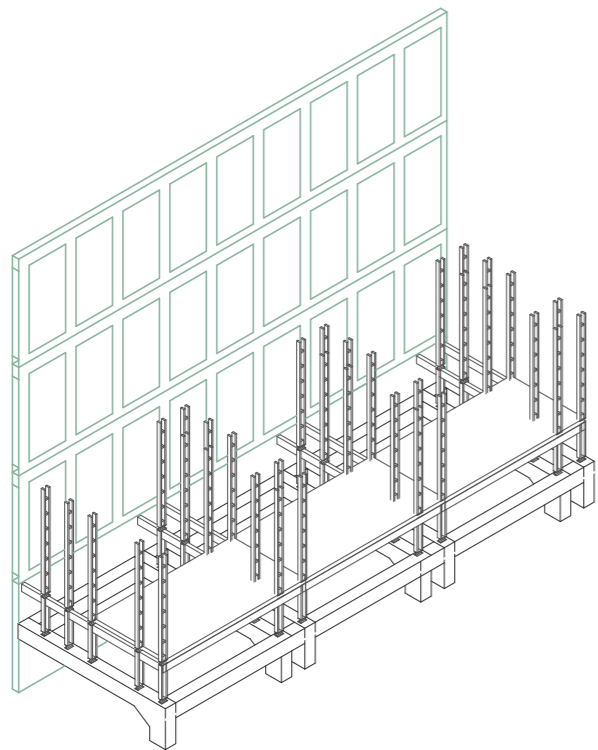

Thank you!