

ARCHITECTURE FOR THE DISPLACED BERLIN'S MIGRATION COURT

One building representing the resettlement procedure in the arrival city of Berlin

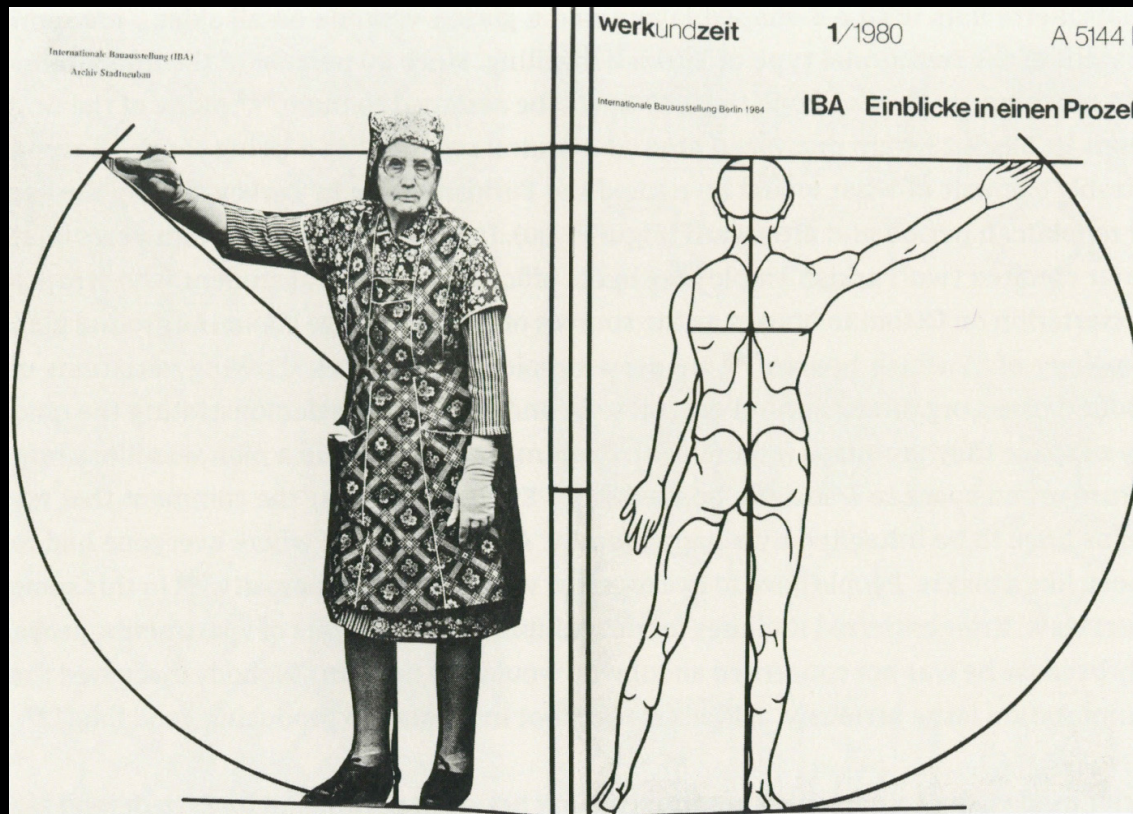

COMPLEX PROJECTS

Nienke Kloosterman

January/19/2024

INTRODUCTION

RESEARCH

DESIGN BRIEF

DESIGN PROCESS & CONCEPT

IMPLEMENTATION

DEVELOPMENT

CONCLUSION

INTRODUCTION

RESEARCH

DESIGN BRIEF

DESIGN PROCESS & CONCEPT

IMPLEMENTATION

DEVELOPMENT

CONCLUSION



ARCHITECTURE FOR THE DISPLACED BERLIN'S MIGRATION COURT

One building representing the resettlement procedure in the arrival city of Berlin

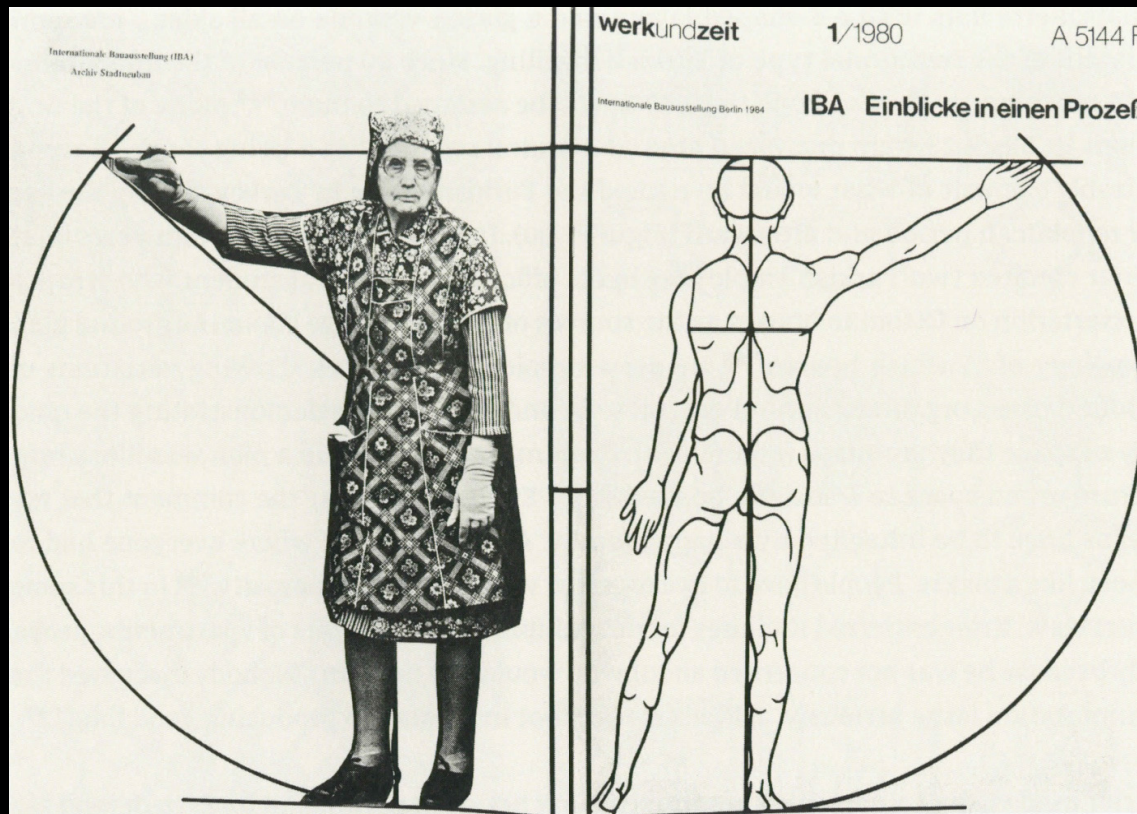

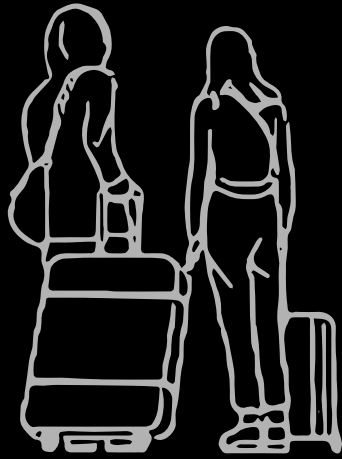

arriving



court

BERLIN'S MIGRATION COURT

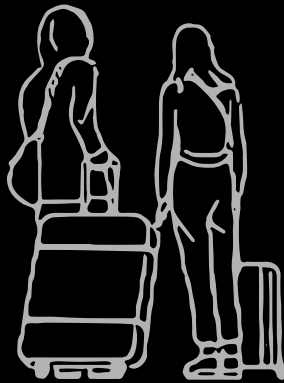

arriving

resettlement
procedure



court

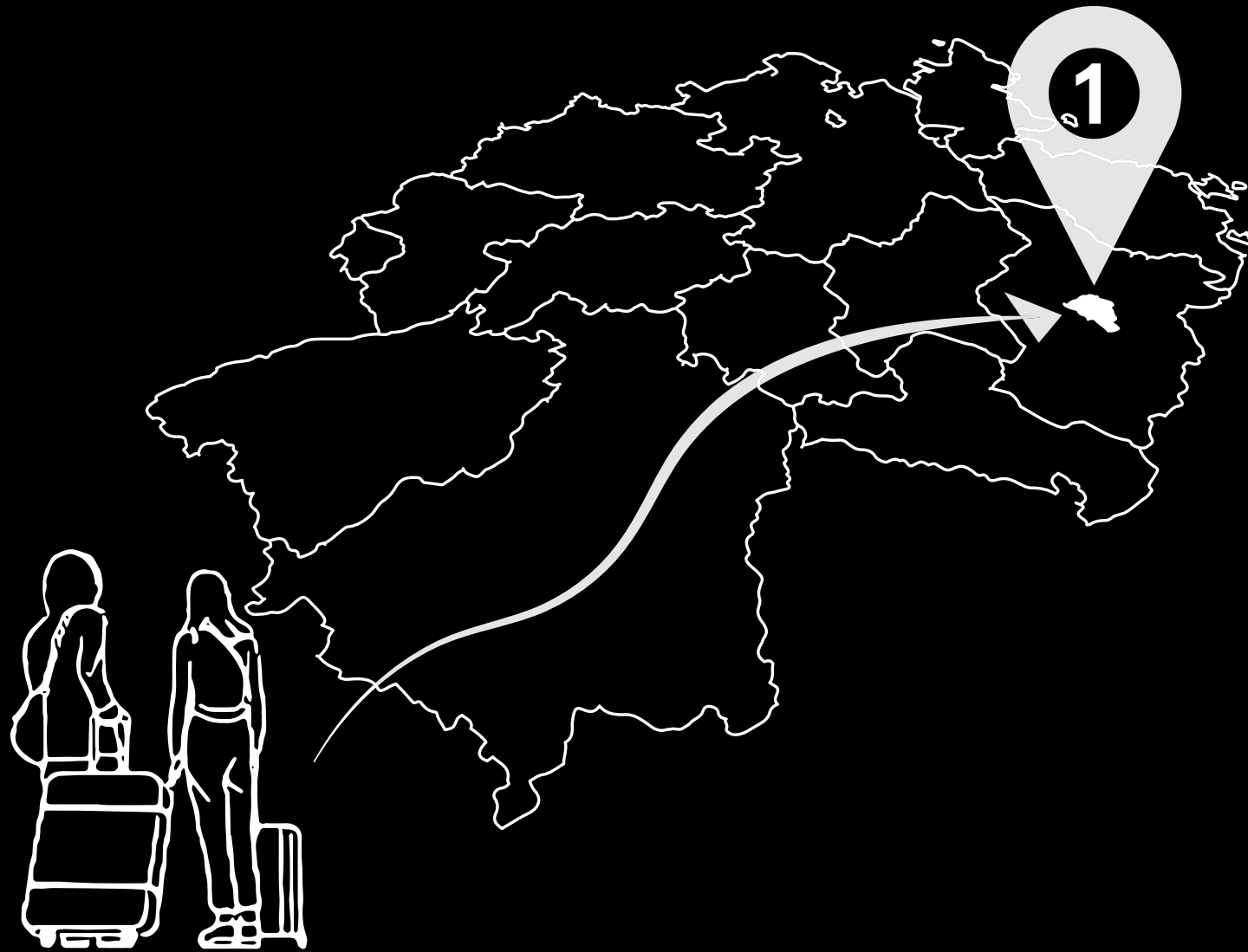



INTRODUCTION

RESEARCH

DESIGN BRIEF

DESIGN PROCESS & CONCEPT

IMPLEMENTATION

DEVELOPMENT

CONCLUSION

LIST OF RESEARCH OBSERVATIONS

MIGRATION IS A **MEGATREND**

MIGRATION IS **DIVERSE**

MIGRATION IS **INVISIBLE** IN THE CITYSCAPE

MIGRATION IS PART OF **POLITICAL DEBATE**

MIGRATION IS PART OF **SOCIETAL DEBATE**

THE **TEMPORARINESS** OF MIGRATION IS FICTION

FLUCTUATIONS IN MIGRATION NUMBERS **DESIRE FLEXIBILITY**



MID-2022 WE HAVE REACHED
THE **100 MILLION** MARK OF
FORCIBLY DISLACED PEOPLE
WORLDWIDE

- UNHCR

MIGRATION IS A MEGATREND

2000

2007

2013

2022

MID-2022 WE HAVE REACHED
THE **100 MILLION** MARK OF
FORCIBLY DISLACED PEOPLE
WORLDWIDE

- UNHCR

2000

2007

2013

2022

research

MULTIPLE REASONS



internationalization



recent events



climate migration

research

NEW ARCHITYPE





MIGRATION IS DIVERSE

DIVERSE REASONS TO DISPLACE



war or
opression



better
opportunities



climate



study or work

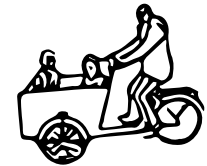

family, friends
or love

DISPLACED PEOPLE

displaced person: someone who has been forced to leave the place where they live, especially because of war or oppression or natural disaster.

USER-CENTRIC APPROACH

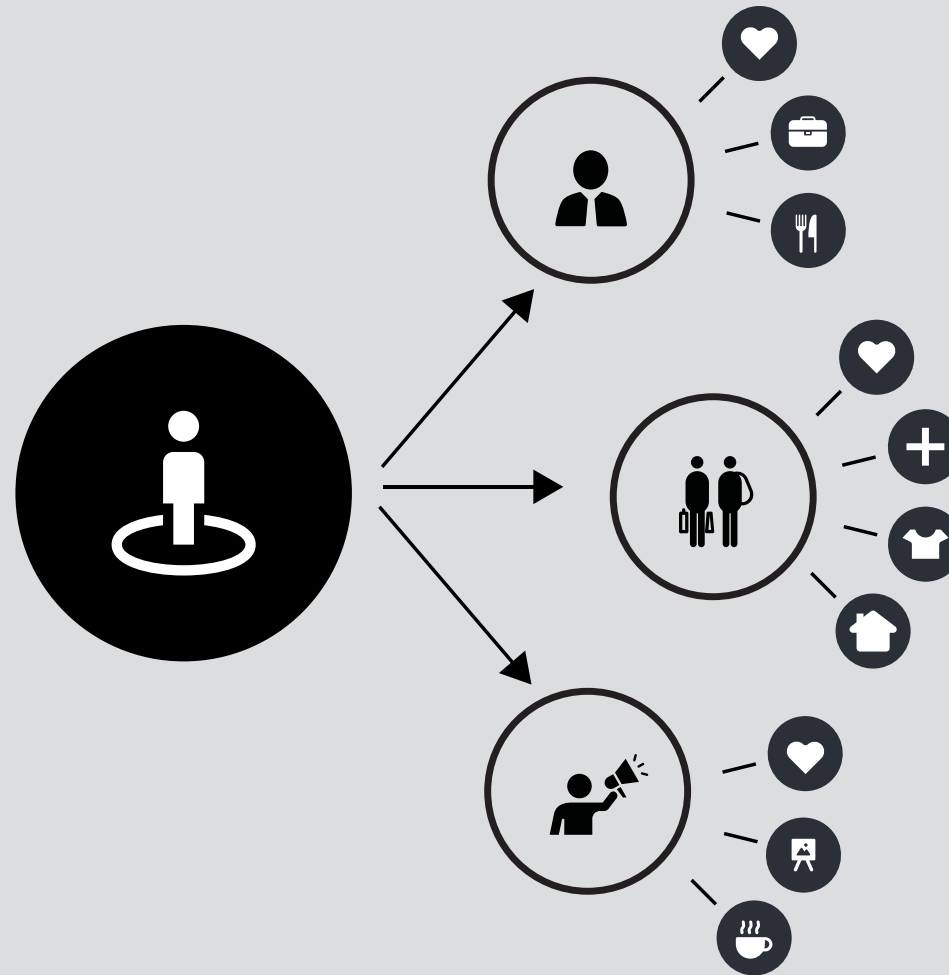

Landesamt
für Flüchtlingsangelegenheiten

BERLIN



Arrival center for
asylum seekers



MIGRATION IS INVISIBLE IN THE CITYSCAPE

ON THE EDGES OF SOCIETY

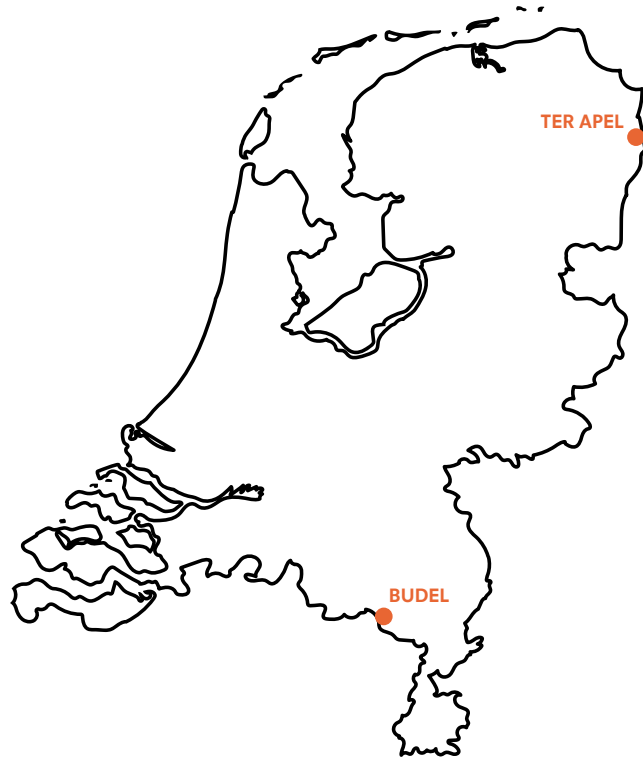

map of The Netherlands
on the edges of the country...



map of Berlin
or scattered through the city

DIFFERENT LOCATIONS FOR ONE PROCESS

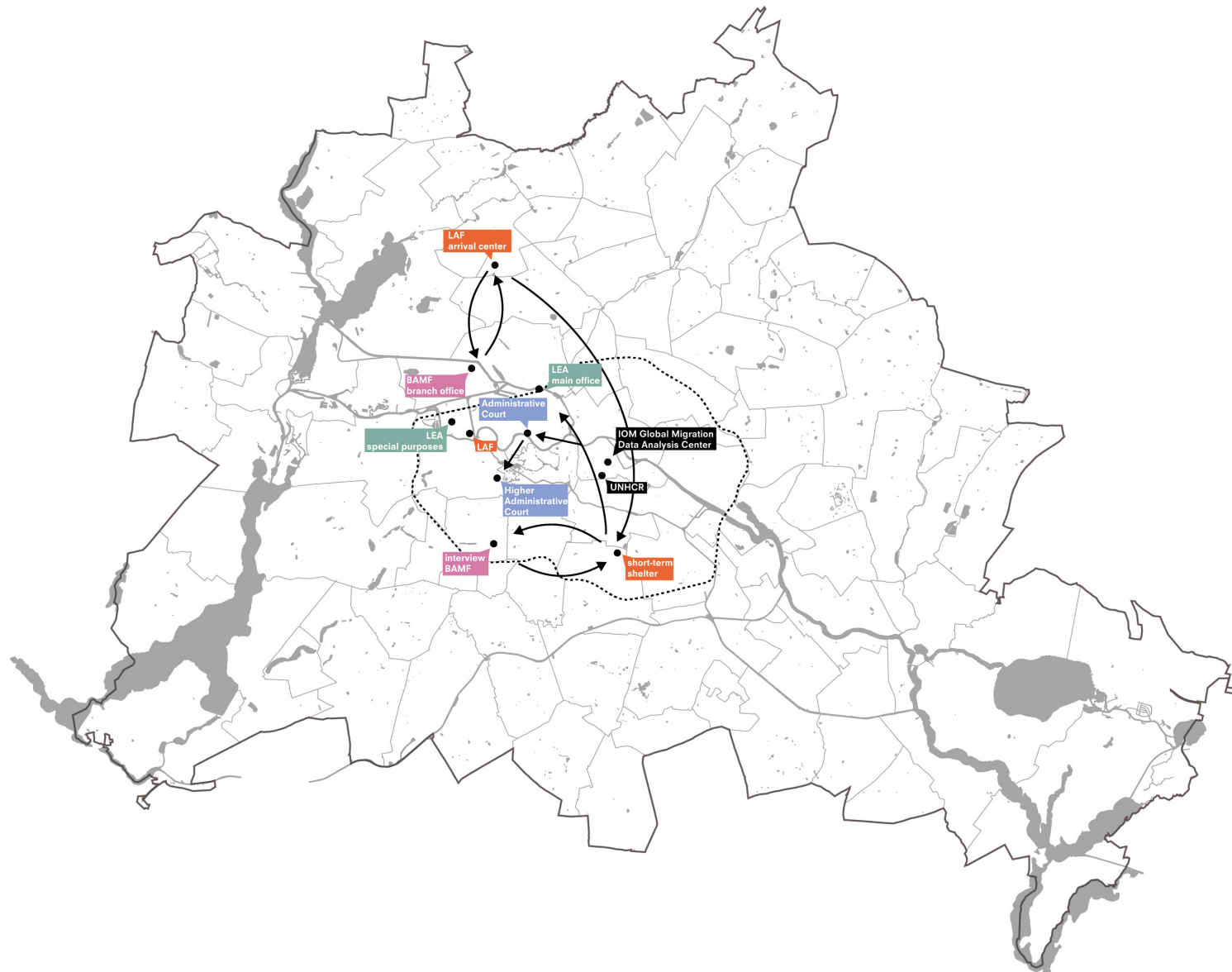

PRIORITY AND PROMINENCE

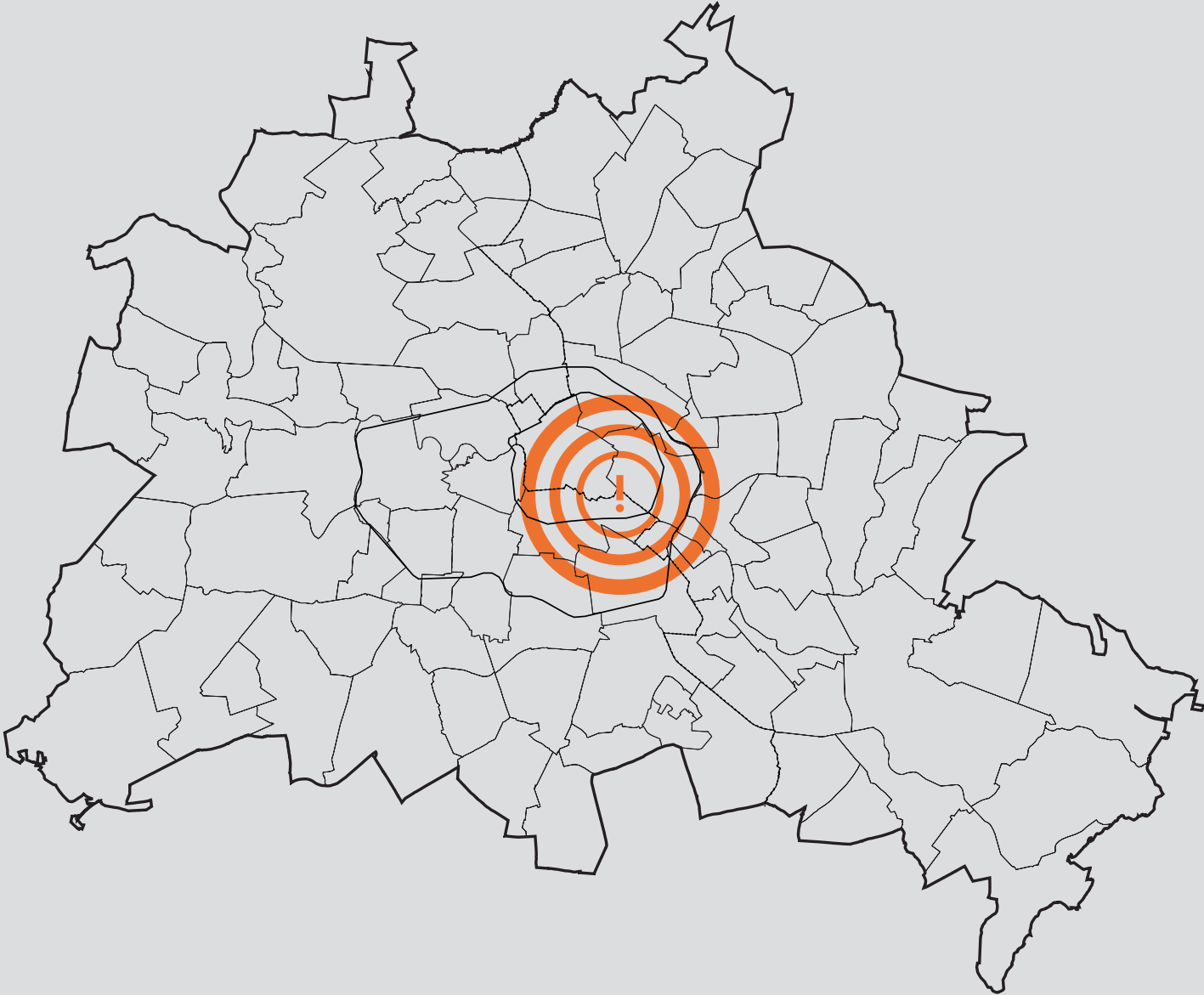

A man in a light blue shirt and glasses is being interviewed by a crowd of reporters in a city street. The man is looking slightly to the right of the camera. He is surrounded by several microphones, some with logos like 'BNP', 'radio', and 'NOS'. There are also cameras and other people in the background, suggesting a public event or press conference. The background shows a brick building with a large arched doorway.

MIGRATION IS PART OF POLITICAL DEBATE

PART OF THE POLITICAL DEBATE



Sign in

Home

News

Sport

Earth

Reel

NEWS

Home | [Israel-Gaza war](#) | [War in Ukraine](#) | [Climate](#) | [Video](#) | [World](#) | [UK](#) | [Business](#) | [Tech](#) | [Science](#)

World | [Africa](#) | [Asia](#) | [Australia](#) | [Europe](#) | [Latin America](#) | [Middle East](#) | [US & Canada](#)

Mark Rutte: Dutch coalition government collapses in migration row

8 July 2023



WORLD

U.S.

ELECTION 2024

POLITICS

SPORTS

ENTERTAINMENT

BUSINESS

SCIENCE

FACT CHECK

ODDITIES

HEALTH

VIDEO

- [Israel-Hamas war](#)
- [Election 2024](#)
- [US winter storms](#)
- [Government shutdown](#)
- [Shawn Barber dies](#)

WORLD NEWS

Dutch election candidates make migration a key campaign issue in the crowded Netherlands

BY MIKE CORDER

Updated 7:07 AM CET, November 12, 2023

DURABLE BUILDING

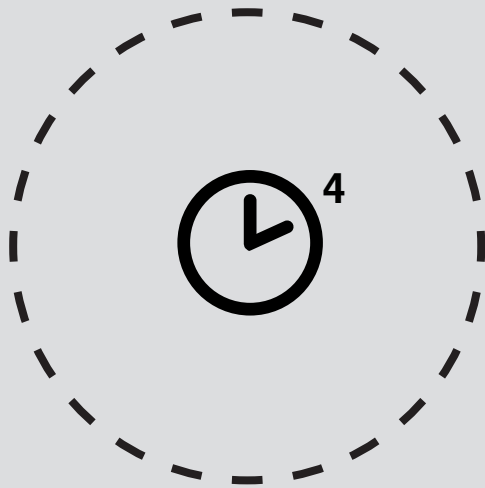

**short-term
politics**



**long-term
building**



MIGRATION IS PART OF SOCIETAL DEBATE

PART OF THE SOCIETAL DEBATE

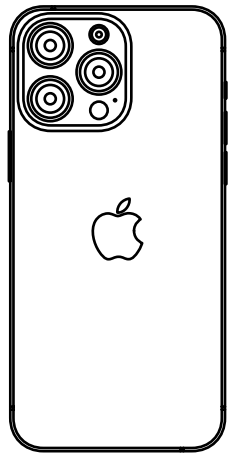

digitalization

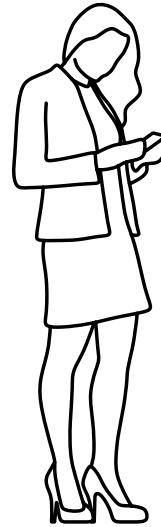

social isolation



fear of others

HIGH-ACCEPTANCE FOR DIVERSITY

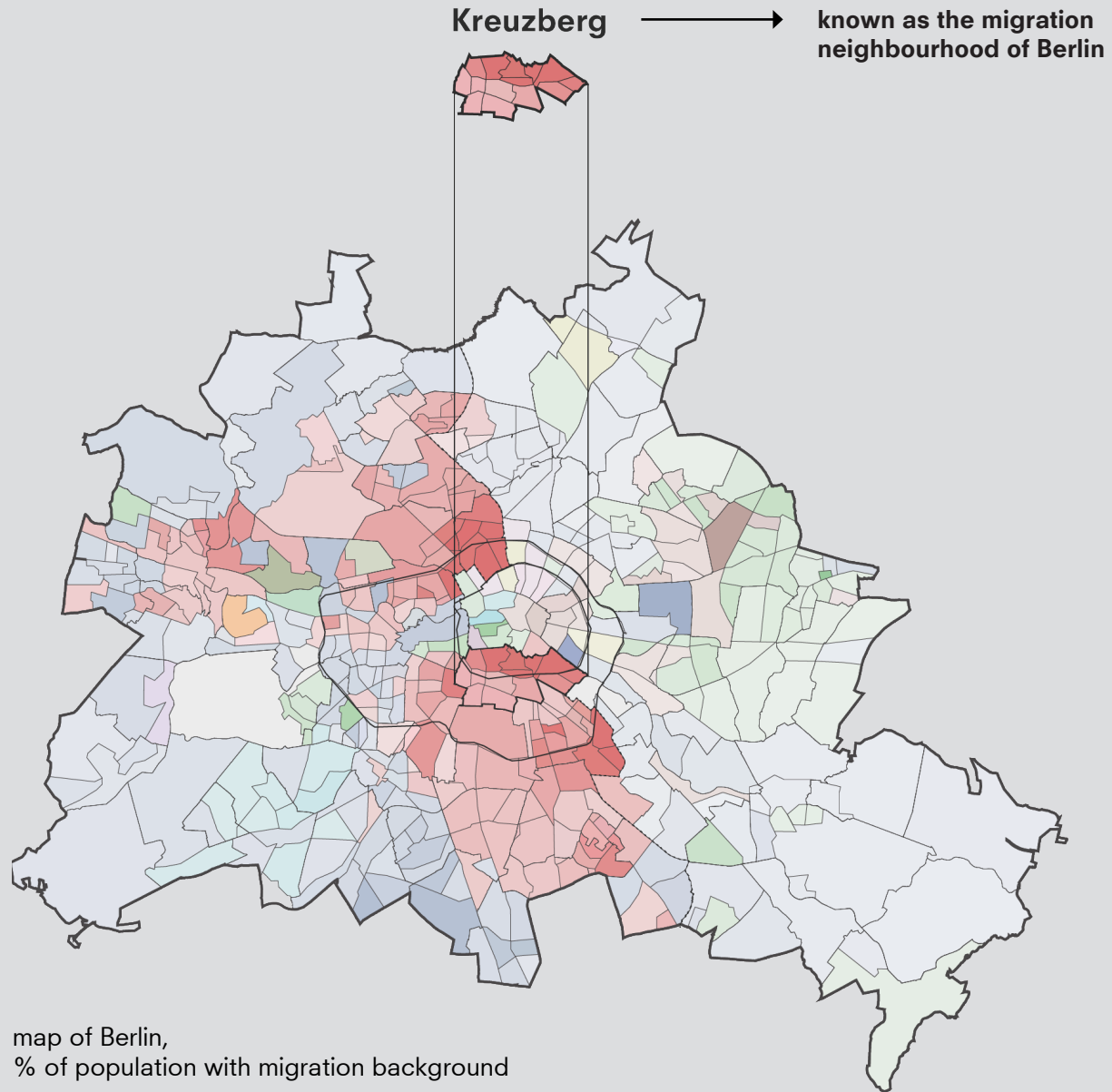

TEMPORARINESS IS FICTION



research
RESEARCH

labor shortage, **guest workers** from **Southern European countries**



displaced people from **conflict zones**, such as **Afghanistan, Iraq** and former **Yugoslavia**



since 1989, Germany has continued to receive a large number of **displaced people** from **various regions**



WW2

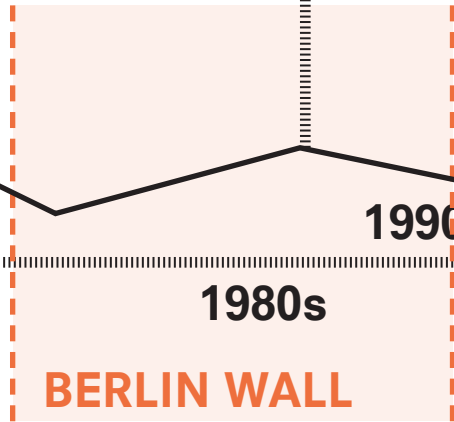

large influx of migrants following the **fall of the Wall** from the **former Soviet Union** and **within the country**



1980s
1990s
2010s
2015



European Migrant Crisis

PERMANENT FACE

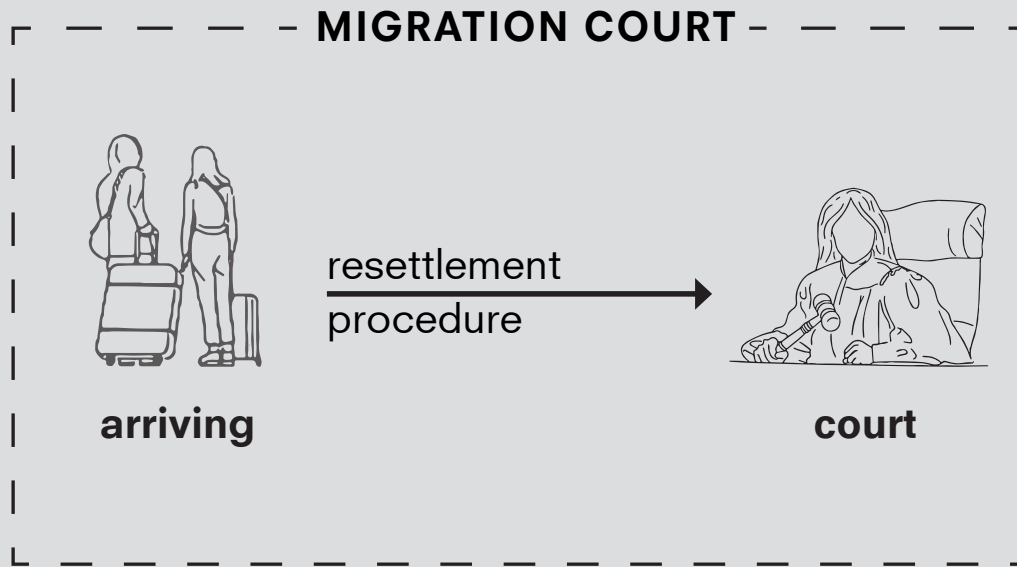

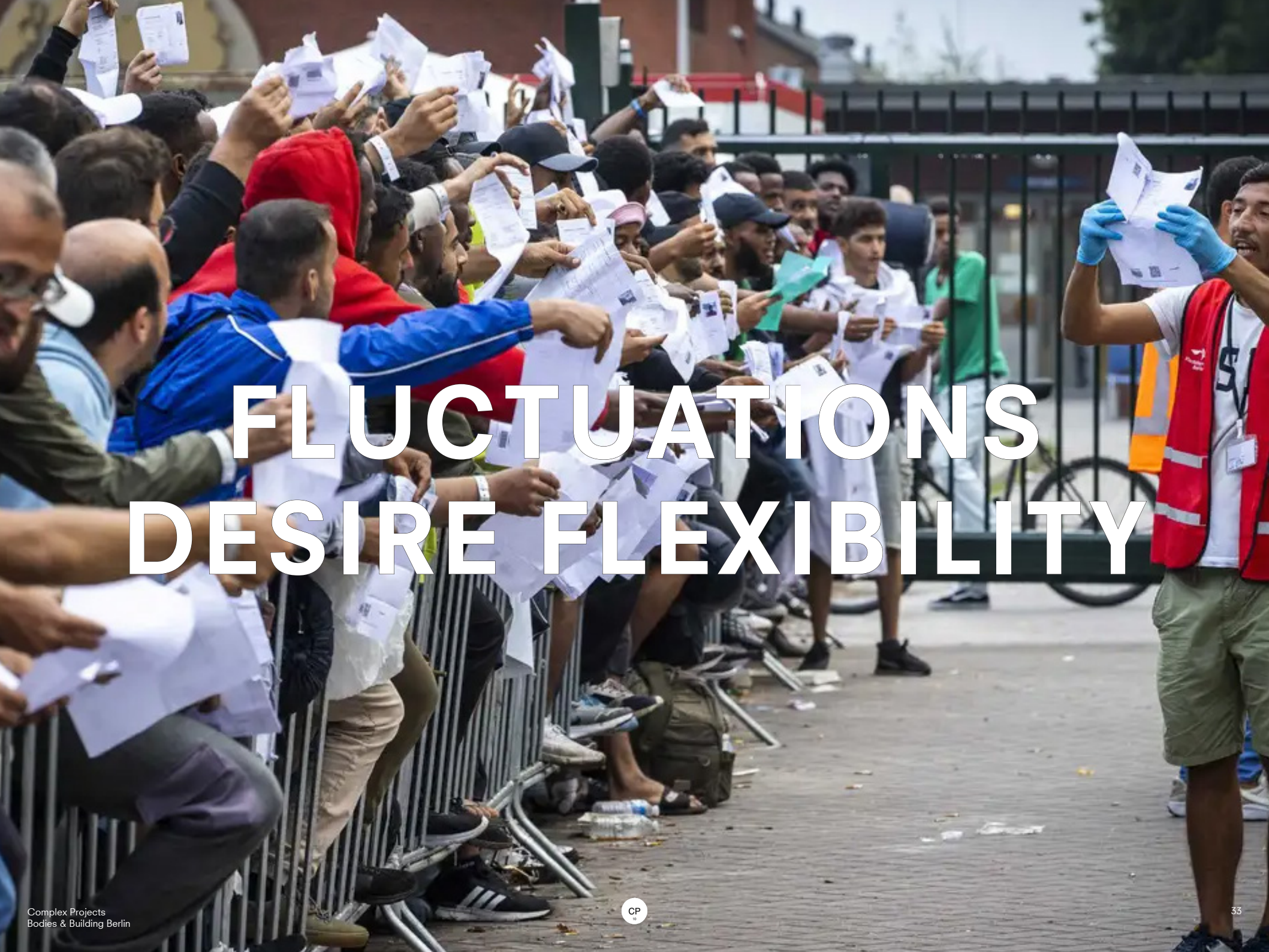

FLUCTUATIONS DESIRE FLEXIBILITY

FLUCTUATIONS DUE TO EVENTS

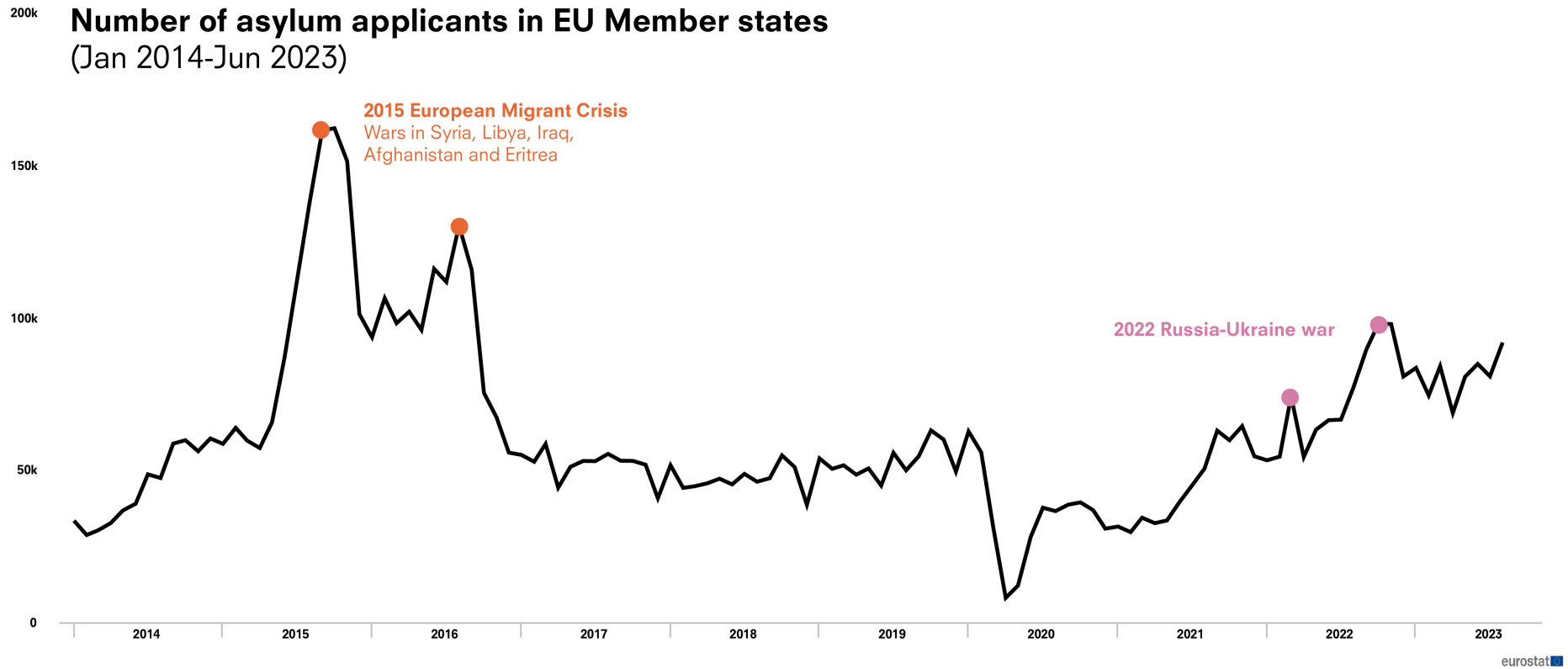

FLUCTUATIONS IN SEASONS

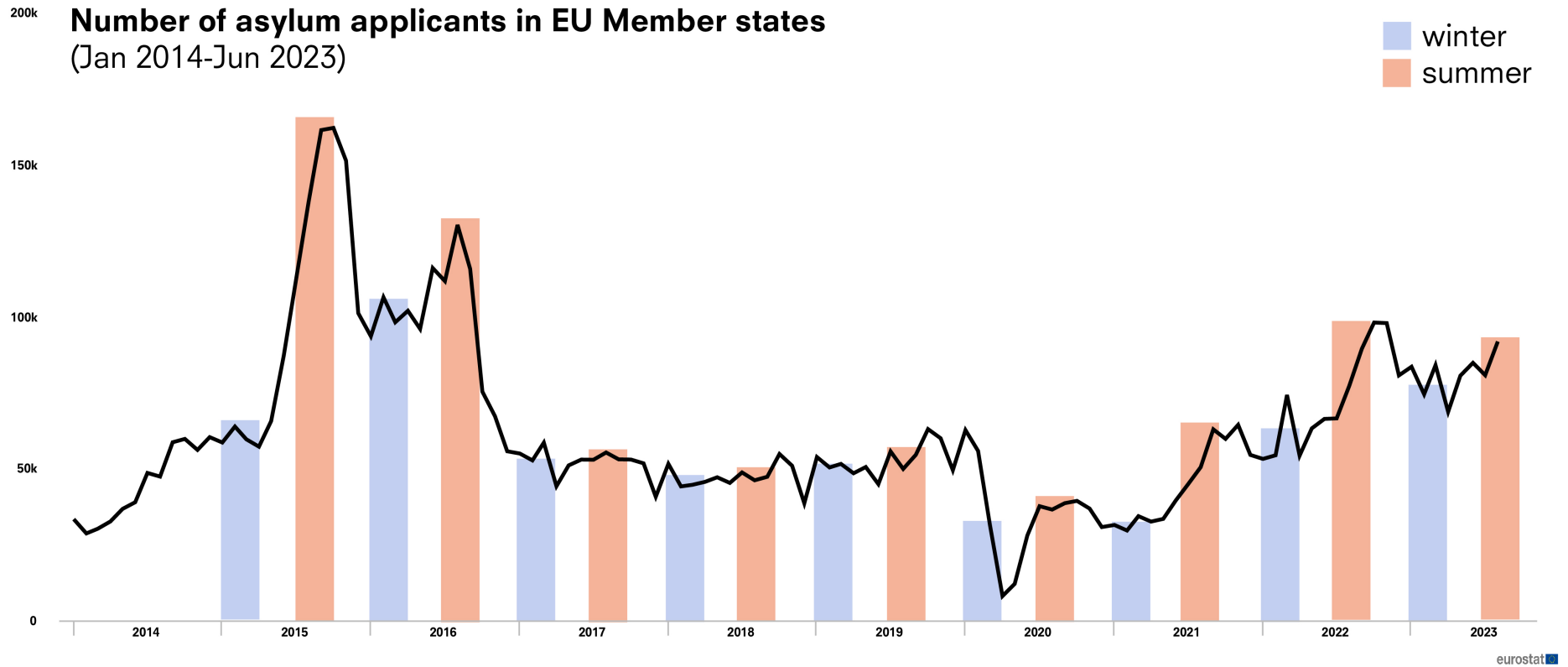

FLEXIBLE BUILDING

SCENARIO A

arriving



interview

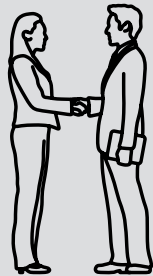

SCENARIO B

arriving



interview



FROM RESEARCH OBSERVATIONS TO BUILDING REQUIREMENTS

MIGRATION IS A MEGATREND	→	NEW ARCHITYPE
MIGRATION IS DIVERSE	→	USER-CENTRIC
MIGRATION IS INVISIBLE IN THE CITYSCAPE	→	PRIORITY
MIGRATION IS PART OF POLITICAL DEBATE	→	DURABILITY
MIGRATION IS PART OF SOCIETAL DEBATE	→	SOCIAL INCLUSIVITY
THE TEMPORARINESS OF MIGRATION IS FICTION	→	PERMANENT FACE
FLUCTUATIONS IN MIGRATION NUMBERS DESIRE FLEXIBILITY	→	FLEXIBILITY

ONE BUILDING



RESEARCH QUESTION

How can a building treat **displaced people** in a **societal inclusive** way while maintaining **institutional efficiency**?



research

USER-CENTRIC



INTRODUCTION

RESEARCH

DESIGN BRIEF

DESIGN PROCESS & CONCEPT

IMPLEMENTATION

DEVELOPMENT

CONCLUSION

design brief

COMPLEX PROJECTS GRADUATION STUDIO



BERLIN'S MIGRATION COURT

DESIGN BRIEF

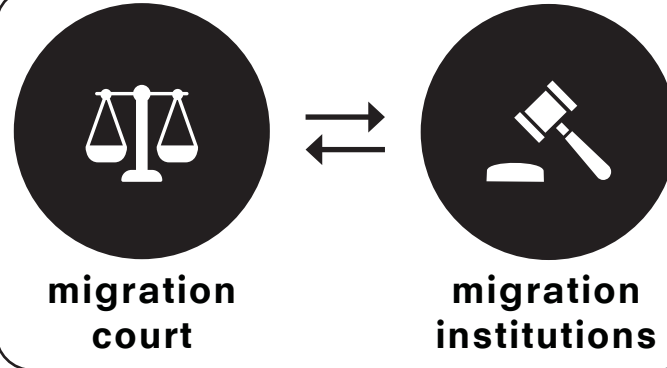

CLIENT

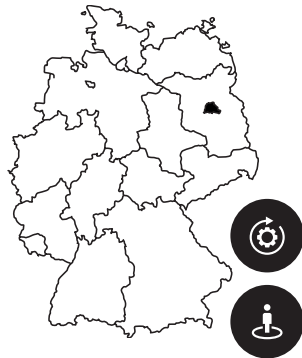

PROGRAM

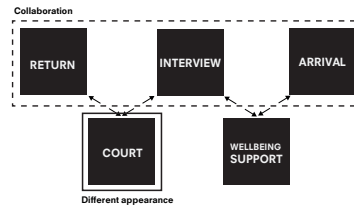

SITE



CLIENT

CLIENT MATRIX

INITIATOR
GERMAN
GOVERNMENT

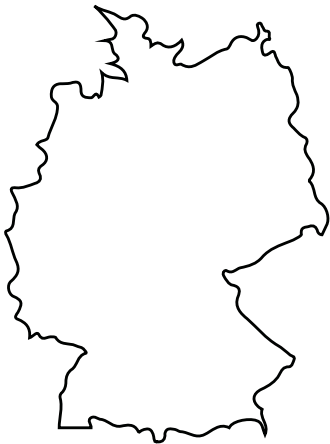

CLIENT
BERLIN
GOVERNMENT



STAKEHOLDERS
VERWALTUNGSGERICHT,
BAMF, LAF, LEA

VERWALTUNGS
GERICHT

BAMF

LAF

LEA

USERS
PUBLIC, EMPLOYEES,
DISPLACED PEOPLE

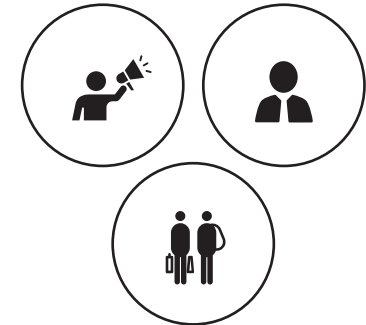

PROCEDURE OVERVIEW

BAMF	LAF
LEA	court

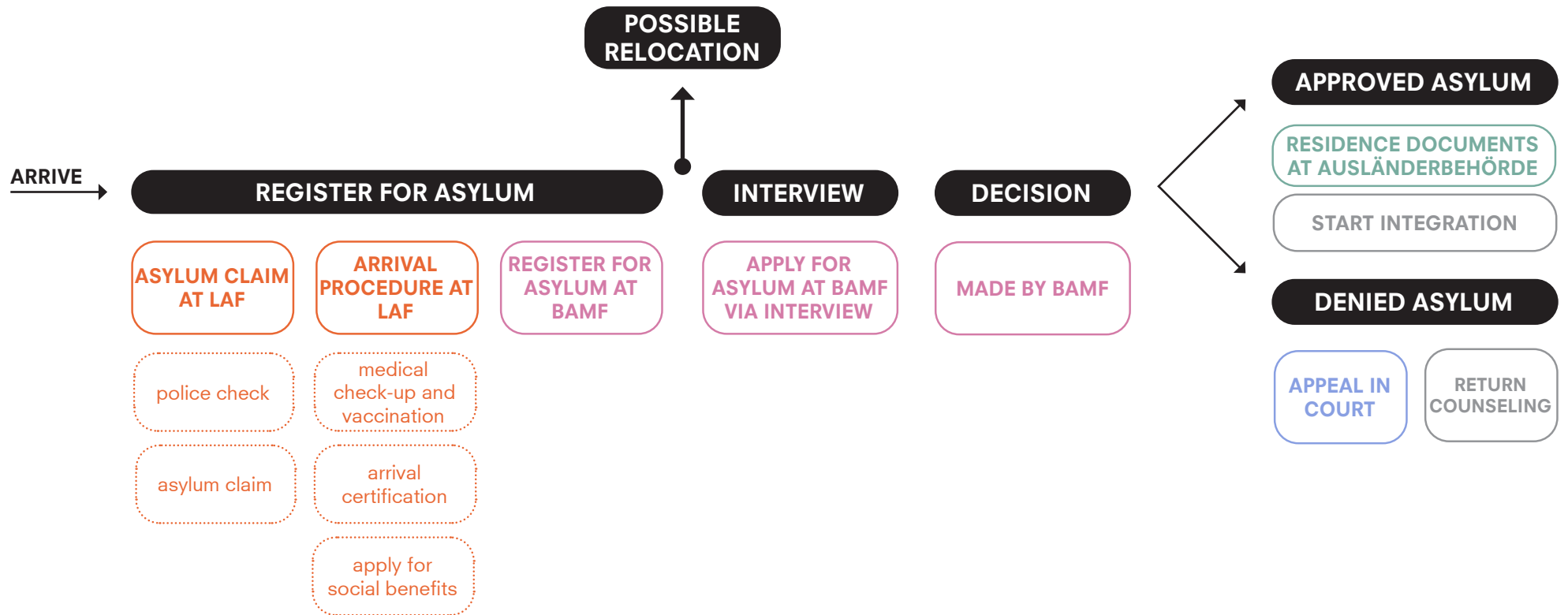

RESETTLEMENT INSTITUTIONS OVERVIEW

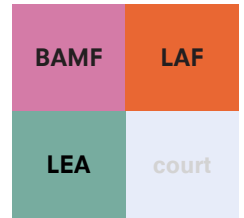

FEDERAL LEVEL: GERMANY



STATE LEVEL: BERLIN



RESETTLEMENT INSTITUTIONS OVERVIEW

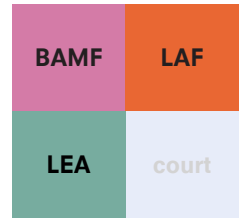

FEDERAL LEVEL: GERMANY

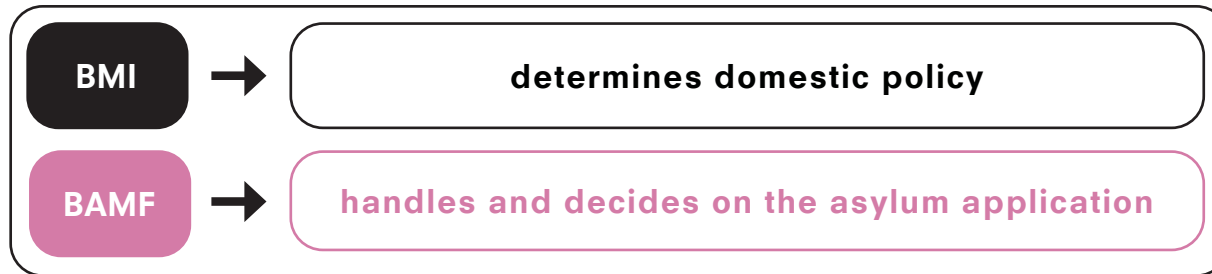

STATE LEVEL: BERLIN



PROCEDURE TIMELINE

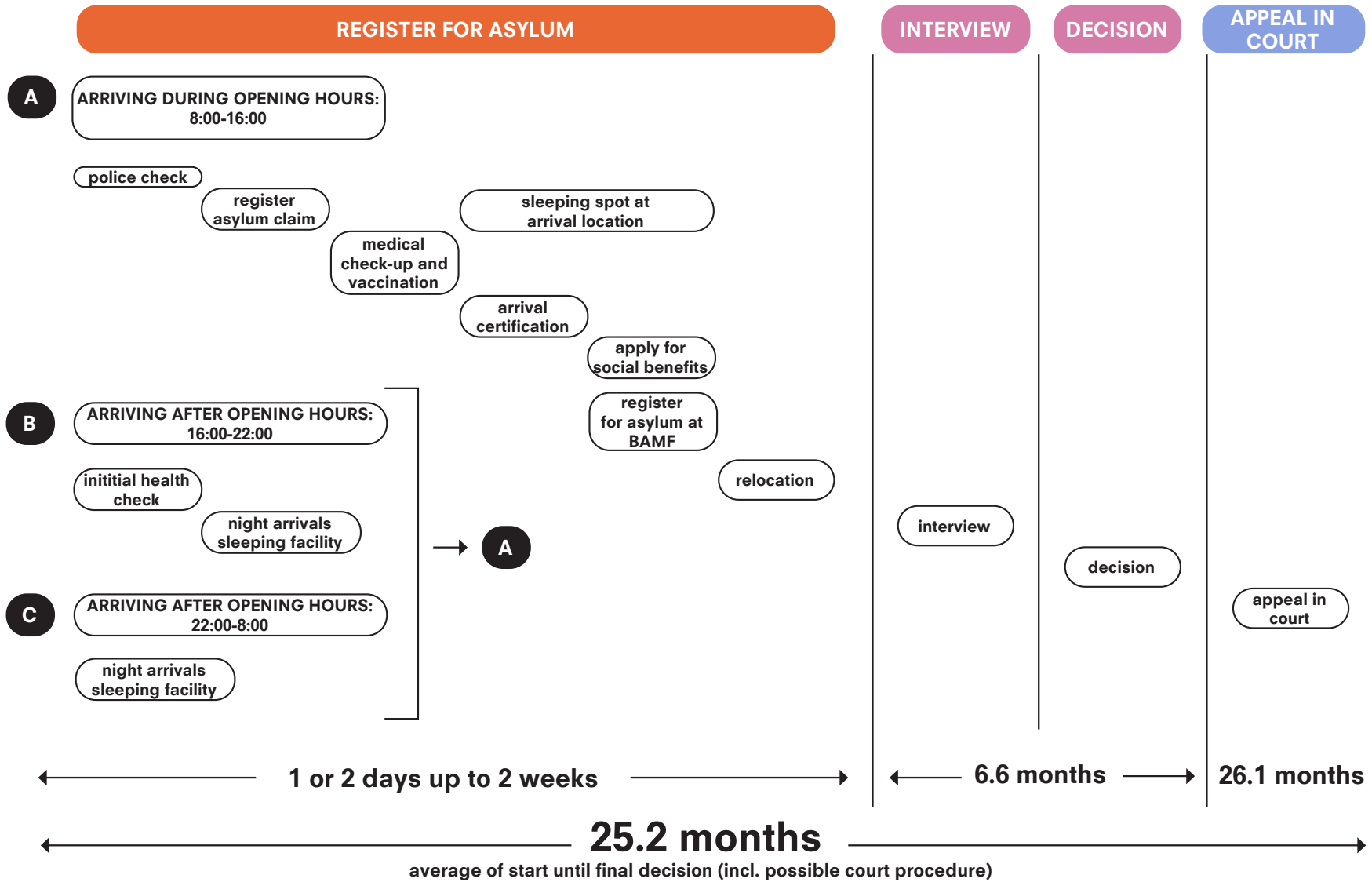

client

RESEARCH

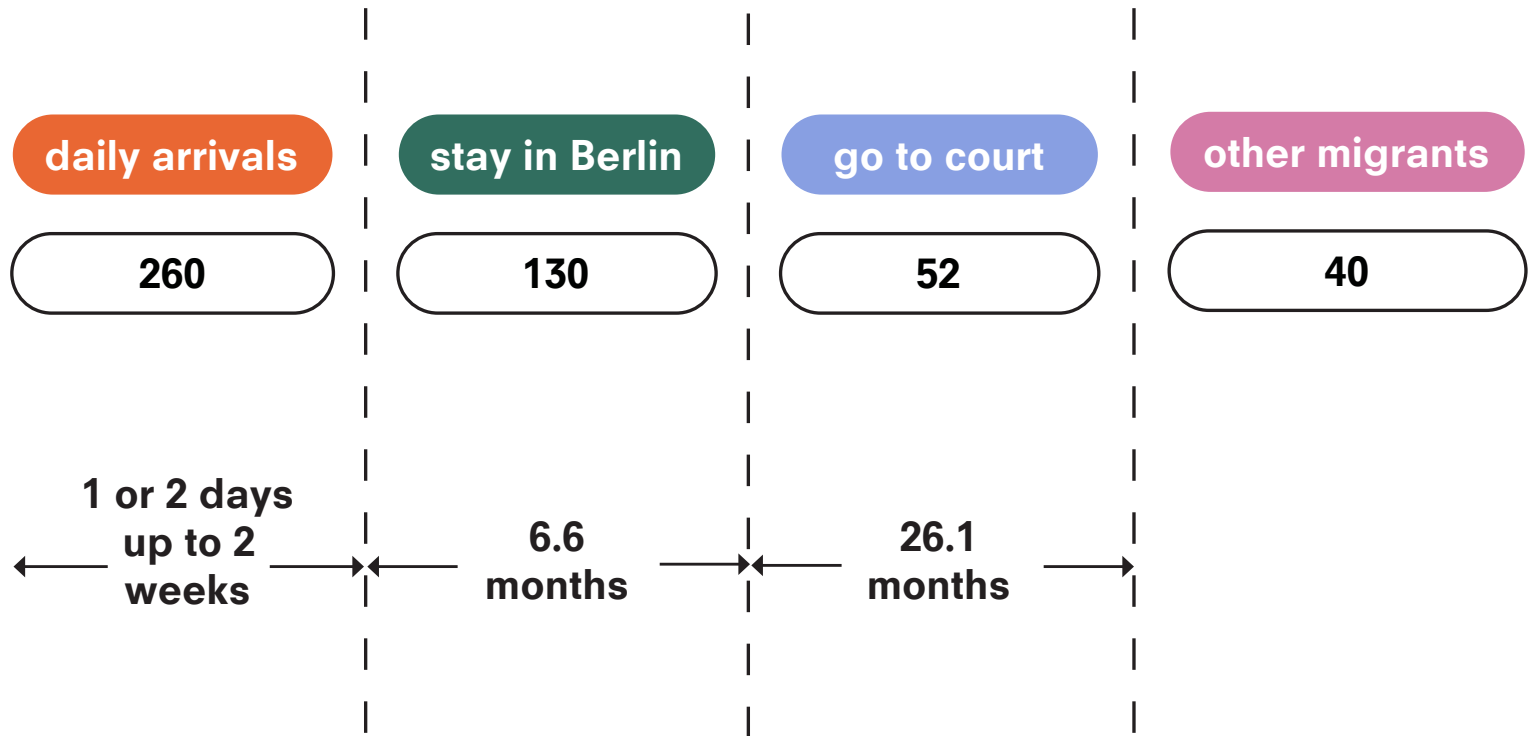

CLIENT CONCLUSION MATRIX

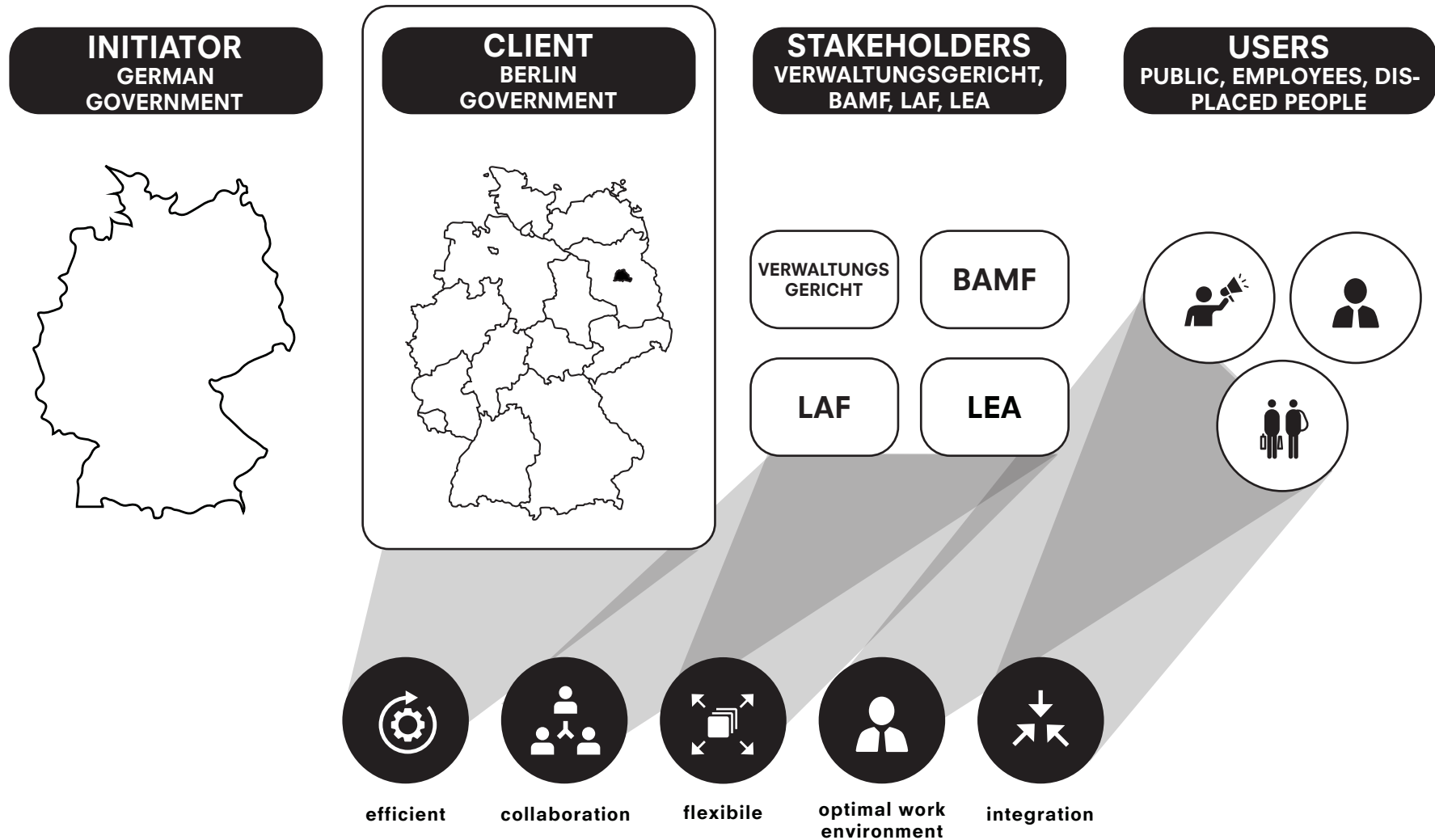

PROGRAM

design brief
PROGRAM

resettlement procedure



arriving



court

BRINGING THE PROGRAM TOGETHER



BRINGING THE PROGRAM TOGETHER

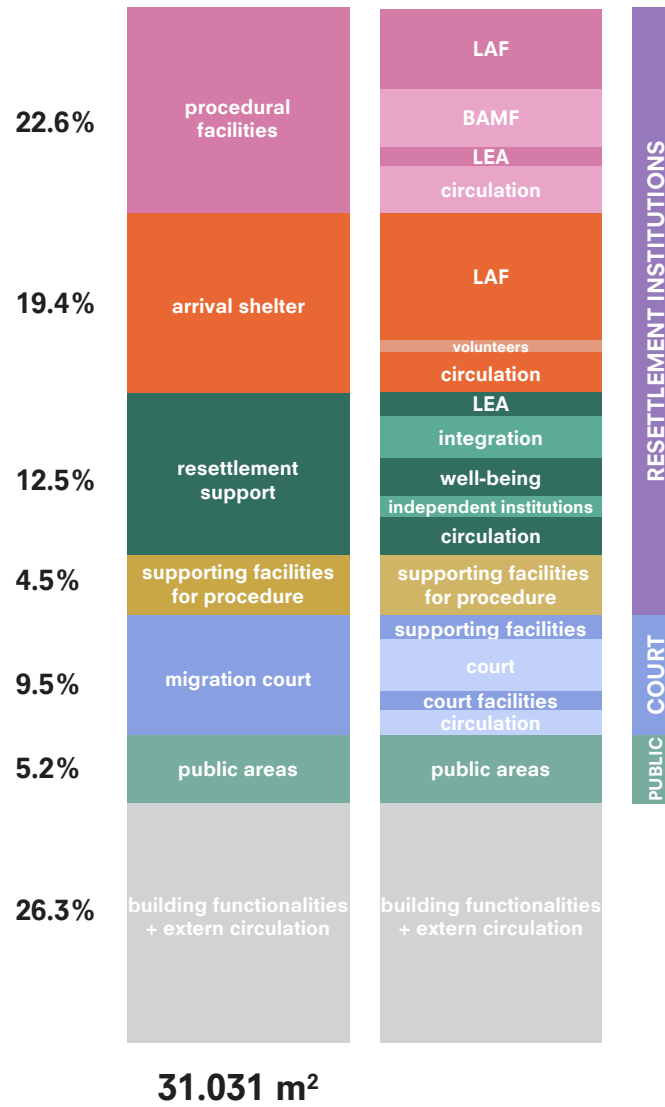

ONE BUILDING

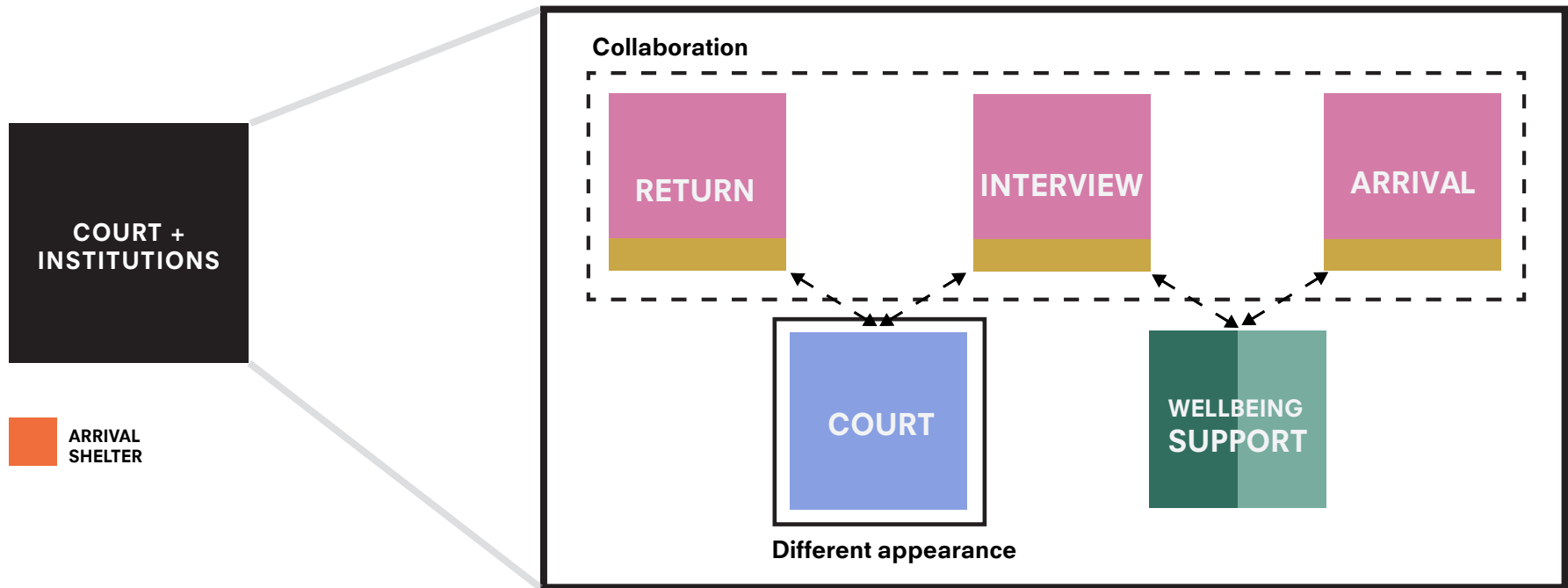

introduction

USER NEEDS

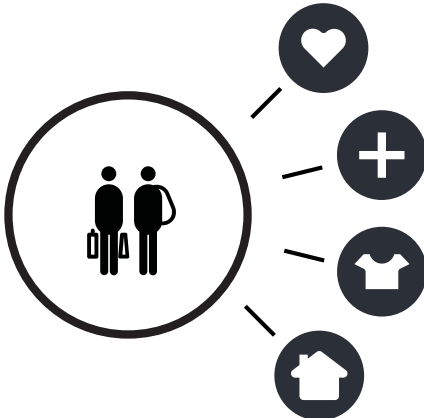

displaced

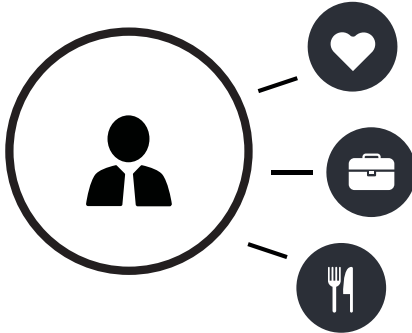

employees

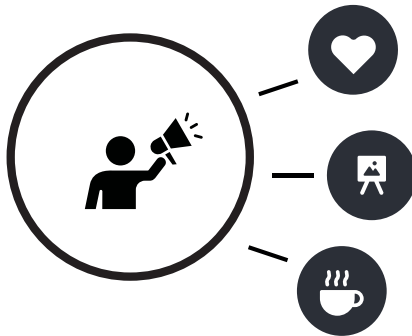

public

USER NUMBERS & PROGRAM

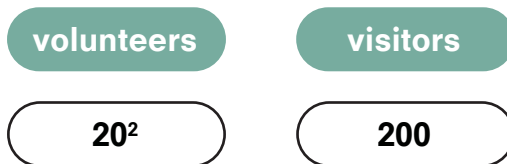
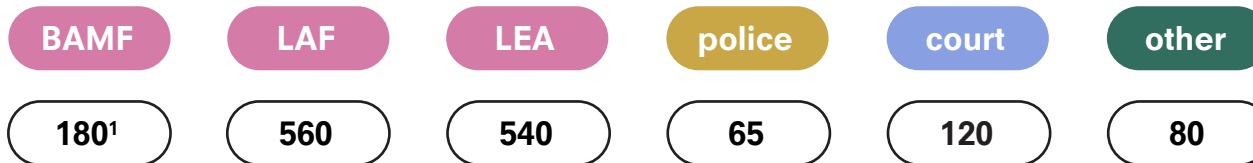
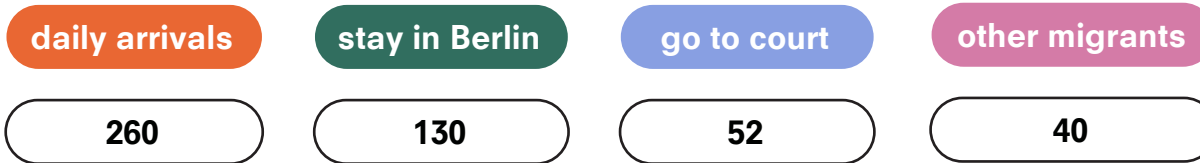

¹ 8.300 total:
2.800 HQ,
5.500 in ca.
60 locations

² average of 13
volunteers on
regular basis
per LAF shelter

OVERVIEW PROGRAM PROCES PER USER

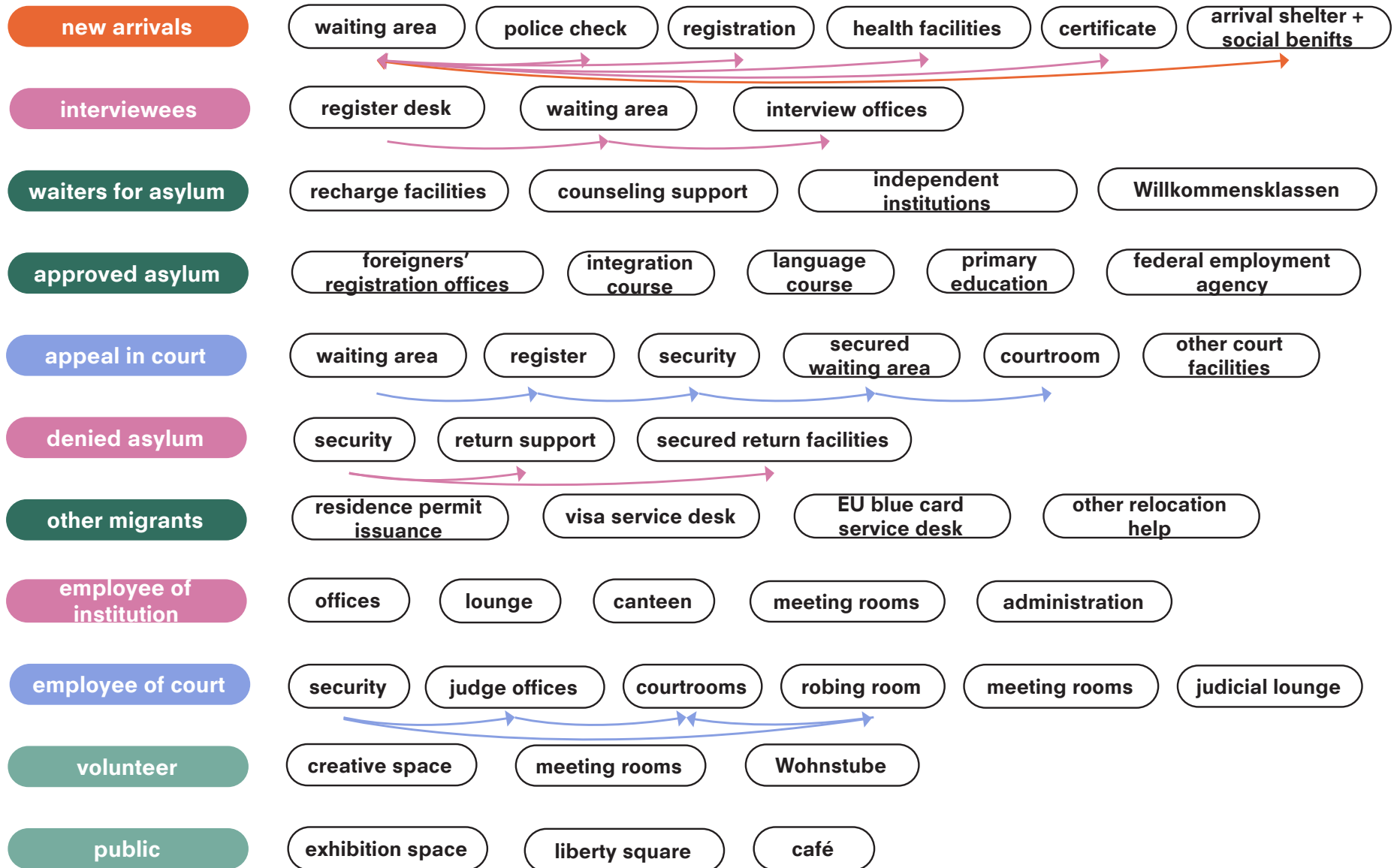

PROGRAM CONCLUSION MATRIX

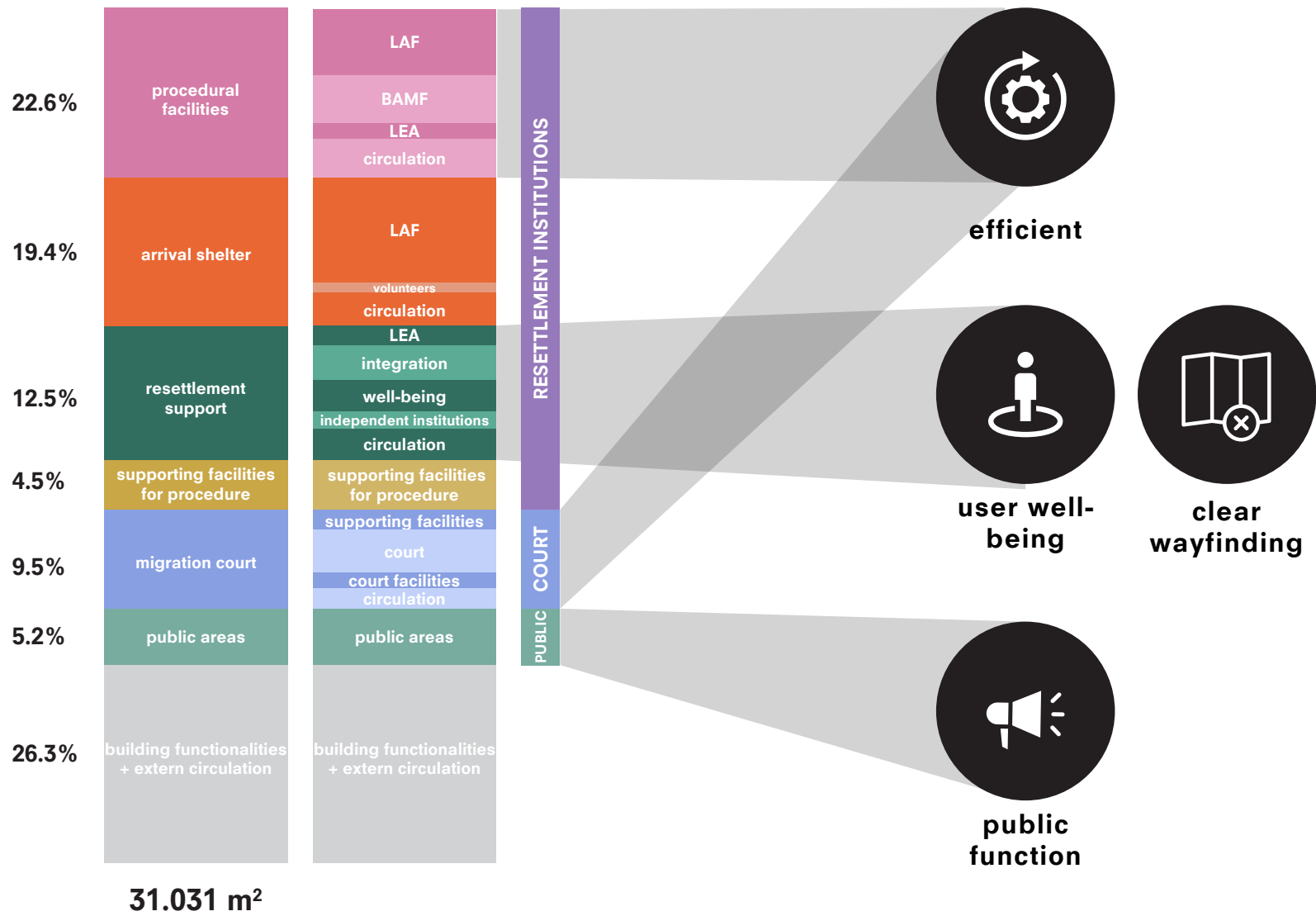

SITE

SITE OVERVIEW

XL
CITY OF
BERLIN

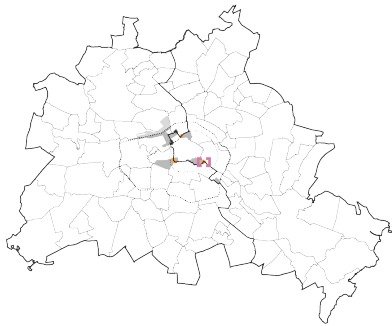

L
S-BAHN
REGION



M
OSTBAHNHOF TO
ST.-THOMAS-KIRCHE

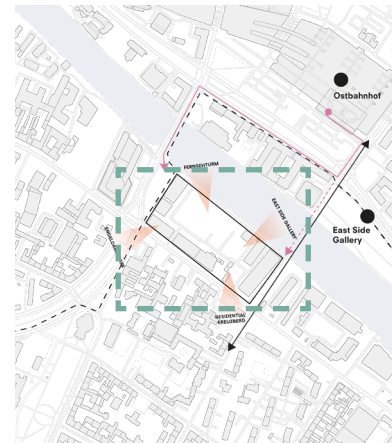

S
SPREE AND
MAUER

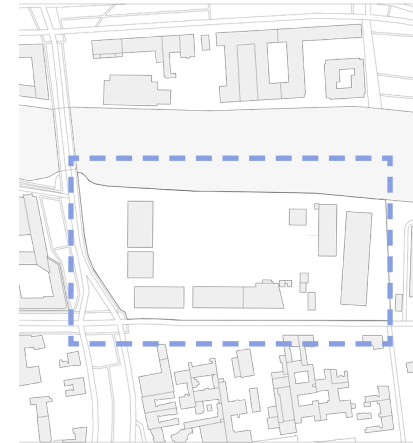

research the ambitions to determine
requirements for potential sites



urban analysis for
3 site options



detailed analysis for
chosen site

WHY GERMANY?



GERMANY IS WORLD'S 3RD TOP HOST COUNTRY

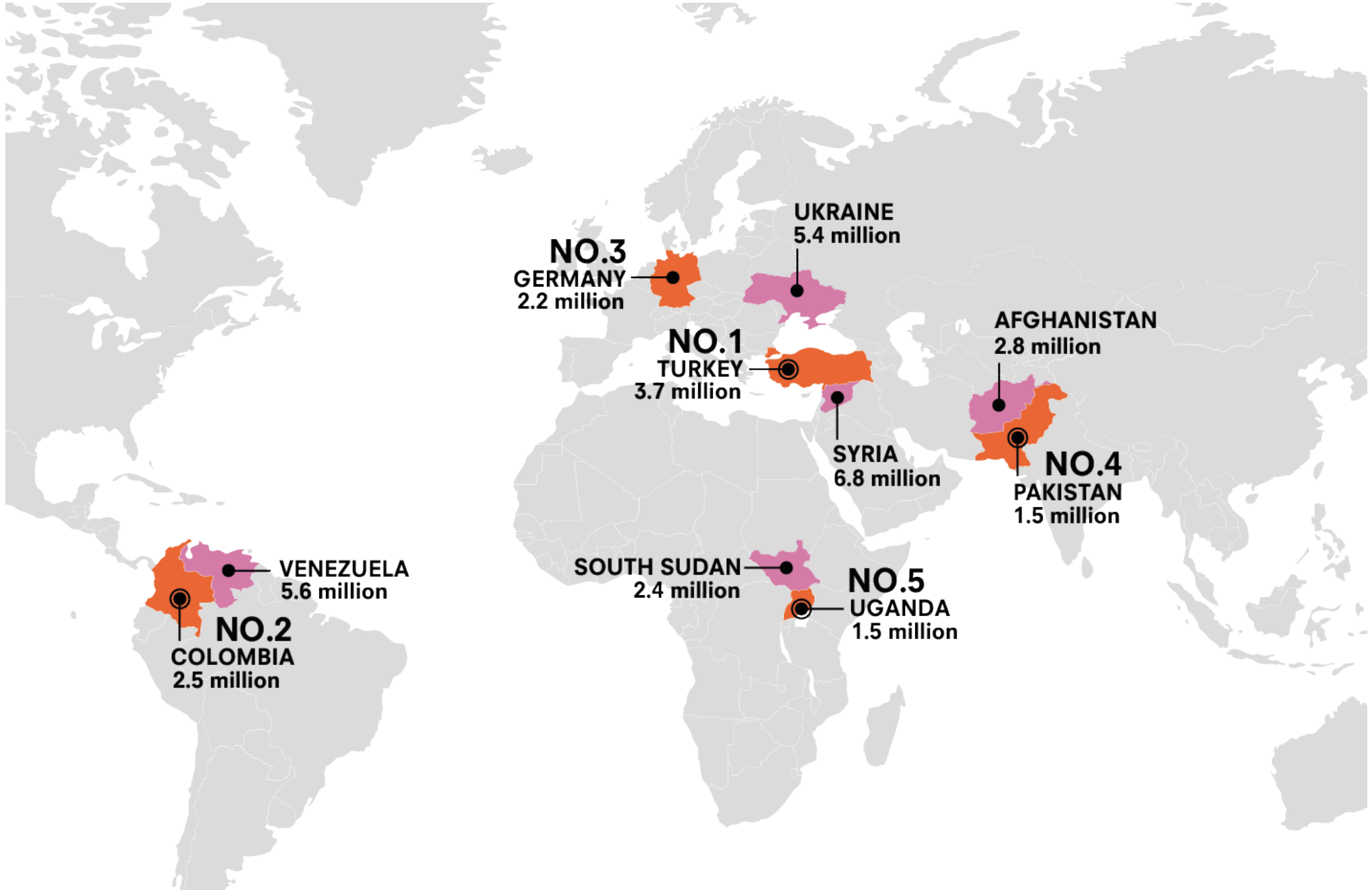

site

GERMANY'S WILLKOMMENSKULTUR

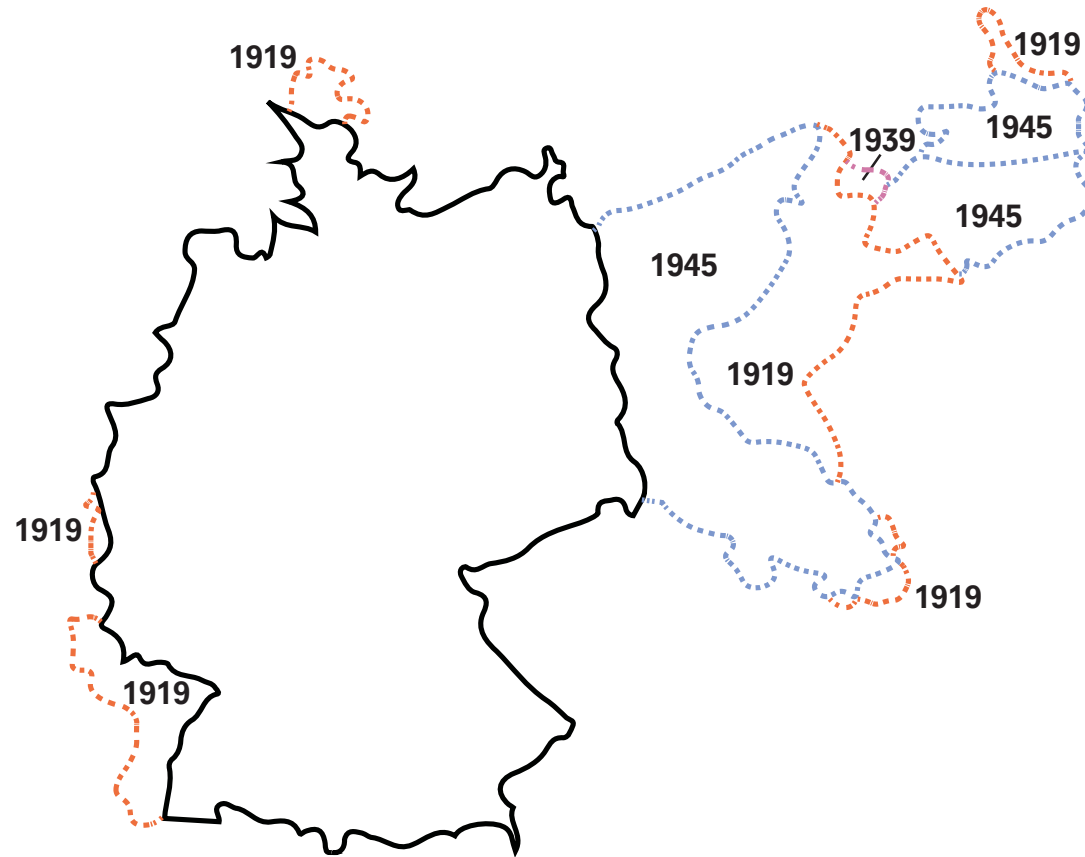

WHY

BERLIN?

site

OPEN, DIVERSE CITY

1 OF 3.5 MILLION INHABITANTS
HAVE A MIGRATION BACKGROUND

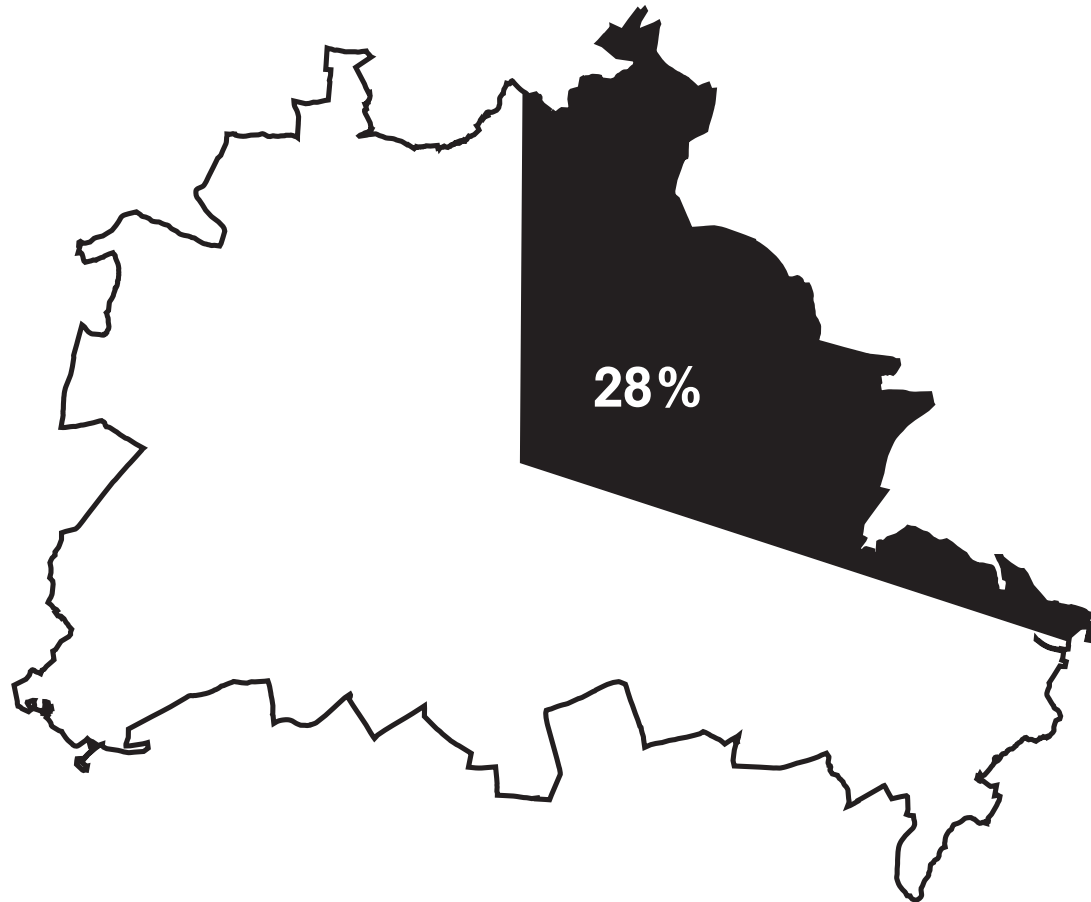

BERLIN: MIGRATION BACKGROUND

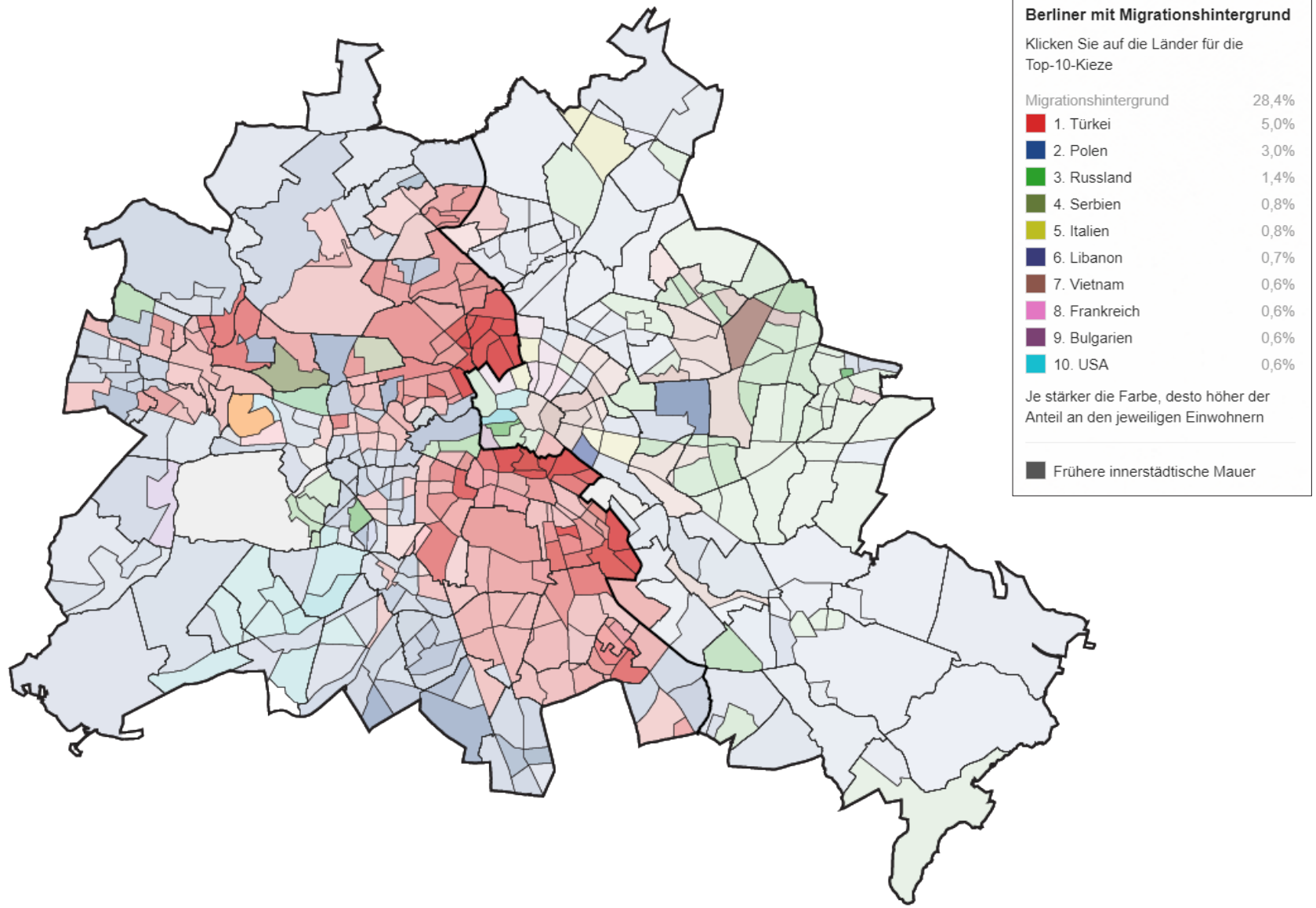

site

BERLIN: THE ROLE OF THE MAUER



site

BERLIN AS THE ARRIVAL CITY



WHY KREUZBERG?

site

KREUZBERG: A MIGRANT NEIGHBOURHOOD - NOW

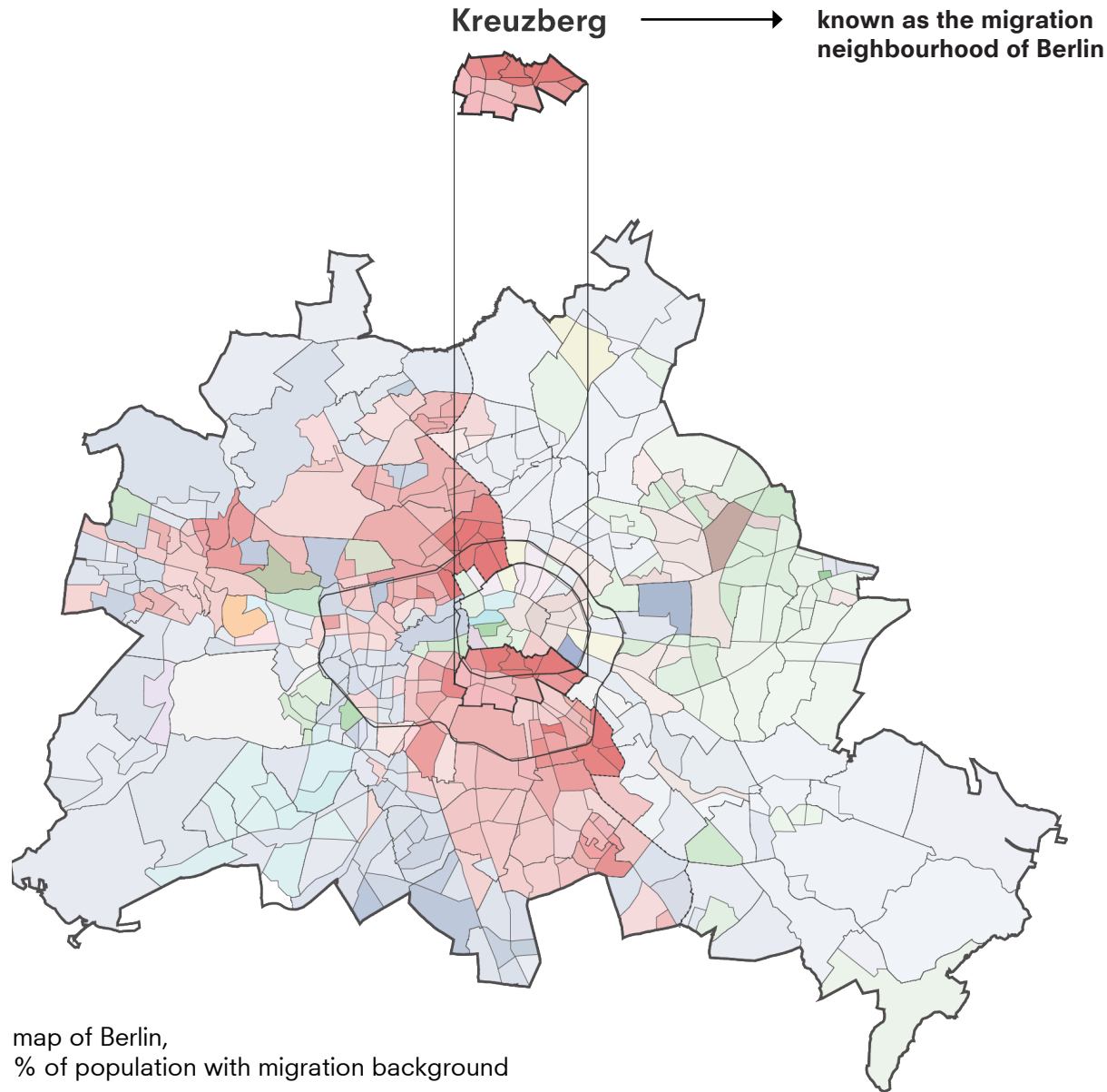

map of Berlin,
% of population with migration background

KREUZBERG: A MIGRANT NEIGHBOURHOOD - THEN

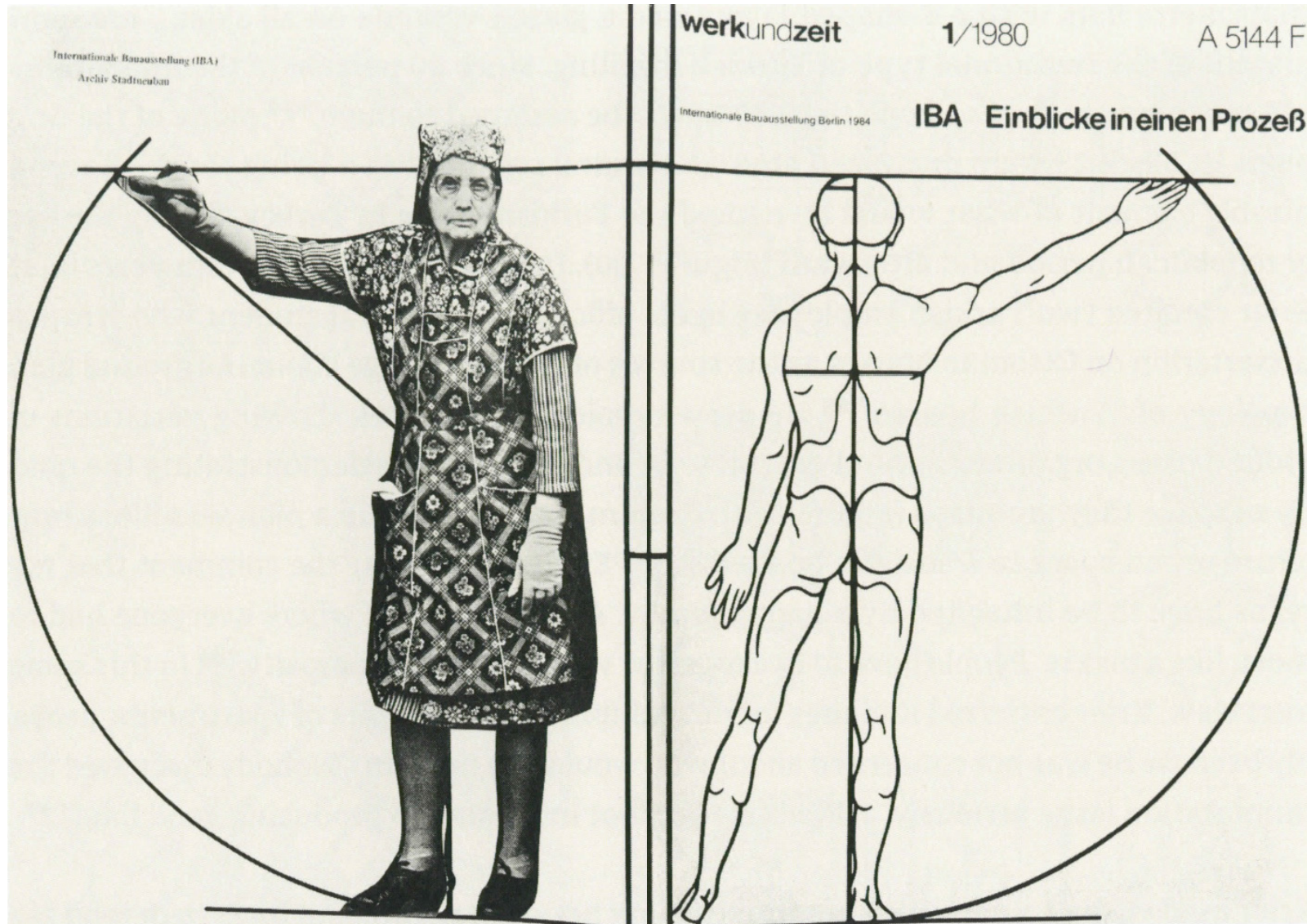

WHY HERE?

site
PRIORITY

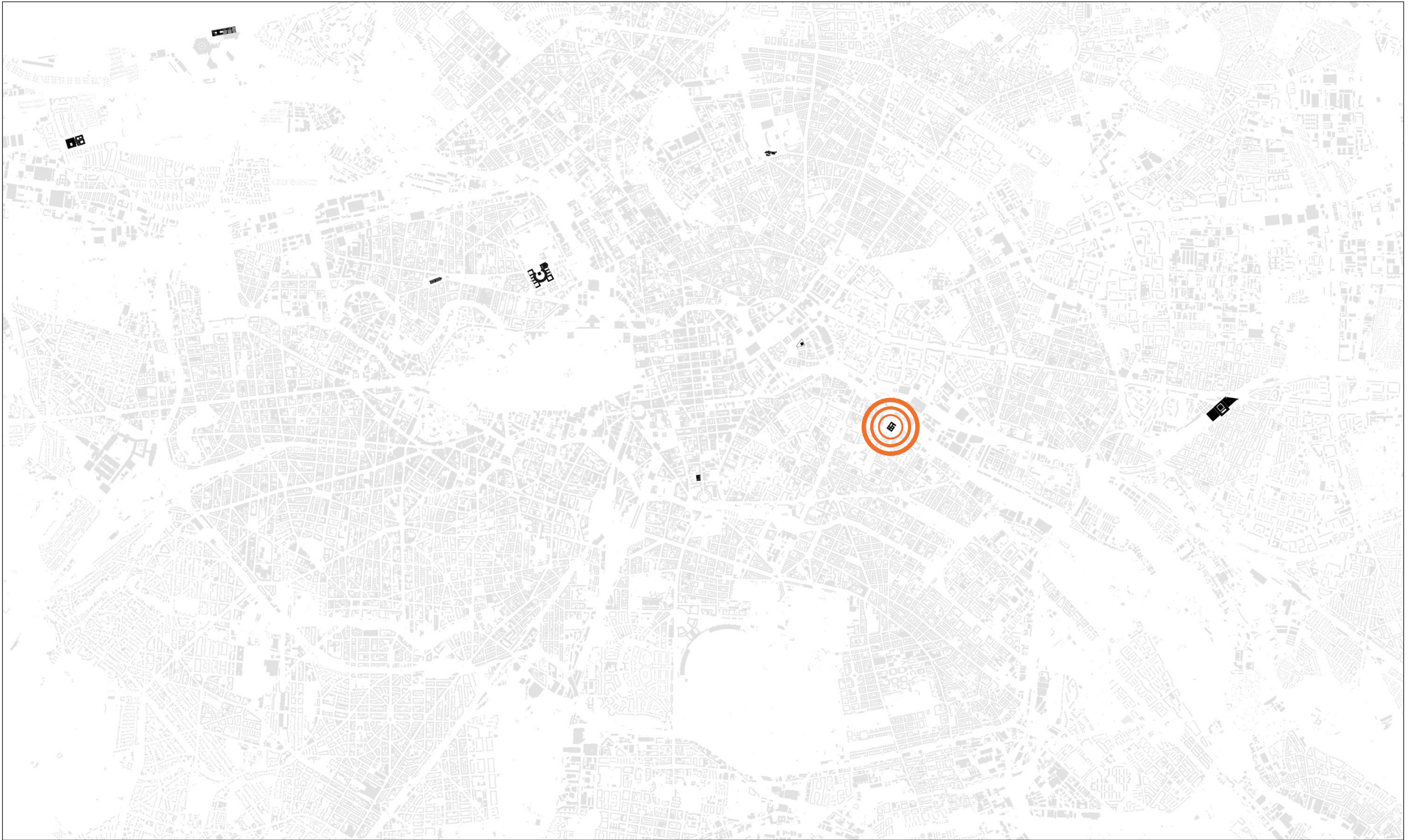

site

ORIENTATION

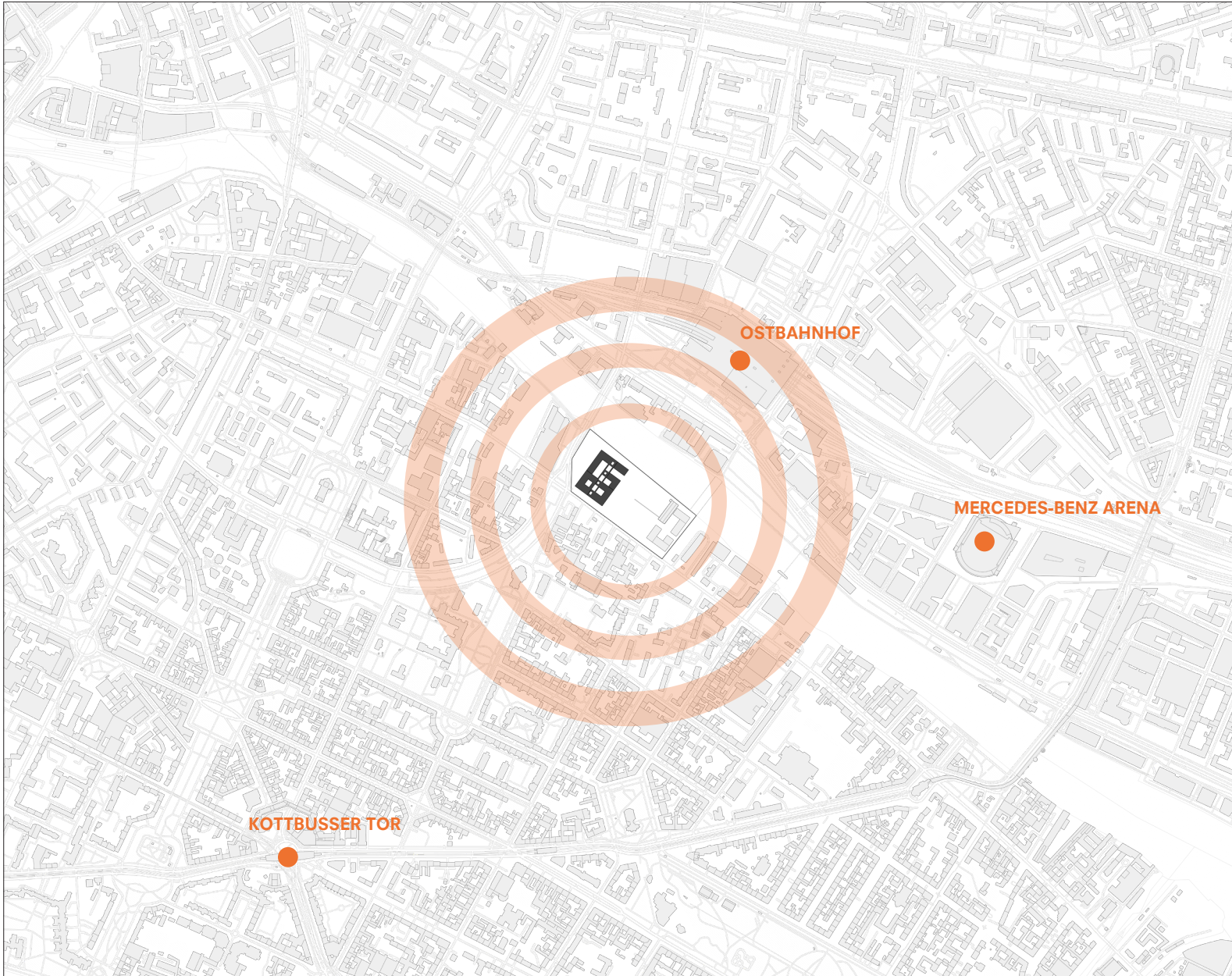

site

GREAT ACCESSIBILITY



site

HISTORY OF LOCATION

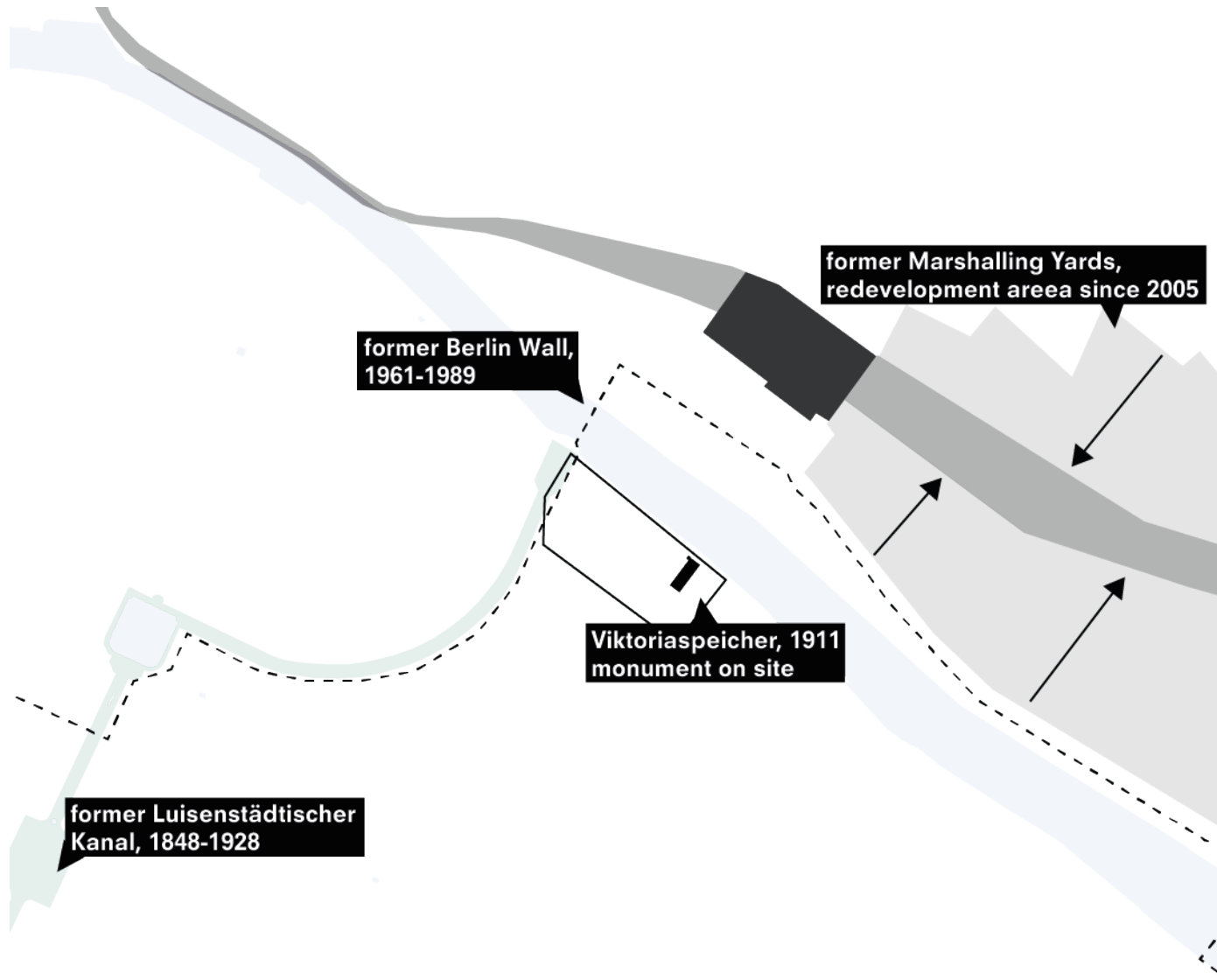

site

BROWN FIELD



site

SITE PLAN

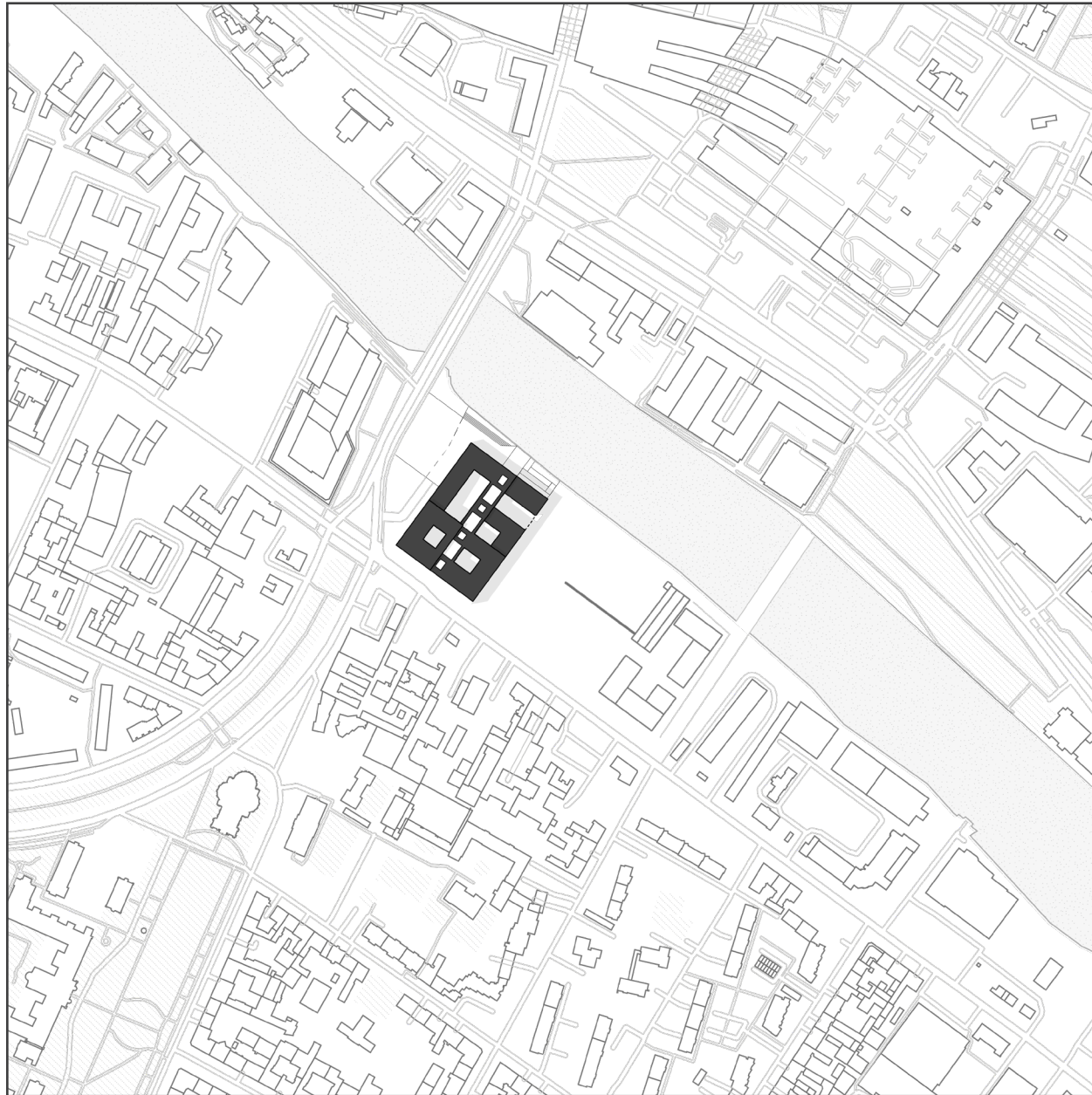

SITE CONCLUSION MATRIX

XL
CITY OF
BERLIN

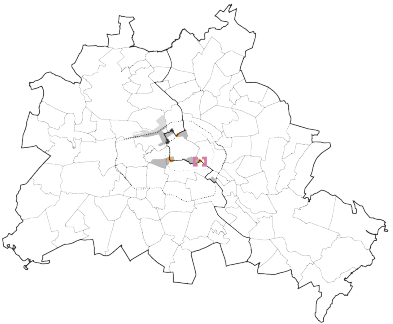

L
S-BAHN
REGION



M
OSTBAHNHOF TO
ST.-THOMAS-KIRCHE

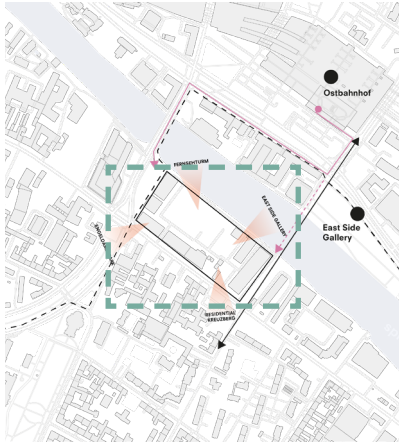

S
SPREE AND
MAUER

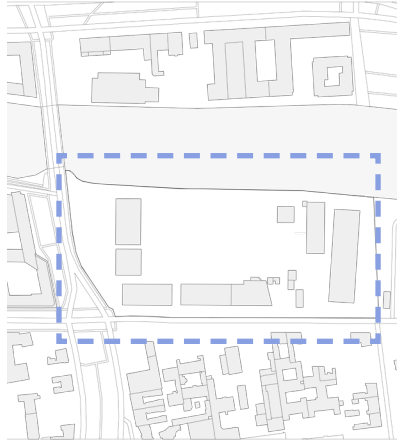

sustainable development priority symbolic integration

accessibility symbolic

integration environmental visibility

priority symbolic integration

accessibility environmental visibility

design brief
OVERVIEW

CLIENT

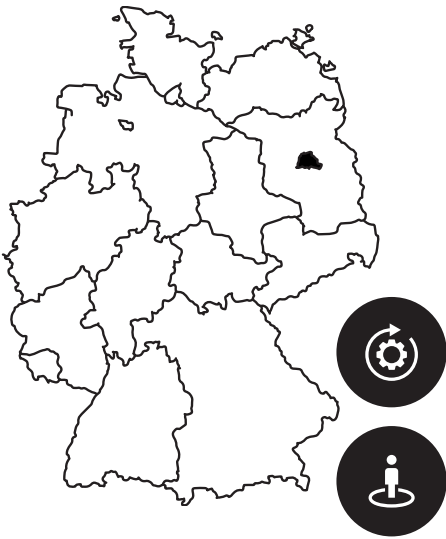

PROGRAM

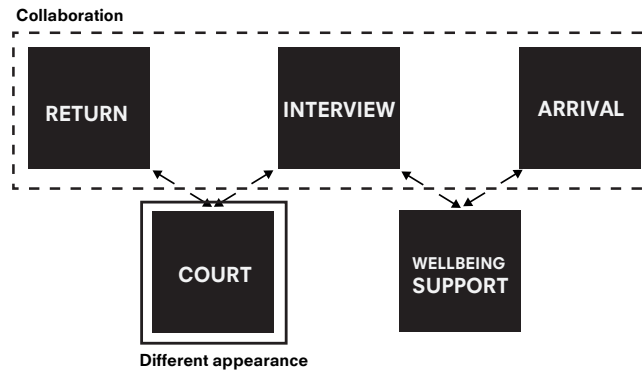

SITE



INTRODUCTION

RESEARCH

DESIGN BRIEF

DESIGN PROCESS & CONCEPT

IMPLEMENTATION

DEVELOPMENT

CONCLUSION

site

URBAN ANALYSIS

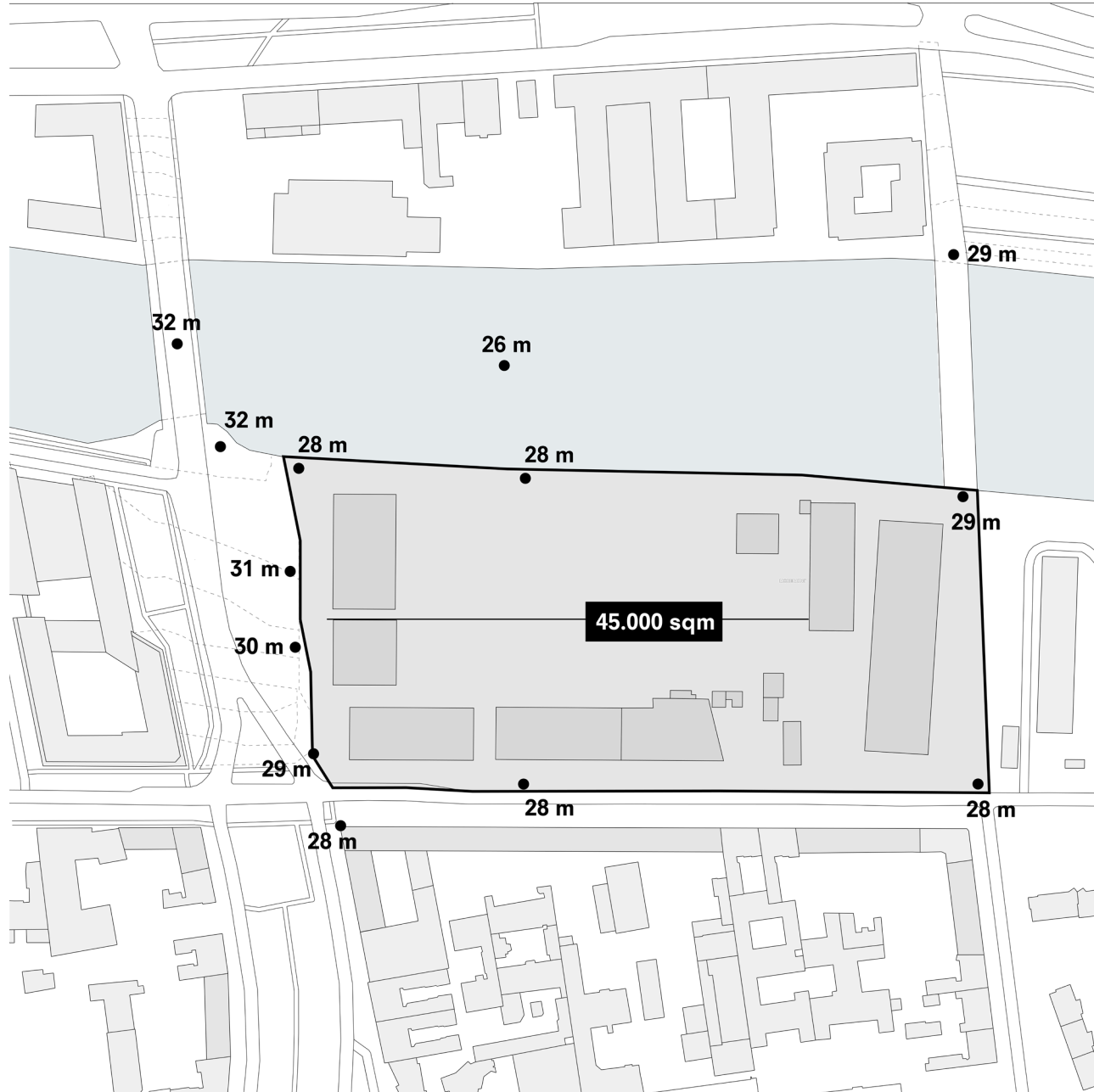

site

URBAN ANALYSIS

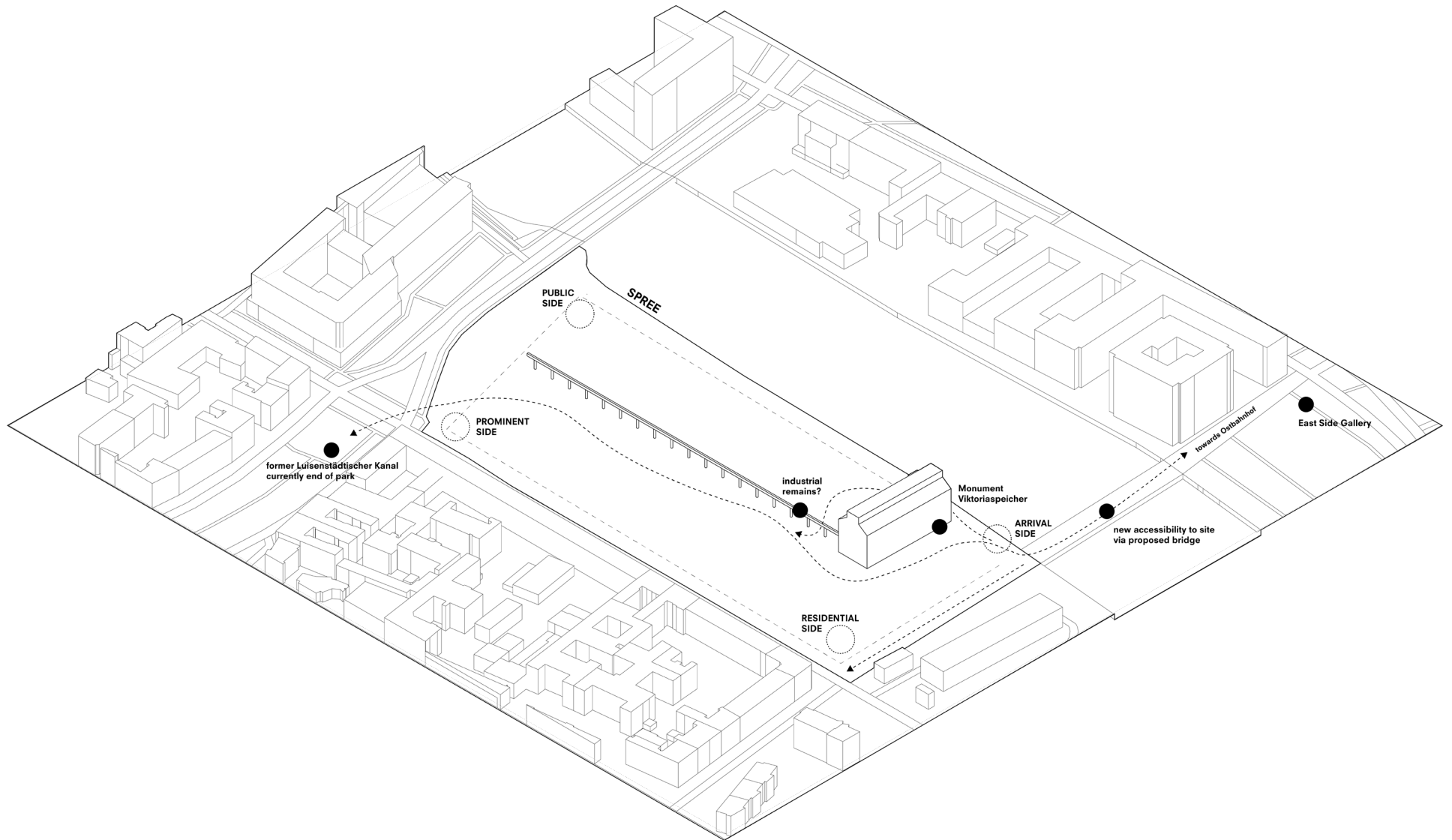

site

URBAN ZONING PLAN

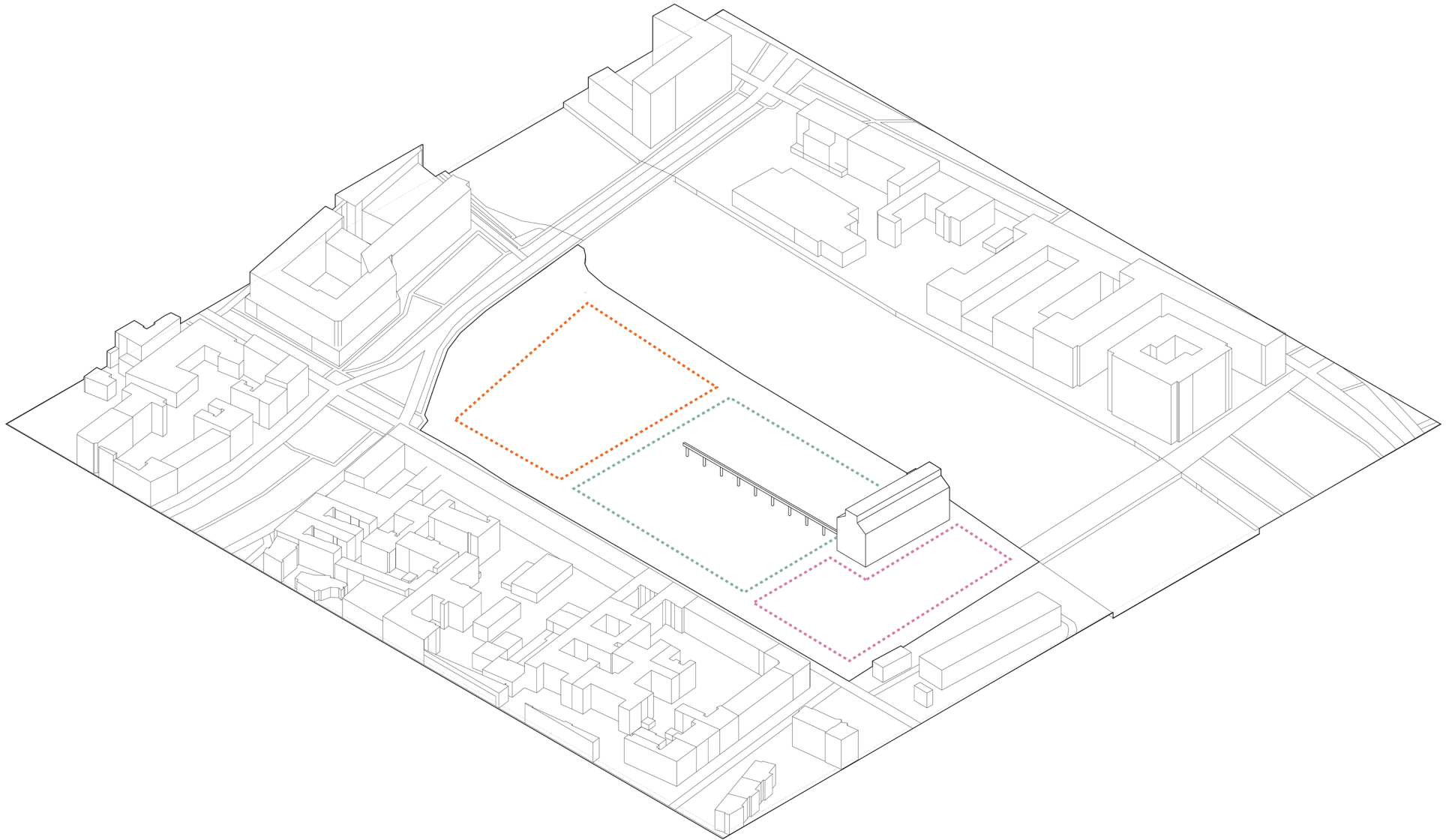

concept
BUILDING TESTS

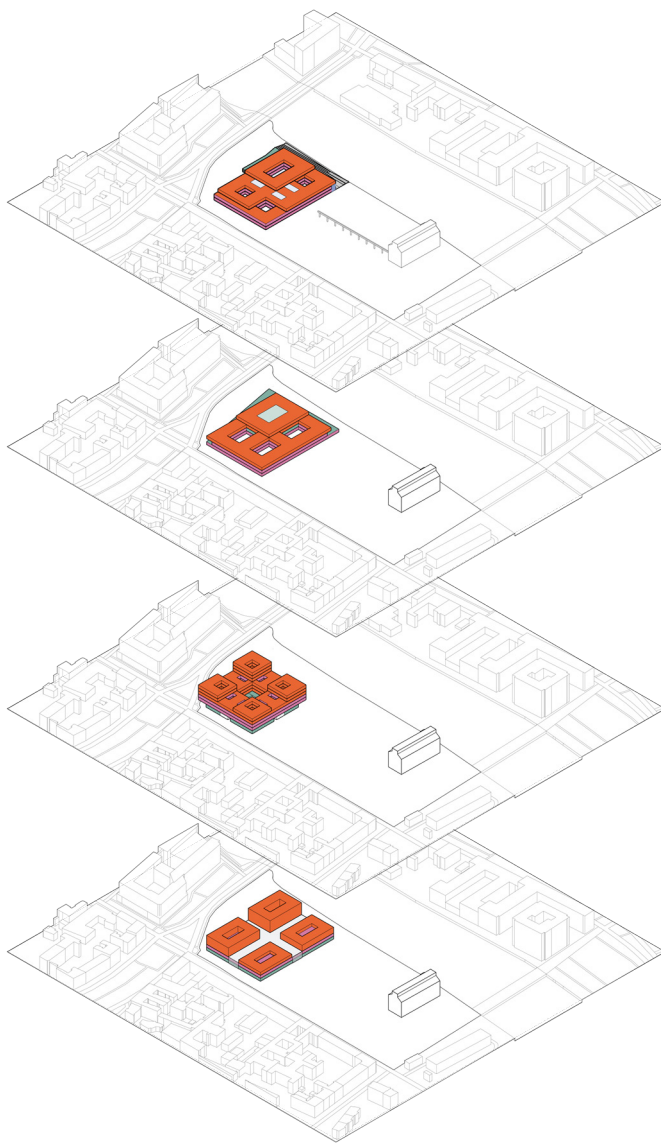
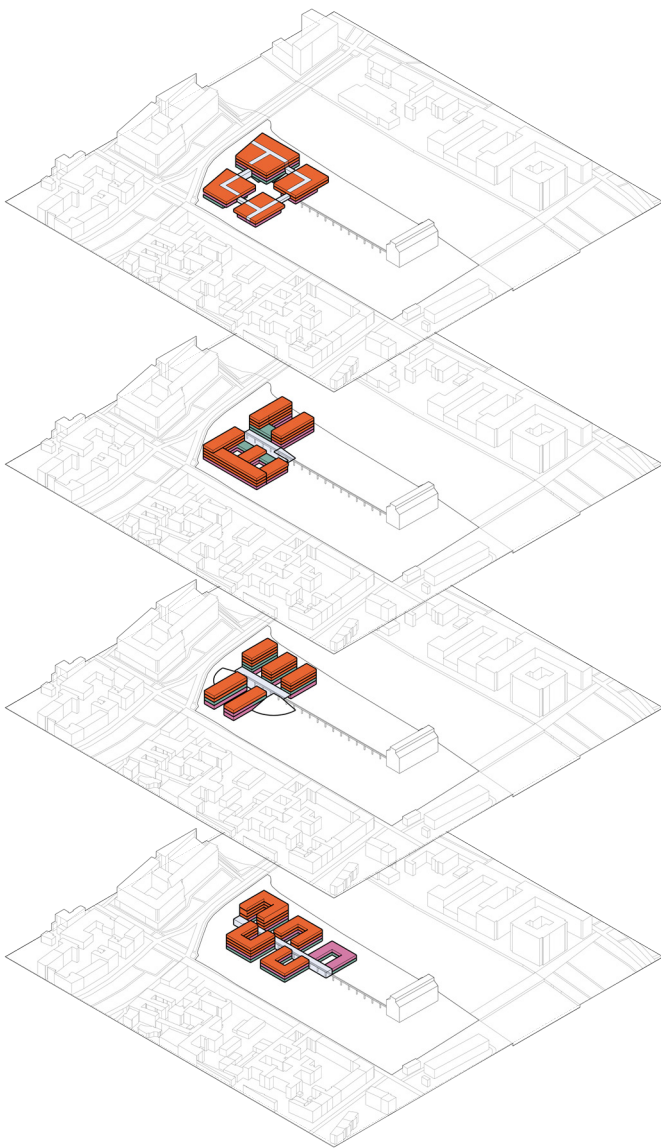

concept

ONE BUILDING

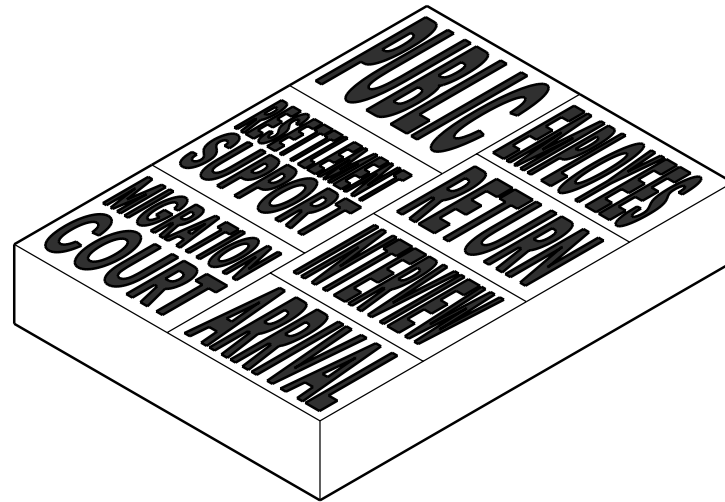

concept

COURTYARDS FOR VISUAL CONNECTION

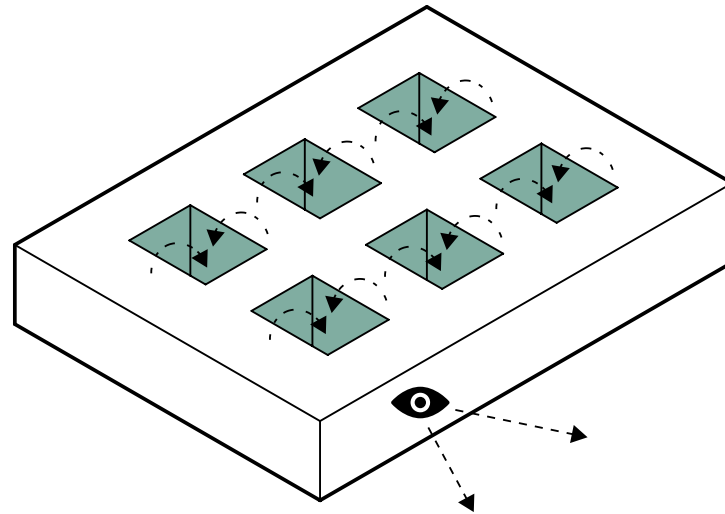

concept

COURTYARD AS ELEMENT

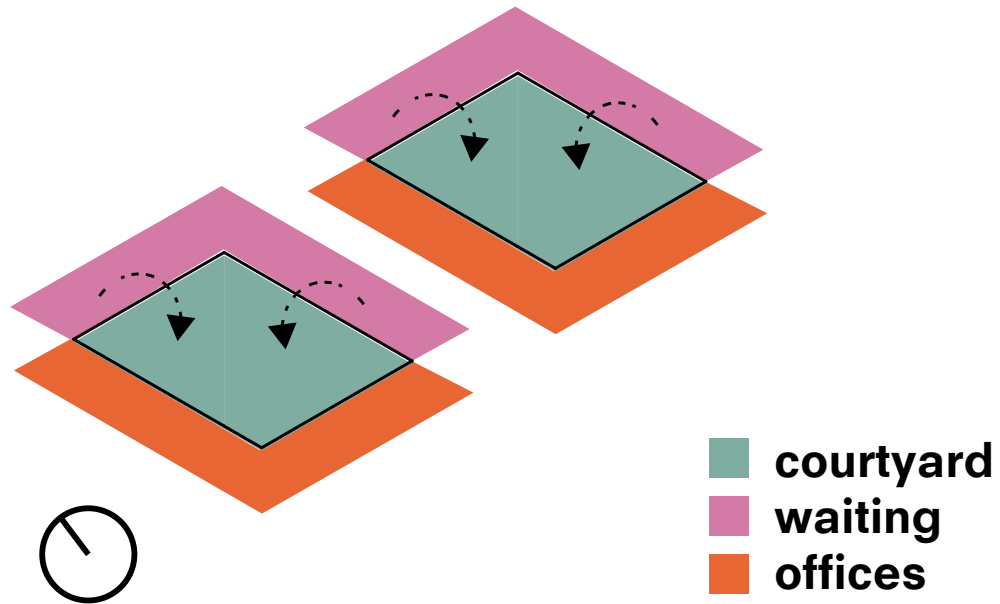

concept

INNER STREET

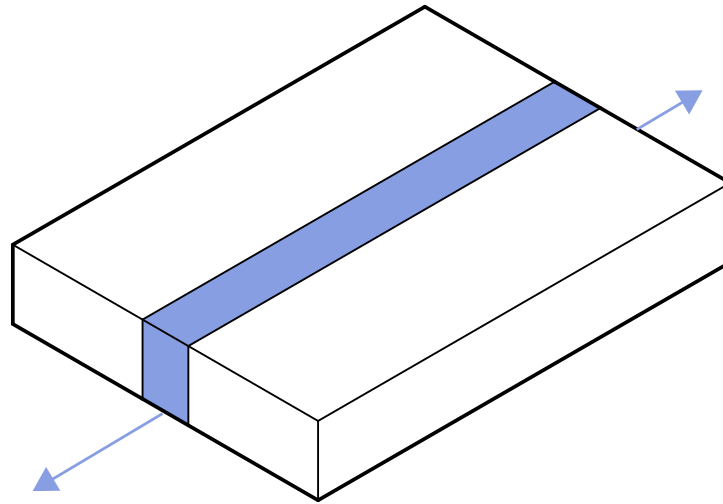

concept

ENTRANCE

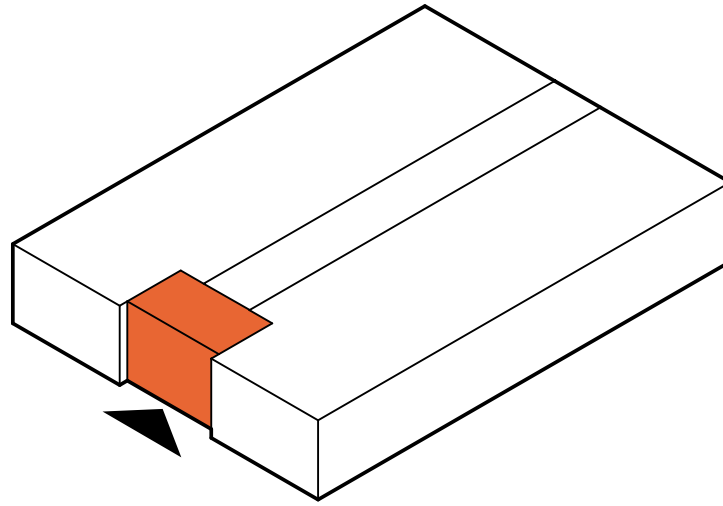

concept

FORM IN THE CONTEXT

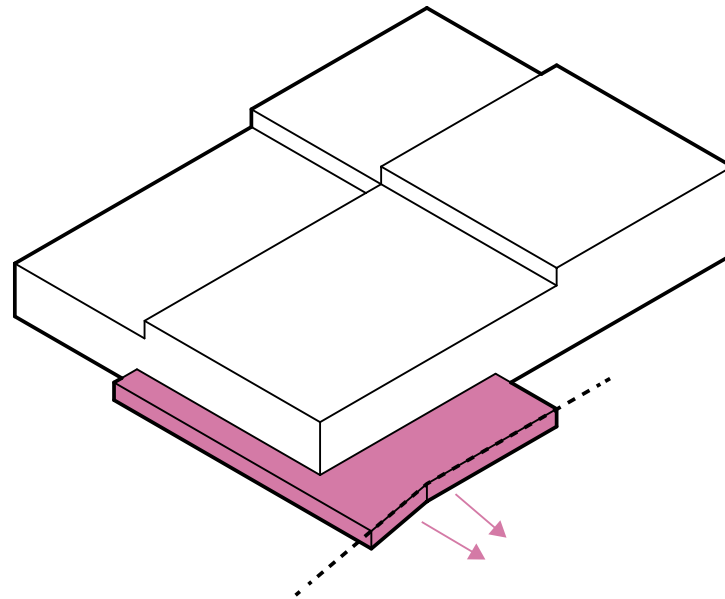

concept

FORM IN THE CONTEXT

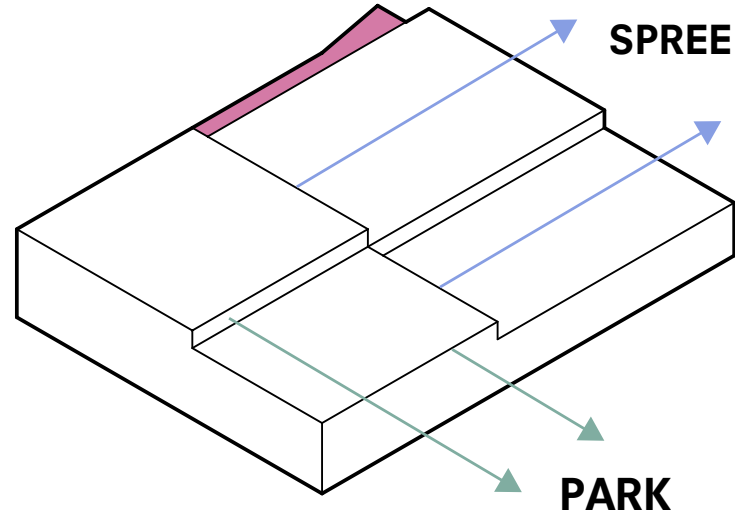

concept
LEVELS

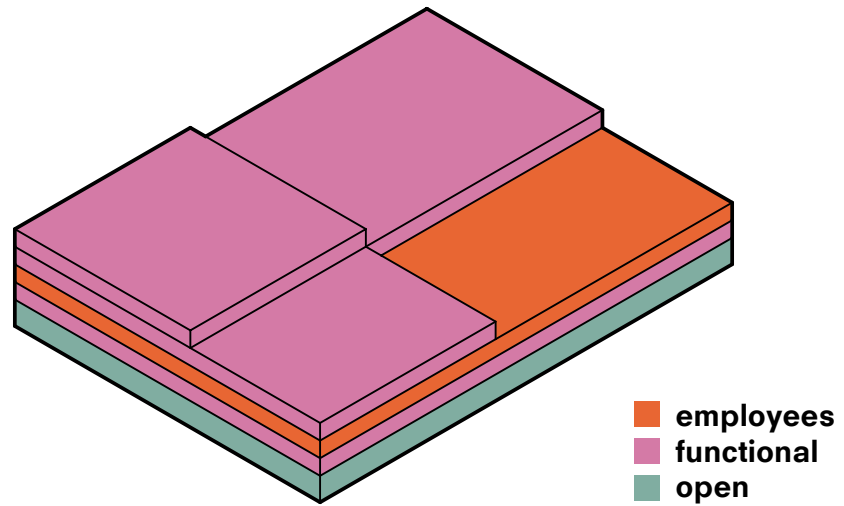

concept

CONTRASTING MATERIALISATION

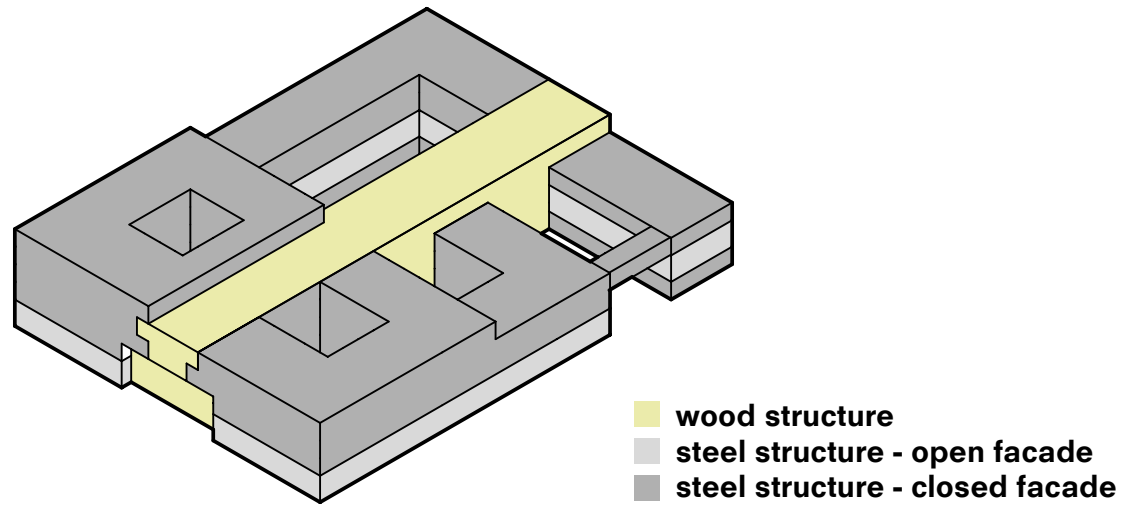

concept

CHARACTERS OF COURTYARDS

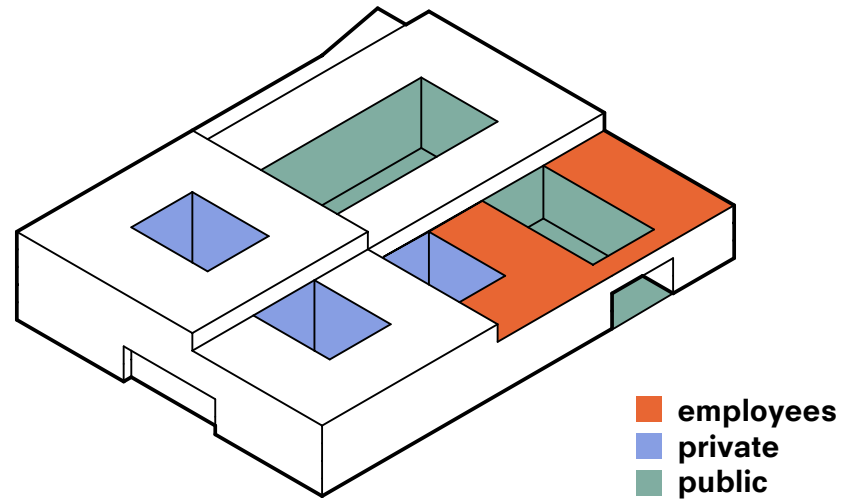

concept

USER FLOWS

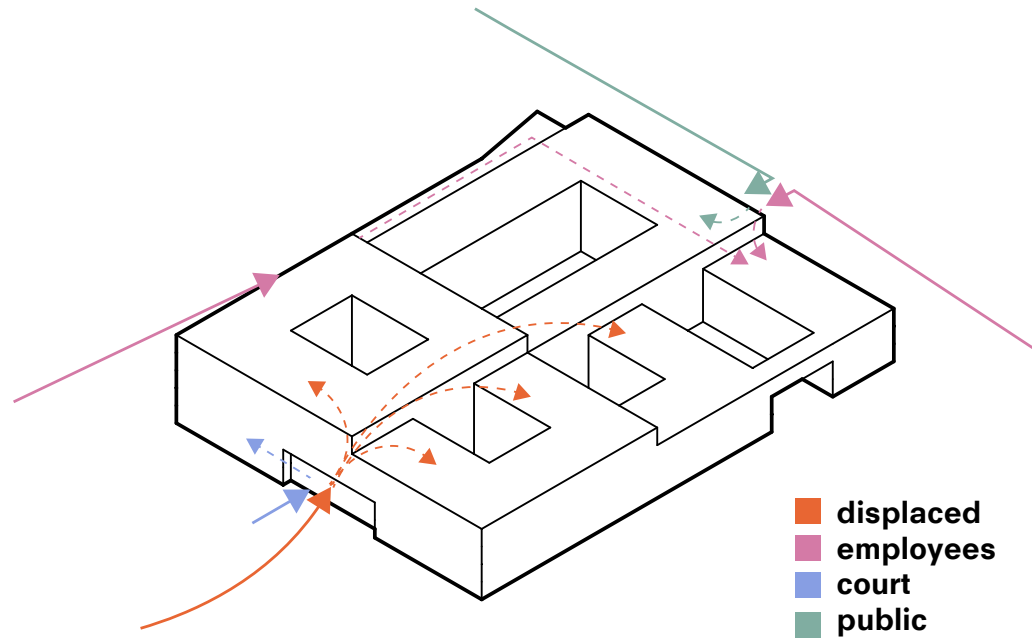

INTRODUCTION

RESEARCH

DESIGN BRIEF

DESIGN PROCESS & CONCEPT

IMPLEMENTATION

DEVELOPMENT

CONCLUSION

USER PERSPECTIVES



displaced



employee



court



public

DISPLACED PERSPECTIVE

A white line-art illustration of two people standing with their luggage. The person on the left is wearing a tank top and shorts, and is pulling a large rolling suitcase. The person on the right is wearing a long-sleeved shirt and pants, and is standing next to a smaller rolling suitcase. The illustration is centered behind the main title text.

implementation
SITE PLAN

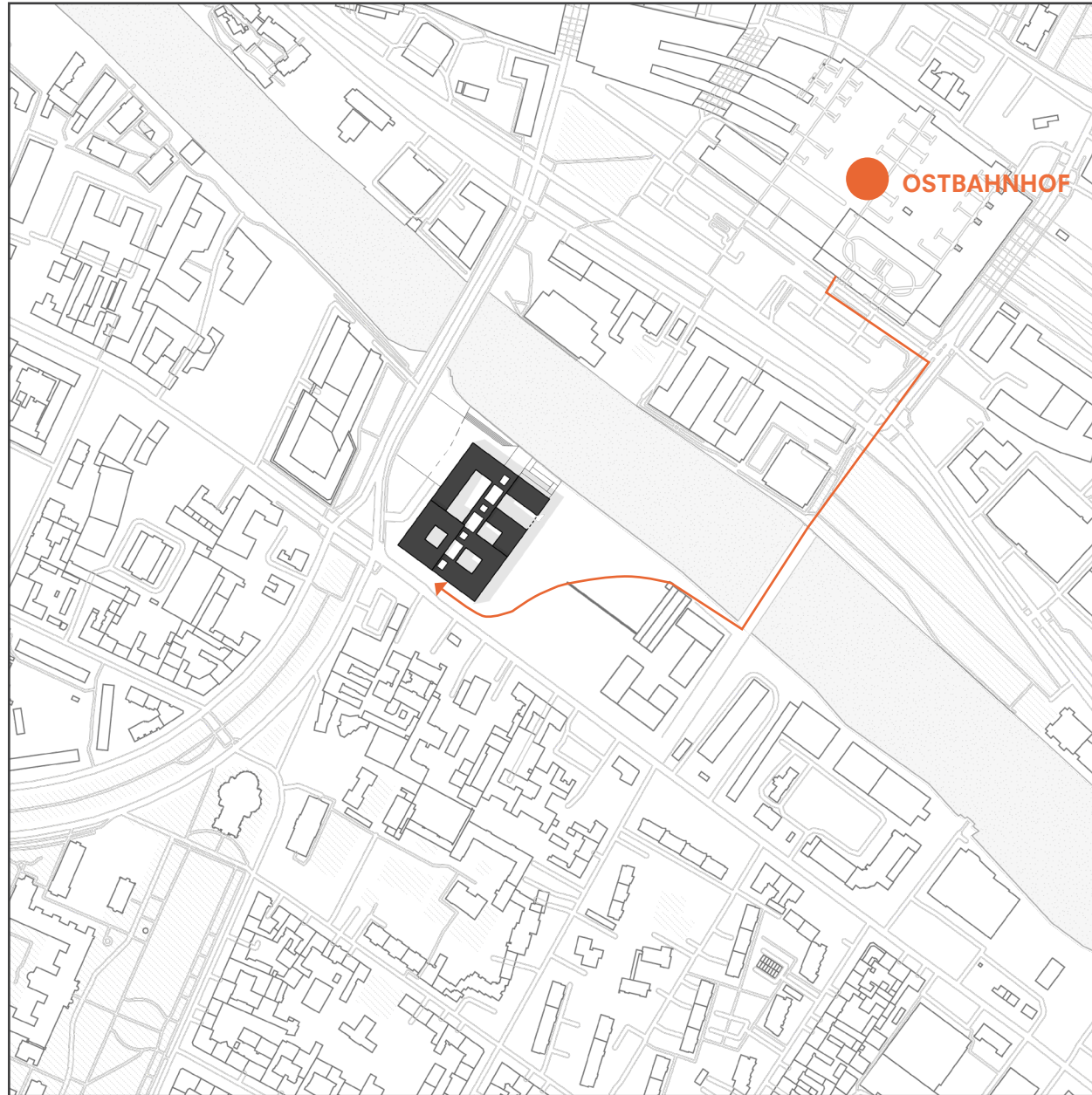

implementation

THE PROPOSED BRIDGE



URBAN IMPLEMENTATION

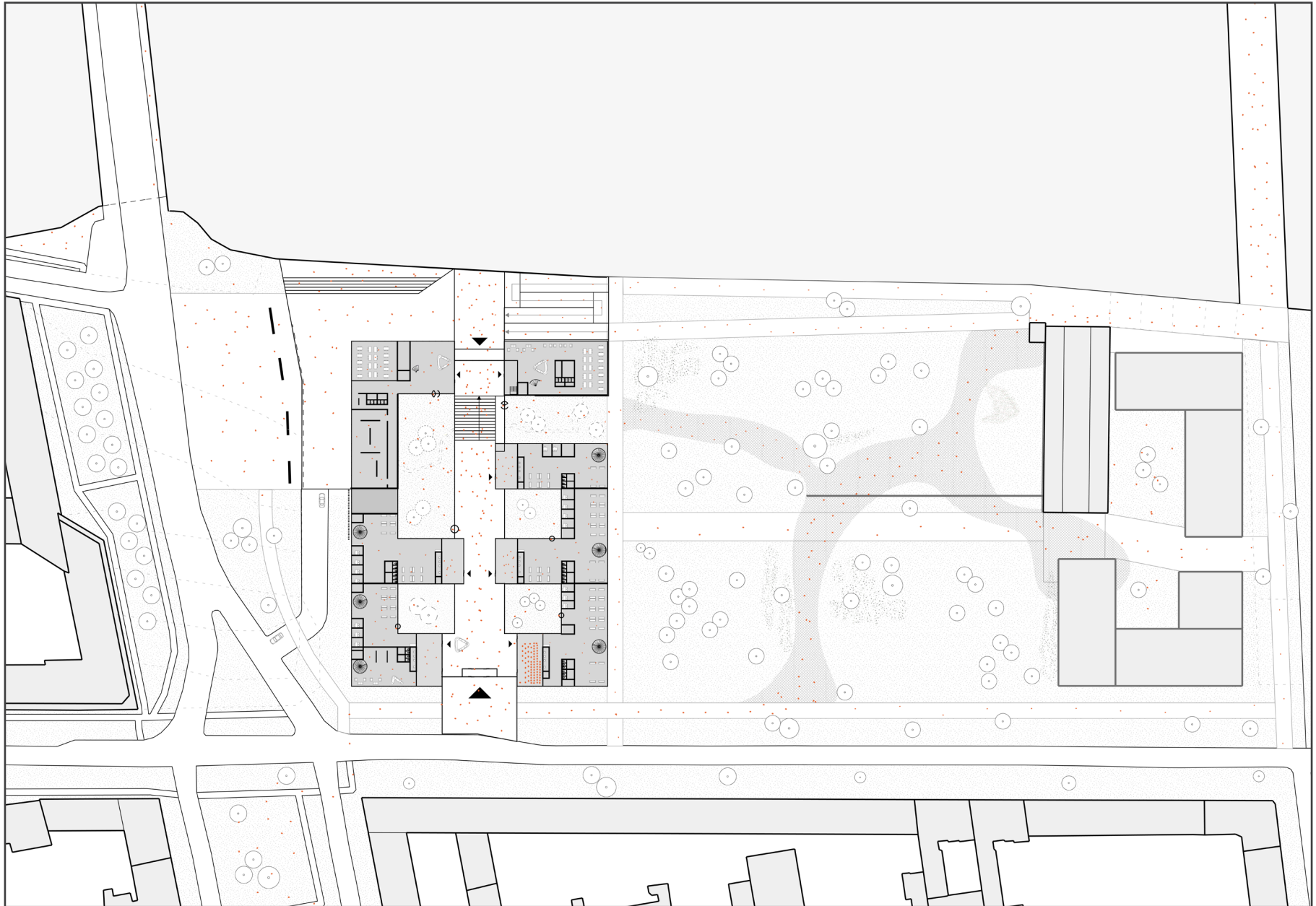

implementation

ARRIVING ON SITE



implementation
THROUGH THE PARK



implementation
THROUGH THE PARK



implementation

MAIN ENTRANCE



implementation
INNER STREET



implementation
SECTION MODEL



implementation

INSIDE STREET SECTION

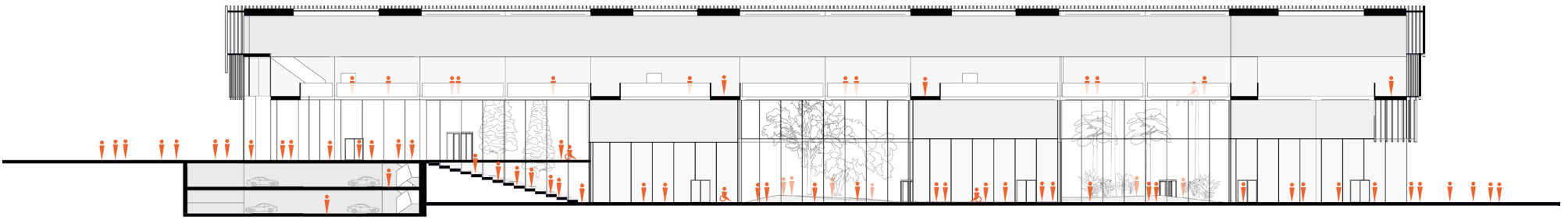
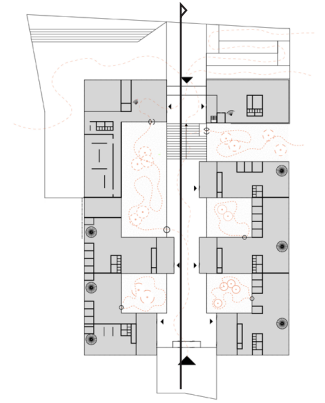

implementation

WELCOME TO GERMANY

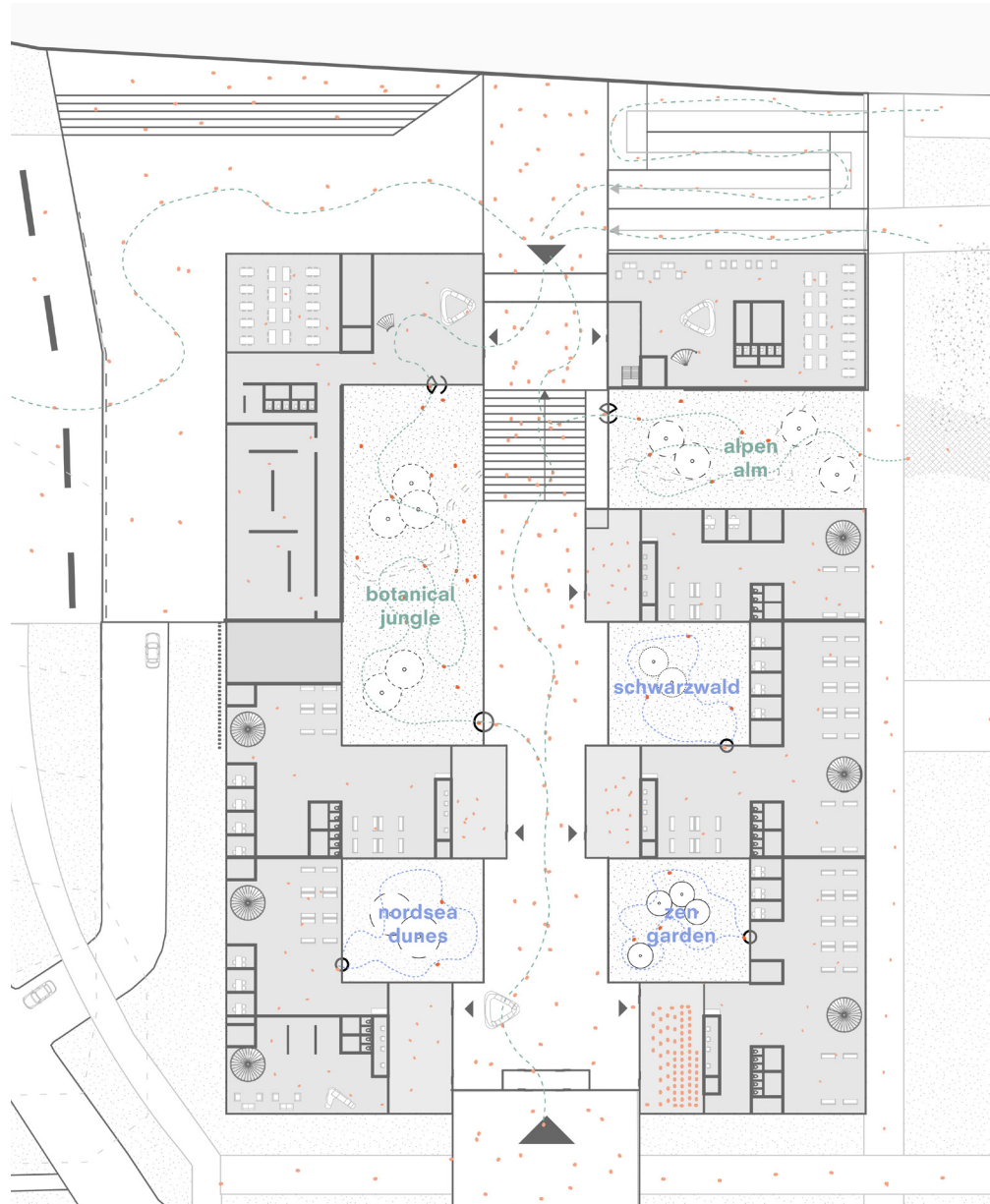

implementation

MAIN ENTRANCE



implementation

MAIN ENTRANCE



implementation

VISIBILITY OF COURTYARDS



implementation
COURTYARDS



implementation

DEPARTMENT ADDRESS



implementation
SECURITY





implementation
ARRIVING ON SITE



implementation

ARRIVING BY CAR

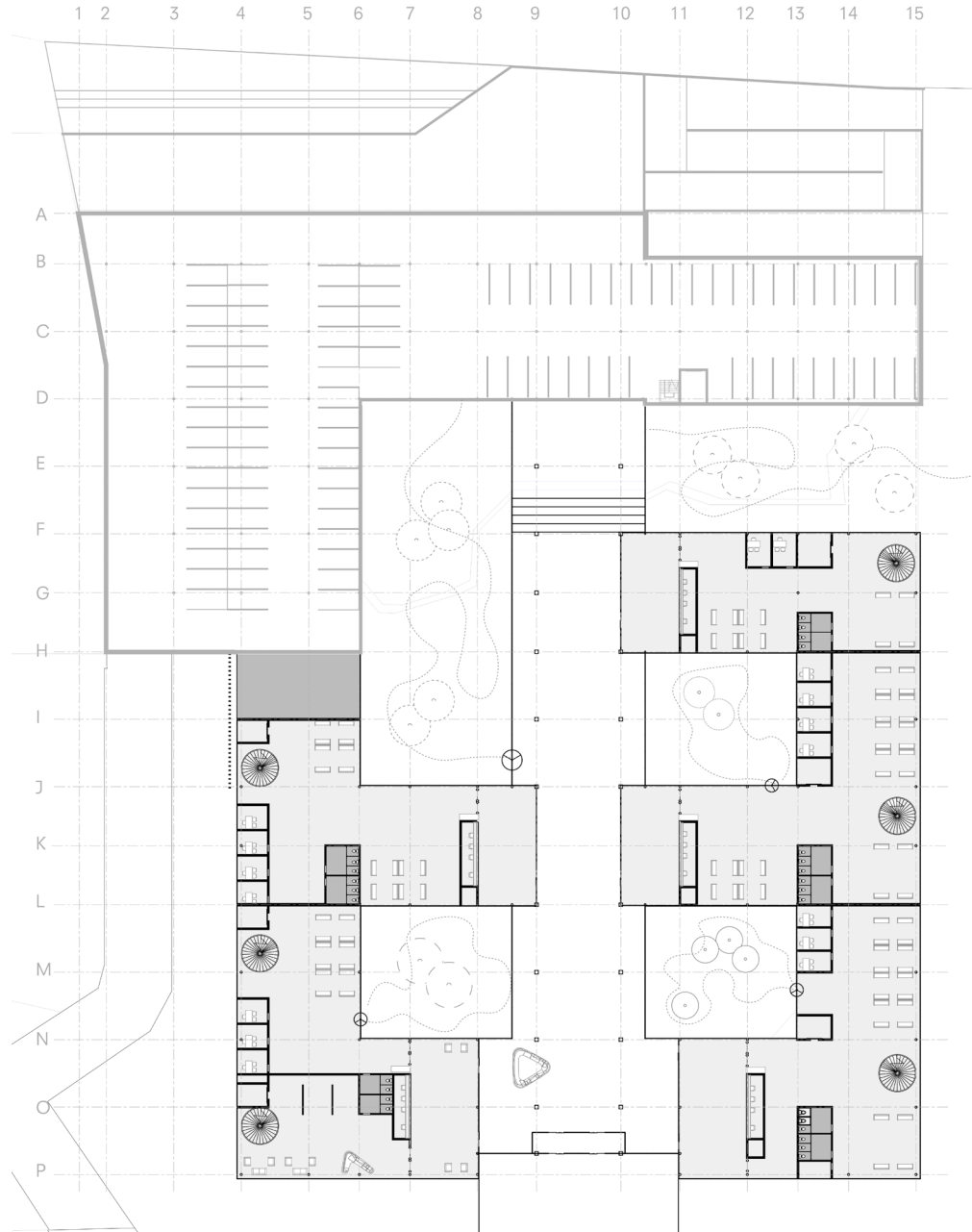

implementation
ARRIVING ON SITE



implementation

ARRIVING VIA NORTH ENTRANCE



implementation
STREET SECTION

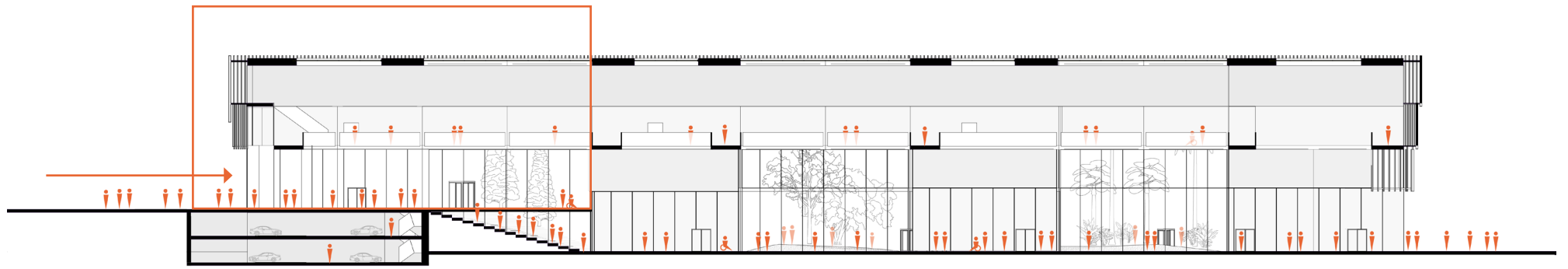
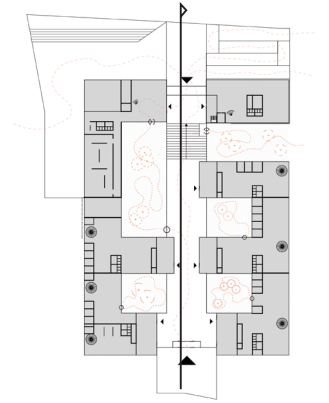

implementation
COURTYARDS SECTION

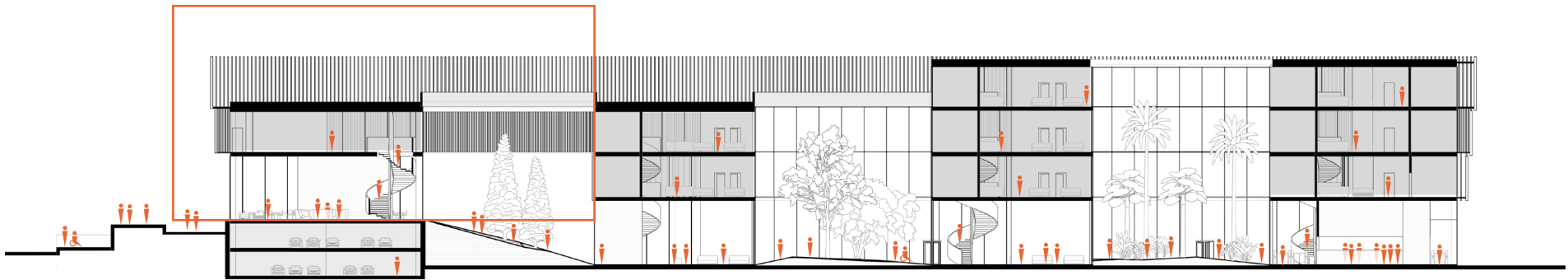
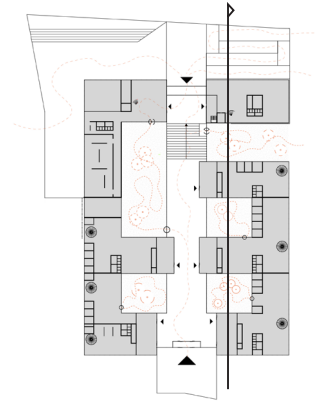

implementation

STREET COURTYARD RELATION



implementation

TOP GROUND FLOOR PLAN 1:200

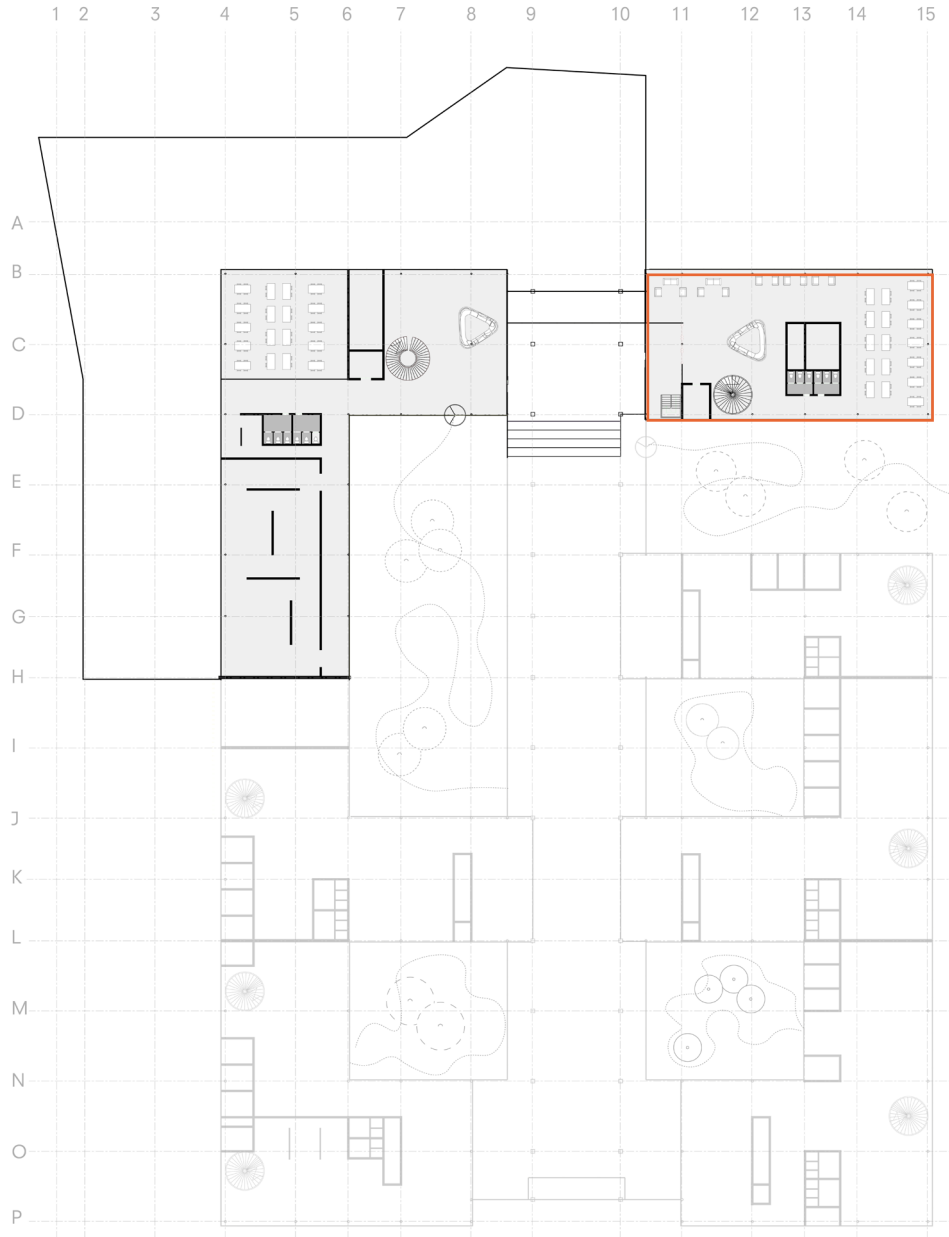

+4000



implementation
SKY BRIDGE



+10000



implementation
INNER STREET



 lumion

implementation **COLLABORATION**

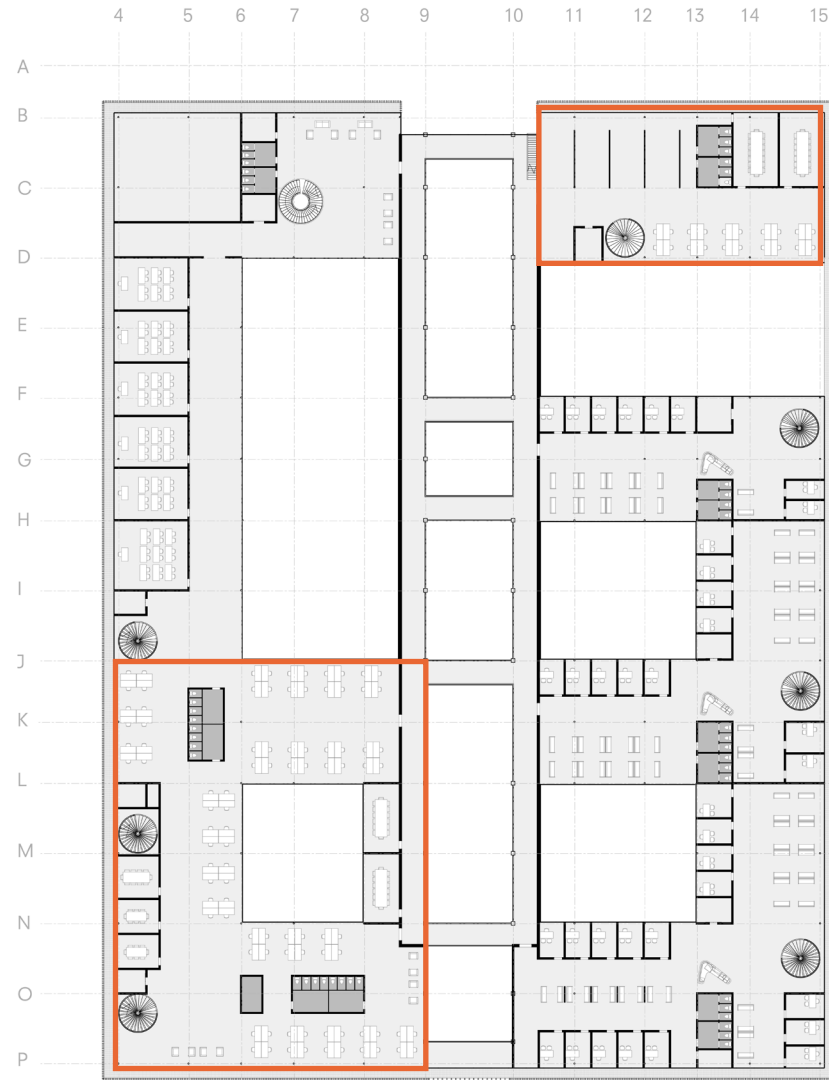

+10000



implementation

FLEXIBLE WORKSPACES



implementation

EMPLOYEE ROOFTOP



COURT PERSPECTIVE

A white line drawing of a judge sitting at a bench, holding a gavel. The drawing is positioned behind the main title text.

implementation
SECTION ENTRANCE

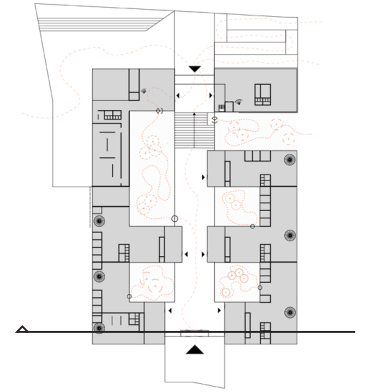

implementation

ACCENT IN FORM

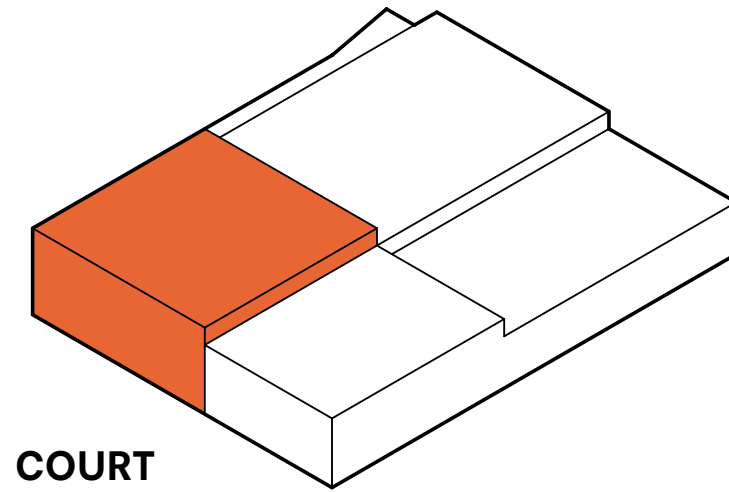

implementation
FOURTH FLOOR PLAN

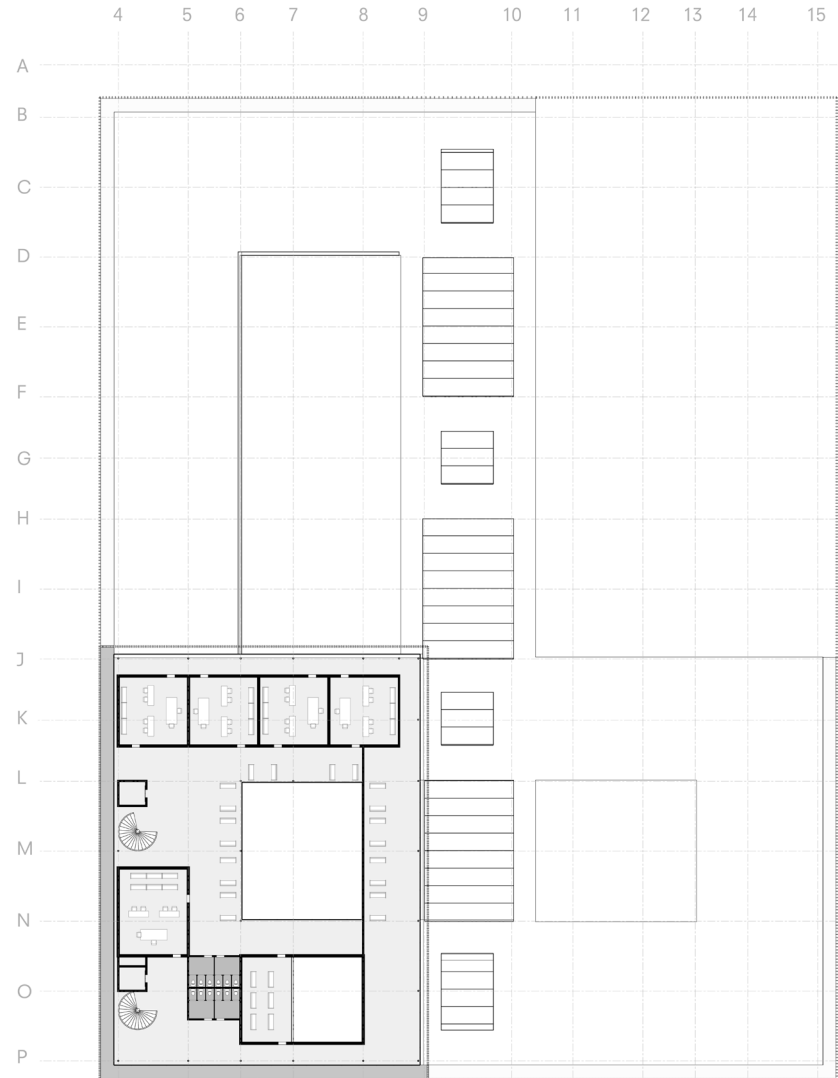

+18000



implementation
COURTROOM



PUBLIC PERSPECTIVE



implementation

LIBERTY SQUARE



implementation

SPREE SIT STAIRS

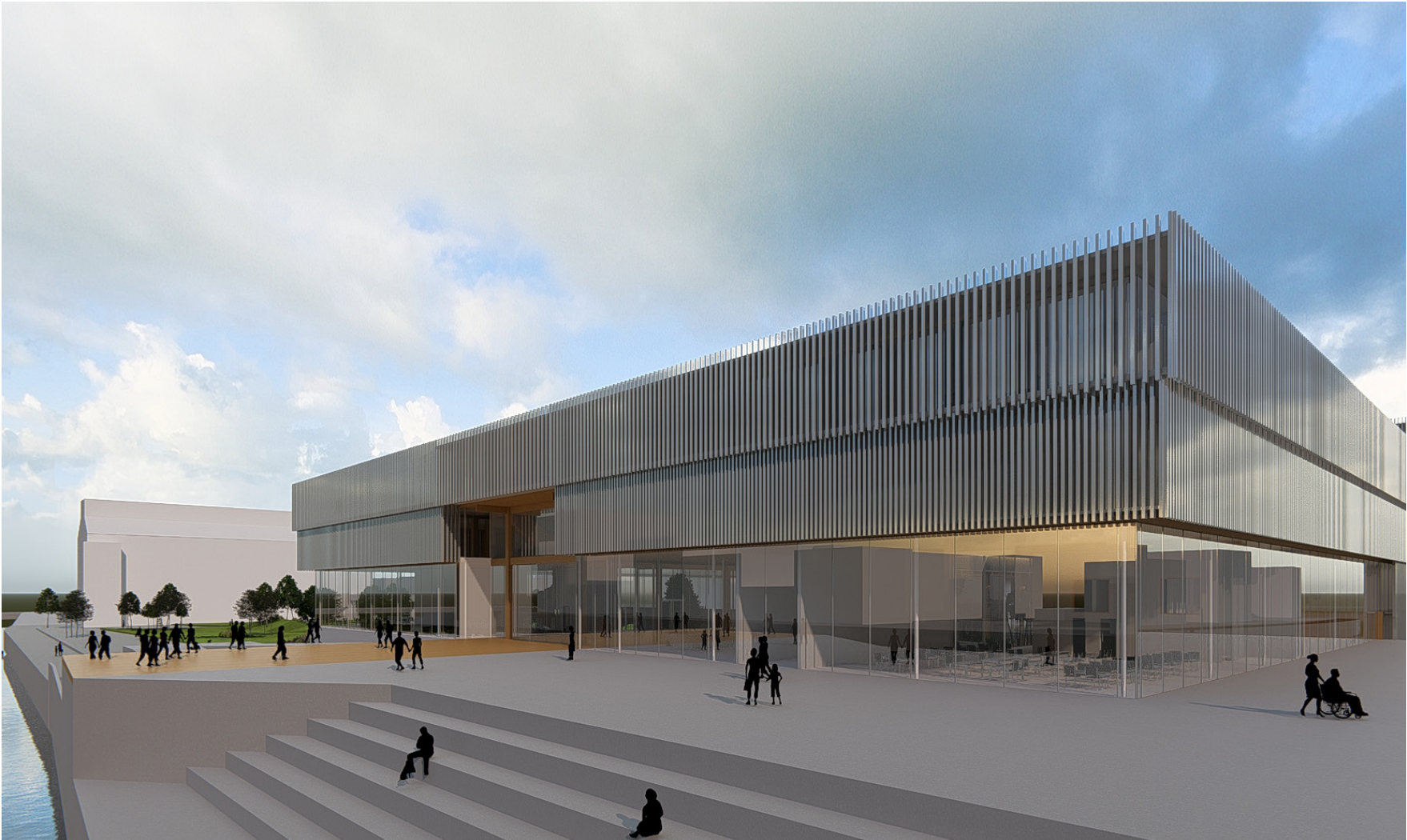

implementation

TOP GROUND FLOOR PLAN 1:200

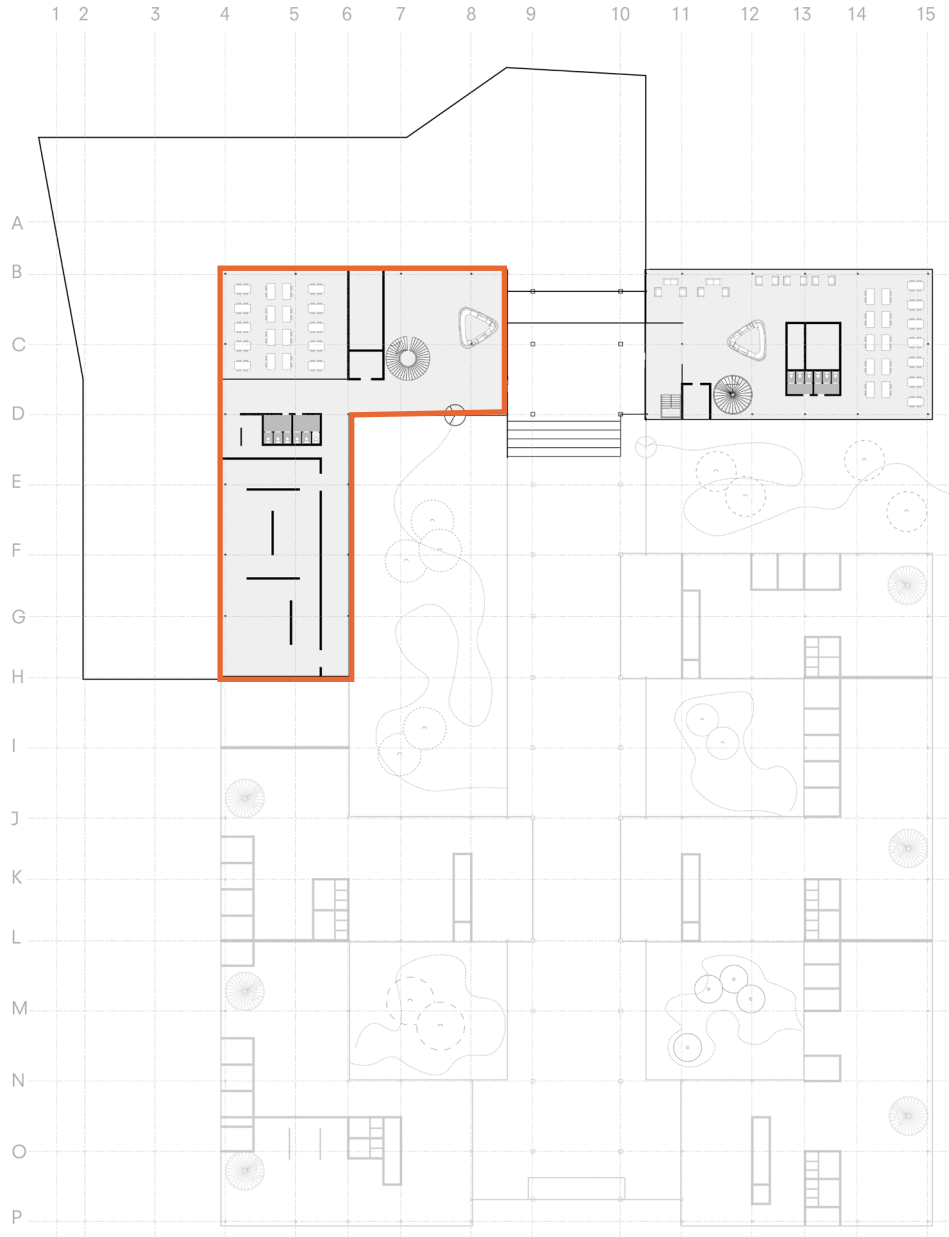

+4000



implementation

SUPPORTING FUNCTIONS

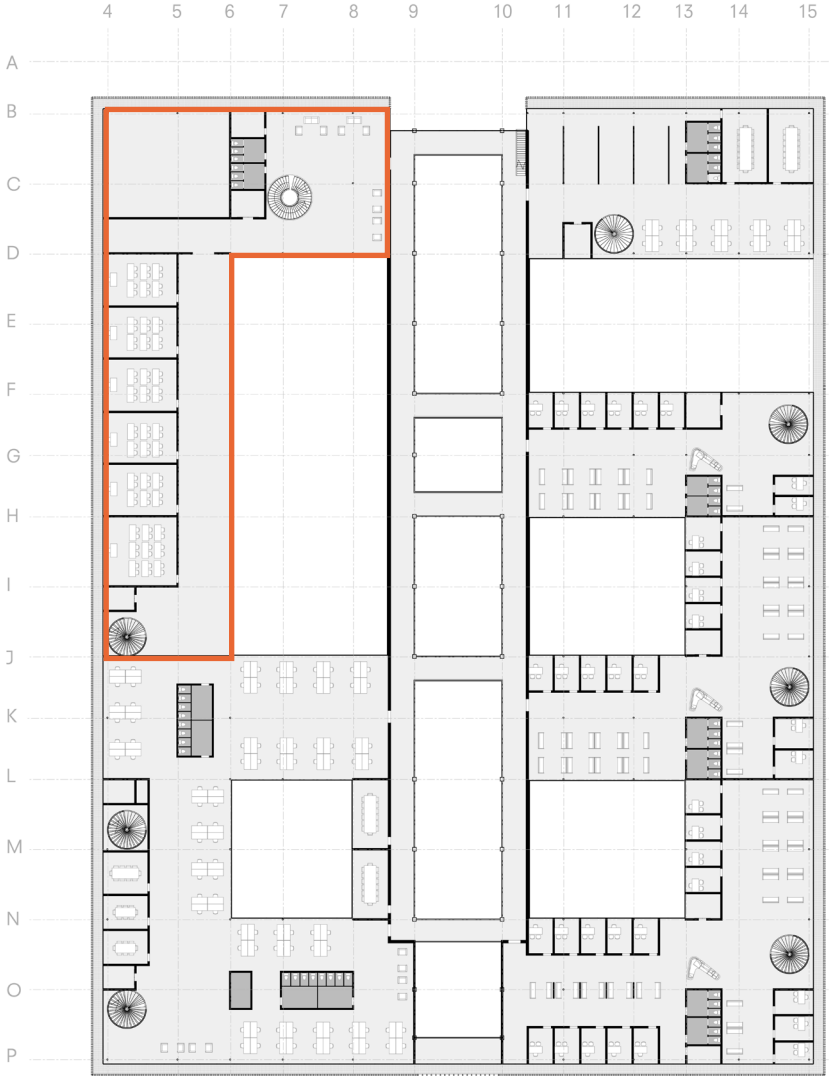

SCENARIOS IN FLEXIBILITY

BACKLOG IN A SINGLE DEPARTMENT

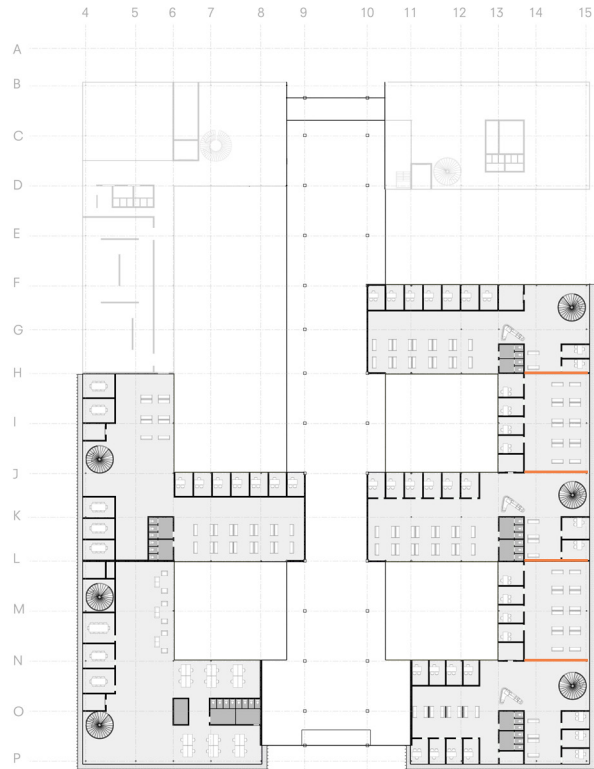

First floor | +6000



Second floor | +10000

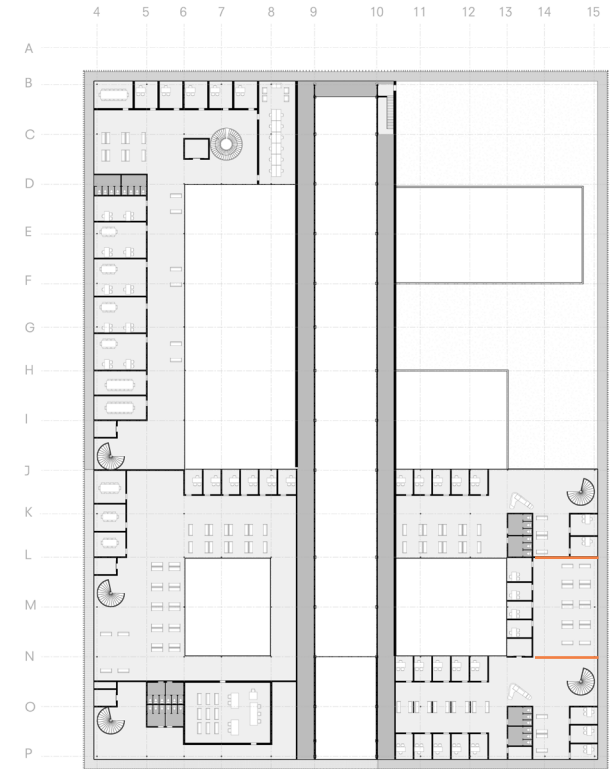

Third floor | +14000

implementation

FLEXIBLE ELEMENT

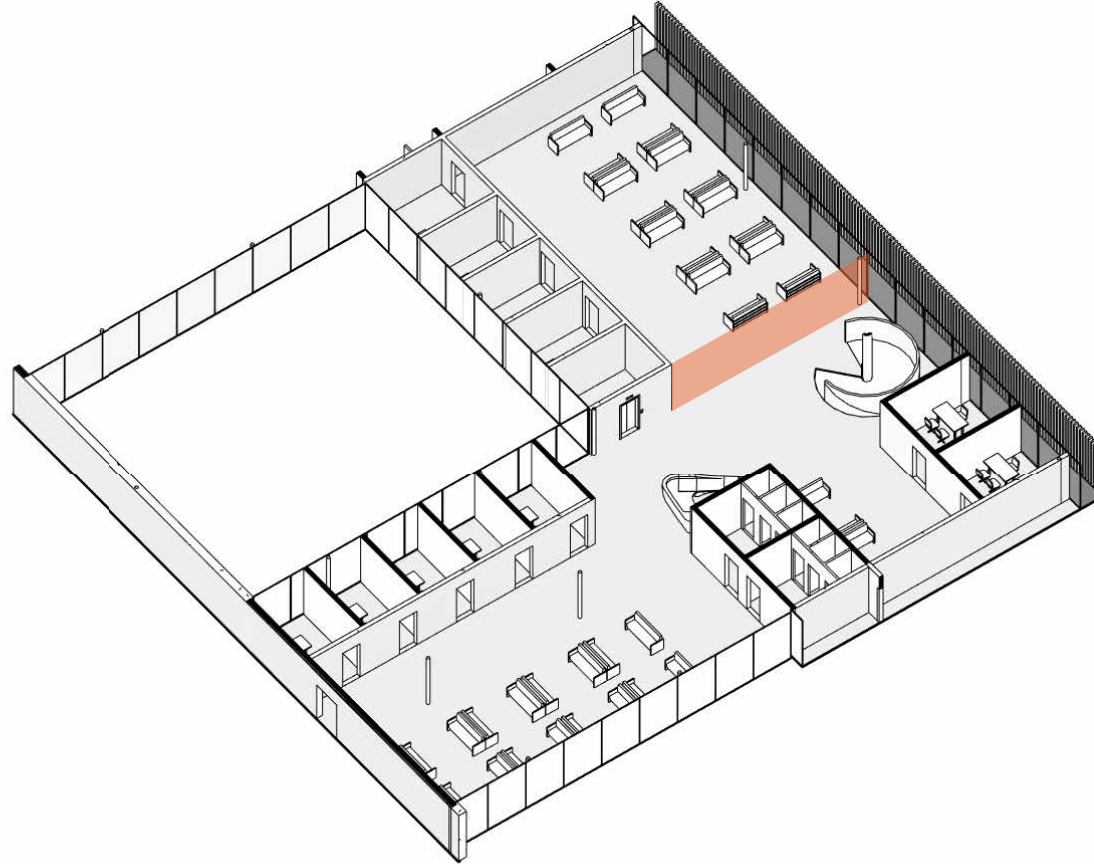

SMALL BACKLOG: MUF SHELTER

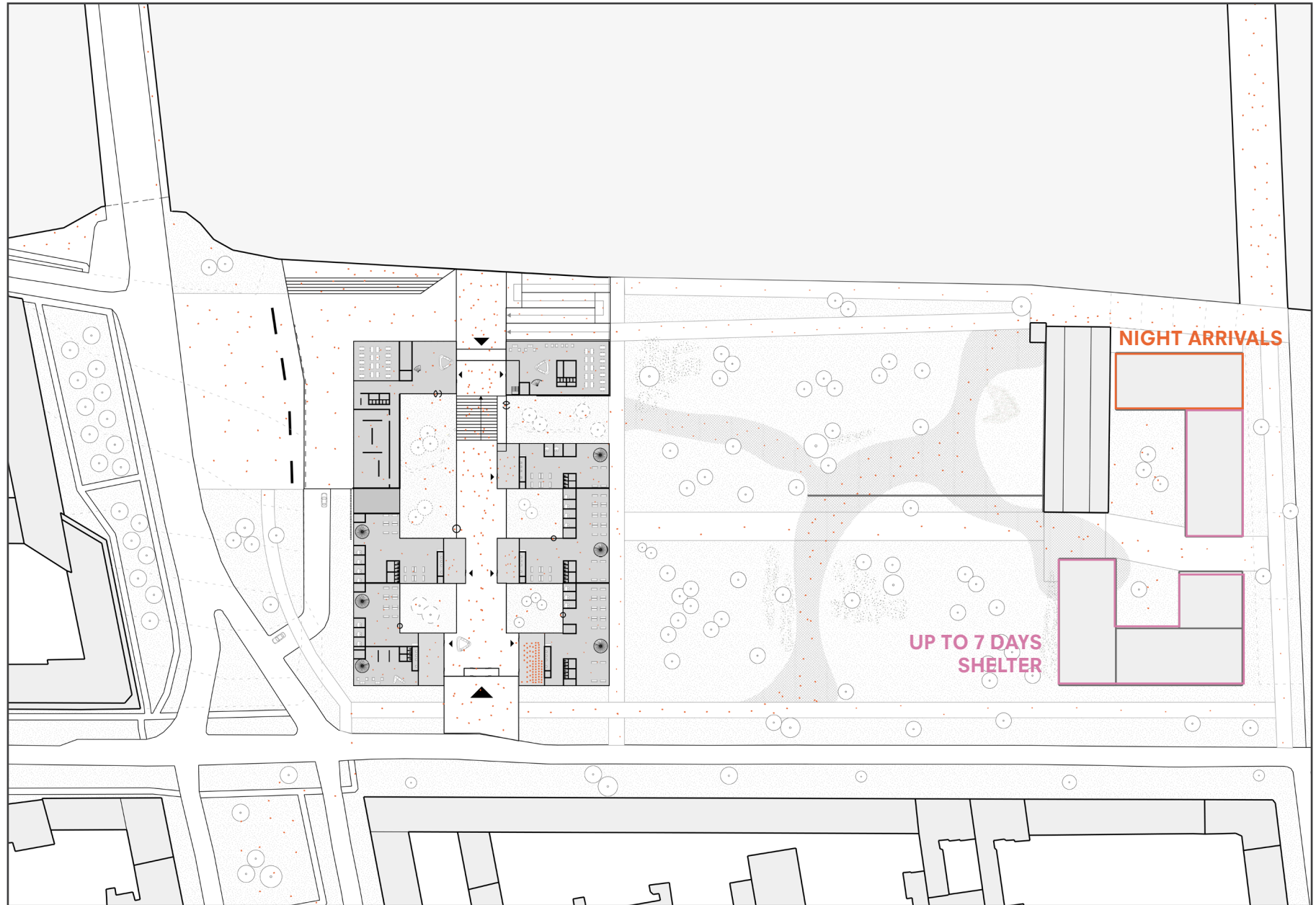

MEDIUM BACKLOG: TWO ARRIVAL DEPARTMENTS

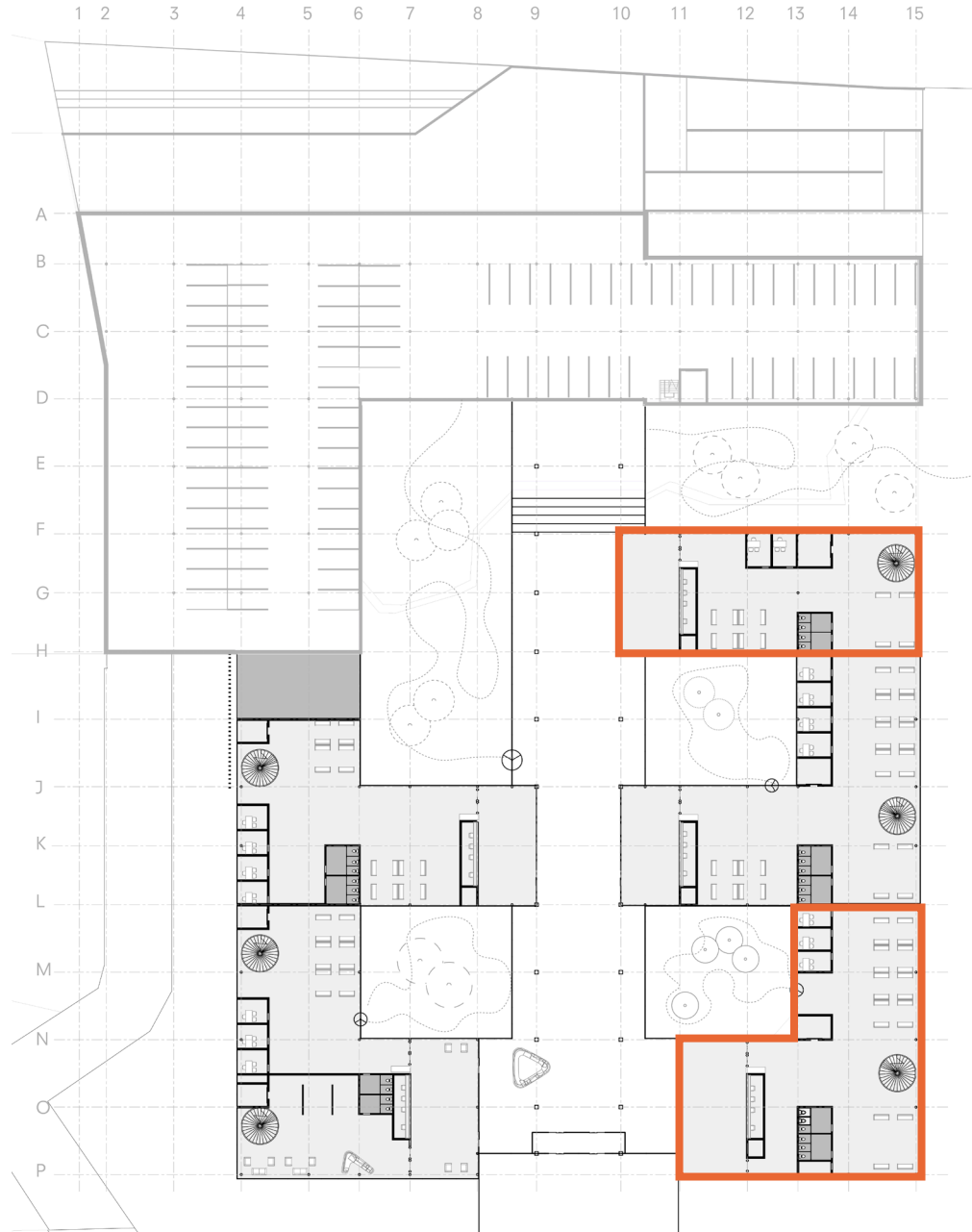

BIG BACKLOG: PARKING LOT AS TEMPORARY SHELTER

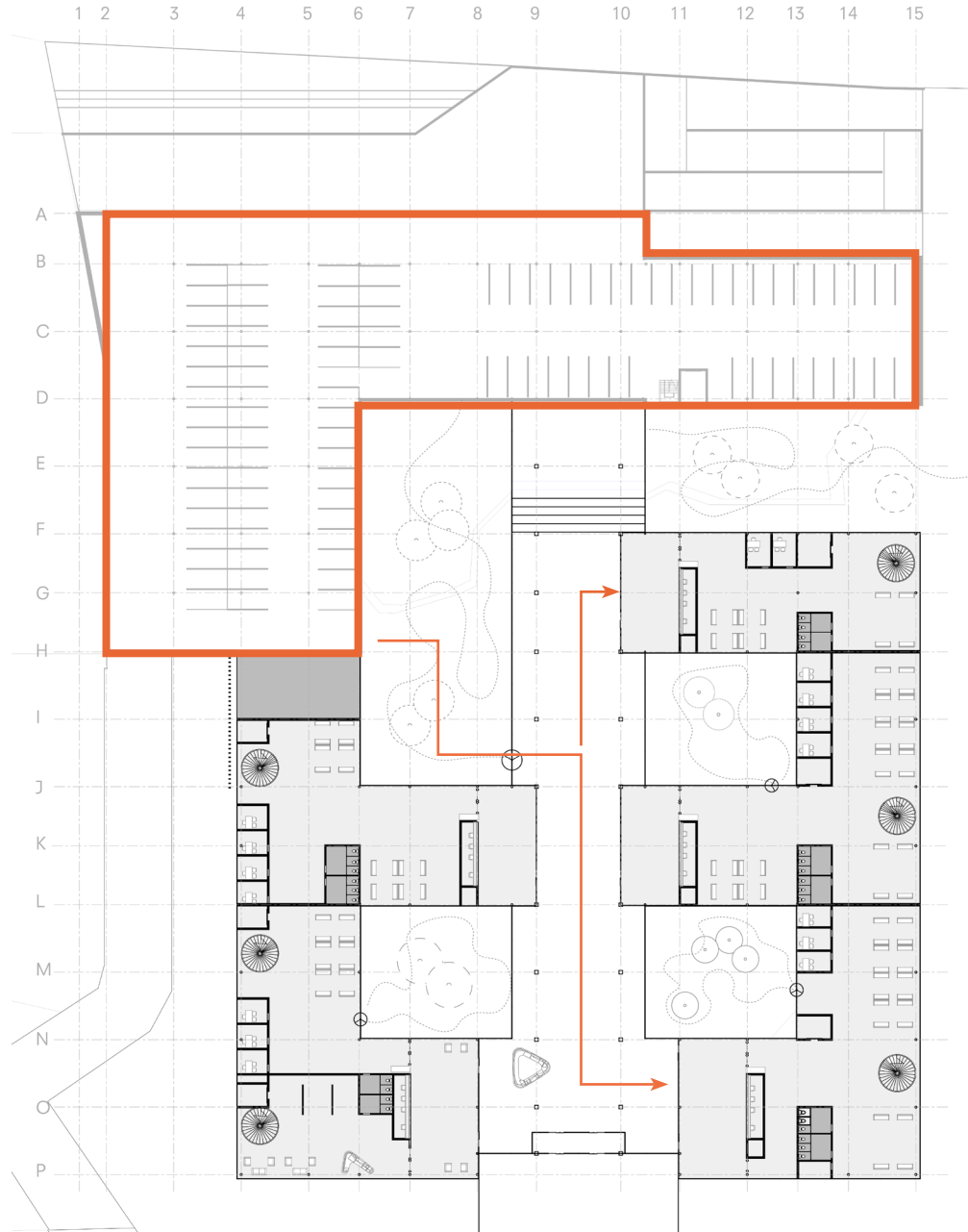

BIG BACKLOG: UPSCALE MUF

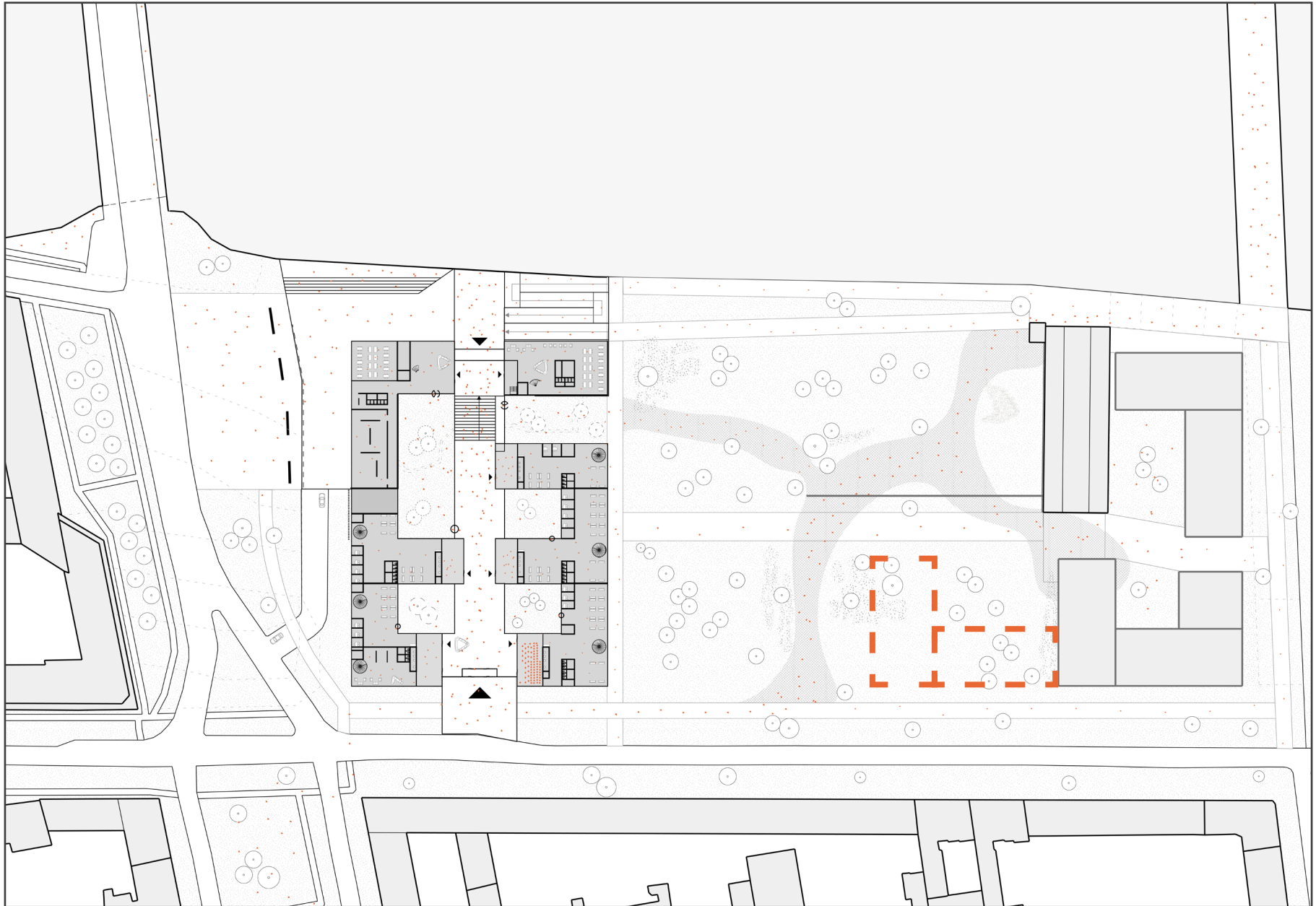

INTRODUCTION

RESEARCH

DESIGN BRIEF

CONCEPT

IMPLEMENTATION

DEVELOPMENT

CONCLUSION

development

CONSTRUCTION AXO

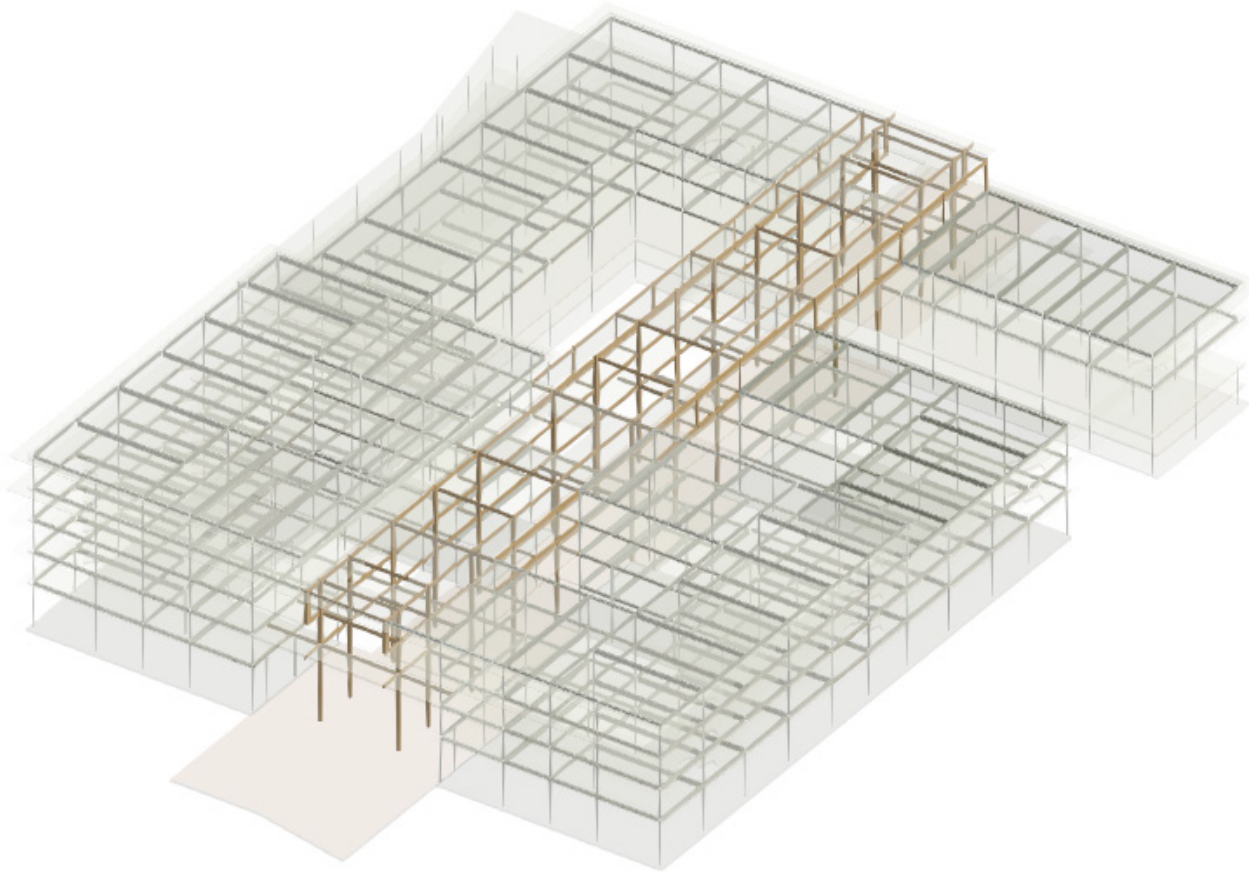

development

CONSTRUCTION AXO

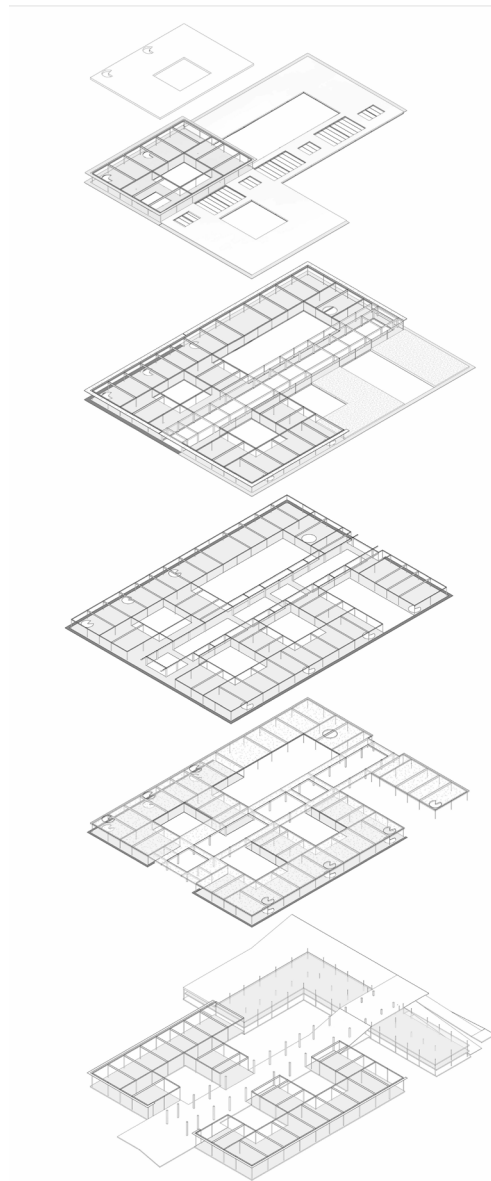

development

BUILDING PERFORMANCE



**sustainable
comfort**

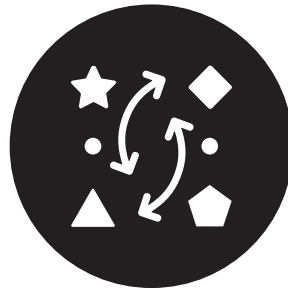

**adaptability
in use**



durability

development CLIMATE SECTION

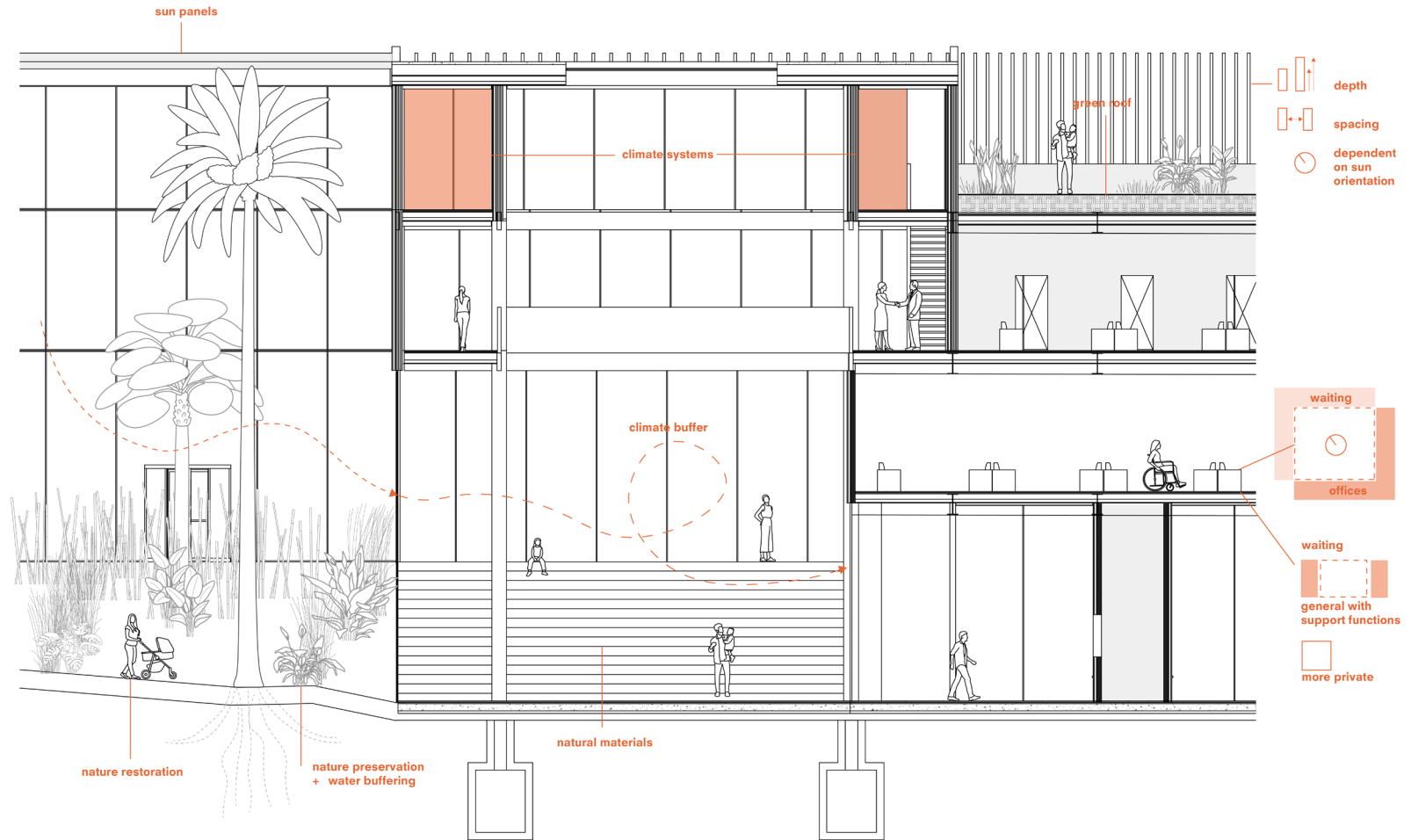

development

INTERIOR FRAGMENT 1:50

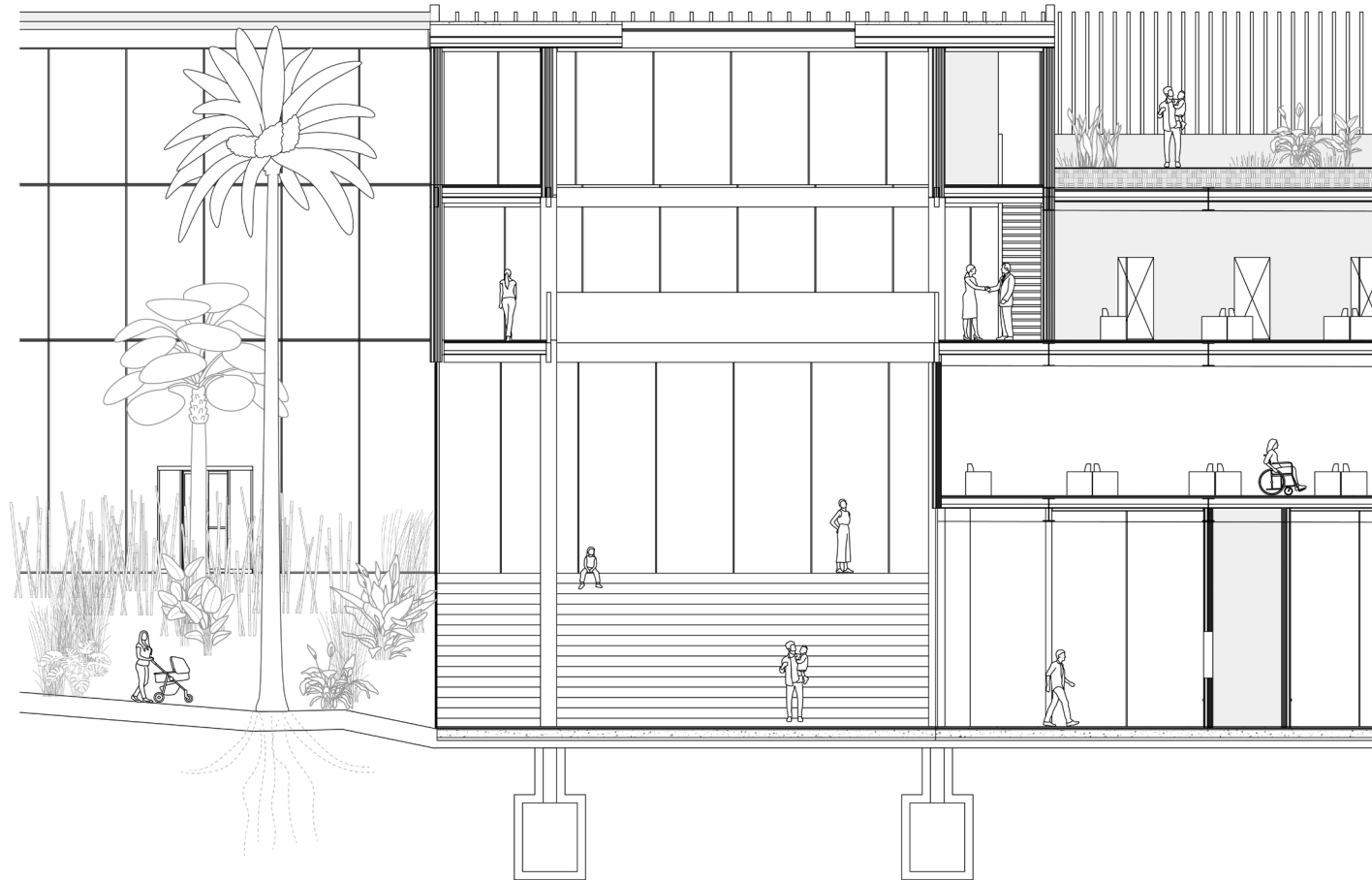

development
MATERIALS

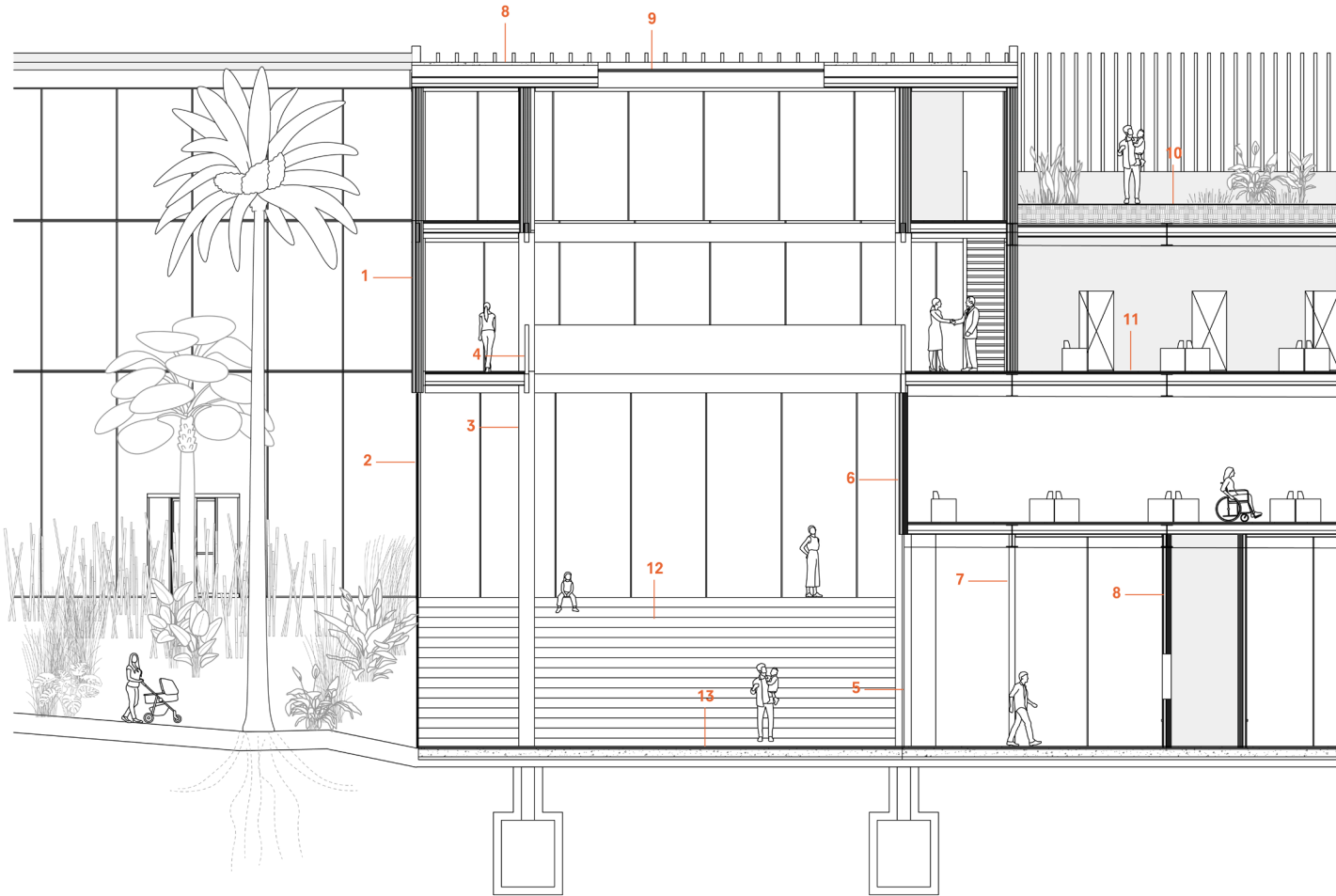

development

CRITICAL DETAILS

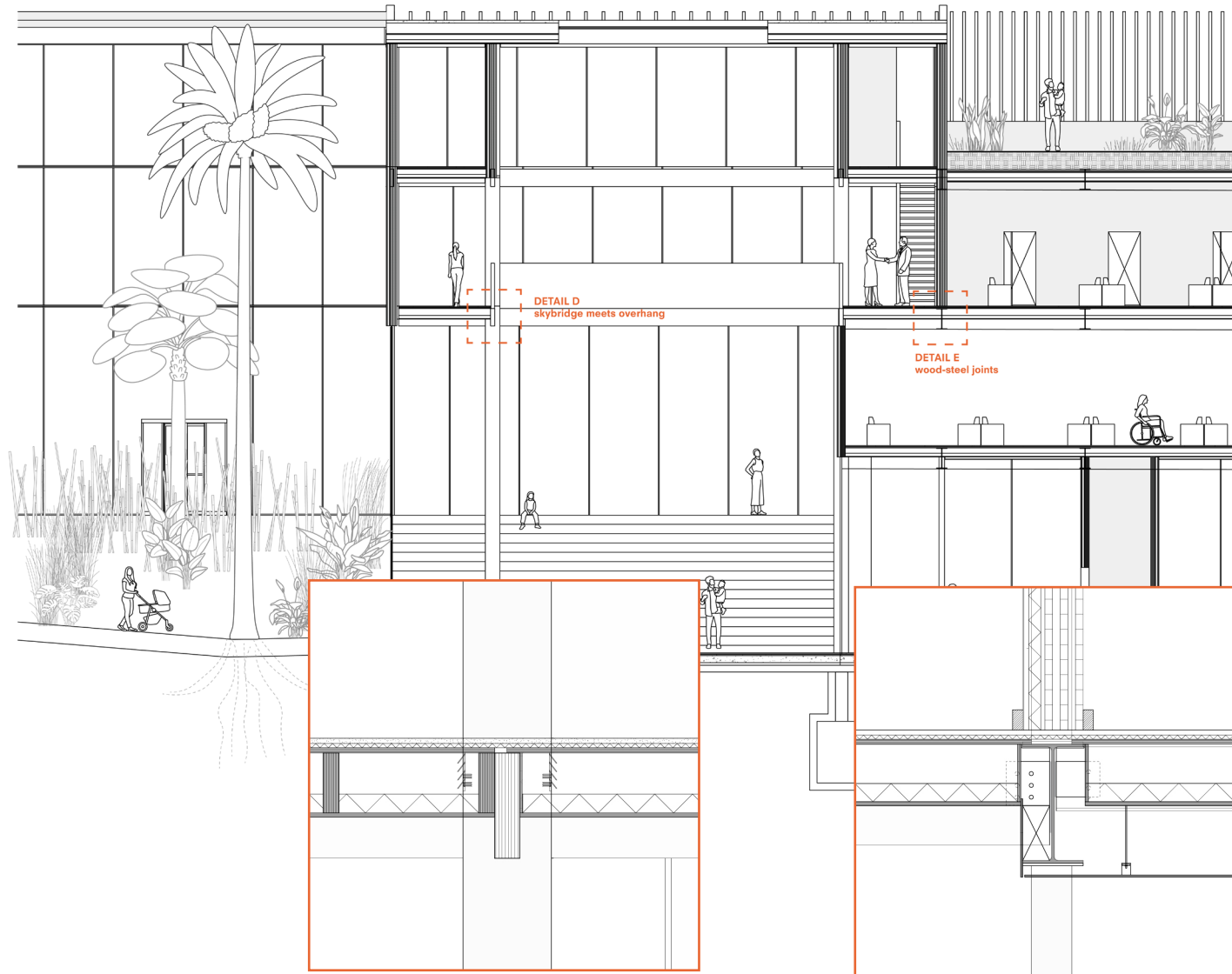

development

FACADE FRAGMENT 1:20

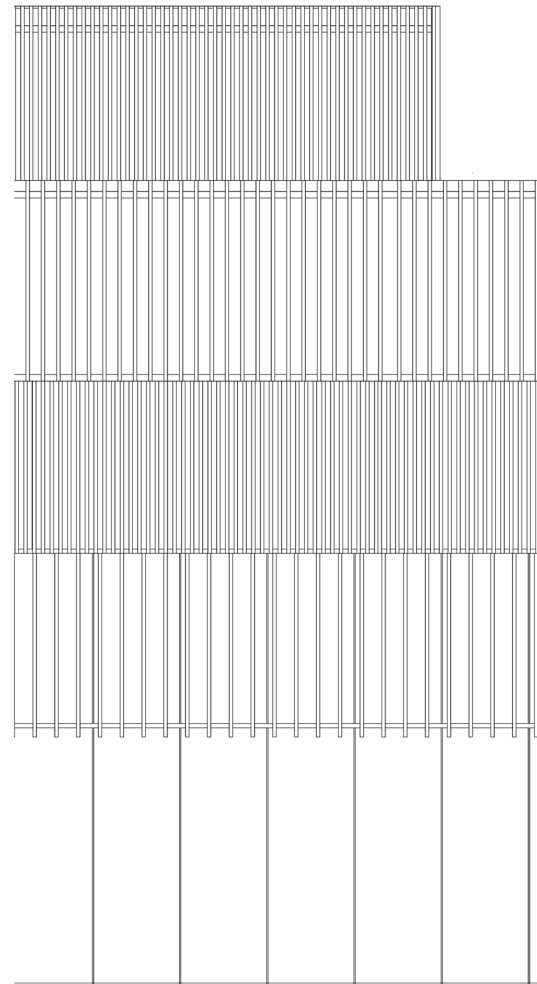
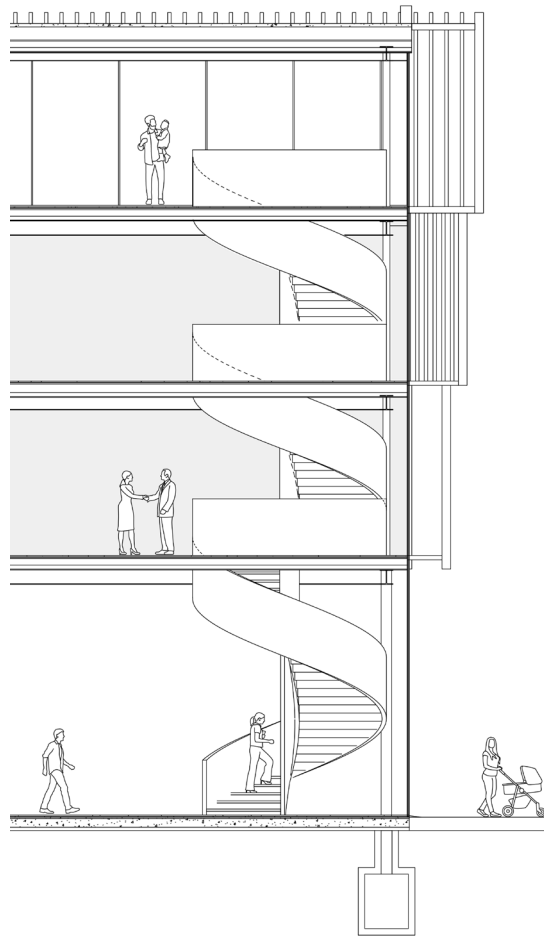

development
MATERIALS

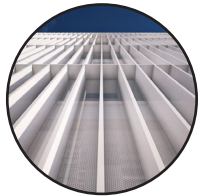
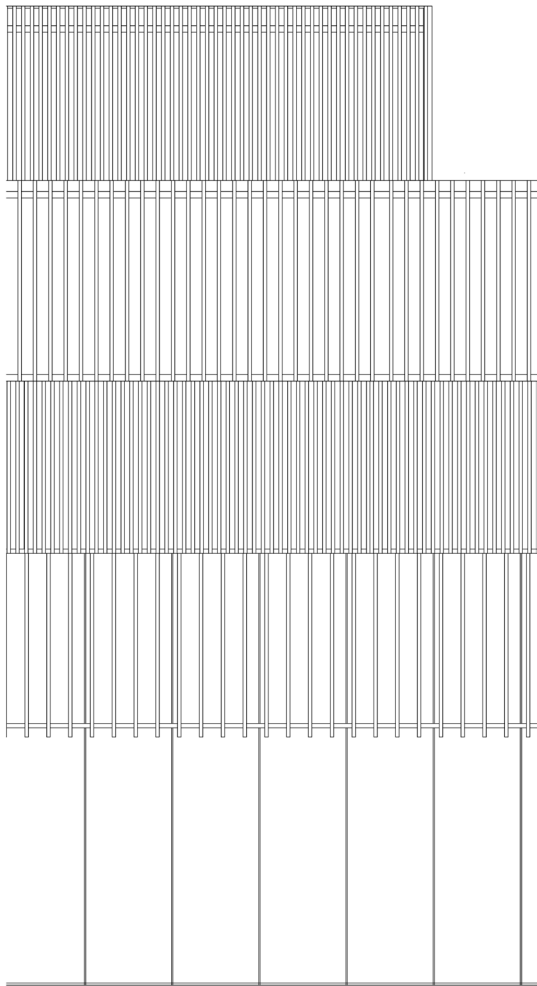
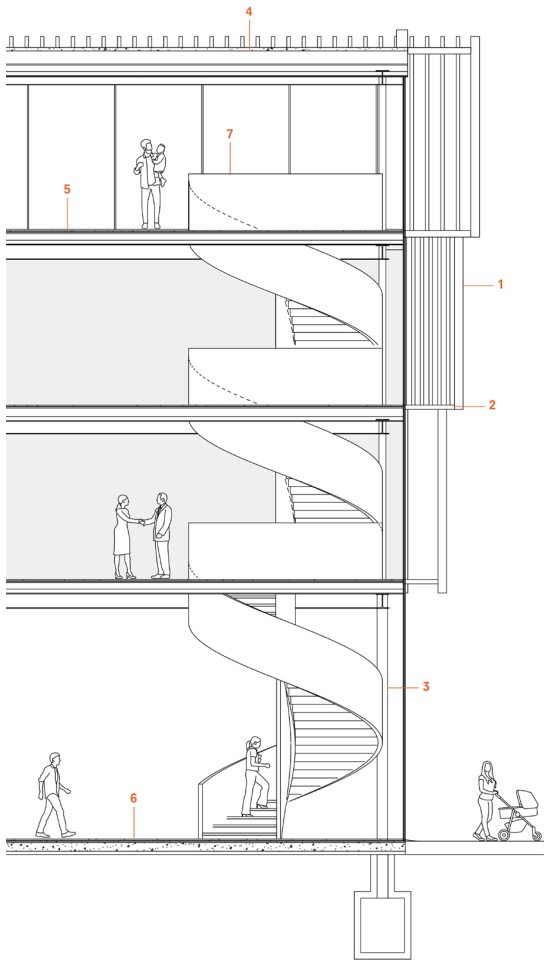

development

ARCHITECTURAL DETAILS

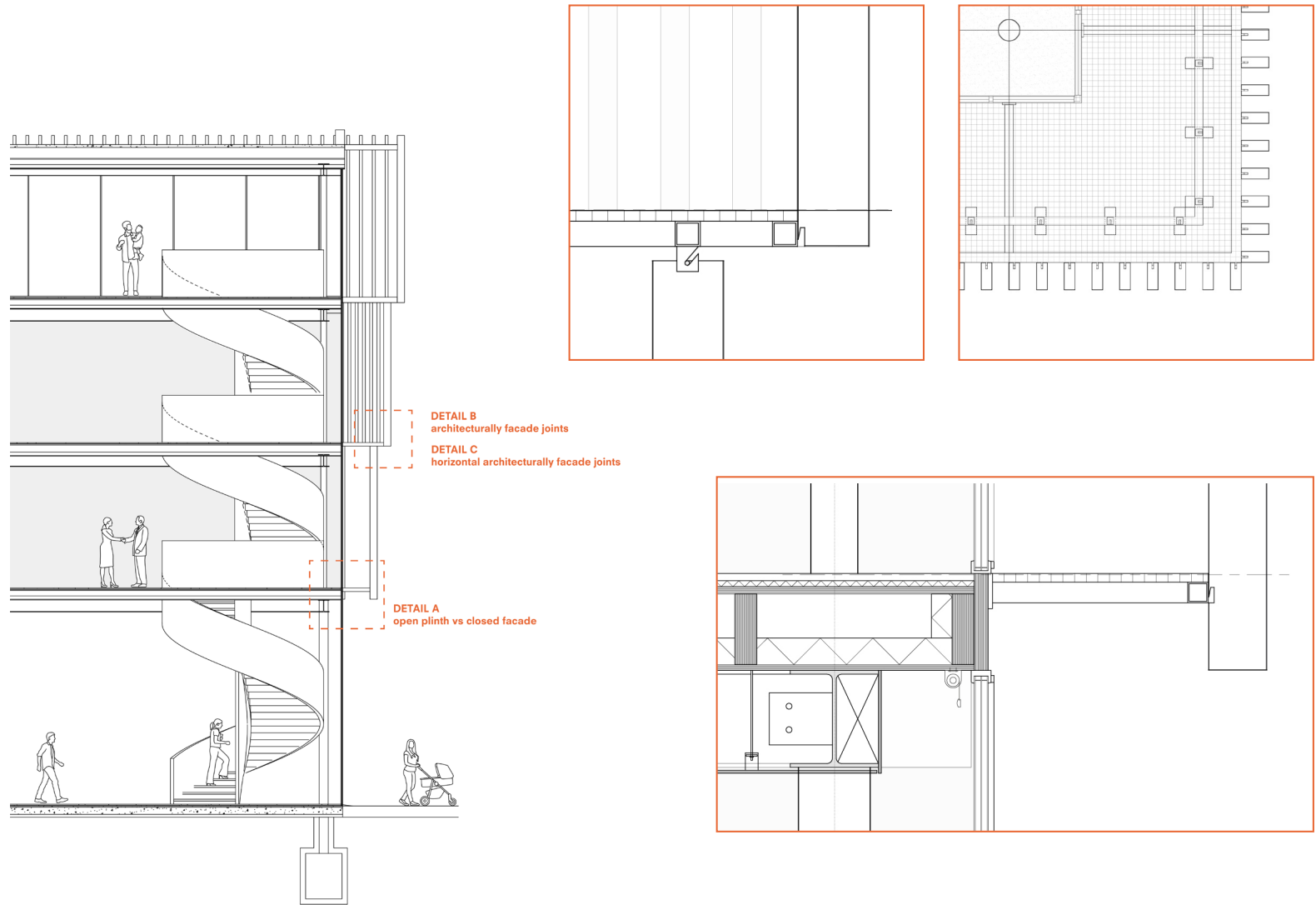

development

FACADE PRINCIPLES

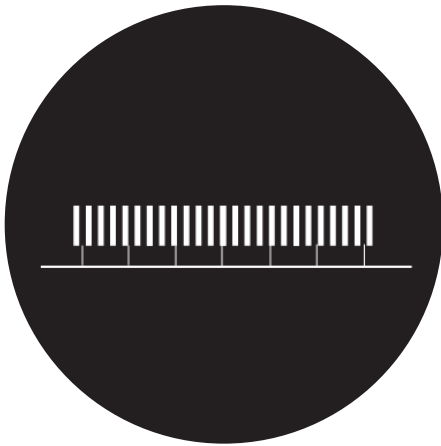

implementation
MODEL

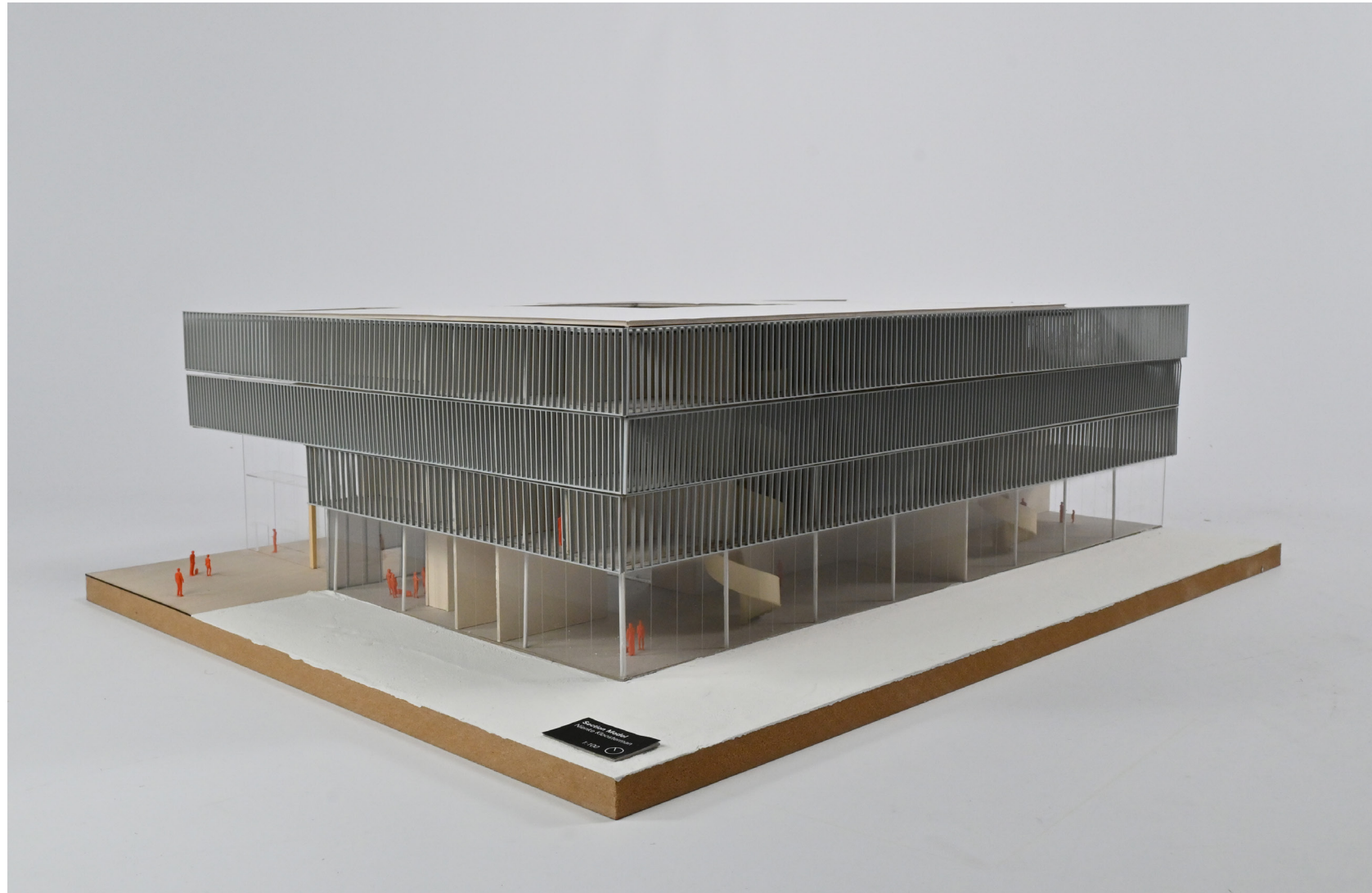

implementation
MODEL



development
SLAT FACADE

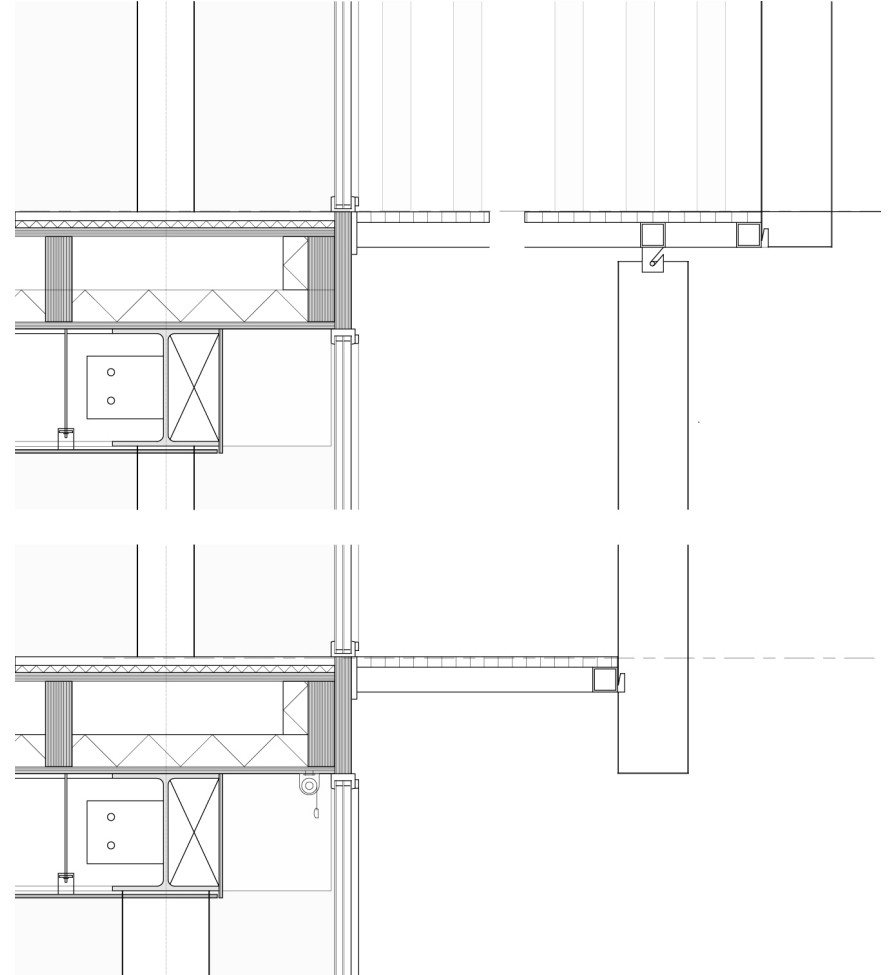
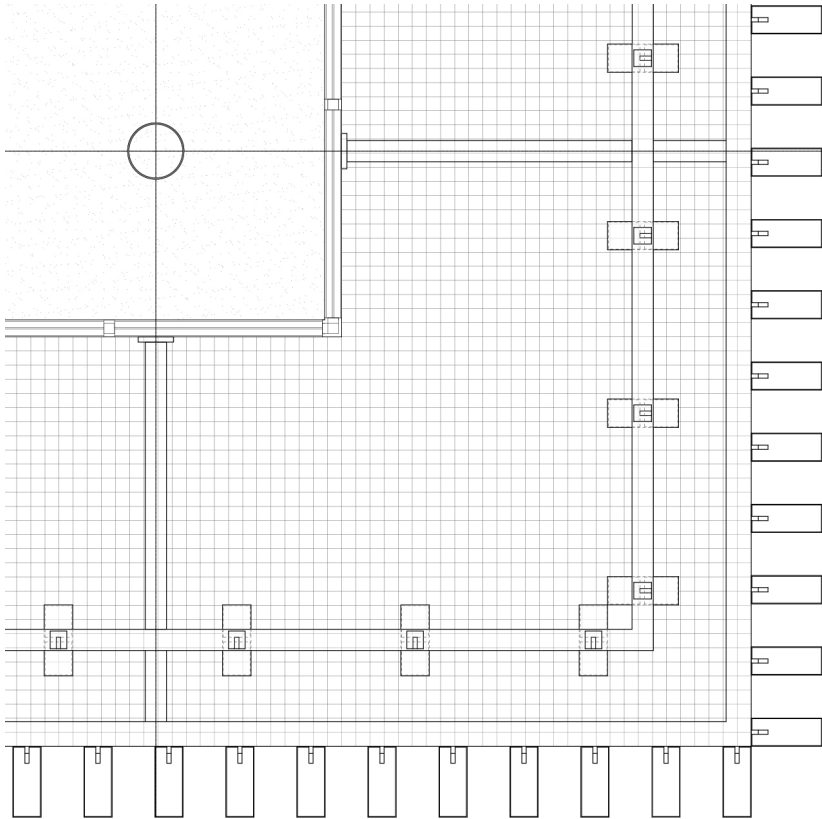

development
DETAIL B

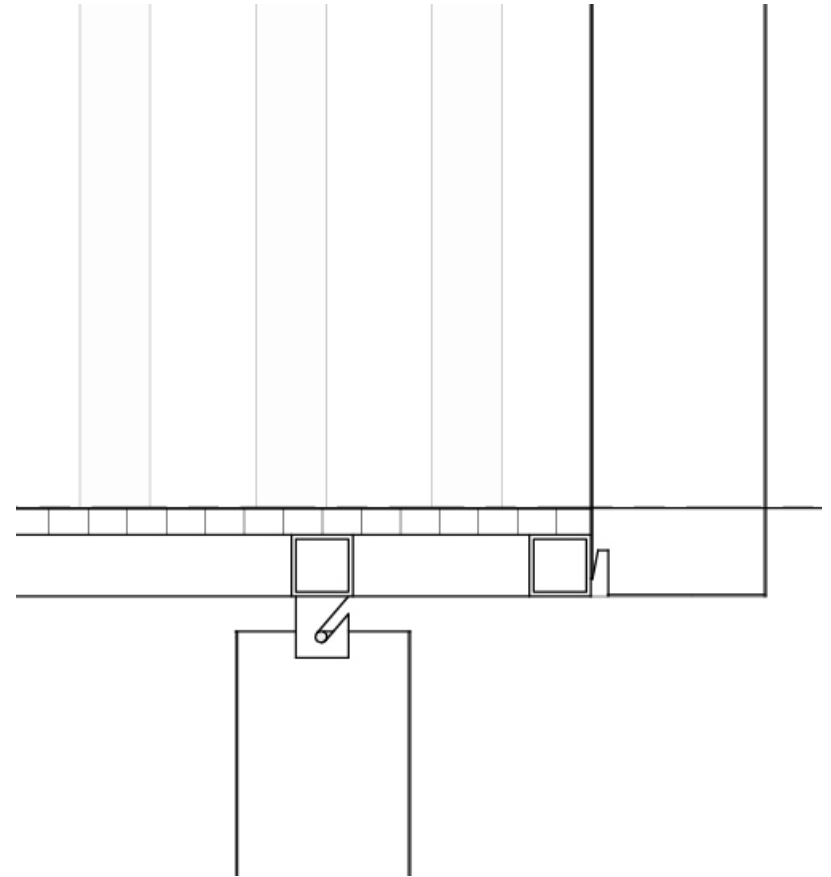
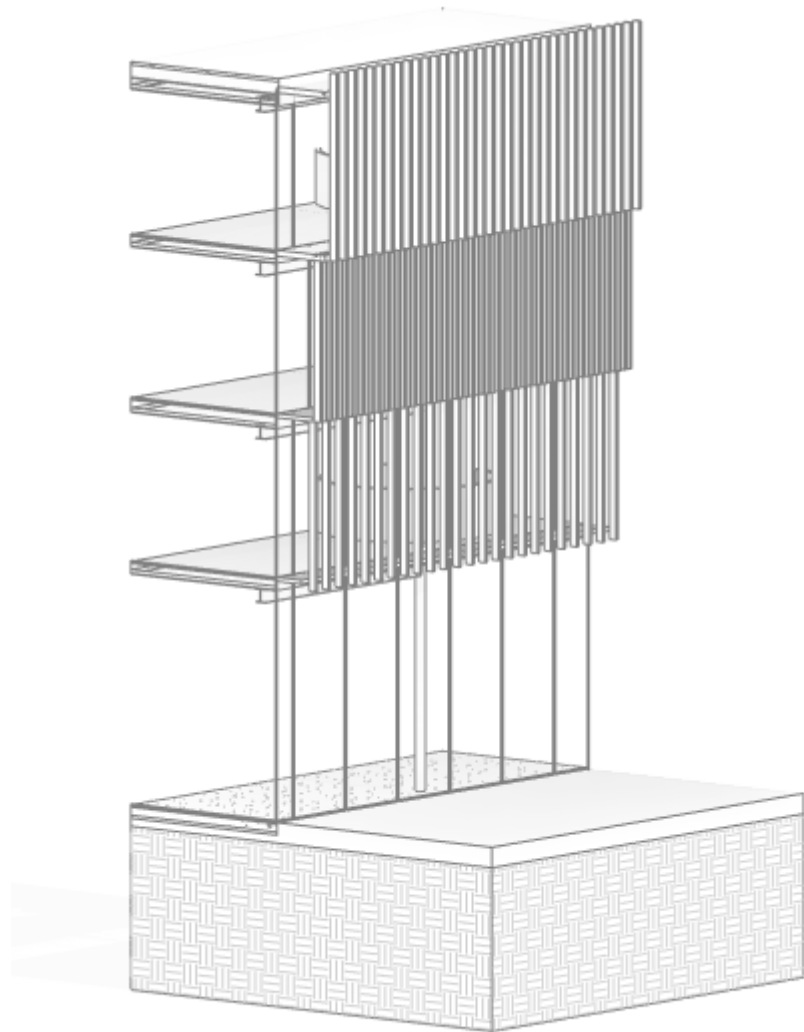

INTRODUCTION

RESEARCH

DESIGN BRIEF

DESIGN PROCESS & CONCEPT

IMPLEMENTATION

DEVELOPMENT

CONCLUSION

RESEARCH QUESTION

How can a building treat **displaced people** in a **societal inclusive** way while maintaining **institutional efficiency**?



conclusion

CONCLUSION

MIGRATION COURT



arriving

resettlement
procedure



court

conclusion

CONCLUSION

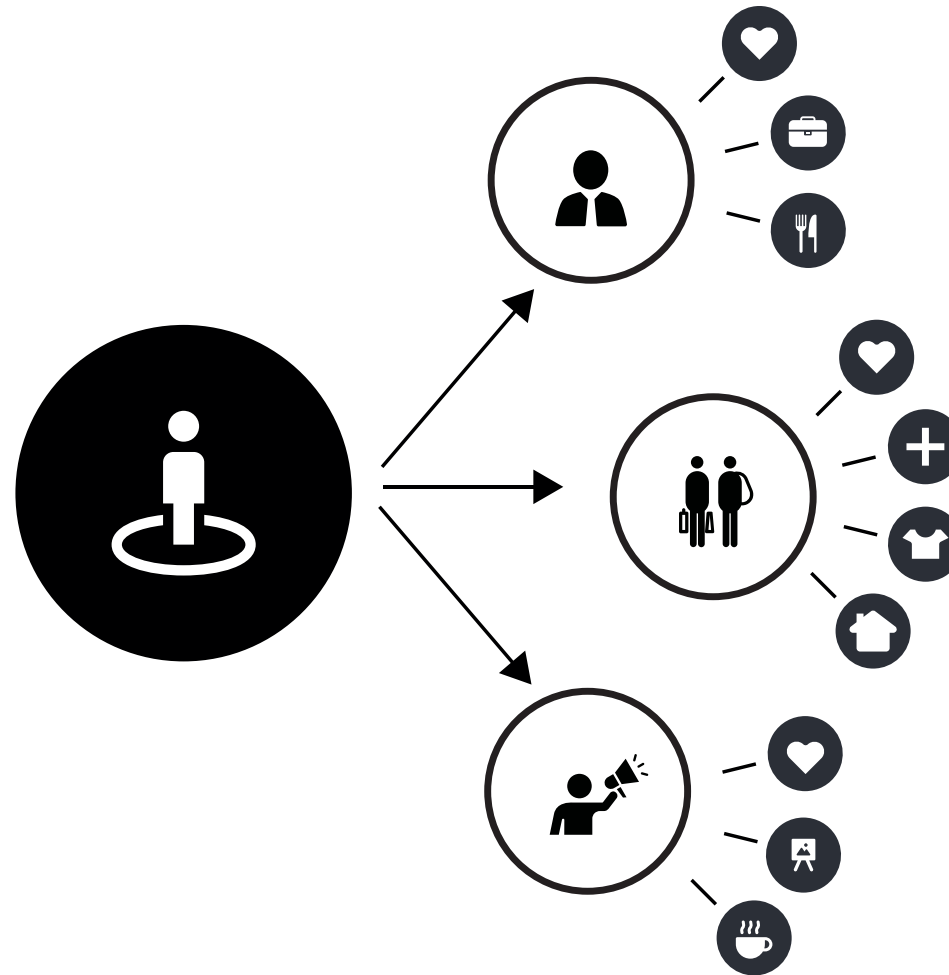

conclusion

INCLUSIVE DESIGN

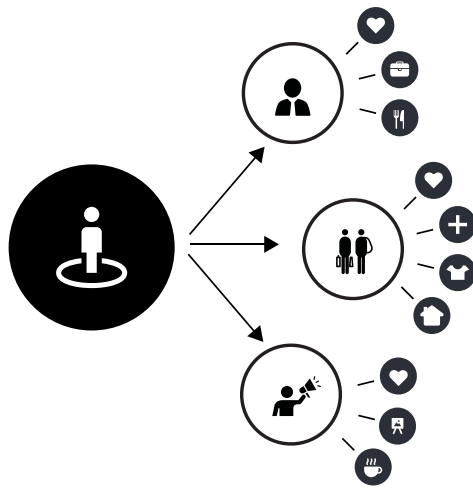

is responding to
the users needs

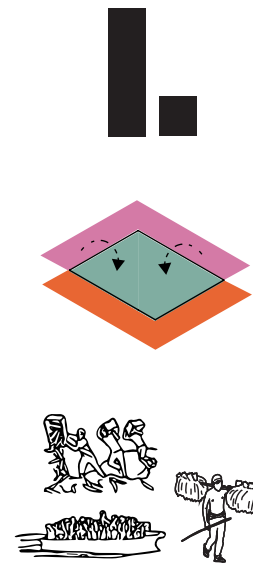

program

environmental
psychology

diversity of
users

AI WEIWEI

“People of different cultures and backgrounds have to learn to live with each other.”

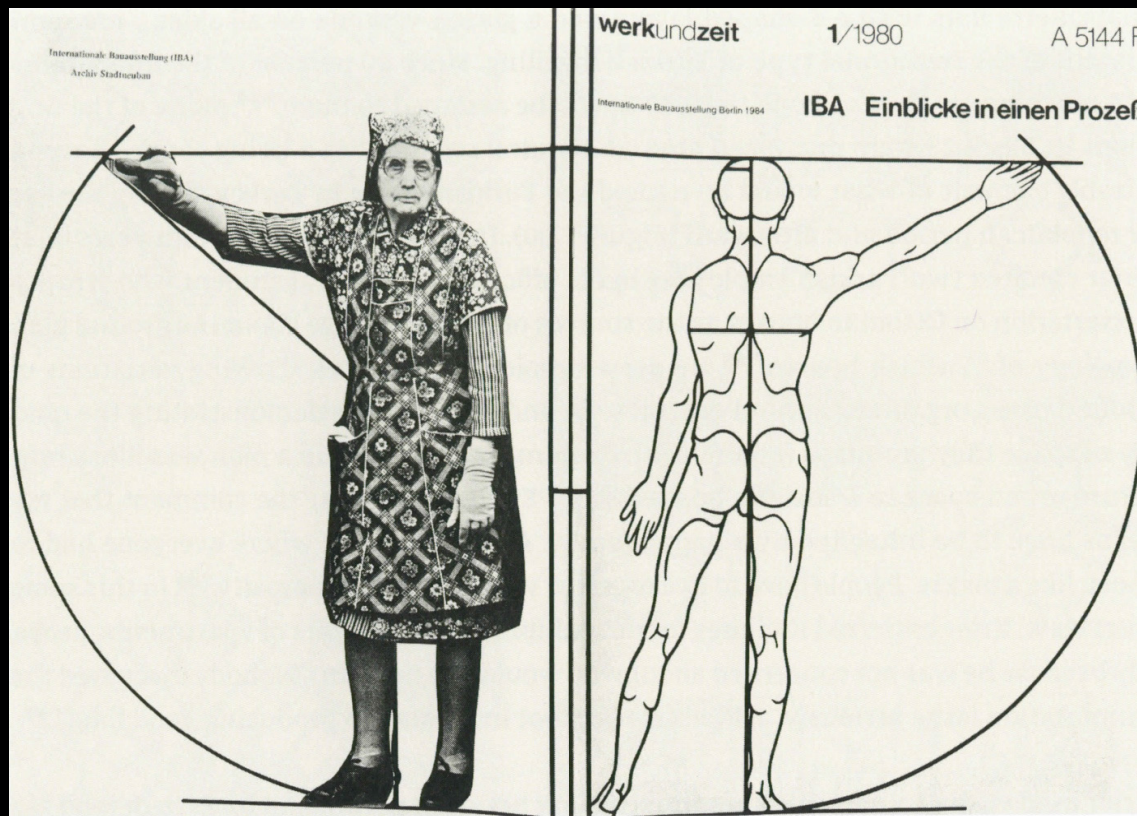

THANK YOU!

implementation
CIRCULATION

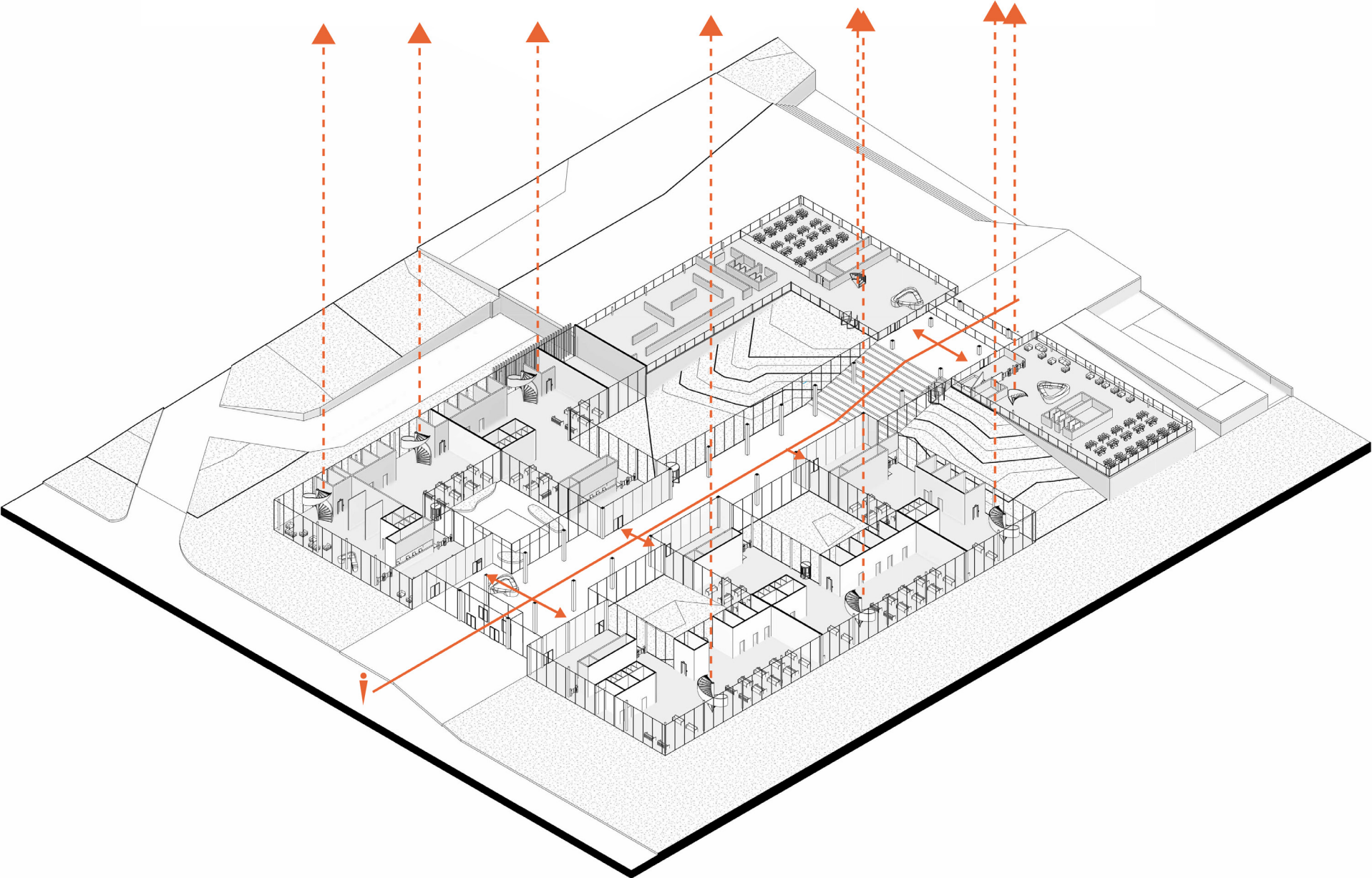

implementation

CIRCULATION

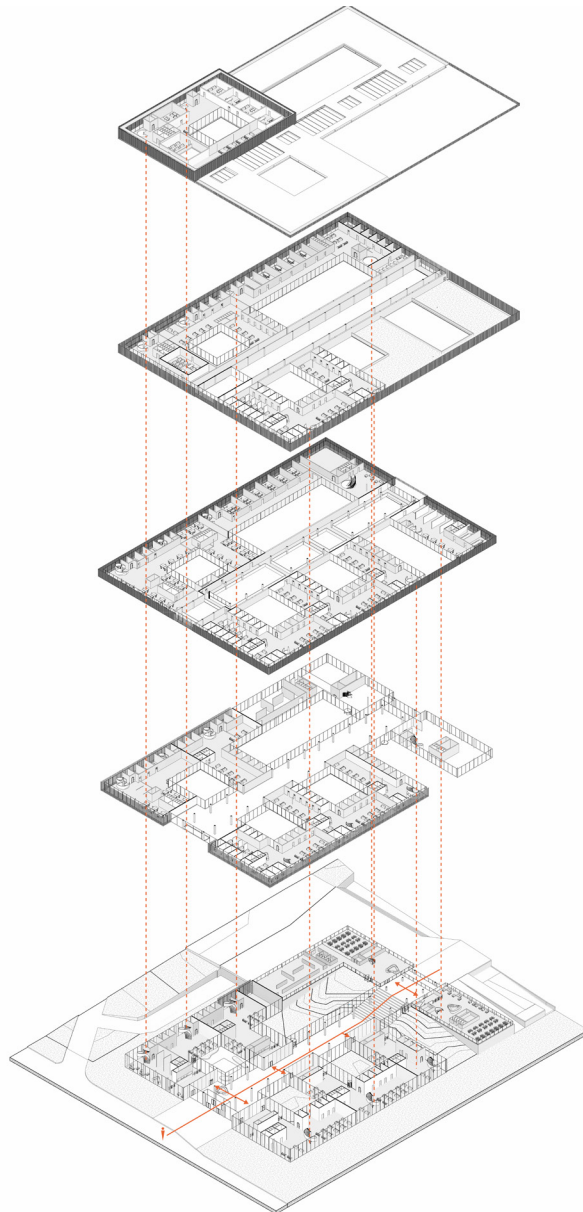

implementation
AXO FLOORS

