

Design principles of multifunctional flood defences

Voorendt, Mark

DOI

[10.4233/uuid:31ec6c27-2f53-4322-ac2f-2852d58dfa05](https://doi.org/10.4233/uuid:31ec6c27-2f53-4322-ac2f-2852d58dfa05)

Publication date

2017

Document Version

Final published version

Citation (APA)

Voorendt, M. (2017). *Design principles of multifunctional flood defences*. [Dissertation (TU Delft), Delft University of Technology]. <https://doi.org/10.4233/uuid:31ec6c27-2f53-4322-ac2f-2852d58dfa05>

Important note

To cite this publication, please use the final published version (if applicable).
Please check the document version above.

Copyright

Other than for strictly personal use, it is not permitted to download, forward or distribute the text or part of it, without the consent of the author(s) and/or copyright holder(s), unless the work is under an open content license such as Creative Commons.

Takedown policy

Please contact us and provide details if you believe this document breaches copyrights.
We will remove access to the work immediately and investigate your claim.

Design principles of multifunctional flood defences

M.Z. Voorendt



DESIGN PRINCIPLES OF
MULTIFUNCTIONAL FLOOD DEFENCES

Proefschrift

ter verkrijging van de graad van doctor
aan de Technische Universiteit Delft,
op gezag van de Rector Magnificus prof. ir. K. C. A. M. Luyben,
voorzitter van het College voor Promoties,
in het openbaar te verdedigen op maandag 26 juni 2017 om 10:00 uur

door

MARKUS ZEGERARDUS VOORENDT

weg- en waterbouwkundig ingenieur,
Hogeschool Utrecht
geboren te Utrecht, Nederland

This dissertation has been approved by the promotor:

Prof.drs.ir. J.K. Vrijling

Composition of the doctoral committee

chairperson:

Rector Magnificus TU Delft

promotor:

prof.drs.ir. J.K. Vrijling Faculty of Civil Engineering & Geosciences, TU Delft

members:

dr.ir. H.G. Voortman Arcadis Nederland BV

independent members:

prof.dr.ir. J. Berlamont Faculty of Engineering Science, KU Leuven

prof.dr.ir. M.J.C.M. Hertogh Faculty of Civil Engineering & Geosciences, TU Delft

prof.dr.ir. S.N. Jonkman Faculty of Civil Engineering & Geosciences, TU Delft

prof.dr.ir. V.J. Meyer Faculty of Architecture, TU Delft

dr.ir. K.J. Bakker WAD43 BV

The research has financially been supported by:



Key words: multifunctional flood defences, integrated design

Printed by: Ipskamp Drukkers BV

Cover photo: Rheinufertunnel in Düsseldorf, Germany, 2015 (by the author)

Copyright © 2017, 2018 M.Z. Voorendt

ISBN 978-94-028-0678-6

This slightly improved edition contains several minor corrections of typing errors and improper wording. An electronic version of the original dissertation is available on <http://repository.tudelft.nl/>

This dissertation was typeset using the LaTeX typesetting system originally developed by Leslie Lamport, based on TeX created by Donald Knuth. Numbers are represented by Arabic numerals with spaces as thousands separators and commas as decimal marks, in accordance with the Eurocodes. Names of towns, lakes and rivers in the Netherlands are spelled according to their Dutch names.

PREFACE

The present dissertation has been developed as part of a larger research programme on 'integral and sustainable design of multifunctional flood defences', subsidised by and carried out in commission of the Dutch Technology Foundation (STW). The foundation is part of the Netherlands Organisation for Scientific Research (NWO) and is partly funded by the Ministry of Economic Affairs. The programme is one of the 'Perspective' programmes that are organised within consortia of research institutes and potential users of the results. The programme consists of fifteen projects in which various aspects of multifunctional flood defences are studied. For details of the programme, one is referred to the project proposal, which can be found on www.flooddefences.org.

I feel fortunate that I have grown up and have been living in a low-lying country that has accomplished to keep itself 'artificially alive' for centuries by its flood defence system. In my department at Delft University of Technology, a generation of hydraulic engineers worked on the design of the famous Dutch Delta Works, one of the 'Seven Wonders of the Modern World' according to the American Society of Civil Engineers. Almost all of them have retired by now, but I am glad that I have been able to learn from the last of them, my promotor prof.dr.ir. Han Vrijling. The awareness of working in an environment of such a rich tradition has certainly 'coloured' this dissertation, which therefore concentrates on the Dutch circumstances rather than compares international developments.

I am extremely grateful and indebted to my promotor prof.dr.ir. Han Vrijling, who offered me the opportunity to acquire the title of PhD that I need for my career in hydraulic engineering at TU Delft, which already enriched my life immensely. I would like to express my special appreciation and thank him for allowing me to grow in my profession. I am also much obliged to the members of my doctoral committee, prof.dr.ir. Jean Berlamont, prof.dr.ir. Marcel Hertogh, prof.dr.ir. Bas Jonkman, prof.dr.ir. Han Meyer, dr.ir. Klaas Jan Bakker and dr.ir. Hessel Voortman for critically assessing the dissertation and the propositions, and for being the examiners during the doctoral defence ceremony.

The research project was externally supported by Witteveen+Bos (especially ir. Paul Ravenstijn and ir. Gerben Spaargaren), Arcadis (dr. ing. Marco Veendorp and dr.ir. Hessel Voortman), Deltares (dr.ir. Meindert Van) and STOWA (ir. Henk van Hemert). All their help is highly appreciated.

Prof.dr.ir Marcel Stive, my former chief, is paid many tributes to, for allowing and trusting me to make a career switch. Ir. Wilfred Molenaar is forever gratefully acknowledged for stimulating me for many years to participate in teaching activities on hydraulic structures, and for temporarily taking over several of my tasks to en-

able me to finish my research. Many other colleagues have helped me: ir. Henk Jan Verhagen, who took over the coordination of the Field work Hydraulic Engineering during the last year of my research, and patiently answered my uncountable questions. Furthermore, dr.ir Jarit de Gijt, ir. Pieter Huisman, prof.dr. Jill Slinger, dr.ir. Karel Terwel, ir. Ad van der Toorn, ir.drs. Jules Verlaan, ir. Joannes Visser and dr.ir. Paul Visser are acknowledged for helping or encouraging me. My first chiefs, dr.ir Jan van de Graaff and prof.ir. Kees d'Angremond always offered me many possibilities to develop and have an interesting career in the department of Hydraulic Engineering. Support has always been provided in a professional way by Agnes Groenestein, Petra Jorritsma, drs. Lenie Wasmus, Inge van Rooij and dr. Judith Schooneveld. Drs. Mariëtte van Tilburg was extremely helpful in improving my English. This dissertation could not have been written without the help and support of all these people.

Executive secretary of my Faculty, drs. Stijn van Boxmeer, is acknowledged for letting me realise that an administrative career is definitely not what I aspire. I thank Chantal van Woggelum, for taking over my previous job, which enabled me to start the present research. I am also grateful to drs.ing. Hans de Boer, who, together with my promotor, involved me in the activities of the Delft Research Initiative on Infrastructures & Mobility and the minor on Integrated Design of Infrastructures, which has led to warm contacts with the Faculty of Architecture at Delft University of Technology. In addition, my colleagues from the research programme on 'Integral and Sustainable Design of Multifunctional Flood Defences' are thanked for their enthusiasm and inspiration. Especially dr. Baukje Kothuis and project leader prof.dr.ir. Matthijs Kok are acknowledged for their efforts to connect all individual researchers.

The supervision of many students has helped me to develop ideas on multifunctional flood defences and integrated design, especially BSc-students Coen Disberg, Anna Eskes, Sander Geertzen, Mohamed Harrouni, Sedad Igdir, Lise Jansen, Maarten Lanter, Lisa Liefertink, Rick van der Meijs, Tristan Quinten, Bas Quirijns, Frank Smorenburg, Daan Sotiriadis, Rick van Tilborg, Rens Van, Patrick Verrrips, Marieke de Wit and MSc-students Yoeri Jongerius, Jorrit Kentrop, Rick Pijpers, Guido van Rinsum, Bob van Rooijen, Chris Siverd and Mattia Tintori. The students participating in the course on Environment & Infrastructures of the minor on Integrated Design of Infrastructures were very helpful with testing the design method, proposed in this dissertation.

Last, I would like to thank my family, friends, acquaintances and neighbours for supporting me and showing interest in my research. Explaining my work has really helped me. Especially I would like to express my gratitude to my parents, for their love and encouragement, without whom I would never have enjoyed so many opportunities.

*Mark Voorendt
Delft, May 2017*

SUMMARY

Multifunctional flood defences are structures that primarily protect land from being covered by water coming from oceans, seas, rivers, lakes and other waterways, and that simultaneously serve other purposes. The 'other purposes' are commonly fulfilled by hydraulic structures (for example, discharge sluices), infrastructures (roads, cables, pipes) and buildings, objects & shared use (houses, trees, sunbathing meadows). The present dissertation focuses on the combination of flood protection with functions that are fulfilled by means of buildings and objects (other than hydraulic structures and infrastructures), with a high degree of structural integration. This can typically be found in the urban context, where the combination of long-term flood protection and spatial quality is considered crucial for the viability of cities along rivers and seas.

The buildings and objects in multifunctional flood defences are combined with the structural elements that are primarily intended to contribute to the flood-protecting function. The composition of such a combined structure is more complex and diverse than of regular flood defences, so the design of multifunctional flood defences requires extra attention. The objective of this dissertation therefore is to develop a method for the design of multifunctional flood defences. The method concentrates on the verification of the flood protection function. The verification is a step in the design process that ensures a feasible and functioning result. Design projects for the realisation of flood defences are usually part of a more extensive strategy to reduce flood risks, formalised in regional, national or international policies.

The research objective of this dissertation was therefore achieved by answering research questions that are related to the three levels of taking care of flood risk reduction. These research questions are (from a general to a more specific level):

1. What issues determine the chosen strategy for flood risk reduction in the Netherlands?
2. What method can best be used for the integrated and sustainable design of multifunctional flood defences?
3. How should design concepts of multifunctional flood defences be verified (concentrating on the flood-protection function)?

The approaches to find the answers to the three research questions are briefly explained below.

The approach to research question 1 (influences on strategy)

Literature was studied to understand the context in which strategies of flood risk reduction have been developed in the Netherlands. It appeared that the flood protection strategy has always been the result of available technological knowledge, experience and organisational capabilities. An efficient and effective strategy of flood risk reduction was often hampered by the lack of funding for construction or maintenance. Interest in flood protection has varied due to political conflicts and policy changes, which often impeded a long-term strategy. A major obstruction for an effective strategy has been the mismatch between the geographical scale of the problem and the geographical expanse of governing institutions. This only gradually improved in the nineteenth century, after the foundation of national committees like, such as the Dutch governmental agency, Rijkswaterstaat, in 1798, and a Royal Advisory Committee instated in 1809 by King Louis Napoléon Bonaparte. The influence of society on decision-making regarding flood defences has changed in 1970s. Instead of basing the strategy only on economic (cost-benefit) arguments, values of landscape, nature and culture were gradually involved. This can be explained by a shift of societal well-being. Meanwhile, society has become more complex and more people have become involved in policy-making and management. These governance aspects pose challenges to those who are involved in developing effective and efficient flood risk reduction strategies.

The approach to research question 2 (design method)

The methodology of design was studied in general and more specifically, it was attempted to find an approach that would be suitable to the design of integrated and sustainable multifunctional flood defences. The engineering and the spatial design approaches have grown apart since the 1970s in academics as well as in parts of practice. This has led to a sub-optimal process of first engineering flood defences and then attempting to let them improve the spatial quality, or the other way around. The challenge for this dissertation was therefore to integrate the systematic approach of the engineering method and the creative and learning character of the spatial design method. The advantages of an integrated approach are that it aims at solving a specific societal problem, it can be sub-divided into phases and it can be applied by a multi-disciplinary project team. The integrated design method developed in this dissertation consists of seven main steps, and is cyclic and highly iterative. It enables creativity, experimenting and learning from developing concepts, and offers possibilities to organise the process. It takes landscape, nature and cultural values into account, includes stakeholder participation and involves multiple disciplines in the design process. The method ensures that feasible and functional results are reached.

The proposed method has been tested by student design teams and indeed appeared to be systematic, intuitive and creative. If attention for several aspects of application of the proposed method is taken into account, an integrated design is guaranteed.

The approach to research question 3 (verification)

Most importantly, it should explicitly be verified whether multifunctional flood defences are able to fulfil their flood-retaining function. The verification needs extra attention, because the structural composition of multifunctional flood defences is usually more complex than of regular flood defences. Therefore, a method was developed for a *qualitative structural verification*, making use of generic structural element types that can be distinguished in multifunctional flood defences. Examples of structural element types are water-retaining elements, erosion protecting elements and supporting elements. With the help of the element types, it can be verified whether a specific structure is able to function as a flood defence. Twenty-eight existing cases were studied to give reasonable proof that the derived element types can indeed be recognized and that there are no elements that don't fit in the derived typology.

The qualitative structural verification of a design concept should be followed by an in-depth *quantitative structural verification* to ensure structural integrity and constructability. This quantitative structural verification is similar to regular flood defences, but the influence of the 'other' function on existing failure mechanisms has to be included. Furthermore, potential new failure mechanisms have to be considered. Especially scour around buildings and materials unusual for flood-retaining structures are points of attention. A sequence for the quantitative structural verification of multifunctional flood defence was developed.

Four cases were studied in more detail to validate the qualitative verification method, as proposed in this dissertation. The case studies concentrate on the verification of the flood protecting function, but include other design steps as well, to demonstrate how the qualitative structural verification is embedded in an entire design loop. The first case concerns the sea defence of the coastal town of Katwijk aan Zee, which is combined with a parking garage. The second case concerns a shopping complex in Rotterdam, called the Roof Park, which is combined with a river dike. A boulevard along a river in Rotterdam, called the 'Boompjes', combined with sports and leisure functions, forms the third case. The last case deals with a river dike in Sliedrecht, where houses on both sides of the crest impede simple dike reinforcement.

From the case studies it is concluded that the verification method, as described and validated in this dissertation, is workable and useful. The overall method for integrated and sustainable design has been tested with student groups and the qualitative structural verification has been validated in the present dissertation. Apart from the technical aspects shown in the cases, it is, however, recommended to solve the problems concerning governance aspects, because they still seem to be the main impediment for the design and realisation of multifunctional flood defences. The present dissertation offers a helping hand by proposing to vary the roles of structural elements during the development of concepts, which provides insight in the consequences for governance and makes them open to discussion.

SAMENVATTING

Multifunctionele waterkeringen zijn constructies, die het primaire oogmerk hebben, land te beschermen tegen overstroming vanuit oceanen, zeeën rivieren, meren en andere waterwegen, en die tevens andere functies hebben dan hoogwaterbescherming. Deze 'andere functies' worden gewoonlijk vervuld door waterbouwkundige kunstwerken (bijvoorbeeld uitwateringssluizen), infrastructuren (wegen, kabels, leidingen) en gebouwen, objecten en gedeeld gebruik (huizen, bomen, ligweiden). Dit proefschrift richt zich op de combinatie van hoogwaterbescherming met functies die worden vervuld door middel van gebouwen en objecten (anders dan waterbouwkundige constructies en infrastructuren), met een hoge mate van constructieve integratie. Deze combinatie is typisch voor de stedelijke context, waar lange-termijn hoogwaterbescherming en ruimtelijke kwaliteit cruciaal worden geacht voor de leefbaarheid van steden langs rivieren en zeeën.

Gebouwen en objecten worden in multifunctionele waterkeringen gecombineerd met constructieve elementen die primair bedoeld zijn om bij te dragen aan de waterkerende functie. De samenstelling van dergelijke gecombineerde, of multifunctionele, constructies is vaak complexer en meer divers dan van gebruikelijke waterkeringen, waardoor het ontwerp van multifunctionele waterkeringen meer aandacht vraagt. De doelstelling van deze dissertatie is daarom, een methode te ontwikkelen voor het ontwerp van multifunctionele waterkeringen. De methode concentreert zich op de verificatie van de waterkerende functie. De verificatie is een stap in het ontwerpproces die een haalbare en functionerende oplossing waarborgt. Ontwerpprojecten voor de realisatie van waterkeringen zijn doorgaans onderdeel van uitgebreidere strategieën om overstromingsrisico's te reduceren, geformaliseerd in regionaal, nationaal en internationaal beleid.

Het onderzoeksdoel van deze dissertatie werd bereikt door antwoord te geven op onderzoeksvragen die gerelateerd zijn aan de drie niveau's van organisatie van hoogwaterbescherming. Deze onderzoeksvragen zijn (gerangschikt van algemeen naar meer specifiek niveau):

1. Welke aspecten bepalen de gekozen strategie van overstromingsrisicoreductie in Nederland?
2. Welke methode kan het best gebruikt worden voor het integraal en duurzaam ontwerpen van multifunctionele waterkeringen?
3. Hoe dienen ontwerpconcepten van multifunctionele waterkeringen het best geverifieerd te worden (gericht op de waterkerende functie)?

De werkwijzen voor het vinden van de antwoorden op de drie onderzoeksvragen worden hieronder kort toegelicht.

De werkwijze voor onderzoeksvraag 1 (invloeden op strategie)

Literatuur is bestudeerd om de context te begrijpen waarin strategieën voor de reductie van overstromingsrisico's in Nedeland worden ontwikkeld. Het blijkt dat de strategie altijd het resultaat is geweest van beschikbare technische kennis, ervaring en organisatorische vaardigheden. Een doelmatige en doeltreffende strategie werd vaak verhinderd door een tekort aan financiële middelen voor constructie of onderhoud. De aandacht voor hoogwaterbescherming was wisselend door politieke conflicten en beleidsveranderingen, die een lange-termijnstrategie vaak in de weg stonden. Een grote belemmering voor een effectieve strategie was ook de wanverhouding tussen de geografische schaal van het probleem en het geografische bereik van heersende instellingen. Dit verbeterde pas geleidelijk in de negentiende eeuw, na de oprichting van nationale instellingen als Rijkswaterstaat in 1798 en een Koninklijke Adviescommissie die in 1809 werd ingesteld door Koning Lodewijk Napoléon Bonaparte.

De invloed van de maatschappij op de besluitvorming aangaande hoogwaterbescherming veranderde vanaf de zeventiger jaren van de vorige eeuw. In plaats van het baseren van de strategie op alleen economische (kosten-baten) overwegingen, werden ook waarden van landschap, natuur en cultuur erbij betrokken. Dit kan verklaard worden door de verbetering van het niveau van maatschappelijk welzijn. Ondertussen is de maatschappij ook complexer geworden en zijn meer mensen met verschillende achtergronden betrokken bij besluitvorming en bestuur. Deze bestuursaspecten vormen een grote uitdaging voor degenen die betrokken zijn bij het ontwikkelen van doelmatige en doeltreffende strategieën voor het reduceren van overstromingsrisico's.

De werkwijze voor onderzoeksvraag 2 (ontwerpmethode)

De methodologie van het ontwerpen in het algemeen is onderzocht en meer specifiek is er gezocht naar een aanpak die geschikt is voor geïntegreerd en duurzaam ontwerp van multifunctionele waterkeringen. The methoden voor technisch en ruimtelijk ontwerp zijn sinds de jaren 1970 in academische kringen en ook in delen van de praktijk uit elkaar gegroeid. Dit heeft geleid tot een sub-optimaal proces van het eerst technisch ontwerpen van waterkeringen en dan pogen deze constructies te laten bijdragen aan de ruimtelijke kwaliteit, of andersom. De uitdaging voor dit promotieonderzoek was daarom, de systematische ingenieursmethode te combineren met het creatieve en lerende karakter van de aanpak van het ruimtelijk ontwerp. De voordelen van de ingenieursmethode zijn dat het is gericht op het oplossen van specifieke maatschappelijke problemen, dat het kan worden onderverdeeld in fasen en dat het gebruikt kan worden door multidisciplinaire projectteams. De in deze dissertatie ontwikkelde integrale ontwerpmethode bestaat uit zeven hoofdstappen en is cyclisch en zeer iteratief. Het laat ruimte voor creativiteit, experimenteren en leren van het ontwikkelen van concepten en biedt ook gelegenheid om het ontwerpproces te organiseren. Het neemt waarden van landschap, natuur en cultuur in beschouwing, betreft belanghebbenden in het proces en combineert verscheidene

disciplines in het ontwerp. De methode waarborgt een haalbaar en functionerend resultaat.

De voorgestelde methode is uitgetoetst door groepen ontwerpende studenten en blijkt inderdaad systematisch, intuïtief en creatief te werken. Indien tevens enkele aanvullende aandachtspunten voor de toepassing van de voorgestelde methode in acht worden genomen, is een geïntegreerd ontwerp gegarandeerd.

De werkwijze voor onderzoeksvraag 3 (verificatie)

Het meest van belang is de explicite verificatie van de waterkerende functie van een multifunctionele waterkering. Deze verificatie behoeft extra aandacht, omdat de constructieve samenstelling van multifunctionele waterkeringen meestal complexer is dan van reguliere waterkeringen. Daarom is een methode voor een *kwalitatieve functionele verificatie* ontwikkeld, die gebruikt maakt van generieke constructieve elementtypen die in multifunctionele waterkeringen onderscheiden kunnen worden. Voorbeelden van deze elementtypen zijn waterkerende elementen, erosiebeschermende elementen en ondersteunende elementen. Met behulp van deze elementtypen kan geverifieerd worden of een specifieke constructie in principe in staat is om als waterkering te fungeren. Achtentwintig gevallen zijn bestudeerd om er een redelijk bewijs van te geven dat de afgeleide elementtypen inderdaad herkend kunnen worden en dat er geen elementen zijn die niet binnen de afgeleide typologie vallen.

De kwalitatieve constructieve verificatie van een ontwerpconcept dient gevolgd te worden door een *kwantitatieve constructieve verificatie*, om de constructieve integriteit en maakbaarheid te waarborgen. Deze kwantitatieve constructieve verificatie kijkt in wezen niet af van die van reguliere waterkeringen, waarvoor een reeks van verificatiestappen wordt aanbevolen. Echter, de invloed van de 'andere' functie op de gebruikelijke faalmechanismen dient in de beschouwing te worden betrokken. Ook met potentiële nieuwe faalmechanismen moet rekening worden gehouden. Bijzondere aandachtspunten zijn erosie langs gebouwen en voor waterkeringen ongebruikelijke materialen. Een preferente sequentie is opgesteld voor de kwantitatieve constructieve verificatie van multifunctionele waterkeringen.

Vier praktijkgevallen zijn bestudeerd ten behoeve van de in deze dissertatie ontwikkelde kwalitatieve verificatiemethode. Dit richtte zich voornamelijk op de waterkerende functie, maar ook de andere ontwerpstappen zijn beschouwd om te tonen hoe de kwalitatieve constructieve verificatie is ingebed in een gehele ontwerpplus. Het eerste praktijkgeval betreft de kustbescherming van Katwijk aan Zee, die is gecombineerd met een parkeergarage. Het tweede geval betreft een winkelcomplex in Rotterdam, genoemd 'Het Dakpark', dat is gecombineerd met een rivierdijk. Een boulevard langs een rivier in Rotterdam, 'De Boompjes', is gecombineerd met sport- en ontspanningsfuncties en vormt het derde praktijkgeval. Het laatste uitgewerkte voorbeeld is een rivierdijk in Sliedrecht, waar huizen aan beide zijden van de dijk een eenvoudige dijkversterking onmogelijk maken.

De gehele ontwerpmethode voor geïntegreerd en duurzaam ontwerp is getoetst door groepen studenten. De methode liet voldoende vrijheid voor de creatieve ontwikkeling van concepten en bood voldoende steun om een goed resultaat te garanderen.

De methode van kwalitatieve constructieve verificatie is in deze dissertatie gevalideerd door middel van de toepassing op de vier praktijkgevallen. Daaruit kan geconcludeerd worden dat de voorgestelde verificatiemethode werkbaar en nuttig is. Naast de beschouwde technische aspecten verdient het echter aanbeveling, de problemen aangaande bestuur en beheer op te lossen, aangezien dat nog de grootste belemmering lijkt te zijn voor het ontwerp en realiseren van multifunctionele waterkeringen. Dit proefschrift doet daartoe een handreiking door voor te stellen, bij de ontwikkeling van diverse concepten de rollen van de constructieve elementen te variëren en zo de consequenties voor bestuur en beheer inzichtelijk en bespreekbaar te maken.

CONTENTS

Preface	i
Summary	iii
Samenvatting	vii
1 Introduction	1
1.1 On flood protection in general	1
1.2 Motivation for studying multifunctional flood defences.	2
1.3 Flood defences in general	3
1.4 Multifunctionality.	5
1.4.1 Definition and motivation to combine functions.	6
1.4.2 Additional functions of flood defences	6
1.4.3 On the priority of functions	9
1.4.4 Risks caused by combining functions	10
1.4.5 Spatial integration	11
1.5 Problem, research objective and method	14
1.5.1 Problem description	14
1.5.2 Research objective	14
1.5.3 Research method	15
1.6 Outline of this dissertation and reading guide.	16
1.6.1 Outline of this dissertation.	16
1.6.2 Reading guide	16
2 The Dutch flood risk strategy	19
2.1 Early history up to the end of the Middle Ages	20
2.2 Technological advances from 1600 to 1800	24
2.3 Scientific advances from 1800 to 1950.	27
2.4 The flood of 1953 and the Delta Committee.	34
2.5 The second half of the twentieth century	37
2.5.1 Construction of the Delta Works	37
2.5.2 More appreciation for landscape, nature and culture	37
2.5.3 Policies to improve the river dikes since the 1970s	40
2.5.4 Formalisation of the safety standard	47
2.6 The early 21st century.	53
2.6.1 Societal and political changes	53
2.6.2 The Veerman Committee	55
2.6.3 The multi-layer flood risk reduction approach.	57
2.6.4 The flood safety standard per 2017.	59
2.7 Concluding remarks	65

3	Engineering and spatial design	67
3.1	Introduction to design	67
3.2	The engineering design method	70
3.2.1	The method used in Civil Engineering	70
3.2.2	Using the engineering method for type solutions	74
3.2.3	Other engineering disciplines	75
3.2.4	The Systems Engineering method	77
3.2.5	The engineering process in terms of HWBP-projects	79
3.3	The spatial design approach	81
3.3.1	Description of main features	81
3.3.2	Research by design	84
3.3.3	Multiple layers approaches	84
3.3.4	Spatial quality	85
3.4	Comparison of engineering and spatial design	88
4	Integrated design of multifunctional flood defences	91
4.1	Introduction	91
4.2	Outline of an integrated design method	92
4.3	The phases of the integrated method	95
4.3.1	Design phase 1: Exploration of the problem	95
4.3.2	Design phase 2: Development of concepts	97
4.3.3	Design phase 3: Functional specification	99
4.3.4	Design phase 4: Verification of concepts	101
4.3.5	Design phase 5: Evaluation of alternatives	103
4.3.6	Design phase 6: Validation of the proposed solution	106
4.3.7	Design phase 7: Decision	107
4.4	Integrating sustainability principles	109
4.4.1	Introduction	109
4.4.2	Eco-dynamic design	110
4.4.3	Making a design sustainable	112
4.5	Integrating multiple disciplines	114
4.6	Integrating stakeholders' interests	119
4.7	Organisation of the design process	122
4.7.1	Project organisation	122
4.7.2	Team work	123
4.7.3	Contracting forms	125
4.8	Validation of the integrated design method	127
4.9	Concluding remarks	128
5	Verification of multifunctional flood defences	133
5.1	Introduction	133
5.2	Qualitative structural verification	134
5.2.1	Introduction	134
5.2.2	Deriving structural functions	136
5.2.3	Deriving structural element types	138
5.2.4	Recognizing structural element types	142

5.2.5	Validation of the typology	144
5.2.6	Concluding remarks on the method	148
5.3	Quantitative structural verification	149
5.3.1	Relating structural elements to failure mechanisms	150
5.3.2	Recommended verification sequence	153
5.3.3	Influence of buildings on dike failure	156
5.3.4	Verification of macro-stability	164
5.3.5	Erosion near objects	165
5.3.6	Masonry and glass elements in dikes.	168
5.3.7	Application of the new Dutch design tools	172
5.4	Concluding remarks	173
6	Validation of the method of qualitative structural verification	175
6.1	Case study 1: Coastal protection of Katwijk	176
6.1.1	Exploration	176
6.1.2	Development of concepts	177
6.1.3	Qualitative structural verification of the concepts	183
6.1.4	Evaluation of the concepts	187
6.1.5	Quantitative verification of the preferred alternative.	189
6.2	Case study 2: The roof park in Rotterdam	192
6.2.1	Exploration	192
6.2.2	Development of concepts	194
6.2.3	Qualitative structural verification of the concepts	195
6.2.4	Evaluation of the alternatives	199
6.3	Case study 3: De Boompjes, Rotterdam	201
6.3.1	Exploration	201
6.3.2	Development of concepts	204
6.3.3	Qualitative structural verification of the concepts	205
6.3.4	Evaluation of the alternatives	210
6.4	Case study 4: Merwede dike Sliedrecht	212
6.4.1	Exploration	212
6.4.2	Development of concepts	216
6.4.3	Qualitative structural verification of the concepts	218
6.4.4	Evaluation of the alternatives	223
6.5	Concluding remarks	224
7	Conclusions and recommendations	227
7.1	Introduction	227
7.2	Conclusions.	227
7.3	Recommendations	230
	APPENDICES	233
A	Examples of multifunctional flood defences	235
A.1	The Voorstraat in Dordrecht	235
A.2	The Noordendijk in Dordrecht	239
A.3	Parking garage in Zwijndrecht.	241

A.4	The river front of Kampen.	243
A.5	The river front of Hamburg	246
B	The establishment of the basic water level by the Delta Committee	251
B.1	Historical study of high water levels.	251
B.2	Extrapolation of water level measurements	253
B.3	Econometric optimisation	257
C	Evaluation of the current design education	261
D	Acceptable flood risk	265
D.1	Introduction	265
D.2	The individual death criterion	266
D.3	The multiple deaths criterion	268
D.4	The economic criterion	270
D.5	The Dutch standard per 2017	275
E	Reliability of flood defences	279
E.1	Theory on structural safety	279
E.2	Deterministic design (level 0)	282
E.3	Semi-probabilistic design (level I).	283
E.4	Full probabilistic design (level III).	285
E.5	Simplified probabilistic design (level II).	289
E.6	Multiple failure mechanisms	290
E.7	Reliability of flood defences.	293
F	Quantitative structural verification of the Katwijk concept	299
F.1	Requirements	299
F.2	Boundary conditions	300
F.3	Dune height and erosion volume	302
F.4	Overtopping	304
F.5	Lateral shear	304
F.6	Rotational stability	305
F.7	Bearing capacity subsoil	306
F.8	Settlement	306
F.9	Uplift of the structure	307
F.10	Piping.	308
F.11	Scour or leakage next to an object.	310
F.12	Cables, pipes	310
F.13	Strength of structural elements	310
F.14	The modified concept.	311
	Glossary	313
	References	319
	Curriculum vitae and publications	341
	Propositions	343

1

INTRODUCTION

1.1 ON FLOOD PROTECTION IN GENERAL

'Kein Deich, kein Land, kein Leben' is the title of a book written by Johann Kramer, dealing with the history of coastal protection along the German North Sea (Kramer, 1989). This title plainly expresses a feeling of necessity regarding protection against floods in areas where people reside next to rivers or seas with a fluctuating water level, threatening life and economy. In the preface of this book, Kramer writes:

Es sind mehrere Millionen Menschen, die von der dänischen bis zur holländischen Grenze nur im Schutze der Deiche leben und Arbeiten können und dort große materielle Werte geschaffen haben. Ohne Deiche würden in tief liegenden Marschgebieten täglich zweimal ihre Arbeits- und Wohnplätze überschwemmt werden. Während Sturmflutkatastrophen - wie 1962 - würden sie mehrere Meter hoch vom Wasser bedeckt sein. Der Küstenschutz ist aus der bitteren Erfahrung zahlreicher Sturmflutkatastrophen in der Vergangenheit gewachsen.¹

This notion could hardly be expressed more clearly. It is therefore a basic principle for the present research that the main function of a flood defence is the protection of the hinterland against flooding. This is especially relevant for 'Multifunctional Flood Defences (MFDs)' or 'Multi-Purpose Levees (MPLs)', where the flood defence function is combined with other functions, like accommodating housing or parking cars. Other functions should not become more important than the primary function of a flood defence.

This chapter first explains the motivation for a study of multifunctional flood defences. Then, a description of regular flood defences is given, followed by a section on combining functions in flood defences, including spatial aspects and potential

¹Millions of people between the Danish and Dutch borders can only live and work there and acquire much wealth, because of the protection provided by dikes. Without dikes, their work and dwelling places in low lying marshes would be flooded twice a day. During storm surges, like in 1962, they would be covered by metres of water. Coastal protection has been developed because of the dire experience of many storm surge catastrophes in the past.

risks introduced by combining functions. Subsequently, the research problem is formulated, followed by the research objective and the method that developed to achieve this objective. The last section of this chapter gives an outline of this dissertation.

1.2 MOTIVATION FOR STUDYING MULTIFUNCTIONAL FLOOD DEFENCES

Worldwide, increasing numbers of people and assets are protected against flooding by flood defence systems. The Organisation for Economic Co-operation and Development (OECD) estimates that by 2070, up to 140 million people and 30 000 billion euro in economic assets in large port cities around the world will be secured in this way. The flood protection systems, however, will have to be maintained and improved, as large parts will deteriorate because of weathering. The need of improvement is even higher as the flood safety standard becomes stricter, because of the ever increasing value of the protected areas and the predicted rise of water levels. Expanding cities require new flood defences to protect the recently intensively occupied areas (Kok et al., 2013).

Improvement of flood defence systems and reduction of flood risk in new areas will require considerable investments, but concerns are whether there will be sufficient financial resources to cover the costs. Another complicating factor is the urban pressure on the use of land, which conflicts with land claims for flood defence systems. Moreover, climatic and economic uncertainties have to be dealt with when complying with the requested level of flood protection. The complexity of these factors calls for technological and institutional innovations in flood defence technology (Kok et al., 2013).

Innovations, in the form of multifunctional flood defences, have also been addressed in the report of the Veerman Committee 2008, which advised the Dutch government on the future flood protection strategy. The Veerman Committee recommended, among other recommendations, integrated and multifunctional solutions to deal with the lack of space and, thus, deliver added value to society (Veerman Committee, 2008).

However, the integrated and sustainable design of multifunctional flood defences poses several challenges that need scientific attention. A considerable problem is the governance of multifunctional flood defences: the responsibility for providing protection against floods is now separated from the concerns of real estate owners or other users of these flood defence systems, which could cause governance conflicts that are usually avoided by deciding for plain mono-functional flood defences. Furthermore, the implementation of an effective governance strategy is complicated by the uncertainties in real estate developments. Another problem is the fact that flood defences, from the point of view of integration in built-on areas, are considered as undesirable objects in the environment. Furthermore, future adaptations of flood defence systems can be complicated, if the time scales of the

combined functions deviate from the design life time of the flood defence. This demands for flexibility and ability to adapt multifunctional flood defences. Lastly, new methods have to be agreed upon to determine the safety of the combined systems, especially because the behaviour of objects in embankments is not yet very well studied (Kok et al., 2013).

The present dissertation aims at increasing the knowledge needed for an integrated and sustainable design of multifunctional flood defences. It is related to the PhD-research of Bianca Stalenberg (2010), who developed a concept for adaptable flood defences to create physical synergy in urban river fronts by combining urban functions and flood protection into multifunctional structures. The present dissertation focusses on structural design aspects, in particular concentrating on the flood protection function.

1.3 FLOOD DEFENCES IN GENERAL

Before exploring the characteristics of multifunctional flood defences, this section briefly defines and characterises flood defences in general.

A flood defence is a *hydraulic structure with the primary objective to protect land from being covered by water coming from oceans, seas, rivers, lakes and other waterways*.² This seems a correct definition, as it comprises the four main categories of flood defences mentioned in the 'Fundamentals on Flood Protection' of the Technical Advisory Committee on the Flood Defences (TAW - GW, 1998):

1. dunes;
2. soil structures (dikes, dams);
3. specific water retaining structures (cofferdams, gravity walls, sheet pile walls, etc.);
4. engineering works (sluices, locks, cut-offs, storm surge barriers, pumping stations, etc.).

Flood defences in the Netherlands are legally divided into primary and secondary flood defences. Primary flood defences protect against flooding from front-line waters. Front-line waters are surface waters like seas, lakes and rivers, which are directly influenced when there is a high storm surge or high river discharge. Rivers are divided in lower and upper rivers, depending on whether they experience tidal influences from the sea, or not. Secondary (or regional) flood defences protect against high water levels of surface waters other than front-line waters.

A main principle for flood protection is that flood defences form a continuous line, including potential areas of higher land, entirely enclosing the area that has to be protected. This area is called a *dike ring area*. Flood protection also implies an

²This definition is based on (Collins World English Dictionary, 2012), (European Commission, 2007b), (USACE, 2012) and the lecture notes on Flood Defences of Delft University of Technology (Jonkman and Schweckendiek, 2016).

1

abstract system, consisting of the organisation of the operation and maintenance of the system, and the settling of safety levels and assessment methods.

It should be noted that the terms 'flood' or 'land being covered by water', which are used in the definition of 'flood defence' are not very useful for verifying the safety of flood defences, because they do not indicate the severity of a flood. Therefore, the 'risk' concept is often preferred to judge the safety of flood defences. 'Risk' considers the failure probability of the flood defence and the consequences of a flood.

The Dutch Technical Advisory Committee for the Flood Defences (*Technische Adviescommissie voor de Waterkeringen*, TAW) made a classification of flood defence structures, distinguishing function, location, type and threat per flood defence class, see Table 1.1. This classification takes the loads acting on the flood defence into account, which has consequences for the shape of flood defences.

<i>location</i>	<i>function</i>	<i>type</i>	<i>threat</i>
primary flood defences; direct retention of water			
· around the dike ring area	· protect dike ring area against outer water · separate dike ring from water with controlled water levels	· dunes · sea dikes · delta dikes · river dikes · IJsselmeer dikes · structures (locks etc.)	· sea · sea · sea and sea/river · large rivers · IJsselmeer and rivers · dependant on location
· not part of a dike ring and in between dike ring areas	· connect dike ring areas · separate water volumes	· dams · structures (locks, storm surge barriers, etc.)	· sea, river, IJsselmeer
primary flood defences: indirect retention of water			
· part of a dike ring and in between dike ring areas (sometimes with different safety levels)	· protect dike ring area against <u>indirect</u> threats of water · separate dike ring areas	· compartmentation dikes · lake dikes · structures (locks, etc.)	· sea, rivers, IJsselmeer · delta lake, Markermeer
secondary flood defences; indirect retention of water			
· inside dike ring area	· compartmentation inside dike ring areas · reduction of inundated area · escape route	· (soil) dikes · structures	· indirect water (after collapse of primary defence, polder quay, aor small river quay)
polder dikes			
· inside dike ring area	· maintain the polder outlet · protect polder areas	· (soil) quays · structures (retaining walls, etc.)	· polder waters
dikes in Limburg			
· within the Maasvallei	· protect the river forelands	· (soil) quays · structures (retaining walls, etc.)	· rivers
dikes of small rivers			
· inside dike ring area	· protection of dike ring area against water from small river	· (soil) quays · structures	· small rivers

Table 1.1: Classification of flood defences based on their role in the flood control system, in the part of the Netherlands where dike ring areas are located (TAW)

1.4 MULTIFUNCTIONALITY

This section introduces the multifunctional use of flood defences by giving a definition of multifunctionality and by presenting an overview of functions that can be combined with (regular) flood defences. It elaborates on the priority of the different functions of multifunctional flood defences and briefly mentions several risks that are introduced by combining functions in flood defences. It then focuses on the spatial dimension of multifunctional flood defences, which is especially relevant for the built environment. Several examples of multifunctional flood defences are presented in Appendix A.

1.4.1 DEFINITION AND MOTIVATION TO COMBINE FUNCTIONS

Multifunctional flood defences are structures with the primary objective to protect land from being covered by water coming from oceans, seas, rivers, lakes and other waterways, and that also serve other purposes than flood protection.

In the Netherlands, it is now attempted to combine the necessity for improving the flood defence system with the urge to improve the urban spatial quality. The improvement of existing flood defences can be necessary because of increased flood risk, caused by:

- expected increase of water levels / river discharges;
- increased economic activity;
- increased population;
- decreased risk acceptance;
- deterioration over time by weathering;
- damage due to incidents.

Improvement can be carried out as part of scheduled maintenance, preventive maintenance (after rejection during an assessment) or by repair.

The necessity of improving the urban quality is a reaction to the ideas of the Modern Movement in the 1950s and 1960s, where architects like Le Corbusier and Giedion pleaded for more spacious cities. This was accomplished by creating a new balance between large open spaces and voluminous (tower)buildings. In addition, new infrastructures were created to improve the accessibility of the cities and to improve the safety against floods. The result was the separation and destruction of many neighbourhoods by the construction of motorways, and the blocking of the relation of originally water-oriented cities with rivers or seas. It led to a deterioration of the quality of life in cities worldwide.

A counter-development can be observed since the 1980s, when new spatial concepts were developed that decreased the dominant role of large-scale infrastructures. In the Netherlands, therefore, a new type of waterfronts has been created that is well-integrated in the urban context, like the Oosterdokseiland in Amsterdam, and the Kop van Zuid and the Stadshavens in Rotterdam. Combining durable flood protection with spatial quality is crucial for all cities along rivers and seas (Meyer, 2017).

1.4.2 ADDITIONAL FUNCTIONS OF FLOOD DEFENCES

The definition of 'multifunctional flood defences' given in the previous section is very broad and implies that most flood defences can be denominated 'multifunctional'. For example, a dike with a road on its crest already is a multifunctional flood defence, because it combines facilitating road transport with protecting against flooding. Several examples of flood defences with additional functions are presented in Figure 1.1, and a few examples are more extensively described in Appendix A.



(a) sheep grazing on a dike (Termunterzijl, 2014)



(b) pedestrian path on a river dike (Tiel, 2012)



(c) wind turbines on a dike (Maasvlakte, 2011)



(d) navigation lock (Zevenhuizer Verlaat, 2005)

Figure 1.1: Examples of combined functions in flood defences

Dr.ir. Ronald Waterman (2010), a Dutch advisor on water systems, mentioned many specific functions in coastal zones, which are of great importance:

- safety;
- environment in general;
- nature;
- landscape and seascape;
- water resources management;
- energy;
- agriculture, aquaculture and fishery;
- mining and storage;
- construction sites for living and working;
- recreation and tourism;
- transfer and distribution centres and related activities;
- infrastructure;
- transport modules;
- information and communication technology;
- environment in particular (air/water/soil quality improvement);
- environment in particular (waste reduction and usage);
- government and /non-government organisations & citizen participation;
- public health and welfare, culture & history;

- education and research;
- defence, safety and security;
- economy and employment;
- finance.

Another, non-exhaustive list of additional functions that can be combined with flood protection is given below. The additional functions are grouped by the type of structures that are commonly used to fulfil these functions.

Additional functions fulfilled by hydraulic structures

Hydraulic structures can be part of flood defences.³ They have their own specific function, but also have to comply with the requirements of the flood defence. Several examples are:

- providing passage for shipping (navigation lock);
- letting pass peaks in river discharges (discharge sluice, spillway);
- disposing of superfluous rainwater (pumping station)
- providing passage for pedestrians, motorised and non-motorised vehicles (cut-off in city walls);
- enabling berthing and (un)loading of ships (quay wall).

Additional functions fulfilled by infrastructures

Another category of structures that can be combined with flood defences are infrastructures, like roads, cables and pipes. These functions are:

- transport of vehicles (roadway, railway, tramway, cycle path, pedestrian path, stair passage);
- providing rescue ways or shelter places;
- providing parking space (parking garage);
- transport of fresh or waste water (sewerage);
- transport of natural liquid gas (through-pipe);
- transport of electricity for power supply (cable);
- transport of data (copper or fibreglass cable).

Additional functions fulfilled by buildings, objects and shared use

The last group of secondary functions consists of functions fulfilled by all kinds of buildings (not being hydraulic structures) and shared use of the flood defence (like recreation, sports and nature):

- providing space for housing (house) or public activities (school);
- providing foundation for wind turbines;
- enable economic activity on the flood defence itself (office, workplace, factory, restaurant, crematory);
- providing space for putting cattle to pasture;
- providing space for farming;
- providing swimming facilities (pool);
- improving the spatial quality;

³The term 'hydraulic structure' (*waterbouwkundige constructie*) is defined in the Glossary of this book.

- enabling recreation (sunbathing meadow, benches);
- supplying drinking water (dune-water works).

Combining hydraulic structures, infrastructures and shared use in a flood defence is a quite common practice and apparently causes no specific design problems. The verification of these structures is therefore not considered in this dissertation. However, the consideration of a combination of buildings and objects with the flood defence function, is more particular. The present research therefore focuses on the combination of flood protection with buildings and objects with a high degree of structural integration, other than hydraulic structures and infrastructures. These buildings and objects are, when not combined with a flood defence, usually not intended to contribute to the flood-protecting function.

1.4.3 ON THE PRIORITY OF FUNCTIONS

It is apparent that one of the functions of a multifunctional flood defence is protecting against floods. If flood protection is a general interest, and general interest prevails over private interest, flood protection should be the primary function. This also applies, if multiple other functions of general interest are combined, and one of them is protecting against floods. It is stipulated by Dutch constitution that the concern of the government is aimed at the habitability of the low-lying country and the protection and improvement of the environment (*De zorg van de overheid is gericht op de bewoonbaarheid van het land en de bescherming en verbetering van het leefmilieu* (Article 21 of Chapter 1 of the Dutch Constitution)). The Water Act more specifically defines dike ring areas that have a normative protection level.

For example, houses of which the lower parts of the façades are intended to protect the hinterland against floods, which is denominated as 'functional integration', have flood protection as their primary function. Such houses can for example be found along the IJsselkade in Kampen and the Voorstraat in Dordrecht. The door openings of these houses and other low situated openings can be closed with 'stop logs' when high river levels have been forecast. Providing space for living is a secondary function. This at least applies to the parts of the houses designated as flood defence. Another example of a structure with two functions is a navigation lock in a canal that crosses a flood defence. A navigation lock as an engineering structure is part of the flood defence, so the flood protection should be dominant.

For the structural verification of flood defence structures, however, the discussion about the protection against floods being a primary or secondary function is not very relevant, as long as the requirements connected to the flood defence function are and remain clear and non-negotiable (because the safety levels are laid down in Dutch law). The consequence could be that, in design, secondary functions can be compromised if the primary function so requires. The design of a house can for example be altered to allow for inspection of its water-retaining walls if it is part of a flood defence.

1.4.4 RISKS CAUSED BY COMBINING FUNCTIONS

The design and administration of multifunctional flood defences is a complex process, because:

- multiple functions have to be combined;
- possibly different spatial scale levels come together;
- the design life time can vary per function;
- secondary functions can change in time;
- the actual development of secondary functions (urban growth) is often not planned at all;
- different laws are applicable to multiple functions;
- different authorities are involved, causing much bureaucracy;
- the safety level of the flood defence function can change in time;
- the method of evaluating the safety can change in time;
- loading conditions change in time;
- many stakeholders and possibly more than one client are involved;
- agreements on responsibilities and finance are not standard;
- there are different design cultures combined;
- different construction codes apply;
- there are many criteria to evaluate and compare design alternatives.

This complexity introduces more risks for multifunctional flood defences, compared to regular flood defences. Multifunctionality, namely, often implies 'multi-structurality' which, from a technical point of view, is more complicated. A complex of structural elements does not only have to resist external loads, but the structural elements mutually influence each other in a mechanical way. This could have a negative impact on the strength or stability of the flood defence and thus, possibly, lead to failure of the flood defence if this has not been sufficiently taken into account in the structural design. Furthermore, the construction of multifunctional flood defences is likely, but not necessarily, more complicated than of regular flood defences: there are more different structural elements that have to be connected. Higher complexity leads to higher risks.

Another risk is introduced by designers without experience with hydraulic structures. Designers of parking garages, for example, could easily forget seepage screens if these parking garages have to protect against floods. Another example: just the possibility of installing bulkheads in door openings is not sufficient to make houses suitable as flood defences: considerable horizontal forces will be caused by the high water level and the properties of the subsoil should be taken into account, as seepage water could easily flow around the houses or into their cellars if the subsoil is too permeable. Additional measures will then have to be taken to stabilise these houses and to prevent seepage, which was the case in the city of Dordrecht, see Section A.1.

Risks can also be caused by the operation and use of multifunctional structures: If responsibilities are not clearly and correctly defined, wrong decisions are likely to occur. Also, the neglect of the flood defence function, because of the presence of

'competing' functions and interest of the owner or operator, is a risk. The factor time plays an important role here. Responsibilities can be initially be arranged very well, but after some time (decades), the ownership can change without transfer of the awareness of the responsibilities. Examples of this risk are two restaurant owners: one, in the town of Vlissingen, started digging a wine cellar without being aware that his restaurant was part of a primary flood defence; another restaurant owner, in the town of Harlingen, drilled holes in the flood defence wall for water pipes for a new toilet group.

Another additional risk is that maintenance and inspection can be hampered by the secondary use of flood defences. Creating possibilities for inspection and maintenance should be part of the design process, but changes in attitudes over time of involved groups could have a negative impact on these aspects. For example, as house ownership succeeds, the awareness of living in a flood defence could diminish.

The above mentioned risks of multifunctional flood defences can be dealt with in the design or in the maintenance and operating procedures. Lowering risks, however, often implies increasing the costs.

1.4.5 SPATIAL INTEGRATION

Urban planning concepts of multiple land-use usually refer to situations of intensively used space (Hooimeijer et al., 2001). This can be achieved by morphological integration of functions (stacking of multiple functions in one building or structure), by combined use of space (multiple functions in a certain defined area) and by temporarily shared use of the same space. The degree of spatial integration used in this dissertation is based upon a classification by Ellen et al. (2011), modified by Van Veelen et al. (2015), who distinguished four spatial dimensions of multifunctionality that can be used to evaluate the degree of spatial and functional integration:

1. Shared use: A flood defence structure is (temporarily) used by another function, without any adjustments to its basic structure. It is, generally quite well possible to use the flood defence for infrastructure, recreation and farming, as long as the functioning and shape of the flood defence is not altered. The main effect of the secondary function regarding the flood defence is that it poses extra loads.
2. Spatial optimisation: The basic shape of the flood defence is adapted to create space for other structures. These structures are technically spoken not part of flood defence structure. Spatial optimisation is found in many places in the highly urbanised areas of the Dutch delta. The most compact shape is obtained if a vertical retaining wall is applied, which replaces a dike slope or berm, leaving space for, e.g., housing.
3. Structural integration: An object is built on, in or under the flood defence structure, but does not directly retain water. The concept of structural integration is used in situations where the current dike is 'over-dimensioned' (super dike) or many times stronger than necessary (concept of 'unbreachable' dike).

4. Functional + structural integration: The water-retaining element of the flood defence also functions as a part of the structure with another function (the 'object'). Although this concept is technically feasible, it is hard to find realised examples of full integration. There are some historically evolved situations in which the dike is part of a medieval city wall (Kampen) or of a row of old buildings (Dordrecht).

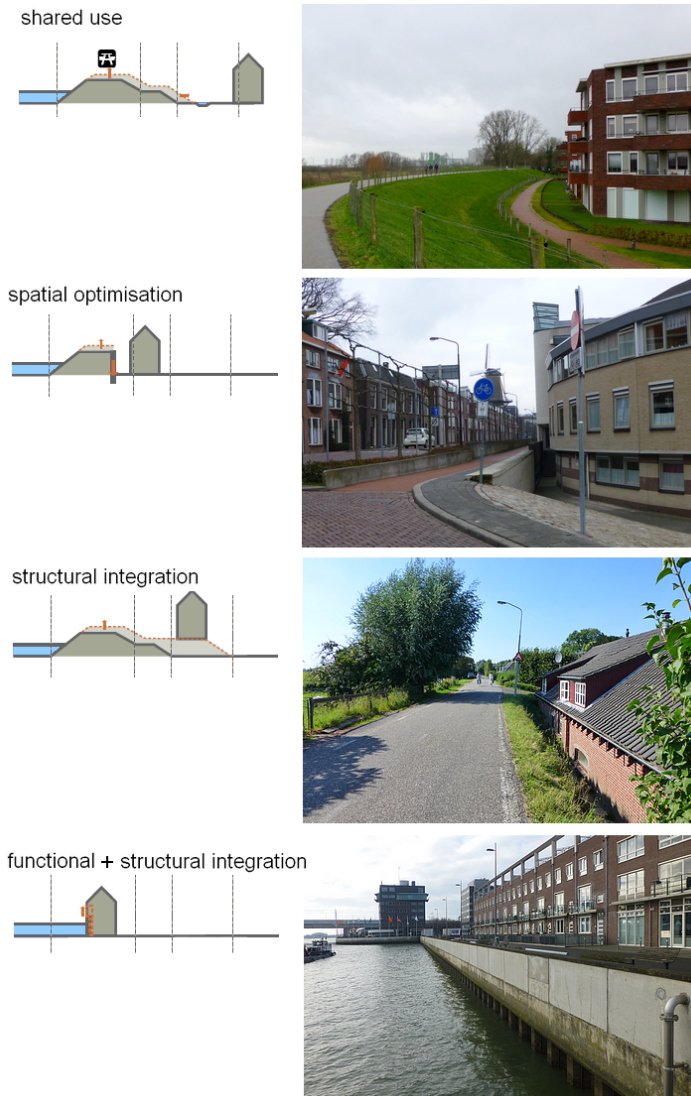

Figure 1.2: Degrees of spatial integration according to Van Veelen et al. (2015): Wageningen (2013), Dordrecht (2013), Herwijnen (2012), Zwijndrecht (2017)

The degrees of integration are illustrated with Figure 1.2. The picture of 'shared use' is of the Grebbedijk near the town of Wageningen, along the Nederrijn river, where the apartment blocks are located at some distance behind the dike, so they are not integrated. The road, however, is located on the crest of the dike and it causes extra loads on the dike body. The example of 'spatial optimisation' is the Noordendijk in Dordrecht, where houses are located on both sides of this dike and the Wantij river is on the left side. The slope of the dike on the right side has been replaced by a vertical wall, allowing the row of houses to come close to the dike crest.⁴ An example of 'structural integration' is given by a dike house along the Waal, near the town of Herwijnen. The parking garage under the quay in the town of Zwijndrecht along the Oude Maas could have been a good example of 'functional integration', as one of the walls of the garage is combined with the quay wall, but the formal primary flood defence, a dike, is located about 150 metres behind the quay. This implies that the area between the quay and the dike does not have to meet the safety standard of the adjacent dike ring area. Details of the dikes in Dordrecht and Zwijndrecht are explained in Appendix A.

The main generic conclusion of the paper of Van Veelen et al. (2015) is that the method can be helpful to both urban planners and hydraulic engineers to develop a mutual understanding of the various interests from a flood management and spatial development perspective. Because of the design-based classification, the method can be applied to discuss spatial integration of multifunctional flood defence structures in different governance contexts.⁵

⁴This only applies to the first houses on the side of the city centre. For the largest part, the Noordendijk is an example of 'functional' integration, see Appendix A.2.

⁵This section mainly comes from a book chapter by Van Veelen, Voorendt and De Zwet, 2015.

1.5 PROBLEM, RESEARCH OBJECTIVE AND METHOD

1.5.1 PROBLEM DESCRIPTION

In practice, only a few examples can be found of fully integrated multifunctional flood defences, which is a result of avoiding conflicts instead of solving them. To mention just a few examples:

- Düsseldorf (Germany): The tunnel parallel to the flood defence along the Rijn river (see picture on the cover page) is not structurally combined with the quay wall;
- Katwijk aan Zee (the Netherlands): A parking garage along the beach has not been integrated with a new sea dike, although some of the design alternatives offered such a possibility (see section 6.1);
- Rotterdam (the Netherlands): The dike next to the 'roof park' is structurally separated from the shopping/parking complex, although it visually looks integrated (see section 6.2);
- Tokyo (Japan): A floating barrier-wall protects a modern building front along the Sumida river, but this protection could have been integrated into the buildings themselves.

The main problem is that water boards and other authorities are reluctant to combine flood defence with other functions, because they do not want the primary function to become threatened. Therefore, there have to be clear agreements on responsibilities between involved parties if functions are combined. These governance aspects are a main problem for the realisation of multifunctional flood defences.

Because of the complexity of the design task and the multiplicity of involved stakeholders, an integrated design approach is required for multifunctional flood defences. The multidisciplinary of the design team brings different design cultures together. It is not clear what design method would be most suitable. In addition, the composition of multifunctional flood defences is more complex and diverse than of flood defences in general. Therefore, the verification of the safety of these structures is an important design aspect, but it is questionable whether the usual approach is suitable to multifunctional flood defences as well.

1.5.2 RESEARCH OBJECTIVE

The main research objective is therefore to find an integrated and sustainable design method that is suitable to multifunctional flood defences and, in addition, more specifically answers the question how the safety of these structures should be verified.

The present dissertation focuses on the combination of flood protection with buildings and objects, other than engineering structures and infrastructures, with a high degree of structural integration. These buildings and objects are usually, when not combined with a flood defence, not intended to contribute to the flood-protecting

function. The research focuses on the Netherlands, because of its advanced flood protection strategy, the availability of knowledge and the accessibility of data.

Governance aspects are not part of the research objective of the present dissertation. They are covered in another project of the research programme on the 'integral and sustainable design of multifunctional flood defences' (see the Preface).

1.5.3 RESEARCH METHOD

The integrated and sustainable design of multifunctional flood defences is usually part of a more comprehensive strategy to reduce flood risks, formalised in regional, national or international policies. These strategies are heavily influenced by society and have an direct and indirect impact on the design of flood defences. Design projects for the realisation of flood defences usually implement a more comprehensive strategy to reduce flood risks. A design for multifunctional flood defences therefore has to take multiple interests into account. Because multifunctional flood defences deviate from regular flood defences in appearance and structural complexity, the verification of the safety of these structures requires special attention.

Thus, the verification is part of the design process and the design process is the implementation of a flood risk reduction strategy. The research objective is therefore translated into three research questions:

1. What issues determine the chosen strategy for flood risk reduction in the Netherlands?
2. What method can best be used for the integrated and sustainable design of multifunctional flood defences?
3. How should design concepts of multifunctional flood defences be verified (concentrating on the flood-protection function)?

The first research question is answered by a literature review on the Dutch history on flood protection, to understand the context in which flood defence design projects are executed. Recent societal developments that influence the flood protection policy are included in this study, for which some new explanations from the fields of psychology and sociology are explored. The second question, what design method would be suitable, is answered by studying the literature on design methodology and by devising a method that acknowledges the advantages of the engineering method and the spatial design approach. The proposed method is validated by way of a pilot, carried out by student groups. The third research question, on the verification, is answered by describing the usual verification of flood defences, studying potential shortcomings and finding a way to fill this gap. The proposed verification method is then validated with several cases from the field.

1.6 OUTLINE OF THIS DISSERTATION AND READING GUIDE

1.6.1 OUTLINE OF THIS DISSERTATION

The main objective of this dissertation is achieved by answering the three research questions that have been derived from this objective.

Chapter 2 of this dissertation answers the first research question (What determines the chosen strategy for flood risk reduction?). It describes the strategy of reducing flood risks in the Netherlands over time and includes a description of the societal developments that have influenced this strategy.

To find the answer to the second research question, regarding a suitable design method, Chapter 3 first describes the current approaches of engineering and spatial design. Chapter 4 combines the advantages of the spatial design and engineering approaches into an integrated design method. The proposed method is based on experience gained from working with and supervising students, and from discussions with professional hydraulic engineers and landscape architects. This chapter explicitly links the present research project with the over-all STW research programme (see Preface).

The third question, regarding the verification of multifunctional flood defences, is answered in Chapters 5 and 6. Chapter 5 first describes the verification of the safety of multifunctional flood defences. A method for an explicit *qualitative structural verification* is developed, which should precede a *quantitative structural verification*, for which points of attention that are specific for multifunctional flood defences are explained.

The method of qualitative structural verification is validated in Chapter 6, where different design concepts are developed for four cases. Finally, conclusions are drawn and recommendations are given in Chapter 7.

1.6.2 READING GUIDE

This dissertation covers a wide range of topics related to the design of multifunctional flood defences. The reading guide is intended to direct readers to relevant parts of this dissertation. All seriously interested readers are recommended to at least read the summary, the introduction (Chapter 1) and the conclusions & recommendations (Chapter 7).

Readers that are familiar with the past and present Dutch strategy of flood risk reduction can skip Chapter 2. However, several sections of that chapter could still be interesting, especially the section dealing with the development of the flood safety standard by the Delta Committee and the section covering the period until that safety standard was adopted in the Dutch law in 1996 (Sections 2.4, 2.5 and Appendix B).

People who are mainly interested in the overall design process are recommended to read Chapters 3 and 4. Those who are also interested in the verification of the safety

of multifunctional flood defences should read Chapter 5, and Appendix E as well if they are not familiar to the method of verification of regular flood defences. Chapter 6 is interesting for those who would like to see a demonstration of the verification method, applied on real cases of multifunctional flood defences.

Much existing knowledge has been presented in a concise way in this dissertation, clearer than in other sources, such as the description of the establishment of the safety level during the last century (Sections 2.3 through 2.5) and the explanation of the three ways of reasoning of the Delta Committee to find an allowable critical water level of NAP + 5,00 m at Hoek van Holland (Appendix B. New are the description of the integrated design method (Chapter 4), the recommended sequence of structural verification steps (Section 5.3.2), as well as the introduction of a qualitative structural verification (derived in Chapter 5, and validated in Chapter 6).

An overview of the changes in the Dutch Water Act per 1 January 2017 can be found in Section 2.6.4 and Appendices D.5 and E.7.

Several specific hydraulic engineering terms and acronyms are defined in the Glossary at the end of this book, before the References.

2

THE DUTCH FLOOD RISK STRATEGY

This Chapter sketches the main development of the flood defence system in the Netherlands from early history until now. It describes what has determined the chosen strategy for flood risk reduction in the Netherlands during the centuries. Early attempts to protect the Netherlands against floods are described first, followed by developments in the study of hydraulic loading and soil properties. The storm surges of 1916 and 1953 induced the Dutch government to improve the flood protection level, for which a more scientific approach was chosen than in earlier centuries. This resulted in sophisticated flood protection philosophies for the Southern Sea Works, the Delta Works and the flood protection system after completion of these works. After publication of the Delta Report in 1960, it took until 1996 until the flood safety level was incorporated in a law. During that period, several river committees studied the safety policy, resulting in advices that, to a greater or lesser extent, influenced the flood risk strategy. Because of societal changes, values of landscape, nature and culture became more prevalent in the flood protection policy since the 1970s. This drastically influenced the flood protection strategy. In 2007, the Dutch Government installed the Veerman Committee that gave advice on the future flood protection strategy, taking into account recent climate change scenarios. The latest developments, such as the national assessment of primary flood defences, the multi-layer flood safety and the change towards a flood risk approach, are described as well.

Several books extensively describe the history of flood protection in the Netherlands, like Van de Ven (1993), Huisman (2004), Ten Brinke (2007), Burgers (2014) and Meyer (2016), but in this dissertation the particular focus is on the establishment of the safety level during the last century (Sections 2.3 through 2.5). Three ways of reasoning to find an allowable critical water level of NAP + 5,00 m at Hoek van Holland are described in Appendix B. This is done more extensively than in other literature, as far as known to the author of this dissertation. It should be remarked beforehand that the division of the historical developments in periods is artificial, because developments are gradual and partly occur simultaneously.¹

¹An earlier version of this chapter has been published as a technical report 'The 'Development of the Dutch flood safety strategy' (Voorendt, 2015b).

2.1 EARLY HISTORY UP TO THE END OF THE MIDDLE AGES

The Netherlands are located in a deltaic area where the rivers Rijn, Maas, Schelde and Eems flow into the North Sea. Sea, rivers, and land have formed a dynamic system, which since early times ever more interfered with the spatial and occupational ambitions of the inhabitants of the low countries, as population increased. The inhabitants of the low countries had to cope with regular floods and the resulting loss of goods and lives. The first inhabitants of the Frisian land (in the north of the Netherlands) therefore settled down on higher plains, but this came to an end when, due to climate change, these plains flooded ever more frequently.

In the first century AD Pliny the Elder, a Roman magistrate and natural philosopher, visited the Netherlands and characterised a pitiful country, where

... two times in each period of a day and a night, the ocean with a fast tide submerges an immense plain, thereby hiding the secular fight of the Nature, whether the area is sea or land. There this miserable race inhabits raised pieces of ground, or platforms, which they have moored by hand above the level of the highest known tide. Living in huts built on the chosen spots, they seem like sailors in ships if water covers the surrounding country, but like shipwrecked people when the tide has withdrawn itself, and around their huts they catch fish which tries to escape with the expiring tide. It is for them not possible to keep herds and live on milk such as the surrounding tribes. They cannot even fight with wild animals, because all the bush country lies too far away. (Gaius Plinius Secundus, 78)

As a result of the recurring floods, from the sixth century BC, many people moved to higher land areas like the 'Drents Plateau', or started to build mounds (*terpen* in Dutch), to elevate their dwellings to a height less prone to floods (Figure 2.1). The artificial mounds were usually not more than four or five metres above average sea level, but the highest mound, Hogebeintum in Friesland, was about 8,80 m above average sea level. Incidentally more rigorous measures were attempted: already in the first or second century BC, at the Frisian town of Peins (in the municipality Franeker), a dike was constructed of which a 40-meter section was discovered recently. Around 1000 AD, dikes started to be constructed on a larger scale to protect larger areas of land. For example, the first parts of the 'Slachtedijk' in Friesland, a 42 km long sleeper dike between Oosterbierum and Rauwerd (a small town on an artificial mound), were constructed before 1000 AD. This dike was for a large part constructed on higher land areas, for which permission from the land owners was required (Staatsbosbeheer, 2016). Monasteries, like in Aduard (in the province of Groningen), founded in 1192, often organised the construction of these first dikes to protect their estates (Bosker, 2008).

The inhabitants of small towns and hamlets also started to cooperate to manage the water. The first known collaboration of this kind was in Utrecht, around 1122, where twenty towns worked together to dam the Kromme Rijn near Wijk bij Duurstede. This collective was in 1323 institutionalised in the *Hoogheemraadschap van den*

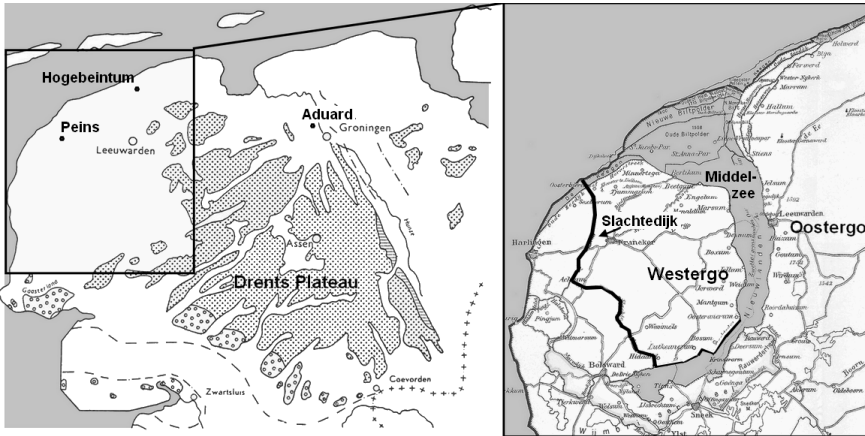

Figure 2.1: Modern map of Friesland and Groningen with the Drents Plateau (left, from www.regiocanons.nl) and a map of Friesland indicating the former Middle Sea (right, from www.geheugenvannederland.nl)

Lekdijk Bovendams ('Water board of the Lek dike upstream of the dam'). The first water board, the *Hoogheemraadschap van Rijnland*, was meanwhile founded in 1255 by Count William II of Holland. Inhabitants of embanked areas were obliged to financially contribute to the construction and maintenance of dikes.

Since about 1250, a growing number of water boards (*waterschappen* and *hoogheemraadschappen* in Dutch) were organised to coordinate the farmers who were responsible for the maintenance of the dikes and water courses. The regulations for farmers and landlords were established in farmstead systems (*verhoefslagstelsels*), by-laws (*keuren*) and ledgers (*leggers*). Farmstead systems contain regulations about the apportionment of dike maintenance responsibilities. By-laws are collections of legal regulations applying to rivers, brooks, ditches and flood defences that are administered by the water board, but also by other parties. Ledgers are legal documents that contain information on the functional requirements and maintenance duties regarding hydraulic works like water courses, flood defences, catchment areas and corresponding structures. They also contain specific information on the status of channels and flood defences, dimensions and shapes of hydraulic works, position and dimensions of maintenance strips and protecting zones along water courses and flood defences. These regulations generally implied that the land owners were responsible for the maintenance of the dikes on their properties and for maintaining the required crest level. They were also responsible for the revetments on the dikes and have the materials in stock necessary for these scour-protecting measures in stock. By-laws and ledgers are legal documents up to now and are complementary to the present Water Act (Dubbelman, 1999).

The control of water quantities was not only required to protect against high water levels of the sea, lakes or rivers, but also to reduce the consequences of the exploitation of peat lands. Peat was excavated in large amounts for salt production and fuel.

Initially, back quays (*achterkades*) were constructed to prevent water intrusion in the excavated parts of land from higher, not yet exploited, land, but good dewatering caused settling of the peat. Therefore, ditches and streams had to be dug deeper, but in the long term this did not sufficiently help and dikes and dams with sluices were constructed. In the province of North Holland, many small dikes were constructed to protect against the intruding sea and bank erosion of lakes. This led to construction of the 100 km long West Frisian Circle dike (*Westfriese Omringdijk*), which was completed around 1250. The West Frisian Circle dike did not only function to protect against floods, but it was also an important road connection. In the second half of the 13th century, Count Floris V improved the organisation and coordination of dike maintenance in the province of North Holland, but did this not last due to political unrest. However, he was more successful with the decision to enclose the Alblasserwaard polder in the province of South Holland by dikes in 1277, which was the start of the 'Hoogheemraadschap van de Alblasserwaard' water board. The situation in the province of North Holland only improved when William III of Holland ruled this part of the Netherlands. He also gave orders to protect the town of Staveren (in the province of Friesland) with a dike (1325), followed by Duke Albrecht of Bavaria who, in 1398, initiated construction of the sea dikes around Oostergo and Westergo, two regions ('*gaue*') west and east of the Middle Sea (*Middelzee*, or *Boorndiep* in Dutch), which was an estuary mouth now in the province of Friesland (Figure 2.1) (Beenakker, 1991; Van Buijtenen and Obreen, 1956).

Despite all these efforts, flood defences failed regularly, as in 1164 (Saint Juliana's Flood, about 20 000 fatalities), 1362 (Marcellus Flood, 25 000 to 40 000 or even more fatalities), 1421 (Saint Elisabeth's Flood, one of the most well-known floods, but 'only' about 2000 fatalities) and in 1570 (All Saints' Flood, more than 20 000 fatalities) and 1717 (Christmas Flood, more than 14 000 fatalities). However, the measures to protect against floods had two main consequences that counteracted their effectiveness. Firstly, the construction of river dikes caused a narrowing of the river beds, which impeded the deposition of fine sediments in wide floodplains, but intensified sedimentation of the riverbed. This negatively impacted the navigability of the rivers, but also caused higher water levels, thus increasing the flood probability of the areas behind the dikes. Secondly, the dikes along estuaries influenced the propagation of high water levels from the sea, thus causing an increase of the water levels along the dikes. Deep scour channels originated with steep slopes next to the dikes and the threat of liquefaction endangered the dikes as well (Buisman and van Engelen, 2000; Dubbelman, 1999).

Moreover, the effectiveness of the measures to protect against floods was also hampered by a lack of cooperation of neighbouring polders, due to self-interest and the lack of long-term interests. The result was that the solutions for one area became the problems of another area. Furthermore, land-owners were not always willing to spend their money and efforts on improving dikes, which on a short term interfered with their economic activities, especially when they felt no urgency to protect against floods after a period with no critical water levels. Therefore, a strong exercise

of power was needed to make the flood protection measures effective. However, not all rulers had an equal interest in flood protection and sometimes a change of ruler implied a discontinuation of the existing strategy. There were often disputes between municipalities and water boards. Furthermore, regular lack of financial funds, inadequate technology, insufficient knowledge and incapable administrators did not help very much in achieving a good flood protection (Dubbelman, 1999).

The traditional Dutch design of flood defences, dikes specifically, was based on locally available construction materials and on experience. The crest height of dikes and other flood defences was based upon the highest observed water level, adding a half or one metre to determine the design crest height, and an additional freeboard if these flood defences were exposed to wave attack. The geometry depended on the available construction materials, the properties of the subsoil, the characteristics of the water impact and local practice.

The state of the profession of dike construction has been documented in a well-known, but unfinished, book by Andries Vierlingh (1578). Vierlingh was a superintendent who became dike warden (*dijkgraaf* in Dutch) in the Dutch province of Brabant. He was involved in the dike construction of the Klundert, a small peat river in Brabant near the town of Steenberg, and supervised several land reclamation and coastal protection works. Apparently, he was quite successful because his advice was sought from several other provinces as well. The required expertise comprised reclamation works (for instance of the Zijpe river in the province of North Holland), lock construction, bank protection works as well as dike breach closure (near the town of Middelburg in the province of Zeeland) and dike construction around polders. His dike design approach was based on practice and did not have a physical background. Based upon experience, Vierlingh remarked that the height of a dike was crucial for its functioning (... *de meeste salicheijt hanght aen de hoochte van eenen dijck*) and that gentle dike slopes cause less wave run-up than steep slopes. Figure 2.2 shows two illustrations from this book: a cross-section of a dike with clay coffers and a cross-section of a submerged dam (actually, a 'groyne') with flow lines, demonstrating how erosion holes would develop and cause this dam (perpendicular to an estuary dike) to be unsuitable to reclaim land (Vierlingh, 1578).

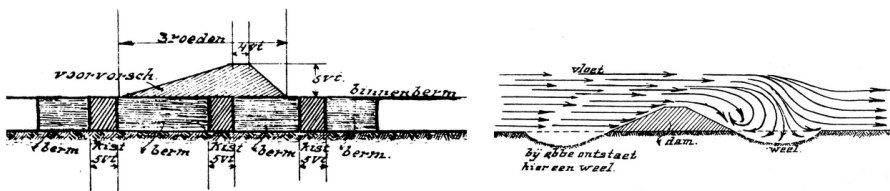

Figure 2.2: Two illustrations from the book of Andries Vierlingh

2.2 TECHNOLOGICAL ADVANCES FROM 1600 TO 1800

Because the traditionally constructed dikes, as described above, failed regularly, attempts were undertaken to improve dike designs by studying the loads acting on the flood defences (first by studying water levels and later also wave heights) and by better estimation of the resistance of flood defences against these loads by studying the properties and the behaviour of soil. Systematic research of material properties and hydraulic conditions improved the estimation of the reliability of flood defences, resulting in more accurate designs. Thus, the first numerical insights in the Netherlands were gained by Nicolaus Cruquius (Nicolaas Kruik, 1575-1650), who became well-known as a land surveyor, cartographer, astronomer and weatherman. He was a pioneer of hydraulic research, because he wanted to compare the water levels in the polders with the height of the dikes and the mean sea water level, which were measured by him. He was the first to visualise water depths with contours of depth (isobaths), as can be seen in his map of the Merwede river (Van der Ham, 2003b; Cruquius and Geurts, 2006).

The reclamation of low lands was boosted by the invention of the wind mill. The first wind mill in Holland was probably built near the town of Alkmaar by Floris van Alkemade and Jan Grietensoon in 1408. Wind mills, propagated by famous Dutch hydraulic engineers like Jan Adriaansz. Leeghwater, Simon Stevin and Jan Anne Beijerinck, were applied by the water boards, sometimes in a series of two or three to reach the discharge head, required to remove the water out of a polder via belt canals (the maximum discharge head per wind mill is about 1,5 m). The head per wind mill could be increased up to four or five metres by applying Archimedean screws instead of paddle wheels. In spite of these improvements, there was still a need for more powerful machines, which were also less dependent on fluctuating wind velocities.

The Dutch universities of that time had acquired a good reputation, but did not aim at applying their knowledge for direct use by society. Amateur physicists therefore filled this gap by organising themselves in societies aiming at solving topical and urgent problems. The first of these societies, the Holland Society of Sciences (*Hollandse Maatschappij der Wetenschappen*), was founded in 1753. This society regularly held contests on issues related to physics, chemistry, geology, biology. Contests on hydraulic engineering problems were very frequent, but the response was very disappointing in terms of quantity and quality (Meyer, 2016). The Batavian Society for Experimental Philosophy (*Bataafsche Genootschap der Proefondervindelijke Wijsbegeerte*), founded in 1769 in Rotterdam, stimulated the improvement of the technology for draining low-lying areas.² The Batavian Society initiated the construction of a steam pumping station, working according to the principles of Boulton and Watt. It was imported from England and successfully tested in Blijdorp

²This society was founded by Steven Hoogendijk and funded with his fortune after he had passed away. The society stimulated advances in science by awarding medals for answers to prize questions. Influential members of this society were Cornelius Nozeman, Cornelis Kraijenhoff, Carel Joannes Matthes, Pieter van Bleiswyk (see Section 2.3) and Frederik Willem Conrad sr. The society was presided from 2015 to 2016 by my promotor, prof.dr.s.ir. Han Vrijling, emeritus professor in Hydraulic Engineering.

near Rotterdam in 1787. Steam engines then gradually became more popular and with the help of three of these powerful engines, even the ever expanding lake of the Haarlemmermeer could be reclaimed³ (Figure 2.3) (Van der Ham, 2003a).



Figure 2.3: Steam pumping station 'The Cruquius', the biggest steam engine on Earth, 2015

Cities in the Dutch delta frequently had to solve the conflict of interests regarding the discharging regime in the polder between citizens and farmers. The citizens desired regular refreshment of the canals that also served as sewerage systems and prevented sedimentation of the harbours that required a fluctuating water level behind the discharge sluices. The farmers, on the other hand, benefited from a constant water level that would prevent their lands to become either too marshy or too dry. These conflicts were difficult to solve and sometimes led to sabotage. In several towns it was therefore decided to construct the city hall on the dam, including a police office and a jail, and to construct a discharge reservoir as a buffer. Additional conflicts were caused by the question who should pay for the discharge sluices, reservoirs and harbour canals, because of the double function of these city harbours: providing space for the berthing of ships and simultaneous discharging of polders. Overall, it can be concluded that the urban development in the Netherlands was heavily influenced by the interrelation between the dynamics of the natural water systems and the dynamics of society. The increasing problems of control over water, including flood protection, resulting from a growing complexity, could finally not be solved on a local scale and had to be dealt with on the national level.

Meanwhile, many efforts were undertaken to improve the flood protection and

³In the twentieth century, most wind mills and steam pumping stations were replaced by diesel and electrical pumping stations.

navigability of the Dutch main rivers. They were wide and shallow and contained many sandbanks. Initially, the lack of central leadership and the lack of technical tools, like dredgers, hampered the desired improvements. Only in the first half of the eighteenth century, the Pannekoek Canal has been dug, which directed more water from the Bovenrijn river to the Benedenrijn river. The Bijlandsch Kanaal, which was constructed in 1771, has led to the present situation, where two third of the Rijn river discharge is diverted through this canal towards the Waal river.

These, and other, measures did not yet adequately improve the flood safety, because the discharge of water and ice remained main concerns. The problem with ice was that shoals clogged together, creating dams that obstructed the discharge of river water, leading to increased water levels behind de dams resulting in flooding of land behind the dikes. River management was not regulated at that time, which led to a variety of measures to utilise the floodplains between summer and winter dikes. This caused obstruction of the river flow at several locations. About 500 breaches of river dikes took place in the 18th and 19th century, sometimes leading to floods stretching from Lobith to Alblasterdam and from Arnhem to 's-Hertogenbosch.

Therefore, to improve the water management in the Netherlands, the Bureau for Water Management (*Bureau voor de Waterstaat*) was founded in 1798 (the predecessor of the present Rijkswaterstaat). This institute provided the condition for planning the required improvements at a national level. Furthermore, Louis Napoléon Bonaparte, who ruled the Netherlands from 1806 to 1810, instated a Royal Advisory Committee in 1809, which has led to a few short-term measures. To improve navigability of the Rijn river, the Central Commission for Navigation on the Rijn was founded in 1815 as an outcome of the Congress of Vienna after the defeat of Napoléon Bonaparte. The Commission proposed several measures for improvement, but they did not result in the desired break-through in the problematic river management and flood safety. The breakthrough only happened in 1850, when Johan Rudolph Thorbecke, Prime Minister of the Netherlands, ordered a major improvement of the big rivers and dredging of river mouths towards the sea (like the Nieuwe Merwede, the Nieuwe Waterweg and the Bergsche Maas). The efforts to reduce flood risks were counteracted by building residential and industrial areas in the winter beds of the rivers, whether or not followed by diking the summer beds of the rivers to reduce the flood risk of the newly built areas. This can be attributed to a faulty spatial planning policy in which long-term effects were not sufficiently taken into account.⁴

To enable shipping throughout the year, major river improvements were carried out since the second half of the 19th century. They consisted of *regulation* of the winter bed, to achieve a constant gradient in the water level and constant flow velocities during high discharges, and *normalisation* of the summer bed, mostly by the construction of groynes and training walls. When these measures did not suffice during low discharges in summertime, rivers were *canalised*, by constructing fixed or moveable weirs and navigation locks. Shipping over the Maas river in the province

⁴According to Berlamont (2001), the situation in Flanders did not differ much from the Netherlands in this respect.

of Limburg improved by the construction of the Juliana canal, including three sets of navigation locks, and several weirs and short-cuts of river bends. Together with the diking of the summer beds, these measures, however, have led to an increase of the downstream flood risk (Burgers, 2014; Metzelaar, 1979; Van de Ven, 1993; Meyer, 2016).

2.3 SCIENTIFIC ADVANCES FROM 1800 TO 1950

Pieter van Bleiswyk (Grand-pensionary, the most important civil servant of the estates, of the County of Holland), wrote his dissertation at Leiden University in 1745 in the Latin language (titled *Specimen Physico Mathematicum inaugerale de Aggeribus*). This is the first known dissertation of treating the design of dikes on the basis of a scientific approach. Van Bleiswyk reasoned that the acting water pressure should be resisted by a reactive load from the embankment, equal in magnitude but opposite in direction. However, he did not have knowledge of the numerical relation between vertical and horizontal soil pressures. His work was of high importance to the awareness of the people involved in the design and maintenance of dikes. However, the Latin language was an obstacle for many people, so dr. Jan Esdré translated this work into Dutch and gave it the title *Natuur-en wiskundige verhandeling over het aanleggen en versterken der dyken* (Physical and Mathematical dissertation on the construction and reinforcement of dikes) and expanded it with clarifications and exemplifications. The translation was published 32 years after the original version, in 1778. Two illustrations of this work are depicted in Figure 2.4 (Van Bleiswyk, 1778).

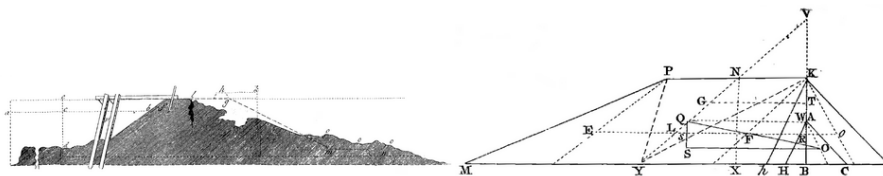

Figure 2.4: Two illustrations from the dissertation of Van Bleiswyk (1778)

It was the French engineer Charles Augustin de Coulomb who further developed the theory on the quantification of soil pressures. In 1773 he addressed the Academy of Science in Paris with an essay *sur une application des regles des maximis et minimis a quelques problèemes de statique relatifs a l'architecture*.⁵ He introduced the concepts of active and passive soil pressures (Coulomb, 1776). At that time, the friction concept was known thanks to engineers like Sébastien de Vauban, Pierre Bullet, Bernard de Bélidor and Pierre Couplet des Tortreaux. Coulomb added the cohesion term. Later on, the theory was expanded by William Rankine for soil at motion, by József Jáký for soil at rest and by Heinrich Müller-Breslau and Fritz

⁵'On the application of the rules of maxima and minima to certain statics problems relevant to architecture.'

Kötter to include wall friction and slanting walls (Rankine, 1857; Jáky, 1948; Kötter, 1903; Müller-Breslau, 1906). Studies of soil mechanics in the Netherlands, boosted after the collapse of a railway embankment in Weesp, advanced the knowledge on dike design.⁶ In 1934, this eventually gave rise to the establishment of the Dutch Laboratory of Soil Mechanics in Delft, which is now part of Deltares. The initiative for the foundation of this research institute, specialised in studies of soft soils, came from the Delft professors Albert Keverling Buisman and Gerrit van Mourik Broekman.

Improvement in the estimation of loading was achieved by studying the characteristics of water loads. Mathematicians like Daniel Bernoulli, Leonhard Euler, Jean-Baptiste le Rond d'Alembert and Pierre-Simon Laplace obtained results in the field of hydrodynamics that are relevant up to present date. These results, however, were purely mathematical and had major restrictions for the application to real problems. Hydraulicians like Robert Manning (flow resistance in pipes), Antoine de Chézy (flow in pipes and open channels), Jules Dupuit and Henry Darcy (both groundwater flow) obtained more useful results, albeit by using empirical methods. This empiricism was gradually combined with theory, initially by model tests where certain aspects could systematically be studied. The relation between scale models and reality was further studied by scientists like William Froude, Osborne Reynolds and Ernst Mach.

Because of the ever expanding scientific knowledge, the design of flood defences has been much improved over the last century in the Netherlands. The major floods of 1916 and 1953 boosted the technological and political developments. The first event, the flood of 1916, together with the desire to increase agricultural production after the stagnation in food supply during the First World War, prompted construction of the Zuiderzee Works, including the Afsluitdijk closure dam.

Cornelis Lely, Dutch civil engineer and later minister, already led a technical research team that studied the possibility of closing-off the Zuiderzee between 1886 and 1891. The result of this study was a plan to close-off and partially reclaim the Zuiderzee. It was a large project for which finances were still lacking. In 1913, Lely as a third time Minister of Transport and Public Works used his position to push the Zuiderzee Works through the parliament and gained support from other politicians after the 1916 flood. Several plans to enclose the Zuiderzee were then developed (like the plan for a proposed law in 1907, as depicted in Figure 2.5). In 1919, the *Dienst der Zuiderzeewerken* (Zuiderzee Works Department), a new governmental body, became responsible for supervising the construction and initial management.

A scientific approach was chosen for the design of the Afsluitdijk. A state committee studied the expected influence of the future dam on the tidal flow, storm surge levels and wave run-up along the coasts of the provinces of Noord Holland, Friesland, Groningen and the West Frisian Islands. The committee was instated in 1918 by

⁶In 1918 a passenger train derailed near Weesp, because of liquefaction of the railway embankment towards the Amsterdam-Rijn canal over a length of 95 m. This was caused by the extensive rain in the preceding time and the poor state of the railway embankment.

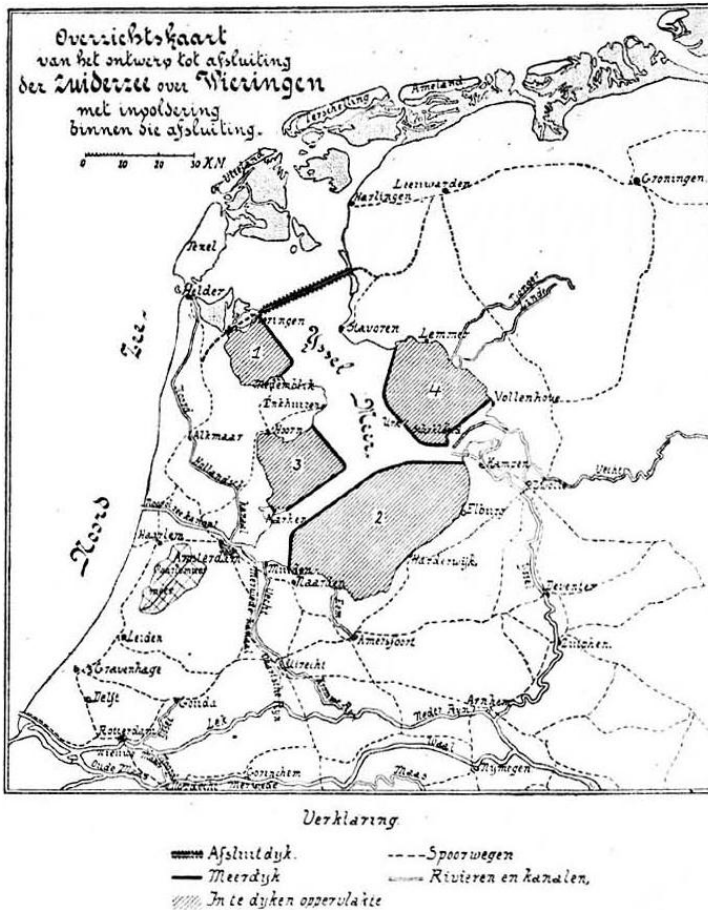

Figure 2.5: Sketch of the 'Plan Zuiderzeewerken 1907' (tresor TU Delft)

Minister Lely and chaired by prof.dr. Hendrik Antoon Lorentz (further referred to as the 'Lorentz Committee'), who was assisted in carrying out the hydrodynamic research by ir. Johannes Theodoor Thijsse⁷ (Vreugdenhil et al., 2001; Lorentz, 1926).

The prediction of the change in water levels after construction of the Afsluitdijk was one of the main scientific challenges. Lorentz, helped by Thijsse, therefore schematised the Waddenzee and Zuiderzee as a system of tidal channels through which the tide could propagate. He applied a hydrodynamic theory to calculate the flow through these channels, using one-dimensional flow models (by Saint-Venant) and a quasi-linear system of partial differential equations (by Riemann). The quadratic hydrodynamic friction was replaced and simplified by a linear fric-

⁷Thijsse propagated scale model tests and was the first director of the Dutch Hydraulic Laboratory (founded in 1927). Later, he acquired a PhD title and became professor in theoretical and practical hydraulics at Delft Institute of Technology in 1938.

tion. Lorentz and Thijsse could thus carry out their calculations as though the friction were proportional to the flow velocity. In this way, they derived long-wave equations for tidal movements in shallow water. Consequently, the periodical tidal flows through the network of channels could be estimated by an iterative process of making corrections in 'flow circles'. These hand calculations were very complex and time consuming (Vreugdenhil et al., 2001). Dr.ir. Johan van Veen, however, tried to solve the problem using the analogy to electricity. He assumed that tidal currents could be approached by electrical alternating currents, including phenomena like resistance, capacity, potential and self-induction. The method was simpler and quicker, but also less accurate. Thijsse, assisted by Nannis Pieter Mazure, an engineer at the Southern Sea Works, was even opposed to his method because he considered its results too unreliable⁸ (Van der Ham, 2003b).

After the mathematical calculations were done, including a safety margin to cope with uncertainties, the Lorentz Committee concluded that construction of the Afsluitdijk closure dam would most probably result in an increase in storm surge levels of more than one metre along the existing coast line near the Afsluitdijk, diminishing further away from the dam. Tidal channels would have to deal with stronger currents and also wave run-up would increase to 0,50 m (Lorentz, 1926). Finally, after taking the studies into account, the Afsluitdijk was designed and constructed between 1927 and 1932, connecting the village of Zurich (in the province of Friesland) with Den Oever (in the province of North Holland). Its total length is 32 kilometres and its width is 90 metres. Its initial crest level was NAP + 7,25 m.

After the storm surge of 13 and 14 January 1931, a state committee, chaired by Hendricus Gerardus van de Sande-Bakhuyzen, by professor in astronomy of Leiden University, was instated to study whether the improvement of several flood defences along the lower rivers, especially the Nieuwe Waterweg, could have caused an increase of the water level during this storm. The committee did not find any reasons to confirm this, but also did not have the mathematical tools to underpin such a conclusion. The committee assumed that the highest observed wind set-up of 2,80 m at Hoek van Holland was the highest possible, and that an according water level of NAP + 3,40 m at Hoek van Holland should be taken into account. The probability that this level would be exceeded during random year was estimated at 1/68. The committee based this conclusion on measurements during 30 years (1887-1917), see Figure 2.6, where a double linear scale was used (Sande Bakhuyzen et al., 1920).

Van Veen, who was employed at the Research Department of Rijkswaterstaat concerning Estuaries, Lower Rivers and Coasts (*Studiedienst van de Zeearmen, Benedenrivieren en Kusten*), studied sedimentation and sand transport, but later also tidal movements for which he developed a new calculation method. In several

⁸Van Veen's employee Johan Schönfeld, who became full professor in Fluid Mechanics at Delft University of Technology and promotor of prof. Jurjen Battjes, later improved the electrical analogon by introducing non-linear resistance elements. This led to the development of a larger electrical analogon in 1954, which culminated in DELTAR, an analogue calculator built by The Deltadienst of Rijkswaterstaat and the Technical-Physical Office of TNO. It was used between 1960 and 1982 for application in the Dutch delta area, mainly for several closure works (Vreugdenhil et al., 2001).

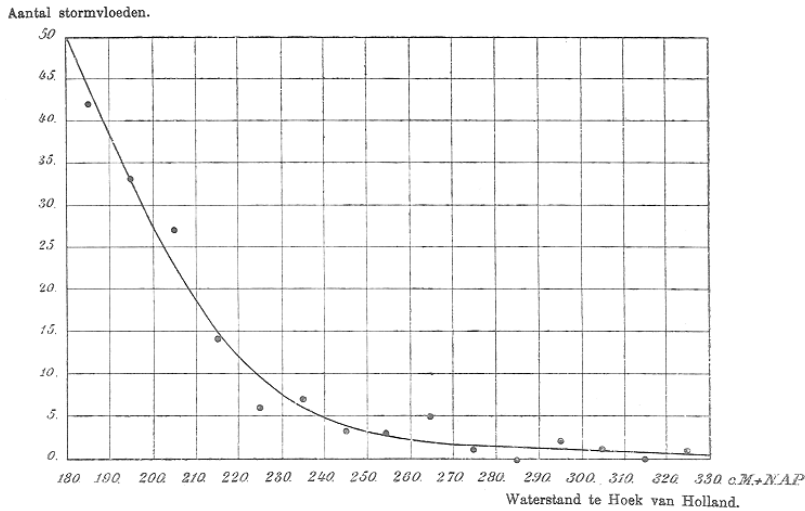

Figure 2.6: Storm occurrences between 1887 and 1917 at Hoek van Holland (Sande Bakhuyzen et al., 1920)

special cases, these tests could be simulated by simple calculation models (Van der Ham, 2003b). He also studied the state of the Dutch Southwestern Delta, about which he wrote an alarming report in 1939. He stated that the storm surge levels could be much higher than had been assumed until then. One of his employees, ir. Pieter Wemelsfelder, studied the statistical patterns of storm surge levels, which he was able to extrapolate to extreme values. Wemelsfelder analysed registrations between 1888 and 1937, in which period 35 287 high water levels were measured. He only considered high waters above the mean level of NAP + 0,88 m, resulting in about 17 500 measurement points, because the lower values were insignificant. He calculated how many times per year various water levels, varying with steps of 0,10 m, exceeded these values, drawing the result in a graph on a semi-logarithmic scale to better include the very low frequencies that corresponded to high values of extreme water levels, see figure 2.7, line A. Line B was corrected for succeeding measurement points that were related by the same storm event. Both lines coincide for higher water levels.

Wemelsfelder assumed an exponential relation between exceedance frequency and water level and was able to find a mathematical expression for the probability of exceedance. He demonstrated that higher water levels were much more likely to occur than assumed until then, as for instance by the study of Sande Bakhuyzen et al. (1920), which was an alarming finding. For instance, if one would be sure for 90% that a structure can resist the occurring water levels during a century, it should be dimensioned for an extreme water level of NAP + 4,08 m, corresponding to an average exceedance frequency of once per 1000 years and not NAP + 3,28 m, which was at that time the highest known water level for Hoek van Holland. According to tradition of adding 1 m to the highest observed water level, the corresponding dike

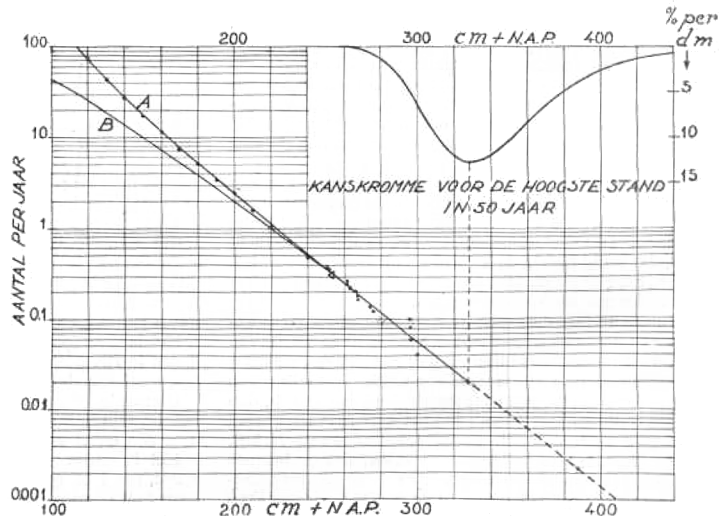

Figure 2.7: The relation between high water level and occurrences per year, as found by Wemelsfelder (1939)

height would then become $\text{NAP} + 3,28 + 1,00 = \text{NAP} + 4,28$ m. With this statistical relation, Wemelsfelder was able to define the term 'storm surge level'. He related storms to wind speeds of 8 or more on the scale of Beaufort. These wind speeds occurred with an average frequency of 0,5 per year. With help of the found relation between exceedance frequency and water levels, the corresponding water level, i.e. the storm surge level, could be found. Consequently, the likelihood of occurrence of a storm surge in a certain year could be calculated.

After Wemelsfelder published his alarming findings in 'De Ingenieur' of 3 March 1939 (Wemelsfelder, 1939), a Storm Surge Committee (*Stormvloedcommissie*) was instated to estimate future possible water levels along the coast to be taken into account. The chairman of the committee was Van Veen. Based on the analysis of Wemelsfelder, the Storm Surge Committee estimated the boundary conditions applied to flood defence structures for the year 2000 AD, accepting water levels that could be exceeded with a frequency of 1/300 per year. These storm surge levels were considerably higher than the observed levels. For Hoek van Holland, the design storm surge level was thus estimated at $\text{NAP} + 4,00$ or $\text{NAP} + 4,05$ m, while the highest observed level was at $\text{NAP} + 3,28$ m. The committee also calculated the design crest height of estuary dikes away from the coast. These design heights would have required reinforcement of many of the dikes, unless it would be decided to close-off estuaries.

The Storm Surge Committee of 1939 made some reservations regarding their calculations, because of yet unresolved uncertainties. The design levels of the Committee were nevertheless used for the reinforcement of dikes in the province of Noord-Brabant and for newly constructed dikes. It indeed appeared that the crest height

had to be considerably increased. In its final report of 1942, the Storm Surge Committee of 1939 confirmed that most dikes in the Northern delta area were unreliable and in need of reinforcement, considering expected higher water levels in future. Two years later it also appeared that most dikes in the province of Zeeland were too low. Politics, however, did not follow the advice of reinforcement of the dikes in Zeeland. It is often said that the Second World War was the cause of not improving the flood safety situation in the post-war years.⁹ Van der Ham, however, mentions that Rijkswaterstaat, the water boards and the local authorities were acutely aware of the critical conditions of the flood defences, but refrained from acting adequately. In 1946, this time in a secret document 'Overview Main Flood Defences of Zeeland,' Rijkswaterstaat again reported that almost 60 km of dike did not meet the requirements and several very weak spots had a height deficiency of 1,30 m (Van der Ham, 2003c, 2007).

Studies regarding the situation in the provinces of Zeeland and Zuid Holland had been carried out, mainly by Van Veen, partly before the installation of the Storm Surge Committee in 1939, for the closure of several branches of the lower rivers and estuaries, resulting in so-called islands plans. The Two-Islands plan comprised the closure of the Brielse Maas river branch. The Three-Islands plan combined Walcheren, Noord-Beveland en Zuid-Beveland, with the Sloedam that was already constructed for the railroad to Vlissingen, and a new dam in the Zandkreek near Veere.¹⁰ The Four-Islands Plan comprised the connection of the islands Voorne, Putten, IJsselmonde and Hoekse Waard. For this plan, dams were needed in the Oude Maas, Brielse Maas and Spui. Next, the Five-Islands Plan extended the Four-Islands plan to Dordrecht (Figure 2.8). Most of these plans were not realised, only the Botlek (1950), Brielse Maas river (1950) and the Braakman estuary (1952) were closed-off in the crisis years after the Second World War. The purpose of these early closures was predominantly to reduce salt intrusion from the sea (Deltacommissie, 1960a). However, the problem of the critical conditions of the flood defences in Zeeland was not dealt with. Unfortunately, like in 1916, a disaster had to occur before action was taken to improve the flood protection in the south-western part of the Netherlands.

⁹The closure of the gaps in the sea dikes of Walcheren, made in 1944 by allied forces to inundate this island as a military strategic measure, was a major challenge which took away the attention from other weak spots that had not yet led to failure.

¹⁰The Three-Islands plan was realised with only a few alterations as part of the Delta Plan in the period of 1958 to 1961, see next section.

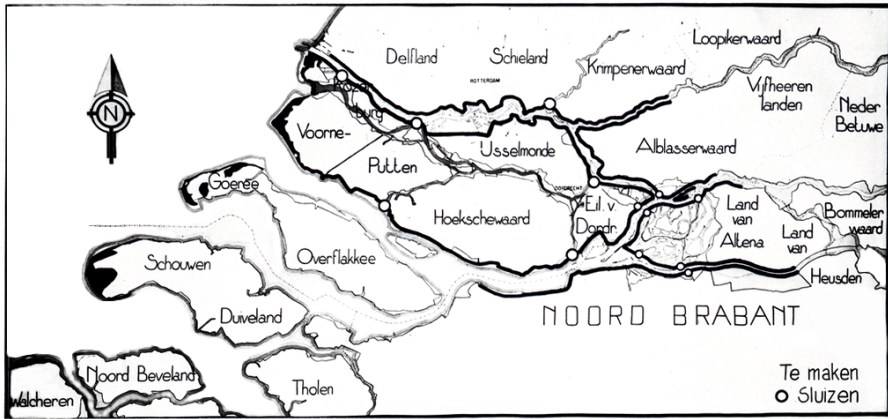

Figure 2.8: The Five-Islands Plan of Johan van Veen (Beeldbank Rijkswaterstaat)

2.4 THE FLOOD OF 1953 AND THE DELTA COMMITTEE

On 1 February 1953 a storm surge caused 67 dike breaches in the South Western part of the Netherlands, resulting in the flooding of 165 000 hectare of land. As a result more than 72 000 individuals had to be evacuated, 1836 individuals perished¹¹ and the economic losses amounted 1,5 billion guilders in the Netherlands¹². This disaster resulted in a renewed awareness of the risks of living in an estuarine area. Already per 18 February 1953 a state committee had been appointed by Jacob Algra, the Minister of Transport, Public Works and Water management.¹³ The new committee, referred to as the 'Delta Committee', concluded that the flood protection along the entire Dutch coast was insufficient, which should be improved as soon as possible. The committee advised the minister on the urgent measures that were needed to prevent future flood disasters.¹⁴

The Delta Committee, of which the members are depicted in Figure 2.9, according to its assignment, studied what level of flood safety could be considered sufficiently high and how this safety level should be attained. The committee gave its first advice in May 1953, answering the 'how' question: to heighten the dike of the island of Schouwen and to close-off the Hollandse IJssel with a storm surge barrier. Later on, the committee advised to close-off the estuaries of the Oosterschelde, the Grevelingen and the Haringvliet as well. The next advice comprised the

¹¹The storm also caused casualties outside the Netherlands: 307 in the United Kingdom and 22 in Belgium.

¹²The Delta Report mentions an amount of considerably more than 1,1 billion guilders. 1,5 billion guilders is mentioned by (Toussaint, 1998). David van Dantzig, Dutch mathematician, professor at Delft University of Technology and the University of Amsterdam, and one of the founders of the *Mathematisch Centrum*, mentions 1,5 to 2,0 billion guilders (Van Dantzig, 1956).

¹³the Storm Surge Committee of 1939 was implicitly abolished because its secretary, Johan van Veen, had been dismissed from his function by a rivalling director-general

¹⁴The dike breaches were meanwhile closed, and the flooded land was reclaimed and drained before the winter of 1953/1954 commenced

execution of the 'Three Islands Plan': the connection of Walcheren, Noord- and Zuid-Beveland by damming of the Veerse Gat and the Zandkreek. The last advice, presented in 1957, contained further considerations on the closure of the estuaries and the totality of recommendations was, after approval of the Dutch House of Representatives (*Tweede Kamer der Staten-Generaal*) and the Senate (*Eerste Kamer der Staten-Generaal*), formalised in the Delta Act of 1958, which was then signed by the Queen, HM Juliana.¹⁵



Figure 2.9: Photograph of the members of the Delta Committee (Beeldbank Rijkswaterstaat)

The committee followed three ways of reasoning to find an acceptable safety level:

1. A historical study of high water levels, using studies of the Royal Dutch Meteorological Institute (KNMI);
2. An extrapolation of water level measurements to find what storm surge levels can be expected in future, using a statistical analysis of Rijkswaterstaat (carried out by Wemelsfelder);
3. An econometric optimisation: the execution of a cost-benefit analysis to find an optimum between investments in flood protection and obtained risk reduction, using studies of the Mathematical Centre (Van Dantzig).

These ways of reasoning are explained in more detail in Appendix B. They all led to a design water level of NAP + 5,00 m near the town of Hoek van Holland, which is located about 25 km west of Rotterdam. According to the ways of reasoning

¹⁵The Delta Act has been withdrawn on 28 September 2005 and was succeeded by the Act on the Flood Defence of 21 December 1995.

numbers 2 and 3, this water level was related to a yearly exceedance probability of 1/10 000. The safety level was based on a combination of controlling both economic and death risks. The Delta Committee rationalised that a larger flood probability was acceptable for areas with a lower population density and with higher land levels (the north of the Netherlands) or in smaller sub-areas (the south-western part of the Netherlands) and the West Frisian Islands. For the north and the south-western part of the Netherlands a 2,5 times higher exceedance probability was considered acceptable because of the lower economic value of that part of the country. Along the rivers, a higher flood probability was accepted as well, because extreme river levels can be forecast well in advance (up to a few days), which would lead to lower consequences in case of a flood, in contrary to coasts where storm surge levels can only be predicted a few hours in advance. Furthermore, fresh river water causes less damage than salt sea water. Finally, river dike breaches are not exposed to scour due to tidal variations.

For Hoek van Holland, the exceedance probability of 1/10 000 was related to a basic water level (*basispeil*) of NAP + 5,00 m, but at other locations along the coast and tidal inlets the corresponding water level would be different. Rijkswaterstaat, after consultation of the Mathematical Centre and the Dutch meteorological institute, drew up exceedance frequency lines for various locations along the coast. The slope of the exceedance probability lines of stations at other locations than Hoek van Holland was assumed to be almost equal to the relation found for Hoek van Holland for the range between 10^{-3} and 10^{-4} per year. The basic water levels of the locations outside Hoek van Holland were derived from the exceedance probability lines. Design levels to be used for the determination of the crest level of flood defences were derived from these basic levels, taking into account whether or not a flood defence protects vital or extremely high economic interests. The design level could thus be higher or lower than the determined basic level (Deltacommissie, 1960a).

The Delta Committee had estimated the basic levels for a large number of measurement stations along the Dutch coast, but recommended to determine these levels with more accuracy when more measurement data would become available. This additional study, carried out about 30 years later, resulted in a report of the State Institute for Coast and Sea (Rijksinstituut voor Kust en Zee, RIKZ), which was published in 1993 (Van Urk, 1993). For the renewed estimation of basic water levels, the method of the Delta Committee was applied in a fine-tuned way. Information of the water level measurements was now interpreted for each separate measuring station. Enough data were available now to calculate the levels for the Western Waddenzee, instead of doing interpolations.¹⁶ The result of this study was a lower set of basic levels compared to the Delta Committee report, especially for the western Waddenzee (for Hoek van Holland it did not change).

In 1956, while the Delta Committee was drafting its report, the safety standard for the Dutch rivers was established as well. This was done at the request of the Province

¹⁶The Delta Committee did not possess over long series of measurements for this area, because of the construction of the Afsluitdijk closure dam for the Zuiderzee in 1932.

of Gelderland, which had asked the Minister of Traffic and Water Management, Mr. Algera, what the design level for river dikes would have to be. In his reply letter of 1956, the Minister responded that for the Rijn river a design discharge of 18 000 m³/s at Lobith is considered very safe, implying that it did not have to be implemented too tightly. This calculation used the statistical method of the Delta Committee and the design level corresponded to an average exceedance frequency of 1/3000 per year (RIVM, 2004; Van Heezik, 2007). This safety level was maintained until 1977 when the Committee on River Dikes (*Commissie Rivierdijken*, also called the *Commissie Becht*) came up with another safety level. Meanwhile, in the period between 1956 and 1977, the responsible authorities had not succeeded in improving the dikes up to level, which became apparent when the Committee on River Dikes had analysed that 450 km of river dikes did not comply with the 1/3000 norm (Yska, 2009).

2.5 THE SECOND HALF OF THE TWENTIETH CENTURY

2.5.1 CONSTRUCTION OF THE DELTA WORKS

Between 1956 and 1997, the Delta Plan was executed based on the safety levels recommended by the Delta Committee. The plan mainly comprised the shortening of the coast line by dams and appurtenant navigation locks, discharges sluices, compartment dams and dike reinforcements in the Provinces of Zeeland, Zuid-Holland and Noord-Brabant, see Figure 2.10. For a description of the construction of the Delta Works, reference is made to other literature, such as Stuvell (1962) and De Haan and Haagsma (1984). A major change in the design strategy during the construction of the storm surge barrier in the Oosterschelde estuary, because of more appreciation of landscape, nature and culture, is described in the following section.

In 1994, the American Society of Civil Engineers (ASCE) selected the Dutch North Sea Protection works (the Zuiderzee works and the Delta Works) as one of the 'Seven Wonders of the Modern World' that pay tribute to the greatest civil engineering achievements of the 20th century: *This singularly unique, vast and complex system of dams, floodgates, storm surge barriers and other engineered works literally allows the Netherlands to exist. For centuries, the people of the Netherlands have repeatedly attempted to push back the sea, only to watch brutal storm surges flood their efforts, since the nation sits below sea level and its land mass is still sinking. (...) The North Sea Protection Works exemplifies the ability of humanity to exist side-by-side with the forces of nature* (ASCE, 1994).

2.5.2 MORE APPRECIATION FOR LANDSCAPE, NATURE AND CULTURE

In the late 1960s, after having largely recovered from the disastrous Second World War, a change in Dutch society became apparent. A growing number of people did not agree with the idea that society was best served by pronouncedly basing policy



Figure 2.10: The Delta Works according to the Delta Plan of 1960 (Stuvel, 1962)

on economic and technological considerations. Authorities became less respected and young people started to rebel against established conventions and institutes. The consequence for large infrastructural projects was that values of landscape, nature and culture ('LNC-values') had to be taken into account more prominently. The change in societal attitude became very apparent during the planning phase of the closure of the Oosterschelde estuary. Initially a dam was proposed, as was usual for the closure of estuaries. Construction of the dam had already started when fishermen, shellfish farmers, sea-yachtsmen and environmental organizations started to protest against it. In 1974, this ultimately led to a temporary stop of the dam construction and a reconsideration of the plan. A committee, instated by the Dutch government and chaired by Jan Klaasesz (also Commissioner of the Queen of the province of South-Holland), advised to construct a barrier with closable openings in the remaining part of the unfinished dam. The intrusion of salt water and tidal currents in the Oosterschelde would thus be preserved. This advice was followed by the government (Den Uyl cabinet): construction continued in 1976 and was finished in 1986 (De Haan and Haagsma, 1984).

Discussion on the reasons for a societal shift

In general, societal engagement was growing and citizens ever more intervened in governmental policy. The increased interest in LNC-values is often explained by Maslow's theory on the hierarchy of needs. Abraham Maslow, an American psychologist, arranged types of human needs from a basic physiological to more sophisticated levels of safety, belongingness & love, esteem and self-actualisation. Later, Viktor Frankl (an Austrian neurologist and psychiatrist) added the spiritual level of self-transcendence to Maslow's system Frankl (1959). Human beings strive at fulfilling their needs starting at the lowest level. Higher levels are usually only

fulfilled if the needs of lower levels are already sufficiently satisfied. Maslow's hierarchy is often represented as a pyramid, with the basic needs at its base. This dissertation attempts to relate Maslow's psychological needs to types of behaviour and existential levels.¹⁷ Figure 2.11 shows an alternative for Maslow's pyramid, including the social impact of the types of behaviour and the attitude regarding flood protection strategies.

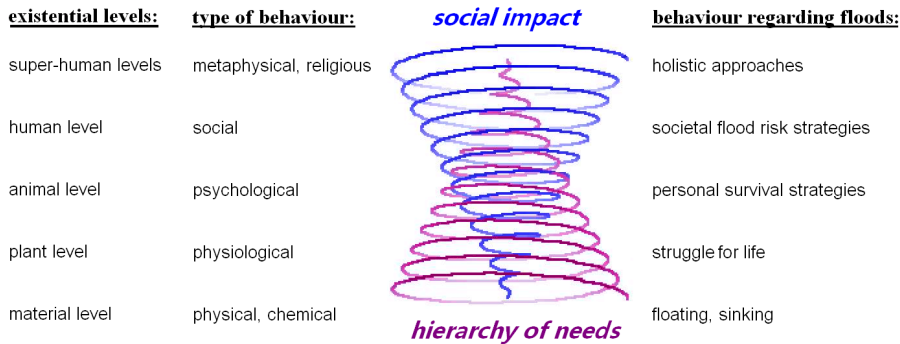

Figure 2.11: Hierarchy of causes and reasons for human behaviour

Maslow's theory is also attempted to explain developments in society. Integrated flood-protection policies usually aim to bring society to a higher level of the Maslow pyramid, resulting in a higher level of well-being. Applying the analogy of this pyramid to societal developments, starting with construction works to fulfil the lowest layers (such as building infrastructure, flood defences, irrigation and drainage systems), leading to increased productivity and reduced costs, will eventually result in a higher average level of prosperity. Absolute safety is not possible: several risks will remain, and natural hazards can still (temporarily) threaten the physiological needs in a prosperous country. Preventing natural disasters, according to the approach, appears to be attractive, because it increases the level of prosperity and it reduces the uncertainty. Since the 1960s, a gradual shift of the need to protect against flooding to higher levels in the Maslow hierarchy can be observed in the Netherlands. This is probably caused by a well-functioning flood protection system and decreasing awareness amongst the Dutch people of flood risks. Thus it seems that the present Dutch multi-layered flood risk approach has arisen from a shift in the hierarchy of needs.

Measures to improve the prosperity of a society have the highest impact if they are related to the lowest layers of Maslow's pyramid and aim at reducing the probability

¹⁷These existential levels have been derived from the ontological levels of the 'Great Chain of Being', as known from ancient philosophers like Plato, Aristotle, Plotinus, and Proclus, and which were further developed during the Middle Ages and Neoplatonism. Biologists like Carolus Linnaeus and Karl Ludwig von Bertalanffy used these existential levels in their theories. Kenneth Ewart Boulding, a British economist together with Von Bertalanffy founder of the of General Systems Theory, distinguished nine levels of organisation accordingly arranged in a hierarchy. These levels can be arranged depending on the intensity of interaction with the environment (ranging from a closed to a fully open system) and complexity (ranging from a rational to a social system).

of occurrence of natural hazards. The lowest two layers can be satisfied by, for example, the design and construction of housing, roads, canals, bridges, drainage and irrigation. These measures enhance income and reduce costs. In addition, reducing the probability of the destruction of values by the extreme forces of nature increases societal stability and safety. If floods hamper societal prosperity, the situation can be improved by attempting to decrease the expected value of the losses due to floods, or by attempting to reduce its standard deviation.

The probability distribution of the losses due to natural hazards is in most cases characterised by a standard deviation that is larger than the expected value: $\sigma(L) > \mu(L)$. A decrease of the expected value $\mu(L)$ of the loss is proportional to the reduction of the flood probability ($\mu(L) = p \cdot L$), whereas reducing the standard deviation of the losses, $\sigma(L)$, which is a measure for the uncertainties, is proportional to the square root of the flood probability ($\sigma(L) = \sqrt{p(1-p)} \cdot L^2 \sim \sqrt{p} \cdot L$). This is illustrated in Figure 2.12. A flood prevention approach, which effectuates the expected value of the loss, is therefore more effective than a relief centred approach, aiming at reduction of the consequences of a flood, because that only effectuates the standard deviation. This implies that it only becomes effective to invest in reducing possible consequences of a flood, if already considerable preventive measures have been taken to improve the basic conditions (Vrijling, 2014a). Section 2.6.3 explains more about the multi-layer policy of flood risk reduction by both types of measures.

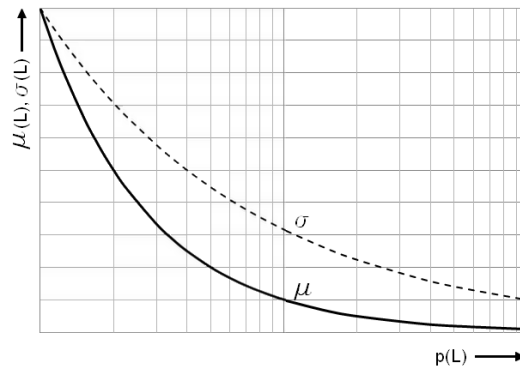

Figure 2.12: Influence of the expected value $\mu(L)$ and the standard deviation $\sigma(L)$ on the probability of losses due to natural disasters $p(L)$

2.5.3 POLICIES TO IMPROVE THE RIVER DIKES SINCE THE 1970S

Because of the societal changes, as described above, LNC-values came to the attention of policy-makers since 1969.¹⁸ Since 1973 on, active protests were organized against traditional dike reinforcements and construction of closure dams. For example, students from the town of Utrecht squatted two dike houses and this can

¹⁸The dissertation of Heems and Kothuis (2012) extensively describes societal developments and discourses related to flood protection in the Netherlands in a wider perspective.

be seen as a starting point for the revolt against dike improvements as several organisations were mobilising the population to protest. The change in society also caused conflicts in the 1970s in the towns of Brakel and Sliedrecht, where river dikes needed to be reinforced, while simply removing houses and trees was not accepted any more. In Brakel, dike improvement along the Waal required the removal of 140 houses and the historical town hall. Because the carefulness of the municipal administrators was called in question, inhabitants and pressure groups (like the *Stichting Natuur en Milieu*) organised opposition against the dike improvement plans that did not take LNC-values into account. Despite the fact that most of the plans to demolish the houses were carried out after all, the conflict of Brakel appeared to be a turning point. Similar problems arose in Sliedrecht, along the Beneden-Merwede, where, as a result of the protests, a start was made to systematically study new possibilities of improving multifunctional dikes (Huis in 't Veld et al., 1986). Dike improvements still appeared technically possible, but the entire process appeared much more complex than before. Protests in Sliedrecht were more successful than in Brakel¹⁹ (Yska, 2009).

Another motivation for a more interdisciplinary strategy came from several complications of the Delta Works. Environmental problems gradually originated, such as large amounts of blue algae, lack of oxygen and the decline of sand banks and fish migration in the closed-off estuaries (Programmabureau Zuidwestelijke Delta, 2009). Several complications were not foreseen, but others were foreseen and remedied, like erosion at the end of the bed protection of the Oosterschelde barrier and the disturbance of fish migration by the Haringvliet dam.²⁰ The societal agitation led to the instatement of the Committee on River Dikes in 1975, to advise on the optimisation of stakeholder participation. These stakeholders became more influential due to societal changes. So, the Committee on River Dikes deliberately took LNC-values into account to find optimal solutions. The committee assumed that the failure probability of river dikes was equal to the exceedance probability²¹ and used a cost-benefit analysis to compare three alternatives. This way of reasoning, called 'sophisticated design' (*uitgekiend ontwerp*), resulted in flood defences that only just met all safety requirements. The Committee finally advised a design discharge at Lobith of 16 500 m³/s with a corresponding average exceeding frequency of 1/1250 per year. The draw-back of this 'sophisticated design' was that accordingly constructed or reinforced dikes did not meet the requirements any more after the slightest change of the boundary conditions.²² As a result, many of the just reinforced dikes failed the next formal assessment. To avoid this problem, a robustness height surcharge is nowadays included in the calculation of the design crest height of river dikes.

¹⁹Reference is made to Section 6.4 for background information on the Sliedrecht project.

²⁰Possible bed erosion in the flow channels between the Oosterschelde barrier piers should have been monitored, followed by rock dumping when needed. To enable fish migration through the Haringvliet dam, fish tunnels have been constructed in the piers of the dewatering sluices

²¹This differs from the Delta Committee, which assumed a factor of 12,5 between both probabilities.

²²Boundary conditions tend to become more severe: higher water levels, larger river discharges, higher waves.

Ideas to integrate LNC-values in flood protection measures were further elaborated in 1987 in the 'Stork Plan' (*Plan Ooievaar*). The aim was to revive the complete biotic river system in relation to societal activities, like agriculture, shipping, safety measures, mineral extraction and recreation. The Stork Plan was created by scientists of various disciplines.²³ Water retention and nature development were stimulated in the river forelands and river courses should as much as possible be restored to their natural state. The plan was the start of a new thinking about rivers and could be conceived as a predecessor of the later 'Living Rivers' and 'Room for the River' projects. Notwithstanding the plans to involve LNC-values in sophisticated flood defence design, hundreds of trees were planned to be demolished for dike improvements in Neerijnen, along the Waal river, and Zutphen, along the Gelderse IJssel river, and tensions between people in favour of dike reinforcements and LNC-activists persisted. Opposition against dike improvements was strengthened by the publication of a book, 'Attila on the bulldozer', of which the most remarkable article was written by Wageningen nature preservationist Jan Bervaes, who argued that no dike at all would be able to withstand the ice dams that had occurred in the past, so dike reinforcement would make no sense at all.²⁴ The stance by several newspapers (HP-De Tijd, NRC Handelsblad, De Volkskrant and De Telegraaf) added to the negative sentiments, and Rijkswaterstaat lost much of the respect it had gained the previous years (Van Heezik, 2007).



Figure 2.13: Covers of the books 'Ooievaar. The future of the river area' and 'Attila on the Bulldozer'

Because of all opposition, the Committee Assessment of Starting Points for River Dike Reinforcement (*Commissie Toetsing Uitgangspunten Rivierdijkversterking*) was established in 1992 to reconsider the safety standard, related to the changes

²³The authors were Dick de Bruin, Dick Hamhuis, Lodewijk van Nieuwenhuize, Willem Overmars, Dirk Sijmons and Frans Vera.

²⁴Actually, these ice dams did not occur any more since the 1950s because of the warming of the big rivers by cooling waters of heavy industry upstream.

in society. The Committee, chaired by Kees Boertien,²⁵ based its advice (the final report was only 12 pages) on a scientific study carried out by Delft Hydraulics and RAND-Corporation (WL-RAND) and concentrated on the situation of the Rijn delta. The Boertien 1 Committee advised to base the flood safety level on the following elements:

- probability of an individual to perish because of a flood;
- economic damage in case of a flood;
- disruption of society in case of a flood;
- damage of dike reinforcement to LNC-values;
- costs of dike reinforcement.

Of these aspects, the individual death probability and the economic damage criterion were the most important. The philosophy of acceptability of flood risk was developed by 'task force Probabilistic Method' of the Technical Advisory Committee for the Flood Defences (TAW). The aim was to find a societally acceptable risk level related to hydraulic structures, systems and activities. The task force followed two approaches to determine an acceptable flood risk level:

1. a mathematical-economic method with emphasis on damage expectations, which would lead to an economical optimum;
2. a method based on statistics of casualties.

These two approaches can lead to considerably differing results. The second method would often lead to much higher investments, so because of macro-economic reasons, it was advised to generally follow the first approach (Vrijling, 1985).

The design river discharge at that time was 16 500 m³/s at Lobith, corresponding to an exceedance probability of 1/1250, but one of the extrapolation methods used by WL/RAND resulted in a design discharge of 15 000 m³/s. The Committee Boertien 1 adopted this lower discharge as the new standard, mainly to reduce dike reinforcements and preserve LNC-values. The report of WL/RAND mentions that the economic value had increased considerably since 1977, but the appreciation of LNC-values had grown too in the same period. The norm of 1/1250 was considered too low by WL/RAND considering the economic risk, but for the sake of LNC-values a higher norm was not advised (Walker et al., 1993). In the spring of 1993, the Dutch government adopted the advice of the Boertien 1 Committee almost unchanged. TAW task forces developed five directives to incorporate LNC-values in designs of dikes or dike improvements, to apply the policy.²⁶

The attitude of Rijkswaterstaat, the Province of Gelderland and several water boards gradually changed, resulting in efficient involvement of stakeholder interests in the planning of dike reinforcement. The tree-covered dikes near the towns of Neerijnen and Zutphen became pilot projects for the new approach. By applying

²⁵Because Boertien also chaired another river committee, the Commissie Toetsing Uitgangspunten Rivierdijkversterking is often referred to as the Boertien 1 Committee.

²⁶The five developed guides concern vision development, making an inventory and valuation of LNC-aspects, policy analysis, structural design and spatial design.

steel sheet-pile walls in the dike, only 19 of 1900 trees on the dike near Zutphen had to be demolished. After the pilots, this approach was used for other river dikes. Despite the pilot projects and the focus on the Dutch delta works, attention to the state of river dikes diminished and the maintenance and safety level of these dikes was not optimal during the second half of the twentieth century. High water levels of the Rijn, Waal and Maas in 1993 and 1995 therefore almost lead to a national catastrophe. The Maas flooded in Limburg in 1993, affecting 6000 houses and causing 8000 inhabitants to be evacuated. In 1995, the Maas caused floods again in Limburg, but the situation was less severe than two years earlier. The water in the Rijn delta reached high levels in 1995, leading to a critical condition of the dikes and to the preventive evacuation of 200 000 inhabitants along the Rijn and Waal rivers (Yska, 2009).

The 1993 and 1995 high river discharges attracted much attention and brought flood protection back on the political agenda. The events of 1993 led to a strong call for dike reinforcements, which was the impetus to instate the Committee Maas Flood (*Commissie Watersnood Maas*), better known as the Committee Boertien 2, which concentrated on the situation along the Maas river. Boertien 2 advised a protection level of 1/250 for existing dwellings and 1/1250 for newly built-on areas along parts of the Maas that were not protected by dikes (Yska, 2009).²⁷

Although the river dikes in the provinces of Noord-Brabant and Gelderland did not breach in 1995, the high discharges induced the formulation of a new policy on flood defence (Delta Act for the Major Rivers - *Deltawet Grote Rivieren*). Dike improvements were executed with a high priority to resist a Rijn discharge of 15 000 m³/s at Lobith and of 3650 m³/s for the Maas. The design discharges were raised to 16 000 m³/s and to 3800 m³/s respectively due to findings of the national assessment of primary flood defences in 2001. Figure 2.14 shows a graph with exceedance probabilities of water levels of the Rijn at Lobith. Two trend lines are drawn in this graph: one including and one excluding the discharge peaks of 1993 and 1995. The aim of the Delta Act for the Major Rivers was the reduction of the administrative and legal complexity of improvement works. The intention was to improve 148 km of dikes and construct 143 km of quays before the end of 1996.

The changes in normative river discharges, as advised by several committees, is summarised in table 2.1.

To preserve the characteristic fluvial landscape, the Dutch government launched the 'Room for the River' planning programme in 2007, where spatial quality²⁸ became an important aspect, besides flood protection. The Room for the River programme is intended to restore the 'original' course of the river and to make better use of the major bed, or to enlarge it to create more space for high discharges, reducing high water levels. The problems were caused by the construction of dikes in the major beds, to prevent flooding of the hinterland, at varying distances from each

²⁷In the Flood Defence Act, which was enacted in 1995, several secondary dikes along the Maas got the status of primary flood defence.

²⁸'Spatial quality' is defined in Section 3.3.4 as 'the degree of satisfying utility, scenic and future values of different interests in spatial planning'.

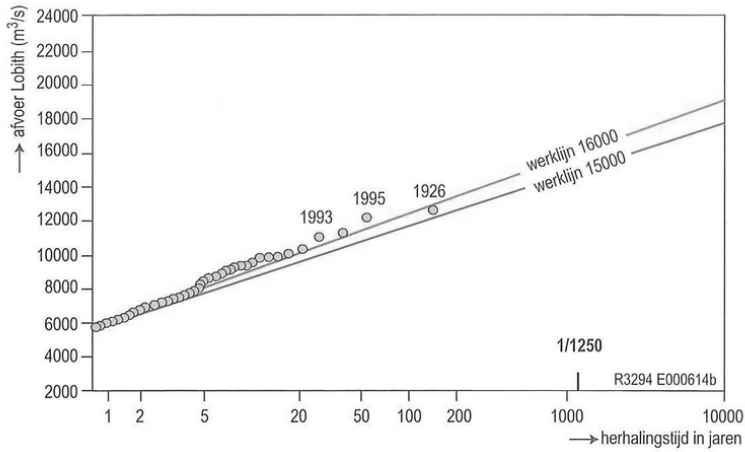

Figure 2.14: Governing high water discharge line before and after the discharge peaks of 1993 and 1995 (RIVM, 2004)

	Tot 1953	Delta-commissie 1/3000 per jaar	Becht 1/1250 per jaar	Boertien 1/1250 per jaar	HR2001 1/1250 per jaar
	Toeslag		Toeslag		
Bovenrijn bovenstrooms Lobithse Overlaat	13500	18000	16500	15000	16000
Bovenrijn benedenstrooms Lobithse Overlaat	12000				
Waal	8250	11250	150	0	9500
Pannerdensch Kanaal bovenstrooms Kandia	3750	6750	350	75	5500
Pannerdensch Kanaal benedenstrooms Kandia	5000				
Nederrijn-Lek	2700	3950	250	50	3250
IJssel	2300	2800	250	25	2250

Table 2.1: Advised normative river discharges (RIVM, 2004)

other. The narrowing of the river courses was problematic for the discharge of ice in winter. Water discharge was furthermore impeded by ferry groynes, osier beds used for land accretion, brickworks and other use of the forelands, which led to a reduced capacity for high river discharges (Burgers, 2014). The Room for the River Programme therefore restored the winter beds by cleaning up the flood plains, by

creating retention areas and by excavating channels in the winter bed.²⁹ Removing industry and agriculture from the flood plains had a negative economic impact. Houses in flood plains are unwanted objects in the Room for the River projects, despite the fact that habitation of flood plains is favoured by house owners (Van Gerven, 2004). Figure 2.15 shows a schematic presentation of dike repositioning measures to create more space for rivers. The project was to be completed at the latest in 2015.

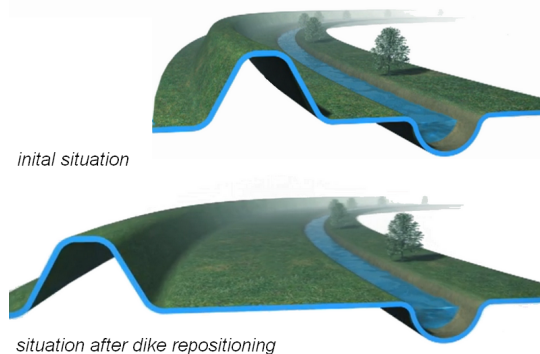

Figure 2.15: Schematic presentation of dike repositioning measures - notice that the proportions are far from realistic (www.ruimtevoorderivier.nl)

In 2000, the Committee Watermanagement 21st Century (*commissie Waterbeheer voor de 21e eeuw*, 'WB21', also known as the *Commissie Tielrooij*) was appointed to advise on the adjustments of the national flood protection system necessary to cope with climate change. The committee advised to top-off discharge peaks by first retaining water, then holding it in separate areas and, finally, discharging it towards the sea. This three-step approach was better known as the 'retain, store, discharge' approach (*vasthouden, bergen, afvoeren*). For primary flood defences the committee advised to change from an exceedance probability to a risk approach. It advised to set up standards for regional flood defences. Both recommendations were not elaborated by the committee.

The possibility of inundating specific areas of land in a controlled way to save other parts from flooding during extreme circumstances was elaborated by the Committee Inundation Areas (*Commissie Noodoverloopgebieden*), chaired by politician and agricultural engineer David Luteijn (2000-2001). The advice did not include the required safety level to be obtained by these measures, but several areas were proposed to be allocated to be deliberately flooded in case of extremely high water levels. The heavy resistance against these plans and studies that concluded that these inundation areas were not effective (De Boer, 2003), and calculations showing

²⁹This approach was not new, but earlier attempts, such as a law prohibiting the use of the forelands in the early 18th century, and advices of the early river committees of 1821 and 1828, taking into account the study of Ferrand and Van der Kun (Lintsen, 1993), were not sufficient to protect against the presently expected long-term effects of climate change.

that only very small water level reductions would be obtained by the inundation areas (Kok et al., 2003), resulted in rejection of the report by the Dutch House of Commons (Yska, 2009).

The Dutch policy to reduce flood risk with help of inundation areas (*noodoverloopgebieden*) became less far-reaching than previously proposed by the Committee Inundation Areas: The Dutch National Water Plan 2009-2015 mentions that inundation areas have in the past been successfully applied in vulnerable downstream areas, but it was not specified where. The spillways, however, have not been used for many decades, because the areas have meanwhile been developed, which makes the effectiveness of inundation doubtful. In the past years the contribution of inundation areas to flood risk reduction was studied, as well as which areas would be suitable to inundate. Initially three areas were selected: Rijnstrangen and the Ooijpolder for the Rijn and the Beersche Overlaat for the Maas (see Figure 2.16 for the location of the Beersche Overlaat). The available research results, however, do not sufficiently support the effectiveness of inundation areas. The selected areas for the Rijn were therefore withdrawn. In the cabinet point of view 'Rampenbeheersing Overstromingen' (2006), the Beersche Overlaat has been preserved for the safety of the town of 's-Hertogenbosch and the A2 highway (Nationaal Waterplan, 2009).

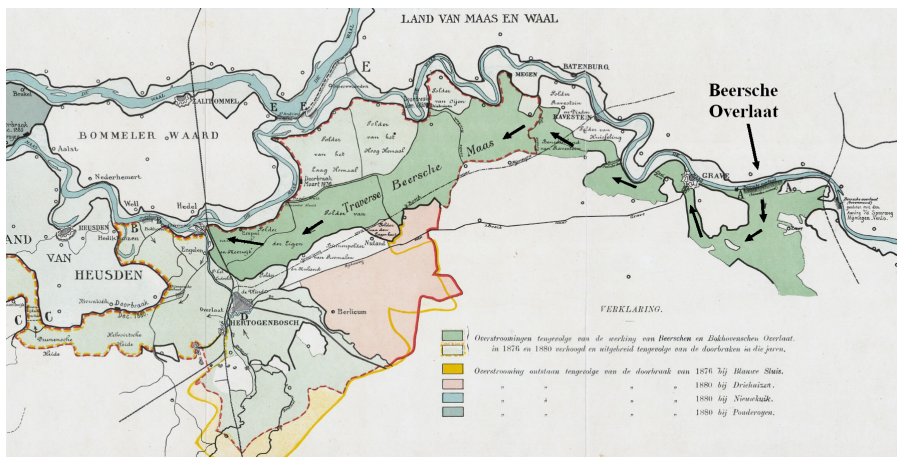

Figure 2.16: Map with the present 'Beersche Overlaat' and the resulting course of the water during extreme discharge (collectie Brabants Historisch Informatie Centrum)

2.5.4 FORMALISATION OF THE SAFETY STANDARD

LEGISLATION IN THE NETHERLANDS

Minimum required flood safety levels, expressed as minimum frequencies with which the local design water levels were allowed to be exceeded, were derived by the Delta Committee and published in its interim report of 1955. However, these levels were not proscribed by the Delta Act, enforced in 1958 and which

contained regulations regarding the closure of sea-arms and the reinforcement of flood defences. Notwithstanding the fact that the safety level was not stipulated by law, it was the common design practice of Rijkswaterstaat to use the safety levels since the appearance of the reports of the Delta Committee, which appears from several documents of Rijkswaterstaat (1969), (1972). The recommended safety levels were used for the calculations of the dimensions and the costs of the structures of the Delta Works.

The advice of the Becht Committee to base dike reinforcements along the big rivers on water levels related to a discharge of 16 500 m³/s (discharge of the Rijn near Lobith) was agreed upon by the House of Representatives in 1978. The design standards of the Becht Committee and the Delta Committee appeared to overlap for the lower river areas. Therefore, it was concluded that the safety standard for areas enclosed by flood defences had to be based upon water levels related to natural phenomena with only one probability of occurrence. In 1993, this led to the establishment of design water levels, after discussion with the House of Representatives, and the normative water levels for the Maas river, as proposed by the Becht Committee. Later on, safety standards for the dikes around the IJsselmeer were proposed by the Technical Advisory Committee for the Flood Defences (TAW).

When the Delta Project and the river reinforcements neared completion, the flood safety of other flood-prone areas had to be taken care of. As most efforts since 1953 aimed at the flood protection along the coast and the main rivers, the improvement of other flood defences fell behind. Moreover, the Delta Act was about to fall due, requiring a new law at national level. It was felt that flood protection was a fundamental task of the government, conform article 21 of the Dutch Constitution. In the following years (1988-1995), various committees and politicians were involved in the creation of the new Flood Defence Act (*Wet op de Waterkering*), which was prepared by a task force chaired by ir. Tjalle de Haan.

A draft of the law, including a clarification, was presented to the Dutch Council of State (*Raad van State*) on 25 July 1988, which issued an advice on 19 April 1989. The advice was presented to HM Queen Beatrix on 13 June 1989. An adapted version of the draft law, including an explanation, was thereupon sent to the members of the House of Representatives on 23 June 1989. Discussion followed with the Minister of Transport, Public Works and Water Management (*Verkeer en Waterstaat*), Ms. Nelie Smit-Kroes. Because of all the questions of the representatives, several aspects had to be given a second thought. The resulting document, a Memorandum in Reply (*Memorie van Antwoord*), was sent by the new Minister, Ms. J.R.H. Maij-Weggen, and received by the representatives only on 12 April 1994. There were two reasons for this late reply. Firstly, the decentralisation of granting subsidies to administrators of primary flood defences had to be finished before the Flood Defence Act would be effectuated. Secondly, the results of the points of departure for the river dike reinforcements had to be evaluated. The Boertien Committee had issued a report, which was discussed by the representatives on 27 April 1993. The (near) river floods of 1993 and 1995 resulted in a sense of urgency, which offered the minister a possibility to quickly put forward the Flood Defence Act, especially

because the Act gave directions for financing the Boertien Committee measures.

The Flood Defence Act defined 53 dike ring areas: areas entirely surrounded by flood defences or higher land areas, related to one safety standard. The division in dike rings was gradually developed by Rijkswaterstaat in the 1980s in cooperation with the provinces and water boards. In 2006, the dike ring areas along the Maas river in the provinces of Limburg and eastern Brabant were added, resulting in a list of 100 dike ring areas in total.

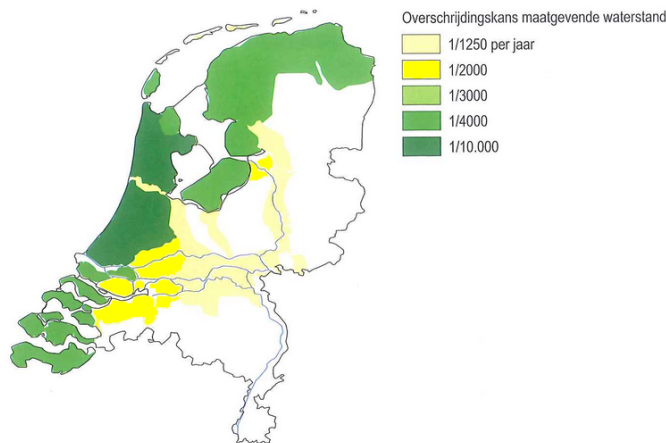

Figure 2.17: Normative exceedance probabilities as stipulated by the Flood Defence Act (RIVM, 2004)

The normative exceedance probabilities for dike rings along the coast and lakes as proposed by the Delta Committee were adopted in the Flood Defence Act. A map of the Netherlands with the normative exceedance probabilities is shown in Figure 2.17. The normative exceedance probability for upper rivers was set at 1/1250, like advised upon by the Becht and Boertien committees. For transitional zones between upper and lower rivers, and for the IJsselmeer, the normative exceedance probability was fixed at 1/2000. The correctness of the choice of the normative levels was only verified in 2005, when the failure probabilities were calculated (RIVM, 2004), (Rijkswaterstaat, 2005). Design water levels were derived from these normative exceedance frequencies.

Other recommendations of the Delta Committee, like over-topping volume criteria, were laid down in guidelines of the Technical Advisory Committee for the Flood Defences (TAW). The Flood Defence Act also stipulated that the quality of the primary flood defences should be assessed every five years.

Since 2009, the safety level against floods is assigned to dike sections and is regulated by law (Water Act, *Waterwet* 2009). This act replaces eight former acts:

- Act on the Management of the Structures of the Ministry of Waterways and Public Works 1891 (*Wet beheer Rijkswaterstaatswerken* (the 'wet' parts));

- Water Control Act ('wet' parts) 1900 (*Waterstaatswet*);
- Land Reclamation Act 1904 (*Wet droogmakerijen en indijkingen*);
- Act on the Pollution of Surface Water 1969 (*Wet verontreiniging oppervlaktewateren*);
- Act on Polluted Sea Water 1975 (*Wet verontreiniging zeeewater*);
- Groundwater Act 1981 (*Grondwaterwet*);
- Water Management Act 1989 (*Wet op de waterhuishouding*);
- Flood Defence Act 1996 (*Wet op de waterkering*).

The Flood Defence Act was completely adopted by the Water Act without changes in content, but all articles were rewritten and moved to various parts of the Water Act. The Water Act additionally prescribes that the minister specifies what hydraulic boundary conditions should be taken into account to calculate the assessment levels (*toetspeilen*). The water boards have to check at the functioning of their primary flood defences at least every twelve years.

Other relevant acts and regulations are/were:

- Water Control act 1900 (*Waterstaatswet*);
- Rivers Act 1908, 1999 (*Rivierenwet, Wet beheer Rijkswaterstaatswerken*);
- Expropriation Act 1857 (*Ontheffingswet*);
- Spatial Planning Act 1962 (*Wet op de ruimtelijke ordening*);
- Pollution of Water Surface Act 1971 (*Wet verontreiniging oppervlaktewateren*);
- Soil Protection Act 1986 (*Bodembeschermingswet*);
- Water Board Act 1991 (*Waterschapswet*);
- Environmental Management Act 1993 (*Wet Milieubeheer*);
- Provincial Regulations.

(Weijers and Tonneijck, 2009)

In addition, in case of multifunctional flood defences, the following acts are relevant:

- Housing Act 1902 (*Woningwet*)
- Act on City and Village Renewal 1984 (*Wet op de stads- en dorpsvernieuwing*)

The Dutch Water Act stipulates that the Minister is responsible for the establishment and publication of technical guidelines for the design, management and maintenance of primary flood defences (article 2.6). To comply with the law, requirements should be formulated with respect to the retaining height, reliability of closure means (acceptable volume of water flowing through) and the strength and stability of hydraulic structures. The technical guidelines serve as recommendations for those, who are responsible for the management and supervision. Strict compliance with these guidelines is not obligatory, because that would reduce the possibilities for optimal custom-made measures. It is, however, recommended to follow the guidelines, because they are considered to contain the best generally accepted technical knowledge.

The Water Act has changed per 1 January 2017 to allow for an advanced flood risk calculation, based on a probabilistic approach and to update the acceptable risk

level. Section 2.6.4 gives more details on the changes. The Water Act will become part of the 'Environment and Planning Act' (*Omgevingswet*) that will come into force per 2019. The Environment and Planning Act integrates 26 current acts on building, environment, water, spatial planning and nature. The integration aims at facilitating construction projects. The Dutch House of Representatives approved the Environment and Planning Act on 1 July 2015 and the Senate did the same early 2016, which was followed by publication in the Statute Book (*Staatsblad*). The national government made agreements with the municipalities, provinces and water boards to prepare the implementation of the new act.

THE ASSESSMENT OF FLOOD DEFENCES

In the early 1990s, the Technical Advisory Committee for the Flood Defences (TAW) organised the first systematic assessment of 3200 km of primary dikes at national level. In 1993, TAW issued a report on the most important 1730 km of secondary dikes (from a total of 14 000 km), of which 156 km were rejected.

Since 1996, the obligation to assess the primary flood defences has been stipulated by law. According to the Water Act (article 2.12, first member), the Dutch primary flood defences have to be periodically assessed, with a minimum frequency of once per 12 years. Originally, the assessment frequency in the Flood Defence Act of 1996 was once per five years. The five-year period was based upon two considerations. Firstly, it was reasoned that the flood defence and the characteristics of the threatening outer water would not drastically change within this period. Therefore, it was expected that potential shortcomings could be detected and repaired in good time. Secondly, after five years there would still be sufficient actual knowledge within the organisation of the maintaining authority regarding the actual problems of the previous period. The assessment period was reduced to once per six years in the Water Act of 2009, and in 2013 it was further reduced to once per 12 years (Government of the Netherlands, 2013). The knowledge to judge the resistance against extreme water levels and waves has been laid down in the Regulations Safety Assessment (*Voorschrift Toetsen op Veiligheid, VTV*). The regulations contain calculation rules that are based upon many years of research on the loads on and strength of flood defences. There are nevertheless knowledge gaps regarding extreme circumstances. To cover the uncertainties, the assessment method makes use of safety factors (Vrijling, 2012).

The modification of the Water Act per 1 January 2017 has consequences for the assessment of flood defences, because their safety will have to be assessed according to the new method, based on a failure probability rather than on an exceedance probability approach. All primary flood defences will have to comply with the new safety standard per 2050. More details on the modified Water Act can be found in Section 2.6.4 and Appendices D.5 and E.7.

EUROPEAN LEGISLATION

2

In the 20th century, much effort has been put in the regulation of water quantities in the main rivers, but these interventions had undesired side effects on the terrestrial and aquatic environment. In addition, large amounts of waste water discharged into the water systems caused a negative impact on the water quality and the aquatic life. This was regulated by national Dutch laws, like the Pollution of Surface Waters Act (1970), but the problem is an international issue, as big rivers are typically cross-boundary phenomena. It took several decades before the countries of the Rijn basin and the North Sea area reached a mutual understanding and took measures to reduce pollution. The Dutch government already undertook the first international diplomatic steps in 1932 to reduce the chloride content in the Rijn. This was not successful, but the Rijn states created the International Rijn Commission (1950), which studied the type and quantity of pollution. Initially, this did not lead to specific arrangements to reduce pollution, but in 1972, because of a 'dying' Rijn and pressure from society, the ministers of the Rijn states asked the International Rijn Commission to draw up a long-term programme to reduce all sources of pollution. The proposed conventions and executive programme were adopted by the involved ministers and the European Union became a member of the International Rijn Commission. After a delay, the European Union approved on the proposed measures and the pollutant loads decreased, leading to better water quality and return of aquatic life in the Rijn. The water quality in the Maas had to be improved as well and, as a consequence, international treaties for the Maas were signed by France, Flanders, Brussels, Wallone and the Netherlands in 1994, after years of deliberations (Huisman, 2004).

There are now two directives relevant for the regulation of water quantities in the European Union: The first one is the Water Framework Directive (*Kaderrichtlijn Water*), mainly dealing with water quality, and the other one is the Floods Directive, mainly dealing with water quantities. Both directives are shortly elucidated below.

The Water Framework Directive (2000) aims at restoring Europe's waters and forms a potential template for future environmental regulations. It creates a long-term perspective for the management and protection of bodies of water such as rivers, lakes, coastal waters and groundwater. It aims at a 'good status' as an objective for all bodies of water by 2015. Integration is accomplished through river basin districts rather than by administrative boundaries. Members of the European Union were required to prepare river basin management plans by 2009 in order to provide a flexible and cost-effective instrument to deal with water-related issues. The directive also includes the assessment and monitoring of waters and the use of economic tools, like water pricing policies and the polluter-pays principle. The consultation and involvement of the public in drawing up water policy is included as well (European Union, 2007).

In 2007, the Floods Directive of the European Commission on the assessment and management of flood risks came into force. Member states of the European Union are now required to judge whether all water courses and coast lines are at risk from

flooding and to map the flood extent, assets and humans at risk in these areas. Adequate and coordinate measures to reduce the flood risk are mandatory. The directive gives the public the right of access to this information and a voice in the planning process. The Floods Directive shall be carried out in coordination with the Water Framework Directive. Flood risk and river basin management plans, as well as procedures for the participation during the preparation of these plans are also arranged by the Floods Directive (European Commission, 2007a).

2.6 THE EARLY 21ST CENTURY

Since the last three decades of the twentieth century, more appreciation of values of landscape, nature and culture led to a change in the flood risk reduction strategy. Further societal and political changes can be observed in the early years of the 21st century (Section 2.6.1). These developments have influenced the modern flood risk reduction strategy (Sections 2.6.2 and 2.6.3). Advances in risk analysis enabled a switch to a failure probability based safety standard, replacing the old exceedance probability approach (Section 2.6.4).

2.6.1 SOCIETAL AND POLITICAL CHANGES

Because of the shift in societal well-being, more societal and political groups have become involved in the decision-making process regarding the strategy on flood risk reduction since the 1970s. These groups give different meanings to topics related to flood risk. Moreover, they are not always consistent in their idiom, so the debate on flood protection can become confusing. PhD-researchers Heems and Kothuis (2012) found that the communication on flood protection provided by the Dutch authorities is misleading and confusing: On the one hand authorities give the impression that the Dutch people live in the safest delta in the world and that flood protection is a task of the authorities, but on the other hand authorities communicate that the Dutch should prepare for flood disasters themselves.³⁰ There is a wide variety of discussion platforms and fora, where many controversies and misunderstandings arise. People with different backgrounds, expertise and temperaments contribute to this, easily confusing the debate. The backgrounds of the various groups also differ. Authorities and experts consider flood defence against the background of a threat, whereas society generally reasons with victory in 'defeating' the water as a common perception. Participation of the general public in flood defence projects therefore has proven to also have negative side effects like mutual disappointment, indignation, loss of confidence and even distrust (Heems and Kothuis, 2012).

³⁰An example of giving people trust is the article of Dutch 'Water Ambassador' Henk Ovink, with the title 'Our delta is the safest in the world' (Financieel Dagblad of 2 November 2015). An example of stressing that people should prepare themselves is the campaign of the Minister of Infrastructure and Public Works, Melanie Schulz van Haegen, to let inhabitants of the Netherlands buy survival packages (De Volkskrant, 26 January 2013) and be prepared to evacuate in case of a flood (multi-layered safety policy, which is explained in Section 2.6.3).

Rijcken (2015) studied newly developed 'ideas', or opinions, after the completion of the Dutch Delta Works around 1990, about how the flood risk system works and should work. He reviewed the most important Dutch documents on the national flood risk policy, scientific papers and non-scientific documents for quotes that illustrate that these ideas are inspired by societal interest, and for concepts like 'spatial quality of water landscapes', 'reduction of dependency on technology' and 'natural values'. Many of these ideas are 'debatable' and lack technical and factual knowledge to be taken seriously.

The three most prominent and controversial ideas were:

- water is our friend, not our enemy;
- a focus on preventing flooding catches us in a spiral of risk, which should and can be reversed;
- we have to move along with nature and strive for natural solutions.

The proposers of these ideas presented them as logical conclusions, but they were developed without a systematic objective comparison of alternatives. Sometimes, this was done deliberately, reasoning that the ends justify all means, even if they introduce negative effects like reduction in flood risk or unnecessary high expenses. Several (other) policy-makers considered the content of the ideas of minor importance and focussed on the procedures. It appeared to be difficult to exactly determine how influential these ideas have been in decision-making, because there are more factors that influence the decision-making process. However, it was concluded that widely shared ideas have impact on the decision-making process and that flood risk strategies are weakened if ideas are based upon questionable arguments, whereas nature and physics just follow their own logic (Rijcken, 2015).

The societal changes had an impact on the policy in the Netherlands, which altered the way of involving technology. A clear example is the abolition of the Technical Advisory Committee for the Flood Defences (TAW). The Dutch liberal cabinet Balkenende II strived at minimizing the national system of advisory committees. In 2005, Secretary of State, Schultz van Haegen, therefore abolished the TAW. The TAW was founded in 1965 with the task to advise the Minister of Traffic and Public Works on the national flood safety policy and on all scientific and all technology-related aspects considered relevant to flood safety, including the design, administration and maintenance of flood defences. The tasks of the TAW have been taken over by the 'Advisory Committee Water' (*Adviescommissie Water*), to advise on the national flood safety policy, and by the 'Expertise Network Flood Safety' (*Expertise Netwerk Waterveiligheid*, ENW), a 'knowledge network' of specialists in flood safety, to advise on technological issues, but not any more on policy itself.

Another example of the changed role of technology is the reorganisation of Rijkswaterstaat. Its role has always been the practical execution of the public works and water management, but its way of operating has drastically changed during the first years of the twenty-first century. In line with neo-liberal anglo-saxon politics, Bert Keijts, at that time director-general of Rijkswaterstaat, restructured the organisation of Rijkswaterstaat in such a way that it from then on focussed on process

management, while technological knowledge was outsourced to 'the market'.³¹ The staff was reduced from 12 000 in 2003 to about 7900 in 2014 and will be further reduced to 6400 in 2018. This has already led to an enormous loss of knowledge about physical processes and loss of capabilities of designing, constructing and maintaining hydraulic systems and structures. The negligence of deep scour holes near the Oosterschelde storm surge barrier, which were repeatedly detected during monitoring over the past years, is one of the most striking examples. An extensive description of the transformation of Rijkswaterstaat can be found in Metze (2010).

2.6.2 THE VEERMAN COMMITTEE

In 2007, the Dutch government, more specifically the Ministries of Public Works and Internal Affairs, set up a committee to give advice on the feared consequences of 'rapidly' changing climate change on the Dutch coast and its hinterland. The committee, officially called the 'State Committee for Sustainable Coastal Development' (*Staatscommissie voor Duurzame Kustontwikkeling*), was chaired by dr. Cees Veerman, former minister of Agriculture. In this dissertation, this committee is therefore further referred to as the 'Veerman Committee'.



Figure 2.18: Photograph of the members of the Veerman Committee (www.deltacommissie.com)

The Veerman Committee (Figure 2.18) is often compared to the Delta Committee of the 1950s, and was referred to by the committee itself as the 'Second Delta Committee,' but there are big differences. A remarkable difference is the composition of the committees: The members of the Delta Committee were all male and almost all of them had a hydraulic engineering background. The Veerman Committee, installed about 55 years later than the Delta Committee, was composed of members with

³¹A similar development can be noticed in the re-organisation of other Dutch public utilities like the water boards and railroad infrastructure management.

various backgrounds. Only two members had a hydraulic engineering background and 1/3 of the nine members was female, in accordance with the government policy. The 'policy problem' of the Veerman Committee also comprised spatial planning, climate change, innovation, rural development, etc., so their advice on the flood protection policy required more integration of policy fields (Yska, 2009).

The mandate of the Veerman Committee was broader than that of the Delta Committee of the 1950s, which was primarily concerned with hydraulic engineering works 'to counter an acute threat'. The Veerman Committee summarized its ambitions in the question: *How can we ensure that future generations will continue to find our country an attractive place [...] to live and work, to invest and take their leisure?* The recommendations of the report of the Veerman Committee, presented on 3 September 2008, therefore explicitly took into account the interactions with life and work, agriculture, nature, recreation, landscape, infrastructure and energy, next to flood protection and securing fresh water supplies. The concept was to 'work with water' to improve the quality of the environment. This would also offer opportunities for innovative ideas and applications. 'New forms of nature' were intended to be created, and water to be used for food production and energy generation.

The Veerman Committee estimated the North Sea level rise to be in between 0,65 to 1,3 m by 2100, and 2,0 to 4,0 m by 2200, including the effect of land subsidence. The maximum river discharges in 2100 were estimated at around 18 000 m³/s for the Rijn river and 4600 m³/s for the Maas river. The Veerman Committee formulated twelve main recommendations for the short and medium term. It was, for example, recommended to switch to an approach based on over-all failure probabilities, instead of exceedance probabilities, and to raise the overall flood protection level with a factor 10, in several areas even more.³² The level of the IJsselmeer (exclusive the Markermeer) as a fresh water basin would have to be raised with 1,50 m³³.

It was further recommended to base decisions on building in low-lying, flood-prone areas on a cost-benefit analysis. New land development outside the dikes should not reduce the river's discharge capacity or the future water levels in the lakes. The 'building with nature' principle was propagated for the North Sea coast and the influence of the beach nourishments along this coast on the adaptation of the Wadden Sea area to sea level rise had to be monitored and analysed in an international context. Several additional measures were recommended to improve the water management of the Rijn-Maas-Schelde estuary, like sand nourishments in the

³²The outcome of two studies carried out by Deltares in 2011, a societal cost-revenues analysis (*maatschappelijke kosten-batenanalyse, MKBA*) and a loss of life risk analysis (*slachtofferisicoanalyse, SLA*), however, did not support this recommendation. Instead, it has been decided that only three areas deserve extra attention regarding extra safety (Atsma, 2011).

³³This proposal has been revoked in the Delta Programme 2013. It appeared that, because of the ingenuity of the Dutch water system with its many regulatory possibilities, the fresh water storage capacity can be sufficiently enlarged without raising the water level that much, in combination with a flexible level control during summer. A water level rise of 0,20 m of the IJsselmeer and Markermeer, anticipating a period of drought in summer, would be sufficient to prevent salt intrusion until 2050, in combination with a water level lowering of 0,10 m during droughts. Pumping stations will probably be necessary in future, after sea level rise, to discharge superfluous water from the IJsselmeer into the Waddenzee.

Oosterschelde, dike reinforcements along the Westerschelde and a re-arrangement of several other estuaries.

The costs of the implementation of the new flood protection programme until 2050 was estimated at 1,2 to 1,6 billion euro per year, and 0,9 to 1,5 billion euro per year in the period 2050 - 2100.³⁴ The financial means would have to be secured by a Delta Fund, under administration of the Minister of Finance. The Delta Fund should be supplied with a combination of loans and the transfer of (part of) the natural gas revenues. It was also recommended to create a national fund and set up rules for withdrawals from the fund. The organisation of flood protection would have to be strengthened by providing a 'cohesive' national administration and a regional authority for the implementation and by initiating a permanent Parliamentary Committee.

The new flood protection programme has been embedded, financially, politically and administratively, in a new 'Delta Act'. This Act has been promulgated in 2009. A 'Delta Commissioner' was installed per 1 February 2010 to implement and elaborate the advice of the Veerman Committee into an ongoing Delta Programme. The process of revision of the standards started with the policy project 'Flood Protection 21st Century' (*Waterveiligheid 21ste Eeuw* in Dutch). After four years of analyses and development of strategy, five key decisions were presented to the Parliament. Three decisions concerned national policy frameworks (on flood risk management, fresh water supply and reconstruction of the built environment) and two concerned overall strategies for areas with strong interaction of flood risk and fresh water supply (IJsselmeer lake and the Rijn-Maas delta). A 'Delta Fund' of about 1 billion euro per year was created to provide financial means for the execution of the plans, per 2020 (van Alphen, 2014).

2.6.3 THE MULTI-LAYER FLOOD RISK REDUCTION APPROACH

The presently used approach of multi-layer safety (*meerlaagsveiligheid*) was introduced by the Dutch Ministry of Public Works in the National Water Plan 2009-2015 (Ministerie van Verkeer en Waterstaat, 2009), which is the successor of the Fourth Memorandum on Water Management (*Vierde Nota Waterhuishouding*) of 1998. The multi-layer approach aims at reducing flood risks by decreasing the probability of flooding (layer 1), and by reducing the consequences of floods by way of spatial solutions measures (layer two) and by way of crisis management (layer three) (see Figure 2.19). The strategy of the Delta Committee consisted of investing in only the first layer. In the new Dutch policy, this approach has been expanded with the two other layers. The formal contribution of the second and third layer to the flood risk reduction implies acceptance of a higher flood probability compared to the previous one-layer approach of only flood protection.

The rationale for the second and third layer is given in Chapter 4.1 of the National Water Plan (Ministerie van Verkeer en Waterstaat, 2009): '*Because the probability*

³⁴Amounts in euro at 2007 price levels, including Dutch Value Added Tax (BTW).

of flooding can never be completely excluded, the future attention should not only concentrate on avoiding floods (prevention), but also on reducing the numbers of casualties and material losses in case of an eventual flood, and to promote recovery after a flood. Possible measures reside in the sphere of spatial planning, taking into account the flood risks and the operation of disaster management (evacuation, disaster planning). In consequence of the response of the cabinet on the advice of the Committee Luteijn (August 2000), to increase the safety, measures like emergency catchments and compartmentalization came into sight.

Regarding constraint of the consequences of a flooding, special attention should be given to the protection of vital infrastructure, like energy and drinking water supply, and telecommunication and ICT. They can become dysfunctional as a result of the flooding. Moreover, many of these objects are crucial, especially during floods to prevent societal disorder as good as possible.'

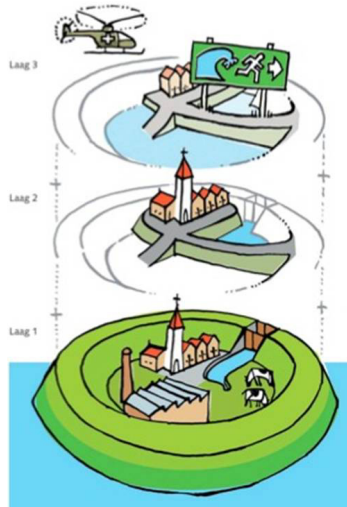

Figure 2.19: The three layers of multi-layer flood safety according to the National Water Plan 2009-2015

Several historical events caused this shift in thinking about flood protection. The Dutch Delta Works were about to be finished, when the large rivers (Rijn, Maas, Waal) caused floods and near-floodings in 1993 and 1995. This led to a change in thinking about flood management in different approaches to deal with floods than prevention by permanent structures. The multi-layered strategy aimed at giving more space to the rivers, which was implemented in the project Room for the River. This strategy was succeeded by the safety chain approach that considered alternative protection measures next to prevention. The flooding of New Orleans, USA, after Hurricane Katrina, called to mind the severity of the impact of a failing flood prevention system. Dutch history, as well as examples from other countries, show that there is an abundance of flood management measures that might ease the impact of floods.

A mathematical risk approach carried out by Vrijling (2014b) and Tsimopoulou (2015) led to the following observations:

- the effectiveness of resources spent on prevention is most probably higher than on repression, because repression only becomes effective after a flood, when economic damage has already occurred;
- private insurance of flood damage forces to a higher protection level, because the insurance premium exceeds the risk by a certain factor. The total costs of prevention plus insurance will therefore increase compared to only prevention;
- optimal investment is limited to one safety layer, which is the layer with the lower marginal prevention costs.

This leads to the conclusion that a multi-layer approach for reducing flood risks defies economic reasoning. In most cases, a one-layer safety approach is economically optimal. It is also noted that the multi-layer system can only work if all layers can withstand the full force of a flood. For the third layer, the disaster management, this is certainly not the case: the entire population of a polder cannot be evacuated on a short notice (Vrijling, 2014b). Measures in the second layer, however, can be justified if other values than flood protection become prevalent (Kolen et al., 2012).

The multi-layer flood risk reduction approach was incorporated in the Delta Programme 2014 (Deltacommissaris, 2013).

2.6.4 THE FLOOD SAFETY STANDARD PER 2017

The flood risk approach per 1 January 2017 comprises two main improvements compared to the old approach as proposed by the Delta Committee in 1960 (Deltacommissie, 1960a). Firstly, advanced flood risk calculation methods allow a more differentiated estimation of the actual reliability of flood defences than the old exceedance probability approach. Secondly, the safety standard has been updated, because the actual flood risk has increased over time due to growth of the population and increased economic values in the protected areas. These two developments are briefly described in this section.

IMPROVEMENTS OF PROBABILISTIC METHODS

The Delta Committee recommended an *exceedance probability* approach as the Dutch flood safety standard, but it realised that this was not ideal, because dikes can also fail due to other failure mechanisms than only wave overtopping or overflow. Other shortcomings of the then chosen approach are:

- All flood defences around a dike ring area are assigned the same acceptable exceedance probability, but the various sections comprised in a dike ring do not necessarily provide the same degree of safety. This is not optimal from an economic point of view;
- It is not possible to achieve a balanced design per dike section with regard to the various failure mechanisms;

- The influence of the overall length of a flood defence is not taken into account;
- The magnitude of the damage of loss in case of failure has no influence on the design;
- The actual flood probability is not known.

2

A more advanced method based on *failure probabilities* has advantages compared to the method based on exceedance probabilities (Stichting CUR, 1990):

- Dike rings as technical systems are described and analysed as a whole;
- The components of flood defence systems and subsystems can be designed more accurately;
- Estimation of the contribution of the diverse structural parts to the flood defence function is improved;
- Uncertainties are rationally incorporated in the safety assessment of the system;
- Costs of system improvements and cost of damage or loss expectations can be taken into account per protected region;
- Insight increases in the sensitivity of the failure probability of the system regarding the distinguished uncertainties;
- Prioritization of improvements of flood defence systems can be obtained, as more detailed and differentiated information is available;
- Politicians will have a comprehensive conception of the circumstances and informed statements can be made.

Combined with the multi-layer flood safety policy, the *failure probability* method allows for integration of flood protection and urban development.

The Delta Committee therefore already recommended to make a switch towards a complete *failure probability*, or risk-approach, when knowledge and techniques would be sufficiently advanced to be applied (Deltacommissie, 1960c). The Committee River Dikes (*Commissie Rivierdijken*, better known as the *Comitee Becht*), which advised the Minister in 1977 on the upper rivers policy, realised that a dike might be able to retain the design water level, but might as well fail due to other failure mechanisms at lower water levels. It was acknowledged that there was no clear insight into the actual flood probability of a polder. In response to this advice, the Advisory Board of the Water Council (*Raad van de Waterstaat*) advised to consider whether it would be possible to come to a standard based upon a risk analysis of all involved aspects. As already mentioned, the Veerman Committee also recommended to switch to an approach based on failure probabilities (Veerman Committee, 2008).

Since the 1970s, many efforts have been made to increase the knowledge on probabilistic methods, risk analysis, risk acceptance and damage estimation. In 1979, a task force 'Probabilistic Method' of the Technical Advisory Committee on Flood Defences was installed to advise the Minister on this topic (TAW - LR2, 1989). One of the first publications on probabilistic design of flood defences was issued by a preliminary workgroup 'Probabilistic method' (Bakker et al., 1979), soon followed by a publication on the probabilistic design of sea defences (Bakker and Vrijling, 1980).

Meanwhile, experience on the probabilistic method was gained by the introduction of probabilistic principles in engineering by professors Jan Agema, Adolf Bouma and Dick Dicke, of Delft University of Technology. The Oosterschelde barrier has been the first storm surge barrier in the world, fully designed according to probabilistic methods. A considerable contribution to this design was made by Han Vrijling, who later became professor of Hydraulic Structures and Probabilistic Design at Delft University of Technology. Together with prof. Ton Vrouwenvelder, Vrijling initiated and further anchored probabilistic design in the academic curriculum in Civil Engineering education since 1982.³⁵ Vrijling and Vrouwenvelder made a considerable contribution to the CUR/TAW report on the probabilistic design of flood defences (Stichting CUR, 1990).

Since 2006, the increased knowledge on risk calculations enabled the development of a policy to replace the previous approach of basing dike height (and indirectly also other dike properties) on a design water level with a prescribed exceedance probability, with a flood risk approach where multiple failure mechanisms are considered. It was explicitly announced in the National Water Plan 2009-2015 that such a revision process would be started. The drawing-up and formalisation of the new flood safety standard was organised in a 'policy programme' called 'Flood Risk 21st Century' (*Waterveiligheid 21^e eeuw*) and continued in the 'Delta Programme Safety' (Kind, 2013).

The project organisation 'Flood risk in the Netherlands' (*Veiligheid Nederland in Kaart, VNK*) completed a flood risk analysis, based on failure probabilities of dike segments. This organisation, an initiative of the Ministry of Infrastructures and the Environment, the Union of Water Boards (*Unie van Waterschappen, UvW*), and the Inter-provincial Consultation Association (*Interprovinciaal Overleg, IPO*), performed the calculations for 55 dike ring areas in the Netherlands and for three dike rings along the Maas river in Limburg. The calculations were completed at the end of 2014 and the results were used as input for the new safety approach.

IMPROVEMENTS IN THE ESTIMATION OF SAFETY LEVELS

In 1985, TAW Task Force 10 published a report that was intended as a contribution to the political discussion on flood risk acceptability (Vrijling, 1985). Three main criteria for settling an acceptable risk level were motivated:

1. individual death probability, based on a comparison to death probabilities due to other causes;
2. multiple deaths probability, according to a comparison to the number of fatalities due to traffic accidents per number of inhabitants;
3. economic optimum of investments in flood protection and the thereby obtained damage reduction.

These basic criteria are still used for determining an acceptable flood risk level and their application to the new Dutch safety standard are, amongst others, described

³⁵The author of this dissertation modestly reports that he is glad that he was able to prevent this field of knowledge to be removed from the job profile of Vrijlings' successor, prof. Bas Jonkman.

by Jonkman et al. (2011); Kind (2013) and Jongejan and Maaskant (2015). They are basically the same as derived by Vrijling (1985) and briefly described below. A mathematical explanation of these criteria is given in Appendix D.

2

- The *local individual death criterion* is the probability that an individual, staying at a certain location during one year, perishes due to a flood.³⁶ It takes the possibilities of evacuation into account. Evacuation is more effective along river dikes than in coastal areas, because high river levels are more predictable in due time than storm surge levels at sea. Individuals who do not evacuate during a flood threat are most exposed to danger. The probability that they will not survive depends on flood characteristics (mainly the flood propagation and flood depth) and the behaviour and vulnerability of individuals (see Jonkman (2007) for more background on loss of life estimations due to floods). The basic, individual, safety level is settled at $1 \cdot 10^{-5}$ and can also be achieved by measures in the second and third layer of the multi-layer approach (see Section 2.6.3).
- The *multiple deaths criterion* is the probability that N individuals, residing at one location during a random year, die due to a flood event.³⁷ It is a measure of the societal impact of a flood. From a societal point of view, the likelihood of a large number of fatalities per flood is of importance. A flood with a large number of fatalities, has more societal impact than many floods with less fatalities per event. Locations with a high probability of multiple deaths get more protection. It has been studied what dike segments in the Netherlands would have the highest influence on the multiple deaths probabilities. These 'hot spots' were assigned a higher protection level than the required level based on the local individual death criterion or the economical optimum.
- The *economical criterion* consists of a balance between investments in flood risk reduction and the obtained damage reduction. The flood consequences have been calculated per segment for 2050, as well as the costs of obtaining a ten times better protection level. The total damage consists of economic damage and monetised consequences of fatalities and less severely affected people.

A societal cost-benefit analysis and analyses of the risk of loss of life have been carried out as a part of the policy programme 'Flood Risk 21st Century', which was used as a base for the new flood safety standard (Kind, 2011). For the cost-benefit analysis, economically optimal protection levels were calculated per dike ring. The highest protection levels were found for the rivers area, for central Holland and for Almere. The investments required for adapting the present situation to the calculated levels were estimated at about 5 to 10 billion euro, exclusive the costs to compensate for the effects of climate change and the costs of projects in operation.

³⁶In the Netherlands, this criterion is known as *lokaal individueel risico*, *LIR*, which could be confusing because it is a 'probability' rather than a 'risk', according to the definition 'risk = probability x consequences.'

³⁷In the Netherlands, this criterion is known as the *groepsrisico* or *maatschappelijk risico*, which is a 'probability' as well.

The safety levels per location are based on a risk approach and divided into six safety classes, with a failure probability ranging from 1/300 to 1/100 000. The failure probability is the likelihood that the loads on a flood defence exceed its resistance, in which case it will fail.³⁸ All relevant failure mechanisms are taken into account, and not only the probability of overflow and wave overtopping. The new approach comprises a failure probability norm per dike segment, and not per dike ring area.

In practice, the criteria of individual death and economic efficiency determine the safety level per dike section. Of these two criteria, the economical criterion appears to be determining for most dike sections. The multiple deaths criterion gives rise to stricter criteria for only a few dike sections. At locations where the resulting maximum failure probability of two adjacent dike sections differs with a factor 10 (or more), an intermediate section is defined with an intermediate failure probability requirement (Van der Most et al., 2014). Figure 2.20 shows a geographical map with the old and new safety levels next to each other.

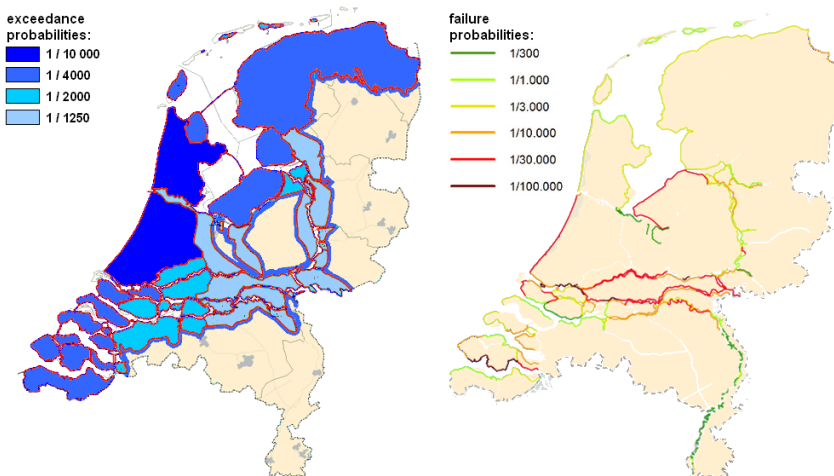

Figure 2.20: Old (left) and new (right) flood safety standard in the Netherlands

The highest allowable failure probabilities apply to dike sections in the riverine areas, the provinces of South Holland and Flevoland and the Rijn-Maas delta. The individual death criterion mainly determines the standard in the Rijn-Maas delta, and economic efficiency determines the safety level of the other sections. Implementation of the new safety approach will lead to a considerable reduction of individual death criterion and a substantial improvement of the economic optimum (Van der Most et al., 2014).

Dams are treated differently from *dunes* and *dikes* in the new approach. Until 2017, dams had to comply with the standard of the most critical dike behind the dam.

³⁸In the Water Act, this 'failure probability' is denominated as a flood probability (*overstromingskans*), which could be a cause of confusion.

This was workable, because the standard was related to a design water level with a certain exceedance probability. However, the new approach is based on a failure probability, requiring another approach: The failure probability of dams is therefore derived from the ratio of economic losses and investments for improvements. For *large dams* that close-off large bodies of water, like the IJsselmeer and the Markermeer, the approach is different, as the buffering capacity of the large water bodies dampens the impact on the flood probability of the areas behind the dikes along these lakes. The acceptable failure probability of large dams has therefore been derived from an assessment of the functioning of the hydraulic system.

The failure probability of *movable barriers* should be incorporated in the governing hydraulic boundary conditions of the flood defences behind the barrier as is convention in current practice, because it is not feasible to limit their probabilities of failure to a negligible impact on the hinterland. It may especially be difficult to reduce the probability of non-closure of the gates of these barriers.

However, due to the lack of data, the failure probability of most dams and barriers cannot (yet) be determined. Therefore, a semi-quantitative approach was used to roughly determine the required safety level of these structures. Consequently, if their reliability would appear to be lower than the determined failure requirement, a full cost-benefit and risk analysis will be endeavoured to more precisely determine the safety level (Van der Most et al., 2014).

IMPLEMENTATION OF THE NEW FLOOD RISK STANDARD

The fifth edition of the Delta Programme 2014 contained a proposal for new flood defence standards based on a combined failure probability of all failure mechanisms rather than on exceedance probabilities. The Water Act was successively changed per 1 January 2017 to enforce a uniform individual flood risk of $1 \cdot 10^{-5}$ and to base the assessment and design criteria on a flood risk related to dike segments instead of dike ring areas. All primary flood defences should comply with the new safety standard in 2050 at latest (Ministry of Infrastructure and Environment, 2016). Meanwhile, the improvement of flood defences continues with the Flood Protection Programme 2017-2022 (*Hoogwaterbeschermingsprogramma* 2017-2022) with a budget of more than $5 \cdot 10^9$ euro.

2.7 CONCLUDING REMARKS

Summarised, history shows that the flood risk reduction strategy is influenced by:

- sense of urgency;
- attitude of politicians and civilians;
- the actual risk and willingness of society to accept risks;
- possibilities to organise an effective implementation of the strategy;
- available scientific knowledge and technology;
- available funding;
- level of societal development;
- the valuation of LNC functions;
- societal involvement.

Severe flood events create a heightened sense of urgency to improve the present flood risk reduction strategy. Politicians and citizens are more willing to invest in flood safety at such times. Technology can only be applied if it is related to societal standards and values, and a complex of societal forces determines which technology is applied. Societal changes, besides unforeseen effects on the natural environment, can introduce unforeseen feedback on the realised systems, which can sometimes lead to unexpected changes in the hydraulic system.

It appeared that the flood reduction strategy can be formulated at the local, regional, national and international level, consistent with policies of spatial planning. The Dutch flood-risk approach was initially organised at the local level of a polder, but appeared over time to be not very efficient, nor effective. The situation has improved considerably since the founding of Rijkswaterstaat in 1798, and the establishment of a Royal Advisory Committee in 1809 by King Louis Napoléon Bonaparte. From then on, the flood protection strategy and navigability were taken care of at a national level. Integration of ecological and societal systems with the water system has led to more extensive approaches, also taking values of landscape, nature and culture into account.

At present, many people of diverse backgrounds are involved in decision-making processes on the flood risk reduction strategy, making it even more complex. For effective policies on flood risk reduction, cooperation is required between the various levels of decision-making, actively involving stakeholders in the design process. Ideas on 'T-shaped' or 'thumbtack-shaped' engineers, with a broad ability to apply knowledge across their own field of expertise, yet possessing of functional, disciplinary skills, that take human factors into account, are an answer to the need of society for practical specialists with a broad perspective. The 'T-shaped engineers' know how to interact with stakeholders, work within multi-disciplinary design teams and are able to contribute to feasible solutions with a sound engineering background (Geerken, 2013; Hertogh, 2013; Kamp, 2016).

Furthermore, the process of integrated design and the ideal composition of design teams can be improved to do justice to the different kind of contributions of the participating groups (Chapter 4 explains how such an integrated design can be

carried out). Landscape architect prof.ir. Dirk Sijmons explains that people who are able to combine rationality and irrationality, can accomplish a higher level of quality of life (Sijmons, 2008). Combining different disciplines and cultures into a design team would thus be beneficial for multifunctional design projects.

3

ENGINEERING AND SPATIAL DESIGN

Chapter 2 described the past developments in the Dutch flood risk reduction strategy and showed how they were influenced by society. Spatial designers and hydraulic engineers aim at implementing the strategy in feasible designs of multi-functional flood defences, but they use different approaches, as engineering and spatial design have grown apart since the 1970s in academics as well as in parts of practice. This chapter describes both approaches: Section 3.1 first introduces the term 'design', and the generally used methods in engineering and spatial design are outlined in Sections 3.2 and 3.3. Chapter 4 combines spatial design and engineering into one integrated design method.¹

3.1 INTRODUCTION TO DESIGN

Mick Eekhout, professor in Product Development at Delft University of Technology, characterised design as *the tunnel through which the results of scientific research are brought to society* (Van Genderen, 2007). This definition emphasizes the *application* of knowledge of natural, social or psychological processes for the benefit of society. More generally, design can be described as the process of creating an optimal plan or convention for realising an object or a system that is required to satisfy a need. This definition seems more complete, because it explicitly mentions the *objective* of the process: satisfying a need, or in other words: solving a present or foreseen problem.²

Depending on the specific purpose and field of application, several kinds of design can be distinguished, such as industrial, urban, engineering, and product design. These design types partially overlap, but Taura and Nagai (2009) present a stricter division of design categories. They distinguish 'drawing,' 'problem solving' and 'ideal pursuing':

¹ A preliminary version of Chapters 3 and 4 has been published as a technical report 'The 'Delft design method' for hydraulic engineering' (Voorendt, 2015a).

² Design is here considered as a process, or a series of activities. It is, elsewhere, often also used to denominate the product of such a process.

- *Drawing* is the *expression of images in the form of pictures or sketches*. This type of design is strongly associated with art. A more precise denomination of this design category would be 'artistic drawing', because 'drawings' are also used as tools in the other two design categories. 'Artistic drawing' should even not be regarded as a form of design, because design is primarily functional, rather than contemplative (Forsey, 2013). Taura and Nagai (2009) explain that although the drawing process seems to be creative, it cannot create a truly new output because it only transforms an abstract image into a concrete figure or shape. Drawing does not necessarily aim at realistic 'solutions', so that way of designing differs more fundamentally from the other two classes.
- *Problem solving* is the procedural aspect of design is stressed and is mainly applied to a activities that aim at finding solutions for actual or foreseen future problems. A problem is defined as the discrepancy between the current state and the desired objective. The process of developing a solution is synonymous with the design process.
- *Ideal pursuing* is triggered by an urge to create an ideal environment, rather than by solving actual 'problems'. It concerns ideas that conform to the perspective of the future and something which is meant to be, which can only be predicted by human beings.

'Ideal pursuing' resembles 'problem solving', in the case that a realistic outcome is desired. This dissertation concentrates on the approaches of problem solving and ideal pursuing. The problem solving approach can be recognised in the general 'engineering method' and ideal pursuing is related to the design approach.

The general form of a systematic process to accomplish a problem-solving design is called a *design method*. Unlike mathematics, it is ambiguous: in a design there is generally more than one valid solution that solves the problem. The outcome of a design, the solution, highly depends on chosen requirements and criteria. Modern design methodology as a scientific discipline originated in 1962, at the Conference of Design Methods in London³ (Cross, 1993). Several modern engineering methods were developed and described in the early 1960s. They distinguished the design steps of analysis, synthesis, development and evaluation, which were different in final appearance, but had a sequential design process subdivided into comparable steps in common (Visser, 2016).

After the initial studies of the 1960s, ample literature has been published on design and design methods in a wide variety, but the variety is mainly a matter of terminology. Most methods are based upon the same, natural, cyclic way of problem-solving and are described as the *empirical cycle in reflection* and are characterized by five basic stages (De Groot, 1961):

³However, several earlier attempts to a scientific approach of design are known, like 'De Stijl' and Bauhaus in the 1920s (Bayazit, 2004).

1. observation;
2. presumption;
3. expectation;
4. verification;
5. evaluation.

Problem-solving starts with *observing* the situation and then, with available knowledge and skills, the problem-solver has *presumptions* about activities that could solve the problem, and *expectations* about the effects of these activities on the observed situation. Then it has to be verified whether the expected effects match the desired effects. In engineering, an explicit activity of creating concepts has to be included, and also the subsequent verification of these concepts to check whether they would meet the expectations. Finally, the problem-solver evaluates the result of his thinking process by asking 'what did I learn from the process?' and 'how can I apply the gained experience (possibly for a next cycle)?'.

In engineering design, Vrijling distinguishes the following main design phases, wherein the creation activity is mentioned explicitly (Vrijling, 1996):

1. observe;
2. model;
3. predict;
4. do and verify;
5. improve the model if needed.

This process is embedded in logical thinking and psychological theories and protocol analyses show that this cycle is generic and unavoidable (De Groot, 1961). The intuitive character of the design process is helpful for novice designers and relatively 'simple' design tasks, but for more advanced and complex problems, designers need skills, knowledge and understanding as well. Lawson and Dorst (2009) even describe designing as *one of the most complex and sophisticated things we can do with our minds*.

The advantages of a systematic approach can be summarised with (Siers, 2004):

- one does not jump to solutions too soon;
- it provides a way to organise the design process;
- a good overview of design activities is obtained;
- there is a small likelihood that essential aspects are overlooked;
- it facilitates decision-making;
- the chance increases that an effective product or system is created

There are also disadvantages of systematic approaches, especially when they offer too few possibilities to deal with ill-defined and complex problems, obstruct creativity and reduce possibilities to learn from the design process. The obstacle was the incentive for architects to develop their own approach as a scientific discipline. As a result, the design of multifunctional flood defences is now usually divided in two phases, where engineering is followed by a spatial design, or the other way around. It seems more efficient to combine both approaches in such a way that the

advantages of each approach are maintained. After briefly describing the engineering method (Section 3.2) and the design approach (Section 3.3), this dissertation therefore attempts to develop a design method that integrates both approaches (Chapter 4).

3.2 THE ENGINEERING DESIGN METHOD

3

Engineering design models have been developed in a systematic and scientific way since the early nineteen-sixties of the previous century. This development has led to a generally accepted model, which describes the engineering process as a sequence of activities, leading to typical results like performance specifications, function structures, principal solutions and documentation. The design activities are grouped into four main design stages: clarification of the design objective, conceptual design, embodiment design and detailed design. In general, the aim of engineering is to find and define shapes and materials to make the system capable of performing the desired physical behaviour in the most efficient and effective way. The consensus model is based on the approach followed in systems engineering (see also Section 3.2.4). Engineers from Germany, like Pahl and Beitz (1986) and Hubka (1989), were the main contributors to the development of the consensus model (Roozenburg and Cross, 1991).

This section describes the engineering method as applied in civil engineering. The application of the engineering method for several other disciplines is also briefly looked at, for possible incorporation in a combined method for multifunctional flood defences. A link with the present practice is made by briefly describing the systems engineering method and the process for multi-annual programmes on infrastructure, space and transport (MIRT), as applied in the Dutch Flood Protection Plan (HWBP).

3.2.1 THE METHOD USED IN CIVIL ENGINEERING

The civil engineering method is a typical systems engineering approach. The rationale stems from a need to solve a societal issue, starting with an investigation of the problem, followed by the formulation of the design objective to solve the problem. This objective is formulated in an abstract way, namely as the fulfilment of a function. It is transformed into specific shapes and materials during the design process.

Basic characteristics of the engineering method are:

- analysing the problem;
- defining a project objective and the (main) functions of the desired system;
- defining requirements and making an inventory of boundary conditions;
- transforming functions into specific systems or structures. This transformation starts with generating provisional shapes that are not necessarily realistic or fulfilling all requirements, but during the process, these initial concepts are

transformed into verified and evaluated concrete and detailed solutions. This kind of reasoning is also denominated as *innovative abduction*⁴ (Roozenburg and Eekels, 1995);

- developing various concepts that are optimised, systematically evaluated and compared to each other;
- improving provisional design solutions by iterations, or recursions, when more knowledge and insight has been acquired. Finding the right system definition, for instance, is often an iterative process;
- cyclically repeating the series of design sequences, adding more detail to the design.

A distinction is made between iterative and cyclic moves in a design process: *iterative* means that steps are repeated or re-done with more knowledge. *Cyclic* means that the same steps are done at a more detailed system level. The first cycle starts at the level of a complete system (e.g., a complete marina). It should then be repeated for the subsystems (the jetties, boat house and canteen belonging to the marina) and the elements of the sub-subsystems (the walls, floor and roof of the canteen).

The distinction of several design steps is essential for applying phasing of the design process and for organizing the activities that are needed to come to a working solution. In 1980, prof.ir. Jan Stuij, at that time lecturer at Delft University of Technology, already distinguished the phases of defining the problem (finding the desired functions of the future system), structuring (finding ways to fulfil the functions), shaping (determining the main dimensions) and dimensioning (structural design), to be elaborated in several design cycles, at different levels of detail, starting with the over-all system level and ending with a very detailed component level. The different levels of detailing result in different products: A conceptual design (*schetsontwerp*) is the least detailed level, followed by a tentative design (*voorontwerp*, VO) and a final design (*definitief ontwerp*, DO). This implies that after the initial cycle, there are multiple design processes, carried out by different people at different design levels. This requires a good organisation of the entire design process and intermediate reports after every design phase.

The result of an engineering process is usually a report that includes technical drawings and material specifications, but it can also be a software model or a prototype model. The first products of a conceptual design are mostly quite general and broad, but should be good enough to make a reliable cost estimate for the entire project, as the first overall designs are used to decide whether a tender proposal should be made. If it seems technically possible to realise the project for a reasonable price, a tender can be put out. It requires much experience and knowledge to judge whether a tentative design suffices to make a good cost estimate.

A flow scheme of the entire process was presented in the 1980's as in Figure 3.1. The

⁴Innovative abduction differs from *deduction*, because it cannot be replaced by an algorithm that step by step, with certainty, generates solutions for design problems. The intuition and creativity of the designer plays an essential role in the design process. Innovative abduction also differs from *induction*, because it aims at the totality of the entity that has to be created and not only one certain aspect of the considered reality.

design starts with a study of the problem and proceeds by formulating a design objective, formulated at an abstract level (as a function). Alternative solutions are then developed that aim at reaching the objective. The alternatives are then evaluated with help of criteria, after which these alternatives are compared and the best one can be selected and elaborated in a design cycle at more detailed level. The design process ends in actual shaped objects, structures or systems that fulfil the functional requirements and, thus, solve the problem (Pols, 1982).

3

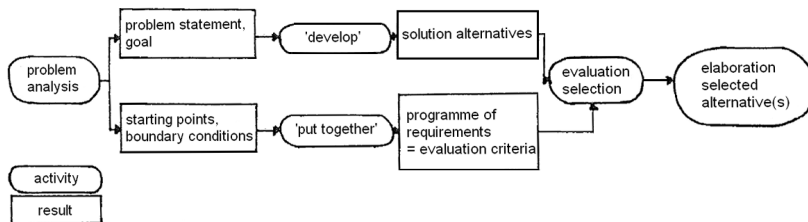

Figure 3.1: Flow scheme of problem solving, used for the education of civil engineers (Pols, 1982)

Later on, the design process for civil engineering projects was given shape in accordance to Norbert Roozenburg and Johannes Eekels, professors at the faculty of Industrial Design at Delft University of technology. Roozenburg and Eekels distinguished several design phases, as indicated in Figure 3.2 and is explained below. The design process is presented as a systematic and chronological activity, but in reality it is less straightforward and less rational than suggested by the presented flow diagrams.

Analysis

The *Analysis* phase usually starts with exploring the backgrounds and the problem motivation. An inventory of involved stakeholders sheds light on the involved interests. Process and function analyses give insight in the desired performance of the system or structure that has to be realised. An investigation of the environment and boundary conditions gives information on the restrictions of the solution space. A problem statement briefly summarises the core of the problem and the design objective describes the expected performance of the future system in an abstract way (the future functioning should be described, not specific shapes). A programme of functional requirements can be derived from the design objective and criteria for comparison of concepts (in the Evaluation phase) can be derived from the stakeholders' interests. A project planning can then be drawn up and an inventory of risks, that could threaten the success of the project, can be made.

Synthesis

In the *Synthesis* phase, the abstract design definition transforms into shapes and gets material properties. Usually, several provisional concepts are generated, for instance, by using brainstorming sessions, attribute listing, or by drawing morphological maps. Exploratory sketches should be made to trigger and enhance the

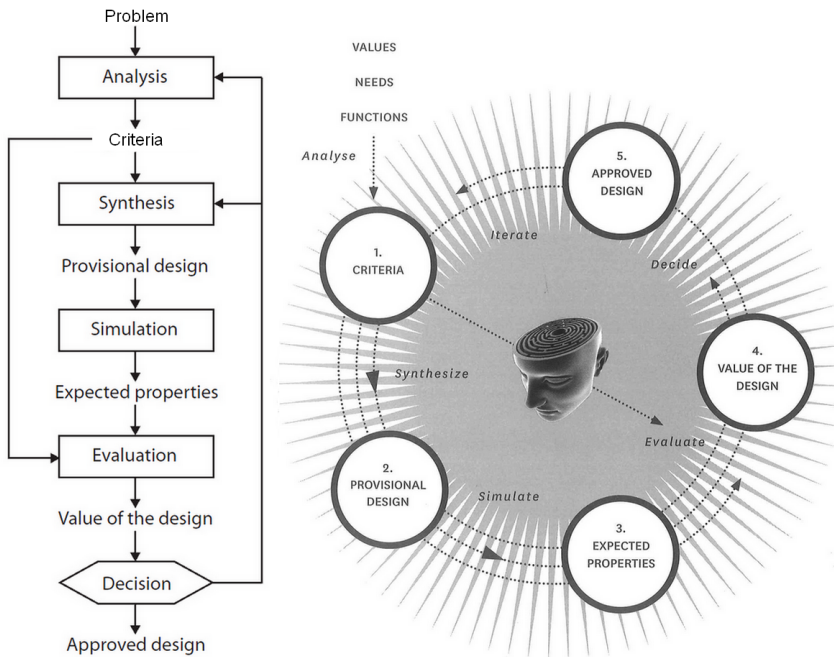

Figure 3.2: The basic design cycle of Roozenburg and Eekels as represented in Roozenburg and Eekels (1995) (left) and in the Delft Design Guide (2013) (right)

thinking on solutions and to stimulate creativity. The result of the Synthesis phase only consists of provisional concepts that might or might not meet the requirements, so successive phases are needed to complete the design.

Simulation

In the *Simulation phase*, the concepts created in the *Synthesis*, are verified to check whether they will function properly as defined in the project objective and specified in the programme of requirements, defined at the detailing level of the design loop under consideration. A wide range of theories, formulas, tables, scale models, prototypes, drawings and research methods from technical and behavioural science are at the disposal of the designer. They all model reality, more or less simplifying it. *Simulations* can be used as a verification tool, for example to check a transport infrastructure system to detect bottlenecks. For structural designs, *calculations* are suitable to determine the dimensions of the system or the structure. Typically, during this design phase, the technical system and the main dimensions are derived from functional requirements and the dimensions of structural members (like floors, walls, columns, etc.) follow from requirements regarding structural integrity in more detailed design loops. If functional requirements cannot, or only problematically, be quantified, the effects of concepts can be simulated and the extend of meeting these requirements can be checked with help of interviews, questionnaires, focus

groups or user observations.

Evaluation

In the *Evaluation* phase, the feasibility of alternative solutions is evaluated by finding a right balance between the created values and the sacrifices needed to achieve these values. The suitable type or level of evaluation depends on the scale of the project and its owner. Broad debate seems to be appropriate to large-scale infrastructure, but for 'smaller' projects a multi-criteria approach seems to be better, because the marginal cost of the project would not balance with the marginal value obtained with this approach. Politicians include aspects like environment, health, culture, aesthetics, etc. in their considerations. Cost-benefit analyses include elements like growth, employment, currency and inflation. Cash-flow only comprises financial profits and losses (Bakker, 2000).

Decision

The best alternatives can be proposed to the client and the consequences of choosing an alternative can be discussed. The chosen solution has to be affordable, which means that the client has to have sufficient solvency (the degree to which the assets exceed the liabilities) and liquidity (the ability to pay short-term obligations). In addition, in a capitalist economy, the dividend of the project has to be competitive with other dividends in the economic market. It could also be useful to consider the value and costs of alternatives during longer periods, because that could alter the attractiveness of each alternative. For instance, if not only construction costs are considered, but also the costs of maintenance and demolishing or re-use are included, sustainable alternatives could become more interesting, if long-term trend changes within the lifetime can be foreseen. It should be noticed, that cash inflow and outflow have less effect further in the future.

If the client likes the 'winning' alternative and is able to afford that solution, a new design cycle can be started, where more detailed calculations and drawings are generated for the subsystems within the system that was designed in the previous cycle. The objective and programme of requirements and all further design steps are then aimed at the subsystem and as a consequence, they will be more specific than in the previous design cycle. A new cycle could also be used to re-consider the programme of requirements, for instance when the costs of the best alternatives appear to be unaffordable. To complete the design project, the final results have to be communicated to the client and other involved parties in a final report. Professional engineers usually document their solutions in such a way that they can be constructed or manufactured (Hertogh and Bosch-Rekvelde (2014), Delft Design Guide (2013), Roozenburg and Eekels (1995) and Workgroup IID (2013)).

3.2.2 USING THE ENGINEERING METHOD FOR TYPE SOLUTIONS

The engineering method is sometimes used to evaluate the suitability of existing types of structures or products. For example, it could be used for a study on what types of disembarking structure would be most suitable for a specific berthing place. This differs from the design of tailor-made systems or structures, because

existing alternatives are used instead of specifically developed new systems or structures. This implies that the development of developing potential concepts (the *Synthesis*) consists of making an inventory of existing solutions, or so-called 'principle solutions'. The possibilities of making the standard solutions fit to the requirements are often more limited than in the case of tailor-made alternatives. Nonetheless, the same development cycle can be used as for tailor-made products. Often, a design uses a combination of standard elements and tailor-made solutions.

The engineering method can also be used for developing a framework that supports the choice between standard solutions for not very specifically defined circumstances. It could, for instance, be used to determine what kinds of breakwaters would be most suitable per type of inland harbour. In that case, the specific circumstances and the boundary conditions are not clear, because the framework is location-independent as long as it concerns inland waterways, thus, it is not possible to include the judgement whether the various types meet site-specific requirements in the framework. Moreover: the requirements can only be formulated in a qualitative way, if at all. For this purpose, the *likelihood that solution types meet the requirements* should be used as a criterion (with a high weighting factor) in the evaluation of solution types. It is advised to set up criteria for all individual main requirements and not only for one criterion of meeting all the requirements as a whole. So, in our example, the likelihood that a breakwater type will sufficiently provide calm water for shipping, the likelihood that it will be sufficiently stable, will be reasonably constructable, etc., should be formulated as criteria.

3.2.3 OTHER ENGINEERING DISCIPLINES

INDUSTRIAL DESIGN

Industrial designers are familiar with the method described by Roozenburg and Eekels. Their main idea of the method has been described in Section 3.2, but it should be noticed that several tools have been introduced in civil engineering that were not mentioned by Roozenburg and Eekels (Visser, 2016). Examples of these tools are the stakeholder analysis, process analysis and multi-criteria evaluation. The main design phases are already depicted in Figure 3.2, according to the original publication of Roozenburg and Eekels, and the Delft Design Guide (2013).

Frido Smulders, associate professor in Product Innovation Management & Entrepreneurship at Delft University of Technology, has developed a model for the product life cycle development, called the 'IDER model'. It consists of four main elements: Initiating a new product life cycle, Designing concepts for the product, Engineering the product and the process and Realisation. The last element is usually not considered as a part of the design process, but it is not uncommon that parts of the design process have to be repeated because of an unanticipated experience during the realisation of the product (Smulders, 2014). The 'Evaluation' design phase, which is usually part of other engineering methods, seems to be excluded in the IDER-model, so apparently that phase is not required for innovation, or it might be included in the 'Engineering' element of the IDER-model.

AEROSPACE ENGINEERING

According to Visser (2016), the design process taught at the Faculty of Aerospace Engineering is structured through four main steps, following the model that was developed by prof. Gerhard Pahl at Technische Universität Darmstadt (Pahl et al., 2007):

- analysis;
- conceptual design;
- preliminary design;
- detailed design.

The process is sequential, but iterative and converges towards the result. Several specific design tools are used, like the following:

- 'Axiom Design' as part of the Analysis: Professor Nam P. Suh introduced two kernel axioms, namely to maintain functional requirements independently (the 'independence axiom') and to minimize information content (the 'information axiom');
- 'Multiple Attribute Decision Making' (MADM) can be used as a mathematical method for the evaluation of the design;
- 'Multidisciplinary Analysis and Design Optimization' can be used to solve design conflicts throughout the entire design process;
- 'Parametric design formulation', for system integration to find a final conceptual design;
- 'Reduced-Order Modelling' (ROM) to reduce complexity when parametric formulation is limited;
- 'Funnel Design' that decreases the design boundaries.

That a design method is not sufficient to generate useful concepts, has been demonstrated by professor Egbert Torenbeek, of aircraft design at Delft University of Technology. He stressed the importance of the relation between the friction/weight ratio and the velocity of types of transport means regarding their feasibility. He studied the effect of different configurations of wings, fuselages, tail- and steer-planes on this relation to generate new airplane concepts (Torenbeek, 2000).

MECHANICAL ENGINEERING

Mechanical Engineers mostly use the design model of prof. Harry van den Kroonenberg, Twente University (Siers, 2004). Van den Kroonenberg based his method on the 'general systems theory' as developed in the 1940s by Von Bertalanffy (1951). It consists of three main phases:

- problem definition, including an orientation and analysis of the problem, resulting in a design objective and requirements;
- function fulfilling phase, where different ways are explored in which the desired function can be fulfilled;
- shaping phase, where selected concepts get shape and material properties.

Van den Kroonenberg emphasizes the interrelation between the design of the object and the design of the manufacturing. The difference with civil engineering is, that mechanical engineering products are often manufactured in mass, while in civil engineering usually only one unique product is created and the construction of it is impermanent and once only. The suitability for mass production therefore plays an important role in the evaluation of alternatives of mechanical systems. The 'Kessel ring diagram' is often used as a helpful tool, where the degree of realisability is plotted against the degree of functionality to determine whether alternatives are acceptable (Zeiler, 2014).

In addition to the method of Van den Kroonenberg, the faculty of Mechanical Engineering of TU Delft incorporated the Concurrent Engineering (CE)-mark to formulate minimal requirements for safety and ergonomics. To support the study of functions, the relation between design aspects transportation, of transformation and accumulation on the one hand, and matter, energy and information on the other hand, is made explicit. Morphological charts are used to derive technical components from defined functions (Visser, 2016).

Hylke Crone, TU Delft professor in Theory, Design and Construction of Machines and Mechanisms, emphasized that the design of products is heavily influenced by the cost price of the production machinery, the specific requirements per client and by the production time. Solutions can be found by considering:

- application of a modular design;
- study of the effects of machine adjustments en production process on the production;
- development of more intelligent operation systems;
- improved application of computer aided design (CAD) information;
- integration of fields, such as material science, mathematics, theoretical mechanics, physics, electrical engineering, informatics and automatic control engineering.

Innovation of diverse knowledge fields is considered the basis of innovation, which is needed for the growth of productivity of the industry (Crone, 2003).

3.2.4 THE SYSTEMS ENGINEERING METHOD

Systems Engineering is an application of the 'General Systems Theory', which was introduced by the Austrian biologist Ludwig von Bertalanffy and UK economist Kenneth Boulding. The General Systems Theory employs a systems approach to understand complex phenomena and problems, focussing on the system's structure. Engineering design projects, according to this approach, are structured in a vertical dimension, corresponding to the lifetime phases of a product, and a horizontal dimension, corresponding to the problem-solving processes. The subdivision into phases creates many interfaces, where interface problems can occur. These potential problems should be explicitly addressed in the design of systems.

The design method of civil engineering systems is described in the Dutch Guideline

Systems Engineering (2013) as follows. Systems Engineering is *an interdisciplinary approach and means to enable the realisation of successful systems. It focuses on defining customer needs and required functionality early in the development cycle, documenting requirements, then proceeding with design synthesis and system validation while considering the complete problem: Operations - Performance - Test - Manufacturing - Cost & Schedule - Training & Support - Disposal. Systems Engineering integrates all the disciplines and speciality groups into a team effort forming a structured development process that proceeds from concept to production to operation. Systems Engineering considers both the business and technical needs of all stakeholders with the objective of providing a quality product that meet the users needs* (International Council on Systems Engineering, 2015). The method incorporates the realisation, use/maintenance and demolition/re-use phases of the system, including the organisation of the entire process, but only the *design* of systems according to the Systems Engineering approach (the left half of Figure 3.3) is considered in this dissertation.

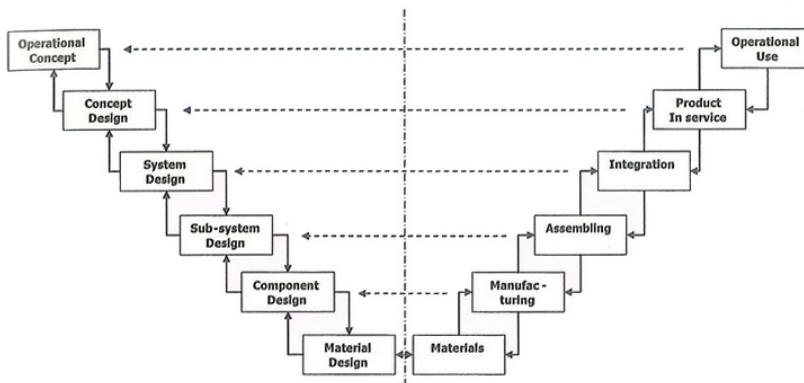

Figure 3.3: Systems Engineering V-model for the design and realisation of systems (Hopman, 2007)

The design process according to Guideline Systems Engineering (2013) basically follows the phases as described by Roozenburg and Eekels, but a different terminology is used. For instance, *development* is used instead of design, and *specifying* is mentioned as the process of determining the requirements and possibilities, obtained by interaction between analysing, structuring, allocating and designing.

In the Guideline Systems Engineering (2013) there is no clear distinction between the interests of the client and the interests of the stakeholders. All interests are listed in a Customer Requirements Specification (*Klant-Eisen Specificatie*, KES) containing a description of the intended functionality, the requirements per stakeholder, the available solution space, and a description of the system of interest of the client. This specification should be maintained and continuously updated during the development of the system. All phases within systems engineering aim at demonstrating that the system is optimally developed, based upon the defined Customer

Requirements Specification. A point of attention is that integrated aspects, such as weight and space, are not automatically addressed in the systems engineering model.

The Guideline Systems Engineering (2013) explains that all activities that are required to prove that the solution meets the requirements and suits the needs of the client, are covered by verification and validation. *Verification* shows that a solution objectively and explicitly meets the requirements formulated for the considered level of detail. *Validation* shows that a solution is suitable for the intended use. In other words: verification is checking whether the system can be properly constructed (efficiency), and validation is checking whether the right system can be constructed (effectiveness). Both verification and validation should be carried out taking into account the appropriate level of detail for the design cycle under consideration.

The optimisation steps used in *Value Engineering* are quite similar to those in systems engineering. Value engineering can be defined as a method that aims at improving the value of a system. Value is defined as the ratio of function to cost and can therefore be increased by either reducing the cost or by improving the functionality. The basic functions of a system should be preserved during the optimisation process, not reduced. The main stages in Value Engineering are:

- information phase;
- function analysis phase;
- creative phase;
- evaluation phase;
- development phase;
- presentation phase.

In order to qualify as a *Value study*, an organized *Job plan*, including the six phases described above, has to be drawn up by a multidisciplinary group of experienced professionals and project stakeholders (VMS, 2015).

3.2.5 THE ENGINEERING PROCESS IN TERMS OF HWBP-PROJECTS

The design process followed in projects of the Dutch Flood Protection Plan (HWBP) follows the phases as defined in the systematics of the multi-annual programmes on Infrastructure, Space and Transport (*Meerjarenprogramma's Infrastructuur, Ruimte en Transport, MIRT*), in which the Dutch national government works together with regional and local governments. The MIRT-programmes initially aimed at budgeting the main infrastructure, but the scope gradually widened and presently includes problem analyses, effect estimation, 'market engagement' and communication with the surroundings to come to founded choices. In MIRT, the entire process is divided into four main phases:

- orientation (*verkenning*);
- plan development (*planuitwerking*);
- realisation;

- maintenance.

Within the Orientation phase, the following phases are distinguished:

- initiative, formulated in a start document MIRT 1;
- start, resulting in a *plan* and a description of the scope;
- analysis, which leads to a memorandum about the favourable solutions;
- evaluation, resulting in an environmental impact plan, an overview effects infrastructure and a draft structure vision;
- decision-making, ending in a description of the organisational structure of the project (*structuurvisie* in Dutch) and a preferred decision MIRT2

There are several types of MIRT-orientations on the organisational structure of the project, of which the details are described in documents like Stoop et al. (2010). The Orientation phase is followed by the plan development, yet traditional design approaches can be recognized in this MIRT methodology.

The method followed in the Dutch Flood Protection Programme (Figure 3.4) distinguishes four main phases: initiative, exploration (*verkenning*), plan elaboration (*planuitwerking*) and realisation. A preferred concept is selected at the end of the development phase and further developed during the next phase. A best solution is selected from an endless number of potential solutions by continuously making choices, while proceeding from a lesser to more detailed level (HWBP, 2014; Knoeff and Heijn, 2015).

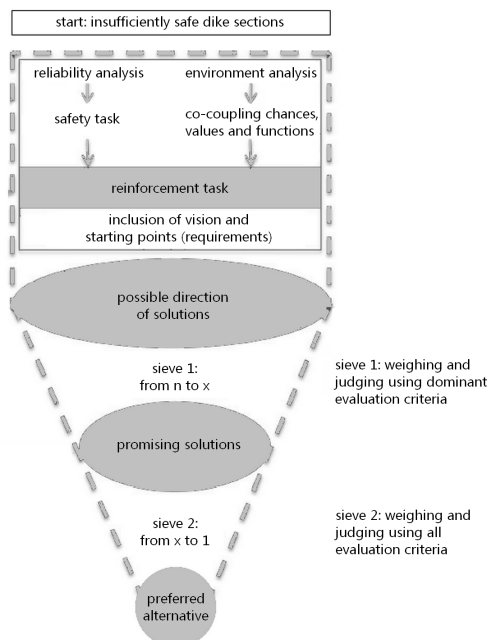

Figure 3.4: The design process of the exploration phase of HWBP-projects (Knoeff and Heijn, 2015)

Requirements are denominated as 'starting points' (*uitgangspunten*) in HWBP terms.

3.3 THE SPATIAL DESIGN APPROACH

This section explains the main outlines of the design approach that is used in landscape architecture and urbanism.

3.3.1 DESCRIPTION OF MAIN FEATURES

Early spatial design methods, like the model of Mayer (1970) were often very similar to engineering methods as described in the previous section. From the early 1970s, architectural design methodologists like Hillier et al. (1984) criticised this shared view. They mainly opposed the many analyses that preceded the development of concepts. Instead, they proposed that designers first bring their own preconceptions to bear the problem, develop a 'solution conjecture' and subject the conjectured solution to analysis and evaluation. The conjecture model has been further developed by Darke (1984), who proposed a generator-conjecture-analysis model, in which 'primary generators' or 'prestructures' are the basis for the development of solution concepts. 'Productive reasoning', which is a way of abduction, in developing concepts was preferred by March (1984), preceding steps of deductive and inductive reasoning, which he considered as an iterative process. According to Roozenburg and Cross (1991), the result of these criticisms has been a 'general rejection of any linear, sequential, analysis-synthesis-evaluation scheme'.

Visser (2016) studied the design education taught at the Architecture Faculty of Delft University of Technology and found a description of their perspective in Van Dooren et al. (2014). Van Dooren distinguishes five generic elements in their conceptual framework:

- a process of experimenting or exploring and deciding, which includes analysing, associating, generating concepts on the one hand and finding criteria, testing and evaluating on the other hand;
- finding a guiding theme or qualities that helps creating a coherent and consistent result;
- inclusion of the following different domains or work fields: space, material, site, function and socio-cultural context;
- embedding the design in a broader context, called a 'frame of reference' or 'library'. These references provide patterns, diagrams, rules of thumb and solutions to be used in the experiments;
- a visual language of sketching and making scale models, or 'laboratory' is used as a structuring element to organize designing.

According to the European Association for Architectural Education, the architectural design process is a way to new insights, knowledge, practices or products. The results make it discussable, accessible and useful (EAAE, 2016). Van Dooren et al.

(2014) explain that designing in Architecture should be considered as an interwoven process and that there is no fixed step-by-step sequence. The process can be visualised as shown in Figure 3.5. The distinction of the five generic elements aims to be helpful for architecture students 'in the overall confusing learning process'.

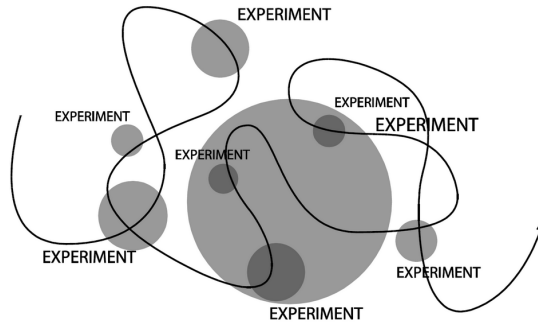

Figure 3.5: The design process of Schön (1983) as applied in Architecture
(Van Dooren et al., 2014)

In this approach, ideas of Schön can be recognized (Schön, 1983). Schön furthermore described design as a process of 'framing' a problem, succeeded by performing 'moves' towards a solution and the 'evaluation' of these moves. This process is iterative, because the evaluation can be followed by new 'moves' or new 'framing'. Hence, designers propose, experiment and learn from the results, going through many 'learning circles', until they achieve satisfactory results (Lawson and Dorst, 2009).

Lawson and Dorst (2009) expanded the model of Schön by distinguishing five main design activities (see Figure 3.6):

- Formulating, comprising the reformulation of problems or the identification of elements to make them explicit and to develop their characteristics. It also comprises framing of the design situation, which means selective viewing, enabling the handling of the complexity of the design by providing structure and direction to thinking;
- Representing, to externalise the thoughts of the designer. This is mainly done with help of drawings, which enables interacting on these thoughts;
- Moving, as the activity of solution creation. This can be a new move which has not been seen before in the process, or a move that alters or develops existing states of the solution;
- Evaluating, to judge between design alternatives. Evaluations can be objective or subjective and it should be possible to make judgements about the relative benefits of alternatives, or if they rely on incompatible measurement methods. Sometimes, this judgement should be suspended to allow for additional creative development of concepts;
- Managing, which comprises reflection on proposed concepts and enabling

stepping back to make modifications for improvement. Monitoring of the design process, as well as continuous briefing, can be regarded as part of the managing activity.

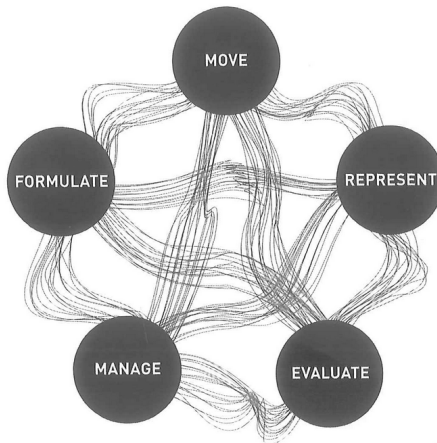

Figure 3.6: Design model 1 of Lawson and Dorst (2009)

Lawson and Dorst (2009) point out that there are basically three types of thinking that can be applied in the design process. It can be helpful to be aware of these types and realise what type is most useful for a specific design challenge or team:

- *Convention-based design thinking* proceeds over conventional paths, following the 'rules of play'. Largely, regular design practice occurs according to this routine, rule-based behaviour, mostly leading to standard solutions.
- *Situation-based design thinking* attempts to create concepts that are appropriate to particular settings. The 'rules' are considered as guidelines and are not mechanically applied. Design becomes more improvised.
- In *strategy-based thinking*, designers consciously design the process itself and create the design situation themselves. The strategy then becomes an important object of reflection.

Professor Eekhout (Delft University of Technology) emphasised the importance of generating concepts as a tool for thinking and developing building components. He, after organisational obstacles, was able to found a Product Development Studio, where many students were inspired to develop, sketch, draw and elaborate their ideas and developed craftsmanship skills. Eekhout remarked that the best architectural education is based on a continuous integration of architecture and building technology, because mature architects will have to dive deep into building technology, otherwise they cannot materialize the designs (Eekhout, 2015a,b).

Despite the current design practice, Eekhout emphasised that systematic and methodical thinking are useful to reduce the probability of failed building designs. Such an orderly approach, however, should never 'smother' originality. A systematic

approach is also better for didactic and reporting purposes and is to be preferred in case of:

- new design projects;
- extensive design projects;
- complex design projects;
- experimental design projects;
- ultra-quick design projects.

3

Quality control is often required in these kinds of projects (Eekhout, 1997).

3.3.2 RESEARCH BY DESIGN

Design as a way of pursuing an ideal is increasingly viewed as a form of research where potential futures are envisioned. This is referred to as 'research by design.' For architects, the evaluation of potential solutions is often more important than analysing the problem itself. Design is then used as a tool to investigate the effects of changes and to develop more widely applicable instruments and tools. Drawing is used as a way to investigate and conceptualize spatial phenomena, rather than a technique to express solidified ideas (Palmboom, 2016).

There are several definitions of 'research by design' that have been classified by Roggema (2016). He identified three main phases of research by design and proposed a methodological approach. He defined research by design as *method, which uses design to research spatial solutions for a certain area, accommodating a design process, consisting of a pre-design phase, a design phase and a post-design phase, herewith providing a philosophical and normative basis for the design process, allowing to investigate the qualities and problems of a location and test its (spatial) potentials, meanwhile creating the freedom to move with the proposals in uncharted territory, and producing new insights and knowledge interesting and useful for a wide audience.*

Roggema argued that research by design should be embedded in the local, cultural and political context. Unexpected explorations should be possible to identify best fitting solutions. It should also emphasise the development of new knowledge and be beneficial for a broad public. He distinguished three main phases in this research by design process. First, the *pre-design*, focusses on what is there, in an analytical way. Second, the *design*, explores and develops what could be there. Third, the *post-design* reflects on what will be there. It should be noticed that 'Research by Design' is only useful for ill-defined or wicked problems. For simple problems, scientific or engineering methods of inquiry are more suitable.

3.3.3 MULTIPLE LAYERS APPROACHES

The Multiple-layer approach was introduced by McHarg (1969), who used layers, or overlays, of factors to reveal spatial patterns of 'intrinsic suitabilities' for diverse land uses. The approach was converted in the Netherlands by De Hoog et al. (1998)

to a three-layer model to identify and solve the complex relation between processes of different time scales. The subsurface, the network and the occupation layers were distinguished and the spatial assignment should be solved in such a way that the layers separately are consistent and logical, but are interrelated and interact to make sense in the combination. Sijmons (1998) defined three different layers. The first layer is the water system, the condition of existence of the Netherlands. The second layer is formed by infrastructure, which has a big steering influence on all following social-spatial processes. The third layer is the layer of housing, business, agriculture, cultural institutions, etc. Sijmons considered the first layer to be the most important, and it should be the foundation while developing spatial plans, followed by the second and third layer. The design challenge is to solve the complications caused by the relation between the layers.

In urbanism, it is common to use 'urban layers' to develop spatial concepts.⁵ Heeling et al. (2002) distinguish five layers: The base layer is formed by the unbuilt ground that has to be suitable for housing and other human activities, which form the upper layer. Three intermediate layers are used to concretise this use in physical-spatial shapes. The 'city map' layer separates public from private space and as such indicates the possibilities for the use of the ground layer. The structure of the city map is heavily influenced by possibilities to modify the ground layer and to create a subsoil infrastructure of cables, pipes and sewerage. The two layers on top of the 'city map' can be considered as elaborations of the city map: the 'public space' layer, dealing with profiles of streets and roads, technical structures, materials, civil and hydraulic engineering works; the 'buildings' layer, concerning the space for private development. These five layers are related to each other and it depends on the designer which layer is chosen to start with.

A similar layer approach, the System Exploration Environment & Subsoil (SEES), was developed in a collaboration between Deltares, TUD, TNO, The Dutch Ministry of Infrastructure and Environment, the Municipality of Rotterdam and the Foundation of Knowledge Development and Transfer Soil (SKB). Their method aims at the collaboration of engineers and urban designers to explore and develop the natural and cultural urban system. SEES displays layers of people, cycles, buildings, public spaces and infrastructures, see Figure 3.7 (Maring and Hooimeijer, 2017).

The multiple layer approaches are thus helpful to attune several levels of processes with different time scales. Spatial quality is a derivative of this process.

3.3.4 SPATIAL QUALITY

Urban design and landscape architecture strive at improving, or at least maintaining, the spatial quality of an area. Spatial quality can be defined as 'the degree of satisfying utility, scenic and future values of different interests in spatial planning' (www.encyclo.nl, 2016). Spatial quality applies to economic, ecological, social and cultural fields, which link spatial quality to 'sustainability', which is described in

⁵The urban layers can also be used to explore the environment and to verify concepts.

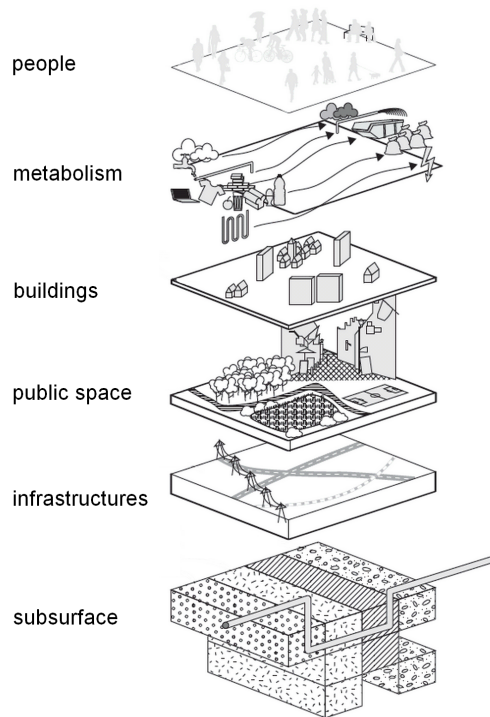

Figure 3.7: Urban layers according to the System Exploration Environment & Subsoil method (Maring and Hooimeijer, 2017)

Section 4.4.

Since the 1980's, the Dutch government has strived for a coherent vision on spatial quality. The first Architectural Memorandum (*Architectuurnota*) was written by the Ministries of Well-being, Public Health and Culture (WVC) and Spatial Planning (VROM) in 1991, and more Memorandi followed, issued by a growing number of Ministries. The memorandi showed an increasing concern for spatial quality, which was considered to be helpful for attracting people and businesses to return to the cities that became deteriorated after the megalomaniac interventions of the 'Modern Movement' (see Section 1.4.1). The architectural memorandi aimed at combining the various interests and claims that were considered of great importance to society. In contrast to flood protection, it is not (yet) possible to quantify spatial quality in terms of economic value. It is therefore hard to weigh both types of value against each other.

Lynch (1960) formulated another way to determine spatial quality in urban areas. He defined five 'performance dimensions', or criteria, that determine the degree of city performance:

- Vitality, which is the degree in which the urban area supports the essential, biological performance of human beings, like the supply of water, air, energy and food;
- Sense, the degree of fit between the city form and the way it is recognised by people and organised in their minds. It reflects the clarity in which the space is perceived;
- Fit, which is the match between function (action) and form (the physical city). People feel comfortable if there is congruence between form and patterns of behaviour;
- Accessibility, which is the reachability by means of transportation, but also access to services, information and the established interaction;
- Control, the degree in which people control the environment, which gives people feelings of power and stability.

Furthermore, Lynch (1960) identified six components of city sense that define how a city is perceived. This is called the 'sense of the city', which represents the relation between the physical environment and cognition. These components can be used to analyse the city, but also to create new concepts:

- Formal elements
 - Identity: The characterisation of a place;
 - Structure: Location of an object in the space, considering the relation between the object and the observer, but also with other objects;
 - Meaning: What the place of object stands for or represents;
- Informal elements
 - Congruence: The relation of the form to its function;
 - Transparency: The visibility of process occurring in the place to users;
 - Legibility: The quality that makes a space or an object understandable.

Lynch (1960) reasoned that the visual quality of the built environment is determined by the characteristics of environmental elements. The degree in which these characteristics evoke a strong image in an observer is called *imageability*. A highly imageable environment indicates a good form and strong identity. Therefore, it would be well recognizable to the observer. Elements that constitute the mental representation consist of paths, edges, districts, nodes and landmarks. Distinction of these elements can be helpful for stimulating the analysis of an urban area.

In integrated designs, maintaining or improving the spatial quality of the project location can be included in the design objective. The programme of requirements should contain requirements regarding spatial planning or sustainability, otherwise most probably a plain structure, with a low spatial quality, will be the result of the design process. Spatial requirements that can be included in an integrated design are described by Nillesen (2012), who used the three main components of spatial quality of Vitruvius (Pollio, 15):

- Utility
 - residential, commercial, recreational or public functions;
 - accessibility and routing;
 - ecological functioning;
 - maintainability;
- Robustness
 - reversibility;
 - development opportunities;
 - multifunctional space utilisation;
 - robustness;
 - flexibility;
 - durability;
- Attractiveness
 - identity of the location / surroundings;
 - recognition of structures;
 - cultural recognition;
 - spatial recognition;
 - diversity / alteration;
 - uniqueness;
 - logic of spatial arrangement;
 - image;
 - water-safety experience;
 - attractiveness;
 - intervention scale versus location scale;
 - relation to the water.

(All terms according to (Nillesen, 2012))

3.4 COMPARISON OF ENGINEERING AND SPATIAL DESIGN

Roozenburg and Cross (1991) compared the approaches of engineering and spatial design that had grown apart since the 1970's. A major difference they found, was the linear, sequential nature of the engineering method, compared to the spiral, cyclic nature of spatial design. The engineering method emphasises the sequence of stages of the design process, whereas the spatial design approach emphasises the cycle of cognitive processes to be performed by the designer. The engineering method is therefore more prescriptive, as it specifies the sequence of stages during the development of the system. The spatial design approach is more descriptive, because it emphasises the thought-processes that have to be employed by the designer.

Furthermore, it is said that spatial design problems are inherently ill-defined, whereas problems in engineering are more usually well-defined (Roozenburg and Cross, 1991). The problem structure in engineering can be decomposed into distinct sub-problems and the subproblems into subsub-problems and in this way a problem branch can be created. Problems in spatial planning are less suitable

to such a tree-like hierarchical decomposition, because subsets of related urban elements may overlap or have no connection (Alexander, 1966). The difference between the analytical character of the engineering method and the experimental and learning character of the design method has already been mentioned earlier in this chapter.

In addition, Dorst (2011) points out that there is a difference in the type of abduction. In engineering, it is known what value has to be achieved and what pattern of relations (the laws of physics) can be helpful to achieve that value. Finding solutions in engineering thus mainly consists of creating a system or structure that accomplishes the value creation. This is called 'normal abduction'. Similar, in 'design abduction', the means to accomplish the value have to be found, but the pattern of the relations is unknown as well. So, only the outcome of the process, the desired value, is known in a spatial design. This implies that both the system and the pattern of relations have to be found. They are dependent on each other, so they should be developed in parallel and tested in conjunction.

Table 3.1 summarises the supposed differences between both design approaches.

Engineering design	Spatial design
Linear, sequential process	Cyclic, iterative process
Prescriptive	Descriptive
Problem is well-defined	Problem is ill-defined
Problem is decomposable into parts	Problem is not decomposable
Analytical character	Experimental, learning character
Normal abduction	Design abduction

Table 3.1: Comparison of the engineering and spatial design method, with the supposed differences (based on Stolk (2016))

The following chapter endeavours to develop a combined overall design method that maintains the strengths of both existing approaches, but avoids their weaknesses.

4

INTEGRATED DESIGN OF MULTIFUNCTIONAL FLOOD DEFENCES

The previous chapter described the design approaches in engineering and spatial design. Applying different approaches, however, leads to a sub-optimal process of first engineering flood defences and then attempting to let them improve the spatial quality, or the other way around. The present chapter therefore endeavours to develop a single method that is suitable to the integrated and sustainable design of multifunctional flood defences. The method combines the advantages of the engineering and the spatial design approach and gives space to both idealism and realism. An outline of the integrated method is given in Section 4.2 and Section 4.3 explains every phase in more detail. How landscape, nature and culture values can be included in the integrated design method is explained in Section 4.4 and involving multiple design disciplines in the process is described in Section 4.5. Section 4.6 deals with the integration of stakeholders' interests in the process and organisational aspects are briefly dealt with in Section 4.7. The chapter ends with a validation of the integrated design method (Section 4.8) and concluding remarks (Section 4.9).

4.1 INTRODUCTION

The complexity of designing multifunctional flood defences, as explained in Section 1.4.4, requires a systematic and logical approach to streamline the course of activities and to make the process efficient, effective and transparent. Phasing of the design activities is needed to enable a good organisation of the entire process. Furthermore, all (sub)systems have to be included in the design. On the other hand, a learning, experimenting and reflecting approach is needed to get a grip on the complex, and often poor, or ill-defined, problems and its interrelationship with the environment.

An integrated approach is therefore recommended for the design of multifunctional flood defences, where the advantages of the problem-solving engineering design method are combined with the advantages of the creative and learning approach

of spatial designers. The disadvantages of both approaches should be avoided. Despite the remark of Lawson and Dorst (2009), that *combining the two fundamentally different thinking styles of problem solving and creativity means that design is somewhat at odds with the normal ways in which we classify and understand the world*, this dissertation attempts to describe such a combination. On the other hand, they also state that *there is no way in which all of design can be reduced to a problem solving activity*. This can be regarded as a motivation to describe such a combined design method. Although several engineering consultants already use such a combined method, others don't, and in the academic world there is still a division in two design cultures.

4

4.2 OUTLINE OF AN INTEGRATED DESIGN METHOD

The task of finding a method for an integrated and sustainable design of multifunctional flood defences concentrates on combining the two main design cultures of engineers and spatial designers. Having a second look at Table 3.1, it appears that several supposed differences are not that different at all. The engineering method as used in education and in practice, is highly iterative and cyclic as in spatial design. In hydraulic engineering, it is common practice that design steps are redone because of insight gained during the design process, or because of newly acquired information. It is also usual that the sequence of design steps is repeated at ever more detailed levels, which implies a cyclic approach. Furthermore, hydraulic engineering problems are often not well-defined, especially not when they concern large-scale projects, where many stakeholders are involved and multiple systems interfere. Thus, in this respect, it does not differ from spatial design.

These observations reduce the differences to the following characteristics: the engineering method is decomposable, analytical, normally abductive and prescriptive, and the spatial design method is not-decomposable, experimental, design abductive and descriptive. These four characteristics are highly related, which facilitates the attempt to combine both design approaches. Furthermore, the two approaches seem largely complementary, because the strengths of the one method are the weaknesses of the other method, and the other way around. The challenge is to obtain a combination where both approaches reinforce and not weaken each other. This dissertation attempts to find the solution by putting the essential activities of both methods in the right order and by applying the tools in the right detailing cycle.

The main engineering design stages as defined by Roozenburg and Eekels (1995) are considered to be essential and logical steps in an efficient and effective design process (see Figure 3.2). The advantage of their method is that it is intuitive, yet consists of a logical succession of design phases, all of which are necessary. Therefore, the engineering design stages are maintained in the combined method. The challenge, however, is to make the process not too analytical in an early stage, because that can easily lead to an unnecessary limitation of the solution space. Neither should the method restrict itself to creative and generative activities, because that would

result in a too inefficient process, which, especially for complex problems, could too easily lead to solutions that are not feasible. The iterative nature of the engineering method offers possibilities to experiment and to learn and improve earlier design steps, which can be obtained by combining both design approaches.

An integrated design process starts with a necessary first stage, in which activities are carried out to have a first indication about what is going on and what the purpose of the assignment is, who are involved and what circumstances play a role (phase 1). The next step is the generation of ideas or concepts, which moves the process towards a solution and helps to understand the problem and possibly fine-tunes the problem statement and design objective (phase 2). If the first design stage is less analytical than in the civil engineering process, ideas can be created without too many restrictions. A successive step is required to make the generated concepts feasible, for which the requirements and boundary conditions have to be listed and verified (phases 3 and 4). An evaluation and selection of design alternatives should then be made (phase 5), based on criteria that are considered to be of importance to the client and to the stakeholders, and even in this stage the problem could become more distinct, which could lead to iterative moves to earlier design steps. If desired, the selected alternative can be validated as a check of the appropriateness of the programme of requirements (phase 6). Finally, it can formally be decided to accept the selected alternative and to proceed the design or construction process, or to improve the alternative by (partially) repeating one or more design steps (phase 7). The method thus is iterative and cyclic, and includes experimental processes and outcome evaluations.

This combined design approach thus contains seven design phases, as shown in Figure 4.1, where other life-cycle stages of the system are included. The combined approach was improved with help of a quick scan of design exercises made by students of Delft University of Technology. The seven main design phases, including the improvements, are explained in the following subsections.

4

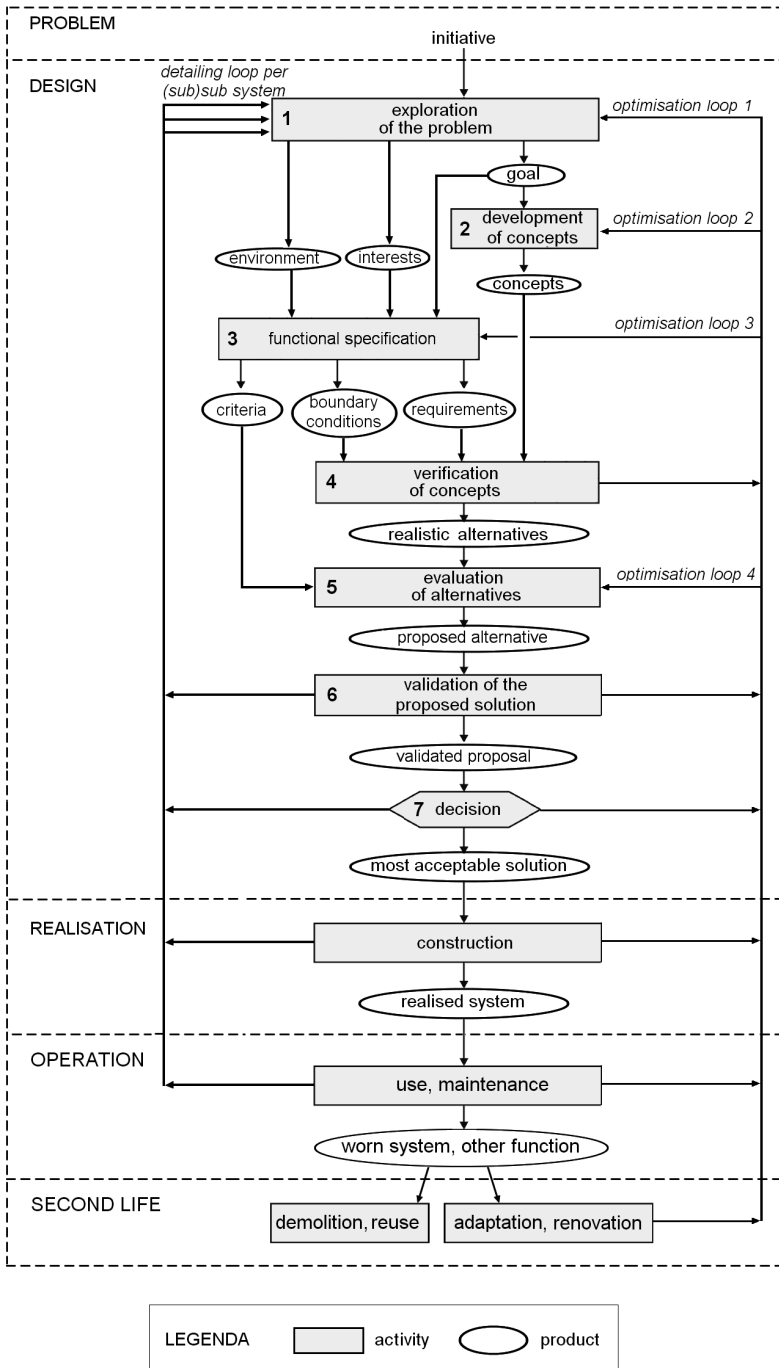

Figure 4.1: The proposed process for integrated design (including other life-cycle stages)

4.3 THE PHASES OF THE INTEGRATED METHOD

The seven main design phases of the proposed integrated design method for multi-functional flood defences are explained one by one.

4.3.1 DESIGN PHASE 1: EXPLORATION OF THE PROBLEM

The first phase of the integrated design method consists of an orientation on the problem and its environment. This is in accordance with both the design and engineering approaches, but it is much less analytical than the Analysis phase of the engineering method as described by Roozenburg and Eekels (1995), which results in a first phase that is less explicit and less prescriptive. This allows for a creative abduction development of concepts (design phase 2), without too many limitations. The activities of the first design phase aim at formulating an initially tentative design objective that should give an idea of the problem. Without a design objective, the development of concepts would have no focus, which would be highly inefficient.

The question of 'who, when and where' should be explored: who experiences a problem, when is it experienced and under what circumstances? Furthermore, the environment in which the problem occurs and where the resulting system or structure will have to be realised, as well as who would be affected by realising the solution, have to be explored. A tentative problem statement briefly summarises the core of the problem and the design objective describes the expected performance of the future system in abstracto by describing the desired functionality (the future functioning should be described, not specific shapes of systems or structures).

An inventory of landscape elements can be useful as a base for the spatial integration of the new system in the environment. A way to obtain a clear overview is by, for example, creating a 'dike score' (*dijkpartituur* in Dutch), where all elements of the dike and its surrounding are graphically represented (Figure 4.2). It is also standard to draw maps marking historical elements (like wetlands, ferry access, houses, buildings, industry, former peat extraction, monuments); likewise maps can be made with characteristics of the dike landscape, such as types of dike and land use.

One of the task forces of the Dutch Technical Advisory Committees on Flood Defences (TAW) wrote a report on the making of an inventory and the valuing of the aspects of Landscape, Nature and Culture (LNC-aspects) (1994). The task force recommended to make the inventory of LNC-aspects at three levels of integration: at the regional level, the trajectory level and the dike level. For the assignment of values to the LNC-aspects, they advised to distinguish authorised values (generally assigned and acknowledged values) from project-related values (specific values assigned by professionals and sanctioned by involved parties). The inventory and valuing of LNC-values is preferably carried out in two phases. The first phase consists of a first exploration of essential LNC-aspects as part of the development of a vision. The second phase is an elaborate and directed inventory, guided by the

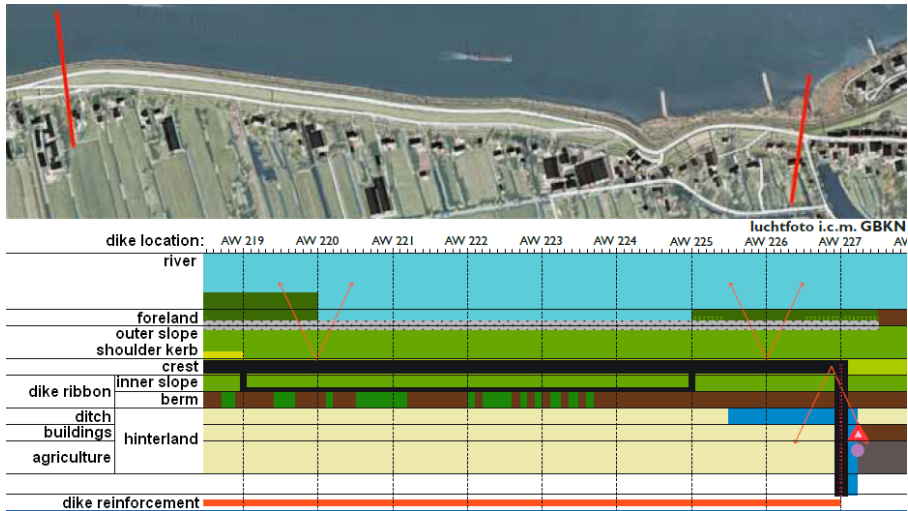

Figure 4.2: Example of a 'dike score' (*dijkpartituur*), part of the Lek dike near Opperstok, Alblasserwaard (HNS, 2010)

vision. The first phase, together with the development of a vision for the project, can best be executed in the first design loop, when over-all ideas are being developed. The second phase can be part of a more detailed design loop.¹

The Exploration of the Problem phase deviates from the Analysis in civil engineering methods, because most analyses are moved to other design phases that take place after the development of concepts. This makes the Exploration of the Problem phase much more basic and leaves more freedom in developing concepts.

After the first exploring activities, a *problem statement* is provisionally formulated, attuned to the detail level of the design loop in progress. It can at that level be modified if more information and insight become available during the generation or verification of concepts. The problem statement should not be too narrowly formulated, nor too broad, as that would result in sub-optimal solutions or in more design cycles than necessary.

The *design objective* should be a functioning system that solves the stated problem. The objective is primarily formulated in an abstract way, for instance 'providing a transport connection between two river sides' as part of a wider infrastructural plan, instead of 'create a bridge' or 'create a tunnel'. The design objective, like the problem statement, is attuned to the considered detailing level in the cyclic design process. The first cycle is often on a regional scale where strategical decisions are made. It should be kept in mind that considering a higher scale level could lead to other project definitions (and solutions). For instance, a dike reinforcement can be the project objective if the problem is defined at a local level, but a measure to

¹Further recommendations to incorporate LNC-values in the design of flood defences are given in Section 4.4.

regulate river discharges could be the outcome if the problem is considered at a regional level.

To foster an integrated approach, the design objective should be formulated integrally, containing all relevant (main) aspects. This is essential, because the functions and requirements of the future system are derived from the design objective. If the design objective is not complete, neither will be the programme of requirements, nor will the concepts be checked in relation to these aspects and the result will not necessarily be an integrated design.

4.3.2 DESIGN PHASE 2: DEVELOPMENT OF CONCEPTS

In the design Development of Concepts phase, the abstractly formulated design objective transforms into specific shapes and gets material properties. A properly formulated design objective aims at fulfilling the intended main function, but also specifies the intended sub-functions. In so doing, it should give sufficient direction to generate initial concepts.

Usually, several provisional concepts are generated, for instance by using brainstorming sessions, by attribute listing, or by drawing morphological maps. Other methods that can be used are the fish trap model, analogies & metaphors, synectics, and scamper. Bianca Stalenberg developed an *Urban Flood protection matrix* as part of her PhD-research, to facilitate the development of concepts for multifunctional flood defences as part of urban river fronts (Stalenberg, 2010), but many other methods can be developed and used to stimulate the creative process (see for example the Delft Design Guide, 2013).

The *research by design* principle (see Section 3.3.2), which can be used as a way of ideal pursuing, but also as a way to develop concepts to solve an actual problem, fits naturally in this combined design method and has its 'centre of gravity' in this Development of Concepts phase. Through iterative moves throughout the design process, it also gives input to the design objective.

Exploratory sketches should be made to trigger and enhance the thinking on solutions and stimulate creativity. They are preferably made by hand without too much help of drawing aids, as the process of sketching is part of the activity of generating and exploring concepts, and not merely the visualisation of the result. Exploratory sketching can therefore be considered as 'visual thinking', or 'externalised thinking'. It has been shown that the human mind works more creatively if hand sketches are made. Moreover, the sketches should not be too detailed, nor too precise, because that would hamper creativity, especially during initial design stages (Liu and Sorby, 2007). Exploratory sketches can be used in interactions with colleague-designers, to contribute to the thought process (Schön, 1983). Conversation is also a means of the sharpening of thoughts and ideas and is therefore also useful in the development of concepts.

The design objective should be kept in mind during the creative process, but the feasibility of the concepts is of later concern. During the development of concepts,

it is recommended to devise ways in which the main functions can be performed. It is the challenge to develop different *visions* on how one will experience residing in or using a certain (sub)system and how it can be integrated in the environment. The development of a spatial plan belongs to this design phase. In a first design loop, concepts are developed in a free and creative way, but in more detailed loops, the spatial plan can be derived from the analysis of system functions, making use of techniques like *circle graphs* and *bubble diagrams* (see Hertogh and Bosch-Rekvelde (2014)). In Spatial Design, layer models are used to attune processes that take place with different development rates (see Section 3.3.3). For the integration of a dike in the environment, it is essential to start developing visions at a high scale level, preferably the regional level, and to pay attention to the continuity in longitudinal direction. At a local level, concepts can be developed based upon principle possibilities of reinforcement without demolition of buildings and with minimal changes of the landscape, constructing an entirely new dike or over-dimensioning the dike to minimise future problems with buildings on the dike (TAW - HRO, 1994). The generated concepts can be helpful for the client or the design team in finding additional criteria for the evaluation of optimised concepts, later in the design process.

A crucial point of attention is the potential integration of functions. The design method subdivides functions into sub-functions and a tendency exists to look for separate solutions per sub-function, such as developing a hotel and a flood defence separately. However, combining sub-functions into one structure or system can lead to innovative and more effective solutions.

In this stage, rather than in the Exploration, *reference projects* could be looked at. They can provide additional ideas to those already found in the Exploration of the Problem phase. The study of reference projects can be useful to increase insight in the functioning of the desired system or structure and could possibly lead to a reformulation of the design objective.

In practice, for design loops where the structural properties are detailed, the Development of Concepts phase is often combined with the succeeding phase of the Verification of Concepts, because experienced designers have the techniques readily available. Non-experienced engineers and students are advised to make an inventory of generally available technologies and construction methods as part of the Development of Concepts phase. This inventory can be used in the following phase to transfer them into realistic alternatives.

The outcome of the Development of Concepts phase only consists of provisional concepts that might or might not meet the requirements, thus successive phases are needed to achieve a functional, feasible and acceptable result. If concepts then appear to be not functional, feasible or acceptable, they can be optimised by an iterative move, or they can be combined with (elements of) other concepts. It can also be attempted to adapt concepts to create *additional values* if earlier developed concepts appeared to generate too little value.

4.3.3 DESIGN PHASE 3: FUNCTIONAL SPECIFICATION

The design objective describes the purpose of the system that has to be created, but it has to be specified in more detail. This is carried out in the Functional Specification phase, where not only the desired functioning is specified, but it is also specified under what circumstances the system should function and what risks could hamper its performance. The Functional Specification consists of making a list, or *programme of requirements & evaluation criteria*, and making an *inventory of boundary conditions and relevant laws & regulations* and an *inventory of risks*. The elements of the Functional Specification have to be formulated at the level that is appropriate to the design loop under consideration.

The Functional Specification starts with deriving the main requirements from the desired system functions. They specify the expected design result and have to be given or agreed upon by the client. To obtain a clear overview of requirements, it can be helpful to group them by type:

- functional requirements, which qualitatively or quantitatively describe the desired behaviour, or performance, of the system or subsystem under defined conditions;
- aspect requirements, which describe specific characteristics of the system that support the primary functioning of the system;
- external interface requirements, which originate from the fact that the system often crosses or borders adjacent elements in its surroundings when one element influences the other;
- internal interface requirements, which originate at the boundaries between subsystems or elements within the system that is under design. Also the subsystems created by different disciplines, like mechanical, electrical and civil engineering should be well-connected.

The performance dimensions as defined by Lynch (1960) (see Section 3.3.4) can be adapted as requirements as well for multifunctional flood defences.

To obtain a clear overview of requirements, it can be helpful to group them by type.² The Guideline on Functional Specification of Rijkswaterstaat (2005) distinguishes five types of requirements, including *boundary conditions*. However, boundary conditions differ principally from requirements, because requirements indicate what is desired, while boundary conditions restrict the possibilities to what is possible in a given environment. Thus, four types of requirements remain: functional requirements, aspect requirements, external interface requirements and internal interface requirements. For more explanation of these types of requirements, reference is made to the Guideline on Functional Specification of Rijkswaterstaat (2005).

Optional wishes of the client are usually formulated as evaluation criteria to be used to compare alternatives in the Evaluation of Concepts phase. Interests of secondary

²Grouping of requirements could also be counter-productive when too much effort is made to define and distinguish types. The main issue is that all relevant requirements are listed in such a way that they can be used for verifying conceptual solutions later in the design process

stakeholders (stakeholders other than the client) are usually formulated as criteria as well, but the client could decide to formulate them as requirements if he considers them essential. A clear distinction should therefore be made between *requirements* and *criteria*. All generated concepts have to comply with the requirements formulated for the design cycle under consideration before they can systematically be evaluated (in the multi-criteria evaluation). Therefore, requirements should not be used as criteria for the evaluation of alternatives.

It could be argued that several requirements could be complied to even better than strictly needed, for instance with a lower failure probability than required, which would be a reason to include a requirement as a criterion. The drawback is that the alternative, functioning better than strictly required, will possibly be more expensive. That would make the alternative less feasible.

4

Sometimes, stakeholder interests are formulated as requirements, instead of criteria: stakeholder interests become major design considerations and social acceptance of the project by the concerned stakeholders is very likely. However, it is difficult to satisfy all stakeholders, because of conflicting interests. Another disadvantage is that, if all major stakeholders interests would be formulated as requirements, the selection of the best alternative can only be based on a comparison of costs because, in that case, there are no criteria left for the evaluation. This can feel unnatural or uncomfortable for those who are familiar with the basic design method, but it is the consequence of the approach.

A major drawback of formulating stakeholders' interest as requirements, is that stakeholders often do not consider the over-all consequences of formulating their interests as requirements. Firstly, they often do not oversee the consequences for society as a whole of putting forward their interests as requirements. Secondly, they often have single-issue interests, and an overarching design and decision process is needed to balance all the stakeholders' interests (next to the client's requirements). This can only be done if these interests are formulated as criteria.

Boundary conditions can comprise many aspects given by the environment where the solution has to be realised. They often limit the possibilities and could pose a major challenge in the realisation of generated concepts. Boundary conditions can, amongst others, be subdivided into:

- meteorological conditions (wind velocity and direction, temperature, humidity);
- hydraulic conditions (water levels, wave heights, structural erosion or accretion);
- nautical conditions (governing ship, shipping intensity, maximum wait for a lock, max. currents for navigability)³;
- geo-technical conditions (soil properties, layers, groundwater, ground levels, land subsidence);
- geological conditions (presence of hills, mountains, rivers, lakes, sea, earthquake conditions).

³The client could also decide to specify these nautical characteristics as requirements.

Sometimes, it is difficult to find useful data for these boundary conditions. While in the Netherlands long series of wave and water level measurements are available and can be used to calculate water levels corresponding to required safety levels, abroad this is often not the case. For example, soil properties are required for the design of foundations, but, even in the Netherlands, sounding graphs are not readily available of the exact project location. The magnitude of wind and other loads is uncertain, so it is a typical task for an engineer to deal with these uncertainties. Data acquisition campaigns can be carried out to do additional measurements. Typical questions to be answered are then: how many data are needed, at what distance from each other, in what sample frequency, with what accuracy and with what measurement devices? If there are no sufficiently reliable data available, especially for extreme conditions, governing boundary conditions can be obtained through mathematical calculations, computer simulations, scale models or prototypes (if well validated).

An inventory of relevant *laws, regulations and municipal plans* should be undertaken to make a design feasible, because the resulting over-all system will have to comply with mandatory rules, or to fit in overarching plans. Rules can be formulated at international level (like European laws and intercontinental treaties), national level (Dutch laws), regional level (provincial regulations, by-laws of water boards) and local level (municipality regulations).

Requirements, boundary conditions and laws & regulations have to be taken into account in the next design phase, the Verification of Concepts, and criteria will be used in the Evaluation of Alternatives.

The Functional Specification phase is suitable to make an *inventory of risks* for the project. To manage these risks, the RISMAN method is often used, but there are more tools available, like the Failure Mode Effect & Criticality Analysis (FMECA). These methods identify risks and, depending on the combination of probability and consequences, four types of measures can be considered: prevention, transmission, mitigation and acceptance (U.S. Department of Defense, 1949). Risks that should be avoided, have to be dealt with in the Verification of Concepts phase. Risks that are considered acceptable or unmanageable can be included in the Evaluation of Alternatives, either as costs or as criteria.

4.3.4 DESIGN PHASE 4: VERIFICATION OF CONCEPTS

In the Verification of Concepts phase, it is verified whether the concepts created in the Development of Concepts phase will actually fulfil the desired function as defined in the project objective and specified in the programme of requirements as defined at the detailing level of the design loop under consideration. A wide range of theories, formulas, tables, scale models, prototypes, drawings and research methods from technical and behavioural science are at the disposal of the designer. They all model reality, more or less simplifying it. It can be helpful to distinguish a *functional verification* from a *structural verification*.

A *Functional verification* checks whether a concept is able to fulfil its main functions. Typically, during this phase, a technical system has to be developed to make the system function: For instance, gates and a filling- and emptying system for navigation locks, entrances and exits and a main parking lay-out for parking garages need and the water-retaining element and the erosion protection for dikes. The main dimensions of the system or structure are derived from functional requirements, thus taking the boundary conditions into account. For example, the main dimensions of a navigation lock are determined by the size of the governing vessel and maximum waiting times, in regard to the varying water levels at both sides of the structure. In the case of the parking garage: the number of cars to be parked simultaneously determine the main dimensions of a parking garage, given the available area for construction.

In all cases, it should be verified whether the required space is available. A *sieve analysis* and a *potential surface analysis* can be used for this purpose. The project location can be a variable in the different design concepts and the choice of the location has to be balanced against the advantages and disadvantages of other design aspects.

If functional requirements cannot, or only problematically, be quantified, the effects of concepts can be simulated and the extend of meeting these requirements can be checked with the help of interviews, questionnaires, focus groups or user observations (see also Nillesen (2012)). For example, emotional impact of concepts can be tested with use of product emotion measurement instruments (like PrEmos, developed by Desmet (2003)). A simulation can be used to experience psychological or social aspects of design alternatives and qualitative requirements regarding human well-being or social comfort can be checked.

A *structural verification* succeeds a functional verification, to check whether a concept that can be realised. The technical system and the ensuring of the structural integrity, which usually comprises stability, strength and constructability checks, need to be elaborated in detail. Thus, the dimensions and locations of structural elements (like floors, walls, columns, etc.) and the mechanical schematisation of the connections (like fixed connections, roller bearings and hinges) are determined, for which technical calculations are suitable.

Construction aspects should be included in the Verification of Concepts design phase: Firstly, because constructability is a main requirement for a realistic system. Secondly, governing load situations often occur during the construction phase and will be overlooked if only the operation phase is taken into account, which could lead to collapse of the system before it is completed.

The structural verification differs per discipline: civil engineers and architects mostly develop custom-made structures, starting with requirements as a guidance for the creation of concepts. Electro-technical and mechanical engineers often have ready-made alternatives within their reach in catalogues. Their properties have just to be compared to the requirements. This also applies to civil engineers and architects when it comes to designing structural details: their properties can often be found in product catalogues as well. More standardisation in civil engineering could be beneficial in terms of manufacturing and maintenance.

For multifunctional flood defences, the structural verification is described in Chapter 5. The structural verification of multifunctional flood defences resembles the verification of regular flood defences, which is described in Appendix E, but several specific points of attention can be found in Section 5.3.

A relatively new tool that can be used for the Verification of Concepts is *Building Information Modelling* (BIM). It involves the generation and management of digital representations of physical and functional characteristics of places. BIM extends the traditional two-dimensional technical drawings beyond 3D, augmenting the three primary spatial dimensions with the dimensions of time and cost. BIM therefore covers spatial relations, lighting analysis, geographic information, quantities and properties of building components besides the usual geometry. It is therefore very suitable in the 'Verification of Concepts' phase, resulting in less errors and a shorter design period, but it can also be used for the realisation of the system, or for maintenance purposes (Smith and Tardif, 2009). BIM can be helpful in discussions with the client, and in the communication with the constructor. During early design phases, however, BIM can pose obstacles to integrate design, because BIM models are not very suitable to move from conceptual design to engineering and back. To further promote and develop the possibilities of BIM, Delft University of Technology has initiated a BIM-lab in 2013. This inter-faculty development laboratory is guided by prof. Marcel Hertogh, professor in Integrated Design and Management.

The functional and structural verification of design concepts can be carried out at different design levels. For navigation locks, for instance, the feasibility of mitre gates, lift gates, roller gates and so on should be considered. First, this is done in a provisional way during the conceptual design cycle and later, for the selected gate type, during the structural design cycle, where structural details are dealt with.

Sometimes expert opinions can provide insight into the feasibility of proposed alternatives. For the use of this technique, individual experts can be consulted, but a wider range of experience can be involved by bringing various experts together. It can result in an approval, a conditional approval or a rejection of concepts. Expert opinions should be verified with the help of advanced techniques, possibly during more detailed design cycles.

4.3.5 DESIGN PHASE 5: EVALUATION OF ALTERNATIVES

In this dissertation, *concepts* are distinguished from *alternatives*, to avoid potential confusion. Concepts are not yet verified ideas, and they possibly do not meet all requirements. Alternatives are verified concepts, so all alternatives that survived the Verification of Concepts can be expected to be working solutions that can be evaluated in the Evaluation of Alternatives phase. The feasibility of alternative solutions is evaluated by finding a right balance between the created values and the sacrifices needed to achieve these values. It must be ascertained that the design alternatives meet all requirements at the moment of evaluation (this actually is the aim of the Verification of Concepts phase), otherwise the comparison between alternatives would be 'unfair', because 'good' alternatives would have to compete

with 'not fully matured' concepts. Even worse: it could lead to selection of non-functional solutions.

Difficulties in estimating this balance of created values and sacrifices are:

- not all values and sacrifices are (objectively) quantifiable;
- (part of) the values and sacrifices often reside outside the project boundaries.

The feasibility of project alternatives can therefore be considered at different levels of economic focus:

- political science, where a multi-criteria evaluation is a suitable tool, but also broad societal debates can be used;
- macro economy, where cost-benefit analyses are used;
- micro economy, where cash flows are analysed.

4

The suitable type or level of evaluation depends on the scale of the project and its owner. Broad debate seems to be appropriate to large-scale infrastructure, but for 'smaller' projects a Multi-Criteria Evaluation (MCE) seems to be more suitable because the marginal cost of the project would not balance with the marginal value obtained with this approach. Politicians include aspects like environment, health, culture, aesthetics, etc. in their considerations. Cost-benefit analyses include elements like growth, employment, currency and inflation. Cash-flow only comprises financial profits and losses (Bakker, 2000).

In a multi-criteria approach, the values, or 'qualities' of the design alternatives are determined with the help of relevant qualitative criteria. The criteria are derived from the clients' wishes and stakeholders' interests, which are typically non-quantifiable. They usually consist of values such as human life, nature, culture, spatial quality, but involve more technical values as well, such as maintainability and disturbance to the surroundings by construction activities. Weighting factors are assigned to these criteria, because not all criteria are equally important. Subsequently, the design alternatives get scores per criterion. After determining the total score, or value, per alternative, it is easy to compare them to each other. The client should be involved in estimating the weighting factors of the criteria and in scoring the alternatives. The designer could, for instance, present the table with unweighed criteria and discuss with the client what criterion should have more or less influence. The designer and client then immediately get a feeling of the sensitivity of the weights and scores.

TAW - HLNC (1994) recommends the following criteria for the evaluation of dike sections:

- landscape
 - coherence of elements and patterns in the landscape;
 - coherence of shapes & natural processes and functions assigned to the landscape;
 - readability of the natural system;
 - readability of the historical development of the landscape;

- visual coherence.
- nature
 - characterisation of the dike landscape by ecosystems;
 - rarity of ecosystems and species;
 - diversity per ecologically homogeneous area or per dike section;
 - likelihood of success for establishment and survival of natural communities and species;
 - substitutability of species in terms of required time and extent;
- cultural history
 - rarity of the element at different scale levels;
 - authenticity of used materials, concepts and functions;
 - coherence of elements with their surroundings;
 - characterisation of the element for the area;
 - symbolism the element regarding historical events
- social-economic functions
 - number of houses that will have to be demolished;
 - accessibility of agricultural fields and potential shelters;
 - accessibility of industry or companies, available space and vulnerability to flooding;
 - possibilities for recreation, including accessibility and attractiveness of the recreational area;
 - impact for traffic, including road safety and noise;
- administration and maintenance
 - possibilities for inspection and maintenance and repair of the flood defence;
 - influence on the flow profile of the river;
- cost
 - purchase of ground and estate;
 - inventories and design;
 - remediation of polluted soil;
 - construction;
 - administration and maintenance.

The extent in which concepts comply with these criteria is a measure for their contribution to the spatial quality. Geertzen and Liefink (2017) made an inventory of ways to include the LNC criteria in a dike design, which could facilitate the client, the stakeholders and the design team.

Costs are sometimes included in a MCE by dividing the total value per alternative (i.e., the sum of weighting factor x score per criterion) by the costs: the value-cost ratio. This way of incorporating costs, however, is part of a macro-economic consideration where all values are expressed in monetary units. Formulating economic costs and benefits as a criterion creates possibilities to assign a weighting factor to the economic aspect, which fits better in a political setting (see also Bogardi et al. (1991)).

If a Cost-Benefit Analysis (CBA) is used as an evaluation tool, according to the

engineering approach, an optimum is found where the added value V_A and costs C are balanced:

$$V_A - C = 0 \quad (4.1)$$

In Figure 4.3, this point is indicated with 'max. value, still profitable'. The horizontal axis usually represents the quantity of produced products (Q), but for hydraulic engineering projects, it can be interpreted as the 'solution space', for instance the scale of the project (alternatives), or the number of additional functions. From an

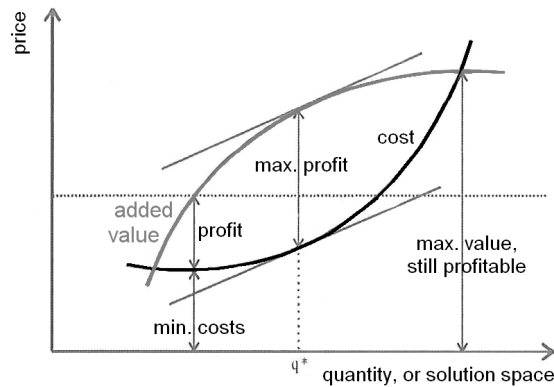

Figure 4.3: Engineering design optimum, after Bakker (2000)

economic point of view, an optimum design is achieved when the profit is maximal. This optimum can be found when regarding marginal values $\frac{dV_A}{dQ}$ and marginal costs $\frac{dC}{dQ}$:

$$\frac{dV_A}{dQ} = \frac{dC}{dQ} \quad (4.2)$$

This is also indicated in Figure 4.4 ('max. profit', point q^*), but economists usually draw a graph that represents the marginal values and costs (the values and cost of producing one extra unit), as in Figure 4.4, but they tend to forget that the project still has to be affordable ($V_A - C = 0$).

The expenditures and costs of a system are preferably considered over the entire life time. Unavoidable risks can also be included as criteria or costs in an evaluation of alternatives.

4.3.6 DESIGN PHASE 6: VALIDATION OF THE PROPOSED SOLUTION

Because this design method can be used at several detailing levels, solutions for the discriminate subsystems and components will have to be integrated into a complete, functioning system and total costs, spatial aspects and planning have to be considered: technical drawings indicate how the structure has to be constructed, material quantities and equipment should be estimated, and a construction planning should be prepared.

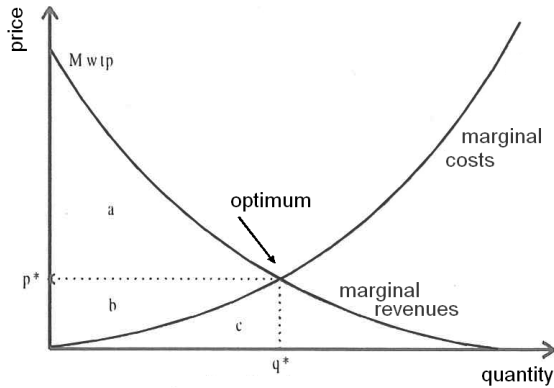

Figure 4.4: Economical design optimum, after Bakker (2000)

It is recommended to subsequently carry out a final check on the validity of the entire design, whether the design objective has been adequately formulated and correctly translated into requirements. Validation is the confirmation, obtained through objective evidence, that the system will perform its intended functions. Validation is a check whether the right system has been designed, whilst verification is a check whether the system design is correct. If the requirements do correctly define the desired system, and the system is verified against the requirements, the resulting system will fulfil its purpose. Part of a validation is a check whether the used starting points are applicable to the design and a judgement whether the used design method is suitable for its purpose.

In practice, Validation becomes more important because contract managers presently tend to have a poor sense of the reality (see Section 2.6). It is therefore proposed to add this phase to the usual design sequence.

4.3.7 DESIGN PHASE 7: DECISION

The best alternatives are usually proposed to the client and the consequences of the preferred alternative can be discussed. The choice for an alternative for medium-scale projects can be based on a division of the values (the outcome of a multi-criteria evaluation) by the costs for each alternative. The result is a value-cost ratio per alternative, which is more or less a 'value for money' ratio. Net present value calculations are used to represent future costs and revenues. The higher the value-cost ratio, the better the alternative. However, value-cost ratios give no insight in the absolute magnitude of values and costs.

The ratio of values and costs of the alternatives can therefore better be drawn in a graph, like in Figure 4.5. Alternatives 1, 2 and 4 in the example have about the same value-cost ratio, but there are big differences in the absolute magnitudes of values

and costs. Therefore, the value-cost ratio alone does not give a clue to decide what alternative is to be preferred.

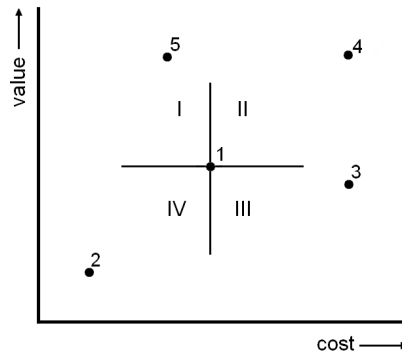

Figure 4.5: Graph with values and costs as a tool to find the best alternative

In his discussions with clients, dr.ir. H.G. Voortman of Arcadis therefore draws quadrants around the alternatives. The quadrants should be drawn with their origin in a chosen reference alternative for comparison with other alternatives. Other alternatives situated in quadrant I are always more interesting than the reference alternative, because they create more value for less money. Alternatives in quadrant III are always less preferable, because they create less value for more money. Alternatives in quadrants II and IV need more consideration and here the available budget could be a deciding factor. It could be helpful to consider the value and costs of alternatives during longer periods, because that could shift their position in the graph. For instance, if not only construction costs are considered, but also the costs of maintenance and demolishing or re-use, sustainable alternatives become more interesting.

To make a decision, the client has to be able to afford the solution: he has to have sufficient solvency (the degree to which the assets exceed the liabilities) and liquidity (the ability to pay short-term obligations). Moreover, in a capitalist economy, the dividend of the project has to be competitive with other dividends in the economic market. It could be useful to consider the value and costs of alternatives during longer periods, because that could shift their position in the graph. For instance, if not only construction costs are considered, but also the costs of maintenance and demolishing or re-use, sustainable alternatives could become more interesting, if long-term trend changes within the lifetime can be foreseen. It should be noticed again, that cash inflows and outflows have less effect further in the future.

If the client is not satisfied with the thus proposed alternative, or is not able to pay for it, four design optimisation moves are possible. Firstly, it should be checked whether the right evaluation criteria have been used with correct weighting factors. Secondly, it can be endeavoured to enhance the preferred, but not yet fully satisfactory, alternative by combining it with strong elements of other alternatives. Thirdly, it can be attempted to find possibilities for extra functionality (surplus value) that

will generate more value and/or income. Fourthly, the design objective and the programme of requirements can be adjusted to make it less ambitious.

If the client likes the 'winning' alternative and is able to afford that solution, a new design cycle can be started, where more detailed calculations and drawings are generated for the subsystems within the system that was designed in the previous cycle. The objective and programme of requirements and all other phases then aim at the subsystem and they are more specific than in the previous design cycle. A new cycle could also be used to re-consider the programme of requirements, for instance when the costs of the best alternatives appear to be unaffordable.

In case of infrastructural projects, decision-making is regulated by law or other procedures. Everyone should be offered the possibility to consult and participate in the design project. This can be organised in different stages of the design. The decision is usually formalised by signing a legal document, according to which a next detailing loop is started, or the design project will be finalised. In the last case, the final results will be communicated to the client and other involved parties in a final report. Engineers usually document their solutions in such a specific way that they can be constructed or manufactured.

4.4 INTEGRATING SUSTAINABILITY PRINCIPLES

This section explains how landscape, natural and cultural values can be included in an integrated design in a sustainable way. Sustainability is related to *spatial quality*, which has already been described as part of Section 3.3.

4.4.1 INTRODUCTION

The term 'sustainability' was first used in the early 1980s and was popularized after publication of the Brundtland Report of 1987.⁴ The term has been open to different interpretations, but according to McLennan (2004), who is considered one of the most influential individuals in the 'Green Building' movement today, sustainable design is *the philosophy of designing physical objects, the built environment, and services to comply with the principles of social, economic, and ecological sustainability*. This definition contains the three elements, or 'pillars' of sustainability that are commonly included: society, economy and environment. These elements are well-known as the three P's of 'People, Planet, Profit' as defined by Elkington (1994).

Social sustainability

Social sustainability could be defined as *a process for creating sustainable, successful places that promote well-being, by understanding what people need from the places they live and work. Social sustainability combines design of the physical realm with*

⁴The report, titled 'Our common future', of the World Commission on Environment and Development (WCED), chaired by the prime minister of Norway, Gro Harlem Brundtland. The main finding of the report was that the current environmental problems are caused by poverty in one part of the world, and by non-sustainable consumption and production in another part of the world.

design of the social world - infrastructure to support social and cultural life, social amenities, systems for citizen engagement and space for people and places to evolve (Woodcraft et al., 2011).

Economic sustainability

Economic sustainability is used to identify various strategies that make it possible to use available resources to their best advantage. The idea is to promote the use of those resources in a way that is both efficient and responsible, and likely to provide long-term benefits. In the case of a business operation, it calls for using resources so that the business continues to function over a number of years, while consistently returning a profit. The objective is to establish profitability over the long term. A profitable business is much more likely to remain stable and continue to operate from one year to the next. From this perspective, this strategy can be seen as a tool to make sure the business does have a future and continues to contribute to the financial welfare of the owners, the employees, and to the community where it is located (Collins World English Dictionary, 2015).

4

Ecological design

Ecological design is defined by Sim van der Ryn, leader in the field of sustainable architecture, as any form of design that minimizes environmentally destructive impacts by integrating itself with living processes (Van der Ryn and Cowan, 2007). Ecological design takes the environment into account as an additional factor to those that are already used, in particular using energy conservation, efficient insulation, rainwater, solar radiation, wind-power, and recycling technologies.

4.4.2 ECO-DYNAMIC DESIGN

The concept of *Eco-dynamic design* is quite similar to ecological design, but it not only comprises living nature, but also physical processes. Eco-dynamic design could be described as the *integration of disciplines, knowledge, information and methods in the 'green-blue' development process related to wet infrastructure (decision-making, design, realisation, use, maintenance). The dynamism of the natural system is optimally taken into account, whereby cost and benefits are balanced for human and society against a background of a sustainable perspective. To achieve this objective, aspects like decision-making, design, biotic, a-biotic, socio-economic system knowledge, construction, monitoring and modelling should be integrated as leading research and application areas (Stichting Ecoshape, 2008).* In other words: The idea behind eco-dynamic design is using the processes of nature to accomplish a water infrastructure, meanwhile preserving nature. Understanding of the natural dynamics can enlarge the possibilities to integrate nature in the development and design process. Eco-dynamic design aims at minimising the negative effects of interventions, and maximising the potentials of the system.

Eco-dynamic design involves the *flexible integration of land in water and vice versa, using materials, forces and interactions, present in nature, taking into account both existing and potential nature values, and the bio-geomorphology and geo-hydrology of the ambient environment (Waterman, 2010).* Eco-dynamic design is an

integrated approach aiming at fulfilling various objectives, considering hydraulics, morphology, ecology and the societal context. Waterman (2010) distinguishes 22 relevant elements for a multifunctional sustainable coastal zone development.

It is essential for an eco-dynamic design that both the needs for society and the ecosystem are specified in terms of functional requirements. Engineers are able to design appropriate systems, provided that eco-dynamic design tools are available. The eco-dynamic design process has seven phases and is iterative, like the traditional engineering process:

1. Define the multi-actor, multi-value problem: a wide scope of the problem, and the diversity of perspectives and values taken into account;
2. Include multi-disciplinary knowledge, apply principles from hydraulic engineering and specify preliminary functional requirements, as well as natural boundary conditions;
3. Sketch and describe preliminary designs;
4. Select promising designs in terms of hydraulic engineering principles;
5. Test or verify designs through prototyping or modelling;
6. Incorporate relevant new knowledge, revise functional requirements, refine or re-design, re-test and verify in terms of hydraulic engineering principles;
7. Select the final design for multi-actor evaluation.

(Slinger and Vreugdenhil, 2016)

Tools to include ecosystems values in an integrated eco-dynamical design can be provided by the following eleven ecological principles. If these principles are applied fully across multiple time and space scales, the inherent character and functional integrity of the ecosystem should be maintained.

1. Pursuit of continuity of physical processes, like water and sediment flows and land-water interfaces in the ecosystem;
2. Minimisation of direct human disturbance of the ecosystem, because direct disturbance may affect the health of the ecosystem;
3. Minimisation of endogeneity (level of invasion of an ecosystem by exotic species), which is preferred above invasive colonisation;
4. Preserve viability of populations to prevent extinction;
5. Create opportunities for endangered populations and particular species;
6. Pursuit of trophic web integrity to maintain a healthy interaction of all species in an ecosystem;
7. Create or maintain opportunities for ecological succession of species from pioneer stage to climax stage;
8. Aim at zone integrity aims to ensure that the natural mosaic of the ecosystem is fully represented;
9. Preserve characteristic (in)organic cycles to secure the integrity of the throughputs of carbon, nitrogen, phosphorous and silicon in an ecosystem to support and enable the ecosystem character and functioning;
10. Maintain or optimise the characteristic physical-chemical water quality over time and space to prevent triggering atypical, unwanted events;

11. Strive for resilience that enables the ecosystem to withstand and even benefit from reasonable, foreseeable disturbances.

The essence of these principles is that they conserve and restore the dynamics of ecological networks and landscapes over time and space. Engineers can support the environmental scientists in this endeavour, in designing healthy and functional ecosystems and applying ecological design principles to deliver nature-friendly solutions (Slinger and Vreugdenhil, 2016). The challenge is to find the right balance between interfering to conserve or restore ecology and letting nature take its course.

The eco-dynamic design process as described by Slinger and Vreugdenhil (2016) fits very well in the integrated design method as described in this chapter, with its wide scope and an open attitude to include diverse disciplines. It represents a fundamentally different starting point in which societal or ecosystem needs are not represented by a single client, but by a range of stakeholders, who can contribute to the design process with their knowledge of the environment.

The quantification of eco-dynamic principles for the design of flood defence systems is still a challenge. Specifically the contribution of eco-dynamic measures to flood risk reduction is a subject of ongoing research. For example, the effect of salt marshes in the forelands of the Wadden Sea was studied by Van Loon-Steensma (2014), who concluded that integration of salt marshes in long-term adaptation strategies appears promising, but will not take away the necessity of heightening dikes in the future in regard to sea level rise scenarios. However, Van Loon-Steensma has shown that the restoration of salt marshes offers possibilities for mutual reinforcement of flood protection and nature conservation and enhancement. Presently, new methods are developed within the BE-SAFE programme at Delft University of Technology to assess how, and to what extent, vegetated foreshores can contribute to flood risk reduction.

An example of eco-dynamic design as a new approach for coastal protection is the 'sand engine' project: Instead of frequent beach nourishments along the coast of the Netherlands, 21 million cubic metres of sand was deposited at one location. Natural processes, in the form of waves and currents, gradually spread the sand along the coastline over about twenty kilometres, causing less damage and instead preserving the natural dune environment. Monitoring research programmes like 'NatureCoast' and 'Nearshore Monitoring and Modelling (NEMO)', study the effects of this intervention on the morphology, ecology and as well on safety (because of changing flow patterns).

4.4.3 MAKING A DESIGN SUSTAINABLE

The three elements of sustainability can be included in design by incorporating them into the design objective and by subsequently setting up sustainability requirements. Possible conflicting requirements for social and economic sustainability will have to be resolved during the design process. As an alternative for requirements, the elements of sustainability can serve as criteria for the comparison of alternative

solutions in the Evaluation phase.

Furthermore, the right tools and the expertise to use them have to be available in the design team (several tools were already presented in Section 3.3.4). Sustainable design is an attitude to be embraced by the client and design team members, who have to be aware of the changing impact of technology on ecosystems. Ecological design, manifesting itself as an expression of a sustainable philosophy in the beginning of the twenty-first century, attempted to achieve integration of human actions with a sustainable use of natural resources and, limiting the negative impact of human actions and thus maintain the integrity of both economy and ecology (Çelik, 2013). The life-cycle approach, the 'cradle-to-cradle' and 'eco-dynamic design' concepts can be seen in line with the sustainable design principles.

Van Rinsum (2017) made an inventory of available tools to include sustainability aspects in the design of flood defences. He described four tools that were developed by 'Duurzaam GWW' ('Sustainable Civil Engineering'), which is a partnership between Rijkswaterstaat, the provinces and the municipalities. The first tool is the 'Environment Index' (*omgevingswijzer* in Dutch), which was developed by Rijkswaterstaat, see Figure 4.6. It consists of a diagram that includes twelve themes. It can per theme be indicated to what extent it has been taken into account in the design. It is not a way to quantitatively indicate the contributions of these themes, but it aims at promoting the awareness of sustainability aspects and stimulates the discussion. The Environment Index is intended for the initiation and pre-project phases of projects.

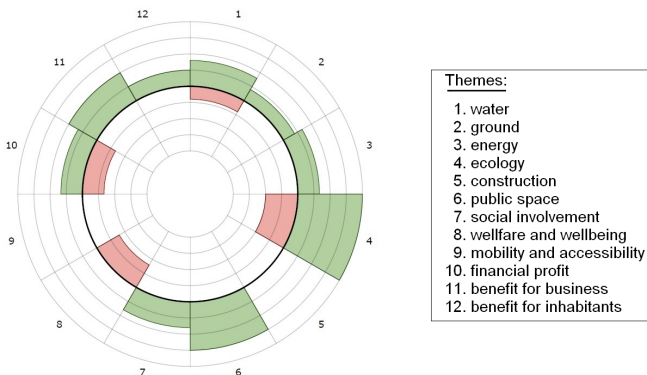

Figure 4.6: Example of an 'Environment index' as developed by Rijkswaterstaat

A similar tool, is the 'Ambition web' (*Ambitiweb* in Dutch), which can be used to specify and use sustainability themes throughout the entire duration of design projects (Figure 4.7). The Ambition web is a visual representation of the ambition level per sustainability theme. Ambition level 1 indicates an awareness in the largest contributing aspect per theme and intention to obtain a minimal sustainability performance. Level 2 comprises the specification of concrete objectives to obtain significant improvements. Level 3 is the most ambitious and indicates a positive

contribution to the theme, instead of making it less harmful.

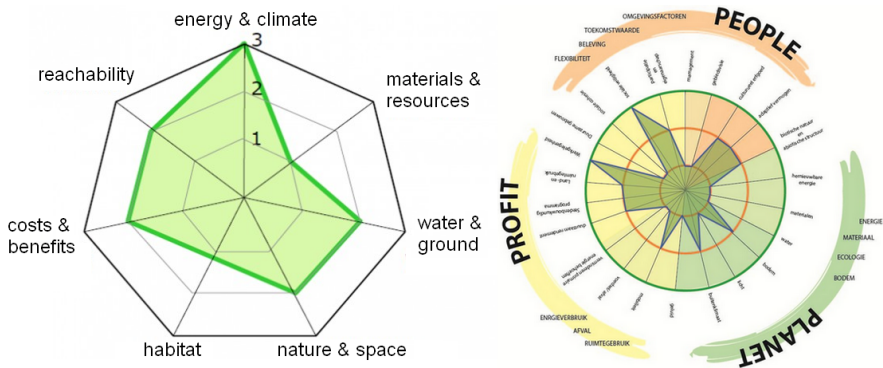

Figure 4.7: Two examples of an 'Ambition web'. Left: a basic web from www.duurzaamgw.nl; right: a more advanced web from movaes.nl

Calculation models like 'DuboCalc' and the 'CO₂ performance scale' (*CO₂ prestatieladder* in Dutch) are quantitative methods to assess the sustainability of a design, preferably during the entire life time of the system or structure.

Van Rinsum (2017) recommended to involve sustainability from an early stage in design project, because that will increase the possibilities to include sustainability aspects and decrease the costs of making modifications. Sustainability themes have to be made concrete, to avoid discussions on a high level of abstraction that lead to no result. The possibilities become clearer if sustainability themes are specified and related points of attention are recognised.

While technology aims to solve perceived societal problems, current opinion is, that *with technological hegemony, our ecosystems have gained little and lost a lot* (Thayer jr., 1998).⁵ In this respect, the development of *appropriate technology*, initiated by Schumacher already in 1973, can be understood. It is a philosophy and movement initiated by Fritz Schumacher that aims at enhancing the self-reliance of people on local levels by applying intermediate technology, that is designed to be compatible with its local setting and to be applied at the appropriate scale (Schumacher, 1973).

4.5 INTEGRATING MULTIPLE DISCIPLINES

Integrated design is a collaborative method for designing products, systems or structures. The multidisciplinary approach creates optimal synergy where the borders between disciplines disappear. It aims at better results and less costs

⁵It should be noticed that many environmental organizations make selective or misleading use of scientific results to influence the policy on environmental issues, as has been demonstrated by Lomborg (2001).

compared to monodisciplinary designing. An integrated design process is based on fulfilling the objective of the client by integrating:

- system thinking: the integration of abstractions starting with analysing the real needs instead of immediately drawing up solutions;
- life cycle thinking: methodical design, where the integration is incorporated during the entire life time of the system or product, including costs and revenues;
- structural thinking: disciplines are integrated, which requires archiving all project information in a structured way.

It is not sufficient to include experts of various disciplines in the design team. They tend to design only their own part or sub-system, resulting in a design that consists of separate mono-disciplinary solutions with problems at the interfaces. A multidisciplinary design team is not a guarantee for an integrated design. An integrated design requires inter-disciplinarity, which involves the combining of two or more disciplines into one design activity. It is about creating something new by crossing boundaries, and thinking across them. To achieve inter-disciplinarity, the multi-disciplinary team has to cooperate intensively during the phases of functional specification, generation of concepts and evaluation, at least during the first design-cycles. The individual project members should understand the basic principles of other disciplines and above all, understand their language and culture. It is important that all members support the chosen design method, acknowledge the added value of integrated designing and see enough opportunities to contribute to the project with his or her expertise.

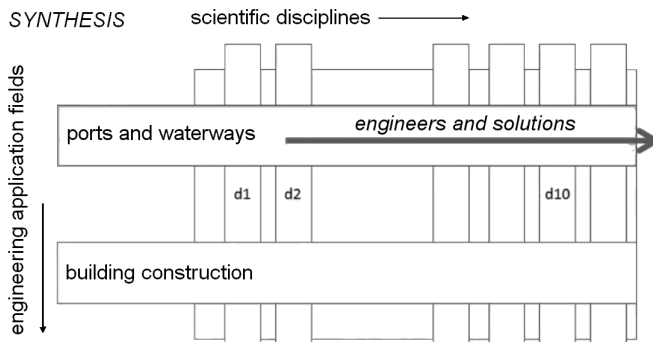

Figure 4.8: Engineering combines several scientific disciplines to obtain realistic solutions (Vrijling, Waterbouwdag 2012)

When it comes to a more detailed design, for instance the technical design of a reinforced concrete element, it is less problematic, and even desired if this part is executed by a specialist. In this respect it is good to realise that there is a difference between using the proper tools and properly using the tools: it is the difference between doing the calculations and making a design, as illustrated in Figure 4.9. The integrating activities are typically suited for a group approach, whereas working

on design calculations can be done by individual specialists. The results of detailed calculations will have to be integrated in the overall design activity.



Figure 4.9: The difference between only properly using tools (knowing how to bake brick) and using the proper tools (constructing a castle out of these brick) (Malbork castle, Poland)

4

A method aiming at the integrated and concurrent design of products is *Concurrent Engineering*, developed by the Institute for Defense Analysis (USA). It is the totality of organisational and technical measures that enable simultaneous development of a product. It is intended to initiate the developers to consider all the elements of the product life cycle. Advantages of working in multidisciplinary teams are a clear understanding of problems and risks. Developers that are aware of joint interests are able to develop more creative solutions. The execution of parallel activities requires efficient and effective communication skills and therefore, it is essential that the process is well structured and managed. If concurrent engineering is carried out by different companies, it is denominated as *Collaborative Approach*. In that case, explicit agreements will have to be made on the objectives of the involved parties, organisational procedures, knowledge, skills and communication (Zeiler, 2014).

Striving for an integrated approach implies that the activities of all members of the design team fit within the same design framework and are aware of the objective in terms of functionality. In principle this should not be a problem, because the way of problem solving is natural, but doing it in an explicit systematic way could arouse resistance by landscape architects and urban designers who are used to a less formal approach. However, it is unavoidable that the work is structured somehow, if more people are involved in the process and the complexity increases. Phasing of the process will force all members to keep pace with the project, enhancing the effectiveness of the interactivity.

Within Delft University of Technology a task force has been formed in response to a societal need for problem solving, following an integrated approach by multidisciplinary teams. Delft University of Technology houses many disciplines and fields, but they are more-science driven and they are specializing themselves little by little. Design, however, integrates knowledge and experience in order to solve complex issues within the domain of application. Collaboration is therefore seen as the key to reunite the disciplines of architecture and civil engineering. The minor on Integrated Design of Infrastructures, which started in September 2015, is the result

of an effort of this task force *to stimulate collaboration due to its engineering nature, architectural expression and its environmental context of cities and landscapes.*

This task force produced a framework wherein *differing disciplines, 'lenses', types of infrastructure and all relevant related issues* can be positioned (Workgroup IID, 2013), see figure 4.10.

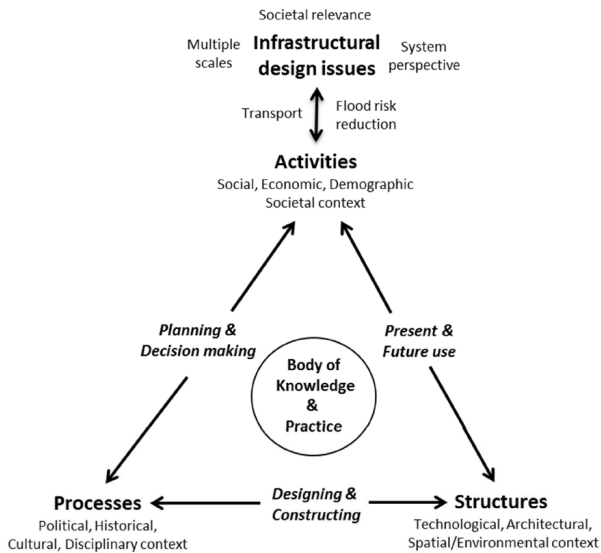

Figure 4.10: Framework for integrated infrastructure design, developed at Delft University of Technology (De Boer, 2015)

Five hypothetical 'lenses' have initially been recognised during working sessions as themes to focus on, or to magnify, several relevant design aspects throughout the entire design process. Finally, ten lenses have been distinguished in Workgroup IID (2013):

1. Functionality (FT): Will an structure work for its defined purpose? Is it useful? Can functions be combined?;
2. Intervention scales (IV): Could a structure be seen as a single object or should it be seen as part of a local or regional network and neighbourhood, city or landscape? Intruding and dominating or celebrated as an iconic landmark?
3. Performance (PF): How to secure the performance of infrastructures regarding its reliability, availability, maintainability and safety (RAMS) during its life cycle-phases of design, build, maintenance and renewal or demolition?
4. Collaboration (CB): Will engineers, designers, architects, managers and politicians understand each other as specialists in their own field in approaching a complex societal issue? What about involvement of interest groups and citizens?
5. Complexity (CP): Technical, political, administrative, legal, organisational and managerial, social or financial? Or all together?

6. Permanence (PM): Buildings come and go within a time-stretch of decades, what about patterns, grids?
7. Perception (PC): How will be the perception of locations and sceneries by commuters or travellers as users of (infra-)structures influenced by speed?
8. Spatial quality (SQ): Are spaces, places and its structures blank or do they express an identity? User experience is a key for appreciation and for its present and future use.
9. Sustainability (SN): Could future generations still make use of the present and new realized infrastructures regarding its life span and changing economic and climatic conditions? Can we design and construct infrastructures with a smaller spatial and ecological footprint and with less use of natural resources?
10. Added value (AV): How to create new or more social, economic and/or environmental benefits which could create commitment and support from politicians, civilians and other stakeholders for decision making and which could justify large investments?

'Adaptation & reuse' would be a useful addition to this list. These lenses provide cross-connections that connect the different disciplines.⁶ Awareness and use of these lenses during the exploration phase of the design process could improve the integrated nature of the final solution. By including these lenses in setting up the programme of requirements, integrality is the expected result. Table 4.1 shows such a set of requirements, arranged per domain.

If people and organisations from different disciplines succeed working together, the following advantages can be obtained (Zeiler, 2014):

- a higher value can be created for the client;
- interests of stakeholders are taken into account;
- fewer modifications are needed during the realisation;
- costs of failure during construction are lower;
- the costs of the entire process are lower.

⁶Reality is not subdivided into various disciplines - it is mankind that splits reality up into separate fields of knowledge and then concludes that these fields have to be integrated to, again, understand reality. It is still a challenge to develop a direct, real holistic, approach wherein reality is not initially cut up into pieces.

Ambition	Domain	Main requirements	Sub requirements
Designing Integrated, innovative, and interdisciplinary infrastructure solutions with added value	Technical	<ul style="list-style-type: none"> • Goal effectiveness [FT], [PF], [CB] • Functional integration [FT], [PF], [SQ], [CB], [CP] • Performance [PF], [FT], [CB] • Sustainability [SN]. [FT], [PF], [SQ], [CP] • Architectural quality [IV], [SQ], [PC], [FT] • System integration [FT], [PF], [IV], [SQ], [CB] 	<ul style="list-style-type: none"> • Issue/project dependencies • Constructability, structural efficiency • Reliability, Availability, Maintainability, Safety • Functional & technical life span, Adaptivity/ Flexibility, Resilience, Renewability, Resource efficiency • 'Vitruvius': utilitas, firmitas, venustas • Overall perf., pos./neg. effects
	Social	<ul style="list-style-type: none"> • Public support [CP], [CB] • Impact on health neighbouring residents [SQ], [CP], [CB] • Stakeholder involvement [CP], [CB] • User value & experience [FT], [PF], [PC], [SQ] • Meeting regulations/procedures [CP] • Added value/Opportunities [AV] 	<ul style="list-style-type: none"> • Resistance & protest, agreement, appreciation • Emissions, noise, life expectancy, illness, quality of life • Communication, consultation, co-creation, consensus • Usefulness, appreciation • Licences, lawsuits • Issue/project dependent
	Economical	<ul style="list-style-type: none"> • Value/Cost ratio [FT], [PF], [AV], [CP], [CB] • Build and construct risks [CP], [PF], [FT] • Impact on (ongoing) activities & functions [FT], [PF], [CP] • Added value/Opportunities [AV] 	<ul style="list-style-type: none"> • Cost efficient, best value • Still to be defined • Still to be defined • Issue/project dependent
	Environmental	<ul style="list-style-type: none"> • Land use [SQ], [SN], [PM] • Urban integration [SQ], [IV], [SN], [PM], [CB] • Landscape integration [SQ], [IV], [SN], [PM], [CB] • Added value/Opportunities [AV] 	<ul style="list-style-type: none"> • Density, distance, function mix, liveability, land & real estate prices, fragmentation, coherence • Social/spatial quality • Site-specific, aesthetic, kinesthetic, semiotic, sensorial, systemic • Issue/project dependent
	Ecological	<ul style="list-style-type: none"> • Impact on flora and fauna [SQ], [SN] • Impact on soil, air, water [SQ], [SN] • Added value/Opportunities [AV] 	<ul style="list-style-type: none"> • Diversity, extinction, migration • Pollution, deterioration, erosion • Issue/project dependent

Table 4.1: Programme of requirements related to the 'lenses' as developed within the IID workgroup of Delft University of Technology (De Boer, 2016)

4.6 INTEGRATING STAKEHOLDERS' INTERESTS

A problem is most probably perceived by all stakeholders in a different way. The consequence is that it is very unlikely that a solution can be found that fully satisfies all stakeholders. This means that a compromise will have to be reached. Moreover, the client sometimes already proposes a solution without having studied the actual problem properly. This could guide the process in the wrong direction, so the client should be convinced that a thorough problem analysis is needed.

An inventory of stakeholders includes the client and all relevant involved external parties. It is important to know what their interest is, in what stage of the project they become relevant and how much influence and power they have. It should indicate how the stakeholders will be involved in the project, ranging from providing information in local newspapers, to organising participation meetings, and to adopting several of their interests as requirements (besides the clients' requirements). Usually, stakeholders interests are formulated as criteria (besides the clients' wishes that are not formulated as requirements) that are used later in the design process to evaluate design alternatives.

Matos Castaño described that different actors can have different interpretations of a problem and the process to be followed, which can easily lead to dilemmas. However, looking at the situation from different angles, or 'lenses', can stimulate deliberation about the issue at stake. Matos Castaño unravelled the role of frames as a tool in the occurrence of dilemmas in design projects aiming at multifunctional solutions. She developed a 'dilemma cube' that would be helpful in gaining insight in the social context by stakeholder interaction. It is a tool to be used in a discussion giving insight in different and alternative views, thus making the dilemmas explicit (Matos Castaño, 2016).

Nillesen (2015) distinguishes interactive stakeholder sessions and expert sessions as *successful work formats to reach an integrated design*. The objective of interactive stakeholder sessions is to share knowledge, find facts teamwise, identify relevant topics and assignments and create a mutual understanding for different viewpoints. Expert sessions aim at collecting, sharing and creating knowledge. Both types of sessions can be used in various stages of the design. Nillesen reports that interactive stakeholder sessions were used for the functional specification and development scenarios, for the discussion of concepts prepared by experts based on the first session and finally for the discussion of design proposals that were developed by a multidisciplinary expert team.

Heems, one of the PostDocs of the STW research programme of the current research project, made an inventory of best practices for stakeholder participation. These 'tips', which can be used as a source of inspiration and as a check list, have been based on the experience of 'learning communities'. Two hundred ideas have been collected during a workshop in 2014, organised by Delft University of Technology and Rijkswaterstaat. They have been grouped within seven themes and are presented here to give an idea of their scope.

- Timing
 - Think in advance about the right time to communicate your plans with which stakeholders;
 - Try to find out what would motivate policy-makers: There are more possibilities (time, money) if they are in favour of the project;
 - Don't make the planning too tight if other interest cannot be combined in an early stage.
- Relations
 - Invest time in building-up personal relations with (representatives of) all stakeholders;
 - Let employees be part of network organisations where knowledge can be shared, thoughts developed together in an early stage and ideas can be created;
 - Attune information (management) between involved parties to increase involvement;
- Participation
 - Don't only explain to users of space what is going on, but also use their knowledge. This will improve the quality and accelerate the decision-

- making process;
- Don't create unrealistic expectations;
- Bring public and private parties in direct contact with each other;
- Imagination
 - Use a 'chance chart' instead of an executional programme to look further ahead;
 - Communicate in word and image, not only text;
 - Clearly visualise what the implications will be for a certain area and don't wait until other parties come up with plans;
- Shifting boundaries
 - Think as early as possible with all involved parties about the relation between water and space. Check the effectiveness and efficiency of existing assessments;
 - Share all spatial plans with the water board and have a positive attitude when evaluating plans;
 - Dare to release the autonomy within the sectoral responsibilities;
- Creating financial coalitions
 - Water boards better play their role in urban areas, because that is the area where most of the income comes from;
 - Don't start a cooperation with discussing the distribution of costs, but better bring the sources of budget together later during the process;
 - Combine new projects on all occasions during the process. Have patience and wait for possibilities;
- Creating space
 - Be open to the interests of others, be honest and curious. Visit the field together, especially during rainfall;
 - Approach the combination of water and space as a world to live in, not as a system;
 - Also consider de areas outside the project area during plan-making. Study the effects of both areas effects on each other and look for interaction.

For more information on these best practices, reference is made to the publication of Heems (2015). 'Strategic stakeholder management' (*strategisch omgevingsmanagement, SOM*) is a similar approach that has been developed to involve stakeholders, to prevent or resolve conflicts. The five key elements of this approach are: early involvement of stakeholders, good preparation of the discussions, openness and clearness on the effects, make agreements and act accordingly, and maintenance a monitoring of relations. Tools, like matrices check lists and tables, have been developed to facilitate the activities (Paul and Wesselink, 2010).

4.7 ORGANISATION OF THE DESIGN PROCESS

The design scheme as presented in Figure 4.1 looks straight-forward, but one should realise that after the initial design cycle, multiple cycles at subsystem and component level will follow that occur simultaneously, involving various disciplines. This implies that many people work together and that coordination is required to assure that the right people do the right things together at the right moments. The budget and time have to be controlled and contacts with the client and stakeholders have to be streamlined. This requires a good organization of the entire process. The design team should therefore work well as a group, in good relation with the client and other stakeholders. The organization of the work should be aligned to the form of contracting. These two aspects are briefly treated in the following sections.⁷

4

4.7.1 PROJECT ORGANISATION

Good project management is required for the design process of multifunctional flood defences, because of the complexity of integrated design projects. This involves aspects, as time, activities, disciplines and cultures. Therefore, it is necessary that agreements are made on:

- organisational structure;
- staffing;
- sub-teams;
- tasks and responsibilities;
- organizational culture;
- way of cooperation.

The coordination of the processes of groups with varying backgrounds deserves special attention. Project management structures the process of integrated design and monitors the project regarding time, budget, information and quality. It is important to agree upon the method of project management in advance and to assure that all team members work according to this method consistently. OTIB (2016) characterise good project management:

- clear structure;
- coordination of people, means and activities;
- noting down agreements;
- way of quantifying results;
- an instrument to communicate with the client and other stakeholders.

Within the High Water Protection Plan (HWBP), projects are managed according to an Integrated Project Management Model (IPM)⁸. The model describes the roles and activities within the HWBP and forms the base of the cooperation of the HWBP programme office and the managers (Van de Graaff and van Eck, 2010).

⁷The description in this section is far from sufficient to properly organise the process of integrated design. However, it is considered out of the scope of the present dissertation to further elaborate on this important aspect of the design process.

⁸Nowadays, Rijkswaterstaat entirely works on an IPM basis.

IPM defines five processes, and accordingly five roles exist that can be played by one or more people:

- project management, aimed at securing of quality, money and time; by the project manager;
- risk management, to control risks during the project; by the risk manager;
- environmental management for the relation with the stakeholders during the project; by the environment manager;
- technical management, to control technical and substantive aspects; by the technical manager;
- contract management to control risks that originate between client and 'market'; by the contract manager.

4.7.2 TEAM WORK

Good teamwork is essential for the design process. British researcher and management theorist Meredith Belbin studied the effectiveness of team work, initially in management teams. He concluded that an effective team has members that cover nine key roles in managing the team and carrying out its work (Belbin, 1981). People can have several of these roles, but mostly one role is predominant. They can develop their 'weaker' roles when needed. These roles are:

- plant: creatively generates ideas;
- resource Investigator: pursues contacts and opportunities;
- co-ordinator: distributes and tunes tasks;
- shaper: pursues objectives with vigour;
- monitor evaluator: observes and judges what is going on in the team;
- team worker: facilitates smooth inter-personal relations in the team;
- implementer: transforms suggestions and ideas into positive action;
- completer / finisher: makes sure that the result has good quality;
- specialist: is a source of knowledge to the team members.

Belbin's theory has been regularly used in professional and educational settings and has proved to be a useful tool in analysing the performance of groups. Especially for not too well-functioning groups, it is helpful to know what roles are missing, or overrepresented. Awareness of deviations of the ideal group composition helps reinforcing the weak spots.

American psychologist Timothy Leary developed a method to analyse behaviour of individuals and interactions between group members (Leary, 1957). He used an interaction circle, which is a graphical representation of different types of behaviour and their effects on others (Figure 4.11). Filling out such a circle for an entire design team provides insight and can help team members in deciding how to interact. The interaction circle contains two axes. The vertical axis indicates the degree of dominance and the vertical axis the degree of collectivism. Dominance is complementary behaviour, because a dominant role provokes a docile role (and the other way around). Collectivism is symmetrical behaviour, because collective

or solitary attitude of one person provokes the same attitude from other people. The behaviour per person is indicated in the circle. If two people are in the same quadrant, they maintain the same behaviour. If they are vertically opposed, a complementary reaction will be evoked, so behaviour that is complementary will reinforce the behaviour of the other person. If behaviour of two people is on the same horizontal line, it will have a constructive effect. This method has been regularly used in education at Delft University of Technology.

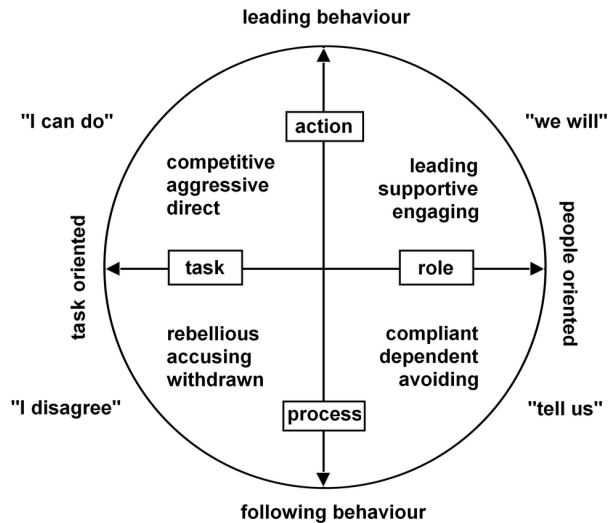

Figure 4.11: Interaction circle of T. Leary (www.pinterest.com)

Another approach to understand the functioning of teams is provided with the Organisational Cultural Model as developed by Geert Hofstede et al. (2010), professor in Social Psychology at Maastricht University⁹. He defined organisational culture as *the way in which members of an organisation relate to each other, their work and the outside world in comparison to other organisations*. Hofstede distinguishes eight dimensions or variables that enable alignment of organisational culture and strategy:

- means-oriented vs. goal-oriented;
- internally driven vs. externally driven;
- easygoing work discipline vs. strict work discipline;
- local vs. professional;
- open system vs. closed system;
- employee-oriented vs. work-oriented;
- degree of acceptance of leadership style;
- degree of identification with the organisation.

Based on questionnaires under employees, the mean organisational behaviour can

⁹Hofstede graduated in 1953 at Delft University of Technology in Mechanical Engineering.

be determined. The dimensions hereby get scores from 0 to 100. The result can be helpful in explaining matches or mismatches with the kind or desired behaviour in a group.

Two examples of tools for the evaluation of group work are Scorion and Rubrics. Scorion is a web-based evaluation tool, which has been developed for Delft University of Technology. With this tool, students evaluate each other's role in the group process. The application covers the entire logistic process: it creates questionnaires, sends the forms to the participants, sends a reminder when needed and finally creates reports. The weak points can be discussed in the group to improve the collaboration and better ensure an optimal result. A rubric is an analytical scale of evaluation that gives insight into strong and weak aspects of people working in a team. The feedback allows people to adjust their behaviour or learning objectives. Rubrics are suitable for self-reflection on skills and competencies as well as on the way of working to reach the aimed result. Rubrics have been developed for communication, acquirement of information, presenting, collaboration and planning & organisation.

4.7.3 CONTRACTING FORMS

The direct result of a design process is a 'scheme', not a realised product or constructed system. Therefore, after the design process is completed, a process of construction, manufacturing, assembling integration, etc. is required to finally create something, as already shown in Figure 3.3.

In the present construction practice, it is quite common to combine design and construction into one contract, sometimes including financing and maintenance. The aim of making these combinations is to optimize the 'product' and the entire process to create and maintain that product. This also stimulates to consider all life stages of a product or system. The usual life-cycle stages are shown in Figure 4.12. A design that takes all these stages into account is called a life-cycle design.

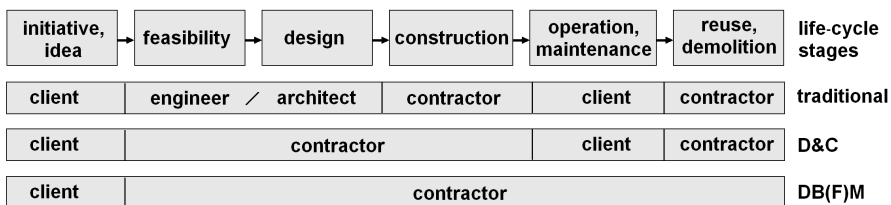

Figure 4.12: Life cycle stages and involved parties

Today, there are many possibilities to divide activities and to assign them to the involved parties. In the traditional contracting agreement, the client carried out the conceptual phase (the analysis including setting up the design objective and first client requirements) and the development phase (system specification and subse-

quent design, also carried out by a firm of consulting engineers). The realisation phase was carried out by the contractor and maintenance was done by the client or a third party in commission of the client. In a *Design & Construct* contract, the contractor carries out the design and construction phases, which implies a partial shift of activities from the client to the contractor. In a *Design, Build and Maintain* contract (DBM), also the maintenance is included in the contract. This can be further extended to arranging the finance for the project, which is called a *Design, Build, Finance and Maintain* contract (DBFM). It has also been endeavoured to let the contractor arrange all planning permissions, but for large projects this can easily lead to delays and (near-)bankruptcy of the contractor. There are many more contract forms and it has to be determined per contract how activities, risks and responsibilities are divided. If exploitation is also part of the contract, it is called a DBFMO-contract: *Design, Build, Finance, Maintain and Operate*.

4

All contracting types, however, are based on the following organisational forms:

- Funded integrated contracts, where only two parties are involved: the client and the contractor. The contractor offers a total package including finance, design, construction and maintenance or operation. Examples of this kind of contracts are FBOOMT, BOOT, DBFO, BFO, DBFM and DBM;
- Integrated contractors contracts, where an integrated contract is offered by the client who presents a complete solution based on an integrated course of design and construction. The client draws up an extensive programme of functional requirements, sometimes also technical requirements. Examples of this contracting form are main contracting, turnkey contracting, engineering procurement contracting, design & construct, detailed design & construct and design & build;
- Traditional contracts, which separate responsibilities for commissioning, designing and constructing. Examples of these contract are general contracting, building team, mono or multidisciplinary partnering and subcontracting.
- Integrated engineering contracts, which make use of advisers or engineering consultants to integrate more tasks in the construction process. Examples are management contracting, construction management, total engineering and engineering contracting;
- Management contracts, which involve specialists or a specialised manager for the different tasks in the building process. The advisory and realisation commissions are therefore strongly subdivided.

The most important issue that determines the choice for a construction organisation form and contracting form, is to distinguish between contract forms and peer reviewing (Roelofs and Reinderink, 2005).

4.8 VALIDATION OF THE INTEGRATED DESIGN METHOD

The integrated design method as proposed in this dissertation was tested in 2016 in the course 'Environment & Infrastructures' at Delft University of Technology.¹⁰ The assignment was to develop an integrated spatial plan for the improvement of the dikes of the Hollandse IJssel river. The dikes appeared to be unstable under design conditions and, in the future there will most likely be a dike height deficiency because of ongoing land subsidence (up to 0,90 m per century). Main design aspects, next to flood protection, were urban functions including spatial quality. The following elements should have been implemented in the plans: creation of 5000 m² of new tidal nature in the river, recreational space and a new quay or harbour for a wood factory along the river.

Students were instructed to use one entire loop of the integrated design cycle at a conceptual level to come to an optimal solution. To 'force' them not to skip or combine design phases, they were instructed to deal with every phase in a separate chapter.¹¹ Detailed calculations were not required, but creative conceptual solutions were. The students were explicitly instructed not to consider only solutions that solve the flood safety problem, but to create alternatives that combine other possible functions as well. The assignment had to be resolved spatially and technically using principle plans. Active stakeholder participation was reduced to an inventory of interests and translating these interests into evaluation criteria or requirements.

The reports were evaluated by the teaching team, and the students were asked to reflect on the method. Most student were positive about the proposed integrated method. They confirmed that it allowed for free, creative development of concepts, while having sufficient background to address the relevant main design aspects. The design steps were logical and sufficed to guarantee a functioning solution (although only one design loop was elaborated). The experimental and learning character were sufficiently included, while the method allowed students of multiple disciplines to work together.

However, not everything went perfect during the execution of the work. The lecturers had already presented a background on the area, with the result that all students initially skipped the 'Exploration of the Problem' phase and started to develop concepts without having characterised the environment and without formulating a design objective. Most students started drawing cross-sections of dike profiles for developing concepts, whilst they should have considered an areal plane first. They also tended to hand out tasks and perform them individually, in stead of in groups. Moreover: one group even elaborated several design phases simultaneously; other groups skipped necessary iterative moves.

Several students remarked that they missed a criterion to judge the 'integrality' of their solution. This was a very good point, because a method that integrates the

¹⁰This course is part of the minor 'Integrated Design of Infrastructures.

¹¹The 'Functional Specification' phase was not yet defined as a separate phase, but the activities that come under this phase were carried out after developing concepts.

design and engineering approach, used in a process where multiple disciplines are integrated, does not necessarily lead to optimally integrated solutions. After all, structures in which all functions are integrated are not always the best solutions (this depends requirements and the criteria). Therefore, the 'degree of integration' is not per se a good criterion. It makes more sense to add a criterion whether one function strengthens another function to judge the integrality of a solution.

The shortcomings found in this validation mainly concern the *application* of the method, not the method itself. They were used to draw up a list of recommendations, which can be found in the concluding section of this chapter. They will also be taken into account when formulating a new assignment for the course of next year.

4

4.9 CONCLUDING REMARKS

In this chapter, a method was developed and validated for the integrated and sustainable design of multifunctional flood defences. It combines the spatial design and engineering approaches, taking the recently more appreciated values of sustainability into account and actively involves stakeholders. Overall, it can be concluded that the integrated design method, as proposed in this chapter, works well and can be applied to the design of multifunctional flood defences, involving multiple disciplines. In the student assignment, the involvement of stakeholders was only simulated, so that part of the method could not accurately be validated.

The proposed method should be considered as a tool to an end rather than an end in itself and its application differs, depending on the level of expertise of the designer. Dreyfus (2003) distinguishes six levels of experts, ranging from novice to experts and visionaries. Novices will strictly follow a method and consider object features as given by experts. Experts have a more intuitive response to a specific situation and perform the appropriate actions straight away. Visionaries have fully mastered a design method as a tool and are capable of varying elements of the method and strive at expanding the domain, paying attention to other domains as well and even developing new ways.

A list of recommended activities per design phases, in chronological order, leaving out the required iterative moves, would than look like:

1. Exploration of the problem
 - (a) finding general backgrounds and problem motivation (client-oriented);
 - (b) making an inventory of the environment and the project location (including the spatial boundaries of the project);
 - (c) making an inventory of involved stakeholders;
 - (d) making an inventory of main system functions;
 - (e) formulating a brief problem statement;
 - (f) determining the desired functions of the future system;
 - (g) describing the design objective (including all main design aspects);

2. Development of concepts
 - (a) developing visions and generating creative ideas;
 - (b) making an inventory of reference projects and possibly include them as additional concepts, or use them to generate new concepts;
 - (c) making an ideal spatial plan with optimal relations between the main system components;
 - (d) generating ideas to create more revenues (if this was not sufficient in a previous design cycle);
 - (e) optimising or combining concepts that did not meet the requirements in a previous Verification of Concepts phase;
 - (f) possibly combining strong elements of various concepts, after prior verification of initial concepts;
3. Functional specification
 - (a) putting up a programme of requirements and evaluation criteria;
 - (b) making a list of physical boundary conditions;
 - (c) making an inventory of prevailing laws and regulations;
 - (d) making an inventory of risks;
4. Verification of concepts
 - (a) performing a process and relation analysis;
 - (b) finding potentially suitable project locations (e.g., with help of a sieve analysis or a potential surface analysis);
 - (c) fitting the ideal spatial plan in suitable project locations;
 - (d) checking whether the concepts meet all requirements and avoid unacceptable risks;
 - (e) rejecting concepts that still not meet the requirements;
5. Evaluation of alternatives
 - (a) assigning weighting factors to the evaluation criteria;
 - (b) scoring the criteria per alternative in a multi criteria evaluation;
 - (c) including costs and acceptable risks;
 - (d) including a criterion of functions strengthening each other to judge the integrality of the alternatives.
6. Validation of the proposed solution
 - (a) doing a final check on the validity of the outcome of the design process.
7. Decision
 - (a) making a proposal for the best alternative, based on values and costs;
 - (b) the client decides to accept the best alternative, or decides to move back in the design cycle to redo several of the phases with more knowledge;

Probably, not all mentioned activities are relevant for all projects, so this list should be considered as a guide, not as a prescription!

Conditions that have to be met for the well-functioning of the integrated method are:

- clear awareness of the distinction between the design activities and the utility of the method as a whole;
- despite the iterative character of the design process: basically carrying out the design phases in the right order;
- reflecting after every design phase and go back to an earlier phase when needed;
- inclusion of all design aspects, landscape, natural and cultural values in the design objective;
- start developing concepts at a regional level, not by sketching cross-sections of dike profiles;
- assigning requirements to all main design aspects;
- making a clear distinction between requirements and criteria;
- waiting with making an iterative move until all failure mechanisms have been checked;
- involving stakeholders in the project from an early stage;
- composing a balanced multifunctional design team and working together from the start of the project;
- collaborating of the members of the design team as much as possible (not divide tasks and work them out separately).

4

Looking again at the comparison of the approaches for engineering and spatial design (Table 4.2), the integrated method is iterative and cyclic, like the separate methods. It is both prescriptive, in distinguishing the specific character of different design activities and specifying a logical sequence of activities, and descriptive, in emphasizing the thought-processes of the designer. As in engineering and in spatial design, the integrated method is suitable for ill-defined problems. Decomposable problems can be solved in an analytical way, with quantitative verification methods (like structural mechanics). Non-decomposable problems can be solved in a creative way and verified with qualitative methods (such as simulations). Analytical tools can be used in the integrated method, but not too early in the design process, as that would spoil the creative processes. The many possibilities for iterative moves makes the method highly suitable for experimenting and learning, especially during early design cycles. Both normal and design abduction can be applied in the integrated method.

The integrated design method as described in this chapter merely describes the *reasoning* of the design phases. Therefore, it should be decided per type of project and per detailing phase what methods are applicable. Both spatial design and engineering tools can be applied in the integrated method, but it should be decided per detailing loop whether the problem is decomposable or not, whether an analytical or a learning approach is suitable or whether concepts should be verified with help of quantitative or qualitative methods, etc. The approach described by Nillesen (2017), for example, would fit within the approach described in the present chapter.

Engineering design	Spatial design	Integrated design
Cyclic, iterative process	Cyclic, iterative process	Cyclic, iterative process
Prescriptive	Descriptive	Prescriptive and descriptive
Problem is ill-defined	Problem is ill-defined	Problem is ill-defined
Problem is decomposable into parts	Problem is not decomposable	Both kinds of problems
Analytical character	Experimental character	Experimental and analytical
Normal abduction	Design abduction	Normal and design abduction

Table 4.2: Comparison of the engineering, the spatial and the integrated design method (based on Stolk (2016))

It can be concluded that the ways of reasoning in engineering and spatial design are not mutually exclusive, but complementary. Spatial design tools tend to be more appropriate in the first detailing loop(s) of a design process, whereas engineering methods are more suitable in later, more detailed loops. This has been illustrated by (De Bont et al., 2013), see Figure 4.13. The picture suggests that the typical spatial design activities precede the typical engineering activities, which is basically right, but within the design team there should preferably be an overlap and a same mindset in overall design reasoning and an incentive of the team members to work together. The method described in this chapter is intended to provide a framework for such an integrated design process.

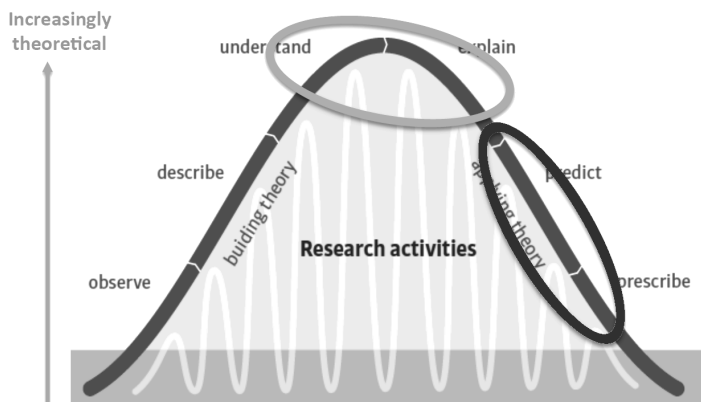

Figure 4.13: Practice of designing and innovating (De Bont et al., 2013)

5

VERIFICATION OF MULTIFUNCTIONAL FLOOD DEFENCES

The previous chapters studied the role of society on flood risk reduction strategies and sketched an outline for a method for the integrated and sustainable design of multifunctional flood defences that should take these influences into account. As part of such a design, it should explicitly be verified whether multifunctional flood defences are able to fulfil their flood-retaining function. This can be complicated, because such flood defences are composed of several structural elements that are usually not part of a flood defence. The present chapter deals with the verification of the designs of multifunctional flood defences. Chapter 6 validates the method that is explained in the present chapter with the help of four cases from practice.

5.1 INTRODUCTION

The verification of flood defences can apply to both planned and existing structures. In case of planned flood defences, the object of a verification is the *design* of the structures. A good design ensures that the created structure or system fulfils the intended functions. Verifying whether the result meets all requirements regarding functionality and structural integrity is an essential part of a design. This means that the requirements regarding the desired performance are checked as well as the basic structural aspects of strength and stability. The verification of the state of existing flood defences was officially called *assessment* (*toetsing* in Dutch. Since 2017 the official term used in the Netherlands changed to *beoordeling*).

The main difference between a design and an assessment is that designs comprise more functions than only flood protection. Furthermore, the required flood safety level for designs is higher than for assessments, to allow for gradual degradation of the structure without immediately reaching an unacceptable safety level. Most costs for realising new flood defences are fixed, therefore striving for a low probability of unfair rejection (or avoiding under-dimensioning) is better affordable for designs than for assessments. In addition, the material properties in a design can often be prescribed, but for an assessment, the material properties of existing flood defences

have to be inspected or tested, which can be problematic in several cases. In the first place, relevant technical drawings and design calculations are often not available any more. In addition, it is often problematic to determine the material properties of structural elements that are embedded in the soil, or that are not very accessible. As a consequence of this, the schematisation uncertainty of designs is less than for assessments. The uncertainties of the estimation of loads, in contrary, are higher for designs than for assessments, because designs have to cover the entire lifetime of flood defences, whereas assessments only deal with the situation at the moment of assessment. Another difference is the reference period. For designs, the reference period is the design life time, which varies from 50 to 100 years for flood defences. The reference period for assessments is the period between two assessments, which presently is 12 years at most. The difference in the reference period mostly impacts the expected boundary conditions, such as sea level rise.

The present dissertation only deals with the design verification of multifunctional flood defences. Because of the structural complexity and unusual appearances of these flood defences, it comprises two types of verification: a *qualitative structural verification*, which should precede a *quantitative structural verification*. For regular flood defences, these two types of verification are not strictly separated. Section 5.2 develops a method to perform the functional verification: By distinguishing the role of structural elements, different design concepts can be functionally verified. This should be followed by a *structural verification* as described for regular flood defences in Appendix E, with several points of attention that are specific for multifunctional flood defences (Section 5.3).

5

5.2 QUALITATIVE STRUCTURAL VERIFICATION

In this section, a method for an explicit verification of the flood protecting function of multifunctional flood defences is developed by distinguishing the roles of the structural elements in a multifunctional flood defence. The roles of the structural elements are found by a function analysis of the water-retaining function, and are related to structural elements types, such as water-retaining and supporting elements. This section ends with a validation of the typology.¹

5.2.1 INTRODUCTION

The shapes of present hydraulic structures are often the result of a development over decades, where original forms have been modified more than once. The structural elements mostly served one specific function, for example, providing structural stability, or protecting against erosion. During the modifications, however, multiple functions were combined in the same structural element. The gradual development of these hydraulic structures is illustrated with an example of the development of

¹An earlier version of this section will be published as an article 'Structural evaluation of multifunctional flood defences using generic element types' for the proceedings of the Joint International Conference on Coastal Structures & Solutions to Coastal Disasters, Boston, 2015 (Voorendt et al., 2017).

mooring places of vessels. Initially, ship sizes were relatively small, thus simple jetties were sufficient to facilitate loading and unloading of cargo and (dis)embarking of people (Figure 5.1-a).

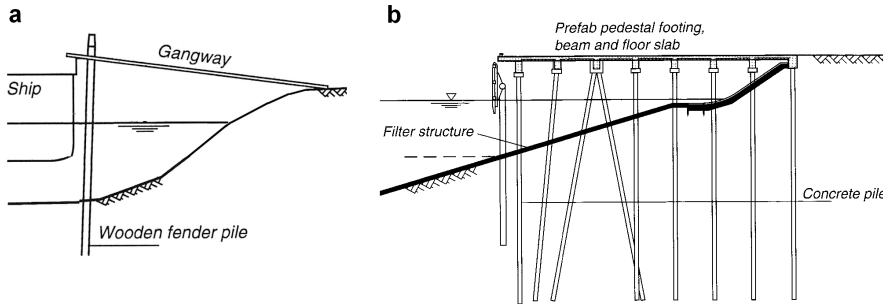

Figure 5.1: Development of quay wall structures (1 of 3) (De Gijt and Broeken, 2013)

The increase in vessel sizes required bigger mooring facilities and, additionally, erosion protection was applied when the mooring facilities became more complex (Figure 5.1-b). In order to create more space on quays, anchored sheet-pile walls were used to retain soil (Figure 5.2-a). To resist the loads from carriages and trucks, mooring structures had to become stronger. Gravity structures, used as quay walls, were very well capable to carry these vehicles and enable large vessels to moor (Figure 5.2-b).

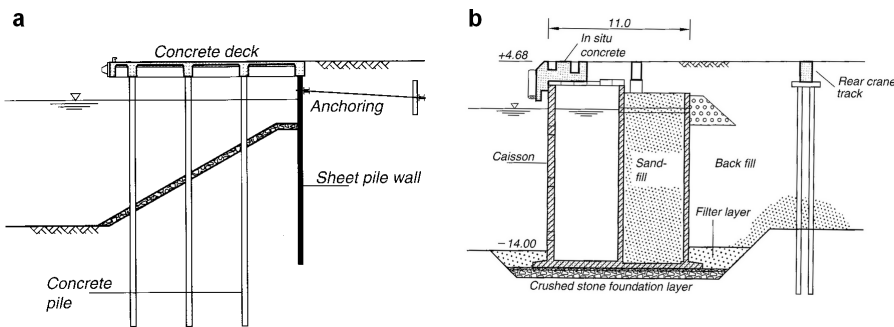

Figure 5.2: Development of quay wall structures (2 of 3) (De Gijt and Broeken, 2013)

Simultaneously, these structures took over the erosion protection function from the revetment on the slope, present under the former jetties. The functions of supporting structural elements, such as sheet-pile walls and anchors were integrated in the gravity structure as well. Later on, tracks for cranes were integrated into quay structures and even railroad tracks (Figure 5.3).

With time passing, the reasons for these modifications became less obvious, which makes judging the structural performance of these elements more challenging.

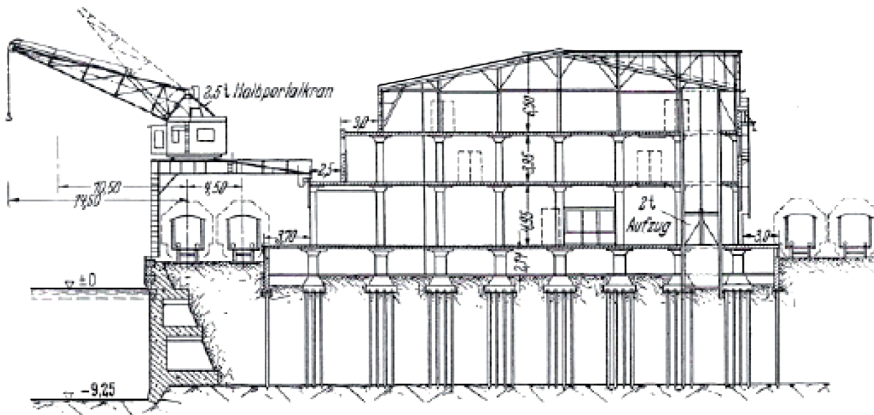

Figure 5.3: Development of quay wall structures (3 of 3) (Bolle, 1941)

5

Especially in case of integrating urban functions in flood defences, the situation becomes complicated and often an analysis is needed to determine the structural functions of the elements. The aim of this section, therefore, is to find a way to verify the structural performance of flood defences, the assessment of existing structures and the judgement whether structural alterations would be acceptable. This section first identifies functions of structural elements regarding flood protection. The advantage of making functions of structural elements explicit is, that an evaluation method based on these functions has a generic character and enables evaluation of unusual shapes and combinations, such as multifunctional flood defences. Successively, it is explained how these structural elements can be identified in flood defences. The following steps were undertaken to accomplish this:

- A function analysis was used to divide the general main function of flood defences, which is retaining water, into several structural functions;
- The derived structural functions were related to structural element types, and therefore these elements are defined by their structural function and not by specific shapes. These element types are therefore generic;
- A method of recognizing these functional elements was developed;
- The method was then verified with help of twenty eight different real cases.

These steps are described below in more detail.

5.2.2 DERIVING STRUCTURAL FUNCTIONS

By definition, a flood defence protects land from being covered by water. This means that a flood defence limits the volume of passing water, to reduce the potential flood consequences to acceptable levels. Sub-functions can be derived from this main function by considering the way in which water can flow across a flood defence.

This is possible in only four ways: over, through, under, or around the structure (Figure 5.4):

1. The volume of water passing over the flood defence depends on the retaining height. The flood defence, which reaches up to this height, prevents overflow or wave-overtopping volumes higher than what is considered acceptable. This acceptability is judged by considering the reliability and usability of the flood defence itself and the storage capacity of the protected area behind the flood defence;
2. The amount of water passing through the flood defence relates to the permeability of the material of which a flood defence is composed, or the cross-sectional area of the gates or other openings present in the flood defence;
3. The volume of water passing under a flood defence depends on the permeability of the subsoil and the interface between flood defence and subsoil;
4. The quantity of water passing around a flood defence can only be controlled if the flood defence entirely surrounds the area that has to be protected. The structural transitions between flood defence structures or segments should have the same volume-limiting functions as the adjacent flood defence sections or structures.

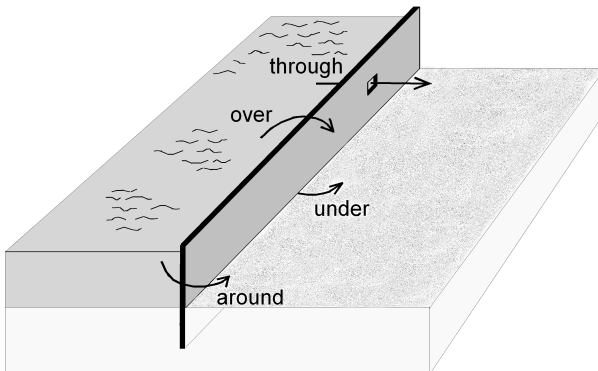

Figure 5.4: Four ways in which water can flow across a flood defence (schematic)

The four structural functions that are directly related to the main function thus are: to prevent water flowing over, through, under, or around the structure in too high quantities. In addition to this, additional structural functions regarding flood-protection have been derived from the inherent requirement of structural integrity. The functioning of a structure in general depends on its ability to resist the acting loads evoked by its presence. This implies that a flood defence has to be sufficiently strong and stable, otherwise it will structurally fail. The strength of a material is its ability to resist the stresses working in that material. Strength can be attenuated by erosion or corrosion, or by other mechanical or chemical effects. In case of repetitive loading and unloading, fatigue can affect the structural strength. Stability indicates the capability of a structure to maintain its shape and position. Strength and stability are needed to transfer the acting loads to the earth that finally has to

resist all loads.

In addition to strength and stability, the stiffness of a structure is an important characteristic. Stiffness is less a relevant issue for embankments, but it is for slender walls, such as sheet-pile walls. It is mainly relevant regarding usage (serviceability), which is mostly important for secondary functions of flood defences. However, stiffness can, indirectly, affect the structural integrity of the flood defence: In case of insufficient stiffness, a structural element could deflect in such a way that loads accumulate. The loads can become larger than the structure is able to resist, thus in that case, as a second order effect, these loads could exceed the present strength.

To summarize, a flood defence performs the following structural functions:

- to retain water:
 - to provide sufficient retaining height (overflow, overtopping);
 - to prevent water from flowing through the flood defence (permeability, area of openings);
 - to prevent water from flowing under the flood defence (transitions, permeability);
 - to prevent water from flowing around the flood defence (transitions, dike rings).
- to transfer the acting loads to the earth:
 - to provide strength;
 - to provide stability;
- to finally resist all transferred external and internal loads.

These structural functions are generic, and are therefore applicable to multifunctional flood defences.

5.2.3 DERIVING STRUCTURAL ELEMENT TYPES

After having derived the structural functions from the main function of flood defences, they were linked to types of structural elements that together compose flood defences. Huis in 't Veld et al. (1986), Venmans et al. (1992), Voortman and Vrijling (2004) and the International Levee Handbook (2013) distinguished element types, but in the present study, structural elements are more systematically related to structural functions. This section identifies eight types of elements that can be part of plain flood defences. Types 5 and 6 are specific for multifunctional flood defences:

0. *External elements*

External elements are not considered to be a part of the flood defence. They neither act as additional loads on the flood defence, nor are assumed to contribute to its strength or stability.

1. *Water-retaining elements*

Water-retaining elements serve the structural functions of preventing water flowing over and through a flood defence. Water-retaining elements can be fixed or moveable, but the movable water-retaining elements are separately

denominated as 'closure means' (see type number 5). Examples of fixed water-retaining elements are sheet-pile walls and specific elements, such as façades of houses in a multifunctional flood defence. In sand dikes with a clay cover, the water-retaining elements consist of the clay cover together with the sand core and the subsoil. The permeability of the clay layer is just slightly less than the sand core, because of the presence of cracks, vegetation and animal activity in the clay.

2. *Erosion-proof elements*

Water-retaining elements are directly exposed to water, thus can suffer from erosion by waves or currents, which could over time lead to failure of the water-retaining function. Protection against erosion is provided by erosion-proof elements, such as a grass layer, or concrete blocks on the outer slope of a dike. Elements that protect against internal (backward) erosion do resort under this type.

3. *Supporting elements*

All loads on water-retaining elements have to be transferred to the earth. Added to the external loads are the loads coming from the flood defence itself (self-weight). This structural function of transferring the loads to the subsoil is taken care of by supporting elements. These elements can only function if they are sufficiently strong and stable. Typical supporting elements are the core of a dike, the structural frame, foundation piles of 'hard' flood defence structures, filter elements and drainage elements.

4. *The subsoil*

The subsoil should bear the loads that are transferred to it by the supporting elements. Preventing water flowing under a flood defence is covered by the subsoil: The sub-soil should be sufficiently impermeable to prevent unacceptable volumes of water passing into the hinterland. The subsoil should prevent failure of the defence due to this seepage flow. This failure becomes a threat if seepage leads to internal backward erosion. The subsoil should resist all external and internal forces.

5. *Closure means*

Closure means are moveable water-retaining elements. These can be the gates in a navigation lock, a cut-off in a dike, the windows of a house and the doors of integrated parking garages (if they are designed to retain water). Likewise, mobile barriers and emergency structures belong to the structural element type of closure means. It was considered to include closure means in the type of water-retaining elements, but it was refrained from doing so, because the requirements regarding closure means are often stricter than for water-retaining elements.

6. *Secondary elements*

All structural elements that are somehow part of the flood defence structure, but not intended to contribute to the flood defence function, are considered to be 'secondary elements'. These elements serve other functions than flood protection and regarding this flood protection function, they only provide extra loads on structural elements that contribute to fulfilling the flood de-

fence function. These loads can come from the interior of these elements, for example of pipes for the transport of water or gas, or from the exterior, like the trucks on the road on top of a dike.

7. *Transitions*

Structural transitions are the interfaces between the beginning and ending of separate structural elements. Transitions mark a potential discontinuity in stiffness, roughness, structural coherence, or other material properties. In addition, they can mark a change in geometry, such as a bend between the slope of an embankment and the horizontal ground level, or discontinuities of structural elements that can prevent too high material stresses, caused by changes in temperature or by uneven settlements. The discontinuities tend to concentrate flow and can therefore induce physical processes leading to failure mechanisms as erosion and piping. In the Netherlands, often a distinction is made between structures that connect different types of structural elements (*aansluitconstructies*), mostly seepage screens, and transitions from one to another type of revetment (*overgangsconstructies*).

8. *Wave-damping elements*

The purpose of wave-damping elements is to dissipate wave energy to reduce wave run-up on slopes and thus limit overtopping discharges. The wave-damping elements can be identified, based on geometry, or material properties. Fore-lands, dike berms, vegetation and rough blocks are good examples of wave-damping elements.

Strictly considered, the type of 'Transitions' could be omitted from this list, because the potential functions that could be performed by these elements are covered by all other element types. However, they are considered as a separate element type in this study, because they are vulnerable to failure.

The International Levee Handbook (2013, Section 3.2.1.2) mentions that *to perform its desired function, a segment of levee should be composed of components compatible with the loads engendered by the levee's environment, allowing for water retention up to the design level*. This requires resistance against the acting loads, evoked by the existence of the flood defence, and therefore requires:

- protection against surface/external erosion on the waterside, of the crest and, possibly, on the land side;
- resistance to internal erosion;
- mass stability of the constructed levee, including stability of the foundations.

To achieve these requirements, the International Levee Handbook specifies the following structural functions that have to be ensured by the elements. It is now checked whether the present dissertation does not exclude any element type. Table 5.1 therefore compares the structural functions mentioned in the International Levee Handbook with the element types of the present dissertation.

It is emphasized that the type of non-water retaining objects does not fit in this approach: non-water retaining objects are not necessarily 'secondary elements' in the present approach. Sewage pipes, for instance, are usually denominated

International Levee Handbook	This dissertation
external protection	type 2 elements (erosion protection)
stability	type 3 elements (supporting elements)
impermeability	type 1 elements (water-retaining elements)
drainage	type 3 elements (supporting elements)
filtration	type 3 elements (supporting elements)

Table 5.1: Relation between element types mentioned in the International Levee Handbook and this dissertation

non-water retaining objects, but in the present classification they are considered to be supporting elements (not secondary elements). 'Vegetation', another non-water retaining object, could be classified as erosion protection, wave damping or, insofar the roots are considered, as a supporting element. In all these examples, the non-water retaining object is not a secondary element.

It seems interesting to have a closer look at the types of structures mentioned in the Guideline Engineering Structures (*Leidraad Kunstwerken, LK*) (TAW - LK, 2003) and Directive Safety Assessment 2006 (*Voorschrift Toetsen op Veiligheid primaire waterkeringen, VTV2006*) (VTV-2006, 2007). The following categories of structures are distinguished in the Guideline Engineering Structures regarding strength requirements of the flood defence:

- structures that on their own fulfil the water-retaining function (navigation locks, flow sluices, guard locks, storm surge barriers, cut-offs, coffer dams, diaphragm walls);
- structures that fulfil the water-retaining function together with a soil structure (sheet-pile walls, pile walls, retaining walls, reinforced soil structures);
- structures that retain water after failure of another structure (pumping stations, culverts, pipes and tunnels - all structures with closure means or with enclosure dikes (for tunnels));
- structures without water-retaining function that could negatively impact the flood defence when they fail (the structures mentioned under type 3, but without closure means or replacement water-retaining structures).

The Guideline Engineering Structures then distinguishes:

- closure means;
- connecting structures;
- transitional structures;
- remaining structures:
 - tube-shaped structures that cross a dike (pipes, culverts, siphons, tunnels without enclosing dikes);
 - remaining structures and objects (cables, wind turbines, noise barriers, pylons, piers, roads, abutments). The presence of these objects comes from functions that are additional to flood defence;
 - vegetation (trees, bushes).

The last types mostly correspond to the types of non-water retaining objects mentioned in the Directive Safety Assessment 2006 (VTV2006):

- buildings (houses, commercial buildings);
- vegetation (trees, bushes, grass);
- pipes & cables;
- other non-water retaining objects (roads, abutments, guidance structures, jetties and quay walls not being part of a flood defence).

These structures and objects, as mentioned in the Guideline Engineering Structures and Directive Safety Assessment 2006, are all covered by the eight structural element types derived in the present research. The difference is that the present study considers all structures and objects as structural elements that together fulfil the function of flood protection. The role of these elements is only considered in relation to the flood protecting function. This different approach comes from the requirement of making the approach generic.

5

As already pointed out, structural elements can fulfil multiple structural functions at the same time. Examples of structural parts that serve multiple structural functions are:

- Sheet pile walls retain water, but they are erosion-proof by themselves because the material is sufficiently strong. They can retain soil and provide vertical support if needed;
- Revetments on an outer slope provide necessary protection of an embankment against erosion, but can meanwhile reduce wave run-up and improve the water resistance of the flood defence;
- A caisson quay wall retains water and is erosion-proof. It is sufficiently strong and stable to transfer the loads to the subsoil.

5.2.4 RECOGNIZING STRUCTURAL ELEMENT TYPES

THE PROCEDURE OF RECOGNISING ELEMENT TYPES

The procedure to recognize the different structural element types in a mono- or multifunctional flood defence starts with finding the structural part(s) that perform the water-retaining function. Subsequently, the erosion-proof elements and the supporting elements are searched for, followed by the sub-soil, closure means, secondary elements, transitions and wave-damping elements.

ELABORATION ON WATER-RETAINING ELEMENTS

To recognise the structural elements, it is important to distinguish structural elements that protect the hinterland against flooding from elements that retain water as well, but only protect the structure itself from filling with water. So, it can occur that a wall can retain water, but is not a part of a flood defence, as illustrated in Figure 5.5.

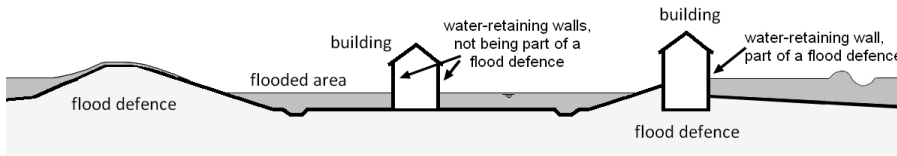

Figure 5.5: The walls of the house in the middle retain water, but are not part of the flood defence, the outer wall of the house at the right side is part of a flood defence

To formulate the difference in the Dutch situation: a flood defence is part of the first layer of the Dutch multi-layer flood defence approach (Ministerie van Verkeer en Waterstaat, 2009), which is the flood prevention layer.² If, for example, a house is made watertight to protect the furniture and belongings of its inhabitants, its outer walls keep the water out of the house, but do not prevent the hinterland from being flooded. Such a wall does not prevent the hinterland from being flooded and therefore it is not a 'type 1 element'. In that case, the wall belongs to the second layer of the multi-layer safety approach, which aims at reducing damage and loss of life in case of a potential flood. The walls of the houses in the Hafencity of Hamburg are often thought to be part of a flood defence, but they are not, see Appendix A. So only if water-retaining walls are part of the first layer of the multi-layer safety approach, they can be classified as 'type 1 elements'.³

The consequences of failure of a flood defence can have a different magnitude than failure of a water retaining wall that is not part of a flood defence. The damage after the breaching of a sea dike, for instance, will probably be much larger than the damage to a water-proof parking garage in an unprotected area due to collapse of one of the walls of the garage, caused by a high river level.

ELABORATION ON SECONDARY ELEMENTS

The distance to a dike determines whether or not a house or building influences the flood protecting function of the dike. If it is located sufficiently far away from the dike, it is situated outside the 'influence zone' and in that case, the building should not be identified as a secondary element (type 6), but as an external element (type 0).

For determining the boundaries of the influence zone the following rule of thumb could be used: (Beijersbergen and Spaargaren, 2009):

- the outer boundary line is located at a distance of $4H$ from the toe of the dike;
- the inner boundary line is located at a distance of $4H$ from the heel of the dike, or $18 \Delta H$ from the outer crest line, if there is a possibility of internal backward erosion,

²see Section 2.6.3 for an explanation of this multi-layer approach.

³A comparison of the cost-effectiveness of investing in the first or in the second layer has been carried out by Tsimopoulou (2015).

where H is the height difference between the ground level (at the considered side of the dike) and the crest level, and ΔH is the difference between the design or assessment water level and the crest level, see Figure 5.6.

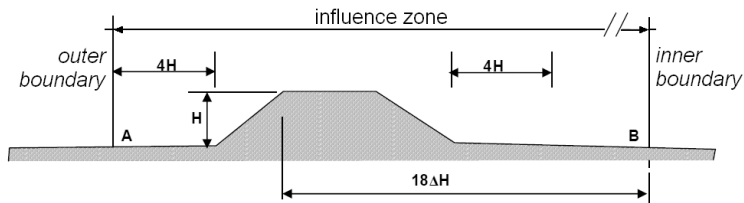

Figure 5.6: General and rough schematisation of the influence zone of a dike (Beijersbergen and Spaargaren, 2009)

VTV2006 defines the 'evaluation profile' (*beoordelingsprofiel*) for elements that are situated within the influence zone, but nevertheless do not affect the flood-retaining function. This only applies to over-dimensioned flood defences. The evaluation profile is the contour line of critical lines regarding outer erosion, overtopping, piping/heave, macro instability and micro instability (Figure 5.7).

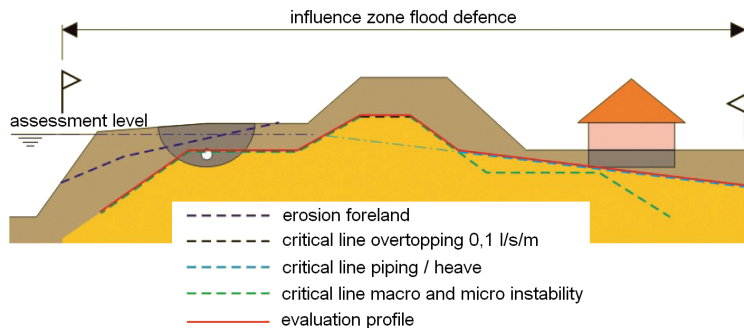

Figure 5.7: The evaluation profile of a dike (VTV-2006, 2007) (proportions distorted)

5.2.5 VALIDATION OF THE TYPOLOGY

The derived typology is generic and is supposed to be helpful for verifying whether a multifunctional flood defence is able to fulfil its main function. The hypothesis, that a flood defence can be composed of the eight derived generic element types, which as a whole ensure its flood-protecting function, is validated in this section with help of twenty-eight examples.

A SIMPLE EXAMPLE

To start with, a modern monofunctional dike along an upper river in the Netherlands was studied. Figure 5.8 shows a cross-section of the dike. It consists of a sand core,

which is covered with a clay layer. The subsoil consists of river clay. The indicated water level is an extreme water level; normally, the river water does not reach the toe of the dike.

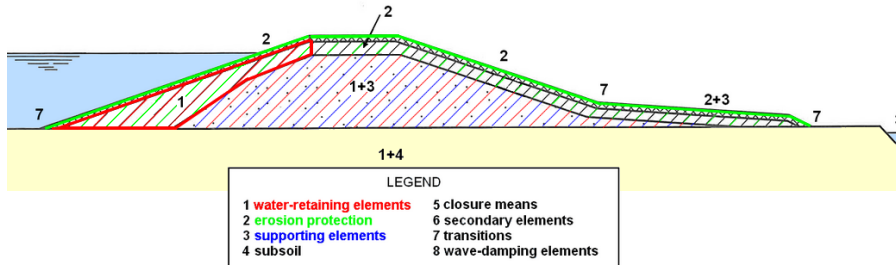

Figure 5.8: Schematic cross section of a typical modern dike along a Dutch upper river (van Leusen and van der Velden, 1998)

The identification of structural elements starts with the water-retaining elements. The water-retaining function is performed by a clay layer on the outer slope (normally spoken 0,5 to 1,0 m thick), together with the dike core and the subsoil. This is indicated in the Figure with number 1. The clay cover not only retains water, it protects the dike against erosion as well. The surface of the clay layer (leaf mould) is grown with grass, of which the roots provide extra strength to the cover.⁴ The erosion-protecting elements are indicated with number 2.

The supporting, or stability-providing, elements are then sought for: The sand dike core is an element that supports the water retaining clay layer. The inner berm is considered a geometrical element that provides extra stability. The inner ditch enables drainage of the dike core, providing extra stability. (number 3). The subsoil consists of the river clay beneath the dike (number 4). Closure elements number 5 and secondary elements (number 6) are not present. There are several geometrical transitions, indicated with number 7. There are no specific wave-damping elements in this flood defence (number 8). The dike slope will reduce the wave energy and thus reduce wave-overtopping, but it is not a separate element (its effect is included in the equations to calculate waver-overtopping discharges).

In principle, all elements together are able to sufficiently retain water and provide the stability that is required for the structural integrity of the flood defence. An additional quantitative structural verification is needed to estimate the precise geometry and properties.

A QUAY WITH AN EXTENDABLE WALL

The second example comes from Hinborgh (2010), who studied the applicability of a 'floating barrier.' He proposed to improve the present flood defence by constructing

⁴Not all roots in all cases have a positive effect on the reliability of a dike. Especially the roots of trees can cause severe weakening of the dike resistance.

a floating barrier in front of the old quay wall, with which it is structurally connected, see Figure 5.9.⁵

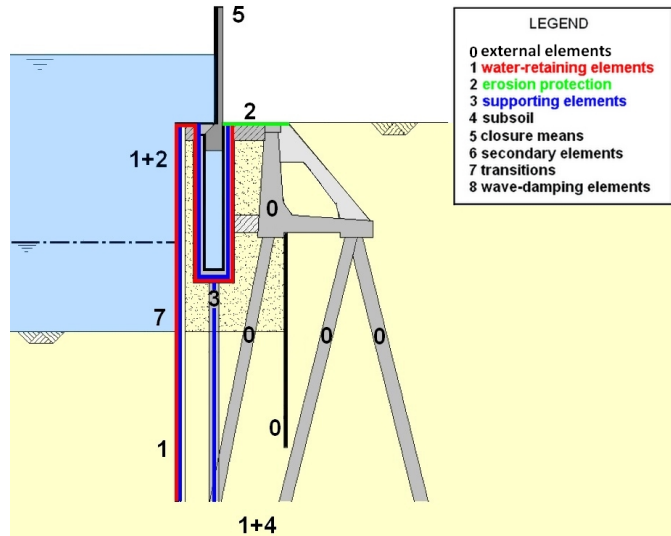

Figure 5.9: Design of a 'Floating barrier' in Dordrecht (Hinborgh, 2010)

The concrete casing of the floating barrier and the sheet pile wall below the concrete barrier are water-retaining elements (type 1). The old quay wall and its sheet pile wall are not intended to retain water and can in a design be considered as not to support the new wall, nor to influence the loads acting on the new wall (type 0). If the contribution of the old quay wall on the reliability of the flood defence can be determined, it could be characterised as a supporting element (type 3). The case of the floating barrier and the sheet pile wall are erosion-proof (type 2). Supporting elements (type 3) consist of concrete piles below the barrier. The old wall transfers its loads towards the subsoil (type 4). The gate of the floating barrier is a typical closure element (type 5). The transition from the new sheetpile wall to the harbour bed is vulnerable to scour (type 7).

In this example, the entirety of elements sufficiently retains water, while providing sufficient stability required for fulfilling that function.

A MULTIFUNCTIONAL DIKE

An overtopping-resistant multifunctional sea or lake dike is depicted in Figure 5.10. In this example, an outer berm is present to reduce the wave run-up during design conditions. However, the berm could also be a sandy beach, in which case it would resemble a typical Belgian sea dike. This example contains all structural element types, except for type 5, the 'closure means'.

⁵Recently, such a floating barrier, with a length of 330 m, has been constructed in the Dutch town of Spakenburg. Its retaining height is 0,80 m.

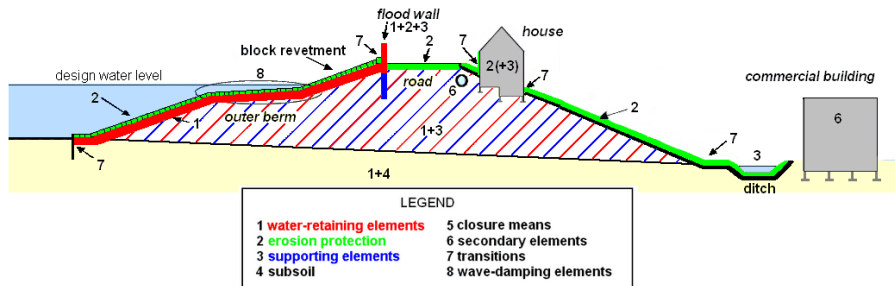

Figure 5.10: Sea dike with structural elements

First, water-retaining elements are identified (type 1). The clay layer that seals off the sand core at the outer dike slope is an obvious water-retaining element. Another water-retaining element is the permanent flood wall at the outer crest line, in the form of sheet-piles. It forms an additional water-retaining element, constructed as an improvement measure to increase the retaining height.

Consecutively, erosion-protective elements (type 2) are searched for. In this example it appears that concrete columns or blocks on the outer slope protect against erosion. On the inner slope, a clay layer with grass protects against erosion from over-topping waves. Another element that protects against erosion due to wave over-topping, is the asphalt layer of the road on the crest of the dike. More exclusively erosion-protective elements are not present, but the flood wall combines this function with retaining water, and the house on the inner slope protects the core against erosion.

Then, type 3 elements, supporting elements, are identified. The most obvious one is the dike core, which supports the water-retaining clay layer. Another one is the flood wall, which was already detected as an erosion-proof water-retaining element. The shallow-founded house on the inner slope is a supporting element, because it partly replaces the dike core material in transferring the loads to the subsoil. Depending on the design specifications, the influence of the house on the stability of the dike could be positive or negative when compared to the situation without the house. The same applies to the sewage pipe: it influences the load transfer towards the subsoil.

The subsoil bearing the dike core, including all external loads acting on it, is the type 4 element. Closure means (type 5), are not present in this example. One secondary element (type 6) can be detected: a commercial building next to the dike. This element is considered to be part of a dike, because it influences the stability of the inner slope if it is not too far from the dike. If it is located sufficiently far away from the dike, the building should not be identified as a secondary element, but as an external element (type 0). It can occur, that secondary elements are initially not part of a flood defence, but will become part of it after a future dike reinforcement (after widening of a dike, for example).

A transition (type 7) can be found at the interface of the house on the dike and the grass layer. For instance, it can consist of a strip of asphalt-mastic that prevents scour at this transition. Another transition is formed by the interface of the sheet-pile flood-wall and the revetment. The interface between the road and the dike cover (clay layer) is a transitional element as well. Finally, the outer berm can be detected, an example of a wave-damping element (type 8) that reduces wave forces during extreme conditions, because waves will break due to the shallowness created by the berm, which dissipates energy. This reduces over-topping volumes, allowing a lower crest height.

All elements together should prevent water from flowing over, under, through or around the flood defence. In principle, the flood defence is sufficiently stable.

VALIDATION OF THE TYPOLOGY ON OTHER CASES

Until now, the method of finding structural element types has been described with the example of a regular dike, a quay with an extendible flood wall and a multifunctional dike. In total, twenty-eight cross-sections of various flood defences were studied. The studied examples include typical mono-functional flood defences, such as sea dikes, river dikes and lake dikes, as well as a dike coffer and an extendible flood wall. Multifunctional flood defences were studied as well, for instance the Roof Park in Rotterdam, houses in Dordrecht and a quay in Hamburg. A discharge sluice was analysed as an example of a hydraulic structure and a reservoir dam as an example with an atypical form. Thus, a broad range of examples was covered.⁶ It appeared that the typology was helpful in judging whether the flood defences could be sufficiently capable of retaining water. The real proof should come from a successive quantitative structural verification.

5

5.2.6 CONCLUDING REMARKS ON THE METHOD

In the previous sections, the method of finding structural element types has been described and has been applied to various real cases to assess its usability. In principle, in the twenty-eight studied cross-sections, all element types could be identified and no new types appeared. The wide variety of studied structures assures that the distinguished structural element types are indeed generic. Unfortunately, the technical details were not clear enough in several cases, causing difficulties in estimating the precise function of several structural elements. In these cases, assumptions had to be made, after which it, after all, was possible to identify the element types.

While validating the method, several observations were made:

- Water-retaining elements always appear to fulfil two structural functions, which is preventing water flowing *over* and water flowing *through* a flood defence. It is nevertheless important to distinguish the two functions of the

⁶A systematic description of these cases can be provided on request - please contact the author of this dissertation when interested.

retaining element, because they entail different kinds of requirements regarding height and permeability. This distinction is relevant for the reliability analysis of flood defences.

- Structural elements can have different roles during consecutive life stages. The function or required geometry of an element can therefore change per stage. This certainly has to be taken into account when making a structural evaluation.
- The exact dividing line between supporting soil wedges and the subsoil is sometimes hard to draw, because at forehand it is difficult to estimate the exact sliding planes. Even calculation methods, such as those developed by Bishop, Spencer and Rankine, only offer approximations. However, it is expected that this will not hamper the development of an assessment method for multifunctional flood defences, because the current design practice deals quite well with it.
- In several cases, secondary elements can initially not be part of a flood defence, but will become part of it after future reinforcement (after widening of a dike, for example). A design can anticipate these future changes.⁷
- Technical drawings of longitudinal sections of flood defences can hardly be found in project reports and in lecture notes, although they were needed for construction. The availability of these drawings seems to be restricted to structural engineers and constructors. Assuming that these people now what they are doing, it could nevertheless be questioned whether there is a relation between the low availability of longitudinal sections and several observed failures of transitions between dike sections, as in New Orleans during hurricane Katrina (Kok et al., 2007).

The typology of structural elements regarding flood-protection as defined in this dissertation appears to be generic, because it is based on a function analysis rather than on traditional forms. Distinguishing structural element types gives insight in the consequences of combining functions in structural elements and in the functioning of a multifunctional flood defence as a whole. As a consequence, insight is acquired in the efficiency of the combination of functions: several of the studied examples look innovative, but are not.

5.3 QUANTITATIVE STRUCTURAL VERIFICATION

The structural elements, derived in the previous section, can be related to failure mechanisms. The probability of occurrence of the failure mechanisms can be compared to the required maximum failure probability. The method of such a quantitative structural verification is described in Appendix E for regular flood defences. This section presents additional aspects that are specific for the structural verification of multifunctional flood defences. It explains how the structural element types, derived in the previous section, can be related to failure mechanisms. The check of

⁷When anticipating uncertain future developments, one should realise that extra investments needed to make a structure adaptive should balance the risk, see also Section 3.2.1, under 'Evaluation'.

failure mechanisms is embedded in a recommended sequence for the verification of most hydraulic structures, of soil embankments and of multifunctional flood defences. The usual failure mechanisms are described extensively in design guides of flood defences, such as the guide lines and technical reports of the Technical Advisory Committee on the Flood Defences (TAW) and the International Levee Handbook, and are briefly described in Appendix E.7. This section explains several additional aspects of failure mechanisms that are specific for multifunctional flood defences.

5.3.1 RELATING STRUCTURAL ELEMENTS TO FAILURE MECHANISMS

After finding the specific role of each structural element, it can be checked whether the totality meets the reliability requirements regarding flood protection (checking secondary functions is outside the scope of this dissertation). This implies a check whether the amount of water passing the structure remains limited to the small quantities that are considered acceptable. Failure to fulfil this main function happens when the loads exceed the resistance of the structure in one of the failure mechanisms. As a first step, the overview of usual failure mechanisms for soil structures as presented in Figure E.9 has been extended, see Figure 5.11. The failure mechanism of earthquakes has been added because it is a realistic threat, even in the Netherlands, although not an event with a high failure probability.

About the additional failure mechanisms in this figure: Recent gas-extraction induced tremors have taken place in the northern province of Groningen, but already in 1992 an earthquake caused longitudinal fissures in the Maas dikes near Leeuwen in the southern province of Limburg. Instability of revetment due to waves or currents is explicitly mentioned, because it is not sure whether it is already comprised in 'erosion outer slope'. Seepage, water flowing through or under the dike core without extruding sediment particles, does not yet cause structural failure of a flood defence, but could result in too much water in the hinterland. Uplift and heave can be considered as initial stages of piping, but can occur on a larger scale as well, so they are mentioned separately too. Animal and human actions can cause extra loads, or influence the strength of the structure. The other additional failure mechanisms are typical for multifunctional flood defences. It must be kept in mind that the earlier mentioned mechanism of piping can occur through the soil-structure interface as well.

Relating relevant failure mechanisms to structural elements is a task to be carried out by professional hydraulic engineers. These relations can be visualized in a diagram as in Figure 5.12.

The 'Floodsite' research programme studied these relations, resulting in a matrix of flood defence assets and failure modes by hydraulic load conditions, indicating what combinations can be the cause of potential failure (Allsop et al., 2007). Their report describes the physics of these failure mechanisms and can be helpful when identifying relevant failure mechanisms. The matrix with the overview of failure modes per 'asset' is depicted in Table 5.2. Especially for multi-functional flood

The usually mentioned failure mechanisms

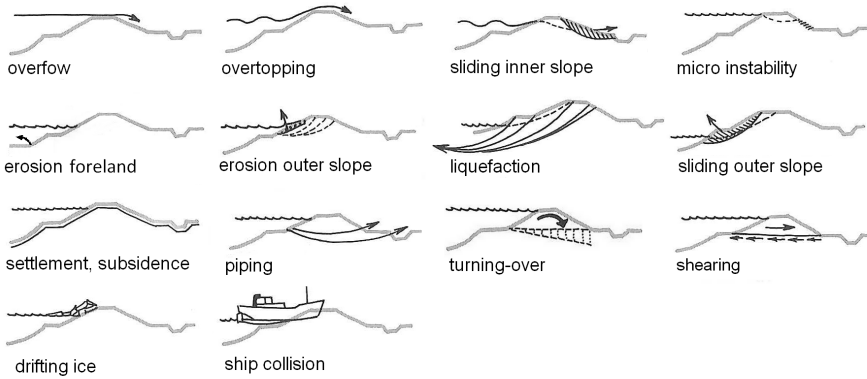

Additional failure mechanisms

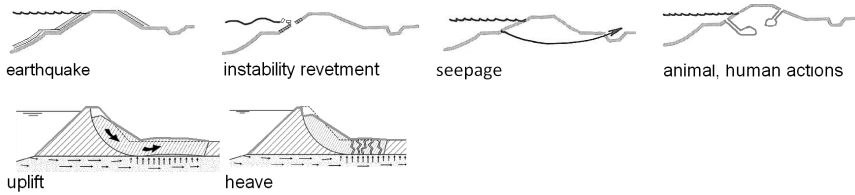

Failure mechanisms typical for multifunctional flood defences

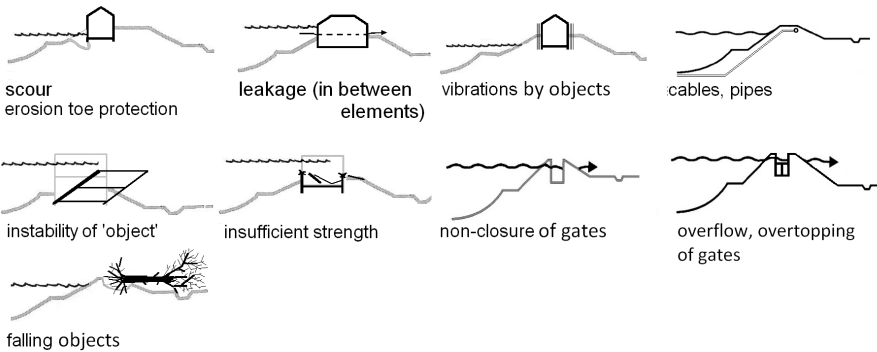

Figure 5.11: Extended overview of failure mechanisms, including ageing mechanisms based on Huis in 't Veld et al. (1986) and TAW - GW (1998)

defences, the stability of the structure as a whole should be included in the overview of relevant failure mechanisms. This concerns mechanisms, such as lateral shear, overturning and dimensional stability.

The relation between failure mechanisms can successively be schematised in a

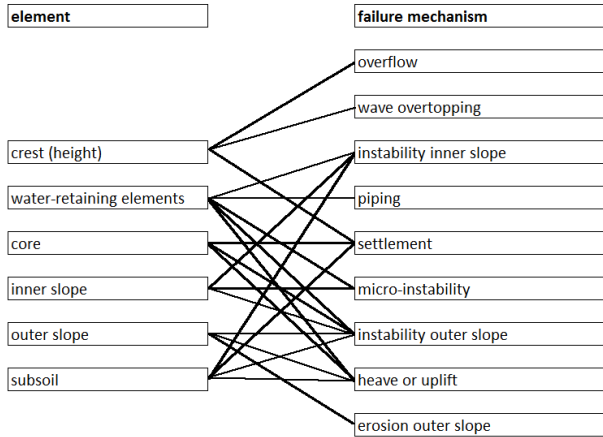

Figure 5.12: Failure mechanisms related to structural elements (adapted from Huis in 't Veld et al. (1986))

5

	Water level difference across structure						wave loading						lateral flow velocity		structure impact				operational failure	
	erosion of surface by overflow	bulk sliding or overturning	deep slip or slide	shallow slip or slide	pipng or internal erosion	crest level too low - overflow (functional failure)	erosion of seaward face / slope	bulk displacement of defence / seaward element	local surface failure or element displacement	erosion of landward face / slope	crest level too low - overtopping	erosion (scour) of bed or bank	ship or similar impact	ice effect	debris	operational failure	operation or closing failure			
foreshore, dunes and bank																				
sand beach and dune (fine granular material)	X					+	X			X	+	+	-	-	+					
shingle / gravel / rock beach or ridge (coarse granular material)	+					-	+	X			+	+	-	-	+					
embankments and revetments																				
homogeneous embankments (primarily cohesive materials)	X	+	X	X	X	X	X	+	X	X	X	X	+		+					
composite embankments, multiple layers, etc.	+	X	X	X	+	+	+	+	+	+	+	+	+		+					
revetment protection embankments	X			X	+	+	X		X	X	+	X	-	-	+					
walls																				
mass concrete vertical or battered walls	+	-	+		+	+	X	X	X	+	+	+	-	-	-					
sheet pile, cantilever or tied back	+	X	+		+	+	+	+	-	+	+	+	+	+	+					
crown or parapet wall on structure	+	X	+		X	+						+	+	-	+					
point structures																				
barriers		-	-		+	+		-	-		X	+	X	X	X	X				
sluices, gates		-	-		+	+		-	-	+	+	-	-	-			-			

Legenda: = failure mechanism not likely to occur + = possible failure
 X = possible failure - = possible failure, but mechanism not described by Floodsite

Table 5.2: Matrix with failure modes per asset / loading combination, after Allsop et al. (2007)

fault tree (Appendix E.6). This is a helpful tool to calculate the over-all failure probability of a flood defence (dike section) in a probabilistic or semi-probabilistic way (Appendix E.4). Comparison of the actual over-all failure probability with the maximum allowed failure probability yields a judgement whether the flood defence is safe enough.

When considering the failure of flood defences, one should realise that there is a difference between deterioration and failure. Deterioration can lead to failure under design conditions (or, even more favourable conditions), if that process is not stopped in time and if the state of the flood defence is not restored in time. Damage resulting from deterioration is related to the failure of the elements of a flood defence. If elements are not sufficiently reliable, as a consequence the flood defence is not able to fulfil its function at the defined safety level. Structural failure, finally, occurs if a breach of significant size has originated (International Levee Handbook, 2013).

5.3.2 RECOMMENDED VERIFICATION SEQUENCE

The difficulty of the design of hydraulic structures is that it is highly abductive: there is no strict way of reasoning that derives material shapes from functional specifications. The hydraulic engineer has therefore to assume provisional concepts of solutions that could work, and check their functionality and structural integrity afterwards. Furthermore, construction aspects highly influence the characteristics of hydraulic structures, but it is difficult to know how a structure should be built, if characteristics of the structure are not yet known. In addition, the structure that is required to resist the external loads, acts as a load by its self-weight. The dimensions of a structure, or its elements, usually follow from strength calculations given the acting loads, thus profiles of structural elements will have to be assumed first, in which case the self-weight can be added to the external loads. Successively, it can be checked whether the assumed profiles will provide sufficient resistance.

Because of these three reasons, the verification process of hydraulic structures is highly iterative and, because of the interdependency of the verification steps, the question is where to start. It would be ideal if all steps could be performed simultaneously. In fact, there is no ideal sequence of verification steps, but there are sequences that work better than other. The experience of the engineer in duty will determine the efficiency of the design process and the order of design steps. This section proposes a verification sequence, which has been tested by BSc and MSc students and has proved to work reasonably. A description of the mentioned individual verification activities can be found in many books, but the proposed specific sequence is new.

Structural verification of hydraulic structures

The recommended steps and the order of the steps for the verification of hydraulic structures that do not (partly) consist of a soil embankment are:

- Check whether the (main) functions will be fulfilled (flood defences primarily retain water, of which the main structural characteristics are the retaining height and the water-tightness);
- Determine the main dimensions of the structure or system, needed to fulfil the main function;
- Choose a suitable main construction method:
 - in situ / prefab / combination;

- 'in the dry' → (construction pit);
 - ◊ sealing of floor: clay / underwater concrete;
 - ◊ sealing of walls: vertical walls / natural slopes + dewatering;
- 'in the wet' → caissons, piles, under water construction;
- Consider whether the structure can be built without temporary elements;
- Figure out what steps are needed for construction: draw a construction sequence⁸:
 - check constructability;
 - inventory of all load situations;
- Provide sufficient stability for temporary and permanent structures (during critical load situations):
 - piping
 - foundation: shallow or deep? (bearing capacity and settlement of the subsoil);
 - check buoyancy: tension piles/anchors or additional ballast needed?
 - lateral shear;
 - rotational stability;
 - embedded depth of retaining walls;
 - potential support of walls (struts / anchors / permanent structure);
 - ensure dimensional stability of the load-bearing structure;
 - scour;
 - earthquake impact;
 - human and animal actions;
- Check the strength of the structural elements + connections (+leakage!);
- Check deformations and displacements.

5

Structural verification of soil embankments

For soil embankments, dikes for example, the same steps can be followed, but the applicability of the steps should be considered per situation. Only for the stability checks, several other specific failure mechanisms will have to be taken into account:

- water passing through or over the structure (non-structural failure, incl. seepage);
- overflow (structural failure);
- wave overtopping (structural failure);
- macro-instability inner or outer slope;
- micro-instability;
- erosion outer slope or foreshore
- instability revetment;
- settlement of the dike itself;
- drifting ice;
- ship collision;
- uplift and heave;

⁸A construction sequence is a series of schematic sketches of a typical cross section of the structure. Each sketch shows only one alteration with respect to the previous sketch. Preferably, sketches for the operation and maintenance phase are included as well, to obtain a complete overview of load situations.

- liquefaction.

For dunes, the present volume of sand needed to resist erosion by a storm should be checked.

Structural verification of structures in soil embankments

If (hard) structures are located in a soil embankment, their influence on the mechanisms mentioned above have to be checked. They introduce additional failure mechanisms, which have to be verified as well (see Section 5.3.1). Typical additional failure mechanisms for multifunctional flood defences are:

- uplift of a structure in an embankment;
- rotational instability of a structure in an embankment;
- lateral shear of a structure in an embankment;
- scour or leakage next to an object (including cables and pipes);
- non-closure of gates or other openings;
- height of gates;
- strength of the structural elements in an embankment;
- impact of vibrations of objects;
- falling objects (such as trees and wind turbines).

To improve the use of the correct methods and calculations, it is strongly recommended to explicitly follow the next steps for every structural calculation:

- make a situation sketch by hand (cross-section) including water levels and ground levels;
- choose the most critical load situation (from the construction sequence) and sketch a load diagram by hand;
- think of a way to resist the loads; make a hand sketch of the structure or element, indicating components, materials and connections (this can be in various shapes);
- make a mechanical scheme of the supporting structure or element;
- check stability and strength, considering potential failure mechanisms (ULS). For the strength check: determine critical cross-sections and draw shear force and moment diagrams. Mention the source of the model or equation and motivate why it is applicable to the actual situation. If it is not (entirely) applicable: reason how the model can be changed, or find another approach to do the check;
- check whether deflections/displacements are acceptable (SLS);
- reflect on the outcome of the calculation: is the magnitude reasonable? Comparison with similar structures under similar conditions will provide information about the order of magnitude.

The proposed steps are intended to support the verification process and should not be used as a recipe that guarantees a well-functioning result: critical thinking is always necessary during every step of a design. Furthermore, it does not cover all possible types of structures. For floating caissons, for example, the main dimensions appear to be mostly determined by the transport phase, for which sufficient uplift

force is required to provide keel clearance, and the length-width ratio is determined by requirements related to the navigability during towing over water.

As the design phases of developing and verifying concepts are closely related, it is recommended to consider the steps of the sequence above for the development of concepts as well. The steps should then only be inventoried and considered as different possibilities, like gathering the pieces of a puzzle. While subsequently verifying these concepts, these same steps can be used to find realistic solutions, with help of reasoning and calculations, which resembles 'fitting the pieces of a puzzle together'. Depending on the complexity of a structure, it could be decided to elaborate several of these steps during a more detailed design cycle.

5.3.3 INFLUENCE OF BUILDINGS ON DIKE FAILURE

Theory

Traditional failure mechanisms of flood defences can be influenced, or new mechanisms can be introduced, if multiple functions are combined. A multifunctional flood defence often consists of a soil embankment, combined with a hard structure. The International Levee Handbook (2013) shows examples of these 'composite' flood defences, although not necessarily multifunctional, see Figure 5.13. The examples are expensive solutions that could be considered if traditional ways of dike reinforcement are not possible. The shown cross-sections, however, do not show such a necessity. As can be seen in the Figure, the presence of a hard structure usually changes the geometry of a dike at the location of that structure and thus influences the reliability of the flood defence.

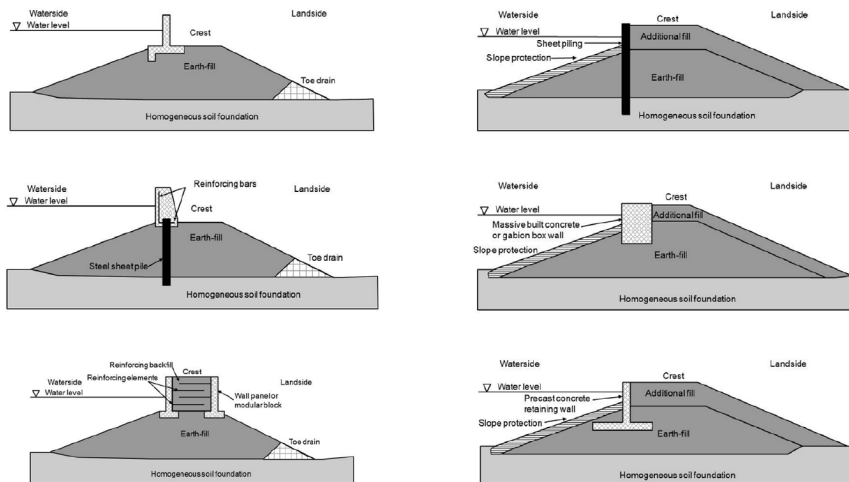

Figure 5.13: Examples of 'composite' flood defences (International Levee Handbook, 2013)

The main drawback of buildings on outer slopes of dikes is that they often intersect with the water-retaining soil layer. In these cases, attention should be paid to the

water-tightness of the walls (in relation to settlements), the connections of the walls to the surrounding water-retaining layer and the crossing of pipes. Settlement leading to piping is a threat, if the building is founded on piles. In principal, there are two main solutions to prevent consecutive problems: the building can be located outside the theoretical dike profile, or the building can partly or entirely be integrated in the flood defence. In the last case, the building can be water-retaining (Figure 5.14a and b), or perform one of the other sub-functions that indirectly support the water-retaining function (provide erosion-protection or support).

If an existing building cannot be modified, the water-retaining function of the dike can be taken over by an additional element behind the building (Figure 5.14c and d). It is possible to create a water-retaining structure that functions independently of the soil body of the dike, such as a cofferdam (Figure 5.14e). Buildings on inner slopes, (Figure 5.14f) can shorten the seepage path, possibly leading to unacceptable quantities of water behind the dike, and can have a negative influence on the macro-instability of the inner slope. Both effects can usually be remedied with a sufficiently gentle slope (Huis in 't Veld et al., 1986).

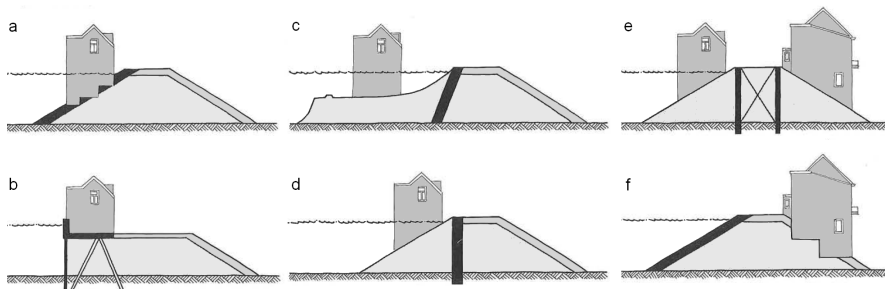

Figure 5.14: Principal ways of combining buildings with dikes, (Huis in 't Veld et al., 1986)

The stability provided by houses or other objects in dikes is usually not taken into account when designing or assessing flood defences. In case of designs, one reason is that the presence of a house in a dike is not guaranteed, because it can be removed at a certain future time. For assessments, it is difficult to determine the actual strength of the masonry walls. The Dutch assessment method, as described in VTV-2006 (2007), offers the possibility of an 'advanced assessment', where the contribution of houses and other non-water-retaining objects can be calculated, but this has not yet been executed, most probably because there is no method available with short computing times (Jongorius, 2016).

Figure 5.15 shows possible locations of hard structures in a dike. The structure in Figure 5.15a is located outside the influence zone of the dike, so in a structural way it is not part of the flood defence. Figure 5.15b shows a structure at the toe of the dike, whereas Figure 5.15c shows a structure at more or less the same location, but intersecting with the dike profile. The same applies to Figure 5.15d, the location is at the outer crest line, higher on the slope. Figure 5.15e presents a structure on top of the dike, on the crest. Figures 5.15a through 5.15e can be drawn for the inner dike

slope as well. Figure 5.15f shows a structure in a dike body and Figure 5.15g differs from this where the outer slope is 'replaced' by the hard structure. In case of Figure 5.15h, the entire embankment as a flood defence is replaced by the hard structure.

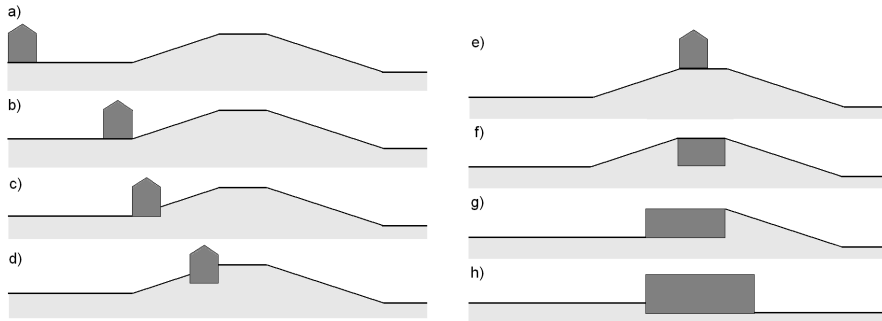

Figure 5.15: Possible locations of a secondary object in or on a dike

5

Figure 5.15 is only a schematic representation of the locations of the hard structure on or in a dike; structural details are not elaborated here. The details can only be elaborated per particular case if boundary conditions and requirements are known. Calculations will show how much strength and stability can be obtained.

A 'hard structure', often a concrete 'box', can influence the usual failure mechanisms in several ways. It can change:

- height;
- weight;
- slope roughness;
- slope angle;
- flow patterns;
- response to wave attack;
- consistency of the soil by vibrations;
- height of the phreatic line;
- support of water-retaining elements;
- number of interfaces between hard structures and soil;
- use of conventional or innovative materials.

The influence of these aspects on failure mechanisms is as follows:

The effective retaining height of a dike can be influenced by the presence of additional structures, if these structures form a continuous line. An increase in retaining height implies better protection against floods (if other characteristics are adequately dealt with in the design), but a partial lowering of dike heights should be compensated for, for example with help of gates or stop logs.

The structure in or on the soil body can increase the weight of an embankment, especially if the structure has a shallow foundation. This influences the shear or rotational stability of the embankment as a whole, or of partial slip bodies. It affects

consolidation and settling of soil. Whether this influence is positive or negative, depends on the location of the structure in the dike profile. If it is located right next to a dike, it will have a positive effect, because it will counteract the driving moment (Figure 5.16a). If it is located on the crest of a dike, its influence on stability is negative, because it will increase the driving moment around a certain rotation point (Figure 5.16b). If the embankment is partly excavated to make space for the structure, it could happen that the weight of the structure is less than the weight of the removed soil (Figure 5.16c and d). This should be taken into account as well in stability calculations.

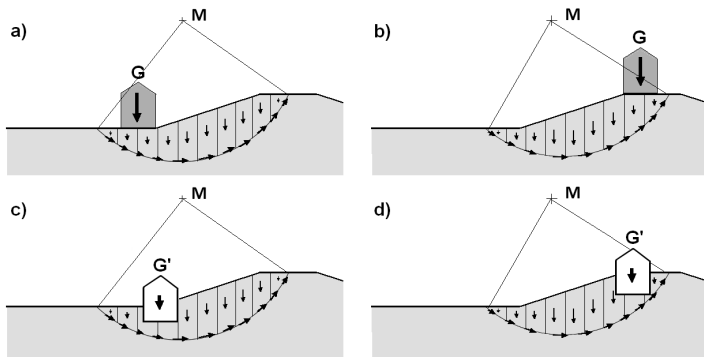

Figure 5.16: Secondary structure increasing the resisting moment (a), increasing the driving moment (b), decreasing the resisting moment (c) or decreasing the driving moment (d). In cases a) and b), the structure is located on the dike; in cases c) and d), the structure is located in the dike and weighs less than the volume of soil that it replaces.

The presence of a 'secondary' structure can influence the wave run-up characteristics, by changing the slope roughness or the slope angle, which has consequences for over-topping or overflow and succeeding failure modes. It can change the erosion-protection capabilities of a dike: a concrete wall will give a better protection against erosion than a clay/grass layer, but scour can arise at the interfaces of the hard structure and the soil.

Vibrations can be caused by combining secondary functions with flood protection. For example, heavy machinery or wind turbines can cause cyclic loading, which will have to be resisted by the structure itself and by the subsoil. For the structure itself, cyclic accelerations will cause extra horizontal loads on structural elements. To resist these loads, the elements have to be sufficiently strong. Vibrations exerted on the subsoil can cause liquefaction and extra consolidation. Vibrations of wind turbines are, by the way, mainly caused by variability of the wind velocity and by vibrations in the mast, and not by rotation of the rotor blades (Hölscher, 2016).

A secondary structure in a dike can change the way in which forces are transferred to the subsoil: the 'other' structure can (partly) take over the resistance capacity of an active soil wedge. Leaking water in between or under secondary structures can cause a significant rise of the phreatic line, which reduces the strength of the soil

and negatively affects macro and micro stability. This influence will decrease after time, after a drop of the surface water level. Moreover, secondary structures often have a relative short length, so the phreatic line at the location of the secondary structure will be influenced by boundary effects. Structures that drain the dike, counteract the rise of the phreatic line in the dike.

Application

To study the impact of buildings in a dike more systematically, the specific case of a building in a sea dike along the Dutch North Sea coast has been elaborated.⁹ The aim was to study the influence of the location of the building in or on a sea dike regarding failure mechanisms.

The first step was to do an inventory of usual failure mechanisms for flood defences in general, see Section 5.3.1. For Dutch sea dikes along the North Sea, the following generic failure mechanisms are not relevant:

- Overturning of normal sea dikes is very unlikely and only to be expected if a dike is very narrow in combination with very steep slopes and little self-weight. The dike considered is assumed to have normal proportions and material properties, thus this failure mechanism can be omitted from the design of the dike;
- Seismic activity: The probability of significant seismic activity along the North Sea coast is very low. The probability that this would coincide with extreme water levels is negligible (TAW - LZMD, 1999);
- Drifting ice: During very cold winters in the last century ice floes were observed along the North Sea, but the temperature and salinity of the North Sea don't allow significant icing. Moreover, the concurrence of extreme water levels plus severe wave attack and icing is negligible. For Dutch sea dikes, ice collision is not considered in the design (TAW - LZMD, 1999);
- Non-closure of gates in hydraulic structures (mechanical or anthropogenic): We consider a normal sea dike segment, without hydraulic structures.

Leaving out the negligible failure mechanisms mentioned above, and combining 3+4 and 5+6, the following list of relevant failure mechanisms is obtained.

1. Overtopping (related to erosion of the crest and inner slope)
2. Settlement
3. Stability foreshore and outer slope (erosion, liquefaction, shear)
4. Macro-instability (of inner and outer slope)
5. Micro-instability (instability of the outer slope protection)
6. Horizontal sliding
7. Piping
8. Animal actions: shipworms, rats, moles, rabbits, cattle, etc.
9. Human actions: ship collision, piercing, vandalism/terrorism/bombing, bad maintenance/repair, etc.

⁹This work was done in a preliminary stage of writing an article on an application of the functional resonance analysis method (FRAM) to the analysis of risks of multifunctional flood defences (Anvarifar et al., 2016).

10. Collapse or unfavourable influence of secondary objects or secondary use (for example traffic loads, buildings, trees, pipes, etc.)

First, it was studied how the addition of a building to a sea dike, without modifications in the dike geometry, would influence the likelihood of occurrence of the main failure mechanisms of a sea dike. The building is simply considered as a closed concrete box, without entrances/exits or attached cables or sewerage pipes. The building is based on a shallow, plane foundation. It is separated from the sea by a beach and water will only reach the dike in case of a storm surge (Figure 5.17). Location 1 and 5 are outside the area where possible slip circles can occur. In a geotechnical way, they can be considered to not influence the dike. Locations 2 and 4 are outside the dike body, but within the area where slip (macro-instability) can occur. Locations 3a through 3d are in or on top of the dike.

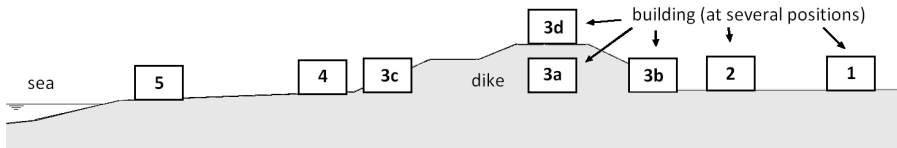

Figure 5.17: Considered locations of a building on a dike

Table 5.3 indicates how the presence of a building at different locations could influence the probability of occurrence of the main failure mechanisms. Only the influence of a well-functioning building on dike failure mechanisms is considered here. An explanation is given below, per failure mechanism.

	1. overtopping	2. uneven settlement	3. instability foreshore and outer slope	4. macro-instability	5. micro-instability	6. horizontal sliding	7. piping	8. animal actions	9. human actions
location 1	0	0	0	0	0	0	0	0	0
location 2	-	0 / -	0	++	0	0/+	0	0	-
location 3a	0	0 / -	0	+	0	-	--	0	--
location 3b	--	-	0	-	0 / +	0	-	0/+	--
location 3c	+	-	-	-	0	0	0	0/+	--
location 3d	-- / ++ ¹⁾	-	0	--	0	+	0	0/+	--
location 4	++	0 / -	--	++	0	0	0	0	-
location 5	+	0	-	0	0	0	0	0	0

¹⁾ negative for the crest, positive for the inner slope

Table 5.3: Influence of the location of the secondary structure on failure mechanisms: negative impact (-), neutral impact (0), or positive impact (+)

1. Overtopping: Waves that overtop a dike can cause the inner slope or crest to erode or soften, which could lead to a breaching process. The presence of a building could have a positive impact on overtopping, if it would dissipate wave energy before the waves reach the dike, which is the case when the building is located in front of the dike. This effect becomes larger, the nearer the building is located to the dike, as long as the waves only overtop the building and not the dike as well. A building located on top of the dike would reduce the overtopping volume, which is good regarding erosion or softening of the inner slope. At several locations the building increases the probability of scour on the interface between concrete and dike, due to more severe wave attack, especially where no erosion protection is applied.
2. Settlement: The weight of the building causes compaction of the soil below it, but this effect is less next to to the building. This causes uneven settlement, which could lead to damage to the dike, such as cracks, or initial backward erosion paths. If soil is excavated for the construction of the building, for instance when it is located inside the dike core, the result could be a reduction of the weight acting on the subsoil. This causes a negative settlement, mostly indicated as 'relaxation' or 'swell'. Uneven settlement outside the influence zone of the dike is considered to have no influence on the flood protecting function. Adjacent to the dike a small effect could be expected and the largest effects will originate when the building is located on the slopes or crest of the dike.
3. Instability of the foreshore and outer slope: The influence of the building on erosion, liquefaction or shear effects on the foreshore and outer slope is mostly negative. This only happens when the structure is located in front of the dike, not at the back side. There is a positive effect where the foreshore or outer slope is replaced by a concrete structure, but the transitions in between the stiff concrete structure and the slope or foreshore are vulnerable to scour.
4. Macro-instability: The weight of the building can positively or negatively influence the slipping of a soil body under influence of gravity: The effect depends on whether the weight reinforces the driving moment of the slip body (negative impact), or counter-acts the slip mechanism (positive impact).
5. Micro-instability of the inner slope: A concrete structure provides much more resistance against (local) heave or uplift than a soil body, so the presence of a building on the inner slope works positively. At other locations there is no influence regarding micro-instability.
6. Horizontal sliding: Lateral shearing of the entire dike body is not very likely as long as it has considerable weight. The extra weight of a building on top of the dike would make this failure mechanism even less probable. However, when the building is located inside the dike core, it is likely that the total weight on the subsoil reduces. Moreover, it could form a horizontal initial slip plane, which could cause horizontal sliding.
7. Piping (internal backward erosion): Piping under plain Dutch sea dikes is a very unlikely mechanism, but the presence of a large concrete structure in a sea dike can increase the probability of such a failure mode. The interface

between the concrete structure and the soil is vulnerable to piping, if there is a difference in water levels at both sides of the dike for a sufficiently long period and in combination with a possibility for sand particles to extrude. This only plays a role if the building is located in the dike core, or in the inner slope.

8. Animal actions: The most unfavourable and likely damage imposed to a sea dike by animals is by rabbits. They can only dig in soil, so the more soil is replaced by concrete, the less possibility there is for animals to dig holes.
9. Human actions: Secondary use of a flood defence increases the failure probability due to human actions considerably, because the primary interest of secondary users is usually not flood protection. This can lead to less awareness or even negligence of the flood protection function. Moreover, secondary users are usually not capable of taking care of flood defence structures, because of lack of knowledge and awareness. The probability of errors of humans, responsible for operating and maintaining the flood defences, increases, as the structure becomes more complex. Operational errors may occur, but errors by management personnel are more likely (Terwel, 2014). Another type of unfortunate human actions is the result of design errors: designers with no or little structural knowledge of flood defences can easily pass by basic structural design principles (for example resulting in the omission of seepage screens or insufficient crest height).

Overall, it can be concluded that the most negative impact of a well-functioning building is on the failure mechanisms of overtopping, macro-instability and human actions. The probability of piping only considerably increases if a building is constructed inside the dike. The effect of animal activity decreases only slightly due to the presence of a building. Micro-instability is almost never affected. As could be expected, the influence of a building on dike failure mechanisms decreases, if the distance between building and dike becomes larger. The most unfavourable location of the building is on the inner slope. A building on that location has a negative impact on five failure mechanisms and is slightly positive on two mechanisms. For most other locations there is a mixture of positive and negative impact. The impact, especially the negative effects, should be taken into account when designing the multifunctional flood defence.

Likewise, the impact of the collapse of a building on the failure mechanisms of a sea dike was studied. It appeared that collapse of the building mainly impacts the overtopping failure probability, in a negative or positive way, depending on the location of the building and specific circumstances. Micro-instability is negatively affected, mainly if a building is located on the inner slope of the dike. The likelihood of piping can increase or decrease when the building collapses, depending on specific circumstances. Other types of failure are hardly influenced by collapse of the building.

The question what difference it would make if the (not collapsing) building would retain water as part of the flood defence, appeared to make not much difference. In the first place, it is sensible to make the building flood-retaining on locations 1, 2,

4 and 5. For location 3a there are several ways to structurally integrate the flood-retaining parts of the building in the sea dike, but it is not expected that making one of the walls flood-retaining would have any impact on possible failure mechanisms. For location 3b it would make sense to make the building flood-retaining, if the building is higher than the dike crest, although it does seem not a logical solution. However, if a building would be water-retaining, it would not significantly influence the failure mechanisms. A flood-retaining building on the outer slope would make sense, but has no foreseen influence on dike failure mechanisms. A water-retaining building on top of the dike would imply that the dike crest can be lower and this affects several failure mechanisms. Wave overtopping volumes will increase if a flood-retaining slope is replaced by a vertical wall. The probability of internal backward erosion (piping) below the structure will increase because of a higher difference in water levels on both sides of the building. To conclude: a water-retaining building does not influence the dike failure mechanisms as presented in Table 5.3. Only a consecutive lowering of the dike crest height would have a negative impact on the overtopping and piping failure mechanisms.

5

This exercise was hypothetical to conceive the influence of a building on failure mechanisms in general. For specific cases, circumstances can deviate from this study and different conclusions can therefore be the result.

5.3.4 VERIFICATION OF MACRO-STABILITY

The verification of dike designs and the implicated uncertainties, with the help of existing Level II probabilistic methods is a complex and time-consuming task. The Finite Element Methods (FEM) used in the Level II methods are not very suitable for the required calculations with shear strength parameters near soil failure. Bakker (2005) is therefore developing a method to check the macro-stability failure mechanism, which only requires a small number of finite element calculations that can be used for dikes containing structural elements, such as sheet-piles. The method of Bakker would be suitable to multifunctional dikes.

The proposed method derives safety factors from finite element calculations with a reduced shear strength, which is accomplished with the implementation of a so-called ϕ/c -reduction. Failure is supposed to be described by undrained shear strength parameters. The failure probability can be calculated with help of the safety factors, if soil properties, dike geometry, phreatic lines, external loads and the strength of the structural elements are known.

It is expected that the fully developed model can determine the reliability of dikes with structural elements with a small number of stability calculations. The verification can be based upon actual uncertainties related to the location under consideration. This would especially be beneficial for the assessment of existing dikes, because this method is expected to considerably reduce the rejected number of dikes with supposed macro-stability deficiencies.

The random finite element method (RFEM) has found increased use, as it is conceptually simple to implement and capable to comprehensively analyse the effects of soil spatial variability. The biggest drawback, however, is its computationally expensiveness. Li (2017) demonstrated the potential benefit of a 3D conditional simulation in geotechnical cost-effective designs. She developed a framework for 3D conditional simulations, and recommended to extend it to include more complicated cases for cost-effective site investigation plans and designs. Furthermore, the effect of indirect measurements corresponding to system responses can be included in the framework, such as deformations and pore pressure measurements. The framework can be extended to longer slopes with multiple segments, consisting of distinctly different properties (strength, load and geometry), including drained conditions.

5.3.5 EROSION NEAR OBJECTS

'Erosion' is especially relevant for 'hard structures' in soil embankments, vertical walls on granular beds and for the transition of revetment to soil bed. It includes internal backward erosion (or 'piping'). In this section, several types of erosion are described. Ongoing erosion can undermine multifunctional flood defences and should therefore be dealt with in a design.

The distribution and volumes of overtopping waves cause pressure fluctuations, which form the main load on inner slopes of grass dikes. Pijpers (2013) identified five types of erosion that could play a role on slopes of flood defences:

- surface erosion;
- block erosion;
- wave impact erosion;
- erosion at geometrical transitions;
- scour around objects.

These phenomena are briefly explained below.

Surface erosion is superficial erosion of the grass top layer, which usually starts at a weak spot in the grass cover and gradually proceeds until a certain depth is reached. Verheij et al. (2010) found the following expression to calculate the maximum scour depth on inner slopes due to surface erosion:

$$h_{max} = \frac{\sum_{i=1}^N ((0,7 \cdot \alpha \cdot U_{m,i} - U_c)^2) \cdot t_m}{E_{soil}} \quad (5.1)$$

$$E_{soil} = 61,5 \cdot 10^3 \cdot \frac{U_c^2}{\sqrt{g \cdot d_a}}$$

where:

h_{max}	[m]	= maximum scour depth
$U_{m,i}$	[m/s]	= representative depth-averaged velocity at overtopping
U_c	[m/s]	= critical depth-averaged velocity
t_m	[s]	= duration of the exposure to waves
E_{soil}	[m/s]	= erosion parameter
N	[-]	= number of waves
d_a	[m]	= coefficient, $d_a = 0,004$
α	[-]	= turbulence constant, $\alpha = 1,5 + 5 \cdot r_0$

For slender objects (piles, piers, trees), the maximum scour depth is:

$$\begin{aligned} h_{max} &= 2,0 \cdot b \quad \text{if } b/h \ll 1 \\ h_{max} &= 1,9 \cdot h_0 \quad \text{if } b/h \approx 1 \end{aligned} \quad (5.2)$$

Surface erosion, however, is not a very common failure mechanism for dikes.

Block erosion is a failure mechanism where pieces, or blocks, of turf are extruded from the cover layer, causing successive erosion of the underlying soil. Block erosion is a sudden and fast effect, involving a form of fatigue. The influence of fatigue on the critical flow velocity can be calculated with:

$$\begin{aligned} U_{0,c} &= K_{v,u} \cdot U_{0,c} \\ K_{v,u} &= \frac{1}{1,5 + 5 \cdot r_0} \left(\sqrt{\frac{\alpha_{soil} \cdot \lambda_{ref}}{t \cdot \sqrt{g \cdot d_a}}} + 1 \right) \end{aligned} \quad (5.3)$$

where:

$U_{0,c}$	[m/s]	= critical depth-averaged velocity including fatigue effect
U_c	[m/s]	= critical depth-averaged velocity without fatigue
$K_{v,u}$	[m]	= fatigue factor
α_{soil}	[m ² /s]	= empirical constant, $\alpha_{soil} = 6,15 \cdot 10^6$
r_0	[-]	= relative depth-averaged turbulence intensity
t	[s]	= time of exposure
λ_{ref}	[m]	= reference height for the initiation of erosion

Wave impact erosion of clay covers was studied by Führeböter (1966), for which he formulated a theory, based on shear failure. The theory was improved by Stanczak (2007) by adding a self-weight component and shear strength at both sides of the mobilized soil blocks. His model, however, needs the shape of the mobilized blocks, which on forehand cannot be known. Therefore, Mous (2010) formulated equations based on uplift and critical pressures regarding the initiation of erosion, using Hoffmans' et.al. model (2009). He found a maximum scour depth of:

$$\begin{aligned} h_{max} &= \sum_{i=1}^N \frac{(P_{up,i}(z) - p_c(z)) \cdot t_{imp}}{E_p} \\ E_p &= \alpha_{soil} \cdot \frac{\rho_s}{\rho_w} \cdot \frac{(p_c - (1 - N) \cdot p_w)}{\sqrt{\Delta \cdot g \cdot d_a}} \end{aligned} \quad (5.4)$$

where:

- $p_{up,i}$ [N/m²] = representative uplift pressure
- $p_c(z)$ [N/m²] = critical uplift pressure
- t_{imp} [s] = representative wave impact time
- N [-] = number of waves
- $E_p(z)$ [m/s] = erosion parameter, according to Hoffmans (2012)
- α_{soil} [-] = calibration coefficient, $\alpha_{soil} = 5,5 \cdot 10^3$

Erosion at geometrical transitions is mainly a problem at the heel of a dike (where the inner slope meets the horizontal ground plain). For this phenomenon, studied by several researchers, the model of Hoffmans (2012) is often used:

$$h_{max} = U_{DL} \cdot \sqrt{\sin(s) \cdot \frac{q \cdot U_m}{g} - h_t} \quad (5.5)$$

$$U_{DL} = \frac{23}{\sqrt{U_c \cdot \left(\frac{\Delta}{\nu \cdot g}\right)^{1/3}}}$$

where:

- U_{DL} [-] = soil strength parameter
- ν [m²/s] = kinematic viscosity
- h_t [m] = overtopping water depth

Scour near objects can be caused by more mechanisms than the usual ones for grass erosion, as described in the previous sections. Pijpers (2013) made an inventory of aspects that play a role near objects:

- with respect to loading:
 - flow velocity;
 - water pressure;
 - flow depth;
 - turbulence;
 - water-air ratio;
- with respect to material (resistance):
 - grass quality;
 - root strength;
 - soil cohesion;
 - shear strength;
 - suction pressure.

The location determines what failure effects are relevant; in particular the direction of water impact is important. If the water hits the object perpendicularly (in front of the object), the flow velocity will be low near the object, but the dynamic pressures will be high. If the water flows parallel along the object, the flow velocity will be high, but the pressure will be low.¹⁰ In the first case, a pressure erosion model can

¹⁰This distinction is more pronounced for rectangular than for round objects where the transition between these two models seems to be more gradual.

be used and in the second case a flow erosion model can be applied.

For the pressure model, a potential fissure between the soil and the structure makes a difference. If there is no fissure, which is likely in winter, the damage pressure model of van der Meer et al. (2010) can be used to describe the erosion process, because the load and strength of this model are formulated as in velocities. The model for situations with a fissure is different, in that water will flow into the fissure and cause an additional pressure on the side face of grass turf 'elements'. Shear forces will originate along a slip plane, which should be resisted to avoid damage or failure. Erosion next to objects is mainly caused by the flow velocity of water. Therefore, the original model of van der Meer et al. (2010) can be used to describe the erosion process.

Experiments of Pijpers (2013), that did not cover all possible situations, showed that the development of these models is promising, but that more research is required to approach reality more accurately. Inclusion of friction in the models would be one of the improvements. Furthermore, the transition zone between the pressure and the velocity model should be studied in more detail and appropriate testing facilities would be very helpful. Finally, practical design rules should be formulated.

5

Aguilar-López (2016) recently studied the effects of erosion based failure mechanisms of multifunctional flood defences in probabilistic design and safety assessment. He concluded that internal backward erosion (piping) is most likely to occur if a flood defence is founded over an aquifer with small sediment particle sizes (for a high inflow) and a high hydraulic conductivity (for a low transport resistance). These two conditions have contrary effects, because smaller particles usually imply a lower hydraulic conductivity of the aquifer. The most critical combination can be experimentally found by sampling particle sizes and hydraulic conductivity. If a structure is embedded in a dike, it will decrease the internal backward erosion effect, because the structure diverts the seepage flow, which results in a pressure loss inside the aquifer flow (in other words: the gradient becomes smaller).¹¹ Aguilar-López studied the influence of a paved road on a dike crest and concluded that the smooth road surface increases the probability of scouring of the grass cover at the inner slope. He developed tools to include the mentioned effects of structural embedment in probabilistic design calculations.

5.3.6 MASONRY AND GLASS ELEMENTS IN DIKES

Masonry walls or glass panels can contribute to the stability or strength of multifunctional dikes that are combined with non-hydraulic engineering structures like houses, parking garages and restaurants. Failure of multifunctional flood defences due to insufficient strength of masonry or glass elements, requires special attention in the structural design, as it is uncommon in plain flood defences.

¹¹It should, however, be taken into account that structures on pile foundations will generally increase the probability of piping, because of the likelihood that a gap will originate between the settling or subsiding soil and the structure.

MASONRY

If buildings are supposed to contribute to the reliability of a flood defence, their walls should have sufficient strength. This can be checked quantitatively with a strength calculation if there is enough information about loading and resistance. The walls should be schematised in the correct manner. Determining the reliability of concrete walls is quite common in hydraulic engineering, but it is uncommon to take the strength of masonry walls into account.

Loads from the adjacent soil can be calculated with the usual theories of Jaky and Rankine / Müller-Breslau, where lateral soil pressure depends on the effective vertical soil pressure and the degree of compaction of the soil (mostly caused by displacement of the object or wall). In failure state, shear resistance between the moving soil body and remaining soil can cause an arching effect. The shearing resistance tends to keep the yielding mass in its original position, resulting in a change of the pressure on both of the yielding part's support and the adjoining part of soil. This effect has to be taken into account in case of relatively short structures, such as dike houses, since it will influence the horizontal soil pressures in an active or passive way. Active arching occurs, if a structure is more compressible or displaces (or deforms) more than the surrounding soil.

The pressure of groundwater on a wall or object depends on the phreatic line, which will vary in time, especially in case of varying surface water levels, overtopping waves and precipitation. Mostly, a high phreatic line ('undrained conditions') acts more unfavourable than a low phreatic line ('drained conditions'). The development of the phreatic line (or surface) can be computed with help of groundwater flow models, but these can be rather complex and assumptions will have to be made, for instance on the duration of a high water. The technical report 'Water pressures at dikes' (TAW 2004) gives several practical schematisations that can be considered for the design of flood defences. Additional loads come from the self-weight of buildings and variable loads coming from traffic.¹²

Jongerius (2016) described the schematisation of a soil-retaining wall in a dike house: forces and moments are transferred to supporting elements and the magnitude of the stresses in the wall can be determined with help of a structural mechanics schematisation, and successively, the material properties to fulfil the strength requirement can be calculated. Figure 5.18a illustrates a house in a dike slope, where the soil retaining wall is assumed to have a fixed support at the low end and a free support at the high end (the floor is supposed at the height of the slope intersection). The shear force and moment diagrams are shown as well. Figure 5.18a illustrates the same situation, but with two free supports. In this case, the bending field moments are smaller than in the first case.

In reality, the supports are not 100% free, nor 100% fixed. In engineering, a conservative guess is usually made of the real schematisation. Regarding the loads, it

¹²The Guide of Structural Design of TAW (1994) recommends a traffic load of 400 kN per 12 m' during design water level (coming from a truck with sandbags, even if there is no road on the dike), which corresponds to 13 kN/m² over a width of 2,5m.

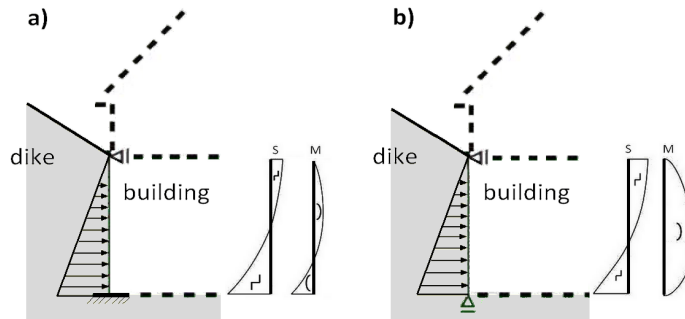

Figure 5.18: Two ways of schematising a soil retaining wall in a building (Jongerius, 2016, modified)

5

should be noticed that a hydrostatic load should be added to the building in Figure 5.18, which shows a two-dimensional situation, whilst in reality, part of the loads will be resisted by the side walls, not only by the ground and intermediate floors. It should be taken into account that discontinuities of a wall, such as doors and windows, can considerably weaken the strength of a masonry wall as a whole.

If the critical load combination is found and the structure is schematised, the maximum occurring normal, shear and bending stresses can be calculated. As explained by Jongerius (2016), bending failure can basically occur in two directions, see Figure 5.19. The bending strength is different for both directions and depends on the quality of both the brick and the joints.

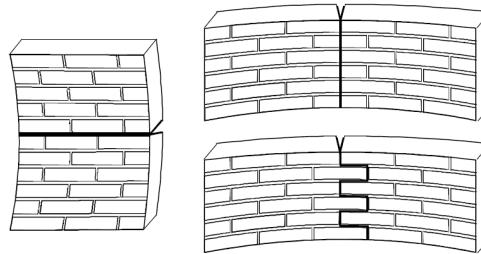

Figure 5.19: Two modes of bending of masonry walls (Eurocode 6, part 1 2013, part 1.1)

The impact of loads caused by overtopping waves on masonry walls was studied by Chen (2016). She considered sea dikes along the Belgian coast and, assuming material properties as specified in Eurocode 6, concluded that no damage is expected for 1/1000 conditions. For more extreme conditions, for instance 1/10 000 with wave heights of more than 2,1 m, collapse of masonry buildings within 20 m from the sea front can be expected for most typical wall configurations. She regarded several dimensions of wall panels and different types of support of the walls.

GLASS ELEMENTS

If secondary functions are combined in flood defences, the question arises whether glass elements can be used as part of retaining walls. Glass, however, is a very uncommon building material in hydraulic engineering, so its suitability for the purpose of flood protection cannot be taken for granted. Kentrop (2016) studied the properties of glass and its potential use in secondary flood defences. He concluded that there are several drawbacks to use glass as a water-retaining construction material in flood defences. A first main drawback is the brittle structure of glass, which causes the material to suddenly fracture, in case of overloading. Cracks in glass elements easily propagate towards the edges, so local failure mostly implies failure of the entire element. Another drawback is that there are no satisfactory descriptors yet for the strength of glass, due to the large number of parameters that has to be taken into account and due to the fact that it heavily depends on the quality of the production process. These drawbacks can largely be overcome by applying heat-treatment to the glass, introducing compressive pre-stresses at the glass surface, and by composing the glass elements out of laminated glass plies to introduce robustness.

Kentrop (2016) identified four main failure mechanisms of flood-retaining glass elements:

- overloading by hydrostatic pressure, for which probabilistic calculations can be performed with a reasonable accuracy;
- impact loads, mainly due to ship collisions and vandalism;
- fire;
- explosions.

For impact loads, fire and explosions, a deterministic calculation, or a qualitative analysis was done. A full probabilistic calculation appeared too laborious and problematic, as too many details were unknown or uncertain to make a sufficiently reliable calculation. It was concluded that a second row of glass elements was required to take over the water-retaining function if the first glass layer would fail. Ship collision, one of the mechanisms with the highest failure probability, should preferably be prevented by a protective structure or shallow foreshore in front of the glass elements.

Chen (2016) studied the impact of loads caused by overtopping waves on glass windows in houses at the inner crest line of sea dikes. She used the Eurocodes to calculate the reliability of glass elements, taking into account the hydraulic loads, the overtopping process, failure mechanisms and the strength of the glass. For typical locations along the Belgian coast, it appeared that the ground floor windows in external walls can be expected to break under 1/1000 storm conditions, depending on the wave characteristics, the level of the beach in front of the sea dike, the width of the dike, and the strength and the way of support of the front wall.

5.3.7 APPLICATION OF THE NEW DUTCH DESIGN TOOLS

A short description of the prescribed method for verification of regular flood defences can be found in Appendix E.7. Multifunctional flood defences deviate from regular flood defences because of their different composition. The Guideline Designing with Flood Probabilities (Rijkswaterstaat, 2015b) gives several possibilities to adapt the prescribed verification method. This is relevant for multifunctional flood defences, and it should per case be considered in what way the method can be adapted.

The first possibility consists of modifying the standard failure probability requirement distribution factors as given in Table 5.4. This can be useful if:

- The actual failure probability requirement distribution factor appears to be considerably higher than the standard value as given in the table. This is especially relevant for failure mechanisms with a small standard probability requirement factor, like macro instability, and the change is considerable (> 5 times larger).
- The spatial impact of using an inexpensive solution (in soil) becomes too big when using the standard failure probability requirement factors, for example near special objects.
- One of the standard failure mechanisms appears to be irrelevant. For instance, if special measures are applied to prevent piping, the failure probability requirement factor for that mechanism can be reduced and used for other mechanisms.

5

type of flood defence	failure mechanism	segment type	
		sandy coast	other (dikes)
dike	overflow and overtopping	0%	24% ^c
	uplift and piping	0%	24% ^c
	macro instability	0%	4%
	inner slope damage revetment and erosion	0%	10%
engineering work	non-closure	0%	4%
	piping	0%	2%
	structural failure	0%	2%
dune	dune erosion	70%	0% / 10% ^d
other		30%	30% / 20%
Total		100%	100%

Table 5.4: Standard failure probability requirement distribution for the assessment of flood defences per 2017 (Jongejan, 2013)

Rijkswaterstaat (2015b) advises to only adapt the failure probability requirement distribution if this is justified on a phenomenological basis, but not if it would only marginally influence the total investment. Neither should the distribution be adapted if it only applies to a small part of a dike segment and the uncertainties in the basic schematisation are large or, if other starting points, for example the basic

schematisation and the length effect, are more determining. Another possibility to optimise the design of flood defences, is to reduce the length over which a failure mechanism is relevant, if this can be based upon phenomenological considerations. Such a reduction would lead to reduction of the concerning failure probability requirement factor, allowing for lower probability requirements for other failure mechanisms. The overtopping discharge requirement could be increased, which is allowed if demonstrated that the flood defence would not fail and the storage capacity of the hinterland would not be exceeded.

5.4 CONCLUDING REMARKS

The verification of reliability of multifunctional flood defences has been divided into a qualitative and a quantitative structural verification. An explicit qualitative structural verification is additional to the quantitative structural verification, common to the design of regular flood defences. For the qualitative verification, a generic method was developed for identifying the role of structural elements and qualitatively judging the capability of a structure of fulfilling its flood protecting function. As concluded in Section 5.2.6, the method of qualitative structural verification, as derived in this chapter, is generic and helpful in a design.

The qualitative verification should be followed by a quantitative structural verification, for which the usual engineering tools and methods can be used, as indicated in Appendix E. Several additional aspects that are specific for multifunctional flood defences, such as masonry and glass elements, are described in Section 5.3. With help of the two types of structural verification, it should be possible to calculate whether a flood defence is able to resist the expected loads. Its calculated failure probability has to be more than the safety level as stipulated by law. The following chapter validates the verification method as described in the present chapter, focussing on the qualitative functional verification of the flood protecting function, but including other main design aspects.

6

VALIDATION OF THE METHOD OF QUALITATIVE STRUCTURAL VERIFICATION

This chapter validates the method of qualitative structural verification, which was developed in the previous chapter. With help of four cases, it is demonstrated how the qualitative structural verification creates insight in the flood protecting performance of multifunctional flood defences. The qualitative structural verification helps motivating the choice for concepts for further elaboration in the design process. This chapter concentrates on the primary function of multifunctional flood defences, because doubts about the flood safety of such flood defences are a main impediment for implementation of multifunctional flood defences, next to governance issues that are not covered in this dissertation (see Chapter 1).

Four different cases are selected for the validation. The first case concerns the coastal protection near Katwijk aan Zee, where a parking garage is integrated in the dunes. The second case is a city dike in Rotterdam, with a shopping complex. A quay in Rotterdam, with a busy boulevard, forms the third case, and the last case is a river dike near Sliedrecht, with houses built on both the inner and the outer slope.

To demonstrate the application of the method of qualitative structural verification as a part of an overall design, the other design steps of the integrated design method, as described in described in Chapter 4, are included as well. However, they are not executed with a high level of detail and creativity, as the specific aim of this chapter is to only validate the design step of the qualitative structural verification of design concepts. The overall integrated design method has already been validated in Section 4.8. The first case study includes an additional *quantitative structural evaluation*, to accurately validate whether the preceding qualitative structural verification connects well to the quantitative verification.

6.1 CASE STUDY 1: COASTAL PROTECTION OF KATWIJK

6.1.1 EXPLORATION

BACKGROUND

The first case study concerns the improvement of the coastal defence of Katwijk aan Zee. The town is located along the Dutch coast of the North Sea, near the original mouth of the Rhine. At the end of the twentieth century, part of the town of Katwijk did not appear to be sufficiently protected against storm surges from sea: about 3000 inhabitants were exposed to an unacceptable flood risk, as the primary flood defence deviated from the coast line and was running through the village. Moreover, part of the in-town flood defence appeared to become too weak in future (2050), and so it would threaten part of the province of South Holland, see Figure 6.1 (Stuurgroep Visie Hollandse Kust, 2001).

In 2002, a study of the Technical Advisory Committee for the Flood Defences (TAW) concluded that the wave impact on the coast was more severe than previously had been assumed. The new hydraulic boundary conditions, as calculated by Rijkswaterstaat, and improved assessment methods indicated that the sea defence of Katwijk was at that time already incapable of resisting a water level corresponding to an exceedance probability of 1/10 000: under extreme conditions, erosion would undermine the boulevard. Furthermore, wave overtopping volumes in the weak dike section through the town would exceed the maximum acceptable amount. Katwijk was therefore denoted as one of the weak links along the Dutch coast and action was required to improve the situation (RIKZ, 2003).



Figure 6.1: The original primary flood defence running through the town of Katwijk aan Zee (Kustwerk Katwijk, 2013)

An additional problem was the occupation of parking space along the boulevard, which was filled up to 120% on weekends, and 90 to 100% on weekdays, causing a high pressure on the local transportation system. Most of the parking spots near the beach were taken up by service vehicles, company vehicles, business owners and tourists, leaving virtually no space for residents to park their cars, in spite of

two parking garages in the vicinity (Mobicon Concordis groep, 2008).

DESIGN OBJECTIVE

The project objective was to improve the flood defence in such a way, that Katwijk and the province would meet the safety standard of an exceedance probability of dike ring 14 (1/10 000), and simultaneously to solve the parking problem by creating underground parking space for about 660 cars. Preservation of spatial quality was an important issue for this project: the dune landscape, the visual relation with the sea and the approachability of the beach were important issues (Kustwerk Katwijk, 2013).

6.1.2 DEVELOPMENT OF CONCEPTS

For the present research, several concepts were developed to improve the flood protection of Katwijk, meanwhile dealing with growing parking problems along the boulevard. As a starting point for the development of all concepts, the new coastal defence was assumed to be situated right along the coast instead of through the village (Figure 6.2). Six concepts were studied for this case: four concepts

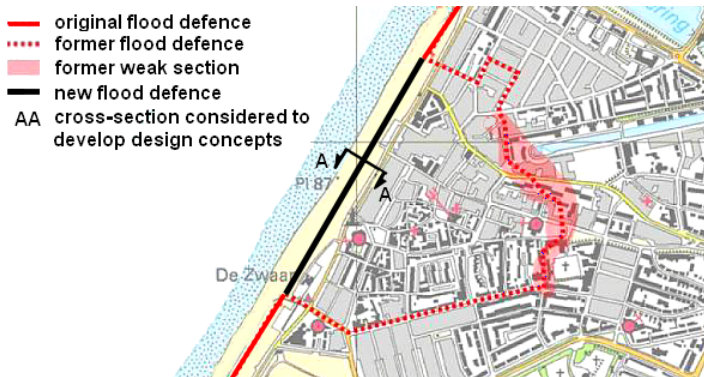

Figure 6.2: The location of the new flood defence, next to the original defence line of Katwijk aan Zee (Kustwerk Katwijk, 2013)

were developed for this dissertation, aiming at the integration of the new flood defence of Katwijk with the parking garage. In addition, the existing "Multi Barrier" concept was studied, which was developed by research and consultancy institutes, but rejected by the client because it had not been proven that the costs would be lower than the preferred alternative. The last studied concept was the alternative, as developed by Arcadis and Haskoning consultants, which has finally been built.

The same area was considered for the development of all concepts: the cross-section near the Voorstraat, where the street level is NAP + 6,00 m. In Figure 6.2, the considered cross-section is marked with AA. In this cross-section, a removable beach restaurant is located on the beach, in front of the dunes. The design water level at

the end of the design lifetime of the new flood defence (100 year), corresponding to an exceedance probability of 1/10 000, is NAP + 6,40 m, including a storm set-up, the effect of local atmospheric depressions and a mid scenario for predicted sea level rise.

In general, a main design variable for dunes as flood defences is the sand volume in a cross-shore profile. The sand volume has to be sufficient for a dune to survive a storm surge, which means that erosion cannot proceed until breaching of the dunes occurs, including the safety margin. The amount of dune sand is determined by the height and the width of the dunes.

The height of a flood defence is relevant for reducing wave-overtopping volumes. These volumes are usually limited to protect the rear sides of flood defences against erosion or softening and consequent failure, or to prevent the consequences for the hinterland caused by too high water volumes behind the flood defence. For Dutch dunes, however, this is most of the time not a relevant criterion, because dunes would fail by erosion of outer slopes before they could fail by wave-overtopping.

The six different concepts of this section were developed by making use of the basic design variables related to flood protection. The two other design objectives of providing space for parking and preserving spatial quality were taken into account as well. Subsequently, the concepts were structurally validated in a qualitative way (Section 6.1.3), to test whether the method of qualitative structural evaluation, as described in Section 5.3 works well. The succeeding design phases of Evaluation of Concepts and Quantitative Structural Verification were added, to observe whether the qualitative structural verification fits in the overall design process (Sections 6.1.4 and 6.1.5).

6

CONCEPT 1 'EMBEDDED BERM'

The main idea of the first concept was to create very low dunes, enabling a direct view on the sea from the first and second floor of the boulevard houses (Figure 6.3). The subsoil two-storey parking garage was located between the promenade and the

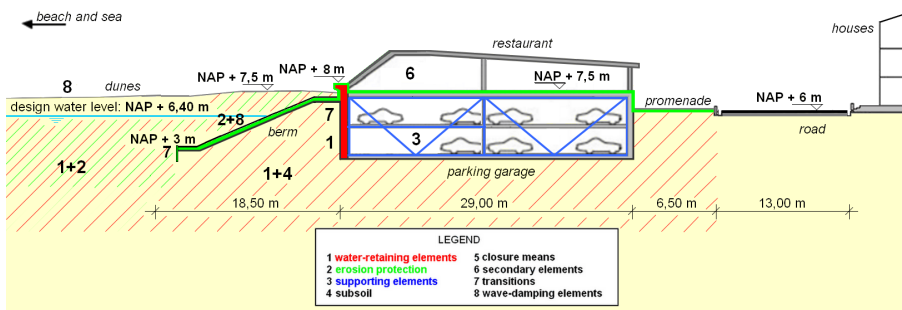

Figure 6.3: Design concept 1 for the flood defence of Katwijk with embedded berm

dunes. The temporary beach restaurants were replaced by permanent restaurants

behind the row of dunes, on top of the parking garage. It was doubted whether the amount of sand in the dunes would resist a design storm, therefore a berm with a revetment of concrete elements has been positioned in front of the garage to prevent ongoing erosion, which would have to be verified in a later design step.

The height of the flood wall that demarcates the promenade was limited to NAP + 8,00 m to provide clear sight lines from the boulevard houses into the direction of the sea. The parking garage contains two decks, but if desired it can be a single deck, as there is plenty of space in longitudinal direction (parallel to the boulevard).

CONCEPT 2 'DEEP RETAINING WALL'

The 'Deep retaining wall' concept is quite similar to the first concept, but there are variations. The promenade was elevated with 1,5 m and equals the height of the dune crest, creating sight lines from the boulevard towards the sea, in between the restaurants. The restaurants were made transparent by using glass elements. Instead of creating a berm to stop dune erosion, the beach was nourished with an extra volume of sand, widening the beach with 100 m. If the extra volume would be insufficient to withstand a storm, further erosion will be stopped by the extra depth of the garage wall. As the nourished sand gradually washes away, beach nourishment will have to be repeated every five to ten years. The consequences of wave-overtopping were reduced by a parapet on top of the water-retaining garage wall and a sewerage pipe system along the promenade. The parapet also helps to avoid sand drifting over the promenade and the road. See Figure 6.4. The boulevard

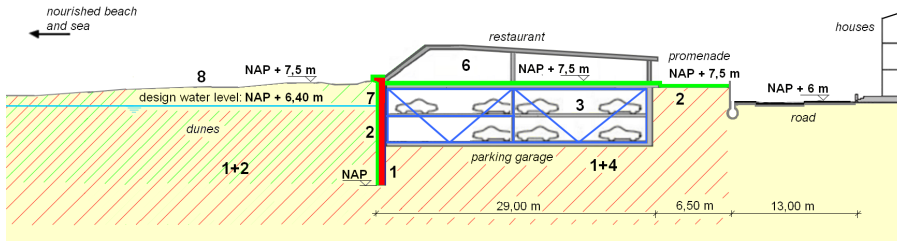

Figure 6.4: Design concept 2 for the flood defence of Katwijk with the deep retaining wall

is slightly higher than in the previous concept (NAP + 7,50 m) and the top of the garage is lowered to NAP + 7,50 m to improve the view from the boulevard over the sea.

CONCEPT 3 'GARAGE UNDER THE BOULEVARD'

The 'Garage under the boulevard' concept is basically the same as concept 2, but the garage was shifted to a position under the road and it consists of only one storey to avoid deep excavation (Figure 6.5). The parked cars were arranged in four parallel rows, making the parking garage about twice as long, compared to previous concepts. This resulted in more space for the dunes, increasing the dune

volume and thus requiring less beach nourishment to provide sufficient resistance against erosion. The additional space can be used for a club or bicycle parking. Aesthetically, this concept does not add much compared to concept 2: the view on the sea is good from both the restaurant and the promenade, there are dunes in front of the promenade, and the beach is well accessible over dune paths. Other characteristics are as in concept 2.

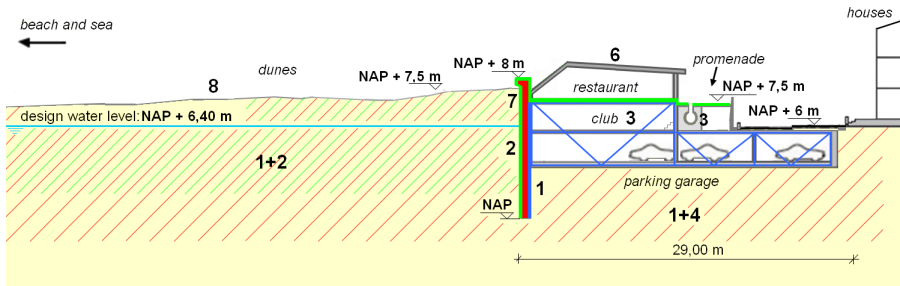

Figure 6.5: Design concept 3 for the flood defence of Katwijk with the garage under the boulevard

6

CONCEPT 4 'HOUSES ON TOP OF THE GARAGE'

A drastic alternative is to 'move' the present boulevard houses to the other side of the road, to improve their view. This implies the construction of new houses. The old houses can either be preserved, or demolished and be replaced by new houses, which is more expensive. The new promenade is located between the new houses and the dunes, but the road is at the land side of the new houses, see Figure 6.6. The houses and the promenade are situated at a higher level than in the previous

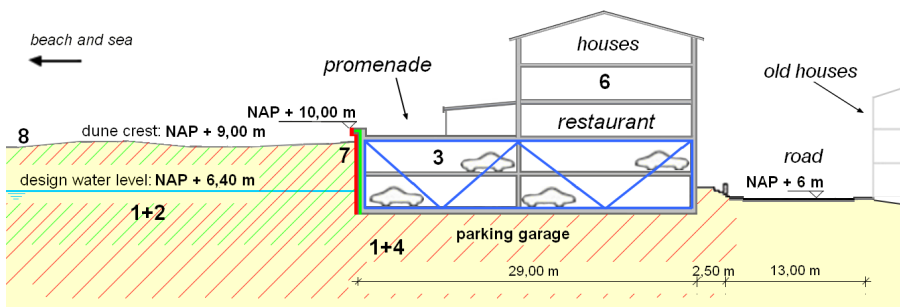

Figure 6.6: Design concept 4 for the flood defence of Katwijk with the houses on top of the garage.

concepts. In this concept, the dunes are higher and wider. The beach and the sea are very well visible from the houses and the promenade, as they are located at a higher level than in previous concepts. The ground floor of the houses can be used for permanent restaurants, including terraces with sea view. Shops and game halls are located in between the restaurants, as well as the porches for the apartments.

CONCEPT 5 'WALL IN DUNE'

The 'Wall in dune' concept studied for this research was developed by researchers of the Delft University of Technology, the Netherlands Organization for Applied Scientific Research (TNO), Rotterdam's municipal engineering department, the Dutch 'Knowledge Partner for Construction' (SBRCURnet), and other research agencies. They created a design with a diaphragm wall of 15 to 20 meter depth, forming the main water-retaining element. A parking garage was planned behind the wall as a solution for the parking problems during the tourist season. Figure 6.7 shows a cross-section. During summer, seasonal beach restaurants can be located

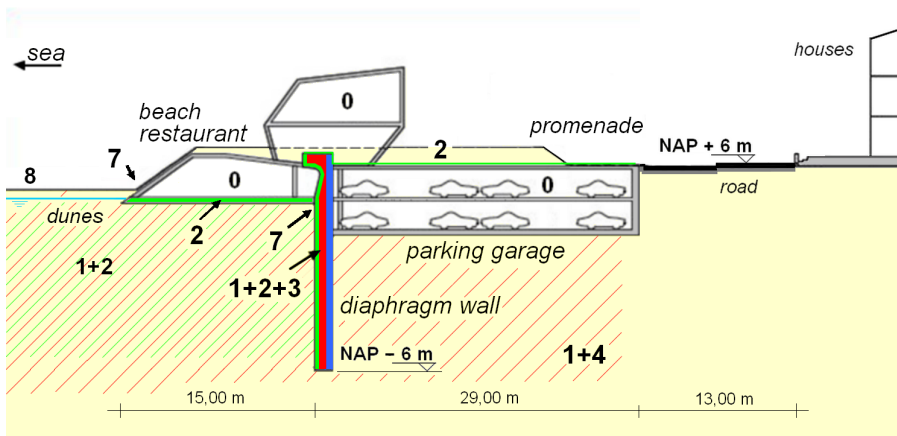

Figure 6.7: Design concept 5: The wall-in-dune alternative for Katwijk, Netherlands

in front of the garage, or further towards the beach. A small building was planned on top of the wall; its function is specified as 'residence' (house). On top of the garage, there is a layer of sand with marram grass, creating a dune-like landscape.

CONCEPT 6 'DIKE-IN-DUNE', AS BUILT

The weaker part of the dunes was reinforced from October 2013 to February 2015 with a dike, embedded in the dunes. A sub-soil parking garage for 660 cars was constructed between the dike and the boulevard. Meanwhile, the dune area was widened and reshaped.

To make the top of the dunes as low as possible, for aesthetic reasons, the beach was widened with about 100 metres and an embedded dike was built in the dunes (as the berm of concept 1). This dike-in-dune was constructed along the part of the boulevard that was too low to retain critical water levels, a stretch of about 900 m. The total width of the dunes over the dike, from boulevard to dune toe, is about 120 m. This is 90 m wider than in the original situation. The dike consists of a sand core and is covered by concrete blocks on top of a filter layer and geotextile (Figures 6.8 and 6.9).

The crest level of the flood defence could have been as low as NAP + 7,50 m, but for aesthetic reasons, the dike was covered with sand, bringing the top of the dunes to a maximum level of about NAP + 8,50 m. At locations where the original dunes were already higher than NAP + 7,50 to 8,00 m, the existing dune top level was maintained. The crest of the dike has a width of 11,00 m. The dike will be exposed to wave attack when the sand on and in front of it will have eroded. The remaining sand in front of the dike will sufficiently reduce wave overtopping. The dike can relative easily be adapted in the future, if necessary (Arcadis, 2013).

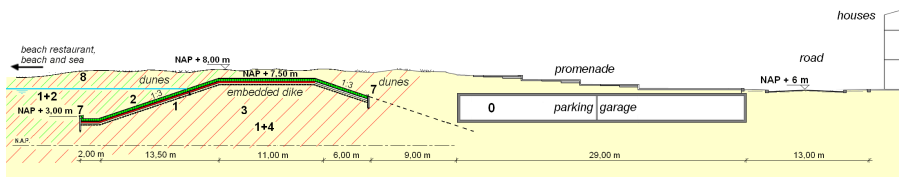

Figure 6.8: Design concept 6: Technical cross-sectional drawing of the dike-in-dune (Kustwerk Katwijk, 2013)



Figure 6.9: Katwijk: construction of the dike-in-dune, February 2014

A top-view and longitudinal section of the parking garage are depicted in Figure 6.11. The garage has been awarded with the architecture price 'Building of the year 2016 by the Dutch Association of Architect Offices (*Branchevereniging van Nederlandse Architectenbureau's*, BNA). The jury considered the structure 'frontier shifting': *It is not only an excellent edifice, but shows how the Netherlands should in the future deal with the spatial planning of our coast.* It received the public award as well. In addition, the garage was awarded the international award for infrastructure 2016 from World Architecture News (WAN). The jury motivated its choice amongst others with: *Integrating the parking garage with the water defence system (sic) not only protects Katwijk from the Sea, but also offers the tourists an opportunity to park directly near the beach.*



Figure 6.10: Katwijk: car entrance to the underground parking garage. The dike is embedded in the dunes (on left side of the picture, hidden under the sand), May 2015

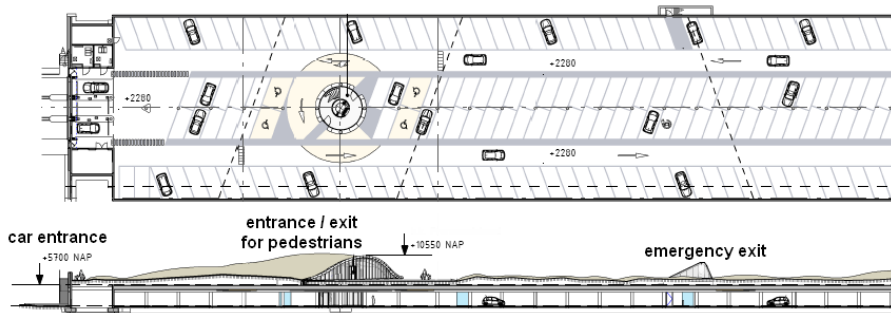

Figure 6.11: Katwijk: technical drawing of the parking garage, the most Southern part (final design Kustwerk Katwijk, 2014)

6.1.3 QUALITATIVE STRUCTURAL VERIFICATION OF THE CONCEPTS

This section describes the qualitative structural verification of the developed concepts: a check whether they are in accordance with the design objective, which comprises the two main requirements: protecting against floods and solving the parking problem and preserving the spatial quality. The qualitative structural verification per concept is followed by a comparison of the concepts. Based on the comparison, the best concept is selected and additionally verified in a quantitative structural way (Section 6.1.5), because a qualitative structural verification is only a partial verification. The other main functions are verified as well, to better simulate the overall design process.

CONCEPT 1 'EMBEDDED BERM'

Figure 6.3 shows the element type numbers as specified in the previous chapter. The water-retaining function is performed by the dunes and the rear wall of the garage

(element type 1). The rear wall and roof of the garage protect against erosion during extreme water levels and the berm prevents scour in front of the garage. The volume of the dunes and the beach should suffice to withstand erosion due to a storm (type 2). The structure of the garage itself should provide stability to prevent collapse of the garage. A shallow foundation is expected to provide sufficient bearing capacity (type 3). The subsoil (type 4) consists of sand and its volume should, together with the beach and dunes, sufficiently limit seepage to acceptable amounts. There are no closure means that are part of the water-retaining wall (type 5) and the restaurant on top of the garage only provides extra weight on the structural elements that contribute to the flood-protecting function (type 6). Transitions can be found where the berm meets the water-retaining wall and the dunes (type 7). The dunes dampen the waves, but only until they have eroded away. From then on, the berm takes over the wave-damping function.

The top level of the water-retaining wall is limited to NAP + 8,00 m, to provide clear views from the boulevard houses in direction of the sea. For people standing on the boulevard, with street level at NAP + 6,00 m, there will be no view of the sea.

The restaurant, which is combined with the flood defence, does not retain water, nor does it provide additional stability to the retaining wall. In principle, the restaurant could obstruct the clear view from the boulevard over the sea, but it is only present over a small part of the boulevard and it could be made transparent using glass elements.

6

The 'embedded berm' concept could be functional (but it has to be checked in more detail with a quantitative structural verification), however the embedded berm is an expensive solution. The 900 metre stretch of the boulevard suffices to accommodate the required number of 660 cars (for a one storey garage with about 660 oblique parking spots in four rows, a length of about 500 m is sufficient). The sea is not visible from the promenade, but at least, it is visible from the first and second floor of the boulevard houses. The dune landscape is well preserved by embedding the berm in the sand. The beach can be approached from the promenade over dune paths.

CONCEPT 2 'DEEP RETAINING WALL'

Figure 6.4 shows a cross-section of the 'deep retaining wall' concept with the deep retaining wall, indicating the structural element types. The dunes and the rear wall of parking garage are water-retaining elements (type 1). This wall could be constructed as a diaphragm wall, but the construction requires heavy and expensive machinery, therefore pre-stressed concrete sheet-pile walls were chosen as an alternative. The wall has taken over the erosion-protection function of the berm of the previous concept (type 2). Other details are basically the same as in the previous example. Noticeably, the floors of the parking garage and the restaurant provide support for the diaphragm wall (type 3). The roof of the restaurant applies loads on the retaining wall, but no support (type 6).

Wave overtopping, if dune erosion would proceed until the wall, is much less a

problem than in concept 1, because a drainage system behind the promenade discharges overtopped wave volumes. It thus prevents that large overtopping water quantities flow into the low-laying part the town of Katwijk. Erosion of the inner 'slope' of the multifunctional flood defences, caused by overtopping, is much less a problem, as there is no such inner slope and the pavement is erosion-proof.

The parking capacity of the garage is the same as in the previous concept. The promenade has a clear view over the sea, even where restaurants are located in between, because of the transparent character of the restaurants. Access to the beach is as good as in the first concept and the dune character is preserved.

CONCEPT 3 'GARAGE UNDER THE BOULEVARD'

The 'garage under the boulevard' concept is basically the same as concept 2, but the garage is shifted under the road (Figure 6.5). This implies that there is ample space for dunes, so less beach nourishment is needed to provide the required amount of sand volume. The beach therefore causes a smaller deviation of the smooth, curved, coast line of Holland.

The dunes and the rear garage wall are water-retaining elements (type 1). Protection against erosion is provided by the same elements (type 2) and by the roof of the garage regarding the overtopping of waves. The water-retaining wall is embedded in the dunes, so it will provide part of its own stability, but it is laterally supported by the roof and floors of the parking garage. The restaurant does not contribute to the flood-retaining function (type 6). Transitions can be found in front of the parking garage (type 7), while the dunes and the beach dampen the waves (type 8).

The garage consists of one storey, but in case of four rows of cars, there is plenty of space under this part of the boulevard. The additional space, for example for a dancing or a bicycle parking, creates extra value. Aesthetically, this concept does not add much compared to concept 2: The view on the sea from the restaurant and promenade is good; there are dunes in front of the promenade and the beach is well accessible over dune paths.

The road cannot be used during construction. The promenade can temporarily be relocated around the construction site, over the dunes. The inconvenience during construction is considerably higher than in the previous concepts, as the traffic has to find another way through the town and construction work is in close proximity to residential houses.

CONCEPT 4 'HOUSES ON TOP OF THE GARAGE'

In the 'houses on top of the garage' concept, the dunes are higher than in concept 3, so they can for most part take care of the flood-protecting function, for which the garage wall is hardly needed (Figure 6.6).

Water-retaining elements in this concept consist of the sand volume of the dunes and the beach, in combination with the water-retaining rear wall of the parking

garage and the subsoil (type 1 elements). As a first speculation, a 30 m wide dune strip at about NAP + 9,00 m is assumed to provide sufficient erosion volume. Additional measures to prevent scour are therefore not needed. The volume of sand prevents the erosion from propagating too far, but it can finally be stopped by the water-retaining wall of the parking garage (type 2).

The water-retaining wall is supported by the parking garage (type 3). The superstructure on top of the garage (the houses plus restaurants or shops) has no function regarding the flood defence, so they are secondary elements, causing extra loads on several structural elements that are part of the flood defence (type 6). Noticeable transitions are in front of the garage wall, with respect to potential erosion, and in front of the garage at the road side, with respect to potential piping (type 7). The dunes and the beach reduce overtopping volumes by damping the waves (type 8).

There is sufficient space for cars and bicycles. The promenade is located immediately next to the dunes, so the visual relation between the promenade and the sea is optimal. From the restaurant and all floors of the new houses as well, the visual relation with the sea is excellent. The 'houses on top of the garage' concept is much more expensive to construct than the previous concepts, but much value is created by the new houses with a magnificent view. It provides an opportunity to create a new aesthetic impetus for the entire sea front of the town of Katwijk. It is expected that property developers will be willing to invest in such a project and will make a profit when selling the houses after completion.

The sea is not visible any more when driving on the coastal road, and demolishing and re-building the houses along the boulevard is expensive. The houses and the boulevard can be constructed at a higher level, reducing the need for repeated beach nourishments. The concept offers an opportunity to upgrade the spatial quality of the boulevard as a whole.

CONCEPT 5 'WALL IN DUNE'

The flood protecting function of the dunes in the 'wall in dune' concept is reinforced by a diaphragm wall that stops erosion if it would have proceeded as far as the revetment in front of the structure. The seasonal beach restaurant is located outside the area that is protected against floods, so, in this respect, it is vulnerable. There is no sewerage system to dispose of potential overtopped wave volumes, but it could be added in a later design stage if needed. The two-deck parking garage has sufficient space to retain all 660 cars (Figure 6.7).

The diaphragm wall is water-retaining, together with the dunes (type 1). The restaurant and the parking garage (type 0) are not part of the flood defence structure, only the restaurant floor contributes to flood protection, as it protects against erosion (type 2). In addition, erosion-protection is provided by the sand volume of the beach and the dunes, and by the water-retaining wall itself. During an extreme storm, the restaurant will be washed away, but usually it will be removed before the storm season. The diaphragm wall is designed to still fulfil its flood-protection function after dune erosion during a design storm, without support of the other structural

elements of the parking garage (types 1+2+3). The weight of the building on top of the wall is transferred to the subsoil via the parking garage and the restaurant, not via the diaphragm wall. Therefore, the building on top of the wall is not part of the flood defence (type 0).

In this concept, there are ample possibilities to create aesthetic value. There are clear and wide view lines from the promenade towards the sea. However, from the ground floor of the houses, the sea is not visible. The 'wall in dune' concept is scarcely integrated: in a structural way, the flood defence is not combined with other functions, except for the floor of the beach restaurant. In this solution, therefore, agreements on responsibilities and finance are less complicated than in case of a structure with a higher degree of integration. The added value regarding the spatial quality of living and recreating is obvious, though difficult to quantify.

CONCEPT 6 'DIKE-IN-DUNE', AS BUILT

The parking garage is located between the dike-in-dune and the boulevard (Figure 6.10). The car parking and the flood defence structures are completely separated (Figure 6.8), so the garage is not a part of the flood defence (type 0). The parking garage, therefore, does not resort under the Dutch Water Act and therefore no requirements apply to the parking garage, relating to flood protection. As a result, it is, from a structural point of view, not a multifunctional flood defence.

The volume of sand of the beach and the dunes mainly provides sufficient protection against flooding (type 1). The expanded beach, the dunes and the dike revetment protect against erosion (type 2). The dike core supports the dike cover layer (type 3). There are material transitions at the lowest points of the dike slopes and geometrical transitions at locations where the slopes of the dike meet the horizontal parts (type 7). Especially the material transitions need extra attention in a more detailed quantitative structural verification.

There is no visual relation with the sea, neither from the boulevard, nor from the ground floor of the houses. The effect of lowering the dunes as much as possible by beach nourishment and by the construction of a dike in the dunes, is partly counteracted by re-introducing the dune character through the special shape of the exit points of the garage (staircases and elevators for pedestrians leaving or entering the garage). The parking has sufficient space for all 660 cars.

6.1.4 EVALUATION OF THE CONCEPTS

In the previous sections, the structural aspects of six concepts regarding flood protection were verified. By varying the functions of the structural elements, different concepts were developed, leading to different ways and degrees of integration. With the qualitative structural verification, it was checked, whether the concepts would in principle be able to fulfil the main functional requirements of protecting against floods and solving the parking problem.

The first concept, with a berm in front of the garage, is unnecessarily expensive. If the revetment function is integrated in the water-retaining wall of the garage, a less expensive and less extensive solution is obtained (concept 2). A spatially optimised solution is presented in concept 3, where the boulevard is situated on top of the roof of the parking garage. Concept 4 is a variation on concept 3, but the location of the road and the houses has been switched. In concept 5, the flood defence and the garage are separate structures. The floor of the restaurant protects against erosion. Concept 6, is neither spatially integrated, nor structurally integrated.

For a systematic comparison of the concepts, the following criteria were used:

1. aesthetics;
2. view on the sea from the houses and the boulevard;
3. addition of a leisure function;
4. inconvenience during construction;
5. costs;
6. possibilities to resolve governance issues.

The multi-criteria evaluation can be found in Table 6.1. The weighting factors and scores per criterion are subjective and should be discussed with the client and other stakeholders when desired, in case of a real design case.

6

alternatives:	weighing factor	1. embedded berm		2. deep retaining wall		3. garage under boulevard		4. houses on the garage		5. wall in dune		6. as built	
		score	score x weight	score	score x weight	score	score x weight	score	score x weight	score	score x weight	score	score x weight
1. aesthetics	10%	5	0,5	4	0,4	2	0,2	4	0,4	4	0,4	5	0,5
2. view on the sea	20%	2	0,4	3	0,6	3	0,6	5	1,0	5	1,0	1	0,2
3. leisure function	10%	3	0,3	3	0,3	3	0,3	5	0,5	5	0,5	1	0,1
4. inconvenience construction	5%	4	0,2	4	0,2	1	0,1	5	0,3	2	0,1	5	0,3
5. costs of the flood defence	30%	2	0,6	3	0,9	3	0,9	5	1,5	2	0,6	1	0,3
6. governance issues	25%	1	0,3	1	0,3	1	0,3	1	0,3	4	1,0	5	1,3
Total weighted score per concept	100%		2,3		2,7		2,3		3,9		3,6		2,6

Table 6.1: Multi-criteria evaluation for the Katwijk alternatives

From a structural point of view, the fourth concept ('houses on the garage') is interesting, because it combines three structural functions into the retaining wall. Furthermore, the structure as a whole combines at least four main functions: protect against floods, provide space for living, provide parking space, support a promenade, accommodate restaurants or other leisure functions (shops, game halls, etc.). The largest drawbacks of concept 4 are the costs and the fact that all householders along the boulevard will have to move (albeit to a comfortable house with a view on the

sea). The selection of a preferred concept, however, comprises more aspects than the evaluation of the function of structural elements: the interests of stakeholders and wishes of clients play a role and can be included in a design by carrying out a multi criteria evaluation. The fourth concept offers ample possibilities to create value, so it is very likely to have a high score in such a multi criteria evaluation. The attractiveness of adding houses to the concept, however, is highly dependent on the economical situation: during a conjuncture, adding houses will get a much lower score than during a favourable investment climate. With or without the additional houses, concept four gets a high score and is therefore selected and subjected to a quantitative structural verification in the following section.

6.1.5 QUANTITATIVE VERIFICATION OF THE PREFERRED ALTERNATIVE

Although the objective of this chapter is to validate the method of *qualitative* structural verification, the design step of *quantitative* structural verification is executed for the Katwijk case as well, to demonstrate how it can be ascertained that a proposed alternative is realistic. The quantitative structural verification is broadly explained in this section, while the specific details can be found in Appendix F.

To prevent failure, it is necessary to verify whether of the structure as a whole is sufficiently water-retaining and stable, and that the elements are sufficiently strong. It can now be undertaken to find relevant failure mechanisms by considering the entire structure and the structural elements. The result is shown in Figure 6.12. One should realise that the included secondary elements, such as the garage roof, have to meet the requirements related to flood protection as well as to the parking, restaurant or living objectives, but this research only is focussed on the performance of multifunctional flood defences as a flood defence. Successively, a fault tree can be devised, leaving out the structural elements, see Figure 6.13.

The performance of the structure as a flood defence can be verified using different methods, ranging from a deterministic calculation to a full probabilistic method. For the preferred concept, in this stage of the design, a tentative check suffices. A more detailed quantitative structural verification can take place during later design cycles.

As a first check, it is verified whether the flood defence as a whole is sufficiently water-retaining. This is secured if the water-retaining elements, as well as the transitions and subsoil are sufficiently high and impermeable. The height, in combination with the width, of the dunes in front of the structure should provide a volume of sand that is sufficiently large to withstand a design storm. After the storm, a defined residual dune profile should still be present, to provide extra safety. A first calculation can be found in Appendix F, where it turns out that 30 m wide dunes with a crest height of NAP + 9,00 m are sufficient to protect against a design storm. This implies that the garage structure is not needed as a flood defence.

The advantage of being aware of the possibility of combining different functions into structural elements, is that alternative solutions can easily be generated and

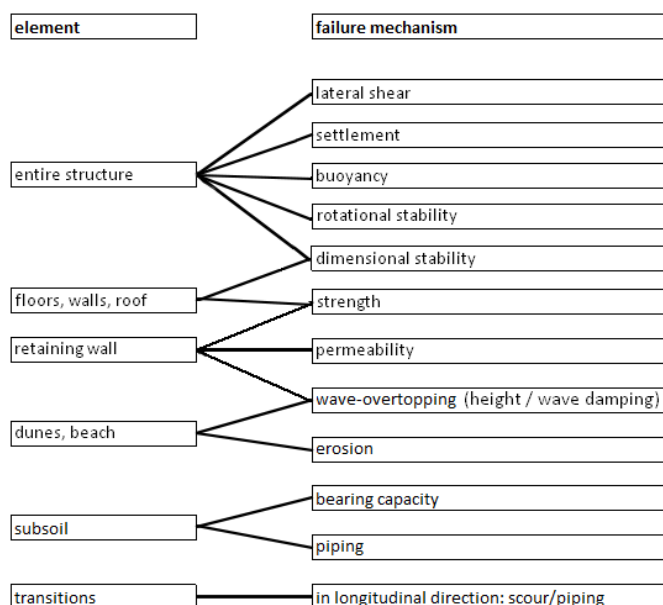

Figure 6.12: Structural elements and potential failure mechanisms for design alternative 4 of the flood defence of Katwijk

evaluated. In this case, applying less dune sand can be considered. The presence of a hard structure can compensate for a shortage of dune volume. This is probably less expensive, as less sand will have to be applied, which could (partly) compensate for the extra costs that are induced by structurally integrating the water-retaining element with the parking garage. Thus, a change of the concept is proposed: the height of the dune crest is modified to NAP + 8,00 m (one metre lower than original). A calculation shows that in this case, the garage structure is indeed required to take over a part of the erosion-protection function (Appendix F). The structure is a fully integrated multifunctional flood defence.

In the Netherlands, erosion of the inner slope of dunes is usually not verified, because erosion of the outer slope would lead to a breach before the inner slope would fail. Furthermore, the dune crest of the concept is relatively wide and situated above the design water level, which makes an inner slope failure due to overtopping waves even less likely. The flood-retaining function is secured, if the structure fulfils the requirements of structural safety (stability + strength). The stability of the entire structure is secured if:

- the structure does not slip aside;
- the structure does not settle or float;
- the structure does not turn over;
- the structure will not be undermined by piping or scour;

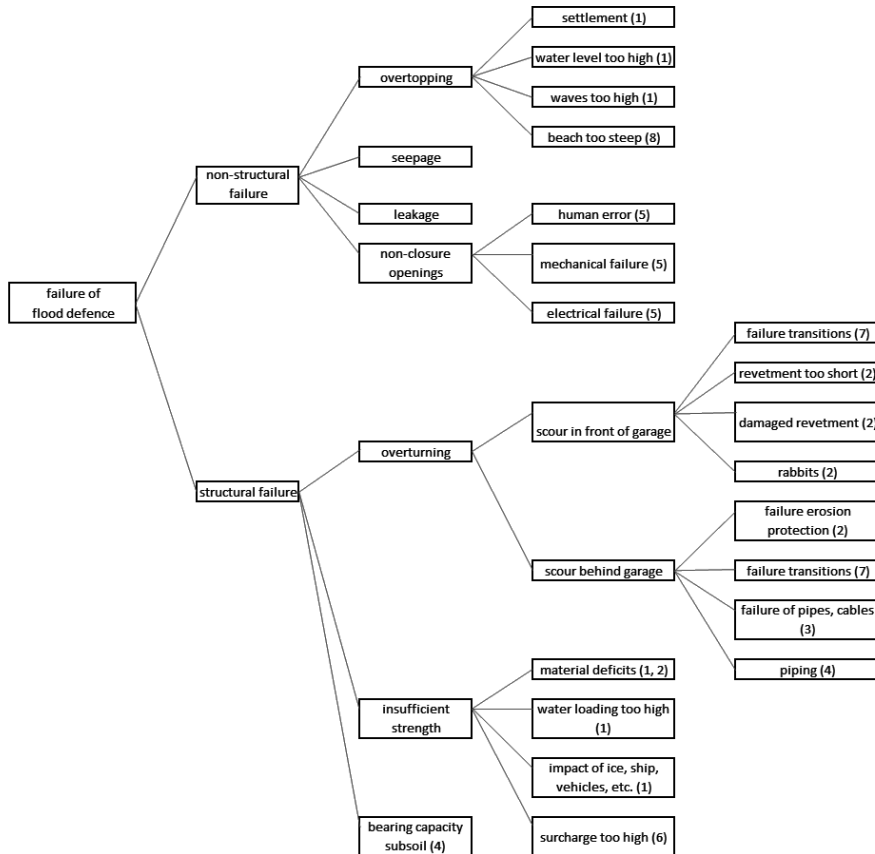

Figure 6.13: Fault tree for design alternative 4 of the flood defence of Katwijk.
All events are connected by 'OR-gates'.

- the structure does not deform unacceptably.

There is sufficient friction under the bottom slab of the building to prevent lateral shear, given the weight and width of the structure. Settlement can be limited to acceptable amounts if there is sufficient bearing capacity. In this case, the dune sand delivers enough bearing capacity, otherwise foundation piles would be necessary to reach a stronger soil layer. Potential uplift of the structure is checked as well. The uplift is caused by displacement of water by the structure (Archimedes' Law) during extreme high water levels and should not exceed the self-weight and ballast of the structure. This is not a problem in the present case. Turning-over does not occur, because the resulting action force does not intersect with the core of the bottom slab (the middle one third of the width of the slab) and the soil does not have to deliver tensile force to compensate the acting loads. It cannot be guaranteed that no

pipings will occur during extremely high water levels, so, in this concept, a seepage screen of 10 m depth is introduced in this concept at the sea side of the structure, under the garage wall.

Deformation is secured by sufficiently stiff elements and by constructing joints according to the mechanical schematisation used for the structural design. Strength of the structural members (including the retaining wall) is provided by the concrete quality, wall thickness, and the steel reinforcement. Relevant transitions are the interfaces between the beach and the bed protection (restaurant floor) and between the bed protection and the diaphragm wall. Other transitions in perpendicular direction are not critical, because the wall itself is able to provide sufficient strength and stability, next to the additional bed protection. Transitions in longitudinal direction of the garage can consist of wing walls to prevent scour just in front of the head walls. This results in a slightly adapted concept 4, which is shown in Figure 6.14.

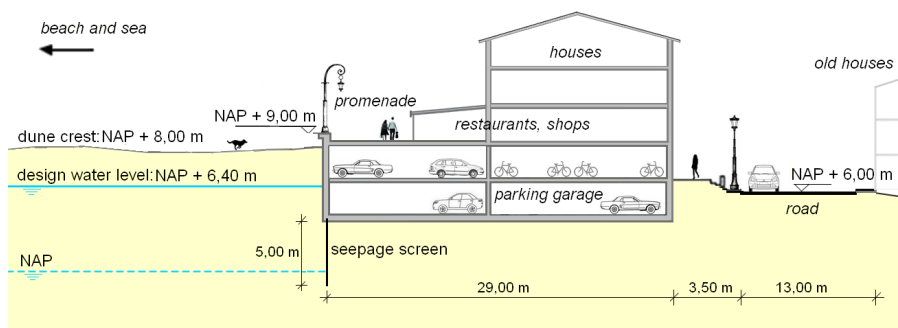

Figure 6.14: Cross-section of the modified concept no. 4 for the Katwijk parking garage

Calculations for the checks of all relevant failure mechanisms can be found in Appendix F.

6.2 CASE STUDY 2: THE ROOF PARK IN ROTTERDAM

6.2.1 EXPLORATION

BACKGROUND

The Roof Park (*Dakpark* in Dutch) project is a redevelopment project on a former marshalling yard in the 'Vierhavengebied' or 'Rechter Maasoever', in the Delfshaven district of Rotterdam (Figure 6.15). The marshalling yard (Figure 6.16) formed a spatial barrier between the old city district (the Bospolder and Tussendijken quarters) and the port area (Mathenesse) of Rotterdam.

The city district directly north of the marshalling yard, Delfshaven, has become a densely populated residential area, with mainly low income and immigrant families.

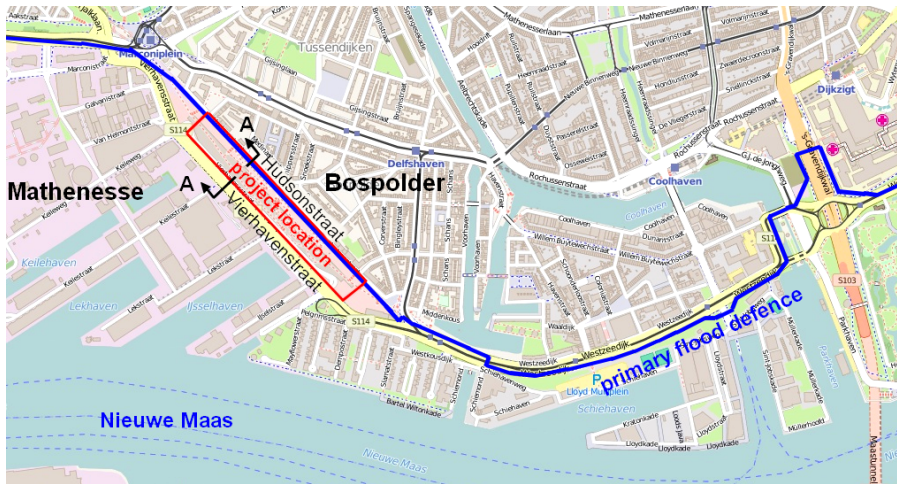

Figure 6.15: Location of the Roof Park in Rotterdam (modified from OpenStreetMap)

About 35 % of the inhabitants are unemployed, three times the average in Rotterdam (12%), and about 25% of the population is younger than 15 years old. This district suffers from criminality, such as car burglaries, robberies, shootings, drugs-use and prostitution. In Delfshaven, the houses are part of rental- and social housing projects, which are in need of renovation while the construction of new houses creates an everlasting construction site. Delfshaven is clearly lacking a green zone (Staring et al., 2002; Wiki Delfshaven, 2014).

6



Figure 6.16: Rotterdam: Original marshalling yard in 1992 (photo: Ben van Wevering)

The flood defence, the 'Delflandse dijk', located between the marshalling yard and the Hudsonstraat (the blue line in Figure 6.15), was assessed and appeared to insufficiently protect against floods, assuming a future sea level rise and taking the

closing regime of the storm surge barriers into account. Therefore, the dike needs to be improved within fifty years.

The marshalling yard had become redundant because of developments of the Port of Rotterdam. The inhabitants of the Bospolder quarter wanted to develop a district park at that location. The Dutch rail-road company, NS, however, wanted to maintain two tracks.

According to Siemerink (2012), the main stakeholders in this project are:

- The municipality of Rotterdam, the client of this project. The Roof Park project is part of a large plan that aims at reviving the old city harbour districts of Rotterdam. The City Harbours project is an extensive programme in which the city of Rotterdam transforms old port areas and industrial areas into high quality mixed use urban areas;
- The Dutch Ministry of Infrastructure and Environment is an important grant provider of the project. It has recognized the development of Rotterdam City Ports as a project of national importance as it contributes financial support out of various grant programs to the redevelopments projects;
- The Water Board of Delfland is responsible for the Delflandse Dijk, which is part of dike ring 14;
- Residents of the Bospolder-Tussendijken city quarters, who strive for a community park on the former rail yard since 1998;
- The Port Authority of Rotterdam is the original land owner and initiated the business development in this area.

6

DESIGN OBJECTIVE

The objective of this project was to improve the viability of the city district of Delfshaven, and particularly of the Bospolder quarter: more green space and recreational spaces. The local economy had to be improved, to be achieved by creating a shopping area and parking facilities. The initial wish to create offices was apparently dropped, as they were not included in the final design. The barrier between the city district and the port had to be made less apparent. The flood defence function had to be maintained and possibly improved, anticipating on future developments.

6.2.2 DEVELOPMENT OF CONCEPTS

The development of the concepts for the roof park was restricted by the project location: the boundaries are indicated in Figure 6.15 and the cross-section A-A in the middle of the area, in between the Vierhavenstraat (in the south-west) and the Hudsonstraat (in the north-east) was studied in detail. The idea of creating a park on the roof of a parking garage or a shopping mall was maintained in all concepts, respecting the requirement of the Dutch rail-road company to maintain two tracks. This enables a good comparison of concepts with the realised alternative.¹ Parallel

¹In reality, the Dutch rail-road company later abandoned their ideas to maintain the tracks after the design had been completed. If the company would have done that earlier, the park would most probably

to the dike, a district heating pipeline for collectively heating the houses exists, which should be considered in the new design as well.

The present research developed four concepts and studied the realised alternative, to be called concept number five. The different concepts were obtained by varying the degree of integration of functions and by varying the role of structural elements regarding flood protection. Meanwhile, other aspects were combined in the design to achieve the design objective.

A main structural element is the water-retaining element. Its minimum height is related to the governing water level, including the expected effect of sea level rise. The water board assumes a design water level of NAP + 4,35 m in 2100, which is about 1 m above the present street level (Vierhavenstraat). The significant wave height is expected to be less than 0,5 m, regarding the long approach distance of waves in very shallow water.

In the different concepts, the location of the water-retaining element varies from the front, via an intermediate position somewhere in the multifunctional complex, to the rear. This variation has consequences for the connectivity between the different parts of the complex, the location of entrances to the complex and the location of the complex (or parts of it) in- or outside the flood-protected area. In longitudinal direction, the water-retaining wall as part of the flood defence has to connect to the existing dike for the continuity of the flood defence system.

The developed concepts are explained in the following subsection, combined with their qualitative structural verification.

6.2.3 QUALITATIVE STRUCTURAL VERIFICATION OF THE CONCEPTS

CONCEPT 1 'FLOOD-RETAINING GARAGE WALL'

In the 'flood-retaining garage wall' concept, a shopping mall is created at the location of the former marshalling yard. The parking garage is located at the water side of the complex and the shops are located at the same level on the land side (Figure 6.17). A green park is located on the roof of the complex, including a playground for children, a barbecue site, a sunbathing meadow, a barbecue site, a field for ball games and a skate park. The ground surface gradually mounts up, starting at street level of the Vierhavenstraat at NAP + 3,75 m, reaching a level of NAP + 10,00 m above the shops. The shops are located at the land side for a good accessibility from the adjacent city quarters. The parking garage is located at the Vierhavenstraat and is accessible from the head ends of the complex, therefore it does not increase traffic in the Hudsonstraat and other parts of the Bospolder city quarter.

The former dike is abandoned as a primary flood defence and is replaced by a water-retaining wall plus seepage screen at the Vierhavenstraat side of the complex. The pipes of the district heating system are moved a few meters towards the Hudsonstraat, creating extra space for the shopping complex. The reinforced concrete

have been realised at ground level, with the flood defence as a playful line element.

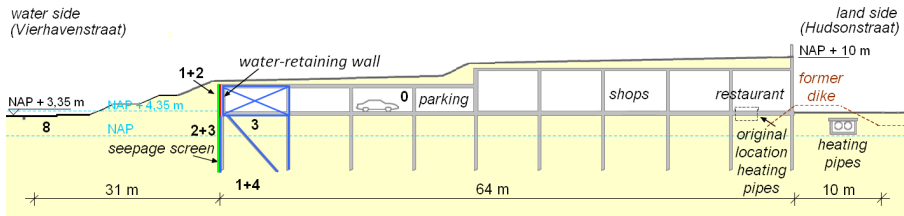

Figure 6.17: Design concept 1: Flood-retaining garage wall

wall at the rear side of the garage is the water-retaining element of the flood defence (type 1), which locates the complex at the safe side of the flood defence. A sheet-pile seepage screen (type 3) protects against piping during extreme conditions. The rear wall and the seepage screen protect against erosion (type 2) if the soil in front of it would have washed away during a storm, which is very unlikely because no waves of considerable height can reach the complex.

Stability of the water-retaining wall is provided by adjacent structural elements, specifically the roof, the floor, the walls in transverse direction and the foundation piles, including oblique piles that resist the horizontal soil and water pressures (type 3 elements). The other parts of the complex are not needed to provide stability for the flood-retaining wall (type 0). Transitions in cross-direction seem not very troublesome, but transitions in length-direction need extra attention because they have to connect with the existing primary flood defence on both sides of the shopping mall (not indicated in the cross-section).

6

CONCEPT 2 'SEPARATE FLOOD-RETAINING WALL'

The 'separate flood-retaining wall' concept resembles the first concept, but the parking garage is located at the side of the Hudsonstraat and the old district heating pipes remain in their original place, which requires a floor level higher than the pipes (Figure 6.18). Leaving the pipes at their original location saves much costs, as moving city pipes is very expensive (van Veelen et al., 2015). The heating pipes are still accessible through hatches in the garage floor. The shops are located behind the garage, which makes access easy from the parking garage, but no daylight can enter the shops. This could be acceptable for a supermarket, but not for a restaurant. Therefore, the restaurant, and possibly a teashop as well, are located on top of the complex. On the roof of the garage there is place for vegetation and leisure, as in the first concept.

The water-retaining wall (element type 1 + 2) is structurally separated from the shopping complex. It is stable on itself (type 3) and it needs no support from the shopping complex structure. The separation of functions could facilitate arrangements regarding responsibilities and financing. However, this concept is inefficient regarding costs, because of the double wall (i.e., the retaining wall has to be deeper and thicker than an integrated wall).

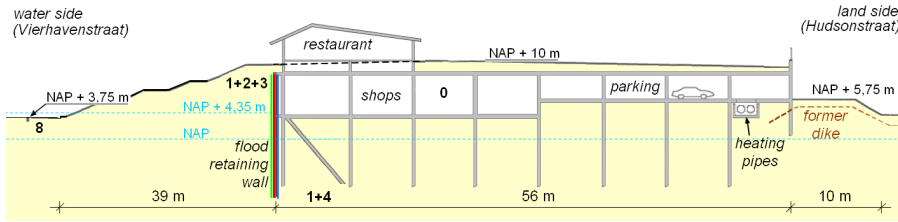

Figure 6.18: Design concept 2: Separate flood-retaining wall

CONCEPT 3 'FLOOD-RETAINING BACK WALL'

In the 'flood-retaining back wall' concept, the slope starts at ground level at the Hudsonstraat side and goes up towards the side of the Vierhavenstraat. To create a wider green area at the side of the Hudsonstraat, the structure of the complex is more 'compacted' than in the previous concepts, which is achieved by piling up part of the shops on the garage. This allows day-light in part of the shops and creates the possibility of an 'indoor' restaurant at the Vierhavenstraat. As before, green and leisure functions can be located on the roof of the complex. The heating pipes were moved towards the shopping complex, as a result of which the ground level can be lowered and (part of) the excavated soil can be used to cover the roof. Multi-storey apartment blocks with private parking garages can optionally be built at the Hudsonstraat side. This was not required, but could create extra value for the project.

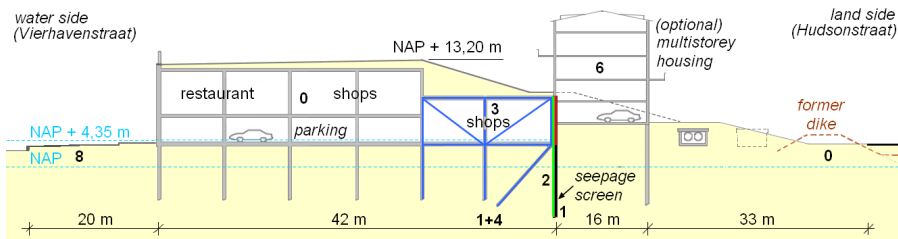

Figure 6.19: Design concept 3: Flood retaining back wall

The water-retaining wall (element type 1) is situated at the rear side of the shopping complex, which is at the side of the Hudsonstraat. A seepage screen under the water-retaining wall prevents piping (type 2). The water-retaining wall is integrated with the multistorey housing blocks, which implies that a part of the weight of the housing blocks (type 6) causes extra vertical loading on this wall. The shops adjacent to the water-retaining wall have a supporting function, allowing for a shorter and slender retaining wall.

CONCEPT 4 'FLOOD-RETAINING INTERMEDIATE WALL'

The last concept created for this research, the 'flood-retaining intermediate wall', resembles the first concept, but the water-retaining wall is in the middle of the complex (Figure 6.20). The parking is located at the Vierhavenstraat side and the shops are at the other side. The parking garage and the shops are located at the same level, which is convenient to reach the shops from the parking garage and vice versa. The heating pipes are moved towards the Hudsonstraat, to create space that allows construction of the entire complex at ground level. As in concept 3, multi-storey housing blocks are an optional addition to the design. Green and leisure functions are located on the roof of the shopping complex.

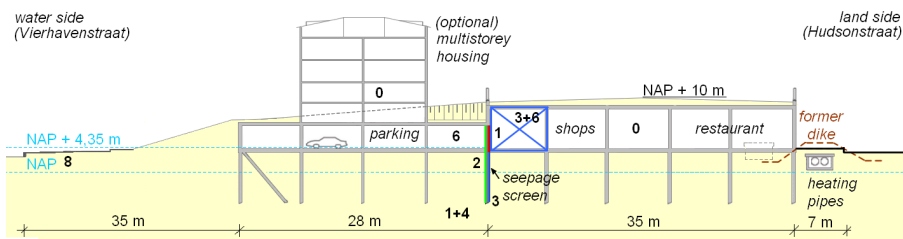

Figure 6.20: Design concept 4: Flood-retaining intermediate wall

6

The intermediate wall between the parking and the shops is the water-retaining wall of the flood defence (type 1), which requires door openings in the wall to allow people to pass from the garage to the shops and to allow supply of the shops. The openings have to be closed-off by gates in case of high water. The water-retaining wall is horizontally braced by the shop complex and vertically by foundation piles (type 3). A seepage screen below the water-retaining wall prevents against piping (type 2).

CONCEPT 5: THE REALISED ALTERNATIVE

The actually built alternative is a multifunctional building and has been combined with a shopping boulevard, a playground, a neighbourhood garden and a Mediterranean garden with an orangery. A retail space of 25 000 m² has been created under the city park. A car park for about 750 cars has been integrated into the structure (Figures 6.21 and 6.22). The gardens bring nature into the district and the project as a whole will increase employment. The Roof Park has a length of 1200 metres, a width of 85 metres and a height of 9 metres. The design has been carried out by DURA Vermeer and the master plan has been made by Buro Sant en Co. Construction of the structure has been completed in 2013 (Stichting Dakpark Rotterdam, 2012).

The Water Board of Delfland initially strongly opposed this project, but it was finally realised after all, under pressure of the Rotterdam Municipality. The water board has only been involved as a licensing authority and the municipality promised to



Figure 6.21: Rotterdam: The shops of the Roofpark with the park on the roof, view to the south-east, April 2016

pay the extra costs of the future strengthening of the flood defence (Siemerink, 2012).



Figure 6.22: Rotterdam: The park on the roof of the shopping complex, view to the north-west, April 2016

The shops and the park are integrated, as can be seen in Figure 6.23. The water retaining function, however, is performed by the original dike only. The dike is embedded in a larger body of soil, to not affect the original geometry. The Roof Park therefore is not a fully integrated multifunctional flood defence. The 'theoretical dike profile' contains all elements as present in normal dikes: a water-retaining and erosion-protecting clay cover (types 1 + 2), a supporting dike core (type 3), subsoil that should provide bearing capacity (type 4) and geometrical transitions (type 7). The soil on the theoretical dikes causes extra loads and settlement (type 6).

6.2.4 EVALUATION OF THE ALTERNATIVES

The main differences of the concepts regarding flood protection are the degree of integration of functions in the flood defence and the location of the flood defence in

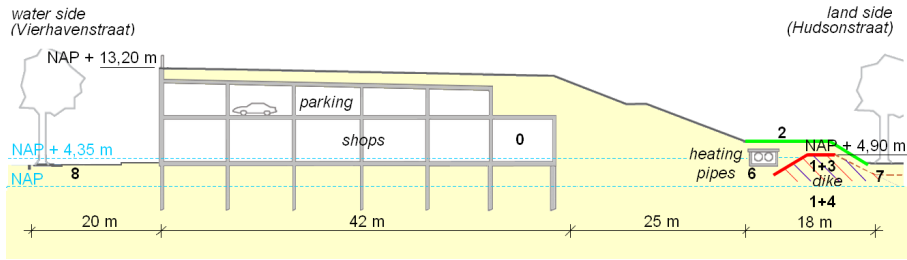

Figure 6.23: Rotterdam: cross section of the 'Roof Park', after Van Veelen (2012)

the cross-section. From a structural point of view, it is very attractive to combine the flood defence with the shopping complex. For reasons of governance, however, it could be preferred to separate the structures. This, however, leads to a less efficient structure in terms of costs (double walls) or space.

If there is enough space, the entire complex can be built at ground level to allow easy access to the shops from the garage, instead of elevators and stairs to be used in a two-storey complex. A one-level complex decreases the total height of the structure, which has the advantage of reducing the barrier function between the city quarter (Hudsonstraat) and the harbour side (Vierhavenstraat).

Regarding the location of the water-retaining wall, it is preferably located as near to the water as possible, because it will protect a larger area, including the shopping complex. If an intermediate wall would be preferred as flood-retaining wall, only a part of the complex, preferably the shops, will be sufficiently protected against floods, and another part will be located outside the protected area, preferably the parking garage, which will reduce the damage in case of a flood.

If removal of the original dike and integration of the flood protection function in the shopping complex would be allowed, it would create more design freedom. The same applies to the possibility of translocating the district heating pipes. There are ample possibilities to create and vary green and leisure areas, and even to add extra houses. The multistorey houses should not be designed as a closed front, because it would increase the barrier function of the complex and decrease the green area. Housing blocks are therefore preferred.

The orientation of the entire complex is an important consideration for the design. It seems the most logical option to locate an inclining green (grass) plane at the side of the parking garage and the shops/restaurant at the other side where natural light can come in. It should be decided what part of the complex would be located at the side of the city district: the green slope or the façades of the shops. The contrast between the two possibilities is large: the green slope would create a restful, relaxed atmosphere, while the shops and restaurants are lively and active. Both possibilities have their own advantages.

The structure of concept 1 is very efficient in space and cost and locates the shopping complex behind the flood defence. It allows for supplying the shops from

within the parking garage. A disadvantage of this concept is that the heating pipes will have to be displaced, which is supposedly very expensive. If desired, during a period of economical growth, multistorey housing blocks, as proposed for concepts 3 and 4, can be combined in concept 1. A motivation for preferring concept 1 is given by the multi-criteria evaluation as shown in Table 6.2. Figure 6.24 shows the preferred concept.

alternatives:	weighing factor	1. flood retaining garage wall		2. separate flood retaining wall		3. flood retaining back wall		4. flood-retaining intermediate wall		5. realised alternative	
		score	score x weight	score	score x weight	score	score x weight	score	score x weight	score	score x weight
1. barrier function of the complex	20%	4	0,8	4	0,8	1	0,2	3	0,6	1	0,2
2. complex flood-protected?	15%	5	0,8	5	0,8	1	0,2	3	0,5	1	0,2
3. reachability shops from parking	20%	5	1,0	4	0,8	3	0,6	5	1,0	3	0,6
4. displacement heating pipes	10%	5	0,5	4	0,4	1	0,1	1	0,1	5	0,5
5. costs of the flood defence	15%	5	0,8	3	0,5	3	0,5	2	0,3	5	0,8
6. governance issues	20%	2	0,4	2	0,4	1	0,2	1	0,2	5	1,0
Total weighted score per concept	100%		4,2		3,6		1,7		2,7		3,2

Table 6.2: Multi-criteria evaluation for the Dakpark concepts

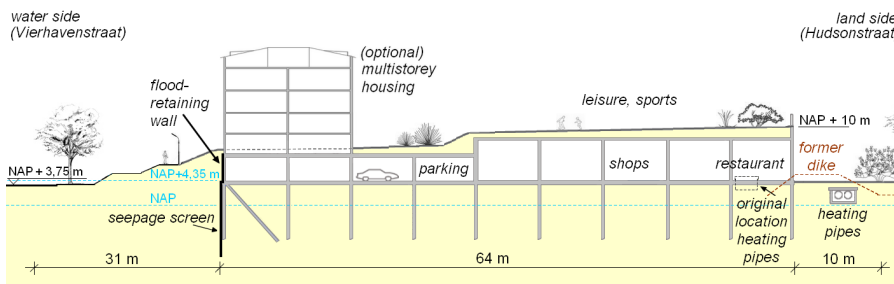

Figure 6.24: Rotterdam: cross section of the 'Roof Park', concept 1 with optional housing blocks

6.3 CASE STUDY 3: DE BOOMPJES, ROTTERDAM

6.3.1 EXPLORATION

BACKGROUND

The 'Boompjes' is a major thoroughfare in Rotterdam along the Nieuwe Maas river, the extension of the Maasboulevard between the present Erasmus bridge and Willems bridge (Figure 6.25). It is part of an extension of the medieval town and the harbour of Rotterdam, originally outside the diked area. A promenade

was constructed in 1615, in between the Leuvehaven and the Oude Haven, which was planted with a double row of linden trees. Willows were planted nearer to the water. Hence the name of the road, 'Boompjes', which means 'Small trees'. From 1787, the leisure function of the promenade was suppressed by the traffic function, that had increased after construction of the Willemsbrug (Williams Bridge) in 1878. Ferries to England used to depart and arrive at the Boompjes until the end of the nineteenth century, when the town of Hoek van Holland took over this function.

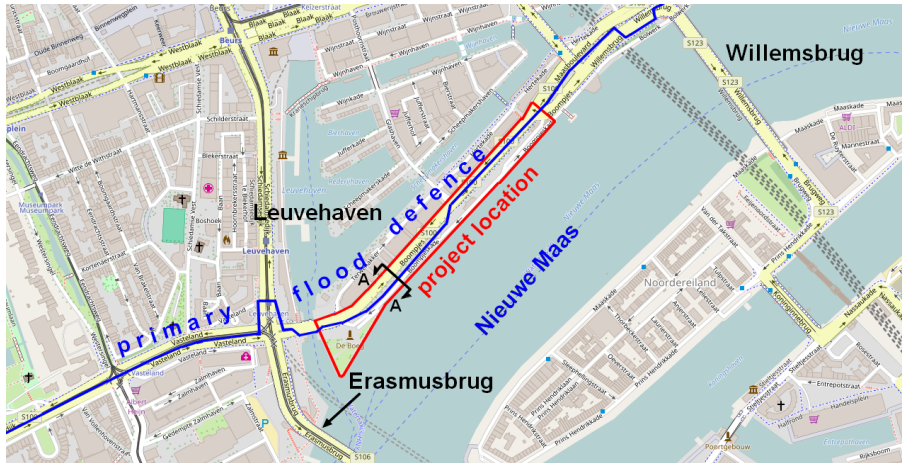

Figure 6.25: Location of the Boompjes in Rotterdam (modified from OpenStreetMap)

The Boompjes was severely damaged during the WWII bombing of Rotterdam by the German military in 1944. At present, the building of the former headquarters of Nedlloyd (called the 'Willemswerf'), the offices of Rijkswaterstaat Zuid-Holland and a branch office of De Nederlandsche Bank are located along the Boompjes. There are several restaurants, a deep parking garage and a berthing place for the water taxi. There are plans to construct a new building of 110 m height with space for 344 apartments, called 'The Terraced Tower' because of its many green terraces.

The old primary flood defence of Rotterdam was formed by the Schielandse Hoge Zeedijk, including the Hoogstraat, which runs over the original dam in the Binnenrotte river that gave its name to Rotterdam. After completion of the reconstruction of the destroyed city of Rotterdam, in 1961, the Maasboulevard and the Boompjes became the new primary flood defence. This implies that it complies to the requirements related to flood protection of dike ring 14. Since 1997, the area is extra well protected against storm surges from the sea by the Maeslant movable barrier.

The Boompjes, that used to be a nice esplanade along a lively harbour, became a windy, dreary area, cut-off from the city by the traffic and, thus, avoided by people. The area has been restructured around 2010 and the Boompjes currently consists of a four-lane road for motorised traffic, a bicycle lane, a pedestrian path, a grass-covered slope (that can be used as a sun-bathing field in summer) and a paved lower quay that is suitable for running, skating or boarding activities (see Figure

6.26, which does not show the slope and the lower quay, and Figure 6.27). The lower quay forms a mooring place for river cruise boats. At the south-western end of the boulevard, there are several restaurants, a mostly closed 'event location' near the water and a sports club near the Willems bridge.



Figure 6.26: Rotterdam: the Boompjes seen in western direction, November 2016

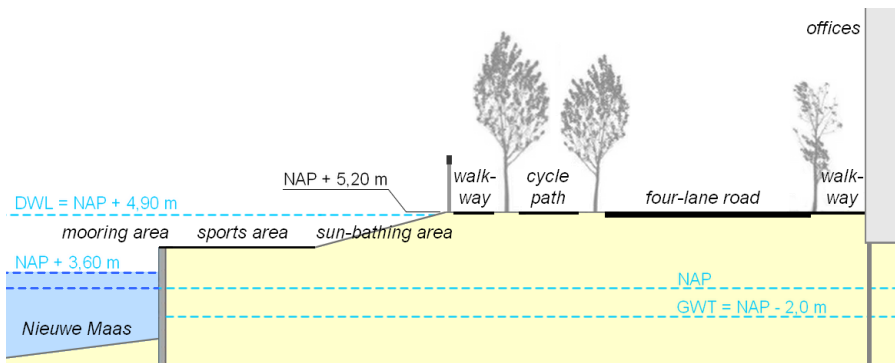

Figure 6.27: Rotterdam: cross-section of the Boompjes seen in western direction, November 2016
DWL = design water level; GWT = ground water table

The municipality of Rotterdam is owner of the ground in the project area; the Water Board Schieland and Krimenerwaard (HHSK) is responsible for the flood protection provided by the dike. The entire public space of the Boompjes resorts under the jurisdiction of HHSK. Rijkswaterstaat manages the river bank line, the boundary of the Nieuwe Maas as a shipping route. (De Urbanisten et al., 2010; Stichting Vers Beton, 2015)

DESIGN OBJECTIVE

The municipality of Rotterdam has studied possibilities to reintroduce the promenade by diverting car traffic through a tunnel. The objective apparently was to involve the Boompjes in the 'urban fabric' by taking away, or reducing, the barrier that is presently formed by the four lane road, the pedestrian and cycle paths, and by replacing it by urban functions, such as leisure, recreation and sports.

A good connection with the road over the Willems bridge is indispensable, but this part of the design is not considered in the present research, as it would make the case study unnecessarily complex to demonstrate the development and verification of concepts for this multifunctional flood defence with the help of distinguishing structural elements.

6.3.2 DEVELOPMENT OF CONCEPTS

Three concepts were developed for the present dissertation and two existing concepts were added that were developed by 'De Urbanisten', an office for urban research, design and landscape. A starting point for the new development of concepts for the Boompjes is that the throughway traffic is directed via an open or a closed tunnel, more or less at the location of the present road. This frees the area at street level for the creation of attractive space for citizens and tourists in front of the offices. Possibilities for development are: an amusement park with for example a Ferris wheel, a pancake house and carousel; a park with a tea house, playgrounds and a pond with fountains; or a sports area for running and skating, a sunbathing field and a skateboarding park. It is, however, a challenge to create a recreational park area that is attractive at every time of the day and during all seasons. Therefore, a combination of activities that change with the seasons would work best (for example, use the sun-bathing field in summer as an ice rink in winter). This research focusses on spaces for these activities and concentrates on the alternatives that can be combined with the structural functioning of the flood defence.

The capacity of the tunnel remains the same as the present ground-level road, which consists of two lanes in each direction. Including two emergency walkways and an intermediate wall, the entire width of the tunnel becomes about 16,00 m. The required net height of a closed tunnel is about 4,50 m, which includes a clearance of 0,50 m (COB, 2015). The traffic situation near the Willems bridge is complex, but is outside the scope of this case study, which concentrates on cross-section AA in Figure 6.25. In the cross-section, the distance between the quay and the buildings is about 50 m. The present ground level near the buildings north of the road is at NAP + 5,20 m and the ground water table there is at NAP - 2,00 m. The average water level in the Nieuwe Maas is about NAP + 1,00 m and the design water level at present is NAP + 3,60 m, but anticipating a mid-scenario climate change, the design water level at the end of the design life time (100 years) becomes NAP + 4,20 m, assuming that the rise of the water level near the Boompjes is the same as the mid-scenario rise of the sea level. *A better motivated design water level prognosis is required for a more detailed design cycle. The flood defences adjacent to the Boompjes*

should be adapted as well to provide sufficient flood protection of the hinterland. The freeboard, required to limit wave overtopping to a reasonable discharge of 10 l/s/m, is about 0,70 m (for vertical walls as well as for slopes,², assuming a significant wave height of 0,75 m. This brings the required crest level of the flood defence at NAP + 5,50 m (including an additional height for robustness and length-effect).

6.3.3 QUALITATIVE STRUCTURAL VERIFICATION OF THE CONCEPTS

CONCEPT 1 'LOWERED ROAD'

In 'lowered road' concept, the road is situated as near to the river as possible, to create the widest possible area behind the road for leisure and green functions (Figure 6.28). The road is situated at a lower level than the promenade/leisure part, to reduce visual and noise hindrance from the traffic for people on the higher part. The initial idea was to make it even deeper, but that would cause uplift of the road during high water levels (see concept 2). The road is situated at a level that will on average be exceeded once per 100 year, which is about NAP + 3,4 m. The second wall will retain water levels up to a level with an exceedance probability of 1/10 000 (NAP + 5,50 m), which complies with the legal safety standard of the concerned dike ring area.

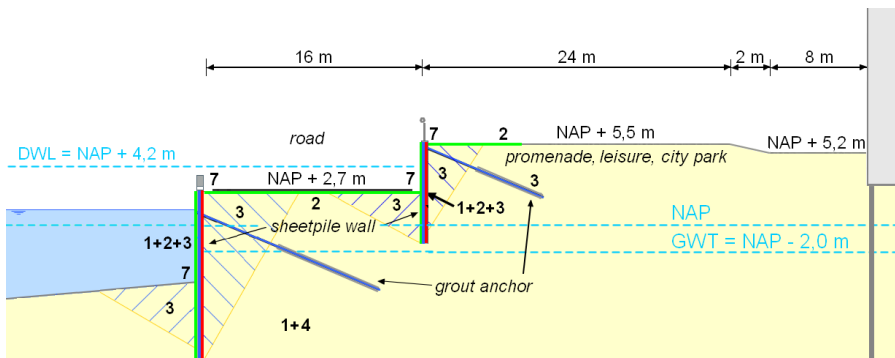

Figure 6.28: Rotterdam, De Boompjes: Design concept 1 'lowered road'

The two sheet-pile walls of this concept are water-retaining elements (element type 1), together with the subsoil. These steel elements protect themselves against erosion (type 2) and the road in between the two walls prevent scour by overtopping waves. The sheet-pile walls partly provide their own stability by embedment in the soil, and grout anchors provide extra support (type 3). Several geometrical transitions are located right in front of and behind the sheet-pile walls (type 7).

There are many possibilities for a promenade and a city park in between the road and the buildings: there is a strip of 34 m width available. The level difference

²The overtopping height for a vertical wall has been calculated with the method of Franco et al. (1994) and for a slope with the method of the European Overtopping Manual (2016).

The sheet-pile wall at the river side under the open tunnel provides extra stability because it reduces the uplift force (type 3).

CONCEPT 3 'LOW PROMENADE + ROAD TUNNEL'

A road at a higher or lower ground surface level, as in the first two concepts, remains a barrier between the city and the river, despite the attempts to minimize this disadvantage. Therefore, a road tunnel was developed as concept no. 3 (Figure 6.30), locating the road below ground level, out of sight.

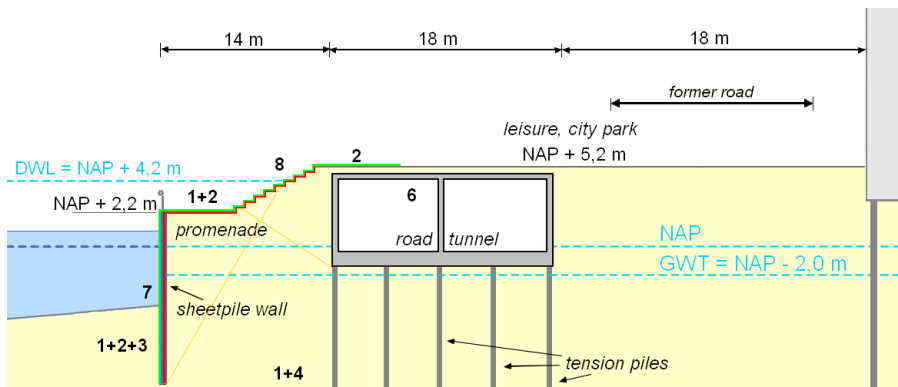

Figure 6.30: Rotterdam, De Boompjes: Design concept 3 'low promenade + road tunnel'

The promenade is located directly along the river, at a relatively low level. This is done because of two reasons: firstly, it improves the visual relation of pedestrians on the promenade and the park, as the vertical distance between them is relatively small (only 1,2 m regarding the average water level at present). Secondly, it increases the experience and awareness of the dynamics of nature, because the promenade at this height will on average flood every 10 years and even more frequently if the average river level would rise in the future. The road tunnel is located at a distance from the river, otherwise, if it would be located under the low-lying promenade, it would require a deep construction and additional measures to prevent uplift.

The sheet-pile wall is the water-retaining element of the flood defence, together with the promenade and the stairs that lead to the required height regarding flood protection (element type 1). These elements protect against erosion by waves and currents, or by overtopping waves (type 2). The sheet-pile quay wall provides its own stability by embedment in the subsoil (type 3). Because of its limited retaining height (about 6 m), support by anchoring is not necessary. The promenade reduces the wave height (type 8), and thus the retaining height can be slightly lower than in the previous concepts. The passive soil pressure zone of the tunnel crosses the active zone of the quay wall, as the tunnel applies extra loads on the quay wall (type 6).

The area available for sports, recreation, etc. in this concept is quite large, with the

is located at a distance from the river (as in concept 4) and the quay wall is not intended to retain floods (Figure 6.32). The flood-retaining function is fulfilled by a diaphragm wall in front of the tunnel. The quay is located at a relatively low level of NAP + 2,8 m, but the crest of the flood defence is higher than in the previous concepts: at NAP + 7,6 m. This can be explained by assuming an extreme scenario for the rise of the river water during the design life time of 100 years. A less extreme scenario results in a retaining height equal to the top of the tunnel structure (NAP + 6,6 m).

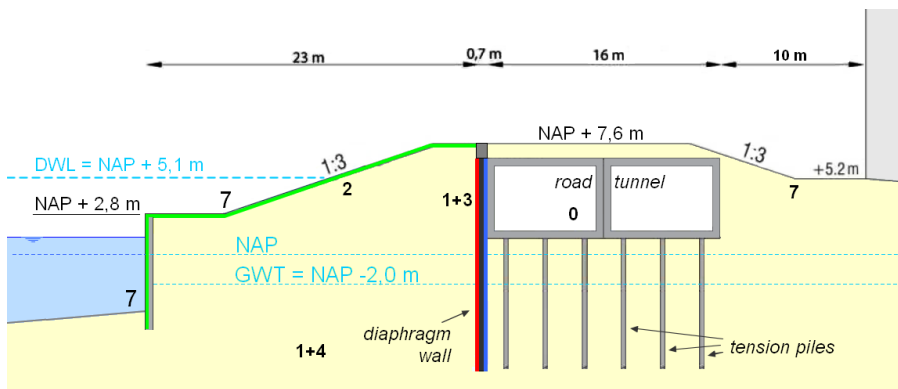

Figure 6.32: Design concept 5, as proposed by De Urbanisten (modified from De Urbanisten et al. (2010))

The diaphragm wall is water-retaining (element type 1), and provides self-stability (type 3), even if the tunnel would not be present, during construction or demolition. The slope towards the river and the quay wall protects against erosion (type 2). The motorised traffic passes through the tunnel (type 0) and much space is available for recreation, sports and vegetation. The tunnel is located below the present road.

CONCEPT 6: 'ROAD TUNNEL NEXT TO THE RIVER', AS PROPOSED DE URBANISTEN

The 'Road tunnel next to the river' concept, generated by De Urbanisten et al. (2010), is shown in Figure 6.33. The motorised traffic is directed through a road tunnel, as in the three preceding concepts. However, the tunnel is located directly along the river. The ground level rises from the present level of NAP + 5,2 m near the buildings to the level of NAP + 7,6 m, which would be required to retain a design water level that corresponds to an extreme water level rise scenario. For a less extreme scenario, NAP + 6,6 m would be sufficient.

The tunnel wall adjacent to the river is a water-retaining element, as well as the sheet-pile wall under the tunnel (bordering the river) (element type 1). The sheet-pile wall protects against erosion (type 2) and provides resistance against resulting loads in horizontal direction (type 3). The tunnel and its foundation piles provide resistance against horizontal loads, but raking piles need to be added to prevent intolerable lateral displacement (type 3). The foundation piles function as tension piles to prevent uplift during high water levels. The second, inland, tunnel tube is

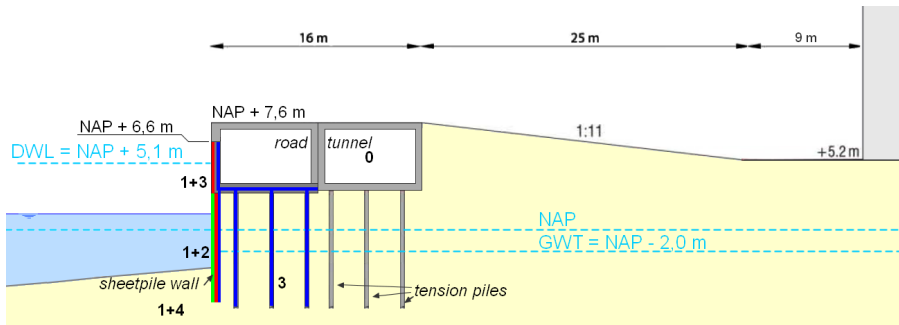

Figure 6.33: Design concept 6, as proposed by De Urbanisten (modified from De Urbanisten et al. (2010))

separated from the other tube, so it is considered not to influence the flood defence in a structural sense. A transition (type 7) from the sheet-pile wall towards the river bed could be a vulnerable spot for scour due to turbulence caused by ship propellers.

In this concept, the tunnel is integrated with the flood defence, which is efficient in the use of materials and construction. It is a robust design, intended to be safe for the worst prognoses of water level rise, resulting in a relatively high ground level, as in the previous concept. It enables the use of the entire Boompjes area of 50 m wide for leisure, recreation and sports activities.

6

6.3.4 EVALUATION OF THE ALTERNATIVES

All concepts can be detailed in such a way that they meet all requirements, but the differences become clear during the evaluation of the concepts. Firstly, the area available for recreation and sports functions differs: the concepts with road tunnels score considerably higher than the concepts with the road at ground level, albeit a lowered ground level. Secondly, the positively experienced relation with the water is stronger for the concepts, where the promenade is located adjacent to the river. A lower level of the promenade increases an awareness of the dynamism of the river, as the promenade will once in a while be flooded and strengthen the relation with nature. Thirdly, the inconvenience coming from motorised traffic is minimal for the concepts with a road tunnel. Fourthly, constructability scores higher in concepts where the open or closed tunnel is located aside of the present boulevard. Finally, regarding costs, the tunnel concepts are the most expensive.

Concluding, it can be stated that concepts 1 and 2 are interesting in case of a tight budget. Concept 3 scores relatively well, but the various functions are structurally not integrated. Concepts 3 and 4 score low on integrality, because the water-retaining element is separated from the road tunnel. Concepts 4 and 5 are difficult to construct without traffic disruption or expensive temporary roads, as the tunnel is located under the present road. Concepts 5 and 6 are unnecessarily expensive regarding their relatively high retaining height (extra sand is required to

raise the ground level). The water-retaining wall of concept 6 is separated from the tunnel wall, which is not cost-effective.

Based on the evaluation of the chosen criteria, concept 3 'low promenade + road tunnel' seems to offer the best possibilities, but the score does not differ too much from concepts 4 and 6, see Table 6.3. Possibilities, furthermore, are to re-introduce the original character of the old 'Boompjes' area, by planting two rows of linden trees. An example of adding a leisure function in the form of an amusement park is indicated in Figure 6.34, but there are many more possibilities. The realised alternative can easily be adapted if the assumed scenario for water level rise will appear to be too low after time. The capacity of the tension piles will initially have to be over-dimensioned, otherwise the concept cannot be adapted in future.

concepts:	weighing factor	1. lowered road		2. open tunnel		3. low promenade + road tunnel		4. tunnel + separate quay wall		5. road tunnel with low promenade		6. road tunnel next to river	
		score	score x weight	score	score x weight	score	score x weight	score	score x weight	score	score x weight	score	score x weight
1. width recreational area	20%	2	0,4	2	0,4	4	0,8	4	0,8	5	1,0	5	1,0
2. relationship with the river	15%	2	0,3	3	0,5	4	0,6	3	0,5	5	0,8	3	0,5
3. disturbance by traffic	15%	1	0,2	3	0,5	5	0,8	5	0,8	5	0,8	5	0,8
4. disturbance during construction	10%	5	0,5	5	0,5	4	0,4	1	0,1	1	0,1	5	0,5
5. costs flood defence	20%	4	0,8	3	0,6	4	0,8	4	0,8	3	0,6	5	1,0
6. governance issues	20%	1	0,2	1	0,2	3	0,6	5	1,0	3	0,6	1	0,2
Total weighted score per concept	100%		2,4		2,6		4,0		3,9		3,8		3,9

Table 6.3: Multi-criteria evaluation for the Boompjes concepts

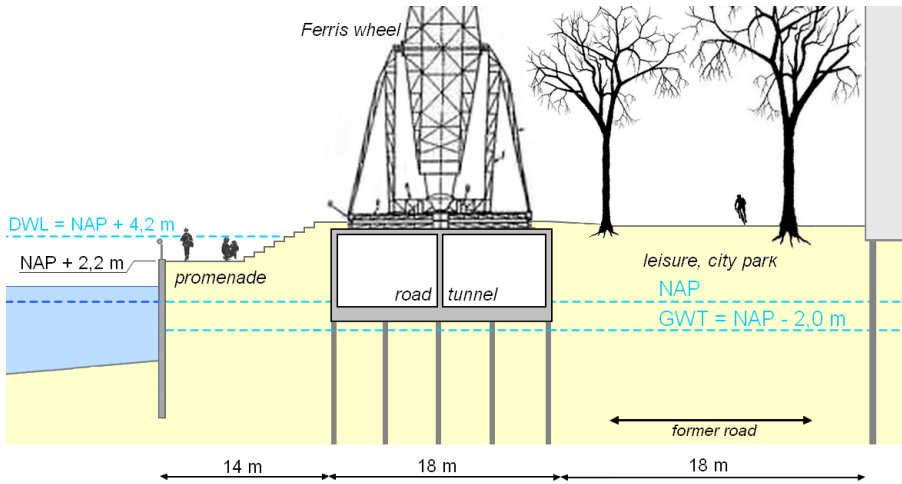

Figure 6.34: Optimised design concept for the Boompjes, based on concept 3

6.4 CASE STUDY 4: MERWEDE DIKE SLIEDRECHT

6

6.4.1 EXPLORATION

BACKGROUND

Sliedrecht is a town in the province of South Holland, located along the Beneden Merwede, which is a branch of the Rhine river (Figure 6.35).

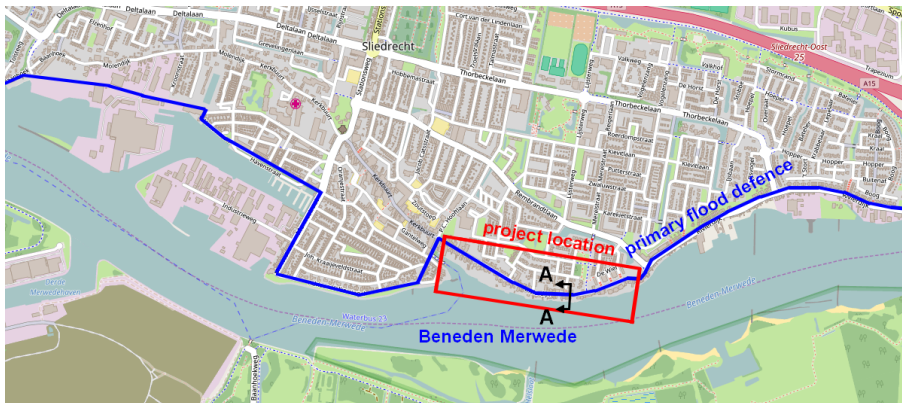

Figure 6.35: Map of Sliedrecht, indicating the project location (modified from OpenStreetMap)

Sliedrecht is part of the Alblasterwaard region, which features a strong maritime character, as it is the birth place of many large dredging companies and at present houses the Dredging Museum. The region has an important agricultural sector and

a rich cultural-historical identity. Over time, the Merwede dike has been colonised by the people as a safe place to live compared with the low-lying polder area. After centuries of development, houses were built on both the dike slopes and the street passes between the houses over the crest of the dike, as in Figure 6.36.



Figure 6.36: Sliedrecht, ribbon development along both sides of the dike, November 2016 (the river is at the left side)

Thus, it is not surprising that the improvement of the dikes in Sliedrecht has for a long time been an object of study, as it would affect many houses and their owners. Already in the 1970s, it appeared that the dikes of Sliedrecht did not meet the safety level proposed by the Delta Committee. The demolition of many houses, to enable dike improvement, was a very likely prospect, but because of a changing societal (democratic) awareness, inhabitants of the dike villages started opposing the demolition plans. Their opinion was that, especially in urban areas, plain 'green dikes' conflict with housing, city shapes and economical activities. Moreover, a characteristic and often unique spatial quality would be completely and irreversibly destroyed by a green dike. Therefore, (re)construction of plain 'green' dikes could no longer be considered as the only and best solution only because that was the least expensive option. Figure 6.37 shows the interface of land and water at Sliedrecht.

An integrated approach for solving the dike improvements was not very common in the Netherlands around 1970 and detailed legal guidelines for solving these complex and diverse problems were not available. The presence of houses in and on the dike was frowned upon, among others due to the disastrous experiences during the storm surge of 1953. Therefore, in the 1970s, the province of Gelderland appointed a committee, the *Coördinatie Commissie Dijkverzwaren*, CCD, to advise the Board of the Province (*Provinciaal Bestuur*, GS) on these problems. The CCD committee concluded that it was indeed not acceptable to neglect the values of the landscape, nature and culture on and around flood defences. On the other hand, it was recognised that the original interests of water control should not become subordinate, because the protection of the polders against floods remained crucial. The report of the CDD, however, did not reassure the stakeholders in Sliedrecht, who



Figure 6.37: Sliedrecht, seen from the Beneden Merwede, May 2012

continued to have objections. An Interdisciplinary Study Group Spatial Planning (*Interdisciplinaire Studiegroep Planologie, ISP*), of Delft University of Technology, was appointed to resolve the conflicts. The ISP group proposed smart, integrated designs, taking various interests into account (Baltissen et al., 1984).

6

The Ministry of Traffic and Water Control commissioned the development and comparison of several alternatives for a special pilot project in Sliedrecht in 1986. Therefore, a steering committee was appointed by TAW to carry out the requested policy analysis, for which a project team did the preliminary work developing alternatives for the required dike improvements. The project team consisted of five members of the Ministry of Public Works (Rijkswaterstaat) with expertise on project management, hydraulic engineering, policy analysis, environment and planning, safety issues and dike design. This project group was supported by various other groups and had to produce a report within three months (Huis in 't Veld et al., 1986).

The project group developed several alternatives for two test dike reaches, from which selections were proposed. Criteria for the selection of these representative dike sections were, amongst others: the crest level of the dike, the type of buildings (the distance between frontage or cellar wall and dike axis or the presence of a cellar in the dike body), the geometry of the existing soil massive, the ground level outside the dike, and the location of the building in the cross-section of the dike.

After the positive reception of the report that dealt with only two dike reaches, the project group was commissioned to study the entire river dike of Sliedrecht (Huis in 't Veld et al., 1987). This report was approved by the TAW steering committee in 1987. A good evaluation of the interests of the various stakeholders was crucial for this study. The report, however, had to be completed within six months, so the form of a policy analysis was chosen for the study, to avoid premature choices. Another reason for postponing a final selection from the alternatives was the idea to build a storm surge barrier west of Rotterdam, which might have obviated the need for a dike improvement at Sliedrecht. In 1997 the completion of a storm surge

barrier in the Nieuwe Waterweg (the *Maeslantkering*), in combination with a barrier in the Hartel canal, and a reduction of the acceptable safety level from 1/4000 to 1/2000 reduced the need for complicated dike improvement measures. Several improvements have been carried out after the near-river floods in 1995, but to a lesser extent than had been anticipated.

A new dike of over 600 m was constructed in front of the existing dike (completed in 2006). The improvement of the eastern part of the Rivierdijk comprised the demolition of houses on both sides of the dike, heightening and widening the dike and building new houses along the inner slope with more distance to the dike crest, which would facilitate potential future dike reinforcement (Figure 6.38).

The dike improvements were completed in 2007. However, the improvement measures were designed and executed in a short period, because of the urgency that was felt to improve the protection against floods. The dike improvements were therefore 'not related to the spatial and economical ambitions of the region'. Unfortunately, not all executed works appeared to be effective: according to the municipality of Sliedrecht, 6 m deep sheet-pile walls on the inner side of the dike near the Baanhoek appeared not sufficient to stop the seepage, because the deeper subsoil was more permeable than had been assumed. Therefore it was expected that during high water levels, the houses behind the dike would experience hindrance from seepage water, but the safety of the hinterland was not threatened. The water board 'Rivierenland' generated several alternatives and finally decided to pump back the seepage water, when necessary (Municipality of Sliedrecht, 2012; Projectgroep gebiedsopgave Sliedrecht, 2016).



Figure 6.38: Sliedrecht, part of the improved dike, November 2016 (the river is at the left side)

The dikes at the northern part of the Alblasserwaard are currently being reinforced (2017), but because of the new safety standard of the new Water Act per 2017, these dikes will have to be improved again before 2050. Especially one part of the Rivierdijk, the 'project location' indicated in Figure 6.35, needs attention, because it is one of the weakest spots in the flood defence and, perhaps, the most difficult

stretch to improve, as houses are present on both the inner and outer slope of the dike.

A Multi-annual study on Infrastructure, Space and Transport (MIRT) was carried out to further elaborate the preferred strategy for the Rijnmond-Drechtsteden region as indicated in the Delta Programme. The preferred strategy still maintains prevention of floods by means of flood defences as the main measure to reduce flood risks in that region, in combination with reducing water levels by creating more room for the river. The MIRT study was completed in September 2016.

DESIGN OBJECTIVE

The objective for the new reinforcement of the dikes in Sliedrecht along the Beneden Merwede is to comply with the new flood safety standards as stipulated by Water Act of 1 January 2017.

Because a clear objective is not given in the spatial plan (Projectgroep gebiedsopgave Sliedrecht, 2016), it is assumed that, in addition, the traffic function of the dike should be maintained and possibly improved. The title of the part of the MIRT report that deals with Sliedrecht ('Inspiration document for relating spatial and flood safety tasks') suggests that spatial quality should be included in the design objective.³ The housing function should be maintained as well and the atmosphere should be authentic (ribbon development). According to several newspaper articles, the present number of parking spots is nearly sufficient, so that number should not become less in the future.

6

6.4.2 DEVELOPMENT OF CONCEPTS

Concepts that are intended to be integrated in the existing environment, should primarily be developed regarding the surrounding area and not strictly per dike cross-section. Thus, in this dissertation, four concepts were developed and one existing alternative from the 'Inspiration Document' for the MIRT study (Projectgroep gebiedsopgave Sliedrecht, 2016) was added as the fifth concept. For the qualitative verification regarding flood protection, only one cross-section of the dike was elaborated, at location AA in Figure 6.35. The following paragraphs first describe the main boundary conditions that were relevant for developing concepts. Figure 6.39 shows an overview of the present situation.

Sliedrecht is part of dike ring area number 16, which has a normative exceedance probability of 1/2000, corresponding to a present assessment water level of NAP + 3,50 m (Hydraulische Randvoorwaarden, 2006). The design life time of the dike,

³An explicit description of the objective for the plan development is lacking in this MIRT study, which apparently is a consequence of the chosen 'research by design' approach. It is remarkable that none of the nine members of the project group 'Gebiedsopgave Sliedrecht' and only one of the 18 consulted experts had an hydraulic engineering background, whilst the focus of their report is on dike improvement. The project group and its technical advisory committee for the reinforcement plans in 1986 consisted of 11 people, of which 8 had an hydraulic engineering background. The MIRT project group, by the way, came up with concepts that were similar to the ideas of 1986.

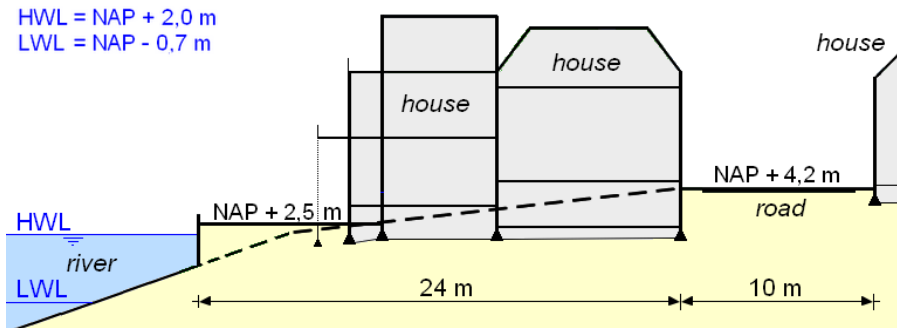

Figure 6.39: Sliedrecht, cross-section AA of the dike at the considered project location.
HWL = high water level; LWL = low water level)

needing improvement, is assumed to be 100 years, as it is difficult to modify this part of the dike. The design crest level should take changing extreme river levels during this period into account, but quantifying this change is difficult because of uncertainties. The Spatial Planning Key Decision 'Room for the River 2006' (*planologische kernbeslissing 'Ruimte voor de Rivier 2006'*) legally prescribes a design peak discharge of the Rhine of $18\,000\text{ m}^3/\text{s}$ near Lobith in the year 2100. Local water levels can be derived from this discharge by means of computer models, given a configuration of river branches. TAW - ALRd (2008) lists these computed water levels for 2100, given a discharge of $18\,000\text{ m}^3$ at Lobith and given the present configuration: near Sliedrecht (river kilometre 968), the design water level is listed as NAP + 3,50 m, which is the same as the present assessment level. Extrapolation to the year 2120 (the end of the design life of the structure) gives the same level, but is based on a 1/2000 exceedance probability. The standard per 1 January 2017, however is 1/10 000, so 0,20 m is added to find the governing water level in 2120, plus 0,30 m as a robustness surcharge, according to TAW - ALRd (2008).⁴ This results in a design water level of NAP + 4,00 m.

The design crest level is based on the design water level, but an extra height of 0,50 m is added to reduce the effect of overtopping waves.⁵ Including this overtopping height, the resulting design crest height of the flood defence is NAP + 4,00 + 0,50 = NAP + 4,50 m. This is about 0,30 m higher than the present crest level.

The road level of the Merwede dike is at NAP + 4,20 m, and its width is about 8 m

⁴According to TAW - ALRd (2008), the difference between the water levels related to an exceedance probability of 1/2000 and 1/10 000 in the Nieuwe Maas near the mouth of the Hollandse IJssel is 0,20 m. That location differs from the project location studied in this research, so it cannot simply be stated that the 0,20 m will apply to the Beneden Merwede near Sliedrecht. The assumption of 0,20 m height surcharge near Sliedrecht is therefore only indicative, but considered sufficiently accurate for the purpose of the present research.

⁵The overtopping height was calculated with a maximum specific overtopping discharge of 10 l/s/m , with the equation of the Overtopping Manual (2016) for dike sections with an outer slope and with Franco et al. (1994) for vertical walls. The resulting overtopping heights were less than 0,50 m, which is the minimum freeboard, therefore that minimum value has been used.

at cross-section AA (Figure 6.35). Another important boundary condition is the navigation width of the Nieuwe Merwede, which at present is too small (175 m instead of 200 m) and it should not become narrower.

The subsoil consists of sand and clay layers. A sand layer with high a bearing capacity, the Holocene formation of Kreftenheye, is located below NAP - 13 m (\pm 1 m). On top of the sand layer there is a 8 m clay layer with an intermediate 2 m fine-sand layer, the formation of Echteld. A small settlement of the dike can be expected if additional height is added to the crest level, because of the presence of clay layers.

6.4.3 QUALITATIVE STRUCTURAL VERIFICATION OF THE CONCEPTS

CONCEPT 1 'COFFERDAM IN DIKE'

In the 'Cofferdam in dike' concept, the crest level of the dike was raised to NAP + 4,5 m, which was required to limit overtopping discharges to acceptable quantities (Figure 6.40). At locations where houses are situated in the outer dike slope, wave heights will be reduced to almost 0,0 m before they reach the crest, probably even if the houses would have collapsed. Therefore, NAP + 4,5 m is only required in between the houses. However, it would be impractical if the dike height would vary from NAP + 4,2 to 4,5 m, and it would reduce the driving comfort for vehicles over the irregular dike, so a crest level of NAP + 4,5 m will be set for the entire dike stretch.

Since there is no space for a regular reinforcement with soil, a cofferdam, to retain the added soil up to the required level of NAP + 4,5 m and to provide additional stability, is designed in the existing dike. The houses on both sides of the dike remain unaffected, only there is a 0,30 m step towards the elevated road, in front of the houses.

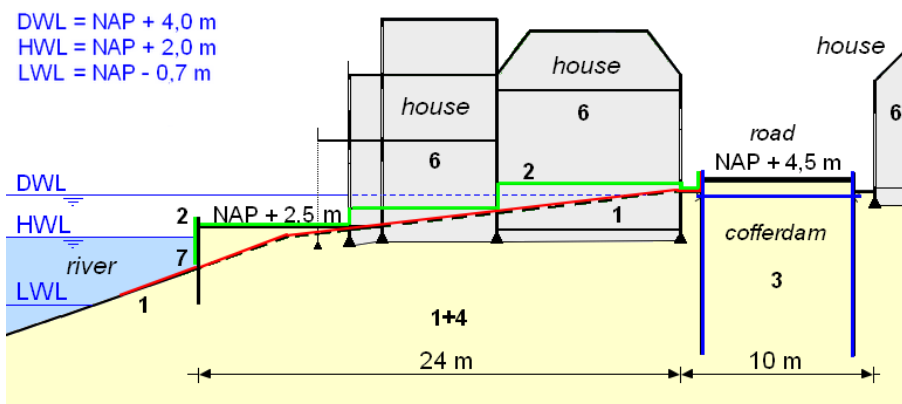

Figure 6.40: Slidrecht river dike: Design concept 1 'Cofferdam in dike'

The water-retaining function is fulfilled by the clay dike cover and by a part of the cofferdam, together with the subsoil (element type 1). Protection against erosion

(type 2) is provided by the outer dike slope and the house. The two sheet pile walls of the cofferdam are connected to each other with an anchor and, together with a sufficient embedded depth, they provide stability (type 3). The houses don't have an intended function regarding flood protection, but act as loads on the dike (type 6). A typical transition is located in between the bank protection and the river bed (type 7).

Based on this verification, it can be concluded that the 'Cofferdam in dike' concept in principle meets the requirement of improved flood protection (although details will have to be checked with help of a quantitative structural verification). The spatial quality is more or less preserved, because the impact of the 0,30 m elevation of the middle part of the dike crest is very limited. The houses are maintained, as was required, but the road will become narrower, so either the number of parking spots will be reduced, or the traffic will have to be restricted to one direction. This concept, therefore, does not meet the second main requirement.

CONCEPT 2 'WATER-RETAINING INNER FAÇADE'

The required crest-level of the 'Water-retaining inner façade' concept is obtained by the dike plus the lowest part of the façades of the houses at the dike crest side, which are designed to be water-retaining (Figure 6.41). If doorways cannot be elevated, they will have to be closed-off with stop logs during extreme river discharges, for which fixtures will have to be provided. In between the houses, the required retaining height will have to be provided with flood walls of the same height (NAP + 4,5 m). Movable bulkheads will be used where the wall crosses driveways.

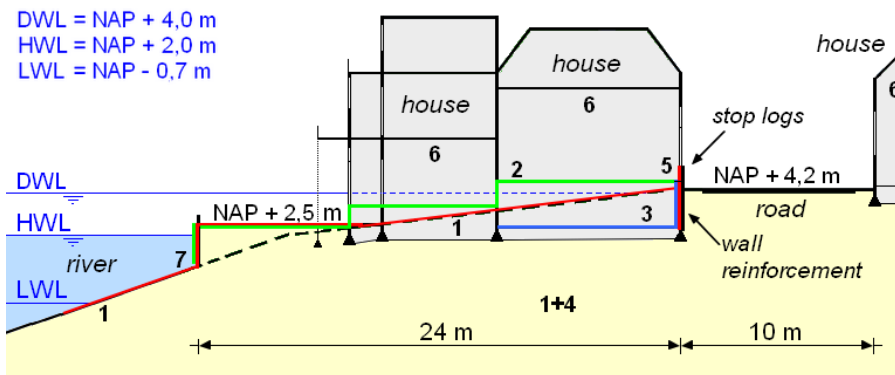

Figure 6.41: Sliedrecht river dike: Design concept 2: 'Water-retaining inner façade'

The clay cover on the outer slope of the dike retains water, together with sufficiently impervious sub-soil and the lower parts of the façades of the houses up to NAP + 4,5 m (type 1). Closure means in the form of stop-logs will have to be placed in doorways during high water levels (type 5). Protection against erosion is provided by the clay cover of the dike and by the house (type 2). The structure of the house provides support in the form a water-retaining lower part of the façade (type 3).

The non-water retaining structural elements of the house can be considered as secondary elements (type 6).

The incidental placement of movable parts requires a good organisation and regular testing, but in principle, the flood-protection function is fulfilled in this concept. This solution requires several adaptations of the houses, but the houses do not have to be demolished. The width of the road remains the same, and traffic and parking patterns do not have to change (except for the construction period). The spatial quality is not affected if proper construction materials (masonry) are used for the walls in between the houses.

CONCEPT 3 'WATER-RETAINING RIVERSIDE FAÇADE'

The 'Water-retaining riverside façade' concept is alike the second concept, but here the walls at the riverside of the houses act as a water-retaining element (Figure 6.42). In this situation, the lower part of the walls will have to be reinforced to resist hydrostatic loads, and doorways will have to be closed-off with stop logs during high water levels. Walls and cut-offs with stop-logs will have to be present in between the houses as well. Extra attention will have to be paid to prevent potential piping and seepage through the floors of the cellars of the houses (one of the cone penetration tests indicated sand under the houses on the outer dike slope).

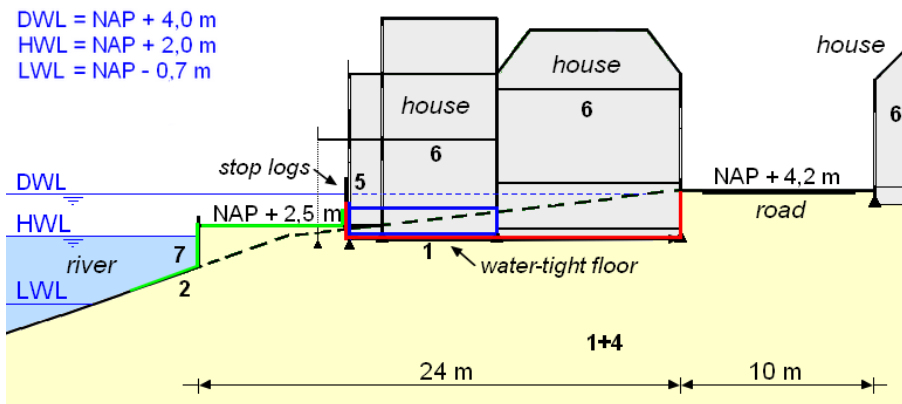

Figure 6.42: Sliedrecht river dike: Design concept 3 'Water-retaining riverside façade'

The water retaining elements (type 1) are: the lower part of the river-side walls of the house, the seepage screen, the watertight cellar floor and the subsoil. Erosion protection is provided by the river bank (type 2). The house itself supports the water-retaining wall (type 3). Stop logs are needed as closure means (type 5) and the houses (except for the water-retaining parts of the river-side wall) act as secondary elements (type 6). As in the previously discussed concepts, the transition in front of the river bank needs protection to prevent scour (type 7).

The house interior is protected during extreme water levels, for which a large part of the water-retaining wall will have to be reinforced. The retaining walls in between

the houses will have to be higher than in the previous concept, if they are in line with the river-side walls of the houses. This concept can be realised in such a way that the flood protection function is met, but the modifications to the houses are considerable and the aesthetic quality is dubious. The traffic and parking functions remain unaffected.

CONCEPT 4 'EXTENDABLE RETAINING WALL'

In the 'Extendable retaining wall' concept, the water-retaining element is located near the river, and is not integrated into the house (Figure 6.43). The water-retaining walls consists of a concrete L-wall with a sheet-pile wall beneath it. The L-wall is founded on piles in the bearing sand layer below NAP - 13 m. A sheet-pile wall instead of this L-wall would be less expensive, but it would probably undermine the bearing capacity of the shallow foundation of the house. The top of the L-wall is roughly 1 m above ground level, and it does not spoil the view over the river. A moveable extension wall can temporarily be constructed on top of the L-wall in case of extremely high water levels. This requires several recesses in the L-wall to install vertical poles. Stop-logs can then be installed in between these poles (Figure A.13).

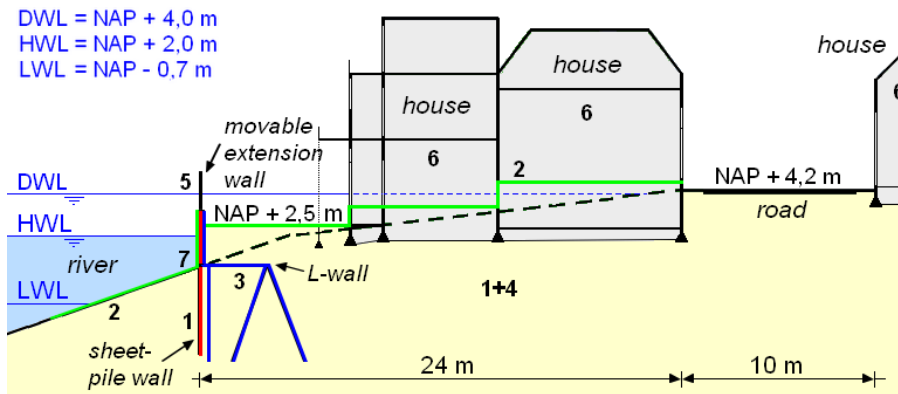

Figure 6.43: Sliedrecht river dike: Design concept 4 'Extendable retaining wall'

The water-retaining function is performed by the L-wall, the sheet-pile wall and the subsoil (type 1). Erosion-protection is provided by the outer slope, the L-wall and the house that intersects the outer slope (type 2). Foundation piles support the L-wall (type 3). The moveable extension wall is an additional means of closure (type 5) and the house probably acts as a permanent load on the sheet-pile wall (type 6, otherwise type 0). The transition in front of the water-retaining wall requires scour protection (type 7).

The function of flood protection is fulfilled in this concept, but a well organised incidental installation of closure means during high water levels is required. This could be considered a disadvantage, but is balanced by the advantages that the

traffic and parking functions are not affected. The horizontal ground plane just behind the L-wall could even create possibilities for improving the spatial quality. Construction of this concept is possible without problems for the existing houses. However, the L-wall complicates construction of the flood defence and makes it unnecessarily expensive. A concept with deeper sheet pile walls with stiffer elements or anchors would eliminate this shortcoming.

CONCEPT 5 'FLOOD-RETAINING WALKWAY', AS PROPOSED IN THE MIRT STUDY

The 'Flood-retaining walkway' concept has been proposed in the MIRT study for Sliedrecht (Projectgroep gebiedsopgave Sliedrecht, 2016), see Figure 6.44. The flood defence consists of a cofferdam adjacent to the river, in front of the dike and the houses.⁶ A wall at each side of the walkway consists of pre-stressed concrete sheet-pile elements. The walkway wall at the river side is low: it extends about 1,2 m above walkway level, but the wall at land side reaches up to the required crest level of NAP + 4,5 m.

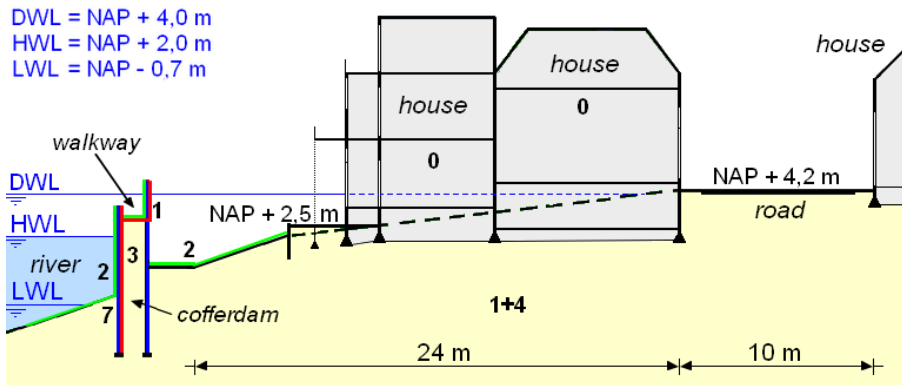

Figure 6.44: Sliedrecht river dike: Design concept 5 'Flood-retaining walkway' (reconstructed from an artistic impression in the MIRT report)

The outer wall of the cofferdam retains the water, together with the subsoil (type 1). The cofferdam and the outer dike slope protect against erosion (type 2) and the cofferdam provides its own stability (type 3). The houses seem to not structurally affect the cofferdam (type 0). Scour protection should be installed at the transition between the cofferdam and the river bed (type 7).

The 'Flood-retaining walkway' concept needs to be optimised in a structural way: in the MIRT report drawing it seems unstable and is likely to turn over due to high hydrostatic pressures during high river levels. Furthermore, the 'feet' under the sheet-pile walls are not practical and should be left out. However, the concept can be made flood-proof. The inner wall of the walkway reaches up to NAP + 4,5 m and

⁶The MIRT report erroneously indicates this cofferdam as a 'sheet-pile wall' (*diepwand*) and in an article in magazine 'De Ingenieur' (May 2016) it is indicated as an 'outer diaphragm wall' (*buitendiepwand*), which does not match with the original drawing.

will largely spoil the view from the ground floor of the house. By maintaining the outer dike slope, the 3 mm high outer wall of the cofferdam will be visible from the house and the dike crest, which does not necessarily improve the spatial quality. The traffic and parking function of the dike will not change by the realisation of this concept.

6.4.4 EVALUATION OF THE ALTERNATIVES

All concepts described in this section can be designed in such a way that they meet all requirements, except for the first concept, where either the traffic or the parking function will be compromised. If the problem would be studied at a larger scale, one-directional traffic on the dike could appear to be feasible and create a clearer and safer situation. However, for the time being, the first concept is rejected. The second and third concept require adaptations of the existing houses, and especially the existing shallow strip foundations could be problematic. This makes these concepts less attractive.

Construction of the fourth and fifth concept will not be problematic for the existing houses and avoid problems with existing sewerage and cables in the dike body. The fourth concept is feasible, but needs extra organisational measures regarding incidental installation of the movable extension walls. The fifth concept permanently blocks the river view from the ground floors of the dike houses on the outer slope and the advantage of creating a walkway is not evident. All five concepts are expensive, so cost considerations would not very much influence the choice for one of the concepts. Taking all advantages and disadvantages into account, concept 4 seems the most promising of the developed concepts, see the multi-criteria evaluation in Table 6.4, and should be elaborated in a design loop at a more detailed level. In a more detailed design loop, different types of movable closure means can be considered. See Figure 6.45 for an impression of the preferred concept.

concepts:	weighing factor	1. cofferdam in dike		2. water-retaining inner fa gade		3. water-retaining river-side fa gade		4. extendable retaining wall		5. flood-retaining walkway	
		score	score x weight	score	score x weight	score	score x weight	score	score x weight	score	score x weight
criteria:											
1. adaptation existing houses	10%	<i>rejected</i>		1	0,1	1	0,1	3	0,3	5	0,5
2. ease of 'operation'	10%		5	0,5	5	0,5	3	0,3	5	0,5	
3. view over the river	30%		5	1,5	5	1,5	5	1,5	1	0,3	
4. possibilities for inspection, maintenance	30%		2	0,6	2	0,6	3	0,9	5	1,5	
5. costs	20%		3	0,6	3	0,6	3	0,6	3	0,6	
Total weighted score per concept	100%			3,3		3,3		3,6		3,4	

Table 6.4: Multi-criteria evaluation for the Sliedrecht dike concepts

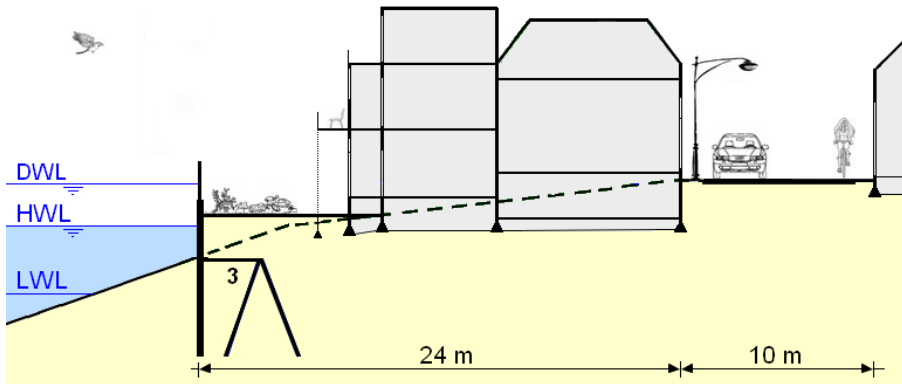

Figure 6.45: Sliedrecht river dike: The preferred concept (no. 4)

6.5 CONCLUDING REMARKS

Four case studies have been selected to demonstrate the use of a *qualitative* structural verification. It was developed as an additional design step because of the multiplicity of appearances and structural composition of multifunctional flood defences. The case studies showed that the developed method of qualitative structural verification works well, because it is helpful as a first step in determining whether multifunctional flood defences are able to retain water. It appears to fit logically in the entire design process.

An additional *quantitative* structural verification is required to determine the dimensions of the structural elements and check the stability of the structure. This was elaborated for the Katwijk case for the preferred alternative. The preference was based on the qualitative structural verification. The order of design steps was: qualitative structural verification - evaluation - selection - quantitative structural verification. However, it became clear that it is better to base the evaluation and selection of an alternative on a complete (qualitative and quantitative) verification. That right order thus is: qualitative structural verification - quantitative structural verification - evaluation - selection.

It was not the purpose of this chapter to in general evaluate what degree of integration of multifunctional flood defences would be optimal.⁷ However, conclusions can be drawn, based on the case studies. The preferences of the design alternatives can be briefly motivated as follows:

- The study of the Katwijk coastal defence showed that the concept in which the flood retaining wall was integrated in the parking garage, scored very well. The choice was based on high scores on the criteria of costs and aesthetics / view on the sea, despite foreseen issues regarding governance;

⁷See Section 1.4.5 for an overview of the degrees of spatial and structural integration.

- The best alternative for the 'Dakpark' in Rotterdam concerned a flood-retaining wall, integrated in a parking garage as well. It was selected because of a high score on almost all criteria; only governance issues were considered as a main impediment;
- The best 'Boompjes' tunnel alternative appeared to be scarcely integrated with the flood defence. It scored reasonably well on all criteria, ranging from recreational possibilities, to aesthetics, disturbance, costs and governance issues;
- The preferred alternative of the Sliedrecht case was not fully integrated as well, and was selected because it did not score low on any criterion, except for the river view, which was very good.

It cannot in general be concluded what degree of integration would lead to the best design alternative, as the evaluation and selection of alternative solutions are highly dependent on the chosen criteria and weighting factors, which depend on the client and other stakeholders. Solving governance issues can increase the attractiveness of multifunctional concepts, especially if the creation of more value coincides with cost reduction. It can, however, also lead to an increase of costs, for example if wide 'Delta Dikes' are created. It should be judged whether the added values justify the extra costs, compared to other investments in society that could have been afforded with the extra money.

While verifying concepts by distinguishing structural element types, as derived in Chapter 5, it appeared that varying the role of structural elements works very well for developing design concepts. In this way, insight in the consequences for governance is obtained, which makes the concepts open to discussion. Preferably, the administrators of the flood defence, or their representatives, join the design sessions for an optimal mutual understanding and interaction with the design team. In this way, it is expected that part of the governance issues regarding multifunctional flood defences can be resolved.

7

CONCLUSIONS AND RECOMMENDATIONS

7.1 INTRODUCTION

This dissertation attempted to find a suitable method for the integrated design of multifunctional flood defences. Chapter 4 combined spatial design and engineering into one over-all design approach. This resulted in an iterative and cyclic method with seven main design phases. One of the phases comprises the verification of developed concepts, comprising a check whether the concepts fulfil the requirements. A specific method for the verification of the flood defence function was proposed in Chapter 5. The validation of the proposed methods was executed at two levels: the combined overall design method was validated in Section 4.8 and the verification method was validated with help of four case studies in Chapter 6. The following conclusions are based on these validations.

7.2 CONCLUSIONS

Three research questions were formulated to achieve the objective of finding a design method for multifunctional flood defences, indicating how the reliability of developed concepts can be verified:

1. What issues determine the chosen strategy for flood risk reduction in the Netherlands?
2. What method can best be used for the integrated and sustainable design of multifunctional flood defences?
3. How should design concepts of multifunctional flood defences be verified (concentrating on the flood-protection function)?

The conclusions are given per research question and on overall level.

1. Flood risk reduction strategy

The history of the flood risk strategy in the Netherlands was studied in Chapter 2, to find the factors that determine the strategy of flood risk reduction. History shows that severe flood events create a heightened sense of urgency among civilians and

politicians to improve the flood risk reduction strategy. As technology can only be applied if it is related to societal standards and values, a complex of societal forces determines what technology is applied. Societal changes, besides unforeseen effects on the natural environment, introduce unforeseen feedback on realised systems, which may lead to unexpected changes in the hydraulic system.

It appeared that the flood reduction strategy can be formulated at the local, regional, national and international level, consistent with policies of spatial planning. The Dutch flood-risk approach was initially organised at the local level of a polder, but appeared over time to be not very efficient, nor effective. The situation has improved considerably since the founding of Rijkswaterstaat in 1798, and the establishment of a Royal Advisory Committee in 1809 by King Louis Napoléon Bonaparte. From then on, flood protection and navigability were taken care of at a national level and international collaboration was organised as well. Integration of ecological and social systems with the water system has led to more extensive approaches, taking values of landscape, nature and culture into account.

At present, many experts of diverse backgrounds are involved in decision-making processes on the flood risk reduction strategy, which adds a level of complexity. For effective, realistic policies on flood risk reduction, cooperation is required between the scale levels of decision-making, including involved stakeholders. For the implementation of the strategy in specific designs of multifunctional flood defences, an integrated design method is necessary.

2. Integrated design of multifunctional flood defences

A higher quality of life in flood prone areas can be achieved, if systems are designed by teams in which multiple disciplines and design cultures are combined, and stakeholders are allowed to participate in the design process. Chapter 4 therefore developed and validated a method for the integrated and sustainable design of multifunctional flood defences by multidisciplinary design teams. It combines the design approach and the engineering method, taking the recently more appreciated values of landscape, nature and culture into account and actively involving stakeholders.

It can be concluded that the ways of reasoning in engineering and spatial design are not mutually exclusive, but complementary. The integrated design method, as proposed in this dissertation, combines both approaches in such a way that the weaknesses of the one approach are replaced by the strengths of the other approach. All necessary design steps are included in the proposed integrated design method and it offers ample possibilities for the creative development of concepts.

The proposed integrated design process is iterative and cyclic, subsequently, knowledge acquired in the process can be used to experiment and to improve the previous steps for further development of the design. Therefore, the 'research by design' principle, as used in Architecture, fits well in the integrated method. On the other hand, the method is systematic and transparent and is therefore suitable for organising the process and achieving a feasible result in an efficient and effective way.

Typical spatial design activities usually precede the typical engineering activities, but within the design team there should preferably be an overlap and a same mindset in overall design reasoning and an incentive to work together. The application of the proposed method depends on the expertise level of the design teams: advanced designers can modify the method by adding or skipping elements, or by changing the order of activities.

A validation of the method by student teams showed that an integrated design is the expected result, if a multidisciplinary, balanced design team works well together and is using the proposed method with the appropriate tools and by involving stakeholders from an early stage. The involvement of stakeholders was simulated, thus the method could not be well validated regarding stakeholders' participation.

Overall, it can be concluded that the integrated design method, as proposed in Chapter 4, works well and can be applied to the design of multifunctional flood defences, involving multiple disciplines. It is expected that the combined method not only works for multifunctional flood defences, but for other design tasks as well, where spatial planning and engineering have to be combined.

3. Verification of multifunctional flood defences

It was proposed in this dissertation to divide the verification of the reliability of multifunctional flood defences into two phases: a *qualitative* and a succeeding *quantitative* structural verification.

For the *qualitative structural verification*, a generic method was developed in Chapter 5, for identifying the role of structural elements and qualitatively judging the capability of a structure of fulfilling its flood protecting function. The typology of structural elements regarding flood-protection as defined in this dissertation is generic, because it is based on a function analysis rather than on specific shapes. Distinguishing structural element types gives insight in the consequences of combining functions in structural elements and in the functioning of a multifunctional flood defence as a whole. The typology can therefore be used as a tool for the qualitative structural verification of designs of multifunctional flood defences. By using the method, insight can be acquired in the efficiency of the combination of functions. It was observed that several of the studied examples that initially seemed innovative, mainly because of their fancy names, were not.

The qualitative structural verification should be followed by a *quantitative structural verification*, for which the usual engineering tools and methods can be used. It should be checked per situation whether and how a building or object in a flood defence affects the failure mechanisms that are common to regular flood defences, and whether the particular building or object introduces new failure mechanisms. Specialised knowledge is required to determine the strength and stability of structural elements that consist of uncommon materials, such as masonry and glass. The reliability of multifunctional flood defences can be determined with the available probabilistic or semi-probabilistic methods.

Four case studies were elaborated to demonstrate the application of the qualitative

structural verification. Other design steps were included in the case studies as well, to find out whether the qualitative structural verification is well integrated in the entire design process. The case studies showed that the developed method of qualitative structural verification works well, because it is helpful in determining whether a multifunctional flood defence will be able to protect against floods. The design step of qualitative structural verification appeared to fit logically in the entire design process.

General conclusions

The distinction of structural element types, intended for the verification of concepts, can very well be used for the development of concepts as well. By varying the role of structural elements, different concepts can be obtained, where the consequences become clear regarding responsibilities, finance and possibilities for inspection and maintenance. This creates possibilities for the discussion of the advantages and disadvantages of the concepts. It is expected that this can bridge the gap with governance, if the administrators are interested in feasible solutions and are in favour of a clear and transparent process of decision-making.

It cannot in general be concluded what degree of integration would lead to the best design alternative, as the evaluation and selection of alternative solutions are highly dependent on the criteria and weighting factors, which depend on the client and other stakeholders. Solving governance issues can increase the attractiveness of multifunctional concepts, especially if the creation of more value coincides with cost reduction. It can, however, also lead to an increase of costs, for example if wide 'Delta Dikes' are created.

7

The choice for combining functions in a multifunctional flood defence and the degree in which they are integrated is a political consideration. The flood-protection function cannot be compromised, as it is stipulated by law (Water Act), and it is verified during the design to ascertain that it is properly taken into account. The creation of additional values, however, influences the total costs of the project, and it should be kept in mind that a penny can only be spent once. It is a political decision what type of contribution to society is best justified, and transparency and disclosure of administration, enforced by the Act on Public Access to Government Information, requires a well-founded weighting of interests and a clear procedure of decision-making. The integrated design method as presented in this dissertation fits well in such an approach.

7.3 RECOMMENDATIONS

Presently, the main resistance against the application of integrated multifunctional flood defences is formed by governance aspects. It is recommended to policy- and decision-makers to have a certain practical knowledge about flood protection strategies and realisation of flood defences, because it will make their policies more efficient and effective. Practical knowledge will provide more insight in realistic possibilities to combine functions in flood defences. Flood risk reduction strategies

are therefore recommended to be developed by integrating multiple disciplines, such as commonly applied in design teams. This still leaves space for idealism, but it should be combined with realism to ensure feasible strategies and accountability of spending public funds.

The method for the integrated design of multifunctional flood defences, as proposed in this dissertation, has been validated by student groups. However, the assignment was not very extensive and the students were novice designers. It is therefore recommended to fine-tune the method in future assignments by experienced designers.

The method of qualitative structural verification is recommended to, possibly, assign different consequence classes (and according safety margins) or design life times to structural elements. This can make the system more efficient and reduce the costs.

(Semi-)probabilistic design methods are available for the structural verification of multifunctional flood defences, in which objects and buildings can be included. However, the inclusion of objects and buildings is either devious or inaccurate, especially for full probabilistic designs (level II or level III calculations). Therefore, it is recommended to further develop a probabilistic design framework for multifunctional flood defences.

It is recommended to evaluate concepts that have been both qualitatively and quantitatively verified. A qualitative structural verification is not a full verification, thus it would be premature to base an evaluation and selection of concepts that have only been verified in a qualitative structural way.

A special point of attention for the verification of (multifunctional) flood defences are the transitions in longitudinal direction, perpendicular to the cross-sections. It is recommended to pay as much attention to longitudinal transitions as to transverse transitions.

The ledger zones of the Water Boards indicate areas that are intended to ensure the flood protecting function, for which structural modifications are prohibited or restricted. The width of the core zone (*waterstaatswerk* in Dutch) is based on failure mechanisms of 'standard' flood defences, specifically macro-instability. If macro-instability cannot occur in case of a dike composition that differs from the regular dikes, the width of the core zone could be reduced, which would increase the possibilities of combining functions in flood defences. It is therefore recommended to reconsider the width of the ledger zones of multifunctional flood defences. The advantages of multiple use of a dike should be balanced against the disadvantage of potential reduced adaptability in case of required future dike reinforcement.

APPENDICES

A

EXAMPLES OF MULTIFUNCTIONAL FLOOD DEFENCES

Integration of flood protection with urban functions has already been applied in many towns along rivers and seas, though the degree of integration is often limited. The combined flood defences usually consist of a series of small-scale, tailor-made solutions to preserve the urban use of these water fronts. Along many urban rivers, the flood defence consists of flood-retaining house façades, flap gates in roads, cut-offs with stop logs and flood walls on quays. This appendix shows several of these examples. Background information is included per location, to show the entanglement of these structures in the urban area, including historical, cultural, economical and spatial aspects.

A.1 THE VOORSTRAAT IN DORDRECHT

The first example is the flood defence in the city of Dordrecht, a Dutch town along the Oude Maas, a branch of the Waal river. The initial river banks were raised and transformed into dikes, to increase the protection against fluvial floods, caused by both high river discharges and by propagating high water levels of the North Sea. From the 15th century onwards, the city has expanded several times towards the river, outside the dikes. Both sides of the dike have been built-on and it has become a busy shopping street, called the *Voorstraat* (Figure A.1).

The presence of the houses on both sides of the dike complicated the required reinforcement around 1917. Therefore, removable stop logs in doorways and bulkheads in alleys in between the houses were used for achieving a sufficient retaining height. The stop logs were installed in front of the door openings at the street side of the houses of the Voorstraat, Prinsenstraat and Riedijk (Figure A.3). In the Grote Kalkstraat, Houtsteiger and Boomstraat that cross the Voorstraat, large cut-offs for bulkheads were constructed, as can be seen in Figure A.3 (without bulkheads). The improved housing fronts could nevertheless not prevent flooding of the area inside the dikes during the storm surge of 1953. It was therefore decided to install sheet piles under the houses at the street side, with concrete beams on top of these sheet

A

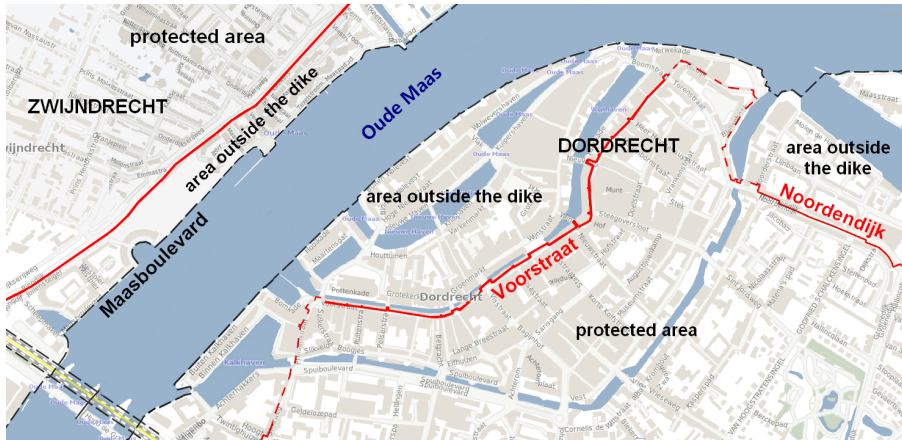

Figure A.1: Map of Dordrecht and Zwiindrecht (modified from risicokaart.nl)
The primary flood defence is indicated with red lines



Figure A.2: Dordrecht: fixtures for temporary sealing of door openings with stop logs in houses along the Voorstraat in Dordrecht, March 2013

pile walls to reinforce the houses and to connect the sheetpiles with the façades (Figure A.4). The system of closable doorways and alleys remained unchanged after 1953. With the modifications after 1953, the flood defence became sufficiently high, but the reliability of the system was not guaranteed. The stop logs were stored inside the houses, but several residents had used them for timber or for fire wood. Therefore, the water board presently organises a simulation of a flood event every year to stimulate the awareness of the residents¹ (Stalenberg, 2010). A study in 2013 proved that the bulkheads in the doorways of individual houses did not improve the reliability of the flood defence: the probability of non-closure appeared too high. The uncertain presence of the stop logs in the doorway of the houses has therefore been excluded from the reliability calculations. The large gates in the alleys that

¹The stop log and gates, by the way, are stored in the area outside the dikes.



A

Figure A.3: Dordrecht: a moveable gate in a recess in one of the alleys crossing the Voorstraat next to a bridge (the Voorstraat is at the left side), March 2013

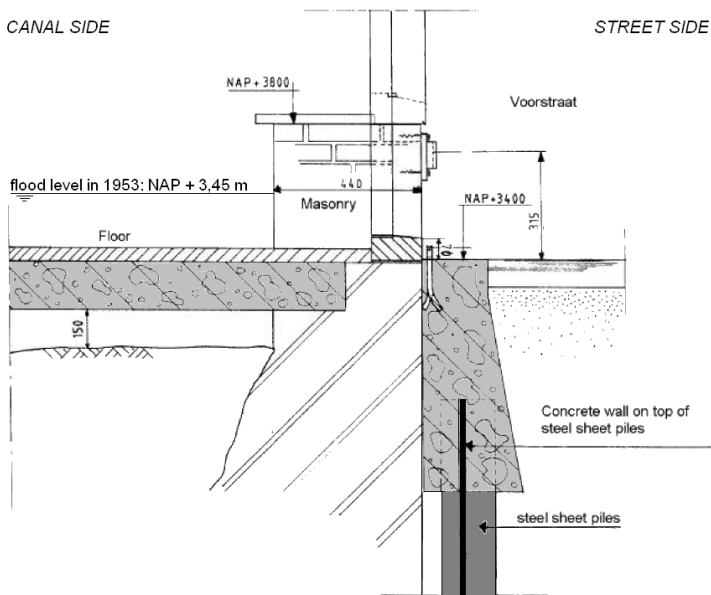

Figure A.4: Dordrecht: sheetpile wall under the houses along the Voorstraat in Dordrecht (unknown source, adapted)

cross the Voorstraat, however, are still considered sufficiently reliable (Schelfhout and Sloopjes, 2013).

During the last decades, several solutions were studied to solve the problem in

A

Dordrecht, such as the study of the 'Task Force 1981/1982', Heidemij Adviesbureau in 1985, with advice from Vrijling and Flórián of Delft University of Technology, and Bouwdienst Rijkswaterstaat in 1985 as well. An alternative for the solution of Heidemij is depicted in Figure A.5: a concrete retaining wall has been integrated in the houses at the waterside of the houses along the Voorstraat. This alternative solution was rejected because of the high realisation costs and negative opinion of the residents.

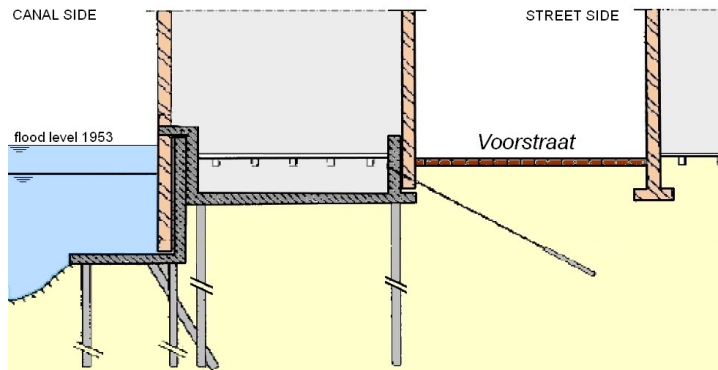

Figure A.5: Alternative design for Dordrecht: concrete retaining wall integrated in a house, modified from Van 't Verlaat (1998)

Van 't Verlaat (1998) attempted to divide the total alignment into sections and assigned a best solution to each section (Figure A.6). A design was made for a vertically sliding gate barrier, integrated in a quay wall at a representative section. Various alignments were possible, protecting a smaller or larger part of the city. One

Profiel Ia: breed profiel	Profiel Ib: smaal profiel	Profiel II: bebouwing aan water	Profiel III: bebouwing aan kaden	Profiel IV: kruising bebouwing	Profiel V: kruising wegen / bruggen
keuze:					
grondophoging	verticale schuif	keermuur geïntegreerd in de panden	verticale schuif op de kade	damwand	verticale schuif

Figure A.6: Alternative designs for Dordrecht: selected best structural solution per flood defence section (Van 't Verlaat, 1998)

of the alternatives was a moveable barrier that would be stowed away in a recess of the quay wall under normal circumstances (Figure A.7). During extreme high water

levels, the recess would fill with water and the barrier would start floating because of the buoyant force, and be kept in place by the water pressure. Thus, the quay wall would automatically be extended in height when necessary. When the water level would drop again, the recess would be emptied and the gate would return to its resting position in the recess (Hinborgh, 2010). Since 1996, the new Maeslant storm

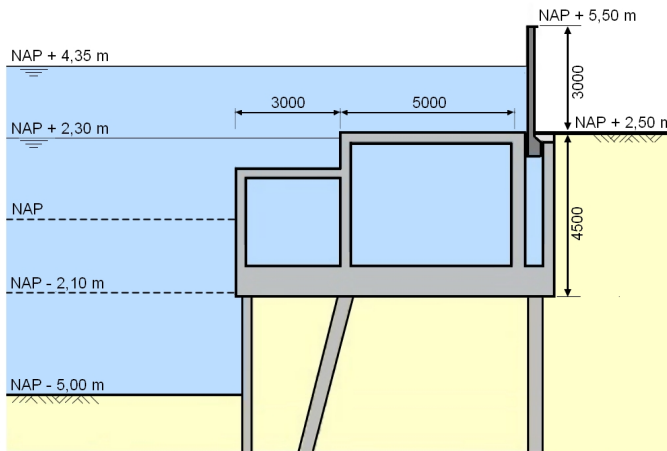

Figure A.7: Alternative design for Dordrecht: floating barrier integrated in a quay (modified from Hinborgh (2010))

surge barrier barrier has protected the area of Rotterdam. The barrier reduces the water levels near Dordrecht during storm surge conditions at sea, but a solution for the increasing flood discharge on the river Merwede - Oude Maas has not yet been found (Stalenberg, 2010).

A.2 THE NOORDENDIJK IN DORDRECHT

The Noordendijk, east of the city centre of Dordrecht, was improved in 1997 and in 1998, after twenty years of discussions and preparatory activities. Water board 'De Groote Waard' initiated the project, called the 'Dordtse Wand' (Figure A.8). The functions of flood protection, living and transport were combined in this project. The reinforcement of the flood defence was realised by excavating the existing dike slope and by constructing an L-shaped wall. This wall is founded on piles and a seepage screen prevents piping. The retaining wall reaches up to NAP + 4,30 m and has a design life span of 100 years. The 500 meter long L-wall was integrated with the foundation of a new row of single-family houses. This enabled the creation of space for cycle and pedestrian paths and a green belt at the former slope. At several locations, the ground floor of the houses extends further into the dike, creating space for private parking garages, the entrance of which is at the low-lying polder level (Figure A.9).

The retaining wall was designed with a surplus height of 0,65 m to anticipate future

A



Figure A.8: Improved Noordendijk, Dordrecht, March 2013 (river side at the right)

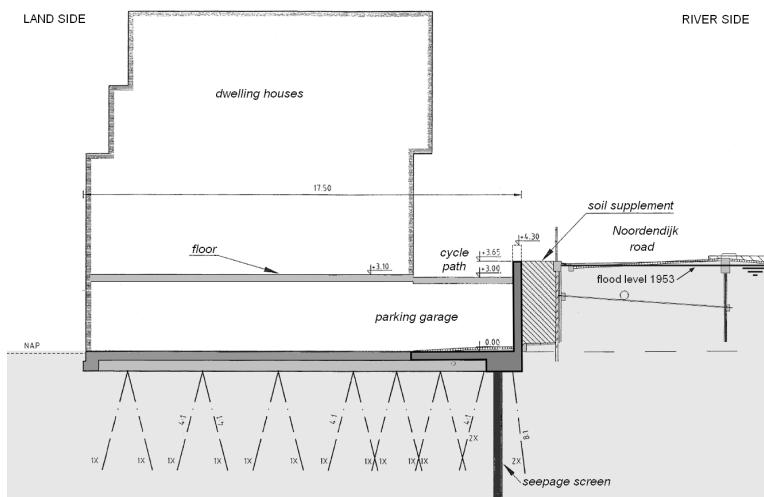

Figure A.9: Improved Noordendijk, Dordrecht: cross section Dordtse Wand
(Technical drawing Water Board De Groote Waard, 1997)

climate change effects. The design life time of the concrete structure is 100 years, but no additional provisions were made in the houses to allow separation of the two structures, in case of potential future demolition or renewal.

Although the flood wall was almost entirely constructed in a 3,5 meter high dike body, causing the wall to retain soil, the Water Board Hollandse Delta considered the wall as the primary water-retaining structure. The flood wall, as a flood defence, is owned by the water board, but given that it is part of a private property,

the water board had to make special arrangements with the house owners. The involved parties signed a covenant to ensure protection against floods and enable inspection and maintenance of the flood defence. The purchase contract of the houses contains requirements to guarantee the preservation of the water retaining function. House owners, for instance, are not allowed to bore holes in the retaining walls (Van Veelen et al., 2015; Van der Veen, 2003). It has been reported in 2015 that several minor cracks in the L-wall caused disagreement between house owners and water board about the responsibility for the repair of these cracks.

A.3 PARKING GARAGE IN ZWIJNDRECHT

Zwijndrecht was founded on a sand dune on the northern bank of the current river Oude Maas. It was protected by dikes from early days. Because of frequent failure of these dikes, the construction and maintenance became regulated in the 14th century. This regulation stimulated the foundation of new urban areas, which became part of the town of Zwijndrecht in the second half of the nineteenth century. The crests of the dikes were used as roads, and dwellings were constructed on both sides of the dike. Like in Dordrecht, the dikes of Zwijndrecht needed improvement after the storm surge of 1953, for which most dike houses were demolished (i.e. most of the town of Zwijndrecht, as this town was a typical 'dike village'). Only the road has been rebuilt after the dike improvement.

A large part of modern Zwijndrecht, containing the harbour and industrial activities, is located outside the dikes. Since the end of the twentieth century, the municipality is transforming this area into an area containing residential and office buildings, protected against river floods by a quay wall. In addition, the interior of the ground floors of the houses was made resilient to flooding. The 'Westkeetshaven' of Zwijndrecht was transformed into a living and working area, in the beginning of the twenty-first century (Figure A.10).



Figure A.10: Zwijndrecht: the Maasboulevard, part of the renewed 'Westkeetshaven', May 2012

A

Also the Westkeetshaven area is located outside the primary flood defence, but the economic relation between the ground level of this area and the flood probability was studied: An economic optimum was found for the ground level of NAP + 3,10 m, with a corresponding average exceedance frequency of 1/600 per year. The area was extended into the river for thirteen metres. To accomplish this, a new sheet pile quay wall has been constructed. The old quay wall, consisting of sheet piles, is still part of the present water retaining structure. The old sheet piles were connected to new sheet piles with anchors. The area in between the two sheet pile walls serves as an underground car park (Figures A.11 and A.12). Every house has access to this car park. (Stalenberg, 2010).



Figure A.11: Zwijndrecht: The parking garage under the Maasboulevard, May 2012.
The sheet pile wall behind the car is water-retaining

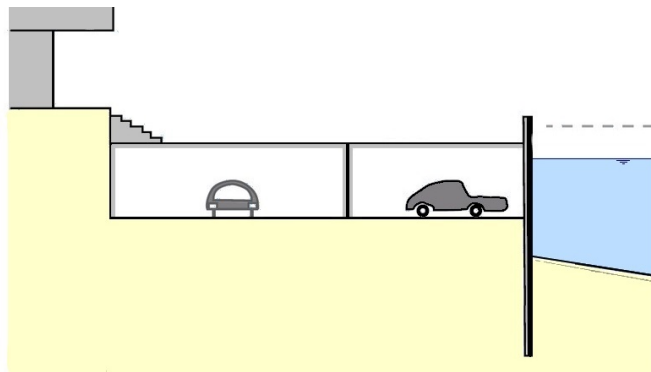

Figure A.12: Zwijndrecht: Cross-section of the parking garage under the Maasboulevard
modified from Stalenberg (2010)

Although a water-retaining garage wall was combined with a quay wall, this is not a formal flood defence. The primary river dike is located about 150 m landward. However, the combined garage/quay wall could have been part of a primary flood defence and as such it is an interesting example.

A.4 THE RIVER FRONT OF KAMPEN

Kampen is located along the Gelderse IJssel river. To protect the town of Kampen and to meanwhile preserve the typical character of this old Hanseatic trading city, measures have been carried out to combine the flood defence with other functions. An existing quay wall was upgraded and combined with stop logs to provide extra height. The historic city wall, in line with many private gardens and a few buildings, was improved, which required the cooperation of the owners of the houses and buildings. The flood defence line crosses streets at several places, with closable gates. A 'flood brigade' (*hoogwaterbrigade*), consisting of volunteers, was formed by the water board to take safety measures when needed. This is tested once per year, see Figure A.13.



Figure A.13: Kampen: the flood brigade is extending the flood wall with aluminium elements (IJsselTV, 5-1-2012)

Thus, the flood defence of Kampen is combined with living, transport, parking, recreation and history preservation functions. Figures A.14 and A.15 show examples of the multifunctional flood defence. Figure A.16 shows a design sketch of a flap barrier on the quay, which was finally not selected to be built.

A



Figure A.14: Kampen: attention has been paid to 'minor' details, such as closing-off cellars, November 2011



Figure A.15: Kampen: flap gate; the flood defence switches from the far side of the road (which is at the river side) to the near side, November 2011

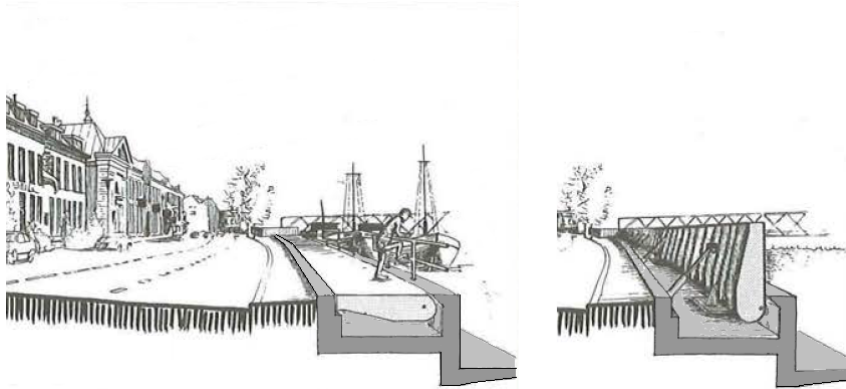

Figure A.16: Design sketch of a flap barrier in Kampen.
Left: normal conditions, right: during high river discharge (TAW, druk op de dijken 1995)

A

A.5 THE RIVER FRONT OF HAMBURG

Hamburg is a major trade and harbour city in the north of Germany, situated about 110 kilometres from the mouth of the river Elbe. The North Sea flood in the night from 16 to 17 February 1962 mainly affected the German coastal regions and particularly the city of Hamburg. The houses of about 60 000 people were destroyed and the death toll in Hamburg amounted to 315. The flood was caused by a low-pressure system that approached the Deutsche Bucht (a bight, north of Hamburg), coming from the southern Polar Sea. A storm with a wind force of 9 Beaufort and peak wind velocities of 200 km/h pushed water into the Deutsche Bucht, leading to a water surge that the dikes could not withstand. The water reached a level of NN + 5,70 m, which was 0,46 m higher than the highest water level up to then, which was registered in 1825. Breaches in coastal dikes and the river dikes along the Elbe and Weser caused widespread flooding of huge areas. Especially the river dikes that had not been heightened after the storm surge of 1952 were heavily damaged in 1962, while most sea dikes withstood the surge (Wikipedia, 2012). More than 60 breaches occurred in the dikes with a total length of about 1,5 kilometres. The flooded area amounted 12 500 hectares, about 1/6th of the total area of Hamburg (Landesbetrieb SBG, 2012).

As a response to these floods, emergency plans were drawn up. The coastline was shortened as a preventive measure, which left several river arms and bays detached from the sea. In addition, the design water-retaining height was raised to NN + 6,70 m and many dikes were reinforced in horizontal direction as well, with more gentle slopes. In January 1976, a storm surge exceeded the one of 1962, leading to a water level of NN + 6,45 m. The reinforced dikes were sufficiently high and stable to withstand this level, but there was much damage in the less protected harbour area of Hamburg. The construction of a storm surge barrier in the Elbe mouth near Brokdorf was studied, but could not be agreed upon by the various Bundesländer. Therefore, in the mid 90s, a flood protection programme was started to raise the retaining height by about one metre to NN + 7,30 at St. Pauli, about 2 km West of Hamburg. The calculation method was sophisticated now, taking local hydraulic conditions as wave run-up into account per dike section. This led to varying retaining heights from NN + 7,50 m up to NN + 9,25 m (Landesbetrieb SBG, 2012).

In 2000 a start was made with a project of the redevelopment of an old harbour area in between the Speicherstadt quarter and the Elbe. This redeveloped area, the HafenCity, is intended for work, living, retail-trade, recreation, gastronomy and culture. The HafenCity area is located outside the area protected by dikes (see figure A.17), because its proximity to the water gives the area much of its charm and dikes would take away many of the sight lines down to the water (Municipality of Hamburg, 2012).

All new buildings in the Hafencity are built on artificial mounds at about NN + 8 m, which is safe for most extreme water levels. On the sides exposed to wind, such as the southern sides of Sandtorkai and Kaiserkai, the external perimeter lies at NN

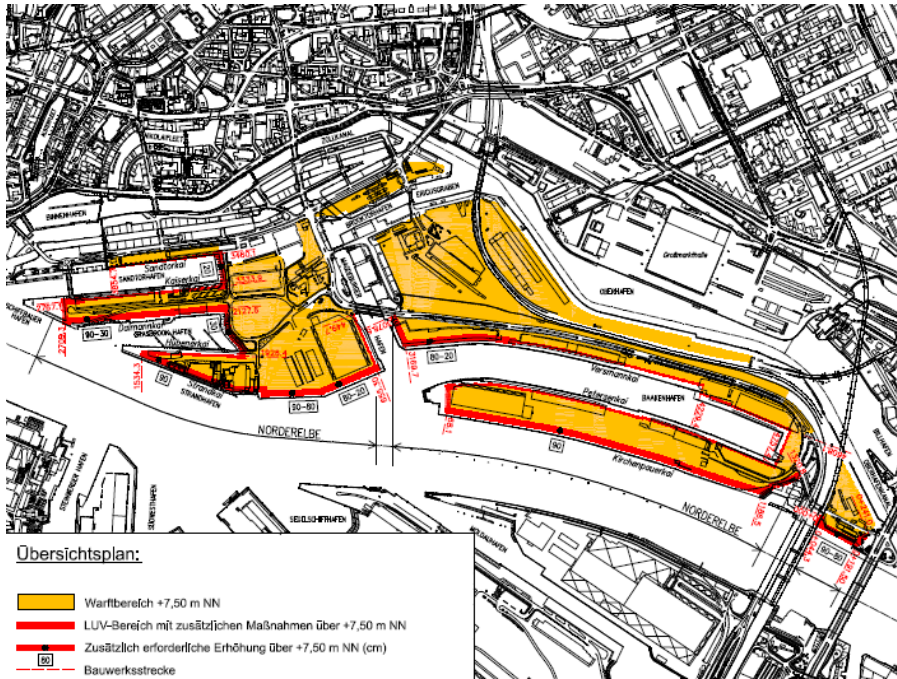

Figure A.17: Hafencity Hamburg, Germany

+ 8,03 m to NN + 8,60 m. It is the responsibility of the private developers of these buildings to construct the artificial mounds, and the number of artificial mounds is increases with the number of buildings. This development reduced the necessity of financing local flood-protection measures years, or even decades, ahead of the sale and deployment of the sites. Thus, the mounds solution has the side-effect of allowing the development of a new topography, improving the character and the quality of the city area (Municipality of Hamburg, 2012). See Figures A.18 and A.19 for an impression of the apartment blocks in the Hafencity. The flood-proof plinths provide space for underground parking garages, reducing the volume of private transport in the new part of town and taking away the necessity for additional ground-level parking spots. Roads and bridges were built above the flood-line, at least 7,5 meters above sea level.

A broad strip, up to 15 meters wide along the edges of the restored historic quays, is located at the existing NN + 4,00 to 5,50 m level of the Hafencity area and provides 10,5 kilometres of waterside walks. It considerably contributes to public urban space right next to the water. The Hafencity can continue to function virtually without restriction, even during a flood and despite its 'island' situation. However, during high water levels, a few underground parking garage entrances will have to close their flood gates. In this way, the retrospective elevation of the roadways passing directly along the historic warehouses was avoided, which preserved the identity

A



Figure A.18: Hamburg: apartment blocks in the Hafencity (Am Sandtorkai), May 2012

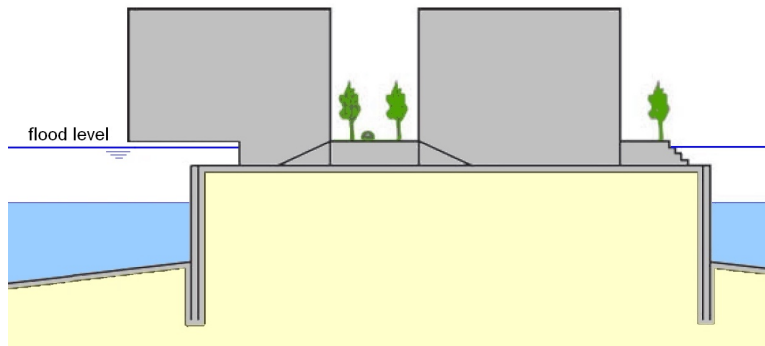

Figure A.19: Hamburg: a cross-section of the apartment blocks along the Sandtorkai (Pols, Kronberger et al., 2007)

and function of the whole Speicherstadt ensemble. The plans for the redeveloped Speicherstadt were based upon the acceptability of flooding of the area in case of extreme high water (Municipality of Hamburg, 2012). Therefore, windows in the lowest storey were designed to withstand high water pressures and steel bulkheads prevent eventual damage on the glass windows by floating debris (Figure A.20). It is not allowed to live on the ground floors, so this area is used for car parks, restaurants and offices. The apartment blocks have a different access level, to cope with varying water levels around the blocks. There are escape routes at different heights to guarantee a safe evacuation if needed (Stalenberg, 2010).

The new multifunctional quay walls along the 'Baumwall' and 'Vorsetzen', just west of the Hafencity, contain a parking floor, public toilets at street level and three sites for new buildings that include a restaurant and a kiosk. Temporary structures were used to secure the flood protecting function during the replacement of old structures by the new flood defence. See figure A.21 for an example of a



Figure A.20: Hamburg: steel bulkheads can be closed to protect the windows of apartment blocks along the Sandtorkai, May 2012

multifunctional flood defence combined with a parking garage under construction.



Figure A.21: Hamburg: multifunctional quay wall near the Baumwall under construction, May 2012

B

THE ESTABLISHMENT OF THE BASIC WATER LEVEL BY THE DELTA COMMITTEE

The Delta Committee, according to its assignment, studied what level of flood safety could be considered high enough and how this safety level should be attained. It followed three ways of reasoning to find an acceptable safety level:

1. A historical study of high water levels, using studies of the Royal Dutch Meteorological Institute (KNMI);
2. An extrapolation of water level measurements to find what storm surge levels can be expected in future, using a statistical analysis of Rijkswaterstaat (carried out by Wemelsfelder);
3. An econometric optimisation, which comprised the execution of a cost-benefit analysis to find an optimum between investments in flood protection and obtained risk reduction, using studies of the Mathematical Centre (Van Dantzig).

The ways of reasoning are explained in more detail in this appendix.

B.1 HISTORICAL STUDY OF HIGH WATER LEVELS

For the first way of reasoning, the Delta Committee attempted to determine what maximum water level could physically be attained, starting with an attempt to find the highest storm surge level reached in the past (Chapter 3.0 of the final report). The storm surge of 1953 reached a level of NAP + 3,85 m at Hoek van Holland, which was the level of the normal astronomical tide (NAP + 0,81 m) plus a 'storm effect' of 3,04 m. That storm surge level was considered to have an average exceedance frequency of about 1/300 per year (Deltacommissie, 1960a, p. 30).¹

It appeared that the water level of the 1953 storm surge exceeded all previously recorded water levels. The top level of 1953, NAP + 3,85 m, exceeded the highest

¹Other mentioned frequencies are: 1/222 per year by the Mathematical Centre, (Deltacommissie, 1960c, p/ 72) and 1/250 per year according to the Storm Surge Report (RWS and KNMI, 1961, p. 108) and by Wemelsfelder, (Deltacommissie, 1960d, p. 77)

recorded level of 23 December 1894 (NAP + 3,28 m) by more than half a metre. The most severe storm surge since 1800 occurred on 4 February 1825, when an area of 370 000 m² was flooded, almost three times as much as in 1953. The maximum water level at Hoek van Holland in 1825 is not known, because no measurements were done at that location, but the committee concluded that it can be assumed that a storm surge like in 1825 would not have reached the level of 1953, even if the sea level rise since 1825 could be taken into account.²

It was difficult to find out whether storm surges before 1825 would have been more severe than in 1953. Extensive description of the floods of 1421 (Saint Elisabeths Flood), 1570 (All Saints Flood), 1686 and 1775 were available, but water levels were not measured at that time. The committee did not have the impression that these water levels exceeded the level of the storm surge of 1953. The circumstances during the storm surge of 1953, however, could have been worse. In the Delta Report it is mentioned that more unfavourable circumstances could have caused an additional water level elevation of 1,15 m. An internal note of the Dutch contractor HBM explains that the 1,15 m elevation consisted of four components (Van der Pot, 1977):

1. The main contribution to the additional elevation of 1,15 m comes from the astronomical tide: 0,44 m should be added to the water level reached in 1953, because it was not as high as it could have been during the storm surge. Two days before the storm surge (i.e., on 30 January 1953, 0:44 h) it was a full moon, which caused spring tide in Zeeland with a delay of about $2\frac{1}{4}$ days. This means that on 1 February 1953, a spring tide occurred in the province of Zeeland, but it was not an extremely high one. This was caused by the distance between the moon and the earth, which was at a maximum on 1 February 1953 (the moon was in its apo-apsis) and thus the combined force of attraction of the moon and the earth was minimal.
2. The water level could have been an additional 0,30 m higher, if the course of the low pressure area of 1 February 1953 would have been the most unfavourable for the water levels along the Dutch South-Western coast.
3. If the maximum wind set-up would have coincided with the astronomical tide, the water level would have been another 0,21 m higher.
4. Resonance of the maritime basin, finally could have worsened the case with 0,20 m.

These effects, which could have aggravated the disaster, are presented in table B.1.

Adding these 1,15 m to the reached level of NAP + 3,85 m at Hoek van Holland, a 'basic level' of NAP + 5,00 m was obtained, which was finally chosen as a starting point for the Delta Committee. It was calculated excluding effects of future closure dams and other interventions, nor did it include effects of chart datum subsidence or water level fluctuations of short periods.

The influence of the discharge of the main rivers on the storm surge level was taken into consideration. RWS and KNMI (1961) describe that in 1953, the discharge of

²For Texel, almost 200 km North of Hoek van Holland, the levels of 1825 and 1953 were comparable, but there they were considerably lower than in Hoek van Holland.

Effect	Resulting elevation
maximum tide	0,44 m
'optimal' course of the low pressure area	0,30 m
coincidence of max wind set-up and astronomical HW	0,21 m
resonance of the maritime basin	0,20 m
total	1,15 m

Table B.1: Additional effects that could have raised the extreme water level at Hoek van Holland in 1953

the rivers Rijn and Maas was lower than the usual winter average: there was only 67% of the average Rijn discharge (measured at Lobith) and 80% of the average Maas discharge (near Lith). This implies that the water level of the lower rivers could have been higher than in 1953. If the storm surge on 1 February would have coincided with the high discharge of 1941, the river levels would have been 0,13 to 0,50 m higher, depending on the location. For the calculation of the basic water level of Hoek van Holland, however, this river level elevation is not of any influence, because the water levels were measured at sea.

The physical approach described in this section, however, is criticised because any of the parameters that together constituted the 'storm effect' might still have been more unfavourable. The Royal Dutch Meteorological Institute (*Koninklijk Nederlands Meteorologisch Instituut*, KNMI) carried out studies that showed that considerably higher storm surge levels are physically possible. According to KNMI, a storm set-up of more than 5 m could be possible, about 2 m higher than observed during the storm surge of 1953 (Deltacommissie, 1960b). This would result in a basic level of NAP + 7,00 m (or even higher) near Hoek van Holland. The Delta Committee, however, considered this level impossible, because of meteorological reasons. In fact, the committee concluded that it is not possible at all to predict a water level that cannot be exceeded.

B.2 EXTRAPOLATION OF WATER LEVEL MEASUREMENTS

As a second way of reasoning, the Delta Committee considered an estimation of future storm surge levels by means of extrapolation of past water level measurements. Rijkswaterstaat was asked to write a contribution. As already described, in 1939 Van Veen and Wemelsfelder found that the storm surge levels could be much higher than had been assumed until then. In the statistical approach of Wemelsfelder, it is acknowledged that no maximum storm surge level can be found, but it is obvious that the likelihood of exceedance decreases substantially with the height of the water level. The exceedance frequency of extreme water levels can be found by extrapolation of a series of water level measurements, far beyond the observation range. It should be noted that Wemelsfelder had disposition over a relatively large number of data, because water levels in the Netherlands were systematically measured since halfway the nineteenth century. Nevertheless, the measurement period was not long enough to obtain a good accuracy for modelling the tails of the water

level distribution over time.

As already explained in the previous section, the Delta Committee assumed a water level of NAP + 5,00 m at Hoek van Holland as a basic level for further considerations. To find the corresponding exceedance frequency of this basic level, extrapolation of the found trend was necessary. Because of the uncertainties of the course of this line above NAP + 3,00 m, the Delta Committee had asked the Mathematical Centre in Amsterdam, with help of the Dutch Meteorological Institute, to assist. The Delta Committee also asked Rijkswaterstaat to study the problem, which was mainly carried out by Wemelsfelder. Their contributions can be found in the appendices of the Delta Report (Deltacommissie, 1960c,d).

The Mathematical Centre, under guidance of Van Dantzig and prof. Jan Hemelrijk, studied the water level records of Rijkswaterstaat between 1888 and 1956 with aid of the Royal Meteorological Institute for making the selection of relevant data. Van Dantzig found an exponential function better suitable to describe the distribution of high-water levels than the Gumbel function that was proposed by Wemelsfelder. The results of both functions were comparable within the range of high water level up to NAP + 6,00 m, but the exponential function was easier to use in a mathematical sense and the extrapolation of the line beyond the measurement points was less arbitrary (Deltacommissie, 1960c, p19).

Cor van der Ham, employee of the KNMI and the first weatherman on Dutch television, took several measures to homogenise the data set (Deltacommissie, 1960c):

1. Measurement points were restricted to the months November, December and January, because of reasons of representativeness and only one measurement point was included per storm surge. The set of selected data was extensively analysed by the Mathematical Centre. It advised to use an exponential distribution with an exceedance frequency line that intersected a water level of NAP + 5,13 m at a frequency of 10^{-4} per year.
2. The selection was based on low pressure areas (causes of storms) instead of separate high-waters. Successive high-waters can namely be correlated (being caused by the same low pressure area), which is incorrect for a statistical analysis.
3. Van der Ham studied the tracks of the centres of the low pressure areas in the period between 1989 and 1953 that had caused a high or low water set-up of more than 1,60 m near Hellevoetsluis. It appeared that not all low pressure areas were equally threatening. Only those, following a 'track' in a certain part of the North Sea, were considered dangerous for the Netherlands on meteorological grounds. Hoek van Holland was consequently chosen as a representative station for the Netherlands, insofar as it concerns the behaviour of severe storm surges. A selection was made of high water levels at Hoek van Holland with a set-up of minimal 0,50 m and a low pressure track through the corresponding window was selected.

After the Mathematical Centre had presented its results, the Delta Committee consulted representatives of this institute and of the Department of Water Management

(Directie Waterhuishouding en Waterbeweging) of Rijkswaterstaat. It was agreed to assume a work line as indicated in Figure B.1: the thick line, with a bend at around NAP + 3,00 m. This graph shows the highest 30 storm surges plus the 40th surge. The relation between exceedance frequency and water levels is given by an exponential function, in accordance with the study of Wemelsfelder (1939), which results in a straight line through the part with not-extreme water levels, plotted on a half-logarithmic scale like in Figure B.1.

B

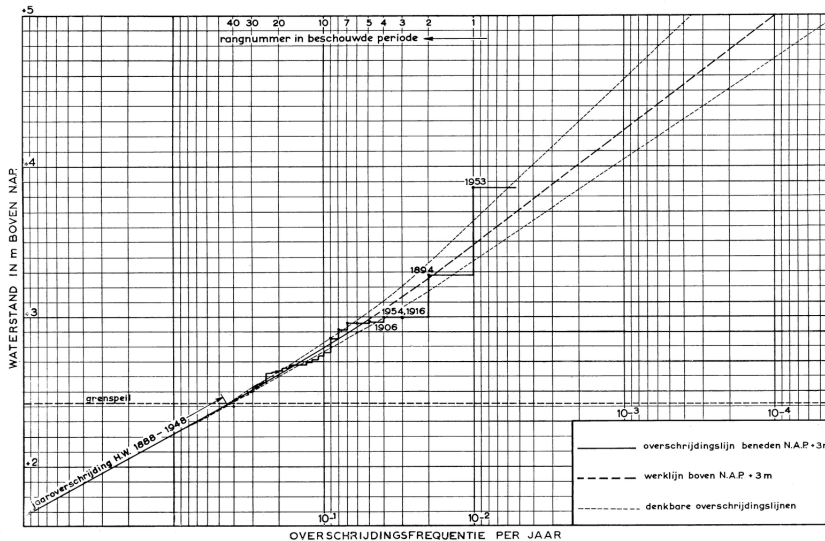

Figure B.1: Water level exceedance line at Hoek van Holland from measurements between 1859 and 1958 (Deltacommissie, 1960a)

It should be noted that there is a bend in this line, just above NAP + 3,00 m. The Delta Committee justifies this bend in its report by stating that, notwithstanding the fact that there are arguments to assume that the exceedance line above NAP + 3,00 m could deviate to lower water levels than indicated by a straight line (downward deviation), the assumption was not supported by measurements. On the contrary, a deviation towards higher water levels was considered more likely, because of several highest measurement points. The presence of these highest measurement points was statistically not demonstrable, but if a larger class of distributions would be used as a base for the adoption of an exceedance line to the measurements, a considerable upward deviation would be obtained (Deltacommissie, 1960a). In a publication other than the contribution to the Delta Report, Van Dantzig gives a possible explanation for the bend: he suggests that the highest storm surges are caused by storms of a different type than the lower surges, which could cause a kink in the trend line. Van Dantzig also remarks that the group of storms that followed the tracks, selected by Van der Ham and analysed by Hemelrijk of the Mathematical Centre, clearly resulted in a different straight line. The estimated halving height found by the Mathematical Institute was 0,21 to 0,25 m higher and the

95% confidence limit was 0,24 to 0,26 m higher. The estimated Wemelsfelder-line then becomes $h = 2,03 - 0,75 \log(p)$ (Van Dantzig, 1956).

After having initially agreed upon the workline as indicated in figure B.1, the Mathematical Centre made more calculations and found higher levels than NAP + 5,00 m for the average exceedance frequency of 10^{-4} per year. After more discussions with Rijkswaterstaat, the Mathematical Centre finally stated that it considered the level of NAP + 5,00 m 'not entirely unacceptable', though on the low side, as an estimate for the entirely statistically determined level with an exceedance frequency of 10^{-4} per year.

The relation between water level and exceedance frequency was found with the help of measurements over long periods of time. However, the level reached in 1953 was not included in this calculation. This omission is in line with the remark of Wemelsfelder, that 'the generic shape of a frequency curve should not include the highest, the one but highest and the two but highest levels' (Wemelsfelder, 1939). The highest measurements, namely, cannot be expected to be situated on the frequency curve, because the distribution of measurements becomes wider if the frequency decreases (Deltacommissie, 1960c). Due to all the uncertainties, the Delta Committee advised to use the exceedance graph only with 'great caution' (Deltacommissie, 1960c).

The question then was what exceedance probability would be suitable as a criterion. Any chosen criterion is bound to be subjective, but the Delta Committee preferred to include flood consequences in the estimation of an acceptable safety level anyway. The committee considered a probability that an individual would die because of a flood reasonable, if this was 1% in a lifetime, or approximately 1% per 100 year. This is the exceedance probability that corresponds to the level of NAP + 5,00 m at Hoek van Holland according to the exceedance line preferred by the Delta Committee (Deltacommissie, 1960c; Valken and Bischoff van Heemskerk, 1963).

In 2014, ir. Henk Jan Verhagen, Delft University of Technology, performed an analysis of 150 years of storm surge data at Hoek van Holland (from 1863 to 2013). He used the Peak over Threshold method with a lower boundary of NAP + 2,25 m, assuming an exponential distribution. Subsequent peaks that were obviously related by the same storm event were reduced to single data points. All data were corrected for a relative sea level rise of 0,22 m per century. Assuming a straight line through these points, plotted in a log-linear graph, the 1953 storm appears to have an exceedance probability of 1/390. After linear extrapolation, the water level corresponding to an exceedance probability of 1/10 000 appears to be slightly less than NAP + 5,00 m, namely about NAP + 4,84 m (figure B.2).

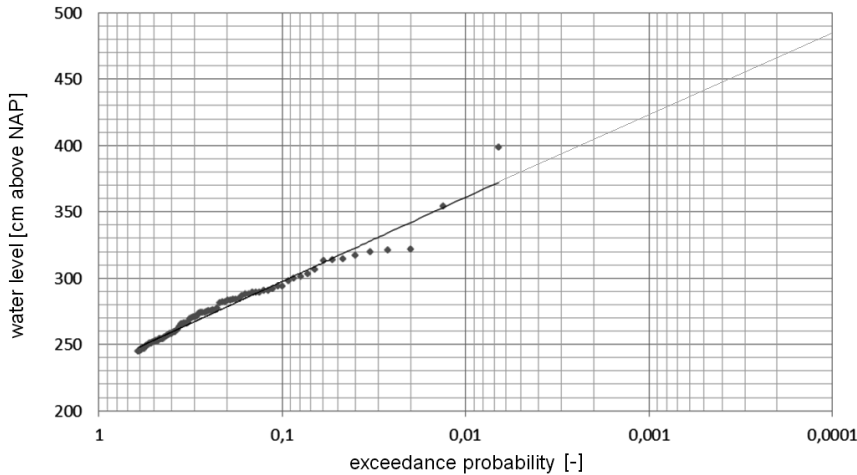

Figure B.2: Water level exceedance line at Hoek van Holland from measurements of high water levels (> NAP + 2.25 m) between 1863 and 2013, assuming an exponential distribution (Verhagen, 2014), extrapolation by the author of this dissertation

B.3 ECONOMETRIC OPTIMISATION

Because the selection of a design level on the basis of physical or statistical considerations appeared to be unavoidably subjective, a joint economic and statistical basis was attempted as a third way of reasoning to solve the problem. The Delta Report therefore contains an econometric calculation, in which investments in protective measures are balanced with the therewith obtained flood risk reduction.³ The insight into this approach was delivered by a contribution of Van Dantzig and Kriens (Deltacommissie, 1960c).

The main idea of the economic optimisation was to summarise the capital to be invested in flood prevention and the capitalized anticipated value of the margin of damage due to flooding, and then find the smallest value (Figure B.3). This principle was worked out analytically by the Mathematical Centre and graphically by Rijkswaterstaat.

To estimate the risk reduction, Van Dantzig, of the Mathematical Centre, used the estimate of the Central Bureau for Statistics (*Centraal Bureau voor de Statistiek, CBS*) of $24 \cdot 10^9$ guilders for capital goods and sustainable consumptive commodities in central Holland (dike ring 14).⁴ This value was the magnitude of the consequences of a flood in case of complete loss of capital goods. Not included in this value were production deprivations and, to a much lesser extent, neither were losses of infrastructure, administered by the national authorities, social disruption and

³For the obtained risk reduction the Committee used the present value of the imaginary insurance premium that would be required to cover the remaining flood risk for the areas behind the dikes.

⁴In 2005 it was estimated at $290 \cdot 10^9$ euro (Rijkswaterstaat, 2005).

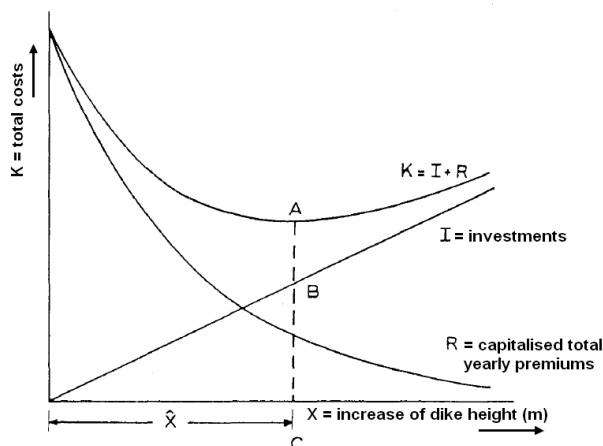

Figure B.3: Econometric estimate of investments and capitalised disaster damage (represented by yearly total premiums)(Deltacommissie, 1960c)

loss of lives. On the other hand, over-estimations were made in the econometric calculation: they consisted of partially preserved real estate in higher situated areas and partial preservation of productivity of the population. The net effect of this over- and underestimation was that no adjustment in the estimation of the economic value of the area was made.

The calculations to find this optimum protection level, however, contained many uncertainties. To start with, only a tentative estimation could be made of the costs of the reinforcements of existing dikes, construction of new dikes and carrying out other flood protection projects and of the capitalised expenditure of maintenance of such a large scale project. In addition, the magnitude of consequences of a flood was extremely difficult to estimate, because it was difficult to forecast the economic developments, and the impacts of floods vary considerably. Furthermore, the selected rate of interest is an uncertain factor for the capitalisation of the damage. Yet, the uncertainties of extrapolation of the frequency curves are much bigger. Besides, the selection of the critical failure mechanism (wave run-up / overflow) introduces uncertainties, as many factors are not taken into account, such as factors related to dike construction. However, the population growth, as well as the economic development and numerous other imponderables, such as human suffering, loss of life, and disruption of daily life, were taken into consideration.

Van Dantzig was reluctant to express the value of human life in monetary units, out of ethical reasons. He considered to make a comparison with investments that were made in society to reduce other types of risk, or to look at the insurance benefits in case of loss of life, but these ideas appeared to lead to unacceptable or insignificant results. So, Van Dantzig refrained from directly quantifying the value of human life. The same applies to cultural values. To nevertheless include non-economic values, Van Dantzig proposed to multiply the total economic value of a protected area with

a factor to include non-economic values. He considered a multiplication factor of 2 'certainly not too high'. (Deltacommissie, 1960c). Instead of quantifying human life, he reasoned what preventive investments per individual would be acceptable, compared to other types of disasters, and looked at life insurance premiums. He reasoned that even an amount of 100 000 guilders per individual, which would certainly go *'far beyond any sum that would be acceptable (...) as a norm for all cases*, and would not lead to significant improvement of the flood protection level, corresponding to 0,03 m higher dikes. Any acceptable monetary equivalent for the loss of life, on the other hand, would not be feasible (Van Dantzig, 1956). He finally advised to base the factor on political considerations, not on mathematical-statistical, economic or technical analyses (Deltacommissie, 1960c).

It was then calculated by Van Dantzig that if a complete economic loss would occur with a probability of failure in a year of $1/125\,000$, it would balance with the investments in risk reduction by flood protection, which were estimated 150 million guilders per year (net present value). After application of these dike reinforcement measures the flood risk, defined as the probability of occurrence of a flood in a year multiplied with the insured value, was estimated at 13,5 million guilders. This corresponds with a design water level of NAP + 6,00 m at Hoek van Holland, called the disaster level (*ramppeil*). The economic considerations mentioned in the foregoing analysis would be valid if a large number of risks could be insured on this basis. This, in fact, is not applicable to flood risk, because a succeeding flood would have a considerable influence on the outcome of the calculations. This is one of the weakest points of these econometric calculations. Notwithstanding the arbitrary outcome of the econometric approach, it gives a more insight in the involved factors than the previous described ways of reasoning (Sections B.1 and B.2) (Valken and Bischoff van Heemskerk, 1963).

Ultimately, the Delta Committee did not fully support the outcome of the advice of Van Dantzig: due to the lack of numerical insight in failure mechanisms it appeared impossible to determine the probability of failure of a dike. It also appeared that the assumption of a disaster with complete loss of goods in case of exceedance of the design level was overstated. The Delta Committee also deviated from the proposal of Van Dantzig to include non-economic losses in the analysis. Consequently, it did not adopt the advice to multiply the economic losses with a factor two to account for the loss of lives, because the assumption that a dike failure would result in maximal damage already implied an extra safety margin (RIVM, 2004).

The Delta Committee did not adopt the disaster level of NAP + 6,00 m as a design level, as proposed by Van Dantzig, because exceedance of the design level would, after all, not immediately result in maximum damage. Instead, the committee translated the *failure* probability criterion of $1/125\,000$ (with a corresponding disaster level of NAP + 6,00 m) into an *exceedance* probability of $1/10\,000$ (and corresponding 'design level' of NAP + 5,00 m) at the reference location of Hoek van Holland (Deltacommissie, 1960a).

A difference of opinion arose between the Delta Committee and Van Dantzig, on

exactly this issue. Van Dantzig stated that the committee would in the future regret its too low standard (RIVM, 2004). The committee admitted that a maximum storm surge level could not be estimated, thus the probability of a disaster remained, whichever storm surge level would be selected as a base for reinforcement of primary flood defences. The committee recognised that other considerations could lead to higher safety standards, but was of the opinion that flood risk should not be regarded in an isolated way, but should be considered in relation to other types of risks. With respect to this fact, the committee considered the proposed basic levels related to a 1/10 000 exceedance probability as an acceptable limit for the risk of storm surges. Moreover, levels based on a 1/10 000 norm would obtain a safety standard as much as 30 times higher than the storm surge level of 1953 (Deltacommissie, 1960a).

The Delta Committee thus found a probability of 1/10 000 during a random year acceptable for the exceedance of the design water level. Finally, it was calculated whether the investments needed to accomplish this safety level could be afforded by the Dutch state. The investments in flood protection for the first 20 to 25 years were estimated at 2,0 to 2,2 billion guilders in total, or 100 to 125 million guilders per year, assuming that construction works would take about 20 to 25 years. One year of investments equalled about 10% of the economic damage caused by the storm surge of 1953, which could be afforded in a short term without severe disruptions. Compared to the total of 27,6 billion guilders of total national expenditures in 1955, the protection of the Netherlands at the indicated level would cost 0,5% of these expenditures, which was considered affordable and acceptable (Deltacommissie, 1960a).

C

EVALUATION OF THE CURRENT DESIGN EDUCATION

This appendix evaluates recent experiences with design education at Delft University of Technology. The findings were used to improve the developed design method as described in Chapter 4 of this dissertation.

The author of this work has gained experience with the basic engineering design method as supervisor of students, working in groups or individually. The curriculum of the BSc education on Civil Engineering at Delft University of Technology has changed per September 2013 and since then, the design skills of our students have reduced: Basic design skills are now only taught in the the first BSc-year¹. MSc-students from abroad often entirely lack these design skills.

A quick-scan of about 25 recent BSc- and MSc reports was carried out in spring 2016, to get an impression of the design skills of civil engineering students. The studied works comprise reports of project groups Civil Engineering, BSc-theses Hydraulic Engineering and MSc-theses Hydraulic Engineering. The findings are that many essential elements were present in the reports, but, depending on supervisors and students, it was observed that:

- the approach was not always systematic;
- the design steps were not not always carried out in a logical order;
- different levels of detail were commingled (subsystem and component level, for instance, were treated in one design cycle);
- sometimes steps were carried out but for no use;
- sometimes methods were wrongly applied;
- knowledge of constructability aspects was weak.

¹The new BSc-curriculum was proposed by prof.ir. Frank Sanders, educational director, and was accepted by the BSc-education committee and the management team of the faculty of Civil Engineering and Geosciences. Initially, all courses on engineering design were removed from the curriculum. It was the initiative of prof.dr.ir. Marcel Hertogh to maintain a course of five European credits on engineering design in the first year of the education of civil engineers, compulsory for all BSc Civil Engineering students, and an elective design course for third-year BSc-students.

Furthermore, a quick-scan has been carried out of integrated designs, made by students of one of the minors (academic year 2015-2016):

1. Spatial and hydraulic design of river dikes (six student groups):
 - most groups only included flood protection in the project goal, so no spatial quality or transport;
 - most groups did not set-up a list of requirements;
 - most groups did not verify the generated concepts;
 - the result was scarcely integrated;
2. Design of complex urban infrastructure (four student groups):
 - no group did a specific problem analysis;
 - only one group mentioned design goals (which was not the group that made the masterplan);
 - 'goals' were derived from developed concepts, not for the problem analysis;
 - requirements, verification and/or evaluation were lacking in most cases, or quite weak;
 - the approach was not very systematic;
 - integrality of the solutions was not guaranteed.

The exercise for the integrated design of river dikes was given again in the academic year 2016-2017, but with stricter instructions: The students were forced to relate every main design step to one corresponding chapter. Furthermore, the order of activities (more or less according to Figure 4.1) was specifically prescribed. The results had much improved compared to the first year, but they were not yet optimal. The main reason was, that the students were allowed to form mixed groups themselves, resulting groups in which not all disciplines were equally represented. Furthermore, it appeared that the students had assigned tasks and worked on them individually. This led to concepts that lacked the diversity that could have come from group work. It was also not expected that several of the students would work on tasks simultaneously, but should have been executed successively. For example, concepts were developed before exploring the problem, and calculations were verified before concepts had been developed. This was not according to the method as described in Chapter 4 and will be taken into account in the assignment for next year.

In 2016, a design exercise was introduced in one of the bachelor courses on hydraulic structures. The assignment was to make a design of a hydraulic structure, but almost all students initially only made calculations, so, no situation sketches, no load sketches, no explicit schematisations, no systematic consideration of different load situations, and no checks whether the used methods were applicable!

In general, it was observed that students too soon jump to specific solutions: They choose familiar structures and almost without any exception, all generated concepts meet all requirements from the beginning. This implicates that the concepts were not developed freely and that the creativity was restricted by the requirements. Students tended to apply familiar calculation methods, but 'forgot' to make a systematic inventory of load situations and did not check whether methods are

applicable to the specific circumstances. This easily lead to suboptimal or plainly not-functioning results.

Overall, the observation was that the design skills of the students are deteriorating. This is not caused by the method itself, as it works quite natural and systematic: the design method used in civil engineering is very well suitable. However, the method is not always systematically applied and it is used in various ways and not always in a logical order.

It should be noticed that the supervisors of these students are generally well-experienced and have much patience and didactic skills, therefore the systems designed by our students are finally not bad at all. It is, however, believed by the author of this dissertation that the *application* of the design method can be improved, given the lacking profound designing background of students. This could reduce the efforts of the supervisors and help students to find a decent design line.²

The quick-scan of student work has led to the following improvements / points of attention regarding the design method:

- clear awareness of the distinction between the design activities and the utility of the method as a whole;
- despite the iterative character of the design process: basically carrying out the design phases in the right order;
- reflecting after every design phase and go back to an earlier phase when needed;
- inclusion of all design aspects, landscape, natural and cultural values in the design objective;
- start developing concepts at a regional level, not by sketching cross-sections of dike profiles;
- assigning requirements to all main design aspects;
- making a clear distinction between requirements and criteria;
- involving stakeholders in the project from an early stage;
- composing a balanced multifunctional design team and working together from the start of the project;
- collaborating of the members of the design team as much as possible (not divide tasks and work them out separately).

To improve the use of the correct methods and calculations, it is strongly recommended to explicitly follow the next steps for every structural calculation:

- make a situation sketch by hand (cross-section) including water levels and ground levels;
- choose the most critical load situation (from the construction sequence) and sketch a load diagram by hand;
- think of a way to resist the loads; make a hand sketch of the structure or element, indicating components, materials and connections (this can be in

²After all, supervisors have to pay attention to trivial matters as well, as language and reporting techniques, as well as motivate and coach students.

various shapes);

- make a mechanical scheme of the supporting structure or element;
- check stability and strength, considering potential failure mechanisms (ULS). For the strength check: determine critical cross-sections and draw shear force and moment diagrams. Mention the source of the model or equation and motivate why it is applicable to the actual situation. If it is not (entirely) applicable: reason how the model can be changed, or find another approach to do the check;
- check whether deflections/displacements are acceptable (SLS);
- reflect on the outcome of the calculation: is the magnitude reasonable? Comparison with similar structures under similar conditions will provide information about the order of magnitude.

Most of the improvements have been tested on students with positive results and have been included in Sections 4.9 and 5.3.2 of this dissertation.

D

ACCEPTABLE FLOOD RISK

The verification of the reliability of flood defences comprises the comparison of the actual failure probability with the required safety level regarding flooding, including a safety margin for the uncertainties. The safety level can be based on the failure probability or the risk that is considered acceptable by society. This appendix describes the criteria that determine the safety level in the Netherlands regarding floods.

D.1 INTRODUCTION

The required safety level in the Netherlands is determined by the risk or probability that is still considered acceptable by society. It basically answers the question 'How safe is safe enough?'. Already in 1985, Task Force 10 of the Technical Advisory Committee for the Flood Defences (TAW) distinguished three criteria upon which the acceptable safety level can be determined: the individual death criterion, the multiple deaths criterion and the economic criterion (Vrijling, 1985). In the ideal case, the acceptable safety level is based upon the strictest of these three criteria. However, if the individual death criterion or the multiple deaths criterion deviate too much from the economic optimum, flood protection will appear to be not affordable any more, and the economic criterion will be predominant (Vrijling et al., 2011).

The acceptable safety level according to economic criterion can be calculated in a relatively objective manner, but the estimation of the safety level related to the individual death casualty criterion and the multiple deaths criterion is partly based on subjective considerations: it is found by balancing advantages and unwanted disadvantages. According to Van Eeten et al. (2012), the main factors are voluntariness, fairness and reprehensibility. At first sight, these factors seem to be objective, but they can be interpreted and framed in different ways. Vrijling et al. (2011) describe that the determination of the height of the acceptance level is subjective and depends, next to the age and personal attitude of the decision maker(s), on:

- the extent of voluntariness of exposure to the threat, and possibilities for an

- individual to avoid the threat;
- the extent in which the threat is recognizable;
- the advantages for the individual to oppose the threat;
- the societal advantages of opposing the threat;
- the historical background of the threat (frequency of occurrence).

The following influences could be added to this list (Van Eeten et al., 2012):

- new threats are less accepted than known threats;
- threats that are concentrated in time and location are less accepted than diffuse threats.

In addition, Berlamont (2001) mentions a lack of synergy with nature as a factor of a lower acceptance of flood events.

D

The three main criteria that determine the safety level for flooding are explained in the following sections. The last section of this appendix explains how these criteria are embedded in the new Netherlands safety standard.

D.2 THE INDIVIDUAL DEATH CRITERION

The individual death criterion (*individueel risico* (sic) in Dutch) consists of the accepted probability that an individual, staying at a certain location for one random year, perishes as a consequence of a flood. Individual death probabilities can be presented in contour maps, where iso-probability contour lines connect locations with equal probabilities of fatality (Figure D.1).

The Netherlands have a high standard regarding flood protection, because of the large amount of economic activities and the large numbers of people living or working in low-lying areas: 65% of the gross national product is earned in areas below the average sea level and more than 9 million people live in this area. Because of the high protection standard, the probability to lose an individual life due to flood in the Netherlands is considerably lower than in the surrounding countries (RIVM, 2004).

The point of departure for finding the acceptable value of the individual death probability is the condition that the probability of a person to perish because of floods is not larger than the probability to die due to other events (illnesses, accidents). The 'localised death probability' can be described with the following equation:

$$p_d = p_f \cdot p_{d|f} < \beta^* \cdot 10^{-4} \quad (\text{D.1})$$

where:

- p_d [-] = localized flood probability
- p_f [-] = probability of flooding in a random year
- $p_{d|f}$ [-] = mortality (= probability of perishing, given a flood event)
- β^* [-] = discretion factor, or policy factor, varying between 1,0 and 0,1 for floods

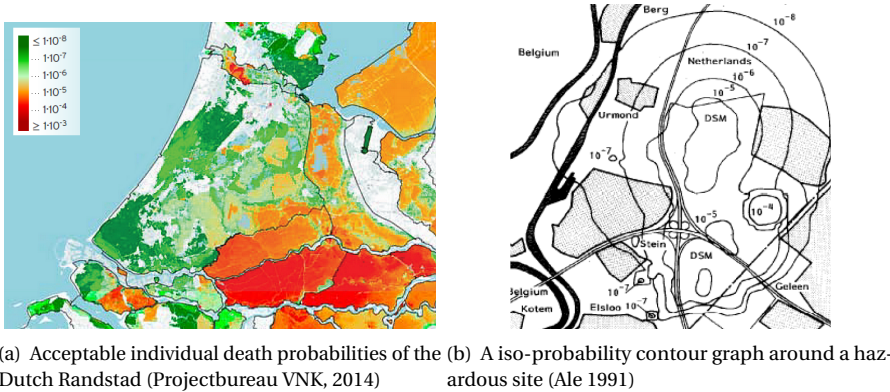

Figure D.1: Individual death probabilities

D

Jonkman (2007) concluded that an order estimate of loss of life due to coastal flood events can, in general, be obtained by assuming that 1% of the exposed population will not survive. The Fundamentals of High Water Protection Guideline of ENW (2016) mentions mortalities of 10 % for small, deep polders, 1 % for large deep polders and 0,1 % for shallow polders.

The value of the discretion factor β^* depends on the voluntariness of the exposure to a certain threat: For voluntary events, higher risks are accepted than for involuntary risks. The same applies to direct benefit of an activity or event: the more benefit, the higher the acceptance of the threat. For incidents related to LPG-stations, for instance, the value of the discretion factor β^* is about 0,01, whereas for activities as mountaineering, β^* is about 100. For floods, β^* is about 0,1 to 1,0. Flood risk is not voluntary, but flooding is still a natural risk, though reduced by the human intervention of building flood defences. Therefore, flood risk is more accepted than risks caused solely by human activities (Vrijling et al., 2011).

Because of affordability reasons, a value of $\beta^* = 0,1$ for floods is used in the Netherlands. In a study of Task Force E of the Technical Advisory Committee for the Flood Defences, a value of $\beta^* = 0,3$ was used (Vrouwenvelder and Wubs, 1989).

The 'localized death probability' (*plaatsgebonden risico, PR*), does not reckon with the possibility of preventive evacuation, which could reduce the number of casualties considerably. This effect is included in the 'local individual death probability' (*lokaal individueel risico, LIR*) and comprises two aspects:

1. the period between the prediction of a flood and the actual moment of flooding;
2. the fact whether or not the evacuation is well organised.

The relation between the localized death probability and the local individual death

probability, LIR , is:

$$LIR = p_d \cdot (1 - f_e) \quad (D.2)$$

where:

f_e [-] = evacuation fraction

The evacuation fraction, f_e , is the part of the people that can be evacuated in a short time. A failed preventive evacuation, however, could lead to an increase of the number of casualties (Kolen, 2013).

In western Europe, the acceptable individual death probability for many types of threats is 10^{-6} (Lerche and Glaesser, 2006). In the Netherlands, the former Ministry of Housing, Spatial Planning and the Environment (VROM) determined that the individual death probability is set to 10^{-6} for new situations and 10^{-5} for existing situations (Ale and Piers, 2000). The Water Act of 1 January 2017 stipulates a local individual death probability due to a flood of 10^{-5} , which should be met everywhere in the Netherlands in 2050.

D

D.3 THE MULTIPLE DEATHS CRITERION

The multiple deaths criterion (*groepsrisico* or *maatschappelijk risico* (sic) in Dutch) is the probability that a number of people, staying in an area during a random year, simultaneously die, due to a flood. The multiple deaths criterion is a measure for the societal disruption, because it takes the population density of the area into account. The reason to consider the multiple deaths criterion besides the individual deaths criterion is the psychological effect that single events with large numbers of fatalities are considered to be more severe than a large number of accidents with a small number of fatalities per event.

For the multiple deaths probability, the following criterion applies:

$$P_{dg} = p_f \cdot p_{d|f} \cdot N_p < \beta_i \cdot MF, \quad (D.3)$$

where:

P_{dg} [-] = multiple deaths probability
 p_f [-] = probability of flooding in a random year
 $p_{d|f}$ [-] = probability of deceasing of an individual, given a flood event
 N_p [-] = number of people that is exposed to the flood
 β_i [-] = policy factor
 MF [-] = country-specific factor

According to Vrijling et al. (2005), the value MF is based on:

- the minimum death rate of the population;
- the ratio between the involuntary accident death rate (exclusive diseases) and the minimum death rate;
- the number of hazardous activities in a country (in average 20 sectors);

- the size of the population of the country.

The multiple deaths probabilities can be represented in a graph, displaying the number of fatalities (N) on the horizontal axis and the cumulative annual probability that N persons will die due to a flood (F) on the vertical axis (Ministry of Infrastructure and Environment, 2012). This kind of graphs is known as FN -curves. An example of an FN -curve is presented in Figure D.2. The number of deadly victims per dike ring varies, because of the disparity in population density, the depth of the polder levels and the rate of flood propagation. The consequences of a flood in numbers of deadly victims and economic loss in the Netherlands are higher than at many places abroad. A higher safety level can be obtained by decreasing the probability of flooding (improving flood prevention) (RIVM, 2004). In Figure D.2, two straight lines indicate norms with different policy factors β_i .

D

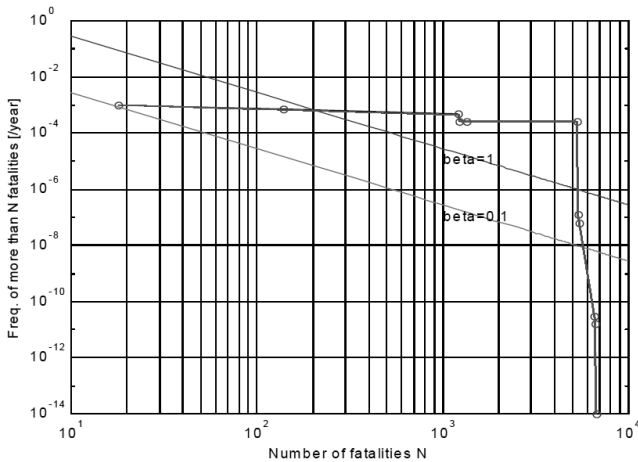

Figure D.2: FN-curve for the Brielse Polder with lines for $\beta_i = 0,1$ and 1 (Vrijling et al., 2011)

Societal risk aversion appears to be related to the magnitude of the disaster. Many small accidents are more acceptable than single major accidents with many victims. The standard deviation of the number of fatalities $\sigma(N_d)$ reflects this difference. Risk aversion can consequently be represented by increasing the expectation of the total number of fatalities in a year, $E(N_d)$, by a multiple of the standard deviation of the distribution of that number of fatalities N_d . This multiple is the risk aversion index, k (Vrijling et al., 2005).

The criterion for a nationally acceptable flood probability then becomes:

$$E(N_d) + k \cdot \sigma(N_d) < \beta_i \cdot MF \tag{D.4}$$

D.4 THE ECONOMIC CRITERION

The economic criterion is based on a balance of investments in flood protection and obtained damage reduction. The investment costs consist of the planning, the organisation, the design, the construction and the maintenance costs, aiming at reducing flood risks. The obtained damage reduction is related to the reduced failure probability and the total of material damage in case of a flood. The damage depends on the total material value present in a protected area and the rate of destruction which depends on several flood characteristics.

The consequences of a flood are determined by many factors. They are summarised by Stichting CUR (1990):

D

- boundary conditions that influence the flooding process:
 - flood depth;
 - flow velocity in the flooded area;
 - direction and magnitude of wind;
 - duration of flooding;
 - quality of the water;
 - weather conditions other than wind characteristics: temperature, precipitation, fog;
- value-related characteristics of the inundated region:
 - size of the polder;
 - population;
 - buildings;
 - means of subsistence (agriculture, industry, forestry, recreation, etc.);
 - warning and precaution possibilities;
 - evacuation and rescue possibilities.

These characteristics determine either the total economic value in the flooded area, or the part of this total value that will be lost due to a flood. Material damage s can be estimated as the product of the maximum possible damage s_{max} (100% of the value is lost) and the damage factor $c_i(d)$ (Stichting CUR, 1990):

$$s = c_i(d) \cdot s_{max} \quad (D.5)$$

A similar, but more differentiated, equation for the total damage is given by Jonkman et al. (2008):

$$D = \sum_i^m \sum_r^n \alpha_i h(r) D_{max,i} n_{i,r} \quad (D.6)$$

where:

- D = total direct damage due to a flood;
- $D_{max,i}$ = maximum damage per damage or land-use category i ;
- $\alpha_i h(r)$ = stage-damage function that expresses the fraction of maximum damage;e for category i as a function of flood characteristics at a particular location r ;
- i = damage or land use category;

- r = location in flooded area;
 m = number of damage categories;
 n = number of locations in flooded area;
 h_r = hydraulic characteristics of the flood at a particular location;
 $n_{i,r}$ = number of objects of damage category i at location r .

The maximum damage is the replacement value of all concerned properties. The damage factor indicates the degree of destruction and depends on the type of property and flood characteristics. According to (Voortman, 2003) the damage factor depends on:

- maximum flood depth;
- speed of water level increase, denoted flooding speed;
- flow velocity;
- wind velocity;
- wind direction.

D

Flood simulation models usually reckon with multiple breaches in a ring dike. In the method used in the Veiligheid Nederland in Kaart project ('Flood Risk in the Netherlands,' VNK), for instance, the number a dike segments that can fail simultaneously is limited to 13. The failure of a dike segment can result in a decrease of the hydraulic loads, which effect can be included in the simulation model. VNK distinguishes three basic cases:

1. a breach does not cause a decrease of the hydraulic loads;
2. a breach causes a decrease of loads and the breach occurs in the weakest segment;
3. a breach causes a decrease of loads and the breach occurs in the segment that is loaded first.

The estimation of the consequences should include the possibility of multiple breaches. In the VNK project this was done by adding the water depths caused by single breaches, limited by the worst case scenario. Regarding the water level rise and the horizontal flow of the water, the maximum values for single breaches were used for the VNK model. Reliable results were obtained for breaches that did not overlap. For overlapping breaches, several inaccuracies showed up, but these appeared to be relatively small. The VNK project organisation estimated the economic value of the Dutch dike ring areas. It calculated the economic losses by considering the total flooded area and the type of land use. For the estimation of the loss of life, the rate of the flood water rise and the horizontal flow velocity was taken into account, as well as the effects of preventive evacuation (Projectbureau VNK2, 2011).

Domino-effects (indirect effects) and societal disruption outside the flooded area are effects that should be included in a good damage estimation. Damage to qualitative aspects, such as nature, landscape, ecology and culture is difficult to include in a quantitative damage calculation, because of the variety in methods of valuing the

non-monetary impacts. A generally accepted approach that includes all relevant pieces of information is therefore still missing.

The economic approach of Van Dantzig, which was adopted by the Delta Committee, was based on a constant exceedance probability based on an economic optimum directly after an investment (see Section 2.4 of this dissertation). The Centraal Planbureau (the Dutch Office for Economic Policy Analysis, CPB), later wrote a report in which it is stated that the approach of Van Dantzig was 'incomplete and wrong' (Eijgenraam, 2006). In a realistic optimal safety strategy, the expected yearly loss due to floods is predominant, not the exceedance probability. Only under several conditions it is optimal to keep this expected yearly loss at the same level. In that case, if potential consequences increase because of growing economic value, the flood probability has to decrease in the course of time to keep the expected loss within its boundaries. Eijgenraam (2006) gives the formulas for these optimal boundaries for more complicated cases, including the effects of:

- economic growth;
- rise of the water level;
- increase of investment costs;
- different developments of relative prices;
- actual loss by flooding depending on the height of the dike and/or the level of the water.

Eijgenraam (2006) assumed a linear relation between the investment costs and the required increase of the dike height:

$$I(u, h, t) = F(u)e^{\lambda(h+u)} = I(u)e^{\lambda h} \quad (\text{D.7})$$

where:

- | | |
|------------------------|--|
| I [€] | = investment per m' dike |
| u [m] | = increase of the dike height |
| h [m] | = height of the dike before the reinforcement |
| t [-] | = time of investment |
| λ [€] | = increase in investment cost per cm dike heightening |
| F [m ⁻¹] | = exponential distribution function for extreme water levels |

The Delta Committee made a cost-benefit analysis as described in Section 2.4, and calculated an optimal failure probability per dike ring area. This failure probability was related to an extreme water level that would still have to be resisted by the dikes. The height of these dikes was related to this extreme water level and was assumed to be a deterministic quantity. If overflow of the dike would immediately lead to a flood, the risk would be:

$$R = P(h) \cdot D \quad (\text{D.8})$$

where:

- R [€] = flood risk
- $P(h)$ [-] = probability that in a random year an area will be flooded
- D [€] = material damage in case of flood

From an economic point of view, the cost of flood risk reduction should be compared with the obtained savings in the form of avoided loss. The cost of this expected loss over the service life is assumed to be a measure for the total loss. If the desired risk reduction is solely obtained by heightening the dike, the cost of this safety measure is partly constant and partly related to the increase of the dike height (Figure D.3, left). The total cost is the sum of the dike heightening cost and the cash value of the expected losses. For a first estimate, it could be assumed that overflow immediately implies flooding. The optimal dike height can successively be determined by a differentiation with respect to the decision variable h_0 , to obtain the value for the minimum total cost (Figure D.3, right).

D

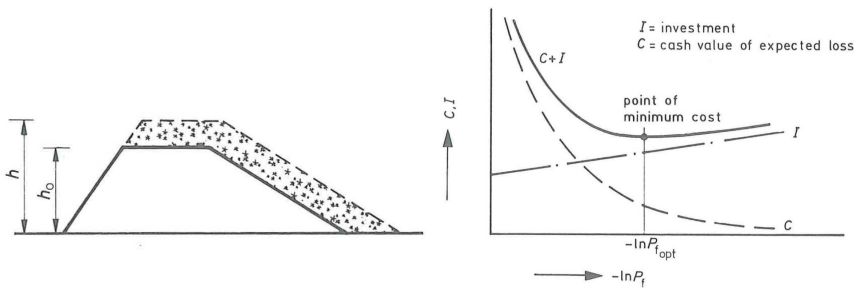

(a) Quantity of earth moving for heightening a dike (b) Determining the optimal height of a dike

Figure D.3: Economic optimum (Stichting CUR, 1990)

The total cost Q , as a function of the height of the improved dike, in case of an economically optimised probability of failure $P_{f, opt}$ then is:

$$Q = I(P_{f, opt}) + V_p(P_{f, opt}D) \tag{D.9}$$

where:

- Q [€] = total cost
- I [€] = investments
- $P_{f, opt}$ [-] = optimised probability of flooding
- V_p [-] = present value operator
- D [-] = economic damage in case of a flood

To calculate the total cost, the present value of the risk $V_p(R)$ over an infinite period is relevant, rather than the risk per year:

$$V_p(R) = e^{-\frac{h-A}{B}} \cdot \frac{D}{r} \quad (\text{D.10})$$

where:

r [-] = rate of interest

The total cost $Q(h)$ is the sum of investments in the protective dike system $I(h)$ and the present value of the remaining acceptable risk:

$$Q(h) = I(h) + V_p(R) \quad (\text{D.11})$$

The investment consists of initial cost I_0 , for instance for mobilisation, and the marginal cost of raising the dike I_1 , which is a function of the elevated height $h - h_0$. Therefore:

$$Q(h) = I_0 + I_1(h - h_0) + e^{-\frac{h-A}{B}} \cdot \frac{D}{r} \quad (\text{D.12})$$

where:

I_0 [€] = initial investments
 I_1 [€] = marginal cost of raising the dike
 $h - h_0$ [m] = dike elevation
 A [m] = location parameter
 B [m] = scale parameter
 D [€] = material damage
 I' [€] = cost (investment) per m' dike improvement
 r [-] = rate of interest

After differentiation of $Q(h)$ and equating the derivative to 0, it can be found that:

$$e^{-\frac{h_{opt}-A}{B}} = P_{f,opt} = \frac{I_1 \cdot B \cdot r}{D} \quad (\text{D.13})$$

If inflation and growth of the economy are taken into account as well, the optimal dike height $h_{o,opt}$ can consequently be determined according to:

$$h_{o,opt} = A + B \cdot \ln\left(\frac{D}{I' \cdot B \cdot (r' - g)}\right) \quad (\text{D.14})$$

where:

I' [€] = cost (investment) per m' dike improvement
 r' [-] = real rate of interest (= interest rate - inflation = $r - i$)
 g [-] = growth rate of the economy

(Stichting CUR, 1990), (Vrijling et al., 2011)

D.5 THE DUTCH STANDARD PER 2017

Since 1 January 2017, the Dutch Water Act prescribes failure probability requirements per dike segment (p_{norm}) instead of per dike ring area, which was the case until 2017. A dike segment (*dijktraject*) is a part of a primary flood defence, characterised by an equal flood threat and equal consequences. 234 segments have been distinguished with lengths varying from 0,2 to 47 km and the annual failure probability requirements range from 1/100 to 1/1 000 000 per segment. The failure probability (called *overstromingskans* in the Dutch Water Act of 2017) is defined as *the probability of loss of the water-retaining capacity of a dike segment, causing flooding of the protected area, resulting in loss of life or substantial economic damage*.¹ The normative failure probability requirements are based upon a consideration of the three criteria mentioned before in this appendix. The normative failure probability is interpreted as a 'signal value': a threshold probability that indicates whether improvement of a flood defence is required before the failure probability reaches the maximum allowed value (p_{max}). The motivation to translate the norm probability into a signal value and not into a maximum allowable failure probability requirement, which has a *higher* failure probability, is the fact that safety margins were used in the determination of the norm probabilities. The safety margins were used to allow for time for improvement after exceedance of the signal value.

Figure D.4 shows the maximum allowed failure probability p_{max} , the signal value p_{norm} and the optimal design probability. They decrease over time to compensate for the growth of the population and economic assets that have to be protected, which means that the norm probability needs to become stricter over time to maintain the same failure probability along the dike segment under consideration. The actual failure probability of a dike segment is indicated in Figure D.4 with the thick black saw-tooth line. It shows a gradual increase of the failure probability, caused by degradation, climate change and land subsidence. The discontinuities are caused by periodical dike improvements.

The *signal value* is the strictest of two criteria: It is either the mid probability resulting from an economic approach, or the failure probability corresponding to a local individual death probability of $0,5 \cdot 10^{-5}$. The *mid probability* is the average annual risk during an optimal interval between two improvements, divided by the economic damage in the considered year. The thus determined signal value can be adjusted, if the multiple deaths criterion gives rise to do so. This is the case, if large numbers of casualties can be expected during a flood, if essential infrastructure has to be protected, or if policy-makers wish to do so for other reasons.

The *optimal design probability* is a failure probability that is determined with help of a life cycle cost (LCC) approach. It is calculated in such a way, that the actual failure probability does not exceed the maximum allowed failure probability at the end of the (design) lifetime, or maintenance period, of the flood defence. The optimal

¹It is not specified in the law what is to be comprised under *substantial economic damage*, because it is highly dependent on local circumstances. However, in practice it can be assumed that an average water depth in an entire zip code area of more than 0,20 m will cause considerable damage.

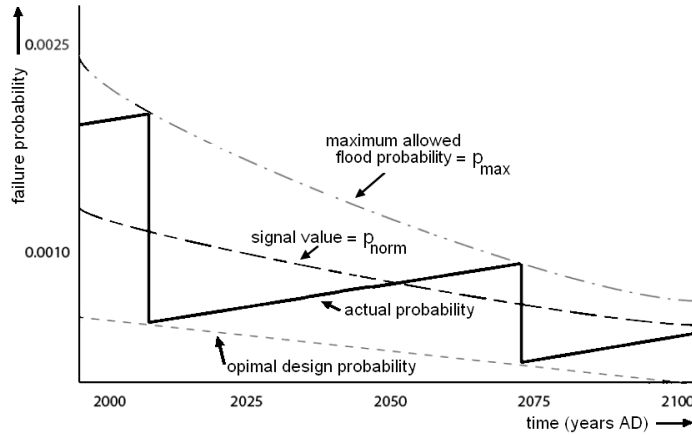

Figure D.4: Changes in failure probabilities over time, described in WTI2017 (after Kind (2013))

design probability is smaller than the signal value, to account for an increase of the flood probability. In specific cases, the optimal design probability can deviate to a higher extent from the mid probability, such as for engineering structures with very high adaptation costs, or with a long design life time.

The *maximum allowed probability*, p_{max} is the strictest of two criteria as well: it is either the maximum optimal failure probability from an economic perspective, or the failure probability corresponding to a local individual death probability of 10^{-5} . The maximum allowed probability is three times higher than the signal value. The reliability of flood defences is usually evaluated per failure mechanism and per cross-section. Therefore, the failure probability requirement has to be known both per failure mechanism and per cross-section. How the failure probability requirement $p_{max,i,j}$ is derived from the maximum allowed probability p_{max} per dike segment, is explained below.

The maximum allowed failure probability per dike segment p_{max} should not be exceeded by the actual failure probability:

$$p_f < p_{max} \quad (D.15)$$

Failure can be caused by several failure mechanisms, therefore the overall failure probability requirement per dike segment is distributed over these failure mechanisms. The *failure probability requirement distribution factor* ('faalkansruimtefactor' in Dutch) ω indicates what portion of the overall failure probability requirement is assigned to each failure mechanism. The failure probability requirement per dike segment for failure mechanism i can be calculated according to:

$$p_{max,i} = p_{max} \cdot \omega_i \quad (D.16)$$

where for n failure mechanisms $\sum_{i=1}^n \omega_i = 1,00$

There are many potential failure mechanisms, but a limited set is predominant and all other mechanisms are comprised in a category 'other'. Jongejan (2013) developed a generic failure probability distribution for the reduced set of failure mechanisms, based on the results of the VNK-project, see Table D.1. Deviations from the percentages in this table hardly influence the safety factors used in semi-probabilistic calculations. However, it is allowed to deviate from the standard distribution, if this is sufficiently motivated (Rijkswaterstaat, 2015a).

type of flood defence	failure mechanism	segment type	
		sandy coast	other (dikes)
dike	overflow and overtopping	0%	24% ^c
	uplift and piping	0%	24% ^c
	macro instability	0%	4%
	inner slope		
	damage revetment and erosion	0%	10%
engineering work	non-closure	0%	4%
	piping	0%	2%
	structural failure	0%	2%
dune	dune erosion	70%	0% / 10% ^d
other		30%	30% / 20%
Total		100%	100%

Table D.1: Standard failure probability requirement distribution for the assessment of flood defences per 2017 (Jongejan, 2013)

The failure probability requirement of a cross-section is smaller than the failure probability requirement of a segment, because of a partial correlation or independency between different sections. This effect is called the 'length effect' and is expressed by N_i . The length effect varies per failure mechanism, because the degree of partial correlation differs per failure mechanism. The failure probability requirement for cross-section j , for failure mechanism i can be calculated with:

$$p_{max,i,j} = \frac{p_{max} \cdot \omega_i}{N_i} \quad (D.17)$$

and $N_i = 1 + \frac{a_i \cdot l_s}{b_i}$

where:

- N_i = length effect factor for failure mechanism i
- a_i = part of the length of the segment relevant for failure mechanism i
- b_1 = representative length for the analysis of a cross-section
- l_s = length of the dike segment

Factor a takes two effects into account: 1) the fact that not all sections significantly contribute to the failure probability on segment level, and 2) the correlation between or inside dike sections. Values for N , varying from 1 to 3, are specified per dike segment in the Guideline Designing with Flood Probabilities (Rijkswater-

staat, 2015b). Figure D.5 shows a graphical presentation of the failure probability requirement distribution.

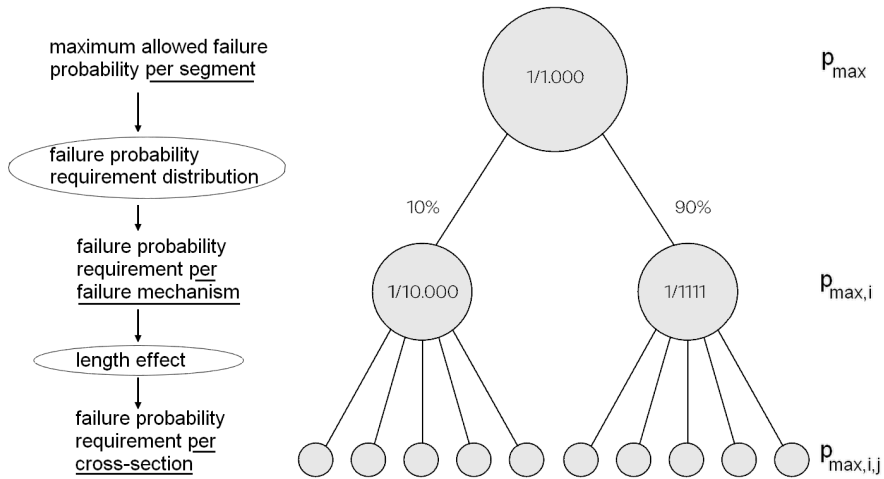

Figure D.5: From norm per dike segment to norm per cross-section per failure mechanism (modified from ENW - GHB (2016))

For a semi-probabilistic design, the reliability index β has been calculated to estimate the required partial safety factors. The reliability index is related to the failure probability requirement as follows:

$$\beta_{i,j} = -\Phi^{-1}(p_{max,i,j}) \quad (D.18)$$

where Φ^{-1} represents the inverse function of the normal distribution. How partial safety factors can be calculated using the found reliability index is indicated in Appendix E.4. The partial safety factors are given in the Guideline Designing with Flood Probabilities (2015b), together with modelling factors and schematisation factors.

E

RELIABILITY OF FLOOD DEFENCES

This appendix describes the main methods for determining the reliability of flood defences. Reliability is the ability of a structure to perform its function adequately. Sections E.1 through E.6, describe the theory on structural reliability in general and Section E.7 explains how the theory can be applied to the design of flood defences.¹

E.1 THEORY ON STRUCTURAL SAFETY

To determine the dimensions of structural elements of a civil engineering structure, the expected loads and material characteristics have to be known. If the loads exceed the resistance, the structure will fail and will no longer be able to fulfil its function. Not being able to fulfil a function can relate to persistent, transient, accidental or seismic situations. Failure is permanent, if a structure collapses. Limit states are conditions just before failure. Several limit state types can be distinguished. The Eurocodes, which are European building codes, give the following overview of limit states:

- Serviceability limit state (SLS), indicating disruption of normal use;
- Ultimate limit state (ULS), indicating collapse of all or part of the structure:
 - Loss of static equilibrium of the structure or any part of it, considered as a rigid body (EQU);
 - Internal failure of the structure or structural elements, including footings, piles, basement walls, etc., in which the strength of construction materials or excessive deformation of the structure governs (STR);
 - Failure or excessive deformation of the ground in which the strengths of soil or rock are significant in providing resistance (GEO);
 - Fatigue failure of the structure or structural elements (FAT).

Instead of fatigue failure, Eurocode 7, for geotechnical design, mentions:

¹Part of this appendix has meanwhile been included in the 'Manual Hydraulic Structures,' which is course material at Delft University of Technology.

- Loss of equilibrium due to uplift by water pressure (buoyancy) or other vertical actions (UPL);
- Hydraulic heave, internal erosion and piping caused by hydraulic gradients (HYD).

In a structural design, both the ultimate limit state and the serviceability limit state have to be taken into account. The ultimate limit state refers to the stability and strength of the structure and subsoil, whilst the serviceability limit state is related to the safety of use. Sometimes, a damage limit state is distinguished, indicating unacceptable damage but no immediate failure. Usually, the damage limit state is included in the ultimate limit state.

In general, a structure does not collapse if its solicitation can be resisted:

$$S < R \quad (\text{E.1})$$

where:

$$\begin{aligned} S &= \text{solicitation} \\ R &= \text{resistance} \end{aligned}$$

The type of solicitation and resistance depends on the considered failure mechanism. It could be a force, if a horizontal or vertical equilibrium is checked, or a turning moment, if a rotational equilibrium is considered. If the water retaining height of a flood defence has to be determined, loading and resistance are expressed as elevations above a reference level (m above NAP in the Netherlands).

In modern standards, as the Eurocodes, the relation between solicitation and resistance is often expressed as a dimensionless unity-check:

$$S/R < 1 \quad (\text{E.2})$$

if no safety margin is incorporated.

The relation between solicitation and resistance can be expressed as a limit state function Z , of which the general equation is:

$$Z = R - S \quad (\text{E.3})$$

If $Z < 0$, the structure will fail according to the given mode.

In practice, several types of uncertainties have to be taken into account in an engineering design. There are four main categories of uncertainties:

1. physical or inherent uncertainties;
2. statistical uncertainties;
3. modelling uncertainties;
4. human error.

Physical uncertainties consist of randomness or variations in nature. Variables can change in time (water level, for example), or in space (dike height). These uncertainties are mainly caused by a lack of data on loading or strength and, according to Feitsma (2002), consist of:

- uncertainties in the estimation of the load:
 - permanent loads (G):
 - ◊ self-weight;
 - ◊ soil pressure;
 - variable loads (Q):
 - ◊ hydrostatic pressure and currents;
 - ◊ waves;
 - ◊ precipitation;
 - ◊ wind;
 - ◊ temperature;
 - ◊ traffic;
 - ◊ fauna, cattle;
 - exceptional loads (A):
 - ◊ ship collision;
 - ◊ ice loads;
 - ◊ explosions, earth quakes;
- uncertainties in the estimation of the strength:
 - geometry;
 - phreatic line, degree of consolidation;
 - material properties.

Statistical uncertainties occur, if the distribution function of the possible values of loading or strength are not exactly known, or if the parameters of the distribution function are determined using a limited number of data. *Modelling uncertainties* are caused by the imperfectness of the models that describe the failure modes, which are natural phenomena. This can be caused by a lack of knowledge of these processes, or by over-simplification. *Financial uncertainties*, such as construction costs and damage costs, are comprised in this category of modelling uncertainties. Finally, *human errors* often form a big threat to the reliability of a structure.

The uncertainties can be taken into account by applying a safety margin between loading and strength. There are various calculation techniques available to incorporate a safety margin in a structural design. These techniques are classified according to the following levels:

- Level 0: deterministic design;
- Level I: semi-probabilistic design;
- Level II: simplified probabilistic design;
- Level III: full probabilistic design.

These methods are briefly explained in the following sections.

E.2 DETERMINISTIC DESIGN (LEVEL 0)

Based on experience, or engineering judgement, overall safety factors (γ) can be applied as a margin between loading and strength. In general, a structure is considered safe, if:

$$S \cdot \gamma < R, \quad (\text{E.4})$$

where $\gamma > 1,0$ [-]

In the Netherlands, until the twentieth century, the crest height of flood defences was based on the highest observed water level (often the water level that caused most recent flood), plus a freeboard (fb , waakhoogte) of 0,5 to 1,0 metres to account for wave overtopping and uncertainties (Figure E.1):

$$S + fb < R, \quad (\text{E.5})$$

where $0,5\text{ m} \leq fb \leq 1,0\text{ m}$

E

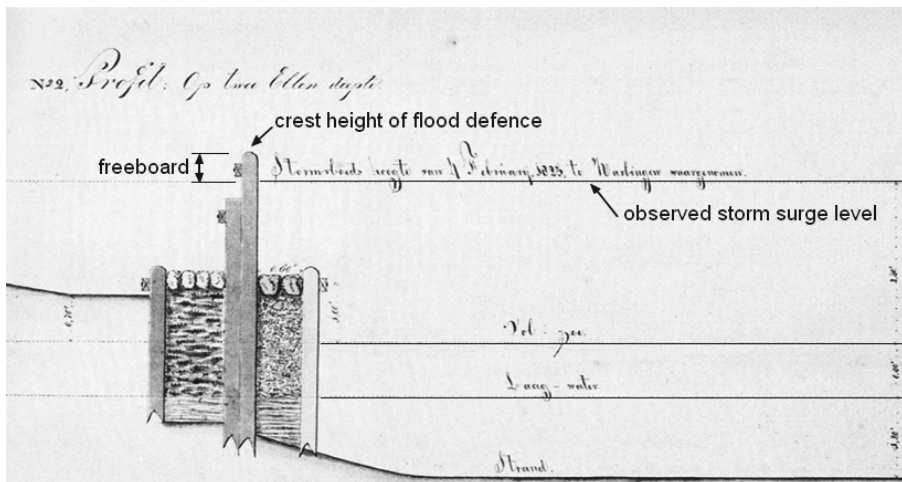

Figure E.1: Example of a traditional deterministic design of a flood defence (source unknown)

The deterministic method was applied when it was not yet possible to make strength calculations, due to lacking numerical insight into failure mechanisms and difficulties in estimating the governing loads. Safety factors were not based on the quantification of the uncertainties, therefore it was very difficult to determine the extent of over-design (or under-design), relative to the desired level of safety. This was overcome by introducing (semi-) probabilistic techniques, which is explained in the following sections.

E.3 SEMI-PROBABILISTIC DESIGN (LEVEL I)

THEORY

In semi-probabilistic designs, load and strength variables are treated as stochastics, which means that their possible values are distributed around a mean value μ (Figure E.2). The characteristic value of the strength R_k is the value that is exceeded by 95% of the samples. The characteristic value of the load S_k is the value that is exceeded by only 5% (in other words: the single tails represent 5% of the values).

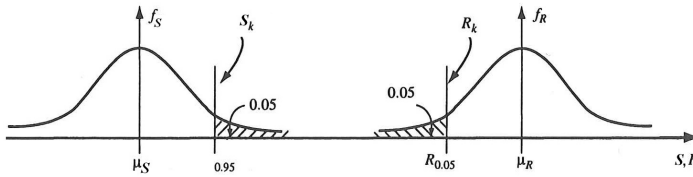

Figure E.2: Characteristic values for strength R_k and loads S_k (Melchers, 2001)

The characteristic values deviate from the mean values, depending on the 'width' of the distribution, which, in case of normal distributions of loading and strength, can be expressed as a function of the standard deviation:

$$R_k = \mu_R - k_R \cdot \sigma_R \quad (\text{E.6})$$

$$S_k = \mu_S + k_S \cdot \sigma_S \quad (\text{E.7})$$

where:

- k_R = material assessment factor, related to a 95% probability range, $k_{R=}$ 1,64 for an infinite number of samples; for a finite number of samples, the factor becomes larger [-]
- k_S = load assessment factor, for steel and concrete structures ≈ 0
- μ_R = mean value of the strength
- μ_S = mean value of the loading
- σ_R = standard deviation of the strength distribution
- σ_S = standard deviation of the load distribution

The characteristic values of strength and loading are used to obtain the representative values that are needed to evaluate the limit states (SLS or ULS):

$$R_{rep} = \psi_R \cdot R_k \quad (\text{E.8})$$

$$S_{rep} = \psi_S \cdot S_k \quad (\text{E.9})$$

where:

- ψ_R = material reduction factor [-]
- ψ_S = combination factor [-]
- R_k = characteristic value of the strength

S_k = characteristic value of the load

The characteristic value of a load is the main representative value that can be assigned to loads. For the material properties, the representative value generally equals the characteristic value ($\psi_R = 1$). The representative values are related to design values by partial safety factors. The design values are used for limit state checks: the design value of the strength has to be larger than the design value of the load:

$$\left\{ R_d = \frac{R_{rep}}{\gamma_R} \right\} > \left\{ S_d = \gamma_S \cdot S_{rep} \right\} \quad (\text{E.10})$$

where:

R_d = design value of the strength (force, stress or height)

S_d = design value of the load (force, stress or height)

R_{rep} = representative value of the strength

S_{rep} = representative value of the load

γ_R = partial safety factor for the strength (material factor) [-]

γ_S = partial safety factor of the load (load factor) [-]

For the estimation of the design water level, needed to determine the hydrostatic loads and the water-retaining height of a flood defence or engineering structure, a statistical approach based on the extrapolation of water level measurements can be used, see Section E.7.

LOAD COMBINATIONS

The steps to obtain a design value needed for a design calculation of a load are:

- estimate the types of the load (permanent, variable or accidental);
- discern all realistic loads;
- estimate the partial load factors for all relevant combinations of loads;
- combine the loads in such a way that the most critical circumstances are obtained.

For fundamental load combinations, the Eurocode distinguishes permanent and variable loads. Loads from pre-stressing are treated as a separate permanent loads and the main variable load is treated apart from other variable loads. In case of a load combination with only one variable load, the magnitude of the variable load is obtained by multiplying its representative value with the concerning partial load factor. If several variable loads are combined, the main variable load should be distinguished from other variable loads, which do not necessarily act simultaneously. The magnitude of the variable loads, other than the main variable load, can be reduced in a design calculation, because of the small likelihood of simultaneous occurrence. The thus obtained representative value of the 'other' variable loads is called the 'combination value.'

E.4 FULL PROBABILISTIC DESIGN (LEVEL III)

Both level II and level III calculations are probabilistic design methods. Level II methods are simplifications of full probabilistic design methods, level III. The full probabilistic design is explained first (this section) and then the simplified methods (Section E.5).

In a probabilistic design, the loading as well as the strength are considered as stochastics. This means that, due to acknowledged uncertainties, the values of loading and strength can deviate from their most probable (average) value. Multiple failure mechanisms can be included in the failure probability calculations, which makes the full probabilistic method more accurate than a semi-probabilistic calculation. The equations for the probability density functions of loading and resistance depend on the kind of distribution. Often, especially for strength parameters, a normal or Gaussian distribution is assumed, in which case the probability density function $f(x)$ is defined as:

$$f(x) = \frac{1}{\sigma\sqrt{2\pi}} e^{-\frac{1}{2}\left(\frac{x-\mu}{\sigma}\right)^2} \quad (\text{E.11})$$

The cumulative distribution function $F(x)$, is generally defined as:

$$F(x) = P(X \leq x) = \int_{u=-\infty}^x f(u) du \quad (\text{E.12})$$

and the cumulative normal distribution function is:

$$F(x) = \frac{1}{\sqrt{2\pi}} \int_{t=-\infty}^z e^{-\frac{t^2}{2}} dt \quad (\text{E.13})$$

where:

- x = value of loading or resistance
- t = dummy integration variable
- z = $(x - \mu) / \sigma$
- σ = standard deviation
- μ = mean value of x

An example of a probability density function and a cumulative distribution function is given in Figure E.3.

The probability of failure is the probability that the loading exceeds the resistance:

$$p_f = P(R < S) = P(Z < 0) \quad (\text{E.14})$$

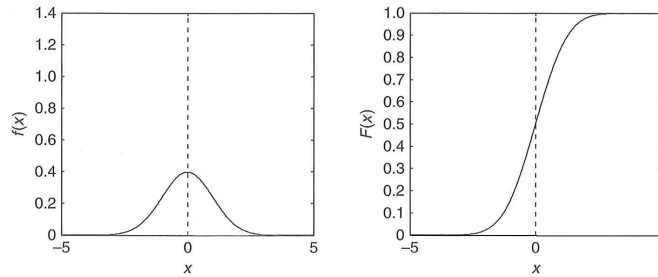

Figure E.3: Example of a probability density function $f(x)$ and a distribution function $F(x)$ (Reeve, 2010)

where Z is the limit state function and the probability of failure is identical with the probability of limit state violation. R and S are represented by (marginal) density functions f_R and f_S .

E

Level III-methods are full probabilistic approaches in which the probability density functions of all stochastic variables are described and included. A probability density function is a function that describes the relative likelihood for a random variable to take on a given value. Figure E.4 shows the probability density functions of the loading $f_s(s)$ and strength $f_r(r)$ as well as the resulting probability density function of the limit state $f_z(z)$. The failure probability p_f is represented by the area where $Z < 0$ (the small grey area).

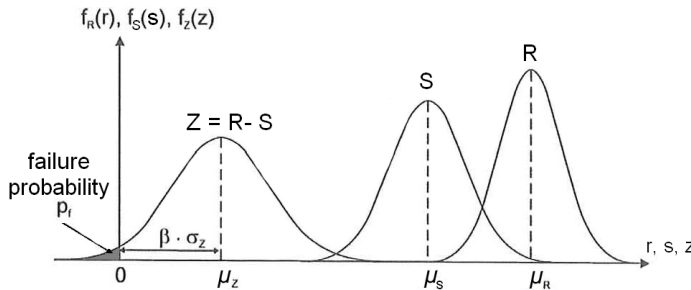

Figure E.4: The limit state function in relation to solicitation and resistance distributions (Böckmann, 2012)

A 'wide' distribution around the average limit state value μ_Z implies a large uncertainty, while a 'tight' distribution indicates a high certainty. The 'wideness' of the distribution should be judged relative to its mean value to obtain a good impression of the reliability. A useful expression for judging the reliability of a structure is the reliability index β , which is related to the mean value and the standard deviation of the limit state distribution:

$$\beta = \frac{\mu_Z}{\sigma_Z} \tag{E.15}$$

where:

$$\begin{aligned}\beta &= \text{reliability index} \\ \mu_Z &= \text{mean value of the limit state density function: } \mu_Z = \mu_R - \mu_S \\ \sigma_Z &= \text{standard deviation of the limit state density function: } \sigma_Z = \sqrt{\sigma_R^2 + \sigma_S^2}\end{aligned}$$

It can be seen in Figure E.4 that $\mu_Z = \beta \cdot \sigma_Z$.

The influence of the distribution of the load or resistance on the distribution of the limit state function is usually expressed by the influence coefficient:

$$\alpha_R = \frac{\sigma_R}{\sigma_Z}; \alpha_S = -\frac{\sigma_S}{\sigma_Z} \quad (\text{E.16})$$

while:

$$\sum_{i=1}^n \alpha_i^2 = 1 \quad (\text{E.17})$$

where:

$$\begin{aligned}\alpha &= \text{influence coefficient for the strength } (\alpha_R) \text{ or load } (\alpha_S) \\ \sigma &= \text{standard deviation of the strength } (\sigma_R), \text{ load } (\sigma_S), \\ &\text{or limit state function } (\sigma_Z)\end{aligned}$$

Level III and level II calculations can be used to derive the partial factors used in level I calculations, if the reliability index β , influence coefficients α and variance coefficients V are known:

$$\gamma_R = \gamma_M = \frac{1 - k_R \cdot V_R}{1 - \alpha_R \cdot \beta \cdot V_R} \quad (\text{E.18})$$

$$\gamma_S = \frac{1 - \alpha_S \cdot \beta \cdot V_S}{1 - k_S \cdot V_S} \quad (\text{E.19})$$

where:

$$\begin{aligned}k &= \text{factor that indicates the limit of the representative value of strength } (k_R) \\ &\text{or load } (k_S) \text{ (see equation E.6)} \\ V &= \text{coefficient of variation for strength } (V_R) \text{ or load } (V_S): V = \sigma/\mu \\ \alpha &= \text{influence coefficient for strength } (\alpha_R) \text{ or load } (\alpha_S) \\ \beta &= \text{reliability index (see equation E.15)}\end{aligned}$$

The probability of occurrence of possible combinations of load and strength can be plotted in a three-dimensional graph, as in Figure E.5. The probability of occurrence of the combination of load and strength is presented perpendicular to the R-S plane as a volume. If a likely combination lies in the $Z < 0$ field, failure of the structure can be expected.

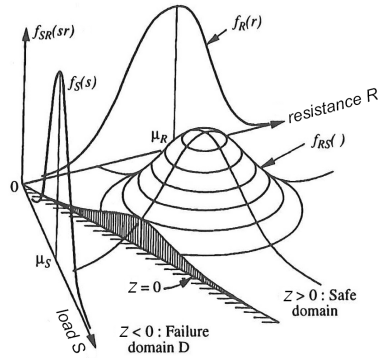

Figure E.5: Three-dimensional probability distribution of strength and load and joint density function, with failure domain D (Melchers, 2001)

E

The joint probability density function f_{RS} for statistically independent variables is:

$$f_{RS}(r, s) = f_R(r) f_S(s) \quad (\text{E.20})$$

Figure E.5 shows such a joint density function $f_{R,S}$, including the $Z = 0$ line.

The joint cumulative distribution function then is:

$$F_{R,S}(r, s) = P[(R \leq r) \cap (S \leq s)] = \int_{-\infty}^r \int_{-\infty}^s f_{R,S}(r, s) dr ds \quad (\text{E.21})$$

with corresponding failure probability:

$$p_f = F_{R,S}(r, s) = \int_{-\infty}^r \int_{-\infty}^s f_{R,S}(r, s) dr ds \quad (\text{E.22})$$

which, for independent variables, is the same as:

$$p_f = \int_{-\infty}^r \int_{-\infty}^s f_R(r) f_S(s) dr ds \quad (\text{E.23})$$

The failure probability of a structure is related to this reliability index as follows:

$$p_f = \Phi(-\beta_N) \quad (\text{E.24})$$

where

- p_f = probability of structural failure
 Φ = function of the normal distribution
 β_N = reliability index for a life time of N years

The reliability index depends on a multitude of parameters, having their own distribution of values (Vrouwenvelder et al., 2004). Examples of these aspects are:

- loads (self-weight, wind)
- material properties (yield stress, creep factors, duration effects)
- diversions of dimensions (wooden beams, concrete cover, positioning of the reinforcement bars)
- eccentricities (supports, obliqueness)
- computational model for loads (uneven floor loading, wind turbulence)
- computational model for strength (connections, shear force, crack width)

In level III - computations, the type of integrals as shown before can be solved, but it becomes a complicated and laborious task, especially if n exceeds 5. In several cases with not too low failure probabilities, however, the integral can be solved with help of a Monte Carlo simulation.

In the Monte Carlo simulation method, a large number of values of the basic variables is generated according to their type of distribution. In this way, a large number of 'experiments' is artificially simulated to obtain the results. This can be done for both loading and resistance, to obtain the limit state function. The required number of Monte Carlo simulations and the calculation time depend on the required precision of the answer. The number of simulations should therefore correspond to at least ten times the length of the return period of interest. However, the most extreme events require large sample sizes, which leads to elaborate computations. Approximation methods, level II methods, are therefore often be used to reduce the large numbers of calculations.

E

E.5 SIMPLIFIED PROBABILISTIC DESIGN (LEVEL II)

Most of the level II methods approximate the reliability function and the main variables to a simple reliability function that is linear in the variables. Furthermore, the variables are assumed to be independent and normally distributed. The results are slightly less accurate than level III methods, but considerably less complicated.

For level II methods, the following equation can be used for both dependent and independent R and S :

$$\mu_Z = \mu_R - \mu_S \quad (\text{E.25})$$

If R and S are independent:

$$\sigma_G = \sqrt{\sigma_R^2 + \sigma_S^2} \quad (\text{E.26})$$

If R and S are dependent:

$$\sigma_G = \sqrt{\sigma_R^2 + \sigma_S^2 - 2\rho\sigma_R\sigma_S} \quad (\text{E.27})$$

where ρ is the correlation coefficient.

Because $\frac{Z - \mu_Z}{\sigma_Z}$ is unit standard normal, the failure probability can be written as:

$$P_f = P(Z \leq 0) = \int_{-\infty}^0 f_Z(x) dx = \Phi\left(\frac{0 - \mu_Z}{\sigma_G}\right) = \Phi(-\beta) \quad (\text{E.28})$$

where Φ is the standard normal distribution and β is the reliability index.

The probability of failure is equal to the area of the shaded region in E.4. In the general case of a linear limit state function of n normally distributed variables, the limit state function can be presented as in Figure E.6 (left side).

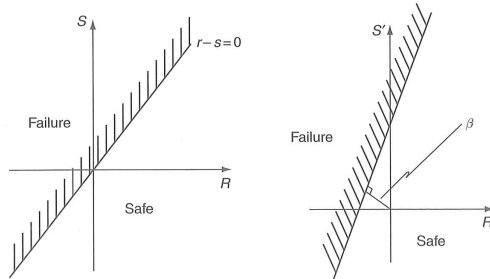

Figure E.6: Graphic interpretation of the limit state function Z (Reeve, 2010)

Variables for R and S can be standardised according to: $R' = \frac{R - \mu_R}{\sigma_R}$ and $S' = \frac{S - \mu_S}{\sigma_S}$ so that the limit state function becomes:

$$Z = R - S = \sigma_R \cdot R' - \sigma_S \cdot S' + (\mu_R - \mu_S) \quad (\text{E.29})$$

$Z = 0$ then describes a line in the plane formed by R' and S' , which is depicted in Figure E.6, right side. The reliability index is the shortest distance from the origin to the $Z = 0$ line.

Depending on the order of approximation, first-order risk methods (FORMs) or second-order risk methods (SORMs) can be distinguished. A description of these methods can be found in specialised books on probabilistic design, such as (Stichting CUR, 1997), (Reeve, 2010) and (Melchers, 2001).

E.6 MULTIPLE FAILURE MECHANISMS

In a probabilistic design, multiple failure mechanisms can be included to obtain realistic and accurate results. A failure probability approach allows to calculate the reliability of systems composed of multiple structural parts, which is often the case for multifunctional flood defences (Vrijling, 2012). Methods that deal with multiple

structural parts and multiple failure mechanisms are described in the following paragraphs.

Regarding system reliability, two types of failure categories can be distinguished: series systems and parallel systems. In a *series system*, the failure of one structural part (F_i) will automatically lead to failure of the entire system (F_s). The system's strength (R_{sys}) is determined by the strength of the weakest element (R_i):

$$F_s = \cup F_i \quad (E.30)$$

$$R_{sys} = \min(R_i) \quad (E.31)$$

A ring dike is an example of a series system.

A *parallel system* will only fail (F_p) if all structural elements have failed. The system strength is determined by the strength of its strongest element:

$$F_p = \cap F_i \quad (E.32)$$

$$R_{sys} = \max(R_i) \quad (E.33)$$

The multi-layered flood safety approach assumes a parallel system, which is not very efficient in combination with the series protection system of dike ring areas.

The failure probabilities of systems can be calculated, if the failure probabilities of the structural elements are known, and if it is known whether these events are dependent or independent. The difference in failure probability of a dependent and an independent system is considerable. The failure probability of a dependent series system, for example, is equal to the largest failure probability of the separate subsystems. For an independent series system, the failure probability is equal to the addition of the failure probabilities of all subsystems. The correlation between failure mechanisms of flood defences predominantly comes from the main loading, an extreme water level. The influence of this loading on the various failure mechanisms, however, can be quite different. The 'length effect' plays a role as well in the determination of the dependency of systems, because it takes the spatial variation of systems (a dike particularly) into account.

For series systems of two elements M_1 and M_2 , the probability of failure is:

$$P_f = P(M_1 \cup M_2) \quad (E.34)$$

For parallel systems the failure probability is:

$$P_f = P(M_1 \cap M_2) \quad (E.35)$$

This difference between a series and a parallel system regarding failure probability can be illustrated with a basic fault tree, as presented in Figure E.7. A fault tree is a *description of the logical interconnection between various component failures and*

events within a system (Reeve, 2010). Logical operators, called gates, are used to combine events to obtain an event at a higher level. Logical operators (Boolean operators) can be AND, OR or NOT. Different sets of component failures are logically connected in a fault tree and, if values are assigned to component reliabilities, the probability of failure of the top element can be calculated, indicating the failure of the system as a whole.

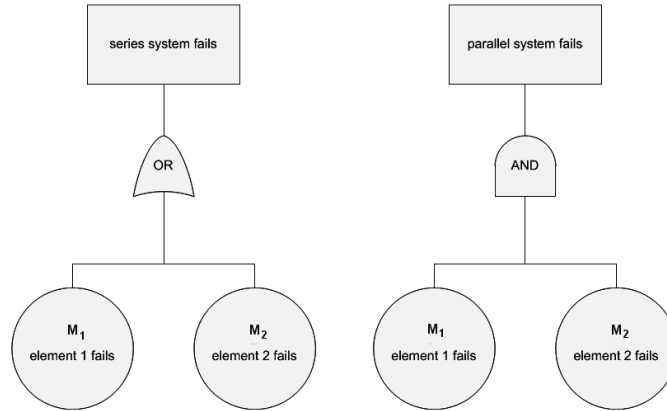

Figure E.7: Fault tree for a series and a parallel system

Table E.1 gives the equations to calculate the system failure probability. The equations give the lower and upper bounds, for perfect correlations and mutually exclusive events (the failure of an element is called an event).

System type	failure probability of dependent events	failure probability of independent events	failure probability of mutually exclusive events
series system	$\max_{i=1,n} P_i$ lower bound	$1 - \prod_{i=1}^n (1 - P_i)$	$\sum_{i=1}^n P_i$ upper bound
parallel system	$\min_{i=1,n} P_i$ upper bound	$\prod_{i=1}^n P_i$	0 lower bound

Table E.1: Failure probabilities per system type (Voortman, 2003)

There are different methods to obtain overview of the elements that together determine the overall failure probability. The most common are the event tree, the failure tree and the cause-consequence diagram. These methods can be used as a tool in level II or level III calculations, because they visualise how the failure modes combine and interact. An example of a fault tree is shown in Figure E.8.

Methods to include correlations of failure modes in (semi)probabilistic calculations have to be further developed, as well as time-dependencies. The aim of such a

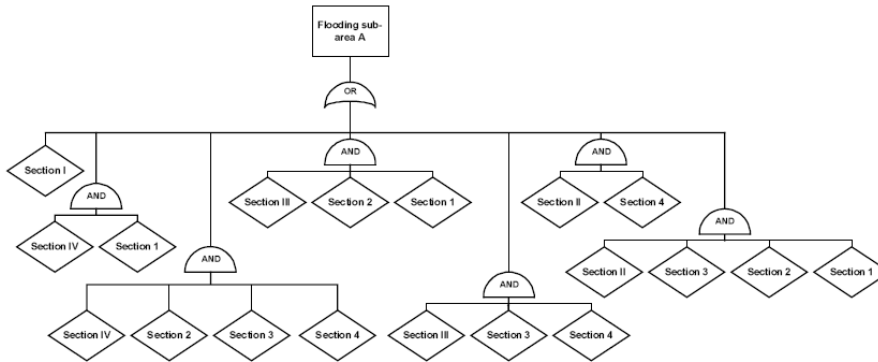

Figure E.8: Example of a fault tree for flooding of an area being part of a dike ring (Voortman, 2003)

development is to determine the appropriate joint density functions. Roscoe (2017) partly described the application of Bayesian networks using Gaussian copulas, but gives several recommendations for further research.

E

E.7 RELIABILITY OF FLOOD DEFENCES

Since 1 January 2017, the Dutch law specifies a maximum failure probability per dike segment.² The actual failure probability of a dike segment should not exceed the stipulated maximum failure probability (the failure probability requirement). The actual failure probability is usually calculated considering multiple failure mechanisms per cross-section of a dike, therefore the failure probability requirement should be specified per cross-section. Appendix D.5 explains how the failure probability requirement per cross-section can be derived from the failure probability requirement per segment³ (specifically Figure D.5 and Equation D.17).

The usual failure mechanisms for flood defences are depicted in Figure E.9. The Design Tools 2014 specify a limited number of predominant failure mechanisms and aggregates the other mechanisms into a category 'other', see Table D.1, in which the probability requirements for these failure mechanisms are specified.

The semi-probabilistic method of determining the reliability of Dutch flood defences is described in the Background Report Design Tools 2014 of Rijkswaterstaat (2015a) and is based on the same theory as in the previous sections of this appendix.

²The Water Act literally mentions a *flood probability*, but it actually is a *failure probability* of the flood defence within the considered segment, according to the explanation in ENW - GHB (2016). It is confusing that the two types of probabilities have been tangled up, and is supposedly caused by the final report of the Commissie Veerman (2008, p. 123), where the exceedance probability of the old standard was interpreted as a *flood probability* and for the new standard, the term *failure probability* was not used.

³A dike *cross-section* represents a dike *section*.

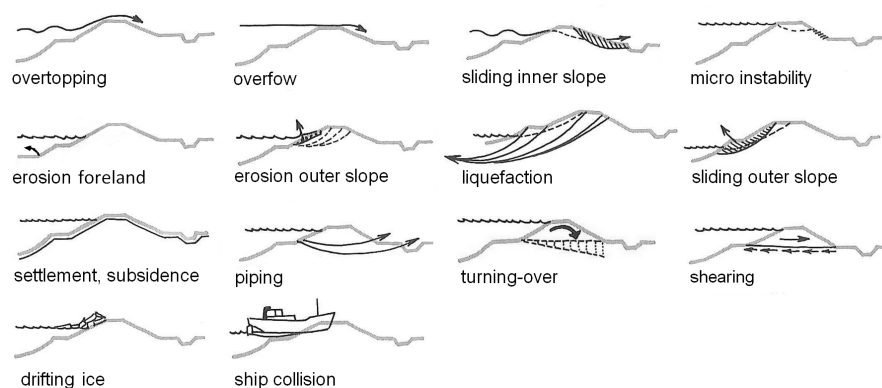

Figure E.9: Overview of failure mechanisms for regular flood defences (dikes), modified from Huis in 't Veld et al. (1986)

E

It specifies the design water levels and the partial safety factors. Four types of safety factors are taken into account: model factors, material factors, schematisation factors and a safety factor related to the reliability coefficient. The last mentioned factor is related to the safety level and the length effect. The main design principles are explained below, according to Rijkswaterstaat (2015b) and Rijkswaterstaat (2015a). It should be noted that the presently described definitions and methods can change in future, because studies are still going on and not all documents are definite yet.

Design loads

Hydraulic boundary conditions have to be determined according to the report 'Method Determining Hydraulic Design Boundary Conditions for HBWP 2015 projects' (Den Bieman and Smale, 2015). Computer programmes (the so-called 'Hydro' models) are available to calculate the hydraulic boundary conditions at specific locations. The expected effects of climate change will have to be taken into account, in the form of sea or lake level rise, or in the form of an increase in peak river discharges. For all projects, climate scenario W+ has to be taken into account according to the Dutch meteorological institute KNMI, which implies a sea level rise of 0,60 m in between 1990 and 2100 (KNMI, 2006).

The design water level for all failure mechanisms, except overflow and overtopping, is related to an exceedance probability that equals the maximum allowable failure probability per dike segment as stipulated by law. The design water level determines the representative value of the hydrostatic loads that should be used to demonstrate that the failure probability requirement is fulfilled. Uncertainties in the used modelling and statistics should be taken into account by applying surcharges on the critical water level, design wave height and wave period. The design water level regarding overflow and overtopping should be considered per cross-section, not per entire dike segment.

Overflow and overtopping

Overflow, or ingress of water into the protected region will occur if the water level at a flood defence exceeds the crest level of the structure. Wave overtopping is the mean discharge of the waves coming across the crest of a flood defence. Both phenomena can lead to an exceedance of the storage capacity of the hinterland, a flood. The most severe case of failure is breaching, caused by ongoing erosion of the inner slope of a dike (structural failure). Flooding caused by overflow or overtopping of a dike that remains intact is a more gradual process. The dike crest height should be determined in such a way that the exceedance probability of the critical overtopping discharge $p_{f,overtopping,j}$ does not exceed the failure probability requirement per cross-section $p_{max,overtopping,j}$:

$$p_{f,overtopping,j} < p_{max,overtopping,j} = \frac{p_{max} \cdot \omega_{HT}}{N_{HT}} \quad (E.36)$$

where:

- ω_{HT} = failure probability requirement distribution factor for overtopping
- N_{HT} = factor for the length effect of overflow and overtopping
- p_{max} = maximum failure probability per dike segment

The value of ω_{HT} is specified in Table D.1 and N_{HT} varies from 1 to 3.

The values of the critical overtopping discharge depend on the erosion resistance of the inner slopes of the dikes. For high quality inner slopes, 10 l/s/m should be used (if the significant wave height at the toe of the dike does not exceed 3 m), for less quality slopes 5 l/s/m and if there are no additional requirements for the inner slope, 0,1 l/s/m. The probability of exceedance of the critical overtopping discharges can be calculated with the 'Hydra' computer models, which use a probability distribution, derived from overtopping tests, see Figure E.10.

Piping

Piping is the mechanism of the entrainment of soil particles by the erosive action of seepage flow. The magnitude of this flow depends on the water level difference on both sides of the flood defence, the geometry of the flood defence and the permeability. Piping is very sensitive to the outflow intensity. The occurrence of piping mainly depends on the properties of the sand layer, of which the mean grain diameter D_{50} and the coefficient of uniformity $U = \frac{D_{60}}{D_{10}}$ are the most important parameters. The duration of the water level difference determines if piping will occur.

Piping comprises two stages of failure: first, the dike cover layer at the inner side of the dike starts lifting up. This happens if the buoyant pressure on the aquifer at the land side of the dike exceeds the weight of the cover layer. If this has happened, backward erosion starts, which could lead to the growth of pipes under the dike. The resistance against piping can be calculated according to the adapted model of Sellmeijer (Förster et al., 2012, p.66)

The probability of failure due to piping per cross-section should not exceed the

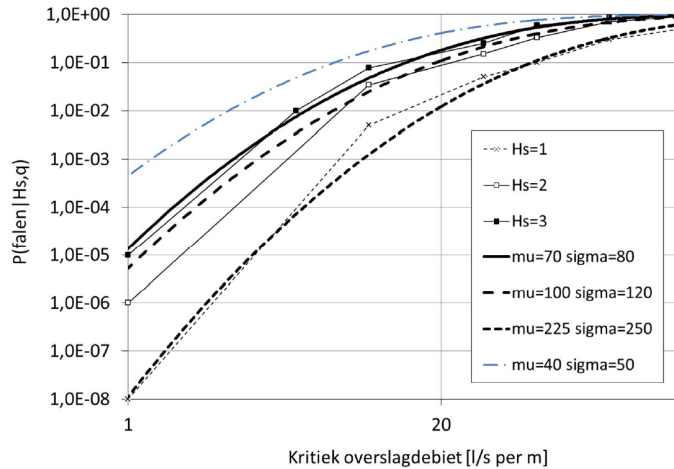

Figure E.10: Lognormal distributions of critical overtopping discharges on logarithmic scale (Rijkswaterstaat, 2015a)

E

requirement per cross-section:

$$p_{f,piping,j} < p_{max,piping,j} \quad (E.37)$$

$$p_{f,piping,j} = p(Z_{uplift} < 0 \cap Z_{heave} < 0) \quad (E.38)$$

$$p_{max,piping,j} = \frac{p_{max} \cdot \omega_{PI}}{N_{PI}} \quad (E.39)$$

For practical use with semi-probabilistic design principles, the failure probability requirement has been 'translated' to partial safety factors via equations D.18, E.18 and E.19 for both uplift and heave.

Macro instability inner slope

Macro-instability is the failure mechanism of large slope failure due to the absence of an equilibrium of moments acting upon a mass of soil. This mass of soil is bounded by the ground levels, the slope and the sliding plane. The acting forces on the soil body are the gravity force and the external forces (for instance the weight of a house on a shallow foundation) and, on the other hand, the shearing forces along the sliding plane. The shearing resistance consists of the cohesion of the soil c' and the internal shearing resistance which depends on the effective soil stress perpendicular to the sliding surface and the angle of internal friction $\sigma'_n \tan \phi$. In the calculation methods, as Fellenius' and Bishops', the possible sliding body is divided into a number of vertical slices (Figure E.11).

Instead of the traditional Mohr-Coulomb model, Critical State Soil Mechanics (CSSM) has to be used for characterising soil behaviour. Drained soil behaviour should be assumed for soil types with a high permeability, as sand, and undrained behaviour for soil types with a low permeability. The CSSM model distinguishes

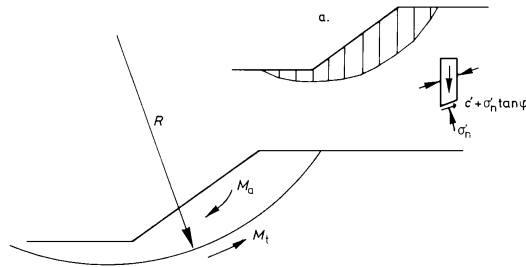

Figure E.11: Macro instability with division of sliding body into vertical slices (Stichting CUR, 1990)

between normally consolidated and over-consolidated soil behaviour and uses the ultimate limit state of soil instead of the strength found with laboratory tests with small deformations (triaxial or direct simple shear tests).

The probability of failure, caused by macro-instability, should not exceed the requirement per cross-section:

$$P_{f,piping,j} < P_{max,macro-instability,j} \quad (E.40)$$

Preferably, the sliding model of Spencer - Van der Meij is used, but if it would not lead to sufficiently reliable results, the Lift Van model is prescribed. The phreatic line in the dike can be schematised with help of the rules-of-thumb as indicated in the TAW Technical Report on Water Pressures (TAW - TRWbD, 2004). The assumption of a fully saturated dike gives (very) conservative results. The failure probability requirement has been 'translated' to partial safety factors for practical use with semi-probabilistic calculations.

Longitudinal structures

Longitudinal structures (*langsconstructies*) are structures in a dike body, parallel to the length axis of the dike, such as stability screens, coffer dams, quay walls, movable flood defences and retaining walls. For a flood defence that consists of a soil body with a longitudinal structure, the same failure probability requirement distribution applies as for regular flood defences. The available failure probability requirement has to be translated to a requirement at sub-failure mechanism level, depending on the type of longitudinal structure. There are no rules for the distribution of the failure probability requirement over sub-failure mechanisms. The reliability of a dike cross-section with a longitudinal structure can be calculated with semi-probabilistic methods, for which partial safety factors can be found in the Guideline Designing with Flood Probabilities (Rijkswaterstaat, 2015b).

Revetment

Design rules for asphalt revetment are specified in TAW Report Asphalt for Retaining Water (TAW - TRAvW, 2002) and STOWA Report State of the Art Asphalt Revetments (STOWA, 2010). The present design method of asphalt revetment is a deterministic method, based on schematisation of failure mechanisms and calculation rules from

applied mechanics. The use of conservative design values for the input parameters leads to safe results.

Placed stone revetments can be designed according to TAW Technical Report Design of Placed Stone Revetment (TAW - TROS, 2003), which has been used for the 'Steen-toets2010' computer model. A semi-probabilistic method is used for the reliability evaluation of this kind of revetment. An overall safety factor is recommended in the Guideline Designing with Flood Probabilities (Rijkswaterstaat, 2015b). The level of the transition from stone revetment to a grass cover can be determined according to the rules given in the TAW Technical Report Design of Placed Stone Revetments (TAW - TROS, 2003).

Hydraulic structures

The present Guideline Hydraulic Structures (TAW - LK, 2003) gives design rules that are related to failure probability requirements. The present requirements are related to the values of the newly defined maximum allowed failure probabilities. The actual exceedance probability of the critical overflow or overtopping discharge over hydraulic engineering structures should not exceed the requirement at a certain cross-section:

$$p_{f,overtopping,j} < p_{max,overtopping,j} = \frac{p_{max} \cdot \omega_{HT}}{N_{HT}} \quad (E.41)$$

The length effect factor N_{HT} depends on the variability of the orientation of the hydraulic engineering structures in the dike segment and not on their number. The Top of Structure level can be derived from design rules, given a critical overtopping discharge.

The reliability of closures of hydraulic engineering structures is sufficiently reliable, if:

$$p_{f,closure,j} < p_{max,closure,j} = \frac{p_{max} \cdot \omega_{BS}}{N_{BS}} \quad (E.42)$$

ω_{BS} is given in Table D.1 and the value of N_{BS} depends on the number of engineering structure with a considerable contribution to this failure mechanism per dike segment.

For piping under or around hydraulic engineering structures the following applies:

$$p_{f,piping,structure,j} < p_{max,piping,j} = \frac{p_{max} \cdot \omega_{PIes}}{N_{PIes}} \quad (E.43)$$

ω_{PIes} is given in Table D.1 and the value of N_{BS} depends on the number of hydraulic engineering structures with a considerable contribution to this failure mechanism per dike segment.

There are no design rules for determining the strength and stability of the hydraulic structures, but it is expected that a structural design according to Eurocode 3, with consequence class 3 and a design life time of 50 or 100 years, will result in a sufficiently reliable design, irrespective of the norm class.

F

QUANTITATIVE STRUCTURAL VERIFICATION OF THE KATWIJK CONCEPT

The design concept that appeared the most interesting for the coastal defence of Katwijk, the 'Houses on top of the garage' concept, was described in Section 6.1, see picture F.1. This appendix verifies whether the concept is realistic with help of basic deterministic methods.

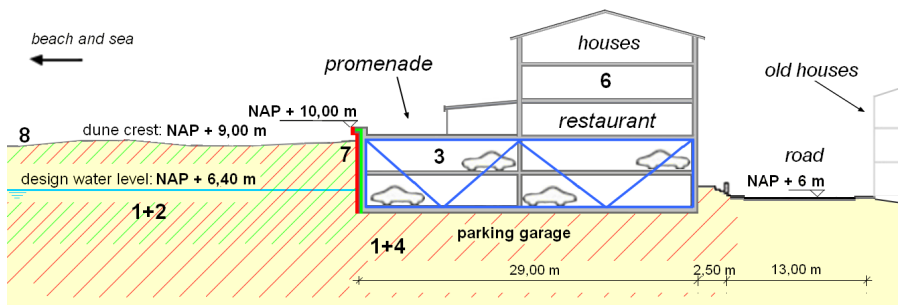

Figure F.1: Design concept 4 for the flood defence of Katwijk with the dunes at delta height.

F.1 REQUIREMENTS

For the structural verification, requirements regarding flood protection and structural integrity are checked. The requirements are met, if the failure mechanisms presented in Section 4.3.4 cannot occur. The following failure mechanisms are considered to be relevant:

- Provide sufficient flood protection:
 - dune erosion;
 - wave-overtopping;
- Provide sufficient stability for temporary and permanent structures:
 - lateral shear of a structure in an embankment;

- rotational stability of a structure in an embankment;
- bearing capacity subsoil;
- settlement;
- uplift of a structure in an embankment;
- piping;
- scour or leakage next to an object;
- cables, pipes;
- strength of the structural elements in an embankment;
- Provide sufficient strength of the structural elements + connections (+leakage!).

F.2 BOUNDARY CONDITIONS

Relevant boundary conditions are the design water level, the design wave height and the ground surface level. The ground level is determined by the dunes that are designed with a height of up to NAP + 9,00 m.

The design water level of the sea surface is derived from the assessment water level, as given by Rijkswaterstaat (Ministerie van Verkeer en Waterstaat, 2006):

assessment level:	NAP + 5,80 m
short-term local atmospheric depressions:	0,30 m
relative sea level rise during 50 years:	0,30 m
design water level:	NAP + 6,40 m

The assessment level is derived from water level measurements and includes storm set-up. In addition, it includes a 'decimating height' to compensate for not doing a probabilistic calculation. There is no full dependency between short-term local atmospheric depressions and high-water measurements, so part of this effect (0,30 m) has been added to find the design water level. A surcharge for sea level rise is included as well. For the time being, a design life time of 50 years is assumed. For a W+ climate change scenario (0,60 m per century), this corresponds to 0,30 m per 50 years. If this scenario would appear to become too low in future, it will be relatively easy to adapt the flood defence by adding sand volume to the dunes and heightening the flood wall in front of the promenade.

Values for spring tide (highest high water spring, HHWS) and neap tide (lowest low water spring, LLWS) have been derived from the 'Waterdata' website of Rijkswaterstaat:

HHWS =	NAP + 1,40 m
LLWS =	NAP - 0,75 m

The main ground and water levels are shown in Figure F.2.

The significant wave height at sea, H_s , is 8,55 m according to Ministerie van Verkeer en Waterstaat (2006), but due to climate change, this value is expected to increase, thus 8,75 m is assumed as a design value.

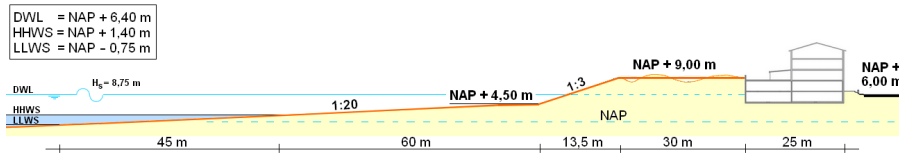

Figure F.2: Cross-section over the boulevard, dunes and beach of Katwijk, concept 4, with main ground and water levels

Unfortunately, there are no cone penetration tests available for the project location, but there is a bore sample profile known south-west of the Zeereepstraat. This bore sample profile is shown in Figure E.3. It is about 850 m away from the project location, therefore it is very uncertain that the weak soil layers between NAP-3,00 m and NAP-4,00 m are present at the case location as well. Therefore, it is assumed that the subsoil below the parking garage consists entirely of sand layers. For a detailed design, better and more soil data are needed!

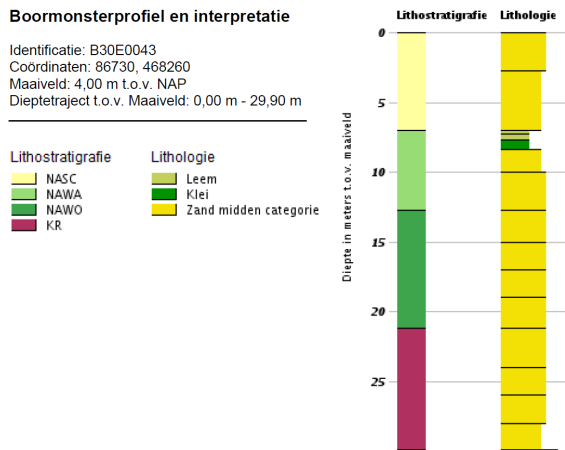

Figure E.3: Bore sample profile near Katwijk

The sand is assumed to have the following characteristics:

- $\gamma = 20 \text{ kN/m}^3$ (specific weight of sand)
- $\gamma_s = 18 \text{ kN/m}^3$ (specific weight of saturated sand)
- $\phi = 30^\circ$ (angle of internal friction)
- $K_a = 0,33$ [-] (active soil coefficient)
- $K_p = 3$ [-] (passive soil coefficient)
- $K_0 = 0,50$ [-] (neutral soil coefficient)

According to the final project plan of Arcadis (2013), concept 6 in this dissertation, the ground water table is between NAP + 2,00 to NAP + 3,00 m at the project location.

F.3 DUNE HEIGHT AND EROSION VOLUME

The shape of a dune profile is mainly determined by the wave height, the grain size of the sand, the wind and the distance from the shore. Higher waves and finer sand generally cause a more gentle profile, whereas lower waves and coarser sand lead to a steeper profile. During a storm, the still water level and wave height increase, causing erosion of the dunes and accretion of the foreshore. The erosion volume equals the accretion volume, provided that there is no significant long-shore current.

The storm profile can be simplified by assuming a gentle slope of 1:40 for the foreshore between storm surge level, SSL, and $SSL - H_s$. The slope from SSL to the dune top is 1:1, as well as the slope seaward from $SSL - H_s$, see Figure F4. The equilibrium profile is based on the rule of Bruun (1954), who studied the rate of shoreline retreat related to the rate of sea level rise, which he found to be proportional.

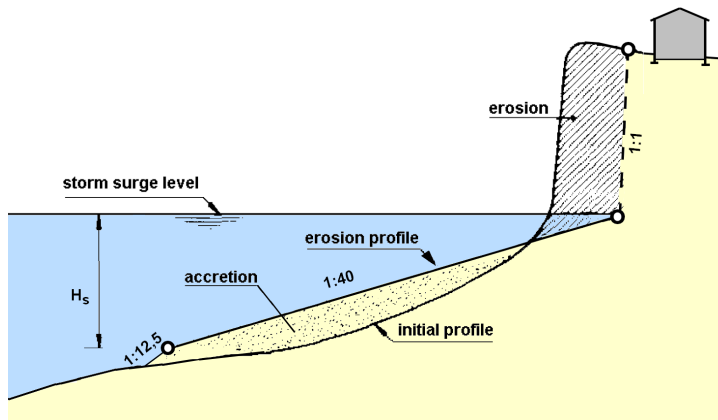

Figure F4: Dune profile after a storm according to the Bruun rule-of-thumb (not to scale)

For the calculation of the required erosion volume for the project location of the Katwijk case, the Bruun rule-of-thumb is used. The dark blue line in Figure F5 shows the dune profile after a storm.

The volume of dune sand in the cross-section suffices, but there is an additional rule to be checked: after storm erosion, a minimal residual profile should still be present, to provide extra safety. The residual profile is described in Section 27 of TAW-Technical Report Dune Erosion (TAW - TRDa, 2007). The profile starts at the intersection of the design water level with the dune slope after erosion, including 25% extra erosion volume. From the intersection point, the 'critical erosion point,' the outer slope is 1:1, leading to the crest of the minimum required residual profile with a height h_0 and a width of 3 m. The inner slope of the minimum residual profile is 1:2.

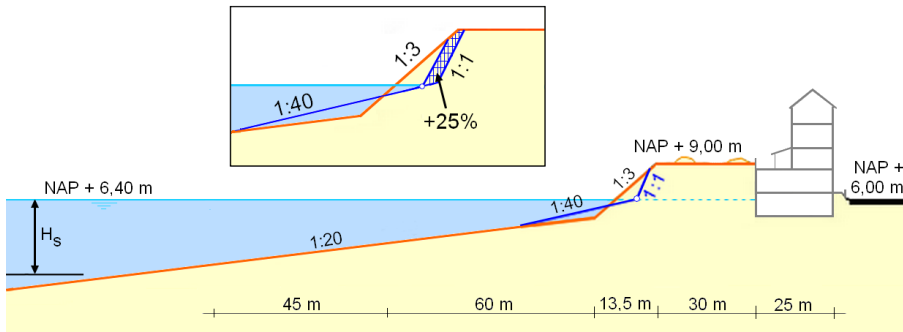

Figure F5: Dune profile for concept 4, after a storm according to the rule-of-thumb (horizontal and vertical scales are not the same!)

The minimum dune height h_{cr} after storm erosion, given in TAW - TRDa (2007) is:

$$h_{cr} > DWL + 6,40 + 0,12 \cdot T_p \sqrt{H_s} \quad (E.1)$$

with a minimum of $DWL + 2,50$ m. The dune crest should be at least 3,0 m wide. In the present example, $T_p = 14,3$ s and $H_s = 8,75$ m, so $h_{cr} > DWL + 6,40 + 0,12 \cdot 14,3 \sqrt{8,75} = NAP + 11,50$ m

The minimum required residual profile is shown in Figure F6.

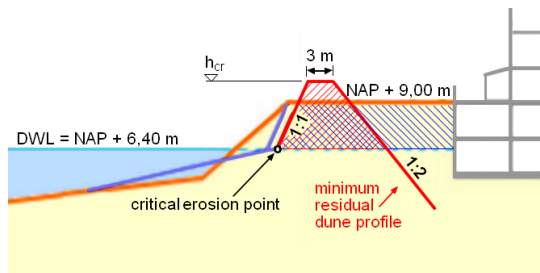

Figure F6: Minimum residual erosion profile of dunes (TAW - TRDa, 2007)

It appears that the proposed dune height of NAP + 9,00 m is too low for a single row of dunes. According to an additional study of TAW (Verhagen, 1990), however, extra dune width can compensate for a lower dune height: *Lowering of the crest is possible, if the volume above the design level remains the same.* This implies that the blue shaded area in Figure F6 should at least equal the red shaded area. The minimum residual (red shaded) area is about 55 m², which corresponds to a minimum required width of about 20 m for the designed dune crest height of NAP + 9,0 m. It demonstrates that 30 m of dunes with an average crest height of NAP + 9,00 m is sufficiently erosion-resistant.

As the volume of the dunes in front of the garage suffices to withstand a design storm, the parking garage is not needed to provide additional erosion protection or

water-retention. The dune crest can therefore be lowered and still provide sufficient flood safety. If the dune crest level would, for example, be NAP + 8,00 m, the required dune width has to be at least 35 m to provide sufficient erosion volume. However, there is only a width of about 30 m present in this concept, but the garage wall can have to take over part of the erosion-protecting function of the dunes. A modification of this concept is therefore proposed, with the dune height at NAP + 8,00 m. The structure will have to be designed in such a way that it is stable and strong to resist the loads (for instance, including sufficient concrete cover to deal with sea water). The reinforced concrete structure will not erode and thus be able to replace part of the dunes.

It should be checked whether erosion can undermine the garage. This can only happen, if the extra dune volume, present as a safety margin, would have completely eroded away. Undermining appears to be not likely as long as the critical erosion point (which is the lowest level of the residual volume = NAP + 6,40 m) is located higher than the bottom of the garage (NAP + 4,60 m), provided that there is more erosion volume present than the required minimum amount (including the 25% extra amount required as a safety margin).

F.4 OVERTOPPING

Wave-overtopping is a common failure mechanism for Dutch coastal flood defences, but not for dunes, because dune erosion of the outer slope will occur before wave-overtopping can become a threat for the inner slope. However, for structures in dunes, wave-overtopping could become relevant, if the dune in front of the structure would have washed away and the structure itself is exposed to wave attack. This is not the case in the present concept, therefore wave-overtopping is not considered as a relevant failure mechanism.

F.5 LATERAL SHEAR

A shallow foundation is assumed, of which the bearing capacity is checked in Section E7. Lateral shear of the entire structure will not occur if:

$$\Sigma H < f \cdot \Sigma V \quad (\text{E.2})$$

The most critical situation for lateral shear occurs during a realistic combination of maximal horizontal loads and minimal vertical loads. Construction work on flood defences during storm season is not allowed, therefore a storm surge level cannot coincide with an 'empty' construction pit. Therefore, the most critical situation for lateral shear is when a storm surge would coincide with the construction stage of a completed garage, but without superstructure (restaurants and houses). The vertical forces in the critical stage mainly consist of the self-weight of the garage, variable loads and the uplift force coming from the groundwater beneath the garage. In the most critical situation regarding shearing, the weight is minimal, which

implies that the variable loads should be neglected. In the considered stage, the self-weight of the structure is at least 800 kN/m' (neglecting side walls and columns) and the uplift force is 261 kN/m' (assuming the design water level at sea side and the ground water table at ground level, NAP + 4,60 m, at the land side), resulting in a total vertical downward force of $\Sigma V = 800 - 261 = 539 \text{ kN/m'}$.

The total horizontal force is calculated for the same circumstances: a design water level combined with a dune crest of NAP + 8,00 m. Assuming a specific weight of sand of 18 kN/m³ (dry) and 20 kN/m³ (saturated) and using a neutral soil coefficient (no displacements allowed), this results in a total horizontal force of $\Sigma H = 62 \text{ kN/m'}$ (see Figure E7).

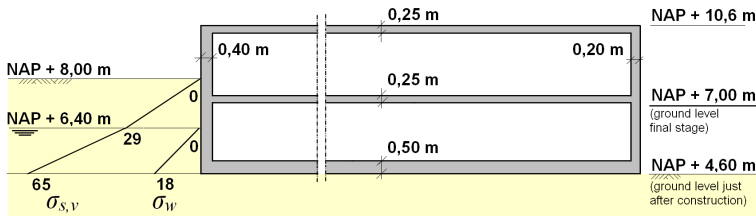

Figure E7: Cross-section concept 4 with dune crest at NAP + 8,00 m

The friction coefficient for cast concrete on clean fine sand is about 0,45 [-] (USACE Technical letter), therefore

$$\Sigma H < f \cdot \Sigma V \Rightarrow 62 < (0,45 \cdot 539 = 243) \quad \checkmark \quad (E.3)$$

according to which lateral shear can be considered to be no problem.

F.6 ROTATIONAL STABILITY

A structure is considered to be rotationally stable, if the work line of the resulting acting force intersects the core of the structure at its base. If this criterion is met, the soil does not have to deliver tensile strength to obtain a stable structure (soil is barely capable of providing tensile strength). The core is the 1/3 part in the middle of the base of the structure:

$$\frac{\Sigma M}{\Sigma V} < \frac{1}{6} b \quad (E.4)$$

Rotational instability is not very likely to occur in the stage that only the parking garage part has been constructed, therefore, the stage in which the entire superstructure is completed is considered for checking rotational stability. The check of the work line through the core of the structure is valid for stiff structures, but the structure is relatively slender, so it will deform slightly under the vertical forces, causing compression stresses in the soil under the entire bottom slab, so no tensile stresses are needed for an equilibrium and rotational instability will not occur.

F.7 BEARING CAPACITY SUBSOIL

The bearing capacity of the subsoil should be sufficient to resist the acting loads.

As a rule-of-thumb, for a preliminary design, the bearing capacity is assumed to be about 500 kN/m² (BS8004), which applies to medium dense to dense sand. The bearing capacity should be more than the acting vertical loads, for which 10 kN per m² floor area is assumed (self-weight plus variable loads). The rule-of-thumb has been verified for this case with a simple calculation: For the part with the superstructure, there are five layers in the building, so the total load will be about 50 kN/m², which is an order of 10 less than the assumed soil bearing capacity.

A more precise determination of the bearing capacity under a shallow foundation is provided by the method of Prandtl & Brinch-Hansen. The method includes a reduction of the bearing capacity due to horizontal loads and can be used in a more detailed design loop.

F.8 SETTLEMENT

Settlement of only sand layers will be no major issue as such, but there can be differences in settlements below the low and the high part of the structure, which will cause stresses in the structure, which have to be resisted by the strength of the structural members. Therefore, the expected total settlement below both parts is calculated, according to the theory of Koppejan, extended with the effect of creep (secondary settlement):

$$\Delta h = \left(\frac{U}{C'_p} + \frac{1}{C'_s} \log(t) \right) \cdot \ln \left(\frac{\sigma'_{v,i} + \Delta\sigma'_v}{\sigma'_{v,i}} \right) \cdot h \quad (\text{E.5})$$

where:

Δh	=	settlement of a soil layer with thickness h
U	=	degree of consolidation in the final situation = 1 [-]
C'_p	=	primary compression coefficient ≈ 1000 [-]
C'_s	=	secondary compression coefficient $\approx \infty$ [-]
t	=	time until end of settlement = 10 000 [days]
$\sigma'_{v,i}$	=	average initial effective vertical stress in the soil layer
$\Delta\sigma'_v$	=	average increase in effective stress in the soil layer
h	=	thickness of the settling soil layer

The sand layers above the Formation of Kreftenheye (Figure E3) are considered to be able to slightly settle, but the Formation of Kreftenheye itself, a layer from the late Pleistocene or early Holocene, is considered to be without settlement (possible subsidence of this layer is included in the relative sea level rise). This formation is located at a depth of NAP - 17 m and lower. Therefore, the layer prone to settlement is located between the ground level and NAP - 17,00 m. The average effective soil stress in the upper sand layers has the same magnitude as the effective stress in the

middle of this layer, which is at at NAP - 6,20 m. The initial effective stress at that depth is $(1,60 \cdot 18 + 9,20 \cdot 20 - 9,20 \cdot 10) = 121 \text{ kN/m}^2$, when no structure is present yet.

The weight of the structure causes additional stresses. There is a low part of the structure at sea side (parking garage) and a high part at land side (parking garage plus superstructure), so the weight varies over the width of the structure. This implies that the settlement at land side will be more than at sea side. Initially, the settlements under both parts are calculated separately. In reality, the structure cannot show discontinuities in vertical displacement (no dilation), so stresses will be caused in the structure by the difference in settlement (or inclination towards the land side), which will have to be resisted by the strength of the structural members.

The additional stress by the structure is $2 \cdot 10 = 20 \text{ kN/m}^2$ for the low part of the structure with two storeys and $5 \cdot 10 = 50 \text{ kN/m}^2$ for the high part with five storeys (using the same rule-of-thumb as in the bearing capacity check). This structure has a finite width, so a spread of the vertical stress under an angle of 45° is assumed. This results in a reduction factor of 0,60 at NAP - 6,20 m. So, the average additional effective vertical stress is $\Delta\sigma'_v = 20 \cdot 0,51 = 10,20 \text{ kN/m}^2$ under the low part, and $\Delta\sigma'_v = 50 \cdot 0,51 = 15,50 \text{ kN/m}^2$ under the high part. This results in the following settlements:

$$\Delta h = \left(\frac{1}{1000} + \frac{1}{\infty} \log(10000) \right) \cdot \ln \left(\frac{121+10,20}{121} \right) \cdot 24,00 = 0,002 \text{ m for the low part}$$

$$\Delta h = \left(\frac{1}{1000} + \frac{1}{\infty} \log(10000) \right) \cdot \ln \left(\frac{121+25,50}{121} \right) \cdot 24,00 = 0,004 \text{ m for the high part.}$$

This settlement is negligible and the difference between both parts will not lead to significant stresses in or displacements of the structure that cannot be resisted.



F.9 UPLIFT OF THE STRUCTURE

Uplift is most likely to occur immediately after construction, during a storm surge when the superstructure has not yet been built. For the uplift check, a design water level is assumed at sea side (NAP + 6,40 m) and a high ground water table at the heel of the structure at land side (NAP + 4,60 m). The maximum water pressure then is $p = h \cdot \gamma_w = (6,40 - 4,60) \cdot 10 = 18 \text{ kN/m}^2$ (Figure E.8).

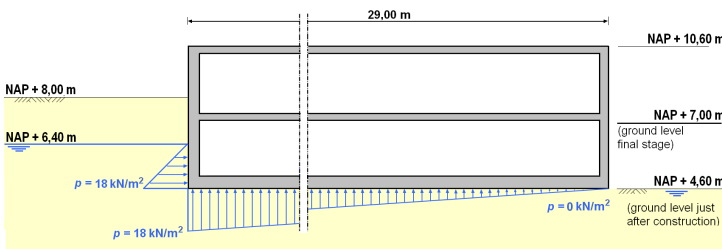

Figure E.8: Schematic sketch of Katwijk concept for the calculation of uplift

The total weight then is about $20 \text{ kN/m}^2 \cdot 29 \text{ m} = 580 \text{ kN/m}'$ and the uplift force is

$0,5 \cdot 18,0 \cdot 29 = 261 \text{ kN/m}$. So, even in this extreme situation, the uplift force is less than half the weight and therefore no uplift of the structure is expected in any life stage.

F.10 PIPING

There are a few conditions which have to be met before piping can occur. Firstly, there has to be an inclination of the water table during a sufficiently long time. Secondly, the subsoil has to be sufficiently permeable, which is most likely at the interface between two soil layers or along a hard structure. Thirdly, there has to be a possibility of entrainment of sand particles in the vicinity of the flood defence.

Piping under dunes or sea dikes is improbable in the Netherlands, but it could occur under special circumstances. The differential head over the structure would be maximal during a storm surge, immediately after construction when there still is a possibility of sand boil formation and the water level at the sea side of the structure is NAP + 6,40 m and at land side NAP + 2,00 m (the lowest groundwater table under normal circumstances), see Figure F.9.

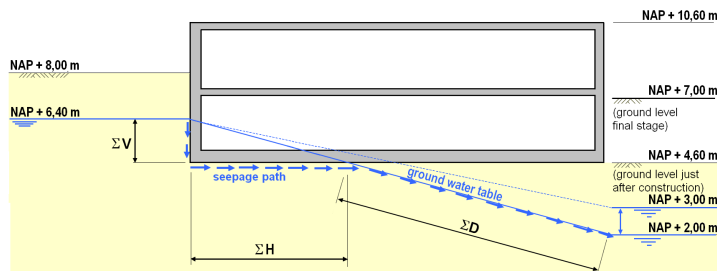

Figure F.9: Schematic sketch of Katwijk concept for checking piping situation with maximum differential head (not to scale)

There is no possibility of sand entrainment in this case, therefore another case with a lower differential head is checked: Storm surge level outside (NAP + 6,40 m) and a ground water table at ground level (NAP + 4,60 m during a temporary situation), see Figure F.10. In this case, extrusion of sand particles is possible if other conditions are unfavourable.

There are two well-known rules-of-thumb for checking the possibility of piping for conceptual designs: The method of W.G. Bligh (1915) applies to piping through soils, while the method of E.W. Lane (1935) has been derived for piping under (masonry) structures. Part of the seepage path goes along the concrete structure and another part through the sand, so in principle, a combination of both methods should be applied. For simplicity, both equations are checked separately.

According to Bligh, piping would not occur if

$$L > \gamma \cdot C_B \cdot \Delta H \quad (\text{F.6})$$

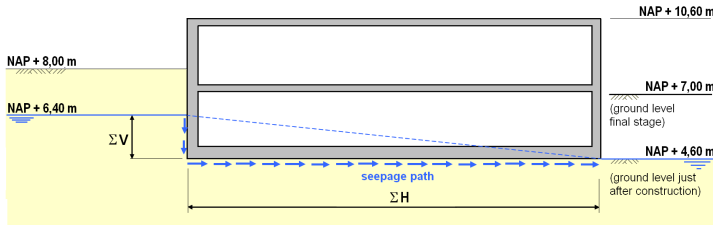

Figure F.10: Schematic sketch of Katwijk concept for checking piping situation with ground water table at excavation level (not to scale)

The seepage length is $L = \Sigma V + \Sigma H = 1,80 + 29,00 = 30,8\text{m}$. γ is the safety factor (1,5) and C_B is a constant derived from experiments. For fine sand C_B is 15 [-]. ΔH is the differential head across the structure, so $6,40 - 4,60 = 1,80\text{m}$.

So, $\gamma \cdot C_B \cdot \Delta H = 1,5 \cdot 15 \cdot 1,80 = 40,5\text{m}$, which is more than the seepage length. Therefore, additional measures have to be taken to prevent piping.

The Lane method is checked as well for piping along the structure. In this case:

$$L > \gamma \cdot C_L \cdot \Delta H \tag{F.7}$$

where: L = length of the seepage path with a reduction of the horizontal part: $L = \Sigma V + \frac{1}{3}\Sigma H = 1,80 + \frac{1}{3}29,00 = 11,5\text{m}$. This is shorter than $\gamma \cdot C_L \cdot \Delta H = 1,5 \cdot 7,5 \cdot 1,80 = 20,25\text{m}$.

The conclusion is that, according to the rule of Bligh, there is a shortage of seepage length of $40,5 - 30,8 = 9,7\text{m}$ and according to the rule of Lane, the shortage is $20,25 - 11,5 = 8,75\text{m}$. So, Bligh is the most critical in this case.

Before attempting to solve the problem with seepage screens (or other measures), the permanent situation is considered. For the permanent situation, the seepage path will be much longer, because sand particles will not be able to extrude next to the garage, because of the presence of the pavement. The first possibility of particle extrusion will be east of the road, adding about 16 m to the seepage path. In that case, $L = \Sigma L_{vert} + \Sigma L_{hor} = 1,80 + (29,00 + 16,00) = 46,80\text{m}$, which still is more than 40,50 m (Bligh); and $L = \Sigma L_{vert} + \Sigma L_{hor} = 1,80 + \frac{1}{3} \cdot (29,00 + 16,00) = 16,80\text{m}$, which is still less than 20,25 m (Lane). Therefore, in the permanent situation after construction, measures to prevent piping are needed.

A seepage screen is proposed to prevent piping. Without the screen, the shortage in seepage length would be about 10 m in a temporary situation just after construction (see above), so a screen of 5 m under the bottom of the garage would suffice (the seepage path goes down and up along the screen).

F.11 SCOUR OR LEAKAGE NEXT TO AN OBJECT

After a storm, there will still be a residual profile present in front of the garage, but aside from the structure, perpendicular to the cross-sections as presented earlier figures, the erosion will be more severe, see Figure F.11a. A transitional structure (a wing wall) can prevent this extra erosion. The wall should reach at least as far as the erosion line in an undisturbed situation.

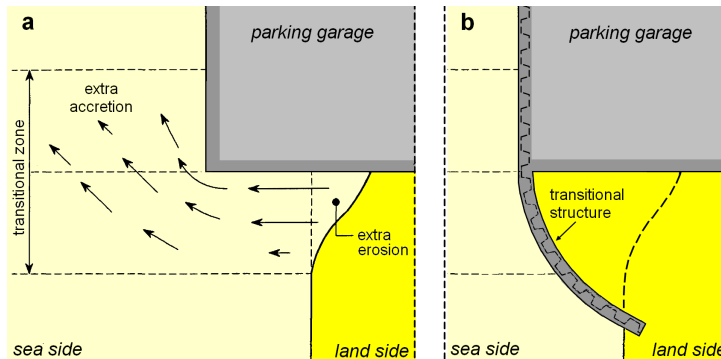

Figure F.11: Top view of the end of the structure: a) without and b) with transitional structure (modified from Steetzel, 1993)

F

F.12 CABLES, PIPES

Failure of the flood defence due to the presence of cables and pipes should and can be avoided. Main concerns are leaking or exploding pipes, or piping along transverse pipes or cables. For a conceptual design, the presence of usual cables or pipes is not an obstacle and detailing needs to be done in a more detailed design loop to prevent failure of these objects.

F.13 STRENGTH OF STRUCTURAL ELEMENTS

The structural elements can be dimensioned in such a way that they resist all internal stresses caused by external loads plus the self-weight. This is usually done by calculating normal force, shear force and moment diagrams, and a successive determination of the acting stresses and appropriate material properties, such as the form and the quality of the structural elements. This is usually done as part of a more detailed design loop and is not elaborated for the verification of the present conceptual design.

F.14 THE MODIFIED CONCEPT

Including the lowering of the dune crest and the addition of the seepage screen, the modified concept no. 4 can be seen in Figure F.12. The transitional side structure is shown in Figure F.11b.

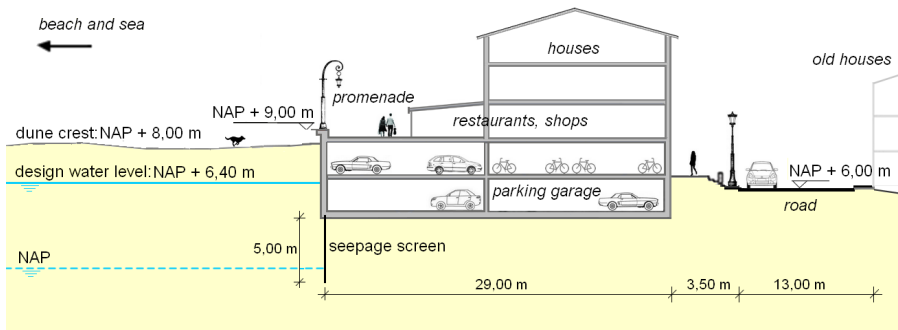

Figure F.12: Cross-section of the modified concept no. 4 for the Katwijk parking garage

GLOSSARY

assessment level / toetspeil

water level, governing for the evaluation of the actual reliability of an existing flood defence

by-law / keur

statute of a Water Board, containing regulations for the administration of flood defences, water courses and accompanying engineering structures

closure level / sluitpeil

front-line water level at which the closure of a gate should be started to prevent that the water level will exceed the open retaining level

collapse / bezwijken

(sudden) breakdown of a structure due to insufficient strength or stability

construction height / aanleghoogte

top of structure level of a dike just after construction, needed to meet the criteria for maximum wave overtopping discharges at the end of the design life period

crest freeboard, overtopping height / golfoverslaghoogte

retaining height needed to prevent overflow or overtopping discharges higher than allowed

dike ring / dijkring

continuous line of flood defences, possibly in combination with higher land areas, around an area to be protected against floods

dike ring area / dijkringgebied

part of land enclosed by a dike ring (also called 'embanked area')

dike section / dijkvak

part of a dike with equal geometrical, material and loading characteristics

dike segment / dijktraject

stretch of a dike with an equal required safety level

dwelling mound, artificial dwelling hill / terp

man-made soil body on which dwellings, or churches, were built to reduce the flood risk

engineering structure / kunstwerk

man-made civil structure as part of infrastructure. Most hydraulic structures are engineering structures. Exceptions are dunes and dikes, that are denominated as hydraulic structures, but usually not as engineering structures.

Buildings' like houses, sports halls and office buildings are not comprised in the term 'engineering structure'

ENW, Expertise Netwerk Waterveiligheid

Expertise Network Flood Risk, a network of specialists on flood risk. ENW advises governmental institutions on current issues and innovations

failure / falen

inability of a structure or structural member to fulfil the specified functional requirements

fault tree / foutenboom

graphic presentation of the logical interconnection between various component failures and events within a system

flood / overstroming

the temporary covering of land by water

flood defence / waterkering

hydraulic structure intended to protect land from being covered by water

flood risk / overstromingsrisico

multiplication of the flood probability and the consequences of a potential flood

flood safety / overstromingsveiligheid

freedom from harm or danger in case of a flood

freeboard / waakhoogte, kruinhoogtemarge

retaining height needed to compensate for wave overtopping (= crest freeboard), local wave set-up, shower gusts and seiches

front-line water / buitenwater

surface waters like seas, lakes and rivers, that are directly influenced when there is a storm surge or high river discharge

higher land areas / hoge gronden

areas of land that naturally have a ground level higher than the minimum required level regarding flood protection

hydraulic structure / waterbouwkundige constructie

an arrangement and organization of interrelated elements in a material object or system, which is used to divert, restrict, stop or otherwise manage the natural flow of water, or to facilitate sailing or mooring of vessels

human error / menselijke fout

a departure from acceptable or desired practice on part of an individual that can result in unacceptable or undesired results

HWBP, Hoogwaterbeschermingsplan

The Dutch flood protection plan

individual death probability / individueel risico

the probability that in a random year, an individual, at a certain location, will die due to a flood, taking the possibilities of evacuation into account

inundation / inundatie

deliberate flooding of land (specifically for military purposes)

ledger / legger

legal document used by the Dutch Water Boards for official registration of the flood defences as regards their location, shape, dimensions and structural composition. Ledger zones indicate the area where structural modifications are restricted

length effect / lengte-effect

increase in failure probability with the length of a flood defence due to partial correlation or independence between different cross sections and / or elements

localized individual death probability / plaatsgebonden risico

the probability that in a random year, an individual, at a certain location, will die due to a flood, not taking the possibilities of evacuation into account

MIRT, Meerjarenprogramma Infrastructuur, Ruimte en Transport

Multi-annual programme for the study on Infrastructure, Space and Transport, organised by national and regional authorities

multifunctional flood defence / multifunctionele waterkering

structure that is intended to protect land from covering by water, and that also serves other purposes. More narrowly defined, this concerns a structure in which flood protection is combined with functions other than those fulfilled by hydraulic structures or infrastructures, with a high degree of structural integration

multiple deaths probability / groepsrisico, maatschappelijk risico

the probability that in a random year, a certain number of N individuals, staying at a certain location, will die due to a flood

NAP, Normaal Amsterdams Peil

vertical datum in use in the Netherlands and large parts of Western Europe

open retaining level / open keerpeil

level of the outer water that would just not lead to an unallowable discharge through an opening with closure means in a hydraulic structure

piping / zanduitspoeling

internal backward erosion, where seepage water causes extrusion of sand particles out of a dike embankment. Ongoing sand extrusion results in small pipes, or tunnels, that can eventually cause structural failure of the dike

polder / polder

low lying area, often below sea-level, protected against floods by a surround-

ing dike in combination with drainage for rainfall and upcoming ground water

probability / kans

likelihood of an event (a flood in case of flood protection)

regular flood defence / reguliere waterkering

plain flood defence that is not combined with buildings, objects or other non-engineering structures

reference crest level / dijktafelhoogte

top of structure level at the end of the design life time, which is required to meet the criteria for maximum wave overtopping discharges

reliability / betrouwbaarheid

the ability of a structure or system to perform its required function adequately for a specified period of time under stated conditions

RWS, Rijkswaterstaat

government agency as part of the Dutch Ministry of Infrastructure and the Environment, responsible for the practical execution of the public works and water management

risk / risico

a function of the probabilities and the magnitude of specific consequences of undesired events

robustness / robuustheid

the ability of a structure to survive after initial damage

seepage screen / kwelscherm

wall to extend the percolation distance of water under or around a hydraulic structure in order to prevent failure of this structure due to extruding sand

shoulder kerb / tuimelkade

elevated edging of a dike crest

solution space / oplossingsruimte

entirety of all possible solutions

spatial quality / ruimtelijke kwaliteit

the degree of satisfying utility, scenic and future values of different interests in spatial planning

stability / stabiliteit

resistance against moving (rotation or displacement) or deformation of a structure or structural element

stiffness / stijfheid

resistance against deflection of a structure or structural member

storm surge / stormvloed

high water with an average exceedance frequency of once per two year. This high water is usually caused by a storm, coinciding with astronomic high (spring) tides and an hour-averaged wind velocity of minimal 15 m/s.

STOWA, Stichting Toegepast Onderzoek Waterbeheer

Foundation for Applied Water Research, the research centre for administrators of regional flood defences in the Netherlands

strength / sterkte

resistance against internal stresses in a structure or structural element

structural element / constructief element

part of a building or engineering structure that either directly contributes to the functioning of the structure, or indirectly by providing structural integrity (examples are columns, piers, gates, floors and foundation piles)

structural integrity / constructieve integriteit

the state of a structure of being whole and fulfilling its function. In other words: the capability of a structure to resist all actions, as well as specified accidental phenomena, it will have to withstand during construction work and anticipated use

structural safety / constructieve veiligheid

see 'structural integrity'

TAW, Technische Adviescommissie voor de Waterkeringen

Technical Advisory Committee for the Flood Defences. The task of the TAW was to advice the Minister on all technical aspects relevant to flood safety, including the design, the administration and the maintenance of flood defences

toe berm / plasberm, kreukelberm

revetment at the toe of a dike, with reed, brushwood, rubble (sometimes with stone), which protects a dike or dam soil against erosion by currents or waves

VNK, Veiligheid Nederland in Kaart

project 'Flood Risk in the Netherlands', initiated by Rijkswaterstaat, executed between 2001 and 2014 to analyse the flood risks in the Netherlands

water board / waterschap, hoogheemraadschap

regional authority that is administratively responsible for the quantitative and qualitative water management in an area

waterway dike / schaaldijk

dike, located directly along the summer bed of a river

REFERENCES

- Aguilar-López, J. P. (2016). *Probabilistic safety assessment of multi-functional flood defences*. PhD thesis, Twente University. (cited on page 168)
- Ale, B. J. M. & Piers, M. (2000). The assessment and management of third party risk around a major airport. *Journal of Hazardous Materials*, 71:1–6. (cited on page 268)
- Alexander, C. (1966). A city is not a tree. *Design*. (cited on page 89)
- Allsop, W., Kortenhuis, A., & Morris, M. (2007). Failure Mechanisms for Flood Defence Structures. Technical report, Floodsite consortium. (cited on pages 150 and 152)
- Alphen, J. van (2014). The Delta Programme and updated flood risk management policies in the Netherlands. *Flood risk management*, (9):310–319. (cited on page 57)
- Anvarifar, F., Voorendt, M. Z., Zevenbergen, C., & Thissen, W. (2016). An application of the functional resonance analysis method (FRAM) to risk analysis of multifunctional flood defences in the Netherlands. *Journal of Reliability Engineering and System Safety*. (cited on page 160)
- Arcadis (2013). Projectplan kustversterking Katwijk. Technical report, Hoogheemraadschap van Rijnland. (cited on page 301)
- ASCE (1994). The seven wonders of the modern world. website www.asce.org. (cited on page 37)
- Atsma, J. (2011). Letter to the chairman of the Dutch House of Commons, concerning the state of affairs of the flood defence policy. (cited on page 56)
- Bakker, H. L. (2005). Failure probability of river dikes strengthened with structural elements. In *Proceedings of the 16th International Conference on Soil Mechanics and Geotechnical Engineering*, pages 1845–1848. (cited on page 164)
- Bakker, K. J. (2000). *Soil Retaining Structures - Development of Models for Structural Analysis*. PhD thesis, Delft University of Technology. (cited on pages 74, 104, 106, and 107)
- Bakker, W. T. J. N. P., Hulten, H. van, Goppel, J. M., Loenen, G. van, Roos, A., Seijffert, J. J., & Vrijling, J. K. (1979). Rapport voorwerkgroep probabilistische methode (Report pre-work group probabilistic method). Technical report, Centrum voor onderzoek waterkeringen. (cited on page 60)

- Bakker, W. T. J. N. P. & Vrijling, J. K. (1980). Probabilistic design of sea defences. Technical report, Rijkswaterstaat. (cited on page 60)
- Baltissen, J., Kloosterman, R., Stel, J. van der, & Top, H. van den (1984). Denkend aan Holland. Eindrapport ISP-Dijkverbetering Deel 1 (Thinking about Holland. Final report ISP - dike improvement part 1). Technical report, Delft University of Technology. (cited on page 214)
- Bayazit, N. (2004). *Design Issues*, chapter Investigat. Massachusetts Institute of Technology. (cited on page 68)
- Beenakker, J. J. M. (1991). *Holland en het water in de Middeleeuwen. Strijd tegen het water en beheersing en gebruik van het water (Holland and the water in the Middle Ages. Struggle against the water and constraining and using the water)*, chapter Dijken in Nederland, pages 41–55. Hilversum Verloren. (cited on page 22)
- Beijersbergen, J. A. & Spaargaren, G. R. (2009). Vuistregels voor het beheerdersoordeel bij de toetsing van niet-waterkerende objecten (Rules-of-thumb for the assessment of non-water retaining objects). Technical report, Province Zuid-Holland, department Water. (cited on pages 143 and 144)
- Belbin, R. M. (1981). *Management teams*. Heinemann, London. (cited on page 123)
- Berlamont, J. (2001). Overstromingen; Waarom, waar, wanneer en hoe? (Floods: why, where, when and how?). In *Symposium 'ruimte voor water', de beste verzekering tegen wateroverlast*. (cited on pages 26 and 266)
- Bertalanffy, L. von (1951). General system theory: a new approach to unity of science. In *Human biology*, volume 23, pages 302–312. (cited on page 76)
- Bieman, J. den & Smale, A. (2015). Werkwijze bepaling hydraulische ontwerprandvoorwaarden ten behoeven van HBWP 2015 projecten (Method Determining hydraulic design boundary conditions for HBWP2015 projects). Technical report, Deltares. (cited on page 294)
- Bleiswyk, P. van (1778). *Natuur- en wiskundige verhandeling over het versterken en aanleggen der dyken (Physical and mathematical treatise on the improvement and construction of dikes) Translated from Latin into Dutch and annotated by Jan Esdré*. PhD thesis, Leiden University. (cited on page 27)
- Böckmann, J. (2012). *Probabilistische Analyse der Zuverlässigkeit von Ufereinfassungen aus Stahlbeton-Schlitzwänden (Probabilistic reliability analysis of quay walls consisting of diaphragm walls)*. PhD thesis, Leibniz Universität Hannover. (cited on page 286)
- Boeijen, A. van, Daalhuizen, J., Zijlstra, J., & Schaar, R. van der (2013). *Delft Design Guide*. BIS Publishers. (cited on pages 73, 74, 75, and 97)
- Boer, E. de (2003). Het noodoverloopgebied: airbag of luchtzak? (The inundation area: airbag of empty bag?). Technical report, Delft University of Technology. (cited on page 46)

- Boer, H. de (2016). Introduction to the minor "Integrated design of infrastructures". (cited on page 119)
- Bogardi, I., Saeijs, H. L. F., & J.K.Vrijling (1991). Involvement of ecology in decision process. *Journal of hydraulic research*, 29:20–23. (cited on page 105)
- Bolle, A. (1941). *Hafenanlagen für Stückgutumschlag*. Springer Berlin. (cited on page 136)
- Bont, C. de , Ouden, E. den , Schifferstein, R., Smulders, F., & Voort, M. van der (2013). *Advanced design methods for successful innovation*. Design United. (cited on page 131)
- Bosker, F. (2008). *Zeedijken in het Noorden (Sea dikes in the North)*. Uitgeverij Noordboek. (cited on page 20)
- Brinke, W. B. M. ten (2007). *Land in zee! De watergeschiedenis van Nederland (Land in sea! The water history of the Netherlands)*. Veen. (cited on page 19)
- Bruun, P. (1954). Coast erosion and the development of beach profiles. *Technical memorandum US Beach Erosion Board, vol. 44*. (cited on page 302)
- Buijtenen, M. P. van & Obreen, H. T. (1956). *Westergo's IJsselmeerdijken (The IJsselmeer dikes of Westergo)*. A.J. Osinga NV, Bolsward. (cited on page 22)
- Buisman, J. & Engelen, A. F. V. van (2000). *Duizend jaar weer, wind en water in de Lage Landen (Thousand years of weather, wind and water in the Low Countries)*. Van Wijnen. (cited on page 22)
- Burgers, T. (2014). *Nederlands grote rivieren. Drie eeuwen strijd tegen overstromingen (The big rivers of the Netherlands. Three centuries of fighting floods)*. Uitgeverij Matrijs. (cited on pages 19, 27, and 45)
- Çelik, F. (2013). *Ecological landscape design*, chapter 13, pages 225–250. Intech. (cited on page 113)
- Chen, X. (2016). *Impacts of overtopping waves on buildings on coastal dikes*. PhD thesis, Delft University of Technology. (cited on pages 170 and 171)
- CIRIA (2013). *The international levee handbook*. (cited on pages 138, 140, 153, and 156)
- COB (2015). *Handboek Tunnelbouw. Civieltechnisch ontwerp en realisatie van tunnels (Hand book tunnel construction. Civil-technical design and realisation of tunnels)*. Centrum Ondergronds Bouwen. (cited on page 204)
- Collins World English Dictionary (2012). Collins World English Dictionary. website <http://www.collinsdictionary.com>. (cited on page 3)
- Collins World English Dictionary (2015). No Title. website www.wisegeek.com. (cited on page 110)

- Commissie Veerman (2008). *Samen werken met water. Een land dat leeft, bouwt aan zijn toekomst (Working together with water. A living country, creates its future.* (cited on page 293)
- Coulomb, C. A. (1776). *Essai sur une application des regles des maximis et minimis a quelques problemes de statique relatifs a l'architecture. Memoires de l'Academie Royale pres Divers Savants (Treatise on an application of rules for maxima and minima for some statistical problems related to architecture).* Memoires de l'Academie Royale pres Divers Savants, Vol. 7. (cited on page 27)
- Crone, H. (2003). *Het tuig dat werkt (The gear that works). Farewell lecture.* Delft University of Technology. (cited on page 77)
- Cross, N. (1993). *Design Methodology and Relationships with Science*, chapter A History. Springer Netherlands. (cited on page 68)
- Cruquius, N. & Geurts, H. (2006). *Het oudste weerboekje van Nederland: de weerwaarnemingen van Nicolaas Cruquius.* Van Wijnen, Franeker. (cited on page 24)
- Dantzig, D. van (1956). Economic decision problems for flood prevention. *Econometrica*, 24:276–287. (cited on pages 34, 256, and 259)
- Darke, J. (1984). *Developments in design methodology*, chapter The primary generator and the design process. Wiley, Chichester. (cited on page 81)
- De Urbanisten, Gemeente Rotterdam, Arcadis, Royal Haskoning, Deltares, Hoogheemraadschap van Schieland en de Krimpenerwaard, Gemeente Schiedam, Waterschap Hollandse Delta, & Hoogheemraadschap Delfland (2010). *Veilige en goed ingepaste waterkeringen in Rotterdam (Safe and well-integrated flood defences in Rotterdam).* National Research Programme Knowledge for Climate. (cited on pages 203, 208, 209, and 210)
- Deltacommissaris (2013). Deltaprogramma 2014. Werk aan de delta. Kansrijke oplossingen voor opgaven en ambities. (Delta programme 2014). Technical report, Ministerie van Infrastructuur en Milieu; Ministerie van Economische Zaken. (cited on page 59)
- Deltacommissie (1960a). Rapport Deltacommissie deel 1. Eindverslag en interimadviezen. Technical report, -. (cited on pages 33, 36, 59, 251, 255, 259, and 260)
- Deltacommissie (1960b). Rapport Deltacommissie deel 2. Bijdragen 1 - Meteorologische en oceanografische aspecten van stormvloed (Report Delta Committee part 2. Contributions 1 - meteorological and oceanographical aspects of storm surges). Technical report, -. (cited on page 253)
- Deltacommissie (1960c). Rapport Deltacommissie deel 3. Bijdragen 2 - Beschouwingen over stormvloed en getijbeweging door het Mathematisch Centrum (Report Delta Committee part 3. Contributions 2 - Considerations on storm surges and tidal movements). Technical report, -. (cited on pages 60, 251, 254, 256, 257, 258, and 259)

- Deltacommissie (1960d). Rapport Deltacommissie deel 4. Bijdragen 3 - Beschouwingen over stormvloeden en getijbeweging door Rijkswaterstaat (Report Delta Committee part 4. Contributions 3 - Considerations on storm surges and tidal movements). Technical report, -. (cited on pages 251 and 254)
- Desmet, P. (2003). *Funology: from Usability to Enjoyment (pp. 111-123)*, chapter Measuring, pages 111–123. Dordrecht: Kluwer Academic Publishers. (cited on page 102)
- Dooren, E. J. G. C. van , Boshuizen, E., Merrienboer, E. van , Asselbergs, M. F., & Dorst, M. J. van (2014). Making explicit in design education: Generic elements in the design process. *International journal of technology and design education*. (cited on pages 81 and 82)
- Dorst, C. H. (2011). The core of 'design thinking' and its application. *Design Studies*, 23:521–532. (cited on page 89)
- Dreyfus, H. L. (2003). The Spinoza lectures. University of Amsterdam. (cited on page 128)
- Dubbelman, H. (1999). *Maatschappelijke golven in de Waterbouwkunde (Societal waves in hydraulic engineering)*. PhD thesis, Delft University of Technology. (cited on pages 21, 22, and 23)
- EAAE (2016). European Association for Architectural Education: Charter on Architectural Research wiki. website <http://reseaearch.wikidot.com>. (cited on page 81)
- Eekhout, M. (1997). *POPO of ontwerpmethoden voor bouwproducten en bouwcomponenten (POPO or design methods for building products and building components)*. Delft University Press. (cited on page 84)
- Eekhout, M. (2015a). *Lectures on innovation in building technology*. IOS Press. (cited on page 83)
- Eekhout, M. (2015b). *Technologisch ontwerpen in spagaat tussen innovaties en wetenschap*. Delft University of Technology. (cited on page 83)
- Eeten, M. van , Noordegraaf-Eelens, L., Ferket, J., & Februari, M. (2012). Waarom burgers risico's accepteren en waarom bestuurders dat niet zien (Why citizens accept risks and why administrators don't recognize that). (cited on pages 265 and 266)
- Eijgenraam, C. J. J. (2006). Optimal safety standards for dike-ring areas - CPB Discussion Paper. Technical report, Centraal Planbureau. (cited on page 272)
- Elkington, J. (1994). Towards the sustainable corporation: Win-win-win business strategies for sustainable development. *California Management Review*, 36, no. 2(2):90–100. (cited on page 109)

- Ellen, G., Hommes, S., Kalweit, A. M., Lamoen, F. van , Melisie, E., Maring, L., Paalman, M., Peerdeman, K., Rooij, S. A. M. van , & Steingrover, E. G. (2011). Multifunctioneel landgebruik als adaptatiestrategie - Puzzelen met ondernemers en beleidsmakers (multifunctional use of land as adaptation strategy - puzzling with entrepreneurs and policy makers). Technical report, Kennis voor Klimaat. (cited on page 11)
- ENW - GHB (2016). *Grondslagen voor Hoogwaterbescherming (Fundamentals of High Water Protection)*. Expertisenetwerk Waterveiligheid. (cited on pages 267, 278, and 293)
- Eurocode 6 (2013). European Standard EN 1997. Eurocode 6. Design of masonry structures. (cited on page 170)
- European Commission (2007a). EU Floods Directive. website ec.europa.eu. (cited on page 53)
- European Commission (2007b). *European Floods Directive*. European Commission. (cited on page 3)
- European Union (2007). Water Framework Directive. website ec.europa.eu. (cited on page 52)
- EurOtop Team (2016). Manual on wave overtopping of sea defences and related structures. An overtopping manual largely based on European research, but for worldwide application. Technical report, EurOtop Team. (cited on pages 205 and 217)
- Feitsma, I. (2002). Betrouwbaarheidsanalyse van dijken (Reliability analysis of dikes). Technical report, Delft University of Technology. (cited on page 281)
- Forsey, J. (2013). *The aesthetics of design*. Oxford University Press. (cited on page 68)
- Förster, U., Ham, G. van der , Calle, E., & Kruse, G. (2012). Zandmeevoerende wellen (Piping). Technical report, Deltares. (cited on page 295)
- Franco, L., Gerloni, M. de , & Meer, J. W. van der (1994). Wave overtopping on vertical and composite breakwaters. In *Proceedings of the 24th International Conference on Coastal Engineering, Kobe*, pages 1030–1044. (cited on pages 205 and 217)
- Frankl, V. E. (1959). *Man's search for meaning: An introduction to logotherapy (original title: ... trotzdem Ja zum Leben sagen: Ein Psychologe erlebt das Konzentrationslager)*. Beacon Press. (cited on page 38)
- Gaius Plinius Secundus (78). *Naturalis historia (Natural history)*. Artemis & Winkler. (cited on page 20)
- Geerken, B. (2013). *Waterwereld (Water world), inaugural speech*. Delft University of Technology. (cited on page 65)

- Geertzen, S. & Liefstink, L. (2017). Een inpassingsmethode voor multifunctionele dijken. Technical report, Delft University of Technology. (cited on page 105)
- Genderen, P. van (2007). Introduction. In Eekhout, M. & Tomiyama, T., editors, *Delft Science in design 2*, volume 3 of *Research in design*, pages 11–12. Delft University of Technology, IOS Press. (cited on page 67)
- Gerven, K. van (2004). Dijkdoorbraken in Nederland. Ontstaan, voorkómen en bestrijden. Master's thesis, Delft University of Technology. (cited on page 46)
- Gijt, J. G. de & Broeken, M. L. (2013). Quay Walls. (cited on page 135)
- Government of the Netherlands (2013). Wet van 15 mei 2013 tot wijziging van de Waterwet. Staatsblad. (cited on page 51)
- Graaff, R. J. M. van de & Eck, N. V. van (2010). *Integraal Programmabeheersplan HWBP*. Programmabureau HWBP. (cited on page 122)
- Groot, A. D. de (1961). *Methodologie. Grondslagen van onderzoek en denken in de gedragswetenschappen (Methodology. Basics of research and thinking in behavioral sciences)*. Van Gorcum, Assen. (cited on pages 68 and 69)
- Guideline Systems Engineering (2013). *Guideline for Systems Engineering within the civil engineering sector*. Prorail, Rijkswaterstaat, NL Ingenieurs, Bouwend Nederland, Vereniging van Waterbouwers, Uneto VNI. (cited on pages 77, 78, and 79)
- Haan, H. de & Haagsma, I. (1984). *De Deltawerken. Techniek, politiek, achtergronden. (The Delta works. Technology, politics and backgrounds)*. Waltman, Delft. (cited on pages 37 and 38)
- Ham, W. van der (2003a). *Hollandse polders (Dutch polders)*. Boom, Amsterdam. (cited on page 25)
- Ham, W. van der (2003b). *Meester van de zee. Johan van Veen, waterstaatsingenieur. (Master of the sea. Johan van Veen, State hydraulic engineer)*. Uitgeverij Balans. (cited on pages 24, 30, and 31)
- Ham, W. van der (2003c). Watersnoodramp van 1953 was te voorkomen. *Tijdschrift voor Waterstaatsgeschiedenis*, 12:21–31. (cited on page 33)
- Ham, W. van der (2007). *Hollanders en het water: Twintig eeuwen strijd en profijt (The Dutch and the water. Twenty centuries of struggle and benefit)*. Uitgeverij Verloren BV, Hilversum. (cited on page 33)
- Heeling, J., Meyer, H., & Westrik, J. (2002). *Het ontwerp van de stadsplattegrond (The design of the city map)*. SUN. (cited on page 85)
- Heems, T. (2015). *Zoden aan de dijk. Samenwerken aan water en ruimte. (Turf on the dike. Cooperating on water and space)*. (cited on page 121)

- Heems, T. & Kothuis, B. (2012). *Voorbij de mythe van droge voeten. Nederlanders, waterveiligheid en overstromingsdreiging*. PhD thesis, University of Maastricht. (cited on pages 40 and 53)
- Heezik, A. van (2007). *Strijd om de rivieren. 200 jaar rivierenbeleid in Nederland of de opkomst en ondergang van het streven naar de normale rivier*. PhD thesis, Delft University of Technology. (cited on pages 37 and 42)
- Hertogh, M. & Bosch-Rekvelde, M. G. C. (2014). *Integraal ontwerp en beheer (Integrated Design and Maintenance)*. Lecture notes. Delft University of Technology. (cited on pages 74 and 98)
- Hertogh, M. J. C. M. (2013). *Connect and renew, inaugural speech*. Delft University of Technology. (cited on page 65)
- Hillier, W., Musgrove, J., & O'Sullivan, P. (1984). *Developments in design methodology*, chapter Knowledge and design methodology. Wiley, Chichester. (cited on page 81)
- Hinborgh, M. (2010). Flood defence town centre Dordrecht. Master's thesis, Delft University of Technology. (cited on pages 145, 146, and 239)
- HNS (2010). *Handreiking ruimtelijke kwaliteit dijkversterking Lekdijk Kinderdijk - Schoonhovenseveer (Guide spatial quality dike reinforcement Lek dik Kinderdijk - Schoonhovenseveer)*. H + N + S Landschapsarchitecten. (cited on page 96)
- Hoffmans, G. J. C. M. (2012). *The influence of turbulence on soil erosion*. Eburon. (cited on page 167)
- Hoffmans, G. J. C. M., Akkerman, G. J., Verheij, H. J., Van Hoven, A., & Meer, J. van der (2009). The erodibility of grassed inner dike slopes against wave overtopping. Technical report, Deltares, Royal Haskoning, Delft University of Technology, Van der Meer Consulting. (cited on page 166)
- Hofstede, G., Hofstede, G. J., & Minkov, M. (2010). *Cultures and Organizations: Software of the Mind, Third Edition*. McGraw-Hill Books. (cited on page 124)
- Hölscher, P. (2016). Dynamisch gedrag van een on-shore windturbine (Dynamic behaviour of an on-shore wind turbine). *Geotechniek*. (cited on page 159)
- Hoog, M. de , Sijmons, D., & Verschuuren, S. (1998). *Het metropolitane debat*, chapter Herontwerp van het laagland (Re-design of the low land). (cited on page 84)
- Hooimeijer, P., Kroon, H., & Luttik, J. (2001). *Kwaliteit in meervoud. Conceptualisering and operationalisering van ruimtelijke kwaliteit voor meervoudig ruimtegebruik (Quality in plural. Conceptualisation and operationalisation of spatial quality for plural use of space)*. Habiforum. (cited on page 11)

- Hopman, H. (2007). Innovation-focused ship design. Developments and options from a European perspective. In Eekhout, M. & Tomiyama, T., editors, *Delft Science in Design 2*, volume 3 of *Research in Design*, pages 111–124. Delft University of Technology, IOS Press. (cited on page 78)
- Hubka, V. (1989). *Principles of engineering design*. Springer Verlag, New York. (cited on page 70)
- Huis in 't Veld, J. C., Ebbens, E. H., Epema, W., Graaf, K. de , Hoozemans, H. J. M., Korf, W., Vrijling, J. K., & Westerhoven, J. G. (1986). Proefproject dijkverbetering Sliedrecht (Test project dike reinforcement Sliedrecht). Technical report, Rijkswaterstaat. (cited on pages 41, 138, 151, 152, 157, 214, and 294)
- Huis in 't Veld, J. C., Ebbens, E. H., Epema, W., Graaf, K. de , Hoozemans, H. J. M., Korf, W., Vrijling, J. K., & Westerhoven, J. G. (1987). Beleidsanalyse dijkversterking Sliedrecht. Eindrapportage (Policy analysis dike reinforcement Sliedrecht. Final report). Technical report, Rijkswaterstaat. (cited on page 214)
- Huisman, P. (2004). *Water in the Netherlands - managing checks and balances*. Netherlands Hydrological Society. (cited on pages 19 and 52)
- HWBP (2014). Handreiking verkenning HWBP-projecten (Guideline exploration HWBP projects). Technical report, Programmabureau Hogwaterbeschermingsprogramma. (cited on page 80)
- International Council on Systems Engineering (2015). InNCOSE The Netherlands. website www.incose.nl. (cited on page 78)
- Jáky, J. (1948). Pressure in soils. In *2nd ICSMFE, Vol. 1, London*. (cited on page 28)
- Jongejan, R. B. (2013). Vaststellen uitgangspunten definitieve kalibratie, WTI2017 (Determination of starting points of the final calibration). Technical report, Deltares. (cited on pages 172 and 277)
- Jongejan, R. B. & Maaskant, B. (2015). Quantifying flood risk in the Netherlands. *Risk Analysis*, 35(2):252–264. (cited on page 62)
- Jongerius, Y. (2016). Probabilistic analysis of a dike with a building in the profile. Master's thesis, Delft University of Technology. (cited on pages 157, 169, and 170)
- Jonkman, S., Jongejan, R., & Maaskant, B. (2011). The use of individual and societal risk criteria within the Dutch flood safety policy. Nationwide estimates of societal risk and policy applications. *Risk Analysis*, 31(2):282–300. (cited on page 62)
- Jonkman, S. & Schweckendiek, T. (2016). *Flood defences. Lecture notes*. Delft University of Technology. (cited on page 3)
- Jonkman, S. N. (2007). *Loss of life estimation in flood risk assessment*. PhD thesis, Delft University of Technology. (cited on pages 62 and 267)

- Jonkman, S. N., Bockarjova, M., Kok, M., & Bernardini, P. (2008). Integrated hydrodynamic and economic modelling of flood damage in the Netherlands. *Ecological economics*, 66:77–90. (cited on page 270)
- Kamp, A. (2016). *Engineering education in the rapidly changing world*. Delft University of Technology. (cited on page 65)
- Kentrop, J. (2016). Design and reliability evaluation of a multifunctional glass flood defence. Master's thesis, Delft University of Technology. (cited on page 171)
- Kind, J. M. (2011). Maatschappelijke kosten-batenanalyse waterveiligheid 21e eeuw. Technical report, Deltares. (cited on page 62)
- Kind, J. M. (2013). Economically efficient flood protection standards for the Netherlands. *Flood risk management*. (cited on pages 61, 62, and 276)
- KNMI (2006). Climate change scenarios 2006 for the Netherlands. Technical report, Koninklijk Nederlands Meteorologisch Instituut. (cited on page 294)
- Knoeff, H. & Heijn, K. (2015). Nieuwe normering en ontwerpen in HWBP-projecten (New standards and designing in HWBP projects). Memo. (cited on page 80)
- Kok, M., Stijnen, J. W., Barendregt, A., Heynert, K., Hooijer, A., & Dijkman, J. (2003). Beperking van overstromingsrisico's langs de bovenrivieren; een verkennende beleidsanalyse van rampenbeheersing en structurele maatregelen langs de Rijn-takken (Reduction of flood risks along the upper rivers; an exploratory policy analysis of disaster con. Technical report, HKV and Deltares. (cited on page 47)
- Kok, M., Vermeij-Van den Braak, E., Kanning, W., Kolen, B., Thonus, B., & Adams-Tonk, A. (2007). Twee jaar na Katrina. De catastrofale overstroming van New Orleans (Two years after Katrina. The catastrophic flood of New Orleans). Technical report, Delft University of Technology and HKV. (cited on page 149)
- Kok, M., Vrijling, J. K., & Zevenbergen, C. (2013). Towards an integrated evaluation framework for multi-functional flood defences. *Comprehensive Flood Risk Management*, pages 921–925. (cited on pages 2 and 3)
- Kolen, B. (2013). *Certainty of uncertainty in evacuation for threat driven response: principles of adaptive evacuation management for flood risk planning in the Netherlands*. PhD thesis, Radboud Universiteit Nijmegen. (cited on page 268)
- Kolen, B., Zethof, M., & Maaskant, B. (2012). Meerlaagsveiligheid: Globale verkenning aan de hand van voorbeelden. Toepassing basisvisie afwegingskader Meerlaagsveiligheid. Technical report, -. (cited on page 59)
- Kötter, F. (1903). Die Bestimmung des Drucks an gekrümmten Gleitflächen, eine Aufgabe aus der Lehre vom Erddruck. In *Sitzungsberichte der Akademie der Wissenschaften*. (cited on page 28)

- Kramer, J. (1989). *Kein Deich, kein Land, kein Leben. Geschichte des Küstenschutzes an der Nordsee (No dike, no land, no life. History of coastal protection along the North Sea)*. Rautenberg, Leer. (cited on page 1)
- Kustwerk Katwijk (2013). Projectplan kustversterking Katwijk (Project plan reinforcement coastal protection Katwijk). Technical report, Hoogheemraadschap van Rijnland. (cited on pages 176, 177, and 182)
- Landesbetrieb SBG (2012). Sturmflutschutz in Hamburg. Gestern - heute - morgen. (Storm surge protection in Hamburg. Yesterday - today - tomorrow) Berichte des Landesbetriebes Strassen, Brücken und Gewässer Nr. 10/2012. (cited on page 246)
- Lawson, B. & Dorst, K. (2009). *Design expertise*. Architectural Press. (cited on pages 69, 82, 83, and 92)
- Leary, T. (1957). *Interpersonal Diagnosis of Personality*. Ronald Press, New York. (cited on page 123)
- Lerche, I. & Glaesser, W. (2006). *Environmental risk assessment: quantitative measures, anthropogenic influences, human impact*. Springer, Berlin. (cited on page 268)
- Leusen, B. van & Velden, J. W. van der (1998). *Rivieren en stuwen (Rivers and weirs)*. Educatieve Partners Nederland. (cited on page 145)
- Li, Y. (2017). *Reliability of long heterogeneous slopes in 3D. Model performance and conditional simulation*. PhD thesis, Delft University of Technology. (cited on page 165)
- Lintsen, H. (1993). *Geschiedenis van de techniek in Nederland. De wording van een moderne samenleving 1800-1890. Deel II (History of the technology in the Netherlands. The development of a modern society 188-1890. Part II)*. Walburg Pers BV. (cited on page 46)
- Liu, D. K. & Sorby, S. (2007). *Visualisation, modeling and graphics for engineering design*. Delmar Cengage Learning Inc. (cited on page 97)
- Lomborg, B. (2001). *The skeptical environmentalist. Measuring the real state of the world*. Cambridge University Press. (cited on page 114)
- Loon-Steensma, J. M. van (2014). *Salt marshes for flood protection. Long-term adaptation by combining functions in flood defence*. PhD thesis, Wageningen University. (cited on page 112)
- Lorentz, H. A. (1926). Verslag van de staatscommissie met opdracht te onderzoeken in hoeverre, als gevolg de afsluiting van de Zuiderzee te verwachten is dat tijdens storm hogere waterstanden en een grotere golfoploop, dan thans het geval is, zullen voorkomen voor de kust van het vaste land van Noord-Holland, Friesland

- en Groningen, alsmede vóór de daarvoor gelegen Noordzee-eilanden. Beschrijving van de stormvloeden in de periode 1824-1926. Opzet van tweedimensionale getijberekeningen voor de Waddenzee, golfploopberekeningen (Report of the state committee of the study of the possible increase of water levels and wave runoff due to closure of the Southern Sea, etc.). Technical report, Algemene Landsdrukkerij. (cited on pages 29 and 30)
- Lynch, K. (1960). *The image of the city*. Harvard University Press. (cited on pages 86, 87, and 99)
- March, L. (1984). *Developments in design methodology*, chapter The logic of design. Wiley, Chichester. (cited on page 81)
- Maring, L. & Hooimeijer, F. (2017). System Exploration Environment and Subsurface (SEES). website publicwiki.deltares.nl/display/SEES/. (cited on pages 85 and 86)
- Matos Castaño, J. (2016). *Frames and dilemmas in multifunctional projects*. PhD thesis, Twente University. (cited on page 120)
- Mayer, T. (1970). *Emerging methods in environmental design and planning*, chapter Appraisal in the building design process. MIT Press. (cited on page 81)
- McHarg, I. L. (1969). *Design with nature*. Wiley. (cited on page 84)
- McLennan, J. F. (2004). *The philosophy of sustainable design*. Ecotone Publishing Company LLC. (cited on page 109)
- Meer, J. van der , Hardeman, B., Steendam, G., Schüttrumpf, H., & Verheij, H. (2010). Flow depths and velocities at crest and inner slope of a dike, in theory and with the wave overtopping simulator. *Coastal Engineering*. (cited on page 168)
- Melchers, R. E. (2001). *Structural reliability analysis and prediction. Second edition*. John Wiley & Sons. (cited on pages 283, 288, and 290)
- Metze, M. (2010). *Veranderend getij. Rijkswaterstaat in crisis. (Changing tide. Rijkswaterstaat in crisis)*. Uitgeverij Balans. (cited on page 55)
- Metzelaar, W. (1979). *Nederland Deltaland*. Educaboek. (cited on page 27)
- Meyer, H. (2016). *De staat van de delta. Waterwerken, stadsontwikkeling en natievorming in Nederland (The state of the delta. Water works, urban development and nation building in the Netherlands)*. Vantilt, Nijmegen. (cited on pages 19, 24, and 27)
- Meyer, H. (2017). *Integral design of multifunctional flood defences. Multidisciplinary approaches and examples*, chapter How infrastructure can support and destroy the public domain of the city, pages 96–97. Delft University Publishers. (cited on page 6)

- Ministerie van Verkeer en Waterstaat (2006). *Hydraulische Randvoorwaarden primaire waterkeringen voor de derde toetsronde 2006-2011 (HR 2006) (Hydraulic boundary conditions primary flood defences for the third national assessment)*. Ministerie van Verkeer en Waterstaat. (cited on pages 216 and 300)
- Ministerie van Verkeer en Waterstaat (2009). Nationaal Waterplan 2009-2015. Technical report, Ministerie van Verkeer en Waterstaat, Ministerie van Volkshuisvesting, Ruimtelijke Ordening en Milieubeheer, Ministerie van Landbouw, Natuur en Voedselkwaliteit. (cited on pages 47, 57, and 143)
- Ministry of Infrastructure and Environment (2012). Ministry of Infrastructure and Environment. website www.infomil.nl. (cited on page 269)
- Ministry of Infrastructure and Environment (2016). Wijziging van de Waterwet en enkele andere wetten. Brief van de minister van infrastructuur en milieu aan de Eerste Kamer der Staten-Generaal, stuk nummer 34 436. (cited on page 64)
- Mobicon Concordis groep (2008). Stilstaan bij parkeren. Parkeerbeleid Katwijk 2009 - 2018 (Standing stil for parking. Parking policy 2009 - 2018). Technical report, Gemeente Katwijk. (cited on page 177)
- Most, H. van der , Tánczos, I., Bruijn, K. de , & Wagenaar, D. (2014). New, risk-based standards for flood protection in the Netherlands. In *6th International Conference on flood management*. (cited on pages 63 and 64)
- Mous, B. (2010). Wave impact on grass covered outer slopes. Master's thesis, Delft University of Technology. (cited on page 166)
- Müller-Breslau, H. F. B. (1906). *Erddruck auf Stützmauern (Soil pressure on retaining walls)*. Alfred Kroner, Stuttgart. (cited on page 28)
- Municipality of Hamburg (2012). Hafencity. website www.hafencity.com. (cited on pages 246, 247, and 248)
- Municipality of Sliedrecht (2012). Municipality of Sliedrecht. website www.sliedrecht.nl. (cited on page 215)
- Netten, J. van (2005). *Handreiking functioneel specificeren (Guide for functional specifications)*. Expertisecentrum Opdrachtgeverschap (ECO). (cited on page 99)
- Nillesen, A. L. (2012). Water-safety strategies and local-scale spatial quality. *Municipal Engineer*, 166(M1):16–23. (cited on pages 87, 88, and 102)
- Nillesen, A. L. (2015). *Research in Urbanism Series Vol. III 'Flowscales'*, chapter The synergy between flood risk protection and spatial quality in coastal cities, pages 255–274. IOS Press, under the imprint Delft University Press. (cited on page 120)
- Nillesen, A. L. (2017). *Spatial quality as a decisive criteria in the formulation of flood risk protection strategies. An integrated approach for flood risk strategy development, in which spatial quality is a decisive ex-ante criteria*. PhD thesis, Delft University of Technology. (cited on page 130)

- OTIB (2016). Integraal samenwerken (Integrated cooperation). website integraal-samenwerken.otib.nl. (cited on page 122)
- Pahl, G. & Beitz, W. (1986). *Konstruktionslehre: Handbuch für Studium und Praxis*. Springer Verlag, Berlin. (cited on page 70)
- Pahl, G., Beitz, W., Feldhusen, J., & Grote, K.-H. (2007). *Engineering Design. A Systematic Approach*. Springer. (cited on page 76)
- Palmboom, F. (2016). *Delta Interventions. Design and engineering in urban water landscapes*, chapter Research,, pages 122–123. Delft University Publishers. (cited on page 84)
- Paul, R. & Wesselink, M. (2010). *Handboek strategisch omgevingsmanagement (Handbook strategical stakeholder management)*. Vakmedianet Management. (cited on page 121)
- Pijpers, R. (2013). Vulnerability of structural transitions in flood defences. Master's thesis, Delft University of Technology. (cited on pages 165, 167, and 168)
- Pollio, M. V. (15). *De architectura (on architecture)*. Athenaeum-Polak. (cited on page 87)
- Pols, A. A. J. (1982). *Syllabus college beginselen ontwerpen, planning en organisatie fc25 (lecture notes basics of the design, planning and organisation)*. Delft University of Technology. (cited on page 72)
- Pot, B. van der (1977). Enige highlights en termen die veel aangehaald worden uit het werk van de delta-commissie. Intern memo HBM. (cited on page 252)
- Projectbureau VNK (2014). De veiligheid van Nederland in kaart. Eindrapport (Flood risk in the Netherlands. Final report). Technical report, Rijkswaterstaa. (cited on page 267)
- Projectbureau VNK2 (2011). Flood risk in the Netherlands. VNK2 The method in brief. Technical report, VNK. (cited on page 271)
- Projectgroep gebiedsopgave Sliedrecht (2016). MIRT-onderzoek Alblasserwaard-Vijfheerenlanden: Gebiedsopgave Sliedrecht. Inspiratiedocument voor het verbinden van ruimtelijke en waterveiligheidsopgaven. Technical report. (cited on pages 215, 216, and 222)
- Rankine, W. (1857). *On the stability of loose earth. Philosophical Transactions of the Royal Society of London, Vol. 147*. Royal Society of London. (cited on page 28)
- Reeve, D. (2010). *Risk and reliability: coastal and hydraulic engineering*. Spon Press. (cited on pages 286, 290, and 292)
- Rijcken, T. (2015). *Research in Urbanism Series Vol. III 'Flowscales'*, chapter A critical approach ot some new ideas about the Dutch flood risk system, pages 293–322. IOS Press, under the imprint Delft University Press. (cited on pages 53 and 54)

- Rijkswaterstaat (1969). Onderzoek naar de huidige veiligheid van verschillende zeewaterkeringen. Technical report, Rijkswaterstaat. (cited on page 48)
- Rijkswaterstaat (1972). Over het berekenen van Deltaprofielen voor dijken langs de Westerschelde (On the calculation of delta profiles for dikeas along the Western Scheldt). Technical report, Directie Zeeland, studiedienst Vlissingen. (cited on page 48)
- Rijkswaterstaat (2005). Flood Risks and Safety in the Netherlands (Floris). Technical report, VNK. (cited on pages 49 and 257)
- Rijkswaterstaat (2015a). Achtergrondrapport ontwerpinstrumentarium 2014 (Background report design tools 2014). (cited on pages 277, 293, 294, and 296)
- Rijkswaterstaat (2015b). Handreiking ontwerpen met overstromingskansen (Guideline designing with flood probabilities). (cited on pages 172, 277, 278, 294, 297, and 298)
- RIKZ (2003). Naar integraal kustzonebeleid. Beleidsagenda voor de kust (Towards an integrated coastal zone policy. Policy agenda for the coast). Technical report, Rijkswaterstaat, Rijksinstituut voor Kust en Zee. (cited on page 176)
- Rinsum, G. P. van (2017). Toepassing duurzaamheid in ontwerp (regionale) waterkeringen (Application of sustainability in the design of (regional) flood defences). Technical report, Delft University of Technology / IV Infra (internship report). (cited on pages 113 and 114)
- RIVM (2004). Risico's in bedijkte termen. Technical report, Milieu- en Natuurplanbureau. (cited on pages 37, 45, 49, 259, 260, 266, and 269)
- Roelofs, B. & Reinderink, H. (2005). *Bouworganisatie- en contractvormen (Forms of building organisations and contracts)*. ONRI. (cited on page 126)
- Roggema, R. (2016). Research by design: Proposition for a methodological approach. *Urban science*. (cited on page 84)
- Roozenburg, N. & Cross, N. (1991). Models of the design process: integrating across the disciplines. *Design studies*. (cited on pages 70, 81, and 88)
- Roozenburg, N. F. M. & Eekels, J. (1995). *Product Design: Fundamentals and Methods*. John Wiley & Sons Ltd. (cited on pages 71, 73, 74, 92, and 95)
- Roscoe, K. (2017). *Bayesian networks for levee system reliability. Reliability updating and model verification*. PhD thesis, Delft University of Technology. (cited on page 293)
- RWS and KNMI (1961). Verslag over de stormvloed van 1953. Technical report, Rijkswaterstaat en het Koninklijk Nederlands Meteorologisch Instituut. (cited on pages 251 and 252)

- Ryn, S. van der & Cowan, S. (2007). *Ecological Design, Tenth Anniversary Edition*. Islan Press, Washington DC. (cited on page 110)
- Sande Bakhuyzen, H. G. v. d., Ramaer, J., & Everdingen, E. v. (1920). Verslag van de Staatscommissie benoemd bij koninklijk besluit van 20 maart 1916, no. 23 met opdracht een onderzoek in te stellen omtrent de oorzaken van de buitengewoon hoge waterstanden, tijdens den stormvloed van 13/14 januari 1916 voorgekomen op de in. Technical report, Staatscommissie 23. (cited on pages 30 and 31)
- Schelfhout, H. & Slootjes, N. (2013). Overloop Voorstraat Dordrecht bij falende vloedschotten (Overflow Voorstraat Dordrecht in case of failing flood panels). Technical report, Deltares. (cited on page 237)
- Schön, D. A. (1983). *The reflective practitioner. How professionals think in action*. Basic books, New York. (cited on pages 82 and 97)
- Schumacher, E. F. (1973). *Small is beautiful: A study of economics as if people mattered*. Harper Perennial. (cited on page 114)
- Siemerink, T. (2012). Fact Sheet Roof Park Rotterdam. not published. (cited on pages 194 and 199)
- Siers, F. J. (2004). *Methodisch ontwerpen volgens H.H. van den Kroonenberg (Methodical design according to H.H. van den Kroonenberg*. Noordhoff Uitgevers. (cited on pages 69 and 76)
- Sijmons, D. (1998). = *Landschap (= Landscape)*. Architectura & Natura Pers 1998. (cited on page 85)
- Sijmons, D. (2008). Het deskundigenoordeel als instrument voor ruimtelijke kwaliteit (The expert opinion as an instrument for spatial quality). In *Jaarverslag Kwaliteitsteam Ruimte voor de Rivier 2006, 2007*. Rijkswaterstaat. (cited on page 66)
- Slinger, J. & Vreugdenhil, H. (2016). Building with Nature design process. Dataset. <http://dx.doi.org/10.4121/uuid:d7ee3203-05a4-42d3-99e5-304a31d34870>. (cited on pages 111 and 112)
- Smith, D. K. & Tardif, M. (2009). *Building Information Modeling: A strategic implementation guide for architects, engineers, constructors, and real estate asset managers*. Wiley. (cited on page 103)
- Smulders, F. (2014). The IDER-model. Towards an integrated vocabulary to describe innovating. In *15th International CINet Conference: Operating Innovation - Innovating Operations*. (cited on page 75)
- Staatsbosbeheer (2016). Slachtedyk. website www.natuurlijkwandelen.nl. (cited on page 20)

- Stalenberg, B. (2010). *Design of floodproof urban water fronts*. PhD thesis, Delft University of Technology. (cited on pages 3, 97, 236, 239, 242, and 248)
- Stanczak, G. (2007). Laboratory tests on the erosion of clay revetment of sea dike with and without a grass cover induced by breaking wave impact. Technical report, Floodsite. (cited on page 166)
- Staring, R., Engbersen, G., & Ypeij, A. (2002). Armoede, migranten en informaliteit in Rotterdam-Delfshaven (Poverty, migrants and informality in Rotterdam-Delfshaven). Technical report, RISBO Contractresearch BV / Erasmus Universiteit Rotterdam. (cited on page 193)
- Steetzel, H. (1993). Effect bebouwing op de mate van duinafslag (Effect buildings on the rate of dune erosion). Technical report, Waterloopkundig Laboratorium. (cited on page 310)
- Stichting CUR (1990). Probabilistic design of flood defences (report 141). Technical report, CUR - TAW. (cited on pages 60, 61, 270, 273, 274, and 297)
- Stichting CUR (1997). *Probabilities in civil engineering, part 1: probabilistic design in theory*. CUR-publicatie 190. Stichting CUR. (cited on page 290)
- Stichting Dakpark Rotterdam (2012). Dakpark Rotterdam. website www.dakparkrotterdam.nl. (cited on page 198)
- Stichting Ecoshape (2008). *Programmavoorstel Building with Nature (Programme proposal Building with Nature)*. Stichting Ecoshape. (cited on page 110)
- Stichting Vers Beton (2015). 400 jaar tobben met de Boompjes (400 years of worries about the Boompjes). website <https://versbeton.nl/2015/04/400-jaar-tobben-met-de-boompjes/>. (cited on page 203)
- Stolk, E. H. (2016). *Ontwerp (Design). Presentation for the course Environment and Infrastructures*. Delft University of Technology. (cited on pages 89 and 131)
- Stoop, H., Arts, J., Dongen, M. van, Kruijsbergen, S. van, & Laak, P. van de (2010). *Handreiking MIRT-verkenning*. Projectdirectie Sneller & Beter. (cited on page 80)
- STOWA (2010). State of the Art Asphalt Revetments. Technical report, Foundation for Applied Water Research. (cited on page 297)
- Stuurgroep Visie Hollandse Kust (2001). Visie Hollandse Kust 2050. Technical report. (cited on page 176)
- Stuvel, H. J. (1962). *Het Deltaplan (The Delta Plan)*. Scheltema & Holkema NV Amsterdam. (cited on pages 37 and 38)
- Taura, T. & Nagai, Y. (2009). A definition of design and its creative features. In *Proceedings of International Association of Societies of Design Research*. (cited on pages 67 and 68)

- TAW - ALRd (2008). *Addendum 1 Leidraad Rivierdijken (Addendum 1 Guidelines River dikes)*. Technische Adviescommissie voor de Waterkeringen. (cited on page 217)
- TAW - GW (1998). *Grondslagen voor Waterkeren (Fundamentals of Flood Protection)*. Technische Adviescommissie voor de Waterkeringen. (cited on pages 3 and 151)
- TAW - HLNC (1994). *Handreiking inventarisatie en waardering LNC-aspecten (Guide inventory and valuating LNC-aspects)*. Technische Adviescommissie voor de Waterkeringen. (cited on pages 95 and 104)
- TAW - HRO (1994). *Handreiking Ruimtelijk Ontwerpen (Guide Spatial design)*. Technische Adviescommissie voor de Waterkeringen. (cited on page 98)
- TAW - LK (2003). *Leidraad Kunstwerken (Guideline Engineering Structures)*. Technische Adviescommissie voor de Waterkeringen. (cited on pages 141 and 298)
- TAW - LR2 (1989). *Leidraad voor het ontwerpen van Rivierdijken. Deel 2 - benedenriviereengebied (Guidelines for the design of river dikes. Part 2 - lower river area)*. Technische Adviescommissie voor de Waterkeringen. (cited on page 60)
- TAW - LZMD (1999). *Leidraad Zee- en Meerdijken (Guideline Sea and Lake Dikes)*. Staatsuitgeverij 's-Gravenhage. (cited on page 160)
- TAW - RCO (1994). *Handreiking Constructief Ontwerpen (Guide on structural design)*. Technische Adviescommissie voor de Waterkeringen. (cited on page 169)
- TAW - TRAvW (2002). *Technisch Rapport Asphalt voor Waterkeren (Technical report Asphalt for flood protection)*. Technische Adviescommissie voor de Waterkeringen. (cited on page 297)
- TAW - TRDa (2007). *Technisch Rapport Duinafslag (Technical report dune erosion)*. Technische Adviescommissie voor de Waterkeringen. (cited on pages 302 and 303)
- TAW - TROS (2003). *Technisch Rapport Ontwerp van Steenzettingen (Technical report Design of Stone Revetments)*. Technische Adviescommissie voor de Waterkeringen. (cited on page 298)
- TAW - TRWbD (2004). *Technisch Rapport Waterspanningen bij Dijken (Technical report water pressures near dikes)*. Technische Adviescommissie voor de Waterkeringen. (cited on pages 169 and 297)
- Terwel, K. (2014). *Structural safety. Study into critical factors in the design and construction process*. PhD thesis, Delft University of Technology. (cited on page 163)
- Thayer jr., R. L. (1998). Landscape as an ecologically revealing language. *Landscape Journal*, 17 issue 2:118–129. (cited on page 114)
- Torenbeek, E. (2000). *We nemen een schoon vel tekenpapier (We take a clean sheet of drawing paper)*. Farewell lecture. Delft University Press. (cited on page 76)

- Toussaint, H. C. (1998). *Zeedykshoogte zynde negen voet vyf duym boven stadtspeyl, uitgemeten en uitgekiend, De geschiedenis van de algemene dienst van de Rijkswaterstaat (Sea dike height being nine feet and five inches above city level. The history of the general department of Rijkswaterstaat.* Ministerie van Verkeer en Waterstaat, Directoraat-generaal Rijkswaterstaat. (cited on page 34)
- Tsimopoulou, V. (2015). *Economic optimisation of flood risk management projects.* PhD thesis, Delft University of Technology. (cited on pages 59 and 143)
- Urk, A. van (1993). De basispeilen langs de Nederlandse kust. Eindverslag van het onderzoek naar de kansen op extreem hoge waterstanden langs de Nederlandse Kust. Technical report, Rijksinstituut voor Kust en Zee (RIKZ). (cited on page 36)
- U.S. Department of Defense (1949). Military standard. Procedures for Performing a Failure Mode, Effects and Criticality Analysis. (cited on page 101)
- USACE (2012). Coastal & Hydraulic Laboratory. website chl.erdc.usace.army.mil. (cited on page 3)
- Valken, K. F. & Bischoff van Heemskerk, W. C. (1963). Selected aspects of Hydraulic Engineering. Liber Amicorum dedicated to Johannes Theodoor Thijsse. Some aspects of the Delta Project. Technical report, Delft University of Technology. (cited on pages 256 and 259)
- Van 't Verlaat, S. (1998). Waterkering Dordrecht (Flood defence Dordrecht). Master's thesis, Delft University of Technology. (cited on page 238)
- Veelen, P. C. van (2012). Urban design challenges and opportunities of multi-functional urban flood defenses. Poster, presented at symposium Water and the City, Delft. (cited on page 200)
- Veelen, P. C. van, Voorendt, M. Z., & Zwet, C. van der (2015). *Research in Urbanism Series Vol. III 'Flowscales'*, chapter Design challenges of multifunctional flood defences. A comparative approach to assess spatial and structural integration, pages 275–291. IOS Press, under the imprint Delft University Press. (cited on pages 11, 12, 13, 196, and 241)
- Veen, B. van der (2003). Inventarisatie van multifunctioneel gebruik van primaire waterkeringen (Inventory of multifunctional use of primary flood defences). Technical report, Delft Hydraulics. (cited on page 241)
- Veerman Committee (2008). *Working together with water. A living land builds for its future. Findings of the Deltacommissie 2008.* Deltacommissie. (cited on pages 2 and 60)
- Ven, G. P. van de (1993). *Leefbaar laagland: geschiedenis van de waterbeheersing en landaanwinning in Nederland.* tichting Matrijs, Utrecht. (cited on pages 19 and 27)

- Venmans, A. A. M., Haan, E. J. den , & Barends, F. B. J. (1992). State of the art Dutch dyke technology. Technical report, Delft Geotechnics. (cited on page 138)
- Verhagen, H. (1990). *Note no. WBA-N-90.058*. Rijkswaterstaat, dienst weg- en waterbouwkunde. (cited on page 303)
- Verheij, H., Hoffmans, G., Steendam, G., Meer, J. van der , & Hoven, A. v. (2010). *Golfoverslag en Sterkte Grasbekleding: Evaluatie Afsluitdijk*. Technical report, Deltares. (cited on page 165)
- Vierlingh, A. (1578). *Tractaet van Dyckagie (Treatise on embanking)*. Martinus Nijhoff, 's-Gravenhage. (cited on page 23)
- Visser, J. L. (2016). Design methodological spectrum at Delft University of Technology. Work report. (cited on pages 68, 75, 76, 77, and 81)
- VMS (2015). Value methodology standard. (cited on page 79)
- Voorendt, M. Z. (2015a). *The 'Delft design method' for hydraulic engineering*. Bee's Books, Amsterdam. (cited on page 67)
- Voorendt, M. Z. (2015b). *The development of the Dutch flood safety strategy*. Bee's Books, Amsterdam. (cited on page 19)
- Voorendt, M. Z., Vrijling, J. K., & Voortman, H. G. (2017). Structural evaluation of multifunctional flood defenses using generic element types. In *Coastal structures & solutions to natural disasters*, page 12. joint international conference on coastal structures and solutions to coastal disasters, USACE. (cited on page 134)
- Voortman, H. G. (2003). *Risk-based design of large-scale flood defence systems*. PhD thesis, Delft University of Technology. (cited on pages 271, 292, and 293)
- Voortman, H. G. & Vrijling, J. K. (2004). Optimal design of flood defence systems in a changing climate. *Heron*, 49 no.1. (cited on page 138)
- Vreugdenhil, K., Alberts, G., & Gelder, P. van (2001). Waterloopkunde. Een eeuw wiskunde en werkelijkheid. *NAW*, 5/2:267–276. (cited on pages 29 and 30)
- Vrijling, J. K. (1985). Enkele gedachten aangaande een aanvaardbaar risiconiveau in Nederland (Several thoughts on an acceptable risk level in the Netherlands). Technical report, Technische Adviescommissie voor de Waterkeringen, werkgroep 10. (cited on pages 43, 61, 62, and 265)
- Vrijling, J. K. (1996). *Ontwerp (Design). Presentation for the course Introduction Hydraulic Engineering*. Delft University of Technology. (cited on page 69)
- Vrijling, J. K. (2012). Memo aan de Vaste Commissie voor Infrastructuur en Milieu van de Tweede Kamer der Staten-Generaal, betreffende het Rondetafelgesprek Hoogwaterbescherming op 20 maart 2012. (cited on pages 51 and 290)

- Vrijling, J. K. (2014a). From forces of nature to design loads. Presentation for the 100th international symposium of the Japan Society of Civil Engineers, Tokyo. (cited on page 40)
- Vrijling, J. K. (2014b). Multi layer safety, a generally efficient solution or work for all? In Steenbergen et al, editor, *Safety, Reliability and Risk Analysis: Beyond the Horizon.*, pages 37–43. ESREL, Taylor & Francis Group, London. (cited on page 59)
- Vrijling, J. K., Gelder, P. H. A. J. M. van , & Ouwerkerk, S. J. (2005). Criteria for acceptable risk in the Netherlands. *Infrastructure Risk Management Processes: Natural, Accidental, and Deliberate Hazards.* (cited on pages 268 and 269)
- Vrijling, J. K., Schweckendiek, T., & Kanning, W. (2011). Safety standards of flood defences. *Proceedings of the 3rd International Symposium on Geotechnical Safety and Risk, ISGSR 2011, Munich, Germany.* (cited on pages 265, 267, 269, and 274)
- Vrouwenvelder, A., Scholten, N. P. M., & Winter, P. E. de (2004). Veiligheidsbeoordeling bestaande bouw. Achtergrondrapport bij het desbetreffende deel van het Bouwbesluit 2004. Technical report, TNO Bouw. (cited on page 289)
- Vrouwenvelder, A. & Wubs, A. J. (1989). Bepaling toelaatbare inundatiefrequentie. Case study dijkkring Alblasserwaard / Vijfheerenlanden. Technical report, TAW-E. (cited on page 267)
- VTV-2006 (2007). *Voorschrift toetsen op veiligheid primaire waterkeringen 2006 (Directive safety assessment primary flood defences 2006).* Ministerie van Verkeer en Waterstaat. (cited on pages 141, 144, and 157)
- Walker, W., Abrahamse, A., Bolten, J., Braber, M. den , Garber, S., Kahan, J., Kok, M., & Riet, O. van de (1993). Toetsing uitgangspunten rivierdijkversterkingen. Deelrapport 1: Veiligheid tegen overstromingen. Veiligheidsanalyse, kostenschatting en effectenbepaling (Assessment starting points river dike reinforcements. Part 1: Safety against floods. Safety analysis,. Technical report, Ministerie van Verkeer en Waterstaat. (cited on page 43)
- Waterman, R. (2010). *Integrated coastal policy via Building with Nature.* PhD thesis, Delft University of Technology. (cited on pages 7, 110, and 111)
- Weijers, J. B. A. & Tonneijck, M. R. (2009). *Flood defences (lecture notes CT5314).* Delft University of Technology. (cited on page 50)
- Wemelsfelder, P. J. (1939). Wetmatigheden in het optreden van stormvloed. *De Ingenieur*, 3:31–35. (cited on pages 32, 255, and 256)
- Wiki Delfshaven (2014). Bospolder-Tussendijken. website <http://wikidelfshaven.nl>. (cited on page 193)
- Wikipedia (2012). Wikipedia - Sturmflut 1962. website de.wikipedia.org. (cited on page 246)

- Woodcraft, S., Bacon, N., Caistor-Arendar, L., & Hackett, T. (2011). *Design for Social Sustainability. A framework for creating thriving new communities*. Social Life, a Young Foundation venture. (cited on page 110)
- Workgroup IID (2013). *Integraal ontwerpen van infrastructuren. Aanzet van een agenda voor onderwijs en onderzoek (Integrated design of infrastructures. Beginning of an programme for education and research)*. Technical report, Delft University of Technology, workgroup Integrated Infrastructures Design. (cited on pages 74 and 117)
- Yska, D. W. A. (2009). *Van Deltacommissie naar Deltacommissie. De rol van adviescommissies in de besluitvorming over veiligheidsnormen voor hoogwaterbescherming*. Master's thesis, Twente University. (cited on pages 37, 41, 44, 47, and 56)
- Zeiler, W. (2014). *Basisboek ontwerpen. Van methodisch ontwerpen naar integraal ontwerpen. (Basis book designing. From methodic design to integrated design)*. Noordhoff Uitgevers. (cited on pages 77, 116, and 118)

CURRICULUM VITAE AND PUBLICATIONS

CURRICULUM VITÆ

Full name

Markus Zegeardus Voorendt

Birth

12 March 1965 in Utrecht, Netherlands

Nationality

Dutch

Contact details

telephone: 015-2783340

E-mail: M.Z.Voorendt@tudelft.nl

Career

1990-present: Delft University of Technology, Department of Hydraulic Engineering:

- Researcher and lecturer Hydraulic Structures
- Executive secretary
- Management assistant
- System administrator
- Research assistant

1988-1990: KIWA NV, Department of Concrete Structures:

- Technical advisor product and process assessment

Education

1984-1988: Higher vocational education (Hogeschool Utrecht):

- Civil Engineering (graduate track: structural engineering)
- diploma: 1988

1983-1984: Institute of Technology Twente (TH Twente):

- Electrotechnical Engineering

1977-1983: Secondary school (Atheneum):

- graduate subjects: maths, physics, chemistry, biology, Dutch, English, German
- diploma: 1983

PUBLICATIONS

2017: E. Anvarifar, M.Z. Voorendt, C. Zevenbergen and W.A.H. Thissen:
An application of the Functional Resonance Analysis Method (FRAM) to risk analysis of multifunctional flood defences in the Netherlands
In: Journal of Reliability Engineering & System Safety

M.Z. Voorendt, J.K. Vrijling and H.G. Voortman:
Structural evaluation of multifunctional flood defenses using generic element types In: Proceedings of the International Joint Conference on Coastal Structures & Solutions to coastal disasters Boston, September 2015. (not yet published)

J. Kentrop, M.Z. Voorendt and B.L. Lassing-Van der Spek:
Betrouwbaarheid glazen waterkering transparant gemaakt
In: Land + Water: vakblad voor civiel- en milieutechniek. 2017 nr. 1

2016: Y.R. Jongerius, M.Z. Voorendt and J.J. Kool:
Invloed bebouwing op de betrouwbaarheid van een dijk
In: Land + Water: vakblad voor civiel- en milieutechniek. 2016 nr. 9

M.Z. Voorendt:
Dike design Lecture for the MOOC on Building with Nature, Delft University of Technology

2015: P.C. van Veelen, M.Z. Voorendt and C. van der Zwet:
Design challenges of multifunctional flood defences: A comparative approach to assess spatial and structural integration
In: Research in Urbanism Series. volume 3

M.Z. Voorendt:
The 'Delft design method' for hydraulic engineering
Technical report. Delft University of Technology

M.Z. Voorendt:
The development of the Dutch flood safety strategy
Technical report. Delft University of Technology

2014: J. van Mechelen, G. van Meurs and M.Z. Voorendt:
Eenduidige rekenmethode voor een multifunctionele dijk
In: Land + Water: vakblad voor civiel- en milieutechniek. 2014 nr. 5

Propositions

accompanying the dissertation

DESIGN PRINCIPLES OF MULTIFUNCTIONAL FLOOD DEFENCES

by

Mark Voorendt

1. '*Die Natur versteht gar keinen Spaß, sie ist immer wahr, immer ernst, immer streng; sie hat immer Recht, und die Fehler und Irrtümer sind immer die des Menschen*' (J.W. von Goethe). Each failing flood defence, by whichever mechanism, therefore is the responsibility of man.
2. Millions of euros have sometimes been spent on dike reinforcement projects to preserve characteristic dike houses, but the scenic value is often completely counteracted by the rows of cars parked in front of them.
3. The term 'meekoppelkans' (*co-coupling opportunity*), often used in Dutch flood risk policy, is misleading, as the development of nature along rivers often appears to be less expensive when executed apart from flood protection measures.
4. The art of engineering consists of dealing with uncertainties.
5. The management of nature, based on the fixation of a certain state, does not recognise the dynamism that is characteristic to nature, and is therefore unnatural.
6. An educational policy aiming at abolishing blackboards, the online offering of entire engineering curricula and largely digitising exams, neglects the quintessence of scientific-technical education.
7. The extensive and unfocussed collection and storage of personal data of unsuspected civilians to combat terrorism is a disproportional means.
8. Because, in the present society, responsibilities are often delegated without the appropriate competences, abuses rarely affect the rulers, while the executing experts are often blamed.
9. A human is on earth not to pursuit personal happiness, but to do his duty.
10. The big frustration of a PhD-candidate is not being able to find the book that he needs, until he realises that he is looking for the book he has to write himself.

These propositions are regarded as opposable and defensible, and have been approved as such by the supervisor prof.dr.ir. J.K. Vrijling.

Stellingen

behorende bij het proefschrift

DESIGN PRINCIPLES OF MULTIFUNCTIONAL FLOOD DEFENCES

door

Mark Voorendt

1. *'Die Natur versteht gar keinen Spafs, sie ist immer wahr, immer ernst, immer strenge; sie hat immer Recht, und die Fehler und Irrtümer sind immer die des Menschen'* (J.W. von Goethe). Iedere falende waterkering, in welke vorm dan ook, is daarom de verantwoordelijkheid van de mens.
2. Er worden bij dijkverbeteringsprojecten soms miljoenen euro's uitgegeven aan het behoud van karakteristieke dijkwoningen, maar de belevingswaarde daarvan wordt teniet gedaan door de rijen daarvoor geparkeerde auto's.
3. Het in het huidige waterveiligheidsbeleid gebruikte begrip 'meekoppelkans' is misleidend, aangezien het ontwikkelen van natuur langs rivieren vaak goedkoper is te realiseren indien het apart van hoogwaterbeschermingsmaatregelen wordt uitgevoerd.
4. De kunst van techniek bestaat uit het omgaan met onzekerheden.
5. Natuurbeheer, gericht op het fixeren van een bepaalde toestand, doet geen recht aan de dynamiek die de natuur eigen is en is daarom tegennatuurlijk.
6. Onderwijsbeleid gericht op het afschaffen van schoolborden, het online aanbieden van gehele ingenieursopleidingen en het vergaand digitaliseren van tentamens gaat voorbij aan het wezen van technisch-wetenschappelijk onderwijs.
7. Het door de overheid op grote schaal ongericht verzamelen en opslaan van privégegevens van niet verdachte burgers voor de bestrijding van terrorisme is een disproportioneel middel.
8. Doordat in de huidige maatschappij verantwoordelijkheden vaak worden gedelegeerd zonder de daarbij behorende bevoegdheden, brengen misstanden zelden schade toe aan de machthebbers, terwijl de schuld in de schoenen wordt geschoven van de uitvoerende experts.
9. Een mens is niet op aarde om zichzelf gelukkig te maken, maar om zijn plicht te doen.
10. De grote frustratie van een promovendus is het niet kunnen vinden van het boek dat hij nodig heeft, tot hij beseft dat hij het boek zoekt dat hij zelf dient te schrijven.

Deze stellingen worden opponeerbaar en verdedigbaar geacht en zijn als zodanig goedgekeurd door de promotor prof.dr.s.ir. J.K. Vrijling.