

Performance evaluation of a smart buffer control at a wastewater treatment plant

van Daal-Rombouts, Petra; Benedetti, L; Jonge, J; Weijers, S; Langeveld, Jeroen

DOI

[10.1016/j.watres.2017.08.042](https://doi.org/10.1016/j.watres.2017.08.042)

Publication date

2017

Document Version

Accepted author manuscript

Published in

Water Research

Citation (APA)

van Daal-Rombouts, P., Benedetti, L., Jonge, J., Weijers, S., & Langeveld, J. (2017). Performance evaluation of a smart buffer control at a wastewater treatment plant. *Water Research*, 125, 180–190. <https://doi.org/10.1016/j.watres.2017.08.042>

Important note

To cite this publication, please use the final published version (if applicable). Please check the document version above.

Copyright

Other than for strictly personal use, it is not permitted to download, forward or distribute the text or part of it, without the consent of the author(s) and/or copyright holder(s), unless the work is under an open content license such as Creative Commons.

Takedown policy

Please contact us and provide details if you believe this document breaches copyrights. We will remove access to the work immediately and investigate your claim.

PERFORMANCE EVALUATION OF A SMART BUFFER CONTROL AT A WASTEWATER TREATMENT PLANT

P. van Daal-Rombouts^{1*,2}, L. Benedetti³, J. de Jonge⁴, S. Weijers⁴, J. Langeveld^{1,5}

¹ Delft University of Technology, P.O. Box 5048, 2600 GA Delft, The Netherlands

² Witteveen+Bos, P.O. Box 233, 7400 AE Deventer, The Netherlands

³ Waterways d.o.o., Gornji Vukojevac 10A, 44272 Lekenik, Croatia

⁴ Waterschap De Dommel, PO Box 10.001, 5280 DA Boxtel, The Netherlands

⁵ Partners4UrbanWater, Javastraat 104A, 6524 MJ Nijmegen, The Netherlands

* corresponding author: p.m.m.vandaal-rombouts@tudelft.nl, +31 6 5090 9369

Abstract

Real time control (RTC) is increasingly seen as a viable method to optimise the functioning of wastewater systems. Model exercises and case studies reported in literature claim a positive impact of RTC based on results without uncertainty analysis and flawed evaluation periods. This paper describes two integrated RTC strategies at the wastewater treatment plant (WWTP) Eindhoven, the Netherlands, that aim to improve the use of the available tanks at the WWTP and storage in the contributing catchments to reduce the impact on the receiving water. For the first time it is demonstrated that a significant improvement can be achieved through the application of RTC in practice. The Storm Tank Control is evaluated based on measurements and reduces the number of storm water settling tank discharges by 44% and the discharged volume by an estimated 33%, decreasing dissolved oxygen depletion in the river. The Primary Clarifier Control is evaluated based on model simulations. The maximum event NH₄ concentration in the effluent reduced on average 19% for large events, while the load reduced 20%. For all 31 events the reductions are 11 and 4% respectively. Reductions are significant taking uncertainties into account, while using representative evaluation periods.

Keywords

modelling, monitoring, impact based RTC, integrated control, uncertainty analysis, wastewater systems

List of abbreviations

ASM2d	activated sludge model No.2D
BS	booster pumping station between PCs and activated sludge tanks
CSO	combined sewer overflow
DO	dissolved oxygen
DWF	dry weather flow
EFF	effluent
ES	catchment Eindhoven Stad
INF	influent
H	water level
m AD	Normal Amsterdam Water Level
MG	mixing gutter after influent pumping station
NH4	ammonium
NS	catchment Nuenen-Son
PC	primary clarifier
Q	flow
Q_{BIO}	total flow to the activated sludge tanks
$Q_{\text{BIO_max}}$	maximum current hydraulic capacity of the activated sludge tanks
Q_{ES}	influent flow from catchment ES
Q_{INF}	total influent flow from all three catchments
$Q_{\text{INF_max}}$	maximum current total influent capacity from all three catchments
Q_{NS}	influent flow from catchment NS
Q_{RZ}	influent flow from catchment RZ
Q_{SST}	flow toward the SST
RMSE	root mean squared error
RTC	real time control
RZ	catchment Riool Zuid
SST	storm water settling tank
WWF	wet weather flow
WWTP	wastewater treatment plant

1 Introduction

Following regulations like the Water Framework Directive, water governing authorities are turning to more integrated optimisation of their wastewater systems (Blumensaat et al., 2012; Rauch et al., 2005). Technological advances in monitoring, modelling and data communication, see e.g. (Benedetti et al., 2013; Campisano et al., 2013), make the application of real time control (RTC) an increasingly accepted method to do so.

RTC aims at enhancing the performance of a system by improving the use of the available infrastructure, as opposed to changing the infrastructure itself. In wastewater management several strategies are reported: i) volume based, making optimal use of the available system capacity (e.g. Dirckx et al., 2011; Weyand, 2002), ii) quality based, exploiting differences in pollution levels (Lacour et al., 2011; Seggelke and Rosenwinkel, 2002; Vezzaro et al., 2014), and iii) impact based, taking differences in the vulnerability of the receiving waters into account (Erbe and Schütze, 2005; Langeveld et al., 2013; Risholt et al., 2002).

All references mentioned report on modelling exercises only, some applied to real cases, as they make up the bulk of literature available. Some practical applications of RTC in wastewater system management have emerged. Early examples of the application of integrated volume based RTC can be found in Québec (Pleau et al., 2005) and Barcelona (Puig et al., 2009). In (Grum et al., 2011) one of the first descriptions of the integrated, impact based RTC for Copenhagen is described, while a case study in Wilhelmshaven can be found in (Seggelke et al., 2013). Quality based RTC has been implemented in the sewer system of Wuppertal (Hoppe et al., 2011).

(Van Daal-Rombouts et al., 2017) noted that no uniform methodology is available for the performance evaluation of RTC in wastewater systems for case studies. Further they state that the period applied in the evaluation should be carefully considered and uncertainties should be explicitly taken into account. They propose a methodology that incorporates these aspects but have not demonstrated its applicability.

The research presented here focusses on the wastewater treatment plant (WWTP) of Eindhoven, the Netherlands. The wastewater system is characterised by a densely populated area that poses a large stress on the local receiving waters, consisting of small lowland rivers and creeks, through WWTP effluent and numerous combined sewer overflows (CSOs). Ecological water quality is affected by dissolved oxygen (DO) depletion and ammonium (NH₄) peaks. Previous research by (Langeveld et al., 2013) has shown the WWTP to be an important source for both NH₄ peaks and DO depletion and that application of integrated, impact based RTC could help mitigate these problems.

This paper deals with two complementary impact based RTC scenarios and their performance evaluation. Both aim at improving the use of the available tanks at the WWTP and storage volume in the contributing catchments: i) Storm Tank Control. Optimises the operation of the WWTP storm water settling tank (SST) with respect to

the contributing catchments to reduce unnecessary discharges of the SST and subsequent DO depletion. And ii) Primary Clarifier Control. Optimises the operation of the primary clarifiers (PCs) and influent pumping station to reduce peak loading of the activated sludge tanks and subsequent NH₄ peaks.

The performance evaluation is carried out following the methodology described in (Van Daal-Rombouts et al., 2017). To the authors knowledge it is the first real world case where both a representative evaluation period is applied as well as uncertainties are explicitly taken into account.

This paper is organised as follows. Section 2 introduces the wastewater system and WWTP under consideration, the RTC scenarios and the methods applied in the performance evaluation. Section 3 describes the results of the performance evaluation, which is followed by a discussion on the results in section 4. Finally, conclusions are presented in section 5.

Supplementary material is presented in the appendix. Section A supplies additional figures to support some descriptions and claims in this paper. The reader will be referred to the appendix at the appropriate locations. Section B elaborates on the implementation of the RTC scenarios. Section C supplies details about a field test to investigate the impact of applying only one PC instead of three during dry weather flow (DWF) conditions.

2 Materials and method

2.1 Wastewater system Eindhoven

The wastewater system of Eindhoven is displayed in the appendix section A, and consists of a WWTP, three contributing combined sewer catchments and the river Dommel as receiving surface water for both the WWTP effluent and approximately 200 CSOs.

Sewer catchment 'Eindhoven Stad' (ES) serves the city of Eindhoven and contributes approximately 45% to the total influent of the WWTP. Catchment 'Riool Zuid' (RZ) serves seven municipalities south of Eindhoven through a 31 km transport sewer and also contributes approximately 45% to the WWTP influent. Catchment 'Nuenen-Son' (NS) is located to the northeast of Eindhoven and represents less than 10% of the influent; In terms of optimisation of the wastewater system NS is considered insignificant. As the WWTP is located in Eindhoven, with a connected area of approximately 2,000 ha and which sewer consists of one looped gravity system, the functioning of ES is strongly influenced by the operation of the influent pumping station. This influence is much less significant for RZ due to the transport sewer, where a pumping station acts as a barrier and several municipal sewer systems are connected through pumps. In the transport sewer between the WWTP and the pumping station approximately 10,000 m³ idle storage is available.

The receiving waters consist of a network of small lowland rivers that eventually combine into the river Dommel that originates in Belgium and flows northward into the river Meuse. In dry summer periods the WWTP effluent can constitute up to 50% of the rivers base flow, under storm conditions this increases to 90%.

2.2 WWTP Eindhoven

A schematic overview of WWTP Eindhoven is displayed in figure 1. The WWTP has a capacity of 750,000 population equivalent and a maximum hydraulic capacity of 35,000 m³/h. It generally consists of an influent pumping station with a pumping chamber for each catchment and three identical treatment lines. Each treatment line has a maximum hydraulic capacity of 8,750 m³/h and consists of one PC, an activated sludge tank and four secondary clarifiers. In between the PCs and the activated sludge tanks the water is mixed at a booster pumping station (BS). To bypass the treatment lines in case of high inflows, a storm water settling tank (SST) is available to store and eventually discharge partly settled wastewater.

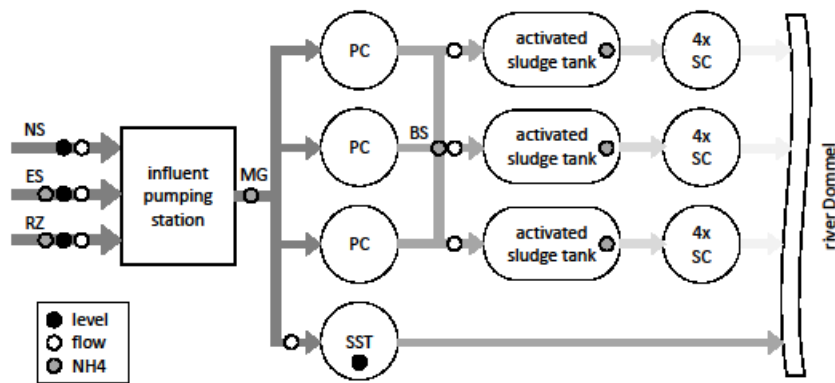

Fig 1. Schematic overview of WWTP Eindhoven. Relevant measuring locations are indicated by dots

2.2.1 Measurements

Quantity and quality measurements are performed at the WWTP as part of daily operation. For this study only a small number of measurements is used as indicated in figure 1: i) influent flows from the catchments and flows to the activated sludge tanks. At 6 April 2016 an additional calculated flow to the SST became available. ii) Water levels in the influent chambers and the SST. And iii) NH₄ concentrations in the influent flows of ES and RZ, in the mixing gutter before the PCs (referred to as MG), in the flow towards the booster station (BS) and in each activated sludge tank.

All flow and water level measurements are near continuously available in the WWTP SCADA control system. The NH₄ measurements are performed every five minutes.

Water levels at all CSOs in the contributing sewer catchments are measured at a one-minute time step. These measurements are sent to a central database every 24 hours, making them available for system analysis but not for active control.

Data handling

The monitoring data applied in this study show deficiencies. To be able to apply the data in direct analysis and as input for WWTP model simulations, these deficiencies were remedied. For this purpose, all data was post processed to generate a uniform time axis with a one-minute time step and missing individual data points were filled through linear interpolation. Additional processing was performed for the flow and NH₄ measurements as described below.

Communication errors lead to two and five hours of missing data on 19 and 23 May 2016 respectively. As this occurred during two large rain events, the WWTP was at its maximum intake before and after the communication error. The missing flow values were filled by the linear interpolation between the last and first available measurements.

For the NH₄ measurements, no additional corrections were made for locations ES and RZ as only selected periods have been applied. For locations MG and BS, the analysers

experienced problems with an automatic cleaning and calibration procedure. The resulting repetitive drops in the registered series were removed.

The NH₄ sensors at locations MG and BS are redundant as they are separated by a PC only, introducing a time shift but having little influence on the NH₄ concentration (correlation factor $R^2 = 0.79$ over a period of 5.5 months). Using the measurements at BS, six periods of missing data or general sensor failure at location MG were filled or replaced with time shifted data. Finally, drift in the NH₄ measurements at location MG was corrected to a daily average of 45 mg/l based on 24 hour composite samples at the same location. In the appendix section A, an example of the raw and processed NH₄ measurement series for location MG is displayed.

2.2.2 WWTP model

The WWTP is modelled with the WEST simulator (www.mikepoweredbydhi.com) using a modified ASM2d bio kinetic model (Gernaey and Jørgensen, 2004). A specific secondary settling model developed to cope with wet weather conditions (sludge buffering and peaks of effluent solids) was applied (Benedetti et al., 2011).

The available monitoring and process control data allowed a thorough calibration combined with an analysis of the required model structure. The model was calibrated on data from 2010 by adjusting the bio kinetic model parameters as little as possible, while paying more attention to the quality of data and information on system characteristics and operation.

It is considered beyond the scope of this paper to go into detail on the model setup and calibration. More details can be found in (Amerlinck, 2015). The model verification is described in section 2.4.3.

2.2.3 Standard control

In the standard WWTP control the SST is operated during all storm events as intended in its design: the total influent is split equally over three treatment lines and one water line. From an integrated point of view many of these SST discharges are deemed (partly) unnecessary as there is no threat of discharges from the CSOs in the contributing catchments. In the appendix section A this is illustrated. Furthermore, if SST discharges are necessary, the SST is operated well below its maximum capacity, possibly causing needless CSO discharges. As the CSOs are generally not equipped with settling tanks, discharges from the SST are preferred to minimise pollution to the receiving water.

The standard control for the PCs operates all three PCs (total volume 26,250 m³) alike and continuously. During DWF conditions the tanks are filled with raw sewage and have a hydraulic retention time of four hours, which reduces to one hour for maximum influent flows. At the onset of a rain event the stored concentrated sewage is transported at wet weather flow (WWF) rate to the activated sludge tanks. The resulting peak load to the aeration tanks contributes to NH₄ peaks in the WWTP effluent. Some examples are displayed in the appendix section A.

2.3 Storm Tank Control

2.3.1 Aim

The Storm Tank Control aims to optimise the operation of the SST with respect to the sewer catchments to 1) reduce unnecessary SST discharges and subsequent DO depletion in the receiving waters and 2) utilise the SST to its full capacity when discharges are necessary to minimise CSO discharges. At the same time an increase in the number of CSO events in the catchments should be avoided.

2.3.2 Design

The Storm Tank Control incorporates the functioning of the contributing sewer catchments ES and RZ into the operation of the SST through the water level measurements in the respective influent chambers. A flow diagram of the Storm Tank Control is displayed in figure 2, where thick black lines indicate changes with respect to the standard control. The SST is operated if the total influent flow (Q_{INF}) surpasses the current maximum flow to the activated sludge tanks (Q_{BIO_max}) under the condition that it may only discharge when the CSOs of ES are prone to spill. Nevertheless, the SST is allowed to fill independent of the water level in ES to make use of the storage capacity of the tank.

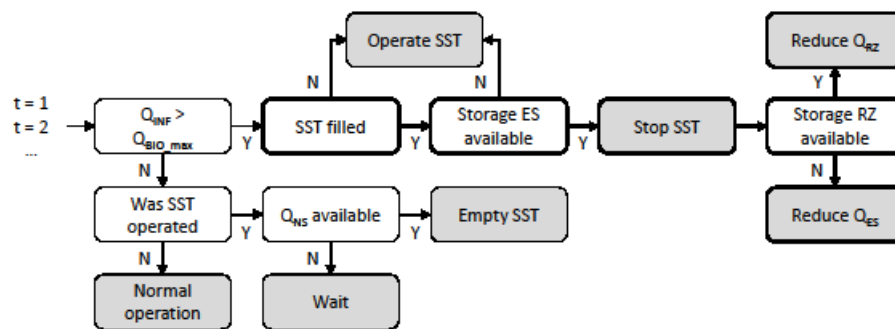

Fig 2. Flow diagram of SST operation with the Storm Tank Control. Flow is followed for every time step in the WWTP SCADA control system. Thick black lines indicate changes with respect to the standard control

Storage in the catchments is activated if the water level in ES remains below a certain threshold by reducing the influent flow from either ES or RZ, where RZ is reduced whenever possible to use the available idle storage. Once the water level in ES rises above the threshold, the SST is operated at its maximum allowed capacity to favour SST discharges over regular CSO discharges. As soon as the water level in ES falls below the threshold, the SST is taken out of operation reducing the duration of SST discharges. The SST emptying procedure was not changed; It is emptied back into the influent chamber of NS once influent capacity for NS (Q_{NS}) is available.

2.3.3 Evaluation

The Storm Tank Control is evaluated based on measurements. Two data sets representative for the SST functioning with the Storm Tank Control and the standard control were selected. The most important criterion for the evaluation periods is that

the full range of inflow conditions is present in which the SST could logically be operated, where the main differentiation arises from the catchments from which the majority of the flow is originating. To representatively assess the water levels and flow capacities, minimum requirements for the availability and quality of the measurements were set: the measuring interval should not exceed 2 minutes and uncertainties should not exceed 5 cm or 5% (1σ) respectively. The rather loose uncertainties arise from the need to mainly follow the dynamics of the measurements rather than knowing the absolute value.

Following the volume based approach of the control, the assessment parameters applied are the number of SST fills and discharges, the total discharged volume, the discharge duration, the event mean total influent flow during a discharge and the event mean discharged flow. No water quality parameters were taken into account. Quality oriented parameters have no added value over volume oriented parameters, as the control does not target the treatment process. Additionally, CSO events from catchment ES are applied to evaluate possible side effects.

All applied parameters are available as part of daily operation at the WWTP, or can easily be derived from them. The measurements are processed at a one-minute time step, satisfying the demand. The accuracy of the flow measurements is $<1\%$ as described in (Schilperoort, 2011). The uncertainty of the water level measurements is estimated to be 3 cm based on redundant measurements in the influent line. Both remain within the limits set.

The evaluation period for the standard control (reference period) ranges from January 2012 to November 2014. The period for the Storm Tank Control (controlled period) runs from December 2014 to 15 October 2015. In these periods, to the authors' knowledge, no significant changes in the catchments, at the WWTP or in the operation occurred other than the Storm Tank Control. Regarding the inflow conditions 131 events occurred in which the SST could have been operated for the reference period and 35 with the Storm Tank Control activated. For the standard control 43 events occurred with inflow mainly originating from ES, for 8 events from RZ only and for 47 events from ES and RZ. For the Storm Tank Control this occurred for 3, 3 and 17 events respectively. As multiple events are available for each situation these evaluation periods are deemed sufficient to evaluate the performance.

Additional to the events, rainfall statistics on the evaluation periods derived from a Royal Netherlands Meteorological Institute hourly precipitation measurement at Eindhoven airport are presented in table 1. The period during the application of the Storm Tank Control was a little dryer in all respects than for the standard control.

The final evaluation step is described in the results section.

2.4 Primary Clarifier Control

2.4.1 Aim

The aim of the Primary Clarifier Control is to optimise the operation of the PCs to reduce peak loading of the activated sludge tanks and subsequently reduce NH₄ peaks in the WWTP effluent. For this purpose, the influent pumping station settings were adjusted as well to utilise the in-sewer storage. The Storm Tank Control is incorporated in the Primary Clarifier Control.

2.4.2 Design

The Primary Clarifier Control, schematically displayed in figure 3, operates the influent pumping stations and PCs based on the maximum current activated sludge capacity (Q_{BIO_max}) and the water levels in the pumping chambers, as a measure for the available storage capacity in the catchments. It consists of four phases depending on the inflow conditions: 0 - DWF, 1 - start WWF, 2 - WWF and 3 - limited WWF. The hydraulic capacity at which the WWTP is operated differs for each phase and can only (but not necessarily) reach its maximum in phase 2. This allows for wastewater storage in the catchments, where storage in RZ is favoured over ES whenever possible. An additional phase 4 was introduced as fall back scenario. It is applied automatically in case of technical failures, or manually if desired by the operators. The Storm Tank Control is embedded in the Primary Clarifier Control in phases 1, 2 and 4. Due to the combined constraints of the controls, the SST can fill but not discharge in phase 1. In phases 2 and 4 the SST can fill and discharge.

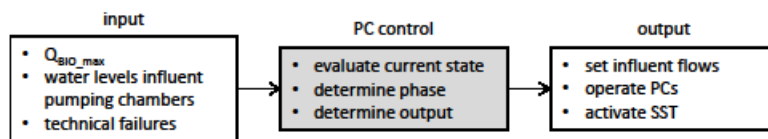

Fig 3. Schematic overview of the Primary Clarifier Control

An example of the operation of the Primary Clarifier Control in case of a spatially uniform, strong rain event is presented in figure 4. During DWF only one PC is operational. At the onset of WWF, the control switches to phase 1 where the SST is filled and an additional PC is operated. The influent from RZ is reduced to activate the available storage and allow additional influent flow from ES. As the catchments gradually fill, phase 2 is activated: the influent is maximised, all PC are operational and the SST discharges. Once the influent flows have largely reduced at the end of the rain event, the control switches to phase 3: one PC is taken out of operation and the SST can not be activated. This phase continues until DWF is reached or a return to phase 2 is necessary.

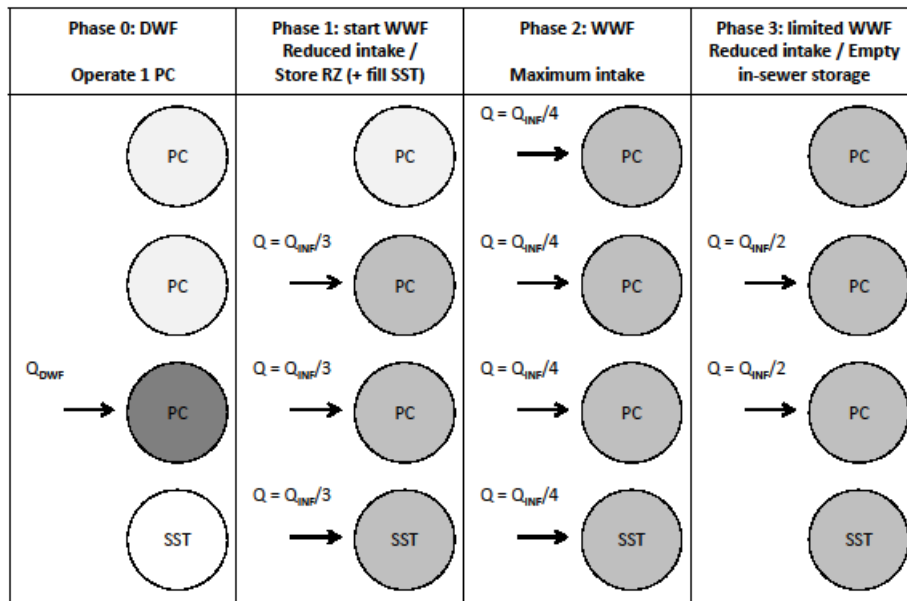

Fig 4. Example of the operation of the Primary Clarifier Control in case of a spatially uniform, strong rain event

As during phase 0 only one PC is operated, the storage of concentrated sewage in the PCs is reduced to a third of the standard control. The PCs are dynamically operated such that they contain as diluted sewage as possible given the hydraulic conditions. To further reduce the peak load when PCs are added, they are partly emptied during DWF.

Prior to the detailed design and implementation of the Primary Clarifier Control a field test was executed to investigate the impact of applying only one PC instead of three during DWF. No adverse effects on the removal efficiency were found. Section C of the appendix contains a brief description of the field test and its results.

2.4.3 Evaluation

The evaluation of the Primary Clarifier Control is based on WWTP model simulations. An evaluation based on measurements is not possible, due to simultaneous optimisation and testing of WWTP controls and maintenance of WWTP components during the evaluation period that could all influence the NH₄ effluent concentrations.

The demands on the evaluation period for the Primary Clarifier Control mainly go into the range of inflow conditions, as for the evaluation of the Storm Tank Control. Several small (control remains in phase 3 without influent flow limitation), medium (control remains in phase 3 with influent flow limitation) and large events (control switches to phase 2) are required to get sufficient insight in the controls performance.

The preparation of the input data sets for the WWTP model and verification of the WWTP model itself will be described in the following sections. The final evaluation step will be described in section 3.

Preparation of data sets

Data for the evaluation is available between 15 March and 22 November 2016 with the exception of June. In June numerous problems occurred in the wastewater system due to excessive rainfall such as river flooding, extended negative overflows and technical failures at the WWTP. The control was switched to the fall back scenario, making the period unsuitable for the evaluation. In the remaining months 16 small, 14 medium and 15 large events occurred which is deemed sufficient for the purpose. The effect of the absence of winter months will be discussed in section 4.

For the performance evaluation of the Primary Clarifier Control two mutually comparable data sets are needed as WWTP model input: one with the standard control and one with the Primary Clarifier Control. Figure 5 contains a chart that describes the steps taken in deriving these data sets.

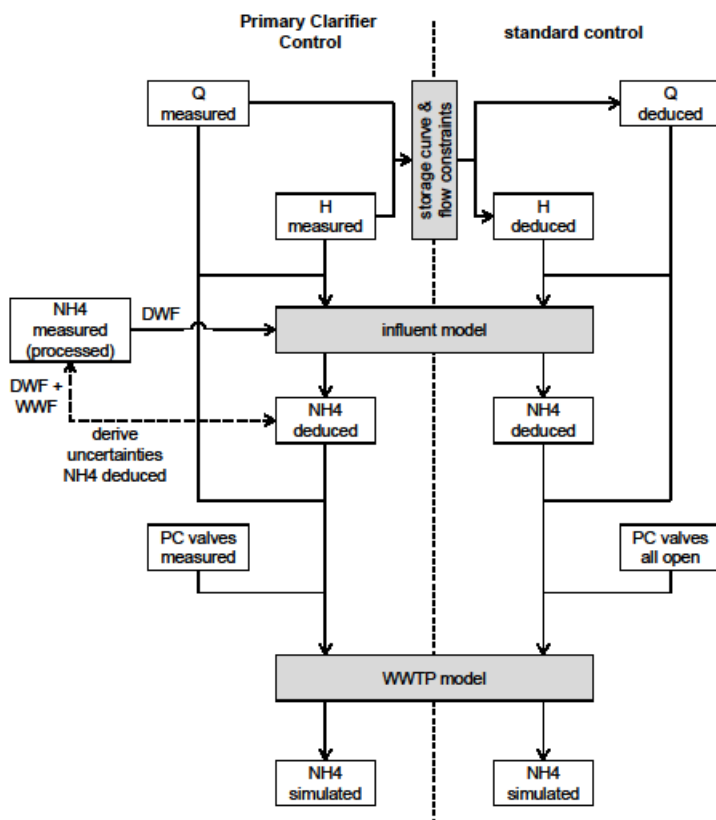

Fig 5. Chart that describes the steps taken in the derivation of the data sets for the evaluation of the Primary Clarifier Control

From the measured influent flows and water levels in the influent chambers with the Primary Clarifier Control activated, the flows and water levels that would have occurred with the standard control have been derived. For this purpose, first the discharge from the catchments is derived from the current flow and change in water level in the influent chambers using static storage curves for the respective catchment. From this discharge and the constraints for the standard control (limiting the maximum intake only), the corresponding influent flows and water levels were deduced. The conversion was

checked through comparing the total influent volume in an event, deviations being <1% for all events.

An influent model was derived for NH₄ that relates the variation in influent quality to influent hydraulics. The model first distinguishes different types of events and then imposes relationships between quantity and quality on a dry weather NH₄ concentration based on these events. It results in a time series containing both DWF and WWF in the WWTP influent. More details on the influent model can be found in (Langeveld et al., 2017). The applied NH₄ influent concentrations were deduced using this model, the influent hydraulics and the measured NH₄ concentration at location MG. The resulting NH₄ concentrations were corrected to preserve the mass balance based on the measured and deduced NH₄ loads. Corrections between -20 and +20% have been applied.

Uncertainties in the input data set for the WWTP model are largely dominated by the uncertainties in the deduced NH₄. The applied uncertainty is derived from the deduced NH₄ concentration for the Primary Clarifier Control and the measured NH₄ concentration. The root mean squared error (RMSE) between the two series equals 5.2 mg/l and is taken as half the (1 σ) uncertainty band.

Additional inputs to the WWTP model are the measured temperature in the activated sludge tanks and in case of the Primary Clarifier Control, the measured status of the valves to operate the PCs.

WWTP model verification

The WWTP model has been verified with respect to the simulated NH₄ concentrations. For this purpose, 7 periods, containing DWF and WWF situations in all seasons in the years 2012 to 2014, were simulated and compared to the measured NH₄ concentrations. The NH₄ model input uncertainty is derived from the measured NH₄ concentration at location MG and the average grab sample concentration. The RMSE between the two series equals 3.6 mg/l and is taken as half the (1 σ) uncertainty band. The (1 σ) uncertainty in the measurements was taken to be 5%, since little deviation was found between the measurements in the three tanks.

The measured WWF NH₄ peaks are nicely captured by the simulations, a representative example of which is presented in the appendix section A. For almost all events the modelled and measured uncertainty bands overlap, over- and underestimations of the peak height occur and the rising and falling slopes have the same angle. This indicates that the model contains no systematic errors with respect to the NH₄ peaks originating from WWF. As these are aimed at in the Primary Clarifier Control, the WWTP model is found to be applicable in the performance evaluation of the Primary Clarifier Control.

3 Results

3.1 Storm Tank Control

An example of the SST operation with the Storm Tank Control is given in figure 6. In the top graph the influent flows are presented and in the bottom graph the corresponding water levels in the influent pumping chambers and the SST are given. The SST fills between 19.30 and 23:00h. Once it is full, the water level in the pumping chamber of ES is checked. As it is below the threshold for CSO spills, set at 13.30 m AD, the SST is taken out of operation by matching the total influent flow and the total flow to the activated sludge tanks through reduction of the influent flow for RZ. This is contrasted by the SST operation with the standard control, and example of which is displayed in the appendix section A.

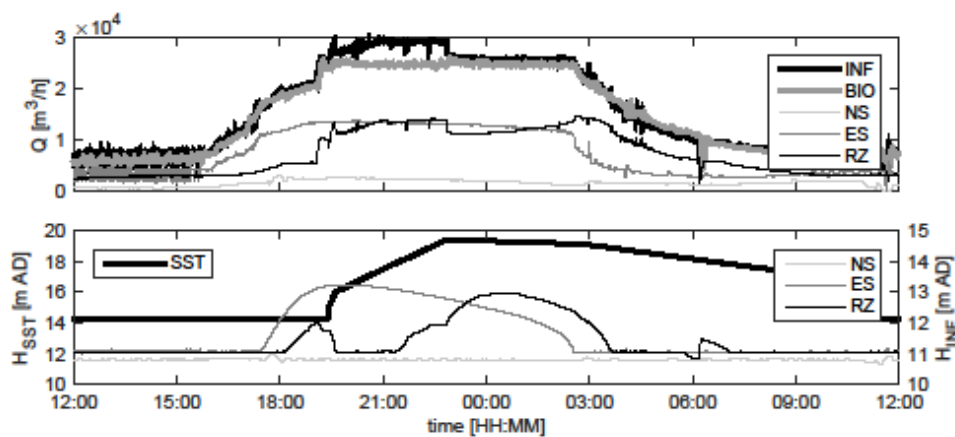

Fig 6. Example of the SST operation with the Storm Tank Control at 28-29 January 2015. The SST is filled and taken out of operation once it is full and storage is available in both ES and RZ. The SST is empty at 14.25 m AD and full at 19.48 m AD

The evaluation period with the standard control comprises 35 months, in which the SST has filled 93 times and discharged 59 times. The evaluation period for the Storm Tank Control comprises 10.5 months, in which the SST has filled 28 times and discharged 10 times. Relative to the number of months data available, the number of times the SST fills is equal for both situations. The number of discharges, however, is reduced 44% by the Storm Tank Control. This is much more than the 16% that could be expected based on the lower number of rain events with more than 7 mm rainfall depth, see table 1. It agrees with the first aim of the Storm Tank Control: reducing the number of discharges.

Table 1. Statistics on the rainfall characteristics in the evaluation periods for the Storm Tank Control. Events with a rainfall depth > 7 mm are deemed interesting for the SST operation as this equals the Dutch design in-sewer storage capacity for combined sewer systems

evaluation period	months		rainfall depth		events > 7 mm		average event rainfall
	[#]	[mm]	[mm/year]	[#]	[#/year]	depth > 7 mm	
reference	35	2262	776	94	32		14.1
controlled	10.5	585	669	24	27		12.7

The second aim was to utilise the SST to its full capacity when discharges are necessary. In figure 7 several statistics for SST discharges derived from the measurements are summarized for the Storm Tank Control and standard control. The median discharged volume (116%) and median event mean discharged flow (91%) are significantly higher for the Storm Tank Control than for the standard control, even though the average event volume is lower in the period for the Storm Tank Control. When the SST is discharging, it is thus operated closer to its maximum capacity than with the standard control. For the median event mean total influent flow during SST discharges a smaller but still significant difference was found (8%). For the duration of a SST discharge (4%) no significant change was found, although fewer outliers with long durations are present.

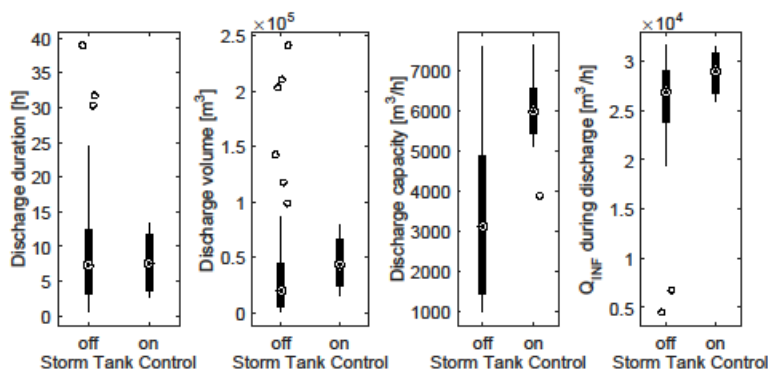

Fig 7. Boxplots for several assessment parameters for SST discharges for all events with the Storm Tank Control and standard control. The discharge capacity and total influent flow are event mean values

From the data an estimate for the total reduction in discharged SST volume by the Storm Tank Control can be derived. This is based on the number of times the SST filled with the Storm Tank Control, the ratio of the number of discharges and fills for the standard control and the event mean discharged volume for the standard control. The SST could have discharged $685 \cdot 10^3 \text{ m}^3$ in the period the Storm Tank Control was active while it discharged only $459 \cdot 10^3 \text{ m}^3$. This amounts to an estimated 33% reduction in discharged volume.

It was found that the SST with the Storm Tank Control only discharges when necessary based on possible CSO discharges. Also no apparent negative effect on the number of CSO discharges was found.

3.2 Primary Clarifier Control

The functioning of the Primary Clarifier Control and its influence on the effluent NH4 concentration is demonstrated in figure 8 (black lines) that successively shows the influent flow, influent NH4 concentration, effluent NH4 concentration and phase of the control. Most of the time the Primary Clarifier Control is operating in phase 0 (DWF mode) with only one PC activated. As the influent flow increases the control switches to phase 1 to activate an additional PC. For the first two events the total inflow remains limited and the control switches to phase 3, avoiding changes in PC operation, to gradually treat all wastewater. The final event displayed requires all PC to be operated in phase 2.

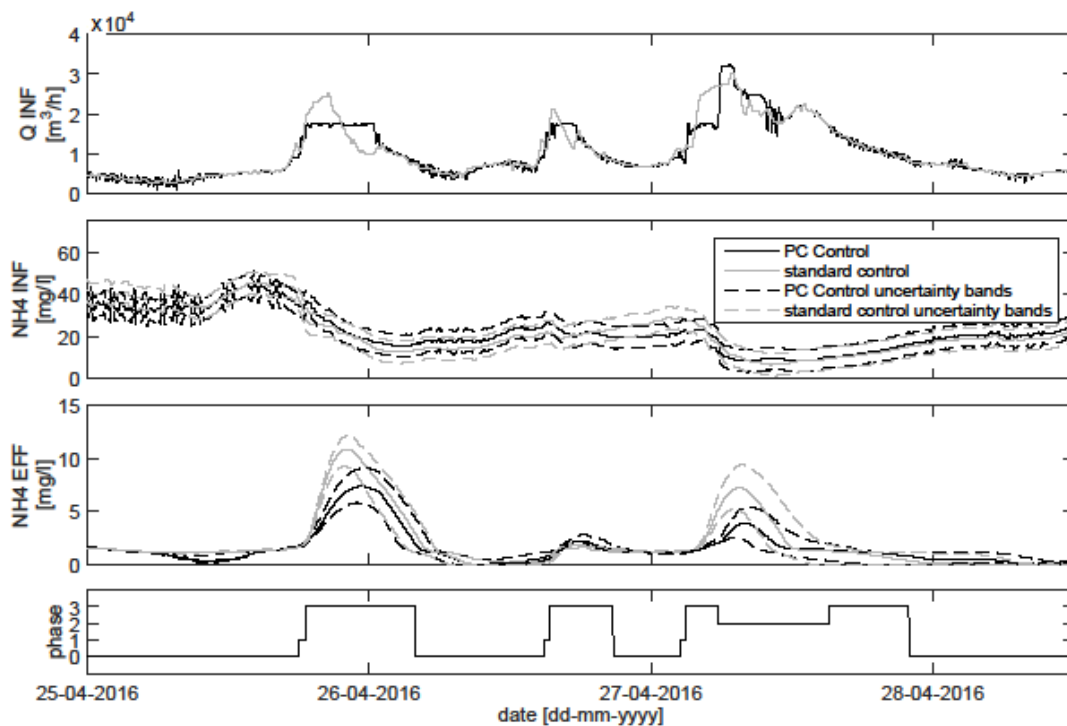

Fig 8. Example of functioning and effect of the Primary Clarifier Control on the NH4 effluent concentration for two medium and one large events compared to the standard control

Comparing the Primary Clarifier Control with the standard control in figure 8 (grey lines), the Primary Clarifier Control limits and/or delays the influent flow. Therefore, at high influent flows the wastewater is more diluted in case of the Primary Clarifier Control. Together with buffering less concentrated sewage in the PCs the influence on the NH4 peaks in the effluent is evident.

Looking at the entire evaluation period, the Primary Clarifier Control has resided in phases 0, 1, 2, 3 and 4 for 86, 1, 3, 7 and 3% of the time, respectively. This means the WWTP can be operated with only one PC for 86% of the time and for at least 94% of the time a reduced number of PCs is sufficient. Besides reducing storage of undiluted sewage in the PCs, this presents operational gains with respect to maintenance, personnel and ultimately costs.

In the analysis of all events, it was found that in some cases the events, or a time span just before them, were clearly treated differently by influent model. These events were excluded from the final analysis for which a total of 10 small, 10 medium and 11 large events remained. Figure 9 contains plots for all the remaining events with the NH₄ effluent maximum peak height on the vertical axis and the total event WWF load on the horizontal axis. Mean values are represented by asterisks and the upper and lower limits by the uncertainty bands. The total event WWF load equals the total event load minus the event 95% DWF load.

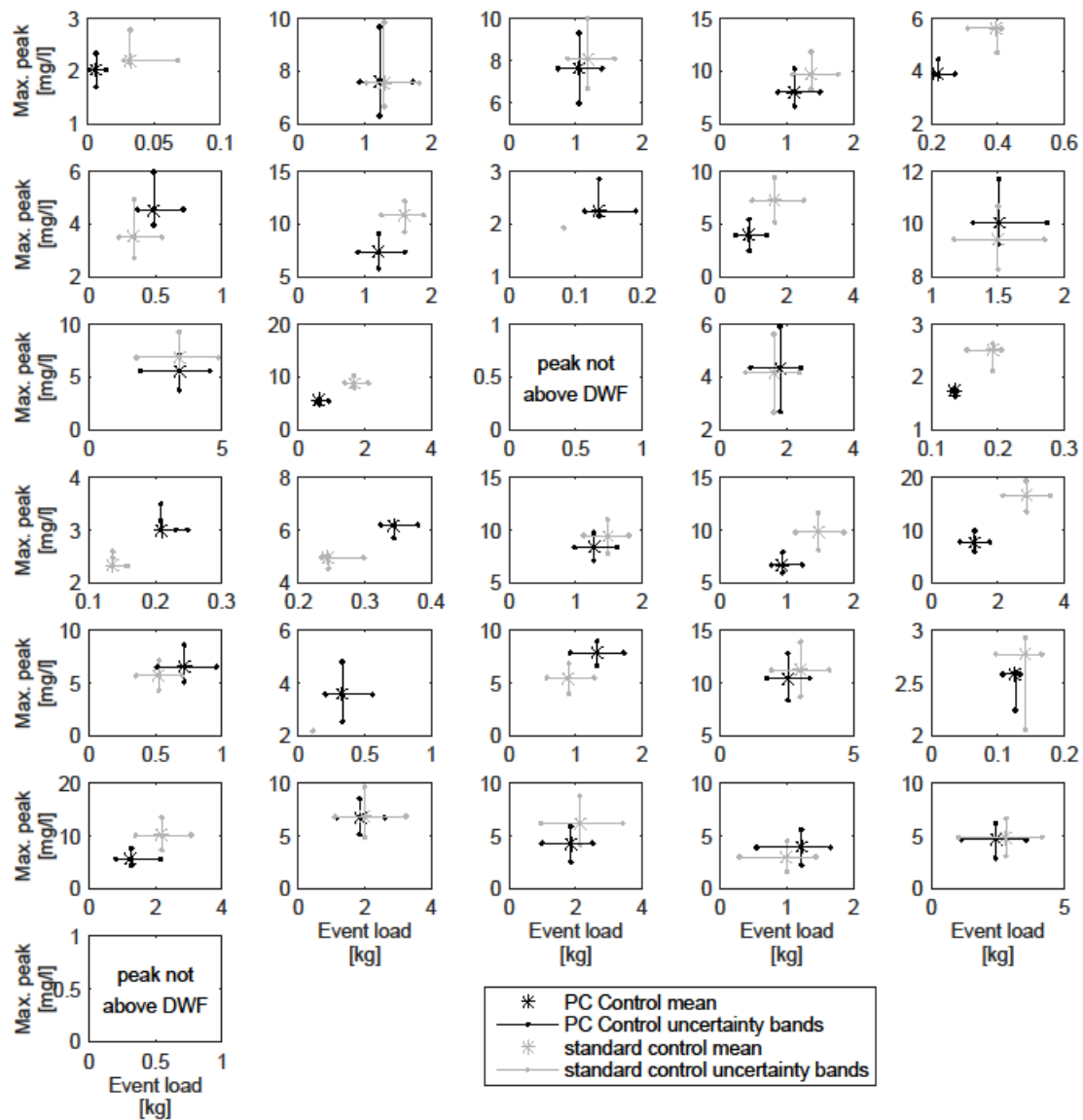

Fig 9. Performance evaluation of the Primary Clarifier Control compared to the standard

control based on the maximum NH4 effluent concentration and total event WWF load for all events. Scales on both axes vary

Positive, neutral or negative performance for the Primary Clarifier Control compared to the standard control was determined based on the plots in figure 9. In a comparison based on mean values, neutral performance is assigned if the differences are less than 15%. Positive performance is assigned, if the difference is at least 15% with the Primary Clarifier Control being lower, and negative otherwise. The results have been summarised in table 2, where an additional distinction between event sizes was made. For small events the overall performance of the Primary Clarifier Control is slightly negative, while for medium events the performance is slightly positive. For large events, however, the performance is distinctly positive. This is also reflected in the mean change over the small, medium or large events. On average an improvement of 11% is found for the maximum NH4 concentration and 4% for the total NH4 event load. For large events the improvement increases to 19 and 20% respectively.

Table 2. Summarised performance of the Primary Clarifier Control compared to the standard control

event size	mean values			significant change			mean change for all events based on mean values	
	positive	neutral	negative	positive	neutral	negative	max peak	event load
	[#]	[#]	[#]	[#]	[#]	[#]	[%]	[%]
small	3	2	5	3	3	4	4	22*
medium	4	3	3	2	7	1	-8	2
large	7	3	1	4	7	0	-19	-20
all	14	8	9	9	17	5	-11	-4

* caused by one event where the maximum concentration does not surpass the 95% DWF concentration, otherwise value would be -8%

To determine the significant performance of the Primary Clarifier Control, the uncertainty bands need to be taken into account. This was done through imagining an ellipse through the uncertainty bands in figure 9 and assessing the overlap of the ellipses. If they overlap, neutral performance was assigned. If there is no overlap, the performance was positive if the ellipse for the Primary Clarifier Control was to the lower left (lower peak and/or lower load) of the ellipse for the standard control, otherwise negative performance was assigned. The results are also summarised in table 2. Including uncertainty analysis results in more events being marked as neutral. The overall conclusions, however, remain the same: the performance of the Primary Clarifier Control is significantly better than the standard control for large events.

The Primary Clarifier Control specifically aims at reducing the NH₄ peaks in the WWTP effluent during storm events. The impact of the control on total effluent loads for standard effluent parameters for the entire evaluation period was checked as well. Overall, the control results in a decrease of the NH₄ load in the effluent (258.8 to 232.5 kg/d), a smaller increase in the nitrate load in the effluent (713.9 to 728.1 kg/d) and a decrease in the total nitrogen load (1,165.1 to 1,139.0 kg/d). The total chemical oxygen demand effluent load decreases a little (4,925.2 to 4,640.7 kg/d). In addition, the total phosphorous load in the effluent also decreases (127.6 to 114.9 kg/d)), showing that the bio-P removal also benefits from decreasing the influent peak loads.

4 Discussion

Determining the performance of the two implemented RTC strategies, taking into account representative evaluation periods and relevant uncertainties, was shown to be possible. To the authors knowledge it is the first time that RTC is demonstrated to have a significant positive effect for a real world case in urban wastewater management. For the Storm Tank Control, with the evaluation based on operational quantity parameters only, this was fairly straightforward. For the Primary Clarifier Control, involving quality parameters and model simulations, the evaluation was much more complex. More detailed consideration and planning at the start of the implementation project, taking the evaluation into account, could have made the evaluation easier. For example, the impact of making simultaneous changes in the WWTP operation could have been more explicitly considered and possibly dealt with differently. In addition, a tailor made monitoring setup for the evaluation would have included an online NH₄ measurement in the effluent.

Additional remarks considering the performance evaluation of the Primary Clarifier Control are as follows. An influent model was applied to achieve comparable input data sets for the WWTP model. While analysing the results almost one third of the events were discarded because the influent model had clearly treated the two sets differently. To determine the impact of the discarded events, they were evaluated nevertheless. The results were found to be very similar, with a bias favouring the Primary Clarifier Control.

The WWTP has been operated at a reduced capacity since June. Because of this, the activated sludge tanks have not been loaded up to their design capacity. Higher loads to the activated sludge tanks lead to higher effluent peaks. As the Primary Clarifier Control aims to reduce the effluent peaks, lower loading of the activated sludge tanks decreases the opportunity for reduction and thus decreasing its apparent performance. As still a significant positive effect is found, the performance of the Primary Clarifier Control is expected to improve when the maximum capacity of the WWTP is restored.

The evaluation period does not contain any winter months. However, the decrease of peak loads to the activated sludge tanks due to the applied Primary Clarifier Control is independent from temperature. In addition, as in winter the wastewater temperature is lower, the efficiency of the WWTP is lower due to slower conversion processes. Consequently, it can be expected that the Primary Clarifier Control will even be more advantageous in winter than in summer time, as the capacity of the WWTP to deal with influent peak decreases with temperature. As such, the results presented in this paper, which do not contain a winter period, will underestimate the effect the Primary Clarifier Control may have on an annual basis. The absence of winter months in the evaluation period therefore do not hamper the validity of the performance analysis results, but renders these on the safe side.

The performance of the Primary Clarifier Control for small events deviates from the overall performance. This is partly caused by an artefact in the WWTP model that results

in temporary NH₄ peaks to the activated sludge tanks when additional, partly empty, PC are added. This artefact is most relevant for small events, when the NH₄ concentration in the influent remains relatively high. It has little influence on the overall performance of the control.

The Primary Clarifier Control is meant to reduce NH₄ peaks in the WWTP effluent that cause negative impacts in the receiving surface water. These are mainly problematic for high peaks and high loads that occur for large events. As the Primary Clarifier Control clearly positively influences the WWTP functioning during large events, without serious deterioration during small and medium events, it is concluded the control functions as intended.

5 Conclusions

Two integrated, impact based controls at WWTP Eindhoven were described and evaluated. Both aim to improve the use of the available tanks at the WWTP and storage in the contributing catchments. For the first time, to the authors' knowledge, it is demonstrated that a significant improvement can be achieved through the application of RTC in practice, taking into account uncertainties and applying a relevant evaluation period.

The Storm Tank Control aims to reduce the SST discharges, causing DO depletion in the receiving waters. Based on measurements it was shown that the Storm Tank Control significantly improves the SST operation compared to the standard control. For the evaluation period, the number of discharges is reduced by 44% and the discharged volume by an estimated 33%. The control had no negative impact on CSO discharges from the contributing catchments.

The Primary Clarifier Control aims to reduce peak loading of the activated sludge tanks, which cause NH₄ peaks in the WWTP effluent and receiving waters. Based on model simulations it was shown that the Primary Clarifier Control significantly improves the NH₄ effluent quality compared to the standard control. The maximum event NH₄ concentration in the evaluation period for large events, that cause most acute problems, is reduced 19% on average while the load reduced 20%. For medium and small events, a smaller positive and slightly negative impact is found respectively. Side effects of the Primary Clarifier Control are operational gains as the WWTP has been operated with a reduced number of PCs for 94% of the time.

Acknowledgements

The authors would like to acknowledge the indispensable contribution of numerous employees of water board De Dommel in the control design and during the implementation and testing of the controls.

The research is performed within the Dutch 'Kennisprogramma Urban Drainage' (Knowledge Programme Urban Drainage). The involved parties are: ARCADIS, Deltares, Evides, Gemeente Almere, Gemeente Arnhem, Gemeente Breda, Gemeente 's-Gravenhage, Gemeentewerken Rotterdam, Gemeente Utrecht, GMB Rioleringsstechniek, KWR Watercycle Research Institute, Royal HaskoningDHV, Stichting RIONED, STOWA, Sweco, Tauw, vandervalk + degroot, Waterboard De Dommel, Waternet and Witteveen+Bos.

References

- Amerlinck, Y., 2015. Model refinements in view of wastewater treatment plant optimization: improving the balance in sub-model detail. Ghent University. doi:10.1017/CBO9781107415324.004
- Benedetti, L., Langeveld, J.G., Comeau, A., Corominas, L., Daigger, G., Martin, C., Mikkelsen, P.S., Vezzaro, L., Weijers, S.R., Vanrolleghem, P.A., 2013. Modelling and monitoring of integrated urban wastewater systems: review on status and perspectives. *Water Sci. Technol.* 68, 1203–1215.
- Benedetti, L., Nyerup Nielsen, C., Thirsing, C., 2011. Modelling for integrated sewer-WWTP operation with ATS in Copenhagen, in: *Proceedings of the 12th Nordic Wastewater Conference*. Helsinki, Finland.
- Blumensaat, F., Staufer, P., Heusch, S., Reußner, F., Schütze, M., Seiffert, S., Gruber, G., Zawilski, M., Rieckermann, J., 2012. Water quality-based assessment of urban drainage impacts in Europe - where do we stand today? *Water Sci. Technol.* 66, 304–313. doi:10.2166/wst.2012.178
- Campisano, A., Cabot Ple, J., Muschalla, D., Pleau, M., Vanrolleghem, P.A., 2013. Potential and limitations of modern equipment for real time control of urban wastewater systems. *Urban Water J.* 1–12. doi:10.1080/1573062X.2013.763996
- Dirckx, G., Schütze, M., Kroll, S., Thoeve, C., De Guedre, G., Van De Steene, B., 2011. Cost-efficiency of RTC for CSO impact mitigation. *Urban Water J.* 8, 367–377. doi:10.1080/1573062X.2011.630092
- Erbe, V., Schütze, M., 2005. An integrated modelling concept for immission-based management of sewer system, wastewater treatment plant and river. *Water Sci. Technol.* 52, 95–103.
- Gernaey, K.V., Jørgensen, S.B., 2004. Benchmarking combined biological phosphorus and nitrogen removal wastewater treatment processes. *Control Eng. Pract.* 12, 357–373. doi:10.1016/S0967-0661(03)00080-7
- Grum, M., Thornberg, D., Christensen, M.L., Shididi, S.A., Thirsing, C., 2011. Full-scale real time control demonstration project in Copenhagen's largest urban drainage catchments, in: *Proceedings of ICUD12*. Porto Alegre, Brazil, pp. 1–7.
- Hoppe, H., Messmann, S., Giga, A., Gruening, H., 2011. A real-time control strategy for separation of highly polluted storm water based on UV-Vis online measurements – from theory to operation. *Water Sci. Technol.* 63, 2287–2293. doi:10.2166/wst.2011.164
- Lacour, C., Joannis, C., Schütze, M., Chebbo, G., 2011. Efficiency of a turbidity-based, real-time control strategy applied to a retention tank: a simulation study. *Water Sci. Technol.* 64, 1533–1539. doi:10.2166/wst.2011.545
- Langeveld, J.G., Benedetti, L., De Klein, J., Nopens, I., Amerlinck, Y., Van Nieuwenhuijzen, A., Flameling, T., Van Zanten, O., Weijers, S.R., 2013. Impact-based integrated real-time control for improvement of the Dommel River water quality. *Urban Water J.* 10, 312–329. doi:10.1080/1573062X.2013.820332
- Langeveld, J.G., Van Daal-Rombouts, P.M.M., Schilperoort, R.P.S., Nopens, I., Flameling, T., Weijers, S.R., 2017. Empirical Sewer Water Quality Model for Generating Influent Data for WWTP Modelling. *Water* 9, 491. doi:10.3390/w9070491

- Pleau, M., Colas, H., Lavallee, P., Pelletier, G., Bonin, R., 2005. Global optimal real-time control of the Quebec urban drainage system. *Environ. Model. Softw.* 20, 401–413. doi:10.1016/j.envsoft.2004.02.009
- Puig, V., Cembrano, G., Romera, J., Quevedo, J., Aznar, B., Ramon, G., Cabot, J., 2009. Predictive optimal control of sewer networks using CORAL tool: Application to Riera Blanca catchment in Barcelona. *Water Sci. Technol.* 60, 869–878. doi:10.2166/wst.2009.424
- Rauch, W., Seggelke, K., Brown, R., Krebs, P., 2005. Integrated approaches in urban storm drainage: where do we stand? *Environ. Manage.* 35, 396–409.
- Risholt, L.P., Schilling, W., Erbe, V., Alex, J., 2002. Pollution based real time control of wastewater systems. *Water Sci. Technol.* 45, 219–28.
- Schilperoort, R.P.S., 2011. Monitoring as a tool for the assessment of wastewater quality dynamics. TU Delft.
- Seggelke, K., Löwe, R., Beeneken, T., Fuchs, L., 2013. Implementation of an integrated real-time control system of sewer system and waste water treatment plant in the city of Wilhelmshaven. *Urban Water J.* 10, 330–341.
- Seggelke, K., Rosenwinkel, K.-H., 2002. Online-simulation of the WWTP to minimise the total emission of WWTP and sewer system. *Water Sci. Technol.* 45, 101–8.
- Van Daal-Rombouts, P.M.M., Gruber, G., Langeveld, J.G., Muschalla, D., Clemens, F.H.L.R., 2017. Performance evaluation of real time control in urban wastewater systems in practice: Review and perspective. *Environ. Model. Softw.* 95, 90–101. doi:10.1016/j.envsoft.2017.06.015
- Vezzaro, L., Christensen, M.L., Thirsing, C., Grum, M., Mikkelsen, P.S., 2014. Water quality-based real time control of integrated urban drainage systems: A preliminary study from Copenhagen, Denmark. *Procedia Eng.* 70, 1707–1716. doi:10.1016/j.proeng.2014.02.188
- Weyand, M., 2002. Real-time control in combined sewer systems in Germany - some case studies. *Urban Water* 4, 347–354.

APPENDIX

Supplementary material accompanying: Van Daal-Rombouts, P.M.M., Benedetti, L., De Jonge, J., Weijers, S.R., Langeveld, J.G. Performance evaluation of a smart buffer control at a wastewater treatment plant. Water Research.

A ADDITIONAL FIGURES

In this appendix additional figures are supplied to support the descriptions in the main paper. To facilitate easy access, in the paper this appendix is referred to at the appropriate locations. Here the figures are supported with captions and references to the appropriate paper sections.

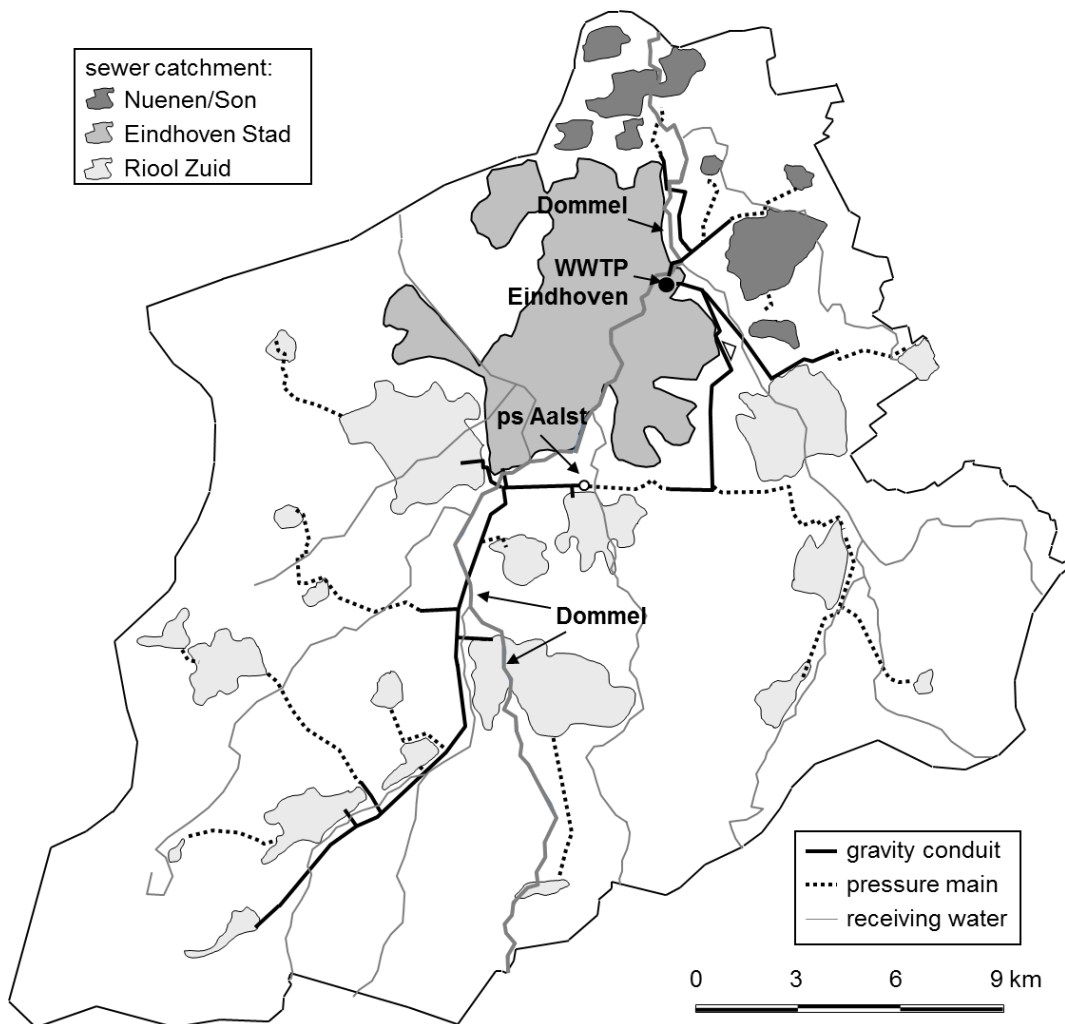

Section 2.1. Overview of the wastewater system of Eindhoven. Figure adapted from (Schilperoort, 2011)

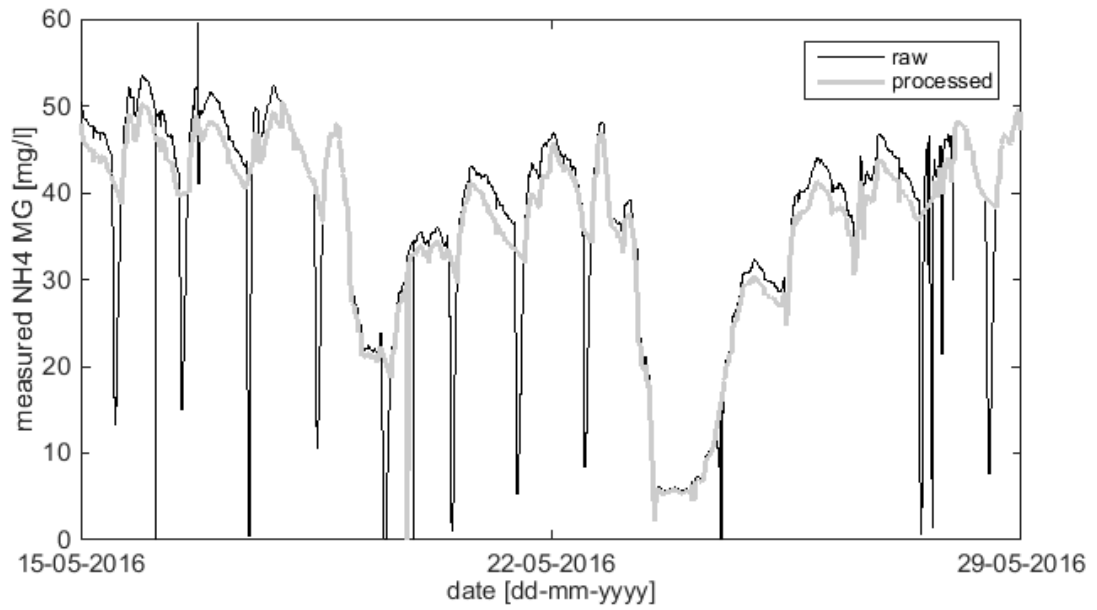

Section 2.2.1. Example of the impact of the applied corrections to the measured NH4 concentrations at location MG

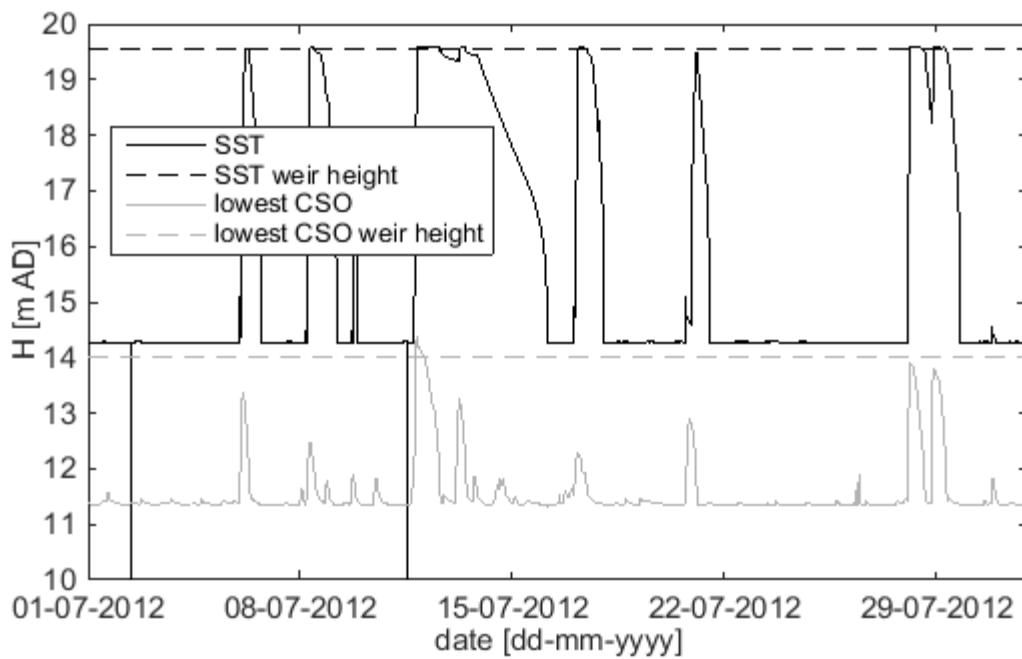

Section 2.2.3 - 1. Example of the water level in the SST with the SST weir level and the water level at the CSO location with the lowest weir level for July 2012

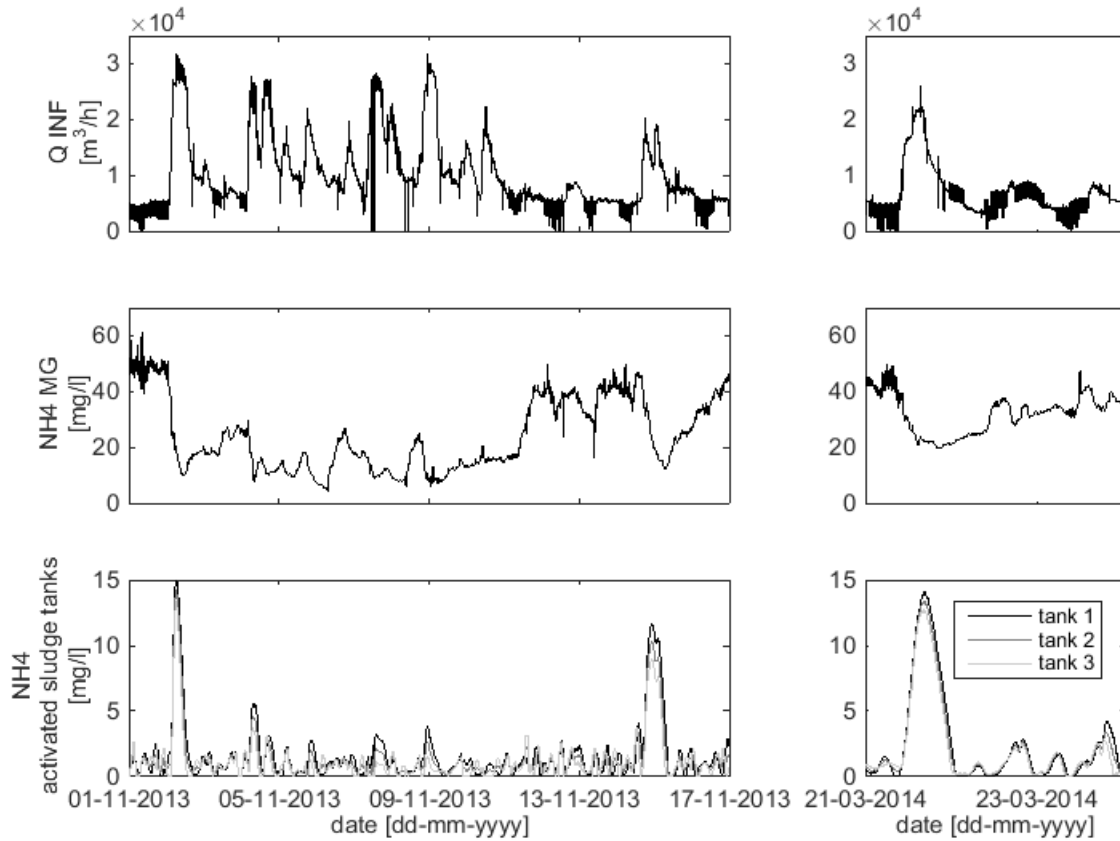

Section 2.2.3 - 2. Example of NH4 peaks in the activated sludge tanks at 2 and 15 November 2013 and 21 December 2014 due to the change from dry to wet weather flow

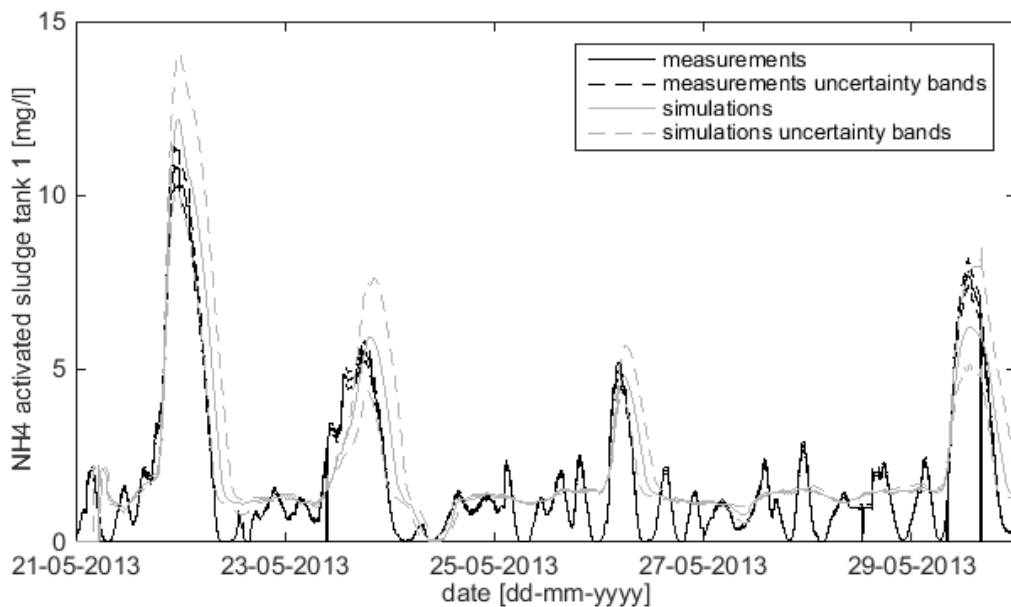

Section 2.4.3. Example of the measured and simulated NH4 concentration for the WWTP model verification

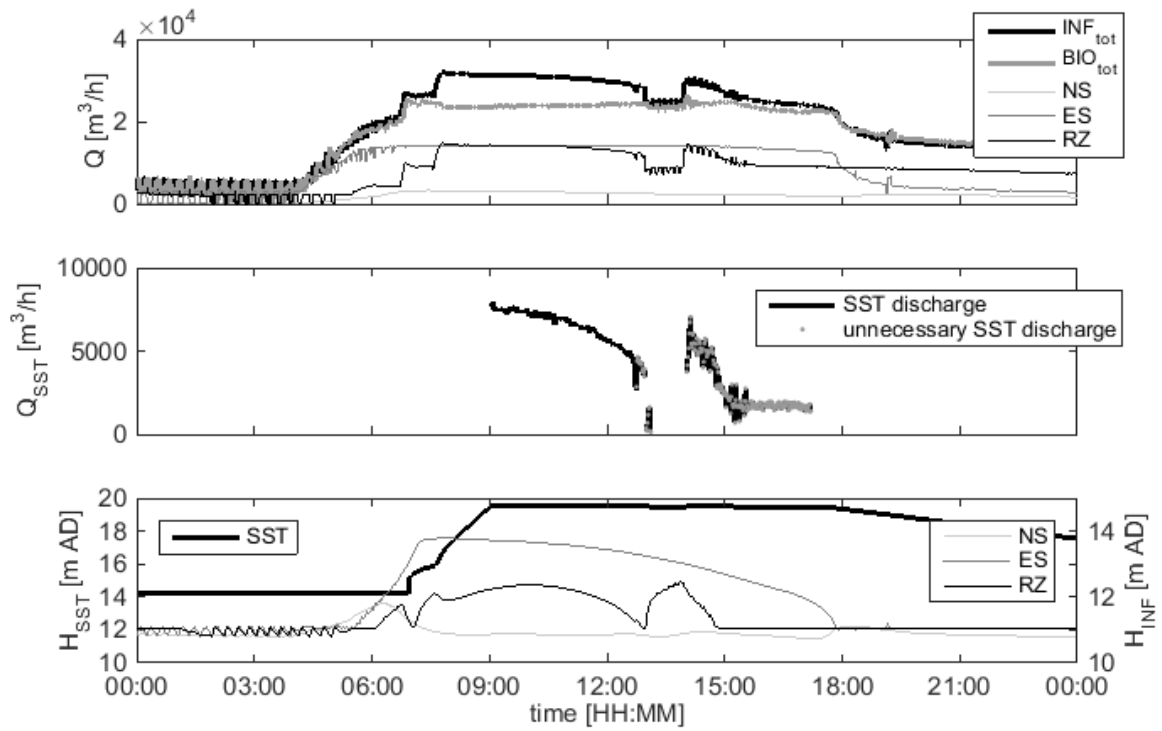

Section 3.1. Example of the SST operation at 8 September 2013 in the standard control. All SST discharges from approximately 13:00h onwards are deemed unnecessary with the Storm Tank Control. The SST is empty at 14.25 m AD and full at 19.48 m AD

B IMPLEMENTATION OF SMART BUFFER CONTROLS

B.1 Storm Tank Control

The Storm Tank Control was first implemented offline. Several historical data sets with measured influent flows and water levels, representing a range of rainfall distributions over the catchments, were tested to ensure proper translation of the design into software. The tests revealed an implementation error, that could have led to the vortex screws filling the SST running dry, which was easily resolved. The control was taken into operation without problems at the end of November 2014.

A screenshot of the implemented control is shown in figure B.1. Colours indicate the current operation and how it arrived there. Additionally, the most important set points calculated by the control and the current water levels in the influent chambers are displayed.

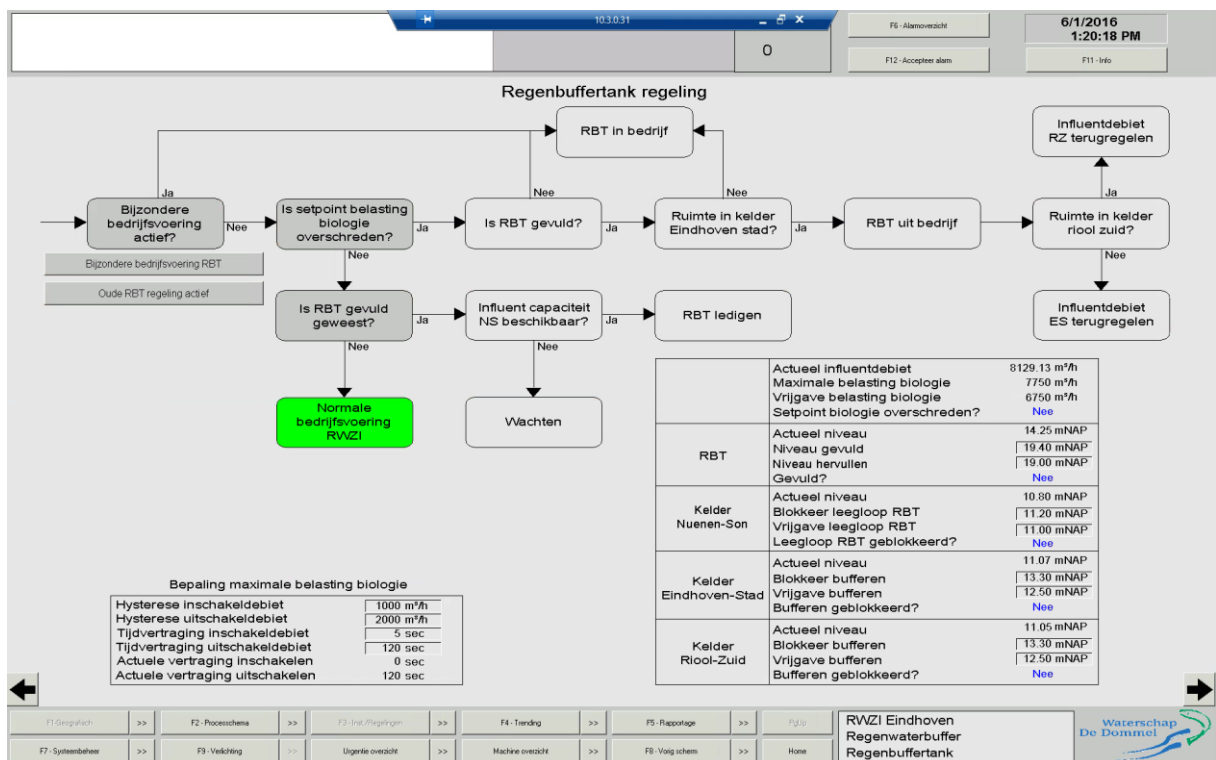

Fig B.1. Screenshot of the implementation of the Storm Tank Control in the SCADA system

B.2 Primary Clarifier Control implementation

To make the Primary Clarifier Control practically feasible, the PCs were equipped with controllable valves as shown in figure B.2. The design was implemented at the end of November 2015 in the SCADA system, a screenshot of which is shown in figure B.3. Colours indicate which phase and PCs are active and if a transition to a new phase is being prepared. Additionally, the most important set points calculated by the control and the current flows and water levels in the influent chambers are displayed. By clicking on a phase a pop-up window appears that details the constraints for switching to another phase. The windows are displayed in figure B.4.

It was not possible to test the implementation of the Primary Clarifier Control design offline, due to the complex network of controls for individual components of the WWTP and interactions between them. Therefore, the Primary Clarifier Control and the conversion from design to software had to be tested simultaneously in the field. For that purpose the control was switched on during working hours only. The test period lasted from the end of November 2015 until halfway March 2016. It was laborious due to the weather dependency, making it impossible to 'rerun' the same event. In some cases, safety features had to be sidestepped to simulate certain behaviour for proper testing.

During the test period several issues were discovered and resolved: e.g. at maximum flows two of the three valves to close of the PCs turned out to be too low, on opening the PC valves to allow higher influent flows the higher flow capacities could be reached before the valves were opened completely, and there turned out to be a contradiction in the changes made to the influent pumping station control and a previously implemented control to prevent blockage of the grates.

Due to observations on the stability of the control in the test period, the Primary Clarifier Control was simplified to make better use of the WWTPs original stable operation at the expense of some optimal buffering in the catchments.



Fig B.2. Picture of the controllable valves to dynamically operate the PCs in the Primary Clarifier Control

6/1/2016 15:44:52.062/74 HDAL - Dijk bijl. Prinses Beatrix 2 10:33:031

55

6/1/2016 1:21:39 PM

F12 - Accepteer alarm

F11 - Info

VBT Regeling

	DWA	start RWA	RWA	einde RWA	Nood- / Storfingfase
	0	1	2	3	4
Q _{bio_grens}	8750	17500	21000	17500	21000
Q _{bio_grens} + Q _{RBT}	8750	26250	29750	17500	29750
Q _{NS} beschikbaar	max 3200	max 3200	max 3200	max 3200	max 3200
Q _{ES} beschikbaar	max 20100	max 21192	max 24692	max 12442	max 24692
Q _{RZ} beschikbaar	max 15000	max 2700	max 16000	max 16000	max 16000
Q _{VBT1}	0	0	max 7000	0	max 7000
Q _{VBT2}	0	max 8750	max 7000	max 8750	max 7000
Q _{VBT3}	max 8750	max 8750	max 7000	max 8750	max 7000
Q _{RBT}	0	max 8750	max 7000	0	max 7000

1104QC01 **Instellingen VBT Regeling**

Omschrijving	Actuele waarde	Instelling
Tijd tot volgende fasebepaling	0 sec	60 sec
Influentdebiet verlaging door TG	5250 m ³ /h	
Influentdebiet verlaging door VBT	0 m ³ /h	
Influentdebiet verlagen met (Actueel = totale verlaging)	5250 m ³ /h	0 m ³ /h
Influentdebieten	NS: 580 m ³ /h ES: 3278 m ³ /h RZ: 4479 m ³ /h TOT: 8336 m ³ /h	
Ontvangkelder niveau's	NS: 10.94 mNAP ES: 11.07 mNAP RZ: 11.09 mNAP	
VBT gebruikt tijdens DWA bedrijf (Let op verdunningswaterafsluiters)		VBT1 VBT2 VBT3
Huidige status RBT regeling	RBT niet actief	

Noodbedrijf

F1 - Overzicht >> F2 - Processchema >> F3 - Inst./Regelingen >> F4 - Trending >> F5 - Rapportage >> F6 - Pagina >> F7 - Systembeheer >> F8 - Verkeiding >> Uigruite overzicht >> Modie overdr. >> F9 - Volg schem >> Home

RWZI Eindhoven
Ontvangst
Influentemaal

Waterschap
De Dommel

Fig B.3. Screenshot of the implementation of the Primary Clarifier Control in the SCADA system

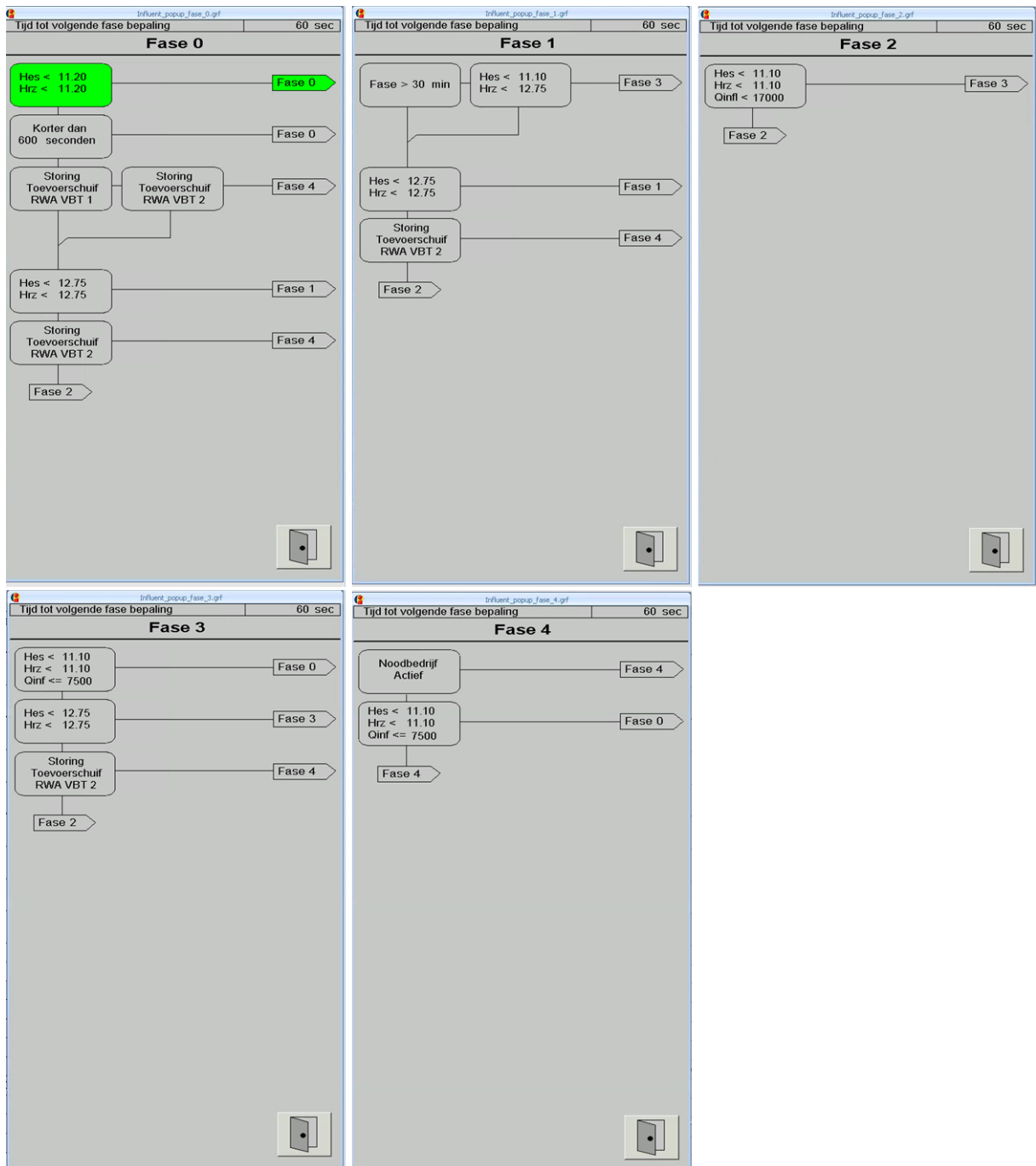

Fig B.4. Pop-up windows that contain constraints for switching to another phase. Windows appear by clicking on a phase in figure B.3

C COMPARISON OF REMOVAL EFFICIENCY OF ONE AGAINST THREE PRIMARY CLARIFIERS DURING DRY WEATHER FLOW

Prior to the detailed design and implementation of the Primary Clarifier Control at WWTP Eindhoven a field test was executed to investigate the impact of applying only one PC instead of three during DWF conditions. For this purpose the WWTP was temporarily modified to treat all wastewater under DWF conditions using only one PC.

The PC influent and PC effluent constituents were intensively monitored by automated, volume proportional, 24-hour grab sampling. The samples were analysed following standard lab-procedures for total P, total COD, BOD5, TSS, NH4 and Nkj. The monitoring period with only one PC spans a total of 18 days spread over 3 periods: 24 and 25 June, 10 to 23 July and 13 to 18 August 2013. The removal efficiency during this period is summarised in table C.1.

The removal efficiency is compared to the reference situation with three PCs. The reference period runs from January 2011 to May 2013. The removal efficiency is based on automated, volume proportional, 24-hour grab samples that are performed for regulatory purposes 60 times per year. Only DWF days were considered, where a DWF day is defined as receiving less than 120,000 m³ influent per day for the current and the two previous days. The removal efficiency during this period is summarised in table C.2.

Comparing the removal efficiencies in tables C.1 and C.2 no significant differences can be found. Based on this, it was concluded that during DWF conditions there is no adverse effect in applying only one instead of three PCs.

Table C.1. Removal efficiency primary clarification during DWF conditions with one PC

removal efficiency	Ptot [%]	CODtot [%]	BOD5 [%]	TSS [%]	NH4 [%]	Nkj [%]
average	12	27	23	54	-2	3
minimal	0	17	-1	33	-10	-30
maximal	33	49	44	71	4	12
standard deviation	10	7	11	8	4	9

Table C.2. Removal efficiency primary clarification during DWF conditions with three PCs

removal efficiency	Ptot [%]	CODtot [%]	BOD5 [%]	TSS [%]	NH4 [%]	Nkj [%]
average	15	28	29	54	n.a.	8
minimal	-2	1	7	18	n.a.	-1
maximal	31	56	51	89	n.a.	23
standard deviation	8	10	10	20	n.a.	4