

A Systematic Review and Classification of Glazing Technologies for Building Façades

Michael, Michalis; Favoino, Fabio; Jin, Qian; Luna-Navarro, Alessandra; Overend, Mauro

DOI

[10.3390/en16145357](https://doi.org/10.3390/en16145357)

Publication date

2023

Document Version

Final published version

Published in

Energies

Citation (APA)

Michael, M., Favoino, F., Jin, Q., Luna-Navarro, A., & Overend, M. (2023). A Systematic Review and Classification of Glazing Technologies for Building Façades. *Energies*, 16(14), Article 5357. <https://doi.org/10.3390/en16145357>

Important note

To cite this publication, please use the final published version (if applicable). Please check the document version above.

Copyright



Other than for strictly personal use, it is not permitted to download, forward or distribute the text or part of it, without the consent of the author(s) and/or copyright holder(s), unless the work is under an open content license such as Creative Commons.

Takedown policy

Please contact us and provide details if you believe this document breaches copyrights. We will remove access to the work immediately and investigate your claim.

Review

A Systematic Review and Classification of Glazing Technologies for Building Façades

Michalis Michael ^{1,*}, Fabio Favoino ², Qian Jin ³, Alessandra Luna-Navarro ⁴ and Mauro Overend ⁴¹ Department of Engineering, University of Cambridge, Cambridge CB2 1TN, UK² Department of Energy, Polytechnic University of Turin, 10129 Torino, Italy; fabio.favoino@polito.it³ College of Architecture and Urban Planning, Tongji University, Shanghai 200092, China; 13168@tongji.edu.cn⁴ Department of Architectural Engineering & Technology, TU Delft, 2628 CD Delft, The Netherlands; a.lunavarro@tudelft.nl (A.L.-N.); m.overend@tudelft.nl (M.O.)

* Correspondence: mm834@cam.ac.uk; Tel.: +44-7557-041333

Abstract: High-performance glazing technologies are essential for achieving the occupant comfort and building energy efficiency required in contemporary and future buildings. In real-world applications, glazing façades are selected from a steadily increasing number of glazing technologies. However, the authors could not identify a systematic and comprehensive review and classification of glazing technologies in the literature. This creates a barrier when comparing typologically different glazing technologies and combining multiple technologies in a glazing unit. This paper provides a systematic review and classification of established and emerging glazing technologies based on publications from 2001–2022 which were interpreted following the PRISMA methodology. This study reveals that the majority of high-performance glazing systems used in practice are in multi-layer glazing configurations and that the glazing system performance can focus on including additional and multiple functionalities, which aim at improving overall building performance. It was also found that there is a large potential for improvement of multilayer, evacuated, aerogels, electrochromic, and solar cell glazing by incorporating other technologies or innovative materials in multi-layer glazing units for either improving existing technologies or for the development of new ones. However, their longevity, robustness, and cost affordability should be ensured.

Keywords: building envelopes; dynamic glazing technologies; emerging glazing technologies; energy consumption; established glazing technologies; glazing technologies; smart windows; systematic review



Citation: Michael, M.; Favoino, F.; Jin, Q.; Luna-Navarro, A.; Overend, M. A Systematic Review and Classification of Glazing Technologies for Building Façades. *Energies* **2023**, *16*, 5357. <https://doi.org/10.3390/en16145357>

Academic Editor: Chi-Ming Lai

Received: 21 May 2023

Revised: 26 June 2023

Accepted: 6 July 2023

Published: 13 July 2023



Copyright: © 2023 by the authors. Licensee MDPI, Basel, Switzerland. This article is an open access article distributed under the terms and conditions of the Creative Commons Attribution (CC BY) license (<https://creativecommons.org/licenses/by/4.0/>).

1. Introduction

1.1. General

Buildings and the building construction sector combined are responsible for 36% of global total end-use energy consumption [1]. In some developed countries, this sector consumes up to 40% of the total energy [2]. In this regard, the glazed openings play a considerable role (about 50% of the energy loss in buildings is attributed to glazing) [3,4] while high-performance glazing façade systems can respond to occupants' requirements and outdoor environment to increase thermal and visual comfort [5,6] with, consequentially, an increase in productivity [7]. Therefore, glazing façades must be designed in detail and appropriately selected to ensure the lowest possible operational energy demand while the highest possible thermal and visual comfort is achieved. Knowledge of their characteristics and properties is essential for deploying rapidly developed glazing technologies in different climates. Previous work that attempted to review/classify glazing technologies can be found in [4,5,8–13]. These are useful, but none provide a comprehensive and systematic review of glazing technologies.

1.2. Previous Research and Data Extraction

Over time, glazing technologies for building façades were studied to an extent, mainly regarding material science, energy simulation, and energy efficiency. In an initial search in international scientific databases, almost 3500 research articles on this subject were published. Around 300 partially reviewed papers were published during the last two decades (2001–2022). The most comprehensive and recently published (2010–2021) review articles are tabulated and presented in Table A1 in Appendix A. In this table, the authors, year of publication, journal, title, and the main categories and features of investigated technologies in 23 review papers are recorded to give an initial overview to the reader. Researchers attempted to review/classify glazing technologies for building façades in these review articles. However, except for one case [14], which is a systematic review, although it is only about smart windows technologies, none of the others provides a comprehensive and systematic review/classification. Although we do not dispute the reliability of existing reviews performed by many scholars in the field of building engineering, we believe that this gap needs to be covered, and protocols developed for systematic reviews must be adopted. By achieving this, systematic reviews in the future could be based on more transparent and reliable criteria, and any implicit assumptions will be minimised while maintaining consistency; More reliable findings and discussions will be provided.

1.3. The Aim and Objectives of This Paper

Studying published literature on glazing technologies for building façades, particularly previous reviews, the authors identified a lack of a systematic and comprehensive review and classification of glazing technologies (already established on the market or under research or development). By applying a systematic review methodology, this work aims to review the literature on glazing technologies published during the last two decades and classify them according to their working principles.

The objectives of the current study are: (i) To provide an avenue for building engineering scholars, performing systematic reviews, to consider the underpinnings of the process for future reviews, (ii) To introduce the established and emerging concepts in glazing technologies and systematically classify them considering their working principles and their salient thermal and visual characteristics (iii) To identify any research gaps and challenges and opportunities for future action and research.

1.4. The Research Flow of This Work

After this section, in Section 2, the methodology of this review is described and presented, whereas, in Sections 3 and 4 the classification of the established and emerging glazing technologies is presented in the form of a glazing technology map constructed by clustering similar/comparable technologies in the same group. The key outcomes and conclusions with further research challenges are outlined in Section 5.

2. Methodology of Review and Classification Scheme

2.1. The Architecture of Methodology

This paper is based on the body of knowledge of existing literature published during the last two decades and deals with glazing technologies for building façades. In particular, this research followed a systematic approach to gather and review the corresponding publications following the below 6-steps methodology:

1. Diverse research to identify the relevant literature on glazing technologies for building façades.
2. Filtering of the initially identified literature, keeping the most relevant/comprehensive and published in the last two decades.
3. Sorting and segregation of final selected publications per type and year of publication.
4. Provide a detailed review of the classified publications and capture all information needed for the next steps.

5. Classify the reviewed glazing technologies into established and emerging technologies with a focus on their working principles and their salient thermal and visual characteristics.
6. Discuss the key findings of the review, identifying the main advantages and drawbacks of each technology and challenges for future research.

Although significant literature reviews have been performed in the area of glazing technologies used for building envelope façades, in most of them, the approaches and principles underpinning these reviews are undefined. Thus, there exists a gap in the building façades literature regarding the ways in which researchers in the area have undertaken systematic reviews. To our best knowledge, the review performed by [14] is a work that followed a consistent methodology to provide an overview of glazing technologies, although this work is only about smart windows technologies with a focus on electrochromic. The term ‘systematic review’ is based on a research protocol that ensures objectivity, the inclusion and exclusion criteria used to select the literature to be reviewed, and the research strategy and methodology. According to [15], systematic reviews constitute an important avenue for academics and practitioners to use existing knowledge to further research and action. Therefore, the present review is a systematic review that follows the methodology and steps of the Preferred Reporting Items for Systematic Reviews and Meta-Analyses (PRISMA) [16]. In this regard, a protocol was developed to support the method of analysis and the inclusion criteria (as described in the following subsections) starting with a comprehensive literature search to identify published literature in the field of glazing technologies used for building façades followed by systematic classification and constructive and reliable discussions and findings that could be a trigger for further research.

2.2. Search Strategy for Documents Selection, Eligibility Criteria, and Classification

The information for this review paper was gathered from scientific databases of international prestige (WoS, Google Scholar, and Scopus), books/Ph.D. theses, Institutions of codes and standards, and manufacturers’ websites. In the first stage, a strategy was followed to search databases for papers of interest, using the criterion TITLE-ABS-KEY (glazing AND technologies OR windows), i.e., the document should include in its title, abstract or keywords the words ‘glazing technologies or windows’ and published in the years 2001–2022. A second narrowed search was followed to include the word ‘review’ additionally. The word ‘systematic’ as a search keyword was not included to prevent the loss of reviews performed without following a systematic review strategy. Indeed, when the word “systematic” was added as an additional search keyword, the result was that the identified documents were only three, of which only one was in the field of glazing technologies. To decide which documents were eligible to be considered for the review (inclusion criteria), the following criteria were adopted: (i) whether the glazing technology is used for building façades, (ii) whether the technology is an established technology in the market, and (iii) the reported technology is an emerging technology under research or development reached the stage of a prototype from which thermal and optical properties can be measured. Literature out of the scope of the interest of this review or not meeting the inclusion criteria was excluded.

The decision on which documents were suitable for the review study was taken following a multi-stage process described and presented in the PRISMA 2020 flow diagram in Appendix A. From 265 potentially eligible studies identified from the narrowed search with the criterion TITLE-ABS-KEY (glazing AND technologies) OR windows AND review, 98 papers were excluded from screening titles and abstracts. Thus, 167 documents were examined for eligibility from which 16 articles were ineligible. From the remaining 151, 20 articles were excluded (ten as very specific, seven as not applicable for building façades, and three as non-English). Thus, finally, 131 (each cited) documents (115 papers, 5 books/Ph.D. theses, and 11 manufacturers’ websites) were included in the review as more representative and relevant for gathering information on glazing technologies for

building façades that would be used to build a comprehensive review and classification based on their functionalities/working principles.

For the authors' convenience to assess and utilize the encapsulated information and data, the selected publications were sorted and segregated into Journal papers (109), manufacturers' sites (11), codes and standards (3), books/Ph.D. theses (5), and conference papers (3), as shown in Figure 1. This figure shows that performing reviews is increasing over time. More than 71% of the publications were performed during the last decade, and less than 12% were conducted before 2006.

Publications reviewed per type and year of publication

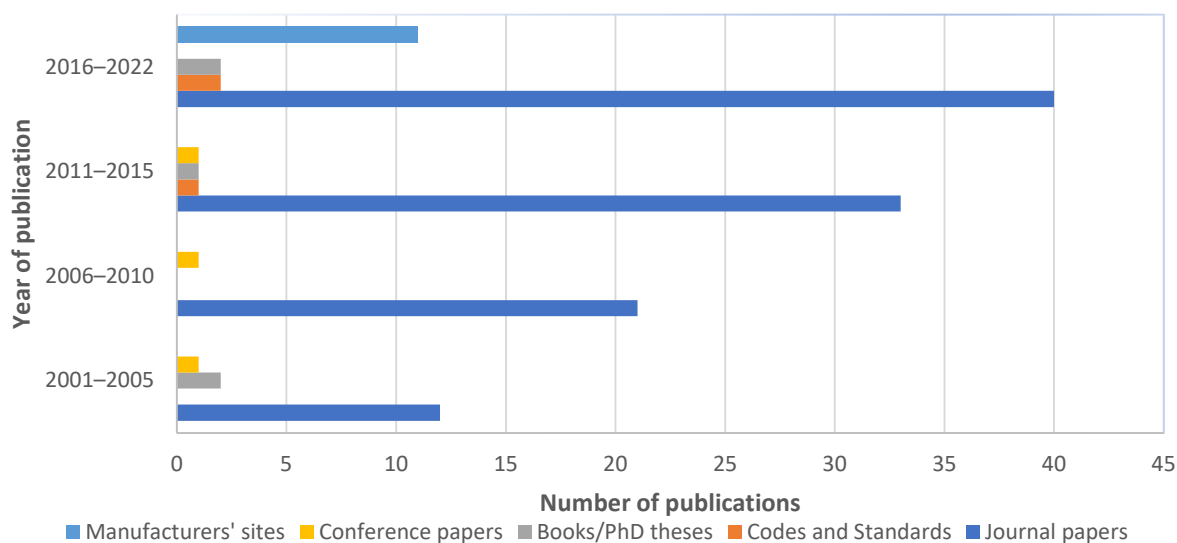

Figure 1. Publications reviewed per type and year of publication.

2.3. Interpretation of Extracted Data

The data given by the authors determined the extraction of data from the literature reviewed. The extracted data were interpreted, compared, and discussed during classification. Different results of individual studies achieved by individual teams of researchers were gathered and compared. It is worth noting that the credibility of the data taken from the reviewed papers is increased as the collected data regarding a glazing technology is acquired from more than one source and the analysed articles are peer-reviewed publications.

The underlying working principles of the leading glazing technologies and their relative merits are described by providing a measure of their performance using the significant performance indicators of the specific glazing technologies (i.e., U-value, g-value, and visible transmittance (VT) for each technology, the ability of power generation for photovoltaic (PV)/Solar cell glazing, switching time and frequencies for switchable glazing, nominal melting temperature, latent heat, heat conductivity, specific heat capacity, and heat storage capacity for phase changing materials (PCM) based glazing etc.). Furthermore, the main functional advantages and disadvantages of glazing technologies are identified, and the technologies are grouped in terms of their appropriateness for heating or cooling-dominated climates. Finally, this paper aims to provide the reader with outcomes from studies on research and development in glazing technologies for building façades and identify the need for further research where applicable.

In the following sections, the study proceeds to analyse the gathered information from the detailed review critically, clustering the glazing technologies, on the basis of their working principles, salient thermal and visual characteristics, and their advantages and disadvantages. The study is completed with a discussion of the key findings of the review, identifying the main advantages and drawbacks of each technology and challenges for future action and research.

3. Classification Scheme and Review of Established Glazing Technologies

According to the 5th step of the previous section, this section includes the results from the systematical review of the established types of glazing technologies, classifying them according to their functionalities/working principles. The main glazing technologies are classified as established and emerging technologies (Figure 2). Established glazing technologies are sub-categorised into static and dynamic technologies, as illustrated in Figure 3. The glazing technologies of each sub-category are described and compared in turn in the subsequent subsections.

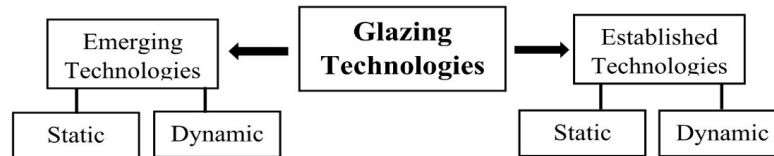

Figure 2. Top-level classification of glazing technologies into established (currently on the market) and emerging (under research or development) technologies.

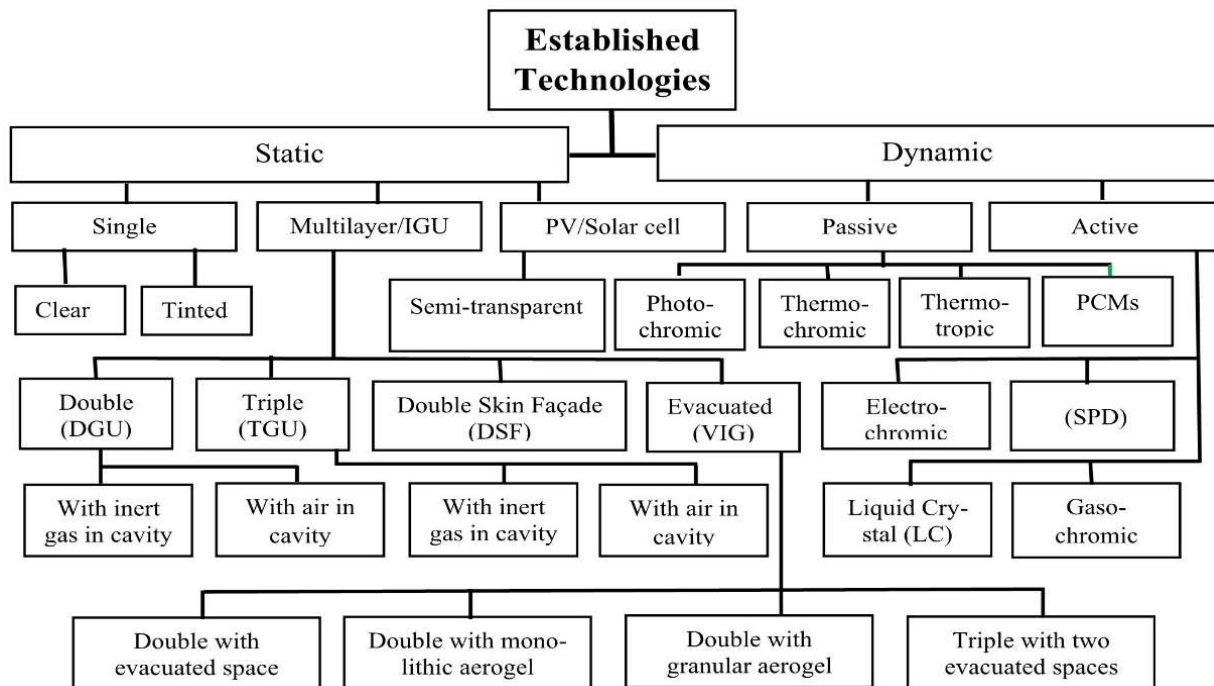

Figure 3. Classification of established glazing technologies (currently available on the market). They are sub-categorised into static and dynamic technologies.

3.1. Static Glazing Technologies

Static glazing technologies are characterised by properties that cannot be modulated according to the environmental conditions or occupants’ needs. The main established static glazing technologies are single glazing units (SGU) (clear or body tinted), multi-layer insulated glazing units (IGU) such as double-glazing units (DGU) and triple glazing units (TGU), evacuated glazing units (EGU) (also known as vacuum insulated glazing (VIG)), DGU with monolithic aerogel, DGU with granular aerogel, TGU with two evacuated cavities and semi-transparent PV/solar cell glazing technology.

3.1.1. Single Glazing Technologies (Clear or Body Tinted)

Compared to all other glazing options, single glazing with clear glass allows the highest transfer of energy and the highest daylight transmission. The performance of single-pane glazing can be improved by body tinting and or coating. The solar control

of single-pane assemblies can remarkably be improved by using spectrally selective tints and coatings [17]. Two main types of glazing coatings exist: (i) offline (aka sputtered or ‘soft’) coatings, which are added after the manufacturing of the glass, usually by chemical dipping of the glass panes or by the evaporation of metals onto the surfaces of the glass panes in a vacuum and (ii) online (aka pyrolytic or ‘hard’) coatings, which are applied when the glass is still hot. This leads to the formation of a solid bond to the glass and therefore, these coatings are usually more durable than offline coatings (e.g., solar control and ‘hard’ low-e coatings are mostly of the online type). The disadvantage of a hard low-e coating is that the U-values are typically higher than those achieved by the soft coatings due to the intervention in its molecular structure [5]. The advantages of soft low-e coatings are that they offer a high visible light transmission and low emissivities resulting in better U-values. However, they have the disadvantage that they are easily damaged and consequently need to be placed on a protected surface (e.g., cavity-facing surface in DGU), need extreme care when handling them, and require two coatings for more durability. Due to this, they are more expensive than hard low-e coatings. Body tinted glazing utilises absorbing materials dispersed in the glass bulk to reduce the g-value of clear glass. Body-tinted glazing products are manufactured by adding small quantities (concentrations of 0.025–1%) of metal oxides (cobalt, titanium, manganese, chromium, etc.) to the molten glass during primary manufacture.

3.1.2. Multilayer Insulated Glazing Technologies

The variations of U-value, g-value, and VT with the thickness of clear, bronze, green and grey tinted single glass are shown in Figure 4, from which it is evident that: (i) the U-value decreases with the glass thickness whereas, the colour of tint has a minor effect on it and (ii) the g-value and VT decrease as the glass thickness increases while green tint provides the smallest solar heat gain and the largest light transmittance compared to the other body tints.

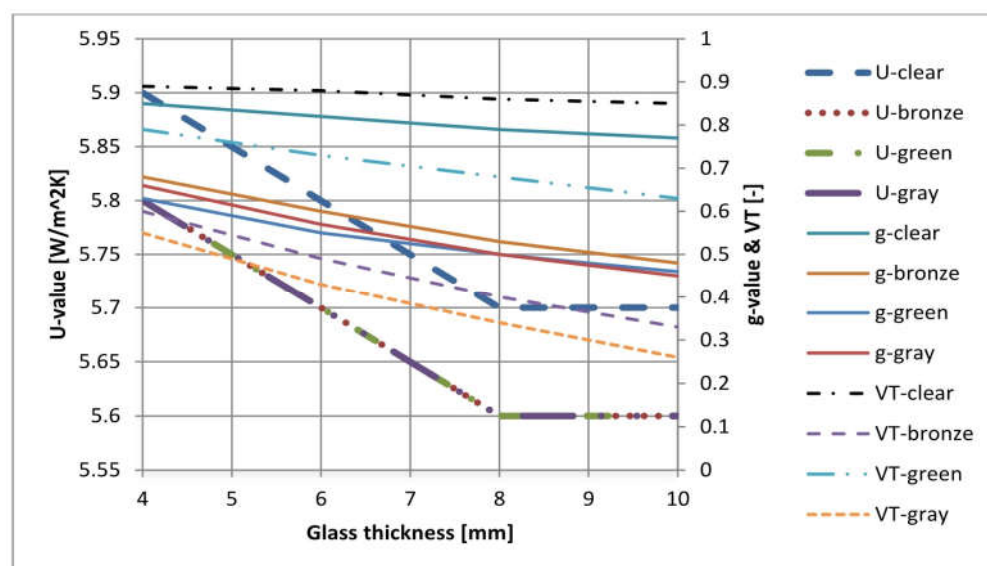

Figure 4. Variation of U-value, g-value, and VT with tint colour and thickness of single glasses. (Values calculated using the LBNL software WINDOW7.7).

Further reductions in the g-value can be achieved by applying a reflective coating [18]. This results in a decrease in the g-value by increasing the surface reflectivity of the material. Reflective coatings usually consist of thin layers of metal or metal oxide, that come in various colours (silver, gold, bronze, etc.).

Multilayer insulated glazing technologies with a low U-value and high visible transmittance are commonly used in new buildings and for upgrading existing buildings. The following techniques can be used independently or in combination to improve the energy

and visual performance beyond what can be achieved in single glazing: (i) modify the glazing material by altering its physical characteristics or chemical composition, (ii) superpose a surface coating to the glazing (e.g., reflective coatings and low-emissivity coatings have been developed to enhance both cooling and heating performance) and (iii) combine various layers of glazing. These approaches may include the use of two or more glass panes, gas fills between the layers of insulating glazing units (IGUs) with low-conductance and thermally improved edge spacers.

The performance of the glazing systems can be improved by incorporating various thin surface coatings (reflective, low-emissivity, self-cleaning). For example, specific wavelengths of visible and non-visible light that are reflected and or transmitted through glass can be regulated by coatings resulting in controlling solar energy and visible light penetrating the glass. In heating-dominated climates, short-wave solar heat enters the building, whereas long-wave heat re-radiated from warm indoor surfaces is reflected by the low-e coating and retained in the building. In cooling-dominated climates, low-e coatings prevent long-wave radiation from warm surfaces outside from entering through the glass [17]. An excellent improvement in occupant comfort is noted as there is a considerable reduction in the radiant heat transfer between the glazing and a person sitting near it.

Another factor that significantly contributes to the performance of multilayer glazing is the type and thickness of gas fills in the space between constituent glass sheets. As higher-performance commercial glazing systems are developed, using low-conductance gas fills becomes more common. The noble gas argon (Ar), having a thermal conductivity of 0.018 W/mK, considerably smaller than the thermal conductivity of air (about 0.026 W/mK), is widely used as a gas fill in glazing units. To achieve lower U-values and even slimmer glazing units, krypton (Kr) and xenon (Xe), with significantly smaller thermal conductivity of approx. 0.0095 W/mK and 0.0055 W/mK, respectively, are used. Nevertheless, these gases are not currently widely used due to their high cost (particularly xenon).

Visual and thermal performance metrics of various types of DGUs and TGUs are shown in Figure 5, from which it is evident that:

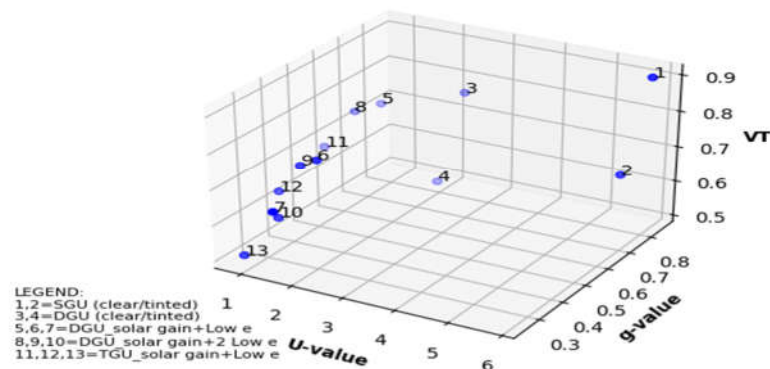

Figure 5. Variation of U-value, g-value, and VT of single and multilayer glazing (values calculated using the LBNL software WINDOW7.7).

1. The tinted SGU (point 2) has a negligible effect on the U-value but reduces solar gain. This is beneficial in cooling-dominated climates or even in heating-dominated climates in the case of office buildings with significant internal cooling demand.
2. (i) A DGU with high solar gain low-e glass (point 5) is designed to reduce heat loss but admit significant solar radiation. This is suitable for buildings in heating-dominated climates (position of low-e coating on surface #3, i.e., the surface of the inner pane facing to the cavity), (ii) a DGU with mid-range solar gain low-e glass (point 6) is suitable for climates with both heating and cooling demands and (iii) a DGU with low solar gain low-e glass (point 7) reduces heat loss in heating seasons and substantially reduces solar heat gain both in heating and cooling seasons. This is ideal for buildings

in cooling-dominated climates (position of low-e coating on surface #2, i.e., the surface of the outer pane facing the cavity).

3. (i) The glass with high solar gain, low-e with room side low-e (point 8) is designed to reduce heat loss but admit solar radiation being suitable for buildings located in heating-dominated climates, (ii) the glass with mid-range solar gain, low-e with room side low-e (point 9) reduces heat loss and admit a reduced amount of solar radiation being suitable for climates with both heating and cooling demands and (iii) the glass with low solar gain, low-e with room side low-e (point 10) reduces solar heat gain while retaining high VT. Recently, an innovative IGU with a multilayer glass core with 3–6 insulating layers is developed, achieving a particularly low U-value of 0.21–0.49 W/m² K [18].

3.1.3. Evacuated (Vacuum) Glazing Technology

The main characteristics of vacuum glazing include low heat loss, high visible transmittance, and slim glazing unit. The heat transfer mechanism through this glazing is limited to radiation since convective and conductive mechanisms are suppressed. This can be achieved when the pressure in the cavity is maintained at or below 0.1 Pa [5,19]. Due to the difference in pressure between the cavity and the ambient, the glass tends to be deformed. To minimise this risk, tiny stainless steel support pillars are installed at equal intervals, as shown in Figure 6, thereby keeping the two glass panes apart.

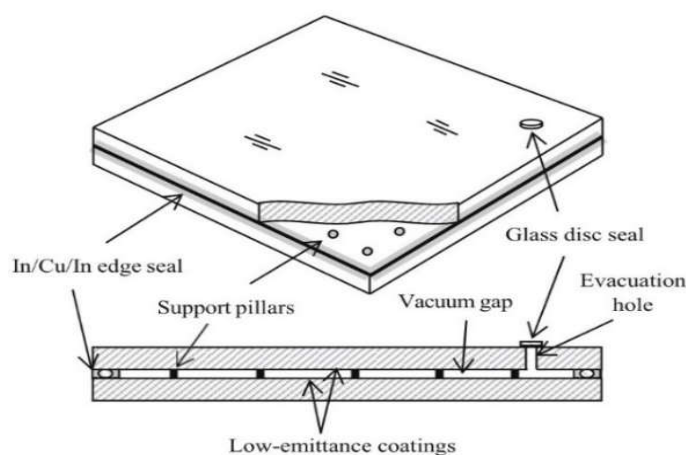

Figure 6. Schematic of double evacuated glazing unit (retrieved from [20]).

Since heat transfer by radiation between two panes does not depend on the distance between them, the thickness of the cavity can be reduced while still providing a highly insulating glazing unit. The thermal conductance of the pillars does not depend on the thermal conductivity of their material. However, it depends on the thermal conductivity of glass sheets, their thickness, and the arrangement of the pillars [21–23]. By applying low-e coating on the surfaces of glass panes facing the cavity, the heat transfer by radiation between the glass panes can be decreased by up to 20% [19,22]. Evacuated glazing is considerably slimmer than conventional multilayer glazing. For example, a commercially available single cavity evacuated glazing has a total thickness of 21 mm compared to a triple glazing unit with the same U-value (0.70 W/m²K) with a total thickness of 40 mm.

3.1.4. Multilayer Evacuated Glazing

It is possible to have multiple evacuated cavities in a glazing unit, for example, a triple evacuated glazing unit. This unit comprises three glass sheets with two evacuated spaces in between, as shown in Figure 7. It is reported that the U_g of this type of glazing unit is very low [24] whereas it has been predicted at 0.5 W/m²K [19].

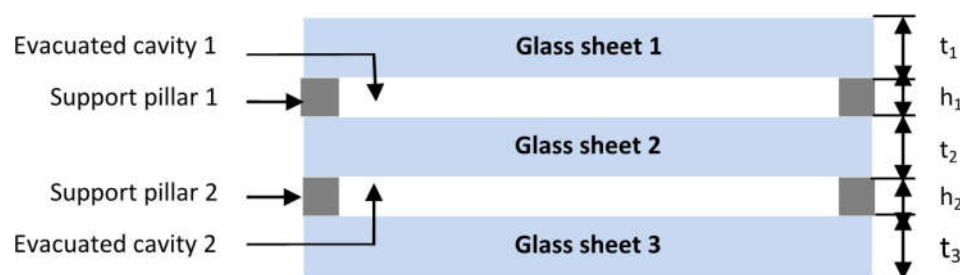

Figure 7. Schematic illustration of the triple evacuated glazing unit.

Furthermore, the theoretical investigations of [25] show that a triple evacuated glazing system, with only 16 mm total thickness and incorporating four low-e coatings with an emissivity of 0.03, could have a U_g -value of $0.24 \text{ W/m}^2\text{K}$. In addition, the triple evacuated glazing is lighter and slimmer than the conventional TGU. The main drawback of such a system is its higher upfront cost than conventional insulated glazing units.

3.1.5. Aerogel Glazing

Using aerogel as cavity insulation in multilayer glazing has been known for more than 50 years. Aerogel is a silica-based, porous material composed of about 4% silica and 96% air. The encapsulated air (or another gas if the cavity is gas-filled), in the form of microscopic cells, prevents heat transfer by convection while allowing light to be transmitted, providing a bluish haze due to the scattering at silica-air interfaces. It is worth noting that the heat transfer by conduction is reduced as the size of the cells is smaller than the mean free path of the air molecules. Thus, the thermal conductivity is as low as 0.013 W/mK [26]. Aerogel is an excellent thermal insulator because it suppresses two of the three modes of heat transfer; conduction, as the composition of aerogel mainly comprises insulating air/gas, and convection. After all, the movement of air/gas is prevented by its microstructure. However, aerogel is a poor radiative insulator because it has a high transmittance for infrared radiation. There are two main types of aerogels currently used in the glazing market, known as monolithic and granular, respectively. A third type, in powder form, is mainly used to reduce the thermal conductivity of cementitious aggregates and ceramics [27].

Several experimental works on aerogel glazing have been performed [28–31]. They show that the most promising aerogel type is monolithic (in the cavity between two 4 mm float glass panes) for two main reasons: (i) better visible transmittance of about 0.62 and (ii) very low value of thermal transmittance (about $0.60 \text{ W/m}^2\text{K}$) when it is sandwiched in a double evacuated glazing of 14 mm thickness. It was found that the granular aerogel glazing results in (i) about 60% light reduction compared to a double-glazing unit with a low-e coating and (ii) U-value marginally above $1.00 \text{ W/m}^2\text{K}$ [29]. The performance parameters of commercial insulated glazing units with different thicknesses consisting of 6 mm interior and exterior glass with aerogel in between are shown in Figure 8 (values from data sheets of the manufacturer [32]) and compared to DGU consisting of 6 mm clear glass panes and air in between them. As expected, the performance parameters decrease as the encapsulated aerogel thickness increases. The aerogel glazing can reduce the glare improving the visual comfort, due to its inherent translucent property [33–35], although views in/out are impaired [28,29]. However, aerogel glazing is not commonly used due to its low transparency and high cost [28].

3.1.6. Semi-Transparent PV/Solar Cell Glazing Technology

Photovoltaic (PV) glazing mitigates daylight and solar heat gain generating renewable electricity. This glazing comprises two glass sheets with PV cells encapsulated between them [36]. In PV glazing, the PV solar cells can be made of a range of materials such as cadmium telluride (CdTe), amorphous silicon (a-Si), micro-morph silicon ($\mu\text{-Si}$), GaAs, Cu_2S , Cu_2O , etc. Silicon solar cells are the most common. Three types of silicon solar

cells exist monocrystalline, multi-crystalline, and amorphous solar cells. Monocrystalline solar cells have a high efficiency (14%–16%), but their cost is relatively high due to the complicated manufacturing process, whereas, multi-crystalline solar cells are cheaper but less efficient (14%).

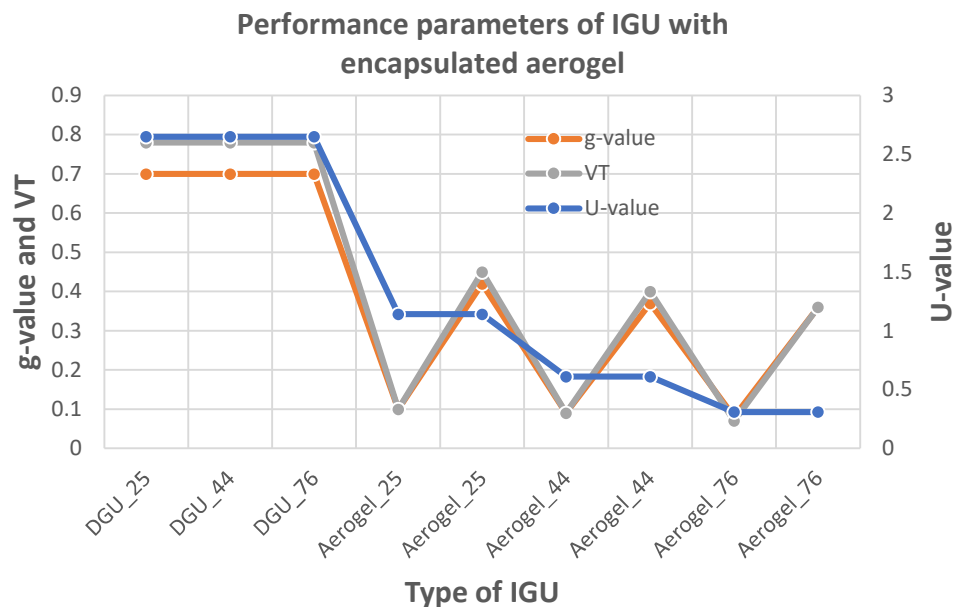

Figure 8. Performance parameters of insulated glazing units with aerogel with different thicknesses compared to DGU 6/air/6 (values from data sheets of the manufacturer [32]).

Silicon PV-based semi-transparent PV glazing offers transparent gaps with transparency between the PV cells. Thus, when solar radiation falls on the portion covered by PV cells, renewable electricity is generated, whereas, the transparent portion allows the solar radiation to be transmitted, resulting in viewing through the glazing, solar heat gain, and daylighting [36]. Another type of semi-transparent PV glazing is based on thin-film PV (amorphous silicon and cadmium telluride). The film thickness can be pretty small, achieving a uniform semitransparency [37], achieving an efficiency of 4.75–8.2 %, g-value of 0.123–0.413, and visible light transmittance of 4.17–9.17% [38,39]. The most efficient solar modules in practice, convert into electricity only around 15% of the incident solar radiation. The power generation amount by a PV glazing and its visible transmittance is inversely proportional, i.e., the larger the VT, the smaller the amount of power generation is, and vice versa [11]. Therefore, an optimal value of VT must be found on a case-by-case basis to maximise the benefit from both functions is maximised [5].

3.2. Dynamic Glazing Technologies

Dynamic glazing technologies (switchable or chromogenic) have optical and thermal properties that can be passively or actively modulated, thereby changing the levels of solar heat gain and daylight in a building. This requires an external stimulus that can trigger the process to alter the thermal and optical properties of the materials used in the dynamic glazing [26]. Such external stimulus could be heat, voltage, an electrical current, or light. Applications of dynamic glazing include the control of glare, solar heat gain, privacy, and daylight. Dynamic glazing can reduce energy demand in buildings, including reduced annual energy and reduced peak energy demand.

This study categorises dynamic glazing technologies into passive and active systems (Figure 3). Passive systems include photochromic (PC), thermochromic (TC), and thermotropic (TT) glazing and phase change materials (PCMs) based glazing. They respond autonomously to external stimuli such as light (photochromic) or heat (thermochromic and PCM) without any additional action from the occupant or building management system. This characteristic results in simple installation and high reliability, but the disadvantage is

that their control is independent of user requirements [40,41]. On the other hand, active systems modulate their optical and thermal characteristics in response to electrical stimuli triggered by pre-established internal or external environmental conditions or by the user. Active systems in the market, electrically controllable, include electrochromic glass (EC), suspended particle devices (SPD), liquid crystal devices (LCD), and gasochromic (GC) glazing.

3.2.1. Passive Dynamic Glazing Technologies

Photochromic (PC) glazing technology

Photochromic glazing autonomously undergoes a reversible change of its thermo-optical properties according to the intensity of incident light. This property is due to organic or inorganic compounds that are incorporated into the glass during manufacture. These compounds (metal halides—chloride and silver bromide) change their optical properties by changing their molecular shape/structure when exposed to light and revert to their original state when the light is removed. This means that the glass reduces its transmittance (by increasing absorbance) as the incident light level increases [42].

Despite the benefits offered by photochromic glazing, their wider application in buildings is impeded by (i) its high cost, (ii) the limitation on the size of panels that can be manufactured, (iii) the difficulty in achieving a uniform distribution of photochromic compound inside the glass and (iv) the inability of the occupants to control their performance directly. Further advantages and disadvantages of photochromic glazing are shown at the end of this section.

Thermochromic (TC) glazing technology

The properties of Thermochromic materials change when heated up to a critical (transition) temperature T_c . An example of a thermochromic material used for window coating is Vanadium oxide, VO_2 . The critical temperature, T_c , for single-crystalline vanadium oxide, is $68\text{ }^\circ\text{C}$. As shown in Figure 9, if the temperature is below T_c , the material is visually and infrared transparent, whereas if the temperature is above T_c , it becomes infrared reflective. This occurs because, at temperatures above T_c , the atomic structure of vanadium oxide changes from monoclinic to tetragonal [43].

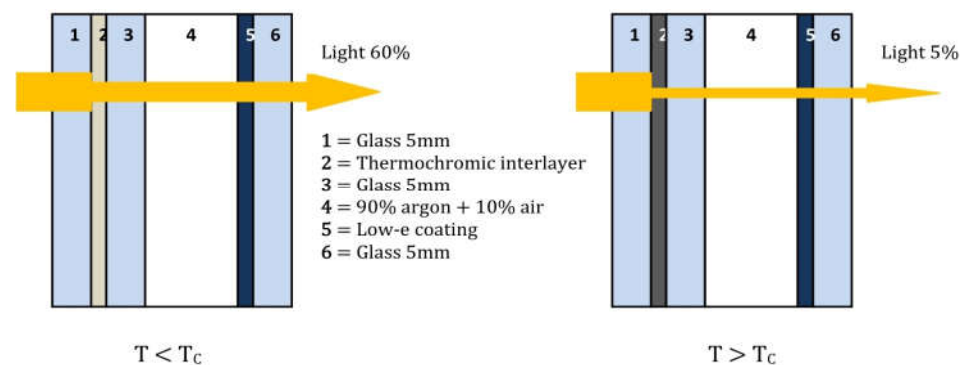

Figure 9. Thermochromic glazing changes state when the temperature reaches the critical value T_c .

Since the critical temperature of vanadium oxide ($68\text{ }^\circ\text{C}$) does not coincide with the comfort set-point temperature in buildings ($18\text{--}25\text{ }^\circ\text{C}$), additives are used to lower the critical temperature of vanadium oxide. It has been shown that to reduce the transition temperature of vanadium oxide thin films to room temperature, tungsten is the most effective dopant. In this case, a tungsten loading of only 2% is required [43].

Thermochromic layers containing thermochromic materials are integrated into glazing, as shown in Figure 9. Thus, according to the glass's surface temperature, the thermochromic glazing's optical properties can autonomously alter. TC glazing can be distinguished into two categories: the TCs, which are always transparent, as only the IR transmission is

changing, while the visible remains unchanged (VO₂-based), and the TCs, which modulate both IR and visible spectrum (TN-LC, leuco dyes, and LETC) [27].

Between the clear state (maximum transparency) and the tinted state (minimum transparency), transparency varies continuously depending on the glass temperature [12]. Further to minimising solar heat gain and maximising daylighting, thermochromic layers, acting as a shading device, help reduce glare and fading and increase occupants' comfort [44]. For a typical thermochromic glazing, the switching speed is 10–12 s [44].

For the deployment of thermochromic glazing, according to [45], the use of thermochromic materials, such as vanadium oxide, directly into the polymeric interlayer used in laminated glass, typically PVB (polyvinyl butyral) with a typical thickness of 1.52 mm is recommended. This solution introduces thermochromic glazing with minimum disruption to existing manufacturing processes, thereby reducing cost. Typical values of VT, g-value, and U-value, in transparent and opaque states, of three types of TC glazing currently in the market are tabulated in Table 1, whereas the advantages and disadvantages of thermochromic glazing are presented at the end of this section.

Table 1. Thermal and visual properties of three TC glazing units (values taken from [12]).

TC Glazing	VT	g-Value	U-Value [W/m ² K]
PLEOTINT SUNTUITIVE CLEAR			
At transparent state	0.60	0.37	1.36
At opaque state	0.13	0.17	1.36
INNOVATIVE GLASS SOLAR SMART			
At transparent state	0.55	0.36	1.36
At opaque state	0.05	0.12	1.36
RAVENBRICK RAVEN WINDOW			
At transparent state	0.33	0.28	1.36
At opaque state	0.05	0.18	1.36

Thermotropic (TT) glazing technology

The optical properties (both visible and solar) of thermotropic (TT) materials are significantly temperature-dependent and can be modulated [27]. Particularly, the optical properties of thermotropic materials are altered when their temperature reaches a specific threshold temperature (the switching temperature). At low temperatures, a thermotropic layer is clear and transparent, whereas, for temperatures greater than the threshold temperature (30–40 °C), the reflected and transmitted light is strongly scattered [46]. Thermotropic layers can be made from materials such as poly (propylene oxide), styrene-hydroxyethyl methacrylate copolymer, trifunctional isocyanate, etc. Types of thermotropic layers include phase-separating systems (Figure 10a), hydrogels [47], polymer blends [48], etc.

The constituents of a thermotropic layer are at least two components with different refractive indices. When the temperature is smaller than the threshold temperature, there is no effect due to the different refractive indices, as all constituents are mixed homogeneously at a molecular level (Figure 10a). In this state, the thermotropic layer has a median refractive index and is highly transparent to solar radiation. However, when the temperature reaches the switching point (between 30 °C and 40 °C), phase separation occurs, i.e., the components separate. Thereby a difference between the refractive indices of both constituents is created [46]. The consequence of this separation is the scattering and reflection of the solar radiation at the interface between the two constituents leading to the white colour of the layer.

An example of applying a thermotropic layer in an IGU is illustrated in the schematic cross-section of Figure 10b [49]. The thermotropic layer is applied between the two exterior glass sheets in a typical IGU. The transparent state mainly corresponds to the heating period when the outside temperature is low and solar gains are desired whereas the opaque state corresponds to the cooling period when the outside temperature is high and the solar gains are not desired as they can lead to overheating of the space. For typical thermotropic

glazing, the switching speed is 8–10 min, whereas the switching range of its g-value and VT is 0.66–0.03 and 0.72–0.32, respectively [49,50]. Commercially available thermotropic glazing has been identified in various types. For example, a double glazing thermotropic glazing consists of a thermotropic resin layer of 1.7 mm and a 2×1 mm clear glass with the change of the optical properties occurring in the temperature range $20\text{ }^{\circ}\text{C}$ to $40\text{ }^{\circ}\text{C}$, a 16 mm gap filled with air and a 4 mm clear glass pane in the innermost side. The reported U-value is $2.72\text{ W/m}^2\text{K}$, whereas the switching range of its g-value and VT is 0.69–0.51 and 0.74–0.4, respectively [51].

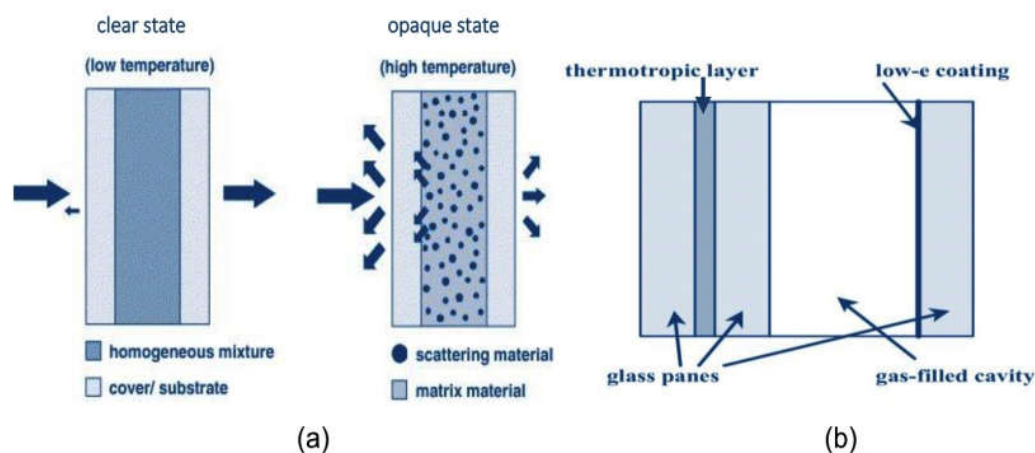

Figure 10. (a) The switching from the clear to the opaque state of a phase-separating thermotropic layer and (b) The cross-section of a thermotropic IGU (retrieved from [49]).

Thermotropic and thermochromic systems can be compared according to their influence on the buildings' energy performance. The operating principle of the first one is based on reflection, and therefore, it has more advantages. Due to the reflection, solar irradiation is prevented from entering the building and is therefore favoured compared to thermochromic glazing, which is based on absorptance. However, both glazing technologies have the ability to self-regulating control of light and heat transfer through the building envelope is their significant advantage [46], as this is achieved without the installation of active controls (although this is a disadvantage in the case of more than one objective, e.g., heating and lighting). Among their disadvantages is that user customisation is not possible and that the switching is delayed due to the heating of the layer, which restricts glare protection [52]. Furthermore, their cost, which is higher than the cost of common glazing, must be reduced [27].

Phase Change Materials (PCMs) glazing technology

Phase Change Materials (PCMs) change phases between solid and liquid states and absorb/release latent heat in an endothermic/exothermic process. PCMs are categorised as organic (paraffin), inorganic (metallics and salt-hydrates such as $\text{Na}_2\text{SO}_4 \cdot 10\text{H}_2\text{O}$), and eutectics (mixtures of organic and inorganic), integrated or micro and macro-encapsulated [53]. The melting temperature of a PCM to be used for glazing systems in buildings should be near the people's comfort temperature (around $25\text{ }^{\circ}\text{C}$) [54]. As an example, the visible transmittance, VT, of a DGU with PCM paraffin wax at the solid ($21\text{ }^{\circ}\text{C}$) and liquid state ($35\text{ }^{\circ}\text{C}$) is 0.54 and 0.85, respectively [55]. The heating and cooling loads decrease because the indoor temperature can be stabilized by the phase change cycle of PCMs. During the selection of a PCM for glazing façades applications, the significant properties to be considered are (i) a suitable temperature range for the phase change (this depends on the climate and the required design temperatures) and (ii) the PCM must be able to absorb and release significant amounts of heat energy [56].

As an example, Figure 11 shows an actual application where PCM is integrated with a TGU [57]. The TGU provides the system with excellent thermal insulation with a max U-value of $0.48\text{ W/m}^2\text{K}$, PCM storage capacity is 1185 Wh/m^2 and storage temperature

of 26–28 °C. Its VT lies in the range 0.08–0.28 or 0.12–0.44 when crystalline or liquid PCM, respectively whereas its seasonal g-value takes values in the range 0.33–0.35 or 0.06–0.09 for winter and summer, respectively.

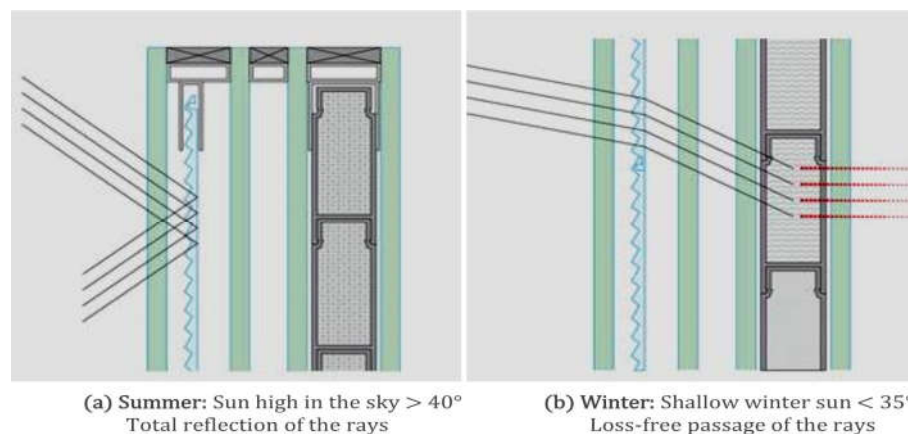

Figure 11. GlassX crystal PCM system: (a) Total reflection of the rays and (b) Loss-free passage of the rays (retrieved from [57]).

Encapsulating a PCM into glazing systems used for building envelopes can (i) significantly decrease the building energy requirements, (ii) enhance the indoor environment comfort [58,59], (iii) store solar energy, and (iv) delay peak temperatures [27]. Among their disadvantages is the overheating risk, the possibility of paraffin leakage, which may impede viewing outside, and that salt hydrates (corrosive) might impede phase segregation [27]. Further advantages and disadvantages of PCM-based glazing and the switching range of their performance metrics are shown at the end of this section, whereas other essential metrics are presented in Table 2.

Table 2. Further essential performance metrics of PCMs.

PCM	Melting Temperature (°C)	Heat Storage Capacity (KJ/Kg)	Specific Heat Capacity (KJ/KgK)	Thermal Conductivity (W/mK)	References
Paraffin wax RT25	25 ± 0.5	147 ± 15	Liq. 2.11 ± 0.11 Sol. 2.90 ± 0.15	Liq. 0.17 ± 0.01 Sol. 0.19 ± 0.01	[60]
CaCl ₂ ·6H ₂ O	27 ± 0.5	190 ± 19	Liq. 2.22 ± 0.11 Sol. 1.50 ± 0.08	Liq. 0.48 ± 0.04 Sol. 0.79 ± 0.03	[61]
LiNO ₃ ·3H ₂ O	30 ± 0.5	270 ± 27	Liq. 1.79 ± 0.09 Sol. 1.23 ± 0.06	Liq. 0.56 ± 0.03 Sol. 1.02 ± 0.05	[61]
Na ₂ SO ₄ ·10H ₂ O	30–32	241	Liq. 3.30 Sol. 1.76	Liq. 0.45 Sol. 0.554	[62]

3.2.2. Active (Chromogenic) Dynamic Glazing Technologies

Several studies have been performed to assess the impact of active dynamic glazing on a building's energy consumption and comfort [63–70]. These studies conclude that the effect highly depends on the climate, building type, and glazing orientation. However, two main issues in using active dynamic glazing are reported: the limited technical documentation among designers, glazing manufacturers, and users and their high costs [71].

This section of the study reviews the leading active dynamic glazing technologies, namely electrochromic (EC), suspended particle devices (SPD), liquid crystal devices (LCD), and gasochromic (GC). These technologies are compared based on their operation principles, performance characteristics and application potential, and their effect on energy efficiency and occupants' comfort.

Electrochromic (EC) glazing technology

Electrochromic glazing allows dynamically controlling of the light and heat entering a building, based on actual conditions, while preserving the view and connection to the outdoors. This occurs due to the altering of colour and properties of an electrochromic (EC) material when a DC voltage is applied across it (Figure 12). Particularly, the transmittance of visible and near-infrared light is changed. Electrochromic glazing is based on two types of materials, organic and inorganic [72–74]. Organic electrochromic are molecules that can alter colour under the processes of oxidation/reduction, and inorganic electrochromic include metal oxides, such as tungsten (W) and nickel (Ni) [14].

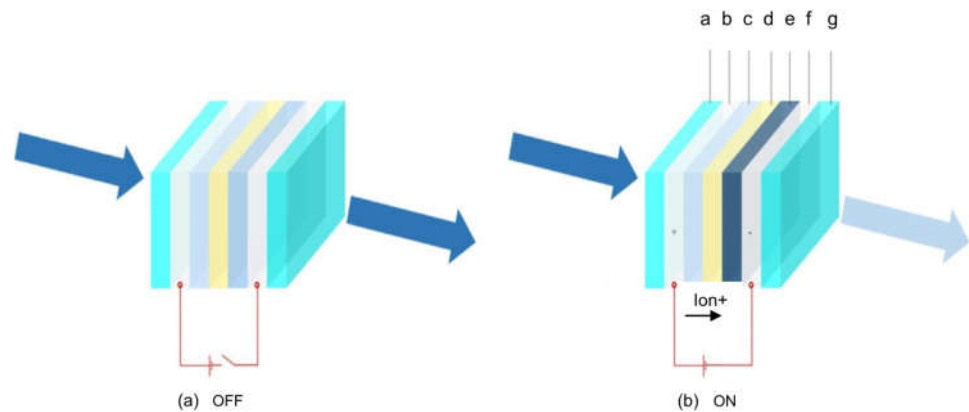

Figure 12. Schematic layered construction of electrochromic glazing in (a) OFF and (b) ON state where a = outer glass pane, b = outer transparent conductive oxides layer (TCO), c = electron accumulator, d = electrolyte, e = electrode, f = inner transparent conductive oxides layer (TCO) and g = inner glass pane.

The principle of operation of electrochromic glazing is illustrated in Figure 13. On the right-hand side figure, under a low voltage of electricity, lithium ions, and electrons migrate from one electrochromic layer to another, and the coating is darkened, whereas, on the left-hand side, lithium ions and electrons return to their initial layer, and the glass comes back to the transparent state [13]. To control this state's change, a voltage of less than 5 V DC is required. Glazing in the dark state can absorb and re-radiate away the unwanted heat, whereas, in the transparent state, it transmits daylight and solar energy. Figure 14 shows a comparison of the dynamic solar performance (g-value and VT) between electrochromic glazing (blue curve) and conventional static glazing (individual data points), providing a balance of light and heat to decrease energy demand. In contrast, in Table 3, the performance parameters of electrochromic glazing in the market are presented.

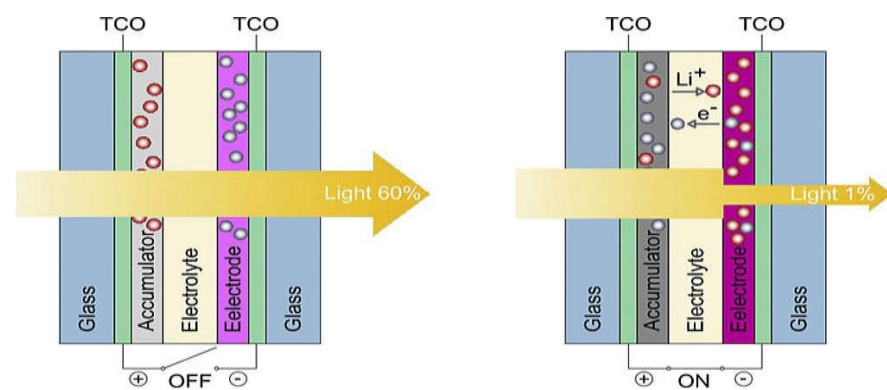

Figure 13. Schematic principle of operation of electrochromic glazing (retrieved from [13]).

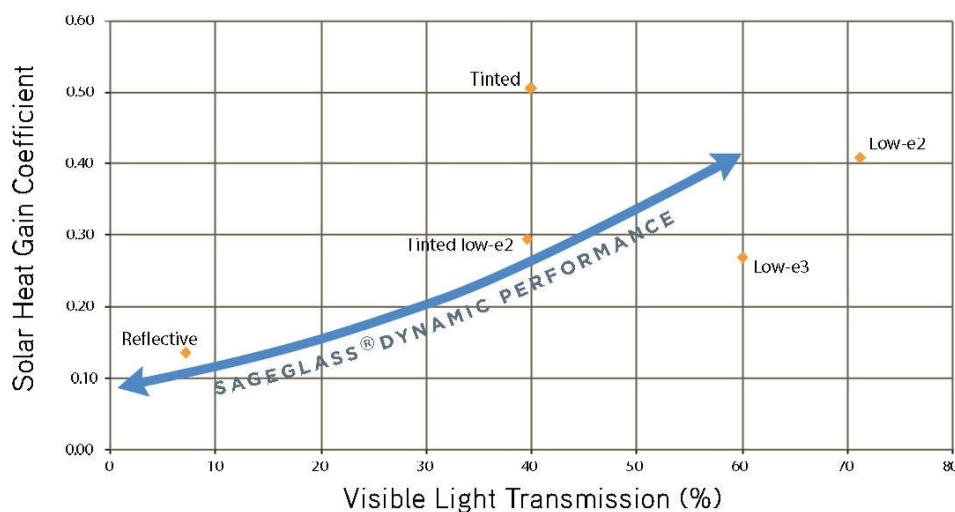

Figure 14. Electrochromic glazing solar performance (blue curve) vs. conventional glazing (individual points) (retrieved from [75]).

Table 3. Performance metrics of electrochromic glazing in the market.

Product	Sgg Sage-Glass	View Dynamic	Gesimat	Econtrol Glas	Conver Light	Gurdian	Infra-Select
Tint State	VT g-Value U _g [W/m ² K]	VT g-Value U _g [W/m ² K]	VT g-Value U _g [W/m ² K]	VT g-Value U _g [W/m ² K]	VT g-Value U _g [W/m ² K]	VT g-Value U _g [W/m ² K]	VT g-Value U _g [W/m ² K]
0	60% 0.41 1.64	58% 0.40 1.59	69% 0.49 1.10 L/e	55% 0.41 1.10 L/e	57% 0.39 1.10 L/e	50% 0.34 1.10-Ar	55% 0.40 1.10-Ar
1/3	18% 0.15 1.64	40% 0.33 1.59	N/D N/D 1.10 L/e	N/D N/D 1.10 L/e	N/D N/D 1.10 L/e	35% 0.24 1.10-Ar	N/D N/D 1.10-Ar
2/3	6% 0.10 1.64	6% 0.11 1.59	N/D N/D 1.10 L/e	N/D N/D 1.10 L/e	N/D N/D 1.10 L/e	18% 0.13 1.10-Ar	N/D N/D 1.10-Ar
3/3	1% 0.09 1.64	1% 0.09 1.59	7% 0.14 1.10 L/e	10% 0.10 1.10 L/e	15% 0.15 1.10 L/e	3% 0.06 1.10-Ar	15% 0.12 1.10-Ar

Electrochromic glazing, among the active dynamic glazings, has the longest track record and durability. Systems installed since the early 2000s are still in entire operation, while it is reported that, theoretically, their service life is expected to be from 30 up to 50 years [73,76]. However, improvement of electrochromic glazing technology, which mainly concerns increasing the number of states and the switching speed (5–10 min), is required. These improvements and a significant cost reduction are expected to lead to a larger up-take of electrochromic glazing in the buildings.

Suspended Particle Devices (SPD)

Suspended particle (SPD) glazing is electroactive. In the absence of the AC voltage, the particles are randomly scattered, blocking the light and appearing dark blue. When an AC voltage is applied to the SPD glazing, the randomly scattered and oriented particles align, and the glazing becomes transparent. SPD glazing generally has 3–5 layers [12]. Particles with optical properties that depend on polarization, such as polyhalite particles, are suspended in an organic fluid between two conductive layers of the transparent thin plastic film [77]. As shown on the left-hand side of Figure 15 (OFF mode), with the power

turned off, the glazing appears dark (or opaque), blue, grey, or black as the suspended particles are randomly oriented, and the light is blocked [78].

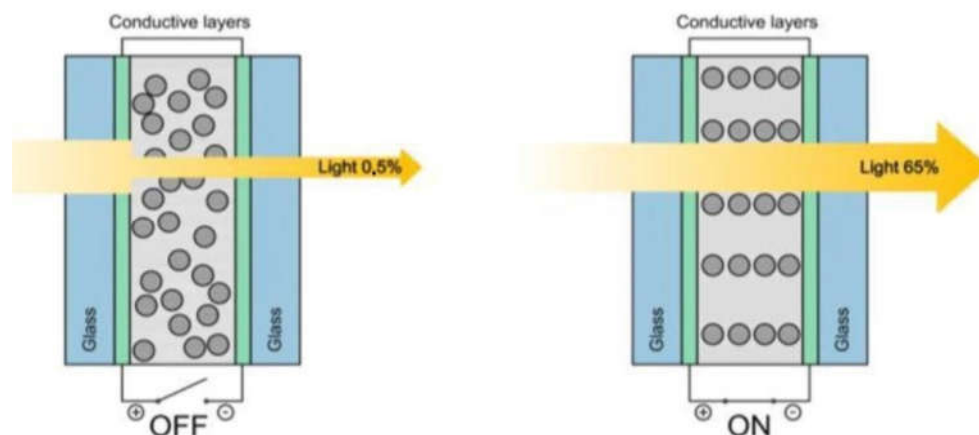

Figure 15. Schematic illustration of suspended particles devices' operation) (retrieved from [12]).

On the ON mode (right-hand-side of Figure 15), with the power switched on, light passes through as the suspended particles align, and the SPD glass panel allows see-through. Thus, the transparency of SPD glazing can modulate the amount of light and heat passing through, and the glazing becomes transparent or translucent. VT and g-value of a typical SPD glazing, at transparent and translucent states, are 0.5%–65% and 0.06–0.57, respectively [79,80]. A very high switching speed also characterises SPD glazing with a switching time of 1–3 s [81]. To change from the OFF (translucent) state to the ON (transparent) one, about 100 volts AC is required.

Additionally, the applied voltage can be regulated to any intermediate state. About 5 W/m^2 is required to switch from one state to another, whereas about 0.55 W/m^2 is needed to maintain a constant transmission state [12]. Compared to electrochromic glazing, SPD glazing has the main advantage that its control is continuous rather than discrete, i.e., its transparency may be tuned at different levels according to the voltage applied. Conversely, the main disadvantage of SPD glazing is that it requires a constant voltage to maintain the transparent state. Therefore, the energy consumption of SPD glazing is typically larger than that of electrochromic glazing. Consequently, from an energy consumption point of view, SPD glazing is preferable for applications in which glazing remains opaque most of the time. More advantages and disadvantages of SPD glazing and the switching range of their properties are shown at the end of this section.

Polymer-dispersed liquid crystal devices (LC)

Liquid crystal (LC) based glazing is electroactive. In this regard, the glass appears as a translucent layer, when the power is off, whereas when the power is on it becomes transparent [82]. An LC consists of two electrical conductors of transparent thin plastic film and a polymer matrix film between them. The dispersed within the film material is in the form of tiny liquid crystal spheres with a diameter of approximately 500 nm [4]. As shown in Figure 16, when no voltage is applied, the liquid crystal spheres are in a random and unaligned state, and the light is scattered [83,84]. Thus, the glass appears as a white translucent layer, which obscures the direct view and provides privacy [4]. On the contrary, when a voltage is applied, the randomly scattered and oriented liquid crystals are aligned, the glass becomes transparent, and the light is transmitted [85].

The transparency is modulated according to the voltage applied when the LC glazing is powered on. However, in the opaque state, the light transmittance is about 50%, while in the active state, it is less than 70% [12]. A disadvantage of liquid crystal glazing is that it is unable to achieve a considerable decrease in the g-value, which usually lies in the range of 0.39–0.53 since it cannot block enough incident solar radiation. Another disadvantage of LC glazing is that, compared to electrochromic glazing, which requires less than a 5 V DC power supply for its operation, LC glazing requires an electric field of 65–110 V AC [4].

This disadvantage leads to the continuous electricity consumption of about $5\text{--}10\text{ W/m}^2$, which is 9–18 times larger than the power an SPD glazing requires to maintain a constant transmission (about 0.55 W/m^2). Another significant disadvantage of LC glazing is that the tinted state allows no visibility. Further advantages and disadvantages of LC glazing and the switching range of their properties are tabulated and presented at the end of this section.

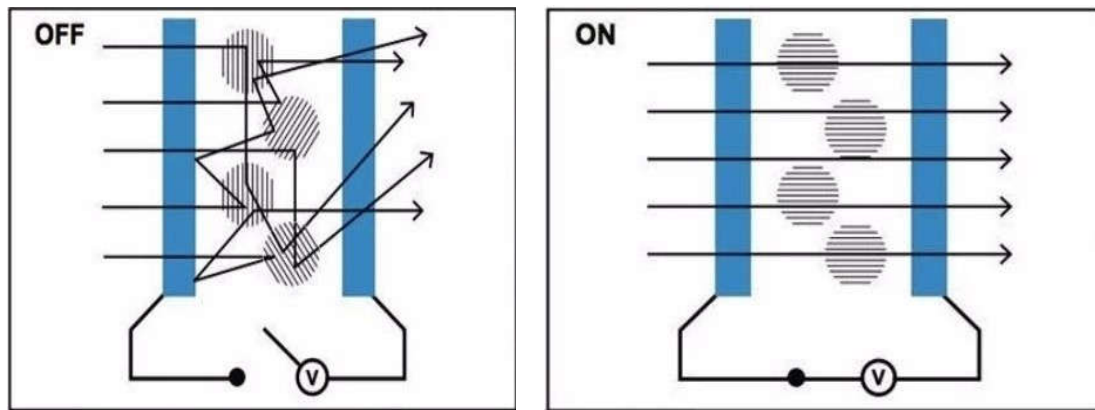

Figure 16. Schematic illustration of LC glazing working mechanism.

Gasochromic (GC) glazing technology

Gasochromic glazing technology is the most commercialised dynamic glazing technology after electrochromic. Its composition and operation are illustrated in Figure 17 [13]. Gasochromic glazing is cheaper than electrochromic due to its simpler assembly and manufacturing process. Furthermore, its transition is about 10 times faster than that of electrochromic, but a narrower operating range characterizes it and requires additional piping [86].

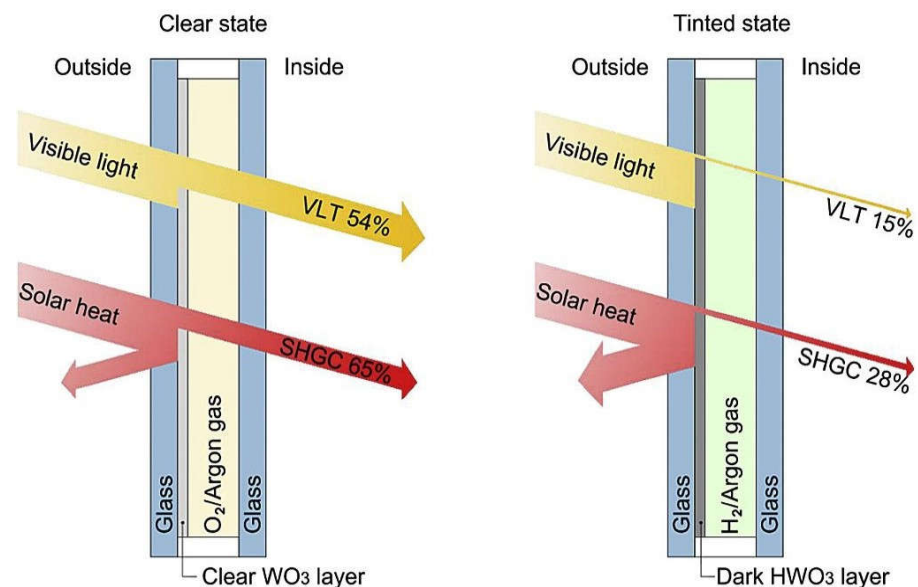

Figure 17. Schematic illustration of gasochromic glazing composition and operation (retrieved from [13]).

Gasochromic glazing exploits the properties of chemo-chromic materials, which change colouration/tint, which is caused by exposure to specific chemical elements. Comparing gasochromic glazing to electrochromic, there is evidence that the layer structure in gasochromic is simpler than in electrochromic. For instance, a WO_3 -based electrochromic

glazing includes a 4–5 layers assembly, whereas a gasochromic glazing requires only a single $\text{WO}_3\text{-Pd/Pt}$ layer. Therefore, gasochromic has a much simpler and cheaper structure [83].

The main characteristics of the dynamic glazing technologies reviewed are shown in Table 4, whereas the main advantages and disadvantages of established glazing technologies reviewed in this work are tabulated in Table 5. Table A2 of Appendix B shows examples of established glazing technologies in the market with their real key performance parameters.

Table 4. Dynamic glazing technologies' performance metrics.

Glazing Technology	U-Value [W/m ² K]	G-Value	VT	Transition Speed	Transition Criterion	References	
Passive Dynamic	Photochromic (PC)	1.80	0.45–0.28	0.75–0.25	10 min	Solar intensity	[12]
	Thermochromic (TC)	1.36	0.37–0.12	0.60–0.05	10–12 s	Temperature 25 °C	[12,44]
	Thermotropic (TT)	3.20	0.66–0.03	0.72–0.32	8–10 min	Temperature 30–40 °C	[48–50]
	Phase change (PCM)	0.48	0.68–0.37	0.80–0.50	Varies with transition temperature	Temperature 21–35 °C	[50,55,57]
Active dynamic	Electrochromic (EC)	0.48 (Air) 0.29 (Ar)	0.49–0.09	0.69–0.01	5–10 min	Voltage 5 V DC	[13,50]
	Suspended particle (SPD)	1.90	0.57–0.06	0.65–0.005	1–3 s	Voltage 100 V AC	[12,50,80,81]
	Liquid crystal (LC)	0.50	0.53–0.39	0.70–0.27	1 s	Voltage 65–110 V AC	[12,13,50]
	Gasochromic (GC)	2.62	0.65–0.28	0.54–0.15	30–60 s	Exposition to Hydrogen or Oxygen	[4,13,50]

Table 5. Features/Advantages and Limitations/Disadvantages of established glazing technologies.

Glazing Technology	Features/Advantages	Limitations/Disadvantages	References	
Static	Single Tinted	<ul style="list-style-type: none"> Reduction of glare Reduction of solar gain (Cooling-dominated climates) 	<ul style="list-style-type: none"> High U-value Reduction of VT Absorption of solar energy (Release of heat into the building) 	[5,17]
	Low-e coated	<ul style="list-style-type: none"> Reflection of NIR & IR radiation Reduction of heat re-radiation by glazing 	<ul style="list-style-type: none"> Reduction of SHGC (high values are required for heating-dominated climates) 	[5,12,17]
	Multilayer glazing/IGU	<ul style="list-style-type: none"> Low U-value Reduction of noise Used to combine various technologies 	<ul style="list-style-type: none"> High overall self-weight and thickness (especially for triple and quadruple glazing) Expensive (compared to single, tinted, coated) 	[17,18,28]
	Evacuated glazing	<ul style="list-style-type: none"> Low U-value Low U-value/thickness ratio Suitable for replacing existing windows 	<ul style="list-style-type: none"> Required pressure in the cavity of 0.1 Pa is (special pillars) The stress exerted on it by atmospheric pressure may damage the glazing unit 	[5,19–25]

Table 5. Cont.

Glazing Technology	Features/Advantages	Limitations/Disadvantages	References	
Dynamic Passive	Semi-transparent PV	<ul style="list-style-type: none"> Limiting solar heat entering the building Generation of clean electricity Production of electricity with lower environmental impact 	<ul style="list-style-type: none"> Low efficiency Low visible transmittance (translucent) High initial cost 	[5,36–38]
	Photochromic glazing	<ul style="list-style-type: none"> Reduction of lighting requirements Glare control Improvement of visual comfort More freedom and design optimization Replacement of shades and blinds 	<ul style="list-style-type: none"> High cost Differences in the time of response In the tinted state, thermal stress may be caused due to high thermal absorption Re-radiation of absorbed energy increases cooling load Inability of control by the occupants 	[12,40–42]
	Thermochromic glazing	<ul style="list-style-type: none"> Reduction of AC load Reduction of glare Improvement of thermal and visual comfort Elimination of traditional solar control devices 	<ul style="list-style-type: none"> Reduction of VT at high temperature Single-variable response Higher transition temperature than room temperature Inability of control by the occupants 	[12,27,43–45]
	Thermotropic glazing	<ul style="list-style-type: none"> Light entering the building is self-regulated Heat transfer through the façade is self-regulated Replacement of traditional solar control systems No complicated installation of active controls 	<ul style="list-style-type: none"> Reduction of VT at high temperature Delay of the switching which restricts glare control Higher cost than conventional glazing Inability of control by the occupants 	[27,46–52]
Dynamic Active	PCMs based glazing	<ul style="list-style-type: none"> Thermal energy storage is high (high latent heat) Reduction of peak loads Replacement of traditional solar control systems Reduction of building environment thermal fluctuation 	<ul style="list-style-type: none"> Thermal performance is reduced after large thermal cycles Reduction of visible transmittance in solid state Translucent /Improvement of light quality transmittance is required A chamber is required for the phase change into liquid 	[50,53–62]
	Electrochromic glazing	<ul style="list-style-type: none"> Retrofitting of existing windows Intelligent daylight management View and connection to the outdoors Automatic and manual control Precise solar control Glare control without shading devices 	<ul style="list-style-type: none"> Slow reverse reaction Not full control of glare and light spots Consumption of electricity during state changing Thermal stress in the darkened state Excessive heat radiated back into a cooled space Expensive 	[13,14,50,72–74,76]
	Suspended Particle (SPD)	<ul style="list-style-type: none"> Actively controllable Privacy control Tuning of transparency at different levels Greater comfort and energy-saving possibilities Block almost up to 100% of light 	<ul style="list-style-type: none"> Continuous voltage is required to maintain the transparent state Slightly hazy at transparent state More power is needed than electrochromic Short time in the market/ No properties verification and very expensive 	[12,50,77,78,80,81]

Table 5. Cont.

Glazing Technology	Features/Advantages	Limitations/Disadvantages	References
Liquid Crystal (LCD)	<ul style="list-style-type: none"> • Privacy control • Tinting at any level • Simple manufacturing process • Actively controllable • Preferable for privacy purposes 	<ul style="list-style-type: none"> • Continuous voltage is needed • Slightly hazy at transparent state • No visibility at the opaque state • Unable to block enough solar radiation • Unable to significantly reduce g-value 	[4,12,13,50,82–85]
Gasochromic glazing	<ul style="list-style-type: none"> • Clear visibility from inside to outside • Ten times faster change of state than EC • Simpler and cheaper structure of layers than in electrochromic, stable, no power required 	<ul style="list-style-type: none"> • Supply units of gas are needed • Piping is required • Disposal of water generated is needed • Narrower operating range 	[4,13,50,83,86]

4. Classification Scheme and Review of Emerging Glazing Technologies

Aiming to improve the overall performance, durability, and economy of already established glazing technologies by either refining existing technologies or employing alternative approaches and innovative materials for the development of new ones, new emerging glazing technologies are currently under research or development. Most of these emerging glazing technologies are about to be available in the market. The technologies examined in this section have been categorised as static and dynamic emerging technologies, as shown in Figure 18. Therefore, this section aims to review the various types of emerging glazing technologies and compare and discuss their working principles, thermal and visual characteristics, and the opportunities for their implementation and introduction in the market.

4.1. Static Emerging Glazing Technologies

Existing static glazing technologies allowed reducing heat load, limiting glare effects, and ensuring the vision through. However, these technologies do not allow tracking the weather conditions and solar route, which would result in modulating solar energy and daylight entering a building. Emerging static glazing technologies reviewed in this study include Transparent Insulation Material fillings (TIMs), suspended films, air sandwiches, heat insulation solar glass (HISG), solar absorbing, and transparent PV/Solar cell glazing.

4.1.1. Transparent Insulation Material Fillings (TIMs) Glazing

Transparent insulating material (TIM) glazing combines the two contrary requirements, namely the high visible transmittance through glazing and the high thermal insulating ability of a glazing system [10]. Typically, a TIM glazing comprises two glass panes with the TIM material encapsulated in between the glass panes. It is reported that these units can remarkably reduce shadowing and glare as well as diffuse light effectively [87]. The U-value of TIM-filled glazing, such as Okalux [88] with 40 mm thickness (Figure 19), is around 1.3 W/m²K, whereas the U-value of Okalux with 80 mm thickness is around 0.8 W/m²K. However, the most challenging issue of TIM-filled glazing is limiting a clear view to the outside.

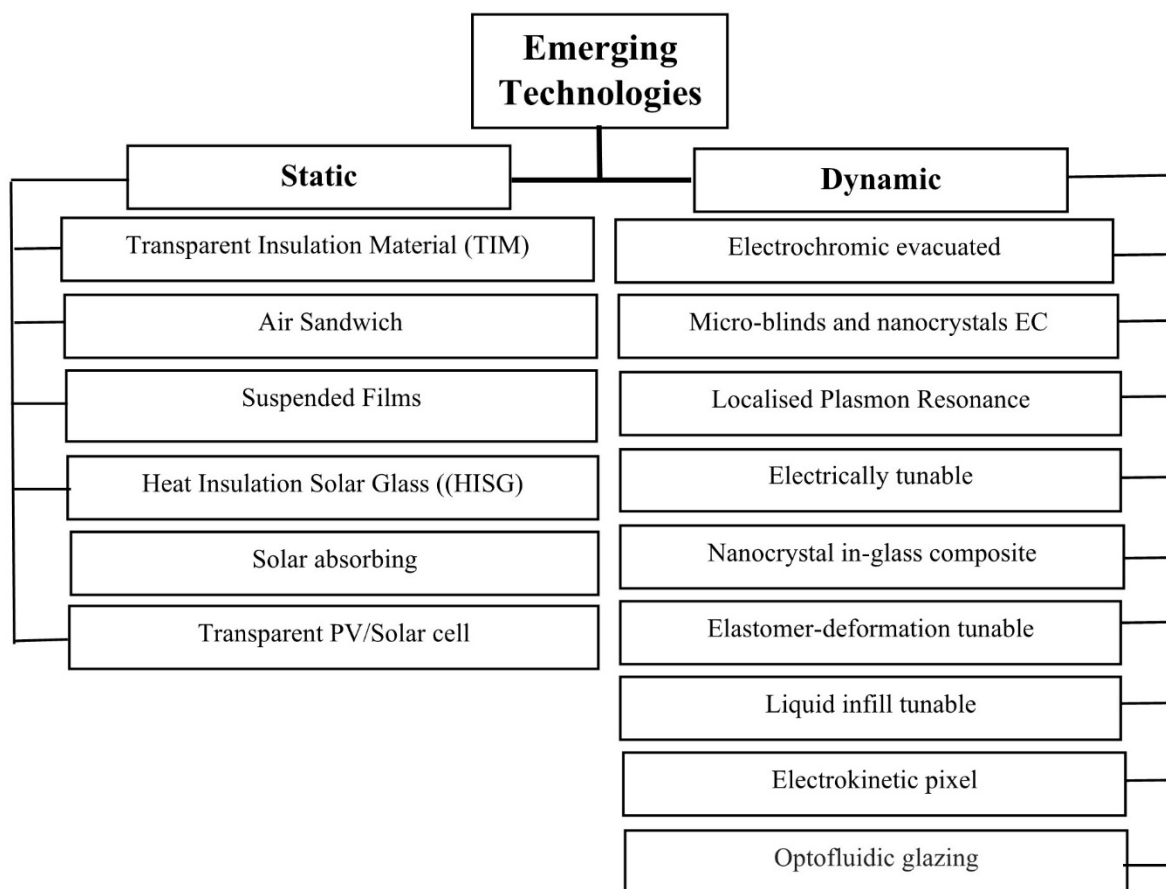

Figure 18. Classification of emerging (currently under research or development) glazing technologies sub-categorised into static and dynamic.

Contrary to their advantages, TIM-enhanced glazing systems have three significant limitations: (i) manufacturing imperfection (the thermal performance is limited due to inhomogeneous cell sizes and broken cells), (ii) too much solar radiation absorption may lead to overheating, and (iii) the production cost is high [27].

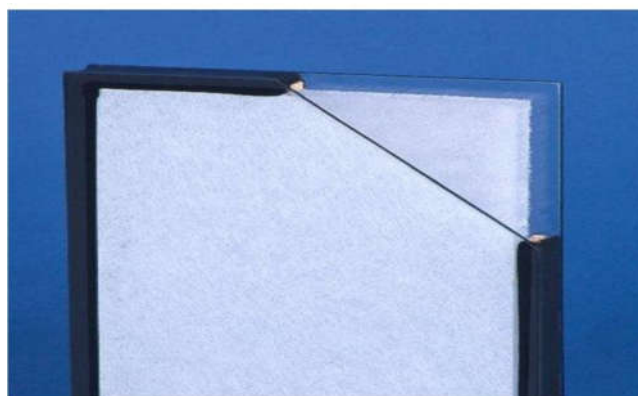

Figure 19. Schematic illustration of Okalux TIM-filled glazing (retrieved from [8]).

4.1.2. Air Sandwich Glazing

This glazing technology has been devised by Sekisui in Japan [89,90]. As shown in Figure 20, this unique product, called an air sandwich, consists of a variable number of thin plastic films with plastic spacers. For insulation, there is air between the films. The U-value and VT depend on the number of air layers, as shown with the three coloured lines, each

for a fixed width of 4, 10, or 100 mm. Each line presents an optimum point at which the U-value becomes minimum, whereas VT is depicted by the black curve with increasing values downwards on the y-axis.

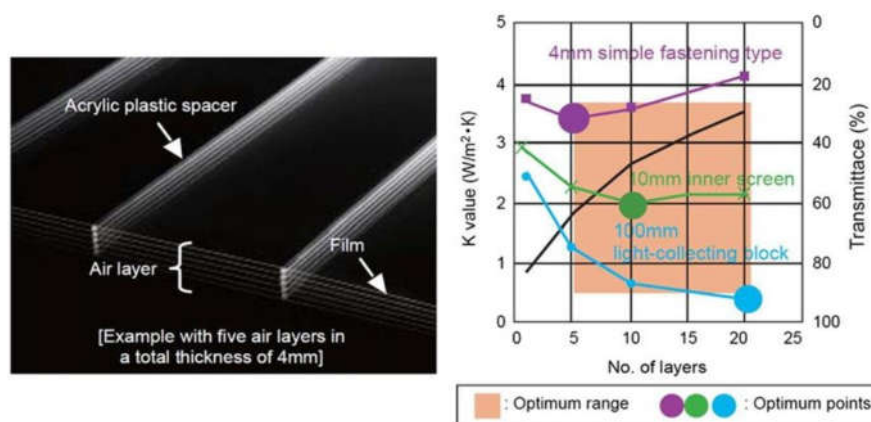

Figure 20. Schematic illustration and performance graphs of the air sandwich glazing developed by Sekisui Company (retrieved from [89,91]).

The performance graphs presented in Figure 20, show that the air sandwich glazing's thermal performance significantly depends on the number of layers used. It is worth noting that the air sandwich glazing has not been used for a long time, and its thermal performance is currently not at the level of the other glazings presented here. However, with further improvements, it may potentially become a viable material for building façades. Furthermore, some serious issues, such as the long-term durability of the plastic films, their ability to maintain smooth and parallel and their resistance to degradation by solar radiation have to be proven.

4.1.3. Glazing with Suspended Films

Suspended films have been devised aiming to improve the thermal performance of glazing by decreasing their weight. Acting as additional glass panes, they are inserted in between the two glass panes of a glazing system. Since suspended films have minimal thicknesses compared with glass panes, they produce significantly thinner and lighter multilayer glazing while providing extra thermal resistance. Two real examples of this type of glazing are products from Serious Materials (Chicago, IL, USA) and Visionwall Solutions Inc (Edmonton, AL, Canada). The glazing from Serious Materials has U-value, g-value, and VT of $0.28 \text{ W/m}^2\text{K}$, 0.17, and 23%, respectively, whereas the corresponding values of the glazing from Visionwall Solutions Inc. are $0.62 \text{ W/m}^2\text{K}$, 0.30, and 50% [11].

From the examples mentioned above, it is deduced that suspended films have competitive U-values with ordinary multilayer glazing. However, they have relatively low g-value and VT. The Visionwall product uses only air as a fill, which results in higher U-value, g-value, and VT values, whereas the Serious Materials glazing uses Xenon fill. It is worth noting that the very low U-value of $0.28 \text{ W/m}^2\text{K}$ the Serious Materials suspended films glazing has, is the lowest value among all the glazing technologies reviewed.

4.1.4. Heat Insulation Solar Glass (HISG)

Heat Insulation Solar Glass (HISG) is a multifunctional glazing technology. In this regard, various properties are combined, such as power generation, self-cleaning, thermal insulation, acoustic insulation, etc. [92]. The composition and operation of HISG are schematically illustrated in Figure 21. This figure (left-hand side part) shows that a transparent a-Si PV module is the main glazing component. This module (right-hand side part of Figure 21) is integrated with TiO_2 nanocoating providing high transmittance and low reflection. A nano TiO_2 photocatalyst coating placed in front of the PV module impedes the accumulation of atmospheric pollutants on the PV module. This plays a vital role in power

generation efficiency as it considerably minimises the light reflection from the surface of the PV module. A nanolayer insulation film with high reflectivity is fixed between two layers of spacers, reflecting the transmitted light back on the PV module, providing a secondary power generation. Rear glass is positioned behind the second spacer layer forming an air gap on each side of the heat insulation film. The two air gaps created significantly improved the thermal insulation of HISG reducing the overall heat transfer coefficient compared to conventional PV glazing. Instead of air, various types of inert gases are used to fill the gaps, providing further heat insulation. This depends on the environmental conditions required.

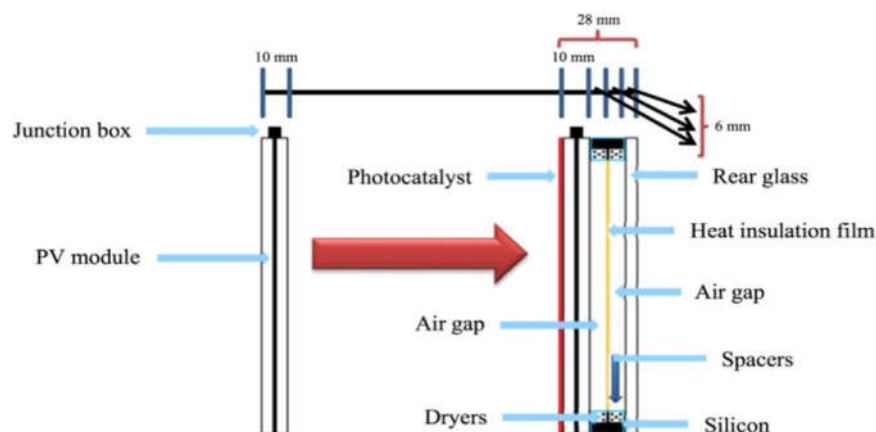

Figure 21. Schematic illustration of HISG (retrieved from [92]).

Using HISG glazing, a decrease of solar heat gain by up to 80%, compared to conventional glazing, is reported [92]. However, its VT remains low, with a value of about 7.15%. The U-value of HISG was found to be $1.10 \text{ W/m}^2\text{K}$ which is competitive with the U-value of typical triple glazing [93]. HISG glazing, having the ability to generate power (further to its significant features of thermal and sound insulation as well as self-cleaning) is expected to become widespread in the future for existing buildings retrofitting as well as for new ones, provided that its low VT and high cost will be improved.

4.1.5. Solar Absorbing Glazing

The meaning of the solar absorbing window was first reported by [94]. This system aimed to remove the heat that was absorbed and stored in the double-glazing cavity using water flow, as schematically illustrated in Figure 22.

In Figure 22a, the composition of the glazing, and the heat transfer mechanisms are schematically illustrated, whereas Figure 22b shows the water flow circuit. The water circuit starts from a water tank and a stream of clean water flows upward within the cavity between two glass sheets. Thus, the absorbed heat inside the cavity of the glazing is removed.

Numerical results show that the water circulation through the cavity of double glazing can (i) efficiently reduce the temperature of the inner glass pane, (ii) reduce heat gain in the room and consequently, the energy consumption for air-conditioning, and (iii) enhance the occupants' comfort. Furthermore, the temperature of the water flow increases due to the absorption of the heat stored in the window cavity, and therefore, it can be used to pre-heat domestic hot water.

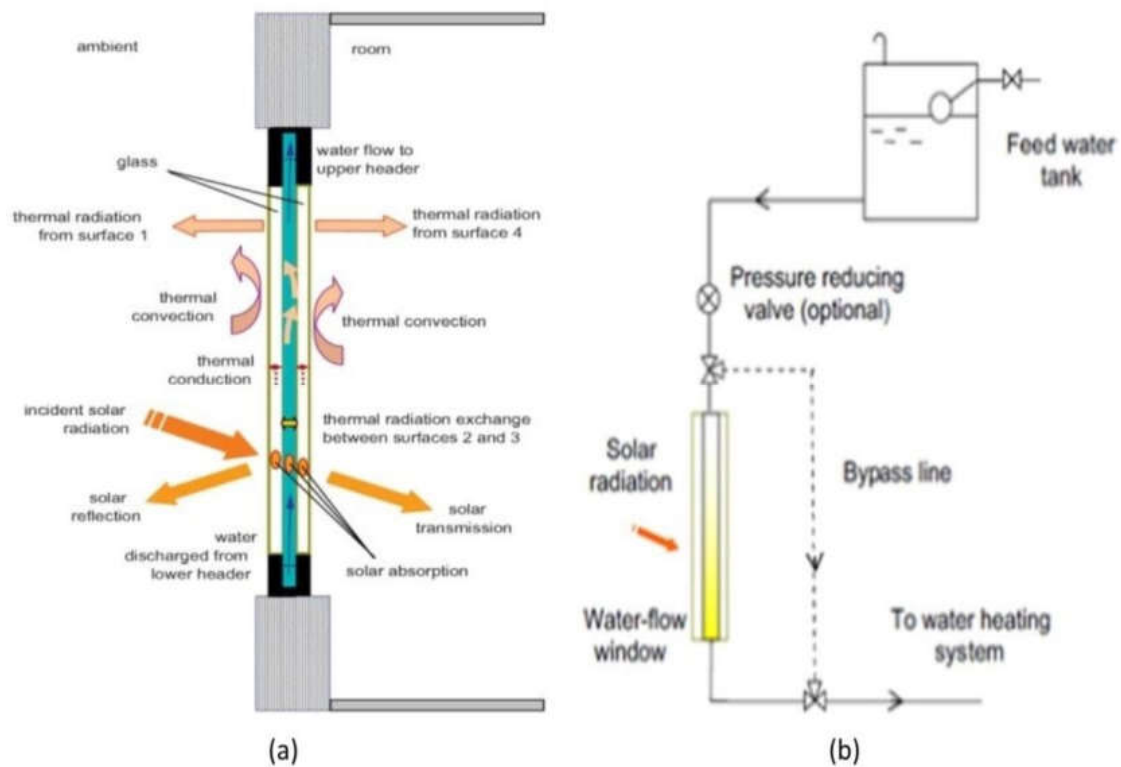

Figure 22. Schematic illustration of solar absorbing glazing (retrieved from [94]).

4.1.6. Transparent PV (TPV)/Solar Cell Glazing Technology

Transparent PV/Solar cell glazing aims to maximise the absorption of ultraviolet (UV) and near-infrared (NIR) light (to be used for power conversion) while optimizing the transmission of visible light. Figure 23a illustrates the transparent PV (TPV) concept on a glazing unit whereas Figure 23b shows a real transparent PV glazing. TPV glazing promises to lower the building’s energy use or even to cover all energy requirements on-site.

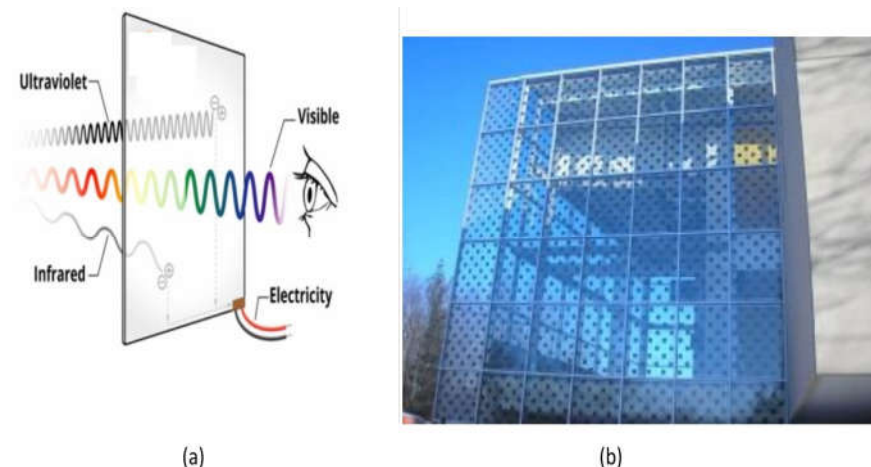

Figure 23. (a) Schematic illustration of the TPV idea and (b) an actual TPV glazing (retrieved from [95,96]).

Transparent solar cells for use in the glazing industry are a highly desirable invention. However, they are faced with a few obstacles. The main one is to find materials that can transmit the visible wavelength of the absorbed light while absorbing photons from the invisible range of wavelengths. Since such materials are difficult to find, about 80% of the technologies are still under development, requiring more improvements. Centres of TPV

research and development exist in Germany, Japan, the USA, and India. It should be noted that 90% of the technologies developed or under development, use Indium-doped tin oxide (ITO) or Fluorine doped tin oxide (FTO) conductors on glass [97,98]. According to [99], these layers reduce the transparency by approximately 15–20% before the deposition of any other materials. Thus, currently, the best transparency achieved is less than 80%.

However, some of the TPV technologies, such as polymer [100], perovskite [101], and transparent luminescent solar concentrator (TLSC) [102], are more mature than other technologies and can be found in developed countries. For instance, Heliatek manufacturer in Germany argues that they have achieved a new 7% efficiency of 40% TPV of perovskite solar panels. Furthermore, at Michigan State University, it is reported that they reached 10% efficiency from TLSC while maintaining an average transmission of about 70% [103]. Transparent PV/Solar cell glazing is not yet commercially available and is still under research and development.

4.2. Dynamic Emerging Glazing Technologies

The development of the existing dynamic glazing technologies enables modulating the g-value (thus, the amount of heat) and VT (thus, the light) penetrated through the glazing while ensuring outside vision. These dynamic glazing technologies, in particular the electrochromic ones, have been proven to be more effective than traditional static glazing regarding the reduction of energy demand for air conditioning and lighting. In addition, they provide occupants' comfort of a higher level and quality. However, the prohibitively high cost does not allow their widespread dissemination and application in the building industry. Hence, new emerging dynamic glazing technologies are currently under research or development. Emerging dynamic glazing technologies which are presented in this section include: Electrochromic evacuated (ECEVG), Integrated micro-blinds and nanocrystals (EC), Localised Plasmon Resonance (LPR), Electrically tunable, Liquid infill tunable, Elastomer-deformation tunable, Electrokinetic pixel, Nanocrystal in-glass composites glazings (NCCGs) and Optofluidic glazing.

4.2.1. Electrochromic Evacuated Glazing (ECEVG)

Recently, a combination of electrochromic and vacuum glazing in a single unit has been investigated [25,104]. To show the potential of this technology, [105] examined and evaluated ECEVG prototypes with VT of 0.63, in the transparent state, and U-values of 0.86 W/m²K. Figure 24 illustrates the layout of an ECEVG.

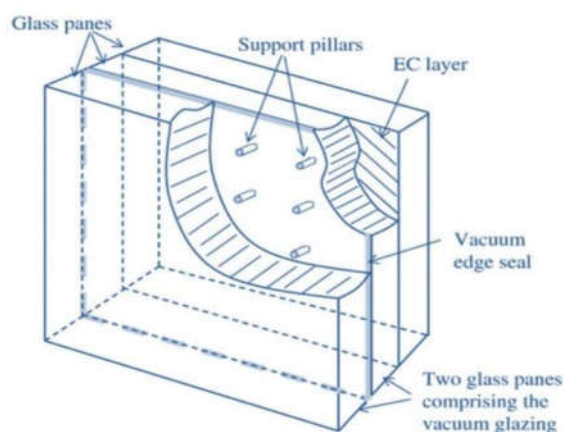

Figure 24. Schematic illustration of an ECEVG (retrieved from [104]).

According to [10], an ECEVG glazing system can be switched between clear and opaque states by applying a DC voltage. This occurs since the applied voltage modifies the density of the electrochromic layer's electrons, leading to a change in the optical properties and state of the system, and consequently, entering solar energy can be modulated. A

significant advantage of ECEVG is that it combines the transmittance of electrochromic glazing, which varies with the low heat loss characteristics of evacuated glazing. Therefore, optimal thermal comfort is achieved while energy consumption is reduced. Work on the energy performance of ECEVG showed that, due to the EC layer, about 10% of incident solar energy in the transparent state and 60–80% in the opaque state is absorbed [104]. Investigation of the energy performance of ECEVG was performed with EC layer facing outdoor or indoor environment. This investigation revealed that the temperature difference between the inside and outside glass pane, when the electrochromic layer was facing the indoor environment, was dangerously high, resulting in the breakdown of the glazing system. In the case of an ECEVG, the electrochromic layer must be placed facing the outdoor instead of the indoor environment.

4.2.2. Integrated Micro-Blinds and Nanocrystals EC

An emerging dynamic glazing technology with incorporated micro-blinds and nanocrystals-based electrochromic materials promises possible future applications in architecture. Integrated micro-blinds consist of inorganic prestressed curling electrodes with a size of the order of 100 μm . They are invisible to the naked eye being able to unwind when they are triggered by a weak electrostatic stimulus [106]. Light passes through when no voltage is applied because the blinds are curled. However, when a voltage is applied, the micro-blinds are stretched under the electrostatic forces induced by the applied voltage, and light is blocked. The performance of this glazing is comparable to that of conventional dynamic electric control glazing [12]. Currently, a few institutions, such as the University of Kassel, Germany [107], the University of Tokyo, Japan, and the Institut National d'Optique, Canada [108] are working on developing this technology.

The main advantages of this glazing technology are: (i) conductive layers of expensive indium-tin oxide are not required, (ii) very small (in the order of milliseconds) activation and deactivation times, and (iii) for further performance improvement in the unwound state, highly reflective materials are used [14]. Current development aims to create market-sized glazing that can independently modulate visible light and infrared solar radiation.

4.2.3. Localised Plasmon Resonance (LPR)

For energy-saving purposes, the reflection of solar radiation at near-infrared wavelengths is vital to prevent heat transfer into space and decrease cooling energy consumption. Therefore, for near-infrared light, reflecting coatings, attached to glazing are important [109–111]. On the other hand, achieving high light transmission in the visible range is also significant to ensure good visibility and decrease electricity consumption for lighting the space. According to [112], Fujifilm Co. Ltd. has developed a spectrally selective film (Nano Silver Pavement, NASIP), which satisfies the above requirements. It consists of randomly distributed silver nanoparticles with disk shapes that reflect near-infrared light. The physical principle of its operation is attributed to plasmon resonances between the nanostructured matter and the incoming light [109].

An LPR film with silver nanoparticles is shown in Figure 25a, whereas Figure 25b depicts a scanning electron microscope (SEM) image of disk-shaped silver nanoparticles [110]. The nanoparticles, which are in disc shape have an average diameter in the range of 100–120 nm, and their thickness is about 10 nm. Furthermore, from Figure 25b, the shape and layout of nanoparticles vary randomly. The fabricated film's spectral properties (reflectance and transmittance), which were observed experimentally, are depicted in Figure 25c.

It can be shown that the reflectance is high for near-infrared light whereas, in the visible and far-infrared regions, the transmittance maintains high. In Figure 25c, particles resonate at frequencies of light with wavelengths of about 900 nm. At this wavelength, light is reflected and scattered, whereas, at the other values of the light wavelength, it is transmitted. The reflectivity and transparency of the film can be modulated by tuning the resonant frequency by controlling the size and shape of nanoparticles.

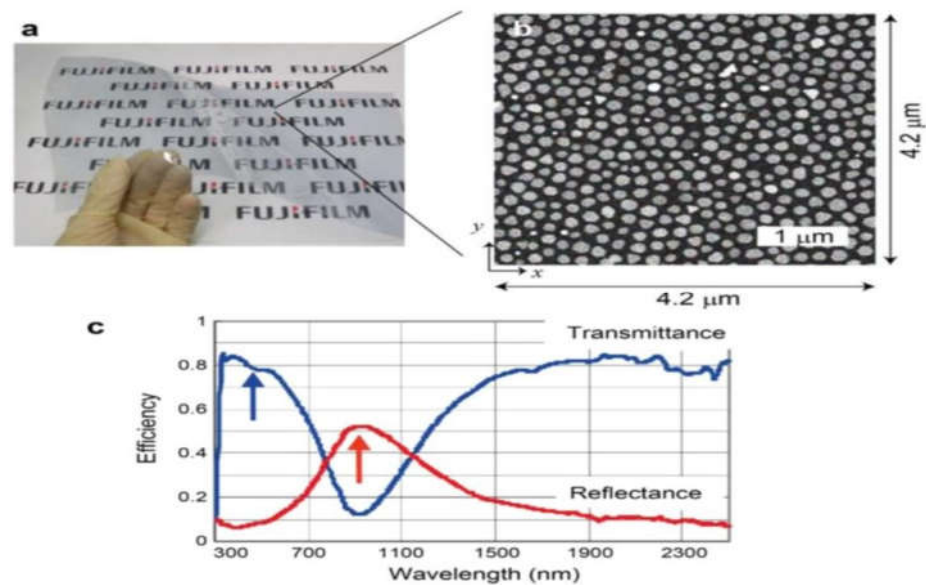

Figure 25. (a) LPR film (b) image indicating the silver nanoparticles (c) measured transmittance and reflectance of the LPR film (retrieved from [112]).

4.2.4. Electrically Tunable Glazing

According to [113], a device has been designed to control the light transmitted through significant areas, such as glazing surfaces. The main feature of this device is that without affecting its colour its transparency is tunable. Its operation is based on the distortion of the soft dielectrics caused by a voltage applied between the two electrodes on either side of the elastomer [4].

The composition of the device, as shown in Figure 26a, includes a core of stiff dielectric between two soft dielectrics, with all three placed between two electrodes at the two ends made from silver nanowires. When a voltage is applied, distortion of the soft dielectrics occurs due to the Coulomb forces induced by the potential difference. Due to this distortion, the incident light is refracted and scattered, as Figure 26b depicts, and the optical transmittance at all wavelengths is decreased. It is worth noting that since the operation of the device is based on geometric changes without any chemical changes, there is no colour change in the device [113].

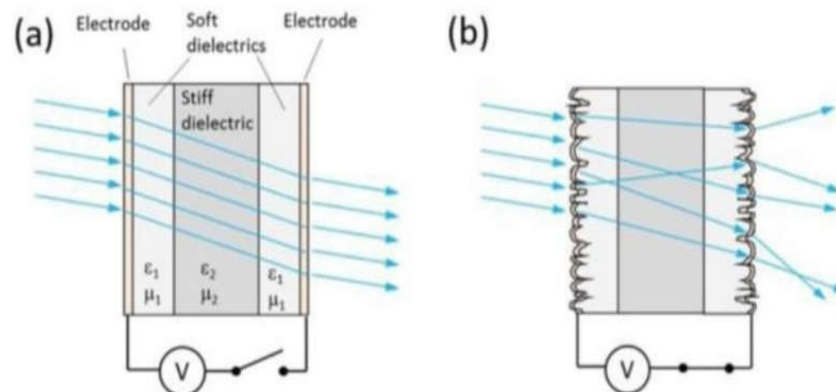

Figure 26. (a) Schematic cross-sectional illustration of the device without voltage applied, (b) with voltage source connected (retrieved with permission from [113] © The Optical Society).

4.2.5. Nanocrystal in-Glass Composites Glazing (NCCG)

Among electrochromic glazing, nanocrystal in-glass composites (NCCG) are the most promising emerging technology for improving the glazing's overall performance (thermal and visual). It allows separate and independent regulation of the transparency of visible

light (VL) and near-infrared (NIR) wavelengths, and, therefore, it is characterised as dual-band dynamic glazing technology [13].

NCCGs technology was initially developed by the University of California, Berkeley, using nanocrystals of Indium-tin-oxide (ITO) in a niobium oxide (NbOx) matrix called NIR-switching electrochromic glazing [114]. This technology, without blocking visible light transmission, allows controlling NIR radiation from a bright mode (fully transparent) to a cool mode (state without VL control), and finally, a no-tinted state (dark mode) controlling both heat and natural light as shown in Figure 27.

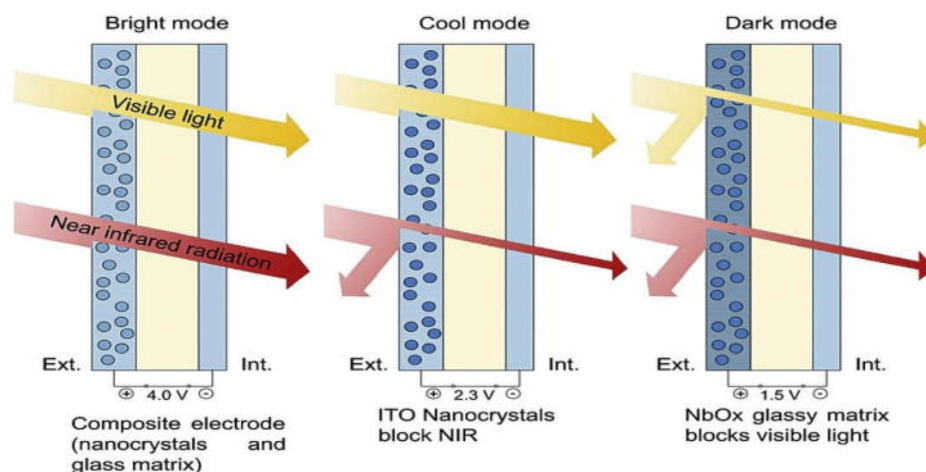

Figure 27. States of nanocrystal in-glass composites glazing of the University of California, Berkeley.

The energy performance of this glazing technology has been investigated using simulations for various types of buildings and weather conditions in the USA and compared to electrochromic glazing [115]. This investigation/comparison shows that dual-band dynamic glazings are the best energy savers for cooling and heating-dominated climates.

4.2.6. Elastomer-Deformation Tunable Glazing

This emerging dynamic glazing technology can vary from a clear to an opaque state, able to diffuse light similarly to LCD glazing. It has different properties and uses from electrochromic. It is based on a mechanical rather than an electrochemical approach to light control [113]. A schematic illustration of the composition and principle of operation of an elastomer-deformation tunable glazing is illustrated in Figure 28. The glass pane is located between two transparent soft dielectrics on which electrically conducting silver nanowires are sprayed. These nanowires do not significantly affect light transmission. They are invisible to the naked eye, and they react to electromagnetic stimuli.

The basis of the operation of this glazing technology is the geometric alteration of the glazed surface, which leads to control light scattering. Thus, the optical state of the glazing changes to any state between transparent and opaque. According to [13], without voltage applied to the system, the glazing is at the clear state, as shown in Figure 28 as nanowires are not energised. On the contrary, by applying a voltage to the system, the nanowires are energised, become electrodes, and, due to Coulomb forces, they move toward each other. Under this movement, the two layers are squeezed and deformed, leading to an irregular surface roughness since nanowires are unevenly distributed. This results in light refraction reducing the glazing VT [116].

Remarkably, the time required for the complete process is less than a second, while the value of the applied voltage can control the irregular surface roughness of the elastomer, and thus, according to this value, tuning of VT is achievable. This is an advantage compared to conventional LCD glazing, which allows only altering from a transparent to an opaque state. The manufacturing process of the subject glazing technology uses elastomer sheets available in large rolls; therefore, it is cheaper compared to the more expensive vacuum

deposition process used by chemical-based dynamic glazing technologies currently used. The best potential of this technology is the possibility of glare control while maintaining an adequate level of diffused light indoors. However, the energy performance of this technology in real-time has not been defined yet.

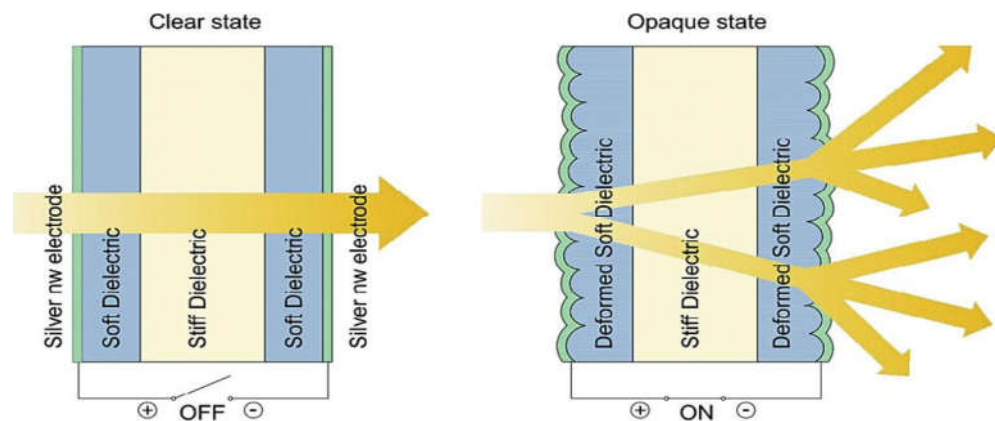

Figure 28. Schematic illustration of composition and principle of operation of elastomer-deformation tunable glazing (retrieved from [13]).

4.2.7. Liquid Infill Tunable Glazing Technology

Liquid infill tunable glazing technology belongs to purely mechanical systems in contrast to the electrochemical systems to which most dynamic glazing technologies belong. For this technology, the use of a liquid for shading purposes is employed. The liquid is pumped in or out of the cavity/cavities of insulated glazing systems. The principle of its operation is schematically illustrated in Figure 29 [13]. The liquid-based technology was developed at the Universita Politecnica delle Marche [117] and includes a triple glazing unit, with one 12 mm cavity used for thermal insulation purposes and a second cavity of 1.5 mm used for the storage tanks of the shading fluid and gas. These tanks are enclosed in the glazing frame, and the circulation of shading fluid is achieved by a pump which, when it is needed, fills the narrow cavity with the shading fluid, whereas the gas is extracted and pumped to the gas tank. Thus, the glazing unit can block unwanted light and heat. Further to the main components described above, the system also employs overflow sensors and valves required for the monitoring of liquid infill.

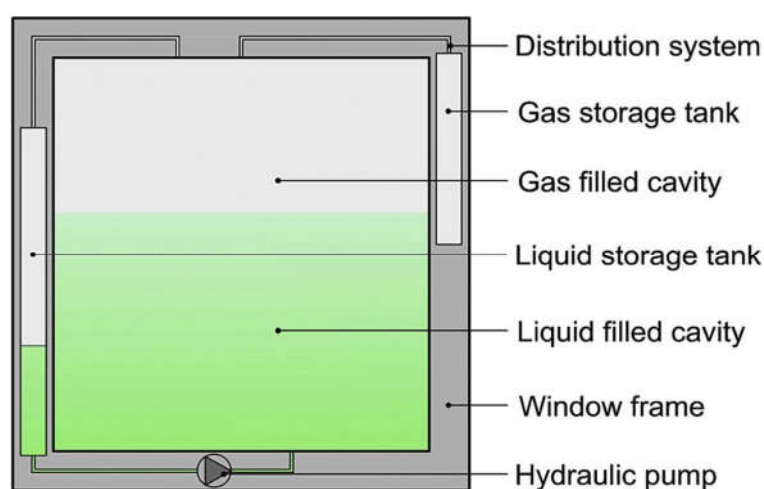

Figure 29. Schematic illustration of the principle of operation of liquid infill tunable window (retrieved from [13]).

Regarding the system's performance, experimental work revealed that the visual and thermal transmittance, at its clear and filled state, is: 68.3% with 47.2% and 16.0% with 18.3%, respectively [13].

The main disadvantage of this technology is the bulky frames needed for the accommodation of piping, pump, and liquid and gas storage tanks. Furthermore, another disadvantage may be the uneven appearance of the glazing in its partly filled state due to the fluid pumping from the bottom of the panes.

4.2.8. Electrokinetic Pixel Glazing Technology

Electrokinetic pixel glazing technology is a polarised particle technology, such as LCD technology, that aims to modulate the colour and temperature of the visible light passing through electrochromic glazing. According to [118], by controlling the movement of coloured particles via an applied voltage, it is possible to modulate separately the transmission and colour of the light entering the glazing.

Figure 30a shows that the glazing consists of two planar electrodes to control how the particles of 2 complementary colours (Blue-Yellow or Red-Cyan or Green-Magenta) carrying opposite electrical charges are dispersed. The principle of operation is schematically illustrated in Figure 30b. Each electrode can be separately charged, positively or negatively, triggering the coloured particles' movement towards another electrode.

According to [13], the movement and final concentration/position of the coloured particles determine the various states/modes characterised by different VT and light colour, as shown in Figure 30b: (i) Dark when electrodes are not charged, and both colour particles are mixed and uniformly dispersed, (ii) Clear state, when outer perimeter electrode is not charged, inner perimeter electrode is negatively charged, hexagonal grid electrode is positively charged and thus colour particles are compacted at the perimeter electrode and the micro-pits without colour dispersion. (iii) Cold hue, when the outer perimeter electrode is negatively charged, the inner perimeter electrode is not charged, hexagonal grid electrode is positively charged, and thus blue particles dispersed. In contrast, yellow particles compacted around the perimeter electrode and, (iv) Warm hue, when the outer perimeter electrode is positively charged, the inner perimeter electrode is not charged, hexagonal grid electrode is negatively charged and thus yellow particles dispersed and blue particles accumulated around the perimeter electrode. A 25 V voltage is required for switching between control states, whereas each state can be maintained with a voltage of ± 10 V [13].

4.2.9. Optofluidic Glazing

The three optical properties, transmission, reflection, and absorption, can be adapted by utilizing the concept of refractive index matching. The optofluidic glazing consists of two transparent layers and an air cavity between the two layers [14]. One of the transparent layers is roughened from the inside. The light rays are reflected and scattered due to the roughened surface, and thus, the light transmittance is reduced. The working mechanism of the optofluidic glazing utilizes the total internal reflection between the material-air interfaces. The cube reflectors reflect the light incident upon them back to the source, whereas the light transmittance increases when the intermediate space is filled with fluid. As the fluid's refractive index increases compared to that of the surrounding material, the refraction decreases, and the transmittance increases.

It is worth mentioning that optofluidic glazing has various maintenance problems. For instance, leakage and low air temperature (less than the freezing point of the liquid) are reported [14]. However, recently, sealed modules have been manufactured using Vero Clear photopolymer [119]. Figure 31 shows a novel optofluidic glazing prototype that can modulate the transmittance of visible light from 8% to 85%. Due to the capability to modulate reflectance and transmittance, solar loads can be controlled, and consequently, the efficiency of heating, ventilation, and air conditioning increases. Furthermore, privacy

panels, dynamic camouflage, and architecture are reported as additional applications of optofluidic glazing [119].

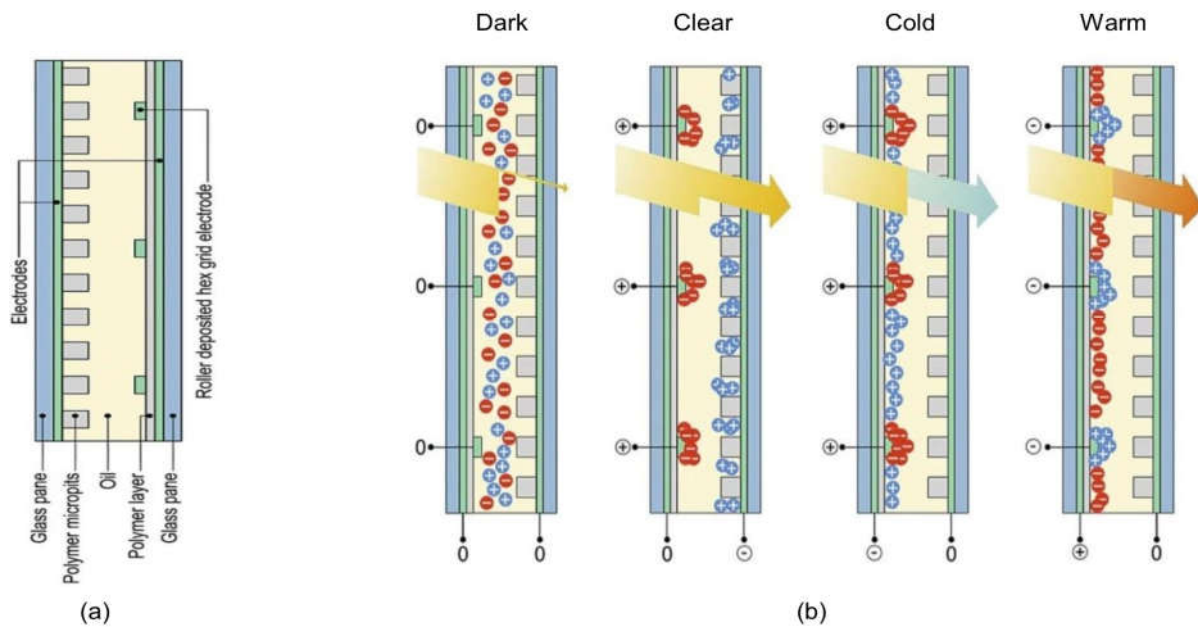

Figure 30. Schematic illustration of: (a) composition and (b) operation principle of electrokinetic pixel glazing technology (redrawn from [13]).

The main advantages and disadvantages of emerging glazing technologies are tabulated and presented in Table 6.

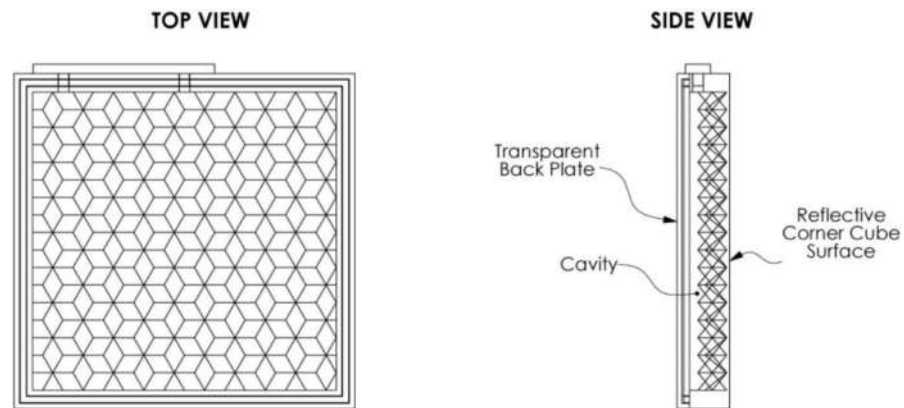

Figure 31. Schematic view of optofluidic glazing prototype (retrieved and modified with permission from [119] © The Optical Society).

Table 6. Features/Advantages and Limitations/Disadvantages of emerging glazing technologies.

Glazing Technology	Features/Advantages	Limitations/Disadvantages	References
Static	<ul style="list-style-type: none"> Reduction of glare U-value and VT vary with the number of air layers Relatively simple process 	<ul style="list-style-type: none"> It has lower thermal performance currently It has not been used for a long time Vulnerable to degradation due to solar radiation 	[89–91]
	<ul style="list-style-type: none"> Among all the glazing technologies it has the lowest U-value Significantly thinner and lighter 	<ul style="list-style-type: none"> Relatively low g-value (High values are needed for cold climates) Relatively low VT 	[11]

Table 6. Cont.

Glazing Technology	Features/Advantages	Limitations/Disadvantages	References
Transparent PV	<ul style="list-style-type: none"> Optimisation of VT and power generation High potential to cover more than 40% of a building's energy needs 	<ul style="list-style-type: none"> Low efficiency Currently, its cost is very high At an early stage of development 	[95–99,101–103]
Heat Insulation Solar Glass (HISG)	<ul style="list-style-type: none"> It provides thermal insulation, power generation, self-cleaning, and acoustic insulation (Multi-functional glazing) Lower U-value compared to conventional PV 	<ul style="list-style-type: none"> Very low VT Improvement of its high cost is needed 	[92,93]
Transparent Insulation Material (TIM)	<ul style="list-style-type: none"> High g-value Significant reduction of heat loss Significant increase in solar gain 	<ul style="list-style-type: none"> Imperfection in the manufacturing process Very high production cost Overheating may occur due to high levels of solar radiation absorption 	[27,87]
Solar absorbing	<ul style="list-style-type: none"> Reduction of inner pane temperature Room heat gain is decreased Air-conditioning electricity reduction Enhanced thermal and visual comfort 	<ul style="list-style-type: none"> Complicated installation Piping and controls are needed Considerable space is required for piping and feed water tank 	[94]
Electrochromic evacuated	<ul style="list-style-type: none"> Optimal thermal comfort Reduction of energy consumption It can be combined with other technologies 	<ul style="list-style-type: none"> High cost A voltage source is needed Longer time to be used is needed 	[10,25,104,105]
Dynamic Micro-blinds and nanocrystals electrochromic	<ul style="list-style-type: none"> Small activation and deactivation times Expensive indium-tin oxide is not needed Independent control of visible light and infrared radiation 	<ul style="list-style-type: none"> Electrostatic stimulus is needed Longer time to be used is needed 	[12,14,106–108]
Electrically tunable	<ul style="list-style-type: none"> Tunable transparency without affecting the glazing colour Control of transmittance of light incident Reduction of lighting energy consumption 	<ul style="list-style-type: none"> At the beginning of the development A longer period of use is needed for the validation of its performance 	[4,113]
Nanocrystal in-glass composites	<ul style="list-style-type: none"> Dual-band dynamic control (independent control of VL and NIR light) Relatively lower cost A wider range of control 	<ul style="list-style-type: none"> Use for longer time is needed for validation of its performance 	[13,114,115]
Electrokinetic pixel	<ul style="list-style-type: none"> Separate modulation of colour and light transmittance Low switching times Control of privacy Lower cost 	<ul style="list-style-type: none"> VL and IR radiation at a lower control range Use for a longer period is needed for validation of its performance 	[13,118]
Elastomer-deformation tunable	<ul style="list-style-type: none"> Switching time less than a second Modulation of privacy Lower cost 	<ul style="list-style-type: none"> No view in the opaque state VL and IR radiation at a lower control range 	[13,113,116]

Table 6. Cont.

Glazing Technology	Features/Advantages	Limitations/Disadvantages	References
Liquid infill tunable	<ul style="list-style-type: none"> • Short switching times • Lower cost • Shading modulation 	<ul style="list-style-type: none"> • VL and IR radiation at a lower control range • Uneven appearance at partly filled state • Bulky frames are needed for tanks 	[13,117]
Localised Plasmon Resonance	<ul style="list-style-type: none"> • High light transmission in the visible range • High reflectance for NIR light • Cooling energy consumption is reduced • Transparency and reflectivity are modulated 	<ul style="list-style-type: none"> • At the beginning of the development • A longer period of use is needed for the validation of its performance 	[109–112]

5. Discussion-Conclusions-Challenges for Future Action or Research

During the last few decades, glazing technologies have rapidly evolved. Despite that, neither comprehensive nor holistic research is identified systematically, reviewing and classifying the various options of glazing technologies. This paper is a systematic review and classification of established and emerging glazing technologies for building façades aiming to meet this gap.

This study provides collection, analysis, and taxonomy of the current information regarding glazing technologies used for buildings' façades. It systematically reviews established and emerging glazing technologies, classifying them according to their functionalities/working principles. Established technologies are the ones that are currently available on the market, whereas the emerging are the ones that are still in the research stage or under development.

The work is focused on the underlying principles of their operation, and their salient performance metrics and has been performed following the PRISMA protocol and guidelines for review studies. The primary target of this study is to gather, analyse, compare, and classify the primary information in the glazing technologies field, providing the reader with a tool helpful for the early design stage of building façades.

Established glazing technologies are sub-categorised into static and dynamic technologies. Static glazing technologies have thermal and optical characteristics that cannot be modulated according to the environmental conditions or occupants' needs, while dynamic glazing technologies have optical and thermal characteristics that can be passively or actively altered, thereby changing the daylight and solar heat gain entering a building.

Among the static glazing technologies, it was found that:

1. Multilayer, aerogel, and evacuated glazing have low overall heat transfer coefficients. However, they are relatively complex and costly, whereas double and triple-insulated glazing has a lower cost and well-documented fabrication processes. They, therefore, have been broadly established in the market. Nevertheless, evacuated and aerogel glazing is expected to increase their market share soon, especially for heating-dominated climates, due to their significantly lower U-values ($0.30 \text{ W/m}^2\text{K}$).
2. The lowest U_g -values found are $0.30 \text{ W/m}^2\text{K}$ and $0.28 \text{ W/m}^2\text{K}$ for aerogel glazing and suspended film insulating glass, respectively. Although aerogels are already in use for translucent applications, they need to improve their transparency and reduce their upfront cost for wider use as a component of building glazing façades.
3. Evacuated glazing is characterized by high visible transmittance and low heat loss. An advantage of evacuated glazing, compared to multilayer glazing, is the low thickness of the glazing unit. This can be a remarkable advantage, mainly when replacing existing windows. A triple evacuated glazing, for instance, with only 16 mm total thickness and four low-e coatings with 0.03 emissivity, could have a U_g -value of $0.24 \text{ W/m}^2\text{K}$. This is a much better U-value than what conventional triple-glazing

units have ($0.90 \text{ W/m}^2\text{K}$). However, the main drawbacks of this system are its high cost and difficulties in manufacturing larger-sized glazing.

4. Photovoltaic glazing, when integrated into highly glazed buildings, outperforms all other commonly used glazing systems. Nevertheless, a few limitations/barriers of PV glazing impede some architects and building developers, from deciding to use semi-transparent PVs at the final design stage. Notable limitations include their high initial cost and low efficiency (high cost-to-efficiency ratio), low visible transmittance (views in/out may be impaired), durability, and limiting solar heat entering the building (particularly for heating-dominated locations).

It is worth mentioning that, apart from having a low U-value, glazing technologies should also be able to modulate the solar radiation penetrating a building. In this regard, dynamic glazing systems can be used to control the amount of heat and light entering a building according to the ambient conditions and the occupants' needs. Compared to the static glazing systems, they behave closer to the ideal glazing and, thereby, provided that a low U-value is achievable, they improve building overall performance further, with the possibility to adapt to different kinds of contexts (i.e., climate, orientation, building use, occupants' needs, etc.).

Particularly, among the dynamic glazing technologies, it was found that:

1. Suspended particle (SPD) and Liquid crystal (LC) glazing technologies are both actively controllable, providing transparency tuning at different levels. Thus, they are used for glare control and privacy according to occupants' needs. This can be achieved using an active layer with variable solar and light transmittance controlled by an external electric field. The same disadvantages characterise LC and SPD glazing; both technologies, to maintain their transparent mode, need an electric field. This requirement results in larger energy consumption than electrochromic glazing, which requires voltage only during switching.
2. Electrochromic (EC) is particularly interesting among the different dynamic glazing technologies. It is currently used to control solar radiation, with a g-value varying from 0.50 to 0.09. EC glazing results in a remarkable decrease in energy consumption needed for air conditioning and lighting during cooling and heating periods. It is evident that in cooling-dominated climates, EC glazing can decrease the lighting energy consumption by up to 26% and the peak cooling loads by about 20%, compared to systems with blinds [26].
3. Gasochromic (GC) glazing technology is the most commercialised dynamic glazing technology after EC. GC is cheaper than EC due to its simpler assembly and manufacturing process. Furthermore, its switching is about 10 times faster than that of EC. However, the performance characteristics of EC outweigh those of GC.

Emerging glazing technologies reviewed in this study are currently under research or development, aiming to improve the performance, economy, and durability of already established technologies by either refining existing technologies or employing alternative approaches and innovative materials to develop new ones. In this regard, due to the significant progress in materials science (nanomaterials), there are opportunities, to design and develop new innovative and multifunctional glazing systems. Emerging technologies have been reviewed and compared, evaluating mainly the physics principles and complexity of their operation, and their Thermo optical performance. Their building application potential and the opportunities for their implementation and introduction in the market have also been compared and discussed, and relevant data are provided to contribute to understanding the impacts on buildings' energy efficiency and occupants' comfort.

The following conclusions regarding emerging glazing technologies can be noted:

1. From the emerging static technologies, suspended film glazing has a competitive U-value with ordinary multilayer glazing while it is significantly thinner and lighter. Its very low U-value ($0.28 \text{ W/m}^2\text{K}$) is the lowest among all the glazing technologies

- reviewed. However, it has a relatively low g-value and VT. Thus, it could be used for cooling-dominated climates provided its low VT will improve.
2. Heat Insulation Solar Glass (HISG) is a multifunctional glazing technology that can generate power (further to its significant features of thermal and sound insulation and self-cleaning). Thus, it is expected to become widespread for existing buildings retrofitting as well as for new ones, provided that its low VT and high cost will be improved.
 3. The absorbed heat inside the cavity of a multilayer glazing can be removed by the solar absorbing glazing avoiding the creation of overheating phenomena. Therefore, it can efficiently reduce the inner glass pane temperature and decrease the room heat gain, thus, the air-conditioning electricity consumption while enhancing the occupants' thermal and visual comfort. Furthermore, the water flow absorbing the heat stored in the glazing cavity increases its temperature, and therefore, it can be used for domestic hot water pre-heating. However, its limitations (complicated installation, required considerable space due to piping, controls, and feed water tank) must be overcome before entering the market.
 4. As an emerging dynamic technology, electrochromic evacuated glazing combines the variable transmittance of electrochromic glazing with the low heat loss properties of evacuated glazing to achieve optimal thermal comfort while energy consumption is reduced. Among its limitations, the high cost and the necessity of a voltage source are highlighted further to the requirement of a long time to be used. The electrically tunable glazing is characterised by tunable transparency; thus, it can control the transmittance of light incident on the façade. Since this technology is at the beginning of its development, it must be used longer to validate its performance.
 5. Liquid infill tunable glazing technology, another promising emerging dynamic technology can prevent unwanted light and heat from entering the building. The main disadvantage of this technology is the bulky frames needed for the accommodation of piping, pump, and liquid and gas storage tanks.
 6. The two glazing technologies, namely Nanocrystal in-glass composites and electrokinetic pixels, refer to the selectivity of NIR and VL transmission, respectively. For these technologies, improved switching time compared to electrochromic technology is expected. However, all these new technologies, except for Nanocrystal in-glass composites, have a lower control range, and currently, only Electrokinetic pixels and Elastomer deformation tunable glazing can achieve privacy in the tinted state.

The glazing market currently offers highly thermal insulated glazing systems with U-values smaller than $0.9 \text{ W/m}^2\text{K}$ for double glazing and $0.4 \text{ W/m}^2\text{K}$ for triple glazing, comparable to the U-values of the opaque building envelope components. However, glazing technologies and systems with integrated devices, innovative materials, processes, and control strategies are still under research and development to modulate the incident solar radiation continuously and dynamically to optimise incoming thermal and lighting flows. The current glazing technologies developed for solar radiation control cannot satisfy living spaces' energy efficiency and environmental conditions requirements. Emerging glazing technologies that are currently under research or development are promising to satisfy new and existing buildings by automatically and continuously varying the energy and light transmittance according to external weather conditions and occupants' requirements. These technologies, along with control systems and strategies monitoring the lighting and air conditioning operation, may result in considerable energy and environmental savings and ensure the improvement of occupants' comfort. However, attention should be given to their hardness, durability, and whole-life economy.

The information gathered from the reviewed studies, as interpreted, and discussed in the current work, provides a helpful tool for finding the most promising technologies. Although the main performance metrics reported by the authors of reviewed papers were U-value, g-value, VT, (and some additional performance metrics for PV solar glazing, PCM, and switchable), the used metrics, many times, do not represent all required parameters for

evaluating a technology within its category. Therefore, it is concluded that it is necessary to categorise and specify the metrics required in a standard way to make it more efficient and helpful to evaluate and compare different glazing technologies.

As it is reflected by the variety of technologies and products available, with different features, purposes, and performances, which are reviewed through this study, it is necessary to redefine the concept of an ‘ideal glazing system’, based on the ‘one-fits-all approach’. In this way, it can adapt to context-specific and multifunctional requirements. The ideal system, among others, should be spectrally tunable, self-powered, with high visible transmittance, and independently modulated in NIR and visible spectra.

Moreover, from the research point of view, we are passing from a simple /clear design objective/requirement related to the glazing, minimizing the heat losses through the glazing, to a wide range of technological solutions for different multifunctional requirements. These requirements have the possibility (now that the technology allows it) of designing and integrating complex multifunctional transparent systems. For the improvement of established glazing technologies, multilayer glazing, evacuated glazing, aerogels, PCM, electrochromic, integrated PV solar glazing, and combined configurations of different technologies, have considerable potential. Therefore, future glazing façades might be units that can perform several more functions than the current glazing units. That is, multifunctional glazing façades may emerge, which might be part of a multifunctional building envelope, addressing, at an affordable cost, all the users’ requirements concerning energy production, energy efficiency, daylight, and occupants’ comfort and well-being.

Author Contributions: Conceptualization, M.M.; methodology, M.M.; formal analysis, M.M.; investigation, M.M.; resources, M.M.; writing—original draft preparation, M.M.; writing—review and editing, M.M., Q.J., F.F., A.L.-N. and M.O.; visualization, M.M.; supervision, M.O., F.F., Q.J., and A.L.-N.; project administration, M.M.; funding acquisition, M.M. and Q.J. All authors have read and agreed to the published version of the manuscript.

Funding: This research has been developed in the framework of a Ph.D. research project. The Cambridge author gratefully acknowledges the EPSRC for funding this research through the EPSRC Centre for Doctoral Training in Future Infrastructure and Built Environment (EPSRC grant reference number EP/L016095/1). The Chinese author would like to acknowledge the financial support from the National Natural Science Foundation of China (Grant No. 52278039). The funders had no role in the design of the study; in the collection, analyses, or interpretation of data; in the writing of the manuscript; or in the decision to publish the results.

Data Availability Statement: The data presented/discussed in this review study are available in the corresponding cited published articles. No new experimental data were created by the authors under this study.

Conflicts of Interest: The authors declare no conflict of interest.

Appendix A

PRISMA 2020 flow diagram for new systematic reviews, which included searches of databases and registers only.

For the paper titled ‘A systematic review and classification of glazing technologies for building façades’.

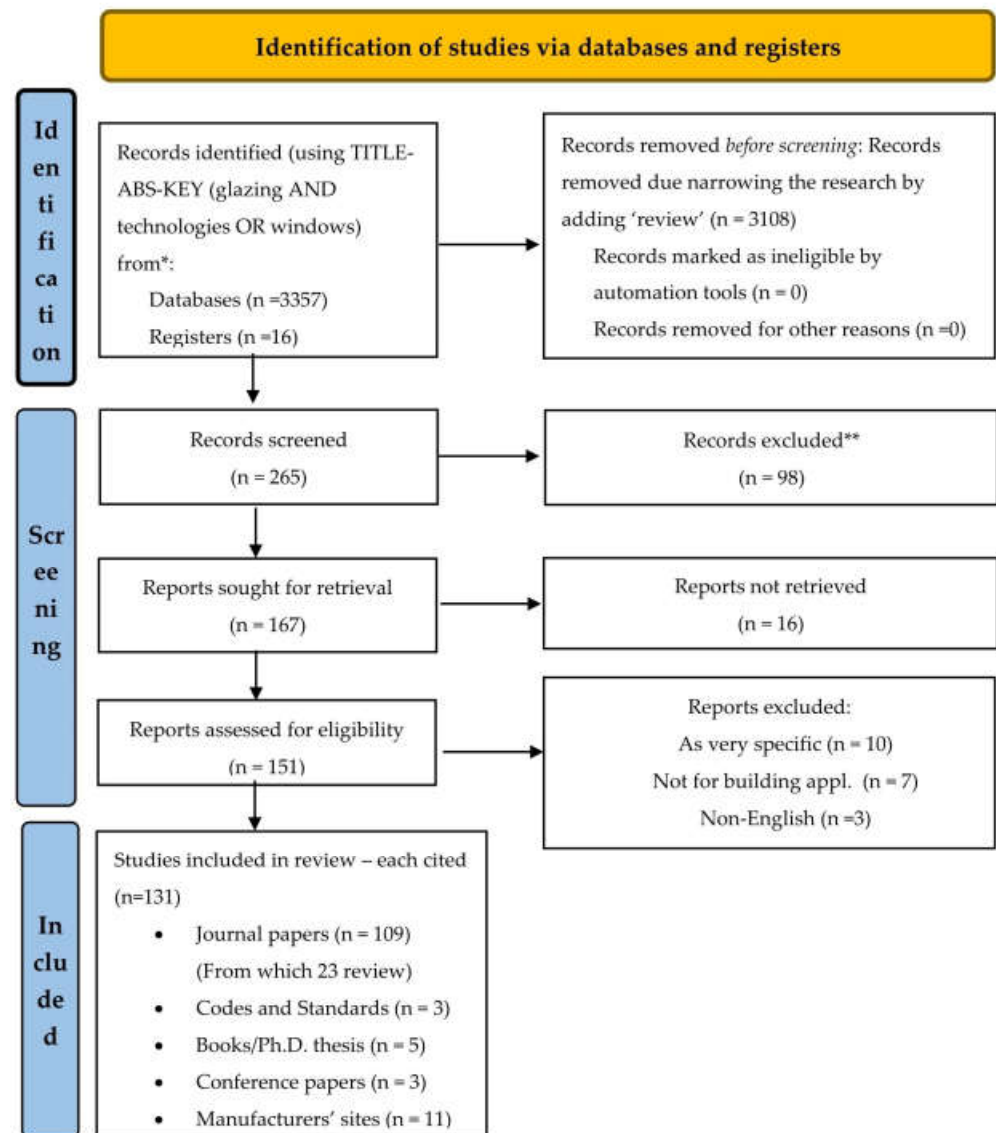

Figure A1. PRISMA 2020 flow diagram for the systematic review * Consider, if feasible to do so, reporting the number of records identified from each database or register searched (rather than the total number across all databases/registers). ** If automation tools were used, indicate how many records were excluded by a human and how many were excluded by automation tools. From: Page, M.J.; McKenzie, J.E.; Bossuyt, P.M.; Boutron, I.; Hoffmann, T.C.; Mulrow, C.D.; et al. [120] The PRISMA 2020 statement: an updated guideline for reporting systematic reviews. For more information, visit: <http://www.prisma-statement.org/> (accessed on the 22 December 2022).

Table A1. Previously performed review research on glazing technologies.

No.	Authors	Year	Journal	Title	Comments
1	Brzezicki, M. [14]	2021	<i>Sustainability (Switzerland)</i>	A systematic review of the most recent concepts in smart windows technologies with a focus on electrochromic	This is the only systematic review in the field found during the literature search, although this paper focuses on electrochromic windows only.
2	Brito-Coimbra, S. et al. [121]	2021	<i>Energies</i>	Building façade retrofit with solar passive technologies: A literature review	This paper reviewed façade retrofit using passive solar technologies (sunspaces, shading, Trombe wall technologies, etc.).
3	Feng, F. et al. [122]	2021	<i>Energy Build.</i>	A critical review of fenestration/window system design methods for high-performance buildings	A review paper that analyses design studies of windows for high-performance buildings
4	Singh, D. et al. [123]	2021	<i>In Environmental Science and Pollution Research</i>	Review on the progress of building-applied/integrated photovoltaic system	This paper reviews BAPV/BIPV building integrated systems focusing on the factors that affect their design and performance.
5	Ghosh, A. [124]	2020	<i>Journal of Cleaner Production</i>	Potential of building integrated and attached/applied photovoltaic (BIPV/BAPV) for adaptive less energy-hungry building's skin: A comprehensive review	This paper includes a review of photovoltaic (PV) glazing encapsulation in a façade by superseding the traditional structural material.
6	Rai, V. et al. [125]	2020	<i>Adv. Eng. Mater.</i>	A Review on Recent Advances in Electrochromic Devices: A Material Approach	This paper consists of a review of EC materials and devices. Their operation mechanism is described and presented. Additionally, recommendations for the improvement of their performance and durability are discussed.
7	Aburas, M. et al. [45]	2019	<i>Appl. Energy</i>	Thermochromic smart window technologies for building application: A review	This paper consists of a review of thermochromic films, coatings, and glazing used to analyse energy-saving capability. For this, computer simulations and full-scale models were used.
8	Aguilar-Santana, J. L. et al. [126]	2019	<i>International Journal of Low-Carbon Technologies</i>	Review on window-glazing technologies and future prospects	This study reviewed conventional and advanced glazing technologies focusing on their properties and performance.
9	Anissa Tabet Aoul, K. et al. [127]	2019	<i>Materials Science and Engineering</i>	Performance of Electrochromic Glazing: State of the Art Review	This paper reviews EC glazing used in building envelopes as an option for sustainable design.

Table A1. Cont.

No.	Authors	Year	Journal	Title	Comments
10	Ke, Y. et al. [128]	2019	<i>Adv. Energy Mater.</i>	Smart Windows: Electro- Thermo-, Mechano-, Photochromics, and Beyond	This paper reviews updated progress in smart windows of each category (Electro-, Thermo-, Mechano-, Photochromics).
11	Lamontagne, B. et al. [106]	2019	<i>J. Micro/Nanolithogr.</i>	'Review of micro shutters for switchable glass	A type of switchable glass, namely micro shutters with distinctive properties, is reviewed.
12	Tällberg, R. et al. [129]	2019	<i>Solar Energy Materials & Solar Cells</i>	Comparison of the energy saving potential of adaptive and controllable smart windows: A state-of-the-art review and simulation studies of thermochromic, photochromic and electrochromic technologies	The two main aims of this review are: (1) To gather from manufacturers, and display the available smart glazing technologies and (2) To perform simulations of building energy performance for windows from each category (thermochromic, photochromic, and electrochromic).
13	Casini, M. [13]	2018	<i>Renewable Energy</i>	Active dynamic windows for buildings: A review	This study offers a valuable review of established market or under-development, active dynamic glazing technologies (electrochromics, gasochromics, etc.).
14	Loonen, R. C. G. M. et al. [130]	2017	<i>Journal of Building Performance Simulation</i>	Review of current status, requirements, and opportunities for building performance simulation of adaptive façades	This review paper presents and analyses the primary information of currently in use building performance simulation (BPS) tools. The characteristics of 5 broadly used BPS tools are presented and discussed. Mainly, this work focuses on their capability to simulate the performance and occupants' comfort of adaptive glazing technologies.
15	Rezaei, S.D. et al. [4]	2017	<i>Solar Energy Materials & Solar Cells</i>	A review of conventional, advanced, and smart glazing technologies and materials for improving indoor environment	Various types of glazing systems and glass coatings are reviewed. Notably, traditional, advanced, and smart technologies for glazing façades are examined and compared; their main characteristics are presented and discussed.
16	Ge, M. et al. [131]	2016	<i>J. Mater. Chem. A</i>	A review of one-dimensional TiO ₂ nanostructured materials for environmental and energy applications	This paper contains a detailed review of one-dimensional TiO ₂ nanostructured materials used in energy applications.
17	Silva, T. et al. [53]	2016	<i>Renewable and Sustainable Energy Reviews</i>	Literature review on the use of phase change materials in glazing and shading solutions	PCM technologies used as translucent and transparent parts of elements in building envelopes, are reviewed.

Table A1. Cont.

No.	Authors	Year	Journal	Title	Comments
18	Wang, Y. et al. [132]	2016	<i>Annu. Rev. Chem. Biomol. Eng.</i>	Switchable Materials for Smart Windows	This paper reviews switchable materials such as thermochromic, electrochromic, and photochromic used for smart windows are reviewed.
19	Casini, M. [12]	2015	<i>International Journal of Civil and Structural Engineering</i>	Smart windows for energy efficiency of buildings	This paper focuses on the potential uses and the benefits achieved using passive and active dynamic glazing technologies as elements of building façades.
20	Cuce, E. & Riffat, S. [11]	2015	<i>Renewable and Sustainable Energy Reviews</i>	A state-of-the-art review of innovative glazing technologies	This paper comprehensively examines technologies and high-performance glazing products, providing real application examples.
21	Ghoshal, S., & Neogi, S. [10]	2014	<i>Energy Procedia</i>	Advanced Glazing System—Energy Efficiency Approach for Buildings a Review	This article provides a review of various kinds of glazing systems. Their characteristics were examined, discussed, and compared.
22	Jelle, B.P. et al. [5]	2012	<i>Solar Energy Materials & Solar Cells</i>	Fenestration of today and tomorrow: A state-of-the-art review and future research opportunities	This paper consists of a detailed review of the highest performing façade elements, a survey of challenges and future research recommendations for the glazing façades industry.
23	Baetens, R. et al. [26]	2010	<i>Solar Energy Materials and Solar Cells</i>	Properties, requirements, and possibilities of smart windows for dynamic daylight and solar energy control in buildings: a state-of-the-art review	EC, LC, GC, and SPD glazing were examined and compared. The study focuses on their ability to control solar energy and daylight entering a building dynamically.

Appendix B. Examples of Established Glazing Technologies in the Market

Table A2. Examples of Established Glazing Technologies on the market indicating their real key performance parameters.

Technology	Manufacturer	Product Name	Configuration	U-Value (W/m ² K)	g-Value	VT	Thickness (mm)	Additional Performance	References
STATIC TECHNOLOGIES									
Single	AGC	Planibel Clearlite	4 mm	5.8	0.88	0.90	4		www.agc-yourglass.com/configurator/ (accessed on the 22 December 2022)
DGU	GUARDIAN GLASS	ClimaGuard A+	4 16 4 mm Cavity 90% Ar	1.2	0.71	0.82	24		https://www.guardianglass.com/eu/en/our-glass/climaguard/product.1352.climaguard-a-?page=1&region=EU&sortBy=a-z&networkOfSuppliers= (accessed on the 22 December 2022)

Table A2. Cont.

Technology	Manufacturer	Product Name	Configuration	U-Value (W/m ² K)	g-Value	VT	Thickness (mm)	Additional Performance	References	
TGU	INTERPANE GLASS	iplus 3CL	4 12 4 12 4	0.5	0.55	0.72	36		https://pdf.archiexpo.com/pdf/interpane-glas-industrie-ag/thermally-insulating-iplus/2672-31567-_3.html (accessed on the 22 December 2022)	
		iplus 3CE	4 12 4 12 4	0.49	0.47	0.71	36			
Multy-cavity	TRIMO	Q-Air	6 chambers	≥0.30	0.09–0.19	0.10–0.33	147		https://catalogs.edilportale.com/Q-Air-Brochure-en-Trim0-0-cat136150fc.pdf (accessed on the 22 December 2022)	
Vacuum	NSG Group	SPACIA Cool	5 0.2 5	0.9	0.51	0.68	10.2		https://www.pilkington.com/en/global/products/product-categories/thermal-insulation/pilkington-spacia#brochures (accessed on the 22 December 2022)	
Aerogel	Okalux GmbH SOLERA	Okagel	4 60 aerogel 6	0.3	0.54	0.45	70		https://www.okalux.de/fileadmin/user_upload/referenzen/Antarktis-Halley_Bay-Forschungsstation_Halley_VI-OKAGEL-2008/Antarctica_HalleyVI_OKAGEL2_en.pdf (accessed on the 22 December 2022)	
		R5 + Aerogel	4 30 aerogel 6 6 13 6	0.6 1.14	0.61 0.1–0.42	0.59 0.1–0.45	40 25			https://www.advancedglazings.com/products/solera (accessed on the 22 December 2022)
Double PV/Solar	Glaswerke Arnold GmbH & Co. KG	Voltarlux ASI ASITHRU-4x-IO	6 0.8PVB 4x 0.8 ASI THRU 16cavi-ty 8 mm	1.1	0.10	0.10	34	Generated power 49 W/m ²	https://www.fresialuminio.it/images/Fresia/Pdf/2008/voltarlux%20datenblatt%202007_09%20%5be%5d.pdf (accessed on the 22 December 2022)	
DYNAMIC TECHNOLOGIES										
Thermo-chromic	INNOVATIVE GLASS	SOLAR-SMART	Cavity with Ar	1.36	0.36–0.12	0.72–0.28	25.4		https://innovativeglasscorp.com/our-products/solarsmart/ (accessed on the 23 December 2022)	
	Pleotint	Suntuitive glass	Suntuitive assembly Ar LE glass	1.36	0.37–0.17	0.54–0.08				https://suntuitiveglass.com/dynamic-glass-performance/ (accessed on the 23 December 2022)
	Raven Window	Smart window	Glass TC filter Ar LE glass	1.36	0.28–0.18	0.33–0.05				https://suntuitiveglass.com/wp-content/uploads/2019/11/Tech-broch.25112019_PL_New.pdf (accessed on the 23 December 2022)
PCM	GLASSX	GLASSX® crystal	Glass 1 space with prism plate and noble gas Glass 2 LE space with inert gas Glass 3 LE PCM Glass 4	Up to 0.48	Winter/ Summer Solid PCM 0.08–0.28 Liquid PCM 0.12–0.44 0.35/0.09		62–86	Storage 1185 Wh/m ² Storage Temp. 26–28 °C	https://docs.google.com/viewerng/viewer?url=https://glassx.jimdo.com/app/download/10112900052/Broschuere_klein_online.pdf?t=1503651139 (accessed on the 23 December 2022)	
Electro-chromic double	SAGE GLASS	SAGEGLASS CLEAR	4 clear 0.89 sentryGlass 2.2SageGlass 12 90%Ar 6 mm clear 4 mm with	0.28	0.41–0.09	0.60–0.01	25.09	Switching time 5–15 min	https://www.sageglass.com/sites/default/files/mkt-043_performance_and_acoustical_data_flyer.pdf (accessed on the 23 December 2022)	
	SAGE GLASS	Classic 42.1EC-12-4	SR2.0 0.89 sentryGlass 2.2 EC 12 4 mm clear LE	1.1	0.40–0.05	0.60–0.01	25.09			https://www.sageglass.com/sites/default/files/sageglass_datasheet_climaplus_42.1ec-12-4_classic_en.pdf (accessed on the 23 December 2022)
Liquid Crystal (LC)	Eyrise	Eyrise s350	23.04 mm / 16 mm argon / 6 mm with solar coating	0.5	0.33–0.09	0.55–0.02	55.04	Switching speed = 1 s	https://www.eyrise.com/our-products/eyrise-s350/ (accessed on the 24 December 2022)	
Suspended particle devices (SPD)	Smart Glass International	SPD Smart Glass	LE glass Ar Laminated SPD Smart Glass	0.24	On-state 0.43–0.35 Off-state 0.37–0.30	On-state 0.25–0.20 Off-state 0.1	24 mm + double-glazed format		http://www.smartglassinternational.com/downloads/SPD_SmartGlassData.pdf (accessed on the 24 December 2022)	

References

1. IIEA; UNEP. *2019 Global Status Report for Buildings and Construction*; Global Alliance for Buildings and Construction (Global ABC) at COP25; International Energy Agency and the United Nations Environment Programme: Madrid, Spain, 2019; Volume 224.
2. U.S. Energy Information Administration (EIA). Available online: <https://www.eia.gov/international/overview/world> (accessed on 22 December 2020).
3. Shaeri, J.; Habibi, A.; Yaghoubi, M.; Chokhachian, A. The Optimum Window-to-Wall Ratio in Office Buildings for Hot-Humid, Hot-Dry, and Cold Climates in Iran. *Environment* **2019**, *6*, 45. [[CrossRef](#)]
4. Rezaei, S.D.; Shannigrahi, S.; Ramakrishna, S. A Review of Conventional, Advanced, and Smart Glazing Technologies and Materials for Improving Indoor Environment. *Sol. Energy Mater. Sol. Cells* **2017**, *159*, 26–51. [[CrossRef](#)]
5. Jelle, B.P.; Hynd, A.; Gustavsen, A.; Arasteh, D.; Goudey, H.; Hart, R. Fenestration of Today and Tomorrow: A State-of-the-Art Review and Future Research Opportunities. *Sol. Energy Mater. Sol. Cells* **2012**, *96*, 1–28. [[CrossRef](#)]
6. Romano, R.; Aelenei, L.; Aelenei, D.; Mazzucchelli, E.S. What Is an Adaptive Façade? Analysis of Recent Terms and Definitions from an International Perspective. *J. Facade Des. Eng.* **2018**, *6*, 65–076. [[CrossRef](#)]
7. Huizenga, C.; Abbaszadeh, S.; Zagreus, L.; Arens, E. Air Quality and Thermal Comfort in Office Buildings: Results of a Large Indoor Environmental Quality Survey. In Proceedings of the Healthy Buildings, 8th International Conference and Exhibition on Healthy Buildings, Lisbon, Portugal, 4–8 June 2006; Volume III, pp. 393–397.
8. Schuman, J.; Rubinstein, F.; Papamichael, K.; Beltran, L.; Lee, E.S.; Selkowitz, S. *Technology Reviews Glazing Systems*; Berkeley Laboratory, University of California: Berkeley, CA, USA, 1992.
9. Wilson, H.R. High-Performance Windows. In Proceedings of the ISES Solar Academy, Freiburg, Germany, 29 August–4 September 2004.
10. Ghoshal, S.; Neogi, S. Advance Glazing System-Energy Efficiency Approach for Buildings a Review. *Energy Procedia* **2014**, *54*, 352–358. [[CrossRef](#)]
11. Cuce, E.; Riffat, S.B. A State-of-the-Art Review on Innovative Glazing Technologies. *Renew. Sustain. Energy Rev.* **2015**, *41*, 695–714. [[CrossRef](#)]
12. Casini, M. Smart Windows for Energy Efficiency of Buildings. *Int. J. Civ. Struct. Eng. IJCSE* **2015**, *2*, 230–238.
13. Casini, M. Active Dynamic Windows for Buildings: A Review. *Renew. Energy* **2018**, *119*, 923–934. [[CrossRef](#)]
14. Brzezicki, M. A Systematic Review of the Most Recent Concepts in Smart Windows Technologies with a Focus on Electrochromics. *Sustainability* **2021**, *13*, 9604. [[CrossRef](#)]
15. Pahlevan-Sharif, S.; Mura, P.; Wijesinghe, S.N.R. A Systematic Review of Systematic Reviews in Tourism. *J. Hosp. Tour. Manag.* **2019**, *39*, 158–165. [[CrossRef](#)]
16. Liberati, A.; Altman, D.G.; Tetzlaff, J.; Mulrow, C.; Gøtzsche, P.C.; Ioannidis, J.P.A.; Clarke, M.; Devereaux, P.J.; Kleijnen, J.; Moher, D. The PRISMA Statement for Reporting Systematic Reviews and Meta-Analyses of Studies That Evaluate Health Care Interventions: Explanation and Elaboration. *J. Clin. Epidemiology* **2009**, *62*, e1–e34. [[CrossRef](#)]
17. Nilsson, A.M.; Roos, A.; Elsevier, B.V. *Evaluation of Optical and Thermal Properties of Coatings for Energy Efficient Windows*; Elsevier: Amsterdam, The Netherlands, 2009; Volume 517, pp. 3173–3177. [[CrossRef](#)]
18. Mohelnikova, J. Materials for Reflective Coatings of Window Glass Applications. *Constr. Build. Mater.* **2009**, *23*, 1993–1998. [[CrossRef](#)]
19. Eames, P.C. Vacuum Glazing: Current Performance and Future Prospects. *Vacuum* **2008**, *82*, 717–722. [[CrossRef](#)]
20. Fang, Y.; Hyde, T.; Eames, P.C.; Hewitt, N. Theoretical and Experimental Analysis of the Vacuum Pressure in a Vacuum Glazing after Extreme Thermal Cycling. *Sol. Energy* **2009**, *83*, 1723–1730. [[CrossRef](#)]
21. Collins, R.E.; Robinson, S.J. Evacuated Glazing. *Sol. Energy* **1991**, *47*, 27–38. [[CrossRef](#)]
22. Collins, R.E.; Simko, T.M. Current Status of the Science and Technology of Vacuum Glazing. *Sol. Energy* **1998**, *62*, 189–213. [[CrossRef](#)]
23. Griffiths, P.W.; Di Leo, M.; Cartwright, P.; Eames, P.C.; Yianoulis, P.; Leftheriotis, G.; Norton, B. Fabrication of Evacuated Glazing at Low Temperature. *Sol. Energy* **1998**, *63*, 243–249. [[CrossRef](#)]
24. Manz, H.; Brunner, S.; Wullschleger, L. Triple Vacuum Glazing: Heat Transfer and Basic Mechanical Design Constraints. *Sol. Energy* **2006**, *80*, 1632–1642. [[CrossRef](#)]
25. Fang, Y.; Hyde, T.; Hewitt, N.; Eames, P.C.; Norton, B. Thermal Performance Analysis of an Electrochromic Vacuum Glazing with Low Emittance Coatings. *Sol. Energy* **2010**, *84*, 516–525. [[CrossRef](#)]
26. Baetens, R.; Jelle, B.P.; Gustavsen, A. Properties, Requirements and Possibilities of Smart Windows for Dynamic Daylight and Solar Energy Control in Buildings: A State-of-the-Art Review. *Sol. Energy Mater. Sol. Cells* **2010**, *94*, 87–105. [[CrossRef](#)]
27. Favoino, F.; Loonen, R.C.G.M.; Michael, M.; De Michele, G.; Avesani, S. 5—Advanced fenestration—Technologies, performance and building integration. In *Rethinking Building Skins*; Gasparri, E., Brambilla, A., Lobaccaro, G., Goia, F., Andalaro, A., Sangiorgio, A., Eds.; Woodhead Publishing Series in Civil and Structural, Engineering; Woodhead Publishing: Cambridge, UK, 2022; pp. 117–154. ISBN 9780128224779. [[CrossRef](#)]
28. Buratti, C.; Moretti, E. Experimental Performance Evaluation of Aerogel Glazing Systems. *Appl. Energy* **2012**, *97*, 430–437. [[CrossRef](#)]
29. Buratti, C.; Moretti, E. Glazing Systems with Silica Aerogel for Energy Savings in Buildings. *Appl. Energy* **2012**, *98*, 396–403. [[CrossRef](#)]

30. Buratti, C.; Moretti, E. Transparent Insulating Materials for Buildings Energy Saving: Experimental Results and Performance Evaluation. In Proceedings of the Third International Conference on Applied Energy, Perugia, Italy, 16–18 May 2011; pp. 1421–1432.
31. Buratti, C. Transparent Insulating Materials: Experimental Data and Buildings Energy Saving Evaluation. *Sustain. World* **2003**, *7*, 231–240.
32. Advanced Glazing. Available online: <http://www.advancedglazings.com> (accessed on 22 March 2020).
33. Huang, Y.; Niu, J.L. Energy and Visual Performance of the Silica Aerogel Glazing System in Commercial Buildings of Hong Kong. *Constr. Build. Mater.* **2015**, *94*, 57–72. [[CrossRef](#)]
34. Huang, Y.; Niu, J.L. Application of Super-Insulating Translucent Silica Aerogel Glazing System on Commercial Building Envelope of Humid Subtropical Climates-Impact on Space Cooling Load. *Energy* **2015**, *83*, 316–325. [[CrossRef](#)]
35. Garnier, C.; Muneer, T.; McCauley, L. Super Insulated Aerogel Windows: Impact on Daylighting and Thermal Performance. *Build. Environ.* **2015**, *94*, 231–238. [[CrossRef](#)]
36. Ghosh, A.; Sundaram, S.; Mallick, T.K. Colour Properties and Glazing Factors Evaluation of Multicrystalline Based Semi-Transparent Photovoltaic-Vacuum Glazing for BIPV Application. *Renew. Energy* **2019**, *131*, 730–736. [[CrossRef](#)]
37. Skandalos, N.; Karamanis, D. PV Glazing Technologies. *Renew. Sustain. Energy Rev.* **2015**, *49*, 306–322. [[CrossRef](#)]
38. Ng, P.K.; Mithraratne, N.; Kua, H.W. Energy Analysis of Semi-Transparent BIPV in Singapore Buildings. *Energy Build.* **2013**, *66*, 274–281. [[CrossRef](#)]
39. Cho, J.S.; Seo, Y.H.; Choi, B.H.; Cho, A.; Lee, A.; Shin, M.J.; Kim, K.; Ahn, S.K.; Park, J.H.; Yoo, J.; et al. Energy Harvesting Performance of Bifacial and Semitransparent Amorphous Silicon Thin-Film Solar Cells with Front and Rear Transparent Conducting Oxide Contacts. *Sol. Energy Mater. Sol. Cells* **2019**, *202*, 110078. [[CrossRef](#)]
40. Granqvist, C.G.; Green, S.; Niklasson, G.A.; Mlyuka, N.R.; von Kræmer, S.; Georén, P. Advances in Chromogenic Materials and Devices. *Thin Solid Film.* **2010**, *518*, 3046–3053. [[CrossRef](#)]
41. Saeli, M.; Piccirillo, C.; Parkin, I.P.; Binions, R.; Ridley, I. Energy Modelling Studies of Thermochromic Glazing. *Energy Build.* **2010**, *42*, 1666–1673. [[CrossRef](#)]
42. Khaled, K.; Berardi, U. Current and Future Coating Technologies for Architectural Glazing Applications. *Energy Build.* **2021**, *244*, 111022. [[CrossRef](#)]
43. Parkin, I.P.; Manning, T.D. Intelligent Thermochromic Windows. *J. Chem. Educ.* **2006**, *83*, 393. [[CrossRef](#)]
44. Xiaohui Zhou, P.E. Demonstration with energy assessments of thermochromic window Systems. *ASHRAE Trans.* **2014**, *120*, 330.
45. Aburas, M.; Soebarto, V.; Williamson, T.; Liang, R.; Ebendorff-Heidepriem, H.; Wu, Y. Thermochromic Smart Window Technologies for Building Application: A Review. *Appl. Energy* **2019**, *255*, 113522. [[CrossRef](#)]
46. Seeboth, A.; Ruhmann, R.; Mühlhng, O. Thermotropic and Thermochromic Polymer Based Materials for Adaptive Solar Control. *Materials* **2010**, *3*, 5143–5168. [[CrossRef](#)]
47. Hartwig, H. Concepts for the Integration of Self-Regulating, Thermotropic Layers in Modern Building Envelopes for the Passive Use of Solar Energy. Ph.D. Thesis, Technical University of Munich, Munich, Germany, 2003.
48. Raicu, A.; Wilson, H.R.; Nitz, P.; Platzer, W.; Wittwer, V.; Jahns, E. Facade Systems with Variable Solar Control Using Thermotropic Polymer Blends. *Sol. Energy* **2002**, *72*, 31–42. [[CrossRef](#)]
49. Raicu, A.; Wilson, H.R.; Nitz, P.; Jahns, E.; Platzer, W.J.; Wittwer, V. Thermotropic Systems-Recent Results on Component Characterisation and Building Integration. In Proceedings of the EuroSun 2000 3rd International Conference on Solar Heating, Cooling, Copenhagen, Denmark, 19–22 June 2000.
50. Ghosh, A.; Norton, B. Advances in Switchable and Highly Insulating Autonomous (Self-Powered) Glazing Systems for Adaptive Low Energy Buildings. *Renew. Energy* **2018**, *126*, 1003–1031. [[CrossRef](#)]
51. Bianco, L.; Goia, F.; Serra, V.; Zinzi, M. Thermal and Optical Properties of a Thermotropic Glass Pane: Laboratory and in-Field Characterization. *Energy Procedia* **2015**, *78*, 116–121. [[CrossRef](#)]
52. Compagno, A. *Intelligent Glass Facades*; Springer: Berlin/Heidelberg, Germany, 1999.
53. Silva, T.; Vicente, R.; Rodrigues, F. Literature Review on the Use of Phase Change Materials in Glazing and Shading Solutions. *Renew. Sustain. Energy Rev.* **2016**, *53*, 515–535. [[CrossRef](#)]
54. Zhang, M.; Medina, M.A.; King, J.B. Development of a Thermally Enhanced Frame Wall with Phase-Change Materials for on-Peak Air Conditioning Demand Reduction and Energy Savings in Residential Buildings. *Int. J. Energy Res.* **2005**, *29*, 795–809. [[CrossRef](#)]
55. Goia, F.; Zinzi, M.; Carnielo, E.; Serra, V. Spectral and Angular Solar Properties of a PCM-Filled Double Glazing Unit. *Energy Build.* **2015**, *87*, 302–312. [[CrossRef](#)]
56. Farid, M.M.; Khudhair, A.M.; Razack, S.A.K.; Al-Hallaj, S. A Review on Phase Change Energy Storage: Materials and Applications. *Energy Convers. Manag.* **2004**, *45*, 1597–1615. [[CrossRef](#)]
57. GlassX Crystal. The Glass That Stores, Heats and Cools. Available online: <http://www.glassxpcm.com/how-glassx-works/> (accessed on 25 December 2019).
58. Song, M.; Niu, F.; Mao, N.; Hu, Y.; Deng, S. Review on Building Energy Performance Improvement Using Phase Change Materials. *Energy Build.* **2018**, *158*, 776–793. [[CrossRef](#)]
59. Liu, Z.; Yu, Z.; Yang, T.; Qin, D.; Li, S.; Zhang, G.; Haghghat, F.; Joybari, M.M. A Review on Macro-Encapsulated Phase Change Material for Building Envelope Applications. *Build. Environ.* **2018**, *144*, 281–294. [[CrossRef](#)]
60. Weinlaeder, H.; Beck, A.; Fricke, J. PCM-facade-panel for daylighting and room heating. *Sol. Energy* **2005**, *78*, 177–186. [[CrossRef](#)]

61. Fokaides, P.A.; Kylili, A.; Kalogirou, S.A. Phase Change Materials (PCMs) Integrated into Transparent Building Elements: A Review. *Mater. Renew. Sustain. Energy* **2015**, *4*, 6. [CrossRef]
62. Li, S.; Zhong, K.; Zhou, Y.; Zhang, X. Comparative Study on the Dynamic Heat Transfer Characteristics of PCM-Filled Glass Window and Hollow Glass Window. *Energy Buildings* **2014**, *85*, 483–492. [CrossRef]
63. Jonsson, A.; Roos, A. Evaluation of Control Strategies for Different Smart Window Combinations Using Computer Simulations. *Sol. Energy* **2010**, *84*, 1–9. [CrossRef]
64. Gillaspie, D.T.; Tenent, R.C.; Dillon, A.C. Metal-Oxide Films for Electrochromic Applications: Present Technology and Future Directions. *J. Mater. Chem.* **2010**, *20*, 9585–9592. [CrossRef]
65. Aste, N.; Compostella, J.; Mazzon, M. Comparative Energy and Economic Performance Analysis of an Electrochromic Window and Automated External Venetian Blind. *Energy Procedia*. **2012**, *30*, 404–413. [CrossRef]
66. Dussault, J.M.; Gosselin, L.; Galstian, T. Integration of Smart Windows into Building Design for Reduction of Yearly Overall Energy Consumption and Peak Loads. *Solar Energy* **2012**, *86*, 3405–3416. [CrossRef]
67. Aldawoud, A. Conventional Fixed Shading Devices in Comparison to an Electrochromic Glazing System in Hot, Dry Climate. *Energy Build.* **2013**, *59*, 104–110. [CrossRef]
68. Jin, Q. Towards a Whole-life Value Optimisation Model for Facade Design. Ph.D. Thesis, University of Cambridge, Cambridge, UK, 2013.
69. Tavares, P.; Bernardo, H.; Gaspar, A.; Martins, A. Control Criteria of Electrochromic Glasses for Energy Savings in Mediterranean Buildings Refurbishment. *Sol. Energy* **2016**, *134*, 236–250. [CrossRef]
70. Favoino, F. Building performance simulation of adaptive facades. PhD Thesis, University of Cambridge, Cambridge, UK, 2016.
71. DOE (U.S. Department of Energy). *Windows and Building Envelope Research and Development: Roadmap for Emerging Technologies*; DOE Energy Efficiency & Renewable Energy: Washington, DC, USA, 2014.
72. Cupelli, D.; Nicoletta, F.P.; Manfredi, S.; De Filpo, G.; Chidichimo, G. Electrically Switchable Chromogenic Materials for External Glazing. *Sol. Energy Mater. Sol. Cells* **2009**, *93*, 329–333. [CrossRef]
73. Granqvist, C.G. Oxide Electrochromics: An Introduction to Devices and Materials. *Sol. Energy Mater. Sol. Cells* **2012**, *99*, 1–13. [CrossRef]
74. Granqvist, C.G. Electrochromics for Smart Windows: Oxide-Based Thin Films and Devices. *Thin Solid Film.* **2014**, *564*, 1–38. [CrossRef]
75. Sageglass. Available online: <https://www.sageglass.com/en/resources> (accessed on 27 March 2019).
76. Viewglass. View Dynamic Glass, Product Guide. Available online: <https://view.com/> (accessed on 27 March 2019).
77. Barrios, D.; Vergaz, R.; Sánchez-Pena, J.M.; García-Cámara, B.; Granqvist, C.G.; Niklasson, G.A. Simulation of the Thickness Dependence of the Optical Properties of Suspended Particle Devices. *Sol. Energy Mater. Sol. Cells* **2015**, *143*, 613–622. [CrossRef]
78. Georg, A.; Georg, A.; Graf, W.; Wittwer, V. Switchable Windows with Tungsten Oxide. *Vacuum* **2008**, *82*, 730–735. [CrossRef]
79. Ghosh, A.; Norton, B.; Duffy, A. Measured Overall Heat Transfer Coefficient of a Suspended Particle Device Switchable Glazing. *Appl. Energy* **2015**, *159*, 362–369. [CrossRef]
80. Lemarchand, P.; Doran, J.; Norton, B. Smart Switchable Technologies for Glazing and Photovoltaic Applications. *Energy Procedia* **2014**, *57*, 1878–1887. [CrossRef]
81. Smartglass/Architectural. Available online: <https://www.smartglass.com/products/#Architectural> (accessed on 23 March 2019).
82. Lampert, C.M. Smart Switchable Glazing for Solar Energy and Daylight Control. *Sol. Energy Mater. Sol. Cells* **1998**, *52*, 207–221. [CrossRef]
83. Kim, Y.; Jung, D.; Jeong, S.; Kim, K.; Choi, W.; Seo, Y. Optical Properties and Optimized Conditions for Polymer Dispersed Liquid Crystal Containing UV Curable Polymer and Nematic Liquid Crystal. *Current Applied Physics* **2015**, *15*, 292–297. [CrossRef]
84. Murray, J.; Ma, D.; Munday, J.N. Electrically Controllable Light Trapping for Self-Powered Switchable Solar Windows. *ACS Photonics* **2017**, *4*, 1–7. [CrossRef]
85. Alghamdi, H.; Almawgani, A.H.M. Smart and Efficient Energy Saving System Using PDLC Glass. In Proceedings of the 2019 Smart City Symposium Prague (SCSP), Prague, Czech Republic, 23–24 May 2019. [CrossRef]
86. Marchwiński, J. Study of Electrochromic (EC) and Gasochromic (GC) Glazing for Buildings in Aspect of Energy Efficiency. *Archit. Civ. Eng. Environ.* **2021**, *14*, 27–38. [CrossRef]
87. Lien, A.G.; Hestnes, A.G.; Aschehoug, Ø. The Use of Transparent Insulation in Low Energy Dwellings in Cold Climates. *Sol. Energy* **1997**, *59*, 27–35. [CrossRef]
88. Archiexpo.com. Available online: <http://www.archiexpo.com/prod/okalux/product-3737-326078.html> (accessed on 3 April 2021).
89. Sekisui. Co. Air Sandwich. Available online: <https://www.sekisui.co.jp/products/> (accessed on 1 April 2019).
90. Sekisui. Co. Light-collecting & Insulation Building Materials for Construction Use. Available online: <https://www.jase-w.eccj.or.jp/technologies/> (accessed on 2 April 2019).
91. Sekisui Chemical Group. Environment-Contributing Products. 2019. Available online: www.se-kisui.co.jp/ (accessed on 7 April 2019).
92. Cuce, E.; Cuce, P.M.; Young, C.H. Energy Saving Potential of Heat Insulation Solar Glass: Key Results from Laboratory and in-Situ Testing. *Energy* **2016**, *97*, 369–380. [CrossRef]
93. Young, C.H.; Chen, Y.L.; Chen, P.C. Heat Insulation Solar Glass and Application on Energy Efficiency Buildings. *Energy Build.* **2014**, *78*, 66–78. [CrossRef]

94. Chow, T.t.; Li, C.; Lin, Z. Innovative Solar Windows for Cooling-Demand Climate. *Sol. Energy Mater. Sol. Cells* **2010**, *94*, 212–220. [[CrossRef](#)]
95. PV-tech.org. Available online: <https://www.pv-tech.org/editors-blog/making-pv-transparent-the-ultimate-bipv-solution> (accessed on 23 August 2021).
96. Solarpanelscompany.com. Available online: <https://solarpanelscompany.com/blog/turning-windows-into-solar-panels/> (accessed on 23 August 2021).
97. Kawashima, T.; Ezure, T.; Okada, K.; Matsui, H.; Goto, K.; Tanabe, N. FTO/ITO Double-Layered Transparent Conductive Oxide for Dye-Sensitized Solar Cells. *J. Photochem. Photobiol. A Chem.* **2004**, *164*, 199–202. [[CrossRef](#)]
98. Zeng, K.; Zhu, F.; Hu, J.; Shen, L.; Zhang, K.; Gong, H. Investigation of Mechanical Properties of Transparent Conducting Oxide Thin Films. *Thin Solid Film.* **2003**, *443*, 60–65. [[CrossRef](#)]
99. Baek, W.H.; Choi, M.; Yoon, T.S.; Lee, H.H.; Kim, Y.S. Use of Fluorine-Doped Tin Oxide Instead of Indium Tin Oxide in Highly Efficient Air-Fabricated Inverted Polymer Solar Cells. *Appl. Phys. Lett.* **2010**, *96*, 133506. [[CrossRef](#)]
100. Chen, C.-C.; Dou, L.; Zhu, R.; Chung, C.-H.; Song, T.-B.; Zheng, Y.B.; Hawks, S.; Li, G.; Weiss, P.S.; Yang, Y. Visibly Transparent Polymer Solar Cells Produced by Solution Processing. *ACS Nano* **2012**, *6*, 7185–7190. [[CrossRef](#)]
101. Roldán-Carmona, C.; Malinkiewicz, O.; Betancur, R.; Longo, G.; Momblona, C.; Jaramillo, F.; Camacho, L.; Bolink, H.J. High Efficiency Single-Junction Semitransparent Perovskite Solar Cells. *Energy Environ. Sci.* **2014**, *7*, 2968–2973. [[CrossRef](#)]
102. Zhao, Y.; Meek, G.A.; Levine, B.G.; Lunt, R.R. Near-Infrared Harvesting Transparent Luminescent Solar Concentrators. *Adv. Opt. Mater.* **2014**, *2*, 606–611. [[CrossRef](#)]
103. Henion, A.; Lunt, R. Transparent Solar Technology Represents Wave of the Future, Text It Michigan State University. Available online: <https://msutoday.msu.edu/news/2017/transparent-solar-technology-represents-wave-of-the-future> (accessed on 30 April 2019).
104. Fang, Y.; Hyde, T.J.; Hewitt, N. Predicted Thermal Performance of Triple Vacuum Glazing. *Sol. Energy* **2010**, *84*, 2132–2139. [[CrossRef](#)]
105. Papaefthimiou, S.; Leftheriotis, G.; Yianoulis, P.; Hyde, T.J.; Eames, P.C.; Fang, Y.; Pennarun, P.Y.; Jannasch, P. Development of Electrochromic Evacuated Advanced Glazing. *Energy Build.* **2006**, *38*, 1455–1467. [[CrossRef](#)]
106. Lamontagne, B.; Fong, N.R.; Song, I.-H.; Ma, P.; Barrios, P.; Poitras, D. Review of Microshutters for Switchable Glass. *J. Micro/Nanolithography MEMS MOEMS* **2019**, *18*, 040901. [[CrossRef](#)]
107. Hillmer, H.; Al-Qargholi, B.; Khan, M.M.; Worapatrakul, N.; Wilke, H.; Woidt, C.; Tatzel, A. Optical MEMS-Based Micromirror Arrays for Active Light Steering in Smart Windows. *Jpn. J. Appl. Phys.* **2018**, *57*, 08PA07. [[CrossRef](#)]
108. Mori, K.; Misawa, K.; Ihida, S.; Takahashi, T.; Fujita, H.; Toshiyoshi, H. A MEMS Electrostatic Roll-Up Window Shade Array for House Energy Management System. *IEEE Photonics Technol. Lett.* **2016**, *28*, 593–596. [[CrossRef](#)]
109. Nanoparticles, D.S.; Kiyoto, N.; Hakuta, S.; Tani, T.; Naya, M.; Kamada, K. Development of a Near-Infrared Reflective Film Using Disk-Shaped Silver Nanoparticles. *Fujifilm Res. Dev.* **2013**, *58*, 55–58.
110. Tani, T.; Hakuta, S.; Kiyoto, N.; Naya, M. Transparent Near-Infrared Reflector Metasurface with Randomly Dispersed Silver Nanodisks. *Opt. Express* **2014**, *22*, 9262. [[CrossRef](#)]
111. Granqvist, C.G. Smart Windows. *Adv. Sci. Technol.* **2008**, *55*, 205–212. [[CrossRef](#)]
112. Naruse, M.; Tani, T.; Yasuda, H.; Tate, N.; Ohtsu, M.; Naya, M. Randomness in Highly Reflective Silver Nanoparticles and Their Localized Optical Fields. *Sci. Rep.* **2014**, *4*, 6077. [[CrossRef](#)]
113. Shian, S.; David, R.; Clarke, D.R. Electrically tunable window device. *Opt. Lett.* **2016**, *41*, 1289–1292. [[CrossRef](#)]
114. Llordés, A.; Garcia, G.; Gazquez, J.; Milliron, D.J. Tunable Near-Infrared and Visible-Light Transmittance in Nanocrystal-in-Glass Composites. *Nature* **2013**, *500*, 323–326. [[CrossRef](#)] [[PubMed](#)]
115. DeForest, N.; Shehabi, A.; Selkowitz, S.; Milliron, D.J. A Comparative Energy Analysis of Three Electrochromic Glazing Technologies in Commercial and Residential Buildings. *Appl. Energy* **2017**, *192*, 95–109. [[CrossRef](#)]
116. Zeng, S.; Zhang, D.; Huang, W.; Wang, Z.; Freire, S.G.; Yu, X.; Smith, A.T.; Huang, E.Y.; Nguon, H.; Sun, L. Bio-Inspired Sensitive and Reversible Mechanochromisms via Strain-Dependent Cracks and Folds. *Nat. Commun.* **2016**, *7*, 11802. [[CrossRef](#)] [[PubMed](#)]
117. Carbonari, A.; Fioretti, R.; Naticchia, B.; Principi, P. Experimental Estimation of the Solar Properties of a Switchable Liquid Shading System for Glazed Facades. *Energy Build.* **2012**, *45*, 299–310. [[CrossRef](#)]
118. Mukherjee, S.; Hsieh, W.L.; Smith, N.; Goulding, M.; Heikenfeld, J. Electrokinetic Pixels with Biprimary Inks for Color Displays and Color-Temperature-Tunable Smart Windows. *Applied Optics.* **2015**, *54*, 5603–5609. [[CrossRef](#)]
119. Wolfe, D.; Goossen, K.W. Evaluation of 3D Printed Optofluidic Smart Glass Prototypes. *Opt. Express* **2017**, *26*, A85–A98. [[CrossRef](#)]
120. Page, M.J.; McKenzie, J.E.; Bossuyt, P.M.; Boutron, I.; Hoffmann, T.C.; Mulrow, C.D.; Shamseer, L.; Tetzlaff, J.M.; Akl, E.A.; Brennan, S.E.; et al. The PRISMA 2020 statement: An updated guideline for reporting systematic reviews. *Int. J. Surg.* **2021**, *88*, 105906. [[CrossRef](#)]
121. Brito-Coimbra, S.; Aelenei, D.; Gomes, M.G.; Rodrigues, A.M. Building Façade Retrofit with Solar Passive Technologies: A Literature Review. *Energies* **2021**, *14*, 1774. [[CrossRef](#)]
122. Feng, F.; Kunwar, N.; Cetin, K.; O'Neill, Z. A Critical Review of Fenestration/Window System Design Methods for High Performance Buildings. *Energy Build.* **2021**, *248*, 111184. [[CrossRef](#)]
123. Singh, D.; Chaudhary, R.; Karthick, A. Review on the progress of building-applied/integrated photovoltaic system. *Environ. Sci. Pollut. Res.* **2021**, *28*, 47689–47724. [[CrossRef](#)] [[PubMed](#)]

124. Ghosh, A. Potential of Building Integrated and Attached / Applied Photovoltaic (BIPV/BAPV) for Adaptive Less Energy-Hungry Building's Skin: A Comprehensive Review. *J. Clean. Prod.* **2020**, *276*, 123343. [[CrossRef](#)]
125. Rai, V.; Singh, R.S.; Blackwood, D.J.; Zhili, D. A Review on Recent Advances in Electrochromic Devices: A Material Approach. *Adv. Eng. Mater.* **2020**, *22*, 202000082. [[CrossRef](#)]
126. Aguilar-Santana, J.L.; Jarimi, H.; Velasco-Carrasco, M.; Riffat, S. Review on Window-Glazing Technologies and Future Prospects. *Int. J. Low-Carbon Technol.* **2019**, *15*, 112–120. [[CrossRef](#)]
127. Anissa Tabet Aoul, K.; Efurosibina Attoye, D.; Al Ghatri, L. Performance of Electrochromic Glazing: State of the Art Review. *IOP Conf. Ser. Mater. Sci. Eng.* **2019**, *603*, 022085. [[CrossRef](#)]
128. Ke, Y.; Chen, J.; Lin, G.; Wang, S.; Zhou, Y.; Yin, J.; Lee, P.S.; Long, Y. Smart Windows: Electro-, Thermo-, Mechano-, Photochromics, and Beyond. *Adv. Energy Mater.* **2019**, *9*, 1902066. [[CrossRef](#)]
129. Tällberg, R.; Jelle, B.P.; Loonen, R.; Gao, T.; Hamdy, M. Comparison of the Energy Saving Potential of Adaptive and Controllable Smart Windows: A State-of-the-Art Review and Simulation Studies of Thermochromic, Photochromic and Electrochromic Technologies. *Sol. Energy Mater. Sol. Cells* **2019**, *200*, 10982. [[CrossRef](#)]
130. Loonen, R.C.G.M.; Favoino, F.; Hensen, J.L.M.; Overend, M. Review of current status, requirements and opportunities for building performance simulation of adaptive facades. *J. Build. Perform. Simul.* **2017**, *10*, 205–223. [[CrossRef](#)]
131. Ge, M.; Cao, C.; Huang, J.; Li, S.; Chen, Z.; Zhang, K.-Q.; Al-Deyab, S.S.; Lai, Y. A review of one-dimensional TiO₂ nanostructured materials for environmental and energy applications. *J. Mater. Chem. A* **2016**, *4*, 6772–6801. [[CrossRef](#)]
132. Wang, Y.; Runnerstrom, E.L.; Milliron, D.J. Switchable Materials for Smart Windows. *Annu. Rev. Chem. Biomol. Eng.* **2016**, *7*, 283–304. [[CrossRef](#)]

Disclaimer/Publisher's Note: The statements, opinions and data contained in all publications are solely those of the individual author(s) and contributor(s) and not of MDPI and/or the editor(s). MDPI and/or the editor(s) disclaim responsibility for any injury to people or property resulting from any ideas, methods, instructions or products referred to in the content.