

Towards an International Data Standard for Immovable Property Valuation

Kara, Abdullah; Çağdaş, Volkan; Işıkdag, Ümit; van Oosterom, P.J.M.; Lemmen, Christiaan; Stubkjær, Erik

Publication date

2017

Document Version

Final published version

Published in

Proceedings FIG Working Week 2017

Citation (APA)

Kara, A., Çağdaş, V., Işıkdag, Ü., van Oosterom, P. J. M., Lemmen, C., & Stubkjær, E. (2017). Towards an International Data Standard for Immovable Property Valuation. In P. Halme (Ed.), *Proceedings FIG Working Week 2017: Surveying the world of tomorrow – From digitalization to augmented reality* International Federation of Surveyors (FIG).

Important note

To cite this publication, please use the final published version (if applicable).
Please check the document version above.

Copyright

Other than for strictly personal use, it is not permitted to download, forward or distribute the text or part of it, without the consent of the author(s) and/or copyright holder(s), unless the work is under an open content license such as Creative Commons.

Takedown policy

Please contact us and provide details if you believe this document breaches copyrights.
We will remove access to the work immediately and investigate your claim.

Towards an International Data Standard for Immovable Property Valuation

**Abdullah KARA, Volkan ÇAĞDAŞ and Ümit İŞIKDAĞ, Turkey,
Peter van OOSTEROM and Christiaan LEMMEN, The Netherlands, Erik STUBKJÆR,
Denmark**

Key words: Immovable Property Valuation; ISO 19152:2012 Land Administration Domain Model (LADM), LADM Valuation Module

SUMMARY

Immovable property valuation is performed by public sector actors for several land management activities, such as property taxation, expropriation or compulsory purchase of land, land re-adjustment and land consolidation; and private sector actors perform valuation for purchase, real estate financing, investment analysis, and further property transactions. The valuation process returns estimated value (e.g. market value) of property units based on their legal, physical, geographic, economic, and environmental characteristics, as recorded at public registries or observed on location. The ISO 19152:2012 Land Administration Domain Model (LADM) presents a conceptual schema for the specification of property units and their legal and geometric characteristics recorded at cadaster and land register, and relates these datasets with other property related datasets (e.g., valuation, taxation, land use, land cover) recorded at external databases. A recently initiated collaborative research (see Çağdaş, 2016) aims at developing a data model for one of these external databases, in terms of a Valuation Module for the ISO 19152:2012 LADM which is supposed to define semantics of valuation databases maintained by public authorities especially for immovable property taxation. The present paper presents preliminary results of this initiative, and describes a draft version of the Valuation Module which specifies the input and output data used and produced when single or mass appraisal processes are performed according to published standards and recommendations. It also presents a questionnaire which was prepared to create an inventory of valuation applications all over the world, and will be used as source data for the elaboration of the draft module. The paper also opens a discussion about this initiative, and calls for contributions of other relevant bodies (e.g. FIG, OGC, TEGOVA, IVSC and IAAO) for the further development of the draft Valuation Module.

Towards an International Information Standard for Immovable Property Valuation (8901)
Abdullah Kara, Volkan Cagdas, Umit Isikdag (Turkey), Peter van Oosterom (Netherlands) and Erik Stubkjaer
(Denmark)

FIG Working Week 2017

Surveying the world of tomorrow - From digitalisation to augmented reality

Helsinki, Finland, May 29–June 2, 2017

Towards an International Data Standard for Immovable Property Valuation

**Abdullah KARA, Volkan ÇAĞDAŞ and Ümit IŞIKDAĞ, Turkey;
Peter van OOSTEROM and Christiaan LEMMEN, The Netherlands;
Erik STUBKJÆR, Denmark**

1. INTRODUCTION

Valuation and taxation of land and immovable property is related to the many processes of land management for achieving towards Sustainable Development Goals (Plimmer and McCluskey, 2016). Appropriate systems are needed for fair and timely valuation of tenure rights for land and property taxation, and other public and private sector activities, such as expropriation or compulsory purchase of land, land re-adjustment and land consolidation, real estate financing, investment analysis, and further property transactions, as indicated by the Voluntary Guidelines on the Responsible Governance of Tenure (FAO, 2012, 18.1). This research focuses on the information management aspect of valuation activities carried out by public organizations for the assessment of properties for recurrently levied immovable property taxes.

Recurrent taxes on immovable property covers taxes levied regularly in respect of the use or ownership of immovable property. These taxes are levied on land and buildings, in the form of a percentage of an assessed property value based on a national rental income, sales price, or capitalised yield; or in terms of other characteristics of real property (e.g., size or location) from which a presumed rent or capital value can be derived (OECD, 2010). According to Grover et al. (2016), the credibility of these taxes depends on the quality of the data used, both of the market prices used and the attributes or characteristics of properties recorded in property inventories or databases. Such inventories, which accommodate regular data maintenance and the updating of land and property characteristics, ownership details and rental and sales information, is one of the most fundamental element underpinning value-based taxation (Thang et al., 2011).

Traditional cadastral systems, which could be seen prototypical form of the above-mentioned property inventories, provide geographical and administrative datasets concerning the legal objects required for valuation. However, cadastral datasets used for identification and registration of legal information in relation to immovable properties, may not be sufficient for today's complex valuation practices (e.g. computer aided mass appraisal). More specifically, they only provide two-dimensional geometry and legal information about property units, whereas valuation practices also require detailed physical, geographic, economic, and environmental characteristics related to components of property units. Moreover, information produced through valuation activities and property market indicators should be recorded for further analysis, dispute resolution and quality control processes. These requirements call for the development valuation inventories or databases which record input and output data used and produced in single or mass appraisal processes.

Towards an International Information Standard for Immovable Property Valuation (8901)
Abdullah Kara, Volkan Cagdas, Umit Isikdag (Turkey), Peter van Oosterom (Netherlands) and Erik Stubkjær (Denmark)

FIG Working Week 2017

Surveying the world of tomorrow - From digitalisation to augmented reality
Helsinki, Finland, May 29–June 2, 2017

Some countries have special registers or databases for storing information about immovable property transactions and providing statistics about property market, such as Sales and Valuation Register in Denmark, Purchase Price Collections in Germany, Sales Price Register in Slovenia. These registers serve valuation sector for different requirements, e.g. estimating property values for property taxation, expropriations, land use planning and monitoring price trends. An efficient land administration infrastructure, which aims to enable the management of information concerning the ownership, value and use of land, is expected to link mentioned sales price databases with other land information systems such as cadastre, land registry, and building and dwelling registries. Such an integration or link between distributed geographic and thematic databases maintained by different organizations can be achieved through spatial data infrastructures (SDIs). The domain-independent standards that specify the spatial and temporal aspects of geographical information (e.g. ISO 19107:2003), and domain-specific standards that specify the semantics of a domain (e.g. ISO 19152:2012) are one of the main components of the SDI (Lemmen et al., 2011).

There are several international standards which focus on procedural aspects of immovable property valuation for fair and transparent valuation practices. These include European Valuation Standards (TEGoVA, 2016), International Valuation Standard (IVSC, 2016), Mass Appraisal of Real Property (IAAO, 2013a), Ratio Studies (IAAO, 2013b). Moreover, there are some international measurement standards that specify the area and volume of land, buildings and building parts for valuation purposes, such as Performance Standards in Building (ISO 9836:2011), International Property Measurement Standards, RICS Code of Measuring Practice (2007), and Area and Space Measurement in Facility Management (CEN 15221-6:2011). Despite the existence of these standards, there is no international standard that defines the semantics of valuation databases, such as the entities, attributes/properties, relationships, constraints of the information model. SDI based integration of land administration databases, however, requires the development of a data content standard for valuation databases.

ISO 19152:2012 Land Administration Domain Model (LADM), as an international land administration standard, focuses on legal requirements, but currently excludes the specifications of external information systems including valuation databases. However, it provides a formalism, which allows for an extension that responds to valuation requirements. This research aims at developing a LADM based international information model valuation databases, namely a Valuation Module for the ISO 19152:2012 LADM. The purpose of this research is to define the semantics of valuation information maintained by public authorities especially for recurrent taxes on immovable property, and to extend the scope of LADM from a fiscal perspective to provide an information model that could be used to construct databases or information systems for immovable property valuation.

This research is carried out according to the following methodology by a number of researchers who are members of a Joint Working Group being established under FIG Commission 7 (Cadastre and Land Management) and FIG Commission 9 (Valuation and the Management of Real Estate). In the first stage of the research, a questionnaire is applied to reveal commonalities and differences in immovable property valuation applications in different countries (Section 2). In the second stage,

Towards an International Information Standard for Immovable Property Valuation (8901)
Abdullah Kara, Volkan Cagdas, Umit Isikdag (Turkey), Peter van Oosterom (Netherlands) and Erik Stubkjær (Denmark)

FIG Working Week 2017
Surveying the world of tomorrow - From digitalisation to augmented reality
Helsinki, Finland, May 29–June 2, 2017

relevant geographic data models (e.g. LADM, CityGML, IndoorGML, InfraGML, INSPIRE data specifications) that would provide a framework for the specification of valuation data model are investigated. Section 3 briefly outlines these standards, and compares their designations from the valuation point of view. In the third stage, a valuation information model, as an extension module for LADM is designed through an iterative process. In addition to specification of ExtValuation class of LADM, some classes and class attributes are adopted from other geographic information standards to more elaborately specify valuation units and their physical, environmental and economical characteristics needed in valuation for taxation practices. Section 4 describes developed Valuation Module for the ISO 19152:2012 LADM. The final section concludes the present paper.

2. An OVERVIEW of IMMOVABLE PROPERTY VALUATION

As a part of the research methodology, a questionnaire is prepared. The purpose is to create a world-wide inventory that reveals commonalities and differences among valuation systems used for recurrently levied immovable property taxes. The questionnaire consists of three sections. First section includes general questions related to structure of valuation systems applied for recurrently levied immovable property taxation. The second and third sections focuses on mass appraisal and single property appraisal procedures, respectively. So far (deadline FIG paper 20 February 2017, while deadline for sending completed questionnaires is 1 April 2017), 10 respondents from Croatia, Cyprus, Denmark, Macedonia, The Netherlands, Slovenia, Turkey and United Kingdom have replied the questionnaire. The responses to the questionnaire and their organized representations are available online at <http://wiki.tudelft.nl/bin/view/Research/ISO19152/ValuationQuestionnaire>. In the following, international valuation approaches for recurrently levied immovable property taxes are explained by the information provided by the questionnaires.

2.1 General structure of valuation systems

Valuation of properties for property taxation are generally under the responsibility of ministry of finance or taxation, land administration authorities or municipalities. Among the respondent countries, this responsibility has been given to valuation administrations affiliated to ministry of finance or taxation in Croatia, Cyprus, Denmark, United Kingdom; municipalities in Macedonia, The Netherlands; municipalities and ministry of finance in Turkey; and national surveying and mapping authority in Slovenia.

Recurrent taxes on immovable property are generally levied on all types of properties– residential, commercial, and industrial, as well as on farm properties. However, some countries tax only land, while a few tax only buildings. Most tax both land and buildings, usually together but in some countries separately (Bird and Slack, 2002). Object of valuation in the recurrently levied property taxes, therefore, may be (a) land (e.g. cadastral parcel), (b) improvements (e.g. buildings), (c) land and improvements together as land property, (d) land and improvements together as condominium (cf. McCluskey, 1999; Bird and Slack, 2002). The valuation units may be further grouped according to national classification schemas. For instance, in Denmark properties are grouped into 41 property

Towards an International Information Standard for Immovable Property Valuation (8901)
Abdullah Kara, Volkan Cagdas, Umit Isikdag (Turkey), Peter van Oosterom (Netherlands) and Erik Stubkjær (Denmark)

FIG Working Week 2017
Surveying the world of tomorrow - From digitalisation to augmented reality
Helsinki, Finland, May 29–June 2, 2017

types, e.g. detached houses, residential condominiums, business and industrial properties, agricultural and forest properties, and building sites.

These objects may be taxed based on monetary value or non-monetary value based measures. In monetary value-based systems, tax assessment is based on, for example, market value, annual rental value, or the acquisition price of properties; while in non-monetary systems assessment is undertaken according to the area or volume value of properties, or using a fixed formula (Youngman and Malme, 1994; McCluskey, 1999; Bird and Slack, 2002; Kitchen, 2003; IAAO, 2014). All respondent countries apply monetary value based systems. Among them Croatia, Cyprus, Denmark, Macedonia, The Netherlands and Slovenia use market or similar value concepts as property tax base. In United Kingdom, commercial properties are taxed based on their market rent (rateable value), while residential properties are assigned to value bands, based on their market values. In Turkey, property taxes are levied based on tax values of properties.

A good-quality land registration system plays an indispensable role in supporting property appraisal (Thang et al., 2011). Land registry and cadastre are the most common public registry that provide legal and geospatial information to valuation organizations in the surveyed countries. Valuation organizations also use information recorded at other land related public registries, such as Land Information System in Cyprus; Building and Dwelling Register, Sales and Valuation Register (SVUR) in Denmark; base registers for buildings and addresses, inhabitants and companies in The Netherlands; Address Register, Cadastre of Public Infrastructure in Slovenia; Address Register and municipal tax inventories in Turkey. Moreover, except for Turkey, all respondent countries have declared availability of national valuation databases, such as eProperty in Croatia; Sales and Valuation Register in Denmark; Registry for Prices and Lease in Macedonia; Base register for assessed values (Basisregistratie WOZ) in The Netherlands; Sales Price Register in Slovenia, and internal valuation database of Valuation Office Agency in United Kingdom. These databases are generally used for storing transaction information (e.g. sale prices, transaction date) and property characteristics (e.g. type of property, area) for implementing mass appraisal system and producing sale price statistics. Various methods are applied for collecting market information that stored in the mentioned databases. For instance, the valuation authority of Denmark, SKAT, has authorization to obtain information from owners of rental properties. Similarly, in United Kingdom, the government has the power to obtain information on lease transactions from non-domestic occupiers. In Slovenia, the sales and rent data are derived from taxation authority and parties. In Macedonia and Turkey, data are collected through declarations submitted by the parties involved in property transaction.

Dissemination of the information about property market to public has of vital importance for market transparency, and fair and equitable taxation. All respondent countries have declared availability of some mechanism for information sharing. In Cyprus, property characteristics and estimated values are open to public, and sales data and GIS based analyses are open to licenced valuer through a web portal. Similarly, in Croatia, only authorized users (e.g. authorized valuers and property agents) can access to valuation information, while in Slovenia sales data, property market reports, property data and property values are online accessible by all citizens. In Denmark, SKAT records sales statistics in the SVUR database, and publishes every six months a sales statistic. Moreover, the Public

Towards an International Information Standard for Immovable Property Valuation (8901)
Abdullah Kara, Volkan Cagdas, Umit Isikdag (Turkey), Peter van Oosterom (Netherlands) and Erik Stubkjaer (Denmark)

FIG Working Week 2017

Surveying the world of tomorrow - From digitalisation to augmented reality
Helsinki, Finland, May 29–June 2, 2017

Information Server, OIS, provides data on Danish properties. Owners have free access to own data, and companies may acquire property data about previous appraisals, property type, parcel area, and specification of most recent property tax. In United Kingdom, there are separate dissemination portals for non-domestic and domestic units in VOA website. Also, sales information and statistics are published through Price Paid Data in the United Kingdom. In Turkey, some municipalities disseminate assessed tax values through web. In The Netherlands, the public "WOZ-waardeloket" makes available the assessed value of residential properties together with other properties such as construction year, property function/type, and building floor size. These can be explored and seen in combination with data from the base register of buildings and shown in a map or aerial photo.

Fair and productive property taxes require not only a good initial valuation but also periodic revaluation to reflect changes in property values. Such periodic revaluations are supposed to reduce the risk of sudden shifts in tax burdens from large increases in assessed values (Bird and Slack, 2002). Among the respondent countries in the survey, general revaluations are made every year in the Netherlands, ever 4 years in Slovenia and in Turkey, and 5 five years in Cyprus and in United Kingdom for non-domestic hereditaments. In Denmark, general revaluations were made every fourth year in the most 20th century, and every second year in 2002-2012 period. A new revaluation is expected to be made after 2018 when a new appraisal system is operational. In Macedonia, general revaluations are very rare, and in most of the municipalities general revaluations have not been made for more than 20 years.

2.2 Mass appraisal procedures

Mass appraisal is the process of valuing a group of properties on a given date and using common data, standardized methods, and statistical testing (Gloude-mans, 1999, p. 1). In contrast to single property appraisal (see Section 2.3), mass appraisal uses statistical models (e.g. additive, multiplicative, hybrid models) that explain the supply and demand of the property market, and statistical methods (e.g. multiple regression analysis, neural networks, adaptive estimation procedure) to analyze these models based on input datasets with relevant properties. In general, these models are the form of standardized sales comparison using a model describing the object characteristics (the similarities and differences of the properties to be valued) and how these characteristics influence prices in the real estate market. It may also include a performance analysis stage, called a 'ratio study' to compare the appraised values with market values in order to determine the accuracy of the appraisal (Gloude-mans, 1999).

Among the respondent countries, Cyprus, Denmark, Slovenia and The Netherlands have computer aided mass appraisal systems. These systems are maintained by Department of Lands and Surveys in Cyprus, municipalities (partly with the support of private companies) in the Netherlands, Ministry of Taxation in Denmark and the Surveying and Mapping Agency in Slovenia. The mass appraisal systems in the respondent countries are mainly used for estimating property values for property taxation, but also for analyzing trends in property market, and other administrative processes. Both systems use in-house developed software, and run datasets recorded in other public registries, such as property area recorded at Cadaster, construction information recorded at Building

Towards an International Information Standard for Immovable Property Valuation (8901)
Abdullah Kara, Volkan Cagdas, Umit Isikdag (Turkey), Peter van Oosterom (Netherlands) and Erik Stubkjaer (Denmark)

FIG Working Week 2017

Surveying the world of tomorrow - From digitalisation to augmented reality
Helsinki, Finland, May 29–June 2, 2017

and Dwelling Register and permitted land use recorded at PlansystemDK in Denmark. In Slovenia, Land Cadaster and Building Cadaster data is a direct input to mass appraisal system, the whole Mass Valuation System and CAMA in Slovenia are based on public registers. In The Netherlands, CAMA systems are developed according to the Dutch legislation. GIS systems are used for viewing properties (using different types of photo's) and analyzing object characteristics. The software development and the mass appraisal itself is conducted by the private sector based on contracts from municipalities and with data from base registers (cadaster, building) and additional data. The Netherlands Council for Real Estate Assessment is responsible for the quality control. Quality control includes ratio studies, but also quality protocols for analyzing the quality of object characteristics registered.

In Denmark, multiple regression analysis based mass appraisal system has been in place since 1981, and is used to value roughly 75% of all properties. Similarly, in Slovenia, valuation models (e.g. valuation zones, valuation tables, additional valuation factors) are solved by multiple regression analysis and GAMLSS (Generalized Additive Models for Location, Scale and Shape). In The Netherlands, for residential properties valuation models are based on sales comparison. Most systems in The Netherlands use clustering as main methodology, while some systems use linear regression (MRA).

In general, parcel characteristics, construction characteristics, and locational characteristics are used as explanatory variables in mass appraisal models. As for parcel characteristics, parcel area and permitted or planned land use are used in all countries that have mass appraisal system. But in the Netherlands both planned (or allowed) and effective use is considered. As for construction characteristics, about 150 variables, including the use of building/unit, building material, installations, dates for building permits are used in Denmark. In Slovenia, depending on the valuation approach different kind of construction characteristics are considered. In sales comparison models, size, year of construction, year of renovation, number of floors, number of apartments in condominium, and availability of elevator, balcony, terrace, garage in the building are used as variables for the valuation of residential properties. In income models, building type, size, micro location characteristics are used for commercial properties. In cost models, building type and size are used as variable for the valuation of agricultural, industrial and public properties. In Cyprus, age, condition, property type, construction type, building category and area are used as construction characteristics. In the Netherlands, type of property, size of property, building year, annexes of the property (e.g. garages), quality of the property, maintenance condition are used. As for locational characteristics, in Slovenia distance from electrical power lines, highways and railways are used, while in Cyprus, distance from the point of interests are employed. In the Netherlands, positive and negative locational characteristics are combined into a 'school mark' for the quality of the location.

Three-dimensional (3D) data is not used in mass appraisal processes in Cyprus, Denmark and Slovenia countries. In Denmark, valuation objects include condominiums, and these condominiums are described by floor plans recorded at the Land Registration Court. Appraisal of condominiums is based on data only, e.g. floor number and area. Similarly, in Slovenia building parts (i.e. apartments) are included in the mass appraisal system on the base of attribute data. Apartments are

Towards an International Information Standard for Immovable Property Valuation (8901)
Abdullah Kara, Volkan Cagdas, Umit Isikdag (Turkey), Peter van Oosterom (Netherlands) and Erik Stubkjaer (Denmark)

FIG Working Week 2017

Surveying the world of tomorrow - From digitalisation to augmented reality
Helsinki, Finland, May 29–June 2, 2017

part of the Building Cadastre and are used in Mass Valuation System, but are not registered as 3D, but as “part of the building”. In The Netherlands, the use of 3D data is limited to some pilot projects. This data is mostly derived from large scale base map in combination with height information (such as AHN, Actual Height Netherlands) and sometimes combined with picture information.

2.3 Single property appraisal procedures

As appears from the questionnaire results, traditional sales comparison, income capitalization and cost approaches are all applied in Croatia, Turkey and United Kingdom. In Cyprus, sales comparison, investment method (income approach), and ‘base method’ is applied. Interestingly, only cost approach is used for every type of property in Macedonia. Since the ambition is to follow market practice, object dependent valuation methods are applied in Denmark.

Geographical or spatial datasets used in single property appraisal include cadastral plans, land use plans in Croatia and Turkey, Ordnance Survey large scale (1:2,500 and 1:1,250) maps in United Kingdom. Moreover, legal information recorded at land registry, and building permits are taken into consideration in all respondent countries. As for locational characteristics, some environmental risks, e.g. contaminated site recorded in the Danish Natural Environmental Portal, flood risk depicted on maps by Danish Agency for Water and Nature Management are considered in Denmark. In Croatia, locational characteristics are available through web services, but they are mostly not considered. In Macedonia and Cyprus, distance from point of interests are used, while in United Kingdom and the Netherlands, locational factors are taken into account but reflected in the analysis of comparable evidence. Construction characteristics used in single property appraisal are mainly derived from national registries in the respondent countries. But in Croatia, these are examined by the valuer on the site. In Denmark, information from the Building and Dwelling Register may be supplemented by a ‘Tilstandsrapport’ (Building Quality Status Report) prepared by certified engineers according to statutory rules. In The Netherlands, cost data for non-marketable properties is collected by the union of municipalities and is available for all municipalities for their valuations. Also municipalities have to collect all income related data for commercial real estate themselves. Mostly they send out questionnaires to owners of users of these properties for this purpose.

3. EVALUATION of GEOGRAPHICAL DATA STANDARDS for VALUATION PURPOSES

There are several international geographical standards that might provide a technical framework for the specification of valuation databases, such as LADM issued by ISO, LandInfra, CityGML, and IndoorGML issued by OGC and INSPIRE data specifications on cadastral parcel and buildings. This section briefly outlines the content of these standards, and evaluates how much these standards represent valuation objects and their legal, physical, geographical, economic and environmental characteristics needed for single and mass appraisal procedures.

Towards an International Information Standard for Immovable Property Valuation (8901)
Abdullah Kara, Volkan Cagdas, Umit Isikdag (Turkey), Peter van Oosterom (Netherlands) and Erik Stubkjær (Denmark)

FIG Working Week 2017

Surveying the world of tomorrow - From digitalisation to augmented reality

Helsinki, Finland, May 29–June 2, 2017

3.1 ISO's LADM

The first standard, ISO 19152:2012 Land Administration Domain Model (LADM) is an abstract conceptual model that focuses on the legal and geographical aspects of land administration. It aims to standardize cadastral systems, but has also capabilities to cover other land-related public registries (e.g., address, land use and land cover, property taxation, and valuation databases). The conceptual data model of ISO 19152 LADM consists of the following three packages: (1) Administrative Package, (2) Spatial Unit Package, and (3) Party Package, as illustrated in Figure 1. The Administrative Package defines the recording units of land administration (LA_BAUnit); and rights (LA_Right), restrictions (LA_Restriction), and responsibilities (LA_Responsibility) established on basic administrative units. The Spatial Unit Package and its Surveying and Representation sub-packages deal with spatial units (e.g. cadastral parcel, legal space building units, and legal space utility networks), and their geometric/topological representation based on ISO and OGC standards. Its specialized subclasses LA_LegalSpaceBuildingUnit and LA_LegalSpaceUtilityNetwork allow for the representation of legal spaces related to building units and utility networks, respectively. Finally, the Party Package includes the LA_Party class, which represents natural and legal people, and the LA_GroupParty class representing the groups consisting of a number of parties both of which play a role in land administration (Lemmen, 2012, p. 96). LADM also provides external classes which relate cadastral information systems with the other property related databases, such as address, taxation, land use, land cover, valuation, physical utility network, and archive databases (see Figure 2). This content of LADM enables representation all types of valuation objects and their legal characteristics, as well as actors that are responsible for valuation activities.

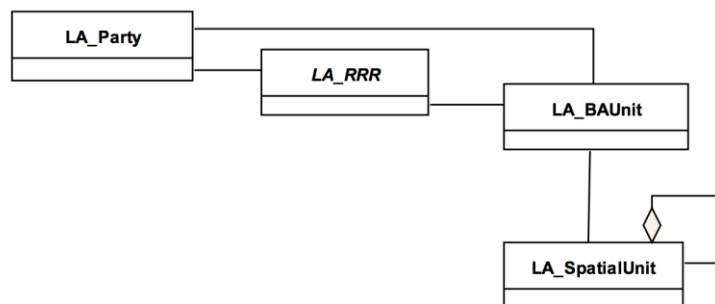

Figure 1. Basic classes of LADM (ISO 19152:2012, p. 8).

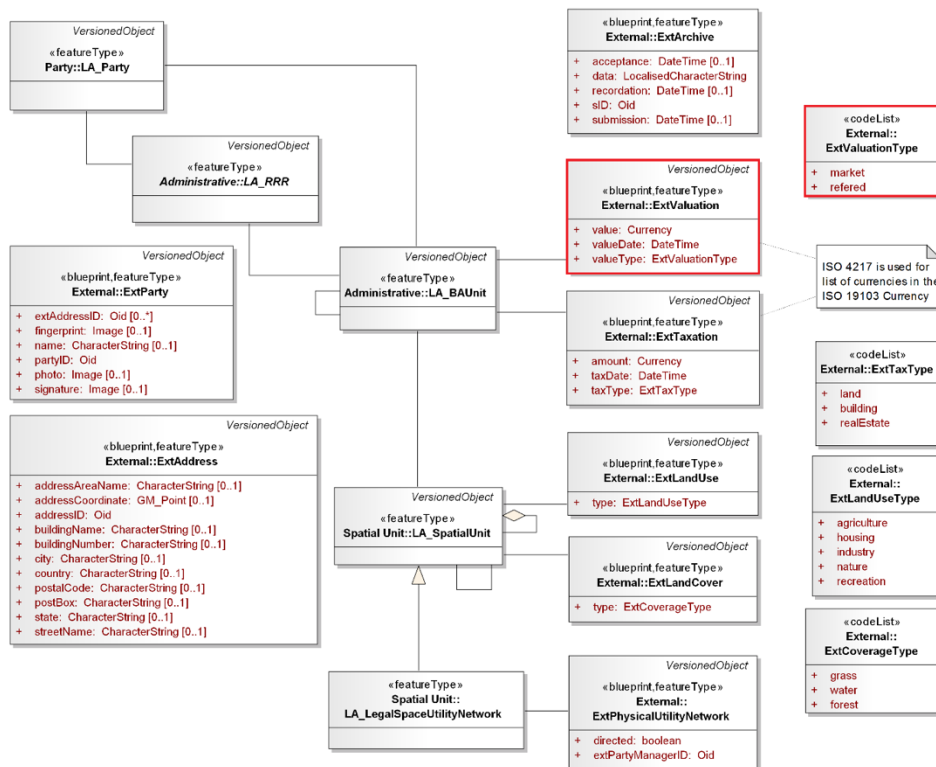

Figure 2. External LADM classes (ISO 19152:2012, p. 104).

3.2 OGC's LandInfra

Next standard, the OGC LandInfra is a conceptual data model focusing on land and civil engineering facilities. It consists of a core LandInfra package, and special packages for Facilities, Project, Alignment, Road, RoadCrossSection, Railway, Survey, Equipment, Observations, SurveyResults, LandFeature, LandDivision and Condominiums. Among the mentioned packages, LandDivision and Condominium are important since they specify the representation of property units, land parcels, and condominiums and their surveying related characteristics. The main class of LandDivision is the PropertyUnit which specifies unit of ownership in land. A PropertyUnit may be a LandedProperty consisting of a number of LandParcel which may also include building and fixtures, or a CondominiumUnit which consists of a number of BuildingPart within a CondominiumBuilding specified according to a CondominiumScheme. LandInfra is not concerned with land recording and database storage unlike LADM, since the scope is limited to activities in respect to civil engineering infrastructure facilities. Therefore, attributes assigned to mentioned classes are mainly related to determination and surveying of boundaries divisions of land. (OGC, 2017).

Towards an International Information Standard for Immovable Property Valuation (8901)

Abdullah Kara, Volkan Cagdas, Umit Isikdag (Turkey), Peter van Oosterom (Netherlands) and Erik Stubkjær (Denmark)

FIG Working Week 2017

Surveying the world of tomorrow - From digitalisation to augmented reality

Helsinki, Finland, May 29–June 2, 2017

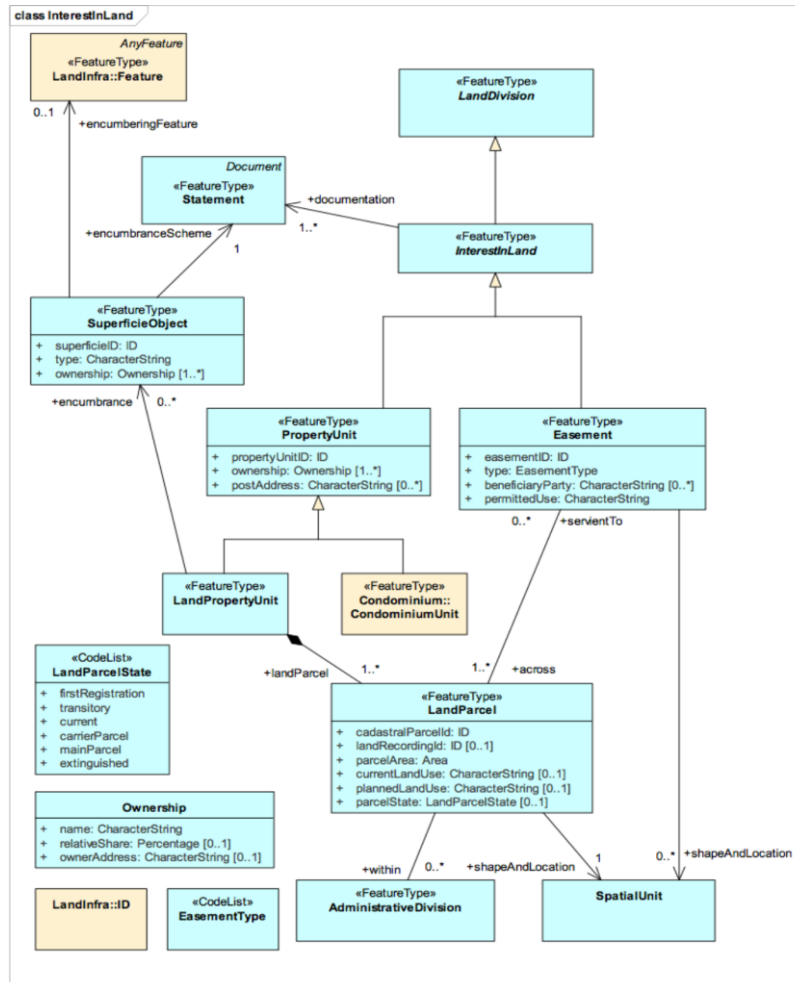

Figure 3. LandInfra InterestInLand context diagram (OGC, 2017)

3.3 OGC's CityGML

The other OGC standard, CityGML is an open data model with an XML-based format for the storage and exchange of virtual 3D city models. It consists of a core module and thematic extension modules including Appearance, Bridge, Building, CityFurniture, CityObjectGroup, Generics, LandUse, Relief, Transportation, Tunnel, Vegetation, WaterBody, and TexturedSurface. Among these modules, Building module has specifications representation of building and building parts, and their physical features. The main class in the Building module is AbstractBuilding, which is either a BuildingPart or a Building. The former is used to model a structural part of a building however, if a building consists of only one (homogeneous) part, the latter class is used. A building may have building installation objects such as chimneys, stairs, antennas, or balconies which are represented by the BuildingInstallation class. Moreover, a Building or BuildingPart consists of Rooms which also may have IntBuildingInstallations. The IntBuildingInstallation is used to model an object inside a building and permanently attached to the building structure, e.g. interior stairs,

Towards an International Information Standard for Immovable Property Valuation (8901)
 Abdullah Kara, Volkan Cagdas, Umit Isikdag (Turkey), Peter van Oosterom (Netherlands) and Erik Stubkjær (Denmark)

railings, radiators and pipes (OGC, 2012, pp. 67–82). CityGML Building module also provides a rich set of attributes for representing physical characteristics of buildings, building parts and their features.

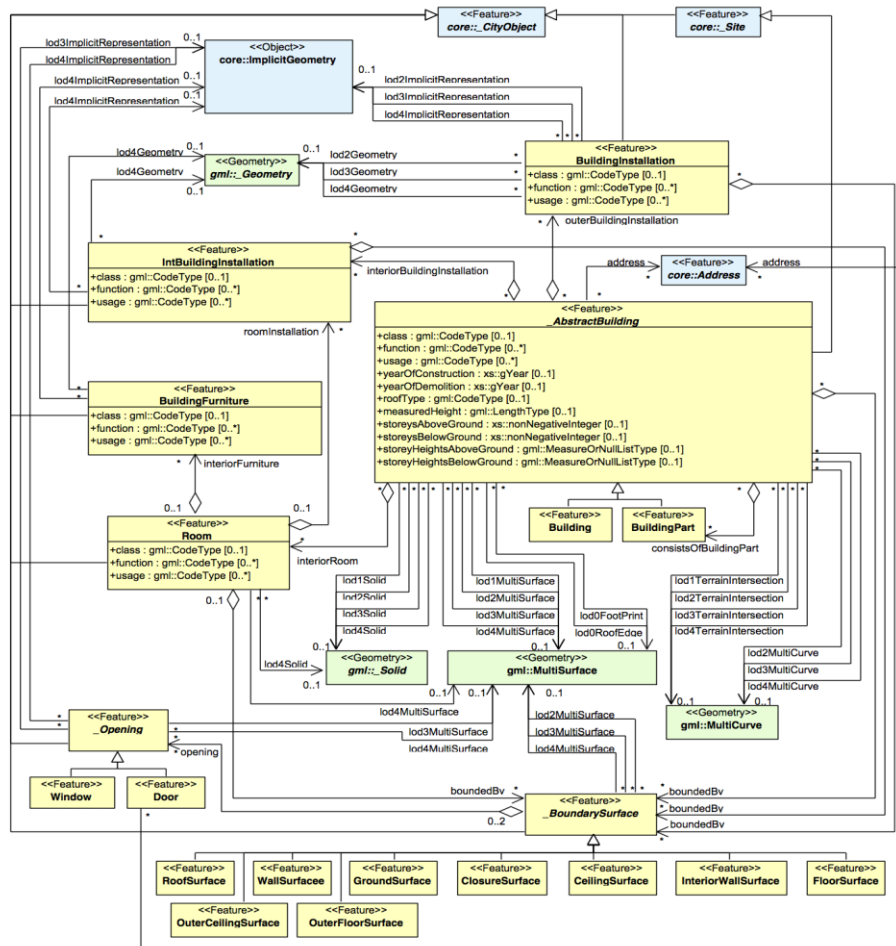

Figure 4. CityGML Building model (OGC, 2012, p. 63)

3.4 OGC's IndoorGML

The last OGC standard, IndoorGML is related to specification of interior space of buildings from geometric, cartographic, and semantic viewpoints. It specifies indoor space (e.g. rooms, corridors, stairs) bounded by architectural components (e.g. roofs, ceilings, walls), and the relationships between indoor spaces. IndoorGML has limited capabilities for the representation of valuation objects (e.g. CellSpace), since the focus is to provide description of indoor space and GML syntax for encoding geoinformation (geometry, network or path) for indoor navigation (OGC, 2016). A recent research by Zlatanova et al. (2016) provides new insights for linking IndoorGML and LADM, but at this moment IndoorGML is considered out of scope for the further investigation.

Towards an International Information Standard for Immovable Property Valuation (8901)
 Abdullah Kara, Volkan Cagdas, Umit Isikdag (Turkey), Peter van Oosterom (Netherlands) and Erik Stubkjaer (Denmark)

FIG Working Week 2017
 Surveying the world of tomorrow - From digitalisation to augmented reality
 Helsinki, Finland, May 29–June 2, 2017

3.5 INSPIRE Cadastral parcels and Buildings

The final two data models which are relevant for the specification of valuation objects are INSPIRE Data Specification on Cadastral parcels and Buildings. They are application schemas in GML published as annexes of the INSPIRE directive which aims at establishing an SDI for the European Union for cross-border access of geographical information for environmental purposes. The INSPIRE data specification on Cadastral parcel (INSPIRE CP) is concerned with the spatial aspect of immovable property units, including basic property units and cadastral parcels. It is consistent with LADM, but does not cover the legal aspect, namely property rights and right holders, like the LandInfra. INSPIRE CP has a core CadastralParcel class for representing cadastral parcels, and auxiliary CadastralZoning, CadastralBoundary and BasicPropertyUnit classes for cadastral zones, cadastral boundaries and basic property units which are the basic units of ownership recorded in land registers. Mandatory attributes assigned to these classes are related to identification and geometrical representation of parcels, cadastral zones, cadastral boundaries and basic property units (INSPIRE D2.8.I.6_v3.1).

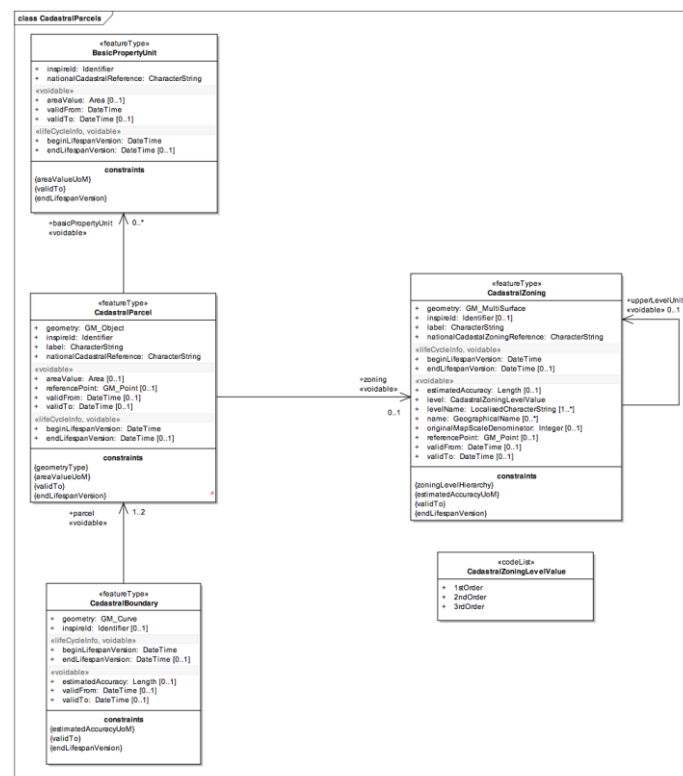

Figure 5. INSPIRE Cadastral parcels application schema (INSPIRE D2.8.I.6, p. 16)

The other data specification, INSPIRE Data Specification on Buildings is a rich data model for the representation of constructions, buildings, building parts, and their features. It provides four profiles for multiple representations of buildings and constructions with different levels of detail both in geometry and semantics. The normative core profiles (Building2D and Building3D) describe

Towards an International Information Standard for Immoveable Property Valuation (8901)
 Abdullah Kara, Volkan Cagdas, Umit Isikdag (Turkey), Peter van Oosterom (Netherlands) and Erik Stubkjær (Denmark)

buildings and building parts, and a limited set of attributes mainly related to temporal aspects (e.g. construction, renovation and demolition dates), physical information (e.g. height, number of floors, elevation) and the classification of buildings according to their physical aspect and current use. The extended profiles (BuildingsExtended2D and BuildingsExtended3D) contain additional feature types (i.e. other constructions, building units and installations) and additional thematic attributes (e.g. material of construction, official area or value, connection to utility networks) (INSPIRE D2.8.III.2).

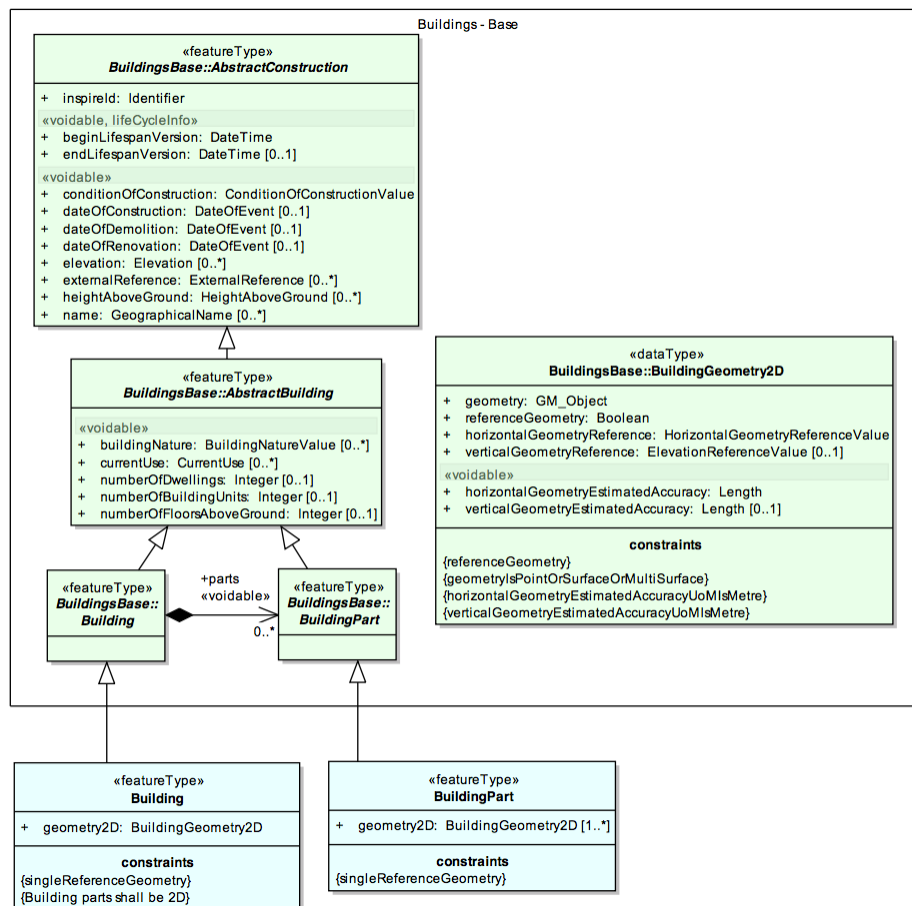

Figure 6. INSPIRE Building 2D application schema (INSPIRE D2.8.III.2_v3.0, p. 52)

3.6 Discussion

As mentioned above, the units of valuation may be only land (e.g. cadastral parcel), only improvements (e.g. buildings), land and improvements together as land property, land and improvements together as condominium property. Table 1 demonstrates these valuation units, and their characteristics used in single or mass appraisal procedures. These characteristics are mostly derived from international valuation standards, including Standard on Automated Valuation Models (IAAO, 2003), Standard on Mass Appraisal of Real Property (IAAO, 2013a), Guidance on

International Mass Appraisal and Related Tax Policy (IAAO, 2014), Standard on Digital Cadastral Maps and Parcel Identifiers (IAAO, 2015), Standard on Manual Cadastral Maps and Parcel Identifiers (IAAO, 2016), International Valuation Standards (IVSC, 2016), European Valuation Standards (TEGoVA, 2016). Table 2-5, below demonstrates how extent these characteristics are represented with classes and class attributes of above outlined geographical data standards.

Table 1. Property characteristics commonly used in valuation processes

Land (e.g. parcel) characteristics	Parcel area (TEGoVA, 2016; IAAO, 2015; IAAO, 2003)
	Topography (IAAO, 2003)
	Land use (TEGoVA, 2016; IAAO, 2003; IVSC, 2016)
	Easement (IAAO, 2003)
	Public restrictions (IAAO, 2003)
Improvement (e.g. building, building unit, other construction) characteristics	Size (IAAO, 2003)
	Living area (IAAO, 2013a)
	Age (IAAO, 2003; TEGoVA, 2016)
	Effective age (IAAO, 2013a)
	Use type
	Number of stories (IAAO, 2014)
	Construction materials (TEGoVA, 2016)
	Construction type (TEGoVA, 2016)
	Construction quality (IAAO, 2014; 2013a; TEGoVA, 2016)
	Available utilities (IAAO, 2013a; 2014)
	Building features (e.g. air-conditioning, fireplace, garage, pool) (IAAO, 2013a)
Energy efficiency (TEGoVA, 2016)	
Locational characteristics	Neighborhood (IAAO, 2003; 2010; 2013a; 2014)
	Risks of natural disasters (IVSC, 2016; TEGoVA, 2016)
	Closeness to point of interests
	External nuisances (e.g. heavy traffic, airport noise) (IAAO, 2013a; 2014)
	View (IAAO, 2003; 2013a; 2014)

Towards an International Information Standard for Immovable Property Valuation (8901)
 Abdullah Kara, Volkan Cagdas, Umit Isikdag (Turkey), Peter van Oosterom (Netherlands) and Erik Stubkjaer (Denmark)

FIG Working Week 2017
 Surveying the world of tomorrow - From digitalisation to augmented reality
 Helsinki, Finland, May 29–June 2, 2017

Table 2. Representation of valuation units in geographical data standards

Valuation unit	Components of valuation units	LADM	LandInfra	CityGML	INSPIRE
Land	Parcel	LA_SpatialUnit	LandParcel	-	CadastralParcel (CP)
Improvements	Building	LA_SpatialUnit ExtPhysicalBuildingUnit	Building CondominiumBuilding	_AbstractBuilding Building	AbstractBuilding (BU)
	Building unit	LA_SpatialUnit ExtPhysicalBuildingUnit	BuildingPart	BuildingPart Room	BuildingPart (BU) AbstractBuildingUnit (BU) Room (BU)
	Other constructions	LA_SpatialUnit ExtPhysicalBuildingUnit	-	-	AbstractConstruction (BU) AbstractOtherConstruction (BU)
Land and improvements together as land property	Land property	LA_BAUnit	PropertyUnit	-	BasicPropertyUnit (CP)
Land and improvements together as condominium property	Condominium main parts	LA_LegalSpaceBuildingUnit	CondominiumUnit	-	-
	Joint facilities	LA_LegalSpaceBuildingUnit	BuildingPart	-	-
	Accessory parts	LA_LegalSpaceBuildingUnit	BuildingPart	-	-

Table 3. Representation of parcel characteristics in geographical data standards

Parcel characteristics	LADM	LandInfra	INSPIRE
Area	area (LA_SpatialUnit)	parcelArea (LandParcel)	areaValue (CadastralParcel) (CP)
Land use	type ExtLandUse	plannedLandUse (LandParcel) currentLandUse (LandParcel)	-
Easement	LA_RRR LA_Restriction	Easement	-
Public restrictions	LA_RRR LA_Restriction	-	Data Specification on Area Management, Restriction, Regulation Zones and Reporting Units Data Specification on Land Use
Topography	-	-	Data Specification on Elevation

Table 4. Representation of construction characteristics in geographical data standards

Construction characteristics	LADM	LandInfra	CityGML	INSPIRE BU
Size	area (LA_SpatialUnit)	floorArea (BuildingPart)	-	officialArea, officialVolume (BuildingAndBuildingUnitInfo)
Living area	-	-	-	-
Chronological age	-	-	yearOfConstruction yearOfDemolition (_AbstractBuilding)	dateOfConstruction, dateOfDemolition (AbstractConstruction)
Effective age	-	-	-	dateOfRenovation (AbstractConstruction) conditionOfConstruction (AbstractConstruction)
Economic life	-	-	-	-
Remaining economic life	-	-	-	-
Number of stories	-	floorNumber (BuildingPart)	storeysAboveGround storeysBelowGround (_AbstractBuilding)	numberOfFloorsAboveGround (AbstractBuilding) numberOfFloorsBelowGround (BuildingInfo)
Construction materials	-	-	-	materialOfStructure, materialOfFacade, materialOfRoof (BuildingInfo)
Construction technique	-	-	-	materialOfStructure (BuildingInfo)
Construction quality	-	-	-	-
Available utilities	utilityNetworkType (LA_LegalSpaceUtilityNetwork) ExtPhysicalUtilityNetwork	type (FacilityPart)	/UtilityNetworkADE	connectionToElectricity, connectionToGas, connectionToSewage, connectionToWater (BuildingAndBuildingUnitInfo)
Other features	-	-	BuildingInstallation Room BuildingFurniture IntBuildingInstallations	numberOfDwellings, numberOfBuildingUnits (AbstractBuilding) Installation AbstractInstallation Room InteriorInstallation AbstractBuildingUnit
Energy efficiency	-	-	/Energy ADE	energyPerformance, heatingSource, heatingSystem (BuildingAndBuildingUnitInfo)

Table 5. Representation of locational characteristics in geographical data standards

Locational characteristics	LADM	LandInfra	INSPIRE
Neighborhood	-	-	-
Risks of natural disasters	-	-	Data Specification on Natural Risk Zones
Closeness to point of interests	-	-	-
External nuisances	-	-	Data Specification on Area Management, Restriction, Regulation Zones and Reporting Units Data Specification on Land Use
View			Data Specification on Elevation

As demonstrated in Table 2, LADM and LandInfra specify of all types of valuation units with different designations for legal and surveying purposes, respectively. Unlike other data models, they both provide limited attributes for the physical aspects of valuation objects. CityGML models buildings and their parts for 3D visualization purposes, and IndoorGML defines spaces in buildings for indoor navigation purposes. Similarly, INSPIRE data specifications on cadastral parcels and buildings specify cadastral parcels, buildings and other constructions for environmental purposes, but ignores the legal aspect. With exception of LADM and LandInfra, the designations of CityGML and INSPIRE data specifications basically focus on the physical aspect of spatial entities for different purposes, but they can be utilized in the development of a data model for valuation databases.

The current research considers LADM as the most relevant basis for the development of a valuation data model, because it is conceptually the most close and emphasizes the relationship to other property related databases, which is outside the scope of LandInfra. LADM is an ISO standard for the domain of land administration, which is related to management of information concerning the ownership, value and use of land. The current version of LADM mainly focuses on the legal and administrative aspects, but can be formally extended to cover valuation, taxation and land use planning related datasets. Moreover, its abstract designing approach provides a flexible frame for the further development of country specific data models. Thus, LADM is taken as the basis for the development of the valuation data model. The next section focuses on the specification of the ExtValuation class of LADM to propose an LADM-compliant data model for valuation databases and information systems.

4. A VALUATION INFORMATION MODEL BASED on ISO LAND ADMINISTRATION DOMAIN MODEL

This section describes the LADM-based valuation information model, labelled with the prefix VM_ and developed through the specification of the ExtValuation classes of LADM, in addition to the new classes, class attributes, and relationships, as well as the constraints. It provides a base model for recording data concerning the parties involved in the valuation practices, valuation units that are the objects of valuation, and their characteristics required in valuation applications (see Figure 6). It is noted that the extension module focuses on only administrative valuations in relation to property tax assessments, and excludes other public and private sector valuation activities.

The objects of valuation (e.g. immovable properties, condominium units, parcel, buildings) are related to the LA_SpatialUnit, LA_LegalSpaceBuildingUnit and LA_BAUnit classes in LADM. The LA_SpatialUnit class and LA_LegalSpaceBuildingUnit focus on the spatial representation of cadastral parcels and legal building units, respectively. They are further used to form the immovable properties represented with the LA_BAUnit class, such as one or more parcels with/without buildings and fixtures, and condominium units. These designations of LADM provide a base for the specification of fiscal objects; however, they should be supported from a fiscal point of view.

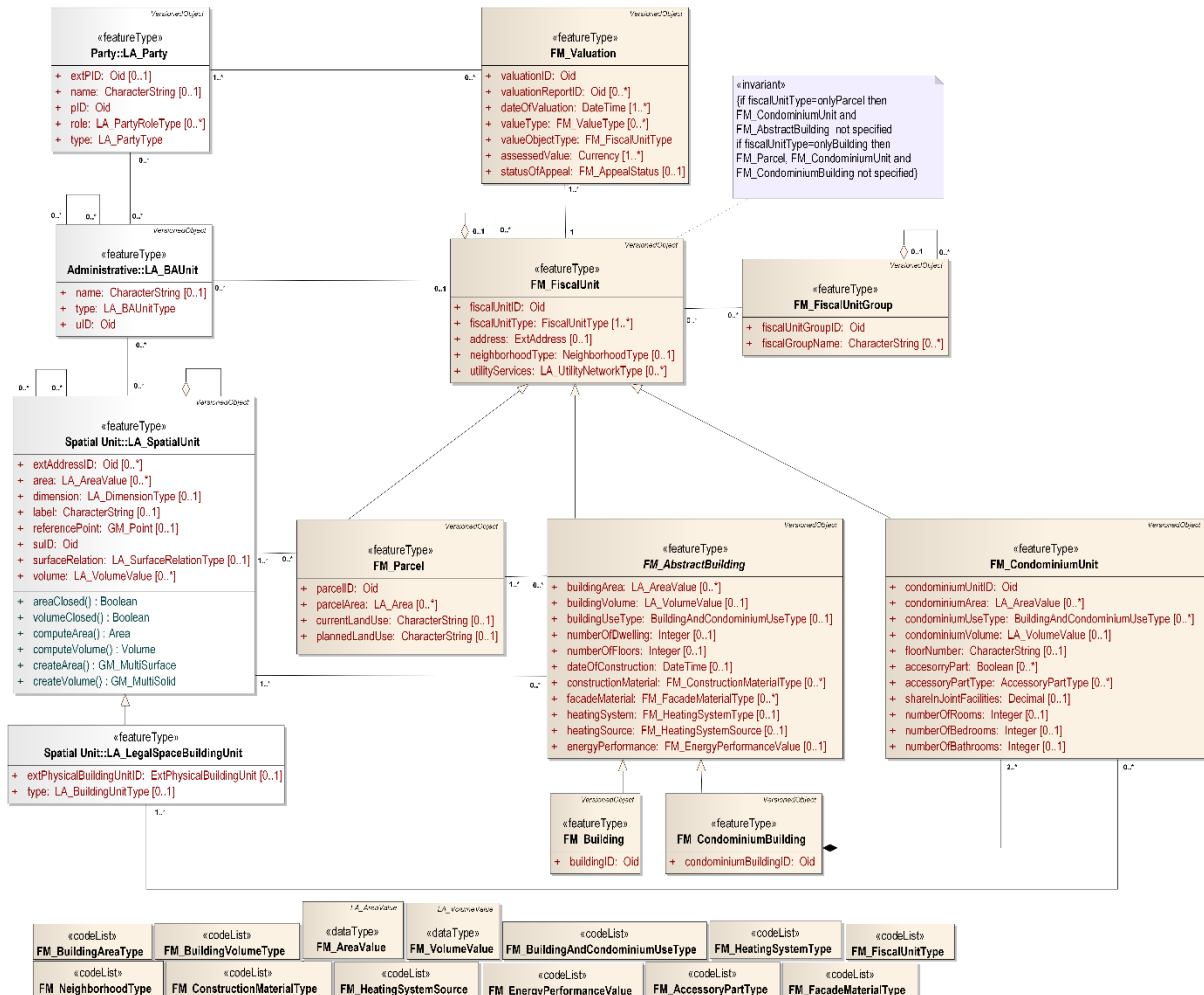

Figure 7. Core classes of fiscal extension module

A cadastral system is generally organized to maintain legal information in relation to immovable properties (i.e., one or more parcels and attached buildings, or condominium units) whereas a valuation database is organized in a way that stores information in relation to parcels, buildings, parcels and buildings together, and condominium units since these components may, individually, be the object of valuation and taxation procedures. Therefore, the developed extension module proposes a parent VM_ValuationUnit class, and VM_Parcel, VM_AbstractBuilding, VM_CondominiumUnit subclasses to represent parcels, buildings and

condominium units, and their physical and fiscal characteristics required by the valuation authorities, as illustrated in Figure 6.

VM_ValuationUnit represents the basic recording unit of valuation registries is associated with LA_BAUnit, which denotes the basic registration unit of cadastral systems. Owing to the constraints created for the valuationUnitType attribute of the VM_ValuationUnit class, the extension module enables the recording of data only for the selected units according to the selected tax base (i.e., only parcels, or only buildings, or parcels and buildings together, or condominiums). For instance, when the valuation base only refers to parcels, then the first constraint determines that a valuation database records information only for parcels and disregards buildings and condominium units. Similarly, the second constraint enables recording of only information concerning buildings when the tax basis only pertains to buildings.

The VM_ValuationUnit class defines common characteristics for the fiscal objects through attributes, such as identifier, fiscal unit type, address, neighborhood type, and available utility services. Among these, the neighborhoodType attribute is used to denote the type of neighborhood where the fiscal unit is located (e.g., urban, rural), and the utilityServices attribute records the available utility services (e.g., natural gas, electricity), enumerated in the VM_NeighborhoodType and LA_UtilityNetworkType code list classes, respectively.

The VM_Parcel class represents cadastral parcels, as well as sub-parcels that are the division of parcels based on official land use for taxation purposes (e.g., France and Spain). In addition to inherited attributes from VM_ValuationUnit, it has attributes for parcel identifiers recorded in the cadastral information system, area, current and planned land uses. The current land use attribute is used to denote the existing use of a cadastral parcel while planned land use is used to show the future use of a parcel indicated by spatial plans (INSPIRE D2.8.III.4). The Hierarchical INSPIRE Land Use Classification System (HILUCS) provides a code list for both existing and planned land use attributes.

For different taxation practices, valuation units may be grouped according to zones (e.g., central business districts, administrative divisions, market zones) that have similar environmental and economic characteristics, or categorized according to functions and types of fiscal units (e.g., commercial, residential, agricultural) that have similar physical characteristics. Moreover, mass appraisal models and ‘ratio study analysis’ may be employed for such groups instead of individual units. This issue is addressed by the VM_ValuationUnitGroup class in the extension module, which includes an identifier and type attributes. It should be noted that VM_ValuationUnitGroup not only groups spatially related fiscal units, but also spatially unrelated units that have similar characteristics, e.g., commercial properties.

LADM is only concerned with the legal space of buildings and building parts (e.g., individually owned apartments, jointly owned building parts), which does not necessarily coincide with the physical space of a building (ISO 19152:2012, p. 11). LADM also relates the legal space of building units with the corresponding physical building units recorded at external databases through the LA_LegalSpaceBuildingUnit class. Before-mentioned two data models, INSPIRE Data Specification on Buildings and CityGML provide a framework for the

Towards an International Information Standard for Immovable Property Valuation (8901)

Abdullah Kara, Volkan Cagdas, Umit Isikdag (Turkey), Peter van Oosterom (Netherlands) and Erik Stubkjaer (Denmark)

FIG Working Week 2017

Surveying the world of tomorrow - From digitalisation to augmented reality

Helsinki, Finland, May 29–June 2, 2017

development of such external databases. Incorporating their approach, an abstract VM_AbstractBuilding class is included in the extension module to specify buildings, building parts, other constructions, and their physical characteristics that are needed for valuation procedures. VM_AbstractBuilding provides a set of common attributes shared by its subclasses, such as area, volume, type of use, building type, number of dwellings and floors of buildings. It also accommodates construction and energy related attributes, i.e. date of construction, construction material, facade material, heating system, heating source and energy performance. INSPIRE Data Specification on Buildings and CityGML have also designations for the specification of building installations (e.g. balcony, winter garden, chimney), building furnitures (e.g. chair, table), and interior installations (e.g. stairs, railings, radiators), especially for 3D visualization purposes. But for the sake of simplicity, these designations have not been adopted to this data model. Figure 7 shows the code list classes that present values for the mentioned attributes, such as VM_BuildingAndCondominiumUseType, VM_ConstructionMaterialType, VM_FacadeMaterialType, VM_HeatingSystemSource, VM_HeatingPerformanceType, and VM_EnergyPerformanceValue.

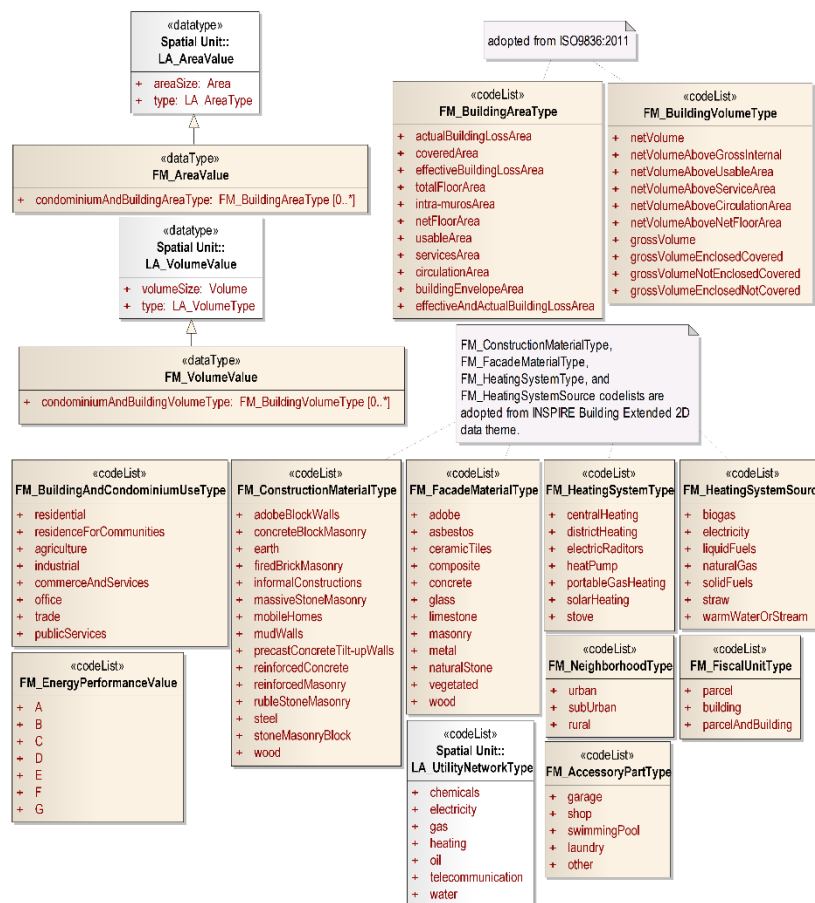

Figure 8. Data types and code list classes for the VM_ValuationUnit class and its subclasses

In LADM, the LA_AreaValue and LA_VolumeValue data types, and the LA_AreaType and LA_VolumeType code lists support the recording the various types of area and volume values (e.g., calculated, official) of spatial units. In the proposed module, these data types are extended with VM_AreaValue and VM_VolumeValue to specify different types of area and volume values of buildings and condominium units (e.g., total floor area, gross volume). The area and volume types defined in the ISO Performance Standards in Building (ISO 9836:2011) are adopted via the VM_BuildingAreaType and VM_BuildingVolumeType code list classes.

VM_AbstractBuilding has two concrete classes, VM_Building and VM_CondominiumBuilding. The former represents buildings that are considered as complementary parts of parcels, but may be taxed or valued separately from the parcels on which they are located. The latter, VM_CondominiumBuilding, is taken from the OGCs LandInfra standard to specify buildings that contain condominium units established according to condominium schemes (OGC, 2017). Both classes inherit attributes from the VM_AbstractBuilding class.

A condominium building consists of (i) condominium units (e.g. flats, shops); (ii) accessory parts assigned for exclusive use by specific condominium units (e.g. garages, storage areas); (iii) and joint facilities covering parcel, structural components (e.g. foundations, roofs), accession areas (e.g. entrance halls, spaces), and other remaining areas of buildings (e.g. staircases, heating rooms). Joint facilities are owned collectively by all the owners of the condominium units according to ownership shares of the condominium units, while accessory parts and the main condominium units are owned individually by the owners of these units (OGC, 2017; Çağdaş, 2013). The extension module proposes a VM_CondominiumUnit class to record the main condominium unit characteristics, such as area and volume, use type, type of condominium, floor number, and number of rooms, bathrooms and bedrooms. Condominium valuation, however, regards not only the main condominium units, but also the related accessory parts and shares in joint facilities. Therefore, VM_CondominiumUnit is supported with a shareInJointFacilities attribute to indicate share of condominium unit in commonly owned areas, with the accessoryPart and accessoryPartType attributes that specify the existence and type of accessory parts (e.g. garage, swimming pool) allocated to the condominium units.

VM_Valuation class, as counterparts of ExtValuation external class of LADM, are created to specify valuation information. The relationships between VM_Valuation, LA_Party and VM_ValuationUnit indicate that a valuation unit may be subject of one or more valuation activities carried out by one or more valuation experts. As shown in Figure 8, the VM_Valuation class focuses on the output data produced within single or mass appraisal processes for property tax assessment. It identifies valuation activities and valuation reports through valuationID and valuationReportID attributes, indicates the valuation date and value type with valuationDate and valueType attributes, and the final assessed value with the assessedValue attribute. Moreover, appealOfStatus attribute and its data type VM_AppealStatus enable tracking status of possible appeals (e.g., appeal date, appeal id, subject of appeal, and status of appeal) against to assessed values.

Generally, the value of a unit may be estimated by different approaches and methods before the final assessment, such as sales comparison, cost and capitalization methods in single

Towards an International Information Standard for Immovable Property Valuation (8901)

Abdullah Kara, Volkan Cagdas, Umit Isikdag (Turkey), Peter van Oosterom (Netherlands) and Erik Stubkjær (Denmark)

FIG Working Week 2017

Surveying the world of tomorrow - From digitalisation to augmented reality

Helsinki, Finland, May 29–June 2, 2017

property appraisal or mass appraisal procedures. VM_SinglePropertyAppraisal created as a subclass of VM_Valuation aims to describe single property appraisal related details using a number of attributes, i.e., valuationBySalesComparisonMethod, valuationByCostMethod, valuationByIncomeMethod, and the corresponding data type classes given in Figure 9.

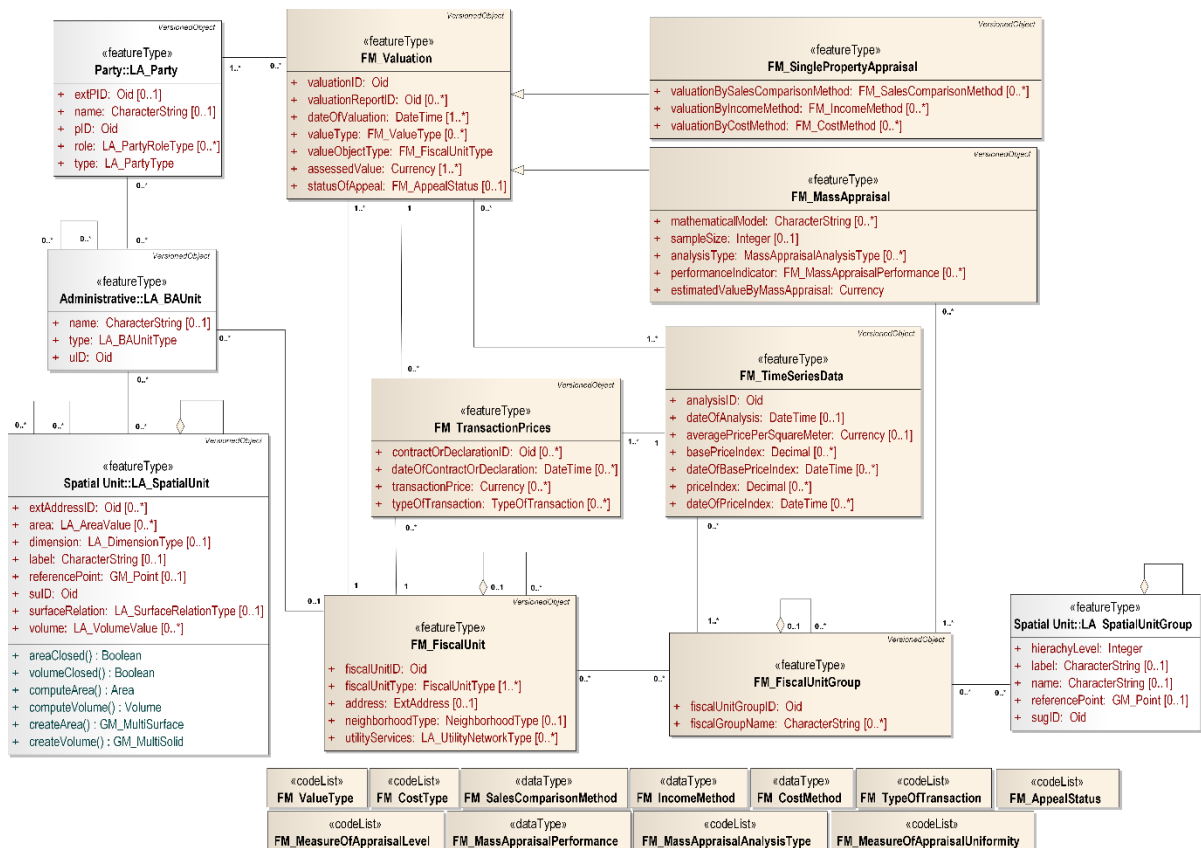

Figure 9. VM_Valuation and related classes

The VM_SalesComparisonMethod data type supports the documentation of comparable valuation units used in the sales comparison approach, and monetary adjustments made for the sale according to the time, location, physical and environmental differences from comparable units to estimate value of subject unit. The VM_CostMethod data type organizes the cost method related details, such as type (e.g., replacement or reproduction cost), source and price of cost, chronological and effective age of improvements, and appreciated depreciations (e.g., physical, functional, external and total depreciations) occurring through the improvements. The VM_IncomeMethod data type renders the potential gross, effective gross and net incomes, operating expenses, capitalization and discount rates, and gross rent multipliers used in the direct and yield capitalization approaches of income capitalization procedures.



Figure 10. Code list and data type classes developed for VM_Valuation and its subclasses

The other subclass of VM_Valuation, VM_MassAppraisal is designed to organize mass appraisal-related information. Specifically, it describes mathematical models, mass appraisal analysis types (e.g., multiple regression analysis), and the sample size of the analysis. It also has a performance indicator attribute and corresponding VM_MassAppraisalPerformance data type. The date of performance analysis, sample size, measures for appraisal level (e.g., mean), appraisal uniformity (e.g., coefficient of dispersion), and values for the selected measurements can be recorded through the VM_MassAppraisalPerformance data type class.

Many countries maintain registers or databases to record data in relation to property transactions, such as the Sales and Valuation Register in Denmark, Purchase Price Collection in Germany, Price Paid Data in the United Kingdom, and sales prices as part of the cadastral information in The Netherlands. In order to support single and mass appraisal procedures, these databases are used to produce periodic sale statistics and price indexes (e.g., Purchase Price Statistics of Real Estates in Finland, House Price Index in the United Kingdom, and the Price Index for existing houses in The Netherlands) that show the total amount and type of transactions, average values, and changes in property values. Such registers or databases are created and updated regularly by information provided from contracts or declarations submitted by the parties (e.g. buyer and/or seller) involved in the property transactions. The valuation data model is supported by the VM_TransactionPrices and VM_TimeSeriesData classes to address information regarding transaction prices and statistics, respectively. VM_TransactionPrices is provided with attributes that characterize the information content of transaction contractor declarations, including the date of contract or declaration, price, date and type of transaction (e.g., sale, heritage, forced sale, and rent prices). The next class, ~~VM_TimeSeriesData~~, is created to represent time series data produced through the analysis of

Towards an International Information Standard for Immovable Property Valuation (8901)

Abdullah Kara, Volkan Cagdas, Umit Isikdag (Turkey), Peter van Oosterom (Netherlands) and Erik Stubkjaer (Denmark)

transaction prices. It is related to VM_ValuationUnitGroup since such analysis can be made based on spatial (e.g. parcels in a municipality) or thematic clusters (e.g., parcels used for agricultural purposes) of fiscal units. In addition to identifier and date attributes, it has attributes to indicate the calculated average transaction prices per square meter of fiscal units. Moreover, it has basePriceIndex and dateOfBasePriceIndex attributes to record the value and date for specification of base index (e.g. Base Index Value = 100 at 2015 January), and priceIndex and dateOfPriceIndex attributes to record the calculated price index at a given date (e.g. Index Value = 120 at 2016 January). Transaction prices and transaction statistics recorded through VM_TransactionPrices and VM_TimeSeriesData are directly used in single and mass appraisal procedures, as indicated by two associations from VM_Valuation to VM_TransactionPrices and VM_TimeSeriesData.

The LA_Party class in LADM represents the natural and legal persons, and groups consisting of a number of parties both of which play a role in land administration. It can also be utilized to record information about parties that are involved in or affected by valuation and taxation procedures. The LA_PartyRoleType code list class, which provides values for the role performed by the parties (e.g., surveyor or notary) in the land administration domain, is therefore extended in the fiscal module to cover valuation and taxation-related roles, such as taxpayers and appraisers.

Finally, the temporal aspect in the extension module is addressed with the VersionedObject class and a number of attributes assigned to the VM_Valuation class. In LADM, VersionedObject is the superclass of all classes either directly or indirectly, and has the beginLifespan and endLifespan attributes to specify the date and time when the object was inserted, changed, and removed from the database. In keeping with the LADM design approach, all classes in the valuation data module are created as a subclass of VersionedObject either directly (e.g., VM_ValuationUnit, VM_Valuation) or indirectly (e.g., VM_Parcel, VM_Building, VM_MassAppraisal). Moreover, several attributes are assigned to the VM_Valuation class to deal with other temporal issues in relation to fiscal procedures, e.g., date of valuation, date of cost for valuation procedures.

5. CONCLUSIONS

This article describes a valuation information model for the specification of inventories or databases used in immovable property valuation. As an extension module of ISO 19152:2012 Land Administration Domain Model, it is designed to facilitate all stages of immovable property valuation, namely the identification of properties, assessment of properties through single or mass appraisal procedures, generation and representation of sales statistics, and dealing with appeals. More specifically, it enables the recording of data concerning the fiscal parties that are involved in valuation practices, property objects that are subject of valuation, as well as their characteristics. It is supposed that such standardization provides governments with a common basis for the development of local or national databases, and a guide for the private sector to develop information technology products. It is expected that this design will be refined by a Joint Working Group which is being established under FIG Commission 7 (Cadastre and Land Management) and FIG Commission 9 (Valuation and the Management of Real Estate), and proposed as a part of LADM 2.0, the revised version of LADM.

Towards an International Information Standard for Immoveable Property Valuation (8901)
Abdullah Kara, Volkan Cagdas, Umit Isikdag (Turkey), Peter van Oosterom (Netherlands) and Erik Stubkjær (Denmark)

FIG Working Week 2017

Surveying the world of tomorrow - From digitalisation to augmented reality
Helsinki, Finland, May 29–June 2, 2017

REFERENCES

Bird, R. M. and Slack, E., 2002. Land and Property Taxation: A Review. World Bank, Washington, DC.

CEN 15221-6:2011 - Space and Area Measurement in Facility Management, 2011-10-19.

ISO 9836:2011 - Performance standards in building — Definition and calculation of area and space indicators, 2011- 10-01.

Çağdaş V., 2013. An Application Domain Extension to CityGML for immovable property taxation: A Turkish case study. International Journal of Applied Earth Observations and Geoinformation, 21(1), 545-555.

Çağdaş, V., Kara, A., van Oosterom, P., Lemmen, C., Isikdag, U., Kathmann, R., and Stubkjær, E., 2016. An initial design of ISO 19152:2012 LADM based valuation and taxation data model. SPRS Annals of the Photogrammetry, Remote Sensing and Spatial Information Sciences., IV-2/W1, 145-154, doi:10.5194/isprs-annals-IV-2-W1-145-2016, 2016.

FAO, 2012. The FAO voluntary guidelines on the responsible governance of tenure of land, fisheries and forests in the context of national food security. Food and Agriculture Organization Of The United Nations, Rome.

Gloude-mans, R.J. 1999. Mass appraisal of real property. Kansas City: International Association of Assessing Officers.

Grover R., Törhönen M.-P., Munro-Faure P., Anand A., 2016. Achieving Successful Implementation of Value-Based Property Tax Reforms in the ECA Region. Paper prepared for presentation at the 2016 World Bank Conference on Land and Poverty. The World Bank - Washington DC, March 14-18, 2016.

IAAO, 2003. Standard on Automated Valuation Models (AVMs). Kansas City, Missouri.

IAAO, 2013a. Standard on Mass Appraisal of Real Property. Kansas City, Missouri.

IAAO, 2013b. Standard on Ratio Studies. Kansas City, Missouri.

IAAO, 2014. Guidance on International Mass Appraisal and Related Tax Policy. Kansas City, Missouri.

IAAO, 2015. Standard on Digital Cadastral Maps and Parcel Identifiers. Kansas City, Missouri.

INSPIRE D2.8.III.2_v3.0. INSPIRE Data Specification on Buildings – Draft Technical Guidelines, 2013-12-10.

Towards an International Information Standard for Immovable Property Valuation (8901)
Abdullah Kara, Volkan Cagdas, Umit Isikdag (Turkey), Peter van Oosterom (Netherlands) and Erik Stubkjær (Denmark)

FIG Working Week 2017

Surveying the world of tomorrow - From digitalisation to augmented reality
Helsinki, Finland, May 29–June 2, 2017

INSPIRE D2.8.I.6_v3.1. INSPIRE Data Specification on Cadastral Parcels – Guidelines, v3.0, 2014-04-17.

ISO 19107:2003 Geographic information -- Spatial schema. International Organization for Standardization (ISO), Geneva.

ISO, BS ISO 9836:2011 - Performance standards in building, Definition and calculation of area and space indicators, 2011-10-01.

ISO TC/211 - ISO 19152:2012. Geographic information – Land Administration Domain Model (LADM).

IVSC, 2016. International Valuation Standards. London, United Kingdom.

Kitchen, H., 2003. Property Taxation: Issues in Implementation. The Consortium for Economic Policy Research.

Lemmen, C. H. J., Van Oosterom, P. J. M., Uitermark, H. T., Zevenbergen, J. A., and Cooper, A. K., 2011. Interoperable domain models: The ISO land administration domain model LADM and its external classes. In UDMS 2011: 28th Urban Data Management Symposium, Delft, The Netherlands, September 28-30, 2011.

Lemmen, C.H.J., 2012. A domain model for land administration. PhD Thesis Technical University Delft. ITC Dissertation 210, ISBN: 978-90-77029-31-2.

McCluskey, W.J., 1999. Comparative Property Tax Systems: An International Comparative Review. Aldershot, UK: Avebury Publishing Limited.

OECD, 2010. Revenue Statistics 1965–2010: 2010 Edition.

OGC, 2012. OpenGIS City Geography Markup Language (CityGML) Encoding Standard (Version 2, Publication Date: 2012-04-04).

OGC, 2016. Indoor GML (Version: 1.0.2, Publication Date: 2016-08-23), Editor: Jiyeong Lee, Ki-Joune Li, Sisi Zlatanova, Thomas H. Kolbe, Claus Nagel, Thomas Becker.

OGC, 2016. Land and Infrastructure Conceptual Model Standard (LandInfra). (Version 1.0, Publication Date: 2016-12-20), Editor: Paul Scarponcini, Contributors: Hans-Christoph Gruler (Survey), Erik Stubkjær (Land), Peter Axelsson, Lars Wikstrom (Rail).

Plimmer, P. and McCluskey, W. J., 2016. Property Taxation for Developing Economies, FIG Publication No. 67, Copenhagen, Denmark.

RICS, 2007. Code of Measuring Practice, 6th edition, Coventry, UK.

Sirmans, S., Macpherson, D. and Zietz, E., 2005. The Composition of Hedonic Pricing Models.

Towards an International Information Standard for Immovable Property Valuation (8901)
Abdullah Kara, Volkan Cagdas, Umit Isikdag (Turkey), Peter van Oosterom (Netherlands) and Erik Stubkjær (Denmark)

FIG Working Week 2017

Surveying the world of tomorrow - From digitalisation to augmented reality
Helsinki, Finland, May 29–June 2, 2017

Journal of Real Estate Literature 2005 13:1, 1-44.

Shugrue, F.R., 1963. The nature of real estate appraisal. In Encyclopedia of Real Estate Appraising (Ed. E.J. Friedman), Fifth edition, Prentice-Hall: Englewood Cliffs, N.J., pp. 3-14.

Tang, B., Wong, S., Liu, S., 2011. Institutions, property taxation and local government finance in China. Urban Studies 48 (5), 847–875.

TEGoVA (2016). European Valuation Standards (EVS). 8th Edition. Gillis: Belgium.

Youngman, J. and Malme, J., 1994. An International Survey of Taxes on Land and Buildings. Boston: Kluwer Law and Taxation Publishers.

Towards an International Information Standard for Immovable Property Valuation (8901)
Abdullah Kara, Volkan Cagdas, Umit Isikdag (Turkey), Peter van Oosterom (Netherlands) and Erik Stubkjær (Denmark)

FIG Working Week 2017

Surveying the world of tomorrow - From digitalisation to augmented reality

Helsinki, Finland, May 29–June 2, 2017

BIOGRAPHICAL NOTES

Abdullah Kara has his BSc in Geomatics Engineering from İstanbul Technical University and his MSc degree in Geomatics Programme of Yıldız Technical University (YTU). He worked as an engineer in the Development of Geographical Data Standards for Turkey National GIS Infrastructure (TUCBS), supported by the Ministry of Environment and Urbanization. He has been working as a research assistant at YTU since 2013. His research field includes land administration, property valuation and geo-spatial data modelling.

Volkan Çağdaş has been working as associate professor in Department of Surveying Engineering, Yıldız Technical University (YTU) since 1999. His research interests cover the technical and the institutional aspects of cadastre and land administration.

Ümit Işıkdag has his MSc in Civil Engineering and PhD (from the University of Salford) in Construction Information Technology with his work on integration of BIM with 3D GIS. His research interests include BIM / IFC, 3D GIS, Internet of Things, RESTful Architectures, BIM 2.0, and Spatial Web Services. He is lecturing in Beykent University Dept. of Civil Engineering and actively involved in the organization of 3D GeoInfo and GeoAdvances Conferences, editorship of International Journal of 3D Information Modeling, and also serving as the Secretary of ISPRS WG II/2.

Peter van Oosterom obtained an MSc in Technical Computer Science in 1985 from Delft University of Technology, the Netherlands. In 1990 he received a PhD from Leiden University. From 1985 until 1995 he worked at the TNO-FEL laboratory in The Hague. From 1995 until 2000 he was senior information manager at the Dutch Cadastre, where he was involved in the renewal of the Cadastral (Geographic) database. Since 2000, he is professor at the Delft University of Technology, and head of the 'GIS Technology' Section, Department OTB, Faculty of Architecture and the Built Environment, Delft University of Technology, The Netherlands. He is the current chair of the FIG Working Group on '3D Cadastres'.

Christiaan Lemmen is international consultant at Kadaster International, The Netherlands. He is visiting researcher at the ITC Faculty, University of Twente, The Netherlands. He is chair of the Working Group 'Fit-For-Purpose Land Administration' of FIG Commission 7, and director of the FIG Bureau of Land Records and Cadastre, OICRF. He is contributing editor of GIM International.

Erik. Stubkjær is professor in Cadastral Science at the Aalborg University. He originated the idea and performed the preparation of the COST-action G9 and served as its chairman. He is member of the Danish Association of Chartered Surveyors, and of the ITsection of the Society of Danish Engineers.

CONTACTS

Abdullah Kara

Yıldız Technical University, Department of Surveying Engineering

34210 Esenler, Istanbul / TURKEY

Tel. + 90 212 383 5322

Fax + 90 212 383 5274

Email: abkara@yildiz.edu.tr

Web site: <http://www.yarbis.yildiz.edu.tr/abkara>

Volkan Çağdaş

Yıldız Technical University, Department of Surveying Engineering

34210 Esenler, Istanbul / TURKEY

Tel. + 90 212 383 5313

Fax + 90 212 383 5274

Email: volkan@yildiz.edu.tr

Web site: <http://yildiz.edu.tr/~volkan/>

Ümit Işıkdag

Mimar Sinan Fine Arts University

Informatics

34427 Şişli, Istanbul / TURKEY

Tel. + 90 212

Fax + 90 212

Email: uisikdag@gmail.com

Web site: <http://www.isikdag.com/>

Peter van Oosterom

Delft University of Technology, Faculty of Architecture and the Built Environment

P.O. Box 5030, 2600 GA Delft / THE NETHERLANDS

Tel.: +31 15 2786950

E-mail: P.J.M.vanOosterom@tudelft.nl

Website: <http://www.gdmc.nl>

Dr. Christiaan Lemmen

Netherlands Cadastre, Land Registry and Mapping Agency, Kadaster International

PO Box 9046, 7300 GH Apeldoorn / THE NETHERLANDS

Phone: +31 88 183 3110

E-mail: Chrit.Lemmen@kadaster.nl

Website: www.kadaster.nl

Erik Stubkjær

Aalborg University, Department of Development and Planning

Fibigerstræde 11. 32, DK-9220 Aalborg Ø / DENMARK

Tel.: +45 9635 8350

Towards an International Information Standard for Immovable Property Valuation (8901)

Abdullah Kara, Volkan Cagdas, Umit Isikdag (Turkey), Peter van Oosterom (Netherlands) and Erik Stubkjær (Denmark)

FIG Working Week 2017

Surveying the world of tomorrow - From digitalisation to augmented reality

Helsinki, Finland, May 29–June 2, 2017

E-mail: +45 9815 6541

Website: <http://www.plan.aau.dk/~est/>

Towards an International Information Standard for Immovable Property Valuation (8901)
Abdullah Kara, Volkan Cagdas, Umit Isikdag (Turkey), Peter van Oosterom (Netherlands) and Erik Stubkjær
(Denmark)

FIG Working Week 2017

Surveying the world of tomorrow - From digitalisation to augmented reality

Helsinki, Finland, May 29–June 2, 2017