

## A mapping method for quick assessment of reactive distillation applicability to ternary reaction systems

Muthia, Rahma; Kiss, Anton A.

**DOI**

[10.1016/j.cep.2023.109529](https://doi.org/10.1016/j.cep.2023.109529)

**Publication date**

2023

**Document Version**

Final published version

**Published in**

Chemical Engineering and Processing - Process Intensification

**Citation (APA)**

Muthia, R., & Kiss, A. A. (2023). A mapping method for quick assessment of reactive distillation applicability to ternary reaction systems. *Chemical Engineering and Processing - Process Intensification*, 193, Article 109529. <https://doi.org/10.1016/j.cep.2023.109529>

**Important note**

To cite this publication, please use the final published version (if applicable). Please check the document version above.

**Copyright**

Other than for strictly personal use, it is not permitted to download, forward or distribute the text or part of it, without the consent of the author(s) and/or copyright holder(s), unless the work is under an open content license such as Creative Commons.

**Takedown policy**

Please contact us and provide details if you believe this document breaches copyrights. We will remove access to the work immediately and investigate your claim.

***Green Open Access added to TU Delft Institutional Repository***

***'You share, we take care!' - Taverne project***

**<https://www.openaccess.nl/en/you-share-we-take-care>**

Otherwise as indicated in the copyright section: the publisher is the copyright holder of this work and the author uses the Dutch legislation to make this work public.



Contents lists available at ScienceDirect

# Chemical Engineering and Processing - Process Intensification

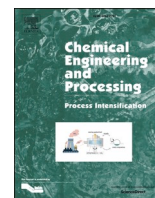
journal homepage: [www.elsevier.com/locate/cep](http://www.elsevier.com/locate/cep)

## A mapping method for quick assessment of reactive distillation applicability to ternary reaction systems

Rahma Muthia<sup>a,b,\*</sup>, Anton A. Kiss<sup>c</sup><sup>a</sup> Department of Chemical Engineering, Faculty of Engineering, Universitas Indonesia, Depok, 16424, Indonesia<sup>b</sup> Sustainable Energy Systems and Policy Research Cluster, Universitas Indonesia, Depok, 16424, Indonesia<sup>c</sup> Department of Chemical Engineering, Delft University of Technology, Van der Maasweg 9, Delft 2629 HZ, The Netherlands

## ARTICLE INFO

## Keywords:

Mapping method  
 Applicability graph  
 Ternary systems  
 Conceptual design  
 Reactive distillation

## ABSTRACT

Reactive distillation (RD) is a process intensification technology that offers opportunities in the chemical industry. However, designing RD columns remains a demanding task as reaction and separation phenomena occur simultaneously in the column. Moreover, in the early phase of conceptual process design, most of the physical and chemical properties information is unknown. Aiming to deal with that constraint, this paper presents the latest development of a mapping method, for the quick evaluation of the RD applicability. Initially, the approach was introduced in our previous work but limited to quaternary reaction systems. The extended method development performed in this work shows the general suitability of the method for ternary reaction systems, in spite of decreased degree of freedom of the systems. The method validation based on an industrial case study shows that the deviations for predicted number of theoretical stages and reflux ratio are less than 10%. Using only generic cases with fixed representative relative volatilities, chemical equilibrium constant and the Damköhler number, end users of the mapping method can quickly perform the RD applicability screening without doing any extensive rigorous simulations for real systems.

### 1. Introduction

Most processes in the chemical industry require reaction and separation operations that enable the conversion of raw materials and the purification of desired product(s). Recycle streams of unconverted reactants or undesired by-products are usually necessary to increase the process efficiency, such as in terms of conversion and selectivity. Such reaction-separation-recycle systems have been widely applied under different operating conditions [1].

The emergence and implementation of the UN Sustainable Development Goals requires that chemical processes are taken to the next level, where it is crucial to modify reaction-separation-recycle systems and develop cheaper, safer, more energy-efficient and sustainable process technologies. This requirement is in line with the purpose of applying process intensification (PI) methods in the chemical industry [2–4]. In the field of PI methods, reactive distillation (RD) are the front-runner [5] as it enables the integration of reaction and distillation processes in a single column (Fig. 1). Among existing unit operations, distillation has become one of the most popular separation techniques being used for hundreds of years for purification purposes [6–7].

Simultaneous reaction and separation in a RD column potentially leads to the process simplification, increased conversion and selectivity, capital saving, reduced energy utilization and chemicals degradation, overcoming of azeotropes and easier separation of close-boiling components [8–11].

Although RD offers significant advantages, there are some possible constraints that may restrict the column operation, i.e. limited operating windows (due to the thermodynamic properties), incompatible orders of volatilities between reactants and products, infeasible separation (due to azeotropes), and diverse conversion and column profiles (due to the existence of multiple steady states) [8,12–13]. Considering those hindrances, process designers must initially perform an applicability assessment of RD technology and carefully consider conceptual column designs in prior to the RD application in the chemical industry.

Over the last three decades, many studies have been developing design methods for screening and evaluating the applicability of RD. Almeida-Rivera et al. [14] distinguished those methods into three categories: heuristic-based, graphical, and optimization-based methods. Heuristic-based approaches suggest design parameters based on previously investigated RD columns and knowledge of conventional distillation processes [15]. While, graphical methods usually include the mass

\* Corresponding author.

E-mail address: [rahmamuthia@ui.ac.id](mailto:rahmamuthia@ui.ac.id) (R. Muthia).<https://doi.org/10.1016/j.cep.2023.109529>

Received 21 February 2023; Received in revised form 8 August 2023; Accepted 1 September 2023

Available online 2 September 2023

0255-2701/© 2023 Elsevier B.V. All rights reserved.

### Nomenclature

$C_i$	molar concentration of compound $i$ [ $\text{mol}\cdot\text{m}^{-3}$ ]
$Da$	Damköhler number [-]
$K_{eq}$	chemical equilibrium constant [-]
$NTS$	number of theoretical stages [-]
$NTS_{min}$	minimum number of theoretical stages [-]
$P$	pressure [atm]
$r$	reaction rate [ $\text{mol}\cdot\text{s}^{-1}$ ]
$R$	gas constant [ $\text{J}\cdot\text{K}^{-1}\cdot\text{mol}^{-1}$ ]
$RR$	reflux ratio [ $\text{mol}\cdot\text{mol}^{-1}$ ]
$RR_{min}$	minimum reflux ratio [ $\text{mol}\cdot\text{mol}^{-1}$ ]
$T$	temperature [K]
$T_b$	boiling point temperature [K]
$x_i$	mol fraction of compound $i$ [-]
$\alpha_{ij}$	relative volatility between compounds $i$ and $j$ [-]

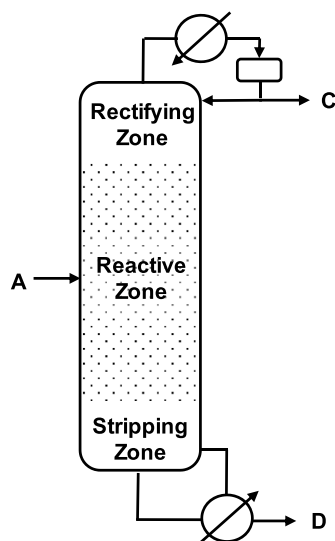

Fig. 1. Schematic representation of a reactive distillation column.

and molar compositions along a RD column for constructing residue curve maps and distillation lines. The residue curves mapping (RCM) can be used to evaluate the applicability of both non-reactive and reactive distillation columns. The usage of RCM relies on thermodynamics that influence the composition profiles and correspondingly obtainable products from the operation of an RD column [16–20].

A graphical method, called the attainable region technique, was proposed by Nisoli et al. [21] to identify the feasible compositions for the processes with simultaneous reaction, mixing and separation. Lee et al. [22–24] developed a different method, which is based on the modified Ponchon-Savarit and McCabe-Thiele methods, to evaluate reactive distillation columns for binary reactions. Other graphical methods are also reported in literature [25–31].

Optimization techniques usually evaluate mathematical relationships among the objectives to be optimized, the decision variables and the constraints in RD processes [32]. For example, Seferlis and Grievink [33] proposed the orthogonal collocation on finite elements (OCFE) to approximate the tray-by-tray model by transforming the discrete number of RD stages into a continuous analogue. Urselmann et al. [34,35] developed a memetic algorithm that combines evolutionary algorithm and mathematical programming methods to optimize the RD column designs. Other optimization techniques for RD are discussed elsewhere

[36–43].

Many available methods discussed above provide a good estimate of the applicability screening and the design of RD columns, but they can only deliver a single set of configurations, such as reflux ratio and the number of theoretical stages, for a single assessment. For example, the static analysis method by Giessler et al. [26] can be used to evaluate the location and the length of reactive stages. The modified fixed point methodology presented by Li et al. [31] is capable of providing the number of theoretical stages, the feed location and actual stages compositions for a pre-determined reboil ratio. However, repeated tasks are needed when one aims to obtain insights into the operation of RD for different configurations, which makes designing a proper RD column an exhausting task.

Furthermore, there is gap in the availability of generic RD design methods that are suitable for many chemical reaction systems [44]. Among those methods discussed above, only a few of them were validated and shown to be suitable for various reaction systems [16,30–31], while many others were proven to be suitable only for specific reaction systems [21,25–27,33–38]. For instance, the OCFE method for obtaining an optimal RD design was proven to be suitable for quaternary reaction systems, which was based on the validation using the case of ethyl acetate production via esterification [33]. But, its capability of assessing ternary systems has still not been validated. The Ponchon-Savarit and McCabe-Thiele methods were applied by Lee et al. [22–24] for assessing the reactive zones and feed location within a reactive distillation column for isomerization and decomposition reactions. Its application to different reaction systems is limited due to its inherent graphical nature [14]. However, both ternary and quaternary reaction systems are equally important as they are most frequently encountered in the chemical industry [1,10,45].

Aiming to overcome such limitations, this paper presents a mapping method, which uses only a few key parameters, i.e., relative volatilities of compounds ( $\alpha_{ij}$ ), chemical equilibrium constants ( $K_{eq}$ ) and the Damköhler numbers ( $Da$ ), of ideal generic cases for quickly assessing the applicability of RD to real reaction systems encountered in the chemical industry. The values of relative volatilities and chemical equilibrium constants can be calculated by using the information obtained from the chemical engineering databases, such as the DECHEMA Chemistry Data Series [46], the Perry's Chemical Engineers' Handbook [47] and the NIST Chemistry WebBook [48]. While, the kinetic data for the Damköhler number calculation is obtained from the literature reporting reaction rate constants based on modeling and/or experimental findings.

The mapping method employs a plot of reflux ratio ( $RR$ ) vs. the number of theoretical stages ( $NTS$ ), which is called the applicability graph, that depicts 'applicable and not-applicable regions' of the operability of reactive distillation technology. By using the approach, one can obtain multiple RD configurations with different combinations of reflux ratio and the number of theoretical stages from a single assessment, which are within the applicable regions of an applicability graph. The originality of this work consists in providing a general method that is suitable for different reaction systems. Previously, Skiborowski [44] identified a research gap, in which although many RD design methods are available, there is a lack of the availability of RD general methods. This development addresses the need for generic methods that are suitable for quaternary and ternary reaction systems, as the RD application was reported to be the most attractive for both reaction systems [1,10,12,45]. The mapping method was previously introduced in our previous studies for assessing the RD applicability to quaternary reaction systems as RD is generally attractive for quaternary or multicomponent reaction systems [49–54]. The current work developed further the mapping method for assessing the RD applicability to ternary reaction systems, which was unaddressed previously.

This original study discusses the extension of the mapping method. Firstly, the paper shows the use of the mapping method to gain insights into the RD operation for ternary systems, which have fewer degrees of freedom. The mapping method is employed to evaluate the RD

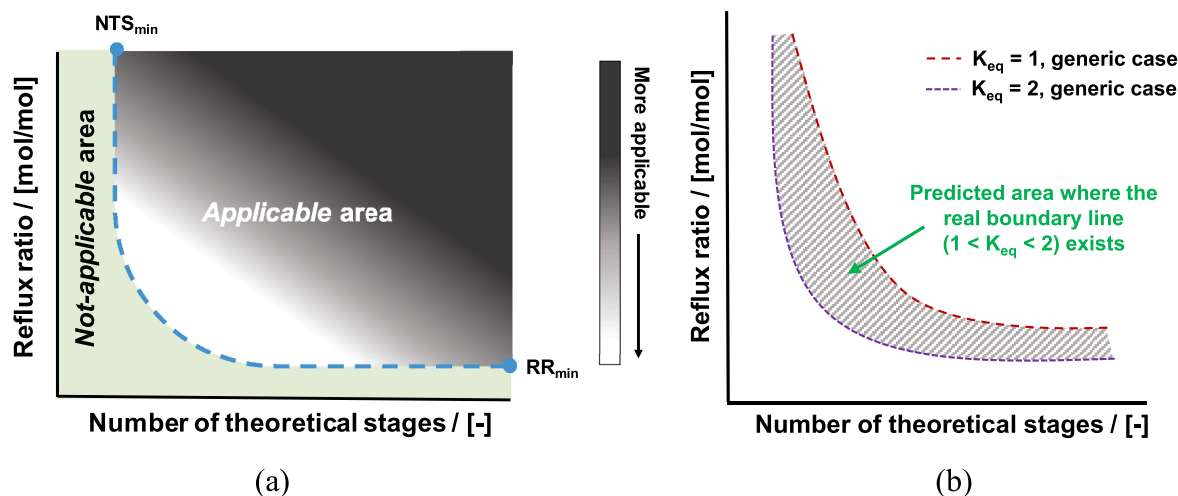

Fig. 2. (a) An illustrative applicability graph, and (b) an illustrative prediction of the boundary line of a real applicability graph; the prediction is based on generic systems.

configurations of generic cases with different feed stages and numbers of reactive and separation stages. By applying the approach, one can obtain an understanding of preferred configurations with the lowest reflux ratios in real systems, which require less investment and operating costs due to smaller column diameters and lower energy requirement. Secondly, the present work demonstrates the suitability of the generalized mapping method for assessing the applicability of reactive distillation to a case study of ternary reaction systems, considering both equilibrium-limited and kinetically controlled reaction models. Note that many other (quaternary) case studies for the method validation have been discussed in our previous work [49,52,54].

The method application is preferred for the RD preliminary assessment at the conceptual design phase, when limited information is available and a quick go-/no-go decision is needed to decide whether a detailed rigorous investigation of RD designs is worthwhile. This novel general approach leads to a simple applicability assessment prior to performing rigorous simulations of real systems.

## 2. Mapping method overview

Previously, the mapping method was introduced for investigating the reactive distillation applicability to near-ideal quaternary systems,  $A + B \rightleftharpoons C + D$  [49]. The assessed subset was the quaternary systems that have two products with the lowest and the highest boiling temperatures,  $T_{b,C} < T_{b,A} < T_{b,B} < T_{b,D}$ . Then, the mapping method was used for other subsets of quaternary systems, in which the effects of boiling point rankings of quaternary reaction systems on the applicability of reactive distillation were studied [51]. Next, Muthia et al. [54] employed the mapping method for gaining knowledge of the optimal feed stages of RD for quaternary systems.

The most prominent characteristic of the mapping method is an “applicability graph”, which is a plot of reflux ratio vs. number of theoretical stages. As illustrated in Fig. 2(a), an applicability graph consists of applicable and not-applicable regions of the RD operability [49]. For an operable RD column, both number of theoretical stages and reflux ratio of a reactive distillation column must be within the applicable region of an applicability graph. The boundary line of an applicability graph is constructed by the configurations with the lowest reflux ratios for different numbers of theoretical stages. Both RR and NTS are equally important in a reactive distillation column design. The investment cost is proportional to the number of theoretical stages that indicates the column height, while the column diameter and influences the amount of energy required are projected by reflux ratio [55]. A larger number of theoretical stages implies the requirement of building a taller

column. A higher reflux ratio means that more vapors is produced and going up through the column, as well as more liquid is returned to the RD column, which causes a larger cross-sectional area (and column diameter) that is needed to accommodate the higher traffic of vapor and liquid. Therefore, both the number of theoretical stages and the reflux ratio influence the capital investment needed. As more vapors / liquid are circulated along the column when a higher reflux ratio is applied, more energy is required to boil up the liquid, which increases the operating cost. Based on a few fixed representative parameters, i.e., relative volatilities of compounds, chemical equilibrium constants and the Damköhler numbers, of ideal generic cases, the mapping method was demonstrated to be capable of predicting the applicability of RD to quaternary reaction systems, as illustrated in Fig. 2(b) [49].

Muthia et al. [54] developed a structured framework for assessing the RD applicability to quaternary mixtures using the mapping method. The proposed steps that need to be carried out by end users of the method consist of: (i) checking the group of boiling point rankings, (ii) calculating representative parameters including key relative volatilities, chemical equilibrium constant and the Damköhler number of the real system, and (iii) selecting the most relevant pre-prepared applicability graphs of generic cases. Analogously, end users apply the mapping method like a global positioning system (GPS), in which representative parameters are overlaid onto generic applicability graphs to quickly predict the applicable regions of RD columns. The study of Muthia et al. [54] demonstrated the suitability of the proposed methodology for non-ideal quaternary reaction systems.

Following the development of the mapping method for quaternary reaction systems by Muthia et al. [49–54], the present work extends the usage of the mapping method for other reaction systems. As reported in [1,10,12,45], reactive distillation technology is promising for many ternary and quaternary reaction systems in the chemical industry. While, the RD setup with two outlet streams at the top and the bottom of the column is less attractive for binary reaction systems that only have a single product. Therefore, the development and the usage of the mapping method are targeted for quaternary and ternary reaction systems. The reduced number of degrees of freedom in ternary reaction systems leads to several possibilities, i.e., the RD assessment using the mapping method becomes easier (for example, due to fewer cases of boiling point ranking), or it would be more challenging (and less accurate) because fewer representative volatilities are defined and fewer degrees of freedom are available (e.g., no multiple reactant feeds, no relative location of feed stages, no reactants ratio).

The considered RD configuration is depicted in Fig. 1, where two outputs are expected coming out of the column. The method can be

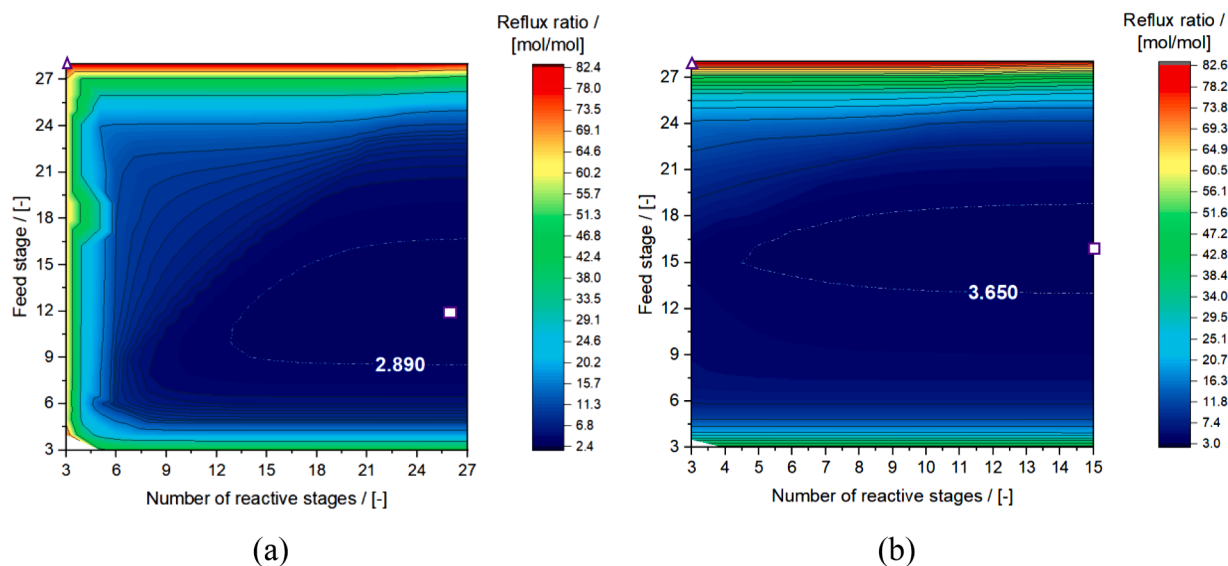

Fig. 3. (a) Contour plots of reflux ratios by varied numbers of reactive stages and feed stages for (a) RS 1 and (b) RS 2. The area on and inside the dash line indicates the preferred configurations with the lowest reflux ratios.

applied to the systems with two reactants and a single product, but it is worth noting that an RD setup usually has both top and bottom outputs. Therefore, the application to such systems takes place either because of a lower degree of conversion, the presence of inert, or the existence of consecutive, parallel and series reactions.

First of all, in Sub-Section 3.1, the method was employed to investigate the preferred configurations with low reflux ratios, in which all possible feed locations along the column was considered. All RD simulations were carried out using the RadFrac model in the Aspen Plus v.11 process simulator. As featured in the mapping method, ideal generic cases with fixed representative parameters, i.e., relative volatilities of compounds, chemical equilibrium constants and the Damköhler numbers, were used for this evaluation. The similar approach was applied previously to quaternary reaction systems [54]. To obtain insights into the RD operation in this study, a fixed number of theoretical stages was specified. For a single NTS, there was a single simulation required, in which the Aspen Plus software allows to perform the sensitivity analysis by varying the starting reactive stage and the length of reactive zone. Additionally, the effect of the number of reactive stages on reflux ratio was also evaluated simultaneously in this study.

To obtain comparable results between multiple configurations with different feed stages and length of reactive stages, the start of reactive stages was fixed close to the top of the column and at the center of the column. When the location and the length of reactive zone inside an RD column are varied, there are many possibilities of the starting and ending of reactive stages; and it may cause difficulties in interpreting the effects on the reflux ratio. Thus, to obtain insights into the effects of the position and the number of reactive stages, there were different starting stages specified: (i) the case with the starting reactive stage close to the top of the column, and (ii) the case with the starting reactive stage at the center of the column. The investigation generated insights into the design of RD column configurations that help column designers to quickly determine the feed location and the required number of reactive stages during the conceptual studies.

Next, in Sub-Section 3.2, the method usage for assessing the RD applicability to ternary reaction systems was validated by using a case study of dissociation reactions,  $A \rightleftharpoons C + D$ , i.e., the metathesis of 2-pentene. The boiling point ranking of the case study is  $T_{b,C} < T_{b,A} < T_{b,D}$ , which is a preferred order when aiming for the top and bottom products with a high purity.

Previously Muthia et al. [54] – see Fig. 3 and related explanation in that paper – provided the procedures describing how to generate RD

applicability graphs and how to apply the mapping method. There are three separate procedures that respectively correspond to: (1) the generation of generic RD applicability graphs, (2) the validation of the graphs using a case study, and (3) the actual use of generic graphs by end users to determine the RD applicability to real systems. The first and second procedures were carried out in this study for the method development and validation. The development of the mapping method for both procedures in this study required extensive simulations in Aspen Plus for both generic and real systems. Note that the real application of the mapping method by end users following the third procedure does not require them to perform any rigorous simulations, but only to calculate key parameters, i.e., representative relative volatilities and chemical equilibrium constant (for equilibrium-limited reactions) or the Damköhler number (in case of the kinetically controlled reactions). The generic graphs required by end users are prepared by map generators (such as the authors of this work), who are the part of a team of researchers or chemical engineers.

As of the first procedure, the simulations for originating generic graphs in Aspen Plus start with selecting the ideal property model and specifying the boiling points and the Antoine coefficients of chemical components for defined relative volatilities. Fixed equilibrium and reaction rate constants are then specified to the simulations. The feed stream is assumed to be a pure reactant in liquid phase at its boiling point. Therefore, it is also assumed that the vapor fraction is zero. As an equimolar reaction is expected, the bottom-to-feed ratio (B/F) of 0.5 is specified in the simulator. It is considered that the phase equilibrium is reached in each rectifying or stripping section and both reaction and phase equilibria are obtained in each reactive stage.

Typically, there are 15–20 simulations conducted to build a complete applicability graph. All simulations were performed by applying a sensitivity analysis and an optimization tool in the process simulator. Aspen Plus software has a built-in sensitivity analysis tool that allows software users to assess the effects of varied parameters on other defined variables. The varied parameters assessed in this study for each NTS included the location of reactive stages inside the column and the numbers of rectifying, reactive and stripping stages. The feed stage was fixed at the preferred location that is suggested in Sub-Section 3.1. In this work, a product purity of 99 mol% was set as a constraint, and it was aimed to achieve the lowest reflux ratio (minimal energy usage) as an objective. These constraint and objective were defined in the built-in optimization tool of Aspen Plus. Therefore, for each NTS, a configuration with the lowest reflux ratio for obtaining the product purity of 99



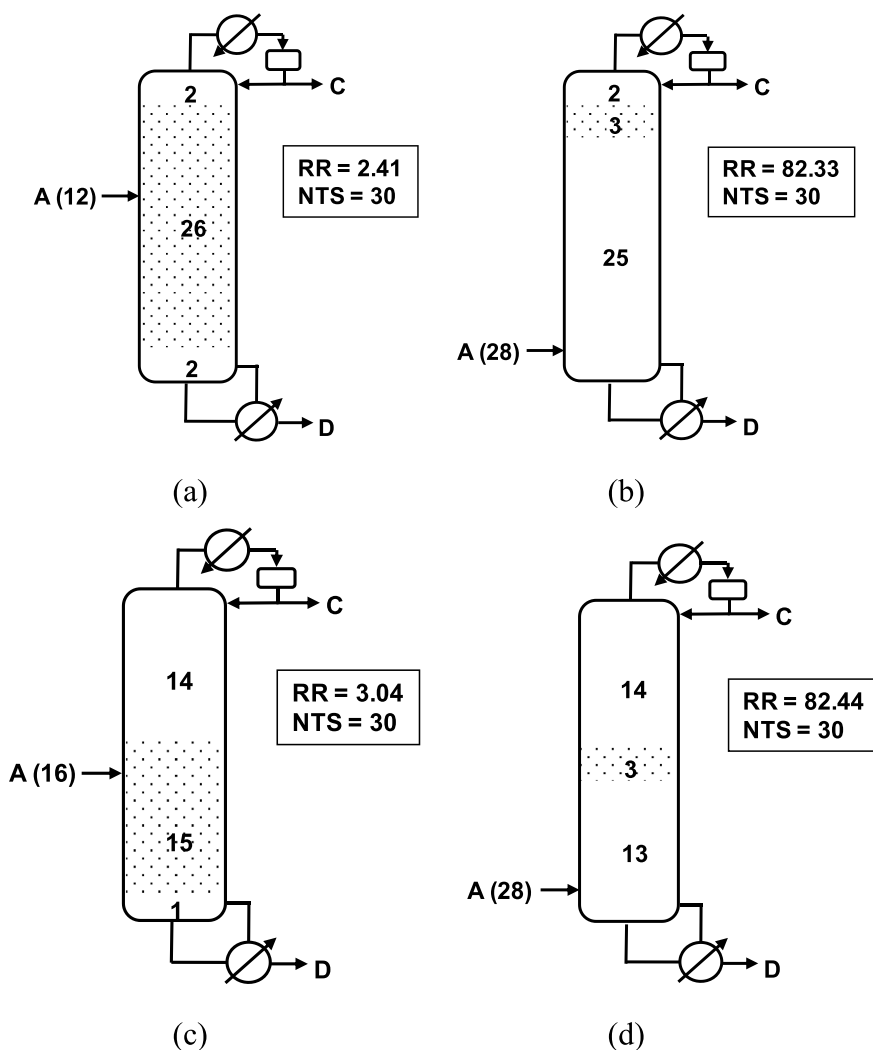

Fig. 4. Schematic configurations with the (a,c) lowest reflux ratios and (b, d) the highest reflux ratios for RS 1 and 2, respectively.

mol% was obtained. The size of “applicable” areas in an applicability graph changes when different purities are desired. This is demonstrated in Figure S1 in the *Supporting Information*. However, it is important to note that the highest product purity is usually preferred for RD application in order to outperform the classic reaction-separation-recycle sequences. Therefore, this study limits the research scope for the system with the products purity of 99 mol%. All configurations with the lowest reflux ratios for different NTS for a boundary line of an applicability area.

As of the second procedure, the generic graphs with matching representative volatilities and chemical equilibrium constants with the case study are then selected for further discussion in the method validation of this work. Other generic applicability graphs can be used similarly for other case studies or real applications. The selected generic graphs are compared with the results of rigorous simulations of the case study. Note that only generic cases are assumed to be with the ideal behavior, but not the case studies which use a suitable property model, temperature-dependent chemical equilibrium constant and real kinetics. For the validation purpose, the maximum acceptable deviation considered for both NTS and RR was  $\pm 50\%$ . This value usually becomes an upper limit for tolerable deviations in the conceptual design phase [56].

The determination of key parameters of real ternary reaction systems adapted the approach that was proposed by Muthia et al. [49,54] for quaternary reaction systems. In contrast to quaternary reaction systems that require three representative relative volatilities, there are only two

representative relative volatilities that need to be specified for ternary reaction systems. They are calculated for 99 mol% pure products at the top and bottom of the column, in which representative  $\alpha_{CA}$  and  $\alpha_{AD}$  are for 99/1 and 1/99 mol% based mixtures, respectively. As there is only one chemical that is reacted away and predominantly present in reactive stages, representative chemical equilibrium constant and Damköhler number are calculated at the boiling point of reactant A. The Damköhler number is defined as,

$$Da = k_f \tau \quad (1)$$

where  $k_f$  and  $\tau$  are the forward reaction rate constant ( $\text{min}^{-1}$ ) and the liquid residence time per reactive stage (min), respectively.

As of the third procedure, end users select the generic graphs with closest matching of representative input parameters with the real system, in order to overlay the representative parameters of the real system onto the generic applicability graphs, such that a go/no-go decision of the RD applicability can be obtained. Specifically, there are two input parameters required to use the method, i.e., relative volatilities and the chemical equilibrium constant. Only for kinetically controlled reactions there is an additional input, i.e., the Damköhler number. It is worth noting that generic graphs are not generated by method end-users, but by the map generators who are the part of a team of researchers or engineers.

The mapping method is useful for the preliminary assessment of RD at the conceptual design phase, when limited information is available

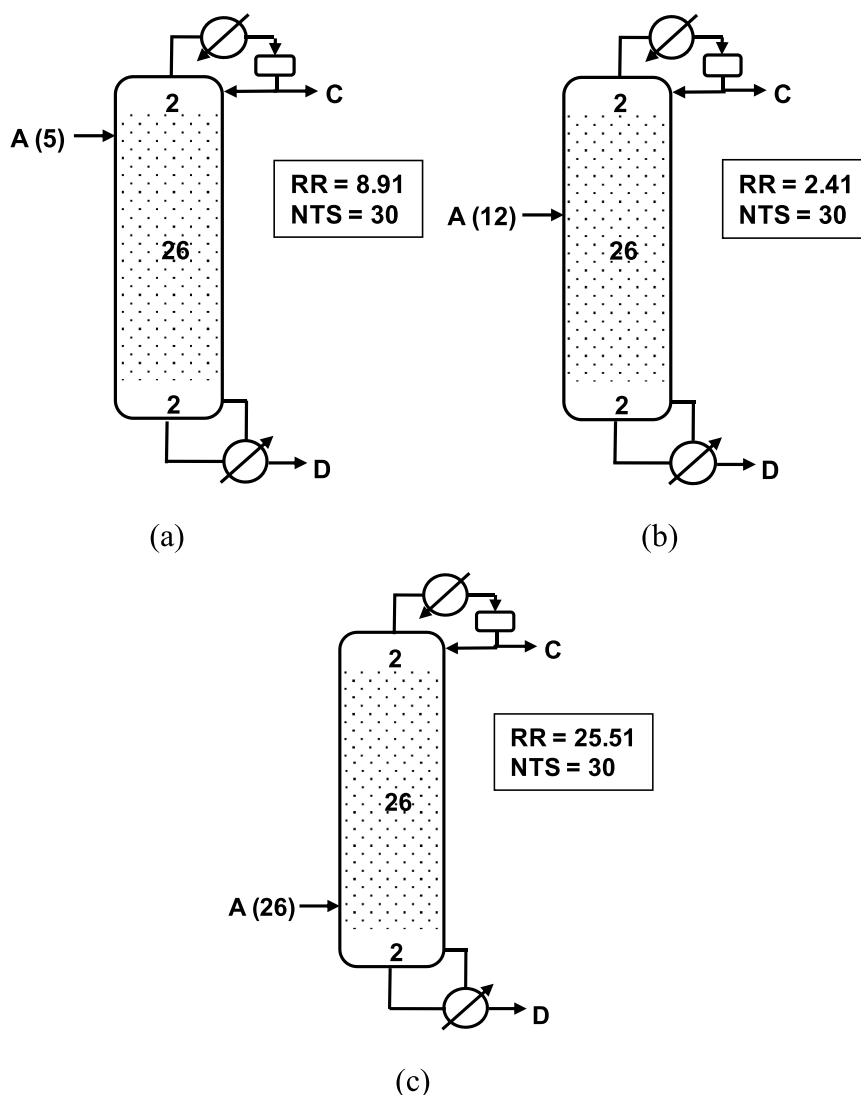

Fig. 5. Schematic configurations of RS 1 with the feed stage (a) close to the top of the reactive stages, (b) at the center of the reactive stages, and (c) close to the end of the reactive stages.

and a quick go-/no-go decision is needed. A small number of design parameters (i.e., relative volatilities for pure products at the top and bottom of the column, chemical equilibrium, and the Damköhler number for kinetically controlled reactions) are needed to predict the applicability of real RD systems from the generic graphs. Multiple configurations with the lowest reflux ratio for each number of theoretical stages can be obtained from a single applicability graph. As the results are limited to the applicability area consisting of operable RD configurations, other design methods with more rigorous models and algorithms may be employed to achieve other specific objectives, such as minimum total annual cost and low reboiler duty. More rigorous models and algorithms, such as stochastic optimization algorithms, can be used to solve multiple RD optimization problems when multiple mathematical relationships have been developed for specific objectives and constraints. However, extensive time is needed to set up those models and to solve the resulting complex optimization problems [32]. Therefore, those rigorous methods are more suitable for detailed design assessments.

### 3. Results and discussion

This part consists of two subsections: insights into RD operation for ternary reaction systems and the method application to a case study,

namely the metathesis of 2-pentene.

#### 3.1. Insights into the RD operation for ternary reaction systems

To gain some valuable insights into RD operation, this study assessed the configurations of a generic case for  $NTS = 2 \cdot NTS_{min}$  ( $NTS = 30$ ). The fixed key parameters considered are  $\alpha_{CA} = 2.7$ ,  $\alpha_{AD} = 1.9$ ,  $K_{eq} = 0.25$ ,  $Da = 0.5$ . Note that any other generic cases can be used for this investigation. The selection of these key parameters were only based on the representative key parameters of the case study that is discussed in Sub-Section 3.2. Figures S2 and S3 in The *Supporting Information* of this paper provide findings for the generic cases with other fixed key parameters, which lead to consistent conclusions in this study.

This work evaluated RD configurations by fixing the start of reactive stages from stage 3, which is close to the top of the column, and settling the start of reactive stages from stage 15, which is at the center of the column. For this discussion, the two cases are called RS 1 and RS 2, respectively. Such arrangement causes the number of rectifying stages fixed for each case. As the length and the end of reactive stages were varied, the numbers of reactive and stripping stages in RS 1 and 2 also changed.

Fig. 3 depicts the gradients of reflux ratios resulted from the changes of the number of reactive stages and the feed stage. A lower number of



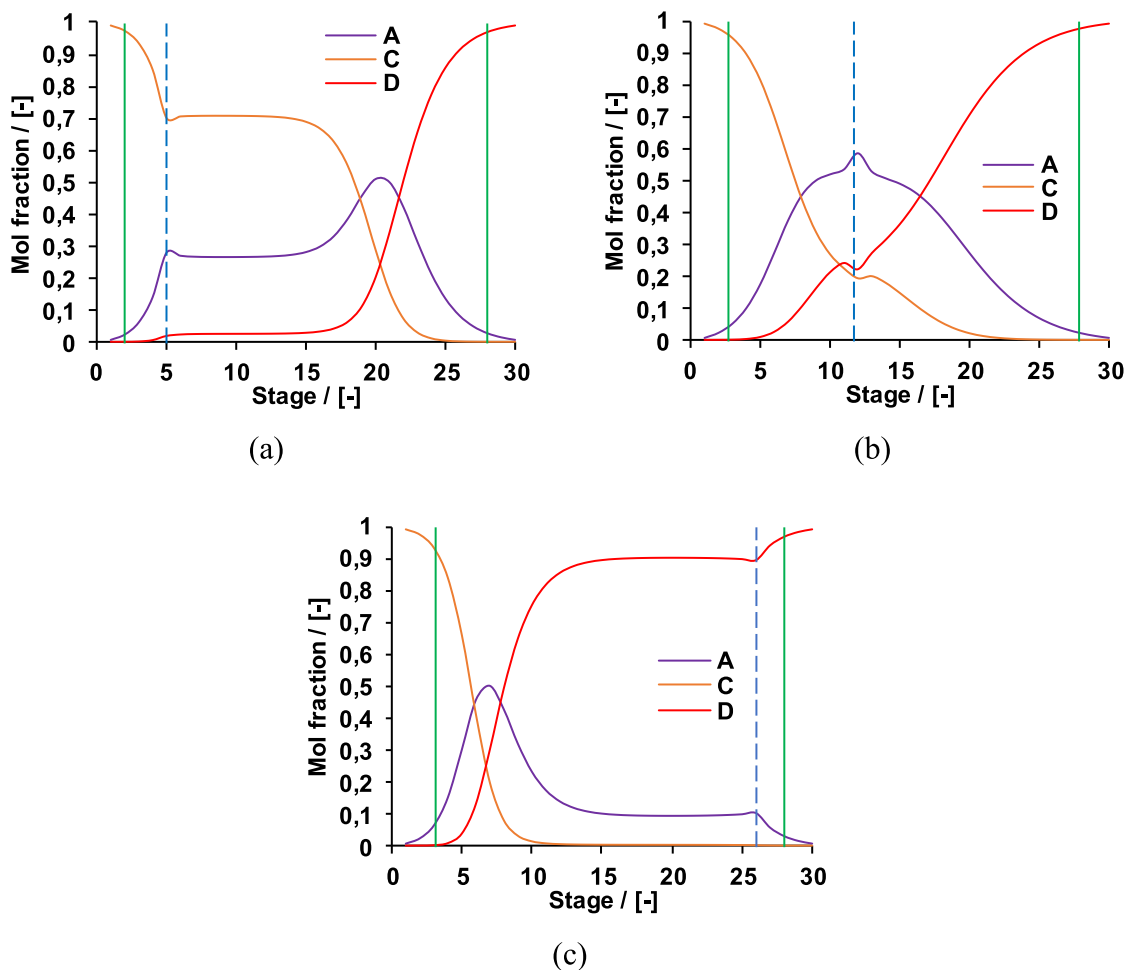

Fig. 6. Composition profiles of RS 1 with the feed stage (a) close to the top of the reactive stages, (b) at the center of the reactive stages, and (c) close to the end of the reactive stages. Vertical solid lines show the start and end of reactive stages. Vertical dash line shows the feed stage.

reactive stages on the  $x$  axis implies more stripping stages as NTS is kept constant at 30, while a smaller feed stage on the  $y$  axis indicates that the reactant is fed close to the top, and vice versa. There are small white areas that can be observed in the bottom left of Fig. 3(a) and (b). It indicates that the combination of feeding the reactant very close to the top and a very small number of reactive stages cannot generate any applicable RD configurations.

For RS 1, the lowest reflux ratio possible is 2.41 (indicated by the square marker in Fig. 3a), where the number of reactive stages is 26 and the reactant is fed on stage 12. As the opposite, the highest reflux ratio is 82.33, where the number of reactive stage and the feed stage are 3 and 28, respectively (indicated by the triangle marker in Fig. 3a). For RS 2, the lowest reflux ratio is 3.04, where the number of reactive stages and the feed stage are 15 and 16, respectively (indicated by the square marker in Fig. 3b). While, the highest reflux ratio is 82.44 for the number of reactive stages of 3 and the feed stage of 28 (pointed by the triangle marker in Fig. 3b). These configurations are presented in Fig. 4. According to these findings, it can be inferred that it is more favorable to have a feed stage within the reactive zone of a reactive distillation column. Besides, it is preferred to have a large number of reactive stages so that the reaction can be pushed to the products side, while the separation takes place simultaneously along the RD column.

The reflux ratios between the lowest RR and the RR that is 1.2 higher than the lowest RR are considered as those resulting the most preferred configurations. Those configurations are on and inside the boundary line depicted in Fig. 3(a) for RS 1. This result gives more emphasis on the

benefit of having a larger reactive zone in terms of lowering reflux ratio, while it is important to locate the feed stage at the center or a bit upper than the center of the column.

For RS 2, the preferred configurations with low reflux ratios, considering those in the range of the lowest RR and the RR that is 1.2 higher than the lowest RR, are on and inside the boundary line shown in Fig. 3(b). Similar to RS 1, having a large number of reactive stages can be beneficial. Interestingly, for RS 2 it is essential to place the feed stage close the upper side of reactive stages. This is a logical consequence of having a shorter reactive zone than in RS 1 so that the feed can still have adequate spaces for reacting away along the RD column.

For a better understanding, three different feed locations are evaluated further for RS 1 and 2, in which the feed stages are located close to the top, at the center and close the bottom of the reactive stages. Fig. 5 presents the three RD configurations for RS 1, and Fig. 6 shows the corresponding composition profiles along the columns. When the reactant is fed at around the center (Fig. 5b), it is then ideally distributed (Fig. 6b) through the reactive zone. Compared to the amount of products in the reactive zone, the reactant is predominantly present at the center of reactive stages and its mol fraction is gradually decreasing when reaching the edges of the reactive zone, which is preferred to enhance the products formation in a reversible reaction system.

When the reactant is fed close to the top (Fig. 5a), an accumulation of the reactant at the end of the reactive stages is essential to prevent the backward reaction (Fig. 6a). Such mechanism requires the increase of reflux ratio (compare reflux ratios in Fig. 5a and b) enabling more liquid

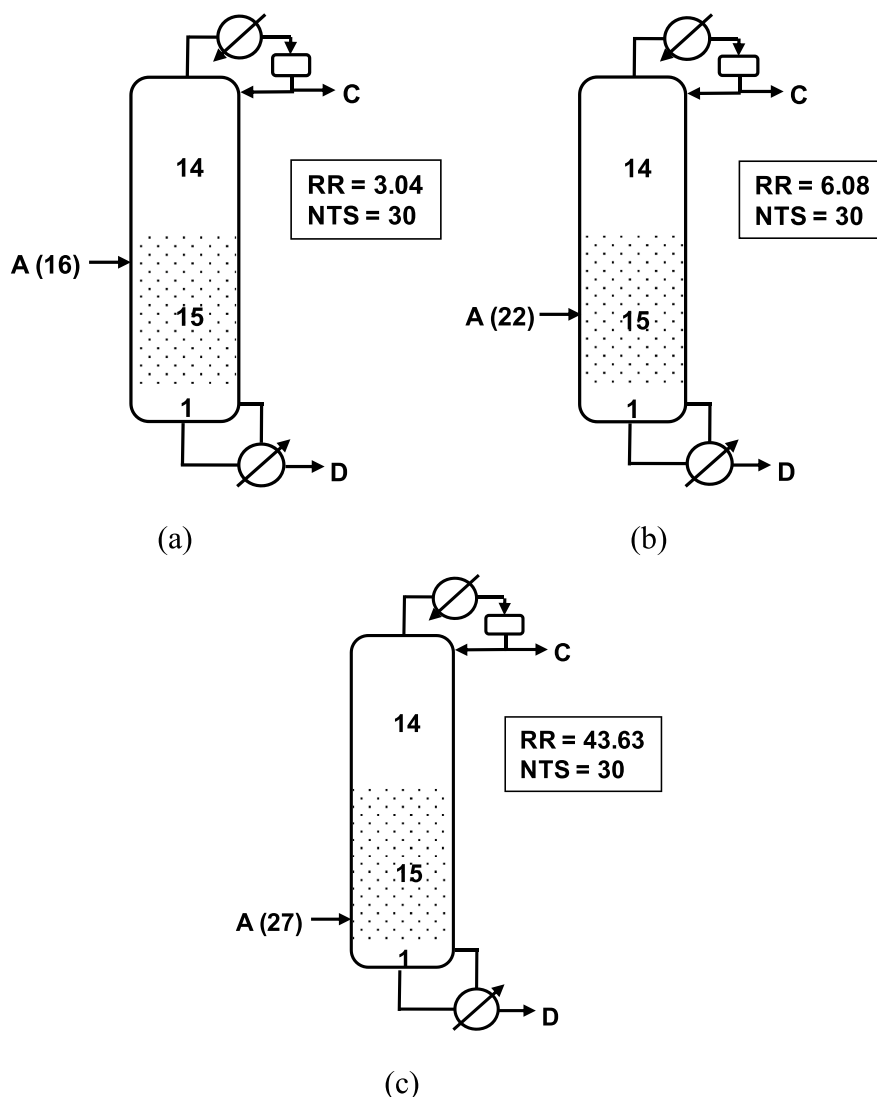

Fig. 7. Schematic configurations of RS 2 with the feed stage (a) close to the top of the reactive stages, (b) at the center of the reactive stages, and (c) close to the end of the reactive stages.

to be sent back to the column for improving the mass and heat transfers. Inversely, for the same reason, an accumulation of the reactant at the beginning of reactive stages is needed in the case of the feed stage is close to the bottom (Fig. 6c). Compared to the other two feed locations in Fig. 5, placing the feed stage close to the bottom requires a significantly larger reflux ratio. As the reactant is the mid-boiling point compound, some amounts of it immediately transforms to the gas phase when it is fed to the bottom of the column and it escapes to the upper stages before reacting away. With a very high reflux ratio supplying a large amount of liquid sent back to the column, the reactant in the liquid phase can be retained due to the vapor-liquid mass and heat transfers.

The three RD configurations for RS 2 with different feed locations are shown in Fig. 7, and their corresponding composition profiles are displayed in Fig. 8. As stated previously, it is preferred to locate the feed stage close to the start of the reactive zone instead of at around the center of the reactive zone. When the mol fraction lines of the reactant inside the reactive zones in Fig. 8(a) and (b) are compared, a higher mol fraction can be observed when the feed stage is located close to the start of the reactive zone. Therefore, one can expect to achieve more products for that feed stage positioning. In Fig. 8(a),  $x_C$  and  $x_D$  leaving the reactive stages are 0.20 and 0.99, respectively. While, in Fig. 8(b) the mol fractions of C and D exiting the reactive stages are 0.09 and 0.99, respectively. When the reactant is fed close to the bottom of the reactive stages

as shown in Fig. 7(c) and Fig. 8(c), again, a significant higher reflux ratio is required to let the reactant stays in the liquid phase, as it easily changes to the vapor phase when it enters the column.

Interestingly, one can observe a high mol fraction of the reactant in Fig. 6 and Fig. 8 – if it is not exactly at the peak of the mol fraction – when both products are in equimolar (see the intersection of the mol fractions of both products in each figure). These profiles explain the phenomena in both reactive and non-reactive stages, in which a high amount of reactant is always required to prevent the backward reaction. Even though the chemicals are not on the reactive stages, the slow backward reaction can still take place in the absence of the catalyst.

For the validation purpose, the findings in this work are compared with those suggested by Al-Arfaj et al. [57]. For the same operating pressure, they recommend an optimum configuration for the feed stage located at the center of the column, when the column is dominated by reactive stages. In their study, the total number of theoretical stages was 38 – in which all of them were reactive stages – and the feed stage was 20. They also reported a similar trend of the peak of the reactant's mol fraction along the column for achieving the maximum conversion and the highest purity of products.

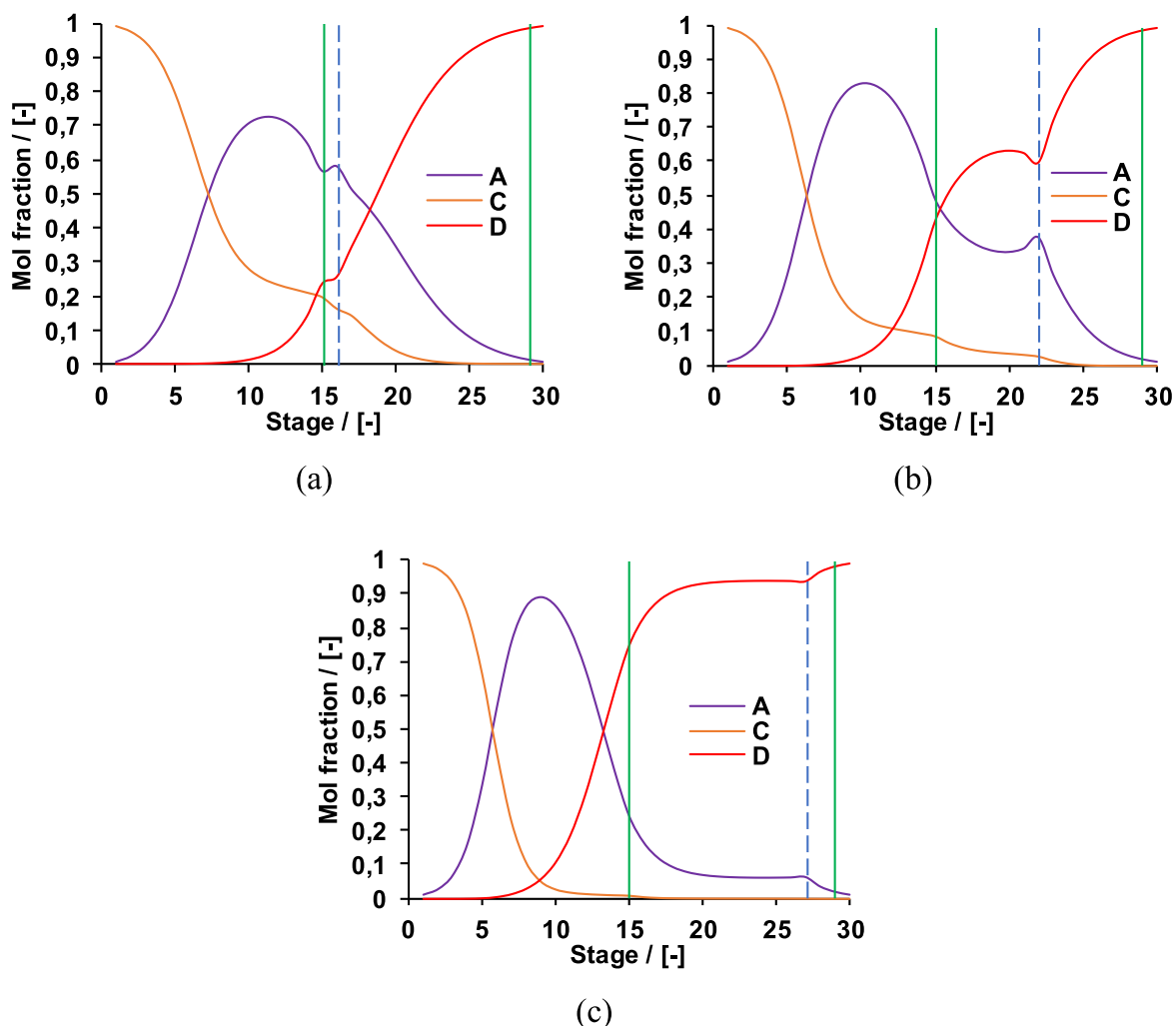
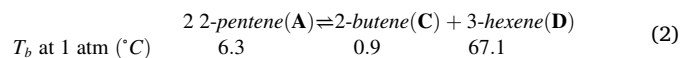

Fig. 8. Composition profiles of RS 1 with the feed stage (a) close to the top of the reactive stages, (b) at the center of the reactive stages, and (c) close to the end of the reactive stages. Vertical solid lines show the start and end of reactive stages. Vertical dash line shows the feed stages.

### 3.2. Application of the mapping method to a case study

The metathesis of 2-pentene represents an important reaction in the valorizing of less valuable olefins into more desired ones [58]. 2-pentene is usually generated as a by-product from fluid catalytic cracking and steam cracking units. The metathesis of 2-pentene yielding olefins follows the reaction mechanism as shown in Eq. (2), in which both products can be used as solvents and cross-linking agents.



The Peng-Robinson model was chosen to represent the thermodynamics behaviors of the ternary system, where no azeotropes were encountered in this reaction. Looking at the normal boiling points of all compounds in Eq. (2), one can expect to obtain the top product dominated by product C and the bottom product mostly composed of product D. As the normal boiling point of product C is relatively low, the operating pressure of reactive distillation needs to be higher than the atmospheric pressure in order to enable the utilization of cooling water in the condenser. For such purpose, the RD column is operated at 5 atm, in which the corresponding boiling points of reactant A, product C and product D are 93.0 °C, 51.7 °C and 129.0 °C, respectively. By applying the rule of the mapping method, the representative relative volatilities for 99 mol% pure products are  $\alpha_{CA} = 2.7$  and  $\alpha_{AD} = 1.9$ .

The chemical equilibrium constant ( $K_{eq}$ ) of this system is 0.25, which is marginally affected by the temperature changes [59,60]. In the case of kinetically controlled reaction, Okasinski and Doherty [59] and Chen et al. [60] suggested the reaction rate ( $r$ ) and the temperature-dependent forward rate constant ( $k_f$ ) formula that are shown in Eqs. (3) and (4), respectively,

$$r = k_f \left( x_A^2 - \frac{x_C x_D}{K_{eq}} \right) \quad (3)$$

$$k_f = 1,776.83 \exp \left( \frac{-6.6 \frac{\text{kcal}}{\text{mol}}}{RT} \right) \text{ min}^{-1} \quad (4)$$

where  $x_i$ ,  $R$  and  $T$  are the mol fraction of compound  $i$ , the gas constant and temperature, respectively. Using the boiling point of reactant A, one can obtain the  $k_f$  of 0.0068  $\text{min}^{-1}$ . For the residence times per reactive stage of 0.25 and 0.5 mins, the representative Damköhler numbers are 0.1 and 0.2, respectively.

Fig. 9 displays generic applicability graphs for varied relative volatilities and chemical equilibrium constants. Note that other combinations of relative volatilities and chemical equilibrium constants can be specified for the generation of many other generic graphs. The method has been demonstrated by Muthia et al. [53] to be suitable for different

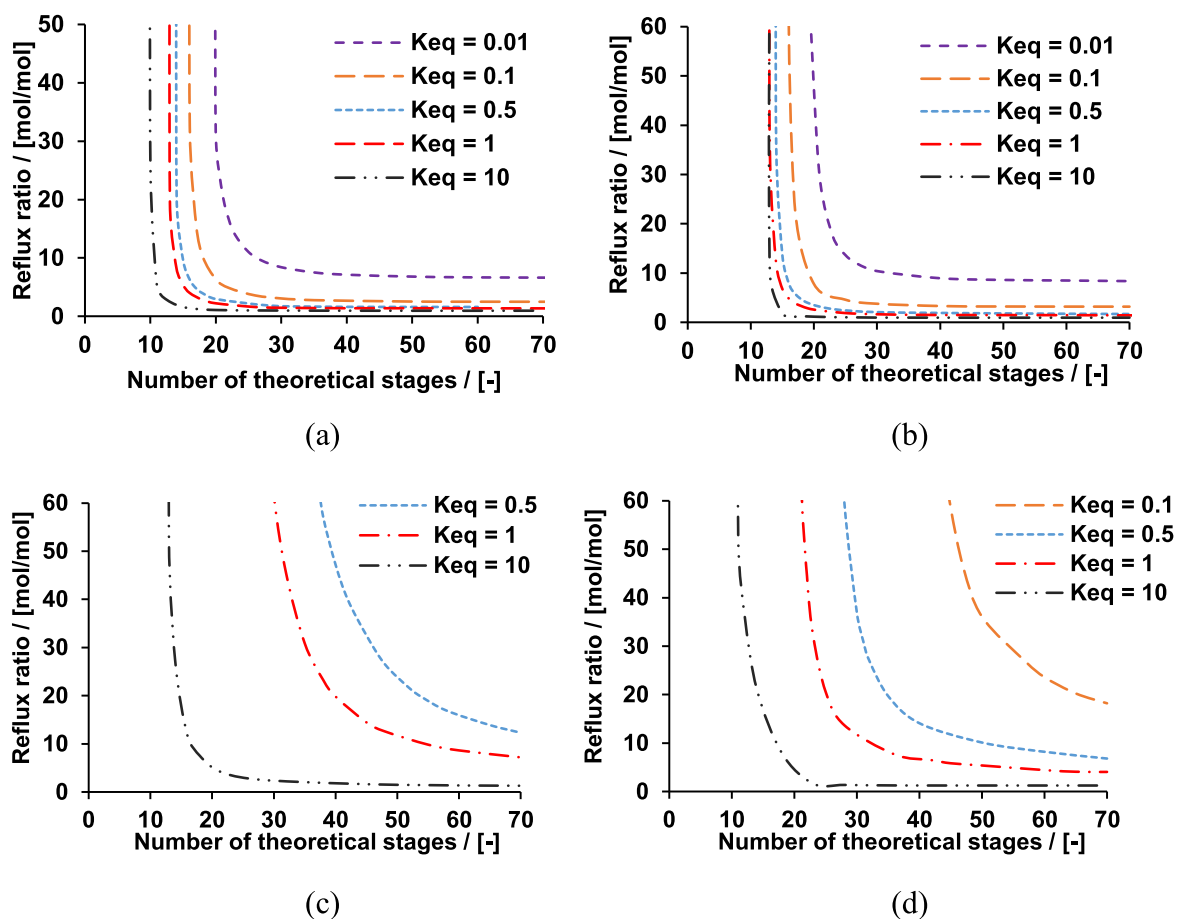

Fig. 9. A set of generic applicability graphs corresponding to different relative volatilities and varied chemical equilibrium constants, for (a)  $\alpha_{CA} = 2.7$  and  $\alpha_{AD} = 1.9$ , (b)  $\alpha_{CA} = 1.9$  and  $\alpha_{AD} = 2.7$ , (c)  $\alpha_{CA} = 1.1$  and  $\alpha_{AD} = 4.0$ , and (d)  $\alpha_{CA} = 4.0$  and  $\alpha_{AD} = 1.1$ .

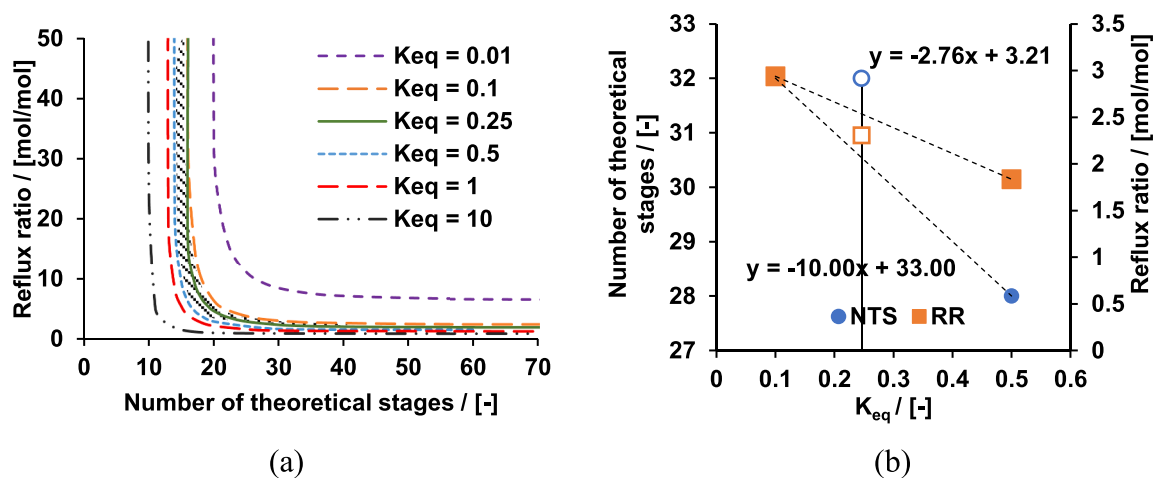

Fig. 10. Results for the metathesis of 2-pentene considering the equilibrium-limited reaction: (a) predicted boundary line of the RD applicability within the shaded area and the actual boundary line of the RD applicability indicated by the solid line, and (b) number of theoretical stages and reflux ratio – solid markers = generic values; open markers = actual values; dash lines = predicted values for different  $K_{eq}$ s.

relative volatility rankings. However, the application of a single RD column to the system with reactant(s) as the heaviest or lightest compound(s) is technically unfavorable. For instance, when reactant A is the heaviest compound, one of the following scenarios may be obtained: (1) having two products at the top, or (2) having an impure product at the bottom because unconverted reactant A is present. This is also proven by

the method described here, in which none of applicability graphs is obtained for such system.

Fig. 9(a) and (b) cover typical ranges of applicability areas encountered in different real systems, while Fig. 9(c) and (d) depict more challenging process due to a lower relative volatility affecting the separation performance. The applicability areas for  $0.01 \leq K_{eq} \leq 10$  are

**Table 1**

Deviations of the predicted number of theoretical stages and reflux ratio from the actual values. EQ and KIN stand for equilibrium-limited and kinetically controlled reactions, respectively.

No.	Cases	Number of theoretical stages / [-]			Reflux ratio / [mol/mol]		
		Actual	Predicted	Deviation	Actual	Predicted	Deviation
1.	Case EQ	32	31	5%	2.28	2.52	11%
2.	Case KIN, $Da = 0.1$	34	32	7%	3.70	3.68	1%
3.	Case KIN, $Da = 0.2$	32	31	2%	3.18	3.37	6%

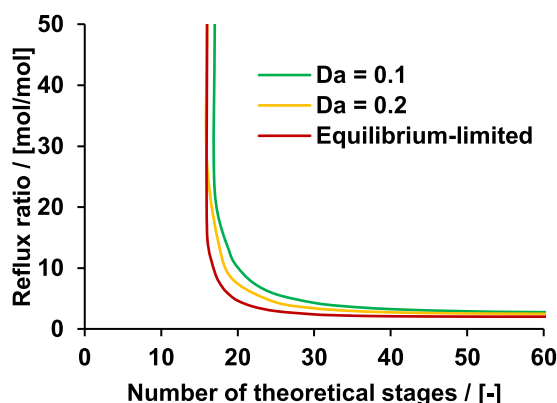

**Fig. 11.** Real applicability graphs of the metathesis of 2-pentene, considering both equilibrium-limited and kinetically controlled reactions.

provided in Fig. 9 as those values are commonly considered for the RD application. For a system with a very low chemical equilibrium constant, i.e.,  $K_{eq} \leq 0.01$ , RD is not likely an attractive technology as conventional reaction processes or other hybrid processes are usually more suitable [61]. While, for a system with a very high chemical equilibrium constant, i.e.,  $K_{eq} \geq 10$ , conventional reaction-separation sequences are usually applied. Among those provided in Fig. 9, the generic graphs with matching representative volatilities with the case study (Fig. 9a) are then selected for further discussion. The other generic applicability graphs can be used similarly for other case studies or real applications.

Fig. 10(a) depicts the applicability graphs of generic cases for varied  $K_{eq}$ s and real system with  $K_{eq} = 0.25$ . The shaded area in the graph suggests the location of the real boundary line, based on the prediction using pre-determined generic boundary lines. It is observed that the

boundary line of the real system (the solid line), which was obtained from rigorous simulations for the validation purpose, nicely fits between the boundary lines of the generic cases for  $K_{eq}$ s of 0.1 and 0.5. The result indicates that representative relative volatilities of compounds and chemical equilibrium constant of generic cases are capable of portraying the chemical and physical phenomena along the column for the real system of the metathesis of 2-pentene.

Fig. 10(b) demonstrates both NTS and RR for the real system obtained from rigorous simulations (shown by open markers) and for generic cases (shown by filled markers). Using the linear interpolation of the generic data points, one can obtain the prediction of both values. The deviation was evaluated by calculating the absolute difference of the prediction and the actual numbers of theoretical stages and reflux ratios over the actual values. The assessed configuration for quantifying the deviation was for  $NTS = 2 \cdot NTS_{min}$ . This selection was only based on our knowledge for the estimation of the optimum configuration of conventional distillation column in the conceptual phase. Table 1 provides the deviations for the equilibrium-limited and kinetically controlled reactions of this case study. For the equilibrium-limited reaction, the predicted NTS and RR are 31 and 2.5, respectively; while the actual NTS and RR are 32 and 2.3, respectively. The deviations of both NTS and RR are satisfyingly acceptable for the conceptual phase, which are 5% and 11%, respectively.

Next, rigorous simulations for the real system with the representative Damköhler numbers of 0.1 and 0.2 (in the case of kinetically controlled reaction) were performed. Fig. 11 displays the real applicability graphs of both equilibrium-limited and kinetically controlled reactions. It can be observed that the boundary line of the applicability graph shifts to the top right when the kinetically controlled reaction with a lower  $Da$  is considered. A lower  $Da$  indicates a slower forward reaction and/or a smaller residence time, which results in a higher reflux ratio (more liquid circulated along the column) required for each number of theoretical stages to achieve the specified product purity.

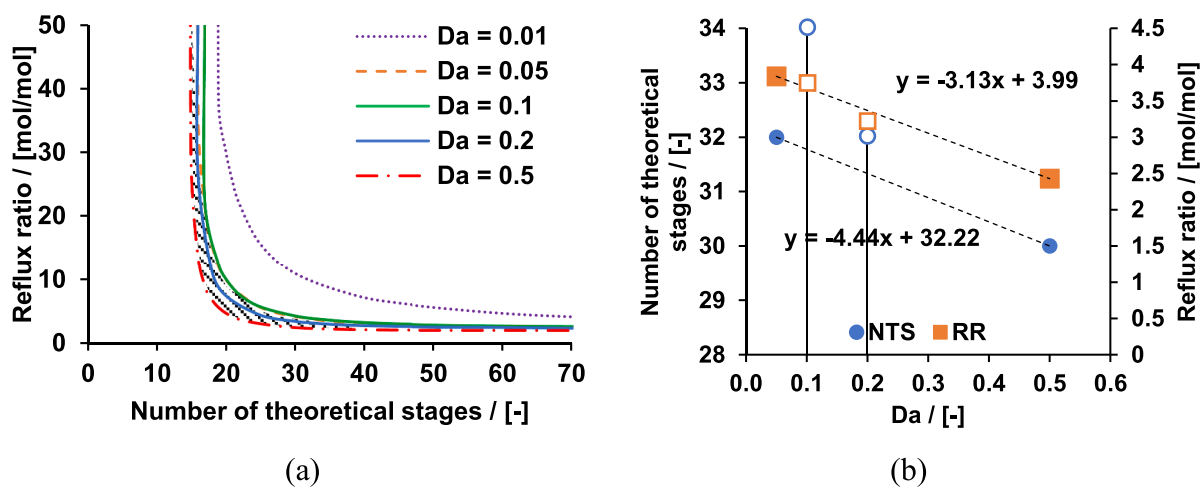

**Fig. 12.** Results for the metathesis of 2-pentene considering the kinetically controlled reaction: (a) predicted boundary line of the RD applicability within the shaded area and the actual boundary line of the RD applicability indicated by the solid line, and (b) number of theoretical stages and reflux ratio – solid markers = generic values; open markers = actual values; dash lines = predicted values for different  $Da$ .

The applicability graphs of generic cases and the real system for the kinetically controlled reaction are displayed in Fig. 12(a). Based on the prediction using generic cases, it is expected to have the real boundary lines for Da of 0.1 and 0.2 within the shaded area, which is in between the generic boundary lines for Da 0.05 and 0.5. The result of rigorous simulations for the real system suggests that most of the parts of the real boundary lines are located between and on those two generic boundary lines. Fig. 12(b) provides the details of NTS and RR for both generic and real systems at  $NTS = 2 \cdot NTS_{min}$ , which were obtained from rigorous simulations. As listed in Table 1, the deviations of both NTS and RR for Da = 0.1 are 7% and 1%, respectively. The deviations of both values for Da = 0.2 are 2% and 6%, respectively. Again, these values satisfy the tolerable deviation for the conceptual design phase.

#### 4. Conclusions

This study has successfully developed and extended the use of a mapping method for quickly assessing the applicability of reactive distillation to ternary systems. The mapping method has been employed to gain some useful insights into the RD operation in ternary reaction systems. For any RD configurations, it is favorable to set a feed stage within the reactive zone of a column. For a column dominated by reactive stages, feeding the reactant at around the center of the column can improve the process performance, in which reflux ratio can be lowered. When the start of reactive stages is moved to the center of the column, however, it is important to keep the feed stage close to the top of the reactive zone. By having this set enabled, the feed can still have adequate spaces for reacting away along the RD column. Interestingly, for any cases, one can expect to identify the peak of the reactant's mol fraction around the stages where both products are in equimolar. Such mechanism helps the system to avoid the backward reaction and, therefore, to obtain products in a high purity.

Using the case study of the metathesis of 2-pentene, and considering both equilibrium-limited and kinetically controlled reactions, this work proves the suitability of the method, in which the deviations for both number of theoretical stages and reflux ratios are less than 10% when the RD applicability was predicted based on generic cases. Similarly, for quaternary reaction systems reported by Muthia et al. [49,52], the method development for ternary reaction systems performed in this paper can fully satisfy the maximum tolerable deviation in the conceptual design phase, i.e.  $\pm 50\%$ , as recommended by Towler and Sinnott [56].

The method has been demonstrated to be suitable for quaternary and ternary reaction systems, for single (non-consecutive, non-parallel, non-series) reactions. Non-ideality, temperature-dependent chemical equilibrium constant and real kinetics are properly taken into account for real reaction systems. Multiple feed locations are considered when applicability graphs are generated using the Aspen Plus software. As a general method, its limitations apply for both quaternary and ternary reaction systems. As demonstrated by Muthia et al. [54] – see Fig. 4 in that paper – while the method works well for systems without azeotropes or with only one azeotrope, the limitation of the mapping method is its unsuitability for the systems having more than one representative relative volatility with the values of 1; thus the mapping method is suggested to be not applicable for those systems. In that case, multiple azeotropes are potentially present between the key compounds determining the representative relative volatilities, and the determined representative relative volatilities of 1 (i.e. azeotropes) could lead to an over- or underestimation of RD applicability areas. Such over- or underestimation subsequently results in a lower method precision, i.e., higher deviation (of over 50%) for the predicted reflux ratios and numbers of theoretical stages.

#### CRedit authorship contribution statement

**Rahma Muthia:** Conceptualization, Methodology, Software, Data

curation, Visualization, Formal analysis, Writing – original draft, Writing – review & editing, Funding acquisition. **Anton A. Kiss:** Conceptualization, Methodology, Visualization, Formal analysis, Validation, Writing – original draft, Writing – review & editing.

#### Declaration of Competing Interest

The authors declare that they have no known competing financial interests or personal relationships that could have appeared to influence the work reported in this paper.

#### Data availability

Data will be made available on request.

#### Acknowledgement

RM gratefully acknowledges Hibah Publikasi Terindeks Internasional (PUTI) Universitas Indonesia No. NKB-1154/UN2.RST/HKP.05.00/2022 for funding this research and thankfully acknowledges student Anastasia Segari Putri Pramudya for improving the data visualization.

#### Supplementary materials

Supplementary material associated with this article can be found, in the online version, at doi:[10.1016/j.cep.2023.109529](https://doi.org/10.1016/j.cep.2023.109529).

#### References

- [1] W.L. Luyben, C.-C. Yu, *Reactive Distillation Design and Control*, John Wiley & Sons, Inc., USA, 2008.
- [2] A.I. Stankiewicz, J.A. Moulijn, Process intensification: transforming chemical engineering, *Chem. Eng. Prog.* 96 (1) (2000) 22–34.
- [3] R. Franke, Process intensification - an industrial point of view, in: F.J. Keil (Ed.), *Modeling of Process Intensification*, Wiley-VCH, Germany, 2007, pp. 9–23.
- [4] P. Lutze, R. Gani, J.M. Woodley, Process intensification: a perspective on process synthesis, *Chem. Eng. Process. Process Intensif.* 49 (6) (2010) 547–558.
- [5] G.J. Harmsen, Reactive distillation: the front-runner of industrial process intensification: a full review of commercial applications, research, scale-up, design and operation, *Chem. Eng. Process. Process Intensif.* 46 (9) (2007) 774–780.
- [6] N. Kockmann, 200 years in innovation of continuous distillation, *ChemBioEng Reviews* 1 (1) (2014) 40–49.
- [7] N. Kockmann, History of distillation, reference module in chemistry, *Mol. Sci. Chem. Eng.* (2017) 1–25.
- [8] R. Taylor, R. Krishna, Modelling reactive distillation, *Chem. Eng. Sci.* 55 (22) (2000) 5183–5229.
- [9] A. Tuchlenski, A. Beckmann, D. Reusch, R. Düssel, U. Weidlich, R. Janowsky, Reactive distillation — industrial applications, process design & scale-up, *Chem. Eng. Sci.* 56 (2) (2001) 387–394.
- [10] A.A. Kiss, Chapter 5: reactive distillation, in: M. Skibrowski, A. Górak (Eds.), *Process Intensification: by Reactive and Membrane-Assisted Separations*, Walter de Gruyter GmbH & CoKG, 2022.
- [11] C. Shu, X. Li, H. Li, X. Gao, Design and optimization of reactive distillation: a review, *Front. Chem. Sci. Eng.* 16 (6) (2022) 799–818.
- [12] T. Keller, Reactive distillation, in: A. Górak, Ž. Olujić (Eds.), *Distillation: Equipment and Process*, Elsevier, Oxford, 2014, pp. 261–294.
- [13] M. Wierschem, A. Górak, Reactive distillation, reference module in chemistry, *Mol. Sci. Chem. Eng.* (2018) 1–10.
- [14] C.P. Almeida-Rivera, P.L.J. Swinkels, J. Grievink, Designing reactive distillation processes: present and future, *Comput. Chem. Eng.* 28 (10) (2004) 1997–2020.
- [15] H. Subawalla, J.R. Fair, Design guidelines for solid-catalyzed reactive distillation systems, *Ind. Eng. Chem. Res.* 38 (10) (1999) 3696–3709.
- [16] D. Barbosa, M.F. Doherty, The simple distillation of homogeneous reactive mixtures, *Chem. Eng. Sci.* 43 (3) (1988) 541–550.
- [17] G.-J.A.F. Fien, Y.A. Liu, Heuristic synthesis and shortcut design of separation processes using residue curve maps: a review, *Ind. Eng. Chem. Res.* 33 (11) (1994) 2505–2522.
- [18] S. Ung, M.F. Doherty, Synthesis of reactive distillation systems with multiple equilibrium chemical reactions, *Ind. Eng. Chem. Res.* 34 (8) (1995) 2555–2565.
- [19] J. Espinosa, P. Aguirre, G. Pérez, Some aspects in the design of multicomponent reactive distillation columns with a reacting core: mixtures containing inerts, *Ind. Eng. Chem. Res.* 35. 12 (1996) 4537–4549.
- [20] Z. Qi, A. Kolah, K. Sundmacher, Residue curve maps for reactive distillation systems with liquid-phase splitting, *Chem. Eng. Sci.* 57 (1) (2002) 163–178.



- [21] A. Nisoli, M.F. Malone, M.F. Doherty, Attainable regions for reaction with separation, *AIChE J* 43 (2) (1997) 374–387.
- [22] J.W. Lee, S. Hauan, K.M. Lien, A.W. Westerberg, A graphical method for designing reactive distillation columns. I. The Ponchon-Savarit method, *Proc. R. Soc. Lond. Ser. A: Math. Phys. Eng. Sci.* 456 (2000) 1953–1964.
- [23] J.W. Lee, S. Hauan, K.M. Lien, A.W. Westerberg, A graphical method for designing reactive distillation columns. II. The McCabe-Thiele method, in: *Proceedings of the Royal Society of London. Series A: Mathematical, Physical and Engineering Sciences* 456, 2000, pp. 1965–1978.
- [24] J.W. Lee, S. Hauan, A.W. Westerberg, Graphical methods for reaction distribution in a reactive distillation column, *AIChE J* 46 (6) (2000) 1218–1233.
- [25] G. Buzad, M.F. Doherty, Design of three-component kinetically controlled reactive distillation columns using fixed-points methods, *Chem. Eng. Sci.* 49 (12) (1994) 1947–1963.
- [26] S. Giessler, R.Y. Danilov, R.Y. Pisarenko, L.A. Serafimov, S. Hasebe, I. Hashimoto, Feasibility study of reactive distillation using the analysis of the statics, *Ind. Eng. Chem. Res.* 37 (11) (1998) 4375–4382.
- [27] S. Giessler, R.Y. Danilov, R.Y. Pisarenko, L.A. Serafimov, S. Hasebe, I. Hashimoto, Feasible separation modes for various reactive distillation systems, *Ind. Eng. Chem. Res.* 38 (10) (1999) 4060–4067.
- [28] T. Frey, J. Stichmair, Thermodynamic fundamentals of reactive distillation, *Chem. Eng. Technol.* 22 (1) (1999) 11–18.
- [29] M. Groemping, R.-M. Dragomir, M. Jobson, Conceptual design of reactive distillation columns using stage composition lines, *Chem. Eng. Process. Process Intensif.* 43 (3) (2004) 369–382.
- [30] A. Jantarasak, R. Gani, A. Görak, S. Assabumrungrat, Methodology for design and analysis of reactive distillation involving multielement systems, *Chem. Eng. Res. Des.* 89 (8) (2011) 1295–1307.
- [31] H. Li, Y. Meng, X. Li, X. Gao, A fixed point methodology for the design of reactive distillation columns, *Chem. Eng. Res. Des.* 111 (2016) 479–491.
- [32] J.G. Segovia-Hernández, S. Hernández, A. Bonilla Petriciolet, Reactive distillation: a review of optimal design using deterministic and stochastic techniques, *Chem. Eng. Process. Process Intensif.* 97 (2015) 134–143.
- [33] P. Seferlis, J. Grievink, Optimal design and sensitivity analysis of reactive distillation units using collocation models, *Ind. Eng. Chem. Res.* 40 (7) (2001) 1673–1685.
- [34] M. Urselmann, S. Barkmann, G. Sand, S. Engell, Optimization-based design of reactive distillation columns using a memetic algorithm, *Comput. Chem. Eng.* 35 (2011) 787–805.
- [35] M. Urselmann, S. Engell, Design of memetic algorithms for the efficient optimization of chemical process synthesis problems with structural restrictions, *Comput. Chem. Eng.* 72 (2015) 87–108.
- [36] A.R. Ciric, D. Gu, Synthesis of nonequilibrium reactive distillation processes by MINLP optimization, *AIChE J* 40 (9) (1994) 1479–1487.
- [37] V. Bansal, J.D. Perkins, E.N. Pistikopoulos, R. Ross, J.M.G. van Schijndel, Simultaneous design and control optimisation under uncertainty, *Comput. Chem. Eng.* 24 (2) (2000) 261–266.
- [38] B.M. Russel, J.P. Henriksen, S.B. Jørgensen, R. Gani, Integration of design and control through model analysis, *Comput. Chem. Eng.* 24 (2) (2000) 967–973.
- [39] J.R. Jackson, I.E. Grossmann, A disjunctive programming approach for the optimal design of reactive distillation columns, *Comput. Chem. Eng.* 25 (11) (2001) 1661–1673.
- [40] M.C. Georgiadis, M. Schenk, E.N. Pistikopoulos, R. Gani, The interactions of design control and operability in reactive distillation systems, *Comput. Chem. Eng.* 26 (4) (2002) 735–746.
- [41] J.F. Burri, V.I. Manousiouthakis, Global optimization of reactive distillation networks using IDEAS, *Comput. Chem. Eng.* 28 (12) (2004) 2509–2521.
- [42] F.E. da Cruz, V.I. Manousiouthakis, Process intensification of reactive separator networks through the IDEAS conceptual framework, *Comput. Chem. Eng.* 105 (2017) 39–55.
- [43] Y. Tian, I. Pappas, B. Burnak, J. Katz, E.N. Pistikopoulos, Simultaneous design & control of a reactive distillation system – A parametric optimization & control approach, *Chem. Eng. Sci.* 230 (2021), 116232.
- [44] M. Skiborowski, Process synthesis and design methods for process intensification, *Curr. Opin. Chem. Eng.* 22 (2018) 216–225.
- [45] R.S. Hiwale, Y.S. Mahajan, N.V. Bhat, S.M. Mahajani, Industrial applications of reactive distillation: recent trends, *Int. J. Chem. React. Eng.* 2 (1) (2004) 1–52.
- [46] J. Gmehling, U. Onken, W. Arlt, P. Grenzheuser, U. Weidlich, B. Kolbe, J. Rarey, *Chemistry Data Series (Volume 1): Vapor-Liquid Equilibrium Data Collection*, DECHEMA, Frankfurt, 2004.
- [47] D.W. Green, R.H. Perry, *Perry's Chemical Engineers' Handbook*, 8th ed., McGraw-Hill Professional Pub, New York, 2007.
- [48] NIST Chemistry WebBook, National Institute of Standards and Technology. US Department of Commerce. <https://webbook.nist.gov/chemistry/>.
- [49] R. Muthia, A.G.T. Reijneveld, A.G.J. van der Ham, A.J.B. ten Kate, G. Bargeman, S. R.A. Kersten, A.A. Kiss, Novel method for mapping the applicability of reactive distillation, *Chem. Eng. Process. Process Intensif.* 128 (2018) 263–275.
- [50] R. Muthia, A.G.J. van der Ham, A.A. Kiss, A novel method for determining the optimal operating points of reactive distillation processes, *Chem. Eng. Trans.* 69 (2018) 595–600.
- [51] R. Muthia, A.G.J. van der Ham, A.A. Kiss, Preliminary economic ranking of reactive distillation processes using a navigation method, *Comput. Aided Chem. Eng.* 43 (2018) 827–832.
- [52] R. Muthia, M. Jobson, A.A. Kiss, Innovative mapping method for screening reactive distillation designs, *Comput. Aided Chem. Eng.* 46 (2019) 739–744.
- [53] R. Muthia, A.G.J. van der Ham, M. Jobson, A.A. Kiss, Effect of boiling point rankings and feed locations on the applicability of reactive distillation to quaternary systems, *Chem. Eng. Res. Des.* 145 (2019) 184–193.
- [54] R. Muthia, M. Jobson, A.A. Kiss, A systematic framework for assessing the applicability of reactive distillation for quaternary mixtures using a mapping method, *Comput. Chem. Eng.* 136 (2020), 106804.
- [55] A.A. Kiss, Novel applications of dividing-wall column technology to biofuel production processes, *J. Chem. Technol. Biotechnol.* 88 (2013) 1387–1404.
- [56] G. Towler, R. Sinnott, *Capital Cost Estimating, Chemical Engineering Design: Principles, Practice and Economics of Plant and Process Design*, Butterworth-Heinemann, USA, 2013, pp. 307–354.
- [57] M.A. Al-Arfaj, W.L. Luyben, Design and control of an olefin metathesis reactive distillation column, *Chem. Eng. Sci.* 57 (2002) 715–733.
- [58] M.A. Ibrahim, M.N. Akhtar, J. Čejka, E. Montanari, H. Balcar, M. Kubů, S.S. Al-Khattaf, Metathesis of 2-pentene over Mo and W supported mesoporous molecular sieves MCM-41 and SBA-15, *J. Ind. Eng. Chem.* 53 (2017) 119–126.
- [59] M.J. Okasinski, M.F. Doherty, Design method for kinetically controlled, staged reactive distillation columns, *Ind. Eng. Chem. Res.* 37 (7) (1998) 2821–2834.
- [60] F. Chen, R.S. Huss, M.F. Malone, M.F. Doherty, Simulation of kinetic effects in reactive distillation, *Comput. Chem. Eng.* 24 (11) (2000) 2457–2472.
- [61] M. Shah, A.A. Kiss, E. Zondervan, A.B. de Haan, A systematic framework for the feasibility and technical evaluation of reactive distillation processes, *Chem. Eng. Process. Process Intensif.* 60 (2012) 55–64.