



COMPLEX PROJECTS GRADUATION STUDIO - P5.0

FEDERAL FOREIGN OFFICE, BERLIN

Group 00 - Bodies, Building, Berlin

Stepan Serdiukov
19/01/2023

1. INTRODUCTION

2. NEW POLITICS

3. DESIGN

**CONCEPT
IMPLEMENTATION
DEVELOPMENT**

5. CONCLUSION

1. INTRODUCTION

2. NEW POLITICS

3. DESIGN

**CONCEPT
IMPLEMENTATION
DEVELOPMENT**

5. CONCLUSION

XXL



EUROPE





GERMANY





BERLIN



Introduction
Context

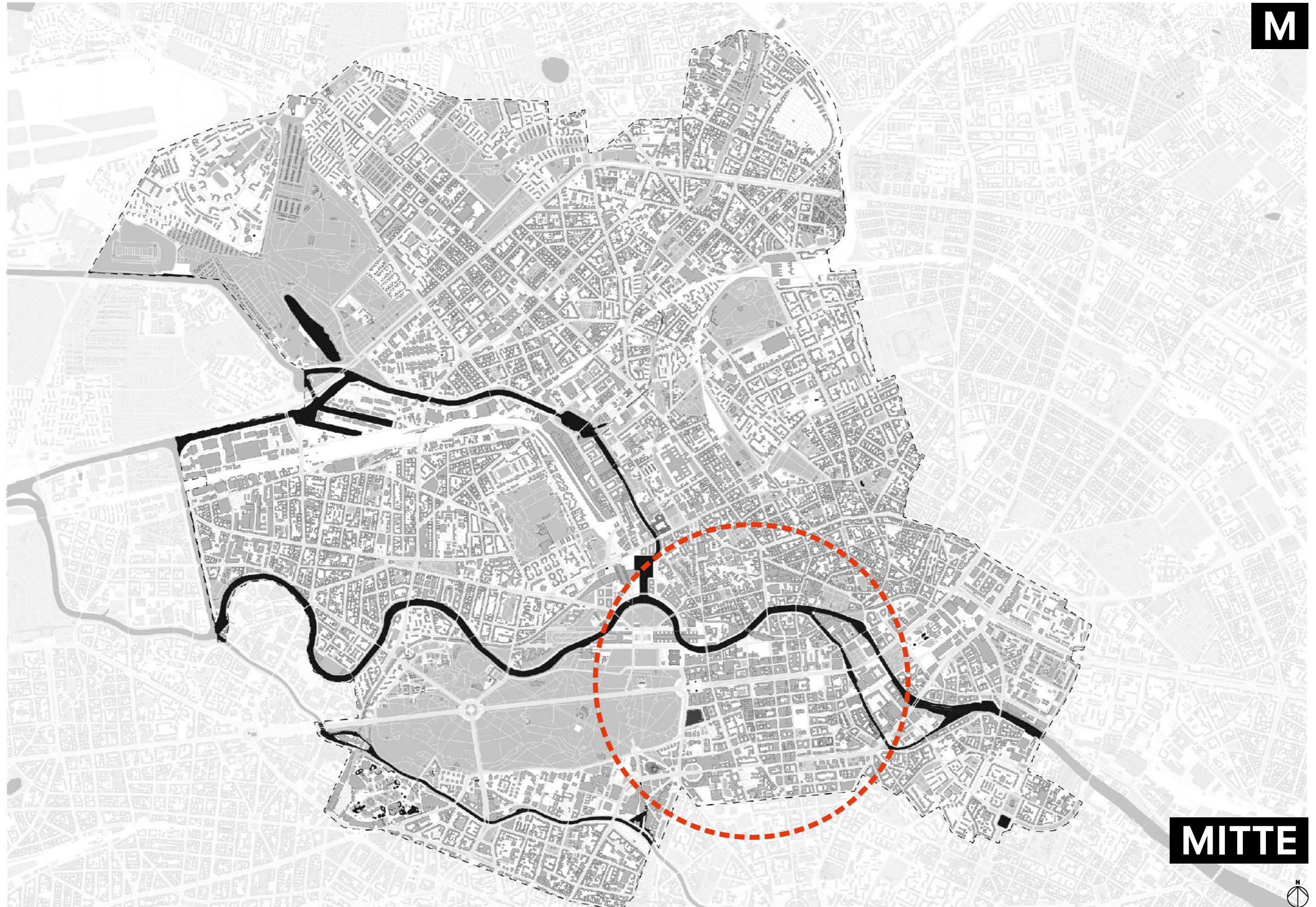

Berlin



LAYERED CITY

“Berlin has very different historical layers of urban architecture that are nested next to each other and intertwined in so-called historical center. Many witnesses of the medieval city coexist with modernism buildings and above all post-war modernism architecture. Those traces must be remained and attract people without hiding its history and covering up its fractures.”

Quote from Regula Lüscher (2010)

The Political Willpower

CAPITAL ISSUE

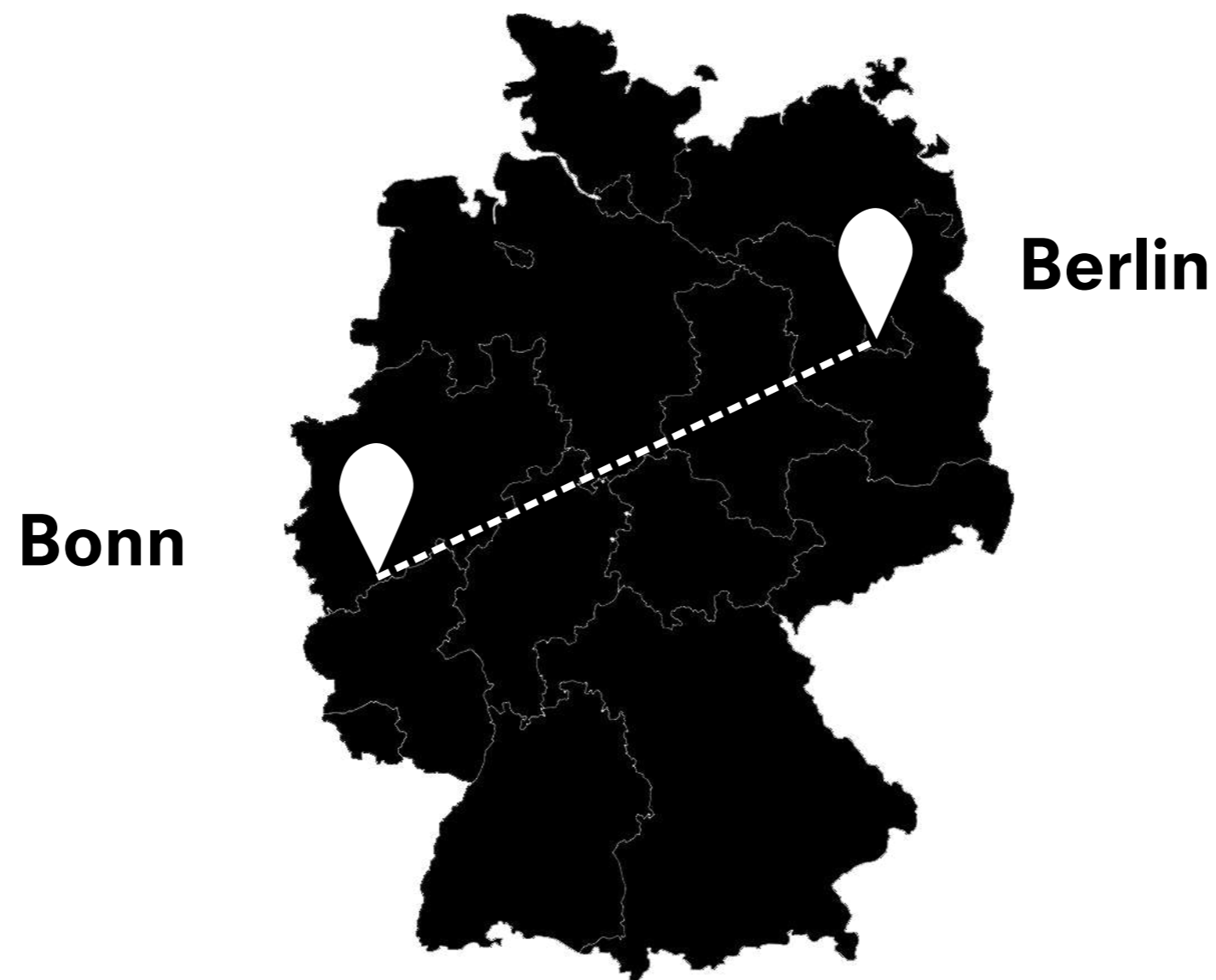

On 31 August 1990, The Unification Treaty, of East Germany within the Federal Republic of Germany under the German Basic Law states that: "The capital of Germany is Berlin. The question of the seat of Parliament and Government will be decided after the unification of Germany"

However, Berlin had the status of being a symbolic capital city. This compromise was made because of not reaching political unity about the future state capital.

The Political Willpower

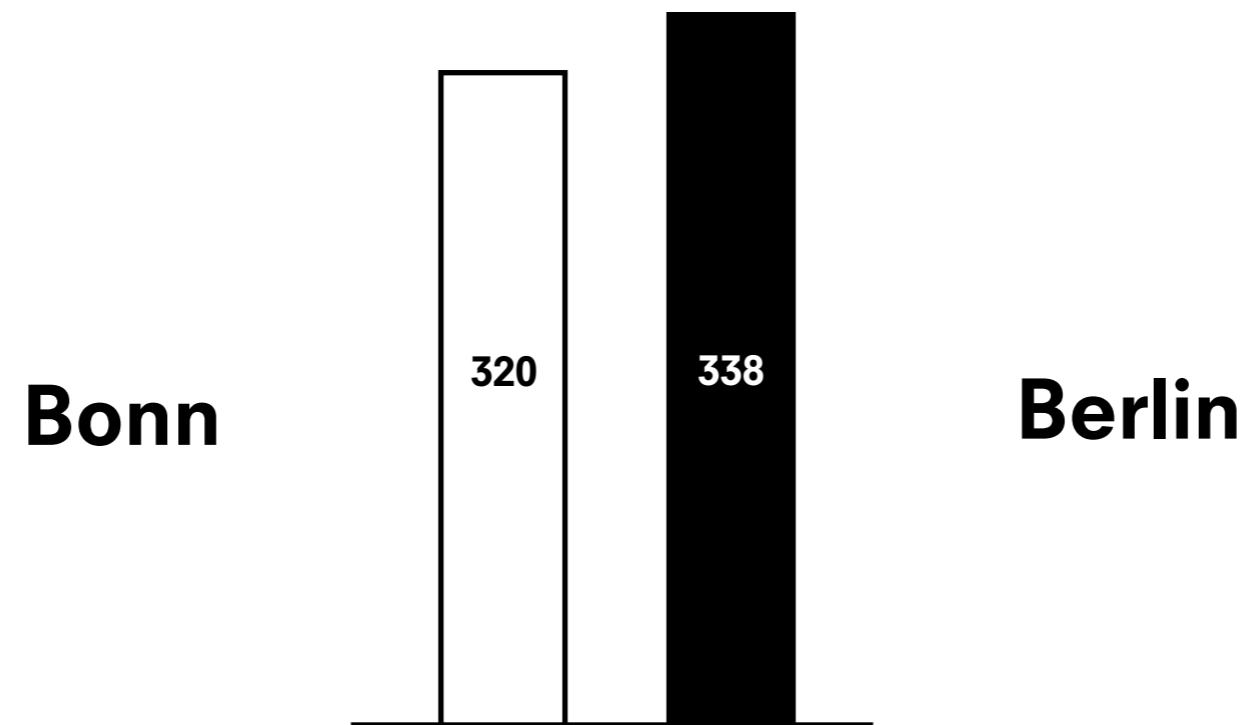

20 June 1991 when the German Bundestag voted on the "Motion for Completion of the German Unification". After a controversial debate the motion was approved by **338 to 320** votes. With the passing of the motion, Berlin was also established as the seat of the German Bundestag.

The Political Willpower

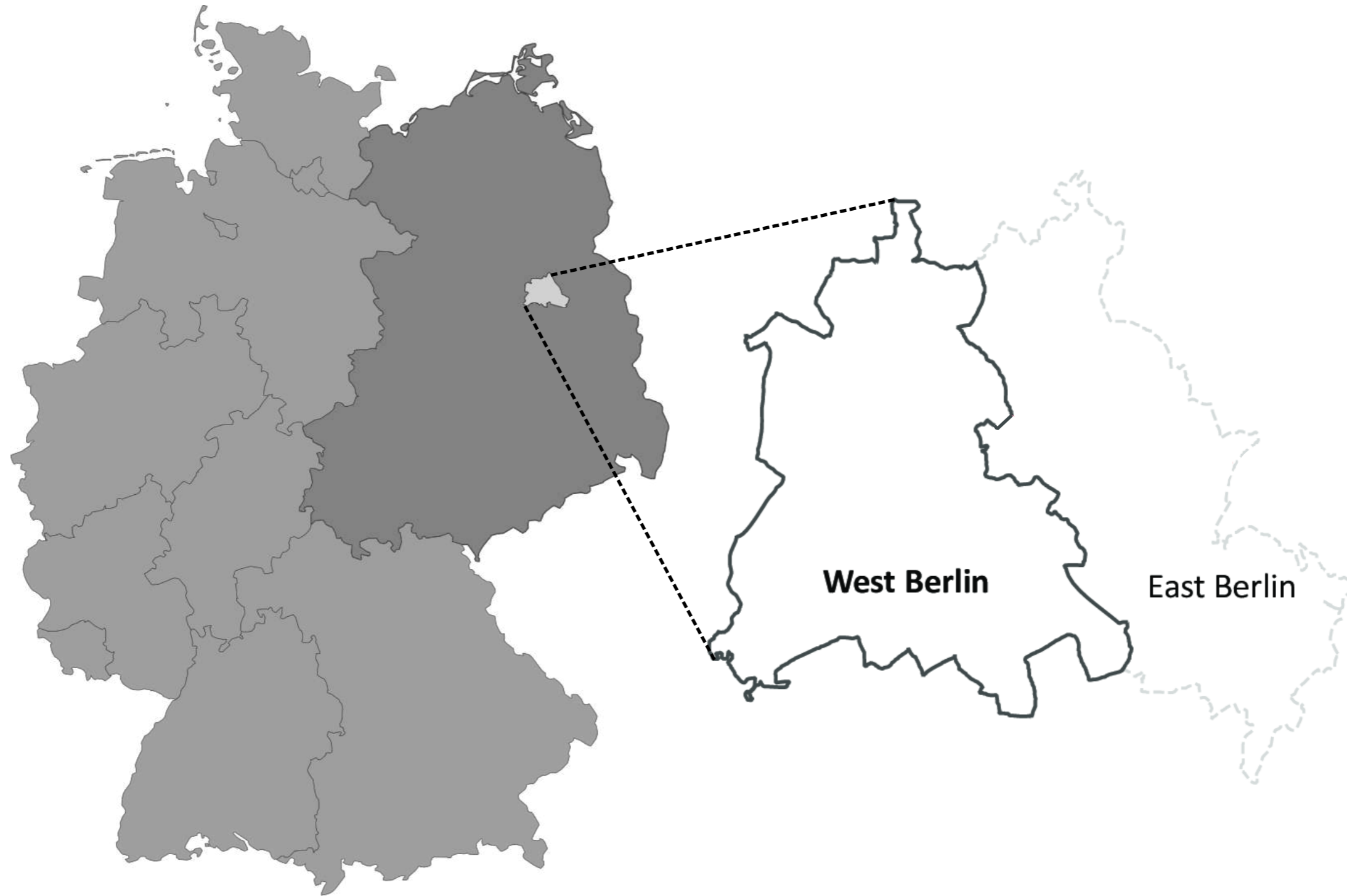

Within a very short period of time, the task was to ensure the functioning of parliament and government in the new capital and to bring together the infrastructure of the formerly divided city, which had been separate for decades.

Government buildings

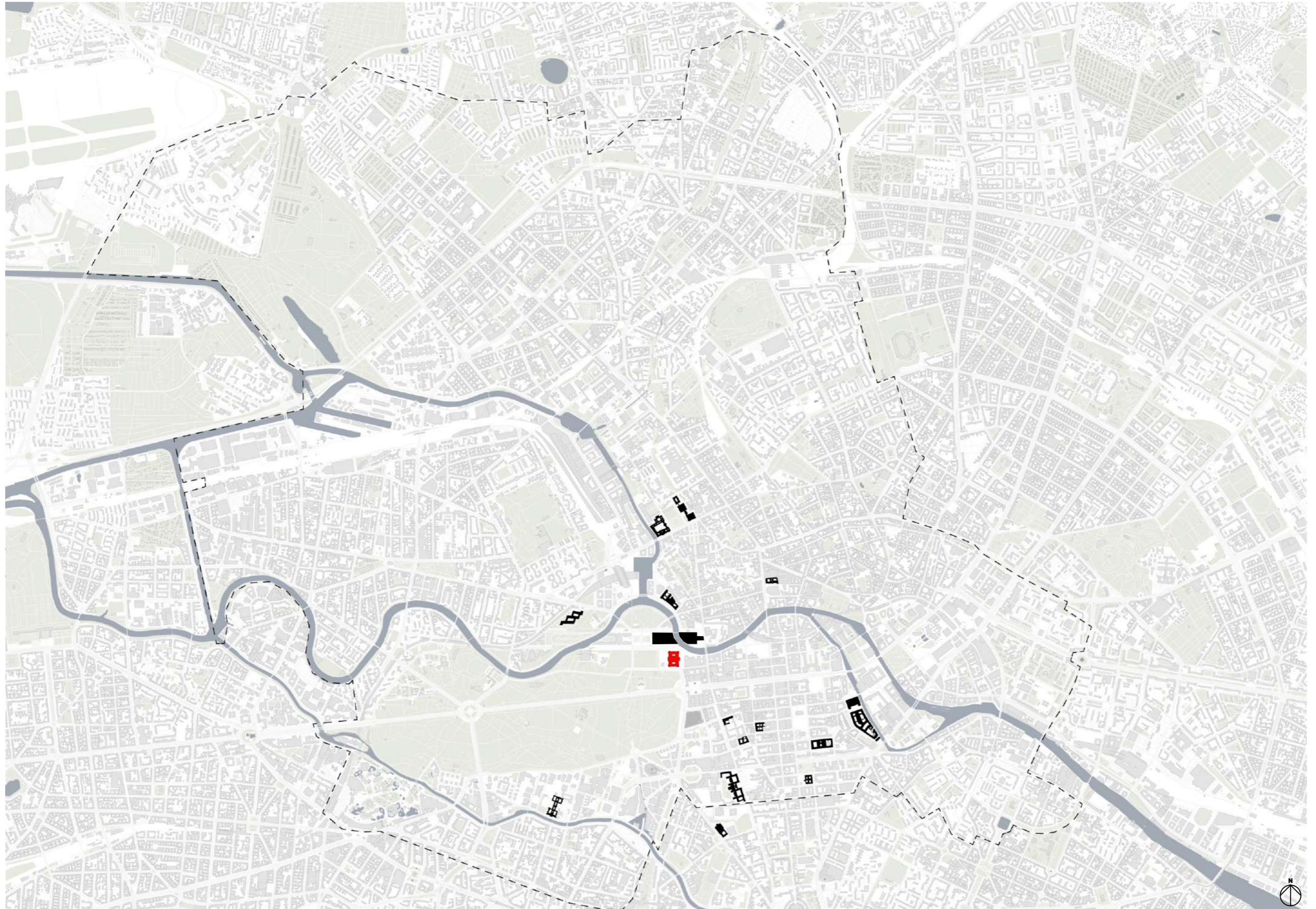

The Political Willpower

The Federal Government was appointed to:

1

The equal integration of parliament and government, the state representations and other capital-related institutions in the center of Berlin

2

The integration of federal institutions into the historically grown and diverse urban structure in order to avoid monofunctional, "deserted" areas

3

The creation of a parliament of short distances by concentrating the functions of the capital on the spatial focal points Spreebogen and Spreeinsel

4

The capital-related construction and expansion of the infrastructure and the improvement of the ecological structure as well

Government district

The ultimate goal was and is the spatial integration of parliament and government, the state representations and other capital-related institutions into the historically grown Berlin city structure, which is characterized by urban vitality. This is how a parliamentary district of short distances was created in the heart of Berlin.

Government district

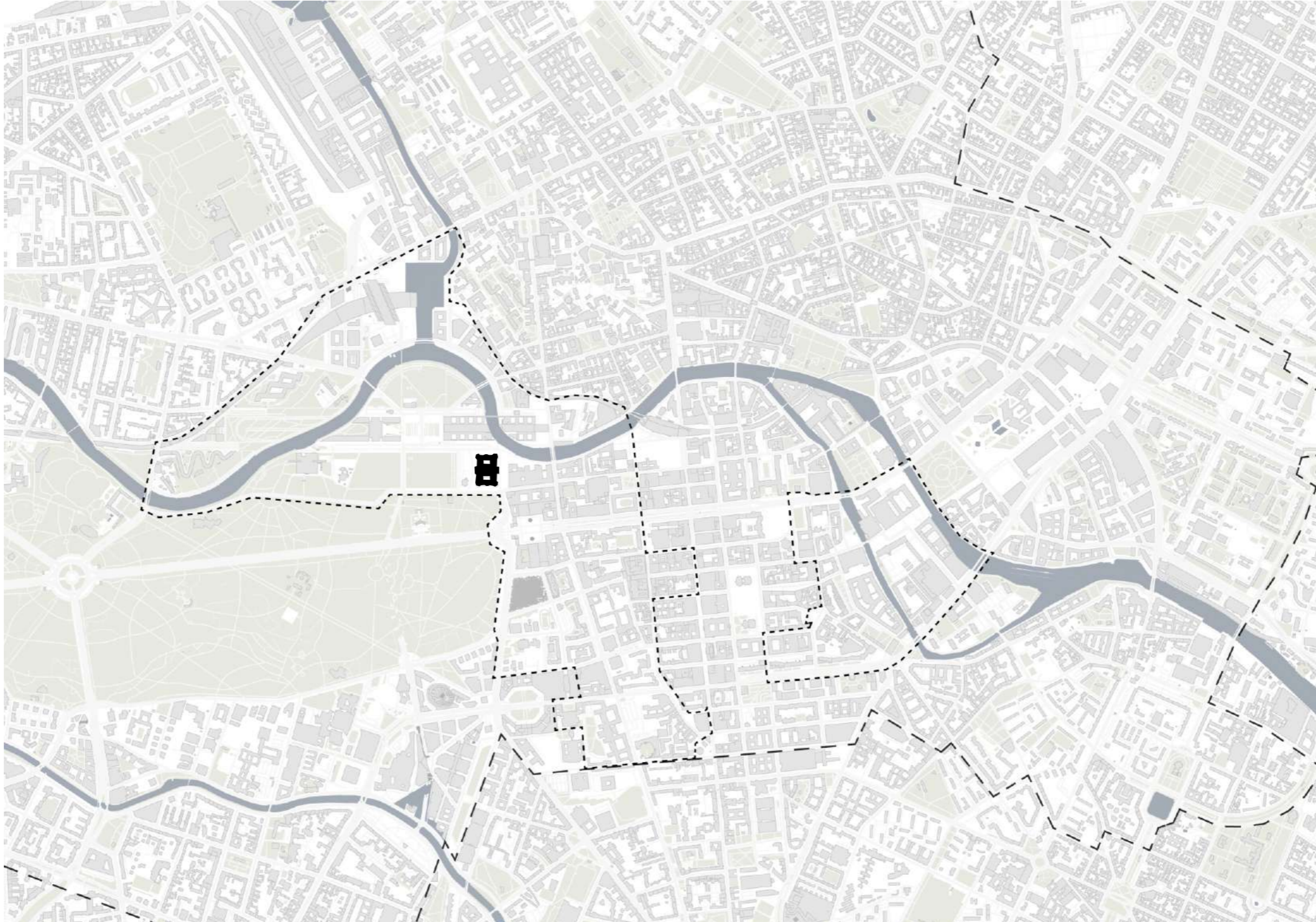

Government buildings



Federal Ministry of Justice



Federal Ministry for Economic Affairs and Energy



Federal Ministry for Digital and Transport



Federal Ministry of Finance



Federal Ministry for Economic Cooperation and Development

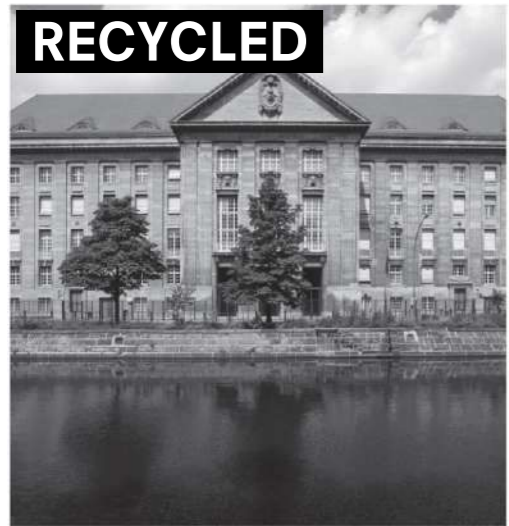

Federal Ministry of Defence

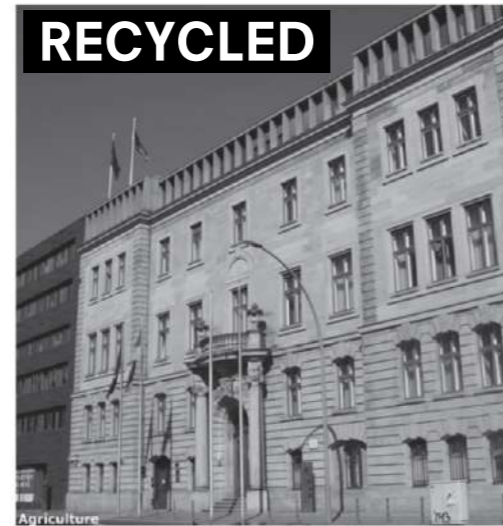

4 Federal Ministry of Food and Agriculture



Federal Ministry of Labour and Social Affairs (Berlin)



Foreign Affairs Office



Ministry for the Environment, Nature Conservation, Nuclear Safety and Consumer Protection (Bonn)

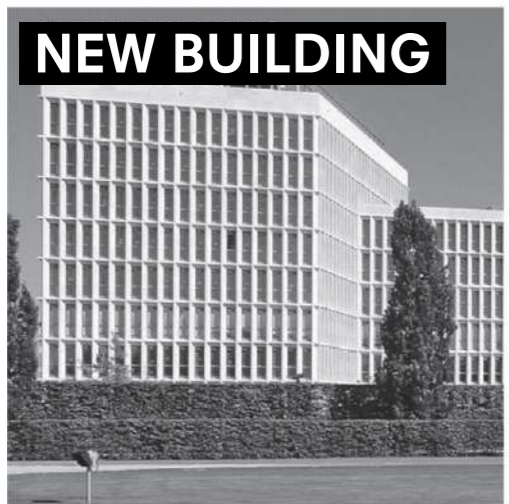

The Federal Ministry of the Interior and for Community



Federal Ministry of Education and Research



Federal Ministry for Family Affairs, Senior Citizens, Women and Youth



Federal Ministry of Health (Berlin, second office located in Bonn)



Federal Ministry for Housing, Urban Development and Building

Government buildings

Ministry buildings in Berlin

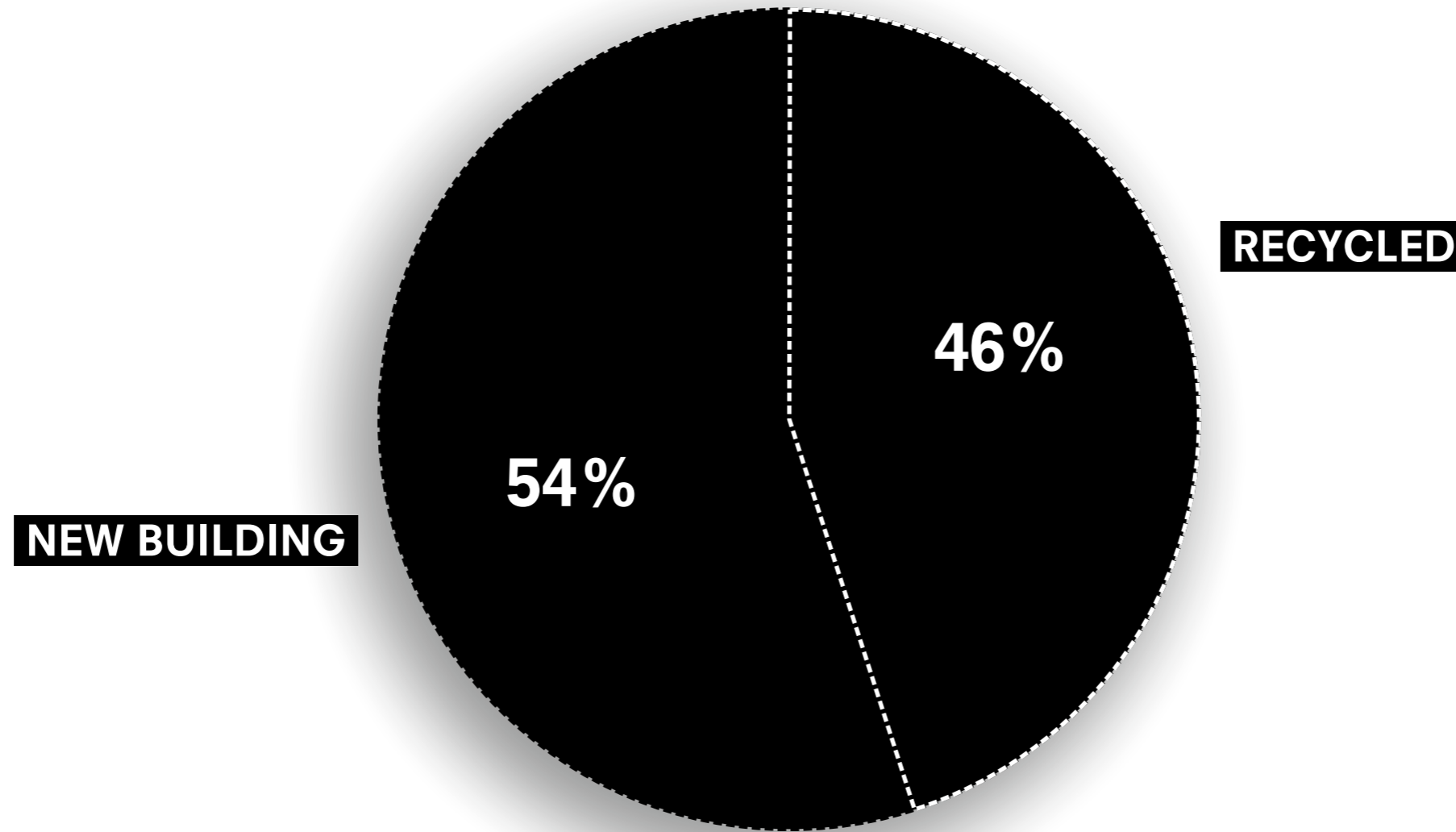

Introduction
Federal foreign office

Designed as a Reichsbank was a symbol for a global restructuring of a city,



The building is not a typical National-Socialist architecture example, it is more a typical example of conservative modernity.



The building was occupied for the needs of Reichsbank. Cash halls, rooms for organization of money circulation, gold and foreign exchange storage and Offices.



After 1945 building was given to a Ministry of Finance of GDR. Later to an East German Communist Party.



After 1991 it became a new Federal Foreign Office.



Multi-layered history of the site was decided to be legible to the public and thus provide a 'visual aid' for critical and self-critical reflection.

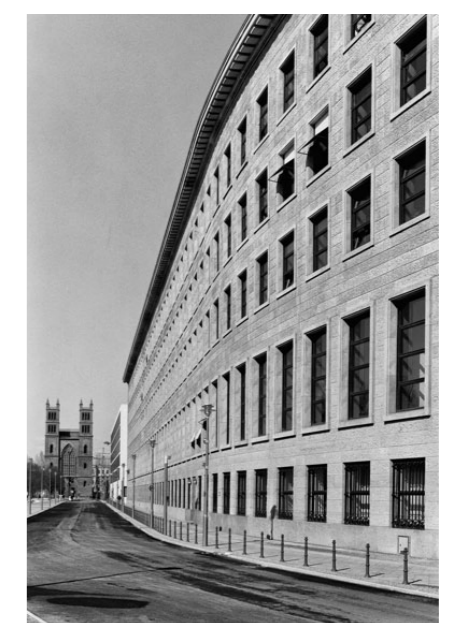
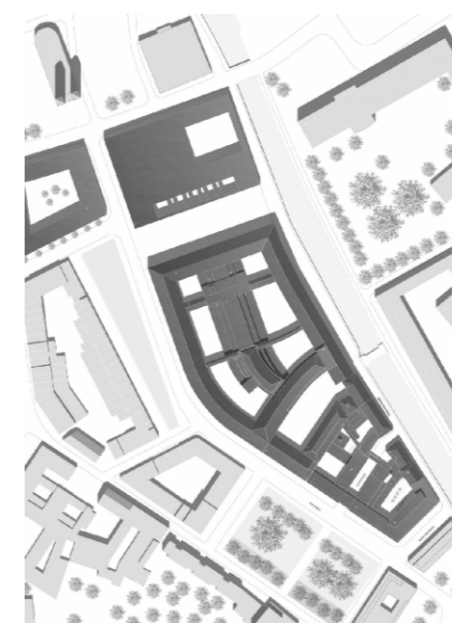
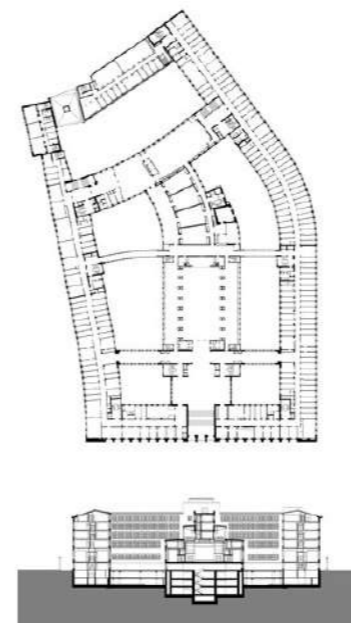

Prof. Hans Kollhoff / Foreign office berlin

1. INTRODUCTION

2. NEW POLITICS

3. DESIGN

**CONCEPT
IMPLEMENTATION
DEVELOPMENT**

5. CONCLUSION

Architectural challenges

NEW POLITICS



Ambition
Main problem



Prof. Hans Kollhoff / Foreign office berlin

Ambition
Main problem



Typical office space

Ambition
Main problem



Prof. Hans Kollhoff / Foreign office berlin

Ambition

Architectural challenges

TECHNOLOGICAL BUILDING



Technological building

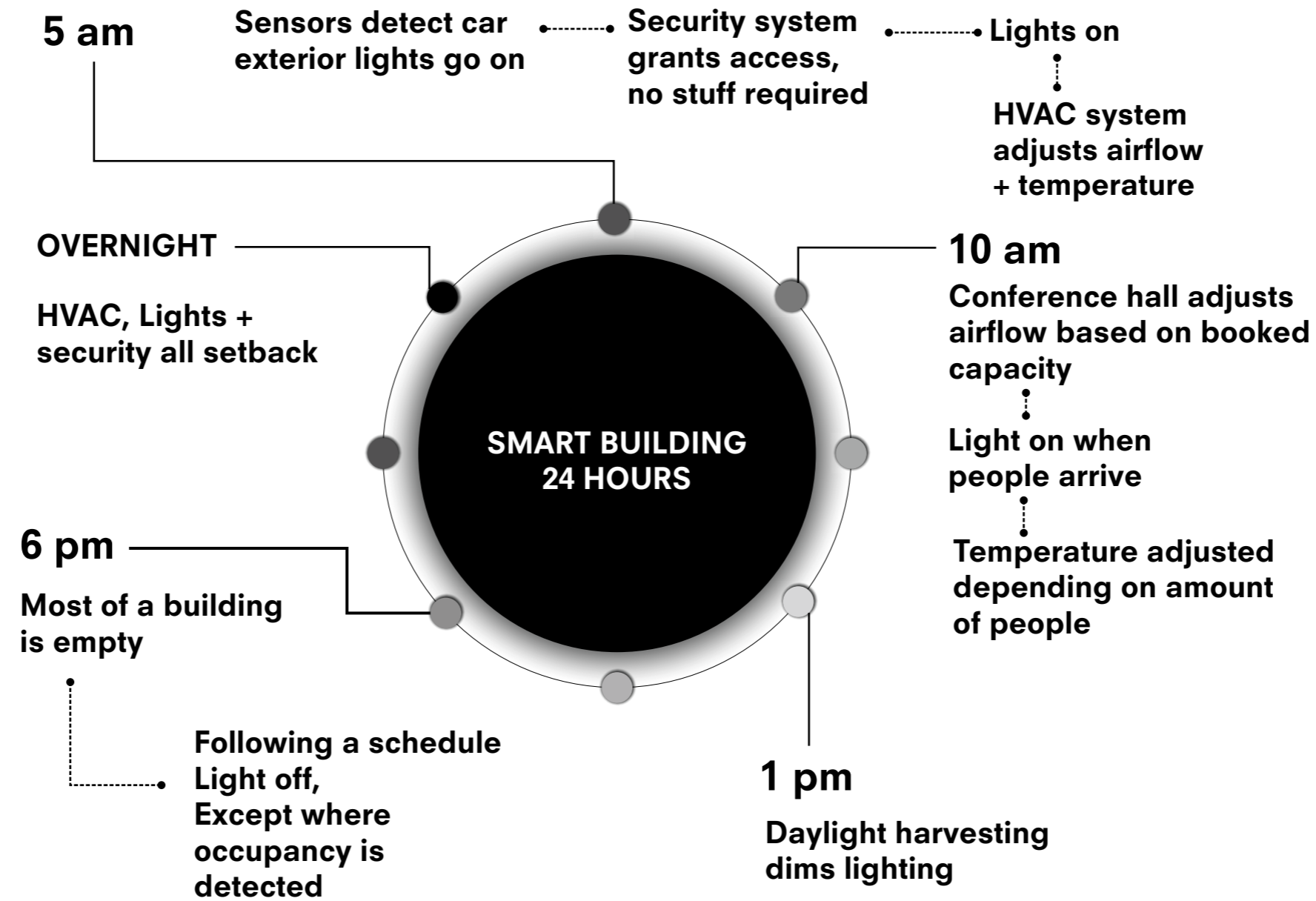

Ambition

Architectural challenges

SAFETY



Ambition

Safeguarding Access Points



Creating Security Layers Through Zoning



Ambition

Securing Outdoor Areas



Ambition

Using Emergency Color Coding and Wayfinding



Ambition

Designing Clear Sightlines



Installing Security Cameras and Metal Detectors



Research topic

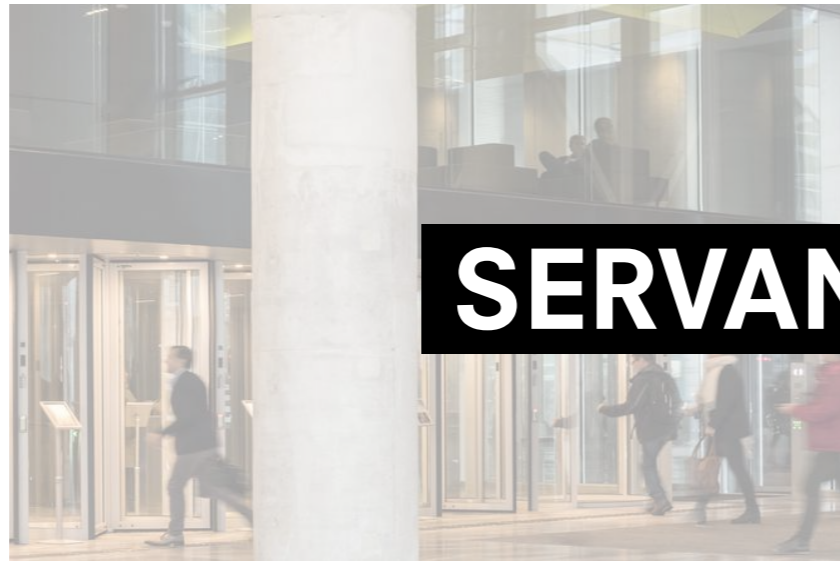

SERVANT SPACE



Research question

How does servant space evolve in the government building
to increase architectural performance?

1. INTRODUCTION

2. NEW POLITICS

3. DESIGN

CONCEPT

IMPLEMENTATION

DEVELOPMENT

5. CONCLUSION

Concept
Chosen Location

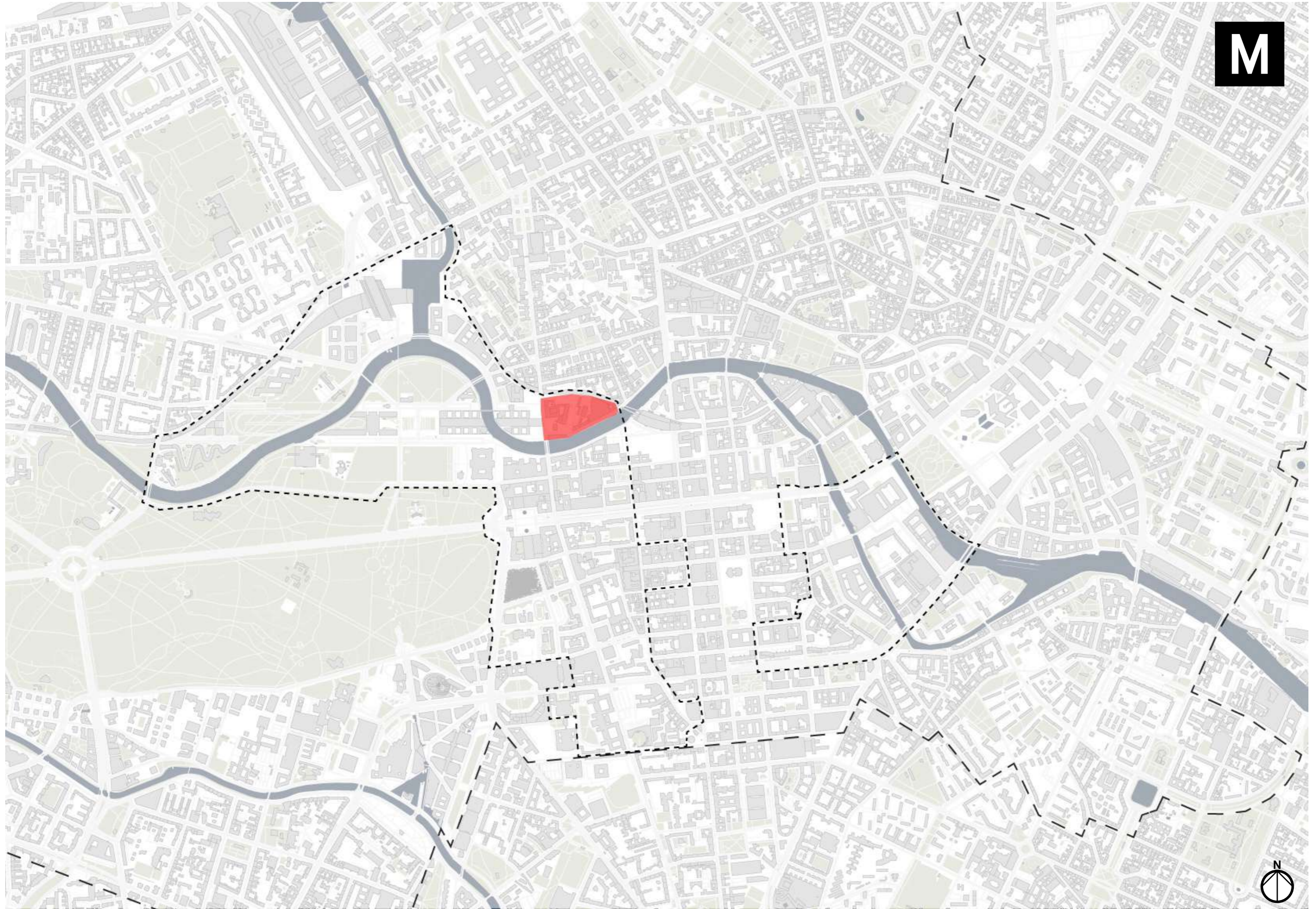

Concept
Chosen Locations

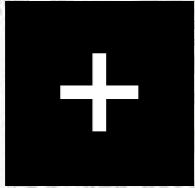
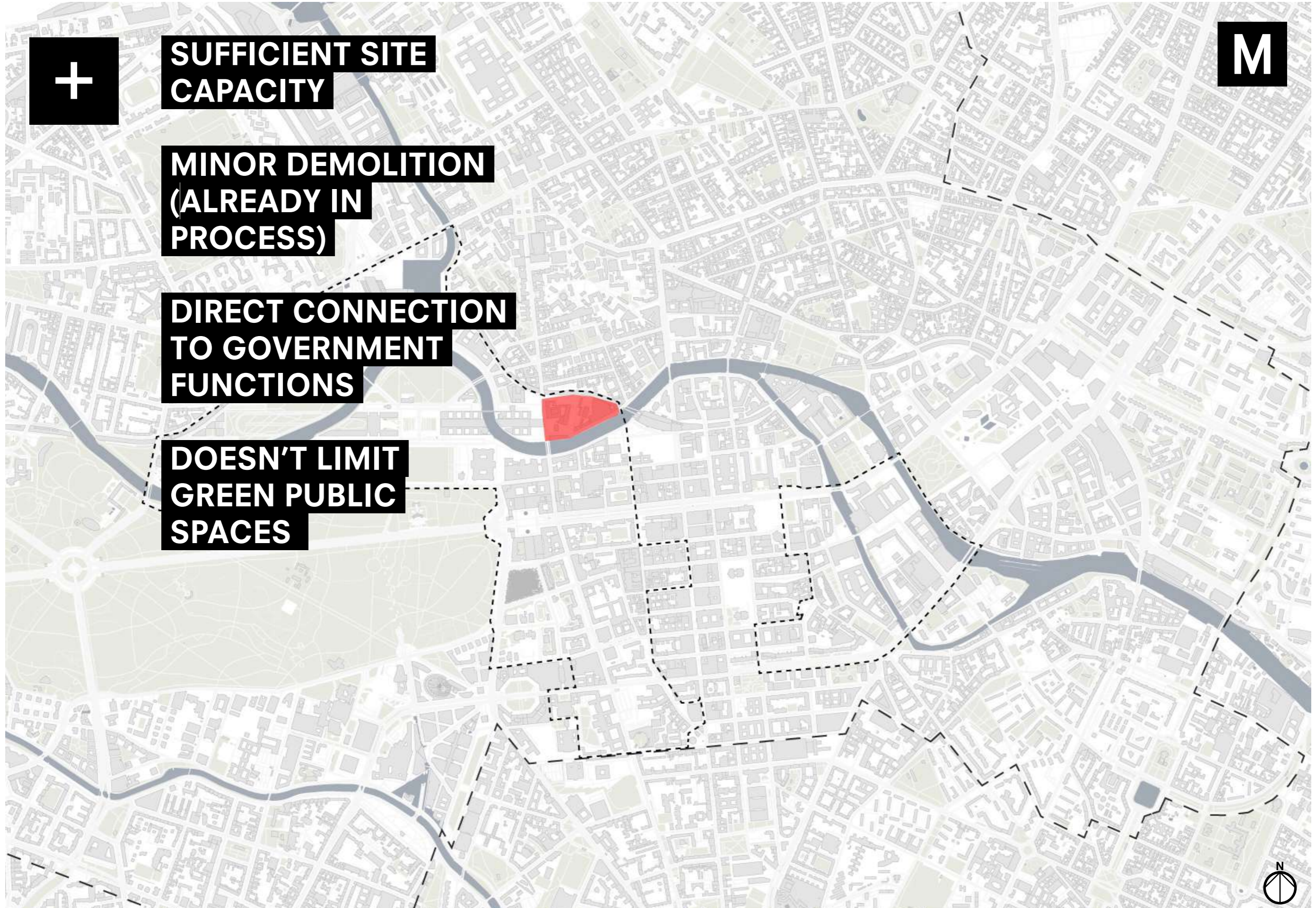

**SUFFICIENT SITE
CAPACITY**



**MINOR DEMOLITION
(ALREADY IN
PROCESS)**

**DIRECT CONNECTION
TO GOVERNMENT
FUNCTIONS**

**DOESN'T LIMIT
GREEN PUBLIC
SPACES**

Concept

Government district and embassies

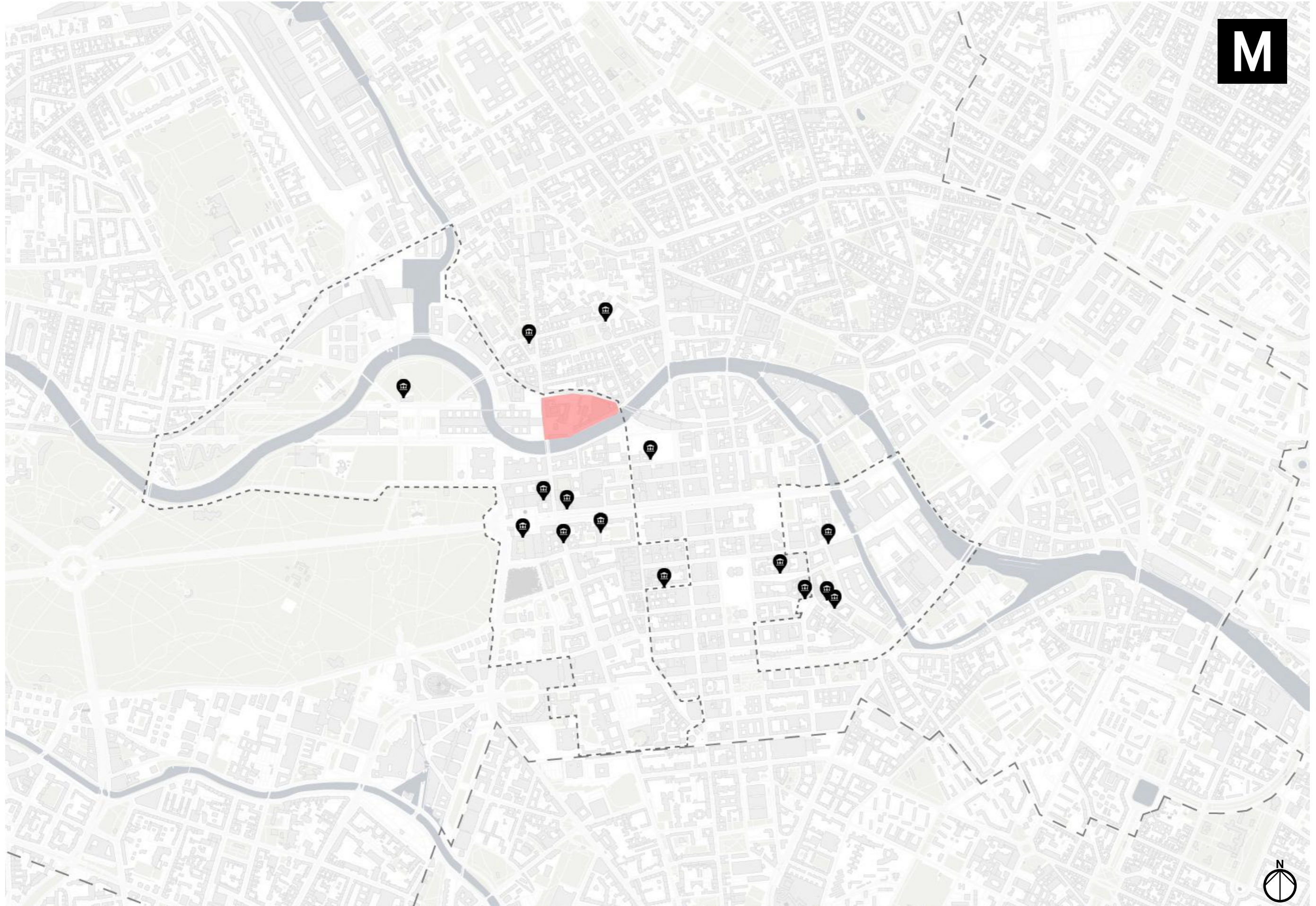

Concept
Transport connection

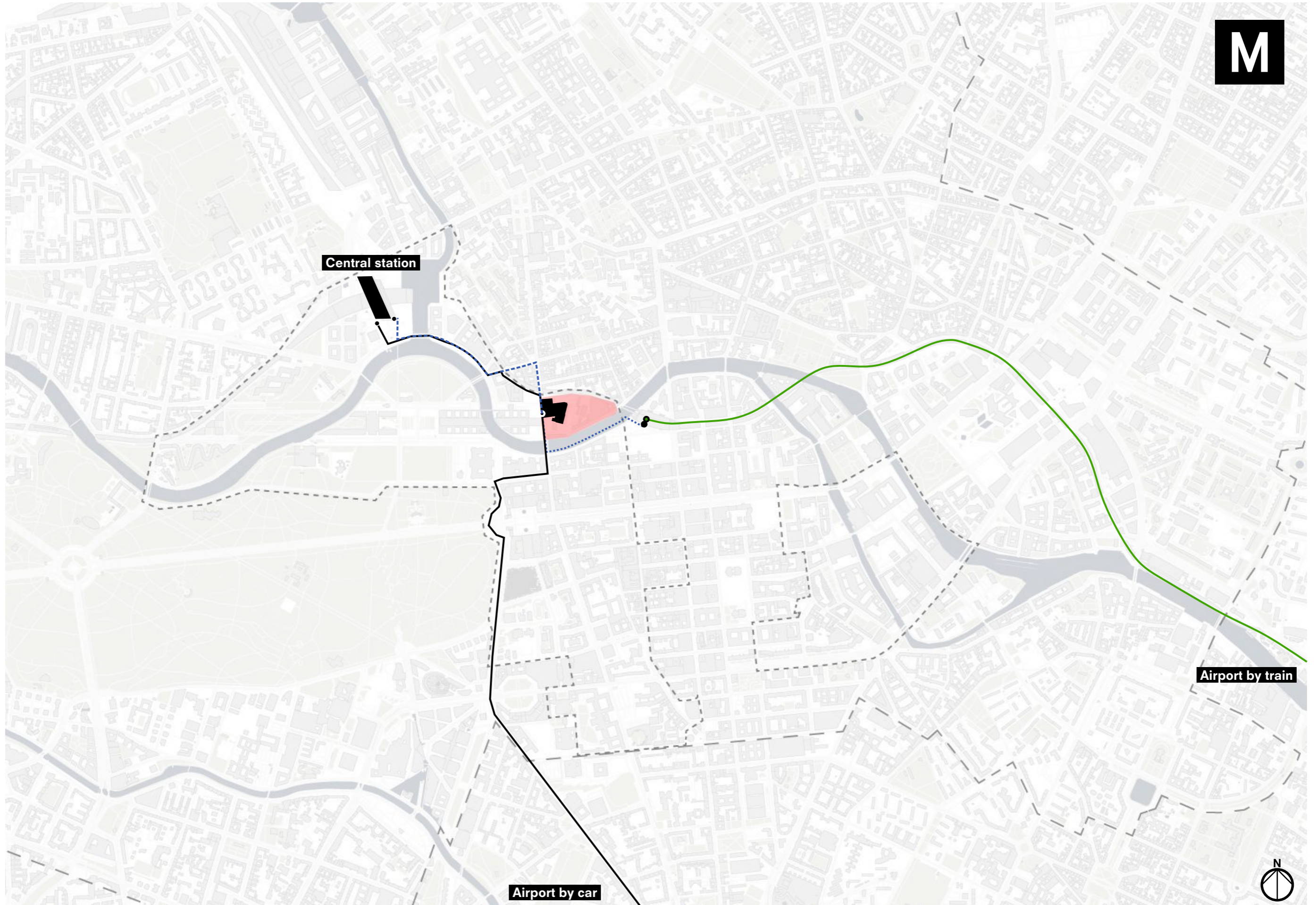

Concept Program

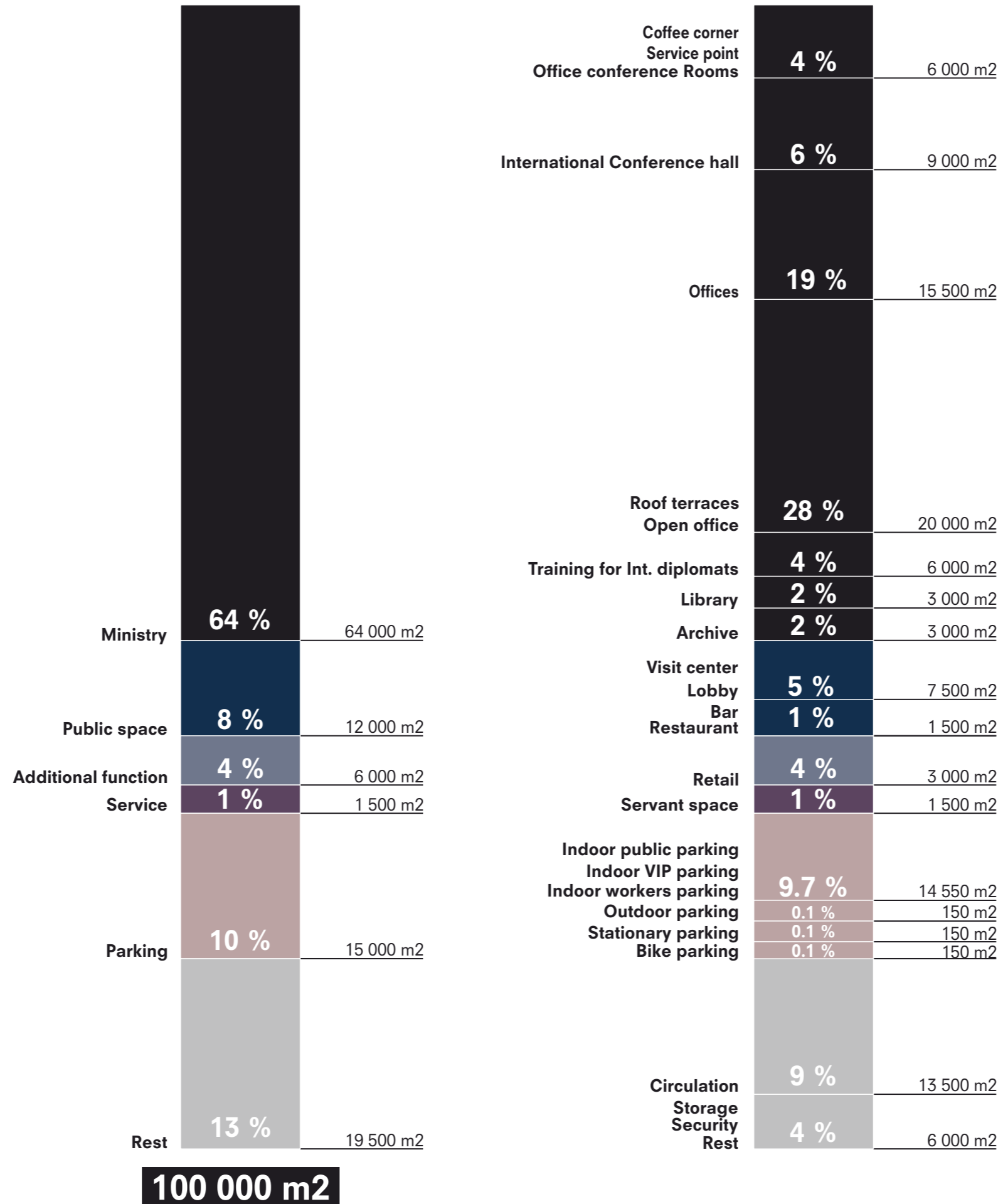

Program requirements

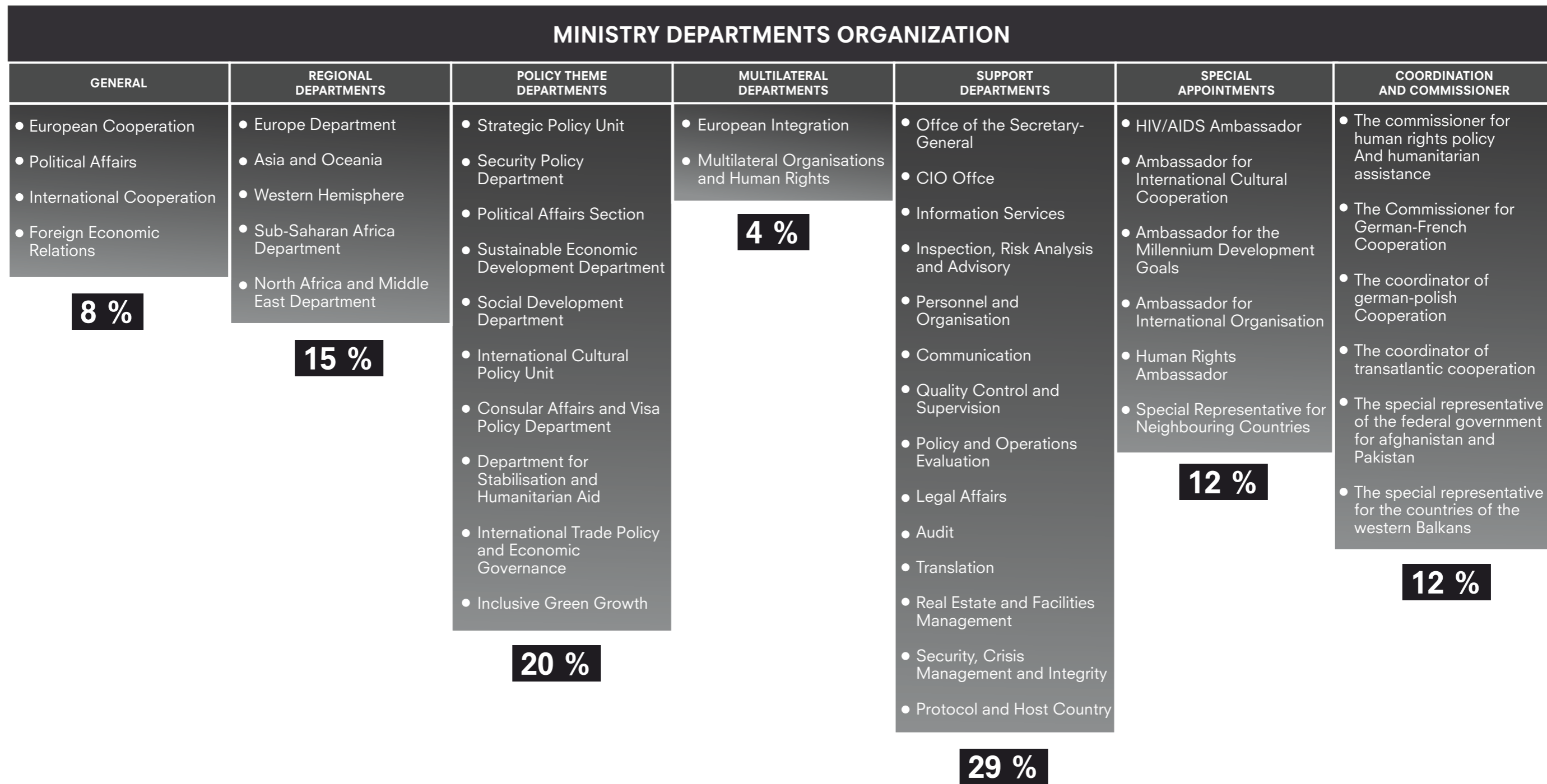

* % FROM THE OFFICE PART OF THE PROGRAM

Concept
Program relation

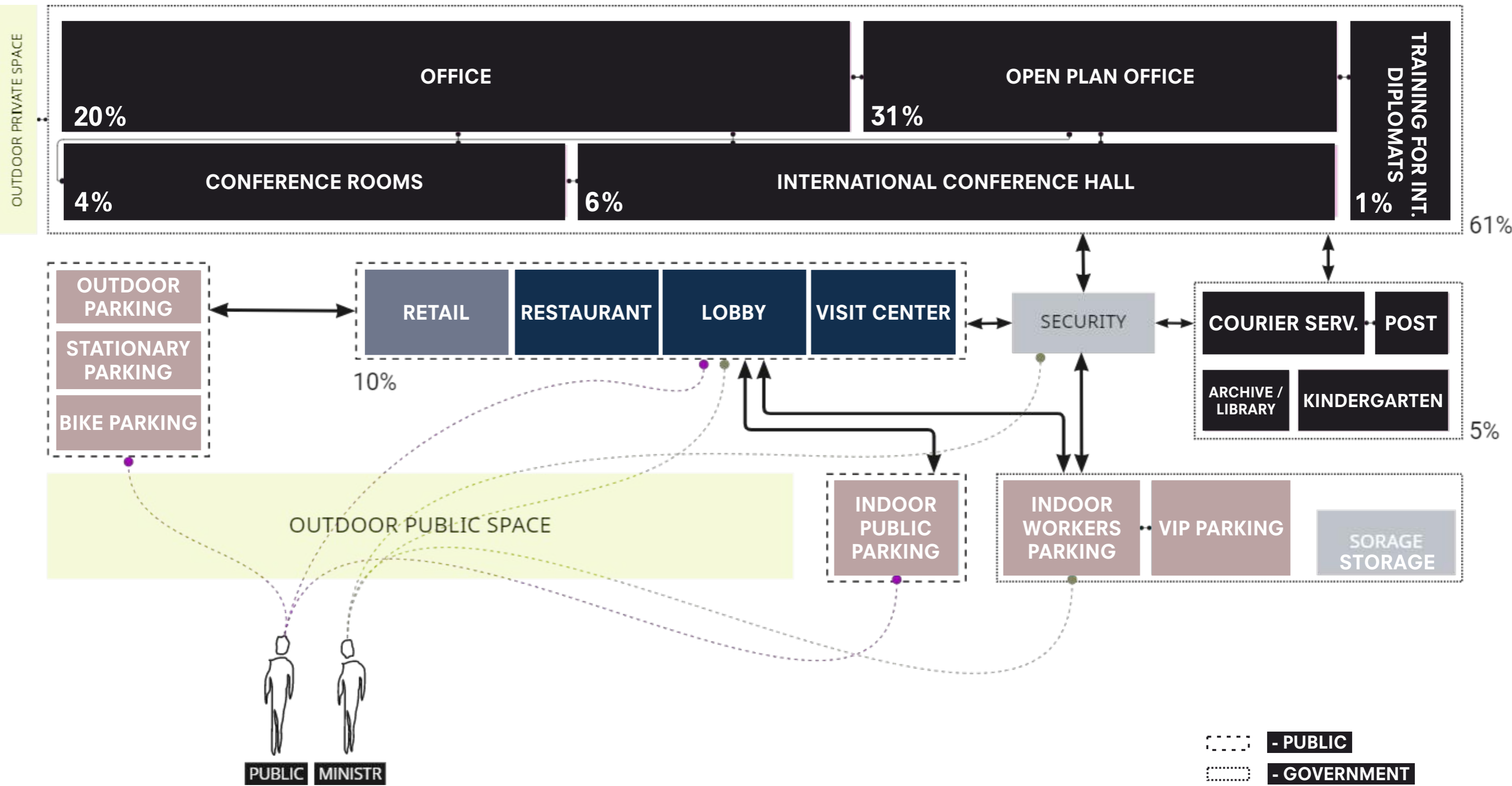

Concept
Program



Implementation
Program

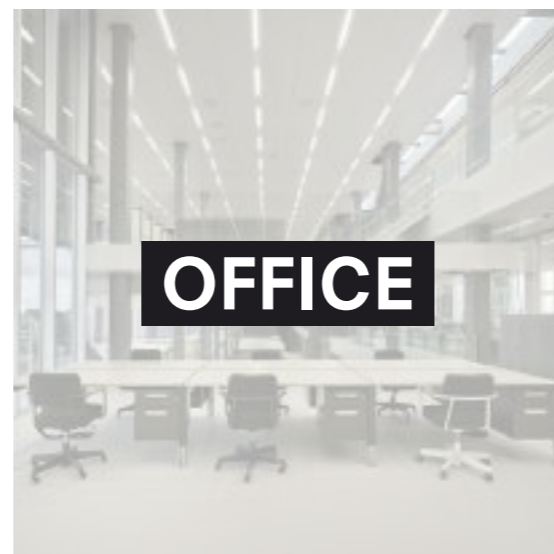

Concept
Design approaches

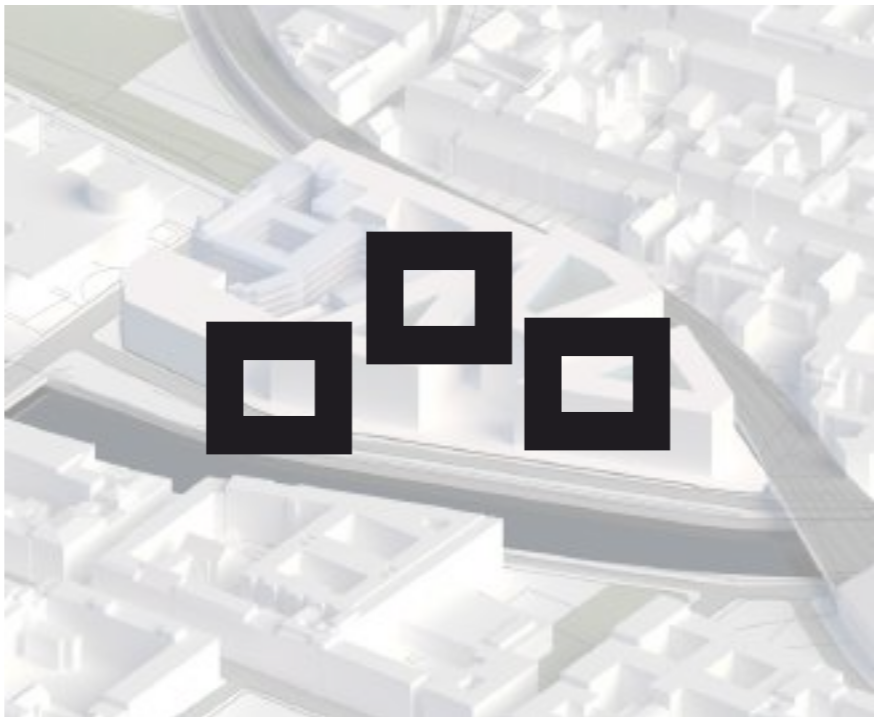
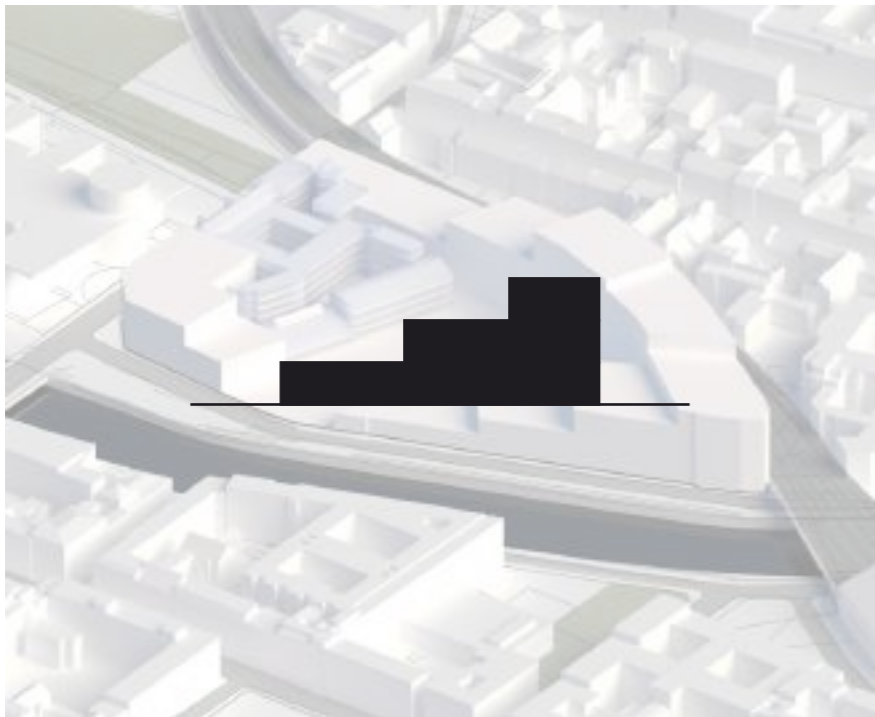
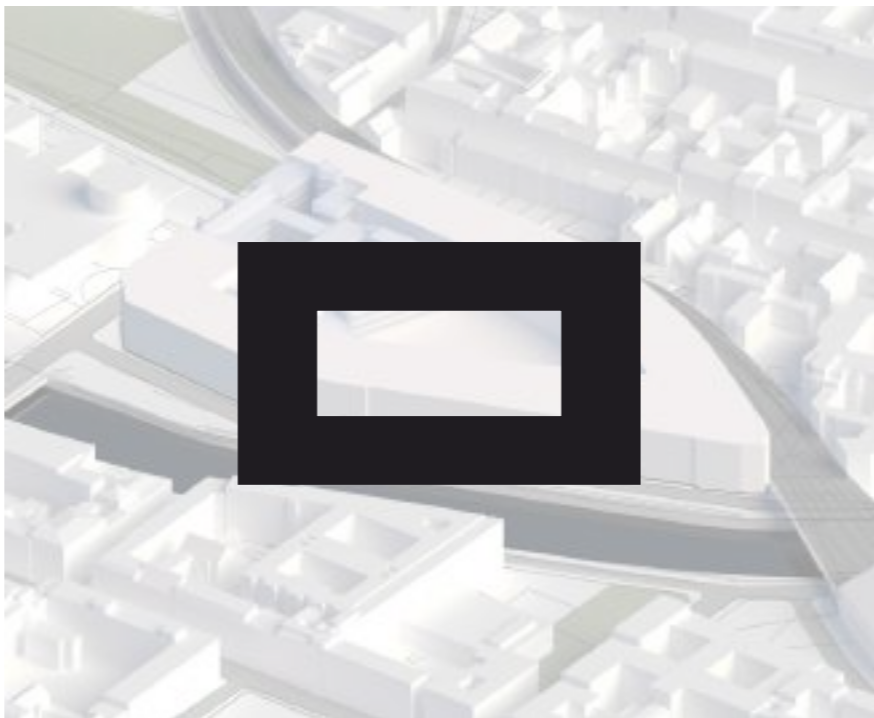
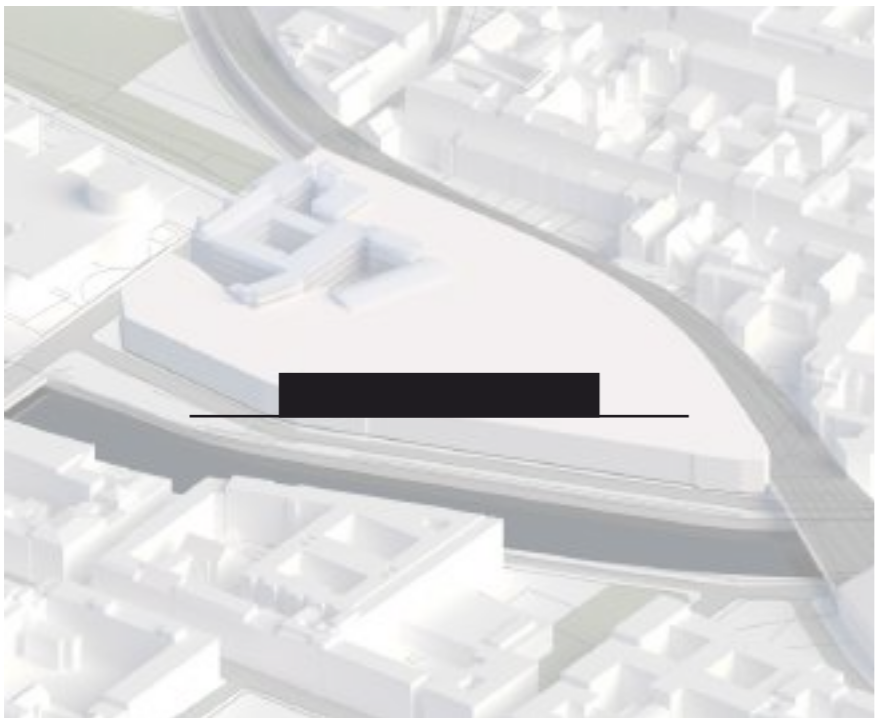

Government buildings



Federal Ministry of Justice



Federal Ministry for Economic Affairs and Energy



Federal Ministry for Digital and Transport



Federal Ministry of Finance



Federal Ministry for Economic Cooperation and Development

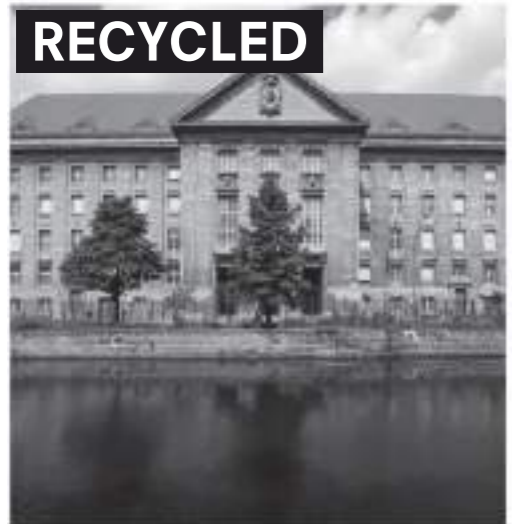

Federal Ministry of Defence



4 Federal Ministry of Food and Agriculture



Federal Ministry of Labour and Social Affairs (Berlin)



Foreign Affairs Office



Ministry for the Environment, Nature Conservation, Nuclear Safety and Consumer Protection (Bonn)



The Federal Ministry of the Interior and for Community



Federal Ministry of Education and Research



Federal Ministry for Family Affairs, Senior Citizens, Women and Youth



Federal Ministry of Health (Berlin, second office located in Bonn)



Federal Ministry for Housing, Urban Development and Building

Concept
Design approaches

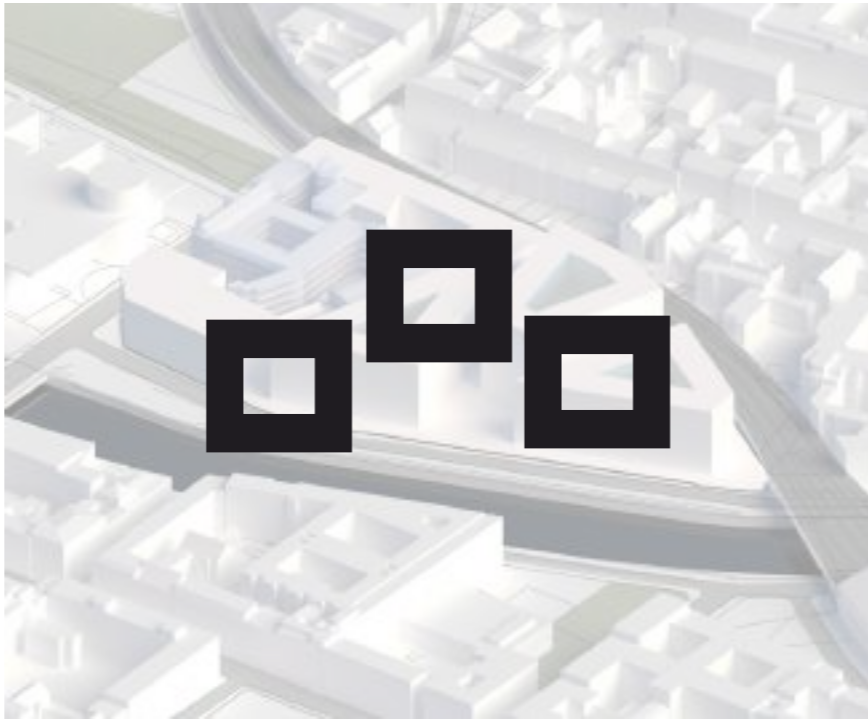

Concept

Program organization

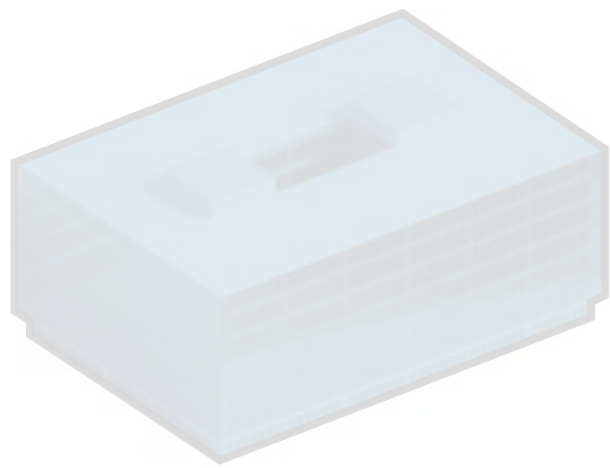

ARCHIVE

COURIER
AND POST

KINDERGARTEN

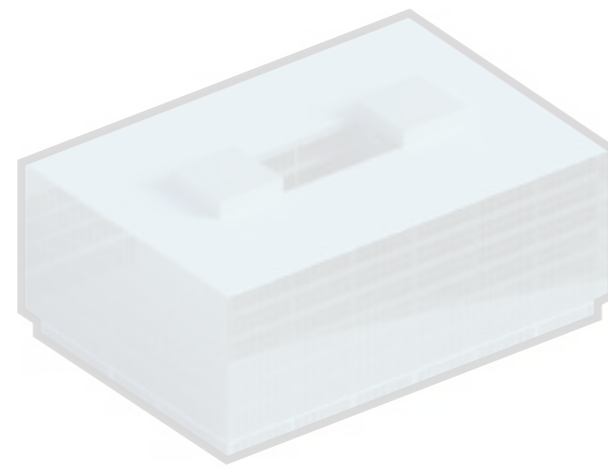

MINISTRY
OFFICES

MINISTRY
DEPARTMENTS

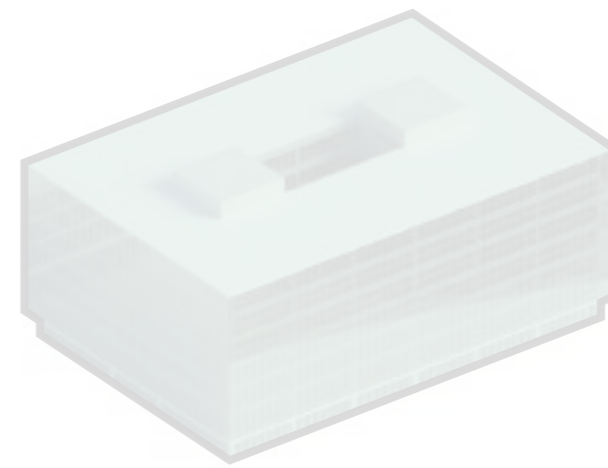

INTERNATIONAL
CONFERENCE

VISITOR
CENTER

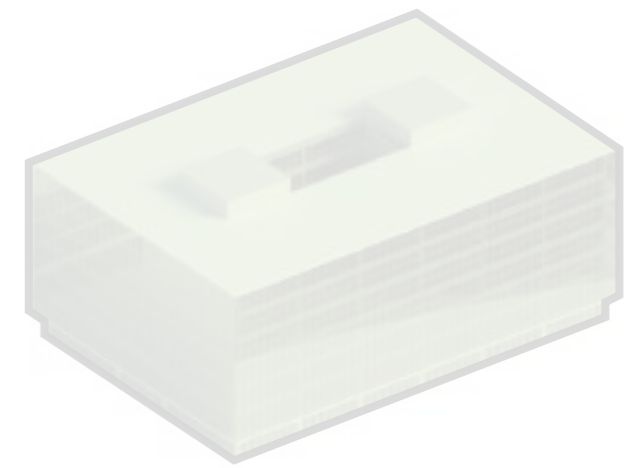

LIBRARY

IMMIGRATION
CENTER

GOVERNMENT
OFFICES

Concept

Program organization

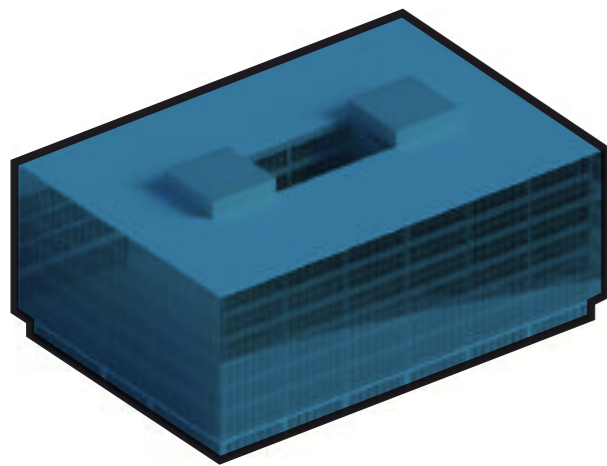

ARCHIVE

**COURIER
AND POST**

KINDERGARTEN

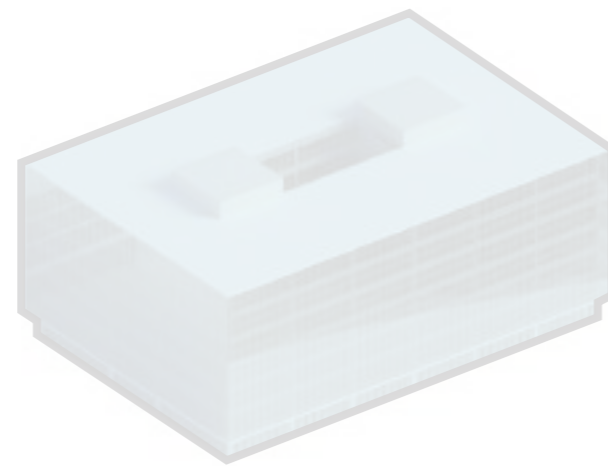

MINISTRY
OFFICES

MINISTRY
DEPARTMENTS

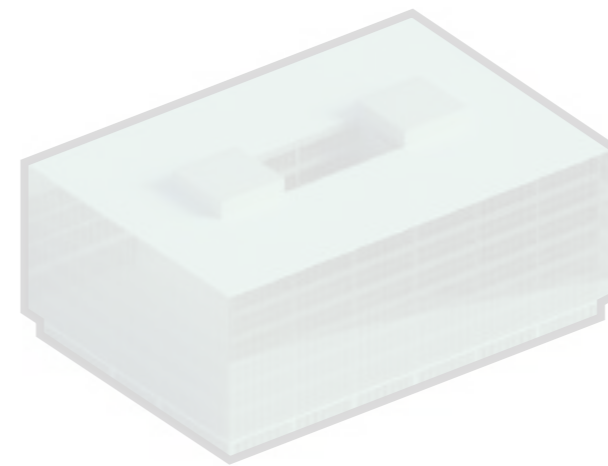

INTERNATIONAL
CONFERENCE

VISITOR
CENTER

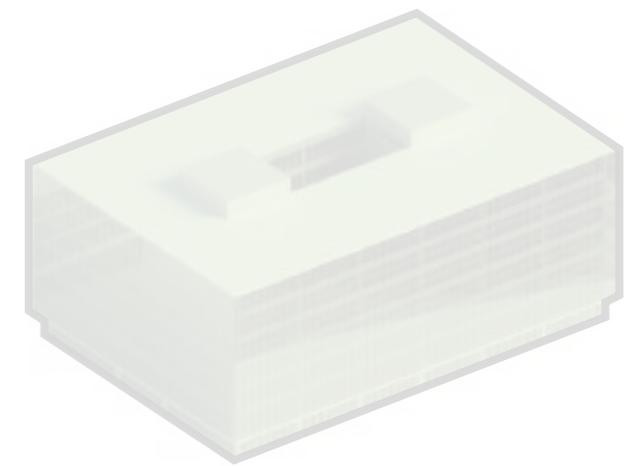

LIBRARY

IMMIGRATION
CENTER

GOVERNMENT
OFFICES

Program organization

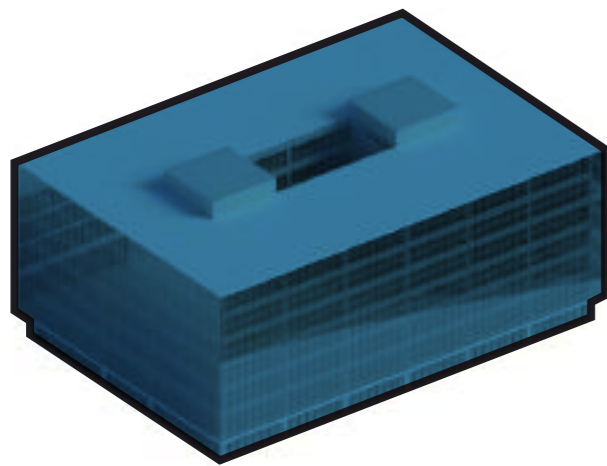

ARCHIVE

**COURIER
AND POST**

KINDERGARTEN

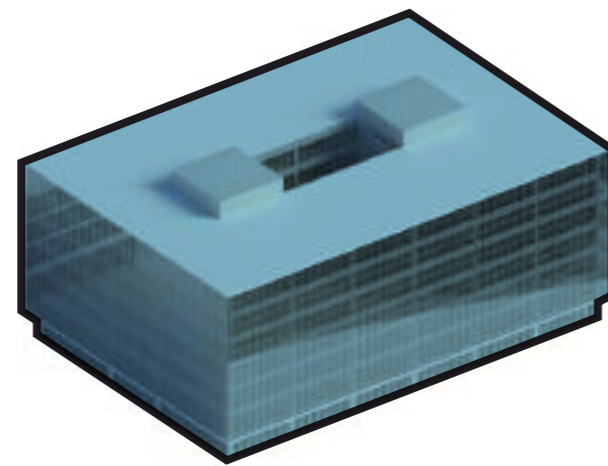

**MINISTRY
OFFICES**

**MINISTRY
DEPARTMENTS**

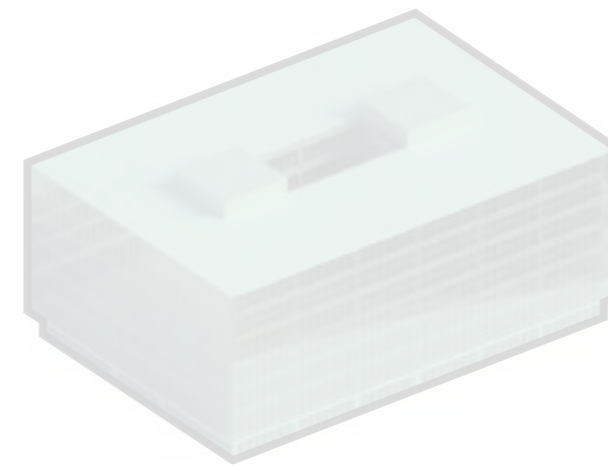

**INTERNATIONAL
CONFERENCE**

**VISITOR
CENTER**

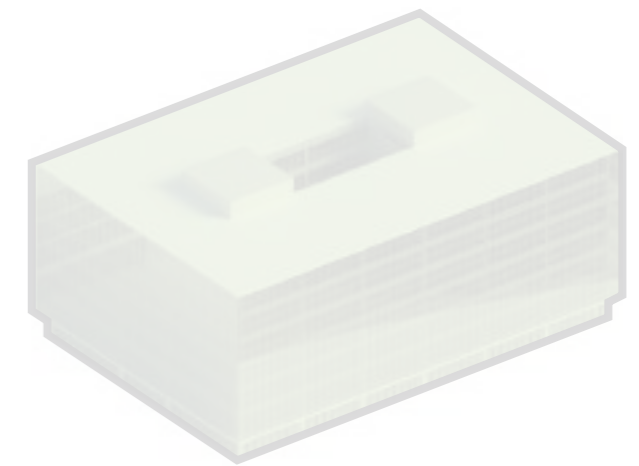

LIBRARY

**IMMIGRATION
CENTER**

**GOVERNMENT
OFFICES**

Concept

Program organization

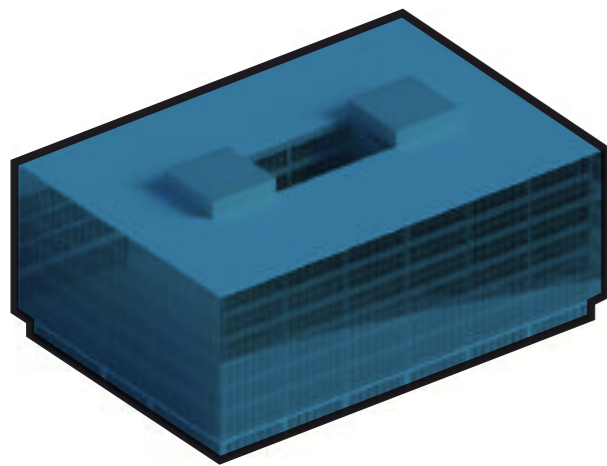

ARCHIVE

**COURIER
AND POST**

KINDERGARTEN

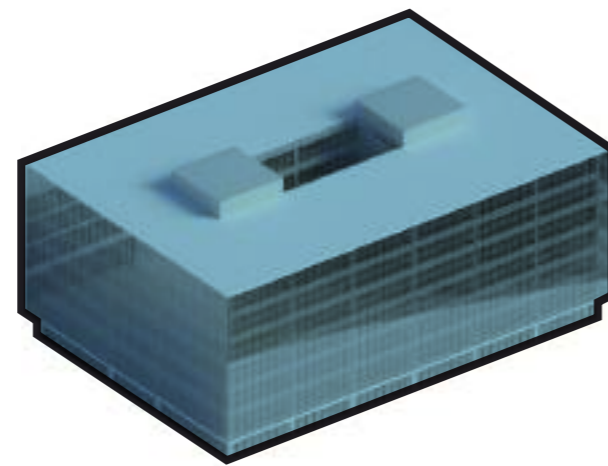

**MINISTRY
OFFICES**

**MINISTRY
DEPARTMENTS**

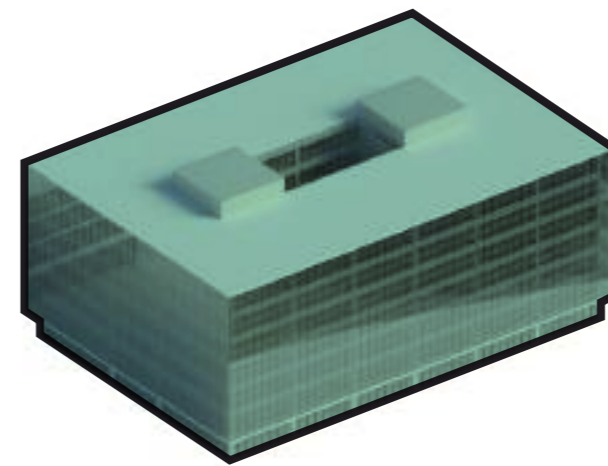

**INTERNATIONAL
CONFERENCE**

**VISDITOR
CENTER**

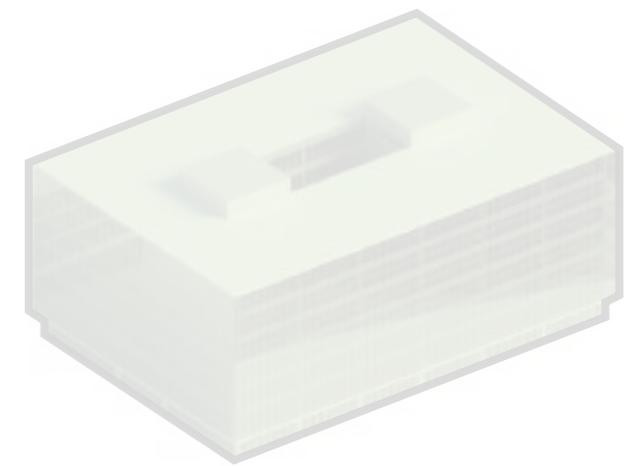

LIBRARY

**IMMIGRATION
CENTER**

**GOVERNMENT
OFFICES**

Program organization

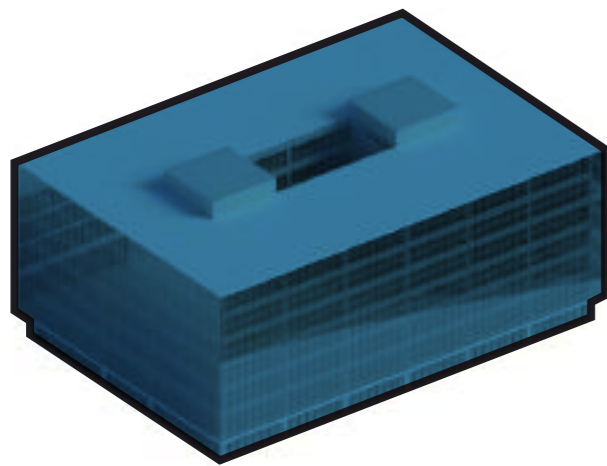

ARCHIVE

**COURIER
AND POST**

KINDERGARTEN

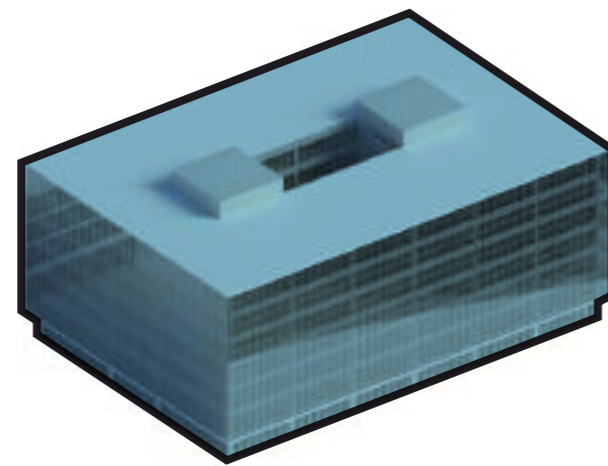

**MINISTRY
OFFICES**

**MINISTRY
DEPARTMENTS**

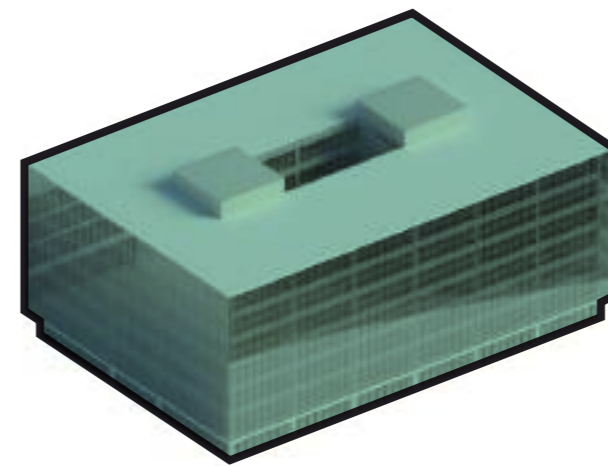

**INTERNATIONAL
CONFERENCE**

**VISITOR
CENTER**

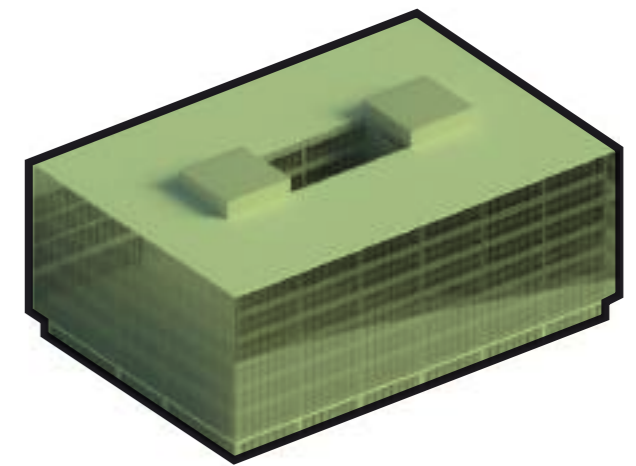

LIBRARY

**IMMIGRATION
CENTER**

**GOVERNMENT
OFFICES**

Concept

Architectural ensemble



Concept

Architectural ensemble

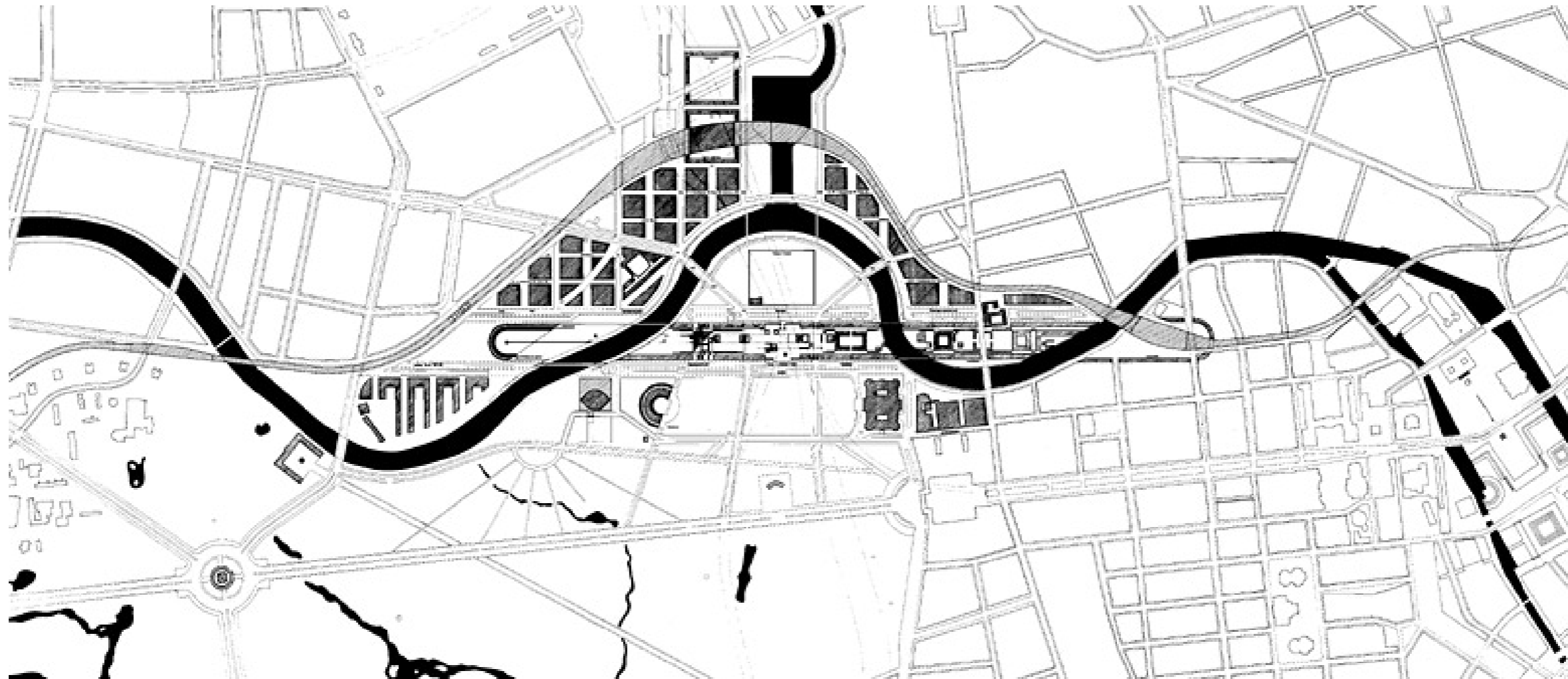

**1993 - the "Band des Bundes"
designed by A. Schultes and Ch.Frank**

Architectural ensemble

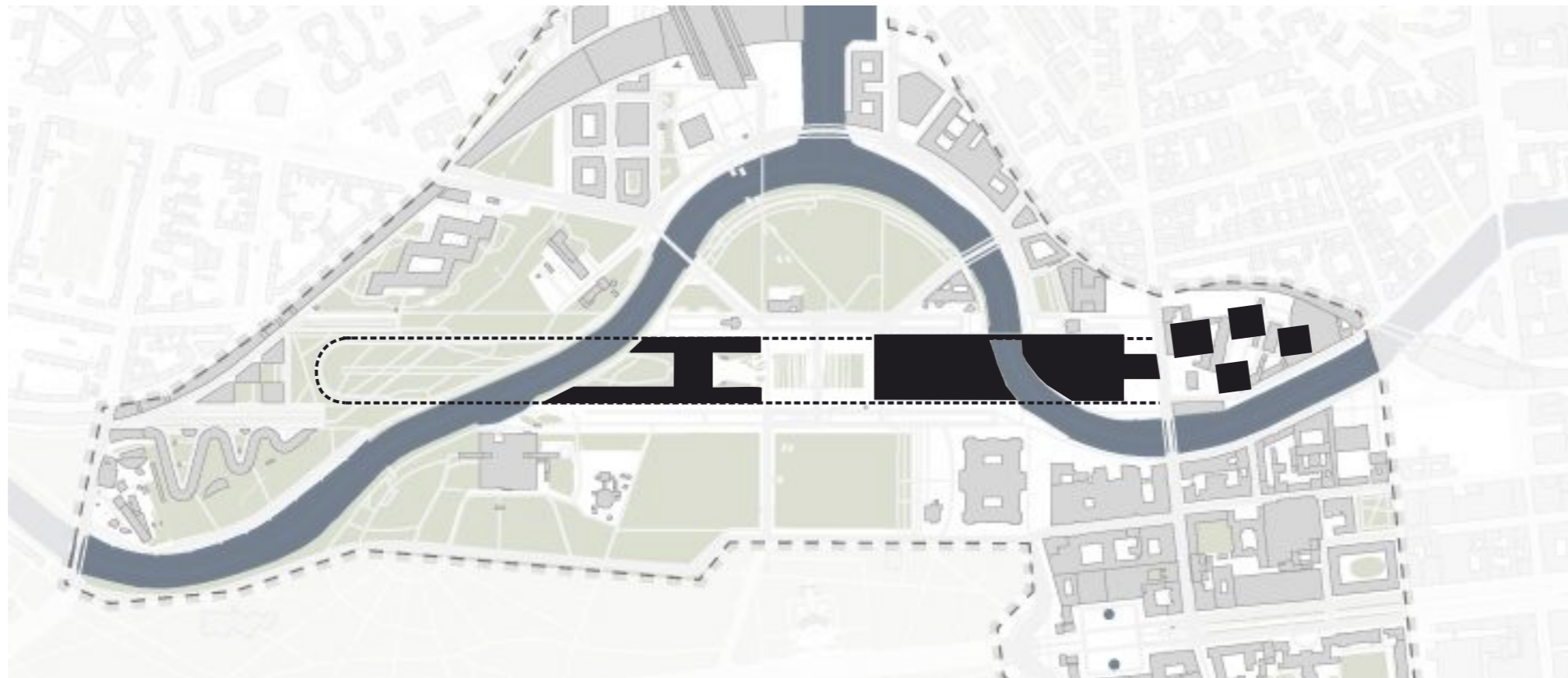
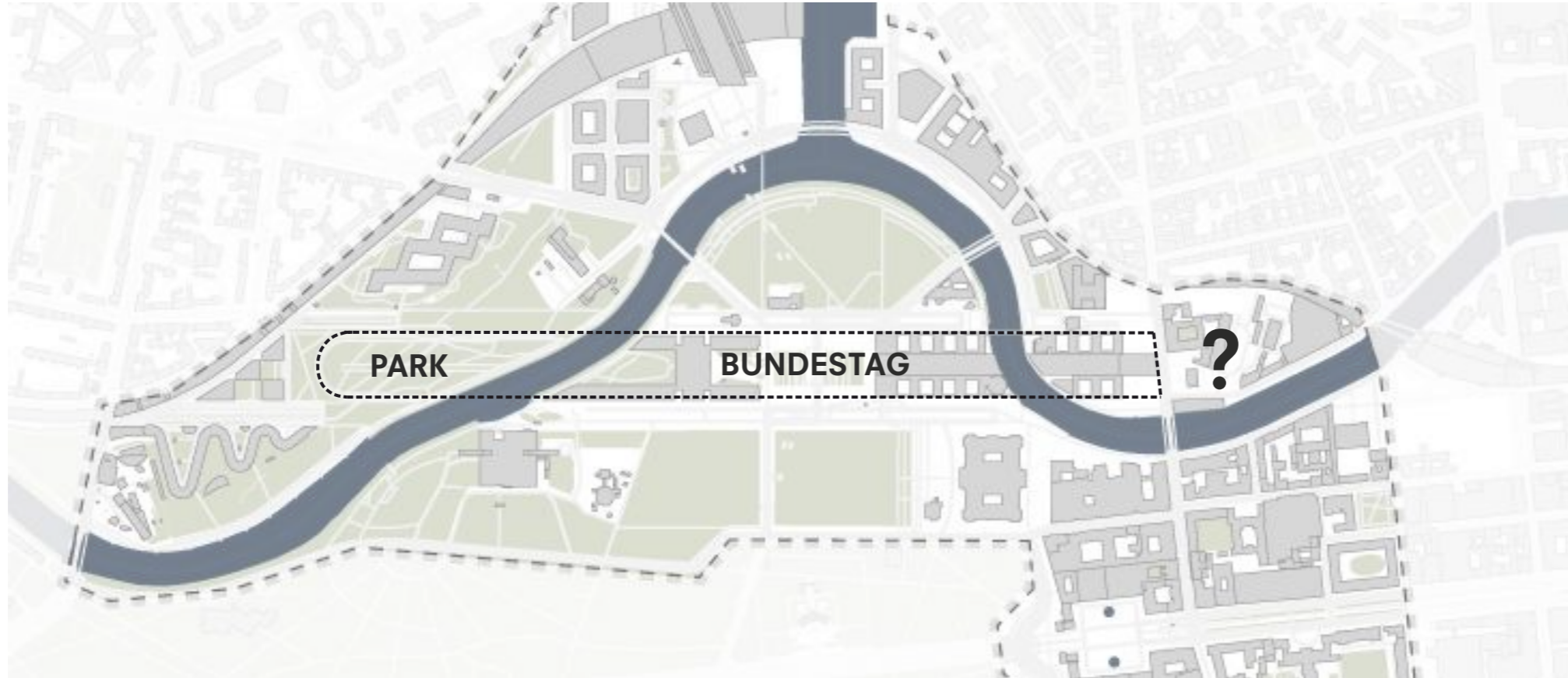

Concept
Site

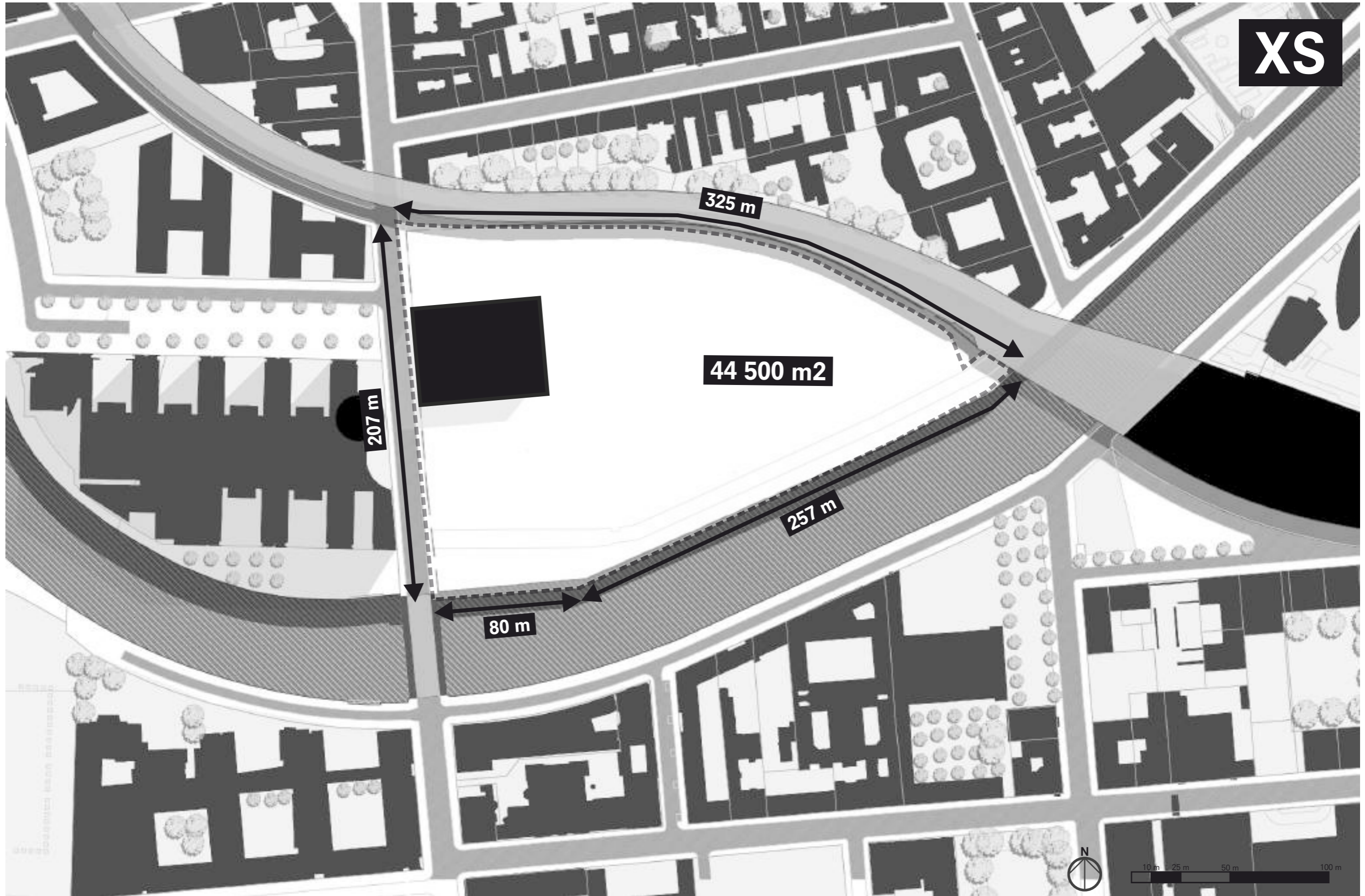

Concept
Volume organization

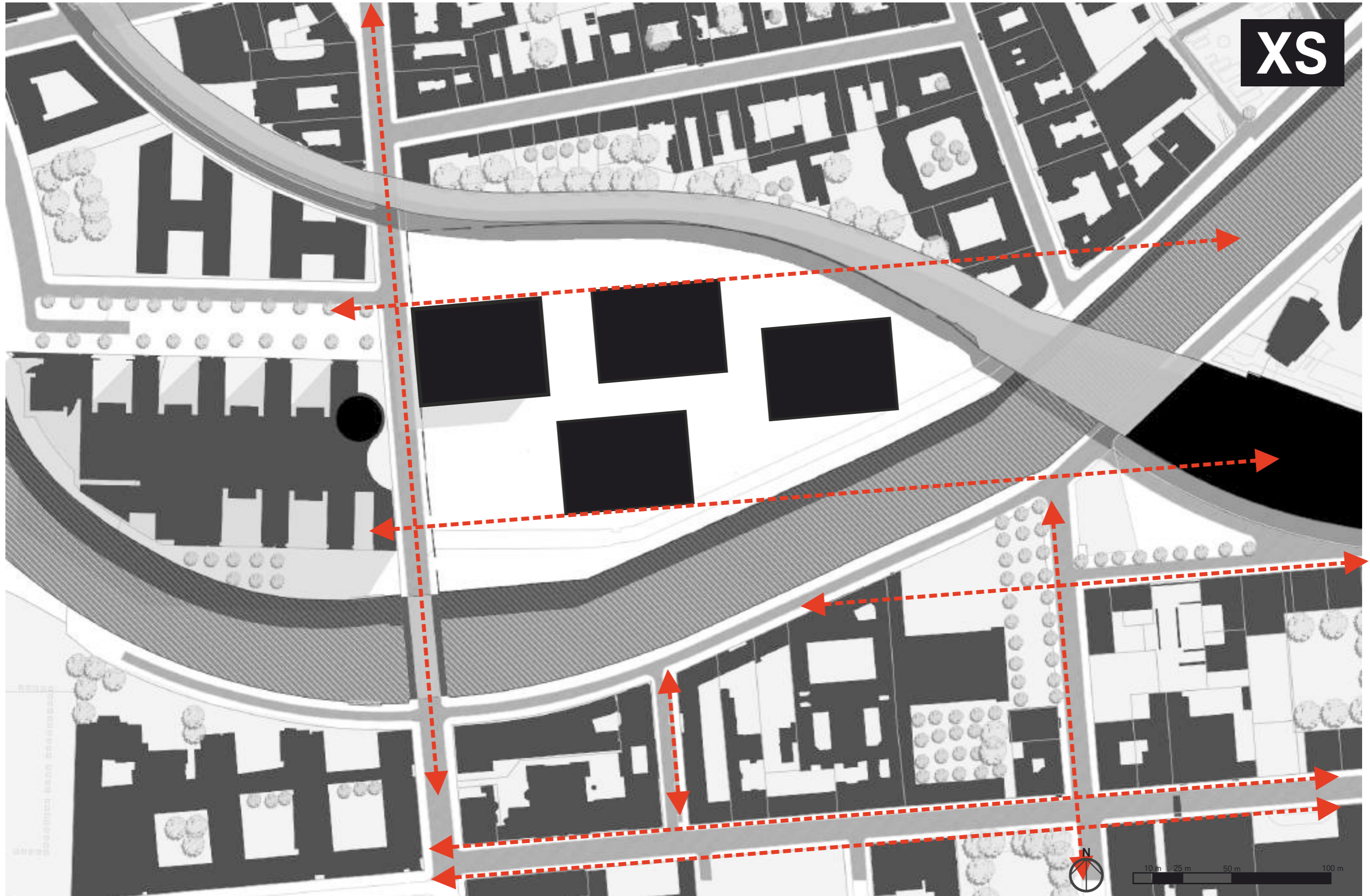

Concept
Volume organization

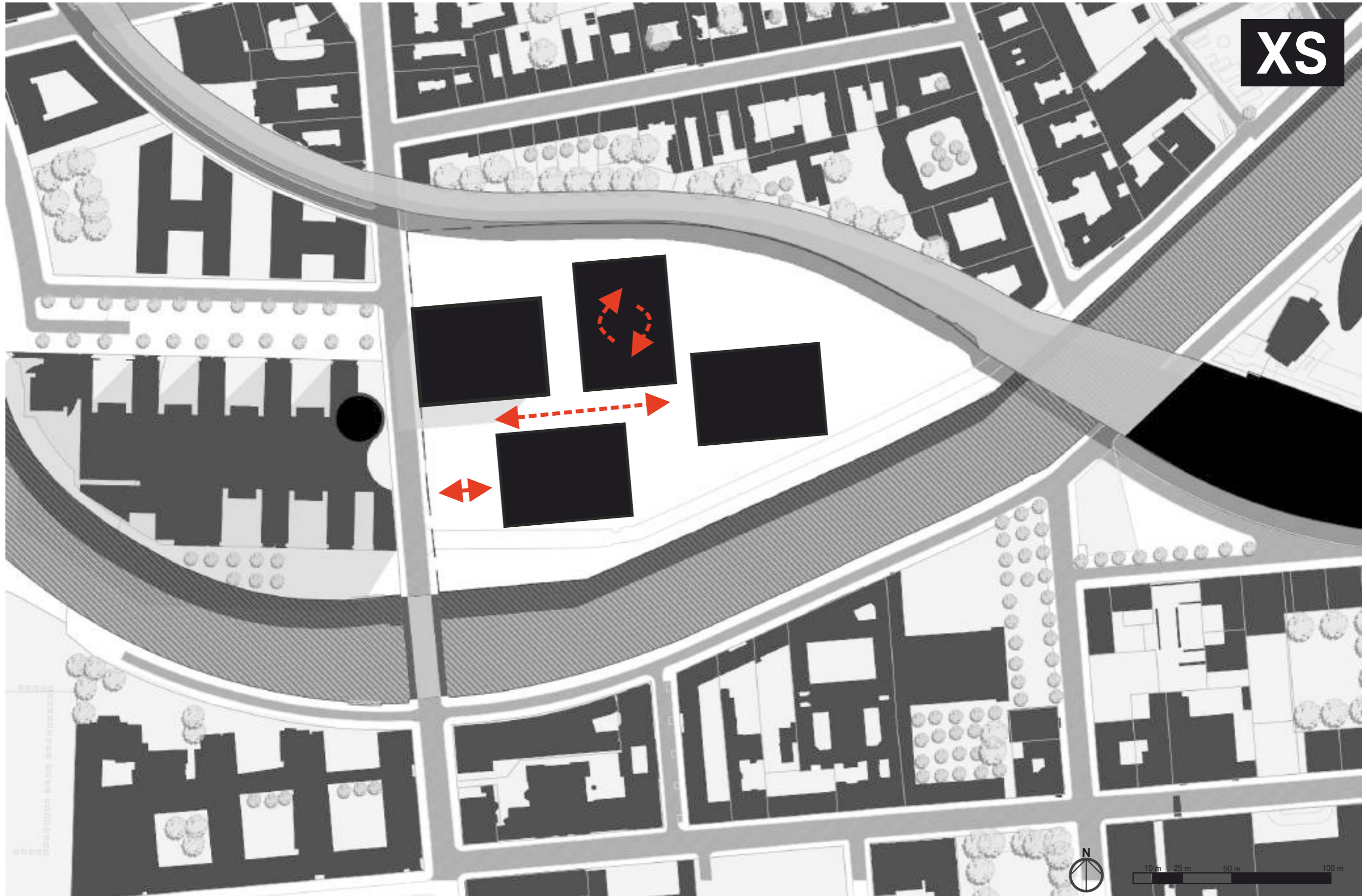

Concept
Volume organization



Concept
Volume organization



Concept

Volume organization



Concept

Volume organization



INTERNATIONAL CONFERENCE

Concept
Volume organization

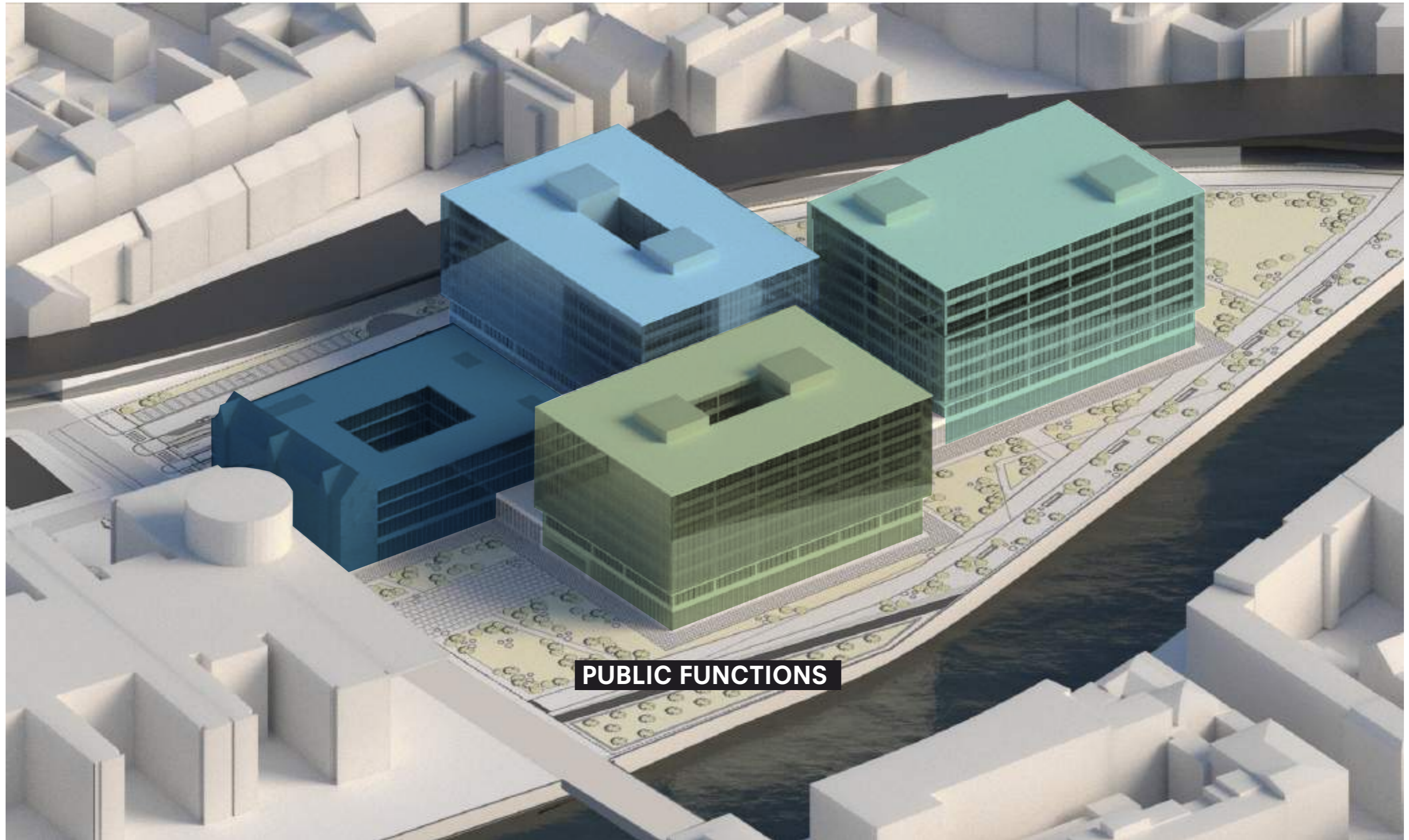

Concept
Podium

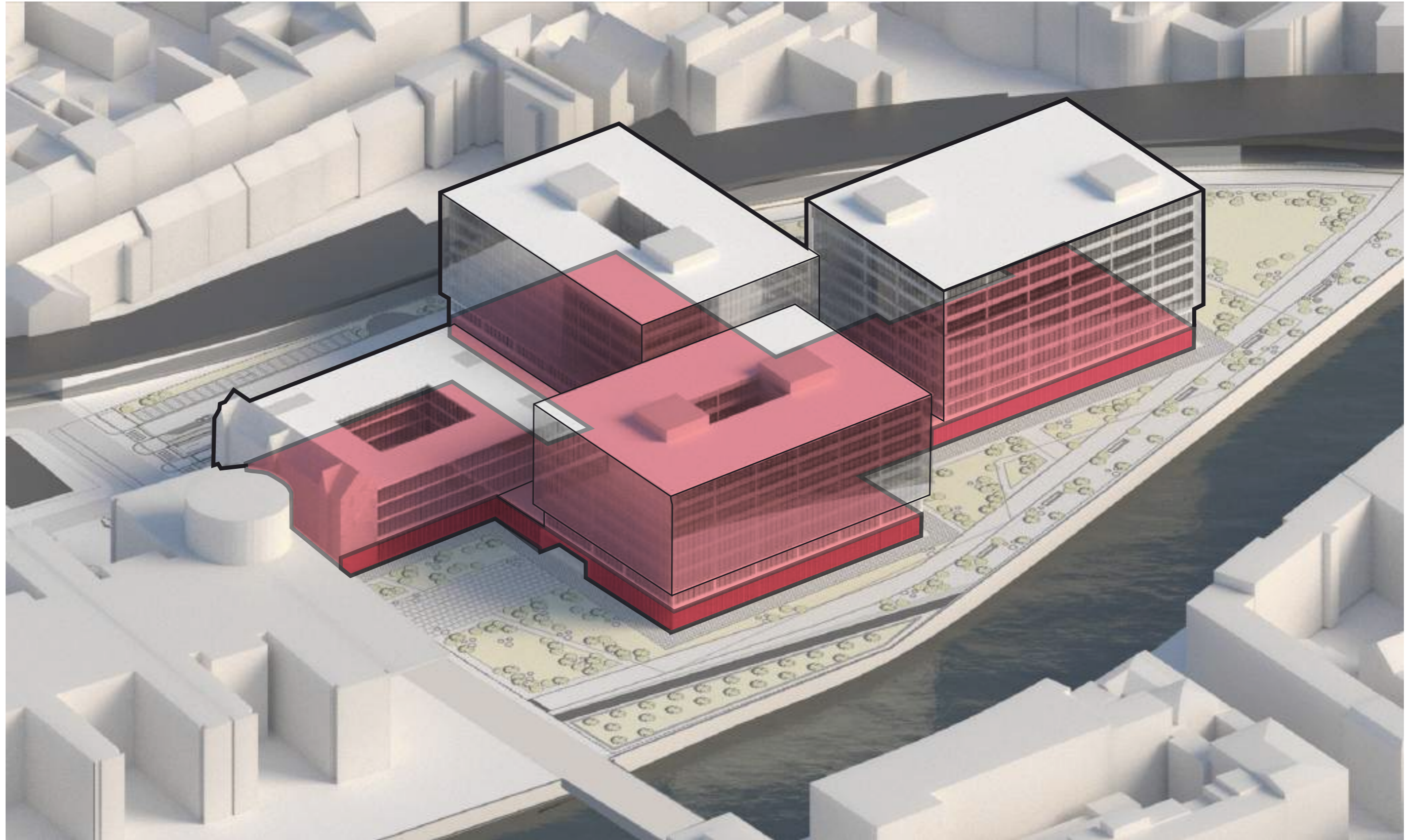

Concept
Podium

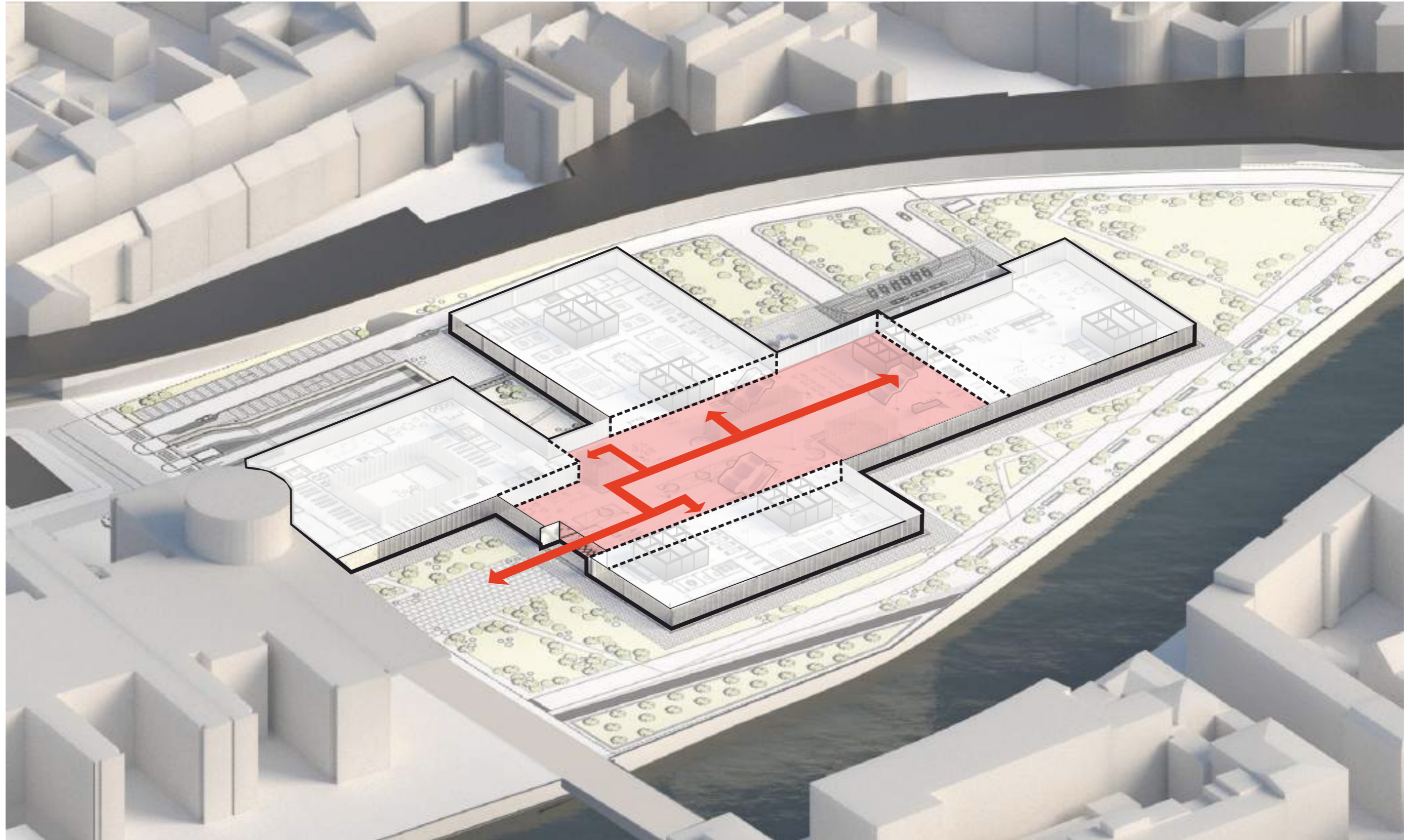

Concept
Patio

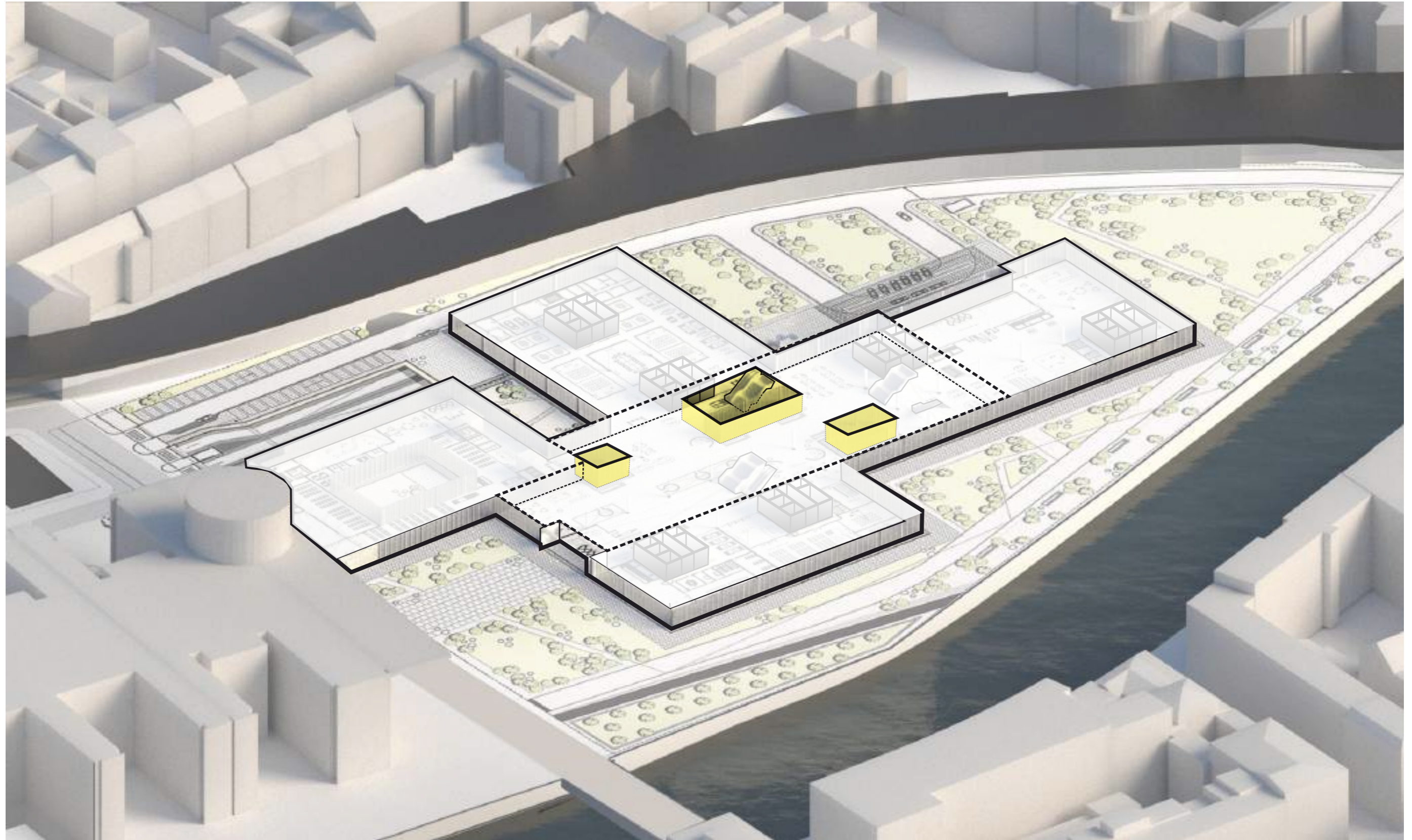

Concept
Transparent facade

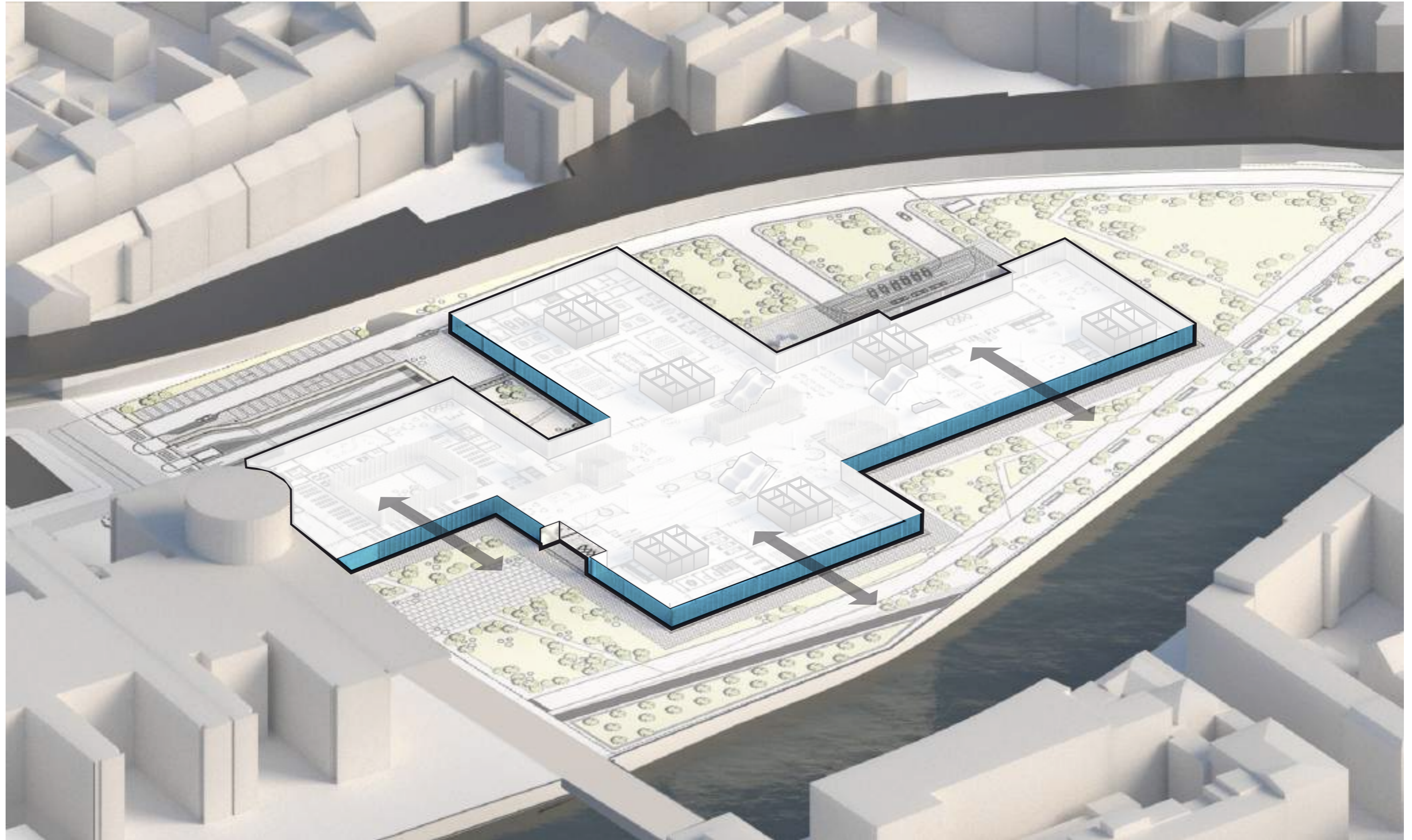

Concept
Security

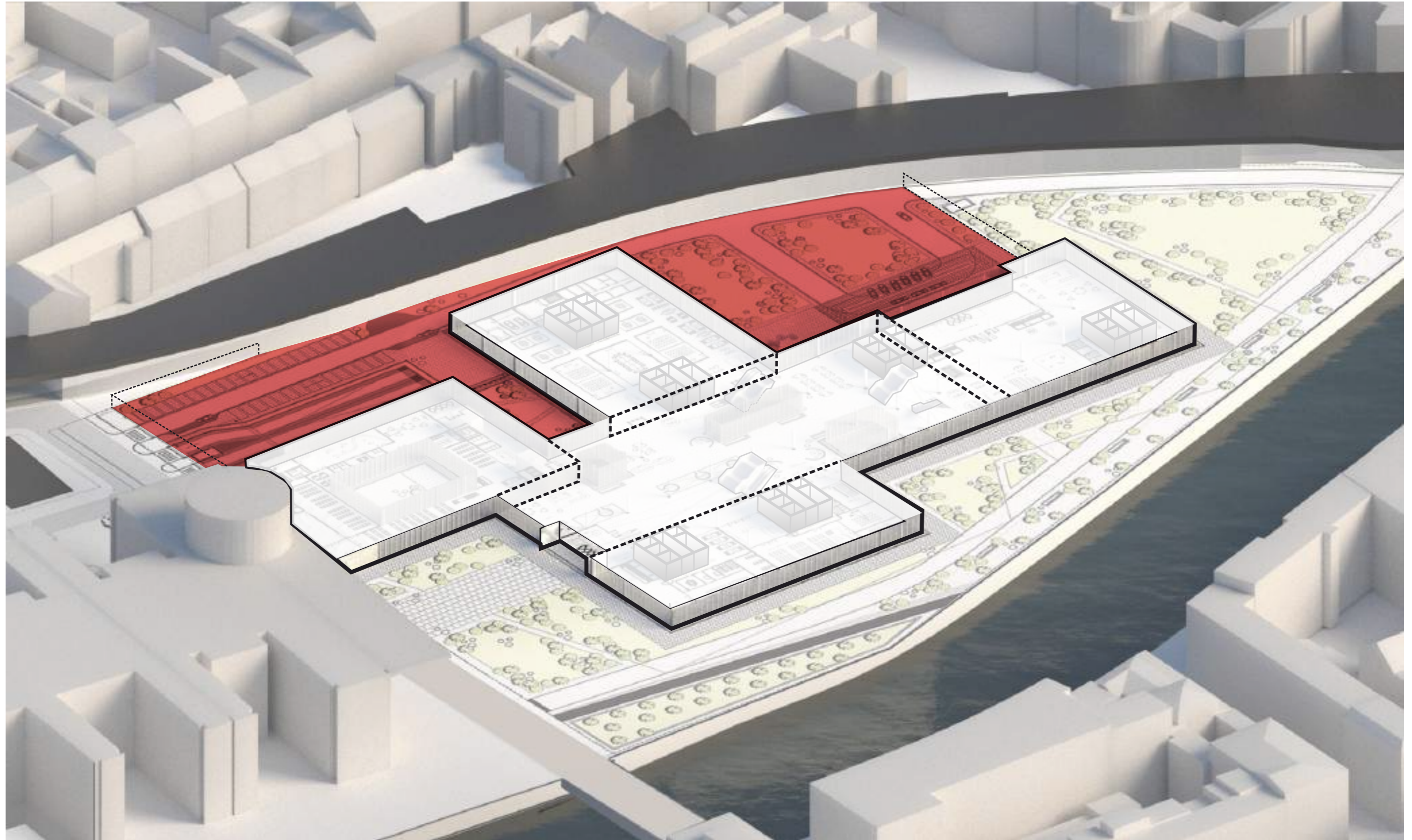

Concept
Security

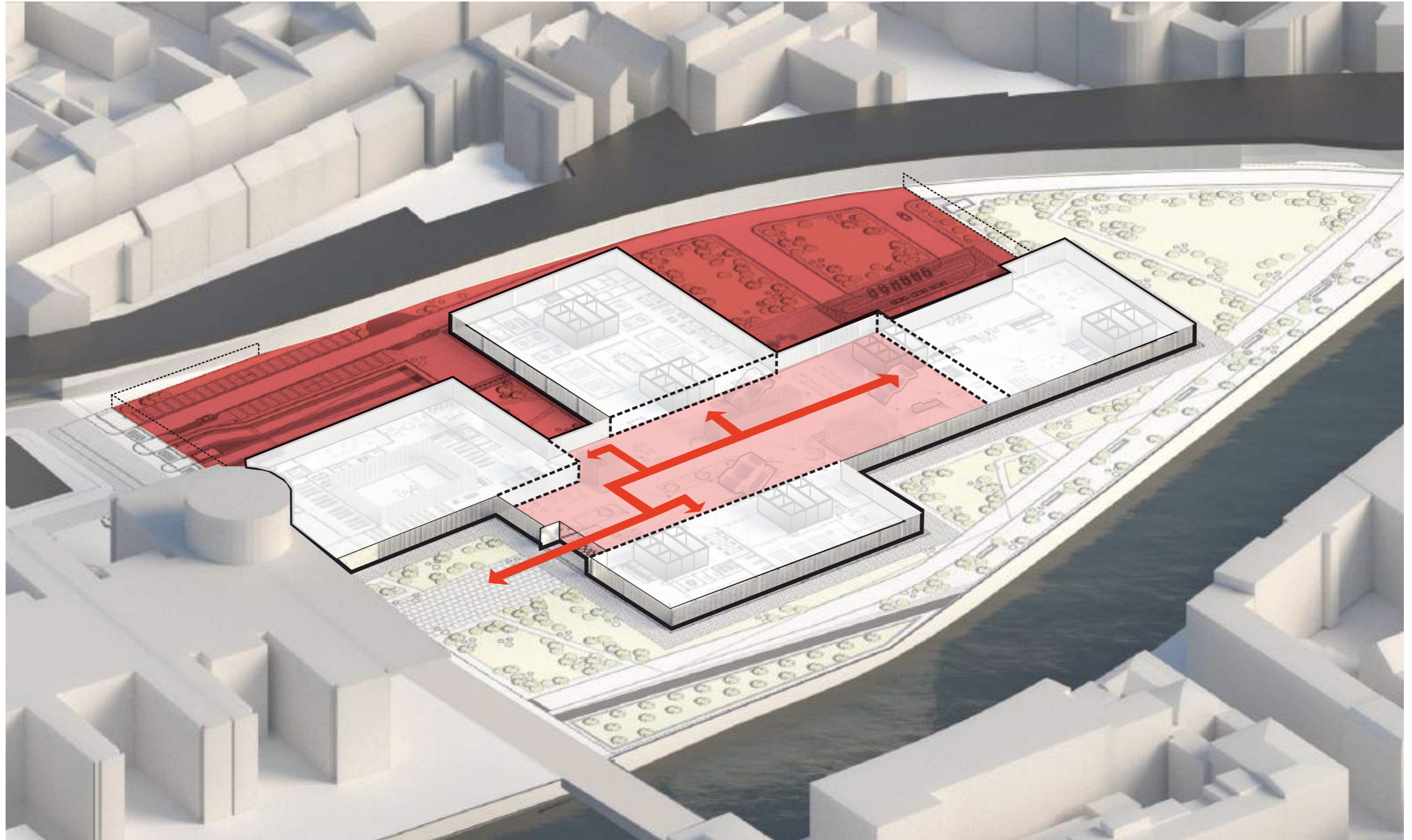

Concept
Security zones

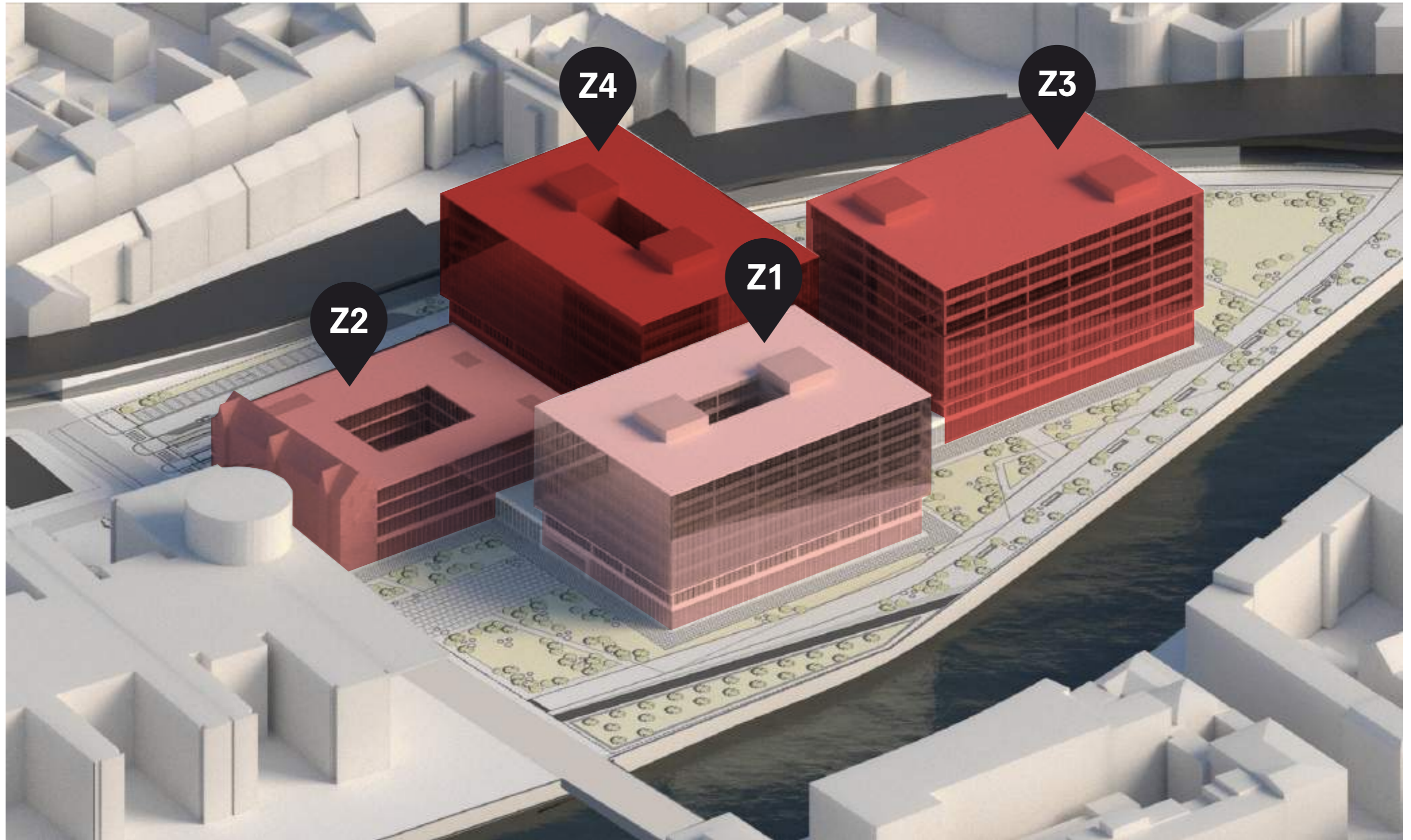

Concept
Outdoor public space

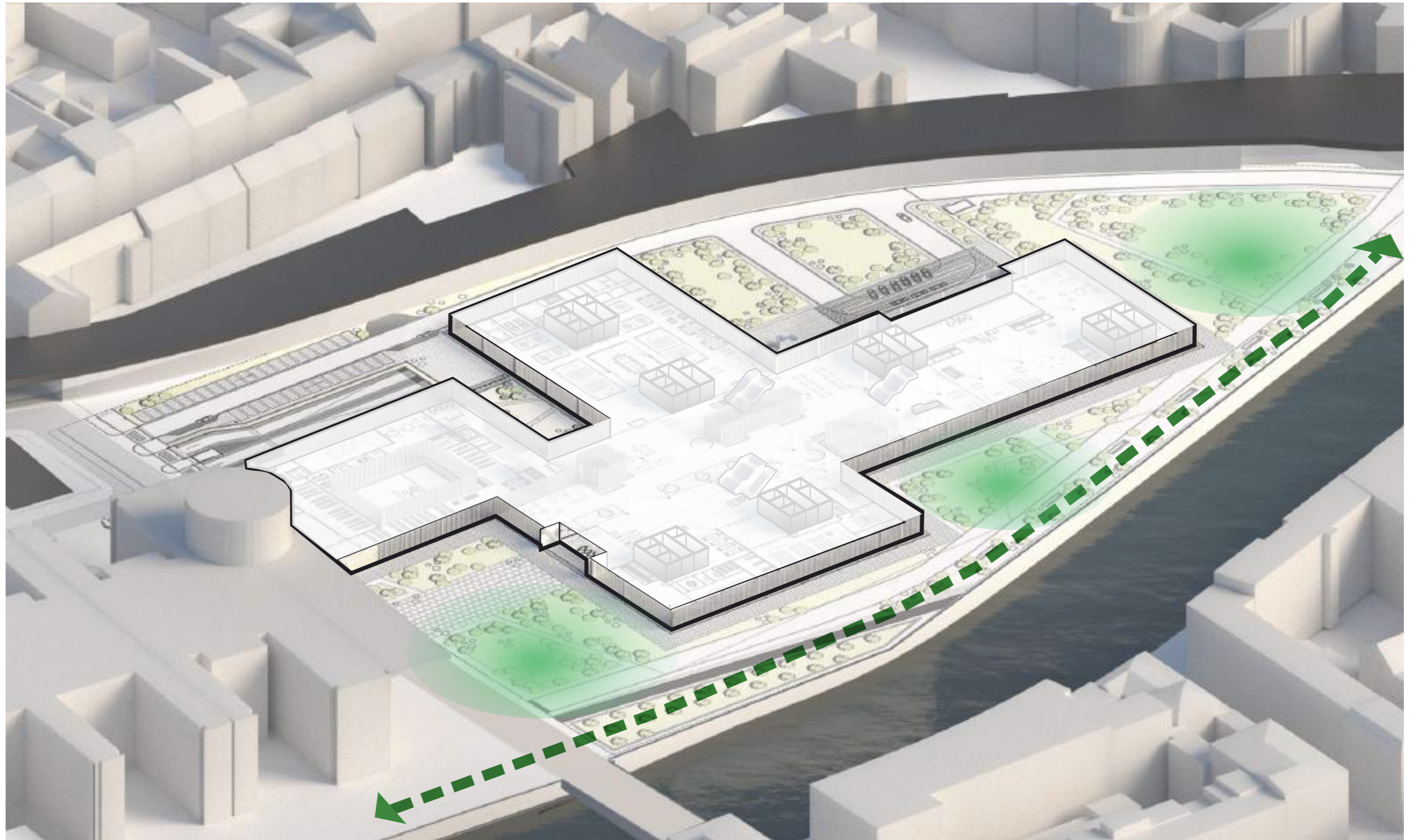

Concept

Outdoor private space

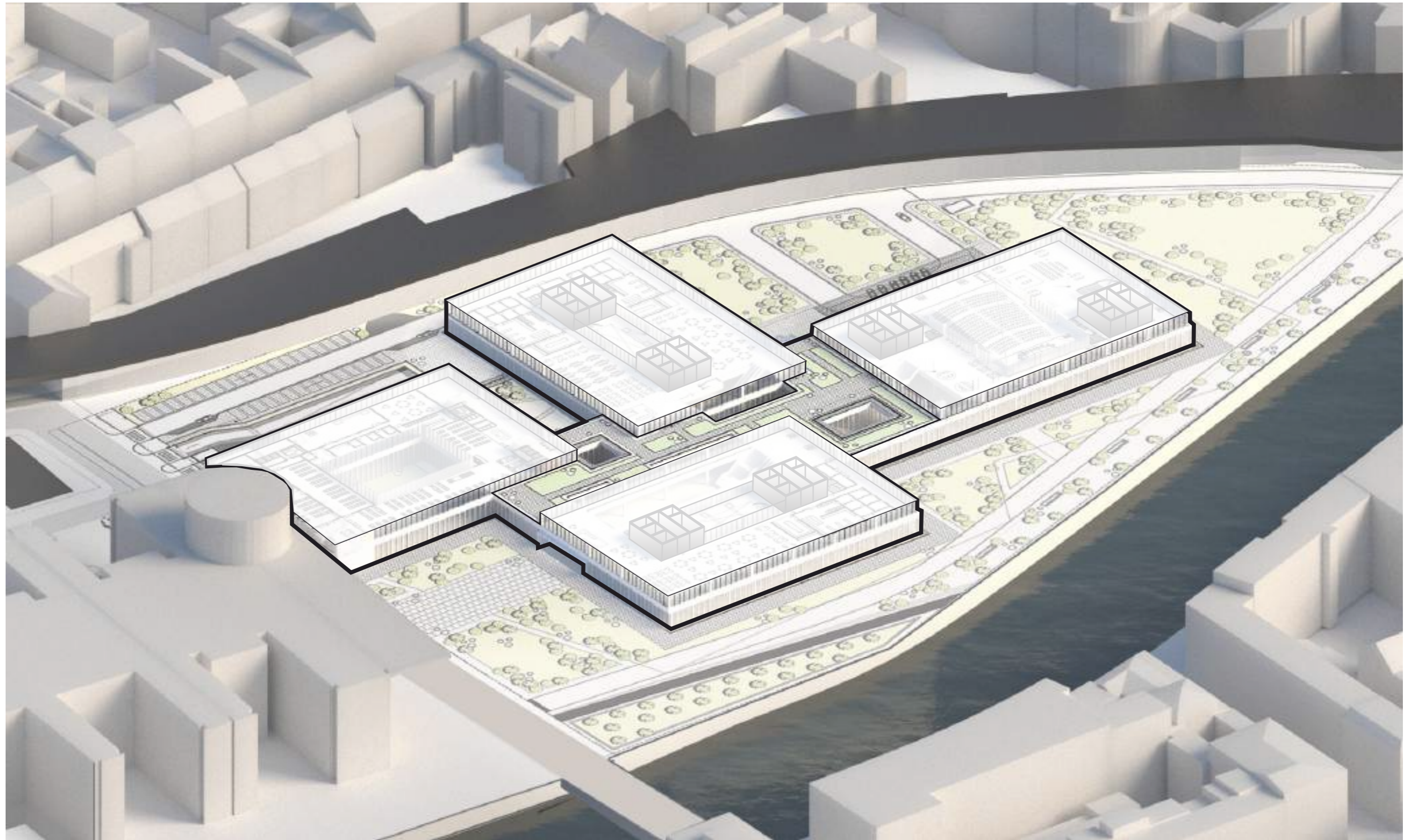

Concept

Outdoor private space

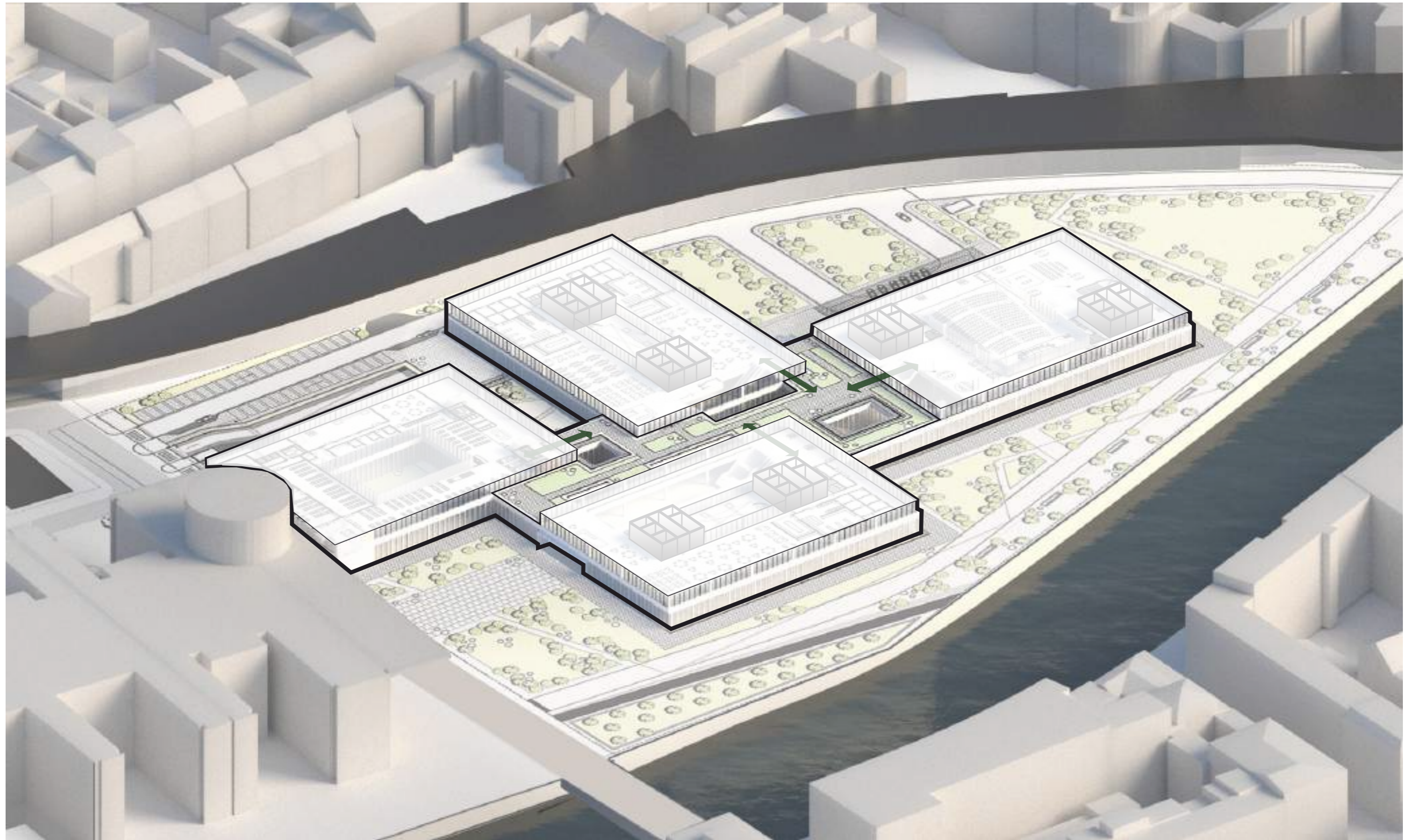

Concept

View from the riverbank



1. INTRODUCTION

2. NEW POLITICS

3. DESIGN

CONCEPT

IMPLEMENTATION

DEVELOPMENT

5. CONCLUSION

Implementation
Plan 1 : 2000

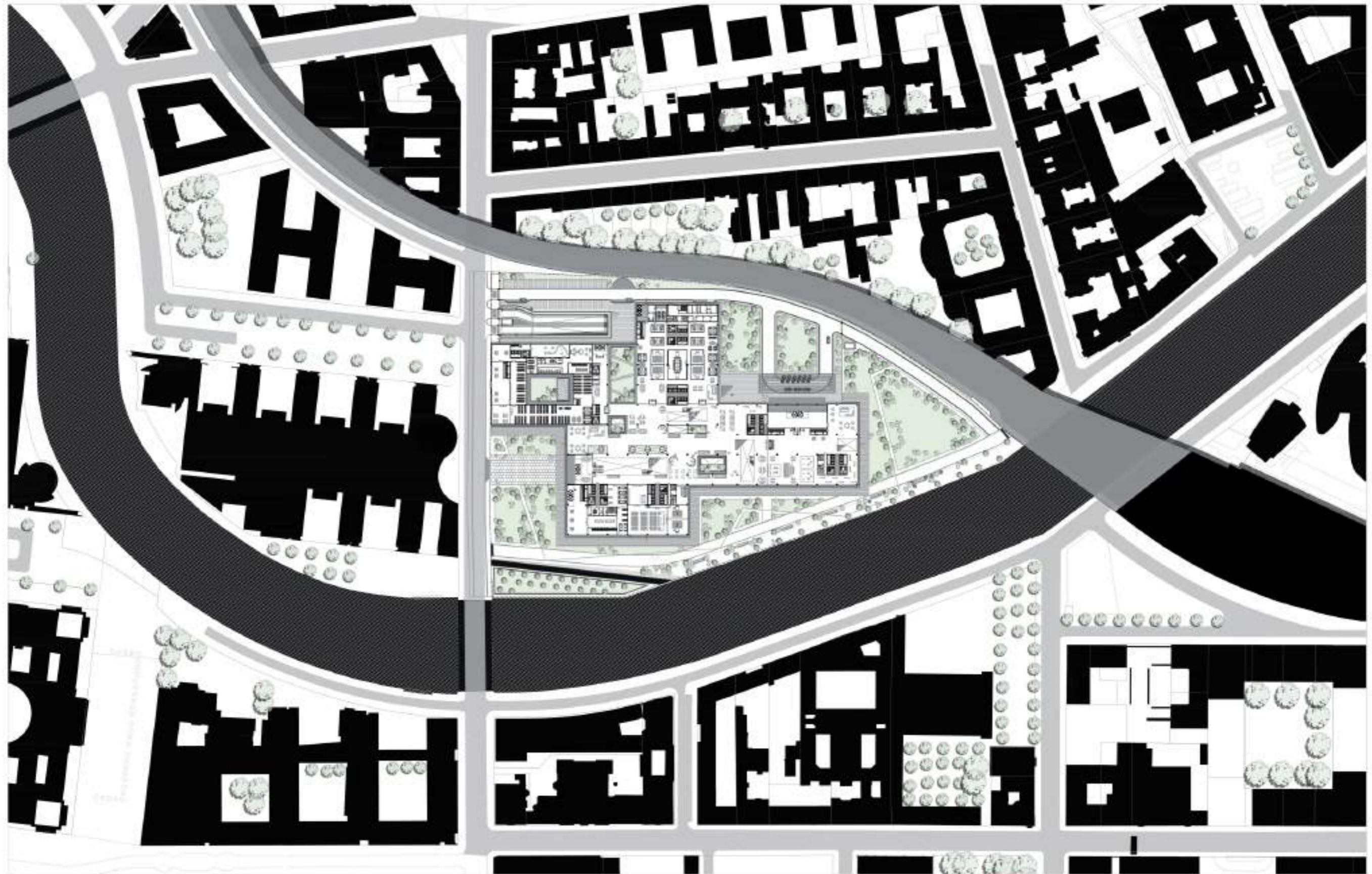

Implementation
Entrance

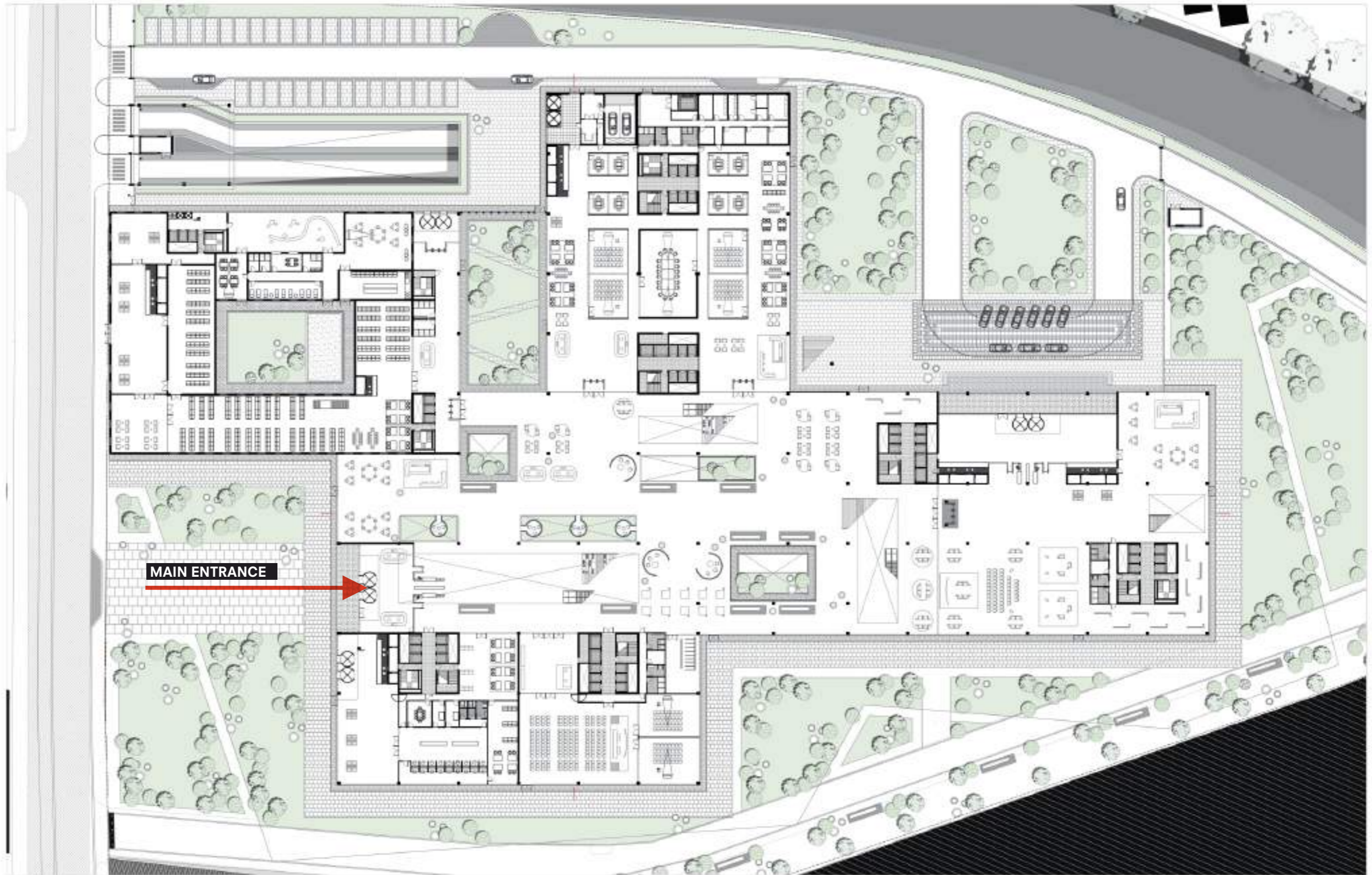

Implementation
Entrance



Implementation Accessibility

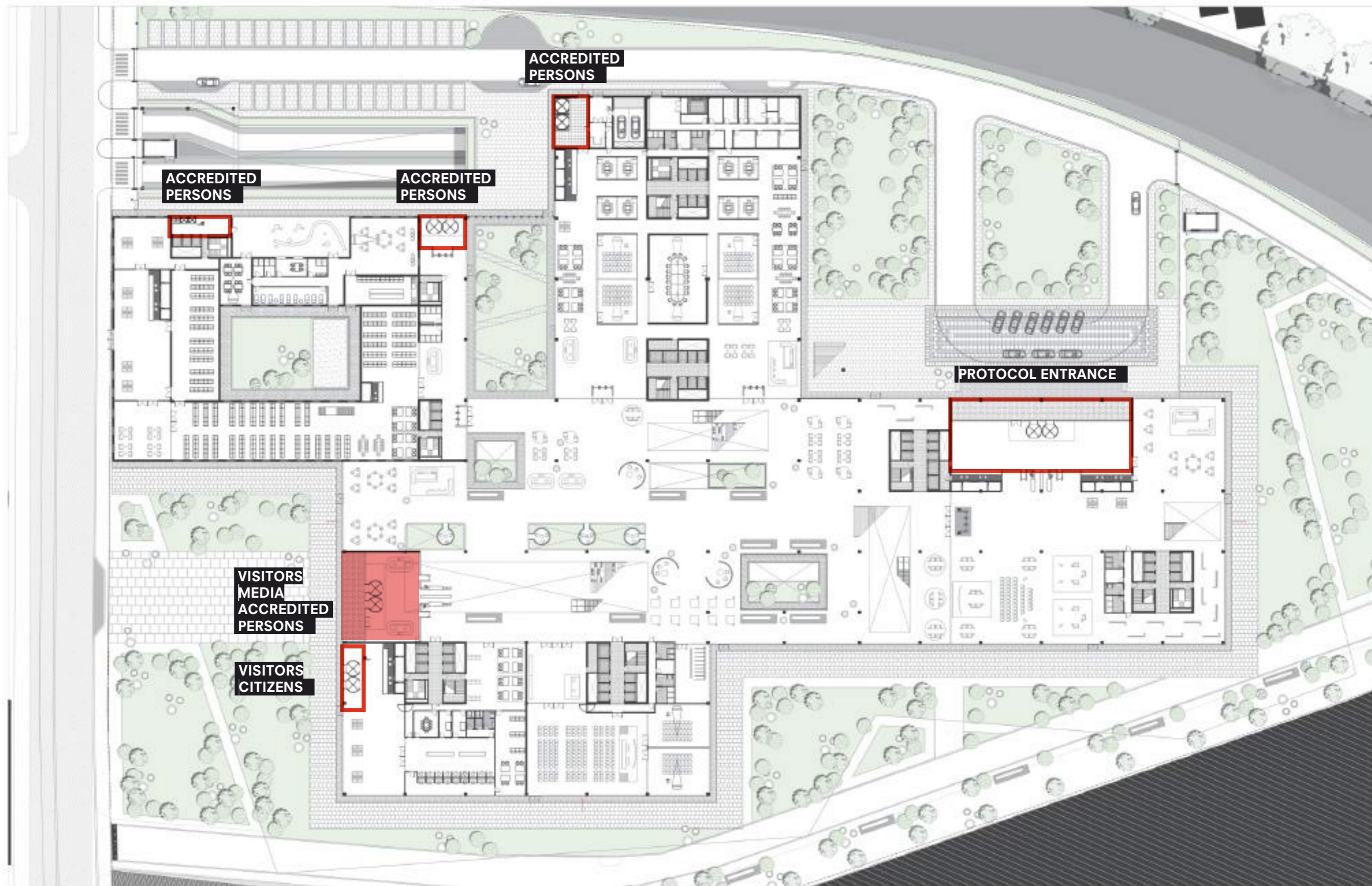

Implementation

Floor plans relation

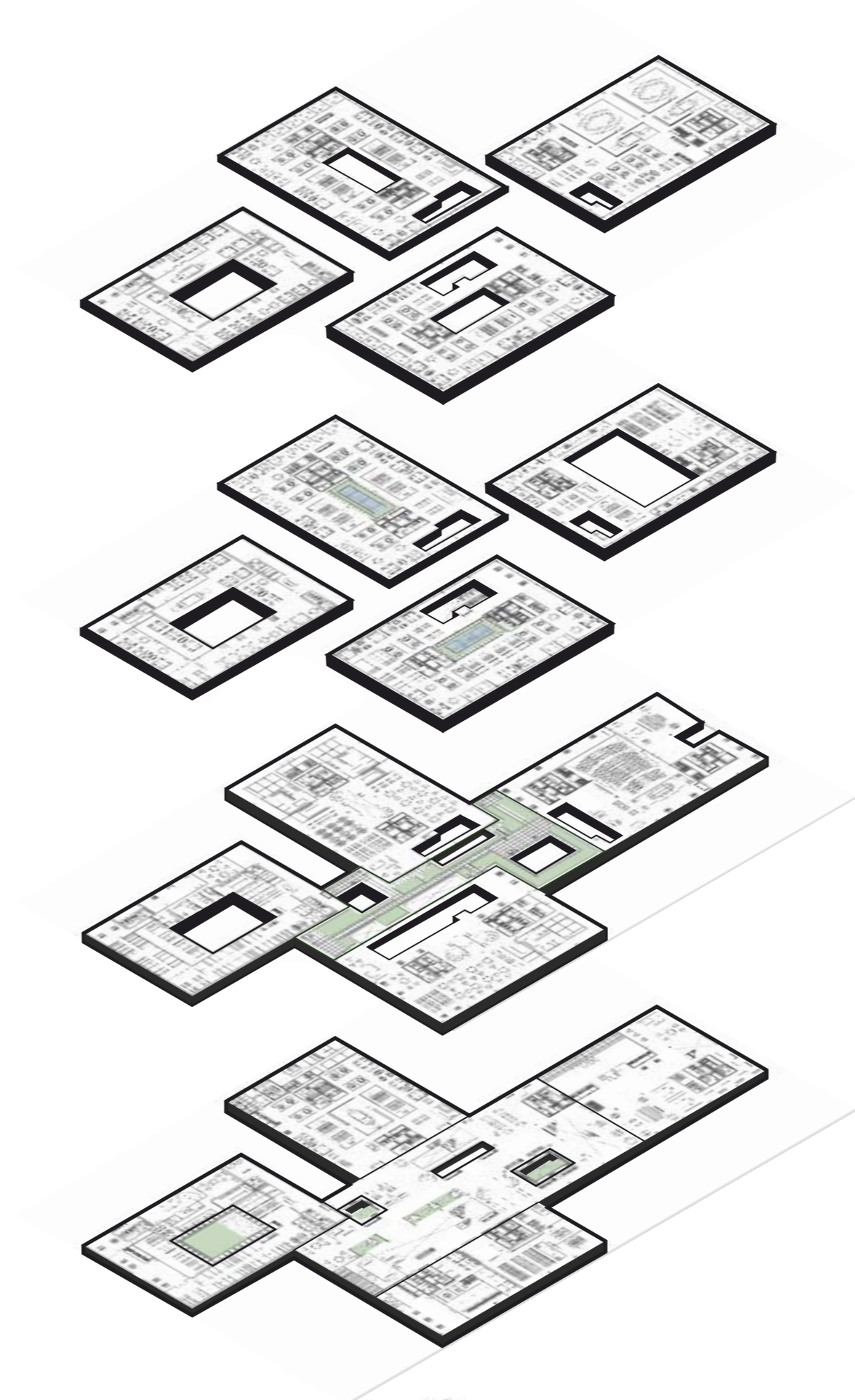



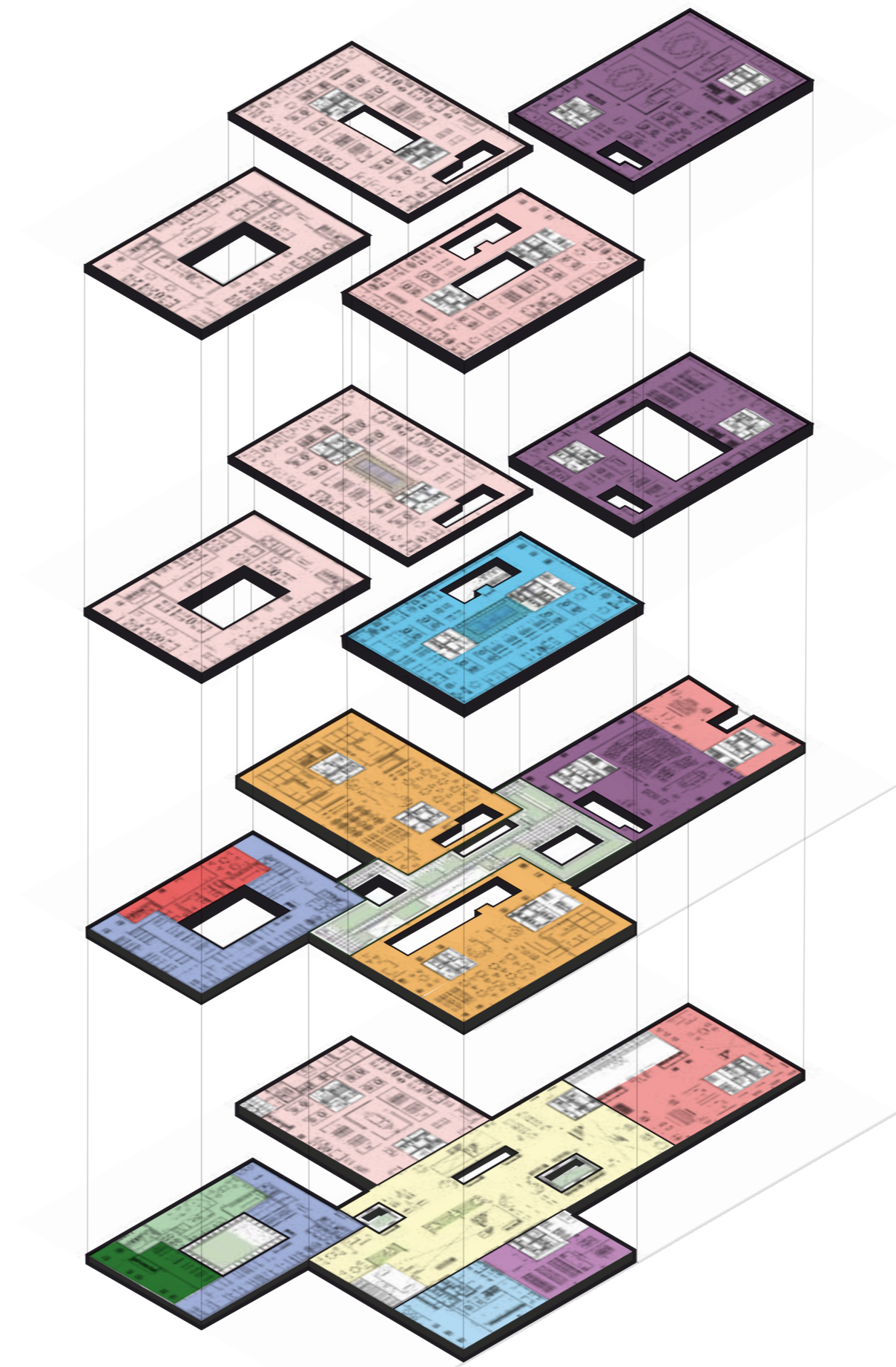

Implementation Program

- POST
- CATERING
- INTERNATIONAL CONFERENCE
- APARTMENTS
- PROTOCOL
- MINISTRY
- KINDERGARTEN
- ARCHIVE
- CENTRAL HALL
- IMMIGRATION
- MEDIA ZONE / CONFERENCE



Security and accessibility zones

-  - ZONE 4
-  - ZONE 3
-  - ZONE 2
-  - ZONE 1

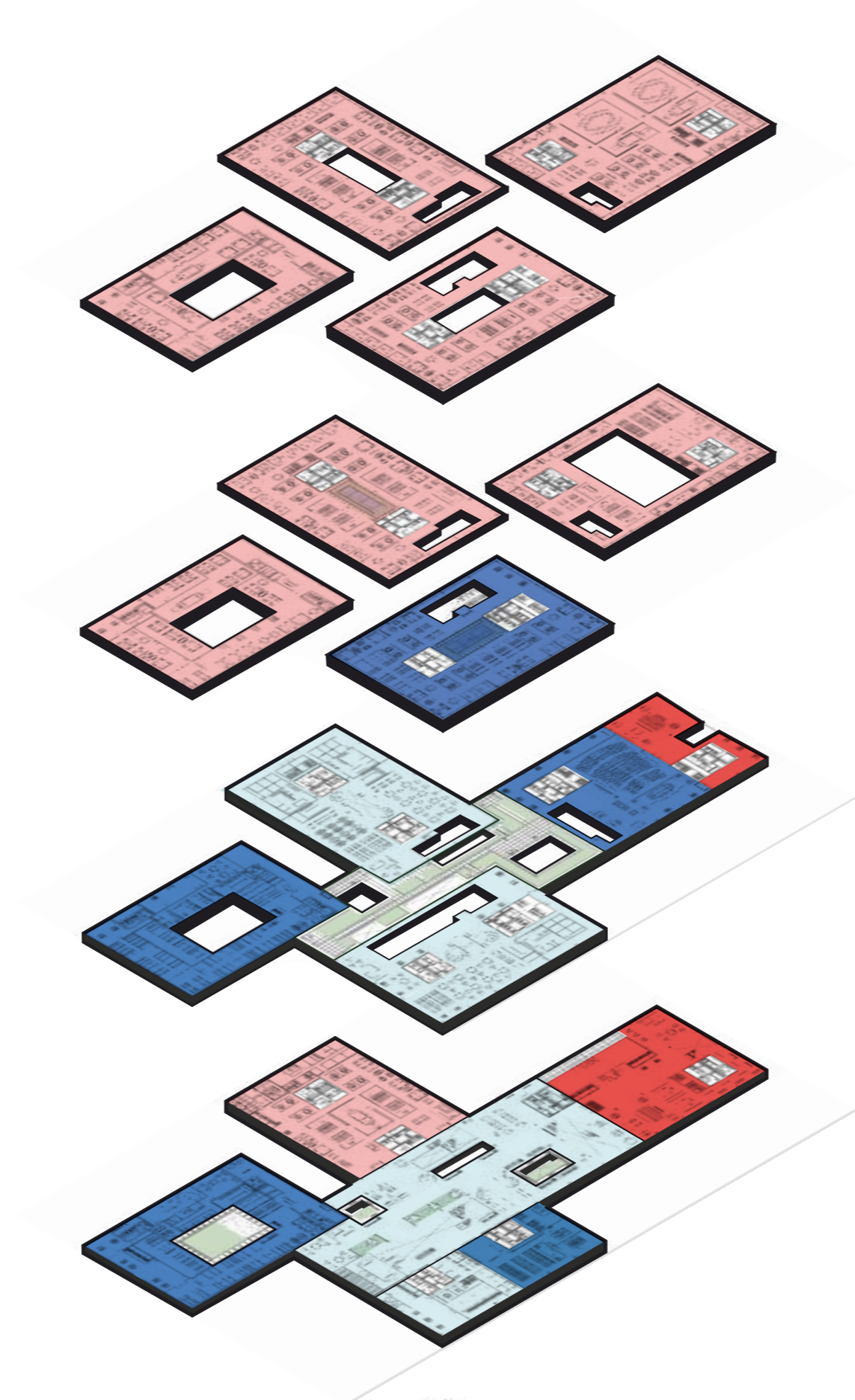

Security and accessibility zones



ZONE 1

ZONE 2

ZONE 3

ZONE 4

Implementation
Circulation division

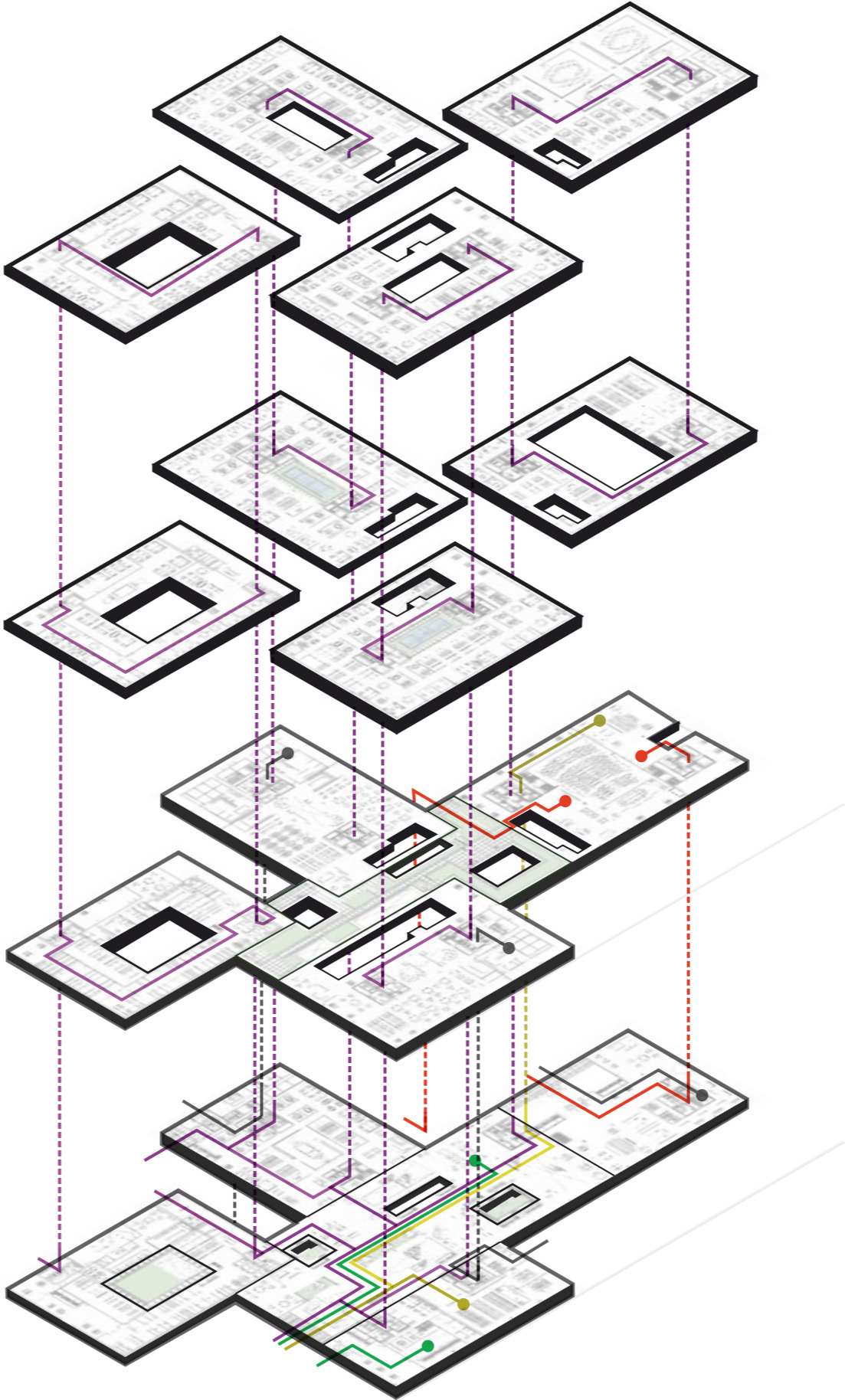

- LOGISTICS
- VISITORS / CITIZENS
- MEDIA
- PROTOCOL
- ACCREDITED PERSONS

Implementation Protocol



- LOGISTICS
- VISITORS / CITIZENS
- MEDIA
- PROTOCOL**
- ACCREDITED PERSONS

Implementation
Protocol vehicle

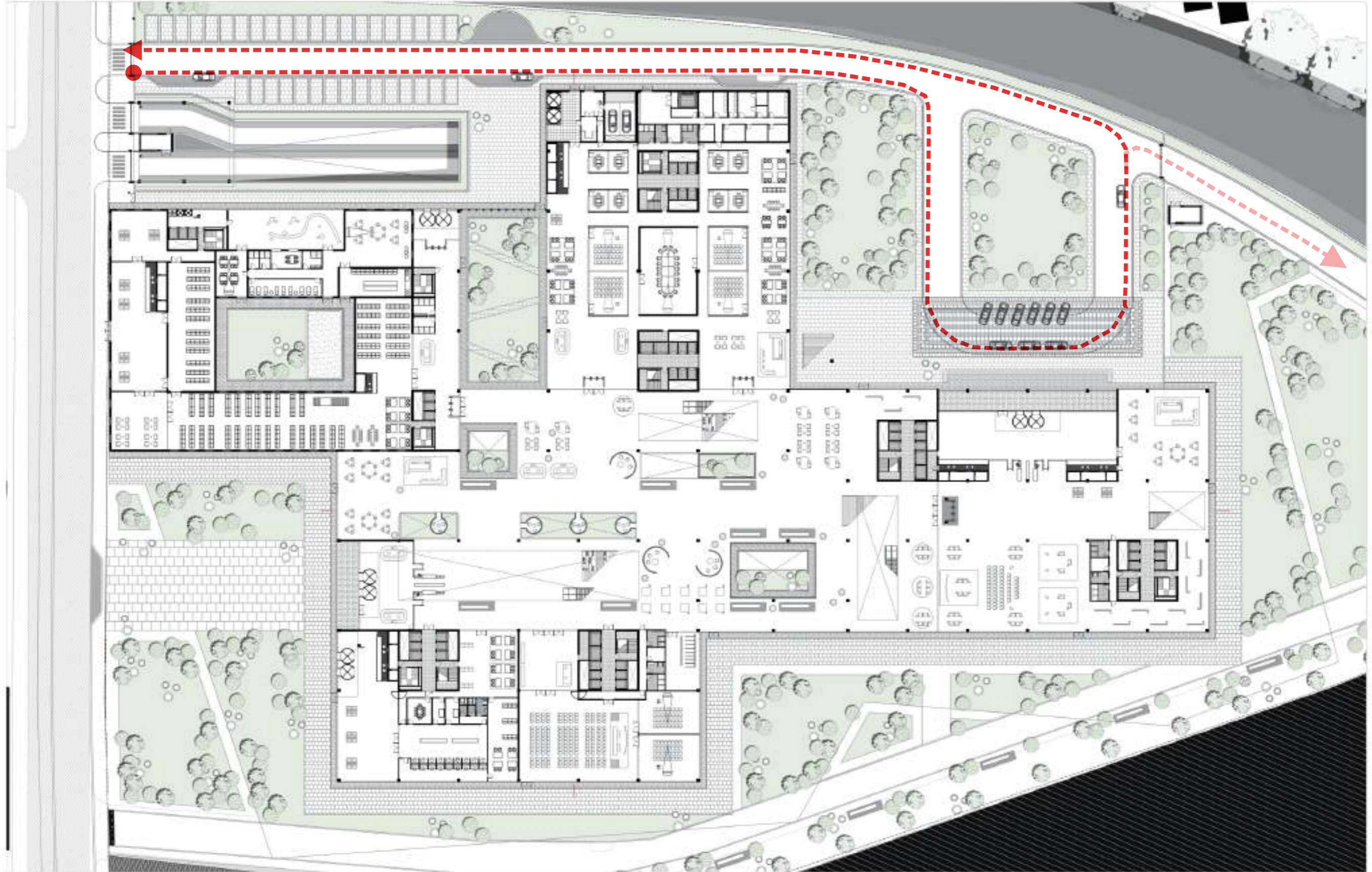

Implementation
Protocol vehicle

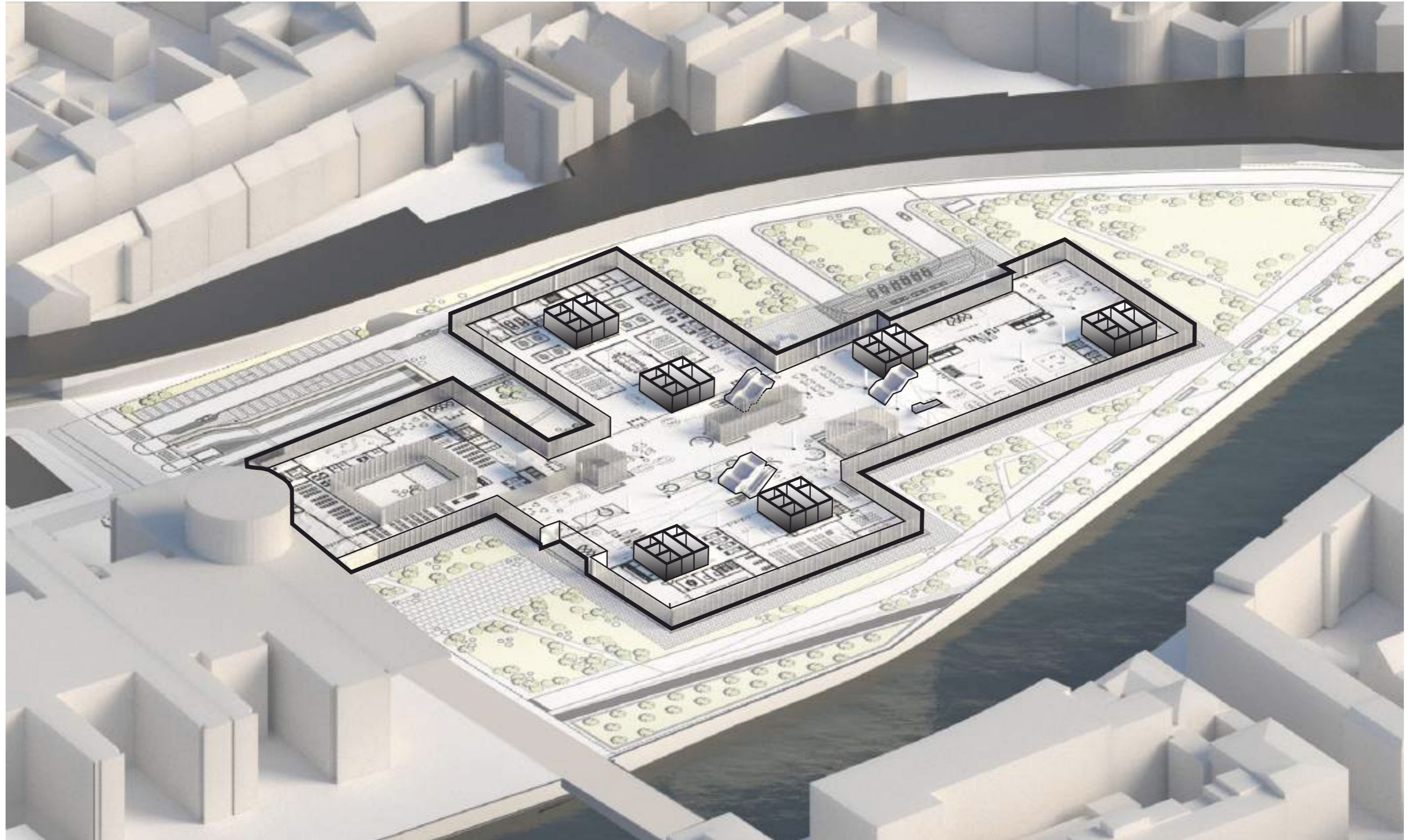

Implementation
Protocol vehicle

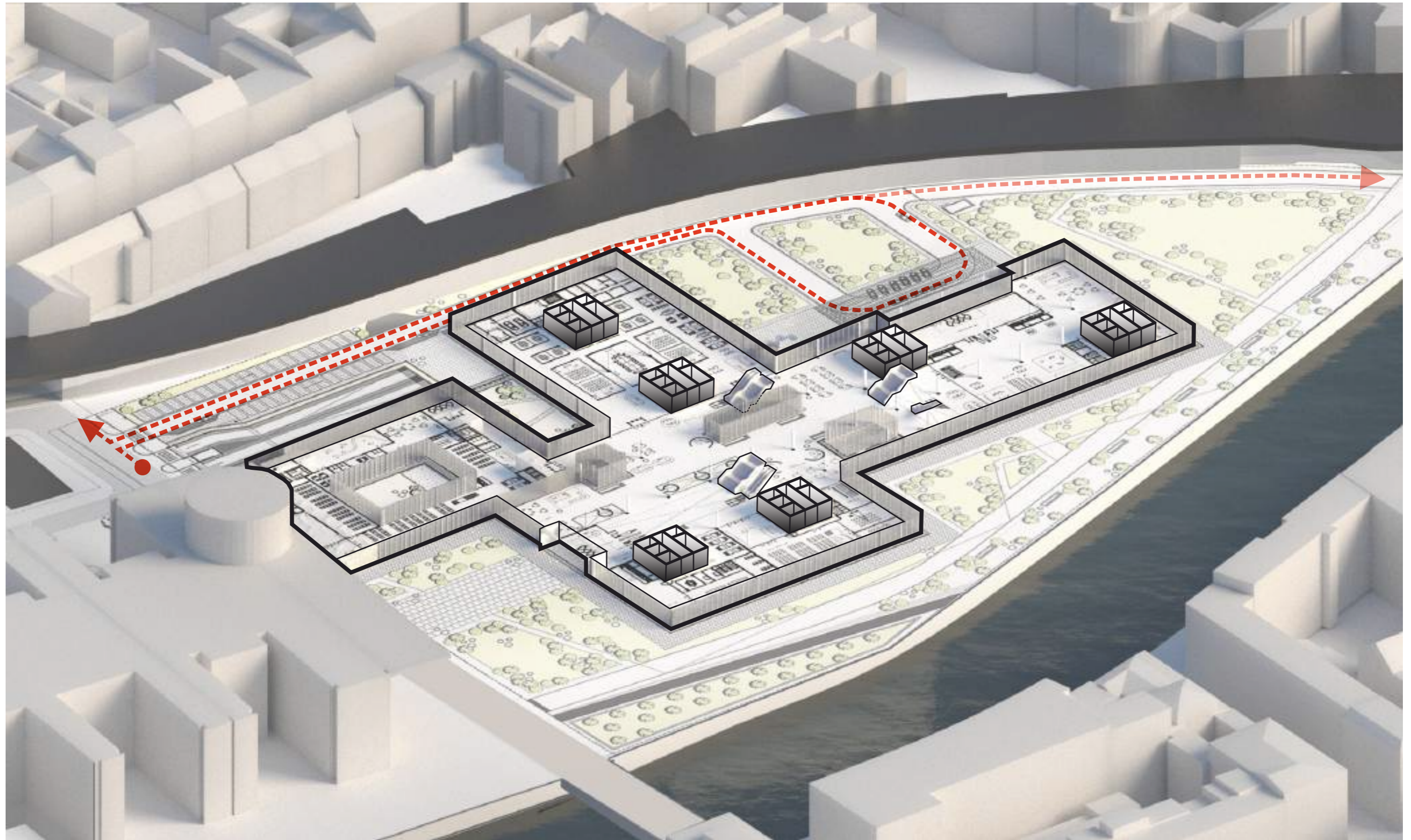

Implementation
Protocol route

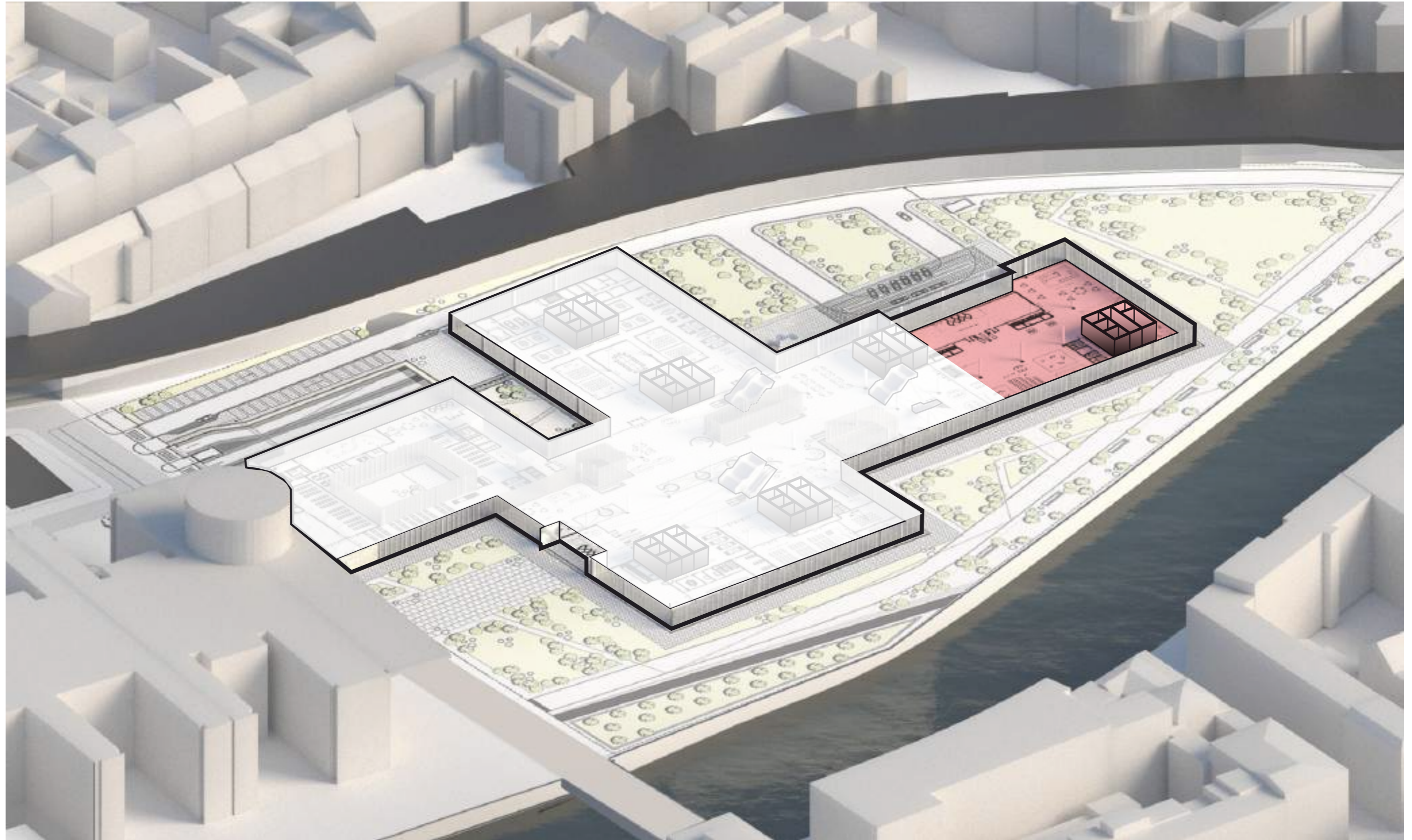

Implementation
Protocol route

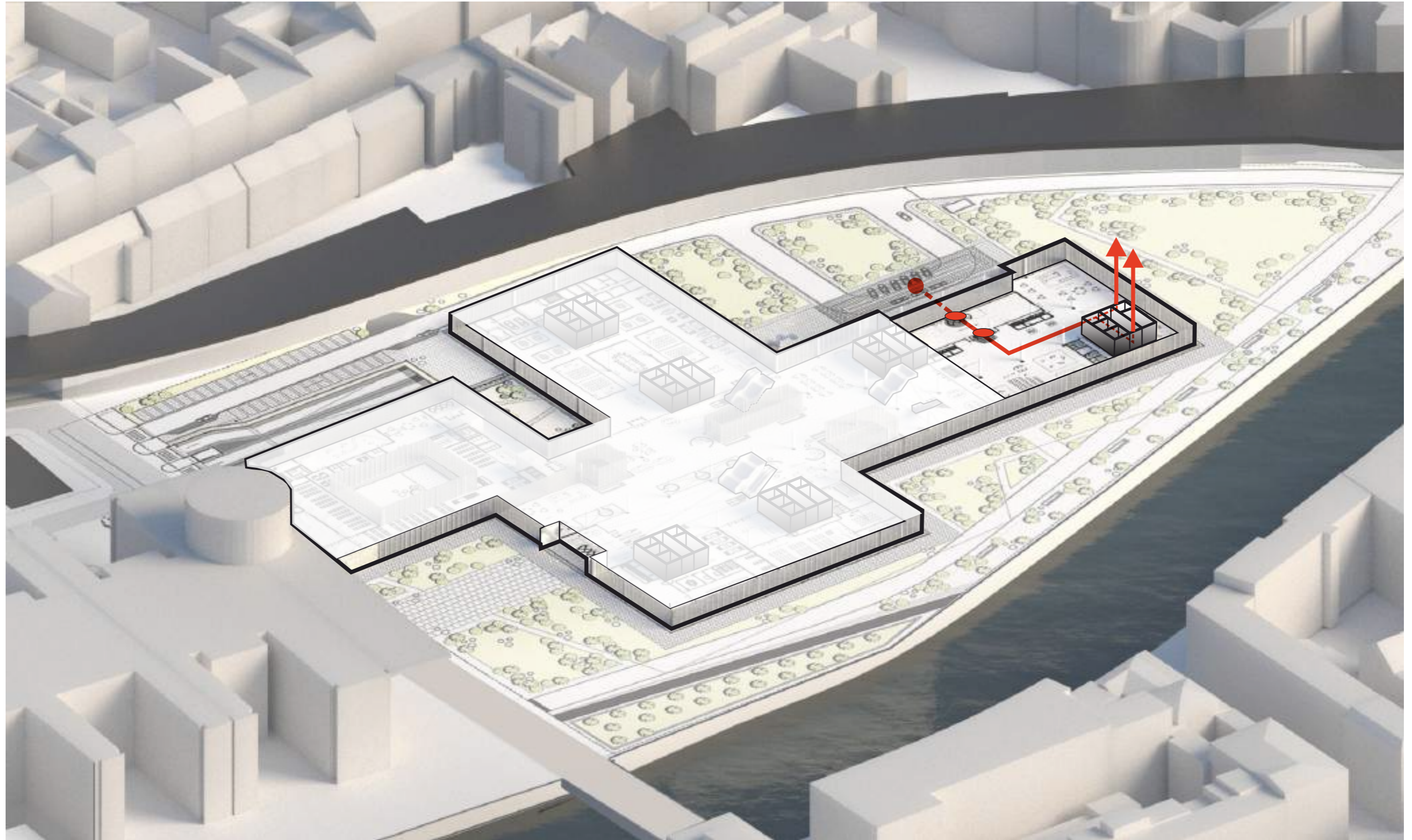

Implementation
Protocol route

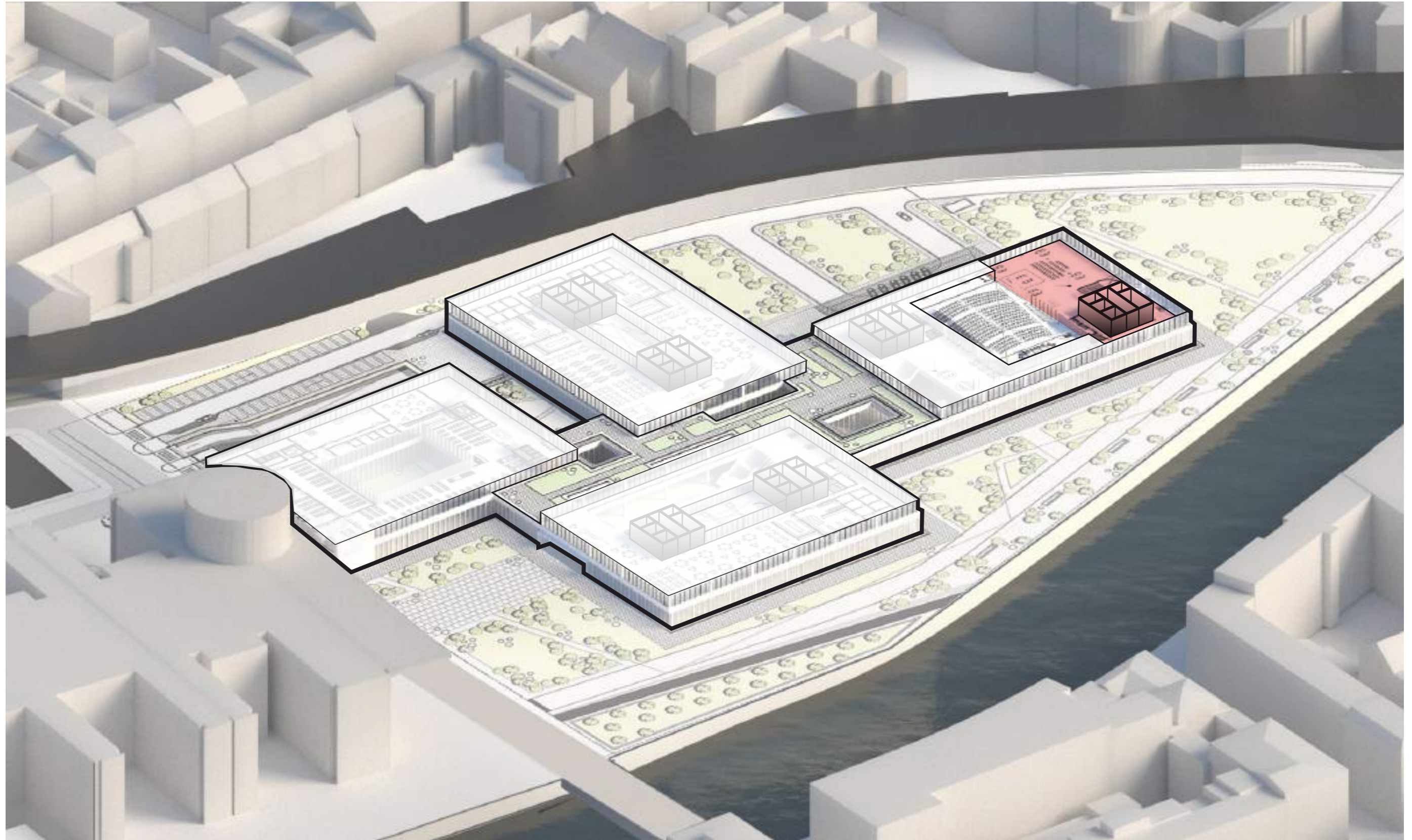

Implementation
Protocol route

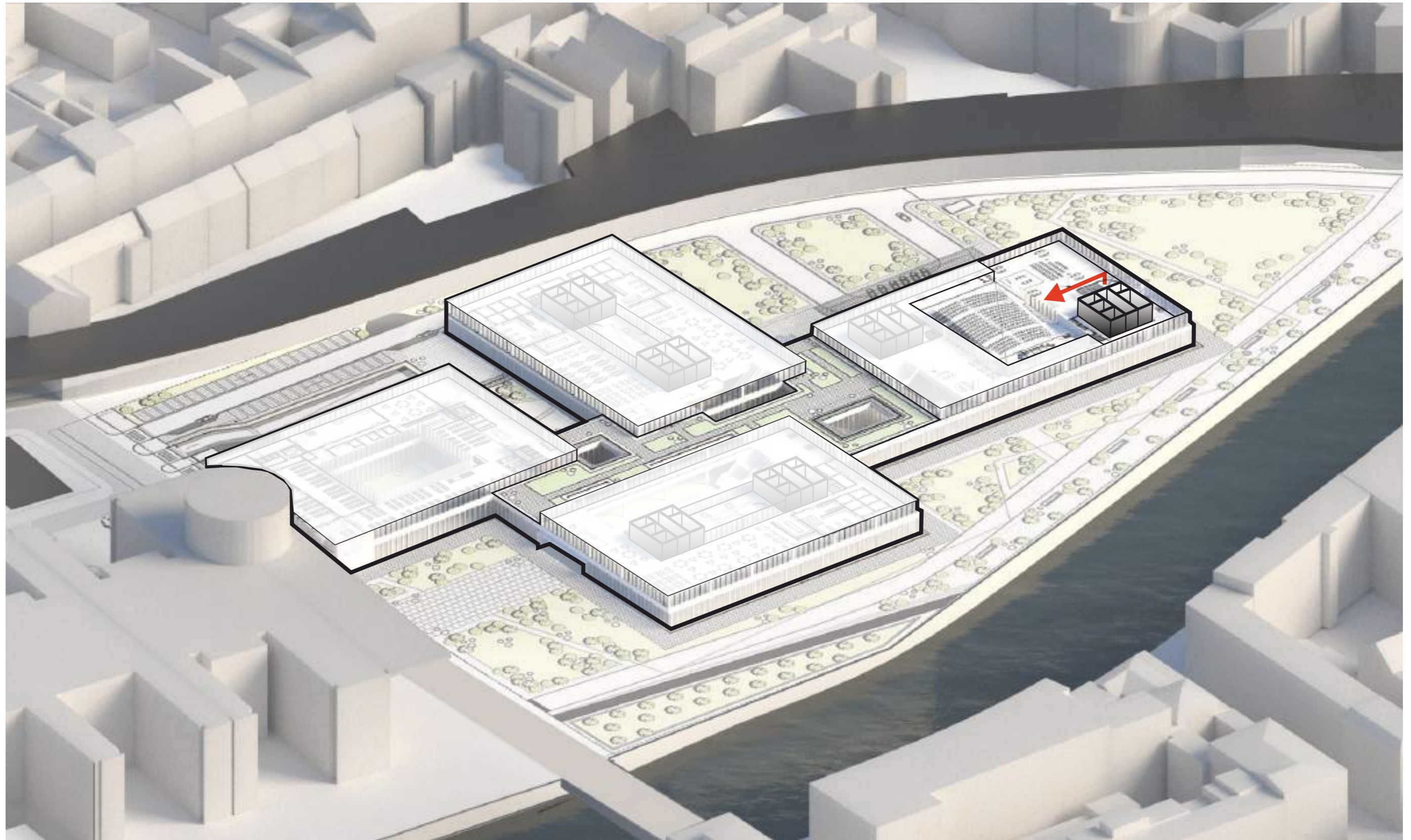

Implementation
Protocol route



Implementation
Media



- LOGISTICS
- VISITORS / CITIZENS
- MEDIA
- PROTOCOL
- ACCREDITED PERSONS

Implementation
Media route

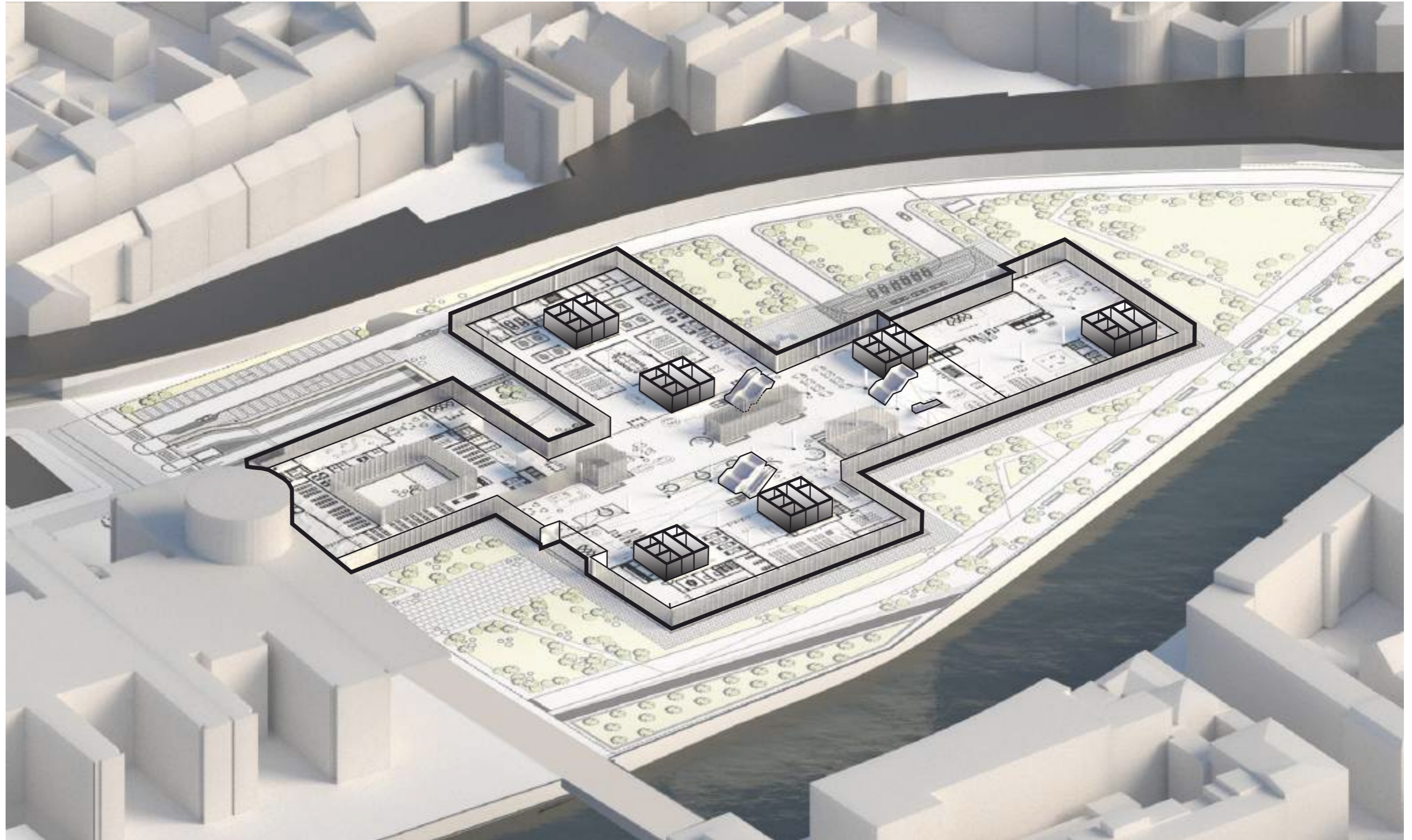

Implementation
Media route

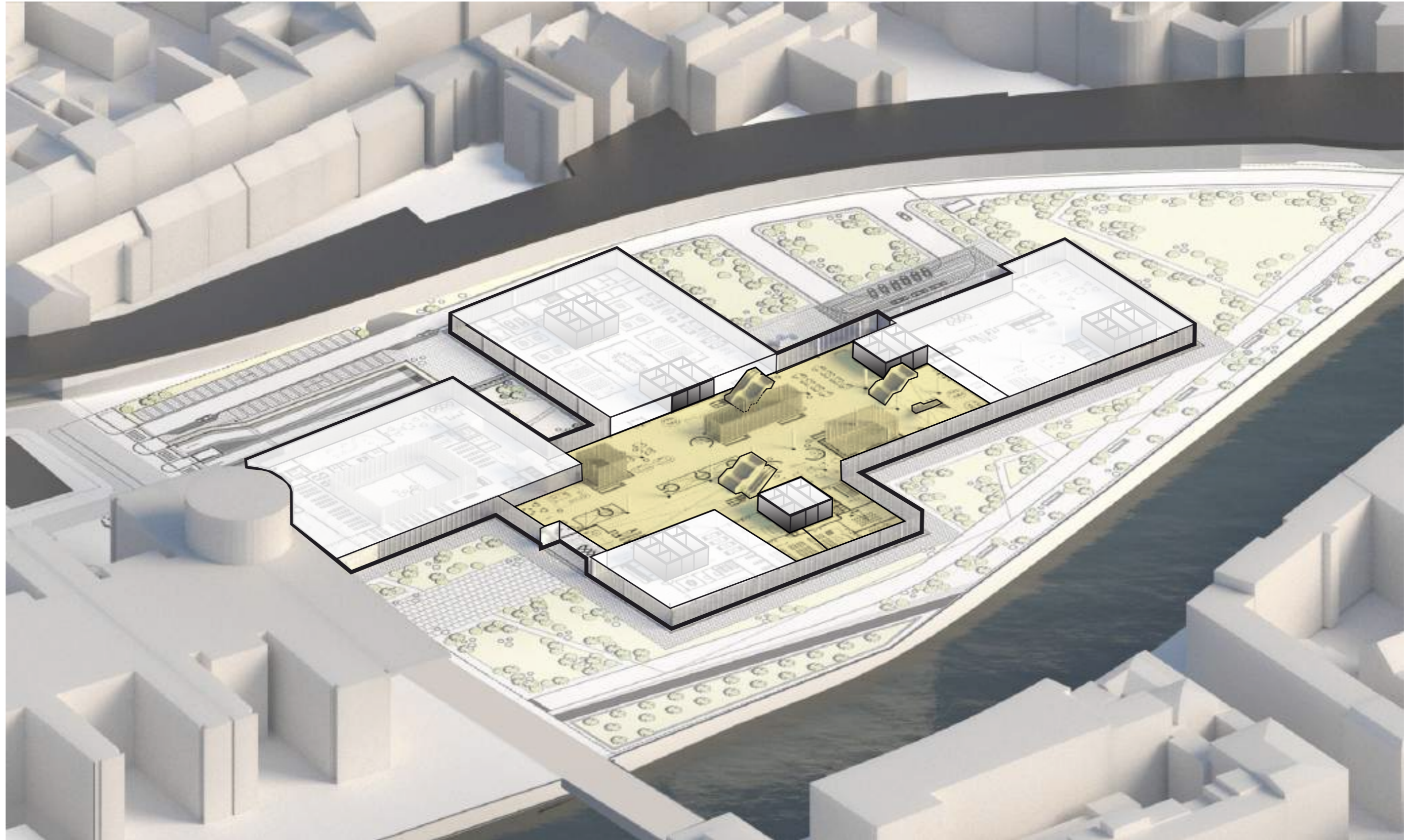

Implementation
Media route

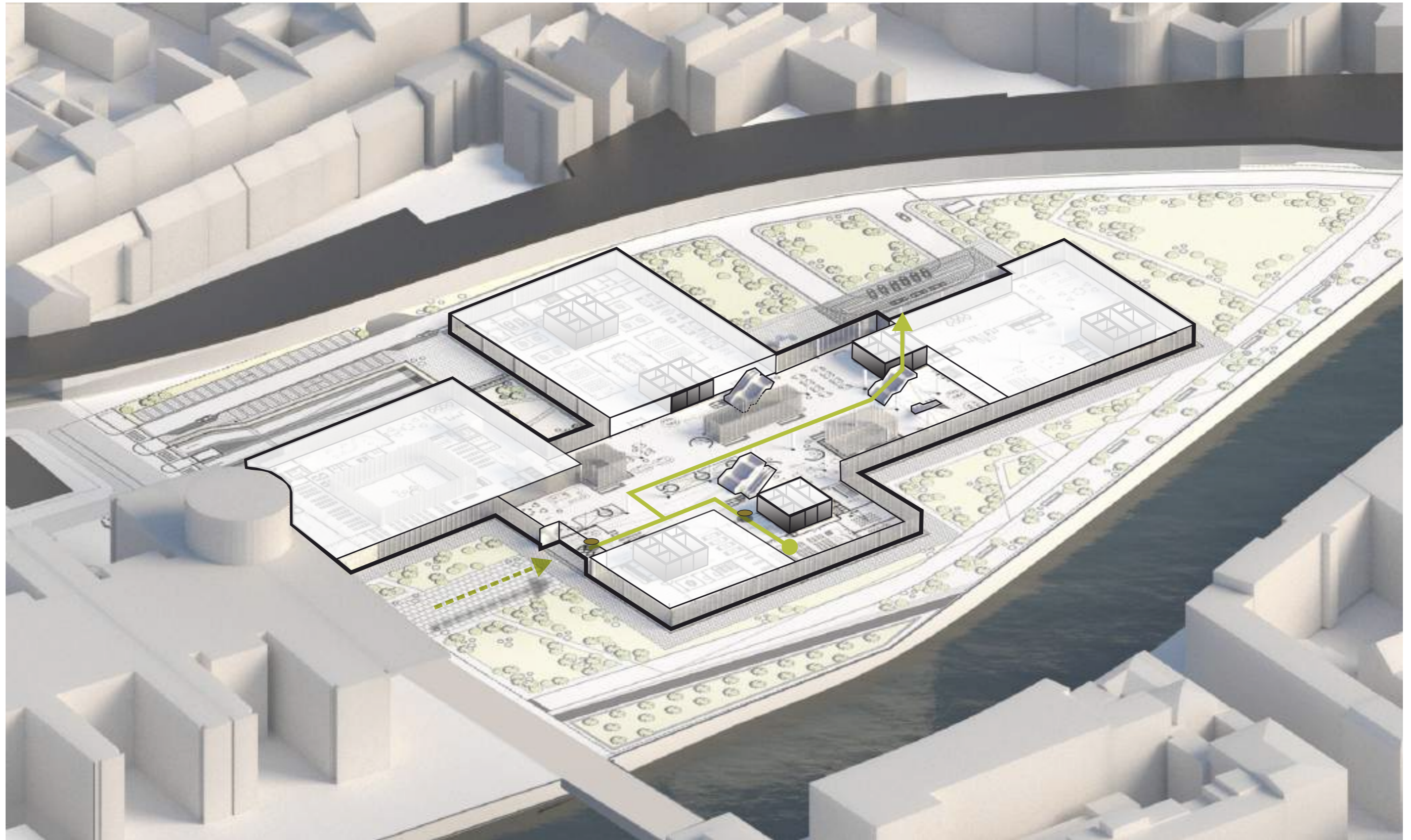

Implementation
Media route

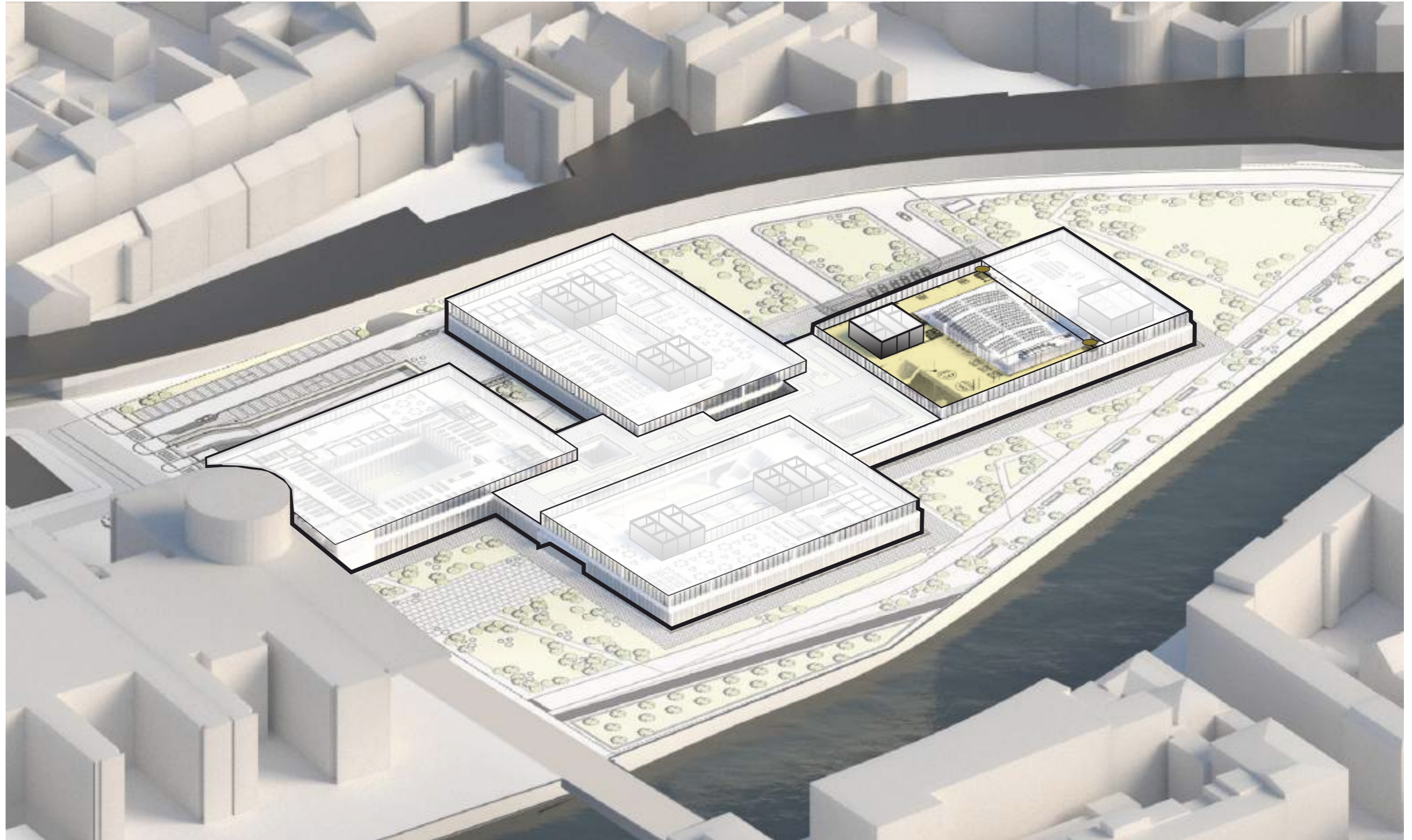

Implementation
Media route

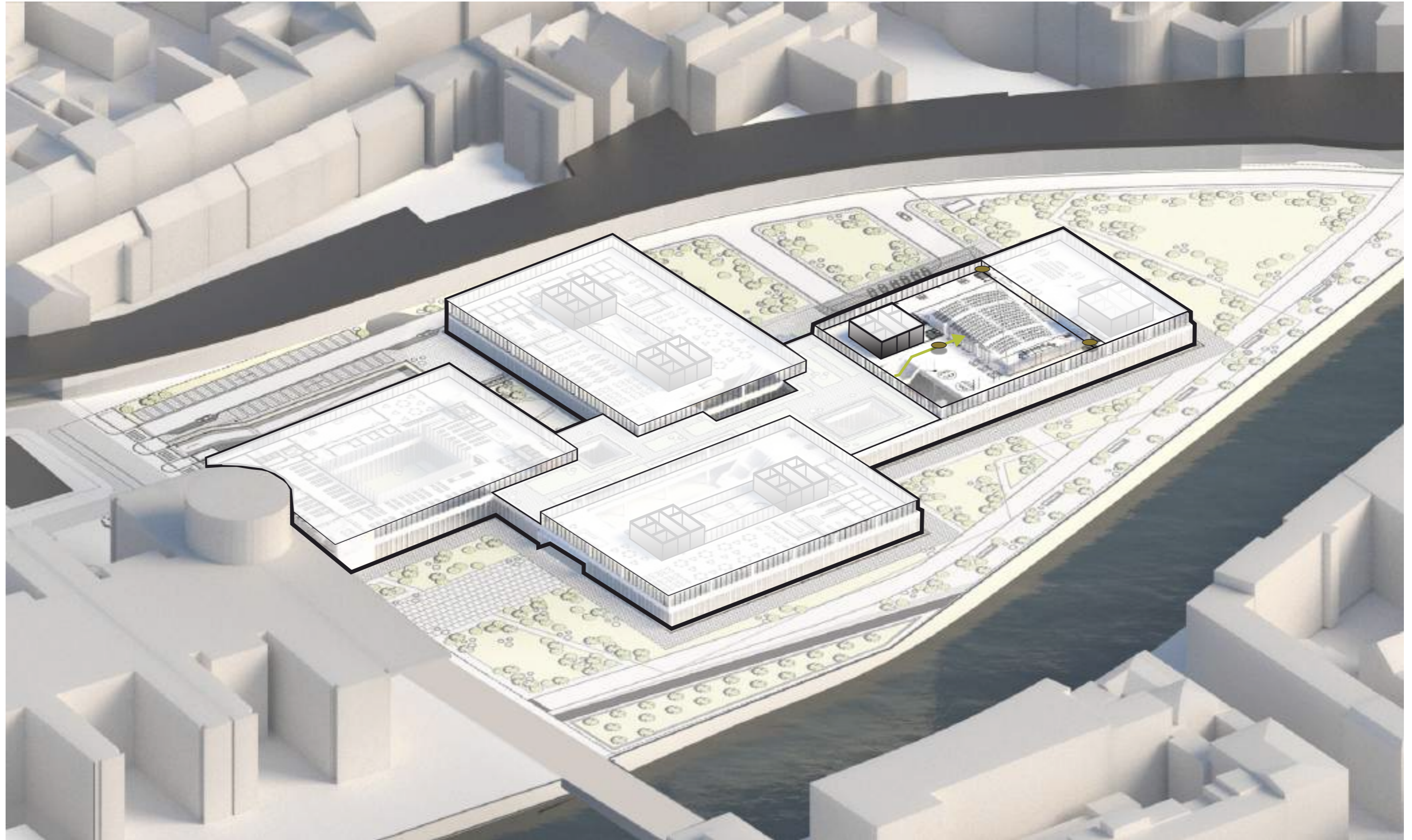

Implementation
Media route



Implementation
Citizens



- LOGISTICS
- VISITORS / CITIZENS
- MEDIA
- PROTOCOL
- ACCREDITED PERSONS

Implementation
Citizen route

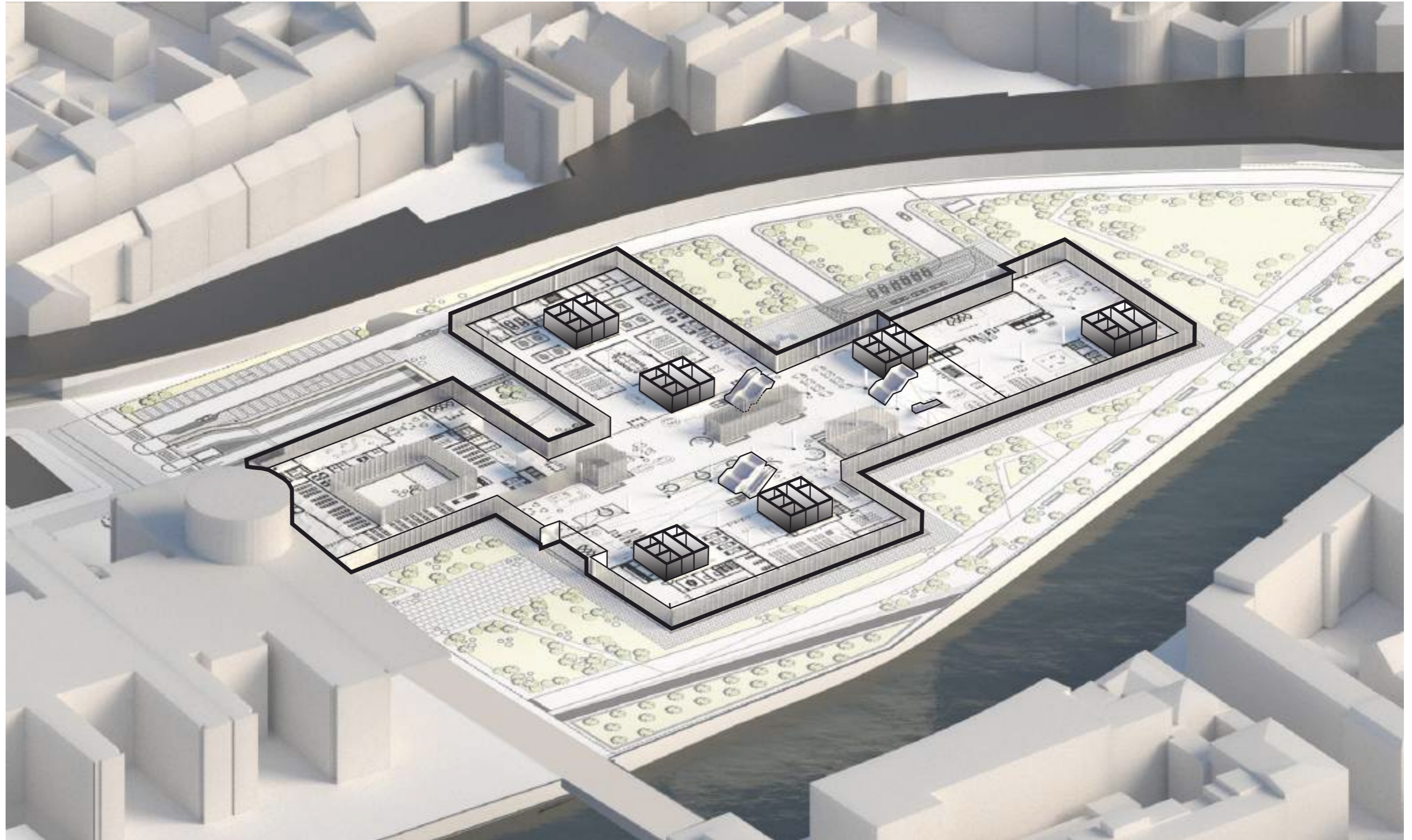

Implementation
Citizen route

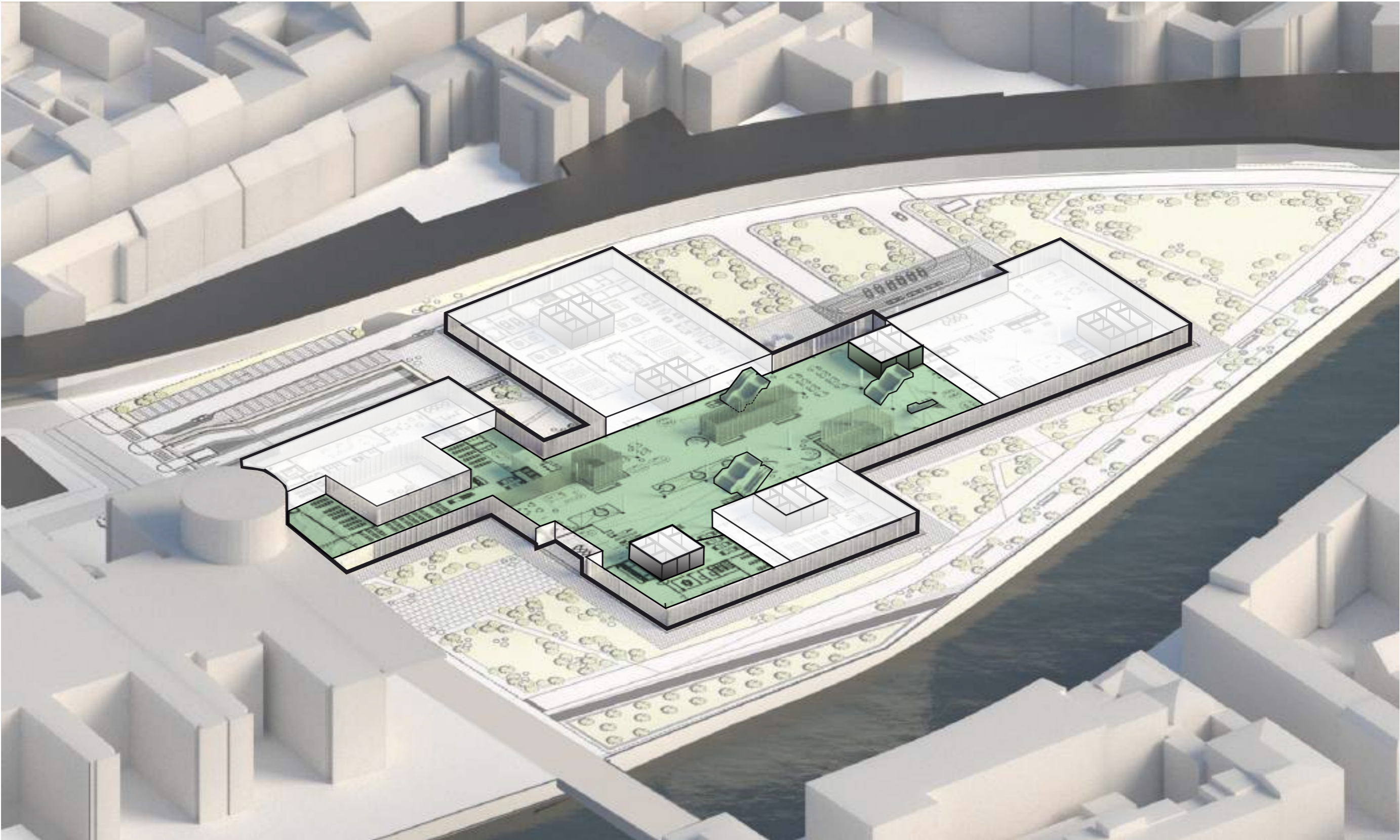

Implementation
Citizen route

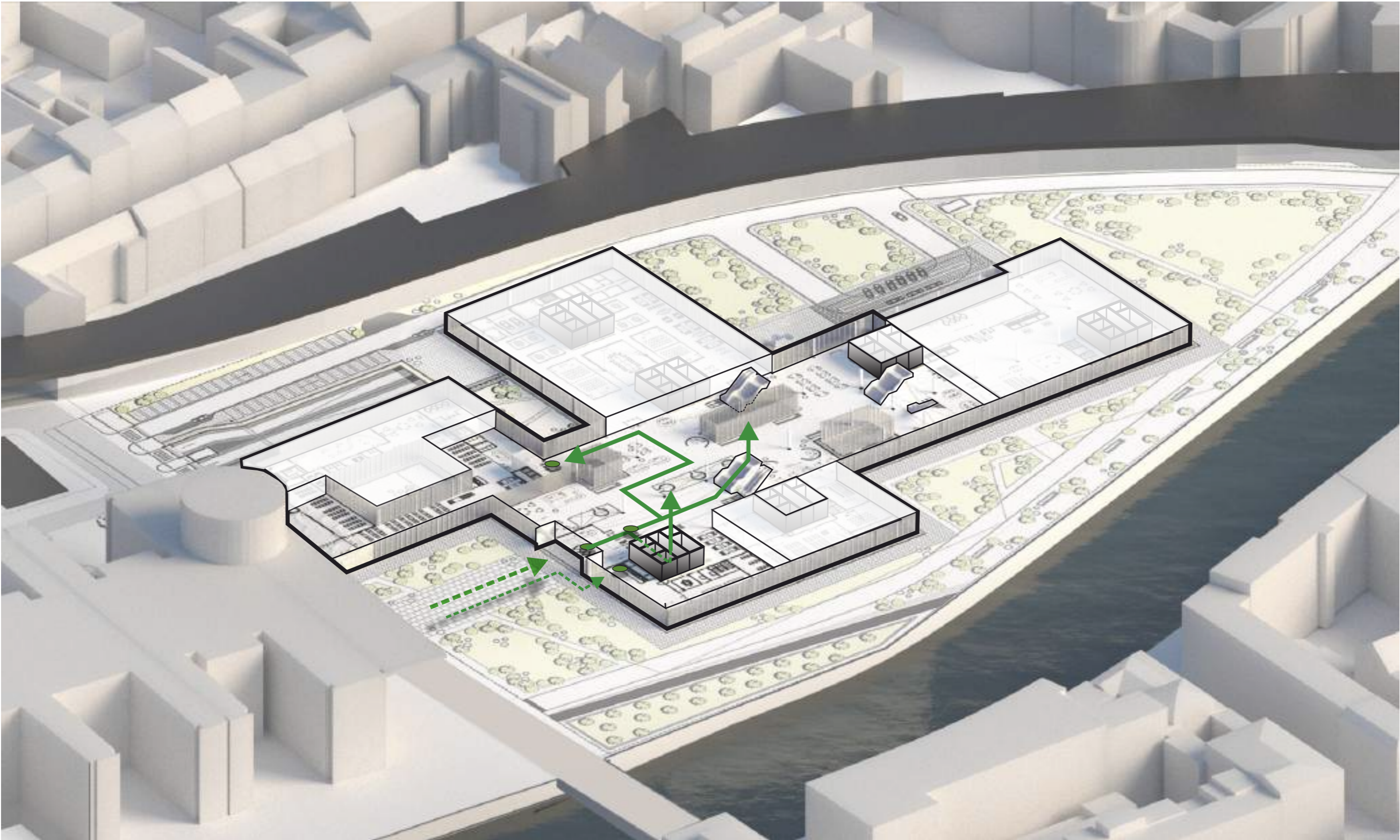

Implementation
Citizen route

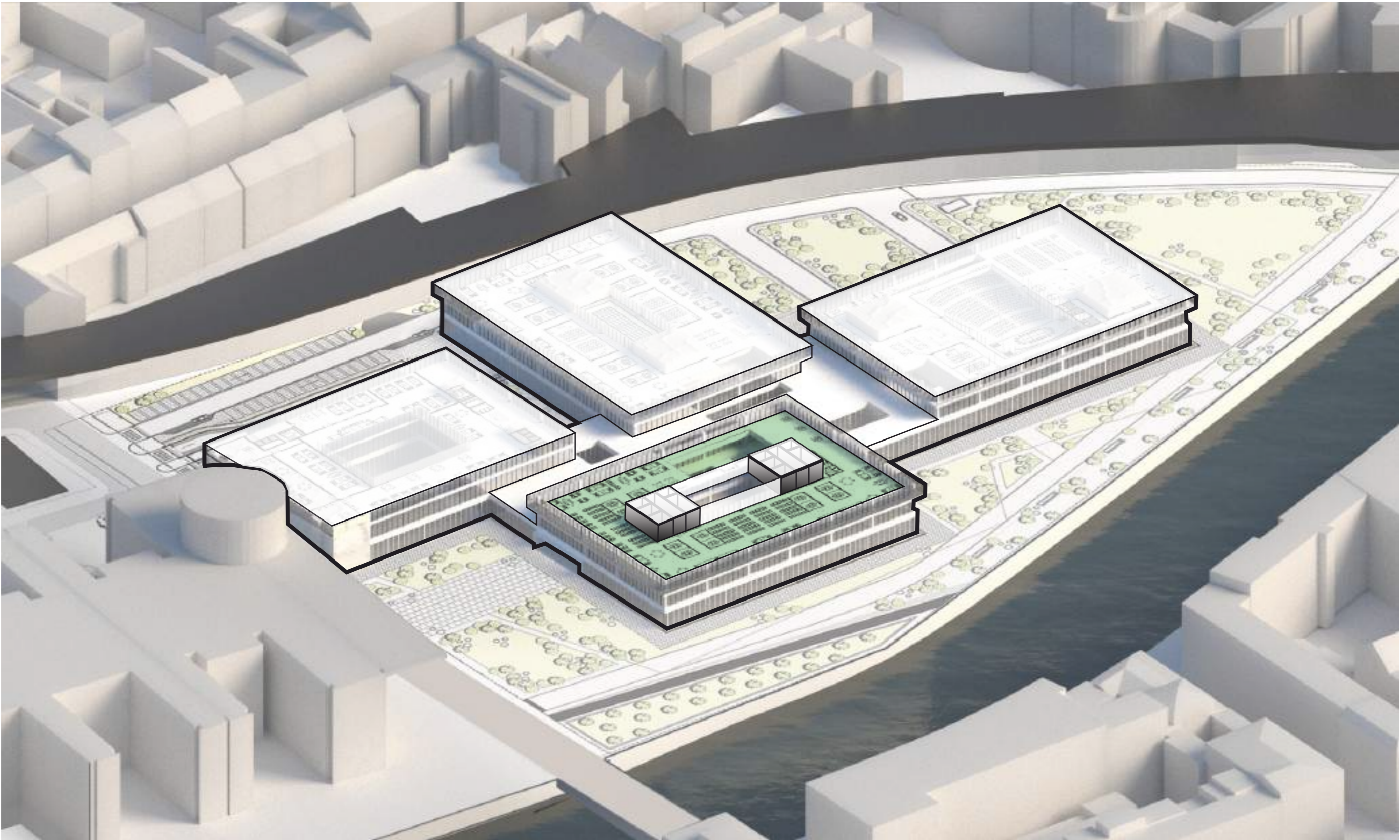

Implementation
Citizen route

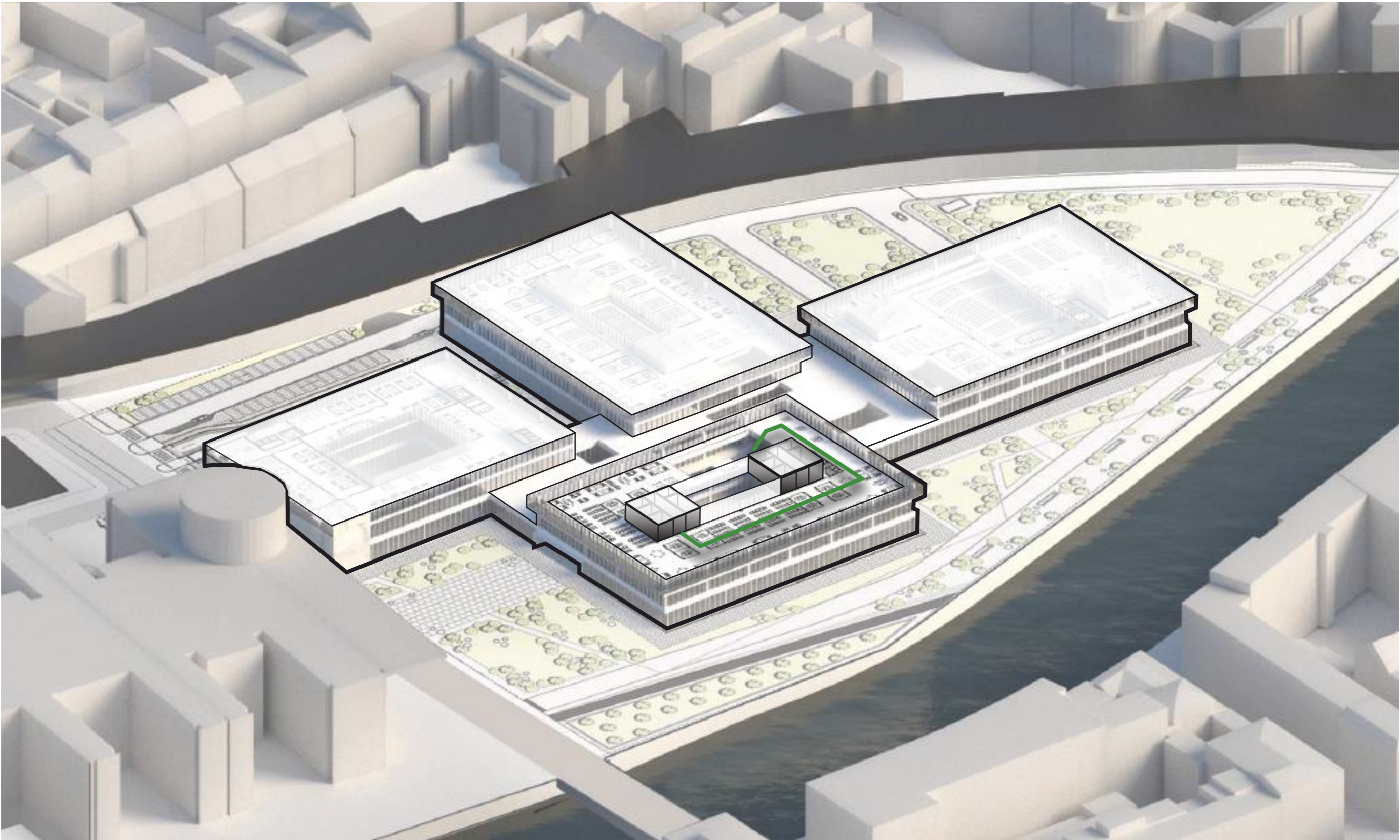

Implementation
Accredited persons



- LOGISTICS
- VISITORS / CITIZENS
- MEDIA
- PROTOCOL
- ACCREDITED PERSONS**

Implementation
Accredited persons route

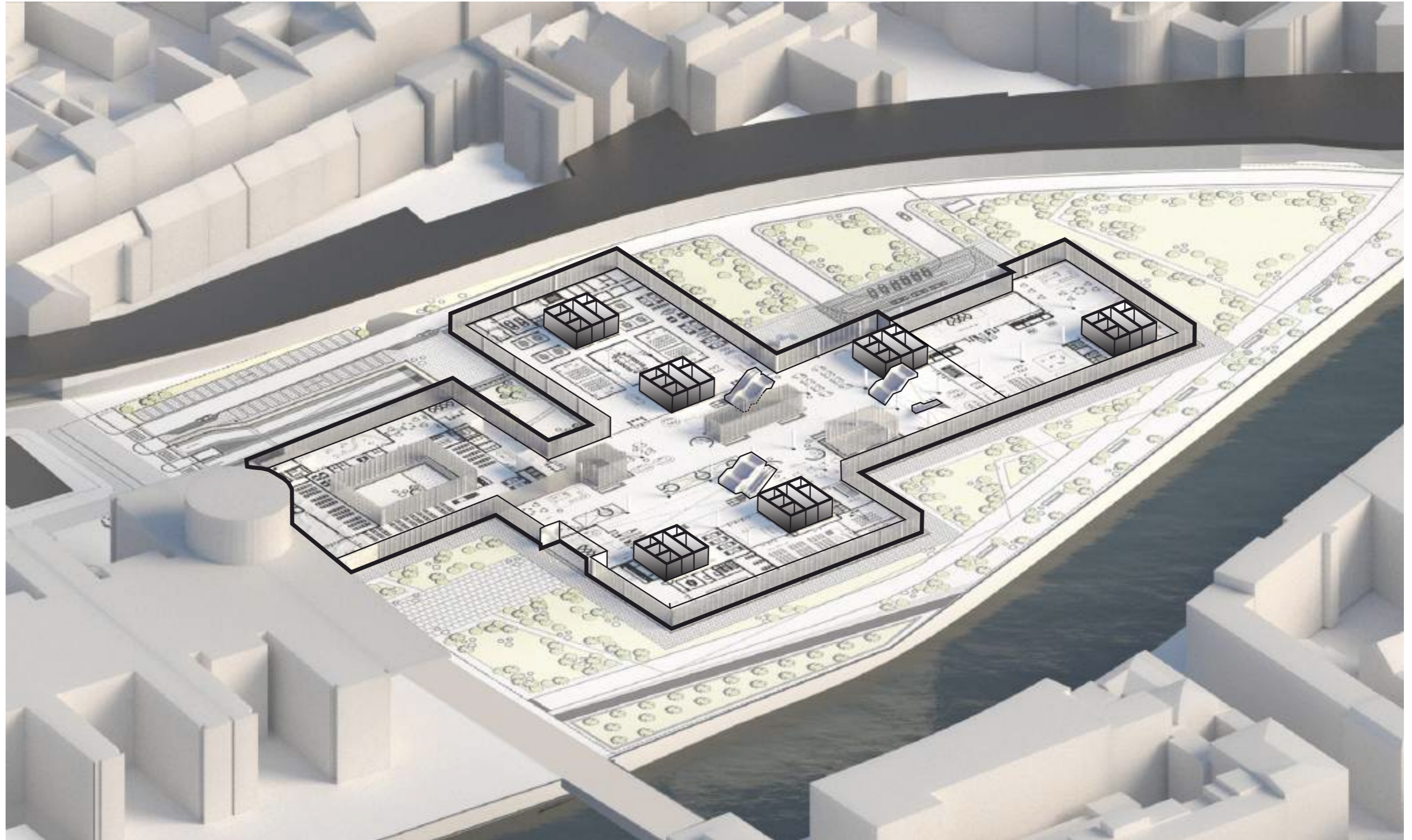

Implementation
Accredited persons route

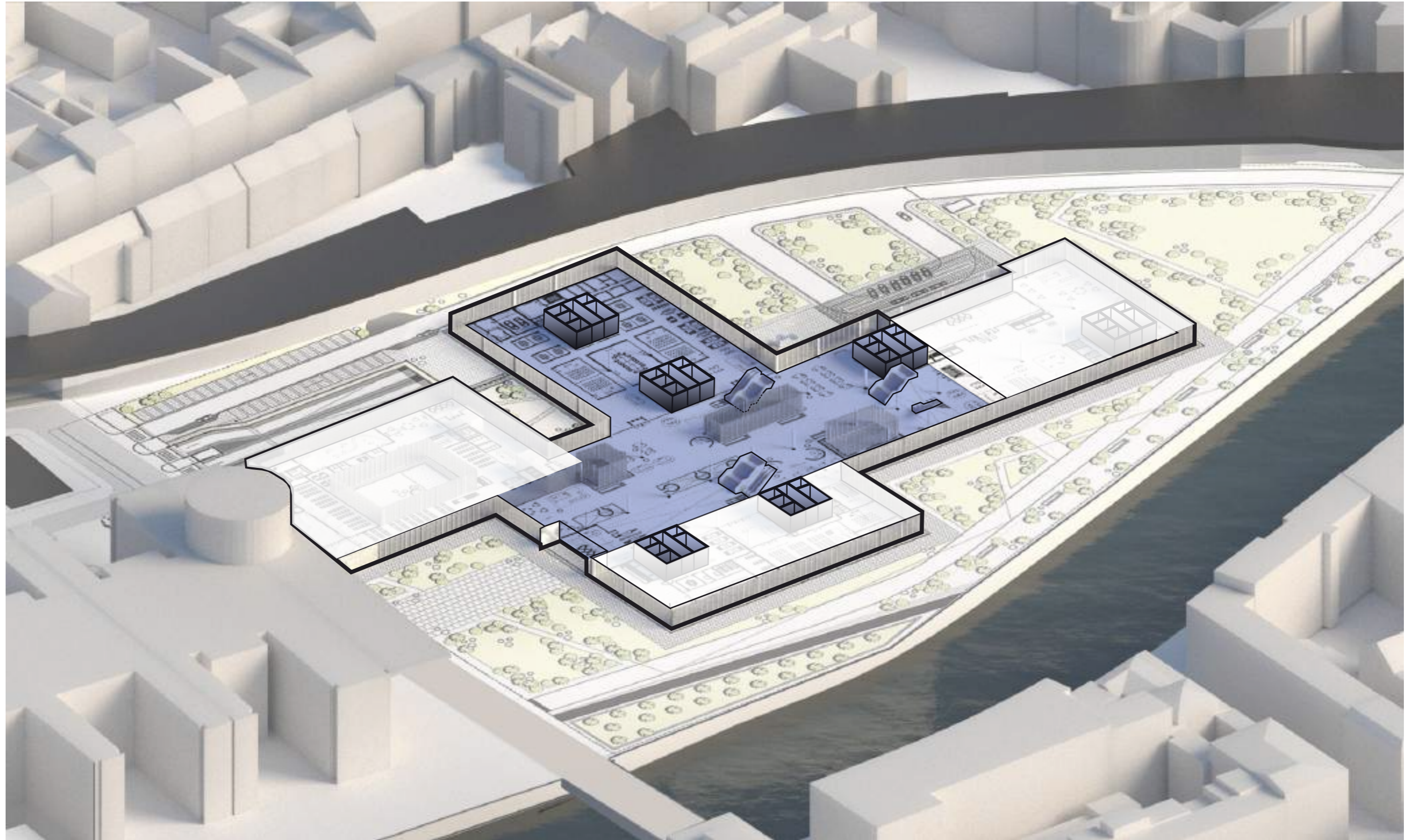

Implementation
Accredited persons route

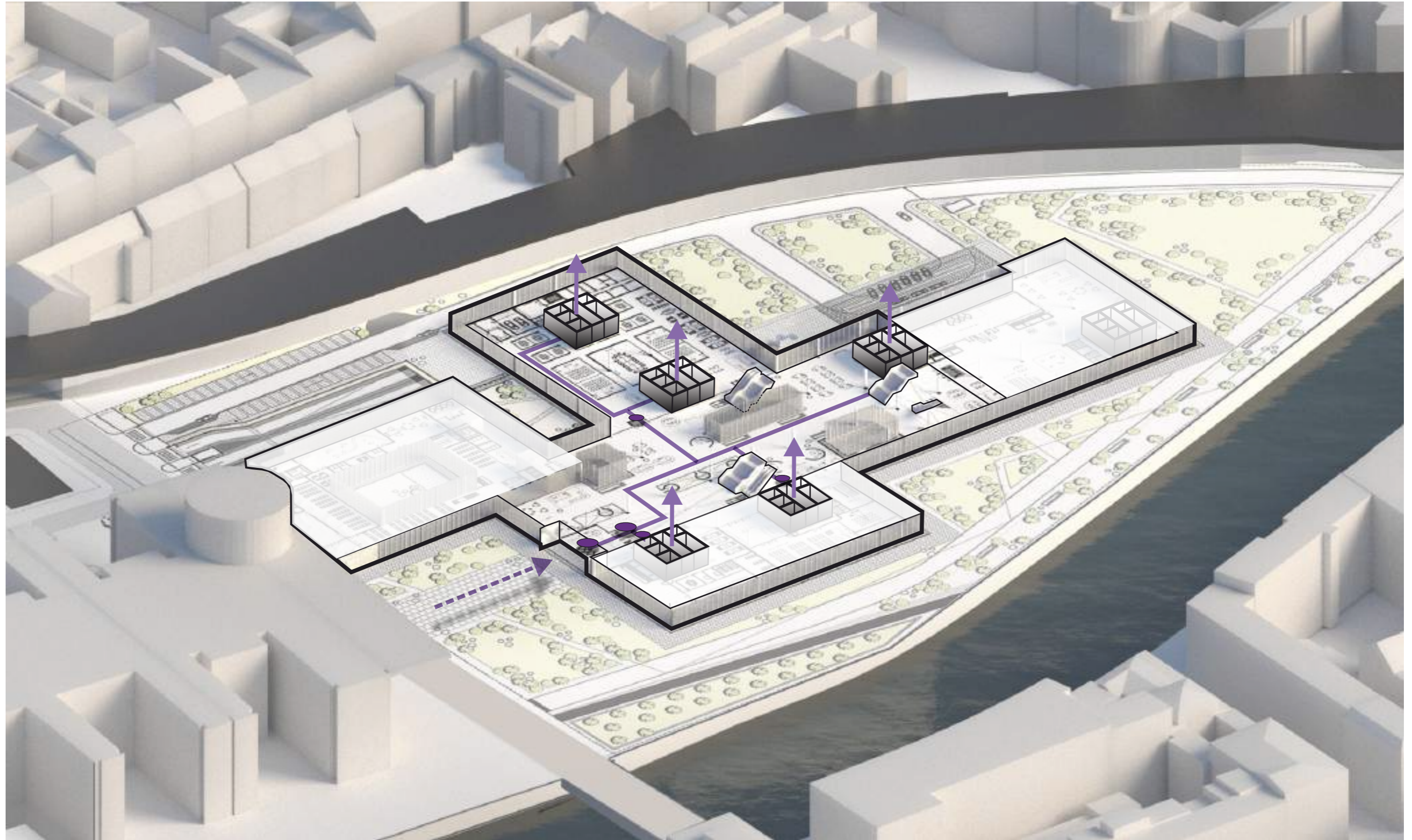

Implementation
Accredited persons route



Implementation
Accredited persons route

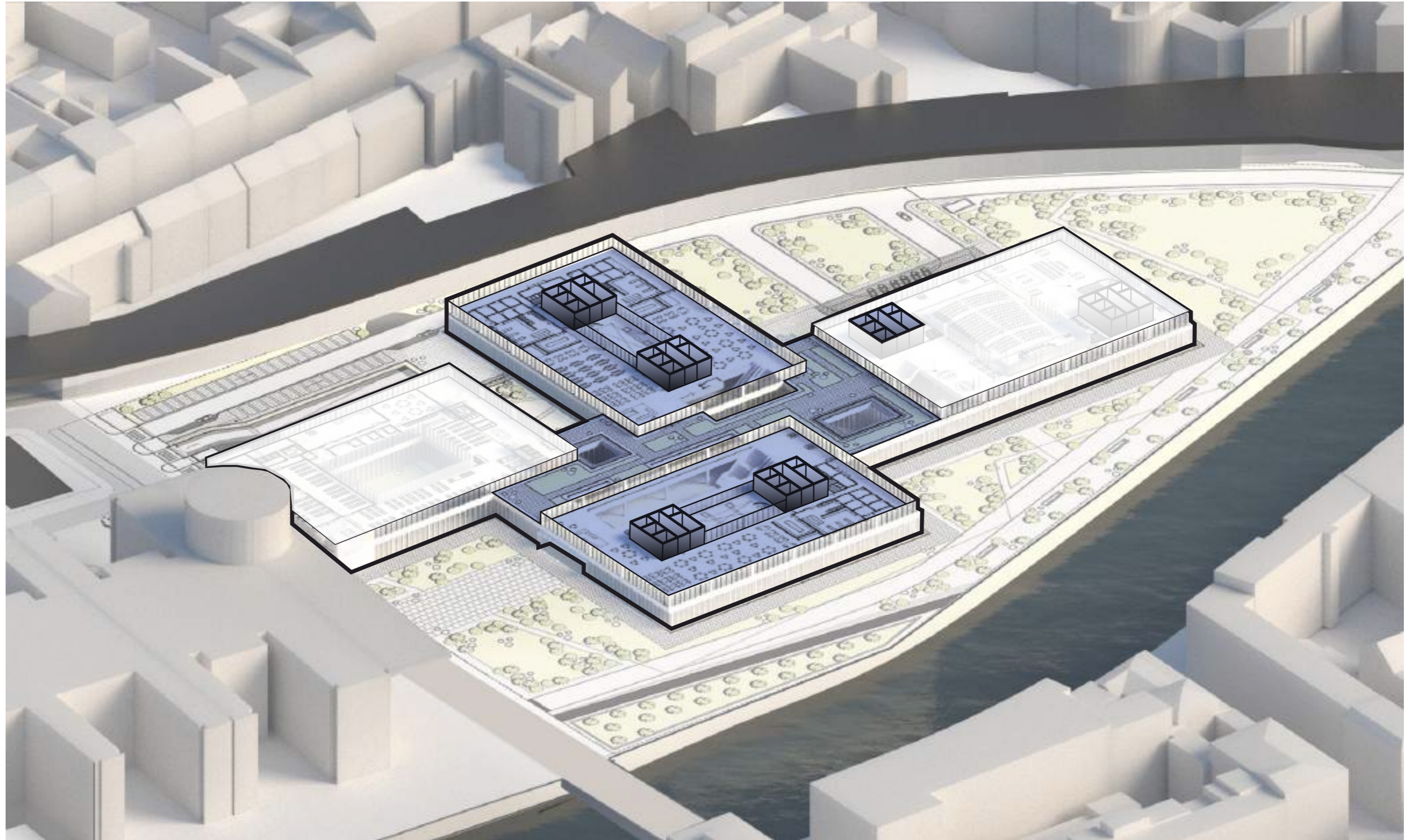

Implementation

Accredited persons route



Implementation
Accredited persons route

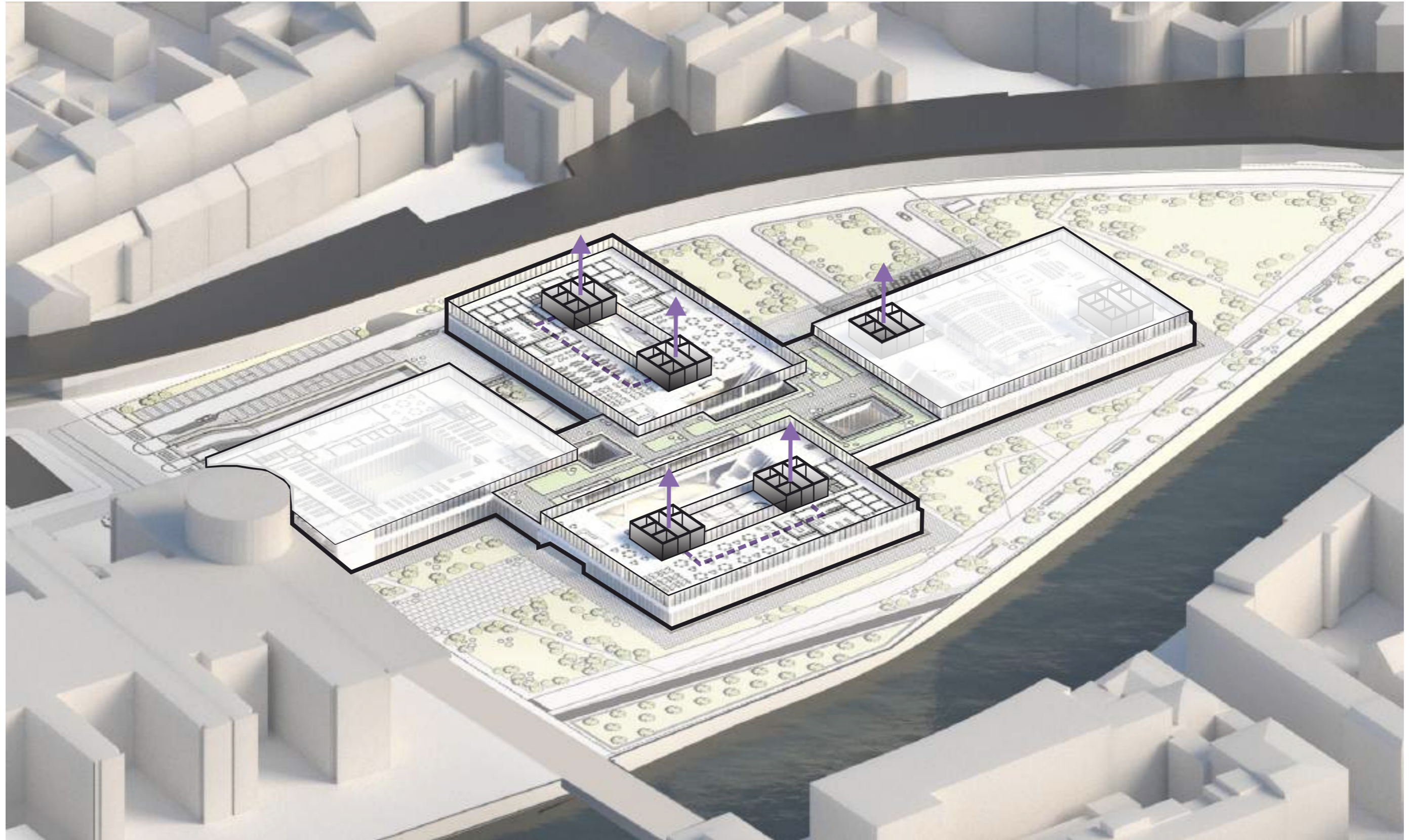

Implementation
Accredited persons route

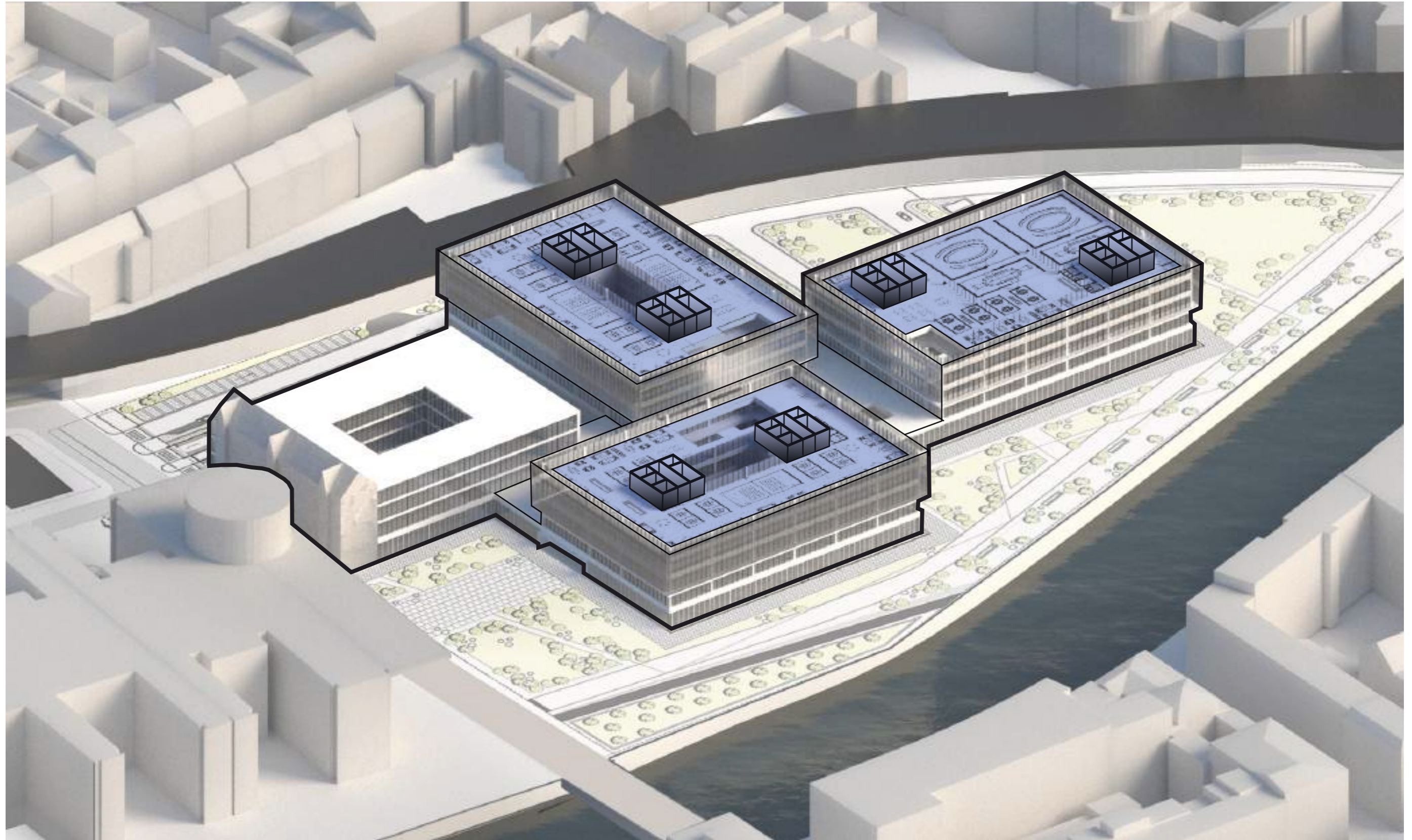

Implementation
Accredited persons route



Implementation
01 floor 1:500

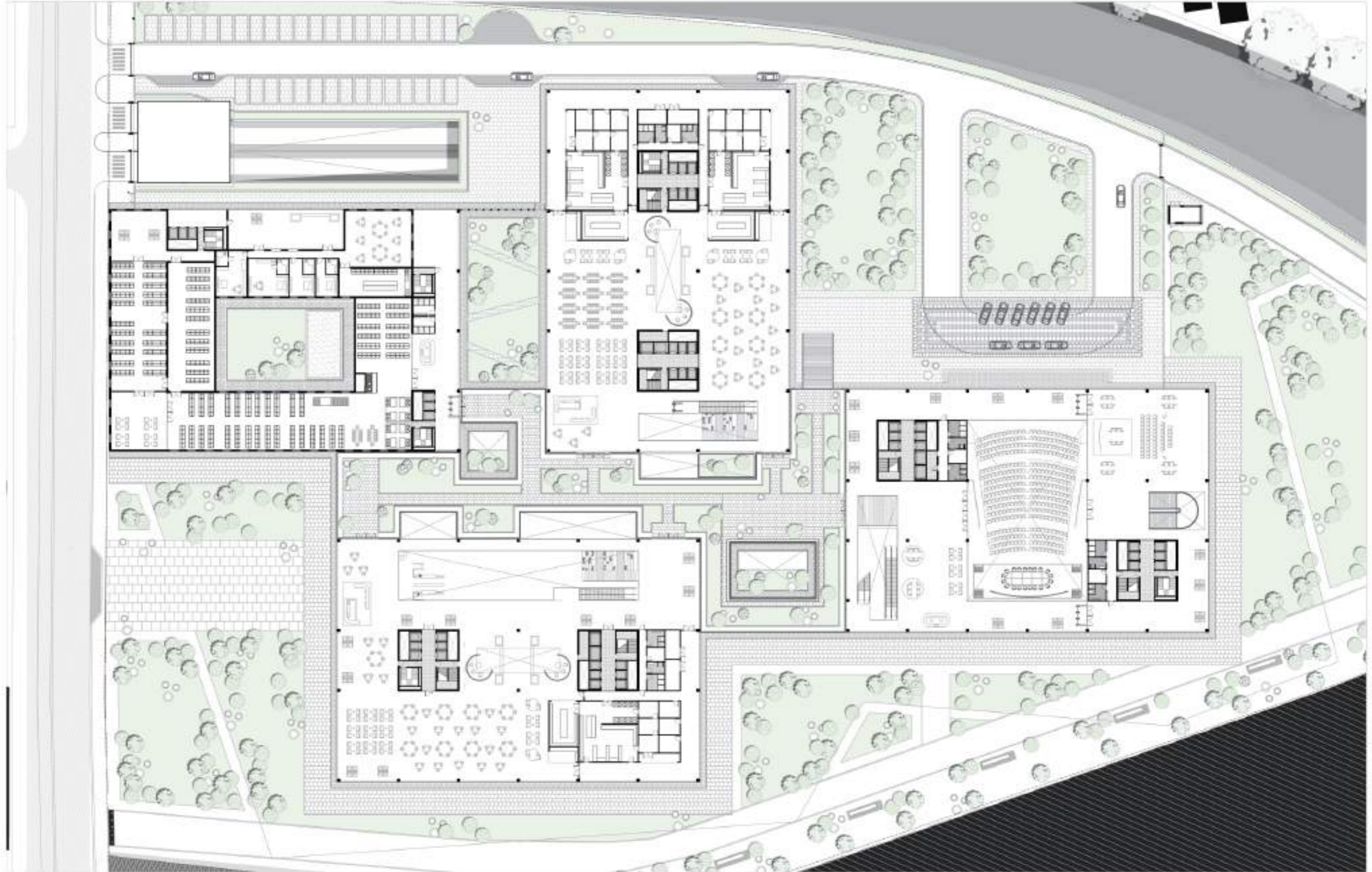

Implementation
02 floor 1:500

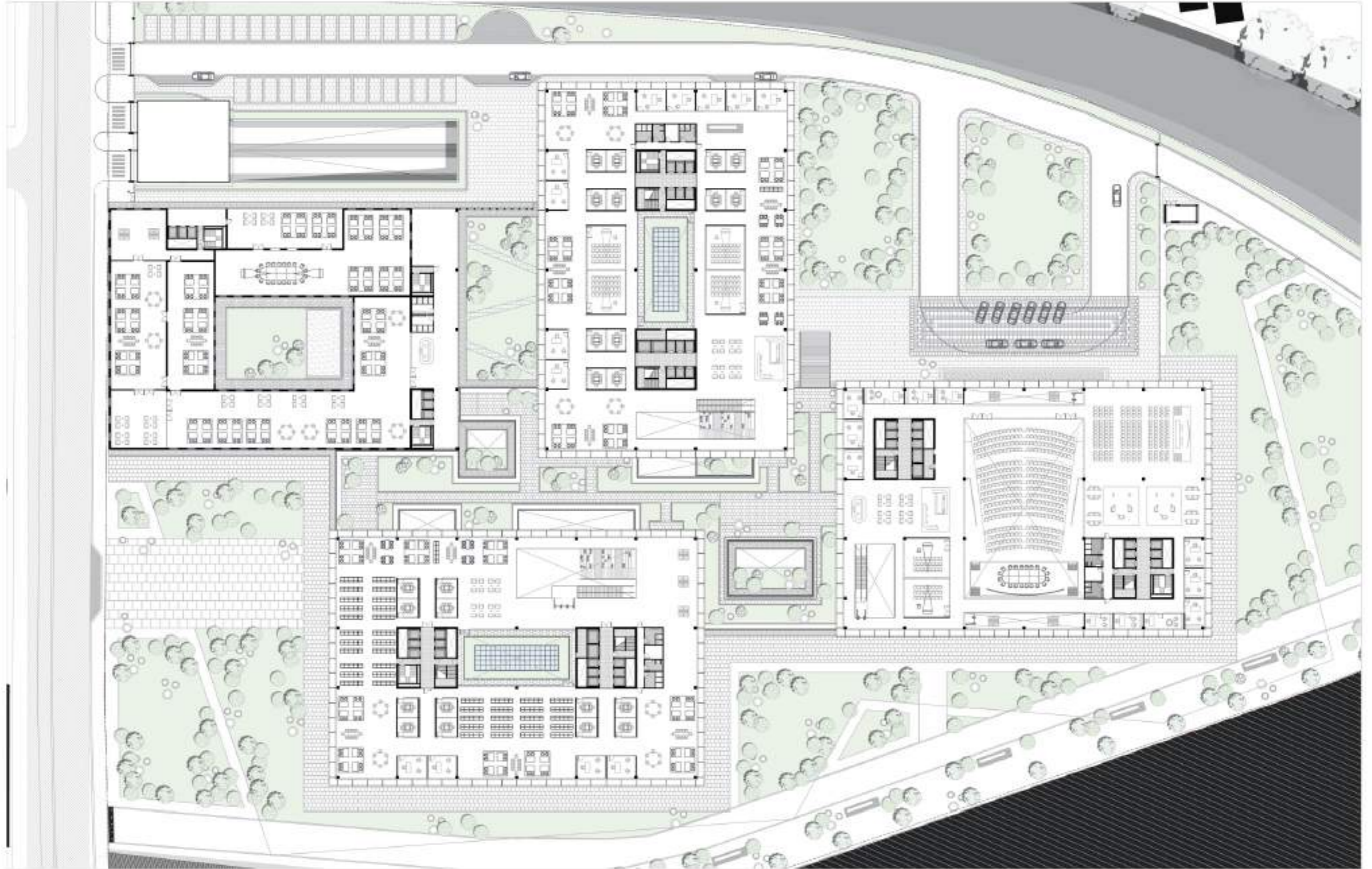

Implementation
03 floor 1:500



Implementation Sections

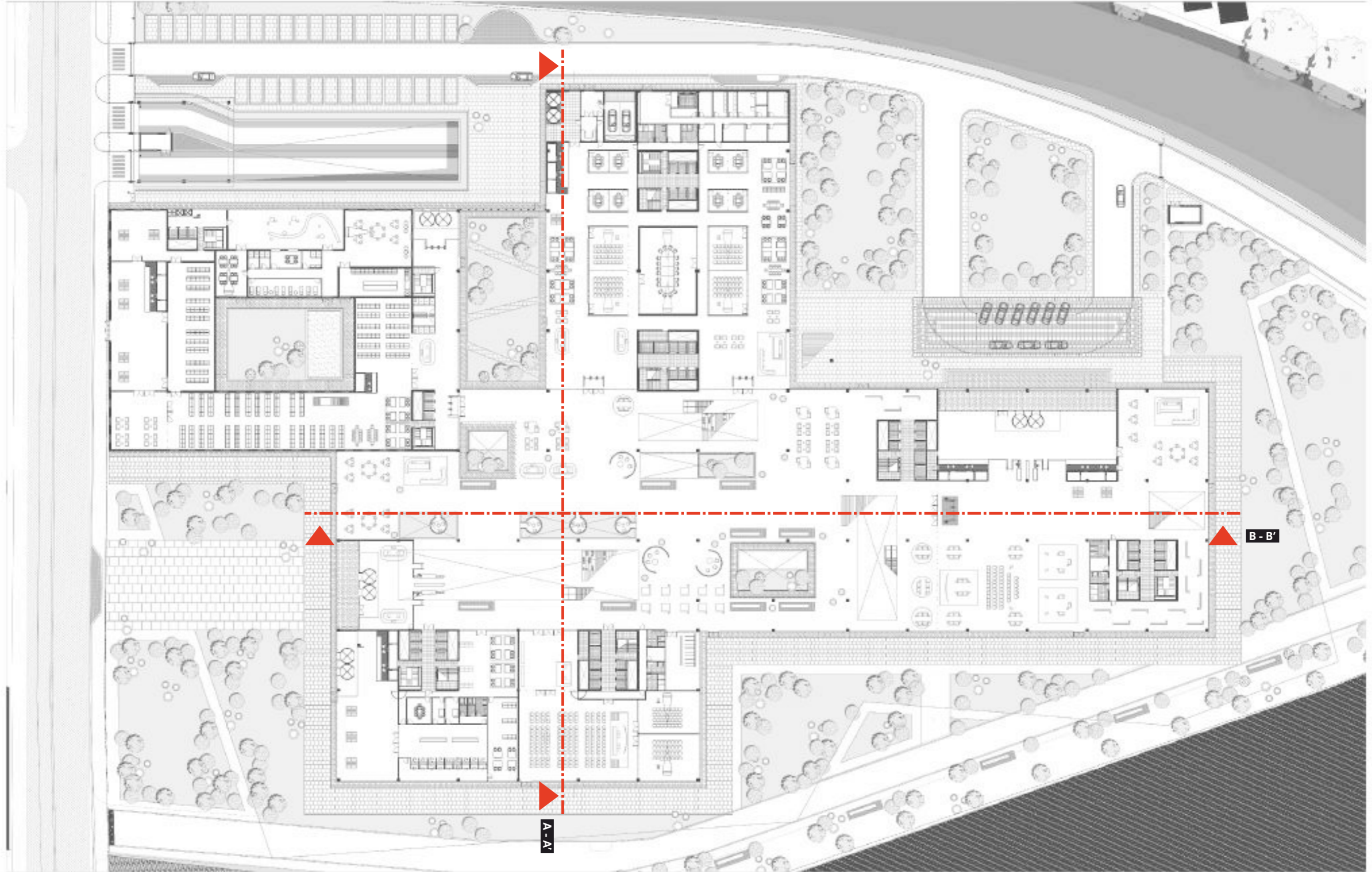

Implementation
Section A - A'

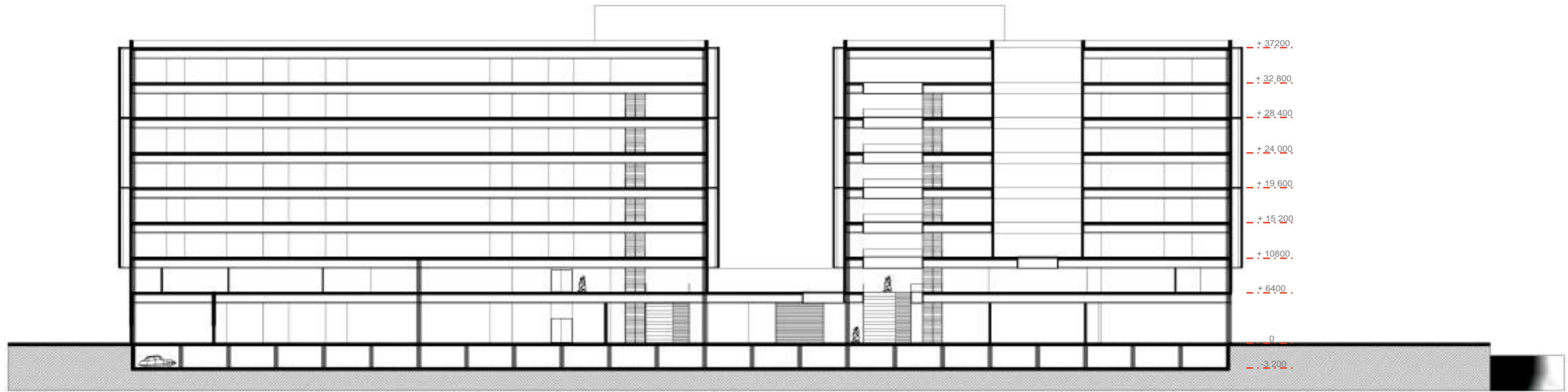

Implementation
Section B - B'

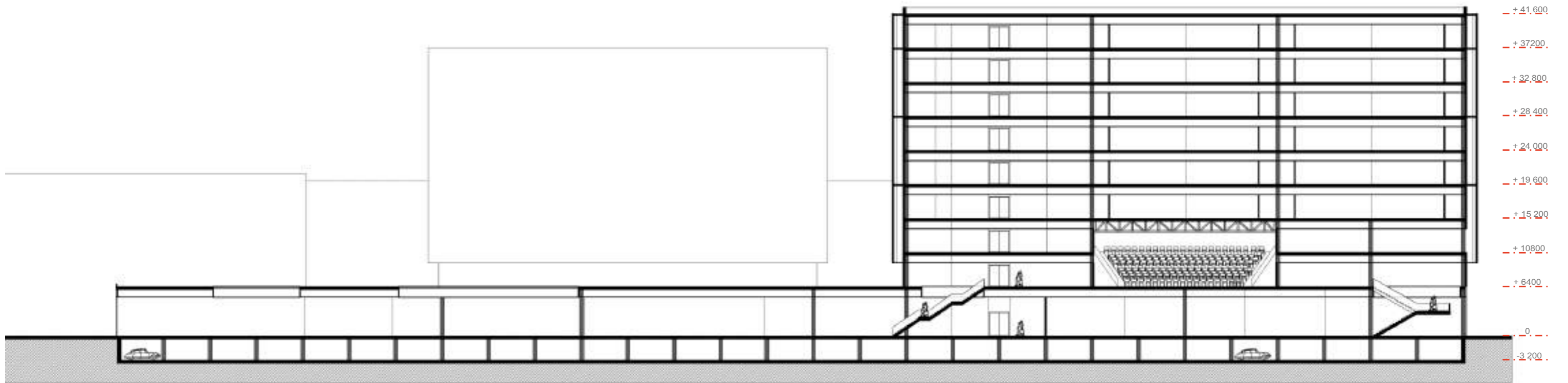

Implementation
Underground parking

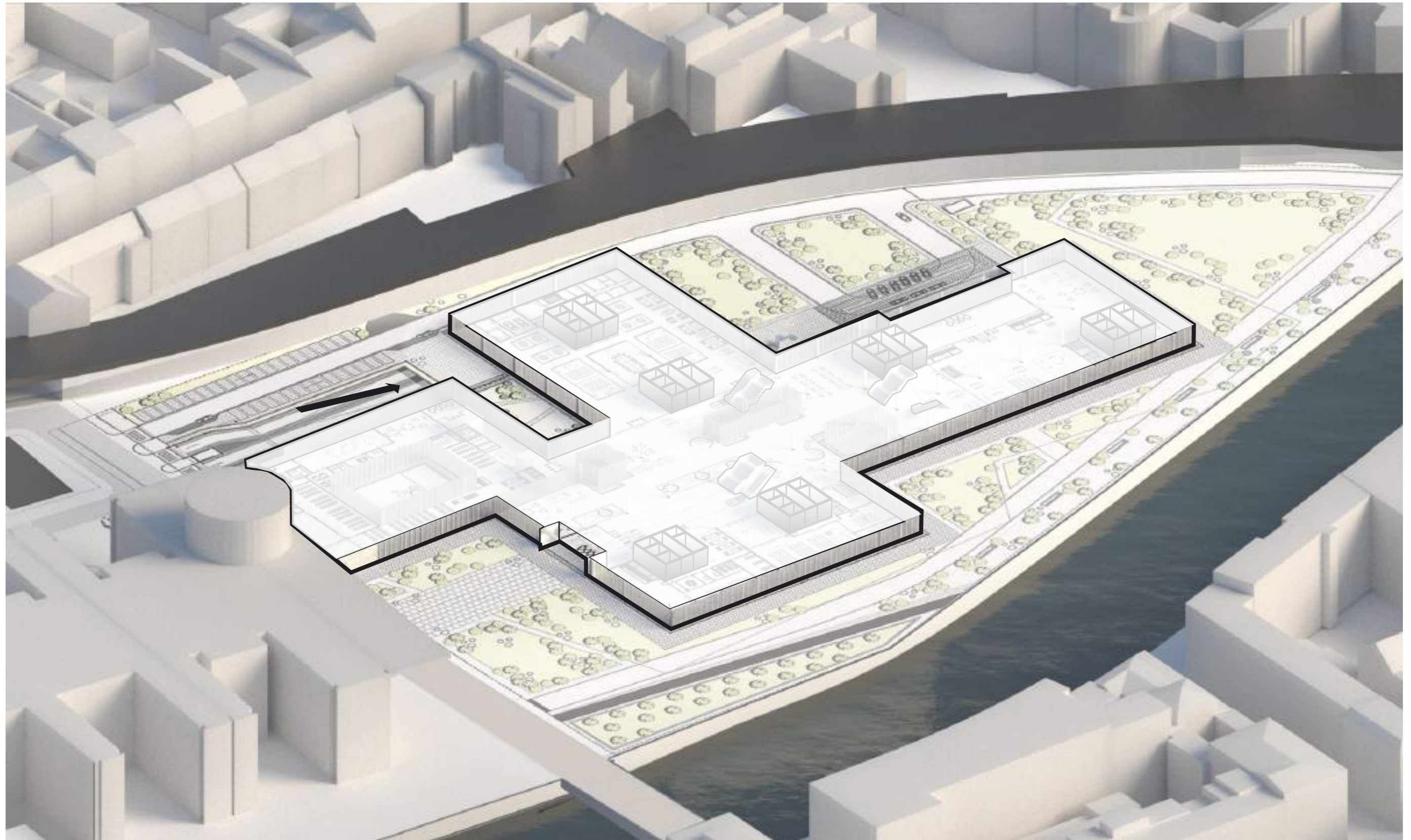

Implementation
Underground parking facilities

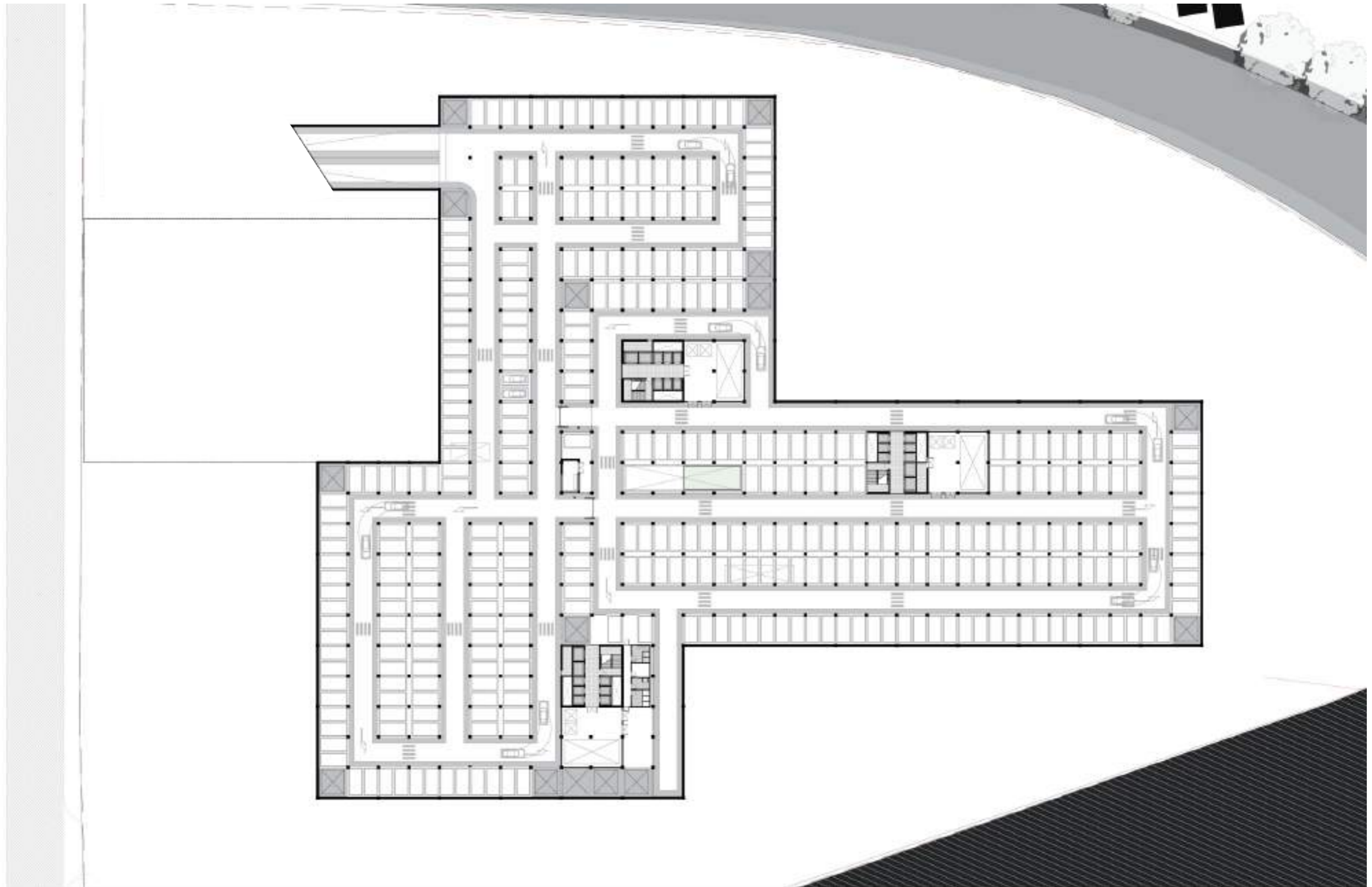

1. INTRODUCTION

2. NEW POLITICS

3. DESIGN

**CONCEPT
IMPLEMENTATION
DEVELOPMENT**

5. CONCLUSION

Development
Construction grid parking

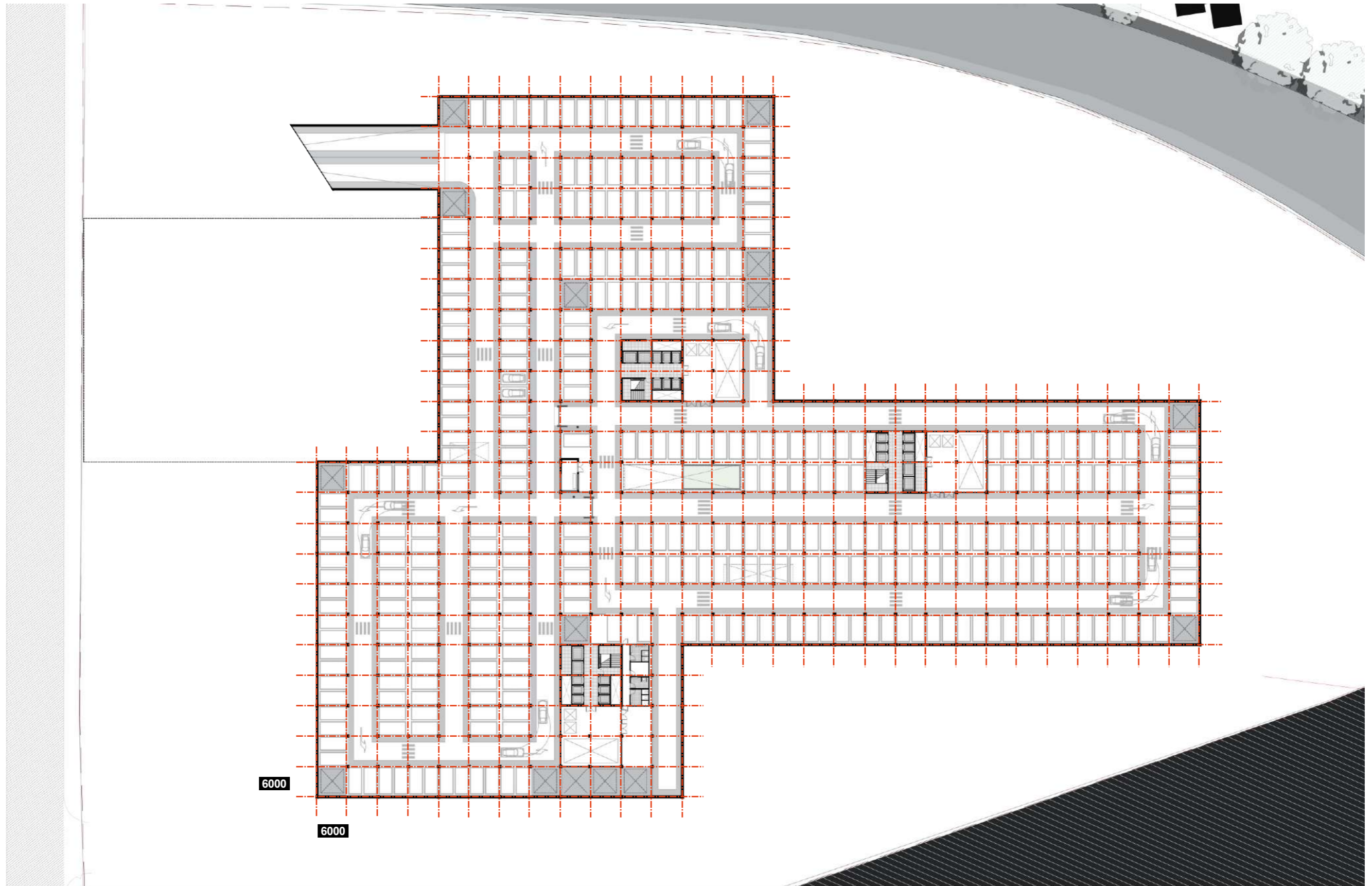

Construction grid ground floor

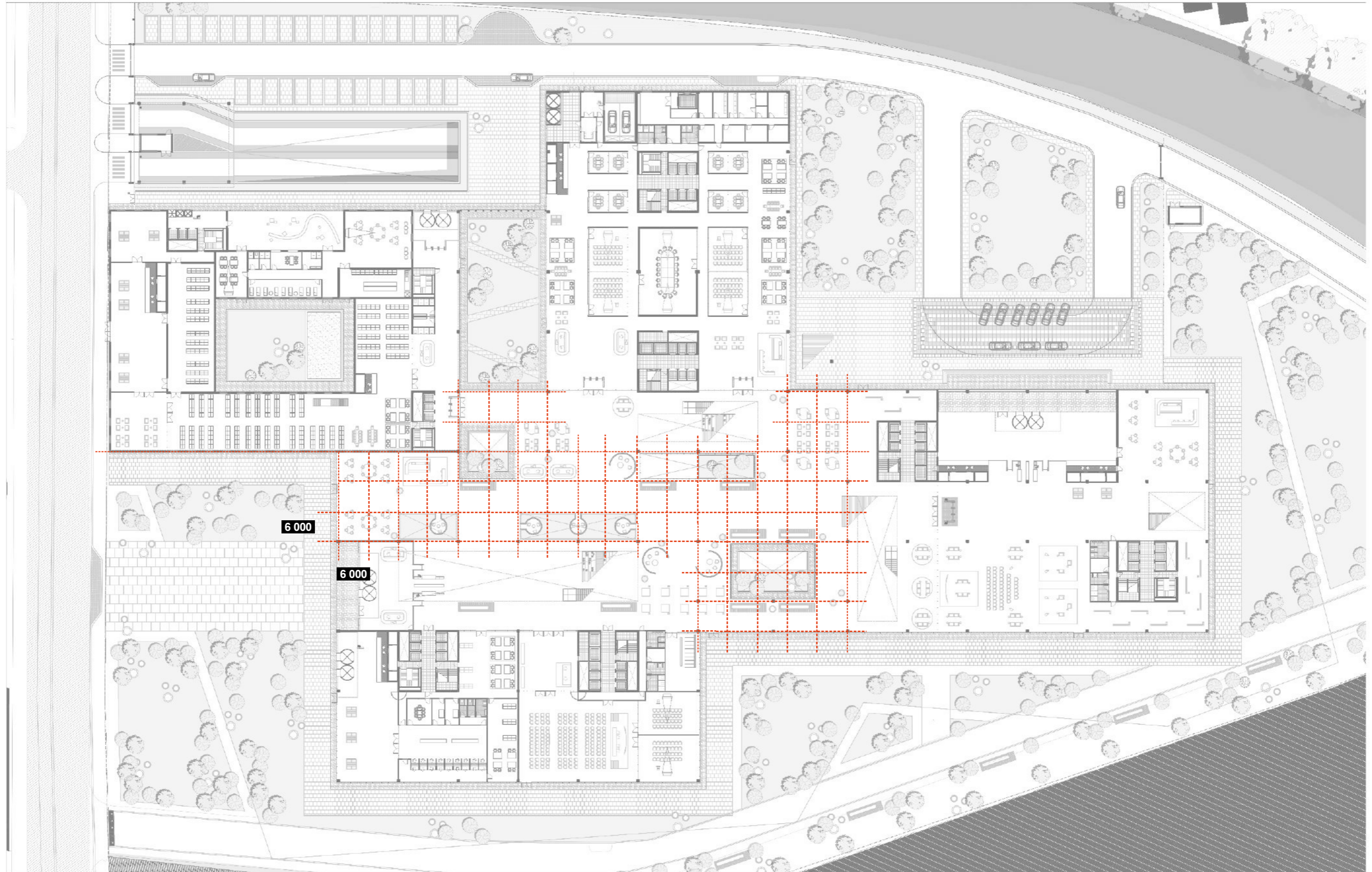

Development
Construction grid ground floor

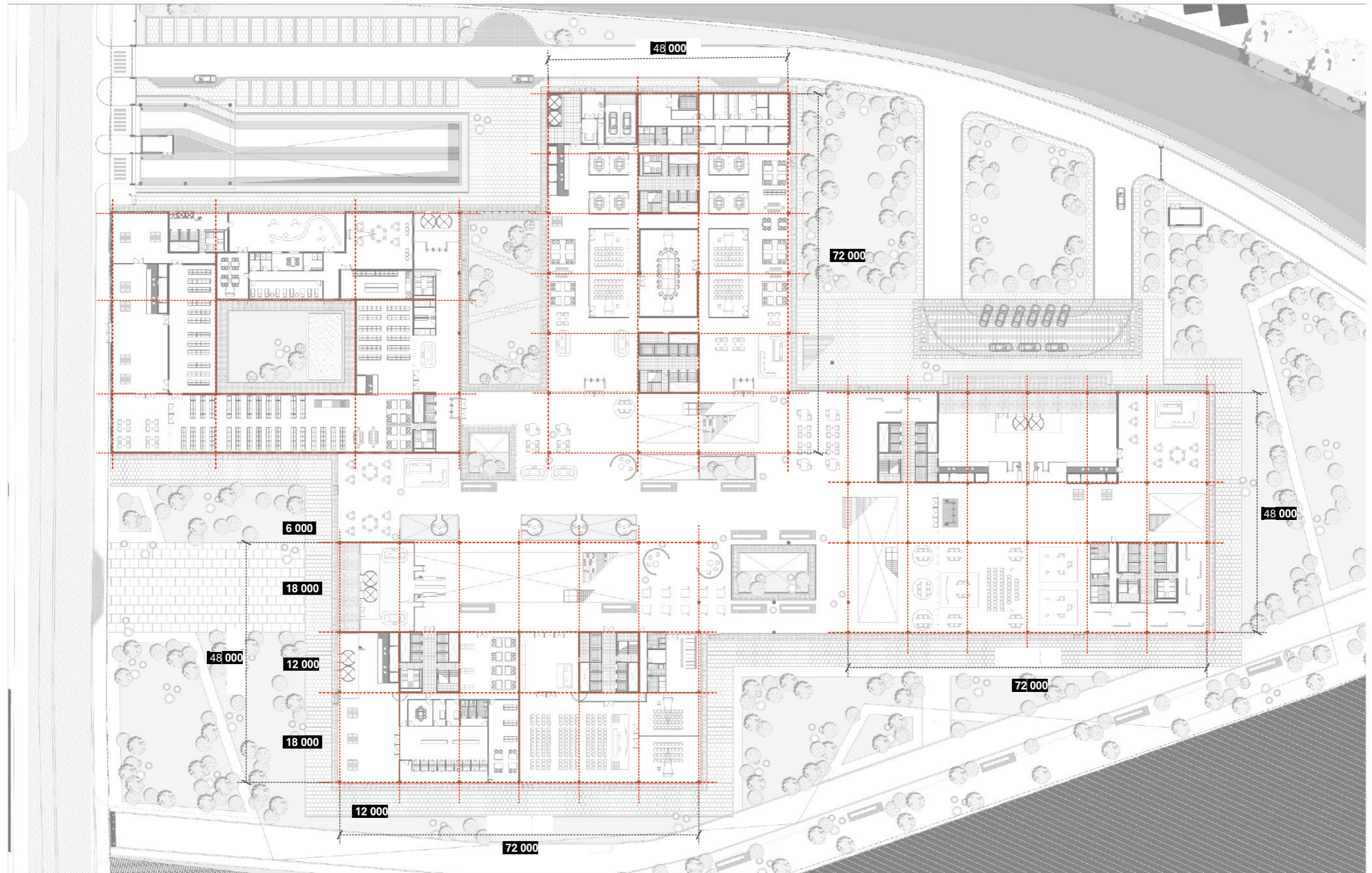

Development
Structural concept

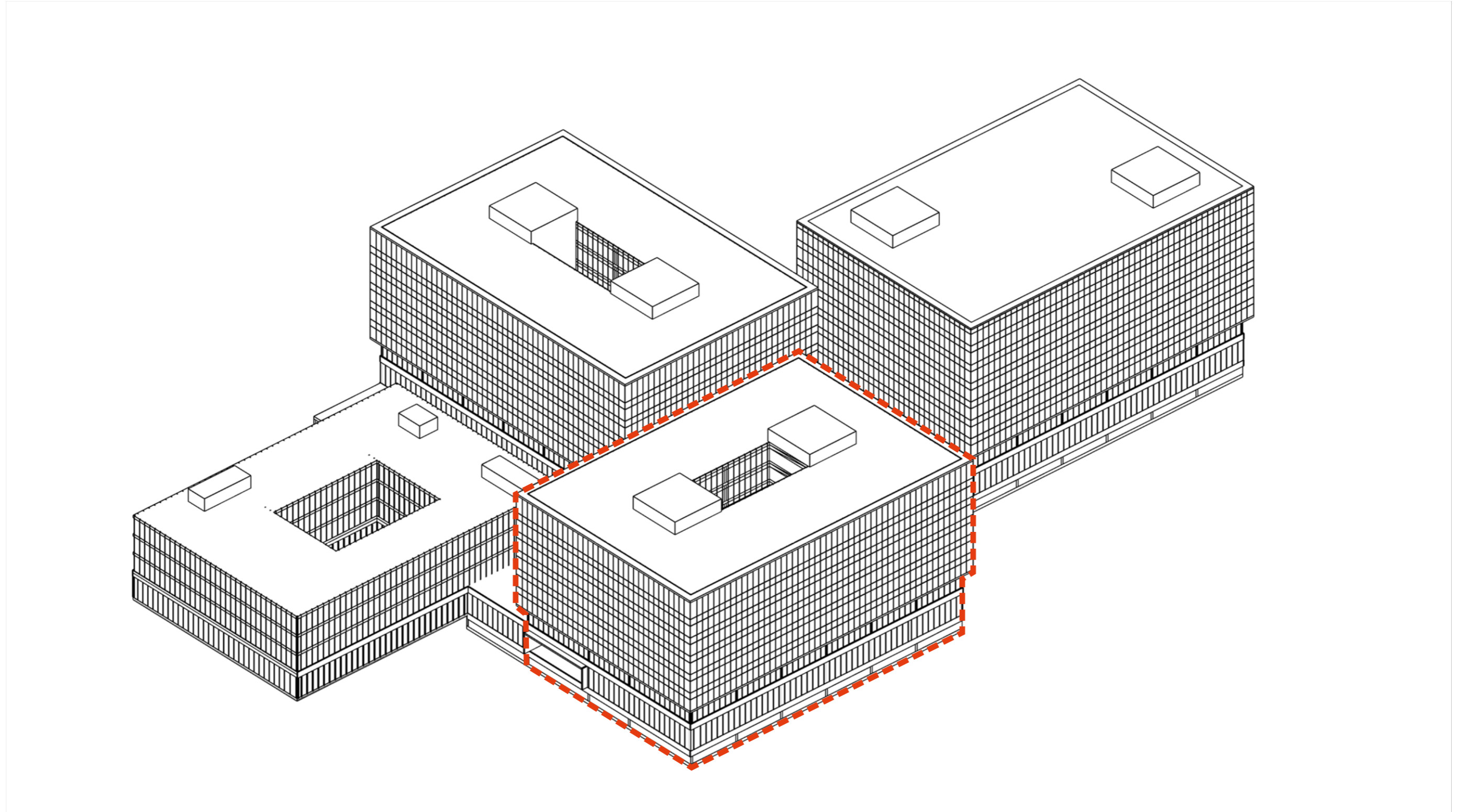

Development
Structural concept

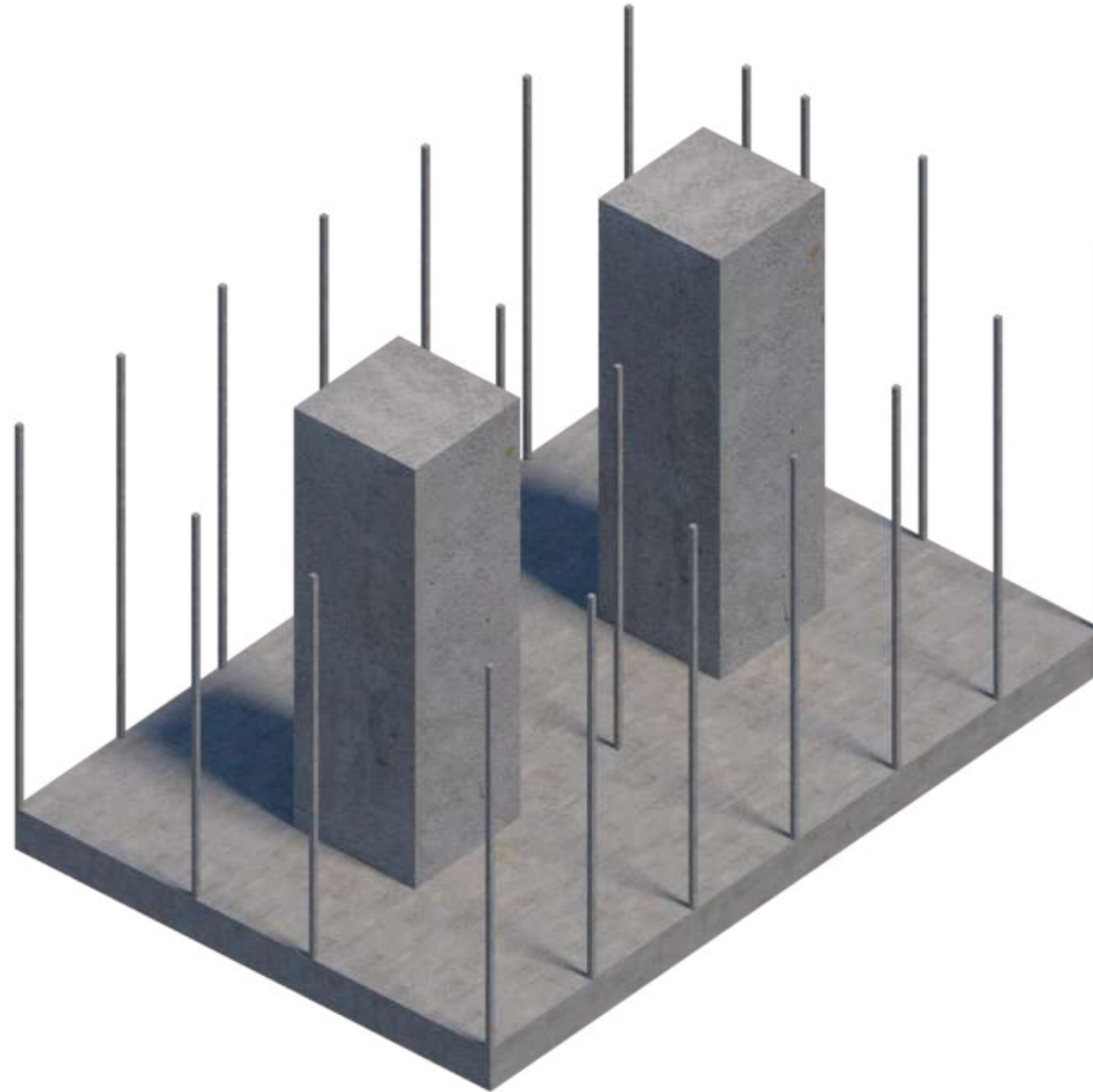

Development
Structural concept

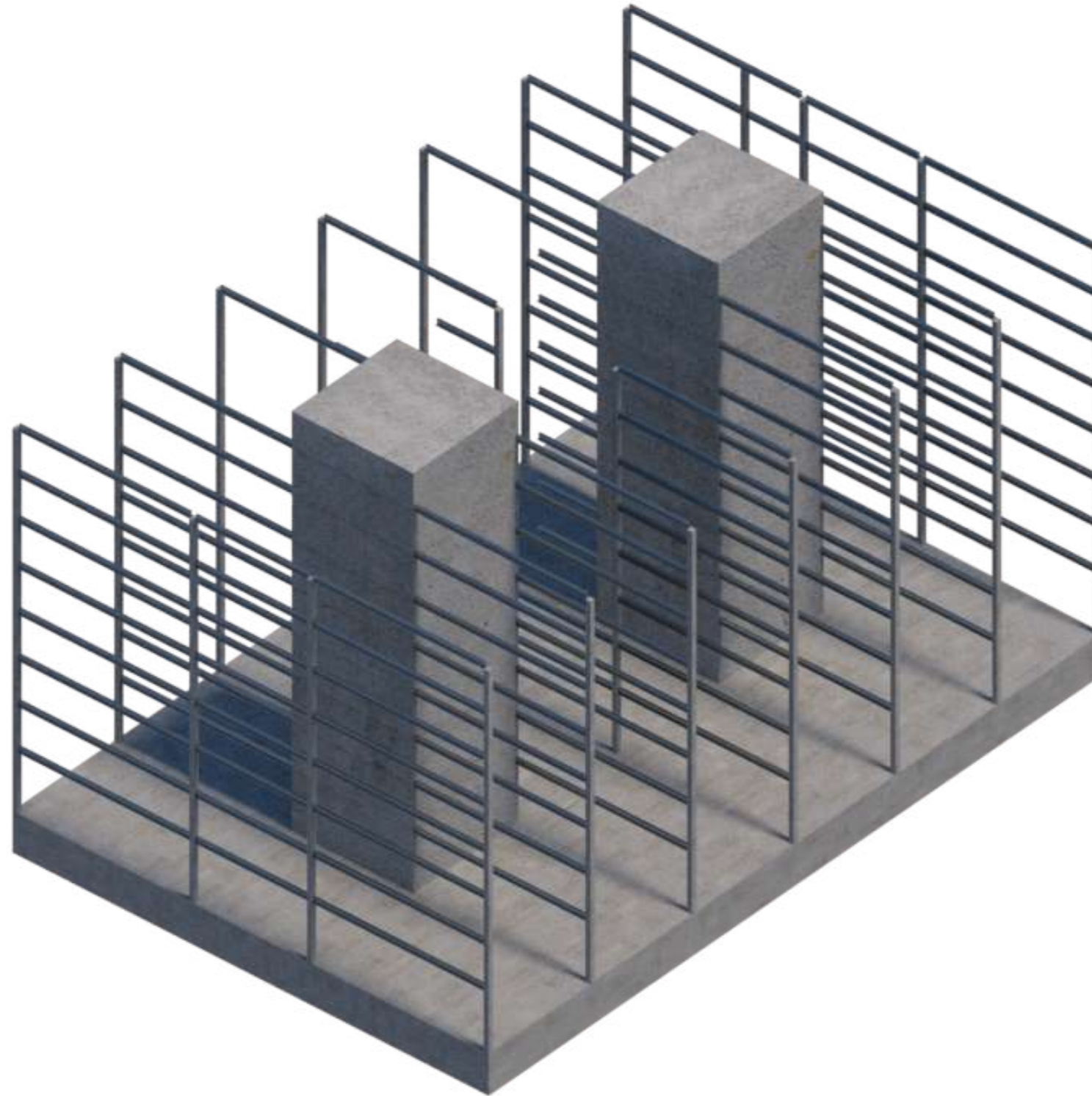

Development
Structural concept

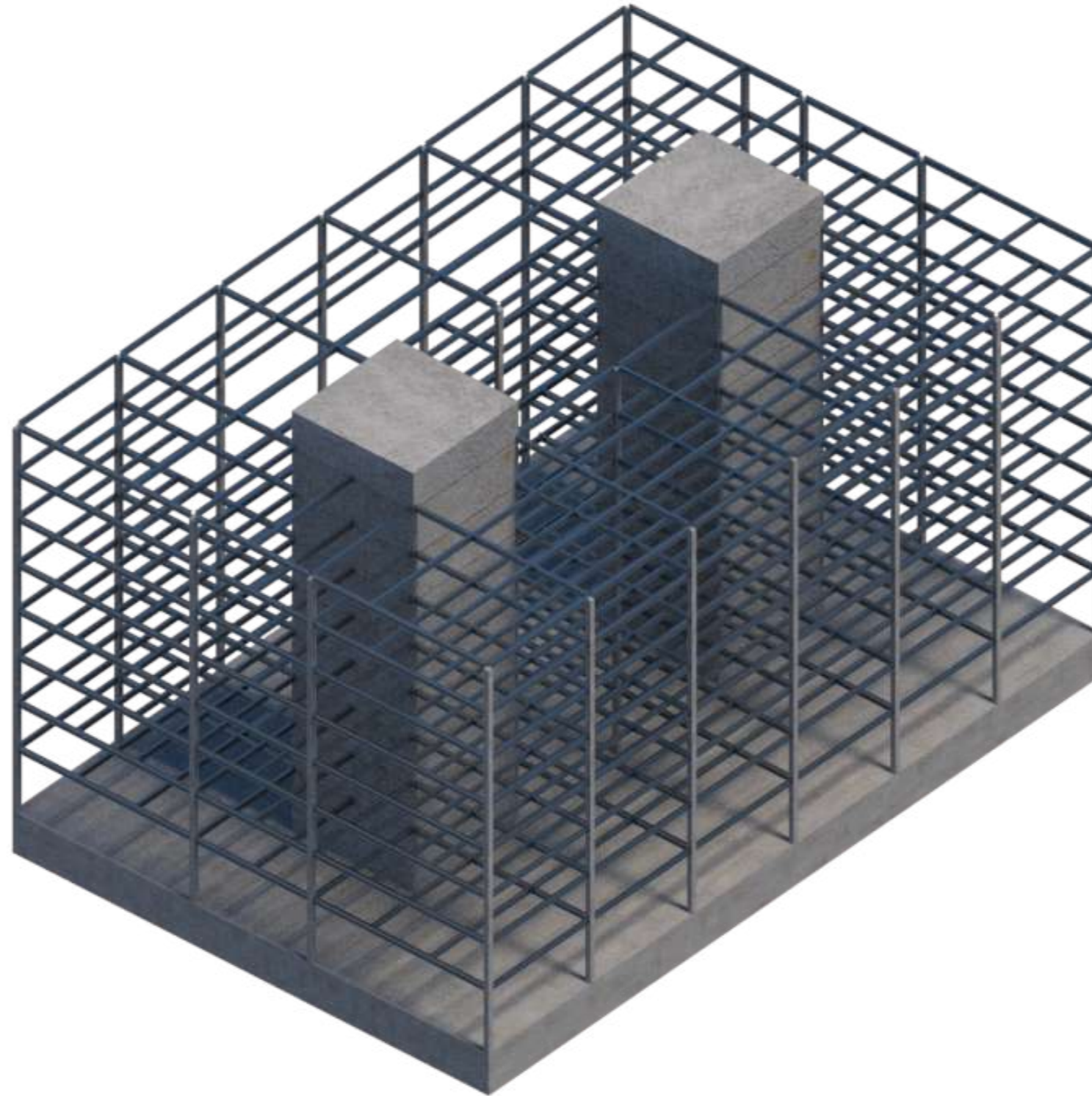

Development
Structural concept

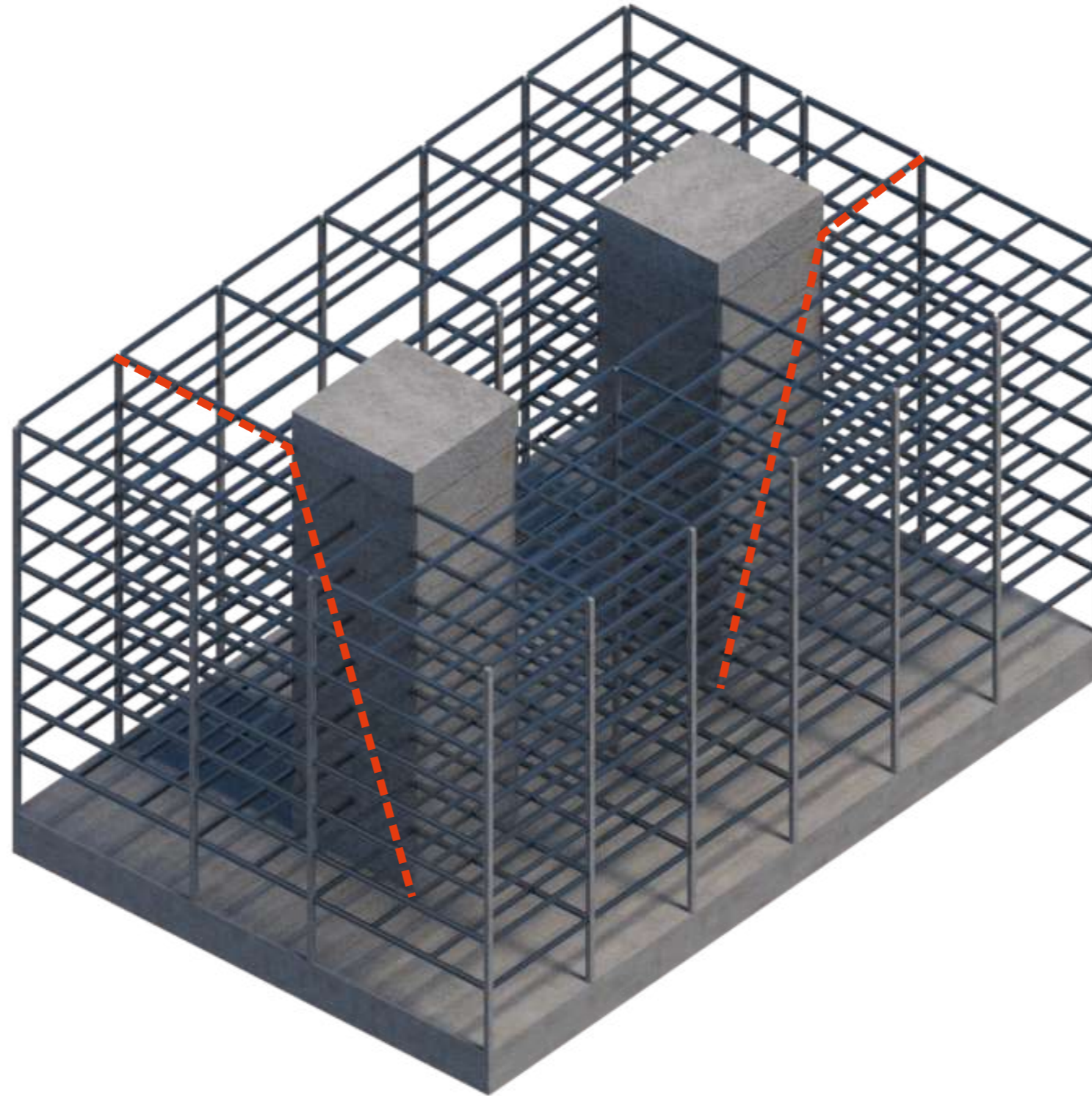

Development
Structural concept

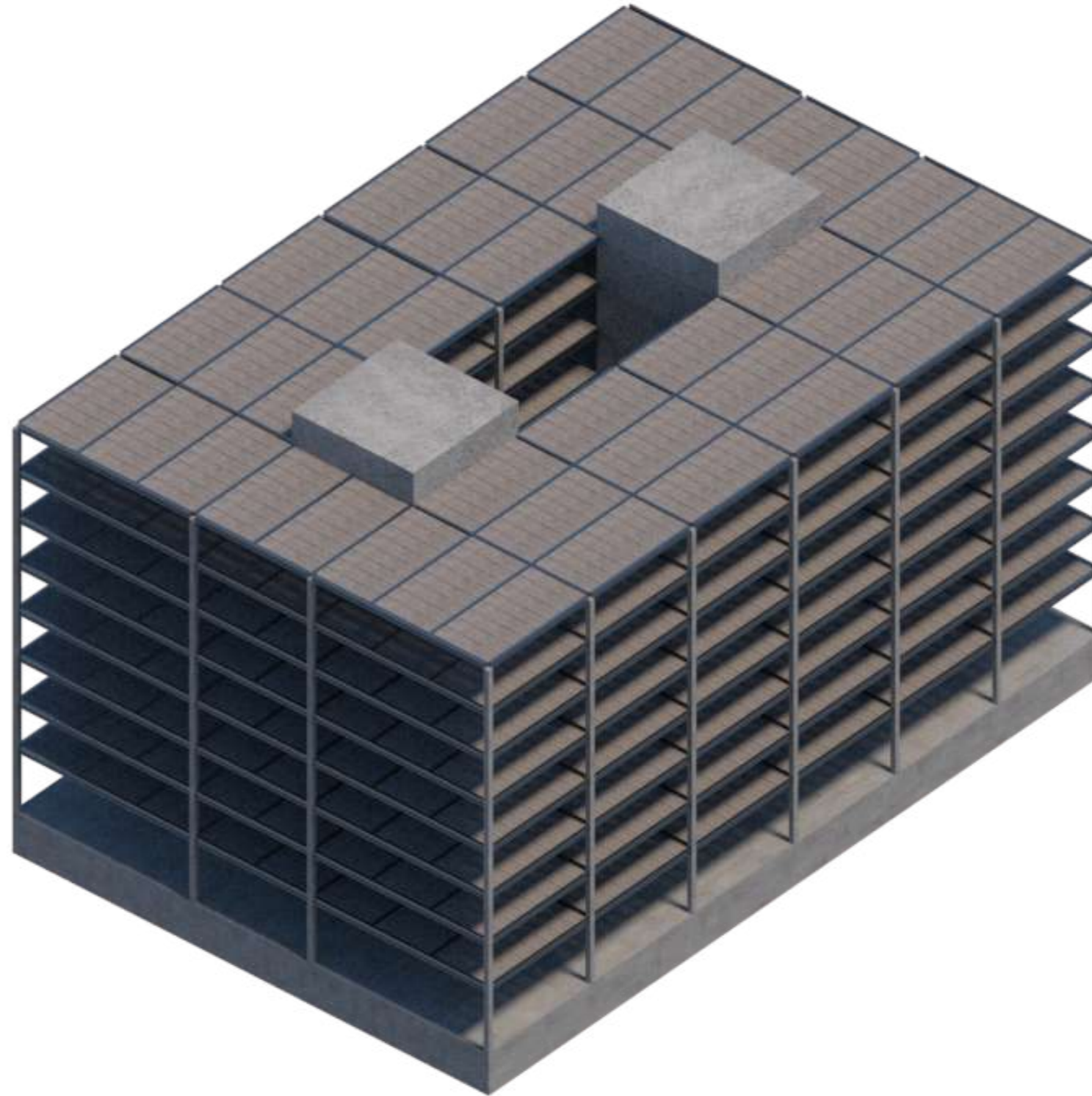

Development
Structural concept

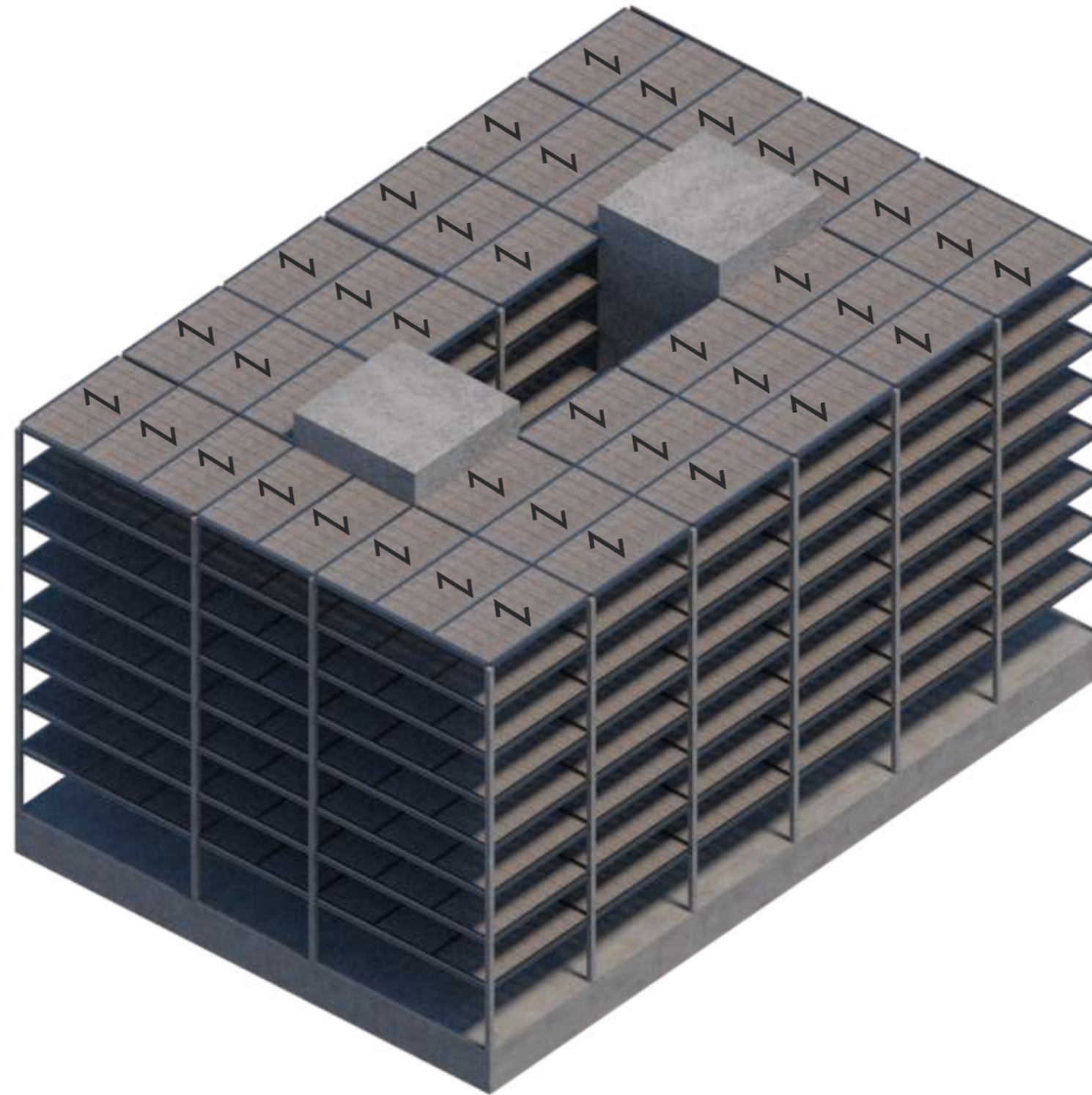

Development
Structural concept

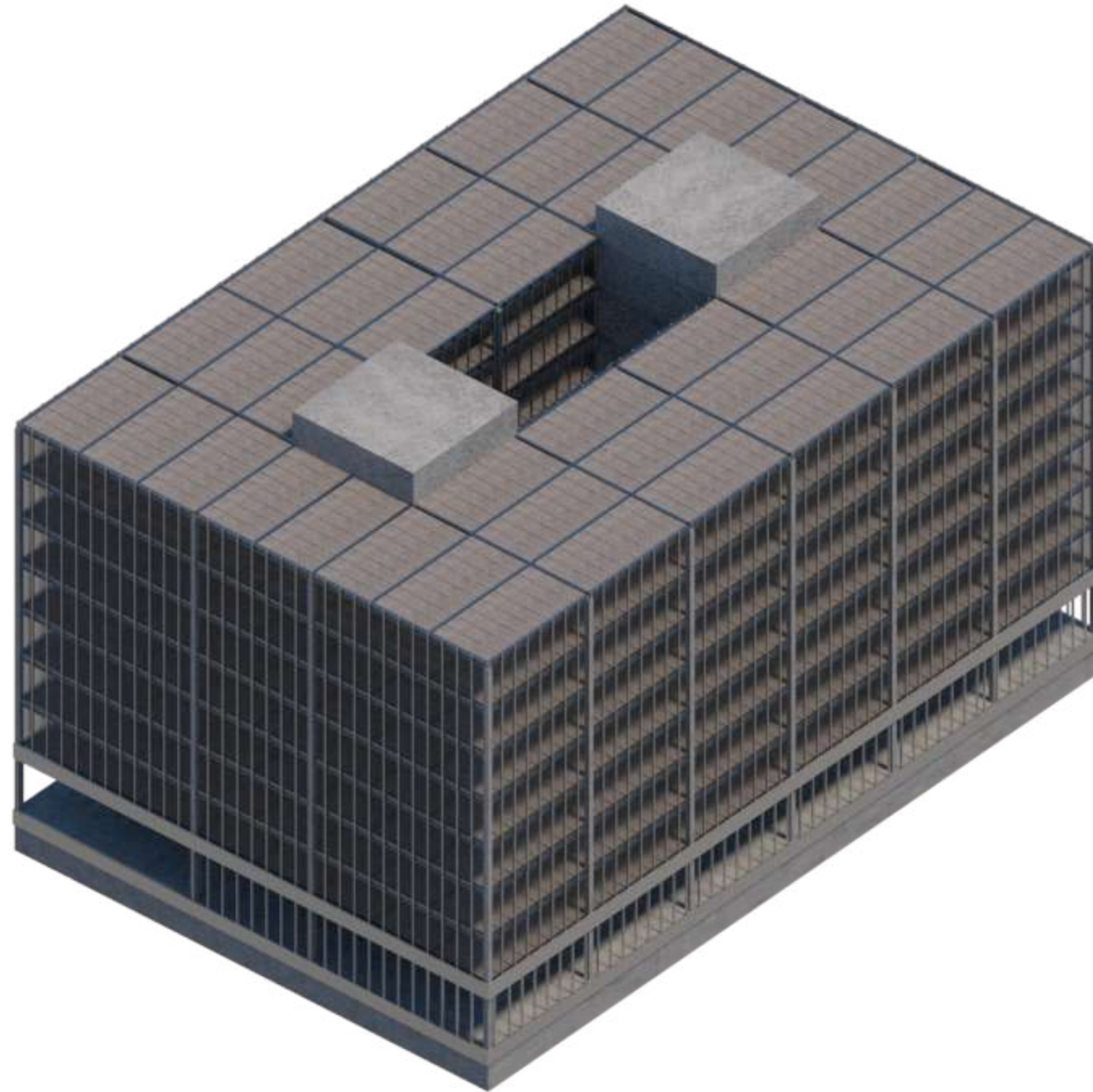

Development
Structural concept

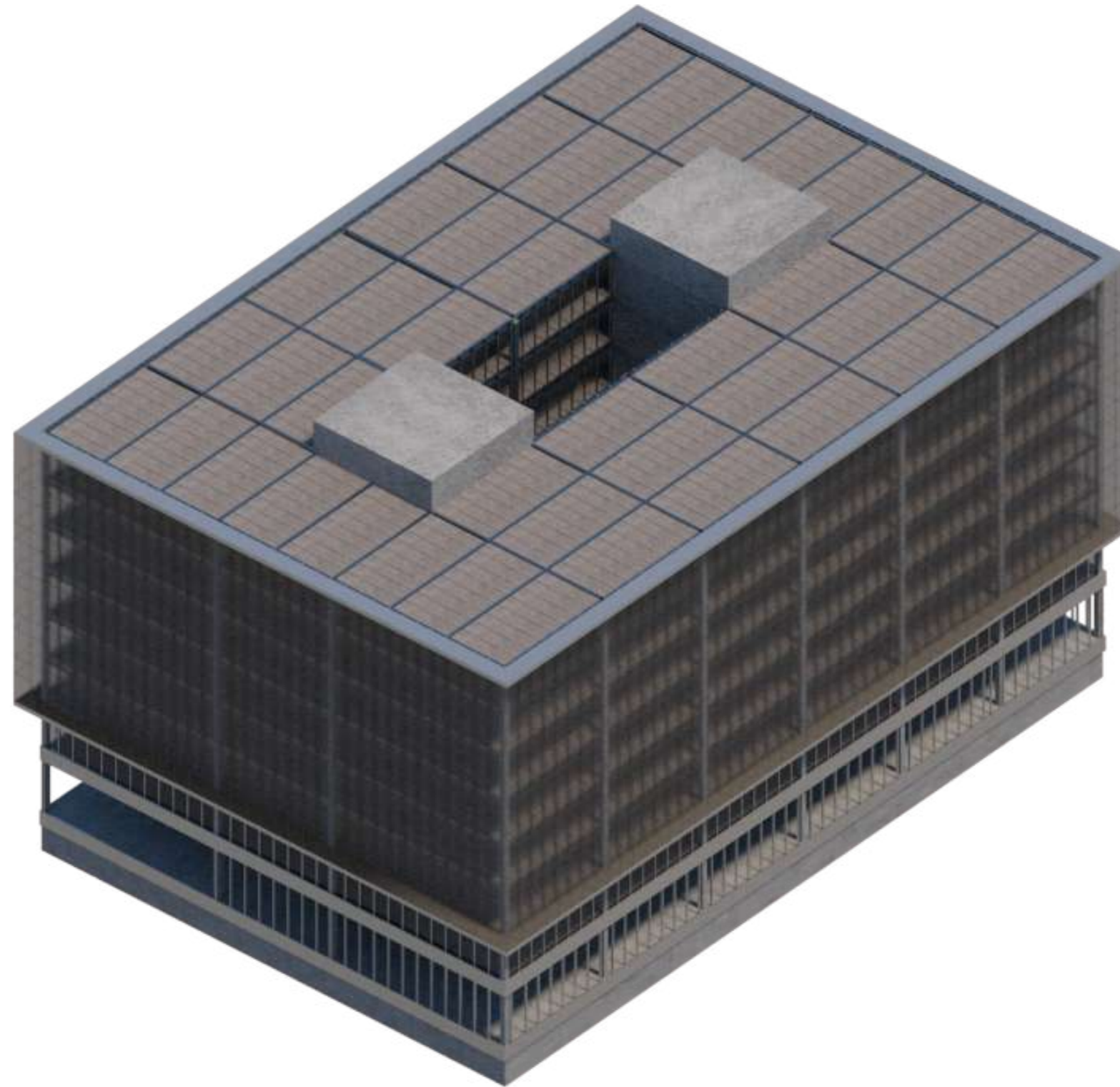

Fire compartment and escape route

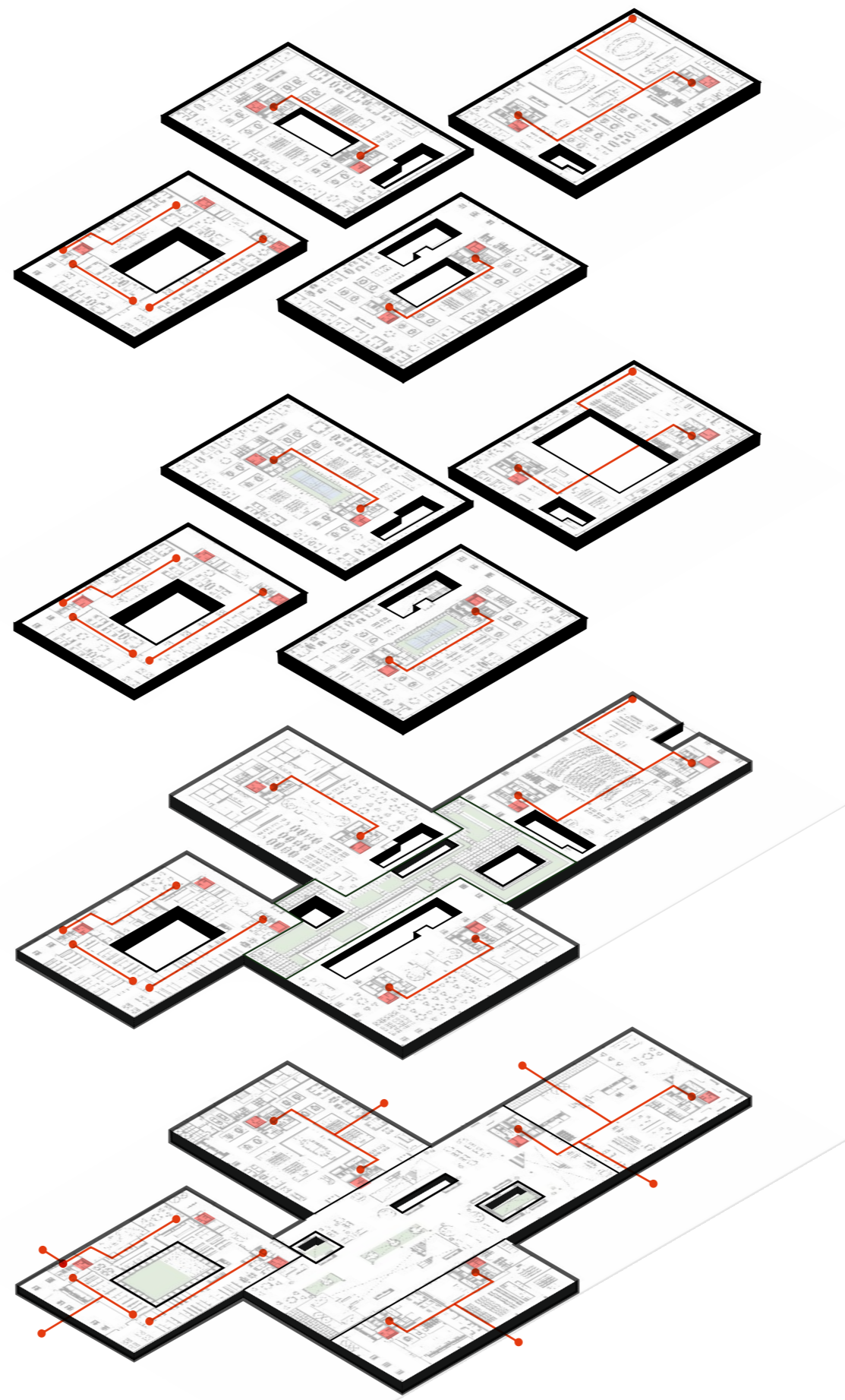

- ESCAPE ROUTE
- ESCAPE STAIR

Development Section

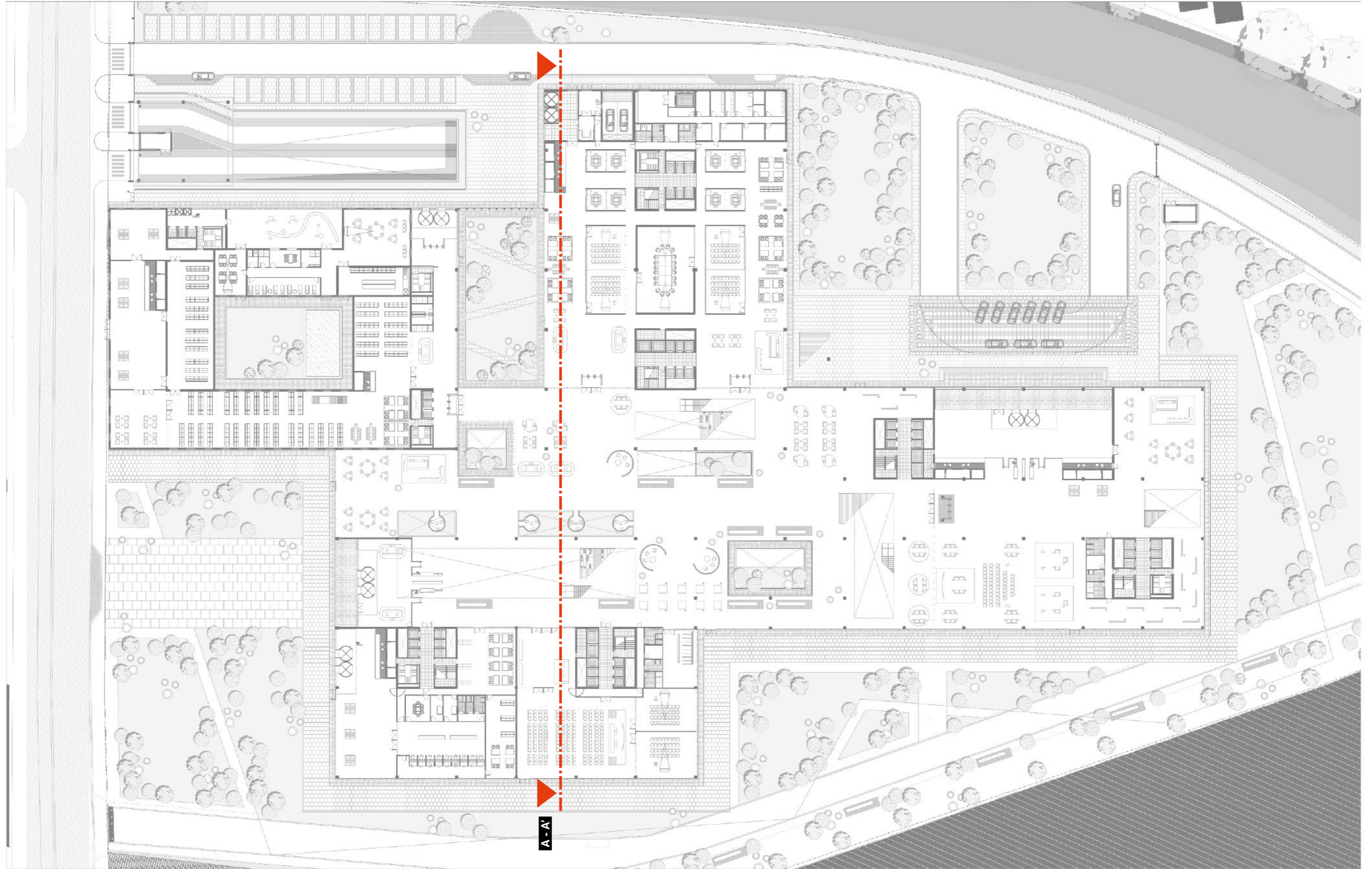

Development
Section 1:50

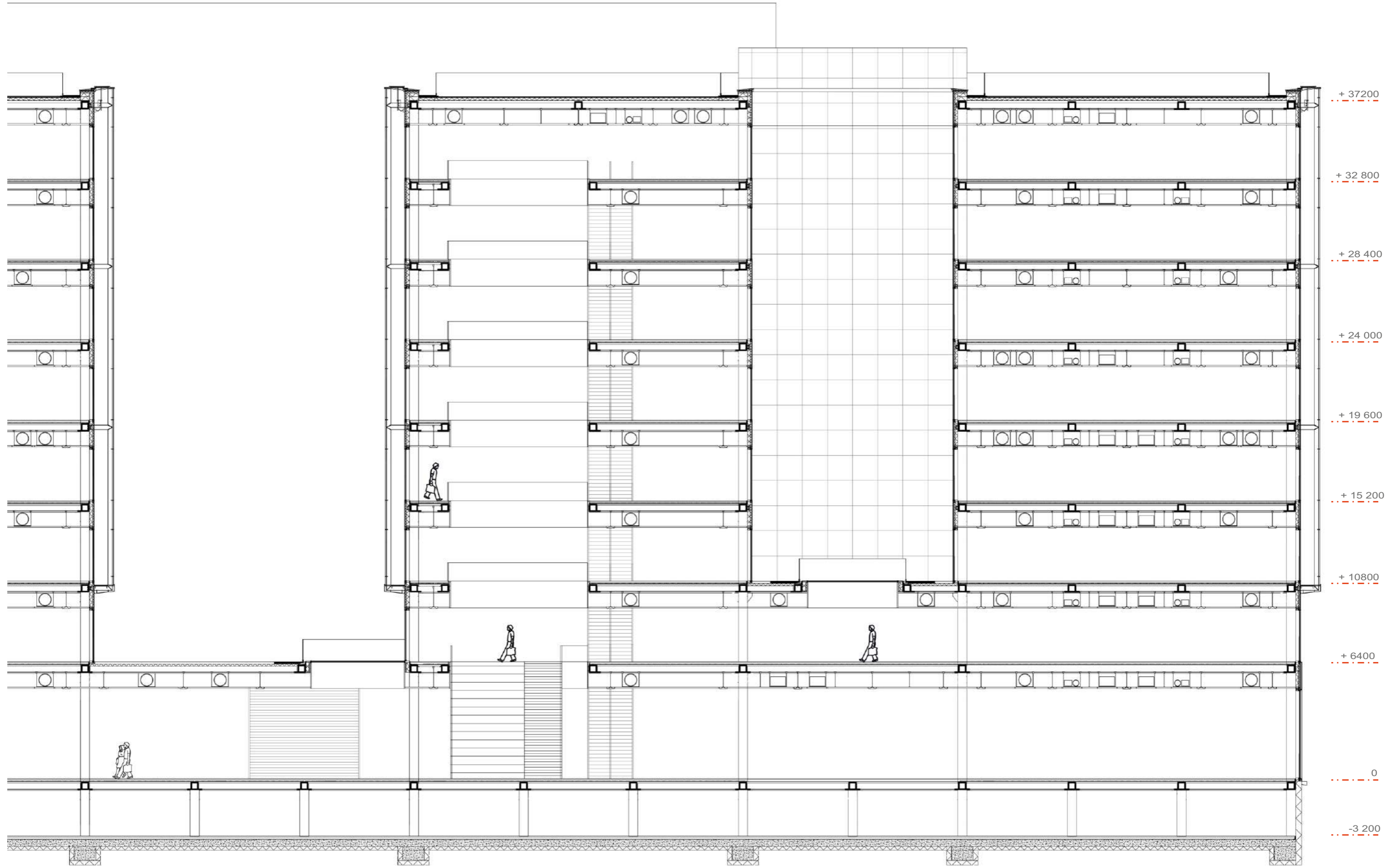

Development
Materialization



Development
Materialization

Interiour



Granite



Wood



Marble

Extariour



Stainless steel



Curtain wall



Green roofing

Development
South facade

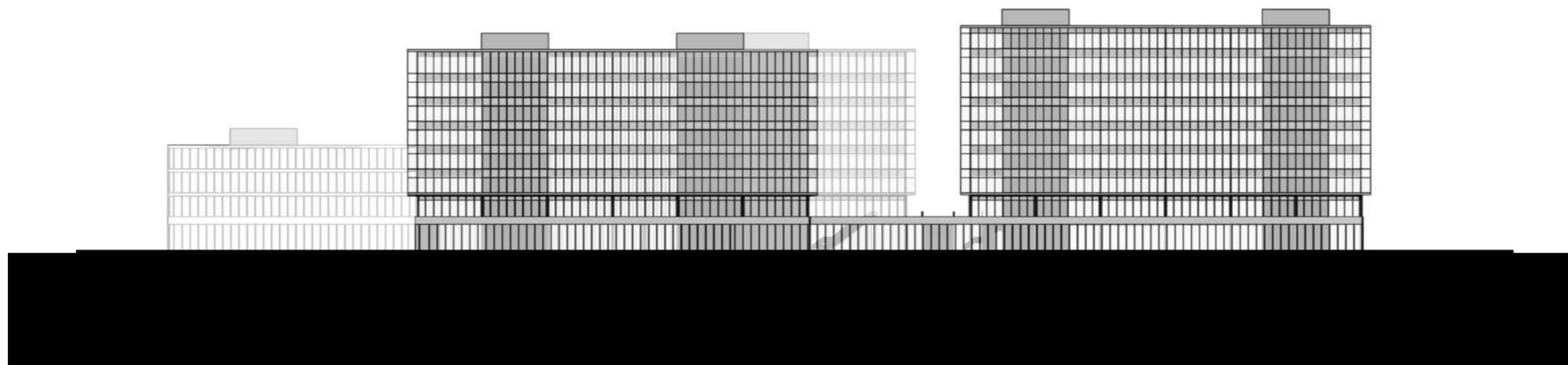
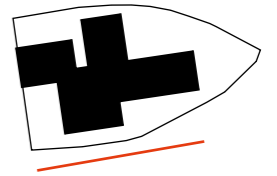

Stainless steel
facade elements



Curtain wall



Natural stone
outdoor tiles



Green roofing

Development
East facade

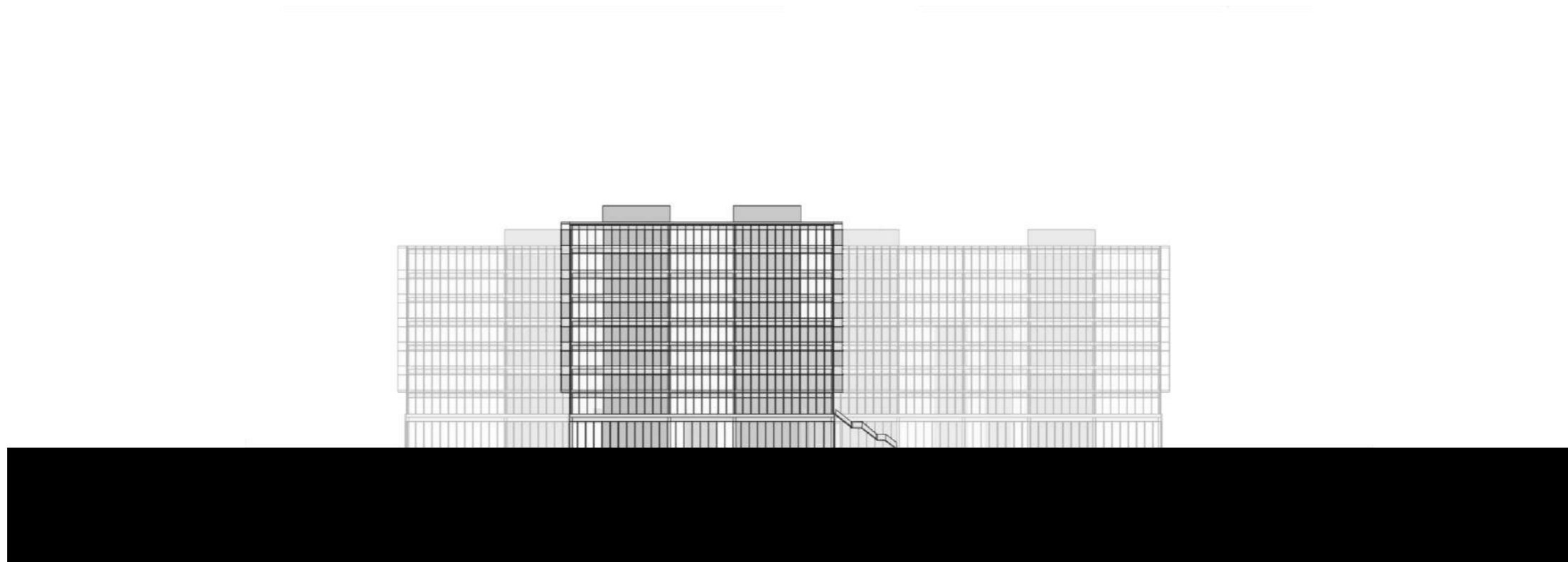
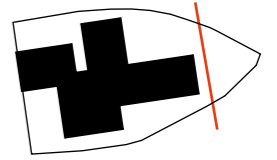

Stainless steel
facade elements



Curtain wall



Natural stone
outdoor tiles



Green roofing

Development
North facade

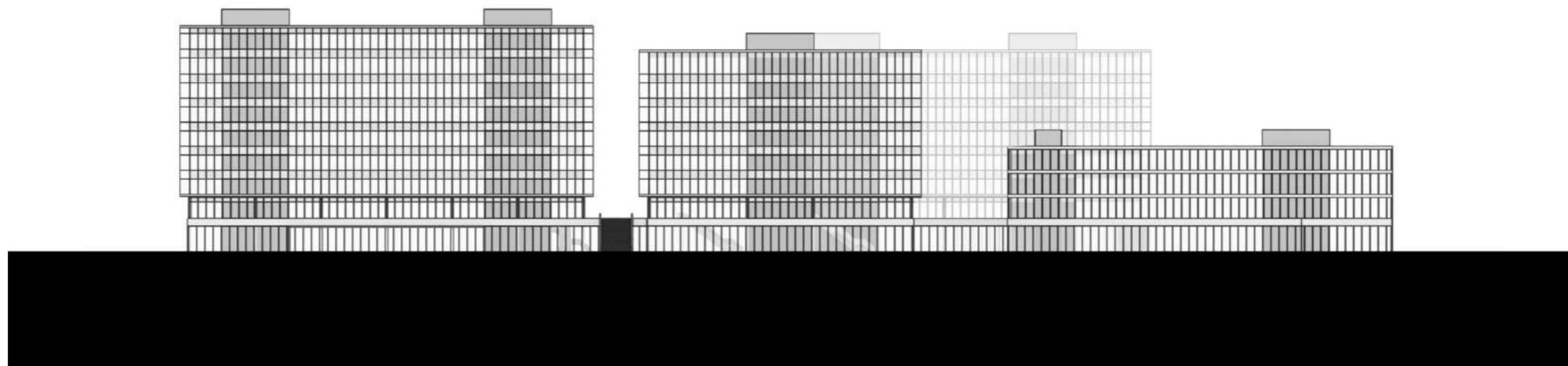
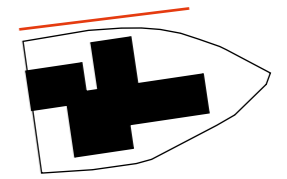

Stainless steel
facade elements



Curtain wall



Natural stone
outdoor tiles



Green roofing

Development
West facade

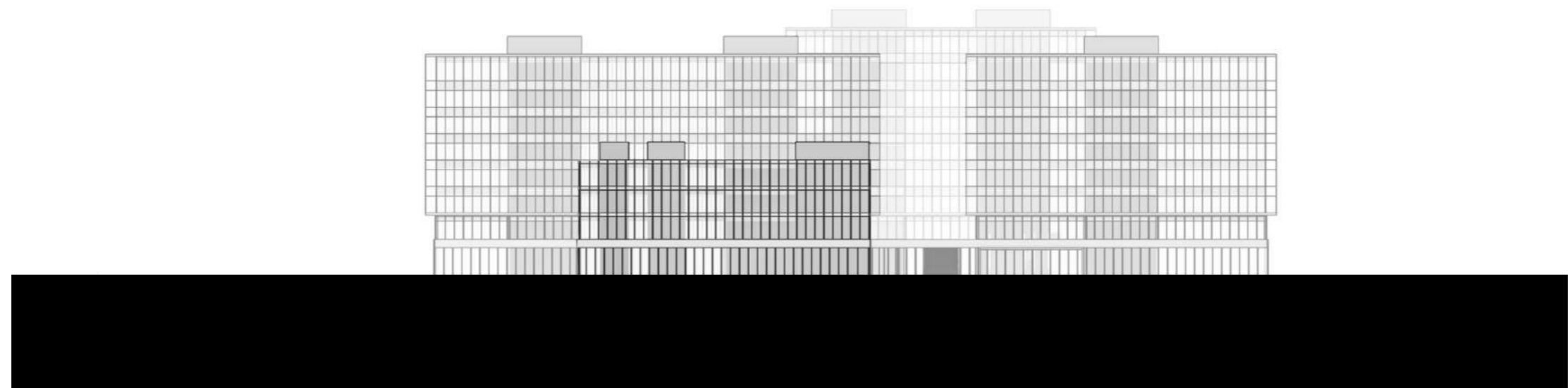
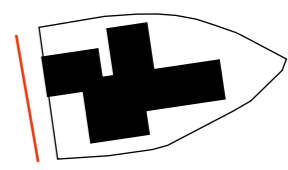

Stainless steel
facade elements



Curtain wall



Natural stone
outdoor tiles



Green roofing

Development
Section 1:20

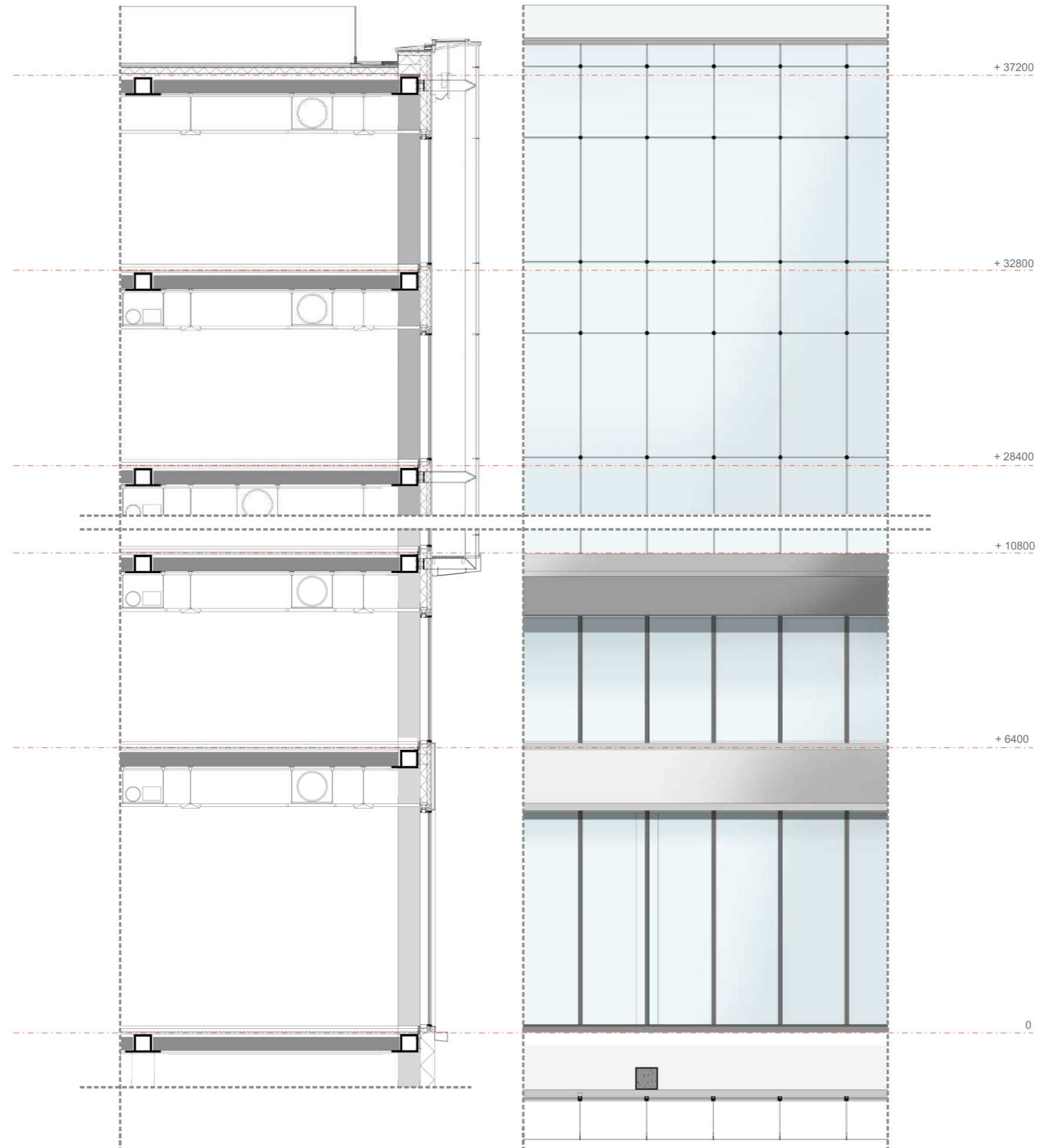

Implementation
Facade impression



Development

Thinking 10 Years Ahead

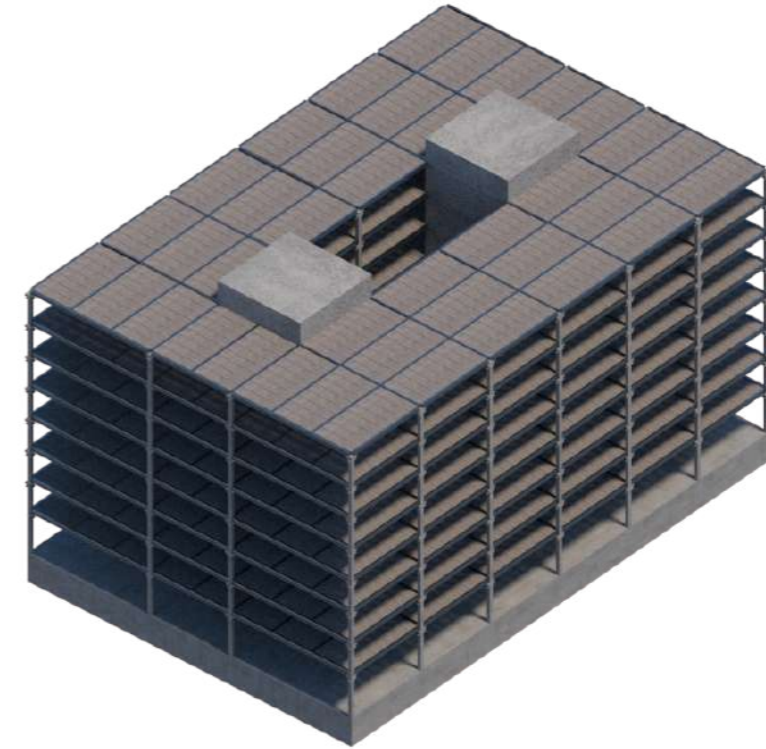
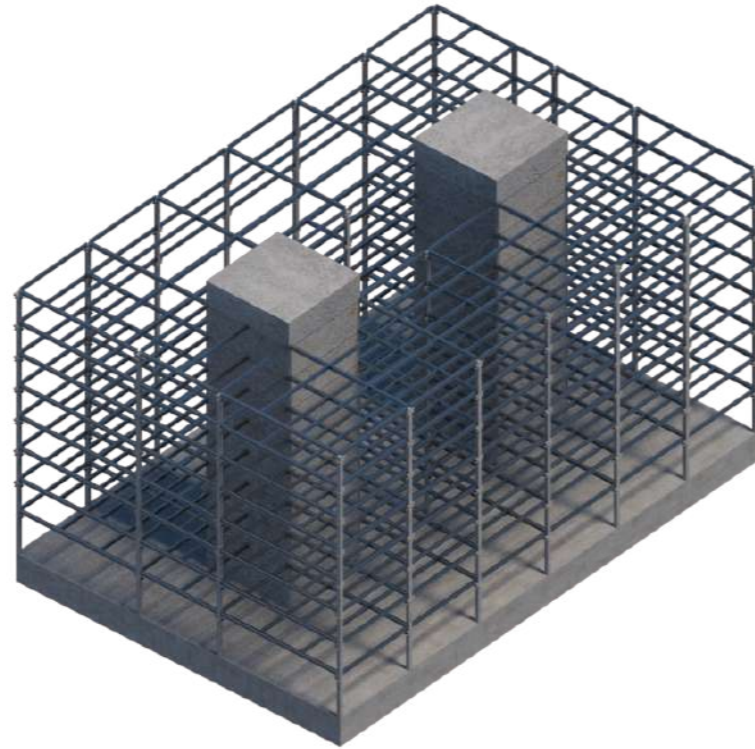

TRANSFORMATION POSSIBILITIES OF A FLOOR PLAN

Development Climate

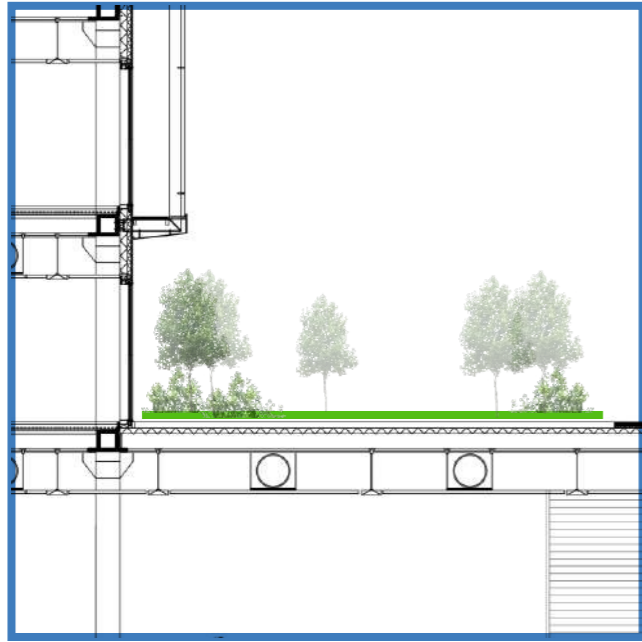

Green podium with a water collection
Natural light via atriums and courts

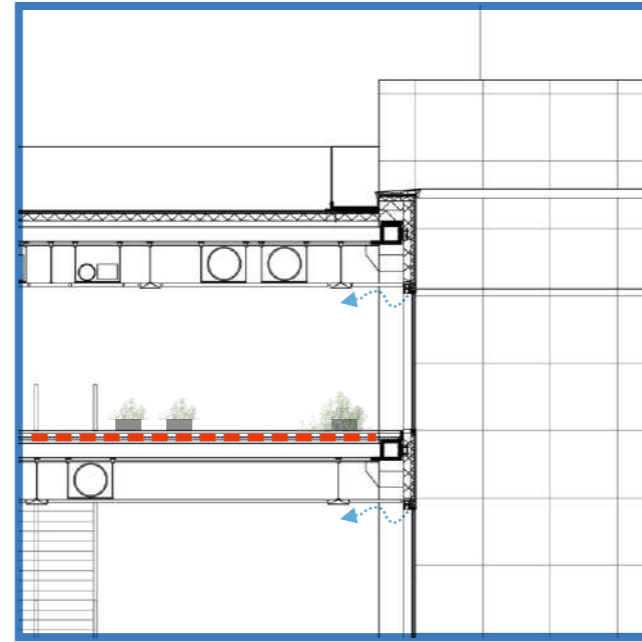

Triple solar glazing
Inner vegetation
Hanged sealing for heating and cooling
Acoustic absorption

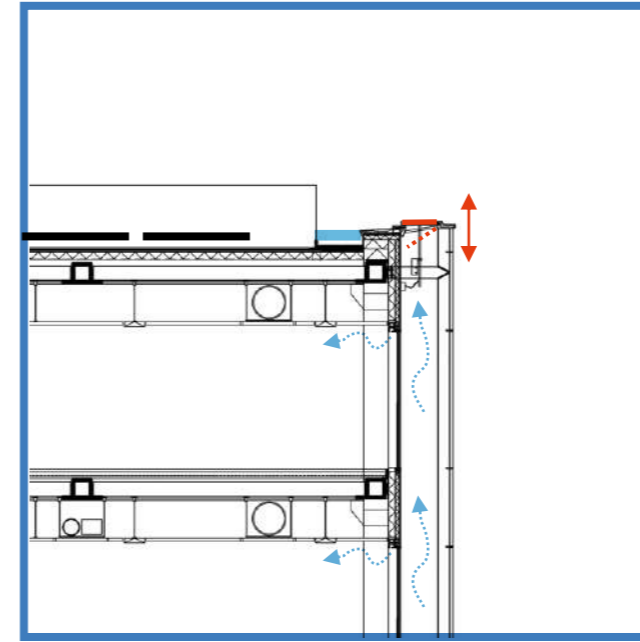

PV panels above roof
Rainwater collection on the roof
Ventilated facade

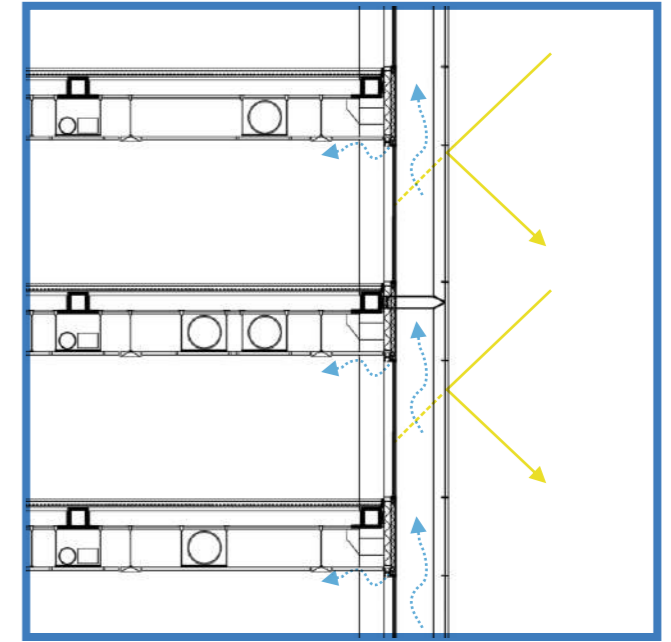

Triple solar glazing
Ventilated facade

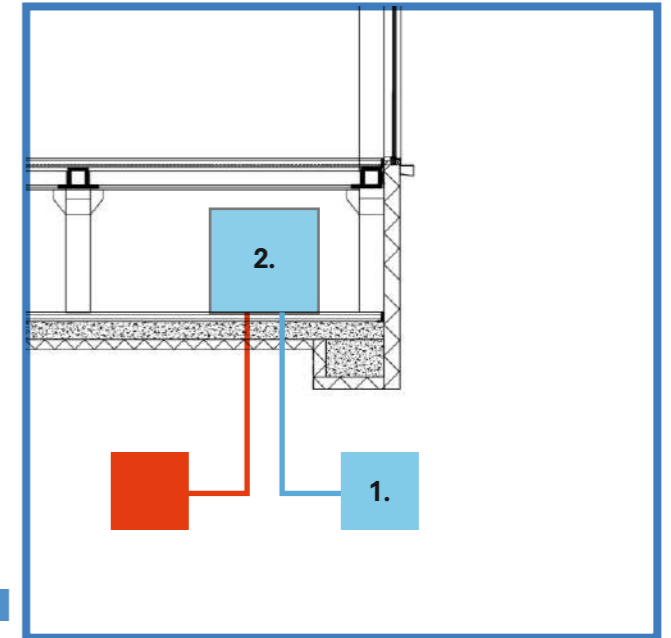
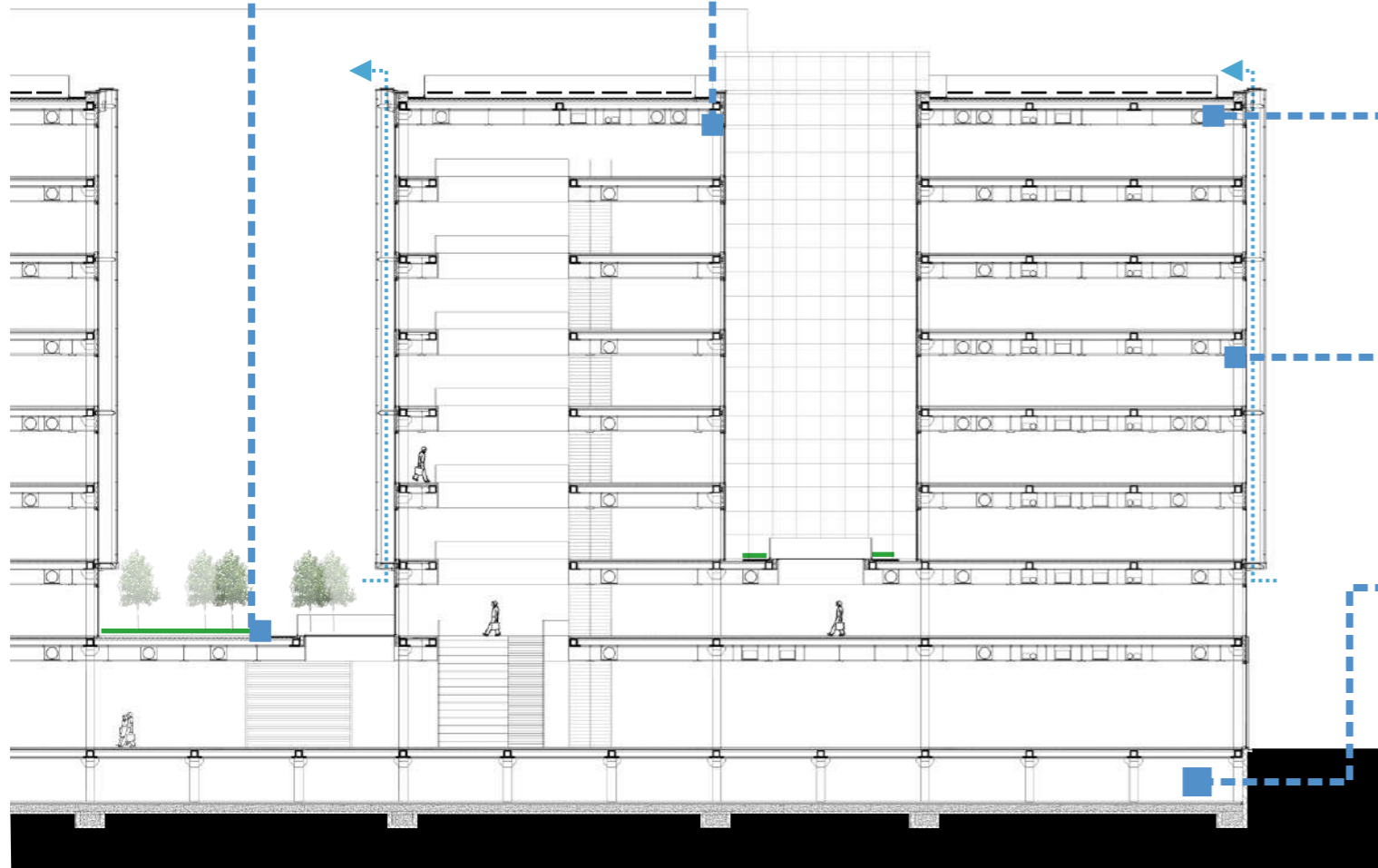

1. Geothermal energy storage
2. Heat pumps for heating and cooling

Implementation
Climate

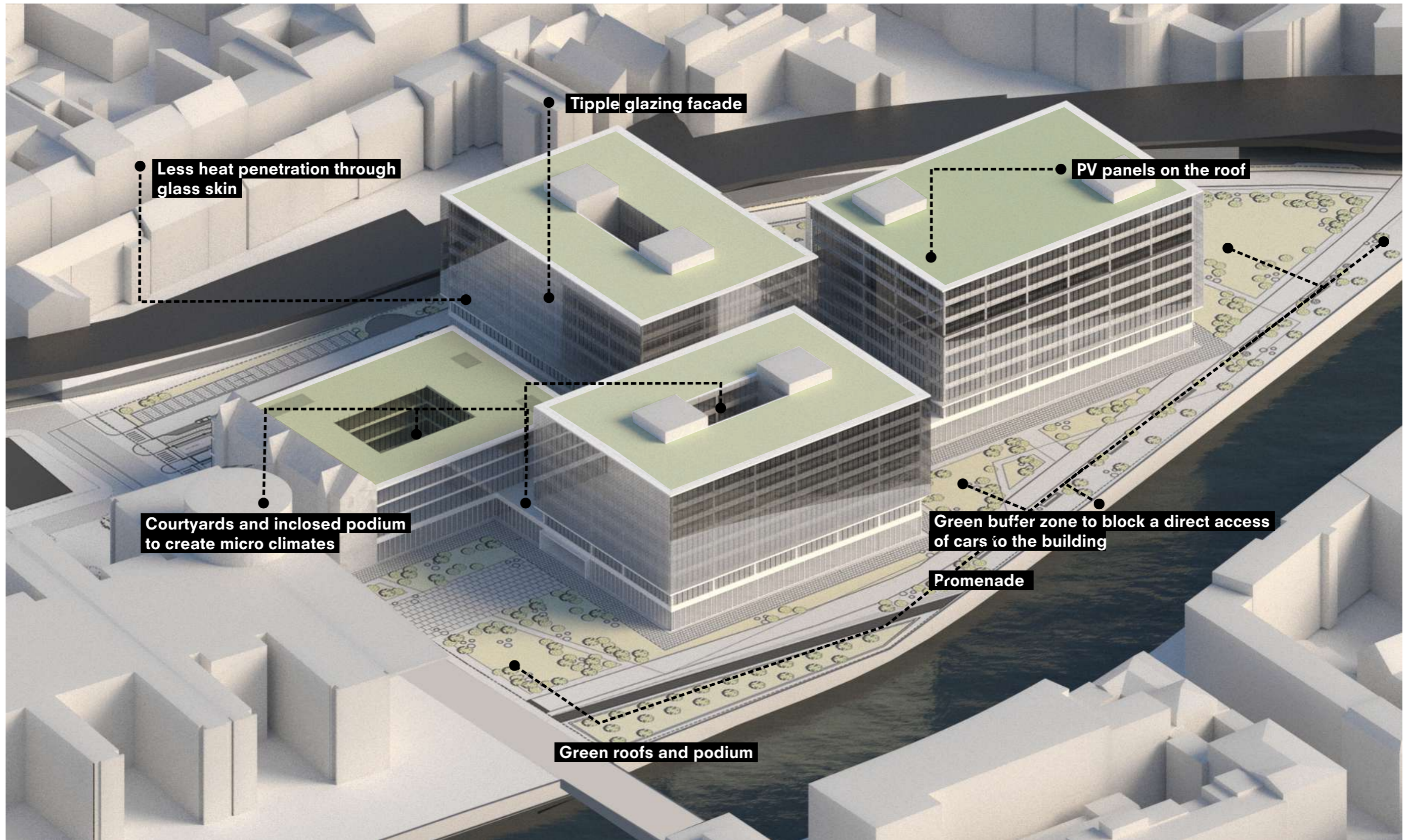

1. INTRODUCTION

2. RESEARCH

3. DESIGN

**CONCEPT
IMPLEMENTATION
DEVELOPMENT**

5. CONCLUSION

Research question

How does servant space evolve in the government building
to increase architectural performance?

Implementation
Federal Foreign Office, Berlin



Implementation
Federal Foreign Office, Berlin



Implementation
Federal Foreign Office, Berlin



Implementation
Federal Foreign Office, Berlin



Thank you