

FinFix: A Soft Gripper With Contact-Reactive Reflex for High-Speed Pick and Place of Fragile Objects

Heeringa, W.M.; Della Santina, C.; Smit, G.

DOI

[10.1109/RoboSoft55895.2023.10122107](https://doi.org/10.1109/RoboSoft55895.2023.10122107)

Publication date

2023

Document Version

Final published version

Published in

Proceedings of the IEEE International Conference on Soft Robotics, RoboSoft 2023

Citation (APA)

Heeringa, W. M., Della Santina, C., & Smit, G. (2023). FinFix: A Soft Gripper With Contact-Reactive Reflex for High-Speed Pick and Place of Fragile Objects. In *Proceedings of the IEEE International Conference on Soft Robotics, RoboSoft 2023* IEEE. <https://doi.org/10.1109/RoboSoft55895.2023.10122107>

Important note

To cite this publication, please use the final published version (if applicable). Please check the document version above.

Copyright

Other than for strictly personal use, it is not permitted to download, forward or distribute the text or part of it, without the consent of the author(s) and/or copyright holder(s), unless the work is under an open content license such as Creative Commons.

Takedown policy

Please contact us and provide details if you believe this document breaches copyrights. We will remove access to the work immediately and investigate your claim.

Green Open Access added to TU Delft Institutional Repository

'You share, we take care!' - Taverne project

<https://www.openaccess.nl/en/you-share-we-take-care>

Otherwise as indicated in the copyright section: the publisher is the copyright holder of this work and the author uses the Dutch legislation to make this work public.

FinFix: a soft gripper with contact-reactive reflex for high-speed pick and place of fragile objects

Willem Heeringa, Cosimo Della Santina, Gerwin Smit

Abstract—Industrial automation calls for precise tasks with cycle times reduced to the minimum. At the same time, when handling delicate products such as fruits and vegetables, accelerations must be kept low to keep interaction forces under a certain threshold to avoid damage. This trade-off hinders the penetration of automation in many relevant application fields. This paper investigates using soft technology to solve this challenge. We propose the FinFix gripper, a non-anthropomorphic soft gripper capable of handling delicate objects at high acceleration using a contact-reactive grasping approach. This gripper has two entirely passive sensorized fingers that establish contact and two active fingers that are actuated pneumatically through a rigid mechanism allowing for rapid closure. We provide exhaustive experimental validation by connecting the gripper to a delta robot. The system can reliably execute pick-and-place cycles in ~ 1 s when the distance between the pick and the place locations is 400 mm, resulting in a peak speed of $\sim 10 \frac{m}{s}$. None of the fragile objects used during the experiments showed any damage. The only information needed is a rough estimation of the object's position to be grasped and a contact event to trigger the reflex. The test results show that the gripper can hold fragile objects during lateral accelerations of 10 g.

I. INTRODUCTION

Many objects that we handle in our daily life are not infinitely rigid, and can be easily damaged if exposed to too much mechanical pressure. Examples include brittle objects, like a light bulb, and objects of which the quality can degrade, like fruits and vegetables. Handling such delicate objects is still an open challenge in robotics, with clear real world implications. Soft grippers have been proposed as an effective solution to the challenge of handling these objects [1], [2]. Examples include grippers for food and vegetables [3], deformable objects [4], and general purpose universal grippers [5], [6].

However, in order for these grasping solutions to be employed in realistic pick-and-place automation scenarios, the grasping operations must be performed reliably and with high speed, i.e. within seconds or less. But, so far, robotic solution for high speed operations have been designed with rigid objects in mind [7]–[10].

To the best of authors' knowledge, the challenge of combining high-speed picking and placing with delicate object grasping is an almost completely unaddressed one.

The work was in part supported under the European Union's Horizon Europe Program from Project EMERGE - Grant Agreement No. 101070918.

W. Heeringa and G. Smit are with the BioMechanical Engineering department, Delft University of Technology, Mekelweg 2, 2628 CD Delft, Netherlands G.Smit@tudelft.nl.

C. Della Santina is with the Cognitive Robotics department, Delft University of Technology, Mekelweg 2, 2628 CD Delft, Netherlands. He is also with the Institute of Robotics and Mechatronics, German Aerospace Center (DLR), 82234 Weßling, Germany C.DellaSantina@tudelft.nl

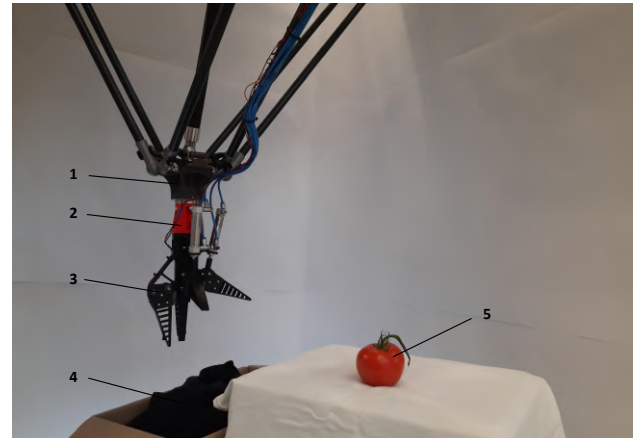

Fig. 1: With this paper we aim to prove that soft grippers can be used to perform extremely fast pick and place of delicate objects. The picture shows the proposed FinFix gripper attached to a delta robot (ABB IRB 360-8/1130 FlexPicker), ready to perform the grasping task. The following elements are highlighted in the picture: 1. Delta robot's proximal part, 2. Adapter flange, 3. FinFix gripper, 4. Object drop-off location, 5. Object to be grasped (a tomato in this case).

An exception is [11], where a silicon-based soft gripper grasps sushi and fried chicken with maximum speed $\sim 1 \frac{m}{s}$. Another exception comes from industry. It is the commercial gripper from Soft Robotics Inc [12]. Inspecting videos of their products, we could see that they their approach is to minimize contact forces by first positioning the gripper above the object, stop it, and then moving it down to grasp the object. This stationary time and 2D positioning can potentially cost much time and requires a precise vision system [13]. More importantly, also for this gripper we could find no example of handling very delicate objects like eggs, tomatoes, or light bulbs.

The goal of the present work is to fill this gap, by proposing and testing a gripper that is capable of handling deformable and delicate objects at high acceleration (≥ 10 g). The gripper should be capable to grasp objects while moving, using a contact-reactive grasping approach. We call this device FinFix. Fig. 1 shows the proposed non anthropomorphic gripper connected to a delta robot, ready to perform the pick-and-place of a tomato. FinFix has four soft FinRay fingers [14], [15], two passive fingers are fixed to the gripper base and sensorized, and two active fingers are actuated and sensor-less.

We discuss the design of FinFix in Secs. II and III, and introduce a simple reflex-based grasping strategy in Sec. IV. We validate the gripper in Sec. V, and we perform experiments with the whole system in Sec. VI. Finally, Sec. VII draws

the conclusion on this work.

II. DESIGN SPECIFICATIONS

A. Functional Requirements

The requirements can be broken down into three different categories: functional requirements, performance criteria and wishes. Since the end goal is to achieve a functional gripper, the functional requirements are the most important for the design, as they set the boundaries for the design, in order to be feasible based on functionality.

a) Soft Contact: In order to prevent bruising or denting of delicate or deformable objects, the gripper must have a soft contact with the object. A soft contact also helps to increase the contact area between the gripper and the object, thus reducing surface pressure, allowing for a higher gripping force.

b) Holding: The gripper must be able to hold a delicate or deformable object while undergoing 10 g or more of lateral acceleration. The value of 10 g is based on the average value of the maximum acceleration and the preferred acceleration of an Adept Quattro 650H robot [16]. We want to be able to securely hold a medium sized tomato, with a mass of around 123 grams [17]. At 10 g this mass results in a lateral force of 12.1 N that the gripper must be able to withstand, to securely hold the tomato during acceleration.

c) Moving Grasp: Contrary to the standard grasping approach, where the gripper is first placed above the object and then moves downwards to the object, the new gripper must be able to grasp the object while moving in the horizontal plane, approaching the object sideways.

d) Object Size Capacity: The gripper must be able to grasp an object with a size of 70 mm. This is based on the size of a medium to large tomato [18] and is comparable to grippers in literature [19].

e) Maximum Mass: The gripper, including object, can have a maximum mass of 2 kg. For the object mass we take the average mass of a medium, whole tomato: 123 gram. This results in a theoretical maximum mass of 1.877 kg for the gripper. At a payload of 2.0 kg, the Adapt Quattro 650H robot can achieve a cycle time of 0.37 s for an adapt cycle of 25/305/25 (in mm) [20].

B. Performance Criteria

The selected criteria in this section can be used to evaluate the performance of the gripper design.

a) Closing Time: The closing time is the time from first object contact, til the object is secured. It has to be as low as possible in order to achieve a low PP cycle time.

b) Payload to Weight Ratio: Keeping the gripper lightweight will result in a higher payload to weight ratio, reducing the cycle time of the robot.

c) Object Size Capacity: A large object size capacity gives the gripper more flexibility in grasping different types of objects. A capacity of 40-100 mm is desirable, based on soft robotics grippers found in literature [19].

d) Grasp Quality: Grasp quality of the gripper can be evaluated based on the type of grasp that the gripper can have on the object e.g. caging, form closure or force closure [21]. Sensing is also part of the grasp quality, because it can help the system adjust the grip accordingly.

C. Wishes

a) Existing Soft Finger Design: Using an existing soft finger design like the Fin Ray[®] Effect fingers by Festo is a wish for two reasons. Firstly, the main focus of this study, lies at grasping while moving using a contact-reactive grasping approach. The Fin Ray[®] Effect fingers are a proven successful design, with data available e.g. on indentation depth as a function the gripping force. Secondly, the available CAD models in combination with research on a 3D printable version makes it easier to make adjustments to fine tune a gripper perfectly suited to our design [14].

b) 3D-Printing: 3D-printing gives freedom in design and design adjustment, and is cost-efficient.

c) Sensing and Feedback: Tactile sensing and force feedback can help to optimise a grasp and adjust it when needed. Tactile data can be used to control slip, grasp stability and contact force [22]. Force feedback can be used to monitor the applied force and keep it consistent.

III. SYSTEM DESCRIPTION

The detailed design includes the calculations of the required actuation force and theoretical closing time of the gripper. Next, the detailed design aspects of gripper finger choice, contact sensing and gripper control are discussed. Lastly, this section also includes the iteration step on the gripper base design, where a first design was printed and improvements were made based on this first prototype.

A. Calculations

1) Actuation Force and Actuator Selection: In order to determine the required actuation force to hold the object during high lateral acceleration, first a FBD is created and shown in Figure 2. Equation 1 shows the relation of the forces depicted in Figure 2.

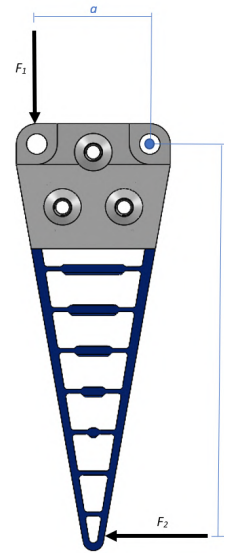

Fig. 2: Force equilibrium diagram for the Fin Ray[®] finger.

$$\left. \begin{aligned} \text{Moment equation : } F_1 \cdot a &= F_2 \cdot b \\ a &= 27.5 \text{ mm} \\ b &= 100 \text{ mm} \end{aligned} \right\} F_1 = 3.63 \cdot F_2 \quad (1)$$

$$\left. \begin{aligned} F_{2,\min} &= m_{\text{object}} \cdot a_{\text{lateral}} \\ a_{\text{lateral}} &= 98.1 \frac{\text{m}}{\text{s}^2} \\ m_{\text{object}} &= 0.123 \text{ kg} \end{aligned} \right\} F_{2,\min} = 12.07 \text{ N} \quad (2)$$

Combining equation 1 and equation 2 results in a minimum force required for F_1 :

$$F_1 = 3.63 \cdot 12.07 = 43.8 \text{ N}$$

Using 3D CAD modelling, a desired stroke of 40 mm was determined for the pneumatic actuators of the two moving fingers. Datasheets from Festo of their DSNU-S series pneumatic actuators, the combined stroke and required force would lead to a DSNU-S-12-40-P-A. This actuator can exert a theoretical force of 67.9 N at 6 bar air pressure, however this would mean that the gripper is limited to a maximum object mass of 0.191 kg or a maximum lateral acceleration of 15.5 g with an object mass of 0.123 kg. Since at this stage it is still possible to incorporate a larger actuator, the decision was made to use Festo's DSNU-S-16-40-P-A pneumatic actuator that can deliver a theoretical advancing force of 120.6 N at 6 bar of air pressure [23]. The higher actuator force results in a theoretical maximum object mass of 0.338 kg at 10 g acceleration or a theoretical maximum lateral acceleration of 27.5 g with an object mass of 0.123 kg.

2) *Closing time:* The closing time of the gripper can be estimated by using the pneumatic sizing calculator by [24]. By setting the input parameters to the values that fit our gripper (mass of 0.5 kg, stroke of 40 mm, assembly position of -90 degrees, extension as direction of movement, pressure of 6 bar, tube length of 1 m and flexible cushioning type) the performance option gives a positioning time 77 ms and the needed size for the supply lines, valve and flow control.

B. Gripper Fingers

Since the main focus of this gripper design lies on the contact-reactive grasping approach and not on designing the fingers of the gripper itself, the decision was made to use the existing Fin Ray[®] finger design by Festo. Festo has CAD models available of three different lengths of fingers. The type that fits this gripper best based on the object size that has to be grasped is the DHAS-GF-80-U-BU. To be able to adjust the design of the finger if needed, to for example integrate a sensor at a later stage, the decision was made to 3D-print the fingers in the same material (Polyurethane) as specified by Festo. The orientation of the two fixed fingers has been set in such a way that the surface which will contact the object is vertical, in this way the finger always make contact with the outer most part of the object independent of the height of the object.

C. Gripper Base

The gripper base is the central part of the gripper, to which all other parts attach to. In order to determine if the thickness of certain parts of the gripper base would be sufficient to be drilled to the exact size and act as a hinge point, a prototype of this parts was printed using an FDM printer that can produce parts with the material PLA. Printing a first prototype helped to gain insights on how the design can be improved to make the printing process go smoother, this has led to the improved 3D model of the gripper base.

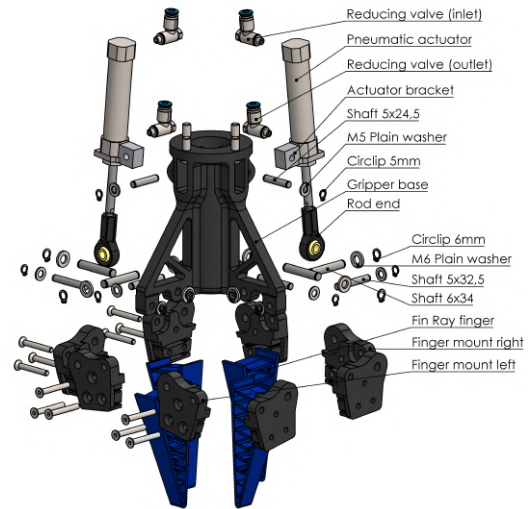

Fig. 3: Exploded view of the 3D design with all part names indicated.

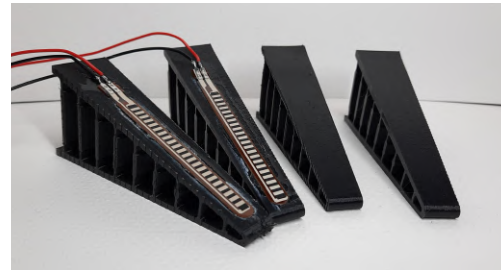

Fig. 4: The four FinRay fingers, with sensors placed on the pressure sensors placed on the two non-actuated fingers.

D. Contact Sensing

In search of a suitable sensor, it was concluded that using a tactile sensor means that not only contact sensing can be achieved, but also pressure monitoring during the holding of the object. However, tactile sensors can be very expensive, e.g. the type 5226 tactile sensor from Pressure Profile Systems Inc. (Los Angeles, CA, USA) costs around USD\$5000 per sensor, including computation unit and software. Therefore the decision was made to focus on a more cost-effective solution. The solution was to attach a flex sensor, attached to the outside surface of the finger, that can be used to detect contact. A small force applied to the inside surface of the finger, will cause a deformation that makes the outside of the finger bend. The flex sensor attached to this outer surface, can be used to detect contact. Additionally by putting the sensor on the outside, it will also be less prone to be damaged. The selected sensor is the SEN-10264 Flex Sensor from Spectra Symbol (Salt Lake City, UT, USA), which costs USD\$9,95 each.

E. Final Design

Figure 3 shows an exploded view of the final detailed design to clarify the indicated parts. The final design consists of a base that can be attached to a manipulator or robotic arm where the other parts attach to. Four flexible fingers can be attached to the base by clamping each of them between two finger mounts, connected by three countersunk hex headed

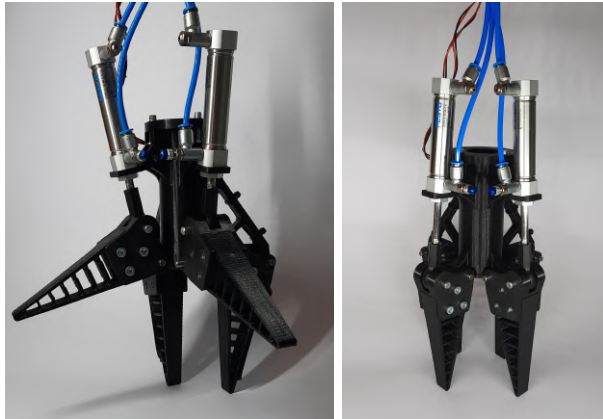

Fig. 5: Assembled prototype in fully open and fully closed configurations.

bolts. The two fixed fingers get mounted to the base with two shafts that are locked in place using circlips. These fingers are sensorized with the flex sensors. The two moving fingers get mounted to the base with one shaft at the hinge point. The hinge points contain two sleeve bearings to reduce friction. The actuator assembly consists of a rod end, the actuator itself and the actuator bracket. The rod end can be directly screwed onto the piston rod to decrease the chance of binding due to misalignment. The actuator assembly can be mounted to the gripper base with two shafts, one at the mounting point of the actuator bracket and one that connects the rod end to the moving finger.

1) *Final Design Assembly:* After all parts were produced and the purchased parts were delivered, it was time to assemble the prototype. Fig. 4 depicts the four fingers, with the flex sensors placed and the two fingers that will be not actuated. Figure 5 shows the final prototype. The final design will be referred to as the FinFix gripper. This name represents the use of two fixed fingers and the use of Fin Ray[®] effect fingers.

IV. REFLEX STRATEGY

Several works in literature have shown that reactive adjustments can improve grasping capability and make robotic systems more robust to uncertainties [25]–[27]. We want to test if a simple reflex strategy is sufficient to perform the desired pick and place tasks thanks to the mechanical intelligence of the device. We assume a rough knowledge of the location of the object. As sensor input we use flex sensors placed at the fingers. The reflex based strategy is as follows (see Figure 6 for a pictorial representation):

- i) The two fingers closer to the object are kept open, so that that the fixed ones form a *soft scoop*.
- ii) The gripper approaches the object placement area at a constant speed following a straight line.
- iii) The gripper slows down to 40% of the speed when it enters the object detection area.
- iv) The first pick on the sensors reading is interpreted as the object being in contact with the gripper. The two open fingers are closed quickly and simultaneously.



(a) Gripper in open configuration aligned with the object.



(b) Gripper entering the reduced-speed area.



(c) A contact with contact with the object is detected.



(d) Gripper grasps the object.



(e) Schematic overview of the grasping cycle path.

Fig. 6: Four stages of the grasping process using contact-reactive grasping.

- v) The robot lifts the object vertically, and travels back to the placing location at maximum speed.
- vi) The gripper is opened and the object placed in the box.

V. EXPERIMENTS: GRIPPER

This section describes the tests of the gripper's capability as a stand alone - i.e., without any reflex control and not connected to a robot.

A. Grasping Force

The goal of this experiment is to determine the force that can be applied between two fingers. We do that by using a load cell placed between the fingers, and progressively

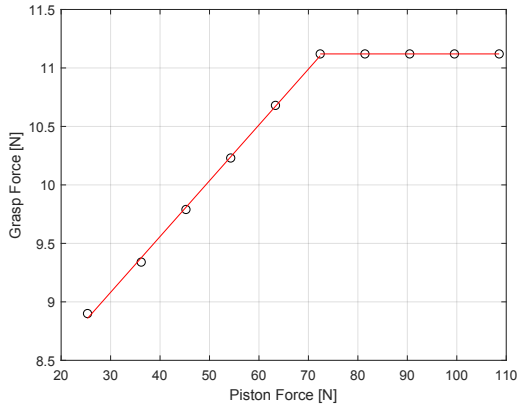

Fig. 7: Plot of the grasping force between a single pair of fingers vs. piston force. Data (circle) are obtained by placing a load cell between the fingers of the gripper and progressively increasing the input pressure.

increasing the pressure. Figure 7 shows the results of this experiment. Note that we display the piston force at the x-axis, calculated from the commanded pressure as $F = Ap - R$, where F is the effective piston force [N], p is the operating pressure [bar], A is the piston area [cm²], $R \approx 10\%[N]$ is an estimation of the static friction force. At 4 bar the maximum pinch force is reached and the fingers only deform into internal buckling without translating any more force.

B. Grasping Capability

The grasping capability test was used to test the two functional requirements: static object size capability and soft contact. The gripper must be able to grasp an object with a size of 70 mm and have soft contact with the object to prevent bruising or denting. Table I lists the objects used, their weight and size, and the air pressure required to hold the object in a stable static grasp. All grasps were successful, with no visible damages to be observed on the objects. Nevertheless, the edge of the fingers pushes into the banana, which can cause bruising. Figure 9 shows the various objects being grasped by the FinFix gripper. The outcome of this grasping capability test was that the lower size limit is around 40 mm and that the gripper shows the best grasps on spherical objects. The upper limit has not been fully explored. However, the results show that the gripper fulfills the requirement of 70 mm.

VI. EXPERIMENTS: PICK AND PLACE

A. Experimental setup

The test setup consists of an IRB 360-8/1130 FlexPicker by ABB. This robot has a handling capacity of 8 kg, working area

TABLE I: Objects used during static grasping test.

	Object size (mm)	Object weight (g)	Air pressure (bar)
Light bulb	60	27	2
Apple	64	118	2
Orange	74	199	2.7
Banana	37	202	2.5
Raw egg	42	56	2
Sugar	45	600	3.8
Battery	76	742	3

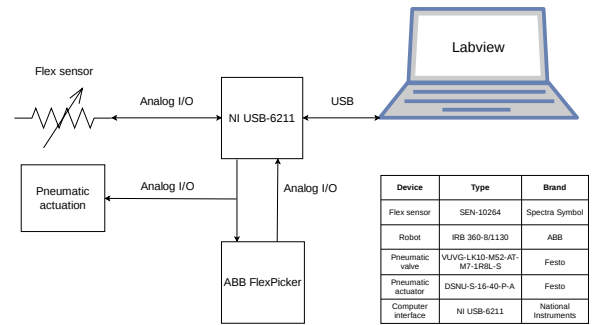

Fig. 8: Schematic overview of the test setup. The resistance of the flex sensors is measured against a set baseline to detect contact with will trigger the closing of the fingers and tell the FlexPicker to stop moving. Once the FlexPicker is at the place location a signal will trigger the release of the object.

with a diameter of 1130 mm and a maximum acceleration of 100 m/s². Figure 8 shows a schematic overview of the test setup and how the various components interact with each other, the brand and type of the components is also included in this figure. Figure 1 shows the gripper attached to the robot, the pick location of the object and a cardboard box with cushioning acting as the drop-off location.

B. Holding the Object

Before going into the reflex-based pick and place task we want to test the gripper in more dynamic conditions. Thus we repeat the static grasp but with the robot moving at high speed. We consider the objects: the tomato, the apple, and the egg. First, we performed a firm grasp of the object. Next, the gripper moved back and forward in a straight line with a travel distance of 400 mm following a chirp pattern in time. This way, speed and acceleration at the end effector were increased until they reached 10 m/s and 100 m/s². Figure 10 shows a series of snapshots from the executed dynamic holding test. None of the three tests resulted in slippage of the object. No damage could be observed on any of the objects, the tomato, apple or egg.

C. Pick and place

We test here the full architecture, including the reflex control strategy discussed in Sec. IV. In this work we consider an approaching speed of 10 m/s. The total travel distance is 400-440 mm for the approach path. Repeatability tests were conducted to determine the success rate for a tomato, an apple and an egg. Figure 11 shows a series of snapshots from the executed full grasping cycle test.

The object is placed in a location that is in line with the programmed path of the gripper. The exact location on the axis of approach can be a range of 40 mm. This means that point where the gripper contacts the object and the start location is 400 mm with an uncertainty of 40 mm. For each of the objects the grasping cycle was repeated 20 times and success or failure was noted down after each cycle. The success rate for the tomato and apple were both 100%, however for the egg only three successive grasping cycles could be completed. After these three test with the egg, the contact sensors started

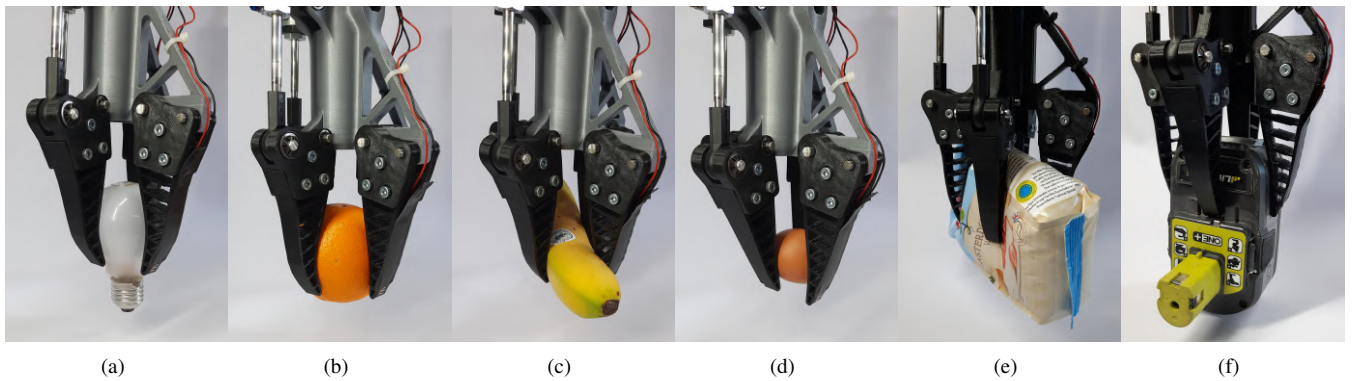

Fig. 9: Grasping test with various objects: (a) a light bulb, (b) an orange, (c) a banana, (d) a raw egg, (e) a bag of sugar and (f) a battery. The latter was included to show that the gripper can hold heavy objects.



Fig. 10: Snapshots of one back-and-forth cycle of the dynamic holding test, while holding a raw egg. It takes less than 0.4s to execute this motion, which was repeated 40 times without producing any damage to the egg.

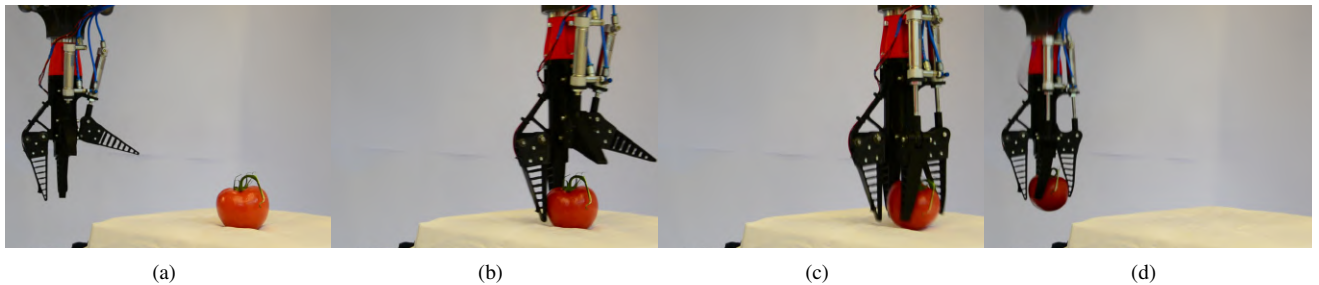

Fig. 11: Snapshots of the full grasping cycle test. The robot is grasping a tomato. The grasping is successfully executed, with no visible damage to the object. The whole experiment lasts for 1.01 s.

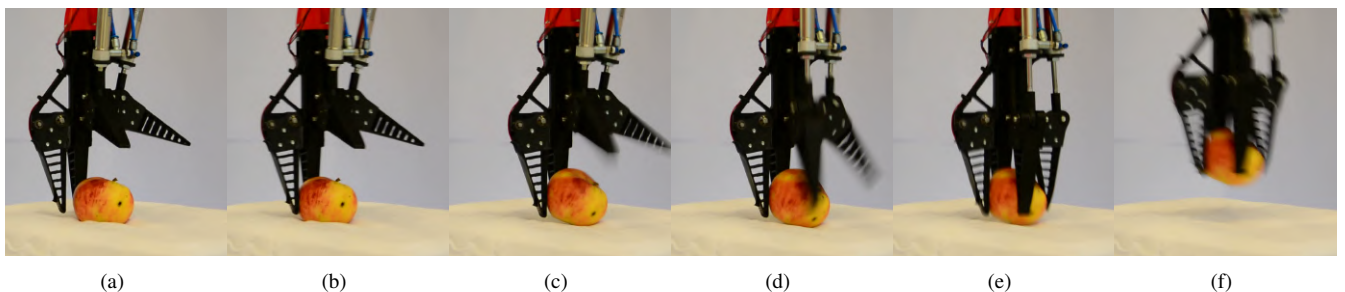

Fig. 12: Snapshots of the reflex-based grasping phase during one full grasping cycle test execution. The robot is grasping an apple. The grasping is successfully executed, with no visible damage to the object. Panel (a) shows the gripper approaching the apple at a high but reduced speed. Note, indeed, that the robot is already moving in the detection area. The contact is established in panel (b) and detected soon after. Indeed, panel (c) already shows the fingers closing. The closure continues in (d) and concludes in (e). The robot lifts the object in (f). The whole sequence is executed in approximately 0.4s.

TABLE II: Breakdown of the cycle times for 5 representative test runs. We report the partial

	1 (s)	2 (s)	3 (s)	4 (s)	5 (s)	Average (s)
Approach	0.391	0.342	0.406	0.306	0.297	0.348
Grasp	0.275	0.279	0.219	0.309	0.311	0.279
Return	0.256	0.284	0.279	0.268	0.282	0.274
Release	0.087	0.090	0.099	0.135	0.144	0.105
Total	1.009	0.995	1.003	1.018	1.004	1.006

to malfunction and it was no longer possible to complete a full grasping cycle.

Figure 12 isolates the moment the object is detected and grasped by means of the reflex strategy described in Sec. IV.

The total cycle time was determined by analysing the video recordings that were made during the grasping test. This cycle time can be split up into three phases: approach movement time, grasping time, return movement time and release time. Table II shows this breakdown of the cycle time for 5 different test runs and also the calculated average times for each phase and the total cycle time. The differences in the approach phase can be explained by the dependency of the object location.

VII. CONCLUSION

In this research, the design of a gripper with the ability of grasping deformable and delicate objects at high acceleration ($\geq 10g$) using a contact-reactive grasping approach while moving has been described; The FinFix Gripper. The research demonstrates the potential of a mostly 3D-printed gripper that can grasp objects at high speed and high acceleration using a contact-reactive grasping approach while moving. This gripper approaches the object from the side and uses contact-reactive grasping to detect contact with the object to determine the exact position. With a total weight of 537 grams and the ability to grasp a tomato with a weight of 174 grams and size of 70 mm in a grasping cycle of only 1 s, the FinFix gripper is a promising design and with further research and development has potential to be used in commercial applications. In the current form the gripper is not yet suitable for commercial use, since not all 3D-printed parts can be guaranteed as food safe contact. Further research should investigate in material properties, fatigue analysis and tactile sensing.

REFERENCES

- [1] J. Hughes, U. Culha, F. Giardina, F. Guenther, A. Rosendo, and F. Iida, "Soft manipulators and grippers: a review," *Frontiers in Robotics and AI*, vol. 3, p. 69, 2016.
- [2] J. F. Elfferich, D. Dodou, and C. Della Santina, "Soft robotic grippers for crop handling or harvesting: A review," *IEEE Access*, vol. 10, pp. 75 428–75 443, 2022.
- [3] C. Blanes, M. Mellado, C. Ortiz, and A. Valera, "Technologies for robot grippers in pick and place operations for fresh fruits and vegetables," *Spanish Journal of Agricultural Research*, vol. 2011, no. 4, pp. 1130–1141, 2011.
- [4] T. B. Jørgensen, S. H. N. Jensen, H. Aanæs, N. W. Hansen, and N. Krüger, "An adaptive robotic system for doing pick and place operations with deformable objects," *Journal of Intelligent & Robotic Systems*, vol. 94, no. 1, pp. 81–100, 2019.
- [5] S. Li, J. J. Stampfli, H. J. Xu, E. Malkin, E. V. Diaz, D. Rus, and R. J. Wood, "A vacuum-driven origami "magic-ball" soft gripper," in *2019 International Conference on Robotics and Automation (ICRA)*. IEEE, 2019, pp. 7401–7408.
- [6] Y. Hao, S. Biswas, E. W. Hawkes, T. Wang, M. Zhu, L. Wen, and Y. Visell, "A multimodal, enveloping soft gripper: Shape conformation, bioinspired adhesion, and expansion-driven suction," *IEEE Transactions on Robotics*, vol. 37, no. 2, pp. 350–362, 2020.
- [7] T. Huang, Z. Li, M. Li, D. G. Chetwynd, and C. M. Gosselin, "Conceptual design and dimensional synthesis of a novel 2-dof translational parallel robot for pick-and-place operations," *J. Mech. Des.*, vol. 126, no. 3, pp. 449–455, 2004.
- [8] J. Mo, Z.-F. Shao, L. Guan, F. Xie, and X. Tang, "Dynamic performance analysis of the x4 high-speed pick-and-place parallel robot," *Robotics and Computer-Integrated Manufacturing*, vol. 46, pp. 48–57, 2017.
- [9] A. Fomin, A. Antonov, V. Glazunov, and G. Carbone, "Dimensional (parametric) synthesis of the hexapod-type parallel mechanism with reconfigurable design," *Machines*, vol. 9, no. 6, p. 117, 2021.
- [10] V. Nabat, M. de la O Rodriguez, O. Company, S. Krut, and F. Pierrot, "Par4: very high speed parallel robot for pick-and-place," in *2005 IEEE/RSJ International Conference on Intelligent Robots and Systems*, 2005, pp. 553–558.
- [11] Y. Yamanaka, S. Katagiri, H. Nabae, K. Suzumori, and G. Endo, "Development of a food handling soft robot hand considering a high-speed pick-and-place task," in *2020 IEEE/SICE International Symposium on System Integration (SII)*. IEEE, 2020, pp. 87–92.
- [12] Soft Robotics Inc., "Global retail pizza company automates fresh dough designed by abi," <https://www.softroboticsinc.com/resource/global-retail-pizza-company-automates-fresh-dough-designed-by-abi/>, 2018, accessed: 2021-06-16.
- [13] H. Alzarok, S. Fletcher, and A. P. Longstaff, "Survey of the current practices and challenges for vision systems in industrial robotic grasping and assembly applications," *Advances In Industrial Engineering And Management (AIEM)*, vol. 9, no. 1, pp. 19–30, 2020.
- [14] K. Elgeneidy, P. Lightbody, S. Pearson, and G. Neumann, "Characterising 3d-printed soft fin ray robotic fingers with layer jamming capability for delicate grasping," in *2019 2nd IEEE International Conference on Soft Robotics (RoboSoft)*. IEEE, 2019, pp. 143–148.
- [15] C. Armanini, I. Hussain, M. Z. Iqbal, D. Gan, D. Praticchizzo, and F. Renda, "Discrete cosserat approach for closed-chain soft robots: Application to the fin-ray finger," *IEEE Transactions on Robotics*, vol. 37, no. 6, pp. 2083–2098, 2021.
- [16] OMRON Corporation, "Quattro 650h/650hs/800h/800hs," https://assets.omron.eu/downloads/manual/en/v4/i597_quattro_650h,_650hs,_800h,_800hs_users_manual_en.pdf, 2019, accessed: 2021-06-29.
- [17] RijkZwaan, "Sunergiekas levert nuttige inzichten over cappricia rz (sunergiekas delivers useful insights on cappricia rz)," *Seeds Services Tomaat*, p. 11, 2010.
- [18] USDA, "Tomatoes, shipping point and market inspection instructions," *United States Department of Agriculture*, p. 10, 2005.
- [19] W. Heeringa, "A gripper for deformable and delicate objects at high acceleration using a contact-reactive grasping approach," *MSc Thesis TU Delft*, 2021.
- [20] OMRON Corporation, "Industrial robotics automation catalog," https://assets.omron.eu/downloads/datasheet/en/v15/i822_industrial_robots_datasheet_en.pdf, 2020, accessed: 2021-06-29.
- [21] M. A. Roa and R. Suárez, "Grasp quality measures: review and performance," *Autonomous robots*, vol. 38, no. 1, pp. 65–88, 2015.
- [22] Z. Kappassov, J.-A. Corrales, and V. Perdereau, "Tactile sensing in dexterous robot hands," *Robotics and Autonomous Systems*, vol. 74, pp. 195–220, 2015.
- [23] Festo, "Round cylinders dsnu-s," <https://www.festo.com/media/pim/046/D15000100152046.PDF>, 2021, accessed: 2021-07-13.
- [24] Festo, "Pneumatic sizing," https://www.festo.com/eap/en_us/PneumaticSizing/, 2021, accessed: 2021-07-29.
- [25] J. Felip, J. Bernabé, and A. Morales, "Contact-based blind grasping of unknown objects," in *2012 12th IEEE-RAS International Conference on Humanoid Robots (Humanoids 2012)*. IEEE, 2012, pp. 396–401.
- [26] R. M. Al-Gaifi, V. Müller, and N. Elkmann, "Reactive grasping using high-resolution tactile sensors," in *2020 IEEE 16th International Conference on Automation Science and Engineering (CASE)*. IEEE, 2020, pp. 463–468.
- [27] C. Della Santina, V. Arapi, G. Averta, F. Damiani, G. Fiore, A. Settimi, M. G. Catalano, D. Bacciu, A. Bicchi, and M. Bianchi, "Learning from humans how to grasp: a data-driven architecture for autonomous grasping with anthropomorphic soft hands," *IEEE Robotics and Automation Letters*, vol. 4, no. 2, pp. 1533–1540, 2019.